

Resumo Executivo

O Presente Relatório tem como objetivo a incorporação de informações que sejam relevantes para que se possa fazer a devida associação aos dados contidos no corpo do documento objeto da classificação de Situação de Emergência caracterizada pelo Módulo 8 do Prodist, que tem como foco o impacto do evento sobre determinada rede geelétrica e cuja denominação é definida como CHI (Consumidor hora interrompido). O parâmetro para enquadramento nesta classificação de expurgo tem como premissa inicial o limite de Consumidor hora interrompido definido pela fórmula descrita no Módulo 01 do Prodist (Revisão - 9), acrescido de todos os outros informes e dados listados no Módulo 08 (Revisão 10) do Prodist. Este enquadramento se apresenta na maioria das vezes em condições climáticas adversas com severidade dos fatores inerentes a situação, caracterizado na maioria dos casos por fortes ventos e chuvas de grande intensidade e continuidade.

Áreas de instabilidade organizadas pela presença de uma frente fria na costa do Brasil atuaram sobre o estado de Goiás entre a manhã do dia 16 e a madrugada do dia 19 de janeiro de 2020.

Conforme informações do Climatedo Meteorologia, o Instituto Nacional de Meteorologia (INMET) detectou rajadas de vento acima de 50km/h entre a manhã do dia 02 e a manhã do dia 07 de janeiro de 2020. A rajada máxima registrada foi de 84,2 km/h na estação de Itumbiara entre as 16h00 e 17h00 do dia 18 de janeiro de 2020.

O sistema de detecção da EarthNetworks registrou 1.222.859 descargas atmosféricas sobre a área de concessão da ENEL em Goiás entre as 11h30 do dia 16 e as 04h30 do dia 19 de janeiro de 2020, o que causou grande instabilidade na rede.

Entre as 09h00 do dia 16 e as 09h00 do dia 17 de janeiro a estação de Jataí do INMET acumulou aproximadamente 24% da média climatológica para o mês de janeiro na região.

Quatro pessoas ficam feridas durante temporal em Pirenópolis - Vendaval também resultou em árvores caídas, ruas interditadas, casas destelhadas, enxurradas em várias vias e derrubou, inclusive, a estrutura de uma feira da cidade. Acesso em: <https://www.emaisgoias.com.br/quatro-pessoas-ficam-feridas-durante-temporal-em-pirenopolis/>

Relatório de Ocorrências do período

Em todo o Estado de Goiás verificou-se também que a intensidade da chuva e dos ventos danificaram a rede de distribuição de energia elétrica em diversos pontos, registrando aproximadamente 284 mil clientes com interrupção no fornecimento de energia elétrica devido a eventos relacionados ao temporal.

Para otimizar o volume de atendimentos e reduzir os tempos de interrupção foram mobilizados os recursos extras da empresa que aumentou o contingente em relação a situação normal de operação. O acompanhamento da quantidade de equipes e o Tempo Médio de Atendimento podem ser consultados na Pág.03 do Relatório em anexo.

O impacto e severidade do evento estão relatados em artigos de mídia, como fotos e reportagens que demonstram os danos na Rede de Distribuição, oriundos dos eventos climáticos no período. Eventos estes que afetaram 284.572 consumidores com CHI de 900.423,01 superior ao de 482.597,74 estabelecido como limite para definição de Situação de Emergência, conforme resumo das informações obrigatórias.

Empresa	ENEL DISTRIBUIÇÃO GOIÁS		
Código do Relatório	CHI-039 - ENEL DISTRIBUIÇÃO GOIÁS		
Evento:	TEMPORAL NA AREA DE CONCESSÃO DA ENEL DISTRIBUIÇÃO GOIAS		
Código COBRADE:	1.3.2.1.2, 1.3.2.1.4 e 1.3.2.1.5	Data Inicio	16/01/2020
			Hora início
			11h30
Código do Evento:	CHI-039-ENEL GO	Data Término	19/01/2020
			Hora Término
			08h59
Valor CHI (Limite e Real)	482.597,74	900.423,01	
Código do Decreto (Se Houver):			
Quantidade de Interrupções (Evento)	4.429		
Início 1ª Incidência (Data e Hora)	16/01/2020 11:33:00		
	Subestações Atingidas	ABADIANIA / ABC / ACREUNA / ADELANDIA / AEROPORTO / AGUA LIMPA (MARZAGAO) / AGUAS LINDAS / ALEXANIA / ALEXANIA TRANSMISSAO / ALMERINDONOPOLIS / ALOANDIA / ALTO BURITI / ALTO PARAISO DE GOIAS / ALVORADA DO NORTE / AMERICANO (RIO VERDE) / AMERICANO DO BRASIL / AMORINOPOLIS / ANAPOLIS UNIVERSITARIA / ANHANGUERA / ANICUNS / ANTONIO DO VITTO / APARECIDA DO RIO DOCE / APORE / ARACU / ARAGARCAS / ARAGOIANA / ARAGUAPAZ / ARARAS / AREIAS / ARENOPSIS / ARUANA / ARUANA (TRANSMISSAO) / ASA BRANCA / ATLANTICO / AURILANDIA / AVELINOPOLIS / BACURI (RIO VERDE) / BARBOSELANDIA / BARREIRO (PORANGATU) / BARRO ALTO / BELA VISTA (TRANSMISSAO) / BOA VISTA / BOM JARDIM / BOM JESUS DE GOIAS / BONFINOPOLIS / BONITO / BONOPOLIS / BRAZABRANTES / BRITANIA / BRITANIA (TRANSMISSAO) / BURITI ALEGRE / BURITI DE GOIAS / BURITIZINHO / CABECEIRAS / CABRIUVA (RIO VERDE) / CACHOEIRA ALTA / CACHOEIRA DOURADA / CACHOEIRA NOVA / CACHOEIRINHA (ITARUMA) / CACU / CAIAPONIA / CALCILANDIA / CALDAS NOVAS / CALDAZINHA / CAMPESTRE / CAMPINAS / CAMPINORTE / CAMPO ALEGRE DE GOIAS / CAMPO LIMPO DE GOIAS / CAMPO NOVO / CAMPOS BELOS / CAMPOS VERDES / CARAIBAS / CARAJAS / CASTELANDIA / CATALAO / CATURAI / CEBRASA FABRICA DA AMBEV / CEMAT/BALIZA / CEPAIGO / CEZARINA / CHAPADAO DO CEU / CIDADE ECLETICA / CIDADE OCIDENTAL / COCALZINHO / COLINACU / CORREGO DO OURO / CORUMBA / CORUMBAIBA / CRISTALINA / CRISTALINA TRANSMISSAO / CRISTIANOPOLIS / CRIXAS / CROMINIA / CUMARI / DAIA - ANAPOLIS / DAMOLANDIA / DESFECHO / DESTILARIA BRASIL CENTRAL / DIMIC / DIORAMA / DOVERLANDIA / EDEALINA / EDEIA / ENERSUL / ESTANIFERA / ESTRELA DO NORTE / FAINA / FAZENDA CANADA / FAZENDA NOVA / FERROVIARIO / FIRMINOPOLIS / FLORES DE GOIAS / FORMIGA / FORMOSO / FRONTEIRA / GAMELEIRA / GIRASSOL / GOIANAPOLIS / GOIANDIRA / GOIANESIA / GOIANIA LESTE / GOIANIRA / GOIAS / GOIATUBA / GOVERLANDIA / GOYA / GUAPO / HEITORAI / HIDROLANDIA / HIDROLINA / IACIARA / INACIOLANDIA / INDEPENDENCIA / INDIARA / INHUMAS / IPAMERI / IPEGUARI / IPORA / ISRAELANDIA / ITABERAI / ITAGUARI / ITAGUARU / ITAJA / ITAPACU / ITAPACI (TRANSMISSAO) / ITAPIRAPUA / ITAPURANGA / ITAPURANGA (TRANSMISSAO) / ITARUMA / ITAUCU / ITIQUIRA (FORMOSA) / ITUMBIARA NOVA / ITUMBIARA VELHA / JACILANDIA / JANDAIA / JARAGUA / JARANAPOLIS / JATAI / JAUPACI / JESUPOLIS / JOVIANIA / JUNDIAI / JURUMIRIM / JUSCELANDIA / JUSSARA / LAGES / LAGOA DA SERRA / LAGOA DO BAUZINHO (RIO VERDE) / LEOPOLDO DE BULHOES / LUZIANIA / MAIRIPOTABA / MAMBAI / MARA ROSA / MARAJOARA / MARCIANOPOLIS / MARIAPOLIS (PADRE BERNARDO) / MARZAGAO / MATO GRANDE / MATRINCHA / MAURILANDIA / MEIA PONTE / MINACU / MINEIROS / MOIPORA / MONTE ALEGRE / MONTES CLAROS DE GOIAS / MONTIVIDIU T / MORRINHOS / MORRO AGUDO / MOSSAMEDES / MOZARLANDIA / MOZARLANDIA (TRANSMISSAO) / MUNDO NOVO DE GOIAS / MUTUNOPOLIS / NAVESLANDIA (JATAI) / NAZARIO / NEROPOLIS / NIQUELANDIA / NOVA AMERICA / NOVA AURORA / NOVA CRIXAS (TRANSMISSAO) / NOVA IGUACU / NOVA PONTE / NOVA VENEZA / NOVO BRASIL / NOVO GAMA / NOVO PLANALTO / OLHOS DAGUA / OLOANA / ORIZONA / OURO VERDE DE GOIAS / OUVIDOR / PACAEMBU (NOVO GAMA) / PADRE BERNARDO / PALESTINA / PALMEIRAS / PALMEIRAS DE GOIAS / PALMELO / PALMINOPOLIS / PAMPLONA / PANAMA / PARANA / PARANAIBA / PARANAIGUARA / PARAUNA SE ALTA TENSAO / PARQUE DAS EMAS (MINEIROS) / PARQUE DAS NACOES / PEROLANDIA / PETROLINA / PILAR / PILOANDIA / PIRACANJUBA / PIRANHAS T / PIRENOPOLIS / PIRES BELO / PIRES DO RIO / PLANALTINA / PLANALTINA (TRANSMISSAO) / PLANALTO / PONTALINA / PORANGATU / PORTEIRAO / PORTELANDIA / PORTO SAO SIMAO / POSSE / POSSELANDIA / PROFESSOR JAMIL / QUEBRA LINHA / QUIRINOPOLIS / REAL / RETIRO / GOIAS / RIO CLARO JATAI MONTIVIDIU / RIO DO PEIXE / RIO DOS BOIS (MAURILANDIA) / RIO PRETO / RIO QUENTE / RIO VERDE / RIO VERMELHO / RIVERLANDIA (RIO VERDE) / ROCHEDO (UEH) / RUBIATABA / SANCLERLANDIA / SANTA BARBARA / SANTA FE DE GOIAS / SANTA HELENA / SANTA RITA DO ARAGUAIA / SANTA ROSA / SANTA ROSA DE GOIAS / SANTA ROSA DO MEIA PONTE / SANTA TEREZA DE GOIAS / SANTA TEREZINHA / SANTO ANTONIO DA BARRA / SANTO ANTONIO DE GOIAS / SANTO ANTONIO DO DESCOBERTO / SAO BARTOLOMEU / SAO DOMINGOS / SAO FRANCISCO DE GOIAS / SAO GABRIEL DE GOIAS / SAO JOAO D ALIANCA / SAO JOAO DA PARAUNA / SAO JUDAS TADEU / SAO LUIZ DOS MONTES BELOS / SAO MIGUEL DO ARAGUAIA / SAO	

			MIGUEL DO PASSA QUATRO / SAO SIMAO / SENADOR CANEDO TRANSMISSAO / SERRA AZUL (JATAI) / SERRA DE CALDAS / SERRANOPOLIS / SILVANIA / SITIO DABADIA / SOUZALANDIA / SUCURI / TAIOBA / TAQUARAL / TAQUARI / TEREZOPOLIS / TERRA VERMELHA / TRAJANOPOLIS (PADRE BERNARDO) / TRES BARRAS / TRES RANCHOS / TRINDADE / TUCUNARE / TURVANIA / TURVELANDIA / URU / URUACU / URUTAI / USINA DE ACUCAR DE GOIANESIA / USINA MAMBAI / VALPARAISO / VARJAO / VENDA SECA / VIANOPOLIS / VICENTINOPOLIS / VILA BOA / VILA CORUMBA / VILA PROPICIO / XAVANTES / XIXA / ZELANDIA / SANTANA / MINEIROS TRANSMISSAO / ALTO HORIZONTE
Início Ultima Incidência (Data e Hora)	19/01/2020 08:55:00		
Média de Duração das Incidências (h)	7,28		
Duração da Incidência mais longa (h)	77,87		
Total de Clientes afetados	284.572	Municípios Atingidos	ABADIA DE GOIAS / ABADIANA / ACREUNA / ADELANDIA / AGUA FRIA DE GOIAS / AGUA LIMPA / AGUAS LINDAS DE GOIAS / ALEXANIA / ALTO HORIZONTE / ALTO PARAISO DE GOIAS / ALVORADA DO NORTE / AMARALINA / AMERICANO DO BRASIL / AMORINOPOLIS / ANAPOLIS / ANHANGUERA / ANICUNS / APARECIDA DE GOIANIA / APARECIDA DO RIO DOCE / APORE / ARACU / ARAGARCAS / ARAGOIANIA / ARAGUAPAZ / ARENOPOLIS / ARUANA / AURILANDIA / AVELINOPOLIS / BALIZA / BARRO ALTO / BELA VISTA DE GOIAS / BOM JARDIM DE GOIAS / BOM JESUS DE GOIAS / BONFINOPOLIS / BONOPOLIS / BRAZABRANTES / BRITANIA / BURITI ALEGRE / BURITI DE GOIAS / BURITINOPOLIS / CABECEIRAS / CACHOEIRA ALTA / CACHOEIRA DE GOIAS / CACHOEIRA DOURADA / CACU / CAIAPONIA / CALDAS NOVAS / CALDAZINHA / CAMPESTRE DE GOIAS / CAMPINACU / CAMPINORTE / CAMPO ALEGRE DE GOIAS / CAMPO LIMPO / CAMPOS BELOS / CAMPOS VERDES / CARMO DO RIO VERDE / CASTELANDIA / CATALAO / CATURAI / CAVALCANTE / CERES / CEZARINA / CHAPADAO DO CEU / CIDADE OCIDENTAL / COCALZINHO DE GOIAS / COLINAS DO SUL / CORREGO DO OURO / CORUMBA DE GOIAS / CORUMBAIBA / CRISTALINA / CRISTIANOPOLIS / CRIXAS / CROMINIA / CUMARI / DAMIANOPOLIS / DAMOLANDIA / DAVINOPOLIS / DIORAMA / DISTRITO FEDERAL / DIVINOPOLIS DE GOIAS / DOVERLANDIA / EDEALINA / EDEIA / ESTRELA DO NORTE / FAINA / FAZENDA NOVA / FIRMINOPOLIS / FLORES DE GOIAS / FORMOSA / FORMOSO / GAMELEIRA DE GOIAS / GOIANAPOLIS / GOIANDIRA / GOIANESIA / GOIANIA / GOIANIRA / GOIAS / GOIATUBA / GOUVELANDIA / GUAPO / GUARAITA / GUARANI DE GOIAS / GUARINOS / HEITORAI / HIDROLANDIA / HIDROLINA / IACIARA / INACIOLANDIA / INDIARA / INHUMAS / IPAMERI / IPIRANGA DE GOIAS / IPORA / ISRAELANDIA / ITABERAI / ITAGUARI / ITAGUARU / ITAJA / ITAPACI / ITAPIRAPUA / ITAPURANGA / ITARUMA / ITAUCU / ITUMBIARA / IVOLANDIA / JANDAIA / JARAGUA / JATAI / JAUPACI / JESUPOLIS / JOVIANIA / JUSSARA / LAGOA SANTA / LEOPOLDO DE BULHOES / LUZIANIA / MAIRIPOTABA / MAMBAI / MARA ROSA / MARZAGAO / MATRINCHA / MAURILANDIA / MIMOSO DE GOIAS / MINACU / MINEIROS / MOIPORA / MONTE ALEGRE DE GOIAS / MONTES CLAROS DE GOIAS / MONTIVIDIU / MONTIVIDIU DO NORTE / MORRINHOS / MORRO AGUDO DE GOIAS / MOSSAMEDES / MOZARLANDIA / MUNDO NOVO DE GOIAS / MUTUNOPOLIS / NAZARIO / NEROPOLIS / NIQUELANDIA / NOVA AMERICA / NOVA AURORA / NOVA CRIXAS / NOVA GLORIA / NOVA IGUACU DE GOIAS / NOVA ROMA / NOVA VENEZA / NOVO BRASIL / NOVO GAMA / NOVO PLANALTO / ORIZONA / OURO VERDE DE GOIAS / OUVIDOR / PADRE BERNARDO / PALESTINA DE GOIAS / PALMEIRAS DE GOIAS / PALMELO / PALMINOPOLIS / PANAMA / PARANAIGUARA / PARAUNA / PEROLANDIA / PETROLINA DE GOIAS / PILAR DE GOIAS / PIRACANJUBA / PIRANHAS / PIRENOPOLIS / PIRES DO RIO / PLANALTINA / PONTALINA / PORANGATU / PORTEIRAO / PORTELANDIA / POSSE / PROFESSOR JAMIL SAFADY / QUIRINOPOLIS / RIALMA / RIO QUENTE / RIO VERDE / RUBIATABA / SANCLERLANDIA / SANTA BARBARA DE GOIAS / SANTA CRUZ DE GOIAS / SANTA FE DE GOIAS / SANTA HELENA DE GOIAS / SANTA ISABEL / SANTA RITA DO ARAGUAIA / SANTA RITA DO NOVO DESTINO / SANTA ROSA DE GOIAS / SANTA TEREZA DE GOIAS / SANTA TEREZINHA DE GOIAS / SANTO ANTONIO DA BARRA / SANTO ANTONIO DE GOIAS / SANTO ANTONIO DO DESCOBERTO / SAO DOMINGOS / SAO FRANCISCO DE GOIAS / SAO JOAO D ALIANCA / SAO JOAO DA PARAUNA / SAO LUIS DE MONTES BELOS / SAO LUIZ DO NORTE / SAO MIGUEL DO ARAGUAIA / SAO MIGUEL DO PASSA QUATRO / SAO PATRICIO / SAO SIMAO / SENADOR CANEDO / SERRANOPOLIS / SILVANIA / SIMOLANDIA / SITIO D ABADIA / TAQUARAL DE GOIAS / TEREZOPOLIS DE GOIAS / TRES RANCHOS / TRINDADE / TROMBAS / TURVANIA / TURVELANDIA / UIRAPURU / URUACU / URUTAI / VALPARAISO DE GOIAS / VARJAO / VIANOPOLIS / VICENTINOPOLIS / VILA BOA / VILA PROPICIO

DANOS CAUSADOS			
Equipamentos Danificado	Importância para o Sistema	Local	Quantidade
Disjuntor/Religador Operado	Proteção do Alimentador	Área de Concessão	87
Chaves Fusíveis Operada	Proteção de Ramais de Alimentadores	Área de Concessão	1.488
Transformador Operado	Proteção do Transformador	Área de Concessão	1.052

Relato técnico sobre a Intervenção realizada em Goiânia e Região Metropolitana					
Informações sobre Equipes	16/01	17/01	18/01	19/01	
Quantidade Usual	738	738	701	615	turmas
Quantidade Adicional	14	55	19	11	turmas
Quantidade Total	752	793	720	626	turmas
Tempos Médios					
Preparação	2,95	5,36	4,14	3,48	Horas
Deslocamento	0,80	0,86	0,86	0,92	Horas
Execução	1,11	1,03	1,13	1,15	Horas
TMAE	4,86	7,25	6,13	5,55	Horas

Principais Dificuldades Encontradas:

Chuvas com ventos fortes provocaram muitos pontos de alagamento e enxurrada, trânsito impedido por vários semáforos desligados dificultando a chegada ao atendimento das ocorrências emergenciais. Em determinadas regiões, decorrente dos fortes ventos, houve o tombamento de árvores nas estruturas de alimentação de média tensão, danos em ramais de ligação dos clientes, impedimentos de acesso e atolamentos em estradas rurais.

Empresa	ENEL DISTRIBUIÇÃO GOIAS		
Valor CHI (Limite e Real)	482.597,74		900.423,01

DOC ORIGEM	MIUNICIPIO	EQP_ORIGEM	CONJUNTO	INI_OCORRENC	FIM_OCORRENC	DT_INI_EVENTO	DT_FIM_EVENTO	DURAÇ	UC INT	CHI	EXPURGO
20200192246	ISRAELANDIA	1270001027	IPORA	16/01/2020 11:33	16/01/2020 12:32	16/01/2020 11:33	16/01/2020 12:32	0,98	1	0,98	CHI
20200192259	ORIZONA	PR12000044RE	PIRES DO RIO S1	16/01/2020 11:36	16/01/2020 17:24	16/01/2020 11:36	16/01/2020 17:24	5,80	11	63,82	CHI
20200192259	PIRES DO RIO	PR12000044RE	PIRES DO RIO S1	16/01/2020 11:36	16/01/2020 17:24	16/01/2020 11:36	16/01/2020 17:24	5,80	74	429,36	CHI
20200192265	ARAGARCAS	AG11354634	ARAGARCAS	16/01/2020 11:38	16/01/2020 15:29	16/01/2020 11:38	16/01/2020 15:29	3,83	86	329,79	CHI
20200192267	AMORINOPOLIS	AM12212987	IPORA	17/01/2020 10:45	17/01/2020 18:40	17/01/2020 10:45	17/01/2020 18:40	7,91	26	205,56	CHI
20200192267	IVOLANDIA	AM12212987	IPORA	17/01/2020 10:45	17/01/2020 18:40	17/01/2020 10:45	17/01/2020 18:40	7,91	9	71,16	CHI
20200192280	GOIAS	10008624150	GOIAS	16/01/2020 11:46	16/01/2020 17:18	16/01/2020 11:46	16/01/2020 17:18	5,54	1	5,54	CHI
20200192288	ANICUNS	AC21289746	ANICUNS	16/01/2020 11:48	16/01/2020 13:00	16/01/2020 11:48	16/01/2020 13:00	1,19	1	1,19	CHI
20200192426	PONTALINA	PK21293007	PONTALINA	16/01/2020 12:02	16/01/2020 15:05	16/01/2020 12:02	16/01/2020 15:05	3,04	2	6,08	CHI
20200192437	GOIANDIRA	10026328800	CATALAO S1	16/01/2020 12:07	16/01/2020 14:03	16/01/2020 12:07	16/01/2020 14:03	1,93	1	1,93	CHI
20200192458	CAIAPONIA	CP12380880	CAIAPONIA	16/01/2020 11:45	16/01/2020 15:30	16/01/2020 11:45	16/01/2020 15:30	3,74	10	37,43	CHI
20200192462	BURITI DE GOIAS	1680000242	FIRMINOPOLIS S2	16/01/2020 12:15	16/01/2020 17:03	16/01/2020 12:15	16/01/2020 17:03	4,79	1	4,79	CHI
20200192466	PIRACANJUBA	PJ21139505	PIRACANJUBA	16/01/2020 12:16	16/01/2020 23:08	16/01/2020 12:16	16/01/2020 23:08	10,87	2	21,73	CHI
20200192468	SANTA HELENA DE GOIAS	10000133211	IPEGUARI	16/01/2020 12:16	16/01/2020 17:33	16/01/2020 12:16	16/01/2020 17:33	5,28	1	5,28	CHI
20200192477	ITAPURANGA	IK12298409	ITAPURANGA	16/01/2020 12:04	16/01/2020 16:01	16/01/2020 12:04	16/01/2020 16:01	3,94	14	55,17	CHI
20200192478	ARAGARCAS	AG11374919	ARAGARCAS	16/01/2020 12:18	17/01/2020 11:55	17/01/2020 09:00	17/01/2020 11:55	2,92	71	207,08	CHI
20200192491	JUSSARA	JR12229982	JUSSARA	16/01/2020 12:25	16/01/2020 17:46	16/01/2020 12:25	16/01/2020 17:46	5,34	6	32,07	CHI
20200192493	IVOLANDIA	IV21165803	IPORA	16/01/2020 12:25	16/01/2020 17:00	16/01/2020 12:25	16/01/2020 17:00	4,58	1	4,58	CHI
20200192713	IPAMERI	IP12352283LD	IPAMERI	16/01/2020 12:32	16/01/2020 14:39	16/01/2020 12:32	16/01/2020 14:39	2,12	2	4,23	CHI
20200192715	SANTA RITA DO ARAGUAIA	SU21027988	SANTA RITA DO ARAGUAIA	16/01/2020 12:32	16/01/2020 17:25	16/01/2020 12:32	16/01/2020 17:25	4,87	1	4,87	CHI
20200192721	PIRACANJUBA	PJ21265201	CRISTIANOPOLIS	16/01/2020 12:35	16/01/2020 15:32	16/01/2020 12:35	16/01/2020 15:32	2,94	2	5,89	CHI
20200192728	PIRES DO RIO	460060909	PIRES DO RIO S1	16/01/2020 12:37	16/01/2020 15:57	16/01/2020 12:37	16/01/2020 15:57	3,32	1	3,32	CHI
20200192737	CRISTALINA	1060027061	CRISTALINA S1	16/01/2020 12:43	16/01/2020 17:22	16/01/2020 12:43	16/01/2020 17:22	4,64	1	4,64	CHI
20200192746	GOIAS	GS12071256	GOIAS	16/01/2020 12:48	16/01/2020 15:24	16/01/2020 12:48	16/01/2020 15:24	2,59	1	2,59	CHI
20200192750	GOIATUBA	GT12000370	GOIATUBA S2	16/01/2020 11:33	16/01/2020 17:00	16/01/2020 11:33	16/01/2020 17:00	5,44	11	59,88	CHI
20200192759	LUZIANIA	3200088800	MARAJOARA	16/01/2020 12:52	16/01/2020 15:39	16/01/2020 12:52	16/01/2020 15:39	2,78	1	2,78	CHI
20200192804	JATAI	290252258	JATAI S3	16/01/2020 13:09	16/01/2020 15:02	16/01/2020 13:09	16/01/2020 15:02	1,88	1	1,88	CHI
20200192807	ARAGARCAS	AG21221248	BOM JARDIM	16/01/2020 13:10	16/01/2020 23:21	16/01/2020 13:10	16/01/2020 23:21	10,18	1	10,18	CHI
20200192810	JATAI	RV12222009	CABRIUVA S2	16/01/2020 13:03	16/01/2020 17:15	16/01/2020 13:03	16/01/2020 17:15	4,19	16	67,10	CHI
20200192810	RIO VERDE	RV12222009	CABRIUVA S2	16/01/2020 13:03	16/01/2020 17:15	16/01/2020 13:03	16/01/2020 17:15	4,19	20	83,88	CHI
20200192812	CROMINIA	JS12120785	ROCHEDO	16/01/2020 13:11	16/01/2020 16:45	16/01/2020 13:11	16/01/2020 16:45	3,56	28	99,59	CHI
20200192812	PROFESSOR JAMIL SAFADY	JS12120785	ROCHEDO	16/01/2020 13:11	16/01/2020 16:45	16/01/2020 13:11	16/01/2020 16:45	3,56	15	53,35	CHI

20200192824	QUIRINOPOLIS	QI21360928	QUIRINOPOLIS	16/01/2020 13:15	16/01/2020 23:20	16/01/2020 13:15	16/01/2020 23:20	10,07	1	10,07	CHI
20200192825	JATAI	290086899	JATAI S3	16/01/2020 13:15	16/01/2020 15:33	16/01/2020 13:15	16/01/2020 15:33	2,29	1	2,29	CHI
20200192832	QUIRINOPOLIS	PC21333337	QUIRINOPOLIS	16/01/2020 13:17	17/01/2020 11:28	16/01/2020 13:17	17/01/2020 11:28	22,17	1	22,17	CHI
20200192833	ACREUNA	2440075900	ACREUNA	16/01/2020 13:19	16/01/2020 21:12	16/01/2020 13:19	16/01/2020 21:12	7,88	1	7,88	CHI
20200192834	SAO LUIS DE MONTES BELOS	SL21180351	SAO LUIZ DOS MONTES BELOS	16/01/2020 13:19	16/01/2020 21:58	16/01/2020 13:19	16/01/2020 21:58	8,65	1	8,65	CHI
20200192846	CALDAS NOVAS	10004534229	CALDAS NOVAS S1	16/01/2020 13:22	16/01/2020 15:14	16/01/2020 13:22	16/01/2020 15:14	1,86	1	1,86	CHI
20200192848	RIO VERDE	630092084	RIO VERDE S2	16/01/2020 13:22	16/01/2020 16:24	16/01/2020 13:22	16/01/2020 16:24	3,03	1	3,03	CHI
20200192855	EDEALINA	ED12223495	PONTALINA	16/01/2020 13:22	16/01/2020 15:33	16/01/2020 13:22	16/01/2020 15:33	2,18	4	8,70	CHI
20200192855	PONTALINA	ED12223495	PONTALINA	16/01/2020 13:22	16/01/2020 15:33	16/01/2020 13:22	16/01/2020 15:33	2,18	2	4,35	CHI
20200192866	CACU	CC21322279	CACHOEIRA ALTA	16/01/2020 13:30	17/01/2020 18:50	16/01/2020 13:30	17/01/2020 18:50	29,33	1	29,33	CHI
20200192877	MATRINCHA	MP21155529	MOZARLANDIA	16/01/2020 13:32	16/01/2020 19:05	16/01/2020 13:32	16/01/2020 19:05	5,55	1	5,55	CHI
20200192886	MORRINHOS	MR11275887	GOIATUBA S1	16/01/2020 13:35	16/01/2020 23:00	16/01/2020 13:35	16/01/2020 23:00	9,41	1	9,41	CHI
20200192898	BALIZA	BH12061407	BOM JARDIM	16/01/2020 13:39	16/01/2020 17:52	16/01/2020 13:39	16/01/2020 17:52	4,21	30	126,28	CHI
20200192900	BALIZA	BH12343730	BOM JARDIM	16/01/2020 13:39	16/01/2020 18:04	16/01/2020 13:39	16/01/2020 18:04	4,40	8	35,22	CHI
20200192908	TURVELANDIA	TD21330359	RIO DOS BOIS	16/01/2020 13:42	16/01/2020 19:16	16/01/2020 13:42	16/01/2020 19:16	5,57	1	5,57	CHI
20200192912	ITAGUARU	IC21065773	ITABERAI S1	16/01/2020 13:43	16/01/2020 17:00	16/01/2020 13:43	16/01/2020 17:00	3,27	1	3,27	CHI
20200192915	GOIANIA	10027038988	REAL S2	16/01/2020 13:44	16/01/2020 17:53	16/01/2020 13:44	16/01/2020 17:53	4,14	1	4,14	CHI
20200192916	CACU	CC12260993	CACHOEIRA ALTA	16/01/2020 13:44	16/01/2020 17:04	16/01/2020 13:44	16/01/2020 17:04	3,34	7	23,41	CHI
20200192917	GOIANIA	GN11001268	CAMPINAS S3	16/01/2020 13:35	16/01/2020 14:34	16/01/2020 13:35	16/01/2020 14:34	0,97	164	158,67	CHI
20200192926	CACHOEIRA DOURADA	CD21305506	CACHOEIRA DOURADA	16/01/2020 13:46	16/01/2020 18:07	16/01/2020 13:46	16/01/2020 18:07	4,35	2	8,70	CHI
20200192933	GOIANIA	10263779	CAMPINAS S3	16/01/2020 13:47	16/01/2020 16:43	16/01/2020 13:47	16/01/2020 16:43	2,93	1	2,93	CHI
20200192934	GOIANIRA	GR21133868	GOIANIRA	16/01/2020 13:47	16/01/2020 18:25	16/01/2020 13:47	16/01/2020 18:25	4,62	1	4,62	CHI
20200192943	LUZIANIA	LZ21304772	MARAJOARA	16/01/2020 13:50	16/01/2020 16:44	16/01/2020 13:50	16/01/2020 16:44	2,89	1	2,89	CHI
20200192948	MORRINHOS	MR31098178	MORRINHOS	16/01/2020 13:51	16/01/2020 21:00	16/01/2020 13:51	16/01/2020 21:00	7,15	1	7,15	CHI
20200192949	RIO QUENTE	2530023329	RIO QUENTE	16/01/2020 13:52	16/01/2020 19:49	16/01/2020 13:52	16/01/2020 19:49	5,95	1	5,95	CHI
20200192958	CAMPO ALEGRE DE GOIAS	CM12266783	CAMPO ALEGRE DE GOIAS	16/01/2020 13:40	16/01/2020 18:41	16/01/2020 13:40	16/01/2020 18:41	5,00	42	210,02	CHI
20200192962	GOIANIA	10025447228	GOYA S2	16/01/2020 13:54	16/01/2020 15:29	16/01/2020 13:54	16/01/2020 15:29	1,57	1	1,57	CHI
20200192969	GOIANIA	GN12051661	ATLANTICO S1	16/01/2020 13:56	16/01/2020 15:47	16/01/2020 13:56	16/01/2020 15:47	1,84	309	568,65	CHI
20200192975	PADRE BERNARDO	PB12052000	PADRE BERNARDO	16/01/2020 13:57	16/01/2020 14:58	16/01/2020 13:57	16/01/2020 14:58	1,00	4	4,01	CHI
20200192978	CAMPESTRE DE GOIAS	GC12005180	TRINDADE	16/01/2020 13:58	16/01/2020 17:26	16/01/2020 13:58	16/01/2020 17:26	3,46	2	6,92	CHI
20200192979	FAINA	FC12199793	GOIAS	16/01/2020 13:59	16/01/2020 22:32	16/01/2020 13:59	16/01/2020 22:32	8,55	15	128,20	CHI
20200192991	PARAUNA	PU21356335	ACREUNA	16/01/2020 14:04	16/01/2020 17:26	16/01/2020 14:04	16/01/2020 17:26	3,36	1	3,36	CHI
20200192995	BALIZA	BH12331250	CAIAPONIA	16/01/2020 13:45	16/01/2020 17:40	16/01/2020 13:45	16/01/2020 17:40	3,91	100	391,11	CHI

20200192999	SENADOR CANEDO	SW11188911	SENADOR CANEDO	16/01/2020 13:45	16/01/2020 15:57	16/01/2020 13:45	16/01/2020 15:57	2,19	123	269,71	CHI
20200193005	GOIANIA	GN11211338	CARAJAS S2	16/01/2020 14:05	16/01/2020 15:09	16/01/2020 14:05	16/01/2020 15:09	1,06	120	126,87	CHI
20200193008	AGUAS LINDAS DE GOIAS	03730234	AGUAS LINDAS DE GOIAS S1	16/01/2020 14:14	16/01/2020 14:24	16/01/2020 14:14	16/01/2020 14:24	0,17	11537	1958,09	CHI
20200193104	MINEIROS	MY21244670	PARQUE DAS EMAS	16/01/2020 14:10	17/01/2020 10:12	16/01/2020 14:10	17/01/2020 10:12	20,02	2	40,04	CHI
20200193108	CAMPO ALEGRE DE GOIAS	CM12152114	CAMPO ALEGRE DE GOIAS	16/01/2020 14:12	16/01/2020 19:46	16/01/2020 14:12	16/01/2020 19:46	5,55	17	94,40	CHI
20200193112	ITAJA	IJ12000013	ITAJA S2	16/01/2020 14:13	16/01/2020 16:15	16/01/2020 14:13	16/01/2020 16:15	2,03	1	2,03	CHI
20200193113	VALPARAISO DE GOIAS	3350053450	PACAEMBU S2	16/01/2020 14:13	16/01/2020 16:21	16/01/2020 14:13	16/01/2020 16:21	2,12	1	2,12	CHI
20200193115	CAIAPONIA	CP12191771	MONTIVIDIU T	16/01/2020 14:14	16/01/2020 19:30	16/01/2020 14:14	16/01/2020 19:30	5,27	10	52,69	CHI
20200193115	JATAI	CP12191771	MONTIVIDIU T	16/01/2020 14:14	16/01/2020 19:30	16/01/2020 14:14	16/01/2020 19:30	5,27	7	36,88	CHI
20200193115	RIO VERDE	CP12191771	MONTIVIDIU T	16/01/2020 14:14	16/01/2020 19:30	16/01/2020 14:14	16/01/2020 19:30	5,27	9	47,42	CHI
20200193122	CROMINIA	CQ21193800	ROCHEDO	16/01/2020 14:16	16/01/2020 17:20	16/01/2020 14:16	16/01/2020 17:20	3,06	1	3,06	CHI
20200193142	CRISTALINA	KR11183651	PAMPLONA	16/01/2020 14:22	16/01/2020 17:35	16/01/2020 14:22	16/01/2020 17:35	3,22	8	25,79	CHI
20200193145	APORE	AE21122786	ITAJA S2	16/01/2020 14:22	16/01/2020 16:03	16/01/2020 14:22	16/01/2020 16:03	1,67	1	1,67	CHI
20200193154	ARAGARCAS	BM12204856	BOM JARDIM	16/01/2020 13:45	16/01/2020 19:29	16/01/2020 13:45	16/01/2020 19:29	5,73	23	131,76	CHI
20200193154	BALIZA	BM12204856	BOM JARDIM	16/01/2020 13:45	16/01/2020 19:29	16/01/2020 13:45	16/01/2020 19:29	5,73	50	286,43	CHI
20200193167	CAMPO ALEGRE DE GOIAS	CT12278103	CATALAO S1	16/01/2020 14:28	16/01/2020 18:00	16/01/2020 14:28	16/01/2020 18:00	3,52	1	3,52	CHI
20200193167	CATALAO	CT12278103	CATALAO S1	16/01/2020 14:28	16/01/2020 18:00	16/01/2020 14:28	16/01/2020 18:00	3,52	15	52,82	CHI
20200193167	DAVINOPOLIS	CT12278103	CATALAO S1	16/01/2020 14:28	16/01/2020 18:00	16/01/2020 14:28	16/01/2020 18:00	3,52	4	14,08	CHI
20200193169	MINEIROS	MY21141680	PARQUE DAS EMAS	16/01/2020 14:29	17/01/2020 10:24	16/01/2020 14:29	17/01/2020 10:24	19,91	1	19,91	CHI
20200193173	GOIANIA	GN11002881	ATLANTICO S2	16/01/2020 14:15	16/01/2020 15:21	16/01/2020 14:15	16/01/2020 15:21	1,09	55	59,90	CHI
20200193174	RIO VERDE	10013545858	RIO VERDE S1	16/01/2020 14:30	16/01/2020 17:26	16/01/2020 14:30	16/01/2020 17:26	2,93	1	2,93	CHI
20200193193	TEREZOPOLIS DE GOIAS	AN21273416	NEROPOLIS S1	16/01/2020 14:34	16/01/2020 18:47	16/01/2020 14:34	16/01/2020 18:47	4,20	1	4,20	CHI
20200193197	GOIANIA	GN11001255	ATLANTICO S2	16/01/2020 14:03	16/01/2020 16:25	16/01/2020 14:03	16/01/2020 16:25	2,36	41	96,95	CHI
20200193305	GOIANIA	GN21376830	FERROVIARIO S1	16/01/2020 14:37	16/01/2020 15:55	16/01/2020 14:37	16/01/2020 15:55	1,29	1	1,29	CHI
20200193317	FAINA	FC12211270	GOIAS	16/01/2020 13:53	16/01/2020 17:16	16/01/2020 13:53	16/01/2020 17:16	3,37	7	23,62	CHI
20200193322	CAMPO ALEGRE DE GOIAS	CM21122441	CAMPO ALEGRE DE GOIAS	16/01/2020 14:41	16/01/2020 15:40	16/01/2020 14:41	16/01/2020 15:40	0,99	1	0,99	CHI
20200193326	CATALAO	10017859113	CATALAO S2	16/01/2020 14:42	16/01/2020 17:55	16/01/2020 14:42	16/01/2020 17:55	3,22	1	3,22	CHI
20200193333	FIRMINOPOLIS	SL12111569	FIRMINOPOLIS S1	16/01/2020 14:44	17/01/2020 19:00	16/01/2020 14:44	16/01/2020 21:15	6,52	6	39,10	CHI
20200193333	SAO LUIS DE MONTES BELOS	SL12111569	FIRMINOPOLIS S1	16/01/2020 14:44	17/01/2020 19:00	16/01/2020 14:44	16/01/2020 21:15	6,52	96	625,63	CHI
20200193333	SAO LUIS DE MONTES BELOS	SL12111569	FIRMINOPOLIS S1	16/01/2020 14:44	17/01/2020 19:00	16/01/2020 14:44	17/01/2020 00:28	9,73	32	311,27	CHI
20200193333	SAO LUIS DE MONTES BELOS	SL12111569	FIRMINOPOLIS S1	16/01/2020 14:44	17/01/2020 19:00	16/01/2020 14:44	17/01/2020 00:50	10,09	10	100,94	CHI
20200193333	FIRMINOPOLIS	SL12111569	FIRMINOPOLIS S1	16/01/2020 14:44	17/01/2020 19:00	16/01/2020 14:44	17/01/2020 09:52	19,14	1	19,14	CHI
20200193333	SAO LUIS DE MONTES BELOS	SL12111569	FIRMINOPOLIS S1	16/01/2020 14:44	17/01/2020 19:00	16/01/2020 14:44	17/01/2020 09:52	19,14	7	133,95	CHI

20200193333	FIRMINOPOLIS	SL12111569	FIRMINOPOLIS S1	16/01/2020 14:44	17/01/2020 19:00	16/01/2020 14:44	17/01/2020 13:00	22,25	7	155,77	CHI
20200193333	SAO LUIS DE MONTES BELOS	SL12111569	FIRMINOPOLIS S1	16/01/2020 14:44	17/01/2020 19:00	16/01/2020 14:44	17/01/2020 13:00	22,25	4	89,01	CHI
20200193333	TURVANIA	SL12111569	FIRMINOPOLIS S1	16/01/2020 14:44	17/01/2020 19:00	16/01/2020 14:44	17/01/2020 13:00	22,25	3	66,76	CHI
20200193333	FIRMINOPOLIS	SL12111569	FIRMINOPOLIS S1	16/01/2020 14:44	17/01/2020 19:00	16/01/2020 14:44	17/01/2020 19:00	28,27	9	254,42	CHI
20200193333	TURVANIA	SL12111569	FIRMINOPOLIS S1	16/01/2020 14:44	17/01/2020 19:00	16/01/2020 14:44	17/01/2020 19:00	28,27	5	141,34	CHI
20200193333	FIRMINOPOLIS	SL12125617	FIRMINOPOLIS S1	16/01/2020 14:44	17/01/2020 19:00	17/01/2020 13:01	17/01/2020 19:00	5,99	8	47,92	CHI
20200193333	SAO LUIS DE MONTES BELOS	SL12125617	FIRMINOPOLIS S1	16/01/2020 14:44	17/01/2020 19:00	17/01/2020 13:01	17/01/2020 19:00	5,99	53	317,50	CHI
20200193333	TURVANIA	SL12125617	FIRMINOPOLIS S1	16/01/2020 14:44	17/01/2020 19:00	17/01/2020 13:01	17/01/2020 19:00	5,99	3	17,97	CHI
20200193338	PALMEIRAS DE GOIAS	PL21000161	PALMEIRAS	16/01/2020 14:47	16/01/2020 15:39	16/01/2020 14:47	16/01/2020 15:39	0,87	1	0,87	CHI
20200193342	EDEIA	EA12160413	VICENTINOPOLIS	16/01/2020 14:48	16/01/2020 17:08	16/01/2020 14:48	16/01/2020 17:08	2,33	2	4,65	CHI
20200193347	CRISTALINA	KR12404434	CRISTALINA S1	16/01/2020 14:49	16/01/2020 16:03	16/01/2020 14:49	16/01/2020 16:03	1,22	7	8,54	CHI
20200193357	PALMEIRAS DE GOIAS	PL21000148	PALMEIRAS	16/01/2020 14:53	16/01/2020 16:26	16/01/2020 14:53	16/01/2020 16:26	1,54	1	1,54	CHI
20200193367	CRISTALINA	KR12383065	CRISTALINA S2	16/01/2020 14:55	16/01/2020 20:17	16/01/2020 14:55	16/01/2020 20:17	5,35	3	16,05	CHI
20200193368	SANCLERLANDIA	SC12008814	FIRMINOPOLIS S2	16/01/2020 14:55	16/01/2020 17:58	16/01/2020 14:55	16/01/2020 17:58	3,03	19	57,65	CHI
20200193381	ARUANA	MP12099916	MATRINCHA	16/01/2020 14:57	16/01/2020 17:38	16/01/2020 14:57	16/01/2020 17:38	2,67	5	13,33	CHI
20200193381	MATRINCHA	MP12099916	MATRINCHA	16/01/2020 14:57	16/01/2020 17:38	16/01/2020 14:57	16/01/2020 17:38	2,67	2	5,33	CHI
20200193391	ANAPOLIS	AN12262521	NEROPOLIS S1	16/01/2020 15:01	16/01/2020 18:47	16/01/2020 15:01	16/01/2020 18:47	3,76	12	45,10	CHI
20200193391	TEREZOPOLIS DE GOIAS	AN12262521	NEROPOLIS S1	16/01/2020 15:01	16/01/2020 18:47	16/01/2020 15:01	16/01/2020 18:47	3,76	9	33,82	CHI
20200193402	CAMPO ALEGRE DE GOIAS	CM21071194	CAMPO ALEGRE DE GOIAS	16/01/2020 15:04	16/01/2020 16:23	16/01/2020 15:04	16/01/2020 16:23	1,33	1	1,33	CHI
20200193405	CAMPO ALEGRE DE GOIAS	CM21130987	CAMPO ALEGRE DE GOIAS	16/01/2020 15:04	16/01/2020 22:04	16/01/2020 15:04	16/01/2020 22:04	6,99	1	6,99	CHI
20200193420	RIO VERDE	630336775	RIO VERDE S1	16/01/2020 15:08	16/01/2020 18:19	16/01/2020 15:08	16/01/2020 18:19	3,19	1	3,19	CHI
20200193422	PALMEIRAS DE GOIAS	590041976	PALMEIRAS	16/01/2020 15:09	16/01/2020 16:28	16/01/2020 15:09	16/01/2020 16:28	1,31	1	1,31	CHI
20200193424	BURITI ALEGRE	BG12000067RE	ITUMBIARA VELHA S2	16/01/2020 14:26	16/01/2020 16:26	16/01/2020 14:26	16/01/2020 16:26	2,00	40	79,94	CHI
20200193424	GOIATUBA	BG12000067RE	ITUMBIARA VELHA S2	16/01/2020 14:26	16/01/2020 16:26	16/01/2020 14:26	16/01/2020 16:26	2,00	2	4,00	CHI
20200193424	ITUMBIARA	BG12000067RE	ITUMBIARA VELHA S2	16/01/2020 14:26	16/01/2020 16:26	16/01/2020 14:26	16/01/2020 16:26	2,00	25	49,97	CHI
20200193436	GOIANIA	10006833800	GOIANIA LESTE S2	16/01/2020 15:12	16/01/2020 16:47	16/01/2020 15:12	16/01/2020 16:47	1,58	1	1,58	CHI
20200193441	ITUMBIARA	IT11091623	ITUMBIARA NOVA	16/01/2020 13:45	16/01/2020 16:25	16/01/2020 13:45	16/01/2020 16:25	2,65	191	507,00	CHI
20200193444	IVOLANDIA	IV21131382	IPORA	16/01/2020 15:14	17/01/2020 07:52	16/01/2020 15:14	17/01/2020 07:52	16,63	1	16,63	CHI
20200193447	CAMPO ALEGRE DE GOIAS	CM21166749	CAMPO ALEGRE DE GOIAS	16/01/2020 15:14	16/01/2020 20:36	16/01/2020 15:14	16/01/2020 20:36	5,36	1	5,36	CHI
20200193448	RIO VERDE	RV12226353	CACHOEIRA ALTA	16/01/2020 15:14	16/01/2020 21:34	16/01/2020 15:14	16/01/2020 21:34	6,33	3	18,98	CHI
20200193453	LUZIANIA	LZ11000044	CRISTALINA S2	16/01/2020 15:14	16/01/2020 17:35	16/01/2020 15:14	16/01/2020 17:35	2,34	19	44,43	CHI
20200193458	AGUAS LINDAS DE GOIAS	10018333174	AGUAS LINDAS DE GOIAS S2	16/01/2020 15:15	16/01/2020 16:16	16/01/2020 15:15	16/01/2020 16:16	1,01	1	1,01	CHI
20200193466	RIO VERDE	RV21212482	MONTIVIDIU T	16/01/2020 15:18	17/01/2020 12:01	16/01/2020 15:18	17/01/2020 12:01	20,71	1	20,71	CHI

20200193474	GOIAS	GS12217234	MATRINCHA	16/01/2020 15:18	16/01/2020 17:47	16/01/2020 15:18	16/01/2020 17:47	2,47	84	207,81	CHI
20200193474	ITAPIRAPUA	GS12217234	MATRINCHA	16/01/2020 15:18	16/01/2020 17:47	16/01/2020 15:18	16/01/2020 17:47	2,47	1	2,47	CHI
20200193474	NOVO BRASIL	GS12217234	MATRINCHA	16/01/2020 15:18	16/01/2020 17:47	16/01/2020 15:18	16/01/2020 17:47	2,47	36	89,06	CHI
20200193477	VALPARAISO DE GOIAS	2860097801	PACAEMBU S1	16/01/2020 15:20	16/01/2020 18:25	16/01/2020 15:20	16/01/2020 18:25	3,08	1	3,08	CHI
20200193485	PALMEIRAS DE GOIAS	PL21000074	PALMEIRAS	16/01/2020 15:22	16/01/2020 17:02	16/01/2020 15:22	16/01/2020 17:02	1,66	1	1,66	CHI
20200193487	ITABERAI	IB21220131	ITABERAI S1	16/01/2020 15:22	16/01/2020 20:13	16/01/2020 15:22	16/01/2020 20:13	4,83	1	4,83	CHI
20200193491	CALDAZINHA	DE21326167	CEPAIGO S2	16/01/2020 15:23	16/01/2020 17:58	16/01/2020 15:23	16/01/2020 17:58	2,58	2	5,16	CHI
20200193701	PARAUNA	PU11000006	PARAUNA	16/01/2020 15:25	16/01/2020 17:28	16/01/2020 15:25	16/01/2020 17:28	2,03	113	229,80	CHI
20200193706	FAZENDA NOVA	FN21295314	BRITANIA	16/01/2020 15:26	16/01/2020 18:26	16/01/2020 15:26	16/01/2020 18:26	2,99	1	2,99	CHI
20200193709	APARECIDA DE GOIANIA	10016622101	INDEPENDENCIA S1	16/01/2020 15:27	16/01/2020 16:26	16/01/2020 15:27	16/01/2020 16:26	0,98	1	0,98	CHI
20200193719	PIRES DO RIO	PR12064876RE	PIRES DO RIO S1	16/01/2020 12:44	16/01/2020 17:40	16/01/2020 12:44	16/01/2020 17:40	4,93	33	162,67	CHI
20200193725	NOVO GAMA	2460022020	PACAEMBU S1	16/01/2020 15:31	16/01/2020 18:57	16/01/2020 15:31	16/01/2020 18:57	3,42	1	3,42	CHI
20200193726	INDIARA	2710013466	EDEIA	16/01/2020 15:31	16/01/2020 17:48	16/01/2020 15:31	16/01/2020 17:48	2,29	1	2,29	CHI
20200193728	CALDAS NOVAS	10002349360	SERRA DE CALDAS	16/01/2020 15:32	16/01/2020 17:00	16/01/2020 15:32	16/01/2020 17:00	1,46	1	1,46	CHI
20200193729	CALDAS NOVAS	CN11040988	SERRA DE CALDAS	16/01/2020 15:28	16/01/2020 18:10	16/01/2020 15:28	16/01/2020 18:10	2,69	92	247,74	CHI
20200193730	CAMPO LIMPO	CV21350785	NEROPOLIS S1	16/01/2020 15:32	16/01/2020 17:43	16/01/2020 15:32	16/01/2020 17:43	2,17	1	2,17	CHI
20200193735	MINEIROS	MY21301881	PARQUE DAS EMAS	16/01/2020 15:33	16/01/2020 17:30	16/01/2020 15:33	16/01/2020 17:30	1,96	1	1,96	CHI
20200193737	GOUVELANDIA	Q12000157	QUIRINOPOLIS	16/01/2020 15:33	16/01/2020 16:30	16/01/2020 15:33	16/01/2020 16:30	0,94	12	11,28	CHI
20200193746	ANAPOLIS	20128472	ANAPOLIS UNIVERSITARIO S2	16/01/2020 15:34	16/01/2020 18:27	16/01/2020 15:34	16/01/2020 18:27	2,88	1	2,88	CHI
20200193747	SILVANIA	SV12202392	DAIA S2	16/01/2020 15:34	16/01/2020 19:15	16/01/2020 15:34	16/01/2020 19:15	3,67	12	44,02	CHI
20200193757	HIDROLANDIA	AO21298342	INDEPENDENCIA S1	16/01/2020 15:35	16/01/2020 18:00	16/01/2020 15:35	16/01/2020 18:00	2,41	2	4,83	CHI
20200193761	SANTA HELENA DE GOIAS	SH11000023	IPEGUARI	16/01/2020 15:14	16/01/2020 17:32	16/01/2020 15:14	16/01/2020 17:32	2,29	111	254,22	CHI
20200193762	JATAI	JT12182034	JATAI S3	16/01/2020 15:36	16/01/2020 16:55	16/01/2020 15:36	16/01/2020 16:55	1,31	126	165,44	CHI
20200193763	GOIAS	90046754	GOIAS	16/01/2020 15:36	16/01/2020 17:50	16/01/2020 15:36	16/01/2020 17:50	2,24	1	2,24	CHI
20200193764	MINEIROS	MY12278372	PARQUE DAS EMAS	16/01/2020 15:37	16/01/2020 21:19	16/01/2020 15:37	16/01/2020 21:19	5,69	3	17,06	CHI
20200193765	CACHOEIRA DOURADA	IT12088560	CACHOEIRA DOURADA	16/01/2020 15:37	16/01/2020 20:25	16/01/2020 15:37	16/01/2020 20:25	4,79	1	4,79	CHI
20200193765	ITUMBIARA	IT12088560	CACHOEIRA DOURADA	16/01/2020 15:37	16/01/2020 20:25	16/01/2020 15:37	16/01/2020 20:25	4,79	4	19,15	CHI
20200193770	COCALZINHO DE GOIAS	ZN21297587	COCALZINHO	16/01/2020 15:38	17/01/2020 22:58	16/01/2020 15:38	17/01/2020 22:58	31,32	1	31,32	CHI
20200193772	GOIANIA	10029441100	AEROPORTO S2	16/01/2020 15:39	16/01/2020 17:27	16/01/2020 15:39	16/01/2020 17:27	1,80	1	1,80	CHI
20200193774	JATAI	JT12196090	JATAI S2	16/01/2020 15:39	16/01/2020 16:55	16/01/2020 15:39	16/01/2020 16:55	1,26	12	15,11	CHI
20200193777	JATAI	JT12374278	JATAI S3	16/01/2020 15:40	16/01/2020 17:41	16/01/2020 15:40	16/01/2020 17:41	2,02	655	1323,65	CHI
20200193780	ITAPURANGA	170044749	ITAPURANGA	16/01/2020 15:40	16/01/2020 21:00	16/01/2020 15:40	16/01/2020 21:00	5,33	1	5,33	CHI
20200193791	IPAMERI	IP21073339	CAMPO ALEGRE DE GOIAS	16/01/2020 15:43	16/01/2020 16:48	16/01/2020 15:43	16/01/2020 16:48	1,08	1	1,08	CHI

20200193799	CRISTIANOPOLIS	BC12300653	CRISTIANOPOLIS	16/01/2020 15:44	16/01/2020 21:17	16/01/2020 15:44	16/01/2020 21:17	5,56	11	61,13	CHI
20200193799	SANTA CRUZ DE GOIAS	BC12300653	CRISTIANOPOLIS	16/01/2020 15:44	16/01/2020 21:17	16/01/2020 15:44	16/01/2020 21:17	5,56	23	127,82	CHI
20200193800	JUSSARA	NB12068896	JUSSARA	16/01/2020 15:44	16/01/2020 17:16	16/01/2020 15:44	16/01/2020 17:16	1,54	2	3,08	CHI
20200193800	NOVO BRASIL	NB12068896	JUSSARA	16/01/2020 15:44	16/01/2020 17:16	16/01/2020 15:44	16/01/2020 17:16	1,54	7	10,77	CHI
20200193901	CUMARI	CT21267010	CATALAO S2	16/01/2020 14:18	16/01/2020 23:13	16/01/2020 14:18	16/01/2020 23:13	8,91	1	8,91	CHI
20200193903	CATALAO	CT12379370	CATALAO S2	16/01/2020 14:29	16/01/2020 16:15	16/01/2020 14:29	16/01/2020 16:15	1,76	48	84,29	CHI
20200193903	CUMARI	CT12379370	CATALAO S2	16/01/2020 14:29	16/01/2020 16:15	16/01/2020 14:29	16/01/2020 16:15	1,76	4	7,02	CHI
20200194101	JAUPACI	JP11349576	IPORA	16/01/2020 15:45	17/01/2020 08:07	16/01/2020 15:45	17/01/2020 08:07	16,37	1	16,37	CHI
20200194103	CEZARINA	CZ21064298	GUAPO S2	16/01/2020 15:45	16/01/2020 20:10	16/01/2020 15:45	16/01/2020 20:10	4,41	1	4,41	CHI
20200194108	JATAI	JT12346022	JATAI S3	16/01/2020 15:47	16/01/2020 18:28	16/01/2020 15:47	16/01/2020 18:28	2,69	259	695,99	CHI
20200194113	URUTAI	UT21417471	PIRES DO RIO S2	16/01/2020 15:49	16/01/2020 17:22	16/01/2020 15:49	16/01/2020 17:22	1,55	1	1,55	CHI
20200194115	INDIARA	IY12205923	EDEIA	16/01/2020 15:50	16/01/2020 18:34	16/01/2020 15:50	16/01/2020 18:34	2,73	33	90,15	CHI
20200194115	PALMEIRAS DE GOIAS	IY12205923	EDEIA	16/01/2020 15:50	16/01/2020 18:34	16/01/2020 15:50	16/01/2020 18:34	2,73	5	13,66	CHI
20200194118	CORUMBA DE GOIAS	ZN21302496	COCALZINHO	16/01/2020 15:50	18/01/2020 11:55	16/01/2020 15:50	18/01/2020 11:55	44,09	1	44,09	CHI
20200194119	EDEIA	EA12160409	VICENTINOPOLIS	16/01/2020 15:02	16/01/2020 17:56	16/01/2020 15:02	16/01/2020 17:56	2,90	20	57,99	CHI
20200194135	CRISTALINA	KR12248700	CRISTALINA S2	16/01/2020 15:54	16/01/2020 17:27	16/01/2020 15:54	16/01/2020 17:27	1,54	18	27,72	CHI
20200194138	GOIANIA	GN11323132	AEROPORTO S2	16/01/2020 15:55	16/01/2020 17:55	16/01/2020 15:55	16/01/2020 17:55	2,00	37	73,95	CHI
20200194143	ARUANA	AK12183254	ARUANA	16/01/2020 13:59	16/01/2020 17:10	16/01/2020 13:59	16/01/2020 17:10	3,18	28	88,92	CHI
20200194152	MINEIROS	MY12336359	PARQUE DAS EMAS	16/01/2020 15:56	16/01/2020 21:51	16/01/2020 15:56	16/01/2020 21:51	5,90	3	17,71	CHI
20200194173	CRISTALINA	KR12388492	CRISTALINA S1	16/01/2020 16:01	16/01/2020 17:33	16/01/2020 16:01	16/01/2020 17:33	1,53	14	21,39	CHI
20200194175	RIO VERDE	RV12326944	MONTIVIDIU T	17/01/2020 07:40	17/01/2020 10:09	17/01/2020 07:40	17/01/2020 10:09	2,48	23	56,95	CHI
20200194178	PIRACANJUBA	PJ11000001	PIRACANJUBA	16/01/2020 15:23	16/01/2020 17:11	16/01/2020 15:23	16/01/2020 17:11	1,79	78	139,69	CHI
20200194187	PIRACANJUBA	PJ21106672	CALDAS NOVAS S1	16/01/2020 16:05	16/01/2020 21:37	16/01/2020 16:05	16/01/2020 21:37	5,53	1	5,53	CHI
20200194200	SAO LUIS DE MONTES BELOS	500120328	SAO LUIZ DOS MONTES BELOS	16/01/2020 16:08	16/01/2020 17:37	16/01/2020 16:08	16/01/2020 17:37	1,48	1	1,48	CHI
20200194504	SAO LUIS DE MONTES BELOS	500071627	SAO LUIZ DOS MONTES BELOS	16/01/2020 16:08	16/01/2020 18:24	16/01/2020 16:08	16/01/2020 18:24	2,25	1	2,25	CHI
20200194507	GOIANIA	GN11049905	ATLANTICO S1	16/01/2020 16:10	16/01/2020 18:40	16/01/2020 16:10	16/01/2020 18:40	2,49	62	154,55	CHI
20200194518	QUIRINOPOLIS	QI11091105	QUIRINOPOLIS	16/01/2020 16:02	16/01/2020 20:00	16/01/2020 16:02	16/01/2020 20:00	3,96	129	510,55	CHI
20200194521	BELA VISTA DE GOIAS	BV12020406	BELA VISTA S2	16/01/2020 16:14	16/01/2020 18:17	16/01/2020 16:14	16/01/2020 18:17	2,05	10	20,49	CHI
20200194532	JATAI	JT12000096	JATAI S3	16/01/2020 16:17	17/01/2020 14:18	16/01/2020 16:17	17/01/2020 14:18	22,01	17	374,16	CHI
20200194537	CAMPO LIMPO	AN21351234	NEROPOLIS S1	16/01/2020 16:18	16/01/2020 18:41	16/01/2020 16:18	16/01/2020 18:41	2,37	2	4,74	CHI
20200194539	JATAI	JT12219503	JATAI S3	16/01/2020 16:18	17/01/2020 09:39	16/01/2020 16:18	17/01/2020 09:39	17,34	5	86,68	CHI
20200194549	CAMPO ALEGRE DE GOIAS	CM21066305	CAMPO ALEGRE DE GOIAS	16/01/2020 16:20	16/01/2020 17:49	16/01/2020 16:20	16/01/2020 17:49	1,49	1	1,49	CHI
20200194559	IPAMERI	IP12057877RE	PIRES DO RIO S2	16/01/2020 16:21	16/01/2020 20:35	16/01/2020 16:21	16/01/2020 20:35	4,22	41	173,22	CHI

20200194561	FAZENDA NOVA	1080027054	JUSSARA	16/01/2020 16:22	16/01/2020 19:30	16/01/2020 16:22	16/01/2020 19:30	3,13	1	3,13	CHI
20200194565	APARECIDA DE GOIANIA	AP11063246	ATLANTICO S2	16/01/2020 16:18	16/01/2020 19:20	16/01/2020 16:18	16/01/2020 19:20	3,02	184	555,68	CHI
20200194569	GOIANIA	GN11166568	GOYA S1	16/01/2020 15:56	16/01/2020 17:14	16/01/2020 15:56	16/01/2020 17:14	1,29	109	140,97	CHI
20200194574	ITABERAI	IB12336256	ITABERAI S1	16/01/2020 16:13	16/01/2020 17:14	16/01/2020 16:13	16/01/2020 17:14	1,00	7	7,03	CHI
20200194578	SILVANIA	SV12041094	DAIA S1	16/01/2020 16:25	16/01/2020 18:14	16/01/2020 16:25	16/01/2020 18:14	1,81	7	12,66	CHI
20200194579	SENADOR CANEDO	10003157839	SENADOR CANEDO	16/01/2020 16:25	16/01/2020 17:39	16/01/2020 16:25	16/01/2020 17:39	1,22	1	1,22	CHI
20200194582	ANAPOLIS	AN11370335	JUNDIAI S2	16/01/2020 16:26	16/01/2020 18:36	16/01/2020 16:26	16/01/2020 18:36	2,16	64	138,20	CHI
20200194587	JATAI	JT12182040	JATAI S3	16/01/2020 15:55	16/01/2020 19:35	16/01/2020 15:55	16/01/2020 19:35	3,66	55	201,16	CHI
20200194589	JATAI	JT11172861	JATAI S3	16/01/2020 15:41	17/01/2020 09:51	16/01/2020 15:41	17/01/2020 09:51	18,15	82	1488,71	CHI
20200194595	PETROLINA DE GOIAS	PG12297874	PETROLINA	16/01/2020 15:59	16/01/2020 19:11	16/01/2020 15:59	16/01/2020 19:11	3,19	14	44,67	CHI
20200194596	GOIANIA	GN11085951	REAL S1	16/01/2020 16:28	16/01/2020 18:33	16/01/2020 16:28	16/01/2020 18:33	2,07	68	140,67	CHI
20200194598	DOVERLANDIA	DV12155481	CAIAPONIA	16/01/2020 15:23	17/01/2020 00:53	16/01/2020 15:23	17/01/2020 00:53	9,50	5	47,50	CHI
20200194600	MORRINHOS	MR12000148	MORRINHOS	16/01/2020 16:29	16/01/2020 17:55	16/01/2020 16:29	16/01/2020 17:55	1,43	25	35,78	CHI
20200194601	CATALAO	OU10400686	CATALAO S1	16/01/2020 15:57	16/01/2020 21:11	16/01/2020 16:31	16/01/2020 16:43	0,20	8	1,64	CHI
20200194601	DAVINOPOLIS	OU10400686	CATALAO S1	16/01/2020 15:57	16/01/2020 21:11	16/01/2020 16:31	16/01/2020 16:43	0,20	10	2,04	CHI
20200194601	OUVIDOR	OU10400686	CATALAO S1	16/01/2020 15:57	16/01/2020 21:11	16/01/2020 16:31	16/01/2020 16:43	0,20	2983	609,86	CHI
20200194601	OUVIDOR	OU10400686	CATALAO S1	16/01/2020 15:57	16/01/2020 21:11	16/01/2020 16:31	16/01/2020 16:43	0,20	610	124,71	CHI
20200194601	OUVIDOR	OU10400686	CATALAO S1	16/01/2020 15:57	16/01/2020 21:11	16/01/2020 16:31	16/01/2020 16:43	0,20	30	6,13	CHI
20200194601	TRES RANCHOS	OU10400686	CATALAO S1	16/01/2020 15:57	16/01/2020 21:11	16/01/2020 16:31	16/01/2020 16:43	0,20	19	3,88	CHI
20200194601	TRES RANCHOS	OU10400686	CATALAO S1	16/01/2020 15:57	16/01/2020 21:11	16/01/2020 16:31	16/01/2020 16:43	0,20	26	5,32	CHI
20200194601	CATALAO	OU10400732	CATALAO S1	16/01/2020 15:57	16/01/2020 21:11	16/01/2020 15:57	16/01/2020 18:05	2,13	221	470,05	CHI
20200194601	CATALAO	OU10400732	CATALAO S1	16/01/2020 15:57	16/01/2020 21:11	16/01/2020 15:57	16/01/2020 18:05	2,13	2	4,25	CHI
20200194601	CUMARI	OU10400732	CATALAO S1	16/01/2020 15:57	16/01/2020 21:11	16/01/2020 15:57	16/01/2020 18:05	2,13	1	2,13	CHI
20200194601	DISTRITO FEDERAL	OU10400732	CATALAO S1	16/01/2020 15:57	16/01/2020 21:11	16/01/2020 15:57	16/01/2020 18:05	2,13	1	2,13	CHI
20200194601	OUVIDOR	OU10400732	CATALAO S1	16/01/2020 15:57	16/01/2020 21:11	16/01/2020 15:57	16/01/2020 18:05	2,13	1	2,13	CHI
20200194601	OUVIDOR	OU10400732	CATALAO S1	16/01/2020 15:57	16/01/2020 21:11	16/01/2020 15:57	16/01/2020 18:05	2,13	1	2,13	CHI
20200194601	TRES RANCHOS	OU10400732	CATALAO S1	16/01/2020 15:57	16/01/2020 21:11	16/01/2020 15:57	16/01/2020 18:05	2,13	1920	4083,73	CHI
20200194601	TRES RANCHOS	OU10400732	CATALAO S1	16/01/2020 15:57	16/01/2020 21:11	16/01/2020 15:57	16/01/2020 18:05	2,13	380	808,24	CHI
20200194601	TRES RANCHOS	OU10400732	CATALAO S1	16/01/2020 15:57	16/01/2020 21:11	16/01/2020 15:57	16/01/2020 18:05	2,13	17	36,16	CHI
20200194601	CATALAO	OU12250323LD	CATALAO S1	16/01/2020 15:57	16/01/2020 21:11	16/01/2020 15:57	16/01/2020 21:11	5,23	2	10,46	CHI
20200194601	OUVIDOR	OU12250323LD	CATALAO S1	16/01/2020 15:57	16/01/2020 21:11	16/01/2020 15:57	16/01/2020 21:11	5,23	3	15,69	CHI
20200194702	CATALAO	CT11372963	CATALAO S2	16/01/2020 16:27	16/01/2020 18:06	16/01/2020 16:27	16/01/2020 18:06	1,64	1	1,64	CHI
20200194903	ABADIANIA	350024534	ANAPOLIS UNIVERSITARIO S1	16/01/2020 16:29	16/01/2020 18:32	16/01/2020 16:29	16/01/2020 18:32	2,04	1	2,04	CHI

20200194904	CORUMBA DE GOIAS	260021441	CORUMBA	16/01/2020 16:30	16/01/2020 17:56	16/01/2020 16:30	16/01/2020 17:56	1,43	1	1,43	CHI
20200194905	ANAPOLIS	21000750	ANAPOLIS UNIVERSITARIO S1	16/01/2020 16:30	16/01/2020 19:10	16/01/2020 16:30	16/01/2020 19:10	2,66	1	2,66	CHI
20200194908	GOIATUBA	VI12057732	VICENTINOPOLIS	16/01/2020 16:31	16/01/2020 19:12	16/01/2020 16:31	16/01/2020 19:12	2,68	3	8,03	CHI
20200194912	GOIAS	GS12188132	GOIAS	16/01/2020 15:54	16/01/2020 17:57	16/01/2020 15:54	16/01/2020 17:57	2,05	24	49,13	CHI
20200194915	PARANAIGUARA	PC12240070	QUIRINOPOLIS	16/01/2020 16:33	17/01/2020 22:58	16/01/2020 16:33	17/01/2020 22:58	30,41	1	30,41	CHI
20200194925	GOIANESIA	550000380	GOIANESIA S2	16/01/2020 16:22	17/01/2020 11:00	16/01/2020 16:22	17/01/2020 11:00	18,63	1	18,63	CHI
20200194928	PIRANHAS	PH21343643	IPORA	16/01/2020 16:37	17/01/2020 17:12	16/01/2020 16:37	17/01/2020 17:12	24,58	1	24,58	CHI
20200194934	PIRENOPOLIS	PV12265425	CORUMBA	16/01/2020 16:38	16/01/2020 20:10	16/01/2020 16:38	16/01/2020 20:10	3,52	220	774,03	CHI
20200194939	GOIATUBA	GT21190909	GOIATUBA S2	16/01/2020 16:39	16/01/2020 19:09	16/01/2020 16:39	16/01/2020 19:09	2,49	1	2,49	CHI
20200194940	JATAI	JT11164167	JATAI S3	16/01/2020 15:39	17/01/2020 05:04	16/01/2020 15:39	17/01/2020 05:04	13,41	110	1474,95	CHI
20200194941	RIO VERDE	RV12332189	CABRIUVA S2	16/01/2020 16:39	16/01/2020 19:48	16/01/2020 16:39	16/01/2020 19:48	3,14	5	15,69	CHI
20200194944	JATAI	290156178	JATAI S3	16/01/2020 16:41	16/01/2020 18:10	16/01/2020 16:41	16/01/2020 18:10	1,49	1	1,49	CHI
20200194956	ACREUNA	EU12056532	EDEIA	16/01/2020 15:39	16/01/2020 18:48	16/01/2020 15:39	16/01/2020 18:48	3,15	5	15,73	CHI
20200194959	GUAPO	GA11000004	GUAPO S1	16/01/2020 16:43	16/01/2020 20:05	16/01/2020 16:43	16/01/2020 20:05	3,35	98	328,65	CHI
20200194961	ORIZONA	LZ21246138	PIRES DO RIO S2	16/01/2020 16:44	17/01/2020 11:40	16/01/2020 16:44	17/01/2020 11:40	18,93	1	18,93	CHI
20200194968	VALPARAISO DE GOIAS	2860219682	MARAJOARA	16/01/2020 16:45	16/01/2020 20:25	16/01/2020 16:45	16/01/2020 20:25	3,66	1	3,66	CHI
20200194969	GOIANIA	15346651	FERROVIARIO S1	16/01/2020 16:45	16/01/2020 22:51	16/01/2020 16:45	16/01/2020 22:51	6,09	1	6,09	CHI
20200194975	CATALAO	CT12013008	CATALAO S2	16/01/2020 15:51	16/01/2020 18:31	16/01/2020 15:51	16/01/2020 18:31	2,65	1	2,65	CHI
20200194975	CUMARI	CT12013008	CATALAO S2	16/01/2020 15:51	16/01/2020 18:31	16/01/2020 15:51	16/01/2020 18:31	2,65	2	5,31	CHI
20200194978	MONTES CLAROS DE GOIAS	ME21323797	IPORA	16/01/2020 16:48	16/01/2020 21:07	16/01/2020 16:48	16/01/2020 21:07	4,31	1	4,31	CHI
20200194980	GOIANIA	16549340	CAMPINAS S3	16/01/2020 16:49	16/01/2020 21:01	16/01/2020 16:49	16/01/2020 21:01	4,20	1	4,20	CHI
20200194982	GOIANIA	10904530	GOIANIA LESTE S1	16/01/2020 16:49	16/01/2020 20:21	16/01/2020 16:49	16/01/2020 20:21	3,53	1	3,53	CHI
20200194988	MORRINHOS	150175711	MORRINHOS	16/01/2020 16:50	16/01/2020 18:30	16/01/2020 16:50	16/01/2020 18:30	1,66	1	1,66	CHI
20200194992	URUTAI	UT21027127	URUTAI	16/01/2020 16:51	16/01/2020 18:40	16/01/2020 16:51	16/01/2020 18:40	1,81	1	1,81	CHI
20200194995	CATALAO	10020270630	CATALAO S2	16/01/2020 16:52	16/01/2020 17:15	16/01/2020 16:52	16/01/2020 17:15	0,39	1	0,39	CHI
20200195105	CATALAO	10020718282	CATALAO S2	16/01/2020 16:26	16/01/2020 17:53	16/01/2020 16:26	16/01/2020 17:53	1,45	1	1,45	CHI
20200195201	PIRENOPOLIS	PV16411500	CORUMBA	16/01/2020 16:47	16/01/2020 22:27	16/01/2020 16:47	16/01/2020 19:47	3,00	1015	3048,67	CHI
20200195201	PIRENOPOLIS	02040214	CORUMBA	16/01/2020 16:47	16/01/2020 22:27	16/01/2020 16:47	16/01/2020 22:25	5,64	820	4623,43	CHI
20200195201	PIRENOPOLIS	PV10403903	CORUMBA	16/01/2020 16:47	16/01/2020 22:27	16/01/2020 16:47	16/01/2020 22:27	5,66	600	3396,50	CHI
20200195303	PIRENOPOLIS	PV12000006	CORUMBA	16/01/2020 16:54	17/01/2020 02:15	16/01/2020 16:54	17/01/2020 02:15	9,34	7	65,37	CHI
20200195309	JOVIANIA	AD12074096	GOIATUBA S1	16/01/2020 16:56	16/01/2020 20:01	16/01/2020 16:56	16/01/2020 20:01	3,09	4	12,37	CHI
20200195309	PONTALINA	AD12074096	GOIATUBA S1	16/01/2020 16:56	16/01/2020 20:01	16/01/2020 16:56	16/01/2020 20:01	3,09	1	3,09	CHI
20200195310	CAIAPONIA	CP12380880	CAIAPONIA	16/01/2020 16:56	16/01/2020 20:35	16/01/2020 16:56	16/01/2020 20:35	3,65	10	36,47	CHI

20200195319	JATAI	290216862	JATAI S2	16/01/2020 16:59	17/01/2020 10:31	16/01/2020 16:59	17/01/2020 10:31	17,53	1	17,53	CHI
20200195325	PALESTINA DE GOIAS	PY21246688	PALESTINA	16/01/2020 17:00	16/01/2020 19:31	16/01/2020 17:00	16/01/2020 19:31	2,50	1	2,50	CHI
20200195328	BOM JESUS DE GOIAS	1250030332	BOM JESUS DE GOIAS	16/01/2020 17:01	16/01/2020 19:56	16/01/2020 17:01	16/01/2020 19:56	2,92	1	2,92	CHI
20200195332	ITUMBIARA	IT11000056	PARANAIBA	16/01/2020 16:51	16/01/2020 19:30	16/01/2020 16:51	16/01/2020 19:30	2,66	62	164,70	CHI
20200195339	PIRENOPOLIS	PV11057882	CORUMBA	16/01/2020 17:00	17/01/2020 11:24	16/01/2020 17:00	17/01/2020 11:24	18,39	160	2942,71	CHI
20200195359	GOIAS	GS12325824	GOIAS	16/01/2020 17:08	16/01/2020 20:00	16/01/2020 17:08	16/01/2020 20:00	2,86	2	5,72	CHI
20200195369	PIRENOPOLIS	PV11000022	CORUMBA	16/01/2020 17:10	16/01/2020 20:18	16/01/2020 17:10	16/01/2020 20:18	3,13	217	678,85	CHI
20200195370	PIRENOPOLIS	PV11190623	CORUMBA	16/01/2020 17:10	16/01/2020 20:55	16/01/2020 17:10	16/01/2020 20:55	3,74	18	67,25	CHI
20200195373	CATALAO	1990115217	CATALAO S2	16/01/2020 17:11	16/01/2020 23:25	16/01/2020 17:11	16/01/2020 23:25	6,23	1	6,23	CHI
20200195377	CRISTALINA	KR12087954	CRISTALINA S2	16/01/2020 17:12	16/01/2020 23:31	16/01/2020 17:12	16/01/2020 23:31	6,30	3	18,90	CHI
20200195378	JATAI	JT11073474	JATAI S3	16/01/2020 17:13	16/01/2020 23:15	16/01/2020 17:13	16/01/2020 23:15	6,03	111	669,58	CHI
20200195379	JATAI	JT12165954	JATAI S2	16/01/2020 16:13	17/01/2020 14:58	16/01/2020 16:13	17/01/2020 14:58	22,74	8	181,91	CHI
20200195385	SILVANIA	SV11383696	VIANOPOLIS	16/01/2020 17:15	16/01/2020 18:56	16/01/2020 17:15	16/01/2020 18:56	1,68	2	3,36	CHI
20200195386	JATAI	JT12061504	JATAI S2	16/01/2020 17:15	17/01/2020 11:53	16/01/2020 17:15	17/01/2020 11:53	18,63	4	74,52	CHI
20200195389	LUZIANIA	LZ12313611	VIANOPOLIS	16/01/2020 17:16	16/01/2020 23:15	16/01/2020 17:16	16/01/2020 23:15	5,98	12	71,76	CHI
20200195398	MORRINHOS	10024214378	MORRINHOS	16/01/2020 17:16	16/01/2020 23:19	16/01/2020 17:16	16/01/2020 23:19	6,04	1	6,04	CHI
20200195403	GOIATUBA	GT12293099	GOIATUBA S2	16/01/2020 17:17	17/01/2020 10:16	16/01/2020 17:17	17/01/2020 10:16	16,99	3	50,98	CHI
20200195407	JARAGUA	JA21241593	JARAGUA	16/01/2020 17:17	17/01/2020 15:42	16/01/2020 17:17	17/01/2020 15:42	22,41	1	22,41	CHI
20200195408	PIRENOPOLIS	PV11273311	CORUMBA	16/01/2020 17:17	16/01/2020 21:36	16/01/2020 17:17	16/01/2020 21:36	4,31	44	189,44	CHI
20200195412	PIRENOPOLIS	PV12123729	CORUMBA	16/01/2020 17:17	16/01/2020 23:54	16/01/2020 17:17	16/01/2020 23:54	6,62	10	66,16	CHI
20200195414	PIRENOPOLIS	PV11289617	CORUMBA	16/01/2020 17:18	17/01/2020 03:03	16/01/2020 17:18	17/01/2020 03:03	9,73	64	622,95	CHI
20200195420	BALIZA	BH12402901	CAIAPONIA	16/01/2020 17:01	16/01/2020 21:19	16/01/2020 17:01	16/01/2020 21:19	4,29	28	120,23	CHI
20200195429	CATALAO	CT12333726	CATALAO S1	16/01/2020 17:22	16/01/2020 19:09	16/01/2020 17:22	16/01/2020 19:09	1,77	1	1,77	CHI
20200195433	AGUA LIMPA	AL12024213	VILA CORUMBA	16/01/2020 17:24	16/01/2020 23:08	16/01/2020 17:24	16/01/2020 23:08	5,73	2	11,46	CHI
20200195439	PIRENOPOLIS	PV21000709	ANAPOLIS UNIVERSITARIO S2	16/01/2020 17:25	16/01/2020 22:16	16/01/2020 17:25	16/01/2020 22:16	4,85	1	4,85	CHI
20200195442	LUZIANIA	04700224	PIRES DO RIO S2	16/01/2020 16:49	17/01/2020 19:55	16/01/2020 16:49	16/01/2020 22:15	5,43	7	38,00	CHI
20200195442	ORIZONA	04700224	PIRES DO RIO S2	16/01/2020 16:49	17/01/2020 19:55	16/01/2020 16:49	16/01/2020 22:15	5,43	26	141,15	CHI
20200195442	LUZIANIA	04700224	PIRES DO RIO S2	16/01/2020 16:49	17/01/2020 19:55	16/01/2020 16:49	16/01/2020 22:47	5,97	9	53,73	CHI
20200195442	ORIZONA	04700224	PIRES DO RIO S2	16/01/2020 16:49	17/01/2020 19:55	16/01/2020 16:49	16/01/2020 22:47	5,97	92	549,29	CHI
20200195442	LUZIANIA	04700224	PIRES DO RIO S2	16/01/2020 16:49	17/01/2020 19:55	17/01/2020 00:44	17/01/2020 01:01	0,28	16	4,53	CHI
20200195442	ORIZONA	04700224	PIRES DO RIO S2	16/01/2020 16:49	17/01/2020 19:55	17/01/2020 00:44	17/01/2020 01:01	0,28	118	33,40	CHI
20200195442	LUZIANIA	04700224	PIRES DO RIO S2	16/01/2020 16:49	17/01/2020 19:55	17/01/2020 09:57	17/01/2020 10:50	0,88	16	14,08	CHI
20200195442	ORIZONA	04700224	PIRES DO RIO S2	16/01/2020 16:49	17/01/2020 19:55	17/01/2020 09:57	17/01/2020 10:50	0,88	118	103,81	CHI

20200195442	LUZIANIA	04700224	PIRES DO RIO S2	16/01/2020 16:49	17/01/2020 19:55	16/01/2020 16:49	17/01/2020 17:39	24,84	306	7600,61	CHI
20200195442	ORIZONA	04700224	PIRES DO RIO S2	16/01/2020 16:49	17/01/2020 19:55	16/01/2020 16:49	17/01/2020 17:39	24,84	36	894,19	CHI
20200195442	LUZIANIA	04700224	PIRES DO RIO S2	16/01/2020 16:49	17/01/2020 19:55	16/01/2020 16:49	17/01/2020 19:55	27,11	2	54,22	CHI
20200195456	APARECIDA DE GOIANIA	12162176	REAL S1	16/01/2020 17:29	16/01/2020 18:23	16/01/2020 17:29	16/01/2020 18:23	0,90	1	0,90	CHI
20200195458	APORE	AE12306286	ITAJA S2	16/01/2020 17:29	17/01/2020 09:33	16/01/2020 17:29	17/01/2020 09:33	16,05	1	16,05	CHI
20200195469	TRINDADE	TR11049499	GOYA S1	16/01/2020 17:31	16/01/2020 20:59	16/01/2020 17:31	16/01/2020 20:59	3,46	150	519,25	CHI
20200195476	SANTA HELENA DE GOIAS	SH11000032	IPEGUARI	16/01/2020 17:06	16/01/2020 21:55	16/01/2020 17:06	16/01/2020 21:55	4,80	108	518,76	CHI
20200195483	PIRENOPOLIS	PV12075866	CORUMBA	16/01/2020 17:33	16/01/2020 21:42	16/01/2020 17:33	16/01/2020 21:42	4,14	1	4,14	CHI
20200195492	PIRENOPOLIS	PV12200549	CORUMBA	16/01/2020 17:37	16/01/2020 20:04	16/01/2020 17:37	16/01/2020 20:04	2,44	303	738,65	CHI
20200195493	GOIANIA	14976614	GOYA S2	16/01/2020 17:38	16/01/2020 22:29	16/01/2020 17:38	16/01/2020 22:29	4,84	1	4,84	CHI
20200195499	ITUMBIARA	690174925	ITUMBIARA VELHA S1	16/01/2020 17:39	17/01/2020 00:05	16/01/2020 17:39	17/01/2020 00:05	6,43	1	6,43	CHI
20200195606	GOIANIA	GN11003139	GOYA S1	16/01/2020 16:48	16/01/2020 18:13	16/01/2020 16:48	16/01/2020 18:13	1,41	142	200,02	CHI
20200195607	CALDAS NOVAS	10028730397	SERRA DE CALDAS	16/01/2020 17:41	17/01/2020 00:17	16/01/2020 17:41	17/01/2020 00:17	6,59	1	6,59	CHI
20200195608	APARECIDA DE GOIANIA	10002532091	INDEPENDENCIA S1	16/01/2020 17:41	16/01/2020 19:12	16/01/2020 17:41	16/01/2020 19:12	1,50	1	1,50	CHI
20200195609	ORIZONA	OZ21338959	PIRES DO RIO S2	16/01/2020 17:42	17/01/2020 15:45	16/01/2020 17:42	17/01/2020 15:45	22,05	1	22,05	CHI
20200195613	GAMELEIRA DE GOIAS	AN12285354	ANAPOLIS UNIVERSITARIO S2	16/01/2020 17:38	17/01/2020 01:39	16/01/2020 17:38	17/01/2020 01:39	8,01	5	40,03	CHI
20200195613	SILVANIA	AN12285354	ANAPOLIS UNIVERSITARIO S2	16/01/2020 17:38	17/01/2020 01:39	16/01/2020 17:38	17/01/2020 01:39	8,01	5	40,03	CHI
20200195621	JATAI	JT11061460	JATAI S3	16/01/2020 16:41	16/01/2020 23:54	16/01/2020 16:41	16/01/2020 23:54	7,20	91	655,28	CHI
20200195628	PIRENOPOLIS	PV12008498	CORUMBA	16/01/2020 17:43	17/01/2020 00:05	16/01/2020 17:43	17/01/2020 00:05	6,38	4	25,51	CHI
20200195631	RIO VERDE	RV12264474	QUIRINOPOLIS	16/01/2020 17:45	16/01/2020 21:46	16/01/2020 17:45	16/01/2020 21:46	4,00	5	20,02	CHI
20200195633	GOIANIRA	GR12353897	MEIA PONTE	16/01/2020 17:39	16/01/2020 19:29	16/01/2020 17:39	16/01/2020 19:29	1,83	285	521,55	CHI
20200195638	PIRENOPOLIS	PV11000021	CORUMBA	16/01/2020 17:01	17/01/2020 13:35	16/01/2020 17:24	17/01/2020 13:35	20,17	158	3187,25	CHI
20200195645	AGUAS LINDAS DE GOIAS	LA12102560	AGUAS LINDAS DE GOIAS S1	16/01/2020 16:25	16/01/2020 19:00	16/01/2020 16:25	16/01/2020 19:00	2,58	176	454,13	CHI
20200195648	AGUAS LINDAS DE GOIAS	LA11102558	AGUAS LINDAS DE GOIAS S1	16/01/2020 16:25	16/01/2020 22:25	16/01/2020 16:25	16/01/2020 22:25	6,01	179	1074,99	CHI
20200195651	CRISTALINA	KR21229248	CRISTALINA S1	16/01/2020 17:49	16/01/2020 18:53	16/01/2020 17:49	16/01/2020 18:53	1,06	1	1,06	CHI
20200195658	ITUMBIARA	IT12305618	PARANAIBA	16/01/2020 17:50	16/01/2020 19:44	16/01/2020 17:50	16/01/2020 19:44	1,91	3	5,73	CHI
20200195661	ANAPOLIS	20062412	ANAPOLIS UNIVERSITARIO S2	16/01/2020 17:50	16/01/2020 19:59	16/01/2020 17:50	16/01/2020 19:59	2,14	1	2,14	CHI
20200195668	PIRENOPOLIS	PV11289629	CORUMBA	16/01/2020 17:51	16/01/2020 22:30	16/01/2020 17:51	16/01/2020 22:30	4,64	93	431,55	CHI
20200195674	VARJAO	VJ21126405	CEZARINA	16/01/2020 17:53	16/01/2020 23:21	16/01/2020 17:53	16/01/2020 23:21	5,46	1	5,46	CHI
20200195682	PIRENOPOLIS	PV21129463	SAO FRANCISCO DE GOIAS	16/01/2020 17:54	16/01/2020 20:29	16/01/2020 17:54	16/01/2020 20:29	2,57	2	5,13	CHI
20200195685	TRINDADE	TR11000044	GOYA S1	16/01/2020 17:45	16/01/2020 22:30	16/01/2020 17:45	16/01/2020 22:30	4,74	92	436,05	CHI
20200195687	GOIANIRA	10010386260	GOIANIRA	16/01/2020 17:55	16/01/2020 22:36	16/01/2020 17:55	16/01/2020 22:36	4,67	1	4,67	CHI
20200195696	COCALZINHO DE GOIAS	ZN12357357	AGUAS LINDAS DE GOIAS S2	16/01/2020 17:57	18/01/2020 20:48	16/01/2020 17:57	17/01/2020 09:36	15,66	7	109,59	CHI

20200195696	SANTO ANTONIO DO DESCOBERTO	ZN12357357	AGUAS LINDAS DE GOIAS S2	16/01/2020 17:57	18/01/2020 20:48	16/01/2020 17:57	17/01/2020 09:36	15,66	8	125,25	CHI
20200195696	COCALZINHO DE GOIAS	ZN12357357	AGUAS LINDAS DE GOIAS S2	16/01/2020 17:57	18/01/2020 20:48	16/01/2020 19:50	17/01/2020 09:36	13,77	1	13,77	CHI
20200195696	COCALZINHO DE GOIAS	ZN10398171	COCALZINHO	16/01/2020 17:57	18/01/2020 20:48	17/01/2020 11:40	17/01/2020 11:59	0,32	854	270,43	CHI
20200195696	CORUMBA DE GOIAS	ZN10398171	COCALZINHO	16/01/2020 17:57	18/01/2020 20:48	17/01/2020 11:40	17/01/2020 11:59	0,32	76	24,07	CHI
20200195696	COCALZINHO DE GOIAS	ZN10398171	AGUAS LINDAS DE GOIAS S2	16/01/2020 17:57	18/01/2020 20:48	17/01/2020 11:40	17/01/2020 13:52	2,21	1	2,21	CHI
20200195696	AGUAS LINDAS DE GOIAS	ZN12290933LD	AGUAS LINDAS DE GOIAS S2	16/01/2020 17:57	18/01/2020 20:48	17/01/2020 11:40	17/01/2020 18:20	6,67	2	13,35	CHI
20200195696	COCALZINHO DE GOIAS	ZN12290933LD	AGUAS LINDAS DE GOIAS S2	16/01/2020 17:57	18/01/2020 20:48	17/01/2020 11:40	17/01/2020 18:20	6,67	48	320,33	CHI
20200195696	COCALZINHO DE GOIAS	ZN12290933LD	AGUAS LINDAS DE GOIAS S2	16/01/2020 17:57	18/01/2020 20:48	17/01/2020 11:59	17/01/2020 18:20	6,36	7	44,50	CHI
20200195696	CORUMBA DE GOIAS	ZN12376764LD	AGUAS LINDAS DE GOIAS S2	16/01/2020 17:57	18/01/2020 20:48	17/01/2020 11:40	17/01/2020 18:51	7,19	1	7,19	CHI
20200195696	SANTO ANTONIO DO DESCOBERTO	ZN12376764LD	AGUAS LINDAS DE GOIAS S2	16/01/2020 17:57	18/01/2020 20:48	17/01/2020 11:40	17/01/2020 18:51	7,19	2	14,37	CHI
20200195696	COCALZINHO DE GOIAS	ZN12357357	AGUAS LINDAS DE GOIAS S2	16/01/2020 17:57	18/01/2020 20:48	16/01/2020 17:57	18/01/2020 15:10	45,21	6	271,27	CHI
20200195696	SANTO ANTONIO DO DESCOBERTO	ZN12357357	AGUAS LINDAS DE GOIAS S2	16/01/2020 17:57	18/01/2020 20:48	16/01/2020 17:57	18/01/2020 15:10	45,21	53	2396,25	CHI
20200195696	SANTO ANTONIO DO DESCOBERTO	ZN12376764LD	AGUAS LINDAS DE GOIAS S2	16/01/2020 17:57	18/01/2020 20:48	16/01/2020 19:50	18/01/2020 15:10	43,32	7	303,27	CHI
20200195696	COCALZINHO DE GOIAS	ZN12376764LD	AGUAS LINDAS DE GOIAS S2	16/01/2020 17:57	18/01/2020 20:48	17/01/2020 11:40	18/01/2020 15:10	27,50	78	2145,07	CHI
20200195696	CORUMBA DE GOIAS	ZN12376764LD	AGUAS LINDAS DE GOIAS S2	16/01/2020 17:57	18/01/2020 20:48	17/01/2020 11:40	18/01/2020 15:10	27,50	1	27,50	CHI
20200195696	SANTO ANTONIO DO DESCOBERTO	ZN12376764LD	AGUAS LINDAS DE GOIAS S2	16/01/2020 17:57	18/01/2020 20:48	17/01/2020 11:40	18/01/2020 15:10	27,50	34	935,03	CHI
20200195696	COCALZINHO DE GOIAS	ZN12376764LD	AGUAS LINDAS DE GOIAS S2	16/01/2020 17:57	18/01/2020 20:48	17/01/2020 11:59	18/01/2020 15:10	27,18	8	217,47	CHI
20200195696	CORUMBA DE GOIAS	ZN12376764LD	AGUAS LINDAS DE GOIAS S2	16/01/2020 17:57	18/01/2020 20:48	17/01/2020 11:59	18/01/2020 15:10	27,18	3	81,55	CHI
20200195696	SANTO ANTONIO DO DESCOBERTO	ZN12376764LD	AGUAS LINDAS DE GOIAS S2	16/01/2020 17:57	18/01/2020 20:48	17/01/2020 11:59	18/01/2020 15:10	27,18	4	108,74	CHI
20200195696	COCALZINHO DE GOIAS	ZN12376764LD	AGUAS LINDAS DE GOIAS S2	16/01/2020 17:57	18/01/2020 20:48	17/01/2020 16:24	18/01/2020 15:10	22,77	3	68,31	CHI
20200195696	CORUMBA DE GOIAS	ZN12376764LD	AGUAS LINDAS DE GOIAS S2	16/01/2020 17:57	18/01/2020 20:48	17/01/2020 16:24	18/01/2020 15:10	22,77	1	22,77	CHI
20200195696	AGUAS LINDAS DE GOIAS	ZN12290933LD	AGUAS LINDAS DE GOIAS S2	16/01/2020 17:57	18/01/2020 20:48	17/01/2020 18:51	18/01/2020 15:10	20,31	2	40,63	CHI
20200195696	COCALZINHO DE GOIAS	ZN12290933LD	AGUAS LINDAS DE GOIAS S2	16/01/2020 17:57	18/01/2020 20:48	17/01/2020 18:51	18/01/2020 15:10	20,31	51	1035,99	CHI
20200195696	CORUMBA DE GOIAS	ZN12290933LD	AGUAS LINDAS DE GOIAS S2	16/01/2020 17:57	18/01/2020 20:48	17/01/2020 18:51	18/01/2020 15:10	20,31	1	20,31	CHI
20200195696	COCALZINHO DE GOIAS	ZN12290933LD	AGUAS LINDAS DE GOIAS S2	16/01/2020 17:57	18/01/2020 20:48	17/01/2020 18:52	18/01/2020 15:10	20,30	3	60,91	CHI
20200195696	CORUMBA DE GOIAS	ZN12290933LD	AGUAS LINDAS DE GOIAS S2	16/01/2020 17:57	18/01/2020 20:48	17/01/2020 18:52	18/01/2020 15:10	20,30	1	20,30	CHI
20200195696	SANTO ANTONIO DO DESCOBERTO	ZN12290933LD	AGUAS LINDAS DE GOIAS S2	16/01/2020 17:57	18/01/2020 20:48	17/01/2020 18:52	18/01/2020 15:10	20,30	2	40,61	CHI
20200195696	COCALZINHO DE GOIAS	ZN12290933LD	AGUAS LINDAS DE GOIAS S2	16/01/2020 17:57	18/01/2020 20:48	18/01/2020 14:07	18/01/2020 15:10	1,05	2	2,10	CHI
20200195696	COCALZINHO DE GOIAS	04190214	AGUAS LINDAS DE GOIAS S2	16/01/2020 17:57	18/01/2020 20:48	18/01/2020 15:15	18/01/2020 15:33	0,29	31	9,09	CHI
20200195696	AGUAS LINDAS DE GOIAS	ZN12290933LD	AGUAS LINDAS DE GOIAS S2	16/01/2020 17:57	18/01/2020 20:48	18/01/2020 15:15	18/01/2020 20:03	4,80	2	9,60	CHI
20200195696	COCALZINHO DE GOIAS	ZN12290933LD	AGUAS LINDAS DE GOIAS S2	16/01/2020 17:57	18/01/2020 20:48	18/01/2020 15:15	18/01/2020 20:03	4,80	55	264,03	CHI
20200195696	COCALZINHO DE GOIAS	ZN12376764LD	AGUAS LINDAS DE GOIAS S2	16/01/2020 17:57	18/01/2020 20:48	18/01/2020 15:15	18/01/2020 20:48	5,55	95	527,57	CHI
20200195696	CORUMBA DE GOIAS	ZN12376764LD	AGUAS LINDAS DE GOIAS S2	16/01/2020 17:57	18/01/2020 20:48	18/01/2020 15:15	18/01/2020 20:48	5,55	7	38,87	CHI

20200195696	SANTO ANTONIO DO DESCOBERTO	ZN12376764LD	AGUAS LINDAS DE GOIAS S2	16/01/2020 17:57	18/01/2020 20:48	18/01/2020 15:15	18/01/2020 20:48	5,55	100	555,33	CHI
20200195696	AGUAS LINDAS DE GOIAS	04190214	AGUAS LINDAS DE GOIAS S2	16/01/2020 17:57	18/01/2020 20:48	18/01/2020 20:28	18/01/2020 20:48	0,33	2	0,67	CHI
20200195696	COCALZINHO DE GOIAS	04190214	AGUAS LINDAS DE GOIAS S2	16/01/2020 17:57	18/01/2020 20:48	18/01/2020 20:28	18/01/2020 20:48	0,33	86	28,69	CHI
20200195696	COCALZINHO DE GOIAS	7823407	AGUAS LINDAS DE GOIAS S2	16/01/2020 17:57	18/01/2020 20:48	18/01/2020 15:15	18/01/2020 20:48	5,55	1	5,55	CHI
20200195697	TRINDADE	10002567936	GOYA S1	16/01/2020 17:57	16/01/2020 22:38	16/01/2020 17:57	16/01/2020 22:38	4,68	1	4,68	CHI
20200195700	GOIANIA	16189474	FERROVIARIO S1	16/01/2020 17:57	16/01/2020 19:56	16/01/2020 17:57	16/01/2020 19:56	1,99	1	1,99	CHI
20200195704	SILVANIA	SV21094739	DAIA S2	16/01/2020 17:57	17/01/2020 09:58	16/01/2020 17:57	17/01/2020 09:58	16,02	1	16,02	CHI
20200195710	TRINDADE	11669792	GOYA S2	16/01/2020 17:58	16/01/2020 20:27	16/01/2020 17:58	16/01/2020 20:27	2,48	1	2,48	CHI
20200195712	PARAUNA	PU12295868	ACREUNA	16/01/2020 17:59	16/01/2020 19:29	16/01/2020 17:59	16/01/2020 19:29	1,50	10	14,98	CHI
20200195713	JATAI	JT12241744	JATAI S3	16/01/2020 16:09	16/01/2020 22:02	16/01/2020 16:09	16/01/2020 22:02	5,88	4	23,51	CHI
20200195714	GOIANIA	15815468	GOIANIA LESTE S1	16/01/2020 17:59	16/01/2020 20:51	16/01/2020 17:59	16/01/2020 20:51	2,85	1	2,85	CHI
20200195715	JATAI	JT21334210	JATAI S3	16/01/2020 17:59	17/01/2020 11:40	16/01/2020 17:59	17/01/2020 11:40	17,67	1	17,67	CHI
20200195719	CRISTALINA	KR12209482	CRISTALINA S1	16/01/2020 18:00	17/01/2020 07:50	16/01/2020 18:00	17/01/2020 07:50	13,83	1	13,83	CHI
20200195721	MORRINHOS	MR21196284	MORRINHOS	16/01/2020 18:00	16/01/2020 23:05	16/01/2020 18:00	16/01/2020 23:05	5,09	1	5,09	CHI
20200195724	RIO VERDE	630210550	RIO VERDE S1	16/01/2020 18:00	17/01/2020 03:50	16/01/2020 18:00	17/01/2020 03:50	9,82	1	9,82	CHI
20200195728	TRINDADE	TR11002505	TRINDADE	16/01/2020 18:00	16/01/2020 23:26	16/01/2020 18:00	16/01/2020 23:26	5,42	196	1062,54	CHI
20200195729	TRINDADE	40225112	GOYA S1	16/01/2020 18:01	16/01/2020 23:41	16/01/2020 18:01	16/01/2020 23:41	5,66	1	5,66	CHI
20200195748	EDEALINA	EA13282645	VICENTINOPOLIS	16/01/2020 17:57	16/01/2020 20:58	16/01/2020 20:15	16/01/2020 20:58	0,72	15	10,75	CHI
20200195748	EDEIA	EA13282645	VICENTINOPOLIS	16/01/2020 17:57	16/01/2020 20:58	16/01/2020 20:15	16/01/2020 20:58	0,72	32	22,94	CHI
20200195748	PONTALINA	EA13282645	VICENTINOPOLIS	16/01/2020 17:57	16/01/2020 20:58	16/01/2020 20:15	16/01/2020 20:58	0,72	1	0,72	CHI
20200195748	VICENTINOPOLIS	EA13282645	VICENTINOPOLIS	16/01/2020 17:57	16/01/2020 20:58	16/01/2020 20:15	16/01/2020 20:58	0,72	2	1,43	CHI
20200195750	CRISTALINA	KR12383056	CRISTALINA S2	16/01/2020 18:04	17/01/2020 08:30	16/01/2020 18:04	17/01/2020 08:30	14,43	6	86,57	CHI
20200195759	CRISTALINA	KR21132211	CRISTALINA S2	16/01/2020 18:07	16/01/2020 23:39	16/01/2020 18:07	16/01/2020 23:39	5,53	1	5,53	CHI
20200195760	ANICUNS	AC12000008	ANICUNS	16/01/2020 18:07	16/01/2020 19:30	16/01/2020 18:07	16/01/2020 19:30	1,37	951	1307,62	CHI
20200195762	TRINDADE	TR11144795	TRINDADE	16/01/2020 17:31	16/01/2020 20:04	16/01/2020 17:31	16/01/2020 20:04	2,54	189	479,22	CHI
20200195770	CACHOEIRA DOURADA	CD11000017	CACHOEIRA DOURADA	16/01/2020 16:14	16/01/2020 23:30	16/01/2020 16:14	16/01/2020 23:30	7,28	70	509,48	CHI
20200195773	PIRENOPOLIS	PV11272979	CORUMBA	16/01/2020 18:10	17/01/2020 00:01	16/01/2020 18:10	17/01/2020 00:01	5,84	59	344,76	CHI
20200195774	COCALZINHO DE GOIAS	CB12070637	COCALZINHO	16/01/2020 18:10	17/01/2020 02:24	16/01/2020 18:10	17/01/2020 02:24	8,23	14	115,17	CHI
20200195778	JATAI	10000379490	JATAI S3	16/01/2020 18:11	17/01/2020 09:18	16/01/2020 18:11	17/01/2020 09:18	15,11	1	15,11	CHI
20200195779	PALMEIRAS DE GOIAS	590028777	PALMEIRAS	16/01/2020 18:11	16/01/2020 21:37	16/01/2020 18:11	16/01/2020 21:37	3,43	1	3,43	CHI
20200195785	CRISTALINA	7505642	PAMPLONA	16/01/2020 18:09	16/01/2020 21:26	16/01/2020 18:09	16/01/2020 21:26	3,27	2	6,54	CHI
20200195792	CAMPO ALEGRE DE GOIAS	CT12130977	CATALAO S1	16/01/2020 14:53	16/01/2020 22:55	16/01/2020 14:53	16/01/2020 22:55	8,02	2	16,04	CHI
20200195792	CATALAO	CT12130977	CATALAO S1	16/01/2020 14:53	16/01/2020 22:55	16/01/2020 14:53	16/01/2020 22:55	8,02	34	272,75	CHI

20200195793	JUSSARA	BT12274297	BRITANIA	16/01/2020 18:13	18/01/2020 21:33	16/01/2020 18:13	17/01/2020 11:36	17,38	35	608,29	CHI
20200195793	JUSSARA	BT12274297	BRITANIA	16/01/2020 18:13	18/01/2020 21:33	18/01/2020 16:05	18/01/2020 21:11	5,10	35	178,47	CHI
20200195793	JUSSARA	JR12018579	BRITANIA	16/01/2020 18:13	18/01/2020 21:33	16/01/2020 18:13	18/01/2020 21:33	51,33	1	51,33	CHI
20200195794	CALDAS NOVAS	760311699	CALDAS NOVAS S1	16/01/2020 18:13	16/01/2020 23:11	16/01/2020 18:13	16/01/2020 23:11	4,97	1	4,97	CHI
20200195901	LUZIANIA	LZ12025119	RIO VERMELHO	16/01/2020 18:15	16/01/2020 20:09	16/01/2020 18:15	16/01/2020 20:09	1,90	23	43,68	CHI
20200195918	GOIANIA	GN12000104	CAMPINAS S1	16/01/2020 18:14	16/01/2020 20:00	16/01/2020 18:14	16/01/2020 20:00	1,75	742	1298,91	CHI
20200195932	ANAPOLIS	AN12351048	ANAPOLIS UNIVERSITARIO S2	16/01/2020 18:02	16/01/2020 20:07	16/01/2020 18:02	16/01/2020 20:07	2,07	17	35,23	CHI
20200195933	GOIANIA	14291149	XAVANTES	16/01/2020 18:21	16/01/2020 22:14	16/01/2020 18:21	16/01/2020 22:14	3,87	1	3,87	CHI
20200195934	SIMOLANDIA	1940021458	IACIARA S2	16/01/2020 18:21	16/01/2020 20:56	16/01/2020 18:21	16/01/2020 20:56	2,57	1	2,57	CHI
20200195937	CORUMBA DE GOIAS	CB21316005	COCALZINHO	16/01/2020 18:22	17/01/2020 09:51	16/01/2020 18:22	17/01/2020 09:51	15,48	2	30,96	CHI
20200195962	GOIANIA	GN12001195	CAMPINAS S1	16/01/2020 18:26	16/01/2020 19:26	16/01/2020 18:26	16/01/2020 19:26	1,00	921	917,67	CHI
20200195965	PIRENOPOLIS	PV12031648	CORUMBA	16/01/2020 18:18	18/01/2020 13:38	16/01/2020 18:18	17/01/2020 12:33	18,25	2	36,50	CHI
20200195965	PIRENOPOLIS	PV12031648	CORUMBA	16/01/2020 18:18	18/01/2020 13:38	16/01/2020 18:18	18/01/2020 13:38	43,33	40	1733,19	CHI
20200195965	PIRENOPOLIS	PV12031648	CORUMBA	16/01/2020 18:18	18/01/2020 13:38	17/01/2020 23:11	18/01/2020 13:38	14,46	2	28,92	CHI
20200195973	GOIANIA	GN11076705	MEIA PONTE	16/01/2020 18:07	17/01/2020 01:25	16/01/2020 18:07	17/01/2020 01:25	7,28	231	1682,71	CHI
20200195976	AGUAS LINDAS DE GOIAS	LA11375260	AGUAS LINDAS DE GOIAS S1	16/01/2020 18:29	16/01/2020 19:34	16/01/2020 18:29	16/01/2020 19:34	1,08	116	125,60	CHI
20200195983	MORRINHOS	MR21335155	MORRINHOS	16/01/2020 18:26	16/01/2020 21:00	16/01/2020 18:26	16/01/2020 21:00	2,57	1	2,57	CHI
20200195987	NOVA VENEZA	NV11282742	INHUMAS S1	16/01/2020 18:11	16/01/2020 23:04	16/01/2020 18:11	16/01/2020 23:04	4,88	114	556,03	CHI
20200195988	JATAI	JT11083555	JATAI S3	16/01/2020 17:22	16/01/2020 20:53	16/01/2020 17:22	16/01/2020 20:53	3,52	156	548,73	CHI
20200195991	BELA VISTA DE GOIAS	BV32249964	BELA VISTA S1	16/01/2020 18:31	16/01/2020 20:31	16/01/2020 18:31	16/01/2020 20:31	1,99	46	91,31	CHI
20200195996	APARECIDA DE GOIANIA	10007233289	ANHANGUERA	16/01/2020 18:32	16/01/2020 19:33	16/01/2020 18:32	16/01/2020 19:33	1,01	1	1,01	CHI
20200196002	GOIANIA	TR11160586	GOYA S2	16/01/2020 17:31	16/01/2020 21:50	16/01/2020 17:31	16/01/2020 21:50	4,31	144	621,32	CHI
20200196005	GAMELEIRA DE GOIAS	SV12056396	DAIA S2	16/01/2020 18:33	16/01/2020 19:35	16/01/2020 18:33	16/01/2020 19:35	1,02	101	103,44	CHI
20200196005	SILVANIA	SV12056396	DAIA S2	16/01/2020 18:33	16/01/2020 19:35	16/01/2020 18:33	16/01/2020 19:35	1,02	1	1,02	CHI
20200196007	JATAI	10026920237	JATAI S3	16/01/2020 18:34	17/01/2020 08:22	16/01/2020 18:34	17/01/2020 08:22	13,80	1	13,80	CHI
20200196015	JATAI	JT11182018	JATAI S2	16/01/2020 17:53	16/01/2020 22:10	16/01/2020 17:53	16/01/2020 22:10	4,28	166	710,80	CHI
20200196033	GOIANIA	11784015	CAMPINAS S3	16/01/2020 18:41	16/01/2020 20:54	16/01/2020 18:41	16/01/2020 20:54	2,21	1	2,21	CHI
20200196035	EDEIA	EA12000039	EDEIA	16/01/2020 18:12	16/01/2020 22:22	16/01/2020 18:12	16/01/2020 22:22	4,17	20	83,32	CHI
20200196036	LUZIANIA	LZ21149730	RIO VERMELHO	16/01/2020 18:41	16/01/2020 20:05	16/01/2020 18:41	16/01/2020 20:05	1,39	1	1,39	CHI
20200196040	GOIANIA	GN12002665	GOYA S1	16/01/2020 18:42	16/01/2020 19:37	16/01/2020 18:42	16/01/2020 19:37	0,90	739	667,77	CHI
20200196041	LUZIANIA	LZ21118982	RIO VERMELHO	16/01/2020 18:43	16/01/2020 20:33	16/01/2020 18:43	16/01/2020 20:33	1,83	1	1,83	CHI
20200196048	SANTA RITA DO ARAGUAIA	SU12184139	SANTA RITA DO ARAGUAIA	16/01/2020 18:45	16/01/2020 22:40	16/01/2020 18:45	16/01/2020 22:40	3,91	1	3,91	CHI
20200196065	COCALZINHO DE GOIAS	ZN11155154	COCALZINHO	16/01/2020 18:24	16/01/2020 19:50	16/01/2020 18:24	16/01/2020 19:50	1,43	124	177,66	CHI

20200196073	GOIANIA	14638216	CARAJAS S1	16/01/2020 18:49	16/01/2020 22:42	16/01/2020 18:49	16/01/2020 22:42	3,88	1	3,88	CHI
20200196085	PETROLINA DE GOIAS	SF12273257RE	SAO FRANCISCO DE GOIAS	16/01/2020 18:41	16/01/2020 22:36	16/01/2020 18:41	16/01/2020 22:36	3,91	60	234,53	CHI
20200196085	PIRENOPOLIS	SF12273257RE	SAO FRANCISCO DE GOIAS	16/01/2020 18:41	16/01/2020 22:36	16/01/2020 18:41	16/01/2020 22:36	3,91	38	148,54	CHI
20200196085	SAO FRANCISCO DE GOIAS	SF12273257RE	SAO FRANCISCO DE GOIAS	16/01/2020 18:41	16/01/2020 22:36	16/01/2020 18:41	16/01/2020 22:36	3,91	42	164,17	CHI
20200196088	BRITANIA	BT12010497	BRITANIA	16/01/2020 18:22	16/01/2020 21:33	16/01/2020 18:22	16/01/2020 21:33	3,18	9	28,60	CHI
20200196090	GAMELEIRA DE GOIAS	SV12072842	DAIA S2	16/01/2020 18:39	16/01/2020 21:22	16/01/2020 18:39	16/01/2020 21:22	2,70	6	16,23	CHI
20200196090	SILVANIA	SV12072842	DAIA S2	16/01/2020 18:39	16/01/2020 21:22	16/01/2020 18:39	16/01/2020 21:22	2,70	2	5,41	CHI
20200196092	GOIANIA	GN11001458	CAMPINAS S1	16/01/2020 18:29	17/01/2020 02:34	16/01/2020 18:29	17/01/2020 02:34	8,07	110	888,16	CHI
20200196096	NOVO GAMA	2900066470	MARAJOARA	16/01/2020 18:55	16/01/2020 19:57	16/01/2020 18:55	16/01/2020 19:57	1,03	1	1,03	CHI
20200196097	GOIANIA	GN12000085	CAMPINAS S1	16/01/2020 18:43	16/01/2020 22:18	16/01/2020 18:43	16/01/2020 22:18	3,58	96	343,92	CHI
20200196110	PIRENOPOLIS	PV11000017	CORUMBA	16/01/2020 16:47	17/01/2020 03:18	16/01/2020 16:47	17/01/2020 03:18	10,52	78	820,26	CHI
20200196208	RIO VERDE	RV12394819	RIO VERDE S1	16/01/2020 18:08	16/01/2020 21:12	16/01/2020 18:08	16/01/2020 21:12	3,06	512	1567,57	CHI
20200196213	PIRENOPOLIS	PV12200562	CORUMBA	16/01/2020 17:06	16/01/2020 22:01	16/01/2020 17:06	16/01/2020 22:01	4,90	103	504,90	CHI
20200196217	PIRENOPOLIS	ZN12216900	COCALZINHO	16/01/2020 19:00	17/01/2020 12:10	16/01/2020 19:00	17/01/2020 12:10	17,16	4	68,64	CHI
20200196218	TRINDADE	10024813620	MEIA PONTE	16/01/2020 19:01	16/01/2020 21:28	16/01/2020 19:01	16/01/2020 21:28	2,44	1	2,44	CHI
20200196221	CATALAO	TH12165137	CATALAO S1	16/01/2020 18:17	16/01/2020 23:58	16/01/2020 18:17	16/01/2020 23:58	5,68	5	28,38	CHI
20200196221	TRES RANCHOS	TH12165137	CATALAO S1	16/01/2020 18:17	16/01/2020 23:58	16/01/2020 18:17	16/01/2020 23:58	5,68	47	266,79	CHI
20200196236	TRINDADE	TR31170658	TRINDADE	16/01/2020 19:07	17/01/2020 01:39	16/01/2020 19:07	17/01/2020 01:39	6,53	1	6,53	CHI
20200196239	JATAI	JT11402475	JATAI S3	16/01/2020 16:26	16/01/2020 23:22	16/01/2020 16:26	16/01/2020 23:22	6,93	62	429,42	CHI
20200196245	CAMPO ALEGRE DE GOIAS	CM21122457	CAMPO ALEGRE DE GOIAS	16/01/2020 19:10	17/01/2020 00:46	16/01/2020 19:10	17/01/2020 00:46	5,60	2	11,20	CHI
20200196247	JUSSARA	1290049765	JUSSARA	16/01/2020 19:10	17/01/2020 02:50	16/01/2020 19:10	17/01/2020 02:50	7,67	1	7,67	CHI
20200196250	TRINDADE	10025893236	GOYA S2	16/01/2020 19:12	16/01/2020 21:31	16/01/2020 19:12	16/01/2020 21:31	2,31	1	2,31	CHI
20200196266	JATAI	JT12324730LD	JATAI S2	16/01/2020 16:13	17/01/2020 16:11	16/01/2020 16:13	17/01/2020 16:11	23,95	2	47,91	CHI
20200196267	ITAPIRAPUA	04750216	MATRINCHA	16/01/2020 19:13	16/01/2020 21:25	16/01/2020 19:13	16/01/2020 21:25	2,19	431	943,29	CHI
20200196267	JUSSARA	04750216	MATRINCHA	16/01/2020 19:13	16/01/2020 21:25	16/01/2020 19:13	16/01/2020 21:25	2,19	4	8,75	CHI
20200196267	SANTA FE DE GOIAS	04750216	MATRINCHA	16/01/2020 19:13	16/01/2020 21:25	16/01/2020 19:13	16/01/2020 21:25	2,19	12	26,26	CHI
20200196269	GOIANESIA	550187844	GOIANESIA S2	16/01/2020 19:13	16/01/2020 23:04	16/01/2020 19:13	16/01/2020 23:04	3,84	1	3,84	CHI
20200196273	COCALZINHO DE GOIAS	ZN12302506	COCALZINHO	16/01/2020 18:54	16/01/2020 21:48	16/01/2020 18:54	16/01/2020 21:48	2,89	16	46,17	CHI
20200196274	GOIANIA	GN11199057	GOYA S1	16/01/2020 19:15	16/01/2020 20:44	16/01/2020 19:15	16/01/2020 20:44	1,48	16	23,64	CHI
20200196277	ABADIA DE GOIAS	TR12310248	GUAPO S1	16/01/2020 19:13	16/01/2020 22:21	16/01/2020 19:13	16/01/2020 22:21	3,13	1	3,13	CHI
20200196277	GUAPO	TR12310248	GUAPO S1	16/01/2020 19:13	16/01/2020 22:21	16/01/2020 19:13	16/01/2020 22:21	3,13	3	9,39	CHI
20200196280	ANAPOLIS	20654091	ANAPOLIS UNIVERSITARIO S2	16/01/2020 19:16	16/01/2020 20:42	16/01/2020 19:16	16/01/2020 20:42	1,43	1	1,43	CHI
20200196281	ANAPOLIS	20532787	JUNDIAI S1	16/01/2020 19:16	17/01/2020 00:04	16/01/2020 19:16	17/01/2020 00:04	4,79	1	4,79	CHI

20200196282	RIO VERDE	630488794	RIO VERDE S1	16/01/2020 19:17	17/01/2020 02:35	16/01/2020 19:17	17/01/2020 02:35	7,30	1	7,30	CHI
20200196284	PADRE BERNARDO	PB11377259	PADRE BERNARDO	16/01/2020 19:17	16/01/2020 20:49	16/01/2020 19:17	16/01/2020 20:49	1,52	57	86,77	CHI
20200196287	CAMPO ALEGRE DE GOIAS	CM12376046	CAMPO ALEGRE DE GOIAS	16/01/2020 12:59	17/01/2020 07:18	16/01/2020 12:59	17/01/2020 07:18	18,30	7	128,11	CHI
20200196287	CATALAO	CM12376046	CAMPO ALEGRE DE GOIAS	16/01/2020 12:59	17/01/2020 07:18	16/01/2020 12:59	17/01/2020 07:18	18,30	3	54,90	CHI
20200196288	BARRO ALTO	AX11406269	ALEXANIA	16/01/2020 19:17	17/01/2020 10:48	16/01/2020 19:17	17/01/2020 10:48	15,50	2	31,00	CHI
20200196292	PIRENOPOLIS	PV11248840	CORUMBA	16/01/2020 17:42	17/01/2020 16:39	16/01/2020 17:42	17/01/2020 16:39	22,94	73	1674,50	CHI
20200196294	JATAI	JT11264356	JATAI S3	16/01/2020 19:18	17/01/2020 15:06	16/01/2020 19:18	17/01/2020 15:06	19,80	101	1999,41	CHI
20200196300	AGUAS LINDAS DE GOIAS	10007010034	AGUAS LINDAS DE GOIAS S1	16/01/2020 19:19	16/01/2020 20:00	16/01/2020 19:19	16/01/2020 20:00	0,67	1	0,67	CHI
20200196301	PALMINOPOLIS	1340003081	PALMEIRAS	16/01/2020 19:20	16/01/2020 21:28	16/01/2020 19:20	16/01/2020 21:28	2,14	1	2,14	CHI
20200196312	GOIANIA	11037891	AEROPORTO S1	16/01/2020 19:23	16/01/2020 23:54	16/01/2020 19:23	16/01/2020 23:54	4,50	1	4,50	CHI
20200196316	POSSE	1480026570	IACIARA S2	16/01/2020 19:24	16/01/2020 20:22	16/01/2020 19:24	16/01/2020 20:22	0,95	1	0,95	CHI
20200196320	GOIANESIA	10015791775	GOIANESIA S2	16/01/2020 19:26	17/01/2020 09:50	16/01/2020 19:26	17/01/2020 09:50	14,39	1	14,39	CHI
20200196321	INHUMAS	IN12253101	INHUMAS S2	16/01/2020 18:14	17/01/2020 00:04	16/01/2020 18:14	17/01/2020 00:04	5,83	47	273,83	CHI
20200196322	CASTELANDIA	DM12041161	RIO DOS BOIS	16/01/2020 19:26	16/01/2020 22:57	16/01/2020 19:26	16/01/2020 22:57	3,50	6	21,02	CHI
20200196324	APARECIDA DE GOIANIA	AP12317436	CEPAIGO S1	16/01/2020 19:27	16/01/2020 21:14	16/01/2020 19:27	16/01/2020 21:14	1,78	2	3,56	CHI
20200196326	COCALZINHO DE GOIAS	ZN11155191	AGUAS LINDAS DE GOIAS S2	16/01/2020 19:27	16/01/2020 21:06	16/01/2020 19:27	16/01/2020 21:06	1,64	201	330,31	CHI
20200196328	LUZIANIA	LZ21061793	RIO VERMELHO	16/01/2020 19:27	16/01/2020 21:01	16/01/2020 19:27	16/01/2020 21:01	1,56	1	1,56	CHI
20200196329	CIDADE OCIDENTAL	DH12170612	MARAJOARA	16/01/2020 19:27	17/01/2020 12:12	16/01/2020 19:27	17/01/2020 12:12	16,74	14	234,34	CHI
20200196334	GOIANIA	GN11050815	REAL S1	16/01/2020 19:20	17/01/2020 00:43	16/01/2020 19:20	17/01/2020 00:43	5,39	182	981,69	CHI
20200196337	COCALZINHO DE GOIAS	ZN21295676	COCALZINHO	16/01/2020 19:28	17/01/2020 08:56	16/01/2020 19:28	17/01/2020 08:56	13,45	1	13,45	CHI
20200196338	SAO DOMINGOS	SD12398370	SAO DOMINGOS	16/01/2020 19:28	17/01/2020 08:59	16/01/2020 19:28	17/01/2020 08:59	13,50	2	27,01	CHI
20200196352	BURITI DE GOIAS	BS21166199	FIRMINOPOLIS S2	16/01/2020 19:30	16/01/2020 21:18	16/01/2020 19:30	16/01/2020 21:18	1,78	2	3,57	CHI
20200196355	TRINDADE	10013333419	TRINDADE	16/01/2020 19:32	17/01/2020 00:18	16/01/2020 19:32	17/01/2020 00:18	4,76	1	4,76	CHI
20200196360	MORRINHOS	MR21000152	MORRINHOS	16/01/2020 19:35	17/01/2020 00:01	16/01/2020 19:35	17/01/2020 00:01	4,42	1	4,42	CHI
20200196364	CATALAO	CT21286343	CATALAO S1	16/01/2020 19:38	17/01/2020 13:19	16/01/2020 19:38	17/01/2020 13:19	17,68	1	17,68	CHI
20200196366	CAMPO ALEGRE DE GOIAS	IP12231414	PIRES DO RIO S2	16/01/2020 19:38	17/01/2020 14:09	16/01/2020 19:38	17/01/2020 14:09	18,51	3	55,54	CHI
20200196371	PIRENOPOLIS	PV12392221	CORUMBA	16/01/2020 16:55	17/01/2020 00:15	16/01/2020 16:55	17/01/2020 00:15	7,33	32	234,64	CHI
20200196378	ANAPOLIS	20838438	ANAPOLIS UNIVERSITARIO S2	16/01/2020 19:40	16/01/2020 20:47	16/01/2020 19:40	16/01/2020 20:47	1,11	1	1,11	CHI
20200196395	GOIANIA	GN11185473	XAVANTES	16/01/2020 19:43	16/01/2020 22:26	16/01/2020 19:43	16/01/2020 22:26	2,72	164	446,13	CHI
20200196396	PIRENOPOLIS	PV21241187	CORUMBA	16/01/2020 19:44	17/01/2020 02:41	16/01/2020 19:44	17/01/2020 02:41	6,94	7	48,56	CHI
20200196397	CHAPADAO DO CEU	DJ12160236	CHAPADAO DO CEU	16/01/2020 19:44	16/01/2020 21:54	16/01/2020 19:44	16/01/2020 21:54	2,15	7	15,06	CHI
20200196398	COCALZINHO DE GOIAS	10008846799	AGUAS LINDAS DE GOIAS S2	16/01/2020 19:44	17/01/2020 00:52	16/01/2020 19:44	17/01/2020 00:52	5,12	1	5,12	CHI
20200196401	FORMOSA	10011663845	ITIQUEIRA	16/01/2020 19:45	16/01/2020 21:28	16/01/2020 19:45	16/01/2020 21:28	1,71	1	1,71	CHI

20200196405	JUSSARA	1290014430	JUSSARA	16/01/2020 19:47	17/01/2020 01:18	16/01/2020 19:47	17/01/2020 01:18	5,52	1	5,52	CHI
20200196408	LUZIANIA	120163834	RIO VERMELHO	16/01/2020 19:47	16/01/2020 21:06	16/01/2020 19:47	16/01/2020 21:06	1,30	1	1,30	CHI
20200196413	GOIANIA	10740491	CAMPINAS S1	16/01/2020 19:49	16/01/2020 21:21	16/01/2020 19:49	16/01/2020 21:21	1,53	1	1,53	CHI
20200196414	GOIANIA	11833609	ATLANTICO S1	16/01/2020 19:49	16/01/2020 20:46	16/01/2020 19:49	16/01/2020 20:46	0,94	1	0,94	CHI
20200196418	GOIAS	2830000554	ITABERAÍ S1	16/01/2020 19:51	16/01/2020 22:35	16/01/2020 19:51	16/01/2020 22:35	2,73	1	2,73	CHI
20200196420	ALVORADA DO NORTE	10029029420	IACIARA S2	16/01/2020 19:51	16/01/2020 21:44	16/01/2020 19:51	16/01/2020 21:44	1,87	1	1,87	CHI
20200196426	JUSSARA	JR21114099	JUSSARA	16/01/2020 19:53	17/01/2020 04:33	16/01/2020 19:53	17/01/2020 04:33	8,66	1	8,66	CHI
20200196431	COCALZINHO DE GOIAS	ZN12137406	AGUAS LINDAS DE GOIAS S2	16/01/2020 19:31	16/01/2020 23:43	16/01/2020 19:31	16/01/2020 23:43	4,18	126	527,24	CHI
20200196432	APARECIDA DE GOIANIA	AP12167331	CARAJAS S1	16/01/2020 20:44	17/01/2020 03:39	16/01/2020 20:44	17/01/2020 03:05	6,33	148	937,58	CHI
20200196432	APARECIDA DE GOIANIA	AP11167082	CARAJAS S1	16/01/2020 20:44	17/01/2020 03:39	16/01/2020 23:33	17/01/2020 03:29	3,93	47	184,78	CHI
20200196432	APARECIDA DE GOIANIA	AP11015060	CARAJAS S1	16/01/2020 20:44	17/01/2020 03:39	16/01/2020 23:38	17/01/2020 03:39	4,03	36	145,07	CHI
20200196433	SITIO D ABADIA	SI12384209	IACIARA S2	16/01/2020 19:55	16/01/2020 23:05	16/01/2020 19:55	16/01/2020 23:05	3,16	4	12,62	CHI
20200196434	LUZIANIA	LZ12313554	VIANOPOLIS	16/01/2020 19:55	17/01/2020 01:23	16/01/2020 19:55	17/01/2020 01:23	5,45	13	70,91	CHI
20200196438	RIO VERDE	10008517124	RIO VERDE S2	16/01/2020 19:56	17/01/2020 01:43	16/01/2020 19:56	17/01/2020 01:43	5,77	1	5,77	CHI
20200196439	JARAGUA	70124279	JARAGUA	16/01/2020 19:56	17/01/2020 00:04	16/01/2020 19:56	17/01/2020 00:04	4,12	1	4,12	CHI
20200196443	GOIANIA	GN11144642	CAMPINAS S2	16/01/2020 19:56	16/01/2020 21:55	16/01/2020 19:56	16/01/2020 21:55	1,98	126	249,69	CHI
20200196447	ITAJA	IJ12124909	CACHOEIRA ALTA	16/01/2020 19:58	16/01/2020 23:30	16/01/2020 19:58	16/01/2020 23:30	3,52	5	17,61	CHI
20200196447	LAGOA SANTA	IJ12124909	CACHOEIRA ALTA	16/01/2020 19:58	16/01/2020 23:30	16/01/2020 19:58	16/01/2020 23:30	3,52	12	42,26	CHI
20200196450	ANAPOLIS	20895483	ANAPOLIS UNIVERSITARIO S2	16/01/2020 19:59	16/01/2020 23:05	16/01/2020 19:59	16/01/2020 23:05	3,08	1	3,08	CHI
20200196452	ITAGUARU	IK12220533	ITAPURANGA	16/01/2020 20:00	17/01/2020 00:05	16/01/2020 20:00	17/01/2020 00:05	4,10	1	4,10	CHI
20200196452	ITAPURANGA	IK12220533	ITAPURANGA	16/01/2020 20:00	17/01/2020 00:05	16/01/2020 20:00	17/01/2020 00:05	4,10	26	106,57	CHI
20200196461	AMERICANO DO BRASIL	KB12065193	ANICUNS	16/01/2020 20:03	17/01/2020 09:42	16/01/2020 20:03	17/01/2020 09:42	13,65	36	491,30	CHI
20200196461	ANICUNS	KB12065193	ANICUNS	16/01/2020 20:03	17/01/2020 09:42	16/01/2020 20:03	17/01/2020 09:42	13,65	2	27,29	CHI
20200196461	MOSSAMEDES	KB12065193	ANICUNS	16/01/2020 20:03	17/01/2020 09:42	16/01/2020 20:03	17/01/2020 09:42	13,65	14	191,06	CHI
20200196467	MINEIROS	MY21035037	PARQUE DAS EMAS	16/01/2020 20:07	17/01/2020 04:29	16/01/2020 20:07	17/01/2020 04:29	8,36	2	16,71	CHI
20200196470	ARUANA	AK21201046	MOZARLANDIA	16/01/2020 20:08	16/01/2020 23:51	16/01/2020 20:08	16/01/2020 23:51	3,70	1	3,70	CHI
20200196474	SENADOR CANEDO	SW11092646	SENADOR CANEDO	16/01/2020 19:59	17/01/2020 00:07	16/01/2020 19:59	17/01/2020 00:07	4,13	138	570,21	CHI
20200196476	GOIANIRA	10002099967	GOIANIRA	16/01/2020 20:11	17/01/2020 02:24	16/01/2020 20:11	17/01/2020 02:24	6,21	1	6,21	CHI
20200196479	GOIATUBA	GT12273783	GOIATUBA S2	16/01/2020 20:11	16/01/2020 23:20	16/01/2020 20:11	16/01/2020 23:20	3,13	40	125,36	CHI
20200196480	APARECIDA DE GOIANIA	200452009	INDEPENDENCIA S2	16/01/2020 20:12	16/01/2020 22:35	16/01/2020 20:12	16/01/2020 22:35	2,37	1	2,37	CHI
20200196482	GOIANIA	12052462	CARAJAS S1	16/01/2020 20:12	16/01/2020 21:10	16/01/2020 20:12	16/01/2020 21:10	0,95	1	0,95	CHI
20200196484	SENADOR CANEDO	SW11203816	SENADOR CANEDO	16/01/2020 19:52	17/01/2020 00:36	16/01/2020 19:52	17/01/2020 00:36	4,73	258	1220,27	CHI
20200196485	ANAPOLIS	20824932	JUNDIAI S1	16/01/2020 20:13	16/01/2020 22:56	16/01/2020 20:13	16/01/2020 22:56	2,71	1	2,71	CHI

20200196490	JATAI	290181021	JATAI S2	16/01/2020 20:15	17/01/2020 14:19	16/01/2020 20:15	17/01/2020 14:19	18,07	1	18,07	CHI
20200196492	COCALZINHO DE GOIAS	9970005448	AGUAS LINDAS DE GOIAS S2	16/01/2020 20:16	16/01/2020 22:54	16/01/2020 20:16	16/01/2020 22:54	2,62	1	2,62	CHI
20200196603	COCALZINHO DE GOIAS	ZN12377435	COCALZINHO	16/01/2020 19:57	16/01/2020 22:46	16/01/2020 19:57	16/01/2020 22:46	2,81	54	151,53	CHI
20200196606	GOIANIA	12303150	ATLANTICO S3	16/01/2020 20:22	16/01/2020 21:55	16/01/2020 20:22	16/01/2020 21:55	1,55	1	1,55	CHI
20200196607	JATAI	290020153	JATAI S3	16/01/2020 20:22	17/01/2020 12:00	16/01/2020 20:22	17/01/2020 12:00	15,63	1	15,63	CHI
20200196621	GOIANIA	GN11040007	CAMPINAS S1	16/01/2020 20:27	16/01/2020 23:10	16/01/2020 20:27	16/01/2020 23:10	2,72	68	185,05	CHI
20200196623	JATAI	JT21234326	JATAI S1	16/01/2020 20:27	17/01/2020 15:27	16/01/2020 20:27	17/01/2020 15:27	18,99	1	18,99	CHI
20200196632	MONTES CLAROS DE GOIAS	ME12139989	IPORA	16/01/2020 20:25	16/01/2020 22:33	16/01/2020 20:25	16/01/2020 22:33	2,12	65	138,12	CHI
20200196636	ITAUCU	PV12271945	CORUMBA	16/01/2020 16:43	17/01/2020 01:23	16/01/2020 16:43	17/01/2020 01:23	8,66	1	8,66	CHI
20200196636	PIRENOPOLIS	PV12271945	CORUMBA	16/01/2020 16:43	17/01/2020 01:23	16/01/2020 16:43	17/01/2020 01:23	8,66	12	103,89	CHI
20200196637	ACREUNA	EU12030223	ACREUNA	16/01/2020 20:30	16/01/2020 22:36	16/01/2020 20:30	16/01/2020 22:36	2,10	3	6,30	CHI
20200196638	MINEIROS	MY12043094	PARQUE DAS EMAS	16/01/2020 20:30	17/01/2020 09:41	16/01/2020 20:30	17/01/2020 09:41	13,18	3	39,54	CHI
20200196638	PEROLANDIA	MY12043094	PARQUE DAS EMAS	16/01/2020 20:30	17/01/2020 09:41	16/01/2020 20:30	17/01/2020 09:41	13,18	2	26,36	CHI
20200196641	COCALZINHO DE GOIAS	ZN12312225	COCALZINHO	16/01/2020 18:50	17/01/2020 10:02	16/01/2020 18:50	17/01/2020 10:02	15,19	8	121,51	CHI
20200196641	VILA PROPICIO	ZN12312225	COCALZINHO	16/01/2020 18:50	17/01/2020 10:02	16/01/2020 18:50	17/01/2020 10:02	15,19	1	15,19	CHI
20200196649	FLORES DE GOIAS	3480008195	FLORES DE GOIAS	16/01/2020 20:35	17/01/2020 01:13	16/01/2020 20:35	17/01/2020 01:13	4,63	1	4,63	CHI
20200196650	JARAGUA	JA12297837	JARAGUA	16/01/2020 20:23	17/01/2020 01:28	16/01/2020 20:23	17/01/2020 01:28	5,07	9	45,64	CHI
20200196653	CALDAS NOVAS	CN12226663	CALDAS NOVAS S1	16/01/2020 20:37	17/01/2020 02:06	16/01/2020 20:37	17/01/2020 02:06	5,47	6	32,82	CHI
20200196665	FLORES DE GOIAS	FB12062351	FLORES DE GOIAS	16/01/2020 20:40	16/01/2020 21:54	16/01/2020 20:40	16/01/2020 21:54	1,22	2	2,44	CHI
20200196667	COCALZINHO DE GOIAS	ZN11155154	COCALZINHO	16/01/2020 20:30	16/01/2020 23:37	16/01/2020 20:30	16/01/2020 23:37	3,10	124	384,64	CHI
20200196669	CATALAO	CT11333561	CATALAO S2	16/01/2020 20:27	16/01/2020 21:16	16/01/2020 20:27	16/01/2020 21:16	0,81	180	145,55	CHI
20200196671	ITAJA	04400214	CACHOEIRA ALTA	16/01/2020 20:41	18/01/2020 20:17	16/01/2020 20:41	17/01/2020 17:40	20,97	31	650,00	CHI
20200196671	ITARUMA	04400214	CACHOEIRA ALTA	16/01/2020 20:41	18/01/2020 20:17	16/01/2020 20:41	17/01/2020 17:40	20,97	30	629,03	CHI
20200196671	ITARUMA	04400214	CACHOEIRA ALTA	16/01/2020 20:41	18/01/2020 20:17	17/01/2020 00:12	17/01/2020 17:40	17,47	1	17,47	CHI
20200196671	CACU	04400214	CACHOEIRA ALTA	16/01/2020 20:41	18/01/2020 20:17	16/01/2020 20:41	18/01/2020 20:17	47,59	4	190,37	CHI
20200196671	ITARUMA	04400214	CACHOEIRA ALTA	16/01/2020 20:41	18/01/2020 20:17	16/01/2020 20:41	18/01/2020 20:17	47,59	100	4759,31	CHI
20200196672	GOIANIRA	CK12015717	INHUMAS S1	16/01/2020 20:38	16/01/2020 22:50	16/01/2020 20:38	16/01/2020 22:50	2,19	42	91,91	CHI
20200196672	TRINDADE	CK12015717	INHUMAS S1	16/01/2020 20:38	16/01/2020 22:50	16/01/2020 20:38	16/01/2020 22:50	2,19	69	150,99	CHI
20200196685	JATAI	JT12000193	JATAI S1	16/01/2020 20:46	17/01/2020 21:55	16/01/2020 20:46	17/01/2020 21:55	25,14	3	75,43	CHI
20200196695	NOVA AURORA	NE21315367	CATALAO S1	16/01/2020 20:48	17/01/2020 05:14	16/01/2020 20:48	17/01/2020 05:14	8,42	1	8,42	CHI
20200196697	ACREUNA	EU12301057	ACREUNA	16/01/2020 20:12	16/01/2020 22:50	16/01/2020 20:12	16/01/2020 22:50	2,62	29	76,03	CHI
20200196698	FORMOSA	FA12376669	ITIQUEIRA	16/01/2020 20:49	17/01/2020 08:27	16/01/2020 20:49	17/01/2020 08:27	11,63	56	651,30	CHI
20200196698	VILA BOA	FA12376669	ITIQUEIRA	16/01/2020 20:49	17/01/2020 08:27	16/01/2020 20:49	17/01/2020 08:27	11,63	6	69,78	CHI

20200196803	JATAI	290337860	JATAI S2	16/01/2020 20:50	17/01/2020 08:39	16/01/2020 20:50	17/01/2020 08:39	11,81	1	11,81	CHI
20200196806	CACU	CC12125755	CACHOEIRA ALTA	16/01/2020 20:52	16/01/2020 23:26	16/01/2020 20:52	16/01/2020 23:26	2,56	63	161,21	CHI
20200196809	MOSSAMEDES	MD12024152	FIRMINOPOLIS S2	16/01/2020 20:52	17/01/2020 00:17	16/01/2020 20:52	17/01/2020 00:17	3,40	109	371,05	CHI
20200196809	SANCLERLANDIA	MD12024152	FIRMINOPOLIS S2	16/01/2020 20:52	17/01/2020 00:17	16/01/2020 20:52	17/01/2020 00:17	3,40	9	30,64	CHI
20200196813	CAIAPONIA	DV12332038	CAIAPONIA	16/01/2020 20:28	16/01/2020 22:32	16/01/2020 20:28	16/01/2020 22:32	2,06	22	45,28	CHI
20200196813	DOVERLANDIA	DV12332038	CAIAPONIA	16/01/2020 20:28	16/01/2020 22:32	16/01/2020 20:28	16/01/2020 22:32	2,06	28	57,63	CHI
20200196821	VIANOPOLIS	VN21325250	VIANOPOLIS	16/01/2020 20:56	16/01/2020 23:34	16/01/2020 20:56	16/01/2020 23:34	2,63	1	2,63	CHI
20200196827	POSSE	PS12168163	IACIARA S2	16/01/2020 20:58	16/01/2020 22:54	16/01/2020 20:58	16/01/2020 22:54	1,93	15	28,94	CHI
20200196833	JARAGUA	JA21070262	JARAGUA	16/01/2020 21:01	16/01/2020 21:40	16/01/2020 21:01	16/01/2020 21:40	0,64	1	0,64	CHI
20200196834	GOIANIA	11815670	CAMPINAS S2	16/01/2020 21:02	16/01/2020 23:22	16/01/2020 21:02	16/01/2020 23:22	2,33	1	2,33	CHI
20200196838	BOM JARDIM DE GOIAS	BM12201516	BOM JARDIM	16/01/2020 21:02	17/01/2020 07:24	16/01/2020 21:02	17/01/2020 07:24	10,36	38	393,54	CHI
20200196839	COCALZINHO DE GOIAS	ZN11209288	COCALZINHO	16/01/2020 19:19	17/01/2020 13:24	16/01/2020 19:19	17/01/2020 13:24	18,07	84	1518,09	CHI
20200196846	ITABERAI	IB12000047	ITABERAI S2	16/01/2020 21:06	17/01/2020 03:55	16/01/2020 21:06	17/01/2020 03:55	6,81	7	47,64	CHI
20200196848	NOVA AURORA	NE12143243	CATALAO S1	16/01/2020 21:02	17/01/2020 09:19	16/01/2020 21:02	17/01/2020 09:19	12,27	5	61,35	CHI
20200196864	ITABERAI	IB12000047	ITABERAI S2	16/01/2020 21:12	17/01/2020 03:55	16/01/2020 21:12	17/01/2020 03:55	6,71	2	13,42	CHI
20200196868	PONTALINA	PK12109373	PONTALINA	16/01/2020 21:09	17/01/2020 10:10	16/01/2020 21:09	17/01/2020 10:10	13,02	5	65,08	CHI
20200196869	CORUMBAIBA	560023560	VILA CORUMBA	16/01/2020 21:14	18/01/2020 16:46	16/01/2020 21:14	18/01/2020 16:46	43,53	1	43,53	CHI
20200196872	NOVA VENEZA	NV11201064	INHUMAS S1	16/01/2020 21:16	16/01/2020 23:30	16/01/2020 21:16	16/01/2020 23:30	2,23	45	100,24	CHI
20200196877	ARAGARCAS	10021068435	IPORA	16/01/2020 21:17	17/01/2020 10:52	16/01/2020 21:17	17/01/2020 10:52	13,58	1	13,58	CHI
20200196889	QUIRINOPOLIS	QI11015561	QUIRINOPOLIS	16/01/2020 21:17	16/01/2020 22:35	16/01/2020 21:17	16/01/2020 22:35	1,30	124	160,99	CHI
20200196893	LUZIANIA	10004388451	RIO VERMELHO	16/01/2020 21:21	16/01/2020 23:09	16/01/2020 21:21	16/01/2020 23:09	1,80	1	1,80	CHI
20200196895	DISTRITO FEDERAL	FA12383392	ITIQUEIRA	16/01/2020 21:22	16/01/2020 23:41	16/01/2020 21:22	16/01/2020 23:41	2,31	2	4,62	CHI
20200196895	FORMOSA	FA12383392	ITIQUEIRA	16/01/2020 21:22	16/01/2020 23:41	16/01/2020 21:22	16/01/2020 23:41	2,31	1	2,31	CHI
20200196896	CORUMBAIBA	560009264	VILA CORUMBA	16/01/2020 21:22	17/01/2020 20:42	16/01/2020 21:22	17/01/2020 20:42	23,32	1	23,32	CHI
20200196898	FORMOSA	FA12051040	ITIQUEIRA	16/01/2020 21:24	17/01/2020 00:29	16/01/2020 21:24	17/01/2020 00:29	3,08	11	33,87	CHI
20200196899	CRISTALINA	KR12383029	CRISTALINA S2	16/01/2020 21:24	17/01/2020 04:03	16/01/2020 21:24	17/01/2020 04:03	6,64	5	33,18	CHI
20200197105	RIO VERDE	630534998	RIO VERDE S1	16/01/2020 21:26	16/01/2020 23:52	16/01/2020 21:26	16/01/2020 23:52	2,42	1	2,42	CHI
20200197109	PALMEIRAS DE GOIAS	590065830	PALMEIRAS	16/01/2020 21:27	16/01/2020 22:08	16/01/2020 21:27	16/01/2020 22:08	0,67	1	0,67	CHI
20200197110	NOVA AURORA	NE12127548	CATALAO S1	16/01/2020 21:10	17/01/2020 04:31	16/01/2020 21:10	17/01/2020 04:31	7,36	39	286,95	CHI
20200197114	CORUMBAIBA	CI12333281RE	VILA CORUMBA	16/01/2020 21:29	17/01/2020 10:00	16/01/2020 21:29	17/01/2020 10:00	12,51	116	1451,13	CHI
20200197120	ITABERAI	IB12086200	ITABERAI S1	16/01/2020 21:32	17/01/2020 11:40	16/01/2020 21:32	17/01/2020 11:40	14,12	11	155,34	CHI
20200197124	MORRO AGUDO DE GOIAS	MS12136795	ITAPURANGA	16/01/2020 21:33	17/01/2020 00:10	16/01/2020 21:33	17/01/2020 00:10	2,61	35	91,23	CHI
20200197125	ITAUCU	IX12396154	INHUMAS S1	16/01/2020 21:34	17/01/2020 01:20	16/01/2020 21:34	17/01/2020 01:20	3,76	4	15,05	CHI

20200197128	PONTALINA	210047240	PONTALINA	16/01/2020 21:37	16/01/2020 23:19	16/01/2020 21:37	16/01/2020 23:19	1,70	1	1,70	CHI
20200197132	CRIXAS	CX12318400	MOZARLANDIA	16/01/2020 21:37	17/01/2020 01:25	16/01/2020 21:37	17/01/2020 01:25	3,79	11	41,67	CHI
20200197141	ALVORADA DO NORTE	AQ12085499	IACIARA S2	16/01/2020 21:43	17/01/2020 12:43	16/01/2020 21:43	17/01/2020 12:43	15,00	3	45,00	CHI
20200197141	FLORES DE GOIAS	AQ12085499	IACIARA S2	16/01/2020 21:43	17/01/2020 12:43	16/01/2020 21:43	17/01/2020 12:43	15,00	2	30,00	CHI
20200197145	MINEIROS	1390147566	PARQUE DAS EMAS	16/01/2020 21:45	16/01/2020 22:54	16/01/2020 21:45	16/01/2020 22:54	1,14	1	1,14	CHI
20200197150	GOIANIA	15372248	CARAJAS S2	16/01/2020 21:47	17/01/2020 00:14	16/01/2020 21:47	17/01/2020 00:14	2,44	1	2,44	CHI
20200197153	JARAGUA	JA12297943	JARAGUA	16/01/2020 21:45	16/01/2020 23:55	16/01/2020 21:45	16/01/2020 23:55	2,16	19	41,08	CHI
20200197156	GOIANIA	GN11136790	FERROVIARIO S1	16/01/2020 21:47	17/01/2020 00:12	16/01/2020 21:47	17/01/2020 00:12	2,41	111	267,48	CHI
20200197159	CAIAPONIA	CP12241166	PALESTINA	16/01/2020 21:49	17/01/2020 07:53	16/01/2020 21:49	17/01/2020 07:53	10,06	4	40,24	CHI
20200197162	GOIANIA	16970755	GOIANIA LESTE S3	16/01/2020 21:49	16/01/2020 23:04	16/01/2020 21:49	16/01/2020 23:04	1,23	1	1,23	CHI
20200197177	MONTES CLAROS DE GOIAS	ME12085895	IPORA	16/01/2020 21:53	17/01/2020 02:41	16/01/2020 21:53	17/01/2020 02:41	4,79	22	105,37	CHI
20200197179	MINEIROS	PW12336959	PARQUE DAS EMAS	16/01/2020 21:54	17/01/2020 18:22	16/01/2020 21:54	17/01/2020 18:22	20,46	5	102,30	CHI
20200197181	GOIANESIA	BA12163310	GOIANESIA S1	16/01/2020 21:54	17/01/2020 07:55	16/01/2020 21:54	17/01/2020 07:55	10,02	2	20,04	CHI
20200197181	VILA PROPICIO	BA12163310	GOIANESIA S1	16/01/2020 21:54	17/01/2020 07:55	16/01/2020 21:54	17/01/2020 07:55	10,02	11	110,22	CHI
20200197190	GOIANIA	GN11000805	GOIANIA LESTE S2	16/01/2020 21:56	17/01/2020 01:48	16/01/2020 21:56	17/01/2020 01:48	3,86	48	185,45	CHI
20200197191	CACHOEIRA DOURADA	00230414	CACHOEIRA DOURADA	16/01/2020 21:43	18/01/2020 11:24	16/01/2020 21:43	16/01/2020 21:55	0,20	1	0,20	CHI
20200197191	BOM JESUS DE GOIAS	00230414	CACHOEIRA DOURADA	16/01/2020 21:43	18/01/2020 11:24	16/01/2020 21:43	17/01/2020 00:04	2,34	33	77,22	CHI
20200197191	BOM JESUS DE GOIAS	00230414	CACHOEIRA DOURADA	16/01/2020 21:43	18/01/2020 11:24	16/01/2020 21:43	17/01/2020 00:04	2,34	4	9,36	CHI
20200197191	CACHOEIRA DOURADA	00230414	CACHOEIRA DOURADA	16/01/2020 21:43	18/01/2020 11:24	16/01/2020 21:43	17/01/2020 00:04	2,34	26	60,84	CHI
20200197191	GOIATUBA	00230414	CACHOEIRA DOURADA	16/01/2020 21:43	18/01/2020 11:24	16/01/2020 21:43	17/01/2020 00:04	2,34	7	16,38	CHI
20200197191	ITUMBIARA	00230414	CACHOEIRA DOURADA	16/01/2020 21:43	18/01/2020 11:24	16/01/2020 21:43	17/01/2020 00:04	2,34	183	428,22	CHI
20200197191	ITUMBIARA	00230414	CACHOEIRA DOURADA	16/01/2020 21:43	18/01/2020 11:24	16/01/2020 21:43	17/01/2020 00:04	2,34	369	863,46	CHI
20200197191	PANAMA	00230414	CACHOEIRA DOURADA	16/01/2020 21:43	18/01/2020 11:24	16/01/2020 21:43	17/01/2020 00:04	2,34	20	46,80	CHI
20200197191	CACHOEIRA DOURADA	00230414	CACHOEIRA DOURADA	16/01/2020 21:43	18/01/2020 11:24	16/01/2020 21:44	17/01/2020 00:04	2,32	2	4,64	CHI
20200197191	ITUMBIARA	00230414	CACHOEIRA DOURADA	16/01/2020 21:43	18/01/2020 11:24	16/01/2020 21:44	17/01/2020 00:04	2,32	1	2,32	CHI
20200197191	CACHOEIRA DOURADA	00230414	CACHOEIRA DOURADA	16/01/2020 21:43	18/01/2020 11:24	16/01/2020 21:43	17/01/2020 03:22	5,64	732	4131,33	CHI
20200197191	INACIOLANDIA	00230414	CACHOEIRA DOURADA	16/01/2020 21:43	18/01/2020 11:24	16/01/2020 21:43	17/01/2020 03:22	5,64	100	564,39	CHI
20200197191	ITUMBIARA	00230414	CACHOEIRA DOURADA	16/01/2020 21:43	18/01/2020 11:24	16/01/2020 21:43	17/01/2020 03:22	5,64	13	73,37	CHI
20200197191	CACHOEIRA DOURADA	00230414	CACHOEIRA DOURADA	16/01/2020 21:43	18/01/2020 11:24	16/01/2020 21:44	17/01/2020 03:22	5,63	3	16,88	CHI
20200197191	INACIOLANDIA	00230414	CACHOEIRA DOURADA	16/01/2020 21:43	18/01/2020 11:24	16/01/2020 21:44	17/01/2020 03:22	5,63	1	5,63	CHI
20200197191	CACHOEIRA DOURADA	CD11088530	CACHOEIRA DOURADA	16/01/2020 21:43	18/01/2020 11:24	17/01/2020 15:59	17/01/2020 23:30	7,50	47	352,71	CHI
20200197191	CACHOEIRA DOURADA	00230414	CACHOEIRA DOURADA	16/01/2020 21:43	18/01/2020 11:24	16/01/2020 21:43	18/01/2020 05:40	31,94	6	191,66	CHI
20200197191	ITUMBIARA	00230414	CACHOEIRA DOURADA	16/01/2020 21:43	18/01/2020 11:24	16/01/2020 21:43	18/01/2020 05:40	31,94	3	95,83	CHI

20200197191	CACHOEIRA DOURADA	00230414	CACHOEIRA DOURADA	16/01/2020 21:43	18/01/2020 11:24	16/01/2020 21:43	18/01/2020 08:46	35,04	1	35,04	CHI
20200197191	ITUMBIARA	00230414	CACHOEIRA DOURADA	16/01/2020 21:43	18/01/2020 11:24	16/01/2020 21:43	18/01/2020 08:46	35,04	8	280,32	CHI
20200197191	CACHOEIRA DOURADA	00230414	CACHOEIRA DOURADA	16/01/2020 21:43	18/01/2020 11:24	16/01/2020 21:43	18/01/2020 09:23	35,66	3	106,99	CHI
20200197191	CACHOEIRA DOURADA	CD13058055	CACHOEIRA DOURADA	16/01/2020 21:43	18/01/2020 11:24	18/01/2020 11:14	18/01/2020 11:24	0,17	689	117,13	CHI
20200197191	INACIOLANDIA	CD13058055	CACHOEIRA DOURADA	16/01/2020 21:43	18/01/2020 11:24	18/01/2020 11:14	18/01/2020 11:24	0,17	85	14,45	CHI
20200197191	ITUMBIARA	CD13058055	CACHOEIRA DOURADA	16/01/2020 21:43	18/01/2020 11:24	18/01/2020 11:14	18/01/2020 11:24	0,17	13	2,21	CHI
20200197192	ARENOPOLIS	AY12390169	ARENOPOLIS	16/01/2020 21:56	16/01/2020 23:49	16/01/2020 21:56	16/01/2020 23:49	1,88	24	45,09	CHI
20200197192	DIORAMA	AY12390169	ARENOPOLIS	16/01/2020 21:56	16/01/2020 23:49	16/01/2020 21:56	16/01/2020 23:49	1,88	3	5,64	CHI
20200197196	SAO SIMAO	SO12108807	CACHOEIRA ALTA	16/01/2020 21:57	17/01/2020 00:53	16/01/2020 21:57	17/01/2020 00:53	2,93	111	325,20	CHI
20200197197	VILA PROPICIO	NP12188681	GOIANESIA S1	16/01/2020 21:45	19/01/2020 01:05	16/01/2020 21:45	18/01/2020 10:41	36,92	82	3027,51	CHI
20200197197	VILA PROPICIO	NP12188681	GOIANESIA S1	16/01/2020 21:45	19/01/2020 01:05	16/01/2020 21:45	19/01/2020 01:05	51,32	5	256,60	CHI
20200197401	LUZIANIA	10024708494	MARAJOARA	16/01/2020 22:00	16/01/2020 22:52	16/01/2020 22:00	16/01/2020 22:52	0,86	1	0,86	CHI
20200197402	PORTELANDIA	PW12303420	PARQUE DAS EMAS	16/01/2020 22:00	17/01/2020 00:00	16/01/2020 22:00	17/01/2020 00:00	2,00	14	27,95	CHI
20200197404	VALPARAISO DE GOIAS	3350014663	PACAEMBU S2	16/01/2020 22:01	16/01/2020 23:18	16/01/2020 22:01	16/01/2020 23:18	1,28	1	1,28	CHI
20200197414	GAMELEIRA DE GOIAS	AN12285354	ANAPOLIS UNIVERSITARIO S2	16/01/2020 20:42	17/01/2020 01:39	16/01/2020 20:42	17/01/2020 01:39	4,94	4	19,74	CHI
20200197414	SILVANIA	AN12285354	ANAPOLIS UNIVERSITARIO S2	16/01/2020 20:42	17/01/2020 01:39	16/01/2020 20:42	17/01/2020 01:39	4,94	14	69,10	CHI
20200197420	ITABERAI	IB12206926	ITABERAI S2	16/01/2020 22:08	17/01/2020 04:30	16/01/2020 22:08	17/01/2020 04:30	6,35	113	717,61	CHI
20200197425	PLANALTINA	PI21218310	PLANALTINA	16/01/2020 22:09	16/01/2020 23:16	16/01/2020 22:09	16/01/2020 23:16	1,10	2	2,21	CHI
20200197429	ITABERAI	IB12000035	ITABERAI S2	16/01/2020 22:11	16/01/2020 23:38	16/01/2020 22:11	16/01/2020 23:38	1,44	60	86,38	CHI
20200197434	EDEIA	ED12000041	EDEIA	16/01/2020 22:12	17/01/2020 10:25	16/01/2020 22:12	17/01/2020 10:25	12,21	25	305,17	CHI
20200197458	SANCLERLANDIA	SC12161001	FIRMINOPOLIS S2	16/01/2020 22:08	17/01/2020 07:26	16/01/2020 22:08	17/01/2020 07:26	9,30	5	46,49	CHI
20200197469	CRISTALINA	KR12199519	PAMPLONA	16/01/2020 22:23	17/01/2020 01:27	16/01/2020 22:23	17/01/2020 01:27	3,05	4	12,20	CHI
20200197475	CALDAZINHA	BV12034389	CEPAIGO S2	16/01/2020 22:25	17/01/2020 07:07	16/01/2020 22:25	17/01/2020 07:07	8,69	45	391,17	CHI
20200197477	ANAPOLIS	10023475577	JUNDIAI S1	16/01/2020 22:26	17/01/2020 18:19	16/01/2020 22:26	17/01/2020 18:19	19,87	1	19,87	CHI
20200197479	MATRINCHA	FC21199786	MATRINCHA	16/01/2020 22:26	17/01/2020 03:50	16/01/2020 22:26	17/01/2020 03:50	5,38	1	5,38	CHI
20200197483	CEZARINA	CZ12228898	CEZARINA	16/01/2020 22:28	17/01/2020 01:52	16/01/2020 22:28	17/01/2020 01:52	3,40	9	30,59	CHI
20200197484	BURITINOPOLIS	BQ12204633RE	IACIARA S2	16/01/2020 22:07	16/01/2020 23:43	16/01/2020 22:07	16/01/2020 23:43	1,58	52	82,35	CHI
20200197484	POSSE	BQ12204633RE	IACIARA S2	16/01/2020 22:07	16/01/2020 23:43	16/01/2020 22:07	16/01/2020 23:43	1,58	105	166,28	CHI
20200197484	SIMOLANDIA	BQ12204633RE	IACIARA S2	16/01/2020 22:07	16/01/2020 23:43	16/01/2020 22:07	16/01/2020 23:43	1,58	61	96,60	CHI
20200197502	GOUVELANDIA	01560414	QUIRINOPOLIS	16/01/2020 22:14	17/01/2020 17:54	16/01/2020 22:14	17/01/2020 00:43	2,49	2011	5001,25	CHI
20200197502	GOUVELANDIA	01560414	QUIRINOPOLIS	16/01/2020 22:14	17/01/2020 17:54	16/01/2020 22:14	17/01/2020 00:43	2,49	13	32,33	CHI
20200197502	QUIRINOPOLIS	01560414	QUIRINOPOLIS	16/01/2020 22:14	17/01/2020 17:54	16/01/2020 22:14	17/01/2020 00:43	2,49	89	221,34	CHI
20200197502	QUIRINOPOLIS	01560414	QUIRINOPOLIS	16/01/2020 22:14	17/01/2020 17:54	16/01/2020 22:14	17/01/2020 00:43	2,49	19	47,25	CHI

20200197502	GOUVELANDIA	01560414	QUIRINOPOLIS	16/01/2020 22:14	17/01/2020 17:54	17/01/2020 03:15	17/01/2020 03:26	0,17	2011	346,34	CHI
20200197502	GOUVELANDIA	01560414	QUIRINOPOLIS	16/01/2020 22:14	17/01/2020 17:54	17/01/2020 03:15	17/01/2020 03:26	0,17	13	2,24	CHI
20200197502	QUIRINOPOLIS	01560414	QUIRINOPOLIS	16/01/2020 22:14	17/01/2020 17:54	17/01/2020 03:15	17/01/2020 03:26	0,17	89	15,33	CHI
20200197502	QUIRINOPOLIS	01560414	QUIRINOPOLIS	16/01/2020 22:14	17/01/2020 17:54	17/01/2020 03:15	17/01/2020 03:26	0,17	23	3,96	CHI
20200197502	INACIOLANDIA	GB13000028	QUIRINOPOLIS	16/01/2020 22:14	17/01/2020 17:54	16/01/2020 22:14	17/01/2020 13:17	15,05	2	30,10	CHI
20200197502	GOUVELANDIA	01560414	QUIRINOPOLIS	16/01/2020 22:14	17/01/2020 17:54	17/01/2020 13:18	17/01/2020 13:23	0,08	2011	167,58	CHI
20200197502	GOUVELANDIA	01560414	QUIRINOPOLIS	16/01/2020 22:14	17/01/2020 17:54	17/01/2020 13:18	17/01/2020 13:23	0,08	13	1,08	CHI
20200197502	QUIRINOPOLIS	01560414	QUIRINOPOLIS	16/01/2020 22:14	17/01/2020 17:54	17/01/2020 13:18	17/01/2020 13:23	0,08	89	7,42	CHI
20200197502	QUIRINOPOLIS	01560414	QUIRINOPOLIS	16/01/2020 22:14	17/01/2020 17:54	17/01/2020 13:18	17/01/2020 13:23	0,08	23	1,92	CHI
20200197502	INACIOLANDIA	GB13000028	QUIRINOPOLIS	16/01/2020 22:14	17/01/2020 17:54	17/01/2020 13:18	17/01/2020 17:21	4,06	2	8,12	CHI
20200197502	BOM JESUS DE GOIAS	01560414	QUIRINOPOLIS	16/01/2020 22:14	17/01/2020 17:54	16/01/2020 22:14	17/01/2020 17:54	19,67	69	1357,00	CHI
20200197502	INACIOLANDIA	01560414	QUIRINOPOLIS	16/01/2020 22:14	17/01/2020 17:54	16/01/2020 22:14	17/01/2020 17:54	19,67	2579	50720,33	CHI
20200197502	INACIOLANDIA	ID13000029	QUIRINOPOLIS	16/01/2020 22:14	17/01/2020 17:54	16/01/2020 22:14	17/01/2020 17:54	19,67	12	236,00	CHI
20200197502	ITUMBIARA	01560414	QUIRINOPOLIS	16/01/2020 22:14	17/01/2020 17:54	16/01/2020 22:14	17/01/2020 17:54	19,67	9	177,00	CHI
20200197509	MOZARLANDIA	MZ13220373	MOZARLANDIA	16/01/2020 23:13	17/01/2020 00:24	16/01/2020 23:38	17/01/2020 00:24	0,77	28	21,54	CHI
20200197509	NOVA CRIXAS	MZ13220373	MOZARLANDIA	16/01/2020 23:13	17/01/2020 00:24	16/01/2020 23:38	17/01/2020 00:24	0,77	34	26,15	CHI
20200197510	PIRENOPOLIS	PV11258980	CORUMBA	16/01/2020 16:47	17/01/2020 00:57	16/01/2020 16:47	17/01/2020 00:57	8,16	31	252,93	CHI
20200197511	JATAI	01030414	JATAI S1	16/01/2020 23:21	17/01/2020 16:04	16/01/2020 23:21	17/01/2020 07:39	8,31	1	8,31	CHI
20200197511	JATAI	JT13365073	JATAI S1	16/01/2020 23:21	17/01/2020 16:04	16/01/2020 23:21	17/01/2020 08:04	8,72	4	34,89	CHI
20200197511	JATAI	01030414	JATAI S1	16/01/2020 23:21	17/01/2020 16:04	17/01/2020 16:01	17/01/2020 16:04	0,05	5	0,27	CHI
20200197511	JATAI	01030414	JATAI S1	16/01/2020 23:21	17/01/2020 16:04	16/01/2020 23:21	17/01/2020 16:04	16,73	2	33,45	CHI
20200197609	AGUAS LINDAS DE GOIAS	LA11136697	AGUAS LINDAS DE GOIAS S1	16/01/2020 22:37	16/01/2020 23:55	16/01/2020 22:37	16/01/2020 23:55	1,29	22	28,33	CHI
20200197630	GOIANIA	GN12200232LD	CAMPINAS S3	16/01/2020 22:45	17/01/2020 04:00	17/01/2020 02:23	17/01/2020 03:56	1,55	258	401,19	CHI
20200197630	GOIANIA	GN11193746	CAMPINAS S3	16/01/2020 22:45	17/01/2020 04:00	16/01/2020 22:45	17/01/2020 04:00	5,25	45	236,19	CHI
20200197635	IPAMERI	IP12017013	IPAMERI	16/01/2020 22:46	17/01/2020 00:05	16/01/2020 22:46	17/01/2020 00:05	1,31	6	7,89	CHI
20200197652	SANTA RITA DO ARAGUAIA	MY12150634	SANTA RITA DO ARAGUAIA	16/01/2020 22:53	17/01/2020 19:57	16/01/2020 22:53	17/01/2020 19:57	21,06	11	231,62	CHI
20200197656	ARAGARCAS	AG12138460	ARAGARCAS	16/01/2020 22:56	17/01/2020 08:20	16/01/2020 22:56	17/01/2020 08:20	9,39	13	122,08	CHI
20200197658	AMERICANO DO BRASIL	IB12000062	ITABERAI S2	16/01/2020 22:37	17/01/2020 08:14	16/01/2020 22:37	17/01/2020 08:14	9,61	11	105,76	CHI
20200197658	ITABERAI	IB12000062	ITABERAI S2	16/01/2020 22:37	17/01/2020 08:14	16/01/2020 22:37	17/01/2020 08:14	9,61	18	173,06	CHI
20200197661	GOIANIA	11717907	GOIANIA LESTE S3	16/01/2020 22:56	16/01/2020 23:50	16/01/2020 22:56	16/01/2020 23:50	0,90	1	0,90	CHI
20200197664	GOIANIA	GN11054888	GOIANIA LESTE S3	16/01/2020 22:49	17/01/2020 00:12	16/01/2020 22:49	17/01/2020 00:12	1,38	154	212,61	CHI
20200197665	GOIANIA	17297382	FERROVIARIO S2	16/01/2020 22:58	17/01/2020 00:11	16/01/2020 22:58	17/01/2020 00:11	1,20	1	1,20	CHI
20200197687	GOUVELANDIA	GB21255639	QUIRINOPOLIS	16/01/2020 23:08	17/01/2020 07:57	16/01/2020 23:08	17/01/2020 07:57	8,81	2	17,62	CHI

20200197693	PIRES DO RIO	BC12060921	PIRES DO RIO S2	16/01/2020 23:11	17/01/2020 00:43	16/01/2020 23:11	17/01/2020 00:43	1,53	23	35,23	CHI
20200197693	SANTA CRUZ DE GOIAS	BC12060921	PIRES DO RIO S2	16/01/2020 23:11	17/01/2020 00:43	16/01/2020 23:11	17/01/2020 00:43	1,53	4	6,13	CHI
20200197694	APARECIDA DE GOIANIA	AP11056185	INDEPENDENCIA S2	16/01/2020 23:11	17/01/2020 04:05	16/01/2020 23:11	17/01/2020 04:05	4,90	148	725,08	CHI
20200197696	PIRENOPOLIS	PV11233216	CORUMBA	16/01/2020 23:11	17/01/2020 16:10	16/01/2020 23:11	17/01/2020 16:10	16,98	120	2037,13	CHI
20200197697	IPAMERI	UT12082354RE	URUTAI	16/01/2020 23:11	17/01/2020 03:09	16/01/2020 23:11	17/01/2020 03:09	3,95	4	15,81	CHI
20200197697	URUTAI	UT12082354RE	URUTAI	16/01/2020 23:11	17/01/2020 03:09	16/01/2020 23:11	17/01/2020 03:09	3,95	30	118,57	CHI
20200197707	CACHOEIRA ALTA	CA12370065	CACHOEIRA ALTA	16/01/2020 23:13	17/01/2020 09:55	16/01/2020 23:13	17/01/2020 09:55	10,70	3	32,10	CHI
20200197709	CALDAS NOVAS	CN11000025	SERRA DE CALDAS	16/01/2020 23:11	17/01/2020 01:03	16/01/2020 23:11	17/01/2020 01:03	1,85	137	253,72	CHI
20200197710	SANCLERLANDIA	SC12194187	FIRMINOPOLIS S2	16/01/2020 23:14	17/01/2020 06:56	16/01/2020 23:14	17/01/2020 06:56	7,69	164	1260,61	CHI
20200197716	CAIAPONIA	CP12357586	PALESTINA	16/01/2020 23:18	17/01/2020 17:40	16/01/2020 23:18	17/01/2020 17:40	18,36	5	91,81	CHI
20200197717	JARAGUA	JA12297378	JARAGUA	16/01/2020 23:19	17/01/2020 01:40	16/01/2020 23:19	17/01/2020 01:40	2,35	40	93,97	CHI
20200197722	IPAMERI	IP21038818	IPAMERI	16/01/2020 23:22	17/01/2020 00:24	16/01/2020 23:22	17/01/2020 00:24	1,03	1	1,03	CHI
20200197723	MAURILANDIA	O1130214	RIO DOS BOIS	16/01/2020 23:22	17/01/2020 01:08	16/01/2020 23:22	17/01/2020 01:08	1,76	2586	4540,58	CHI
20200197723	PORTEIRAO	O1130214	RIO DOS BOIS	16/01/2020 23:22	17/01/2020 01:08	16/01/2020 23:22	17/01/2020 01:08	1,76	28	49,16	CHI
20200197723	TURVELANDIA	O1130214	RIO DOS BOIS	16/01/2020 23:22	17/01/2020 01:08	16/01/2020 23:22	17/01/2020 01:08	1,76	3	5,27	CHI
20200197749	BARRO ALTO	BA12035658	BARRO ALTO	16/01/2020 23:32	17/01/2020 08:37	16/01/2020 23:32	17/01/2020 08:37	9,07	5	45,34	CHI
20200197760	IPAMERI	IP12017034	IPAMERI	17/01/2020 06:48	17/01/2020 07:46	17/01/2020 06:48	17/01/2020 07:46	0,95	18	17,14	CHI
20200197762	QUIRINOPOLIS	QI12226698	SANTA HELENA S1	16/01/2020 23:35	18/01/2020 07:49	16/01/2020 23:35	18/01/2020 07:49	32,23	6	193,35	CHI
20200197763	PIRENOPOLIS	PV11000034	CORUMBA	16/01/2020 23:38	17/01/2020 01:00	16/01/2020 23:38	17/01/2020 01:00	1,36	86	117,17	CHI
20200197774	FORMOSA	610284009	ITIQUEIRA	16/01/2020 23:44	17/01/2020 01:55	16/01/2020 23:44	17/01/2020 01:55	2,17	1	2,17	CHI
20200197776	PIRENOPOLIS	PV11200124	CORUMBA	16/01/2020 23:45	17/01/2020 03:49	16/01/2020 23:45	17/01/2020 03:49	4,07	121	491,97	CHI
20200197777	QUIRINOPOLIS	80089690	QUIRINOPOLIS	16/01/2020 23:46	17/01/2020 07:17	16/01/2020 23:46	17/01/2020 07:17	7,52	1	7,52	CHI
20200197782	NIQUELANDIA	NQ12335416	BARRO ALTO	16/01/2020 23:48	17/01/2020 02:45	16/01/2020 23:48	17/01/2020 02:45	2,94	10	29,36	CHI
20200197785	AVELINOPOLIS	AV21020481	ANICUNS	16/01/2020 23:52	17/01/2020 07:38	16/01/2020 23:52	17/01/2020 07:38	7,76	2	15,52	CHI
20200197815	ITAPIRAPUA	IU12018746	JUSSARA	17/01/2020 00:13	17/01/2020 01:10	17/01/2020 00:13	17/01/2020 01:10	0,95	3	2,85	CHI
20200197819	FORMOSA	610082619	ITIQUEIRA	17/01/2020 00:15	17/01/2020 01:23	17/01/2020 00:15	17/01/2020 01:23	1,12	1	1,12	CHI
20200197826	PARAUNA	PU12304549	PARAUNA	17/01/2020 00:00	17/01/2020 07:39	17/01/2020 00:00	17/01/2020 07:39	7,64	14	106,98	CHI
20200197827	SANCLERLANDIA	SC16409253	FIRMINOPOLIS S2	17/01/2020 00:24	17/01/2020 09:57	17/01/2020 04:34	17/01/2020 09:57	5,38	857	4614,94	CHI
20200197830	PARAUNA	PU21399741	PARAUNA	17/01/2020 00:30	17/01/2020 18:40	17/01/2020 00:30	17/01/2020 16:48	16,29	1	16,29	CHI
20200197830	PARAUNA	PU21332278	PARAUNA	17/01/2020 00:30	17/01/2020 18:40	17/01/2020 00:30	17/01/2020 17:19	16,82	1	16,82	CHI
20200197830	PARAUNA	PU21356320	PARAUNA	17/01/2020 00:30	17/01/2020 18:40	17/01/2020 00:30	17/01/2020 18:28	17,96	1	17,96	CHI
20200197830	PARAUNA	PU21399739	PARAUNA	17/01/2020 00:30	17/01/2020 18:40	17/01/2020 00:30	17/01/2020 18:40	18,17	1	18,17	CHI
20200197833	SAO LUIS DE MONTES BELOS	SL12071351	SAO LUIZ DOS MONTES BELOS	17/01/2020 00:34	17/01/2020 02:46	17/01/2020 00:34	17/01/2020 02:46	2,20	532	1169,37	CHI

20200197835	ANAPOLIS	20298523	ANAPOLIS UNIVERSITARIO S1	17/01/2020 00:35	17/01/2020 01:40	17/01/2020 00:35	17/01/2020 01:40	1,08	1	1,08	CHI
20200197839	QUIRINOPOLIS	QI16409325	QUIRINOPOLIS	16/01/2020 23:58	17/01/2020 23:29	16/01/2020 23:58	17/01/2020 07:32	7,56	1975	14935,39	CHI
20200197839	QUIRINOPOLIS	QI16409325	QUIRINOPOLIS	16/01/2020 23:58	17/01/2020 23:29	16/01/2020 23:58	17/01/2020 07:34	7,60	2513	19107,87	CHI
20200197839	QUIRINOPOLIS	QI10395333	QUIRINOPOLIS	16/01/2020 23:58	17/01/2020 23:29	17/01/2020 07:41	17/01/2020 07:50	0,14	1832	262,08	CHI
20200197839	QUIRINOPOLIS	QI10402323	QUIRINOPOLIS	16/01/2020 23:58	17/01/2020 23:29	17/01/2020 07:41	17/01/2020 10:14	2,54	673	1709,42	CHI
20200197839	QUIRINOPOLIS	QI10402323	QUIRINOPOLIS	16/01/2020 23:58	17/01/2020 23:29	17/01/2020 11:15	17/01/2020 12:07	0,87	673	584,95	CHI
20200197839	QUIRINOPOLIS	QI10402323	QUIRINOPOLIS	16/01/2020 23:58	17/01/2020 23:29	17/01/2020 07:41	17/01/2020 14:38	6,94	90	624,68	CHI
20200197839	QUIRINOPOLIS	QI13000036	QUIRINOPOLIS	16/01/2020 23:58	17/01/2020 23:29	17/01/2020 07:55	17/01/2020 14:38	6,72	1	6,72	CHI
20200197839	QUIRINOPOLIS	QI10402323	QUIRINOPOLIS	16/01/2020 23:58	17/01/2020 23:29	17/01/2020 07:41	17/01/2020 22:30	14,80	3	44,41	CHI
20200197839	QUIRINOPOLIS	QI12000040	QUIRINOPOLIS	16/01/2020 23:58	17/01/2020 23:29	17/01/2020 23:22	17/01/2020 23:29	0,12	91	11,27	CHI
20200197843	PIRENOPOLIS	PV12016354	CORUMBA	16/01/2020 23:02	17/01/2020 08:57	16/01/2020 23:02	17/01/2020 08:57	9,91	35	346,71	CHI
20200197848	SANTA FE DE GOIAS	RN12378850	BRITANIA	17/01/2020 00:45	17/01/2020 09:57	17/01/2020 00:45	17/01/2020 09:57	9,19	19	174,58	CHI
20200197882	ISRAELANDIA	8651696	IPORA	17/01/2020 01:18	17/01/2020 09:38	17/01/2020 01:18	17/01/2020 09:38	8,32	4	33,28	CHI
20200197895	RIO VERDE	RV12327004	RIO VERDE S2	17/01/2020 01:40	17/01/2020 07:42	17/01/2020 01:40	17/01/2020 07:42	6,05	3	18,14	CHI
20200197897	SANCLERLANDIA	SC21164002	FIRMINOPOLIS S2	17/01/2020 01:41	17/01/2020 11:13	17/01/2020 01:41	17/01/2020 11:13	9,52	1	9,52	CHI
20200197898	RIO VERDE	RV12200774	CABRIUVA S2	17/01/2020 01:43	17/01/2020 12:48	17/01/2020 01:43	17/01/2020 12:48	11,08	17	188,33	CHI
20200197914	HIDROLINA	SG10406658	SANTA TEREZINHA	17/01/2020 01:53	18/01/2020 06:29	17/01/2020 01:53	17/01/2020 04:40	2,79	18	50,21	CHI
20200197914	PILAR DE GOIAS	SG10406658	SANTA TEREZINHA	17/01/2020 01:53	18/01/2020 06:29	17/01/2020 01:53	17/01/2020 04:40	2,79	101	281,71	CHI
20200197914	URUACU	SG10406658	SANTA TEREZINHA	17/01/2020 01:53	18/01/2020 06:29	17/01/2020 01:53	17/01/2020 04:40	2,79	4	11,16	CHI
20200197914	PILAR DE GOIAS	SG10406658	SANTA TEREZINHA	17/01/2020 01:53	18/01/2020 06:29	17/01/2020 01:53	17/01/2020 04:55	3,03	6	18,20	CHI
20200197914	SANTA TEREZINHA DE GOIAS	SG10406658	SANTA TEREZINHA	17/01/2020 01:53	18/01/2020 06:29	17/01/2020 01:53	17/01/2020 04:55	3,03	2	6,07	CHI
20200197914	PILAR DE GOIAS	SG10406658	SANTA TEREZINHA	17/01/2020 01:53	18/01/2020 06:29	17/01/2020 01:53	17/01/2020 05:06	3,21	93	298,48	CHI
20200197914	SANTA TEREZINHA DE GOIAS	SG10406658	SANTA TEREZINHA	17/01/2020 01:53	18/01/2020 06:29	17/01/2020 01:53	17/01/2020 05:06	3,21	45	144,43	CHI
20200197914	PILAR DE GOIAS	GG13292490	SANTA TEREZINHA	17/01/2020 01:53	18/01/2020 06:29	17/01/2020 04:41	17/01/2020 09:44	5,05	48	242,19	CHI
20200197914	CRIXAS	O1730454	SANTA TEREZINHA	17/01/2020 01:53	18/01/2020 06:29	17/01/2020 11:23	17/01/2020 11:27	0,06	316	18,08	CHI
20200197914	GUARINOS	O1730454	SANTA TEREZINHA	17/01/2020 01:53	18/01/2020 06:29	17/01/2020 11:23	17/01/2020 11:27	0,06	1179	67,47	CHI
20200197914	ITAPACI	O1730454	SANTA TEREZINHA	17/01/2020 01:53	18/01/2020 06:29	17/01/2020 11:23	17/01/2020 11:27	0,06	6	0,34	CHI
20200197914	PILAR DE GOIAS	O1730454	SANTA TEREZINHA	17/01/2020 01:53	18/01/2020 06:29	17/01/2020 11:23	17/01/2020 11:27	0,06	191	10,93	CHI
20200197914	SANTA TEREZINHA DE GOIAS	O1730454	SANTA TEREZINHA	17/01/2020 01:53	18/01/2020 06:29	17/01/2020 11:23	17/01/2020 11:27	0,06	657	37,60	CHI
20200197914	HIDROLINA	HL13390499	SANTA TEREZINHA	17/01/2020 01:53	18/01/2020 06:29	17/01/2020 04:41	17/01/2020 20:00	15,32	16	245,10	CHI
20200197914	PILAR DE GOIAS	HL13390499	SANTA TEREZINHA	17/01/2020 01:53	18/01/2020 06:29	17/01/2020 04:41	17/01/2020 20:00	15,32	3	45,96	CHI
20200197914	HIDROLINA	HL13390499	SANTA TEREZINHA	17/01/2020 01:53	18/01/2020 06:29	17/01/2020 04:41	17/01/2020 22:56	18,24	1	18,24	CHI
20200197914	PILAR DE GOIAS	HL13390499	SANTA TEREZINHA	17/01/2020 01:53	18/01/2020 06:29	17/01/2020 04:41	17/01/2020 22:56	18,24	1	18,24	CHI

20200197914	HIDROLINA	HL13390499	SANTA TEREZINHA	17/01/2020 01:53	18/01/2020 06:29	17/01/2020 20:08	17/01/2020 22:56	2,79	15	41,88	CHI
20200197914	PILAR DE GOIAS	HL13390499	SANTA TEREZINHA	17/01/2020 01:53	18/01/2020 06:29	17/01/2020 20:08	17/01/2020 22:56	2,79	3	8,38	CHI
20200197914	HIDROLINA	HL12003223	SANTA TEREZINHA	17/01/2020 01:53	18/01/2020 06:29	17/01/2020 04:41	17/01/2020 23:01	18,34	1	18,34	CHI
20200197914	PILAR DE GOIAS	HL12003223	SANTA TEREZINHA	17/01/2020 01:53	18/01/2020 06:29	17/01/2020 04:41	17/01/2020 23:01	18,34	49	898,50	CHI
20200197914	URUACU	HL12003223	SANTA TEREZINHA	17/01/2020 01:53	18/01/2020 06:29	17/01/2020 04:41	17/01/2020 23:01	18,34	4	73,35	CHI
20200197914	HIDROLINA	HL12232531	SANTA TEREZINHA	17/01/2020 01:53	18/01/2020 06:29	17/01/2020 20:08	18/01/2020 06:29	10,34	1	10,34	CHI
20200197920	PIRENOPOLIS	PV11000034	CORUMBA	17/01/2020 02:42	17/01/2020 10:21	17/01/2020 02:42	17/01/2020 10:21	7,65	86	657,47	CHI
20200198006	CORREGO DO OURO	CO12004045	FIRMINOPOLIS S2	17/01/2020 01:50	17/01/2020 10:44	17/01/2020 01:50	17/01/2020 10:44	8,90	16	142,37	CHI
20200198009	PALESTINA DE GOIAS	PY12395457	PALESTINA	17/01/2020 01:53	17/01/2020 13:35	17/01/2020 01:53	17/01/2020 13:35	11,69	4	46,76	CHI
20200198011	RIO VERDE	RV21232716	MONTIVIDIU T	17/01/2020 02:00	17/01/2020 14:36	17/01/2020 02:00	17/01/2020 14:36	12,59	1	12,59	CHI
20200198012	SILVANIA	SV12087780	DAIA S2	17/01/2020 02:02	17/01/2020 09:53	17/01/2020 02:02	17/01/2020 09:53	7,84	18	141,11	CHI
20200198014	SILVANIA	SV12072960	VIANOPOLIS	17/01/2020 02:04	17/01/2020 07:39	17/01/2020 02:04	17/01/2020 07:39	5,57	76	423,28	CHI
20200198014	VIANOPOLIS	SV12072960	VIANOPOLIS	17/01/2020 02:04	17/01/2020 07:39	17/01/2020 02:04	17/01/2020 07:39	5,57	16	89,11	CHI
20200198021	CACHOEIRA ALTA	CA12085443	CACHOEIRA ALTA	17/01/2020 02:16	17/01/2020 11:10	17/01/2020 02:16	17/01/2020 11:10	8,90	31	275,90	CHI
20200198021	CACU	CA12085443	CACHOEIRA ALTA	17/01/2020 02:16	17/01/2020 11:10	17/01/2020 02:16	17/01/2020 11:10	8,90	52	462,80	CHI
20200198021	ITARUMA	CA12085443	CACHOEIRA ALTA	17/01/2020 02:16	17/01/2020 11:10	17/01/2020 02:16	17/01/2020 11:10	8,90	7	62,30	CHI
20200198025	CRIXAS	CX12392061	SANTA TEREZINHA	17/01/2020 02:23	17/01/2020 09:45	17/01/2020 02:23	17/01/2020 09:45	7,36	8	58,86	CHI
20200198037	ACREUNA	EU12249122	ACREUNA	17/01/2020 02:40	17/01/2020 09:03	17/01/2020 02:40	17/01/2020 09:03	6,38	281	1791,61	CHI
20200198061	RIO VERDE	RV11000094	RIO VERDE S1	17/01/2020 03:37	17/01/2020 07:45	17/01/2020 03:37	17/01/2020 07:45	4,13	47	193,88	CHI
20200198067	RIO VERDE	RV21205450	MONTIVIDIU T	17/01/2020 03:52	17/01/2020 13:02	17/01/2020 03:52	17/01/2020 13:02	9,16	1	9,16	CHI
20200198068	IPORA	IR12013991	IPORA	17/01/2020 03:43	17/01/2020 08:36	17/01/2020 03:43	17/01/2020 08:36	4,88	45	219,51	CHI
20200198069	RIO VERDE	RV21260957	CABRIUVA S1	17/01/2020 03:54	17/01/2020 17:35	17/01/2020 03:54	17/01/2020 17:35	13,67	1	13,67	CHI
20200198085	BRITANIA	04750224	MATRINCHA	17/01/2020 04:15	17/01/2020 08:42	17/01/2020 04:15	17/01/2020 08:42	4,46	6	26,77	CHI
20200198085	ITAPIRAPUA	04750224	MATRINCHA	17/01/2020 04:15	17/01/2020 08:42	17/01/2020 04:15	17/01/2020 08:42	4,46	92	410,55	CHI
20200198086	PIRACANJUBA	PJ12009584	PIRACANJUBA	17/01/2020 04:15	17/01/2020 11:30	17/01/2020 04:15	17/01/2020 11:30	7,24	22	159,23	CHI
20200198100	FAINA	FC12147800	GOIAS	17/01/2020 04:27	17/01/2020 07:57	17/01/2020 04:27	17/01/2020 07:57	3,49	91	317,39	CHI
20200198103	MINEIROS	MY21362548	PARQUE DAS EMAS	17/01/2020 04:31	17/01/2020 15:46	17/01/2020 04:31	17/01/2020 15:46	11,24	1	11,24	CHI
20200198120	SANCLERLANDIA	SC12006150	FIRMINOPOLIS S2	17/01/2020 04:53	17/01/2020 11:01	17/01/2020 04:53	17/01/2020 11:01	6,12	32	195,90	CHI
20200198121	FAINA	FC12274422	GOIAS	17/01/2020 04:54	17/01/2020 06:58	17/01/2020 04:54	17/01/2020 06:58	2,06	54	111,15	CHI
20200198126	ARENOPOLIS	AY12000013	ARENOPOLIS	17/01/2020 04:56	17/01/2020 09:35	17/01/2020 04:56	17/01/2020 09:35	4,65	16	74,37	CHI
20200198127	DIORAMA	DI12063493	IPORA	17/01/2020 04:56	18/01/2020 11:29	17/01/2020 04:56	18/01/2020 10:27	29,51	23	678,64	CHI
20200198127	MONTES CLAROS DE GOIAS	DI12063493	IPORA	17/01/2020 04:56	18/01/2020 11:29	17/01/2020 04:56	18/01/2020 10:27	29,51	7	206,54	CHI
20200198127	DIORAMA	DI12062867LD	IPORA	17/01/2020 04:56	18/01/2020 11:29	17/01/2020 04:56	18/01/2020 11:29	30,55	14	427,72	CHI

20200198127	IPORA	DI12062867LD	IPORA	17/01/2020 04:56	18/01/2020 11:29	17/01/2020 04:56	18/01/2020 11:29	30,55	3	91,65	CHI
20200198130	GOIAS	4390000847	MATRINCHA	17/01/2020 04:57	17/01/2020 08:45	17/01/2020 04:57	17/01/2020 08:45	3,80	1	3,80	CHI
20200198136	APARECIDA DE GOIANIA	AP11128088	INDEPENDENCIA S1	17/01/2020 05:03	17/01/2020 07:14	17/01/2020 05:03	17/01/2020 07:14	2,17	164	356,43	CHI
20200198138	MOSSAMEDES	MD12120924	ITABERAI S2	17/01/2020 04:57	17/01/2020 08:11	17/01/2020 04:57	17/01/2020 08:11	3,22	50	160,99	CHI
20200198142	CACHOEIRA DE GOIAS	CG12018660	FIRMINOPOLIS S2	17/01/2020 05:10	17/01/2020 19:46	17/01/2020 05:10	17/01/2020 19:46	14,60	37	540,13	CHI
20200198148	BELA VISTA DE GOIAS	HD12323100	CEPAIGO S2	17/01/2020 05:14	17/01/2020 09:19	17/01/2020 05:14	17/01/2020 09:19	4,07	8	32,56	CHI
20200198148	HIDROLANDIA	HD12323100	CEPAIGO S2	17/01/2020 05:14	17/01/2020 09:19	17/01/2020 05:14	17/01/2020 09:19	4,07	99	402,96	CHI
20200198150	SANCLERLANDIA	SC12006151	FIRMINOPOLIS S2	17/01/2020 05:16	17/01/2020 08:27	17/01/2020 05:16	17/01/2020 08:27	3,18	9	28,62	CHI
20200198154	TRINDADE	TR31045879	TRINDADE	17/01/2020 05:19	17/01/2020 08:49	17/01/2020 05:19	17/01/2020 08:49	3,49	1	3,49	CHI
20200198156	CATALAO	CT12061234	CATALAO S1	17/01/2020 05:20	17/01/2020 09:55	17/01/2020 05:20	17/01/2020 09:55	4,57	22	100,57	CHI
20200198159	IPORA	IR12091286	IPORA	17/01/2020 01:53	17/01/2020 10:47	17/01/2020 01:53	17/01/2020 10:47	8,90	17	151,24	CHI
20200198161	ALVORADA DO NORTE	FB12143258	IACIARA S2	16/01/2020 20:55	17/01/2020 08:14	16/01/2020 20:55	17/01/2020 08:14	11,30	30	339,11	CHI
20200198161	FLORES DE GOIAS	FB12143258	IACIARA S2	16/01/2020 20:55	17/01/2020 08:14	16/01/2020 20:55	17/01/2020 08:14	11,30	27	305,20	CHI
20200198162	TAQUARAL DE GOIAS	TQ12025614	ITABERAI S1	17/01/2020 05:25	17/01/2020 12:30	17/01/2020 05:25	17/01/2020 12:30	7,07	51	360,56	CHI
20200198163	ITABERAI	IB12000060	ITABERAI S2	17/01/2020 05:26	17/01/2020 10:51	17/01/2020 05:26	17/01/2020 10:51	5,41	35	189,51	CHI
20200198168	DOVERLANDIA	MY12217015	PARQUE DAS EMAS	17/01/2020 05:31	17/01/2020 11:53	17/01/2020 05:31	17/01/2020 11:53	6,37	28	178,25	CHI
20200198168	MINEIROS	MY12217015	PARQUE DAS EMAS	17/01/2020 05:31	17/01/2020 11:53	17/01/2020 05:31	17/01/2020 11:53	6,37	9	57,30	CHI
20200198169	CATURAI	CK12376877	ARACU	17/01/2020 05:31	17/01/2020 08:14	17/01/2020 05:31	17/01/2020 08:14	2,70	5	13,52	CHI
20200198173	CATALAO	CT12042327	CATALAO S2	17/01/2020 05:35	17/01/2020 07:32	17/01/2020 05:35	17/01/2020 07:32	1,95	5	9,74	CHI
20200198183	BRITANIA	BT12289912	BRITANIA	17/01/2020 05:38	17/01/2020 14:14	17/01/2020 05:38	17/01/2020 14:14	8,60	3	25,80	CHI
20200198185	INHUMAS	IN12282891	INHUMAS S2	17/01/2020 05:08	17/01/2020 08:11	17/01/2020 05:08	17/01/2020 08:11	3,03	79	239,76	CHI
20200198185	ITAUCU	IN12282891	INHUMAS S2	17/01/2020 05:08	17/01/2020 08:11	17/01/2020 05:08	17/01/2020 08:11	3,03	25	75,87	CHI
20200198185	PETROLINA DE GOIAS	IN12282891	INHUMAS S2	17/01/2020 05:08	17/01/2020 08:11	17/01/2020 05:08	17/01/2020 08:11	3,03	2	6,07	CHI
20200198192	ABADIANIA	AN12221398	ANAPOLIS UNIVERSITARIO S2	17/01/2020 05:44	17/01/2020 09:58	17/01/2020 05:44	17/01/2020 09:58	4,23	3	12,68	CHI
20200198192	ANAPOLIS	AN12221398	ANAPOLIS UNIVERSITARIO S2	17/01/2020 05:44	17/01/2020 09:58	17/01/2020 05:44	17/01/2020 09:58	4,23	1	4,23	CHI
20200198192	PIRENOPOLIS	AN12221398	ANAPOLIS UNIVERSITARIO S2	17/01/2020 05:44	17/01/2020 09:58	17/01/2020 05:44	17/01/2020 09:58	4,23	1	4,23	CHI
20200198198	JESUPOLIS	SF12066036	SAO FRANCISCO DE GOIAS	17/01/2020 05:47	17/01/2020 09:39	17/01/2020 05:47	17/01/2020 09:39	3,86	16	61,80	CHI
20200198199	PIRACANJUBA	PJ12384538	MORRINHOS	17/01/2020 05:47	18/01/2020 11:40	17/01/2020 05:47	18/01/2020 11:40	29,89	18	538,03	CHI
20200198200	NOVA GLORIA	NG12328831	ITAPACI	17/01/2020 05:26	17/01/2020 08:31	17/01/2020 05:26	17/01/2020 08:31	3,09	4	12,36	CHI
20200198225	INDIARA	IY10395372	CEZARINA	17/01/2020 06:01	17/01/2020 08:05	17/01/2020 06:01	17/01/2020 08:05	2,05	42	86,19	CHI
20200198233	RIO VERDE	RV12345375LD	RIO VERDE S2	17/01/2020 07:45	17/01/2020 08:11	17/01/2020 07:45	17/01/2020 08:11	0,42	2	0,84	CHI
20200198257	ARAGUAPAZ	RB10394723	RUBIATABA	17/01/2020 08:13	17/01/2020 12:31	17/01/2020 08:13	17/01/2020 11:55	3,69	1	3,69	CHI
20200198257	MORRO AGUDO DE GOIAS	RB10394723	RUBIATABA	17/01/2020 08:13	17/01/2020 12:31	17/01/2020 08:13	17/01/2020 11:55	3,69	13	47,96	CHI

20200198257	NOVA AMERICA	RB10394723	RUBIATABA	17/01/2020 08:13	17/01/2020 12:31	17/01/2020 08:13	17/01/2020 11:55	3,69	3	11,07	CHI
20200198257	RUBIATABA	RB10394723	RUBIATABA	17/01/2020 08:13	17/01/2020 12:31	17/01/2020 08:13	17/01/2020 11:55	3,69	532	1962,49	CHI
20200198257	CRIXAS	RB12170307	RUBIATABA	17/01/2020 08:13	17/01/2020 12:31	17/01/2020 08:13	17/01/2020 12:31	4,29	1	4,29	CHI
20200198257	RUBIATABA	RB12170307	RUBIATABA	17/01/2020 08:13	17/01/2020 12:31	17/01/2020 08:13	17/01/2020 12:31	4,29	41	175,97	CHI
20200198274	ARENOPOLIS	IV12231088	ARENOPOLIS	17/01/2020 08:37	17/01/2020 16:58	17/01/2020 08:37	17/01/2020 16:58	8,35	4	33,40	CHI
20200198274	IVOLANDIA	IV12231088	ARENOPOLIS	17/01/2020 08:37	17/01/2020 16:58	17/01/2020 08:37	17/01/2020 16:58	8,35	34	283,90	CHI
20200198302	EDEALINA	ED12047071	PONTALINA	17/01/2020 05:48	17/01/2020 10:00	17/01/2020 05:48	17/01/2020 10:00	4,20	3	12,59	CHI
20200198302	EDEIA	ED12047071	PONTALINA	17/01/2020 05:48	17/01/2020 10:00	17/01/2020 05:48	17/01/2020 10:00	4,20	2	8,39	CHI
20200198306	QUIRINOPOLIS	QI12296688	QUIRINOPOLIS	17/01/2020 05:50	18/01/2020 08:38	17/01/2020 05:50	18/01/2020 08:38	26,79	4	107,16	CHI
20200198309	ARENOPOLIS	AY12000042	ARENOPOLIS	17/01/2020 03:28	17/01/2020 12:40	17/01/2020 03:28	17/01/2020 12:40	9,21	23	211,73	CHI
20200198311	VIANOPOLIS	OZ12094830	VIANOPOLIS	17/01/2020 05:14	17/01/2020 08:53	17/01/2020 05:14	17/01/2020 08:53	3,64	15	54,60	CHI
20200198316	JATAI	JT12104535	JATAI S2	17/01/2020 02:39	17/01/2020 11:19	17/01/2020 05:54	17/01/2020 11:19	5,41	1810	9784,56	CHI
20200198320	CALDAS NOVAS	CN21104304	CALDAS NOVAS S1	17/01/2020 05:55	17/01/2020 12:48	17/01/2020 05:55	17/01/2020 11:46	5,84	1	5,84	CHI
20200198320	CALDAS NOVAS	CN12103298	CALDAS NOVAS S1	17/01/2020 05:55	17/01/2020 12:48	17/01/2020 08:12	17/01/2020 12:48	4,60	8	36,78	CHI
20200198322	FORMOSO	FO12143711	MARA ROSA	17/01/2020 04:27	17/01/2020 16:06	17/01/2020 04:27	17/01/2020 16:06	11,65	22	256,26	CHI
20200198323	CAMPO ALEGRE DE GOIAS	CM12156359	CAMPO ALEGRE DE GOIAS	17/01/2020 05:56	17/01/2020 08:21	17/01/2020 05:56	17/01/2020 08:21	2,41	30	72,40	CHI
20200198324	CORUMBAIBA	CI21000503	VILA CORUMBA	17/01/2020 05:57	17/01/2020 11:25	17/01/2020 05:57	17/01/2020 11:25	5,46	1	5,46	CHI
20200198325	ITUMBIARA	IT12033049	BOM JESUS DE GOIAS	17/01/2020 05:58	17/01/2020 12:48	17/01/2020 05:58	17/01/2020 08:40	2,70	6	16,21	CHI
20200198325	ITUMBIARA	IT12033049	BOM JESUS DE GOIAS	17/01/2020 05:58	17/01/2020 12:48	17/01/2020 05:58	17/01/2020 12:48	6,82	1	6,82	CHI
20200198329	GOIANESIA	GE12321377	GOIANESIA S2	17/01/2020 05:35	17/01/2020 08:37	17/01/2020 05:35	17/01/2020 08:37	3,03	15	45,41	CHI
20200198329	VILA PROPICIO	GE12321377	GOIANESIA S2	17/01/2020 05:35	17/01/2020 08:37	17/01/2020 05:35	17/01/2020 08:37	3,03	9	27,24	CHI
20200198331	MINACU	IH12134994	MINACU	17/01/2020 05:59	17/01/2020 09:53	17/01/2020 05:59	17/01/2020 09:53	3,90	11	42,88	CHI
20200198333	FAZENDA NOVA	JP12089836	IPORA	17/01/2020 05:59	17/01/2020 07:14	17/01/2020 05:59	17/01/2020 07:14	1,24	62	77,12	CHI
20200198338	JUSSARA	JR21120520	BRITANIA	17/01/2020 06:01	17/01/2020 19:31	17/01/2020 06:01	17/01/2020 19:31	13,50	1	13,50	CHI
20200198339	JATAI	JT12184110	JATAI S2	17/01/2020 06:01	17/01/2020 15:30	17/01/2020 06:01	17/01/2020 15:30	9,48	2	18,96	CHI
20200198340	CROMINIA	MI12120716	PONTALINA	17/01/2020 06:01	17/01/2020 11:06	17/01/2020 06:01	17/01/2020 11:06	5,08	1	5,08	CHI
20200198340	MAIRIPOTABA	MI12120716	PONTALINA	17/01/2020 06:01	17/01/2020 11:06	17/01/2020 06:01	17/01/2020 11:06	5,08	8	40,62	CHI
20200198341	CASTELANDIA	DM12417231	RIO DOS BOIS	17/01/2020 05:54	17/01/2020 09:52	17/01/2020 05:54	17/01/2020 09:52	3,96	23	91,09	CHI
20200198341	MAURILANDIA	DM12417231	RIO DOS BOIS	17/01/2020 05:54	17/01/2020 09:52	17/01/2020 05:54	17/01/2020 09:52	3,96	1	3,96	CHI
20200198341	QUIRINOPOLIS	DM12417231	RIO DOS BOIS	17/01/2020 05:54	17/01/2020 09:52	17/01/2020 05:54	17/01/2020 09:52	3,96	15	59,40	CHI
20200198347	GOIANIA	13870464	GOIANIA LESTE S3	17/01/2020 06:02	17/01/2020 08:23	17/01/2020 06:02	17/01/2020 08:23	2,35	1	2,35	CHI
20200198350	MOSSAMEDES	1310030215	FIRMINOPOLIS S2	17/01/2020 06:02	17/01/2020 13:35	17/01/2020 06:02	17/01/2020 13:35	7,54	1	7,54	CHI
20200198361	MONTIVIDIU	MV12303520	MONTIVIDIU T	17/01/2020 06:04	17/01/2020 11:18	17/01/2020 06:04	17/01/2020 11:18	5,22	3	15,67	CHI

20200198361	RIO VERDE	MV12303520	MONTIVIDIU T	17/01/2020 06:04	17/01/2020 11:18	17/01/2020 06:04	17/01/2020 11:18	5,22	1	5,22	CHI
20200198371	ITAPURANGA	IK12311015	ITAPURANGA	17/01/2020 06:05	17/01/2020 09:51	17/01/2020 06:05	17/01/2020 09:51	3,76	199	747,47	CHI
20200198379	DOVERLANDIA	DV12138335	CAIAPONIA	17/01/2020 06:06	17/01/2020 09:07	17/01/2020 06:06	17/01/2020 09:07	3,00	37	111,10	CHI
20200198395	CASTELANDIA	ML12064391	RIO DOS BOIS	17/01/2020 06:09	17/01/2020 09:44	17/01/2020 06:09	17/01/2020 09:44	3,58	1	3,58	CHI
20200198395	MAURILANDIA	ML12064391	RIO DOS BOIS	17/01/2020 06:09	17/01/2020 09:44	17/01/2020 06:09	17/01/2020 09:44	3,58	3	10,74	CHI
20200198399	TROMBAS	TB12266003	PORANGATU	17/01/2020 06:09	17/01/2020 21:53	17/01/2020 06:09	17/01/2020 21:53	15,72	2	31,44	CHI
20200198401	JUSSARA	JR12074365	BRITANIA	17/01/2020 06:09	17/01/2020 12:20	17/01/2020 06:09	17/01/2020 12:20	6,17	37	228,21	CHI
20200198401	SANTA FE DE GOIAS	JR12074365	BRITANIA	17/01/2020 06:09	17/01/2020 12:20	17/01/2020 06:09	17/01/2020 12:20	6,17	21	129,52	CHI
20200198403	CAMPO LIMPO	AN21077962	NEROPOLIS S1	17/01/2020 05:55	17/01/2020 09:31	17/01/2020 05:55	17/01/2020 09:31	3,60	2	7,20	CHI
20200198404	CACHOEIRA DOURADA	CD12000176	CACHOEIRA DOURADA	17/01/2020 06:10	17/01/2020 11:40	17/01/2020 06:10	17/01/2020 11:40	5,50	6	32,99	CHI
20200198408	CAIAPONIA	CP12251324	CAIAPONIA	17/01/2020 06:10	18/01/2020 11:23	17/01/2020 06:10	18/01/2020 11:23	29,21	3	87,63	CHI
20200198409	SANTA CRUZ DE GOIAS	BC12300692	PIRES DO RIO S2	17/01/2020 06:05	17/01/2020 08:40	17/01/2020 06:05	17/01/2020 08:40	2,57	10	25,73	CHI
20200198410	CRIXAS	MZ12055650	MOZARLANDIA	17/01/2020 01:16	17/01/2020 09:46	17/01/2020 01:16	17/01/2020 09:46	8,49	75	636,73	CHI
20200198410	MOZARLANDIA	MZ12055650	MOZARLANDIA	17/01/2020 01:16	17/01/2020 09:46	17/01/2020 01:16	17/01/2020 09:46	8,49	5	42,45	CHI
20200198410	NOVA CRIXAS	MZ12055650	MOZARLANDIA	17/01/2020 01:16	17/01/2020 09:46	17/01/2020 01:16	17/01/2020 09:46	8,49	28	237,71	CHI
20200198415	SAO LUIS DE MONTES BELOS	SL32145964	SAO LUIZ DOS MONTES BELOS	17/01/2020 06:06	17/01/2020 11:01	17/01/2020 06:06	17/01/2020 11:01	4,91	36	176,68	CHI
20200198418	PIRENOPOLIS	PV12295641	SAO FRANCISCO DE GOIAS	17/01/2020 03:55	17/01/2020 07:55	17/01/2020 03:55	17/01/2020 07:55	3,99	184	734,11	CHI
20200198420	ORIZONA	OZ21272813	PIRES DO RIO S2	17/01/2020 06:11	17/01/2020 08:31	17/01/2020 06:11	17/01/2020 08:31	2,34	1	2,34	CHI
20200198421	ITARUMA	IM12058485	CACHOEIRA ALTA	17/01/2020 06:11	17/01/2020 08:39	17/01/2020 06:11	17/01/2020 08:39	2,46	3	7,37	CHI
20200198425	SANTA HELENA DE GOIAS	SH11159475	IPEGUARI	17/01/2020 06:12	17/01/2020 17:00	17/01/2020 06:12	17/01/2020 17:00	10,80	38	410,22	CHI
20200198426	SAO FRANCISCO DE GOIAS	SF12072320	SAO FRANCISCO DE GOIAS	17/01/2020 04:24	17/01/2020 07:55	17/01/2020 04:24	17/01/2020 07:55	3,51	216	758,70	CHI
20200198439	VICENTINOPOLIS	VI12091326	VICENTINOPOLIS	17/01/2020 06:14	18/01/2020 18:41	17/01/2020 06:14	18/01/2020 13:09	30,90	3	92,71	CHI
20200198439	PONTALINA	VI12091326	VICENTINOPOLIS	17/01/2020 06:14	18/01/2020 18:41	17/01/2020 06:14	18/01/2020 18:41	36,45	2	72,90	CHI
20200198444	TRES RANCHOS	TH21149124	CATALAO S1	17/01/2020 06:15	17/01/2020 10:40	17/01/2020 06:15	17/01/2020 10:40	4,42	2	8,85	CHI
20200198445	PALESTINA DE GOIAS	PY12396119	PALESTINA	17/01/2020 06:15	17/01/2020 10:40	17/01/2020 06:15	17/01/2020 10:40	4,41	6	26,44	CHI
20200198446	MARA ROSA	MQ12263046	MARA ROSA	17/01/2020 06:03	17/01/2020 13:04	17/01/2020 06:03	17/01/2020 13:04	7,01	7	49,04	CHI
20200198452	JATAI	JT12374237	JATAI S1	17/01/2020 06:13	17/01/2020 23:09	17/01/2020 06:13	17/01/2020 23:09	16,92	19	321,50	CHI
20200198453	JATAI	SX12139578	JATAI S1	17/01/2020 06:16	17/01/2020 09:48	17/01/2020 06:16	17/01/2020 09:48	3,53	13	45,85	CHI
20200198453	SERRANOPOLIS	SX12139578	JATAI S1	17/01/2020 06:16	17/01/2020 09:48	17/01/2020 06:16	17/01/2020 09:48	3,53	33	116,40	CHI
20200198467	SAO LUIS DE MONTES BELOS	SL12145927	SAO LUIZ DOS MONTES BELOS	17/01/2020 06:16	17/01/2020 12:46	17/01/2020 06:16	17/01/2020 12:46	6,48	20	129,68	CHI
20200198468	JATAI	290200568	JATAI S3	17/01/2020 06:17	17/01/2020 14:48	17/01/2020 06:17	17/01/2020 14:48	8,52	1	8,52	CHI
20200198469	BURITINOPOLIS	BQ12168775	IACIARA S2	17/01/2020 06:17	17/01/2020 10:15	17/01/2020 06:17	17/01/2020 10:15	3,98	38	151,24	CHI
20200198472	MINACU	IH12052624	MINACU	17/01/2020 06:17	17/01/2020 11:47	17/01/2020 06:17	17/01/2020 11:47	5,49	16	87,91	CHI

20200198475	ARAGUAPAZ	AZ12188220	MOZARLANDIA	17/01/2020 06:05	17/01/2020 07:39	17/01/2020 06:05	17/01/2020 07:39	1,55	35	54,32	CHI
20200198475	MOZARLANDIA	AZ12188220	MOZARLANDIA	17/01/2020 06:05	17/01/2020 07:39	17/01/2020 06:05	17/01/2020 07:39	1,55	8	12,42	CHI
20200198479	TEREZOPOLIS DE GOIAS	AN21273416	NEROPOLIS S1	17/01/2020 06:18	17/01/2020 13:08	17/01/2020 06:18	17/01/2020 13:08	6,83	1	6,83	CHI
20200198482	COCALZINHO DE GOIAS	19795888	COCALZINHO	17/01/2020 06:06	17/01/2020 22:10	17/01/2020 06:06	17/01/2020 22:10	16,05	85	1364,37	CHI
20200198482	COCALZINHO DE GOIAS	ZN13129310	COCALZINHO	17/01/2020 06:06	17/01/2020 22:10	17/01/2020 06:06	17/01/2020 22:10	16,05	1	16,05	CHI
20200198482	CORUMBA DE GOIAS	19795888	COCALZINHO	17/01/2020 06:06	17/01/2020 22:10	17/01/2020 06:06	17/01/2020 22:10	16,05	233	3739,97	CHI
20200198482	COCALZINHO DE GOIAS	ZN13129310	COCALZINHO	17/01/2020 06:06	17/01/2020 22:10	17/01/2020 13:58	17/01/2020 22:10	8,19	854	6990,94	CHI
20200198482	CORUMBA DE GOIAS	ZN13129310	COCALZINHO	17/01/2020 06:06	17/01/2020 22:10	17/01/2020 13:58	17/01/2020 22:10	8,19	76	622,14	CHI
20200198482	COCALZINHO DE GOIAS	ZN13129310	COCALZINHO	17/01/2020 06:06	17/01/2020 22:10	17/01/2020 17:51	17/01/2020 22:10	4,31	4	17,26	CHI
20200198484	MONTIVIDIU	MV12267623	MONTIVIDIU T	17/01/2020 06:18	17/01/2020 09:36	17/01/2020 06:18	17/01/2020 09:36	3,29	29	95,35	CHI
20200198490	OUIDOR	OU12042459	CATALAO S1	17/01/2020 06:19	17/01/2020 10:18	17/01/2020 06:19	17/01/2020 10:18	3,98	3	11,93	CHI
20200198494	ITARUMA	IM12402357	CACHOEIRA ALTA	17/01/2020 06:19	18/01/2020 09:46	17/01/2020 06:19	18/01/2020 09:46	27,44	6	164,64	CHI
20200198505	CRIXAS	CX12318400	MOZARLANDIA	17/01/2020 06:20	17/01/2020 17:38	17/01/2020 06:20	17/01/2020 17:38	11,28	11	124,13	CHI
20200198512	INDIARA	IY12010814	EDEIA	17/01/2020 06:21	17/01/2020 11:20	17/01/2020 06:21	17/01/2020 11:20	4,97	9	44,73	CHI
20200198513	PIRACANJUBA	PJ12025031	PIRACANJUBA	17/01/2020 06:22	17/01/2020 09:05	17/01/2020 06:22	17/01/2020 09:05	2,72	69	187,35	CHI
20200198516	MONTIVIDIU	MV12267625	MONTIVIDIU T	17/01/2020 06:22	17/01/2020 10:23	17/01/2020 06:22	17/01/2020 10:23	4,00	4	16,00	CHI
20200198521	GOIANIA	13711143	FERROVIARIO S3	17/01/2020 06:24	17/01/2020 07:10	17/01/2020 06:24	17/01/2020 07:10	0,77	1	0,77	CHI
20200198522	IVOLANDIA	IV12129886	IPORA	17/01/2020 02:14	17/01/2020 17:32	17/01/2020 02:14	17/01/2020 17:32	15,30	44	673,36	CHI
20200198522	PALESTINA DE GOIAS	IV12129886	IPORA	17/01/2020 02:14	17/01/2020 17:32	17/01/2020 02:14	17/01/2020 17:32	15,30	12	183,64	CHI
20200198523	BURITI DE GOIAS	BS12076542	FIRMINOPOLIS S2	16/01/2020 22:12	17/01/2020 08:35	16/01/2020 22:12	17/01/2020 08:35	10,37	37	383,73	CHI
20200198524	RIO VERDE	RV12230830	MONTIVIDIU T	17/01/2020 05:44	17/01/2020 16:45	17/01/2020 05:44	17/01/2020 16:45	11,02	7	77,11	CHI
20200198528	FAINA	FC12038664	GOIAS	17/01/2020 06:24	17/01/2020 08:59	17/01/2020 06:24	17/01/2020 08:59	2,57	10	25,68	CHI
20200198530	JUSSARA	JR12220059	JUSSARA	17/01/2020 06:25	17/01/2020 08:40	17/01/2020 06:25	17/01/2020 08:40	2,24	12	26,92	CHI
20200198532	JATAI	JT12182190	JATAI S1	17/01/2020 06:26	17/01/2020 13:03	17/01/2020 06:26	17/01/2020 13:03	6,61	25	165,14	CHI
20200198535	DIORAMA	DI12023266	IPORA	17/01/2020 06:27	17/01/2020 12:12	17/01/2020 06:27	17/01/2020 12:12	5,76	63	362,72	CHI
20200198535	JAUPACI	DI12023266	IPORA	17/01/2020 06:27	17/01/2020 12:12	17/01/2020 06:27	17/01/2020 12:12	5,76	9	51,82	CHI
20200198536	CORUMBAIBA	CI21298612	VILA CORUMBA	16/01/2020 21:29	17/01/2020 13:15	16/01/2020 21:29	17/01/2020 13:15	15,76	1	15,76	CHI
20200198539	ITAPIRAPUA	IU11057823	MATRINCHA	17/01/2020 06:27	17/01/2020 10:40	17/01/2020 06:27	17/01/2020 10:40	4,21	25	105,26	CHI
20200198540	COCALZINHO DE GOIAS	ZN11155154	COCALZINHO	17/01/2020 06:21	17/01/2020 12:33	17/01/2020 06:21	17/01/2020 12:33	6,20	124	768,59	CHI
20200198551	MUTUNOPOLIS	PO12297103	PORANGATU	17/01/2020 05:29	17/01/2020 07:37	17/01/2020 05:29	17/01/2020 07:37	2,13	4	8,52	CHI
20200198551	PORANGATU	PO12297103	PORANGATU	17/01/2020 05:29	17/01/2020 07:37	17/01/2020 05:29	17/01/2020 07:37	2,13	32	68,14	CHI
20200198552	MINACU	IH12236222	MINACU	17/01/2020 06:30	17/01/2020 08:20	17/01/2020 06:30	17/01/2020 08:20	1,83	19	34,81	CHI
20200198554	PLANALTINA	2960143122	PLANALTINA	17/01/2020 06:30	17/01/2020 08:10	17/01/2020 06:30	17/01/2020 08:10	1,66	1	1,66	CHI

20200198555	ABADIANIA	AA12285384	ANAPOLIS UNIVERSITARIO S1	17/01/2020 06:30	17/01/2020 09:48	17/01/2020 06:30	17/01/2020 09:48	3,30	99	326,34	CHI
20200198555	GAMELEIRA DE GOIAS	AA12285384	ANAPOLIS UNIVERSITARIO S1	17/01/2020 06:30	17/01/2020 09:48	17/01/2020 06:30	17/01/2020 09:48	3,30	1	3,30	CHI
20200198558	ARAGUAPAZ	FC12299833	GOIAS	17/01/2020 05:31	17/01/2020 08:15	17/01/2020 05:31	17/01/2020 08:15	2,72	16	43,48	CHI
20200198558	FAINA	FC12299833	GOIAS	17/01/2020 05:31	17/01/2020 08:15	17/01/2020 05:31	17/01/2020 08:15	2,72	9	24,46	CHI
20200198563	RIO VERDE	RV12226317	MONTIVIDIU T	17/01/2020 06:19	17/01/2020 10:25	17/01/2020 06:19	17/01/2020 10:25	4,09	2	8,18	CHI
20200198566	CACHOEIRA DOURADA	CD21293059	CACHOEIRA DOURADA	17/01/2020 06:31	17/01/2020 08:25	17/01/2020 06:31	17/01/2020 08:25	1,90	1	1,90	CHI
20200198572	JUSSARA	JR12073388	BRITANIA	17/01/2020 06:32	17/01/2020 15:47	17/01/2020 06:32	17/01/2020 15:47	9,26	1	9,26	CHI
20200198575	RUBIATABA	RB12110437	RUBIATABA	17/01/2020 06:32	17/01/2020 21:31	17/01/2020 06:32	17/01/2020 21:31	14,97	7	104,82	CHI
20200198576	HEITORAI	IC12376461	ITABERAI S1	17/01/2020 01:15	17/01/2020 08:28	17/01/2020 01:15	17/01/2020 08:28	7,20	7	50,42	CHI
20200198576	ITAGUARU	IC12376461	ITABERAI S1	17/01/2020 01:15	17/01/2020 08:28	17/01/2020 01:15	17/01/2020 08:28	7,20	47	338,52	CHI
20200198583	GOIANIA	GN12133716	CARAJAS S1	17/01/2020 06:33	17/01/2020 07:58	17/01/2020 06:33	17/01/2020 07:58	1,41	4	5,65	CHI
20200198594	PARAUNA	PU12081327	FIRMINOPOLIS S2	17/01/2020 06:34	17/01/2020 09:13	17/01/2020 06:34	17/01/2020 09:13	2,63	18	47,42	CHI
20200198597	COLINAS DO SUL	TI12197726	MINACU	17/01/2020 06:35	17/01/2020 09:53	17/01/2020 06:35	17/01/2020 09:53	3,30	3	9,90	CHI
20200198604	PALMEIRAS DE GOIAS	PL12109625	PALMEIRAS	17/01/2020 06:35	17/01/2020 07:42	17/01/2020 06:35	17/01/2020 07:42	1,10	30	33,07	CHI
20200198605	CAVALCANTE	CJ12163376	FLORES DE GOIAS	17/01/2020 06:36	17/01/2020 10:20	17/01/2020 06:36	17/01/2020 10:20	3,73	16	59,63	CHI
20200198606	ITABERAI	IB12061625	ITABERAI S2	17/01/2020 06:36	17/01/2020 11:10	17/01/2020 06:36	17/01/2020 11:10	4,56	4	18,24	CHI
20200198607	GOIATUBA	GT12000091	GOIATUBA S2	17/01/2020 06:36	17/01/2020 10:32	17/01/2020 06:36	17/01/2020 10:32	3,92	12	47,10	CHI
20200198608	JUSSARA	JR12061411	BRITANIA	17/01/2020 06:34	18/01/2020 09:54	17/01/2020 06:34	18/01/2020 09:54	27,33	2	54,65	CHI
20200198610	CATALAO	10020402404	CATALAO S1	17/01/2020 06:36	17/01/2020 15:19	17/01/2020 06:36	17/01/2020 15:19	8,70	1	8,70	CHI
20200198611	SAO JOAO D ALIANCA	JL21379184	SAO JOAO D ALIANCA	17/01/2020 06:36	17/01/2020 07:30	17/01/2020 06:36	17/01/2020 07:30	0,90	2	1,79	CHI
20200198613	PONTALINA	PK12218118	GOIATUBA S1	17/01/2020 06:37	17/01/2020 09:53	17/01/2020 06:37	17/01/2020 09:53	3,26	3	9,79	CHI
20200198617	SANCLERLANDIA	SC12373733	FIRMINOPOLIS S2	16/01/2020 23:30	17/01/2020 08:00	16/01/2020 23:30	17/01/2020 08:00	8,49	1	8,49	CHI
20200198621	JAUPACI	JP21380898	IPORA	17/01/2020 06:38	17/01/2020 11:10	17/01/2020 06:38	17/01/2020 11:10	4,54	1	4,54	CHI
20200198625	CAMPINACU	UC12244555	PORANGATU	17/01/2020 06:38	17/01/2020 08:29	17/01/2020 06:38	17/01/2020 08:29	1,84	17	31,34	CHI
20200198626	CACU	CC12028258	CACHOEIRA ALTA	17/01/2020 06:00	19/01/2020 18:05	17/01/2020 06:00	17/01/2020 13:30	7,51	4	30,03	CHI
20200198626	CACU	CC12028258	CACHOEIRA ALTA	17/01/2020 06:00	19/01/2020 18:05	17/01/2020 06:00	19/01/2020 18:05	60,08	54	3244,43	CHI
20200198626	QUIRINOPOLIS	CC12028258	CACHOEIRA ALTA	17/01/2020 06:00	19/01/2020 18:05	17/01/2020 06:00	19/01/2020 18:05	60,08	1	60,08	CHI
20200198626	CACU	CC12028258	CACHOEIRA ALTA	17/01/2020 06:00	19/01/2020 18:05	17/01/2020 13:31	19/01/2020 18:05	52,57	4	210,29	CHI
20200198628	CRISTALINA	KR12087954	CRISTALINA S2	17/01/2020 04:44	17/01/2020 09:46	17/01/2020 04:44	17/01/2020 09:46	5,02	3	15,06	CHI
20200198629	MIMOSO DE GOIAS	MJ12377205	PADRE BERNARDO	17/01/2020 06:38	17/01/2020 08:22	17/01/2020 06:38	17/01/2020 08:22	1,72	3	5,17	CHI
20200198630	FAZENDA NOVA	FN12113509	IPORA	17/01/2020 06:38	17/01/2020 10:00	17/01/2020 06:38	17/01/2020 10:00	3,37	36	121,34	CHI
20200198637	DOVERLANDIA	DV21155492	CAIAPONIA	17/01/2020 06:39	17/01/2020 11:15	17/01/2020 06:39	17/01/2020 11:15	4,59	1	4,59	CHI
20200198639	URUACU	UR12082989	URUACU	17/01/2020 06:39	17/01/2020 08:38	17/01/2020 06:39	17/01/2020 08:38	1,97	6	11,81	CHI

20200198642	VIANOPOLIS	VN21289086	VIANOPOLIS	17/01/2020 06:40	17/01/2020 10:12	17/01/2020 06:40	17/01/2020 10:12	3,54	1	3,54	CHI
20200198646	SAO LUIS DE MONTES BELOS	SL12007695	SAO LUIZ DOS MONTES BELOS	17/01/2020 06:32	18/01/2020 09:18	17/01/2020 06:32	18/01/2020 09:18	26,76	9	240,82	CHI
20200198647	PIRENOPOLIS	PV11196715	CORUMBA	17/01/2020 06:40	17/01/2020 10:24	17/01/2020 06:40	17/01/2020 10:24	3,72	66	245,52	CHI
20200198649	ALVORADA DO NORTE	BQ12180925RE	IACIARA S2	17/01/2020 02:53	17/01/2020 08:08	17/01/2020 02:53	17/01/2020 08:08	5,25	1	5,25	CHI
20200198649	BURITINOPOLIS	BQ12180925RE	IACIARA S2	17/01/2020 02:53	17/01/2020 08:08	17/01/2020 02:53	17/01/2020 08:08	5,25	149	782,25	CHI
20200198652	CRISTALINA	KR12183710	CRISTALINA S2	17/01/2020 06:41	17/01/2020 10:46	17/01/2020 06:41	17/01/2020 10:46	4,08	1	4,08	CHI
20200198656	SILVANIA	SV12310203	VIANOPOLIS	17/01/2020 06:41	17/01/2020 09:14	17/01/2020 06:41	17/01/2020 09:14	2,54	6	15,22	CHI
20200198662	CACHOEIRA DOURADA	IT21081122	CACHOEIRA DOURADA	17/01/2020 06:42	17/01/2020 12:37	17/01/2020 06:42	17/01/2020 12:37	5,91	1	5,91	CHI
20200198664	CEZARINA	IY12220511	EDEIA	17/01/2020 06:43	17/01/2020 09:11	17/01/2020 06:43	17/01/2020 09:11	2,46	6	14,79	CHI
20200198664	INDIARA	IY12220511	EDEIA	17/01/2020 06:43	17/01/2020 09:11	17/01/2020 06:43	17/01/2020 09:11	2,46	6	14,79	CHI
20200198665	GOIANDIRA	GD12127685	CATALAO S1	17/01/2020 05:37	17/01/2020 10:51	17/01/2020 05:37	17/01/2020 10:51	5,23	10	52,25	CHI
20200198665	NOVA AURORA	GD12127685	CATALAO S1	17/01/2020 05:37	17/01/2020 10:51	17/01/2020 05:37	17/01/2020 10:51	5,23	12	62,70	CHI
20200198667	QUIRINOPOLIS	QI12217037	QUIRINOPOLIS	17/01/2020 06:43	17/01/2020 08:44	17/01/2020 06:43	17/01/2020 08:44	2,01	432	869,16	CHI
20200198672	APARECIDA DO RIO DOCE	JT12211312	JATAI S1	17/01/2020 06:43	18/01/2020 08:07	17/01/2020 06:43	18/01/2020 08:07	25,40	2	50,80	CHI
20200198672	JATAI	JT12211312	JATAI S1	17/01/2020 06:43	18/01/2020 08:07	17/01/2020 06:43	18/01/2020 08:07	25,40	1	25,40	CHI
20200198682	JARAGUA	SR12019009	INHUMAS S1	17/01/2020 00:39	17/01/2020 07:57	17/01/2020 00:39	17/01/2020 07:57	7,30	2	14,59	CHI
20200198682	SANTA ROSA DE GOIAS	SR12019009	INHUMAS S1	17/01/2020 00:39	17/01/2020 07:57	17/01/2020 00:39	17/01/2020 07:57	7,30	68	496,21	CHI
20200198682	TAQUARAL DE GOIAS	SR12019009	INHUMAS S1	17/01/2020 00:39	17/01/2020 07:57	17/01/2020 00:39	17/01/2020 07:57	7,30	45	328,37	CHI
20200198686	ARAGARCAS	BM12155745	BOM JARDIM	17/01/2020 03:56	17/01/2020 08:18	17/01/2020 03:56	17/01/2020 08:18	4,37	87	379,92	CHI
20200198686	BOM JARDIM DE GOIAS	BM12155745	BOM JARDIM	17/01/2020 03:56	17/01/2020 08:18	17/01/2020 03:56	17/01/2020 08:18	4,37	55	240,18	CHI
20200198687	RIO VERDE	RV12246752	CABRIUVA S2	17/01/2020 02:04	17/01/2020 13:56	17/01/2020 02:04	17/01/2020 13:56	11,86	18	213,49	CHI
20200198688	GOIAS	GS12073885	MATRINCHA	17/01/2020 06:45	17/01/2020 20:48	17/01/2020 06:45	17/01/2020 12:11	5,42	8	43,37	CHI
20200198688	GOIAS	GS12094808LD	MATRINCHA	17/01/2020 06:45	17/01/2020 20:48	17/01/2020 06:45	17/01/2020 13:58	7,21	3	21,62	CHI
20200198688	GOIAS	GS12148797LD	MATRINCHA	17/01/2020 06:45	17/01/2020 20:48	17/01/2020 06:45	17/01/2020 20:48	14,04	3	42,11	CHI
20200198690	PALMEIRAS DE GOIAS	PL12331634	FIRMINOPOLIS S2	17/01/2020 00:12	17/01/2020 08:41	17/01/2020 00:12	17/01/2020 08:41	8,48	13	110,27	CHI
20200198691	FORMOSO	TB12372648	PORANGATU	17/01/2020 06:46	17/01/2020 16:47	17/01/2020 06:46	17/01/2020 16:47	10,01	1	10,01	CHI
20200198691	TROMBAS	TB12372648	PORANGATU	17/01/2020 06:46	17/01/2020 16:47	17/01/2020 06:46	17/01/2020 16:47	10,01	66	660,94	CHI
20200198692	BARRO ALTO	BA12342220	GOIANESIA S1	17/01/2020 06:46	17/01/2020 13:46	17/01/2020 06:46	17/01/2020 13:46	7,00	1	7,00	CHI
20200198697	MOZARLANDIA	MZ12220375	MOZARLANDIA	17/01/2020 04:01	17/01/2020 10:45	17/01/2020 04:01	17/01/2020 10:45	6,75	32	215,95	CHI
20200198699	SERRANOPOLIS	SX12241669	JATAI S1	17/01/2020 06:46	17/01/2020 11:25	17/01/2020 06:46	17/01/2020 11:25	4,63	13	60,24	CHI
20200198702	HIDROLANDIA	HD21158057	PONTALINA	17/01/2020 06:47	17/01/2020 19:45	17/01/2020 06:47	17/01/2020 19:22	12,59	1	12,59	CHI
20200198702	HIDROLANDIA	HD12007560	PONTALINA	17/01/2020 06:47	17/01/2020 19:45	17/01/2020 16:07	17/01/2020 19:45	3,65	13	47,41	CHI
20200198707	QUIRINOPOLIS	RV12301218	SANTA HELENA S1	17/01/2020 06:47	17/01/2020 13:42	17/01/2020 06:47	17/01/2020 13:42	6,90	36	248,49	CHI

20200198707	RIO VERDE	RV12301218	SANTA HELENA S1	17/01/2020 06:47	17/01/2020 13:42	17/01/2020 06:47	17/01/2020 13:42	6,90	16	110,44	CHI
20200198709	PILAR DE GOIAS	GG12340134	SANTA TEREZINHA	17/01/2020 06:48	17/01/2020 15:38	17/01/2020 06:48	17/01/2020 15:38	8,83	3	26,50	CHI
20200198711	PORANGATU	PO12208558	PORANGATU	17/01/2020 06:44	17/01/2020 08:21	17/01/2020 06:44	17/01/2020 08:21	1,60	14	22,45	CHI
20200198715	MINEIROS	MY12390605	PARQUE DAS EMAS	17/01/2020 06:48	18/01/2020 09:39	17/01/2020 06:48	18/01/2020 09:39	26,84	14	375,70	CHI
20200198717	GOIAS	GS12310531	GOIAS	17/01/2020 06:48	17/01/2020 11:09	17/01/2020 06:48	17/01/2020 11:09	4,34	17	73,70	CHI
20200198717	GUARAITA	GS12310531	GOIAS	17/01/2020 06:48	17/01/2020 11:09	17/01/2020 06:48	17/01/2020 11:09	4,34	2	8,67	CHI
20200198717	ITAPURANGA	GS12310531	GOIAS	17/01/2020 06:48	17/01/2020 11:09	17/01/2020 06:48	17/01/2020 11:09	4,34	2	8,67	CHI
20200198718	VARJAO	VJ31009121	GUAPO S2	17/01/2020 06:48	17/01/2020 17:07	17/01/2020 06:48	17/01/2020 17:07	10,30	1	10,30	CHI
20200198723	RIO VERDE	RV12226329	CABRIUVA S2	17/01/2020 01:26	17/01/2020 08:44	17/01/2020 01:26	17/01/2020 08:44	7,29	25	182,28	CHI
20200198725	FORMOSA	FA12233644	SAO JOAO D ALIANCA	17/01/2020 05:59	17/01/2020 13:11	17/01/2020 05:59	17/01/2020 13:11	7,19	22	158,27	CHI
20200198730	PALMEIRAS DE GOIAS	PL12391389	PALMEIRAS	17/01/2020 06:50	17/01/2020 09:20	17/01/2020 06:50	17/01/2020 09:20	2,50	3	7,50	CHI
20200198735	DIORAMA	DI12279325	IPORA	17/01/2020 06:50	17/01/2020 13:40	17/01/2020 06:50	17/01/2020 13:40	6,82	65	443,52	CHI
20200198737	SANTA CRUZ DE GOIAS	CN12409036	CALDAS NOVAS S1	17/01/2020 06:51	17/01/2020 12:35	17/01/2020 06:51	17/01/2020 12:35	5,73	4	22,93	CHI
20200198738	ADELANDIA	SL12019453	FIRMINOPOLIS S2	17/01/2020 05:55	17/01/2020 16:28	17/01/2020 05:55	17/01/2020 16:28	10,55	44	463,98	CHI
20200198738	MOSSAMEDES	SL12019453	FIRMINOPOLIS S2	17/01/2020 05:55	17/01/2020 16:28	17/01/2020 05:55	17/01/2020 16:28	10,55	5	52,73	CHI
20200198738	SANCLERLANDIA	SL12019453	FIRMINOPOLIS S2	17/01/2020 05:55	17/01/2020 16:28	17/01/2020 05:55	17/01/2020 16:28	10,55	30	316,35	CHI
20200198738	SAO LUIS DE MONTES BELOS	SL12019453	FIRMINOPOLIS S2	17/01/2020 05:55	17/01/2020 16:28	17/01/2020 05:55	17/01/2020 16:28	10,55	14	147,63	CHI
20200198741	GOIAS	IK12250614	ITAPURANGA	17/01/2020 06:46	17/01/2020 09:56	17/01/2020 06:46	17/01/2020 09:56	3,16	2	6,32	CHI
20200198741	GUARAITA	IK12250614	ITAPURANGA	17/01/2020 06:46	17/01/2020 09:56	17/01/2020 06:46	17/01/2020 09:56	3,16	16	50,56	CHI
20200198741	ITAPURANGA	IK12250614	ITAPURANGA	17/01/2020 06:46	17/01/2020 09:56	17/01/2020 06:46	17/01/2020 09:56	3,16	21	66,36	CHI
20200198742	SAO LUIS DE MONTES BELOS	SL21003928	SAO LUIZ DOS MONTES BELOS	17/01/2020 06:51	17/01/2020 11:25	17/01/2020 06:51	17/01/2020 11:25	4,57	2	9,13	CHI
20200198743	IPAMERI	IP12071024	IPAMERI	17/01/2020 06:51	17/01/2020 09:38	17/01/2020 06:51	17/01/2020 09:38	2,77	7	19,38	CHI
20200198744	SANTO ANTONIO DO DESCOBERTO	SN21249710	ALEXANIA	17/01/2020 06:51	17/01/2020 10:52	17/01/2020 06:51	17/01/2020 10:52	4,00	1	4,00	CHI
20200198748	JATAI	290185660	JATAI S1	17/01/2020 06:52	17/01/2020 13:23	17/01/2020 06:52	17/01/2020 13:23	6,50	1	6,50	CHI
20200198749	BRITANIA	BT12030159	BRITANIA	17/01/2020 06:37	17/01/2020 14:39	17/01/2020 06:37	17/01/2020 14:39	8,03	2	16,06	CHI
20200198749	JUSSARA	BT12030159	BRITANIA	17/01/2020 06:37	17/01/2020 14:39	17/01/2020 06:37	17/01/2020 14:39	8,03	1	8,03	CHI
20200198752	GOIANESIA	GE12000009RE	GOIANESIA S2	17/01/2020 06:53	17/01/2020 13:10	17/01/2020 10:45	17/01/2020 12:55	2,16	42	90,85	CHI
20200198752	VILA PROPICIO	GE12000009RE	GOIANESIA S2	17/01/2020 06:53	17/01/2020 13:10	17/01/2020 10:45	17/01/2020 12:55	2,16	8	17,30	CHI
20200198752	GOIANESIA	GE12000010RE	GOIANESIA S2	17/01/2020 06:53	17/01/2020 13:10	17/01/2020 11:20	17/01/2020 13:10	1,82	12	21,86	CHI
20200198752	VILA PROPICIO	GE12000010RE	GOIANESIA S2	17/01/2020 06:53	17/01/2020 13:10	17/01/2020 11:20	17/01/2020 13:10	1,82	35	63,76	CHI
20200198753	GOIAS	GS12274255	ITABERAI S1	17/01/2020 06:53	17/01/2020 15:06	17/01/2020 06:53	17/01/2020 15:06	8,20	2	16,41	CHI
20200198754	MINEIROS	PW12219564	PARQUE DAS EMAS	17/01/2020 05:21	17/01/2020 16:18	17/01/2020 05:21	17/01/2020 16:18	10,94	7	76,59	CHI
20200198754	PORTELANDIA	PW12219564	PARQUE DAS EMAS	17/01/2020 05:21	17/01/2020 16:18	17/01/2020 05:21	17/01/2020 16:18	10,94	12	131,30	CHI

20200198760	GOIAS	GS12022123	ITAPURANGA	17/01/2020 06:55	17/01/2020 10:07	17/01/2020 06:55	17/01/2020 10:07	3,20	21	67,30	CHI
20200198760	HEITORAI	GS12022123	ITAPURANGA	17/01/2020 06:55	17/01/2020 10:07	17/01/2020 06:55	17/01/2020 10:07	3,20	6	19,23	CHI
20200198762	CATALAO	CT12042368	CATALAO S1	17/01/2020 06:55	17/01/2020 15:59	17/01/2020 06:55	17/01/2020 15:59	9,07	35	317,33	CHI
20200198762	DISTRITO FEDERAL	CT12042368	CATALAO S1	17/01/2020 06:55	17/01/2020 15:59	17/01/2020 06:55	17/01/2020 15:59	9,07	1	9,07	CHI
20200198768	SAO JOAO D ALIANCA	JL12237037	ITUIQUIRA	17/01/2020 06:56	17/01/2020 11:53	17/01/2020 06:56	17/01/2020 11:53	4,94	21	103,75	CHI
20200198778	SANTO ANTONIO DO DESCOBERTO	SN12082917	MARAJOARA	17/01/2020 06:57	17/01/2020 09:22	17/01/2020 06:57	17/01/2020 09:22	2,40	31	74,55	CHI
20200198780	CAIAPONIA	PY12121107	PALESTINA	17/01/2020 06:58	17/01/2020 09:38	17/01/2020 06:58	17/01/2020 09:38	2,66	49	130,39	CHI
20200198780	PALESTINA DE GOIAS	PY12121107	PALESTINA	17/01/2020 06:58	17/01/2020 09:38	17/01/2020 06:58	17/01/2020 09:38	2,66	35	93,14	CHI
20200198798	MINEIROS	MY21265889	CHAPADAO DO CEU	17/01/2020 07:00	17/01/2020 18:22	17/01/2020 07:00	17/01/2020 18:22	11,36	1	11,36	CHI
20200198802	SITIO D ABADIA	SI12211381	IACIARA S2	17/01/2020 06:39	17/01/2020 08:25	17/01/2020 06:39	17/01/2020 08:25	1,75	28	49,01	CHI
20200198803	SAO MIGUEL DO ARAGUAIA	SM12020623	SAO MIGUEL DO ARAGUAIA	17/01/2020 07:00	17/01/2020 18:33	17/01/2020 07:00	17/01/2020 18:33	11,54	5	57,72	CHI
20200198803	SAO MIGUEL DO ARAGUAIA	SM21020627	SAO MIGUEL DO ARAGUAIA	17/01/2020 07:00	17/01/2020 18:33	17/01/2020 07:00	17/01/2020 18:33	11,56	1	11,56	CHI
20200198804	NOVA CRIXAS	NA12213190	MOZARLANDIA	17/01/2020 06:41	17/01/2020 13:17	17/01/2020 06:41	17/01/2020 13:17	6,60	23	151,74	CHI
20200198805	ACREUNA	EU12301057	ACREUNA	17/01/2020 07:00	17/01/2020 10:26	17/01/2020 07:00	17/01/2020 10:26	3,42	28	95,71	CHI
20200198822	GOIAS	GS12310400	ITABERAI S1	16/01/2020 22:29	17/01/2020 09:01	16/01/2020 22:29	17/01/2020 09:01	10,53	46	484,35	CHI
20200198822	ITABERAI	GS12310400	ITABERAI S1	16/01/2020 22:29	17/01/2020 09:01	16/01/2020 22:29	17/01/2020 09:01	10,53	26	273,77	CHI
20200198823	FAINA	FC12158817	GOIAS	17/01/2020 06:27	17/01/2020 10:53	17/01/2020 06:27	17/01/2020 10:53	4,43	12	53,18	CHI
20200198824	CACHOEIRA ALTA	CA12075132	CACHOEIRA ALTA	17/01/2020 05:54	17/01/2020 09:41	17/01/2020 05:54	17/01/2020 09:41	3,77	23	86,82	CHI
20200198833	MONTE ALEGRE DE GOIAS	MA12212608	SAO DOMINGOS	17/01/2020 07:04	17/01/2020 08:51	17/01/2020 07:04	17/01/2020 08:51	1,78	55	97,79	CHI
20200198834	QUIRINOPOLIS	QI12000005	QUIRINOPOLIS	17/01/2020 00:50	17/01/2020 13:09	17/01/2020 00:50	17/01/2020 13:09	12,31	21	258,58	CHI
20200198843	PIRANHAS	PH12040153	PIRANHAS	17/01/2020 07:05	18/01/2020 09:44	17/01/2020 07:05	18/01/2020 09:44	26,64	1	26,64	CHI
20200198846	CATALAO	GD21053657	CATALAO S1	17/01/2020 07:05	17/01/2020 15:30	17/01/2020 07:05	17/01/2020 15:30	8,40	1	8,40	CHI
20200198851	RIO VERDE	RV12271281	ACREUNA	17/01/2020 07:03	17/01/2020 09:48	17/01/2020 07:03	17/01/2020 09:48	2,74	9	24,63	CHI
20200198854	AGUA FRIA DE GOIAS	NQ12140182	SAO JOAO D ALIANCA	17/01/2020 07:07	17/01/2020 10:28	17/01/2020 07:07	17/01/2020 10:28	3,35	70	234,25	CHI
20200198854	NIQUELANDIA	NQ12140182	SAO JOAO D ALIANCA	17/01/2020 07:07	17/01/2020 10:28	17/01/2020 07:07	17/01/2020 10:28	3,35	6	20,08	CHI
20200198858	PARAUNA	PU12312501	PARAUNA	17/01/2020 07:07	17/01/2020 10:22	17/01/2020 07:07	17/01/2020 10:22	3,24	2	6,49	CHI
20200198860	ARENOPOLIS	00160404	ARENOPOLIS	17/01/2020 05:14	17/01/2020 09:01	17/01/2020 05:14	17/01/2020 09:01	3,78	18	68,10	CHI
20200198860	PALESTINA DE GOIAS	00160404	ARENOPOLIS	17/01/2020 05:14	17/01/2020 09:01	17/01/2020 05:14	17/01/2020 09:01	3,78	5	18,92	CHI
20200198860	PIRANHAS	00160404	ARENOPOLIS	17/01/2020 05:14	17/01/2020 09:01	17/01/2020 05:14	17/01/2020 09:01	3,78	66	249,68	CHI
20200198866	GOIANIA	GN11000277	AEROPORTO S3	17/01/2020 07:08	17/01/2020 12:00	17/01/2020 07:08	17/01/2020 12:00	4,88	10	48,76	CHI
20200198868	JUSSARA	JR12011813	BRITANIA	17/01/2020 06:19	17/01/2020 16:36	17/01/2020 06:19	17/01/2020 16:36	10,28	30	308,26	CHI
20200198874	JANDAIA	JD12308457	PALMEIRAS	17/01/2020 07:08	17/01/2020 09:12	17/01/2020 07:08	17/01/2020 09:12	2,05	18	36,91	CHI
20200198875	RIO VERDE	RV12260714	RIO VERDE S1	17/01/2020 06:57	17/01/2020 08:28	17/01/2020 06:57	17/01/2020 08:28	1,52	2	3,03	CHI

20200198877	CACHOEIRA DOURADA	CD11000017	CACHOEIRA DOURADA	17/01/2020 07:09	17/01/2020 09:37	17/01/2020 07:09	17/01/2020 09:37	2,46	70	172,45	CHI
20200198879	RIO VERDE	RV12260247	RIO VERDE S2	17/01/2020 07:09	17/01/2020 09:39	17/01/2020 07:09	17/01/2020 09:39	2,49	5	12,45	CHI
20200198883	FAINA	GS12042217	GOIAS	17/01/2020 01:46	17/01/2020 10:34	17/01/2020 01:46	17/01/2020 10:34	8,79	74	650,75	CHI
20200198885	BALIZA	BH11330933	CAIAPONIA	17/01/2020 07:10	17/01/2020 11:52	17/01/2020 07:10	17/01/2020 11:52	4,70	1	4,70	CHI
20200198887	FORMOSA	610053929	ITUIQUIRA	17/01/2020 07:10	17/01/2020 08:32	17/01/2020 07:10	17/01/2020 08:32	1,36	1	1,36	CHI
20200198891	PIRENOPOLIS	PV12392221	CORUMBA	17/01/2020 07:10	17/01/2020 15:59	17/01/2020 07:10	17/01/2020 15:59	8,81	32	281,88	CHI
20200198892	CACHOEIRA ALTA	CA12078938	CACHOEIRA ALTA	16/01/2020 21:28	17/01/2020 12:55	16/01/2020 21:28	17/01/2020 12:55	15,44	4	61,77	CHI
20200198893	NIQUELANDIA	NQ12292626	BARRO ALTO	17/01/2020 07:11	17/01/2020 08:42	17/01/2020 07:11	17/01/2020 08:42	1,52	6	9,09	CHI
20200198897	PIRACANJUBA	PJ12352525	PIRACANJUBA	17/01/2020 07:11	17/01/2020 11:54	17/01/2020 07:11	17/01/2020 11:54	4,72	16	75,49	CHI
20200198898	CORREGO DO OURO	CO12300423	SAO LUIZ DOS MONTES BELOS	17/01/2020 07:07	17/01/2020 10:28	17/01/2020 07:07	17/01/2020 10:28	3,36	4	13,43	CHI
20200198899	JUSSARA	JR12101970RE	BRITANIA	17/01/2020 07:11	17/01/2020 16:28	17/01/2020 07:11	17/01/2020 16:28	9,28	11	102,08	CHI
20200198901	CALDAS NOVAS	CN12246675	SERRA DE CALDAS	17/01/2020 07:11	17/01/2020 14:43	17/01/2020 07:11	17/01/2020 14:43	7,53	2	15,05	CHI
20200198908	CEZARINA	CZ21000012	CEZARINA	17/01/2020 07:12	17/01/2020 08:43	17/01/2020 07:12	17/01/2020 08:43	1,52	1	1,52	CHI
20200198920	MOSSAMEDES	SC12323577	FIRMINOPOLIS S2	16/01/2020 23:05	17/01/2020 08:47	16/01/2020 23:05	17/01/2020 08:47	9,68	1	9,68	CHI
20200198920	SANCLERLANDIA	SC12323577	FIRMINOPOLIS S2	16/01/2020 23:05	17/01/2020 08:47	16/01/2020 23:05	17/01/2020 08:47	9,68	63	610,10	CHI
20200198921	SAO SIMAO	SO11000032	CACHOEIRA ALTA	17/01/2020 06:35	17/01/2020 13:00	17/01/2020 06:35	17/01/2020 13:00	6,42	169	1084,32	CHI
20200198926	SAO FRANCISCO DE GOIAS	SF12319863	SAO FRANCISCO DE GOIAS	17/01/2020 04:27	17/01/2020 08:55	17/01/2020 04:27	17/01/2020 08:55	4,47	7	31,28	CHI
20200198927	PARAUNA	RV12048983	ACREUNA	17/01/2020 07:13	17/01/2020 12:32	17/01/2020 07:13	17/01/2020 12:32	5,30	28	148,44	CHI
20200198933	SANCLERLANDIA	SC11194201	FIRMINOPOLIS S2	17/01/2020 07:14	17/01/2020 11:21	17/01/2020 07:14	17/01/2020 11:21	4,10	164	672,95	CHI
20200198934	SAO JOAO D ALIANCA	JL121208788	SAO JOAO D ALIANCA	17/01/2020 07:14	17/01/2020 09:31	17/01/2020 07:14	17/01/2020 09:31	2,27	2	4,54	CHI
20200198937	PIRES DO RIO	PR12270810	PIRES DO RIO S1	17/01/2020 08:56	17/01/2020 12:23	17/01/2020 08:56	17/01/2020 12:23	3,45	32	110,36	CHI
20200198938	PIRES DO RIO	PR21172811	PIRES DO RIO S1	17/01/2020 07:15	17/01/2020 11:02	17/01/2020 07:15	17/01/2020 11:02	3,78	1	3,78	CHI
20200198939	FORMOSO	FO12390372	PORANGATU	17/01/2020 06:21	17/01/2020 16:18	17/01/2020 06:21	17/01/2020 16:18	9,94	6	59,65	CHI
20200198941	DAMOLANDIA	IN12022237	INHUMAS S1	17/01/2020 06:38	17/01/2020 11:55	17/01/2020 06:38	17/01/2020 11:55	5,28	9	47,52	CHI
20200198941	INHUMAS	IN12022237	INHUMAS S1	17/01/2020 06:38	17/01/2020 11:55	17/01/2020 06:38	17/01/2020 11:55	5,28	18	95,03	CHI
20200198941	PETROLINA DE GOIAS	IN12022237	INHUMAS S1	17/01/2020 06:38	17/01/2020 11:55	17/01/2020 06:38	17/01/2020 11:55	5,28	3	15,84	CHI
20200198942	CACHOEIRA ALTA	CA21011513	CACHOEIRA ALTA	17/01/2020 07:15	17/01/2020 11:16	17/01/2020 07:15	17/01/2020 11:16	4,01	1	4,01	CHI
20200198947	GOIAS	IK12274567	GOIAS	17/01/2020 03:29	17/01/2020 09:58	17/01/2020 03:29	17/01/2020 09:58	6,48	5	32,41	CHI
20200198952	COCALZINHO DE GOIAS	ZN12302374	COCALZINHO	16/01/2020 21:03	18/01/2020 21:13	16/01/2020 21:03	18/01/2020 21:13	48,17	8	385,38	CHI
20200198952	CORUMBA DE GOIAS	ZN12302374	COCALZINHO	16/01/2020 21:03	18/01/2020 21:13	16/01/2020 21:03	18/01/2020 21:13	48,17	1	48,17	CHI
20200198955	PIRENOPOLIS	PV21284945	CORUMBA	17/01/2020 07:15	17/01/2020 16:35	17/01/2020 07:15	17/01/2020 16:35	9,32	1	9,32	CHI
20200198959	RIO VERDE	RV12249024	SANTA HELENA S1	17/01/2020 00:56	17/01/2020 14:16	17/01/2020 00:56	17/01/2020 14:16	13,32	4	53,29	CHI
20200198961	ARAGUAPAZ	AZ12238877	MOZARLANDIA	17/01/2020 06:46	17/01/2020 09:32	17/01/2020 06:46	17/01/2020 09:32	2,76	15	41,42	CHI

20200198964	CEZARINA	CZ12025257	CEZARINA	17/01/2020 07:16	17/01/2020 10:27	17/01/2020 07:16	17/01/2020 10:27	3,18	8	25,40	CHI
20200198979	QUIRINOPOLIS	QI21296551	QUIRINOPOLIS	17/01/2020 07:17	18/01/2020 08:15	17/01/2020 07:17	18/01/2020 08:15	24,95	1	24,95	CHI
20200198982	RIO VERDE	RV12271283	CABRIUVA S2	17/01/2020 07:18	17/01/2020 15:02	17/01/2020 07:18	17/01/2020 15:02	7,73	20	154,59	CHI
20200198984	FAINA	FC12147790	GOIAS	17/01/2020 07:18	18/01/2020 11:32	17/01/2020 07:18	18/01/2020 11:32	28,22	5	141,12	CHI
20200199005	SERRANOPOLIS	SX12037674	JATAI S1	17/01/2020 05:35	17/01/2020 15:33	17/01/2020 05:35	17/01/2020 15:33	9,96	37	368,36	CHI
20200199012	INHUMAS	IN12016060	INHUMAS S1	17/01/2020 07:20	17/01/2020 11:25	17/01/2020 07:20	17/01/2020 11:25	4,07	15	61,02	CHI
20200199019	GOIAS	IU12072501	MATRINCHA	17/01/2020 07:21	17/01/2020 18:00	17/01/2020 07:21	17/01/2020 18:00	10,64	13	138,28	CHI
20200199020	ITAPIRAPUA	IU12073722	MATRINCHA	17/01/2020 07:15	17/01/2020 16:52	17/01/2020 07:15	17/01/2020 16:52	9,61	3	28,82	CHI
20200199023	IPORA	AM12402911	IPORA	17/01/2020 07:07	17/01/2020 11:20	17/01/2020 07:07	17/01/2020 11:20	4,21	45	189,55	CHI
20200199030	GOIANESIA	SZ12366599	GOIANESIA S1	17/01/2020 04:05	17/01/2020 10:09	17/01/2020 04:05	17/01/2020 10:09	6,05	11	66,58	CHI
20200199032	CEZARINA	IY12010807	EDEIA	17/01/2020 07:23	17/01/2020 12:10	17/01/2020 07:23	17/01/2020 12:10	4,78	1	4,78	CHI
20200199032	INDIARA	IY12010807	EDEIA	17/01/2020 07:23	17/01/2020 12:10	17/01/2020 07:23	17/01/2020 12:10	4,78	33	157,64	CHI
20200199033	BALIZA	BM12390150	BOM JARDIM	17/01/2020 05:21	17/01/2020 10:31	17/01/2020 05:21	17/01/2020 10:31	5,16	50	258,25	CHI
20200199033	BOM JARDIM DE GOIAS	BM12390150	BOM JARDIM	17/01/2020 05:21	17/01/2020 10:31	17/01/2020 05:21	17/01/2020 10:31	5,16	9	46,48	CHI
20200199034	JARAGUA	JA12273009	JARAGUA	17/01/2020 07:23	17/01/2020 15:36	17/01/2020 07:23	17/01/2020 15:36	8,21	11	90,29	CHI
20200199035	PONTALINA	PK12181924	VICENTINOPOLIS	17/01/2020 06:22	17/01/2020 09:56	17/01/2020 06:22	17/01/2020 09:56	3,56	21	74,66	CHI
20200199036	SAO LUIS DE MONTES BELOS	SL21315373	FIRMINOPOLIS S2	17/01/2020 07:23	17/01/2020 17:28	17/01/2020 07:23	17/01/2020 17:28	10,07	1	10,07	CHI
20200199043	CAMPO ALEGRE DE GOIAS	CM21338744	CAMPO ALEGRE DE GOIAS	17/01/2020 07:24	17/01/2020 15:18	17/01/2020 07:24	17/01/2020 15:18	7,89	2	15,79	CHI
20200199045	JATAI	JT12205195	JATAI S1	17/01/2020 06:13	17/01/2020 23:03	17/01/2020 06:13	17/01/2020 14:49	8,60	22	189,14	CHI
20200199045	JATAI	JT12205195	JATAI S1	17/01/2020 06:13	17/01/2020 23:03	17/01/2020 06:13	17/01/2020 23:03	16,83	21	353,44	CHI
20200199057	JATAI	JT21209737	JATAI S1	17/01/2020 07:25	18/01/2020 08:14	17/01/2020 07:25	18/01/2020 08:14	24,81	1	24,81	CHI
20200199060	PALMINOPOLIS	PP12031600	PALMEIRAS	17/01/2020 06:40	17/01/2020 10:10	17/01/2020 06:40	17/01/2020 10:10	3,50	23	80,58	CHI
20200199079	TRES RANCHOS	TH21000402	CATALAO S1	17/01/2020 07:27	17/01/2020 13:29	17/01/2020 07:27	17/01/2020 13:29	6,03	1	6,03	CHI
20200199080	MATRINCHA	MP12221185	MATRINCHA	17/01/2020 07:19	17/01/2020 09:15	17/01/2020 07:19	17/01/2020 09:15	1,93	56	108,03	CHI
20200199081	APARECIDA DO RIO DOCE	AW12191524	CACHOEIRA ALTA	17/01/2020 06:49	17/01/2020 13:37	17/01/2020 06:49	17/01/2020 13:37	6,80	73	496,38	CHI
20200199081	CACHOEIRA ALTA	AW12191524	CACHOEIRA ALTA	17/01/2020 06:49	17/01/2020 13:37	17/01/2020 06:49	17/01/2020 13:37	6,80	66	448,78	CHI
20200199081	JATAI	AW12191524	CACHOEIRA ALTA	17/01/2020 06:49	17/01/2020 13:37	17/01/2020 06:49	17/01/2020 13:37	6,80	36	244,79	CHI
20200199081	RIO VERDE	AW12191524	CACHOEIRA ALTA	17/01/2020 06:49	17/01/2020 13:37	17/01/2020 06:49	17/01/2020 13:37	6,80	8	54,40	CHI
20200199083	PALMEIRAS DE GOIAS	PL21036112	ANICUNS	17/01/2020 07:27	17/01/2020 08:56	17/01/2020 07:27	17/01/2020 08:56	1,49	1	1,49	CHI
20200199095	IPORA	IR12358520	IPORA	16/01/2020 20:35	17/01/2020 16:28	16/01/2020 20:35	17/01/2020 16:28	19,88	10	198,77	CHI
20200199095	IVOLANDIA	IR12358520	IPORA	16/01/2020 20:35	17/01/2020 16:28	16/01/2020 20:35	17/01/2020 16:28	19,88	8	159,02	CHI
20200199098	FAINA	FC21061039	GOIAS	17/01/2020 07:28	17/01/2020 14:00	17/01/2020 07:28	17/01/2020 14:00	6,54	1	6,54	CHI
20200199101	PIRACANJUBA	PJ12000042RE	PIRACANJUBA	17/01/2020 07:22	17/01/2020 09:44	17/01/2020 07:22	17/01/2020 09:44	2,37	10	23,66	CHI

20200199105	CACU	CC12193929	CACHOEIRA ALTA	17/01/2020 07:29	18/01/2020 12:12	17/01/2020 07:29	18/01/2020 12:12	28,71	1	28,71	CHI
20200199107	AGUAS LINDAS DE GOIAS	4830043661	AGUAS LINDAS DE GOIAS S1	17/01/2020 07:29	17/01/2020 09:27	17/01/2020 07:29	17/01/2020 09:27	1,96	1	1,96	CHI
20200199117	FAINA	FC12307552	GOIAS	17/01/2020 07:30	18/01/2020 12:24	17/01/2020 07:30	18/01/2020 12:24	28,89	4	115,57	CHI
20200199121	ITAPIRAPUA	IU12089757	MATRINCHA	17/01/2020 07:30	17/01/2020 15:30	17/01/2020 07:30	17/01/2020 15:30	7,99	9	71,89	CHI
20200199122	PALMEIRAS DE GOIAS	PL12000232	PALMEIRAS	17/01/2020 07:30	17/01/2020 09:50	17/01/2020 07:30	17/01/2020 09:50	2,32	8	18,57	CHI
20200199123	CRISTALINA	KR123206686	CRISTALINA S2	17/01/2020 07:43	17/01/2020 11:15	17/01/2020 07:43	17/01/2020 11:15	3,52	7	24,67	CHI
20200199123	LUZIANIA	KR123206686	CRISTALINA S2	17/01/2020 07:43	17/01/2020 11:15	17/01/2020 07:43	17/01/2020 11:15	3,52	7	24,67	CHI
20200199124	MAURILANDIA	ML21306550	RIO DOS BOIS	17/01/2020 07:31	17/01/2020 11:16	17/01/2020 07:31	17/01/2020 11:16	3,75	2	7,50	CHI
20200199129	PIRENOPOLIS	PV21171235	CORUMBA	17/01/2020 07:31	17/01/2020 15:40	17/01/2020 07:31	17/01/2020 15:40	8,15	1	8,15	CHI
20200199134	PIRACANJUBA	PJ21161721	ROCHEDO	17/01/2020 07:32	17/01/2020 09:15	17/01/2020 07:32	17/01/2020 09:15	1,70	1	1,70	CHI
20200199135	CEZARINA	CZ12066110	CEZARINA	17/01/2020 07:32	17/01/2020 09:39	17/01/2020 07:32	17/01/2020 09:39	2,10	11	23,12	CHI
20200199141	COCALZINHO DE GOIAS	ZN21135818	COCALZINHO	17/01/2020 07:33	17/01/2020 10:49	17/01/2020 07:33	17/01/2020 10:49	3,26	1	3,26	CHI
20200199144	BOM JARDIM DE GOIAS	BM12253664	BOM JARDIM	17/01/2020 07:33	17/01/2020 11:15	17/01/2020 07:33	17/01/2020 11:15	3,70	8	29,56	CHI
20200199148	BOM JARDIM DE GOIAS	BM12204801	BOM JARDIM	17/01/2020 06:28	17/01/2020 11:37	17/01/2020 06:28	17/01/2020 11:37	5,14	22	113,10	CHI
20200199148	PIRANHAS	BM12204801	BOM JARDIM	17/01/2020 06:28	17/01/2020 11:37	17/01/2020 06:28	17/01/2020 11:37	5,14	4	20,56	CHI
20200199150	BONOPOLIS	BX12262758	SAO MIGUEL DO ARAGUAIA	17/01/2020 07:33	17/01/2020 08:30	17/01/2020 07:33	17/01/2020 08:30	0,93	5	4,67	CHI
20200199151	BOM JARDIM DE GOIAS	BM12064234	BOM JARDIM	17/01/2020 07:34	17/01/2020 10:11	17/01/2020 07:34	17/01/2020 10:11	2,62	4	10,47	CHI
20200199158	ITABERAI	IB12336400	ITABERAI S2	17/01/2020 06:17	17/01/2020 11:02	17/01/2020 06:17	17/01/2020 11:02	4,74	16	75,86	CHI
20200199162	CAMPO LIMPO	AN12000480	NEROPOLIS S1	17/01/2020 07:34	17/01/2020 10:55	17/01/2020 07:34	17/01/2020 10:55	3,34	8	26,71	CHI
20200199164	CRISTALINA	IP21147561	CRISTALINA S1	17/01/2020 07:34	17/01/2020 15:22	17/01/2020 07:34	17/01/2020 15:22	7,79	1	7,79	CHI
20200199165	GOIANIA	GN11207471	ATLANTICO S1	17/01/2020 07:34	17/01/2020 09:13	17/01/2020 07:34	17/01/2020 09:13	1,64	84	137,46	CHI
20200199173	BALIZA	BH11227615	BOM JARDIM	17/01/2020 07:35	17/01/2020 15:32	17/01/2020 07:35	17/01/2020 15:32	7,95	1	7,95	CHI
20200199177	NOVA AURORA	IP21071416	IPAMERI	17/01/2020 07:35	17/01/2020 14:01	17/01/2020 07:35	17/01/2020 14:01	6,43	1	6,43	CHI
20200199181	JATAI	JT12184194	JATAI S1	17/01/2020 06:06	17/01/2020 11:00	17/01/2020 06:06	17/01/2020 11:00	4,89	11	53,74	CHI
20200199181	JATAI	JT21241782	JATAI S1	17/01/2020 06:06	17/01/2020 11:00	17/01/2020 06:06	17/01/2020 11:00	4,89	1	4,89	CHI
20200199182	GAMELEIRA DE GOIAS	SV12084559	DAIA S1	17/01/2020 07:35	17/01/2020 12:18	17/01/2020 07:35	17/01/2020 12:18	4,70	3	14,11	CHI
20200199182	SILVANIA	SV12084559	DAIA S1	17/01/2020 07:35	17/01/2020 12:18	17/01/2020 07:35	17/01/2020 12:18	4,70	1	4,70	CHI
20200199188	VIANOPOLIS	VN12194266	VIANOPOLIS	17/01/2020 07:36	17/01/2020 10:12	17/01/2020 07:36	17/01/2020 10:12	2,60	4	10,39	CHI
20200199189	CORREGO DO OURO	CO12056069	FIRMINOPOLIS S2	17/01/2020 07:00	17/01/2020 10:00	17/01/2020 07:00	17/01/2020 10:00	3,00	3	8,99	CHI
20200199195	EDEIA	EA12086939	EDEIA	17/01/2020 06:42	17/01/2020 08:55	17/01/2020 06:42	17/01/2020 08:55	2,21	9	19,91	CHI
20200199198	PARANAIGUARA	PC12333341	CACHOEIRA ALTA	17/01/2020 07:37	17/01/2020 11:47	17/01/2020 07:37	17/01/2020 11:47	4,16	21	87,40	CHI
20200199200	ARUANA	AK12075533	MOZARLANDIA	17/01/2020 07:37	17/01/2020 16:10	17/01/2020 07:37	17/01/2020 16:10	8,54	3	25,63	CHI
20200199200	MATRINCHA	AK12075533	MOZARLANDIA	17/01/2020 07:37	17/01/2020 16:10	17/01/2020 07:37	17/01/2020 16:10	8,54	1	8,54	CHI

20200199202	BRITANIA	BT12183232	BRITANIA	17/01/2020 07:37	17/01/2020 14:32	17/01/2020 07:37	17/01/2020 14:32	6,91	5	34,54	CHI
20200199205	BURITI DE GOIAS	03350224	FIRMINOPOLIS S2	17/01/2020 10:29	17/01/2020 21:06	17/01/2020 10:29	17/01/2020 14:21	3,87	60	232,37	CHI
20200199205	CORREGO DO OURO	03350224	FIRMINOPOLIS S2	17/01/2020 10:29	17/01/2020 21:06	17/01/2020 10:29	17/01/2020 14:21	3,87	130	503,46	CHI
20200199205	CORREGO DO OURO	03350224	FIRMINOPOLIS S2	17/01/2020 10:29	17/01/2020 21:06	17/01/2020 10:29	17/01/2020 14:21	3,87	6	23,24	CHI
20200199205	NOVO BRASIL	03350224	FIRMINOPOLIS S2	17/01/2020 10:29	17/01/2020 21:06	17/01/2020 10:29	17/01/2020 14:21	3,87	16	61,96	CHI
20200199205	SANCLERLANDIA	03350224	FIRMINOPOLIS S2	17/01/2020 10:29	17/01/2020 21:06	17/01/2020 10:29	17/01/2020 14:21	3,87	212	821,03	CHI
20200199205	BURITI DE GOIAS	03350224	FIRMINOPOLIS S2	17/01/2020 10:29	17/01/2020 21:06	17/01/2020 14:22	17/01/2020 16:10	1,81	60	108,38	CHI
20200199205	CORREGO DO OURO	03350224	FIRMINOPOLIS S2	17/01/2020 10:29	17/01/2020 21:06	17/01/2020 14:22	17/01/2020 16:10	1,81	102	184,25	CHI
20200199205	CORREGO DO OURO	03350224	FIRMINOPOLIS S2	17/01/2020 10:29	17/01/2020 21:06	17/01/2020 14:22	17/01/2020 16:10	1,81	6	10,84	CHI
20200199205	NOVO BRASIL	03350224	FIRMINOPOLIS S2	17/01/2020 10:29	17/01/2020 21:06	17/01/2020 14:22	17/01/2020 16:10	1,81	16	28,90	CHI
20200199205	CORREGO DO OURO	SC13308356	FIRMINOPOLIS S2	17/01/2020 10:29	17/01/2020 21:06	17/01/2020 10:29	17/01/2020 17:56	7,46	1	7,46	CHI
20200199205	SANCLERLANDIA	SC13308356	FIRMINOPOLIS S2	17/01/2020 10:29	17/01/2020 21:06	17/01/2020 10:29	17/01/2020 17:56	7,46	35	260,98	CHI
20200199205	SAO LUIS DE MONTES BELOS	SC13308356	FIRMINOPOLIS S2	17/01/2020 10:29	17/01/2020 21:06	17/01/2020 10:29	17/01/2020 17:56	7,46	61	454,86	CHI
20200199205	BURITI DE GOIAS	SC13308356	FIRMINOPOLIS S2	17/01/2020 10:29	17/01/2020 21:06	17/01/2020 13:40	17/01/2020 17:56	4,28	3	12,84	CHI
20200199205	SANCLERLANDIA	SC13308356	FIRMINOPOLIS S2	17/01/2020 10:29	17/01/2020 21:06	17/01/2020 13:40	17/01/2020 17:56	4,28	29	124,08	CHI
20200199205	SAO LUIS DE MONTES BELOS	SC13308356	FIRMINOPOLIS S2	17/01/2020 10:29	17/01/2020 21:06	17/01/2020 13:40	17/01/2020 17:56	4,28	47	201,09	CHI
20200199205	SANCLERLANDIA	SC13308356	FIRMINOPOLIS S2	17/01/2020 10:29	17/01/2020 21:06	17/01/2020 14:22	17/01/2020 17:56	3,57	209	746,54	CHI
20200199205	CORREGO DO OURO	SC13102360	FIRMINOPOLIS S2	17/01/2020 10:29	17/01/2020 21:06	17/01/2020 14:22	17/01/2020 21:06	6,73	28	188,34	CHI
20200199205	SANCLERLANDIA	SC13102360	FIRMINOPOLIS S2	17/01/2020 10:29	17/01/2020 21:06	17/01/2020 14:22	17/01/2020 21:06	6,73	3	20,18	CHI
20200199206	EDEIA	EA21159156	EDEIA	17/01/2020 07:38	17/01/2020 10:16	17/01/2020 07:38	17/01/2020 10:16	2,63	1	2,63	CHI
20200199209	VICENTINOPOLIS	VI21205009	VICENTINOPOLIS	17/01/2020 07:38	17/01/2020 10:53	17/01/2020 07:38	17/01/2020 10:53	3,24	1	3,24	CHI
20200199211	JATAI	JT12158533	JATAI S1	17/01/2020 06:59	17/01/2020 11:26	17/01/2020 06:59	17/01/2020 11:26	4,44	4	17,75	CHI
20200199215	GOIANIA	10101986	GOIANIA LESTE S3	17/01/2020 07:39	17/01/2020 09:06	17/01/2020 07:39	17/01/2020 09:06	1,45	1	1,45	CHI
20200199220	SANCLERLANDIA	1210012100	FIRMINOPOLIS S2	16/01/2020 23:30	17/01/2020 14:25	16/01/2020 23:30	17/01/2020 14:25	14,91	1	14,91	CHI
20200199225	BALIZA	BH12331252	CAIAPONIA	17/01/2020 06:34	18/01/2020 22:50	17/01/2020 06:34	18/01/2020 22:50	40,26	5	201,32	CHI
20200199228	CACHOEIRA DOURADA	IT12088560	CACHOEIRA DOURADA	17/01/2020 07:37	17/01/2020 09:07	17/01/2020 07:37	17/01/2020 09:07	1,50	1	1,50	CHI
20200199228	ITUMBIARA	IT12088560	CACHOEIRA DOURADA	17/01/2020 07:37	17/01/2020 09:07	17/01/2020 07:37	17/01/2020 09:07	1,50	4	5,99	CHI
20200199229	ACREUNA	EA12257973	EDEIA	17/01/2020 07:40	17/01/2020 11:50	17/01/2020 07:40	17/01/2020 11:50	4,18	11	45,98	CHI
20200199229	EDEIA	EA12257973	EDEIA	17/01/2020 07:40	17/01/2020 11:50	17/01/2020 07:40	17/01/2020 11:50	4,18	25	104,50	CHI
20200199229	INDIARA	EA12257973	EDEIA	17/01/2020 07:40	17/01/2020 11:50	17/01/2020 07:40	17/01/2020 11:50	4,18	7	29,26	CHI
20200199231	FAZENDA NOVA	FN12119562	IPORA	17/01/2020 07:40	17/01/2020 12:42	17/01/2020 07:40	17/01/2020 12:42	5,03	11	55,34	CHI
20200199235	SERRANOPOLIS	SX21166051	JATAI S1	17/01/2020 07:40	17/01/2020 18:15	17/01/2020 07:40	17/01/2020 18:15	10,57	1	10,57	CHI
20200199238	MUTUNOPOLIS	MU12129781	MARA ROSA	17/01/2020 07:40	17/01/2020 10:10	17/01/2020 07:40	17/01/2020 10:10	2,49	7	17,40	CHI

20200199241	JANDAIA	JD21141317	PALMEIRAS	17/01/2020 07:41	17/01/2020 10:09	17/01/2020 07:41	17/01/2020 10:09	2,46	1	2,46	CHI
20200199244	ITAJA	IJ21191669	ITAJA S2	17/01/2020 07:42	17/01/2020 09:05	17/01/2020 07:42	17/01/2020 09:05	1,38	1	1,38	CHI
20200199250	CAIAPONIA	CP12241867	CAIAPONIA	17/01/2020 07:42	18/01/2020 00:17	17/01/2020 07:42	18/01/2020 00:17	16,57	20	331,43	CHI
20200199253	CAMPOS VERDES	VD12380750	SANTA TEREZINHA	17/01/2020 07:43	17/01/2020 10:31	17/01/2020 07:43	17/01/2020 10:31	2,81	3	8,43	CHI
20200199254	GOIATUBA	GT12092703	BOM JESUS DE GOIAS	17/01/2020 07:43	17/01/2020 15:45	17/01/2020 07:43	17/01/2020 15:45	8,03	1	8,03	CHI
20200199275	ANAPOLIS	AN31048302	ANAPOLIS UNIVERSITARIO S2	17/01/2020 07:44	17/01/2020 11:15	17/01/2020 07:44	17/01/2020 11:15	3,50	1	3,50	CHI
20200199277	CEZARINA	CZ21013267	CEZARINA	17/01/2020 07:45	17/01/2020 14:27	17/01/2020 07:45	17/01/2020 14:27	6,70	4	26,79	CHI
20200199283	CALDAS NOVAS	CN11060912	SERRA DE CALDAS	17/01/2020 06:46	17/01/2020 14:51	17/01/2020 06:46	17/01/2020 14:51	8,08	114	921,02	CHI
20200199285	INDIARA	IY12323655	EDEIA	17/01/2020 07:15	17/01/2020 12:22	17/01/2020 07:15	17/01/2020 12:22	5,11	10	51,06	CHI
20200199293	MOSSAMEDES	SC12376380	FIRMINOPOLIS S2	17/01/2020 06:58	17/01/2020 09:44	17/01/2020 06:58	17/01/2020 09:44	2,75	2	5,51	CHI
20200199293	SANCLERLANDIA	SC12376380	FIRMINOPOLIS S2	17/01/2020 06:58	17/01/2020 09:44	17/01/2020 06:58	17/01/2020 09:44	2,75	2	5,51	CHI
20200199294	MINEIROS	MY12166292	CHAPADAO DO CEU	17/01/2020 07:46	18/01/2020 09:19	17/01/2020 07:46	18/01/2020 09:19	25,54	5	127,71	CHI
20200199294	SERRANOPOLIS	MY12166292	CHAPADAO DO CEU	17/01/2020 07:46	18/01/2020 09:19	17/01/2020 07:46	18/01/2020 09:19	25,54	3	76,63	CHI
20200199299	COCALZINHO DE GOIAS	9970011849	AGUAS LINDAS DE GOIAS S2	17/01/2020 07:46	17/01/2020 10:35	17/01/2020 07:46	17/01/2020 10:35	2,80	1	2,80	CHI
20200199308	JATAI	JT12226592	JATAI S1	17/01/2020 06:55	17/01/2020 12:12	17/01/2020 06:55	17/01/2020 12:12	5,27	8	42,16	CHI
20200199309	JATAI	JT12184067	MONTIVIDIU T	17/01/2020 07:48	18/01/2020 11:06	17/01/2020 07:48	18/01/2020 11:06	27,30	3	81,89	CHI
20200199315	CRISTALINA	KR12161100	CRISTALINA S2	17/01/2020 07:43	17/01/2020 09:04	17/01/2020 07:43	17/01/2020 09:04	1,36	314	427,04	CHI
20200199321	JARAGUA	JA21000199	JARAGUA	17/01/2020 07:49	17/01/2020 12:35	17/01/2020 07:49	17/01/2020 12:35	4,76	1	4,76	CHI
20200199324	PIRENOPOLIS	PV11057883	CORUMBA	17/01/2020 07:06	17/01/2020 11:20	17/01/2020 07:06	17/01/2020 11:20	4,24	53	224,72	CHI
20200199331	FLORES DE GOIAS	FB12252148	FLORES DE GOIAS	17/01/2020 07:49	17/01/2020 11:42	17/01/2020 07:49	17/01/2020 11:42	3,87	10	38,69	CHI
20200199343	CRISTIANOPOLIS	CF12300911	CRISTIANOPOLIS	17/01/2020 07:51	17/01/2020 10:10	17/01/2020 07:51	17/01/2020 10:10	2,31	3	6,92	CHI
20200199347	PADRE BERNARDO	PB12196369	PADRE BERNARDO	17/01/2020 07:52	17/01/2020 11:42	17/01/2020 07:52	17/01/2020 11:42	3,83	40	153,14	CHI
20200199354	SANCLERLANDIA	SC12299048	FIRMINOPOLIS S2	17/01/2020 07:52	17/01/2020 15:46	17/01/2020 07:52	17/01/2020 15:46	7,89	4	31,54	CHI
20200199358	GOUVELANDIA	QI12301482	QUIRINOPOLIS	17/01/2020 07:53	17/01/2020 11:21	17/01/2020 07:53	17/01/2020 11:21	3,46	2	6,93	CHI
20200199360	INHUMAS	IN12402838	INHUMAS S1	17/01/2020 07:53	17/01/2020 11:27	17/01/2020 07:53	17/01/2020 11:27	3,56	2	7,12	CHI
20200199362	ARAGUAPAZ	AZ12031001	MOZARLANDIA	17/01/2020 07:53	17/01/2020 11:56	17/01/2020 07:53	17/01/2020 11:56	4,04	5	20,22	CHI
20200199365	RIO VERDE	630563408	RIO VERDE S1	17/01/2020 07:53	17/01/2020 10:04	17/01/2020 07:53	17/01/2020 10:04	2,17	1	2,17	CHI
20200199366	PALMEIRAS DE GOIAS	TV12005304	FIRMINOPOLIS S2	17/01/2020 07:53	17/01/2020 10:15	17/01/2020 07:53	17/01/2020 10:15	2,36	7	16,49	CHI
20200199368	JARAGUA	JA12000214	JARAGUA	17/01/2020 06:35	17/01/2020 10:30	17/01/2020 06:35	17/01/2020 10:30	3,92	51	199,91	CHI
20200199369	BALIZA	BH12360382	BOM JARDIM	17/01/2020 07:54	17/01/2020 20:23	17/01/2020 07:54	17/01/2020 20:23	12,48	3	37,43	CHI
20200199370	FAZENDA NOVA	JP12316446	IPORA	17/01/2020 07:54	17/01/2020 16:20	17/01/2020 07:54	17/01/2020 16:20	8,43	3	25,28	CHI
20200199370	JAUPACI	JP12316446	IPORA	17/01/2020 07:54	17/01/2020 16:20	17/01/2020 07:54	17/01/2020 16:20	8,43	4	33,70	CHI
20200199371	HIDROLANDIA	HD12007560	PONTALINA	17/01/2020 07:54	17/01/2020 11:31	17/01/2020 07:54	17/01/2020 11:31	3,61	13	46,88	CHI

20200199374	CRISTALINA	KR12305295	CRISTALINA S2	17/01/2020 07:55	17/01/2020 18:11	17/01/2020 07:55	17/01/2020 18:11	10,27	2	20,53	CHI
20200199378	COCALZINHO DE GOIAS	1200000356	COCALZINHO	17/01/2020 07:55	17/01/2020 16:09	17/01/2020 07:55	17/01/2020 16:09	8,23	1	8,23	CHI
20200199381	LUZIANIA	LZ12313611	VIANOPOLIS	17/01/2020 07:55	17/01/2020 10:33	17/01/2020 07:55	17/01/2020 10:33	2,62	12	31,48	CHI
20200199383	BOM JARDIM DE GOIAS	BM21221822	BOM JARDIM	17/01/2020 07:55	17/01/2020 22:14	17/01/2020 07:55	17/01/2020 22:14	14,31	1	14,31	CHI
20200199384	ACREUNA	EU11074876	ACREUNA	17/01/2020 07:35	17/01/2020 13:49	17/01/2020 07:35	17/01/2020 13:49	6,22	124	771,83	CHI
20200199385	RIO VERDE	RV12190361	CABRIUVA S2	17/01/2020 06:33	17/01/2020 17:13	17/01/2020 06:33	17/01/2020 17:13	10,66	11	117,23	CHI
20200199390	IPORA	IR21031703	IPORA	17/01/2020 07:56	17/01/2020 11:15	17/01/2020 07:56	17/01/2020 11:15	3,31	1	3,31	CHI
20200199394	LUZIANIA	OZ21114867	PIRES DO RIO S2	17/01/2020 07:56	17/01/2020 13:41	17/01/2020 07:56	17/01/2020 13:41	5,75	1	5,75	CHI
20200199398	ORIZONA	OZ12085014RE	PIRES DO RIO S2	17/01/2020 07:57	17/01/2020 09:55	17/01/2020 07:57	17/01/2020 09:55	1,97	35	69,06	CHI
20200199398	VIANOPOLIS	OZ12085014RE	PIRES DO RIO S2	17/01/2020 07:57	17/01/2020 09:55	17/01/2020 07:57	17/01/2020 09:55	1,97	8	15,78	CHI
20200199399	PIRENOPOLIS	PV21117925	SAO FRANCISCO DE GOIAS	17/01/2020 07:57	17/01/2020 10:00	17/01/2020 07:57	17/01/2020 10:00	2,04	1	2,04	CHI
20200199406	PORTELANDIA	PW12302000	PARQUE DAS EMAS	17/01/2020 07:57	17/01/2020 17:05	17/01/2020 07:57	17/01/2020 17:05	9,12	3	27,36	CHI
20200199412	ARENOPOLIS	AY12188398	ARENOPOLIS	17/01/2020 05:42	17/01/2020 15:19	17/01/2020 05:42	17/01/2020 15:19	9,61	10	96,08	CHI
20200199412	DIORAMA	AY12188398	ARENOPOLIS	17/01/2020 05:42	17/01/2020 15:19	17/01/2020 05:42	17/01/2020 15:19	9,61	7	67,25	CHI
20200199415	ARUANA	MZ12250762	MOZARLANDIA	17/01/2020 18:17	18/01/2020 15:50	17/01/2020 18:17	18/01/2020 15:50	21,54	8	172,35	CHI
20200199415	MOZARLANDIA	MZ12250762	MOZARLANDIA	17/01/2020 18:17	18/01/2020 15:50	17/01/2020 18:17	18/01/2020 15:50	21,54	2	43,09	CHI
20200199416	JATAI	JT11055291	JATAI S2	17/01/2020 07:30	17/01/2020 17:09	17/01/2020 07:30	17/01/2020 17:09	9,64	84	809,64	CHI
20200199417	PALMEIRAS DE GOIAS	PL21000090	PALMEIRAS	17/01/2020 07:58	17/01/2020 09:27	17/01/2020 07:58	17/01/2020 09:27	1,47	1	1,47	CHI
20200199420	CRISTALINA	KR21171585	CRISTALINA S2	17/01/2020 07:59	17/01/2020 11:01	17/01/2020 07:59	17/01/2020 11:01	3,03	1	3,03	CHI
20200199423	GOIAS	GS21364877	ITABERAI S1	17/01/2020 07:59	17/01/2020 10:40	17/01/2020 07:59	17/01/2020 10:40	2,68	1	2,68	CHI
20200199430	JAUPACI	JP12324114	IPORA	17/01/2020 07:59	17/01/2020 18:18	17/01/2020 07:59	17/01/2020 18:18	10,31	1	10,31	CHI
20200199439	APARECIDA DO RIO DOCE	AW11000004	CACHOEIRA ALTA	17/01/2020 07:08	17/01/2020 11:22	17/01/2020 07:08	17/01/2020 11:22	4,22	102	430,72	CHI
20200199444	NOVA AMERICA	NM12246301	RUBIATABA	17/01/2020 08:01	17/01/2020 11:26	17/01/2020 08:01	17/01/2020 11:26	3,41	7	23,89	CHI
20200199446	JATAI	JT12264427	JATAI S2	17/01/2020 07:59	17/01/2020 12:12	17/01/2020 07:59	17/01/2020 12:12	4,21	3	12,64	CHI
20200199452	LUZIANIA	LZ21061814	RIO VERMELHO	17/01/2020 08:01	17/01/2020 09:57	17/01/2020 08:01	17/01/2020 09:57	1,92	1	1,92	CHI
20200199467	BARRO ALTO	BA12068485	BARRO ALTO	17/01/2020 07:49	17/01/2020 10:57	17/01/2020 07:49	17/01/2020 10:57	3,12	1	3,12	CHI
20200199467	SANTA RITA DO NOVO DESTINO	BA12068485	BARRO ALTO	17/01/2020 07:49	17/01/2020 10:57	17/01/2020 07:49	17/01/2020 10:57	3,12	32	99,88	CHI
20200199468	JATAI	JT12211180	JATAI S2	17/01/2020 08:03	18/01/2020 09:22	17/01/2020 08:03	18/01/2020 09:22	25,30	1	25,30	CHI
20200199471	DIORAMA	DI12168628	IPORA	17/01/2020 08:04	17/01/2020 12:50	17/01/2020 08:04	17/01/2020 12:50	4,76	13	61,90	CHI
20200199475	ITAPIRAPUA	GS21072506	MATRINCHA	17/01/2020 08:04	17/01/2020 18:50	17/01/2020 08:04	17/01/2020 18:50	10,76	1	10,76	CHI
20200199482	SERRANOPOLIS	SX12264389	JATAI S1	17/01/2020 07:14	17/01/2020 11:18	17/01/2020 07:14	17/01/2020 11:18	4,05	49	198,65	CHI
20200199483	CAMPO ALEGRE DE GOIAS	CM12086086	CAMPO ALEGRE DE GOIAS	17/01/2020 07:57	17/01/2020 12:41	17/01/2020 07:57	17/01/2020 12:41	4,73	6	28,37	CHI
20200199484	IPAMERI	IP12247905	CRISTALINA S2	17/01/2020 06:49	18/01/2020 07:23	17/01/2020 06:49	18/01/2020 07:23	24,56	33	810,63	CHI

20200199492	PIRENOPOLIS	PV31000620	SAO FRANCISCO DE GOIAS	17/01/2020 08:06	17/01/2020 09:49	17/01/2020 08:06	17/01/2020 09:49	1,72	1	1,72	CHI
20200199497	CACU	CC11247575	CACHOEIRA ALTA	17/01/2020 07:08	18/01/2020 21:16	17/01/2020 07:08	18/01/2020 21:16	38,13	1	38,13	CHI
20200199498	MINEIROS	MY21194648	PARQUE DAS EMAS	17/01/2020 08:06	18/01/2020 15:51	17/01/2020 08:06	18/01/2020 15:51	31,75	1	31,75	CHI
20200199503	ARAGOIANIA	AO32097662	GUAPO S2	17/01/2020 06:44	17/01/2020 10:50	17/01/2020 06:44	17/01/2020 10:50	4,10	4	16,39	CHI
20200199503	VARJAO	AO32097662	GUAPO S2	17/01/2020 06:44	17/01/2020 10:50	17/01/2020 06:44	17/01/2020 10:50	4,10	5	20,48	CHI
20200199508	PARAUNA	PU12110555	PARAUNA	17/01/2020 07:43	17/01/2020 12:14	17/01/2020 07:43	17/01/2020 12:14	4,51	15	67,72	CHI
20200199509	SAO SIMAO	SO11133910	CACHOEIRA ALTA	17/01/2020 07:17	17/01/2020 11:20	17/01/2020 07:17	17/01/2020 11:20	4,06	117	474,89	CHI
20200199511	MORRINHOS	MR12232914	GOIATUBA S2	17/01/2020 08:07	17/01/2020 12:16	17/01/2020 08:07	17/01/2020 12:16	4,14	3	12,43	CHI
20200199513	IPORA	IR12069053	IPORA	17/01/2020 08:07	17/01/2020 11:57	17/01/2020 08:07	17/01/2020 11:57	3,83	14	53,57	CHI
20200199518	ORIZONA	OZ21315070	PIRES DO RIO S2	17/01/2020 08:08	17/01/2020 16:20	17/01/2020 08:08	17/01/2020 16:20	8,22	1	8,22	CHI
20200199519	PONTALINA	PK21223285	VICENTINOPOLIS	17/01/2020 08:08	17/01/2020 11:58	17/01/2020 08:08	17/01/2020 11:58	3,83	1	3,83	CHI
20200199520	BELA VISTA DE GOIAS	BV12000035	BELA VISTA S1	17/01/2020 08:08	17/01/2020 09:40	17/01/2020 08:08	17/01/2020 09:40	1,53	1	1,53	CHI
20200199526	SAO SIMAO	SO21000073	CACHOEIRA ALTA	17/01/2020 08:08	18/01/2020 12:30	17/01/2020 08:08	18/01/2020 12:30	28,36	1	28,36	CHI
20200199529	GOIANIA	13083170	GOYA S1	17/01/2020 08:08	17/01/2020 11:41	17/01/2020 08:08	17/01/2020 11:41	3,55	1	3,55	CHI
20200199540	SILVANIA	SV21199926	VIANOPOLIS	17/01/2020 08:09	17/01/2020 09:54	17/01/2020 08:09	17/01/2020 09:54	1,74	1	1,74	CHI
20200199545	BRITANIA	BT12250825	BRITANIA	17/01/2020 06:31	17/01/2020 13:03	17/01/2020 06:31	17/01/2020 13:03	6,52	4	26,07	CHI
20200199547	CRISTALINA	KR21399485	CRISTALINA S1	17/01/2020 08:10	17/01/2020 09:56	17/01/2020 08:10	17/01/2020 09:56	1,76	1	1,76	CHI
20200199550	CACHOEIRA ALTA	CA12013330	CACHOEIRA ALTA	17/01/2020 06:30	17/01/2020 16:06	17/01/2020 06:30	17/01/2020 16:06	9,60	22	211,10	CHI
20200199559	TURVELANDIA	1760011268	RIO DOS BOIS	17/01/2020 08:11	17/01/2020 11:58	17/01/2020 08:11	17/01/2020 11:58	3,78	1	3,78	CHI
20200199563	CHAPADAO DO CEU	DJ21162532	CHAPADAO DO CEU	17/01/2020 08:11	18/01/2020 11:50	17/01/2020 08:11	18/01/2020 11:50	27,63	1	27,63	CHI
20200199565	ITABERAI	IB31236803	ITABERAI S2	17/01/2020 08:12	17/01/2020 12:09	17/01/2020 08:12	17/01/2020 12:09	3,95	2	7,90	CHI
20200199572	TRINDADE	TR32058209	TRINDADE	17/01/2020 08:12	17/01/2020 13:02	17/01/2020 08:12	17/01/2020 13:02	4,82	7	33,75	CHI
20200199575	MINEIROS	MY11377394	PARQUE DAS EMAS	17/01/2020 07:24	17/01/2020 10:53	17/01/2020 07:24	17/01/2020 10:53	3,47	90	312,23	CHI
20200199578	PIRANHAS	PH12259448RE	PIRANHAS	17/01/2020 05:42	17/01/2020 10:50	17/01/2020 05:42	17/01/2020 10:50	5,14	96	493,15	CHI
20200199583	CAMPINACU	UC12269884	MARA ROSA	17/01/2020 08:13	17/01/2020 11:14	17/01/2020 08:13	17/01/2020 11:14	3,01	5	15,05	CHI
20200199589	CAIAPONIA	CP12072079	CAIAPONIA	17/01/2020 08:13	17/01/2020 14:52	17/01/2020 08:13	17/01/2020 14:52	6,64	8	53,12	CHI
20200199593	AMORINOPOLIS	IR12188430	IPORA	17/01/2020 06:14	17/01/2020 17:32	17/01/2020 06:14	17/01/2020 17:11	10,94	39	426,77	CHI
20200199593	IPORA	IR12188430	IPORA	17/01/2020 06:14	17/01/2020 17:32	17/01/2020 06:14	17/01/2020 17:11	10,94	98	1072,39	CHI
20200199593	AMORINOPOLIS	IR13188427	IPORA	17/01/2020 06:14	17/01/2020 17:32	17/01/2020 06:14	17/01/2020 17:32	11,30	20	226,02	CHI
20200199593	IPORA	IR13188427	IPORA	17/01/2020 06:14	17/01/2020 17:32	17/01/2020 06:14	17/01/2020 17:32	11,30	19	214,72	CHI
20200199593	IVOLANDIA	IR13188427	IPORA	17/01/2020 06:14	17/01/2020 17:32	17/01/2020 06:14	17/01/2020 17:32	11,30	87	983,17	CHI
20200199593	PALESTINA DE GOIAS	IR13188427	IPORA	17/01/2020 06:14	17/01/2020 17:32	17/01/2020 06:14	17/01/2020 17:32	11,30	33	372,93	CHI
20200199595	RIO VERDE	RV21260136	CABRIUVA S1	17/01/2020 08:13	17/01/2020 09:26	17/01/2020 08:13	17/01/2020 09:26	1,20	1	1,20	CHI

20200199601	GOIANIA	10002681224	GOIANIA LESTE S1	17/01/2020 08:14	17/01/2020 10:55	17/01/2020 08:14	17/01/2020 10:55	2,68	1	2,68	CHI
20200199602	PARANAIGUARA	PC12119224	QUIRINOPOLIS	17/01/2020 07:55	17/01/2020 12:43	17/01/2020 07:55	17/01/2020 12:43	4,79	20	95,87	CHI
20200199606	SANCLERLANDIA	SC12068212	FIRMINOPOLIS S2	17/01/2020 07:59	17/01/2020 09:08	17/01/2020 07:59	17/01/2020 09:08	1,15	12	13,75	CHI
20200199610	ITAPIRAPUA	RN12298934LD	BRITANIA	17/01/2020 08:15	18/01/2020 07:36	17/01/2020 08:15	18/01/2020 07:36	23,34	2	46,68	CHI
20200199610	SANTA FE DE GOIAS	RN12298934LD	BRITANIA	17/01/2020 08:15	18/01/2020 07:36	17/01/2020 08:15	18/01/2020 07:36	23,34	11	256,73	CHI
20200199616	MINEIROS	1390106606	PARQUE DAS EMAS	17/01/2020 08:16	17/01/2020 13:25	17/01/2020 08:16	17/01/2020 13:25	5,14	1	5,14	CHI
20200199617	JATAI	JT12000231	JATAI S1	17/01/2020 04:40	17/01/2020 11:39	17/01/2020 04:40	17/01/2020 11:39	6,98	73	509,54	CHI
20200199617	PEROLANDIA	JT12000231	JATAI S1	17/01/2020 04:40	17/01/2020 11:39	17/01/2020 04:40	17/01/2020 11:39	6,98	3	20,94	CHI
20200199619	ITAUCU	PV12271945	CORUMBA	17/01/2020 07:24	17/01/2020 10:43	17/01/2020 07:24	17/01/2020 10:43	3,31	1	3,31	CHI
20200199619	PIRENOPOLIS	PV12271945	CORUMBA	17/01/2020 07:24	17/01/2020 10:43	17/01/2020 07:24	17/01/2020 10:43	3,31	12	39,67	CHI
20200199624	CEZARINA	CZ21312474	CEZARINA	17/01/2020 08:16	17/01/2020 10:40	17/01/2020 08:16	17/01/2020 10:40	2,39	1	2,39	CHI
20200199625	IPAMERI	IP21149991	IPAMERI	17/01/2020 08:16	17/01/2020 11:25	17/01/2020 08:16	17/01/2020 11:25	3,14	2	6,27	CHI
20200199628	RIO VERDE	RV12051746	MONTIVIDIU T	17/01/2020 08:17	17/01/2020 16:45	17/01/2020 08:17	17/01/2020 16:45	8,48	66	559,40	CHI
20200199629	ITAPURANGA	IK12060489	ITAPURANGA	17/01/2020 08:17	17/01/2020 10:47	17/01/2020 08:17	17/01/2020 10:47	2,50	7	17,49	CHI
20200199630	MONTES CLAROS DE GOIAS	ME21086446	IPORA	17/01/2020 08:17	17/01/2020 11:32	17/01/2020 08:17	17/01/2020 11:32	3,24	1	3,24	CHI
20200199633	SANTA HELENA DE GOIAS	SH12131597	SANTA HELENA S1	17/01/2020 08:17	17/01/2020 10:20	17/01/2020 08:17	17/01/2020 10:20	2,04	3	6,12	CHI
20200199636	JATAI	JT21347262	JATAI S1	17/01/2020 08:17	17/01/2020 16:36	17/01/2020 08:17	17/01/2020 16:36	8,30	1	8,30	CHI
20200199639	SANCLERLANDIA	1210011831	FIRMINOPOLIS S2	17/01/2020 08:18	17/01/2020 12:08	17/01/2020 08:18	17/01/2020 12:08	3,83	1	3,83	CHI
20200199641	CEZARINA	IY12010801	EDEIA	17/01/2020 07:35	17/01/2020 09:37	17/01/2020 07:35	17/01/2020 09:37	2,03	6	12,20	CHI
20200199641	INDIARA	IY12010801	EDEIA	17/01/2020 07:35	17/01/2020 09:37	17/01/2020 07:35	17/01/2020 09:37	2,03	5	10,16	CHI
20200199643	RIO VERDE	CP12123360	MONTIVIDIU T	17/01/2020 08:18	17/01/2020 11:43	17/01/2020 08:18	17/01/2020 11:43	3,41	6	20,47	CHI
20200199644	ITAGUARU	IC12219967	ITABERAI S1	17/01/2020 08:18	17/01/2020 11:15	17/01/2020 08:18	17/01/2020 11:15	2,96	16	47,31	CHI
20200199647	CAMPO ALEGRE DE GOIAS	CM21166878	CAMPO ALEGRE DE GOIAS	17/01/2020 08:18	17/01/2020 13:16	17/01/2020 08:18	17/01/2020 13:16	4,95	1	4,95	CHI
20200199648	GOIAS	GS12250581	GOIAS	17/01/2020 08:19	17/01/2020 09:22	17/01/2020 08:19	17/01/2020 09:22	1,05	53	55,64	CHI
20200199654	ARAGUAPAZ	AZ21198857	GOIAS	17/01/2020 08:19	17/01/2020 14:20	17/01/2020 08:19	17/01/2020 14:20	6,01	1	6,01	CHI
20200199658	NIQUELANDIA	NQ21232505	BARRO ALTO	17/01/2020 08:19	17/01/2020 12:53	17/01/2020 08:19	17/01/2020 12:53	4,55	1	4,55	CHI
20200199660	MONTES CLAROS DE GOIAS	ME21161603	IPORA	17/01/2020 08:20	17/01/2020 14:53	17/01/2020 08:20	17/01/2020 14:53	6,54	1	6,54	CHI
20200199666	ARAGUAPAZ	AZ12238246	GOIAS	17/01/2020 08:20	18/01/2020 07:55	17/01/2020 08:20	18/01/2020 07:55	23,57	3	70,71	CHI
20200199677	SILVANIA	SV12072440	DAIA S1	17/01/2020 08:21	17/01/2020 16:35	17/01/2020 08:21	17/01/2020 16:35	8,23	8	65,84	CHI
20200199679	ITAGUARI	II12220226	ITABERAI S1	17/01/2020 08:21	17/01/2020 11:00	17/01/2020 08:21	17/01/2020 11:00	2,65	7	18,53	CHI
20200199681	BOM JESUS DE GOIAS	BJ12000355	BOM JESUS DE GOIAS	17/01/2020 07:00	17/01/2020 11:14	17/01/2020 07:00	17/01/2020 11:14	4,23	5	21,13	CHI
20200199681	GOIATUBA	BJ12000355	BOM JESUS DE GOIAS	17/01/2020 07:00	17/01/2020 11:14	17/01/2020 07:00	17/01/2020 11:14	4,23	5	21,13	CHI
20200199682	AGUA LIMPA	10001064221	VILA CORUMBA	17/01/2020 08:21	17/01/2020 11:25	17/01/2020 08:21	17/01/2020 11:25	3,05	1	3,05	CHI

20200199684	MATRINCHA	MP12250740	MATRINCHA	17/01/2020 08:21	17/01/2020 10:59	17/01/2020 08:21	17/01/2020 10:59	2,62	9	23,57	CHI
20200199686	FAZENDA NOVA	FN12060693	IPORA	17/01/2020 08:21	17/01/2020 10:58	17/01/2020 08:21	17/01/2020 10:58	2,61	11	28,71	CHI
20200199689	RIO VERDE	RV11000163	CABRIUVA S1	17/01/2020 08:22	17/01/2020 16:47	17/01/2020 08:22	17/01/2020 16:47	8,41	3	25,23	CHI
20200199690	CRISTALINA	KR21261448	PAMPLONA	17/01/2020 08:22	17/01/2020 13:12	17/01/2020 08:22	17/01/2020 13:12	4,83	1	4,83	CHI
20200199691	FAZENDA NOVA	FN12031283	JUSSARA	17/01/2020 08:22	17/01/2020 10:41	17/01/2020 08:22	17/01/2020 10:41	2,31	1	2,31	CHI
20200199691	NOVO BRASIL	FN12031283	JUSSARA	17/01/2020 08:22	17/01/2020 10:41	17/01/2020 08:22	17/01/2020 10:41	2,31	2	4,62	CHI
20200199694	LUZIANIA	LZ12305050	CRISTALINA S2	17/01/2020 08:22	17/01/2020 20:45	17/01/2020 08:22	17/01/2020 20:45	12,39	4	49,55	CHI
20200199694	LUZIANIA	LZ12305050	CRISTALINA S2	17/01/2020 08:22	17/01/2020 20:45	17/01/2020 17:07	17/01/2020 20:45	3,64	17	61,80	CHI
20200199701	MARA ROSA	10002057105	MARA ROSA	17/01/2020 08:23	17/01/2020 11:09	17/01/2020 08:23	17/01/2020 11:09	2,76	1	2,76	CHI
20200199717	UIRAPURU	UP21237762	SANTA TEREZINHA	17/01/2020 08:25	17/01/2020 13:00	17/01/2020 08:25	17/01/2020 13:00	4,58	1	4,58	CHI
20200199720	BURITI DE GOIAS	BS21307687	FIRMINOPOLIS S2	16/01/2020 22:12	17/01/2020 10:36	16/01/2020 22:12	17/01/2020 10:36	12,39	1	12,39	CHI
20200199721	APORE	AE21248363	ITAJA S1	17/01/2020 08:26	17/01/2020 14:37	17/01/2020 08:26	17/01/2020 14:37	6,18	1	6,18	CHI
20200199722	MINEIROS	MY12348107	PARQUE DAS EMAS	17/01/2020 07:55	17/01/2020 14:10	17/01/2020 07:55	17/01/2020 14:10	6,23	11	68,58	CHI
20200199728	ITAPURANGA	IK12364710	ITAPURANGA	17/01/2020 08:26	17/01/2020 13:15	17/01/2020 08:26	17/01/2020 13:15	4,82	10	48,16	CHI
20200199731	RIO VERDE	630246622	RIO VERDE S2	17/01/2020 08:26	17/01/2020 11:35	17/01/2020 08:26	17/01/2020 11:35	3,14	1	3,14	CHI
20200199735	MORRINHOS	10010809951	MORRINHOS	17/01/2020 08:27	17/01/2020 10:24	17/01/2020 08:27	17/01/2020 10:24	1,96	1	1,96	CHI
20200199737	INDIARA	IY12205923	EDEIA	17/01/2020 07:24	17/01/2020 10:34	17/01/2020 07:24	17/01/2020 10:34	3,15	33	104,05	CHI
20200199737	PALMEIRAS DE GOIAS	IY12205923	EDEIA	17/01/2020 07:24	17/01/2020 10:34	17/01/2020 07:24	17/01/2020 10:34	3,15	5	15,77	CHI
20200199749	CACHOEIRA ALTA	CA12047662	CACHOEIRA ALTA	17/01/2020 08:24	17/01/2020 10:57	17/01/2020 08:24	17/01/2020 10:57	2,54	4	10,15	CHI
20200199758	ITAPACI	IW12251268	RUBIATABA	17/01/2020 08:29	17/01/2020 12:24	17/01/2020 08:29	17/01/2020 12:24	3,90	3	11,70	CHI
20200199759	RIO VERDE	RV21306312	RIO VERDE S2	17/01/2020 08:30	17/01/2020 14:35	17/01/2020 08:30	17/01/2020 14:35	6,08	1	6,08	CHI
20200199767	CRISTALINA	KR11184828	CRISTALINA S1	17/01/2020 08:31	17/01/2020 13:23	17/01/2020 08:31	17/01/2020 13:23	4,86	1	4,86	CHI
20200199770	CAIAPONIA	CP21247447	PALESTINA	17/01/2020 08:31	18/01/2020 11:05	17/01/2020 08:31	18/01/2020 11:05	26,56	1	26,56	CHI
20200199780	BALIZA	BH11331181	CAIAPONIA	17/01/2020 08:32	17/01/2020 10:57	17/01/2020 08:32	17/01/2020 10:57	2,41	1	2,41	CHI
20200199781	CALDAS NOVAS	760311699	CALDAS NOVAS S1	17/01/2020 08:32	17/01/2020 10:01	17/01/2020 08:32	17/01/2020 10:01	1,47	1	1,47	CHI
20200199791	CAIAPONIA	CP12247460	CAIAPONIA	17/01/2020 08:21	18/01/2020 10:42	17/01/2020 08:21	18/01/2020 10:42	26,35	3	79,05	CHI
20200199797	MONTES CLAROS DE GOIAS	ME12380990	IPORA	17/01/2020 08:33	17/01/2020 13:32	17/01/2020 08:33	17/01/2020 13:32	4,97	5	24,84	CHI
20200199800	SANTA CRUZ DE GOIAS	BC21257197	PIRACANJUBA	17/01/2020 08:34	17/01/2020 12:37	17/01/2020 08:34	17/01/2020 12:37	4,05	1	4,05	CHI
20200199801	SAO LUIS DE MONTES BELOS	SL21144883	SAO LUIZ DOS MONTES BELOS	17/01/2020 08:34	17/01/2020 12:01	17/01/2020 08:34	17/01/2020 12:01	3,45	2	6,89	CHI
20200199803	JOVIANIA	JV21248984	GOIATUBA S1	17/01/2020 08:34	17/01/2020 11:08	17/01/2020 08:34	17/01/2020 11:08	2,56	2	5,12	CHI
20200199810	JARAGUA	JA12047472	JARAGUA	17/01/2020 08:30	17/01/2020 11:02	17/01/2020 08:30	17/01/2020 11:02	2,52	10	25,19	CHI
20200199816	ITABERAI	IB12274556	ITABERAI S2	17/01/2020 08:36	17/01/2020 19:36	17/01/2020 08:36	17/01/2020 19:36	11,00	2	21,99	CHI
20200199816	ITABERAI	IB12274556	ITABERAI S2	17/01/2020 08:36	17/01/2020 19:36	17/01/2020 17:28	17/01/2020 19:36	2,14	7	14,97	CHI

20200199819	ARUANA	MP12041292	MOZARLANDIA	17/01/2020 08:37	17/01/2020 19:16	17/01/2020 08:37	17/01/2020 19:16	10,65	3	31,95	CHI
20200199819	MATRINCHA	MP12041292	MOZARLANDIA	17/01/2020 08:37	17/01/2020 19:16	17/01/2020 08:37	17/01/2020 19:16	10,65	1	10,65	CHI
20200199824	VALPARAISO DE GOIAS	10001471617	PACAEMBU S2	17/01/2020 08:37	17/01/2020 10:44	17/01/2020 08:37	17/01/2020 10:44	2,11	1	2,11	CHI
20200199826	ITAGUARI	JA12038937	ITABERAI S1	17/01/2020 08:37	17/01/2020 12:44	17/01/2020 08:37	17/01/2020 12:44	4,10	3	12,31	CHI
20200199826	ITAGUARU	JA12038937	ITABERAI S1	17/01/2020 08:37	17/01/2020 12:44	17/01/2020 08:37	17/01/2020 12:44	4,10	1	4,10	CHI
20200199826	JARAGUA	JA12038937	ITABERAI S1	17/01/2020 08:37	17/01/2020 12:44	17/01/2020 08:37	17/01/2020 12:44	4,10	6	24,63	CHI
20200199830	APARECIDA DE GOIANIA	10000682665	INDEPENDENCIA S2	17/01/2020 08:38	17/01/2020 11:19	17/01/2020 08:38	17/01/2020 11:19	2,68	1	2,68	CHI
20200199834	SAO LUIS DE MONTES BELOS	SL32145768	SAO LUIZ DOS MONTES BELOS	17/01/2020 08:18	17/01/2020 11:31	17/01/2020 08:18	17/01/2020 11:31	3,20	30	96,11	CHI
20200199836	AURILANDIA	FR12126030	FIRMINOPOLIS S2	17/01/2020 08:39	17/01/2020 13:50	17/01/2020 08:39	17/01/2020 13:50	5,19	9	46,70	CHI
20200199836	FIRMINOPOLIS	FR12126030	FIRMINOPOLIS S2	17/01/2020 08:39	17/01/2020 13:50	17/01/2020 08:39	17/01/2020 13:50	5,19	4	20,76	CHI
20200199840	CORUMBAIBA	CI12060348	VILA CORUMBA	17/01/2020 00:01	17/01/2020 17:14	17/01/2020 00:01	17/01/2020 17:14	17,21	21	361,36	CHI
20200199843	FAZENDA NOVA	FN12009681	IPORA	17/01/2020 08:40	17/01/2020 18:13	17/01/2020 08:40	17/01/2020 18:13	9,55	1	9,55	CHI
20200199852	RIO VERDE	RV21214097	CABRIUVA S2	17/01/2020 08:42	17/01/2020 10:25	17/01/2020 08:42	17/01/2020 10:25	1,72	1	1,72	CHI
20200199860	NOVO BRASIL	IU21183498	JUSSARA	17/01/2020 08:42	18/01/2020 03:29	17/01/2020 08:42	18/01/2020 03:29	18,77	1	18,77	CHI
20200199864	MATRINCHA	MP12199954	MATRINCHA	17/01/2020 08:42	17/01/2020 13:28	17/01/2020 08:42	17/01/2020 13:28	4,75	4	19,00	CHI
20200199867	MINACU	IH21220734	MINACU	17/01/2020 08:43	17/01/2020 10:15	17/01/2020 08:43	17/01/2020 10:15	1,53	2	3,06	CHI
20200199868	MAIRIPOTABA	PK12263491	PONTALINA	17/01/2020 08:38	17/01/2020 15:25	17/01/2020 08:38	17/01/2020 15:25	6,78	5	33,90	CHI
20200199868	PONTALINA	PK12263491	PONTALINA	17/01/2020 08:38	17/01/2020 15:25	17/01/2020 08:38	17/01/2020 15:25	6,78	30	203,43	CHI
20200199869	CAIAPONIA	CP12097751	CAIAPONIA	17/01/2020 08:43	18/01/2020 01:16	17/01/2020 08:43	18/01/2020 01:16	16,55	101	1671,19	CHI
20200199873	SILVANIA	660066749	VIANOPOLIS	17/01/2020 08:43	17/01/2020 10:50	17/01/2020 08:43	17/01/2020 10:50	2,10	1	2,10	CHI
20200199874	SERRANOPOLIS	SX12390576	JATAI S1	17/01/2020 08:43	18/01/2020 09:56	17/01/2020 08:43	18/01/2020 09:56	25,20	9	226,83	CHI
20200199875	SANCLERLANDIA	SC12376362	FIRMINOPOLIS S2	16/01/2020 22:12	17/01/2020 10:08	16/01/2020 22:12	17/01/2020 10:08	11,92	10	119,22	CHI
20200199879	LUZIANIA	LZ11351403	MARAJOARA	17/01/2020 08:44	17/01/2020 10:21	17/01/2020 08:44	17/01/2020 10:21	1,61	14	22,49	CHI
20200199889	CABECEIRAS	CW21184542	ITUIQUIRA	17/01/2020 08:46	17/01/2020 11:50	17/01/2020 08:46	17/01/2020 11:50	3,07	1	3,07	CHI
20200199896	PONTALINA	PK12047392	VICENTINOPOLIS	17/01/2020 07:01	17/01/2020 09:30	17/01/2020 07:01	17/01/2020 09:30	2,47	18	44,53	CHI
202001100003	OUIDOR	TH12000452RE	CATALAO S1	17/01/2020 09:05	17/01/2020 11:51	17/01/2020 09:05	17/01/2020 11:51	2,77	1	2,77	CHI
202001100003	TRES RANCHOS	TH12000452RE	CATALAO S1	17/01/2020 09:05	17/01/2020 11:51	17/01/2020 09:05	17/01/2020 11:51	2,77	91	251,99	CHI
202001100003	TRES RANCHOS	TH12000452RE	CATALAO S1	17/01/2020 09:05	17/01/2020 11:51	17/01/2020 10:07	17/01/2020 11:51	1,72	10	17,25	CHI
202001100013	GOIANIA	GN11189316	CAMPINAS S1	17/01/2020 09:17	17/01/2020 11:40	17/01/2020 09:17	17/01/2020 11:40	2,38	85	202,54	CHI
202001100023	CAIAPONIA	00300214	CAIAPONIA	17/01/2020 09:36	18/01/2020 20:57	17/01/2020 09:37	17/01/2020 12:03	2,43	258	627,16	CHI
202001100023	CAIAPONIA	CP13091229	CAIAPONIA	17/01/2020 09:36	18/01/2020 20:57	17/01/2020 09:37	17/01/2020 13:27	3,83	5	19,13	CHI
202001100023	CAIAPONIA	CP13316464	CAIAPONIA	17/01/2020 09:36	18/01/2020 20:57	17/01/2020 09:37	17/01/2020 20:06	10,48	4	41,93	CHI
202001100023	CAIAPONIA	CP13231282	CAIAPONIA	17/01/2020 09:36	18/01/2020 20:57	17/01/2020 09:37	18/01/2020 09:58	24,35	5	121,75	CHI

202001100023	CAIAPONIA	CP13316465	CAIAPONIA	17/01/2020 09:36	18/01/2020 20:57	17/01/2020 09:37	18/01/2020 20:57	35,33	2	70,67	CHI
202001100036	PIRES DO RIO	10012274052	PIRES DO RIO S1	17/01/2020 07:15	17/01/2020 11:41	17/01/2020 07:15	17/01/2020 11:41	4,43	1	4,43	CHI
202001100102	IPIRANGA DE GOIAS	RB21003342	RUBIATABA	17/01/2020 08:48	17/01/2020 16:13	17/01/2020 08:48	17/01/2020 15:50	7,03	1	7,03	CHI
202001100102	IPIRANGA DE GOIAS	RB12003339	RUBIATABA	17/01/2020 08:48	17/01/2020 16:13	17/01/2020 08:48	17/01/2020 16:13	7,41	2	14,81	CHI
202001100103	CRISTALINA	KR12331959	CRISTALINA S1	17/01/2020 08:49	17/01/2020 12:02	17/01/2020 08:49	17/01/2020 12:02	3,22	1	3,22	CHI
202001100116	CRISTALINA	KR12304869	CRISTALINA S2	17/01/2020 07:34	17/01/2020 12:19	17/01/2020 07:34	17/01/2020 12:19	4,74	16	75,84	CHI
202001100117	ACREUNA	2440046717	ACREUNA	17/01/2020 08:51	17/01/2020 14:46	17/01/2020 08:51	17/01/2020 14:46	5,91	1	5,91	CHI
202001100120	PIRACANJUBA	PJ12082241	PIRACANJUBA	17/01/2020 07:56	18/01/2020 12:12	17/01/2020 07:56	18/01/2020 12:12	28,27	6	169,59	CHI
202001100124	CABECEIRAS	CW12181812	ITIQUEIRA	17/01/2020 08:52	17/01/2020 09:29	17/01/2020 08:52	17/01/2020 09:29	0,62	2	1,23	CHI
202001100126	ORIZONA	OZ12083185	PIRES DO RIO S1	17/01/2020 08:53	17/01/2020 14:31	17/01/2020 08:53	17/01/2020 14:31	5,63	3	16,90	CHI
202001100128	PIRENOPOLIS	PV11057878	CORUMBA	17/01/2020 06:04	17/01/2020 14:21	17/01/2020 06:04	17/01/2020 14:21	8,28	150	1242,00	CHI
202001100130	SANTO ANTONIO DA BARRA	BZ12303292	ACREUNA	17/01/2020 08:54	17/01/2020 15:10	17/01/2020 08:54	17/01/2020 15:10	6,26	4	25,05	CHI
202001100131	SAO JOAO D ALIANCA	JL12342390	SAO JOAO D ALIANCA	17/01/2020 08:54	17/01/2020 11:30	17/01/2020 08:54	17/01/2020 11:30	2,59	4	10,37	CHI
202001100135	GOIANIA	GN11081400	AEROPORTO S2	17/01/2020 08:54	17/01/2020 12:05	17/01/2020 08:54	17/01/2020 12:05	3,17	87	276,06	CHI
202001100137	LUZIANIA	LZ11372297	RIO VERMELHO	17/01/2020 08:54	17/01/2020 10:38	17/01/2020 08:54	17/01/2020 10:38	1,72	20	34,41	CHI
202001100141	ANAPOLIS	21242392	ANAPOLIS UNIVERSITARIO S1	17/01/2020 08:55	17/01/2020 10:59	17/01/2020 08:55	17/01/2020 10:59	2,06	1	2,06	CHI
202001100148	CRISTALINA	KR12397351	CRISTALINA S2	17/01/2020 08:55	17/01/2020 15:43	17/01/2020 08:55	17/01/2020 15:43	6,79	50	339,26	CHI
202001100153	BELA VISTA DE GOIAS	BV21277818	BELA VISTA S1	17/01/2020 08:56	17/01/2020 11:33	17/01/2020 08:56	17/01/2020 11:33	2,61	1	2,61	CHI
202001100155	FLORES DE GOIAS	FB21128625	FLORES DE GOIAS	17/01/2020 08:56	17/01/2020 12:05	17/01/2020 08:56	17/01/2020 12:05	3,14	1	3,14	CHI
202001100156	APARECIDA DE GOIANIA	10030877227	ANHANGUERA	17/01/2020 08:56	17/01/2020 15:52	17/01/2020 08:56	17/01/2020 15:52	6,92	1	6,92	CHI
202001100159	JATAI	RV12212665	CABRIUVA S2	17/01/2020 06:30	17/01/2020 11:52	17/01/2020 06:30	17/01/2020 11:52	5,36	12	64,33	CHI
202001100159	RIO VERDE	RV12212665	CABRIUVA S2	17/01/2020 06:30	17/01/2020 11:52	17/01/2020 06:30	17/01/2020 11:52	5,36	18	96,49	CHI
202001100167	GOIANIA	12708379	GOYA S1	17/01/2020 08:58	17/01/2020 14:07	17/01/2020 08:58	17/01/2020 14:07	5,14	1	5,14	CHI
202001100171	CEZARINA	CZ12010376	CEZARINA	17/01/2020 07:44	17/01/2020 12:48	17/01/2020 07:44	17/01/2020 12:48	5,06	129	652,17	CHI
202001100171	INDIARA	CZ12010376	CEZARINA	17/01/2020 07:44	17/01/2020 12:48	17/01/2020 07:44	17/01/2020 12:48	5,06	16	80,89	CHI
202001100172	TRINDADE	40181972	GOYA S1	17/01/2020 08:58	17/01/2020 12:42	17/01/2020 08:58	17/01/2020 12:42	3,72	1	3,72	CHI
202001100174	MORRINHOS	MR12105036	MORRINHOS	17/01/2020 08:11	17/01/2020 17:06	17/01/2020 08:11	17/01/2020 17:06	8,91	14	124,70	CHI
202001100178	PORANGATU	PO21015307	PORANGATU	17/01/2020 08:59	17/01/2020 12:01	17/01/2020 08:59	17/01/2020 12:01	3,03	1	3,03	CHI
202001100190	CACU	7223508	CACHOEIRA ALTA	17/01/2020 09:01	18/01/2020 12:42	17/01/2020 09:01	18/01/2020 12:42	27,68	1	27,68	CHI
202001100201	FORMOSA	FA12000087	ITIQUEIRA	17/01/2020 09:02	17/01/2020 10:30	17/01/2020 09:02	17/01/2020 10:30	1,46	407	594,67	CHI
202001100202	CORUMBAIBA	CI21090584	VILA CORUMBA	17/01/2020 09:02	17/01/2020 16:40	17/01/2020 09:02	17/01/2020 16:40	7,62	1	7,62	CHI
202001100204	PIRACANJUBA	PJ21152294	PIRACANJUBA	17/01/2020 06:22	17/01/2020 22:32	17/01/2020 06:22	17/01/2020 22:32	16,16	1	16,16	CHI
202001100205	GUARINOS	GF12380720	SANTA TEREZINHA	17/01/2020 09:03	17/01/2020 15:39	17/01/2020 09:03	17/01/2020 15:39	6,60	17	112,15	CHI

202001100207	GOIANESIA	GE12372672	GOIANESIA S1	17/01/2020 08:38	17/01/2020 14:23	17/01/2020 08:38	17/01/2020 14:23	5,74	22	126,19	CHI
202001100211	GOIAS	GS12124722	GOIAS	17/01/2020 09:03	17/01/2020 12:38	17/01/2020 09:03	17/01/2020 12:38	3,57	10	35,72	CHI
202001100213	COCALZINHO DE GOIAS	ZN21297551	COCALZINHO	17/01/2020 09:04	17/01/2020 12:52	17/01/2020 09:04	17/01/2020 12:52	3,80	1	3,80	CHI
202001100214	PARAUNA	PU21142880	PARAUNA	17/01/2020 09:04	17/01/2020 14:00	17/01/2020 09:04	17/01/2020 14:00	4,93	1	4,93	CHI
202001100217	JUSSARA	JR21224235	JUSSARA	17/01/2020 09:04	17/01/2020 15:15	17/01/2020 09:04	17/01/2020 15:15	6,18	1	6,18	CHI
202001100228	SAO LUIS DE MONTES BELOS	SL11312558	SAO LUIZ DOS MONTES BELOS	17/01/2020 09:05	17/01/2020 11:25	17/01/2020 09:05	17/01/2020 11:25	2,33	180	418,60	CHI
202001100229	ITAPURANGA	IK21234783	ITAPURANGA	17/01/2020 09:05	17/01/2020 11:51	17/01/2020 09:05	17/01/2020 11:51	2,76	1	2,76	CHI
202001100232	FAINA	FC12220274	GOIAS	17/01/2020 09:05	17/01/2020 12:10	17/01/2020 09:05	17/01/2020 12:10	3,07	66	202,69	CHI
202001100237	MONTES CLAROS DE GOIAS	ME21138653	IPORA	17/01/2020 09:06	18/01/2020 14:21	17/01/2020 09:06	18/01/2020 14:21	29,25	1	29,25	CHI
202001100240	MORRINHOS	10028464794	MORRINHOS	17/01/2020 09:06	17/01/2020 10:53	17/01/2020 09:06	17/01/2020 10:53	1,78	1	1,78	CHI
202001100244	GOIAS	GS21117814	ITABERAI S1	17/01/2020 09:07	17/01/2020 15:30	17/01/2020 09:07	17/01/2020 15:30	6,38	1	6,38	CHI
202001100245	ALEXANIA	AX12402045	ALEXANIA	17/01/2020 08:07	17/01/2020 16:31	17/01/2020 08:07	17/01/2020 16:31	8,39	91	763,72	CHI
202001100245	SANTO ANTONIO DO DESCOBERTO	AX12402045	ALEXANIA	17/01/2020 08:07	17/01/2020 16:31	17/01/2020 08:07	17/01/2020 16:31	8,39	1	8,39	CHI
202001100246	CRISTALINA	KR21249250	CRISTALINA S1	17/01/2020 09:07	17/01/2020 18:00	17/01/2020 09:07	17/01/2020 18:00	8,87	1	8,87	CHI
202001100247	PIRANHAS	PH12343768	PIRANHAS	17/01/2020 09:07	18/01/2020 11:18	17/01/2020 09:07	18/01/2020 11:18	26,17	6	157,03	CHI
202001100250	JARAGUA	70020450	JARAGUA	17/01/2020 09:08	17/01/2020 13:08	17/01/2020 09:08	17/01/2020 13:08	4,00	1	4,00	CHI
202001100258	GOIANIA	TR12001815	TRINDADE	17/01/2020 09:09	17/01/2020 12:37	17/01/2020 09:09	17/01/2020 12:37	3,46	7	24,24	CHI
202001100258	TRINDADE	TR12001815	TRINDADE	17/01/2020 09:09	17/01/2020 12:37	17/01/2020 09:09	17/01/2020 12:37	3,46	2	6,93	CHI
202001100264	RIO VERDE	RV12305757	MONTIVIDIU T	17/01/2020 09:09	18/01/2020 09:30	17/01/2020 09:09	18/01/2020 09:30	24,34	5	121,68	CHI
202001100268	PADRE BERNARDO	2760053101	PADRE BERNARDO	17/01/2020 09:10	17/01/2020 12:56	17/01/2020 09:10	17/01/2020 12:56	3,77	1	3,77	CHI
202001100270	FORMOSA	610053929	ITIQUEIRA	17/01/2020 09:10	17/01/2020 11:10	17/01/2020 09:10	17/01/2020 11:10	2,00	1	2,00	CHI
202001100272	GOIANIA	16511712	XAVANTES	17/01/2020 09:11	17/01/2020 10:55	17/01/2020 09:11	17/01/2020 10:55	1,73	1	1,73	CHI
202001100280	GOIANIA	10325955	CAMPINAS S1	17/01/2020 09:11	17/01/2020 12:56	17/01/2020 09:11	17/01/2020 12:56	3,74	1	3,74	CHI
202001100289	PIRANHAS	PH12342187	PIRANHAS	17/01/2020 06:18	18/01/2020 07:48	17/01/2020 06:18	18/01/2020 07:48	25,49	2	50,99	CHI
202001100291	APORE	AE12091809	ITAJA S1	17/01/2020 09:13	17/01/2020 19:47	17/01/2020 09:13	17/01/2020 19:47	10,56	5	52,80	CHI
202001100292	SANTA TEREZINHA DE GOIAS	SG12214548	SANTA TEREZINHA	17/01/2020 08:32	17/01/2020 12:22	17/01/2020 08:32	17/01/2020 12:22	3,83	11	42,15	CHI
202001100295	MOSSAMEDES	MD12120930	ITABERAI S2	17/01/2020 09:14	17/01/2020 13:00	17/01/2020 09:14	17/01/2020 13:00	3,77	11	41,42	CHI
202001100296	MINEIROS	PW12303388	PARQUE DAS EMAS	17/01/2020 06:35	17/01/2020 12:53	17/01/2020 06:35	17/01/2020 12:53	6,29	4	25,17	CHI
202001100296	PORTELANDIA	PW12303388	PARQUE DAS EMAS	17/01/2020 06:35	17/01/2020 12:53	17/01/2020 06:35	17/01/2020 12:53	6,29	4	25,17	CHI
202001100298	PIRENOPOLIS	PV11196704	CORUMBA	17/01/2020 06:42	17/01/2020 12:43	17/01/2020 06:42	17/01/2020 12:43	6,01	112	673,09	CHI
202001100300	PETROLINA DE GOIAS	PG21028615	INHUMAS S1	17/01/2020 09:15	17/01/2020 14:05	17/01/2020 09:15	17/01/2020 14:05	4,83	1	4,83	CHI
202001100301	PALMEIRAS DE GOIAS	PL21169765	FIRMINOPOLIS S2	17/01/2020 09:15	17/01/2020 10:45	17/01/2020 09:15	17/01/2020 10:45	1,51	1	1,51	CHI
202001100310	ANAPOLIS	AN11043581	JUNDIAI S2	17/01/2020 09:16	17/01/2020 10:11	17/01/2020 09:16	17/01/2020 10:11	0,91	136	123,91	CHI

202001100312	ANICUNS	AC12391412	ANICUNS	17/01/2020 09:00	17/01/2020 11:06	17/01/2020 09:00	17/01/2020 11:06	2,10	25	52,57	CHI
202001100312	AVELINOPOLIS	AC12391412	ANICUNS	17/01/2020 09:00	17/01/2020 11:06	17/01/2020 09:00	17/01/2020 11:06	2,10	1	2,10	CHI
202001100317	ARAGARCAS	AG21188256	ARAGARCAS	17/01/2020 09:17	17/01/2020 15:04	17/01/2020 09:17	17/01/2020 15:04	5,78	1	5,78	CHI
202001100325	COCALZINHO DE GOIAS	1200030543	COCALZINHO	17/01/2020 09:18	17/01/2020 13:57	17/01/2020 09:18	17/01/2020 13:57	4,64	1	4,64	CHI
202001100329	GOIANIA	GN11002724	CAMPINAS S1	17/01/2020 09:18	17/01/2020 11:47	17/01/2020 09:18	17/01/2020 11:47	2,47	74	182,70	CHI
202001100335	RIO VERDE	10000516528	RIO VERDE S1	17/01/2020 09:19	18/01/2020 04:32	17/01/2020 09:19	18/01/2020 04:32	19,21	1	19,21	CHI
202001100337	COCALZINHO DE GOIAS	PB21214950	AGUAS LINDAS DE GOIAS S2	17/01/2020 09:19	17/01/2020 15:49	17/01/2020 09:19	17/01/2020 15:49	6,49	1	6,49	CHI
202001100341	CACHOEIRA ALTA	CA12384078	CACHOEIRA ALTA	17/01/2020 07:21	17/01/2020 11:58	17/01/2020 07:21	17/01/2020 11:58	4,61	8	36,85	CHI
202001100341	CACU	CA12384078	CACHOEIRA ALTA	17/01/2020 07:21	17/01/2020 11:58	17/01/2020 07:21	17/01/2020 11:58	4,61	1	4,61	CHI
202001100343	URUACU	UR21118029	URUACU	17/01/2020 09:21	17/01/2020 15:04	17/01/2020 09:21	17/01/2020 13:54	4,56	1	4,56	CHI
202001100343	URUACU	UR12117983	URUACU	17/01/2020 09:21	17/01/2020 15:04	17/01/2020 09:21	17/01/2020 15:04	5,73	3	17,19	CHI
202001100344	GOIANIA	14639804	MEIA PONTE	17/01/2020 09:21	17/01/2020 12:00	17/01/2020 09:21	17/01/2020 12:00	2,64	1	2,64	CHI
202001100345	URUACU	UR12117971	URUACU	17/01/2020 09:21	17/01/2020 11:01	17/01/2020 09:21	17/01/2020 11:01	1,66	17	28,18	CHI
202001100351	JATAI	290137020	JATAI S2	17/01/2020 09:22	17/01/2020 18:15	17/01/2020 09:22	17/01/2020 18:15	8,88	1	8,88	CHI
202001100354	TRINDADE	40222147	TRINDADE	17/01/2020 09:22	17/01/2020 16:22	17/01/2020 09:22	17/01/2020 16:22	6,99	1	6,99	CHI
202001100355	PIRENOPOLIS	220050016	CORUMBA	17/01/2020 09:23	17/01/2020 12:31	17/01/2020 09:23	17/01/2020 12:31	3,13	1	3,13	CHI
202001100357	SAO FRANCISCO DE GOIAS	SF21033827	SAO FRANCISCO DE GOIAS	17/01/2020 09:23	17/01/2020 17:15	17/01/2020 09:23	17/01/2020 17:15	7,87	1	7,87	CHI
202001100366	SANTA ISABEL	GE12000139	GOIANESIA S1	17/01/2020 09:04	17/01/2020 13:44	17/01/2020 09:04	17/01/2020 13:44	4,66	14	65,19	CHI
202001100373	CACU	CC12241667	CACHOEIRA ALTA	17/01/2020 09:25	17/01/2020 16:12	17/01/2020 09:25	17/01/2020 16:12	6,77	2	13,54	CHI
202001100374	PIRENOPOLIS	PV21230703	CORUMBA	17/01/2020 09:25	18/01/2020 10:01	17/01/2020 09:25	18/01/2020 10:01	24,58	2	49,17	CHI
202001100383	BOM JESUS DE GOIAS	BJ12000013	BOM JESUS DE GOIAS	17/01/2020 09:27	18/01/2020 08:55	17/01/2020 09:27	18/01/2020 08:55	23,46	168	3941,23	CHI
202001100383	GOIATUBA	BJ12000013	BOM JESUS DE GOIAS	17/01/2020 09:27	18/01/2020 08:55	17/01/2020 09:27	18/01/2020 08:55	23,46	5	117,30	CHI
202001100391	PLANALTINA	2960180404	PLANALTINA	17/01/2020 09:28	17/01/2020 11:25	17/01/2020 09:28	17/01/2020 11:25	1,94	1	1,94	CHI
202001100392	LUZIANIA	LZ12074642	RIO VERMELHO	17/01/2020 09:28	17/01/2020 12:00	17/01/2020 09:28	17/01/2020 12:00	2,53	2	5,05	CHI
202001100419	FIRMINOPOLIS	FR12382556	FIRMINOPOLIS S1	17/01/2020 09:30	17/01/2020 16:03	17/01/2020 09:30	17/01/2020 16:03	6,56	22	144,27	CHI
202001100419	SAO LUIS DE MONTES BELOS	FR12382556	FIRMINOPOLIS S1	17/01/2020 09:30	17/01/2020 16:03	17/01/2020 09:30	17/01/2020 16:03	6,56	7	45,90	CHI
202001100422	NOVA AMERICA	NM12363582	RUBIATABA	17/01/2020 09:30	17/01/2020 14:25	17/01/2020 09:30	17/01/2020 14:25	4,91	3	14,72	CHI
202001100424	PARANAIGUARA	PC12000130	QUIRINOPOLIS	17/01/2020 09:30	17/01/2020 13:26	17/01/2020 09:30	17/01/2020 13:26	3,92	8	31,36	CHI
202001100424	QUIRINOPOLIS	PC12000130	QUIRINOPOLIS	17/01/2020 09:30	17/01/2020 13:26	17/01/2020 09:30	17/01/2020 13:26	3,92	8	31,36	CHI
202001100432	PIRACANJUBA	BC21270805	CALDAS NOVAS S1	17/01/2020 09:33	18/01/2020 16:04	17/01/2020 09:33	18/01/2020 16:04	30,52	1	30,52	CHI
202001100433	SILVANIA	SV12094736	DAIA S2	17/01/2020 09:26	17/01/2020 11:30	17/01/2020 09:26	17/01/2020 11:30	2,06	7	14,44	CHI
202001100435	TAQUARAL DE GOIAS	TQ21217758	ITABERAI S1	17/01/2020 09:33	17/01/2020 17:55	17/01/2020 09:33	17/01/2020 17:55	8,36	1	8,36	CHI
202001100441	NIQUELANDIA	NQ21238689	NIQUELANDIA SUBTRANSMISSAO	17/01/2020 09:33	17/01/2020 11:52	17/01/2020 09:33	17/01/2020 11:52	2,30	1	2,30	CHI

202001100446	PIRENOPOLIS	220053947	CORUMBA	17/01/2020 09:35	17/01/2020 16:05	17/01/2020 09:35	17/01/2020 16:05	6,50	1	6,50	CHI
202001100455	PIRANHAS	PH12038598	PIRANHAS	17/01/2020 07:16	17/01/2020 10:57	17/01/2020 07:16	17/01/2020 10:57	3,68	33	121,50	CHI
202001100460	PIRANHAS	PH12380983	PIRANHAS	17/01/2020 08:52	17/01/2020 18:20	17/01/2020 08:52	17/01/2020 18:20	9,47	6	56,80	CHI
202001100467	JAUPACI	JP12028023	IPORA	17/01/2020 09:36	17/01/2020 12:09	17/01/2020 09:36	17/01/2020 12:09	2,54	7	17,77	CHI
202001100483	CAIAPONIA	CP12067934	MONTIVIDIU T	17/01/2020 07:42	17/01/2020 12:37	17/01/2020 07:42	17/01/2020 12:37	4,90	22	107,90	CHI
202001100483	MONTIVIDIU	CP12067934	MONTIVIDIU T	17/01/2020 07:42	17/01/2020 12:37	17/01/2020 07:42	17/01/2020 12:37	4,90	2	9,81	CHI
202001100484	SAO LUIZ DO NORTE	3090005758	ITAPACI	17/01/2020 09:38	17/01/2020 18:54	17/01/2020 09:38	17/01/2020 18:54	9,26	1	9,26	CHI
202001100487	PIRENOPOLIS	PV11215120	CORUMBA	17/01/2020 09:39	18/01/2020 04:35	17/01/2020 09:39	18/01/2020 04:35	18,93	35	662,69	CHI
202001100493	JATAI	JT11172863	JATAI S2	17/01/2020 09:39	17/01/2020 19:18	17/01/2020 18:18	17/01/2020 19:18	1,00	130	130,04	CHI
202001100495	PIRENOPOLIS	PV12273422	CORUMBA	17/01/2020 09:21	18/01/2020 10:19	17/01/2020 09:21	18/01/2020 10:19	24,97	6	149,80	CHI
202001100498	GOIANIA	10015851	CAMPINAS S1	17/01/2020 09:40	17/01/2020 15:15	17/01/2020 09:40	17/01/2020 15:15	5,57	1	5,57	CHI
202001100500	BALIZA	BH12402901	CAIAPONIA	17/01/2020 09:40	19/01/2020 10:08	17/01/2020 09:40	18/01/2020 14:06	28,43	15	426,47	CHI
202001100500	BALIZA	BH12331384	CAIAPONIA	17/01/2020 09:40	19/01/2020 10:08	17/01/2020 09:40	19/01/2020 10:08	48,47	8	387,74	CHI
202001100502	MINEIROS	MY12209687	PARQUE DAS EMAS	17/01/2020 09:41	17/01/2020 18:50	17/01/2020 09:41	17/01/2020 18:50	9,14	9	82,30	CHI
202001100504	CRISTALINA	KR21251302	CRISTALINA S2	17/01/2020 09:41	17/01/2020 22:05	17/01/2020 09:41	17/01/2020 22:05	12,39	1	12,39	CHI
202001100505	PIRENOPOLIS	10011696719	CORUMBA	17/01/2020 09:41	17/01/2020 14:25	17/01/2020 09:41	17/01/2020 14:25	4,73	1	4,73	CHI
202001100513	CAIAPONIA	CP12235316	PIRANHAS	17/01/2020 09:42	18/01/2020 11:58	17/01/2020 09:42	18/01/2020 11:58	26,26	6	157,57	CHI
202001100518	ITAJA	IJ12226574	ITAJA S2	17/01/2020 08:10	17/01/2020 12:50	17/01/2020 08:10	17/01/2020 12:50	4,65	8	37,24	CHI
202001100520	ITABERAI	AR12019610	ARACU	17/01/2020 08:20	17/01/2020 15:36	17/01/2020 08:20	17/01/2020 15:36	7,25	6	43,52	CHI
202001100521	CRISTALINA	KR12305009	PAMPLONA	17/01/2020 09:43	17/01/2020 12:39	17/01/2020 09:43	17/01/2020 12:39	2,93	6	17,60	CHI
202001100524	JATAI	JT12386939LD	JATAI S2	17/01/2020 08:46	17/01/2020 13:24	17/01/2020 12:30	17/01/2020 13:24	0,89	996	887,55	CHI
202001100525	AMERICANO DO BRASIL	KB12065194	ANICUNS	17/01/2020 09:43	17/01/2020 10:50	17/01/2020 09:43	17/01/2020 10:50	1,11	29	32,20	CHI
202001100525	MOSSAMEDES	KB12065194	ANICUNS	17/01/2020 09:43	17/01/2020 10:50	17/01/2020 09:43	17/01/2020 10:50	1,11	14	15,54	CHI
202001100526	QUIRINOPOLIS	QI21296552	QUIRINOPOLIS	17/01/2020 09:43	18/01/2020 10:15	17/01/2020 09:43	18/01/2020 10:15	24,52	1	24,52	CHI
202001100528	IPORA	10030758392	IPORA	17/01/2020 09:56	17/01/2020 11:55	17/01/2020 09:56	17/01/2020 11:55	1,97	1	1,97	CHI
202001100530	PIRACANJUBA	PJ12263455	PIRACANJUBA	17/01/2020 09:45	17/01/2020 12:55	17/01/2020 09:45	17/01/2020 12:55	3,16	8	25,30	CHI
202001100534	BELA VISTA DE GOIAS	240062929	BELA VISTA S1	17/01/2020 09:45	17/01/2020 12:48	17/01/2020 09:45	17/01/2020 12:48	3,04	1	3,04	CHI
202001100539	ADELANDIA	2330003025	FIRMINOPOLIS S2	17/01/2020 09:46	17/01/2020 14:22	17/01/2020 09:46	17/01/2020 14:22	4,60	1	4,60	CHI
202001100540	NOVO PLANALTO	TA12271828	NOVO PLANALTO	17/01/2020 09:46	18/01/2020 20:11	17/01/2020 09:46	18/01/2020 20:11	34,41	14	481,81	CHI
202001100545	SAO SIMAO	SO21232867	CACHOEIRA ALTA	17/01/2020 09:47	18/01/2020 10:17	17/01/2020 09:47	18/01/2020 10:17	24,50	1	24,50	CHI
202001100547	SANCLERLANDIA	SC12229501	FIRMINOPOLIS S2	17/01/2020 09:47	17/01/2020 11:55	17/01/2020 09:47	17/01/2020 11:55	2,13	2	4,25	CHI
202001100550	FAINA	FC12158726	GOIAS	17/01/2020 09:48	17/01/2020 19:45	17/01/2020 09:48	17/01/2020 19:45	9,96	4	39,84	CHI
202001100551	IPAMERI	IP21313739	CRISTALINA S2	17/01/2020 09:48	17/01/2020 17:25	17/01/2020 09:48	17/01/2020 17:25	7,62	1	7,62	CHI

202001100557	NOVA CRIXAS	NA12380421	NOVA CRIXAS	17/01/2020 09:48	17/01/2020 18:39	17/01/2020 09:48	17/01/2020 18:39	8,83	48	424,07	CHI
202001100559	PORTELANDIA	PW21172853	PARQUE DAS EMAS	17/01/2020 09:49	18/01/2020 20:33	17/01/2020 09:49	18/01/2020 20:33	34,73	1	34,73	CHI
202001100560	VIANOPOLIS	VN12067569	VIANOPOLIS	17/01/2020 09:49	17/01/2020 11:05	17/01/2020 09:49	17/01/2020 11:05	1,26	2	2,51	CHI
202001100562	BOM JESUS DE GOIAS	BJ12256996	BOM JESUS DE GOIAS	17/01/2020 06:09	17/01/2020 17:46	17/01/2020 06:09	17/01/2020 17:46	11,61	14	162,48	CHI
202001100562	GOIATUBA	BJ12256996	BOM JESUS DE GOIAS	17/01/2020 06:09	17/01/2020 17:46	17/01/2020 06:09	17/01/2020 17:46	11,61	49	568,67	CHI
202001100567	PORANGATU	04140224	PORANGATU	17/01/2020 09:50	18/01/2020 02:33	17/01/2020 09:50	17/01/2020 11:22	1,54	2	3,07	CHI
202001100567	PORANGATU	04140224	PORANGATU	17/01/2020 09:50	18/01/2020 02:33	17/01/2020 09:50	17/01/2020 18:42	8,87	29	257,17	CHI
202001100567	PORANGATU	04140224	PORANGATU	17/01/2020 09:50	18/01/2020 02:33	17/01/2020 14:20	17/01/2020 18:42	4,36	2	8,72	CHI
202001100567	MONTIVIDIU DO NORTE	PO13102907	PORANGATU	17/01/2020 09:50	18/01/2020 02:33	17/01/2020 09:50	18/01/2020 02:33	16,72	5	83,61	CHI
202001100567	PORANGATU	04140224	PORANGATU	17/01/2020 09:50	18/01/2020 02:33	17/01/2020 09:50	18/01/2020 02:33	16,72	278	4648,93	CHI
202001100567	PORANGATU	PO13102907	PORANGATU	17/01/2020 09:50	18/01/2020 02:33	17/01/2020 09:50	18/01/2020 02:33	16,72	739	12358,13	CHI
202001100567	SANTA TEREZA DE GOIAS	04140224	PORANGATU	17/01/2020 09:50	18/01/2020 02:33	17/01/2020 09:50	18/01/2020 02:33	16,72	11	183,95	CHI
202001100567	TROMBAS	04140224	PORANGATU	17/01/2020 09:50	18/01/2020 02:33	17/01/2020 09:50	18/01/2020 02:33	16,72	169	2826,15	CHI
202001100571	PIRENOPOLIS	220046761	CORUMBA	17/01/2020 09:50	17/01/2020 16:34	17/01/2020 09:50	17/01/2020 16:34	6,73	1	6,73	CHI
202001100573	CAMPO ALEGRE DE GOIAS	CM21166749	CAMPO ALEGRE DE GOIAS	17/01/2020 09:51	17/01/2020 20:53	17/01/2020 09:51	17/01/2020 20:53	11,02	1	11,02	CHI
202001100574	NOVO BRASIL	1460014082	JUSSARA	17/01/2020 09:51	17/01/2020 17:20	17/01/2020 09:51	17/01/2020 17:20	7,49	1	7,49	CHI
202001100575	FORMOSA	FA12404508	SAO JOAO D ALIANCA	17/01/2020 07:22	17/01/2020 13:39	17/01/2020 07:22	17/01/2020 13:39	6,27	7	43,91	CHI
202001100576	PORANGATU	PO10391979	PORANGATU	17/01/2020 09:59	17/01/2020 22:37	17/01/2020 09:59	17/01/2020 22:37	12,64	23	290,80	CHI
202001100577	NOVO GAMA	NJ12379162	PACAEMBU S1	17/01/2020 09:47	17/01/2020 11:57	17/01/2020 09:47	17/01/2020 11:57	2,15	742	1598,39	CHI
202001100578	DOVERLANDIA	DV21303692	PARQUE DAS EMAS	17/01/2020 09:52	17/01/2020 12:20	17/01/2020 09:52	17/01/2020 12:20	2,46	1	2,46	CHI
202001100579	UIRAPURU	UP12232520	NOVA CRIXAS	17/01/2020 09:52	17/01/2020 18:01	17/01/2020 09:52	17/01/2020 18:01	8,15	1	8,15	CHI
202001100585	CRIXAS	CX12018361	SERRA DO OURO	17/01/2020 09:04	17/01/2020 13:42	17/01/2020 09:04	17/01/2020 12:48	3,72	192	714,03	CHI
202001100585	CRIXAS	CX11244856	SERRA DO OURO	17/01/2020 09:04	17/01/2020 13:42	17/01/2020 09:04	17/01/2020 13:42	4,63	163	754,83	CHI
202001100587	JATAI	290034577	JATAI S3	17/01/2020 09:52	17/01/2020 20:55	17/01/2020 09:52	17/01/2020 20:55	11,03	1	11,03	CHI
202001100592	PIRENOPOLIS	PV11000022	CORUMBA	17/01/2020 09:53	17/01/2020 15:28	17/01/2020 14:09	17/01/2020 15:28	1,32	217	286,68	CHI
202001100596	JATAI	JT12219384RE	JATAI S3	17/01/2020 06:48	17/01/2020 16:40	17/01/2020 06:48	17/01/2020 16:40	9,86	29	285,99	CHI
202001100597	FAZENDA NOVA	FN12199825	JUSSARA	17/01/2020 09:39	18/01/2020 08:23	17/01/2020 09:39	18/01/2020 08:23	22,72	3	68,16	CHI
202001100599	JARAGUA	JA21015227	JARAGUA	17/01/2020 09:54	17/01/2020 11:22	17/01/2020 09:54	17/01/2020 11:22	1,46	2	2,91	CHI
202001100604	PALESTINA DE GOIAS	AY12390161	ARENOPOLIS	17/01/2020 09:55	18/01/2020 09:06	17/01/2020 09:55	18/01/2020 09:06	23,17	6	139,04	CHI
202001100609	PLANALTINA	2960153164	PLANALTINA	17/01/2020 09:56	17/01/2020 11:47	17/01/2020 09:56	17/01/2020 11:47	1,84	1	1,84	CHI
202001100610	PIRENOPOLIS	PV21297822	CORUMBA	17/01/2020 09:56	17/01/2020 12:12	17/01/2020 09:56	17/01/2020 12:12	2,25	1	2,25	CHI
202001100612	URUACU	UR21117938	URUACU	17/01/2020 09:56	17/01/2020 14:50	17/01/2020 09:56	17/01/2020 14:50	4,89	1	4,89	CHI
202001100615	RIO VERDE	RV11023372	RIO VERDE S2	17/01/2020 09:33	17/01/2020 11:28	17/01/2020 09:33	17/01/2020 11:28	1,91	123	234,73	CHI

202001100618	AMARALINA	LC21317102	MARA ROSA	17/01/2020 09:57	17/01/2020 21:54	17/01/2020 09:57	17/01/2020 21:54	11,94	1	11,94	CHI
202001100620	MINEIROS	MY12336249	PARQUE DAS EMAS	17/01/2020 09:57	17/01/2020 16:45	17/01/2020 09:57	17/01/2020 16:45	6,79	3	20,36	CHI
202001100622	SAO FRANCISCO DE GOIAS	SF12335087	SAO FRANCISCO DE GOIAS	17/01/2020 09:57	17/01/2020 17:40	17/01/2020 09:57	17/01/2020 17:40	7,70	10	77,03	CHI
202001100625	ITABERAÍ	IB12382594	ANICUNS	17/01/2020 09:57	17/01/2020 22:45	17/01/2020 09:57	17/01/2020 22:45	12,79	43	550,13	CHI
202001100625	MOSSAMEDES	IB12382594	ANICUNS	17/01/2020 09:57	17/01/2020 22:45	17/01/2020 09:57	17/01/2020 22:45	12,79	5	63,97	CHI
202001100626	FAINA	FC12274421	GOIAS	17/01/2020 08:49	17/01/2020 11:39	17/01/2020 08:49	17/01/2020 11:39	2,83	17	48,14	CHI
202001100628	RIO VERDE	10010382389	RIO VERDE S2	17/01/2020 09:58	18/01/2020 08:49	17/01/2020 09:58	18/01/2020 08:49	22,84	1	22,84	CHI
202001100634	SAO FRANCISCO DE GOIAS	SF11335006	SAO FRANCISCO DE GOIAS	17/01/2020 07:57	17/01/2020 13:21	17/01/2020 07:57	17/01/2020 13:21	5,41	13	70,27	CHI
202001100635	NOVA VENEZA	NV11201064	INHUMAS S1	17/01/2020 09:59	17/01/2020 17:19	17/01/2020 09:59	17/01/2020 17:19	7,32	45	329,61	CHI
202001100636	JARAGUA	JA21064339	GOIANESIA S2	17/01/2020 09:59	17/01/2020 20:45	17/01/2020 09:59	17/01/2020 20:45	10,76	2	21,51	CHI
202001100642	CATALAO	TH12013600RE	CATALAO S1	17/01/2020 08:00	17/01/2020 11:48	17/01/2020 08:00	17/01/2020 11:48	3,80	221	839,00	CHI
202001100642	CUMARI	TH12013600RE	CATALAO S1	17/01/2020 08:00	17/01/2020 11:48	17/01/2020 08:00	17/01/2020 11:48	3,80	1	3,80	CHI
202001100642	DISTRITO FEDERAL	TH12013600RE	CATALAO S1	17/01/2020 08:00	17/01/2020 11:48	17/01/2020 08:00	17/01/2020 11:48	3,80	1	3,80	CHI
202001100642	TRES RANCHOS	TH12013600RE	CATALAO S1	17/01/2020 08:00	17/01/2020 11:48	17/01/2020 08:00	17/01/2020 11:48	3,80	101	383,44	CHI
202001100648	BURITINOPOLIS	BQ12228972	IACIARA S2	17/01/2020 10:01	17/01/2020 16:57	17/01/2020 10:01	17/01/2020 16:57	6,92	4	27,69	CHI
202001100652	CEZARINA	IY12089831	CEZARINA	17/01/2020 10:02	17/01/2020 16:41	17/01/2020 10:02	17/01/2020 16:41	6,64	6	39,85	CHI
202001100652	INDIARA	IY12089831	CEZARINA	17/01/2020 10:02	17/01/2020 16:41	17/01/2020 10:02	17/01/2020 16:41	6,64	2	13,28	CHI
202001100662	MINEIROS	MY21198104	PARQUE DAS EMAS	17/01/2020 10:04	18/01/2020 14:23	17/01/2020 10:04	18/01/2020 14:23	28,32	1	28,32	CHI
202001100664	APARECIDA DO RIO DOCE	AW12191577	CACHOEIRA ALTA	17/01/2020 07:43	17/01/2020 15:19	17/01/2020 07:43	17/01/2020 15:19	7,59	10	75,87	CHI
202001100670	PARAUNA	980012557	PARAUNA	17/01/2020 10:05	17/01/2020 17:02	17/01/2020 10:05	17/01/2020 17:02	6,95	1	6,95	CHI
202001100671	GOIANIA	16495342	GOYA S2	17/01/2020 10:05	17/01/2020 11:51	17/01/2020 10:05	17/01/2020 11:51	1,76	1	1,76	CHI
202001100675	FORMOSA	610146841	ITUIQUIRA	17/01/2020 10:06	17/01/2020 12:49	17/01/2020 10:06	17/01/2020 12:49	2,71	1	2,71	CHI
202001100681	COCALZINHO DE GOIAS	ZN21297589	COCALZINHO	17/01/2020 10:07	17/01/2020 21:50	17/01/2020 10:07	17/01/2020 21:50	11,71	1	11,71	CHI
202001100682	PIRACANJUBA	PJ21244976	PIRACANJUBA	17/01/2020 10:07	17/01/2020 14:43	17/01/2020 10:07	17/01/2020 14:43	4,59	1	4,59	CHI
202001100683	NOVO PLANALTO	TA12192346	SAO MIGUEL DO ARAGUAIA	17/01/2020 10:07	17/01/2020 14:10	17/01/2020 10:07	17/01/2020 14:10	4,05	101	408,66	CHI
202001100685	AMORINOPOLIS	AM12362188	IPORA	17/01/2020 10:07	17/01/2020 18:09	17/01/2020 10:07	17/01/2020 18:09	8,02	4	32,08	CHI
202001100687	ITUMBIARA	690128873	ITUMBIARA VELHA S1	17/01/2020 10:07	17/01/2020 12:14	17/01/2020 10:07	17/01/2020 12:14	2,12	1	2,12	CHI
202001100695	ITUMBIARA	10014458282	ITUMBIARA NOVA	17/01/2020 10:09	17/01/2020 12:00	17/01/2020 10:09	17/01/2020 12:00	1,85	1	1,85	CHI
202001100722	RIO VERDE	RV21213260	MONTIVIDIU T	17/01/2020 11:17	17/01/2020 12:05	17/01/2020 11:17	17/01/2020 12:05	0,80	1	0,80	CHI
202001100723	RIO VERDE	RV21226316	MONTIVIDIU T	17/01/2020 11:17	17/01/2020 11:58	17/01/2020 11:17	17/01/2020 11:58	0,67	1	0,67	CHI
202001100728	MONTIVIDIU	MV12085651	MONTIVIDIU T	17/01/2020 07:45	17/01/2020 13:56	17/01/2020 07:45	17/01/2020 13:56	6,18	13	80,34	CHI
202001100728	RIO VERDE	MV12085651	MONTIVIDIU T	17/01/2020 07:45	17/01/2020 13:56	17/01/2020 07:45	17/01/2020 13:56	6,18	5	30,90	CHI
202001100734	ANAPOLIS	AN12388823	ANAPOLIS UNIVERSITARIO S2	17/01/2020 11:33	17/01/2020 13:13	17/01/2020 11:33	17/01/2020 13:13	1,66	3	4,99	CHI

202001100742	RIO VERDE	630017130	RIO VERDE S2	17/01/2020 12:02	17/01/2020 13:55	17/01/2020 12:02	17/01/2020 13:55	1,87	1	1,87	CHI
202001100802	ITAPURANGA	IK21063176	ITAPURANGA	17/01/2020 10:11	17/01/2020 14:53	17/01/2020 10:11	17/01/2020 14:53	4,70	1	4,70	CHI
202001100806	GOIANIA	GN11002189	FERROVIARIO S3	17/01/2020 10:12	17/01/2020 17:40	17/01/2020 17:17	17/01/2020 17:40	0,37	132	49,32	CHI
202001100821	PADRE BERNARDO	PB12053941	PADRE BERNARDO	17/01/2020 10:14	17/01/2020 17:01	17/01/2020 10:14	17/01/2020 17:01	6,77	2	13,55	CHI
202001100825	CEZARINA	CZ12314866	CEZARINA	17/01/2020 10:15	17/01/2020 14:26	17/01/2020 10:15	17/01/2020 14:26	4,19	3	12,58	CHI
202001100831	CALDAS NOVAS	10028112642	SERRA DE CALDAS	17/01/2020 10:16	17/01/2020 12:45	17/01/2020 10:16	17/01/2020 12:45	2,48	1	2,48	CHI
202001100840	ARAGUAPAZ	AZ12193702	GOIAS	17/01/2020 07:12	17/01/2020 17:52	17/01/2020 07:12	17/01/2020 17:52	10,67	2	21,33	CHI
202001100842	DIORAMA	DI12056935	ARENOPOLIS	17/01/2020 10:18	17/01/2020 23:05	17/01/2020 10:18	17/01/2020 23:05	12,78	2	25,56	CHI
202001100843	RIO VERDE	RV11000038	RIO VERDE S2	17/01/2020 10:12	17/01/2020 19:09	17/01/2020 10:12	17/01/2020 19:09	8,94	27	241,37	CHI
202001100845	CAMPO ALEGRE DE GOIAS	CM12338743	CAMPO ALEGRE DE GOIAS	17/01/2020 10:19	17/01/2020 20:42	17/01/2020 10:19	17/01/2020 20:42	10,37	12	124,47	CHI
202001100846	ABADIANIA	350010535	ANAPOLIS UNIVERSITARIO S1	17/01/2020 10:19	17/01/2020 11:47	17/01/2020 10:19	17/01/2020 11:47	1,45	1	1,45	CHI
202001100850	RIO VERDE	RV11000095	RIO VERDE S1	17/01/2020 10:20	18/01/2020 12:34	17/01/2020 10:20	18/01/2020 12:34	26,23	60	1573,53	CHI
202001100852	TRINDADE	40068821	TRINDADE	17/01/2020 10:21	17/01/2020 16:49	17/01/2020 10:21	17/01/2020 16:49	6,46	1	6,46	CHI
202001100853	QUIRINOPOLIS	80070358	QUIRINOPOLIS	17/01/2020 10:21	17/01/2020 14:58	17/01/2020 10:21	17/01/2020 14:58	4,61	1	4,61	CHI
202001100859	ARENOPOLIS	AY12337174	ARENOPOLIS	17/01/2020 06:48	17/01/2020 13:55	17/01/2020 06:48	17/01/2020 13:55	7,11	13	92,41	CHI
202001100859	PALESTINA DE GOIAS	AY12337174	ARENOPOLIS	17/01/2020 06:48	17/01/2020 13:55	17/01/2020 06:48	17/01/2020 13:55	7,11	3	21,33	CHI
202001100860	CORREGO DO OURO	CO12004043	FIRMINOPOLIS S2	17/01/2020 10:39	17/01/2020 10:55	17/01/2020 10:39	17/01/2020 10:55	0,25	11	2,78	CHI
202001100861	TRINDADE	40117947	GOYA S1	17/01/2020 10:23	17/01/2020 14:57	17/01/2020 10:23	17/01/2020 14:57	4,57	1	4,57	CHI
202001100864	CIDADE OCIDENTAL	10016707140	MARAJOARA	17/01/2020 10:23	17/01/2020 12:40	17/01/2020 10:23	17/01/2020 12:40	2,28	1	2,28	CHI
202001100865	SITIO D ABADIA	SI12211381	IACIARA S2	17/01/2020 10:23	17/01/2020 13:24	17/01/2020 10:23	17/01/2020 13:24	3,00	28	84,09	CHI
202001100869	QUIRINOPOLIS	QI32052457	QUIRINOPOLIS	17/01/2020 09:18	18/01/2020 10:33	17/01/2020 09:18	18/01/2020 10:33	25,24	9	227,17	CHI
202001100871	IPAMERI	IP21226879	IPAMERI	17/01/2020 10:24	17/01/2020 17:17	17/01/2020 10:24	17/01/2020 17:17	6,88	1	6,88	CHI
202001100876	IPORA	IR12021277	ARENOPOLIS	17/01/2020 04:55	17/01/2020 17:17	17/01/2020 04:55	17/01/2020 17:17	12,36	14	173,08	CHI
202001100877	SANCLERLANDIA	SC11102342	FIRMINOPOLIS S2	17/01/2020 10:41	17/01/2020 11:59	17/01/2020 10:41	17/01/2020 11:59	1,30	158	205,09	CHI
202001100879	PIRENOPOLIS	PV21082464	SAO FRANCISCO DE GOIAS	17/01/2020 10:25	17/01/2020 11:53	17/01/2020 10:25	17/01/2020 11:53	1,46	1	1,46	CHI
202001100885	MARA ROSA	MQ12262716	MARA ROSA	17/01/2020 10:25	17/01/2020 14:36	17/01/2020 10:25	17/01/2020 14:36	4,17	3	12,52	CHI
202001100889	DIVINOPOLIS DE GOIAS	GH12241928	SAO DOMINGOS	17/01/2020 10:27	17/01/2020 13:16	17/01/2020 10:27	17/01/2020 13:16	2,82	40	112,61	CHI
202001100889	MONTE ALEGRE DE GOIAS	GH12241928	SAO DOMINGOS	17/01/2020 10:27	17/01/2020 13:16	17/01/2020 10:27	17/01/2020 13:16	2,82	3	8,45	CHI
202001100889	SAO DOMINGOS	GH12241928	SAO DOMINGOS	17/01/2020 10:27	17/01/2020 13:16	17/01/2020 10:27	17/01/2020 13:16	2,82	12	33,78	CHI
202001100891	PORANGATU	PO21339758	PORANGATU	17/01/2020 10:27	17/01/2020 19:27	17/01/2020 10:27	17/01/2020 19:27	9,00	1	9,00	CHI
202001100895	SAO MIGUEL DO ARAGUAIA	SM12228636	SAO MIGUEL DO ARAGUAIA	17/01/2020 10:17	17/01/2020 13:18	17/01/2020 10:17	17/01/2020 13:18	3,01	57	171,73	CHI
202001100900	CRISTALINA	KR21246100	CRISTALINA S2	17/01/2020 10:28	17/01/2020 17:14	17/01/2020 10:28	17/01/2020 17:14	6,75	1	6,75	CHI
202001100903	EDEIA	EA11000003	EDEIA	17/01/2020 10:18	17/01/2020 13:53	17/01/2020 10:18	17/01/2020 13:53	3,58	85	304,37	CHI

202001100904	CRISTIANOPOLIS	CF21093862	CRISTIANOPOLIS	17/01/2020 10:30	17/01/2020 17:17	17/01/2020 10:30	17/01/2020 17:17	6,78	1	6,78	CHI
202001100905	GOIANIA	10568920	GOIANIA LESTE S2	17/01/2020 10:30	17/01/2020 11:40	17/01/2020 10:30	17/01/2020 11:40	1,16	1	1,16	CHI
202001100918	ANICUNS	AC21304688	FIRMINOPOLIS S2	17/01/2020 10:32	17/01/2020 14:03	17/01/2020 10:32	17/01/2020 14:03	3,52	1	3,52	CHI
202001100923	CALDAZINHA	DE12375200	CEPAIGO S2	17/01/2020 10:33	17/01/2020 13:59	17/01/2020 10:33	17/01/2020 13:59	3,42	3	10,26	CHI
202001100926	FORMOSA	10018078263	ITUIQUIRA	17/01/2020 10:34	17/01/2020 12:22	17/01/2020 10:34	17/01/2020 12:22	1,81	1	1,81	CHI
202001100930	JATAI	JT21359759	JATAI S3	17/01/2020 10:35	17/01/2020 16:02	17/01/2020 10:35	17/01/2020 16:02	5,44	1	5,44	CHI
202001100933	PIRENOPOLIS	220029672	CORUMBA	17/01/2020 10:36	17/01/2020 17:15	17/01/2020 10:36	17/01/2020 17:15	6,65	1	6,65	CHI
202001100937	GOIANIA	10004001875	GOYA S1	17/01/2020 10:36	17/01/2020 13:44	17/01/2020 10:36	17/01/2020 13:44	3,13	1	3,13	CHI
202001100942	INHUMAS	IN12098283	INHUMAS S2	17/01/2020 10:36	17/01/2020 15:35	17/01/2020 10:36	17/01/2020 15:35	4,97	2	9,94	CHI
202001100949	CAMPOS VERDES	VD21253051	SANTA TEREZINHA	17/01/2020 10:37	17/01/2020 16:08	17/01/2020 10:37	17/01/2020 16:08	5,51	1	5,51	CHI
202001100958	COCALZINHO DE GOIAS	10023196759	AGUAS LINDAS DE GOIAS S2	17/01/2020 10:39	17/01/2020 15:01	17/01/2020 10:39	17/01/2020 15:01	4,36	1	4,36	CHI
202001100963	VALPARAISO DE GOIAS	2860014105	PACAEMBU S2	17/01/2020 10:40	17/01/2020 11:48	17/01/2020 10:40	17/01/2020 11:48	1,13	1	1,13	CHI
202001100964	PORANGATU	PO11218984	PORANGATU	17/01/2020 10:40	17/01/2020 12:19	17/01/2020 10:40	17/01/2020 12:19	1,65	24	39,55	CHI
202001100968	CAIAPONIA	PY12244702	PALESTINA	17/01/2020 10:23	17/01/2020 17:40	17/01/2020 10:23	17/01/2020 17:40	7,27	49	356,23	CHI
202001100968	PALESTINA DE GOIAS	PY12244702	PALESTINA	17/01/2020 10:23	17/01/2020 17:40	17/01/2020 10:23	17/01/2020 17:40	7,27	2	14,54	CHI
202001100969	PARAUNA	10023007646	PARAUNA	17/01/2020 10:40	17/01/2020 17:26	17/01/2020 10:40	17/01/2020 17:26	6,77	1	6,77	CHI
202001100973	GOIANIA	GN11150305	GOIANIA LESTE S3	17/01/2020 10:31	17/01/2020 14:19	17/01/2020 10:31	17/01/2020 14:19	3,79	54	204,89	CHI
202001100975	ANICUNS	AC21304680	ANICUNS	17/01/2020 10:42	17/01/2020 11:55	17/01/2020 10:42	17/01/2020 11:55	1,21	2	2,43	CHI
202001100988	PONTALINA	PK32060058	MORRINHOS	17/01/2020 10:44	17/01/2020 14:20	17/01/2020 10:44	17/01/2020 14:20	3,60	3	10,81	CHI
202001100989	PALMEIRAS DE GOIAS	PL12137974	PALMEIRAS	17/01/2020 10:44	17/01/2020 12:23	17/01/2020 10:44	17/01/2020 12:23	1,65	3	4,94	CHI
202001100993	CRIXAS	CX12377839	RUBIATABA	17/01/2020 09:54	17/01/2020 19:19	17/01/2020 09:54	17/01/2020 17:43	7,82	11	86,04	CHI
202001100993	CRIXAS	CX12377839	RUBIATABA	17/01/2020 09:54	17/01/2020 19:19	17/01/2020 09:54	17/01/2020 19:19	9,43	3	28,29	CHI
202001100995	SANCLERLANDIA	SC21164056	FIRMINOPOLIS S2	17/01/2020 10:46	17/01/2020 14:30	17/01/2020 10:46	17/01/2020 14:30	3,74	1	3,74	CHI
202001101003	SANCLERLANDIA	SC12391519	FIRMINOPOLIS S2	17/01/2020 10:48	17/01/2020 17:23	17/01/2020 10:48	17/01/2020 17:23	6,58	1	6,58	CHI
202001101003	SAO LUIS DE MONTES BELOS	SC12391519	FIRMINOPOLIS S2	17/01/2020 10:48	17/01/2020 17:23	17/01/2020 10:48	17/01/2020 17:23	6,58	2	13,16	CHI
202001101004	JARAGUA	JA12254078	JARAGUA	17/01/2020 08:32	17/01/2020 14:15	17/01/2020 08:32	17/01/2020 14:15	5,71	25	142,64	CHI
202001101005	LUZIANIA	10014582234	MARAJOARA	17/01/2020 10:48	17/01/2020 13:14	17/01/2020 10:48	17/01/2020 13:14	2,43	1	2,43	CHI
202001101010	CRISTALINA	KR21348844	CRISTALINA S1	17/01/2020 10:49	17/01/2020 19:30	17/01/2020 10:49	17/01/2020 19:30	8,68	3	26,04	CHI
202001101014	VILA PROPICIO	GE21196943	GOIANESIA S1	17/01/2020 10:49	17/01/2020 16:16	17/01/2020 10:49	17/01/2020 16:16	5,44	1	5,44	CHI
202001101016	MORRINHOS	MR21189824	MORRINHOS	17/01/2020 10:49	17/01/2020 12:30	17/01/2020 10:49	17/01/2020 12:30	1,67	1	1,67	CHI
202001101021	SANCLERLANDIA	SC12206494	SAO LUIZ DOS MONTES BELOS	17/01/2020 10:11	17/01/2020 17:58	17/01/2020 10:11	17/01/2020 17:58	7,78	10	77,77	CHI
202001101021	SAO LUIS DE MONTES BELOS	SC12206494	SAO LUIZ DOS MONTES BELOS	17/01/2020 10:11	17/01/2020 17:58	17/01/2020 10:11	17/01/2020 17:58	7,78	1	7,78	CHI
202001101023	LUZIANIA	LZ11000044	CRISTALINA S2	17/01/2020 10:50	17/01/2020 14:33	17/01/2020 10:50	17/01/2020 14:33	3,70	19	70,34	CHI

202001101025	SAO LUIS DE MONTES BELOS	SL21145978	SAO LUIZ DOS MONTES BELOS	17/01/2020 10:52	17/01/2020 16:44	17/01/2020 10:52	17/01/2020 16:44	5,86	2	11,73	CHI
202001101026	IPORA	730117893	IPORA	17/01/2020 10:52	17/01/2020 15:22	17/01/2020 10:52	17/01/2020 15:22	4,50	1	4,50	CHI
202001101029	JATAI	10003941181	JATAI S2	17/01/2020 10:52	17/01/2020 19:15	17/01/2020 10:52	17/01/2020 19:15	8,37	1	8,37	CHI
202001101037	RIO VERDE	RV12271239	MONTIVIDIU T	17/01/2020 10:53	18/01/2020 08:46	17/01/2020 10:53	18/01/2020 08:02	21,16	2	42,32	CHI
202001101037	RIO VERDE	RV12240535	MONTIVIDIU T	17/01/2020 10:53	18/01/2020 08:46	18/01/2020 08:07	18/01/2020 08:46	0,65	3	1,95	CHI
202001101038	ITAUCU	IX21016909	INHUMAS S1	17/01/2020 10:53	17/01/2020 16:30	17/01/2020 10:53	17/01/2020 16:30	5,61	4	22,44	CHI
202001101043	DIORAMA	DI12188303	ARENOPOLIS	17/01/2020 10:41	18/01/2020 06:30	17/01/2020 10:41	18/01/2020 06:30	19,80	28	554,45	CHI
202001101043	MONTES CLAROS DE GOIAS	DI12188303	ARENOPOLIS	17/01/2020 10:41	18/01/2020 06:30	17/01/2020 10:41	18/01/2020 06:30	19,80	1	19,80	CHI
202001101053	COCALZINHO DE GOIAS	ZN21191483	COCALZINHO	17/01/2020 10:55	17/01/2020 20:33	17/01/2020 10:55	17/01/2020 20:33	9,63	1	9,63	CHI
202001101055	CACHOEIRA ALTA	CA12075141	CACHOEIRA ALTA	17/01/2020 10:55	19/01/2020 21:25	17/01/2020 10:55	19/01/2020 21:25	58,49	10	584,88	CHI
202001101059	PARAUNA	PU12104533	PARAUNA	17/01/2020 10:55	17/01/2020 16:19	17/01/2020 10:55	17/01/2020 16:19	5,38	8	43,07	CHI
202001101061	APARECIDA DE GOIANIA	14824127	INDEPENDENCIA S2	17/01/2020 10:56	17/01/2020 14:48	17/01/2020 10:56	17/01/2020 14:48	3,86	1	3,86	CHI
202001101063	CALDAS NOVAS	CN21186189	SERRA DE CALDAS	17/01/2020 10:56	17/01/2020 18:43	17/01/2020 10:56	17/01/2020 18:43	7,77	1	7,77	CHI
202001101066	CAIAPONIA	CP12142981	PALESTINA	17/01/2020 09:10	18/01/2020 11:24	17/01/2020 09:10	18/01/2020 11:24	26,23	12	314,79	CHI
202001101070	ITABERAI	IB21158191	ITABERAI S2	17/01/2020 10:58	18/01/2020 03:55	17/01/2020 10:58	18/01/2020 03:55	16,94	1	16,94	CHI
202001101071	GOIAS	GS21059821	ITABERAI S1	17/01/2020 10:58	17/01/2020 16:18	17/01/2020 10:58	17/01/2020 16:18	5,32	1	5,32	CHI
202001101075	URUACU	UR11038715	URUACU	17/01/2020 10:59	17/01/2020 12:43	17/01/2020 10:59	17/01/2020 12:43	1,72	117	201,27	CHI
202001101081	FORMOSA	FA11085518	ITUIQUIRA	17/01/2020 11:01	17/01/2020 13:14	17/01/2020 11:01	17/01/2020 13:14	2,21	2	4,42	CHI
202001101082	QUIRINOPOLIS	QI21326983	QUIRINOPOLIS	17/01/2020 11:01	18/01/2020 07:55	17/01/2020 11:01	18/01/2020 07:55	20,89	4	83,55	CHI
202001101085	CORUMBA DE GOIAS	CB21027567	CORUMBA	17/01/2020 11:01	17/01/2020 13:45	17/01/2020 11:01	17/01/2020 13:45	2,72	1	2,72	CHI
202001101087	JATAI	290250754	JATAI S2	17/01/2020 11:02	17/01/2020 22:38	17/01/2020 11:02	17/01/2020 22:38	11,59	1	11,59	CHI
202001101088	RIO VERDE	630130395	RIO VERDE S2	17/01/2020 11:02	17/01/2020 23:22	17/01/2020 11:02	17/01/2020 23:22	12,32	1	12,32	CHI
202001101092	GOIANIA	10006609820	CARAJAS S1	17/01/2020 11:05	17/01/2020 16:03	17/01/2020 11:05	17/01/2020 16:03	4,97	1	4,97	CHI
202001101093	ITAPURANGA	IK21169267	ITAPURANGA	17/01/2020 11:05	17/01/2020 17:22	17/01/2020 11:05	17/01/2020 17:22	6,27	1	6,27	CHI
202001101094	CEZARINA	CZ21126223	CEZARINA	17/01/2020 11:16	17/01/2020 18:04	17/01/2020 11:16	17/01/2020 18:04	6,79	1	6,79	CHI
202001101095	QUIRINOPOLIS	RV12271385	CABRIUVA S2	17/01/2020 11:06	18/01/2020 09:49	17/01/2020 11:06	18/01/2020 09:49	22,71	4	90,84	CHI
202001101095	RIO VERDE	RV12271385	CABRIUVA S2	17/01/2020 11:06	18/01/2020 09:49	17/01/2020 11:06	18/01/2020 09:49	22,71	16	363,36	CHI
202001101100	FORMOSA	610214652	ITUIQUIRA	17/01/2020 11:07	17/01/2020 13:05	17/01/2020 11:07	17/01/2020 13:05	1,96	1	1,96	CHI
202001101115	GOIANIA	13334384	ATLANTICO S1	17/01/2020 11:09	17/01/2020 14:31	17/01/2020 11:09	17/01/2020 14:31	3,36	1	3,36	CHI
202001101120	PORANGATU	SE12094693	MARA ROSA	17/01/2020 11:10	17/01/2020 12:30	17/01/2020 11:10	17/01/2020 12:30	1,32	3	3,95	CHI
202001101120	SANTA TEREZA DE GOIAS	SE12094693	MARA ROSA	17/01/2020 11:10	17/01/2020 12:30	17/01/2020 11:10	17/01/2020 12:30	1,32	17	22,40	CHI
202001101121	CAMPO ALEGRE DE GOIAS	CM12042379	CAMPO ALEGRE DE GOIAS	17/01/2020 11:11	17/01/2020 13:56	17/01/2020 11:11	17/01/2020 13:56	2,75	3	8,24	CHI
202001101121	CATALAO	CM12042379	CAMPO ALEGRE DE GOIAS	17/01/2020 11:11	17/01/2020 13:56	17/01/2020 11:11	17/01/2020 13:56	2,75	1	2,75	CHI

202001101121	IPAMERI	CM12042379	CAMPO ALEGRE DE GOIAS	17/01/2020 11:11	17/01/2020 13:56	17/01/2020 11:11	17/01/2020 13:56	2,75	1	2,75	CHI
202001101126	ITUMBIARA	IT21128213	ITUMBIARA NOVA	17/01/2020 11:12	17/01/2020 21:05	17/01/2020 11:12	17/01/2020 21:05	9,88	2	19,77	CHI
202001101135	FAZENDA NOVA	FN21229915	IPORA	17/01/2020 11:14	18/01/2020 13:13	17/01/2020 11:14	18/01/2020 13:13	25,97	1	25,97	CHI
202001101142	FAZENDA NOVA	FN12031812	IPORA	17/01/2020 11:16	17/01/2020 21:06	17/01/2020 11:16	17/01/2020 21:06	9,83	2	19,66	CHI
202001101144	VALPARAISO DE GOIAS	10020848933	MARAJOARA	17/01/2020 11:16	17/01/2020 13:46	17/01/2020 11:16	17/01/2020 13:46	2,51	1	2,51	CHI
202001101147	GOIANIA	11271486	FERROVIARIO S3	17/01/2020 11:16	17/01/2020 14:54	17/01/2020 11:16	17/01/2020 14:54	3,62	1	3,62	CHI
202001101149	UIRAPURU	4210005023	SANTA TEREZINHA	17/01/2020 11:16	17/01/2020 19:24	17/01/2020 11:16	17/01/2020 19:24	8,12	1	8,12	CHI
202001101153	CAIAPONIA	CP12201059	CAIAPONIA	17/01/2020 11:17	18/01/2020 21:51	17/01/2020 11:17	18/01/2020 21:51	34,55	2	69,10	CHI
202001101154	MONTIVIDIU DO NORTE	MX12270910	PORANGATU	17/01/2020 11:18	17/01/2020 19:52	17/01/2020 11:18	17/01/2020 19:52	8,57	7	59,96	CHI
202001101156	PIRANHAS	PH12253708RE	BOM JARDIM	17/01/2020 11:18	18/01/2020 01:35	17/01/2020 11:18	18/01/2020 01:35	14,28	22	314,15	CHI
202001101157	GOIANIA	16479221	CARAJAS S2	17/01/2020 11:18	17/01/2020 12:40	17/01/2020 11:18	17/01/2020 12:40	1,36	1	1,36	CHI
202001101160	ARENOPOLIS	AY12156761	ARENOPOLIS	17/01/2020 11:18	18/01/2020 11:10	17/01/2020 11:18	18/01/2020 11:10	23,85	5	119,27	CHI
202001101162	INHUMAS	IN21393408	INHUMAS S1	17/01/2020 11:18	17/01/2020 15:02	17/01/2020 11:18	17/01/2020 15:02	3,72	1	3,72	CHI
202001101167	JARAGUA	70113646	JARAGUA	17/01/2020 11:19	17/01/2020 18:13	17/01/2020 11:19	17/01/2020 18:13	6,90	1	6,90	CHI
202001101173	GOIANIA	10693750	ATLANTICO S2	17/01/2020 11:19	17/01/2020 16:21	17/01/2020 11:19	17/01/2020 16:21	5,02	1	5,02	CHI
202001101178	MINACU	IH12130486	MINACU	17/01/2020 11:21	17/01/2020 15:46	17/01/2020 11:21	17/01/2020 15:46	4,41	3	13,24	CHI
202001101180	AGUAS LINDAS DE GOIAS	LA11375217	AGUAS LINDAS DE GOIAS S2	17/01/2020 11:21	17/01/2020 12:53	17/01/2020 11:21	17/01/2020 12:53	1,53	31	47,29	CHI
202001101181	GOIANIA	GN12201569	GOYA S2	17/01/2020 11:21	17/01/2020 13:49	17/01/2020 11:21	17/01/2020 13:49	2,46	301	740,04	CHI
202001101182	CRISTALINA	KR11351422	CRISTALINA S2	17/01/2020 11:21	17/01/2020 15:10	17/01/2020 11:21	17/01/2020 15:10	3,80	7	26,63	CHI
202001101188	IPORA	IR12381026	ARENOPOLIS	17/01/2020 11:22	18/01/2020 00:13	17/01/2020 11:22	18/01/2020 00:13	12,84	1	12,84	CHI
202001101189	SANCLERLANDIA	SC11093501	FIRMINOPOLIS S2	17/01/2020 10:20	17/01/2020 13:15	17/01/2020 10:20	17/01/2020 13:15	2,92	179	521,93	CHI
202001101190	CATALAO	GD12127624RE	CATALAO S1	17/01/2020 11:00	17/01/2020 16:30	17/01/2020 11:00	17/01/2020 16:30	5,48	13	71,30	CHI
202001101190	GOIANDIRA	GD12127624RE	CATALAO S1	17/01/2020 11:00	17/01/2020 16:30	17/01/2020 11:00	17/01/2020 16:30	5,48	17	93,24	CHI
202001101190	IPAMERI	GD12127624RE	CATALAO S1	17/01/2020 11:00	17/01/2020 16:30	17/01/2020 11:00	17/01/2020 16:30	5,48	7	38,39	CHI
202001101200	TURVANIA	TV21005757	FIRMINOPOLIS S2	17/01/2020 11:23	17/01/2020 15:41	17/01/2020 11:23	17/01/2020 15:41	4,28	1	4,28	CHI
202001101204	SANCLERLANDIA	SC21190731	FIRMINOPOLIS S2	17/01/2020 11:24	17/01/2020 15:39	17/01/2020 11:24	17/01/2020 15:39	4,24	1	4,24	CHI
202001101212	ITAPIRAPUA	04750226	MATRINCHA	17/01/2020 11:26	19/01/2020 14:30	17/01/2020 11:26	17/01/2020 19:25	7,98	17	135,58	CHI
202001101212	ITAPIRAPUA	IU13008899	MATRINCHA	17/01/2020 11:26	19/01/2020 14:30	17/01/2020 11:26	17/01/2020 19:54	8,47	32	271,07	CHI
202001101212	ITAPIRAPUA	04750226	MATRINCHA	17/01/2020 11:26	19/01/2020 14:30	17/01/2020 11:26	18/01/2020 11:34	24,13	23	554,99	CHI
202001101212	ITAPIRAPUA	IU12020119	MATRINCHA	17/01/2020 11:26	19/01/2020 14:30	18/01/2020 13:06	18/01/2020 14:00	0,89	23	20,51	CHI
202001101212	ITAPIRAPUA	04750224	MATRINCHA	17/01/2020 11:26	19/01/2020 14:30	18/01/2020 13:06	18/01/2020 14:00	0,89	49	43,68	CHI
202001101212	ITAPIRAPUA	04750226	MATRINCHA	17/01/2020 11:26	19/01/2020 14:30	17/01/2020 11:26	19/01/2020 14:29	51,05	4	204,20	CHI
202001101212	ITAPIRAPUA	IU13250543	MATRINCHA	17/01/2020 11:26	19/01/2020 14:30	17/01/2020 18:00	19/01/2020 14:29	44,48	1	44,48	CHI

202001101212	BRITANIA	04750226	MATRINCHA	17/01/2020 11:26	19/01/2020 14:30	17/01/2020 11:26	19/01/2020 14:30	51,06	6	306,35	CHI
202001101212	ITAPIRAPUA	04750226	MATRINCHA	17/01/2020 11:26	19/01/2020 14:30	17/01/2020 11:26	19/01/2020 14:30	51,06	15	765,87	CHI
202001101230	VIANOPOLIS	VN21310170	VIANOPOLIS	17/01/2020 11:30	17/01/2020 16:07	17/01/2020 11:30	17/01/2020 16:07	4,62	1	4,62	CHI
202001101233	INDIARA	IY21361616	EDEIA	17/01/2020 11:30	17/01/2020 12:55	17/01/2020 11:30	17/01/2020 12:55	1,42	1	1,42	CHI
202001101236	NOVA CRIXAS	NA11357704	NOVA CRIXAS	17/01/2020 11:30	18/01/2020 00:45	17/01/2020 11:30	18/01/2020 00:45	13,24	1	13,24	CHI
202001101237	EDEIA	1120030940	EDEIA	17/01/2020 11:30	17/01/2020 14:18	17/01/2020 11:30	17/01/2020 14:18	2,79	1	2,79	CHI
202001101246	GOIAS	HE12250700	ITAPURANGA	17/01/2020 11:21	17/01/2020 13:36	17/01/2020 11:21	17/01/2020 13:36	2,24	9	20,14	CHI
202001101246	HEITORAI	HE12250700	ITAPURANGA	17/01/2020 11:21	17/01/2020 13:36	17/01/2020 11:21	17/01/2020 13:36	2,24	6	13,43	CHI
202001101247	SANCLERLANDIA	SC21164000	FIRMINOPOLIS S2	17/01/2020 11:33	17/01/2020 14:57	17/01/2020 11:33	17/01/2020 14:57	3,40	1	3,40	CHI
202001101257	SILVANIA	SV12022221	DAIA S2	17/01/2020 11:44	17/01/2020 13:06	17/01/2020 11:44	17/01/2020 13:06	1,37	3	4,12	CHI
202001101262	CORREGO DO OURO	CO12004040	FIRMINOPOLIS S2	17/01/2020 11:28	17/01/2020 18:00	17/01/2020 11:28	17/01/2020 18:00	6,52	4	26,09	CHI
202001101267	GOIANDIRA	10016221905	CATALAO S1	17/01/2020 11:37	17/01/2020 17:58	17/01/2020 11:37	17/01/2020 17:58	6,35	1	6,35	CHI
202001101284	JUSSARA	JR12093790	JUSSARA	17/01/2020 11:39	17/01/2020 22:05	17/01/2020 11:39	17/01/2020 22:05	10,43	2	20,86	CHI
202001101292	GOIANIA	11830554	ATLANTICO S2	17/01/2020 11:41	17/01/2020 17:45	17/01/2020 11:41	17/01/2020 17:45	6,07	1	6,07	CHI
202001101293	PORANGATU	PO12282160	PORANGATU	17/01/2020 11:25	17/01/2020 16:43	17/01/2020 11:25	17/01/2020 16:43	5,30	11	58,27	CHI
202001101305	CACU	1140027338	CACHOEIRA ALTA	17/01/2020 11:44	19/01/2020 00:26	17/01/2020 11:44	19/01/2020 00:26	36,70	1	36,70	CHI
202001101308	NIQUELANDIA	NQ12255072	BARRO ALTO	17/01/2020 11:44	17/01/2020 16:26	17/01/2020 11:44	17/01/2020 16:26	4,68	7	32,79	CHI
202001101309	JATAI	290158953	JATAI S3	17/01/2020 11:45	17/01/2020 15:44	17/01/2020 11:45	17/01/2020 15:44	3,98	1	3,98	CHI
202001101310	TRINDADE	TR11238911	GOYA S1	17/01/2020 11:45	17/01/2020 15:41	17/01/2020 11:45	17/01/2020 15:41	3,93	20	78,52	CHI
202001101337	BOM JARDIM DE GOIAS	BM21064178	BOM JARDIM	17/01/2020 11:52	17/01/2020 23:04	17/01/2020 11:52	17/01/2020 23:04	11,19	1	11,19	CHI
202001101340	ADELANDIA	SL12019453	ANICUNS	17/01/2020 09:28	17/01/2020 16:28	17/01/2020 09:28	17/01/2020 16:28	7,00	26	181,99	CHI
202001101340	MOSSAMEDES	SL12019453	ANICUNS	17/01/2020 09:28	17/01/2020 16:28	17/01/2020 09:28	17/01/2020 16:28	7,00	2	14,00	CHI
202001101340	ADELANDIA	SL12019453	FIRMINOPOLIS S2	17/01/2020 09:28	17/01/2020 16:28	17/01/2020 09:28	17/01/2020 16:28	7,00	1	7,00	CHI
202001101343	INDIARA	IY21032285	EDEIA	17/01/2020 11:54	17/01/2020 13:35	17/01/2020 11:54	17/01/2020 13:35	1,68	1	1,68	CHI
202001101362	PILAR DE GOIAS	IW21170005	ITAPACI	17/01/2020 11:56	17/01/2020 16:17	17/01/2020 11:56	17/01/2020 16:17	4,33	1	4,33	CHI
202001101368	PALMINOPOLIS	PP21039129	PALMEIRAS	17/01/2020 11:58	17/01/2020 16:53	17/01/2020 11:58	17/01/2020 16:53	4,92	1	4,92	CHI
202001101372	MOZARLANDIA	AZ21157594	MOZARLANDIA	17/01/2020 11:58	17/01/2020 23:45	17/01/2020 11:58	17/01/2020 23:45	11,77	1	11,77	CHI
202001101374	SAO MIGUEL DO ARAGUAIA	SM12350501	SAO MIGUEL DO ARAGUAIA	17/01/2020 11:58	17/01/2020 15:20	17/01/2020 11:58	17/01/2020 15:20	3,35	6	20,11	CHI
202001101375	SAO MIGUEL DO ARAGUAIA	SM21262557	SAO MIGUEL DO ARAGUAIA	17/01/2020 11:59	17/01/2020 21:13	17/01/2020 11:59	17/01/2020 21:13	9,23	1	9,23	CHI
202001101381	GOIANIRA	CK21098405	INHUMAS S1	17/01/2020 12:00	17/01/2020 15:34	17/01/2020 12:00	17/01/2020 15:34	3,56	1	3,56	CHI
202001101387	NOVA CRIXAS	SM12099600	SAO MIGUEL DO ARAGUAIA	17/01/2020 12:01	17/01/2020 16:45	17/01/2020 12:01	17/01/2020 16:45	4,72	1	4,72	CHI
202001101387	SAO MIGUEL DO ARAGUAIA	SM12099600	SAO MIGUEL DO ARAGUAIA	17/01/2020 12:01	17/01/2020 16:45	17/01/2020 12:01	17/01/2020 16:45	4,72	87	410,95	CHI
202001101390	VARJAO	VJ21397528	GUAPO S2	17/01/2020 12:02	17/01/2020 19:45	17/01/2020 12:02	17/01/2020 19:45	7,71	1	7,71	CHI

202001101392	TRES RANCHOS	TH21149124	CATALAO S1	17/01/2020 12:02	17/01/2020 14:21	17/01/2020 12:02	17/01/2020 14:21	2,30	2	4,60	CHI
202001101395	BELA VISTA DE GOIAS	SQ12318950	CRISTIANOPOLIS	17/01/2020 12:03	17/01/2020 15:06	17/01/2020 12:03	17/01/2020 15:06	3,05	4	12,20	CHI
202001101395	CRISTIANOPOLIS	SQ12318950	CRISTIANOPOLIS	17/01/2020 12:03	17/01/2020 15:06	17/01/2020 12:03	17/01/2020 15:06	3,05	2	6,10	CHI
202001101395	SAO MIGUEL DO PASSA QUATRO	SQ12318950	CRISTIANOPOLIS	17/01/2020 12:03	17/01/2020 15:06	17/01/2020 12:03	17/01/2020 15:06	3,05	20	60,99	CHI
202001101400	GOIATUBA	BJ12309868RE	RIO DOS BOIS	17/01/2020 12:05	17/01/2020 23:21	17/01/2020 12:05	17/01/2020 23:21	11,27	3	33,81	CHI
202001101404	JATAI	JT12211166	JATAI S1	17/01/2020 11:00	17/01/2020 15:39	17/01/2020 11:00	17/01/2020 15:39	4,64	9	41,72	CHI
202001101408	GOIATUBA	GT12050351	GOIATUBA S1	17/01/2020 12:05	17/01/2020 14:16	17/01/2020 12:05	17/01/2020 14:16	2,17	3	6,51	CHI
202001101408	VICENTINOPOLIS	GT12050351	GOIATUBA S1	17/01/2020 12:05	17/01/2020 14:16	17/01/2020 12:05	17/01/2020 14:16	2,17	3	6,51	CHI
202001101410	CATURAI	CK21402878	INHUMAS S1	17/01/2020 12:06	17/01/2020 17:14	17/01/2020 12:06	17/01/2020 17:14	5,12	1	5,12	CHI
202001101411	URUACU	UR11055925	URUACU	17/01/2020 11:12	17/01/2020 13:15	17/01/2020 11:12	17/01/2020 13:15	2,05	188	385,24	CHI
202001101417	PADRE BERNARDO	PB12052000	PADRE BERNARDO	17/01/2020 12:08	17/01/2020 15:10	17/01/2020 12:08	17/01/2020 15:10	3,02	2	6,05	CHI
202001101419	GOIANIA	GN11167790	REAL S2	17/01/2020 12:09	17/01/2020 15:21	17/01/2020 12:09	17/01/2020 15:21	3,20	66	211,00	CHI
202001101421	MORRINHOS	10028058141	MORRINHOS	17/01/2020 12:09	17/01/2020 13:50	17/01/2020 12:09	17/01/2020 13:50	1,67	1	1,67	CHI
202001101430	APARECIDA DE GOIANIA	200453130	INDEPENDENCIA S1	17/01/2020 12:11	17/01/2020 13:25	17/01/2020 12:11	17/01/2020 13:25	1,22	1	1,22	CHI
202001101434	MUNDO NOVO DE GOIAS	MH11037811	NOVA CRIXAS	17/01/2020 11:24	17/01/2020 20:39	17/01/2020 11:24	17/01/2020 20:39	9,26	76	703,61	CHI
202001101437	APARECIDA DE GOIANIA	10029232838	REAL S2	17/01/2020 12:14	17/01/2020 15:58	17/01/2020 12:14	17/01/2020 15:58	3,73	1	3,73	CHI
202001101438	GOIAS	GS21128040	ITABERAI S1	17/01/2020 12:14	17/01/2020 16:09	17/01/2020 12:14	17/01/2020 16:09	3,90	1	3,90	CHI
202001101444	AMARALINA	MU12269538	MARA ROSA	17/01/2020 11:27	17/01/2020 13:23	17/01/2020 11:27	17/01/2020 13:23	1,93	40	77,20	CHI
202001101444	MUTUNOPOLIS	MU12269538	MARA ROSA	17/01/2020 11:27	17/01/2020 13:23	17/01/2020 11:27	17/01/2020 13:23	1,93	36	69,48	CHI
202001101446	BOM JESUS DE GOIAS	BJ12000088RE	BOM JESUS DE GOIAS	17/01/2020 11:59	17/01/2020 17:06	17/01/2020 11:59	17/01/2020 17:06	5,11	10	51,07	CHI
202001101446	GOIATUBA	BJ12000088RE	BOM JESUS DE GOIAS	17/01/2020 11:59	17/01/2020 17:06	17/01/2020 11:59	17/01/2020 17:06	5,11	45	229,84	CHI
202001101450	QUIRINOPOLIS	CA21360868	CACHOEIRA ALTA	17/01/2020 12:16	18/01/2020 10:41	17/01/2020 12:16	18/01/2020 10:41	22,40	1	22,40	CHI
202001101452	PIRENOPOLIS	PV21360325	CORUMBA	17/01/2020 12:17	17/01/2020 16:10	17/01/2020 12:17	17/01/2020 16:10	3,89	2	7,77	CHI
202001101457	IVOLANDIA	PU12090442	MONTIVIDIU T	17/01/2020 11:20	17/01/2020 18:57	17/01/2020 11:20	17/01/2020 18:57	7,61	22	167,36	CHI
202001101457	PARAUNA	PU12090442	MONTIVIDIU T	17/01/2020 11:20	17/01/2020 18:57	17/01/2020 11:20	17/01/2020 18:57	7,61	49	372,75	CHI
202001101459	PORANGATU	PO12136349	NOVO PLANALTO	17/01/2020 12:11	17/01/2020 14:50	17/01/2020 12:11	17/01/2020 14:50	2,64	23	60,61	CHI
202001101461	JATAI	290148935	JATAI S2	17/01/2020 12:19	18/01/2020 07:20	17/01/2020 12:19	18/01/2020 07:20	19,02	1	19,02	CHI
202001101465	SANTA HELENA DE GOIAS	SH21296175	IPEGUARI	17/01/2020 12:19	17/01/2020 15:30	17/01/2020 12:19	17/01/2020 15:30	3,17	1	3,17	CHI
202001101466	GOIANDIRA	2010010468	CATALAO S1	17/01/2020 12:19	17/01/2020 14:49	17/01/2020 12:19	17/01/2020 14:49	2,49	1	2,49	CHI
202001101474	PONTALINA	PK12047065	PONTALINA	17/01/2020 10:44	17/01/2020 15:12	17/01/2020 10:44	17/01/2020 15:12	4,46	10	44,56	CHI
202001101476	PORANGATU	10021455781	PORANGATU	17/01/2020 12:21	17/01/2020 16:38	17/01/2020 12:21	17/01/2020 16:38	4,27	1	4,27	CHI
202001101486	GOIANIA	10472514	GOIANIA LESTE S1	17/01/2020 12:24	17/01/2020 16:01	17/01/2020 12:24	17/01/2020 16:01	3,62	0	0,00	CHI
202001101487	BONOPOLIS	BX12321724	SAO MIGUEL DO ARAGUAIA	17/01/2020 12:19	17/01/2020 13:25	17/01/2020 12:19	17/01/2020 13:25	1,11	5	5,57	CHI

202001101489	ARAGUAPAZ	AZ11274244	GOIAS	17/01/2020 12:24	17/01/2020 17:13	17/01/2020 12:24	17/01/2020 17:13	4,80	45	216,09	CHI
202001101490	QUIRINOPOLIS	7600889	SANTA HELENA S1	16/01/2020 23:35	18/01/2020 14:25	16/01/2020 23:35	18/01/2020 14:25	38,83	2	77,65	CHI
202001101490	RIO VERDE	7600889	SANTA HELENA S1	16/01/2020 23:35	18/01/2020 14:25	16/01/2020 23:35	18/01/2020 14:25	38,83	2	77,65	CHI
202001101490	QUIRINOPOLIS	7600889	SANTA HELENA S1	16/01/2020 23:35	18/01/2020 14:25	18/01/2020 13:57	18/01/2020 14:25	0,47	36	16,80	CHI
202001101490	RIO VERDE	7600889	SANTA HELENA S1	16/01/2020 23:35	18/01/2020 14:25	18/01/2020 13:57	18/01/2020 14:25	0,47	2	0,93	CHI
202001101498	AMORINOPOLIS	10024222460	IPORA	17/01/2020 12:27	17/01/2020 21:06	17/01/2020 12:27	17/01/2020 21:06	8,64	1	8,64	CHI
202001101514	LUZIANIA	120119596	RIO VERMELHO	17/01/2020 12:32	17/01/2020 13:47	17/01/2020 12:32	17/01/2020 13:47	1,24	1	1,24	CHI
202001101516	URUACU	UR21117975	URUACU	17/01/2020 12:32	17/01/2020 14:05	17/01/2020 12:32	17/01/2020 14:05	1,54	1	1,54	CHI
202001101517	CORREGO DO OURO	CO11095409	FIRMINOPOLIS S2	17/01/2020 10:54	17/01/2020 15:00	17/01/2020 10:54	17/01/2020 15:00	4,11	94	386,50	CHI
202001101523	CATALAO	CT21042365	CATALAO S1	17/01/2020 12:35	17/01/2020 17:33	17/01/2020 12:35	17/01/2020 17:33	4,96	2	9,93	CHI
202001101524	JATAI	JT11083836	JATAI S2	17/01/2020 12:35	18/01/2020 12:21	17/01/2020 12:35	18/01/2020 12:21	23,76	1	23,76	CHI
202001101525	SANCLERLANDIA	SC21229813	FIRMINOPOLIS S2	17/01/2020 12:35	17/01/2020 14:26	17/01/2020 12:35	17/01/2020 14:26	1,84	1	1,84	CHI
202001101532	BELA VISTA DE GOIAS	BV21000046	BELA VISTA S1	17/01/2020 12:36	17/01/2020 15:37	17/01/2020 12:36	17/01/2020 15:37	3,01	1	3,01	CHI
202001101537	ORIZONA	3440000951	PIRES DO RIO S2	17/01/2020 12:37	17/01/2020 17:06	17/01/2020 12:37	17/01/2020 17:06	4,48	1	4,48	CHI
202001101543	CAIAPONIA	CP12201857	PALESTINA	17/01/2020 12:06	18/01/2020 10:23	17/01/2020 12:06	18/01/2020 10:23	22,28	3	66,85	CHI
202001101544	SAO LUIS DE MONTES BELOS	SL32145768	SAO LUIZ DOS MONTES BELOS	17/01/2020 12:37	17/01/2020 16:52	17/01/2020 12:37	17/01/2020 16:52	4,24	30	127,12	CHI
202001101545	SAO LUIS DE MONTES BELOS	SL21342965	SAO LUIZ DOS MONTES BELOS	17/01/2020 12:38	17/01/2020 19:56	17/01/2020 12:38	17/01/2020 19:56	7,30	1	7,30	CHI
202001101547	CATALAO	CT12061155	CATALAO S1	17/01/2020 12:38	17/01/2020 15:30	17/01/2020 12:38	17/01/2020 15:30	2,85	4	11,41	CHI
202001101552	CORUMBA DE GOIAS	CB21089840	CORUMBA	17/01/2020 12:38	17/01/2020 16:38	17/01/2020 12:38	17/01/2020 16:38	4,00	1	4,00	CHI
202001101554	TRES RANCHOS	TH21013601	CATALAO S1	17/01/2020 12:40	17/01/2020 16:21	17/01/2020 12:40	17/01/2020 16:21	3,68	2	7,36	CHI
202001101562	SANCLERLANDIA	SC11259165	FIRMINOPOLIS S2	17/01/2020 12:40	17/01/2020 14:12	17/01/2020 12:40	17/01/2020 14:12	1,52	70	106,24	CHI
202001101577	CAMPINACU	UC12197181	PORANGATU	17/01/2020 12:42	17/01/2020 15:47	17/01/2020 12:42	17/01/2020 15:47	3,08	8	24,64	CHI
202001101580	BONOPOLIS	BX12292423	SAO MIGUEL DO ARAGUAIA	17/01/2020 12:42	17/01/2020 15:03	17/01/2020 12:42	17/01/2020 15:03	2,35	2	4,71	CHI
202001101581	ANAPOLIS	AN11185112	ANAPOLIS UNIVERSITARIO S2	17/01/2020 12:42	17/01/2020 13:21	17/01/2020 12:42	17/01/2020 13:21	0,64	19	12,14	CHI
202001101586	ABADIANIA	AA21283589	ANAPOLIS UNIVERSITARIO S1	17/01/2020 12:43	17/01/2020 14:55	17/01/2020 12:43	17/01/2020 14:55	2,20	1	2,20	CHI
202001101588	ANAPOLIS	21314275	ANAPOLIS UNIVERSITARIO S2	17/01/2020 12:43	17/01/2020 17:12	17/01/2020 12:43	17/01/2020 17:12	4,48	1	4,48	CHI
202001101594	ABADIANIA	AA21247429	ANAPOLIS UNIVERSITARIO S1	17/01/2020 12:43	17/01/2020 16:27	17/01/2020 12:43	17/01/2020 16:27	3,72	2	7,44	CHI
202001101598	ITABERAI	IB21105976	ITABERAI S2	17/01/2020 12:44	18/01/2020 09:11	17/01/2020 12:44	18/01/2020 09:11	20,45	1	20,45	CHI
202001101602	HIDROLINA	HL11171827	URUACU	17/01/2020 12:00	17/01/2020 17:29	17/01/2020 12:00	17/01/2020 17:29	5,48	55	301,26	CHI
202001101606	PIRENOPOLIS	220005023	CORUMBA	17/01/2020 12:44	17/01/2020 20:21	17/01/2020 12:44	17/01/2020 20:21	7,60	1	7,60	CHI
202001101608	LUZIANIA	120349206	RIO VERMELHO	17/01/2020 12:44	17/01/2020 15:12	17/01/2020 12:44	17/01/2020 15:12	2,45	1	2,45	CHI
202001101611	GOIANIA	GN11000882	FERROVIARIO S1	17/01/2020 12:14	17/01/2020 13:49	17/01/2020 12:14	17/01/2020 13:49	1,57	163	255,64	CHI
202001101612	ANAPOLIS	AN21267780	ANAPOLIS UNIVERSITARIO S2	17/01/2020 12:45	17/01/2020 18:49	17/01/2020 12:45	17/01/2020 18:49	6,06	1	6,06	CHI

202001101613	MONTIVIDIU	MV21106527	MONTIVIDIU T	17/01/2020 12:45	18/01/2020 10:26	17/01/2020 12:45	18/01/2020 10:26	21,68	1	21,68	CHI
202001101619	CAVALCANTE	CJ12346073	MINACU	17/01/2020 13:41	18/01/2020 13:07	17/01/2020 13:41	18/01/2020 01:06	11,41	188	2144,77	CHI
202001101619	CAVALCANTE	CJ12346073	MINACU	17/01/2020 13:41	18/01/2020 13:07	18/01/2020 05:19	18/01/2020 13:07	7,80	188	1466,03	CHI
202001101621	NOVA IGUACU DE GOIAS	NH12374720	URUACU	17/01/2020 08:07	17/01/2020 18:22	17/01/2020 08:07	17/01/2020 18:22	10,26	7	71,79	CHI
202001101634	GOIANIA	10016041311	XAVANTES	17/01/2020 12:49	17/01/2020 14:24	17/01/2020 12:49	17/01/2020 14:24	1,58	1	1,58	CHI
202001101637	APARECIDA DE GOIANIA	200131035	INDEPENDENCIA S2	17/01/2020 12:49	17/01/2020 17:28	17/01/2020 12:49	17/01/2020 17:28	4,64	1	4,64	CHI
202001101640	MORRINHOS	MR11075104	MORRINHOS	17/01/2020 12:50	17/01/2020 18:55	17/01/2020 12:50	17/01/2020 18:55	6,08	2	12,16	CHI
202001101647	MATRINCHA	MP12089424	MOZARLANDIA	17/01/2020 11:52	18/01/2020 02:02	17/01/2020 11:52	18/01/2020 02:02	14,16	2	28,32	CHI
202001101652	RIO VERDE	RV11306307	RIO VERDE S1	17/01/2020 11:38	17/01/2020 14:45	17/01/2020 11:38	17/01/2020 14:45	3,10	110	341,46	CHI
202001101676	LUZIANIA	10028182721	MARAJOARA	17/01/2020 12:53	17/01/2020 15:20	17/01/2020 12:53	17/01/2020 15:20	2,44	2	4,87	CHI
202001101678	CABECEIRAS	CW21151429	ITIQUEIRA	17/01/2020 12:54	17/01/2020 17:07	17/01/2020 12:54	17/01/2020 17:07	4,21	1	4,21	CHI
202001101679	MORRINHOS	MR12128686RE	MORRINHOS	17/01/2020 12:54	17/01/2020 17:52	17/01/2020 12:54	17/01/2020 17:52	4,97	28	139,10	CHI
202001101680	GOUVELANDIA	Q12000166	QUIRINOPOLIS	17/01/2020 12:54	17/01/2020 17:36	17/01/2020 12:54	17/01/2020 17:36	4,70	19	89,37	CHI
202001101701	APARECIDA DO RIO DOCE	AW12338594	CACHOEIRA ALTA	17/01/2020 13:48	17/01/2020 19:00	17/01/2020 13:48	17/01/2020 19:00	5,19	17	88,19	CHI
202001101701	CACHOEIRA ALTA	AW12338594	CACHOEIRA ALTA	17/01/2020 13:48	17/01/2020 19:00	17/01/2020 13:48	17/01/2020 19:00	5,19	60	311,25	CHI
202001101702	ANICUNS	AC21304640	ANICUNS	17/01/2020 12:57	17/01/2020 15:55	17/01/2020 12:57	17/01/2020 15:55	2,98	2	5,96	CHI
202001101703	GOIANESIA	550161132	GOIANESIA S2	17/01/2020 12:57	17/01/2020 16:29	17/01/2020 12:57	17/01/2020 16:29	3,54	1	3,54	CHI
202001101707	PIRACANJUBA	PJ12000117	PIRACANJUBA	17/01/2020 12:57	20/01/2020 18:50	17/01/2020 12:57	18/01/2020 17:26	28,48	5	142,39	CHI
202001101707	HIDROLANDIA	PJ12000117	PIRACANJUBA	17/01/2020 12:57	20/01/2020 18:50	18/01/2020 13:14	18/01/2020 17:26	4,19	8	33,54	CHI
202001101707	PIRACANJUBA	PJ12000117	PIRACANJUBA	17/01/2020 12:57	20/01/2020 18:50	18/01/2020 13:14	18/01/2020 17:26	4,19	41	171,88	CHI
202001101707	PIRACANJUBA	PJ12000117	PIRACANJUBA	17/01/2020 12:57	20/01/2020 18:50	17/01/2020 12:57	18/01/2020 19:12	30,24	13	393,13	CHI
202001101707	PIRACANJUBA	PJ12249879	PIRACANJUBA	17/01/2020 12:57	20/01/2020 18:50	18/01/2020 13:14	18/01/2020 19:12	5,95	2	11,91	CHI
202001101707	PIRACANJUBA	PJ12249879	PIRACANJUBA	17/01/2020 12:57	20/01/2020 18:50	19/01/2020 10:36	19/01/2020 11:19	0,71	15	10,64	CHI
202001101707	PROFESSOR JAMIL SAFADY	PJ12000117	PIRACANJUBA	17/01/2020 12:57	20/01/2020 18:50	17/01/2020 12:57	20/01/2020 17:24	76,45	1	76,45	CHI
202001101707	PIRACANJUBA	PJ13249775	PIRACANJUBA	17/01/2020 12:57	20/01/2020 18:50	18/01/2020 13:14	20/01/2020 17:24	52,16	2	104,32	CHI
202001101707	PROFESSOR JAMIL SAFADY	PJ12000117	PIRACANJUBA	17/01/2020 12:57	20/01/2020 18:50	17/01/2020 12:57	20/01/2020 18:50	77,87	5	389,35	CHI
202001101707	PROFESSOR JAMIL SAFADY	PJ13032099	PIRACANJUBA	17/01/2020 12:57	20/01/2020 18:50	18/01/2020 13:14	20/01/2020 18:50	53,58	7	375,09	CHI
202001101710	JATAI	JT21165959	JATAI S2	17/01/2020 12:58	18/01/2020 08:41	17/01/2020 12:58	18/01/2020 08:41	19,71	2	39,43	CHI
202001101712	MORRO AGUDO DE GOIAS	RB12156092	RUBIATABA	17/01/2020 11:58	17/01/2020 20:12	17/01/2020 11:58	17/01/2020 20:12	8,23	10	82,27	CHI
202001101716	IPORA	IR12212833	IPORA	17/01/2020 11:52	17/01/2020 17:10	17/01/2020 11:52	17/01/2020 17:10	5,29	4	21,14	CHI
202001101722	CASTELANDIA	DM12417231	RIO DOS BOIS	17/01/2020 13:00	18/01/2020 13:04	17/01/2020 13:00	18/01/2020 13:04	24,06	23	553,46	CHI
202001101722	MAURILANDIA	DM12417231	RIO DOS BOIS	17/01/2020 13:00	18/01/2020 13:04	17/01/2020 13:00	18/01/2020 13:04	24,06	1	24,06	CHI
202001101722	QUIRINOPOLIS	DM12417231	RIO DOS BOIS	17/01/2020 13:00	18/01/2020 13:04	17/01/2020 13:00	18/01/2020 13:04	24,06	15	360,95	CHI

202001101729	GOIANIA	GN11198170	GOYA S1	17/01/2020 12:52	17/01/2020 14:31	17/01/2020 12:52	17/01/2020 14:31	1,64	92	150,47	CHI
202001101733	GOIATUBA	GT12263957	BOM JESUS DE GOIAS	17/01/2020 11:45	17/01/2020 22:31	17/01/2020 11:45	17/01/2020 22:31	10,75	5	53,76	CHI
202001101734	SANTA TEREZINHA DE GOIAS	SG21321813	SANTA TEREZINHA	17/01/2020 13:02	17/01/2020 14:18	17/01/2020 13:02	17/01/2020 14:18	1,26	1	1,26	CHI
202001101736	RIO VERDE	RV11085792	RIO VERDE S1	17/01/2020 12:50	17/01/2020 13:56	17/01/2020 12:50	17/01/2020 13:56	1,09	125	136,25	CHI
202001101737	QUIRINOPOLIS	QI32052820	QUIRINOPOLIS	17/01/2020 06:23	17/01/2020 19:06	17/01/2020 06:23	17/01/2020 19:06	12,71	36	457,62	CHI
202001101743	GOIAS	GS21183470	GOIAS	17/01/2020 13:04	18/01/2020 20:47	17/01/2020 13:04	18/01/2020 20:47	31,71	1	31,71	CHI
202001101748	TRES RANCHOS	TH21149206	CATALAO S1	17/01/2020 13:05	18/01/2020 07:24	17/01/2020 13:05	18/01/2020 07:24	18,30	2	36,61	CHI
202001101757	MORRINHOS	150040787	MORRINHOS	17/01/2020 13:07	17/01/2020 15:32	17/01/2020 13:07	17/01/2020 15:32	2,42	1	2,42	CHI
202001101758	BURITI ALEGRE	BG12263537	ITUMBIARA VELHA S2	17/01/2020 12:49	17/01/2020 19:24	17/01/2020 12:49	17/01/2020 19:24	6,57	5	32,84	CHI
202001101758	ITUMBIARA	BG12263537	ITUMBIARA VELHA S2	17/01/2020 12:49	17/01/2020 19:24	17/01/2020 12:49	17/01/2020 19:24	6,57	7	45,98	CHI
202001101759	CASTELANDIA	ML12360585	RIO DOS BOIS	17/01/2020 12:43	17/01/2020 15:54	17/01/2020 12:43	17/01/2020 15:54	3,17	5	15,84	CHI
202001101759	MAURILANDIA	ML12360585	RIO DOS BOIS	17/01/2020 12:43	17/01/2020 15:54	17/01/2020 12:43	17/01/2020 15:54	3,17	2	6,33	CHI
202001101760	CABECEIRAS	CW12184624	ITUIQUIRA	17/01/2020 13:07	17/01/2020 18:16	17/01/2020 13:07	17/01/2020 18:16	5,13	5	25,67	CHI
202001101765	MOZARLANDIA	MZ12035610	MOZARLANDIA	17/01/2020 09:09	17/01/2020 14:37	17/01/2020 09:09	17/01/2020 14:37	5,46	216	1180,44	CHI
202001101767	MORRINHOS	MR12223458	MORRINHOS	17/01/2020 13:09	17/01/2020 18:22	17/01/2020 13:09	17/01/2020 18:22	5,22	5	26,08	CHI
202001101771	FAZENDA NOVA	FN12217146	JUSSARA	17/01/2020 12:00	17/01/2020 17:20	17/01/2020 12:00	17/01/2020 17:20	5,32	13	69,14	CHI
202001101781	MINEIROS	1390107714	PARQUE DAS EMAS	17/01/2020 13:13	17/01/2020 21:56	17/01/2020 13:13	17/01/2020 21:56	8,71	1	8,71	CHI
202001101783	INDIARA	IY12391429	EDEIA	17/01/2020 13:13	17/01/2020 15:58	17/01/2020 13:13	17/01/2020 15:58	2,75	6	16,48	CHI
202001101785	MORRINHOS	MR12010209	MORRINHOS	17/01/2020 13:14	17/01/2020 15:59	17/01/2020 13:14	17/01/2020 15:59	2,77	9	24,89	CHI
202001101788	PIRENOPOLIS	220076285	CORUMBA	17/01/2020 13:14	17/01/2020 21:49	17/01/2020 13:14	17/01/2020 21:49	8,57	1	8,57	CHI
202001101789	GOIANDIRA	2010023797	CATALAO S1	17/01/2020 13:15	17/01/2020 15:02	17/01/2020 13:15	17/01/2020 15:02	1,78	1	1,78	CHI
202001101797	GOIATUBA	GT12050672	GOIATUBA S1	17/01/2020 13:17	17/01/2020 16:22	17/01/2020 13:17	17/01/2020 16:22	3,08	1	3,08	CHI
202001101797	JOVIANIA	GT12050672	GOIATUBA S1	17/01/2020 13:17	17/01/2020 16:22	17/01/2020 13:17	17/01/2020 16:22	3,08	1	3,08	CHI
202001101797	VICENTINOPOLIS	GT12050672	GOIATUBA S1	17/01/2020 13:17	17/01/2020 16:22	17/01/2020 13:17	17/01/2020 16:22	3,08	3	9,23	CHI
202001101800	URUACU	640101264	URUACU	17/01/2020 13:18	17/01/2020 14:25	17/01/2020 13:18	17/01/2020 14:25	1,11	1	1,11	CHI
202001101814	RIO VERDE	RV13371493	RIO VERDE S1	17/01/2020 13:19	17/01/2020 20:43	17/01/2020 13:19	17/01/2020 20:43	7,39	350	2587,28	CHI
202001101814	SANTA HELENA DE GOIAS	RV13371493	RIO VERDE S1	17/01/2020 13:19	17/01/2020 20:43	17/01/2020 13:19	17/01/2020 20:43	7,39	45	332,65	CHI
202001101818	APARECIDA DE GOIANIA	12830045	INDEPENDENCIA S2	17/01/2020 13:20	17/01/2020 18:44	17/01/2020 13:20	17/01/2020 18:44	5,39	1	5,39	CHI
202001101821	NIQUELANDIA	NQ12201753LD	URUACU	17/01/2020 13:21	17/01/2020 16:56	17/01/2020 13:21	17/01/2020 16:56	3,58	72	257,94	CHI
202001101822	SAO MIGUEL DO ARAGUAIA	4650003983	SAO MIGUEL DO ARAGUAIA	17/01/2020 13:21	17/01/2020 18:11	17/01/2020 13:21	17/01/2020 18:11	4,83	1	4,83	CHI
202001101828	PIRES DO RIO	PR21337208	PIRES DO RIO S1	17/01/2020 12:49	17/01/2020 16:20	17/01/2020 12:49	17/01/2020 16:20	3,52	1	3,52	CHI
202001101829	URUACU	UR11162602	URUACU	17/01/2020 13:23	17/01/2020 15:55	17/01/2020 13:23	17/01/2020 15:55	2,52	31	78,21	CHI
202001101831	CORUMBAIBA	CI12263342	VILA CORUMBA	17/01/2020 13:12	17/01/2020 16:21	17/01/2020 13:12	17/01/2020 16:21	3,15	363	1143,35	CHI

202001101842	ALTO HORIZONTE	9640001022	SANTA TEREZINHA	17/01/2020 13:25	17/01/2020 16:22	17/01/2020 13:25	17/01/2020 16:22	2,94	1	2,94	CHI
202001101844	PLANALTINA	PI12325380	SAO JOAO D ALIANCA	17/01/2020 13:25	17/01/2020 17:39	17/01/2020 13:25	17/01/2020 17:39	4,22	7	29,57	CHI
202001101873	CORREGO DO OURO	CO11000049	FIRMINOPOLIS S2	17/01/2020 13:25	17/01/2020 19:54	17/01/2020 13:25	17/01/2020 19:54	6,47	124	802,04	CHI
202001101877	PONTALINA	210014740	PONTALINA	17/01/2020 13:26	17/01/2020 15:50	17/01/2020 13:26	17/01/2020 15:50	2,39	1	2,39	CHI
202001101882	CRISTALINA	1060048623	CRISTALINA S1	17/01/2020 13:27	18/01/2020 07:55	17/01/2020 13:27	18/01/2020 07:55	18,46	1	18,46	CHI
202001101888	CAMPINORTE	CR12291127	CAMPINORTE	17/01/2020 13:29	17/01/2020 16:05	17/01/2020 13:29	17/01/2020 16:05	2,59	0	0,00	CHI
202001101888	URUACU	CR12291127	CAMPINORTE	17/01/2020 13:29	17/01/2020 16:05	17/01/2020 13:29	17/01/2020 16:05	2,59	170	440,39	CHI
202001101892	SERRANOPOLIS	SX12165995	CHAPADAO DO CEU	17/01/2020 13:18	17/01/2020 17:03	17/01/2020 13:18	17/01/2020 17:03	3,75	4	14,99	CHI
202001101896	MONTIVIDIU	MV21267642	MONTIVIDIU T	17/01/2020 13:29	17/01/2020 20:58	17/01/2020 13:29	17/01/2020 20:58	7,47	2	14,95	CHI
202001101899	PIRES DO RIO	PR12270810	PIRES DO RIO S1	17/01/2020 13:31	17/01/2020 16:00	17/01/2020 13:31	17/01/2020 16:00	2,48	30	74,40	CHI
202001101910	LUZIANIA	3200154960	MARAJOARA	17/01/2020 13:31	17/01/2020 15:24	17/01/2020 13:31	17/01/2020 15:24	1,87	1	1,87	CHI
202001101912	CAIAPONIA	10028235418	CAIAPONIA	17/01/2020 13:32	18/01/2020 07:03	17/01/2020 13:32	18/01/2020 07:03	17,51	1	17,51	CHI
202001101913	ITAPIRAPUA	IU12250536	MATRINCHA	17/01/2020 13:16	18/01/2020 15:41	17/01/2020 13:16	18/01/2020 15:41	26,42	3	79,26	CHI
202001101920	JATAI	JT21241733	JATAI S2	17/01/2020 13:33	18/01/2020 10:45	17/01/2020 13:33	18/01/2020 10:45	21,19	1	21,19	CHI
202001101931	GOIAS	GS21237048	GOIAS	17/01/2020 13:36	17/01/2020 23:56	17/01/2020 13:36	17/01/2020 23:56	10,32	1	10,32	CHI
202001101932	IPORA	IR12039575	IPORA	17/01/2020 10:49	17/01/2020 16:20	17/01/2020 10:49	17/01/2020 16:20	5,51	11	60,59	CHI
202001101936	GOIANAPOLIS	10014781962	DAIA S2	17/01/2020 13:37	17/01/2020 17:47	17/01/2020 13:37	17/01/2020 17:47	4,17	1	4,17	CHI
202001101948	CAMPINORTE	CR12325222	PORANGATU	17/01/2020 12:35	17/01/2020 16:44	17/01/2020 12:35	17/01/2020 16:44	4,13	3	12,40	CHI
202001101950	EDEIA	1120003729	EDEIA	17/01/2020 13:40	17/01/2020 16:22	17/01/2020 13:40	17/01/2020 16:22	2,70	1	2,70	CHI
202001101953	MAURILANDIA	ML21213421	SANTA HELENA S1	18/01/2020 07:34	18/01/2020 09:15	18/01/2020 07:34	18/01/2020 09:15	1,67	1	1,67	CHI
202001101964	AMARALINA	MU12257886	MARA ROSA	17/01/2020 13:41	17/01/2020 23:56	17/01/2020 13:41	17/01/2020 15:19	1,63	36	58,71	CHI
202001101964	MUTUNOPOLIS	MU12257886	MARA ROSA	17/01/2020 13:41	17/01/2020 23:56	17/01/2020 13:41	17/01/2020 15:19	1,63	1	1,63	CHI
202001101964	AMARALINA	MU12257886	MARA ROSA	17/01/2020 13:41	17/01/2020 23:56	17/01/2020 15:20	17/01/2020 23:56	8,61	36	310,03	CHI
202001101964	MUTUNOPOLIS	MU12257886	MARA ROSA	17/01/2020 13:41	17/01/2020 23:56	17/01/2020 15:20	17/01/2020 23:56	8,61	1	8,61	CHI
202001101970	QUIRINOPOLIS	80148463	QUIRINOPOLIS	17/01/2020 13:43	17/01/2020 19:40	17/01/2020 13:43	17/01/2020 19:40	5,94	1	5,94	CHI
202001101982	SANTA HELENA DE GOIAS	10002847149	IPEGUARI	17/01/2020 13:47	18/01/2020 00:13	17/01/2020 13:47	18/01/2020 00:13	10,42	1	10,42	CHI
202001101990	BOM JESUS DE GOIAS	BJ12000057	BOM JESUS DE GOIAS	17/01/2020 11:53	17/01/2020 20:28	17/01/2020 11:53	17/01/2020 20:28	8,57	1	8,57	CHI
202001101990	GOIATUBA	BJ12000057	BOM JESUS DE GOIAS	17/01/2020 11:53	17/01/2020 20:28	17/01/2020 11:53	17/01/2020 20:28	8,57	3	25,71	CHI
202001101995	OUVIDOR	2180010844	CATALAO S1	17/01/2020 13:49	18/01/2020 09:04	17/01/2020 13:49	18/01/2020 09:04	19,26	1	19,26	CHI
202001101996	CATALAO	10002050860	CATALAO S2	17/01/2020 13:49	17/01/2020 15:49	17/01/2020 13:49	17/01/2020 15:49	1,99	1	1,99	CHI
202001101999	PALESTINA DE GOIAS	PY21374917	PALESTINA	17/01/2020 13:49	18/01/2020 18:15	17/01/2020 13:49	18/01/2020 18:15	28,43	1	28,43	CHI
202001102001	RUBIATABA	RB21272740	RUBIATABA	17/01/2020 05:46	17/01/2020 17:57	17/01/2020 05:46	17/01/2020 17:57	12,18	2	24,37	CHI
202001102013	PONTALINA	PK12316644	VICENTINOPOLIS	17/01/2020 13:52	17/01/2020 21:20	17/01/2020 13:52	17/01/2020 21:20	7,47	2	14,94	CHI

202001102022	MORRINHOS	MR12389873	MORRINHOS	17/01/2020 12:37	18/01/2020 10:18	17/01/2020 12:37	18/01/2020 10:18	21,68	39	845,37	CHI
202001102023	NOVA IGUACU DE GOIAS	NH12202113	SANTA TEREZINHA	17/01/2020 13:55	17/01/2020 20:22	17/01/2020 13:55	17/01/2020 20:22	6,45	62	399,80	CHI
202001102026	SANCLERLANDIA	SC21343813	FIRMINOPOLIS S2	17/01/2020 13:55	17/01/2020 16:52	17/01/2020 13:55	17/01/2020 16:52	2,94	1	2,94	CHI
202001102030	MOSSAMEDES	MD21204383	FIRMINOPOLIS S2	17/01/2020 13:58	17/01/2020 15:26	17/01/2020 13:58	17/01/2020 15:26	1,47	1	1,47	CHI
202001102037	PIRENOPOLIS	PV21185162	CORUMBA	17/01/2020 13:58	17/01/2020 15:10	17/01/2020 13:58	17/01/2020 15:10	1,20	2	2,40	CHI
202001102042	GOIANIA	SW12092689	CEPAIGO S1	17/01/2020 13:59	17/01/2020 15:09	17/01/2020 13:59	17/01/2020 15:09	1,16	1	1,16	CHI
202001102042	SENADOR CANEDO	SW12092689	CEPAIGO S1	17/01/2020 13:59	17/01/2020 15:09	17/01/2020 13:59	17/01/2020 15:09	1,16	15	17,34	CHI
202001102043	EDEALINA	ED12000010	PONTALINA	17/01/2020 12:19	17/01/2020 17:36	17/01/2020 12:19	17/01/2020 17:36	5,28	51	269,44	CHI
202001102043	EDEIA	ED12000010	PONTALINA	17/01/2020 12:19	17/01/2020 17:36	17/01/2020 12:19	17/01/2020 17:36	5,28	4	21,13	CHI
202001102043	PONTALINA	ED12000010	PONTALINA	17/01/2020 12:19	17/01/2020 17:36	17/01/2020 12:19	17/01/2020 17:36	5,28	3	15,85	CHI
202001102049	PORANGATU	PO21136943	NOVO PLANALTO	17/01/2020 14:00	18/01/2020 02:43	17/01/2020 14:00	18/01/2020 02:43	12,71	1	12,71	CHI
202001102052	PALMEIRAS DE GOIAS	590060739	PALMEIRAS	17/01/2020 14:00	17/01/2020 15:25	17/01/2020 14:00	17/01/2020 15:25	1,41	1	1,41	CHI
202001102073	VALPARAISO DE GOIAS	10018404179	MARAJOARA	17/01/2020 14:02	17/01/2020 16:25	17/01/2020 14:02	17/01/2020 16:25	2,37	1	2,37	CHI
202001102084	BELA VISTA DE GOIAS	BV12000037	BELA VISTA S1	17/01/2020 13:57	17/01/2020 15:51	17/01/2020 13:57	17/01/2020 15:51	1,89	16	30,22	CHI
202001102085	SANTA TEREZA DE GOIAS	SE12361690	MARA ROSA	17/01/2020 14:04	18/01/2020 09:48	17/01/2020 14:04	18/01/2020 09:48	19,72	3	59,16	CHI
202001102089	MARA ROSA	MQ12082998	MARA ROSA	17/01/2020 13:39	19/01/2020 18:10	17/01/2020 13:39	17/01/2020 19:29	5,84	2	11,67	CHI
202001102089	MARA ROSA	MQ21333936	MARA ROSA	17/01/2020 13:39	19/01/2020 18:10	17/01/2020 13:39	19/01/2020 18:10	52,52	1	52,52	CHI
202001102097	PORANGATU	PO12048411	PORANGATU	17/01/2020 12:19	17/01/2020 18:08	17/01/2020 12:19	17/01/2020 18:08	5,81	17	98,76	CHI
202001102104	AGUA FRIA DE GOIAS	TL11279970	SAO JOAO D ALIANCA	17/01/2020 14:06	17/01/2020 16:11	17/01/2020 14:06	17/01/2020 16:11	2,07	4	8,28	CHI
202001102109	BONFINOPOLIS	TA12247490	NOVO PLANALTO	17/01/2020 12:54	17/01/2020 20:30	17/01/2020 12:54	17/01/2020 20:30	7,59	1	7,59	CHI
202001102109	BONOPOLIS	TA12247490	NOVO PLANALTO	17/01/2020 12:54	17/01/2020 20:30	17/01/2020 12:54	17/01/2020 20:30	7,59	11	83,46	CHI
202001102109	PORANGATU	TA12247490	NOVO PLANALTO	17/01/2020 12:54	17/01/2020 20:30	17/01/2020 12:54	17/01/2020 20:30	7,59	2	15,17	CHI
202001102111	NIQUELANDIA	NQ12251000	URUACU	17/01/2020 14:08	17/01/2020 21:08	17/01/2020 14:08	17/01/2020 21:08	6,99	62	433,35	CHI
202001102121	PANAMA	IT12000099RE	GOIATUBA S1	17/01/2020 14:09	17/01/2020 16:57	17/01/2020 14:09	17/01/2020 16:57	2,79	1	2,79	CHI
202001102121	BURITI ALEGRE	IT12000099RE	PARANAIBA	17/01/2020 14:09	17/01/2020 16:57	17/01/2020 14:09	17/01/2020 16:57	2,79	8	22,28	CHI
202001102121	GOIATUBA	IT12000099RE	PARANAIBA	17/01/2020 14:09	17/01/2020 16:57	17/01/2020 14:09	17/01/2020 16:57	2,79	6	16,71	CHI
202001102121	ITUMBIARA	IT12000099RE	PARANAIBA	17/01/2020 14:09	17/01/2020 16:57	17/01/2020 14:09	17/01/2020 16:57	2,79	40	111,42	CHI
202001102121	PANAMA	IT12000099RE	PARANAIBA	17/01/2020 14:09	17/01/2020 16:57	17/01/2020 14:09	17/01/2020 16:57	2,79	41	114,21	CHI
202001102122	COCALZINHO DE GOIAS	ZN11155154	COCALZINHO	17/01/2020 13:40	17/01/2020 15:18	17/01/2020 13:40	17/01/2020 15:18	1,63	124	201,95	CHI
202001102123	PARAUNA	PU11000006	PARAUNA	17/01/2020 14:10	17/01/2020 20:25	17/01/2020 16:01	17/01/2020 20:25	4,39	113	496,42	CHI
202001102127	AMERICANO DO BRASIL	KB12000017	ANICUNS	17/01/2020 12:50	17/01/2020 16:41	17/01/2020 12:50	17/01/2020 16:41	3,86	18	69,51	CHI
202001102127	ANICUNS	KB12000017	ANICUNS	17/01/2020 12:50	17/01/2020 16:41	17/01/2020 12:50	17/01/2020 16:41	3,86	3	11,58	CHI
202001102132	BONOPOLIS	BX12165447	SAO MIGUEL DO ARAGUAIA	17/01/2020 14:11	18/01/2020 04:51	17/01/2020 14:11	18/01/2020 04:51	14,66	3	43,97	CHI

202001102134	JARAGUA	JA21217346	JARAGUA	17/01/2020 14:11	17/01/2020 17:20	17/01/2020 14:11	17/01/2020 17:20	3,14	1	3,14	CHI
202001102148	PIRES DO RIO	PR21246905	PIRES DO RIO S1	17/01/2020 14:15	17/01/2020 16:42	17/01/2020 14:15	17/01/2020 16:42	2,46	1	2,46	CHI
202001102150	APARECIDA DE GOIANIA	200540798	INDEPENDENCIA S2	17/01/2020 14:15	17/01/2020 17:04	17/01/2020 14:15	17/01/2020 17:04	2,81	1	2,81	CHI
202001102155	ITABERAI	50061859	ITABERAI S2	17/01/2020 14:16	17/01/2020 14:58	17/01/2020 14:16	17/01/2020 14:58	0,70	1	0,70	CHI
202001102162	CAMPO ALEGRE DE GOIAS	CM21071193	CAMPO ALEGRE DE GOIAS	17/01/2020 14:17	18/01/2020 00:43	17/01/2020 14:17	18/01/2020 00:43	10,43	1	10,43	CHI
202001102165	CORUMBAIBA	CI12035404	VILA CORUMBA	17/01/2020 14:17	17/01/2020 18:23	17/01/2020 14:17	17/01/2020 18:23	4,09	85	348,00	CHI
202001102169	GOIANIA	11640224	GOIANIA LESTE S3	17/01/2020 14:17	17/01/2020 16:09	17/01/2020 14:17	17/01/2020 16:09	1,86	1	1,86	CHI
202001102181	GOIAS	GS12071261	GOIAS	17/01/2020 12:15	17/01/2020 19:30	17/01/2020 12:15	17/01/2020 19:30	7,24	7	50,67	CHI
202001102185	CALDAZINHA	DE21239239	SENADOR CANEDO	17/01/2020 14:19	17/01/2020 16:49	17/01/2020 14:19	17/01/2020 16:49	2,50	4	9,99	CHI
202001102192	TRINDADE	10029457716	TRINDADE	17/01/2020 14:19	17/01/2020 17:14	17/01/2020 14:19	17/01/2020 17:14	2,90	1	2,90	CHI
202001102195	TEREZOPOLIS DE GOIAS	10000304474	DAIA S2	17/01/2020 14:20	17/01/2020 19:42	17/01/2020 14:20	17/01/2020 19:42	5,36	1	5,36	CHI
202001102196	BOM JARDIM DE GOIAS	BM21358755	BOM JARDIM	17/01/2020 14:18	17/01/2020 21:37	17/01/2020 14:18	17/01/2020 21:37	7,31	1	7,31	CHI
202001102199	LUZIANIA	10001870503	RIO VERMELHO	17/01/2020 14:21	17/01/2020 15:34	17/01/2020 14:21	17/01/2020 15:34	1,22	1	1,22	CHI
202001102203	CAMPO ALEGRE DE GOIAS	CM12192738RE	CAMPO ALEGRE DE GOIAS	17/01/2020 14:20	17/01/2020 15:23	17/01/2020 14:20	17/01/2020 15:23	1,05	47	49,14	CHI
202001102206	GOIATUBA	GT10408745	GOIATUBA S2	17/01/2020 13:17	18/01/2020 09:19	17/01/2020 13:17	17/01/2020 17:03	3,76	76	285,80	CHI
202001102206	BURITI ALEGRE	MR13044925	GOIATUBA S2	17/01/2020 13:17	18/01/2020 09:19	17/01/2020 13:17	17/01/2020 17:59	4,69	7	32,83	CHI
202001102206	GOIATUBA	MR13044925	GOIATUBA S2	17/01/2020 13:17	18/01/2020 09:19	17/01/2020 13:17	17/01/2020 17:59	4,69	9	42,21	CHI
202001102206	BURITI ALEGRE	BG13000035	GOIATUBA S2	17/01/2020 13:17	18/01/2020 09:19	17/01/2020 13:17	18/01/2020 09:19	20,04	23	460,91	CHI
202001102206	GOIATUBA	BG13000035	GOIATUBA S2	17/01/2020 13:17	18/01/2020 09:19	17/01/2020 13:17	18/01/2020 09:19	20,04	19	380,75	CHI
202001102206	MORRINHOS	BG13000035	GOIATUBA S2	17/01/2020 13:17	18/01/2020 09:19	17/01/2020 13:17	18/01/2020 09:19	20,04	26	521,03	CHI
202001102302	CAVALCANTE	CJ11212410	MINACU	17/01/2020 14:21	17/01/2020 16:25	17/01/2020 14:21	17/01/2020 16:25	2,06	37	76,34	CHI
202001102304	DIORAMA	DI12065700	ARENOPOLIS	17/01/2020 14:21	18/01/2020 01:12	17/01/2020 14:21	18/01/2020 01:12	10,84	7	75,90	CHI
202001102305	SAO DOMINGOS	SD11257821	SAO DOMINGOS	17/01/2020 14:21	17/01/2020 16:49	17/01/2020 14:21	17/01/2020 16:49	2,46	12	29,51	CHI
202001102306	CABECEIRAS	CW12245168	ITUIQUIRA	17/01/2020 14:21	17/01/2020 17:55	17/01/2020 14:21	17/01/2020 17:55	3,56	1	3,56	CHI
202001102315	RIO VERDE	630523850	RIO VERDE S2	17/01/2020 14:23	18/01/2020 14:57	17/01/2020 14:23	18/01/2020 14:57	24,56	1	24,56	CHI
202001102318	ITAPACI	IW21032523	RUBIATABA	17/01/2020 14:24	18/01/2020 03:49	17/01/2020 14:24	18/01/2020 03:49	13,41	1	13,41	CHI
202001102321	ITABERAI	03020416	ITABERAI S1	17/01/2020 13:52	17/01/2020 19:48	17/01/2020 13:52	17/01/2020 15:24	1,52	6	9,14	CHI
202001102321	ITAGUARI	03020416	ITABERAI S1	17/01/2020 13:52	17/01/2020 19:48	17/01/2020 13:52	17/01/2020 15:24	1,52	1406	2141,03	CHI
202001102321	ITAGUARU	03020416	ITABERAI S1	17/01/2020 13:52	17/01/2020 19:48	17/01/2020 13:52	17/01/2020 15:24	1,52	1	1,52	CHI
202001102321	JARAGUA	03020416	ITABERAI S1	17/01/2020 13:52	17/01/2020 19:48	17/01/2020 13:52	17/01/2020 15:24	1,52	271	412,67	CHI
202001102321	TAQUARAL DE GOIAS	03020416	ITABERAI S1	17/01/2020 13:52	17/01/2020 19:48	17/01/2020 13:52	17/01/2020 15:24	1,52	166	252,78	CHI
202001102321	ITABERAI	03020224	ITABERAI S1	17/01/2020 13:52	17/01/2020 19:48	17/01/2020 18:44	17/01/2020 19:47	1,05	6	6,29	CHI
202001102321	ITAGUARI	03020224	ITABERAI S1	17/01/2020 13:52	17/01/2020 19:48	17/01/2020 18:44	17/01/2020 19:47	1,05	1406	1475,13	CHI

202001102321	ITAGUARU	03020224	ITABERAI S1	17/01/2020 13:52	17/01/2020 19:48	17/01/2020 18:44	17/01/2020 19:47	1,05	1	1,05	CHI
202001102321	JARAGUA	03020224	ITABERAI S1	17/01/2020 13:52	17/01/2020 19:48	17/01/2020 18:44	17/01/2020 19:47	1,05	271	284,32	CHI
202001102321	TAQUARAL DE GOIAS	03020224	ITABERAI S1	17/01/2020 13:52	17/01/2020 19:48	17/01/2020 18:44	17/01/2020 19:47	1,05	164	172,06	CHI
202001102321	ITABERAI	03020416	ITABERAI S1	17/01/2020 13:52	17/01/2020 19:48	17/01/2020 13:52	17/01/2020 19:48	5,92	22	130,34	CHI
202001102321	ITAGUARI	03020416	ITABERAI S1	17/01/2020 13:52	17/01/2020 19:48	17/01/2020 13:52	17/01/2020 19:48	5,92	998	5912,87	CHI
202001102321	TAQUARAL DE GOIAS	03020416	ITABERAI S1	17/01/2020 13:52	17/01/2020 19:48	17/01/2020 13:52	17/01/2020 19:48	5,92	47	278,46	CHI
202001102328	ALVORADA DO NORTE	AQ12059558	IACIARA S2	17/01/2020 14:26	17/01/2020 16:10	17/01/2020 14:26	17/01/2020 16:10	1,72	1	1,72	CHI
202001102328	BURITINOPOLIS	AQ12059558	IACIARA S2	17/01/2020 14:26	17/01/2020 16:10	17/01/2020 14:26	17/01/2020 16:10	1,72	1	1,72	CHI
202001102330	ABADIANIA	AA21385097	ANAPOLIS UNIVERSITARIO S1	17/01/2020 14:26	17/01/2020 15:34	17/01/2020 14:26	17/01/2020 15:34	1,12	1	1,12	CHI
202001102335	PROFESSOR JAMIL SAFADY	PJ21077809	PONTALINA	17/01/2020 14:27	18/01/2020 16:53	17/01/2020 14:27	18/01/2020 16:53	26,42	1	26,42	CHI
202001102339	PILAR DE GOIAS	GG21202117	SANTA TEREZINHA	17/01/2020 14:28	18/01/2020 02:45	17/01/2020 14:28	18/01/2020 02:45	12,28	1	12,28	CHI
202001102343	JATAI	290323332	JATAI S2	17/01/2020 14:29	18/01/2020 08:56	17/01/2020 14:29	18/01/2020 08:56	18,45	1	18,45	CHI
202001102347	CAIAPONIA	CP12253985	CAIAPONIA	17/01/2020 13:14	17/01/2020 16:41	17/01/2020 13:14	17/01/2020 16:41	3,44	41	141,18	CHI
202001102350	SENADOR CANEDO	190099215	SENADOR CANEDO	17/01/2020 14:30	17/01/2020 16:47	17/01/2020 14:30	17/01/2020 16:47	2,27	1	2,27	CHI
202001102351	CORREGO DO OURO	CO21026373	FIRMINOPOLIS S2	17/01/2020 14:30	17/01/2020 21:44	17/01/2020 14:30	17/01/2020 21:44	7,22	1	7,22	CHI
202001102354	FORMOSO	FO12294209	MARA ROSA	17/01/2020 14:31	17/01/2020 20:06	17/01/2020 14:31	17/01/2020 20:06	5,58	6	33,48	CHI
202001102355	GUARANI DE GOIAS	GY12257655	SAO DOMINGOS	17/01/2020 14:31	17/01/2020 17:28	17/01/2020 14:31	17/01/2020 17:28	2,94	18	53,00	CHI
202001102355	SAO DOMINGOS	GY12257655	SAO DOMINGOS	17/01/2020 14:31	17/01/2020 17:28	17/01/2020 14:31	17/01/2020 17:28	2,94	13	38,28	CHI
202001102356	GOIAS	GS12206865	MATRINCHA	17/01/2020 14:31	18/01/2020 08:14	17/01/2020 14:31	18/01/2020 08:14	17,71	68	1204,36	CHI
202001102358	PETROLINA DE GOIAS	PG21281389	PETROLINA	17/01/2020 14:31	17/01/2020 19:27	17/01/2020 14:31	17/01/2020 19:27	4,92	1	4,92	CHI
202001102360	URUACU	UR12281005	URUACU	17/01/2020 14:31	17/01/2020 22:51	17/01/2020 14:31	17/01/2020 22:51	8,32	4	33,27	CHI
202001102368	JATAI	JT12234313	JATAI S1	17/01/2020 13:28	17/01/2020 18:24	17/01/2020 13:28	17/01/2020 18:24	4,92	9	44,32	CHI
202001102370	BURITI ALEGRE	BG12263568RE	ITUMBIARA VELHA S2	17/01/2020 12:49	17/01/2020 22:02	17/01/2020 12:49	17/01/2020 18:25	5,60	15	84,00	CHI
202001102370	ITUMBIARA	BG12263568RE	ITUMBIARA VELHA S2	17/01/2020 12:49	17/01/2020 22:02	17/01/2020 12:49	17/01/2020 18:25	5,60	5	28,00	CHI
202001102370	ITUMBIARA	BG12263568RE	ITUMBIARA VELHA S2	17/01/2020 12:49	17/01/2020 22:02	17/01/2020 12:49	17/01/2020 22:02	9,22	1	9,22	CHI
202001102373	SAO JOAO D ALIANCA	JL21264866	SAO JOAO D ALIANCA	17/01/2020 14:33	17/01/2020 20:18	17/01/2020 14:33	17/01/2020 20:18	5,74	1	5,74	CHI
202001102381	NIQUELANDIA	NQ21083022	URUACU	17/01/2020 14:35	17/01/2020 17:25	17/01/2020 14:35	17/01/2020 17:25	2,83	3	8,49	CHI
202001102383	QUIRINOPOLIS	QI21306038	QUIRINOPOLIS	17/01/2020 14:35	17/01/2020 17:25	17/01/2020 14:35	17/01/2020 17:25	2,83	3	8,48	CHI
202001102385	VIANOPOLIS	VN12052254	VIANOPOLIS	17/01/2020 14:35	17/01/2020 19:50	17/01/2020 14:35	17/01/2020 19:50	5,24	123	644,42	CHI
202001102391	SANCLERLANDIA	1210019210	FIRMINOPOLIS S2	17/01/2020 14:36	17/01/2020 17:22	17/01/2020 14:36	17/01/2020 17:22	2,76	1	2,76	CHI
202001102394	SENADOR CANEDO	190062174	SENADOR CANEDO	17/01/2020 14:37	17/01/2020 15:57	17/01/2020 14:37	17/01/2020 15:57	1,33	1	1,33	CHI
202001102396	RUBIATABA	10019005448	RUBIATABA	17/01/2020 14:37	18/01/2020 10:51	17/01/2020 14:37	18/01/2020 10:51	20,24	1	20,24	CHI
202001102402	CALDAS NOVAS	10012525330	VILA CORUMBA	17/01/2020 14:38	17/01/2020 18:40	17/01/2020 14:38	17/01/2020 18:40	4,05	1	4,05	CHI

202001102405	CACHOEIRA DOURADA	IT12088560	CACHOEIRA DOURADA	17/01/2020 14:36	17/01/2020 18:47	17/01/2020 14:36	17/01/2020 18:47	4,18	1	4,18	CHI
202001102405	ITUMBIARA	IT12088560	CACHOEIRA DOURADA	17/01/2020 14:36	17/01/2020 18:47	17/01/2020 14:36	17/01/2020 18:47	4,18	4	16,71	CHI
202001102413	GOIANIRA	10004303987	GOIANIRA	17/01/2020 14:39	17/01/2020 18:20	17/01/2020 14:39	17/01/2020 18:20	3,67	1	3,67	CHI
202001102414	AURILANDIA	AI21118718	FIRMINOPOLIS S2	17/01/2020 14:40	17/01/2020 16:55	17/01/2020 14:40	17/01/2020 16:55	2,25	1	2,25	CHI
202001102417	PIRACANJUBA	PJ12043107	ROCHEDO	17/01/2020 14:40	18/01/2020 09:21	17/01/2020 14:40	18/01/2020 09:21	18,67	3	56,01	CHI
202001102417	PROFESSOR JAMIL SAFADY	PJ12043107	ROCHEDO	17/01/2020 14:40	18/01/2020 09:21	17/01/2020 14:40	18/01/2020 09:21	18,67	1	18,67	CHI
202001102421	NOVA AMERICA	2160004449	RUBIATABA	17/01/2020 14:41	18/01/2020 01:08	17/01/2020 14:41	18/01/2020 01:08	10,44	1	10,44	CHI
202001102426	RIO VERDE	RV21191559	SANTA HELENA S1	17/01/2020 14:43	18/01/2020 12:35	17/01/2020 14:43	18/01/2020 12:35	21,87	2	43,73	CHI
202001102432	CRIXAS	CX11244856	SERRA DO OURO	17/01/2020 14:23	17/01/2020 16:14	17/01/2020 14:23	17/01/2020 16:14	1,85	163	301,41	CHI
202001102440	FORMOSA	FA31051028	SAO JOAO D ALIANCA	17/01/2020 14:46	17/01/2020 18:00	17/01/2020 14:46	17/01/2020 18:00	3,22	1	3,22	CHI
202001102442	JATAI	JT21136079	JATAI S3	17/01/2020 14:46	17/01/2020 19:10	17/01/2020 14:46	17/01/2020 19:10	4,39	1	4,39	CHI
202001102446	JATAI	JT12109029	JATAI S1	17/01/2020 14:18	18/01/2020 07:25	17/01/2020 14:18	18/01/2020 07:25	17,10	28	478,88	CHI
202001102450	PIRANHAS	PH12341825	PIRANHAS	17/01/2020 10:40	18/01/2020 15:02	17/01/2020 10:40	18/01/2020 15:02	28,36	4	113,44	CHI
202001102452	BOM JARDIM DE GOIAS	1880016567	BOM JARDIM	17/01/2020 14:48	17/01/2020 19:04	17/01/2020 14:48	17/01/2020 19:04	4,25	1	4,25	CHI
202001102460	GOIANIA	15764412	GOYA S2	17/01/2020 14:51	17/01/2020 16:15	17/01/2020 14:51	17/01/2020 16:15	1,39	1	1,39	CHI
202001102463	APARECIDA DE GOIANIA	AP11140129	INDEPENDENCIA S1	17/01/2020 14:51	17/01/2020 19:06	17/01/2020 14:51	17/01/2020 19:06	4,24	147	622,63	CHI
202001102464	INHUMAS	30063607	INHUMAS S2	17/01/2020 14:52	17/01/2020 16:50	17/01/2020 14:52	17/01/2020 16:50	1,97	1	1,97	CHI
202001102466	BRITANIA	BT21256300	BRITANIA	17/01/2020 14:52	17/01/2020 16:50	17/01/2020 14:52	17/01/2020 16:50	1,96	1	1,96	CHI
202001102467	DOVERLANDIA	DV21259941	CAIAPONIA	17/01/2020 14:52	18/01/2020 09:16	17/01/2020 14:52	18/01/2020 09:16	18,39	1	18,39	CHI
202001102473	URUACU	UR12317135	URUACU	17/01/2020 14:53	17/01/2020 17:05	17/01/2020 14:53	17/01/2020 17:05	2,19	11	24,07	CHI
202001102476	ARENOPOLIS	1920012609	ARENOPOLIS	17/01/2020 14:54	18/01/2020 19:13	17/01/2020 14:54	18/01/2020 19:13	28,33	1	28,33	CHI
202001102481	JANDAIA	JD21199850	ACREUNA	17/01/2020 14:55	17/01/2020 16:18	17/01/2020 14:55	17/01/2020 16:18	1,38	1	1,38	CHI
202001102485	CAMPINACU	UC12236261	PORANGATU	17/01/2020 14:33	17/01/2020 22:17	17/01/2020 14:33	17/01/2020 22:17	7,75	19	147,21	CHI
202001102485	PORANGATU	UC12236261	PORANGATU	17/01/2020 14:33	17/01/2020 22:17	17/01/2020 14:33	17/01/2020 22:17	7,75	1	7,75	CHI
202001102489	CAMPO ALEGRE DE GOIAS	CM21161420	CAMPO ALEGRE DE GOIAS	17/01/2020 14:55	17/01/2020 23:57	17/01/2020 14:55	17/01/2020 23:57	9,02	1	9,02	CHI
202001102492	ALTO HORIZONTE	AJ12404037	MARA ROSA	17/01/2020 11:47	18/01/2020 20:46	17/01/2020 11:47	18/01/2020 03:49	16,04	21	336,90	CHI
202001102492	ALTO HORIZONTE	AJ12143571	MARA ROSA	17/01/2020 11:47	18/01/2020 20:46	18/01/2020 04:00	18/01/2020 04:35	0,58	22	12,83	CHI
202001102492	ALTO HORIZONTE	MQ10403947	MARA ROSA	17/01/2020 11:47	18/01/2020 20:46	18/01/2020 11:08	18/01/2020 11:42	0,56	68	38,02	CHI
202001102492	MARA ROSA	MQ10403947	MARA ROSA	17/01/2020 11:47	18/01/2020 20:46	18/01/2020 11:08	18/01/2020 11:42	0,56	191	106,80	CHI
202001102492	NOVA IGUACU DE GOIAS	MQ10403947	MARA ROSA	17/01/2020 11:47	18/01/2020 20:46	18/01/2020 11:08	18/01/2020 11:42	0,56	12	6,71	CHI
202001102492	URUACU	MQ10403947	MARA ROSA	17/01/2020 11:47	18/01/2020 20:46	18/01/2020 11:08	18/01/2020 11:42	0,56	1	0,56	CHI
202001102492	ALTO HORIZONTE	AJ12404037	MARA ROSA	17/01/2020 11:47	18/01/2020 20:46	17/01/2020 11:47	18/01/2020 17:16	29,48	10	294,84	CHI
202001102492	MARA ROSA	AJ12404037	MARA ROSA	17/01/2020 11:47	18/01/2020 20:46	17/01/2020 11:47	18/01/2020 17:16	29,48	4	117,94	CHI

202001102492	NOVA IGUACU DE GOIAS	AJ12404037	MARA ROSA	17/01/2020 11:47	18/01/2020 20:46	17/01/2020 11:47	18/01/2020 17:16	29,48	12	353,81	CHI
202001102492	ALTO HORIZONTE	AJ12384909	MARA ROSA	17/01/2020 11:47	18/01/2020 20:46	17/01/2020 11:47	18/01/2020 20:46	32,99	5	164,96	CHI
202001102492	MARA ROSA	AJ12384909	MARA ROSA	17/01/2020 11:47	18/01/2020 20:46	17/01/2020 11:47	18/01/2020 20:46	32,99	1	32,99	CHI
202001102496	BONOPOLIS	BX12198524	SAO MIGUEL DO ARAGUAIA	17/01/2020 12:57	17/01/2020 20:05	17/01/2020 12:57	17/01/2020 20:05	7,13	6	42,77	CHI
202001102506	PILAR DE GOIAS	GG12190086	URUACU	17/01/2020 14:57	17/01/2020 17:35	17/01/2020 14:57	17/01/2020 17:35	2,64	4	10,57	CHI
202001102508	JATAI	JT12182140	JATAI S1	17/01/2020 14:03	17/01/2020 16:58	17/01/2020 14:03	17/01/2020 16:58	2,91	9	26,21	CHI
202001102508	SERRANOPOLIS	JT12182140	JATAI S1	17/01/2020 14:03	17/01/2020 16:58	17/01/2020 14:03	17/01/2020 16:58	2,91	2	5,82	CHI
202001102510	MONTIVIDIU	MV21260820	MONTIVIDIU T	17/01/2020 14:57	17/01/2020 19:08	17/01/2020 14:57	17/01/2020 19:08	4,17	1	4,17	CHI
202001102517	GOIATUBA	BJ12305327	RIO DOS BOIS	17/01/2020 14:59	18/01/2020 13:27	17/01/2020 14:59	18/01/2020 13:27	22,47	3	67,40	CHI
202001102519	MONTIVIDIU	2840016716	MONTIVIDIU T	17/01/2020 14:59	17/01/2020 23:20	17/01/2020 14:59	17/01/2020 23:20	8,36	1	8,36	CHI
202001102525	RIO VERDE	RV12296585	QUIRINOPOLIS	17/01/2020 15:00	18/01/2020 10:41	17/01/2020 15:00	18/01/2020 10:41	19,67	3	59,02	CHI
202001102531	MORRINHOS	MR12000194	MORRINHOS	17/01/2020 12:57	17/01/2020 16:40	17/01/2020 12:57	17/01/2020 16:40	3,71	36	133,72	CHI
202001102533	SAO LUIS DE MONTES BELOS	SL21004161	SAO LUIZ DOS MONTES BELOS	17/01/2020 15:02	17/01/2020 19:00	17/01/2020 15:02	17/01/2020 19:00	3,96	1	3,96	CHI
202001102535	FORMOSA	610284009	ITUIQUIRA	17/01/2020 15:02	17/01/2020 17:09	17/01/2020 15:02	17/01/2020 17:09	2,11	1	2,11	CHI
202001102542	PIRACANJUBA	PJ12000042RE	PIRACANJUBA	17/01/2020 14:25	17/01/2020 17:18	17/01/2020 14:25	17/01/2020 17:18	2,88	10	28,82	CHI
202001102544	SANCLERLANDIA	SC21211014	FIRMINOPOLIS S2	17/01/2020 15:03	17/01/2020 16:37	17/01/2020 15:03	17/01/2020 16:37	1,55	1	1,55	CHI
202001102547	APARECIDA DE GOIANIA	10025277330	INDEPENDENCIA S2	17/01/2020 15:04	17/01/2020 18:18	17/01/2020 15:04	17/01/2020 18:18	3,23	1	3,23	CHI
202001102568	DIORAMA	DI21070145	IPORA	17/01/2020 15:09	18/01/2020 16:05	17/01/2020 15:09	18/01/2020 16:05	24,92	1	24,92	CHI
202001102573	DOVERLANDIA	MY12217015	PARQUE DAS EMAS	17/01/2020 13:00	18/01/2020 09:34	17/01/2020 13:00	18/01/2020 09:34	20,56	31	637,27	CHI
202001102573	MINEIROS	MY12217015	PARQUE DAS EMAS	17/01/2020 13:00	18/01/2020 09:34	17/01/2020 13:00	18/01/2020 09:34	20,56	9	185,01	CHI
202001102585	SAO SIMAO	SO11255742	CACHOEIRA ALTA	17/01/2020 14:29	17/01/2020 19:56	17/01/2020 14:29	17/01/2020 19:56	5,44	43	233,87	CHI
202001102586	DIVINOPOLIS DE GOIAS	6883060	SAO DOMINGOS	17/01/2020 15:11	17/01/2020 17:53	17/01/2020 15:11	17/01/2020 17:53	2,68	1	2,68	CHI
202001102586	SAO DOMINGOS	6883060	SAO DOMINGOS	17/01/2020 15:11	17/01/2020 17:53	17/01/2020 15:11	17/01/2020 17:53	2,68	4	10,73	CHI
202001102587	SANTA RITA DO ARAGUAIA	10003609446	SANTA RITA DO ARAGUAIA	17/01/2020 15:12	17/01/2020 23:54	17/01/2020 15:12	17/01/2020 23:54	8,70	1	8,70	CHI
202001102588	GOIANIA	GN11201077	GOYA S2	17/01/2020 15:12	17/01/2020 16:45	17/01/2020 15:12	17/01/2020 16:45	1,54	101	156,02	CHI
202001102590	PIRACANJUBA	PJ21156548	MORRINHOS	17/01/2020 15:12	18/01/2020 11:54	17/01/2020 15:12	18/01/2020 11:54	20,69	1	20,69	CHI
202001102594	MORRINHOS	MR12128674	MORRINHOS	17/01/2020 15:13	17/01/2020 22:20	17/01/2020 15:13	17/01/2020 22:20	7,12	18	128,09	CHI
202001102596	NIQUELANDIA	NQ21344325	SAO JOAO D ALIANCA	17/01/2020 15:13	17/01/2020 17:50	17/01/2020 15:13	17/01/2020 17:50	2,62	1	2,62	CHI
202001102599	PORANGATU	PO21280269	NOVO PLANALTO	17/01/2020 15:13	18/01/2020 08:40	17/01/2020 15:13	18/01/2020 08:40	17,44	1	17,44	CHI
202001102806	BARRO ALTO	BA10400689	BARRO ALTO	17/01/2020 15:09	18/01/2020 17:32	17/01/2020 15:09	17/01/2020 20:27	5,29	23	121,64	CHI
202001102806	BARRO ALTO	BA10400689	BARRO ALTO	17/01/2020 15:09	18/01/2020 17:32	17/01/2020 15:09	17/01/2020 22:24	7,24	100	724,44	CHI
202001102806	BARRO ALTO	BA13339850	BARRO ALTO	17/01/2020 15:09	18/01/2020 17:32	17/01/2020 15:09	17/01/2020 22:24	7,24	107	775,16	CHI
202001102806	NIQUELANDIA	BA13339850	BARRO ALTO	17/01/2020 15:09	18/01/2020 17:32	17/01/2020 15:09	17/01/2020 22:24	7,24	122	883,82	CHI

202001102806	BARRO ALTO	BA10400689	BARRO ALTO	17/01/2020 15:09	18/01/2020 17:32	17/01/2020 15:09	18/01/2020 17:28	26,30	2	52,61	CHI
202001102806	BARRO ALTO	BA10400689	BARRO ALTO	17/01/2020 15:09	18/01/2020 17:32	17/01/2020 15:09	18/01/2020 17:32	26,39	1	26,39	CHI
202001102820	GOIANIA	GN11000015	FERROVIARIO S3	17/01/2020 15:16	17/01/2020 20:49	17/01/2020 15:16	17/01/2020 20:49	5,54	3	16,63	CHI
202001102833	RIO VERDE	RV12279609	RIO VERDE S1	17/01/2020 14:57	18/01/2020 07:30	17/01/2020 14:57	18/01/2020 07:30	16,54	31	512,81	CHI
202001102838	GOIANIA	14561761	MEIA PONTE	17/01/2020 15:18	17/01/2020 17:57	17/01/2020 15:18	17/01/2020 17:57	2,64	1	2,64	CHI
202001102851	MARZAGAO	MG11155723	VILA CORUMBA	17/01/2020 15:19	17/01/2020 17:30	17/01/2020 15:19	17/01/2020 17:30	2,17	65	140,87	CHI
202001102857	NIQUELANDIA	NQ12208518	NIQUELANDIA SUBTRANSMISSAO	17/01/2020 15:07	17/01/2020 19:57	17/01/2020 15:07	17/01/2020 19:57	4,83	96	463,57	CHI
202001102858	JATAI	JT12210073	JATAI S1	17/01/2020 14:28	17/01/2020 23:03	17/01/2020 14:28	17/01/2020 23:03	8,57	2	17,14	CHI
202001102860	SAO LUIS DE MONTES BELOS	SL21020348	SAO LUIZ DOS MONTES BELOS	17/01/2020 15:21	18/01/2020 08:24	17/01/2020 15:21	18/01/2020 08:24	17,04	2	34,07	CHI
202001102862	QUIRINOPOLIS	QI21100518	QUIRINOPOLIS	17/01/2020 15:22	18/01/2020 09:41	17/01/2020 15:22	18/01/2020 09:41	18,32	1	18,32	CHI
202001102863	PIRACANJUBA	60110156	PIRACANJUBA	17/01/2020 15:22	17/01/2020 16:39	17/01/2020 15:22	17/01/2020 16:39	1,28	1	1,28	CHI
202001102867	CORUMBAIBA	CI12120757	CATALAO S1	17/01/2020 15:22	18/01/2020 11:24	17/01/2020 15:22	18/01/2020 11:24	20,02	12	240,30	CHI
202001102869	NIQUELANDIA	NQ21056789	URUACU	17/01/2020 15:22	17/01/2020 18:37	17/01/2020 15:22	17/01/2020 18:37	3,24	1	3,24	CHI
202001102872	NIQUELANDIA	NQ12398049	URUACU	17/01/2020 15:23	17/01/2020 19:09	17/01/2020 15:23	17/01/2020 19:09	3,77	38	143,14	CHI
202001102874	TRES RANCHOS	TH12077730	CATALAO S1	17/01/2020 15:23	18/01/2020 09:36	17/01/2020 15:23	18/01/2020 09:36	18,21	2	36,43	CHI
202001102876	QUIRINOPOLIS	QI12360901	QUIRINOPOLIS	17/01/2020 15:21	17/01/2020 18:15	17/01/2020 15:21	17/01/2020 18:15	2,89	6	17,34	CHI
202001102877	GOIANIA	GN11199057	GOYA S1	17/01/2020 15:23	17/01/2020 17:25	17/01/2020 15:23	17/01/2020 17:25	2,02	16	32,40	CHI
202001102878	CRISTALINA	KR11170196	CRISTALINA S2	17/01/2020 15:23	17/01/2020 17:17	17/01/2020 15:23	17/01/2020 17:17	1,89	23	43,49	CHI
202001102887	CALDAS NOVAS	PJ12263230	CALDAS NOVAS S1	17/01/2020 15:24	19/01/2020 11:35	17/01/2020 15:24	19/01/2020 11:35	44,17	1	44,17	CHI
202001102887	PIRACANJUBA	PJ12263230	CALDAS NOVAS S1	17/01/2020 15:24	19/01/2020 11:35	17/01/2020 15:24	19/01/2020 11:35	44,17	17	750,85	CHI
202001102889	PARANAIGUARA	SO12000023	CACHOEIRA ALTA	17/01/2020 15:25	18/01/2020 22:50	17/01/2020 15:25	18/01/2020 22:50	31,41	36	1130,65	CHI
202001102889	SAO SIMAO	SO12000023	CACHOEIRA ALTA	17/01/2020 15:25	18/01/2020 22:50	17/01/2020 15:25	18/01/2020 22:50	31,41	20	628,14	CHI
202001102892	APARECIDA DE GOIANIA	200158971	INDEPENDENCIA S2	17/01/2020 15:25	17/01/2020 19:58	17/01/2020 15:25	17/01/2020 19:58	4,54	1	4,54	CHI
202001102901	ARAGUAPAZ	AZ12299825	GOIAS	17/01/2020 07:24	18/01/2020 02:01	17/01/2020 07:24	18/01/2020 02:01	18,61	9	167,48	CHI
202001102903	ALEXANIA	AX10394596	ALEXANIA	17/01/2020 15:23	18/01/2020 19:13	17/01/2020 15:23	17/01/2020 16:58	1,59	48	76,12	CHI
202001102903	CORUMBA DE GOIAS	AX10394596	ALEXANIA	17/01/2020 15:23	18/01/2020 19:13	17/01/2020 15:23	17/01/2020 16:58	1,59	5	7,93	CHI
202001102903	ALEXANIA	AX12211853LD	ALEXANIA	17/01/2020 15:23	18/01/2020 19:13	17/01/2020 15:23	17/01/2020 20:43	5,32	39	207,58	CHI
202001102903	CORUMBA DE GOIAS	AX12211853LD	ALEXANIA	17/01/2020 15:23	18/01/2020 19:13	17/01/2020 15:23	17/01/2020 20:43	5,32	2	10,65	CHI
202001102903	ALEXANIA	AX12362272LD	ALEXANIA	17/01/2020 15:23	18/01/2020 19:13	17/01/2020 15:23	17/01/2020 21:52	6,47	33	213,57	CHI
202001102903	SANTO ANTONIO DO DESCOBERTO	AX12362272LD	ALEXANIA	17/01/2020 15:23	18/01/2020 19:13	17/01/2020 15:23	17/01/2020 21:52	6,47	4	25,89	CHI
202001102903	ALEXANIA	AX12351040LD	ALEXANIA	17/01/2020 15:23	18/01/2020 19:13	17/01/2020 15:23	18/01/2020 19:13	27,82	28	778,99	CHI
202001102905	PORANGATU	PO12286007	PORANGATU	17/01/2020 10:38	18/01/2020 08:44	17/01/2020 10:38	18/01/2020 08:44	22,09	8	176,74	CHI
202001103001	MONTIVIDIU	MV21267608	MONTIVIDIU T	17/01/2020 15:26	18/01/2020 11:34	17/01/2020 15:26	18/01/2020 11:34	20,13	1	20,13	CHI

202001103004	GOIANIA	GN11000507	CAMPINAS S3	17/01/2020 15:27	17/01/2020 16:50	17/01/2020 15:27	17/01/2020 16:50	1,37	132	181,24	CHI
202001103012	AGUA FRIA DE GOIAS	TL21157834	SAO JOAO D ALIANCA	17/01/2020 15:28	17/01/2020 21:13	17/01/2020 15:28	17/01/2020 21:13	5,74	1	5,74	CHI
202001103013	IPORA	IR12353550	IPORA	17/01/2020 15:26	18/01/2020 03:02	17/01/2020 15:26	18/01/2020 03:02	11,59	8	92,73	CHI
202001103018	ITUMBIARA	CD21263733	CACHOEIRA DOURADA	17/01/2020 15:29	19/01/2020 10:15	17/01/2020 15:29	19/01/2020 10:15	42,76	1	42,76	CHI
202001103041	JUSSARA	JR12396219	BRITANIA	17/01/2020 15:34	17/01/2020 18:09	17/01/2020 15:34	17/01/2020 18:09	2,57	3	7,71	CHI
202001103044	NIQUELANDIA	NQ12315526	NIQUELANDIA SUBTRANSMISSAO	17/01/2020 15:35	17/01/2020 23:06	17/01/2020 15:35	17/01/2020 23:06	7,50	1	7,50	CHI
202001103046	CORUMBAIBA	CI12035399	VILA CORUMBA	17/01/2020 15:36	18/01/2020 17:39	17/01/2020 15:36	18/01/2020 17:39	26,05	7	182,33	CHI
202001103047	GOIANIA	GN11000862	FERROVIARIO S2	17/01/2020 15:36	17/01/2020 17:54	17/01/2020 15:36	17/01/2020 17:54	2,30	40	91,87	CHI
202001103051	ORIZONA	OZ21248900	PIRES DO RIO S2	17/01/2020 15:36	17/01/2020 18:22	17/01/2020 15:36	17/01/2020 18:22	2,76	1	2,76	CHI
202001103058	CAMPO ALEGRE DE GOIAS	CT12165146	CATALAO S1	17/01/2020 07:42	17/01/2020 17:20	17/01/2020 07:42	17/01/2020 17:20	9,63	2	19,25	CHI
202001103058	CATALAO	CT12165146	CATALAO S1	17/01/2020 07:42	17/01/2020 17:20	17/01/2020 07:42	17/01/2020 17:20	9,63	31	298,41	CHI
202001103060	NIQUELANDIA	NQ12088704	URUACU	17/01/2020 15:36	17/01/2020 20:13	17/01/2020 15:36	17/01/2020 20:13	4,60	21	96,62	CHI
202001103061	BOM JARDIM DE GOIAS	BM12354692	BOM JARDIM	17/01/2020 07:38	17/01/2020 20:44	17/01/2020 07:38	17/01/2020 20:44	13,09	4	52,35	CHI
202001103066	QUIRINOPOLIS	QI32035343	QUIRINOPOLIS	17/01/2020 15:29	18/01/2020 08:43	17/01/2020 15:29	18/01/2020 08:43	17,22	17	292,74	CHI
202001103070	GOIANESIA	NP21342893	GOIANESIA S2	17/01/2020 15:38	17/01/2020 19:17	17/01/2020 15:38	17/01/2020 19:17	3,64	1	3,64	CHI
202001103072	ARAGUAPAZ	AZ11238815	MOZARLANDIA	17/01/2020 15:39	18/01/2020 07:43	17/01/2020 15:39	18/01/2020 07:43	16,06	1	16,06	CHI
202001103076	APORE	AE21070691	ITAJA S2	17/01/2020 15:40	18/01/2020 06:39	17/01/2020 15:40	18/01/2020 06:39	14,98	1	14,98	CHI
202001103082	URUACU	CR12375637	CAMPINORTE	17/01/2020 14:17	17/01/2020 16:36	17/01/2020 14:17	17/01/2020 16:36	2,31	115	265,75	CHI
202001103088	SAO SIMAO	2240034598	CACHOEIRA ALTA	17/01/2020 15:40	18/01/2020 18:25	17/01/2020 15:40	18/01/2020 18:25	26,74	1	26,74	CHI
202001103094	NIQUELANDIA	NQ11057931	NIQUELANDIA SUBTRANSMISSAO	17/01/2020 14:29	17/01/2020 18:31	17/01/2020 14:29	17/01/2020 18:31	4,02	156	627,29	CHI
202001103098	CORUMBAIBA	CI12263856	VILA CORUMBA	17/01/2020 14:51	17/01/2020 19:58	17/01/2020 14:51	17/01/2020 19:58	5,11	167	853,09	CHI
202001103098	NOVA AURORA	CI12263856	VILA CORUMBA	17/01/2020 14:51	17/01/2020 19:58	17/01/2020 14:51	17/01/2020 19:58	5,11	7	35,76	CHI
202001103099	ALTO HORIZONTE	AJ12100313	SANTA TEREZINHA	17/01/2020 15:12	17/01/2020 21:29	17/01/2020 15:12	17/01/2020 21:29	6,27	9	56,46	CHI
202001103100	ITAPACI	IW12251268	RUBIATABA	17/01/2020 15:41	18/01/2020 11:51	17/01/2020 15:41	18/01/2020 11:51	20,15	3	60,46	CHI
202001103101	GOIATUBA	03840214	GOIATUBA S1	17/01/2020 15:41	17/01/2020 20:57	17/01/2020 18:16	17/01/2020 18:20	0,07	18	1,31	CHI
202001103101	PANAMA	03840214	GOIATUBA S1	17/01/2020 15:41	17/01/2020 20:57	17/01/2020 18:16	17/01/2020 18:20	0,07	10	0,73	CHI
202001103101	RUBIATABA	03840214	GOIATUBA S1	17/01/2020 15:41	17/01/2020 20:57	17/01/2020 18:16	17/01/2020 18:20	0,07	1	0,07	CHI
202001103101	BURITI ALEGRE	03840214	PARANAIBA	17/01/2020 15:41	17/01/2020 20:57	17/01/2020 18:16	17/01/2020 18:20	0,07	8	0,58	CHI
202001103101	GOIATUBA	03840214	PARANAIBA	17/01/2020 15:41	17/01/2020 20:57	17/01/2020 18:16	17/01/2020 18:20	0,07	6	0,44	CHI
202001103101	ITUMBIARA	03840214	PARANAIBA	17/01/2020 15:41	17/01/2020 20:57	17/01/2020 18:16	17/01/2020 18:20	0,07	130	9,43	CHI
202001103101	PANAMA	03840214	PARANAIBA	17/01/2020 15:41	17/01/2020 20:57	17/01/2020 18:16	17/01/2020 18:20	0,07	20	1,45	CHI
202001103101	ITUMBIARA	IT12352687RE	PARANAIBA	17/01/2020 15:41	17/01/2020 20:57	17/01/2020 15:41	17/01/2020 20:57	5,26	99	520,77	CHI
202001103106	BRITANIA	BT11171782	BRITANIA	17/01/2020 15:43	17/01/2020 18:56	17/01/2020 15:43	17/01/2020 18:56	3,21	95	304,84	CHI

202001103113	SANTA CRUZ DE GOIAS	BC12257199	PIRACANJUBA	17/01/2020 15:44	18/01/2020 11:03	17/01/2020 15:44	18/01/2020 11:03	19,32	2	38,63	CHI
202001103115	SITIO D ABADIA	SI21300500	IACIARA S2	17/01/2020 15:44	17/01/2020 18:19	17/01/2020 15:44	17/01/2020 18:19	2,58	1	2,58	CHI
202001103116	MORRINHOS	MR21189822	MORRINHOS	17/01/2020 15:44	18/01/2020 16:51	17/01/2020 15:44	18/01/2020 16:51	25,12	1	25,12	CHI
202001103117	GOIAS	10015315280	GOIAS	17/01/2020 15:44	17/01/2020 16:47	17/01/2020 15:44	17/01/2020 16:47	1,04	1	1,04	CHI
202001103118	AGUA FRIA DE GOIAS	TL12151992	SAO JOAO D ALIANCA	17/01/2020 15:44	17/01/2020 20:42	17/01/2020 15:44	17/01/2020 20:42	4,95	5	24,77	CHI
202001103119	JARAGUA	JA12104703	JARAGUA	17/01/2020 15:44	18/01/2020 07:55	17/01/2020 15:44	18/01/2020 07:55	16,17	3	48,51	CHI
202001103126	CALDAS NOVAS	CN11061298	SERRA DE CALDAS	17/01/2020 15:31	17/01/2020 18:30	17/01/2020 15:31	17/01/2020 18:30	2,97	177	525,54	CHI
202001103127	SAO LUIS DE MONTES BELOS	SL32233383	SAO LUIZ DOS MONTES BELOS	17/01/2020 13:51	17/01/2020 17:20	17/01/2020 13:51	17/01/2020 17:20	3,48	18	62,69	CHI
202001103130	MINEIROS	1390024468	PARQUE DAS EMAS	17/01/2020 15:46	18/01/2020 10:31	17/01/2020 15:46	18/01/2020 10:31	18,73	1	18,73	CHI
202001103132	TRINDADE	10020266209	GOYA S1	17/01/2020 15:47	17/01/2020 17:52	17/01/2020 15:47	17/01/2020 17:52	2,08	1	2,08	CHI
202001103143	RIO VERDE	RV21152710	CABRIUVA S2	17/01/2020 15:48	18/01/2020 11:51	17/01/2020 15:48	18/01/2020 11:51	20,04	2	40,07	CHI
202001103144	APARECIDA DE GOIANIA	200045702	INDEPENDENCIA S1	17/01/2020 15:48	17/01/2020 19:07	17/01/2020 15:48	17/01/2020 19:07	3,30	1	3,30	CHI
202001103147	CORUMBAIBA	CI12000467	VILA CORUMBA	17/01/2020 15:09	18/01/2020 14:09	17/01/2020 15:09	18/01/2020 14:09	22,99	11	252,92	CHI
202001103154	DISTRITO FEDERAL	SN12133153	AGUAS LINDAS DE GOIAS S2	17/01/2020 15:51	17/01/2020 19:33	17/01/2020 15:51	17/01/2020 19:33	3,69	1	3,69	CHI
202001103154	SANTO ANTONIO DO DESCOBERTO	SN12133153	AGUAS LINDAS DE GOIAS S2	17/01/2020 15:51	17/01/2020 19:33	17/01/2020 15:51	17/01/2020 19:33	3,69	35	129,28	CHI
202001103156	CATALAO	IP12404711	IPAMERI	17/01/2020 15:34	17/01/2020 17:32	17/01/2020 15:34	17/01/2020 17:32	1,96	7	13,75	CHI
202001103156	GOIANDIRA	IP12404711	IPAMERI	17/01/2020 15:34	17/01/2020 17:32	17/01/2020 15:34	17/01/2020 17:32	1,96	15	29,46	CHI
202001103156	IPAMERI	IP12404711	IPAMERI	17/01/2020 15:34	17/01/2020 17:32	17/01/2020 15:34	17/01/2020 17:32	1,96	86	168,92	CHI
202001103164	NIQUELANDIA	NQ12398052	NIQUELANDIA SUBTRANSMISSAO	17/01/2020 15:12	17/01/2020 22:07	17/01/2020 15:12	17/01/2020 22:07	6,90	17	117,32	CHI
202001103170	ITAPURANGA	GS21024772	ITAPURANGA	17/01/2020 15:54	17/01/2020 18:21	17/01/2020 15:54	17/01/2020 18:21	2,45	1	2,45	CHI
202001103173	CALDAS NOVAS	CN12056708	SERRA DE CALDAS	17/01/2020 15:38	18/01/2020 00:38	17/01/2020 15:38	18/01/2020 00:38	9,00	37	332,96	CHI
202001103175	GOIANDIRA	GD12127545	CATALAO S1	17/01/2020 13:00	18/01/2020 09:39	17/01/2020 13:00	18/01/2020 09:39	20,64	2	41,29	CHI
202001103176	CACHOEIRA ALTA	CA12075312	CACHOEIRA ALTA	17/01/2020 15:54	18/01/2020 11:24	17/01/2020 15:54	18/01/2020 11:24	19,50	3	58,51	CHI
202001103177	GUARINOS	GF12128386	ITAPACI	17/01/2020 15:54	18/01/2020 00:24	17/01/2020 15:54	18/01/2020 00:24	8,49	6	50,92	CHI
202001103178	SERRANOPOLIS	SX12390581	JATAI S1	17/01/2020 15:55	18/01/2020 11:50	17/01/2020 15:55	18/01/2020 11:50	19,91	5	99,57	CHI
202001103180	CALDAS NOVAS	MG12000361	VILA CORUMBA	17/01/2020 15:55	18/01/2020 12:20	17/01/2020 15:55	18/01/2020 12:20	20,41	3	61,24	CHI
202001103180	CORUMBAIBA	MG12000361	VILA CORUMBA	17/01/2020 15:55	18/01/2020 12:20	17/01/2020 15:55	18/01/2020 12:20	20,41	2	40,83	CHI
202001103187	CROMINIA	CQ12293014	PONTALINA	17/01/2020 15:38	17/01/2020 17:38	17/01/2020 15:38	17/01/2020 17:38	2,00	9	17,97	CHI
202001103190	RIO VERDE	RV12370277	SANTA HELENA S1	17/01/2020 13:55	18/01/2020 10:15	17/01/2020 13:55	18/01/2020 10:15	20,33	17	345,59	CHI
202001103191	NIQUELANDIA	NQ21333954	URUACU	17/01/2020 15:58	17/01/2020 20:30	17/01/2020 15:58	17/01/2020 20:30	4,53	1	4,53	CHI
202001103192	CORREGO DO OURO	CO11000048	FIRMINOPOLIS S2	17/01/2020 15:58	17/01/2020 20:59	17/01/2020 15:58	17/01/2020 20:59	5,01	108	541,17	CHI
202001103197	MORRINHOS	MR11316615	MORRINHOS	17/01/2020 15:45	17/01/2020 19:05	17/01/2020 15:45	17/01/2020 19:05	3,34	98	327,24	CHI
202001103199	ANAPOLIS	20784028	ANAPOLIS UNIVERSITARIO S2	17/01/2020 15:59	17/01/2020 20:42	17/01/2020 15:59	17/01/2020 20:42	4,71	1	4,71	CHI

202001103200	CRISTALINA	KR21305199	CRISTALINA S2	17/01/2020 15:59	18/01/2020 12:21	17/01/2020 15:59	18/01/2020 12:21	20,36	1	20,36	CHI
202001103302	CALDAS NOVAS	CN12216502	VILA CORUMBA	17/01/2020 15:59	18/01/2020 10:30	17/01/2020 15:59	18/01/2020 10:30	18,50	43	795,70	CHI
202001103305	IPAMERI	UT12016916	URUTAI	17/01/2020 15:59	17/01/2020 18:55	17/01/2020 15:59	17/01/2020 18:55	2,92	3	8,77	CHI
202001103305	URUTAI	UT12016916	URUTAI	17/01/2020 15:59	17/01/2020 18:55	17/01/2020 15:59	17/01/2020 18:55	2,92	20	58,49	CHI
202001103311	CRISTALINA	KR12349171	PAMPLONA	17/01/2020 16:00	17/01/2020 19:35	17/01/2020 16:00	17/01/2020 19:35	3,58	1	3,58	CHI
202001103311	LUZIANIA	KR12349171	PAMPLONA	17/01/2020 16:00	17/01/2020 19:35	17/01/2020 16:00	17/01/2020 19:35	3,58	28	100,17	CHI
202001103313	MORRINHOS	MR11275837	GOIATUBA S1	17/01/2020 16:00	18/01/2020 09:26	17/01/2020 16:00	18/01/2020 09:26	17,42	1	17,42	CHI
202001103315	PONTALINA	PK12329369LD	PONTALINA	17/01/2020 16:01	18/01/2020 08:55	17/01/2020 16:01	18/01/2020 08:55	16,90	2	33,79	CHI
202001103316	FLORES DE GOIAS	FB11202225	FLORES DE GOIAS	17/01/2020 16:01	17/01/2020 18:46	17/01/2020 16:01	17/01/2020 18:46	2,74	103	282,28	CHI
202001103326	RIO VERDE	RV12230653	MONTIVIDIU T	17/01/2020 16:04	17/01/2020 17:14	17/01/2020 16:04	17/01/2020 17:14	1,16	2	2,33	CHI
202001103327	NOVO BRASIL	NB21315017	JUSSARA	17/01/2020 16:04	18/01/2020 00:22	17/01/2020 16:04	18/01/2020 00:22	8,30	1	8,30	CHI
202001103328	CAMPINORTE	CR12053035	MARA ROSA	17/01/2020 15:54	17/01/2020 21:24	17/01/2020 15:54	17/01/2020 21:24	5,50	4	21,99	CHI
202001103332	FAINA	FC12299839	GOIAS	17/01/2020 12:17	17/01/2020 21:11	17/01/2020 12:17	17/01/2020 21:11	8,90	13	115,65	CHI
202001103334	MINACU	IH12392286	MINACU	17/01/2020 16:05	17/01/2020 22:20	17/01/2020 16:05	17/01/2020 22:20	6,24	19	118,51	CHI
202001103336	GOIAS	GS12124776	GOIAS	17/01/2020 15:52	18/01/2020 17:36	17/01/2020 15:52	18/01/2020 17:36	25,72	32	823,15	CHI
202001103337	ITABERAI	IB11336372	ITABERAI S2	17/01/2020 16:06	17/01/2020 17:37	17/01/2020 16:06	17/01/2020 17:37	1,52	37	56,18	CHI
202001103339	SAO LUIS DE MONTES BELOS	SL12043785	SAO LUIZ DOS MONTES BELOS	17/01/2020 16:06	17/01/2020 20:08	17/01/2020 16:06	17/01/2020 20:08	4,02	2	8,03	CHI
202001103348	RIO VERDE	RV11159362	SANTA HELENA S1	17/01/2020 15:19	17/01/2020 23:58	17/01/2020 15:19	17/01/2020 23:58	8,64	132	1140,85	CHI
202001103352	CATALAO	10007525670	CATALAO S1	17/01/2020 16:09	17/01/2020 16:52	17/01/2020 16:09	17/01/2020 16:52	0,71	1	0,71	CHI
202001103354	EDEALINA	ED12039150	PONTALINA	17/01/2020 14:25	17/01/2020 18:30	17/01/2020 14:25	17/01/2020 18:30	4,08	3	12,24	CHI
202001103354	EDEIA	ED12039150	PONTALINA	17/01/2020 14:25	17/01/2020 18:30	17/01/2020 14:25	17/01/2020 18:30	4,08	8	32,64	CHI
202001103359	ITABERAI	IB21172545	ITABERAI S1	17/01/2020 16:10	17/01/2020 20:34	17/01/2020 16:10	17/01/2020 20:34	4,40	1	4,40	CHI
202001103369	ITUMBIARA	10011359658	PARANAIBA	18/01/2020 08:00	18/01/2020 17:20	18/01/2020 08:00	18/01/2020 17:20	9,34	1	9,34	CHI
202001103377	SANCLERLANDIA	SC21190731	FIRMINOPOLIS S2	17/01/2020 16:13	17/01/2020 21:45	17/01/2020 16:13	17/01/2020 21:45	5,52	1	5,52	CHI
202001103378	MONTIVIDIU	MV21214249	MONTIVIDIU T	17/01/2020 16:13	17/01/2020 17:10	17/01/2020 16:13	17/01/2020 17:10	0,93	1	0,93	CHI
202001103379	GOIANIA	11319847	FERROVIARIO S2	17/01/2020 16:13	17/01/2020 18:42	17/01/2020 16:13	17/01/2020 18:42	2,47	1	2,47	CHI
202001103380	SAO MIGUEL DO PASSA QUATRO	SQ12104016	BELA VISTA S2	17/01/2020 16:14	17/01/2020 23:26	17/01/2020 16:14	17/01/2020 23:26	7,20	13	93,57	CHI
202001103380	SILVANIA	SQ12104016	BELA VISTA S2	17/01/2020 16:14	17/01/2020 23:26	17/01/2020 16:14	17/01/2020 23:26	7,20	1	7,20	CHI
202001103381	PIRANHAS	1930046914	PIRANHAS	17/01/2020 16:14	17/01/2020 20:31	17/01/2020 16:14	17/01/2020 20:31	4,28	1	4,28	CHI
202001103385	CIDADE OCIDENTAL	10016714499	MARAJOARA	17/01/2020 16:14	17/01/2020 17:55	17/01/2020 16:14	17/01/2020 17:55	1,67	1	1,67	CHI
202001103387	ORIZONA	OZ12048939	PIRES DO RIO S1	17/01/2020 16:15	17/01/2020 18:10	17/01/2020 16:15	17/01/2020 18:10	1,93	7	13,51	CHI
202001103390	PIRES DO RIO	PR12337227	PIRES DO RIO S1	17/01/2020 15:57	17/01/2020 17:59	17/01/2020 15:57	17/01/2020 17:59	2,03	39	79,08	CHI
202001103390	SANTA CRUZ DE GOIAS	PR12337227	PIRES DO RIO S1	17/01/2020 15:57	17/01/2020 17:59	17/01/2020 15:57	17/01/2020 17:59	2,03	1	2,03	CHI

202001103390	URUTAI	PR12337227	PIRES DO RIO S1	17/01/2020 15:57	17/01/2020 17:59	17/01/2020 15:57	17/01/2020 17:59	2,03	1	2,03	CHI
202001103391	CATURAI	CK12018900	INHUMAS S1	17/01/2020 16:15	18/01/2020 02:14	17/01/2020 16:15	18/01/2020 02:14	9,97	3	29,91	CHI
202001103393	SAO DOMINGOS	SD12317864	SAO DOMINGOS	17/01/2020 16:15	17/01/2020 17:47	17/01/2020 16:15	17/01/2020 17:47	1,52	34	51,73	CHI
202001103397	ALTO PARAISO DE GOIAS	BF12105397	SAO JOAO D ALIANCA	17/01/2020 16:15	17/01/2020 18:17	17/01/2020 16:15	17/01/2020 18:17	2,02	224	451,92	CHI
202001103399	ITUMBIARA	IT12316685	ITUMBIARA NOVA	17/01/2020 15:09	18/01/2020 07:44	17/01/2020 15:09	18/01/2020 07:44	16,57	41	679,31	CHI
202001103503	SANTA FE DE GOIAS	RN21357953	BRITANIA	17/01/2020 16:17	18/01/2020 18:19	17/01/2020 16:17	18/01/2020 18:19	26,03	1	26,03	CHI
202001103507	PALMEIRAS DE GOIAS	PL12085286	PALMEIRAS	17/01/2020 16:17	17/01/2020 18:08	17/01/2020 16:17	17/01/2020 18:08	1,83	3	5,50	CHI
202001103510	INDIARA	IY21010818	EDEIA	17/01/2020 16:19	17/01/2020 18:55	17/01/2020 16:19	17/01/2020 18:55	2,61	1	2,61	CHI
202001103511	JATAI	290020153	JATAI S3	17/01/2020 16:19	18/01/2020 10:19	17/01/2020 16:19	18/01/2020 10:19	18,00	1	18,00	CHI
202001103514	IACIARA	IA12164539	IACIARA S2	17/01/2020 16:19	17/01/2020 17:48	17/01/2020 16:19	17/01/2020 17:48	1,48	25	36,92	CHI
202001103519	MINEIROS	MY11346618	PARQUE DAS EMAS	17/01/2020 16:19	17/01/2020 20:33	17/01/2020 16:19	17/01/2020 20:33	4,23	59	249,70	CHI
202001103522	CORUMBAIBA	CI12000093RE	VILA CORUMBA	17/01/2020 15:23	17/01/2020 18:00	17/01/2020 15:23	17/01/2020 18:00	2,60	105	273,09	CHI
202001103523	RIO VERDE	RV12189069	RIO VERDE S2	17/01/2020 13:44	17/01/2020 19:52	17/01/2020 13:44	17/01/2020 19:52	6,13	469	2872,76	CHI
202001103526	MORRINHOS	MR12000276RE	MORRINHOS	17/01/2020 12:55	18/01/2020 07:31	17/01/2020 12:55	18/01/2020 07:31	18,60	43	799,64	CHI
202001103527	QUIRINOPOLIS	QI31191838	QUIRINOPOLIS	17/01/2020 16:21	18/01/2020 08:27	17/01/2020 16:21	18/01/2020 08:27	16,09	1	16,09	CHI
202001103528	JATAI	JT11083511	JATAI S2	17/01/2020 16:21	17/01/2020 23:46	17/01/2020 16:21	17/01/2020 23:46	7,41	0	0,00	CHI
202001103531	FORMOSA	10014914830	ITUIQUIRA	17/01/2020 16:21	17/01/2020 18:00	17/01/2020 16:21	17/01/2020 18:00	1,63	1	1,63	CHI
202001103532	GOIANIA	11319719	ATLANTICO S2	17/01/2020 16:22	17/01/2020 19:33	17/01/2020 16:22	17/01/2020 19:33	3,18	1	3,18	CHI
202001103533	SANTA RITA DO NOVO DESTINO	BA12163300	BARRO ALTO	17/01/2020 15:47	17/01/2020 22:46	17/01/2020 15:47	17/01/2020 22:46	6,97	9	62,77	CHI
202001103547	PANAMA	PX12171365	GOIATUBA S1	17/01/2020 16:22	17/01/2020 20:10	17/01/2020 16:22	17/01/2020 20:10	3,79	6	22,73	CHI
202001103569	BARRO ALTO	DF12382135	BARRO ALTO	17/01/2020 15:42	17/01/2020 22:07	17/01/2020 15:42	17/01/2020 22:07	6,40	34	217,66	CHI
202001103569	SANTA RITA DO NOVO DESTINO	DF12382135	BARRO ALTO	17/01/2020 15:42	17/01/2020 22:07	17/01/2020 15:42	17/01/2020 22:07	6,40	2	12,80	CHI
202001103570	NIQUELANDIA	NQ11000013	NIQUELANDIA SUBTRANSMISSAO	17/01/2020 14:00	17/01/2020 19:54	17/01/2020 14:00	17/01/2020 19:54	5,90	56	330,31	CHI
202001103571	TEREZOPOLIS DE GOIAS	AN21258259	JUNDIAI S1	17/01/2020 16:24	17/01/2020 19:23	17/01/2020 16:24	17/01/2020 19:23	2,98	2	5,96	CHI
202001103573	GOIAS	NB12064413	MATRINCHA	17/01/2020 16:24	18/01/2020 13:30	17/01/2020 16:24	18/01/2020 13:30	21,10	1	21,10	CHI
202001103573	NOVO BRASIL	NB12064413	MATRINCHA	17/01/2020 16:24	18/01/2020 13:30	17/01/2020 16:24	18/01/2020 13:30	21,10	30	632,97	CHI
202001103578	JATAI	JT12202689	JATAI S1	17/01/2020 16:25	18/01/2020 10:57	17/01/2020 16:25	18/01/2020 10:57	18,53	2	37,05	CHI
202001103583	AMARALINA	LC12230319	NOVA CRIXAS	17/01/2020 12:23	18/01/2020 09:04	17/01/2020 12:23	18/01/2020 09:04	20,68	3	62,03	CHI
202001103585	GOIANIA	10016883584	ATLANTICO S1	17/01/2020 16:26	17/01/2020 17:28	17/01/2020 16:26	17/01/2020 17:28	1,03	1	1,03	CHI
202001103586	IPAMERI	IP12404715	IPAMERI	17/01/2020 16:26	17/01/2020 21:06	17/01/2020 16:26	17/01/2020 21:06	4,67	2	9,33	CHI
202001103587	GAMELEIRA DE GOIAS	SV12033468	DAIA S2	17/01/2020 16:26	17/01/2020 17:52	17/01/2020 16:26	17/01/2020 17:52	1,43	14	19,96	CHI
202001103587	SILVANIA	SV12033468	DAIA S2	17/01/2020 16:26	17/01/2020 17:52	17/01/2020 16:26	17/01/2020 17:52	1,43	134	191,06	CHI
202001103591	MORRINHOS	MR12352559	MORRINHOS	17/01/2020 15:56	18/01/2020 08:52	17/01/2020 15:56	18/01/2020 08:52	16,92	10	169,20	CHI

202001103594	GOIATUBA	JV12161205	BOM JESUS DE GOIAS	17/01/2020 16:27	17/01/2020 19:20	17/01/2020 16:27	17/01/2020 19:20	2,88	3	8,63	CHI
202001103597	CATALAO	CT21131480	CATALAO S1	17/01/2020 16:27	18/01/2020 10:20	17/01/2020 16:27	18/01/2020 10:20	17,87	1	17,87	CHI
202001103598	MAURILANDIA	ML21316815	RIO DOS BOIS	17/01/2020 16:27	18/01/2020 07:34	17/01/2020 16:27	18/01/2020 07:34	15,11	2	30,21	CHI
202001103599	RIO VERDE	RV21228697	CABRIUVA S2	17/01/2020 16:27	18/01/2020 10:34	17/01/2020 16:27	18/01/2020 10:34	18,11	1	18,11	CHI
202001103605	CEZARINA	CZ12233347	CEZARINA	17/01/2020 16:29	17/01/2020 19:09	17/01/2020 16:29	17/01/2020 19:09	2,67	3	8,01	CHI
202001103607	SAO LUIZ DO NORTE	SZ12332178	BARRO ALTO	17/01/2020 16:30	17/01/2020 21:10	17/01/2020 16:30	17/01/2020 21:10	4,67	26	121,31	CHI
202001103608	SAO LUIS DE MONTES BELOS	SL21019471	SAO LUIZ DOS MONTES BELOS	17/01/2020 16:30	18/01/2020 01:43	17/01/2020 16:30	18/01/2020 01:43	9,21	1	9,21	CHI
202001103616	GOIANIA	11120976	ATLANTICO S3	17/01/2020 16:30	17/01/2020 18:29	17/01/2020 16:30	17/01/2020 18:29	1,98	1	1,98	CHI
202001103629	ITABERAI	IB21018311	ITABERAI S2	17/01/2020 16:31	18/01/2020 05:56	17/01/2020 16:31	18/01/2020 05:56	13,40	1	13,40	CHI
202001103630	ARUANA	AK12210624	ARUANA	17/01/2020 16:31	17/01/2020 21:29	17/01/2020 16:31	17/01/2020 21:29	4,95	4	19,81	CHI
202001103640	HIDROLINA	SZ21237360	BARRO ALTO	17/01/2020 16:33	18/01/2020 14:20	17/01/2020 16:33	18/01/2020 14:20	21,79	1	21,79	CHI
202001103649	NOVA VENEZA	NV21272457	INHUMAS S1	17/01/2020 16:34	17/01/2020 23:39	17/01/2020 16:34	17/01/2020 23:39	7,07	2	14,14	CHI
202001103650	GOIANIRA	GR21016015	NEROPOLIS S1	17/01/2020 16:35	17/01/2020 22:10	17/01/2020 16:35	17/01/2020 22:10	5,58	2	11,17	CHI
202001103651	BELA VISTA DE GOIAS	CF21230611	BELA VISTA S1	17/01/2020 16:34	17/01/2020 23:05	17/01/2020 16:34	17/01/2020 23:05	6,51	1	6,51	CHI
202001103654	GOIAS	GS12073660	MATRINCHA	17/01/2020 16:35	17/01/2020 20:33	17/01/2020 16:35	17/01/2020 20:33	3,96	11	43,52	CHI
202001103656	CRIXAS	CX12243465	SERRA DO OURO	17/01/2020 16:31	17/01/2020 19:00	17/01/2020 16:31	17/01/2020 19:00	2,48	12	29,79	CHI
202001103666	COCALZINHO DE GOIAS	ZN11155154	COCALZINHO	17/01/2020 15:27	17/01/2020 19:57	17/01/2020 15:27	17/01/2020 19:57	4,49	124	556,17	CHI
202001103681	ITABERAI	IB12090133	ITABERAI S2	17/01/2020 16:39	18/01/2020 10:59	17/01/2020 16:39	18/01/2020 10:59	18,33	2	36,66	CHI
202001103683	ARACU	AR12019445	ARACU	17/01/2020 15:53	17/01/2020 17:50	17/01/2020 15:53	17/01/2020 17:50	1,94	19	36,82	CHI
202001103683	ITABERAI	AR12019445	ARACU	17/01/2020 15:53	17/01/2020 17:50	17/01/2020 15:53	17/01/2020 17:50	1,94	12	23,26	CHI
202001103684	PARANAIGUARA	PC12000120	QUIRINOPOLIS	17/01/2020 16:35	18/01/2020 07:56	17/01/2020 16:35	18/01/2020 07:56	15,34	79	1212,23	CHI
202001103684	QUIRINOPOLIS	PC12000120	QUIRINOPOLIS	17/01/2020 16:35	18/01/2020 07:56	17/01/2020 16:35	18/01/2020 07:56	15,34	5	76,72	CHI
202001103700	MORRINHOS	MR12212245	MORRINHOS	17/01/2020 13:40	17/01/2020 19:26	17/01/2020 13:40	17/01/2020 19:26	5,77	6	34,60	CHI
202001103701	ITAPIRAPUA	IU21089794	MATRINCHA	17/01/2020 16:29	17/01/2020 16:43	17/01/2020 16:29	17/01/2020 16:43	0,23	1	0,23	CHI
202001103702	ITAPIRAPUA	IU21198531	MATRINCHA	17/01/2020 16:43	17/01/2020 17:05	17/01/2020 16:43	17/01/2020 17:05	0,36	1	0,36	CHI
202001103802	MARA ROSA	MQ12182423	MARA ROSA	17/01/2020 16:28	18/01/2020 01:03	17/01/2020 16:28	18/01/2020 01:03	8,58	2	17,16	CHI
202001103807	MIMOSO DE GOIAS	NQ12371855	BARRO ALTO	17/01/2020 16:42	17/01/2020 19:47	17/01/2020 16:42	17/01/2020 19:47	3,07	4	12,28	CHI
202001103807	NIQUELANDIA	NQ12371855	BARRO ALTO	17/01/2020 16:42	17/01/2020 19:47	17/01/2020 16:42	17/01/2020 19:47	3,07	243	746,14	CHI
202001103810	SAO LUIZ DO NORTE	DF21241228	BARRO ALTO	17/01/2020 16:43	17/01/2020 23:40	17/01/2020 16:43	17/01/2020 23:40	6,96	1	6,96	CHI
202001103816	CARMO DO RIO VERDE	RB12391473	RUBIATABA	17/01/2020 16:43	17/01/2020 17:35	17/01/2020 16:43	17/01/2020 17:35	0,86	3	2,58	CHI
202001103816	CERES	RB12391473	RUBIATABA	17/01/2020 16:43	17/01/2020 17:35	17/01/2020 16:43	17/01/2020 17:35	0,86	28	24,05	CHI
202001103816	IPIRANGA DE GOIAS	RB12391473	RUBIATABA	17/01/2020 16:43	17/01/2020 17:35	17/01/2020 16:43	17/01/2020 17:35	0,86	3	2,58	CHI
202001103816	RUBIATABA	RB12391473	RUBIATABA	17/01/2020 16:43	17/01/2020 17:35	17/01/2020 16:43	17/01/2020 17:35	0,86	268	230,18	CHI

202001103816	SAO PATRICIO	RB12391473	RUBIATABA	17/01/2020 16:43	17/01/2020 17:35	17/01/2020 16:43	17/01/2020 17:35	0,86	20	17,18	CHI
202001103830	ALTO PARAISO DE GOIAS	NQ12234731	NIQUELANDIA SUBTRANSMISSAO	17/01/2020 16:38	18/01/2020 02:34	17/01/2020 16:38	18/01/2020 02:34	9,92	12	119,06	CHI
202001103830	NIQUELANDIA	NQ12234731	NIQUELANDIA SUBTRANSMISSAO	17/01/2020 16:38	18/01/2020 02:34	17/01/2020 16:38	18/01/2020 02:34	9,92	13	128,98	CHI
202001103830	SAO JOAO D ALIANCA	NQ12234731	NIQUELANDIA SUBTRANSMISSAO	17/01/2020 16:38	18/01/2020 02:34	17/01/2020 16:38	18/01/2020 02:34	9,92	1	9,92	CHI
202001103838	RIO VERDE	RV12200774	CABRIUVA S2	17/01/2020 16:45	18/01/2020 08:30	17/01/2020 16:45	18/01/2020 08:30	15,74	17	267,50	CHI
202001103847	BRITANIA	BT21292839	BRITANIA	17/01/2020 16:46	17/01/2020 21:33	17/01/2020 16:46	17/01/2020 21:33	4,77	1	4,77	CHI
202001103859	PIRACANJUBA	PJ12011464	MORRINHOS	17/01/2020 14:53	18/01/2020 09:12	17/01/2020 14:53	18/01/2020 09:12	18,31	36	659,07	CHI
202001103862	SANTA CRUZ DE GOIAS	BC21300725	CRISTIANOPOLIS	17/01/2020 16:49	18/01/2020 09:59	17/01/2020 16:49	18/01/2020 09:59	17,17	2	34,33	CHI
202001103872	SAO LUIZ DO NORTE	SZ11336119	BARRO ALTO	17/01/2020 16:51	18/01/2020 13:40	17/01/2020 16:51	18/01/2020 13:40	20,81	1	20,81	CHI
202001103879	PADRE BERNARDO	PB12052000	PADRE BERNARDO	17/01/2020 16:52	17/01/2020 18:01	17/01/2020 16:52	17/01/2020 18:01	1,14	4	4,57	CHI
202001103881	SANTA BARBARA DE GOIAS	SB21259082	TRINDADE	17/01/2020 16:50	17/01/2020 17:46	17/01/2020 16:50	17/01/2020 17:46	0,92	5	4,59	CHI
202001103885	MORRINHOS	MR11035230	MORRINHOS	17/01/2020 16:52	17/01/2020 22:25	17/01/2020 16:52	17/01/2020 22:25	5,55	17	94,33	CHI
202001103889	ORIZONA	OZ21109727	PIRES DO RIO S2	17/01/2020 16:53	18/01/2020 12:10	17/01/2020 16:53	18/01/2020 12:10	19,28	1	19,28	CHI
202001103895	PARANAIGUARA	2230029259	CACHOEIRA ALTA	17/01/2020 16:54	18/01/2020 12:09	17/01/2020 16:54	18/01/2020 12:09	19,26	1	19,26	CHI
202001103898	IPORA	IR21260044	IPORA	17/01/2020 16:54	18/01/2020 11:23	17/01/2020 16:54	18/01/2020 11:23	18,48	1	18,48	CHI
202001103899	ALVORADA DO NORTE	1510014072	IACIARA S2	17/01/2020 16:54	17/01/2020 18:52	17/01/2020 16:54	17/01/2020 18:52	1,96	1	1,96	CHI
202001103900	DOVERLANDIA	DV12245771	CAIAPONIA	17/01/2020 16:38	17/01/2020 19:08	17/01/2020 16:38	17/01/2020 19:08	2,49	4	9,94	CHI
202001103903	NOVA CRIXAS	8570011832	NOVA CRIXAS	17/01/2020 16:55	17/01/2020 21:22	17/01/2020 16:55	17/01/2020 21:22	4,45	1	4,45	CHI
202001103908	PARANAIGUARA	PC12271552	QUIRINOPOLIS	17/01/2020 16:27	18/01/2020 08:43	17/01/2020 16:27	18/01/2020 08:43	16,26	13	211,41	CHI
202001103908	QUIRINOPOLIS	PC12271552	QUIRINOPOLIS	17/01/2020 16:27	18/01/2020 08:43	17/01/2020 16:27	18/01/2020 08:43	16,26	25	406,56	CHI
202001103912	DIVINOPOLIS DE GOIAS	2570009307	SAO DOMINGOS	17/01/2020 16:56	17/01/2020 19:17	17/01/2020 16:56	17/01/2020 19:17	2,34	1	2,34	CHI
202001103914	SANTA TEREZINHA DE GOIAS	10000275555	SANTA TEREZINHA	17/01/2020 16:55	17/01/2020 22:10	17/01/2020 16:55	17/01/2020 22:10	5,25	1	5,25	CHI
202001103916	CABECEIRAS	CW12108845	ITIQUEIRA	17/01/2020 15:11	17/01/2020 19:04	17/01/2020 15:11	17/01/2020 19:04	3,87	11	42,55	CHI
202001103917	JUSSARA	JR12114060	BRITANIA	17/01/2020 16:57	18/01/2020 12:11	17/01/2020 16:57	18/01/2020 12:11	19,22	2	38,44	CHI
202001103926	ADELANDIA	SC12005458	FIRMINOPOLIS S2	17/01/2020 17:00	17/01/2020 19:21	17/01/2020 17:00	17/01/2020 19:21	2,35	2	4,70	CHI
202001103927	CALDAS NOVAS	760226623	CALDAS NOVAS S2	17/01/2020 17:00	17/01/2020 21:41	17/01/2020 17:00	17/01/2020 21:41	4,69	1	4,69	CHI
202001103930	JATAI	JT21165982	JATAI S1	17/01/2020 17:00	18/01/2020 07:54	17/01/2020 17:00	18/01/2020 07:54	14,89	1	14,89	CHI
202001103932	APORE	AE12219486	ITAJA S1	17/01/2020 17:01	18/01/2020 07:50	17/01/2020 17:01	18/01/2020 07:50	14,81	2	29,63	CHI
202001103940	FAZENDA NOVA	FN11242294	IPORA	17/01/2020 17:02	18/01/2020 10:07	17/01/2020 17:02	18/01/2020 10:07	17,09	1	17,09	CHI
202001103941	CAMPINORTE	MQ12380774	MARA ROSA	17/01/2020 17:02	17/01/2020 23:09	17/01/2020 17:02	17/01/2020 23:09	6,11	1	6,11	CHI
202001103941	MARA ROSA	MQ12380774	MARA ROSA	17/01/2020 17:02	17/01/2020 23:09	17/01/2020 17:02	17/01/2020 23:09	6,11	2	12,22	CHI
202001103942	CATALAO	CT21131356	CATALAO S1	17/01/2020 17:02	17/01/2020 20:10	17/01/2020 17:02	17/01/2020 20:10	3,12	1	3,12	CHI
202001103947	LUZIANIA	10007197177	MARAJOARA	17/01/2020 17:03	17/01/2020 17:48	17/01/2020 17:03	17/01/2020 17:48	0,75	1	0,75	CHI

202001103963	PLANALTINA	PI11361426	PLANALTINA	17/01/2020 17:04	17/01/2020 18:16	17/01/2020 17:04	17/01/2020 18:16	1,20	179	215,65	CHI
202001103964	CRISTIANOPOLIS	BC12382052	PIRES DO RIO S2	17/01/2020 17:05	18/01/2020 07:21	17/01/2020 17:05	18/01/2020 07:21	14,28	5	71,39	CHI
202001103964	PIRES DO RIO	BC12382052	PIRES DO RIO S2	17/01/2020 17:05	18/01/2020 07:21	17/01/2020 17:05	18/01/2020 07:21	14,28	31	442,63	CHI
202001103964	SANTA CRUZ DE GOIAS	BC12382052	PIRES DO RIO S2	17/01/2020 17:05	18/01/2020 07:21	17/01/2020 17:05	18/01/2020 07:21	14,28	10	142,78	CHI
202001103974	COCALZINHO DE GOIAS	LA21169014	AGUAS LINDAS DE GOIAS S2	17/01/2020 17:09	18/01/2020 09:00	17/01/2020 17:09	18/01/2020 09:00	15,84	2	31,69	CHI
202001103978	CATALAO	10020402404	CATALAO S1	17/01/2020 17:10	17/01/2020 20:10	17/01/2020 17:10	17/01/2020 20:10	2,99	1	2,99	CHI
202001103980	ANAPOLIS	GP12029291	JUNDIAI S1	17/01/2020 17:02	17/01/2020 18:33	17/01/2020 17:02	17/01/2020 18:33	1,50	1	1,50	CHI
202001103980	GOIANAPOLIS	GP12029291	JUNDIAI S1	17/01/2020 17:02	17/01/2020 18:33	17/01/2020 17:02	17/01/2020 18:33	1,50	1	1,50	CHI
202001103980	TEREZOPOLIS DE GOIAS	GP12029291	JUNDIAI S1	17/01/2020 17:02	17/01/2020 18:33	17/01/2020 17:02	17/01/2020 18:33	1,50	2	3,00	CHI
202001103981	SANCLERLANDIA	SC12391511	FIRMINOPOLIS S2	17/01/2020 17:10	17/01/2020 23:07	17/01/2020 17:10	17/01/2020 23:07	5,93	10	59,34	CHI
202001103983	PARANAIGUARA	PC21204111	QUIRINOPOLIS	17/01/2020 17:11	18/01/2020 12:49	17/01/2020 17:11	18/01/2020 12:49	19,63	1	19,63	CHI
202001103987	CATALAO	CT21250462	CATALAO S1	17/01/2020 17:11	17/01/2020 22:32	17/01/2020 17:11	17/01/2020 22:32	5,33	1	5,33	CHI
202001103988	CAIAPONIA	CP12374977	PALESTINA	17/01/2020 08:22	18/01/2020 09:33	17/01/2020 08:22	18/01/2020 09:33	25,19	43	1083,33	CHI
202001103989	JATAI	JT13196036	JATAI S3	17/01/2020 17:10	17/01/2020 19:05	17/01/2020 17:40	17/01/2020 19:05	1,42	108	153,00	CHI
202001103992	CATALAO	CT12267124	CATALAO S1	17/01/2020 13:16	17/01/2020 19:47	17/01/2020 13:16	17/01/2020 19:47	6,51	22	143,23	CHI
202001104000	CRISTALINA	KR12162504	CRISTALINA S1	17/01/2020 17:13	18/01/2020 10:21	17/01/2020 17:13	18/01/2020 10:21	17,13	10	171,27	CHI
202001104001	COCALZINHO DE GOIAS	04190224	AGUAS LINDAS DE GOIAS S2	17/01/2020 16:57	18/01/2020 06:43	17/01/2020 16:57	17/01/2020 19:35	2,63	2252	5919,63	CHI
202001104001	RIALMA	04190224	AGUAS LINDAS DE GOIAS S2	17/01/2020 16:57	18/01/2020 06:43	17/01/2020 16:57	17/01/2020 19:35	2,63	1	2,63	CHI
202001104001	COCALZINHO DE GOIAS	ZN12230194LD	AGUAS LINDAS DE GOIAS S2	17/01/2020 16:57	18/01/2020 06:43	17/01/2020 16:57	17/01/2020 19:53	2,93	452	1326,62	CHI
202001104001	COCALZINHO DE GOIAS	ZN12102094LD	AGUAS LINDAS DE GOIAS S2	17/01/2020 16:57	18/01/2020 06:43	17/01/2020 16:57	17/01/2020 20:12	3,25	270	877,87	CHI
202001104001	PADRE BERNARDO	ZN12102094LD	AGUAS LINDAS DE GOIAS S2	17/01/2020 16:57	18/01/2020 06:43	17/01/2020 16:57	17/01/2020 20:12	3,25	4	13,01	CHI
202001104001	COCALZINHO DE GOIAS	ZN12390553LD	AGUAS LINDAS DE GOIAS S2	17/01/2020 16:57	18/01/2020 06:43	17/01/2020 16:57	17/01/2020 21:05	4,13	10	41,32	CHI
202001104001	RIALMA	ZN12390553LD	AGUAS LINDAS DE GOIAS S2	17/01/2020 16:57	18/01/2020 06:43	17/01/2020 16:57	17/01/2020 21:05	4,13	1	4,13	CHI
202001104001	COCALZINHO DE GOIAS	ZN12086699LD	AGUAS LINDAS DE GOIAS S2	17/01/2020 16:57	18/01/2020 06:43	17/01/2020 16:57	17/01/2020 23:45	6,81	38	258,68	CHI
202001104001	RIALMA	ZN12086699LD	AGUAS LINDAS DE GOIAS S2	17/01/2020 16:57	18/01/2020 06:43	17/01/2020 16:57	17/01/2020 23:45	6,81	4	27,23	CHI
202001104001	COCALZINHO DE GOIAS	ZN21148329	AGUAS LINDAS DE GOIAS S2	17/01/2020 16:57	18/01/2020 06:43	17/01/2020 16:57	18/01/2020 06:43	13,78	2	27,55	CHI
202001104102	QUIRINOPOLIS	QI12038039	QUIRINOPOLIS	17/01/2020 17:13	18/01/2020 13:22	17/01/2020 17:13	18/01/2020 13:22	20,14	5	100,70	CHI
202001104103	ANAPOLIS	AN21385788	ANAPOLIS UNIVERSITARIO S1	17/01/2020 17:13	17/01/2020 19:05	17/01/2020 17:13	17/01/2020 19:05	1,86	2	3,71	CHI
202001104104	SILVANIA	LB31054433	DAIA S2	17/01/2020 17:13	18/01/2020 05:01	17/01/2020 17:13	18/01/2020 05:01	11,79	2	23,57	CHI
202001104106	GOIANIA	13627879	XAVANTES	17/01/2020 17:14	17/01/2020 19:42	17/01/2020 17:14	17/01/2020 19:42	2,48	1	2,48	CHI
202001104111	NAZARIO	10001589669	ANICUNS	17/01/2020 17:15	17/01/2020 20:51	17/01/2020 17:15	17/01/2020 20:51	3,61	0	0,00	CHI
202001104119	PIRES DO RIO	PR21051329	PIRES DO RIO S1	17/01/2020 17:16	18/01/2020 02:53	17/01/2020 17:16	18/01/2020 02:53	9,62	1	9,62	CHI
202001104122	CEZARINA	CZ12259266	CEZARINA	17/01/2020 14:30	17/01/2020 19:50	17/01/2020 14:30	17/01/2020 19:50	5,33	5	26,64	CHI

202001104123	IPAMERI	IP12404718	IPAMERI	17/01/2020 17:17	17/01/2020 22:50	17/01/2020 17:17	17/01/2020 22:50	5,55	2	11,10	CHI
202001104125	CAMPESTRE DE GOIAS	1230015726	TRINDADE	17/01/2020 17:17	17/01/2020 19:45	17/01/2020 17:17	17/01/2020 19:45	2,46	1	2,46	CHI
202001104139	DISTRITO FEDERAL	05410226	MARAJOARA	17/01/2020 17:19	17/01/2020 19:23	17/01/2020 17:19	17/01/2020 19:23	2,06	49	101,08	CHI
202001104139	NOVO GAMA	05410226	MARAJOARA	17/01/2020 17:19	17/01/2020 19:23	17/01/2020 17:19	17/01/2020 19:23	2,06	7	14,44	CHI
202001104139	SANTO ANTONIO DO DESCOBERTO	05410226	MARAJOARA	17/01/2020 17:19	17/01/2020 19:23	17/01/2020 17:19	17/01/2020 19:23	2,06	813	1677,04	CHI
202001104140	NOVA CRIXAS	8570038072	NOVA CRIXAS	17/01/2020 17:19	17/01/2020 22:48	17/01/2020 17:19	17/01/2020 22:48	5,47	1	5,47	CHI
202001104146	ITABERAI	IB12221135	ITABERAI S1	17/01/2020 17:20	17/01/2020 20:41	17/01/2020 17:20	17/01/2020 20:41	3,34	3	10,03	CHI
202001104150	NIQUELANDIA	NQ12232473	NIQUELANDIA SUBTRANSMISSAO	17/01/2020 15:34	18/01/2020 12:51	17/01/2020 15:34	18/01/2020 12:51	21,27	43	914,65	CHI
202001104154	PIRACANJUBA	MR12031962	MORRINHOS	17/01/2020 16:35	18/01/2020 09:46	17/01/2020 16:35	18/01/2020 09:46	17,18	3	51,54	CHI
202001104155	MINEIROS	MY12133261	PARQUE DAS EMAS	17/01/2020 07:49	17/01/2020 22:13	17/01/2020 07:49	17/01/2020 22:13	14,41	6	86,45	CHI
202001104156	ITABERAI	IB12061625	ITABERAI S2	17/01/2020 17:23	18/01/2020 12:03	17/01/2020 17:23	18/01/2020 12:03	18,66	4	74,64	CHI
202001104157	GOIANDIRA	CT21238476	CATALAO S1	17/01/2020 17:23	18/01/2020 10:18	17/01/2020 17:23	18/01/2020 10:18	16,91	1	16,91	CHI
202001104160	SAO MIGUEL DO PASSA QUATRO	SQ12116239	CRISTIANOPOLIS	17/01/2020 17:10	17/01/2020 21:24	17/01/2020 17:10	17/01/2020 21:24	4,23	27	114,30	CHI
202001104161	LUZIANIA	LZ12203332	VIANOPOLIS	17/01/2020 17:24	18/01/2020 00:04	17/01/2020 17:24	18/01/2020 00:04	6,66	8	53,30	CHI
202001104164	CRISTALINA	KR11170187	CRISTALINA S1	17/01/2020 17:25	17/01/2020 18:48	17/01/2020 17:25	17/01/2020 18:48	1,38	22	30,38	CHI
202001104170	CAMPOS BELOS	820045299	SAO DOMINGOS	17/01/2020 17:25	17/01/2020 20:13	17/01/2020 17:25	17/01/2020 20:13	2,79	1	2,79	CHI
202001104176	PIRES DO RIO	460087770	PIRES DO RIO S1	17/01/2020 17:26	17/01/2020 23:42	17/01/2020 17:26	17/01/2020 23:42	6,26	1	6,26	CHI
202001104187	CRISTALINA	KR12230156	PAMPLONA	17/01/2020 17:29	17/01/2020 20:13	17/01/2020 17:29	17/01/2020 20:13	2,73	13	35,52	CHI
202001104192	SAO SIMAO	10013556906	CACHOEIRA ALTA	17/01/2020 17:30	18/01/2020 10:43	17/01/2020 17:30	18/01/2020 10:43	17,22	1	17,22	CHI
202001104194	GOIATUBA	GT21050614	GOIATUBA S1	17/01/2020 17:30	17/01/2020 18:40	17/01/2020 17:30	17/01/2020 18:40	1,16	1	1,16	CHI
202001104196	ALEXANIA	01350424	MARAJOARA	17/01/2020 17:24	17/01/2020 17:43	17/01/2020 17:24	17/01/2020 17:43	0,33	5	1,64	CHI
202001104196	DISTRITO FEDERAL	01350424	MARAJOARA	17/01/2020 17:24	17/01/2020 17:43	17/01/2020 17:24	17/01/2020 17:43	0,33	3	0,98	CHI
202001104196	NOVO GAMA	01350424	MARAJOARA	17/01/2020 17:24	17/01/2020 17:43	17/01/2020 17:24	17/01/2020 17:43	0,33	2	0,66	CHI
202001104196	NOVO GAMA	01350424	MARAJOARA	17/01/2020 17:24	17/01/2020 17:43	17/01/2020 17:24	17/01/2020 17:43	0,33	11	3,61	CHI
202001104196	SANTO ANTONIO DO DESCOBERTO	01350424	MARAJOARA	17/01/2020 17:24	17/01/2020 17:43	17/01/2020 17:24	17/01/2020 17:43	0,33	505	165,67	CHI
202001104196	SANTO ANTONIO DO DESCOBERTO	01350424	MARAJOARA	17/01/2020 17:24	17/01/2020 17:43	17/01/2020 17:24	17/01/2020 17:43	0,33	13	4,26	CHI
202001104196	SANTO ANTONIO DO DESCOBERTO	01350424	MARAJOARA	17/01/2020 17:24	17/01/2020 17:43	17/01/2020 17:24	17/01/2020 17:43	0,33	21	6,89	CHI
202001104197	LUZIANIA	LZ11061785	MARAJOARA	17/01/2020 17:30	17/01/2020 19:05	17/01/2020 17:30	17/01/2020 19:05	1,57	9	14,15	CHI
202001104198	CAMPO LIMPO	AN21351234	NEROPOLIS S1	17/01/2020 17:30	17/01/2020 18:45	17/01/2020 17:30	17/01/2020 18:45	1,24	2	2,48	CHI
202001104203	ITUMBIRA	IT12305618	PARANAIBA	17/01/2020 17:31	17/01/2020 22:25	17/01/2020 17:31	17/01/2020 22:25	4,89	3	14,68	CHI
202001104210	CHAPADAO DO CEU	DJ11164747	CHAPADAO DO CEU	17/01/2020 17:32	18/01/2020 08:09	17/01/2020 17:32	18/01/2020 08:09	14,60	67	978,22	CHI
202001104223	RIO VERDE	RV21271499	CABRIUVA S2	17/01/2020 17:36	18/01/2020 13:29	17/01/2020 17:36	18/01/2020 13:29	19,88	1	19,88	CHI
202001104224	MORRINHOS	MR12196324	MORRINHOS	17/01/2020 15:47	18/01/2020 07:11	17/01/2020 15:47	18/01/2020 07:11	15,40	6	92,39	CHI

202001104226	MORRINHOS	MR21033127	MORRINHOS	17/01/2020 17:36	18/01/2020 08:06	17/01/2020 17:36	18/01/2020 08:06	14,49	2	28,97	CHI
202001104247	GAMELEIRA DE GOIAS	AN12285354	ANAPOLIS UNIVERSITARIO S2	17/01/2020 17:37	17/01/2020 20:12	17/01/2020 17:37	17/01/2020 20:12	2,57	9	23,15	CHI
202001104247	SILVANIA	AN12285354	ANAPOLIS UNIVERSITARIO S2	17/01/2020 17:37	17/01/2020 20:12	17/01/2020 17:37	17/01/2020 20:12	2,57	19	48,87	CHI
202001104248	FORMOSO	TB12185306	PORANGATU	17/01/2020 17:39	17/01/2020 23:23	17/01/2020 17:39	17/01/2020 23:23	5,73	1	5,73	CHI
202001104248	TROMBAS	TB12185306	PORANGATU	17/01/2020 17:39	17/01/2020 23:23	17/01/2020 17:39	17/01/2020 23:23	5,73	9	51,56	CHI
202001104251	LUZIANIA	LZ12349111	MARAJOARA	17/01/2020 17:12	17/01/2020 20:48	17/01/2020 17:12	17/01/2020 20:48	3,59	157	563,02	CHI
202001104252	PADRE BERNARDO	2760028994	PADRE BERNARDO	17/01/2020 17:39	17/01/2020 18:46	17/01/2020 17:39	17/01/2020 18:46	1,11	1	1,11	CHI
202001104257	LAGOA SANTA	LS21387625	CACHOEIRA ALTA	17/01/2020 17:40	19/01/2020 01:34	17/01/2020 17:40	19/01/2020 01:34	31,89	1	31,89	CHI
202001104259	APARECIDA DE GOIANIA	AP11095597	INDEPENDENCIA S1	17/01/2020 17:34	17/01/2020 19:32	17/01/2020 17:34	17/01/2020 19:32	1,95	89	173,60	CHI
202001104261	PARANAIGUARA	PC21240080	QUIRINOPOLIS	17/01/2020 17:42	18/01/2020 12:59	17/01/2020 17:42	18/01/2020 12:59	19,28	1	19,28	CHI
202001104265	MIMOSO DE GOIAS	MJ12305277	PADRE BERNARDO	17/01/2020 17:20	17/01/2020 19:57	17/01/2020 17:20	17/01/2020 19:57	2,61	16	41,72	CHI
202001104269	CALDAS NOVAS	RQ12100189	RIO QUENTE	17/01/2020 16:33	17/01/2020 19:10	17/01/2020 16:33	17/01/2020 19:10	2,61	133	347,06	CHI
202001104269	MORRINHOS	RQ12100189	RIO QUENTE	17/01/2020 16:33	17/01/2020 19:10	17/01/2020 16:33	17/01/2020 19:10	2,61	8	20,88	CHI
202001104269	PIRACANJUBA	RQ12100189	RIO QUENTE	17/01/2020 16:33	17/01/2020 19:10	17/01/2020 16:33	17/01/2020 19:10	2,61	1	2,61	CHI
202001104269	RIO QUENTE	RQ12100189	RIO QUENTE	17/01/2020 16:33	17/01/2020 19:10	17/01/2020 16:33	17/01/2020 19:10	2,61	122	318,35	CHI
202001104273	IPAMERI	IP12112268	PIRES DO RIO S2	17/01/2020 16:09	18/01/2020 09:29	17/01/2020 16:09	18/01/2020 09:29	17,33	19	329,29	CHI
202001104275	AMORINOPOLIS	IR12188430	IPORA	17/01/2020 17:45	17/01/2020 22:19	17/01/2020 17:45	17/01/2020 22:19	4,56	42	191,47	CHI
202001104275	IPORA	IR12188430	IPORA	17/01/2020 17:45	17/01/2020 22:19	17/01/2020 17:45	17/01/2020 22:19	4,56	22	100,30	CHI
202001104275	IVOLANDIA	IR12188430	IPORA	17/01/2020 17:45	17/01/2020 22:19	17/01/2020 17:45	17/01/2020 22:19	4,56	104	474,12	CHI
202001104275	PALESTINA DE GOIAS	IR12188430	IPORA	17/01/2020 17:45	17/01/2020 22:19	17/01/2020 17:45	17/01/2020 22:19	4,56	12	54,71	CHI
202001104278	AGUA FRIA DE GOIAS	TL12208773	SAO JOAO D ALIANCA	17/01/2020 17:45	17/01/2020 22:42	17/01/2020 17:45	17/01/2020 22:42	4,94	14	69,10	CHI
202001104278	MIMOSO DE GOIAS	TL12208773	SAO JOAO D ALIANCA	17/01/2020 17:45	17/01/2020 22:42	17/01/2020 17:45	17/01/2020 22:42	4,94	29	143,14	CHI
202001104285	CATALAO	1990095723	CATALAO S2	17/01/2020 17:47	17/01/2020 20:35	17/01/2020 17:47	17/01/2020 20:35	2,80	1	2,80	CHI
202001104286	NIQUELANDIA	NQ21210924	URUACU	17/01/2020 17:47	18/01/2020 02:06	17/01/2020 17:47	18/01/2020 02:06	8,31	2	16,61	CHI
202001104288	BOM JESUS DE GOIAS	BJ12222283	RIO DOS BOIS	18/01/2020 07:21	18/01/2020 13:00	18/01/2020 07:21	18/01/2020 13:00	5,64	2	11,28	CHI
202001104292	SANCLERLANDIA	SC21087570	FIRMINOPOLIS S2	17/01/2020 17:48	18/01/2020 07:01	17/01/2020 17:48	18/01/2020 07:01	13,21	1	13,21	CHI
202001104302	RIO VERDE	RV21238678	MONTIVIDIU T	17/01/2020 17:50	18/01/2020 11:46	17/01/2020 17:50	18/01/2020 11:46	17,92	1	17,92	CHI
202001104303	RIO VERDE	SH12222620	RIO VERDE S2	18/01/2020 07:06	18/01/2020 09:04	18/01/2020 07:06	18/01/2020 09:04	1,96	13	25,47	CHI
202001104303	SANTA HELENA DE GOIAS	SH12222620	RIO VERDE S2	18/01/2020 07:06	18/01/2020 09:04	18/01/2020 07:06	18/01/2020 09:04	1,96	38	74,44	CHI
202001104319	CRIXAS	CX11244856	SERRA DO OURO	17/01/2020 17:28	17/01/2020 20:30	17/01/2020 17:28	17/01/2020 20:30	3,03	163	494,25	CHI
202001104320	SANTA ISABEL	GE21063285	GOIANESIA S1	17/01/2020 17:55	18/01/2020 09:03	17/01/2020 17:55	18/01/2020 09:03	15,13	2	30,26	CHI
202001104322	ITUMBIARA	IT11309934	ITUMBIARA VELHA S1	17/01/2020 17:16	17/01/2020 19:48	17/01/2020 17:16	17/01/2020 19:48	2,54	69	175,51	CHI
202001104323	ANICUNS	AC11031057	ANICUNS	17/01/2020 17:25	17/01/2020 23:30	17/01/2020 17:25	17/01/2020 23:30	6,08	90	547,22	CHI

202001104329	PADRE BERNARDO	PB12333235	PADRE BERNARDO	17/01/2020 17:58	18/01/2020 00:32	17/01/2020 17:58	18/01/2020 00:32	6,56	25	164,08	CHI
202001104332	PLANALTINA	PI21109464	PLANALTINA	17/01/2020 17:58	17/01/2020 20:19	17/01/2020 17:58	17/01/2020 20:19	2,34	1	2,34	CHI
202001104339	PIRES DO RIO	PR12409073	PIRES DO RIO S2	17/01/2020 18:00	17/01/2020 20:53	17/01/2020 18:00	17/01/2020 20:53	2,88	3	8,64	CHI
202001104340	GOIANIA	GN11199057	GOYA S1	17/01/2020 18:00	17/01/2020 19:02	17/01/2020 18:00	17/01/2020 19:02	1,03	16	16,40	CHI
202001104341	LUZIANIA	LZ21013823	VIANOPOLIS	17/01/2020 18:00	18/01/2020 01:20	17/01/2020 18:00	18/01/2020 01:20	7,32	1	7,32	CHI
202001104344	PLANALTINA	PI11316961	PLANALTINA	17/01/2020 18:01	17/01/2020 18:55	17/01/2020 18:01	17/01/2020 18:55	0,89	142	126,26	CHI
202001104348	APARECIDA DE GOIANIA	10006905674	INDEPENDENCIA S1	17/01/2020 18:02	17/01/2020 20:53	17/01/2020 18:02	17/01/2020 20:53	2,85	1	2,85	CHI
202001104349	APARECIDA DE GOIANIA	AP11068323	INDEPENDENCIA S2	17/01/2020 17:52	17/01/2020 20:07	17/01/2020 17:52	17/01/2020 20:07	2,25	182	408,84	CHI
202001104351	SAO LUIZ DO NORTE	SZ21073503	BARRO ALTO	17/01/2020 18:02	17/01/2020 22:50	17/01/2020 18:02	17/01/2020 22:50	4,78	1	4,78	CHI
202001104354	PIRACANJUBA	PI21078735	PIRACANJUBA	17/01/2020 18:03	18/01/2020 18:14	17/01/2020 18:03	18/01/2020 18:14	24,18	2	48,36	CHI
202001104355	CIDADE OCIDENTAL	2680172523	MARAJOARA	17/01/2020 18:03	17/01/2020 19:11	17/01/2020 18:03	17/01/2020 19:11	1,13	1	1,13	CHI
202001104356	DISTRITO FEDERAL	PB12163215	PADRE BERNARDO	17/01/2020 18:03	17/01/2020 19:57	17/01/2020 18:03	17/01/2020 19:57	1,90	3	5,69	CHI
202001104356	PADRE BERNARDO	PB12163215	PADRE BERNARDO	17/01/2020 18:03	17/01/2020 19:57	17/01/2020 18:03	17/01/2020 19:57	1,90	278	526,81	CHI
202001104358	INACIOLANDIA	ID21128117	QUIRINOPOLIS	17/01/2020 18:03	17/01/2020 18:42	17/01/2020 18:03	17/01/2020 18:42	0,64	7	4,45	CHI
202001104359	MINACU	IH21208290	MINACU	17/01/2020 18:03	17/01/2020 19:14	17/01/2020 18:03	17/01/2020 19:14	1,18	2	2,37	CHI
202001104363	JATAI	290268230	JATAI S3	17/01/2020 18:04	18/01/2020 04:31	17/01/2020 18:04	18/01/2020 04:31	10,44	1	10,44	CHI
202001104369	PIRACANJUBA	60014234	PIRACANJUBA	17/01/2020 18:05	17/01/2020 19:49	17/01/2020 18:05	17/01/2020 19:49	1,73	1	1,73	CHI
202001104371	NOVO GAMA	NJ11162861	PACAEMBU S1	17/01/2020 18:06	17/01/2020 19:58	17/01/2020 18:06	17/01/2020 19:58	1,87	49	91,43	CHI
202001104372	TRES RANCHOS	TH21013601	CATALAO S1	17/01/2020 18:06	18/01/2020 09:58	17/01/2020 18:06	18/01/2020 09:58	15,86	2	31,71	CHI
202001104373	RIO VERDE	RV12303286	CABRIUVA S2	17/01/2020 16:34	18/01/2020 10:35	17/01/2020 16:34	18/01/2020 10:35	18,01	8	144,07	CHI
202001104379	NOVO GAMA	NJ12219814	PACAEMBU S1	17/01/2020 18:07	17/01/2020 22:01	17/01/2020 18:07	17/01/2020 22:01	3,89	142	551,71	CHI
202001104381	COLINAS DO SUL	TI12355513	NIQUELANDIA SUBTRANSMISSAO	17/01/2020 18:08	18/01/2020 10:03	17/01/2020 18:08	18/01/2020 10:03	15,91	11	175,02	CHI
202001104382	SAO MIGUEL DO ARAGUAIA	SM12240798	SAO MIGUEL DO ARAGUAIA	17/01/2020 18:08	18/01/2020 08:12	17/01/2020 18:08	18/01/2020 08:12	14,06	4	56,23	CHI
202001104385	VARJAO	VJ10394749	GUAPO S2	17/01/2020 18:08	18/01/2020 09:56	17/01/2020 18:08	18/01/2020 00:27	6,31	4	25,24	CHI
202001104385	VARJAO	VJ10394749	GUAPO S2	17/01/2020 18:08	18/01/2020 09:56	18/01/2020 01:34	18/01/2020 02:08	0,56	4	2,26	CHI
202001104385	CEZARINA	VJ10394749	GUAPO S2	17/01/2020 18:08	18/01/2020 09:56	17/01/2020 18:08	18/01/2020 09:56	15,79	8	126,30	CHI
202001104385	VARJAO	VJ10394749	GUAPO S2	17/01/2020 18:08	18/01/2020 09:56	17/01/2020 18:08	18/01/2020 09:56	15,79	43	678,84	CHI
202001104389	ITARUMA	IM21122672	CACHOEIRA ALTA	17/01/2020 18:09	17/01/2020 21:24	17/01/2020 18:09	17/01/2020 21:24	3,24	1	3,24	CHI
202001104396	ARAGARCAS	AG21320802	ARAGARCAS	17/01/2020 18:10	17/01/2020 20:09	17/01/2020 18:10	17/01/2020 20:09	1,97	1	1,97	CHI
202001104397	RIO VERDE	RV21248423	MONTIVIDIU T	17/01/2020 18:10	18/01/2020 11:42	17/01/2020 18:10	18/01/2020 11:42	17,52	1	17,52	CHI
202001104401	ALTO PARAISO DE GOIAS	BF21309087	NIQUELANDIA SUBTRANSMISSAO	17/01/2020 17:49	17/01/2020 19:50	17/01/2020 17:49	17/01/2020 19:50	2,01	1	2,01	CHI
202001104502	PALESTINA DE GOIAS	7711207	PALESTINA	17/01/2020 16:54	17/01/2020 21:19	17/01/2020 16:54	17/01/2020 21:19	4,42	201	889,42	CHI
202001104503	SANTO ANTONIO DO DESCOBERTO	SN12037150	MARAJOARA	17/01/2020 18:12	18/01/2020 12:39	17/01/2020 18:12	18/01/2020 12:39	18,45	2	36,89	CHI

202001104518	SAO PATRICIO	RB21187147	RUBIATABA	17/01/2020 18:14	18/01/2020 14:45	17/01/2020 18:14	18/01/2020 14:45	20,51	2	41,02	CHI
202001104521	CERES	RB12392307	RUBIATABA	17/01/2020 18:10	18/01/2020 11:31	18/01/2020 10:42	18/01/2020 11:31	0,82	21	17,22	CHI
202001104521	RUBIATABA	RB12392307	RUBIATABA	17/01/2020 18:10	18/01/2020 11:31	18/01/2020 10:42	18/01/2020 11:31	0,82	14	11,48	CHI
202001104521	CERES	RB12000048	RUBIATABA	17/01/2020 18:10	18/01/2020 11:31	17/01/2020 18:10	18/01/2020 11:31	17,36	5	86,78	CHI
202001104525	MORRINHOS	MR12000160	MORRINHOS	17/01/2020 18:15	18/01/2020 08:56	17/01/2020 18:15	18/01/2020 08:56	14,68	17	249,56	CHI
202001104529	DIVINOPOLIS DE GOIAS	GH12211667	SAO DOMINGOS	17/01/2020 18:16	17/01/2020 20:14	17/01/2020 18:16	17/01/2020 20:14	1,97	3	5,90	CHI
202001104530	SENADOR CANEDO	15425940	GOIANIA LESTE S1	17/01/2020 18:16	17/01/2020 19:34	17/01/2020 18:16	17/01/2020 19:34	1,30	1	1,30	CHI
202001104535	RIO VERDE	RV21211440	MONTIVIDIU T	17/01/2020 18:16	18/01/2020 13:08	17/01/2020 18:16	18/01/2020 13:08	18,86	1	18,86	CHI
202001104543	SAO LUIS DE MONTES BELOS	SL31145778	SAO LUIZ DOS MONTES BELOS	17/01/2020 18:17	17/01/2020 21:02	17/01/2020 18:17	17/01/2020 21:02	2,75	1	2,75	CHI
202001104546	CAIAPONIA	CP12207949	CAIAPONIA	17/01/2020 17:04	17/01/2020 23:17	17/01/2020 17:04	17/01/2020 23:17	6,20	117	725,89	CHI
202001104546	PIRANHAS	CP12207949	CAIAPONIA	17/01/2020 17:04	17/01/2020 23:17	17/01/2020 17:04	17/01/2020 23:17	6,20	13	80,65	CHI
202001104549	ESTRELA DO NORTE	MU12391986	MARA ROSA	17/01/2020 18:12	17/01/2020 22:00	17/01/2020 18:12	17/01/2020 22:00	3,78	1	3,78	CHI
202001104549	MUTUNOPOLIS	MU12391986	MARA ROSA	17/01/2020 18:12	17/01/2020 22:00	17/01/2020 18:12	17/01/2020 22:00	3,78	100	378,39	CHI
202001104552	NOVO GAMA	NJ11376146	PACAEMBU S1	17/01/2020 18:15	17/01/2020 21:56	17/01/2020 18:15	17/01/2020 21:56	3,67	95	348,68	CHI
202001104557	SAO LUIS DE MONTES BELOS	SL21289845	SAO LUIZ DOS MONTES BELOS	17/01/2020 18:19	17/01/2020 21:55	17/01/2020 18:19	17/01/2020 21:55	3,59	1	3,59	CHI
202001104573	SAO MIGUEL DO PASSA QUATRO	SQ12227184	CRISTIANOPOLIS	17/01/2020 18:23	18/01/2020 07:52	17/01/2020 18:23	18/01/2020 07:52	13,48	6	80,88	CHI
202001104577	QUIRINOPOLIS	80060997	QUIRINOPOLIS	17/01/2020 18:24	17/01/2020 21:47	17/01/2020 18:24	17/01/2020 21:47	3,37	1	3,37	CHI
202001104586	SANTO ANTONIO DO DESCOBERTO	SN12092298	ALEXANIA	17/01/2020 17:38	18/01/2020 13:50	17/01/2020 17:38	18/01/2020 13:50	20,19	16	323,04	CHI
202001104587	BURITI ALEGRE	420046240	ALTO BURITI	17/01/2020 18:25	17/01/2020 21:12	17/01/2020 18:25	17/01/2020 21:12	2,77	1	2,77	CHI
202001104591	CAMPO ALEGRE DE GOIAS	CM12358429	CAMPO ALEGRE DE GOIAS	17/01/2020 16:28	18/01/2020 08:01	17/01/2020 16:28	18/01/2020 08:01	15,55	9	139,91	CHI
202001104599	PORTELANDIA	PW21241835	PARQUE DAS EMAS	17/01/2020 18:27	18/01/2020 16:37	17/01/2020 18:27	18/01/2020 16:37	22,17	1	22,17	CHI
202001104601	GOIANIA	GN11113680	ATLANTICO S3	17/01/2020 18:24	17/01/2020 23:04	17/01/2020 18:24	17/01/2020 23:04	4,65	70	325,79	CHI
202001104602	BARRO ALTO	10029544082	BARRO ALTO	17/01/2020 18:27	18/01/2020 02:15	17/01/2020 18:27	18/01/2020 02:15	7,79	1	7,79	CHI
202001104606	CAIAPONIA	CP12067934	MONTIVIDIU T	17/01/2020 14:46	18/01/2020 20:17	17/01/2020 14:46	18/01/2020 20:17	29,51	23	678,62	CHI
202001104606	MONTIVIDIU	CP12067934	MONTIVIDIU T	17/01/2020 14:46	18/01/2020 20:17	17/01/2020 14:46	18/01/2020 20:17	29,51	2	59,01	CHI
202001104607	NEROPOLIS	10023142039	NEROPOLIS S2	17/01/2020 18:28	17/01/2020 19:43	17/01/2020 18:28	17/01/2020 19:43	1,24	1	1,24	CHI
202001104614	NOVA ROMA	ND21229962	IACIARA S2	17/01/2020 18:29	17/01/2020 19:26	17/01/2020 18:29	17/01/2020 19:26	0,94	1	0,94	CHI
202001104618	MORRINHOS	MR12000248RE	MORRINHOS	17/01/2020 15:32	18/01/2020 10:49	17/01/2020 15:32	18/01/2020 10:49	19,27	28	539,70	CHI
202001104619	AGUAS LINDAS DE GOIAS	LA11189840	AGUAS LINDAS DE GOIAS S1	17/01/2020 18:12	17/01/2020 19:43	17/01/2020 18:12	17/01/2020 19:43	1,51	213	321,81	CHI
202001104620	RIO VERDE	RV12054354	MONTIVIDIU T	17/01/2020 18:30	18/01/2020 11:53	17/01/2020 18:30	18/01/2020 11:53	17,37	2	34,75	CHI
202001104625	RIO VERDE	RV12305819	RIO VERDE S1	17/01/2020 18:31	18/01/2020 10:08	17/01/2020 18:31	18/01/2020 10:08	15,61	1	15,61	CHI
202001104626	NIQUELANDIA	NQ12265966	NIQUELANDIA SUBTRANSMISSAO	17/01/2020 17:46	17/01/2020 20:19	17/01/2020 17:46	17/01/2020 20:19	2,54	24	61,04	CHI
202001104628	QUIRINOPOLIS	8056251	QUIRINOPOLIS	17/01/2020 18:31	18/01/2020 08:29	17/01/2020 18:31	18/01/2020 08:29	13,96	4	55,82	CHI

202001104630	FORMOSA	FA12000030	ITIQUEIRA	17/01/2020 17:50	17/01/2020 19:21	17/01/2020 17:50	17/01/2020 19:21	1,50	603	906,01	CHI
202001104632	IPORA	IR12358520	IPORA	17/01/2020 17:39	17/01/2020 23:39	17/01/2020 17:39	17/01/2020 23:39	6,00	10	59,96	CHI
202001104632	IVOLANDIA	IR12358520	IPORA	17/01/2020 17:39	17/01/2020 23:39	17/01/2020 17:39	17/01/2020 23:39	6,00	8	47,97	CHI
202001104635	CATALAO	CM21063950	CAMPO ALEGRE DE GOIAS	17/01/2020 18:32	18/01/2020 09:59	17/01/2020 18:32	18/01/2020 09:59	15,44	1	15,44	CHI
202001104637	SAO LUIS DE MONTES BELOS	SL11233479	SAO LUIZ DOS MONTES BELOS	17/01/2020 18:32	17/01/2020 20:15	17/01/2020 18:32	17/01/2020 20:15	1,70	199	338,96	CHI
202001104649	SILVANIA	SV21013802	VIANOPOLIS	17/01/2020 18:34	18/01/2020 08:02	17/01/2020 18:34	18/01/2020 08:02	13,46	1	13,46	CHI
202001104664	FORMOSA	FA31180808	ITIQUEIRA	17/01/2020 18:37	17/01/2020 21:52	17/01/2020 18:37	17/01/2020 21:52	3,24	1	3,24	CHI
202001104683	GOIANIA	10004959491	CAMPINAS S2	17/01/2020 18:41	17/01/2020 19:55	17/01/2020 18:41	17/01/2020 19:55	1,22	1	1,22	CHI
202001104685	SAO DOMINGOS	SD21096858	IACIARA S2	17/01/2020 18:41	18/01/2020 09:15	17/01/2020 18:41	18/01/2020 09:15	14,55	1	14,55	CHI
202001104693	GOIANIA	17017506	CARAJAS S2	17/01/2020 18:43	17/01/2020 20:30	17/01/2020 18:43	17/01/2020 20:30	1,77	1	1,77	CHI
202001104695	CAVALCANTE	740010335	FLORES DE GOIAS	17/01/2020 18:44	17/01/2020 20:28	17/01/2020 18:44	17/01/2020 20:28	1,73	1	1,73	CHI
202001104697	FAZENDA NOVA	FN21183429	IPORA	17/01/2020 18:44	18/01/2020 09:43	17/01/2020 18:44	18/01/2020 09:43	14,98	1	14,98	CHI
202001104699	CAIAPONIA	CP12205005	MONTIVIDIU T	18/01/2020 10:21	18/01/2020 10:56	18/01/2020 10:21	18/01/2020 10:56	0,59	9	5,31	CHI
202001104700	CABECEIRAS	CW21184639	ITIQUEIRA	17/01/2020 18:44	18/01/2020 12:16	17/01/2020 18:44	18/01/2020 11:41	16,96	1	16,96	CHI
202001104700	CABECEIRAS	CW12184537	ITIQUEIRA	17/01/2020 18:44	18/01/2020 12:16	18/01/2020 09:22	18/01/2020 12:16	2,91	7	20,35	CHI
202001104701	GOIANIA	16084986	SENADOR CANEDO	17/01/2020 18:44	17/01/2020 22:29	17/01/2020 18:44	17/01/2020 22:29	3,74	1	3,74	CHI
202001104702	GOIANIA	10019999516	GOYA S1	17/01/2020 18:44	17/01/2020 19:58	17/01/2020 18:44	17/01/2020 19:58	1,22	1	1,22	CHI
202001104703	GOUVELANDIA	GB21303168	QUIRINOPOLIS	17/01/2020 18:44	18/01/2020 10:00	17/01/2020 18:44	18/01/2020 10:00	15,25	2	30,51	CHI
202001104704	PIRACANJUBA	7921600	CALDAS NOVAS S1	17/01/2020 17:19	18/01/2020 11:20	17/01/2020 17:19	18/01/2020 11:20	18,01	30	540,24	CHI
202001104717	FAINA	FC21113592	GOIAS	17/01/2020 18:46	18/01/2020 20:32	17/01/2020 18:46	18/01/2020 19:50	25,08	1	25,08	CHI
202001104717	FAINA	FC12274421	GOIAS	17/01/2020 18:46	18/01/2020 20:32	18/01/2020 16:56	18/01/2020 20:32	3,60	16	57,61	CHI
202001104721	ANAPOLIS	AN21265145	ANAPOLIS UNIVERSITARIO S1	17/01/2020 18:46	18/01/2020 01:49	17/01/2020 18:46	18/01/2020 01:49	7,04	2	14,08	CHI
202001104724	GOIANIA	11362030	CAMPINAS S1	17/01/2020 18:47	17/01/2020 20:03	17/01/2020 18:47	17/01/2020 20:03	1,25	1	1,25	CHI
202001104737	CRISTALINA	KR21031673	CRISTALINA S1	17/01/2020 18:51	18/01/2020 08:38	17/01/2020 18:51	18/01/2020 08:38	13,78	1	13,78	CHI
202001104744	ITABERAI	IB21105991	ITABERAI S2	17/01/2020 18:52	18/01/2020 08:32	17/01/2020 18:52	18/01/2020 08:32	13,67	1	13,67	CHI
202001104746	RIO VERDE	RV21322288	CABRIUVA S2	17/01/2020 18:52	18/01/2020 11:41	17/01/2020 18:52	18/01/2020 11:41	16,82	1	16,82	CHI
202001104752	PALMEIRAS DE GOIAS	590050801	PALMEIRAS	17/01/2020 18:52	17/01/2020 20:41	17/01/2020 18:52	17/01/2020 20:41	1,80	1	1,80	CHI
202001104754	ANAPOLIS	20469445	JUNDIAI S1	17/01/2020 18:53	17/01/2020 22:16	17/01/2020 18:53	17/01/2020 22:16	3,37	1	3,37	CHI
202001104765	IPAMERI	IP12112780	IPAMERI	17/01/2020 18:55	18/01/2020 08:43	17/01/2020 18:55	18/01/2020 08:43	13,79	11	151,66	CHI
202001104766	NIQUELANDIA	NQ12341309	NIQUELANDIA SUBTRANSMISSAO	17/01/2020 17:40	18/01/2020 18:32	17/01/2020 17:40	18/01/2020 18:32	24,87	92	2287,78	CHI
202001104768	MAIRIPOTABA	MI21199965	PONTALINA	17/01/2020 18:56	18/01/2020 12:28	17/01/2020 18:56	18/01/2020 12:28	17,53	1	17,53	CHI
202001104773	CALDAS NOVAS	CN21352163	VILA CORUMBA	17/01/2020 18:57	18/01/2020 17:10	17/01/2020 18:57	18/01/2020 17:10	22,23	1	22,23	CHI
202001104774	PIRENOPOLIS	PV21000709	ANAPOLIS UNIVERSITARIO S2	17/01/2020 18:57	17/01/2020 22:30	17/01/2020 18:57	17/01/2020 22:30	3,55	1	3,55	CHI

202001104775	TRINDADE	TR11000037	TRINDADE	17/01/2020 18:56	17/01/2020 19:44	17/01/2020 18:56	17/01/2020 19:44	0,80	45	35,81	CHI
202001104779	BALIZA	3990008004	BOM JARDIM	17/01/2020 18:57	17/01/2020 23:36	17/01/2020 18:57	17/01/2020 23:36	4,63	1	4,63	CHI
202001104780	FORMOSA	610022441	ITIQUEIRA	17/01/2020 18:58	17/01/2020 21:28	17/01/2020 18:58	17/01/2020 21:28	2,51	1	2,51	CHI
202001104789	CRISTALINA	KR12209473LD	CRISTALINA S2	17/01/2020 13:41	17/01/2020 21:06	17/01/2020 13:41	17/01/2020 21:06	7,40	10	74,00	CHI
202001104792	PADRE BERNARDO	PB12053941	PADRE BERNARDO	17/01/2020 19:00	17/01/2020 20:48	17/01/2020 19:00	17/01/2020 20:48	1,79	2	3,59	CHI
202001104795	CRISTALINA	KR21133543	CRISTALINA S1	17/01/2020 19:00	17/01/2020 22:43	17/01/2020 19:00	17/01/2020 22:43	3,70	1	3,70	CHI
202001104796	ALTO PARAISO DE GOIAS	ND12302636	IACIARA S2	17/01/2020 18:32	17/01/2020 20:46	17/01/2020 18:32	17/01/2020 20:46	2,22	18	39,94	CHI
202001104796	NOVA ROMA	ND12302636	IACIARA S2	17/01/2020 18:32	17/01/2020 20:46	17/01/2020 18:32	17/01/2020 20:46	2,22	96	213,01	CHI
202001104796	SAO JOAO D ALIANCA	ND12302636	IACIARA S2	17/01/2020 18:32	17/01/2020 20:46	17/01/2020 18:32	17/01/2020 20:46	2,22	12	26,63	CHI
202001104797	NOVO GAMA	NJ11059740	PACAEMBU S1	17/01/2020 17:33	17/01/2020 23:04	17/01/2020 17:33	17/01/2020 23:04	5,51	130	716,66	CHI
202001104798	IPAMERI	IP12068500	CRISTALINA S2	17/01/2020 09:39	18/01/2020 07:23	17/01/2020 09:39	18/01/2020 07:23	21,73	36	782,38	CHI
202001104799	PADRE BERNARDO	PB12313845	PADRE BERNARDO	17/01/2020 19:01	18/01/2020 08:22	17/01/2020 19:01	18/01/2020 08:22	13,34	2	26,68	CHI
202001104801	ABADIA DE GOIAS	GN10385813	CARAJAS S1	17/01/2020 18:30	18/01/2020 01:05	17/01/2020 19:36	17/01/2020 20:08	0,52	3302	1717,04	CHI
202001104801	GOIANIA	GN10385813	CARAJAS S1	17/01/2020 18:30	18/01/2020 01:05	17/01/2020 19:36	17/01/2020 20:08	0,52	23	11,96	CHI
202001104801	ABADIA DE GOIAS	GN12405691	CARAJAS S1	17/01/2020 18:30	18/01/2020 01:05	17/01/2020 19:36	18/01/2020 01:05	5,49	5	27,43	CHI
202001104801	GOIANIA	GN12405691	CARAJAS S1	17/01/2020 18:30	18/01/2020 01:05	17/01/2020 19:36	18/01/2020 01:05	5,49	9	49,37	CHI
202001104803	ALEXANIA	03190414	ALEXANIA	17/01/2020 18:30	18/01/2020 17:06	17/01/2020 18:30	18/01/2020 03:59	9,49	5	47,45	CHI
202001104803	CORUMBA DE GOIAS	03190414	ALEXANIA	17/01/2020 18:30	18/01/2020 17:06	17/01/2020 18:30	18/01/2020 03:59	9,49	10	94,89	CHI
202001104803	ALEXANIA	03190414	CORUMBA	17/01/2020 18:30	18/01/2020 17:06	17/01/2020 18:30	18/01/2020 03:59	9,49	707	6708,84	CHI
202001104803	CORUMBA DE GOIAS	03190414	CORUMBA	17/01/2020 18:30	18/01/2020 17:06	17/01/2020 18:30	18/01/2020 03:59	9,49	320	3036,53	CHI
202001104803	ALEXANIA	03190414	ALEXANIA	17/01/2020 18:30	18/01/2020 17:06	17/01/2020 18:31	18/01/2020 03:59	9,47	1	9,47	CHI
202001104803	ALEXANIA	CB13108434	ALEXANIA	17/01/2020 18:30	18/01/2020 17:06	17/01/2020 18:31	18/01/2020 03:59	9,47	4	37,89	CHI
202001104803	CORUMBA DE GOIAS	CB13108434	ALEXANIA	17/01/2020 18:30	18/01/2020 17:06	17/01/2020 18:31	18/01/2020 03:59	9,47	5	47,36	CHI
202001104803	ALEXANIA	03190414	CORUMBA	17/01/2020 18:30	18/01/2020 17:06	17/01/2020 18:31	18/01/2020 03:59	9,47	150	1420,83	CHI
202001104803	CORUMBA DE GOIAS	03190414	CORUMBA	17/01/2020 18:30	18/01/2020 17:06	17/01/2020 18:31	18/01/2020 03:59	9,47	43	407,31	CHI
202001104803	ALEXANIA	03190414	ALEXANIA	17/01/2020 18:30	18/01/2020 17:06	17/01/2020 18:30	18/01/2020 09:57	15,45	16	247,24	CHI
202001104803	ALEXANIA	03190414	ALEXANIA	17/01/2020 18:30	18/01/2020 17:06	17/01/2020 18:31	18/01/2020 09:57	15,44	10	154,35	CHI
202001104803	ALEXANIA	03190414	ALEXANIA	17/01/2020 18:30	18/01/2020 17:06	17/01/2020 18:30	18/01/2020 14:04	19,57	4	78,27	CHI
202001104803	ALEXANIA	03190414	ALEXANIA	17/01/2020 18:30	18/01/2020 17:06	18/01/2020 14:06	18/01/2020 17:06	3,00	4	12,00	CHI
202001104820	AURILANDIA	CG12382596	FIRMINOPOLIS S2	17/01/2020 11:40	18/01/2020 03:51	17/01/2020 11:40	18/01/2020 03:51	16,17	24	388,08	CHI
202001104820	CACHOEIRA DE GOIAS	CG12382596	FIRMINOPOLIS S2	17/01/2020 11:40	18/01/2020 03:51	17/01/2020 11:40	18/01/2020 03:51	16,17	2	32,34	CHI
202001104820	MOIPORA	CG12382596	FIRMINOPOLIS S2	17/01/2020 11:40	18/01/2020 03:51	17/01/2020 11:40	18/01/2020 03:51	16,17	1	16,17	CHI
202001104856	GOIATUBA	04580406	BOM JESUS DE GOIAS	17/01/2020 17:01	17/01/2020 19:20	17/01/2020 17:01	17/01/2020 19:20	2,31	126	291,37	CHI

202001104856	GOIATUBA	04580406	BOM JESUS DE GOIAS	17/01/2020 17:01	17/01/2020 19:20	17/01/2020 17:01	17/01/2020 19:20	2,31	103	238,19	CHI
202001104874	AURILANDIA	CG12391526	FIRMINOPOLIS S2	17/01/2020 12:26	17/01/2020 23:00	17/01/2020 12:26	17/01/2020 23:00	10,57	2	21,13	CHI
202001104874	CACHOEIRA DE GOIAS	CG12391526	FIRMINOPOLIS S2	17/01/2020 12:26	17/01/2020 23:00	17/01/2020 12:26	17/01/2020 23:00	10,57	11	116,23	CHI
202001104874	PARAUNA	CG12391526	FIRMINOPOLIS S2	17/01/2020 12:26	17/01/2020 23:00	17/01/2020 12:26	17/01/2020 23:00	10,57	32	338,12	CHI
202001104904	ANICUNS	910007056	ANICUNS	17/01/2020 19:03	18/01/2020 00:54	17/01/2020 19:03	18/01/2020 00:54	5,84	1	5,84	CHI
202001104905	ALEXANIA	AX12402045	ALEXANIA	17/01/2020 18:19	17/01/2020 23:31	17/01/2020 18:19	17/01/2020 23:31	5,20	195	1013,08	CHI
202001104905	SANTO ANTONIO DO DESCOBERTO	AX12402045	ALEXANIA	17/01/2020 18:19	17/01/2020 23:31	17/01/2020 18:19	17/01/2020 23:31	5,20	1	5,20	CHI
202001104907	AGUAS LINDAS DE GOIAS	4830042929	AGUAS LINDAS DE GOIAS S1	17/01/2020 19:03	18/01/2020 09:41	17/01/2020 19:03	18/01/2020 09:41	14,62	1	14,62	CHI
202001104908	GOIANIA	11271486	FERROVIARIO S3	17/01/2020 19:03	17/01/2020 21:41	17/01/2020 19:03	17/01/2020 21:41	2,62	1	2,62	CHI
202001104909	SAO LUIS DE MONTES BELOS	SL32125644	FIRMINOPOLIS S1	17/01/2020 19:03	17/01/2020 21:44	17/01/2020 19:03	17/01/2020 21:44	2,67	15	40,07	CHI
202001104910	PADRE BERNARDO	PB12163217	PADRE BERNARDO	17/01/2020 19:04	17/01/2020 21:15	17/01/2020 19:04	17/01/2020 21:15	2,17	51	110,91	CHI
202001104912	SAO LUIS DE MONTES BELOS	500126525	SAO LUIZ DOS MONTES BELOS	17/01/2020 19:04	17/01/2020 20:48	17/01/2020 19:04	17/01/2020 20:48	1,72	1	1,72	CHI
202001104924	MINACU	IH11207257	MINACU	17/01/2020 19:07	18/01/2020 05:38	17/01/2020 19:07	18/01/2020 05:38	10,51	3	31,54	CHI
202001104929	TAQUARAL DE GOIAS	TQ21217758	ITABERAI S1	17/01/2020 19:09	18/01/2020 08:22	17/01/2020 19:09	18/01/2020 08:22	13,22	1	13,22	CHI
202001104936	CEZARINA	CZ12228898	CEZARINA	17/01/2020 16:43	17/01/2020 20:25	17/01/2020 16:43	17/01/2020 20:25	3,70	9	33,30	CHI
202001104943	SAO LUIS DE MONTES BELOS	SC21165425	SAO LUIZ DOS MONTES BELOS	17/01/2020 19:11	18/01/2020 01:05	17/01/2020 19:11	18/01/2020 01:05	5,89	1	5,89	CHI
202001104945	NIQUELANDIA	NQ21141186	URUACU	17/01/2020 19:12	17/01/2020 22:29	17/01/2020 19:12	17/01/2020 22:29	3,28	1	3,28	CHI
202001104953	CORUMBAIBA	CI12085840	VILA CORUMBA	17/01/2020 19:13	19/01/2020 09:38	17/01/2020 19:13	19/01/2020 09:38	38,42	1	38,42	CHI
202001104954	CATALAO	CT11077433	CATALAO S2	17/01/2020 19:13	17/01/2020 21:33	17/01/2020 19:13	17/01/2020 21:33	2,33	117	273,00	CHI
202001104958	FORMOSA	610067618	ITUIQUIRA	17/01/2020 19:13	17/01/2020 20:52	17/01/2020 19:13	17/01/2020 20:52	1,64	1	1,64	CHI
202001104960	FORMOSO	FO12328885	PORANGATU	17/01/2020 19:14	18/01/2020 00:45	17/01/2020 19:14	18/01/2020 00:45	5,51	4	22,05	CHI
202001104960	SANTA TEREZA DE GOIAS	FO12328885	PORANGATU	17/01/2020 19:14	18/01/2020 00:45	17/01/2020 19:14	18/01/2020 00:45	5,51	12	66,14	CHI
202001104963	NIQUELANDIA	NQ21098059	URUACU	17/01/2020 19:15	18/01/2020 00:01	17/01/2020 19:15	18/01/2020 00:01	4,77	15	71,50	CHI
202001104965	PADRE BERNARDO	PB12330812	PADRE BERNARDO	17/01/2020 19:15	18/01/2020 14:04	17/01/2020 19:15	18/01/2020 14:04	18,81	4	75,25	CHI
202001104966	CAMPO ALEGRE DE GOIAS	CM12379366	CAMPO ALEGRE DE GOIAS	17/01/2020 19:15	18/01/2020 10:07	17/01/2020 19:15	18/01/2020 10:07	14,86	1	14,86	CHI
202001104968	SANCLERLANDIA	SC12382592	FIRMINOPOLIS S2	17/01/2020 19:15	18/01/2020 07:19	17/01/2020 19:15	18/01/2020 07:19	12,05	1	12,05	CHI
202001104974	ITAPIRAPUA	IU12018777	JUSSARA	17/01/2020 18:26	17/01/2020 23:49	17/01/2020 18:26	17/01/2020 23:49	5,37	12	64,49	CHI
202001104979	GOIANIRA	GR11379503	GOIANIRA	17/01/2020 19:16	17/01/2020 20:33	17/01/2020 19:16	17/01/2020 20:33	1,27	26	32,97	CHI
202001104980	CRISTALINA	KR12029221	CRISTALINA S1	17/01/2020 19:16	18/01/2020 08:43	17/01/2020 19:16	18/01/2020 08:43	13,43	4	53,74	CHI
202001104984	APARECIDA DE GOIANIA	15837397	INDEPENDENCIA S1	17/01/2020 19:19	17/01/2020 21:08	17/01/2020 19:19	17/01/2020 21:08	1,82	1	1,82	CHI
202001104985	BOM JESUS DE GOIAS	BJ12000088RE	BOM JESUS DE GOIAS	17/01/2020 18:39	18/01/2020 10:04	17/01/2020 18:39	18/01/2020 10:04	15,41	10	154,14	CHI
202001104985	GOIATUBA	BJ12000088RE	BOM JESUS DE GOIAS	17/01/2020 18:39	18/01/2020 10:04	17/01/2020 18:39	18/01/2020 10:04	15,41	45	693,63	CHI
202001104986	JATAI	290228347	JATAI S3	17/01/2020 19:19	18/01/2020 09:52	17/01/2020 19:19	18/01/2020 09:52	14,55	1	14,55	CHI

202001104989	EDEIA	EA12000059RE	EDEIA	17/01/2020 18:58	17/01/2020 20:27	17/01/2020 18:58	17/01/2020 20:27	1,47	92	135,52	CHI
202001104991	JATAI	JT12036853	JATAI S3	17/01/2020 19:20	18/01/2020 10:15	17/01/2020 19:20	18/01/2020 10:15	14,91	1	14,91	CHI
202001105001	ITUMBIARA	IT21000267	ITUMBIARA NOVA	17/01/2020 19:22	19/01/2020 08:55	17/01/2020 19:22	19/01/2020 08:55	37,55	1	37,55	CHI
202001105003	RIO VERDE	10030669772	RIO VERDE S1	17/01/2020 19:22	18/01/2020 11:38	17/01/2020 19:22	18/01/2020 11:38	16,26	1	16,26	CHI
202001105006	ITUMBIARA	BG12000044	ITUMBIARA VELHA S2	17/01/2020 18:07	17/01/2020 22:02	17/01/2020 18:07	17/01/2020 22:02	3,91	2	7,83	CHI
202001105009	CALDAS NOVAS	CN12182800	SERRA DE CALDAS	17/01/2020 16:37	18/01/2020 07:07	17/01/2020 16:37	18/01/2020 07:07	14,49	10	144,86	CHI
202001105015	JARAGUA	JA11265751	JARAGUA	17/01/2020 18:21	17/01/2020 21:28	17/01/2020 18:21	17/01/2020 21:28	3,11	25	77,72	CHI
202001105016	CRISTALINA	KR12171525	PAMPLONA	17/01/2020 19:24	18/01/2020 11:56	17/01/2020 19:24	18/01/2020 11:56	16,53	17	280,99	CHI
202001105018	PADRE BERNARDO	PB11231527	PADRE BERNARDO	17/01/2020 19:25	17/01/2020 22:39	17/01/2020 19:25	17/01/2020 22:39	3,23	6	19,39	CHI
202001105024	MONTIVIDIU	MV21144624	MONTIVIDIU T	17/01/2020 14:16	18/01/2020 11:31	17/01/2020 14:16	18/01/2020 11:31	21,26	2	42,51	CHI
202001105027	CAIAPONIA	PH12221148	PIRANHAS	17/01/2020 19:26	18/01/2020 12:20	17/01/2020 19:26	18/01/2020 12:20	16,90	3	50,69	CHI
202001105034	FORMOSA	610198087	ITUIQUIRA	17/01/2020 19:27	17/01/2020 21:00	17/01/2020 19:27	17/01/2020 21:00	1,56	1	1,56	CHI
202001105043	EDEALINA	ED21000007	PONTALINA	17/01/2020 19:28	17/01/2020 22:20	17/01/2020 19:28	17/01/2020 22:20	2,85	2	5,71	CHI
202001105044	FLORES DE GOIAS	FB12204157	FLORES DE GOIAS	17/01/2020 19:28	17/01/2020 20:48	17/01/2020 19:28	17/01/2020 20:48	1,32	13	17,17	CHI
202001105045	IPAMERI	IP12404722	IPAMERI	17/01/2020 19:28	18/01/2020 08:39	17/01/2020 19:28	18/01/2020 08:39	13,17	1	13,17	CHI
202001105046	ALTO PARAISO DE GOIAS	BF11048000	FLORES DE GOIAS	17/01/2020 19:28	17/01/2020 21:17	17/01/2020 19:28	17/01/2020 21:17	1,80	80	144,16	CHI
202001105049	PALMELO	PZ12063775RE	PIRES DO RIO S2	17/01/2020 18:17	17/01/2020 21:46	17/01/2020 18:17	17/01/2020 21:46	3,48	23	80,11	CHI
202001105049	PIRES DO RIO	PZ12063775RE	PIRES DO RIO S2	17/01/2020 18:17	17/01/2020 21:46	17/01/2020 18:17	17/01/2020 21:46	3,48	6	20,90	CHI
202001105049	SANTA CRUZ DE GOIAS	PZ12063775RE	PIRES DO RIO S2	17/01/2020 18:17	17/01/2020 21:46	17/01/2020 18:17	17/01/2020 21:46	3,48	26	90,56	CHI
202001105051	URUACU	UR21157364	CAMPINORTE	17/01/2020 19:29	17/01/2020 22:53	17/01/2020 19:29	17/01/2020 22:53	3,39	37	125,57	CHI
202001105055	ORIZONA	2060016508	PIRES DO RIO S2	17/01/2020 19:30	17/01/2020 20:39	17/01/2020 19:30	17/01/2020 20:39	1,15	1	1,15	CHI
202001105058	CATALAO	GD12127624RE	CATALAO S1	17/01/2020 18:08	17/01/2020 23:36	17/01/2020 18:08	17/01/2020 23:36	5,45	14	76,32	CHI
202001105058	GOIANDIRA	GD12127624RE	CATALAO S1	17/01/2020 18:08	17/01/2020 23:36	17/01/2020 18:08	17/01/2020 23:36	5,45	17	92,67	CHI
202001105058	IPAMERI	GD12127624RE	CATALAO S1	17/01/2020 18:08	17/01/2020 23:36	17/01/2020 18:08	17/01/2020 23:36	5,45	7	38,16	CHI
202001105065	ANAPOLIS	20615425	JUNDIAI S2	17/01/2020 19:31	17/01/2020 20:45	17/01/2020 19:31	17/01/2020 20:45	1,23	1	1,23	CHI
202001105066	ARENOPOLIS	AY21196459	ARENOPOLIS	17/01/2020 19:31	18/01/2020 17:03	17/01/2020 19:31	18/01/2020 17:03	21,53	1	21,53	CHI
202001105068	QUIRINOPOLIS	QI11015563	QUIRINOPOLIS	17/01/2020 18:30	17/01/2020 22:32	17/01/2020 18:30	17/01/2020 22:32	4,02	174	699,38	CHI
202001105073	JATAI	AW12200790	CACHOEIRA ALTA	17/01/2020 19:33	18/01/2020 13:13	17/01/2020 19:33	18/01/2020 13:13	17,66	3	52,97	CHI
202001105074	NIQUELANDIA	NQ12171829	NIQUELANDIA SUBTRANSMISSAO	17/01/2020 17:36	18/01/2020 12:12	17/01/2020 17:36	18/01/2020 12:12	18,60	356	6621,20	CHI
202001105089	FLORES DE GOIAS	FB12252148	FLORES DE GOIAS	17/01/2020 19:35	17/01/2020 23:45	17/01/2020 19:35	17/01/2020 23:45	4,16	10	41,63	CHI
202001105094	SANTO ANTONIO DO DESCOBERTO	05410226	MARAJOARA	17/01/2020 19:36	18/01/2020 18:42	17/01/2020 19:36	17/01/2020 21:07	1,52	3	4,56	CHI
202001105094	SANTO ANTONIO DO DESCOBERTO	SN12290451LD	MARAJOARA	17/01/2020 19:36	18/01/2020 18:42	17/01/2020 19:36	17/01/2020 21:22	1,78	72	127,98	CHI
202001105094	DISTRITO FEDERAL	SN13078131	MARAJOARA	17/01/2020 19:36	18/01/2020 18:42	17/01/2020 19:36	17/01/2020 23:11	3,58	49	175,60	CHI

202001105094	SANTO ANTONIO DO DESCOBERTO	SN13078131	MARAJOARA	17/01/2020 19:36	18/01/2020 18:42	17/01/2020 19:36	17/01/2020 23:11	3,58	623	2232,59	CHI
202001105094	NOVO GAMA	SN12248690LD	MARAJOARA	17/01/2020 19:36	18/01/2020 18:42	17/01/2020 19:36	18/01/2020 18:42	23,10	9	207,88	CHI
202001105094	SANTO ANTONIO DO DESCOBERTO	SN12248690LD	MARAJOARA	17/01/2020 19:36	18/01/2020 18:42	17/01/2020 19:36	18/01/2020 18:42	23,10	55	1270,41	CHI
202001105097	INACIOLANDIA	ID21341688	QUIRINOPOLIS	17/01/2020 19:37	18/01/2020 12:10	17/01/2020 19:37	18/01/2020 12:10	16,55	22	364,02	CHI
202001105104	PADRE BERNARDO	PB12382236	PADRE BERNARDO	17/01/2020 19:38	18/01/2020 04:43	17/01/2020 19:38	18/01/2020 04:43	9,08	1	9,08	CHI
202001105116	ABADIA DE GOIAS	TR21107091	CARAJAS S1	17/01/2020 19:40	17/01/2020 22:19	17/01/2020 19:40	17/01/2020 22:19	2,64	1	2,64	CHI
202001105119	SANTA HELENA DE GOIAS	SH11000037	IPEGUARI	17/01/2020 15:23	17/01/2020 21:26	17/01/2020 15:23	17/01/2020 21:26	6,04	91	549,39	CHI
202001105125	GOIANIA	10672448	AEROPORTO S3	17/01/2020 19:42	17/01/2020 22:05	17/01/2020 19:42	17/01/2020 22:05	2,37	1	2,37	CHI
202001105127	JARAGUA	70111236	JARAGUA	17/01/2020 19:43	17/01/2020 23:36	17/01/2020 19:43	17/01/2020 23:36	3,88	1	3,88	CHI
202001105129	PIRACANJUBA	PJ21000041	PIRACANJUBA	17/01/2020 19:44	19/01/2020 13:00	17/01/2020 19:44	19/01/2020 13:00	41,26	1	41,26	CHI
202001105134	GOIANIA	11319720	ATLANTICO S2	17/01/2020 19:44	17/01/2020 20:09	17/01/2020 19:44	17/01/2020 20:09	0,40	1	0,40	CHI
202001105141	GOIANIRA	390026724	GOIANIRA	17/01/2020 19:46	17/01/2020 22:56	17/01/2020 19:46	17/01/2020 22:56	3,17	1	3,17	CHI
202001105155	ALEXANIA	AX12000099	ALEXANIA	17/01/2020 19:47	18/01/2020 14:08	17/01/2020 19:47	18/01/2020 14:08	18,34	12	220,07	CHI
202001105166	JATAI	290202279	JATAI S3	17/01/2020 19:51	18/01/2020 12:06	17/01/2020 19:51	18/01/2020 12:06	16,24	1	16,24	CHI
202001105167	ITUMBIARA	10010720640	PARANAIBA	17/01/2020 19:51	17/01/2020 21:51	17/01/2020 19:51	17/01/2020 21:51	2,00	1	2,00	CHI
202001105169	CATALAO	CT12195296	CATALAO S2	17/01/2020 18:23	17/01/2020 21:03	17/01/2020 18:23	17/01/2020 21:03	2,65	215	570,05	CHI
202001105170	PADRE BERNARDO	PB12261686	PADRE BERNARDO	17/01/2020 19:44	18/01/2020 01:37	17/01/2020 19:44	18/01/2020 01:37	5,88	8	47,02	CHI
202001105172	GOIANIA	10702040	ATLANTICO S2	17/01/2020 19:53	17/01/2020 21:28	17/01/2020 19:53	17/01/2020 21:28	1,58	1	1,58	CHI
202001105174	ITABERAI	IB12206910	ITABERAI S1	17/01/2020 17:28	18/01/2020 09:43	17/01/2020 17:28	18/01/2020 09:43	16,24	16	259,87	CHI
202001105177	GOIANIA	GN21033125	CARAJAS S1	17/01/2020 19:53	17/01/2020 20:29	17/01/2020 19:53	17/01/2020 20:29	0,59	2	1,17	CHI
202001105180	NOVO GAMA	NJ12379162	PACAEMBU S1	17/01/2020 19:05	17/01/2020 23:04	17/01/2020 19:05	17/01/2020 23:04	3,98	595	2369,26	CHI
202001105181	ABADIANIA	AA12258346	ANAPOLIS UNIVERSITARIO S1	17/01/2020 14:02	17/01/2020 23:06	17/01/2020 14:02	17/01/2020 23:06	9,05	21	190,07	CHI
202001105181	CORUMBA DE GOIAS	AA12258346	ANAPOLIS UNIVERSITARIO S1	17/01/2020 14:02	17/01/2020 23:06	17/01/2020 14:02	17/01/2020 23:06	9,05	2	18,10	CHI
202001105184	LUZIANIA	LZ11372289	RIO VERMELHO	17/01/2020 19:55	17/01/2020 21:55	17/01/2020 19:55	17/01/2020 21:55	1,99	77	153,04	CHI
202001105200	GOIANIA	12817582	REAL S1	17/01/2020 19:58	17/01/2020 20:43	17/01/2020 19:58	17/01/2020 20:43	0,74	1	0,74	CHI
202001105206	ANAPOLIS	AN12262497	ANAPOLIS UNIVERSITARIO S1	17/01/2020 20:00	17/01/2020 22:35	17/01/2020 20:00	17/01/2020 22:35	2,58	19	49,04	CHI
202001105221	ANAPOLIS	AN12135733	ANAPOLIS UNIVERSITARIO S2	17/01/2020 20:04	17/01/2020 22:19	17/01/2020 20:04	17/01/2020 22:19	2,25	161	361,76	CHI
202001105223	PADRE BERNARDO	PB12275695	PADRE BERNARDO	17/01/2020 20:04	18/01/2020 11:19	17/01/2020 20:04	18/01/2020 11:19	15,24	5	76,20	CHI
202001105230	SILVANIA	SV12400029	VIANOPOLIS	17/01/2020 20:05	18/01/2020 09:28	17/01/2020 20:05	18/01/2020 09:28	13,37	94	1256,81	CHI
202001105237	GOIANIA	10005716878	CARAJAS S1	17/01/2020 20:08	17/01/2020 21:33	17/01/2020 20:08	17/01/2020 21:33	1,42	1	1,42	CHI
202001105243	CACU	CC21125899	CACHOEIRA ALTA	17/01/2020 20:09	18/01/2020 08:46	17/01/2020 20:09	18/01/2020 08:46	12,60	1	12,60	CHI
202001105244	CRISTIANOPOLIS	CF21107190	CRISTIANOPOLIS	17/01/2020 20:09	17/01/2020 23:54	17/01/2020 20:09	17/01/2020 23:54	3,74	1	3,74	CHI
202001105247	DAMIANOPOLIS	DA12196513	IACIARA S2	17/01/2020 20:10	17/01/2020 22:35	17/01/2020 20:10	17/01/2020 22:35	2,41	59	142,21	CHI

202001105248	ITUMBIARA	05210224	CACHOEIRA DOURADA	17/01/2020 20:04	18/01/2020 19:10	17/01/2020 20:05	17/01/2020 21:35	1,49	286	426,70	CHI
202001105248	ITUMBIARA	BJ13000034	CACHOEIRA DOURADA	17/01/2020 20:04	18/01/2020 19:10	17/01/2020 20:05	17/01/2020 23:24	3,30	22	72,69	CHI
202001105248	CACHOEIRA DOURADA	CD13000031	CACHOEIRA DOURADA	17/01/2020 20:04	18/01/2020 19:10	17/01/2020 20:05	18/01/2020 10:10	14,07	2	28,15	CHI
202001105248	ITUMBIARA	CD13000031	CACHOEIRA DOURADA	17/01/2020 20:04	18/01/2020 19:10	17/01/2020 20:05	18/01/2020 10:10	14,07	30	422,21	CHI
202001105248	ITUMBIARA	05210224	CACHOEIRA DOURADA	17/01/2020 20:04	18/01/2020 19:10	18/01/2020 10:11	18/01/2020 10:35	0,41	308	126,88	CHI
202001105248	CACHOEIRA DOURADA	CD13000031	CACHOEIRA DOURADA	17/01/2020 20:04	18/01/2020 19:10	18/01/2020 10:11	18/01/2020 18:31	8,34	2	16,68	CHI
202001105248	ITUMBIARA	CD13000031	CACHOEIRA DOURADA	17/01/2020 20:04	18/01/2020 19:10	18/01/2020 10:11	18/01/2020 18:31	8,34	30	250,13	CHI
202001105248	CACHOEIRA DOURADA	CD12000197RE	CACHOEIRA DOURADA	17/01/2020 20:04	18/01/2020 19:10	17/01/2020 20:05	18/01/2020 19:10	23,07	26	599,84	CHI
202001105248	ITUMBIARA	CD12000197RE	CACHOEIRA DOURADA	17/01/2020 20:04	18/01/2020 19:10	17/01/2020 20:05	18/01/2020 19:10	23,07	31	715,20	CHI
202001105254	APARECIDA DE GOIANIA	15036546	REAL S1	17/01/2020 20:12	17/01/2020 21:26	17/01/2020 20:12	17/01/2020 21:26	1,23	1	1,23	CHI
202001105263	MAMBAI	MB12085514	IACIARA S2	17/01/2020 20:15	17/01/2020 21:30	17/01/2020 20:15	17/01/2020 21:30	1,25	75	93,65	CHI
202001105267	PADRE BERNARDO	PB12284769	PADRE BERNARDO	17/01/2020 19:12	17/01/2020 21:49	17/01/2020 19:12	17/01/2020 21:49	2,60	65	169,13	CHI
202001105268	LUZIANIA	120103436	RIO VERMELHO	17/01/2020 20:15	17/01/2020 23:27	17/01/2020 20:15	17/01/2020 23:27	3,19	1	3,19	CHI
202001105269	ARUANA	AK12156743	ARUANA	17/01/2020 20:15	18/01/2020 10:49	17/01/2020 20:15	18/01/2020 10:49	14,56	7	101,89	CHI
202001105273	GOIANIA	13197370	CARAJAS S1	17/01/2020 20:16	17/01/2020 21:35	17/01/2020 20:16	17/01/2020 21:35	1,31	1	1,31	CHI
202001105284	GUARINOS	IW12267463	ITAPACI	17/01/2020 09:02	17/01/2020 23:14	17/01/2020 09:02	17/01/2020 23:14	14,19	3	42,58	CHI
202001105284	ITAPACI	IW12267463	ITAPACI	17/01/2020 09:02	17/01/2020 23:14	17/01/2020 09:02	17/01/2020 23:14	14,19	2	28,38	CHI
202001105287	CRISTALINA	KR13413325B	CRISTALINA S2	17/01/2020 20:04	18/01/2020 00:57	17/01/2020 20:04	18/01/2020 00:57	4,89	37	180,91	CHI
202001105289	QUIRINOPOLIS	QI32094314	QUIRINOPOLIS	17/01/2020 20:20	18/01/2020 09:11	17/01/2020 20:20	18/01/2020 09:11	12,84	1	12,84	CHI
202001105290	ARUANA	AK11220043	ARUANA	17/01/2020 20:20	17/01/2020 23:17	17/01/2020 20:20	17/01/2020 23:17	2,94	17	49,92	CHI
202001105294	LUZIANIA	LZ12097148	RIO VERMELHO	17/01/2020 20:20	17/01/2020 21:27	17/01/2020 20:20	17/01/2020 21:27	1,10	32	35,22	CHI
202001105295	IPAMERI	IP21151161	IPAMERI	17/01/2020 20:20	18/01/2020 08:07	17/01/2020 20:20	18/01/2020 08:07	11,77	1	11,77	CHI
202001105304	PALESTINA DE GOIAS	PY21187401	PALESTINA	17/01/2020 20:22	18/01/2020 18:53	17/01/2020 20:22	18/01/2020 18:53	22,51	1	22,51	CHI
202001105310	SENADOR CANEDO	190064250	SENADOR CANEDO	17/01/2020 20:24	17/01/2020 21:43	17/01/2020 20:24	17/01/2020 21:43	1,31	1	1,31	CHI
202001105313	GOIANIA	GN11185473	XAVANTES	17/01/2020 20:23	17/01/2020 21:39	17/01/2020 20:23	17/01/2020 21:39	1,26	164	206,05	CHI
202001105315	RUBIATABA	RB12060965	RUBIATABA	17/01/2020 20:21	17/01/2020 22:24	17/01/2020 20:21	17/01/2020 22:24	2,04	55	112,23	CHI
202001105318	NIQUELANDIA	NQ21197545	NIQUELANDIA SUBTRANSMISSAO	17/01/2020 20:25	17/01/2020 22:16	17/01/2020 20:25	17/01/2020 22:16	1,84	1	1,84	CHI
202001105319	ALEXANIA	AX12398552	ALEXANIA	17/01/2020 19:28	18/01/2020 14:25	17/01/2020 19:28	18/01/2020 14:25	18,95	7	132,63	CHI
202001105321	JATAI	290255703	JATAI S3	17/01/2020 20:26	18/01/2020 07:11	17/01/2020 20:26	18/01/2020 07:11	10,74	1	10,74	CHI
202001105325	MOZARLANDIA	MZ12057407	MOZARLANDIA	17/01/2020 19:51	18/01/2020 07:40	17/01/2020 19:51	18/01/2020 07:40	11,81	6	70,87	CHI
202001105329	GOIANIA	10015452458	CARAJAS S1	17/01/2020 20:28	17/01/2020 21:46	17/01/2020 20:28	17/01/2020 21:46	1,29	1	1,29	CHI
202001105332	JARAGUA	JA12298054	JARAGUA	17/01/2020 20:28	18/01/2020 08:27	17/01/2020 20:28	18/01/2020 08:27	11,97	5	59,85	CHI
202001105336	APARECIDA DE GOIANIA	10006255297	ANHANGUERA	17/01/2020 20:30	17/01/2020 22:03	17/01/2020 20:30	17/01/2020 22:03	1,55	1	1,55	CHI

202001105338	CRISTALINA	KR12210364	CRISTALINA S2	17/01/2020 20:31	18/01/2020 13:51	17/01/2020 20:31	18/01/2020 13:51	17,33	2	34,66	CHI
202001105339	CORUMBAIBA	CI12035404	VILA CORUMBA	17/01/2020 20:31	18/01/2020 11:43	17/01/2020 20:31	18/01/2020 11:43	15,20	85	1291,83	CHI
202001105343	JARAGUA	JA12254078	JARAGUA	17/01/2020 20:17	18/01/2020 18:07	17/01/2020 20:17	17/01/2020 21:30	1,21	25	30,15	CHI
202001105343	JARAGUA	JA12254078	JARAGUA	17/01/2020 20:17	18/01/2020 18:07	17/01/2020 21:31	18/01/2020 18:07	20,61	25	515,15	CHI
202001105351	ANAPOLIS	AN12000193RE	ANAPOLIS UNIVERSITARIO S2	17/01/2020 20:28	18/01/2020 18:24	17/01/2020 20:28	18/01/2020 18:24	21,93	47	1030,53	CHI
202001105351	PIRENOPOLIS	AN12000193RE	ANAPOLIS UNIVERSITARIO S2	17/01/2020 20:28	18/01/2020 18:24	17/01/2020 20:28	18/01/2020 18:24	21,93	16	350,82	CHI
202001105356	APARECIDA DE GOIANIA	13613418	INDEPENDENCIA S2	17/01/2020 20:32	17/01/2020 22:17	17/01/2020 20:32	17/01/2020 22:17	1,73	1	1,73	CHI
202001105357	SANCLERLANDIA	SC12068226	FIRMINOPOLIS S2	17/01/2020 20:33	18/01/2020 08:24	17/01/2020 20:33	18/01/2020 08:24	11,84	5	59,22	CHI
202001105362	GOIANIA	11278237	FERROVIARIO S3	17/01/2020 20:34	17/01/2020 22:25	17/01/2020 20:34	17/01/2020 22:25	1,85	1	1,85	CHI
202001105369	GOIATUBA	04580406	BOM JESUS DE GOIAS	17/01/2020 20:35	18/01/2020 11:33	17/01/2020 20:35	18/01/2020 11:33	14,96	130	1944,29	CHI
202001105369	GOIATUBA	04580406	BOM JESUS DE GOIAS	17/01/2020 20:35	18/01/2020 11:33	17/01/2020 20:35	18/01/2020 11:33	14,96	91	1361,01	CHI
202001105372	BONFINOPOLIS	10000240930	CEPAIGO S2	17/01/2020 20:36	18/01/2020 08:41	17/01/2020 20:36	18/01/2020 08:41	12,07	1	12,07	CHI
202001105378	MARA ROSA	MQ12072578	MARA ROSA	17/01/2020 17:58	17/01/2020 23:27	17/01/2020 17:58	17/01/2020 23:27	5,48	6	32,86	CHI
202001105380	CARMO DO RIO VERDE	IK12298505	ITAPURANGA	17/01/2020 20:38	17/01/2020 23:34	17/01/2020 20:38	17/01/2020 23:34	2,94	35	103,02	CHI
202001105380	ITAPURANGA	IK12298505	ITAPURANGA	17/01/2020 20:38	17/01/2020 23:34	17/01/2020 20:38	17/01/2020 23:34	2,94	9	26,49	CHI
202001105383	LUZIANIA	LZ11072905	RIO VERMELHO	17/01/2020 20:31	17/01/2020 21:55	17/01/2020 20:31	17/01/2020 21:55	1,39	9	12,48	CHI
202001105387	PADRE BERNARDO	PB12163218	PADRE BERNARDO	17/01/2020 20:39	18/01/2020 16:47	17/01/2020 20:39	18/01/2020 16:47	20,13	1	20,13	CHI
202001105390	ITABERAI	IB12099038	ITABERAI S2	17/01/2020 20:23	18/01/2020 00:34	17/01/2020 20:23	18/01/2020 00:34	4,18	15	62,75	CHI
202001105392	IPIRANGA DE GOIAS	RB12003338	RUBIATABA	17/01/2020 20:34	18/01/2020 00:57	17/01/2020 20:34	18/01/2020 00:57	4,38	1	4,38	CHI
202001105392	ITAPACI	RB12003338	RUBIATABA	17/01/2020 20:34	18/01/2020 00:57	17/01/2020 20:34	18/01/2020 00:57	4,38	10	43,76	CHI
202001105392	RUBIATABA	RB12003338	RUBIATABA	17/01/2020 20:34	18/01/2020 00:57	17/01/2020 20:34	18/01/2020 00:57	4,38	127	555,77	CHI
202001105394	COCALZINHO DE GOIAS	ZN21297594	COCALZINHO	17/01/2020 20:40	18/01/2020 10:07	17/01/2020 20:40	18/01/2020 10:07	13,44	1	13,44	CHI
202001105396	NOVA AURORA	NE12143243	CATALAO S1	17/01/2020 18:51	18/01/2020 07:58	17/01/2020 18:51	18/01/2020 07:58	13,12	5	65,58	CHI
202001105509	PARAUNA	PU12081329	PARAUNA	17/01/2020 20:44	17/01/2020 21:34	17/01/2020 20:44	17/01/2020 21:34	0,83	64	53,21	CHI
202001105510	CORUMBAIBA	CI12263856	VILA CORUMBA	18/01/2020 17:33	19/01/2020 10:25	18/01/2020 17:33	19/01/2020 10:25	16,86	159	2680,03	CHI
202001105510	NOVA AURORA	CI12263856	VILA CORUMBA	18/01/2020 17:33	19/01/2020 10:25	18/01/2020 17:33	19/01/2020 10:25	16,86	7	117,99	CHI
202001105511	MORRINHOS	MR21105080	MORRINHOS	17/01/2020 20:44	18/01/2020 13:15	17/01/2020 20:44	18/01/2020 13:15	16,50	1	16,50	CHI
202001105512	APARECIDA DE GOIANIA	10009638529	INDEPENDENCIA S2	17/01/2020 20:44	17/01/2020 22:35	17/01/2020 20:44	17/01/2020 22:35	1,83	1	1,83	CHI
202001105528	ABADIANIA	AA12335610	ANAPOLIS UNIVERSITARIO S1	17/01/2020 20:20	18/01/2020 00:04	17/01/2020 20:20	18/01/2020 00:04	3,72	9	33,47	CHI
202001105536	SILVANIA	660002220	VIANOPOLIS	17/01/2020 20:49	17/01/2020 22:55	17/01/2020 20:49	17/01/2020 22:55	2,09	1	2,09	CHI
202001105547	LUZIANIA	LZ21244577	CRISTALINA S2	17/01/2020 20:51	17/01/2020 23:30	17/01/2020 20:51	17/01/2020 23:30	2,65	1	2,65	CHI
202001105548	ANAPOLIS	AN12267912	NEROPOLIS S1	17/01/2020 20:51	18/01/2020 10:11	17/01/2020 20:51	18/01/2020 10:11	13,33	22	293,22	CHI
202001105548	CAMPO LIMPO	AN12267912	NEROPOLIS S1	17/01/2020 20:51	18/01/2020 10:11	17/01/2020 20:51	18/01/2020 10:11	13,33	1	13,33	CHI

202001105549	SILVANIA	660010136	VIANOPOLIS	17/01/2020 20:51	18/01/2020 03:19	17/01/2020 20:51	18/01/2020 03:19	6,46	1	6,46	CHI
202001105550	APARECIDA DE GOIANIA	10016819606	INDEPENDENCIA S2	17/01/2020 20:52	17/01/2020 22:24	17/01/2020 20:52	17/01/2020 22:24	1,53	1	1,53	CHI
202001105561	BONOPOLIS	BX12013030	SAO MIGUEL DO ARAGUAIA	17/01/2020 20:31	18/01/2020 08:15	17/01/2020 20:31	18/01/2020 08:15	11,73	5	58,64	CHI
202001105562	BONOPOLIS	BX12391924	SAO MIGUEL DO ARAGUAIA	17/01/2020 20:54	18/01/2020 01:14	17/01/2020 20:54	18/01/2020 01:14	4,33	27	116,84	CHI
202001105562	SAO MIGUEL DO ARAGUAIA	BX12391924	SAO MIGUEL DO ARAGUAIA	17/01/2020 20:54	18/01/2020 01:14	17/01/2020 20:54	18/01/2020 01:14	4,33	0	0,00	CHI
202001105565	CRISTALINA	KR12161004	CRISTALINA S2	17/01/2020 19:35	18/01/2020 10:24	17/01/2020 19:35	18/01/2020 10:24	14,80	5	74,02	CHI
202001105585	ARAGUAPAZ	AZ12042908	MOZARLANDIA	17/01/2020 21:00	18/01/2020 04:15	17/01/2020 21:00	18/01/2020 04:15	7,25	46	333,45	CHI
202001105586	LUZIANIA	LZ21304771	MARAJOARA	17/01/2020 21:00	18/01/2020 01:13	17/01/2020 21:00	18/01/2020 01:13	4,21	1	4,21	CHI
202001105589	ITABERAI	IB12000060	ITABERAI S2	17/01/2020 20:43	18/01/2020 09:47	17/01/2020 20:43	18/01/2020 09:47	13,06	35	457,11	CHI
202001105590	RIO VERDE	RV12000248	RIO VERDE S1	17/01/2020 21:00	18/01/2020 08:33	17/01/2020 21:00	18/01/2020 08:33	11,54	1	11,54	CHI
202001105590	SANTA HELENA DE GOIAS	RV12000248	RIO VERDE S1	17/01/2020 21:00	18/01/2020 08:33	17/01/2020 21:00	18/01/2020 08:33	11,54	1	11,54	CHI
202001105592	ARUANA	BT12165391	BRITANIA	17/01/2020 21:00	18/01/2020 18:17	17/01/2020 21:00	18/01/2020 18:17	21,27	25	531,72	CHI
202001105592	BRITANIA	BT12165391	BRITANIA	17/01/2020 21:00	18/01/2020 18:17	17/01/2020 21:00	18/01/2020 18:17	21,27	2	42,54	CHI
202001105596	PIRENOPOLIS	10008513927	CORUMBA	17/01/2020 21:02	18/01/2020 19:20	17/01/2020 21:02	18/01/2020 19:20	22,30	1	22,30	CHI
202001105597	PONTALINA	PK31046066	PONTALINA	17/01/2020 21:02	18/01/2020 12:00	17/01/2020 21:02	18/01/2020 12:00	14,97	1	14,97	CHI
202001105599	RIO VERDE	RV11246784	RIO VERDE S2	17/01/2020 20:20	18/01/2020 02:35	17/01/2020 20:20	18/01/2020 02:35	6,24	79	493,00	CHI
202001105604	RIO VERDE	RV12230653	MONTIVIDIU T	17/01/2020 21:02	18/01/2020 12:21	17/01/2020 21:02	18/01/2020 12:21	15,30	2	30,60	CHI
202001105606	SAO MIGUEL DO ARAGUAIA	SM12390362	SAO MIGUEL DO ARAGUAIA	17/01/2020 21:03	18/01/2020 09:09	17/01/2020 21:03	18/01/2020 09:09	12,10	4	48,39	CHI
202001105617	AURILANDIA	AI21000024	FIRMINOPOLIS S2	17/01/2020 21:07	18/01/2020 09:51	17/01/2020 21:07	18/01/2020 09:51	12,73	1	12,73	CHI
202001105632	FAZENDA NOVA	FN21113471	IPORA	17/01/2020 21:11	18/01/2020 15:33	17/01/2020 21:11	18/01/2020 15:33	18,36	1	18,36	CHI
202001105634	SAO FRANCISCO DE GOIAS	SF12079156	SAO FRANCISCO DE GOIAS	17/01/2020 21:11	17/01/2020 23:00	17/01/2020 21:11	17/01/2020 23:00	1,81	10	18,07	CHI
202001105635	ANAPOLIS	21266062	ANAPOLIS UNIVERSITARIO S2	17/01/2020 21:11	17/01/2020 22:51	17/01/2020 21:11	17/01/2020 22:51	1,65	1	1,65	CHI
202001105646	TRINDADE	40047155	TRINDADE	17/01/2020 21:14	17/01/2020 22:44	17/01/2020 21:14	17/01/2020 22:44	1,50	1	1,50	CHI
202001105670	CAIAPONIA	CP12357586	PALESTINA	17/01/2020 21:22	18/01/2020 10:01	17/01/2020 21:22	18/01/2020 10:01	12,65	5	63,24	CHI
202001105671	BOM JESUS DE GOIAS	BJ12256996	BOM JESUS DE GOIAS	17/01/2020 21:22	18/01/2020 11:05	17/01/2020 21:22	18/01/2020 11:05	13,70	14	191,85	CHI
202001105671	GOIATUBA	BJ12256996	BOM JESUS DE GOIAS	17/01/2020 21:22	18/01/2020 11:05	17/01/2020 21:22	18/01/2020 11:05	13,70	51	698,88	CHI
202001105672	CAMPO ALEGRE DE GOIAS	CM12338743	CAMPO ALEGRE DE GOIAS	17/01/2020 21:22	18/01/2020 11:52	17/01/2020 21:22	18/01/2020 11:52	14,49	12	173,84	CHI
202001105675	LUZIANIA	LZ21313732	MARAJOARA	17/01/2020 21:23	18/01/2020 08:11	17/01/2020 21:23	18/01/2020 08:11	10,80	2	21,59	CHI
202001105676	POSSE	PS12124656	IACIARA S2	17/01/2020 21:22	17/01/2020 23:06	17/01/2020 21:22	17/01/2020 23:06	1,72	17	29,22	CHI
202001105681	CALDAZINHA	BV12080319	CEPAIGO S2	17/01/2020 21:14	18/01/2020 01:35	17/01/2020 21:14	18/01/2020 01:35	4,34	4	17,37	CHI
202001105683	COCALZINHO DE GOIAS	CB12051786	GOIANESIA S1	17/01/2020 21:15	18/01/2020 10:50	17/01/2020 21:15	18/01/2020 10:50	13,58	127	1724,98	CHI
202001105693	PIRENOPOLIS	PV11198350	CORUMBA	17/01/2020 20:17	17/01/2020 22:49	17/01/2020 20:17	17/01/2020 22:49	2,52	52	131,17	CHI
202001105705	CORUMBAIBA	CI12333281RE	VILA CORUMBA	18/01/2020 07:27	18/01/2020 14:07	18/01/2020 07:27	18/01/2020 14:07	6,66	119	792,54	CHI

202001105707	PADRE BERNARDO	PB12275401	PADRE BERNARDO	17/01/2020 20:58	17/01/2020 23:54	17/01/2020 20:58	17/01/2020 23:54	2,93	27	79,03	CHI
202001105709	JATAI	290045794	JATAI S3	17/01/2020 21:28	18/01/2020 11:00	17/01/2020 21:28	18/01/2020 11:00	13,52	1	13,52	CHI
202001105758	ITAPIRAPUA	IU12142895	MATRINCHA	17/01/2020 21:36	18/01/2020 08:05	17/01/2020 21:36	18/01/2020 08:05	10,47	7	73,31	CHI
202001105763	PIRENOPOLIS	PV21000013	CORUMBA	17/01/2020 21:37	18/01/2020 11:00	17/01/2020 21:37	18/01/2020 11:00	13,37	3	40,12	CHI
202001105766	POSSE	10007513524	IACIARA S2	17/01/2020 21:38	18/01/2020 09:01	17/01/2020 21:38	18/01/2020 09:01	11,38	1	11,38	CHI
202001105771	ITUMBIARA	690224229	ITUMBIARA VELHA S1	17/01/2020 21:39	18/01/2020 08:43	17/01/2020 21:39	18/01/2020 08:43	11,07	1	11,07	CHI
202001105772	POSSE	PS11180899	IACIARA S2	17/01/2020 21:40	18/01/2020 12:03	17/01/2020 21:40	18/01/2020 12:03	14,38	12	172,58	CHI
202001105778	MORRINHOS	MR21120830	MORRINHOS	17/01/2020 21:40	18/01/2020 11:42	17/01/2020 21:40	18/01/2020 11:42	14,02	1	14,02	CHI
202001105779	HIDROLANDIA	PJ12074760	PIRACANJUBA	17/01/2020 21:41	19/01/2020 17:48	17/01/2020 21:41	19/01/2020 17:48	44,12	8	352,92	CHI
202001105779	PIRACANJUBA	PJ12074760	PIRACANJUBA	17/01/2020 21:41	19/01/2020 17:48	17/01/2020 21:41	19/01/2020 17:48	44,12	4	176,46	CHI
202001105780	BARRO ALTO	10004590463	GOIANESIA S1	17/01/2020 21:41	18/01/2020 15:13	17/01/2020 21:41	18/01/2020 15:13	17,53	1	17,53	CHI
202001105789	CRIXAS	CX12262895	SERRA DO OURO	17/01/2020 21:40	17/01/2020 23:50	17/01/2020 21:40	17/01/2020 23:50	2,15	10	21,54	CHI
202001105812	LUZIANIA	LZ12362719	CRISTALINA S2	17/01/2020 21:52	18/01/2020 13:17	17/01/2020 21:52	18/01/2020 13:17	15,40	3	46,20	CHI
202001105823	CABECEIRAS	CW21184542	ITUIQUIRA	17/01/2020 21:55	18/01/2020 07:24	17/01/2020 21:55	18/01/2020 07:24	9,47	1	9,47	CHI
202001105830	FAZENDA NOVA	JP12316446	IPORA	17/01/2020 18:48	18/01/2020 06:39	17/01/2020 18:48	18/01/2020 06:39	11,83	3	35,50	CHI
202001105830	JAUPACI	JP12316446	IPORA	17/01/2020 18:48	18/01/2020 06:39	17/01/2020 18:48	18/01/2020 06:39	11,83	4	47,34	CHI
202001105832	VIANOPOLIS	510022080	VIANOPOLIS	17/01/2020 21:59	18/01/2020 00:54	17/01/2020 21:59	18/01/2020 00:54	2,91	1	2,91	CHI
202001105837	CAMPOS VERDES	VD12257334	SANTA TEREZINHA	17/01/2020 21:40	18/01/2020 01:00	17/01/2020 21:40	18/01/2020 01:00	3,33	6	19,96	CHI
202001105842	RIO VERDE	RV12327004	RIO VERDE S2	17/01/2020 22:03	18/01/2020 10:50	17/01/2020 22:03	18/01/2020 10:50	12,78	3	38,34	CHI
202001105850	ANICUNS	AC12000067	ANICUNS	17/01/2020 21:52	18/01/2020 02:27	17/01/2020 21:52	18/01/2020 02:27	4,58	15	68,75	CHI
202001105854	AMARALINA	MU12391653	MARA ROSA	17/01/2020 22:09	18/01/2020 10:15	17/01/2020 22:09	18/01/2020 10:15	12,10	20	241,92	CHI
202001105857	VILA PROPICIO	GE21185213	GOIANESIA S1	17/01/2020 22:10	18/01/2020 10:45	17/01/2020 22:10	18/01/2020 10:45	12,58	1	12,58	CHI
202001105858	IVOLANDIA	IV12037399	IPORA	17/01/2020 20:29	19/01/2020 00:26	17/01/2020 20:29	19/01/2020 00:26	27,94	8	223,55	CHI
202001105862	NIQUELANDIA	NQ12255457	NIQUELANDIA SUBTRANSMISSAO	17/01/2020 21:44	17/01/2020 23:42	17/01/2020 21:44	17/01/2020 23:42	1,96	109	214,06	CHI
202001105863	TRINDADE	40192120	TRINDADE	17/01/2020 22:11	17/01/2020 23:54	17/01/2020 22:11	17/01/2020 23:54	1,71	1	1,71	CHI
202001105864	GOIANIA	14950728	CARAJAS S1	17/01/2020 22:12	18/01/2020 00:13	17/01/2020 22:12	18/01/2020 00:13	2,00	1	2,00	CHI
202001105866	JUSSARA	JR12011813	BRITANIA	17/01/2020 22:13	18/01/2020 16:29	17/01/2020 22:13	18/01/2020 16:29	18,26	29	529,68	CHI
202001105873	MAURILANDIA	ML21279453	RIO DOS BOIS	17/01/2020 22:15	18/01/2020 07:35	17/01/2020 22:15	18/01/2020 07:35	9,32	1	9,32	CHI
202001105875	APORE	AE21154267	ITAJA S1	17/01/2020 22:16	18/01/2020 11:49	17/01/2020 22:16	18/01/2020 11:49	13,55	1	13,55	CHI
202001105876	CACU	CC21027355	CACHOEIRA ALTA	17/01/2020 22:16	18/01/2020 15:40	17/01/2020 22:16	18/01/2020 15:40	17,39	1	17,39	CHI
202001105880	SAO MIGUEL DO PASSA QUATRO	SQ21244738	CRISTIANOPOLIS	17/01/2020 22:17	18/01/2020 09:44	17/01/2020 22:17	18/01/2020 09:44	11,44	1	11,44	CHI
202001105882	MINEIROS	MY12358869	PARQUE DAS EMAS	17/01/2020 22:18	18/01/2020 10:56	17/01/2020 22:18	18/01/2020 10:56	12,63	120	1515,77	CHI
202001105882	SANTA RITA DO ARAGUAIA	MY12358869	PARQUE DAS EMAS	17/01/2020 22:18	18/01/2020 10:56	17/01/2020 22:18	18/01/2020 10:56	12,63	4	50,53	CHI

202001105894	APARECIDA DE GOIANIA	12722212	REAL S2	17/01/2020 22:24	17/01/2020 23:26	17/01/2020 22:24	17/01/2020 23:26	1,02	1	1,02	CHI
202001105897	TRINDADE	40072332	TRINDADE	17/01/2020 22:28	18/01/2020 00:02	17/01/2020 22:28	18/01/2020 00:02	1,56	1	1,56	CHI
202001105899	ITABERAÍ	AR12019610	ARACU	17/01/2020 18:14	18/01/2020 00:31	17/01/2020 18:14	18/01/2020 00:31	6,27	6	37,65	CHI
202001105901	CRISTALINA	KR10395376	CRISTALINA S1	17/01/2020 21:55	18/01/2020 13:15	17/01/2020 21:55	18/01/2020 00:13	2,29	47	107,83	CHI
202001105901	IPAMERI	KR10395376	CRISTALINA S1	17/01/2020 21:55	18/01/2020 13:15	17/01/2020 21:55	18/01/2020 00:13	2,29	6	13,77	CHI
202001105901	CRISTALINA	KR10395376	CRISTALINA S1	17/01/2020 21:55	18/01/2020 13:15	18/01/2020 00:14	18/01/2020 02:42	2,47	27	66,59	CHI
202001105901	IPAMERI	KR10395376	CRISTALINA S1	17/01/2020 21:55	18/01/2020 13:15	18/01/2020 00:14	18/01/2020 02:42	2,47	6	14,80	CHI
202001105901	CRISTALINA	KR12246115LD	CRISTALINA S1	17/01/2020 21:55	18/01/2020 13:15	17/01/2020 21:55	18/01/2020 11:25	13,50	207	2794,85	CHI
202001105901	CRISTALINA	KR12246115LD	CRISTALINA S1	17/01/2020 21:55	18/01/2020 13:15	18/01/2020 00:14	18/01/2020 11:25	11,18	13	145,30	CHI
202001105901	CRISTALINA	KR12237804	CRISTALINA S1	17/01/2020 21:55	18/01/2020 13:15	18/01/2020 00:14	18/01/2020 13:15	13,01	7	91,07	CHI
202001105937	EDEALINA	00500214	EDEIA	17/01/2020 22:58	19/01/2020 10:31	17/01/2020 22:58	17/01/2020 23:04	0,10	1	0,10	CHI
202001105937	EDEIA	00500214	EDEIA	17/01/2020 22:58	19/01/2020 10:31	17/01/2020 22:58	17/01/2020 23:04	0,10	600	58,33	CHI
202001105937	EDEIA	00500214	EDEIA	17/01/2020 22:58	19/01/2020 10:31	17/01/2020 22:58	18/01/2020 03:34	4,60	1924	8853,07	CHI
202001105937	EDEIA	EA16404836	EDEIA	17/01/2020 22:58	19/01/2020 10:31	17/01/2020 23:02	18/01/2020 03:34	4,54	23	104,33	CHI
202001105937	EDEIA	00500214	EDEIA	17/01/2020 22:58	19/01/2020 10:31	17/01/2020 22:58	18/01/2020 04:25	5,46	315	1718,85	CHI
202001105937	ACREUNA	00500214	EDEIA	17/01/2020 22:58	19/01/2020 10:31	17/01/2020 22:58	18/01/2020 04:32	5,57	14	77,94	CHI
202001105937	EDEIA	00500214	EDEIA	17/01/2020 22:58	19/01/2020 10:31	17/01/2020 22:58	18/01/2020 04:32	5,57	61	339,58	CHI
202001105937	INDIARA	00500214	EDEIA	17/01/2020 22:58	19/01/2020 10:31	17/01/2020 22:58	18/01/2020 04:32	5,57	43	239,38	CHI
202001105937	EDEIA	00500214	EDEIA	17/01/2020 22:58	19/01/2020 10:31	17/01/2020 22:58	18/01/2020 10:21	11,38	39	444,00	CHI
202001105937	EDEIA	00500214	EDEIA	17/01/2020 22:58	19/01/2020 10:31	17/01/2020 22:58	18/01/2020 13:51	14,88	20	297,62	CHI
202001105937	EDEIA	EA12000164LD	EDEIA	17/01/2020 22:58	19/01/2020 10:31	18/01/2020 10:22	18/01/2020 13:51	3,49	30	104,59	CHI
202001105937	EDEIA	EA12263293	EDEIA	17/01/2020 22:58	19/01/2020 10:31	18/01/2020 10:22	19/01/2020 10:31	24,16	9	217,40	CHI
202001106010	APARECIDA DE GOIANIA	AP11004615	REAL S1	17/01/2020 22:15	18/01/2020 01:16	17/01/2020 22:15	18/01/2020 01:16	3,01	115	345,96	CHI
202001106012	MOZARLANDIA	MZ12015614	MOZARLANDIA	17/01/2020 22:36	18/01/2020 08:50	17/01/2020 22:36	18/01/2020 08:50	10,23	13	132,93	CHI
202001106014	QUIRINOPOLIS	QI21301487	QUIRINOPOLIS	17/01/2020 22:37	18/01/2020 11:51	17/01/2020 22:37	18/01/2020 11:51	13,23	4	52,93	CHI
202001106015	GOIANIA	16619754	GOYA S1	17/01/2020 22:37	18/01/2020 01:06	17/01/2020 22:37	18/01/2020 01:06	2,48	1	2,48	CHI
202001106018	NEROPOLIS	NR12322425	NEROPOLIS S2	17/01/2020 22:40	18/01/2020 01:33	17/01/2020 22:40	18/01/2020 01:33	2,88	8	23,05	CHI
202001106018	NEROPOLIS	NR12322425	NEROPOLIS S2	17/01/2020 22:40	18/01/2020 01:33	17/01/2020 22:40	18/01/2020 01:33	2,88	26	74,91	CHI
202001106018	SANTO ANTONIO DE GOIAS	NR12322425	NEROPOLIS S2	17/01/2020 22:40	18/01/2020 01:33	17/01/2020 22:40	18/01/2020 01:33	2,88	4	11,52	CHI
202001106019	BURITINOPOLIS	BQ11190576	IACIARA S2	17/01/2020 22:40	18/01/2020 07:59	17/01/2020 22:40	18/01/2020 07:59	9,30	26	241,88	CHI
202001106021	SÃO FRANCISCO DE GOIAS	SF12039351	SÃO FRANCISCO DE GOIAS	17/01/2020 22:41	18/01/2020 01:46	17/01/2020 22:41	18/01/2020 01:46	3,07	20	61,42	CHI
202001106022	VIANOPOLIS	VN12107799	VIANOPOLIS	17/01/2020 19:40	18/01/2020 00:05	17/01/2020 19:40	18/01/2020 00:05	4,40	6	26,42	CHI
202001106027	PADRE BERNARDO	PB12231533	PADRE BERNARDO	17/01/2020 22:46	18/01/2020 13:42	17/01/2020 22:46	18/01/2020 13:42	14,92	24	358,06	CHI

202001106029	FORMOSA	610096102	ITUIQUIRA	17/01/2020 22:47	17/01/2020 23:36	17/01/2020 22:47	17/01/2020 23:36	0,81	1	0,81	CHI
202001106031	ARUANA	MP12041292	MOZARLANDIA	17/01/2020 22:48	18/01/2020 03:31	17/01/2020 22:48	18/01/2020 03:31	4,71	3	14,13	CHI
202001106031	MATRINCHA	MP12041292	MOZARLANDIA	17/01/2020 22:48	18/01/2020 03:31	17/01/2020 22:48	18/01/2020 03:31	4,71	1	4,71	CHI
202001106032	APARECIDA DE GOIANIA	16848731	REAL S2	17/01/2020 22:48	18/01/2020 00:27	17/01/2020 22:48	18/01/2020 00:27	1,64	1	1,64	CHI
202001106033	SAO LUIZ DO NORTE	GE12339967	ITAPACI	17/01/2020 20:21	18/01/2020 16:22	17/01/2020 20:21	18/01/2020 16:22	20,01	3	60,03	CHI
202001106048	MONTE ALEGRE DE GOIAS	MA12211597	SAO DOMINGOS	17/01/2020 23:08	18/01/2020 01:09	17/01/2020 23:08	18/01/2020 01:09	2,01	10	20,06	CHI
202001106052	IACIARA	IA12344241	IACIARA S1	17/01/2020 23:13	18/01/2020 04:25	17/01/2020 23:13	18/01/2020 04:25	5,20	45	233,83	CHI
202001106061	BELA VISTA DE GOIAS	XX03742817	BELA VISTA S1	17/01/2020 23:20	18/01/2020 19:16	17/01/2020 23:20	18/01/2020 19:16	19,92	1	19,92	CHI
202001106065	MATRINCHA	MP12010442	MOZARLANDIA	17/01/2020 23:28	18/01/2020 04:13	17/01/2020 23:28	18/01/2020 04:13	4,75	4	18,99	CHI
202001106067	CRISTALINA	KR21230096	CRISTALINA S1	17/01/2020 23:32	18/01/2020 14:04	17/01/2020 23:32	18/01/2020 14:04	14,53	1	14,53	CHI
202001106070	ARUANA	2380018929	ARUANA	17/01/2020 23:36	18/01/2020 07:03	17/01/2020 23:36	18/01/2020 07:03	7,45	1	7,45	CHI
202001106073	CALDAS NOVAS	760373360	SERRA DE CALDAS	17/01/2020 23:41	18/01/2020 12:30	17/01/2020 23:41	18/01/2020 12:30	12,80	1	12,80	CHI
202001106074	ITUMBIARA	10002453507	ITUMBIARA NOVA	17/01/2020 23:42	18/01/2020 12:55	17/01/2020 23:42	18/01/2020 12:55	13,21	1	13,21	CHI
202001106075	JANDAIA	JD12008614	PALMEIRAS	17/01/2020 23:25	18/01/2020 08:00	17/01/2020 23:25	18/01/2020 08:00	8,59	22	188,97	CHI
202001106075	PARAUNA	JD12008614	PALMEIRAS	17/01/2020 23:25	18/01/2020 08:00	17/01/2020 23:25	18/01/2020 08:00	8,59	6	51,54	CHI
202001106076	BONFINOPOLIS	PO12315103	NOVO PLANALTO	17/01/2020 23:44	18/01/2020 03:51	17/01/2020 23:44	18/01/2020 03:51	4,11	1	4,11	CHI
202001106076	BONOPOLIS	PO12315103	NOVO PLANALTO	17/01/2020 23:44	18/01/2020 03:51	17/01/2020 23:44	18/01/2020 03:51	4,11	1	4,11	CHI
202001106076	PORANGATU	PO12315103	NOVO PLANALTO	17/01/2020 23:44	18/01/2020 03:51	17/01/2020 23:44	18/01/2020 03:51	4,11	2	8,21	CHI
202001106077	ARAGUAPAZ	MS12113246	ITAPURANGA	17/01/2020 23:44	18/01/2020 08:08	17/01/2020 23:44	18/01/2020 08:08	8,39	2	16,77	CHI
202001106077	FAINA	MS12113246	ITAPURANGA	17/01/2020 23:44	18/01/2020 08:08	17/01/2020 23:44	18/01/2020 08:08	8,39	7	58,70	CHI
202001106077	MORRO AGUDO DE GOIAS	MS12113246	ITAPURANGA	17/01/2020 23:44	18/01/2020 08:08	17/01/2020 23:44	18/01/2020 08:08	8,39	7	58,70	CHI
202001106081	ACREUNA	EU12301057	ACREUNA	17/01/2020 23:57	18/01/2020 08:54	17/01/2020 23:57	18/01/2020 08:54	8,94	29	259,28	CHI
202001106085	FIRMINOPOLIS	TV31098061	FIRMINOPOLIS S1	18/01/2020 00:17	18/01/2020 07:24	18/01/2020 00:17	18/01/2020 07:24	7,11	1	7,11	CHI
202001106088	CORREGO DO OURO	CO21059739	FIRMINOPOLIS S2	18/01/2020 00:20	18/01/2020 08:48	18/01/2020 00:20	18/01/2020 08:48	8,46	1	8,46	CHI
202001106089	JUSSARA	RN12250752	BRITANIA	18/01/2020 00:22	18/01/2020 08:55	18/01/2020 00:22	18/01/2020 08:55	8,54	19	162,25	CHI
202001106089	SANTA FE DE GOIAS	RN12250752	BRITANIA	18/01/2020 00:22	18/01/2020 08:55	18/01/2020 00:22	18/01/2020 08:55	8,54	40	341,59	CHI
202001106094	ITUMBIARA	IT11166329	PARANAIBA	18/01/2020 00:32	18/01/2020 11:23	18/01/2020 00:32	18/01/2020 11:23	10,84	3	32,53	CHI
202001106109	GOIANIA	GN11001584	CAMPINAS S3	18/01/2020 00:46	18/01/2020 03:25	18/01/2020 00:46	18/01/2020 03:25	2,65	105	277,99	CHI
202001106201	JUSSARA	BT12245061	BRITANIA	18/01/2020 01:01	18/01/2020 11:30	18/01/2020 01:01	18/01/2020 11:30	10,47	2	20,94	CHI
202001106204	CRIXAS	CX12318400	MOZARLANDIA	18/01/2020 01:13	18/01/2020 12:59	18/01/2020 01:13	18/01/2020 12:59	11,76	11	129,35	CHI
202001106205	CORREGO DO OURO	CO12004045	FIRMINOPOLIS S2	18/01/2020 00:47	18/01/2020 07:58	18/01/2020 00:47	18/01/2020 07:58	7,17	16	114,70	CHI
202001106207	PIRES DO RIO	10030276134	PIRES DO RIO S1	18/01/2020 01:20	18/01/2020 09:53	18/01/2020 01:20	18/01/2020 09:53	8,55	1	8,55	CHI
202001106208	HEITORAI	HE12346692	GOIAS	17/01/2020 21:46	18/01/2020 09:03	17/01/2020 21:46	18/01/2020 09:03	11,27	28	315,56	CHI

202001106212	LUZIANIA	LZ12313611	VIANOPOLIS	18/01/2020 01:59	18/01/2020 08:47	18/01/2020 01:59	18/01/2020 08:47	6,79	10	67,86	CHI
202001106215	JUSSARA	JR21060549	JUSSARA	18/01/2020 02:25	18/01/2020 04:51	18/01/2020 02:25	18/01/2020 04:51	2,43	1	2,43	CHI
202001106216	BOM JARDIM DE GOIAS	BM12212797	BOM JARDIM	18/01/2020 02:30	18/01/2020 07:57	18/01/2020 02:30	18/01/2020 07:57	5,44	87	473,67	CHI
202001106216	PIRANHAS	BM12212797	BOM JARDIM	18/01/2020 02:30	18/01/2020 07:57	18/01/2020 02:30	18/01/2020 07:57	5,44	2	10,89	CHI
202001106217	FAZENDA NOVA	FN12113509	IPORA	18/01/2020 02:41	18/01/2020 11:55	18/01/2020 02:41	18/01/2020 11:55	9,22	36	332,04	CHI
202001106218	GOIAS	GS11090812	GOIAS	18/01/2020 02:53	18/01/2020 07:18	18/01/2020 02:53	18/01/2020 07:18	4,43	2	8,86	CHI
202001106223	CATALAO	IP12404730	IPAMERI	18/01/2020 03:01	18/01/2020 10:47	18/01/2020 03:01	18/01/2020 10:47	7,76	2	15,52	CHI
202001106223	GOIANDIRA	IP12404730	IPAMERI	18/01/2020 03:01	18/01/2020 10:47	18/01/2020 03:01	18/01/2020 10:47	7,76	4	31,03	CHI
202001106223	IPAMERI	IP12404730	IPAMERI	18/01/2020 03:01	18/01/2020 10:47	18/01/2020 03:01	18/01/2020 10:47	7,76	14	108,61	CHI
202001106230	CEZARINA	CZ12000034	CEZARINA	18/01/2020 02:54	18/01/2020 08:09	18/01/2020 02:54	18/01/2020 08:09	5,24	22	115,25	CHI
202001106230	INDIARA	CZ12000034	CEZARINA	18/01/2020 02:54	18/01/2020 08:09	18/01/2020 02:54	18/01/2020 08:09	5,24	9	47,15	CHI
202001106231	CAIAPONIA	CP12374976	PALESTINA	17/01/2020 21:50	18/01/2020 10:36	17/01/2020 21:50	18/01/2020 10:36	12,75	6	76,51	CHI
202001106234	NOVA IGUACU DE GOIAS	GG12375656	SANTA TEREZINHA	18/01/2020 03:54	18/01/2020 09:00	18/01/2020 03:54	18/01/2020 09:00	5,10	6	30,60	CHI
202001106234	PILAR DE GOIAS	GG12375656	SANTA TEREZINHA	18/01/2020 03:54	18/01/2020 09:00	18/01/2020 03:54	18/01/2020 09:00	5,10	14	71,40	CHI
202001106235	OURO VERDE DE GOIAS	PG12060031	PETROLINA	18/01/2020 04:03	18/01/2020 08:33	18/01/2020 04:03	18/01/2020 08:33	4,50	23	103,44	CHI
202001106236	ITAGUARU	JA12328472	JARAGUA	18/01/2020 04:06	18/01/2020 12:09	18/01/2020 04:06	18/01/2020 12:09	8,04	17	136,73	CHI
202001106236	JARAGUA	JA12328472	JARAGUA	18/01/2020 04:06	18/01/2020 12:09	18/01/2020 04:06	18/01/2020 12:09	8,04	1	8,04	CHI
202001106238	COCALZINHO DE GOIAS	ZN13018210	COCALZINHO	18/01/2020 04:10	18/01/2020 10:07	18/01/2020 04:10	18/01/2020 10:07	5,94	854	5071,34	CHI
202001106238	CORUMBA DE GOIAS	ZN13018210	COCALZINHO	18/01/2020 04:10	18/01/2020 10:07	18/01/2020 04:10	18/01/2020 10:07	5,94	76	451,31	CHI
202001106241	SAO MIGUEL DO ARAGUAIA	SM12000063	SAO MIGUEL DO ARAGUAIA	18/01/2020 04:11	18/01/2020 12:24	18/01/2020 04:11	18/01/2020 09:01	4,84	29	140,50	CHI
202001106241	SAO MIGUEL DO ARAGUAIA	SM13315095	SAO MIGUEL DO ARAGUAIA	18/01/2020 04:11	18/01/2020 12:24	18/01/2020 04:11	18/01/2020 12:24	8,22	6	49,33	CHI
202001106242	MAIRIPOTABA	MI12051347	PONTALINA	18/01/2020 04:17	18/01/2020 10:36	18/01/2020 04:17	18/01/2020 10:36	6,31	7	44,19	CHI
202001106242	PONTALINA	MI12051347	PONTALINA	18/01/2020 04:17	18/01/2020 10:36	18/01/2020 04:17	18/01/2020 10:36	6,31	3	18,94	CHI
202001106244	ARENOPOLIS	AY12223147	IPORA	18/01/2020 03:04	18/01/2020 10:23	18/01/2020 03:04	18/01/2020 10:23	7,32	58	424,46	CHI
202001106244	MONTES CLAROS DE GOIAS	AY12223147	IPORA	18/01/2020 03:04	18/01/2020 10:23	18/01/2020 03:04	18/01/2020 10:23	7,32	1	7,32	CHI
202001106244	PIRANHAS	AY12223147	IPORA	18/01/2020 03:04	18/01/2020 10:23	18/01/2020 03:04	18/01/2020 10:23	7,32	1	7,32	CHI
202001106245	DIORAMA	DI12066071	ARENOPOLIS	18/01/2020 04:31	18/01/2020 08:05	18/01/2020 04:31	18/01/2020 08:05	3,57	28	99,86	CHI
202001106247	ADELANDIA	SL12019453	ANICUNS	18/01/2020 04:33	18/01/2020 08:19	18/01/2020 04:33	18/01/2020 08:19	3,75	26	97,53	CHI
202001106247	MOSSAMEDES	SL12019453	ANICUNS	18/01/2020 04:33	18/01/2020 08:19	18/01/2020 04:33	18/01/2020 08:19	3,75	2	7,50	CHI
202001106247	ADELANDIA	SL12019453	FIRMINOPOLIS S2	18/01/2020 04:33	18/01/2020 08:19	18/01/2020 04:33	18/01/2020 08:19	3,75	45	168,80	CHI
202001106247	MOSSAMEDES	SL12019453	FIRMINOPOLIS S2	18/01/2020 04:33	18/01/2020 08:19	18/01/2020 04:33	18/01/2020 08:19	3,75	5	18,76	CHI
202001106247	SANCLERLANDIA	SL12019453	FIRMINOPOLIS S2	18/01/2020 04:33	18/01/2020 08:19	18/01/2020 04:33	18/01/2020 08:19	3,75	30	112,53	CHI
202001106247	SAO LUIS DE MONTES BELOS	SL12019453	FIRMINOPOLIS S2	18/01/2020 04:33	18/01/2020 08:19	18/01/2020 04:33	18/01/2020 08:19	3,75	14	52,52	CHI

202001106248	MIMOSO DE GOIAS	NQ12371855	BARRO ALTO	18/01/2020 04:34	18/01/2020 10:27	18/01/2020 04:34	18/01/2020 10:27	5,89	4	23,57	CHI
202001106248	NIQUELANDIA	NQ12371855	BARRO ALTO	18/01/2020 04:34	18/01/2020 10:27	18/01/2020 04:34	18/01/2020 10:27	5,89	243	1432,01	CHI
202001106249	QUIRINOPOLIS	QI32011354	QUIRINOPOLIS	18/01/2020 00:52	18/01/2020 14:52	18/01/2020 00:52	18/01/2020 14:52	13,99	12	167,87	CHI
202001106252	AURILANDIA	CG12391526	FIRMINOPOLIS S2	18/01/2020 04:41	18/01/2020 08:46	18/01/2020 04:41	18/01/2020 08:46	4,07	2	8,14	CHI
202001106252	CACHOEIRA DE GOIAS	CG12391526	FIRMINOPOLIS S2	18/01/2020 04:41	18/01/2020 08:46	18/01/2020 04:41	18/01/2020 08:46	4,07	11	44,79	CHI
202001106252	PARAUNA	CG12391526	FIRMINOPOLIS S2	18/01/2020 04:41	18/01/2020 08:46	18/01/2020 04:41	18/01/2020 08:46	4,07	32	130,29	CHI
202001106263	ARENOPOLIS	AY12188398	ARENOPOLIS	17/01/2020 22:34	18/01/2020 08:54	17/01/2020 22:34	18/01/2020 08:54	10,33	10	103,34	CHI
202001106263	DIORAMA	AY12188398	ARENOPOLIS	17/01/2020 22:34	18/01/2020 08:54	17/01/2020 22:34	18/01/2020 08:54	10,33	7	72,34	CHI
202001106266	ORIZONA	OZ12022888	PIRES DO RIO S2	17/01/2020 23:05	18/01/2020 10:58	17/01/2020 23:05	18/01/2020 10:58	11,87	37	439,08	CHI
202001106268	CORUMBAIBA	CI12000451	VILA CORUMBA	18/01/2020 05:24	18/01/2020 10:35	18/01/2020 05:24	18/01/2020 10:35	5,18	8	41,41	CHI
202001106268	NOVA AURORA	CI12000451	VILA CORUMBA	18/01/2020 05:24	18/01/2020 10:35	18/01/2020 05:24	18/01/2020 10:35	5,18	7	36,23	CHI
202001106269	MOSSAMEDES	SC12164006	FIRMINOPOLIS S2	18/01/2020 05:24	18/01/2020 08:25	18/01/2020 05:24	18/01/2020 08:25	3,01	11	33,06	CHI
202001106272	IACIARA	IA12344241	IACIARA S1	18/01/2020 05:21	18/01/2020 09:54	18/01/2020 05:21	18/01/2020 09:54	4,54	45	204,29	CHI
202001106278	PARAUNA	PU12080492	PARAUNA	18/01/2020 05:29	18/01/2020 06:45	18/01/2020 05:29	18/01/2020 06:45	1,26	55	69,36	CHI
202001106279	PETROLINA DE GOIAS	PG12230708	PETROLINA	18/01/2020 05:30	18/01/2020 07:29	18/01/2020 05:30	18/01/2020 07:29	1,98	6	11,89	CHI
202001106279	SAO FRANCISCO DE GOIAS	PG12230708	PETROLINA	18/01/2020 05:30	18/01/2020 07:29	18/01/2020 05:30	18/01/2020 07:29	1,98	13	25,76	CHI
202001106283	MINEIROS	MY21226468	PARQUE DAS EMAS	18/01/2020 05:34	18/01/2020 15:24	18/01/2020 05:34	18/01/2020 15:24	9,82	1	9,82	CHI
202001106284	PIRES DO RIO	PR12409073	PIRES DO RIO S2	18/01/2020 05:36	18/01/2020 14:12	18/01/2020 05:36	18/01/2020 14:12	8,59	3	25,77	CHI
202001106290	BELA VISTA DE GOIAS	BV12060809	BELA VISTA S2	18/01/2020 05:40	18/01/2020 11:36	18/01/2020 05:40	18/01/2020 11:36	5,92	3	17,77	CHI
202001106292	DAMOLANDIA	DL12272281	INHUMAS S1	18/01/2020 05:41	18/01/2020 07:54	18/01/2020 05:41	18/01/2020 07:54	2,21	8	17,66	CHI
202001106294	GAMELEIRA DE GOIAS	GL21302371	ANAPOLIS UNIVERSITARIO S2	18/01/2020 05:42	18/01/2020 09:58	18/01/2020 05:42	18/01/2020 09:58	4,26	1	4,26	CHI
202001106298	ANICUNS	AC12391421	ANICUNS	18/01/2020 05:45	18/01/2020 07:13	18/01/2020 05:45	18/01/2020 07:13	1,46	3	4,38	CHI
202001106302	ALTO HORIZONTE	NH12396799	SANTA TEREZINHA	18/01/2020 05:49	18/01/2020 08:48	18/01/2020 05:49	18/01/2020 08:48	2,97	58	172,42	CHI
202001106302	CAMPOS VERDES	NH12396799	SANTA TEREZINHA	18/01/2020 05:49	18/01/2020 08:48	18/01/2020 05:49	18/01/2020 08:48	2,97	7	20,81	CHI
202001106302	PILAR DE GOIAS	NH12396799	SANTA TEREZINHA	18/01/2020 05:49	18/01/2020 08:48	18/01/2020 05:49	18/01/2020 08:48	2,97	1	2,97	CHI
202001106304	CUMARI	CT12011258	CATALAO S2	18/01/2020 05:51	20/01/2020 13:10	18/01/2020 05:51	18/01/2020 08:57	3,11	9	27,99	CHI
202001106304	CUMARI	CT12215631RE	CATALAO S2	18/01/2020 05:51	20/01/2020 13:10	18/01/2020 05:51	18/01/2020 12:05	6,24	9	56,20	CHI
202001106304	GOIANDIRA	CT12215631RE	CATALAO S2	18/01/2020 05:51	20/01/2020 13:10	18/01/2020 05:51	18/01/2020 12:05	6,24	1	6,24	CHI
202001106304	CUMARI	CT12042348	CATALAO S2	18/01/2020 05:51	20/01/2020 13:10	18/01/2020 05:51	18/01/2020 12:58	7,12	6	42,71	CHI
202001106304	GOIANDIRA	CT12042348	CATALAO S2	18/01/2020 05:51	20/01/2020 13:10	18/01/2020 05:51	18/01/2020 12:58	7,12	2	14,24	CHI
202001106304	CUMARI	CT12042341	CATALAO S2	18/01/2020 05:51	20/01/2020 13:10	18/01/2020 05:51	20/01/2020 13:10	55,32	1	55,32	CHI
202001106308	CALDAZINHA	BV12070811	CEPAIGO S2	18/01/2020 05:54	18/01/2020 09:27	18/01/2020 05:54	18/01/2020 09:27	3,55	15	53,20	CHI
202001106309	FORMOSA	FA12402620	ITIQUEIRA	18/01/2020 05:54	18/01/2020 08:34	18/01/2020 05:54	18/01/2020 08:34	2,66	34	90,39	CHI

202001106312	JATAI	JT12234313	JATAI S1	18/01/2020 05:57	18/01/2020 12:06	18/01/2020 05:57	18/01/2020 12:06	6,15	9	55,33	CHI
202001106315	BURITI ALEGRE	IT12000114RE	PARANAIBA	18/01/2020 05:58	18/01/2020 10:21	18/01/2020 05:58	18/01/2020 10:21	4,38	8	35,01	CHI
202001106315	ITUMBIARA	IT12000114RE	PARANAIBA	18/01/2020 05:58	18/01/2020 10:21	18/01/2020 05:58	18/01/2020 10:21	4,38	8	35,01	CHI
202001106315	PANAMA	IT12000114RE	PARANAIBA	18/01/2020 05:58	18/01/2020 10:21	18/01/2020 05:58	18/01/2020 10:21	4,38	2	8,75	CHI
202001106319	GUARANI DE GOIAS	GY12195884	IACIARA S1	18/01/2020 06:00	18/01/2020 09:36	18/01/2020 06:00	18/01/2020 09:36	3,59	10	35,94	CHI
202001106321	CRISTIANOPOLIS	CF12112079	CRISTIANOPOLIS	18/01/2020 06:02	18/01/2020 09:07	18/01/2020 06:02	18/01/2020 09:07	3,09	5	15,45	CHI
202001106324	CRISTALINA	KR12349171	PAMPLONA	18/01/2020 06:03	18/01/2020 09:16	18/01/2020 06:03	18/01/2020 09:16	3,20	1	3,20	CHI
202001106324	LUZIANIA	KR12349171	PAMPLONA	18/01/2020 06:03	18/01/2020 09:16	18/01/2020 06:03	18/01/2020 09:16	3,20	32	102,54	CHI
202001106325	EDEIA	EA12000059RE	EDEIA	18/01/2020 03:43	18/01/2020 15:51	18/01/2020 03:43	18/01/2020 15:51	12,13	93	1128,12	CHI
202001106326	FORMOSO	2410002414	PORANGATU	18/01/2020 06:07	18/01/2020 10:44	18/01/2020 06:07	18/01/2020 10:44	4,61	1	4,61	CHI
202001106340	CAMPO ALEGRE DE GOIAS	6939890	CAMPO ALEGRE DE GOIAS	18/01/2020 06:13	18/01/2020 12:52	18/01/2020 06:13	18/01/2020 12:52	6,65	10	66,49	CHI
202001106340	IPAMERI	6939890	CAMPO ALEGRE DE GOIAS	18/01/2020 06:13	18/01/2020 12:52	18/01/2020 06:13	18/01/2020 12:52	6,65	3	19,95	CHI
202001106346	ITUMBIARA	IT21134682	BOM JESUS DE GOIAS	18/01/2020 06:17	18/01/2020 21:23	18/01/2020 06:17	18/01/2020 21:23	15,08	1	15,08	CHI
202001106350	PIRANHAS	PH21092242	BOM JARDIM	18/01/2020 06:19	18/01/2020 10:36	18/01/2020 06:19	18/01/2020 10:36	4,28	1	4,28	CHI
202001106351	IPORA	IR12222975	IPORA	18/01/2020 05:25	18/01/2020 09:42	18/01/2020 05:25	18/01/2020 09:42	4,27	68	290,66	CHI
202001106351	IVOLANDIA	IR12222975	IPORA	18/01/2020 05:25	18/01/2020 09:42	18/01/2020 05:25	18/01/2020 09:42	4,27	6	25,65	CHI
202001106351	MOIPORA	IR12222975	IPORA	18/01/2020 05:25	18/01/2020 09:42	18/01/2020 05:25	18/01/2020 09:42	4,27	18	76,94	CHI
202001106357	JATAI	JT12205195	JATAI S1	18/01/2020 06:22	18/01/2020 08:48	18/01/2020 06:22	18/01/2020 08:48	2,43	45	109,30	CHI
202001106369	INDIARA	IY12391429	EDEIA	18/01/2020 06:26	18/01/2020 09:35	18/01/2020 06:26	18/01/2020 09:35	3,15	6	18,89	CHI
202001106370	FORMOSA	FA21146122	ITUIQUIRA	18/01/2020 06:26	18/01/2020 08:23	18/01/2020 06:26	18/01/2020 08:23	1,95	1	1,95	CHI
202001106373	SANTA RITA DO ARAGUAIA	MY12150634	SANTA RITA DO ARAGUAIA	17/01/2020 22:44	18/01/2020 12:48	17/01/2020 22:44	18/01/2020 12:48	14,05	11	154,59	CHI
202001106380	APARECIDA DE GOIANIA	AP12000054	CEPAIGO S1	18/01/2020 06:31	18/01/2020 07:52	18/01/2020 06:31	18/01/2020 07:52	1,34	1	1,34	CHI
202001106383	CRISTALINA	KR12118412	PAMPLONA	18/01/2020 06:31	18/01/2020 09:56	18/01/2020 06:31	18/01/2020 09:56	3,40	2	6,80	CHI
202001106385	PILAR DE GOIAS	HL12000025	SANTA TEREZINHA	17/01/2020 01:53	18/01/2020 13:26	17/01/2020 11:33	18/01/2020 13:26	25,88	1	25,88	CHI
202001106392	HIDROLINA	HL12232531	SANTA TEREZINHA	18/01/2020 06:35	19/01/2020 12:16	18/01/2020 06:35	19/01/2020 12:16	29,68	1	29,68	CHI
202001106393	NIQUELANDIA	NQ12330278	NIQUELANDIA SUBTRANSMISSAO	18/01/2020 06:35	18/01/2020 10:02	18/01/2020 06:35	18/01/2020 10:02	3,44	6	20,64	CHI
202001106395	PORANGATU	PO12022073	PORANGATU	18/01/2020 06:20	18/01/2020 08:41	18/01/2020 06:20	18/01/2020 08:41	2,34	43	100,67	CHI
202001106396	MONTE ALEGRE DE GOIAS	MA11280326	SAO DOMINGOS	18/01/2020 06:36	18/01/2020 09:12	18/01/2020 06:36	18/01/2020 09:12	2,59	3	7,77	CHI
202001106398	ITAGUARU	IC12336553	ITABERAI S1	18/01/2020 06:36	18/01/2020 11:22	18/01/2020 06:36	18/01/2020 11:22	4,75	3	14,26	CHI
202001106399	IPORA	IR21188492	IPORA	18/01/2020 06:37	18/01/2020 12:54	18/01/2020 06:37	18/01/2020 12:54	6,28	1	6,28	CHI
202001106404	MUNDO NOVO DE GOIAS	MH11269437	NOVA CRIXAS	18/01/2020 06:38	18/01/2020 09:41	18/01/2020 06:38	18/01/2020 09:41	3,04	1	3,04	CHI
202001106408	CRISTIANOPOLIS	PJ12212204	PIRACANJUBA	18/01/2020 02:01	18/01/2020 13:00	18/01/2020 02:01	18/01/2020 13:00	10,98	4	43,93	CHI
202001106408	PIRACANJUBA	PJ12212204	PIRACANJUBA	18/01/2020 02:01	18/01/2020 13:00	18/01/2020 02:01	18/01/2020 13:00	10,98	5	54,91	CHI

202001106408	SANTA CRUZ DE GOIAS	PJ12212204	PIRACANJUBA	18/01/2020 02:01	18/01/2020 13:00	18/01/2020 02:01	18/01/2020 13:00	10,98	4	43,93	CHI
202001106409	CAIAPONIA	CP12075032	CAIAPONIA	18/01/2020 06:41	18/01/2020 09:50	18/01/2020 06:41	18/01/2020 09:50	3,14	10	31,41	CHI
202001106410	ARAGUAPAZ	AZ12057507	GOIAS	18/01/2020 06:41	18/01/2020 09:00	18/01/2020 06:41	18/01/2020 09:00	2,31	19	43,81	CHI
202001106416	SANCLERLANDIA	SC12005460	FIRMINOPOLIS S2	18/01/2020 06:43	18/01/2020 09:52	18/01/2020 06:43	18/01/2020 09:52	3,14	4	12,57	CHI
202001106419	ITAJA	IJ21000076	CACHOEIRA ALTA	18/01/2020 06:44	19/01/2020 02:58	18/01/2020 06:44	19/01/2020 02:58	20,23	1	20,23	CHI
202001106423	NOVA CRIXAS	NA12091692	NOVA CRIXAS	18/01/2020 01:03	18/01/2020 13:43	18/01/2020 01:03	18/01/2020 13:17	12,22	13	158,87	CHI
202001106423	NOVA CRIXAS	NA13210451	NOVA CRIXAS	18/01/2020 01:03	18/01/2020 13:43	18/01/2020 01:03	18/01/2020 13:43	12,66	9	113,94	CHI
202001106424	ABADIANIA	AA21297633	ANAPOLIS UNIVERSITARIO S1	18/01/2020 06:45	18/01/2020 12:02	18/01/2020 06:45	18/01/2020 12:02	5,27	1	5,27	CHI
202001106425	BALIZA	BH12331465	CAIAPONIA	18/01/2020 05:52	18/01/2020 10:45	18/01/2020 05:52	18/01/2020 10:45	4,88	26	126,91	CHI
202001106430	GOIANDIRA	GD21127629	CATALAO S1	18/01/2020 06:47	18/01/2020 14:08	18/01/2020 06:47	18/01/2020 14:08	7,35	1	7,35	CHI
202001106431	MINEIROS	MY12241805	PARQUE DAS EMAS	17/01/2020 21:23	18/01/2020 09:12	17/01/2020 21:23	18/01/2020 09:12	11,82	15	177,25	CHI
202001106435	PALMEIRAS DE GOIAS	PL12308413	PALMEIRAS	18/01/2020 06:48	18/01/2020 07:50	18/01/2020 06:48	18/01/2020 07:50	1,04	12	12,49	CHI
202001106436	SAO FRANCISCO DE GOIAS	SF12000173	SAO FRANCISCO DE GOIAS	18/01/2020 06:48	18/01/2020 10:21	18/01/2020 06:48	18/01/2020 10:21	3,55	10	35,47	CHI
202001106439	URUACU	UR21156473	CAMPINORTE	18/01/2020 06:48	18/01/2020 10:06	18/01/2020 06:48	18/01/2020 10:06	3,29	8	26,36	CHI
202001106440	ITAPURANGA	IK12299313	ITAPURANGA	18/01/2020 06:35	18/01/2020 11:20	18/01/2020 06:35	18/01/2020 11:20	4,74	33	156,28	CHI
202001106443	MUNDO NOVO DE GOIAS	MH12357676	NOVA CRIXAS	18/01/2020 00:30	18/01/2020 08:38	18/01/2020 00:30	18/01/2020 08:38	8,12	24	194,87	CHI
202001106447	CEZARINA	CZ12000023	CEZARINA	18/01/2020 06:52	18/01/2020 09:37	18/01/2020 06:52	18/01/2020 09:37	2,75	2	5,49	CHI
202001106448	PORANGATU	PO12240663	PORANGATU	18/01/2020 06:52	18/01/2020 18:03	18/01/2020 06:52	18/01/2020 18:03	11,19	3	33,56	CHI
202001106450	SAO LUIS DE MONTES BELOS	SL31145796	SAO LUIZ DOS MONTES BELOS	18/01/2020 06:53	18/01/2020 10:59	18/01/2020 06:53	18/01/2020 10:59	4,09	1	4,09	CHI
202001106465	BARRO ALTO	BA12185125	BARRO ALTO	18/01/2020 06:39	18/01/2020 11:58	18/01/2020 06:39	18/01/2020 11:58	5,31	42	222,97	CHI
202001106468	VICENTINOPOLIS	VI12050320	GOIATUBA S1	18/01/2020 06:57	18/01/2020 08:20	18/01/2020 06:57	18/01/2020 08:20	1,38	1	1,38	CHI
202001106469	MIMOSO DE GOIAS	NQ12251264	BARRO ALTO	18/01/2020 06:57	18/01/2020 19:09	18/01/2020 06:57	18/01/2020 19:09	12,19	7	85,30	CHI
202001106469	VILA PROPICIO	NQ12251264	BARRO ALTO	18/01/2020 06:57	18/01/2020 19:09	18/01/2020 06:57	18/01/2020 19:09	12,19	4	48,74	CHI
202001106470	ITAPURANGA	IK12299324	ITAPURANGA	18/01/2020 06:58	18/01/2020 10:01	18/01/2020 06:58	18/01/2020 10:01	3,04	2	6,09	CHI
202001106474	ITAPURANGA	IK12298447	ITAPURANGA	18/01/2020 06:59	18/01/2020 12:50	18/01/2020 06:59	18/01/2020 12:50	5,85	7	40,94	CHI
202001106477	PORANGATU	PO12345594	PORANGATU	18/01/2020 07:00	18/01/2020 12:20	18/01/2020 07:00	18/01/2020 12:20	5,33	1	5,33	CHI
202001106483	ANAPOLIS	AN21325313	ANAPOLIS UNIVERSITARIO S2	18/01/2020 07:01	18/01/2020 09:46	18/01/2020 07:01	18/01/2020 09:46	2,75	3	8,25	CHI
202001106484	FIRMINOPOLIS	FR12312448	FIRMINOPOLIS S1	18/01/2020 07:01	18/01/2020 15:31	18/01/2020 07:01	18/01/2020 15:31	8,49	3	25,47	CHI
202001106496	BELA VISTA DE GOIAS	BV12291753	BELA VISTA S1	18/01/2020 07:03	18/01/2020 08:56	18/01/2020 07:03	18/01/2020 08:56	1,88	87	163,68	CHI
202001106498	ORIZONA	OZ21114924	PIRES DO RIO S2	18/01/2020 07:03	18/01/2020 17:50	18/01/2020 07:03	18/01/2020 17:50	10,78	1	10,78	CHI
202001106499	CAMPO ALEGRE DE GOIAS	CM21338744	CAMPO ALEGRE DE GOIAS	18/01/2020 07:03	19/01/2020 07:21	18/01/2020 07:03	19/01/2020 07:21	24,30	2	48,59	CHI
202001106512	SERRANOPOLIS	SX21156826	JATAI S1	17/01/2020 18:28	18/01/2020 15:58	17/01/2020 18:28	18/01/2020 15:58	21,49	1	21,49	CHI
202001106517	CACHOEIRA ALTA	RV12071929	CACHOEIRA ALTA	18/01/2020 07:14	18/01/2020 08:39	18/01/2020 07:14	18/01/2020 08:39	1,41	2	2,83	CHI

202001106517	RIO VERDE	RV12071929	CACHOEIRA ALTA	18/01/2020 07:14	18/01/2020 08:39	18/01/2020 07:14	18/01/2020 08:39	1,41	22	31,10	CHI
202001106520	CAIAPONIA	CP12252503	CAIAPONIA	17/01/2020 08:20	18/01/2020 11:43	17/01/2020 08:20	18/01/2020 11:43	27,38	6	164,31	CHI
202001106530	ITAPIRAPUA	IU12016406	MATRINCHA	18/01/2020 08:30	18/01/2020 09:34	18/01/2020 08:30	18/01/2020 09:34	1,06	12	12,72	CHI
202001106552	CAMPINORTE	01120214	MARA ROSA	18/01/2020 09:05	18/01/2020 14:38	18/01/2020 09:05	18/01/2020 10:08	1,04	12	12,50	CHI
202001106552	ESTRELA DO NORTE	01120214	MARA ROSA	18/01/2020 09:05	18/01/2020 14:38	18/01/2020 09:05	18/01/2020 10:08	1,04	7	7,29	CHI
202001106552	MARA ROSA	01120214	MARA ROSA	18/01/2020 09:05	18/01/2020 14:38	18/01/2020 09:05	18/01/2020 10:08	1,04	3297	3433,46	CHI
202001106552	CAMPINORTE	MQ16408526	MARA ROSA	18/01/2020 09:05	18/01/2020 14:38	18/01/2020 09:05	18/01/2020 10:52	1,79	17	30,39	CHI
202001106552	MARA ROSA	MQ16408526	MARA ROSA	18/01/2020 09:05	18/01/2020 14:38	18/01/2020 09:05	18/01/2020 10:52	1,79	644	1151,33	CHI
202001106552	CAMPINORTE	MQ16408526	MARA ROSA	18/01/2020 09:05	18/01/2020 14:38	18/01/2020 09:05	18/01/2020 14:38	5,54	5	27,72	CHI
202001106552	MARA ROSA	MQ16408526	MARA ROSA	18/01/2020 09:05	18/01/2020 14:38	18/01/2020 09:05	18/01/2020 14:38	5,54	21	116,42	CHI
202001106601	JUSSARA	RN12057000	BRITANIA	18/01/2020 07:03	18/01/2020 10:59	18/01/2020 07:03	18/01/2020 10:59	3,93	4	15,70	CHI
202001106601	SANTA FE DE GOIAS	RN12057000	BRITANIA	18/01/2020 07:03	18/01/2020 10:59	18/01/2020 07:03	18/01/2020 10:59	3,93	1	3,93	CHI
202001106603	TRES RANCHOS	TH21281449	CATALAO S1	18/01/2020 07:04	18/01/2020 10:47	18/01/2020 07:04	18/01/2020 10:47	3,72	1	3,72	CHI
202001106604	GOIANESIA	GE12080453	GOIANESIA S1	18/01/2020 07:04	18/01/2020 11:20	18/01/2020 07:04	18/01/2020 11:20	4,28	3	12,84	CHI
202001106609	ALVORADA DO NORTE	AQ12078443	IACIARA S2	18/01/2020 07:04	18/01/2020 08:49	18/01/2020 07:04	18/01/2020 08:49	1,74	5	8,71	CHI
202001106610	ORIZONA	OZ21085073	PIRES DO RIO S2	18/01/2020 07:04	18/01/2020 11:20	18/01/2020 07:04	18/01/2020 11:20	4,25	1	4,25	CHI
202001106612	BURITINOPOLIS	BQ11208227	IACIARA S2	18/01/2020 07:05	18/01/2020 11:29	18/01/2020 07:05	18/01/2020 11:29	4,40	26	114,40	CHI
202001106613	PIRANHAS	PH21092243	BOM JARDIM	18/01/2020 07:05	18/01/2020 11:05	18/01/2020 07:05	18/01/2020 11:05	3,99	1	3,99	CHI
202001106616	LUZIANIA	LZ12041409	RIO VERMELHO	18/01/2020 07:05	18/01/2020 10:11	18/01/2020 07:05	18/01/2020 10:11	3,08	6	18,50	CHI
202001106619	NOVA IGUACU DE GOIAS	NH12317131	CAMPINORTE	18/01/2020 04:57	18/01/2020 09:26	18/01/2020 04:57	18/01/2020 09:26	4,49	43	193,03	CHI
202001106623	JUSSARA	JR12373835	BRITANIA	18/01/2020 07:06	18/01/2020 14:42	18/01/2020 07:06	18/01/2020 14:42	7,59	2	15,17	CHI
202001106628	NOVO GAMA	NJ11201101	MARAJOARA	18/01/2020 07:07	18/01/2020 08:25	18/01/2020 07:07	18/01/2020 08:25	1,29	106	137,06	CHI
202001106631	ARAGUAPAZ	AZ12099866	MOZARLANDIA	18/01/2020 07:04	18/01/2020 11:13	18/01/2020 07:04	18/01/2020 11:13	4,15	3	12,44	CHI
202001106632	CALDAS NOVAS	CN12110281	CALDAS NOVAS S1	18/01/2020 07:08	19/01/2020 20:06	18/01/2020 07:08	18/01/2020 14:14	7,10	3	21,31	CHI
202001106632	CALDAS NOVAS	CN12110281	CALDAS NOVAS S1	18/01/2020 07:08	19/01/2020 20:06	18/01/2020 07:08	19/01/2020 19:30	36,37	11	400,03	CHI
202001106632	CALDAS NOVAS	CN12110281	CALDAS NOVAS S1	18/01/2020 07:08	19/01/2020 20:06	18/01/2020 07:08	19/01/2020 19:38	36,50	1	36,50	CHI
202001106632	CALDAS NOVAS	CN12110281	CALDAS NOVAS S1	18/01/2020 07:08	19/01/2020 20:06	18/01/2020 07:08	19/01/2020 19:51	36,72	1	36,72	CHI
202001106632	CALDAS NOVAS	CN12110281	CALDAS NOVAS S1	18/01/2020 07:08	19/01/2020 20:06	18/01/2020 07:08	19/01/2020 20:06	36,98	1	36,98	CHI
202001106638	NOVO PLANALTO	SM12099146RE	SAO MIGUEL DO ARAGUAIA	18/01/2020 07:08	18/01/2020 09:40	18/01/2020 07:08	18/01/2020 09:40	2,53	0	0,00	CHI
202001106638	SAO MIGUEL DO ARAGUAIA	SM12099146RE	SAO MIGUEL DO ARAGUAIA	18/01/2020 07:08	18/01/2020 09:40	18/01/2020 07:08	18/01/2020 09:40	2,53	52	131,59	CHI
202001106642	SANTA FE DE GOIAS	RN12362415	BRITANIA	18/01/2020 07:09	18/01/2020 09:28	18/01/2020 07:09	18/01/2020 09:28	2,31	18	41,58	CHI
202001106643	RIO VERDE	RV21301280	SANTA HELENA S1	18/01/2020 07:09	18/01/2020 13:09	18/01/2020 07:09	18/01/2020 13:09	5,99	1	5,99	CHI
202001106644	GOIANIA	GN11322882	GOIANIA LESTE S2	18/01/2020 07:06	18/01/2020 10:46	18/01/2020 07:06	18/01/2020 10:46	3,66	109	399,24	CHI

202001106649	RIO VERDE	RV12000206	RIO VERDE S1	18/01/2020 07:10	18/01/2020 11:48	18/01/2020 07:10	18/01/2020 11:48	4,63	3	13,90	CHI
202001106652	ITAGUARU	IC12307618	ITAPURANGA	18/01/2020 07:09	18/01/2020 09:50	18/01/2020 07:09	18/01/2020 09:50	2,68	6	16,09	CHI
202001106653	ORIZONA	OZ12022850RE	PIRES DO RIO S2	18/01/2020 06:33	18/01/2020 17:58	18/01/2020 06:33	18/01/2020 09:53	3,33	6	20,00	CHI
202001106653	PIRES DO RIO	OZ12022850RE	PIRES DO RIO S2	18/01/2020 06:33	18/01/2020 17:58	18/01/2020 06:33	18/01/2020 09:53	3,33	11	36,67	CHI
202001106653	PIRES DO RIO	PR12159861LD	PIRES DO RIO S2	18/01/2020 06:33	18/01/2020 17:58	18/01/2020 06:33	18/01/2020 17:58	11,42	43	491,24	CHI
202001106657	GOIANESIA	GE12000180	GOIANESIA S2	18/01/2020 06:48	18/01/2020 09:56	18/01/2020 06:48	18/01/2020 09:56	3,12	20	62,40	CHI
202001106663	GOIANIA	GN11001668	REAL S1	18/01/2020 07:13	18/01/2020 09:19	18/01/2020 07:13	18/01/2020 09:19	2,10	92	193,20	CHI
202001106672	BURITI ALEGRE	420010725	ALTO BURITI	18/01/2020 07:14	18/01/2020 19:50	18/01/2020 07:14	18/01/2020 19:50	12,60	1	12,60	CHI
202001106673	MARA ROSA	MQ12208421	MARA ROSA	17/01/2020 22:17	18/01/2020 11:44	17/01/2020 22:17	18/01/2020 11:44	13,46	15	201,86	CHI
202001106675	MORRINHOS	MR21064833	GOIATUBA S1	18/01/2020 07:15	18/01/2020 09:55	18/01/2020 07:15	18/01/2020 09:55	2,66	1	2,66	CHI
202001106678	SAO FRANCISCO DE GOIAS	SF12066028	SAO FRANCISCO DE GOIAS	18/01/2020 07:16	18/01/2020 08:46	18/01/2020 07:16	18/01/2020 08:46	1,49	2	2,98	CHI
202001106682	NOVA IGUACU DE GOIAS	NH12262884	SANTA TEREZINHA	18/01/2020 06:50	18/01/2020 12:43	18/01/2020 06:50	18/01/2020 12:43	5,87	5	29,37	CHI
202001106684	CHAPADAO DO CEU	DJ12164067	CHAPADAO DO CEU	18/01/2020 07:17	18/01/2020 15:23	18/01/2020 07:17	18/01/2020 15:23	8,10	5	40,48	CHI
202001106689	GOIANIA	16966715	MEIA PONTE	18/01/2020 07:18	18/01/2020 08:37	18/01/2020 07:18	18/01/2020 08:37	1,30	1	1,30	CHI
202001106690	MINEIROS	MY12024312	PARQUE DAS EMAS	18/01/2020 06:13	18/01/2020 11:18	18/01/2020 06:13	18/01/2020 11:18	5,08	69	350,39	CHI
202001106690	SANTA RITA DO ARAGUAIA	MY12024312	PARQUE DAS EMAS	18/01/2020 06:13	18/01/2020 11:18	18/01/2020 06:13	18/01/2020 11:18	5,08	17	86,33	CHI
202001106696	ORIZONA	OZ21022881	PIRES DO RIO S2	18/01/2020 07:20	18/01/2020 14:53	18/01/2020 07:20	18/01/2020 14:53	7,54	2	15,07	CHI
202001106700	CACHOEIRA ALTA	CA12078938	CACHOEIRA ALTA	18/01/2020 07:21	18/01/2020 10:28	18/01/2020 07:21	18/01/2020 10:28	3,11	4	12,44	CHI
202001106704	MONTIVIDIU	RV21060226	MONTIVIDIU T	18/01/2020 07:22	18/01/2020 09:59	18/01/2020 07:22	18/01/2020 09:59	2,61	1	2,61	CHI
202001106708	LUZANIA	LZ12333211	CRISTALINA S2	18/01/2020 07:08	18/01/2020 13:17	18/01/2020 07:08	18/01/2020 13:17	6,15	19	116,83	CHI
202001106709	PLANALTINA	PI12361252	PLANALTINA	18/01/2020 07:23	18/01/2020 09:44	18/01/2020 07:23	18/01/2020 09:44	2,35	33	77,52	CHI
202001106711	FORMOSO	TB12185306	PORANGATU	18/01/2020 07:23	18/01/2020 08:49	18/01/2020 07:23	18/01/2020 08:49	1,42	1	1,42	CHI
202001106711	TROMBAS	TB12185306	PORANGATU	18/01/2020 07:23	18/01/2020 08:49	18/01/2020 07:23	18/01/2020 08:49	1,42	10	14,24	CHI
202001106721	MUNDO NOVO DE GOIAS	MH12125346	NOVA CRIXAS	18/01/2020 07:25	18/01/2020 18:37	18/01/2020 07:25	18/01/2020 18:37	11,18	1	11,18	CHI
202001106736	CACU	CC12360934	CACHOEIRA ALTA	18/01/2020 07:28	18/01/2020 13:58	18/01/2020 07:28	18/01/2020 13:58	6,49	13	84,42	CHI
202001106736	ITARUMA	CC12360934	CACHOEIRA ALTA	18/01/2020 07:28	18/01/2020 13:58	18/01/2020 07:28	18/01/2020 13:58	6,49	7	45,46	CHI
202001106750	CUMARI	CY21285938	CATALAO S2	18/01/2020 07:31	18/01/2020 10:20	18/01/2020 07:31	18/01/2020 10:20	2,81	1	2,81	CHI
202001106752	IACIARA	IA12091616	IACIARA S1	18/01/2020 05:53	18/01/2020 08:56	18/01/2020 05:53	18/01/2020 08:56	3,03	45	136,55	CHI
202001106754	PILAR DE GOIAS	19694834	SANTA TEREZINHA	18/01/2020 07:31	18/01/2020 11:01	18/01/2020 07:31	18/01/2020 11:01	3,49	2	6,98	CHI
202001106763	DOVERLANDIA	MY12036563	PARQUE DAS EMAS	18/01/2020 06:14	18/01/2020 12:43	18/01/2020 06:14	18/01/2020 12:43	6,48	72	466,48	CHI
202001106765	MONTES CLAROS DE GOIAS	1440012330	IPORA	18/01/2020 07:33	18/01/2020 11:04	18/01/2020 07:33	18/01/2020 11:04	3,51	1	3,51	CHI
202001106766	PIRANHAS	PH12340050	PIRANHAS	18/01/2020 07:33	18/01/2020 12:25	18/01/2020 07:33	18/01/2020 12:25	4,86	6	29,13	CHI
202001106773	FORMOSA	FA12194802	ITIQUEIRA	18/01/2020 07:34	18/01/2020 09:53	18/01/2020 07:34	18/01/2020 09:53	2,30	12	27,63	CHI

202001106776	GOIANIA	GN10385817	CARAJAS S1	18/01/2020 07:35	18/01/2020 14:58	18/01/2020 10:57	18/01/2020 11:01	0,06	767	47,94	CHI
202001106776	GOIANIA	GN10385817	CARAJAS S2	18/01/2020 07:35	18/01/2020 14:58	18/01/2020 10:57	18/01/2020 11:01	0,06	3540	221,25	CHI
202001106776	GOIANIA	04530274	CARAJAS S2	18/01/2020 07:35	18/01/2020 14:58	18/01/2020 11:04	18/01/2020 12:20	1,27	4	5,08	CHI
202001106776	GOIANIA	GN10385817	CARAJAS S2	18/01/2020 07:35	18/01/2020 14:58	18/01/2020 14:06	18/01/2020 14:58	0,85	4	3,40	CHI
202001106776	GOIANIA	GN10400444	CAMPINAS S1	18/01/2020 07:35	18/01/2020 14:58	18/01/2020 14:07	18/01/2020 14:58	0,84	3984	3350,99	CHI
202001106776	GOIANIA	GN10400444	CARAJAS S1	18/01/2020 07:35	18/01/2020 14:58	18/01/2020 14:07	18/01/2020 14:58	0,84	767	645,13	CHI
202001106776	GOIANIA	GN10400444	CARAJAS S2	18/01/2020 07:35	18/01/2020 14:58	18/01/2020 14:07	18/01/2020 14:58	0,84	6861	5770,86	CHI
202001106778	ARAGARCAS	AG12234256	ARAGARCAS	18/01/2020 07:35	18/01/2020 11:53	18/01/2020 07:35	18/01/2020 11:53	4,30	17	73,06	CHI
202001106780	PARANAIGUARA	QI21306053	QUIRINOPOLIS	18/01/2020 07:35	18/01/2020 11:35	18/01/2020 07:35	18/01/2020 11:35	3,99	2	7,99	CHI
202001106786	PADRE BERNARDO	PB11284778	PADRE BERNARDO	18/01/2020 07:36	18/01/2020 12:19	18/01/2020 07:36	18/01/2020 12:19	4,72	7	33,02	CHI
202001106790	HEITORAI	HE11227155	ITABERAI S1	18/01/2020 07:36	18/01/2020 10:05	18/01/2020 07:36	18/01/2020 10:05	2,49	1	2,49	CHI
202001106794	MINEIROS	MY12133261	PARQUE DAS EMAS	18/01/2020 07:36	18/01/2020 12:38	18/01/2020 07:36	18/01/2020 12:38	5,03	6	30,16	CHI
202001106796	VALPARAISO DE GOIAS	2860220490	MARAJOARA	18/01/2020 07:36	18/01/2020 08:50	18/01/2020 07:36	18/01/2020 08:50	1,22	1	1,22	CHI
202001106800	SAO MIGUEL DO ARAGUAIA	SM12099600	SAO MIGUEL DO ARAGUAIA	18/01/2020 07:30	18/01/2020 23:12	18/01/2020 07:30	18/01/2020 22:12	14,70	2	29,40	CHI
202001106800	NOVA CRIXAS	SM13282154	SAO MIGUEL DO ARAGUAIA	18/01/2020 07:30	18/01/2020 23:12	18/01/2020 07:30	18/01/2020 23:12	15,69	1	15,69	CHI
202001106800	SAO MIGUEL DO ARAGUAIA	SM13282154	SAO MIGUEL DO ARAGUAIA	18/01/2020 07:30	18/01/2020 23:12	18/01/2020 07:30	18/01/2020 23:12	15,69	85	1333,37	CHI
202001106801	ACREUNA	TD12033677LD	ACREUNA	18/01/2020 07:37	18/01/2020 10:46	18/01/2020 07:37	18/01/2020 10:46	3,14	8	25,13	CHI
202001106801	EDEIA	TD12033677LD	ACREUNA	18/01/2020 07:37	18/01/2020 10:46	18/01/2020 07:37	18/01/2020 10:46	3,14	13	40,84	CHI
202001106801	TURVANIA	TD12033677LD	ACREUNA	18/01/2020 07:37	18/01/2020 10:46	18/01/2020 07:37	18/01/2020 10:46	3,14	1	3,14	CHI
202001106801	TURVELANDIA	TD12033677LD	ACREUNA	18/01/2020 07:37	18/01/2020 10:46	18/01/2020 07:37	18/01/2020 10:46	3,14	25	78,53	CHI
202001106802	ANAPOLIS	GP12029277	JUNDIAI S1	18/01/2020 07:37	18/01/2020 13:14	18/01/2020 07:37	18/01/2020 13:14	5,60	1	5,60	CHI
202001106802	TEREZOPOLIS DE GOIAS	GP12029277	JUNDIAI S1	18/01/2020 07:37	18/01/2020 13:14	18/01/2020 07:37	18/01/2020 13:14	5,60	3	16,81	CHI
202001106803	OUVIDOR	OU21333592	CATALAO S1	18/01/2020 07:37	18/01/2020 12:30	18/01/2020 07:37	18/01/2020 12:30	4,87	1	4,87	CHI
202001106804	SAO LUIS DE MONTES BELOS	SC21165425	SAO LUIZ DOS MONTES BELOS	18/01/2020 07:38	18/01/2020 09:42	18/01/2020 07:38	18/01/2020 09:42	2,07	1	2,07	CHI
202001106829	ITABERAI	AR12019610	ARACU	18/01/2020 07:34	18/01/2020 11:57	18/01/2020 07:34	18/01/2020 11:57	4,37	6	26,21	CHI
202001106835	CRISTALINA	KR12101526	CRISTALINA S1	18/01/2020 06:09	18/01/2020 09:42	18/01/2020 06:09	18/01/2020 09:42	3,54	55	194,94	CHI
202001106835	LUZIANIA	KR12101526	CRISTALINA S1	18/01/2020 06:09	18/01/2020 09:42	18/01/2020 06:09	18/01/2020 09:42	3,54	30	106,33	CHI
202001106842	AMORINOPOLIS	AM12091215LD	IPORA	18/01/2020 07:44	18/01/2020 10:40	18/01/2020 07:44	18/01/2020 10:40	2,93	1	2,93	CHI
202001106843	MONTES CLAROS DE GOIAS	ME12088948	IPORA	18/01/2020 07:44	18/01/2020 12:39	18/01/2020 07:44	18/01/2020 12:39	4,91	2	9,82	CHI
202001106846	LUZIANIA	10004481907	MARAJOARA	18/01/2020 07:44	18/01/2020 08:49	18/01/2020 07:44	18/01/2020 08:49	1,07	1	1,07	CHI
202001106847	BURITI ALEGRE	BG12000160	ITUMBIARA VELHA S2	18/01/2020 07:43	18/01/2020 15:02	18/01/2020 07:43	18/01/2020 15:02	7,31	243	1775,79	CHI
202001106848	IPORA	IR12069053	IPORA	18/01/2020 07:44	18/01/2020 09:56	18/01/2020 07:44	18/01/2020 09:56	2,18	14	30,58	CHI
202001106850	JATAI	JT12303012	JATAI S1	18/01/2020 07:45	18/01/2020 09:01	18/01/2020 07:45	18/01/2020 09:01	1,26	2	2,52	CHI

202001106851	LUZIANIA	LZ12394913	MARAJOARA	18/01/2020 07:45	18/01/2020 11:22	18/01/2020 07:45	18/01/2020 11:22	3,61	3	10,83	CHI
202001106852	MUTUNOPOLIS	SE12352924	MARA ROSA	18/01/2020 07:45	18/01/2020 10:05	18/01/2020 07:45	18/01/2020 10:05	2,32	6	13,95	CHI
202001106852	SANTA TEREZA DE GOIAS	SE12352924	MARA ROSA	18/01/2020 07:45	18/01/2020 10:05	18/01/2020 07:45	18/01/2020 10:05	2,32	1	2,32	CHI
202001106853	PORANGATU	PO21136928	PORANGATU	18/01/2020 07:45	19/01/2020 01:57	18/01/2020 07:45	19/01/2020 01:57	18,19	1	18,19	CHI
202001106854	ITUMBIARA	IT21333851	ITUMBIARA VELHA S1	18/01/2020 07:46	18/01/2020 11:55	18/01/2020 07:46	18/01/2020 11:55	4,15	3	12,45	CHI
202001106856	CALDAS NOVAS	760415584	SERRA DE CALDAS	18/01/2020 07:47	18/01/2020 14:32	18/01/2020 07:47	18/01/2020 14:32	6,75	1	6,75	CHI
202001106857	FORMOSA	FA12376669	ITIQUEIRA	18/01/2020 07:47	18/01/2020 13:20	18/01/2020 07:47	18/01/2020 13:20	5,54	56	310,18	CHI
202001106857	VILA BOA	FA12376669	ITIQUEIRA	18/01/2020 07:47	18/01/2020 13:20	18/01/2020 07:47	18/01/2020 13:20	5,54	6	33,23	CHI
202001106861	CACHOEIRA DOURADA	CD12000005	CACHOEIRA DOURADA	18/01/2020 07:38	18/01/2020 10:01	18/01/2020 07:38	18/01/2020 10:01	2,37	9	21,33	CHI
202001106861	ITUMBIARA	CD12000005	CACHOEIRA DOURADA	18/01/2020 07:38	18/01/2020 10:01	18/01/2020 07:38	18/01/2020 10:01	2,37	20	47,39	CHI
202001106863	CIDADE OCIDENTAL	DH11277131	MARAJOARA	18/01/2020 07:48	18/01/2020 11:28	18/01/2020 07:48	18/01/2020 11:28	3,66	1	3,66	CHI
202001106869	PORANGATU	PO12208558	PORANGATU	18/01/2020 07:49	18/01/2020 10:19	18/01/2020 07:49	18/01/2020 10:19	2,50	14	34,94	CHI
202001106870	PIRACANJUBA	PJ12000208	CALDAS NOVAS S1	18/01/2020 07:49	18/01/2020 19:00	18/01/2020 07:49	18/01/2020 19:00	11,18	1	11,18	CHI
202001106872	PADRE BERNARDO	PB12248296	PADRE BERNARDO	18/01/2020 07:50	18/01/2020 09:10	18/01/2020 07:50	18/01/2020 09:10	1,33	6	7,97	CHI
202001106874	VIANOPOLIS	VN12052243	VIANOPOLIS	18/01/2020 07:50	18/01/2020 09:56	18/01/2020 07:50	18/01/2020 09:56	2,09	4	8,36	CHI
202001106875	ORIZONA	4690000385	PIRES DO RIO S2	18/01/2020 07:50	18/01/2020 13:30	18/01/2020 07:50	18/01/2020 13:30	5,67	1	5,67	CHI
202001106877	PADRE BERNARDO	PB12375232	PADRE BERNARDO	18/01/2020 07:50	18/01/2020 13:23	18/01/2020 07:50	18/01/2020 13:23	5,54	15	83,08	CHI
202001106880	TRINDADE	40114028	TRINDADE	18/01/2020 07:51	18/01/2020 09:52	18/01/2020 07:51	18/01/2020 09:52	2,01	1	2,01	CHI
202001106881	MINEIROS	MY21246681	SANTA RITA DO ARAGUAIA	18/01/2020 07:51	18/01/2020 11:27	18/01/2020 07:51	18/01/2020 11:27	3,59	1	3,59	CHI
202001106886	QUIRINOPOLIS	QI21326636	QUIRINOPOLIS	18/01/2020 07:51	18/01/2020 11:13	18/01/2020 07:51	18/01/2020 11:13	3,36	1	3,36	CHI
202001106889	FLORES DE GOIAS	FB12239102	IACIARA S2	18/01/2020 07:52	18/01/2020 10:16	18/01/2020 07:52	18/01/2020 10:16	2,39	19	45,43	CHI
202001106890	SANTA TEREZINHA DE GOIAS	SG21237491	SANTA TEREZINHA	18/01/2020 07:52	18/01/2020 13:42	18/01/2020 07:52	18/01/2020 13:42	5,82	1	5,82	CHI
202001106893	RIO VERDE	RV21228693	CABRIUVA S2	18/01/2020 07:53	18/01/2020 11:10	18/01/2020 07:53	18/01/2020 11:10	3,27	1	3,27	CHI
202001106894	ABADIANIA	AA21381634	ANAPOLIS UNIVERSITARIO S1	18/01/2020 07:53	18/01/2020 11:06	18/01/2020 07:53	18/01/2020 11:06	3,20	2	6,40	CHI
202001106896	CATALAO	CT12195296	CATALAO S2	18/01/2020 07:53	18/01/2020 08:55	18/01/2020 07:53	18/01/2020 08:55	1,02	215	218,82	CHI
202001106897	CRIXAS	CX12302060	SERRA DO OURO	18/01/2020 07:53	18/01/2020 11:11	18/01/2020 07:53	18/01/2020 11:11	3,28	1	3,28	CHI
202001106898	CAMPOS BELOS	CH12384785	SAO DOMINGOS	18/01/2020 07:53	18/01/2020 09:33	18/01/2020 07:53	18/01/2020 09:33	1,65	5	8,25	CHI
202001106899	GUARINOS	GF12244419	SANTA TEREZINHA	18/01/2020 07:54	18/01/2020 20:33	18/01/2020 07:54	18/01/2020 20:33	12,65	5	63,24	CHI
202001106900	CRIXAS	CX21145550	RUBIATABA	18/01/2020 07:54	18/01/2020 12:15	18/01/2020 07:54	18/01/2020 12:15	4,35	1	4,35	CHI
202001106902	CAVALCANTE	740014523	FLORES DE GOIAS	18/01/2020 07:54	18/01/2020 12:13	18/01/2020 07:54	18/01/2020 12:13	4,30	1	4,30	CHI
202001106903	MATRINCHA	MP21021519	MOZARLANDIA	18/01/2020 07:54	19/01/2020 07:54	18/01/2020 07:54	19/01/2020 07:54	23,98	1	23,98	CHI
202001106912	SERRANOPOLIS	SX21216683	JATAI S1	18/01/2020 07:56	18/01/2020 16:01	18/01/2020 07:56	18/01/2020 16:01	8,08	1	8,08	CHI
202001106913	TAQUARAL DE GOIAS	II12217089	ITABERAI S1	18/01/2020 07:56	18/01/2020 12:47	18/01/2020 07:56	18/01/2020 12:47	4,85	2	9,69	CHI

202001106915	GOIAS	GS12091169	MATRINCHA	18/01/2020 07:56	19/01/2020 13:11	18/01/2020 07:56	19/01/2020 13:11	29,24	9	263,17	CHI
202001106916	SANCLERLANDIA	SC12036215	FIRMINOPOLIS S2	18/01/2020 07:56	18/01/2020 10:30	18/01/2020 07:56	18/01/2020 10:30	2,56	1	2,56	CHI
202001106918	PALMELO	PZ12063775RE	PIRES DO RIO S2	18/01/2020 07:09	18/01/2020 11:33	18/01/2020 07:09	18/01/2020 11:33	4,41	23	101,40	CHI
202001106918	PIRES DO RIO	PZ12063775RE	PIRES DO RIO S2	18/01/2020 07:09	18/01/2020 11:33	18/01/2020 07:09	18/01/2020 11:33	4,41	6	26,45	CHI
202001106918	SANTA CRUZ DE GOIAS	PZ12063775RE	PIRES DO RIO S2	18/01/2020 07:09	18/01/2020 11:33	18/01/2020 07:09	18/01/2020 11:33	4,41	26	114,63	CHI
202001106923	IPAMERI	IP12265555	CAMPO ALEGRE DE GOIAS	18/01/2020 07:57	18/01/2020 16:20	18/01/2020 07:57	18/01/2020 16:20	8,38	7	58,63	CHI
202001106928	DAMIANOPOLIS	SI21288865	IACIARA S2	18/01/2020 07:58	18/01/2020 09:54	18/01/2020 07:58	18/01/2020 09:54	1,92	1	1,92	CHI
202001106930	JATAI	JT12008872	JATAI S1	18/01/2020 07:59	18/01/2020 16:14	18/01/2020 07:59	18/01/2020 16:14	8,25	10	82,46	CHI
202001106932	ANAPOLIS	AN12009341	NEROPOLIS S1	18/01/2020 07:59	18/01/2020 15:59	18/01/2020 13:12	18/01/2020 15:59	2,77	8	22,20	CHI
202001106932	PIRENOPOLIS	AN12009341	NEROPOLIS S1	18/01/2020 07:59	18/01/2020 15:59	18/01/2020 13:12	18/01/2020 15:59	2,77	19	52,72	CHI
202001106937	HIDROLANDIA	HD21007563	PONTALINA	18/01/2020 08:00	18/01/2020 09:43	18/01/2020 08:00	18/01/2020 09:43	1,71	1	1,71	CHI
202001106942	PEROLANDIA	DP12260465	JATAI S1	18/01/2020 07:43	18/01/2020 10:40	18/01/2020 07:43	18/01/2020 10:40	2,94	9	26,48	CHI
202001106944	GOIANIA	10163074	FERROVIARIO S1	18/01/2020 08:01	18/01/2020 10:07	18/01/2020 08:01	18/01/2020 10:07	2,08	1	2,08	CHI
202001106945	PETROLINA DE GOIAS	PG21008420	PETROLINA	18/01/2020 08:02	18/01/2020 09:55	18/01/2020 08:02	18/01/2020 09:55	1,89	1	1,89	CHI
202001106946	IPAMERI	IP12247905	CRISTALINA S2	18/01/2020 07:28	18/01/2020 12:58	18/01/2020 07:28	18/01/2020 12:58	5,49	41	225,08	CHI
202001106949	GOIANIRA	GR31135470	GOIANIRA	18/01/2020 08:03	18/01/2020 10:14	18/01/2020 08:03	18/01/2020 10:14	2,18	1	2,18	CHI
202001106956	ALEXANIA	AX11379448	CORUMBA	18/01/2020 08:03	18/01/2020 15:11	18/01/2020 08:03	18/01/2020 15:11	7,12	43	306,35	CHI
202001106957	ITAPACI	IW12210177	ITAPACI	18/01/2020 08:03	18/01/2020 10:45	18/01/2020 08:03	18/01/2020 10:45	2,69	7	18,83	CHI
202001106957	PILAR DE GOIAS	IW12210177	ITAPACI	18/01/2020 08:03	18/01/2020 10:45	18/01/2020 08:03	18/01/2020 10:45	2,69	3	8,07	CHI
202001106959	PALESTINA DE GOIAS	PY12342606	PALESTINA	18/01/2020 06:33	18/01/2020 12:21	18/01/2020 06:33	18/01/2020 12:21	5,80	6	34,79	CHI
202001106961	SANTA HELENA DE GOIAS	SH12279533	IPEGUARI	18/01/2020 08:03	18/01/2020 10:31	18/01/2020 08:03	18/01/2020 10:31	2,45	32	78,48	CHI
202001106963	GOIAS	GS12274373	GOIAS	18/01/2020 08:04	18/01/2020 12:23	18/01/2020 08:04	18/01/2020 12:23	4,31	12	51,74	CHI
202001106965	ACREUNA	EU21045537	ACREUNA	18/01/2020 08:04	18/01/2020 11:35	18/01/2020 08:04	18/01/2020 11:35	3,51	1	3,51	CHI
202001106970	APARECIDA DE GOIANIA	10002313560	INDEPENDENCIA S1	18/01/2020 08:04	18/01/2020 09:41	18/01/2020 08:04	18/01/2020 09:41	1,60	1	1,60	CHI
202001106974	CAIAPONIA	CP12345397	CAIAPONIA	18/01/2020 08:05	18/01/2020 23:34	18/01/2020 08:05	18/01/2020 23:34	15,47	7	108,30	CHI
202001106984	PARAUNA	PU12391518	PARAUNA	18/01/2020 07:39	18/01/2020 09:47	18/01/2020 07:39	18/01/2020 09:47	2,12	25	53,03	CHI
202001106986	RIO VERDE	RV21260258	CABRIUVA S1	18/01/2020 08:06	18/01/2020 10:40	18/01/2020 08:06	18/01/2020 10:40	2,57	1	2,57	CHI
202001106987	SERRANOPOLIS	SX12296510	JATAI S1	18/01/2020 08:06	18/01/2020 12:23	18/01/2020 08:06	18/01/2020 12:23	4,27	3	12,82	CHI
202001106990	MORRINHOS	MR21128658	MORRINHOS	18/01/2020 08:06	18/01/2020 11:46	18/01/2020 08:06	18/01/2020 11:46	3,66	1	3,66	CHI
202001106992	CAMPO ALEGRE DE GOIAS	CM12156359	CAMPO ALEGRE DE GOIAS	18/01/2020 06:32	18/01/2020 13:03	18/01/2020 06:32	18/01/2020 13:03	6,52	31	202,00	CHI
202001106994	CATURAI	CK21033527	INHUMAS S1	18/01/2020 08:07	18/01/2020 12:13	18/01/2020 08:07	18/01/2020 12:13	4,09	1	4,09	CHI
202001107000	CRISTALINA	KR12209482	CRISTALINA S1	18/01/2020 08:09	18/01/2020 12:42	18/01/2020 08:09	18/01/2020 12:42	4,55	1	4,55	CHI
202001107007	SERRANOPOLIS	SX12324832	JATAI S1	18/01/2020 08:04	18/01/2020 14:18	18/01/2020 08:04	18/01/2020 14:18	6,22	13	80,92	CHI

202001107008	NIQUELANDIA	NQ12392038	NIQUELANDIA SUBTRANSMISSAO	18/01/2020 08:10	18/01/2020 12:40	18/01/2020 08:10	18/01/2020 12:40	4,48	3	13,45	CHI
202001107010	FIRMINOPOLIS	SL12125617	FIRMINOPOLIS S1	18/01/2020 08:11	18/01/2020 09:57	18/01/2020 08:11	18/01/2020 09:57	1,76	17	30,00	CHI
202001107010	SAO LUIS DE MONTES BELOS	SL12125617	FIRMINOPOLIS S1	18/01/2020 08:11	18/01/2020 09:57	18/01/2020 08:11	18/01/2020 09:57	1,76	53	93,53	CHI
202001107010	TURVANIA	SL12125617	FIRMINOPOLIS S1	18/01/2020 08:11	18/01/2020 09:57	18/01/2020 08:11	18/01/2020 09:57	1,76	8	14,12	CHI
202001107011	MINEIROS	MY12260468	PARQUE DAS EMAS	18/01/2020 08:11	18/01/2020 10:25	18/01/2020 08:11	18/01/2020 10:25	2,23	5	11,15	CHI
202001107012	DIVINOPOLIS DE GOIAS	GH21150387	SAO DOMINGOS	18/01/2020 08:11	18/01/2020 09:54	18/01/2020 08:11	18/01/2020 09:54	1,71	1	1,71	CHI
202001107013	IPAMERI	IP21133615	CRISTALINA S2	18/01/2020 08:11	18/01/2020 15:26	18/01/2020 08:11	18/01/2020 15:26	7,24	1	7,24	CHI
202001107014	AGUA FRIA DE GOIAS	NQ12140182	SAO JOAO D ALIANCA	18/01/2020 08:11	18/01/2020 12:21	18/01/2020 08:11	18/01/2020 12:21	4,16	69	286,73	CHI
202001107014	NIQUELANDIA	NQ12140182	SAO JOAO D ALIANCA	18/01/2020 08:11	18/01/2020 12:21	18/01/2020 08:11	18/01/2020 12:21	4,16	6	24,93	CHI
202001107017	PADRE BERNARDO	PB11231527	PADRE BERNARDO	18/01/2020 08:12	19/01/2020 08:52	18/01/2020 08:12	19/01/2020 08:52	24,66	6	147,95	CHI
202001107022	SANCLERLANDIA	SC12125685	FIRMINOPOLIS S2	18/01/2020 08:13	18/01/2020 11:01	18/01/2020 08:13	18/01/2020 11:01	2,80	1	2,80	CHI
202001107026	DAMOLANDIA	DL12272281	INHUMAS S1	18/01/2020 08:13	18/01/2020 13:41	18/01/2020 08:13	18/01/2020 13:41	5,46	8	43,64	CHI
202001107027	POSSE	PS12132043	IACIARA S2	18/01/2020 08:13	18/01/2020 11:36	18/01/2020 08:13	18/01/2020 11:36	3,37	36	121,33	CHI
202001107030	ARENOPOLIS	AY12231061	ARENOPOLIS	18/01/2020 08:13	18/01/2020 20:08	18/01/2020 08:13	18/01/2020 20:08	11,90	2	23,80	CHI
202001107033	PADRE BERNARDO	PB21255449	PADRE BERNARDO	18/01/2020 08:14	18/01/2020 17:04	18/01/2020 08:14	18/01/2020 17:04	8,83	1	8,83	CHI
202001107035	FAZENDA NOVA	FN12390148	IPORA	18/01/2020 08:15	18/01/2020 10:46	18/01/2020 08:15	18/01/2020 10:46	2,51	3	7,52	CHI
202001107035	ISRAELANDIA	FN12390148	IPORA	18/01/2020 08:15	18/01/2020 10:46	18/01/2020 08:15	18/01/2020 10:46	2,51	10	25,06	CHI
202001107040	LEOPOLDO DE BULHOES	1910000088	DAIA S2	18/01/2020 08:15	18/01/2020 12:24	18/01/2020 08:15	18/01/2020 12:24	4,13	1	4,13	CHI
202001107041	NIQUELANDIA	NQ12335361	NIQUELANDIA SUBTRANSMISSAO	18/01/2020 08:16	18/01/2020 20:59	18/01/2020 08:16	18/01/2020 20:59	12,71	8	101,70	CHI
202001107047	SERRANOPOLIS	SX12238882LD	JATAI S1	18/01/2020 08:17	18/01/2020 18:33	18/01/2020 08:17	18/01/2020 18:33	10,26	4	41,03	CHI
202001107049	CATALAO	CT21266809	CATALAO S1	18/01/2020 08:17	18/01/2020 15:45	18/01/2020 08:17	18/01/2020 15:45	7,47	1	7,47	CHI
202001107050	ADELANDIA	2330002010	FIRMINOPOLIS S2	18/01/2020 08:17	18/01/2020 10:09	18/01/2020 08:17	18/01/2020 10:09	1,86	1	1,86	CHI
202001107052	APARECIDA DE GOIANIA	10024015278	INDEPENDENCIA S1	18/01/2020 08:17	18/01/2020 09:25	18/01/2020 08:17	18/01/2020 09:25	1,12	1	1,12	CHI
202001107053	QUIRINOPOLIS	80057809	QUIRINOPOLIS	18/01/2020 08:18	18/01/2020 10:33	18/01/2020 08:18	18/01/2020 10:33	2,25	1	2,25	CHI
202001107054	JUSSARA	RN12045571	BRITANIA	18/01/2020 07:06	18/01/2020 20:08	18/01/2020 07:06	18/01/2020 20:08	13,03	4	52,10	CHI
202001107054	SANTA FE DE GOIAS	RN12045571	BRITANIA	18/01/2020 07:06	18/01/2020 20:08	18/01/2020 07:06	18/01/2020 20:08	13,03	7	91,18	CHI
202001107055	FORMOSA	FA11363512	SAO JOAO D ALIANCA	18/01/2020 08:18	18/01/2020 11:46	18/01/2020 08:18	18/01/2020 11:46	3,46	1	3,46	CHI
202001107056	PORANGATU	PO12371842	NOVO PLANALTO	18/01/2020 08:18	18/01/2020 12:02	18/01/2020 08:18	18/01/2020 12:02	3,73	1	3,73	CHI
202001107057	GOIANIA	GN21001917	GOIANIA LESTE S2	18/01/2020 08:18	18/01/2020 11:35	18/01/2020 08:18	18/01/2020 11:35	3,28	1	3,28	CHI
202001107058	CRISTALINA	KR21183839	PAMPLONA	18/01/2020 08:18	18/01/2020 12:43	18/01/2020 08:18	18/01/2020 12:43	4,41	1	4,41	CHI
202001107062	GOIANIA	12012488	CAMPINAS S1	18/01/2020 08:18	18/01/2020 09:26	18/01/2020 08:18	18/01/2020 09:26	1,12	1	1,12	CHI
202001107063	RIO VERDE	RV12371401	RIO VERDE S1	18/01/2020 08:10	18/01/2020 10:00	18/01/2020 08:10	18/01/2020 10:00	1,83	26	47,50	CHI
202001107064	JATAI	JT11073268	JATAI S3	18/01/2020 08:19	18/01/2020 12:20	18/01/2020 08:19	18/01/2020 12:20	4,02	187	751,90	CHI

202001107068	SANTA CRUZ DE GOIAS	BC12389805	PIRES DO RIO S2	18/01/2020 08:13	18/01/2020 11:02	18/01/2020 08:13	18/01/2020 11:02	2,81	9	25,28	CHI
202001107069	LUZIANIA	10011977343	MARAJOARA	18/01/2020 08:20	18/01/2020 09:48	18/01/2020 08:20	18/01/2020 09:48	1,47	1	1,47	CHI
202001107071	GOIAS	GS12076722	GOIAS	18/01/2020 07:06	18/01/2020 11:15	18/01/2020 07:06	18/01/2020 11:15	4,14	14	58,02	CHI
202001107073	AGUAS LINDAS DE GOIAS	4830165390	AGUAS LINDAS DE GOIAS S1	18/01/2020 08:20	18/01/2020 10:33	18/01/2020 08:20	18/01/2020 10:33	2,21	1	2,21	CHI
202001107075	GOIANIA	12709270	GOYA S1	18/01/2020 08:21	18/01/2020 10:38	18/01/2020 08:21	18/01/2020 10:38	2,28	1	2,28	CHI
202001107076	SITIO D ABADIA	SI12384220	IACIARA S2	18/01/2020 08:21	18/01/2020 11:10	18/01/2020 08:21	18/01/2020 11:10	2,81	14	39,36	CHI
202001107077	CRIXAS	CX12295212	SERRA DO OURO	18/01/2020 08:06	18/01/2020 10:00	18/01/2020 08:06	18/01/2020 10:00	1,89	28	52,92	CHI
202001107078	SAO JOAO D ALIANCA	JL12404385	SAO JOAO D ALIANCA	18/01/2020 08:21	18/01/2020 11:32	18/01/2020 08:21	18/01/2020 11:32	3,17	56	177,60	CHI
202001107079	APARECIDA DE GOIANIA	10030877227	ANHANGUERA	18/01/2020 08:21	18/01/2020 09:59	18/01/2020 08:21	18/01/2020 09:59	1,62	1	1,62	CHI
202001107082	VILA BOA	FA21042057	ITUIQUIRA	18/01/2020 08:22	18/01/2020 09:41	18/01/2020 08:22	18/01/2020 09:41	1,31	1	1,31	CHI
202001107085	PARANAIGUARA	QI21119382	QUIRINOPOLIS	18/01/2020 08:22	18/01/2020 13:47	18/01/2020 08:22	18/01/2020 13:47	5,41	1	5,41	CHI
202001107086	PADRE BERNARDO	PB11336082	PADRE BERNARDO	18/01/2020 08:22	18/01/2020 12:15	18/01/2020 08:22	18/01/2020 12:15	3,88	4	15,54	CHI
202001107091	FORMOSO	FO11222829	PORANGATU	18/01/2020 08:24	18/01/2020 12:35	18/01/2020 08:24	18/01/2020 12:35	4,17	93	387,60	CHI
202001107094	DAMOLANDIA	DL12272312	INHUMAS S1	18/01/2020 08:08	18/01/2020 11:08	18/01/2020 08:08	18/01/2020 11:08	2,99	15	44,84	CHI
202001107094	INHUMAS	DL12272312	INHUMAS S1	18/01/2020 08:08	18/01/2020 11:08	18/01/2020 08:08	18/01/2020 11:08	2,99	3	8,97	CHI
202001107102	ABADIANIA	AA21124396	ANAPOLIS UNIVERSITARIO S2	18/01/2020 08:27	18/01/2020 10:22	18/01/2020 08:27	18/01/2020 10:22	1,91	1	1,91	CHI
202001107104	FORMOSA	FA21135133	ITUIQUIRA	18/01/2020 08:28	18/01/2020 15:55	18/01/2020 08:28	18/01/2020 15:55	7,45	1	7,45	CHI
202001107108	RIO VERDE	RV12049047	RIO VERDE S2	18/01/2020 08:29	18/01/2020 10:07	18/01/2020 08:29	18/01/2020 10:07	1,63	28	45,60	CHI
202001107112	TURVANIA	2820000119	FIRMINOPOLIS S2	18/01/2020 08:30	18/01/2020 12:14	18/01/2020 08:30	18/01/2020 12:14	3,73	1	3,73	CHI
202001107115	ALEXANIA	AX11101793	ALEXANIA	18/01/2020 07:55	18/01/2020 15:08	18/01/2020 07:55	18/01/2020 15:08	7,22	48	346,37	CHI
202001107122	DIORAMA	ME21277833	ARENOPOLIS	18/01/2020 08:32	19/01/2020 17:07	18/01/2020 08:32	19/01/2020 17:07	32,57	8	260,60	CHI
202001107123	AGUAS LINDAS DE GOIAS	4830197172	AGUAS LINDAS DE GOIAS S1	18/01/2020 08:33	18/01/2020 10:02	18/01/2020 08:33	18/01/2020 10:02	1,48	1	1,48	CHI
202001107124	LUZIANIA	LZ12290683	MARAJOARA	18/01/2020 08:33	18/01/2020 12:53	18/01/2020 08:33	18/01/2020 12:53	4,33	16	69,27	CHI
202001107128	SENADOR CANEDO	13184799	SENADOR CANEDO	18/01/2020 08:34	18/01/2020 12:30	18/01/2020 08:34	18/01/2020 12:30	3,93	1	3,93	CHI
202001107129	ORIZONA	OZ21143756	PIRES DO RIO S2	18/01/2020 08:34	18/01/2020 13:52	18/01/2020 08:34	18/01/2020 13:52	5,30	1	5,30	CHI
202001107133	RIO VERDE	630007081	RIO VERDE S2	18/01/2020 08:34	18/01/2020 10:35	18/01/2020 08:34	18/01/2020 10:35	2,01	1	2,01	CHI
202001107134	CORREGO DO OURO	CO21279077	FIRMINOPOLIS S2	18/01/2020 08:34	18/01/2020 11:12	18/01/2020 08:34	18/01/2020 11:12	2,62	1	2,62	CHI
202001107135	CRISTALINA	KR21196356	PAMPLONA	18/01/2020 08:34	18/01/2020 13:44	18/01/2020 08:34	18/01/2020 13:44	5,16	1	5,16	CHI
202001107137	PORANGATU	840056217	PORANGATU	18/01/2020 08:34	18/01/2020 10:46	18/01/2020 08:34	18/01/2020 10:46	2,18	1	2,18	CHI
202001107141	CRISTALINA	KR12183725	CRISTALINA S2	18/01/2020 11:46	18/01/2020 18:00	18/01/2020 11:46	18/01/2020 18:00	6,23	1	6,23	CHI
202001107148	AMORINOPOLIS	AM12072351	IPORA	18/01/2020 08:36	18/01/2020 12:05	18/01/2020 08:36	18/01/2020 12:05	3,47	5	17,36	CHI
202001107149	EDEALINA	ED21325694	PONTALINA	18/01/2020 08:36	18/01/2020 19:24	18/01/2020 08:36	18/01/2020 19:24	10,79	1	10,79	CHI
202001107156	VALPARAISO DE GOIAS	XX28279001LD	PACAEMBU S1	18/01/2020 08:38	18/01/2020 10:34	18/01/2020 08:38	18/01/2020 10:34	1,93	834	1611,24	CHI

202001107157	BOM JARDIM DE GOIAS	BM12065721	BOM JARDIM	18/01/2020 08:03	18/01/2020 13:07	18/01/2020 08:03	18/01/2020 13:07	5,06	6	30,37	CHI
202001107158	JATAI	290098324	JATAI S3	18/01/2020 08:38	18/01/2020 16:35	18/01/2020 08:38	18/01/2020 16:35	7,94	1	7,94	CHI
202001107161	IACIARA	IA12244056	IACIARA S1	18/01/2020 08:39	18/01/2020 09:38	18/01/2020 08:39	18/01/2020 09:38	0,98	2	1,97	CHI
202001107166	SERRANOPOLIS	DJ12164060	CHAPADAO DO CEU	18/01/2020 08:39	18/01/2020 10:18	18/01/2020 08:39	18/01/2020 10:18	1,64	8	13,14	CHI
202001107167	CORUMBAIBA	CI12021239	VILA CORUMBA	18/01/2020 08:39	19/01/2020 10:03	18/01/2020 08:39	19/01/2020 10:03	25,39	1	25,39	CHI
202001107170	ABADIA DE GOIAS	TR12391381	GUAPO S1	18/01/2020 08:39	18/01/2020 14:10	18/01/2020 08:39	18/01/2020 14:10	5,50	3	16,51	CHI
202001107172	PALMEIRAS DE GOIAS	PL21386431	PALMEIRAS	18/01/2020 08:40	18/01/2020 11:00	18/01/2020 08:40	18/01/2020 11:00	2,33	4	9,32	CHI
202001107174	CHAPADAO DO CEU	9880006233	CHAPADAO DO CEU	18/01/2020 08:40	18/01/2020 19:59	18/01/2020 08:40	18/01/2020 19:59	11,31	1	11,31	CHI
202001107180	FORMOSA	FA12116856	SAO JOAO D ALIANCA	18/01/2020 08:41	18/01/2020 12:59	18/01/2020 08:41	18/01/2020 12:59	4,29	7	30,02	CHI
202001107191	JATAI	JT21153996	JATAI S1	18/01/2020 08:43	18/01/2020 10:09	18/01/2020 08:43	18/01/2020 10:09	1,42	4	5,69	CHI
202001107192	SAO MIGUEL DO ARAGUAIA	SM11240811	SAO MIGUEL DO ARAGUAIA	18/01/2020 08:43	18/01/2020 10:40	18/01/2020 08:43	18/01/2020 10:40	1,94	1	1,94	CHI
202001107193	PANAMA	IT12000117	PARANAIBA	18/01/2020 08:43	18/01/2020 13:11	18/01/2020 08:43	18/01/2020 13:11	4,45	2	8,90	CHI
202001107195	MATRINCHA	MP12299716	MATRINCHA	18/01/2020 08:22	18/01/2020 13:39	18/01/2020 08:22	18/01/2020 13:39	5,28	20	105,54	CHI
202001107198	NIQUELANDIA	NQ12264236	NIQUELANDIA SUBTRANSMISSAO	18/01/2020 08:44	19/01/2020 03:15	18/01/2020 08:44	19/01/2020 03:15	18,51	3	55,53	CHI
202001107201	SANTA TEREZINHA DE GOIAS	SG12380710	SANTA TEREZINHA	18/01/2020 08:39	18/01/2020 13:20	18/01/2020 08:39	18/01/2020 13:20	4,69	5	23,47	CHI
202001107207	EDEALINA	ED12038904	PONTALINA	18/01/2020 07:58	18/01/2020 11:46	18/01/2020 07:58	18/01/2020 11:46	3,79	4	15,16	CHI
202001107210	CRISTALINA	KR12383065	CRISTALINA S2	18/01/2020 08:46	18/01/2020 14:02	18/01/2020 08:46	18/01/2020 14:02	5,26	3	15,77	CHI
202001107211	NIQUELANDIA	2750005092	NIQUELANDIA SUBTRANSMISSAO	18/01/2020 08:47	18/01/2020 14:14	18/01/2020 08:47	18/01/2020 14:14	5,45	1	5,45	CHI
202001107215	GOIAS	GS12234111	GOIAS	18/01/2020 08:48	19/01/2020 10:26	18/01/2020 08:48	19/01/2020 10:26	25,63	51	1307,14	CHI
202001107216	SAO MIGUEL DO PASSA QUATRO	SQ12104215	CRISTIANOPOLIS	18/01/2020 09:02	18/01/2020 11:16	18/01/2020 09:02	18/01/2020 11:16	2,22	3	6,66	CHI
202001107218	DOVERLANDIA	DV12138334	CAIAPONIA	18/01/2020 07:57	19/01/2020 08:04	18/01/2020 07:57	19/01/2020 08:04	24,11	15	361,62	CHI
202001107221	PIRENOPOLIS	PV21286530	CORUMBA	18/01/2020 08:50	18/01/2020 16:59	18/01/2020 08:50	18/01/2020 16:59	8,14	1	8,14	CHI
202001107225	JARAGUA	JA12040435	SAO FRANCISCO DE GOIAS	18/01/2020 08:43	18/01/2020 10:28	18/01/2020 08:43	18/01/2020 10:28	1,74	3	5,23	CHI
202001107225	JESUPOLIS	JA12040435	SAO FRANCISCO DE GOIAS	18/01/2020 08:43	18/01/2020 10:28	18/01/2020 08:43	18/01/2020 10:28	1,74	18	31,36	CHI
202001107246	MOZARLANDIA	MZ12057128	MOZARLANDIA	18/01/2020 08:55	18/01/2020 12:31	18/01/2020 08:55	18/01/2020 12:31	3,60	5	17,98	CHI
202001107246	NOVA CRIXAS	MZ12057128	MOZARLANDIA	18/01/2020 08:55	18/01/2020 12:31	18/01/2020 08:55	18/01/2020 12:31	3,60	1	3,60	CHI
202001107250	ITAPIRAPUA	10024161770	MATRINCHA	18/01/2020 08:55	18/01/2020 11:45	18/01/2020 08:55	18/01/2020 11:45	2,83	1	2,83	CHI
202001107252	GOIANIA	14634510	MEIA PONTE	18/01/2020 08:55	18/01/2020 10:05	18/01/2020 08:55	18/01/2020 10:05	1,16	1	1,16	CHI
202001107257	ABADIANIA	AA12258344	ANAPOLIS UNIVERSITARIO S1	18/01/2020 08:48	18/01/2020 10:23	18/01/2020 08:48	18/01/2020 10:23	1,59	93	148,05	CHI
202001107257	GAMELEIRA DE GOIAS	AA12258344	ANAPOLIS UNIVERSITARIO S1	18/01/2020 08:48	18/01/2020 10:23	18/01/2020 08:48	18/01/2020 10:23	1,59	10	15,92	CHI
202001107261	PLANALTINA	PI11149011	PLANALTINA	18/01/2020 08:56	18/01/2020 13:13	18/01/2020 08:56	18/01/2020 13:13	4,27	54	230,42	CHI
202001107266	FAZENDA NOVA	FN12292864	JUSSARA	18/01/2020 08:57	18/01/2020 12:55	18/01/2020 08:57	18/01/2020 12:55	3,96	2	7,92	CHI
202001107267	SANTA BARBARA DE GOIAS	SB12186355	TRINDADE	18/01/2020 08:50	18/01/2020 23:00	18/01/2020 08:50	18/01/2020 23:00	14,16	9	127,48	CHI

202001107274	RIO VERDE	RV12024714	RIO VERDE S1	18/01/2020 08:32	18/01/2020 11:10	18/01/2020 08:32	18/01/2020 11:10	2,63	22	57,83	CHI
202001107275	PIRENOPOLIS	PV21377590	CORUMBA	18/01/2020 08:58	18/01/2020 18:24	18/01/2020 08:58	18/01/2020 18:24	9,43	1	9,43	CHI
202001107278	QUIRINOPOLIS	QI21296584	QUIRINOPOLIS	18/01/2020 08:58	18/01/2020 11:23	18/01/2020 08:58	18/01/2020 11:23	2,41	1	2,41	CHI
202001107280	GOIANESIA	550028407	GOIANESIA S2	18/01/2020 08:59	18/01/2020 11:05	18/01/2020 08:59	18/01/2020 11:05	2,10	1	2,10	CHI
202001107282	NIQUELANDIA	NQ11171101	BARRO ALTO	18/01/2020 08:59	19/01/2020 02:23	18/01/2020 08:59	19/01/2020 02:23	17,40	1	17,40	CHI
202001107285	LUZIANIA	LZ21059753	PAMPLONA	18/01/2020 08:59	18/01/2020 14:49	18/01/2020 08:59	18/01/2020 14:49	5,82	2	11,65	CHI
202001107286	CALDAS NOVAS	CN21331851	SERRA DE CALDAS	18/01/2020 08:59	18/01/2020 13:21	18/01/2020 08:59	18/01/2020 13:21	4,36	1	4,36	CHI
202001107287	INDIARA	IY21102313	EDEIA	18/01/2020 08:59	18/01/2020 10:15	18/01/2020 08:59	18/01/2020 10:15	1,27	1	1,27	CHI
202001107290	ANAPOLIS	21159737	ANAPOLIS UNIVERSITARIO S2	18/01/2020 09:00	18/01/2020 11:46	18/01/2020 09:00	18/01/2020 11:46	2,76	1	2,76	CHI
202001107294	ABADIANIA	AA31077923	ANAPOLIS UNIVERSITARIO S1	18/01/2020 09:01	18/01/2020 13:44	18/01/2020 09:01	18/01/2020 13:44	4,71	1	4,71	CHI
202001107295	PARAUNA	PU12361889	PARAUNA	18/01/2020 09:01	18/01/2020 11:26	18/01/2020 09:01	18/01/2020 11:26	2,41	4	9,65	CHI
202001107296	ARUANA	AK12250808	ARUANA	18/01/2020 09:01	18/01/2020 10:16	18/01/2020 09:01	18/01/2020 10:16	1,24	4	4,97	CHI
202001107301	CHAPADAO DO CEU	DJ21162537	CHAPADAO DO CEU	18/01/2020 09:02	18/01/2020 13:42	18/01/2020 09:02	18/01/2020 13:42	4,66	1	4,66	CHI
202001107303	CEZARINA	CZ21154000	CEZARINA	18/01/2020 09:02	18/01/2020 13:15	18/01/2020 09:02	18/01/2020 13:15	4,21	3	12,62	CHI
202001107308	MOSSAMEDES	MD12000176	FIRMINOPOLIS S2	18/01/2020 09:03	18/01/2020 11:08	18/01/2020 09:03	18/01/2020 11:08	2,07	37	76,70	CHI
202001107309	CATALAO	CT12053651	CATALAO S1	18/01/2020 09:03	18/01/2020 18:00	18/01/2020 09:03	18/01/2020 18:00	8,94	1	8,94	CHI
202001107309	GOIANDIRA	CT12053651	CATALAO S1	18/01/2020 09:03	18/01/2020 18:00	18/01/2020 09:03	18/01/2020 18:00	8,94	1	8,94	CHI
202001107310	CALDAZINHA	BV21070004	BELA VISTA S2	18/01/2020 09:03	18/01/2020 19:05	18/01/2020 14:07	18/01/2020 18:46	4,65	2	9,30	CHI
202001107310	BELA VISTA DE GOIAS	BV12012075	BELA VISTA S2	18/01/2020 09:03	18/01/2020 19:05	18/01/2020 18:05	18/01/2020 19:05	1,00	31	31,00	CHI
202001107310	CALDAZINHA	BV12012075	BELA VISTA S2	18/01/2020 09:03	18/01/2020 19:05	18/01/2020 18:05	18/01/2020 19:05	1,00	4	4,00	CHI
202001107310	SILVANIA	BV12012075	BELA VISTA S2	18/01/2020 09:03	18/01/2020 19:05	18/01/2020 18:05	18/01/2020 19:05	1,00	24	24,00	CHI
202001107314	MINEIROS	MY21374367	PARQUE DAS EMAS	18/01/2020 09:05	18/01/2020 11:18	18/01/2020 09:05	18/01/2020 11:18	2,21	2	4,42	CHI
202001107318	ANAPOLIS	AN21288996	ANAPOLIS UNIVERSITARIO S1	18/01/2020 09:05	18/01/2020 11:51	18/01/2020 09:05	18/01/2020 11:51	2,75	2	5,51	CHI
202001107319	LUZIANIA	LZ21168111	CRISTALINA S2	18/01/2020 09:06	18/01/2020 18:36	18/01/2020 09:06	18/01/2020 18:36	9,50	1	9,50	CHI
202001107333	COLINAS DO SUL	TI12243076	NIQUELANDIA SUBTRANSMISSAO	18/01/2020 09:03	19/01/2020 02:08	18/01/2020 09:03	19/01/2020 02:08	17,08	3	51,24	CHI
202001107340	GOIANIA	16754141	CARAJAS S1	18/01/2020 09:08	18/01/2020 11:18	18/01/2020 09:08	18/01/2020 11:18	2,15	1	2,15	CHI
202001107341	JATAI	JT21144761	JATAI S1	18/01/2020 09:08	18/01/2020 15:43	18/01/2020 09:08	18/01/2020 15:43	6,57	1	6,57	CHI
202001107346	JATAI	290039381	JATAI S2	18/01/2020 09:09	18/01/2020 14:41	18/01/2020 09:09	18/01/2020 14:41	5,54	1	5,54	CHI
202001107348	COCALZINHO DE GOIAS	ZN12297780	COCALZINHO	18/01/2020 08:50	18/01/2020 16:10	18/01/2020 08:50	18/01/2020 16:10	7,32	9	65,87	CHI
202001107354	IPAMERI	NE12082774	CATALAO S1	18/01/2020 07:11	18/01/2020 12:19	18/01/2020 07:11	18/01/2020 12:19	5,14	14	71,97	CHI
202001107354	NOVA AURORA	NE12082774	CATALAO S1	18/01/2020 07:11	18/01/2020 12:19	18/01/2020 07:11	18/01/2020 12:19	5,14	16	82,25	CHI
202001107355	ANAPOLIS	AN12262491	ANAPOLIS UNIVERSITARIO S1	18/01/2020 09:06	18/01/2020 10:32	18/01/2020 09:06	18/01/2020 10:32	1,42	40	56,87	CHI
202001107357	SITIO D ABADIA	SI12329755	IACIARA S2	18/01/2020 09:11	18/01/2020 12:30	18/01/2020 09:11	18/01/2020 12:30	3,30	5	16,52	CHI

202001107359	NIQUELANDIA	NQ21403460	NIQUELANDIA SUBTRANSMISSAO	18/01/2020 09:12	18/01/2020 23:29	18/01/2020 09:12	18/01/2020 23:29	14,28	1	14,28	CHI
202001107360	SANTA HELENA DE GOIAS	SH12279536	IPEGUARI	18/01/2020 09:12	18/01/2020 13:07	18/01/2020 09:12	18/01/2020 13:07	3,91	1	3,91	CHI
202001107362	PORANGATU	PO21380230	NOVO PLANALTO	18/01/2020 09:12	18/01/2020 11:40	18/01/2020 09:12	18/01/2020 11:40	2,45	1	2,45	CHI
202001107365	RIO VERDE	630318402	RIO VERDE S2	18/01/2020 09:13	18/01/2020 12:36	18/01/2020 09:13	18/01/2020 12:36	3,37	1	3,37	CHI
202001107366	MINACU	IH12288127	MINACU	18/01/2020 09:13	18/01/2020 13:50	18/01/2020 09:13	18/01/2020 13:50	4,61	6	27,68	CHI
202001107368	PALMEIRAS DE GOIAS	PL21125174	PALMEIRAS	18/01/2020 09:14	18/01/2020 11:07	18/01/2020 09:14	18/01/2020 11:07	1,87	1	1,87	CHI
202001107371	RIO VERDE	RV21155857	SANTA HELENA S1	18/01/2020 09:15	18/01/2020 20:15	18/01/2020 09:15	18/01/2020 20:15	11,00	1	11,00	CHI
202001107378	APARECIDA DE GOIANIA	200265611	INDEPENDENCIA S1	18/01/2020 09:16	18/01/2020 10:52	18/01/2020 09:16	18/01/2020 10:52	1,60	1	1,60	CHI
202001107380	CARMO DO RIO VERDE	RB12051013	RUBIATABA	18/01/2020 08:12	18/01/2020 16:49	18/01/2020 08:12	18/01/2020 16:49	8,60	3	25,81	CHI
202001107380	SAO PATRICIO	RB12051013	RUBIATABA	18/01/2020 08:12	18/01/2020 16:49	18/01/2020 08:12	18/01/2020 16:49	8,60	3	25,81	CHI
202001107381	GOIANIA	10194060	AEROPORTO S1	18/01/2020 09:17	18/01/2020 10:50	18/01/2020 09:17	18/01/2020 10:50	1,55	1	1,55	CHI
202001107383	PIRANHAS	PH21236891	BOM JARDIM	18/01/2020 09:17	18/01/2020 21:00	18/01/2020 09:17	18/01/2020 21:00	11,70	1	11,70	CHI
202001107385	CAIAPONIA	CP12119626	CAIAPONIA	18/01/2020 08:56	18/01/2020 16:10	18/01/2020 08:56	18/01/2020 16:10	7,23	97	701,09	CHI
202001107385	PIRANHAS	CP12119626	CAIAPONIA	18/01/2020 08:56	18/01/2020 16:10	18/01/2020 08:56	18/01/2020 16:10	7,23	13	93,96	CHI
202001107387	NOVO GAMA	NJ11149846	PACAEMBU S1	18/01/2020 09:18	18/01/2020 10:35	18/01/2020 09:18	18/01/2020 10:35	1,28	98	125,49	CHI
202001107389	CORUMBAIBA	CI12092137	CATALAO S1	18/01/2020 06:52	18/01/2020 17:50	18/01/2020 06:52	18/01/2020 17:50	10,97	7	76,81	CHI
202001107390	ORIZONA	OZ21136909	PIRES DO RIO S2	18/01/2020 09:18	18/01/2020 14:20	18/01/2020 09:18	18/01/2020 14:20	5,02	1	5,02	CHI
202001107393	JATAI	RV12222009	CABRIUVA S2	18/01/2020 09:17	18/01/2020 11:46	18/01/2020 09:17	18/01/2020 11:46	2,48	16	39,63	CHI
202001107393	RIO VERDE	RV12222009	CABRIUVA S2	18/01/2020 09:17	18/01/2020 11:46	18/01/2020 09:17	18/01/2020 11:46	2,48	20	49,53	CHI
202001107396	CRIXAS	CX21181028	SANTA TEREZINHA	18/01/2020 09:19	18/01/2020 18:00	18/01/2020 09:19	18/01/2020 18:00	8,67	1	8,67	CHI
202001107399	PALESTINA DE GOIAS	CP21231113	PALESTINA	18/01/2020 09:20	18/01/2020 17:52	18/01/2020 09:20	18/01/2020 17:52	8,53	1	8,53	CHI
202001107400	RIO VERDE	630540421	RIO VERDE S1	18/01/2020 09:20	18/01/2020 10:44	18/01/2020 09:20	18/01/2020 10:44	1,39	1	1,39	CHI
202001107401	SENADOR CANEDO	10019694197	SENADOR CANEDO	18/01/2020 09:20	18/01/2020 13:10	18/01/2020 09:20	18/01/2020 13:10	3,83	1	3,83	CHI
202001107403	ANICUNS	AC21299131	ANICUNS	18/01/2020 09:20	18/01/2020 10:59	18/01/2020 09:20	18/01/2020 10:59	1,64	1	1,64	CHI
202001107409	FAZENDA NOVA	JP12316446	IPORA	18/01/2020 09:22	19/01/2020 16:27	18/01/2020 09:22	19/01/2020 16:27	31,08	3	93,23	CHI
202001107409	JAUPACI	JP12316446	IPORA	18/01/2020 09:22	19/01/2020 16:27	18/01/2020 09:22	19/01/2020 16:27	31,08	4	124,30	CHI
202001107410	GAMELEIRA DE GOIAS	GL12265246	DAIA S2	18/01/2020 09:22	18/01/2020 13:44	18/01/2020 09:22	18/01/2020 13:44	4,36	6	26,14	CHI
202001107411	BURITI DE GOIAS	BS12099754	FIRMINOPOLIS S2	18/01/2020 07:36	18/01/2020 09:41	18/01/2020 07:36	18/01/2020 09:41	2,08	13	27,05	CHI
202001107423	SAO MIGUEL DO ARAGUAIA	SM12245801	SAO MIGUEL DO ARAGUAIA	18/01/2020 09:25	18/01/2020 13:00	18/01/2020 09:25	18/01/2020 13:00	3,58	3	10,74	CHI
202001107425	QUIRINOPOLIS	QI21147691	QUIRINOPOLIS	18/01/2020 09:26	18/01/2020 12:06	18/01/2020 09:26	18/01/2020 12:06	2,67	2	5,33	CHI
202001107428	SANTA HELENA DE GOIAS	SH12301283	IPEGUARI	18/01/2020 06:29	18/01/2020 13:48	18/01/2020 06:29	18/01/2020 13:48	7,31	7	51,14	CHI
202001107431	CORUMBA DE GOIAS	CB12072262	COCALZINHO	18/01/2020 09:26	18/01/2020 14:23	18/01/2020 09:26	18/01/2020 13:11	3,74	4	14,96	CHI
202001107431	CORUMBA DE GOIAS	CB21243951	COCALZINHO	18/01/2020 09:26	18/01/2020 14:23	18/01/2020 09:26	18/01/2020 14:23	4,94	1	4,94	CHI

202001107435	CEZARINA	MI12308017	PONTALINA	18/01/2020 07:03	18/01/2020 12:37	18/01/2020 07:03	18/01/2020 12:37	5,58	9	50,22	CHI
202001107435	MAIRIPOTABA	MI12308017	PONTALINA	18/01/2020 07:03	18/01/2020 12:37	18/01/2020 07:03	18/01/2020 12:37	5,58	8	44,64	CHI
202001107438	GOIANIA	16400288	CARAJAS S1	18/01/2020 09:27	18/01/2020 11:06	18/01/2020 09:27	18/01/2020 11:06	1,64	1	1,64	CHI
202001107439	JARAGUA	70027080	JARAGUA	18/01/2020 09:27	18/01/2020 14:02	18/01/2020 09:27	18/01/2020 14:02	4,57	1	4,57	CHI
202001107440	PIRENOPOLIS	220077289	CORUMBA	18/01/2020 09:28	18/01/2020 20:18	18/01/2020 09:28	18/01/2020 20:18	10,83	1	10,83	CHI
202001107453	MINACU	IH12250175	MINACU	18/01/2020 09:29	18/01/2020 12:45	18/01/2020 09:29	18/01/2020 12:45	3,25	3	9,76	CHI
202001107456	IPAMERI	IP21100330	IPAMERI	18/01/2020 09:29	18/01/2020 12:40	18/01/2020 09:29	18/01/2020 12:40	3,17	1	3,17	CHI
202001107459	NOVO GAMA	NJ12379166	PACAEMBU S1	18/01/2020 09:30	18/01/2020 12:16	18/01/2020 09:30	18/01/2020 12:16	2,75	2	5,50	CHI
202001107462	PORANGATU	PO12241996	PORANGATU	18/01/2020 09:31	18/01/2020 14:10	18/01/2020 09:31	18/01/2020 14:10	4,64	80	370,87	CHI
202001107463	ALEXANIA	AX21312836	ALEXANIA	18/01/2020 09:31	18/01/2020 15:13	18/01/2020 09:31	18/01/2020 15:13	5,69	2	11,37	CHI
202001107468	SANTO ANTONIO DO DESCOBERTO	AX21351221	ALEXANIA	18/01/2020 09:33	18/01/2020 17:17	18/01/2020 09:33	18/01/2020 17:17	7,73	1	7,73	CHI
202001107472	GOIAS	90014893	GOIAS	18/01/2020 09:34	18/01/2020 14:06	18/01/2020 09:34	18/01/2020 14:06	4,53	1	4,53	CHI
202001107473	MINACU	IH21197831	MINACU	18/01/2020 09:32	18/01/2020 14:04	18/01/2020 09:32	18/01/2020 14:04	4,52	1	4,52	CHI
202001107476	JATAI	290086899	JATAI S3	18/01/2020 09:35	18/01/2020 16:27	18/01/2020 09:35	18/01/2020 16:27	6,85	1	6,85	CHI
202001107478	NIQUELANDIA	10018316725	NIQUELANDIA SUBTRANSMISSAO	18/01/2020 09:36	18/01/2020 11:26	18/01/2020 09:36	18/01/2020 11:26	1,83	1	1,83	CHI
202001107479	APARECIDA DE GOIANIA	10017777923	INDEPENDENCIA S2	18/01/2020 09:36	18/01/2020 11:19	18/01/2020 09:36	18/01/2020 11:19	1,71	1	1,71	CHI
202001107481	NOVA AMERICA	NM12363582	RUBIATABA	18/01/2020 09:37	18/01/2020 17:42	18/01/2020 09:37	18/01/2020 17:42	8,08	3	24,24	CHI
202001107482	JATAI	290067911	JATAI S3	18/01/2020 09:37	18/01/2020 10:44	18/01/2020 09:37	18/01/2020 10:44	1,10	1	1,10	CHI
202001107484	FAINA	FC12268652	GOIAS	18/01/2020 09:38	18/01/2020 12:30	18/01/2020 09:38	18/01/2020 12:30	2,86	1	2,86	CHI
202001107488	ITUMBIARA	IT12088642	ITUMBIARA NOVA	18/01/2020 08:19	18/01/2020 11:20	18/01/2020 08:19	18/01/2020 11:20	3,00	10	30,03	CHI
202001107498	SAO MIGUEL DO ARAGUAIA	830055642	SAO MIGUEL DO ARAGUAIA	18/01/2020 09:40	18/01/2020 14:41	18/01/2020 09:40	18/01/2020 14:41	5,02	1	5,02	CHI
202001107500	CACHOEIRA DE GOIAS	CG21321286	FIRMINOPOLIS S2	18/01/2020 09:40	18/01/2020 11:13	18/01/2020 09:40	18/01/2020 11:13	1,54	1	1,54	CHI
202001107501	ITABERAI	IB12310505	ITABERAI S2	18/01/2020 09:40	18/01/2020 10:31	18/01/2020 09:40	18/01/2020 10:31	0,84	15	12,57	CHI
202001107503	SANTA CRUZ DE GOIAS	BC21256454	PIRES DO RIO S2	18/01/2020 09:41	18/01/2020 13:20	18/01/2020 09:41	18/01/2020 13:20	3,65	1	3,65	CHI
202001107504	NIQUELANDIA	NQ21247181	URUACU	18/01/2020 09:41	18/01/2020 21:17	18/01/2020 09:41	18/01/2020 21:17	11,59	1	11,59	CHI
202001107509	ALTO HORIZONTE	AJ21292608	SANTA TEREZINHA	18/01/2020 09:43	18/01/2020 12:44	18/01/2020 09:43	18/01/2020 12:44	3,01	1	3,01	CHI
202001107511	SAO FRANCISCO DE GOIAS	490020525	SAO FRANCISCO DE GOIAS	18/01/2020 09:43	18/01/2020 12:30	18/01/2020 09:43	18/01/2020 12:30	2,79	1	2,79	CHI
202001107514	MINACU	IH21288088	MINACU	18/01/2020 09:43	18/01/2020 11:20	18/01/2020 09:43	18/01/2020 11:20	1,60	1	1,60	CHI
202001107515	HIDROLANDIA	HD12024197	CEPAIGO S2	18/01/2020 09:43	18/01/2020 11:19	18/01/2020 09:43	18/01/2020 11:19	1,59	2	3,17	CHI
202001107516	DOVERLANDIA	MY12364401	PARQUE DAS EMAS	18/01/2020 09:44	18/01/2020 18:01	18/01/2020 09:44	18/01/2020 18:01	8,28	1	8,28	CHI
202001107516	MINEIROS	MY12364401	PARQUE DAS EMAS	18/01/2020 09:44	18/01/2020 18:01	18/01/2020 09:44	18/01/2020 18:01	8,28	2	16,56	CHI
202001107520	GOIANIA	11957761	AEROPORTO S1	18/01/2020 09:45	18/01/2020 11:41	18/01/2020 09:45	18/01/2020 11:41	1,94	1	1,94	CHI
202001107526	CAMPINORTE	CR12172326	MARA ROSA	18/01/2020 08:58	18/01/2020 14:00	18/01/2020 08:58	18/01/2020 14:00	5,03	4	20,12	CHI

202001107526	FORMOSO	CR12172326	MARA ROSA	18/01/2020 08:58	18/01/2020 14:00	18/01/2020 08:58	18/01/2020 14:00	5,03	3	15,09	CHI
202001107527	INACIOLANDIA	CD12011456	CACHOEIRA DOURADA	18/01/2020 09:47	18/01/2020 15:30	18/01/2020 09:47	18/01/2020 15:30	5,71	5	28,53	CHI
202001107530	FORMOSA	FA12395983	FLORES DE GOIAS	18/01/2020 09:48	18/01/2020 11:37	18/01/2020 09:48	18/01/2020 11:37	1,81	98	177,33	CHI
202001107537	MORRINHOS	MR21171723	MORRINHOS	18/01/2020 09:49	18/01/2020 13:44	18/01/2020 09:49	18/01/2020 13:44	3,91	1	3,91	CHI
202001107540	GOIANIA	GN11041232	GOYA S1	18/01/2020 09:49	18/01/2020 11:44	18/01/2020 09:49	18/01/2020 11:44	1,90	2	3,81	CHI
202001107545	RIO VERDE	RV21260092	RIO VERDE S1	18/01/2020 09:50	18/01/2020 11:58	18/01/2020 09:50	18/01/2020 11:58	2,14	1	2,14	CHI
202001107546	COCALZINHO DE GOIAS	ZN12086557	AGUAS LINDAS DE GOIAS S2	18/01/2020 07:12	18/01/2020 11:08	18/01/2020 07:12	18/01/2020 11:08	3,93	6	23,56	CHI
202001107546	RIALMA	ZN12086557	AGUAS LINDAS DE GOIAS S2	18/01/2020 07:12	18/01/2020 11:08	18/01/2020 07:12	18/01/2020 11:08	3,93	2	7,85	CHI
202001107547	CEZARINA	CZ21154056	CEZARINA	18/01/2020 09:50	18/01/2020 12:17	18/01/2020 09:50	18/01/2020 12:17	2,44	1	2,44	CHI
202001107549	QUIRINOPOLIS	QI21035320	QUIRINOPOLIS	18/01/2020 09:51	18/01/2020 11:10	18/01/2020 09:51	18/01/2020 11:10	1,31	1	1,31	CHI
202001107554	COCALZINHO DE GOIAS	ZN21258205	COCALZINHO	18/01/2020 07:52	18/01/2020 12:52	18/01/2020 07:52	18/01/2020 12:52	5,00	1	5,00	CHI
202001107555	LUZIANIA	LZ12389578	VIANOPOLIS	18/01/2020 09:27	18/01/2020 12:58	18/01/2020 09:27	18/01/2020 12:58	3,51	18	63,16	CHI
202001107556	NEROPOLIS	160036161	NEROPOLIS S2	18/01/2020 09:52	18/01/2020 12:23	18/01/2020 09:52	18/01/2020 12:23	2,51	1	2,51	CHI
202001107560	CACHOEIRA ALTA	CA12095040	CACHOEIRA ALTA	18/01/2020 09:30	19/01/2020 10:42	18/01/2020 09:30	19/01/2020 10:42	25,19	5	125,96	CHI
202001107562	AGUAS LINDAS DE GOIAS	10009274519	AGUAS LINDAS DE GOIAS S2	18/01/2020 09:55	18/01/2020 15:04	18/01/2020 09:55	18/01/2020 15:04	5,15	1	5,15	CHI
202001107573	APARECIDA DE GOIANIA	10015100110	REAL S1	18/01/2020 10:00	18/01/2020 11:14	18/01/2020 10:00	18/01/2020 11:14	1,22	1	1,22	CHI
202001107574	CACHOEIRA DOURADA	CD12257146	CACHOEIRA DOURADA	18/01/2020 10:00	18/01/2020 11:05	18/01/2020 10:00	18/01/2020 11:05	1,07	229	245,60	CHI
202001107579	CACHOEIRA ALTA	CA21219325	CACHOEIRA ALTA	18/01/2020 10:01	19/01/2020 08:57	18/01/2020 10:01	19/01/2020 08:57	22,92	2	45,84	CHI
202001107584	JATAI	JT21241697	JATAI S1	18/01/2020 10:02	18/01/2020 12:56	18/01/2020 10:02	18/01/2020 12:56	2,88	1	2,88	CHI
202001107585	COCALZINHO DE GOIAS	ZN21084623	AGUAS LINDAS DE GOIAS S2	18/01/2020 10:03	18/01/2020 13:43	18/01/2020 10:03	18/01/2020 13:43	3,67	1	3,67	CHI
202001107590	MORRINHOS	MR12394199	MORRINHOS	18/01/2020 06:45	18/01/2020 11:04	18/01/2020 06:45	18/01/2020 11:04	4,31	7	30,16	CHI
202001107605	LUZIANIA	10006655775	RIO VERMELHO	18/01/2020 10:07	18/01/2020 15:31	18/01/2020 10:07	18/01/2020 15:31	5,40	1	5,40	CHI
202001107606	PIRENOPOLIS	PV11264950	CORUMBA	18/01/2020 10:07	18/01/2020 12:52	18/01/2020 10:07	18/01/2020 12:52	2,74	37	101,31	CHI
202001107612	NOVA ROMA	ND12115565	IACIARA S2	18/01/2020 10:07	18/01/2020 11:40	18/01/2020 10:07	18/01/2020 11:40	1,54	136	209,44	CHI
202001107616	AGUA LIMPA	AL21263204	VILA CORUMBA	18/01/2020 10:08	19/01/2020 10:15	18/01/2020 10:08	19/01/2020 10:15	24,10	1	24,10	CHI
202001107626	AMORINOPOLIS	IR12188355	IPORA	17/01/2020 22:53	18/01/2020 23:47	17/01/2020 22:53	18/01/2020 23:47	24,89	7	174,21	CHI
202001107626	IPORA	IR12188355	IPORA	17/01/2020 22:53	18/01/2020 23:47	17/01/2020 22:53	18/01/2020 23:47	24,89	3	74,66	CHI
202001107627	ANAPOLIS	AN12258566	ANAPOLIS UNIVERSITARIO S2	18/01/2020 10:11	18/01/2020 13:29	18/01/2020 10:11	18/01/2020 13:29	3,29	6	19,75	CHI
202001107628	QUIRINOPOLIS	QI21298306	QUIRINOPOLIS	18/01/2020 10:11	18/01/2020 13:18	18/01/2020 10:11	18/01/2020 13:18	3,11	1	3,11	CHI
202001107633	TRINDADE	10022586774	GOYA S2	18/01/2020 10:12	18/01/2020 12:13	18/01/2020 10:12	18/01/2020 12:13	2,00	1	2,00	CHI
202001107634	SAO LUIS DE MONTES BELOS	500110086	SAO LUIZ DOS MONTES BELOS	18/01/2020 10:12	18/01/2020 12:03	18/01/2020 10:12	18/01/2020 12:03	1,83	1	1,83	CHI
202001107636	FIRMINOPOLIS	FR12382556	FIRMINOPOLIS S1	18/01/2020 10:13	18/01/2020 19:14	18/01/2020 10:13	18/01/2020 18:14	8,02	1	8,02	CHI
202001107636	FIRMINOPOLIS	FR12186309LD	FIRMINOPOLIS S1	18/01/2020 10:13	18/01/2020 19:14	18/01/2020 10:13	18/01/2020 18:40	8,44	17	143,46	CHI

202001107636	SAO LUIS DE MONTES BELOS	FR12186309LD	FIRMINOPOLIS S1	18/01/2020 10:13	18/01/2020 19:14	18/01/2020 10:13	18/01/2020 18:40	8,44	7	59,07	CHI
202001107636	FIRMINOPOLIS	FR12299099	FIRMINOPOLIS S1	18/01/2020 10:13	18/01/2020 19:14	18/01/2020 10:13	18/01/2020 19:14	9,02	4	36,08	CHI
202001107637	SANTO ANTONIO DO DESCOBERTO	SN11183717	MARAJOARA	18/01/2020 10:13	18/01/2020 14:42	18/01/2020 10:13	18/01/2020 14:42	4,47	3	13,41	CHI
202001107639	ABADIANIA	10002890583	ANAPOLIS UNIVERSITARIO S1	18/01/2020 10:14	18/01/2020 11:38	18/01/2020 10:14	18/01/2020 11:38	1,39	1	1,39	CHI
202001107641	GOIANIA	GN11003092	AEROPORTO S1	18/01/2020 10:11	18/01/2020 15:00	18/01/2020 10:11	18/01/2020 15:00	4,81	20	96,16	CHI
202001107642	GOIANIA	10018295027	CARAJAS S2	18/01/2020 10:14	18/01/2020 12:27	18/01/2020 10:14	18/01/2020 12:27	2,21	1	2,21	CHI
202001107646	VALPARAISO DE GOIAS	10030114754	PACAEMBU S1	18/01/2020 10:15	18/01/2020 11:35	18/01/2020 10:15	18/01/2020 11:35	1,33	1	1,33	CHI
202001107648	JATAI	JT12187749	JATAI S1	18/01/2020 10:15	18/01/2020 20:12	18/01/2020 10:15	18/01/2020 20:12	9,94	1	9,94	CHI
202001107649	PIRACANJUBA	PJ12032540	PIRACANJUBA	18/01/2020 06:56	18/01/2020 17:26	18/01/2020 06:56	18/01/2020 17:26	10,49	6	62,94	CHI
202001107654	FIRMINOPOLIS	SL12111569	FIRMINOPOLIS S1	18/01/2020 10:18	18/01/2020 12:39	18/01/2020 10:18	18/01/2020 12:39	2,34	17	39,84	CHI
202001107654	SAO LUIS DE MONTES BELOS	SL12111569	FIRMINOPOLIS S1	18/01/2020 10:18	18/01/2020 12:39	18/01/2020 10:18	18/01/2020 12:39	2,34	63	147,65	CHI
202001107654	TURVANIA	SL12111569	FIRMINOPOLIS S1	18/01/2020 10:18	18/01/2020 12:39	18/01/2020 10:18	18/01/2020 12:39	2,34	8	18,75	CHI
202001107660	PIRACANJUBA	PJ12025290	PIRACANJUBA	18/01/2020 10:05	18/01/2020 11:50	18/01/2020 10:05	18/01/2020 11:50	1,74	18	31,35	CHI
202001107663	SANCLERLANDIA	SC21160183	FIRMINOPOLIS S2	18/01/2020 10:19	18/01/2020 14:44	18/01/2020 10:19	18/01/2020 14:44	4,40	1	4,40	CHI
202001107665	CRISTALINA	KR21246075	CRISTALINA S2	18/01/2020 10:20	18/01/2020 14:34	18/01/2020 10:20	18/01/2020 14:34	4,23	1	4,23	CHI
202001107667	INDIARA	IY21039707	EDEIA	18/01/2020 10:20	18/01/2020 17:42	18/01/2020 10:20	18/01/2020 17:42	7,35	1	7,35	CHI
202001107669	GOIATUBA	GT12033074	BOM JESUS DE GOIAS	18/01/2020 10:21	18/01/2020 12:54	18/01/2020 10:21	18/01/2020 12:54	2,54	17	43,18	CHI
202001107676	MINEIROS	1390154546	PARQUE DAS EMAS	18/01/2020 10:24	18/01/2020 12:15	18/01/2020 10:24	18/01/2020 12:15	1,84	1	1,84	CHI
202001107677	SAO LUIS DE MONTES BELOS	SL21028645	FIRMINOPOLIS S2	18/01/2020 10:24	18/01/2020 11:53	18/01/2020 10:24	18/01/2020 11:53	1,48	2	2,95	CHI
202001107685	BONOPOLIS	BX21286695	SAO MIGUEL DO ARAGUAIA	18/01/2020 10:26	18/01/2020 19:25	18/01/2020 10:26	18/01/2020 19:25	8,98	1	8,98	CHI
202001107686	AGUA LIMPA	AL12075701	VILA CORUMBA	18/01/2020 08:59	18/01/2020 17:50	18/01/2020 08:59	18/01/2020 17:50	8,85	4	35,39	CHI
202001107688	SAO LUIS DE MONTES BELOS	SL32111610	FIRMINOPOLIS S1	18/01/2020 10:27	18/01/2020 12:53	18/01/2020 10:27	18/01/2020 12:53	2,43	30	72,90	CHI
202001107689	PIRES DO RIO	BC21012016	PIRES DO RIO S2	18/01/2020 10:27	18/01/2020 13:31	18/01/2020 10:27	18/01/2020 13:31	3,05	1	3,05	CHI
202001107691	JATAI	JT12080471	JATAI S1	18/01/2020 10:28	19/01/2020 09:50	18/01/2020 10:28	19/01/2020 09:50	23,36	6	140,18	CHI
202001107695	RIO VERDE	RV21284364	SANTA HELENA S1	18/01/2020 10:29	19/01/2020 01:51	18/01/2020 10:29	19/01/2020 01:51	15,36	1	15,36	CHI
202001107696	PROFESSOR JAMIL SAFADY	PJ12077816	PONTALINA	18/01/2020 07:01	18/01/2020 12:30	18/01/2020 07:01	18/01/2020 12:30	5,47	2	10,94	CHI
202001107697	HIDROLANDIA	HD21400520	PONTALINA	18/01/2020 10:29	18/01/2020 13:15	18/01/2020 10:29	18/01/2020 13:15	2,76	1	2,76	CHI
202001107698	SANTA FE DE GOIAS	01650214	BRITANIA	18/01/2020 10:20	20/01/2020 01:14	18/01/2020 10:20	18/01/2020 12:15	1,92	318	609,15	CHI
202001107698	FAZENDA NOVA	01650214	BRITANIA	18/01/2020 10:20	20/01/2020 01:14	18/01/2020 10:20	18/01/2020 12:19	1,99	212	422,35	CHI
202001107698	JAUPACI	01650214	BRITANIA	18/01/2020 10:20	20/01/2020 01:14	18/01/2020 10:20	18/01/2020 12:19	1,99	2	3,98	CHI
202001107698	JUSSARA	01650214	BRITANIA	18/01/2020 10:20	20/01/2020 01:14	18/01/2020 10:20	18/01/2020 12:19	1,99	329	655,44	CHI
202001107698	SANTA FE DE GOIAS	01650214	BRITANIA	18/01/2020 10:20	20/01/2020 01:14	18/01/2020 10:20	18/01/2020 12:19	1,99	54	107,58	CHI
202001107698	JUSSARA	RN16408481	BRITANIA	18/01/2020 10:20	20/01/2020 01:14	18/01/2020 12:08	18/01/2020 12:19	0,19	19	3,63	CHI

202001107698	SANTA FE DE GOIAS	RN16408481	BRITANIA	18/01/2020 10:20	20/01/2020 01:14	18/01/2020 12:08	18/01/2020 12:19	0,19	39	7,44	CHI
202001107698	JUSSARA	01650214	BRITANIA	18/01/2020 10:20	20/01/2020 01:14	18/01/2020 13:00	18/01/2020 13:22	0,35	22	7,79	CHI
202001107698	SANTA FE DE GOIAS	01650214	BRITANIA	18/01/2020 10:20	20/01/2020 01:14	18/01/2020 13:00	18/01/2020 13:22	0,35	385	136,35	CHI
202001107698	JUSSARA	RN10394715	BRITANIA	18/01/2020 10:20	20/01/2020 01:14	18/01/2020 12:35	18/01/2020 15:18	2,72	132	358,82	CHI
202001107698	SANTA FE DE GOIAS	RN10394715	BRITANIA	18/01/2020 10:20	20/01/2020 01:14	18/01/2020 12:35	18/01/2020 15:18	2,72	25	67,96	CHI
202001107698	FAZENDA NOVA	RN10394715	BRITANIA	18/01/2020 10:20	20/01/2020 01:14	18/01/2020 12:35	18/01/2020 15:39	3,07	140	429,29	CHI
202001107698	JUSSARA	RN10394715	BRITANIA	18/01/2020 10:20	20/01/2020 01:14	18/01/2020 12:35	18/01/2020 15:39	3,07	20	61,33	CHI
202001107698	JUSSARA	RN10394715	BRITANIA	18/01/2020 10:20	20/01/2020 01:14	18/01/2020 12:35	18/01/2020 17:31	4,93	103	507,90	CHI
202001107698	FAZENDA NOVA	FN13362430	BRITANIA	18/01/2020 10:20	20/01/2020 01:14	18/01/2020 12:35	18/01/2020 19:30	6,92	61	422,14	CHI
202001107698	JAUPACI	FN13362430	BRITANIA	18/01/2020 10:20	20/01/2020 01:14	18/01/2020 12:35	18/01/2020 19:30	6,92	2	13,84	CHI
202001107698	JUSSARA	FN13362430	BRITANIA	18/01/2020 10:20	20/01/2020 01:14	18/01/2020 12:35	18/01/2020 19:30	6,92	11	76,12	CHI
202001107698	JUSSARA	JR12033556	BRITANIA	18/01/2020 10:20	20/01/2020 01:14	18/01/2020 17:37	18/01/2020 20:34	2,94	61	179,31	CHI
202001107698	FAZENDA NOVA	RN10394715	BRITANIA	18/01/2020 10:20	20/01/2020 01:14	18/01/2020 12:35	18/01/2020 21:15	8,67	8	69,39	CHI
202001107698	JUSSARA	RN10394715	BRITANIA	18/01/2020 10:20	20/01/2020 01:14	18/01/2020 12:35	18/01/2020 21:15	8,67	1	8,67	CHI
202001107698	FAZENDA NOVA	RN10394715	BRITANIA	18/01/2020 10:20	20/01/2020 01:14	18/01/2020 12:35	18/01/2020 21:34	8,99	1	8,99	CHI
202001107698	JUSSARA	RN10394715	BRITANIA	18/01/2020 10:20	20/01/2020 01:14	18/01/2020 12:35	18/01/2020 21:34	8,99	58	521,45	CHI
202001107698	JUSSARA	JR12259759	BRITANIA	18/01/2020 10:20	20/01/2020 01:14	18/01/2020 17:37	18/01/2020 22:20	4,72	6	28,30	CHI
202001107698	JUSSARA	JR12198907	BRITANIA	18/01/2020 10:20	20/01/2020 01:14	18/01/2020 17:37	18/01/2020 23:21	5,73	7	40,10	CHI
202001107698	JUSSARA	JR13306809	BRITANIA	18/01/2020 10:20	20/01/2020 01:14	18/01/2020 17:37	19/01/2020 15:08	21,51	5	107,56	CHI
202001107698	JUSSARA	JR13306809	BRITANIA	18/01/2020 10:20	20/01/2020 01:14	19/01/2020 08:53	19/01/2020 15:08	6,25	7	43,75	CHI
202001107698	FAZENDA NOVA	JR12033556	BRITANIA	18/01/2020 10:20	20/01/2020 01:14	19/01/2020 16:30	19/01/2020 20:26	3,94	9	35,47	CHI
202001107698	JUSSARA	JR12033556	BRITANIA	18/01/2020 10:20	20/01/2020 01:14	19/01/2020 16:30	19/01/2020 20:26	3,94	108	425,67	CHI
202001107698	JUSSARA	JR12198907	BRITANIA	18/01/2020 10:20	20/01/2020 01:14	19/01/2020 15:20	19/01/2020 20:47	5,45	12	65,34	CHI
202001107698	JUSSARA	JR12396219	BRITANIA	18/01/2020 10:20	20/01/2020 01:14	18/01/2020 17:37	19/01/2020 21:59	28,35	3	85,06	CHI
202001107698	JUSSARA	JR12306818	BRITANIA	18/01/2020 10:20	20/01/2020 01:14	18/01/2020 17:37	19/01/2020 23:00	29,38	5	146,89	CHI
202001107698	JUSSARA	JR12259891	BRITANIA	18/01/2020 10:20	20/01/2020 01:14	18/01/2020 17:37	20/01/2020 00:03	30,42	7	212,95	CHI
202001107698	JUSSARA	JR12198907	BRITANIA	18/01/2020 10:20	20/01/2020 01:14	18/01/2020 17:37	20/01/2020 01:14	31,62	9	284,56	CHI
202001107698	JUSSARA	JR12198907	BRITANIA	18/01/2020 10:20	20/01/2020 01:14	20/01/2020 00:36	20/01/2020 01:14	0,64	27	17,34	CHI
202001107699	GOIANIA	10015452458	CARAJAS S1	18/01/2020 10:29	18/01/2020 12:33	18/01/2020 10:29	18/01/2020 12:33	2,05	1	2,05	CHI
202001107702	MAIRIPOTABA	MI12060670	PONTALINA	18/01/2020 07:50	18/01/2020 11:19	18/01/2020 07:50	18/01/2020 11:19	3,48	11	38,24	CHI
202001107705	MOZARLANDIA	MZ21326038	MOZARLANDIA	18/01/2020 08:12	18/01/2020 17:57	18/01/2020 08:12	18/01/2020 17:57	9,74	1	9,74	CHI
202001107708	SAO DOMINGOS	4910001191	SAO DOMINGOS	18/01/2020 10:40	18/01/2020 12:45	18/01/2020 10:40	18/01/2020 12:45	2,07	1	2,07	CHI
202001107709	ALEXANIA	AX21144014	ALEXANIA	18/01/2020 09:16	18/01/2020 11:37	18/01/2020 09:16	18/01/2020 11:37	2,34	1	2,34	CHI

202001107726	ARUANA	AK13134450	ARUANA	18/01/2020 11:37	19/01/2020 19:26	18/01/2020 11:37	19/01/2020 19:26	31,83	8	254,61	CHI
202001107801	BONFINOPOLIS	BO11195684	CEPAIGO S2	18/01/2020 10:30	18/01/2020 19:43	18/01/2020 10:30	18/01/2020 19:43	9,21	99	912,18	CHI
202001107802	CATALAO	CT12266101	CATALAO S1	18/01/2020 10:30	18/01/2020 12:18	18/01/2020 10:30	18/01/2020 12:18	1,79	5	8,96	CHI
202001107805	MONTIVIDIU	10003487995	MONTIVIDIU T	18/01/2020 10:32	18/01/2020 14:25	18/01/2020 10:32	18/01/2020 14:25	3,88	1	3,88	CHI
202001107811	SANTA HELENA DE GOIAS	400059071	RIO VERDE S1	18/01/2020 10:33	18/01/2020 22:13	18/01/2020 10:33	18/01/2020 22:13	11,67	1	11,67	CHI
202001107812	LUZIANIA	LZ21248668	MARAJOARA	18/01/2020 10:34	18/01/2020 11:58	18/01/2020 10:34	18/01/2020 11:58	1,40	7	9,80	CHI
202001107813	RIO VERDE	RV12340902	RIO VERDE S1	18/01/2020 10:34	18/01/2020 12:10	18/01/2020 10:34	18/01/2020 12:10	1,60	35	55,86	CHI
202001107814	CRIXAS	CX21319122	SANTA TEREZINHA	18/01/2020 10:34	18/01/2020 23:00	18/01/2020 10:34	18/01/2020 23:00	12,43	1	12,43	CHI
202001107815	JATAI	JT12182192	JATAI S2	18/01/2020 10:34	18/01/2020 14:00	18/01/2020 10:34	18/01/2020 14:00	3,43	28	95,91	CHI
202001107821	CACU	CC21235983	CACHOEIRA ALTA	18/01/2020 10:35	18/01/2020 22:06	18/01/2020 10:35	18/01/2020 22:06	11,51	7	80,54	CHI
202001107829	SANTO ANTONIO DO DESCOBERTO	2210171290	ALEXANIA	18/01/2020 10:37	18/01/2020 13:48	18/01/2020 10:37	18/01/2020 13:48	3,18	1	3,18	CHI
202001107836	PIRACANJUBA	PJ12082177	MORRINHOS	18/01/2020 10:40	18/01/2020 21:26	18/01/2020 10:40	18/01/2020 21:26	10,77	16	172,27	CHI
202001107838	MINEIROS	1390039605	PARQUE DAS EMAS	18/01/2020 10:40	18/01/2020 12:18	18/01/2020 10:40	18/01/2020 12:18	1,62	1	1,62	CHI
202001107841	LEOPOLDO DE BULHOES	LB12270653	DAIA S2	18/01/2020 10:41	18/01/2020 16:48	18/01/2020 10:41	18/01/2020 16:48	6,11	3	18,33	CHI
202001107843	CORUMBA DE GOIAS	CB12382194	CORUMBA	18/01/2020 10:41	18/01/2020 14:02	18/01/2020 10:41	18/01/2020 14:02	3,34	5	16,69	CHI
202001107849	PIRENOPOLIS	PV21241189	CORUMBA	18/01/2020 10:43	18/01/2020 14:56	18/01/2020 10:43	18/01/2020 14:56	4,21	1	4,21	CHI
202001107850	RIO VERDE	630134169	RIO VERDE S2	18/01/2020 10:43	18/01/2020 16:50	18/01/2020 10:43	18/01/2020 16:50	6,11	1	6,11	CHI
202001107852	MINACU	IH12134994	MINACU	18/01/2020 10:43	18/01/2020 15:41	18/01/2020 10:43	18/01/2020 15:41	4,96	11	54,55	CHI
202001107857	MORRINHOS	MR21036226	GOIATUBA S2	18/01/2020 10:44	18/01/2020 12:26	18/01/2020 10:44	18/01/2020 12:26	1,70	1	1,70	CHI
202001107860	GOIANDIRA	GD21042542	CATALAO S1	18/01/2020 10:45	18/01/2020 12:01	18/01/2020 10:45	18/01/2020 12:01	1,26	1	1,26	CHI
202001107861	SANTA HELENA DE GOIAS	SH11000035	IPEGUARI	18/01/2020 10:19	18/01/2020 13:12	18/01/2020 10:19	18/01/2020 13:12	2,87	101	290,07	CHI
202001107862	MINEIROS	MY12303860	PARQUE DAS EMAS	18/01/2020 10:45	18/01/2020 15:09	18/01/2020 10:45	18/01/2020 15:09	4,39	5	21,96	CHI
202001107864	IPORA	730017126	IPORA	18/01/2020 10:45	18/01/2020 13:19	18/01/2020 10:45	18/01/2020 13:19	2,55	1	2,55	CHI
202001107866	CORREGO DO OURO	CO12071657	FIRMINOPOLIS S2	18/01/2020 10:46	18/01/2020 12:14	18/01/2020 10:46	18/01/2020 12:14	1,47	3	4,40	CHI
202001107877	CORUMBA DE GOIAS	CB11139866	CORUMBA	18/01/2020 10:47	18/01/2020 15:00	18/01/2020 10:47	18/01/2020 15:00	4,20	106	445,26	CHI
202001107887	SENADOR CANEDO	SW12323299	SENADOR CANEDO	18/01/2020 10:47	18/01/2020 12:37	18/01/2020 10:47	18/01/2020 12:37	1,82	1171	2135,77	CHI
202001107889	PIRANHAS	PH12051610	PIRANHAS	18/01/2020 10:50	19/01/2020 08:02	18/01/2020 10:50	19/01/2020 08:02	21,19	1	21,19	CHI
202001107890	GOIANIA	16189474	FERROVIARIO S1	18/01/2020 10:51	18/01/2020 12:43	18/01/2020 10:51	18/01/2020 12:43	1,85	1	1,85	CHI
202001107891	RIO VERDE	RV21278691	SANTA HELENA S1	18/01/2020 10:51	18/01/2020 21:18	18/01/2020 10:51	18/01/2020 21:18	10,43	1	10,43	CHI
202001107892	PORTEIRAO	CL21295999	RIO DOS BOIS	18/01/2020 10:52	18/01/2020 14:13	18/01/2020 10:52	18/01/2020 14:13	3,35	1	3,35	CHI
202001107897	CORUMBA DE GOIAS	CB12319750	CORUMBA	18/01/2020 10:53	18/01/2020 17:24	18/01/2020 10:53	18/01/2020 17:24	6,51	17	110,71	CHI
202001107903	SANTA TEREZA DE GOIAS	SE21286677	PORANGATU	18/01/2020 10:54	18/01/2020 19:57	18/01/2020 10:54	18/01/2020 19:57	9,04	1	9,04	CHI
202001107913	SANTA HELENA DE GOIAS	SH12279533	IPEGUARI	18/01/2020 10:57	18/01/2020 16:00	18/01/2020 10:57	18/01/2020 16:00	5,04	32	161,34	CHI

202001107930	PADRE BERNARDO	PB12377293	PADRE BERNARDO	18/01/2020 08:53	18/01/2020 11:57	18/01/2020 08:53	18/01/2020 11:57	3,06	11	33,67	CHI
202001107934	RIO VERDE	RV21116562	QUIRINOPOLIS	18/01/2020 11:00	18/01/2020 17:31	18/01/2020 11:00	18/01/2020 17:31	6,51	1	6,51	CHI
202001107935	GOIANIA	15574945	XAVANTES	18/01/2020 11:00	18/01/2020 12:19	18/01/2020 11:00	18/01/2020 12:19	1,31	1	1,31	CHI
202001107940	ITAPIRAPUA	IU12067919	MATRINCHA	18/01/2020 08:37	18/01/2020 19:35	18/01/2020 08:37	18/01/2020 19:35	10,97	8	87,77	CHI
202001107941	CATALAO	CT12072923	CATALAO S1	18/01/2020 11:01	18/01/2020 13:20	18/01/2020 11:01	18/01/2020 13:20	2,32	3	6,96	CHI
202001107949	DOVERLANDIA	4220013211	CAIAPONIA	18/01/2020 11:02	18/01/2020 14:45	18/01/2020 11:02	18/01/2020 14:45	3,71	1	3,71	CHI
202001107959	NIQUELANDIA	NQ12072538	NIQUELANDIA SUBTRANSMISSAO	18/01/2020 11:04	18/01/2020 15:09	18/01/2020 11:04	18/01/2020 15:09	4,08	3	12,24	CHI
202001107961	BOM JARDIM DE GOIAS	BM12354692	BOM JARDIM	18/01/2020 09:09	19/01/2020 11:36	18/01/2020 09:09	19/01/2020 11:36	26,46	4	105,84	CHI
202001107967	INHUMAS	30076869	INHUMAS S1	18/01/2020 11:05	18/01/2020 14:07	18/01/2020 11:05	18/01/2020 14:07	3,03	1	3,03	CHI
202001107968	AGUAS LINDAS DE GOIAS	LA11136697	AGUAS LINDAS DE GOIAS S1	18/01/2020 11:05	18/01/2020 14:33	18/01/2020 11:05	18/01/2020 14:33	3,46	22	76,14	CHI
202001107975	GOIANIA	10017338334	CARAJAS S2	18/01/2020 11:06	18/01/2020 11:55	18/01/2020 11:06	18/01/2020 11:55	0,81	1	0,81	CHI
202001107976	GOIANIA	10017188049	CARAJAS S2	18/01/2020 11:06	18/01/2020 12:58	18/01/2020 11:06	18/01/2020 12:58	1,86	1	1,86	CHI
202001107984	VICENTINOPOLIS	6743242	VICENTINOPOLIS	18/01/2020 11:07	19/01/2020 16:20	18/01/2020 11:07	19/01/2020 16:20	29,21	1	29,21	CHI
202001107985	BARRO ALTO	00560424	BARRO ALTO	18/01/2020 10:47	18/01/2020 14:46	18/01/2020 10:47	18/01/2020 10:53	0,11	21	2,37	CHI
202001107985	GOIANESIA	00560424	BARRO ALTO	18/01/2020 10:47	18/01/2020 14:46	18/01/2020 10:47	18/01/2020 10:53	0,11	4	0,45	CHI
202001107985	SANTA RITA DO NOVO DESTINO	00560424	BARRO ALTO	18/01/2020 10:47	18/01/2020 14:46	18/01/2020 10:47	18/01/2020 10:53	0,11	209	23,63	CHI
202001107985	SAO LUIZ DO NORTE	00560424	BARRO ALTO	18/01/2020 10:47	18/01/2020 14:46	18/01/2020 10:47	18/01/2020 10:53	0,11	14	1,58	CHI
202001107985	BARRO ALTO	00560424	GOIANESIA S1	18/01/2020 10:47	18/01/2020 14:46	18/01/2020 10:47	18/01/2020 10:53	0,11	15	1,70	CHI
202001107985	GOIANESIA	00560424	GOIANESIA S1	18/01/2020 10:47	18/01/2020 14:46	18/01/2020 10:47	18/01/2020 10:53	0,11	47	5,31	CHI
202001107985	GOIANESIA	00560424	GOIANESIA S1	18/01/2020 10:47	18/01/2020 14:46	18/01/2020 10:47	18/01/2020 10:53	0,11	115	13,00	CHI
202001107985	SANTA RITA DO NOVO DESTINO	00560424	GOIANESIA S1	18/01/2020 10:47	18/01/2020 14:46	18/01/2020 10:47	18/01/2020 10:53	0,11	515	58,22	CHI
202001107985	GOIANESIA	GE10326280	GOIANESIA S1	18/01/2020 10:47	18/01/2020 14:46	18/01/2020 10:47	18/01/2020 13:24	2,62	10	26,24	CHI
202001107985	BARRO ALTO	00560424	GOIANESIA S1	18/01/2020 10:47	18/01/2020 14:46	18/01/2020 10:47	18/01/2020 14:46	3,99	90	359,23	CHI
202001107985	BARRO ALTO	00560424	GOIANESIA S1	18/01/2020 10:47	18/01/2020 14:46	18/01/2020 10:47	18/01/2020 14:46	3,99	660	2634,32	CHI
202001107985	BARRO ALTO	GE13333177	GOIANESIA S1	18/01/2020 10:47	18/01/2020 14:46	18/01/2020 10:47	18/01/2020 14:46	3,99	6	23,95	CHI
202001107985	COCALZINHO DE GOIAS	00560424	GOIANESIA S1	18/01/2020 10:47	18/01/2020 14:46	18/01/2020 10:47	18/01/2020 14:46	3,99	1	3,99	CHI
202001107985	GOIANESIA	00560424	GOIANESIA S1	18/01/2020 10:47	18/01/2020 14:46	18/01/2020 10:47	18/01/2020 14:46	3,99	112	447,04	CHI
202001107985	GOIANESIA	GE10326280	GOIANESIA S1	18/01/2020 10:47	18/01/2020 14:46	18/01/2020 10:47	18/01/2020 14:46	3,99	1	3,99	CHI
202001107985	GOIANESIA	GE13333177	GOIANESIA S1	18/01/2020 10:47	18/01/2020 14:46	18/01/2020 10:47	18/01/2020 14:46	3,99	8	31,93	CHI
202001107985	PADRE BERNARDO	00560424	GOIANESIA S1	18/01/2020 10:47	18/01/2020 14:46	18/01/2020 10:47	18/01/2020 14:46	3,99	10	39,91	CHI
202001107985	SANTA RITA DO NOVO DESTINO	00560424	GOIANESIA S1	18/01/2020 10:47	18/01/2020 14:46	18/01/2020 10:47	18/01/2020 14:46	3,99	7	27,94	CHI
202001107985	VILA PROPICIO	00560424	GOIANESIA S1	18/01/2020 10:47	18/01/2020 14:46	18/01/2020 10:47	18/01/2020 14:46	3,99	818	3264,96	CHI
202001107994	TURVELANDIA	TD21281210	RIO DOS BOIS	18/01/2020 11:09	19/01/2020 08:30	18/01/2020 11:09	19/01/2020 08:30	21,35	1	21,35	CHI

202001107997	DAMIANOPOLIS	DA21256711	IACIARA S2	18/01/2020 11:09	18/01/2020 13:01	18/01/2020 11:09	18/01/2020 13:01	1,86	2	3,72	CHI
202001108006	MINEIROS	MY12370552	PARQUE DAS EMAS	18/01/2020 09:41	18/01/2020 13:30	18/01/2020 09:41	18/01/2020 13:30	3,81	7	26,66	CHI
202001108006	PORTELANDIA	MY12370552	PARQUE DAS EMAS	18/01/2020 09:41	18/01/2020 13:30	18/01/2020 09:41	18/01/2020 13:30	3,81	3	11,42	CHI
202001108007	JANDAIA	00190214	PALMEIRAS	18/01/2020 11:00	18/01/2020 12:35	18/01/2020 11:00	18/01/2020 12:06	1,10	1	1,10	CHI
202001108007	INDIARA	00190214	PALMEIRAS	18/01/2020 11:00	18/01/2020 12:35	18/01/2020 11:00	18/01/2020 12:10	1,17	142	166,34	CHI
202001108007	JANDAIA	00190214	PALMEIRAS	18/01/2020 11:00	18/01/2020 12:35	18/01/2020 11:00	18/01/2020 12:10	1,17	661	774,29	CHI
202001108007	PALMEIRAS DE GOIAS	00190214	PALMEIRAS	18/01/2020 11:00	18/01/2020 12:35	18/01/2020 11:00	18/01/2020 12:10	1,17	38	44,51	CHI
202001108007	PARAUNA	00190214	PALMEIRAS	18/01/2020 11:00	18/01/2020 12:35	18/01/2020 11:00	18/01/2020 12:10	1,17	6	7,03	CHI
202001108007	JANDAIA	00190214	PALMEIRAS	18/01/2020 11:00	18/01/2020 12:35	18/01/2020 11:00	18/01/2020 12:12	1,20	543	649,79	CHI
202001108007	JANDAIA	00190214	PALMEIRAS	18/01/2020 11:00	18/01/2020 12:35	18/01/2020 11:00	18/01/2020 12:35	1,58	795	1254,33	CHI
202001108007	JANDAIA	00190214	PALMEIRAS	18/01/2020 11:00	18/01/2020 12:35	18/01/2020 11:00	18/01/2020 12:35	1,59	112	177,96	CHI
202001108007	PARAUNA	00190214	PALMEIRAS	18/01/2020 11:00	18/01/2020 12:35	18/01/2020 11:00	18/01/2020 12:35	1,59	45	71,50	CHI
202001108007	JANDAIA	JD10404112	PALMEIRAS	18/01/2020 11:00	18/01/2020 12:35	18/01/2020 12:06	18/01/2020 12:35	0,49	1	0,49	CHI
202001108013	EDEIA	1120027965	EDEIA	18/01/2020 11:12	18/01/2020 22:10	18/01/2020 11:12	18/01/2020 22:10	10,97	1	10,97	CHI
202001108014	GOIANESIA	SZ21264880	ITAPACI	18/01/2020 11:12	18/01/2020 14:55	18/01/2020 11:12	18/01/2020 14:55	3,72	1	3,72	CHI
202001108016	BOM JESUS DE GOIAS	IT12033781	CACHOEIRA DOURADA	18/01/2020 11:11	18/01/2020 18:00	18/01/2020 11:11	18/01/2020 18:00	6,83	3	20,48	CHI
202001108016	ITUMBIARA	IT12033781	CACHOEIRA DOURADA	18/01/2020 11:11	18/01/2020 18:00	18/01/2020 11:11	18/01/2020 18:00	6,83	3	20,48	CHI
202001108017	AMARALINA	LC21200485	SAO MIGUEL DO ARAGUAIA	18/01/2020 11:12	18/01/2020 21:00	18/01/2020 11:12	18/01/2020 21:00	9,80	2	19,60	CHI
202001108018	PIRANHAS	PH21092241	BOM JARDIM	18/01/2020 11:13	18/01/2020 21:57	18/01/2020 11:13	18/01/2020 21:57	10,73	1	10,73	CHI
202001108026	RIO VERDE	630229399	RIO VERDE S1	18/01/2020 11:13	18/01/2020 14:03	18/01/2020 11:13	18/01/2020 14:03	2,82	1	2,82	CHI
202001108030	MINEIROS	MY12358869	PARQUE DAS EMAS	18/01/2020 11:14	18/01/2020 20:21	18/01/2020 11:14	18/01/2020 20:21	9,10	120	1092,27	CHI
202001108030	SANTA RITA DO ARAGUAIA	MY12358869	PARQUE DAS EMAS	18/01/2020 11:14	18/01/2020 20:21	18/01/2020 11:14	18/01/2020 20:21	9,10	4	36,41	CHI
202001108035	AGUAS LINDAS DE GOIAS	LA11375290	AGUAS LINDAS DE GOIAS S1	18/01/2020 11:07	18/01/2020 13:35	18/01/2020 11:07	18/01/2020 13:35	2,46	213	524,16	CHI
202001108039	AGUAS LINDAS DE GOIAS	4830025920	AGUAS LINDAS DE GOIAS S2	18/01/2020 11:16	18/01/2020 14:29	18/01/2020 11:16	18/01/2020 14:29	3,21	1	3,21	CHI
202001108041	SENADOR CANEDO	10028066853	SENADOR CANEDO	18/01/2020 11:17	18/01/2020 13:43	18/01/2020 11:17	18/01/2020 13:43	2,43	1	2,43	CHI
202001108065	RIO VERDE	10017202858	RIO VERDE S1	18/01/2020 11:20	18/01/2020 15:58	18/01/2020 11:20	18/01/2020 15:58	4,62	1	4,62	CHI
202001108071	RIO VERDE	10002115636	RIO VERDE S1	18/01/2020 11:21	18/01/2020 14:58	18/01/2020 11:21	18/01/2020 14:58	3,60	1	3,60	CHI
202001108073	GOIATUBA	BJ12000114	BOM JESUS DE GOIAS	18/01/2020 11:22	18/01/2020 18:07	18/01/2020 11:22	18/01/2020 18:07	6,74	13	87,68	CHI
202001108080	GOIANIA	15663966	XAVANTES	18/01/2020 11:24	18/01/2020 13:28	18/01/2020 11:24	18/01/2020 13:28	2,06	1	2,06	CHI
202001108086	MARA ROSA	MQ12168867	MARA ROSA	18/01/2020 11:24	18/01/2020 17:17	18/01/2020 11:24	18/01/2020 17:17	5,89	1	5,89	CHI
202001108090	AGUAS LINDAS DE GOIAS	10025915388	AGUAS LINDAS DE GOIAS S1	18/01/2020 11:26	18/01/2020 12:45	18/01/2020 11:26	18/01/2020 12:45	1,31	1	1,31	CHI
202001108095	CALDAS NOVAS	10005648724	SERRA DE CALDAS	18/01/2020 11:27	18/01/2020 14:34	18/01/2020 11:27	18/01/2020 14:34	3,12	1	3,12	CHI
202001108105	AGUAS LINDAS DE GOIAS	LA12389408	AGUAS LINDAS DE GOIAS S2	18/01/2020 11:29	18/01/2020 17:09	18/01/2020 11:29	18/01/2020 14:31	3,04	108	328,17	CHI

202001108105	AGUAS LINDAS DE GOIAS	LA12389408	AGUAS LINDAS DE GOIAS S2	18/01/2020 11:29	18/01/2020 17:09	18/01/2020 14:33	18/01/2020 15:15	0,70	50	34,92	CHI
202001108105	AGUAS LINDAS DE GOIAS	LA12349034LD	AGUAS LINDAS DE GOIAS S2	18/01/2020 11:29	18/01/2020 17:09	18/01/2020 11:29	18/01/2020 15:30	4,02	20	80,35	CHI
202001108105	AGUAS LINDAS DE GOIAS	LA11062219	AGUAS LINDAS DE GOIAS S2	18/01/2020 11:29	18/01/2020 17:09	18/01/2020 14:33	18/01/2020 17:09	2,59	58	150,51	CHI
202001108117	VALPARAISO DE GOIAS	VA11192924	PACAEMBU S1	18/01/2020 11:34	18/01/2020 16:26	18/01/2020 15:51	18/01/2020 16:26	0,58	88	51,33	CHI
202001108122	ANAPOLIS	AN12093255	ANAPOLIS UNIVERSITARIO S2	18/01/2020 11:34	18/01/2020 12:55	18/01/2020 11:34	18/01/2020 12:55	1,33	81	108,07	CHI
202001108123	GOIATUBA	GT12295929	RIO DOS BOIS	18/01/2020 11:35	19/01/2020 08:57	18/01/2020 11:35	19/01/2020 08:57	21,36	2	42,71	CHI
202001108124	SAO FRANCISCO DE GOIAS	SF21343945	SAO FRANCISCO DE GOIAS	18/01/2020 11:35	18/01/2020 20:49	18/01/2020 11:35	18/01/2020 20:49	9,22	1	9,22	CHI
202001108125	VALPARAISO DE GOIAS	2860057530	PACAEMBU S1	18/01/2020 11:35	18/01/2020 13:07	18/01/2020 11:35	18/01/2020 13:07	1,52	1	1,52	CHI
202001108130	CORUMBAIBA	IP12404719	IPAMERI	18/01/2020 11:38	18/01/2020 16:44	18/01/2020 11:38	18/01/2020 16:44	5,11	16	81,76	CHI
202001108130	IPAMERI	IP12404719	IPAMERI	18/01/2020 11:38	18/01/2020 16:44	18/01/2020 11:38	18/01/2020 16:44	5,11	72	367,92	CHI
202001108130	NOVA AURORA	IP12404719	IPAMERI	18/01/2020 11:38	18/01/2020 16:44	18/01/2020 11:38	18/01/2020 16:44	5,11	2	10,22	CHI
202001108133	SAO LUIS DE MONTES BELOS	SL32145926	SAO LUIZ DOS MONTES BELOS	18/01/2020 11:39	18/01/2020 14:37	18/01/2020 11:39	18/01/2020 14:37	2,96	2	5,92	CHI
202001108134	CAIAPONIA	CP12342197	CAIAPONIA	18/01/2020 11:39	19/01/2020 09:39	18/01/2020 11:39	19/01/2020 09:39	21,99	2	43,99	CHI
202001108138	CORREGO DO OURO	CO12054671	FIRMINOPOLIS S2	18/01/2020 11:39	18/01/2020 15:11	18/01/2020 11:39	18/01/2020 15:11	3,52	3	10,57	CHI
202001108141	ITAGUARU	UA21092287	ITAPURANGA	18/01/2020 11:41	18/01/2020 15:40	18/01/2020 11:41	18/01/2020 15:40	3,98	3	11,93	CHI
202001108142	PANAMA	PX12309830	GOIATUBA S1	18/01/2020 11:20	18/01/2020 13:33	18/01/2020 11:20	18/01/2020 13:33	2,20	2	4,41	CHI
202001108146	ABADIANIA	AA31059851	ANAPOLIS UNIVERSITARIO S1	18/01/2020 11:42	18/01/2020 16:53	18/01/2020 11:42	18/01/2020 16:53	5,17	1	5,17	CHI
202001108147	FAZENDA NOVA	FN21063094	IPORA	18/01/2020 11:42	18/01/2020 17:08	18/01/2020 11:42	18/01/2020 17:08	5,42	1	5,42	CHI
202001108148	ACREUNA	EU21219445	ACREUNA	18/01/2020 11:43	18/01/2020 17:53	18/01/2020 11:43	18/01/2020 17:53	6,17	1	6,17	CHI
202001108150	FAINA	FC21299846	GOIAS	18/01/2020 11:43	18/01/2020 16:17	18/01/2020 11:43	18/01/2020 16:17	4,56	1	4,56	CHI
202001108152	CAMPO ALEGRE DE GOIAS	CM12376046	CAMPO ALEGRE DE GOIAS	18/01/2020 10:36	18/01/2020 22:05	18/01/2020 10:36	18/01/2020 22:05	11,48	7	80,34	CHI
202001108152	CATALAO	CM12376046	CAMPO ALEGRE DE GOIAS	18/01/2020 10:36	18/01/2020 22:05	18/01/2020 10:36	18/01/2020 22:05	11,48	3	34,43	CHI
202001108159	PADRE BERNARDO	PB11275378	PADRE BERNARDO	18/01/2020 11:46	18/01/2020 12:40	18/01/2020 11:46	18/01/2020 12:40	0,88	3	2,65	CHI
202001108160	GOIANIA	GN12077038	ATLANTICO S3	18/01/2020 11:23	18/01/2020 13:10	18/01/2020 11:23	18/01/2020 13:10	1,77	193	341,07	CHI
202001108162	PORANGATU	PO12057986	PORANGATU	18/01/2020 11:47	18/01/2020 15:42	18/01/2020 11:47	18/01/2020 15:42	3,91	77	300,79	CHI
202001108163	PARAUNA	PU21295883	ACREUNA	18/01/2020 11:47	18/01/2020 14:44	18/01/2020 11:47	18/01/2020 14:44	2,94	2	5,88	CHI
202001108173	AMARALINA	MU12391981	MARA ROSA	18/01/2020 11:51	19/01/2020 09:24	18/01/2020 11:51	19/01/2020 09:24	21,55	5	107,75	CHI
202001108173	MUTUNOPOLIS	MU12391981	MARA ROSA	18/01/2020 11:51	19/01/2020 09:24	18/01/2020 11:51	19/01/2020 09:24	21,55	5	107,75	CHI
202001108175	LEOPOLDO DE BULHOES	LB21353375	DAIA S2	18/01/2020 11:51	18/01/2020 13:25	18/01/2020 11:51	18/01/2020 13:25	1,56	1	1,56	CHI
202001108178	HIDROLINA	SZ10400555	ITAPACI	18/01/2020 10:58	19/01/2020 04:09	18/01/2020 10:58	18/01/2020 16:24	5,43	108	586,02	CHI
202001108178	SAO LUIZ DO NORTE	SZ10400555	ITAPACI	18/01/2020 10:58	19/01/2020 04:09	18/01/2020 10:58	18/01/2020 16:24	5,43	10	54,26	CHI
202001108178	SAO LUIZ DO NORTE	SZ10400555	ITAPACI	18/01/2020 10:58	19/01/2020 04:09	18/01/2020 16:25	18/01/2020 20:09	3,74	10	37,40	CHI
202001108178	HIDROLINA	SZ10400555	ITAPACI	18/01/2020 10:58	19/01/2020 04:09	18/01/2020 16:25	19/01/2020 04:09	11,74	108	1267,50	CHI

202001108178	SAO LUIZ DO NORTE	SZ10400555	ITAPACI	18/01/2020 10:58	19/01/2020 04:09	18/01/2020 20:10	19/01/2020 04:09	7,99	10	79,86	CHI
202001108187	MINEIROS	MY11359695	PARQUE DAS EMAS	18/01/2020 11:51	18/01/2020 13:08	18/01/2020 11:51	18/01/2020 13:08	1,27	27	34,33	CHI
202001108200	SAO MIGUEL DO PASSA QUATRO	SQ21116217	CRISTIANOPOLIS	18/01/2020 11:56	18/01/2020 15:28	18/01/2020 11:56	18/01/2020 15:28	3,53	1	3,53	CHI
202001108203	GOIANIA	10028974679	INDEPENDENCIA S1	18/01/2020 11:57	18/01/2020 14:02	18/01/2020 11:57	18/01/2020 14:02	2,08	2	4,16	CHI
202001108206	CEZARINA	10025301037	CEZARINA	18/01/2020 11:58	18/01/2020 15:23	18/01/2020 11:58	18/01/2020 15:23	3,42	1	3,42	CHI
202001108207	CORUMBA DE GOIAS	CB21121726	CORUMBA	18/01/2020 11:58	18/01/2020 18:45	18/01/2020 11:58	18/01/2020 18:45	6,78	1	6,78	CHI
202001108214	QUIRINOPOLIS	80011494	QUIRINOPOLIS	18/01/2020 12:00	18/01/2020 14:14	18/01/2020 12:00	18/01/2020 14:14	2,22	1	2,22	CHI
202001108219	QUIRINOPOLIS	QI21107388	QUIRINOPOLIS	18/01/2020 12:02	18/01/2020 14:54	18/01/2020 12:02	18/01/2020 14:54	2,86	1	2,86	CHI
202001108221	GOIANIA	GN11166137	FERROVIARIO S2	18/01/2020 11:19	18/01/2020 13:14	18/01/2020 11:19	18/01/2020 13:14	1,91	67	127,71	CHI
202001108222	PARANAIGUARA	PC21308774	QUIRINOPOLIS	18/01/2020 12:03	18/01/2020 14:03	18/01/2020 12:03	18/01/2020 14:03	2,00	1	2,00	CHI
202001108224	CRISTIANOPOLIS	CF21300626	CRISTIANOPOLIS	18/01/2020 12:03	18/01/2020 17:19	18/01/2020 12:03	18/01/2020 17:19	5,26	1	5,26	CHI
202001108227	CIDADE OCIDENTAL	10001767583	MARAJOARA	18/01/2020 12:04	18/01/2020 17:57	18/01/2020 12:04	18/01/2020 17:57	5,88	1	5,88	CHI
202001108229	ALEXANIA	AX12000108	CORUMBA	18/01/2020 08:29	18/01/2020 16:00	18/01/2020 08:29	18/01/2020 16:00	7,51	10	75,08	CHI
202001108229	CORUMBA DE GOIAS	AX12000108	CORUMBA	18/01/2020 08:29	18/01/2020 16:00	18/01/2020 08:29	18/01/2020 16:00	7,51	4	30,03	CHI
202001108232	NOVO GAMA	10003025487	MARAJOARA	18/01/2020 12:04	18/01/2020 13:24	18/01/2020 12:04	18/01/2020 13:24	1,32	1	1,32	CHI
202001108233	TRINDADE	40211083	TRINDADE	18/01/2020 12:05	18/01/2020 16:38	18/01/2020 12:05	18/01/2020 16:38	4,55	1	4,55	CHI
202001108237	PIRENOPOLIS	PV12370305	CORUMBA	18/01/2020 12:06	18/01/2020 19:28	18/01/2020 12:06	18/01/2020 19:28	7,37	18	132,58	CHI
202001108243	FORMOSA	FA12376648	ITUIQUIRA	18/01/2020 12:07	18/01/2020 14:26	18/01/2020 12:07	18/01/2020 14:26	2,30	3	6,91	CHI
202001108245	HIDROLANDIA	HD21000272	CEPAIGO S2	18/01/2020 12:08	18/01/2020 17:40	18/01/2020 12:08	18/01/2020 17:40	5,53	2	11,05	CHI
202001108250	QUIRINOPOLIS	10004995650	QUIRINOPOLIS	18/01/2020 12:09	18/01/2020 15:37	18/01/2020 12:09	18/01/2020 15:37	3,45	1	3,45	CHI
202001108251	JATAI	JT12184067	MONTIVIDIU T	18/01/2020 12:09	19/01/2020 00:03	18/01/2020 13:52	19/01/2020 00:03	10,19	3	30,58	CHI
202001108252	MARA ROSA	ET21281758	MARA ROSA	18/01/2020 12:10	18/01/2020 14:56	18/01/2020 12:10	18/01/2020 14:56	2,76	1	2,76	CHI
202001108253	FAZENDA NOVA	IS12381080	IPORA	18/01/2020 12:10	19/01/2020 03:52	18/01/2020 12:10	19/01/2020 03:52	15,69	9	141,20	CHI
202001108253	ISRAELANDIA	IS12381080	IPORA	18/01/2020 12:10	19/01/2020 03:52	18/01/2020 12:10	19/01/2020 03:52	15,69	2	31,38	CHI
202001108254	NIQUELANDIA	NQ12400337	URUACU	18/01/2020 12:10	18/01/2020 17:00	18/01/2020 12:10	18/01/2020 17:00	4,82	16	77,19	CHI
202001108260	IPORA	IR21193348	IPORA	18/01/2020 01:19	18/01/2020 13:22	18/01/2020 01:19	18/01/2020 13:22	12,04	1	12,04	CHI
202001108267	GOIANIRA	GR21226740	TRINDADE	18/01/2020 12:14	18/01/2020 14:49	18/01/2020 12:14	18/01/2020 14:49	2,58	1	2,58	CHI
202001108269	VALPARAISO DE GOIAS	2860156027	MARAJOARA	18/01/2020 12:15	18/01/2020 16:03	18/01/2020 12:15	18/01/2020 16:03	3,80	1	3,80	CHI
202001108271	VALPARAISO DE GOIAS	2860103643	PACAEMBU S1	18/01/2020 12:15	18/01/2020 17:33	18/01/2020 12:15	18/01/2020 17:33	5,29	1	5,29	CHI
202001108274	SAO FRANCISCO DE GOIAS	SF12000173	SAO FRANCISCO DE GOIAS	18/01/2020 11:53	18/01/2020 19:31	18/01/2020 11:53	18/01/2020 19:31	7,62	12	91,50	CHI
202001108276	GOIATUBA	140039594	GOIATUBA S2	18/01/2020 12:18	18/01/2020 14:48	18/01/2020 12:18	18/01/2020 14:48	2,49	1	2,49	CHI
202001108282	ALEXANIA	7361482	CORUMBA	18/01/2020 05:38	18/01/2020 22:30	18/01/2020 05:38	18/01/2020 22:30	16,87	3	50,60	CHI
202001108283	LUZIANIA	LZ10404052	RIO VERMELHO	18/01/2020 12:17	19/01/2020 06:42	18/01/2020 12:20	18/01/2020 18:37	6,28	25	157,12	CHI

202001108283	LUZIANIA	LZ10404052	RIO VERMELHO	18/01/2020 12:17	19/01/2020 06:42	18/01/2020 18:39	18/01/2020 21:02	2,39	23	54,94	CHI
202001108283	LUZIANIA	LZ21000025	RIO VERMELHO	18/01/2020 12:17	19/01/2020 06:42	18/01/2020 18:39	18/01/2020 21:29	2,83	1	2,83	CHI
202001108283	LUZIANIA	LZ10404052	RIO VERMELHO	18/01/2020 12:17	19/01/2020 06:42	18/01/2020 12:20	19/01/2020 00:07	11,78	1	11,78	CHI
202001108283	LUZIANIA	LZ13404052B	RIO VERMELHO	18/01/2020 12:17	19/01/2020 06:42	18/01/2020 21:16	19/01/2020 00:07	2,84	23	65,40	CHI
202001108283	LUZIANIA	LZ21000026	RIO VERMELHO	18/01/2020 12:17	19/01/2020 06:42	18/01/2020 18:39	19/01/2020 01:26	6,79	1	6,79	CHI
202001108283	LUZIANIA	LZ10404052	RIO VERMELHO	18/01/2020 12:17	19/01/2020 06:42	18/01/2020 12:20	19/01/2020 06:42	18,36	26	477,47	CHI
202001108283	LUZIANIA	LZ10404052	RIO VERMELHO	18/01/2020 12:17	19/01/2020 06:42	19/01/2020 00:10	19/01/2020 06:42	6,52	25	163,09	CHI
202001108284	MONTES CLAROS DE GOIAS	ME12023298	IPORA	18/01/2020 12:22	18/01/2020 23:14	18/01/2020 12:22	18/01/2020 23:14	10,86	4	43,43	CHI
202001108285	QUIRINOPOLIS	80052071	QUIRINOPOLIS	18/01/2020 12:22	18/01/2020 21:35	18/01/2020 12:22	18/01/2020 21:35	9,20	1	9,20	CHI
202001108286	NIQUELANDIA	NQ12262815	NIQUELANDIA SUBTRANSMISSAO	18/01/2020 12:22	18/01/2020 17:51	18/01/2020 12:22	18/01/2020 17:51	5,48	11	60,26	CHI
202001108288	JATAI	290034620	JATAI S3	18/01/2020 12:23	18/01/2020 17:16	18/01/2020 12:23	18/01/2020 17:16	4,90	1	4,90	CHI
202001108290	CAMPO ALEGRE DE GOIAS	CM12142253	CAMPO ALEGRE DE GOIAS	18/01/2020 12:23	18/01/2020 17:44	18/01/2020 12:23	18/01/2020 17:44	5,34	3	16,02	CHI
202001108291	GOIANIA	16976927	GOYA S1	18/01/2020 12:24	18/01/2020 13:59	18/01/2020 12:24	18/01/2020 13:59	1,57	1	1,57	CHI
202001108294	MINEIROS	1390176918	PARQUE DAS EMAS	18/01/2020 12:26	18/01/2020 14:48	18/01/2020 12:26	18/01/2020 14:48	2,36	1	2,36	CHI
202001108302	JANDAIA	JD11007169	PALMEIRAS	18/01/2020 12:51	18/01/2020 15:52	18/01/2020 12:51	18/01/2020 15:38	2,78	119	330,32	CHI
202001108302	JANDAIA	JD13000010	PALMEIRAS	18/01/2020 12:51	18/01/2020 15:52	18/01/2020 13:51	18/01/2020 15:52	2,02	110	221,86	CHI
202001108324	CORUMBAIBA	CI12263342	VILA CORUMBA	17/01/2020 17:55	19/01/2020 10:06	17/01/2020 17:55	19/01/2020 10:06	40,17	387	15546,22	CHI
202001108401	CALDAS NOVAS	CN11067941	CALDAS NOVAS S2	18/01/2020 12:28	18/01/2020 17:12	18/01/2020 12:28	18/01/2020 17:12	4,72	64	302,03	CHI
202001108405	ANAPOLIS	10012167540	ANAPOLIS UNIVERSITARIO S2	18/01/2020 12:30	18/01/2020 16:32	18/01/2020 12:30	18/01/2020 16:32	4,02	1	4,02	CHI
202001108409	RIO VERDE	630079419	RIO VERDE S1	18/01/2020 12:31	18/01/2020 16:19	18/01/2020 12:31	18/01/2020 16:19	3,79	1	3,79	CHI
202001108412	CAIAPONIA	CP21391226	CAIAPONIA	18/01/2020 12:32	19/01/2020 22:58	18/01/2020 12:32	19/01/2020 22:58	34,43	1	34,43	CHI
202001108415	ORIZONA	OZ21070040	PIRES DO RIO S2	18/01/2020 12:33	18/01/2020 16:21	18/01/2020 12:33	18/01/2020 16:21	3,80	1	3,80	CHI
202001108425	LUZIANIA	LZ12051365	CRISTALINA S2	18/01/2020 12:36	18/01/2020 18:55	18/01/2020 12:36	18/01/2020 18:55	6,31	3	18,93	CHI
202001108426	SANTA HELENA DE GOIAS	SH21022676	IPEGUARI	18/01/2020 12:36	18/01/2020 16:45	18/01/2020 12:36	18/01/2020 16:45	4,14	1	4,14	CHI
202001108429	TEREZOPOLIS DE GOIAS	TJ11144796	DAIA S2	18/01/2020 12:34	18/01/2020 14:32	18/01/2020 12:34	18/01/2020 14:32	1,96	187	365,84	CHI
202001108438	INACIOLANDIA	ID12271587	CACHOEIRA DOURADA	18/01/2020 08:12	18/01/2020 18:07	18/01/2020 08:12	18/01/2020 18:07	9,90	12	118,85	CHI
202001108444	RIO VERDE	RV21237115	CABRIUVA S2	18/01/2020 12:44	18/01/2020 15:50	18/01/2020 12:44	18/01/2020 15:50	3,10	1	3,10	CHI
202001108446	CORUMBA DE GOIAS	CB12221413	CORUMBA	18/01/2020 10:04	18/01/2020 14:44	18/01/2020 10:04	18/01/2020 14:44	4,65	4	18,60	CHI
202001108449	NAZARIO	8688429	ANICUNS	18/01/2020 12:45	18/01/2020 16:18	18/01/2020 12:45	18/01/2020 16:18	3,56	3	10,67	CHI
202001108451	GOIANIA	11969155	CARAJAS S2	18/01/2020 12:45	18/01/2020 14:14	18/01/2020 12:45	18/01/2020 14:14	1,47	1	1,47	CHI
202001108463	GOIANIA	11192069	GOYA S2	18/01/2020 12:49	18/01/2020 13:58	18/01/2020 12:49	18/01/2020 13:58	1,14	1	1,14	CHI
202001108465	SANTO ANTONIO DO DESCOBERTO	SN11131982	MARAJOARA	18/01/2020 12:51	18/01/2020 17:32	18/01/2020 12:51	18/01/2020 17:32	4,68	53	247,85	CHI
202001108467	SAO LUIS DE MONTES BELOS	SL31111603	FIRMINOPOLIS S1	18/01/2020 12:51	18/01/2020 16:24	18/01/2020 12:51	18/01/2020 16:24	3,54	1	3,54	CHI

202001108469	NOVO GAMA	NJ11201180	PACAEMBU S1	18/01/2020 11:11	18/01/2020 15:08	18/01/2020 11:11	18/01/2020 15:08	3,95	106	418,32	CHI
202001108472	FAZENDA NOVA	FN12113509	IPORA	18/01/2020 12:45	19/01/2020 04:02	18/01/2020 12:45	19/01/2020 04:02	15,27	36	549,67	CHI
202001108473	GOIANIA	10019095340	FERROVIARIO S1	18/01/2020 12:52	18/01/2020 14:06	18/01/2020 12:52	18/01/2020 14:06	1,22	1	1,22	CHI
202001108474	IPORA	IR21039606	IPORA	18/01/2020 12:53	19/01/2020 07:49	18/01/2020 12:53	19/01/2020 07:49	18,93	1	18,93	CHI
202001108475	GOIANIA	14634510	MEIA PONTE	18/01/2020 12:53	18/01/2020 14:45	18/01/2020 12:53	18/01/2020 14:45	1,86	1	1,86	CHI
202001108486	ALVORADA DO NORTE	AQ21251193	IACIARA S2	18/01/2020 12:55	18/01/2020 15:29	18/01/2020 12:55	18/01/2020 15:29	2,56	2	5,11	CHI
202001108496	ARUANA	AK12310710	ARUANA	18/01/2020 12:58	18/01/2020 14:38	18/01/2020 12:58	18/01/2020 14:38	1,67	21	35,11	CHI
202001108497	VARJAO	VJ21244447	GUAPO S2	18/01/2020 12:58	19/01/2020 03:36	18/01/2020 12:58	19/01/2020 03:36	14,63	3	43,88	CHI
202001108502	JESUPOLIS	JE21139767	SAO FRANCISCO DE GOIAS	18/01/2020 12:59	18/01/2020 17:00	18/01/2020 12:59	18/01/2020 17:00	4,01	1	4,01	CHI
202001108504	DIORAMA	DI21126770	IPORA	18/01/2020 12:59	18/01/2020 16:48	18/01/2020 12:59	18/01/2020 16:48	3,80	1	3,80	CHI
202001108508	SENADOR CANEDO	10002767102	SENADOR CANEDO	18/01/2020 13:00	18/01/2020 15:09	18/01/2020 13:00	18/01/2020 15:09	2,14	1	2,14	CHI
202001108514	DOVERLANDIA	DV12235070	PARQUE DAS EMAS	18/01/2020 13:03	18/01/2020 21:38	18/01/2020 13:03	18/01/2020 21:38	8,58	5	42,91	CHI
202001108520	SAO MIGUEL DO PASSA QUATRO	SQ21111712	CRISTIANOPOLIS	18/01/2020 13:04	18/01/2020 16:04	18/01/2020 13:04	18/01/2020 16:04	2,99	1	2,99	CHI
202001108529	GOIANIRA	GR32045882	TRINDADE	18/01/2020 13:06	19/01/2020 09:16	18/01/2020 13:06	19/01/2020 09:16	20,15	1	20,15	CHI
202001108535	MINEIROS	PW12301784	PARQUE DAS EMAS	18/01/2020 13:09	18/01/2020 16:40	18/01/2020 13:09	18/01/2020 16:40	3,52	9	31,64	CHI
202001108540	GOIATUBA	GT31044898	GOIATUBA S2	18/01/2020 13:12	18/01/2020 19:20	18/01/2020 13:12	18/01/2020 19:20	6,15	1	6,15	CHI
202001108544	SAO JOAO D ALIANCA	JL21264866	SAO JOAO D ALIANCA	18/01/2020 13:13	18/01/2020 18:25	18/01/2020 13:13	18/01/2020 18:25	5,19	1	5,19	CHI
202001108545	INHUMAS	IN11012237	INHUMAS S2	18/01/2020 13:13	18/01/2020 15:20	18/01/2020 13:13	18/01/2020 15:20	2,11	78	164,84	CHI
202001108546	JATAI	JT12264366	JATAI S2	18/01/2020 13:13	18/01/2020 15:03	18/01/2020 13:13	18/01/2020 15:03	1,82	65	118,35	CHI
202001108550	FAZENDA NOVA	FN12229882	FIRMINOPOLIS S2	18/01/2020 13:14	18/01/2020 18:45	18/01/2020 13:14	18/01/2020 18:45	5,51	2	11,02	CHI
202001108552	RIO VERDE	RV21289552	RIO VERDE S1	18/01/2020 13:15	18/01/2020 15:40	18/01/2020 13:15	18/01/2020 15:40	2,42	1	2,42	CHI
202001108553	NOVO GAMA	NJ11290801	PACAEMBU S1	18/01/2020 13:15	18/01/2020 16:37	18/01/2020 13:15	18/01/2020 16:37	3,36	10	33,64	CHI
202001108560	GOIATUBA	BJ21030854	RIO DOS BOIS	18/01/2020 13:16	18/01/2020 19:18	18/01/2020 13:16	18/01/2020 19:18	6,02	1	6,02	CHI
202001108571	ARAGOIANIA	AO32000019	GUAPO S2	18/01/2020 12:31	18/01/2020 18:00	18/01/2020 12:31	18/01/2020 18:00	5,48	16	87,64	CHI
202001108578	CRIXAS	CX12283275	SERRA DO OURO	18/01/2020 12:20	18/01/2020 20:20	18/01/2020 12:20	18/01/2020 20:20	7,99	2	15,97	CHI
202001108580	RIO VERDE	10011980867	RIO VERDE S2	18/01/2020 13:24	18/01/2020 18:10	18/01/2020 13:24	18/01/2020 18:10	4,76	1	4,76	CHI
202001108591	GOIATUBA	BJ21263554	BOM JESUS DE GOIAS	18/01/2020 13:27	18/01/2020 13:35	18/01/2020 13:27	18/01/2020 13:35	0,12	1	0,12	CHI
202001108595	GOIANIA	GN11001775	FERROVIARIO S3	18/01/2020 13:29	18/01/2020 14:14	18/01/2020 13:29	18/01/2020 14:14	0,74	12	8,89	CHI
202001108597	VARJAO	VJ12271768	CEZARINA	18/01/2020 13:30	19/01/2020 16:18	18/01/2020 13:30	19/01/2020 16:18	26,81	2	53,61	CHI
202001108598	CATALAO	10005882689	CATALAO S2	18/01/2020 13:30	18/01/2020 14:22	18/01/2020 13:30	18/01/2020 14:22	0,86	1	0,86	CHI
202001108606	CORUMBA DE GOIAS	CB12382383	CORUMBA	18/01/2020 13:33	18/01/2020 18:44	18/01/2020 13:33	18/01/2020 18:44	5,18	9	46,58	CHI
202001108608	PORTEIRAO	10030949384	RIO DOS BOIS	18/01/2020 13:33	18/01/2020 22:10	18/01/2020 13:33	18/01/2020 22:10	8,61	0	0,00	CHI
202001108610	GOIATUBA	GT12000178	BOM JESUS DE GOIAS	18/01/2020 12:32	18/01/2020 17:46	18/01/2020 12:32	18/01/2020 17:46	5,22	29	151,38	CHI

202001108613	GOIANIA	GN11199234	CAMPINAS S1	18/01/2020 13:16	18/01/2020 15:32	18/01/2020 13:16	18/01/2020 15:32	2,25	47	105,83	CHI
202001108618	CAMPOS VERDES	VD12257334	SANTA TEREZINHA	18/01/2020 13:36	19/01/2020 03:06	18/01/2020 13:36	19/01/2020 03:06	13,49	6	80,91	CHI
202001108620	GOIANIA	14301593	MEIA PONTE	18/01/2020 13:38	18/01/2020 15:45	18/01/2020 13:38	18/01/2020 15:45	2,13	1	2,13	CHI
202001108623	PIRENOPOLIS	PV12056014	CORUMBA	18/01/2020 13:34	18/01/2020 17:37	18/01/2020 13:34	18/01/2020 17:37	4,04	45	181,59	CHI
202001108633	MINEIROS	1390009972	PARQUE DAS EMAS	18/01/2020 13:42	18/01/2020 16:55	18/01/2020 13:42	18/01/2020 16:55	3,22	1	3,22	CHI
202001108634	SERRANOPOLIS	JT21219480	JATAI S1	18/01/2020 13:42	18/01/2020 17:32	18/01/2020 13:42	18/01/2020 17:32	3,82	1	3,82	CHI
202001108640	SAO LUIS DE MONTES BELOS	SL21180364	FIRMINOPOLIS S1	18/01/2020 13:43	18/01/2020 17:18	18/01/2020 13:43	18/01/2020 17:18	3,57	3	10,71	CHI
202001108641	ITUMBIARA	IT12208196	CACHOEIRA DOURADA	18/01/2020 13:43	18/01/2020 22:36	18/01/2020 13:43	18/01/2020 22:36	8,87	1	8,87	CHI
202001108642	CASTELANDIA	DM12417231	RIO DOS BOIS	18/01/2020 13:44	18/01/2020 22:43	18/01/2020 13:44	18/01/2020 22:43	8,98	23	206,60	CHI
202001108642	MAURILANDIA	DM12417231	RIO DOS BOIS	18/01/2020 13:44	18/01/2020 22:43	18/01/2020 13:44	18/01/2020 22:43	8,98	1	8,98	CHI
202001108642	QUIRINOPOLIS	DM12417231	RIO DOS BOIS	18/01/2020 13:44	18/01/2020 22:43	18/01/2020 13:44	18/01/2020 22:43	8,98	15	134,74	CHI
202001108644	CACHOEIRA DOURADA	3290003113	CACHOEIRA DOURADA	18/01/2020 13:45	18/01/2020 19:54	18/01/2020 13:45	18/01/2020 19:54	6,14	1	6,14	CHI
202001108645	GOIANESIA	550108040	GOIANESIA S2	18/01/2020 13:45	18/01/2020 16:34	18/01/2020 13:45	18/01/2020 16:34	2,81	1	2,81	CHI
202001108649	GOIAS	GS12336487	ITABERAI S1	18/01/2020 13:46	18/01/2020 16:49	18/01/2020 13:46	18/01/2020 16:49	3,04	2	6,07	CHI
202001108651	PADRE BERNARDO	9980010179	PADRE BERNARDO	18/01/2020 13:47	18/01/2020 16:04	18/01/2020 13:47	18/01/2020 16:04	2,28	1	2,28	CHI
202001108654	APARECIDA DE GOIANIA	AP11383871	INDEPENDENCIA S2	18/01/2020 13:23	18/01/2020 18:21	18/01/2020 13:23	18/01/2020 18:21	4,97	26	129,13	CHI
202001108662	MARA ROSA	MQ12313418	MARA ROSA	18/01/2020 13:06	18/01/2020 17:15	18/01/2020 13:06	18/01/2020 17:15	4,13	6	24,80	CHI
202001108663	CACHOEIRA DOURADA	IT12088560	CACHOEIRA DOURADA	18/01/2020 13:53	18/01/2020 18:49	18/01/2020 13:53	18/01/2020 18:49	4,92	1	4,92	CHI
202001108663	ITUMBIARA	IT12088560	CACHOEIRA DOURADA	18/01/2020 13:53	18/01/2020 18:49	18/01/2020 13:53	18/01/2020 18:49	4,92	4	19,68	CHI
202001108665	JATAI	JT12296500	JATAI S3	18/01/2020 12:50	18/01/2020 14:30	18/01/2020 12:50	18/01/2020 14:30	1,66	466	773,30	CHI
202001108668	ADELANDIA	DN12259109	ANICUNS	18/01/2020 13:55	18/01/2020 19:21	18/01/2020 13:55	18/01/2020 19:21	5,43	6	32,56	CHI
202001108669	ITAPIRAPUA	IU12020184	JUSSARA	18/01/2020 11:01	18/01/2020 17:54	18/01/2020 11:01	18/01/2020 17:54	6,89	6	41,31	CHI
202001108671	PALMEIRAS DE GOIAS	PL12349319	PALMEIRAS	18/01/2020 13:55	19/01/2020 18:19	18/01/2020 13:55	19/01/2020 16:27	26,52	1	26,52	CHI
202001108671	PALMEIRAS DE GOIAS	PL12349319	PALMEIRAS	18/01/2020 13:55	19/01/2020 18:19	18/01/2020 13:55	19/01/2020 16:49	26,89	1	26,89	CHI
202001108671	PALMEIRAS DE GOIAS	PL12206447	PALMEIRAS	18/01/2020 13:55	19/01/2020 18:19	19/01/2020 16:50	19/01/2020 17:54	1,06	1	1,06	CHI
202001108671	PALMEIRAS DE GOIAS	PL12206447	PALMEIRAS	18/01/2020 13:55	19/01/2020 18:19	19/01/2020 17:28	19/01/2020 17:54	0,43	2	0,86	CHI
202001108671	PALMEIRAS DE GOIAS	PL21274646	PALMEIRAS	18/01/2020 13:55	19/01/2020 18:19	19/01/2020 18:14	19/01/2020 18:19	0,08	1	0,08	CHI
202001108674	AGUAS LINDAS DE GOIAS	4830332762	AGUAS LINDAS DE GOIAS S1	18/01/2020 13:57	18/01/2020 15:18	18/01/2020 13:57	18/01/2020 15:18	1,35	1	1,35	CHI
202001108680	BALIZA	BH12396127	BOM JARDIM	18/01/2020 13:58	18/01/2020 20:38	18/01/2020 13:58	18/01/2020 20:38	6,65	1	6,65	CHI
202001108680	BOM JARDIM DE GOIAS	BH12396127	BOM JARDIM	18/01/2020 13:58	18/01/2020 20:38	18/01/2020 13:58	18/01/2020 20:38	6,65	1	6,65	CHI
202001108684	RUBIATABA	RB21194719	RUBIATABA	18/01/2020 14:00	19/01/2020 00:51	18/01/2020 14:00	19/01/2020 00:51	10,84	1	10,84	CHI
202001108685	PLANALTINA	10026960573	PLANALTINA	18/01/2020 14:00	18/01/2020 16:50	18/01/2020 14:00	18/01/2020 16:50	2,83	1	2,83	CHI
202001108688	ALEXANIA	480010158	ALEXANIA	18/01/2020 14:01	18/01/2020 16:34	18/01/2020 14:01	18/01/2020 16:34	2,54	1	2,54	CHI

202001108703	GOIANIA	12098036	GOYA S1	18/01/2020 14:05	18/01/2020 15:36	18/01/2020 14:05	18/01/2020 15:36	1,51	1	1,51	CHI
202001108704	SANTA CRUZ DE GOIAS	BC21257197	PIRACANJUBA	18/01/2020 14:05	18/01/2020 14:50	18/01/2020 14:05	18/01/2020 14:50	0,75	1	0,75	CHI
202001108705	PADRE BERNARDO	PB21377280	PADRE BERNARDO	18/01/2020 14:05	18/01/2020 17:53	18/01/2020 14:05	18/01/2020 17:53	3,79	2	7,59	CHI
202001108711	ARAGOIANIA	AO31064815	GUAPO S2	18/01/2020 14:07	18/01/2020 20:21	18/01/2020 14:07	18/01/2020 20:21	6,23	1	6,23	CHI
202001108719	CACHOEIRA DOURADA	CD11134639	CACHOEIRA DOURADA	18/01/2020 14:09	18/01/2020 16:42	18/01/2020 14:09	18/01/2020 16:42	2,54	48	121,95	CHI
202001108726	CAMPINACU	UC12236261	PORANGATU	18/01/2020 09:27	18/01/2020 16:10	18/01/2020 09:27	18/01/2020 16:10	6,72	19	127,59	CHI
202001108726	PORANGATU	UC12236261	PORANGATU	18/01/2020 09:27	18/01/2020 16:10	18/01/2020 09:27	18/01/2020 16:10	6,72	1	6,72	CHI
202001108728	ANAPOLIS	AN21366453	ANAPOLIS UNIVERSITARIO S1	18/01/2020 14:12	18/01/2020 15:51	18/01/2020 14:12	18/01/2020 15:51	1,65	2	3,29	CHI
202001108734	GOIANIA	12190810	CARAJAS S1	18/01/2020 14:13	19/01/2020 07:25	18/01/2020 14:13	19/01/2020 07:25	17,20	1	17,20	CHI
202001108740	IPAMERI	IP12248620	CRISTALINA S2	18/01/2020 13:33	18/01/2020 18:03	18/01/2020 13:33	18/01/2020 18:03	4,50	8	35,98	CHI
202001108751	HIDROLINA	HL12003219	URUACU	18/01/2020 13:36	18/01/2020 23:11	18/01/2020 13:36	18/01/2020 23:11	9,57	72	689,26	CHI
202001108758	GOIANESIA	GE12360291	GOIANESIA S2	18/01/2020 14:17	18/01/2020 17:00	18/01/2020 14:17	18/01/2020 17:00	2,72	8	21,73	CHI
202001108766	CALDAS NOVAS	760223129	SERRA DE CALDAS	18/01/2020 14:18	18/01/2020 16:06	18/01/2020 14:18	18/01/2020 16:06	1,80	1	1,80	CHI
202001108769	GOIANIA	17416309	CARAJAS S2	18/01/2020 14:18	18/01/2020 16:48	18/01/2020 14:18	18/01/2020 16:48	2,48	1	2,48	CHI
202001108770	APARECIDA DE GOIANIA	200259090	CEPAIGO S1	18/01/2020 14:19	18/01/2020 15:29	18/01/2020 14:19	18/01/2020 15:29	1,15	1	1,15	CHI
202001108771	LUZIANIA	120298612	RIO VERMELHO	18/01/2020 14:19	18/01/2020 16:11	18/01/2020 14:19	18/01/2020 16:11	1,85	1	1,85	CHI
202001108773	SAO LUIS DE MONTES BELOS	SL12306962	FIRMINOPOLIS S2	18/01/2020 13:34	18/01/2020 16:47	18/01/2020 13:34	18/01/2020 16:47	3,21	26	83,53	CHI
202001108774	CORREGO DO OURO	CO12299163	FIRMINOPOLIS S2	18/01/2020 14:20	18/01/2020 21:39	18/01/2020 14:20	18/01/2020 21:39	7,30	13	94,92	CHI
202001108778	SANTA CRUZ DE GOIAS	BC21302056	PIRACANJUBA	18/01/2020 14:21	18/01/2020 20:02	18/01/2020 14:21	18/01/2020 20:02	5,68	1	5,68	CHI
202001108781	CATALAO	IP12404711	IPAMERI	18/01/2020 14:03	18/01/2020 15:39	18/01/2020 14:03	18/01/2020 15:39	1,59	7	11,12	CHI
202001108781	GOIANDIRA	IP12404711	IPAMERI	18/01/2020 14:03	18/01/2020 15:39	18/01/2020 14:03	18/01/2020 15:39	1,59	15	23,82	CHI
202001108781	IPAMERI	IP12404711	IPAMERI	18/01/2020 14:03	18/01/2020 15:39	18/01/2020 14:03	18/01/2020 15:39	1,59	86	136,57	CHI
202001108789	NIQUELANDIA	NQ12288338	NIQUELANDIA SUBTRANSMISSAO	18/01/2020 14:22	19/01/2020 00:12	18/01/2020 14:22	19/01/2020 00:12	9,83	5	49,14	CHI
202001108791	SANTA RITA DO ARAGUAIA	SU12324789	SANTA RITA DO ARAGUAIA	18/01/2020 14:22	18/01/2020 19:20	18/01/2020 14:22	18/01/2020 19:20	4,95	4	19,81	CHI
202001108794	CRISTALINA	KR21214916	CRISTALINA S2	18/01/2020 14:23	18/01/2020 17:34	18/01/2020 14:23	18/01/2020 17:34	3,18	1	3,18	CHI
202001108797	SAO JOAO DA PARAUNA	FR21308857	FIRMINOPOLIS S2	18/01/2020 14:24	18/01/2020 16:08	18/01/2020 14:24	18/01/2020 16:08	1,73	1	1,73	CHI
202001108802	ALEXANIA	AX11210817	CORUMBA	18/01/2020 14:25	18/01/2020 20:27	18/01/2020 14:25	18/01/2020 20:27	6,02	102	613,81	CHI
202001108803	BELA VISTA DE GOIAS	BV21238091	BELA VISTA S2	18/01/2020 14:25	18/01/2020 16:39	18/01/2020 14:25	18/01/2020 16:39	2,22	2	4,43	CHI
202001108804	NIQUELANDIA	NQ21266050	NIQUELANDIA SUBTRANSMISSAO	18/01/2020 14:26	18/01/2020 19:51	18/01/2020 14:26	18/01/2020 19:51	5,41	1	5,41	CHI
202001108806	GOIANIA	12432982	GOYA S2	18/01/2020 14:26	18/01/2020 16:43	18/01/2020 14:26	18/01/2020 16:43	2,27	1	2,27	CHI
202001108809	SERRANOPOLIS	SX21308119	CHAPADAO DO CEU	18/01/2020 14:27	18/01/2020 17:28	18/01/2020 14:27	18/01/2020 17:28	3,01	1	3,01	CHI
202001108813	CAMPO LIMPO	AN21258745	NEROPOLIS S1	18/01/2020 14:29	18/01/2020 16:59	18/01/2020 14:29	18/01/2020 16:59	2,50	2	5,00	CHI
202001108814	GOIATUBA	140072524	GOIATUBA S2	18/01/2020 14:29	18/01/2020 17:14	18/01/2020 14:29	18/01/2020 17:14	2,74	1	2,74	CHI

202001108817	MINACU	4020123045	MINACU	18/01/2020 14:30	18/01/2020 17:19	18/01/2020 14:30	18/01/2020 17:19	2,81	1	2,81	CHI
202001108821	JATAI	290331547	JATAI S2	18/01/2020 14:31	18/01/2020 19:45	18/01/2020 14:31	18/01/2020 19:45	5,23	1	5,23	CHI
202001108823	INDIARA	IY12194009	PALMEIRAS	18/01/2020 14:32	18/01/2020 15:38	18/01/2020 14:32	18/01/2020 15:38	1,11	18	20,04	CHI
202001108825	NIQUELANDIA	NQ21266421	NIQUELANDIA SUBTRANSMISSAO	18/01/2020 14:32	18/01/2020 17:00	18/01/2020 14:32	18/01/2020 17:00	2,46	1	2,46	CHI
202001108829	PORANGATU	PO12133988	PORANGATU	18/01/2020 14:34	18/01/2020 17:34	18/01/2020 14:34	18/01/2020 17:34	2,99	2	5,98	CHI
202001108835	TAQUARAL DE GOIAS	TQ12300097	ITABERAI S1	18/01/2020 14:13	18/01/2020 17:05	18/01/2020 14:13	18/01/2020 17:05	2,85	6	17,12	CHI
202001108837	ORIZONA	OZ21137576	PIRES DO RIO S2	18/01/2020 14:35	18/01/2020 20:43	18/01/2020 14:35	18/01/2020 20:43	6,12	1	6,12	CHI
202001108842	AGUAS LINDAS DE GOIAS	4830348940	AGUAS LINDAS DE GOIAS S2	18/01/2020 14:37	18/01/2020 15:40	18/01/2020 14:37	18/01/2020 15:40	1,04	1	1,04	CHI
202001108843	LUZIANIA	3200070790	MARAJOARA	18/01/2020 14:37	18/01/2020 16:39	18/01/2020 14:37	18/01/2020 16:39	2,02	1	2,02	CHI
202001108847	PIRACANJUBA	PJ21000150	PIRACANJUBA	18/01/2020 14:39	20/01/2020 15:10	18/01/2020 14:39	20/01/2020 15:10	48,50	1	48,50	CHI
202001108849	GOIANIA	10009493032	AEROPORTO S1	18/01/2020 14:40	18/01/2020 18:05	18/01/2020 14:40	18/01/2020 18:05	3,40	1	3,40	CHI
202001108853	PIRENOPOLIS	PV12084791	CORUMBA	18/01/2020 14:13	18/01/2020 16:17	18/01/2020 14:13	18/01/2020 16:17	2,06	9	18,54	CHI
202001108856	PADRE BERNARDO	PB21063170	PADRE BERNARDO	18/01/2020 14:43	18/01/2020 19:31	18/01/2020 14:43	18/01/2020 19:31	4,79	1	4,79	CHI
202001108859	ANHANGUERA	AH12082025	CATALAO S1	18/01/2020 14:44	18/01/2020 20:53	18/01/2020 14:44	18/01/2020 20:53	6,15	2	12,30	CHI
202001108863	SANTO ANTONIO DO DESCOBERTO	SN11128771	ALEXANIA	18/01/2020 14:06	18/01/2020 17:44	18/01/2020 14:06	18/01/2020 17:44	3,62	184	666,34	CHI
202001108884	CAMPOS BELOS	CH12232591	SAO DOMINGOS	18/01/2020 14:48	18/01/2020 19:22	18/01/2020 14:48	18/01/2020 15:45	0,96	1	0,96	CHI
202001108884	CAMPOS BELOS	CH21232264	SAO DOMINGOS	18/01/2020 14:48	18/01/2020 19:22	18/01/2020 15:46	18/01/2020 18:22	2,60	1	2,60	CHI
202001108884	CAMPOS BELOS	CH21232264	SAO DOMINGOS	18/01/2020 14:48	18/01/2020 19:22	18/01/2020 18:30	18/01/2020 19:22	0,88	1	0,88	CHI
202001108885	INHUMAS	IN11365567	INHUMAS S2	18/01/2020 13:26	18/01/2020 15:29	18/01/2020 13:26	18/01/2020 15:29	2,04	87	177,70	CHI
202001108888	CUMARI	CY12078706	CATALAO S1	18/01/2020 14:43	19/01/2020 09:29	18/01/2020 14:43	19/01/2020 09:29	18,76	9	168,81	CHI
202001108898	PORTELANDIA	PW12303429	PARQUE DAS EMAS	18/01/2020 13:46	18/01/2020 20:56	18/01/2020 13:46	18/01/2020 20:56	7,15	10	71,53	CHI
202001108909	ITAPURANGA	IK12000013	ITAPURANGA	18/01/2020 14:53	18/01/2020 16:06	18/01/2020 14:53	18/01/2020 16:06	1,20	150	180,17	CHI
202001108910	AMERICANO DO BRASIL	KB12000021	ANICUNS	18/01/2020 14:54	18/01/2020 17:09	18/01/2020 14:54	18/01/2020 17:09	2,25	1	2,25	CHI
202001108910	ITABERAI	KB12000021	ANICUNS	18/01/2020 14:54	18/01/2020 17:09	18/01/2020 14:54	18/01/2020 17:09	2,25	4	9,00	CHI
202001108910	MOSSAMEDES	KB12000021	ANICUNS	18/01/2020 14:54	18/01/2020 17:09	18/01/2020 14:54	18/01/2020 17:09	2,25	2	4,50	CHI
202001108918	IPAMERI	IP21163101	CRISTALINA S2	18/01/2020 14:55	18/01/2020 19:53	18/01/2020 14:55	18/01/2020 19:53	4,96	1	4,96	CHI
202001108919	CATALAO	CT21106330	CATALAO S1	18/01/2020 14:55	18/01/2020 17:20	18/01/2020 14:55	18/01/2020 17:20	2,41	1	2,41	CHI
202001108925	CASTELANDIA	RV12370119	RIO DOS BOIS	18/01/2020 14:56	18/01/2020 19:27	18/01/2020 14:56	18/01/2020 19:27	4,52	8	36,16	CHI
202001108925	RIO VERDE	RV12370119	RIO DOS BOIS	18/01/2020 14:56	18/01/2020 19:27	18/01/2020 14:56	18/01/2020 19:27	4,52	4	18,08	CHI
202001108932	ORIZONA	OZ21231492	PIRES DO RIO S2	18/01/2020 14:57	18/01/2020 19:32	18/01/2020 14:57	18/01/2020 19:32	4,58	1	4,58	CHI
202001108937	NEROPOLIS	BW12320401	NEROPOLIS S1	18/01/2020 14:44	18/01/2020 16:43	18/01/2020 14:44	18/01/2020 16:43	1,98	9	17,80	CHI
202001108938	AGUAS LINDAS DE GOIAS	LA12078157	AGUAS LINDAS DE GOIAS S1	18/01/2020 14:48	18/01/2020 15:54	18/01/2020 14:48	18/01/2020 15:54	1,10	394	433,18	CHI
202001108943	CRISTALINA	KR21305151	PAMPLONA	18/01/2020 14:59	18/01/2020 18:07	18/01/2020 14:59	18/01/2020 18:07	3,14	1	3,14	CHI

202001108948	CAIAPONIA	MV12030666	MONTIVIDIU T	18/01/2020 15:00	18/01/2020 17:35	18/01/2020 15:00	18/01/2020 17:35	2,58	16	41,26	CHI
202001108948	MONTIVIDIU	MV12030666	MONTIVIDIU T	18/01/2020 15:00	18/01/2020 17:35	18/01/2020 15:00	18/01/2020 17:35	2,58	23	59,31	CHI
202001108953	CAMPINORTE	2040022254	MARA ROSA	18/01/2020 15:00	18/01/2020 18:21	18/01/2020 15:00	18/01/2020 18:21	3,34	1	3,34	CHI
202001108966	NIQUELANDIA	NQ12141859	URUACU	18/01/2020 15:03	19/01/2020 21:11	18/01/2020 15:03	18/01/2020 23:43	8,68	1	8,68	CHI
202001108966	NIQUELANDIA	NQ12141859	URUACU	18/01/2020 15:03	19/01/2020 21:11	18/01/2020 23:44	19/01/2020 21:11	21,45	1	21,45	CHI
202001108968	PALMEIRAS DE GOIAS	10028311750	PALMEIRAS	18/01/2020 15:03	18/01/2020 17:47	18/01/2020 15:03	18/01/2020 17:47	2,73	1	2,73	CHI
202001108971	COCALZINHO DE GOIAS	ZN12258524RE	COCALZINHO	18/01/2020 14:05	19/01/2020 03:05	18/01/2020 14:05	19/01/2020 03:05	12,99	55	714,31	CHI
202001108983	LUZIANIA	LZ21109868	CRISTALINA S2	18/01/2020 15:05	18/01/2020 20:31	18/01/2020 15:05	18/01/2020 20:31	5,43	1	5,43	CHI
202001108995	CORUMBAIBA	IP12242504	IPAMERI	18/01/2020 15:06	18/01/2020 17:21	18/01/2020 15:06	18/01/2020 17:21	2,25	1	2,25	CHI
202001108995	IPAMERI	IP12242504	IPAMERI	18/01/2020 15:06	18/01/2020 17:21	18/01/2020 15:06	18/01/2020 17:21	2,25	8	17,97	CHI
202001108996	GOIANIA	GN11235719	XAVANTES	18/01/2020 14:57	18/01/2020 17:27	18/01/2020 14:57	18/01/2020 17:27	2,51	36	90,49	CHI
202001109004	GOIANIA	GN11000808	GOIANIA LESTE S1	18/01/2020 15:07	18/01/2020 16:46	18/01/2020 15:07	18/01/2020 16:46	1,65	134	220,88	CHI
202001109008	MORRO AGUDO DE GOIAS	RB12126565	RUBIATABA	18/01/2020 14:44	18/01/2020 18:38	18/01/2020 14:44	18/01/2020 18:38	3,89	3	11,67	CHI
202001109008	RUBIATABA	RB12126565	RUBIATABA	18/01/2020 14:44	18/01/2020 18:38	18/01/2020 14:44	18/01/2020 18:38	3,89	57	221,73	CHI
202001109011	MUTUNOPOLIS	MU11269542	MARA ROSA	18/01/2020 15:08	18/01/2020 23:31	18/01/2020 15:08	18/01/2020 23:31	8,38	1	8,38	CHI
202001109031	LUZIANIA	LZ21348965	VIANOPOLIS	18/01/2020 15:12	18/01/2020 17:46	18/01/2020 15:12	18/01/2020 17:46	2,56	2	5,11	CHI
202001109035	NOVO BRASIL	NB12341209	JUSSARA	18/01/2020 15:13	18/01/2020 21:00	18/01/2020 15:13	18/01/2020 21:00	5,77	6	34,60	CHI
202001109038	PETROLINA DE GOIAS	PG12015781	PETROLINA	18/01/2020 14:48	18/01/2020 17:13	18/01/2020 14:48	18/01/2020 17:13	2,41	24	57,75	CHI
202001109039	SANTA HELENA DE GOIAS	SH12370214	SANTA HELENA S1	18/01/2020 15:14	18/01/2020 18:10	18/01/2020 15:14	18/01/2020 18:10	2,93	1	2,93	CHI
202001109041	NOVA VENEZA	NV21323109	NEROPOLIS S1	18/01/2020 15:14	18/01/2020 19:24	18/01/2020 15:14	18/01/2020 19:24	4,16	1	4,16	CHI
202001109042	SENADOR CANEDO	190058729	SENADOR CANEDO	18/01/2020 15:14	18/01/2020 18:09	18/01/2020 15:14	18/01/2020 18:09	2,91	1	2,91	CHI
202001109044	ORIZONA	OZ12352263	PIRES DO RIO S2	18/01/2020 15:14	18/01/2020 17:54	18/01/2020 15:14	18/01/2020 17:54	2,65	72	191,14	CHI
202001109052	ITABERAI	IB12310505	ITABERAI S2	18/01/2020 15:16	18/01/2020 17:59	18/01/2020 15:16	18/01/2020 17:59	2,71	21	56,93	CHI
202001109054	SANTO ANTONIO DA BARRA	BZ12303301	ACREUNA	18/01/2020 15:16	18/01/2020 18:35	18/01/2020 15:16	18/01/2020 18:35	3,31	5	16,54	CHI
202001109058	PIRENOPOLIS	PV12302141	SAO FRANCISCO DE GOIAS	18/01/2020 14:56	18/01/2020 19:30	18/01/2020 14:56	18/01/2020 19:30	4,55	93	423,59	CHI
202001109068	SENADOR CANEDO	SW12323299	SENADOR CANEDO	18/01/2020 15:19	18/01/2020 17:00	18/01/2020 15:19	18/01/2020 17:00	1,67	1171	1960,45	CHI
202001109069	ALEXANIA	AX21000018	ALEXANIA	18/01/2020 15:19	18/01/2020 23:17	18/01/2020 15:19	18/01/2020 23:17	7,96	1	7,96	CHI
202001109072	CORUMBA DE GOIAS	CB21155934	CORUMBA	18/01/2020 15:20	18/01/2020 19:58	18/01/2020 15:20	18/01/2020 19:58	4,63	1	4,63	CHI
202001109073	VARJAO	VJ21197067	GUAPO S2	18/01/2020 15:20	19/01/2020 11:54	18/01/2020 15:20	19/01/2020 11:54	20,55	1	20,55	CHI
202001109075	PARANAIGUARA	PC21326919	QUIRINOPOLIS	18/01/2020 15:21	18/01/2020 21:45	18/01/2020 15:21	18/01/2020 21:45	6,39	1	6,39	CHI
202001109084	NOVA AURORA	NE21063880	CATALAO S1	18/01/2020 15:23	19/01/2020 11:30	18/01/2020 15:23	19/01/2020 11:30	20,11	1	20,11	CHI
202001109087	GOIANIA	GN11168593	FERROVIARIO S2	18/01/2020 15:23	18/01/2020 16:22	18/01/2020 15:23	18/01/2020 16:22	0,97	59	57,51	CHI
202001109098	GOIANIA	GN11001398	FERROVIARIO S3	18/01/2020 15:12	18/01/2020 17:27	18/01/2020 15:12	18/01/2020 17:27	2,24	134	300,46	CHI

202001109099	RIO VERDE	RV21045263	MONTIVIDIU T	18/01/2020 15:26	19/01/2020 01:02	18/01/2020 15:26	19/01/2020 00:31	9,09	1	9,09	CHI
202001109099	RIO VERDE	RV21045263	MONTIVIDIU T	18/01/2020 15:26	19/01/2020 01:02	19/01/2020 00:32	19/01/2020 00:38	0,11	1	0,11	CHI
202001109099	RIO VERDE	RV12040471	MONTIVIDIU T	18/01/2020 15:26	19/01/2020 01:02	18/01/2020 21:28	19/01/2020 01:02	3,55	1	3,55	CHI
202001109102	CORUMBAIBA	CI12060020	CATALAO S1	18/01/2020 14:30	18/01/2020 17:50	18/01/2020 14:30	18/01/2020 17:50	3,33	110	366,36	CHI
202001109102	MORRINHOS	CI12060020	CATALAO S1	18/01/2020 14:30	18/01/2020 17:50	18/01/2020 14:30	18/01/2020 17:50	3,33	1	3,33	CHI
202001109102	NOVA AURORA	CI12060020	CATALAO S1	18/01/2020 14:30	18/01/2020 17:50	18/01/2020 14:30	18/01/2020 17:50	3,33	9	29,98	CHI
202001109109	GOIANAPOLIS	GP12107245	DAIA S2	18/01/2020 15:16	18/01/2020 19:56	18/01/2020 15:16	18/01/2020 19:56	4,66	4	18,63	CHI
202001109114	GOIANIA	GN11002788	ATLANTICO S2	18/01/2020 15:29	18/01/2020 18:17	18/01/2020 15:29	18/01/2020 18:17	2,79	37	103,25	CHI
202001109119	ITAPIRAPUA	IU21121420	MATRINCHA	18/01/2020 15:30	18/01/2020 18:10	18/01/2020 15:30	18/01/2020 18:10	2,65	1	2,65	CHI
202001109138	GOIANIA	GN11002392	FERROVIARIO S2	18/01/2020 15:35	18/01/2020 23:44	18/01/2020 15:35	18/01/2020 23:44	8,15	24	195,52	CHI
202001109140	JUSSARA	JR21022266	BRITANIA	18/01/2020 15:35	19/01/2020 09:34	18/01/2020 15:35	19/01/2020 09:34	17,98	1	17,98	CHI
202001109143	CORUMBA DE GOIAS	10001276822	CORUMBA	18/01/2020 15:36	18/01/2020 21:40	18/01/2020 15:36	18/01/2020 21:40	6,06	1	6,06	CHI
202001109146	AGUAS LINDAS DE GOIAS	4830390762	AGUAS LINDAS DE GOIAS S1	18/01/2020 15:36	18/01/2020 16:56	18/01/2020 15:36	18/01/2020 16:56	1,32	1	1,32	CHI
202001109153	CRIXAS	IW12211868	RUBIATABA	18/01/2020 15:31	18/01/2020 20:38	18/01/2020 15:31	18/01/2020 20:38	5,11	12	61,34	CHI
202001109153	GUARINOS	IW12211868	RUBIATABA	18/01/2020 15:31	18/01/2020 20:38	18/01/2020 15:31	18/01/2020 20:38	5,11	5	25,56	CHI
202001109153	ITAPACI	IW12211868	RUBIATABA	18/01/2020 15:31	18/01/2020 20:38	18/01/2020 15:31	18/01/2020 20:38	5,11	19	97,12	CHI
202001109157	CORUMBAIBA	CI21062833	VILA CORUMBA	18/01/2020 17:01	19/01/2020 10:25	18/01/2020 17:01	19/01/2020 10:25	17,40	1	17,40	CHI
202001109159	ORIZONA	OZ12043232RE	PIRES DO RIO S2	18/01/2020 14:32	18/01/2020 18:30	18/01/2020 14:32	18/01/2020 18:30	3,96	48	189,95	CHI
202001109160	CRISTALINA	KR12168463	CRISTALINA S1	18/01/2020 15:38	18/01/2020 20:38	18/01/2020 15:38	18/01/2020 20:38	4,99	3	14,97	CHI
202001109164	GOIANIA	GN12001501	XAVANTES	18/01/2020 15:28	19/01/2020 13:03	18/01/2020 15:28	18/01/2020 19:04	3,60	116	417,34	CHI
202001109164	GOIANIA	GN12150418LD	XAVANTES	18/01/2020 15:28	19/01/2020 13:03	18/01/2020 15:28	19/01/2020 08:43	17,25	27	465,73	CHI
202001109164	GOIANIA	GN12324615LD	XAVANTES	18/01/2020 15:28	19/01/2020 13:03	18/01/2020 15:28	19/01/2020 12:15	20,77	2	41,54	CHI
202001109164	GOIANIA	GN11207465	XAVANTES	18/01/2020 15:28	19/01/2020 13:03	18/01/2020 15:28	19/01/2020 12:34	21,09	14	295,20	CHI
202001109164	GOIANIA	GN11127908	XAVANTES	18/01/2020 15:28	19/01/2020 13:03	18/01/2020 15:28	19/01/2020 12:57	21,47	8	171,75	CHI
202001109164	GOIANIA	GN21090344	XAVANTES	18/01/2020 15:28	19/01/2020 13:03	18/01/2020 15:28	19/01/2020 13:03	21,57	2	43,15	CHI
202001109169	ORIZONA	OZ12114531	PIRES DO RIO S2	18/01/2020 14:56	18/01/2020 19:57	18/01/2020 14:56	18/01/2020 19:57	5,01	25	125,36	CHI
202001109171	NEROPOLIS	NR12164392	NEROPOLIS S2	18/01/2020 15:33	18/01/2020 17:28	18/01/2020 15:33	18/01/2020 17:28	1,91	36	68,78	CHI
202001109173	RIO VERDE	630505706	RIO VERDE S1	18/01/2020 15:40	18/01/2020 21:24	18/01/2020 15:40	18/01/2020 21:24	5,72	1	5,72	CHI
202001109178	SANTO ANTONIO DE GOIAS	BW21163946	NEROPOLIS S1	18/01/2020 15:41	19/01/2020 03:11	18/01/2020 15:41	19/01/2020 03:11	11,50	1	11,50	CHI
202001109182	TROMBAS	TB12185404	PORANGATU	18/01/2020 15:41	18/01/2020 20:20	18/01/2020 15:41	18/01/2020 20:20	4,64	3	13,93	CHI
202001109190	GOIANIA	GN11003127	CAMPINAS S2	18/01/2020 15:36	19/01/2020 00:49	18/01/2020 15:36	19/01/2020 00:49	9,20	156	1435,63	CHI
202001109193	ORIZONA	OZ12073391	PIRES DO RIO S2	18/01/2020 15:28	18/01/2020 17:25	18/01/2020 15:28	18/01/2020 17:25	1,94	10	19,36	CHI
202001109196	IACIARA	IA12257594	IACIARA S2	18/01/2020 15:43	18/01/2020 17:03	18/01/2020 15:43	18/01/2020 17:03	1,32	5	6,59	CHI

202001109198	GOIANIA	GN11193012	XAVANTES	18/01/2020 15:44	18/01/2020 19:00	18/01/2020 15:44	18/01/2020 19:00	3,26	132	430,69	CHI
202001109199	BURITI ALEGRE	BG12263537	ITUMBIARA VELHA S2	18/01/2020 15:43	18/01/2020 18:05	18/01/2020 15:43	18/01/2020 18:05	2,36	5	11,78	CHI
202001109199	ITUMBIARA	BG12263537	ITUMBIARA VELHA S2	18/01/2020 15:43	18/01/2020 18:05	18/01/2020 15:43	18/01/2020 18:05	2,36	7	16,49	CHI
202001109200	GOIANIA	GN11246352	GOYA S2	18/01/2020 15:40	18/01/2020 21:12	18/01/2020 15:40	18/01/2020 21:12	5,52	94	518,62	CHI
202001109205	PORANGATU	PO12064911	NOVO PLANALTO	18/01/2020 15:39	18/01/2020 18:30	18/01/2020 15:39	18/01/2020 18:30	2,84	135	383,93	CHI
202001109206	QUIRINOPOLIS	QI31203937	QUIRINOPOLIS	18/01/2020 15:45	18/01/2020 17:16	18/01/2020 15:45	18/01/2020 17:16	1,51	2	3,01	CHI
202001109209	SAO LUIS DE MONTES BELOS	SL12391445	FIRMINOPOLIS S1	18/01/2020 15:45	18/01/2020 18:17	18/01/2020 15:45	18/01/2020 18:17	2,52	6	15,12	CHI
202001109217	LUZIANIA	L20317965	RIO VERMELHO	18/01/2020 15:47	18/01/2020 22:10	18/01/2020 15:47	18/01/2020 22:10	6,38	1	6,38	CHI
202001109222	GOIANIA	GN12390538	FERROVIARIO S1	18/01/2020 15:32	18/01/2020 17:44	18/01/2020 15:32	18/01/2020 17:44	2,20	1106	2433,20	CHI
202001109225	VILA PROPICIO	NP21141270	BARRO ALTO	18/01/2020 15:49	18/01/2020 20:03	18/01/2020 15:49	18/01/2020 20:03	4,22	1	4,22	CHI
202001109228	ORIZONA	OZ12022882	PIRES DO RIO S2	18/01/2020 15:49	19/01/2020 00:15	18/01/2020 15:49	19/01/2020 00:15	8,42	20	168,39	CHI
202001109229	GOIANIA	GN11000729	GOIANIA LESTE S2	18/01/2020 15:50	18/01/2020 20:55	18/01/2020 15:50	18/01/2020 20:55	5,08	31	157,58	CHI
202001109240	SENADOR CANEDO	SW11239214	SENADOR CANEDO	18/01/2020 15:37	18/01/2020 18:39	18/01/2020 15:37	18/01/2020 18:39	3,03	160	484,67	CHI
202001109244	VIANOPOLIS	510017137	VIANOPOLIS	18/01/2020 15:52	18/01/2020 18:31	18/01/2020 15:52	18/01/2020 18:31	2,65	1	2,65	CHI
202001109248	PARAUNA	PU21067612	ACREUNA	18/01/2020 15:52	18/01/2020 17:55	18/01/2020 15:52	18/01/2020 17:55	2,04	1	2,04	CHI
202001109249	TEREZOPOLIS DE GOIAS	TJ21135764	DAIA S2	18/01/2020 15:53	18/01/2020 20:41	18/01/2020 15:53	18/01/2020 20:41	4,80	4	19,19	CHI
202001109257	IPAMERI	IP12266903	IPAMERI	18/01/2020 15:54	18/01/2020 17:28	18/01/2020 15:54	18/01/2020 17:28	1,56	3	4,69	CHI
202001109263	GUARINOS	GG12318446	URUACU	18/01/2020 15:33	18/01/2020 20:10	18/01/2020 15:33	18/01/2020 20:10	4,62	1	4,62	CHI
202001109263	PILAR DE GOIAS	GG12318446	URUACU	18/01/2020 15:33	18/01/2020 20:10	18/01/2020 15:33	18/01/2020 20:10	4,62	113	521,81	CHI
202001109263	SANTA TEREZINHA DE GOIAS	GG12318446	URUACU	18/01/2020 15:33	18/01/2020 20:10	18/01/2020 15:33	18/01/2020 20:10	4,62	4	18,47	CHI
202001109264	ITUMBIARA	IT21249846	ITUMBIARA VELHA S2	18/01/2020 15:55	18/01/2020 18:29	18/01/2020 15:55	18/01/2020 18:29	2,57	25	64,13	CHI
202001109265	VARJAO	GA21235827	GUAPO S2	18/01/2020 15:55	19/01/2020 13:57	18/01/2020 15:55	19/01/2020 13:57	22,03	1	22,03	CHI
202001109269	JUSSARA	JR21311045	BRITANIA	18/01/2020 15:55	19/01/2020 10:40	18/01/2020 15:55	19/01/2020 10:40	18,74	1	18,74	CHI
202001109281	CALDAS NOVAS	CN11071420	SERRA DE CALDAS	18/01/2020 15:47	18/01/2020 17:13	18/01/2020 15:47	18/01/2020 17:13	1,42	290	412,36	CHI
202001109282	ANAPOLIS	GL12389474	DAIA S2	18/01/2020 15:43	18/01/2020 18:36	18/01/2020 15:43	18/01/2020 18:36	2,88	4	11,52	CHI
202001109282	GAMELEIRA DE GOIAS	GL12389474	DAIA S2	18/01/2020 15:43	18/01/2020 18:36	18/01/2020 15:43	18/01/2020 18:36	2,88	33	95,03	CHI
202001109284	APARECIDA DE GOIANIA	AP11251718	REAL S2	18/01/2020 15:57	18/01/2020 22:48	18/01/2020 15:57	18/01/2020 22:48	6,85	99	677,90	CHI
202001109292	AGUA FRIA DE GOIAS	TL12365947	SAO JOAO D ALIANCA	18/01/2020 15:57	18/01/2020 19:45	18/01/2020 15:57	18/01/2020 19:45	3,79	2	7,57	CHI
202001109293	MINEIROS	MY21337071	PARQUE DAS EMAS	18/01/2020 15:59	18/01/2020 17:35	18/01/2020 15:59	18/01/2020 17:35	1,60	1	1,60	CHI
202001109296	RIO VERDE	RV21191769	MONTIVIDIU T	18/01/2020 15:59	19/01/2020 09:20	18/01/2020 15:59	19/01/2020 09:20	17,34	1	17,34	CHI
202001109297	BRAZABRANTES	BR12319562	NEROPOLIS S1	18/01/2020 15:24	18/01/2020 19:08	18/01/2020 15:24	18/01/2020 19:08	3,73	39	145,48	CHI
202001109299	NOVO PLANALTO	TA12354470	NOVO PLANALTO	18/01/2020 14:50	18/01/2020 19:26	18/01/2020 14:50	18/01/2020 19:26	4,59	15	68,90	CHI
202001109301	APORE	AE12343398	ITAJA S1	18/01/2020 16:00	18/01/2020 18:39	18/01/2020 16:00	18/01/2020 18:39	2,63	2	5,27	CHI

202001109304	GOIANIRA	10006346500	GOIANIRA	18/01/2020 16:01	18/01/2020 19:58	18/01/2020 16:01	18/01/2020 19:58	3,94	1	3,94	CHI
202001109313	AGUAS LINDAS DE GOIAS	10009695719	AGUAS LINDAS DE GOIAS S1	18/01/2020 16:03	18/01/2020 16:45	18/01/2020 16:03	18/01/2020 16:45	0,70	1	0,70	CHI
202001109315	PARANAIGUARA	CA21136225	QUIRINOPOLIS	18/01/2020 16:03	19/01/2020 09:30	18/01/2020 16:03	19/01/2020 09:30	17,45	1	17,45	CHI
202001109317	ORIZONA	OZ21300548	PIRES DO RIO S2	18/01/2020 16:03	19/01/2020 11:35	18/01/2020 16:03	19/01/2020 11:35	19,52	2	39,04	CHI
202001109319	JATAI	290329516	JATAI S2	18/01/2020 16:04	18/01/2020 17:19	18/01/2020 16:04	18/01/2020 17:19	1,25	1	1,25	CHI
202001109320	PIRENOPOLIS	PV21385773	CORUMBA	18/01/2020 16:04	18/01/2020 18:49	18/01/2020 16:04	18/01/2020 18:49	2,75	4	10,99	CHI
202001109322	NEROPOLIS	NR21000014	NEROPOLIS S2	18/01/2020 16:04	18/01/2020 18:15	18/01/2020 16:04	18/01/2020 18:15	2,18	1	2,18	CHI
202001109325	CRISTALINA	KR12287383	CRISTALINA S1	18/01/2020 16:05	19/01/2020 09:03	18/01/2020 16:05	19/01/2020 09:03	16,96	83	1407,93	CHI
202001109334	ANAPOLIS	20815384	JUNDIAI S1	18/01/2020 16:06	18/01/2020 20:30	18/01/2020 16:06	18/01/2020 20:30	4,39	1	4,39	CHI
202001109336	CATALAO	CT12399850	CATALAO S1	18/01/2020 15:14	18/01/2020 17:18	18/01/2020 15:14	18/01/2020 17:18	2,05	52	106,64	CHI
202001109336	GOIANDIRA	CT12399850	CATALAO S1	18/01/2020 15:14	18/01/2020 17:18	18/01/2020 15:14	18/01/2020 17:18	2,05	41	84,08	CHI
202001109349	GOIANIA	GN11167946	XAVANTES	18/01/2020 15:47	18/01/2020 17:59	18/01/2020 15:47	18/01/2020 17:59	2,19	62	136,04	CHI
202001109351	CACHOEIRA DOURADA	02670214	CACHOEIRA DOURADA	18/01/2020 16:09	18/01/2020 17:27	18/01/2020 16:09	18/01/2020 17:27	1,31	736	963,55	CHI
202001109351	INACIOLANDIA	02670214	CACHOEIRA DOURADA	18/01/2020 16:09	18/01/2020 17:27	18/01/2020 16:09	18/01/2020 17:27	1,31	90	117,83	CHI
202001109351	ITUMBIARA	02670214	CACHOEIRA DOURADA	18/01/2020 16:09	18/01/2020 17:27	18/01/2020 16:09	18/01/2020 17:27	1,31	13	17,02	CHI
202001109356	CRISTIANOPOLIS	CF12112080	CRISTIANOPOLIS	18/01/2020 16:10	18/01/2020 23:13	18/01/2020 16:10	18/01/2020 23:13	7,05	17	119,83	CHI
202001109356	PIRACANJUBA	CF12112080	CRISTIANOPOLIS	18/01/2020 16:10	18/01/2020 23:13	18/01/2020 16:10	18/01/2020 23:13	7,05	58	408,84	CHI
202001109363	ANAPOLIS	AN12258715	ANAPOLIS UNIVERSITARIO S2	18/01/2020 16:11	18/01/2020 18:05	18/01/2020 16:11	18/01/2020 18:05	1,89	51	96,62	CHI
202001109370	NOVA GLORIA	NG12181340	RUBIATABA	18/01/2020 16:12	18/01/2020 23:06	18/01/2020 16:12	18/01/2020 23:06	6,90	15	103,49	CHI
202001109374	GOIANIA	GN11000872	FERROVIARIO S2	18/01/2020 15:24	18/01/2020 17:33	18/01/2020 15:24	18/01/2020 17:33	2,15	48	102,97	CHI
202001109377	LUZIANIA	LZ12396830	MARAJOARA	18/01/2020 16:12	19/01/2020 10:53	18/01/2020 16:12	19/01/2020 09:35	17,38	15	260,77	CHI
202001109377	LUZIANIA	LZ12396830	MARAJOARA	18/01/2020 16:12	19/01/2020 10:53	18/01/2020 16:12	19/01/2020 10:21	18,16	14	254,17	CHI
202001109377	LUZIANIA	LZ12396830	MARAJOARA	18/01/2020 16:12	19/01/2020 10:53	18/01/2020 16:12	19/01/2020 10:53	18,68	27	504,38	CHI
202001109379	NIQUELANDIA	NQ21232462	BARRO ALTO	18/01/2020 16:12	19/01/2020 02:54	18/01/2020 16:12	19/01/2020 02:54	10,68	1	10,68	CHI
202001109385	CORREGO DO OURO	CO11055907	FIRMINOPOLIS S2	18/01/2020 16:13	18/01/2020 20:35	18/01/2020 16:13	18/01/2020 20:35	4,35	138	600,61	CHI
202001109393	PORANGATU	840030654	PORANGATU	18/01/2020 16:14	18/01/2020 18:12	18/01/2020 16:14	18/01/2020 18:12	1,96	1	1,96	CHI
202001109396	ANAPOLIS	AN12386259	ANAPOLIS UNIVERSITARIO S2	18/01/2020 16:14	18/01/2020 23:39	18/01/2020 16:14	18/01/2020 23:39	7,40	7	51,83	CHI
202001109400	GOIATUBA	GT21033080	BOM JESUS DE GOIAS	18/01/2020 16:15	18/01/2020 20:45	18/01/2020 16:15	18/01/2020 20:45	4,49	1	4,49	CHI
202001109402	JARAGUA	031604128	SAO FRANCISCO DE GOIAS	18/01/2020 15:02	18/01/2020 17:00	18/01/2020 15:02	18/01/2020 17:00	1,97	19	37,37	CHI
202001109402	JESUPOLIS	031604128	SAO FRANCISCO DE GOIAS	18/01/2020 15:02	18/01/2020 17:00	18/01/2020 15:02	18/01/2020 17:00	1,97	928	1825,32	CHI
202001109402	JESUPOLIS	031604128	SAO FRANCISCO DE GOIAS	18/01/2020 15:02	18/01/2020 17:00	18/01/2020 15:02	18/01/2020 17:00	1,97	124	243,90	CHI
202001109402	PETROLINA DE GOIAS	031604128	SAO FRANCISCO DE GOIAS	18/01/2020 15:02	18/01/2020 17:00	18/01/2020 15:02	18/01/2020 17:00	1,97	12	23,60	CHI
202001109402	PETROLINA DE GOIAS	031604128	SAO FRANCISCO DE GOIAS	18/01/2020 15:02	18/01/2020 17:00	18/01/2020 15:02	18/01/2020 17:00	1,97	3	5,90	CHI

202001109402	PETROLINA DE GOIAS	031604128	SAO FRANCISCO DE GOIAS	18/01/2020 15:02	18/01/2020 17:00	18/01/2020 15:02	18/01/2020 17:00	1,97	3	5,90	CHI
202001109402	PIRENOPOLIS	031604128	SAO FRANCISCO DE GOIAS	18/01/2020 15:02	18/01/2020 17:00	18/01/2020 15:02	18/01/2020 17:00	1,97	989	1945,31	CHI
202001109402	PIRENOPOLIS	031604128	SAO FRANCISCO DE GOIAS	18/01/2020 15:02	18/01/2020 17:00	18/01/2020 15:02	18/01/2020 17:00	1,97	326	641,22	CHI
202001109402	PIRENOPOLIS	031604128	SAO FRANCISCO DE GOIAS	18/01/2020 15:02	18/01/2020 17:00	18/01/2020 15:02	18/01/2020 17:00	1,97	1	1,97	CHI
202001109402	SAO FRANCISCO DE GOIAS	031604128	SAO FRANCISCO DE GOIAS	18/01/2020 15:02	18/01/2020 17:00	18/01/2020 15:02	18/01/2020 17:00	1,97	19	37,37	CHI
202001109402	SAO FRANCISCO DE GOIAS	031604128	SAO FRANCISCO DE GOIAS	18/01/2020 15:02	18/01/2020 17:00	18/01/2020 15:02	18/01/2020 17:00	1,97	74	145,55	CHI
202001109402	SAO FRANCISCO DE GOIAS	031604128	SAO FRANCISCO DE GOIAS	18/01/2020 15:02	18/01/2020 17:00	18/01/2020 15:02	18/01/2020 17:00	1,97	25	49,17	CHI
202001109402	SAO FRANCISCO DE GOIAS	031604128	SAO FRANCISCO DE GOIAS	18/01/2020 15:02	18/01/2020 17:00	18/01/2020 15:02	18/01/2020 17:00	1,97	1	1,97	CHI
202001109404	BALIZA	BH21228520	BOM JARDIM	17/01/2020 11:19	18/01/2020 19:28	17/01/2020 11:19	18/01/2020 19:28	32,15	2	64,30	CHI
202001109410	CATALAO	OU10400732	CATALAO S1	18/01/2020 16:47	18/01/2020 23:42	18/01/2020 16:47	18/01/2020 18:21	1,58	221	348,57	CHI
202001109410	CATALAO	OU10400732	CATALAO S1	18/01/2020 16:47	18/01/2020 23:42	18/01/2020 16:47	18/01/2020 18:21	1,58	2	3,15	CHI
202001109410	CUMARI	OU10400732	CATALAO S1	18/01/2020 16:47	18/01/2020 23:42	18/01/2020 16:47	18/01/2020 18:21	1,58	1	1,58	CHI
202001109410	DISTRITO FEDERAL	OU10400732	CATALAO S1	18/01/2020 16:47	18/01/2020 23:42	18/01/2020 16:47	18/01/2020 18:21	1,58	1	1,58	CHI
202001109410	OUVIDOR	OU10400732	CATALAO S1	18/01/2020 16:47	18/01/2020 23:42	18/01/2020 16:47	18/01/2020 18:21	1,58	1	1,58	CHI
202001109410	OUVIDOR	OU10400732	CATALAO S1	18/01/2020 16:47	18/01/2020 23:42	18/01/2020 16:47	18/01/2020 18:21	1,58	1	1,58	CHI
202001109410	TRES RANCHOS	OU10400732	CATALAO S1	18/01/2020 16:47	18/01/2020 23:42	18/01/2020 16:47	18/01/2020 18:21	1,58	1904	3003,03	CHI
202001109410	TRES RANCHOS	OU10400732	CATALAO S1	18/01/2020 16:47	18/01/2020 23:42	18/01/2020 16:47	18/01/2020 18:21	1,58	358	564,65	CHI
202001109410	TRES RANCHOS	OU10400732	CATALAO S1	18/01/2020 16:47	18/01/2020 23:42	18/01/2020 16:47	18/01/2020 18:21	1,58	17	26,81	CHI
202001109410	CATALAO	OU10400732	CATALAO S1	18/01/2020 16:47	18/01/2020 23:42	18/01/2020 18:22	18/01/2020 23:31	5,15	2	10,29	CHI
202001109410	OUVIDOR	OU10400732	CATALAO S1	18/01/2020 16:47	18/01/2020 23:42	18/01/2020 18:22	18/01/2020 23:31	5,15	1	5,15	CHI
202001109410	CATALAO	OU13078805	CATALAO S1	18/01/2020 16:47	18/01/2020 23:42	18/01/2020 16:47	18/01/2020 23:42	6,91	2	13,83	CHI
202001109410	OUVIDOR	OU13078805	CATALAO S1	18/01/2020 16:47	18/01/2020 23:42	18/01/2020 16:47	18/01/2020 23:42	6,91	3	20,74	CHI
202001109410	CATALAO	OU10400732	CATALAO S1	18/01/2020 16:47	18/01/2020 23:42	18/01/2020 18:22	18/01/2020 23:42	5,32	222	1180,92	CHI
202001109410	CUMARI	OU10400732	CATALAO S1	18/01/2020 16:47	18/01/2020 23:42	18/01/2020 18:22	18/01/2020 23:42	5,32	1	5,32	CHI
202001109410	DISTRITO FEDERAL	OU10400732	CATALAO S1	18/01/2020 16:47	18/01/2020 23:42	18/01/2020 18:22	18/01/2020 23:42	5,32	1	5,32	CHI
202001109410	OUVIDOR	OU10400732	CATALAO S1	18/01/2020 16:47	18/01/2020 23:42	18/01/2020 18:22	18/01/2020 23:42	5,32	1	5,32	CHI
202001109410	TRES RANCHOS	OU10400732	CATALAO S1	18/01/2020 16:47	18/01/2020 23:42	18/01/2020 18:22	18/01/2020 23:42	5,32	1922	10223,97	CHI
202001109410	TRES RANCHOS	OU10400732	CATALAO S1	18/01/2020 16:47	18/01/2020 23:42	18/01/2020 18:22	18/01/2020 23:42	5,32	362	1925,64	CHI
202001109410	TRES RANCHOS	OU13078805	CATALAO S1	18/01/2020 16:47	18/01/2020 23:42	18/01/2020 18:22	18/01/2020 23:42	5,32	17	90,43	CHI
202001109414	GOIANIA	GN11001419	CAMPINAS S2	18/01/2020 17:11	19/01/2020 02:30	18/01/2020 17:11	19/01/2020 02:30	9,30	70	651,19	CHI
202001109501	APARECIDA DE GOIANIA	200105516	INDEPENDENCIA S1	18/01/2020 16:15	18/01/2020 16:58	18/01/2020 16:15	18/01/2020 16:58	0,71	1	0,71	CHI
202001109506	SANTO ANTONIO DO DESCOBERTO	SN12092298	ALEXANIA	18/01/2020 16:17	19/01/2020 02:13	18/01/2020 19:52	19/01/2020 01:07	5,25	15	78,71	CHI
202001109506	SANTO ANTONIO DO DESCOBERTO	SN21093530	ALEXANIA	18/01/2020 16:17	19/01/2020 02:13	18/01/2020 19:51	19/01/2020 02:13	6,38	1	6,38	CHI

202001109509	PORANGATU	PO21170966	PORANGATU	18/01/2020 16:17	19/01/2020 08:02	18/01/2020 16:17	19/01/2020 08:02	15,74	1	15,74	CHI
202001109510	ITAPIRAPUA	IU21142810	MATRINCHA	18/01/2020 16:17	18/01/2020 22:36	18/01/2020 16:17	18/01/2020 22:36	6,31	1	6,31	CHI
202001109516	EDEIA	EA21127722	EDEIA	18/01/2020 16:18	18/01/2020 21:06	18/01/2020 16:18	18/01/2020 21:06	4,79	1	4,79	CHI
202001109522	APARECIDA DE GOIANIA	10019443453	ANHANGUERA	18/01/2020 16:19	18/01/2020 18:07	18/01/2020 16:19	18/01/2020 18:07	1,79	1	1,79	CHI
202001109525	ANAPOLIS	20727495	JUNDIAI S1	18/01/2020 16:20	18/01/2020 17:34	18/01/2020 16:20	18/01/2020 17:34	1,23	1	1,23	CHI
202001109529	ITAGUARU	IC21117653	JARAGUA	18/01/2020 16:20	18/01/2020 20:10	18/01/2020 16:20	18/01/2020 20:10	3,83	1	3,83	CHI
202001109537	MONTES CLAROS DE GOIAS	ME12334949	IPORA	18/01/2020 16:21	18/01/2020 20:23	18/01/2020 16:21	18/01/2020 20:23	4,02	8	32,15	CHI
202001109542	SAO MIGUEL DO ARAGUAIA	SM12334361	SAO MIGUEL DO ARAGUAIA	18/01/2020 16:22	18/01/2020 18:30	18/01/2020 16:22	18/01/2020 18:30	2,13	4	8,51	CHI
202001109549	PLANALTINA	PI12099511	PLANALTINA	18/01/2020 16:24	18/01/2020 19:33	18/01/2020 16:24	18/01/2020 19:33	3,15	17	53,47	CHI
202001109553	NOVA GLORIA	NG21145671	RUBIATABA	18/01/2020 16:25	19/01/2020 11:45	18/01/2020 16:25	19/01/2020 11:45	19,33	1	19,33	CHI
202001109556	BONFINOPOLIS	LB12000017	CEPAIGO S2	18/01/2020 15:33	18/01/2020 17:28	18/01/2020 15:33	18/01/2020 17:28	1,90	68	129,46	CHI
202001109556	LEOPOLDO DE BULHOES	LB12000017	CEPAIGO S2	18/01/2020 15:33	18/01/2020 17:28	18/01/2020 15:33	18/01/2020 17:28	1,90	12	22,85	CHI
202001109562	PONTALINA	MI21181922	PONTALINA	18/01/2020 16:26	19/01/2020 15:47	18/01/2020 16:26	19/01/2020 15:47	23,33	1	23,33	CHI
202001109572	GOIANIA	GN12000504	FERROVIARIO S1	18/01/2020 15:40	18/01/2020 17:51	18/01/2020 15:40	18/01/2020 17:51	2,18	532	1160,65	CHI
202001109573	GOIANIA	GN11168577	GOIANIA LESTE S2	18/01/2020 15:23	19/01/2020 03:26	18/01/2020 15:23	19/01/2020 03:26	12,05	69	831,57	CHI
202001109575	ITUMBIARA	690062163	ITUMBIARA VELHA S1	18/01/2020 16:30	19/01/2020 07:30	18/01/2020 16:30	19/01/2020 07:30	15,00	1	15,00	CHI
202001109577	LUZIANIA	LZ11067357	MARAJOARA	18/01/2020 16:31	18/01/2020 19:15	18/01/2020 16:31	18/01/2020 19:15	2,73	18	49,14	CHI
202001109583	ITAPACI	IW21224013	RUBIATABA	18/01/2020 16:32	19/01/2020 14:20	18/01/2020 16:32	19/01/2020 14:20	21,79	1	21,79	CHI
202001109586	PIRACANJUBA	PJ12381148	PIRACANJUBA	18/01/2020 07:05	19/01/2020 07:05	18/01/2020 07:05	19/01/2020 07:05	23,99	6	143,95	CHI
202001109589	CAMPO ALEGRE DE GOIAS	CM12379366	CAMPO ALEGRE DE GOIAS	18/01/2020 16:33	19/01/2020 09:40	18/01/2020 16:33	19/01/2020 09:40	17,11	1	17,11	CHI
202001109590	CATALAO	CT12042327	CATALAO S2	18/01/2020 16:30	19/01/2020 07:00	18/01/2020 16:30	19/01/2020 07:00	14,49	5	72,44	CHI
202001109593	ITUMBIARA	BG12363928	ITUMBIARA VELHA S2	18/01/2020 16:34	18/01/2020 20:09	18/01/2020 16:34	18/01/2020 20:09	3,57	4	14,28	CHI
202001109594	APARECIDA DE GOIANIA	AP21251635	INDEPENDENCIA S2	18/01/2020 16:34	18/01/2020 19:34	18/01/2020 16:34	18/01/2020 19:34	2,99	1	2,99	CHI
202001109599	BRITANIA	BT12316174	BRITANIA	18/01/2020 16:35	19/01/2020 07:31	18/01/2020 16:35	19/01/2020 07:31	14,92	3	44,76	CHI
202001109601	ITAPURANGA	IK21129767	ITAPURANGA	18/01/2020 16:36	18/01/2020 18:20	18/01/2020 16:36	18/01/2020 18:20	1,73	1	1,73	CHI
202001109602	GOIANIA	GN11002108	FERROVIARIO S1	18/01/2020 15:55	18/01/2020 21:29	18/01/2020 15:55	18/01/2020 21:29	5,55	49	272,17	CHI
202001109603	RIO VERDE	SH12000198	IPEGUARI	18/01/2020 16:14	18/01/2020 20:38	18/01/2020 16:14	18/01/2020 20:38	4,40	3	13,19	CHI
202001109603	SANTA HELENA DE GOIAS	SH12000198	IPEGUARI	18/01/2020 16:14	18/01/2020 20:38	18/01/2020 16:14	18/01/2020 20:38	4,40	7	30,78	CHI
202001109612	GOIANIA	14306062	GOIANIA LESTE S1	18/01/2020 16:38	19/01/2020 08:16	18/01/2020 16:38	19/01/2020 08:16	15,62	1	15,62	CHI
202001109616	TRINDADE	TR12000052	TRINDADE	18/01/2020 16:39	19/01/2020 17:06	18/01/2020 16:39	18/01/2020 17:55	1,26	105	132,10	CHI
202001109616	TRINDADE	TR12000052	TRINDADE	18/01/2020 16:39	19/01/2020 17:06	18/01/2020 17:56	19/01/2020 13:45	19,82	1	19,82	CHI
202001109616	TRINDADE	TR12000052	TRINDADE	18/01/2020 16:39	19/01/2020 17:06	18/01/2020 17:56	19/01/2020 14:20	20,41	51	1040,98	CHI
202001109616	TRINDADE	TR12000052	TRINDADE	18/01/2020 16:39	19/01/2020 17:06	18/01/2020 17:56	19/01/2020 15:32	21,61	1	21,61	CHI

202001109616	TRINDADE	TR12000052	TRINDADE	18/01/2020 16:39	19/01/2020 17:06	18/01/2020 17:56	19/01/2020 16:31	22,59	26	587,33	CHI
202001109616	TRINDADE	TR12000052	TRINDADE	18/01/2020 16:39	19/01/2020 17:06	18/01/2020 17:56	19/01/2020 16:57	23,03	25	575,68	CHI
202001109616	TRINDADE	TR12000052	TRINDADE	18/01/2020 16:39	19/01/2020 17:06	18/01/2020 17:56	19/01/2020 17:06	23,17	1	23,17	CHI
202001109618	MARA ROSA	MQ12262459	MARA ROSA	18/01/2020 15:07	18/01/2020 18:30	18/01/2020 15:07	18/01/2020 18:30	3,37	29	97,85	CHI
202001109637	ABADIANIA	AA21101468	ANAPOLIS UNIVERSITARIO S1	18/01/2020 16:44	19/01/2020 00:19	18/01/2020 16:44	19/01/2020 00:19	7,57	1	7,57	CHI
202001109641	IACIARA	IA21218849	IACIARA S2	18/01/2020 16:45	18/01/2020 18:34	18/01/2020 16:45	18/01/2020 18:34	1,81	1	1,81	CHI
202001109642	APARECIDA DE GOIANIA	200131035	INDEPENDENCIA S2	18/01/2020 16:45	18/01/2020 17:33	18/01/2020 16:45	18/01/2020 17:33	0,79	1	0,79	CHI
202001109643	GOIANIA	GN11322882	GOIANIA LESTE S2	18/01/2020 15:07	18/01/2020 19:20	18/01/2020 15:07	18/01/2020 19:20	4,21	109	458,65	CHI
202001109647	LUZIANIA	3200174995	MARAJOARA	18/01/2020 16:46	18/01/2020 19:41	18/01/2020 16:46	18/01/2020 19:41	2,91	1	2,91	CHI
202001109649	JARAGUA	70017153	JARAGUA	18/01/2020 16:47	18/01/2020 17:55	18/01/2020 16:47	18/01/2020 17:55	1,13	1	1,13	CHI
202001109650	CATURAI	CK12071217	ARACU	18/01/2020 16:47	18/01/2020 22:34	18/01/2020 16:47	18/01/2020 22:34	5,78	5	28,91	CHI
202001109659	CATALAO	CT11000046	CATALAO S2	18/01/2020 16:48	18/01/2020 21:19	18/01/2020 16:48	18/01/2020 21:19	4,52	81	365,74	CHI
202001109660	CORUMBAIBA	CI21127884	VILA CORUMBA	18/01/2020 16:48	19/01/2020 11:07	18/01/2020 16:48	19/01/2020 11:07	18,31	2	36,63	CHI
202001109661	CAMPESTRE DE GOIAS	GC10400645	TRINDADE	18/01/2020 16:25	18/01/2020 19:16	18/01/2020 16:25	18/01/2020 18:07	1,70	1	1,70	CHI
202001109661	CAMPESTRE DE GOIAS	GC10400645	TRINDADE	18/01/2020 16:25	18/01/2020 19:16	18/01/2020 16:25	18/01/2020 19:16	2,85	6	17,12	CHI
202001109661	PALMEIRAS DE GOIAS	GC10400645	TRINDADE	18/01/2020 16:25	18/01/2020 19:16	18/01/2020 16:25	18/01/2020 19:16	2,85	1	2,85	CHI
202001109670	ITUMBIARA	IT21166467	ITUMBIARA VELHA S2	18/01/2020 16:49	19/01/2020 10:06	18/01/2020 16:49	19/01/2020 10:06	17,27	1	17,27	CHI
202001109676	MUTUNOPOLIS	MU12192453	MARA ROSA	18/01/2020 16:50	19/01/2020 08:21	18/01/2020 16:50	19/01/2020 08:21	15,51	1	15,51	CHI
202001109676	PORANGATU	MU12192453	MARA ROSA	18/01/2020 16:50	19/01/2020 08:21	18/01/2020 16:50	19/01/2020 08:21	15,51	1	15,51	CHI
202001109683	ANAPOLIS	AN12004481	NEROPOLIS S1	18/01/2020 16:48	18/01/2020 17:58	18/01/2020 16:48	18/01/2020 17:58	1,17	8	9,32	CHI
202001109703	ANAPOLIS	AN12000863	JUNDIAI S2	18/01/2020 16:54	18/01/2020 19:08	18/01/2020 16:54	18/01/2020 19:08	2,22	392	870,35	CHI
202001109705	GOIANESIA	550073206	GOIANESIA S2	18/01/2020 16:54	19/01/2020 14:06	18/01/2020 16:54	19/01/2020 14:06	21,20	1	21,20	CHI
202001109708	SANTA TEREZA DE GOIAS	2430012759	MARA ROSA	18/01/2020 16:55	18/01/2020 21:20	18/01/2020 16:55	18/01/2020 21:20	4,40	1	4,40	CHI
202001109711	BALIZA	BH12226864	BOM JARDIM	18/01/2020 16:56	18/01/2020 23:39	18/01/2020 16:56	18/01/2020 23:39	6,72	1	6,72	CHI
202001109714	GOIANIA	GN12193016	XAVANTES	18/01/2020 16:03	18/01/2020 18:37	18/01/2020 16:03	18/01/2020 18:37	2,57	257	659,42	CHI
202001109720	ITAPACI	IW12243655	ITAPACI	18/01/2020 16:58	19/01/2020 03:22	18/01/2020 16:58	19/01/2020 03:22	10,39	2	20,78	CHI
202001109723	ABADIANIA	AA12377766	ANAPOLIS UNIVERSITARIO S1	18/01/2020 16:21	18/01/2020 23:11	18/01/2020 16:21	18/01/2020 23:11	6,83	9	61,48	CHI
202001109729	LUZIANIA	LZ11000044	CRISTALINA S2	18/01/2020 17:00	18/01/2020 21:25	18/01/2020 17:00	18/01/2020 21:25	4,41	19	83,81	CHI
202001109731	ANAPOLIS	AN12381938	ANAPOLIS UNIVERSITARIO S2	18/01/2020 17:00	18/01/2020 21:36	18/01/2020 17:00	18/01/2020 21:36	4,59	173	794,31	CHI
202001109735	CAMPINACU	UC21321316	PORANGATU	18/01/2020 17:01	18/01/2020 20:31	18/01/2020 17:01	18/01/2020 20:31	3,49	1	3,49	CHI
202001109736	CAMPESTRE DE GOIAS	GC17399994	TRINDADE	18/01/2020 17:07	18/01/2020 23:30	18/01/2020 17:07	18/01/2020 23:30	6,38	163	1040,53	CHI
202001109738	GOIANIA	GN11220963	MEIA PONTE	18/01/2020 16:02	18/01/2020 22:28	18/01/2020 16:02	18/01/2020 22:28	6,42	99	635,94	CHI
202001109751	GOIANIA	GN12053643	GOIANIA LESTE S2	18/01/2020 16:58	18/01/2020 21:35	18/01/2020 16:58	18/01/2020 21:35	4,61	119	549,12	CHI

202001109754	ITUMBIARA	IT11000059	PARANAIBA	18/01/2020 17:05	18/01/2020 23:30	18/01/2020 17:05	18/01/2020 23:30	6,43	165	1060,22	CHI
202001109755	ORIZONA	OZ12300909	PIRES DO RIO S2	18/01/2020 17:05	18/01/2020 21:04	18/01/2020 17:05	18/01/2020 21:04	3,97	13	51,66	CHI
202001109768	CRISTALINA	KR21251302	CRISTALINA S2	18/01/2020 17:09	19/01/2020 07:47	18/01/2020 17:09	19/01/2020 07:47	14,63	1	14,63	CHI
202001109769	OURO VERDE DE GOIAS	OV12326130	NEROPOLIS S2	18/01/2020 16:06	19/01/2020 08:02	18/01/2020 16:06	19/01/2020 08:02	15,92	39	620,89	CHI
202001109772	ITUMBIARA	690085345	ITUMBIARA VELHA S1	18/01/2020 17:10	18/01/2020 22:04	18/01/2020 17:10	18/01/2020 22:04	4,89	1	4,89	CHI
202001109773	URUACU	10000224632	CAMPINORTE	18/01/2020 17:10	18/01/2020 20:27	18/01/2020 17:10	18/01/2020 20:27	3,28	1	3,28	CHI
202001109775	NIQUELANDIA	NQ12293907	URUACU	18/01/2020 17:10	18/01/2020 22:34	18/01/2020 17:10	18/01/2020 22:34	5,39	4	21,56	CHI
202001109776	GOIANIRA	10006091383	GOIANIRA	18/01/2020 17:10	18/01/2020 22:02	18/01/2020 17:10	18/01/2020 22:02	4,85	1	4,85	CHI
202001109781	ANAPOLIS	AN21090660	ANAPOLIS UNIVERSITARIO S2	18/01/2020 17:12	19/01/2020 00:24	18/01/2020 17:12	19/01/2020 00:24	7,20	1	7,20	CHI
202001109782	SAO SIMAO	SO21216658	CACHOEIRA ALTA	18/01/2020 17:12	18/01/2020 20:22	18/01/2020 17:12	18/01/2020 20:22	3,17	1	3,17	CHI
202001109792	ITUMBIARA	IT12305616	ITUMBIARA NOVA	18/01/2020 16:37	19/01/2020 15:57	18/01/2020 16:37	19/01/2020 15:57	23,33	6	139,97	CHI
202001109799	CATALAO	CT21215629	CATALAO S1	18/01/2020 17:15	19/01/2020 06:13	18/01/2020 17:15	19/01/2020 06:13	12,97	2	25,93	CHI
202001109800	SENADOR CANEDO	SW12252400	SENADOR CANEDO	18/01/2020 17:03	18/01/2020 18:39	18/01/2020 17:03	18/01/2020 18:39	1,59	1259	1999,36	CHI
202001109813	MINACU	TB12185305	PORANGATU	18/01/2020 17:03	18/01/2020 19:28	18/01/2020 17:03	18/01/2020 19:28	2,40	12	28,85	CHI
202001109813	TROMBAS	TB12185305	PORANGATU	18/01/2020 17:03	18/01/2020 19:28	18/01/2020 17:03	18/01/2020 19:28	2,40	93	223,61	CHI
202001109816	PIRACANJUBA	PJ12326569	CRISTIANOPOLIS	18/01/2020 17:19	18/01/2020 19:39	18/01/2020 17:19	18/01/2020 19:39	2,33	29	67,43	CHI
202001109817	GOIANIA	GN11335555	CAMPINAS S2	18/01/2020 15:41	18/01/2020 19:25	18/01/2020 15:41	18/01/2020 19:25	3,73	113	421,11	CHI
202001109821	ABADIANIA	AA21399371	ANAPOLIS UNIVERSITARIO S1	18/01/2020 17:20	18/01/2020 23:37	18/01/2020 17:20	18/01/2020 23:37	6,28	4	25,12	CHI
202001109823	MAIRIPOTABA	MI21217756	PONTALINA	18/01/2020 17:20	19/01/2020 16:06	18/01/2020 17:20	19/01/2020 16:06	22,76	1	22,76	CHI
202001109825	FORMOSO	TB10396085	PORANGATU	18/01/2020 17:12	18/01/2020 18:04	18/01/2020 17:12	18/01/2020 17:39	0,45	2	0,91	CHI
202001109825	MONTIVIDIU DO NORTE	TB10396085	PORANGATU	18/01/2020 17:12	18/01/2020 18:04	18/01/2020 17:12	18/01/2020 17:39	0,45	1102	501,10	CHI
202001109825	TROMBAS	TB10396085	PORANGATU	18/01/2020 17:12	18/01/2020 18:04	18/01/2020 17:12	18/01/2020 17:39	0,45	242	110,04	CHI
202001109825	MONTIVIDIU DO NORTE	MX10400351	PORANGATU	18/01/2020 17:12	18/01/2020 18:04	18/01/2020 17:12	18/01/2020 18:04	0,87	627	544,97	CHI
202001109825	TROMBAS	MX10400351	PORANGATU	18/01/2020 17:12	18/01/2020 18:04	18/01/2020 17:12	18/01/2020 18:04	0,87	22	19,12	CHI
202001109836	ABADIANIA	AA12302333	ANAPOLIS UNIVERSITARIO S1	18/01/2020 17:04	18/01/2020 20:25	18/01/2020 17:04	18/01/2020 20:25	3,34	8	26,73	CHI
202001109839	LUZIANIA	120396063	RIO VERMELHO	18/01/2020 17:23	18/01/2020 18:49	18/01/2020 17:23	18/01/2020 18:49	1,43	1	1,43	CHI
202001109845	ANAPOLIS	AN11003272	JUNDIAI S1	18/01/2020 17:21	18/01/2020 19:14	18/01/2020 17:21	18/01/2020 19:14	1,88	140	262,54	CHI
202001109846	GOIAS	GS31073691	MATRINCHA	18/01/2020 17:24	18/01/2020 20:21	18/01/2020 17:24	18/01/2020 20:21	2,95	1	2,95	CHI
202001109847	TEREZOPOLIS DE GOIAS	AN12258841	JUNDIAI S2	18/01/2020 17:24	18/01/2020 23:49	18/01/2020 17:24	18/01/2020 23:49	6,40	3	19,21	CHI
202001109850	ORIZONA	IP12217837	PIRES DO RIO S2	18/01/2020 17:25	18/01/2020 21:26	18/01/2020 17:25	18/01/2020 21:26	4,01	1	4,01	CHI
202001109851	CORUMBAIBA	CI12035404	VILA CORUMBA	18/01/2020 16:53	19/01/2020 10:20	18/01/2020 16:53	19/01/2020 10:20	17,45	85	1483,27	CHI
202001109856	MAIRIPOTABA	MR12000060RE	MORRINHOS	18/01/2020 17:26	18/01/2020 19:48	18/01/2020 17:26	18/01/2020 19:48	2,36	13	30,74	CHI
202001109856	MORRINHOS	MR12000060RE	MORRINHOS	18/01/2020 17:26	18/01/2020 19:48	18/01/2020 17:26	18/01/2020 19:48	2,36	32	75,67	CHI

202001109856	PIRACANJUBA	MR12000060RE	MORRINHOS	18/01/2020 17:26	18/01/2020 19:48	18/01/2020 17:26	18/01/2020 19:48	2,36	7	16,55	CHI
202001109856	PONTALINA	MR12000060RE	MORRINHOS	18/01/2020 17:26	18/01/2020 19:48	18/01/2020 17:26	18/01/2020 19:48	2,36	10	23,65	CHI
202001109857	GOIANIA	GN11162013	FERROVIARIO S3	18/01/2020 17:05	18/01/2020 22:38	18/01/2020 17:05	18/01/2020 22:38	5,55	70	388,31	CHI
202001109862	LEOPOLDO DE BULHOES	LB21211817	DAIA S2	18/01/2020 17:27	19/01/2020 02:43	18/01/2020 17:27	19/01/2020 02:43	9,26	1	9,26	CHI
202001109864	MARA ROSA	MQ12162718	MARA ROSA	18/01/2020 14:52	18/01/2020 18:39	18/01/2020 14:52	18/01/2020 18:39	3,77	5	18,84	CHI
202001109872	ANAPOLIS	AN21238150	JUNDIAI S1	18/01/2020 17:30	18/01/2020 23:18	18/01/2020 17:30	18/01/2020 23:18	5,80	1	5,80	CHI
202001109876	APARECIDA DE GOIANIA	17093223	INDEPENDENCIA S2	18/01/2020 17:30	18/01/2020 18:38	18/01/2020 17:30	18/01/2020 18:38	1,12	1	1,12	CHI
202001109877	MORRINHOS	MR21284220	MORRINHOS	18/01/2020 17:30	19/01/2020 22:45	18/01/2020 17:30	19/01/2020 22:45	29,24	1	29,24	CHI
202001109878	CUMARI	AH12316045	CATALAO S1	18/01/2020 14:36	19/01/2020 09:36	18/01/2020 14:36	19/01/2020 09:36	19,00	18	341,95	CHI
202001109880	VALPARAISO DE GOIAS	VA12261805	PACAEMBU S2	18/01/2020 16:58	18/01/2020 21:49	18/01/2020 16:58	18/01/2020 19:45	2,77	618	1712,20	CHI
202001109880	VALPARAISO DE GOIAS	VA10414104	PACAEMBU S2	18/01/2020 16:58	18/01/2020 21:49	18/01/2020 19:47	18/01/2020 21:34	1,78	568	1010,09	CHI
202001109880	VALPARAISO DE GOIAS	VA10414104	PACAEMBU S2	18/01/2020 16:58	18/01/2020 21:49	18/01/2020 21:27	18/01/2020 21:34	0,11	2876	315,56	CHI
202001109880	VALPARAISO DE GOIAS	VA11169034	PACAEMBU S2	18/01/2020 16:58	18/01/2020 21:49	18/01/2020 19:47	18/01/2020 21:49	2,04	50	101,82	CHI
202001109882	GOIANESIA	550153056	GOIANESIA S2	18/01/2020 17:32	19/01/2020 00:20	18/01/2020 17:32	19/01/2020 00:20	6,81	1	6,81	CHI
202001109892	ALEXANIA	AX11379448	CORUMBA	18/01/2020 17:37	18/01/2020 19:40	18/01/2020 17:37	18/01/2020 19:40	2,05	43	88,03	CHI
202001109893	VARJAO	VJ10394749	GUAPO S2	18/01/2020 17:36	19/01/2020 21:58	18/01/2020 17:37	18/01/2020 19:30	1,89	4	7,56	CHI
202001109893	VARJAO	VJ10394749	GUAPO S2	18/01/2020 17:36	19/01/2020 21:58	18/01/2020 19:39	18/01/2020 20:01	0,37	4	1,48	CHI
202001109893	VARJAO	VJ10394749	GUAPO S2	18/01/2020 17:36	19/01/2020 21:58	18/01/2020 22:21	18/01/2020 22:41	0,34	4	1,35	CHI
202001109893	VARJAO	VJ10394749	GUAPO S2	18/01/2020 17:36	19/01/2020 21:58	19/01/2020 11:50	19/01/2020 12:06	0,28	4	1,10	CHI
202001109893	VARJAO	VJ13326208	GUAPO S2	18/01/2020 17:36	19/01/2020 21:58	18/01/2020 17:37	19/01/2020 18:02	24,42	12	293,04	CHI
202001109893	VARJAO	VJ12310244	GUAPO S2	18/01/2020 17:36	19/01/2020 21:58	18/01/2020 17:37	19/01/2020 18:56	25,33	5	126,66	CHI
202001109893	CEZARINA	VJ32099633	GUAPO S2	18/01/2020 17:36	19/01/2020 21:58	18/01/2020 17:37	19/01/2020 19:30	25,88	8	207,06	CHI
202001109893	VARJAO	VJ32099633	GUAPO S2	18/01/2020 17:36	19/01/2020 21:58	18/01/2020 17:37	19/01/2020 19:30	25,88	9	232,94	CHI
202001109893	VARJAO	VJ32099627LD	GUAPO S2	18/01/2020 17:36	19/01/2020 21:58	18/01/2020 17:37	19/01/2020 21:12	27,60	11	303,58	CHI
202001109893	VARJAO	VJ12310181	GUAPO S2	18/01/2020 17:36	19/01/2020 21:58	18/01/2020 17:37	19/01/2020 21:58	28,36	6	170,15	CHI
202001109894	SAO MIGUEL DO ARAGUAIA	SM12321016	NOVA CRIXAS	18/01/2020 17:37	18/01/2020 21:15	18/01/2020 17:37	18/01/2020 21:15	3,62	7	25,33	CHI
202001109895	ARENOPOLIS	AY12390170	ARENOPOLIS	18/01/2020 15:01	18/01/2020 22:30	18/01/2020 15:01	18/01/2020 22:30	7,47	8	59,74	CHI
202001109900	OUVIDOR	OU12190458RE	CATALAO S1	18/01/2020 16:29	18/01/2020 20:58	18/01/2020 16:29	18/01/2020 19:31	3,04	1	3,04	CHI
202001109900	CATALAO	OU12190458RE	CATALAO S1	18/01/2020 16:29	18/01/2020 20:58	18/01/2020 16:29	18/01/2020 20:58	4,49	8	35,89	CHI
202001109900	OUVIDOR	OU12190458RE	CATALAO S1	18/01/2020 16:29	18/01/2020 20:58	18/01/2020 16:29	18/01/2020 20:58	4,49	22	98,69	CHI
202001109904	CAIAPONIA	RV10400629	MONTIVIDIU T	18/01/2020 17:31	18/01/2020 18:54	18/01/2020 17:31	18/01/2020 18:54	1,38	248	341,69	CHI
202001109904	CAIAPONIA	RV10400629	MONTIVIDIU T	18/01/2020 17:31	18/01/2020 18:54	18/01/2020 17:31	18/01/2020 18:54	1,38	21	28,93	CHI
202001109904	JATAI	RV10400629	MONTIVIDIU T	18/01/2020 17:31	18/01/2020 18:54	18/01/2020 17:31	18/01/2020 18:54	1,38	7	9,64	CHI

202001109904	MONTIVIDIU	RV10400629	MONTIVIDIU T	18/01/2020 17:31	18/01/2020 18:54	18/01/2020 17:31	18/01/2020 18:54	1,38	4	5,51	CHI
202001109904	MONTIVIDIU	RV10400629	MONTIVIDIU T	18/01/2020 17:31	18/01/2020 18:54	18/01/2020 17:31	18/01/2020 18:54	1,38	60	82,67	CHI
202001109904	RIO VERDE	RV10400629	MONTIVIDIU T	18/01/2020 17:31	18/01/2020 18:54	18/01/2020 17:31	18/01/2020 18:54	1,38	81	111,60	CHI
202001109904	RIO VERDE	RV10400629	MONTIVIDIU T	18/01/2020 17:31	18/01/2020 18:54	18/01/2020 17:31	18/01/2020 18:54	1,38	2	2,76	CHI
202001109907	IPAMERI	02940214	MORRINHOS	18/01/2020 18:38	20/01/2020 20:08	18/01/2020 18:38	18/01/2020 18:42	0,07	1	0,07	CHI
202001109907	MORRINHOS	02940214	MORRINHOS	18/01/2020 18:38	20/01/2020 20:08	18/01/2020 18:38	18/01/2020 18:42	0,07	333	22,20	CHI
202001109907	IPAMERI	02940214	MORRINHOS	18/01/2020 18:38	20/01/2020 20:08	18/01/2020 18:43	18/01/2020 20:32	1,83	1	1,83	CHI
202001109907	MORRINHOS	02940214	MORRINHOS	18/01/2020 18:38	20/01/2020 20:08	18/01/2020 18:43	18/01/2020 20:32	1,83	146	267,14	CHI
202001109907	MORRINHOS	02940214	MORRINHOS	18/01/2020 18:38	20/01/2020 20:08	18/01/2020 20:39	18/01/2020 20:56	0,28	68	19,38	CHI
202001109907	MORRINHOS	02940214	MORRINHOS	18/01/2020 18:38	20/01/2020 20:08	18/01/2020 18:43	18/01/2020 22:16	3,56	144	513,00	CHI
202001109907	MORRINHOS	02940214	MORRINHOS	18/01/2020 18:38	20/01/2020 20:08	18/01/2020 22:17	18/01/2020 22:42	0,42	68	28,84	CHI
202001109907	MORRINHOS	02940214	MORRINHOS	18/01/2020 18:38	20/01/2020 20:08	18/01/2020 18:43	19/01/2020 00:07	5,40	45	243,06	CHI
202001109907	MORRINHOS	MR13142429	MORRINHOS	18/01/2020 18:38	20/01/2020 20:08	18/01/2020 22:17	19/01/2020 04:05	5,80	143	829,76	CHI
202001109907	MORRINHOS	MR10406908	MORRINHOS	18/01/2020 18:38	20/01/2020 20:08	18/01/2020 20:33	19/01/2020 13:30	16,95	1	16,95	CHI
202001109907	MORRINHOS	MR10406908	MORRINHOS	18/01/2020 18:38	20/01/2020 20:08	18/01/2020 20:33	19/01/2020 13:32	16,99	2	33,97	CHI
202001109907	MORRINHOS	MR10406908	MORRINHOS	18/01/2020 18:38	20/01/2020 20:08	18/01/2020 20:33	19/01/2020 13:50	17,29	48	829,72	CHI
202001109907	MORRINHOS	MR10406908	MORRINHOS	18/01/2020 18:38	20/01/2020 20:08	19/01/2020 16:53	19/01/2020 20:20	3,46	15	51,84	CHI
202001109907	MORRINHOS	MR10406908	MORRINHOS	18/01/2020 18:38	20/01/2020 20:08	19/01/2020 20:21	19/01/2020 21:18	0,95	3	2,84	CHI
202001109907	MORRINHOS	MR10406908	MORRINHOS	18/01/2020 18:38	20/01/2020 20:08	18/01/2020 20:33	20/01/2020 03:38	31,09	6	186,53	CHI
202001109907	IPAMERI	MR10406908	MORRINHOS	18/01/2020 18:38	20/01/2020 20:08	18/01/2020 20:33	20/01/2020 07:22	34,82	1	34,82	CHI
202001109907	MORRINHOS	MR10406908	MORRINHOS	18/01/2020 18:38	20/01/2020 20:08	18/01/2020 20:33	20/01/2020 07:22	34,82	21	731,19	CHI
202001109907	MORRINHOS	MR12040540RE	MORRINHOS	18/01/2020 18:38	20/01/2020 20:08	19/01/2020 20:21	20/01/2020 11:14	14,88	12	178,57	CHI
202001109907	MORRINHOS	MR13320222	MORRINHOS	18/01/2020 18:38	20/01/2020 20:08	19/01/2020 16:53	20/01/2020 11:43	18,83	36	677,88	CHI
202001109907	MORRINHOS	MR12153461LD	MORRINHOS	18/01/2020 18:38	20/01/2020 20:08	18/01/2020 22:17	20/01/2020 12:11	37,91	2	75,82	CHI
202001109907	MORRINHOS	02940214	MORRINHOS	18/01/2020 18:38	20/01/2020 20:08	20/01/2020 12:12	20/01/2020 12:15	0,06	211	12,02	CHI
202001109907	MORRINHOS	MR12153461LD	MORRINHOS	18/01/2020 18:38	20/01/2020 20:08	20/01/2020 12:12	20/01/2020 14:17	2,09	2	4,17	CHI
202001109907	MORRINHOS	02940214	MORRINHOS	18/01/2020 18:38	20/01/2020 20:08	20/01/2020 12:12	20/01/2020 17:27	5,25	3	15,74	CHI
202001109907	IPAMERI	02940214	MORRINHOS	18/01/2020 18:38	20/01/2020 20:08	20/01/2020 12:12	20/01/2020 17:50	5,63	1	5,63	CHI
202001109907	MORRINHOS	02940214	MORRINHOS	18/01/2020 18:38	20/01/2020 20:08	20/01/2020 12:12	20/01/2020 17:50	5,63	27	151,98	CHI
202001109907	MORRINHOS	02940214	MORRINHOS	18/01/2020 18:38	20/01/2020 20:08	20/01/2020 12:12	20/01/2020 19:28	7,28	12	87,33	CHI
202001109907	MORRINHOS	02940214	MORRINHOS	18/01/2020 18:38	20/01/2020 20:08	20/01/2020 12:12	20/01/2020 20:08	7,94	36	285,83	CHI
202001110004	ITARUMA	IJ12107422	ITAJA S2	18/01/2020 17:39	19/01/2020 12:45	18/01/2020 17:39	19/01/2020 07:27	13,80	35	483,13	CHI
202001110004	ITARUMA	IJ12107422	ITAJA S2	18/01/2020 17:39	19/01/2020 12:45	19/01/2020 07:28	19/01/2020 08:20	0,88	8	7,06	CHI

202001110004	ITARUMA	IM13296707	ITAJA S2	18/01/2020 17:39	19/01/2020 12:45	19/01/2020 07:28	19/01/2020 12:45	5,29	33	174,55	CHI
202001110008	TRINDADE	10000835984	GOYA S1	18/01/2020 17:41	19/01/2020 02:11	18/01/2020 17:41	19/01/2020 02:11	8,49	1	8,49	CHI
202001110014	PIRES DO RIO	460059944	PIRES DO RIO S1	18/01/2020 17:42	18/01/2020 21:16	18/01/2020 17:42	18/01/2020 21:16	3,56	1	3,56	CHI
202001110020	DAVINOPOLIS	02630226	CATALAO S1	18/01/2020 17:28	18/01/2020 22:50	18/01/2020 17:28	18/01/2020 22:50	5,35	10	53,51	CHI
202001110020	OUVIDOR	02630226	CATALAO S1	18/01/2020 17:28	18/01/2020 22:50	18/01/2020 17:28	18/01/2020 22:50	5,35	268	1434,10	CHI
202001110038	CRISTALINA	KR21183839	PAMPLONA	18/01/2020 17:46	18/01/2020 21:53	18/01/2020 17:46	18/01/2020 21:53	4,11	1	4,11	CHI
202001110040	VILA BOA	2880001256	IACIARA S2	18/01/2020 17:46	18/01/2020 21:37	18/01/2020 17:46	18/01/2020 21:37	3,83	1	3,83	CHI
202001110044	CEZARINA	IY21138553	EDEIA	18/01/2020 17:47	18/01/2020 19:02	18/01/2020 17:47	18/01/2020 19:02	1,24	1	1,24	CHI
202001110045	MINEIROS	MY21374002	PARQUE DAS EMAS	18/01/2020 17:48	19/01/2020 10:05	18/01/2020 17:48	19/01/2020 10:05	16,28	1	16,28	CHI
202001110047	INHUMAS	IN21098282	INHUMAS S2	18/01/2020 17:48	19/01/2020 09:27	18/01/2020 17:48	19/01/2020 09:27	15,64	1	15,64	CHI
202001110050	ORIZONA	2060016569	PIRES DO RIO S2	18/01/2020 17:49	18/01/2020 19:48	18/01/2020 17:49	18/01/2020 19:48	1,98	1	1,98	CHI
202001110051	PIRACANJUBA	BV21010790	BELA VISTA S1	18/01/2020 17:49	19/01/2020 11:34	18/01/2020 17:49	19/01/2020 11:34	17,75	3	53,25	CHI
202001110058	CROMINIA	CQ31060574	ROCHEDO	18/01/2020 17:49	19/01/2020 13:40	18/01/2020 17:49	19/01/2020 13:00	19,17	1	19,17	CHI
202001110058	CROMINIA	CQ12060616	ROCHEDO	18/01/2020 17:49	19/01/2020 13:40	18/01/2020 19:05	19/01/2020 13:40	18,57	20	371,49	CHI
202001110059	GOIANIA	GN12071938	XAVANTES	18/01/2020 17:38	18/01/2020 22:04	18/01/2020 17:38	18/01/2020 22:04	4,43	61	269,94	CHI
202001110062	GOIANIA	13979814	GOYA S2	18/01/2020 17:50	18/01/2020 21:55	18/01/2020 17:50	18/01/2020 21:55	4,08	1	4,08	CHI
202001110063	DOVERLANDIA	DV21151196	CAIAPONIA	18/01/2020 17:50	19/01/2020 09:48	18/01/2020 17:50	19/01/2020 09:48	15,96	1	15,96	CHI
202001110065	DIORAMA	DI12063493	IPORA	18/01/2020 17:21	19/01/2020 00:29	18/01/2020 17:21	19/01/2020 00:29	7,13	37	263,81	CHI
202001110065	IPORA	DI12063493	IPORA	18/01/2020 17:21	19/01/2020 00:29	18/01/2020 17:21	19/01/2020 00:29	7,13	3	21,39	CHI
202001110065	MONTES CLAROS DE GOIAS	DI12063493	IPORA	18/01/2020 17:21	19/01/2020 00:29	18/01/2020 17:21	19/01/2020 00:29	7,13	7	49,91	CHI
202001110072	CAMPESTRE DE GOIAS	GC11193206	TRINDADE	18/01/2020 17:52	18/01/2020 20:31	18/01/2020 17:52	18/01/2020 20:31	2,64	179	473,45	CHI
202001110074	CAMPO ALEGRE DE GOIAS	CM21166749	CAMPO ALEGRE DE GOIAS	18/01/2020 17:52	19/01/2020 13:29	18/01/2020 17:52	19/01/2020 13:29	19,61	1	19,61	CHI
202001110081	NEROPOLIS	NR12009253	NEROPOLIS S2	18/01/2020 18:21	18/01/2020 23:36	18/01/2020 18:21	18/01/2020 23:36	5,24	2	10,48	CHI
202001110084	IPAMERI	IP21159906	CRISTALINA S2	18/01/2020 13:33	19/01/2020 03:26	18/01/2020 13:33	19/01/2020 03:26	13,88	1	13,88	CHI
202001110086	DAMIANOPOLIS	MB12192159	IACIARA S2	18/01/2020 17:55	18/01/2020 20:07	18/01/2020 17:55	18/01/2020 20:07	2,19	15	32,82	CHI
202001110086	MAMBAI	MB12192159	IACIARA S2	18/01/2020 17:55	18/01/2020 20:07	18/01/2020 17:55	18/01/2020 20:07	2,19	30	65,65	CHI
202001110090	ITUMBIARA	IT12304200	ITUMBIARA NOVA	18/01/2020 17:57	19/01/2020 10:24	18/01/2020 17:57	19/01/2020 10:24	16,45	7	115,14	CHI
202001110092	PLANALTINA	PI11349645	PLANALTINA	18/01/2020 17:57	18/01/2020 18:27	18/01/2020 17:57	18/01/2020 18:27	0,49	101	49,94	CHI
202001110094	AGUAS LINDAS DE GOIAS	LA11136659	AGUAS LINDAS DE GOIAS S2	18/01/2020 17:57	18/01/2020 19:17	18/01/2020 17:57	18/01/2020 19:17	1,32	48	63,37	CHI
202001110095	MAMBAI	1570018288	IACIARA S2	18/01/2020 17:57	18/01/2020 19:06	18/01/2020 17:57	18/01/2020 19:06	1,14	1	1,14	CHI
202001110097	CAMPO ALEGRE DE GOIAS	CM21077541	CAMPO ALEGRE DE GOIAS	18/01/2020 17:58	19/01/2020 09:54	18/01/2020 17:58	19/01/2020 09:54	15,92	1	15,92	CHI
202001110098	ABADIANIA	AA12084806	CORUMBA	18/01/2020 17:46	18/01/2020 19:41	18/01/2020 17:46	18/01/2020 19:41	1,90	2	3,81	CHI
202001110100	GOIANIA	GN11161296	GOIANIA LESTE S2	18/01/2020 16:34	18/01/2020 19:29	18/01/2020 16:34	18/01/2020 19:29	2,90	33	95,72	CHI

202001110114	MORRO AGUDO DE GOIAS	MS12113277	ITAPURANGA	18/01/2020 16:58	18/01/2020 19:34	18/01/2020 16:58	18/01/2020 19:34	2,60	17	44,12	CHI
202001110115	SIMOLANDIA	SA21180633	IACIARA S2	18/01/2020 18:02	18/01/2020 22:43	18/01/2020 18:02	18/01/2020 22:43	4,68	1	4,68	CHI
202001110122	EDEIA	1120001150	EDEIA	18/01/2020 18:02	18/01/2020 22:57	18/01/2020 18:02	18/01/2020 22:57	4,91	1	4,91	CHI
202001110124	SANTO ANTONIO DE GOIAS	GR12002128	NEROPOLIS S1	18/01/2020 15:07	18/01/2020 21:53	18/01/2020 15:07	18/01/2020 21:53	6,76	6	40,54	CHI
202001110125	GOIANIA	GN11194319	FERROVIARIO S1	18/01/2020 18:02	19/01/2020 00:29	18/01/2020 18:02	19/01/2020 00:29	6,45	125	805,69	CHI
202001110128	PIRACANJUBA	PJ12412508	CRISTIANOPOLIS	18/01/2020 17:58	18/01/2020 20:21	18/01/2020 17:58	18/01/2020 20:21	2,37	12	28,44	CHI
202001110132	GOIANDIRA	CT21238476	CATALAO S1	18/01/2020 18:03	19/01/2020 15:00	18/01/2020 18:03	19/01/2020 15:00	20,94	1	20,94	CHI
202001110147	CATALAO	1990286073	CATALAO S2	18/01/2020 18:07	19/01/2020 08:49	18/01/2020 18:07	19/01/2020 08:49	14,69	1	14,69	CHI
202001110153	LUZIANIA	120180030	RIO VERMELHO	18/01/2020 18:08	18/01/2020 22:05	18/01/2020 18:08	18/01/2020 22:05	3,94	1	3,94	CHI
202001110155	INDIARA	IY21289793	EDEIA	18/01/2020 18:08	18/01/2020 21:07	18/01/2020 18:08	18/01/2020 21:07	2,98	1	2,98	CHI
202001110166	GOIANIA	17462770	CAMPINAS S2	18/01/2020 18:11	19/01/2020 00:21	18/01/2020 18:11	19/01/2020 00:21	6,17	1	6,17	CHI
202001110176	ITABERAI	IB11359459	ITABERAI S2	18/01/2020 18:12	18/01/2020 20:18	18/01/2020 18:12	18/01/2020 20:18	2,09	1	2,09	CHI
202001110180	MAIRIPOTABA	MI21049507	PONTALINA	18/01/2020 18:12	18/01/2020 23:15	18/01/2020 18:12	18/01/2020 23:15	5,05	2	10,10	CHI
202001110206	ARUANA	AK12156743	ARUANA	18/01/2020 18:17	18/01/2020 20:24	18/01/2020 18:17	18/01/2020 20:24	2,10	7	14,70	CHI
202001110211	APARECIDA DE GOIANIA	AP11004898	REAL S1	18/01/2020 18:19	19/01/2020 00:03	18/01/2020 23:46	19/01/2020 00:03	0,28	58	16,45	CHI
202001110216	CRISTALINA	KR21391163	CRISTALINA S2	18/01/2020 18:20	19/01/2020 09:49	18/01/2020 18:20	19/01/2020 09:49	15,47	2	30,93	CHI
202001110220	ITUMBIARA	IT12309855RE	PARANAIBA	18/01/2020 17:53	19/01/2020 11:05	18/01/2020 17:53	19/01/2020 11:05	17,19	28	481,34	CHI
202001110221	BELA VISTA DE GOIAS	HD12036495	CEPAIGO S2	18/01/2020 18:03	18/01/2020 20:39	18/01/2020 18:03	18/01/2020 20:39	2,59	1	2,59	CHI
202001110221	HIDROLANDIA	HD12036495	CEPAIGO S2	18/01/2020 18:03	18/01/2020 20:39	18/01/2020 18:03	18/01/2020 20:39	2,59	14	36,29	CHI
202001110224	GOIANIA	GN11000400	FERROVIARIO S1	18/01/2020 18:12	18/01/2020 19:18	18/01/2020 18:12	18/01/2020 19:18	1,10	114	125,05	CHI
202001110225	AGUAS LINDAS DE GOIAS	4830095387	AGUAS LINDAS DE GOIAS S1	18/01/2020 18:22	18/01/2020 19:47	18/01/2020 18:22	18/01/2020 19:47	1,42	1	1,42	CHI
202001110229	GOIANIA	10001152554	GOYA S2	18/01/2020 18:22	18/01/2020 21:46	18/01/2020 18:22	18/01/2020 21:46	3,39	1	3,39	CHI
202001110251	CATALAO	CT12266322	CATALAO S1	18/01/2020 17:19	19/01/2020 06:17	18/01/2020 17:19	19/01/2020 06:17	12,95	38	492,12	CHI
202001110252	CATALAO	CT21143483	CATALAO S1	18/01/2020 18:26	18/01/2020 21:14	18/01/2020 18:26	18/01/2020 21:14	2,79	2	5,58	CHI
202001110289	ITUMBIARA	IT10404068	ITUMBIARA VELHA S1	18/01/2020 18:27	20/01/2020 17:18	20/01/2020 14:34	20/01/2020 14:38	0,08	214	16,35	CHI
202001110289	ITUMBIARA	IT21105380	ITUMBIARA VELHA S1	18/01/2020 18:27	20/01/2020 17:18	18/01/2020 18:27	20/01/2020 17:18	46,85	1	46,85	CHI
202001110302	ITUMBIARA	IT11000169	ITUMBIARA VELHA S1	18/01/2020 16:56	18/01/2020 22:17	18/01/2020 16:56	18/01/2020 22:17	5,36	189	1012,36	CHI
202001110303	BELA VISTA DE GOIAS	BV12011704	BELA VISTA S1	18/01/2020 15:04	19/01/2020 10:43	18/01/2020 15:04	19/01/2020 08:57	17,90	7	125,28	CHI
202001110303	BELA VISTA DE GOIAS	BV12011066LD	BELA VISTA S1	18/01/2020 15:04	19/01/2020 10:43	18/01/2020 15:04	19/01/2020 10:43	19,65	10	196,53	CHI
202001110310	POSSE	SA12320454	IACIARA S2	18/01/2020 18:31	18/01/2020 22:02	18/01/2020 18:31	18/01/2020 22:02	3,50	25	87,51	CHI
202001110311	INHUMAS	IN11194323	INHUMAS S2	18/01/2020 18:19	18/01/2020 20:02	18/01/2020 18:19	18/01/2020 20:02	1,71	111	189,38	CHI
202001110312	ITUMBIARA	IT12081094RE	ITUMBIARA NOVA	18/01/2020 17:23	18/01/2020 20:23	18/01/2020 17:23	18/01/2020 20:23	2,99	81	242,24	CHI
202001110324	GOIANIA	GN11076705	MEIA PONTE	18/01/2020 18:35	18/01/2020 21:09	18/01/2020 18:35	18/01/2020 21:09	2,56	231	590,53	CHI

202001110333	FORMOSA	FA11146198	ITUIQUIRA	18/01/2020 18:26	18/01/2020 19:35	18/01/2020 18:26	18/01/2020 19:35	1,15	149	171,27	CHI
202001110348	CATURAI	CK12018886	INHUMAS S1	18/01/2020 18:41	18/01/2020 23:46	18/01/2020 18:41	18/01/2020 23:46	5,08	5	25,39	CHI
202001110354	CALDAS NOVAS	CN11213823	CALDAS NOVAS S1	18/01/2020 18:20	18/01/2020 20:45	18/01/2020 18:20	18/01/2020 20:45	2,41	69	165,95	CHI
202001110355	GOIANIA	10018418110	CARAJAS S1	18/01/2020 18:42	18/01/2020 20:29	18/01/2020 18:42	18/01/2020 20:29	1,78	1	1,78	CHI
202001110357	AGUAS LINDAS DE GOIAS	4830255986	AGUAS LINDAS DE GOIAS S1	18/01/2020 18:42	18/01/2020 19:31	18/01/2020 18:42	18/01/2020 19:31	0,81	1	0,81	CHI
202001110361	ARENOPOLIS	AY12358539	ARENOPOLIS	18/01/2020 18:43	19/01/2020 14:29	18/01/2020 18:43	19/01/2020 14:29	19,76	1	19,76	CHI
202001110361	PALESTINA DE GOIAS	AY12358539	ARENOPOLIS	18/01/2020 18:43	19/01/2020 14:29	18/01/2020 18:43	19/01/2020 14:29	19,76	5	98,79	CHI
202001110364	LUZIANIA	3200085032	MARAJOARA	18/01/2020 18:43	18/01/2020 21:08	18/01/2020 18:43	18/01/2020 21:08	2,40	1	2,40	CHI
202001110365	GOIANIA	15563443	GOYA S2	18/01/2020 18:43	18/01/2020 20:54	18/01/2020 18:43	18/01/2020 20:54	2,17	0	0,00	CHI
202001110370	IPORA	730151669	IPORA	18/01/2020 18:45	18/01/2020 22:29	18/01/2020 18:45	18/01/2020 22:29	3,73	1	3,73	CHI
202001110375	CATALAO	1990098918	CATALAO S2	18/01/2020 18:46	19/01/2020 08:52	18/01/2020 18:46	19/01/2020 08:52	14,10	1	14,10	CHI
202001110383	IPAMERI	IP12062746	IPAMERI	18/01/2020 18:47	18/01/2020 19:36	18/01/2020 18:47	18/01/2020 19:36	0,80	3	2,40	CHI
202001110393	GOIATUBA	GT12037538	GOIATUBA S2	18/01/2020 18:51	19/01/2020 17:28	18/01/2020 18:51	19/01/2020 17:28	22,60	2	45,21	CHI
202001110398	INACIOLANDIA	CD21000091	CACHOEIRA DOURADA	18/01/2020 18:53	18/01/2020 23:16	18/01/2020 18:53	18/01/2020 23:16	4,38	1	4,38	CHI
202001110409	QUIRINOPOLIS	QI12271548	QUIRINOPOLIS	18/01/2020 17:59	18/01/2020 20:30	18/01/2020 17:59	18/01/2020 20:30	2,52	17	42,76	CHI
202001110411	GOIANIA	14066245	XAVANTES	18/01/2020 18:56	19/01/2020 01:21	18/01/2020 18:56	19/01/2020 01:21	6,41	1	6,41	CHI
202001110413	GOIANESIA	GE12315762	GOIANESIA S2	18/01/2020 17:47	18/01/2020 21:20	18/01/2020 17:47	18/01/2020 21:20	3,55	675	2394,56	CHI
202001110414	GOIANIA	16598118	FERROVIARIO S2	18/01/2020 18:56	19/01/2020 09:57	18/01/2020 18:56	19/01/2020 09:57	15,00	1	15,00	CHI
202001110417	CRISTIANOPOLIS	PJ12212204	PIRACANJUBA	18/01/2020 18:56	19/01/2020 18:20	18/01/2020 18:56	19/01/2020 18:20	23,38	4	93,54	CHI
202001110417	PIRACANJUBA	PJ12212204	PIRACANJUBA	18/01/2020 18:56	19/01/2020 18:20	18/01/2020 18:56	19/01/2020 18:20	23,38	5	116,92	CHI
202001110417	SANTA CRUZ DE GOIAS	PJ12212204	PIRACANJUBA	18/01/2020 18:56	19/01/2020 18:20	18/01/2020 18:56	19/01/2020 18:20	23,38	4	93,54	CHI
202001110421	ITUMBIARA	IT12000414	ITUMBIARA NOVA	18/01/2020 18:58	19/01/2020 09:45	18/01/2020 18:58	19/01/2020 09:45	14,78	7	103,44	CHI
202001110439	POSSE	PS21124634	IACIARA S1	18/01/2020 19:01	18/01/2020 21:05	18/01/2020 19:01	18/01/2020 21:05	2,05	1	2,05	CHI
202001110444	PILAR DE GOIAS	HL12253801	SANTA TEREZINHA	18/01/2020 10:59	19/01/2020 01:34	18/01/2020 10:59	19/01/2020 01:34	14,57	3	43,71	CHI
202001110451	VALPARAISO DE GOIAS	10005117125	MARAJOARA	18/01/2020 19:03	18/01/2020 20:16	18/01/2020 19:03	18/01/2020 20:16	1,21	1	1,21	CHI
202001110460	SANTA CRUZ DE GOIAS	CF21381822	CRISTIANOPOLIS	18/01/2020 19:04	19/01/2020 08:02	18/01/2020 19:04	19/01/2020 08:02	12,96	1	12,96	CHI
202001110477	ITUMBIARA	IT12352687RE	PARANAIBA	18/01/2020 16:58	19/01/2020 10:20	18/01/2020 16:58	19/01/2020 10:20	17,36	100	1736,42	CHI
202001110481	CRISTIANOPOLIS	CF21247840	PIRES DO RIO S2	18/01/2020 19:10	19/01/2020 01:56	18/01/2020 19:10	19/01/2020 01:56	6,76	2	13,52	CHI
202001110485	ITUMBIARA	BG21000035	ITUMBIARA VELHA S2	18/01/2020 19:11	19/01/2020 15:19	18/01/2020 19:11	19/01/2020 15:19	20,12	1	20,12	CHI
202001110488	PIRES DO RIO	460122927	PIRES DO RIO S1	18/01/2020 19:11	18/01/2020 22:20	18/01/2020 19:11	18/01/2020 22:20	3,13	1	3,13	CHI
202001110489	BURITI ALEGRE	BG21140157	ITUMBIARA VELHA S2	18/01/2020 19:12	19/01/2020 11:33	18/01/2020 19:12	19/01/2020 11:33	16,34	1	16,34	CHI
202001110490	OUVIDOR	OU12215733	CATALAO S1	18/01/2020 17:26	18/01/2020 21:53	18/01/2020 17:26	18/01/2020 21:53	4,45	156	694,16	CHI
202001110495	MAMBAI	MB11161460	IACIARA S2	18/01/2020 19:13	18/01/2020 23:49	18/01/2020 19:13	18/01/2020 23:49	4,60	3	13,79	CHI

202001110498	GOIANIA	GN11000836	GOIANIA LESTE S1	18/01/2020 18:07	18/01/2020 20:33	18/01/2020 18:07	18/01/2020 20:33	2,42	59	142,65	CHI
202001110499	MAIRIPOTABA	CZ21060559	PONTALINA	18/01/2020 19:14	19/01/2020 15:30	18/01/2020 19:14	19/01/2020 15:30	20,27	2	40,53	CHI
202001110504	ITUMBIARA	IT11304179	ITUMBIARA NOVA	18/01/2020 19:14	19/01/2020 12:17	18/01/2020 19:14	19/01/2020 12:17	17,04	1	17,04	CHI
202001110507	CRISTALINA	KR21240982	CRISTALINA S1	18/01/2020 19:15	18/01/2020 21:15	18/01/2020 19:15	18/01/2020 21:15	1,99	1	1,99	CHI
202001110513	MAMBAI	MB12243113	IACIARA S2	18/01/2020 18:48	18/01/2020 21:01	18/01/2020 18:48	18/01/2020 21:01	2,22	271	600,34	CHI
202001110528	SANTA TEREZINHA DE GOIAS	SG12380710	SANTA TEREZINHA	18/01/2020 13:38	18/01/2020 20:23	18/01/2020 13:38	18/01/2020 20:23	6,74	5	33,69	CHI
202001110538	MORRINHOS	MR12121217	MORRINHOS	18/01/2020 18:58	19/01/2020 00:30	18/01/2020 18:58	19/01/2020 00:30	5,54	15	83,11	CHI
202001110543	ITUMBIARA	BG12000044	ITUMBIARA VELHA S2	18/01/2020 19:20	18/01/2020 20:38	18/01/2020 19:20	18/01/2020 20:38	1,30	3	3,89	CHI
202001110550	CATALAO	CT12195316	CATALAO S2	18/01/2020 19:27	19/01/2020 14:42	18/01/2020 19:27	19/01/2020 14:42	19,24	27	519,56	CHI
202001110553	CAMPO ALEGRE DE GOIAS	CM12042353	CAMPO ALEGRE DE GOIAS	18/01/2020 19:27	19/01/2020 11:31	18/01/2020 19:27	19/01/2020 11:31	16,06	5	80,28	CHI
202001110558	INDIARA	10024842786	EDEIA	18/01/2020 19:28	19/01/2020 07:19	18/01/2020 19:28	19/01/2020 07:19	11,84	1	11,84	CHI
202001110577	IPAMERI	IP21195225	IPAMERI	18/01/2020 19:34	18/01/2020 20:51	18/01/2020 19:34	18/01/2020 20:51	1,27	2	2,54	CHI
202001110583	LUZIANIA	10026696000	RIO VERMELHO	18/01/2020 19:35	18/01/2020 20:36	18/01/2020 19:35	18/01/2020 20:36	1,00	1	1,00	CHI
202001110586	CORUMBA DE GOIAS	CB12297694	CORUMBA	18/01/2020 13:16	19/01/2020 09:57	18/01/2020 13:16	19/01/2020 09:57	20,67	34	702,89	CHI
202001110587	PALESTINA DE GOIAS	PY12395436	PALESTINA	18/01/2020 07:39	19/01/2020 06:42	18/01/2020 07:39	19/01/2020 06:42	23,04	5	115,18	CHI
202001110599	DAMIANOPOLIS	5150000867	IACIARA S2	18/01/2020 19:38	18/01/2020 22:09	18/01/2020 19:38	18/01/2020 22:09	2,50	1	2,50	CHI
202001110607	CRISTIANOPOLIS	CF12300616	CRISTIANOPOLIS	18/01/2020 19:41	19/01/2020 01:02	18/01/2020 19:41	19/01/2020 01:02	5,35	8	42,78	CHI
202001110626	SANTO ANTONIO DO DESCOBERTO	SN12078187	MARAJOARA	18/01/2020 19:41	20/01/2020 00:00	18/01/2020 19:41	19/01/2020 15:49	20,13	17	342,16	CHI
202001110626	SANTO ANTONIO DO DESCOBERTO	SN12078187	MARAJOARA	18/01/2020 19:41	20/01/2020 00:00	18/01/2020 19:41	20/01/2020 00:00	28,32	16	453,16	CHI
202001110626	SANTO ANTONIO DO DESCOBERTO	SN12078187	MARAJOARA	18/01/2020 19:41	20/01/2020 00:00	19/01/2020 23:02	20/01/2020 00:00	0,98	17	16,67	CHI
202001110633	BURITI ALEGRE	BG21110223	ITUMBIARA VELHA S2	18/01/2020 19:51	19/01/2020 11:54	18/01/2020 19:51	19/01/2020 11:54	16,05	1	16,05	CHI
202001110636	CATALAO	1990270429	CATALAO S2	18/01/2020 19:51	19/01/2020 00:33	18/01/2020 19:51	19/01/2020 00:33	4,69	1	4,69	CHI
202001110637	CAMPO ALEGRE DE GOIAS	CM12231703	CAMPO ALEGRE DE GOIAS	18/01/2020 19:22	19/01/2020 08:46	18/01/2020 19:22	19/01/2020 08:46	13,40	10	133,99	CHI
202001110640	MORRINHOS	MR12000344	MORRINHOS	18/01/2020 18:46	18/01/2020 22:50	18/01/2020 18:46	18/01/2020 22:50	4,06	27	109,69	CHI
202001110645	LUZIANIA	10007398237	RIO VERMELHO	18/01/2020 19:55	18/01/2020 22:06	18/01/2020 19:55	18/01/2020 22:06	2,18	1	2,18	CHI
202001110650	ORIZONA	OZ32052336	PIRES DO RIO S2	18/01/2020 19:55	18/01/2020 22:21	18/01/2020 19:55	18/01/2020 22:21	2,42	10	24,18	CHI
202001110690	SANTA CRUZ DE GOIAS	BC21359947	PIRES DO RIO S2	18/01/2020 19:58	18/01/2020 21:34	18/01/2020 19:58	18/01/2020 21:34	1,58	1	1,58	CHI
202001110693	GOIANIA	GN11193227	AEROPORTO S2	18/01/2020 15:53	18/01/2020 21:49	18/01/2020 15:53	18/01/2020 21:49	5,93	30	177,86	CHI
202001110696	VALPARAISO DE GOIAS	VA11092921	PACAEMBU S1	18/01/2020 19:56	18/01/2020 21:23	18/01/2020 19:56	18/01/2020 21:23	1,44	229	329,76	CHI
202001110703	GOIANIA	GN11356666	CAMPINAS S2	18/01/2020 15:50	19/01/2020 04:52	18/01/2020 15:50	19/01/2020 04:52	13,02	52	677,17	CHI
202001110708	FLORES DE GOIAS	FB12106993	FLORES DE GOIAS	18/01/2020 20:03	18/01/2020 21:48	18/01/2020 20:03	18/01/2020 21:48	1,74	15	26,10	CHI
202001110708	FORMOSA	FB12106993	FLORES DE GOIAS	18/01/2020 20:03	18/01/2020 21:48	18/01/2020 20:03	18/01/2020 21:48	1,74	9	15,66	CHI
202001110708	SAO JOAO D ALIANCA	FB12106993	FLORES DE GOIAS	18/01/2020 20:03	18/01/2020 21:48	18/01/2020 20:03	18/01/2020 21:48	1,74	5	8,70	CHI

202001110711	SANTA CRUZ DE GOIAS	BC21186563	PIRES DO RIO S2	18/01/2020 20:03	18/01/2020 21:34	18/01/2020 20:03	18/01/2020 21:34	1,50	1	1,50	CHI
202001110714	CALDAS NOVAS	CN11214036	SERRA DE CALDAS	18/01/2020 19:48	19/01/2020 00:54	18/01/2020 19:48	19/01/2020 00:54	5,09	118	600,95	CHI
202001110724	RIO QUENTE	RQ12100189	RIO QUENTE	18/01/2020 20:05	18/01/2020 23:02	18/01/2020 20:05	18/01/2020 23:02	2,94	75	220,35	CHI
202001110730	PONTALINA	PK12099534	VICENTINOPOLIS	18/01/2020 20:10	18/01/2020 21:47	18/01/2020 20:10	18/01/2020 21:47	1,61	3	4,83	CHI
202001110747	CAMPO ALEGRE DE GOIAS	CM12166728	CAMPO ALEGRE DE GOIAS	18/01/2020 20:14	19/01/2020 12:35	18/01/2020 20:14	19/01/2020 12:35	16,34	35	571,83	CHI
202001110762	NOVA ROMA	ND12256420	IACIARA S2	19/01/2020 06:15	19/01/2020 09:17	19/01/2020 06:15	19/01/2020 09:17	3,03	29	87,95	CHI
202001110772	CIDADE OCIDENTAL	10004896767	MARAJOARA	18/01/2020 20:24	18/01/2020 21:45	18/01/2020 20:24	18/01/2020 21:45	1,35	1	1,35	CHI
202001110781	CATALAO	IP12404730	IPAMERI	18/01/2020 20:03	18/01/2020 21:51	18/01/2020 20:03	18/01/2020 21:51	1,79	2	3,58	CHI
202001110781	GOIANDIRA	IP12404730	IPAMERI	18/01/2020 20:03	18/01/2020 21:51	18/01/2020 20:03	18/01/2020 21:51	1,79	4	7,16	CHI
202001110781	IPAMERI	IP12404730	IPAMERI	18/01/2020 20:03	18/01/2020 21:51	18/01/2020 20:03	18/01/2020 21:51	1,79	14	25,08	CHI
202001110788	AGUA FRIA DE GOIAS	TL12180555	SAO JOAO D ALIANCA	18/01/2020 20:28	18/01/2020 23:10	18/01/2020 20:28	18/01/2020 23:10	2,70	1	2,70	CHI
202001110791	ORIZONA	OZ21043237	PIRES DO RIO S2	18/01/2020 20:28	18/01/2020 23:39	18/01/2020 20:28	18/01/2020 23:39	3,17	1	3,17	CHI
202001110797	SANTA CRUZ DE GOIAS	BC12110028RE	PIRES DO RIO S2	18/01/2020 20:20	18/01/2020 21:34	18/01/2020 20:20	18/01/2020 21:34	1,22	17	20,81	CHI
202001110798	AGUAS LINDAS DE GOIAS	LA21206542	AGUAS LINDAS DE GOIAS S2	18/01/2020 20:30	18/01/2020 21:40	18/01/2020 20:30	18/01/2020 21:40	1,16	1	1,16	CHI
202001110804	CATALAO	CT11166815	CATALAO S2	18/01/2020 20:26	18/01/2020 22:54	18/01/2020 20:26	18/01/2020 22:54	2,45	149	365,71	CHI
202001110809	LUZIANIA	10006011827	RIO VERMELHO	18/01/2020 20:33	18/01/2020 21:40	18/01/2020 20:33	18/01/2020 21:40	1,11	1	1,11	CHI
202001110835	COLINAS DO SUL	TI12344613	MINACU	18/01/2020 16:50	19/01/2020 08:10	18/01/2020 16:50	19/01/2020 08:10	15,34	13	199,39	CHI
202001110835	URUACU	TI12344613	MINACU	18/01/2020 16:50	19/01/2020 08:10	18/01/2020 16:50	19/01/2020 08:10	15,34	1	15,34	CHI
202001110855	CATALAO	CT12250337	CATALAO S1	18/01/2020 16:55	19/01/2020 04:17	18/01/2020 16:55	19/01/2020 04:17	11,35	30	340,51	CHI
202001110861	PONTALINA	PK12050288	GOIATUBA S1	18/01/2020 20:42	19/01/2020 07:24	18/01/2020 20:42	19/01/2020 07:24	10,69	7	74,83	CHI
202001110865	EDEALINA	ED12000010	PONTALINA	18/01/2020 20:20	19/01/2020 07:03	18/01/2020 20:20	19/01/2020 07:03	10,71	51	546,29	CHI
202001110865	EDEIA	ED12000010	PONTALINA	18/01/2020 20:20	19/01/2020 07:03	18/01/2020 20:20	19/01/2020 07:03	10,71	3	32,13	CHI
202001110865	PONTALINA	ED12000010	PONTALINA	18/01/2020 20:20	19/01/2020 07:03	18/01/2020 20:20	19/01/2020 07:03	10,71	3	32,13	CHI
202001110880	POSSE	PS12143770	IACIARA S2	18/01/2020 21:08	18/01/2020 21:54	18/01/2020 21:08	18/01/2020 21:54	0,76	109	82,51	CHI
202001110881	CAMPO ALEGRE DE GOIAS	CM21122439	CAMPO ALEGRE DE GOIAS	18/01/2020 18:17	19/01/2020 09:24	18/01/2020 18:17	19/01/2020 09:24	15,12	1	15,12	CHI
202001110882	FORMOSA	FA21180824	ITIQUEIRA	18/01/2020 21:09	18/01/2020 23:53	18/01/2020 21:09	18/01/2020 23:53	2,73	1	2,73	CHI
202001110888	AGUAS LINDAS DE GOIAS	LA11382905	AGUAS LINDAS DE GOIAS S2	18/01/2020 20:56	18/01/2020 21:49	18/01/2020 20:56	18/01/2020 21:49	0,87	263	228,23	CHI
202001110889	AGUAS LINDAS DE GOIAS	LA11133126	AGUAS LINDAS DE GOIAS S2	18/01/2020 21:13	18/01/2020 21:58	18/01/2020 21:13	18/01/2020 21:58	0,74	52	38,64	CHI
202001110912	COCALZINHO DE GOIAS	ZN21247802	AGUAS LINDAS DE GOIAS S2	18/01/2020 20:50	19/01/2020 14:12	18/01/2020 20:50	19/01/2020 14:12	17,38	1	17,38	CHI
202001110915	PORANGATU	PO12172408	PORANGATU	18/01/2020 07:44	19/01/2020 00:06	18/01/2020 07:44	19/01/2020 00:06	16,36	4	65,44	CHI
202001111012	RIO QUENTE	RQ12263194LD	RIO QUENTE	18/01/2020 20:51	19/01/2020 10:48	18/01/2020 20:51	19/01/2020 10:48	13,94	1386	19324,31	CHI
202001111012	CALDAS NOVAS	RQ12263194LD	RIO QUENTE	18/01/2020 20:51	19/01/2020 10:48	19/01/2020 10:30	19/01/2020 10:48	0,30	134	40,57	CHI
202001111012	MORRINHOS	RQ12263194LD	RIO QUENTE	18/01/2020 20:51	19/01/2020 10:48	19/01/2020 10:30	19/01/2020 10:48	0,30	52	15,74	CHI

202001111012	PIRACANJUBA	RQ12263194LD	RIO QUENTE	18/01/2020 20:51	19/01/2020 10:48	19/01/2020 10:30	19/01/2020 10:48	0,30	1	0,30	CHI
202001111012	RIO QUENTE	RQ12263194LD	RIO QUENTE	18/01/2020 20:51	19/01/2020 10:48	19/01/2020 10:30	19/01/2020 10:48	0,30	194	58,74	CHI
202001111021	PIRACANJUBA	PJ21035723	CRISTIANOPOLIS	18/01/2020 21:28	19/01/2020 09:56	18/01/2020 21:28	19/01/2020 09:56	12,46	1	12,46	CHI
202001111024	AGUA LIMPA	RQ12063059RE	VILA CORUMBA	18/01/2020 20:28	19/01/2020 11:55	18/01/2020 20:28	19/01/2020 11:55	15,45	16	247,19	CHI
202001111024	CALDAS NOVAS	RQ12063059RE	VILA CORUMBA	18/01/2020 20:28	19/01/2020 11:55	18/01/2020 20:28	19/01/2020 11:55	15,45	20	308,99	CHI
202001111024	MORRINHOS	RQ12063059RE	VILA CORUMBA	18/01/2020 20:28	19/01/2020 11:55	18/01/2020 20:28	19/01/2020 11:55	15,45	5	77,25	CHI
202001111024	RIO QUENTE	RQ12063059RE	VILA CORUMBA	18/01/2020 20:28	19/01/2020 11:55	18/01/2020 20:28	19/01/2020 11:55	15,45	112	1730,34	CHI
202001111033	GUARANI DE GOIAS	SD12134707	SAO DOMINGOS	18/01/2020 21:33	19/01/2020 05:35	18/01/2020 21:33	19/01/2020 05:35	8,03	3	24,08	CHI
202001111033	SAO DOMINGOS	SD12134707	SAO DOMINGOS	18/01/2020 21:33	19/01/2020 05:35	18/01/2020 21:33	19/01/2020 05:35	8,03	79	634,04	CHI
202001111039	VALPARAISO DE GOIAS	10009275442	PACAEMBU S2	18/01/2020 21:41	19/01/2020 00:40	18/01/2020 21:41	19/01/2020 00:40	2,97	1	2,97	CHI
202001111041	PLANALTINA	PI21110970	PLANALTINA	18/01/2020 21:44	18/01/2020 22:47	18/01/2020 21:44	18/01/2020 22:47	1,05	1	1,05	CHI
202001111082	CRISTALINA	KR21183732	CRISTALINA S2	18/01/2020 22:09	19/01/2020 10:31	18/01/2020 22:09	19/01/2020 10:31	12,36	1	12,36	CHI
202001111095	ITUMBIARA	690100978	ITUMBIARA VELHA S1	18/01/2020 22:19	19/01/2020 10:18	18/01/2020 22:19	19/01/2020 10:18	11,98	1	11,98	CHI
202001111099	LUZIANIA	LZ21153611	PACAEMBU S1	18/01/2020 22:23	19/01/2020 01:21	18/01/2020 22:23	19/01/2020 01:21	2,96	1	2,96	CHI
202001111120	MARZAGAO	MG21120771	VILA CORUMBA	18/01/2020 22:38	19/01/2020 15:10	18/01/2020 22:38	19/01/2020 15:10	16,53	1	16,53	CHI
202001111128	LUZIANIA	LZ12016676	RIO VERMELHO	18/01/2020 22:43	18/01/2020 23:38	18/01/2020 22:43	18/01/2020 23:38	0,91	27	24,67	CHI
202001111132	NOVO GAMA	NJ11201165	PACAEMBU S1	18/01/2020 22:49	18/01/2020 23:21	18/01/2020 22:49	18/01/2020 23:21	0,53	19	10,05	CHI
202001111144	NEROPOLIS	NR21365653	NEROPOLIS S2	18/01/2020 17:54	19/01/2020 01:05	18/01/2020 17:54	19/01/2020 01:05	7,18	1	7,18	CHI
202001111150	LUZIANIA	LZ21153318	CRISTALINA S2	18/01/2020 23:15	19/01/2020 16:00	18/01/2020 23:15	19/01/2020 16:00	16,74	1	16,74	CHI
202001111151	NOVO GAMA	10004722505	PACAEMBU S1	18/01/2020 23:15	19/01/2020 00:14	18/01/2020 23:15	19/01/2020 00:14	0,98	1	0,98	CHI
202001111199	ITABERAI	IB11000012	ITABERAI S2	18/01/2020 18:45	19/01/2020 00:27	18/01/2020 18:45	19/01/2020 00:27	5,68	17	96,63	CHI
202001111246	IACIARA	IA12195746	IACIARA S2	19/01/2020 01:40	19/01/2020 09:59	19/01/2020 01:40	19/01/2020 09:59	8,31	1	8,31	CHI
202001111261	FLORES DE GOIAS	FB12285966	FLORES DE GOIAS	19/01/2020 02:21	19/01/2020 08:05	19/01/2020 02:21	19/01/2020 08:05	5,73	67	383,82	CHI
202001111293	FORMOSA	7194593	ITUIQUIRA	19/01/2020 04:43	19/01/2020 08:07	19/01/2020 04:43	19/01/2020 08:07	3,40	42	142,61	CHI
202001111310	CATALAO	CT12077507	CATALAO S1	18/01/2020 16:32	19/01/2020 05:12	18/01/2020 16:32	19/01/2020 05:12	12,67	8	101,32	CHI
202001111560	ALTO PARAISO DE GOIAS	JL12302830	SAO JOAO D ALIANCA	19/01/2020 06:10	20/01/2020 21:06	19/01/2020 06:10	19/01/2020 14:01	7,85	1	7,85	CHI
202001111560	SAO JOAO D ALIANCA	JL12302830	SAO JOAO D ALIANCA	19/01/2020 06:10	20/01/2020 21:06	19/01/2020 06:10	19/01/2020 14:01	7,85	160	1255,91	CHI
202001111560	SAO JOAO D ALIANCA	JL21156501	SAO JOAO D ALIANCA	19/01/2020 06:10	20/01/2020 21:06	19/01/2020 14:05	19/01/2020 19:05	5,00	1	5,00	CHI
202001111560	ALTO PARAISO DE GOIAS	JL12302830	SAO JOAO D ALIANCA	19/01/2020 06:10	20/01/2020 21:06	19/01/2020 14:05	19/01/2020 21:44	7,65	1	7,65	CHI
202001111560	SAO JOAO D ALIANCA	JL12302830	SAO JOAO D ALIANCA	19/01/2020 06:10	20/01/2020 21:06	19/01/2020 14:05	19/01/2020 21:44	7,65	13	99,44	CHI
202001111560	SAO JOAO D ALIANCA	JL13154492	SAO JOAO D ALIANCA	19/01/2020 06:10	20/01/2020 21:06	19/01/2020 14:05	20/01/2020 11:25	21,34	39	832,17	CHI
202001111560	SAO JOAO D ALIANCA	JL13154492	SAO JOAO D ALIANCA	19/01/2020 06:10	20/01/2020 21:06	20/01/2020 11:46	20/01/2020 13:08	1,36	39	52,90	CHI
202001111560	SAO JOAO D ALIANCA	JL12218555LD	SAO JOAO D ALIANCA	19/01/2020 06:10	20/01/2020 21:06	19/01/2020 14:05	20/01/2020 13:33	23,47	107	2511,02	CHI

202001111560	ALTO PARAISO DE GOIAS	JL12257606	SAO JOAO D ALIANCA	19/01/2020 06:10	20/01/2020 21:06	19/01/2020 06:10	20/01/2020 19:08	36,96	2	73,92	CHI
202001111560	SAO JOAO D ALIANCA	JL12257606	SAO JOAO D ALIANCA	19/01/2020 06:10	20/01/2020 21:06	19/01/2020 06:10	20/01/2020 19:08	36,96	81	2993,78	CHI
202001111560	ALTO PARAISO DE GOIAS	JL12302830	SAO JOAO D ALIANCA	19/01/2020 06:10	20/01/2020 21:06	20/01/2020 19:11	20/01/2020 20:12	1,01	3	3,04	CHI
202001111560	SAO JOAO D ALIANCA	JL12302830	SAO JOAO D ALIANCA	19/01/2020 06:10	20/01/2020 21:06	20/01/2020 19:11	20/01/2020 20:12	1,01	240	243,47	CHI
202001111560	SAO JOAO D ALIANCA	JL21156501	SAO JOAO D ALIANCA	19/01/2020 06:10	20/01/2020 21:06	20/01/2020 10:59	20/01/2020 21:06	10,11	1	10,11	CHI
202001111582	CRISTALINA	10020693603	CRISTALINA S1	19/01/2020 06:15	19/01/2020 08:21	19/01/2020 06:15	19/01/2020 08:21	2,10	1	2,10	CHI
202001111607	POSSE	PS12122519	IACIARA S2	19/01/2020 06:21	19/01/2020 08:04	19/01/2020 06:21	19/01/2020 08:04	1,71	10	17,14	CHI
202001111609	MONTE ALEGRE DE GOIAS	MA12212608	SAO DOMINGOS	19/01/2020 06:24	19/01/2020 08:08	19/01/2020 06:24	19/01/2020 08:08	1,73	55	95,03	CHI
202001111633	POSSE	PS12132047	IACIARA S2	19/01/2020 06:35	19/01/2020 08:38	19/01/2020 06:35	19/01/2020 08:38	2,05	1	2,05	CHI
202001111673	COCALZINHO DE GOIAS	ZN12389402	AGUAS LINDAS DE GOIAS S2	19/01/2020 06:49	19/01/2020 10:59	19/01/2020 06:49	19/01/2020 10:59	4,16	2	8,33	CHI
202001111709	CORUMBAIBA	CI12392153	VILA CORUMBA	18/01/2020 14:39	19/01/2020 11:31	18/01/2020 14:39	19/01/2020 11:31	20,86	4	83,44	CHI
202001111751	ORIZONA	OZ21382058	PIRES DO RIO S2	18/01/2020 18:44	19/01/2020 13:09	18/01/2020 18:44	19/01/2020 13:09	18,41	2	36,81	CHI
202001111812	FORMOSA	VB12164674	ITIQUEIRA	19/01/2020 07:01	19/01/2020 09:31	19/01/2020 07:01	19/01/2020 09:31	2,49	44	109,44	CHI
202001111812	VILA BOA	VB12164674	ITIQUEIRA	19/01/2020 07:01	19/01/2020 09:31	19/01/2020 07:01	19/01/2020 09:31	2,49	6	14,92	CHI
202001111862	BOM JESUS DE GOIAS	BJ12392116	BOM JESUS DE GOIAS	18/01/2020 20:29	19/01/2020 14:00	18/01/2020 20:29	19/01/2020 14:00	17,51	15	262,71	CHI
202001111958	CORUMBAIBA	CI12112863	VILA CORUMBA	17/01/2020 20:44	19/01/2020 10:56	17/01/2020 20:44	19/01/2020 10:56	38,19	3	114,58	CHI
202001111959	CORUMBAIBA	CI21027245	VILA CORUMBA	18/01/2020 11:20	19/01/2020 10:47	18/01/2020 11:20	19/01/2020 10:47	23,45	1	23,45	CHI
202001111960	CORUMBAIBA	CI12234658	VILA CORUMBA	18/01/2020 12:40	19/01/2020 10:38	18/01/2020 12:40	19/01/2020 10:38	21,95	1	21,95	CHI
202001112029	FLORES DE GOIAS	FB12286863	FLORES DE GOIAS	19/01/2020 07:24	19/01/2020 12:20	19/01/2020 07:24	19/01/2020 12:20	4,93	85	418,72	CHI
202001112149	FORMOSA	FA12106838	SAO JOAO D ALIANCA	19/01/2020 07:38	19/01/2020 10:55	19/01/2020 07:38	19/01/2020 10:55	3,28	4	13,13	CHI
202001112166	FLORES DE GOIAS	FB12255011	FLORES DE GOIAS	19/01/2020 07:40	19/01/2020 10:49	19/01/2020 07:40	19/01/2020 10:49	3,15	355	1116,97	CHI
202001112166	SAO JOAO D ALIANCA	FB12255011	FLORES DE GOIAS	19/01/2020 07:40	19/01/2020 10:49	19/01/2020 07:40	19/01/2020 10:49	3,15	1	3,15	CHI
202001112167	POSSE	PS12237062	IACIARA S2	19/01/2020 07:40	19/01/2020 10:46	19/01/2020 07:40	19/01/2020 10:46	3,09	17	52,53	CHI
202001112169	ALTO PARAISO DE GOIAS	BF21163462	FLORES DE GOIAS	19/01/2020 07:40	19/01/2020 18:20	19/01/2020 07:40	19/01/2020 18:20	10,66	1	10,66	CHI
202001112219	VALPARAISO DE GOIAS	3350022969	PACAEMBU S1	19/01/2020 07:46	19/01/2020 10:38	19/01/2020 07:46	19/01/2020 10:38	2,86	1	2,86	CHI
202001112272	FORMOSA	FA12218285	SAO JOAO D ALIANCA	19/01/2020 07:53	19/01/2020 13:51	19/01/2020 07:53	19/01/2020 13:51	5,96	6	35,77	CHI
202001112304	FLORES DE GOIAS	FB12252148	FLORES DE GOIAS	19/01/2020 07:48	19/01/2020 09:24	19/01/2020 07:48	19/01/2020 09:24	1,60	10	15,98	CHI
202001112339	ALTO PARAISO DE GOIAS	BF12096495	SAO JOAO D ALIANCA	19/01/2020 08:07	19/01/2020 11:45	19/01/2020 08:07	19/01/2020 11:45	3,62	7	25,32	CHI
202001112356	PLANALTINA	PI12131789	PLANALTINA	19/01/2020 08:11	19/01/2020 11:00	19/01/2020 08:11	19/01/2020 11:00	2,82	8	22,53	CHI
202001112378	ALTO PARAISO DE GOIAS	ND12302636	IACIARA S2	19/01/2020 07:50	19/01/2020 12:13	19/01/2020 07:50	19/01/2020 12:13	4,37	18	78,70	CHI
202001112378	NOVA ROMA	ND12302636	IACIARA S2	19/01/2020 07:50	19/01/2020 12:13	19/01/2020 07:50	19/01/2020 12:13	4,37	96	419,73	CHI
202001112378	SAO JOAO D ALIANCA	ND12302636	IACIARA S2	19/01/2020 07:50	19/01/2020 12:13	19/01/2020 07:50	19/01/2020 12:13	4,37	12	52,47	CHI
202001112413	CAMPO ALEGRE DE GOIAS	CM12216102	CAMPO ALEGRE DE GOIAS	18/01/2020 22:29	19/01/2020 10:06	18/01/2020 22:29	19/01/2020 10:06	11,62	10	116,17	CHI

202001112432	FLORES DE GOIAS	FB12204157	FLORES DE GOIAS	19/01/2020 08:23	19/01/2020 12:09	19/01/2020 08:23	19/01/2020 12:09	3,75	13	48,81	CHI
202001112465	ALTO PARAISO DE GOIAS	BF12062192	SAO JOAO D ALIANCA	19/01/2020 08:30	19/01/2020 13:30	19/01/2020 08:30	19/01/2020 13:30	5,00	1	5,00	CHI
202001112511	DAMIANOPOLIS	SI12202236	IACIARA S2	19/01/2020 07:38	19/01/2020 10:23	19/01/2020 07:38	19/01/2020 10:23	2,74	27	73,90	CHI
202001112511	SITIO D ABADIA	SI12202236	IACIARA S2	19/01/2020 07:38	19/01/2020 10:23	19/01/2020 07:38	19/01/2020 10:23	2,74	1	2,74	CHI
202001112516	ALTO PARAISO DE GOIAS	BF12105397	SAO JOAO D ALIANCA	19/01/2020 06:41	19/01/2020 09:00	19/01/2020 06:41	19/01/2020 09:00	2,31	224	516,94	CHI
202001112563	IPAMERI	IP21158138	CRISTALINA S2	19/01/2020 08:43	19/01/2020 11:02	19/01/2020 08:43	19/01/2020 11:02	2,31	1	2,31	CHI
202001112567	POSSE	PS11199471	IACIARA S2	19/01/2020 08:44	19/01/2020 10:25	19/01/2020 08:44	19/01/2020 10:25	1,68	32	53,84	CHI
202001112606	SANTO ANTONIO DO DESCOBERTO	1850004551	MARAJOARA	19/01/2020 08:54	20/01/2020 09:13	19/01/2020 08:54	20/01/2020 09:13	24,32	1	24,32	CHI
202001112614	MONTE ALEGRE DE GOIAS	MA12217827	SAO DOMINGOS	19/01/2020 08:55	19/01/2020 11:20	19/01/2020 08:55	19/01/2020 11:20	2,41	28	67,44	CHI
202001199208	CAMPO ALEGRE DE GOIAS	CM12333445RE	CAMPO ALEGRE DE GOIAS	18/01/2020 18:17	19/01/2020 07:48	18/01/2020 18:17	19/01/2020 07:48	13,52	64	865,07	CHI
202001199208	CATALAO	CM12333445RE	CAMPO ALEGRE DE GOIAS	18/01/2020 18:17	19/01/2020 07:48	18/01/2020 18:17	19/01/2020 07:48	13,52	19	256,82	CHI
202001199208	IPAMERI	CM12333445RE	CAMPO ALEGRE DE GOIAS	18/01/2020 18:17	19/01/2020 07:48	18/01/2020 18:17	19/01/2020 07:48	13,52	8	108,13	CHI
202001201915	JATAI	RV12038514	CABRIUVA S1	18/01/2020 15:50	19/01/2020 07:59	18/01/2020 15:50	19/01/2020 07:59	16,14	6	96,84	CHI
202001201915	RIO VERDE	RV12038514	CABRIUVA S1	18/01/2020 15:50	19/01/2020 07:59	18/01/2020 15:50	19/01/2020 07:59	16,14	77	1242,76	CHI
202001203040	ORIZONA	OZ12017060	PIRES DO RIO S2	18/01/2020 15:23	18/01/2020 18:33	18/01/2020 15:23	18/01/2020 18:33	3,16	6	18,98	CHI
202001219023	RIO VERDE	RV12260130	CABRIUVA S1	18/01/2020 14:43	18/01/2020 16:05	18/01/2020 14:43	18/01/2020 16:05	1,36	1	1,36	CHI
202001219806	RIO VERDE	RV12062719	CABRIUVA S2	18/01/2020 11:17	19/01/2020 17:02	19/01/2020 10:16	19/01/2020 17:02	6,76	7	47,35	CHI
202001221862	RIO VERDE	RV12230862	CABRIUVA S1	18/01/2020 09:39	18/01/2020 14:40	18/01/2020 09:39	18/01/2020 13:07	3,46	2	6,91	CHI
202001221862	RIO VERDE	RV12260130	CABRIUVA S1	18/01/2020 09:39	18/01/2020 14:40	18/01/2020 13:25	18/01/2020 14:40	1,24	1	1,24	CHI
202001221877	RIO VERDE	RV12260692	CABRIUVA S1	18/01/2020 08:40	18/01/2020 10:15	18/01/2020 08:40	18/01/2020 10:15	1,58	1	1,58	CHI
202001221902	NOVA CRIXAS	NA12334349	NOVA CRIXAS	17/01/2020 23:17	18/01/2020 02:11	17/01/2020 23:17	18/01/2020 02:11	2,91	86	250,31	CHI
202001222116	GOIANESIA	GE12297305	GOIANESIA S1	17/01/2020 20:45	18/01/2020 04:40	17/01/2020 20:45	18/01/2020 04:40	7,90	130	1027,61	CHI
202001222398	NIQUELANDIA	NQ12353847	URUACU	17/01/2020 17:16	18/01/2020 01:23	17/01/2020 17:16	18/01/2020 01:23	8,11	12	97,27	CHI
202001224102	ACREUNA	EU12056532	EDEIA	17/01/2020 14:25	18/01/2020 02:23	17/01/2020 14:25	18/01/2020 02:23	11,96	5	59,82	CHI
202001225466	ANICUNS	AC12304642	ANICUNS	17/01/2020 10:15	17/01/2020 13:44	17/01/2020 10:15	17/01/2020 13:44	3,47	7	24,32	CHI
202001229373	JATAI	RV12038514	CABRIUVA S1	17/01/2020 08:07	17/01/2020 11:07	17/01/2020 08:07	17/01/2020 11:07	2,99	6	17,94	CHI
202001229373	RIO VERDE	RV12038514	CABRIUVA S1	17/01/2020 08:07	17/01/2020 11:07	17/01/2020 08:07	17/01/2020 11:07	2,99	77	230,21	CHI
202001229451	PIRENOPOLIS	PV12388829	CORUMBA	17/01/2020 08:06	17/01/2020 19:15	17/01/2020 17:20	17/01/2020 19:15	1,93	19	36,58	CHI
202001229603	JATAI	JT12184049	JATAI S1	17/01/2020 05:10	17/01/2020 16:51	17/01/2020 05:10	17/01/2020 16:51	11,68	64	747,68	CHI
202001229603	SERRANOPOLIS	JT12184049	JATAI S1	17/01/2020 05:10	17/01/2020 16:51	17/01/2020 05:10	17/01/2020 16:51	11,68	32	373,84	CHI
202001232202	PIRENOPOLIS	PV12357379	CORUMBA	17/01/2020 06:32	17/01/2020 19:11	17/01/2020 06:32	17/01/2020 19:11	12,64	1	12,64	CHI
202001232645	APORE	SX12153265	JATAI S1	16/01/2020 17:20	17/01/2020 06:20	16/01/2020 17:20	17/01/2020 06:20	12,99	7	90,94	CHI
202001232645	ITARUMA	SX12153265	JATAI S1	16/01/2020 17:20	17/01/2020 06:20	16/01/2020 17:20	17/01/2020 06:20	12,99	1	12,99	CHI

202001232645	SERRANOPOLIS	SX12153265	JATAI S1	16/01/2020 17:20	17/01/2020 06:20	16/01/2020 17:20	17/01/2020 06:20	12,99	4	51,97	CHI
202001237244	GOIANESIA	GE12040720	GOIANESIA S2	17/01/2020 21:04	18/01/2020 02:32	17/01/2020 21:04	18/01/2020 02:25	5,35	996	5327,22	CHI
202001237244	GOIANESIA	GE13000192	GOIANESIA S2	17/01/2020 21:04	18/01/2020 02:32	17/01/2020 21:04	18/01/2020 02:25	5,35	370	1978,99	CHI
202001237244	GOIANESIA	GE13000192	GOIANESIA S2	17/01/2020 21:04	18/01/2020 02:32	18/01/2020 00:16	18/01/2020 02:25	2,14	164	351,51	CHI
202001237244	GOIANESIA	GE13000192	GOIANESIA S2	17/01/2020 21:04	18/01/2020 02:32	17/01/2020 21:04	18/01/2020 02:32	5,47	3811	20835,58	CHI
202001237244	SANTA ISABEL	GE13000192	GOIANESIA S2	17/01/2020 21:04	18/01/2020 02:32	17/01/2020 21:04	18/01/2020 02:32	5,47	1	5,47	CHI
202001237394	GOIATUBA	GT10408745	GOIATUBA S2	18/01/2020 17:06	20/01/2020 13:22	18/01/2020 17:06	18/01/2020 18:49	1,70	76	129,35	CHI
202001237394	GOIATUBA	GT10408745	GOIATUBA S2	18/01/2020 17:06	20/01/2020 13:22	18/01/2020 20:15	18/01/2020 20:28	0,22	76	16,38	CHI
202001237394	BURITI ALEGRE	GT10408745	GOIATUBA S2	18/01/2020 17:06	20/01/2020 13:22	18/01/2020 17:06	20/01/2020 00:01	30,92	6	185,50	CHI
202001237394	GOIATUBA	GT10408745	GOIATUBA S2	18/01/2020 17:06	20/01/2020 13:22	18/01/2020 17:06	20/01/2020 00:01	30,92	9	278,25	CHI
202001237394	BURITI ALEGRE	GT10408745	GOIATUBA S2	18/01/2020 17:06	20/01/2020 13:22	18/01/2020 17:06	20/01/2020 08:26	39,33	23	904,55	CHI
202001237394	GOIATUBA	GT10408745	GOIATUBA S2	18/01/2020 17:06	20/01/2020 13:22	18/01/2020 17:06	20/01/2020 08:26	39,33	19	747,24	CHI
202001237394	MORRINHOS	GT10408745	GOIATUBA S2	18/01/2020 17:06	20/01/2020 13:22	18/01/2020 17:06	20/01/2020 08:26	39,33	26	1022,54	CHI
202001237394	BURITI ALEGRE	BG12000019	GOIATUBA S2	18/01/2020 17:06	20/01/2020 13:22	18/01/2020 17:06	20/01/2020 13:22	44,26	1	44,26	CHI
202001237404	GOIAS	GS12206865	MATRINCHA	16/01/2020 23:05	17/01/2020 05:03	16/01/2020 23:05	17/01/2020 05:03	5,97	68	405,73	CHI
202001237407	GOIANIA	GN11001594	GOIANIA LESTE S2	16/01/2020 16:57	16/01/2020 20:06	16/01/2020 16:57	16/01/2020 20:06	3,14	103	323,79	CHI
202001237410	RIO VERDE	630203878	CABRIUVA S2	18/01/2020 11:17	19/01/2020 10:16	18/01/2020 11:17	19/01/2020 10:16	22,99	1	22,99	CHI
2020011700030	BURITI ALEGRE	03450234	ALTO BURITI	17/01/2020 13:18	17/01/2020 14:09	17/01/2020 13:18	17/01/2020 14:09	0,85	1	0,85	CHI
2020011700072	ARAGARCAS	00110224	ARAGARCAS	17/01/2020 03:54	17/01/2020 04:34	17/01/2020 03:54	17/01/2020 04:34	0,67	3277	2184,67	CHI
2020011700072	BOM JARDIM DE GOIAS	00110224	ARAGARCAS	17/01/2020 03:54	17/01/2020 04:34	17/01/2020 03:54	17/01/2020 04:34	0,67	54	36,00	CHI
2020011700074	ARENOPOLIS	05560424	ARENOPOLIS	17/01/2020 03:56	17/01/2020 04:30	17/01/2020 03:56	17/01/2020 04:30	0,57	11	6,23	CHI
2020011700074	PIRANHAS	05560424	ARENOPOLIS	17/01/2020 03:56	17/01/2020 04:30	17/01/2020 03:56	17/01/2020 04:30	0,57	67	37,97	CHI
2020011700074	PIRANHAS	05560424	PIRANHAS	17/01/2020 03:56	17/01/2020 04:30	17/01/2020 03:56	17/01/2020 04:30	0,57	2	1,13	CHI
2020011700075	ARAGARCAS	00240406	BOM JARDIM	17/01/2020 03:56	17/01/2020 04:29	17/01/2020 03:56	17/01/2020 04:29	0,55	31	17,05	CHI
2020011700075	BALIZA	00240406	BOM JARDIM	17/01/2020 03:56	17/01/2020 04:29	17/01/2020 03:56	17/01/2020 04:29	0,55	328	180,40	CHI
2020011700075	BOM JARDIM DE GOIAS	00240406	BOM JARDIM	17/01/2020 03:56	17/01/2020 04:29	17/01/2020 03:56	17/01/2020 04:29	0,55	3860	2123,00	CHI
2020011700075	PIRANHAS	00240406	BOM JARDIM	17/01/2020 03:56	17/01/2020 04:29	17/01/2020 03:56	17/01/2020 04:29	0,55	42	23,10	CHI
2020011700075	ARENOPOLIS	05560214	PIRANHAS	17/01/2020 03:56	17/01/2020 04:29	17/01/2020 03:56	17/01/2020 04:29	0,55	11	6,05	CHI
2020011700075	BOM JARDIM DE GOIAS	05560214	PIRANHAS	17/01/2020 03:56	17/01/2020 04:29	17/01/2020 03:56	17/01/2020 04:29	0,55	18	9,90	CHI
2020011700075	CAIAPONIA	05560224	PIRANHAS	17/01/2020 03:56	17/01/2020 04:29	17/01/2020 03:56	17/01/2020 04:29	0,55	1	0,55	CHI
2020011700075	PIRANHAS	05560214	PIRANHAS	17/01/2020 03:56	17/01/2020 04:29	17/01/2020 03:56	17/01/2020 04:29	0,55	2144	1179,20	CHI
2020011700075	PIRANHAS	05560224	PIRANHAS	17/01/2020 03:56	17/01/2020 04:29	17/01/2020 03:56	17/01/2020 04:29	0,55	3142	1728,10	CHI
2020011700098	ABADIA DE GOIAS	02002	ANAPOLIS UNIVERSITARIO S1	17/01/2020 12:38	17/01/2020 12:41	17/01/2020 12:38	17/01/2020 12:41	0,05	1	0,05	CHI

2020011700098	ABADIANIA	00201	ANAPOLIS UNIVERSITARIO S1	17/01/2020 12:38	17/01/2020 12:41	17/01/2020 12:38	17/01/2020 12:41	0,05	67	3,35	CHI
2020011700098	ABADIANIA	02001	ANAPOLIS UNIVERSITARIO S1	17/01/2020 12:38	17/01/2020 12:41	17/01/2020 12:38	17/01/2020 12:41	0,05	1486	74,30	CHI
2020011700098	ABADIANIA	00202	ANAPOLIS UNIVERSITARIO S1	17/01/2020 12:38	17/01/2020 12:41	17/01/2020 12:38	17/01/2020 12:41	0,05	133	6,65	CHI
2020011700098	ABADIANIA	02002	ANAPOLIS UNIVERSITARIO S1	17/01/2020 12:38	17/01/2020 12:41	17/01/2020 12:38	17/01/2020 12:41	0,05	3505	175,25	CHI
2020011700098	ABADIANIA	00050414	ANAPOLIS UNIVERSITARIO S1	17/01/2020 12:38	17/01/2020 12:41	17/01/2020 12:38	17/01/2020 12:41	0,05	22	1,10	CHI
2020011700098	ABADIANIA	00232	ANAPOLIS UNIVERSITARIO S1	17/01/2020 12:38	17/01/2020 12:41	17/01/2020 12:38	17/01/2020 12:41	0,05	28	1,40	CHI
2020011700098	ABADIANIA	00050424	ANAPOLIS UNIVERSITARIO S1	17/01/2020 12:38	17/01/2020 12:41	17/01/2020 12:38	17/01/2020 12:41	0,05	15	0,75	CHI
2020011700098	ANAPOLIS	00201	ANAPOLIS UNIVERSITARIO S1	17/01/2020 12:38	17/01/2020 12:41	17/01/2020 12:38	17/01/2020 12:41	0,05	431	21,55	CHI
2020011700098	ANAPOLIS	00202	ANAPOLIS UNIVERSITARIO S1	17/01/2020 12:38	17/01/2020 12:41	17/01/2020 12:38	17/01/2020 12:41	0,05	368	18,40	CHI
2020011700098	ANAPOLIS	00050404	ANAPOLIS UNIVERSITARIO S1	17/01/2020 12:38	17/01/2020 12:41	17/01/2020 12:38	17/01/2020 12:41	0,05	1	0,05	CHI
2020011700098	ANAPOLIS	00050414	ANAPOLIS UNIVERSITARIO S1	17/01/2020 12:38	17/01/2020 12:41	17/01/2020 12:38	17/01/2020 12:41	0,05	61	3,05	CHI
2020011700098	ANAPOLIS	00050424	ANAPOLIS UNIVERSITARIO S1	17/01/2020 12:38	17/01/2020 12:41	17/01/2020 12:38	17/01/2020 12:41	0,05	93	4,65	CHI
2020011700098	CORUMBA DE GOIAS	02001	ANAPOLIS UNIVERSITARIO S1	17/01/2020 12:38	17/01/2020 12:41	17/01/2020 12:38	17/01/2020 12:41	0,05	61	3,05	CHI
2020011700098	CORUMBA DE GOIAS	02002	ANAPOLIS UNIVERSITARIO S1	17/01/2020 12:38	17/01/2020 12:41	17/01/2020 12:38	17/01/2020 12:41	0,05	4	0,20	CHI
2020011700098	GAMELEIRA DE GOIAS	00202	ANAPOLIS UNIVERSITARIO S1	17/01/2020 12:38	17/01/2020 12:41	17/01/2020 12:38	17/01/2020 12:41	0,05	32	1,60	CHI
2020011700098	GAMELEIRA DE GOIAS	02002	ANAPOLIS UNIVERSITARIO S1	17/01/2020 12:38	17/01/2020 12:41	17/01/2020 12:38	17/01/2020 12:41	0,05	11	0,55	CHI
2020011700125	AGUAS LINDAS DE GOIAS	03730214	AGUAS LINDAS DE GOIAS S1	17/01/2020 15:10	17/01/2020 15:13	17/01/2020 15:10	17/01/2020 15:13	0,05	16560	828,00	CHI
2020011700125	AGUAS LINDAS DE GOIAS	03730224	AGUAS LINDAS DE GOIAS S1	17/01/2020 15:10	17/01/2020 15:13	17/01/2020 15:10	17/01/2020 15:13	0,05	13435	671,75	CHI
2020011700125	COCALZINHO DE GOIAS	03730214	AGUAS LINDAS DE GOIAS S1	17/01/2020 15:10	17/01/2020 15:13	17/01/2020 15:10	17/01/2020 15:13	0,05	3	0,15	CHI
2020011700125	COCALZINHO DE GOIAS	03730224	AGUAS LINDAS DE GOIAS S1	17/01/2020 15:10	17/01/2020 15:13	17/01/2020 15:10	17/01/2020 15:13	0,05	269	13,45	CHI
2020011800063	JARAGUA	47401	SAO FRANCISCO DE GOIAS	18/01/2020 15:02	18/01/2020 17:00	18/01/2020 15:02	18/01/2020 17:00	1,97	3	5,90	CHI
2020011800063	JESUPOLIS	47401	SAO FRANCISCO DE GOIAS	18/01/2020 15:02	18/01/2020 17:00	18/01/2020 15:02	18/01/2020 17:00	1,97	37	72,77	CHI
2020011800063	JESUPOLIS	47402	SAO FRANCISCO DE GOIAS	18/01/2020 15:02	18/01/2020 17:00	18/01/2020 15:02	18/01/2020 17:00	1,97	26	51,13	CHI
2020011800063	PETROLINA DE GOIAS	47401	SAO FRANCISCO DE GOIAS	18/01/2020 15:02	18/01/2020 17:00	18/01/2020 15:02	18/01/2020 17:00	1,97	1	1,97	CHI
2020011800063	PETROLINA DE GOIAS	53901	SAO FRANCISCO DE GOIAS	18/01/2020 15:02	18/01/2020 17:00	18/01/2020 15:02	18/01/2020 17:00	1,97	1	1,97	CHI
2020011800063	PIRENOPOLIS	53901	SAO FRANCISCO DE GOIAS	18/01/2020 15:02	18/01/2020 17:00	18/01/2020 15:02	18/01/2020 17:00	1,97	105	206,50	CHI
2020011800063	PIRENOPOLIS	53902	SAO FRANCISCO DE GOIAS	18/01/2020 15:02	18/01/2020 17:00	18/01/2020 15:02	18/01/2020 17:00	1,97	3	5,90	CHI
2020011800063	SAO FRANCISCO DE GOIAS	47402	SAO FRANCISCO DE GOIAS	18/01/2020 15:02	18/01/2020 17:00	18/01/2020 15:02	18/01/2020 17:00	1,97	11	21,63	CHI
2020011900061	AGUAS LINDAS DE GOIAS	03730424	AGUAS LINDAS DE GOIAS S2	19/01/2020 08:32	19/01/2020 08:46	19/01/2020 08:32	19/01/2020 08:46	0,23	2	0,46	CHI
2020011900061	AGUAS LINDAS DE GOIAS	03730424	AGUAS LINDAS DE GOIAS S2	19/01/2020 08:32	19/01/2020 08:46	19/01/2020 08:32	19/01/2020 08:46	0,23	11	2,54	CHI
2020011900061	COCALZINHO DE GOIAS	03730424	AGUAS LINDAS DE GOIAS S2	19/01/2020 08:32	19/01/2020 08:46	19/01/2020 08:32	19/01/2020 08:46	0,23	177	40,81	CHI
2020011900061	COCALZINHO DE GOIAS	03730424	AGUAS LINDAS DE GOIAS S2	19/01/2020 08:32	19/01/2020 08:46	19/01/2020 08:32	19/01/2020 08:46	0,23	2979	686,82	CHI
2020011900061	COCALZINHO DE GOIAS	03730424	AGUAS LINDAS DE GOIAS S2	19/01/2020 08:32	19/01/2020 08:46	19/01/2020 08:32	19/01/2020 08:46	0,23	8	1,84	CHI

2020011900061	CORUMBA DE GOIAS	03730424	AGUAS LINDAS DE GOIAS S2	19/01/2020 08:32	19/01/2020 08:46	19/01/2020 08:32	19/01/2020 08:46	0,23	7	1,61	CHI
2020011900061	DISTRITO FEDERAL	03730424	AGUAS LINDAS DE GOIAS S2	19/01/2020 08:32	19/01/2020 08:46	19/01/2020 08:32	19/01/2020 08:46	0,23	1	0,23	CHI
2020011900061	PADRE BERNARDO	03730424	AGUAS LINDAS DE GOIAS S2	19/01/2020 08:32	19/01/2020 08:46	19/01/2020 08:32	19/01/2020 08:46	0,23	4	0,92	CHI
2020011900061	RIALMA	03730424	AGUAS LINDAS DE GOIAS S2	19/01/2020 08:32	19/01/2020 08:46	19/01/2020 08:32	19/01/2020 08:46	0,23	6	1,38	CHI
2020011900061	SANTO ANTONIO DO DESCOBERTO	03730424	AGUAS LINDAS DE GOIAS S2	19/01/2020 08:32	19/01/2020 08:46	19/01/2020 08:32	19/01/2020 08:46	0,23	8416	1940,36	CHI
2020011900061	SANTO ANTONIO DO DESCOBERTO	03730424	AGUAS LINDAS DE GOIAS S2	19/01/2020 08:32	19/01/2020 08:46	19/01/2020 08:32	19/01/2020 08:46	0,23	283	65,25	CHI
2020011900061	SANTO ANTONIO DO DESCOBERTO	03730424	AGUAS LINDAS DE GOIAS S2	19/01/2020 08:32	19/01/2020 08:46	19/01/2020 08:32	19/01/2020 08:46	0,23	98	22,59	CHI
2020011900061	SANTO ANTONIO DO DESCOBERTO	03730424	AGUAS LINDAS DE GOIAS S2	19/01/2020 08:32	19/01/2020 08:46	19/01/2020 08:32	19/01/2020 08:46	0,23	49	11,30	CHI

Plotagem das Ocorrências conforme a Espacialização das Chuvas

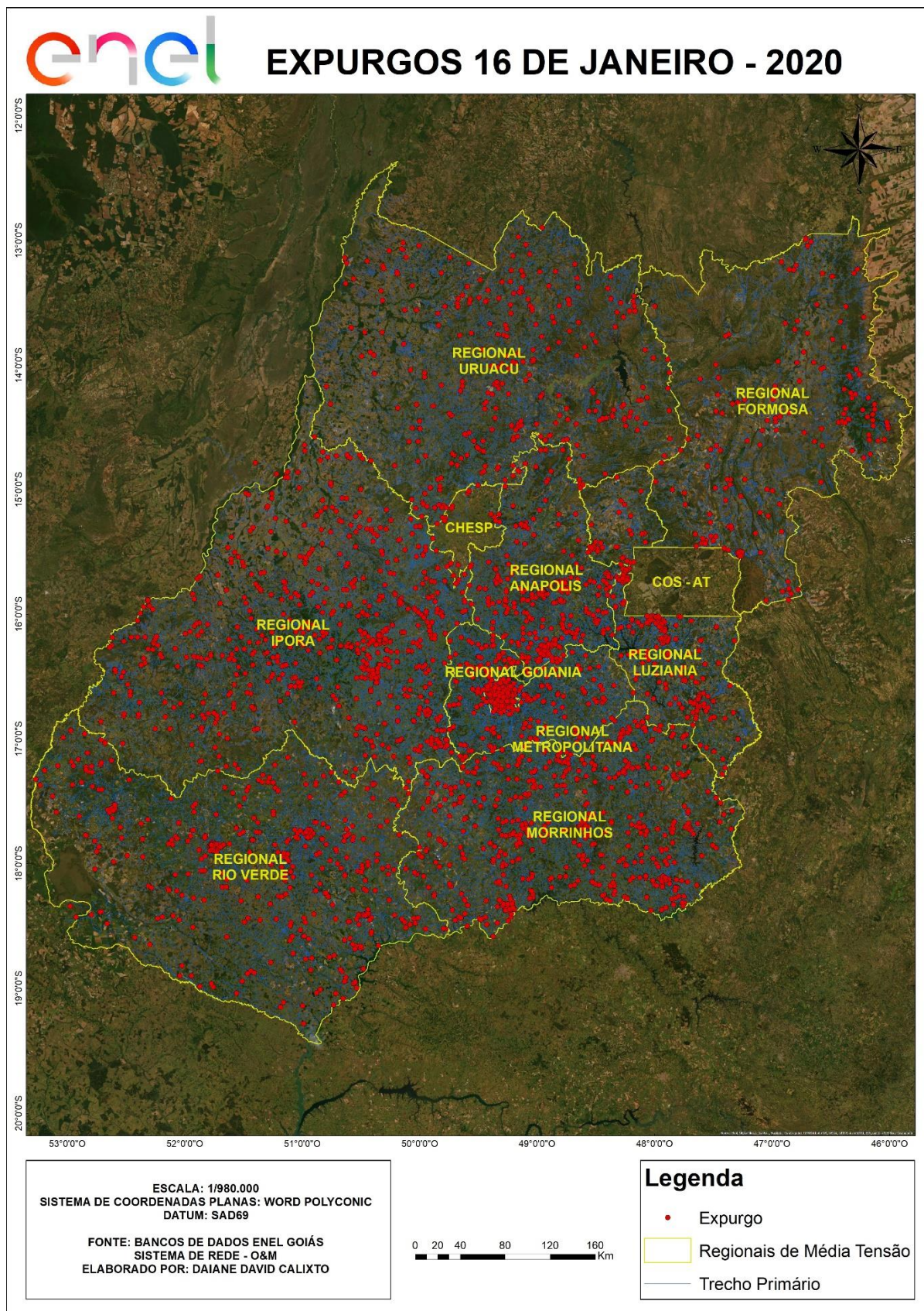

Diagramas Unifilares

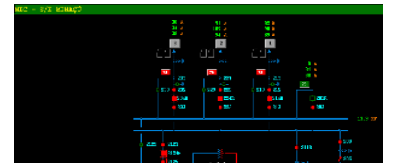
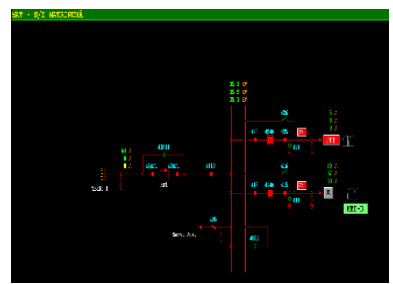
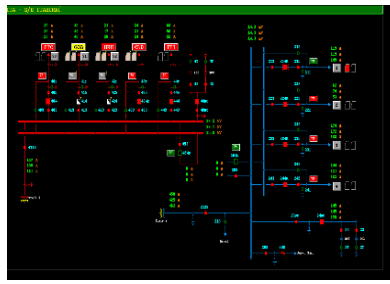
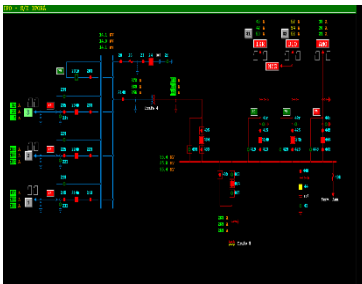
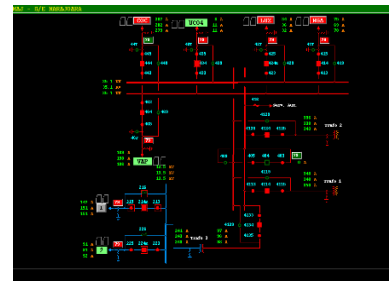
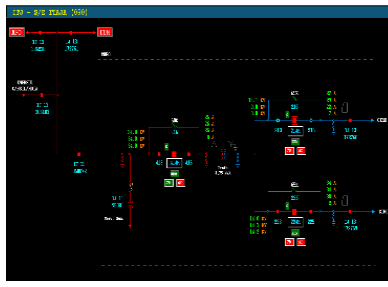
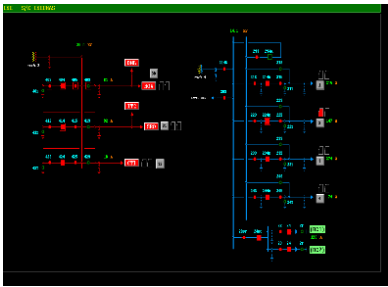
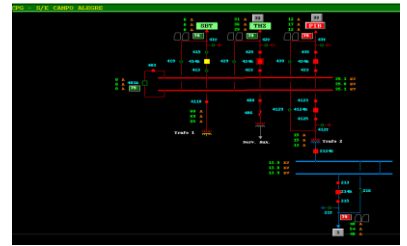
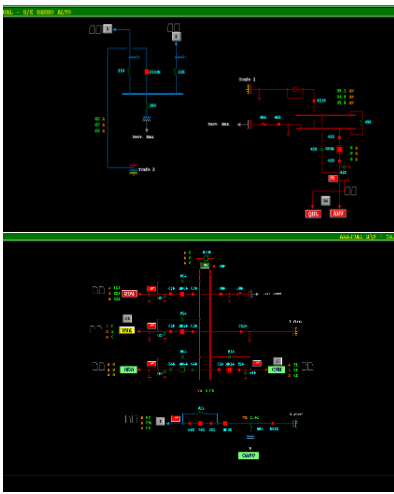
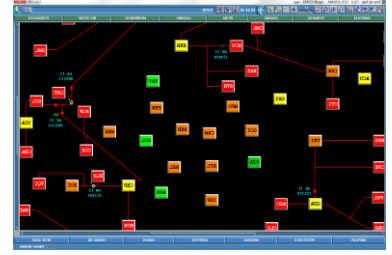
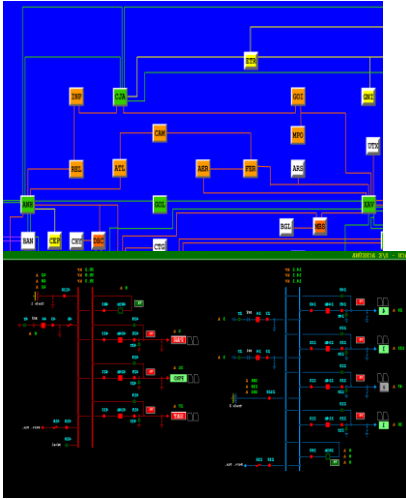

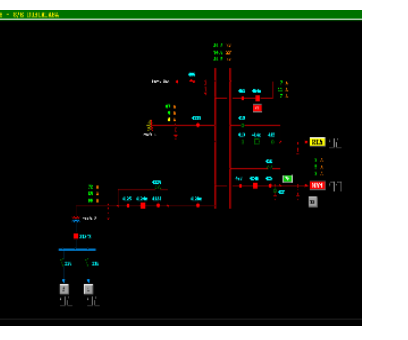
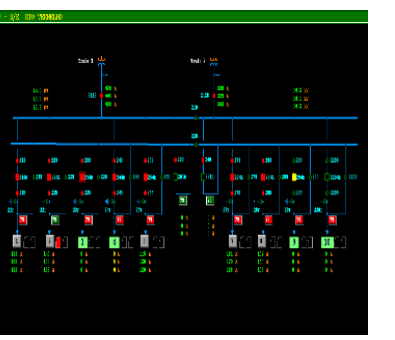
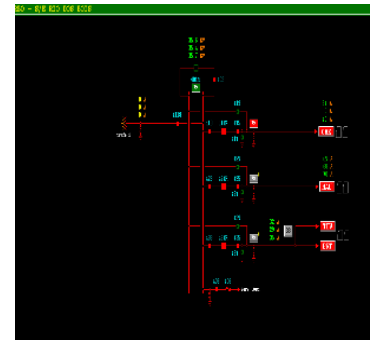
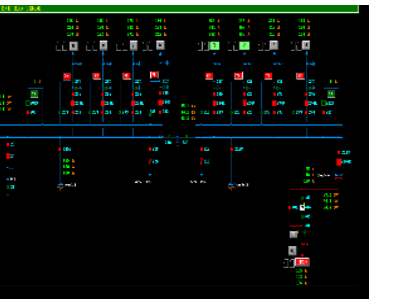
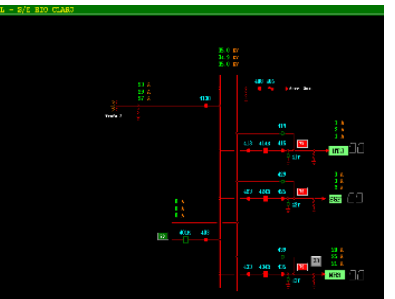
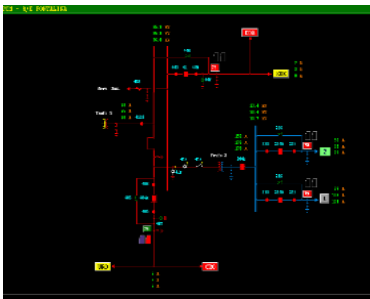
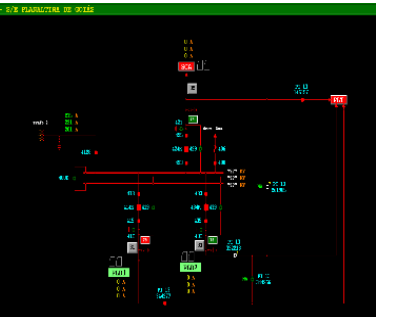
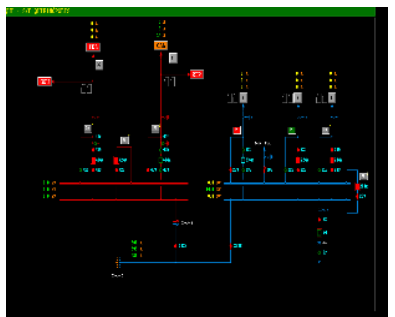
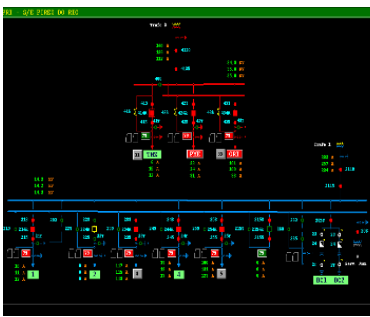
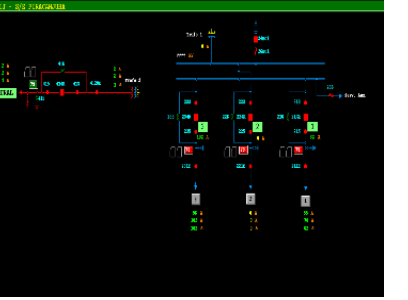
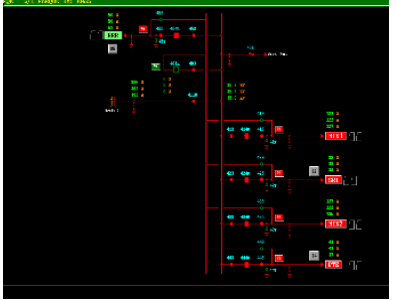
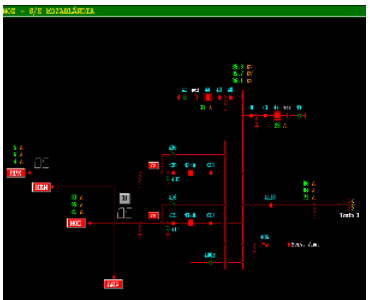
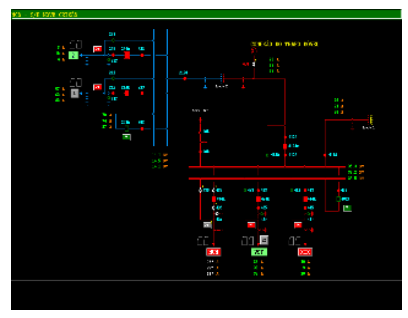
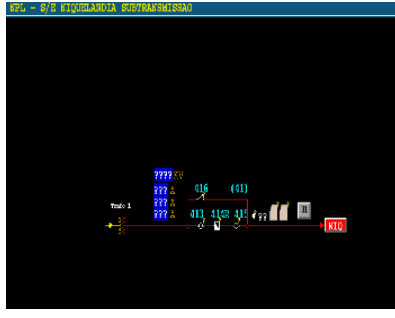

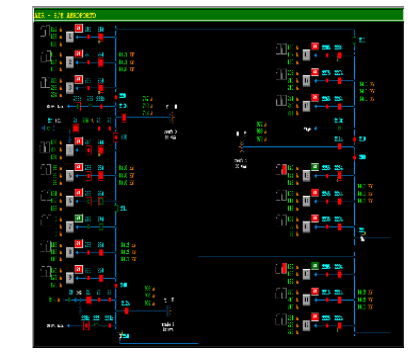
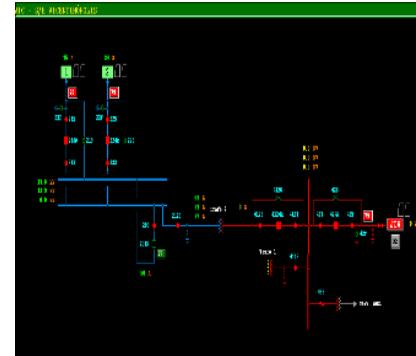
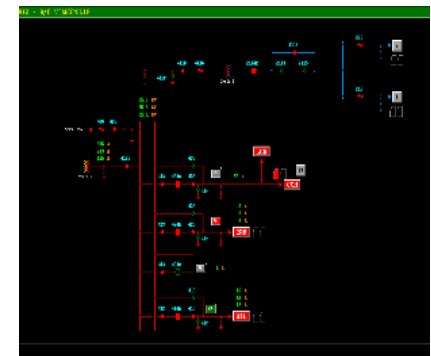
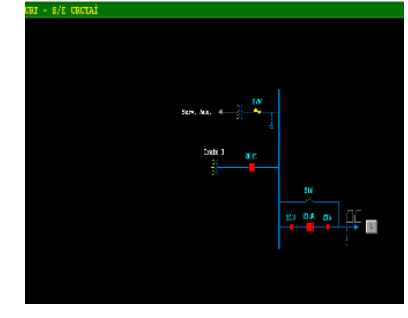
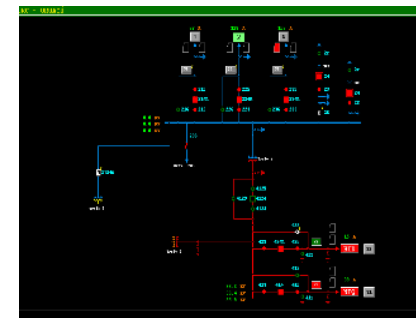
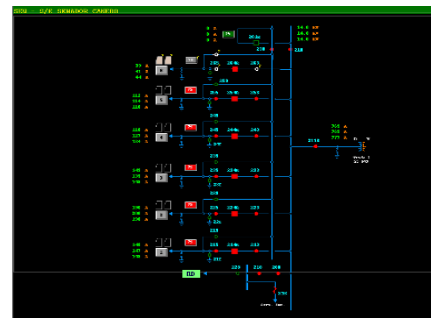
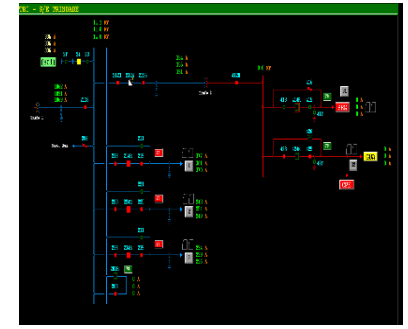
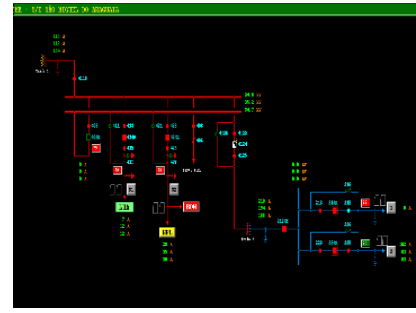
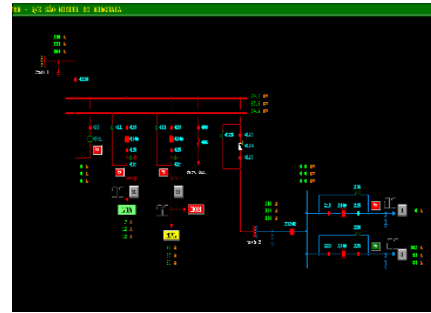
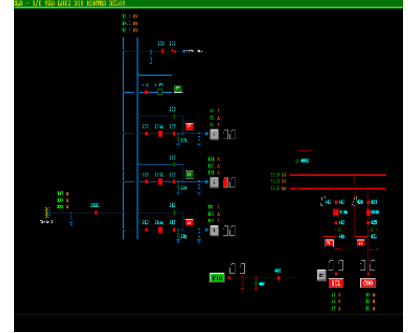
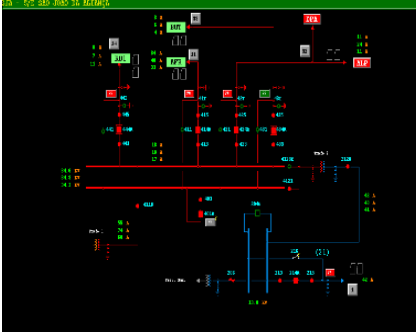
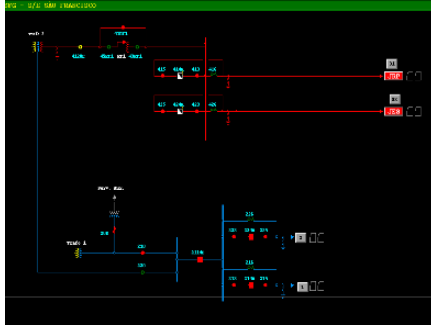
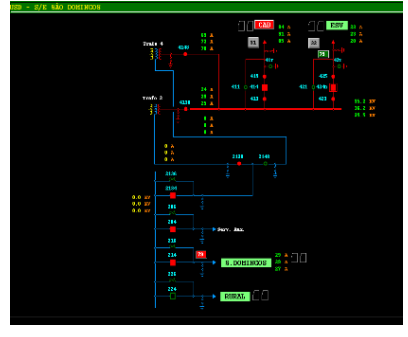
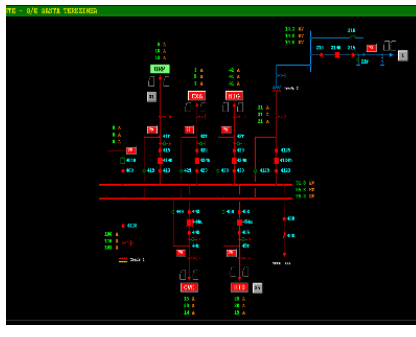
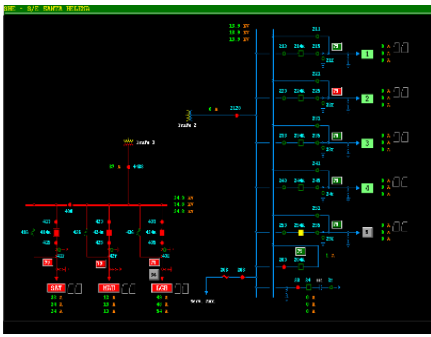

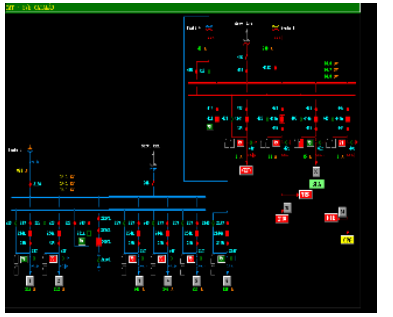
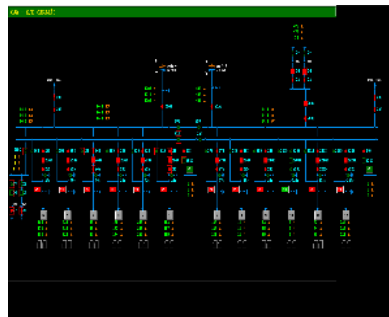
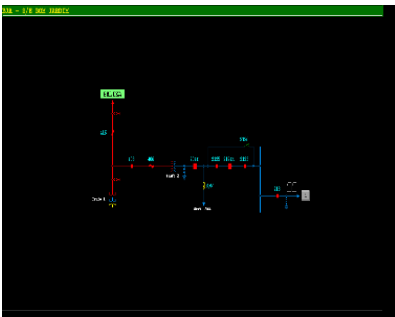
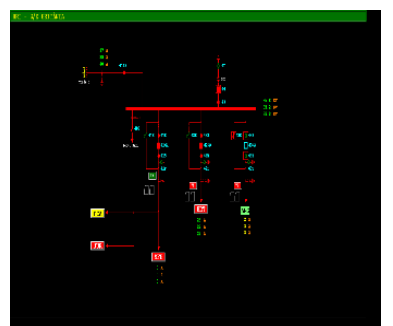
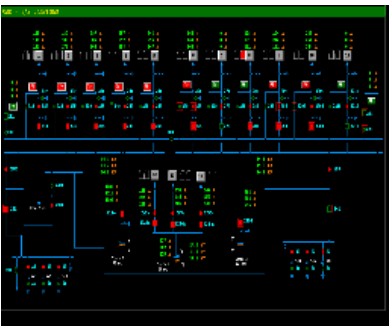
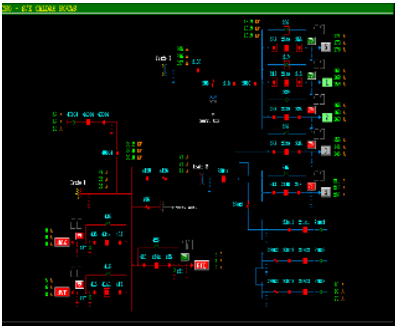
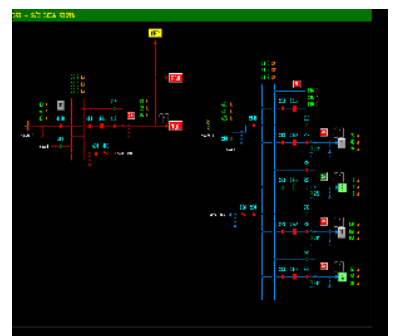
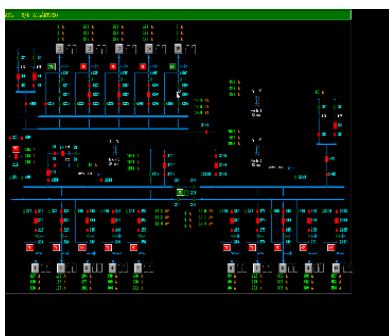
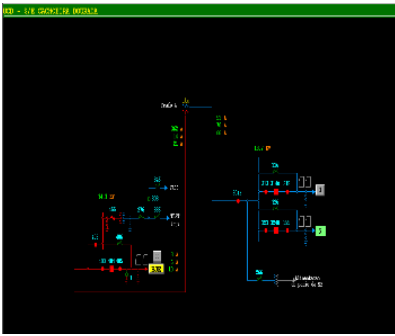
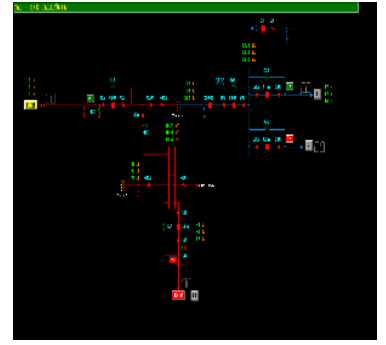
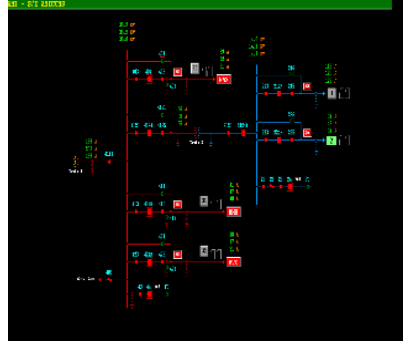
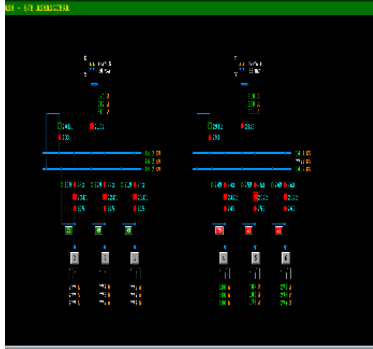
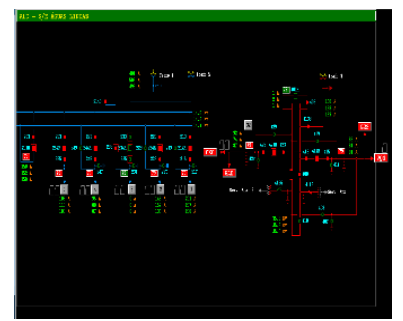
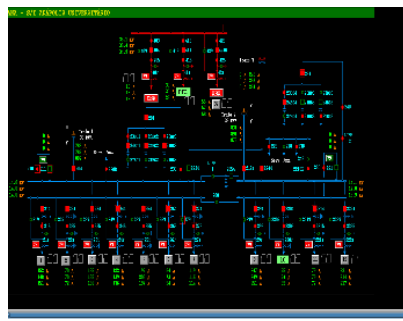
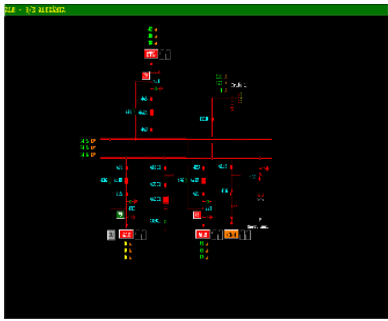

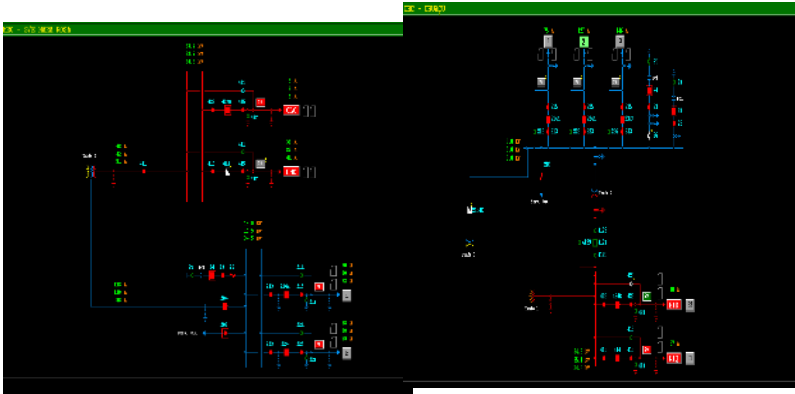
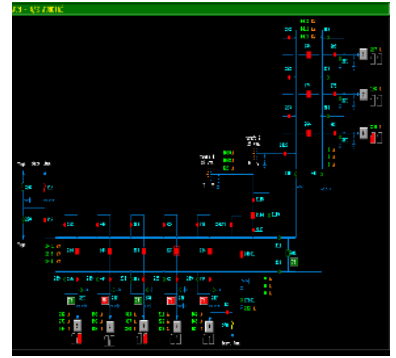
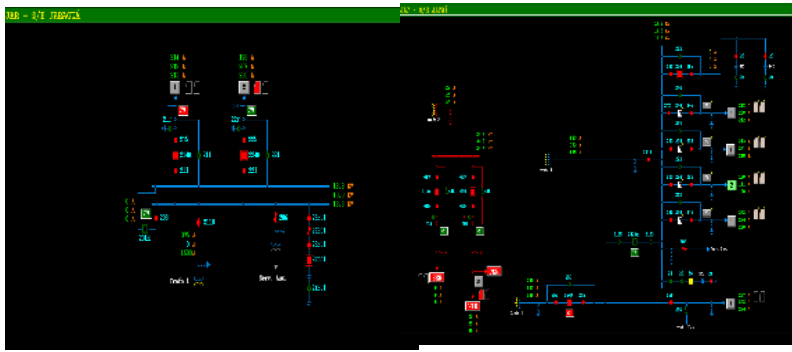

DEMAIS EVIDÊNCIAS

DADOS TÉCNICO - OPERACIONAIS ENEL GO

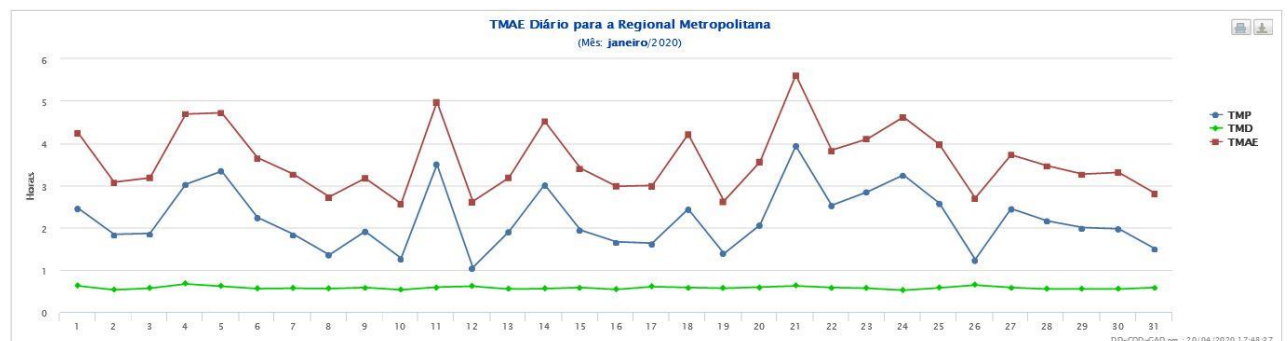
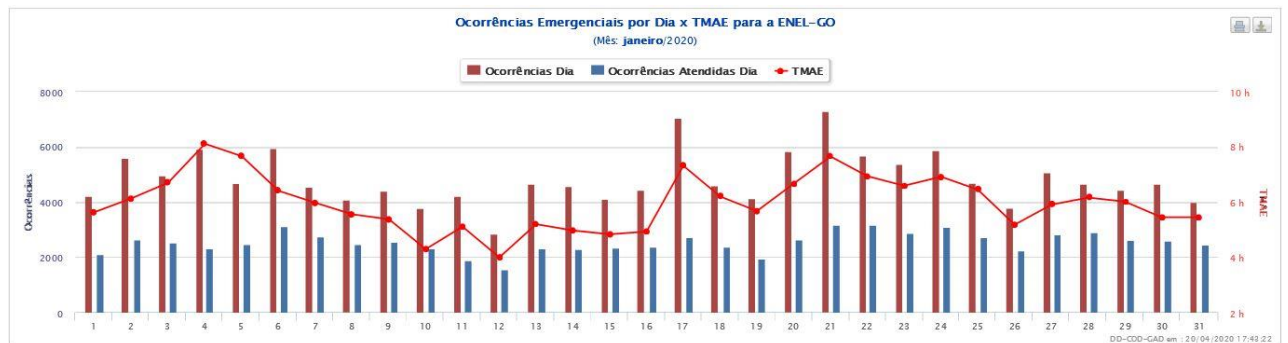

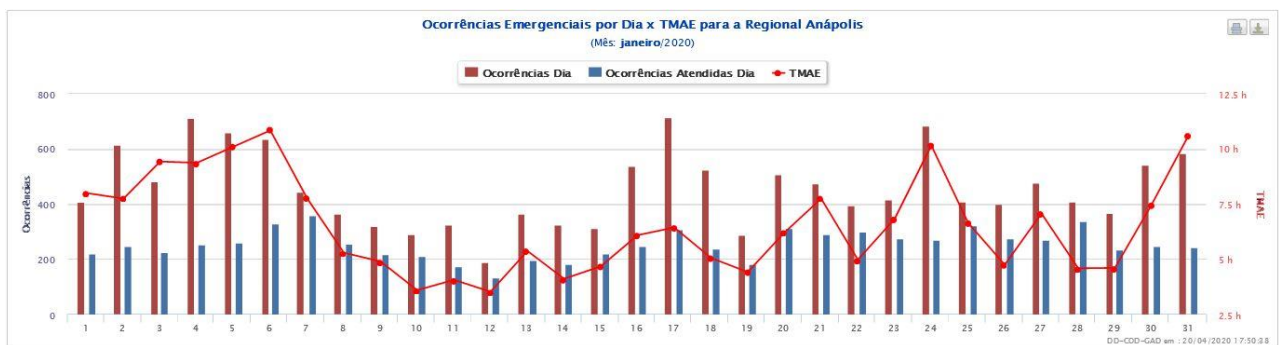
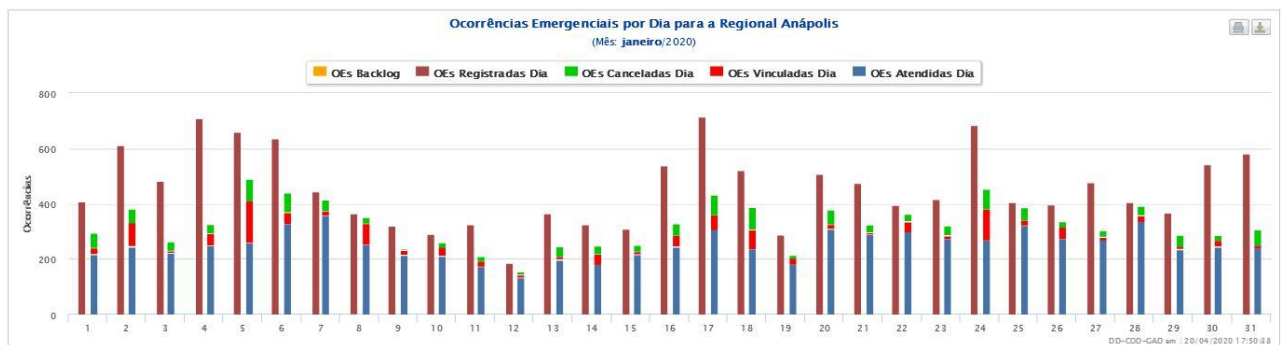
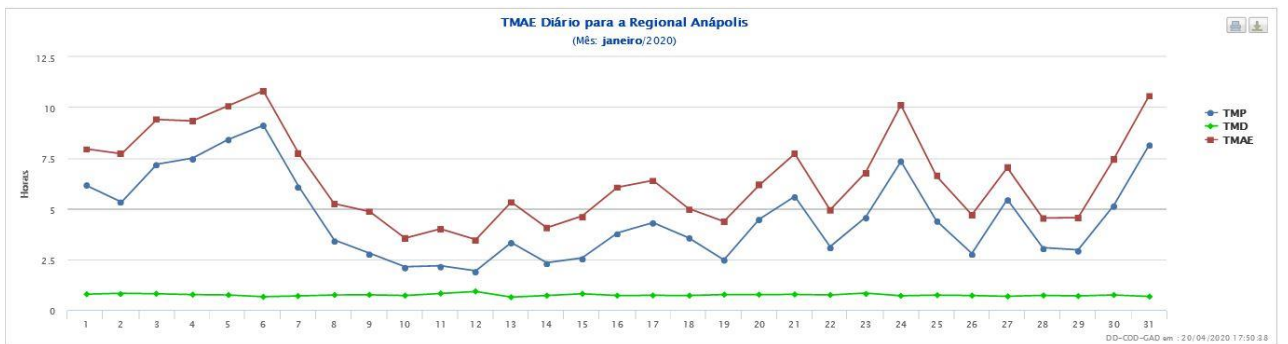
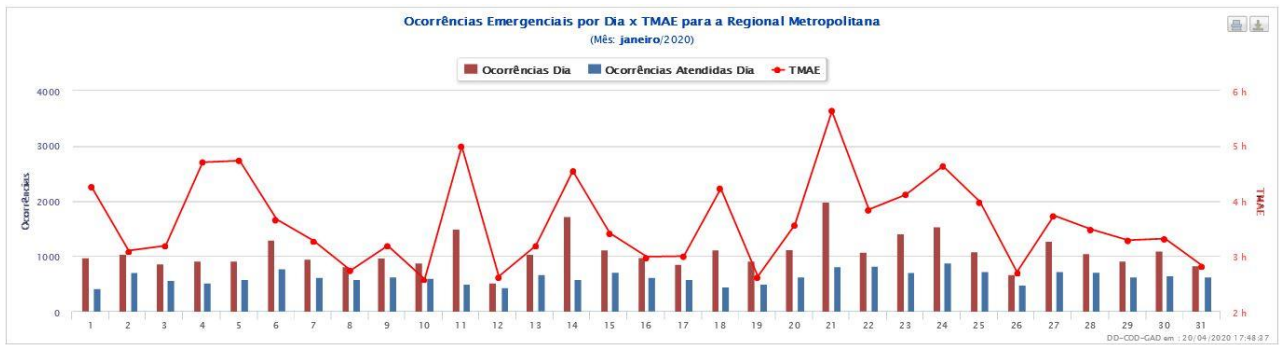

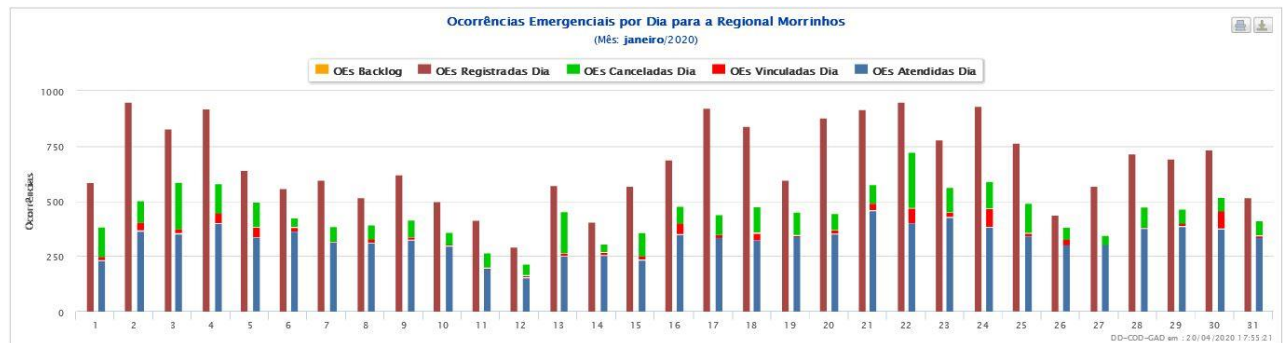
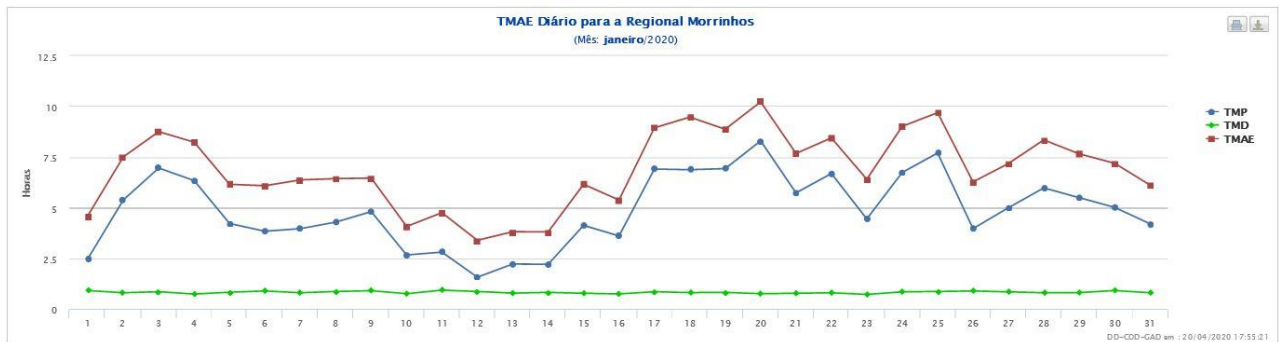
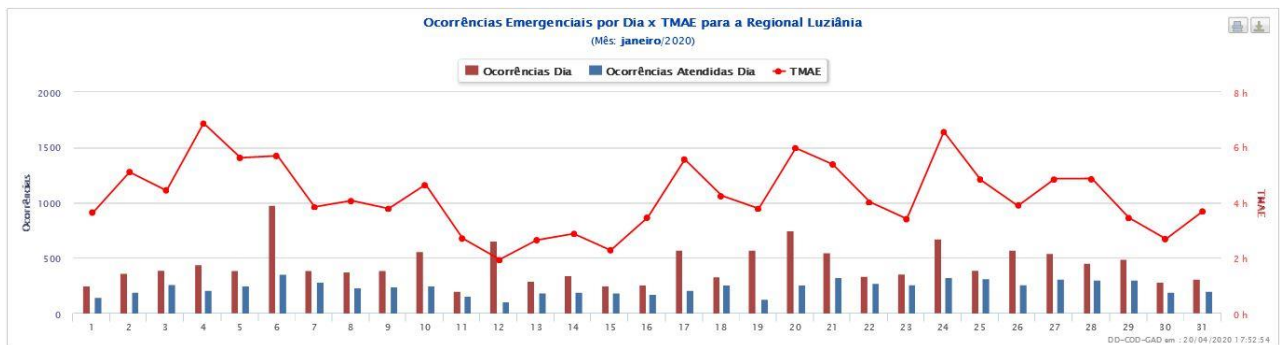
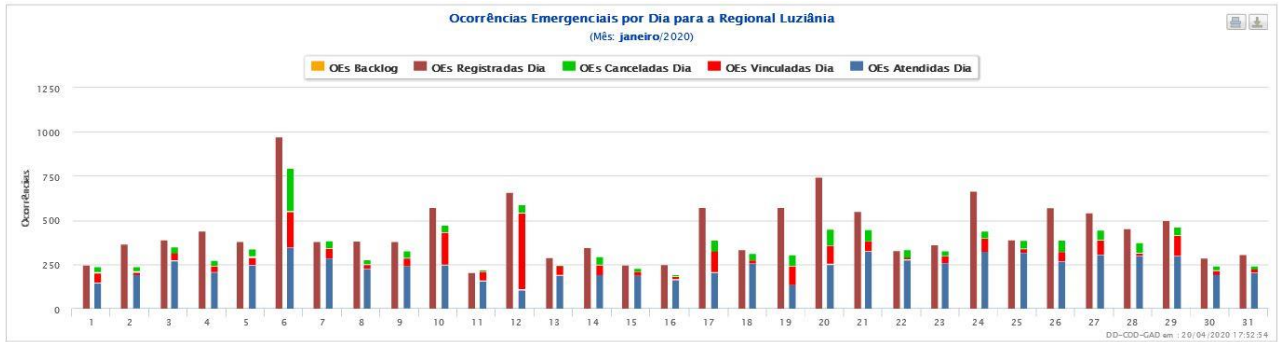
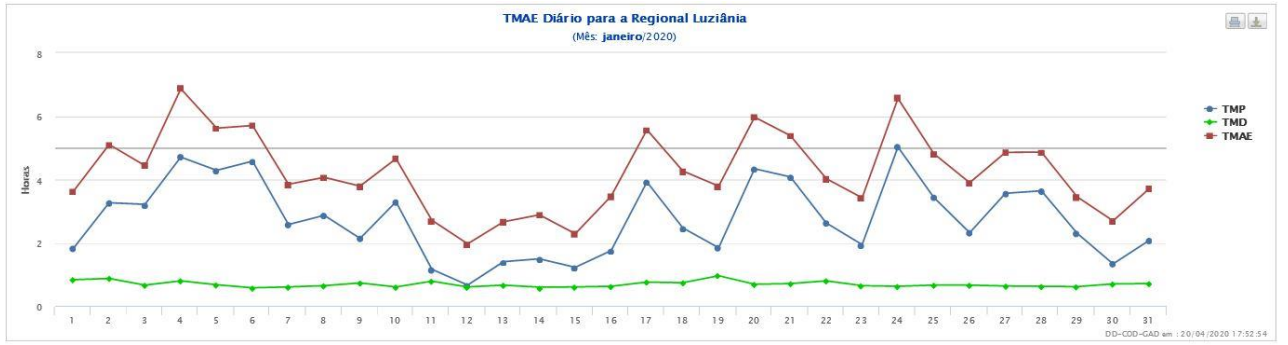

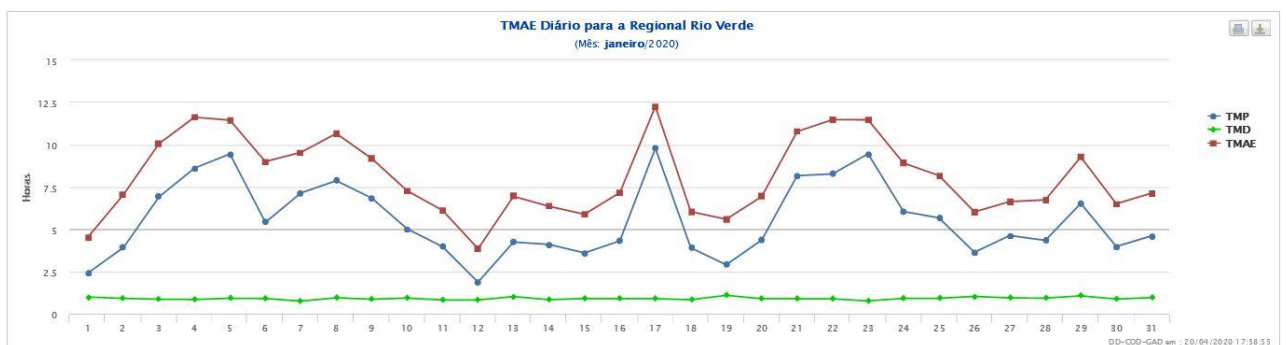
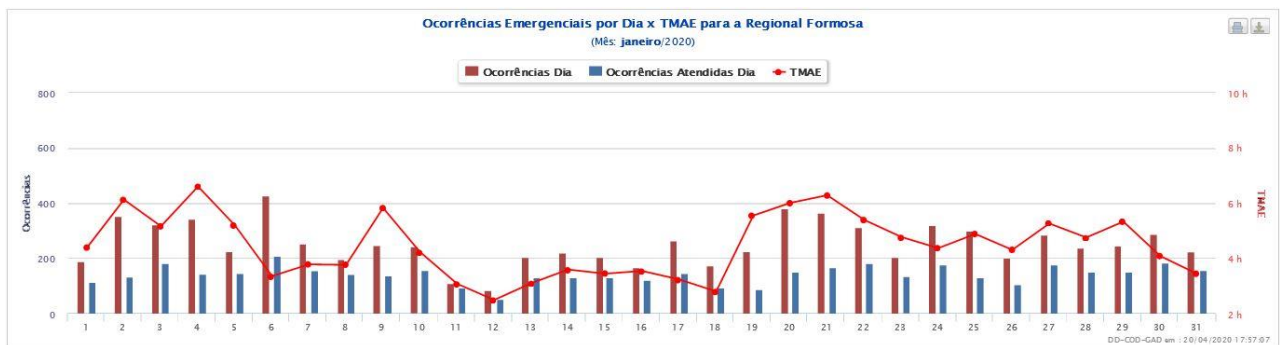
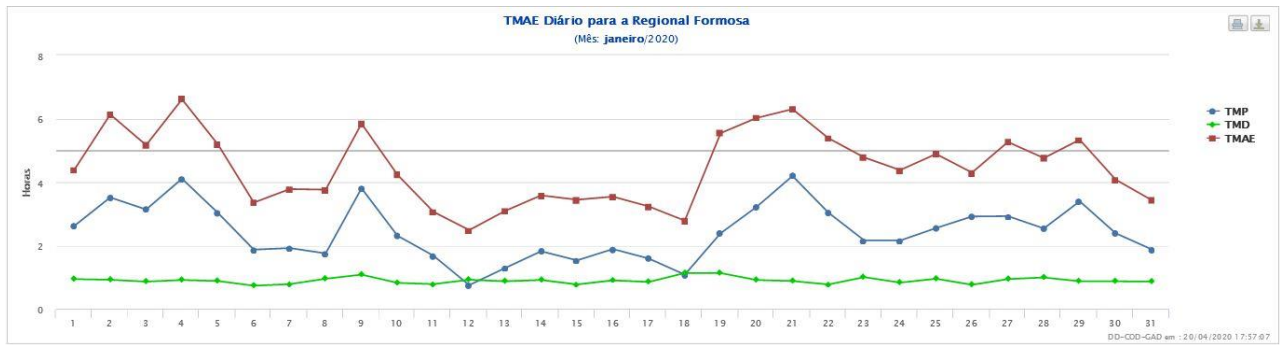
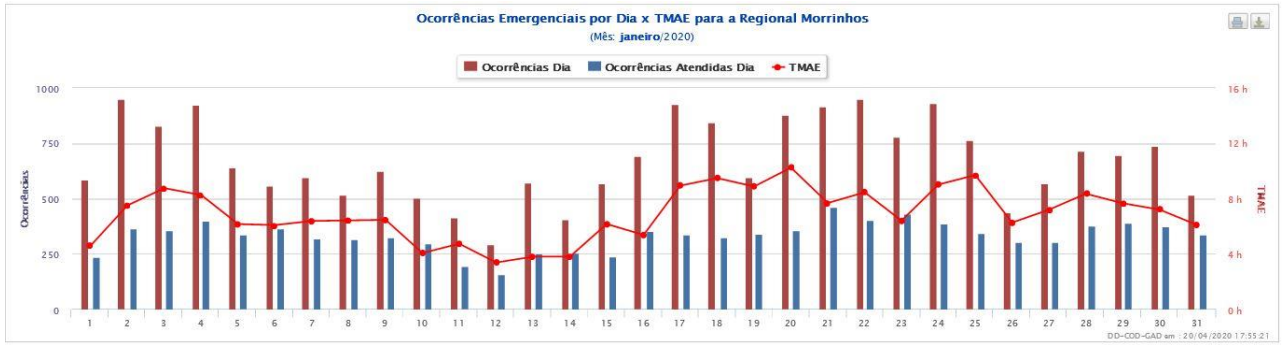

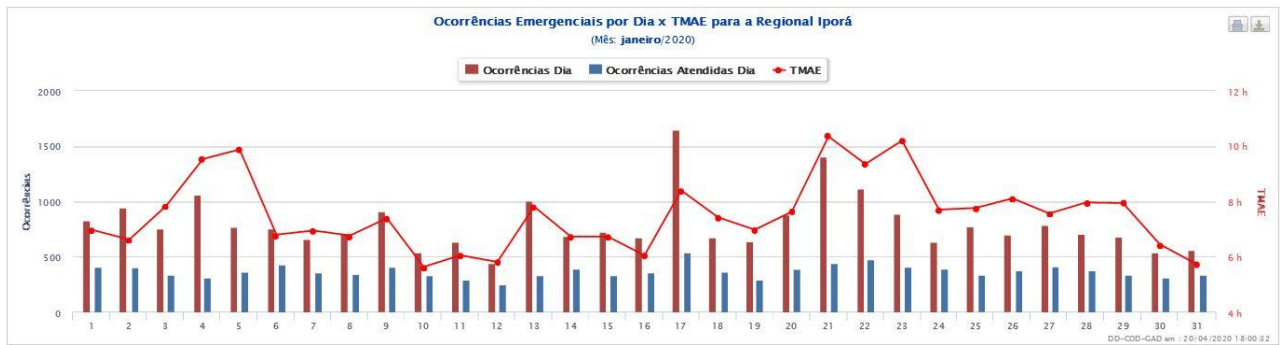
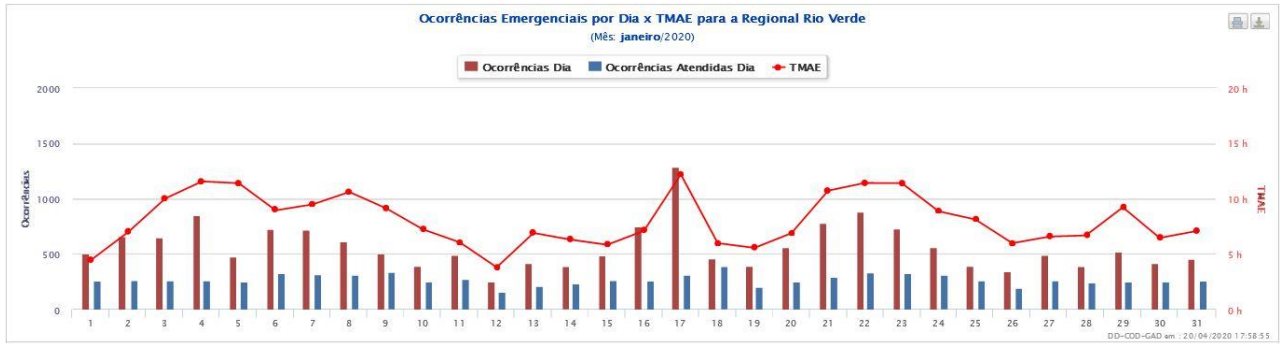

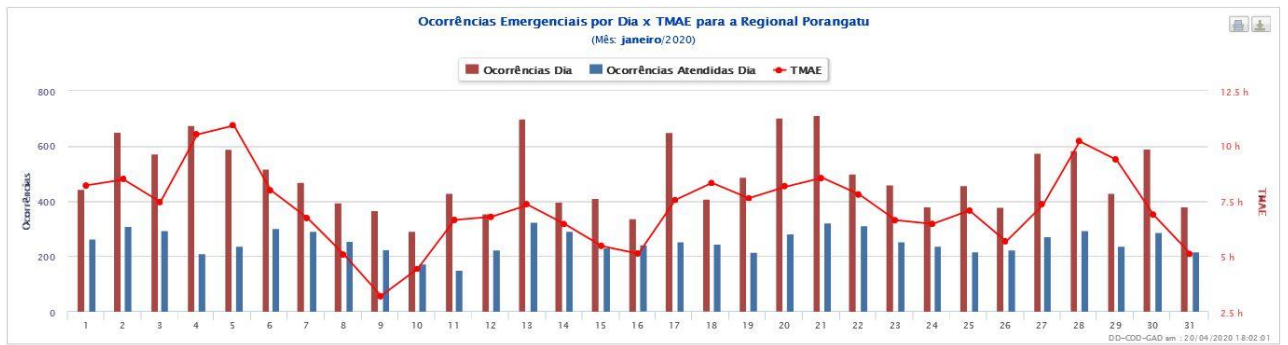
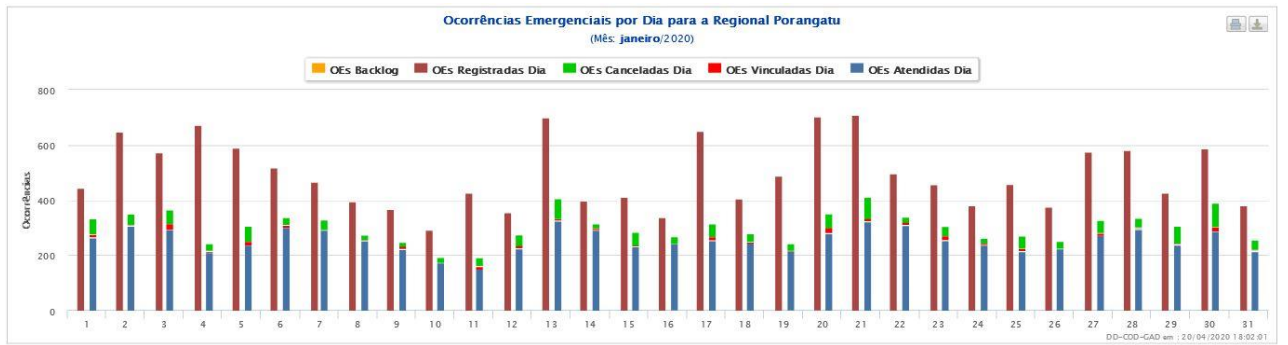
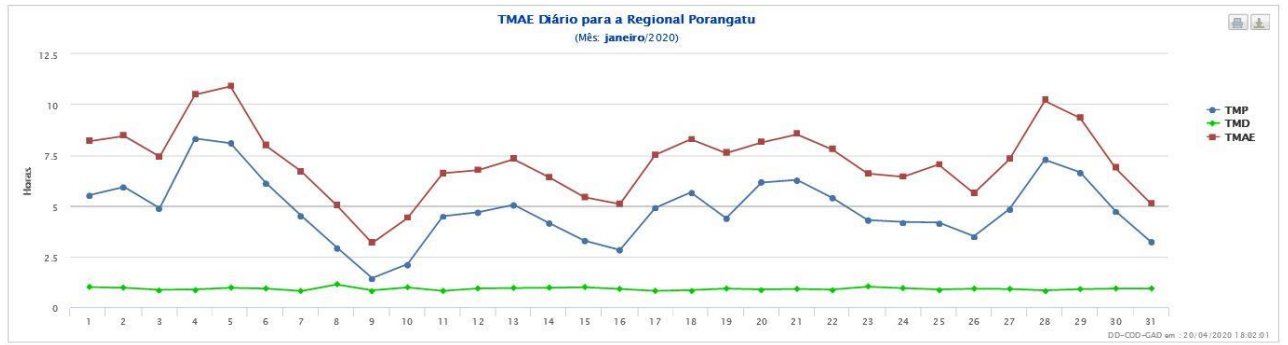

CLIMATEMPO

**Laudo Meteorológico de Evento Climático -
ENEL Goiás - 22 de janeiro de 2020**

São Paulo, SP, Brasil Fevereiro de 2020

Sumário

1	ANÁLISE DE EVENTO METEOROLÓGICO	2
1.1	Descrição do Evento.....	2
1.2	Abrangência do Evento	6
2	CLASSIFICAÇÃO COBRADE	22
3	RESUMO DO EVENTO	23
4	REFERÊNCIAS.....	28

1 Análise de Evento Meteorológico

1.1 Descrição do Evento

Na figura a seguir é apresentada a área de concessão da ENELDISTRIBUIÇÃO GOIÁS, dividida em regiões, a serem analisadas neste relatório.



Figura 1 – Regiões atendidas pela ENEL Goiás.

A passagem de uma frente fria que se deslocou lentamente pela costa do Sudeste favoreceu a formação de áreas de instabilidade sobre o estado de Goiás entre os dias 16 e 18 de janeiro de 2020.

Nas Figuras 2 e 3 são apresentadas as descargas atmosféricas nuvem-solo (raios) e nuvem-nuvem detectadas pelo sistema Earth Networks. Entre as 11h30 do dia 16 e 04h30 do dia 19 de janeiro de 2020 foram registrados 48774 raios nuvem-solo e 74085 descargas nuvem-nuvem sobre a área da ENEL DISTRIBUIÇÃO GOIÁS.

Na tabela 1 são apresentadas as rajadas de vento maiores ou iguais a 50 km/h registradas pelo Instituto Nacional de Meteorologia (INMET) representativas da área de concessão da ENEL Goiás. Como é possível observar, o maior valor registrado foi de 84,2

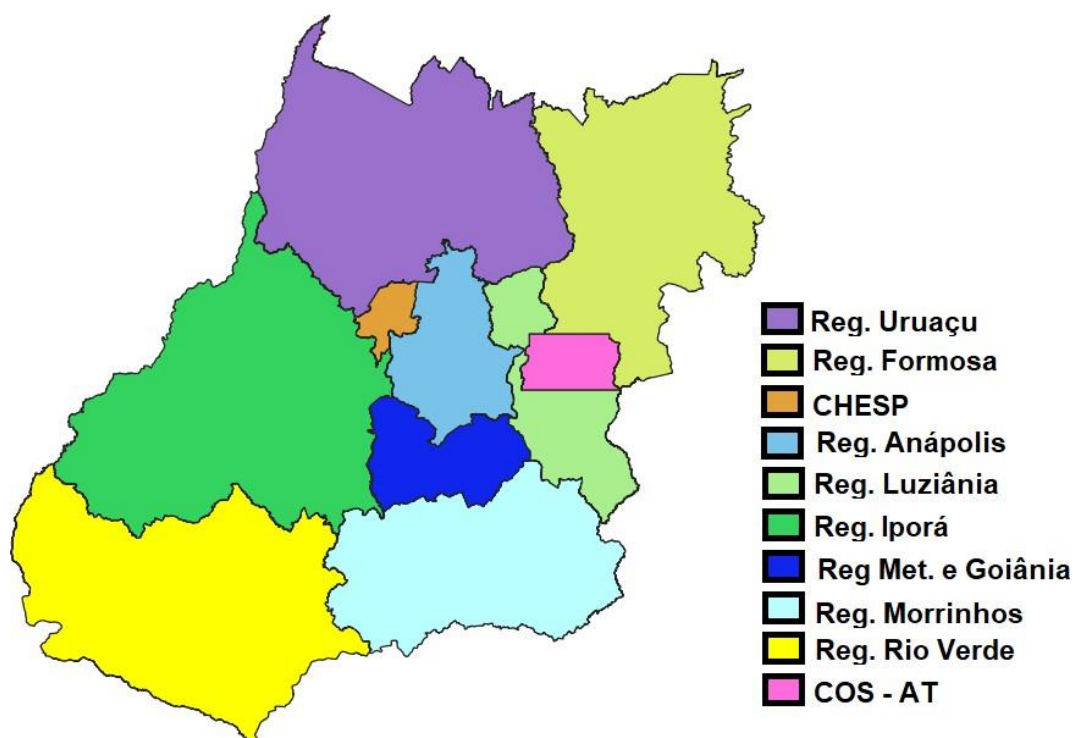
km/h, classificado como ventania forte pela escala Beaufort, na estação de Itumbiara entre as 16h00 e 17h00 do dia 18 de janeiro de 2020.

O INMET também registrou chuva forte na área de interesse (segundo a American Meteorological Society - Sociedade Meteorológica Americana -, chuvas com taxa entre 2,5mm a 7,6 mm por hora são consideradas moderadas e aquelas com taxa superior a 7,6 mm por hora são consideradas chuva forte). Na tabela 2 são apresentados os registros de acumulados horários superiores a 7,6 mm durante o período analisado.

Nas tabelas de 3, 4 e 5 são apresentados os acumulados diários, também registrados pelo INMET, entre os dias 16 e 19 de janeiro de 2020. O maior volume diário registrado foi na estação de Jataí entre as 09h00 do dia 16 e as 09h00 do dia 17 de janeiro, com 64,8 mm acumulados, o que corresponde a aproximadamente 24% da média climatológica para o mês de janeiro na região.



Figura 2 – Descargas atmosféricas nuvem-solo (em preto) detectadas pelo sistema Earth Networks entre 11h30 do dia 16 e 04h30 do dia 19 de janeiro de 2020 sobre a área de concessão da CELG Distribuição.



Figura 3 – Descargas atmosféricas nuvem-nuvem (em vermelho) detectadas pelo sistema Earth Networks entre 11h30 do dia 16 e 04h30 do dia 19 de janeiro de 2020 sobre a área de concessão da CELG Distribuição.

Tabela 1 – Rajadas de vento maiores ou iguais a 50 km/h registradas pelo INMET. Segundo a escala Beaufort, ventos entre 50 e 61 km/h são classificados como vento forte, entre 62 e 74 km/h como ventania e entre 75 e 88 km/h como ventania forte.

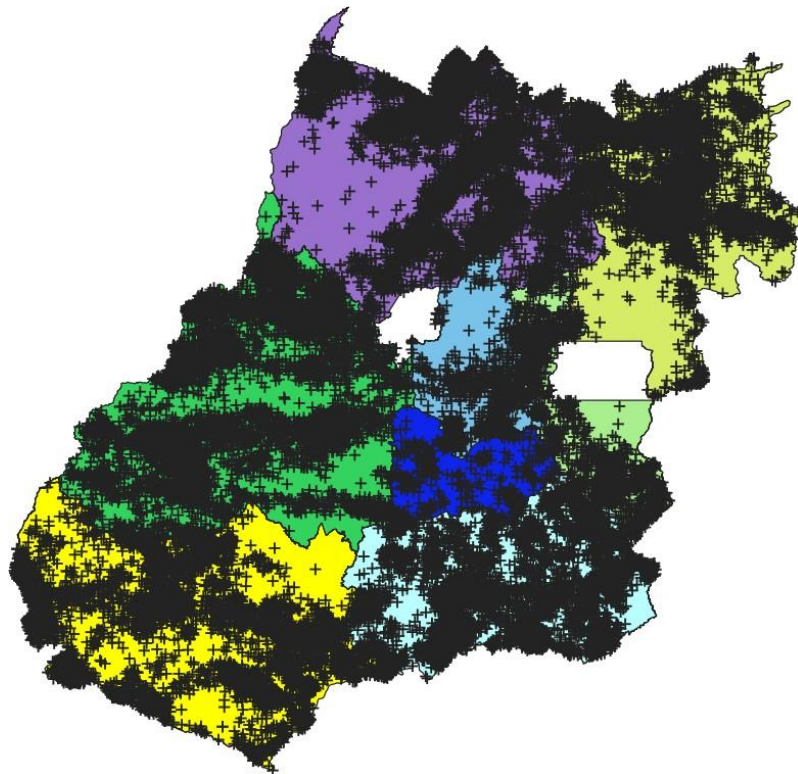
Estação	Horário	Rajada (km/h)
Catalão	Entre 15h e 16h do dia 18/1/2020	62.3
Catalão	Entre 16h e 17h do dia 18/1/2020	62.3
Goiás	Entre 15h e 16h do dia 18/1/2020	57.6
Iporá	Entre 1h e 2h do dia 17/1/2020	59.0
Itumbiara	Entre 16h e 17h do dia 18/1/2020	84.2
Jataí	Entre 15h e 16h do dia 16/1/2020	59.0
Jataí	Entre 16h e 17h do dia 16/1/2020	63.4

Tabela 2 – Acumulado horário de chuva registrado pelo INMET.

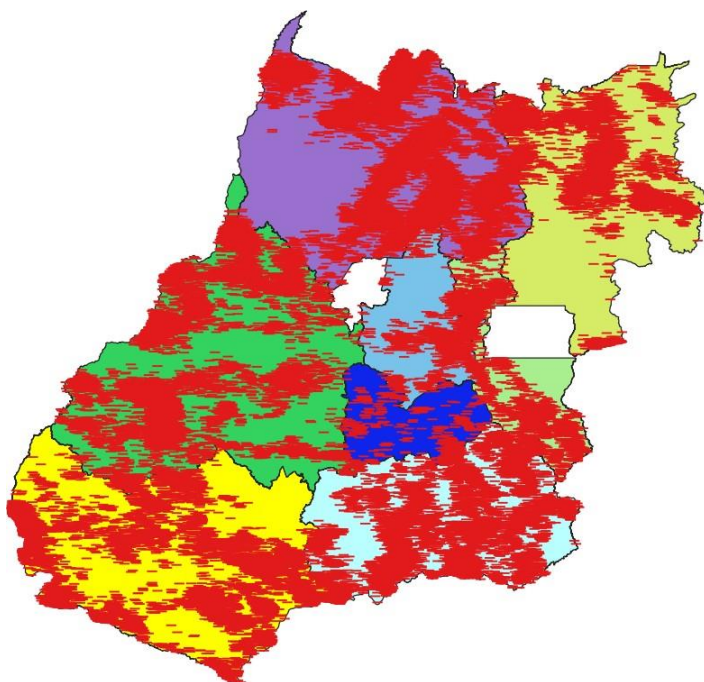
Estação	Horário	Precipitação (mm)
Catalão	Entre 18h e 19h do dia 17/1/2020	19.6
Cristalina	Entre 15h e 16h do dia 16/1/2020	7.8
Goiás	Entre 1h e 2h do dia 17/1/2020	12.6
Goiás	Entre 16h e 17h do dia 18/1/2020	10.6
Iporá	Entre 1h e 2h do dia 17/1/2020	14.4
Itapaci	Entre 8h e 9h do dia 17/1/2020	12
Itumbiara	Entre 16h e 17h do dia 18/1/2020	27.8
Jataí	Entre 16h e 17h do dia 16/1/2020	8
Jataí	Entre 0h e 1h do dia 17/1/2020	9.4
Jataí	Entre 1h e 2h do dia 17/1/2020	10.4
Luziânia	Entre 18h e 19h do dia 17/1/2020	28.2
Luziânia	Entre 19h e 20h do dia 17/1/2020	8.8
Mineiros	Entre 1h e 2h do dia 17/1/2020	14
Morrinhos	Entre 12h e 13h do dia 17/1/2020	9
Morrinhos	Entre 18h e 19h do dia 18/1/2020	26.8
Paraúna	Entre 6h e 7h do dia 17/1/2020	9.6
Pires do Rio	Entre 15h e 16h do dia 17/1/2020	21.4
Pires do Rio	Entre 16h e 17h do dia 17/1/2020	26.6

Tabela 3 – Precipitação acumulada entre 09h do dia 16 e 09h do dia 17 de janeiro de 2020. FONTE: INMET

Estação	Precipitação Acumulada(mm)
JATAÍ	64,8
IPORÁ	38,8
MINEIROS	36,6
GOIÁS	25,4
PIRENOPOLIS	25,2

Tabela 4 – Precipitação acumulada entre 09h do dia 17 e 09h do dia 18 de janeiro de 2020. FONTE: INMET

Estação	Precipitação Acumulada(mm)
PIRES DO RIO	49,8
LUZIANIA	37,8
CATALÃO	31,2
MORRINHOS	25,2

Tabela 5 – Precipitação acumulada entre 09h do dia 18 e 09h do dia 19 de janeiro de 2020. FONTE: INMET

Estação	Precipitação Acumulada(mm)
ITUMBIARA	28,2
MORRINHOS	27,0

1.2 Abrangência do Evento

A seguir são apresentadas as imagens realçadas do satélite GOES-16 entre as 15h00 do dia 16 e 05h00 do dia 19 de janeiro de 2020. Os tons em vermelho e preto indicam a presença de nuvens de grande desenvolvimento vertical, geralmente associadas à ocorrência de tempo severo.

15h00 - 16 de janeiro de 2020



Figura 4 – Imagens realçadas do satélite GOES-16 das 15h00 do dia 16 de janeiro de 2020.
FONTE: Cptec/INPE.

17h00 - 16 de janeiro de 2020

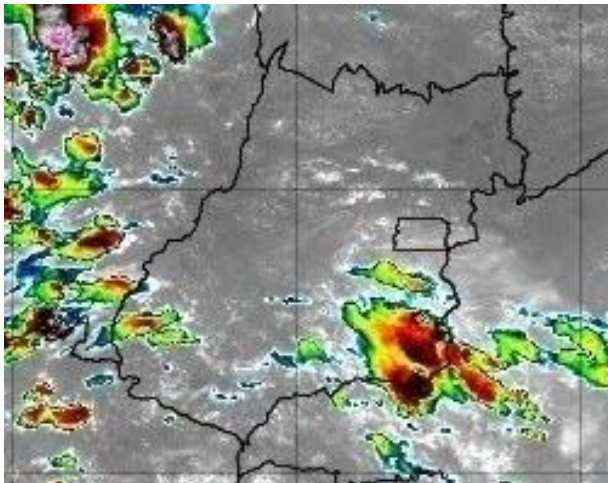

Figura 5 – Imagens realçadas do satélite GOES-16 das 17h00 do dia 16 de janeiro de 2020.
FONTE: Cptec/INPE.

19h00 - 16 de janeiro de 2020



Figura 6 – Imagens realçadas do satélite GOES-16 das 19h00 do dia 16 de janeiro de 2020.
FONTE: Cptec/INPE.

21h00 - 16 de janeiro de 2020



Figura 7 – Imagens realçadas do satélite GOES-16 das 21h00 do dia 16 de janeiro de 2020.
FONTE: Cptec/INPE.

23h00 - 16 de janeiro de 2020

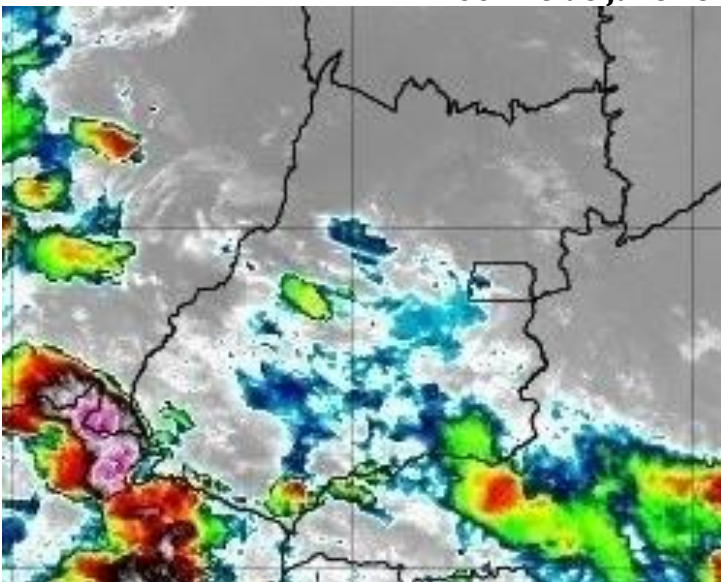

Figura 8 – Imagens realçadas do satélite GOES-16 das 23h00 do dia 16 de janeiro de 2020.
FONTE: Cptec/INPE.

01h00 - 17 de janeiro de 2020

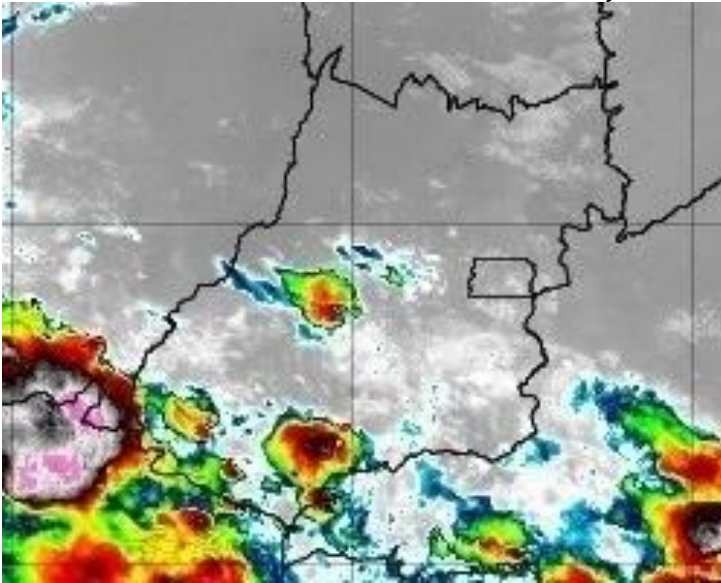

Figura 9 – Imagens realçadas do satélite GOES-16 das 01h00 do dia 17 de janeiro de 2020.
FONTE: Cptec/INPE.

03h00 - 17 de janeiro de 2020

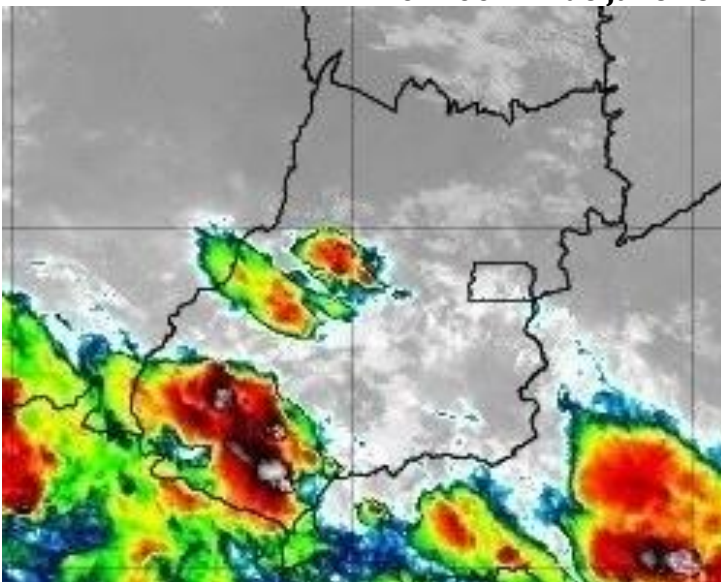

Figura 10 – Imagens realçadas do satélite GOES-16 das 03h00 do dia 17 de janeiro de 2020. FONTE: Cptec/INPE.

05h00 - 17 de janeiro de 2020

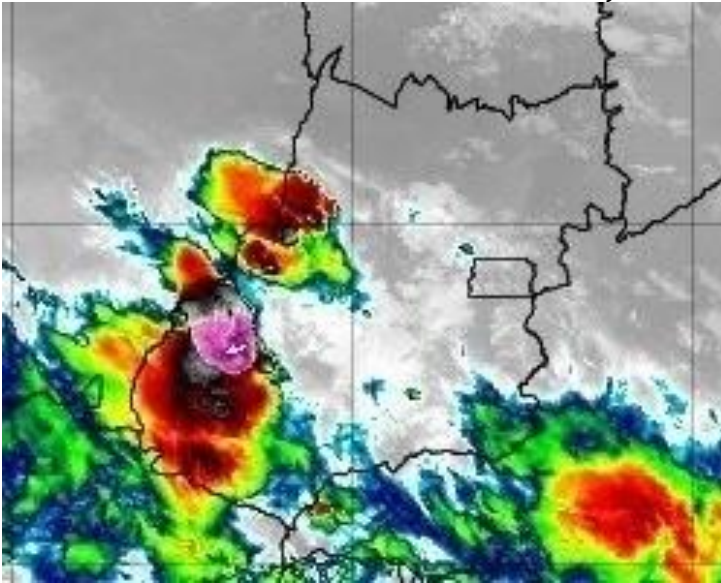

Figura 11 – Imagens realçadas do satélite GOES-16 das 05h00 do dia 17 de janeiro de 2020. FONTE: Cptec/INPE.

07h00 - 17 de janeiro de 2020

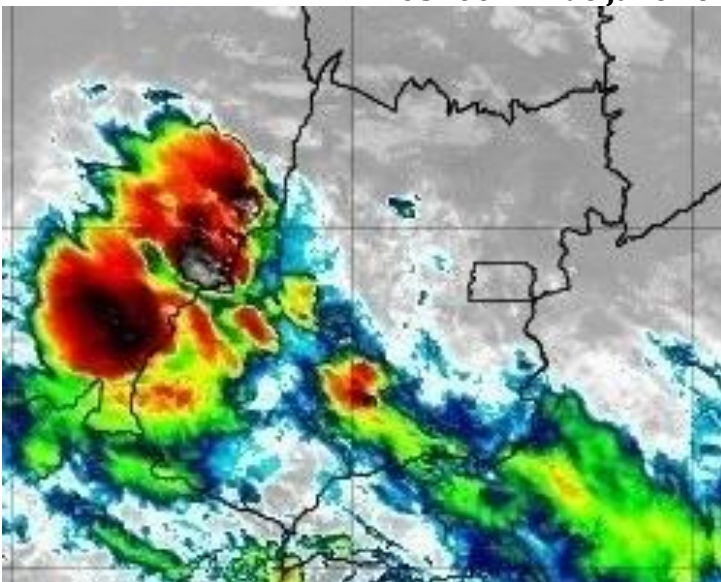

Figura 12 – Imagens realçadas do satélite GOES-16 das 07h00 do dia 17 de janeiro de 2020. FONTE: Cptec/INPE.

09h00 - 17 de janeiro de 2020

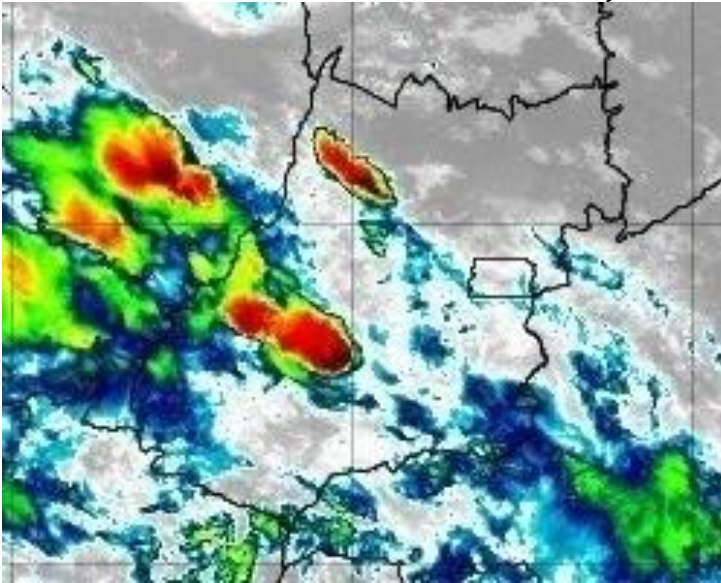

Figura 13 – Imagens realçadas do satélite GOES-16 das 09h00 do dia 17 de janeiro de 2020. FONTE: Cptec/INPE.

11h00 - 17 de janeiro de 2020

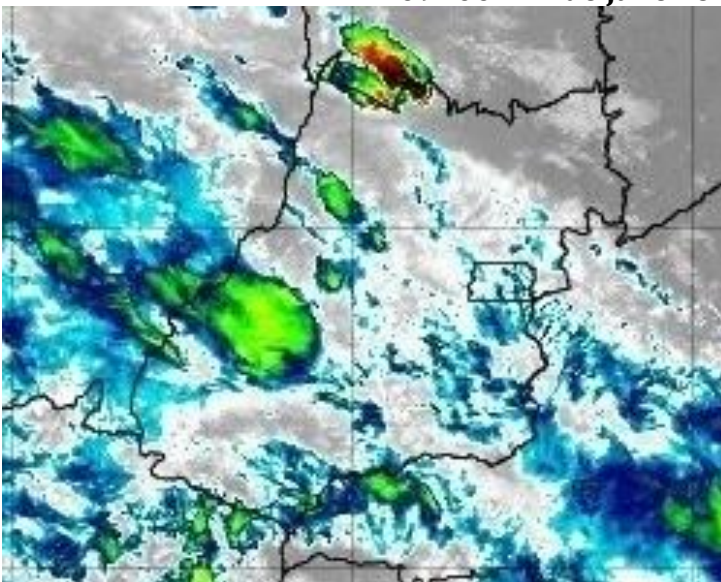

Figura 14 – Imagens realçadas do satélite GOES-16 das 11h00 do dia 17 de janeiro de 2020. FONTE: Cptec/INPE.

13h00 - 17 de janeiro de 2020

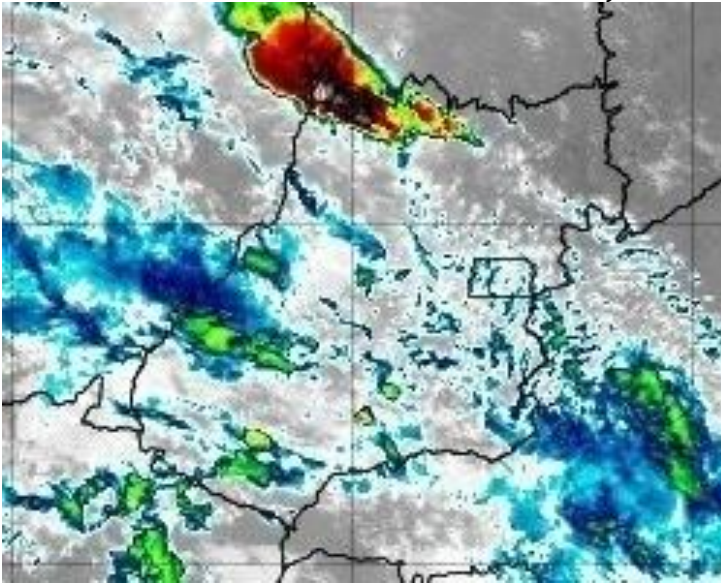

Figura 15 – Imagens realçadas do satélite GOES-16 das 13h00 do dia 17 de janeiro de 2020. FONTE: Cptec/INPE.

15h00 - 17 de janeiro de 2020

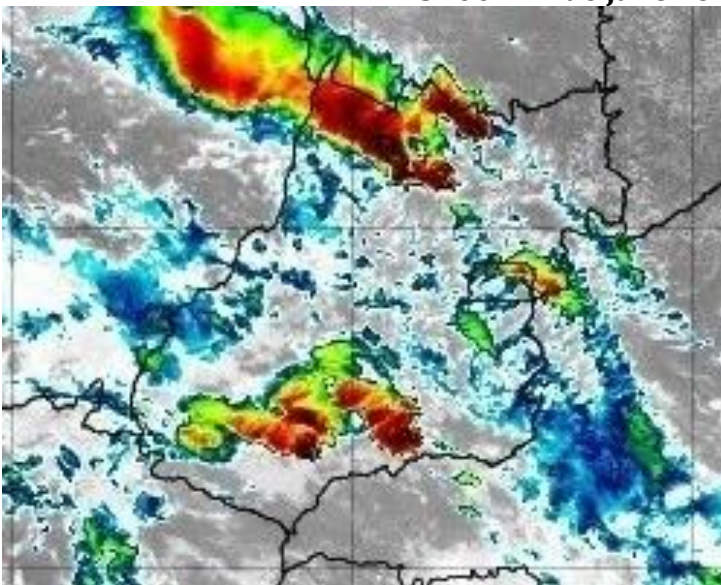

Figura 16 – Imagens realçadas do satélite GOES-16 das 15h00 do dia 17 de janeiro de 2020. FONTE: Cptec/INPE.

17h00 - 17 de janeiro de 2020

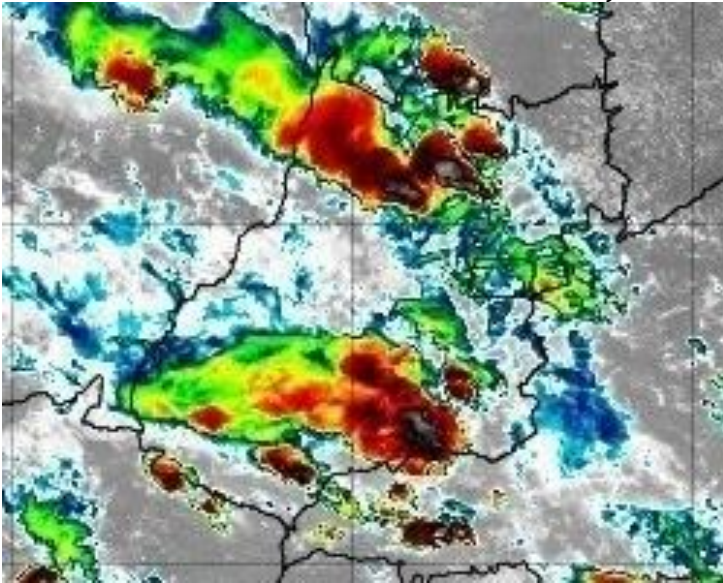

Figura 17 – Imagens realçadas do satélite GOES-16 das 17h00 do dia 17 de janeiro de 2020. FONTE: Cptec/INPE.

19h00 - 17 de janeiro de 2020



Figura 18 – Imagens realçadas do satélite GOES-16 das 19h00 do dia 17 de janeiro de 2020. FONTE: Cptec/INPE.

21h00 - 17 de janeiro de 2020



Figura 19 – Imagens realçadas do satélite GOES-16 das 21h00 do dia 17 de janeiro de 2020. FONTE: Cptec/INPE.

23h00 - 17 de janeiro de 2020

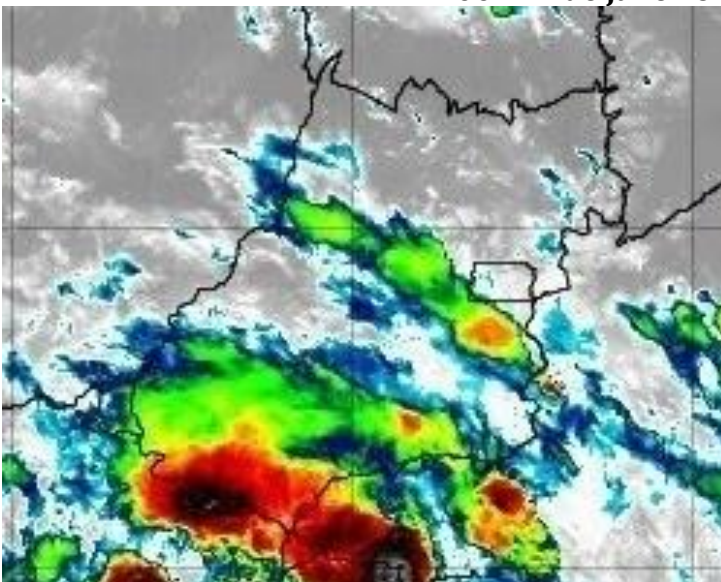

Figura 20 – Imagens realçadas do satélite GOES-16 das 23h00 do dia 17 de janeiro de 2020. FONTE: Cptec/INPE.

01h00 - 18 de janeiro de 2020

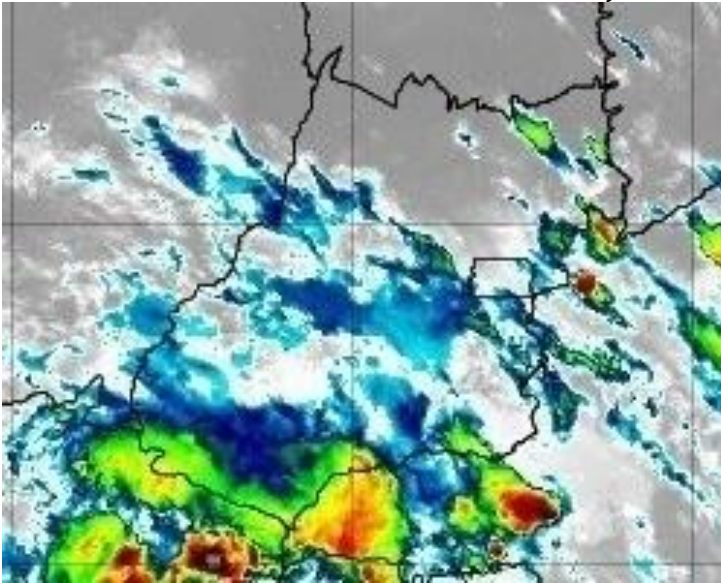

Figura 21 – Imagens realçadas do satélite GOES-16 das 01h00 do dia 18 de janeiro de 2020. FONTE: Cptec/INPE.

03h00 - 18 de janeiro de 2020

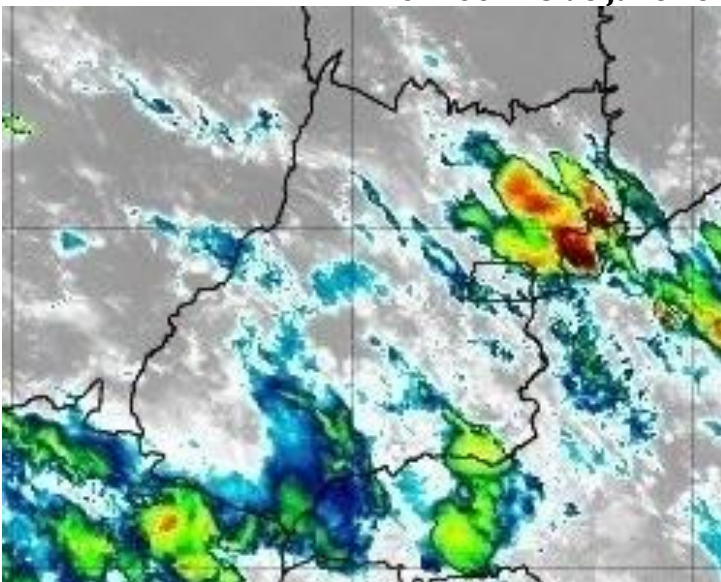

Figura 22 – Imagens realçadas do satélite GOES-16 das 03h00 do dia 18 de janeiro de 2020. FONTE: Cptec/INPE.

05h00 - 18 de janeiro de 2020

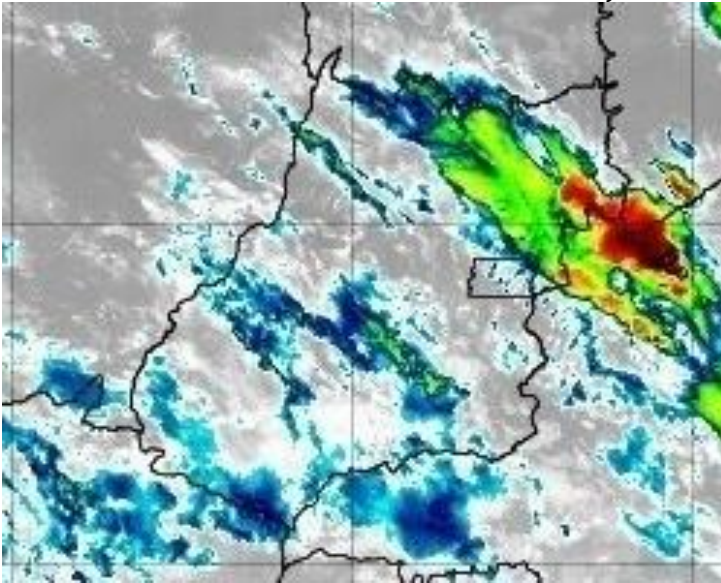

Figura 23 – Imagens realçadas do satélite GOES-16 das 05h00 do dia 18 de janeiro de 2020. FONTE: Cptec/INPE.

07h00 - 18 de janeiro de 2020

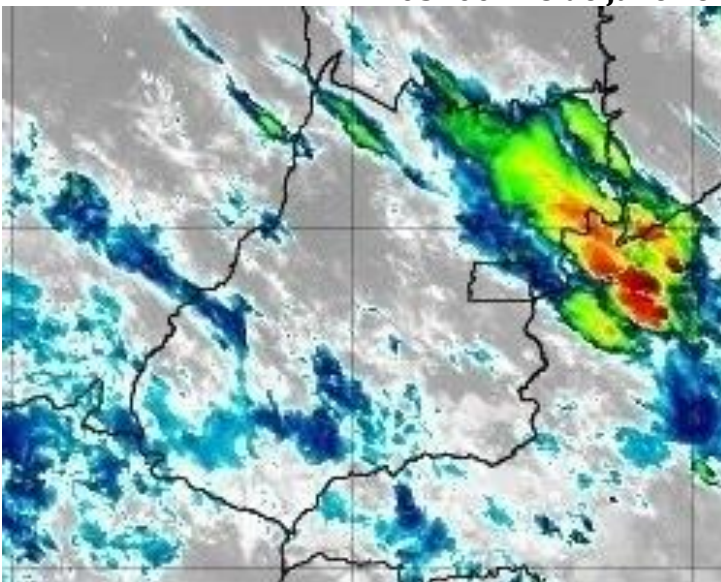

Figura 24 – Imagens realçadas do satélite GOES-16 das 07h00 do dia 18 de janeiro de 2020. FONTE: Cptec/INPE.

09h00 - 18 de janeiro de 2020

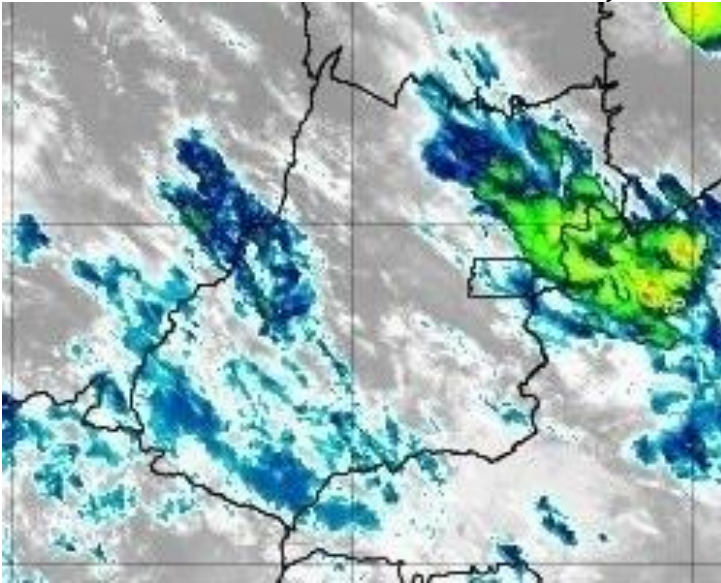

Figura 25 – Imagens realçadas do satélite GOES-16 das 09h00 do dia 18 de janeiro de 2020. FONTE: Cptec/INPE.

11h00 - 18 de janeiro de 2020

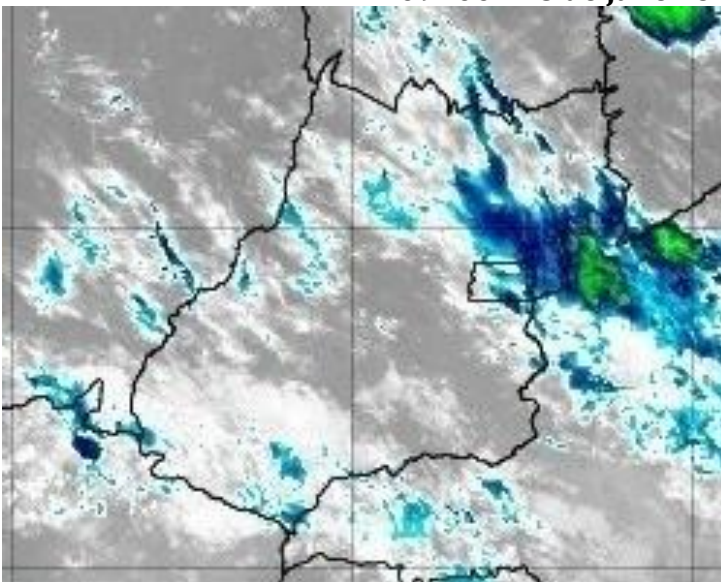

Figura 26 – Imagens realçadas do satélite GOES-16 das 11h00 do dia 18 de janeiro de 2020. FONTE: Cptec/INPE.

13h00 - 18 de janeiro de 2020

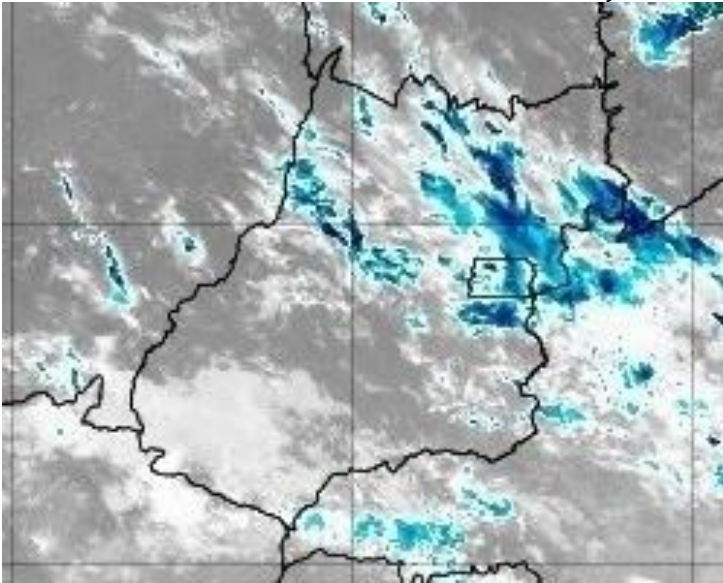

Figura 27 – Imagens realçadas do satélite GOES-16 das 13h00 do dia 18 de janeiro de 2020. FONTE: Cptec/INPE.

15h00 - 18 de janeiro de 2020

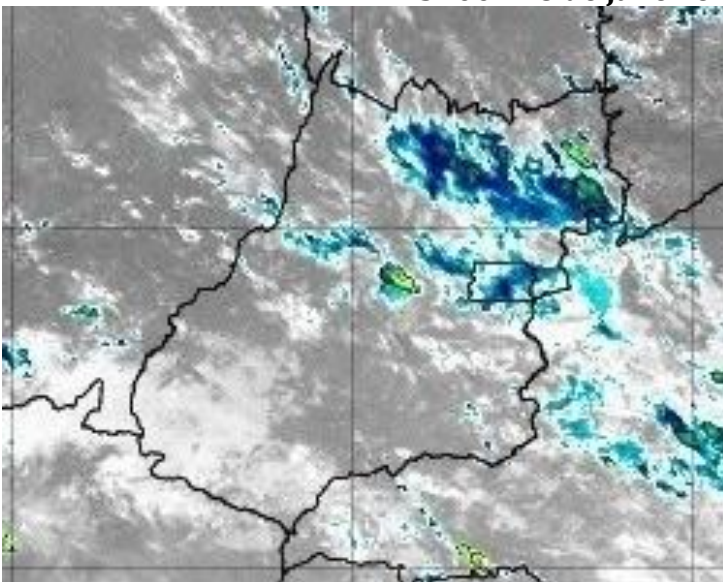

Figura 28 – Imagens realçadas do satélite GOES-16 das 15h00 do dia 18 de janeiro de 2020. FONTE: Cptec/INPE.

17h00 - 18 de janeiro de 2020

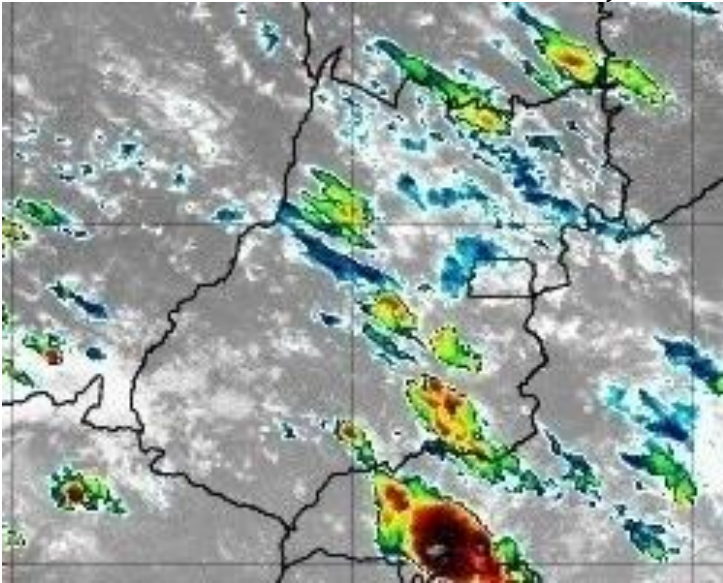

Figura 29 – Imagens realçadas do satélite GOES-16 das 17h00 do dia 18 de janeiro de 2020. FONTE: Cptec/INPE.

19h00 - 18 de janeiro de 2020

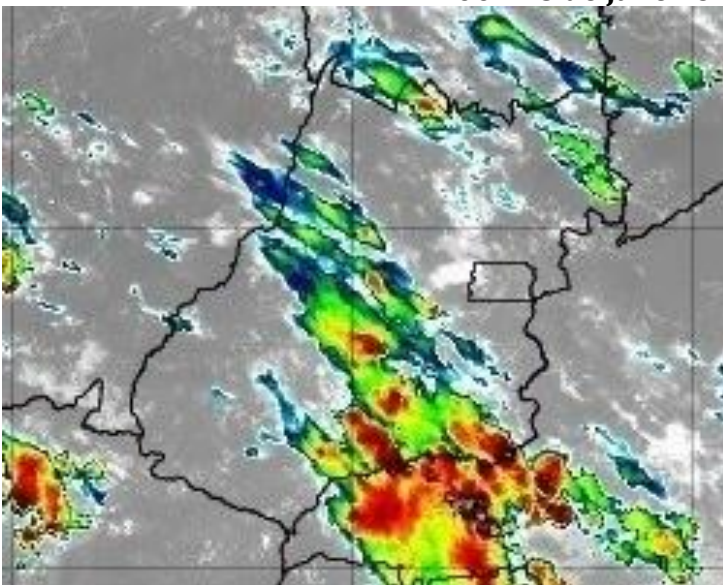

Figura 30 – Imagens realçadas do satélite GOES-16 das 19h00 do dia 18 de janeiro de 2020. FONTE: Cptec/INPE.

23h00 - 18 de janeiro de 2020



Figura 31 – Imagens realçadas do satélite GOES-16 das 23h00 do dia 18 de janeiro de 2020. FONTE: Cptec/INPE.

01h00 - 19 de janeiro de 2020

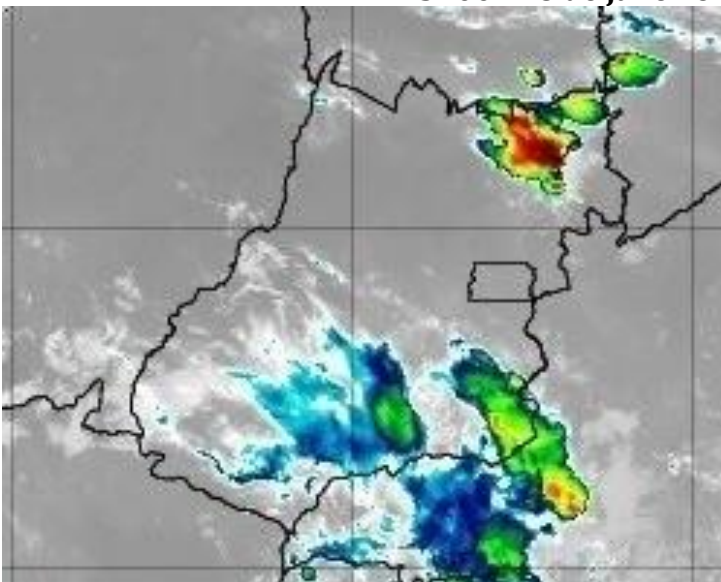

Figura 32 – Imagens realçadas do satélite GOES-16 das 01h00 do dia 19 de janeiro de 2020. FONTE: Cptec/INPE.

03h00 - 19 de janeiro de 2020



Figura 33 – Imagens realçadas do satélite GOES-16 das 03h00 do dia 19 de janeiro de 2020. FONTE: Cptec/INPE.

05h00 - 19 de janeiro de 2020



Figura 34 – Imagens realçadas do satélite GOES-16 das 05h00 do dia 19 de janeiro de 2020. FONTE: Cptec/INPE.

2 Classificação COBRADE

O COBRADE (Classificação e Codificação Brasileira de Desastres) foi criado com o intuito de adequar a classificação brasileira à classificação utilizada pela ONU na classificação de desastres e nivelar o país aos demais organismos de gestão de desastres do mundo.

Baseados nos dados analisados nos itens anteriores, podemos classificar o evento ocorrido na ENEL em Goiás como Vendaval (Código 1.3.2.1.5), Tempestade de raios (Código 1.3.2.1.2) e Chuvas intensas (Código 1.3.2.1.4).

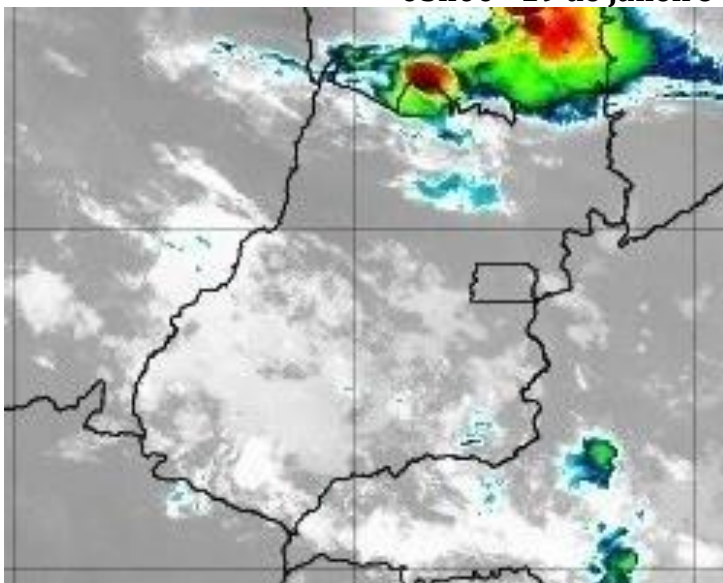
3 Resumo do Evento

Áreas de instabilidade organizadas pela presença de uma frente fria na costa do Brasil atuaram sobre o estado de Goiás entre a manhã do dia 16 e a madrugada do dia 19 de janeiro de 2020.

O sistema de detecção da EarthNetworks registrou 1222859 descargas atmosféricas sobre a área de concessão da ENEL em Goiás entre as 11h30 do dia 16 e as 04h30 do dia 19 de janeiro de 2020.

Rajadas de vento forte, ventania e ventania forte foram registradas pelo INMET durante o evento. A rajada máxima registrada foi de 84,2 km/h na estação de Itumbiara entre as 16h00 e 17h00 do dia 18 de janeiro de 2020.

Entre as 09h00 do dia 16 e as 09h00 do dia 17 de janeiro a estação de Jataí do INMET acumulou aproximadamente 24% da média climatológica para o mês de janeiro na região.

Tabela 6 – Resumo do evento Regional Rio Verde

Número/Código do Evento	
Número/Código do Relatório	
Descrição	Forte deslocamento de uma massa de ar em uma região. Tempestade com intensa atividade elétrica no interior das nuvens, com grande desenvolvimento vertical. Chuvas com acumulados significativos.
Código COBRADE	1.3.2.1.5 - Vendaval e 1.3.2.1.2 - Tempestade de raios e 1.3.2.1.4 - Chuvas intensas
Hora início do evento	12h00 do dia 16 de janeiro de 2020
Hora de fim do evento	18h00 do dia 18 de janeiro de 2020
Abrangência	Regional Rio Verde

Tabela 7 – Resumo do evento Regional Morrinhos

Número/Código do Evento	
Número/Código do Relatório	
Descrição	Forte deslocamento de uma massa de ar em uma região. Tempestade com intensa atividade elétrica no interior das nuvens, com grande desenvolvimento vertical. Chuvas com acumulados significativos.
Código COBRADE	1.3.2.1.5 - Vendaval e 1.3.2.1.2 - Tempestade de raios e 1.3.2.1.4 - Chuvas intensas
Hora início do evento	11h30 do dia 16 de janeiro de 2020
Hora de fim do evento	23h00 do dia 18 de janeiro de 2020
Abrangência	Regional Morrinhos

Tabela 8 – Resumo do evento Regional Metropolitana e Goiânia

Número/Código do Evento	
Número/Código do Relatório	
Descrição	Forte deslocamento de uma massa de ar em uma região. Tempestade com intensa atividade elétrica no interior das nuvens, com grande desenvolvimento vertical. Chuvas com acumulados significativos.
Código COBRADE	1.3.2.1.5 - Vendaval e 1.3.2.1.2 - Tempestade de raios e 1.3.2.1.4 - Chuvas intensas
Hora início do evento	13h30 do dia 16 de janeiro de 2020
Hora de fim do evento	19h00 do dia 18 de janeiro de 2020
Abrangência	Regional Metropolitana e Goiânia

Tabela 9 – Resumo do evento Regional Iporá

Número/Código do Evento	
Número/Código do Relatório	
Descrição	Forte deslocamento de uma massa de ar em uma região. Tempestade com intensa atividade elétrica no interior das nuvens, com grande desenvolvimento vertical. Chuvas com acumulados significativos.
Código COBRADE	1.3.2.1.5 - Vendaval e 1.3.2.1.2 - Tempestade de raios e 1.3.2.1.4 - Chuvas intensas
Hora início do evento	11h30 do dia 16 de janeiro de 2020
Hora de fim do evento	19h00 do dia 18 de janeiro de 2020
Abrangência	Regional Iporá

Tabela 10 – Resumo do evento Regional Luziânia

Número/Código do Evento	
Número/Código do Relatório	
Descrição	Forte deslocamento de uma massa de ar em uma região. Tempestade com intensa atividade elétrica no interior das nuvens, com grande desenvolvimento vertical. Chuvas com acumulados significativos.
Código COBRADE	1.3.2.1.5 - Vendaval e 1.3.2.1.2 - Tempestade de raios e 1.3.2.1.4 - Chuvas intensas
Hora início do evento	12h30 do dia 16 de janeiro de 2020
Hora de fim do evento	02h00 do dia 19 de janeiro de 2020
Abrangência	Regional Luziânia

Tabela 11 – Resumo do evento Regional Anápolis

Número/Código do Evento	
Número/Código do Relatório	
Descrição	Forte deslocamento de uma massa de ar em uma região. Tempestade com intensa atividade elétrica no interior das nuvens, com grande desenvolvimento vertical. Chuvas com acumulados significativos.
Código COBRADE	1.3.2.1.5 - Vendaval e 1.3.2.1.2 - Tempestade de raios e 1.3.2.1.4 - Chuvas intensas
Hora início do evento	15h30 do dia 16 de janeiro de 2020
Hora de fim do evento	18h00 do dia 18 de janeiro de 2020
Abrangência	Regional Anápolis

Tabela 12 – Resumo do evento Regional Uruaçu

Número/Código do Evento	
Número/Código do Relatório	
Descrição	Forte deslocamento de uma massa de ar em uma região. Tempestade com intensa atividade elétrica no interior das nuvens, com grande desenvolvimento vertical. Chuvas com acumulados significativos.
Código COBRADE	1.3.2.1.5 - Vendaval e 1.3.2.1.2 - Tempestade de raios e 1.3.2.1.4 - Chuvas intensas
Hora início do evento	01h30 do dia 17 de janeiro de 2020
Hora de fim do evento	18h00 do dia 18 de janeiro de 2020
Abrangência	Regional Uruaçu

Tabela 13 – Resumo do evento Regional Formosa

Número/Código do Evento	
Número/Código do Relatório	
Descrição	Forte deslocamento de uma massa de ar em uma região. Tempestade com intensa atividade elétrica no interior das nuvens, com grande desenvolvimento vertical. Chuvas com acumulados significativos.
Código COBRADE	1.3.2.1.5 - Vendaal e 1.3.2.1.2 - Tempestade de raios e 1.3.2.1.4 - Chuvas intensas
Hora início do evento	18h00 do dia 16 de janeiro de 2020
Hora de fim do evento	04h30 do dia 19 de janeiro de 2020
Abrangência	Regional Formosa

4 Referências

- RMetS Royal Meteorological Society – Beaufort Scale - <https://www.rmets.org/weather-and-climate/observing/beaufort-scale>
- Instituto Nacional de Meteorologia (INMET) - <http://www.inmet.gov.br>
- Cptec/INPE- <https://www.cptec.inpe.br/>
- Centro de Hidrografia da Marinha do Brasil - <https://www.marinha.mil.br/chm/>
- Meteorology Glossary - American Meteorological Society - <http://glossary.ametsoc.org/>

Anexos

A.1 Carta Sinótica



Figura A1 - Carta sinótica para as 1200Z do dia 16 de janeiro de 2020 (09h00 do dia 16 de janeiro de 2020 hora local. FONTE: Marinha do Brasil).



LEGENDA			
	Frente Fria	A	Alta Pressão
	Frente Quente	B	Baixa Pressão
	Instabilidade		Zona de Convergência

Figura A2 - Carta sinótica para as 1200Z do dia 17 de janeiro de 2020 (09h00 do dia 17 de janeiro de 2020 hora local). FONTE: Marinha do Brasil).

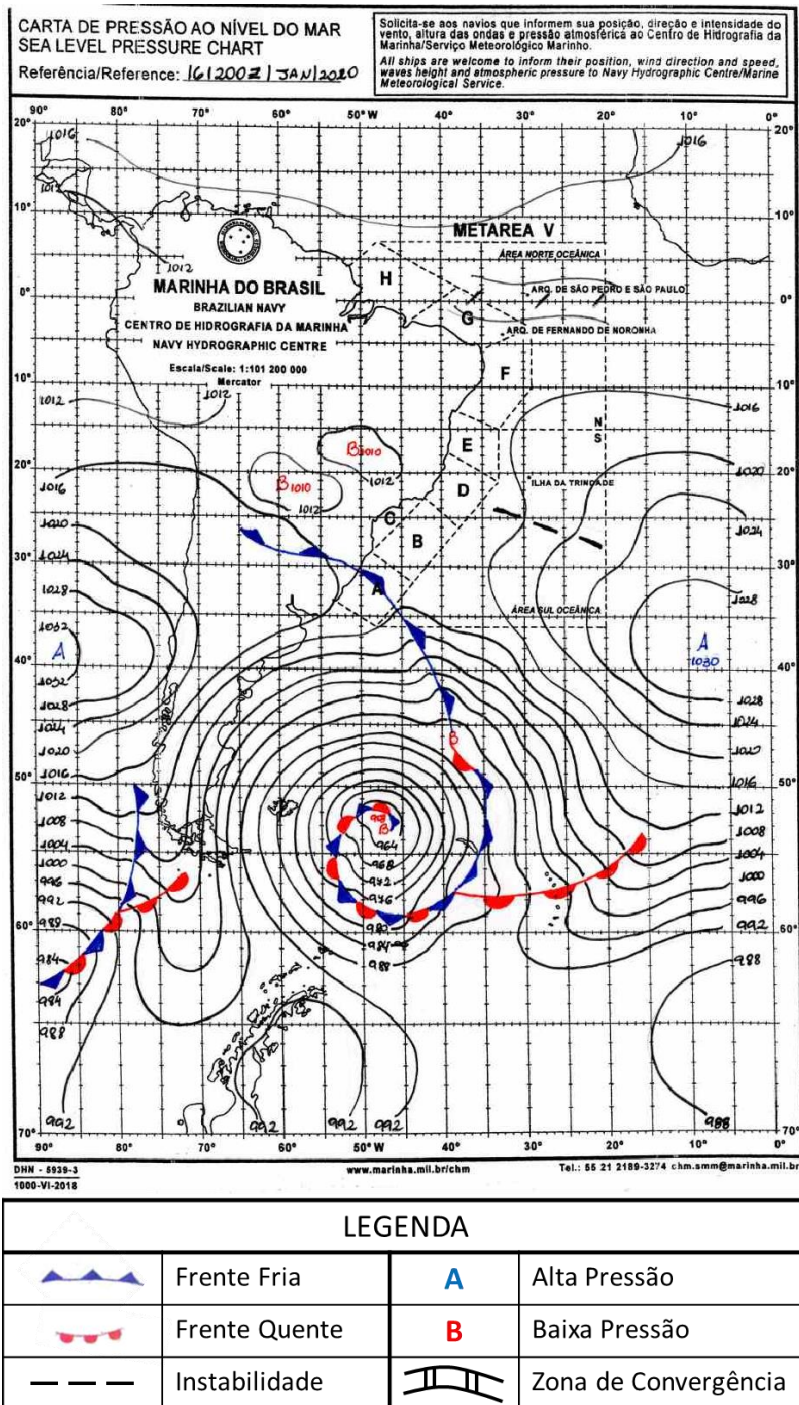
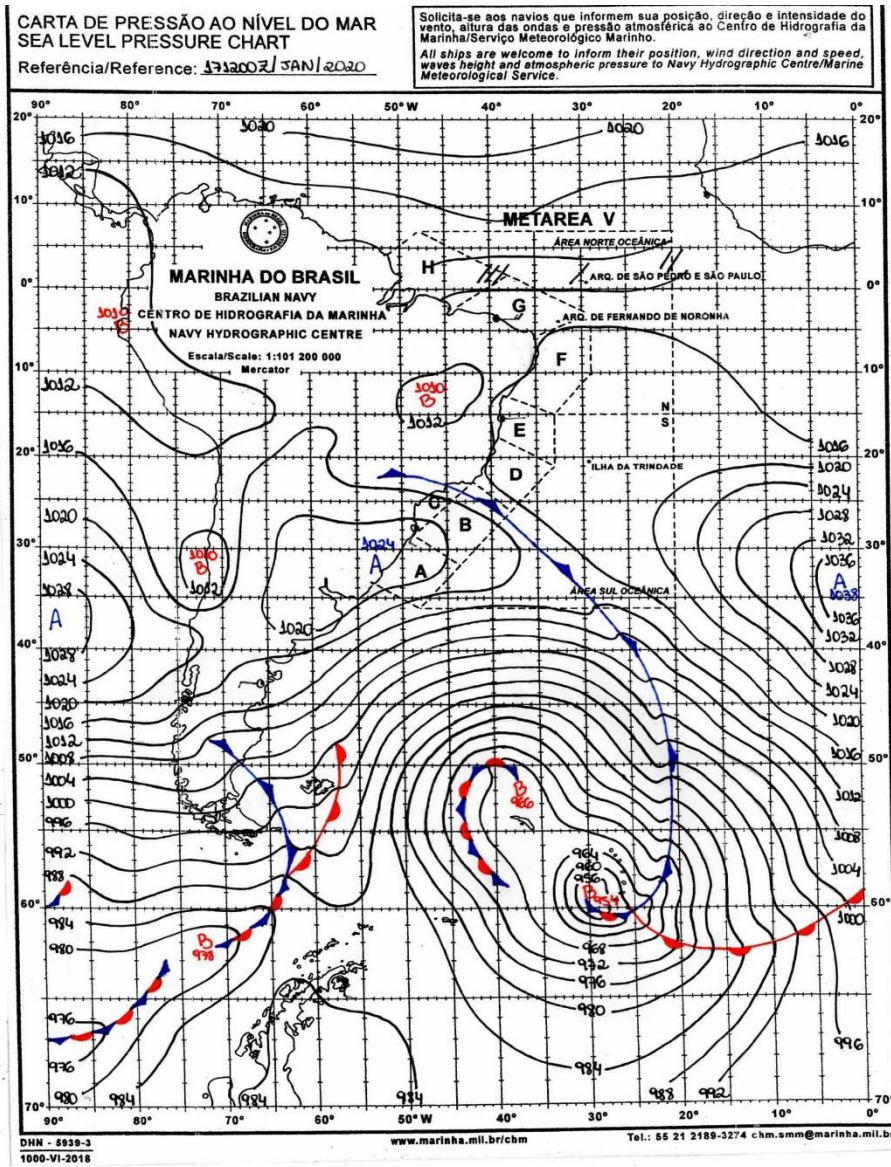
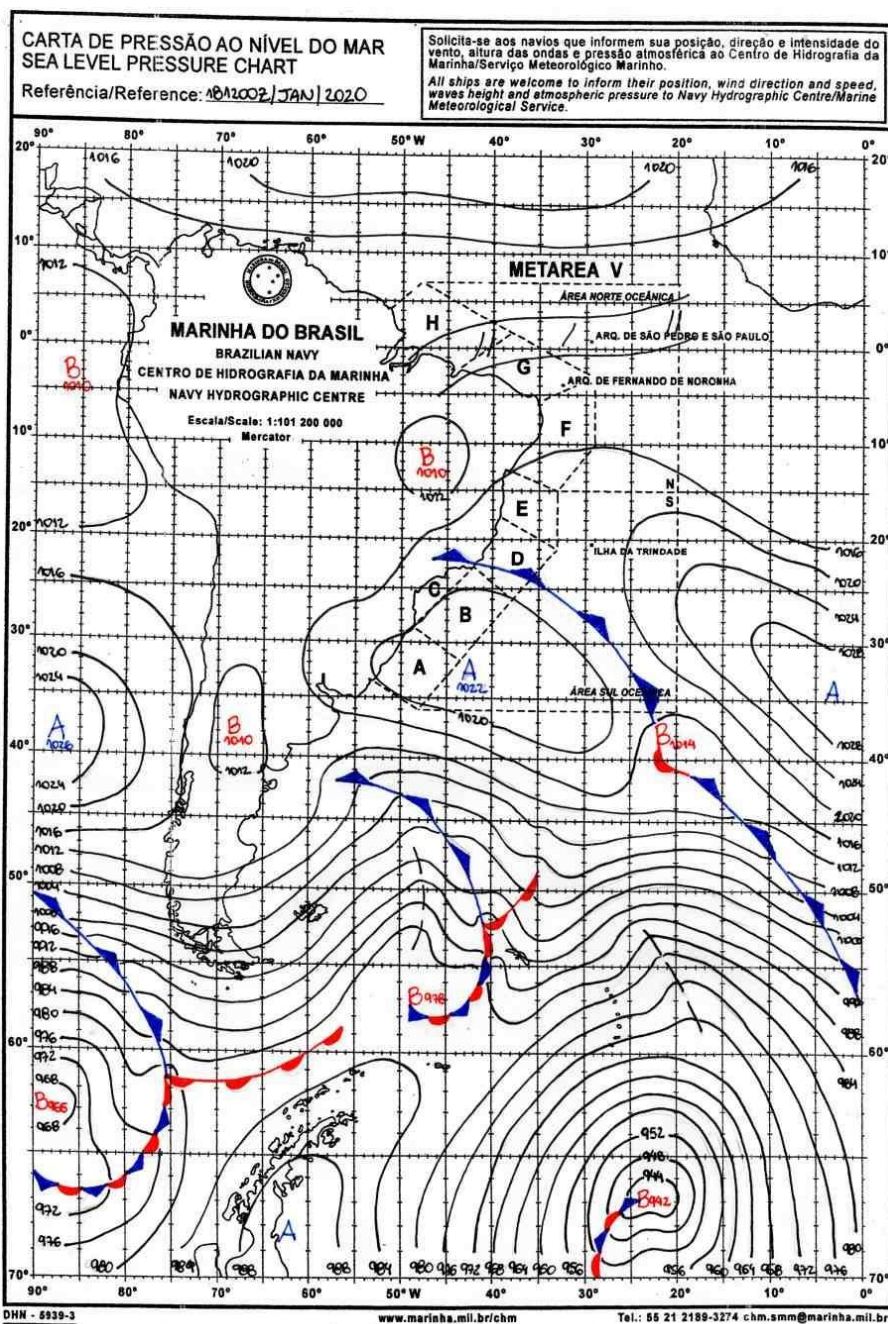

LEGENDA			
	Frente Fria	A	Alta Pressão
	Frente Quente	B	Baixa Pressão
	Instabilidade		Zona de Convergência

Figura A3 - Carta sinótica para as 1200Z do dia 18 de janeiro de 2020 (09h00 do dia 18 de janeiro de 2020 hora local. FONTE: Marinha do Brasil).

Notícias associadas

- Quatro pessoas ficam feridas durante temporal em Pirenópolis

<https://www.emaisgoias.com.br/quatro-pessoas-ficam-feridas-durante-temporal-em-pirenopolis/>

- Chuva causa estragos em Pires do Rio

<http://g1.globo.com/goias/videos/t/todos-os-videos/v/chuva-causa-estragos-em-pires-do-rio/8247171/>

- Ventania leva barraca de feirantes em Pirenópolis (GO). Veja

<https://www.metropoles.com/brasil/ventania-leva-barraca-de-feirantes-em-pirenopolis-go-assista>

Bianca Lobo Silva

Meteorologista

CREA 5063840461



ⓘ Não seguro | www.inmet.gov.br/sim/abre_graficos.php

Instituto Nacional de Meteorologia - INMET

Umidade Relativa do Ar 00h UTC

Estação: JATAI (GO) - 01/2020

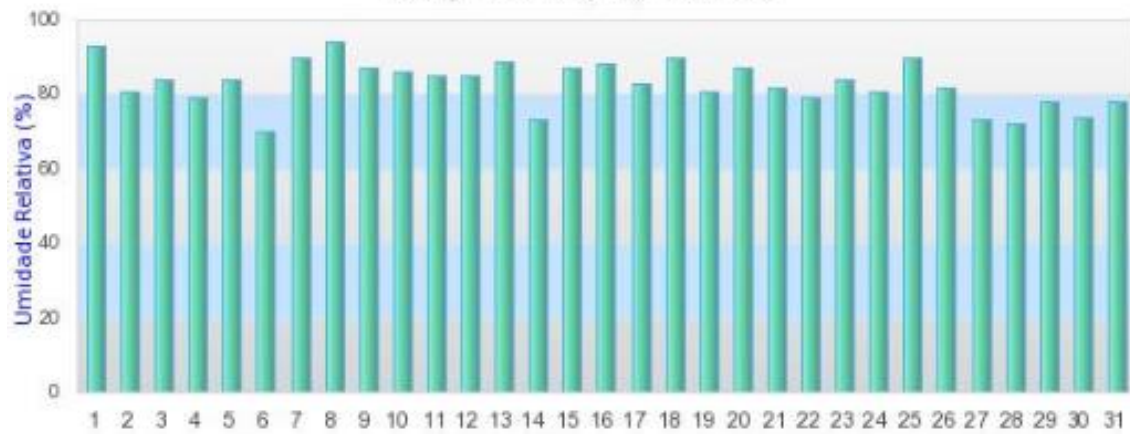

Dias do Mês

Instituto Nacional de Meteorologia - INMET

Chuva Acumulada 24h

Estação: JATAI - 01/2020

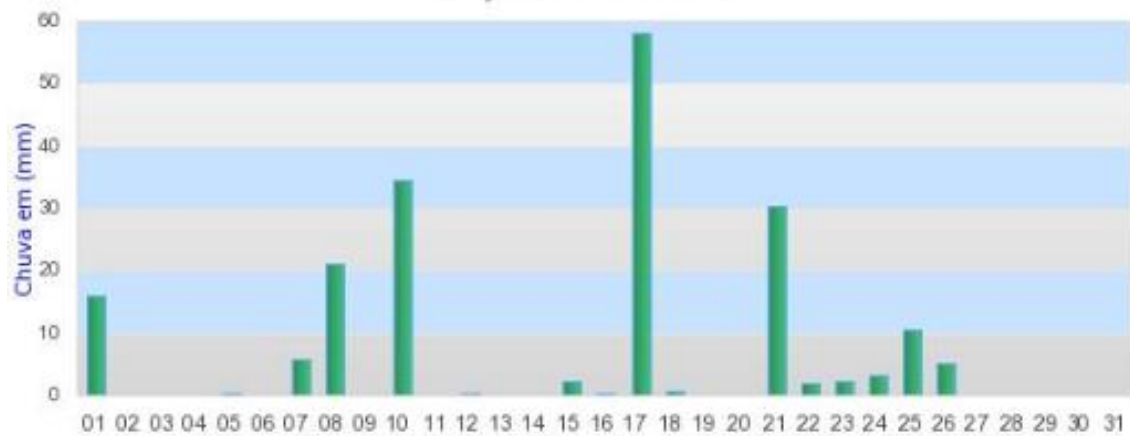

Dias do Mês

Instituto Nacional de Meteorologia - INMET

Umidade Relativa do Ar 00h UTC
Estação: PIRENOPOLIS (GO) - 01/2020

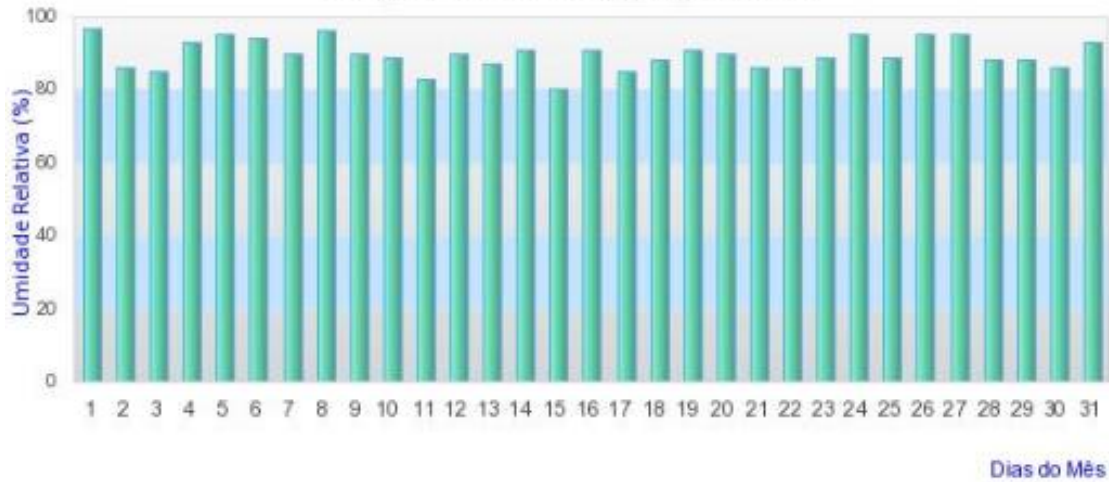

Instituto Nacional de Meteorologia - INMET

Chuva Acumulada 24h
Estação: PIRENOPOLIS - 01/2020

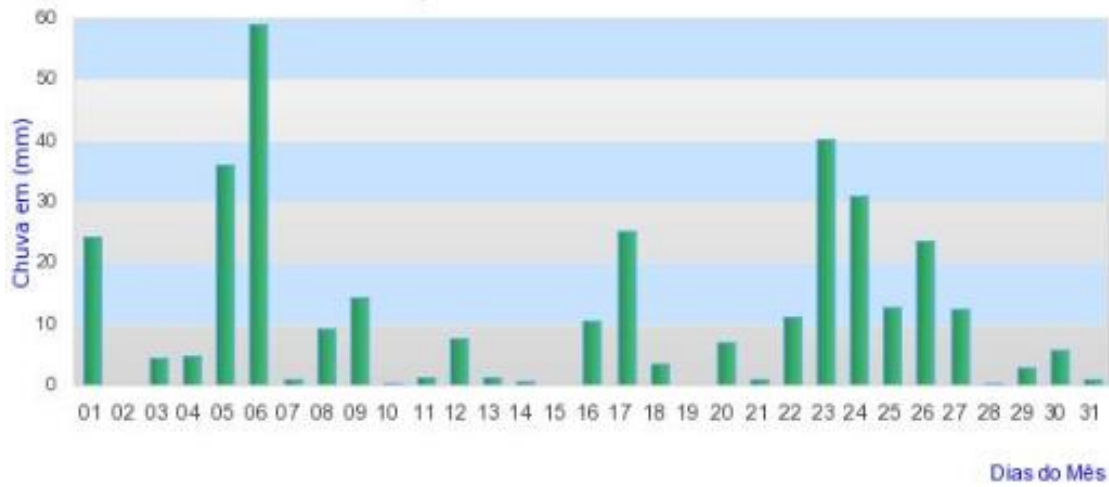

Instituto Nacional de Meteorologia - INMET

Umidade Relativa do Ar 00h UTC
Estação: RIO VERDE (GO) - 01/2020

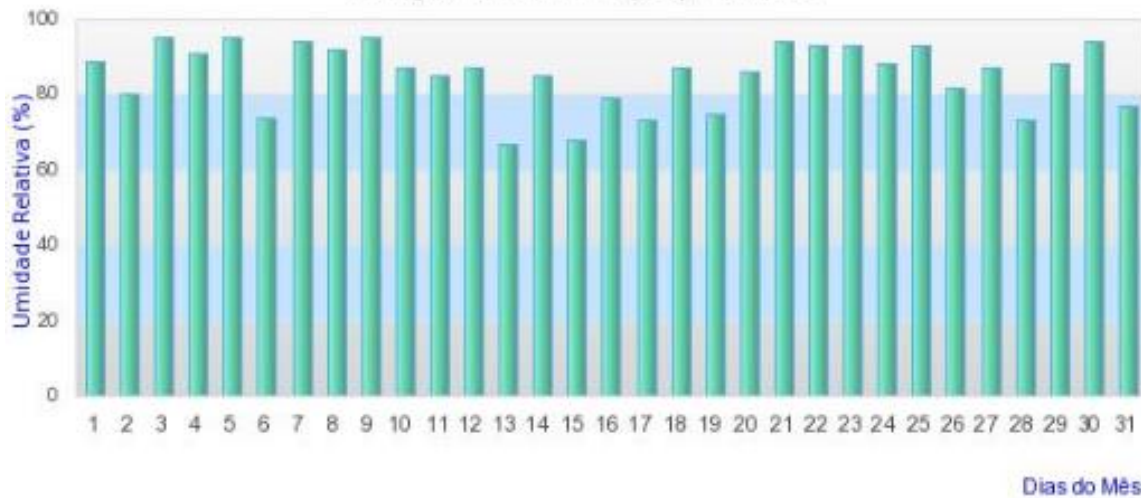

Instituto Nacional de Meteorologia - INMET

Chuva Acumulada 24h
Estação: RIO VERDE - 01/2020

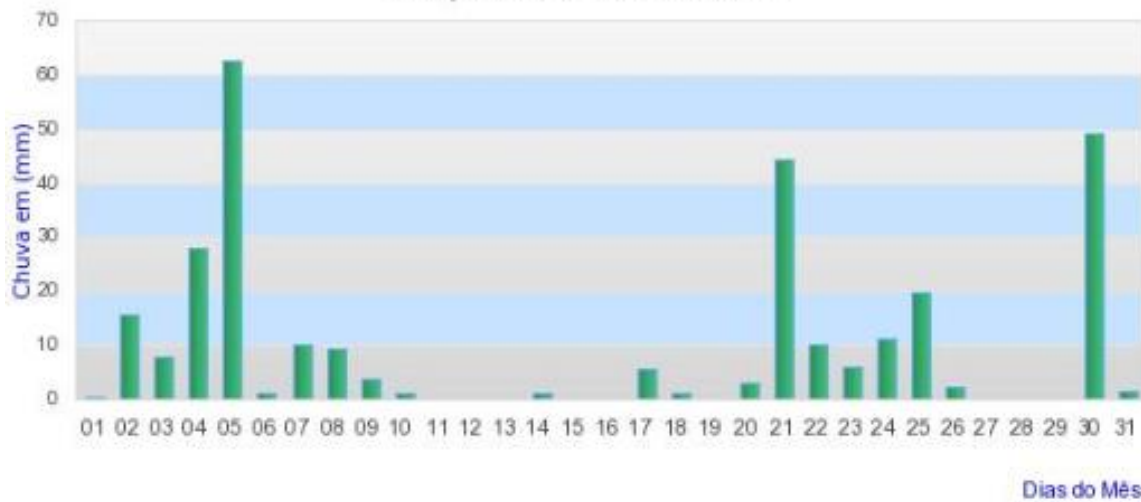

NOTÍCIAS RELACIONADAS

<https://www.metropoles.com/brasil/ventania-leva-barraca-de-feirantes-em-pirenopolis-go-assista>

<https://www.metropoles.com/brasil/ventania-leva-barraca-de-feirantes-em-pirenopolis-go-assista>



METRÓPOLES

Ventania leva barraca de feirantes em Pirenópolis (GO). Veja

Cidade goiana sofreu enchentes e parte da infraestrutura foi comprometida. Até o momento, não há informações de feridos

REPRODUÇÃO



enel
REGIONAL DE IPORA

CIDADE: NOVO BRASIL - GO

DIA: 17-01-2020

RELATO: CÔRREGOS E RIOS TRANSBORDARAM NA REGIÃO DE NOVO BRASIL, OCASIONANDO TRANSTORNOS E DIFICULTANDO PASSAGEM DE EQUIPES DE EMERGÊNCIAS PARA ATENDER CLIENTES SEM ENERGIA.

VENTO FORTE



Quatro pessoas ficam feridas durante temporal em Pirenópolis

Vendaval também resultou em árvores caídas, ruas interditadas, casas destelhadas, enxurradas em várias vias e derrubou, inclusive, a estrutura de uma feira da cidade



Jessica Santos

Do Mais Goiás | Em: 17/01/2020 às 10:20:42



Dia:16/01/2020
Cidade: Goiânia

Relato: Cabo Partido AT sobre a MT após temporal na região.



<http://g1.globo.com/goias/videos/t/todos-os-videos/v/chuva-causa-estragos-em-%20pires-do-rio/8247171/>

iro | g1.globo.com/goias/videos/t/todos-os-videos/v/chuva-causa-estragos-em-%20pires-do-rio/8247171/



Chuva causa estragos em Pires do Rio

MAIS INFORMAÇÕES |

[Tweeter](#)



Dia: 16/01/2020
Cidade: Pirenópolis

Relato: No final da tarde desta sexta-feira (16), uma tempestade atingiu Pirenópolis, que fica a 123 quilômetros da capital. A chuva não passou de 15 minutos, mas o vento intenso destelhou parte da Igreja Matriz, algumas casas e casarões no Centro Histórico, além de derrubar, no mínimo, 300 árvores e danificar uma tenda montada em frente à igreja. A rede elétrica também apresentou problemas.



Força-tarefa retira árvores do chão e limpa a sujeira nas ruas após estragos provocados por temporal, em Pirenópolis

Vídeos e fotos gravados por turistas e moradores registram os estragos e quando tendas de uma feira são levadas pela força do vento.

Por Rafael Oliveira, G1 GO

17/01/2020 16h00 - Atualizado há 3 meses

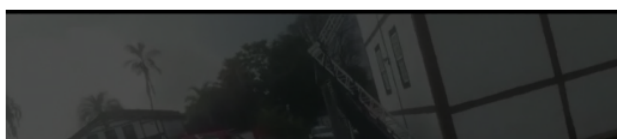

Dia:18/01/2020

Cidade: Goiânia

Relato: Grande chuva com fortes ventos diversas arvores quebradas, e cabos partidos

<https://g1.globo.com/go/goias/noticia/2020/01/16/temporal-destelha-casas-derruba-arvores-arrasta-barracas-e-inunda-ruas-historicas-de-pirenopolis.ghtml>

https://g1.globo.com/go/goias/noticia/2020/01/16/temporal-destelha-casas-derruba-arvores-arrasta-barracas-e-inunda-ruas-historicas-de-pirenopolis.ghtml

[globo.com](#) | [g1](#) | [globoesporte](#) | [gshow](#) | [videos](#)

MENU



GOIÁS



Temporal destelha casas, derruba árvores, arrasta barracas e deixa feridos em Pirenópolis

Vídeos registram pânico das pessoas na cidade histórica, que teve ruas interditadas. Segundo o Corpo de Bombeiros, município não tem energia.

Por Rafael Oliveira, G1 GO

16/01/2020 18h39 - Atualizado há 3 meses



CIDADE: ITABERAÍ - GO

DIA: 16-01-2020

RELATO: VENDEVAL NO MUNICÍPIO DE ITABERAÍ, FEZ COM QUE EUCALIPTO CAÍSSE SOBRE A REDE DE MT, OCASIONANDO DANOS A REDE ELÉTRICA.

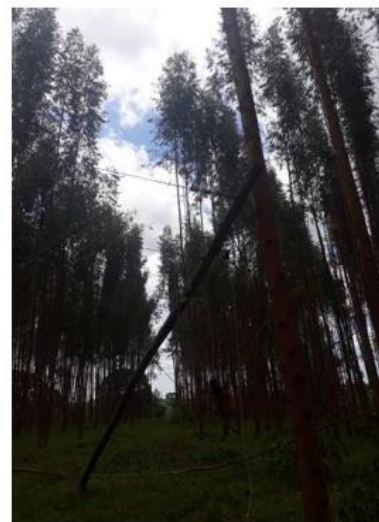

https://diaonline.ig.com.br/2020/01/16/tempestade-causa-estragos-e-assusta-moradores-de-pirenopolis/?utm_source=Lilian+Camargo&utm_campaign=diaonline-author

→ ↻ 🔒 https://diaonline.ig.com.br/2020/01/16/tempestade-causa-estragos-e-assusta-moradores-de-pirenopolis/?utm_source=Lilian+Camargo&utm_campaign=diaonline-author

Tempestade causa estragos e assusta moradores de Pirenópolis

Imagens registradas por moradores da cidade mostraram os estragos causados pela tempestade. Na ocasião tendas de feirantes da Feira da Família foram levadas pela ventania.



Lilian Camargo
16/01/2020, 19h55



Foto: Reprodução

//diaonline.ig.com.br/qoias/



enel
REGIONAL DE IPORA

CIDADE: MOSSAMEDES - GO

DIA: 18-01-2020

RELATO: EQUIPE DESLOCANDO PARA UM ATENDIMENTO DE EMERGÊNCIA, MAS NÃO CONSEGUIU TER ACESSO AO CLIENTE, DEVIDO CÔRREGO MUITO CHEIO POR CONSTANTES CHUVAS NA REGIÃO.

<http://g1.globo.com/goias/jatv-1edicao/videos/t/edicoes/v/forca-tarefa-retira-arvores-e-limpa-ruas-apos-estragos-provocados-por-chuva-em-pirenopolis/8247113/>

g1.globo.com/goias/jatv-1edicao/videos/t/edicoes/v/forca-tarefa-retira-arvores-e-limpa-ruas-apos-estragos-provocados-por-chuva-em-pire

[globo.com](#) | [g1](#) | [globoesporte](#) | [gshow](#) | [videos](#)

MARCUS DIAS

MENU

G1

GOIÁS
TV ANHANGUERA

Q BUSCAR



Força-tarefa retira árvores e limpa ruas após estragos provocados por chuva em Pirenópolis

MAIS INFORMAÇÕES | [Twitter](#) | [Curtir 0](#)



Dia: 16/01/2020
Cidade: Pirenópolis

Relato: No final da tarde desta sexta-feira (16), uma tempestade atingiu Pirenópolis, que fica a 123 quilômetros da capital. A chuva não passou de 15 minutos, mas o vento intenso destelhou parte da Igreja Matriz, algumas casas e casarões no Centro Histórico, além de derrubar, no mínimo, 300 árvores e danificar uma tenda montada em frente à igreja. A rede elétrica também apresentou problemas.

<https://g1.globo.com/go/goias/noticia/2020/01/17/apos-temporal-com-oito-feridos-forca-tarefa-retira-arvores-do-chao-e-limpa-a-sujeira-nas-ruas-em-pirenopolis.ghtml>

<https://g1.globo.com/go/goias/noticia/2020/01/16/temporal-destelha-casas-derruba-arvores-arrasta-barracas-e-inunda-ruas-historicas-de-pirenopolis.ghtml>

https://diaonline.ig.com.br/2020/01/16/tempestade-causa-estragos-e-assusta-moradores-de-pirenopolis/?utm_source=Lilian+Camargo&utm_campaign=diaonline-author

<https://www.emaisgoias.com.br/ventania-derruba-estrutura-de-feira-em-pirenopolis/>

<http://g1.globo.com/goias/jatv-1edicao/videos/t/edicoes/v/forca-tarefa-retira-arvores-e-limpa-ruas-apos-estragos-provocados-por-chuva-em-pirenopolis/8247113/>