

Resumo Executivo

O Presente Relatório tem como objetivo a incorporação de informações que sejam relevantes para que se possa fazer a devida associação aos dados contidos no corpo do documento objeto da classificação de Situação de Emergência caracterizada pelo Módulo 8 do Prodist, que tem como foco o impacto do evento sobre determinada rede geoeletrica e cuja denominação é definida como CHI (Consumidor hora interrompido). O parâmetro para enquadramento nesta classificação de expurgo tem como premissa inicial o limite de Consumidor hora interrompido definido pela fórmula descrita no Módulo 01 do Prodist (Revisão - 9), acrescido de todos os outros informes e dados listados no Módulo 08 (Revisão 10) do Prodist. Este enquadramento se apresenta na maioria das vezes em condições climáticas adversas com severidade dos fatores inerentes a situação, caracterizado na maioria dos casos por fortes ventos e chuvas de grande intensidade e continuidade.

Entre a manhã do dia 11/02/2020 – terça-feira - e a madrugada do dia 14/02/2020 – sexta-feira – Áreas de instabilidade associadas a organização e manutenção de uma zona de convergência de umidade favoreceram a formação de nuvens de tempestade que avançaram sobre o estado de Goiás.

Conforme informações do Climatempo Meteorologia, o Instituto Nacional de Meteorologia (INMET) detectou rajadas de vento acima de 50km/h entre a manhã do dia 11 de fevereiro e a madrugada do dia 14 de fevereiro de 2020. Na cidade de Goiás ocorreram ventos de até 56,9 km/h entre as 14h e 15h do dia 12/02/2020, vento classificado como vento forte pela escala Beaufort.

O sistema de detecção da EarthNetworks registrou 53.032 descargas atmosféricas (22.019 raios nuvem-solo e 31.013 descargas nuvem-nuvem) sobre a área de concessão da ENEL em Goiás entre as 11h00 do dia 11 e 01h45 do dia 14 de fevereiro de 2020, o que causou grande instabilidade na rede.

Chuva forte e volumosa foi registrada pelo INMET em estações representativas da área de concessão da ENEL Distribuição Goiás. Na estação de Iporá foram acumulados 46,4 mm de chuva entre as 18h e 19h do dia 12 de fevereiro. Entre as 09h do dia 12 e 09h do dia 13 de fevereiro foram acumulados o correspondente a 47% da média climatológica para o mês na região.

Chuva provoca cheia do rio claro, moradores sofre prejuízos em condomínios em Montes

Claros de Goiás –O acumulo das fortes chuvas que atingem a região de Montes Claros fez o nível do Rio Claro subir fora de sua caixa normal nesta segunda feira (10) e no começo da tarde desta quarta- feira (12) as águas começaram a invadir as casas dos moradores. Acesso em:

<https://rioclaronews.com.br/noticia/388/chuva-provoca-cheia-do-rio-claro-moradores-sofre-prejuizos-em-condominios-em-montes-claros-de-goias.html>

Relatório de Ocorrências do período

Em todo o Estado de Goiás verificou-se também que a intensidade da chuva e dos ventos danificaram a rede de distribuição de energia elétrica em diversos pontos, registrando aproximadamente 236 mil clientes com interrupção no fornecimento de energia elétrica devido a eventos relacionados ao temporal.

Para otimizar o volume de atendimentos e reduzir os tempos de interrupção foram mobilizados os recursos extras da empresa que aumentou o contingente em relação a situação normal de operação. O acompanhamento da quantidade de equipes e o Tempo Médio de Atendimento podem ser consultados na Pág.02 do Relatório em anexo.

O impacto e severidade do evento estão relatados em artigos de mídia, como fotos e reportagens que demonstram os danos na Rede de Distribuição, oriundos dos eventos climáticos no período. Eventos estes que afetaram 236.524 consumidores com CHI de 564.977,26 superior ao de 482.597,74 estabelecido como limite para definição de Situação de Emergência, conforme resumo das informações obrigatórias.

Empresa	ENEL DISTRIBUIÇÃO GOIÁS		
Código do Relatório	CHI-042 - ENEL DISTRIBUIÇÃO GOIÁS		
Evento:	TEMPORAL NA AREA DE CONCESSÃO DA ENEL DISTRIBUIÇÃO GOIAS		
Código COBRADE:	1.3.1.2.0	Data Inicio	11/02/2020
		Hora início	11h00
Código do Evento:	CHI-042-ENEL GO	Data Término	14/02/2020
		Hora Término	08h59
Valor CHI (Limite e Real)	482.597,74	564.977,26	
Código do Decreto (Se Houver):			
Quantidade de Interrupções (Evento)	3.480		
Início 1ª Incidência (Data e Hora)	11/02/2020 11:22	Subestações Atingidas	<p>ABADIANIA / ABC / ACREUNA / ADELANDIA / AEROPORTO / AGUA LIMPA (MARZAGAO) / AGUAS LINDAS / ALEXANIA / ALEXANIA TRANSMISSAO / ALMERINDONOPOLIS / ALOANDIA / ALPHAVILLE / ALTO BURITI / ALTO PARAISO DE GOIAS / ALVORADA DO NORTE / AMERICANO DO BRASIL / AMORINOPOLIS / ANAPOLIS UNIVERSITARIA / ANHANGUERA / ANICUNS / APARECIDA DO RIO DOCE / APORE / ARACU / ARAGARCAS / ARAGOIANIA / ARAGUAPAZ / ARARAS / ARENOPOLIS / ARUANA (TRANSMISSAO) / ASA BRANCA / ATLANTICO / AURILANDIA / AVELINOPOLIS / BACURI (RIO VERDE) / BARBOSELANDIA / BARCELONA / BARREIRO (PORANGATU) / BARRO ALTO / BELA VISTA (TRANSMISSAO) / BOM JARDIM / BOM JESUS DE GOIAS / BONFINOPOLIS / BONITO / BONOPOLIS / BRAZABRANTES / BRITANIA / BRITANIA (TRANSMISSAO) / BURITI ALEGRE / BURITI DE GOIAS / BURITIZINHO / CABECEIRAS / CABRIUVA (RIO VERDE) / CACHOEIRA ALTA / CACHOEIRA DOURADA / CACHOEIRA NOVA / CACHOEIRINHA (ITARUMA) / CACU / CAIAPONIA / CALCILANDIA / CALDAS NOVAS / CALDAZINHA / CAMPESTRE / CAMPINAS / CAMPINORTE / CAMPO ALEGRE DE GOIAS / CAMPO LIMPO DE GOIAS / CAMPO NOVO / CAMPOS BELOS / CAMPOS VERDES / CARAIBAS / CARAJAS / CASTELANDIA / CATALAO / CATURAI / CEBRASA FABRICA DA AMBEV / CEMAT/BALIZA / CEPALGO / CEZARINA / CHAPADAO DO CEU / CIDADE ECLETICA / CIDADE OCIDENTAL / COCALZINHO / COLINACU / CORUMBA / CORUMBAIBA / CRISTALINA / CRISTALINA TRANSMISSAO / CRISTIANOPOLIS / CRIXAS / CROMINIA / CUMARI / DAIA - ANAPOLIS / DAMOLANDIA / DAVINOPOLIS / DESFECHO / DESTILARIA BRASIL CENTRAL / DIMIC / DIORAMA / DORCELINO PEIXOTO DE MORAES / DOVERLANDIA / EDEALINA / EDEIA / ENERSUL / ESTRELA DO NORTE / FAINA / FAZENDA NOVA / FERROVIARIO / FIRMINOPOLIS / FLORES DE GOIAS / FORMOSO / FRONTEIRA / GAMELEIRA / GIRASSOL / GOIANAPOLIS / GOIANDIRA / GOIANESIA / GOIANIA LESTE / GOIANIRA / GOIAS / GOIATUBA / GOYA / GUAPO / HEITORAI / HIDROLANDIA / IACIARA / INACIOLANDIA / INDEPENDENCIA / INDIARA / INHUMAS / IPAMERI / IPEGUARI / IPORA / ISRAELANDIA / ITABERAI / ITAGUARI / ITAGUARU / ITAJA / ITAPACI / ITAPACI (TRANSMISSAO) / ITAPIRAPUA / ITAPURANGA / ITAPURANGA (TRANSMISSAO) / ITARUMA / ITAUCU / ITIQUIRA (FORMOSA) / ITUMBIARA NOVA / ITUMBIARA VELHA / JACILANDIA / JANDAIA / JARAGUA / JARANAPOLIS / JATAI / JAUPACI / JESUPOLIS / JOVIANIA / JUNDIAI / JURUMIRIM / JUSCELANDIA / JUSSARA / LAGES / LAGOA DA SERRA / LAGOA DO BAUZINHO (RIO VERDE) / LEOPOLDO DE BULHOES / LUZIANIA / MAIRIPOTABA / MAMBAI / MARA ROSA / MARAJOARA / MARCIANOPOLIS / MARIAPOLIS (PADRE BERNARDO) / MARZAGAO / MATO GRANDE / MATRINCHA / MAURILANDIA / MEIA PONTE / MINACU / MINEIROS / MINEIROS TRANSMISSAO / MOIPORA / MONTE ALEGRE / MONTES CLAROS DE GOIAS / MONTIVIDIU T / MORRINHOS / MOSSAMEDES / MOZARLANDIA / MOZARLANDIA (TRANSMISSAO) / MUNDO NOVO DE GOIAS / MUTUNOPOLIS / NAVESLANDIA (JATAI) / NAZARIO / NEROPOLIS / NIQUELANDIA / NOVA AMERICA / NOVA AURORA / NOVA CRIXAS (TRANSMISSAO) / NOVA IGUAUCU / NOVA PONTE / NOVA VENEZA / NOVO BRASIL / NOVO GAMA / NOVO PLANALTO / OLHOS DAGUA / OLOANA / ORIZONA / OURO VERDE DE GOIAS / OUVIDOR / PACAEMBU (NOVO GAMA) / PADRE BERNARDO / PALESTINA / PALMEIRAS DE GOIAS / PALMELO / PALMINOPOLIS / PAMPLONA / PANAMA / PARANA / PARANAIBA / PARANAIGUARA / PARAUNA SE ALTA TENSAO / PARQUE DAS EMAS (MINEIROS) / PARQUE DAS NACOES / PEROLANDIA / PETROLINA / PILAR / PIRACANJUBA / PIRANHAS T / PIRENOPOLIS / PIRES BELO / PIRES DO RIO / PLANALTINA / PLANALTINA (TRANSMISSAO) / PLANALTO / PONTALINA / PORANGATU / PORTEIRAO / PORTELANDIA / PORTO SAO SIMAO / POSSE / POSSELANDIA / PROFESSOR JAMIL / QUEBRA LINHA / QUIRINOPOLIS / REAL / RETIRO / GOIAS / RIO CLARO / JATAI MONTIVIDIU / RIO DO PEIXE / RIO DOS BOIS (MAURILANDIA) / RIO PRETO / RIO QUENTE / RIO VERDE / RIO VERMELHO / RIVERLANDIA (RIO VERDE) / RUBIATABA / SANCLERLANDIA / SANTA BARBARA / SANTA FE DE GOIAS / SANTA HELENA / SANTA RITA DO ARAGUAIA / SANTA ROSA / SANTA ROSA DO MEIA PONTE / SANTA TEREZA DE GOIAS / SANTA TEREZINHA / SANTANA / SANTO ANTONIO DA BARRA / SANTO ANTONIO DE GOIAS / SANTO ANTONIO DO DESCOBERTO / SAO BARTOLOMEU / SAO DOMINGOS / SAO FRANCISCO DE GOIAS / SAO GABRIEL DE GOIAS / SAO JOAO D ALIANCA / SAO LUIZ DOS MONTES BELOS / SAO MIGUEL DO ARAGUAIA / SAO MIGUEL DO PASSA QUATRO / SAO SIMAO / SENADOR CANEDO TRANSMISSAO / SERRA AZUL (JATAI) / SERRA DE CALDAS / SERRANOPOLIS / SILVANIA / SITIO</p>

			DABADIA / SOUZALANDIA / TAIOBA / TAQUARI / TEREZOPOLIS / TERRA VERMELHA / TRES BARRAS / TRES RANCHOS / TRINDADE / TURVANIA / TURVELANDIA / URUACU / URUTAI / USINA DE ACUCAR DE GOIANESIA / USINA MAMBAI / VALPARAISO / VARJAO / VENDA SECA / VIANOPOLIS / VICENTINOPOLIS / VILA CORUMBA / VILA PROPICIO / XAVANTES / XIXA / ZELANDIA / VILA BOA
Início Última Incidência (Data e Hora)	14/02/2020 08:51	Municípios Atingidos	ABADIA DE GOIAS / ABADIANIA / ACREUNA / AGUA FRIA DE GOIAS / AGUA LIMPA / AGUAS LINDAS DE GOIAS / ALEXANIA / ALOANDIA / ALTO HORIZONTE / ALTO PARAISO DE GOIAS / ALVORADA DO NORTE / AMARALINA / AMERICANO DO BRASIL / AMORINOPOLIS / ANAPOLIS / ANICUNS / APARECIDA DE GOIANIA / APARECIDA DO RIO DOCE / APORE / ARACU / ARAGARCAS / ARAGOIANIA / ARAGUAPAZ / ARUANA / AURILANDIA / AVELINOPOLIS / BALIZA / BARRO ALTO / BELA VISTA DE GOIAS / BOM JARDIM DE GOIAS / BOM JESUS DE GOIAS / BONFINOPOLIS / BONOPOLIS / BRAZABRANTES / BRITANIA / BURITI ALEGRE / BURITI DE GOIAS / BURITINOPOLIS / CABECEIRAS / CACHOEIRA ALTA / CACHOEIRA DE GOIAS / CACHOEIRA DOURADA / CACU / CAIAPONIA / CALDAS NOVAS / CALDAZINHA / CAMPESTRE DE GOIAS / CAMPINACU / CAMPINORTE / CAMPO ALEGRE DE GOIAS / CAMPO LIMPO / CAMPOS BELOS / CAMPOS VERDES / CARMO DO RIO VERDE / CASTELANDIA / CATALAO / CATURAI / CAVALCANTE / CERES / CEZARINA / CHAPADAO DO CEU / CIDADE OCIDENTAL / COCALZINHO DE GOIAS / COLINAS DO SUL / CORREGO DO OURO / CORUMBA DE GOIAS / CORUMBAIBA / CRISTALINA / CRISTIANOPOLIS / CRIXAS / CROMINIA / CUMARI / DAMIANOPOLIS / DAMOLANDIA / DAVINOPOLIS / DIORAMA / DISTRITO FEDERAL / DIVINOPOLIS DE GOIAS / DOVERLANDIA / EDEALINA / EDEIA / ESTRELA DO NORTE / FAINA / FAZENDA NOVA / FIRMINOPOLIS / FLORES DE GOIAS / FORMOSA / FORMOSO / GAMELEIRA DE GOIAS / GOIANAPOLIS / GOIANDIRA / GOIANESIA / GOIANIA / GOIANIRA / GOIAS / GOIATUBA / GOUVELANDIA / GUAPO / GUARAITA / GUARANI DE GOIAS / GUARINOS / HEITORAI / HIDROLANDIA / IACIARA / INACIOLANDIA / INDIARA / INHUMAS / IPAMERI / IPORA / ITABERAI / ITAGUARI / ITAGUARU / ITAJA / ITAPACI / ITAPIRAPUA / ITAPURANGA / ITARUMA / ITAUCU / ITUMBIARA / IVOLANDIA / JANDAIA / JARAGUA / JATAI / JAUPACI / JESUPOLIS / JOVIANIA / JUSSARA / LAGOA SANTA / LEOPOLDO DE BULHOES / LUZIANIA / MAMBAI / MARA ROSA / MARZAGAO / MATRINCHA / MAURILANDIA / MIMOSO DE GOIAS / MINACU / MINEIROS / MOIPORA / MONTE ALEGRE DE GOIAS / MONTES CLAROS DE GOIAS / MONTIVIDIU / MONTIVIDIU DO NORTE / MORRINHOS / MOSSAMEDES / MOZARLANDIA / MUNDO NOVO DE GOIAS / MUTUNOPOLIS / NAZARIO / NEROPOLIS / NIQUELANDIA / NOVA AMERICA / NOVA AURORA / NOVA CRIXAS / NOVA IGUACU DE GOIAS / NOVA ROMA / NOVA VENEZA / NOVO BRASIL / NOVO GAMA / NOVO PLANALTO / ORIZONA / OURO VERDE DE GOIAS / OUVIDOR / PADRE BERNARDO / PALESTINA DE GOIAS / PALMEIRAS DE GOIAS / PALMINOPOLIS / PANAMA / PARANAIGUARA / PARAUNA / PEROLANDIA / PETROLINA DE GOIAS / PILAR DE GOIAS / PIRACANJUBA / PIRANHAS / PIRENOPOLIS / PIRES DO RIO / PLANALTINA / PONTALINA / PORANGATU / PORTEIRAO / PORTELANDIA / POSSE / PROFESSOR JAMIL SAFADY / QUIRINOPOLIS / RIO QUENTE / RIO VERDE / RUBIATABA / SANCLERLANDIA / SANTA BARBARA DE GOIAS / SANTA CRUZ DE GOIAS / SANTA FE DE GOIAS / SANTA HELENA DE GOIAS / SANTA RITA DO ARAGUAIA / SANTA RITA DO NOVO DESTINO / SANTA TEREZA DE GOIAS / SANTA TEREZINHA DE GOIAS / SANTO ANTONIO DA BARRA / SANTO ANTONIO DE GOIAS / SANTO ANTONIO DO DESCOBERTO / SAO DOMINGOS / SAO FRANCISCO DE GOIAS / SAO JOAO D ALIANCA / SAO LUIS DE MONTES BELOS / SAO LUIZ DO NORTE / SAO MIGUEL DO ARAGUAIA / SAO MIGUEL DO PASSA QUATRO / SAO PATRICIO / SAO SIMAO / SENADOR CANEDO / SERRANOPOLIS / SILVANIA / SIMOLANDIA / SITIO D ABADIA / TAQUARAL DE GOIAS / TERESINA DE GOIAS / TEREZOPOLIS DE GOIAS / TRES RANCHOS / TRINDADE / TROMBAS / TURVANIA / TURVELANDIA / UIRAPURU / URUACU / URUANA / URUTAI / VALPARAISO DE GOIAS / VARJAO / VIANOPOLIS / VICENTINOPOLIS / VILA BOA / VILA PROPICIO
Média de Duração das Incidências (h)	6,45		
Duração da Incidência mais longa (h)	72,91		
Total de Clientes afetados	236.524		

DANOS CAUSADOS			
Equipamentos Danificado	Importância para o Sistema	Local	Quantidade
Disjuntor/Religador Operado	Proteção do Alimentador	Área de Concessão	78
Chaves Fusíveis Operada	Proteção de Ramais de Alimentadores	Área de Concessão	967
Transformador Operado	Proteção do Transformador	Área de Concessão	854

Relato técnico sobre a Intervenção realizada em Goiânia e Região Metropolitana					
Informações sobre Equipes	11/02	12/02	13/02	14/02	
Quantidade Usual	719	720	720	720	turmas
Quantidade Adicional	0	15	20	30	turmas
Quantidade Total	719	735	740	750	turmas
Tempos Médios					
Preparação	2,29	4,19	3,91	3,86	Horas
Deslocamento	0,80	0,85	0,84	0,85	Horas
Execução	0,98	1,03	1,09	1,05	Horas
TMAE	4,75	6,07	5,84	5,75	Horas

Principais Dificuldades Encontradas:

Chuvas com ventos fortes provocaram muitos pontos de alagamento e enxurrada, trânsito impedido por vários semáforos desligados dificultando a chegada ao atendimento das ocorrências emergenciais. Em determinadas regiões, decorrente dos fortes ventos, houve o tombamento de árvores nas estruturas de alimentação de média tensão, danos em ramais de ligação dos clientes, impedimentos de acesso e atolamentos em estradas rurais.

Empresa	ENEL DISTRIBUIÇÃO GOIAS		
Valor CHI (Limite e Real)	482.597,74		564.977,26

DOC ORIGEM	MIUNICIPIO	EQP_ORIGEM	CONJUNTO	INI_OCORRENC	FIM_OCORRENC	DT_INI_EVENTO	DT_FIM_EVENTO	DURAÇ	UC INT	CHI	EXPURGO
20200251200	ANAPOLIS	AN11000273	JUNDIAI S1	11/02/2020 11:22	11/02/2020 13:12	11/02/2020 11:22	11/02/2020 13:12	1,84	156	287,56	CHI
20200251325	ALTO PARAISO DE GOIAS	BF12129915	FLORES DE GOIAS	11/02/2020 11:29	11/02/2020 14:28	11/02/2020 11:29	11/02/2020 14:28	2,97	23	68,27	CHI
20200251228	LUZIANIA	LZ21345904	MARAJOARA	11/02/2020 11:30	11/02/2020 22:23	11/02/2020 11:30	11/02/2020 22:23	10,87	2	21,74	CHI
20200251235	LEOPOLDO DE BULHOES	LB11089944	DAIA S2	11/02/2020 11:32	11/02/2020 18:19	11/02/2020 11:32	11/02/2020 18:19	6,77	43	291,18	CHI
20200251264	BURITINOPOLIS	MB12314303	IACIARA S2	11/02/2020 11:34	11/02/2020 12:57	11/02/2020 11:34	11/02/2020 12:57	1,37	2	2,74	CHI
20200251264	MAMBAI	MB12314303	IACIARA S2	11/02/2020 11:34	11/02/2020 12:57	11/02/2020 11:34	11/02/2020 12:57	1,37	3	4,11	CHI
20200251594	CAIAPONIA	CP12380880	CAIAPONIA	11/02/2020 11:35	11/02/2020 18:30	11/02/2020 11:35	11/02/2020 18:30	6,92	11	76,07	CHI
20200251249	LUZIANIA	120399544	RIO VERMELHO	11/02/2020 11:38	11/02/2020 18:48	11/02/2020 11:38	11/02/2020 18:48	7,16	1	7,16	CHI
20200251256	MOSSAMEDES	MD12066158	FIRMINOPOLIS S2	11/02/2020 11:39	11/02/2020 15:52	11/02/2020 11:39	11/02/2020 15:52	4,21	3	12,64	CHI
20200251256	MOSSAMEDES	MD12066158	FIRMINOPOLIS S2	11/02/2020 11:39	11/02/2020 15:52	11/02/2020 15:07	11/02/2020 15:52	0,75	18	13,41	CHI
20200251257	BOM JARDIM DE GOIAS	BM21221818	BOM JARDIM	11/02/2020 11:39	11/02/2020 16:19	11/02/2020 11:39	11/02/2020 16:19	4,65	1	4,65	CHI
20200251259	CIDADE OCIDENTAL	10008437708	MARAJOARA	11/02/2020 11:40	11/02/2020 18:49	11/02/2020 11:40	11/02/2020 18:49	7,14	1	7,14	CHI
20200251266	BURITINOPOLIS	BQ21229000	IACIARA S2	11/02/2020 11:42	11/02/2020 14:05	11/02/2020 11:42	11/02/2020 14:05	2,37	6	14,22	CHI
20200251273	ITABERAI	50080520	ITABERAI S2	11/02/2020 11:47	11/02/2020 13:37	11/02/2020 11:47	11/02/2020 13:37	1,83	1	1,83	CHI
20200251279	IPORA	IR12014026	IPORA	11/02/2020 11:49	11/02/2020 17:16	11/02/2020 11:49	11/02/2020 17:16	5,44	4	21,78	CHI
20200251286	PALMEIRAS DE GOIAS	PL21321986	PALMEIRAS	11/02/2020 11:50	12/02/2020 12:27	11/02/2020 11:50	12/02/2020 12:27	24,60	1	24,60	CHI
20200251290	LUZIANIA	LZ21247958	CRISTALINA S2	11/02/2020 11:52	11/02/2020 18:50	11/02/2020 11:52	11/02/2020 18:50	6,95	1	6,95	CHI
20200251291	SAO LUIS DE MONTES BELOS	SL21180372	SAO LUIZ DOS MONTES BELOS	11/02/2020 11:53	12/02/2020 10:34	11/02/2020 11:53	12/02/2020 10:34	22,68	1	22,68	CHI
20200251368	LUZIANIA	LZ11028135	MARAJOARA	11/02/2020 11:57	11/02/2020 13:14	11/02/2020 11:57	11/02/2020 13:14	1,27	206	262,59	CHI
20200251350	JARAGUA	JA21090034	JARAGUA	11/02/2020 11:58	11/02/2020 14:34	11/02/2020 11:58	11/02/2020 14:34	2,59	1	2,59	CHI
20200251310	BONOPOLIS	PO12394943	MARA ROSA	11/02/2020 12:00	11/02/2020 14:36	11/02/2020 12:00	11/02/2020 14:36	2,60	2	5,20	CHI
20200251310	PORANGATU	PO12394943	MARA ROSA	11/02/2020 12:00	11/02/2020 14:36	11/02/2020 12:00	11/02/2020 14:36	2,60	10	25,99	CHI
20200251312	BALIZA	BH21233795	BOM JARDIM	11/02/2020 12:00	11/02/2020 15:17	11/02/2020 12:00	11/02/2020 15:17	3,28	3	9,85	CHI
20200251329	BURITINOPOLIS	3610007148	IACIARA S2	11/02/2020 12:06	11/02/2020 16:31	11/02/2020 12:06	11/02/2020 16:31	4,41	1	4,41	CHI
20200251343	SILVANIA	21243876	DAIA S1	11/02/2020 12:10	11/02/2020 16:37	11/02/2020 12:10	11/02/2020 16:37	4,44	1	4,44	CHI
20200251345	PLANALTINA	PI12322789	PLANALTINA	11/02/2020 12:11	11/02/2020 15:05	11/02/2020 12:11	11/02/2020 15:05	2,90	38	110,17	CHI
20200251348	JANDAIA	JD12008673	PALMEIRAS	11/02/2020 12:12	12/02/2020 01:50	11/02/2020 12:12	12/02/2020 01:50	13,63	13	177,23	CHI
20200251355	LUZIANIA	120017179	RIO VERMELHO	11/02/2020 12:14	11/02/2020 15:03	11/02/2020 12:14	11/02/2020 15:03	2,80	1	2,80	CHI
20200251357	PLANALTINA	2960050417	PLANALTINA	11/02/2020 12:15	11/02/2020 13:39	11/02/2020 12:15	11/02/2020 13:39	1,39	1	1,39	CHI
202002191286	SANTA TEREZINHA DE GOIAS	SG12318464	SANTA TEREZINHA	11/02/2020 12:15	12/02/2020 15:07	11/02/2020 12:15	11/02/2020 16:20	4,08	10	40,84	CHI
202002191286	UIRAPURU	SG12318464	SANTA TEREZINHA	11/02/2020 12:15	12/02/2020 15:07	11/02/2020 12:15	11/02/2020 16:20	4,08	12	49,00	CHI
202002191286	SANTA TEREZINHA DE GOIAS	SG12318464	SANTA TEREZINHA	11/02/2020 12:15	12/02/2020 15:07	11/02/2020 12:15	12/02/2020 10:26	22,18	14	310,58	CHI

202002191286	CAMPOS VERDES	SG12318464	SANTA TEREZINHA	11/02/2020 12:15	12/02/2020 15:07	11/02/2020 12:15	12/02/2020 11:34	23,31	5	116,53	CHI
202002191286	SANTA TEREZINHA DE GOIAS	SG12318464	SANTA TEREZINHA	11/02/2020 12:15	12/02/2020 15:07	11/02/2020 12:15	12/02/2020 11:34	23,31	1	23,31	CHI
202002191286	CAMPOS VERDES	SG12318464	SANTA TEREZINHA	11/02/2020 12:15	12/02/2020 15:07	11/02/2020 12:15	12/02/2020 14:57	26,69	2	53,38	CHI
202002191286	SANTA TEREZINHA DE GOIAS	SG12318464	SANTA TEREZINHA	11/02/2020 12:15	12/02/2020 15:07	11/02/2020 12:15	12/02/2020 14:57	26,69	8	213,52	CHI
202002191286	CAMPOS VERDES	SG12318464	SANTA TEREZINHA	11/02/2020 12:15	12/02/2020 15:07	11/02/2020 12:15	12/02/2020 15:07	26,86	6	161,14	CHI
20200251361	SANCLERLANDIA	SC12391519	FIRMINOPOLIS S2	11/02/2020 12:16	11/02/2020 14:50	11/02/2020 12:16	11/02/2020 14:50	2,56	1	2,56	CHI
20200251361	SAO LUIS DE MONTES BELOS	SC12391519	FIRMINOPOLIS S2	11/02/2020 12:16	11/02/2020 14:50	11/02/2020 12:16	11/02/2020 14:50	2,56	2	5,12	CHI
20200251524	IPAMERI	IP12068500	CRISTALINA S2	11/02/2020 12:16	11/02/2020 16:41	11/02/2020 12:16	11/02/2020 16:41	4,41	62	273,23	CHI
20200251372	AGUAS LINDAS DE GOIAS	4830104790	AGUAS LINDAS DE GOIAS S1	11/02/2020 12:20	11/02/2020 13:59	11/02/2020 12:20	11/02/2020 13:59	1,65	1	1,65	CHI
20200251376	LUZIANIA	120449330	RIO VERMELHO	11/02/2020 12:21	11/02/2020 15:30	11/02/2020 12:21	11/02/2020 15:30	3,14	1	3,14	CHI
20200251378	CACHOEIRA DE GOIAS	CG21321286	FIRMINOPOLIS S2	11/02/2020 12:22	11/02/2020 17:07	11/02/2020 12:22	11/02/2020 17:07	4,74	1	4,74	CHI
20200251385	PETROLINA DE GOIAS	PG12230708	PETROLINA	11/02/2020 12:24	11/02/2020 21:24	11/02/2020 12:24	11/02/2020 21:24	9,00	6	53,99	CHI
20200251385	SAO FRANCISCO DE GOIAS	PG12230708	PETROLINA	11/02/2020 12:24	11/02/2020 21:24	11/02/2020 12:24	11/02/2020 21:24	9,00	13	116,97	CHI
20200251389	CAIAPONIA	CP12395430	PALESTINA	11/02/2020 12:25	12/02/2020 10:20	11/02/2020 12:25	11/02/2020 19:22	6,95	3	20,84	CHI
20200251389	PALESTINA DE GOIAS	CP12395430	PALESTINA	11/02/2020 12:25	12/02/2020 10:20	11/02/2020 12:25	12/02/2020 10:20	21,92	1	21,92	CHI
20200251508	CAIAPONIA	930015605	CAIAPONIA	11/02/2020 12:32	12/02/2020 08:44	11/02/2020 12:32	12/02/2020 08:44	20,19	1	20,19	CHI
20200251516	JATAI	JT12167855	JATAI S1	11/02/2020 12:34	11/02/2020 14:36	11/02/2020 12:34	11/02/2020 14:36	2,03	1	2,03	CHI
20200251517	CACHOEIRA DOURADA	IT12088560	CACHOEIRA DOURADA	11/02/2020 12:34	11/02/2020 19:57	11/02/2020 12:34	11/02/2020 19:57	7,38	1	7,38	CHI
20200251517	ITUMBIARA	IT12088560	CACHOEIRA DOURADA	11/02/2020 12:34	11/02/2020 19:57	11/02/2020 12:34	11/02/2020 19:57	7,38	4	29,51	CHI
20200251752	BURITI ALEGRE	MR12000170RE	MORRINHOS	11/02/2020 12:34	11/02/2020 15:40	11/02/2020 12:34	11/02/2020 15:40	3,10	1	3,10	CHI
20200251752	MORRINHOS	MR12000170RE	MORRINHOS	11/02/2020 12:34	11/02/2020 15:40	11/02/2020 12:34	11/02/2020 15:40	3,10	54	167,40	CHI
20200252331	JATAI	CP12147712	CAIAPONIA	11/02/2020 12:35	12/02/2020 12:50	11/02/2020 12:35	12/02/2020 12:50	24,24	3	72,72	CHI
20200252331	RIO VERDE	CP12147712	CAIAPONIA	11/02/2020 12:35	12/02/2020 12:50	11/02/2020 12:35	12/02/2020 12:50	24,24	4	96,97	CHI
20200251529	FLORES DE GOIAS	FB12106993	FLORES DE GOIAS	11/02/2020 12:36	11/02/2020 13:40	11/02/2020 12:36	11/02/2020 13:40	1,05	15	15,80	CHI
20200251529	FORMOSA	FB12106993	FLORES DE GOIAS	11/02/2020 12:36	11/02/2020 13:40	11/02/2020 12:36	11/02/2020 13:40	1,05	9	9,48	CHI
20200251529	SAO JOAO D ALIANCA	FB12106993	FLORES DE GOIAS	11/02/2020 12:36	11/02/2020 13:40	11/02/2020 12:36	11/02/2020 13:40	1,05	5	5,27	CHI
20200251533	JATAI	JT12072680	JATAI S1	11/02/2020 12:37	11/02/2020 17:53	11/02/2020 12:37	11/02/2020 17:53	5,25	15	78,81	CHI
20200251536	CATALAO	CT12250392	CATALAO S2	11/02/2020 12:38	11/02/2020 14:27	11/02/2020 12:38	11/02/2020 14:27	1,80	584	1051,52	CHI
20200251537	ALTO PARAISO DE GOIAS	BF21129910	FLORES DE GOIAS	11/02/2020 12:39	11/02/2020 15:35	11/02/2020 12:39	11/02/2020 15:35	2,93	1	2,93	CHI
20200251544	PONTALINA	210034191	PONTALINA	11/02/2020 12:41	11/02/2020 14:44	11/02/2020 12:41	11/02/2020 14:44	2,04	1	2,04	CHI
20200251547	CRISTALINA	KR11315549	CRISTALINA S1	11/02/2020 12:42	12/02/2020 09:12	11/02/2020 12:42	12/02/2020 09:12	20,49	5	102,46	CHI
20200251714	NIQUELANDIA	NQ12280419	NIQUELANDIA SUBTRANSMISSAO	11/02/2020 12:44	11/02/2020 14:08	11/02/2020 12:44	11/02/2020 14:08	1,40	64	89,30	CHI
20200251558	MONTIVIDIU DO NORTE	MX12065532	PORANGATU	11/02/2020 12:47	11/02/2020 17:05	11/02/2020 12:47	11/02/2020 17:05	4,30	3	12,90	CHI

20200251563	CORUMBA DE GOIAS	CB21221503	CORUMBA	11/02/2020 12:48	11/02/2020 18:17	11/02/2020 12:48	11/02/2020 18:17	5,47	1	5,47	CHI
20200251568	RIO VERDE	RV12360624	CABRIUVA S2	11/02/2020 12:49	12/02/2020 13:26	11/02/2020 12:49	12/02/2020 13:26	24,61	0	0,00	CHI
20200251569	INDIARA	2710000370	EDEIA	11/02/2020 12:49	11/02/2020 18:14	11/02/2020 12:49	11/02/2020 18:14	5,41	1	5,41	CHI
20200251580	LEOPOLDO DE BULHOES	LB12351258	DAIA S2	11/02/2020 12:52	11/02/2020 16:23	11/02/2020 12:52	11/02/2020 16:23	3,51	9	31,57	CHI
20200251583	GOIATUBA	GT12048500	GOIATUBA S2	11/02/2020 12:55	11/02/2020 17:15	11/02/2020 12:55	11/02/2020 17:15	4,33	7	30,29	CHI
20200251584	AGUA FRIA DE GOIAS	TL12208773	SAO JOAO D ALIANCA	11/02/2020 12:55	11/02/2020 15:34	11/02/2020 12:55	11/02/2020 15:34	2,64	14	36,98	CHI
20200251584	MIMOSO DE GOIAS	TL12208773	SAO JOAO D ALIANCA	11/02/2020 12:55	11/02/2020 15:34	11/02/2020 12:55	11/02/2020 15:34	2,64	29	76,60	CHI
20200251587	ITABERAI	50028467	ITABERAI S2	11/02/2020 12:55	11/02/2020 16:47	11/02/2020 12:55	11/02/2020 16:47	3,85	1	3,85	CHI
20200252559	NIQUELANDIA	NQ11197624	NIQUELANDIA SUBTRANSMISSAO	11/02/2020 12:55	11/02/2020 16:32	11/02/2020 12:55	11/02/2020 16:32	3,61	49	177,00	CHI
20200251595	GOIATUBA	570014190	GOIATUBA S1	11/02/2020 12:59	11/02/2020 17:34	11/02/2020 12:59	11/02/2020 17:34	4,59	1	4,59	CHI
20200251600	INDIARA	IY21312451	CEZARINA	11/02/2020 13:00	12/02/2020 17:02	11/02/2020 13:00	12/02/2020 17:02	28,04	1	28,04	CHI
20200251704	MINACU	IH12207740	MINACU	11/02/2020 13:01	11/02/2020 20:27	11/02/2020 13:01	11/02/2020 20:27	7,43	100	742,81	CHI
20200251713	PORTELANDIA	PW21322118	PARQUE DAS EMAS	11/02/2020 13:04	11/02/2020 17:18	11/02/2020 13:04	11/02/2020 17:18	4,23	1	4,23	CHI
20200251717	DOVERLANDIA	DV11193274	CAIAPONIA	11/02/2020 13:05	11/02/2020 14:50	11/02/2020 13:05	11/02/2020 14:50	1,74	6	10,45	CHI
20200251718	ABADIANIA	AA12388794	DAIA S2	11/02/2020 13:05	11/02/2020 16:42	11/02/2020 13:05	11/02/2020 16:42	3,60	4	14,41	CHI
20200251729	CAIAPONIA	CP12243936	PIRANHAS	11/02/2020 13:08	11/02/2020 23:05	11/02/2020 13:08	11/02/2020 23:05	9,93	1	9,93	CHI
20200251734	FAINA	FC21345283	GOIAS	11/02/2020 13:10	11/02/2020 14:23	11/02/2020 13:10	11/02/2020 14:23	1,20	1	1,20	CHI
20200251874	ANICUNS	AC12259103	FIRMINOPOLIS S2	11/02/2020 13:10	11/02/2020 18:30	11/02/2020 13:10	11/02/2020 18:30	5,33	19	101,24	CHI
20200251958	URUTAI	UT12417470	PIRES DO RIO S2	11/02/2020 13:10	11/02/2020 20:35	11/02/2020 13:10	11/02/2020 20:35	7,41	4	29,66	CHI
20200251736	PORANGATU	10025981810	PORANGATU	11/02/2020 13:12	11/02/2020 16:40	11/02/2020 13:12	11/02/2020 16:40	3,46	1	3,46	CHI
20200251738	URUACU	640002316	URUACU	11/02/2020 13:12	11/02/2020 15:30	11/02/2020 13:12	11/02/2020 15:30	2,29	1	2,29	CHI
20200251740	ITUMBIARA	IT12305616	ITUMBIARA NOVA	11/02/2020 13:12	11/02/2020 18:01	11/02/2020 13:12	11/02/2020 18:01	4,80	6	28,81	CHI
20200251744	NOVA ROMA	TE21236383	FLORES DE GOIAS	11/02/2020 13:14	11/02/2020 16:14	11/02/2020 13:14	11/02/2020 16:14	3,00	1	3,00	CHI
20200251750	URUACU	UR21379784	MARA ROSA	11/02/2020 13:16	11/02/2020 16:50	11/02/2020 13:16	11/02/2020 16:50	3,56	2	7,11	CHI
20200251756	ALTO PARAISO DE GOIAS	BF21129911	FLORES DE GOIAS	11/02/2020 13:17	11/02/2020 15:06	11/02/2020 13:17	11/02/2020 15:06	1,80	1	1,80	CHI
20200251758	ITABERAI	IB21212421	ITABERAI S1	11/02/2020 13:18	11/02/2020 15:22	11/02/2020 13:18	11/02/2020 15:22	2,07	1	2,07	CHI
20200251763	POSSE	5320002572	IACIARA S2	11/02/2020 13:21	11/02/2020 16:09	11/02/2020 13:21	11/02/2020 16:09	2,80	1	2,80	CHI
20200251770	TRES RANCHOS	TH12280739	CATALAO S1	11/02/2020 13:21	11/02/2020 20:23	11/02/2020 13:21	11/02/2020 20:23	7,03	2	14,06	CHI
20200251771	FIRMINOPOLIS	10008612798	FIRMINOPOLIS S1	11/02/2020 13:23	11/02/2020 17:31	11/02/2020 13:23	11/02/2020 17:31	4,13	1	4,13	CHI
20200251772	ANAPOLIS	AN11000273	JUNDIAI S1	11/02/2020 13:23	11/02/2020 18:38	11/02/2020 13:23	11/02/2020 18:38	5,24	156	818,18	CHI
20200251776	ITUMBIARA	10026531818	ITUMBIARA VELHA S1	11/02/2020 13:24	11/02/2020 16:25	11/02/2020 13:24	11/02/2020 16:25	3,01	1	3,01	CHI
20200251777	QUIRINOPOLIS	QI32038046	QUIRINOPOLIS	11/02/2020 13:24	12/02/2020 00:08	11/02/2020 13:24	12/02/2020 00:08	10,72	24	257,38	CHI
20200251786	MONTIVIDIU	MV21200063	MONTIVIDIU T	11/02/2020 13:26	11/02/2020 16:11	11/02/2020 13:26	11/02/2020 16:11	2,74	1	2,74	CHI

20200251794	MINEIROS	MY12303820	PARQUE DAS EMAS	11/02/2020 13:29	12/02/2020 10:23	11/02/2020 13:29	12/02/2020 10:23	20,90	28	585,11	CHI
20200251794	SANTA RITA DO ARAGUAIA	MY12303820	PARQUE DAS EMAS	11/02/2020 13:29	12/02/2020 10:23	11/02/2020 13:29	12/02/2020 10:23	20,90	2	41,79	CHI
20200251796	ANAPOLIS	20933502	ANAPOLIS UNIVERSITARIO S2	11/02/2020 13:29	11/02/2020 17:29	11/02/2020 13:29	11/02/2020 17:29	3,99	1	3,99	CHI
20200251797	ITABERAÍ	IB31198974	ITABERAÍ S2	11/02/2020 13:30	11/02/2020 15:10	11/02/2020 13:30	11/02/2020 15:10	1,66	1	1,66	CHI
20200251617	VALPARAISO DE GOIAS	03860244	PACAEMBU S1	11/02/2020 13:31	11/02/2020 17:25	11/02/2020 13:31	11/02/2020 13:57	0,43	10166	4365,73	CHI
20200251617	VALPARAISO DE GOIAS	03860244	PACAEMBU S1	11/02/2020 13:31	11/02/2020 17:25	11/02/2020 13:31	11/02/2020 14:45	1,23	1146	1406,08	CHI
20200251617	VALPARAISO DE GOIAS	03860244	PACAEMBU S1	11/02/2020 13:31	11/02/2020 17:25	11/02/2020 13:31	11/02/2020 17:25	3,89	724	2819,18	CHI
20200251802	ITAPURANGA	IK21325972	ITAPURANGA	11/02/2020 13:31	11/02/2020 15:10	11/02/2020 13:31	11/02/2020 15:10	1,65	1	1,65	CHI
20200251804	PIRACANJUBA	60072374	PIRACANJUBA	11/02/2020 13:31	11/02/2020 18:54	11/02/2020 13:31	11/02/2020 18:54	5,37	1	5,37	CHI
20200251813	ITAPURANGA	IK12326020	ITAPURANGA	11/02/2020 13:33	11/02/2020 16:15	11/02/2020 13:33	11/02/2020 16:15	2,69	2	5,37	CHI
20200251817	PONTALINA	PK11000003	PONTALINA	11/02/2020 13:34	11/02/2020 14:10	11/02/2020 13:34	11/02/2020 14:10	0,59	96	56,96	CHI
20200251836	AMARALINA	LC21168896	MARA ROSA	11/02/2020 13:37	11/02/2020 16:37	11/02/2020 13:37	11/02/2020 16:37	2,98	1	2,98	CHI
20200251838	FORMOSA	FA12394153	ITUIQUIRA	11/02/2020 13:38	11/02/2020 15:23	11/02/2020 13:38	11/02/2020 15:23	1,74	19	33,13	CHI
20200251840	MAURILANDIA	ML12303334	RIO DOS BOIS	11/02/2020 13:39	11/02/2020 16:43	11/02/2020 13:39	11/02/2020 16:43	3,06	14	42,88	CHI
20200251840	RIO VERDE	ML12303334	RIO DOS BOIS	11/02/2020 13:39	11/02/2020 16:43	11/02/2020 13:39	11/02/2020 16:43	3,06	2	6,13	CHI
20200251851	SAO FRANCISCO DE GOIAS	SF21221173	SAO FRANCISCO DE GOIAS	11/02/2020 13:42	11/02/2020 17:41	11/02/2020 13:42	11/02/2020 17:41	3,98	2	7,95	CHI
20200252742	NOVO GAMA	NJ11192955	PACAEMBU S1	11/02/2020 13:42	11/02/2020 19:18	11/02/2020 13:42	11/02/2020 19:18	5,59	111	620,46	CHI
20200251854	OUVIDOR	CT21000085	CATALAO S1	11/02/2020 13:43	11/02/2020 18:57	11/02/2020 13:43	11/02/2020 18:57	5,23	2	10,46	CHI
20200251896	NOVO GAMA	NJ11305083	MARAJOARA	11/02/2020 13:44	11/02/2020 18:44	11/02/2020 13:44	11/02/2020 18:44	5,00	377	1883,32	CHI
20200251858	CAMPO ALEGRE DE GOIAS	CM21071194	CAMPO ALEGRE DE GOIAS	11/02/2020 13:45	12/02/2020 23:56	11/02/2020 13:45	12/02/2020 23:56	34,18	1	34,18	CHI
20200251862	CAMPOS VERDES	VD11055151	SANTA TEREZINHA	11/02/2020 13:46	12/02/2020 12:40	11/02/2020 13:46	12/02/2020 12:40	22,89	4	91,57	CHI
20200251864	ALTO PARAISO DE GOIAS	BF21399133	FLORES DE GOIAS	11/02/2020 13:46	11/02/2020 16:08	11/02/2020 13:46	11/02/2020 16:08	2,36	1	2,36	CHI
20200251867	SANTO ANTONIO DO DESCOBERTO	SN21246914	AGUAS LINDAS DE GOIAS S2	11/02/2020 13:47	11/02/2020 21:23	11/02/2020 13:47	11/02/2020 21:23	7,60	2	15,19	CHI
20200251869	GOIANESIA	550070680	GOIANESIA S2	11/02/2020 13:48	11/02/2020 15:37	11/02/2020 13:48	11/02/2020 15:37	1,81	1	1,81	CHI
20200251880	ITAPURANGA	IK12310887	ITAPURANGA	11/02/2020 13:52	11/02/2020 18:42	11/02/2020 13:52	11/02/2020 18:42	4,83	2	9,67	CHI
20200251882	JATAI	JT11274079	JATAI S3	11/02/2020 13:52	11/02/2020 16:10	11/02/2020 13:52	11/02/2020 16:10	2,29	90	205,97	CHI
20200251885	RIO VERDE	630311316	CABRIUVA S1	11/02/2020 13:53	12/02/2020 09:01	11/02/2020 13:53	12/02/2020 09:01	19,13	0	0,00	CHI
20200251890	BOM JARDIM DE GOIAS	BM21335389	BOM JARDIM	11/02/2020 13:55	11/02/2020 19:01	11/02/2020 13:55	11/02/2020 19:01	5,09	1	5,09	CHI
20200251893	JANDAIA	PU12215442	PARAUNA	11/02/2020 13:56	13/02/2020 10:25	11/02/2020 13:56	13/02/2020 10:25	44,48	3	133,45	CHI
20200251895	CRIXAS	CX12322605	SERRA DO OURO	11/02/2020 13:56	11/02/2020 16:20	11/02/2020 13:56	11/02/2020 16:20	2,40	16	38,37	CHI
20200252327	ALEXANIA	AX11000006	ALEXANIA	11/02/2020 13:56	11/02/2020 19:09	11/02/2020 13:56	11/02/2020 19:09	5,21	72	375,12	CHI
20200251902	MINACU	IH12171869	MINACU	11/02/2020 13:57	11/02/2020 15:12	11/02/2020 13:57	11/02/2020 15:12	1,25	74	92,25	CHI
20200251905	SANTA CRUZ DE GOIAS	BC21233865	CALDAS NOVAS S1	11/02/2020 13:58	11/02/2020 18:27	11/02/2020 13:58	11/02/2020 18:27	4,48	1	4,48	CHI

20200252304	PIRES DO RIO	PR12166937	PIRES DO RIO S1	11/02/2020 13:58	11/02/2020 17:31	11/02/2020 13:58	11/02/2020 17:31	3,55	111	393,96	CHI
20200251913	SANTA CRUZ DE GOIAS	BC12023183	CRISTIANOPOLIS	11/02/2020 13:59	11/02/2020 17:56	11/02/2020 13:59	11/02/2020 17:56	3,94	43	169,43	CHI
20200251917	VALPARAISO DE GOIAS	2860161990	MARAJOARA	11/02/2020 13:59	11/02/2020 18:03	11/02/2020 13:59	11/02/2020 18:03	4,05	1	4,05	CHI
20200251918	PLANALTINA	2960073752	PLANALTINA	11/02/2020 14:00	11/02/2020 15:48	11/02/2020 14:00	11/02/2020 15:48	1,81	1	1,81	CHI
20200252348	IPAMERI	IP12017034	IPAMERI	11/02/2020 14:00	11/02/2020 18:46	11/02/2020 14:00	11/02/2020 18:46	4,76	47	223,79	CHI
20200251926	MINEIROS	MY12253766	PARQUE DAS EMAS	11/02/2020 14:01	12/02/2020 00:39	11/02/2020 14:01	12/02/2020 00:39	10,63	1	10,63	CHI
20200251927	AMARALINA	MU12384317	MARA ROSA	11/02/2020 14:01	11/02/2020 18:13	11/02/2020 14:01	11/02/2020 18:13	4,19	4	16,75	CHI
20200251927	MUTUNOPOLIS	MU12384317	MARA ROSA	11/02/2020 14:01	11/02/2020 18:13	11/02/2020 14:01	11/02/2020 18:13	4,19	20	83,76	CHI
20200251929	NOVO GAMA	10018894583	MARAJOARA	11/02/2020 14:03	11/02/2020 21:56	11/02/2020 14:03	11/02/2020 21:56	7,88	1	7,88	CHI
20200251931	ARAGARCAS	BM11369919	BOM JARDIM	11/02/2020 14:03	11/02/2020 16:42	11/02/2020 14:03	11/02/2020 16:42	2,64	1	2,64	CHI
20200252367	CAIAPONIA	RV12030683	MONTIVIDIU T	11/02/2020 14:06	11/02/2020 18:18	11/02/2020 14:06	11/02/2020 18:18	4,19	201	843,08	CHI
20200252367	RIO VERDE	RV12030683	MONTIVIDIU T	11/02/2020 14:06	11/02/2020 18:18	11/02/2020 14:06	11/02/2020 18:18	4,19	3	12,58	CHI
20200251944	MONTIVIDIU DO NORTE	MX11241199	PORANGATU	11/02/2020 14:07	11/02/2020 18:22	11/02/2020 14:07	11/02/2020 18:22	4,26	1	4,26	CHI
20200251946	FORMOSA	610073370	ITUIQUIRA	11/02/2020 14:07	11/02/2020 17:10	11/02/2020 14:07	11/02/2020 17:10	3,05	1	3,05	CHI
20200251950	CAMPOS BELOS	10005718714	SAO DOMINGOS	11/02/2020 14:07	11/02/2020 15:18	11/02/2020 14:07	11/02/2020 15:18	1,17	1	1,17	CHI
20200252381	SANTA RITA DO NOVO DESTINO	BA12168170	BARRO ALTO	11/02/2020 14:07	11/02/2020 16:38	11/02/2020 14:07	11/02/2020 16:38	2,51	17	42,74	CHI
20200251959	SANTA TEREZINHA DE GOIAS	SG21217656	SANTA TEREZINHA	11/02/2020 14:09	12/02/2020 11:12	11/02/2020 14:09	12/02/2020 11:12	21,03	1	21,03	CHI
20200251956	SAO DOMINGOS	SD12344106	SAO DOMINGOS	11/02/2020 14:10	11/02/2020 16:26	11/02/2020 14:10	11/02/2020 16:26	2,27	6	13,60	CHI
20200251977	IPAMERI	UT10400553	URUTAI	11/02/2020 14:11	12/02/2020 05:04	11/02/2020 14:11	12/02/2020 05:04	14,88	43	639,65	CHI
20200251977	URUTAI	UT10400553	URUTAI	11/02/2020 14:11	12/02/2020 05:04	11/02/2020 14:11	12/02/2020 05:04	14,88	39	580,15	CHI
20200252527	SANTA HELENA DE GOIAS	SH11056895	IPEGUARI	11/02/2020 14:12	11/02/2020 17:17	11/02/2020 14:12	11/02/2020 17:17	3,07	145	444,79	CHI
20200251971	IPAMERI	IP12080281	PIRES DO RIO S2	11/02/2020 14:13	12/02/2020 14:13	11/02/2020 14:13	12/02/2020 14:13	23,99	2	47,98	CHI
20200251971	ORIZONA	IP12080281	PIRES DO RIO S2	11/02/2020 14:13	12/02/2020 14:13	11/02/2020 14:13	12/02/2020 14:13	23,99	1	23,99	CHI
20200252371	PLANALTINA	PI12262312	PLANALTINA	11/02/2020 14:13	11/02/2020 16:35	11/02/2020 14:13	11/02/2020 16:35	2,36	10	23,63	CHI
20200252520	FORMOSA	FA12085474	ITUIQUIRA	11/02/2020 14:14	11/02/2020 16:32	11/02/2020 14:14	11/02/2020 16:32	2,29	29	66,55	CHI
20200252589	VALPARAISO DE GOIAS	LZ12000352	PACAEMBU S1	11/02/2020 14:18	11/02/2020 16:35	11/02/2020 14:18	11/02/2020 16:35	2,27	294	666,56	CHI
20200251996	RIO VERDE	630317320	RIO VERDE S1	11/02/2020 14:20	12/02/2020 06:08	11/02/2020 14:20	12/02/2020 06:08	15,79	1	15,79	CHI
20200251998	PONTALINA	VI12047300	VICENTINOPOLIS	11/02/2020 14:21	11/02/2020 18:29	11/02/2020 14:21	11/02/2020 18:29	4,13	2	8,27	CHI
20200251998	VICENTINOPOLIS	VI12047300	VICENTINOPOLIS	11/02/2020 14:21	11/02/2020 18:29	11/02/2020 14:21	11/02/2020 18:29	4,13	3	12,40	CHI
20200252303	CACHOEIRA ALTA	CA21283024	CACHOEIRA ALTA	11/02/2020 14:21	11/02/2020 23:32	11/02/2020 14:21	11/02/2020 23:32	9,17	1	9,17	CHI
20200252307	NIQUELANDIA	NQ12392034	URUACU	11/02/2020 14:22	11/02/2020 16:22	11/02/2020 14:22	11/02/2020 16:22	1,99	4	7,94	CHI
20200252318	ESTRELA DO NORTE	ET12256551	MARA ROSA	11/02/2020 14:22	12/02/2020 09:07	11/02/2020 14:22	12/02/2020 09:07	18,74	9	168,70	CHI
20200252315	LUZIANIA	120307510	RIO VERMELHO	11/02/2020 14:23	11/02/2020 18:03	11/02/2020 14:23	11/02/2020 18:03	3,65	1	3,65	CHI

20200252317	AGUAS LINDAS DE GOIAS	4830241800	AGUAS LINDAS DE GOIAS S1	11/02/2020 14:24	11/02/2020 15:57	11/02/2020 14:24	11/02/2020 15:57	1,55	1	1,55	CHI
20200252325	GOIANIA	GN12350750	CEPAIGO S1	11/02/2020 14:26	11/02/2020 17:40	11/02/2020 14:26	11/02/2020 17:40	3,23	1	3,23	CHI
20200252328	SAO MIGUEL DO ARAGUAIA	830077443	SAO MIGUEL DO ARAGUAIA	11/02/2020 14:27	11/02/2020 16:14	11/02/2020 14:27	11/02/2020 16:14	1,79	1	1,79	CHI
20200252332	AMARALINA	MH12391970LD	NOVA CRIXAS	11/02/2020 14:29	11/02/2020 19:46	11/02/2020 14:29	11/02/2020 19:46	5,29	1	5,29	CHI
20200252332	MUNDO NOVO DE GOIAS	MH12391970LD	NOVA CRIXAS	11/02/2020 14:29	11/02/2020 19:46	11/02/2020 14:29	11/02/2020 19:46	5,29	4	21,16	CHI
20200252342	CATALAO	CT21344524	CATALAO S1	11/02/2020 14:30	11/02/2020 16:54	11/02/2020 14:30	11/02/2020 16:54	2,39	1	2,39	CHI
20200252344	ITAPIRAPUA	IU11264128	MATRINCHA	11/02/2020 14:31	12/02/2020 09:20	11/02/2020 14:31	12/02/2020 09:20	18,81	1	18,81	CHI
20200252346	APARECIDA DE GOIANIA	AP11095068	ATLANTICO S2	11/02/2020 14:32	11/02/2020 17:25	11/02/2020 14:32	11/02/2020 17:25	2,88	209	601,75	CHI
20200252739	ITUMBIARA	IT12391000	ITUMBIARA VELHA S1	11/02/2020 14:33	11/02/2020 17:56	11/02/2020 14:33	11/02/2020 17:56	3,38	768	2597,97	CHI
20200252739	ITUMBIARA	IT16411375	ITUMBIARA VELHA S1	11/02/2020 14:33	11/02/2020 17:56	11/02/2020 17:51	11/02/2020 17:56	0,09	1485	127,05	CHI
20200253125	ACREUNA	JD12255748	ACREUNA	11/02/2020 14:33	11/02/2020 19:14	11/02/2020 14:33	11/02/2020 19:14	4,68	5	23,39	CHI
20200253125	JANDAIA	JD12255748	ACREUNA	11/02/2020 14:33	11/02/2020 19:14	11/02/2020 14:33	11/02/2020 19:14	4,68	1	4,68	CHI
20200252357	AGUA FRIA DE GOIAS	JL12270094	SAO JOAO D ALIANCA	11/02/2020 14:34	11/02/2020 19:05	11/02/2020 14:34	11/02/2020 19:05	4,51	1	4,51	CHI
20200252357	SAO JOAO D ALIANCA	JL12270094	SAO JOAO D ALIANCA	11/02/2020 14:34	11/02/2020 19:05	11/02/2020 14:34	11/02/2020 19:05	4,51	8	36,11	CHI
20200252360	SANTA HELENA DE GOIAS	400050687	IPEGUARI	11/02/2020 14:35	11/02/2020 17:50	11/02/2020 14:35	11/02/2020 17:50	3,25	1	3,25	CHI
20200252362	GOIANESIA	10008998645	GOIANESIA S2	11/02/2020 14:35	11/02/2020 16:45	11/02/2020 14:35	11/02/2020 16:45	2,17	1	2,17	CHI
20200252363	SANTA TEREZA DE GOIAS	SE12262714	PORANGATU	11/02/2020 14:35	11/02/2020 20:28	11/02/2020 14:35	11/02/2020 20:28	5,88	14	82,30	CHI
20200252373	BARRO ALTO	GE12092176	GOIANESIA S1	11/02/2020 14:37	12/02/2020 01:30	11/02/2020 14:37	12/02/2020 01:30	10,89	1	10,89	CHI
20200252379	APARECIDA DO RIO DOCE	AW12189038	CACHOEIRA ALTA	11/02/2020 14:38	11/02/2020 18:07	11/02/2020 14:38	11/02/2020 17:48	3,17	24	75,97	CHI
20200252379	CACHOEIRA ALTA	AW21131529	CACHOEIRA ALTA	11/02/2020 14:38	11/02/2020 18:07	11/02/2020 17:40	11/02/2020 18:07	0,44	1	0,44	CHI
20200252382	CORUMBA DE GOIAS	CB21027567	CORUMBA	11/02/2020 14:40	11/02/2020 17:14	11/02/2020 14:40	11/02/2020 17:14	2,55	1	2,55	CHI
20200252383	EDEIA	EA12033516	RIO DOS BOIS	11/02/2020 14:40	11/02/2020 17:44	11/02/2020 14:40	11/02/2020 17:44	3,05	2	6,10	CHI
20200252391	VALPARAISO DE GOIAS	10007189441	PACAEMBU S1	11/02/2020 14:43	11/02/2020 17:39	11/02/2020 14:43	11/02/2020 17:39	2,92	1	2,92	CHI
20200252393	GOIANESIA	GE21236923	GOIANESIA S2	11/02/2020 14:43	11/02/2020 21:20	11/02/2020 14:43	11/02/2020 21:20	6,62	1	6,62	CHI
20200252396	ITAPIRAPUA	IU12206874	MATRINCHA	11/02/2020 14:44	12/02/2020 00:11	11/02/2020 14:44	12/02/2020 00:11	9,45	1	9,45	CHI
20200252398	IPAMERI	580057987	IPAMERI	11/02/2020 14:44	11/02/2020 20:20	11/02/2020 14:44	11/02/2020 20:20	5,59	1	5,59	CHI
20200252501	TROMBAS	TB12156640	PORANGATU	11/02/2020 14:44	11/02/2020 19:05	11/02/2020 14:44	11/02/2020 19:05	4,33	95	411,72	CHI
20200252511	ANAPOLIS	AN11157954	ANAPOLIS UNIVERSITARIO S2	11/02/2020 14:47	11/02/2020 21:10	11/02/2020 20:12	11/02/2020 21:10	0,96	104	99,78	CHI
20200252513	INHUMAS	IN21000195	ARACU	11/02/2020 14:47	11/02/2020 19:54	11/02/2020 14:47	11/02/2020 19:54	5,11	2	10,22	CHI
20200252515	ALOANDIA	PK21171729	GOIATUBA S1	11/02/2020 14:47	11/02/2020 15:57	11/02/2020 14:47	11/02/2020 15:57	1,15	1	1,15	CHI
20200252516	ITABERAI	10007295799	ITABERAI S2	11/02/2020 14:49	11/02/2020 19:26	11/02/2020 14:49	11/02/2020 19:26	4,61	1	4,61	CHI
20200252557	SAO JOAO D ALIANCA	JL12049197	SAO JOAO D ALIANCA	11/02/2020 14:51	11/02/2020 16:54	11/02/2020 14:51	11/02/2020 16:54	2,04	6	12,22	CHI
20200252529	ALTO HORIZONTE	AJ12143571	MARA ROSA	11/02/2020 14:54	11/02/2020 16:33	11/02/2020 14:54	11/02/2020 16:33	1,65	37	60,99	CHI

20200252529	MARA ROSA	AJ12143571	MARA ROSA	11/02/2020 14:54	11/02/2020 16:33	11/02/2020 14:54	11/02/2020 16:33	1,65	5	8,24	CHI
20200252529	NOVA IGUAÇU DE GOIAS	AJ12143571	MARA ROSA	11/02/2020 14:54	11/02/2020 16:33	11/02/2020 14:54	11/02/2020 16:33	1,65	12	19,78	CHI
20200252534	GOIANIA	11420157	CAMPINAS S1	11/02/2020 14:55	11/02/2020 16:53	11/02/2020 14:55	11/02/2020 16:53	1,96	1	1,96	CHI
20200252535	BOM JESUS DE GOIAS	JV12222565RE	VICENTINOPOLIS	11/02/2020 14:55	11/02/2020 16:08	11/02/2020 14:55	11/02/2020 16:08	1,21	3	3,64	CHI
20200252535	GOIATUBA	JV12222565RE	VICENTINOPOLIS	11/02/2020 14:55	11/02/2020 16:08	11/02/2020 14:55	11/02/2020 16:08	1,21	14	16,97	CHI
20200252535	JOVIANIA	JV12222565RE	VICENTINOPOLIS	11/02/2020 14:55	11/02/2020 16:08	11/02/2020 14:55	11/02/2020 16:08	1,21	6	7,27	CHI
20200252535	VICENTINOPOLIS	JV12222565RE	VICENTINOPOLIS	11/02/2020 14:55	11/02/2020 16:08	11/02/2020 14:55	11/02/2020 16:08	1,21	2	2,42	CHI
20200252569	CAMPO ALEGRE DE GOIAS	02250434	CAMPO ALEGRE DE GOIAS	11/02/2020 14:55	13/02/2020 14:45	11/02/2020 14:55	11/02/2020 17:16	2,35	125	293,23	CHI
20200252569	CATALAO	02250434	CAMPO ALEGRE DE GOIAS	11/02/2020 14:55	13/02/2020 14:45	11/02/2020 14:55	11/02/2020 17:16	2,35	59	138,40	CHI
20200252569	CAMPO ALEGRE DE GOIAS	02250434	CAMPO ALEGRE DE GOIAS	11/02/2020 14:55	13/02/2020 14:45	11/02/2020 14:55	11/02/2020 17:44	2,82	64	180,27	CHI
20200252569	CAMPO ALEGRE DE GOIAS	02250434	CAMPO ALEGRE DE GOIAS	11/02/2020 14:55	13/02/2020 14:45	11/02/2020 21:15	11/02/2020 21:19	0,06	64	3,56	CHI
20200252569	CAMPO ALEGRE DE GOIAS	02250434	CAMPO ALEGRE DE GOIAS	11/02/2020 14:55	13/02/2020 14:45	11/02/2020 14:55	13/02/2020 10:56	44,02	16	704,30	CHI
20200252569	CAMPO ALEGRE DE GOIAS	CM13203185	CAMPO ALEGRE DE GOIAS	11/02/2020 14:55	13/02/2020 14:45	13/02/2020 11:23	13/02/2020 11:36	0,21	125	26,56	CHI
20200252569	CATALAO	CM13203185	CAMPO ALEGRE DE GOIAS	11/02/2020 14:55	13/02/2020 14:45	13/02/2020 11:23	13/02/2020 11:36	0,21	59	12,54	CHI
20200252569	CAMPO ALEGRE DE GOIAS	02250434	CAMPO ALEGRE DE GOIAS	11/02/2020 14:55	13/02/2020 14:45	11/02/2020 14:55	13/02/2020 11:37	44,69	14	625,61	CHI
20200252569	CAMPO ALEGRE DE GOIAS	02250434	CAMPO ALEGRE DE GOIAS	11/02/2020 14:55	13/02/2020 14:45	11/02/2020 14:55	13/02/2020 14:45	47,82	5	239,10	CHI
20200252537	CAMPOS BELOS	CH12384777	SAO DOMINGOS	11/02/2020 14:56	11/02/2020 16:45	11/02/2020 14:56	11/02/2020 16:45	1,81	13	23,55	CHI
20200252539	POSSE	PS11212686	IACIARA S1	11/02/2020 14:57	11/02/2020 18:26	11/02/2020 14:57	11/02/2020 18:26	3,47	9	31,22	CHI
20200252540	GOIANIA	GN11272034	GOYA S1	11/02/2020 14:57	11/02/2020 16:17	11/02/2020 14:57	11/02/2020 16:17	1,32	29	38,23	CHI
20200252549	VILA PROPICIO	NP21235920	GOIANESIA S1	11/02/2020 15:00	11/02/2020 19:00	11/02/2020 15:00	11/02/2020 19:00	3,99	2	7,99	CHI
20200252552	COCALZINHO DE GOIAS	10005906618	AGUAS LINDAS DE GOIAS S2	11/02/2020 15:00	11/02/2020 16:28	11/02/2020 15:00	11/02/2020 16:28	1,45	1	1,45	CHI
20200252560	MINACU	IH12317057	MINACU	11/02/2020 15:02	11/02/2020 17:47	11/02/2020 15:02	11/02/2020 17:47	2,74	5	13,69	CHI
20200252566	MONTIVIDIU DO NORTE	MX11241212	PORANGATU	11/02/2020 15:03	11/02/2020 18:42	11/02/2020 15:03	11/02/2020 18:42	3,64	1	3,64	CHI
20200252567	BONOPOLIS	BX21321746	SAO MIGUEL DO ARAGUAIA	11/02/2020 15:03	11/02/2020 19:11	11/02/2020 15:03	11/02/2020 19:11	4,12	1	4,12	CHI
20200252570	SANTA RITA DO ARAGUAIA	SU11256807	SANTA RITA DO ARAGUAIA	11/02/2020 15:04	11/02/2020 22:05	11/02/2020 15:04	11/02/2020 22:05	7,00	1	7,00	CHI
20200252573	INHUMAS	30133531	INHUMAS S2	11/02/2020 15:05	11/02/2020 18:18	11/02/2020 15:05	11/02/2020 18:18	3,22	1	3,22	CHI
20200252578	NEROPOLIS	NR12325422	NEROPOLIS S2	11/02/2020 15:05	11/02/2020 17:40	11/02/2020 15:05	11/02/2020 17:40	2,57	8	20,57	CHI
20200252580	CALDAS NOVAS	CN11246635	SERRA DE CALDAS	11/02/2020 15:06	11/02/2020 18:23	11/02/2020 15:06	11/02/2020 18:23	3,28	42	137,88	CHI
20200252582	IPORA	IR11005247	IPORA	11/02/2020 15:06	11/02/2020 15:40	11/02/2020 15:06	11/02/2020 15:40	0,56	55	30,68	CHI
20200252701	MONTE ALEGRE DE GOIAS	MA12233174	SAO DOMINGOS	11/02/2020 15:12	11/02/2020 17:00	11/02/2020 15:12	11/02/2020 17:00	1,78	17	30,34	CHI
20200252702	CAMPOS BELOS	CH11077826	SAO DOMINGOS	11/02/2020 15:13	11/02/2020 18:25	11/02/2020 15:13	11/02/2020 18:25	3,20	93	297,34	CHI
20200252705	LUZIANIA	120278364	RIO VERMELHO	11/02/2020 15:13	11/02/2020 17:06	11/02/2020 15:13	11/02/2020 17:06	1,87	1	1,87	CHI
20200252709	ALEXANIA	10029938285	ALEXANIA	11/02/2020 15:14	11/02/2020 16:18	11/02/2020 15:14	11/02/2020 16:18	1,05	1	1,05	CHI

20200252715	QUIRINOPOLIS	QI12226698	SANTA HELENA S1	11/02/2020 15:14	11/02/2020 19:36	11/02/2020 15:14	11/02/2020 19:36	4,36	6	26,13	CHI
20200252710	ITAPIRAPUA	IU12142824	MATRINCHA	11/02/2020 15:15	11/02/2020 20:36	11/02/2020 15:15	11/02/2020 20:36	5,35	13	69,53	CHI
20200252712	CATALAO	CT12338751	CATALAO S1	11/02/2020 15:15	11/02/2020 21:57	11/02/2020 15:15	11/02/2020 21:57	6,70	4	26,79	CHI
20200252718	RIO VERDE	RV21273698	CABRIUVA S2	11/02/2020 15:17	11/02/2020 19:30	11/02/2020 15:17	11/02/2020 19:30	4,22	1	4,22	CHI
20200252725	AGUA FRIA DE GOIAS	JL12261887	SAO JOAO D ALIANCA	11/02/2020 15:18	12/02/2020 13:28	11/02/2020 15:18	12/02/2020 08:50	17,54	2	35,08	CHI
20200252725	SAO JOAO D ALIANCA	JL12261887	SAO JOAO D ALIANCA	11/02/2020 15:18	12/02/2020 13:28	11/02/2020 15:18	12/02/2020 08:50	17,54	8	140,32	CHI
20200252725	AGUA FRIA DE GOIAS	JL12261887	SAO JOAO D ALIANCA	11/02/2020 15:18	12/02/2020 13:28	11/02/2020 20:00	12/02/2020 08:50	12,85	4	51,39	CHI
20200252725	SAO JOAO D ALIANCA	JL12261887	SAO JOAO D ALIANCA	11/02/2020 15:18	12/02/2020 13:28	11/02/2020 20:00	12/02/2020 08:50	12,85	9	115,62	CHI
20200252725	AGUA FRIA DE GOIAS	JL12261887	SAO JOAO D ALIANCA	11/02/2020 15:18	12/02/2020 13:28	12/02/2020 09:33	12/02/2020 10:08	0,57	6	3,44	CHI
20200252725	SAO JOAO D ALIANCA	JL12261887	SAO JOAO D ALIANCA	11/02/2020 15:18	12/02/2020 13:28	12/02/2020 09:33	12/02/2020 10:08	0,57	17	9,75	CHI
20200252725	AGUA FRIA DE GOIAS	TL12337490LD	SAO JOAO D ALIANCA	11/02/2020 15:18	12/02/2020 13:28	11/02/2020 20:00	12/02/2020 13:28	17,48	3	52,44	CHI
20200252725	SAO JOAO D ALIANCA	TL12337490LD	SAO JOAO D ALIANCA	11/02/2020 15:18	12/02/2020 13:28	11/02/2020 20:00	12/02/2020 13:28	17,48	1	17,48	CHI
20200252734	URUACU	640088302	URUACU	11/02/2020 15:21	11/02/2020 16:34	11/02/2020 15:21	11/02/2020 16:34	1,21	1	1,21	CHI
20200252846	GUARINOS	GF12099025	SANTA TEREZINHA	11/02/2020 15:21	11/02/2020 17:35	11/02/2020 15:21	11/02/2020 17:35	2,22	219	486,48	CHI
20200252752	ACREUNA	EU21104067	ACREUNA	11/02/2020 15:22	11/02/2020 21:44	11/02/2020 15:22	11/02/2020 21:44	6,36	1	6,36	CHI
20200252745	INHUMAS	30032325	INHUMAS S2	11/02/2020 15:23	11/02/2020 16:31	11/02/2020 15:23	11/02/2020 16:31	1,13	1	1,13	CHI
20200252750	JANDAIA	JD21158995	PALMEIRAS	11/02/2020 15:24	12/02/2020 19:30	11/02/2020 15:24	12/02/2020 19:30	28,09	1	28,09	CHI
20200252754	ABADIANIA	AA21144049	ANAPOLIS UNIVERSITARIO S1	11/02/2020 15:24	11/02/2020 16:57	11/02/2020 15:24	11/02/2020 16:57	1,54	1	1,54	CHI
20200252758	DAMOLANDIA	270009176	INHUMAS S1	11/02/2020 15:26	11/02/2020 20:27	11/02/2020 15:26	11/02/2020 20:27	5,02	1	5,02	CHI
20200252760	GOIANIA	11104351	AEROPORTO S1	11/02/2020 15:26	11/02/2020 17:39	11/02/2020 15:26	11/02/2020 17:39	2,21	1	2,21	CHI
20200253112	BARRO ALTO	BA11055045	BARRO ALTO	11/02/2020 15:26	11/02/2020 18:13	11/02/2020 15:26	11/02/2020 18:13	2,77	165	456,73	CHI
20200252766	GOIANIA	15267787	ATLANTICO S1	11/02/2020 15:27	11/02/2020 16:43	11/02/2020 15:27	11/02/2020 16:43	1,26	1	1,26	CHI
20200252767	GOIANIA	12134338	CAMPINAS S2	11/02/2020 15:27	11/02/2020 16:27	11/02/2020 15:27	11/02/2020 16:27	0,99	1	0,99	CHI
20200252772	APORE	IJ12194905	ITAJA S2	11/02/2020 15:29	11/02/2020 19:19	11/02/2020 15:29	11/02/2020 19:19	3,83	1	3,83	CHI
20200252772	ITAJA	IJ12194905	ITAJA S2	11/02/2020 15:29	11/02/2020 19:19	11/02/2020 15:29	11/02/2020 19:19	3,83	182	697,46	CHI
20200252775	RIO VERDE	630389871	RIO VERDE S2	11/02/2020 15:29	12/02/2020 01:56	11/02/2020 15:29	12/02/2020 01:56	10,44	1	10,44	CHI
20200252777	GOIATUBA	JV12026571	GOIATUBA S1	11/02/2020 15:30	11/02/2020 19:39	11/02/2020 15:30	11/02/2020 19:39	4,16	4	16,62	CHI
20200252781	NEROPOLIS	160078969	NEROPOLIS S2	11/02/2020 15:31	11/02/2020 16:47	11/02/2020 15:31	11/02/2020 16:47	1,26	1	1,26	CHI
20200252782	APARECIDA DE GOIANIA	10559097	REAL S2	11/02/2020 15:31	11/02/2020 18:16	11/02/2020 15:31	11/02/2020 18:16	2,74	1	2,74	CHI
20200252784	SANCLERLANDIA	SC12391519	FIRMINOPOLIS S2	11/02/2020 15:32	11/02/2020 17:49	11/02/2020 15:32	11/02/2020 17:49	2,27	1	2,27	CHI
20200252784	SAO LUIS DE MONTES BELOS	SC12391519	FIRMINOPOLIS S2	11/02/2020 15:32	11/02/2020 17:49	11/02/2020 15:32	11/02/2020 17:49	2,27	2	4,54	CHI
2020021100061	CAMPOS BELOS	07601	SAO DOMINGOS	11/02/2020 15:32	11/02/2020 15:36	11/02/2020 15:32	11/02/2020 15:36	0,07	4603	306,87	CHI
2020021100061	CAMPOS BELOS	07602	SAO DOMINGOS	11/02/2020 15:32	11/02/2020 15:36	11/02/2020 15:32	11/02/2020 15:36	0,07	2683	178,87	CHI

2020021100061	CAMPOS BELOS	02090414	SAO DOMINGOS	11/02/2020 15:32	11/02/2020 15:36	11/02/2020 15:32	11/02/2020 15:36	0,07	90	6,00	CHI
2020021100061	CAMPOS BELOS	07632	SAO DOMINGOS	11/02/2020 15:32	11/02/2020 15:36	11/02/2020 15:32	11/02/2020 15:36	0,07	153	10,20	CHI
2020021100061	CAMPOS BELOS	07633	SAO DOMINGOS	11/02/2020 15:32	11/02/2020 15:36	11/02/2020 15:32	11/02/2020 15:36	0,07	362	24,13	CHI
2020021100061	CAVALCANTE	34301	SAO DOMINGOS	11/02/2020 15:32	11/02/2020 15:36	11/02/2020 15:32	11/02/2020 15:36	0,07	170	11,33	CHI
2020021100061	DIVINOPOLIS DE GOIAS	02090414	SAO DOMINGOS	11/02/2020 15:32	11/02/2020 15:36	11/02/2020 15:32	11/02/2020 15:36	0,07	2238	149,20	CHI
2020021100061	DIVINOPOLIS DE GOIAS	07633	SAO DOMINGOS	11/02/2020 15:32	11/02/2020 15:36	11/02/2020 15:32	11/02/2020 15:36	0,07	3	0,20	CHI
2020021100061	MONTE ALEGRE DE GOIAS	07601	SAO DOMINGOS	11/02/2020 15:32	11/02/2020 15:36	11/02/2020 15:32	11/02/2020 15:36	0,07	54	3,60	CHI
2020021100061	MONTE ALEGRE DE GOIAS	34301	SAO DOMINGOS	11/02/2020 15:32	11/02/2020 15:36	11/02/2020 15:32	11/02/2020 15:36	0,07	1902	126,80	CHI
2020021100061	MONTE ALEGRE DE GOIAS	02090414	SAO DOMINGOS	11/02/2020 15:32	11/02/2020 15:36	11/02/2020 15:32	11/02/2020 15:36	0,07	156	10,40	CHI
2020021100061	MONTE ALEGRE DE GOIAS	07633	SAO DOMINGOS	11/02/2020 15:32	11/02/2020 15:36	11/02/2020 15:32	11/02/2020 15:36	0,07	717	47,80	CHI
2020021100061	NOVA ROMA	34301	SAO DOMINGOS	11/02/2020 15:32	11/02/2020 15:36	11/02/2020 15:32	11/02/2020 15:36	0,07	57	3,80	CHI
2020021100061	SAO DOMINGOS	02090214	SAO DOMINGOS	11/02/2020 15:32	11/02/2020 15:36	11/02/2020 15:32	11/02/2020 15:36	0,07	2381	158,73	CHI
2020021100061	SAO DOMINGOS	02090414	SAO DOMINGOS	11/02/2020 15:32	11/02/2020 15:36	11/02/2020 15:32	11/02/2020 15:36	0,07	395	26,33	CHI
2020021100061	SAO DOMINGOS	07633	SAO DOMINGOS	11/02/2020 15:32	11/02/2020 15:36	11/02/2020 15:32	11/02/2020 15:36	0,07	287	19,13	CHI
20200252785	QUIRINOPOLIS	QI21092926	QUIRINOPOLIS	11/02/2020 15:33	11/02/2020 16:56	11/02/2020 15:33	11/02/2020 16:56	1,38	3	4,15	CHI
20200252786	ALTO PARAISO DE GOIAS	9380000175	FLORES DE GOIAS	11/02/2020 15:33	11/02/2020 17:22	11/02/2020 15:33	11/02/2020 17:22	1,81	1	1,81	CHI
20200252789	INDIARA	2710030040	EDEIA	11/02/2020 15:33	11/02/2020 20:29	11/02/2020 15:33	11/02/2020 20:29	4,93	1	4,93	CHI
2020021100060	GUARANI DE GOIAS	02090424	SAO DOMINGOS	11/02/2020 15:33	11/02/2020 15:37	11/02/2020 15:33	11/02/2020 15:37	0,07	149	10,55	CHI
2020021100060	MONTE ALEGRE DE GOIAS	02090424	SAO DOMINGOS	11/02/2020 15:33	11/02/2020 15:37	11/02/2020 15:33	11/02/2020 15:37	0,07	2	0,14	CHI
2020021100060	NOVA ROMA	02090424	SAO DOMINGOS	11/02/2020 15:33	11/02/2020 15:37	11/02/2020 15:33	11/02/2020 15:37	0,07	3	0,21	CHI
2020021100060	SAO DOMINGOS	02090424	SAO DOMINGOS	11/02/2020 15:33	11/02/2020 15:37	11/02/2020 15:33	11/02/2020 15:37	0,07	1157	81,95	CHI
20200252792	ITUMBIARA	BG12000045	ITUMBIARA VELHA S2	11/02/2020 15:34	11/02/2020 19:16	11/02/2020 15:34	11/02/2020 19:16	3,69	1	3,69	CHI
20200252801	BOM JESUS DE GOIAS	BJ12305420	BOM JESUS DE GOIAS	11/02/2020 15:36	14/02/2020 16:30	11/02/2020 15:36	12/02/2020 18:24	26,80	2	53,60	CHI
20200252801	BOM JESUS DE GOIAS	BJ12305420	BOM JESUS DE GOIAS	11/02/2020 15:36	14/02/2020 16:30	11/02/2020 15:36	12/02/2020 18:24	26,80	1	26,80	CHI
20200252801	BOM JESUS DE GOIAS	BJ12305420	BOM JESUS DE GOIAS	11/02/2020 15:36	14/02/2020 16:30	11/02/2020 15:36	14/02/2020 16:30	72,91	1	72,91	CHI
20200252809	CAIAPONIA	CP11020883	CAIAPONIA	11/02/2020 15:38	12/02/2020 10:52	11/02/2020 15:38	12/02/2020 10:52	19,23	151	2903,14	CHI
20200252813	GOIANIA	13971232	MEIA PONTE	11/02/2020 15:39	11/02/2020 17:56	11/02/2020 15:39	11/02/2020 17:56	2,28	1	2,28	CHI
20200252814	JATAI	JT21267500	JATAI S1	11/02/2020 15:39	11/02/2020 21:16	11/02/2020 15:39	11/02/2020 21:16	5,61	2	11,22	CHI
20200252823	GOIANESIA	550011316	GOIANESIA S2	11/02/2020 15:39	11/02/2020 18:22	11/02/2020 15:39	11/02/2020 18:22	2,72	1	2,72	CHI
20200252825	POSSE	PS21217893	IACIARA S2	11/02/2020 15:41	11/02/2020 18:08	11/02/2020 15:41	11/02/2020 18:08	2,44	3	7,31	CHI
20200252830	INDIARA	10027771812	PALMEIRAS	11/02/2020 15:42	12/02/2020 20:01	11/02/2020 15:42	12/02/2020 20:01	28,31	1	28,31	CHI
20200252888	GOIANIA	GN12395299	REAL S2	11/02/2020 15:43	11/02/2020 16:53	11/02/2020 15:43	11/02/2020 16:53	1,17	332	387,33	CHI
20200252618	RIO VERDE	RV11159450	RIO VERDE S1	11/02/2020 15:44	11/02/2020 17:14	11/02/2020 16:30	11/02/2020 17:14	0,74	79	58,28	CHI

20200252836	CACHOEIRA ALTA	CA21031295	CACHOEIRA ALTA	11/02/2020 15:44	12/02/2020 00:25	11/02/2020 15:44	12/02/2020 00:25	8,68	1	8,68	CHI
20200253207	BARRO ALTO	BA12064534	BARRO ALTO	11/02/2020 15:44	12/02/2020 12:27	11/02/2020 15:44	12/02/2020 12:27	20,71	7	145,00	CHI
20200252850	BOM JESUS DE GOIAS	1250033187	BOM JESUS DE GOIAS	11/02/2020 15:45	11/02/2020 23:44	11/02/2020 15:45	11/02/2020 23:44	7,97	1	7,97	CHI
20200252848	RIO VERDE	RV21028153	SANTA HELENA S1	11/02/2020 15:46	11/02/2020 22:03	11/02/2020 15:46	11/02/2020 22:03	6,27	1	6,27	CHI
20200252851	CORUMBA DE GOIAS	CB21111172	CORUMBA	11/02/2020 15:47	11/02/2020 18:10	11/02/2020 15:47	11/02/2020 18:10	2,38	1	2,38	CHI
20200252853	ANAPOLIS	20196702	JUNDIAI S2	11/02/2020 15:47	11/02/2020 19:12	11/02/2020 15:47	11/02/2020 19:12	3,40	1	3,40	CHI
20200252862	MINEIROS	MY21274160	PARQUE DAS EMAS	11/02/2020 15:51	11/02/2020 21:21	11/02/2020 15:51	11/02/2020 21:21	5,50	1	5,50	CHI
20200252863	GOIANIA	GN11166137	FERROVIARIO S2	11/02/2020 15:51	11/02/2020 17:12	11/02/2020 15:51	11/02/2020 17:12	1,34	67	89,98	CHI
20200252868	JARAGUA	JA12353176	JARAGUA	11/02/2020 15:53	11/02/2020 19:56	11/02/2020 15:53	11/02/2020 19:56	4,05	6	24,29	CHI
20200252870	MONTE ALEGRE DE GOIAS	MA11164523	SAO DOMINGOS	11/02/2020 15:53	11/02/2020 19:29	11/02/2020 15:53	11/02/2020 19:29	3,60	137	493,43	CHI
20200252872	DIVINOPOLIS DE GOIAS	GH12211210	SAO DOMINGOS	11/02/2020 15:53	11/02/2020 19:46	11/02/2020 15:53	11/02/2020 19:46	3,87	18	69,72	CHI
20200252971	RIO VERDE	RV12260643	CABRIUVA S2	11/02/2020 15:53	12/02/2020 01:29	11/02/2020 15:53	12/02/2020 01:29	9,60	8	76,84	CHI
20200252878	AGUA FRIA DE GOIAS	TL12320501	SAO JOAO D ALIANCA	11/02/2020 15:55	11/02/2020 19:09	11/02/2020 15:55	11/02/2020 19:09	3,23	36	116,37	CHI
20200252881	DISTRITO FEDERAL	FA12383392	ITIQUEIRA	11/02/2020 15:55	12/02/2020 07:14	11/02/2020 15:55	12/02/2020 07:14	15,32	2	30,64	CHI
20200252881	FORMOSA	FA12383392	ITIQUEIRA	11/02/2020 15:55	12/02/2020 07:14	11/02/2020 15:55	12/02/2020 07:14	15,32	1	15,32	CHI
20200252621	CAMPINACU	FO10328897	PORANGATU	11/02/2020 15:56	11/02/2020 16:26	11/02/2020 15:56	11/02/2020 16:26	0,50	1514	758,68	CHI
20200252621	CAMPINORTE	FO10328897	PORANGATU	11/02/2020 15:56	11/02/2020 16:26	11/02/2020 15:56	11/02/2020 16:26	0,50	149	74,67	CHI
20200252621	FORMOSO	FO10328897	PORANGATU	11/02/2020 15:56	11/02/2020 16:26	11/02/2020 15:56	11/02/2020 16:26	0,50	46	23,05	CHI
20200252621	MINACU	FO10328897	PORANGATU	11/02/2020 15:56	11/02/2020 16:26	11/02/2020 15:56	11/02/2020 16:26	0,50	43	21,55	CHI
20200252621	PORANGATU	FO10328897	PORANGATU	11/02/2020 15:56	11/02/2020 16:26	11/02/2020 15:56	11/02/2020 16:26	0,50	1	0,50	CHI
20200252889	CALDAS NOVAS	CN21180297	CALDAS NOVAS S1	11/02/2020 15:57	11/02/2020 22:06	11/02/2020 15:57	11/02/2020 22:06	6,14	1	6,14	CHI
20200252893	NOVO GAMA	10015131252	PACAEMBU S1	11/02/2020 15:58	12/02/2020 00:37	11/02/2020 15:58	12/02/2020 00:37	8,64	1	8,64	CHI
20200252896	FORMOSA	FA12129989	ITIQUEIRA	11/02/2020 15:59	11/02/2020 17:37	11/02/2020 15:59	11/02/2020 17:37	1,63	154	251,19	CHI
20200252901	FORMOSA	10019969480	ITIQUEIRA	11/02/2020 16:00	11/02/2020 16:36	11/02/2020 16:00	11/02/2020 16:36	0,59	1	0,59	CHI
20200253083	LUZIANIA	LZ12313611	VIANOPOLIS	11/02/2020 16:01	11/02/2020 20:30	11/02/2020 16:01	11/02/2020 20:30	4,47	11	49,22	CHI
20200253500	CAMPINACU	IH12181684	MINACU	11/02/2020 16:02	11/02/2020 20:17	11/02/2020 16:02	11/02/2020 20:17	4,24	22	93,19	CHI
20200253500	MINACU	IH12181684	MINACU	11/02/2020 16:02	11/02/2020 20:17	11/02/2020 16:02	11/02/2020 20:17	4,24	61	258,40	CHI
20200252907	PLANALTINA	PI11136679	PLANALTINA	11/02/2020 16:03	11/02/2020 17:26	11/02/2020 16:03	11/02/2020 17:26	1,38	83	114,77	CHI
20200252909	TRINDADE	TR32055832	TRINDADE	11/02/2020 16:03	11/02/2020 17:23	11/02/2020 16:03	11/02/2020 17:23	1,33	5	6,64	CHI
20200253422	CEZARINA	IY12089831	CEZARINA	11/02/2020 16:03	11/02/2020 21:51	11/02/2020 16:03	11/02/2020 21:51	5,80	6	34,77	CHI
20200253422	INDIARA	IY12089831	CEZARINA	11/02/2020 16:03	11/02/2020 21:51	11/02/2020 16:03	11/02/2020 21:51	5,80	2	11,59	CHI
20200252912	LUZIANIA	LZ21219797	MARAJOARA	11/02/2020 16:04	11/02/2020 18:13	11/02/2020 16:04	11/02/2020 18:13	2,15	1	2,15	CHI
20200252915	CAMPO ALEGRE DE GOIAS	CT10394223	CATALAO S1	11/02/2020 16:04	11/02/2020 17:53	11/02/2020 16:04	11/02/2020 17:15	1,17	2	2,35	CHI

20200252915	CAMPO ALEGRE DE GOIAS	CT13192542	CATALAO S1	11/02/2020 16:04	11/02/2020 17:53	11/02/2020 16:04	11/02/2020 17:15	1,17	1	1,17	CHI
20200252915	CATALAO	CT10394223	CATALAO S1	11/02/2020 16:04	11/02/2020 17:53	11/02/2020 16:04	11/02/2020 17:15	1,17	547	641,66	CHI
20200252915	CATALAO	CT10394223	CATALAO S1	11/02/2020 16:04	11/02/2020 17:53	11/02/2020 16:04	11/02/2020 17:15	1,17	453	531,39	CHI
20200252915	CATALAO	CT13192542	CATALAO S1	11/02/2020 16:04	11/02/2020 17:53	11/02/2020 16:04	11/02/2020 17:15	1,17	209	245,17	CHI
20200252915	CAMPO ALEGRE DE GOIAS	CT10400690	CATALAO S1	11/02/2020 16:04	11/02/2020 17:53	11/02/2020 16:04	11/02/2020 17:31	1,45	2	2,89	CHI
20200252915	CATALAO	CT10400690	CATALAO S1	11/02/2020 16:04	11/02/2020 17:53	11/02/2020 16:04	11/02/2020 17:31	1,45	1563	2260,71	CHI
20200252915	DAVINOPOLIS	CT10400690	CATALAO S1	11/02/2020 16:04	11/02/2020 17:53	11/02/2020 16:04	11/02/2020 17:31	1,45	6	8,68	CHI
20200252915	DISTRITO FEDERAL	CT10400690	CATALAO S1	11/02/2020 16:04	11/02/2020 17:53	11/02/2020 16:04	11/02/2020 17:31	1,45	1	1,45	CHI
20200252915	CAMPO ALEGRE DE GOIAS	CT10394223	CATALAO S1	11/02/2020 16:04	11/02/2020 17:53	11/02/2020 16:04	11/02/2020 17:53	1,80	1	1,80	CHI
20200252915	CATALAO	CT10394223	CATALAO S1	11/02/2020 16:04	11/02/2020 17:53	11/02/2020 16:04	11/02/2020 17:53	1,80	25	45,06	CHI
20200252915	DAVINOPOLIS	CT10394223	CATALAO S1	11/02/2020 16:04	11/02/2020 17:53	11/02/2020 16:04	11/02/2020 17:53	1,80	6	10,81	CHI
20200253224	CATURAI	CK11265160	INHUMAS S1	11/02/2020 16:04	11/02/2020 19:51	11/02/2020 16:04	11/02/2020 19:51	3,78	83	313,69	CHI
20200252919	PIRANHAS	PH11260022	PIRANHAS	11/02/2020 16:05	11/02/2020 17:30	11/02/2020 16:05	11/02/2020 17:30	1,41	67	94,51	CHI
20200252920	FORMOSA	610066572	ITUIQUIRA	11/02/2020 16:05	11/02/2020 18:13	11/02/2020 16:05	11/02/2020 18:13	2,13	1	2,13	CHI
20200252922	GOIANIA	GN11000507	CAMPINAS S3	11/02/2020 16:05	11/02/2020 17:59	11/02/2020 16:05	11/02/2020 17:59	1,89	132	249,59	CHI
20200252924	SANTA FE DE GOIAS	2070006901	BRITANIA	11/02/2020 16:05	12/02/2020 05:01	11/02/2020 16:05	12/02/2020 05:01	12,92	1	12,92	CHI
20200252622	ALVORADA DO NORTE	00010434	IACIARA S2	11/02/2020 16:07	13/02/2020 19:04	11/02/2020 16:07	11/02/2020 17:47	1,66	106	175,55	CHI
20200252622	BURITINOPOLIS	00010434	IACIARA S2	11/02/2020 16:07	13/02/2020 19:04	11/02/2020 16:07	11/02/2020 17:47	1,66	442	732,00	CHI
20200252622	BURITINOPOLIS	00010434	IACIARA S2	11/02/2020 16:07	13/02/2020 19:04	11/02/2020 16:07	11/02/2020 17:47	1,66	7	11,59	CHI
20200252622	DAMIANOPOLIS	00010434	IACIARA S2	11/02/2020 16:07	13/02/2020 19:04	11/02/2020 16:07	11/02/2020 17:47	1,66	1489	2465,95	CHI
20200252622	DAMIANOPOLIS	00010434	IACIARA S2	11/02/2020 16:07	13/02/2020 19:04	11/02/2020 16:07	11/02/2020 17:47	1,66	3	4,97	CHI
20200252622	MAMBAI	00010434	IACIARA S2	11/02/2020 16:07	13/02/2020 19:04	11/02/2020 16:07	11/02/2020 17:47	1,66	2886	4779,54	CHI
20200252622	MAMBAI	00010434	IACIARA S2	11/02/2020 16:07	13/02/2020 19:04	11/02/2020 16:07	11/02/2020 17:47	1,66	80	132,49	CHI
20200252622	MAMBAI	00010434	IACIARA S2	11/02/2020 16:07	13/02/2020 19:04	11/02/2020 16:07	11/02/2020 17:47	1,66	17	28,15	CHI
20200252622	SITIO D ABADIA	00010434	IACIARA S2	11/02/2020 16:07	13/02/2020 19:04	11/02/2020 16:07	11/02/2020 17:47	1,66	1	1,66	CHI
20200252622	ALVORADA DO NORTE	00010434	IACIARA S2	11/02/2020 16:07	13/02/2020 19:04	11/02/2020 16:07	11/02/2020 19:02	2,91	13	37,83	CHI
20200252622	DAMIANOPOLIS	00010434	IACIARA S2	11/02/2020 16:07	13/02/2020 19:04	11/02/2020 16:07	11/02/2020 19:08	3,01	132	397,61	CHI
20200252622	SITIO D ABADIA	00010434	IACIARA S2	11/02/2020 16:07	13/02/2020 19:04	11/02/2020 16:07	11/02/2020 19:08	3,01	265	798,24	CHI
20200252622	SITIO D ABADIA	00010434	IACIARA S2	11/02/2020 16:07	13/02/2020 19:04	11/02/2020 16:07	11/02/2020 20:06	3,98	91	361,80	CHI
20200252622	SITIO D ABADIA	00010434	IACIARA S2	11/02/2020 16:07	13/02/2020 19:04	11/02/2020 16:07	11/02/2020 21:18	5,17	440	2276,39	CHI
20200252622	SITIO D ABADIA	00010434	IACIARA S2	11/02/2020 16:07	13/02/2020 19:04	11/02/2020 16:07	11/02/2020 21:51	5,73	23	131,74	CHI
20200252622	ALVORADA DO NORTE	00010434	IACIARA S2	11/02/2020 16:07	13/02/2020 19:04	11/02/2020 22:43	11/02/2020 22:52	0,15	119	17,85	CHI
20200252622	BURITINOPOLIS	00010434	IACIARA S2	11/02/2020 16:07	13/02/2020 19:04	11/02/2020 22:43	11/02/2020 22:52	0,15	423	63,45	CHI

20200252622	BURITINOPOLIS	00010434	IACIARA S2	11/02/2020 16:07	13/02/2020 19:04	11/02/2020 22:43	11/02/2020 22:52	0,15	7	1,05	CHI
20200252622	DAMIANOPOLIS	00010434	IACIARA S2	11/02/2020 16:07	13/02/2020 19:04	11/02/2020 22:43	11/02/2020 22:52	0,15	132	19,80	CHI
20200252622	DAMIANOPOLIS	00010434	IACIARA S2	11/02/2020 16:07	13/02/2020 19:04	11/02/2020 22:43	11/02/2020 22:52	0,15	1489	223,35	CHI
20200252622	DAMIANOPOLIS	00010434	IACIARA S2	11/02/2020 16:07	13/02/2020 19:04	11/02/2020 22:43	11/02/2020 22:52	0,15	3	0,45	CHI
20200252622	MAMBAI	00010434	IACIARA S2	11/02/2020 16:07	13/02/2020 19:04	11/02/2020 22:43	11/02/2020 22:52	0,15	2886	432,90	CHI
20200252622	MAMBAI	00010434	IACIARA S2	11/02/2020 16:07	13/02/2020 19:04	11/02/2020 22:43	11/02/2020 22:52	0,15	84	12,60	CHI
20200252622	MAMBAI	00010434	IACIARA S2	11/02/2020 16:07	13/02/2020 19:04	11/02/2020 22:43	11/02/2020 22:52	0,15	17	2,55	CHI
20200252622	SITIO D ABADIA	00010434	IACIARA S2	11/02/2020 16:07	13/02/2020 19:04	11/02/2020 22:43	11/02/2020 22:52	0,15	265	39,75	CHI
20200252622	SITIO D ABADIA	00010434	IACIARA S2	11/02/2020 16:07	13/02/2020 19:04	11/02/2020 22:43	11/02/2020 22:52	0,15	91	13,65	CHI
20200252622	SITIO D ABADIA	00010434	IACIARA S2	11/02/2020 16:07	13/02/2020 19:04	11/02/2020 22:43	11/02/2020 22:52	0,15	1	0,15	CHI
20200252622	SITIO D ABADIA	00010434	IACIARA S2	11/02/2020 16:07	13/02/2020 19:04	11/02/2020 22:43	11/02/2020 22:52	0,15	463	69,45	CHI
20200252622	ALVORADA DO NORTE	00010434	IACIARA S2	11/02/2020 16:07	13/02/2020 19:04	11/02/2020 16:07	12/02/2020 10:42	18,58	5	92,89	CHI
20200252622	SITIO D ABADIA	00010434	IACIARA S2	11/02/2020 16:07	13/02/2020 19:04	11/02/2020 16:07	12/02/2020 10:42	18,58	115	2136,57	CHI
20200252622	SITIO D ABADIA	00010434	IACIARA S2	11/02/2020 16:07	13/02/2020 19:04	11/02/2020 16:07	12/02/2020 10:42	18,58	22	408,74	CHI
20200252622	ALVORADA DO NORTE	00010434	IACIARA S2	11/02/2020 16:07	13/02/2020 19:04	12/02/2020 10:42	12/02/2020 11:15	0,55	119	65,55	CHI
20200252622	BURITINOPOLIS	00010434	IACIARA S2	11/02/2020 16:07	13/02/2020 19:04	12/02/2020 10:42	12/02/2020 11:15	0,55	423	233,00	CHI
20200252622	BURITINOPOLIS	00010434	IACIARA S2	11/02/2020 16:07	13/02/2020 19:04	12/02/2020 10:42	12/02/2020 11:15	0,55	7	3,86	CHI
20200252622	DAMIANOPOLIS	00010434	IACIARA S2	11/02/2020 16:07	13/02/2020 19:04	12/02/2020 10:42	12/02/2020 11:15	0,55	132	72,71	CHI
20200252622	DAMIANOPOLIS	00010434	IACIARA S2	11/02/2020 16:07	13/02/2020 19:04	12/02/2020 10:42	12/02/2020 11:15	0,55	1485	817,99	CHI
20200252622	DAMIANOPOLIS	00010434	IACIARA S2	11/02/2020 16:07	13/02/2020 19:04	12/02/2020 10:42	12/02/2020 11:15	0,55	3	1,65	CHI
20200252622	MAMBAI	00010434	IACIARA S2	11/02/2020 16:07	13/02/2020 19:04	12/02/2020 10:42	12/02/2020 11:15	0,55	2886	1589,70	CHI
20200252622	MAMBAI	00010434	IACIARA S2	11/02/2020 16:07	13/02/2020 19:04	12/02/2020 10:42	12/02/2020 11:15	0,55	84	46,27	CHI
20200252622	MAMBAI	00010434	IACIARA S2	11/02/2020 16:07	13/02/2020 19:04	12/02/2020 10:42	12/02/2020 11:15	0,55	17	9,36	CHI
20200252622	SITIO D ABADIA	00010434	IACIARA S2	11/02/2020 16:07	13/02/2020 19:04	12/02/2020 10:42	12/02/2020 11:15	0,55	265	145,97	CHI
20200252622	SITIO D ABADIA	00010434	IACIARA S2	11/02/2020 16:07	13/02/2020 19:04	12/02/2020 10:42	12/02/2020 11:15	0,55	91	50,13	CHI
20200252622	SITIO D ABADIA	00010434	IACIARA S2	11/02/2020 16:07	13/02/2020 19:04	12/02/2020 10:42	12/02/2020 11:15	0,55	1	0,55	CHI
20200252622	SITIO D ABADIA	00010434	IACIARA S2	11/02/2020 16:07	13/02/2020 19:04	12/02/2020 10:42	12/02/2020 11:15	0,55	463	255,04	CHI
20200252622	ALVORADA DO NORTE	00010434	IACIARA S2	11/02/2020 16:07	13/02/2020 19:04	13/02/2020 11:54	13/02/2020 12:05	0,19	119	23,01	CHI
20200252622	BURITINOPOLIS	00010434	IACIARA S2	11/02/2020 16:07	13/02/2020 19:04	13/02/2020 11:54	13/02/2020 12:05	0,19	442	85,45	CHI
20200252622	BURITINOPOLIS	00010434	IACIARA S2	11/02/2020 16:07	13/02/2020 19:04	13/02/2020 11:54	13/02/2020 12:05	0,19	7	1,35	CHI
20200252622	DAMIANOPOLIS	00010434	IACIARA S2	11/02/2020 16:07	13/02/2020 19:04	13/02/2020 11:54	13/02/2020 12:05	0,19	123	23,78	CHI
20200252622	DAMIANOPOLIS	00010434	IACIARA S2	11/02/2020 16:07	13/02/2020 19:04	13/02/2020 11:54	13/02/2020 12:05	0,19	1489	287,87	CHI
20200252622	DAMIANOPOLIS	00010434	IACIARA S2	11/02/2020 16:07	13/02/2020 19:04	13/02/2020 11:54	13/02/2020 12:05	0,19	3	0,58	CHI

20200252622	MAMBAI	00010434	IACIARA S2	11/02/2020 16:07	13/02/2020 19:04	13/02/2020 11:54	13/02/2020 12:05	0,19	2886	557,96	CHI
20200252622	MAMBAI	00010434	IACIARA S2	11/02/2020 16:07	13/02/2020 19:04	13/02/2020 11:54	13/02/2020 12:05	0,19	84	16,24	CHI
20200252622	MAMBAI	00010434	IACIARA S2	11/02/2020 16:07	13/02/2020 19:04	13/02/2020 11:54	13/02/2020 12:05	0,19	17	3,29	CHI
20200252622	SITIO D ABADIA	00010434	IACIARA S2	11/02/2020 16:07	13/02/2020 19:04	13/02/2020 11:54	13/02/2020 12:05	0,19	265	51,23	CHI
20200252622	SITIO D ABADIA	00010434	IACIARA S2	11/02/2020 16:07	13/02/2020 19:04	13/02/2020 11:54	13/02/2020 12:05	0,19	91	17,59	CHI
20200252622	SITIO D ABADIA	00010434	IACIARA S2	11/02/2020 16:07	13/02/2020 19:04	13/02/2020 11:54	13/02/2020 12:05	0,19	1	0,19	CHI
20200252622	SITIO D ABADIA	00010434	IACIARA S2	11/02/2020 16:07	13/02/2020 19:04	13/02/2020 11:54	13/02/2020 12:05	0,19	463	89,51	CHI
20200252622	ALVORADA DO NORTE	00010434	IACIARA S2	11/02/2020 16:07	13/02/2020 19:04	11/02/2020 16:07	13/02/2020 16:30	48,37	53	2563,55	CHI
20200252622	SITIO D ABADIA	00010434	IACIARA S2	11/02/2020 16:07	13/02/2020 19:04	11/02/2020 16:07	13/02/2020 16:30	48,37	14	677,16	CHI
20200252622	ALVORADA DO NORTE	SI13243067	IACIARA S2	11/02/2020 16:07	13/02/2020 19:04	12/02/2020 10:52	13/02/2020 16:30	29,63	5	148,17	CHI
20200252622	SITIO D ABADIA	SI13243067	IACIARA S2	11/02/2020 16:07	13/02/2020 19:04	12/02/2020 10:52	13/02/2020 16:30	29,63	18	533,41	CHI
20200252622	SITIO D ABADIA	SI13243067	IACIARA S2	11/02/2020 16:07	13/02/2020 19:04	12/02/2020 10:52	13/02/2020 16:42	29,85	115	3432,33	CHI
20200252622	SITIO D ABADIA	SI13243067	IACIARA S2	11/02/2020 16:07	13/02/2020 19:04	12/02/2020 10:52	13/02/2020 16:42	29,85	4	119,39	CHI
20200252622	SITIO D ABADIA	SI13303997	IACIARA S2	11/02/2020 16:07	13/02/2020 19:04	13/02/2020 18:18	13/02/2020 18:34	0,27	463	124,50	CHI
20200252622	SITIO D ABADIA	SI13303998	IACIARA S2	11/02/2020 16:07	13/02/2020 19:04	13/02/2020 18:18	13/02/2020 18:34	0,28	90	25,23	CHI
20200252622	DAMIANOPOLIS	SI13213702	IACIARA S2	11/02/2020 16:07	13/02/2020 19:04	13/02/2020 18:21	13/02/2020 18:35	0,23	123	28,67	CHI
20200252622	SITIO D ABADIA	SI13213702	IACIARA S2	11/02/2020 16:07	13/02/2020 19:04	13/02/2020 18:21	13/02/2020 18:35	0,23	265	61,76	CHI
20200252622	SITIO D ABADIA	00010434	IACIARA S2	11/02/2020 16:07	13/02/2020 19:04	11/02/2020 16:07	13/02/2020 19:04	50,94	18	916,89	CHI
20200252930	MOSSAMEDES	MD12066158	FIRMINOPOLIS S2	11/02/2020 16:07	11/02/2020 18:40	11/02/2020 16:07	11/02/2020 18:40	2,55	21	53,50	CHI
20200252933	CRISTALINA	KR12230274	CRISTALINA S2	11/02/2020 16:07	11/02/2020 18:12	11/02/2020 16:07	11/02/2020 18:12	2,07	9	18,64	CHI
20200252935	BELA VISTA DE GOIAS	10004473920	BELA VISTA S2	11/02/2020 16:08	11/02/2020 17:28	11/02/2020 16:08	11/02/2020 17:28	1,33	1	1,33	CHI
20200252936	SAO MIGUEL DO ARAGUAIA	SM12095569	SAO MIGUEL DO ARAGUAIA	11/02/2020 16:08	13/02/2020 18:21	11/02/2020 16:08	12/02/2020 19:09	27,02	4	108,10	CHI
20200252936	SAO MIGUEL DO ARAGUAIA	SM12095569	SAO MIGUEL DO ARAGUAIA	11/02/2020 16:08	13/02/2020 18:21	11/02/2020 16:08	13/02/2020 18:21	50,22	1	50,22	CHI
20200252938	ITABERAI	IB21229643	ITABERAI S1	11/02/2020 16:08	11/02/2020 17:19	11/02/2020 16:08	11/02/2020 17:19	1,17	1	1,17	CHI
20200252945	CRISTALINA	1060081134	CRISTALINA S1	11/02/2020 16:09	11/02/2020 20:25	11/02/2020 16:09	11/02/2020 20:25	4,26	1	4,26	CHI
20200254245	BURITI ALEGRE	MR12000170RE	MORRINHOS	11/02/2020 16:11	11/02/2020 23:00	11/02/2020 16:11	11/02/2020 23:00	6,80	1	6,80	CHI
20200254245	MORRINHOS	MR12000170RE	MORRINHOS	11/02/2020 16:11	11/02/2020 23:00	11/02/2020 16:11	11/02/2020 23:00	6,80	53	360,53	CHI
20200252624	ALTO HORIZONTE	01730444	SANTA TEREZINHA	11/02/2020 16:12	12/02/2020 01:52	11/02/2020 16:12	11/02/2020 18:31	2,32	9	20,86	CHI
20200252624	CAMPOS VERDES	01730444	SANTA TEREZINHA	11/02/2020 16:12	12/02/2020 01:52	11/02/2020 16:12	11/02/2020 18:31	2,32	1948	4515,03	CHI
20200252624	CAMPOS VERDES	01730444	SANTA TEREZINHA	11/02/2020 16:12	12/02/2020 01:52	11/02/2020 16:12	11/02/2020 18:31	2,32	46	106,62	CHI
20200252624	CAMPOS VERDES	01730444	SANTA TEREZINHA	11/02/2020 16:12	12/02/2020 01:52	11/02/2020 16:12	11/02/2020 18:31	2,32	25	57,94	CHI
20200252624	MARA ROSA	01730444	SANTA TEREZINHA	11/02/2020 16:12	12/02/2020 01:52	11/02/2020 16:12	11/02/2020 18:31	2,32	68	157,61	CHI
20200252624	PILAR DE GOIAS	01730444	SANTA TEREZINHA	11/02/2020 16:12	12/02/2020 01:52	11/02/2020 16:12	11/02/2020 18:31	2,32	6	13,91	CHI

20200252624	SANTA TEREZINHA DE GOIAS	01730444	SANTA TEREZINHA	11/02/2020 16:12	12/02/2020 01:52	11/02/2020 16:12	11/02/2020 18:31	2,32	50	115,89	CHI
20200252624	SANTA TEREZINHA DE GOIAS	01730444	SANTA TEREZINHA	11/02/2020 16:12	12/02/2020 01:52	11/02/2020 16:12	11/02/2020 18:31	2,32	346	801,95	CHI
20200252624	CAMPOS VERDES	01730444	SANTA TEREZINHA	11/02/2020 16:12	12/02/2020 01:52	11/02/2020 16:12	11/02/2020 19:59	3,78	1	3,78	CHI
20200252624	SANTA TEREZINHA DE GOIAS	01730444	SANTA TEREZINHA	11/02/2020 16:12	12/02/2020 01:52	11/02/2020 16:12	11/02/2020 19:59	3,78	50	188,83	CHI
20200252624	CAMPOS VERDES	01730444	SANTA TEREZINHA	11/02/2020 16:12	12/02/2020 01:52	11/02/2020 16:12	11/02/2020 20:51	4,65	18	83,65	CHI
20200252624	SANTA TEREZINHA DE GOIAS	01730444	SANTA TEREZINHA	11/02/2020 16:12	12/02/2020 01:52	11/02/2020 16:12	11/02/2020 20:51	4,65	45	209,13	CHI
20200252624	CAMPOS VERDES	01730444	SANTA TEREZINHA	11/02/2020 16:12	12/02/2020 01:52	11/02/2020 16:12	12/02/2020 01:52	9,67	9	87,07	CHI
20200252624	SANTA TEREZINHA DE GOIAS	01730444	SANTA TEREZINHA	11/02/2020 16:12	12/02/2020 01:52	11/02/2020 16:12	12/02/2020 01:52	9,67	56	541,75	CHI
20200252624	UIRAPURU	01730444	SANTA TEREZINHA	11/02/2020 16:12	12/02/2020 01:52	11/02/2020 16:12	12/02/2020 01:52	9,67	45	435,34	CHI
20200252624	SANTA TEREZINHA DE GOIAS	SG13330123	SANTA TEREZINHA	11/02/2020 16:12	12/02/2020 01:52	11/02/2020 16:44	12/02/2020 01:52	9,14	10	91,44	CHI
20200252624	UIRAPURU	SG13330123	SANTA TEREZINHA	11/02/2020 16:12	12/02/2020 01:52	11/02/2020 16:44	12/02/2020 01:52	9,14	12	109,73	CHI
20200252968	FORMOSA	FA21041979	ITIQUEIRA	11/02/2020 16:13	11/02/2020 18:55	11/02/2020 16:13	11/02/2020 18:55	2,70	4	10,79	CHI
20200252973	NEROPOLIS	NR11350456	NEROPOLIS S2	11/02/2020 16:15	11/02/2020 17:09	11/02/2020 16:15	11/02/2020 17:09	0,89	98	87,49	CHI
20200252982	ALTO PARAISO DE GOIAS	BF21346794	SAO JOAO D ALIANCA	11/02/2020 16:16	11/02/2020 17:34	11/02/2020 16:16	11/02/2020 17:34	1,28	1	1,28	CHI
20200252988	GOIANIA	10013925146	CEPAIGO S1	11/02/2020 16:17	11/02/2020 22:01	11/02/2020 16:17	11/02/2020 22:01	5,72	1	5,72	CHI
20200252989	SENADOR CANEDO	190049522	SENADOR CANEDO	11/02/2020 16:17	11/02/2020 20:26	11/02/2020 16:17	11/02/2020 20:26	4,14	1	4,14	CHI
20200252999	LUZIANIA	10002284284	RIO VERMELHO	11/02/2020 16:19	11/02/2020 18:43	11/02/2020 16:19	11/02/2020 18:43	2,39	1	2,39	CHI
20200253003	APARECIDA DE GOIANIA	15399771	REAL S1	11/02/2020 16:20	11/02/2020 20:20	11/02/2020 16:20	11/02/2020 20:20	3,99	1	3,99	CHI
20200253009	RUBIATABA	RB11287124	RUBIATABA	11/02/2020 16:21	11/02/2020 17:33	11/02/2020 16:21	11/02/2020 17:33	1,19	62	73,59	CHI
20200253135	CACU	CC12097352	CACHOEIRA ALTA	11/02/2020 16:21	11/02/2020 21:49	11/02/2020 16:21	11/02/2020 21:49	5,46	7	38,21	CHI
20200253015	RUBIATABA	RB11003300	RUBIATABA	11/02/2020 16:22	11/02/2020 23:38	11/02/2020 16:22	11/02/2020 23:38	7,25	73	529,59	CHI
20200253023	CHAPADAO DO CEU	9880011381	CHAPADAO DO CEU	11/02/2020 16:22	11/02/2020 17:04	11/02/2020 16:22	11/02/2020 17:04	0,69	1	0,69	CHI
20200253027	FORMOSA	FA12051040	ITIQUEIRA	11/02/2020 16:24	12/02/2020 11:34	11/02/2020 16:24	12/02/2020 11:34	19,18	11	210,96	CHI
20200253031	ESTRELA DO NORTE	ET12182387	MARA ROSA	11/02/2020 16:25	11/02/2020 19:13	11/02/2020 16:25	11/02/2020 19:13	2,80	3	8,40	CHI
20200253032	LUZIANIA	LZ11163904	RIO VERMELHO	11/02/2020 16:25	11/02/2020 19:35	11/02/2020 16:25	11/02/2020 19:02	2,63	149	391,46	CHI
20200253032	LUZIANIA	LZ12031082	RIO VERMELHO	11/02/2020 16:25	11/02/2020 19:35	11/02/2020 19:02	11/02/2020 19:35	0,54	148	80,04	CHI
20200253036	PIRES DO RIO	10029430621	PIRES DO RIO S1	11/02/2020 16:26	11/02/2020 20:20	11/02/2020 16:26	11/02/2020 20:20	3,90	1	3,90	CHI
20200253043	OUVIDOR	10016855980	CATALAO S1	11/02/2020 16:27	11/02/2020 19:58	11/02/2020 16:27	11/02/2020 19:58	3,51	1	3,51	CHI
20200253051	PARAUNA	PU21319339	PARAUNA	11/02/2020 16:28	11/02/2020 22:08	11/02/2020 16:28	11/02/2020 22:08	5,66	1	5,66	CHI
20200253061	APARECIDA DE GOIANIA	200514910	INDEPENDENCIA S1	11/02/2020 16:30	11/02/2020 18:41	11/02/2020 16:30	11/02/2020 18:41	2,17	1	2,17	CHI
20200253065	VALPARAISO DE GOIAS	VA11041541	MARAJOARA	11/02/2020 16:31	11/02/2020 20:46	11/02/2020 19:15	11/02/2020 20:46	1,52	197	298,78	CHI
20200253066	ABADIANIA	AA12115043	ANAPOLIS UNIVERSITARIO S1	11/02/2020 16:31	11/02/2020 18:34	11/02/2020 16:31	11/02/2020 18:34	2,04	1	2,04	CHI
20200253072	PLANALTINA	PI12344170	PLANALTINA	11/02/2020 16:33	11/02/2020 17:45	11/02/2020 16:33	11/02/2020 17:45	1,19	1	1,19	CHI

20200253079	QUIRINOPOLIS	80009505	QUIRINOPOLIS	11/02/2020 16:34	11/02/2020 23:03	11/02/2020 16:34	11/02/2020 23:03	6,47	1	6,47	CHI
20200253238	CAMPO ALEGRE DE GOIAS	CM12270743	CAMPO ALEGRE DE GOIAS	11/02/2020 16:34	12/02/2020 19:39	11/02/2020 16:34	12/02/2020 19:39	27,07	16	433,15	CHI
20200253238	IPAMERI	CM12270743	CAMPO ALEGRE DE GOIAS	11/02/2020 16:34	12/02/2020 19:39	11/02/2020 16:34	12/02/2020 19:39	27,07	20	541,44	CHI
20200253086	BELA VISTA DE GOIAS	XX12662884	BELA VISTA S2	11/02/2020 16:36	12/02/2020 18:30	11/02/2020 16:36	12/02/2020 18:30	25,89	2	51,79	CHI
20200253089	PADRE BERNARDO	PB12313941	PADRE BERNARDO	11/02/2020 16:37	11/02/2020 18:42	11/02/2020 16:37	11/02/2020 18:42	2,07	4	8,28	CHI
20200253093	CRIXAS	CX21319032	SERRA DO OURO	11/02/2020 16:38	11/02/2020 21:26	11/02/2020 16:38	11/02/2020 21:26	4,79	1	4,79	CHI
20200253095	EDEIA	10030902833	EDEIA	11/02/2020 16:38	11/02/2020 19:59	11/02/2020 16:38	11/02/2020 19:59	3,35	1	3,35	CHI
20200253165	FORMOSA	FA12376643	ITIQUEIRA	11/02/2020 16:38	11/02/2020 20:32	11/02/2020 16:38	11/02/2020 20:32	3,89	100	389,44	CHI
20200253103	ACREUNA	2440051488	ACREUNA	11/02/2020 16:39	12/02/2020 00:02	11/02/2020 16:39	12/02/2020 00:02	7,38	1	7,38	CHI
20200253104	NOVO GAMA	10024644682	PACAEMBU S1	11/02/2020 16:40	11/02/2020 20:31	11/02/2020 16:40	11/02/2020 20:31	3,84	1	3,84	CHI
20200253108	CABECEIRAS	CW21184606	ITIQUEIRA	11/02/2020 16:41	11/02/2020 17:58	11/02/2020 16:41	11/02/2020 17:58	1,28	1	1,28	CHI
20200253111	GOIANDIRA	GD21041842	CATALAO S1	11/02/2020 16:41	11/02/2020 20:00	11/02/2020 16:41	11/02/2020 20:00	3,30	1	3,30	CHI
20200253113	FLORES DE GOIAS	FB11211693	FLORES DE GOIAS	11/02/2020 16:42	11/02/2020 20:47	11/02/2020 16:42	11/02/2020 20:47	4,07	3	12,20	CHI
20200253116	APORE	AE12253601	ITAJA S1	11/02/2020 16:43	11/02/2020 19:36	11/02/2020 16:43	11/02/2020 19:36	2,87	6	17,24	CHI
20200253117	IACIARA	IA11195766	IACIARA S1	11/02/2020 16:43	12/02/2020 01:46	11/02/2020 16:43	12/02/2020 01:46	9,04	52	469,99	CHI
20200253118	ARAGARCAS	AG21316282	ARAGARCAS	11/02/2020 16:44	12/02/2020 08:27	11/02/2020 16:44	12/02/2020 08:27	15,72	1	15,72	CHI
20200253121	BELA VISTA DE GOIAS	BV21043300	BELA VISTA S1	11/02/2020 16:44	11/02/2020 19:40	11/02/2020 16:44	11/02/2020 19:40	2,93	2	5,87	CHI
20200253124	COCALZINHO DE GOIAS	ZN21221330	COCALZINHO	11/02/2020 16:45	11/02/2020 19:47	11/02/2020 16:45	11/02/2020 19:47	3,03	1	3,03	CHI
20200253126	SAO DOMINGOS	SD12389277	SAO DOMINGOS	11/02/2020 16:45	11/02/2020 23:33	11/02/2020 16:45	11/02/2020 23:33	6,79	25	169,64	CHI
20200253128	SAO MIGUEL DO ARAGUAIA	SM21170905	SAO MIGUEL DO ARAGUAIA	11/02/2020 16:46	11/02/2020 20:51	11/02/2020 16:46	11/02/2020 20:51	4,08	1	4,08	CHI
20200253131	GUARANI DE GOIAS	GY12271725	IACIARA S1	11/02/2020 16:48	11/02/2020 19:31	11/02/2020 16:48	11/02/2020 19:31	2,72	3	8,15	CHI
20200253136	CORUMBAIBA	CI21098627	VILA CORUMBA	11/02/2020 16:49	11/02/2020 18:55	11/02/2020 16:49	11/02/2020 18:55	2,10	1	2,10	CHI
20200253140	URUACU	640095800	URUACU	11/02/2020 16:49	11/02/2020 18:20	11/02/2020 16:49	11/02/2020 18:20	1,52	1	1,52	CHI
20200253143	VICENTINOPOLIS	VI12257166	VICENTINOPOLIS	11/02/2020 16:50	11/02/2020 20:57	11/02/2020 16:50	11/02/2020 20:57	4,11	7	28,78	CHI
20200253145	ARAGUAPAZ	AZ12242480	MOZARLANDIA	11/02/2020 16:51	11/02/2020 17:57	11/02/2020 16:51	11/02/2020 17:57	1,09	16	17,49	CHI
20200253410	MINACU	IH12339952	MINACU	11/02/2020 16:53	11/02/2020 21:18	11/02/2020 16:53	11/02/2020 21:18	4,41	16	70,62	CHI
20200253153	OUVIDOR	CT21266219	CATALAO S1	11/02/2020 16:54	11/02/2020 19:59	11/02/2020 16:54	11/02/2020 19:59	3,08	1	3,08	CHI
20200253159	GOIANIA	GN21158355	XAVANTES	11/02/2020 16:57	12/02/2020 01:52	11/02/2020 16:57	12/02/2020 01:52	8,91	1	8,91	CHI
20200253162	CRIXAS	CX21400896	RUBIATABA	11/02/2020 16:57	12/02/2020 03:17	11/02/2020 16:57	12/02/2020 03:17	10,32	1	10,32	CHI
20200253171	APARECIDA DE GOIANIA	AP11205324	ANHANGUERA	11/02/2020 16:58	11/02/2020 18:43	11/02/2020 16:58	11/02/2020 18:43	1,74	14	24,29	CHI
20200253419	QUIRINOPOLIS	QI12096888	QUIRINOPOLIS	11/02/2020 16:58	11/02/2020 22:44	11/02/2020 16:58	11/02/2020 22:44	5,76	20	115,23	CHI
20200253541	SAO DOMINGOS	SD12398397	SAO DOMINGOS	11/02/2020 16:58	11/02/2020 21:31	11/02/2020 16:58	11/02/2020 21:31	4,55	6	27,27	CHI
20200253179	ORIZONA	OZ12084921RE	PIRES DO RIO S2	11/02/2020 17:00	11/02/2020 18:22	11/02/2020 17:00	11/02/2020 18:22	1,36	110	149,29	CHI

20200253179	VIANOPOLIS	OZ12084921RE	PIRES DO RIO S2	11/02/2020 17:00	11/02/2020 18:22	11/02/2020 17:00	11/02/2020 18:22	1,36	17	23,07	CHI
20200253191	IACIARA	IA12000013	IACIARA S1	11/02/2020 17:02	11/02/2020 20:40	11/02/2020 17:02	11/02/2020 20:40	3,62	8	28,98	CHI
20200253496	GOIANIA	GN11001592	GOIANIA LESTE S2	11/02/2020 17:02	11/02/2020 20:05	11/02/2020 17:02	11/02/2020 20:05	3,04	183	556,88	CHI
20200253202	GOIANIA	10985335	FERROVIARIO S3	11/02/2020 17:04	11/02/2020 20:20	11/02/2020 17:04	11/02/2020 20:20	3,25	1	3,25	CHI
20200253302	CRISTALINA	KR10400710	PAMPLONA	11/02/2020 17:04	12/02/2020 12:30	11/02/2020 17:04	12/02/2020 01:19	8,24	21	173,09	CHI
20200253302	CRISTALINA	KR12383076	PAMPLONA	11/02/2020 17:04	12/02/2020 12:30	11/02/2020 17:04	12/02/2020 12:30	19,42	44	854,57	CHI
20200253302	CRISTALINA	KR12209519	PAMPLONA	11/02/2020 17:04	12/02/2020 12:30	11/02/2020 17:04	12/02/2020 12:30	19,42	1	19,42	CHI
20200253203	QUIRINOPOLIS	QI32052457	QUIRINOPOLIS	11/02/2020 17:05	11/02/2020 21:41	11/02/2020 17:05	11/02/2020 21:41	4,60	9	41,40	CHI
20200253206	FORMOSA	FA21122050	PLANALTINA	11/02/2020 17:05	11/02/2020 18:50	11/02/2020 17:05	11/02/2020 18:50	1,74	1	1,74	CHI
202002174625	IACIARA	IA12206168LD	IACIARA S1	11/02/2020 17:05	11/02/2020 23:44	11/02/2020 17:05	11/02/2020 23:44	6,65	715	4753,96	CHI
20200253668	TRINDADE	TR11207466	TRINDADE	11/02/2020 17:07	11/02/2020 20:32	11/02/2020 17:07	11/02/2020 20:32	3,41	74	252,13	CHI
20200253227	MAURILANDIA	ML32191806	RIO DOS BOIS	11/02/2020 17:08	11/02/2020 21:56	11/02/2020 17:08	11/02/2020 21:56	4,78	31	148,32	CHI
20200253227	RIO VERDE	ML32191806	RIO DOS BOIS	11/02/2020 17:08	11/02/2020 21:56	11/02/2020 17:08	11/02/2020 21:56	4,78	12	57,41	CHI
20200253230	MATRINCHA	4370003302	MATRINCHA	11/02/2020 17:09	12/02/2020 13:40	11/02/2020 17:09	12/02/2020 13:40	20,51	1	20,51	CHI
20200254118	DIVINOPOLIS DE GOIAS	MA12261976	SAO DOMINGOS	11/02/2020 17:10	11/02/2020 20:57	11/02/2020 17:10	11/02/2020 20:57	3,77	3	11,31	CHI
20200254118	MONTE ALEGRE DE GOIAS	MA12261976	SAO DOMINGOS	11/02/2020 17:10	11/02/2020 20:57	11/02/2020 17:10	11/02/2020 20:57	3,77	43	162,13	CHI
20200253237	DIORAMA	ME12184441	IPORA	11/02/2020 17:11	11/02/2020 19:35	11/02/2020 17:11	11/02/2020 19:35	2,39	11	26,31	CHI
20200253237	MONTES CLAROS DE GOIAS	ME12184441	IPORA	11/02/2020 17:11	11/02/2020 19:35	11/02/2020 17:11	11/02/2020 19:35	2,39	68	162,65	CHI
20200253239	SAO JOAO D ALIANCA	JL21146223	SAO JOAO D ALIANCA	11/02/2020 17:11	12/02/2020 06:59	11/02/2020 17:11	12/02/2020 06:59	13,78	1	13,78	CHI
20200253243	PLANALTINA	PI12149015	PLANALTINA	11/02/2020 17:14	11/02/2020 19:35	11/02/2020 17:14	11/02/2020 19:35	2,35	23	54,06	CHI
20200253245	SAO MIGUEL DO ARAGUAIA	830080752	SAO MIGUEL DO ARAGUAIA	11/02/2020 17:14	11/02/2020 21:30	11/02/2020 17:14	11/02/2020 21:30	4,27	1	4,27	CHI
20200253303	CAMPOS BELOS	CH21129649	SAO DOMINGOS	11/02/2020 17:16	11/02/2020 17:30	11/02/2020 17:17	11/02/2020 17:30	0,22	1	0,22	CHI
20200253264	ITAPACI	100086780	ITAPACI	11/02/2020 17:19	11/02/2020 22:12	11/02/2020 17:19	11/02/2020 22:12	4,88	1	4,88	CHI
20200253266	ABADIANIA	AA12350816	DAIA S2	11/02/2020 17:19	13/02/2020 16:36	11/02/2020 17:19	13/02/2020 16:36	47,29	1	47,29	CHI
20200253272	QUIRINOPOLIS	80118070	QUIRINOPOLIS	11/02/2020 17:19	12/02/2020 00:14	11/02/2020 17:19	12/02/2020 00:14	6,90	1	6,90	CHI
20200253273	PALMEIRAS DE GOIAS	TV12005728	FIRMINOPOLIS S2	11/02/2020 17:19	11/02/2020 20:29	11/02/2020 17:19	11/02/2020 20:29	3,15	5	15,76	CHI
20200253273	TURVANIA	TV12005728	FIRMINOPOLIS S2	11/02/2020 17:19	11/02/2020 20:29	11/02/2020 17:19	11/02/2020 20:29	3,15	4	12,61	CHI
20200253499	ACREUNA	EU12214067	ACREUNA	11/02/2020 17:19	12/02/2020 02:35	11/02/2020 17:19	12/02/2020 02:35	9,25	52	481,17	CHI
20200253276	SILVANIA	SV21272190	CEPAIGO S2	11/02/2020 17:20	11/02/2020 18:18	11/02/2020 17:20	11/02/2020 18:18	0,96	1	0,96	CHI
20200253284	CIDADE OCIDENTAL	LZ12072636	MARAJOARA	11/02/2020 17:21	12/02/2020 08:44	11/02/2020 17:21	12/02/2020 08:44	15,37	19	292,09	CHI
20200253286	IACIARA	IA11164693	IACIARA S1	11/02/2020 17:21	11/02/2020 23:44	11/02/2020 17:21	11/02/2020 23:44	6,39	118	753,46	CHI
20200253287	SERRANOPOLIS	SX12264389	JATAI S1	11/02/2020 17:21	13/02/2020 16:50	11/02/2020 17:21	12/02/2020 09:25	16,07	8	128,56	CHI
20200253287	SERRANOPOLIS	SX12264389	JATAI S1	11/02/2020 17:21	13/02/2020 16:50	11/02/2020 17:21	12/02/2020 12:07	18,76	19	356,42	CHI

20200253287	SERRANOPOLIS	SX12264389	JATAI S1	11/02/2020 17:21	13/02/2020 16:50	11/02/2020 17:21	12/02/2020 13:42	20,35	15	305,20	CHI
20200253287	SERRANOPOLIS	SX12264389	JATAI S1	11/02/2020 17:21	13/02/2020 16:50	11/02/2020 17:21	12/02/2020 18:55	25,56	8	204,44	CHI
20200253287	ITARUMA	SX12264389	JATAI S1	11/02/2020 17:21	13/02/2020 16:50	11/02/2020 17:21	12/02/2020 21:30	28,14	1	28,14	CHI
20200253287	SERRANOPOLIS	SX12264389	JATAI S1	11/02/2020 17:21	13/02/2020 16:50	11/02/2020 17:21	12/02/2020 21:30	28,14	3	84,42	CHI
20200253287	APORE	SX12264389	JATAI S1	11/02/2020 17:21	13/02/2020 16:50	11/02/2020 17:21	13/02/2020 16:50	47,47	7	332,30	CHI
20200253445	NIQUELANDIA	NQ12280419	NIQUELANDIA SUBTRANSMISSAO	11/02/2020 17:21	11/02/2020 18:56	11/02/2020 17:21	11/02/2020 18:56	1,57	63	99,05	CHI
20200253291	MINEIROS	MY12133261	PARQUE DAS EMAS	11/02/2020 17:22	11/02/2020 22:30	11/02/2020 17:22	11/02/2020 22:30	5,13	6	30,78	CHI
20200253658	SENADOR CANEDO	SW11092178	SENADOR CANEDO	11/02/2020 17:22	11/02/2020 19:56	11/02/2020 17:22	11/02/2020 19:56	2,56	157	401,31	CHI
20200253297	ALTO PARAISO DE GOIAS	BF12264707	FLORES DE GOIAS	11/02/2020 17:23	11/02/2020 18:50	11/02/2020 17:23	11/02/2020 18:50	1,44	23	33,02	CHI
20200253298	SANTA HELENA DE GOIAS	400117459	IPEGUARI	11/02/2020 17:24	11/02/2020 21:02	11/02/2020 17:24	11/02/2020 21:02	3,62	1	3,62	CHI
20200253299	AURILANDIA	AI21125123	FIRMINOPOLIS S2	11/02/2020 17:24	11/02/2020 21:50	11/02/2020 17:24	11/02/2020 21:50	4,42	1	4,42	CHI
20200253493	ALTO PARAISO DE GOIAS	ND12302636	IACIARA S2	11/02/2020 17:26	11/02/2020 21:16	11/02/2020 17:26	11/02/2020 21:16	3,82	18	68,84	CHI
20200253493	NOVA ROMA	ND12302636	IACIARA S2	11/02/2020 17:26	11/02/2020 21:16	11/02/2020 17:26	11/02/2020 21:16	3,82	97	370,97	CHI
20200253493	SAO JOAO D ALIANCA	ND12302636	IACIARA S2	11/02/2020 17:26	11/02/2020 21:16	11/02/2020 17:26	11/02/2020 21:16	3,82	12	45,89	CHI
202002191223	IACIARA	IA12206168LD	IACIARA S1	11/02/2020 17:27	11/02/2020 23:44	11/02/2020 17:27	11/02/2020 22:38	5,18	1	5,18	CHI
202002191223	IACIARA	IA12206168LD	IACIARA S1	11/02/2020 17:27	11/02/2020 23:44	11/02/2020 17:27	11/02/2020 23:44	6,29	18	113,20	CHI
202002191223	GUARANI DE GOIAS	01230214	IACIARA S1	11/02/2020 17:27	11/02/2020 23:44	11/02/2020 22:25	11/02/2020 23:44	1,32	1292	1701,13	CHI
202002191223	IACIARA	01230214	IACIARA S1	11/02/2020 17:27	11/02/2020 23:44	11/02/2020 22:25	11/02/2020 23:44	1,32	3378	4447,70	CHI
202002191223	POSSE	01230214	IACIARA S1	11/02/2020 17:27	11/02/2020 23:44	11/02/2020 22:25	11/02/2020 23:44	1,32	171	225,15	CHI
202002191223	SAO DOMINGOS	01230214	IACIARA S1	11/02/2020 17:27	11/02/2020 23:44	11/02/2020 22:25	11/02/2020 23:44	1,32	1	1,32	CHI
20200253412	URUACU	640122978	URUACU	11/02/2020 17:28	12/02/2020 00:13	11/02/2020 17:28	12/02/2020 00:13	6,74	1	6,74	CHI
20200253542	IPAMERI	IP12247905	CRISTALINA S2	11/02/2020 17:28	12/02/2020 14:04	11/02/2020 17:28	12/02/2020 00:12	6,74	18	121,36	CHI
20200253542	IPAMERI	IP12247905	CRISTALINA S2	11/02/2020 17:28	12/02/2020 14:04	11/02/2020 17:28	12/02/2020 14:04	20,60	24	494,32	CHI
20200253413	GOIANIA	GN12000977	GOYA S1	11/02/2020 17:29	11/02/2020 19:17	11/02/2020 17:29	11/02/2020 19:17	1,79	2	3,58	CHI
20200253431	INACIOLANDIA	ID21128162	QUIRINOPOLIS	11/02/2020 17:33	12/02/2020 08:10	11/02/2020 17:33	12/02/2020 08:10	14,61	1	14,61	CHI
20200253434	APARECIDA DE GOIANIA	200582940	ANHANGUERA	11/02/2020 17:34	11/02/2020 20:21	11/02/2020 17:34	11/02/2020 20:21	2,77	1	2,77	CHI
20200253453	PORTEIRAO	CL12303762	RIO DOS BOIS	11/02/2020 17:40	12/02/2020 09:55	11/02/2020 17:40	12/02/2020 09:55	16,25	1	16,25	CHI
20200253463	GUAPO	AO32095517	GUAPO S2	11/02/2020 17:40	11/02/2020 22:16	11/02/2020 17:40	11/02/2020 22:16	4,61	18	82,96	CHI
20200253463	ARAGOIANIA	AO32095517	GUAPO S2	11/02/2020 17:40	11/02/2020 22:16	11/02/2020 21:13	11/02/2020 22:16	1,05	44	46,35	CHI
20200253459	FORMOSA	FA12251132	ITIQUEIRA	11/02/2020 17:41	12/02/2020 09:58	11/02/2020 17:41	12/02/2020 09:58	16,27	5	81,37	CHI
20200253466	FORMOSA	FA21334134	SAO JOAO D ALIANCA	11/02/2020 17:43	12/02/2020 11:42	11/02/2020 17:43	12/02/2020 11:42	17,98	1	17,98	CHI
20200253634	SAO FRANCISCO DE GOIAS	SF12039351	SAO FRANCISCO DE GOIAS	11/02/2020 17:43	11/02/2020 19:33	11/02/2020 17:43	11/02/2020 19:33	1,83	20	36,64	CHI
20200253475	CATALAO	CT12134367	CATALAO S1	11/02/2020 17:45	12/02/2020 15:03	11/02/2020 17:45	12/02/2020 15:03	21,29	11	234,21	CHI

20200253479	APARECIDA DE GOIANIA	200105980	INDEPENDENCIA S2	11/02/2020 17:45	11/02/2020 18:40	11/02/2020 17:45	11/02/2020 18:40	0,90	1	0,90	CHI
20200253591	RIO VERDE	RV12111052	CABRIUVA S2	11/02/2020 17:45	12/02/2020 05:03	11/02/2020 17:45	12/02/2020 05:03	11,29	29	327,40	CHI
20200253485	APARECIDA DE GOIANIA	15345695	INDEPENDENCIA S1	11/02/2020 17:48	11/02/2020 20:07	11/02/2020 17:48	11/02/2020 20:07	2,31	1	2,31	CHI
20200253487	SENADOR CANEDO	14125183	CEPAIGO S1	11/02/2020 17:48	11/02/2020 23:25	11/02/2020 17:48	11/02/2020 23:25	5,60	1	5,60	CHI
20200253490	PIRES DO RIO	PR12166937	PIRES DO RIO S1	11/02/2020 17:49	11/02/2020 18:32	11/02/2020 17:49	11/02/2020 18:32	0,72	111	79,40	CHI
20200253492	NEROPOLIS	160057206	NEROPOLIS S2	11/02/2020 17:49	11/02/2020 22:32	11/02/2020 17:49	11/02/2020 22:32	4,71	1	4,71	CHI
20200253495	GOIANIA	GN11328207	CAMPINAS S2	11/02/2020 17:50	11/02/2020 21:41	11/02/2020 20:06	11/02/2020 21:41	1,58	63	99,43	CHI
20200253503	RIO VERDE	RV21240400	CABRIUVA S2	11/02/2020 17:54	12/02/2020 11:54	11/02/2020 17:54	12/02/2020 11:54	17,99	1	17,99	CHI
20200253504	CRISTALINA	KR12171519	CRISTALINA S1	11/02/2020 17:54	12/02/2020 11:34	11/02/2020 17:54	12/02/2020 11:34	17,65	12	211,85	CHI
20200253507	INACIOLANDIA	10016986707	QUIRINOPOLIS	11/02/2020 17:55	12/02/2020 07:32	11/02/2020 17:55	12/02/2020 07:32	13,60	1	13,60	CHI
20200253510	LUZIANIA	120047809	RIO VERMELHO	11/02/2020 17:55	12/02/2020 09:31	11/02/2020 17:55	12/02/2020 09:31	15,58	1	15,58	CHI
20200253512	SILVANIA	SV11078466	VIANOPOLIS	11/02/2020 17:56	11/02/2020 19:56	11/02/2020 17:56	11/02/2020 19:56	1,99	145	289,11	CHI
20200253519	GOIANIA	12498245	ATLANTICO S3	11/02/2020 17:58	11/02/2020 19:37	11/02/2020 17:58	11/02/2020 19:37	1,65	1	1,65	CHI
20200253520	CALDAS NOVAS	760418627	CALDAS NOVAS S2	11/02/2020 17:58	11/02/2020 22:54	11/02/2020 17:58	11/02/2020 22:54	4,93	1	4,93	CHI
20200253524	COCALZINHO DE GOIAS	ZN12319184	COCALZINHO	11/02/2020 17:58	11/02/2020 21:04	11/02/2020 17:58	11/02/2020 21:04	3,09	4	12,38	CHI
20200253664	FORMOSA	FA32042715	SAO JOAO D ALIANCA	11/02/2020 17:58	12/02/2020 09:40	11/02/2020 17:58	12/02/2020 09:40	15,70	3	47,09	CHI
20200253531	GOIANIA	10007316052	ATLANTICO S2	11/02/2020 17:59	11/02/2020 20:00	11/02/2020 17:59	11/02/2020 20:00	2,00	1	2,00	CHI
20200253537	CACHOEIRA ALTA	CA21229345	CACHOEIRA ALTA	11/02/2020 18:00	11/02/2020 19:22	11/02/2020 18:00	11/02/2020 19:22	1,35	1	1,35	CHI
20200253794	GOIANIA	GN12001185	CAMPINAS S1	11/02/2020 18:00	11/02/2020 19:50	11/02/2020 18:00	11/02/2020 19:50	1,82	487	888,10	CHI
20200253539	LAGOA SANTA	IJ21154807	CACHOEIRA ALTA	11/02/2020 18:01	11/02/2020 23:37	11/02/2020 18:01	11/02/2020 23:37	5,59	1	5,59	CHI
20200253540	QUIRINOPOLIS	8054518	QUIRINOPOLIS	11/02/2020 18:01	12/02/2020 11:46	11/02/2020 18:01	12/02/2020 11:46	17,74	3	53,23	CHI
20200253550	CATALAO	10023928440	CATALAO S2	11/02/2020 18:04	11/02/2020 21:15	11/02/2020 18:04	11/02/2020 21:15	3,18	1	3,18	CHI
20200253552	SANTA TEREZINHA DE GOIAS	10002087250	SANTA TEREZINHA	11/02/2020 18:04	12/02/2020 01:47	11/02/2020 18:04	12/02/2020 01:47	7,70	0	0,00	CHI
20200254221	APORE	04320224	ITAJA S1	11/02/2020 18:04	12/02/2020 20:15	11/02/2020 18:04	12/02/2020 12:17	18,21	9	163,93	CHI
20200254221	APORE	04320224	ITAJA S1	11/02/2020 18:04	12/02/2020 20:15	11/02/2020 18:04	12/02/2020 15:00	20,93	52	1088,48	CHI
20200254221	APORE	04320224	ITAJA S1	11/02/2020 18:04	12/02/2020 20:15	11/02/2020 18:04	12/02/2020 15:00	20,93	15	313,98	CHI
20200254221	APORE	04320224	ITAJA S1	11/02/2020 18:04	12/02/2020 20:15	11/02/2020 18:04	12/02/2020 20:15	26,18	33	863,90	CHI
20200253554	ITABERAI	IB21235436	ITABERAI S1	11/02/2020 18:05	11/02/2020 20:44	11/02/2020 18:05	11/02/2020 20:44	2,66	2	5,32	CHI
20200253655	CACHOEIRA ALTA	RV12227747	QUIRINOPOLIS	11/02/2020 18:09	12/02/2020 09:31	11/02/2020 18:09	12/02/2020 09:31	15,37	7	107,57	CHI
20200253655	RIO VERDE	RV12227747	QUIRINOPOLIS	11/02/2020 18:09	12/02/2020 09:31	11/02/2020 18:09	12/02/2020 09:31	15,37	3	46,10	CHI
20200253736	PORTEIRAO	CL11128270	RIO DOS BOIS	11/02/2020 18:11	11/02/2020 23:37	11/02/2020 18:11	11/02/2020 23:37	5,43	62	336,56	CHI
20200253797	IACIARA	IA11000004	IACIARA S1	11/02/2020 18:11	11/02/2020 20:02	11/02/2020 18:11	11/02/2020 20:02	1,84	101	186,26	CHI
20200253584	SAO DOMINGOS	SD12389273LD	SAO DOMINGOS	11/02/2020 18:15	12/02/2020 19:15	11/02/2020 18:15	12/02/2020 19:15	25,01	28	700,15	CHI

20200253588	CATALAO	CT21318672	CATALAO S1	11/02/2020 18:15	11/02/2020 22:43	11/02/2020 18:15	11/02/2020 22:43	4,45	1	4,45	CHI
20200253589	SAO LUIS DE MONTES BELOS	10007759965	SAO LUIZ DOS MONTES BELOS	11/02/2020 18:16	12/02/2020 09:21	11/02/2020 18:16	12/02/2020 09:21	15,08	1	15,08	CHI
20200253594	IPAMERI	IP21071401	PIRES DO RIO S2	11/02/2020 18:16	12/02/2020 10:11	11/02/2020 18:16	12/02/2020 10:11	15,92	1	15,92	CHI
20200253598	GOIATUBA	GT11310080	GOIATUBA S2	11/02/2020 18:17	11/02/2020 19:43	11/02/2020 18:17	11/02/2020 19:43	1,43	138	197,15	CHI
20200253603	TURVANIA	TV21111565	FIRMINOPOLIS S1	11/02/2020 18:18	12/02/2020 10:08	11/02/2020 18:18	12/02/2020 10:08	15,83	1	15,83	CHI
20200253605	PLANALTINA	2960122003	PLANALTINA	11/02/2020 18:18	11/02/2020 20:46	11/02/2020 18:18	11/02/2020 20:46	2,47	1	2,47	CHI
20200253607	NOVO BRASIL	NB21292691	JUSSARA	11/02/2020 18:19	11/02/2020 23:41	11/02/2020 18:19	11/02/2020 23:41	5,36	1	5,36	CHI
20200253612	APARECIDA DE GOIANIA	200368321	INDEPENDENCIA S1	11/02/2020 18:20	11/02/2020 21:29	11/02/2020 18:20	11/02/2020 21:29	3,14	1	3,14	CHI
20200253628	NIQUELANDIA	2750042763	NIQUELANDIA SUBTRANSMISSAO	11/02/2020 18:24	11/02/2020 21:10	11/02/2020 18:24	11/02/2020 21:10	2,76	1	2,76	CHI
20200253633	ANAPOLIS	20721845	JUNDIAI S1	11/02/2020 18:24	11/02/2020 21:55	11/02/2020 18:24	11/02/2020 21:55	3,51	1	3,51	CHI
20200253640	JATAI	290269787	JATAI S3	11/02/2020 18:24	11/02/2020 18:45	11/02/2020 18:24	11/02/2020 18:45	0,35	1	0,35	CHI
20200253635	GOIANIA	10003066957	CARAJAS S2	11/02/2020 18:25	11/02/2020 19:21	11/02/2020 18:25	11/02/2020 19:21	0,93	1	0,93	CHI
20200253636	ORIZONA	OZ21172810	PIRES DO RIO S2	11/02/2020 18:25	12/02/2020 08:54	11/02/2020 18:25	12/02/2020 08:54	14,47	1	14,47	CHI
20200253638	RIO VERDE	630323690	RIO VERDE S1	11/02/2020 18:26	12/02/2020 00:24	11/02/2020 18:26	12/02/2020 00:24	5,96	1	5,96	CHI
20200253639	PARAUNA	EU21000197	ACREUNA	11/02/2020 18:26	11/02/2020 22:58	11/02/2020 18:26	11/02/2020 22:58	4,52	1	4,52	CHI
20200253641	AGUAS LINDAS DE GOIAS	4830222610	AGUAS LINDAS DE GOIAS S1	11/02/2020 18:26	11/02/2020 19:33	11/02/2020 18:26	11/02/2020 19:33	1,10	1	1,10	CHI
20200253643	ITUMBIARA	IT11000132	PARANAIBA	11/02/2020 18:27	11/02/2020 20:12	11/02/2020 18:27	11/02/2020 20:12	1,74	29	50,39	CHI
20200253644	CACHOEIRA ALTA	CA12305852	CACHOEIRA ALTA	11/02/2020 18:27	12/02/2020 09:20	11/02/2020 18:27	12/02/2020 09:20	14,89	3	44,66	CHI
20200253644	CACU	CA12305852	CACHOEIRA ALTA	11/02/2020 18:27	12/02/2020 09:20	11/02/2020 18:27	12/02/2020 09:20	14,89	1	14,89	CHI
20200253700	ACREUNA	EU12214065	ACREUNA	11/02/2020 18:27	11/02/2020 23:47	11/02/2020 18:27	11/02/2020 23:47	5,33	5	26,64	CHI
20200253652	PALMEIRAS DE GOIAS	10028779841	PALMEIRAS	11/02/2020 18:30	11/02/2020 22:30	11/02/2020 18:30	11/02/2020 22:30	4,00	1	4,00	CHI
20200253653	AGUAS LINDAS DE GOIAS	4830285449	AGUAS LINDAS DE GOIAS S1	11/02/2020 18:30	11/02/2020 19:33	11/02/2020 18:30	11/02/2020 19:33	1,04	1	1,04	CHI
20200253771	APORE	AE12107317	ITAJA S1	11/02/2020 18:30	12/02/2020 11:33	11/02/2020 18:30	12/02/2020 11:33	17,05	79	1347,17	CHI
20200253771	ITARUMA	AE12107317	ITAJA S1	11/02/2020 18:30	12/02/2020 11:33	11/02/2020 18:30	12/02/2020 11:33	17,05	1	17,05	CHI
20200253660	GOIANDIRA	GD21203144	CATALAO S1	11/02/2020 18:31	12/02/2020 08:58	11/02/2020 18:31	12/02/2020 08:58	14,44	1	14,44	CHI
20200253663	QUIRINOPOLIS	80126790	QUIRINOPOLIS	11/02/2020 18:31	12/02/2020 02:56	11/02/2020 18:31	12/02/2020 02:56	8,40	1	8,40	CHI
20200253665	PLANALTINA	PI12085567	PLANALTINA	11/02/2020 18:31	11/02/2020 21:42	11/02/2020 18:31	11/02/2020 21:42	3,17	5	15,85	CHI
20200253671	MONTE ALEGRE DE GOIAS	MA21321337	SAO DOMINGOS	11/02/2020 18:33	11/02/2020 20:27	11/02/2020 18:33	11/02/2020 20:27	1,90	1	1,90	CHI
20200253673	RIO VERDE	10011037499	RIO VERDE S2	11/02/2020 18:33	12/02/2020 11:36	11/02/2020 18:33	12/02/2020 11:36	17,05	1	17,05	CHI
20200253676	APARECIDA DE GOIANIA	14249601	INDEPENDENCIA S2	11/02/2020 18:33	11/02/2020 22:31	11/02/2020 18:33	11/02/2020 22:31	3,96	1	3,96	CHI
20200253677	SAO DOMINGOS	SD21161796	SAO DOMINGOS	11/02/2020 18:33	12/02/2020 10:18	11/02/2020 18:33	12/02/2020 10:18	15,74	1	15,74	CHI
20200254106	FORMOSA	FA12322723	ITUIQUIRA	11/02/2020 18:33	12/02/2020 04:30	11/02/2020 18:33	12/02/2020 04:30	9,94	25	248,42	CHI
20200253684	ANAPOLIS	20686717	ANAPOLIS UNIVERSITARIO S2	11/02/2020 18:35	11/02/2020 20:40	11/02/2020 18:35	11/02/2020 20:40	2,07	1	2,07	CHI

20200253692	COLINAS DO SUL	TI12170026	MINACU	11/02/2020 18:37	11/02/2020 20:13	11/02/2020 18:37	11/02/2020 20:13	1,60	6	9,60	CHI
20200253695	CALDAZINHA	BV21059724	SENADOR CANEDO	11/02/2020 18:37	12/02/2020 12:43	11/02/2020 18:37	12/02/2020 12:38	18,02	3	54,07	CHI
20200253695	BELA VISTA DE GOIAS	BV12059729	SENADOR CANEDO	11/02/2020 18:37	12/02/2020 12:43	12/02/2020 11:13	12/02/2020 12:43	1,50	5	7,48	CHI
20200253695	CALDAZINHA	BV12059729	SENADOR CANEDO	11/02/2020 18:37	12/02/2020 12:43	12/02/2020 11:13	12/02/2020 12:43	1,50	17	25,45	CHI
20200253697	SAO DOMINGOS	SD12170565	SAO DOMINGOS	11/02/2020 18:37	12/02/2020 10:23	11/02/2020 18:37	12/02/2020 10:23	15,76	5	78,78	CHI
20200253702	CATALAO	CT12399858	CATALAO S2	11/02/2020 18:38	12/02/2020 07:38	11/02/2020 18:38	12/02/2020 07:38	12,99	10	129,90	CHI
20200253702	CUMARI	CT12399858	CATALAO S2	11/02/2020 18:38	12/02/2020 07:38	11/02/2020 18:38	12/02/2020 07:38	12,99	1	12,99	CHI
20200253705	GOIANIA	14200960	REAL S1	11/02/2020 18:39	11/02/2020 20:47	11/02/2020 18:39	11/02/2020 20:47	2,13	1	2,13	CHI
20200254410	IPAMERI	IP12215692	PIRES DO RIO S2	11/02/2020 18:40	12/02/2020 11:30	11/02/2020 18:40	12/02/2020 11:30	16,84	3	50,53	CHI
20200253711	MONTES CLAROS DE GOIAS	ME12088949	IPORA	11/02/2020 18:41	11/02/2020 20:38	11/02/2020 18:41	11/02/2020 20:38	1,94	50	96,76	CHI
20200253715	CRISTALINA	1060040673	CRISTALINA S1	11/02/2020 18:42	11/02/2020 22:51	11/02/2020 18:42	11/02/2020 22:51	4,14	1	4,14	CHI
20200253716	ITARUMA	IM11382666	ITAJA S2	11/02/2020 18:42	12/02/2020 08:53	11/02/2020 18:42	12/02/2020 08:53	14,17	1	14,17	CHI
20200253720	CABECEIRAS	CW12049389	ITUIQUIRA	11/02/2020 18:43	11/02/2020 20:39	11/02/2020 18:43	11/02/2020 20:39	1,92	14	26,89	CHI
20200253727	SAO LUIS DE MONTES BELOS	500085602	SAO LUIZ DOS MONTES BELOS	11/02/2020 18:45	11/02/2020 21:56	11/02/2020 18:45	11/02/2020 21:56	3,18	1	3,18	CHI
20200253729	PIRES DO RIO	PR12166937	PIRES DO RIO S1	11/02/2020 18:45	12/02/2020 02:09	11/02/2020 18:45	12/02/2020 02:09	7,40	111	821,09	CHI
20200253910	GOIANIA	GN11109314	FERROVIARIO S3	11/02/2020 18:45	11/02/2020 21:52	11/02/2020 18:45	11/02/2020 21:52	3,10	55	170,53	CHI
20200253917	BOM JESUS DE GOIAS	ID12128151	QUIRINOPOLIS	11/02/2020 18:45	11/02/2020 23:27	11/02/2020 18:45	11/02/2020 23:27	4,69	69	323,67	CHI
20200253917	INACIOLANDIA	ID12128151	QUIRINOPOLIS	11/02/2020 18:45	11/02/2020 23:27	11/02/2020 18:45	11/02/2020 23:27	4,69	40	187,63	CHI
20200253917	ITUMBIARA	ID12128151	QUIRINOPOLIS	11/02/2020 18:45	11/02/2020 23:27	11/02/2020 18:45	11/02/2020 23:27	4,69	5	23,45	CHI
20200253735	MONTIVIDIU	10007416103	MONTIVIDIU T	11/02/2020 18:47	11/02/2020 20:43	11/02/2020 18:47	11/02/2020 20:43	1,93	1	1,93	CHI
20200253741	IPAMERI	IP21152421	IPAMERI	11/02/2020 18:50	12/02/2020 09:24	11/02/2020 18:50	12/02/2020 09:24	14,56	1	14,56	CHI
20200253742	GOIANIA	10182913	AEROPORTO S1	11/02/2020 18:50	12/02/2020 00:17	11/02/2020 18:50	12/02/2020 00:17	5,44	1	5,44	CHI
20200253747	JOVIANIA	JV12375075	GOIATUBA S1	11/02/2020 18:51	12/02/2020 07:47	11/02/2020 18:51	12/02/2020 07:47	12,93	6	77,58	CHI
20200253749	PORTELANDIA	PW21302971	PARQUE DAS EMAS	11/02/2020 18:51	12/02/2020 14:07	11/02/2020 18:51	12/02/2020 14:07	19,26	1	19,26	CHI
20200253754	PIRACANJUBA	PJ12381140	PIRACANJUBA	11/02/2020 18:52	11/02/2020 21:05	11/02/2020 18:52	11/02/2020 21:05	2,20	9	19,84	CHI
20200253755	ITAJA	IJ12214313	ITAJA S2	11/02/2020 18:52	11/02/2020 22:52	11/02/2020 18:52	11/02/2020 22:52	4,00	2	7,99	CHI
20200253924	CATALAO	CT11161377	CATALAO S2	11/02/2020 18:53	11/02/2020 23:57	11/02/2020 18:53	11/02/2020 23:57	5,06	138	698,43	CHI
20200253761	NOVO PLANALTO	TA12365617	SAO MIGUEL DO ARAGUAIA	11/02/2020 18:54	12/02/2020 04:22	11/02/2020 18:54	12/02/2020 04:22	9,46	1	9,46	CHI
20200253762	BOM JARDIM DE GOIAS	BM12297154	BOM JARDIM	11/02/2020 18:54	12/02/2020 00:01	11/02/2020 18:54	12/02/2020 00:01	5,11	2	10,22	CHI
20200253768	URUACU	UR21339995	URUACU	11/02/2020 18:55	11/02/2020 22:24	11/02/2020 18:55	11/02/2020 22:24	3,48	1	3,48	CHI
20200253769	GOIANIA	10917070	GOIANIA LESTE S1	11/02/2020 18:55	12/02/2020 00:52	11/02/2020 18:55	12/02/2020 00:52	5,93	1	5,93	CHI
20200253774	PEROLANDIA	MY12301872	PARQUE DAS EMAS	11/02/2020 18:57	12/02/2020 00:10	11/02/2020 18:57	12/02/2020 00:10	5,21	4	20,85	CHI
20200253776	NEROPOLIS	160039496	NEROPOLIS S2	11/02/2020 18:59	11/02/2020 22:16	11/02/2020 18:59	11/02/2020 22:16	3,27	1	3,27	CHI

20200253792	BALIZA	BH12362214	BOM JARDIM	11/02/2020 19:04	12/02/2020 02:58	11/02/2020 19:04	12/02/2020 02:58	7,89	4	31,56	CHI
20200254058	NOVO GAMA	NJ11211944	PACAEMBU S1	11/02/2020 19:05	11/02/2020 22:55	11/02/2020 19:05	11/02/2020 22:55	3,83	16	61,21	CHI
20200253798	SANTO ANTONIO DA BARRA	BZ12316322	ACREUNA	11/02/2020 19:06	11/02/2020 22:43	11/02/2020 19:06	11/02/2020 22:43	3,62	3	10,85	CHI
20200253902	GOIANIA	16637252	GOYA S2	11/02/2020 19:08	11/02/2020 20:52	11/02/2020 19:08	11/02/2020 20:52	1,72	1	1,72	CHI
20200253911	ESTRELA DO NORTE	ET21051087	MARA ROSA	11/02/2020 19:10	11/02/2020 20:30	11/02/2020 19:10	11/02/2020 20:30	1,32	1	1,32	CHI
20200253913	GOIANIA	17271368	INDEPENDENCIA S2	11/02/2020 19:10	11/02/2020 22:56	11/02/2020 19:10	11/02/2020 22:56	3,76	1	3,76	CHI
20200253915	GOIATUBA	GT21190949	GOIATUBA S2	11/02/2020 19:10	11/02/2020 21:53	11/02/2020 19:10	11/02/2020 21:53	2,71	1	2,71	CHI
20200254031	CAMPOS BELOS	CH11028138	SAO DOMINGOS	11/02/2020 19:10	11/02/2020 21:41	11/02/2020 19:10	11/02/2020 21:41	2,50	74	185,10	CHI
20200253919	CATALAO	CT21131051	CATALAO S1	11/02/2020 19:11	12/02/2020 19:11	11/02/2020 19:11	12/02/2020 19:11	24,00	1	24,00	CHI
20200253930	GOIANIA	10030616644	MEIA PONTE	11/02/2020 19:14	11/02/2020 23:20	11/02/2020 19:14	11/02/2020 23:20	4,09	1	4,09	CHI
20200253952	AURILANDIA	AI12206461	FIRMINOPOLIS S2	11/02/2020 19:16	11/02/2020 21:12	11/02/2020 19:16	11/02/2020 21:12	1,93	13	25,11	CHI
20200253952	FIRMINOPOLIS	AI12206461	FIRMINOPOLIS S2	11/02/2020 19:16	11/02/2020 21:12	11/02/2020 19:16	11/02/2020 21:12	1,93	16	30,91	CHI
20200253940	CACU	CC21193943	CACHOEIRA ALTA	11/02/2020 19:17	12/02/2020 12:50	11/02/2020 19:17	12/02/2020 12:50	17,56	1	17,56	CHI
20200253941	PLANALTINA	PI11096301	PLANALTINA	11/02/2020 19:17	11/02/2020 20:50	11/02/2020 19:17	11/02/2020 20:50	1,53	27	41,44	CHI
20200253943	APARECIDA DE GOIANIA	200603358	ANHANGUERA	11/02/2020 19:18	11/02/2020 20:49	11/02/2020 19:18	11/02/2020 20:49	1,52	1	1,52	CHI
20200253944	APARECIDA DE GOIANIA	AP11141714	CEPAIGO S1	11/02/2020 19:18	11/02/2020 21:23	11/02/2020 19:18	11/02/2020 21:23	2,08	15	31,23	CHI
20200253959	BELA VISTA DE GOIAS	BV21145268	BELA VISTA S1	11/02/2020 19:20	12/02/2020 03:29	11/02/2020 19:20	12/02/2020 03:29	8,14	1	8,14	CHI
20200254020	FORMOSA	FA12131868	ITIQUEIRA	11/02/2020 19:20	11/02/2020 20:21	11/02/2020 19:20	11/02/2020 20:21	1,01	684	690,65	CHI
20200253960	PARANAIGUARA	2230005670	CACHOEIRA ALTA	11/02/2020 19:21	12/02/2020 10:19	11/02/2020 19:21	12/02/2020 10:19	14,97	1	14,97	CHI
20200253965	EDEALINA	ED11108008	PONTALINA	11/02/2020 19:22	11/02/2020 20:40	11/02/2020 19:22	11/02/2020 20:40	1,30	115	149,50	CHI
20200253969	BURITINOPOLIS	MB12361385	IACIARA S2	11/02/2020 19:22	12/02/2020 12:00	11/02/2020 19:22	12/02/2020 12:00	16,62	19	315,74	CHI
20200253975	BELA VISTA DE GOIAS	240018746	BELA VISTA S1	11/02/2020 19:24	11/02/2020 20:51	11/02/2020 19:24	11/02/2020 20:51	1,44	1	1,44	CHI
20200253976	ABADIANIA	10001434754	ANAPOLIS UNIVERSITARIO S1	11/02/2020 19:25	11/02/2020 22:45	11/02/2020 19:25	11/02/2020 22:45	3,33	1	3,33	CHI
20200254042	GUARINOS	GF11099026	SANTA TEREZINHA	11/02/2020 19:27	11/02/2020 23:01	11/02/2020 19:27	11/02/2020 23:01	3,56	130	463,09	CHI
20200253996	CAMPINORTE	CR21266626	MARA ROSA	11/02/2020 19:29	12/02/2020 10:28	11/02/2020 19:29	12/02/2020 10:28	14,98	1	14,98	CHI
20200254001	FLORES DE GOIAS	FB12211536	IACIARA S2	11/02/2020 19:29	12/02/2020 13:47	11/02/2020 19:29	12/02/2020 13:47	18,29	13	237,78	CHI
20200254002	APARECIDA DE GOIANIA	AP11350709	INDEPENDENCIA S2	11/02/2020 19:29	11/02/2020 21:37	11/02/2020 19:29	11/02/2020 21:37	2,12	87	184,32	CHI
20200254029	GOIAS	GS21217484	GOIAS	11/02/2020 19:38	12/02/2020 09:58	11/02/2020 19:38	12/02/2020 09:58	14,33	1	14,33	CHI
20200254033	HIDROLANDIA	180004591	PONTALINA	11/02/2020 19:39	11/02/2020 22:00	11/02/2020 19:39	11/02/2020 22:00	2,36	1	2,36	CHI
20200254035	VALPARAISO DE GOIAS	2860124865	MARAJOARA	11/02/2020 19:41	11/02/2020 23:02	11/02/2020 19:41	11/02/2020 23:02	3,35	1	3,35	CHI
20200254047	PIRES DO RIO	PR21272839	PIRES DO RIO S1	11/02/2020 19:46	12/02/2020 03:25	11/02/2020 19:46	12/02/2020 03:25	7,64	1	7,64	CHI
20200254048	PARANAIGUARA	PC12000128	CACHOEIRA ALTA	11/02/2020 19:46	12/02/2020 01:04	11/02/2020 19:46	12/02/2020 01:04	5,29	25	132,22	CHI
20200254056	GUARINOS	GF12314379	SANTA TEREZINHA	11/02/2020 19:48	11/02/2020 23:53	11/02/2020 19:48	11/02/2020 23:53	4,07	3	12,21	CHI

20200254057	QUIRINOPOLIS	QI12000274	QUIRINOPOLIS	11/02/2020 19:48	12/02/2020 04:38	11/02/2020 19:48	12/02/2020 04:38	8,82	4	35,27	CHI
20200254064	SAO SIMAO	SO21163371	CACHOEIRA ALTA	11/02/2020 19:50	11/02/2020 21:50	11/02/2020 19:50	11/02/2020 21:50	1,99	1	1,99	CHI
20200254066	GOIANIA	12762921	GOYA S2	11/02/2020 19:51	11/02/2020 21:31	11/02/2020 19:51	11/02/2020 21:31	1,66	1	1,66	CHI
20200254107	CRISTALINA	KR12287383	CRISTALINA S1	11/02/2020 19:51	12/02/2020 10:56	11/02/2020 19:51	12/02/2020 10:56	15,07	78	1175,29	CHI
20200254071	PLANALTINA	PI12257800	PLANALTINA	11/02/2020 19:53	11/02/2020 22:50	11/02/2020 19:53	11/02/2020 22:50	2,95	4	11,79	CHI
20200254073	PLANALTINA	2960111431	PLANALTINA	11/02/2020 19:54	11/02/2020 21:58	11/02/2020 19:54	11/02/2020 21:58	2,08	1	2,08	CHI
20200254074	APARECIDA DE GOIANIA	200316023	ANHANGUERA	11/02/2020 19:54	11/02/2020 22:11	11/02/2020 19:54	11/02/2020 22:11	2,28	1	2,28	CHI
20200254075	ARUANA	AK12396237	BRITANIA	11/02/2020 19:54	11/02/2020 23:00	11/02/2020 19:54	11/02/2020 23:00	3,09	4	12,36	CHI
20200254167	GOIANIA	GN11200572	CARAJAS S1	11/02/2020 19:56	11/02/2020 21:34	11/02/2020 19:56	11/02/2020 21:34	1,62	150	243,58	CHI
20200254084	FORMOSA	610214184	ITUIQUIRA	11/02/2020 19:57	11/02/2020 20:56	11/02/2020 19:57	11/02/2020 20:56	0,97	1	0,97	CHI
20200254097	GOIANIA	GN11167476	ATLANTICO S2	11/02/2020 19:59	12/02/2020 01:30	11/02/2020 19:59	12/02/2020 01:30	5,51	168	925,17	CHI
20200254121	ORIZONA	OZ11140712	PIRES DO RIO S2	11/02/2020 19:59	11/02/2020 20:50	11/02/2020 19:59	11/02/2020 20:50	0,84	146	122,15	CHI
20200254154	GOIANIA	GN11043787	CARAJAS S2	11/02/2020 19:59	11/02/2020 21:19	11/02/2020 19:59	11/02/2020 21:19	1,33	121	160,83	CHI
20200254127	GOIANIA	GN11001619	XAVANTES	11/02/2020 20:00	11/02/2020 21:35	11/02/2020 20:00	11/02/2020 21:35	1,57	231	362,61	CHI
20200254096	SAO SIMAO	SO11060847	CACHOEIRA ALTA	11/02/2020 20:01	11/02/2020 22:48	11/02/2020 20:01	11/02/2020 22:48	2,78	107	297,55	CHI
20200254101	GOIANIA	13950370	CARAJAS S1	11/02/2020 20:02	11/02/2020 21:25	11/02/2020 20:02	11/02/2020 21:25	1,38	1	1,38	CHI
20200254111	GOIANESIA	10023156439	GOIANESIA S2	11/02/2020 20:04	11/02/2020 23:44	11/02/2020 20:04	11/02/2020 23:44	3,67	1	3,67	CHI
20200254122	AGUAS LINDAS DE GOIAS	4830405455	AGUAS LINDAS DE GOIAS S2	11/02/2020 20:07	11/02/2020 22:47	11/02/2020 20:07	11/02/2020 22:47	2,66	1	2,66	CHI
20200254124	MINACU	IH12317057	MINACU	11/02/2020 20:07	12/02/2020 01:23	11/02/2020 20:07	12/02/2020 01:23	5,25	5	26,27	CHI
20200254126	ANAPOLIS	20592401	ANAPOLIS UNIVERSITARIO S2	11/02/2020 20:07	11/02/2020 22:10	11/02/2020 20:07	11/02/2020 22:10	2,04	1	2,04	CHI
20200254148	ITAJA	IJ12063067	ITAJA S2	11/02/2020 20:08	12/02/2020 02:09	11/02/2020 20:08	12/02/2020 02:09	6,01	3	18,04	CHI
20200254148	LAGOA SANTA	IJ12063067	ITAJA S2	11/02/2020 20:08	12/02/2020 02:09	11/02/2020 20:08	12/02/2020 02:09	6,01	12	72,15	CHI
20200254137	RIO VERDE	630048290	RIO VERDE S1	11/02/2020 20:10	12/02/2020 17:15	11/02/2020 20:10	12/02/2020 17:15	21,07	1	21,07	CHI
20200254159	GUARINOS	IW12201636	ITAPACI	11/02/2020 20:10	11/02/2020 20:52	11/02/2020 20:10	11/02/2020 20:52	0,68	7	4,79	CHI
20200254159	ITAPACI	IW12201636	ITAPACI	11/02/2020 20:10	11/02/2020 20:52	11/02/2020 20:10	11/02/2020 20:52	0,68	244	167,00	CHI
20200254159	PILAR DE GOIAS	IW12201636	ITAPACI	11/02/2020 20:10	11/02/2020 20:52	11/02/2020 20:10	11/02/2020 20:52	0,68	1	0,68	CHI
20200254140	ITAPIRAPUA	IU12142895	MATRINCHA	11/02/2020 20:11	11/02/2020 23:23	11/02/2020 20:11	11/02/2020 23:23	3,20	8	25,57	CHI
20200254143	GOIANIA	15366492	XAVANTES	11/02/2020 20:11	11/02/2020 22:24	11/02/2020 20:11	11/02/2020 22:24	2,21	1	2,21	CHI
20200254165	ITAPURANGA	IK12307340	ITAPURANGA	11/02/2020 20:14	11/02/2020 22:50	11/02/2020 20:14	11/02/2020 22:50	2,59	196	507,37	CHI
20200254166	AMARALINA	MU12391981	MARA ROSA	11/02/2020 20:16	11/02/2020 23:56	11/02/2020 20:16	11/02/2020 23:56	3,66	5	18,28	CHI
20200254166	MUTUNOPOLIS	MU12391981	MARA ROSA	11/02/2020 20:16	11/02/2020 23:56	11/02/2020 20:16	11/02/2020 23:56	3,66	5	18,28	CHI
2020021100072	GUARANI DE GOIAS	02090424	SAO DOMINGOS	11/02/2020 20:16	11/02/2020 20:28	11/02/2020 20:16	11/02/2020 20:28	0,19	149	28,81	CHI
2020021100072	MONTE ALEGRE DE GOIAS	02090424	SAO DOMINGOS	11/02/2020 20:16	11/02/2020 20:28	11/02/2020 20:16	11/02/2020 20:28	0,19	2	0,39	CHI

2020021100072	NOVA ROMA	02090424	SAO DOMINGOS	11/02/2020 20:16	11/02/2020 20:28	11/02/2020 20:16	11/02/2020 20:28	0,19	3	0,58	CHI
2020021100072	SAO DOMINGOS	02090424	SAO DOMINGOS	11/02/2020 20:16	11/02/2020 20:28	11/02/2020 20:16	11/02/2020 20:28	0,19	1163	224,85	CHI
20200254169	GOIANIA	AO31088999	INDEPENDENCIA S2	11/02/2020 20:17	11/02/2020 23:10	11/02/2020 20:17	11/02/2020 23:10	2,88	6	17,26	CHI
20200254175	GOIAS	90064598	GOIAS	11/02/2020 20:19	11/02/2020 23:27	11/02/2020 20:19	11/02/2020 23:27	3,12	1	3,12	CHI
20200254184	EDEALINA	ED21000002	PONTALINA	11/02/2020 20:22	11/02/2020 21:29	11/02/2020 20:22	11/02/2020 21:29	1,11	1	1,11	CHI
20200254186	LUZIANIA	10014664656	RIO VERMELHO	11/02/2020 20:23	11/02/2020 21:27	11/02/2020 20:23	11/02/2020 21:27	1,06	1	1,06	CHI
20200254189	GOIANIA	10008992671	CAMPINAS S1	11/02/2020 20:25	11/02/2020 22:01	11/02/2020 20:25	11/02/2020 22:01	1,60	1	1,60	CHI
20200254192	GOIANIA	12584770	INDEPENDENCIA S1	11/02/2020 20:25	11/02/2020 21:57	11/02/2020 20:25	11/02/2020 21:57	1,52	1	1,52	CHI
20200254202	GOIANESIA	GE12357342	GOIANESIA S2	11/02/2020 20:28	12/02/2020 00:05	11/02/2020 20:28	12/02/2020 00:05	3,60	18	64,88	CHI
20200254202	VILA PROPICIO	GE12357342	GOIANESIA S2	11/02/2020 20:28	12/02/2020 00:05	11/02/2020 20:28	12/02/2020 00:05	3,60	9	32,44	CHI
20200254211	NOVO GAMA	NJ12344854	PACAEMBU S1	11/02/2020 20:29	12/02/2020 10:35	11/02/2020 20:29	12/02/2020 10:35	14,09	219	3086,68	CHI
20200254232	NOVO GAMA	NJ12344854	PACAEMBU S1	11/02/2020 20:29	12/02/2020 10:35	11/02/2020 20:29	12/02/2020 10:35	14,09	10	140,94	CHI
20200254217	ARUANA	MP13170271	MOZARLANDIA	11/02/2020 20:36	12/02/2020 09:48	11/02/2020 20:36	12/02/2020 09:48	13,20	6	79,22	CHI
20200254217	MATRINCHA	MP13170271	MOZARLANDIA	11/02/2020 20:36	12/02/2020 09:48	11/02/2020 20:36	12/02/2020 09:48	13,20	5	66,02	CHI
20200254217	ARUANA	MP13170271	MOZARLANDIA	11/02/2020 20:36	12/02/2020 09:48	12/02/2020 08:54	12/02/2020 09:48	0,90	1	0,90	CHI
20200254217	MATRINCHA	MP13170271	MOZARLANDIA	11/02/2020 20:36	12/02/2020 09:48	12/02/2020 08:54	12/02/2020 09:48	0,90	6	5,42	CHI
20200254220	JATAI	JT21348505	JATAI S1	11/02/2020 20:37	11/02/2020 23:20	11/02/2020 20:37	11/02/2020 23:20	2,71	1	2,71	CHI
20200254222	BOM JARDIM DE GOIAS	PH12201913	PIRANHAS	11/02/2020 20:37	12/02/2020 07:41	11/02/2020 20:37	12/02/2020 07:41	11,06	2	22,11	CHI
20200254222	PIRANHAS	PH12201913	PIRANHAS	11/02/2020 20:37	12/02/2020 07:41	11/02/2020 20:37	12/02/2020 07:41	11,06	11	121,63	CHI
20200254223	AGUAS LINDAS DE GOIAS	LA11126499	AGUAS LINDAS DE GOIAS S2	11/02/2020 20:37	11/02/2020 21:32	11/02/2020 20:37	11/02/2020 21:32	0,90	280	253,09	CHI
20200254231	ANICUNS	910034898	ANICUNS	11/02/2020 20:39	11/02/2020 23:25	11/02/2020 20:39	11/02/2020 23:25	2,75	1	2,75	CHI
20200254237	ARAGUAPAZ	AZ12042877	MOZARLANDIA	11/02/2020 20:42	11/02/2020 23:16	11/02/2020 20:42	11/02/2020 23:16	2,56	85	217,74	CHI
20200254237	MOZARLANDIA	AZ12042877	MOZARLANDIA	11/02/2020 20:42	11/02/2020 23:16	11/02/2020 20:42	11/02/2020 23:16	2,56	2	5,12	CHI
20200254880	PALMEIRAS DE GOIAS	PL12000267	PALMEIRAS	11/02/2020 20:43	12/02/2020 11:43	11/02/2020 20:43	12/02/2020 11:43	14,99	3	44,97	CHI
20200254816	FORMOSA	FA12140789	ITIQUEIRA	11/02/2020 20:44	12/02/2020 07:48	11/02/2020 20:44	12/02/2020 07:48	11,07	14	154,93	CHI
20200254249	GOIATUBA	GT12024290	GOIATUBA S2	11/02/2020 20:45	11/02/2020 23:18	11/02/2020 20:45	11/02/2020 23:18	2,54	16	40,68	CHI
20200254256	CRISTALINA	KR21261547	CRISTALINA S2	11/02/2020 20:48	12/02/2020 00:44	11/02/2020 20:48	12/02/2020 00:44	3,93	3	11,79	CHI
20200254257	GOIANIA	12976854	XAVANTES	11/02/2020 20:48	12/02/2020 00:07	11/02/2020 20:48	12/02/2020 00:07	3,30	1	3,30	CHI
20200254307	JANDAIA	JD11000035	PALMEIRAS	11/02/2020 20:49	12/02/2020 00:31	11/02/2020 20:49	12/02/2020 00:31	3,71	108	400,14	CHI
20200254279	PLANALTINA	2960082893	PLANALTINA	11/02/2020 20:51	11/02/2020 23:35	11/02/2020 20:51	11/02/2020 23:35	2,72	1	2,72	CHI
20200254290	ALTO PARAISO DE GOIAS	3870010706	FLORES DE GOIAS	11/02/2020 20:54	11/02/2020 22:04	11/02/2020 20:54	11/02/2020 22:04	1,15	1	1,15	CHI
20200254292	APARECIDA DE GOIANIA	11058511	REAL S1	11/02/2020 20:54	11/02/2020 23:02	11/02/2020 20:54	11/02/2020 23:02	2,12	1	2,12	CHI
20200254304	AGUAS LINDAS DE GOIAS	LA11375039	AGUAS LINDAS DE GOIAS S2	11/02/2020 20:54	12/02/2020 00:09	11/02/2020 20:54	12/02/2020 00:09	3,25	241	782,65	CHI

20200254609	JUSSARA	JR12011813	BRITANIA	11/02/2020 20:57	12/02/2020 09:15	11/02/2020 20:57	12/02/2020 09:15	12,30	29	356,59	CHI
20200254302	PALMINOPOLIS	PP12259881	PALMEIRAS	11/02/2020 20:59	11/02/2020 23:17	11/02/2020 20:59	11/02/2020 23:17	2,29	6	13,74	CHI
20200254317	IPAMERI	IP11089951	IPAMERI	11/02/2020 21:02	11/02/2020 23:07	11/02/2020 21:02	11/02/2020 23:07	2,08	218	452,96	CHI
20200254329	GOIANESIA	GE12215070	GOIANESIA S1	11/02/2020 21:12	12/02/2020 00:18	11/02/2020 21:12	12/02/2020 00:18	3,10	24	74,33	CHI
20200254339	GOIAS	GS12206865	MATRINCHA	11/02/2020 21:14	12/02/2020 07:40	11/02/2020 21:14	12/02/2020 07:40	10,42	68	708,47	CHI
20200254327	TRINDADE	TR12230638	TRINDADE	11/02/2020 21:16	11/02/2020 23:08	11/02/2020 21:16	11/02/2020 23:08	1,86	1409	2627,78	CHI
20200254336	ARAGUAPAZ	AZ12061016	GOIAS	11/02/2020 21:17	12/02/2020 03:17	11/02/2020 21:17	12/02/2020 03:17	6,00	22	131,98	CHI
20200254336	FAINA	AZ12061016	GOIAS	11/02/2020 21:17	12/02/2020 03:17	11/02/2020 21:17	12/02/2020 03:17	6,00	20	119,98	CHI
20200254654	CRISTALINA	KR12162510	PAMPLONA	11/02/2020 21:18	12/02/2020 08:31	11/02/2020 21:18	12/02/2020 08:31	11,20	53	593,81	CHI
20200254341	GOIANIA	10019340166	GOYA S2	11/02/2020 21:20	11/02/2020 23:20	11/02/2020 21:20	11/02/2020 23:20	1,98	1	1,98	CHI
20200254370	INHUMAS	IN11365566	INHUMAS S2	11/02/2020 21:26	11/02/2020 22:15	11/02/2020 21:26	11/02/2020 22:15	0,80	48	38,57	CHI
20200254357	BURITINOPOLIS	MB12026276	IACIARA S2	11/02/2020 21:30	12/02/2020 21:01	11/02/2020 21:30	12/02/2020 21:01	23,51	2	47,02	CHI
20200254359	ITUMBIARA	IT11000019	ITUMBIARA VELHA S1	11/02/2020 21:31	11/02/2020 22:48	11/02/2020 21:31	11/02/2020 22:48	1,28	126	161,21	CHI
20200254378	CAIAPONIA	DV12332038	CAIAPONIA	11/02/2020 21:34	12/02/2020 02:36	11/02/2020 21:34	12/02/2020 02:36	5,02	22	110,49	CHI
20200254378	DOVERLANDIA	DV12332038	CAIAPONIA	11/02/2020 21:34	12/02/2020 02:36	11/02/2020 21:34	12/02/2020 02:36	5,02	28	140,63	CHI
20200254372	GOIAS	GS12220436	GOIAS	11/02/2020 21:36	12/02/2020 08:02	11/02/2020 21:36	12/02/2020 08:02	10,43	2	20,86	CHI
20200254385	ANAPOLIS	20417755	ANAPOLIS UNIVERSITARIO S1	11/02/2020 21:43	11/02/2020 23:48	11/02/2020 21:43	11/02/2020 23:48	2,07	1	2,07	CHI
20200254390	GOIANIA	15955394	CARAJAS S2	11/02/2020 21:45	12/02/2020 00:05	11/02/2020 21:45	12/02/2020 00:05	2,32	1	2,32	CHI
20200254398	MINACU	IH12337406	MINACU	11/02/2020 21:48	11/02/2020 23:31	11/02/2020 21:48	11/02/2020 23:31	1,71	41	70,20	CHI
20200254399	RUBIATABA	RB21272715	RUBIATABA	11/02/2020 21:48	12/02/2020 08:43	11/02/2020 21:48	12/02/2020 08:43	10,91	2	21,82	CHI
20200254417	CALDAS NOVAS	CN11114789	SERRA DE CALDAS	11/02/2020 21:51	11/02/2020 23:08	11/02/2020 21:51	11/02/2020 23:08	1,27	77	98,03	CHI
20200254409	BRITANIA	BT12396220	BRITANIA	11/02/2020 21:54	12/02/2020 14:35	11/02/2020 21:54	12/02/2020 14:35	16,67	2	33,33	CHI
20200254409	JUSSARA	BT12396220	BRITANIA	11/02/2020 21:54	12/02/2020 14:35	11/02/2020 21:54	12/02/2020 14:35	16,67	9	150,00	CHI
20200254420	GOIANIA	GN10403980	ATLANTICO S1	11/02/2020 21:55	12/02/2020 00:21	11/02/2020 21:55	12/02/2020 00:21	2,43	493	1197,99	CHI
20200254420	GOIANIA	GN10403980	ATLANTICO S1	11/02/2020 21:55	12/02/2020 00:21	12/02/2020 00:02	12/02/2020 00:21	0,30	681	206,38	CHI
20200254418	ITAPACI	IW21328856	ITAPACI	11/02/2020 22:00	12/02/2020 02:10	11/02/2020 22:00	12/02/2020 02:10	4,16	1	4,16	CHI
20200254430	SAO LUIS DE MONTES BELOS	SL12003981	SAO LUIZ DOS MONTES BELOS	11/02/2020 22:05	12/02/2020 00:43	11/02/2020 22:05	12/02/2020 00:43	2,63	211	554,99	CHI
20200254431	AGUAS LINDAS DE GOIAS	4830028507	AGUAS LINDAS DE GOIAS S1	11/02/2020 22:05	11/02/2020 23:29	11/02/2020 22:05	11/02/2020 23:29	1,39	1	1,39	CHI
20200254450	GOIAS	GS12073710	MATRINCHA	11/02/2020 22:15	12/02/2020 09:54	11/02/2020 22:15	12/02/2020 09:54	11,65	13	151,42	CHI
20200254451	PIRACANJUBA	PJ21315856	PIRACANJUBA	11/02/2020 22:15	12/02/2020 09:13	11/02/2020 22:15	12/02/2020 09:13	10,95	1	10,95	CHI
20200254453	SENADOR CANEDO	SW12180051	GOIANIA LESTE S2	11/02/2020 22:16	12/02/2020 00:14	11/02/2020 22:16	12/02/2020 00:14	1,96	113	221,26	CHI
20200254453	SENADOR CANEDO	SW12180051	GOIANIA LESTE S2	11/02/2020 22:16	12/02/2020 00:14	11/02/2020 22:50	12/02/2020 00:14	1,41	63	88,65	CHI
20200254463	LUZIANIA	3200252763	MARAJOARA	11/02/2020 22:20	12/02/2020 00:30	11/02/2020 22:20	12/02/2020 00:30	2,17	1	2,17	CHI

20200254464	FIRMINOPOLIS	FR21259237	FIRMINOPOLIS S1	11/02/2020 22:21	12/02/2020 07:36	11/02/2020 22:21	12/02/2020 07:36	9,24	1	9,24	CHI
20200254468	INHUMAS	IN11365566	INHUMAS S2	11/02/2020 22:23	11/02/2020 23:06	11/02/2020 22:23	11/02/2020 23:06	0,72	48	34,36	CHI
20200254470	GOIANIA	GN11003125	GOYA S1	11/02/2020 22:23	12/02/2020 00:50	12/02/2020 00:38	12/02/2020 00:50	0,20	45	9,01	CHI
20200254476	CACU	CC12097352	CACHOEIRA ALTA	11/02/2020 22:27	12/02/2020 12:55	11/02/2020 22:27	12/02/2020 12:55	14,46	6	86,79	CHI
20200254477	CACHOEIRA ALTA	CA21214220	CACHOEIRA ALTA	11/02/2020 22:27	12/02/2020 05:07	11/02/2020 22:27	12/02/2020 05:07	6,66	1	6,66	CHI
20200254483	GOIAS	GS21319434	ITAPURANGA	11/02/2020 22:29	12/02/2020 08:05	11/02/2020 22:29	12/02/2020 08:05	9,58	1	9,58	CHI
20200254484	ANAPOLIS	20610452	ANAPOLIS UNIVERSITARIO S1	11/02/2020 22:29	12/02/2020 00:01	11/02/2020 22:29	12/02/2020 00:01	1,53	1	1,53	CHI
20200254486	CACHOEIRA ALTA	CA21308234	CACHOEIRA ALTA	11/02/2020 22:32	12/02/2020 07:42	11/02/2020 22:32	12/02/2020 07:42	9,16	1	9,16	CHI
20200254499	VIANOPOLIS	VN12052251	VIANOPOLIS	11/02/2020 22:42	12/02/2020 01:43	11/02/2020 22:42	12/02/2020 01:43	3,01	12	36,16	CHI
20200254526	INHUMAS	IN12012916	INHUMAS S1	11/02/2020 22:57	12/02/2020 01:07	11/02/2020 22:57	12/02/2020 01:07	2,16	3	6,49	CHI
20200254528	GOIANIA	11755260	GOYA S2	11/02/2020 22:58	12/02/2020 01:09	11/02/2020 22:58	12/02/2020 01:09	2,18	1	2,18	CHI
20200254530	JATAI	JT12000096	JATAI S3	11/02/2020 23:00	12/02/2020 11:13	11/02/2020 23:00	12/02/2020 10:25	11,43	8	91,41	CHI
20200254530	JATAI	JT12000154	JATAI S3	11/02/2020 23:00	12/02/2020 11:13	11/02/2020 23:00	12/02/2020 11:13	12,22	9	110,01	CHI
20200254537	CAMPOS VERDES	3790035255	SANTA TEREZINHA	11/02/2020 23:23	12/02/2020 11:52	11/02/2020 23:23	12/02/2020 11:52	12,47	1	12,47	CHI
20200254544	GOIANIA	GN11144642	CAMPINAS S2	11/02/2020 23:27	12/02/2020 00:21	11/02/2020 23:27	12/02/2020 00:21	0,89	124	110,81	CHI
20200254644	CACU	CC12075913	CACHOEIRA ALTA	11/02/2020 23:45	12/02/2020 17:13	11/02/2020 23:45	12/02/2020 17:13	17,46	13	226,94	CHI
20200254644	ITARUMA	CC12075913	CACHOEIRA ALTA	11/02/2020 23:45	12/02/2020 17:13	11/02/2020 23:45	12/02/2020 17:13	17,46	32	558,61	CHI
20200254548	PLANALTINA	PI11043458	PLANALTINA	11/02/2020 23:46	12/02/2020 00:49	11/02/2020 23:46	12/02/2020 00:49	1,04	32	33,29	CHI
20200254605	GOIANDIRA	GD12000007	CATALAO S1	12/02/2020 00:49	12/02/2020 08:58	12/02/2020 00:49	12/02/2020 08:58	8,14	104	846,30	CHI
20200254605	NOVA AURORA	GD12000007	CATALAO S1	12/02/2020 00:49	12/02/2020 08:58	12/02/2020 00:49	12/02/2020 08:58	8,14	15	122,06	CHI
20200254611	ABADIANIA	SV12265211	DAIA S2	12/02/2020 01:45	12/02/2020 08:35	12/02/2020 01:45	12/02/2020 08:35	6,83	4	27,33	CHI
20200254611	ANAPOLIS	SV12265211	DAIA S2	12/02/2020 01:45	12/02/2020 08:35	12/02/2020 01:45	12/02/2020 08:35	6,83	4	27,33	CHI
20200254611	GAMELEIRA DE GOIAS	SV12265211	DAIA S2	12/02/2020 01:45	12/02/2020 08:35	12/02/2020 01:45	12/02/2020 08:35	6,83	120	820,00	CHI
20200254612	ITAJA	IJ21131583	ITAJA S2	12/02/2020 02:01	12/02/2020 07:35	12/02/2020 02:01	12/02/2020 07:35	5,56	2	11,13	CHI
20200254613	BURITI ALEGRE	BG12263537	ITUMBIARA VELHA S2	12/02/2020 02:04	12/02/2020 08:30	12/02/2020 02:04	12/02/2020 08:30	6,42	5	32,12	CHI
20200254613	ITUMBIARA	BG12263537	ITUMBIARA VELHA S2	12/02/2020 02:04	12/02/2020 08:30	12/02/2020 02:04	12/02/2020 08:30	6,42	7	44,97	CHI
20200255439	URUTAI	UT21382048	PIRES DO RIO S2	12/02/2020 03:01	12/02/2020 22:38	12/02/2020 03:01	12/02/2020 22:38	19,61	1	19,61	CHI
202002174637	URUTAI	UT12337239	PIRES DO RIO S2	12/02/2020 03:01	12/02/2020 14:38	12/02/2020 03:01	12/02/2020 13:58	10,95	5	54,76	CHI
202002174637	URUTAI	UT12417470	PIRES DO RIO S2	12/02/2020 03:01	12/02/2020 14:38	12/02/2020 03:01	12/02/2020 14:38	11,61	4	46,44	CHI
20200254667	VILA PROPICIO	GE12243252	GOIANESIA S1	12/02/2020 03:16	12/02/2020 09:15	12/02/2020 03:16	12/02/2020 09:15	5,98	11	65,76	CHI
20200254620	BELA VISTA DE GOIAS	BV12059729	SENADOR CANEDO	12/02/2020 03:36	12/02/2020 10:14	12/02/2020 03:36	12/02/2020 10:14	6,63	5	33,17	CHI
20200254620	CALDAZINHA	BV12059729	SENADOR CANEDO	12/02/2020 03:36	12/02/2020 10:14	12/02/2020 03:36	12/02/2020 10:14	6,63	17	112,77	CHI
20200254622	PLANALTINA	PI11164575	PLANALTINA	12/02/2020 04:14	12/02/2020 08:21	12/02/2020 04:14	12/02/2020 08:21	4,11	199	818,55	CHI

20200254443	MINEIROS	PW12219564	PARQUE DAS EMAS	12/02/2020 04:15	12/02/2020 15:54	12/02/2020 04:15	12/02/2020 15:54	11,63	7	81,44	CHI
20200254443	PORTELANDIA	PW12219564	PARQUE DAS EMAS	12/02/2020 04:15	12/02/2020 15:54	12/02/2020 04:15	12/02/2020 15:54	11,63	12	139,61	CHI
20200254628	FAZENDA NOVA	NB12020225	JUSSARA	12/02/2020 04:27	12/02/2020 10:28	12/02/2020 04:27	12/02/2020 10:28	6,01	38	228,50	CHI
20200254628	JUSSARA	NB12020225	JUSSARA	12/02/2020 04:27	12/02/2020 10:28	12/02/2020 04:27	12/02/2020 10:28	6,01	1	6,01	CHI
20200254628	NOVO BRASIL	NB12020225	JUSSARA	12/02/2020 04:27	12/02/2020 10:28	12/02/2020 04:27	12/02/2020 10:28	6,01	38	228,50	CHI
20200254630	GOIANIA	GN12001615	GOIANIA LESTE S2	12/02/2020 04:32	12/02/2020 09:49	12/02/2020 04:32	12/02/2020 09:49	5,27	86	453,63	CHI
20200254631	MONTIVIDIU DO NORTE	MX12187848	PORANGATU	12/02/2020 04:36	12/02/2020 08:55	12/02/2020 04:36	12/02/2020 08:55	4,31	15	64,72	CHI
20200254631	TROMBAS	MX12187848	PORANGATU	12/02/2020 04:36	12/02/2020 08:55	12/02/2020 04:36	12/02/2020 08:55	4,31	1	4,31	CHI
20200254933	IPAMERI	IP12287085	IPAMERI	12/02/2020 04:39	12/02/2020 11:33	12/02/2020 04:39	12/02/2020 10:20	5,67	40	226,78	CHI
20200254933	IPAMERI	GD12075517	IPAMERI	12/02/2020 04:39	12/02/2020 11:33	12/02/2020 04:39	12/02/2020 11:33	6,89	14	96,40	CHI
20200254633	IPAMERI	IP12071440	IPAMERI	12/02/2020 04:41	13/02/2020 08:53	12/02/2020 04:41	13/02/2020 08:53	28,19	2	56,37	CHI
20200254634	ITAPURANGA	IK12021644	ITAPURANGA	12/02/2020 04:41	12/02/2020 05:50	12/02/2020 04:41	12/02/2020 05:50	1,14	27	30,67	CHI
20200254635	CATALAO	CT12011272	CATALAO S1	12/02/2020 04:42	12/02/2020 08:54	12/02/2020 04:42	12/02/2020 08:54	4,19	172	720,49	CHI
20200255170	AVELINOPOLIS	AV12054063	ANICUNS	12/02/2020 04:53	12/02/2020 16:52	12/02/2020 04:53	12/02/2020 16:52	11,97	3	35,90	CHI
20200254641	GOIANIA	GN11000446	CAMPINAS S3	12/02/2020 04:58	12/02/2020 05:35	12/02/2020 04:58	12/02/2020 05:35	0,62	84	51,80	CHI
20200254646	JATAI	MY10401498	PARQUE DAS EMAS	12/02/2020 05:14	13/02/2020 17:57	12/02/2020 05:14	12/02/2020 08:20	3,09	29	89,59	CHI
20200254646	MINEIROS	MY10401498	PARQUE DAS EMAS	12/02/2020 05:14	13/02/2020 17:57	12/02/2020 05:14	12/02/2020 08:20	3,09	10	30,89	CHI
20200254646	PEROLANDIA	MY10401498	PARQUE DAS EMAS	12/02/2020 05:14	13/02/2020 17:57	12/02/2020 05:14	12/02/2020 08:20	3,09	18	55,60	CHI
20200254646	MINEIROS	MY10401498	PARQUE DAS EMAS	12/02/2020 05:14	13/02/2020 17:57	12/02/2020 05:14	12/02/2020 09:19	4,08	23	93,82	CHI
20200254646	PEROLANDIA	MY10401498	PARQUE DAS EMAS	12/02/2020 05:14	13/02/2020 17:57	12/02/2020 05:14	12/02/2020 09:19	4,08	1	4,08	CHI
20200254646	MINEIROS	MY10401498	PARQUE DAS EMAS	12/02/2020 05:14	13/02/2020 17:57	12/02/2020 05:14	12/02/2020 09:21	4,10	129	529,26	CHI
20200254646	SERRANOPOLIS	MY10401498	PARQUE DAS EMAS	12/02/2020 05:14	13/02/2020 17:57	12/02/2020 05:14	12/02/2020 09:21	4,10	7	28,72	CHI
20200254646	MINEIROS	MY10401498	PARQUE DAS EMAS	12/02/2020 05:14	13/02/2020 17:57	12/02/2020 05:14	13/02/2020 00:22	19,13	13	248,65	CHI
20200254646	JATAI	JT10400621	PARQUE DAS EMAS	12/02/2020 05:14	13/02/2020 17:57	13/02/2020 10:43	13/02/2020 10:47	0,07	29	2,14	CHI
20200254646	MINEIROS	JT10400621	PARQUE DAS EMAS	12/02/2020 05:14	13/02/2020 17:57	13/02/2020 10:43	13/02/2020 10:47	0,07	10	0,74	CHI
20200254646	PEROLANDIA	JT10400621	PARQUE DAS EMAS	12/02/2020 05:14	13/02/2020 17:57	13/02/2020 10:43	13/02/2020 10:47	0,07	18	1,33	CHI
20200254646	MINEIROS	MY10401498	PARQUE DAS EMAS	12/02/2020 05:14	13/02/2020 17:57	12/02/2020 05:14	13/02/2020 17:11	35,94	7	251,55	CHI
20200254646	MINEIROS	MY13092334	PARQUE DAS EMAS	12/02/2020 05:14	13/02/2020 17:57	13/02/2020 10:43	13/02/2020 17:11	6,46	13	83,98	CHI
20200254646	JATAI	MY13196100	PARQUE DAS EMAS	12/02/2020 05:14	13/02/2020 17:57	13/02/2020 17:54	13/02/2020 17:57	0,06	29	1,63	CHI
20200254646	MINEIROS	MY13196100	PARQUE DAS EMAS	12/02/2020 05:14	13/02/2020 17:57	13/02/2020 17:54	13/02/2020 17:57	0,06	10	0,56	CHI
20200254646	PEROLANDIA	MY13196100	PARQUE DAS EMAS	12/02/2020 05:14	13/02/2020 17:57	13/02/2020 17:54	13/02/2020 17:57	0,06	18	1,01	CHI
20200255400	JUSSARA	JR12022269	BRITANIA	12/02/2020 05:19	12/02/2020 10:18	12/02/2020 05:19	12/02/2020 10:18	4,97	30	149,17	CHI
20200255400	MONTES CLAROS DE GOIAS	JR12022269	BRITANIA	12/02/2020 05:19	12/02/2020 10:18	12/02/2020 05:19	12/02/2020 10:18	4,97	249	1238,15	CHI

20200254946	PARANAIGUARA	PC12047562	QUIRINOPOLIS	12/02/2020 05:20	12/02/2020 10:25	12/02/2020 05:20	12/02/2020 10:25	5,08	21	106,71	CHI
20200254651	BONFINOPOLIS	BO11212383	CEPAIGO S2	12/02/2020 05:24	12/02/2020 08:58	12/02/2020 05:24	12/02/2020 08:58	3,56	87	309,84	CHI
20200254701	CAVALCANTE	TI10401551	MINACU	12/02/2020 05:41	13/02/2020 13:46	12/02/2020 05:41	12/02/2020 07:34	1,89	304	576,08	CHI
20200254701	COLINAS DO SUL	TI10401551	MINACU	12/02/2020 05:41	13/02/2020 13:46	12/02/2020 05:41	12/02/2020 07:34	1,89	43	81,48	CHI
20200254701	COLINAS DO SUL	TI13340351	MINACU	12/02/2020 05:41	13/02/2020 13:46	12/02/2020 05:41	12/02/2020 08:23	2,70	1	2,70	CHI
20200254701	CAVALCANTE	TI10401551	MINACU	12/02/2020 05:41	13/02/2020 13:46	12/02/2020 08:23	12/02/2020 08:42	0,31	304	95,17	CHI
20200254701	COLINAS DO SUL	TI10401551	MINACU	12/02/2020 05:41	13/02/2020 13:46	12/02/2020 08:23	12/02/2020 08:42	0,31	43	13,46	CHI
20200254701	COLINAS DO SUL	TI13340351	MINACU	12/02/2020 05:41	13/02/2020 13:46	12/02/2020 05:41	12/02/2020 10:51	5,17	12	61,99	CHI
20200254701	CAVALCANTE	TI10401551	MINACU	12/02/2020 05:41	13/02/2020 13:46	12/02/2020 10:13	12/02/2020 10:53	0,65	304	198,70	CHI
20200254701	COLINAS DO SUL	TI10401551	MINACU	12/02/2020 05:41	13/02/2020 13:46	12/02/2020 10:13	12/02/2020 10:53	0,65	43	28,11	CHI
20200254701	COLINAS DO SUL	TI13340351	MINACU	12/02/2020 05:41	13/02/2020 13:46	12/02/2020 05:41	12/02/2020 12:27	6,78	139	942,00	CHI
20200254701	COLINAS DO SUL	TI12237626	MINACU	12/02/2020 05:41	13/02/2020 13:46	12/02/2020 05:41	12/02/2020 13:35	7,90	52	410,68	CHI
20200254701	NIQUELANDIA	TI12237626	MINACU	12/02/2020 05:41	13/02/2020 13:46	12/02/2020 05:41	12/02/2020 13:35	7,90	1	7,90	CHI
20200254701	URUACU	TI12237626	MINACU	12/02/2020 05:41	13/02/2020 13:46	12/02/2020 05:41	12/02/2020 13:35	7,90	1	7,90	CHI
20200254701	COLINAS DO SUL	TI12237626	MINACU	12/02/2020 05:41	13/02/2020 13:46	12/02/2020 10:13	12/02/2020 13:35	3,35	1	3,35	CHI
20200254701	CAVALCANTE	TI10401551	MINACU	12/02/2020 05:41	13/02/2020 13:46	12/02/2020 14:05	12/02/2020 14:15	0,17	304	52,78	CHI
20200254701	COLINAS DO SUL	TI10401551	MINACU	12/02/2020 05:41	13/02/2020 13:46	12/02/2020 14:05	12/02/2020 14:15	0,17	235	40,80	CHI
20200254701	NIQUELANDIA	TI10401551	MINACU	12/02/2020 05:41	13/02/2020 13:46	12/02/2020 14:05	12/02/2020 14:15	0,17	1	0,17	CHI
20200254701	URUACU	TI10401551	MINACU	12/02/2020 05:41	13/02/2020 13:46	12/02/2020 14:05	12/02/2020 14:15	0,17	1	0,17	CHI
20200254701	ALTO PARAISO DE GOIAS	BF10395392	NIQUELANDIA SUBTRANSMISSAO	12/02/2020 05:41	13/02/2020 13:46	12/02/2020 15:04	12/02/2020 16:41	1,63	525	854,44	CHI
20200254701	ALTO PARAISO DE GOIAS	NQ10383169	NIQUELANDIA SUBTRANSMISSAO	12/02/2020 05:41	13/02/2020 13:46	12/02/2020 15:04	12/02/2020 17:03	1,99	12	23,93	CHI
20200254701	COLINAS DO SUL	NQ10383169	NIQUELANDIA SUBTRANSMISSAO	12/02/2020 05:41	13/02/2020 13:46	12/02/2020 15:04	12/02/2020 17:03	1,99	18	35,89	CHI
20200254701	NIQUELANDIA	NQ10383169	NIQUELANDIA SUBTRANSMISSAO	12/02/2020 05:41	13/02/2020 13:46	12/02/2020 15:04	12/02/2020 17:03	1,99	394	785,70	CHI
20200254701	SAO JOAO D ALIANCA	NQ10383169	NIQUELANDIA SUBTRANSMISSAO	12/02/2020 05:41	13/02/2020 13:46	12/02/2020 15:04	12/02/2020 17:03	1,99	1	1,99	CHI
20200254701	CAVALCANTE	TI12156216RE	MINACU	12/02/2020 05:41	13/02/2020 13:46	12/02/2020 05:41	12/02/2020 18:36	12,92	65	839,53	CHI
20200254701	COLINAS DO SUL	TI12156216RE	MINACU	12/02/2020 05:41	13/02/2020 13:46	12/02/2020 05:41	12/02/2020 18:36	12,92	40	516,63	CHI
20200254701	COLINAS DO SUL	BF10395392	MINACU	12/02/2020 05:41	13/02/2020 13:46	12/02/2020 15:04	12/02/2020 20:12	5,14	12	61,72	CHI
20200254701	ALTO PARAISO DE GOIAS	BF10395392	NIQUELANDIA SUBTRANSMISSAO	12/02/2020 05:41	13/02/2020 13:46	12/02/2020 15:04	12/02/2020 20:12	5,14	24	123,45	CHI
20200254701	CAVALCANTE	BF10395392	NIQUELANDIA SUBTRANSMISSAO	12/02/2020 05:41	13/02/2020 13:46	12/02/2020 15:04	12/02/2020 20:12	5,14	57	293,19	CHI
20200254701	COLINAS DO SUL	BF10395392	NIQUELANDIA SUBTRANSMISSAO	12/02/2020 05:41	13/02/2020 13:46	12/02/2020 15:04	12/02/2020 20:12	5,14	1168	6007,74	CHI
20200254701	NIQUELANDIA	BF10395392	NIQUELANDIA SUBTRANSMISSAO	12/02/2020 05:41	13/02/2020 13:46	12/02/2020 15:04	12/02/2020 20:12	5,14	4	20,57	CHI
20200254701	CAVALCANTE	TI10401551	MINACU	12/02/2020 05:41	13/02/2020 13:46	13/02/2020 01:15	13/02/2020 01:26	0,18	369	67,14	CHI
20200254701	COLINAS DO SUL	TI10401551	MINACU	12/02/2020 05:41	13/02/2020 13:46	13/02/2020 01:15	13/02/2020 01:26	0,18	222	40,39	CHI

20200254701	COLINAS DO SUL	TI13340351	MINACU	12/02/2020 05:41	13/02/2020 13:46	12/02/2020 05:41	13/02/2020 02:20	20,65	66	1362,90	CHI
20200254701	COLINAS DO SUL	TI12156244RE	MINACU	12/02/2020 05:41	13/02/2020 13:46	12/02/2020 05:41	13/02/2020 02:57	21,27	66	1403,69	CHI
20200254701	COLINAS DO SUL	TI13340351	MINACU	12/02/2020 05:41	13/02/2020 13:46	12/02/2020 05:41	13/02/2020 10:01	28,34	7	198,40	CHI
20200254701	COLINAS DO SUL	TI12295042LD	MINACU	12/02/2020 05:41	13/02/2020 13:46	12/02/2020 05:41	13/02/2020 13:46	32,09	2	64,17	CHI
20200254660	SANTA CRUZ DE GOIAS	BC21280312	PIRES DO RIO S2	12/02/2020 05:57	12/02/2020 08:39	12/02/2020 05:57	12/02/2020 08:39	2,69	1	2,69	CHI
20200254873	MINEIROS	MY12043894	PARQUE DAS EMAS	12/02/2020 05:57	12/02/2020 10:00	12/02/2020 05:57	12/02/2020 10:00	4,04	80	323,33	CHI
20200254664	DIVINOPOLIS DE GOIAS	GH12156343RE	SAO DOMINGOS	12/02/2020 06:00	12/02/2020 09:02	12/02/2020 06:00	12/02/2020 09:02	3,03	127	384,99	CHI
20200254664	MONTE ALEGRE DE GOIAS	GH12156343RE	SAO DOMINGOS	12/02/2020 06:00	12/02/2020 09:02	12/02/2020 06:00	12/02/2020 09:02	3,03	15	45,47	CHI
20200254664	SAO DOMINGOS	GH12156343RE	SAO DOMINGOS	12/02/2020 06:00	12/02/2020 09:02	12/02/2020 06:00	12/02/2020 09:02	3,03	1	3,03	CHI
20200254986	GOIANDIRA	GD12250481	CATALAO S1	12/02/2020 06:01	12/02/2020 10:44	12/02/2020 06:01	12/02/2020 10:44	4,72	75	353,65	CHI
20200254668	FORMOSA	FA12202274	ITIQUEIRA	12/02/2020 06:04	12/02/2020 07:27	12/02/2020 06:04	12/02/2020 07:27	1,38	5	6,91	CHI
20200254695	PIRES DO RIO	PR12080258RE	URUTAI	12/02/2020 06:04	12/02/2020 10:20	12/02/2020 06:04	12/02/2020 10:20	4,28	8	34,20	CHI
20200254695	URUTAI	PR12080258RE	URUTAI	12/02/2020 06:04	12/02/2020 10:20	12/02/2020 06:04	12/02/2020 10:20	4,28	62	265,07	CHI
20200254671	ABADIANIA	AA12258352	ANAPOLIS UNIVERSITARIO S1	12/02/2020 06:06	12/02/2020 09:28	12/02/2020 06:06	12/02/2020 09:28	3,37	9	30,29	CHI
20200254671	CORUMBA DE GOIAS	AA12258352	ANAPOLIS UNIVERSITARIO S1	12/02/2020 06:06	12/02/2020 09:28	12/02/2020 06:06	12/02/2020 09:28	3,37	2	6,73	CHI
20200255396	ITARUMA	IM12029171	CACHOEIRA ALTA	12/02/2020 06:09	12/02/2020 16:10	12/02/2020 06:09	12/02/2020 16:10	10,01	5	50,07	CHI
20200254676	BELA VISTA DE GOIAS	BV21037736	BELA VISTA S1	12/02/2020 06:12	12/02/2020 07:17	12/02/2020 06:12	12/02/2020 07:17	1,08	2	2,17	CHI
20200254678	BELA VISTA DE GOIAS	BV12337806	BELA VISTA S2	12/02/2020 06:13	12/02/2020 09:05	12/02/2020 06:13	12/02/2020 09:05	2,87	16	45,85	CHI
20200256509	CACU	CC12293980	CACHOEIRA ALTA	12/02/2020 06:13	12/02/2020 16:00	12/02/2020 06:13	12/02/2020 16:00	9,78	6	58,66	CHI
20200255113	CUMARI	CY12203045RE	CATALAO S1	12/02/2020 06:16	12/02/2020 12:12	12/02/2020 06:16	12/02/2020 11:18	5,03	29	145,75	CHI
20200255113	CUMARI	CY12203045RE	CATALAO S1	12/02/2020 06:16	12/02/2020 12:12	12/02/2020 06:16	12/02/2020 12:12	5,92	7	41,44	CHI
20200254970	PIRENOPOLIS	PV12115149	GOIANESIA S1	12/02/2020 06:18	12/02/2020 09:49	12/02/2020 06:18	12/02/2020 09:49	3,50	3	10,50	CHI
20200254970	VILA PROPICIO	PV12115149	GOIANESIA S1	12/02/2020 06:18	12/02/2020 09:49	12/02/2020 06:18	12/02/2020 09:49	3,50	2	7,00	CHI
20200254684	DIORAMA	DI12123918	ARENOPOLIS	12/02/2020 06:19	12/02/2020 10:36	12/02/2020 06:19	12/02/2020 10:36	4,28	5	21,38	CHI
20200254684	MONTES CLAROS DE GOIAS	DI12123918	ARENOPOLIS	12/02/2020 06:19	12/02/2020 10:36	12/02/2020 06:19	12/02/2020 10:36	4,28	1	4,28	CHI
20200254685	MINEIROS	MY12390605	PARQUE DAS EMAS	12/02/2020 06:19	12/02/2020 12:03	12/02/2020 06:19	12/02/2020 12:03	5,73	15	85,89	CHI
20200254686	ALEXANIA	480079560	ALEXANIA	12/02/2020 06:19	12/02/2020 10:46	12/02/2020 06:19	12/02/2020 10:46	4,44	1	4,44	CHI
20200254698	DAVINOPOLIS	IO12028236	CATALAO S1	12/02/2020 06:25	12/02/2020 15:15	12/02/2020 06:25	12/02/2020 15:15	8,82	3	26,47	CHI
20200254698	OUVIDOR	IO12028236	CATALAO S1	12/02/2020 06:25	12/02/2020 15:15	12/02/2020 06:25	12/02/2020 15:15	8,82	25	220,62	CHI
20200254698	TRES RANCHOS	IO12028236	CATALAO S1	12/02/2020 06:25	12/02/2020 15:15	12/02/2020 06:25	12/02/2020 15:15	8,82	1	8,82	CHI
20200254699	TRINDADE	TR12015761	INHUMAS S1	12/02/2020 06:28	12/02/2020 09:24	12/02/2020 06:28	12/02/2020 09:24	2,93	16	46,92	CHI
20200254803	DAVINOPOLIS	IO12000012RE	CATALAO S1	12/02/2020 06:30	12/02/2020 09:44	12/02/2020 06:30	12/02/2020 09:44	3,23	84	271,46	CHI
20200254803	DISTRITO FEDERAL	IO12000012RE	CATALAO S1	12/02/2020 06:30	12/02/2020 09:44	12/02/2020 06:30	12/02/2020 09:44	3,23	12	38,78	CHI

20200254808	PORANGATU	PO12141124	NOVO PLANALTO	12/02/2020 06:34	12/02/2020 10:01	12/02/2020 06:34	12/02/2020 10:01	3,45	20	68,93	CHI
20200255127	NIQUELANDIA	NQ12113859	URUACU	12/02/2020 06:34	12/02/2020 10:26	12/02/2020 06:34	12/02/2020 10:26	3,86	17	65,61	CHI
20200254810	CRIXAS	NM21121749	RUBIATABA	12/02/2020 06:35	12/02/2020 10:04	12/02/2020 06:35	12/02/2020 10:04	3,48	1	3,48	CHI
20200254811	CORUMBAIBA	CI12112863	VILA CORUMBA	12/02/2020 06:35	12/02/2020 17:36	12/02/2020 06:35	12/02/2020 17:36	11,01	4	44,03	CHI
20200254812	SANTA HELENA DE GOIAS	SH21322295	IPEGUARI	12/02/2020 06:35	12/02/2020 10:13	12/02/2020 06:35	12/02/2020 10:13	3,63	1	3,63	CHI
20200254979	CRISTALINA	KR12163676	PAMPLONA	12/02/2020 06:38	12/02/2020 09:59	12/02/2020 06:38	12/02/2020 09:59	3,34	26	86,82	CHI
20200254979	DISTRITO FEDERAL	KR12163676	PAMPLONA	12/02/2020 06:38	12/02/2020 09:59	12/02/2020 06:38	12/02/2020 09:59	3,34	4	13,36	CHI
20200254979	LUZIANIA	KR12163676	PAMPLONA	12/02/2020 06:38	12/02/2020 09:59	12/02/2020 06:38	12/02/2020 09:59	3,34	2	6,68	CHI
20200254824	SAO MIGUEL DO PASSA QUATRO	SQ12088077	CRISTIANOPOLIS	12/02/2020 06:39	12/02/2020 11:21	12/02/2020 06:39	12/02/2020 11:21	4,70	18	84,54	CHI
20200254825	MONTE ALEGRE DE GOIAS	MA12233165	SAO DOMINGOS	12/02/2020 06:39	12/02/2020 08:40	12/02/2020 06:39	12/02/2020 08:40	2,01	6	12,04	CHI
20200254826	JARAGUA	JA12009229	JARAGUA	12/02/2020 06:40	12/02/2020 13:20	12/02/2020 06:40	12/02/2020 13:20	6,66	3	19,98	CHI
20200254828	SANTA CRUZ DE GOIAS	BC21027018	PIRES DO RIO S2	12/02/2020 06:40	12/02/2020 09:35	12/02/2020 06:40	12/02/2020 09:35	2,91	1	2,91	CHI
20200254829	SANTA CRUZ DE GOIAS	PZ21000458	PIRES DO RIO S2	12/02/2020 06:40	12/02/2020 09:02	12/02/2020 06:40	12/02/2020 09:02	2,35	1	2,35	CHI
20200254830	SANTA TEREZINHA DE GOIAS	SG12202092	SANTA TEREZINHA	12/02/2020 06:41	12/02/2020 14:56	12/02/2020 06:41	12/02/2020 14:56	8,25	6	49,49	CHI
20200254833	SAO SIMAO	SO11060847	CACHOEIRA ALTA	12/02/2020 06:42	12/02/2020 16:45	12/02/2020 08:30	12/02/2020 16:45	8,25	107	882,75	CHI
20200254834	QUIRINOPOLIS	QI21096905	QUIRINOPOLIS	12/02/2020 06:42	12/02/2020 12:50	12/02/2020 06:42	12/02/2020 12:50	6,13	1	6,13	CHI
20200254956	IPAMERI	GD12161081	CATALAO S1	12/02/2020 06:42	12/02/2020 12:43	12/02/2020 06:42	12/02/2020 12:43	6,01	6	36,08	CHI
20200254837	HIDROLANDIA	HD12000148	PONTALINA	12/02/2020 06:44	12/02/2020 10:22	12/02/2020 06:44	12/02/2020 10:22	3,63	1	3,63	CHI
20200255108	ANICUNS	AC12158912	FIRMINOPOLIS S2	12/02/2020 06:44	12/02/2020 13:56	12/02/2020 06:44	12/02/2020 13:56	7,20	60	431,98	CHI
20200254840	QUIRINOPOLIS	QI12163448	SANTA HELENA S1	12/02/2020 06:46	12/02/2020 11:53	12/02/2020 06:46	12/02/2020 11:53	5,11	10	51,14	CHI
20200254840	RIO VERDE	QI12163448	SANTA HELENA S1	12/02/2020 06:46	12/02/2020 11:53	12/02/2020 06:46	12/02/2020 11:53	5,11	1	5,11	CHI
20200254845	MORRINHOS	MR12040540RE	MORRINHOS	12/02/2020 06:49	12/02/2020 09:44	12/02/2020 06:49	12/02/2020 09:44	2,92	48	140,32	CHI
20200255227	IPAMERI	NE12035437	CATALAO S1	12/02/2020 06:52	12/02/2020 10:36	12/02/2020 06:52	12/02/2020 10:36	3,73	15	56,00	CHI
20200255227	NOVA AURORA	NE12035437	CATALAO S1	12/02/2020 06:52	12/02/2020 10:36	12/02/2020 06:52	12/02/2020 10:36	3,73	27	100,80	CHI
20200254856	AGUA FRIA DE GOIAS	TL21130372	SAO JOAO D ALIANCA	12/02/2020 06:53	12/02/2020 09:00	12/02/2020 06:53	12/02/2020 09:00	2,13	1	2,13	CHI
20200254857	CATALAO	CT12318667	CATALAO S1	12/02/2020 06:53	12/02/2020 14:27	12/02/2020 06:53	12/02/2020 14:27	7,56	3	22,67	CHI
20200254857	DAVINOPOLIS	CT12318667	CATALAO S1	12/02/2020 06:53	12/02/2020 14:27	12/02/2020 06:53	12/02/2020 14:27	7,56	4	30,23	CHI
20200254862	CORUMBA DE GOIAS	ZN21302340	COCALZINHO	12/02/2020 06:55	12/02/2020 09:14	12/02/2020 06:55	12/02/2020 09:14	2,32	1	2,32	CHI
20200254864	SANTA CRUZ DE GOIAS	450010284	PIRES DO RIO S2	12/02/2020 06:55	12/02/2020 11:40	12/02/2020 06:55	12/02/2020 11:40	4,74	1	4,74	CHI
20200254865	IACIARA	IA12164539	IACIARA S2	12/02/2020 06:55	12/02/2020 10:21	12/02/2020 06:55	12/02/2020 10:21	3,42	24	82,13	CHI
20200254867	IACIARA	IA12164692	IACIARA S1	12/02/2020 06:56	12/02/2020 08:04	12/02/2020 06:56	12/02/2020 08:04	1,13	118	133,01	CHI
20200254870	CORUMBAIBA	CI21098627	VILA CORUMBA	12/02/2020 06:56	12/02/2020 09:43	12/02/2020 06:56	12/02/2020 09:43	2,77	1	2,77	CHI
20200254879	DIORAMA	DI12023288	IPORA	12/02/2020 06:59	12/02/2020 11:31	12/02/2020 06:59	12/02/2020 11:31	4,53	10	45,28	CHI

20200254881	ITUMBIARA	BG21000035	ITUMBIARA VELHA S2	12/02/2020 06:59	12/02/2020 10:10	12/02/2020 06:59	12/02/2020 10:10	3,17	1	3,17	CHI
20200254950	SANTA CRUZ DE GOIAS	BC12110027RE	PIRES DO RIO S2	12/02/2020 06:59	12/02/2020 10:18	12/02/2020 06:59	12/02/2020 10:18	3,32	28	92,87	CHI
202002191276	ARAGARCAS	BM12204862	IPORA	12/02/2020 06:59	12/02/2020 12:18	12/02/2020 06:59	12/02/2020 12:18	5,31	2	10,62	CHI
20200254882	SENADOR CANEDO	SW11265258	GOIANIA LESTE S1	12/02/2020 07:00	12/02/2020 08:18	12/02/2020 07:00	12/02/2020 08:18	1,31	82	107,19	CHI
20200254887	SAO JOAO D ALIANCA	JL12146125	SAO JOAO D ALIANCA	12/02/2020 07:02	12/02/2020 15:16	12/02/2020 07:02	12/02/2020 15:16	8,22	3	24,67	CHI
20200254895	GOIANESIA	GE21000044	GOIANESIA S2	12/02/2020 07:06	12/02/2020 08:02	12/02/2020 07:06	12/02/2020 08:02	0,94	1	0,94	CHI
20200254897	OURO VERDE DE GOIAS	OV21015275	NEROPOLIS S2	12/02/2020 07:06	12/02/2020 15:48	12/02/2020 07:06	12/02/2020 15:48	8,69	1	8,69	CHI
20200254901	SANTA RITA DO ARAGUAIA	SU21142758	SANTA RITA DO ARAGUAIA	12/02/2020 07:08	13/02/2020 11:58	12/02/2020 07:08	13/02/2020 11:58	28,82	1	28,82	CHI
20200254905	IPAMERI	IP21300583	IPAMERI	12/02/2020 07:10	13/02/2020 09:38	12/02/2020 07:10	13/02/2020 09:38	26,47	2	52,93	CHI
20200254906	IACIARA	1550020010	IACIARA S1	12/02/2020 07:10	12/02/2020 09:04	12/02/2020 07:10	12/02/2020 09:04	1,90	1	1,90	CHI
20200254908	AMARALINA	MQ12391955	NOVA CRIXAS	12/02/2020 07:12	12/02/2020 12:09	12/02/2020 07:12	12/02/2020 12:09	4,95	2	9,90	CHI
20200254908	MARA ROSA	MQ12391955	NOVA CRIXAS	12/02/2020 07:12	12/02/2020 12:09	12/02/2020 07:12	12/02/2020 12:09	4,95	3	14,85	CHI
20200254910	EDEIA	EA12257998	EDEIA	12/02/2020 07:12	12/02/2020 09:36	12/02/2020 07:12	12/02/2020 09:36	2,39	83	198,28	CHI
20200254911	NOVO GAMA	NJ21330673	PACAEMBU S1	12/02/2020 07:12	12/02/2020 17:59	12/02/2020 07:12	12/02/2020 17:59	10,78	1	10,78	CHI
20200254912	MORRINHOS	MR21269287	MORRINHOS	12/02/2020 07:14	12/02/2020 08:41	12/02/2020 07:14	12/02/2020 08:41	1,45	1	1,45	CHI
20200254913	ITABERAI	IB12105484	ITABERAI S2	12/02/2020 07:14	12/02/2020 09:07	12/02/2020 07:14	12/02/2020 09:07	1,87	9	16,83	CHI
20200254913	ITAPURANGA	IB12105484	ITABERAI S2	12/02/2020 07:14	12/02/2020 09:07	12/02/2020 07:14	12/02/2020 09:07	1,87	1	1,87	CHI
20200254916	RIO VERDE	630557275	CABRIUVA S1	12/02/2020 07:15	12/02/2020 15:41	12/02/2020 07:15	12/02/2020 15:41	8,42	1	8,42	CHI
20200254917	PARAUNA	PU12301457	ACREUNA	12/02/2020 07:15	12/02/2020 18:06	12/02/2020 07:15	12/02/2020 18:06	10,83	1	10,83	CHI
20200254919	DOVERLANDIA	DV12171957	CAIAPONIA	12/02/2020 07:16	12/02/2020 09:18	12/02/2020 07:16	12/02/2020 09:18	2,02	24	48,57	CHI
20200254923	BARRO ALTO	10018578282	BARRO ALTO	12/02/2020 07:18	12/02/2020 14:42	12/02/2020 07:18	12/02/2020 14:42	7,40	1	7,40	CHI
20200254926	QUIRINOPOLIS	QI21125820	QUIRINOPOLIS	12/02/2020 07:19	12/02/2020 09:15	12/02/2020 07:19	12/02/2020 09:15	1,92	1	1,92	CHI
20200254927	CACHOEIRA ALTA	CA21303711	CACHOEIRA ALTA	12/02/2020 07:19	12/02/2020 11:54	12/02/2020 07:19	12/02/2020 11:54	4,57	1	4,57	CHI
202002191201	MINACU	IH12339952	MINACU	12/02/2020 07:19	12/02/2020 12:46	12/02/2020 07:19	12/02/2020 12:46	5,44	16	87,06	CHI
20200254932	APARECIDA DE GOIANIA	AP11095068	ATLANTICO S2	12/02/2020 07:21	12/02/2020 08:56	12/02/2020 07:21	12/02/2020 08:56	1,58	209	330,63	CHI
20200254934	PARANAIGUARA	PC12295754	CACHOEIRA ALTA	12/02/2020 07:23	12/02/2020 17:45	12/02/2020 07:23	12/02/2020 17:45	10,37	3	31,12	CHI
20200254952	ITUMBIARA	IT11065318	ITUMBIARA VELHA S1	12/02/2020 07:23	12/02/2020 10:28	12/02/2020 07:23	12/02/2020 10:28	3,08	195	600,22	CHI
20200255107	RIO VERDE	RV12237206	CABRIUVA S2	12/02/2020 07:24	12/02/2020 11:39	12/02/2020 07:24	12/02/2020 11:39	4,24	6	25,41	CHI
20200254942	IVOLANDIA	IV12201972	IPORA	12/02/2020 07:25	12/02/2020 16:14	12/02/2020 07:25	12/02/2020 16:14	8,82	2	17,63	CHI
20200254942	MOIPORA	IV12201972	IPORA	12/02/2020 07:25	12/02/2020 16:14	12/02/2020 07:25	12/02/2020 16:14	8,82	5	44,08	CHI
20200255104	CRISTALINA	KR12366452	PAMPLONA	12/02/2020 07:25	12/02/2020 11:35	12/02/2020 07:25	12/02/2020 11:35	4,16	10	41,63	CHI
20200254957	PADRE BERNARDO	PB12305256	PADRE BERNARDO	12/02/2020 07:28	12/02/2020 14:25	12/02/2020 07:28	12/02/2020 14:25	6,96	2	13,91	CHI
20200255529	CORUMBAIBA	CI12060031	CATALAO S1	12/02/2020 07:29	12/02/2020 12:39	12/02/2020 07:29	12/02/2020 12:39	5,16	6	30,98	CHI

20200254964	MAURILANDIA	ML12303334	RIO DOS BOIS	12/02/2020 07:31	12/02/2020 11:39	12/02/2020 07:31	12/02/2020 11:39	4,13	14	57,78	CHI
20200254964	RIO VERDE	ML12303334	RIO DOS BOIS	12/02/2020 07:31	12/02/2020 11:39	12/02/2020 07:31	12/02/2020 11:39	4,13	2	8,25	CHI
20200254968	MUNDO NOVO DE GOIAS	MH11269075	NOVA CRIXAS	12/02/2020 07:31	12/02/2020 09:30	12/02/2020 07:31	12/02/2020 09:30	1,97	1	1,97	CHI
20200254969	APARECIDA DE GOIANIA	10017569204	INDEPENDENCIA S1	12/02/2020 07:31	12/02/2020 08:59	12/02/2020 07:31	12/02/2020 08:59	1,45	1	1,45	CHI
20200254974	FORMOSA	FA12204778	ITIQUEIRA	12/02/2020 07:33	12/02/2020 12:17	12/02/2020 07:33	12/02/2020 12:17	4,73	19	89,87	CHI
20200254978	ANICUNS	AC12306938	ANICUNS	12/02/2020 07:34	12/02/2020 20:20	12/02/2020 07:34	12/02/2020 20:20	12,77	2	25,55	CHI
20200254978	ANICUNS	AC12306938	ANICUNS	12/02/2020 07:34	12/02/2020 20:20	12/02/2020 16:30	12/02/2020 20:20	3,84	1	3,84	CHI
20200254980	DOVERLANDIA	MY12209669	PARQUE DAS EMAS	12/02/2020 07:34	12/02/2020 11:23	12/02/2020 07:34	12/02/2020 11:23	3,80	12	45,64	CHI
20200254982	ABADIANIA	AA12297751	ANAPOLIS UNIVERSITARIO S1	12/02/2020 07:34	12/02/2020 11:04	12/02/2020 07:34	12/02/2020 11:04	3,49	27	94,10	CHI
20200254983	GOIAS	GS21278273	ITABERAI S1	12/02/2020 07:34	12/02/2020 08:07	12/02/2020 07:34	12/02/2020 08:07	0,53	1	0,53	CHI
20200255380	FORMOSA	FA11046281	ITIQUEIRA	12/02/2020 07:34	12/02/2020 09:13	12/02/2020 07:34	12/02/2020 09:13	1,65	192	315,89	CHI
20200254988	RIO VERDE	RV12327004	RIO VERDE S2	12/02/2020 07:36	12/02/2020 12:06	12/02/2020 07:36	12/02/2020 12:06	4,49	3	13,46	CHI
20200254993	BONOPOLIS	BX12165447	SAO MIGUEL DO ARAGUAIA	12/02/2020 07:38	12/02/2020 09:33	12/02/2020 07:38	12/02/2020 09:33	1,91	3	5,73	CHI
20200254997	ACREUNA	EU11264504	ACREUNA	12/02/2020 07:39	12/02/2020 11:19	12/02/2020 07:39	12/02/2020 11:19	3,68	1	3,68	CHI
20200254999	SANTO ANTONIO DA BARRA	BZ12213478	SANTA HELENA S1	12/02/2020 07:39	12/02/2020 09:50	12/02/2020 07:39	12/02/2020 09:50	2,17	5	10,84	CHI
20200255000	QUIRINOPOLIS	QI31234632	QUIRINOPOLIS	12/02/2020 07:39	12/02/2020 15:35	12/02/2020 07:39	12/02/2020 15:35	7,92	1	7,92	CHI
20200255101	CABECEIRAS	CW12042559	ITIQUEIRA	12/02/2020 07:39	12/02/2020 13:05	12/02/2020 07:39	12/02/2020 13:05	5,42	1	5,42	CHI
20200255102	PIRENOPOLIS	PV12362322	CORUMBA	12/02/2020 07:40	12/02/2020 11:53	12/02/2020 07:40	12/02/2020 11:53	4,20	22	92,49	CHI
20200255495	PIRENOPOLIS	PV21318017	CORUMBA	12/02/2020 07:40	12/02/2020 22:18	12/02/2020 07:40	12/02/2020 22:18	14,62	3	43,86	CHI
20200255103	MINEIROS	MY21296292	PARQUE DAS EMAS	12/02/2020 07:41	12/02/2020 22:39	12/02/2020 07:41	12/02/2020 22:39	14,97	1	14,97	CHI
20200255114	JARAGUA	JA21211896	JARAGUA	12/02/2020 07:44	12/02/2020 09:33	12/02/2020 07:44	12/02/2020 09:33	1,81	1	1,81	CHI
20200255246	JUSSARA	JR12198791	JUSSARA	12/02/2020 07:44	12/02/2020 09:32	12/02/2020 07:44	12/02/2020 09:32	1,79	111	198,17	CHI
20200255123	GOIANIA	10006989487	FERROVIARIO S3	12/02/2020 07:46	12/02/2020 09:26	12/02/2020 07:46	12/02/2020 09:26	1,66	1	1,66	CHI
20200255129	VALPARAISO DE GOIAS	2860082573	PACAEMBU S1	12/02/2020 07:49	12/02/2020 10:04	12/02/2020 07:49	12/02/2020 10:04	2,25	1	2,25	CHI
20200255132	BARRO ALTO	BA21181768	BARRO ALTO	12/02/2020 07:49	12/02/2020 13:46	12/02/2020 07:49	12/02/2020 13:46	5,94	3	17,82	CHI
20200255135	ORIZONA	OZ12095354	PIRES DO RIO S2	12/02/2020 07:50	12/02/2020 14:45	12/02/2020 07:50	12/02/2020 14:45	6,91	17	117,42	CHI
20200255430	ORIZONA	OZ21095355	PIRES DO RIO S2	12/02/2020 07:50	12/02/2020 17:50	12/02/2020 07:50	12/02/2020 17:50	9,99	1	9,99	CHI
20200255137	IPORA	IR12289241	IPORA	12/02/2020 07:52	12/02/2020 10:10	12/02/2020 07:52	12/02/2020 10:10	2,30	5	11,49	CHI
20200255140	CUMARI	CY12000309	CATALAO S1	12/02/2020 07:53	12/02/2020 13:04	12/02/2020 07:53	12/02/2020 13:04	5,17	12	62,08	CHI
20200255141	ITAJA	IM12301779	CACHOEIRA ALTA	12/02/2020 07:53	12/02/2020 13:40	12/02/2020 07:53	12/02/2020 13:40	5,77	6	34,63	CHI
20200255150	URUTAI	UT12115680	PIRES DO RIO S2	12/02/2020 07:54	12/02/2020 11:29	12/02/2020 07:54	12/02/2020 11:29	3,57	33	117,75	CHI
20200255155	MORRINHOS	MR21121110	MORRINHOS	12/02/2020 07:56	12/02/2020 10:55	12/02/2020 07:56	12/02/2020 10:55	2,98	1	2,98	CHI
20200255157	GOIANIA	12697965	GOIANIA LESTE S1	12/02/2020 07:56	12/02/2020 11:04	12/02/2020 07:56	12/02/2020 11:04	3,12	1	3,12	CHI

20200255165	DOVERLANDIA	DV12380595	PARQUE DAS EMAS	12/02/2020 07:58	12/02/2020 14:19	12/02/2020 07:58	12/02/2020 14:19	6,34	3	19,01	CHI
20200255167	CATALAO	CT12093871	CATALAO S1	12/02/2020 07:59	12/02/2020 17:31	12/02/2020 07:59	12/02/2020 17:31	9,52	36	342,78	CHI
20200255168	TRINDADE	10022206343	GOYA S2	12/02/2020 08:00	12/02/2020 09:22	12/02/2020 08:00	12/02/2020 09:22	1,36	1	1,36	CHI
20200255171	FORMOSA	FA12202282	ITIQUEIRA	12/02/2020 08:00	12/02/2020 10:03	12/02/2020 08:00	12/02/2020 10:03	2,03	5	10,17	CHI
20200255182	CAMPINACU	UC12236229	PORANGATU	12/02/2020 08:02	12/02/2020 09:10	12/02/2020 08:02	12/02/2020 09:10	1,13	28	31,60	CHI
20200255185	EDEIA	EA21033517	RIO DOS BOIS	12/02/2020 08:03	12/02/2020 12:58	12/02/2020 08:03	12/02/2020 12:58	4,90	1	4,90	CHI
20200255192	FORMOSA	610290095	ITIQUEIRA	12/02/2020 08:05	12/02/2020 10:04	12/02/2020 08:05	12/02/2020 10:04	1,97	1	1,97	CHI
20200255193	PADRE BERNARDO	PB11275510	PADRE BERNARDO	12/02/2020 08:05	12/02/2020 12:55	12/02/2020 08:05	12/02/2020 12:55	4,82	5	24,12	CHI
20200255204	MONTIVIDIU DO NORTE	MX21156609	PORANGATU	12/02/2020 08:08	12/02/2020 10:17	12/02/2020 08:08	12/02/2020 10:17	2,14	1	2,14	CHI
20200255205	PEROLANDIA	DP12358894	JATAI S1	12/02/2020 08:09	12/02/2020 11:47	12/02/2020 08:09	12/02/2020 11:47	3,64	3	10,91	CHI
20200255210	GOIANESIA	PV21221306	GOIANESIA S2	12/02/2020 08:10	12/02/2020 12:15	12/02/2020 08:10	12/02/2020 12:15	4,09	1	4,09	CHI
20200255211	LUZIANIA	3200012958	MARAJOARA	12/02/2020 08:10	12/02/2020 14:03	12/02/2020 08:10	12/02/2020 14:03	5,88	1	5,88	CHI
20200255212	FORMOSA	FA31096307	SAO JOAO D ALIANCA	12/02/2020 08:10	12/02/2020 17:51	12/02/2020 08:10	12/02/2020 17:51	9,68	2	19,36	CHI
20200255213	GOIAS	02270214	ITABERAI S1	12/02/2020 08:10	12/02/2020 10:35	12/02/2020 08:10	12/02/2020 10:35	2,41	176	423,48	CHI
20200255213	ITABERAI	02270214	ITABERAI S1	12/02/2020 08:10	12/02/2020 10:35	12/02/2020 08:10	12/02/2020 10:35	2,41	3	7,22	CHI
20200255403	NIQUELANDIA	NQ12234274	NIQUELANDIA SUBTRANSMISSAO	12/02/2020 08:12	12/02/2020 11:45	12/02/2020 08:12	12/02/2020 11:45	3,55	8	28,39	CHI
20200255228	SAO MIGUEL DO ARAGUAIA	SM12252091	SAO MIGUEL DO ARAGUAIA	12/02/2020 08:13	12/02/2020 12:13	12/02/2020 08:13	12/02/2020 12:13	4,00	61	243,98	CHI
20200255229	LUZIANIA	LZ21330698	MARAJOARA	12/02/2020 08:13	12/02/2020 18:04	12/02/2020 08:13	12/02/2020 17:52	9,66	1	9,66	CHI
20200255229	LUZIANIA	LZ12330674	MARAJOARA	12/02/2020 08:13	12/02/2020 18:04	12/02/2020 15:46	12/02/2020 18:04	2,29	1	2,29	CHI
20200255231	CALDAS NOVAS	760420350	SERRA DE CALDAS	12/02/2020 08:13	12/02/2020 09:39	12/02/2020 08:13	12/02/2020 09:39	1,43	1	1,43	CHI
20200255232	ITABERAI	50122022	ITABERAI S2	12/02/2020 08:14	12/02/2020 11:42	12/02/2020 08:14	12/02/2020 11:42	3,47	1	3,47	CHI
20200255233	CRISTALINA	10003188181	CRISTALINA S1	12/02/2020 08:14	12/02/2020 16:22	12/02/2020 08:14	12/02/2020 16:22	8,13	1	8,13	CHI
20200255234	GOIANIA	11395497	CAMPINAS S3	12/02/2020 08:14	12/02/2020 09:55	12/02/2020 08:14	12/02/2020 09:55	1,68	1	1,68	CHI
20200255236	AURILANDIA	AI12073526	FIRMINOPOLIS S2	12/02/2020 08:14	13/02/2020 15:08	12/02/2020 08:14	13/02/2020 15:08	30,90	7	216,29	CHI
20200255236	CACHOEIRA DE GOIAS	AI12073526	FIRMINOPOLIS S2	12/02/2020 08:14	13/02/2020 15:08	12/02/2020 08:14	13/02/2020 15:08	30,90	1	30,90	CHI
20200255236	AURILANDIA	AI12073526	FIRMINOPOLIS S2	12/02/2020 08:14	13/02/2020 15:08	13/02/2020 11:30	13/02/2020 15:08	3,64	6	21,83	CHI
20200255236	CACHOEIRA DE GOIAS	AI12073526	FIRMINOPOLIS S2	12/02/2020 08:14	13/02/2020 15:08	13/02/2020 11:30	13/02/2020 15:08	3,64	2	7,28	CHI
20200255240	URUACU	640026680	URUACU	12/02/2020 08:15	12/02/2020 09:41	12/02/2020 08:15	12/02/2020 09:41	1,43	1	1,43	CHI
20200255241	ANAPOLIS	21354753	ANAPOLIS UNIVERSITARIO S2	12/02/2020 08:15	12/02/2020 10:51	12/02/2020 08:15	12/02/2020 10:51	2,59	1	2,59	CHI
20200255250	LUZIANIA	LZ11261630	RIO VERMELHO	12/02/2020 08:16	12/02/2020 10:37	12/02/2020 08:16	12/02/2020 10:37	2,34	173	404,72	CHI
20200255251	ITABERAI	50009898	ITABERAI S2	12/02/2020 08:16	12/02/2020 10:34	12/02/2020 08:16	12/02/2020 10:34	2,28	1	2,28	CHI
20200259256	SANTA CRUZ DE GOIAS	BC12021436	PIRES DO RIO S2	12/02/2020 08:16	12/02/2020 21:37	12/02/2020 08:16	12/02/2020 21:37	13,34	4	53,38	CHI
20200255255	GOIANIA	GN11038778	GOIANIA LESTE S2	12/02/2020 08:17	12/02/2020 11:16	12/02/2020 08:17	12/02/2020 11:16	2,98	16	47,62	CHI

20200255256	FORMOSA	610219250	ITUIQUIRA	12/02/2020 08:18	12/02/2020 10:55	12/02/2020 08:18	12/02/2020 10:55	2,62	1	2,62	CHI
20200255260	ITAGUARU	JA12328472	JARAGUA	12/02/2020 08:19	12/02/2020 10:15	12/02/2020 08:19	12/02/2020 10:15	1,93	15	28,97	CHI
20200255260	JARAGUA	JA12328472	JARAGUA	12/02/2020 08:19	12/02/2020 10:15	12/02/2020 08:19	12/02/2020 10:15	1,93	1	1,93	CHI
20200255261	LUZIANIA	LZ11030506	RIO VERMELHO	12/02/2020 08:19	12/02/2020 13:21	12/02/2020 10:32	12/02/2020 13:21	2,82	50	141,19	CHI
20200255270	FAZENDA NOVA	FN21089377	JUSSARA	12/02/2020 08:19	12/02/2020 15:28	12/02/2020 08:19	12/02/2020 15:28	7,14	1	7,14	CHI
20200255269	CAMPOS BELOS	820037473	SAO DOMINGOS	12/02/2020 08:20	12/02/2020 10:00	12/02/2020 08:20	12/02/2020 10:00	1,66	1	1,66	CHI
20200255275	BRAZABRANTES	IN12321577	INHUMAS S1	12/02/2020 08:20	12/02/2020 11:41	12/02/2020 08:20	12/02/2020 11:41	3,34	2	6,67	CHI
20200255275	DAMOLANDIA	IN12321577	INHUMAS S1	12/02/2020 08:20	12/02/2020 11:41	12/02/2020 08:20	12/02/2020 11:41	3,34	3	10,01	CHI
20200255301	ALEXANIA	480050170	ALEXANIA	12/02/2020 08:22	12/02/2020 14:42	12/02/2020 08:22	12/02/2020 14:42	6,33	1	6,33	CHI
20200255304	SAO MIGUEL DO ARAGUAIA	SM12313426	SAO MIGUEL DO ARAGUAIA	12/02/2020 08:22	12/02/2020 15:28	12/02/2020 08:22	12/02/2020 15:28	7,09	3	21,27	CHI
20200258511	IPAMERI	IP12000071	IPAMERI	12/02/2020 08:22	12/02/2020 15:01	12/02/2020 08:22	12/02/2020 15:01	6,64	5	33,21	CHI
20200255306	LUZIANIA	10015245010	MARAJOARA	12/02/2020 08:23	12/02/2020 10:56	12/02/2020 08:23	12/02/2020 10:56	2,55	1	2,55	CHI
20200255308	MINACU	4020052233	MINACU	12/02/2020 08:23	12/02/2020 19:35	12/02/2020 08:23	12/02/2020 19:35	11,19	1	11,19	CHI
20200255309	SAO SIMAO	SO21255766	CACHOEIRA ALTA	12/02/2020 08:23	12/02/2020 11:32	12/02/2020 08:23	12/02/2020 11:32	3,13	1	3,13	CHI
20200255310	MARA ROSA	MQ21325193	MARA ROSA	12/02/2020 08:24	12/02/2020 16:24	12/02/2020 08:24	12/02/2020 16:24	8,00	1	8,00	CHI
20200255311	ANAPOLIS	21285421	ANAPOLIS UNIVERSITARIO S1	12/02/2020 08:24	12/02/2020 14:12	12/02/2020 08:24	12/02/2020 14:12	5,80	1	5,80	CHI
20200255321	CAMPINORTE	CR12028610	CAMPINORTE	12/02/2020 08:26	12/02/2020 10:37	12/02/2020 08:26	12/02/2020 10:37	2,18	1	2,18	CHI
20200255324	PALMEIRAS DE GOIAS	590026598	PALMEIRAS	12/02/2020 08:26	12/02/2020 12:52	12/02/2020 08:26	12/02/2020 12:52	4,42	1	4,42	CHI
20200255326	CACU	SO12303104	CACHOEIRA ALTA	12/02/2020 08:27	12/02/2020 14:06	12/02/2020 08:27	12/02/2020 14:06	5,65	1	5,65	CHI
20200255326	SAO SIMAO	SO12303104	CACHOEIRA ALTA	12/02/2020 08:27	12/02/2020 14:06	12/02/2020 08:27	12/02/2020 14:06	5,65	2	11,29	CHI
20200255539	SAO SIMAO	SO21303063	CACHOEIRA ALTA	12/02/2020 08:27	12/02/2020 14:53	12/02/2020 08:27	12/02/2020 14:53	6,43	1	6,43	CHI
20200255337	BOM JESUS DE GOIAS	1250078602	BOM JESUS DE GOIAS	12/02/2020 08:28	12/02/2020 10:50	12/02/2020 08:28	12/02/2020 10:50	2,35	1	2,35	CHI
20200255335	NIQUELANDIA	NQ21348732	BARRO ALTO	12/02/2020 08:30	12/02/2020 11:20	12/02/2020 08:30	12/02/2020 11:20	2,84	1	2,84	CHI
20200255342	CATALAO	CT21127695	CATALAO S1	12/02/2020 08:31	12/02/2020 21:53	12/02/2020 08:31	12/02/2020 21:53	13,36	1	13,36	CHI
20200255343	ANAPOLIS	AN11264479	DAIA S1	12/02/2020 08:31	12/02/2020 14:14	12/02/2020 08:31	12/02/2020 14:14	5,71	179	1021,69	CHI
20200255344	MINEIROS	MY12195611	PARQUE DAS EMAS	12/02/2020 08:31	12/02/2020 18:28	12/02/2020 08:31	12/02/2020 18:28	9,94	6	59,65	CHI
20200255042	NOVA IGUACU DE GOIAS	NH13235649	SANTA TEREZINHA	12/02/2020 08:32	12/02/2020 18:30	12/02/2020 15:32	12/02/2020 18:30	2,95	28	82,65	CHI
20200255346	POSSE	1480067511	IACIARA S2	12/02/2020 08:32	12/02/2020 12:40	12/02/2020 08:32	12/02/2020 12:40	4,12	1	4,12	CHI
20200255347	MORRINHOS	MR21015088	MORRINHOS	12/02/2020 08:32	12/02/2020 10:55	12/02/2020 08:32	12/02/2020 10:55	2,37	1	2,37	CHI
20200255357	SANTA RITA DO NOVO DESTINO	BA21000051	BARRO ALTO	12/02/2020 08:34	12/02/2020 13:54	12/02/2020 08:34	12/02/2020 13:54	5,33	1	5,33	CHI
20200255366	PLANALTINA	10001513395	PLANALTINA	12/02/2020 08:36	12/02/2020 10:22	12/02/2020 08:36	12/02/2020 10:22	1,76	1	1,76	CHI
20200255379	CACHOEIRA ALTA	CA21193946	CACHOEIRA ALTA	12/02/2020 08:36	13/02/2020 01:16	12/02/2020 08:36	13/02/2020 01:16	16,67	1	16,67	CHI
20200255368	CAIAPONIA	MV12075145	MONTIVIDIU T	12/02/2020 08:37	12/02/2020 12:29	12/02/2020 08:37	12/02/2020 12:29	3,87	12	46,40	CHI

20200255368	MONTIVIDIU	MV12075145	MONTIVIDIU T	12/02/2020 08:37	12/02/2020 12:29	12/02/2020 08:37	12/02/2020 12:29	3,87	3	11,60	CHI
20200255369	GOIATUBA	GT21134603	BOM JESUS DE GOIAS	12/02/2020 08:37	12/02/2020 09:56	12/02/2020 08:37	12/02/2020 09:56	1,32	1	1,32	CHI
20200255376	NOVA IGUACU DE GOIAS	NH21317119	SANTA TEREZINHA	12/02/2020 08:39	12/02/2020 22:08	12/02/2020 08:39	12/02/2020 22:08	13,48	1	13,48	CHI
20200255377	GOIANIA	GN11053210	AEROPORTO S2	12/02/2020 08:39	12/02/2020 10:41	12/02/2020 08:39	12/02/2020 10:41	2,03	25	50,73	CHI
20200255382	GOIATUBA	140012400	GOIATUBA S2	12/02/2020 08:40	12/02/2020 09:35	12/02/2020 08:40	12/02/2020 09:35	0,92	1	0,92	CHI
20200255385	GOIANESIA	GE12000076	GOIANESIA S2	12/02/2020 08:40	12/02/2020 09:32	12/02/2020 08:40	12/02/2020 09:32	0,85	5	4,27	CHI
20200255386	MOZARLANDIA	MZ12055655	MOZARLANDIA	12/02/2020 08:40	12/02/2020 11:31	12/02/2020 08:40	12/02/2020 11:31	2,84	2	5,67	CHI
20200255387	PIRES DO RIO	460108517	PIRES DO RIO S1	12/02/2020 08:41	12/02/2020 18:39	12/02/2020 08:41	12/02/2020 18:39	9,97	1	9,97	CHI
20200255395	GOIANESIA	GE12000108	GOIANESIA S1	12/02/2020 08:42	12/02/2020 11:30	12/02/2020 08:42	12/02/2020 11:30	2,80	1	2,80	CHI
20200255395	SANTA RITA DO NOVO DESTINO	GE12000108	GOIANESIA S1	12/02/2020 08:42	12/02/2020 11:30	12/02/2020 08:42	12/02/2020 11:30	2,80	1	2,80	CHI
20200255401	RIO VERDE	RV12123334	RIO VERDE S1	12/02/2020 08:43	12/02/2020 18:39	12/02/2020 08:43	12/02/2020 18:39	9,93	5	49,67	CHI
20200255404	RIO VERDE	RV21260668	CABRIUVA S1	12/02/2020 08:44	12/02/2020 13:25	12/02/2020 08:44	12/02/2020 13:25	4,67	1	4,67	CHI
20200255409	APARECIDA DE GOIANIA	200631688	INDEPENDENCIA S2	12/02/2020 08:45	12/02/2020 09:42	12/02/2020 08:45	12/02/2020 09:42	0,94	1	0,94	CHI
20200255413	JATAI	JT21241244	JATAI S1	12/02/2020 08:45	12/02/2020 11:05	12/02/2020 08:45	12/02/2020 11:05	2,32	1	2,32	CHI
20200255414	OUVIDOR	OU21266819	CATALAO S1	12/02/2020 08:45	12/02/2020 14:39	12/02/2020 08:45	12/02/2020 14:39	5,89	1	5,89	CHI
20200255419	CABECEIRAS	CW21224216	ITIQUEIRA	12/02/2020 08:47	12/02/2020 19:22	12/02/2020 08:47	12/02/2020 19:22	10,58	1	10,58	CHI
20200255421	CATALAO	CT12000073	CATALAO S2	12/02/2020 08:47	12/02/2020 10:56	12/02/2020 08:47	12/02/2020 10:56	2,15	210	450,86	CHI
20200255496	CRISTALINA	03940406	CRISTALINA S2	12/02/2020 08:50	12/02/2020 11:09	12/02/2020 08:50	12/02/2020 11:09	2,32	285	660,33	CHI
20200255496	CRISTALINA	03940406	CRISTALINA S2	12/02/2020 08:50	12/02/2020 11:09	12/02/2020 08:50	12/02/2020 11:09	2,32	643	1489,80	CHI
20200255496	CRISTALINA	KR13203451	CRISTALINA S2	12/02/2020 08:50	12/02/2020 11:09	12/02/2020 08:50	12/02/2020 11:09	2,32	25	57,92	CHI
20200255434	APARECIDA DE GOIANIA	AP12165676	ATLANTICO S3	12/02/2020 08:51	12/02/2020 10:32	12/02/2020 08:51	12/02/2020 10:32	1,67	165	275,73	CHI
20200255435	MATRINCHA	MP12206480	MATRINCHA	12/02/2020 08:51	12/02/2020 10:37	12/02/2020 08:51	12/02/2020 10:37	1,75	7	12,26	CHI
20200255436	ALEXANIA	AX21064505	ALEXANIA	12/02/2020 08:52	13/02/2020 08:11	12/02/2020 08:52	13/02/2020 08:11	23,31	1	23,31	CHI
20200255438	CATALAO	CT12266101	CATALAO S1	12/02/2020 08:52	12/02/2020 11:11	12/02/2020 08:52	12/02/2020 11:11	2,31	5	11,56	CHI
20200255442	INDIARA	IY21000001	EDEIA	12/02/2020 08:53	12/02/2020 22:00	12/02/2020 08:53	12/02/2020 22:00	13,12	1	13,12	CHI
20200255444	GUAPO	GA12000019	GUAPO S1	12/02/2020 08:53	12/02/2020 11:18	12/02/2020 08:53	12/02/2020 11:18	2,41	1	2,41	CHI
20200255445	EDEALINA	ED11359988	PONTALINA	12/02/2020 08:53	12/02/2020 09:54	12/02/2020 08:53	12/02/2020 09:54	1,00	5	5,02	CHI
20200255450	QUIRINOPOLIS	QI21100389	QUIRINOPOLIS	12/02/2020 08:54	12/02/2020 11:10	12/02/2020 08:54	12/02/2020 11:10	2,26	1	2,26	CHI
20200255451	PALESTINA DE GOIAS	PY12033300	PALESTINA	12/02/2020 08:54	12/02/2020 13:25	12/02/2020 08:54	12/02/2020 13:25	4,51	7	31,57	CHI
20200255457	CAIAPONIA	CP12245298	CAIAPONIA	12/02/2020 08:54	12/02/2020 12:27	12/02/2020 08:54	12/02/2020 12:27	3,54	5	17,71	CHI
20200255455	ANAPOLIS	21143377	ANAPOLIS UNIVERSITARIO S2	12/02/2020 08:55	12/02/2020 12:35	12/02/2020 08:55	12/02/2020 12:35	3,68	1	3,68	CHI
20200255456	ITAPIRAPUA	IU12067919	MATRINCHA	12/02/2020 08:55	12/02/2020 17:44	12/02/2020 08:55	12/02/2020 17:44	8,81	8	70,50	CHI
20200260608	SANTA CRUZ DE GOIAS	3570010956	PIRES DO RIO S2	12/02/2020 08:55	13/02/2020 09:37	12/02/2020 08:55	13/02/2020 09:37	24,69	1	24,69	CHI

20200255060	SAO MIGUEL DO ARAGUAIA	SM13342075	SAO MIGUEL DO ARAGUAIA	12/02/2020 08:56	13/02/2020 15:20	12/02/2020 08:56	12/02/2020 17:57	9,01	6	54,06	CHI
20200255060	SAO MIGUEL DO ARAGUAIA	SM13342075	SAO MIGUEL DO ARAGUAIA	12/02/2020 08:56	13/02/2020 15:20	13/02/2020 09:11	13/02/2020 11:12	2,02	2	4,04	CHI
20200255060	SAO MIGUEL DO ARAGUAIA	SM12043260LD	SAO MIGUEL DO ARAGUAIA	12/02/2020 08:56	13/02/2020 15:20	12/02/2020 08:56	13/02/2020 11:50	26,89	6	161,36	CHI
20200255060	SAO MIGUEL DO ARAGUAIA	SM13380778	SAO MIGUEL DO ARAGUAIA	12/02/2020 08:56	13/02/2020 15:20	13/02/2020 09:11	13/02/2020 15:20	6,14	3	18,42	CHI
20200255461	GOIANIA	16939530	ATLANTICO S1	12/02/2020 08:56	12/02/2020 09:30	12/02/2020 08:56	12/02/2020 09:30	0,56	1	0,56	CHI
20200255464	GOIANIA	12138150	FERROVIARIO S2	12/02/2020 08:56	12/02/2020 10:32	12/02/2020 08:56	12/02/2020 10:32	1,59	1	1,59	CHI
20200255468	VALPARAISO DE GOIAS	2860119407	PACAEMBU S1	12/02/2020 08:57	12/02/2020 09:07	12/02/2020 08:57	12/02/2020 09:07	0,16	1	0,16	CHI
20200255471	GOIANIA	GN11169110	ATLANTICO S3	12/02/2020 08:57	12/02/2020 11:47	12/02/2020 08:57	12/02/2020 11:47	2,83	44	124,30	CHI
20200255482	GOIANIA	11601231	AEROPORTO S1	12/02/2020 09:01	12/02/2020 12:55	12/02/2020 09:01	12/02/2020 12:55	3,89	1	3,89	CHI
20200255485	CAMPOS BELOS	CH12211230	SAO DOMINGOS	12/02/2020 09:01	12/02/2020 11:44	12/02/2020 09:01	12/02/2020 11:44	2,71	3	8,12	CHI
20200255486	RIO VERDE	6545168	RIO VERDE S1	12/02/2020 09:01	13/02/2020 08:33	12/02/2020 09:01	13/02/2020 08:33	23,52	1	23,52	CHI
20200255491	GOIANIA	16562884	ATLANTICO S1	12/02/2020 09:04	12/02/2020 11:32	12/02/2020 09:04	12/02/2020 11:32	2,47	1	2,47	CHI
20200255500	PIRENOPOLIS	220066670	CORUMBA	12/02/2020 09:06	12/02/2020 12:32	12/02/2020 09:06	12/02/2020 12:32	3,43	1	3,43	CHI
20200255502	ORIZONA	OZ21186226	PIRES DO RIO S2	12/02/2020 09:06	12/02/2020 12:29	12/02/2020 09:06	12/02/2020 12:29	3,38	1	3,38	CHI
20200255504	SANTO ANTONIO DO DESCOBERTO	SN21341317	AGUAS LINDAS DE GOIAS S2	12/02/2020 09:06	12/02/2020 13:00	12/02/2020 09:06	12/02/2020 13:00	3,88	1	3,88	CHI
20200255731	FAINA	GS12042217	GOIAS	12/02/2020 09:07	12/02/2020 14:52	12/02/2020 09:07	12/02/2020 14:52	5,75	74	425,27	CHI
20200255510	AGUAS LINDAS DE GOIAS	10025400485	AGUAS LINDAS DE GOIAS S1	12/02/2020 09:08	12/02/2020 11:27	12/02/2020 09:08	12/02/2020 11:27	2,31	1	2,31	CHI
20200255514	QUIRINOPOLIS	QI21298306	QUIRINOPOLIS	12/02/2020 09:08	12/02/2020 10:36	12/02/2020 09:08	12/02/2020 10:36	1,45	1	1,45	CHI
20200257239	LUZIANIA	LZ12059688	RIO VERMELHO	12/02/2020 09:08	12/02/2020 12:46	12/02/2020 09:08	12/02/2020 12:46	3,63	294	1065,75	CHI
20200255521	FAINA	FC11194571	GOIAS	12/02/2020 09:11	12/02/2020 10:19	12/02/2020 09:11	12/02/2020 10:19	1,13	2	2,26	CHI
20200255522	BALIZA	BH12334535	BOM JARDIM	12/02/2020 09:11	12/02/2020 11:11	12/02/2020 09:11	12/02/2020 11:11	2,00	18	35,92	CHI
20200255527	DOVERLANDIA	MY21324380	PARQUE DAS EMAS	12/02/2020 09:12	12/02/2020 19:18	12/02/2020 09:12	12/02/2020 19:18	10,09	1	10,09	CHI
20200255538	PEROLANDIA	DP11254638	JATAI S1	12/02/2020 09:13	12/02/2020 12:37	12/02/2020 09:13	12/02/2020 12:37	3,38	1	3,38	CHI
20200255542	ANAPOLIS	20386011	JUNDIAI S1	12/02/2020 09:14	12/02/2020 11:36	12/02/2020 09:14	12/02/2020 11:36	2,36	1	2,36	CHI
20200255553	SENADOR CANEDO	GN21001630	CEPAIGO S1	12/02/2020 09:16	12/02/2020 11:21	12/02/2020 09:16	12/02/2020 11:21	2,08	1	2,08	CHI
20200255554	BURITI DE GOIAS	BS11397404	FIRMINOPOLIS S2	12/02/2020 09:16	12/02/2020 14:35	12/02/2020 09:16	12/02/2020 14:35	5,31	1	5,31	CHI
20200255557	IVOLANDIA	IV12162553	IPORA	12/02/2020 09:16	12/02/2020 18:57	12/02/2020 09:16	12/02/2020 18:57	9,68	7	67,73	CHI
20200255562	TRINDADE	40024647	TRINDADE	12/02/2020 09:17	12/02/2020 10:37	12/02/2020 09:17	12/02/2020 10:37	1,32	1	1,32	CHI
20200255563	MARZAGAO	MG11333274	VILA CORUMBA	12/02/2020 09:17	12/02/2020 21:36	12/02/2020 09:17	12/02/2020 18:55	9,63	8	77,04	CHI
20200255563	CALDAS NOVAS	MG12391489	VILA CORUMBA	12/02/2020 09:17	12/02/2020 21:36	12/02/2020 18:24	12/02/2020 21:36	3,20	1	3,20	CHI
20200255563	MARZAGAO	MG12391489	VILA CORUMBA	12/02/2020 09:17	12/02/2020 21:36	12/02/2020 18:24	12/02/2020 21:36	3,20	4	12,79	CHI
20200255601	MONTIVIDIU	MV12189021	MONTIVIDIU T	12/02/2020 09:19	12/02/2020 12:29	12/02/2020 09:19	12/02/2020 12:29	3,16	3	9,48	CHI
20200255603	CRISTALINA	1060131356	CRISTALINA S1	12/02/2020 09:19	12/02/2020 12:37	12/02/2020 09:19	12/02/2020 12:37	3,29	1	3,29	CHI

20200255610	MORRINHOS	MR21182934	GOIATUBA S2	12/02/2020 09:21	12/02/2020 12:27	12/02/2020 09:21	12/02/2020 12:27	3,09	1	3,09	CHI
20200255618	APARECIDA DE GOIANIA	200035976	INDEPENDENCIA S1	12/02/2020 09:22	12/02/2020 11:33	12/02/2020 09:22	12/02/2020 11:33	2,18	1	2,18	CHI
20200255619	MINEIROS	MY12260337	PARQUE DAS EMAS	12/02/2020 09:22	12/02/2020 14:20	12/02/2020 09:22	12/02/2020 14:20	4,96	527	2612,75	CHI
20200255620	ESTRELA DO NORTE	ET12143710	MARA ROSA	12/02/2020 09:22	12/02/2020 12:44	12/02/2020 09:22	12/02/2020 12:44	3,36	4	13,43	CHI
20200255620	SANTA TEREZA DE GOIAS	ET12143710	MARA ROSA	12/02/2020 09:22	12/02/2020 12:44	12/02/2020 09:22	12/02/2020 12:44	3,36	4	13,43	CHI
20200255621	GOIANIA	17430458	GOIANIA LESTE S1	12/02/2020 09:22	12/02/2020 11:47	12/02/2020 09:22	12/02/2020 11:47	2,40	1	2,40	CHI
20200255626	GOIAS	GS21310763	GOIAS	12/02/2020 09:23	12/02/2020 11:36	12/02/2020 09:23	12/02/2020 11:36	2,20	2	4,41	CHI
20200255632	GAMELEIRA DE GOIAS	SV21197303	DAIA S2	12/02/2020 09:25	12/02/2020 10:49	12/02/2020 09:25	12/02/2020 10:49	1,39	1	1,39	CHI
20200255639	QUIRINOPOLIS	QI21116472	QUIRINOPOLIS	12/02/2020 09:26	12/02/2020 17:20	12/02/2020 09:26	12/02/2020 17:20	7,89	1	7,89	CHI
20200255641	CAMPOS VERDES	10029980281	SANTA TEREZINHA	12/02/2020 09:26	12/02/2020 13:24	12/02/2020 09:26	12/02/2020 13:24	3,95	1	3,95	CHI
20200255642	SENADOR CANEDO	SW11161501	CEPAIGO S1	12/02/2020 09:27	12/02/2020 18:40	12/02/2020 09:27	12/02/2020 18:40	9,22	32	295,05	CHI
20200255643	PLANALTINA	2960111431	PLANALTINA	12/02/2020 09:27	12/02/2020 10:49	12/02/2020 09:27	12/02/2020 10:49	1,36	1	1,36	CHI
20200255646	LUZIANIA	120179556	RIO VERMELHO	12/02/2020 09:28	12/02/2020 11:05	12/02/2020 09:28	12/02/2020 11:05	1,62	1	1,62	CHI
20200255647	PIRES DO RIO	PZ12231670	PIRES DO RIO S2	12/02/2020 09:28	13/02/2020 11:49	12/02/2020 09:28	13/02/2020 11:49	26,34	3	79,01	CHI
20200255648	ITAUCU	110004231	INHUMAS S1	12/02/2020 09:28	12/02/2020 15:33	12/02/2020 09:28	12/02/2020 15:33	6,07	1	6,07	CHI
20200255651	URUTAI	10023365321	URUTAI	12/02/2020 09:29	12/02/2020 10:47	12/02/2020 09:29	12/02/2020 10:47	1,30	1	1,30	CHI
20200255654	CATALAO	CT21281725	CATALAO S1	12/02/2020 09:29	12/02/2020 20:45	12/02/2020 09:29	12/02/2020 20:45	11,25	1	11,25	CHI
20200255659	NIQUELANDIA	2750004373	NIQUELANDIA SUBTRANSMISSAO	12/02/2020 09:30	13/02/2020 01:00	12/02/2020 09:30	13/02/2020 01:00	15,49	1	15,49	CHI
20200255660	MINEIROS	MY21324419	PARQUE DAS EMAS	12/02/2020 09:31	12/02/2020 18:30	12/02/2020 09:31	12/02/2020 18:30	8,97	1	8,97	CHI
202002556735	CATALAO	CT12266062RE	CATALAO S1	12/02/2020 09:31	12/02/2020 15:39	12/02/2020 09:31	12/02/2020 15:39	6,12	85	520,20	CHI
202002556735	OUVIDOR	CT12266062RE	CATALAO S1	12/02/2020 09:31	12/02/2020 15:39	12/02/2020 09:31	12/02/2020 15:39	6,12	1	6,12	CHI
20200255664	ITUMBIARA	IT21088627	PARANAIBA	12/02/2020 09:32	12/02/2020 11:08	12/02/2020 09:32	12/02/2020 11:08	1,59	1	1,59	CHI
20200255668	GOIANIA	GN11229357	GOIANIA LESTE S3	12/02/2020 09:33	12/02/2020 11:23	12/02/2020 09:33	12/02/2020 11:23	1,82	117	213,10	CHI
20200255669	RIO VERDE	RV21028144	SANTA HELENA S1	12/02/2020 09:34	12/02/2020 12:49	12/02/2020 09:34	12/02/2020 12:49	3,26	1	3,26	CHI
20200255674	LUZIANIA	3200019515	MARAJOARA	12/02/2020 09:35	12/02/2020 11:31	12/02/2020 09:35	12/02/2020 11:31	1,93	1	1,93	CHI
20200255687	LUZIANIA	LZ12137225	VIANOPOLIS	12/02/2020 09:37	12/02/2020 11:48	12/02/2020 09:37	12/02/2020 11:48	2,18	14	30,47	CHI
20200255692	CACHOEIRA ALTA	CA21031295	CACHOEIRA ALTA	12/02/2020 09:38	12/02/2020 16:19	12/02/2020 09:38	12/02/2020 16:19	6,68	1	6,68	CHI
20200255693	JARAGUA	JA21157792	JARAGUA	12/02/2020 09:38	12/02/2020 23:29	12/02/2020 09:38	12/02/2020 23:29	13,84	1	13,84	CHI
20200255697	NOVA VENEZA	GR12002131	NEROPOLIS S1	12/02/2020 09:39	12/02/2020 16:36	12/02/2020 09:39	12/02/2020 16:36	6,94	1	6,94	CHI
20200255697	SANTO ANTONIO DE GOIAS	GR12002131	NEROPOLIS S1	12/02/2020 09:39	12/02/2020 16:36	12/02/2020 09:39	12/02/2020 16:36	6,94	1	6,94	CHI
20200255801	PORTELANDIA	PW21303806	PARQUE DAS EMAS	12/02/2020 09:39	12/02/2020 12:10	12/02/2020 09:39	12/02/2020 12:10	2,51	1	2,51	CHI
20200255701	MONTE ALEGRE DE GOIAS	MA12233174	SAO DOMINGOS	12/02/2020 09:40	12/02/2020 11:48	12/02/2020 09:40	12/02/2020 11:48	2,13	17	36,24	CHI
20200255702	ANAPOLIS	20821645	ANAPOLIS UNIVERSITARIO S2	12/02/2020 09:40	12/02/2020 13:14	12/02/2020 09:40	12/02/2020 13:14	3,56	1	3,56	CHI

20200255705	AGUAS LINDAS DE GOIAS	10008508010	AGUAS LINDAS DE GOIAS S1	12/02/2020 09:40	12/02/2020 10:24	12/02/2020 09:40	12/02/2020 10:24	0,72	1	0,72	CHI
20200255710	DAMIANOPOLIS	DA12256688	IACIARA S2	12/02/2020 09:42	12/02/2020 21:28	12/02/2020 09:42	12/02/2020 21:28	11,75	4	47,02	CHI
20200255715	COCALZINHO DE GOIAS	10008946254	AGUAS LINDAS DE GOIAS S2	12/02/2020 09:44	12/02/2020 12:01	12/02/2020 09:44	12/02/2020 12:01	2,27	1	2,27	CHI
20200255721	BOM JESUS DE GOIAS	BJ12366462	CACHOEIRA DOURADA	12/02/2020 09:46	12/02/2020 12:41	12/02/2020 09:46	12/02/2020 12:41	2,91	3	8,73	CHI
20200255725	GOIANIA	10002437714	ATLANTICO S1	12/02/2020 09:47	12/02/2020 12:36	12/02/2020 09:47	12/02/2020 12:36	2,81	1	2,81	CHI
20200255727	AGUAS LINDAS DE GOIAS	4830078407	AGUAS LINDAS DE GOIAS S1	12/02/2020 09:47	12/02/2020 11:17	12/02/2020 09:47	12/02/2020 11:17	1,49	1	1,49	CHI
20200255736	QUIRINOPOLIS	QI11370050	QUIRINOPOLIS	12/02/2020 09:47	12/02/2020 19:15	12/02/2020 09:47	12/02/2020 19:15	9,48	22	208,53	CHI
20200255730	CORREGO DO OURO	CO21079903	SAO LUIZ DOS MONTES BELOS	12/02/2020 09:48	12/02/2020 12:55	12/02/2020 09:48	12/02/2020 12:55	3,11	1	3,11	CHI
20200255768	RIO VERDE	RV12300023	RIO VERDE S2	12/02/2020 09:48	12/02/2020 12:33	12/02/2020 09:48	12/02/2020 12:33	2,74	10	27,37	CHI
20200255739	JATAI	290078702	JATAI S2	12/02/2020 09:50	12/02/2020 15:47	12/02/2020 09:50	12/02/2020 15:47	5,94	1	5,94	CHI
20200255769	AMORINOPOLIS	AM12039409	IPORA	12/02/2020 09:51	12/02/2020 13:30	12/02/2020 09:51	12/02/2020 13:30	3,65	5	18,24	CHI
20200255769	IPORA	AM12039409	IPORA	12/02/2020 09:51	12/02/2020 13:30	12/02/2020 09:51	12/02/2020 13:30	3,65	1	3,65	CHI
20200255748	JUSSARA	JR21259925	BRITANIA	12/02/2020 09:52	12/02/2020 11:54	12/02/2020 09:52	12/02/2020 11:54	2,03	1	2,03	CHI
20200255750	JARAGUA	70025563	JARAGUA	12/02/2020 09:52	12/02/2020 18:32	12/02/2020 09:52	12/02/2020 18:32	8,67	1	8,67	CHI
20200257227	GOIANIA	GN12002623	GOYA S2	12/02/2020 09:52	12/02/2020 11:55	12/02/2020 09:52	12/02/2020 11:55	2,05	304	622,44	CHI
20200255754	CAMPOS VERDES	VD12257334	SANTA TEREZINHA	12/02/2020 09:53	12/02/2020 13:55	12/02/2020 09:53	12/02/2020 13:55	4,03	6	24,17	CHI
20200255756	ANAPOLIS	AN12285314	ANAPOLIS UNIVERSITARIO S2	12/02/2020 09:53	12/02/2020 13:06	12/02/2020 09:53	12/02/2020 13:06	3,20	4	12,82	CHI
20200256104	NOVA ROMA	ND11314144	IACIARA S2	12/02/2020 09:54	12/02/2020 11:14	12/02/2020 09:54	12/02/2020 11:14	1,32	6	7,95	CHI
20200259259	SANTA CRUZ DE GOIAS	BC21025344	PIRES DO RIO S2	12/02/2020 09:54	12/02/2020 21:58	12/02/2020 09:54	12/02/2020 21:58	12,05	1	12,05	CHI
20200255764	MINEIROS	MY21365075	PARQUE DAS EMAS	12/02/2020 09:55	13/02/2020 10:52	12/02/2020 09:55	13/02/2020 10:52	24,94	1	24,94	CHI
20200255767	MARZAGAO	MG12182533	VILA CORUMBA	12/02/2020 09:55	12/02/2020 12:12	12/02/2020 09:55	12/02/2020 12:12	2,27	3	6,82	CHI
20200255767	RIO QUENTE	MG12182533	VILA CORUMBA	12/02/2020 09:55	12/02/2020 12:12	12/02/2020 09:55	12/02/2020 12:12	2,27	3	6,82	CHI
20200255772	FORMOSA	FA21120073	ITIQUEIRA	12/02/2020 09:57	12/02/2020 13:17	12/02/2020 09:57	12/02/2020 13:17	3,33	1	3,33	CHI
20200255775	GOIANESIA	550185215	GOIANESIA S2	12/02/2020 09:57	12/02/2020 14:09	12/02/2020 09:57	12/02/2020 14:09	4,19	1	4,19	CHI
20200255778	PIRES DO RIO	460018905	PIRES DO RIO S1	12/02/2020 09:58	12/02/2020 12:22	12/02/2020 09:58	12/02/2020 12:22	2,39	1	2,39	CHI
20200255780	GOIANIA	12352860	GOIANIA LESTE S2	12/02/2020 09:58	12/02/2020 11:41	12/02/2020 09:58	12/02/2020 11:41	1,71	1	1,71	CHI
20200255781	CATALAO	CT21150915	CATALAO S1	12/02/2020 09:58	12/02/2020 18:50	12/02/2020 09:58	12/02/2020 18:50	8,85	2	17,71	CHI
20200255783	ANAPOLIS	20858826	ANAPOLIS UNIVERSITARIO S2	12/02/2020 09:59	12/02/2020 11:18	12/02/2020 09:59	12/02/2020 11:18	1,31	1	1,31	CHI
20200255785	JATAI	JT11228563	JATAI S3	12/02/2020 10:00	12/02/2020 12:33	12/02/2020 10:00	12/02/2020 12:33	2,55	1	2,55	CHI
20200255795	VICENTINOPOLIS	VI12218227	VICENTINOPOLIS	12/02/2020 10:00	12/02/2020 13:01	12/02/2020 10:00	12/02/2020 13:01	3,01	3	9,02	CHI
20200255789	GOIANIA	12872520	GOIANIA LESTE S1	12/02/2020 10:01	12/02/2020 11:24	12/02/2020 10:01	12/02/2020 11:24	1,38	1	1,38	CHI
20200255794	LEOPOLDO DE BULHOES	LB21155221	DAIA S2	12/02/2020 10:02	12/02/2020 14:34	12/02/2020 10:02	12/02/2020 14:34	4,53	1	4,53	CHI
20200255796	ALTO PARAISO DE GOIAS	BF11320577	FLORES DE GOIAS	12/02/2020 10:02	12/02/2020 11:33	12/02/2020 10:02	12/02/2020 11:33	1,51	77	116,03	CHI

20200255798	ITABERAÍ	50028832	ITABERAÍ S2	12/02/2020 10:02	12/02/2020 11:39	12/02/2020 10:02	12/02/2020 11:39	1,60	1	1,60	CHI
20200255800	JARAGUA	JA12000241	JARAGUA	12/02/2020 10:04	12/02/2020 11:52	12/02/2020 10:04	12/02/2020 11:52	1,79	2	3,58	CHI
20200256203	CATALAO	1990068355	CATALAO S2	12/02/2020 10:05	12/02/2020 14:22	12/02/2020 10:05	12/02/2020 14:22	4,28	1	4,28	CHI
20200256204	GOIANIA	15532458	GOIANIA LESTE S2	12/02/2020 10:05	12/02/2020 12:43	12/02/2020 10:05	12/02/2020 12:43	2,63	1	2,63	CHI
20200256208	PORANGATU	PO21117469	PORANGATU	12/02/2020 10:05	12/02/2020 11:15	12/02/2020 10:05	12/02/2020 11:15	1,16	1	1,16	CHI
20200256211	GOIANIA	15410122	GOYA S2	12/02/2020 10:05	12/02/2020 16:23	12/02/2020 10:05	12/02/2020 16:23	6,28	1	6,28	CHI
20200256214	PIRENOPOLIS	ZN21371793	COCALZINHO	12/02/2020 10:06	12/02/2020 15:27	12/02/2020 10:06	12/02/2020 15:27	5,35	2	10,70	CHI
20200256303	NOVO PLANALTO	TA12293657	SAO MIGUEL DO ARAGUAIA	12/02/2020 10:08	12/02/2020 22:51	12/02/2020 10:08	12/02/2020 16:10	6,02	75	451,42	CHI
20200256303	NOVO PLANALTO	TA12293657	SAO MIGUEL DO ARAGUAIA	12/02/2020 10:08	12/02/2020 22:51	12/02/2020 16:11	12/02/2020 22:51	6,67	75	500,17	CHI
20200256502	NEROPOLIS	NR12319494	NEROPOLIS S2	12/02/2020 10:10	12/02/2020 12:28	12/02/2020 10:10	12/02/2020 12:28	2,28	1	2,28	CHI
20200256502	OURO VERDE DE GOIAS	NR12319494	NEROPOLIS S2	12/02/2020 10:10	12/02/2020 12:28	12/02/2020 10:10	12/02/2020 12:28	2,28	21	47,97	CHI
20200256511	GOIANIA	GN21090061	CAMPINAS S1	12/02/2020 10:12	12/02/2020 13:51	12/02/2020 10:12	12/02/2020 13:51	3,66	1	3,66	CHI
20200256514	CUMARI	CY12203050	CATALAO S1	12/02/2020 10:12	12/02/2020 16:55	12/02/2020 10:12	12/02/2020 16:55	6,70	13	87,16	CHI
20200256519	DAVINOPOLIS	IO12304014	CATALAO S1	12/02/2020 10:13	12/02/2020 12:48	12/02/2020 10:13	12/02/2020 12:48	2,58	7	18,03	CHI
20200256601	ITABERAÍ	IB12061584	ITABERAÍ S1	12/02/2020 10:13	12/02/2020 11:48	12/02/2020 10:13	12/02/2020 11:48	1,58	1	1,58	CHI
20200256522	CATALAO	1990023256	CATALAO S2	12/02/2020 10:14	12/02/2020 13:56	12/02/2020 10:14	12/02/2020 13:56	3,69	1	3,69	CHI
20200256527	ABADIANIA	AA12205765	ANAPOLIS UNIVERSITARIO S1	12/02/2020 10:15	12/02/2020 15:29	12/02/2020 10:15	12/02/2020 15:29	5,23	3	15,68	CHI
20200256536	RUBIATABA	RB21245406	RUBIATABA	12/02/2020 10:19	12/02/2020 17:58	12/02/2020 10:19	12/02/2020 17:58	7,64	1	7,64	CHI
20200256538	ITAPACI	IW21326678	ITAPACI	12/02/2020 10:20	12/02/2020 17:00	12/02/2020 10:20	12/02/2020 17:00	6,66	1	6,66	CHI
20200257294	GOIANDIRA	CY12081407	CATALAO S1	12/02/2020 10:21	12/02/2020 16:15	12/02/2020 10:21	12/02/2020 16:15	5,89	6	35,33	CHI
20200256550	JANDAIA	JD12008673	PALMEIRAS	12/02/2020 10:22	12/02/2020 14:03	12/02/2020 10:22	12/02/2020 14:03	3,68	13	47,86	CHI
20200256551	GOIANESIA	GE21000213	GOIANESIA S2	12/02/2020 10:23	12/02/2020 15:40	12/02/2020 10:23	12/02/2020 15:40	5,29	1	5,29	CHI
20200256552	FORMOSA	FA21271168	SAO JOAO D ALIANCA	12/02/2020 10:23	12/02/2020 16:58	12/02/2020 10:23	12/02/2020 16:58	6,58	1	6,58	CHI
20200256553	NOVA CRIXAS	NA21115814	NOVA CRIXAS	12/02/2020 10:23	13/02/2020 09:34	12/02/2020 10:23	13/02/2020 09:34	23,18	1	23,18	CHI
20200256556	CORUMBAIBA	CI21098627	VILA CORUMBA	12/02/2020 10:24	13/02/2020 09:32	12/02/2020 10:24	13/02/2020 09:32	23,13	1	23,13	CHI
20200256563	QUIRINOPOLIS	QI21246775	QUIRINOPOLIS	12/02/2020 10:25	12/02/2020 14:47	12/02/2020 10:25	12/02/2020 14:47	4,35	1	4,35	CHI
20200256564	IPAMERI	IP12031355	IPAMERI	12/02/2020 10:25	13/02/2020 21:58	12/02/2020 10:25	12/02/2020 22:20	11,91	10	119,10	CHI
20200256564	IPAMERI	IP12031355	IPAMERI	12/02/2020 10:25	13/02/2020 21:58	12/02/2020 10:25	12/02/2020 23:09	12,72	1	12,72	CHI
20200256564	IPAMERI	IP12031355	IPAMERI	12/02/2020 10:25	13/02/2020 21:58	12/02/2020 10:25	13/02/2020 21:58	35,53	1	35,53	CHI
20200256564	IPAMERI	IP12031355	IPAMERI	12/02/2020 10:25	13/02/2020 21:58	13/02/2020 11:50	13/02/2020 21:58	10,13	1	10,13	CHI
20200256564	IPAMERI	IP12031355	IPAMERI	12/02/2020 10:25	13/02/2020 21:58	13/02/2020 11:50	13/02/2020 21:58	10,12	9	91,11	CHI
20200256567	URUACU	10010071685	URUACU	12/02/2020 10:26	12/02/2020 14:35	12/02/2020 10:26	12/02/2020 14:35	4,14	1	4,14	CHI
20200256568	ITARUMA	FA12242862	ITIQUEIRA	12/02/2020 10:26	12/02/2020 12:10	12/02/2020 10:26	12/02/2020 12:10	1,72	1	1,72	CHI

20200256570	GOIANESIA	GE12317834	GOIANESIA S2	12/02/2020 10:27	12/02/2020 14:40	12/02/2020 10:27	12/02/2020 14:40	4,21	5	21,04	CHI
20200256578	VALPARAISO DE GOIAS	10010033155	PACAEMBU S2	12/02/2020 10:29	12/02/2020 15:01	12/02/2020 10:29	12/02/2020 15:01	4,53	1	4,53	CHI
20200256581	GOIANIA	13418919	GOIANIA LESTE S1	12/02/2020 10:29	12/02/2020 12:57	12/02/2020 10:29	12/02/2020 12:57	2,46	1	2,46	CHI
20200256582	URUTAI	UT21337187	URUTAI	12/02/2020 10:29	12/02/2020 11:20	12/02/2020 10:29	12/02/2020 11:20	0,84	1	0,84	CHI
20200256583	MIMOSO DE GOIAS	MJ12071970	PADRE BERNARDO	12/02/2020 10:30	12/02/2020 12:03	12/02/2020 10:30	12/02/2020 12:03	1,55	23	35,56	CHI
20200256586	JATAI	JT21129180	JATAI S3	12/02/2020 10:31	12/02/2020 16:16	12/02/2020 10:31	12/02/2020 16:16	5,75	1	5,75	CHI
20200256590	GUARANI DE GOIAS	SD12153745	SAO DOMINGOS	12/02/2020 10:31	12/02/2020 12:26	12/02/2020 10:31	12/02/2020 12:26	1,91	2	3,82	CHI
20200256590	SAO DOMINGOS	SD12153745	SAO DOMINGOS	12/02/2020 10:31	12/02/2020 12:26	12/02/2020 10:31	12/02/2020 12:26	1,91	213	407,24	CHI
20200257269	PIRENOPOLIS	SF12211811	CORUMBA	12/02/2020 10:31	12/02/2020 13:29	12/02/2020 10:31	12/02/2020 13:29	2,97	26	77,10	CHI
20200257269	SAO FRANCISCO DE GOIAS	SF12211811	CORUMBA	12/02/2020 10:31	12/02/2020 13:29	12/02/2020 10:31	12/02/2020 13:29	2,97	2	5,93	CHI
20200256594	CALDAS NOVAS	CN11182808	CALDAS NOVAS S2	12/02/2020 10:32	12/02/2020 15:00	12/02/2020 10:32	12/02/2020 15:00	4,45	1	4,45	CHI
20200256595	PLANALTINA	2960035570	PLANALTINA	12/02/2020 10:32	12/02/2020 12:22	12/02/2020 10:32	12/02/2020 12:22	1,82	1	1,82	CHI
20200256706	ORIZONA	OZ21300852	PIRES DO RIO S2	12/02/2020 10:36	13/02/2020 08:10	12/02/2020 10:36	13/02/2020 08:10	21,56	1	21,56	CHI
20200256710	GOIANIA	10031052370	CARAJAS S2	12/02/2020 10:37	12/02/2020 11:39	12/02/2020 10:37	12/02/2020 11:39	1,03	0	0,00	CHI
20200256712	JATAI	JT12260439	JATAI S1	12/02/2020 10:38	12/02/2020 13:43	12/02/2020 10:38	12/02/2020 13:43	3,08	2	6,16	CHI
20200256716	JATAI	JT12205147	JATAI S1	12/02/2020 10:39	12/02/2020 17:15	12/02/2020 10:39	12/02/2020 17:15	6,59	1	6,59	CHI
20200256716	JATAI	JT12205147	JATAI S1	12/02/2020 10:39	12/02/2020 17:15	12/02/2020 14:44	12/02/2020 17:15	2,51	25	62,74	CHI
20200256720	MARA ROSA	2260010265	MARA ROSA	12/02/2020 10:40	12/02/2020 19:46	12/02/2020 10:40	12/02/2020 19:46	9,10	1	9,10	CHI
20200256726	MAURILANDIA	DM12230837	RIO DOS BOIS	12/02/2020 10:41	12/02/2020 15:35	12/02/2020 10:41	12/02/2020 15:35	4,89	4	19,56	CHI
20200256728	MINEIROS	MY12149350	PARQUE DAS EMAS	12/02/2020 10:42	13/02/2020 08:56	12/02/2020 10:42	13/02/2020 08:56	22,23	8	177,82	CHI
20200256730	NOVO PLANALTO	TA12391895	NOVO PLANALTO	12/02/2020 10:42	12/02/2020 15:32	12/02/2020 10:42	12/02/2020 15:32	4,82	6	28,93	CHI
20200256733	LUZIANIA	LZ21277179	PAMPLONA	12/02/2020 10:43	12/02/2020 20:46	12/02/2020 10:43	12/02/2020 20:46	10,04	1	10,04	CHI
20200256739	ANICUNS	AC21278611	ANICUNS	12/02/2020 10:44	12/02/2020 14:32	12/02/2020 10:44	12/02/2020 14:32	3,79	1	3,79	CHI
20200257242	GOIATUBA	GT11208060	GOIATUBA S2	12/02/2020 10:45	12/02/2020 12:40	12/02/2020 10:45	12/02/2020 12:40	1,91	54	103,18	CHI
20200256752	INHUMAS	IN12253101	INHUMAS S2	12/02/2020 10:47	12/02/2020 16:51	12/02/2020 10:47	12/02/2020 16:51	6,06	49	296,94	CHI
20200256758	FLORES DE GOIAS	3480016064	FLORES DE GOIAS	12/02/2020 10:49	12/02/2020 18:52	12/02/2020 10:49	12/02/2020 18:52	8,05	1	8,05	CHI
20200256760	MORRINHOS	MR21196318	MORRINHOS	12/02/2020 10:49	12/02/2020 12:05	12/02/2020 10:49	12/02/2020 12:05	1,27	1	1,27	CHI
20200256762	PIRACANJUBA	PJ21199386	PIRACANJUBA	12/02/2020 10:49	12/02/2020 12:20	12/02/2020 10:49	12/02/2020 12:20	1,50	2	3,00	CHI
20200256766	APARECIDA DE GOIANIA	AP12165676	ATLANTICO S3	12/02/2020 10:50	12/02/2020 12:41	12/02/2020 10:50	12/02/2020 12:41	1,85	122	225,36	CHI
20200256766	APARECIDA DE GOIANIA	AP11383892	ATLANTICO S3	12/02/2020 10:50	12/02/2020 12:41	12/02/2020 10:50	12/02/2020 12:41	1,86	43	80,03	CHI
20200257103	APARECIDA DE GOIANIA	AP12106559	REAL S2	12/02/2020 10:51	12/02/2020 12:48	12/02/2020 10:51	12/02/2020 12:48	1,94	325	631,85	CHI
20200257104	FORMOSA	FA32042716	SAO JOAO D ALIANCA	12/02/2020 10:51	14/02/2020 13:14	12/02/2020 10:51	13/02/2020 17:43	30,86	1	30,86	CHI
20200257104	FORMOSA	FA32042716	SAO JOAO D ALIANCA	12/02/2020 10:51	14/02/2020 13:14	13/02/2020 17:46	14/02/2020 13:14	19,47	1	19,47	CHI

20200257106	QUIRINOPOLIS	QI21119899	QUIRINOPOLIS	12/02/2020 10:51	12/02/2020 16:04	12/02/2020 10:51	12/02/2020 16:04	5,21	1	5,21	CHI
20200257208	CRISTALINA	10006490288	PAMPLONA	12/02/2020 10:53	12/02/2020 14:07	12/02/2020 10:53	12/02/2020 14:07	3,23	0	0,00	CHI
20200257206	GOIANIA	15732113	XAVANTES	12/02/2020 10:54	12/02/2020 15:22	12/02/2020 10:54	12/02/2020 15:22	4,47	1	4,47	CHI
20200257210	AGUAS LINDAS DE GOIAS	4830277702	AGUAS LINDAS DE GOIAS S2	12/02/2020 10:54	12/02/2020 15:30	12/02/2020 10:54	12/02/2020 15:30	4,59	1	4,59	CHI
20200257214	AGUAS LINDAS DE GOIAS	10010800849	AGUAS LINDAS DE GOIAS S1	12/02/2020 10:56	12/02/2020 12:03	12/02/2020 10:56	12/02/2020 12:03	1,12	1	1,12	CHI
20200257216	MORRINHOS	150064093	MORRINHOS	12/02/2020 10:56	12/02/2020 14:02	12/02/2020 10:56	12/02/2020 14:02	3,09	1	3,09	CHI
20200257218	ITAPURANGA	170105799	ITAPURANGA	12/02/2020 10:56	12/02/2020 17:27	12/02/2020 10:56	12/02/2020 17:27	6,50	1	6,50	CHI
20200257231	RIO VERDE	RV10400679	RIO VERDE S1	12/02/2020 10:56	13/02/2020 19:28	12/02/2020 10:56	13/02/2020 19:28	32,53	96	3122,59	CHI
20200257229	CALDAS NOVAS	10016122702	CALDAS NOVAS S2	12/02/2020 10:58	12/02/2020 18:52	12/02/2020 10:58	12/02/2020 18:52	7,90	1	7,90	CHI
20200257232	RIO VERDE	RV12324028	CABRIUVA S2	12/02/2020 10:59	13/02/2020 13:39	12/02/2020 10:59	13/02/2020 13:39	26,66	5	133,28	CHI
20200257236	CAMPOS BELOS	820027583	SAO DOMINGOS	12/02/2020 11:00	13/02/2020 12:20	12/02/2020 11:00	13/02/2020 12:20	25,34	1	25,34	CHI
20200257240	CRISTALINA	1060096319	CRISTALINA S1	12/02/2020 11:02	12/02/2020 15:18	12/02/2020 11:02	12/02/2020 15:18	4,26	1	4,26	CHI
20200257243	PLANALTINA	PI11063082	PLANALTINA	12/02/2020 11:02	12/02/2020 18:31	12/02/2020 11:02	12/02/2020 18:31	7,47	266	1986,43	CHI
20200257247	IPAMERI	NE12035437	CATALAO S1	12/02/2020 11:04	12/02/2020 16:52	12/02/2020 11:04	12/02/2020 16:52	5,79	15	86,91	CHI
20200257247	NOVA AURORA	NE12035437	CATALAO S1	12/02/2020 11:04	12/02/2020 16:52	12/02/2020 11:04	12/02/2020 16:52	5,79	27	156,44	CHI
20200258239	MINEIROS	MY12241641	PARQUE DAS EMAS	12/02/2020 11:05	12/02/2020 21:04	12/02/2020 11:05	12/02/2020 21:04	9,97	3	29,90	CHI
20200258239	SANTA RITA DO ARAGUAIA	MY12241641	PARQUE DAS EMAS	12/02/2020 11:05	12/02/2020 21:04	12/02/2020 11:05	12/02/2020 21:04	9,97	2	19,93	CHI
20200257257	PORTEIRAO	CL12338603	RIO DOS BOIS	12/02/2020 11:06	13/02/2020 03:35	12/02/2020 11:06	13/02/2020 03:35	16,48	1	16,48	CHI
20200257264	GUAPO	GA21000342	GUAPO S2	12/02/2020 11:08	12/02/2020 14:14	12/02/2020 11:08	12/02/2020 14:14	3,09	1	3,09	CHI
20200257271	GOIANIA	15544825	FERROVIARIO S1	12/02/2020 11:10	12/02/2020 13:08	12/02/2020 11:10	12/02/2020 13:08	1,95	1	1,95	CHI
20200258321	APARECIDA DO RIO DOCE	AW12341086LD	CACHOEIRA ALTA	12/02/2020 11:11	13/02/2020 10:42	12/02/2020 11:11	13/02/2020 10:42	23,51	5	117,53	CHI
20200259261	SANTA CRUZ DE GOIAS	BC21027013	PIRES DO RIO S2	12/02/2020 11:11	13/02/2020 08:46	12/02/2020 11:11	13/02/2020 08:46	21,57	1	21,57	CHI
20200257278	PARAUNA	PU21136889	PARAUNA	12/02/2020 11:12	12/02/2020 15:08	12/02/2020 11:12	12/02/2020 15:08	3,92	2	7,85	CHI
20200257280	ORIZONA	OZ12000353	PIRES DO RIO S1	12/02/2020 11:14	12/02/2020 20:06	12/02/2020 11:14	12/02/2020 20:06	8,86	34	301,32	CHI
20200258003	GOIATUBA	03680224	RIO DOS BOIS	12/02/2020 11:15	13/02/2020 21:30	12/02/2020 11:15	12/02/2020 20:20	9,07	2	18,14	CHI
20200258003	PORTEIRAO	03680224	RIO DOS BOIS	12/02/2020 11:15	13/02/2020 21:30	12/02/2020 11:15	12/02/2020 20:20	9,07	4	36,29	CHI
20200258003	GOIATUBA	03680224	RIO DOS BOIS	12/02/2020 11:15	13/02/2020 21:30	13/02/2020 01:30	13/02/2020 01:55	0,42	2	0,84	CHI
20200258003	PORTEIRAO	03680224	RIO DOS BOIS	12/02/2020 11:15	13/02/2020 21:30	13/02/2020 01:30	13/02/2020 01:55	0,42	4	1,68	CHI
20200258003	GOIATUBA	03680224	RIO DOS BOIS	12/02/2020 11:15	13/02/2020 21:30	12/02/2020 11:15	13/02/2020 21:30	34,23	17	581,99	CHI
20200258003	PORTEIRAO	03680224	RIO DOS BOIS	12/02/2020 11:15	13/02/2020 21:30	12/02/2020 11:15	13/02/2020 21:30	34,23	2	68,47	CHI
20200257293	CAVALCANTE	CJ11255469	FLORES DE GOIAS	12/02/2020 11:17	12/02/2020 13:09	12/02/2020 11:17	12/02/2020 13:09	1,86	61	113,66	CHI
20200257300	INDIARA	2710023290	EDEIA	12/02/2020 11:20	12/02/2020 21:47	12/02/2020 11:20	12/02/2020 21:47	10,46	1	10,46	CHI
20200257324	GOIANIRA	GR10402773	GOIANIRA	12/02/2020 11:20	12/02/2020 15:11	12/02/2020 15:07	12/02/2020 15:11	0,07	684	45,60	CHI

20200257324	GOIANIRA	GR12394646LD	GOIANIRA	12/02/2020 11:20	12/02/2020 15:11	12/02/2020 11:20	12/02/2020 15:11	3,85	1167	4489,38	CHI
20200257317	ACREUNA	EU21104067	ACREUNA	12/02/2020 11:23	12/02/2020 18:18	12/02/2020 11:23	12/02/2020 18:18	6,91	1	6,91	CHI
20200258008	CACHOEIRA DOURADA	IT12088560	CACHOEIRA DOURADA	12/02/2020 11:24	12/02/2020 17:37	12/02/2020 11:24	12/02/2020 17:37	6,21	1	6,21	CHI
20200258008	ITUMBIARA	IT12088560	CACHOEIRA DOURADA	12/02/2020 11:24	12/02/2020 17:37	12/02/2020 11:24	12/02/2020 17:37	6,21	4	24,84	CHI
20200257325	VICENTINOPOLIS	VI12218196	VICENTINOPOLIS	12/02/2020 11:26	12/02/2020 16:12	12/02/2020 11:26	12/02/2020 16:12	4,76	5	23,81	CHI
20200257336	VALPARAISO DE GOIAS	2860335750	MARAJOARA	12/02/2020 11:28	12/02/2020 13:00	12/02/2020 11:28	12/02/2020 13:00	1,52	1	1,52	CHI
20200257343	FORMOSA	610291970	ITIQUEIRA	12/02/2020 11:30	12/02/2020 15:11	12/02/2020 11:30	12/02/2020 15:11	3,68	1	3,68	CHI
20200257860	IPORA	IR12014026	IPORA	12/02/2020 11:30	12/02/2020 14:19	12/02/2020 11:30	12/02/2020 14:19	2,81	4	11,23	CHI
20200257352	PORANGATU	PO12390257	PORANGATU	12/02/2020 11:32	12/02/2020 15:25	12/02/2020 11:32	12/02/2020 15:25	3,87	4	15,49	CHI
20200257356	URUACU	640125517	URUACU	12/02/2020 11:33	12/02/2020 16:56	12/02/2020 11:33	12/02/2020 16:56	5,38	1	5,38	CHI
20200257359	TRINDADE	13543568	GOYA S2	12/02/2020 11:34	12/02/2020 17:13	12/02/2020 11:34	12/02/2020 17:13	5,65	1	5,65	CHI
20200257360	GOIANIA	10680354	CAMPINAS S3	12/02/2020 11:34	12/02/2020 13:05	12/02/2020 11:34	12/02/2020 13:05	1,51	1	1,51	CHI
20200257362	FORMOSA	610312650	ITIQUEIRA	12/02/2020 11:36	12/02/2020 16:55	12/02/2020 11:36	12/02/2020 16:55	5,31	1	5,31	CHI
20200257365	LUZIANIA	3200019424	MARAJOARA	12/02/2020 11:38	12/02/2020 12:48	12/02/2020 11:38	12/02/2020 12:48	1,17	1	1,17	CHI
20200257706	ABADIANIA	AA21108286	ANAPOLIS UNIVERSITARIO S1	12/02/2020 11:46	12/02/2020 16:13	12/02/2020 11:46	12/02/2020 16:13	4,43	1	4,43	CHI
20200257707	CALDAS NOVAS	10020070584	SERRA DE CALDAS	12/02/2020 11:46	12/02/2020 15:16	12/02/2020 11:46	12/02/2020 15:16	3,48	1	3,48	CHI
20200257710	ABADIANIA	AA21144049	ANAPOLIS UNIVERSITARIO S1	12/02/2020 11:50	12/02/2020 17:03	12/02/2020 11:50	12/02/2020 17:03	5,21	1	5,21	CHI
20200257711	ANAPOLIS	21236240	ANAPOLIS UNIVERSITARIO S2	12/02/2020 11:50	12/02/2020 19:35	12/02/2020 11:50	12/02/2020 19:35	7,75	1	7,75	CHI
20200257717	SAO MIGUEL DO ARAGUAIA	SM12086469	SAO MIGUEL DO ARAGUAIA	12/02/2020 11:52	12/02/2020 13:52	12/02/2020 11:52	12/02/2020 13:52	1,99	458	912,06	CHI
20200257718	GOIANIA	10004514260	XAVANTES	12/02/2020 11:52	12/02/2020 15:09	12/02/2020 11:52	12/02/2020 15:09	3,27	1	3,27	CHI
20200257719	PLANALTINA	PI11354358	PADRE BERNARDO	12/02/2020 11:53	12/02/2020 18:52	12/02/2020 11:53	12/02/2020 18:52	6,98	2	13,96	CHI
20200259257	SANTA CRUZ DE GOIAS	BC21027018	PIRES DO RIO S2	12/02/2020 11:54	12/02/2020 19:03	12/02/2020 11:54	12/02/2020 19:03	7,15	1	7,15	CHI
20200257732	GOIANIA	10349753	CAMPINAS S1	12/02/2020 11:55	12/02/2020 15:56	12/02/2020 11:55	12/02/2020 15:56	4,01	1	4,01	CHI
20200257733	MUNDO NOVO DE GOIAS	MH11269075	NOVA CRIXAS	12/02/2020 11:55	12/02/2020 13:41	12/02/2020 11:55	12/02/2020 13:41	1,76	1	1,76	CHI
20200257734	JUSSARA	JR11259700	JUSSARA	12/02/2020 11:55	12/02/2020 16:40	12/02/2020 11:55	12/02/2020 16:40	4,74	75	355,29	CHI
20200257735	AGUAS LINDAS DE GOIAS	10017271957	AGUAS LINDAS DE GOIAS S2	12/02/2020 11:55	12/02/2020 14:04	12/02/2020 11:55	12/02/2020 14:04	2,13	1	2,13	CHI
20200257736	CATALAO	1990156062	CATALAO S2	12/02/2020 11:56	13/02/2020 00:36	12/02/2020 11:56	13/02/2020 00:36	12,67	1	12,67	CHI
20200257741	BURITINOPOLIS	BQ12344370RE	IACIARA S2	12/02/2020 11:56	12/02/2020 14:15	12/02/2020 11:56	12/02/2020 14:15	2,30	256	589,94	CHI
20200257741	MAMBAI	BQ12344370RE	IACIARA S2	12/02/2020 11:56	12/02/2020 14:15	12/02/2020 11:56	12/02/2020 14:15	2,30	1	2,30	CHI
20200257801	CATALAO	1990188350	CATALAO S2	12/02/2020 11:57	12/02/2020 13:42	12/02/2020 11:57	12/02/2020 13:42	1,74	1	1,74	CHI
20200257803	RIO VERDE	10007274007	RIO VERDE S1	12/02/2020 11:58	13/02/2020 11:33	12/02/2020 11:58	13/02/2020 11:33	23,58	1	23,58	CHI
20200257805	CAIAPONIA	CP11334931	CAIAPONIA	12/02/2020 11:59	12/02/2020 19:12	12/02/2020 17:14	12/02/2020 19:12	1,97	123	242,28	CHI
20200257807	GOIATUBA	JV21047702	GOIATUBA S1	12/02/2020 11:59	12/02/2020 15:01	12/02/2020 11:59	12/02/2020 15:01	3,03	1	3,03	CHI

20200257819	GUARINOS	IW12072411	ITAPACI	12/02/2020 12:00	12/02/2020 15:34	12/02/2020 12:00	12/02/2020 15:34	3,56	20	71,21	CHI
20200257819	ITAPACI	IW12072411	ITAPACI	12/02/2020 12:00	12/02/2020 15:34	12/02/2020 12:00	12/02/2020 15:34	3,56	60	213,62	CHI
20200257817	ITUMBIARA	690356237	PARANAIBA	12/02/2020 12:01	12/02/2020 15:22	12/02/2020 12:01	12/02/2020 15:22	3,36	1	3,36	CHI
20200257820	ITAPACI	IW21167997	ITAPACI	12/02/2020 12:02	12/02/2020 21:15	12/02/2020 12:02	12/02/2020 21:15	9,21	1	9,21	CHI
202002191202	SANTA CRUZ DE GOIAS	BC12083545	PIRES DO RIO S2	12/02/2020 12:02	12/02/2020 15:17	12/02/2020 12:02	12/02/2020 15:17	3,24	2	6,47	CHI
20200257828	APORE	AE21391170	ITAJA S1	12/02/2020 12:03	12/02/2020 15:00	12/02/2020 12:03	12/02/2020 15:00	2,94	1	2,94	CHI
20200257831	VALPARAISO DE GOIAS	2860174789	MARAJOARA	12/02/2020 12:05	12/02/2020 16:37	12/02/2020 12:05	12/02/2020 16:37	4,52	1	4,52	CHI
20200257838	BALIZA	BM12390150	BOM JARDIM	12/02/2020 12:08	12/02/2020 14:20	12/02/2020 12:08	12/02/2020 14:20	2,19	51	111,90	CHI
20200257838	BOM JARDIM DE GOIAS	BM12390150	BOM JARDIM	12/02/2020 12:08	12/02/2020 14:20	12/02/2020 12:08	12/02/2020 14:20	2,19	9	19,75	CHI
20200257840	PIRACANJUBA	PJ21263525	PIRACANJUBA	12/02/2020 12:09	12/02/2020 14:30	12/02/2020 12:09	12/02/2020 14:30	2,34	1	2,34	CHI
20200257841	CEZARINA	CZ12000034	CEZARINA	12/02/2020 12:09	12/02/2020 19:15	12/02/2020 12:09	12/02/2020 19:15	7,09	22	156,04	CHI
20200257841	INDIARA	CZ12000034	CEZARINA	12/02/2020 12:09	12/02/2020 19:15	12/02/2020 12:09	12/02/2020 19:15	7,09	9	63,83	CHI
20200257843	HIDROLANDIA	HD31216135	GUAPO S2	12/02/2020 12:09	12/02/2020 15:09	12/02/2020 12:09	12/02/2020 15:09	2,99	1	2,99	CHI
20200258127	MOZARLANDIA	MZ12058572	MOZARLANDIA	12/02/2020 12:10	12/02/2020 17:20	12/02/2020 12:10	12/02/2020 17:20	5,16	2	10,32	CHI
20200257851	APARECIDA DE GOIANIA	200223781	INDEPENDENCIA S1	12/02/2020 12:11	12/02/2020 14:37	12/02/2020 12:11	12/02/2020 14:37	2,43	1	2,43	CHI
20200259320	ALVORADA DO NORTE	FB12143258	IACIARA S2	12/02/2020 12:12	12/02/2020 19:26	12/02/2020 12:12	12/02/2020 19:26	7,23	30	216,93	CHI
20200259320	FLORES DE GOIAS	FB12143258	IACIARA S2	12/02/2020 12:12	12/02/2020 19:26	12/02/2020 12:12	12/02/2020 19:26	7,23	27	195,24	CHI
202002191203	CORREGO DO OURO	CO12054684	FIRMINOPOLIS S2	12/02/2020 12:13	12/02/2020 17:40	12/02/2020 12:13	12/02/2020 17:40	5,44	6	32,61	CHI
20200257867	ITUMBIARA	IT21166385	ITUMBIARA NOVA	12/02/2020 12:17	12/02/2020 16:50	12/02/2020 12:17	12/02/2020 16:50	4,54	1	4,54	CHI
20200257869	MUNDO NOVO DE GOIAS	4240024299	NOVA CRIXAS	12/02/2020 12:17	12/02/2020 17:11	12/02/2020 12:17	12/02/2020 17:11	4,89	1	4,89	CHI
20200258159	ITAUCU	IX12319550	ITABERAI S1	12/02/2020 12:17	12/02/2020 16:32	12/02/2020 12:17	12/02/2020 16:32	4,25	5	21,24	CHI
20200257870	AGUAS LINDAS DE GOIAS	4830242580	AGUAS LINDAS DE GOIAS S1	12/02/2020 12:18	12/02/2020 14:05	12/02/2020 12:18	12/02/2020 14:05	1,78	1	1,78	CHI
20200257872	SAO MIGUEL DO ARAGUAIA	SM12022155	SAO MIGUEL DO ARAGUAIA	12/02/2020 12:18	12/02/2020 16:25	12/02/2020 12:18	12/02/2020 16:25	4,11	6	24,64	CHI
20200258058	ALTO PARAISO DE GOIAS	BF12129915	FLORES DE GOIAS	12/02/2020 12:19	12/02/2020 16:20	12/02/2020 12:19	12/02/2020 16:20	4,02	23	92,38	CHI
20200258027	PARAUNA	PU12080492	PARAUNA	12/02/2020 12:24	12/02/2020 22:00	12/02/2020 16:07	12/02/2020 17:18	1,19	31	36,81	CHI
20200258027	PARAUNA	PU12391518	PARAUNA	12/02/2020 12:24	12/02/2020 22:00	12/02/2020 12:24	12/02/2020 17:30	5,09	2	10,19	CHI
20200258027	PARAUNA	PU12391518	PARAUNA	12/02/2020 12:24	12/02/2020 22:00	12/02/2020 12:24	12/02/2020 22:00	9,59	23	220,53	CHI
20200258028	ANICUNS	AC21060662	ANICUNS	12/02/2020 12:25	12/02/2020 18:27	12/02/2020 12:25	12/02/2020 18:27	6,03	1	6,03	CHI
20200258033	GOIANIA	GN11403126	GOIANIA LESTE S1	12/02/2020 12:27	12/02/2020 14:17	12/02/2020 13:50	12/02/2020 14:17	0,45	23	10,30	CHI
20200258036	GOIANIA	10069343	CAMPINAS S2	12/02/2020 12:27	12/02/2020 15:14	12/02/2020 12:27	12/02/2020 15:14	2,77	1	2,77	CHI
20200258052	APARECIDA DE GOIANIA	AP11166116	ATLANTICO S3	12/02/2020 12:27	12/02/2020 15:38	12/02/2020 12:27	12/02/2020 15:38	3,17	77	244,30	CHI
20200258004	JUSSARA	JR12022269	BRITANIA	12/02/2020 12:28	12/02/2020 21:32	12/02/2020 12:28	12/02/2020 21:32	9,05	30	271,53	CHI
20200258004	MONTES CLAROS DE GOIAS	JR12022269	BRITANIA	12/02/2020 12:28	12/02/2020 21:32	12/02/2020 12:28	12/02/2020 21:32	9,05	262	2371,39	CHI

20200258009	AMARALINA	8272548	NOVA CRIXAS	12/02/2020 12:30	12/02/2020 15:07	12/02/2020 12:30	12/02/2020 15:07	2,61	1	2,61	CHI
20200258009	MUNDO NOVO DE GOIAS	8272548	NOVA CRIXAS	12/02/2020 12:30	12/02/2020 15:07	12/02/2020 12:30	12/02/2020 15:07	2,61	7	18,29	CHI
20200258013	SAO FRANCISCO DE GOIAS	SF21000137	SAO FRANCISCO DE GOIAS	12/02/2020 12:31	13/02/2020 19:38	12/02/2020 12:31	13/02/2020 19:38	31,11	1	31,11	CHI
20200258181	PARAUNA	BZ10394760	ACREUNA	12/02/2020 12:32	13/02/2020 15:22	12/02/2020 12:32	12/02/2020 16:59	4,45	19	84,62	CHI
20200258181	SANTO ANTONIO DA BARRA	BZ10394760	ACREUNA	12/02/2020 12:32	13/02/2020 15:22	12/02/2020 12:32	12/02/2020 16:59	4,45	55	244,95	CHI
20200258181	SANTO ANTONIO DA BARRA	BZ10407792	ACREUNA	12/02/2020 12:32	13/02/2020 15:22	12/02/2020 17:03	12/02/2020 17:18	0,25	102	25,39	CHI
20200258181	SANTO ANTONIO DA BARRA	BZ10394760	ACREUNA	12/02/2020 12:32	13/02/2020 15:22	12/02/2020 17:03	13/02/2020 01:27	8,40	27	226,77	CHI
20200258181	RIO VERDE	BZ10394760	ACREUNA	12/02/2020 12:32	13/02/2020 15:22	12/02/2020 23:51	13/02/2020 01:27	1,60	42	67,14	CHI
20200258181	SANTO ANTONIO DA BARRA	BZ10394760	ACREUNA	12/02/2020 12:32	13/02/2020 15:22	12/02/2020 23:51	13/02/2020 01:27	1,60	38	60,75	CHI
20200258181	SANTO ANTONIO DA BARRA	BZ10394760	ACREUNA	12/02/2020 12:32	13/02/2020 15:22	12/02/2020 17:03	13/02/2020 14:29	21,42	24	514,11	CHI
20200258181	PARAUNA	BZ13402205E	ACREUNA	12/02/2020 12:32	13/02/2020 15:22	12/02/2020 12:32	13/02/2020 15:22	26,83	140	3756,82	CHI
20200258181	RIO VERDE	BZ13402205E	ACREUNA	12/02/2020 12:32	13/02/2020 15:22	12/02/2020 12:32	13/02/2020 15:22	26,83	99	2656,61	CHI
20200258181	PARAUNA	BZ13402205E	ACREUNA	12/02/2020 12:32	13/02/2020 15:22	12/02/2020 17:03	13/02/2020 15:22	22,31	19	423,94	CHI
20200258181	SANTO ANTONIO DA BARRA	BZ13402205E	ACREUNA	12/02/2020 12:32	13/02/2020 15:22	12/02/2020 17:03	13/02/2020 15:22	22,31	4	89,25	CHI
20200257903	CRIXAS	MZ10404285	MOZARLANDIA	12/02/2020 12:33	13/02/2020 11:58	12/02/2020 18:01	12/02/2020 18:11	0,16	26	4,04	CHI
20200257903	MOZARLANDIA	MZ10404285	MOZARLANDIA	12/02/2020 12:33	13/02/2020 11:58	12/02/2020 18:01	12/02/2020 18:11	0,16	73	11,36	CHI
20200257903	MOZARLANDIA	MZ12055650	MOZARLANDIA	12/02/2020 12:33	13/02/2020 11:58	12/02/2020 18:01	13/02/2020 02:41	8,66	2	17,32	CHI
20200257903	NOVA CRIXAS	MZ12055650	MOZARLANDIA	12/02/2020 12:33	13/02/2020 11:58	12/02/2020 18:01	13/02/2020 02:41	8,66	23	199,19	CHI
20200257903	CRIXAS	MZ12150974LD	MOZARLANDIA	12/02/2020 12:33	13/02/2020 11:58	12/02/2020 18:01	13/02/2020 11:58	17,95	4	71,79	CHI
20200257903	NOVA CRIXAS	MZ12150974LD	MOZARLANDIA	12/02/2020 12:33	13/02/2020 11:58	12/02/2020 18:01	13/02/2020 11:58	17,95	4	71,79	CHI
20200258043	MATRINCHA	MP21247243	MATRINCHA	12/02/2020 12:35	13/02/2020 12:08	12/02/2020 12:35	13/02/2020 12:08	23,54	4	94,17	CHI
20200258044	PLANALTINA	2960079158	PLANALTINA	12/02/2020 12:35	12/02/2020 15:20	12/02/2020 12:35	12/02/2020 15:20	2,74	1	2,74	CHI
20200258047	AGUAS LINDAS DE GOIAS	10021159821	AGUAS LINDAS DE GOIAS S2	12/02/2020 12:37	12/02/2020 14:59	12/02/2020 12:37	12/02/2020 14:59	2,35	1	2,35	CHI
20200258255	RIO VERDE	RV12306400	CABRIUVA S2	12/02/2020 12:40	12/02/2020 20:06	12/02/2020 12:40	12/02/2020 20:06	7,42	4	29,70	CHI
20200257905	APARECIDA DE GOIANIA	AP11383892	ATLANTICO S3	12/02/2020 12:41	12/02/2020 16:00	12/02/2020 14:59	12/02/2020 16:00	1,01	43	43,63	CHI
20200258063	PIRES DO RIO	PR12336187	PIRES DO RIO S1	12/02/2020 12:42	12/02/2020 15:42	12/02/2020 12:42	12/02/2020 15:42	3,00	3	8,99	CHI
20200258063	URUTAI	PR12336187	PIRES DO RIO S1	12/02/2020 12:42	12/02/2020 15:42	12/02/2020 12:42	12/02/2020 15:42	3,00	1	3,00	CHI
20200258064	GOIANIA	17225097	GOYA S2	12/02/2020 12:42	12/02/2020 15:37	12/02/2020 12:42	12/02/2020 15:37	2,91	1	2,91	CHI
20200258066	PIRACANJUBA	60028993	PIRACANJUBA	12/02/2020 12:42	12/02/2020 19:56	12/02/2020 12:42	12/02/2020 19:56	7,22	1	7,22	CHI
20200258070	JUSSARA	JR12229982	JUSSARA	12/02/2020 12:43	12/02/2020 15:35	12/02/2020 12:43	12/02/2020 15:35	2,86	6	17,15	CHI
20200258283	MOSSAMEDES	MD12066158	FIRMINOPOLIS S2	12/02/2020 12:43	12/02/2020 16:55	12/02/2020 12:43	12/02/2020 16:55	4,19	19	79,56	CHI
20200258073	ITAPURANGA	IK12311015	ITAPURANGA	12/02/2020 12:44	12/02/2020 17:21	12/02/2020 12:44	12/02/2020 17:21	4,61	199	917,50	CHI
20200258080	AGUAS LINDAS DE GOIAS	4830162340	AGUAS LINDAS DE GOIAS S2	12/02/2020 12:46	12/02/2020 14:27	12/02/2020 12:46	12/02/2020 14:27	1,67	1	1,67	CHI

20200258081	BURITI ALEGRE	BG21000147	ITUMBIARA VELHA S2	12/02/2020 12:46	12/02/2020 16:31	12/02/2020 12:46	12/02/2020 16:31	3,73	1	3,73	CHI
20200258082	SENADOR CANEDO	SW11340405	SENADOR CANEDO	12/02/2020 12:47	12/02/2020 14:58	12/02/2020 12:47	12/02/2020 14:58	2,18	32	69,82	CHI
20200258084	AGUAS LINDAS DE GOIAS	4830292417	AGUAS LINDAS DE GOIAS S1	12/02/2020 12:47	12/02/2020 15:53	12/02/2020 12:47	12/02/2020 15:53	3,10	1	3,10	CHI
20200258087	GOIAS	GS12274242	MATRINCHA	12/02/2020 12:48	12/02/2020 23:48	12/02/2020 19:03	12/02/2020 23:48	4,75	94	446,47	CHI
20200258088	GOIAS	GS21145619	GOIAS	12/02/2020 12:48	12/02/2020 14:38	12/02/2020 12:48	12/02/2020 14:38	1,83	1	1,83	CHI
20200258091	MORRINHOS	MR12223584	PONTALINA	12/02/2020 12:48	12/02/2020 17:43	12/02/2020 12:48	12/02/2020 17:43	4,90	1	4,90	CHI
20200258094	PLANALTINA	PI21359585	PLANALTINA	12/02/2020 12:49	12/02/2020 16:19	12/02/2020 12:49	12/02/2020 16:19	3,48	1	3,48	CHI
20200258100	SILVANIA	SV12248004	DAIA S2	12/02/2020 12:51	12/02/2020 16:48	12/02/2020 12:51	12/02/2020 16:48	3,94	23	90,68	CHI
20200258101	SAO LUIS DE MONTES BELOS	SL21022403	SAO LUIZ DOS MONTES BELOS	12/02/2020 12:51	12/02/2020 16:20	12/02/2020 12:51	12/02/2020 16:20	3,48	1	3,48	CHI
20200258107	HIDROLANDIA	HD21073238	CEPAIGO S2	12/02/2020 12:53	12/02/2020 18:02	12/02/2020 12:53	12/02/2020 18:02	5,15	1	5,15	CHI
20200258108	PEROLANDIA	MY12301872	PARQUE DAS EMAS	12/02/2020 12:53	14/02/2020 12:27	12/02/2020 12:53	13/02/2020 14:07	25,23	3	75,69	CHI
20200258108	PEROLANDIA	MY12301872	PARQUE DAS EMAS	12/02/2020 12:53	14/02/2020 12:27	12/02/2020 12:53	14/02/2020 12:05	47,20	1	47,20	CHI
20200258108	PEROLANDIA	MY12301872	PARQUE DAS EMAS	12/02/2020 12:53	14/02/2020 12:27	14/02/2020 09:20	14/02/2020 12:27	3,12	3	9,35	CHI
20200258114	ALVORADA DO NORTE	AQ12131772	IACIARA S2	12/02/2020 12:53	12/02/2020 18:53	12/02/2020 12:53	12/02/2020 15:59	3,10	1	3,10	CHI
20200258114	SIMOLANDIA	AQ12131772	IACIARA S2	12/02/2020 12:53	12/02/2020 18:53	12/02/2020 12:53	12/02/2020 15:59	3,10	1	3,10	CHI
20200258114	ALVORADA DO NORTE	AQ11096318	IACIARA S2	12/02/2020 12:53	12/02/2020 18:53	12/02/2020 12:53	12/02/2020 18:53	6,00	117	702,26	CHI
20200258143	JATAI	SX12264387	JATAI S1	12/02/2020 12:53	12/02/2020 19:25	12/02/2020 12:53	12/02/2020 19:25	6,52	7	45,65	CHI
20200258143	SERRANOPOLIS	SX12264387	JATAI S1	12/02/2020 12:53	12/02/2020 19:25	12/02/2020 12:53	12/02/2020 19:25	6,52	22	143,47	CHI
20200258117	APARECIDA DE GOIANIA	16845262	INDEPENDENCIA S2	12/02/2020 12:54	12/02/2020 17:04	12/02/2020 12:54	12/02/2020 17:04	4,16	1	4,16	CHI
20200258125	CAIAPONIA	CP12380880	CAIAPONIA	12/02/2020 12:57	12/02/2020 17:22	12/02/2020 12:57	12/02/2020 17:22	4,41	11	48,51	CHI
20200258126	GOIAS	IB12210550	ITABERAI S1	12/02/2020 12:57	12/02/2020 14:24	12/02/2020 12:57	12/02/2020 14:24	1,44	2	2,89	CHI
20200258126	ITABERAI	IB12210550	ITABERAI S1	12/02/2020 12:57	12/02/2020 14:24	12/02/2020 12:57	12/02/2020 14:24	1,44	36	51,97	CHI
20200258128	ITAJA	IJ21188955	ITAJA S2	12/02/2020 12:58	12/02/2020 13:43	12/02/2020 12:58	12/02/2020 13:43	0,75	1	0,75	CHI
20200258131	LUZIANIA	LZ11168139	MARAJOARA	12/02/2020 12:58	12/02/2020 16:00	12/02/2020 12:58	12/02/2020 16:00	3,03	31	93,82	CHI
20200262825	DAVINOPOLIS	IO12073927	CATALAO S1	12/02/2020 12:58	13/02/2020 09:04	12/02/2020 22:56	13/02/2020 09:04	10,12	49	495,98	CHI
202002191269	DAVINOPOLIS	2950006330	CATALAO S1	12/02/2020 12:58	12/02/2020 22:56	12/02/2020 12:58	12/02/2020 22:56	9,97	1	9,97	CHI
20200258138	SANTO ANTONIO DO DESCOBERTO	O3560406	AGUAS LINDAS DE GOIAS S2	12/02/2020 13:00	12/02/2020 15:11	12/02/2020 13:00	12/02/2020 15:11	2,17	175	380,43	CHI
20200258139	GOIANDIRA	GD21143410	CATALAO S1	12/02/2020 13:00	12/02/2020 20:20	12/02/2020 13:00	12/02/2020 20:20	7,32	2	14,65	CHI
20200258228	ANICUNS	AC12391423	ANICUNS	12/02/2020 13:02	12/02/2020 14:45	12/02/2020 13:02	12/02/2020 14:45	1,71	17	29,01	CHI
20200259791	PETROLINA DE GOIAS	PG12017366	PETROLINA	12/02/2020 13:02	12/02/2020 18:46	12/02/2020 13:02	12/02/2020 18:46	5,73	34	194,89	CHI
20200259791	SAO FRANCISCO DE GOIAS	PG12017366	PETROLINA	12/02/2020 13:02	12/02/2020 18:46	12/02/2020 13:02	12/02/2020 18:46	5,73	8	45,86	CHI
20200258153	JESUPOLIS	JE11026781	SAO FRANCISCO DE GOIAS	12/02/2020 13:03	13/02/2020 11:31	12/02/2020 13:03	13/02/2020 11:31	22,46	67	1504,91	CHI
20200258155	MATRINCHA	MP12299715LD	MATRINCHA	12/02/2020 13:03	13/02/2020 11:04	12/02/2020 13:03	13/02/2020 11:04	22,01	13	286,08	CHI

20200258161	CIDADE OCIDENTAL	10014454619	MARAJOARA	12/02/2020 13:05	12/02/2020 19:11	12/02/2020 13:05	12/02/2020 19:11	6,09	1	6,09	CHI
20200258163	ITAJA	2300012590	ITAJA S2	12/02/2020 13:05	12/02/2020 14:34	12/02/2020 13:05	12/02/2020 14:34	1,47	1	1,47	CHI
20200258164	COCALZINHO DE GOIAS	ZN21215026	COCALZINHO	12/02/2020 13:05	13/02/2020 07:59	12/02/2020 13:05	13/02/2020 07:59	18,90	1	18,90	CHI
20200258384	ALEXANIA	AX12071331	ALEXANIA	12/02/2020 13:05	12/02/2020 17:58	12/02/2020 13:05	12/02/2020 17:58	4,87	8	38,97	CHI
20200258384	SANTO ANTONIO DO DESCOBERTO	AX12071331	ALEXANIA	12/02/2020 13:05	12/02/2020 17:58	12/02/2020 13:05	12/02/2020 17:58	4,87	3	14,61	CHI
20200258178	FAINA	GS10400430	MATRINCHA	12/02/2020 13:06	13/02/2020 08:48	12/02/2020 13:06	12/02/2020 15:22	2,27	13	29,54	CHI
20200258178	GOIAS	GS10400430	MATRINCHA	12/02/2020 13:06	13/02/2020 08:48	12/02/2020 13:06	12/02/2020 15:22	2,27	65	147,68	CHI
20200258178	MATRINCHA	GS10400430	MATRINCHA	12/02/2020 13:06	13/02/2020 08:48	12/02/2020 13:06	12/02/2020 15:22	2,27	300	681,58	CHI
20200258178	FAINA	GS13055009	MATRINCHA	12/02/2020 13:06	13/02/2020 08:48	12/02/2020 13:06	13/02/2020 07:55	18,82	4	75,27	CHI
20200258178	GOIAS	GS13055009	MATRINCHA	12/02/2020 13:06	13/02/2020 08:48	12/02/2020 13:06	13/02/2020 07:55	18,82	3	56,45	CHI
20200258178	FAINA	GS12362364	MATRINCHA	12/02/2020 13:06	13/02/2020 08:48	12/02/2020 13:06	13/02/2020 08:48	19,71	11	216,80	CHI
20200258178	GOIAS	GS12362364	MATRINCHA	12/02/2020 13:06	13/02/2020 08:48	12/02/2020 13:06	13/02/2020 08:48	19,71	8	157,67	CHI
20200258178	MATRINCHA	GS12362364	MATRINCHA	12/02/2020 13:06	13/02/2020 08:48	12/02/2020 13:06	13/02/2020 08:48	19,71	1	19,71	CHI
20200258176	GOIANIA	GN11282958	GOYA S1	12/02/2020 13:08	12/02/2020 14:11	12/02/2020 13:08	12/02/2020 14:11	1,04	63	65,59	CHI
20200258904	PIRENOPOLIS	PV21185014	SAO FRANCISCO DE GOIAS	12/02/2020 13:08	13/02/2020 12:55	12/02/2020 13:08	13/02/2020 12:55	23,78	2	47,57	CHI
2020021200034	DAMOLANDIA	01450506	PETROLINA	12/02/2020 13:08	12/02/2020 22:09	12/02/2020 13:08	12/02/2020 14:41	1,55	1	1,55	CHI
2020021200034	JESUPOLIS	01450506	PETROLINA	12/02/2020 13:08	12/02/2020 22:09	12/02/2020 13:08	12/02/2020 14:41	1,55	1	1,55	CHI
2020021200034	OURO VERDE DE GOIAS	01450506	PETROLINA	12/02/2020 13:08	12/02/2020 22:09	12/02/2020 13:08	12/02/2020 14:41	1,55	27	41,84	CHI
2020021200034	PETROLINA DE GOIAS	01450506	PETROLINA	12/02/2020 13:08	12/02/2020 22:09	12/02/2020 13:08	12/02/2020 14:41	1,55	2738	4243,14	CHI
2020021200034	PETROLINA DE GOIAS	01450506	PETROLINA	12/02/2020 13:08	12/02/2020 22:09	12/02/2020 13:08	12/02/2020 14:41	1,55	1504	2330,78	CHI
2020021200034	SAO FRANCISCO DE GOIAS	01450506	PETROLINA	12/02/2020 13:08	12/02/2020 22:09	12/02/2020 13:08	12/02/2020 14:41	1,55	1	1,55	CHI
2020021200034	SAO FRANCISCO DE GOIAS	01450506	PETROLINA	12/02/2020 13:08	12/02/2020 22:09	12/02/2020 13:08	12/02/2020 14:41	1,55	25	38,74	CHI
2020021200034	PETROLINA DE GOIAS	PV13370344	SAO FRANCISCO DE GOIAS	12/02/2020 13:08	12/02/2020 22:09	12/02/2020 13:08	12/02/2020 17:06	3,98	3	11,94	CHI
2020021200034	PIRENOPOLIS	PV13370344	SAO FRANCISCO DE GOIAS	12/02/2020 13:08	12/02/2020 22:09	12/02/2020 13:08	12/02/2020 17:06	3,98	329	1309,15	CHI
2020021200034	JARAGUA	SF13211815	SAO FRANCISCO DE GOIAS	12/02/2020 13:08	12/02/2020 22:09	12/02/2020 13:08	12/02/2020 17:26	4,30	232	998,12	CHI
2020021200034	JESUPOLIS	SF13211815	SAO FRANCISCO DE GOIAS	12/02/2020 13:08	12/02/2020 22:09	12/02/2020 13:08	12/02/2020 17:26	4,30	5	21,51	CHI
2020021200034	SAO FRANCISCO DE GOIAS	SF13211815	SAO FRANCISCO DE GOIAS	12/02/2020 13:08	12/02/2020 22:09	12/02/2020 13:08	12/02/2020 17:26	4,30	690	2968,53	CHI
2020021200034	SAO FRANCISCO DE GOIAS	SF13297560	SAO FRANCISCO DE GOIAS	12/02/2020 13:08	12/02/2020 22:09	12/02/2020 13:08	12/02/2020 19:32	6,40	1432	9166,39	CHI
2020021200034	JARAGUA	JA10394588	JARAGUA	12/02/2020 13:08	12/02/2020 22:09	12/02/2020 19:32	12/02/2020 19:50	0,31	157	49,32	CHI
2020021200034	PIRENOPOLIS	JA10394588	JARAGUA	12/02/2020 13:08	12/02/2020 22:09	12/02/2020 19:32	12/02/2020 19:50	0,31	95	29,85	CHI
2020021200034	JARAGUA	JA10394588	SAO FRANCISCO DE GOIAS	12/02/2020 13:08	12/02/2020 22:09	12/02/2020 19:32	12/02/2020 19:50	0,31	233	73,20	CHI
2020021200034	JESUPOLIS	JA10394588	SAO FRANCISCO DE GOIAS	12/02/2020 13:08	12/02/2020 22:09	12/02/2020 19:32	12/02/2020 19:50	0,31	5	1,57	CHI
2020021200034	SAO FRANCISCO DE GOIAS	JA10394588	SAO FRANCISCO DE GOIAS	12/02/2020 13:08	12/02/2020 22:09	12/02/2020 19:32	12/02/2020 19:50	0,31	692	217,40	CHI

2020021200034	JARAGUA	JA10394588	JARAGUA	12/02/2020 13:08	12/02/2020 22:09	12/02/2020 19:54	12/02/2020 20:00	0,10	156	16,08	CHI
2020021200034	PIRENOPOLIS	JA10394588	JARAGUA	12/02/2020 13:08	12/02/2020 22:09	12/02/2020 19:54	12/02/2020 20:00	0,10	95	9,79	CHI
2020021200034	JARAGUA	JA10394588	SAO FRANCISCO DE GOIAS	12/02/2020 13:08	12/02/2020 22:09	12/02/2020 19:54	12/02/2020 20:00	0,10	233	24,01	CHI
2020021200034	JESUPOLIS	JA10394588	SAO FRANCISCO DE GOIAS	12/02/2020 13:08	12/02/2020 22:09	12/02/2020 19:54	12/02/2020 20:00	0,10	5	0,52	CHI
2020021200034	SAO FRANCISCO DE GOIAS	JA10394588	SAO FRANCISCO DE GOIAS	12/02/2020 13:08	12/02/2020 22:09	12/02/2020 19:54	12/02/2020 20:00	0,10	692	71,31	CHI
2020021200034	ANAPOLIS	AN12273408RE	ANAPOLIS UNIVERSITARIO S2	12/02/2020 13:08	12/02/2020 22:09	12/02/2020 19:32	12/02/2020 20:08	0,61	80	48,93	CHI
2020021200034	PIRENOPOLIS	AN12273408RE	ANAPOLIS UNIVERSITARIO S2	12/02/2020 13:08	12/02/2020 22:09	12/02/2020 19:32	12/02/2020 20:08	0,61	54	33,03	CHI
2020021200034	SAO FRANCISCO DE GOIAS	03165116	SAO FRANCISCO DE GOIAS	12/02/2020 13:08	12/02/2020 22:09	12/02/2020 13:08	12/02/2020 20:12	7,07	1	7,07	CHI
2020021200034	JARAGUA	03165126	SAO FRANCISCO DE GOIAS	12/02/2020 13:08	12/02/2020 22:09	12/02/2020 13:08	12/02/2020 20:12	7,07	22	155,50	CHI
2020021200034	JESUPOLIS	03165126	SAO FRANCISCO DE GOIAS	12/02/2020 13:08	12/02/2020 22:09	12/02/2020 13:08	12/02/2020 20:12	7,07	966	6828,01	CHI
2020021200034	JESUPOLIS	03165126	SAO FRANCISCO DE GOIAS	12/02/2020 13:08	12/02/2020 22:09	12/02/2020 13:08	12/02/2020 20:12	7,07	83	586,67	CHI
2020021200034	PETROLINA DE GOIAS	03165126	SAO FRANCISCO DE GOIAS	12/02/2020 13:08	12/02/2020 22:09	12/02/2020 13:08	12/02/2020 20:12	7,07	1	7,07	CHI
2020021200034	PETROLINA DE GOIAS	03165126	SAO FRANCISCO DE GOIAS	12/02/2020 13:08	12/02/2020 22:09	12/02/2020 13:08	12/02/2020 20:12	7,07	3	21,21	CHI
2020021200034	PIRENOPOLIS	03165126	SAO FRANCISCO DE GOIAS	12/02/2020 13:08	12/02/2020 22:09	12/02/2020 13:08	12/02/2020 20:12	7,07	1	7,07	CHI
2020021200034	SAO FRANCISCO DE GOIAS	03165126	SAO FRANCISCO DE GOIAS	12/02/2020 13:08	12/02/2020 22:09	12/02/2020 13:08	12/02/2020 20:12	7,07	85	600,81	CHI
2020021200034	SAO FRANCISCO DE GOIAS	03165126	SAO FRANCISCO DE GOIAS	12/02/2020 13:08	12/02/2020 22:09	12/02/2020 13:08	12/02/2020 20:12	7,07	25	176,71	CHI
2020021200034	SAO FRANCISCO DE GOIAS	03165126	SAO FRANCISCO DE GOIAS	12/02/2020 13:08	12/02/2020 22:09	12/02/2020 13:08	12/02/2020 20:12	7,07	1	7,07	CHI
2020021200034	SAO FRANCISCO DE GOIAS	SF13297555	SAO FRANCISCO DE GOIAS	12/02/2020 13:08	12/02/2020 22:09	12/02/2020 13:08	12/02/2020 20:37	7,50	448	3357,76	CHI
2020021200034	JARAGUA	SF13203680	JARAGUA	12/02/2020 13:08	12/02/2020 22:09	12/02/2020 20:03	12/02/2020 21:06	1,04	156	162,24	CHI
2020021200034	PIRENOPOLIS	SF13203680	JARAGUA	12/02/2020 13:08	12/02/2020 22:09	12/02/2020 20:03	12/02/2020 21:06	1,04	95	98,80	CHI
2020021200034	JARAGUA	SF13203680	SAO FRANCISCO DE GOIAS	12/02/2020 13:08	12/02/2020 22:09	12/02/2020 20:03	12/02/2020 21:06	1,04	233	242,32	CHI
2020021200034	JESUPOLIS	SF13203680	SAO FRANCISCO DE GOIAS	12/02/2020 13:08	12/02/2020 22:09	12/02/2020 20:03	12/02/2020 21:06	1,04	5	5,20	CHI
2020021200034	SAO FRANCISCO DE GOIAS	SF13203680	SAO FRANCISCO DE GOIAS	12/02/2020 13:08	12/02/2020 22:09	12/02/2020 20:03	12/02/2020 21:06	1,04	692	719,68	CHI
2020021200034	PETROLINA DE GOIAS	SF13297418	SAO FRANCISCO DE GOIAS	12/02/2020 13:08	12/02/2020 22:09	12/02/2020 13:08	12/02/2020 21:36	8,48	87	737,91	CHI
2020021200034	PIRENOPOLIS	SF13297418	SAO FRANCISCO DE GOIAS	12/02/2020 13:08	12/02/2020 22:09	12/02/2020 13:08	12/02/2020 21:36	8,48	57	483,46	CHI
2020021200034	SAO FRANCISCO DE GOIAS	SF13297418	SAO FRANCISCO DE GOIAS	12/02/2020 13:08	12/02/2020 22:09	12/02/2020 13:08	12/02/2020 21:36	8,48	220	1865,97	CHI
2020021200034	PETROLINA DE GOIAS	PV13370485	SAO FRANCISCO DE GOIAS	12/02/2020 13:08	12/02/2020 22:09	12/02/2020 13:08	12/02/2020 22:09	9,02	13	117,24	CHI
2020021200034	PIRENOPOLIS	PV13370485	SAO FRANCISCO DE GOIAS	12/02/2020 13:08	12/02/2020 22:09	12/02/2020 13:08	12/02/2020 22:09	9,02	1178	10623,92	CHI
2020021200034	SAO FRANCISCO DE GOIAS	PV13370485	SAO FRANCISCO DE GOIAS	12/02/2020 13:08	12/02/2020 22:09	12/02/2020 13:08	12/02/2020 22:09	9,02	20	180,37	CHI
2020021200034	PIRENOPOLIS	PV13370485	SAO FRANCISCO DE GOIAS	12/02/2020 13:08	12/02/2020 22:09	12/02/2020 18:39	12/02/2020 22:09	3,50	6	20,98	CHI
2020021200034	PIRENOPOLIS	PV13370485	SAO FRANCISCO DE GOIAS	12/02/2020 13:08	12/02/2020 22:09	12/02/2020 21:44	12/02/2020 22:09	0,40	1	0,40	CHI
20200258185	IPORA	IR12358520	IPORA	12/02/2020 13:10	13/02/2020 10:06	12/02/2020 13:10	13/02/2020 10:06	20,93	10	209,30	CHI
20200258185	IVOLANDIA	IR12358520	IPORA	12/02/2020 13:10	13/02/2020 10:06	12/02/2020 13:10	13/02/2020 10:06	20,93	8	167,44	CHI

20200258960	CRISTALINA	KR12305272	CRISTALINA S2	12/02/2020 13:10	12/02/2020 16:47	12/02/2020 13:10	12/02/2020 16:47	3,61	11	39,74	CHI
20200258189	BELA VISTA DE GOIAS	XX10199020	BELA VISTA S2	12/02/2020 13:11	12/02/2020 18:00	12/02/2020 13:11	12/02/2020 18:00	4,82	12	57,79	CHI
20200258210	MINEIROS	MY12253766	PARQUE DAS EMAS	12/02/2020 13:14	13/02/2020 15:12	12/02/2020 13:14	13/02/2020 15:12	25,95	1	25,95	CHI
20200258224	FORMOSA	FA11363505	SAO JOAO D ALIANCA	12/02/2020 13:16	12/02/2020 20:58	12/02/2020 13:16	12/02/2020 20:58	7,69	2	15,37	CHI
20200258230	RUBIATABA	RB21120759	RUBIATABA	12/02/2020 13:17	12/02/2020 17:10	12/02/2020 13:17	12/02/2020 17:10	3,87	2	7,74	CHI
20200258237	JARAGUA	JA21059961	SAO FRANCISCO DE GOIAS	12/02/2020 13:18	12/02/2020 15:41	12/02/2020 13:18	12/02/2020 15:41	2,38	1	2,38	CHI
20200258244	PORANGATU	PO12378923	PORANGATU	12/02/2020 13:20	12/02/2020 15:47	12/02/2020 13:20	12/02/2020 15:47	2,44	2	4,89	CHI
20200258247	PALESTINA DE GOIAS	PY12374996	PALESTINA	12/02/2020 13:21	12/02/2020 15:20	12/02/2020 13:21	12/02/2020 15:20	1,98	4	7,92	CHI
20200258250	HIDROLANDIA	HD11037889	CEPAIGO S2	12/02/2020 13:21	12/02/2020 15:55	12/02/2020 13:21	12/02/2020 15:55	2,55	43	109,66	CHI
20200258251	PETROLINA DE GOIAS	PG21215186	PETROLINA	12/02/2020 13:22	13/02/2020 03:59	12/02/2020 13:22	13/02/2020 03:59	14,62	1	14,62	CHI
20200258256	RIO VERDE	QI12402316	QUIRINOPOLIS	12/02/2020 13:22	13/02/2020 09:22	12/02/2020 13:22	13/02/2020 09:22	19,99	3	59,96	CHI
20200258258	ITABERAI	IB12380752	ITABERAI S2	12/02/2020 13:23	12/02/2020 17:36	12/02/2020 13:23	12/02/2020 17:36	4,21	1	4,21	CHI
20200258260	IPAMERI	IP12404731	IPAMERI	12/02/2020 13:24	12/02/2020 14:31	12/02/2020 13:24	12/02/2020 14:31	1,12	7	7,81	CHI
20200258261	GOIANIA	GN11042139	ATLANTICO S1	12/02/2020 13:24	12/02/2020 16:04	12/02/2020 13:24	12/02/2020 16:04	2,66	150	399,54	CHI
20200258264	MONTIVIDIU	MV21189022	MONTIVIDIU T	12/02/2020 13:24	12/02/2020 16:52	12/02/2020 13:24	12/02/2020 16:52	3,45	2	6,91	CHI
20200258338	INDIARA	JD12272364	PALMEIRAS	12/02/2020 13:24	13/02/2020 07:19	12/02/2020 13:24	13/02/2020 07:19	17,90	5	89,52	CHI
20200258338	PALMEIRAS DE GOIAS	JD12272364	PALMEIRAS	12/02/2020 13:24	13/02/2020 07:19	12/02/2020 13:24	13/02/2020 07:19	17,90	21	376,00	CHI
20200258267	TRES RANCHOS	2170002784	CATALAO S1	12/02/2020 13:25	12/02/2020 22:44	12/02/2020 13:25	12/02/2020 22:44	9,31	1	9,31	CHI
20200258272	RIO VERDE	630030030	RIO VERDE S1	12/02/2020 13:25	13/02/2020 02:25	12/02/2020 13:25	13/02/2020 02:25	12,99	1	12,99	CHI
20200258277	APARECIDA DE GOIANIA	AP11050802	REAL S1	12/02/2020 13:26	12/02/2020 21:11	12/02/2020 13:26	12/02/2020 21:11	7,75	40	309,84	CHI
20200258282	MINACU	4020036537	MINACU	12/02/2020 13:27	12/02/2020 20:12	12/02/2020 13:27	12/02/2020 20:12	6,74	1	6,74	CHI
20200258288	OUVIDOR	TH21068466	CATALAO S1	12/02/2020 13:29	13/02/2020 08:33	12/02/2020 13:29	13/02/2020 08:33	19,06	1	19,06	CHI
20200258290	MORRINHOS	MR21000142	MORRINHOS	12/02/2020 13:29	12/02/2020 16:30	12/02/2020 13:29	12/02/2020 16:30	3,00	1	3,00	CHI
20200257286	CACHOEIRA ALTA	RV12227747	QUIRINOPOLIS	12/02/2020 13:30	13/02/2020 00:04	12/02/2020 20:43	13/02/2020 00:04	3,35	7	23,45	CHI
20200257286	RIO VERDE	RV12227747	QUIRINOPOLIS	12/02/2020 13:30	13/02/2020 00:04	12/02/2020 20:43	13/02/2020 00:04	3,35	3	10,05	CHI
20200258294	PALMEIRAS DE GOIAS	PL21241008	PALMEIRAS	12/02/2020 13:31	12/02/2020 16:06	12/02/2020 13:31	12/02/2020 16:06	2,58	1	2,58	CHI
20200258302	NOVA IGUACU DE GOIAS	MQ21013353	CAMPINORTE	12/02/2020 13:32	12/02/2020 15:25	12/02/2020 13:32	12/02/2020 15:25	1,88	1	1,88	CHI
20200258305	CALDAS NOVAS	760431024	SERRA DE CALDAS	12/02/2020 13:32	12/02/2020 15:45	12/02/2020 13:32	12/02/2020 15:45	2,21	1	2,21	CHI
20200258307	CRISTALINA	KR21305007	PAMPLONA	12/02/2020 13:33	12/02/2020 16:08	12/02/2020 13:33	12/02/2020 16:08	2,58	1	2,58	CHI
20200258311	PIRES DO RIO	BC12051685	PIRES DO RIO S2	12/02/2020 13:34	12/02/2020 19:09	12/02/2020 13:34	12/02/2020 19:09	5,58	54	301,11	CHI
20200258311	SANTA CRUZ DE GOIAS	BC12051685	PIRES DO RIO S2	12/02/2020 13:34	12/02/2020 19:09	12/02/2020 13:34	12/02/2020 19:09	5,58	26	144,98	CHI
20200258313	CACHOEIRA ALTA	10009552250	CACHOEIRA ALTA	12/02/2020 13:34	12/02/2020 17:27	12/02/2020 13:34	12/02/2020 17:27	3,88	1	3,88	CHI
20200258320	GOIANIA	17347257	MEIA PONTE	12/02/2020 13:36	12/02/2020 15:14	12/02/2020 13:36	12/02/2020 15:14	1,62	1	1,62	CHI

20200258818	MUNDO NOVO DE GOIAS	MH12125309	NOVA CRIXAS	12/02/2020 13:36	14/02/2020 12:35	12/02/2020 13:36	12/02/2020 23:37	10,03	2	20,06	CHI
20200258818	MUNDO NOVO DE GOIAS	NA13350035	NOVA CRIXAS	12/02/2020 13:36	14/02/2020 12:35	12/02/2020 13:36	14/02/2020 12:35	46,99	1	46,99	CHI
20200258818	NOVA CRIXAS	NA13350035	NOVA CRIXAS	12/02/2020 13:36	14/02/2020 12:35	12/02/2020 13:36	14/02/2020 12:35	46,99	3	140,97	CHI
202002191239	MINACU	IH10400794	MINACU	12/02/2020 13:37	12/02/2020 14:02	12/02/2020 13:37	12/02/2020 14:02	0,43	665	283,73	CHI
202002191239	TROMBAS	IH10400794	MINACU	12/02/2020 13:37	12/02/2020 14:02	12/02/2020 13:37	12/02/2020 14:02	0,43	6	2,56	CHI
20200258324	GOIANESIA	GE12381275	GOIANESIA S2	12/02/2020 13:38	12/02/2020 16:11	12/02/2020 13:38	12/02/2020 16:11	2,55	282	718,55	CHI
20200258326	PIRENOPOLIS	PV21403396	COCALZINHO	12/02/2020 13:38	12/02/2020 19:58	12/02/2020 13:38	12/02/2020 19:58	6,33	1	6,33	CHI
20200258331	ACREUNA	EU12026734	RIO DOS BOIS	12/02/2020 13:38	12/02/2020 19:23	12/02/2020 13:38	12/02/2020 19:23	5,74	18	103,23	CHI
20200258331	TURVELANDIA	EU12026734	RIO DOS BOIS	12/02/2020 13:38	12/02/2020 19:23	12/02/2020 13:38	12/02/2020 19:23	5,74	19	108,97	CHI
20200258349	ARUANA	03200434	ARUANA	12/02/2020 13:38	12/02/2020 15:00	12/02/2020 13:38	12/02/2020 15:00	1,37	8	10,96	CHI
20200258355	GOIANIA	GN11043939	CAMPINAS S2	12/02/2020 13:38	12/02/2020 16:38	12/02/2020 13:38	12/02/2020 16:38	2,99	174	519,97	CHI
20200258898	IPORA	IR12289241	IPORA	12/02/2020 13:38	13/02/2020 09:53	12/02/2020 13:38	13/02/2020 09:53	20,25	5	101,24	CHI
20200260379	PARANAIGUARA	PC12093843	QUIRINOPOLIS	12/02/2020 13:38	12/02/2020 22:25	12/02/2020 13:38	12/02/2020 22:25	8,78	2	17,55	CHI
20200258371	FORMOSA	FA12228229	SAO JOAO D ALIANCA	12/02/2020 13:39	12/02/2020 19:50	12/02/2020 13:39	12/02/2020 19:50	6,17	46	283,99	CHI
20200258339	SANTO ANTONIO DO DESCOBERTO	SN21290682	MARAJOARA	12/02/2020 13:40	13/02/2020 09:03	12/02/2020 13:40	13/02/2020 09:03	19,37	1	19,37	CHI
20200258340	ANAPOLIS	20951826	JUNDIAI S2	12/02/2020 13:40	12/02/2020 19:50	12/02/2020 13:40	12/02/2020 19:50	6,15	1	6,15	CHI
20200258346	PIRACANJUBA	PJ12068868	PIRACANJUBA	12/02/2020 13:41	12/02/2020 16:35	12/02/2020 13:41	12/02/2020 16:35	2,89	11	31,84	CHI
20200258360	GOIANIA	GN10394599	XAVANTES	12/02/2020 13:41	12/02/2020 23:02	12/02/2020 13:41	12/02/2020 23:02	9,34	387	3615,44	CHI
20200258351	CAMPOS BELOS	CH21218678	SAO DOMINGOS	12/02/2020 13:42	12/02/2020 15:32	12/02/2020 13:42	12/02/2020 15:32	1,82	1	1,82	CHI
20200258363	PIRANHAS	1930005250	PIRANHAS	12/02/2020 13:44	12/02/2020 15:22	12/02/2020 13:44	12/02/2020 15:22	1,63	1	1,63	CHI
20200258375	PIRACANJUBA	PJ21316613	PIRACANJUBA	12/02/2020 13:45	13/02/2020 07:26	12/02/2020 13:45	13/02/2020 07:26	17,67	1	17,67	CHI
20200258562	SANTO ANTONIO DO DESCOBERTO	SN12351060	ALEXANIA	12/02/2020 13:46	12/02/2020 16:38	12/02/2020 13:46	12/02/2020 16:38	2,86	3	8,58	CHI
20200258378	GOIANIRA	10030715529	MEIA PONTE	12/02/2020 13:47	12/02/2020 20:09	12/02/2020 13:47	12/02/2020 20:09	6,37	1	6,37	CHI
20200258382	FORMOSA	FA12392207	ITIQUEIRA	12/02/2020 13:49	12/02/2020 15:06	12/02/2020 13:49	12/02/2020 15:06	1,28	2	2,56	CHI
20200258388	NIQUELANDIA	NQ21348434	URUACU	12/02/2020 13:49	12/02/2020 21:33	12/02/2020 13:49	12/02/2020 21:33	7,72	6	46,31	CHI
20200258544	CABECEIRAS	CW12287236	ITIQUEIRA	12/02/2020 13:49	12/02/2020 17:52	12/02/2020 13:49	12/02/2020 17:52	4,04	17	68,61	CHI
20200258393	CAIAPONIA	CP21170351	CAIAPONIA	12/02/2020 13:51	12/02/2020 21:22	12/02/2020 13:51	12/02/2020 21:22	7,50	1	7,50	CHI
20200258522	GOIANIA	GN12373691	XAVANTES	12/02/2020 13:52	12/02/2020 20:46	12/02/2020 13:52	12/02/2020 20:46	6,89	57	392,68	CHI
20200258522	NEROPOLIS	GN12373691	XAVANTES	12/02/2020 13:52	12/02/2020 20:46	12/02/2020 13:52	12/02/2020 20:46	6,89	22	151,56	CHI
20200258398	URUACU	640045935	URUACU	12/02/2020 13:53	12/02/2020 18:31	12/02/2020 13:53	12/02/2020 18:31	4,63	1	4,63	CHI
20200258400	ALEXANIA	AX12313335	ALEXANIA	12/02/2020 13:54	12/02/2020 20:27	12/02/2020 13:54	12/02/2020 20:27	6,55	1	6,55	CHI
20200258503	FLORES DE GOIAS	FB12045259	IACIARA S2	12/02/2020 13:54	12/02/2020 14:54	12/02/2020 13:54	12/02/2020 14:54	0,99	411	407,23	CHI
20200258503	SITIO D ABADIA	FB12045259	IACIARA S2	12/02/2020 13:54	12/02/2020 14:54	12/02/2020 13:54	12/02/2020 14:54	0,99	118	116,92	CHI

20200258512	PONTALINA	10004483560	PONTALINA	12/02/2020 13:58	12/02/2020 17:07	12/02/2020 13:58	12/02/2020 17:07	3,15	1	3,15	CHI
20200258517	BELA VISTA DE GOIAS	BV32028722	BELA VISTA S1	12/02/2020 13:59	12/02/2020 20:54	12/02/2020 13:59	12/02/2020 20:54	6,91	15	103,70	CHI
20200258518	JATAI	JT12205193	JATAI S1	12/02/2020 13:59	13/02/2020 08:00	12/02/2020 13:59	13/02/2020 08:00	18,02	1	18,02	CHI
20200258520	BURITI DE GOIAS	BS12376378	FIRMINOPOLIS S2	12/02/2020 13:59	12/02/2020 17:20	12/02/2020 13:59	12/02/2020 17:20	3,34	1	3,34	CHI
20200258521	GOIAS	GS12037486	ITABERAÍ S1	12/02/2020 13:59	12/02/2020 14:51	12/02/2020 13:59	12/02/2020 14:51	0,85	5	4,25	CHI
20200258525	PARAUNA	PU12301167	ACREUNA	12/02/2020 14:01	12/02/2020 19:41	12/02/2020 14:01	12/02/2020 19:41	5,66	14	79,30	CHI
20200258528	SANTA CRUZ DE GOIAS	BC12023183	CRISTIANOPOLIS	12/02/2020 14:02	12/02/2020 19:21	12/02/2020 14:02	12/02/2020 19:21	5,32	43	228,78	CHI
20200258529	SANTO ANTONIO DO DESCOBERTO	SN12305099	ALEXANIA	12/02/2020 14:03	13/02/2020 10:14	12/02/2020 14:03	13/02/2020 10:14	20,18	4	80,73	CHI
20200258541	GOIANIA	GN11059678	XAVANTES	12/02/2020 14:03	12/02/2020 15:47	12/02/2020 14:03	12/02/2020 15:47	1,72	88	151,19	CHI
20200259475	RIO VERDE	RV12172877	CABRIUVA S2	12/02/2020 14:03	12/02/2020 23:53	12/02/2020 14:03	12/02/2020 23:53	9,83	11	108,15	CHI
20200260349	CAMPO LIMPO	AN12267847	NEROPOLIS S1	12/02/2020 14:03	12/02/2020 17:52	12/02/2020 14:03	12/02/2020 17:52	3,81	59	224,74	CHI
20200258545	OURO VERDE DE GOIAS	NR21011607	NEROPOLIS S2	12/02/2020 14:05	12/02/2020 18:57	12/02/2020 14:05	12/02/2020 18:57	4,86	3	14,57	CHI
20200258547	ALEXANIA	AX21185102	CORUMBA	12/02/2020 14:05	13/02/2020 11:33	12/02/2020 14:05	13/02/2020 11:33	21,46	1	21,46	CHI
20200258551	POSSE	SA12211553	IACIARA S2	12/02/2020 14:06	12/02/2020 16:37	12/02/2020 14:06	12/02/2020 16:37	2,52	27	67,95	CHI
20200258551	SIMOLANDIA	SA12211553	IACIARA S2	12/02/2020 14:06	12/02/2020 16:37	12/02/2020 14:06	12/02/2020 16:37	2,52	37	93,12	CHI
20200258553	INHUMAS	30122673	INHUMAS S2	12/02/2020 14:06	13/02/2020 00:48	12/02/2020 14:06	13/02/2020 00:48	10,70	1	10,70	CHI
20200258554	FAINA	FC11037764	GOIAS	12/02/2020 14:06	12/02/2020 21:15	12/02/2020 14:06	12/02/2020 21:15	7,14	38	271,37	CHI
20200258601	ITAJA	2300018889	ITAJA S2	12/02/2020 14:06	12/02/2020 15:11	12/02/2020 14:06	12/02/2020 15:11	1,07	1	1,07	CHI
20200258559	CABECEIRAS	CW21181839	ITIQUEIRA	12/02/2020 14:08	12/02/2020 20:26	12/02/2020 14:08	12/02/2020 20:26	6,30	1	6,30	CHI
20200258560	ALTO PARAISO DE GOIAS	BF21336774	FLORES DE GOIAS	12/02/2020 14:08	12/02/2020 14:56	12/02/2020 14:08	12/02/2020 14:56	0,79	1	0,79	CHI
20200259355	ACREUNA	JD12255748	ACREUNA	12/02/2020 14:08	12/02/2020 17:35	12/02/2020 14:08	12/02/2020 17:35	3,44	5	17,19	CHI
20200259355	JANDAIA	JD12255748	ACREUNA	12/02/2020 14:08	12/02/2020 17:35	12/02/2020 14:08	12/02/2020 17:35	3,44	1	3,44	CHI
20200258566	ITABERAÍ	IB21900002	ITABERAÍ S1	12/02/2020 14:09	12/02/2020 19:05	12/02/2020 14:09	12/02/2020 19:05	4,93	1	4,93	CHI
20200258570	CALDAZINHA	10008556219	CEPAIGO S2	12/02/2020 14:10	12/02/2020 17:08	12/02/2020 14:10	12/02/2020 17:08	2,96	1	2,96	CHI
20200258579	BOM JARDIM DE GOIAS	BM12256610	BOM JARDIM	12/02/2020 14:10	12/02/2020 19:47	12/02/2020 14:10	12/02/2020 19:47	5,61	3	16,84	CHI
20200258573	IACIARA	10000700493	IACIARA S1	12/02/2020 14:11	12/02/2020 16:00	12/02/2020 14:11	12/02/2020 16:00	1,80	1	1,80	CHI
20200258812	GOIANIA	GN16413781	AEROPORTO S1	12/02/2020 14:12	12/02/2020 17:20	12/02/2020 14:43	12/02/2020 15:20	0,63	802	501,92	CHI
20200258812	GOIANIA	02400264	AEROPORTO S1	12/02/2020 14:12	12/02/2020 17:20	12/02/2020 14:43	12/02/2020 15:22	0,65	490	316,19	CHI
20200258812	GOIANIA	19987245	AEROPORTO S1	12/02/2020 14:12	12/02/2020 17:20	12/02/2020 14:43	12/02/2020 17:20	2,61	704	1840,37	CHI
20200258584	FORMOSA	FA12000130	ITIQUEIRA	12/02/2020 14:14	12/02/2020 16:53	12/02/2020 14:14	12/02/2020 16:53	2,63	14	36,87	CHI
20200258593	CAIAPONIA	CP21340106	PALESTINA	12/02/2020 14:15	13/02/2020 15:55	12/02/2020 14:15	13/02/2020 15:55	25,65	1	25,65	CHI
20200258810	ANAPOLIS	AN12335072	ANAPOLIS UNIVERSITARIO S2	12/02/2020 14:15	12/02/2020 17:28	12/02/2020 14:15	12/02/2020 17:28	3,21	11	35,34	CHI
20200259335	ITUMBIARA	IT12000308RE	PARANAIBA	12/02/2020 14:15	12/02/2020 15:35	12/02/2020 14:15	12/02/2020 15:35	1,32	92	121,31	CHI

20200258808	CORUMBA DE GOIAS	CB21382156	CORUMBA	12/02/2020 14:19	13/02/2020 08:39	12/02/2020 14:19	13/02/2020 08:39	18,33	1	18,33	CHI
20200258820	GOIANIA	GN11272034	GOYA S1	12/02/2020 14:20	12/02/2020 15:47	12/02/2020 14:20	12/02/2020 15:47	1,44	29	41,88	CHI
20200258826	MIMOSO DE GOIAS	MJ12313854	PADRE BERNARDO	12/02/2020 14:22	12/02/2020 15:47	12/02/2020 14:22	12/02/2020 15:47	1,41	19	26,87	CHI
20200258833	GOIANIA	GN11058033	GOYA S1	12/02/2020 14:22	12/02/2020 16:21	12/02/2020 14:22	12/02/2020 16:21	1,97	64	126,35	CHI
20200258850	APARECIDA DE GOIANIA	AP11003012	ANHANGUERA	12/02/2020 14:22	12/02/2020 16:55	12/02/2020 14:22	12/02/2020 16:55	2,54	38	96,40	CHI
20200258884	ANAPOLIS	AN12258718	JUNDIAI S2	12/02/2020 14:22	12/02/2020 17:14	12/02/2020 14:22	12/02/2020 17:14	2,86	21	60,09	CHI
20200258838	LUZIANIA	LZ21013823	VIANOPOLIS	12/02/2020 14:23	12/02/2020 19:24	12/02/2020 14:23	12/02/2020 19:24	5,01	1	5,01	CHI
20200258839	RIO VERDE	RV12305757	MONTIVIDIU T	12/02/2020 14:23	12/02/2020 17:28	12/02/2020 14:23	12/02/2020 17:28	3,07	5	15,35	CHI
20200258840	ITAGUARI	II11049701	ITABERAI S1	12/02/2020 14:23	12/02/2020 15:56	12/02/2020 14:23	12/02/2020 15:56	1,54	194	298,11	CHI
20200258842	CAMPO LIMPO	AN21351237	NEROPOLIS S1	12/02/2020 14:24	12/02/2020 17:17	12/02/2020 14:24	12/02/2020 17:17	2,87	3	8,61	CHI
20200258844	PIRENOPOLIS	PV21135433	CORUMBA	12/02/2020 14:25	12/02/2020 18:44	12/02/2020 14:25	12/02/2020 18:44	4,31	1	4,31	CHI
20200258845	CRIXAS	CX12201610	SANTA TEREZINHA	12/02/2020 14:25	12/02/2020 20:13	12/02/2020 14:25	12/02/2020 20:13	5,79	160	926,71	CHI
20200258852	ITUMBIARA	BG21066350	ALTO BURITI	12/02/2020 14:27	12/02/2020 17:40	12/02/2020 14:27	12/02/2020 17:40	3,21	1	3,21	CHI
20200258853	ABADIANIA	350021430	ANAPOLIS UNIVERSITARIO S1	12/02/2020 14:27	12/02/2020 19:07	12/02/2020 14:27	12/02/2020 19:07	4,66	1	4,66	CHI
20200258856	ITAJA	IJ21131583	ITAJA S2	12/02/2020 14:27	12/02/2020 15:44	12/02/2020 14:27	12/02/2020 15:44	1,27	2	2,54	CHI
20200258857	MUTUNOPOLIS	MU12060992	MARA ROSA	12/02/2020 14:28	12/02/2020 17:00	12/02/2020 14:28	12/02/2020 17:00	2,53	3	7,59	CHI
20200258858	SANTO ANTONIO DO DESCOBERTO	SN21341317	AGUAS LINDAS DE GOIAS S2	12/02/2020 14:28	12/02/2020 18:33	12/02/2020 14:28	12/02/2020 18:33	4,08	1	4,08	CHI
20200260249	ABADIANIA	AA11285341	ANAPOLIS UNIVERSITARIO S1	12/02/2020 14:28	12/02/2020 18:04	12/02/2020 14:28	12/02/2020 18:04	3,58	96	344,11	CHI
20200258860	ITABERAI	IB21000027	ITABERAI S2	12/02/2020 14:29	12/02/2020 15:24	12/02/2020 14:29	12/02/2020 15:24	0,91	1	0,91	CHI
20200258862	AGUAS LINDAS DE GOIAS	LA11342912	AGUAS LINDAS DE GOIAS S2	12/02/2020 14:29	12/02/2020 17:30	12/02/2020 14:29	12/02/2020 17:30	3,01	43	129,33	CHI
20200258863	APORE	AE12107317	ITAJA S1	12/02/2020 14:29	13/02/2020 00:10	12/02/2020 14:29	13/02/2020 00:10	9,67	4	38,68	CHI
20200258866	ITABERAI	10001223060	ITABERAI S2	12/02/2020 14:30	12/02/2020 15:57	12/02/2020 14:30	12/02/2020 15:57	1,44	1	1,44	CHI
20200258882	CRISTIANOPOLIS	470013540	CRISTIANOPOLIS	12/02/2020 14:32	13/02/2020 06:41	12/02/2020 14:32	13/02/2020 06:41	16,14	1	16,14	CHI
20200258889	PLANALTINA	10029953420	PLANALTINA	12/02/2020 14:34	12/02/2020 17:03	12/02/2020 14:34	12/02/2020 17:03	2,48	1	2,48	CHI
20200258892	ANAPOLIS	20763815	ANAPOLIS UNIVERSITARIO S1	12/02/2020 14:35	12/02/2020 16:29	12/02/2020 14:35	12/02/2020 16:29	1,90	1	1,90	CHI
20200258975	PIRES DO RIO	PR12080258RE	URUTAI	12/02/2020 14:35	12/02/2020 16:50	12/02/2020 14:35	12/02/2020 16:50	2,24	8	17,90	CHI
20200258975	URUTAI	PR12080258RE	URUTAI	12/02/2020 14:35	12/02/2020 16:50	12/02/2020 14:35	12/02/2020 16:50	2,24	56	125,27	CHI
20200258905	ALEXANIA	AX12095958	CORUMBA	12/02/2020 14:37	13/02/2020 11:33	12/02/2020 14:37	13/02/2020 11:33	20,92	5	104,60	CHI
20200258905	CORUMBA DE GOIAS	AX12095958	CORUMBA	12/02/2020 14:37	13/02/2020 11:33	12/02/2020 14:37	13/02/2020 11:33	20,92	3	62,76	CHI
20200258906	MIMOSO DE GOIAS	PB12333289	PADRE BERNARDO	12/02/2020 14:37	12/02/2020 19:50	12/02/2020 14:37	12/02/2020 19:50	5,20	47	244,50	CHI
20200258906	PADRE BERNARDO	PB12333289	PADRE BERNARDO	12/02/2020 14:37	12/02/2020 19:50	12/02/2020 14:37	12/02/2020 19:50	5,20	5	26,01	CHI
20200259768	CAMPINORTE	CR12164041	MARA ROSA	12/02/2020 14:37	12/02/2020 18:52	12/02/2020 14:37	12/02/2020 18:52	4,24	15	63,58	CHI
20200259768	URUACU	CR12164041	MARA ROSA	12/02/2020 14:37	12/02/2020 18:52	12/02/2020 14:37	12/02/2020 18:52	4,24	4	16,96	CHI

20200258916	BELA VISTA DE GOIAS	SQ12338141	CRISTIANOPOLIS	12/02/2020 14:39	12/02/2020 20:15	12/02/2020 14:39	12/02/2020 20:15	5,59	3	16,78	CHI
20200258916	SAO MIGUEL DO PASSA QUATRO	SQ12338141	CRISTIANOPOLIS	12/02/2020 14:39	12/02/2020 20:15	12/02/2020 14:39	12/02/2020 20:15	5,59	114	637,55	CHI
20200259364	GOIANIA	GN11000400	FERROVIARIO S1	12/02/2020 14:39	12/02/2020 16:39	12/02/2020 14:39	12/02/2020 16:39	1,99	113	224,40	CHI
20200258922	AGUAS LINDAS DE GOIAS	4830414626	AGUAS LINDAS DE GOIAS S2	12/02/2020 14:40	12/02/2020 16:11	12/02/2020 14:40	12/02/2020 16:11	1,51	1	1,51	CHI
20200258924	ACREUNA	2440040405	ACREUNA	12/02/2020 14:40	12/02/2020 20:02	12/02/2020 14:40	12/02/2020 20:02	5,36	1	5,36	CHI
20200260127	JATAI	JT12182066	JATAI S1	12/02/2020 14:40	12/02/2020 19:29	12/02/2020 14:40	12/02/2020 19:29	4,81	23	110,71	CHI
20200260138	GOIANIA	GN11000973	CAMPINAS S1	12/02/2020 14:40	13/02/2020 00:02	12/02/2020 14:40	13/02/2020 00:02	9,36	62	580,27	CHI
20200258927	HEITORAI	HE12310819	ITAPURANGA	12/02/2020 14:41	12/02/2020 18:09	12/02/2020 14:41	12/02/2020 18:09	3,47	10	34,66	CHI
20200258927	ITAGUARU	HE12310819	ITAPURANGA	12/02/2020 14:41	12/02/2020 18:09	12/02/2020 14:41	12/02/2020 18:09	3,47	11	38,12	CHI
20200258953	GOIANIA	13959270	REAL S2	12/02/2020 14:45	12/02/2020 22:06	12/02/2020 14:45	12/02/2020 22:06	7,34	1	7,34	CHI
20200258955	GOIAS	GS12206944	ITABERAI S1	12/02/2020 14:45	12/02/2020 17:02	12/02/2020 14:45	12/02/2020 17:02	2,27	1	2,27	CHI
20200258956	ITABERAI	IB21158791	ITABERAI S2	12/02/2020 14:45	13/02/2020 00:02	12/02/2020 14:45	13/02/2020 00:02	9,27	1	9,27	CHI
20200259273	GOIANIA	GN12000153	REAL S2	12/02/2020 14:45	12/02/2020 21:57	12/02/2020 14:45	12/02/2020 21:57	7,21	540	3892,80	CHI
20200258710	GOIANIA	GN11226807	ATLANTICO S1	12/02/2020 14:47	12/02/2020 16:38	12/02/2020 14:47	12/02/2020 16:38	1,84	65	119,89	CHI
20200258967	POSSE	PS12344418	IACIARA S1	12/02/2020 14:48	14/02/2020 14:35	12/02/2020 14:48	12/02/2020 19:34	4,76	14	66,64	CHI
20200258967	POSSE	PS12344418	IACIARA S1	12/02/2020 14:48	14/02/2020 14:35	12/02/2020 14:48	14/02/2020 14:35	47,77	27	1289,84	CHI
20200258968	VILA PROPICIO	NQ21256618	BARRO ALTO	12/02/2020 14:48	13/02/2020 15:58	12/02/2020 14:48	13/02/2020 15:58	25,16	1	25,16	CHI
20200259206	TRINDADE	TR11162122	TRINDADE	12/02/2020 14:51	12/02/2020 16:11	12/02/2020 14:51	12/02/2020 16:11	1,33	164	218,03	CHI
20200259207	ALTO PARAISO DE GOIAS	BF12129943	FLORES DE GOIAS	12/02/2020 14:51	12/02/2020 17:36	12/02/2020 14:51	12/02/2020 17:36	2,74	1	2,74	CHI
20200259340	GOIANIA	GN11313045	CAMPINAS S1	12/02/2020 14:51	12/02/2020 21:29	12/02/2020 14:51	12/02/2020 21:29	6,63	56	371,40	CHI
20200259212	GOIANIA	16431753	CAMPINAS S3	12/02/2020 14:52	12/02/2020 19:52	12/02/2020 14:52	12/02/2020 19:52	4,99	1	4,99	CHI
20200259218	RIO VERDE	10030934999	RIO VERDE S1	12/02/2020 14:54	13/02/2020 09:41	12/02/2020 14:54	13/02/2020 09:41	18,77	1	18,77	CHI
20200259219	CORUMBA DE GOIAS	SN12376780	ALEXANIA	12/02/2020 14:54	12/02/2020 17:24	12/02/2020 14:54	12/02/2020 17:24	2,48	13	32,30	CHI
20200259219	SANTO ANTONIO DO DESCOBERTO	SN12376780	ALEXANIA	12/02/2020 14:54	12/02/2020 17:24	12/02/2020 14:54	12/02/2020 17:24	2,48	16	39,76	CHI
20200259229	NOVA CRIXAS	NA12397493	NOVA CRIXAS	12/02/2020 14:55	14/02/2020 09:20	12/02/2020 14:55	14/02/2020 09:20	42,42	17	721,18	CHI
20200259247	SAO MIGUEL DO PASSA QUATRO	SQ12231382	CRISTIANOPOLIS	12/02/2020 14:55	12/02/2020 19:56	12/02/2020 14:55	12/02/2020 19:56	5,00	44	220,13	CHI
20200260224	CRIXAS	CX12145544	RUBIATABA	12/02/2020 14:55	13/02/2020 11:19	12/02/2020 14:55	13/02/2020 11:19	20,39	101	2059,47	CHI
20200260224	NOVA CRIXAS	CX12145544	RUBIATABA	12/02/2020 14:55	13/02/2020 11:19	12/02/2020 14:55	13/02/2020 11:19	20,39	1	20,39	CHI
20200259241	POSSE	1480055673	IACIARA S2	12/02/2020 14:56	12/02/2020 15:37	12/02/2020 14:56	12/02/2020 15:37	0,67	1	0,67	CHI
20200259392	PETROLINA DE GOIAS	PG12297931	PETROLINA	12/02/2020 14:56	13/02/2020 19:00	12/02/2020 14:56	13/02/2020 01:04	10,13	105	1064,15	CHI
20200259392	SAO FRANCISCO DE GOIAS	PG12297931	PETROLINA	12/02/2020 14:56	13/02/2020 19:00	12/02/2020 14:56	13/02/2020 01:04	10,13	1	10,13	CHI
20200259392	PETROLINA DE GOIAS	PG12017516	PETROLINA	12/02/2020 14:56	13/02/2020 19:00	12/02/2020 14:56	13/02/2020 01:43	10,78	6	64,65	CHI
20200259392	PETROLINA DE GOIAS	PG12297931	PETROLINA	12/02/2020 14:56	13/02/2020 19:00	12/02/2020 14:56	13/02/2020 07:41	16,74	5	83,70	CHI

20200259392	PETROLINA DE GOIAS	PG12017516	PETROLINA	12/02/2020 14:56	13/02/2020 19:00	13/02/2020 07:13	13/02/2020 19:00	11,78	6	70,66	CHI
20200259392	PETROLINA DE GOIAS	PG12015875LD	PETROLINA	12/02/2020 14:56	13/02/2020 19:00	13/02/2020 11:45	13/02/2020 19:00	7,25	118	855,50	CHI
20200259392	SAO FRANCISCO DE GOIAS	PG12015875LD	PETROLINA	12/02/2020 14:56	13/02/2020 19:00	13/02/2020 11:45	13/02/2020 19:00	7,25	1	7,25	CHI
20200259864	GOIANESIA	GE11000066	GOIANESIA S2	12/02/2020 14:56	12/02/2020 18:18	12/02/2020 14:56	12/02/2020 18:18	3,37	46	154,83	CHI
20200259243	CRIXAS	CX12236026	SERRA DO OURO	12/02/2020 14:57	12/02/2020 17:01	12/02/2020 14:57	12/02/2020 17:01	2,06	7	14,44	CHI
20200259250	FORMOSA	FA12062329	ITIQUEIRA	12/02/2020 14:57	13/02/2020 15:19	12/02/2020 14:57	13/02/2020 15:19	24,37	7	170,57	CHI
20200259254	BELA VISTA DE GOIAS	CF12300739	CRISTIANOPOLIS	12/02/2020 14:58	14/02/2020 01:31	12/02/2020 14:58	12/02/2020 18:07	3,15	40	126,17	CHI
20200259254	CRISTIANOPOLIS	CF12300739	CRISTIANOPOLIS	12/02/2020 14:58	14/02/2020 01:31	12/02/2020 14:58	12/02/2020 18:07	3,15	24	75,70	CHI
20200259254	SAO MIGUEL DO PASSA QUATRO	CF12300739	CRISTIANOPOLIS	12/02/2020 14:58	14/02/2020 01:31	12/02/2020 14:58	12/02/2020 18:07	3,15	5	15,77	CHI
20200259254	BELA VISTA DE GOIAS	CF12300739	CRISTIANOPOLIS	12/02/2020 14:58	14/02/2020 01:31	12/02/2020 18:14	12/02/2020 19:35	1,35	11	14,88	CHI
20200259254	CRISTIANOPOLIS	CF12300739	CRISTIANOPOLIS	12/02/2020 14:58	14/02/2020 01:31	12/02/2020 18:14	12/02/2020 19:35	1,35	18	24,35	CHI
20200259254	BELA VISTA DE GOIAS	BV13203244	CRISTIANOPOLIS	12/02/2020 14:58	14/02/2020 01:31	12/02/2020 18:14	12/02/2020 21:03	2,81	18	50,61	CHI
20200259254	CRISTIANOPOLIS	BV13203244	CRISTIANOPOLIS	12/02/2020 14:58	14/02/2020 01:31	12/02/2020 18:14	12/02/2020 21:03	2,81	6	16,87	CHI
20200259254	BELA VISTA DE GOIAS	SQ12363932LD	CRISTIANOPOLIS	12/02/2020 14:58	14/02/2020 01:31	12/02/2020 18:14	14/02/2020 01:31	31,29	11	344,14	CHI
20200259254	SAO MIGUEL DO PASSA QUATRO	SQ12363932LD	CRISTIANOPOLIS	12/02/2020 14:58	14/02/2020 01:31	12/02/2020 18:14	14/02/2020 01:31	31,29	5	156,43	CHI
20200259266	VILA BOA	FA12153225	IACIARA S2	12/02/2020 14:58	12/02/2020 17:42	12/02/2020 14:58	12/02/2020 17:42	2,73	31	84,49	CHI
20200259268	FAINA	FC11194571	GOIAS	12/02/2020 14:58	12/02/2020 15:54	12/02/2020 14:58	12/02/2020 15:54	0,92	2	1,84	CHI
20200259270	GUARINOS	10025379354	SANTA TEREZINHA	12/02/2020 14:59	12/02/2020 17:42	12/02/2020 14:59	12/02/2020 17:42	2,71	1	2,71	CHI
20200259279	GOIANIA	GN11040729	AEROPORTO S1	12/02/2020 15:00	13/02/2020 01:51	12/02/2020 15:00	13/02/2020 01:51	10,84	28	303,46	CHI
20200259282	FORMOSA	FA12381543	ITIQUEIRA	12/02/2020 15:01	12/02/2020 22:53	12/02/2020 15:01	12/02/2020 21:09	6,13	3	18,39	CHI
20200259282	FORMOSA	FA12381543	ITIQUEIRA	12/02/2020 15:01	12/02/2020 22:53	12/02/2020 15:01	12/02/2020 22:53	7,87	1	7,87	CHI
20200259283	IPAMERI	IP21157433	IPAMERI	12/02/2020 15:01	13/02/2020 13:03	12/02/2020 15:01	13/02/2020 13:03	22,02	1	22,02	CHI
20200259285	ITAJA	IJ21161279	ITAJA S2	12/02/2020 15:03	12/02/2020 16:42	12/02/2020 15:03	12/02/2020 16:42	1,65	1	1,65	CHI
20200259286	GOIANIA	GN11002032	GOIANIA LESTE S3	12/02/2020 15:03	12/02/2020 21:38	12/02/2020 15:03	12/02/2020 21:38	6,57	149	979,47	CHI
20200259289	BRITANIA	BT11252614	BRITANIA	12/02/2020 15:04	12/02/2020 20:00	12/02/2020 15:04	12/02/2020 20:00	4,93	222	1095,26	CHI
20200259293	SAO MIGUEL DO PASSA QUATRO	SQ21128967	CRISTIANOPOLIS	12/02/2020 15:04	13/02/2020 07:39	12/02/2020 15:04	13/02/2020 07:39	16,58	1	16,58	CHI
20200259294	AGUA FRIA DE GOIAS	NQ12140182	SAO JOAO D ALIANCA	12/02/2020 15:04	12/02/2020 21:33	12/02/2020 15:04	12/02/2020 21:33	6,48	68	440,36	CHI
20200259294	NIQUELANDIA	NQ12140182	SAO JOAO D ALIANCA	12/02/2020 15:04	12/02/2020 21:33	12/02/2020 15:04	12/02/2020 21:33	6,48	6	38,85	CHI
20200259307	POSSE	PS12255419	IACIARA S2	12/02/2020 15:06	12/02/2020 18:14	12/02/2020 15:06	12/02/2020 18:14	3,13	12	37,59	CHI
20200260136	ITAUCU	AR12376846	ARACU	12/02/2020 15:06	12/02/2020 19:59	12/02/2020 15:06	12/02/2020 19:59	4,88	9	43,90	CHI
20200259777	GOIANIRA	GR11273554	GOIANIRA	12/02/2020 15:07	12/02/2020 17:24	12/02/2020 15:07	12/02/2020 17:24	2,29	93	212,69	CHI
20200259322	SANTO ANTONIO DO DESCOBERTO	SN21103505	ALEXANIA	12/02/2020 15:08	12/02/2020 18:22	12/02/2020 15:08	12/02/2020 18:22	3,23	1	3,23	CHI
20200259324	GOIATUBA	GT21044615	BOM JESUS DE GOIAS	12/02/2020 15:08	12/02/2020 20:10	12/02/2020 15:08	12/02/2020 20:10	5,02	1	5,02	CHI

20200259329	BELA VISTA DE GOIAS	BV12011713	BELA VISTA S1	12/02/2020 15:09	12/02/2020 17:20	12/02/2020 15:09	12/02/2020 17:20	2,18	14	30,52	CHI
202002191204	GOIANESIA	GE12115059	GOIANESIA S2	12/02/2020 15:10	12/02/2020 16:50	12/02/2020 15:10	12/02/2020 16:50	1,66	1	1,66	CHI
20200259338	PORTELANDIA	PW21302971	PARQUE DAS EMAS	12/02/2020 15:11	12/02/2020 22:27	12/02/2020 15:11	12/02/2020 22:27	7,26	1	7,26	CHI
20200259341	FORMOSA	FA12204777	ITUIQUIRA	12/02/2020 15:12	12/02/2020 18:34	12/02/2020 15:12	12/02/2020 18:34	3,36	2	6,73	CHI
20200260192	BARRO ALTO	DF12194371	BARRO ALTO	12/02/2020 15:13	12/02/2020 19:33	12/02/2020 15:13	12/02/2020 19:33	4,32	67	289,27	CHI
20200260192	SANTA RITA DO NOVO DESTINO	DF12194371	BARRO ALTO	12/02/2020 15:13	12/02/2020 19:33	12/02/2020 15:13	12/02/2020 19:33	4,32	33	142,48	CHI
20200260711	GOIATUBA	BJ12062735	BOM JESUS DE GOIAS	12/02/2020 15:14	12/02/2020 22:35	12/02/2020 15:14	12/02/2020 22:35	7,34	3	22,03	CHI
20200261118	ITAGUARU	JA12027826	JARAGUA	12/02/2020 15:15	12/02/2020 22:22	12/02/2020 15:15	12/02/2020 22:22	7,11	9	63,96	CHI
20200261118	JARAGUA	JA12027826	JARAGUA	12/02/2020 15:15	12/02/2020 22:22	12/02/2020 15:15	12/02/2020 22:22	7,11	18	127,93	CHI
20200259361	TROMBAS	2560013594	PORANGATU	12/02/2020 15:16	12/02/2020 18:47	12/02/2020 15:16	12/02/2020 18:47	3,51	1	3,51	CHI
20200259362	PETROLINA DE GOIAS	PG12061713	PETROLINA	12/02/2020 15:16	12/02/2020 20:37	12/02/2020 15:16	12/02/2020 20:37	5,34	5	26,68	CHI
20200259775	ITAUCU	IX12000021	INHUMAS S1	12/02/2020 15:16	12/02/2020 17:00	12/02/2020 15:16	12/02/2020 17:00	1,73	14	24,24	CHI
20200259775	TAQUARAL DE GOIAS	IX12000021	INHUMAS S1	12/02/2020 15:16	12/02/2020 17:00	12/02/2020 15:16	12/02/2020 17:00	1,73	7	12,12	CHI
20200262415	NIQUELANDIA	4360001904	URUACU	12/02/2020 15:16	13/02/2020 17:15	12/02/2020 15:16	13/02/2020 17:15	25,97	1	25,97	CHI
20200259365	CAMPOS VERDES	VD12055156	SANTA TEREZINHA	12/02/2020 15:17	12/02/2020 17:27	12/02/2020 15:17	12/02/2020 17:27	2,15	4	8,62	CHI
20200259375	ITAGUARI	770013077	ITABERAI S1	12/02/2020 15:18	12/02/2020 17:59	12/02/2020 15:18	12/02/2020 17:59	2,67	1	2,67	CHI
20200259377	MORRINHOS	MR21240035	MORRINHOS	12/02/2020 15:18	12/02/2020 17:20	12/02/2020 15:18	12/02/2020 17:20	2,03	1	2,03	CHI
20200259381	CRIXAS	CX12202067	SERRA DO OURO	12/02/2020 15:19	12/02/2020 21:25	12/02/2020 15:19	12/02/2020 21:25	6,10	1	6,10	CHI
20200259383	GOIANESIA	10013791921	GOIANESIA S2	12/02/2020 15:20	12/02/2020 20:31	12/02/2020 15:20	12/02/2020 20:31	5,20	1	5,20	CHI
20200259391	MINACU	IH12088797	MINACU	12/02/2020 15:20	12/02/2020 17:45	12/02/2020 15:20	12/02/2020 17:45	2,40	162	389,57	CHI
20200259395	SANTA RITA DO NOVO DESTINO	1330000708	GOIANESIA S1	12/02/2020 15:21	13/02/2020 11:01	12/02/2020 15:21	13/02/2020 11:01	19,67	1	19,67	CHI
20200259724	PIRENOPOLIS	SF12211811	CORUMBA	12/02/2020 15:22	13/02/2020 15:14	12/02/2020 15:22	13/02/2020 15:14	23,86	26	620,42	CHI
20200259724	SAO FRANCISCO DE GOIAS	SF12211811	CORUMBA	12/02/2020 15:22	13/02/2020 15:14	12/02/2020 15:22	13/02/2020 15:14	23,86	2	47,72	CHI
20200259408	QUIRINOPOLIS	QI21213258	QUIRINOPOLIS	12/02/2020 15:24	12/02/2020 19:23	12/02/2020 15:24	12/02/2020 19:23	3,97	1	3,97	CHI
20200259424	GOIANIA	GN11281239	GOIANIA LESTE S3	12/02/2020 15:27	12/02/2020 16:23	12/02/2020 15:27	12/02/2020 16:23	0,93	49	45,35	CHI
20200259430	ITABERAI	IB21310639	ITABERAI S2	12/02/2020 15:28	12/02/2020 16:42	12/02/2020 15:28	12/02/2020 16:42	1,22	1	1,22	CHI
20200259431	NOVA ROMA	ND12392246B	IACIARA S2	12/02/2020 15:29	12/02/2020 16:46	12/02/2020 15:29	12/02/2020 16:46	1,28	8	10,27	CHI
20200259431	SAO DOMINGOS	ND12392246B	IACIARA S2	12/02/2020 15:29	12/02/2020 16:46	12/02/2020 15:29	12/02/2020 16:46	1,28	3	3,85	CHI
20200259440	CRISTALINA	KR12389576	CRISTALINA S2	12/02/2020 15:30	12/02/2020 20:32	12/02/2020 15:30	12/02/2020 20:32	5,03	38	191,01	CHI
20200259445	GOIAS	04850216	GOIAS	12/02/2020 15:30	12/02/2020 18:36	12/02/2020 15:30	12/02/2020 18:36	3,09	178	549,28	CHI
20200259445	GUARAITA	04850216	GOIAS	12/02/2020 15:30	12/02/2020 18:36	12/02/2020 15:30	12/02/2020 18:36	3,09	2	6,17	CHI
20200259445	HEITORAI	04850216	GOIAS	12/02/2020 15:30	12/02/2020 18:36	12/02/2020 15:30	12/02/2020 18:36	3,09	33	101,83	CHI
20200259445	ITABERAI	04850216	GOIAS	12/02/2020 15:30	12/02/2020 18:36	12/02/2020 15:30	12/02/2020 18:36	3,09	3	9,26	CHI

20200259445	ITAPURANGA	04850216	GOIAS	12/02/2020 15:30	12/02/2020 18:36	12/02/2020 15:30	12/02/2020 18:36	3,09	5	15,43	CHI
20200259446	NOVA ROMA	ND12392238	IACIARA S2	12/02/2020 15:30	12/02/2020 17:36	12/02/2020 15:30	12/02/2020 17:36	2,08	232	483,72	CHI
20200259447	GOIATUBA	JV12052777	GOIATUBA S1	12/02/2020 15:31	12/02/2020 18:50	12/02/2020 15:31	12/02/2020 18:50	3,32	4	13,26	CHI
20200259450	PADRE BERNARDO	PB12346973	PADRE BERNARDO	12/02/2020 15:31	12/02/2020 18:51	12/02/2020 15:31	12/02/2020 18:51	3,33	5	16,65	CHI
20200259452	ARACU	AR12019252	ARACU	12/02/2020 15:31	12/02/2020 23:40	12/02/2020 15:31	12/02/2020 23:40	8,15	8	65,16	CHI
20200259867	ALTO PARAISO DE GOIAS	BF12264707	FLORES DE GOIAS	12/02/2020 15:31	12/02/2020 16:59	12/02/2020 15:31	12/02/2020 16:59	1,46	24	35,01	CHI
20200259458	ARAGUAPAZ	MP12355886	MATRINCHA	12/02/2020 15:32	13/02/2020 01:50	12/02/2020 15:32	13/02/2020 01:50	10,31	1	10,31	CHI
20200259458	FAINA	MP12355886	MATRINCHA	12/02/2020 15:32	13/02/2020 01:50	12/02/2020 15:32	13/02/2020 01:50	10,31	2	20,62	CHI
20200259465	RIO VERDE	RV21000135	RIO VERDE S1	12/02/2020 15:33	13/02/2020 10:56	12/02/2020 15:33	13/02/2020 10:56	19,38	1	19,38	CHI
20200260312	FORMOSA	FA32058447	SAO JOAO D ALIANCA	12/02/2020 15:33	13/02/2020 21:10	12/02/2020 15:33	13/02/2020 21:10	29,61	2	59,23	CHI
20200259471	ITUMBIARA	690356237	PARANAIBA	12/02/2020 15:34	12/02/2020 16:20	12/02/2020 15:34	12/02/2020 16:20	0,78	1	0,78	CHI
20200259478	CACU	SO21013213	CACHOEIRA ALTA	12/02/2020 15:36	12/02/2020 21:04	12/02/2020 15:36	12/02/2020 21:04	5,47	1	5,47	CHI
20200259501	SANTA CRUZ DE GOIAS	BC21280312	PIRES DO RIO S2	12/02/2020 15:37	12/02/2020 23:23	12/02/2020 15:37	12/02/2020 23:23	7,77	1	7,77	CHI
20200259502	CAVALCANTE	CJ11329660	FLORES DE GOIAS	12/02/2020 15:37	12/02/2020 20:15	12/02/2020 15:37	12/02/2020 20:15	4,63	14	64,85	CHI
20200259601	IACIARA	10030087064	IACIARA S1	12/02/2020 15:37	12/02/2020 17:15	12/02/2020 15:37	12/02/2020 17:15	1,63	1	1,63	CHI
20200259701	URUACU	UR12003415	URUACU	12/02/2020 15:37	12/02/2020 17:38	12/02/2020 15:37	12/02/2020 17:38	2,01	24	48,17	CHI
20200260577	ALTO HORIZONTE	AJ12143571	MARA ROSA	12/02/2020 15:37	12/02/2020 23:35	12/02/2020 15:37	12/02/2020 23:35	7,96	37	294,69	CHI
20200260577	MARA ROSA	AJ12143571	MARA ROSA	12/02/2020 15:37	12/02/2020 23:35	12/02/2020 15:37	12/02/2020 23:35	7,96	5	39,82	CHI
20200260577	NOVA IGUACU DE GOIAS	AJ12143571	MARA ROSA	12/02/2020 15:37	12/02/2020 23:35	12/02/2020 15:37	12/02/2020 23:35	7,96	12	95,58	CHI
20200259717	ANAPOLIS	AN12221274LD	ANAPOLIS UNIVERSITARIO S2	12/02/2020 15:40	13/02/2020 09:01	12/02/2020 15:40	13/02/2020 09:01	17,36	3	52,07	CHI
20200259720	GOIANIA	10274248	CAMPINAS S2	12/02/2020 15:41	12/02/2020 17:17	12/02/2020 15:41	12/02/2020 17:17	1,60	1	1,60	CHI
20200259726	PADRE BERNARDO	PB12305256	PADRE BERNARDO	12/02/2020 15:41	12/02/2020 17:14	12/02/2020 15:41	12/02/2020 17:14	1,54	2	3,08	CHI
20200260139	ANAPOLIS	AN12390315	DAIA S1	12/02/2020 15:41	12/02/2020 22:20	12/02/2020 15:41	12/02/2020 22:20	6,65	174	1156,66	CHI
20200260203	GOIANIA	GN11281237	GOYA S2	12/02/2020 15:41	12/02/2020 16:48	12/02/2020 15:41	12/02/2020 16:48	1,11	43	47,59	CHI
20200260414	ANAPOLIS	AN11032920	ANAPOLIS UNIVERSITARIO S2	12/02/2020 15:41	12/02/2020 18:18	12/02/2020 15:41	12/02/2020 18:18	2,62	123	321,68	CHI
20200259733	MORRINHOS	MR21098620	MORRINHOS	12/02/2020 15:42	12/02/2020 17:30	12/02/2020 15:42	12/02/2020 17:30	1,79	1	1,79	CHI
20200259734	SAO SIMAO	2240004144	CACHOEIRA ALTA	12/02/2020 15:42	13/02/2020 00:29	12/02/2020 15:42	13/02/2020 00:29	8,78	1	8,78	CHI
20200259764	ITUMBIARA	IT12222567	PARANAIBA	12/02/2020 15:42	12/02/2020 16:40	12/02/2020 15:42	12/02/2020 16:40	0,96	574	550,40	CHI
20200259736	BOM JARDIM DE GOIAS	BM12334785	BOM JARDIM	12/02/2020 15:43	12/02/2020 17:18	12/02/2020 15:43	12/02/2020 17:18	1,58	58	91,78	CHI
20200259740	PIRACANJUBA	60087006	PIRACANJUBA	12/02/2020 15:43	12/02/2020 21:50	12/02/2020 15:43	12/02/2020 21:50	6,10	1	6,10	CHI
20200259742	MINEIROS	MY21375936	PARQUE DAS EMAS	12/02/2020 15:44	13/02/2020 13:26	12/02/2020 15:44	13/02/2020 13:26	21,70	1	21,70	CHI
20200259748	PROFESSOR JAMIL SAFADY	JS21373961	ROCHEDO	12/02/2020 15:44	12/02/2020 17:21	12/02/2020 15:44	12/02/2020 17:21	1,60	1	1,60	CHI
20200259871	JAUPACI	JP12006114	IPORA	12/02/2020 15:44	13/02/2020 01:08	12/02/2020 15:44	13/02/2020 01:08	9,40	29	272,63	CHI

20200259750	ANAPOLIS	20491979	JUNDIAI S1	12/02/2020 15:45	12/02/2020 19:02	12/02/2020 15:45	12/02/2020 19:02	3,28	1	3,28	CHI
20200259751	CABECEIRAS	CW12398925	ITIQUEIRA	12/02/2020 15:45	12/02/2020 20:26	12/02/2020 15:45	12/02/2020 20:26	4,68	27	126,29	CHI
20200259756	ITARUMA	IM11382666	ITAJA S2	12/02/2020 15:47	12/02/2020 18:11	12/02/2020 15:47	12/02/2020 18:11	2,40	1	2,40	CHI
20200259759	BRITANIA	BT12220391	BRITANIA	12/02/2020 15:47	12/02/2020 18:03	12/02/2020 15:47	12/02/2020 18:03	2,26	36	81,22	CHI
20200259761	NAZARIO	NZ21233490	ANICUNS	12/02/2020 15:47	12/02/2020 17:24	12/02/2020 15:47	12/02/2020 17:24	1,60	1	1,60	CHI
20200259767	PETROLINA DE GOIAS	PG21285117	PETROLINA	12/02/2020 15:48	13/02/2020 02:20	12/02/2020 15:48	13/02/2020 02:20	10,52	2	21,05	CHI
20200259771	SAO JOAO D ALIANCA	JL21316293	SAO JOAO D ALIANCA	12/02/2020 15:50	12/02/2020 19:06	12/02/2020 15:50	12/02/2020 19:06	3,26	1	3,26	CHI
20200259789	PEROLANDIA	2370001003	JATAI S1	12/02/2020 15:50	13/02/2020 09:23	12/02/2020 15:50	13/02/2020 09:23	17,54	1	17,54	CHI
20200259819	SAO MIGUEL DO PASSA QUATRO	SQ12088077	CRISTIANOPOLIS	12/02/2020 15:50	12/02/2020 22:06	12/02/2020 15:50	12/02/2020 22:06	6,26	18	112,65	CHI
20200259823	RIO VERDE	RV12384685	RIO VERDE S2	12/02/2020 15:50	12/02/2020 20:35	12/02/2020 15:50	12/02/2020 20:35	4,74	2	9,49	CHI
20200259779	CACHOEIRA ALTA	CA12071605	CACHOEIRA ALTA	12/02/2020 15:51	12/02/2020 19:15	12/02/2020 15:51	12/02/2020 19:15	3,39	30	101,62	CHI
20200259781	NOVA ROMA	ND12117611	IACIARA S2	12/02/2020 15:52	12/02/2020 19:42	12/02/2020 15:52	12/02/2020 19:42	3,83	8	30,65	CHI
20200259785	GUARANI DE GOIAS	IA12117790	IACIARA S1	12/02/2020 15:52	12/02/2020 23:06	12/02/2020 15:52	12/02/2020 23:06	7,22	21	151,60	CHI
20200259786	PIRANHAS	PH12381053	PIRANHAS	12/02/2020 15:52	12/02/2020 17:59	12/02/2020 15:52	12/02/2020 17:59	2,11	9	18,96	CHI
20200259787	CUMARI	CY12203049	CATALAO S1	12/02/2020 15:52	13/02/2020 11:20	12/02/2020 15:52	13/02/2020 11:20	19,45	1	19,45	CHI
20200259794	DOVERLANDIA	4220031419	CAIAPONIA	12/02/2020 15:53	12/02/2020 17:04	12/02/2020 15:53	12/02/2020 17:04	1,17	1	1,17	CHI
20200260746	GOIANIA	GN11245618	XAVANTES	12/02/2020 15:53	12/02/2020 18:56	12/02/2020 15:53	12/02/2020 18:56	3,04	104	316,02	CHI
20200259844	GOIANIA	GN10385830	CAMPINAS S1	12/02/2020 15:54	12/02/2020 16:19	12/02/2020 15:54	12/02/2020 16:19	0,42	3962	1678,35	CHI
20200259803	SANTA CRUZ DE GOIAS	PR12090309	PIRES DO RIO S2	12/02/2020 15:55	12/02/2020 21:33	12/02/2020 15:55	12/02/2020 21:33	5,63	3	16,88	CHI
20200259807	FLORES DE GOIAS	FB21252146	FLORES DE GOIAS	12/02/2020 15:55	12/02/2020 16:36	12/02/2020 15:55	12/02/2020 16:36	0,67	2	1,34	CHI
20200259811	VALPARAISO DE GOIAS	VA11136580	MARAJOARA	12/02/2020 15:56	12/02/2020 17:19	12/02/2020 15:56	12/02/2020 17:19	1,38	4	5,52	CHI
20200259814	SERRANOPOLIS	SX21205120	CHAPADAO DO CEU	12/02/2020 15:56	13/02/2020 09:29	12/02/2020 15:56	13/02/2020 09:29	17,54	1	17,54	CHI
20200259815	CORUMBAIBA	CI21081007	VILA CORUMBA	12/02/2020 15:56	13/02/2020 10:51	12/02/2020 15:56	13/02/2020 10:51	18,90	1	18,90	CHI
20200259816	ITAGUARU	IC12353099	ITABERAI S1	12/02/2020 15:57	12/02/2020 19:19	12/02/2020 15:57	12/02/2020 19:19	3,35	70	234,75	CHI
20200259816	URUANA	IC12353099	ITABERAI S1	12/02/2020 15:57	12/02/2020 19:19	12/02/2020 15:57	12/02/2020 19:19	3,35	9	30,18	CHI
20200259828	JATAI	290332503	JATAI S3	12/02/2020 15:59	12/02/2020 18:41	12/02/2020 15:59	12/02/2020 18:41	2,69	1	2,69	CHI
20200259833	MORRINHOS	150181747	MORRINHOS	12/02/2020 16:00	12/02/2020 18:44	12/02/2020 16:00	12/02/2020 18:44	2,73	1	2,73	CHI
20200259846	ITAPACI	IW21146315	ITAPACI	12/02/2020 16:02	13/02/2020 03:11	12/02/2020 16:02	13/02/2020 03:11	11,15	1	11,15	CHI
20200259847	CRISTALINA	10025340164	CRISTALINA S1	12/02/2020 16:02	12/02/2020 18:19	12/02/2020 16:02	12/02/2020 18:19	2,27	1	2,27	CHI
20200259852	BALIZA	BH12402901	CAIAPONIA	12/02/2020 16:02	13/02/2020 08:32	12/02/2020 16:02	13/02/2020 08:32	16,48	27	445,06	CHI
20200260773	PETROLINA DE GOIAS	PG12241141	PETROLINA	12/02/2020 16:02	12/02/2020 22:52	12/02/2020 16:02	12/02/2020 22:52	6,82	8	54,54	CHI
20200262726	NIQUELANDIA	NQ12396807	URUACU	12/02/2020 16:02	13/02/2020 22:52	12/02/2020 16:02	13/02/2020 22:52	30,83	3	92,49	CHI
20200259863	CAMPOS BELOS	CH11262267	SAO DOMINGOS	12/02/2020 16:04	12/02/2020 19:08	12/02/2020 16:04	12/02/2020 19:08	3,06	121	370,63	CHI

20200259868	ANAPOLIS	AN21096676	ANAPOLIS UNIVERSITARIO S2	12/02/2020 16:04	12/02/2020 18:48	12/02/2020 16:04	12/02/2020 18:48	2,72	1	2,72	CHI
20200259869	IPAMERI	IP21133652	CRISTALINA S2	12/02/2020 16:04	12/02/2020 22:17	12/02/2020 16:04	12/02/2020 22:17	6,20	1	6,20	CHI
20200260002	PARAUNA	PU21228081	PARAUNA	12/02/2020 16:06	13/02/2020 11:20	12/02/2020 16:06	13/02/2020 11:20	19,23	1	19,23	CHI
20200260101	RIO QUENTE	RQ21100105	RIO QUENTE	12/02/2020 16:06	12/02/2020 20:53	12/02/2020 16:06	12/02/2020 20:53	4,77	1	4,77	CHI
20200260150	ITAPURANGA	IK12021644	ITAPURANGA	12/02/2020 16:06	12/02/2020 17:53	12/02/2020 16:06	12/02/2020 17:53	1,78	25	44,55	CHI
20200260109	BRITANIA	BT21167524	BRITANIA	12/02/2020 16:07	12/02/2020 17:23	12/02/2020 16:07	12/02/2020 17:23	1,26	2	2,52	CHI
20200260171	MIMOSO DE GOIAS	MJ12286897	PADRE BERNARDO	12/02/2020 16:07	13/02/2020 01:23	12/02/2020 16:07	13/02/2020 01:23	9,25	12	111,03	CHI
20200260433	ALTO PARAISO DE GOIAS	ND12302636	IACIARA S2	12/02/2020 16:07	12/02/2020 18:51	12/02/2020 16:07	12/02/2020 18:51	2,72	18	49,04	CHI
20200260433	NOVA ROMA	ND12302636	IACIARA S2	12/02/2020 16:07	12/02/2020 18:51	12/02/2020 16:07	12/02/2020 18:51	2,72	97	264,27	CHI
20200260433	SAO JOAO D ALIANCA	ND12302636	IACIARA S2	12/02/2020 16:07	12/02/2020 18:51	12/02/2020 16:07	12/02/2020 18:51	2,72	12	32,69	CHI
20200260125	NIQUELANDIA	NQ12197712	NIQUELANDIA SUBTRANSMISSAO	12/02/2020 16:09	12/02/2020 21:19	12/02/2020 16:09	12/02/2020 21:19	5,16	90	464,42	CHI
20200260132	SAO MIGUEL DO ARAGUAIA	SM12321016	NOVA CRIXAS	12/02/2020 16:10	12/02/2020 22:56	12/02/2020 16:10	12/02/2020 22:56	6,77	7	47,37	CHI
20200260143	MINACU	IH11339075	MINACU	12/02/2020 16:11	13/02/2020 09:30	12/02/2020 16:11	13/02/2020 09:30	17,31	1	17,31	CHI
20200260145	BOM JESUS DE GOIAS	1250051670	BOM JESUS DE GOIAS	12/02/2020 16:11	13/02/2020 07:37	12/02/2020 16:11	13/02/2020 07:37	15,42	1	15,42	CHI
20200260146	URUTAI	UT21022343	URUTAI	12/02/2020 16:11	12/02/2020 20:42	12/02/2020 16:11	12/02/2020 20:42	4,50	1	4,50	CHI
20200260153	IPAMERI	IP21332847	URUTAI	12/02/2020 16:12	13/02/2020 00:27	12/02/2020 16:12	13/02/2020 00:27	8,24	1	8,24	CHI
20200260162	FORMOSA	FA21146184	ITUIQUIRA	12/02/2020 16:13	13/02/2020 13:50	12/02/2020 16:13	13/02/2020 13:50	21,61	2	43,21	CHI
20200260167	ITABERAI	IB12364880	ITABERAI S2	12/02/2020 16:14	12/02/2020 20:13	12/02/2020 16:14	12/02/2020 20:13	3,97	3	11,91	CHI
20200260178	CATALAO	CT12130960RE	CATALAO S2	12/02/2020 16:16	12/02/2020 17:51	12/02/2020 16:16	12/02/2020 17:51	1,58	73	115,18	CHI
20200260178	CUMARI	CT12130960RE	CATALAO S2	12/02/2020 16:16	12/02/2020 17:51	12/02/2020 16:16	12/02/2020 17:51	1,58	190	299,78	CHI
20200260178	GOIANDIRA	CT12130960RE	CATALAO S2	12/02/2020 16:16	12/02/2020 17:51	12/02/2020 16:16	12/02/2020 17:51	1,58	6	9,47	CHI
20200260179	NIQUELANDIA	NQ11057935	NIQUELANDIA SUBTRANSMISSAO	12/02/2020 16:16	12/02/2020 20:11	12/02/2020 16:16	12/02/2020 20:11	3,90	115	448,79	CHI
20200261530	GOIAS	IU12060536	MATRINCHA	12/02/2020 16:16	12/02/2020 22:32	12/02/2020 16:16	12/02/2020 22:32	6,26	1	6,26	CHI
20200261530	ITAPIRAPUA	IU12060536	MATRINCHA	12/02/2020 16:16	12/02/2020 22:32	12/02/2020 16:16	12/02/2020 22:32	6,26	16	100,14	CHI
20200260750	SAO MIGUEL DO PASSA QUATRO	SQ12338141	CRISTIANOPOLIS	12/02/2020 16:17	12/02/2020 20:15	12/02/2020 16:17	12/02/2020 20:15	3,95	48	189,71	CHI
20200260193	EDEALINA	ED12372116	PONTALINA	12/02/2020 16:18	12/02/2020 18:10	12/02/2020 16:18	12/02/2020 18:10	1,86	5	9,29	CHI
20200260202	LUZIANIA	LZ11128730	RIO VERMELHO	12/02/2020 16:19	12/02/2020 17:56	12/02/2020 16:19	12/02/2020 17:56	1,61	8	12,88	CHI
20200260336	DOVERLANDIA	DV12212846	CAIAPONIA	12/02/2020 16:19	13/02/2020 01:36	12/02/2020 16:19	13/02/2020 01:36	9,28	22	204,23	CHI
20200260458	GOIANIA	GN11037428	XAVANTES	12/02/2020 16:19	12/02/2020 21:49	12/02/2020 16:19	12/02/2020 21:49	5,50	89	489,50	CHI
20200260484	GOIANIA	GN11180088	CARAJAS S2	12/02/2020 16:19	12/02/2020 19:12	12/02/2020 16:19	12/02/2020 19:12	2,88	88	253,07	CHI
20200260206	QUIRINOPOLIS	QI21119899	QUIRINOPOLIS	12/02/2020 16:20	12/02/2020 18:30	12/02/2020 16:20	12/02/2020 18:30	2,16	1	2,16	CHI
20200260253	MOSSAMEDES	MD12049368	ITABERAI S2	12/02/2020 16:20	12/02/2020 22:45	12/02/2020 16:20	12/02/2020 22:45	6,41	16	102,51	CHI
20200260464	MOSSAMEDES	MD12311080	ITABERAI S2	12/02/2020 16:20	12/02/2020 20:02	12/02/2020 16:20	12/02/2020 20:02	3,68	15	55,27	CHI

20200260212	CATALAO	CT21292308	CATALAO S1	12/02/2020 16:21	12/02/2020 19:46	12/02/2020 16:21	12/02/2020 19:46	3,41	1	3,41	CHI
20200260213	FAINA	GS21086339	GOIAS	12/02/2020 16:21	14/02/2020 00:16	12/02/2020 16:21	14/02/2020 00:02	31,67	1	31,67	CHI
20200260213	FAINA	GS12086336	GOIAS	12/02/2020 16:21	14/02/2020 00:16	13/02/2020 20:23	14/02/2020 00:16	3,88	29	112,66	CHI
20200260217	ITUMBIARA	BJ11134666	BOM JESUS DE GOIAS	12/02/2020 16:22	12/02/2020 19:20	12/02/2020 16:22	12/02/2020 19:15	2,88	146	421,09	CHI
20200260217	ITUMBIARA	BJ11134667	BOM JESUS DE GOIAS	12/02/2020 16:22	12/02/2020 19:20	12/02/2020 16:22	12/02/2020 19:20	2,98	98	292,01	CHI
20200260220	CATALAO	CT21192630	CATALAO S1	12/02/2020 16:22	12/02/2020 19:25	12/02/2020 16:22	12/02/2020 19:25	3,05	1	3,05	CHI
20200260322	JARAGUA	JA10394588	JARAGUA	12/02/2020 16:22	13/02/2020 17:58	13/02/2020 00:15	13/02/2020 10:48	10,56	93	982,03	CHI
20200260322	JARAGUA	JA12090006	JARAGUA	12/02/2020 16:22	13/02/2020 17:58	12/02/2020 16:22	13/02/2020 17:58	25,59	17	435,04	CHI
20200260322	JARAGUA	JA13297379	JARAGUA	12/02/2020 16:22	13/02/2020 17:58	13/02/2020 00:15	13/02/2020 17:58	17,72	46	815,09	CHI
20200260322	PIRENOPOLIS	JA13297379	JARAGUA	12/02/2020 16:22	13/02/2020 17:58	13/02/2020 00:15	13/02/2020 17:58	17,72	95	1683,35	CHI
20200260234	ITABERAI	IB21047466	ITABERAI S2	12/02/2020 16:24	13/02/2020 12:04	12/02/2020 16:24	13/02/2020 12:04	19,68	3	59,03	CHI
20200260239	JATAI	290262689	JATAI S3	12/02/2020 16:24	12/02/2020 18:28	12/02/2020 16:24	12/02/2020 18:28	2,05	1	2,05	CHI
20200260276	ARAGOIANIA	AO32000020	GUAPO S2	12/02/2020 16:24	12/02/2020 18:47	12/02/2020 16:24	12/02/2020 18:47	2,38	27	64,35	CHI
20200260244	COCALZINHO DE GOIAS	CB21086603	AGUAS LINDAS DE GOIAS S2	12/02/2020 16:25	12/02/2020 19:28	12/02/2020 16:25	12/02/2020 19:28	3,04	1	3,04	CHI
20200260246	GOIATUBA	GT21033090	BOM JESUS DE GOIAS	12/02/2020 16:26	13/02/2020 07:25	12/02/2020 16:26	13/02/2020 07:25	14,98	1	14,98	CHI
20200260251	CRIXAS	CX12166640	SANTA TEREZINHA	12/02/2020 16:26	12/02/2020 21:07	12/02/2020 16:26	12/02/2020 21:07	4,67	26	121,43	CHI
20200260255	ALTO PARAISO DE GOIAS	BF12129944	FLORES DE GOIAS	12/02/2020 16:27	12/02/2020 17:04	12/02/2020 16:27	12/02/2020 17:04	0,61	1	0,61	CHI
20200260257	EDEALINA	ED21128522	PONTALINA	12/02/2020 16:27	12/02/2020 19:25	12/02/2020 16:27	12/02/2020 19:25	2,96	1	2,96	CHI
20200259360	NIQUELANDIA	NQ21147657	URUACU	12/02/2020 16:28	12/02/2020 23:04	12/02/2020 16:28	12/02/2020 23:04	6,58	1	6,58	CHI
20200260263	URUTAI	UT21095220	URUTAI	12/02/2020 16:28	13/02/2020 00:33	12/02/2020 16:28	13/02/2020 00:33	8,08	1	8,08	CHI
20200260264	IVOLANDIA	1560007270	IPORA	12/02/2020 16:28	13/02/2020 11:56	12/02/2020 16:28	13/02/2020 11:56	19,46	1	19,46	CHI
20200260269	CRISTALINA	KR12305054	PAMPLONA	12/02/2020 16:28	12/02/2020 20:15	12/02/2020 16:28	12/02/2020 20:15	3,77	136	512,53	CHI
20200260415	ITABERAI	IB12304486	ANICUNS	12/02/2020 16:28	12/02/2020 20:17	12/02/2020 16:28	12/02/2020 20:17	3,80	58	220,46	CHI
20200260415	MOSSAMEDES	IB12304486	ANICUNS	12/02/2020 16:28	12/02/2020 20:17	12/02/2020 16:28	12/02/2020 20:17	3,80	5	19,01	CHI
20200260273	FLORES DE GOIAS	FB11282097	IACIARA S2	12/02/2020 16:29	12/02/2020 19:32	12/02/2020 16:29	12/02/2020 19:32	3,04	2	6,08	CHI
20200260274	MINACU	IH12182453	MINACU	12/02/2020 16:29	12/02/2020 18:40	12/02/2020 16:29	12/02/2020 18:40	2,17	181	393,52	CHI
20200260280	CAMPINORTE	UR12231336	MARA ROSA	12/02/2020 16:30	13/02/2020 00:04	12/02/2020 16:30	13/02/2020 00:04	7,56	2	15,11	CHI
20200260280	URUACU	UR12231336	MARA ROSA	12/02/2020 16:30	13/02/2020 00:04	12/02/2020 16:30	13/02/2020 00:04	7,56	22	166,25	CHI
20200260282	MINEIROS	MY21274160	PARQUE DAS EMAS	12/02/2020 16:30	13/02/2020 10:33	12/02/2020 16:30	13/02/2020 10:33	18,04	1	18,04	CHI
20200260287	TRES RANCHOS	2170010914	CATALAO S1	12/02/2020 16:31	13/02/2020 00:04	12/02/2020 16:31	13/02/2020 00:04	7,55	1	7,55	CHI
20200260326	PIRACANJUBA	PJ12223405RE	PIRACANJUBA	12/02/2020 16:33	12/02/2020 18:04	12/02/2020 16:33	12/02/2020 18:04	1,51	6	9,08	CHI
20200260326	SANTA CRUZ DE GOIAS	PJ12223405RE	PIRACANJUBA	12/02/2020 16:33	12/02/2020 18:04	12/02/2020 16:33	12/02/2020 18:04	1,51	32	48,45	CHI
20200260363	ALTO PARAISO DE GOIAS	BF11320577	FLORES DE GOIAS	12/02/2020 16:34	12/02/2020 17:56	12/02/2020 16:34	12/02/2020 17:56	1,36	77	104,61	CHI

20200260494	ITAPIRAPUA	IU11000008	MATRINCHA	12/02/2020 16:34	13/02/2020 01:54	12/02/2020 16:34	13/02/2020 01:54	9,33	96	895,28	CHI
20200260304	URUACU	CR12410914	MARA ROSA	12/02/2020 16:35	13/02/2020 00:50	12/02/2020 16:35	13/02/2020 00:50	8,23	16	131,75	CHI
20200260320	PLANALTINA	PI11383261	PLANALTINA	12/02/2020 16:38	12/02/2020 19:35	12/02/2020 16:38	12/02/2020 19:35	2,94	45	132,30	CHI
20200260505	TRINDADE	TR12293992	TRINDADE	12/02/2020 16:38	12/02/2020 18:29	12/02/2020 16:38	12/02/2020 18:29	1,84	11	20,26	CHI
20200260330	GOIAS	GS12299761	GOIAS	12/02/2020 16:39	13/02/2020 19:05	12/02/2020 16:39	13/02/2020 14:55	22,26	7	155,81	CHI
20200260330	GOIAS	GS12299761	GOIAS	12/02/2020 16:39	13/02/2020 19:05	12/02/2020 16:39	13/02/2020 19:05	26,43	2	52,87	CHI
20200260334	NIQUELANDIA	NQ21232350	BARRO ALTO	12/02/2020 16:40	13/02/2020 09:12	12/02/2020 16:40	13/02/2020 09:12	16,52	1	16,52	CHI
20200255105	RIO VERDE	RV12025965LD	RIO VERDE S1	12/02/2020 16:41	12/02/2020 19:27	12/02/2020 16:41	12/02/2020 19:27	2,78	9	25,03	CHI
20200260340	SANTO ANTONIO DO DESCOBERTO	LZ21046988	ALEXANIA	12/02/2020 16:42	12/02/2020 20:00	12/02/2020 16:42	12/02/2020 20:00	3,29	1	3,29	CHI
20200261036	IVOLANDIA	IV12390186	IPORA	12/02/2020 16:42	12/02/2020 21:35	12/02/2020 16:42	12/02/2020 21:35	4,88	23	112,20	CHI
20200260342	CIDADE OCIDENTAL	DH11199612	MARAJOARA	12/02/2020 16:43	12/02/2020 18:34	12/02/2020 16:43	12/02/2020 18:34	1,83	117	214,66	CHI
20200260351	SANTO ANTONIO DO DESCOBERTO	2210135807	ALEXANIA	12/02/2020 16:44	12/02/2020 17:36	12/02/2020 16:44	12/02/2020 17:36	0,86	1	0,86	CHI
20200260354	PIRES DO RIO	PR12027084	PIRES DO RIO S1	12/02/2020 16:44	12/02/2020 20:20	12/02/2020 16:44	12/02/2020 20:20	3,58	9	32,26	CHI
20200260354	URUTAI	PR12027084	PIRES DO RIO S1	12/02/2020 16:44	12/02/2020 20:20	12/02/2020 16:44	12/02/2020 20:20	3,58	12	43,01	CHI
20200260373	FAINA	FC11194571	GOIAS	12/02/2020 16:44	12/02/2020 17:36	12/02/2020 16:44	12/02/2020 17:36	0,85	2	1,71	CHI
20200261020	PETROLINA DE GOIAS	PG12382332	PETROLINA	12/02/2020 16:44	12/02/2020 21:20	12/02/2020 16:44	12/02/2020 21:20	4,60	75	344,83	CHI
20200260361	BOM JESUS DE GOIAS	1250004722	BOM JESUS DE GOIAS	12/02/2020 16:45	12/02/2020 23:49	12/02/2020 16:45	12/02/2020 23:49	7,05	1	7,05	CHI
20200260368	SANTA BARBARA DE GOIAS	SB12215253	TRINDADE	12/02/2020 16:46	12/02/2020 20:19	12/02/2020 16:46	12/02/2020 20:19	3,54	3	10,63	CHI
20200260371	GOIANESIA	550047724	GOIANESIA S2	12/02/2020 16:46	12/02/2020 19:25	12/02/2020 16:46	12/02/2020 19:25	2,65	1	2,65	CHI
20200260372	GOIANIA	12963410	CARAJAS S1	12/02/2020 16:46	12/02/2020 21:09	12/02/2020 16:46	12/02/2020 21:09	4,37	1	4,37	CHI
20200260383	ARAGUAPAZ	AZ12238246	GOIAS	12/02/2020 16:48	12/02/2020 20:56	12/02/2020 16:48	12/02/2020 20:56	4,12	3	12,37	CHI
20200260386	CAMPO LIMPO	AN12000275	JUNDIAI S1	12/02/2020 16:49	12/02/2020 19:07	12/02/2020 16:49	12/02/2020 19:07	2,30	3	6,90	CHI
20200260393	JANDAIA	JD12008673	PALMEIRAS	12/02/2020 16:49	12/02/2020 22:18	12/02/2020 16:49	12/02/2020 22:18	5,48	13	71,18	CHI
20200260396	URUACU	640082920	URUACU	12/02/2020 16:49	12/02/2020 18:59	12/02/2020 16:49	12/02/2020 18:59	2,16	1	2,16	CHI
20200260403	SANTO ANTONIO DO DESCOBERTO	SN11370893	ALEXANIA	12/02/2020 16:50	12/02/2020 19:06	12/02/2020 16:50	12/02/2020 19:06	2,26	16	36,20	CHI
20200260406	GOIANDIRA	GD12127652	CATALAO S1	12/02/2020 16:50	13/02/2020 09:16	12/02/2020 16:50	13/02/2020 09:16	16,43	2	32,85	CHI
20200261433	MAMBAI	MB11302672	IACIARA S2	12/02/2020 16:50	12/02/2020 22:16	12/02/2020 16:50	12/02/2020 22:16	5,43	78	423,32	CHI
20200260583	MONTIVIDIU DO NORTE	MX12192266	PORANGATU	12/02/2020 16:51	12/02/2020 20:55	12/02/2020 16:51	12/02/2020 20:55	4,06	60	243,88	CHI
20200260583	TROMBAS	MX12192266	PORANGATU	12/02/2020 16:51	12/02/2020 20:55	12/02/2020 16:51	12/02/2020 20:55	4,06	23	93,49	CHI
20200260429	SANCLERLANDIA	SC12323577	FIRMINOPOLIS S2	12/02/2020 16:53	13/02/2020 09:58	12/02/2020 16:53	13/02/2020 00:05	7,19	6	43,13	CHI
20200260429	SANCLERLANDIA	SC12323577	FIRMINOPOLIS S2	12/02/2020 16:53	13/02/2020 09:58	12/02/2020 16:53	13/02/2020 09:58	17,08	1	17,08	CHI
20200260431	IACIARA	IA11279945	IACIARA S1	12/02/2020 16:54	12/02/2020 21:07	12/02/2020 16:54	12/02/2020 21:07	4,22	18	75,89	CHI
20200260432	AMARALINA	MH12391970LD	NOVA CRIXAS	12/02/2020 16:54	13/02/2020 10:02	12/02/2020 16:54	13/02/2020 10:02	17,13	1	17,13	CHI

20200260432	MUNDO NOVO DE GOIAS	MH12391970LD	NOVA CRIXAS	12/02/2020 16:54	13/02/2020 10:02	12/02/2020 16:54	13/02/2020 10:02	17,13	4	68,52	CHI
20200260435	OUIDOR	2180005290	CATALAO S1	12/02/2020 16:54	13/02/2020 07:51	12/02/2020 16:54	13/02/2020 07:51	14,95	1	14,95	CHI
20200260437	BRITANIA	BT21206759	BRITANIA	12/02/2020 16:54	12/02/2020 21:11	12/02/2020 16:54	12/02/2020 21:11	4,27	1	4,27	CHI
20200260443	RIO VERDE	RV12091916	CABRIUVA S2	12/02/2020 16:55	13/02/2020 11:54	12/02/2020 16:55	13/02/2020 11:54	18,97	29	550,17	CHI
20200260447	BELA VISTA DE GOIAS	SQ21066280	BELA VISTA S1	12/02/2020 16:56	13/02/2020 09:34	12/02/2020 16:56	13/02/2020 09:34	16,63	1	16,63	CHI
20200260451	ANAPOLIS	21184264	JUNDIAI S2	12/02/2020 16:57	12/02/2020 20:07	12/02/2020 16:57	12/02/2020 20:07	3,16	1	3,16	CHI
20200260457	RIO VERDE	RV21240563	RIO VERDE S1	12/02/2020 16:58	13/02/2020 11:36	12/02/2020 16:58	13/02/2020 11:36	18,62	1	18,62	CHI
202002191206	IPORA	IR12074019	IPORA	12/02/2020 16:58	13/02/2020 07:14	12/02/2020 16:58	13/02/2020 07:14	14,26	14	199,66	CHI
20200261171	NEROPOLIS	NR11271853	NEROPOLIS S2	12/02/2020 16:59	12/02/2020 21:02	12/02/2020 16:59	12/02/2020 21:02	4,04	152	613,53	CHI
20200261565	FLORES DE GOIAS	FB12320627	FLORES DE GOIAS	12/02/2020 16:59	12/02/2020 21:11	12/02/2020 16:59	12/02/2020 21:11	4,19	27	113,19	CHI
20200260466	SAO JOAO D ALIANCA	JL21203976	SAO JOAO D ALIANCA	12/02/2020 17:00	12/02/2020 17:55	12/02/2020 17:00	12/02/2020 17:55	0,91	1	0,91	CHI
20200260471	ANAPOLIS	AN12258181	NEROPOLIS S1	12/02/2020 17:01	12/02/2020 20:44	12/02/2020 17:01	12/02/2020 20:44	3,71	6	22,25	CHI
20200260472	GOIANESIA	BA12163310	GOIANESIA S1	12/02/2020 17:01	12/02/2020 23:00	12/02/2020 17:01	12/02/2020 23:00	5,98	2	11,95	CHI
20200260472	VILA PROPICIO	BA12163310	GOIANESIA S1	12/02/2020 17:01	12/02/2020 23:00	12/02/2020 17:01	12/02/2020 23:00	5,98	11	65,75	CHI
20200260482	SAO MIGUEL DO ARAGUAIA	SM12276148	SAO MIGUEL DO ARAGUAIA	12/02/2020 17:01	13/02/2020 11:11	12/02/2020 17:01	13/02/2020 11:11	18,16	11	199,76	CHI
20200260475	VALPARAISO DE GOIAS	2860264407	MARAJOARA	12/02/2020 17:02	12/02/2020 18:53	12/02/2020 17:02	12/02/2020 18:53	1,84	1	1,84	CHI
20200260477	CERES	CE12297440	RUBIATABA	12/02/2020 17:02	13/02/2020 09:39	12/02/2020 17:02	13/02/2020 09:39	16,60	1	16,60	CHI
20200260478	AGUAS LINDAS DE GOIAS	4830327961	AGUAS LINDAS DE GOIAS S2	12/02/2020 17:03	12/02/2020 19:30	12/02/2020 17:03	12/02/2020 19:30	2,45	1	2,45	CHI
20200260486	JATAI	10013298214	JATAI S3	12/02/2020 17:04	13/02/2020 00:16	12/02/2020 17:04	13/02/2020 00:16	7,20	1	7,20	CHI
20200260487	ITARUMA	IM21150612	ITAJA S2	12/02/2020 17:04	12/02/2020 18:57	12/02/2020 17:04	12/02/2020 18:57	1,87	2	3,75	CHI
20200261267	COCALZINHO DE GOIAS	CB12042883	COCALZINHO	12/02/2020 17:04	13/02/2020 00:14	12/02/2020 17:04	13/02/2020 00:14	7,15	9	64,38	CHI
20200260795	BELA VISTA DE GOIAS	BV12010767	BELA VISTA S1	12/02/2020 17:05	12/02/2020 18:53	12/02/2020 17:05	12/02/2020 18:53	1,80	176	317,44	CHI
20200260502	GOIANIA	GN12002634	FERROVIARIO S2	12/02/2020 17:06	12/02/2020 18:24	12/02/2020 17:06	12/02/2020 18:24	1,29	139	178,62	CHI
20200260504	NOVO BRASIL	NB12396210	JUSSARA	12/02/2020 17:07	13/02/2020 12:09	12/02/2020 17:07	13/02/2020 12:09	19,03	7	133,22	CHI
20200260507	DOVERLANDIA	DV21237183	CAIAPONIA	12/02/2020 17:07	13/02/2020 10:34	12/02/2020 17:07	13/02/2020 10:34	17,45	1	17,45	CHI
20200260517	BURITI ALEGRE	BG12263537	ITUMBIARA VELHA S2	12/02/2020 17:08	12/02/2020 18:02	12/02/2020 17:08	12/02/2020 18:02	0,89	4	3,57	CHI
20200260517	ITUMBIARA	BG12263537	ITUMBIARA VELHA S2	12/02/2020 17:08	12/02/2020 18:02	12/02/2020 17:08	12/02/2020 18:02	0,89	6	5,35	CHI
20200261019	FORMOSA	FA32051148	SAO JOAO D ALIANCA	12/02/2020 17:08	13/02/2020 12:06	12/02/2020 17:08	13/02/2020 12:06	18,95	26	492,72	CHI
20200264625	FORMOSA	FA12234935	SAO JOAO D ALIANCA	12/02/2020 17:08	14/02/2020 01:30	12/02/2020 17:08	14/02/2020 01:30	32,36	17	550,07	CHI
20200260519	CIDADE OCIDENTAL	2680181123	MARAJOARA	12/02/2020 17:09	12/02/2020 19:15	12/02/2020 17:09	12/02/2020 19:15	2,10	1	2,10	CHI
20200260526	ANAPOLIS	20840391	ANAPOLIS UNIVERSITARIO S1	12/02/2020 17:10	13/02/2020 01:55	12/02/2020 17:10	13/02/2020 01:55	8,74	1	8,74	CHI
20200260532	SANTA CRUZ DE GOIAS	BC31095884	PIRES DO RIO S2	12/02/2020 17:11	12/02/2020 21:00	12/02/2020 17:11	12/02/2020 21:00	3,81	1	3,81	CHI
20200260544	INHUMAS	IN21132735	INHUMAS S2	12/02/2020 17:16	12/02/2020 19:20	12/02/2020 17:16	12/02/2020 19:20	2,07	11	22,72	CHI

20200260549	FAINA	FC12158820	GOIAS	12/02/2020 17:17	13/02/2020 09:33	12/02/2020 17:17	13/02/2020 09:33	16,26	10	162,57	CHI
20200260552	CRISTALINA	KR12305011	PAMPLONA	12/02/2020 17:17	12/02/2020 20:13	12/02/2020 17:17	12/02/2020 20:13	2,92	1	2,92	CHI
20200260552	LUZIANIA	KR12305011	PAMPLONA	12/02/2020 17:17	12/02/2020 20:13	12/02/2020 17:17	12/02/2020 20:13	2,92	6	17,51	CHI
20200261481	SITIO D ABADIA	FB12285685	IACIARA S2	12/02/2020 17:17	13/02/2020 00:19	12/02/2020 17:17	13/02/2020 00:19	7,02	68	477,55	CHI
20200261566	INHUMAS	IN12000223	INHUMAS S2	12/02/2020 17:19	12/02/2020 19:51	12/02/2020 17:19	12/02/2020 19:51	2,52	274	691,32	CHI
20200260575	ORIZONA	OZ21231569	VIANOPOLIS	12/02/2020 17:21	13/02/2020 08:34	12/02/2020 17:21	13/02/2020 08:34	15,21	1	15,21	CHI
20200260752	IPAMERI	IP12087055	PIRES DO RIO S2	12/02/2020 17:24	12/02/2020 21:49	12/02/2020 17:24	12/02/2020 21:49	4,40	14	61,65	CHI
20200261167	CROMINIA	CQ12000302RE	PONTALINA	12/02/2020 17:24	12/02/2020 20:47	12/02/2020 17:24	12/02/2020 20:47	3,37	32	107,80	CHI
20200261167	PROFESSOR JAMIL SAFADY	CQ12000302RE	PONTALINA	12/02/2020 17:24	12/02/2020 20:47	12/02/2020 17:24	12/02/2020 20:47	3,37	14	47,16	CHI
20200261123	JARAGUA	JA12353176	JARAGUA	12/02/2020 17:28	12/02/2020 21:40	12/02/2020 17:28	12/02/2020 21:40	4,20	6	25,19	CHI
20200262109	PETROLINA DE GOIAS	PG21337677	PETROLINA	12/02/2020 17:29	13/02/2020 18:55	12/02/2020 17:29	13/02/2020 18:55	25,43	2	50,86	CHI
20200260717	FORMOSA	FA12404514	SAO JOAO D ALIANCA	12/02/2020 17:30	14/02/2020 02:40	12/02/2020 17:30	14/02/2020 02:40	33,17	187	6202,37	CHI
20200261038	MINEIROS	MY12347799	PARQUE DAS EMAS	12/02/2020 17:30	12/02/2020 21:04	12/02/2020 17:30	12/02/2020 21:04	3,56	6	21,34	CHI
20200260732	PIRENOPOLIS	GE12197132	CORUMBA	12/02/2020 17:32	13/02/2020 11:50	12/02/2020 17:32	13/02/2020 11:50	18,28	3	54,85	CHI
20200260732	VILA PROPICIO	GE12197132	CORUMBA	12/02/2020 17:32	13/02/2020 11:50	12/02/2020 17:32	13/02/2020 11:50	18,28	2	36,57	CHI
20200260753	PARAUNA	PU12081329	PARAUNA	12/02/2020 17:34	12/02/2020 20:55	12/02/2020 17:34	12/02/2020 20:55	3,35	63	210,84	CHI
20200261245	JARAGUA	JA12328516	JARAGUA	12/02/2020 17:35	13/02/2020 01:42	12/02/2020 17:35	13/02/2020 01:42	8,11	20	162,11	CHI
20200261555	ITAGUARI	II11000034	ITABERAI S1	12/02/2020 17:36	12/02/2020 20:07	12/02/2020 17:36	12/02/2020 20:07	2,51	151	379,18	CHI
20200262416	NIQUELANDIA	NQ12232485	URUACU	12/02/2020 17:36	13/02/2020 05:44	12/02/2020 17:36	13/02/2020 05:44	12,12	3	36,36	CHI
20200260757	PLANALTINA	TL12206256	SAO JOAO D ALIANCA	12/02/2020 17:37	12/02/2020 23:14	12/02/2020 17:37	12/02/2020 23:14	5,62	4	22,47	CHI
20200260764	IPAMERI	IP21382014	CAMPO ALEGRE DE GOIAS	12/02/2020 17:38	12/02/2020 23:44	12/02/2020 17:38	12/02/2020 23:44	6,10	1	6,10	CHI
20200260766	FORMOSA	FA21115708	ITIQUIRA	12/02/2020 17:38	13/02/2020 09:05	12/02/2020 17:38	13/02/2020 09:05	15,44	1	15,44	CHI
20200260767	CACHOEIRA ALTA	CA12024254	CACHOEIRA ALTA	12/02/2020 17:38	12/02/2020 23:37	12/02/2020 17:38	12/02/2020 23:37	5,97	21	125,45	CHI
20200260767	QUIRINOPOLIS	CA12024254	CACHOEIRA ALTA	12/02/2020 17:38	12/02/2020 23:37	12/02/2020 17:38	12/02/2020 23:37	5,97	7	41,82	CHI
20200260772	CAIAPONIA	CP12252503	CAIAPONIA	12/02/2020 17:40	12/02/2020 21:00	12/02/2020 17:40	12/02/2020 21:00	3,33	6	20,00	CHI
20200260786	MONTES CLAROS DE GOIAS	ME12038311	IPORA	12/02/2020 17:46	13/02/2020 18:38	12/02/2020 17:46	13/02/2020 18:38	24,85	8	198,83	CHI
202002191207	MINEIROS	MY12244676	PARQUE DAS EMAS	12/02/2020 17:46	13/02/2020 21:30	12/02/2020 17:46	13/02/2020 21:30	27,72	9	249,48	CHI
20200261969	GOIANIRA	GR11035698	GOIANIRA	12/02/2020 17:47	12/02/2020 21:40	12/02/2020 17:47	12/02/2020 21:40	3,87	244	943,81	CHI
20200260796	CUMARI	2000018252	CATALAO S1	12/02/2020 17:48	12/02/2020 22:51	12/02/2020 17:48	12/02/2020 22:51	5,04	1	5,04	CHI
20200260798	GOIANESIA	GE21115060	GOIANESIA S2	12/02/2020 17:48	12/02/2020 22:56	12/02/2020 17:48	12/02/2020 22:56	5,13	1	5,13	CHI
20200260799	NIQUELANDIA	NQ12325258	SAO JOAO D ALIANCA	12/02/2020 17:48	14/02/2020 14:07	12/02/2020 17:48	14/02/2020 14:07	44,32	3	132,96	CHI
20200261256	IPORA	IR11349692	IPORA	12/02/2020 17:48	13/02/2020 03:39	12/02/2020 17:48	13/02/2020 03:39	9,84	37	363,96	CHI
20200260904	AURILANDIA	AI12000021	FIRMINOPOLIS S2	12/02/2020 17:49	12/02/2020 23:13	12/02/2020 17:49	12/02/2020 23:13	5,40	10	53,97	CHI

20200260905	VARJAO	VJ21254008	GUAPO S2	12/02/2020 17:49	13/02/2020 07:56	12/02/2020 17:49	13/02/2020 07:56	14,11	1	14,11	CHI
20200261016	ARAGARCAS	ME12095835	IPORA	12/02/2020 17:53	13/02/2020 10:51	12/02/2020 17:53	13/02/2020 10:51	16,96	30	508,78	CHI
20200261016	BOM JARDIM DE GOIAS	ME12095835	IPORA	12/02/2020 17:53	13/02/2020 10:51	12/02/2020 17:53	13/02/2020 10:51	16,96	2	33,92	CHI
20200261016	MONTES CLAROS DE GOIAS	ME12095835	IPORA	12/02/2020 17:53	13/02/2020 10:51	12/02/2020 17:53	13/02/2020 10:51	16,96	8	135,68	CHI
20200261018	PILAR DE GOIAS	GG21202104	SANTA TEREZINHA	12/02/2020 17:53	12/02/2020 23:31	12/02/2020 17:53	12/02/2020 23:31	5,62	1	5,62	CHI
20200261028	AURILANDIA	AI12126017	FIRMINOPOLIS S2	12/02/2020 17:53	12/02/2020 23:00	12/02/2020 17:53	12/02/2020 23:00	5,10	5	25,51	CHI
20200261028	CACHOEIRA DE GOIAS	AI12126017	FIRMINOPOLIS S2	12/02/2020 17:53	12/02/2020 23:00	12/02/2020 17:53	12/02/2020 23:00	5,10	4	20,41	CHI
20200261047	LUZIANIA	OZ12402562RE	PIRES DO RIO S2	12/02/2020 17:53	12/02/2020 23:04	12/02/2020 17:53	12/02/2020 23:04	5,20	133	690,97	CHI
20200261047	ORIZONA	OZ12402562RE	PIRES DO RIO S2	12/02/2020 17:53	12/02/2020 23:04	12/02/2020 17:53	12/02/2020 23:04	5,20	7	36,37	CHI
20200261094	CUMARI	CT21077581	CATALAO S2	12/02/2020 17:53	12/02/2020 19:57	12/02/2020 17:53	12/02/2020 19:57	2,06	1	2,06	CHI
20200266610	ARAGARCAS	AG11341727	IPORA	12/02/2020 17:53	13/02/2020 15:52	12/02/2020 17:53	13/02/2020 15:52	21,98	18	395,57	CHI
20200261027	ALTO PARAISO DE GOIAS	BF21222892	FLORES DE GOIAS	12/02/2020 17:55	12/02/2020 19:19	12/02/2020 17:55	12/02/2020 19:19	1,40	2	2,80	CHI
20200261033	AMARALINA	LC11270166	SAO MIGUEL DO ARAGUAIA	12/02/2020 17:56	13/02/2020 09:42	12/02/2020 17:56	13/02/2020 09:42	15,76	1	15,76	CHI
20200261039	CRISTALINA	KR12304800	CRISTALINA S2	12/02/2020 17:57	13/02/2020 00:00	12/02/2020 17:57	13/02/2020 00:00	6,06	66	400,03	CHI
20200261076	ANAPOLIS	AN11349042	JUNDIAI S1	12/02/2020 17:58	12/02/2020 22:10	12/02/2020 17:58	12/02/2020 22:10	4,19	19	79,53	CHI
20200261145	NOVA ROMA	TE12284926	FLORES DE GOIAS	12/02/2020 17:58	12/02/2020 21:03	12/02/2020 17:58	12/02/2020 21:03	3,07	23	70,60	CHI
20200261145	TERESINA DE GOIAS	TE12284926	FLORES DE GOIAS	12/02/2020 17:58	12/02/2020 21:03	12/02/2020 17:58	12/02/2020 21:03	3,07	11	33,76	CHI
20200261581	IPAMERI	IP12248620	CRISTALINA S2	12/02/2020 17:58	12/02/2020 23:23	12/02/2020 17:58	12/02/2020 23:23	5,41	9	48,68	CHI
20200261052	HIDROLANDIA	HD21198434	CEPAIGO S1	12/02/2020 17:59	12/02/2020 20:00	12/02/2020 17:59	12/02/2020 20:00	2,02	1	2,02	CHI
20200261053	IPORA	IR12334815	IPORA	12/02/2020 17:59	13/02/2020 05:06	12/02/2020 17:59	13/02/2020 05:06	11,12	10	111,16	CHI
20200261058	CATALAO	10020717693	CATALAO S2	12/02/2020 18:00	12/02/2020 22:40	12/02/2020 18:00	12/02/2020 22:40	4,66	1	4,66	CHI
20200261059	BOM JARDIM DE GOIAS	BM12201516	BOM JARDIM	12/02/2020 18:00	12/02/2020 23:52	12/02/2020 18:00	12/02/2020 23:52	5,86	38	222,61	CHI
20200261063	CUMARI	CY12281463	CATALAO S1	12/02/2020 18:01	12/02/2020 21:46	12/02/2020 18:01	12/02/2020 21:46	3,75	4	14,99	CHI
20200261282	MIMOSO DE GOIAS	NQ12371855	BARRO ALTO	12/02/2020 18:01	13/02/2020 09:42	12/02/2020 18:01	13/02/2020 09:42	15,68	4	62,73	CHI
20200261282	NIQUELANDIA	NQ12371855	BARRO ALTO	12/02/2020 18:01	13/02/2020 09:42	12/02/2020 18:01	13/02/2020 09:42	15,68	243	3810,92	CHI
20200262005	JARAGUA	JA11070675	JARAGUA	12/02/2020 18:02	12/02/2020 22:16	12/02/2020 18:02	12/02/2020 22:16	4,22	21	88,67	CHI
20200261077	RIO VERDE	RV21260553	RIO VERDE S1	12/02/2020 18:03	13/02/2020 12:04	12/02/2020 18:03	13/02/2020 12:04	18,01	1	18,01	CHI
20200261088	CRISTALINA	KR12096911	PAMPLONA	12/02/2020 18:05	12/02/2020 21:39	12/02/2020 18:05	12/02/2020 21:39	3,56	12	42,72	CHI
20200261754	PARAUNA	PU11000001	PARAUNA	12/02/2020 18:05	12/02/2020 23:15	12/02/2020 18:05	12/02/2020 23:15	5,17	110	568,18	CHI
20200261425	DIORAMA	DI11279326	IPORA	12/02/2020 18:06	13/02/2020 04:40	12/02/2020 18:06	13/02/2020 04:40	10,55	64	675,47	CHI
20200261224	BOM JARDIM DE GOIAS	BM11380932	BOM JARDIM	12/02/2020 18:08	12/02/2020 21:25	12/02/2020 18:08	12/02/2020 21:25	3,27	87	284,39	CHI
20200261873	CAVALCANTE	TE12131896	FLORES DE GOIAS	12/02/2020 18:10	12/02/2020 21:34	12/02/2020 18:10	12/02/2020 21:34	3,39	6	20,34	CHI
20200261873	TERESINA DE GOIAS	TE12131896	FLORES DE GOIAS	12/02/2020 18:10	12/02/2020 21:34	12/02/2020 18:10	12/02/2020 21:34	3,39	20	67,81	CHI

20200261124	LUZIANIA	LZ11128815	RIO VERMELHO	12/02/2020 18:12	13/02/2020 01:47	12/02/2020 18:12	13/02/2020 01:47	7,57	29	219,49	CHI
20200261125	PILAR DE GOIAS	GG21238000	URUACU	12/02/2020 18:13	12/02/2020 23:13	12/02/2020 18:13	12/02/2020 23:13	5,00	1	5,00	CHI
20200261126	GOIANIA	10011739892	XAVANTES	12/02/2020 18:13	12/02/2020 21:36	12/02/2020 18:13	12/02/2020 21:36	3,38	1	3,38	CHI
20200261128	PALMINOPOLIS	PP21013319	PALMEIRAS	12/02/2020 18:13	13/02/2020 08:23	12/02/2020 18:13	13/02/2020 08:23	14,15	1	14,15	CHI
20200261132	MOZARLANDIA	MZ21057147	MOZARLANDIA	12/02/2020 18:14	13/02/2020 22:23	12/02/2020 18:14	13/02/2020 22:23	28,14	1	28,14	CHI
20200261134	MONTIVIDIU DO NORTE	MX12182397	PORANGATU	12/02/2020 18:15	13/02/2020 09:55	12/02/2020 18:15	13/02/2020 09:55	15,66	3	46,98	CHI
20200261173	DIORAMA	JP12074459	IPORA	12/02/2020 18:15	12/02/2020 23:20	12/02/2020 18:15	12/02/2020 23:20	5,08	3	15,25	CHI
20200261173	JAUPACI	JP12074459	IPORA	12/02/2020 18:15	12/02/2020 23:20	12/02/2020 18:15	12/02/2020 23:20	5,08	5	25,41	CHI
20200261138	ITABERAÍ	IB21364855	ITABERAÍ S2	12/02/2020 18:16	12/02/2020 22:55	12/02/2020 18:16	12/02/2020 22:55	4,65	1	4,65	CHI
20200261140	QUIRINOPOLIS	80055941	QUIRINOPOLIS	12/02/2020 18:16	12/02/2020 21:27	12/02/2020 18:16	12/02/2020 21:27	3,18	1	3,18	CHI
20200261146	PORANGATU	PO12378923	PORANGATU	12/02/2020 18:16	12/02/2020 22:31	12/02/2020 18:16	12/02/2020 22:31	4,23	2	8,47	CHI
20200261147	MINACU	CR11257395	PORANGATU	12/02/2020 18:16	13/02/2020 10:35	12/02/2020 18:16	13/02/2020 10:35	16,32	1	16,32	CHI
20200261259	BARRO ALTO	BA12382484	BARRO ALTO	12/02/2020 18:16	12/02/2020 23:31	12/02/2020 18:16	12/02/2020 23:31	5,24	17	89,05	CHI
20200261148	VILA PROPICIO	NQ12252378	BARRO ALTO	12/02/2020 18:17	13/02/2020 11:09	12/02/2020 18:17	13/02/2020 11:09	16,86	12	202,32	CHI
20200261149	PLANALTINA	PI12324338	SAO JOAO D ALIANCA	12/02/2020 18:17	13/02/2020 14:22	12/02/2020 18:17	13/02/2020 14:22	20,07	6	120,45	CHI
20200261151	ITAPIRAPUA	IU21071457	JUSSARA	12/02/2020 18:17	13/02/2020 09:10	12/02/2020 18:17	13/02/2020 09:10	14,87	1	14,87	CHI
20200261158	PALMEIRAS DE GOIAS	PL12000034	PALMEIRAS	12/02/2020 18:18	13/02/2020 07:30	12/02/2020 18:18	13/02/2020 07:30	13,19	3	39,56	CHI
20200261227	NIQUELANDIA	NQ12288161	BARRO ALTO	12/02/2020 18:18	13/02/2020 00:31	12/02/2020 18:18	13/02/2020 00:31	6,21	8	49,65	CHI
20200261159	ITAPURANGA	IK12311423	ITAPURANGA	12/02/2020 18:19	12/02/2020 19:30	12/02/2020 18:19	12/02/2020 19:30	1,18	2	2,36	CHI
20200261160	ITUMBIARA	10006454001	PARANAIBA	12/02/2020 18:19	12/02/2020 18:56	12/02/2020 18:19	12/02/2020 18:56	0,61	1	0,61	CHI
20200261166	LUZIANIA	LZ12261566	VIANOPOLIS	12/02/2020 18:19	12/02/2020 21:30	12/02/2020 18:19	12/02/2020 21:30	3,17	29	92,03	CHI
20200261172	NIQUELANDIA	NQ12280978	URUACU	12/02/2020 18:21	12/02/2020 22:28	12/02/2020 18:21	12/02/2020 22:28	4,11	88	361,68	CHI
20200261174	APARECIDA DE GOIANIA	AP11350709	INDEPENDENCIA S2	12/02/2020 18:21	12/02/2020 19:36	12/02/2020 18:21	12/02/2020 19:36	1,24	87	107,69	CHI
20200261179	GOUVELANDIA	QI12301482	QUIRINOPOLIS	12/02/2020 18:22	12/02/2020 18:47	12/02/2020 18:22	12/02/2020 18:47	0,40	2	0,81	CHI
20200261188	MOZARLANDIA	MZ12058572	MOZARLANDIA	12/02/2020 18:23	13/02/2020 16:06	12/02/2020 18:23	13/02/2020 16:06	21,71	2	43,41	CHI
20200260580	COLINAS DO SUL	TI12397518	NIQUELANDIA SUBTRANSMISSAO	12/02/2020 18:25	13/02/2020 15:18	12/02/2020 18:25	13/02/2020 15:18	20,88	4	83,53	CHI
20200260580	NIQUELANDIA	TI12397518	NIQUELANDIA SUBTRANSMISSAO	12/02/2020 18:25	13/02/2020 15:18	12/02/2020 18:25	13/02/2020 15:18	20,88	126	2631,34	CHI
20200261196	BURITINOPOLIS	BQ21218835	IACIARA S2	12/02/2020 18:25	13/02/2020 08:04	12/02/2020 18:25	13/02/2020 08:04	13,64	6	81,87	CHI
20200261405	IPORA	IR12014029	IPORA	12/02/2020 18:25	13/02/2020 07:56	12/02/2020 18:25	13/02/2020 07:56	13,51	45	607,75	CHI
20200261203	NOVO GAMA	2460020710	PACAEMBU S1	12/02/2020 18:26	12/02/2020 23:07	12/02/2020 18:26	12/02/2020 23:07	4,68	1	4,68	CHI
20200261206	FLORES DE GOIAS	FB21197055	FLORES DE GOIAS	12/02/2020 18:26	13/02/2020 08:40	12/02/2020 18:26	13/02/2020 08:40	14,22	1	14,22	CHI
20200262260	BARRO ALTO	BA12286095LD	BARRO ALTO	12/02/2020 18:26	13/02/2020 01:21	12/02/2020 18:26	13/02/2020 01:21	6,91	182	1257,06	CHI
20200261211	INHUMAS	IN11373072	INHUMAS S2	12/02/2020 18:28	12/02/2020 20:23	12/02/2020 18:28	12/02/2020 20:23	1,91	221	422,60	CHI

20200261728	ITABERAÍ	IB12022008	ITABERAÍ S2	12/02/2020 18:28	13/02/2020 03:53	12/02/2020 18:28	13/02/2020 03:53	9,41	28	263,51	CHI
20200261298	SAO SIMAO	SO11219310	CACHOEIRA ALTA	12/02/2020 18:29	12/02/2020 19:46	12/02/2020 18:29	12/02/2020 19:46	1,28	74	94,51	CHI
20200261221	NOVO GAMA	NJ11214853	PACAEMBU S1	12/02/2020 18:30	12/02/2020 20:02	12/02/2020 18:30	12/02/2020 20:02	1,52	11	16,73	CHI
20200261226	PIRES DO RIO	460131606	PIRES DO RIO S1	12/02/2020 18:31	13/02/2020 07:37	12/02/2020 18:31	13/02/2020 07:37	13,09	1	13,09	CHI
20200261470	AMORINOPOLIS	AM12193408	IPORA	12/02/2020 18:31	13/02/2020 08:38	12/02/2020 18:31	13/02/2020 08:38	14,12	59	832,88	CHI
20200261470	IPORA	AM12193408	IPORA	12/02/2020 18:31	13/02/2020 08:38	12/02/2020 18:31	13/02/2020 08:38	14,12	67	945,82	CHI
20200261512	GOIANIA	GN11001619	XAVANTES	12/02/2020 18:32	12/02/2020 20:05	12/02/2020 18:32	12/02/2020 20:05	1,55	231	357,54	CHI
20200261235	MORRINHOS	MR12189857	MORRINHOS	12/02/2020 18:33	12/02/2020 20:59	12/02/2020 18:33	12/02/2020 20:59	2,42	369	894,01	CHI
20200261239	GOIANIA	13944836	MEIA PONTE	12/02/2020 18:34	12/02/2020 20:41	12/02/2020 18:34	12/02/2020 20:41	2,11	1	2,11	CHI
20200262498	GUARAITA	GK11172041	ITAPURANGA	12/02/2020 18:34	12/02/2020 23:42	12/02/2020 18:34	12/02/2020 23:42	5,13	111	569,34	CHI
20200261247	ITABERAÍ	50010750	ITABERAÍ S2	12/02/2020 18:35	13/02/2020 07:01	12/02/2020 18:35	13/02/2020 07:01	12,42	1	12,42	CHI
20200261257	CUMARI	CY21064065	CATALAO S2	12/02/2020 18:37	13/02/2020 00:14	12/02/2020 18:37	13/02/2020 00:14	5,61	1	5,61	CHI
20200261258	JARAGUA	JA21331944	JARAGUA	12/02/2020 18:37	13/02/2020 02:52	12/02/2020 18:37	13/02/2020 02:52	8,23	1	8,23	CHI
20200261260	SANTA BARBARA DE GOIAS	1030011427	TRINDADE	12/02/2020 18:38	12/02/2020 22:51	12/02/2020 18:38	12/02/2020 22:51	4,21	1	4,21	CHI
20200261268	AGUAS LINDAS DE GOIAS	LA12100236	AGUAS LINDAS DE GOIAS S1	12/02/2020 18:39	12/02/2020 20:15	12/02/2020 18:39	12/02/2020 20:15	1,60	435	696,48	CHI
20200261269	QUIRINOPOLIS	80056659	QUIRINOPOLIS	12/02/2020 18:39	13/02/2020 05:20	12/02/2020 18:39	13/02/2020 05:20	10,68	1	10,68	CHI
20200261922	PIRENOPOLIS	PV21121629	SAO FRANCISCO DE GOIAS	12/02/2020 18:39	13/02/2020 11:49	12/02/2020 18:39	13/02/2020 11:49	17,16	1	17,16	CHI
20200261271	SAO LUIZ DO NORTE	SZ21348611	ITAPACI	12/02/2020 18:40	13/02/2020 11:47	12/02/2020 18:40	13/02/2020 11:47	17,12	1	17,12	CHI
20200261272	BALIZA	BH12331415	CAIAPONIA	12/02/2020 18:40	13/02/2020 09:34	12/02/2020 18:40	13/02/2020 09:34	14,90	9	134,08	CHI
20200261275	ANAPOLIS	AN21019813	ANAPOLIS UNIVERSITARIO S2	12/02/2020 18:40	12/02/2020 20:27	12/02/2020 18:40	12/02/2020 20:27	1,77	1	1,77	CHI
20200261292	CATALAO	CT21042513	CATALAO S1	12/02/2020 18:43	12/02/2020 23:02	12/02/2020 18:43	12/02/2020 23:02	4,31	1	4,31	CHI
20200261294	GUAPO	GA21385142	GUAPO S2	12/02/2020 18:43	12/02/2020 22:19	12/02/2020 18:43	12/02/2020 22:19	3,59	3	10,76	CHI
20200261297	URUTAI	PR21328162	URUTAI	12/02/2020 18:44	12/02/2020 20:56	12/02/2020 18:44	12/02/2020 20:56	2,19	4	8,77	CHI
20200261836	SAO DOMINGOS	SD12218642	SAO DOMINGOS	12/02/2020 18:44	12/02/2020 21:41	12/02/2020 18:44	12/02/2020 21:41	2,95	82	241,67	CHI
20200261401	ITAJA	IJ21161279	ITAJA S2	12/02/2020 18:45	12/02/2020 21:07	12/02/2020 18:45	12/02/2020 21:07	2,36	1	2,36	CHI
20200261403	AMERICANO DO BRASIL	KB12000001	ANICUNS	12/02/2020 18:45	12/02/2020 23:26	12/02/2020 18:45	12/02/2020 23:26	4,67	7	32,70	CHI
20200261408	SERRANOPOLIS	DJ12164269	CHAPADAO DO CEU	12/02/2020 18:46	13/02/2020 23:57	12/02/2020 18:46	13/02/2020 23:57	29,18	5	145,92	CHI
20200261417	MIMOSO DE GOIAS	MJ21320113	PADRE BERNARDO	12/02/2020 18:48	13/02/2020 15:45	12/02/2020 18:48	13/02/2020 15:45	20,95	1	20,95	CHI
20200261418	MINACU	IH11052604	MINACU	12/02/2020 18:48	12/02/2020 23:42	12/02/2020 18:48	12/02/2020 23:42	4,89	30	146,70	CHI
20200261419	SERRANOPOLIS	JT12205191	JATAI S1	12/02/2020 18:48	12/02/2020 21:50	12/02/2020 18:48	12/02/2020 21:50	3,02	2	6,04	CHI
20200261432	CORUMBA DE GOIAS	CB21292211	CORUMBA	12/02/2020 18:51	13/02/2020 09:08	12/02/2020 18:51	13/02/2020 09:08	14,28	2	28,56	CHI
20200261438	URUACU	UR12317135	URUACU	12/02/2020 18:51	13/02/2020 08:42	12/02/2020 18:51	13/02/2020 08:04	13,22	1	13,22	CHI
20200261438	URUACU	UR12317135	URUACU	12/02/2020 18:51	13/02/2020 08:42	12/02/2020 18:51	13/02/2020 08:42	13,84	10	138,43	CHI

20200261856	SAO LUIS DE MONTES BELOS	SL12006899	SAO LUIZ DOS MONTES BELOS	12/02/2020 18:51	12/02/2020 21:20	12/02/2020 18:51	12/02/2020 21:20	2,48	35	86,68	CHI
20200261486	SAO LUIS DE MONTES BELOS	SL21283612	SAO LUIZ DOS MONTES BELOS	12/02/2020 18:51	13/02/2020 02:21	12/02/2020 18:51	13/02/2020 02:21	7,49	1	7,49	CHI
20200261439	BARRO ALTO	BA12064537	BARRO ALTO	12/02/2020 18:52	12/02/2020 20:58	12/02/2020 18:52	12/02/2020 20:58	2,09	7	14,63	CHI
20200261439	VILA PROPICIO	BA12064537	BARRO ALTO	12/02/2020 18:52	12/02/2020 20:58	12/02/2020 18:52	12/02/2020 20:58	2,09	2	4,18	CHI
20200261441	DIORAMA	DI21063448	IPORA	12/02/2020 18:53	13/02/2020 17:29	12/02/2020 18:53	13/02/2020 17:29	22,60	1	22,60	CHI
20200261444	FORMOSA	610049628	ITIQUEIRA	12/02/2020 18:53	12/02/2020 22:01	12/02/2020 18:53	12/02/2020 22:01	3,12	1	3,12	CHI
20200261445	JUSSARA	JR11165337	BRITANIA	12/02/2020 18:53	13/02/2020 05:00	12/02/2020 18:53	13/02/2020 05:00	10,11	53	536,09	CHI
20200261449	PIRANHAS	1930026150	PIRANHAS	12/02/2020 18:54	12/02/2020 21:04	12/02/2020 18:54	12/02/2020 21:04	2,16	1	2,16	CHI
20200261504	CAVALCANTE	CJ12262441	FLORES DE GOIAS	12/02/2020 18:54	12/02/2020 23:15	12/02/2020 18:54	12/02/2020 23:15	4,34	18	78,09	CHI
20200261504	TERESINA DE GOIAS	CJ12262441	FLORES DE GOIAS	12/02/2020 18:54	12/02/2020 23:15	12/02/2020 18:54	12/02/2020 23:15	4,34	2	8,68	CHI
20200261451	DISTRITO FEDERAL	IO21229779	CATALAO S1	12/02/2020 18:56	13/02/2020 11:10	12/02/2020 18:56	13/02/2020 11:10	16,23	5	81,14	CHI
20200261457	ITAPACI	IW12379430	ITAPACI	12/02/2020 18:57	13/02/2020 04:47	12/02/2020 18:57	13/02/2020 04:47	9,83	2	19,65	CHI
20200261459	NIQUELANDIA	NQ21136449	NIQUELANDIA SUBTRANSMISSAO	12/02/2020 18:58	13/02/2020 05:14	12/02/2020 18:58	13/02/2020 05:14	10,26	2	20,53	CHI
20200262202	MINEIROS	PW12219564	PARQUE DAS EMAS	12/02/2020 18:58	13/02/2020 15:29	12/02/2020 18:58	13/02/2020 15:29	20,51	7	143,55	CHI
20200262202	PORTELANDIA	PW12219564	PARQUE DAS EMAS	12/02/2020 18:58	13/02/2020 15:29	12/02/2020 18:58	13/02/2020 15:29	20,51	12	246,08	CHI
20200261467	JATAI	290241832	JATAI S2	12/02/2020 18:59	12/02/2020 21:00	12/02/2020 18:59	12/02/2020 21:00	2,02	1	2,02	CHI
20200261469	VILA BOA	VB21235786	IACIARA S2	12/02/2020 19:00	13/02/2020 07:10	12/02/2020 19:00	13/02/2020 07:10	12,16	1	12,16	CHI
20200261479	MINACU	IH12396740	MINACU	12/02/2020 19:01	13/02/2020 00:42	12/02/2020 19:01	13/02/2020 00:42	5,67	182	1032,39	CHI
20200261559	GOIANIA	GN12200567	CARAJAS S1	12/02/2020 19:01	12/02/2020 20:50	12/02/2020 19:01	12/02/2020 20:50	1,81	150	272,00	CHI
20200261489	ARAGARCAS	AG21140026	ARAGARCAS	12/02/2020 19:02	12/02/2020 23:50	12/02/2020 19:02	12/02/2020 23:50	4,79	1	4,79	CHI
20200261496	HIDROLANDIA	HD11246651	CEPAIGO S2	12/02/2020 19:04	12/02/2020 21:48	12/02/2020 19:04	12/02/2020 21:48	2,72	10	27,19	CHI
20200261503	RIO VERDE	4100001643	SANTA HELENA S1	12/02/2020 19:05	13/02/2020 13:26	12/02/2020 19:05	13/02/2020 13:26	18,34	1	18,34	CHI
20200261586	SAO DOMINGOS	SD12035858	SAO DOMINGOS	12/02/2020 19:06	12/02/2020 20:24	12/02/2020 19:06	12/02/2020 20:24	1,30	903	1175,66	CHI
20200261514	APARECIDA DE GOIANIA	10018468290	ANHANGUERA	12/02/2020 19:07	12/02/2020 20:56	12/02/2020 19:07	12/02/2020 20:56	1,82	1	1,82	CHI
20200261517	NIQUELANDIA	NQ12090406	NIQUELANDIA SUBTRANSMISSAO	12/02/2020 19:08	12/02/2020 20:47	12/02/2020 19:08	12/02/2020 20:47	1,64	3	4,92	CHI
20200261518	PALMEIRAS DE GOIAS	PL12034924	PALMEIRAS	12/02/2020 19:08	13/02/2020 02:45	12/02/2020 19:08	13/02/2020 02:45	7,60	3	22,81	CHI
20200261732	GOIAS	GS12083940	ITABERAI S1	12/02/2020 19:08	12/02/2020 23:12	12/02/2020 19:08	12/02/2020 23:12	4,06	20	81,29	CHI
20200261732	ITABERAI	GS12083940	ITABERAI S1	12/02/2020 19:08	12/02/2020 23:12	12/02/2020 19:08	12/02/2020 23:12	4,06	2	8,13	CHI
20200261520	PARAUNA	PU12314958	PARAUNA	12/02/2020 19:09	13/02/2020 09:39	12/02/2020 19:09	13/02/2020 09:39	14,50	8	115,99	CHI
20200261520	RIO VERDE	PU12314958	PARAUNA	12/02/2020 19:09	13/02/2020 09:39	12/02/2020 19:09	13/02/2020 09:39	14,50	2	29,00	CHI
20200261521	VALPARAISO DE GOIAS	VA11164930	PACAEMBU S1	12/02/2020 19:09	12/02/2020 20:05	12/02/2020 19:09	12/02/2020 20:05	0,93	179	166,47	CHI
20200261857	SAO LUIS DE MONTES BELOS	SL12373573	SAO LUIZ DOS MONTES BELOS	12/02/2020 19:09	12/02/2020 22:03	12/02/2020 19:09	12/02/2020 22:03	2,89	9	25,99	CHI
20200262001	GOIANIA	GN11166128	FERROVIARIO S2	12/02/2020 19:09	12/02/2020 23:49	12/02/2020 19:09	12/02/2020 23:49	4,66	44	205,13	CHI

20200261538	MONTE ALEGRE DE GOIAS	MA12157905	SAO DOMINGOS	12/02/2020 19:11	13/02/2020 00:10	12/02/2020 19:11	13/02/2020 00:10	4,98	7	34,83	CHI
20200261538	SAO DOMINGOS	MA12157905	SAO DOMINGOS	12/02/2020 19:11	13/02/2020 00:10	12/02/2020 19:11	13/02/2020 00:10	4,98	3	14,93	CHI
20200261819	JUSSARA	JR11025073	JUSSARA	12/02/2020 19:11	13/02/2020 01:14	12/02/2020 19:11	13/02/2020 01:14	6,04	173	1045,74	CHI
20200261549	FORMOSO	2410012286	PORANGATU	12/02/2020 19:13	13/02/2020 00:56	12/02/2020 19:13	13/02/2020 00:56	5,71	1	5,71	CHI
20200261551	MONTES CLAROS DE GOIAS	ME12228426	IPORA	12/02/2020 19:13	13/02/2020 09:40	12/02/2020 19:13	13/02/2020 09:40	14,44	3	43,33	CHI
20200261705	CALDAS NOVAS	CN11363672	CALDAS NOVAS S2	12/02/2020 19:13	12/02/2020 19:30	12/02/2020 19:13	12/02/2020 19:30	0,28	15	4,23	CHI
20200261709	PALMEIRAS DE GOIAS	PL12021690	PALMEIRAS	12/02/2020 19:13	13/02/2020 08:46	12/02/2020 19:13	13/02/2020 08:46	13,54	9	121,85	CHI
20200262029	CAIAPONIA	DV12332038	CAIAPONIA	12/02/2020 19:15	13/02/2020 00:24	12/02/2020 19:15	13/02/2020 00:24	5,14	22	113,17	CHI
20200262029	DOVERLANDIA	DV12332038	CAIAPONIA	12/02/2020 19:15	13/02/2020 00:24	12/02/2020 19:15	13/02/2020 00:24	5,14	28	144,03	CHI
20200261577	QUIRINOPOLIS	QI21155908	QUIRINOPOLIS	12/02/2020 19:16	13/02/2020 00:00	12/02/2020 19:16	13/02/2020 00:00	4,73	1	4,73	CHI
20200261593	NIQUELANDIA	NQ12140184	SAO JOAO D ALIANCA	12/02/2020 19:18	13/02/2020 00:22	12/02/2020 19:18	13/02/2020 00:22	5,05	58	293,01	CHI
20200261861	SAO LUIS DE MONTES BELOS	SL12006908	SAO LUIZ DOS MONTES BELOS	12/02/2020 19:18	13/02/2020 02:58	12/02/2020 19:18	13/02/2020 02:58	7,66	6	45,96	CHI
20200261597	INACIOLANDIA	CD12011456	CACHOEIRA DOURADA	12/02/2020 19:19	12/02/2020 21:30	12/02/2020 19:19	12/02/2020 21:30	2,17	5	10,86	CHI
20200261701	UIRAPURU	MH12391944	NOVA CRIXAS	12/02/2020 19:20	13/02/2020 12:36	12/02/2020 19:20	13/02/2020 12:36	17,26	6	103,55	CHI
20200261715	ACREUNA	2440076011	ACREUNA	12/02/2020 19:23	12/02/2020 23:06	12/02/2020 19:23	12/02/2020 23:06	3,71	1	3,71	CHI
20200261722	GOIANIA	16744962	CAMPINAS S2	12/02/2020 19:24	12/02/2020 20:35	12/02/2020 19:24	12/02/2020 20:35	1,18	1	1,18	CHI
20200261725	FORMOSA	10018078263	ITUIQUIRA	12/02/2020 19:24	12/02/2020 20:55	12/02/2020 19:24	12/02/2020 20:55	1,50	1	1,50	CHI
20200261736	COCALZINHO DE GOIAS	ZN12326371	COCALZINHO	12/02/2020 19:26	13/02/2020 12:25	12/02/2020 19:26	13/02/2020 12:25	16,98	7	118,88	CHI
20200261737	GOUVELANDIA	QI21303127	QUIRINOPOLIS	12/02/2020 19:26	12/02/2020 22:37	12/02/2020 19:26	12/02/2020 22:37	3,18	1	3,18	CHI
20200261738	OUVIDOR	OU12390633	CATALAO S1	12/02/2020 19:26	13/02/2020 10:03	12/02/2020 19:26	13/02/2020 10:03	14,61	6	87,65	CHI
20200261741	GOIANIA	14012479	CARAJAS S1	12/02/2020 19:27	12/02/2020 21:07	12/02/2020 19:27	12/02/2020 21:07	1,66	1	1,66	CHI
20200261745	IACIARA	IA21286091	IACIARA S2	12/02/2020 19:27	13/02/2020 03:02	12/02/2020 19:27	13/02/2020 03:02	7,58	1	7,58	CHI
20200261748	ORIZONA	OZ12188739	PIRES DO RIO S2	12/02/2020 19:27	13/02/2020 12:33	12/02/2020 19:27	13/02/2020 12:33	17,09	13	222,14	CHI
20200261762	CACU	CC11095408	CACHOEIRA ALTA	12/02/2020 19:27	12/02/2020 22:57	12/02/2020 19:27	12/02/2020 22:57	3,48	114	397,23	CHI
20200261753	ITAPIRAPUA	IU12380825	MATRINCHA	12/02/2020 19:28	13/02/2020 09:09	12/02/2020 19:28	13/02/2020 09:09	13,68	1	13,68	CHI
20200261756	ALTO PARAISO DE GOIAS	BF10400692	FLORES DE GOIAS	12/02/2020 19:28	12/02/2020 20:50	12/02/2020 19:28	12/02/2020 20:50	1,35	215	291,27	CHI
20200261756	SAO JOAO D ALIANCA	BF10400692	FLORES DE GOIAS	12/02/2020 19:28	12/02/2020 20:50	12/02/2020 19:28	12/02/2020 20:50	1,35	2	2,71	CHI
20200261605	CAMPO ALEGRE DE GOIAS	CT10400688	CATALAO S1	12/02/2020 19:30	13/02/2020 14:45	12/02/2020 19:30	12/02/2020 19:46	0,26	2	0,51	CHI
20200261605	CATALAO	CT10400688	CATALAO S1	12/02/2020 19:30	13/02/2020 14:45	12/02/2020 19:30	12/02/2020 19:46	0,26	549	140,45	CHI
20200261605	CATALAO	CT10400688	CATALAO S1	12/02/2020 19:30	13/02/2020 14:45	12/02/2020 19:30	12/02/2020 19:46	0,26	539	137,89	CHI
20200261605	CATALAO	CT10400688	CATALAO S1	12/02/2020 19:30	13/02/2020 14:45	12/02/2020 19:30	12/02/2020 19:46	0,26	1	0,26	CHI
20200261605	CATALAO	CT10400688	CATALAO S1	12/02/2020 19:30	13/02/2020 14:45	12/02/2020 19:31	12/02/2020 19:46	0,25	1	0,25	CHI
20200261605	CAMPO ALEGRE DE GOIAS	CT10400688	CAMPO ALEGRE DE GOIAS	12/02/2020 19:30	13/02/2020 14:45	12/02/2020 19:30	12/02/2020 21:05	1,58	125	197,78	CHI

20200261605	CATALAO	CT10400688	CAMPO ALEGRE DE GOIAS	12/02/2020 19:30	13/02/2020 14:45	12/02/2020 19:30	12/02/2020 21:05	1,58	59	93,35	CHI
20200261605	CAMPO ALEGRE DE GOIAS	CT10400688	CAMPO ALEGRE DE GOIAS	12/02/2020 19:30	13/02/2020 14:45	12/02/2020 19:31	13/02/2020 14:45	19,23	1	19,23	CHI
20200261773	PADRE BERNARDO	10022134156	PADRE BERNARDO	12/02/2020 19:32	13/02/2020 12:10	12/02/2020 19:32	13/02/2020 12:10	16,63	1	16,63	CHI
20200261774	NIQUELANDIA	4040004773	BARRO ALTO	12/02/2020 19:32	13/02/2020 10:09	12/02/2020 19:32	13/02/2020 10:09	14,61	1	14,61	CHI
20200261775	GOIAS	GS21058286	GOIAS	12/02/2020 19:33	12/02/2020 23:05	12/02/2020 19:33	12/02/2020 23:05	3,53	1	3,53	CHI
20200261784	CATALAO	CT21000089	CATALAO S1	12/02/2020 19:35	12/02/2020 20:17	12/02/2020 19:35	12/02/2020 20:17	0,69	1	0,69	CHI
20200261788	APARECIDA DE GOIANIA	200541912	INDEPENDENCIA S2	12/02/2020 19:36	12/02/2020 21:36	12/02/2020 19:36	12/02/2020 21:36	1,99	1	1,99	CHI
20200261790	TRINDADE	40197943	TRINDADE	12/02/2020 19:37	12/02/2020 22:00	12/02/2020 19:37	12/02/2020 22:00	2,39	1	2,39	CHI
20200261796	SILVANIA	SV21187080	VIANOPOLIS	12/02/2020 19:38	13/02/2020 09:44	12/02/2020 19:38	13/02/2020 09:44	14,08	1	14,08	CHI
20200261797	CATALAO	CT21267038	CATALAO S1	12/02/2020 19:39	12/02/2020 21:14	12/02/2020 19:39	12/02/2020 21:14	1,58	1	1,58	CHI
20200261798	CATALAO	CT21266292	CATALAO S1	12/02/2020 19:39	12/02/2020 20:29	12/02/2020 19:39	12/02/2020 20:29	0,83	1	0,83	CHI
20200261799	SILVANIA	SV12078642	VIANOPOLIS	12/02/2020 19:39	13/02/2020 13:35	12/02/2020 19:39	13/02/2020 13:35	17,93	14	251,08	CHI
20200261803	SANCLERLANDIA	1610002419	FIRMINOPOLIS S2	12/02/2020 19:40	13/02/2020 17:36	12/02/2020 19:40	13/02/2020 17:36	21,93	1	21,93	CHI
20200261806	SANTA TEREZINHA DE GOIAS	SG12202092	SANTA TEREZINHA	12/02/2020 19:40	12/02/2020 23:52	12/02/2020 19:40	12/02/2020 23:52	4,20	6	25,17	CHI
20200262333	MONTES CLAROS DE GOIAS	ME12210017	IPORA	12/02/2020 19:40	13/02/2020 12:58	12/02/2020 19:40	13/02/2020 12:58	17,29	25	432,17	CHI
20200261811	GOIANIA	10005271299	CAMPINAS S2	12/02/2020 19:41	12/02/2020 23:09	12/02/2020 19:41	12/02/2020 23:09	3,46	1	3,46	CHI
20200261812	SAO SIMAO	SO21000073	CACHOEIRA ALTA	12/02/2020 19:41	12/02/2020 23:21	12/02/2020 19:41	12/02/2020 23:21	3,66	1	3,66	CHI
20200261813	SAO MIGUEL DO ARAGUAIA	SM21298965	SAO MIGUEL DO ARAGUAIA	12/02/2020 19:41	12/02/2020 22:16	12/02/2020 19:41	12/02/2020 22:16	2,57	1	2,57	CHI
20200261839	CABECEIRAS	CW21184517	ITUIQUIRA	12/02/2020 19:45	12/02/2020 21:20	12/02/2020 19:45	12/02/2020 21:20	1,57	1	1,57	CHI
20200261841	QUIRINOPOLIS	QI21119914	QUIRINOPOLIS	12/02/2020 19:45	13/02/2020 09:37	12/02/2020 19:45	13/02/2020 09:37	13,85	1	13,85	CHI
20200261843	NIQUELANDIA	10004496270	NIQUELANDIA SUBTRANSMISSAO	12/02/2020 19:45	13/02/2020 04:06	12/02/2020 19:45	13/02/2020 04:06	8,33	1	8,33	CHI
20200261845	PIRES DO RIO	PR12344710	PIRES DO RIO S1	12/02/2020 19:46	13/02/2020 16:14	12/02/2020 19:46	13/02/2020 16:14	20,46	2	40,92	CHI
20200261846	ITABERAÍ	IB12300320	ITABERAÍ S2	12/02/2020 19:46	12/02/2020 21:45	12/02/2020 19:46	12/02/2020 21:45	1,97	21	41,44	CHI
20200261867	CIDADE OCIDENTAL	DH12370719	MARAJOARA	12/02/2020 19:49	12/02/2020 21:50	12/02/2020 19:49	12/02/2020 21:50	2,00	6	12,01	CHI
20200261869	GOIANIA	11632999	GOIANIA LESTE S2	12/02/2020 19:50	13/02/2020 00:12	12/02/2020 19:50	13/02/2020 00:12	4,36	1	4,36	CHI
20200261877	AGUAS LINDAS DE GOIAS	4830069145	AGUAS LINDAS DE GOIAS S1	12/02/2020 19:52	12/02/2020 23:47	12/02/2020 19:52	12/02/2020 23:47	3,91	1	3,91	CHI
20200261882	MUNDO NOVO DE GOIAS	NA12035650	NOVA CRIXAS	12/02/2020 19:53	13/02/2020 07:26	12/02/2020 19:53	13/02/2020 07:26	11,54	8	92,29	CHI
20200261882	NOVA CRIXAS	NA12035650	NOVA CRIXAS	12/02/2020 19:53	13/02/2020 07:26	12/02/2020 19:53	13/02/2020 07:26	11,54	24	276,88	CHI
20200261885	COLINAS DO SUL	TI12237626	MINACU	12/02/2020 19:54	13/02/2020 17:58	12/02/2020 19:54	13/02/2020 17:58	22,06	53	1169,12	CHI
20200261885	NIQUELANDIA	TI12237626	MINACU	12/02/2020 19:54	13/02/2020 17:58	12/02/2020 19:54	13/02/2020 17:58	22,06	1	22,06	CHI
20200261885	URUACU	TI12237626	MINACU	12/02/2020 19:54	13/02/2020 17:58	12/02/2020 19:54	13/02/2020 17:58	22,06	1	22,06	CHI
20200261888	EDEALINA	ED11128653	PONTALINA	12/02/2020 19:56	12/02/2020 21:26	12/02/2020 19:56	12/02/2020 21:26	1,50	124	185,79	CHI
20200261889	PONTALINA	PK32047344	VICENTINOPOLIS	12/02/2020 19:56	12/02/2020 21:25	12/02/2020 19:56	12/02/2020 21:25	1,48	25	36,96	CHI

20200261938	SANTA BARBARA DE GOIAS	SB11215475	TRINDADE	12/02/2020 19:58	12/02/2020 21:27	12/02/2020 19:58	12/02/2020 21:27	1,47	195	287,57	CHI
20200262056	BURITI ALEGRE	MR12000170RE	MORRINHOS	12/02/2020 19:58	13/02/2020 00:53	12/02/2020 19:58	13/02/2020 00:53	4,92	1	4,92	CHI
20200262056	MORRINHOS	MR12000170RE	MORRINHOS	12/02/2020 19:58	13/02/2020 00:53	12/02/2020 19:58	13/02/2020 00:53	4,92	54	265,44	CHI
20200261913	APARECIDA DE GOIANIA	16640597	INDEPENDENCIA S1	12/02/2020 20:01	12/02/2020 21:24	12/02/2020 20:01	12/02/2020 21:24	1,38	1	1,38	CHI
20200261924	MINACU	IH21192456	MINACU	12/02/2020 20:03	13/02/2020 03:55	12/02/2020 20:03	13/02/2020 03:55	7,86	2	15,72	CHI
20200261933	GOIANIA	SW12405640	GOIANIA LESTE S2	12/02/2020 20:05	13/02/2020 02:08	12/02/2020 20:05	13/02/2020 02:08	6,05	4	24,19	CHI
20200264563	CAMPO ALEGRE DE GOIAS	CM12270743	CAMPO ALEGRE DE GOIAS	12/02/2020 20:08	13/02/2020 14:26	12/02/2020 20:08	13/02/2020 14:26	18,30	16	292,77	CHI
20200264563	IPAMERI	CM12270743	CAMPO ALEGRE DE GOIAS	12/02/2020 20:08	13/02/2020 14:26	12/02/2020 20:08	13/02/2020 14:26	18,30	20	365,96	CHI
20200261998	PADRE BERNARDO	PB12377293	PADRE BERNARDO	12/02/2020 20:10	13/02/2020 00:15	12/02/2020 20:10	13/02/2020 00:15	4,08	12	48,92	CHI
20200261955	ANAPOLIS	20959187	ANAPOLIS UNIVERSITARIO S2	12/02/2020 20:11	13/02/2020 03:09	12/02/2020 20:11	13/02/2020 03:09	6,96	1	6,96	CHI
20200261957	APARECIDA DE GOIANIA	200333148	INDEPENDENCIA S1	12/02/2020 20:12	12/02/2020 23:50	12/02/2020 20:12	12/02/2020 23:50	3,63	1	3,63	CHI
20200261976	ANAPOLIS	AN11130801	JUNDIAI S2	12/02/2020 20:12	12/02/2020 22:53	12/02/2020 20:12	12/02/2020 22:53	2,68	125	334,79	CHI
20200262041	JATAI	JT12062162	JATAI S1	12/02/2020 20:14	13/02/2020 09:50	12/02/2020 20:14	13/02/2020 09:50	13,59	36	489,21	CHI
20200261967	MIMOSO DE GOIAS	MJ12377218	PADRE BERNARDO	12/02/2020 20:15	13/02/2020 08:08	12/02/2020 20:15	13/02/2020 08:08	11,87	11	130,60	CHI
20200261968	BURITI ALEGRE	BG21285850	GOIATUBA S2	12/02/2020 20:15	13/02/2020 11:34	12/02/2020 20:15	13/02/2020 11:34	15,31	1	15,31	CHI
20200261980	AMARALINA	MU12391981	MARA ROSA	12/02/2020 20:19	13/02/2020 11:39	12/02/2020 20:19	13/02/2020 11:39	15,33	5	76,63	CHI
20200261980	MUTUNOPOLIS	MU12391981	MARA ROSA	12/02/2020 20:19	13/02/2020 11:39	12/02/2020 20:19	13/02/2020 11:39	15,33	5	76,63	CHI
20200261985	CATALAO	1990079249	CATALAO S2	12/02/2020 20:21	13/02/2020 07:26	12/02/2020 20:21	13/02/2020 07:26	11,08	1	11,08	CHI
20200261999	HIDROLANDIA	HD21275177	PONTALINA	12/02/2020 20:28	13/02/2020 03:46	12/02/2020 20:28	13/02/2020 03:46	7,30	1	7,30	CHI
20200262003	BELA VISTA DE GOIAS	SQ12338141	CRISTIANOPOLIS	12/02/2020 20:28	12/02/2020 23:55	12/02/2020 20:28	12/02/2020 23:55	3,44	3	10,32	CHI
20200262003	SAO MIGUEL DO PASSA QUATRO	SQ12338141	CRISTIANOPOLIS	12/02/2020 20:28	12/02/2020 23:55	12/02/2020 20:28	12/02/2020 23:55	3,44	163	560,45	CHI
20200262006	ALTO PARAISO DE GOIAS	BF12399048	FLORES DE GOIAS	12/02/2020 20:30	12/02/2020 22:02	12/02/2020 20:30	12/02/2020 22:02	1,53	1	1,53	CHI
20200262007	DOVERLANDIA	MY12217015	PARQUE DAS EMAS	12/02/2020 20:31	13/02/2020 11:11	12/02/2020 20:31	13/02/2020 11:11	14,66	30	439,92	CHI
20200262007	MINEIROS	MY12217015	PARQUE DAS EMAS	12/02/2020 20:31	13/02/2020 11:11	12/02/2020 20:31	13/02/2020 11:11	14,66	9	131,98	CHI
20200262011	NIQUELANDIA	NQ12208518	NIQUELANDIA SUBTRANSMISSAO	12/02/2020 20:31	12/02/2020 23:48	12/02/2020 20:31	12/02/2020 23:48	3,27	97	317,19	CHI
20200262047	CRIXAS	CX12391661	SANTA TEREZINHA	12/02/2020 20:31	13/02/2020 00:59	12/02/2020 20:31	13/02/2020 00:59	4,48	31	138,82	CHI
20200262022	GOIANIA	10018497584	REAL S1	12/02/2020 20:33	13/02/2020 02:26	12/02/2020 20:33	13/02/2020 02:26	5,88	1	5,88	CHI
20200262213	CALDAS NOVAS	CN11122149	SERRA DE CALDAS	12/02/2020 20:33	12/02/2020 21:55	12/02/2020 20:33	12/02/2020 21:55	1,36	59	80,42	CHI
20200262287	JATAI	SX12139578	JATAI S1	12/02/2020 20:33	13/02/2020 14:24	12/02/2020 20:33	13/02/2020 14:24	17,85	13	232,04	CHI
20200262287	SERRANOPOLIS	SX12139578	JATAI S1	12/02/2020 20:33	13/02/2020 14:24	12/02/2020 20:33	13/02/2020 14:24	17,85	33	589,01	CHI
20200262031	DAVINOPOLIS	IO21156391	CATALAO S1	12/02/2020 20:36	13/02/2020 09:58	12/02/2020 20:36	13/02/2020 09:58	13,37	1	13,37	CHI
20200262035	JATAI	JT21104678	JATAI S1	12/02/2020 20:37	12/02/2020 22:31	12/02/2020 20:37	12/02/2020 22:31	1,90	1	1,90	CHI
20200262049	LUZIANIA	LZ11168718	RIO VERMELHO	12/02/2020 20:39	12/02/2020 22:00	12/02/2020 20:39	12/02/2020 22:00	1,35	143	193,41	CHI

20200262057	VARJAO	3250000460	GUAPO S2	12/02/2020 20:41	13/02/2020 09:13	12/02/2020 20:41	13/02/2020 09:13	12,52	1	12,52	CHI
20200262063	ANAPOLIS	20809797	JUNDIAI S2	12/02/2020 20:42	12/02/2020 23:53	12/02/2020 20:42	12/02/2020 23:53	3,17	1	3,17	CHI
20200262075	GOIANESIA	GE21000282	GOIANESIA S1	12/02/2020 20:45	13/02/2020 11:20	12/02/2020 20:45	13/02/2020 11:20	14,58	1	14,58	CHI
20200262263	NOVA ROMA	ND12117611	IACIARA S2	12/02/2020 20:45	13/02/2020 02:10	12/02/2020 20:45	13/02/2020 02:10	5,41	8	43,24	CHI
20200262088	NIQUELANDIA	NQ12086253	URUACU	12/02/2020 20:47	15/02/2020 20:00	12/02/2020 20:47	13/02/2020 09:50	13,05	15	195,77	CHI
20200262088	NIQUELANDIA	NQ12086253	URUACU	12/02/2020 20:47	15/02/2020 20:00	13/02/2020 16:39	13/02/2020 16:48	0,15	14	2,10	CHI
20200262088	NIQUELANDIA	NQ12086253	URUACU	12/02/2020 20:47	15/02/2020 20:00	14/02/2020 23:03	14/02/2020 23:42	0,66	14	9,31	CHI
20200262088	NIQUELANDIA	NQ12086253	URUACU	12/02/2020 20:47	15/02/2020 20:00	12/02/2020 20:47	15/02/2020 15:45	66,96	2	133,92	CHI
20200262088	NIQUELANDIA	NQ12086253	URUACU	12/02/2020 20:47	15/02/2020 20:00	12/02/2020 20:47	15/02/2020 15:46	66,98	2	133,95	CHI
20200262088	NIQUELANDIA	NQ12086253	URUACU	12/02/2020 20:47	15/02/2020 20:00	12/02/2020 20:47	15/02/2020 15:47	66,99	1	66,99	CHI
20200262088	NIQUELANDIA	NQ12086253	URUACU	12/02/2020 20:47	15/02/2020 20:00	12/02/2020 20:47	15/02/2020 16:45	67,97	24	1631,17	CHI
20200262088	NIQUELANDIA	NQ12086253	URUACU	12/02/2020 20:47	15/02/2020 20:00	12/02/2020 20:47	15/02/2020 17:52	69,08	1	69,08	CHI
20200262088	NIQUELANDIA	NQ12086253	URUACU	12/02/2020 20:47	15/02/2020 20:00	12/02/2020 20:47	15/02/2020 19:19	70,53	1	70,53	CHI
20200262088	NIQUELANDIA	NQ12086253	URUACU	12/02/2020 20:47	15/02/2020 20:00	12/02/2020 20:47	15/02/2020 20:00	71,21	1	71,21	CHI
20200262091	INHUMAS	IN21132735	INHUMAS S2	12/02/2020 20:48	12/02/2020 22:50	12/02/2020 20:48	12/02/2020 22:50	2,03	11	22,35	CHI
20200262098	SAO JOAO D ALIANCA	JL21268112	FLORES DE GOIAS	12/02/2020 20:50	13/02/2020 10:22	12/02/2020 20:50	13/02/2020 10:22	13,53	2	27,06	CHI
20200262203	CORUMBAIBA	CI12110161	VILA CORUMBA	12/02/2020 20:51	13/02/2020 09:04	12/02/2020 20:51	13/02/2020 09:04	12,22	44	537,48	CHI
20200262211	GOIANIA	10004946047	GOIANIA LESTE S3	12/02/2020 20:54	13/02/2020 00:02	12/02/2020 20:54	13/02/2020 00:02	3,12	1	3,12	CHI
20200262214	DAMOLANDIA	IN12014368	INHUMAS S1	12/02/2020 20:55	13/02/2020 01:10	12/02/2020 20:55	13/02/2020 01:10	4,25	58	246,32	CHI
20200262214	INHUMAS	IN12014368	INHUMAS S1	12/02/2020 20:55	13/02/2020 01:10	12/02/2020 20:55	13/02/2020 01:10	4,25	50	212,35	CHI
20200262214	PETROLINA DE GOIAS	IN12014368	INHUMAS S1	12/02/2020 20:55	13/02/2020 01:10	12/02/2020 20:55	13/02/2020 01:10	4,25	5	21,23	CHI
20200262259	NOVA CRIXAS	NA12380421	NOVA CRIXAS	12/02/2020 20:55	13/02/2020 04:57	12/02/2020 20:55	13/02/2020 04:57	8,04	47	377,68	CHI
20200262220	VALPARAISO DE GOIAS	10010627063	MARAJOARA	12/02/2020 20:56	12/02/2020 22:46	12/02/2020 20:56	12/02/2020 22:46	1,82	1	1,82	CHI
20200262250	GOIANIA	GN11001619	XAVANTES	12/02/2020 20:58	12/02/2020 22:02	12/02/2020 20:58	12/02/2020 22:02	1,06	231	244,80	CHI
20200262233	RIO VERDE	630150576	RIO VERDE S2	12/02/2020 21:00	13/02/2020 11:49	12/02/2020 21:00	13/02/2020 11:49	14,81	1	14,81	CHI
20200262234	SANTA CRUZ DE GOIAS	PZ21000458	PIRES DO RIO S2	12/02/2020 21:01	13/02/2020 18:25	12/02/2020 21:01	13/02/2020 18:25	21,39	1	21,39	CHI
20200262236	APARECIDA DE GOIANIA	16633507	INDEPENDENCIA S1	12/02/2020 21:01	12/02/2020 22:38	12/02/2020 21:01	12/02/2020 22:38	1,60	1	1,60	CHI
20200262240	LUZIANIA	LZ11313688	MARAJOARA	12/02/2020 21:03	12/02/2020 22:37	12/02/2020 21:03	12/02/2020 22:37	1,56	10	15,60	CHI
20200262249	ITAUCU	AR21112860	ARACU	12/02/2020 21:06	13/02/2020 00:15	12/02/2020 21:06	13/02/2020 00:15	3,15	1	3,15	CHI
20200262252	ARAGOIANIA	AO32097601	GUAPO S2	12/02/2020 21:06	13/02/2020 01:07	12/02/2020 21:06	13/02/2020 01:07	4,00	5	20,00	CHI
20200262527	NEROPOLIS	NR11271853	NEROPOLIS S2	12/02/2020 21:09	12/02/2020 23:51	12/02/2020 21:09	12/02/2020 23:51	2,69	152	408,29	CHI
20200262265	IPAMERI	IP21381658	CRISTALINA S2	12/02/2020 21:13	13/02/2020 10:44	12/02/2020 21:13	13/02/2020 10:44	13,51	1	13,51	CHI
20200262304	SENADOR CANEDO	SW11246299	SENADOR CANEDO	12/02/2020 21:14	12/02/2020 22:46	12/02/2020 21:14	12/02/2020 22:46	1,53	119	181,94	CHI

20200262426	ORIZONA	OZ12094953	VIANOPOLIS	12/02/2020 21:16	13/02/2020 08:46	12/02/2020 21:16	13/02/2020 08:46	11,50	7	80,50	CHI
20200262426	VIANOPOLIS	OZ12094953	VIANOPOLIS	12/02/2020 21:16	13/02/2020 08:46	12/02/2020 21:16	13/02/2020 08:46	11,50	103	1184,50	CHI
20200263958	VIANOPOLIS	OZ21095393	VIANOPOLIS	12/02/2020 21:16	13/02/2020 09:57	12/02/2020 21:16	13/02/2020 09:57	12,68	1	12,68	CHI
20200262278	CASTELANDIA	QI12053189	QUIRINOPOLIS	12/02/2020 21:17	13/02/2020 02:52	12/02/2020 21:17	13/02/2020 02:52	5,58	17	94,91	CHI
20200262278	QUIRINOPOLIS	QI12053189	QUIRINOPOLIS	12/02/2020 21:17	13/02/2020 02:52	12/02/2020 21:17	13/02/2020 02:52	5,58	3	16,75	CHI
20200262278	RIO VERDE	QI12053189	QUIRINOPOLIS	12/02/2020 21:17	13/02/2020 02:52	12/02/2020 21:17	13/02/2020 02:52	5,58	1	5,58	CHI
20200262279	GOIANIA	GN12291366	AEROPORTO S2	12/02/2020 21:17	13/02/2020 00:10	12/02/2020 21:17	13/02/2020 00:10	2,88	2	5,76	CHI
20200262280	IACIARA	IA11195766	IACIARA S1	12/02/2020 21:17	12/02/2020 22:19	12/02/2020 21:17	12/02/2020 22:19	1,03	52	53,39	CHI
20200262285	GOIANIA	10011032314	CARAJAS S1	12/02/2020 21:19	12/02/2020 23:17	12/02/2020 21:19	12/02/2020 23:17	1,96	1	1,96	CHI
20200262318	GOIANDIRA	GD12377061	CATALAO S1	12/02/2020 21:22	13/02/2020 07:22	12/02/2020 21:22	13/02/2020 07:22	9,99	14	139,86	CHI
20200262297	DIVINOPOLIS DE GOIAS	MA12398387	SAO DOMINGOS	12/02/2020 21:23	13/02/2020 01:59	12/02/2020 21:23	13/02/2020 01:59	4,58	3	13,75	CHI
20200262297	MONTE ALEGRE DE GOIAS	MA12398387	SAO DOMINGOS	12/02/2020 21:23	13/02/2020 01:59	12/02/2020 21:23	13/02/2020 01:59	4,58	16	73,35	CHI
20200262302	VALPARAISO DE GOIAS	2860305677	MARAJOARA	12/02/2020 21:26	12/02/2020 23:01	12/02/2020 21:26	12/02/2020 23:01	1,58	1	1,58	CHI
20200262306	SAO MIGUEL DO ARAGUAIA	SM12074411	SAO MIGUEL DO ARAGUAIA	12/02/2020 21:28	13/02/2020 00:14	12/02/2020 21:28	13/02/2020 00:14	2,76	10	27,63	CHI
20200262309	PROFESSOR JAMIL SAFADY	PJ12077814	PONTALINA	12/02/2020 21:28	13/02/2020 12:06	12/02/2020 21:28	13/02/2020 12:06	14,62	7	102,36	CHI
20200262311	CRIXAS	CX12134848	SANTA TEREZINHA	12/02/2020 21:30	13/02/2020 04:35	12/02/2020 21:30	13/02/2020 04:35	7,07	3	21,22	CHI
20200262312	COCALZINHO DE GOIAS	10021302403	COCALZINHO	12/02/2020 21:30	13/02/2020 13:32	12/02/2020 21:30	13/02/2020 13:32	16,02	1	16,02	CHI
20200262324	POSSE	PS21218840	IACIARA S2	12/02/2020 21:35	12/02/2020 23:41	12/02/2020 21:35	12/02/2020 23:41	2,10	1	2,10	CHI
20200262336	URUACU	640036119	URUACU	12/02/2020 21:41	13/02/2020 00:50	12/02/2020 21:41	13/02/2020 00:50	3,14	1	3,14	CHI
20200262337	ALTO PARAISO DE GOIAS	3870003880	FLORES DE GOIAS	12/02/2020 21:43	12/02/2020 22:42	12/02/2020 21:43	12/02/2020 22:42	0,98	1	0,98	CHI
20200262446	ESTRELA DO NORTE	MU12076698	MARA ROSA	12/02/2020 21:44	13/02/2020 00:53	12/02/2020 21:44	13/02/2020 00:53	3,16	1	3,16	CHI
20200262446	MUTUNOPOLIS	MU12076698	MARA ROSA	12/02/2020 21:44	13/02/2020 00:53	12/02/2020 21:44	13/02/2020 00:53	3,16	31	97,94	CHI
20200262411	RUBIATABA	RB12028116	RUBIATABA	12/02/2020 21:47	13/02/2020 08:05	12/02/2020 21:47	13/02/2020 08:05	10,29	89	915,56	CHI
20200262351	ORIZONA	OZ12275795	PIRES DO RIO S1	12/02/2020 21:48	13/02/2020 13:05	12/02/2020 21:48	13/02/2020 13:05	15,27	4	61,07	CHI
20200259350	FORMOSA	FA13146118	ITIQUEIRA	12/02/2020 21:49	13/02/2020 23:40	12/02/2020 21:49	13/02/2020 10:36	12,79	1	12,79	CHI
20200259350	DISTRITO FEDERAL	FA13146118	ITIQUEIRA	12/02/2020 21:49	13/02/2020 23:40	12/02/2020 21:49	13/02/2020 23:40	25,84	1	25,84	CHI
20200259350	FORMOSA	FA13146118	ITIQUEIRA	12/02/2020 21:49	13/02/2020 23:40	12/02/2020 21:49	13/02/2020 23:40	25,84	30	775,26	CHI
20200262355	CAMPINORTE	CR13162600	CAMPINORTE	12/02/2020 21:49	13/02/2020 02:10	12/02/2020 21:49	13/02/2020 01:25	3,58	593	2125,74	CHI
20200262355	CAMPINORTE	03262204	CAMPINORTE	12/02/2020 21:49	13/02/2020 02:10	13/02/2020 01:27	13/02/2020 01:56	0,48	593	284,64	CHI
20200262355	CAMPINORTE	03262204	CAMPINORTE	12/02/2020 21:49	13/02/2020 02:10	12/02/2020 21:49	13/02/2020 01:57	4,13	1011	4178,80	CHI
20200262355	NOVA IGUAUCU DE GOIAS	03262204	CAMPINORTE	12/02/2020 21:49	13/02/2020 02:10	12/02/2020 21:49	13/02/2020 01:57	4,13	111	458,80	CHI
20200262355	URUACU	03262204	CAMPINORTE	12/02/2020 21:49	13/02/2020 02:10	12/02/2020 21:49	13/02/2020 01:57	4,13	101	417,47	CHI
20200262355	CAMPINORTE	CR16408542	CAMPINORTE	12/02/2020 21:49	13/02/2020 02:10	12/02/2020 21:49	13/02/2020 02:08	4,32	1249	5394,99	CHI

20200262355	NOVA IGUACU DE GOIAS	CR16408542	CAMPINORTE	12/02/2020 21:49	13/02/2020 02:10	12/02/2020 21:49	13/02/2020 02:08	4,32	4	17,28	CHI
20200262355	URUACU	CR16408542	CAMPINORTE	12/02/2020 21:49	13/02/2020 02:10	12/02/2020 21:49	13/02/2020 02:08	4,32	426	1840,08	CHI
20200262355	CAMPINORTE	CR10410032	CAMPINORTE	12/02/2020 21:49	13/02/2020 02:10	12/02/2020 21:49	13/02/2020 02:09	4,33	854	3694,50	CHI
20200262355	CAMPINORTE	CR10410032	CAMPINORTE	12/02/2020 21:49	13/02/2020 02:10	12/02/2020 21:49	13/02/2020 02:10	4,34	901	3906,59	CHI
20200262355	NOVA IGUACU DE GOIAS	CR10410032	CAMPINORTE	12/02/2020 21:49	13/02/2020 02:10	12/02/2020 21:49	13/02/2020 02:10	4,34	21	91,05	CHI
2020021300049	NOVA IGUACU DE GOIAS	O3260224	CAMPINORTE	12/02/2020 21:49	13/02/2020 01:18	12/02/2020 21:49	13/02/2020 01:18	3,48	1	3,48	CHI
2020021300049	URUACU	O3260224	CAMPINORTE	12/02/2020 21:49	13/02/2020 01:18	12/02/2020 21:49	13/02/2020 01:18	3,48	9	31,35	CHI
20200262356	PILAR DE GOIAS	GG21365406	SANTA TEREZINHA	12/02/2020 21:50	13/02/2020 08:49	12/02/2020 21:50	13/02/2020 08:49	10,98	1	10,98	CHI
202002191229	FLORES DE GOIAS	O2830414	FLORES DE GOIAS	12/02/2020 21:58	13/02/2020 03:48	12/02/2020 21:58	13/02/2020 03:48	5,84	2232	13023,72	CHI
202002191229	NOVA ROMA	O2830414	FLORES DE GOIAS	12/02/2020 21:58	13/02/2020 03:48	12/02/2020 21:58	13/02/2020 03:48	5,84	2	11,67	CHI
202002191229	SAO JOAO D ALIANCA	O2830414	FLORES DE GOIAS	12/02/2020 21:58	13/02/2020 03:48	12/02/2020 21:58	13/02/2020 03:48	5,84	107	624,35	CHI
20200262428	PORANGATU	TB12208457	PORANGATU	12/02/2020 22:02	13/02/2020 08:39	12/02/2020 22:02	13/02/2020 08:39	10,61	1	10,61	CHI
20200262428	TROMBAS	TB12208457	PORANGATU	12/02/2020 22:02	13/02/2020 08:39	12/02/2020 22:02	13/02/2020 08:39	10,61	16	169,72	CHI
20200262430	CAMPOS VERDES	VD12181203	SANTA TEREZINHA	12/02/2020 22:02	13/02/2020 01:02	12/02/2020 22:02	13/02/2020 01:02	2,99	12	35,88	CHI
20200262443	FORMOSA	FA21400953	ITIQUEIRA	12/02/2020 22:07	13/02/2020 10:41	12/02/2020 22:07	13/02/2020 10:41	12,57	2	25,13	CHI
20200262450	APARECIDA DE GOIANIA	200267784	INDEPENDENCIA S2	12/02/2020 22:09	12/02/2020 23:11	12/02/2020 22:09	12/02/2020 23:11	1,02	1	1,02	CHI
20200258526	PIRENOPOLIS	PV12382113	SAO FRANCISCO DE GOIAS	12/02/2020 22:13	13/02/2020 08:45	12/02/2020 22:13	13/02/2020 08:45	10,54	311	3278,03	CHI
20200262464	SAO MIGUEL DO ARAGUAIA	SM12020044	SAO MIGUEL DO ARAGUAIA	12/02/2020 22:14	13/02/2020 01:17	12/02/2020 22:14	13/02/2020 01:17	3,04	3	9,13	CHI
20200262465	MUTUNOPOLIS	MU21315005	MARA ROSA	12/02/2020 22:14	13/02/2020 02:08	12/02/2020 22:14	13/02/2020 02:08	3,89	2	7,78	CHI
20200262469	ANAPOLIS	20380951	ANAPOLIS UNIVERSITARIO S2	12/02/2020 22:15	13/02/2020 01:59	12/02/2020 22:15	13/02/2020 01:59	3,73	1	3,73	CHI
20200262473	URUTAI	600003218	URUTAI	12/02/2020 22:16	13/02/2020 19:40	12/02/2020 22:16	13/02/2020 19:40	21,39	1	21,39	CHI
20200262488	ANAPOLIS	AN12000193RE	ANAPOLIS UNIVERSITARIO S2	12/02/2020 22:16	13/02/2020 16:59	12/02/2020 22:16	13/02/2020 16:59	18,72	48	898,47	CHI
20200262488	PIRENOPOLIS	AN12000193RE	ANAPOLIS UNIVERSITARIO S2	12/02/2020 22:16	13/02/2020 16:59	12/02/2020 22:16	13/02/2020 16:59	18,72	16	299,49	CHI
20200262478	NOVA CRIXAS	NA12354854	NOVA CRIXAS	12/02/2020 22:19	13/02/2020 09:34	12/02/2020 22:19	13/02/2020 09:34	11,24	9	101,16	CHI
20200262533	APARECIDA DE GOIANIA	AP11043097	INDEPENDENCIA S2	12/02/2020 22:20	13/02/2020 01:19	12/02/2020 22:20	13/02/2020 01:19	2,97	138	410,09	CHI
20200262497	ANAPOLIS	20890886	JUNDIAI S1	12/02/2020 22:29	13/02/2020 04:50	12/02/2020 22:29	13/02/2020 04:50	6,34	1	6,34	CHI
20200265026	NOVA ROMA	ND12325863	FLORES DE GOIAS	12/02/2020 22:29	13/02/2020 11:33	12/02/2020 22:29	13/02/2020 11:33	13,06	15	195,90	CHI
20200262508	URUTAI	UT21027127	URUTAI	12/02/2020 22:34	13/02/2020 09:21	12/02/2020 22:34	13/02/2020 09:21	10,78	1	10,78	CHI
20200264025	ORIZONA	OZ12231617	PIRES DO RIO S2	12/02/2020 22:39	13/02/2020 09:49	12/02/2020 22:39	13/02/2020 09:49	11,16	24	267,85	CHI
20200263408	SILVANIA	SV11090102	VIANOPOLIS	12/02/2020 23:13	13/02/2020 07:59	12/02/2020 23:13	13/02/2020 07:59	8,76	206	1805,08	CHI
20200262728	PIRES DO RIO	PR11352216	PIRES DO RIO S1	12/02/2020 23:32	13/02/2020 06:51	12/02/2020 23:32	13/02/2020 06:51	7,31	73	533,69	CHI
20200262552	APARECIDA DE GOIANIA	12467881	INDEPENDENCIA S2	12/02/2020 23:36	13/02/2020 00:46	12/02/2020 23:36	13/02/2020 00:46	1,15	1	1,15	CHI
20200262553	GOIANIA	10010045838	REAL S2	12/02/2020 23:38	13/02/2020 01:05	12/02/2020 23:38	13/02/2020 01:05	1,44	1	1,44	CHI

20200262556	GOIANESIA	550105270	GOIANESIA S2	12/02/2020 23:48	13/02/2020 05:00	12/02/2020 23:48	13/02/2020 05:00	5,19	1	5,19	CHI
20200264483	IPAMERI	IP11261654	CRISTALINA S1	12/02/2020 23:55	13/02/2020 09:34	12/02/2020 23:55	13/02/2020 09:34	9,64	220	2119,94	CHI
20200262570	PONTALINA	AD12060078	GOIATUBA S1	13/02/2020 00:05	13/02/2020 09:40	13/02/2020 00:05	13/02/2020 09:40	9,58	12	114,91	CHI
20200262601	MONTE ALEGRE DE GOIAS	MA12233169	SAO DOMINGOS	13/02/2020 00:08	13/02/2020 00:26	13/02/2020 00:08	13/02/2020 00:26	0,30	18	5,40	CHI
20200262575	CACU	CC21322238	CACHOEIRA ALTA	13/02/2020 00:11	13/02/2020 04:17	13/02/2020 00:11	13/02/2020 04:17	4,09	1	4,09	CHI
20200263513	IPAMERI	IP12313696	CRISTALINA S2	13/02/2020 00:32	13/02/2020 08:49	13/02/2020 00:32	13/02/2020 08:49	8,27	2	16,54	CHI
20200262586	SANTA RITA DO NOVO DESTINO	BA12156230	BARRO ALTO	13/02/2020 00:47	14/02/2020 09:38	13/02/2020 00:47	13/02/2020 15:16	14,48	3	43,44	CHI
20200262586	BARRO ALTO	BA12156230	BARRO ALTO	13/02/2020 00:47	14/02/2020 09:38	13/02/2020 00:47	14/02/2020 09:38	32,85	45	1478,05	CHI
20200262586	SANTA RITA DO NOVO DESTINO	BA12156230	BARRO ALTO	13/02/2020 00:47	14/02/2020 09:38	13/02/2020 00:47	14/02/2020 09:38	32,85	5	164,23	CHI
20200262586	SANTA RITA DO NOVO DESTINO	BA12156230	BARRO ALTO	13/02/2020 00:47	14/02/2020 09:38	14/02/2020 07:39	14/02/2020 09:38	1,98	8	15,87	CHI
20200262587	FLORES DE GOIAS	FB21043488	IACIARA S2	13/02/2020 00:56	13/02/2020 09:39	13/02/2020 00:56	13/02/2020 09:39	8,71	1	8,71	CHI
20200262588	RIO VERDE	RV11092199	RIO VERDE S1	13/02/2020 00:58	13/02/2020 12:16	13/02/2020 00:58	13/02/2020 12:16	11,28	28	315,97	CHI
20200262703	URUTAI	UT12095217	URUTAI	13/02/2020 01:08	13/02/2020 01:30	13/02/2020 01:08	13/02/2020 01:30	0,36	6	2,16	CHI
20200262707	LUZIANIA	3200198860	MARAJOARA	13/02/2020 01:33	13/02/2020 02:21	13/02/2020 01:33	13/02/2020 02:21	0,79	1	0,79	CHI
20200263578	PADRE BERNARDO	PB12290560	PADRE BERNARDO	13/02/2020 02:00	13/02/2020 09:57	13/02/2020 02:00	13/02/2020 09:57	7,94	29	230,36	CHI
20200262718	ITAPACI	IW12044978	ITAPACI	13/02/2020 02:25	13/02/2020 11:16	13/02/2020 02:25	13/02/2020 11:16	8,84	6	53,03	CHI
20200262603	CAMPINACU	FO10328897	PORANGATU	13/02/2020 02:26	13/02/2020 02:40	13/02/2020 02:26	13/02/2020 02:40	0,24	1517	360,71	CHI
20200262603	CAMPINORTE	FO10328897	PORANGATU	13/02/2020 02:26	13/02/2020 02:40	13/02/2020 02:26	13/02/2020 02:40	0,24	149	35,43	CHI
20200262603	FORMOSO	FO10328897	PORANGATU	13/02/2020 02:26	13/02/2020 02:40	13/02/2020 02:26	13/02/2020 02:40	0,24	46	10,94	CHI
20200262603	MINACU	FO10328897	PORANGATU	13/02/2020 02:26	13/02/2020 02:40	13/02/2020 02:26	13/02/2020 02:40	0,24	42	9,99	CHI
20200262603	PORANGATU	FO10328897	PORANGATU	13/02/2020 02:26	13/02/2020 02:40	13/02/2020 02:26	13/02/2020 02:40	0,24	1	0,24	CHI
20200262719	ITAUCU	IX12322432	INHUMAS S1	13/02/2020 02:30	13/02/2020 08:56	13/02/2020 02:30	13/02/2020 08:56	6,43	6	38,59	CHI
20200264826	SAO FRANCISCO DE GOIAS	SF12000173	SAO FRANCISCO DE GOIAS	13/02/2020 03:20	13/02/2020 19:55	13/02/2020 03:20	13/02/2020 19:55	16,58	12	198,98	CHI
20200262732	GOIANESIA	GE12215070	GOIANESIA S1	13/02/2020 03:25	13/02/2020 08:05	13/02/2020 03:25	13/02/2020 08:05	4,66	24	111,78	CHI
20200262740	CAMPINORTE	CR10400663	CAMPINORTE	13/02/2020 03:36	13/02/2020 07:35	13/02/2020 03:36	13/02/2020 07:35	3,99	22	87,78	CHI
20200262740	NOVA IGUACU DE GOIAS	CR10400663	CAMPINORTE	13/02/2020 03:36	13/02/2020 07:35	13/02/2020 03:36	13/02/2020 07:35	3,99	112	446,88	CHI
20200262740	URUACU	CR10400663	CAMPINORTE	13/02/2020 03:36	13/02/2020 07:35	13/02/2020 03:36	13/02/2020 07:35	3,99	102	406,98	CHI
20200264323	PETROLINA DE GOIAS	PG32086638	SAO FRANCISCO DE GOIAS	13/02/2020 03:55	13/02/2020 10:19	13/02/2020 03:55	13/02/2020 10:19	6,38	40	255,39	CHI
20200262746	SANTA CRUZ DE GOIAS	BC21280312	PIRES DO RIO S2	13/02/2020 03:57	13/02/2020 20:52	13/02/2020 03:57	13/02/2020 20:52	16,92	1	16,92	CHI
20200262751	SAO MIGUEL DO PASSA QUATRO	SQ12088077	CRISTIANOPOLIS	13/02/2020 04:25	13/02/2020 10:33	13/02/2020 04:25	13/02/2020 10:33	6,12	18	110,11	CHI
20200263207	CORUMBAlBA	CI12127541	CATALAO S1	13/02/2020 04:36	13/02/2020 10:48	13/02/2020 04:36	13/02/2020 10:48	6,20	24	148,78	CHI
20200263207	NOVA AURORA	CI12127541	CATALAO S1	13/02/2020 04:36	13/02/2020 10:48	13/02/2020 04:36	13/02/2020 10:48	6,20	8	49,59	CHI
20200262763	FORMOSO	TB12372648	PORANGATU	13/02/2020 04:56	13/02/2020 07:50	13/02/2020 04:56	13/02/2020 07:50	2,89	1	2,89	CHI

20200262763	TROMBAS	TB12372648	PORANGATU	13/02/2020 04:56	13/02/2020 07:50	13/02/2020 04:56	13/02/2020 07:50	2,89	65	187,63	CHI
20200262767	SANTO ANTONIO DO DESCOBERTO	SN21148098	AGUAS LINDAS DE GOIAS S2	13/02/2020 05:10	13/02/2020 06:22	13/02/2020 05:10	13/02/2020 06:22	1,19	1	1,19	CHI
20200262768	CRISTALINA	KR12039306	CRISTALINA S1	13/02/2020 05:11	13/02/2020 11:57	13/02/2020 05:11	13/02/2020 11:57	6,76	2	13,51	CHI
20200262771	PORANGATU	PO21192173	PORANGATU	13/02/2020 05:16	13/02/2020 11:57	13/02/2020 05:16	13/02/2020 11:57	6,68	1	6,68	CHI
20200262773	NOVA VENEZA	NV21000158	INHUMAS S1	13/02/2020 05:17	13/02/2020 07:24	13/02/2020 05:17	13/02/2020 07:24	2,11	1	2,11	CHI
2020021300058	ALVORADA DO NORTE	00010214	IACIARA S2	13/02/2020 05:17	13/02/2020 05:20	13/02/2020 05:17	13/02/2020 05:20	0,05	1532	76,60	CHI
2020021300058	ALVORADA DO NORTE	00010224	IACIARA S2	13/02/2020 05:17	13/02/2020 05:20	13/02/2020 05:17	13/02/2020 05:20	0,05	611	30,55	CHI
2020021300058	ALVORADA DO NORTE	00010414	IACIARA S2	13/02/2020 05:17	13/02/2020 05:20	13/02/2020 05:17	13/02/2020 05:20	0,05	153	7,65	CHI
2020021300058	ALVORADA DO NORTE	00010424	IACIARA S2	13/02/2020 05:17	13/02/2020 05:20	13/02/2020 05:17	13/02/2020 05:20	0,05	1	0,05	CHI
2020021300058	ALVORADA DO NORTE	00010434	IACIARA S2	13/02/2020 05:17	13/02/2020 05:20	13/02/2020 05:17	13/02/2020 05:20	0,05	52	2,60	CHI
2020021300058	BURITINOPOLIS	00010214	IACIARA S2	13/02/2020 05:17	13/02/2020 05:20	13/02/2020 05:17	13/02/2020 05:20	0,05	471	23,55	CHI
2020021300058	BURITINOPOLIS	49901	IACIARA S2	13/02/2020 05:17	13/02/2020 05:20	13/02/2020 05:17	13/02/2020 05:20	0,05	195	9,75	CHI
2020021300058	BURITINOPOLIS	00010434	IACIARA S2	13/02/2020 05:17	13/02/2020 05:20	13/02/2020 05:17	13/02/2020 05:20	0,05	3	0,15	CHI
2020021300058	DAMIANOPOLIS	11101	IACIARA S2	13/02/2020 05:17	13/02/2020 05:20	13/02/2020 05:17	13/02/2020 05:20	0,05	57	2,85	CHI
2020021300058	DAMIANOPOLIS	49902	IACIARA S2	13/02/2020 05:17	13/02/2020 05:20	13/02/2020 05:17	13/02/2020 05:20	0,05	832	41,60	CHI
2020021300058	DAMIANOPOLIS	00010434	IACIARA S2	13/02/2020 05:17	13/02/2020 05:20	13/02/2020 05:17	13/02/2020 05:20	0,05	2	0,10	CHI
2020021300058	FLORES DE GOIAS	00010414	IACIARA S2	13/02/2020 05:17	13/02/2020 05:20	13/02/2020 05:17	13/02/2020 05:20	0,05	363	18,15	CHI
2020021300058	FORMOSA	00010414	IACIARA S2	13/02/2020 05:17	13/02/2020 05:20	13/02/2020 05:17	13/02/2020 05:20	0,05	1	0,05	CHI
2020021300058	MAMBAI	49901	IACIARA S2	13/02/2020 05:17	13/02/2020 05:20	13/02/2020 05:17	13/02/2020 05:20	0,05	1470	73,50	CHI
2020021300058	MAMBAI	49902	IACIARA S2	13/02/2020 05:17	13/02/2020 05:20	13/02/2020 05:17	13/02/2020 05:20	0,05	65	3,25	CHI
2020021300058	MAMBAI	00010434	IACIARA S2	13/02/2020 05:17	13/02/2020 05:20	13/02/2020 05:17	13/02/2020 05:20	0,05	4	0,20	CHI
2020021300058	POSSE	00010214	IACIARA S2	13/02/2020 05:17	13/02/2020 05:20	13/02/2020 05:17	13/02/2020 05:20	0,05	63	3,15	CHI
2020021300058	POSSE	00010424	IACIARA S2	13/02/2020 05:17	13/02/2020 05:20	13/02/2020 05:17	13/02/2020 05:20	0,05	38	1,90	CHI
2020021300058	SIMOLANDIA	00010214	IACIARA S2	13/02/2020 05:17	13/02/2020 05:20	13/02/2020 05:17	13/02/2020 05:20	0,05	1363	68,15	CHI
2020021300058	SIMOLANDIA	00010224	IACIARA S2	13/02/2020 05:17	13/02/2020 05:20	13/02/2020 05:17	13/02/2020 05:20	0,05	2	0,10	CHI
2020021300058	SIMOLANDIA	00010424	IACIARA S2	13/02/2020 05:17	13/02/2020 05:20	13/02/2020 05:17	13/02/2020 05:20	0,05	117	5,85	CHI
2020021300058	SITIO D ABADIA	11101	IACIARA S2	13/02/2020 05:17	13/02/2020 05:20	13/02/2020 05:17	13/02/2020 05:20	0,05	50	2,50	CHI
2020021300058	SITIO D ABADIA	42901	IACIARA S2	13/02/2020 05:17	13/02/2020 05:20	13/02/2020 05:17	13/02/2020 05:20	0,05	32	1,60	CHI
2020021300058	SITIO D ABADIA	49901	IACIARA S2	13/02/2020 05:17	13/02/2020 05:20	13/02/2020 05:17	13/02/2020 05:20	0,05	1	0,05	CHI
2020021300058	SITIO D ABADIA	42902	IACIARA S2	13/02/2020 05:17	13/02/2020 05:20	13/02/2020 05:17	13/02/2020 05:20	0,05	274	13,70	CHI
2020021300058	SITIO D ABADIA	00010414	IACIARA S2	13/02/2020 05:17	13/02/2020 05:20	13/02/2020 05:17	13/02/2020 05:20	0,05	81	4,05	CHI
2020021300058	VILA BOA	18901	IACIARA S2	13/02/2020 05:17	13/02/2020 05:20	13/02/2020 05:17	13/02/2020 05:20	0,05	674	33,70	CHI
2020021300058	VILA BOA	00010414	IACIARA S2	13/02/2020 05:17	13/02/2020 05:20	13/02/2020 05:17	13/02/2020 05:20	0,05	30	1,50	CHI

2020021300062	ALVORADA DO NORTE	00015124	IACIARA S2	13/02/2020 05:17	13/02/2020 05:20	13/02/2020 05:17	13/02/2020 05:20	0,05	481	24,05	CHI
2020021300062	ALVORADA DO NORTE	00015124	IACIARA S2	13/02/2020 05:17	13/02/2020 05:20	13/02/2020 05:17	13/02/2020 05:20	0,05	554	27,70	CHI
2020021300062	ALVORADA DO NORTE	00015124	IACIARA S2	13/02/2020 05:17	13/02/2020 05:20	13/02/2020 05:17	13/02/2020 05:20	0,05	140	7,00	CHI
2020021300062	ALVORADA DO NORTE	00015124	IACIARA S2	13/02/2020 05:17	13/02/2020 05:20	13/02/2020 05:17	13/02/2020 05:20	0,05	2	0,10	CHI
2020021300062	ALVORADA DO NORTE	00015124	IACIARA S2	13/02/2020 05:17	13/02/2020 05:20	13/02/2020 05:17	13/02/2020 05:20	0,05	67	3,35	CHI
2020021300062	BURITINOPOLIS	00015124	IACIARA S2	13/02/2020 05:17	13/02/2020 05:20	13/02/2020 05:17	13/02/2020 05:20	0,05	561	28,05	CHI
2020021300062	BURITINOPOLIS	49901	IACIARA S2	13/02/2020 05:17	13/02/2020 05:20	13/02/2020 05:17	13/02/2020 05:20	0,05	247	12,35	CHI
2020021300062	BURITINOPOLIS	00015124	IACIARA S2	13/02/2020 05:17	13/02/2020 05:20	13/02/2020 05:17	13/02/2020 05:20	0,05	4	0,20	CHI
2020021300062	DAMIANOPOLIS	11101	IACIARA S2	13/02/2020 05:17	13/02/2020 05:20	13/02/2020 05:17	13/02/2020 05:20	0,05	75	3,75	CHI
2020021300062	DAMIANOPOLIS	49902	IACIARA S2	13/02/2020 05:17	13/02/2020 05:20	13/02/2020 05:17	13/02/2020 05:20	0,05	692	34,60	CHI
2020021300062	DAMIANOPOLIS	00015124	IACIARA S2	13/02/2020 05:17	13/02/2020 05:20	13/02/2020 05:17	13/02/2020 05:20	0,05	1	0,05	CHI
2020021300062	FLORES DE GOIAS	00015124	IACIARA S2	13/02/2020 05:17	13/02/2020 05:20	13/02/2020 05:17	13/02/2020 05:20	0,05	606	30,30	CHI
2020021300062	IACIARA	00015124	IACIARA S2	13/02/2020 05:17	13/02/2020 05:20	13/02/2020 05:17	13/02/2020 05:20	0,05	1	0,05	CHI
2020021300062	MAMBAI	49901	IACIARA S2	13/02/2020 05:17	13/02/2020 05:20	13/02/2020 05:17	13/02/2020 05:20	0,05	1416	70,80	CHI
2020021300062	MAMBAI	49902	IACIARA S2	13/02/2020 05:17	13/02/2020 05:20	13/02/2020 05:17	13/02/2020 05:20	0,05	19	0,95	CHI
2020021300062	MAMBAI	00015124	IACIARA S2	13/02/2020 05:17	13/02/2020 05:20	13/02/2020 05:17	13/02/2020 05:20	0,05	13	0,65	CHI
2020021300062	POSSE	00015124	IACIARA S2	13/02/2020 05:17	13/02/2020 05:20	13/02/2020 05:17	13/02/2020 05:20	0,05	42	2,10	CHI
2020021300062	POSSE	00015124	IACIARA S2	13/02/2020 05:17	13/02/2020 05:20	13/02/2020 05:17	13/02/2020 05:20	0,05	44	2,20	CHI
2020021300062	SIMOLANDIA	00015124	IACIARA S2	13/02/2020 05:17	13/02/2020 05:20	13/02/2020 05:17	13/02/2020 05:20	0,05	763	38,15	CHI
2020021300062	SIMOLANDIA	00015124	IACIARA S2	13/02/2020 05:17	13/02/2020 05:20	13/02/2020 05:17	13/02/2020 05:20	0,05	1	0,05	CHI
2020021300062	SIMOLANDIA	00015124	IACIARA S2	13/02/2020 05:17	13/02/2020 05:20	13/02/2020 05:17	13/02/2020 05:20	0,05	1	0,05	CHI
2020021300062	SIMOLANDIA	00015124	IACIARA S2	13/02/2020 05:17	13/02/2020 05:20	13/02/2020 05:17	13/02/2020 05:20	0,05	128	6,40	CHI
2020021300062	SITIO D ABADIA	11101	IACIARA S2	13/02/2020 05:17	13/02/2020 05:20	13/02/2020 05:17	13/02/2020 05:20	0,05	215	10,75	CHI
2020021300062	SITIO D ABADIA	42901	IACIARA S2	13/02/2020 05:17	13/02/2020 05:20	13/02/2020 05:17	13/02/2020 05:20	0,05	59	2,95	CHI
2020021300062	SITIO D ABADIA	42902	IACIARA S2	13/02/2020 05:17	13/02/2020 05:20	13/02/2020 05:17	13/02/2020 05:20	0,05	189	9,45	CHI
2020021300062	SITIO D ABADIA	00015124	IACIARA S2	13/02/2020 05:17	13/02/2020 05:20	13/02/2020 05:17	13/02/2020 05:20	0,05	63	3,15	CHI
2020021300062	VILA BOA	18901	IACIARA S2	13/02/2020 05:17	13/02/2020 05:20	13/02/2020 05:17	13/02/2020 05:20	0,05	684	34,20	CHI
2020021300062	VILA BOA	00015124	IACIARA S2	13/02/2020 05:17	13/02/2020 05:20	13/02/2020 05:17	13/02/2020 05:20	0,05	35	1,75	CHI
20200262803	GOIANESIA	GE12360273	GOIANESIA S2	13/02/2020 05:25	13/02/2020 09:32	13/02/2020 05:25	13/02/2020 09:32	4,11	19	78,00	CHI
20200262805	MINACU	IH12207743	MINACU	13/02/2020 05:26	13/02/2020 11:49	13/02/2020 05:26	13/02/2020 11:49	6,38	18	114,90	CHI
20200262806	SANTA HELENA DE GOIAS	TD13249011	RIO DOS BOIS	13/02/2020 05:27	13/02/2020 10:10	13/02/2020 05:27	13/02/2020 10:10	4,71	3	14,13	CHI
20200262806	TURVELANDIA	TD13249011	RIO DOS BOIS	13/02/2020 05:27	13/02/2020 10:10	13/02/2020 05:27	13/02/2020 10:10	4,71	81	381,62	CHI
20200262807	LUZIANIA	LZ12128773LD	RIO VERMELHO	13/02/2020 05:31	13/02/2020 10:07	13/02/2020 05:31	13/02/2020 10:07	4,59	244	1119,28	CHI

20200262809	URUTAI	UT12016932RE	URUTAI	13/02/2020 05:33	14/02/2020 14:05	13/02/2020 05:33	13/02/2020 16:01	10,46	5	52,29	CHI
20200262809	IPAMERI	UT12016932RE	URUTAI	13/02/2020 05:33	14/02/2020 14:05	13/02/2020 05:33	14/02/2020 14:05	32,52	3	97,57	CHI
20200262814	SANTA HELENA DE GOIAS	10017979941	IPEGUARI	13/02/2020 05:38	13/02/2020 08:40	13/02/2020 05:38	13/02/2020 08:40	3,03	1	3,03	CHI
20200262817	DIVINOPOLIS DE GOIAS	MA12398387	SAO DOMINGOS	13/02/2020 05:39	13/02/2020 09:16	13/02/2020 05:39	13/02/2020 09:16	3,61	3	10,84	CHI
20200262817	MONTE ALEGRE DE GOIAS	MA12398387	SAO DOMINGOS	13/02/2020 05:39	13/02/2020 09:16	13/02/2020 05:39	13/02/2020 09:16	3,61	16	57,79	CHI
20200262822	ANAPOLIS	20245737	JUNDIAI S1	13/02/2020 05:50	13/02/2020 07:28	13/02/2020 05:50	13/02/2020 07:28	1,63	1	1,63	CHI
20200263722	ALTO HORIZONTE	AJ12086081	SANTA TEREZINHA	13/02/2020 05:56	13/02/2020 09:10	13/02/2020 05:56	13/02/2020 09:10	3,23	46	148,61	CHI
20200263722	CAMPOS VERDES	AJ12086081	SANTA TEREZINHA	13/02/2020 05:56	13/02/2020 09:10	13/02/2020 05:56	13/02/2020 09:10	3,23	8	25,84	CHI
20200263722	PILAR DE GOIAS	AJ12086081	SANTA TEREZINHA	13/02/2020 05:56	13/02/2020 09:10	13/02/2020 05:56	13/02/2020 09:10	3,23	1	3,23	CHI
20200262835	GOIANIA	GN12000467	CAMPINAS S2	13/02/2020 06:01	13/02/2020 07:33	13/02/2020 06:01	13/02/2020 07:33	1,53	93	142,52	CHI
20200262836	ANAPOLIS	20118855	ANAPOLIS UNIVERSITARIO S2	13/02/2020 06:01	13/02/2020 07:51	13/02/2020 06:01	13/02/2020 07:51	1,82	1	1,82	CHI
20200262000	CAMPO ALEGRE DE GOIAS	CT10400690	CATALAO S1	13/02/2020 06:05	13/02/2020 11:40	13/02/2020 09:20	13/02/2020 10:37	1,27	2	2,54	CHI
20200262000	CATALAO	CT10400690	CATALAO S1	13/02/2020 06:05	13/02/2020 11:40	13/02/2020 09:20	13/02/2020 10:37	1,27	1564	1985,41	CHI
20200262000	DAVINOPOLIS	CT10400690	CATALAO S1	13/02/2020 06:05	13/02/2020 11:40	13/02/2020 09:20	13/02/2020 10:37	1,27	6	7,62	CHI
20200262000	DISTRITO FEDERAL	CT10400690	CATALAO S1	13/02/2020 06:05	13/02/2020 11:40	13/02/2020 09:20	13/02/2020 10:37	1,27	1	1,27	CHI
20200262000	CAMPO ALEGRE DE GOIAS	CT10400405	CATALAO S1	13/02/2020 06:05	13/02/2020 11:40	13/02/2020 06:05	13/02/2020 11:40	5,58	1	5,58	CHI
20200262000	CATALAO	CT10400405	CATALAO S1	13/02/2020 06:05	13/02/2020 11:40	13/02/2020 06:05	13/02/2020 11:40	5,58	11	61,39	CHI
20200262000	DAVINOPOLIS	CT10400405	CATALAO S1	13/02/2020 06:05	13/02/2020 11:40	13/02/2020 06:05	13/02/2020 11:40	5,58	1	5,58	CHI
20200262000	CATALAO	CT10394223	CATALAO S1	13/02/2020 06:05	13/02/2020 11:40	13/02/2020 09:20	13/02/2020 11:40	2,32	14	32,47	CHI
20200262000	DAVINOPOLIS	CT10394223	CATALAO S1	13/02/2020 06:05	13/02/2020 11:40	13/02/2020 09:20	13/02/2020 11:40	2,32	5	11,60	CHI
20200264077	CRISTALINA	KR12389576	CRISTALINA S2	13/02/2020 06:08	13/02/2020 10:01	13/02/2020 06:08	13/02/2020 10:01	3,88	41	159,13	CHI
20200262853	CAMPO ALEGRE DE GOIAS	CM12042353	CAMPO ALEGRE DE GOIAS	13/02/2020 06:13	13/02/2020 22:51	13/02/2020 06:13	13/02/2020 22:51	16,63	5	83,16	CHI
20200262856	ITAPACI	IW12379430	ITAPACI	13/02/2020 06:13	13/02/2020 12:10	13/02/2020 06:13	13/02/2020 12:10	5,94	2	11,87	CHI
20200262857	MORRINHOS	MR21125533	MORRINHOS	13/02/2020 06:13	13/02/2020 08:41	13/02/2020 06:13	13/02/2020 08:41	2,45	1	2,45	CHI
20200263540	FLORES DE GOIAS	FB12250123	FLORES DE GOIAS	13/02/2020 06:14	13/02/2020 11:51	13/02/2020 06:14	13/02/2020 11:51	5,61	80	448,98	CHI
20200263540	SAO JOAO D ALIANCA	FB12250123	FLORES DE GOIAS	13/02/2020 06:14	13/02/2020 11:51	13/02/2020 06:14	13/02/2020 11:51	5,61	20	112,24	CHI
20200262862	GOIANIA	15892554	ATLANTICO S1	13/02/2020 06:16	13/02/2020 08:19	13/02/2020 06:16	13/02/2020 08:19	2,05	1	2,05	CHI
20200263101	CALDAS NOVAS	CN21100155	RIO QUENTE	13/02/2020 06:25	13/02/2020 10:00	13/02/2020 06:25	13/02/2020 10:00	3,57	1	3,57	CHI
20200263579	CRISTALINA	IP12165527	CRISTALINA S1	13/02/2020 06:25	13/02/2020 09:19	13/02/2020 06:25	13/02/2020 09:19	2,89	15	43,30	CHI
20200263202	PORANGATU	PO12240663	PORANGATU	13/02/2020 06:26	13/02/2020 15:23	13/02/2020 06:26	13/02/2020 15:23	8,94	3	26,82	CHI
20200263268	CACHOEIRA DOURADA	IT12088560	CACHOEIRA DOURADA	13/02/2020 06:27	13/02/2020 09:31	13/02/2020 06:27	13/02/2020 09:31	3,06	1	3,06	CHI
20200263268	ITUMBIARA	IT12088560	CACHOEIRA DOURADA	13/02/2020 06:27	13/02/2020 09:31	13/02/2020 06:27	13/02/2020 09:31	3,06	4	12,23	CHI
20200263411	PONTALINA	PK11163480	PONTALINA	13/02/2020 06:29	13/02/2020 08:09	13/02/2020 06:29	13/02/2020 08:09	1,66	120	199,63	CHI

20200264054	ALEXANIA	AX11185413	ALEXANIA	13/02/2020 06:30	13/02/2020 10:03	13/02/2020 06:30	13/02/2020 10:03	3,53	108	381,63	CHI
20200263216	BONOPOLIS	BX12266016	SAO MIGUEL DO ARAGUAIA	13/02/2020 06:31	13/02/2020 08:51	13/02/2020 06:31	13/02/2020 08:51	2,33	9	20,95	CHI
20200263217	BELA VISTA DE GOIAS	BV12019590	BELA VISTA S2	13/02/2020 06:31	13/02/2020 10:25	13/02/2020 06:31	13/02/2020 10:25	3,88	1	3,88	CHI
20200263219	HIDROLANDIA	HD31142544	ROCHEDO	13/02/2020 06:32	13/02/2020 09:14	13/02/2020 06:32	13/02/2020 09:14	2,69	1	2,69	CHI
20200263221	ITUMBIARA	BG12000052	ITUMBIARA VELHA S2	13/02/2020 06:33	13/02/2020 14:28	13/02/2020 06:33	13/02/2020 14:28	7,91	6	47,49	CHI
20200263225	NIQUELANDIA	2750005985	NIQUELANDIA SUBTRANSMISSAO	13/02/2020 06:35	13/02/2020 08:05	13/02/2020 06:35	13/02/2020 08:05	1,50	1	1,50	CHI
20200263227	CAMPINACU	UC12236261	PORANGATU	13/02/2020 06:35	13/02/2020 07:49	13/02/2020 06:35	13/02/2020 07:49	1,23	19	23,32	CHI
20200263227	PORANGATU	UC12236261	PORANGATU	13/02/2020 06:35	13/02/2020 07:49	13/02/2020 06:35	13/02/2020 07:49	1,23	1	1,23	CHI
20200263240	SANTA RITA DO ARAGUAIA	SU12142655	SANTA RITA DO ARAGUAIA	13/02/2020 06:40	13/02/2020 15:00	13/02/2020 06:40	13/02/2020 15:00	8,33	5	41,67	CHI
20200264828	IACIARA	IA12218688	IACIARA S2	13/02/2020 06:40	13/02/2020 20:01	13/02/2020 06:40	13/02/2020 20:01	13,35	3	40,04	CHI
20200263249	MINACU	IH12192297	MINACU	13/02/2020 06:42	13/02/2020 12:32	13/02/2020 06:42	13/02/2020 12:32	5,82	7	40,75	CHI
20200263250	GOIANIA	12893080	XAVANTES	13/02/2020 06:43	13/02/2020 07:49	13/02/2020 06:43	13/02/2020 07:49	1,10	1	1,10	CHI
20200264060	CATALAO	CT12042328	CATALAO S1	13/02/2020 06:43	13/02/2020 10:02	13/02/2020 06:43	13/02/2020 10:02	3,31	12	39,67	CHI
20200263253	APARECIDA DE GOIANIA	200129351	INDEPENDENCIA S2	13/02/2020 06:44	13/02/2020 08:43	13/02/2020 06:44	13/02/2020 08:43	1,98	1	1,98	CHI
20200263257	EDEALINA	1130016472	PONTALINA	13/02/2020 06:45	13/02/2020 08:32	13/02/2020 06:45	13/02/2020 08:32	1,78	1	1,78	CHI
20200263260	PIRES DO RIO	PR21375813	URUTAI	13/02/2020 06:47	13/02/2020 12:04	13/02/2020 06:47	13/02/2020 12:04	5,28	1	5,28	CHI
20200263262	ITARUMA	SX13357285	JATAI S1	13/02/2020 06:47	13/02/2020 16:33	13/02/2020 08:51	13/02/2020 16:12	7,35	1	7,35	CHI
20200263262	SERRANOPOLIS	SX13357285	JATAI S1	13/02/2020 06:47	13/02/2020 16:33	13/02/2020 08:51	13/02/2020 16:12	7,35	157	1154,65	CHI
20200263262	SERRANOPOLIS	SX21032787	JATAI S1	13/02/2020 06:47	13/02/2020 16:33	13/02/2020 06:47	13/02/2020 16:33	9,77	1	9,77	CHI
20200263265	TEREZOPOLIS DE GOIAS	TJ11144797	DAIA S2	13/02/2020 06:48	13/02/2020 09:07	13/02/2020 06:48	13/02/2020 09:07	2,31	220	509,24	CHI
20200263271	VALPARAISO DE GOIAS	VA11041541	MARAJOARA	13/02/2020 06:49	13/02/2020 10:16	13/02/2020 06:49	13/02/2020 10:16	3,44	197	676,91	CHI
20200263274	ANAPOLIS	AN21375929	NEROPOLIS S1	13/02/2020 06:50	13/02/2020 12:31	13/02/2020 06:50	13/02/2020 12:31	5,67	1	5,67	CHI
20200263277	SAO DOMINGOS	SD12389181	SAO DOMINGOS	13/02/2020 06:52	13/02/2020 11:17	13/02/2020 06:52	13/02/2020 11:17	4,41	8	35,31	CHI
20200263278	RIO VERDE	RV12322328	CABRIUVA S2	13/02/2020 06:52	13/02/2020 15:25	13/02/2020 06:52	13/02/2020 15:25	8,54	4	34,17	CHI
20200263551	CRIXAS	CX12391663	SANTA TEREZINHA	13/02/2020 06:52	13/02/2020 11:34	13/02/2020 06:52	13/02/2020 11:34	4,69	3	14,07	CHI
20200263282	TROMBAS	TB12391646	PORANGATU	13/02/2020 06:53	13/02/2020 09:54	13/02/2020 06:53	13/02/2020 09:54	3,01	6	18,07	CHI
20200263283	ALEXANIA	AX21155177	ALEXANIA	13/02/2020 06:53	13/02/2020 11:53	13/02/2020 06:53	13/02/2020 11:53	4,99	2	9,99	CHI
20200263285	MONTIVIDIU DO NORTE	MX12391987	PORANGATU	13/02/2020 06:53	13/02/2020 11:42	13/02/2020 06:53	13/02/2020 11:42	4,80	18	86,48	CHI
20200263287	GOIATUBA	GT21197107	GOIATUBA S1	13/02/2020 06:54	13/02/2020 09:21	13/02/2020 06:54	13/02/2020 09:21	2,45	1	2,45	CHI
20200263288	MARA ROSA	MQ12146955	MARA ROSA	13/02/2020 06:55	13/02/2020 11:58	13/02/2020 06:55	13/02/2020 11:58	5,04	12	60,45	CHI
20200263401	BONOPOLIS	BX12334622	SAO MIGUEL DO ARAGUAIA	13/02/2020 06:56	13/02/2020 09:31	13/02/2020 06:56	13/02/2020 09:31	2,57	14	35,98	CHI
20200263404	PARANAIGUARA	2230014281	CACHOEIRA ALTA	13/02/2020 06:58	13/02/2020 08:24	13/02/2020 06:58	13/02/2020 08:24	1,43	1	1,43	CHI
20200264473	SANTA RITA DO NOVO DESTINO	BA12163300	BARRO ALTO	13/02/2020 06:58	13/02/2020 21:28	13/02/2020 06:58	13/02/2020 21:28	14,49	12	173,87	CHI

20200263412	URUACU	UR21247222	MARA ROSA	13/02/2020 07:01	13/02/2020 09:59	13/02/2020 07:01	13/02/2020 09:59	2,96	1	2,96	CHI
20200263504	MONTE ALEGRE DE GOIAS	MA12236705	SAO DOMINGOS	13/02/2020 07:04	13/02/2020 10:39	13/02/2020 07:04	13/02/2020 10:39	3,57	11	39,27	CHI
20200263504	NOVA ROMA	MA12236705	SAO DOMINGOS	13/02/2020 07:04	13/02/2020 10:39	13/02/2020 07:04	13/02/2020 10:39	3,57	57	203,51	CHI
20200263508	GOIANIA	GN11193741	CAMPINAS S1	13/02/2020 07:05	13/02/2020 08:53	13/02/2020 07:05	13/02/2020 08:53	1,79	54	96,52	CHI
20200263511	URUTAI	UT12337239	PIRES DO RIO S2	13/02/2020 07:06	13/02/2020 09:34	13/02/2020 07:06	13/02/2020 09:34	2,45	4	9,81	CHI
20200263524	LUZIANIA	LZ12383017	PAMPLONA	13/02/2020 07:07	13/02/2020 09:21	13/02/2020 07:07	13/02/2020 09:21	2,22	3	6,67	CHI
20200263530	GOIATUBA	GT12000370	GOIATUBA S2	13/02/2020 07:07	13/02/2020 08:19	13/02/2020 07:07	13/02/2020 08:19	1,19	11	13,05	CHI
20200263548	PIRACANJUBA	PJ12212152	PIRACANJUBA	13/02/2020 07:07	13/02/2020 10:49	13/02/2020 07:07	13/02/2020 10:49	3,70	37	136,87	CHI
20200263913	CAVALCANTE	TE12265878	FLORES DE GOIAS	13/02/2020 07:07	13/02/2020 11:55	13/02/2020 07:07	13/02/2020 11:55	4,80	5	23,98	CHI
20200263913	TERESINA DE GOIAS	TE12265878	FLORES DE GOIAS	13/02/2020 07:07	13/02/2020 11:55	13/02/2020 07:07	13/02/2020 11:55	4,80	1	4,80	CHI
20200263519	MORRINHOS	6270675	MORRINHOS	13/02/2020 07:08	13/02/2020 15:25	13/02/2020 07:08	13/02/2020 15:25	8,28	2	16,56	CHI
20200263520	ALEXANIA	AX12258528	ALEXANIA	13/02/2020 07:08	13/02/2020 14:41	13/02/2020 07:08	13/02/2020 14:41	7,55	36	271,76	CHI
20200263521	APARECIDA DE GOIANIA	17363494	ATLANTICO S3	13/02/2020 07:08	13/02/2020 08:40	13/02/2020 07:08	13/02/2020 08:40	1,53	1	1,53	CHI
20200263527	ITAPACI	IW21335661	ITAPACI	13/02/2020 07:09	13/02/2020 10:40	13/02/2020 07:09	13/02/2020 10:40	3,51	1	3,51	CHI
20200264206	JANDAIA	JD12199849	ACREUNA	13/02/2020 07:11	13/02/2020 11:46	13/02/2020 07:11	13/02/2020 11:46	4,58	4	18,32	CHI
20200263536	GOIANIA	10003843244	ATLANTICO S3	13/02/2020 07:12	13/02/2020 09:31	13/02/2020 07:12	13/02/2020 09:31	2,32	1	2,32	CHI
20200263541	PLANALTINA	10016059830	PLANALTINA	13/02/2020 07:13	13/02/2020 08:21	13/02/2020 07:13	13/02/2020 08:21	1,12	1	1,12	CHI
20200263544	NIQUELANDIA	NQ21344325	SAO JOAO D ALIANCA	13/02/2020 07:14	13/02/2020 13:37	13/02/2020 07:14	13/02/2020 13:37	6,38	1	6,38	CHI
20200263545	BARRO ALTO	BA21016335	BARRO ALTO	13/02/2020 07:14	14/02/2020 11:01	13/02/2020 07:14	14/02/2020 11:01	27,78	1	27,78	CHI
20200263546	CRISTALINA	KR12163676	PAMPLONA	13/02/2020 07:14	15/02/2020 16:30	14/02/2020 06:33	14/02/2020 08:46	2,21	22	48,57	CHI
20200263546	DISTRITO FEDERAL	KR12163676	PAMPLONA	13/02/2020 07:14	15/02/2020 16:30	14/02/2020 06:33	14/02/2020 08:46	2,21	4	8,83	CHI
20200263546	LUZIANIA	KR12163676	PAMPLONA	13/02/2020 07:14	15/02/2020 16:30	14/02/2020 06:33	14/02/2020 08:46	2,21	2	4,42	CHI
20200263546	CRISTALINA	KR12163676	PAMPLONA	13/02/2020 07:14	15/02/2020 16:30	14/02/2020 16:50	14/02/2020 21:13	4,40	22	96,72	CHI
20200263546	DISTRITO FEDERAL	KR12163676	PAMPLONA	13/02/2020 07:14	15/02/2020 16:30	14/02/2020 16:50	14/02/2020 21:13	4,40	4	17,59	CHI
20200263546	LUZIANIA	KR12163676	PAMPLONA	13/02/2020 07:14	15/02/2020 16:30	14/02/2020 16:50	14/02/2020 21:13	4,40	2	8,79	CHI
20200263546	CRISTALINA	KR12383028	PAMPLONA	13/02/2020 07:14	15/02/2020 16:30	13/02/2020 07:14	15/02/2020 16:30	57,26	1	57,26	CHI
20200263546	CRISTALINA	KR12383028	PAMPLONA	13/02/2020 07:14	15/02/2020 16:30	13/02/2020 07:14	15/02/2020 16:30	57,26	3	171,79	CHI
20200263710	JATAI	JT12205194	JATAI S1	13/02/2020 07:14	13/02/2020 09:25	13/02/2020 07:14	13/02/2020 09:25	2,17	7	15,21	CHI
20200263550	GUARANI DE GOIAS	IA12255216	IACIARA S1	13/02/2020 07:15	13/02/2020 18:26	13/02/2020 07:15	13/02/2020 18:26	11,18	4	44,73	CHI
20200263550	IACIARA	IA12255216	IACIARA S1	13/02/2020 07:15	13/02/2020 18:26	13/02/2020 07:15	13/02/2020 18:26	11,18	2	22,36	CHI
20200263554	SANTA TEREZA DE GOIAS	SE21342063	PORANGATU	13/02/2020 07:15	13/02/2020 10:03	13/02/2020 07:15	13/02/2020 10:03	2,79	1	2,79	CHI
20200263568	ANAPOLIS	10029436131	ANAPOLIS UNIVERSITARIO S2	13/02/2020 07:15	13/02/2020 08:48	13/02/2020 07:15	13/02/2020 08:48	1,54	1	1,54	CHI
20200263569	PLANALTINA	PI11351153	PLANALTINA	13/02/2020 07:15	13/02/2020 09:47	13/02/2020 07:15	13/02/2020 09:47	2,52	8	20,14	CHI

20200263570	CUMARI	CY12072255	CATALAO S1	13/02/2020 07:16	13/02/2020 13:00	13/02/2020 07:16	13/02/2020 13:00	5,73	1	5,73	CHI
20200263575	QUIRINOPOLIS	QI21100950	QUIRINOPOLIS	13/02/2020 07:16	13/02/2020 12:36	13/02/2020 07:16	13/02/2020 12:36	5,32	1	5,32	CHI
20200263212	CAVALCANTE	CJ21323192	MINACU	13/02/2020 07:17	13/02/2020 19:02	13/02/2020 07:17	13/02/2020 17:34	10,28	1	10,28	CHI
20200263212	CAVALCANTE	CJ12323193LD	MINACU	13/02/2020 07:17	13/02/2020 19:02	13/02/2020 14:40	13/02/2020 19:02	4,35	4	17,42	CHI
20200263576	GOIANIA	GN11161522	CAMPINAS S1	13/02/2020 07:17	13/02/2020 09:00	13/02/2020 07:17	13/02/2020 09:00	1,72	14	24,01	CHI
20200263702	PARANAIGUARA	PC21093840	QUIRINOPOLIS	13/02/2020 07:20	13/02/2020 09:33	13/02/2020 07:20	13/02/2020 09:33	2,22	1	2,22	CHI
20200263704	CAMPOS VERDES	3790035061	SANTA TEREZINHA	13/02/2020 07:20	13/02/2020 10:12	13/02/2020 07:20	13/02/2020 10:12	2,86	1	2,86	CHI
20200263705	ITUMBIARA	IT12034497	CACHOEIRA DOURADA	13/02/2020 07:20	13/02/2020 11:12	13/02/2020 07:20	13/02/2020 11:12	3,86	5	19,28	CHI
20200263912	PADRE BERNARDO	PB12313941	PADRE BERNARDO	13/02/2020 07:20	13/02/2020 10:44	13/02/2020 07:20	13/02/2020 10:44	3,39	4	13,55	CHI
20200263709	NOVA ROMA	ND12392238	IACIARA S2	13/02/2020 07:21	13/02/2020 17:02	13/02/2020 07:21	13/02/2020 17:02	9,67	242	2340,01	CHI
20200263719	ANAPOLIS	AN21270286	ANAPOLIS UNIVERSITARIO S2	13/02/2020 07:24	13/02/2020 09:56	13/02/2020 07:24	13/02/2020 09:56	2,53	2	5,06	CHI
20200263720	CRISTALINA	KR12153067	CRISTALINA S2	13/02/2020 07:24	13/02/2020 12:10	13/02/2020 07:24	13/02/2020 12:10	4,76	3	14,28	CHI
20200263723	CASTELANDIA	RV12026916	RIO DOS BOIS	13/02/2020 07:25	13/02/2020 09:50	13/02/2020 07:25	13/02/2020 09:50	2,40	12	28,81	CHI
20200263723	RIO VERDE	RV12026916	RIO DOS BOIS	13/02/2020 07:25	13/02/2020 09:50	13/02/2020 07:25	13/02/2020 09:50	2,40	2	4,80	CHI
20200263726	MUTUNOPOLIS	SE12352924	MARA ROSA	13/02/2020 07:26	13/02/2020 08:56	13/02/2020 07:26	13/02/2020 08:56	1,49	6	8,95	CHI
20200263726	SANTA TEREZA DE GOIAS	SE12352924	MARA ROSA	13/02/2020 07:26	13/02/2020 08:56	13/02/2020 07:26	13/02/2020 08:56	1,49	1	1,49	CHI
20200263801	QUIRINOPOLIS	80129201	QUIRINOPOLIS	13/02/2020 07:28	13/02/2020 09:24	13/02/2020 07:28	13/02/2020 09:24	1,92	1	1,92	CHI
20200263809	IACIARA	10001886833	IACIARA S1	13/02/2020 07:30	13/02/2020 21:39	13/02/2020 07:30	13/02/2020 21:39	14,14	1	14,14	CHI
20200263814	ANAPOLIS	AN11000274	JUNDIAI S2	13/02/2020 07:30	13/02/2020 09:09	13/02/2020 07:30	13/02/2020 09:09	1,63	84	137,22	CHI
20200265147	NIQUELANDIA	NQ12234274	NIQUELANDIA SUBTRANSMISSAO	13/02/2020 07:31	13/02/2020 21:06	13/02/2020 07:31	13/02/2020 21:06	13,58	8	108,62	CHI
20200264039	CRISTALINA	KR12366452	PAMPLONA	13/02/2020 07:32	13/02/2020 10:20	13/02/2020 07:32	13/02/2020 10:20	2,79	10	27,89	CHI
20200263901	NOVA CRIXAS	NA12377684LD	NOVA CRIXAS	13/02/2020 07:33	13/02/2020 12:49	13/02/2020 07:33	13/02/2020 12:49	5,25	95	499,12	CHI
20200263906	APARECIDA DE GOIANIA	200189517	CEPAIGO S1	13/02/2020 07:35	13/02/2020 09:24	13/02/2020 07:35	13/02/2020 09:24	1,82	1	1,82	CHI
20200263907	APORE	AE21301899	ITAJA S1	13/02/2020 07:35	13/02/2020 11:49	13/02/2020 07:35	13/02/2020 11:49	4,23	1	4,23	CHI
20200263910	FORMOSA	610070654	ITIQUEIRA	13/02/2020 07:36	13/02/2020 10:38	13/02/2020 07:36	13/02/2020 10:38	3,04	1	3,04	CHI
20200263911	APARECIDA DE GOIANIA	AP21000310	CEPAIGO S1	13/02/2020 07:36	13/02/2020 09:11	13/02/2020 07:36	13/02/2020 09:11	1,58	1	1,58	CHI
20200263923	VILA PROPICIO	NP21353356	BARRO ALTO	13/02/2020 07:39	13/02/2020 15:07	13/02/2020 07:39	13/02/2020 15:07	7,46	1	7,46	CHI
20200263924	GOIANIA	14952725	CARAJAS S2	13/02/2020 07:39	13/02/2020 09:33	13/02/2020 07:39	13/02/2020 09:33	1,89	1	1,89	CHI
20200263927	APARECIDA DE GOIANIA	200176950	INDEPENDENCIA S2	13/02/2020 07:40	13/02/2020 10:14	13/02/2020 07:40	13/02/2020 10:14	2,57	1	2,57	CHI
20200263930	OURO VERDE DE GOIAS	OV12014233	INHUMAS S1	13/02/2020 07:40	13/02/2020 13:18	13/02/2020 07:40	13/02/2020 13:18	5,62	30	168,62	CHI
20200263933	GOUVELANDIA	QI21303147	QUIRINOPOLIS	13/02/2020 07:41	13/02/2020 10:57	13/02/2020 07:41	13/02/2020 10:57	3,27	1	3,27	CHI
20200263936	DAMOLANDIA	DL12272281	INHUMAS S1	13/02/2020 07:42	13/02/2020 09:30	13/02/2020 07:42	13/02/2020 09:30	1,80	8	14,37	CHI
20200263938	ALEXANIA	AX21157932	ALEXANIA	13/02/2020 07:43	13/02/2020 10:27	13/02/2020 07:43	13/02/2020 10:27	2,73	2	5,46	CHI

20200263945	GOIANIA	10246988	CAMPINAS S3	13/02/2020 07:44	13/02/2020 09:42	13/02/2020 07:44	13/02/2020 09:42	1,96	1	1,96	CHI
20200263946	EDEALINA	ED21328994	VICENTINOPOLIS	13/02/2020 07:44	13/02/2020 10:55	13/02/2020 07:44	13/02/2020 10:55	3,18	2	6,36	CHI
20200263948	GAMELEIRA DE GOIAS	SV21249995	DAIA S2	13/02/2020 07:44	13/02/2020 10:27	13/02/2020 07:44	13/02/2020 10:27	2,71	1	2,71	CHI
20200263953	SAO JOAO D ALIANCA	JL11238279	ITUIQUIRA	13/02/2020 07:45	13/02/2020 13:38	13/02/2020 07:45	13/02/2020 13:38	5,87	2	11,75	CHI
20200263955	CALDAZINHA	DE21239766	CEPAIGO S2	13/02/2020 07:45	13/02/2020 11:36	13/02/2020 07:45	13/02/2020 11:36	3,83	1	3,83	CHI
20200263956	CALDAS NOVAS	10019042939	CALDAS NOVAS S2	13/02/2020 07:46	13/02/2020 10:05	13/02/2020 07:46	13/02/2020 10:05	2,33	1	2,33	CHI
20200263960	DIVINOPOLIS DE GOIAS	SD12266366	SAO DOMINGOS	13/02/2020 07:47	13/02/2020 09:41	13/02/2020 07:47	13/02/2020 09:41	1,90	2	3,80	CHI
20200263960	SAO DOMINGOS	SD12266366	SAO DOMINGOS	13/02/2020 07:47	13/02/2020 09:41	13/02/2020 07:47	13/02/2020 09:41	1,90	3	5,70	CHI
20200263968	ITAJA	IJ21400910	CACHOEIRA ALTA	13/02/2020 07:49	13/02/2020 11:10	13/02/2020 07:49	13/02/2020 11:10	3,35	1	3,35	CHI
20200263974	BONOPOLIS	BX12165447	SAO MIGUEL DO ARAGUAIA	13/02/2020 07:50	13/02/2020 11:40	13/02/2020 07:50	13/02/2020 11:40	3,82	3	11,45	CHI
20200263976	PANAMA	IT12000120	PARANAIBA	13/02/2020 07:51	13/02/2020 10:37	13/02/2020 07:51	13/02/2020 10:37	2,77	2	5,53	CHI
20200263985	GOIANDIRA	GD12131092	CATALAO S1	13/02/2020 07:52	13/02/2020 14:08	13/02/2020 07:52	13/02/2020 14:08	6,25	5	31,27	CHI
20200264000	MINEIROS	PW12303388	PARQUE DAS EMAS	13/02/2020 07:54	13/02/2020 13:35	13/02/2020 07:54	13/02/2020 13:35	5,68	4	22,71	CHI
20200264000	PORTELANDIA	PW12303388	PARQUE DAS EMAS	13/02/2020 07:54	13/02/2020 13:35	13/02/2020 07:54	13/02/2020 13:35	5,68	4	22,71	CHI
20200264095	SITIO D ABADIA	FB12285693	IACIARA S2	13/02/2020 07:54	13/02/2020 11:25	13/02/2020 07:54	13/02/2020 11:25	3,51	16	56,10	CHI
20200264007	MINACU	IH21242240	MINACU	13/02/2020 07:55	13/02/2020 12:13	13/02/2020 07:55	13/02/2020 12:13	4,29	1	4,29	CHI
20200264010	URUTAI	UT21336153	URUTAI	13/02/2020 07:55	13/02/2020 23:34	13/02/2020 07:55	13/02/2020 23:34	15,64	1	15,64	CHI
20200262580	MORRINHOS	MR12102435	MORRINHOS	13/02/2020 07:56	13/02/2020 08:55	13/02/2020 07:56	13/02/2020 08:55	0,98	9	8,83	CHI
20200264016	GOIANIA	GN11000492	CAMPINAS S3	13/02/2020 07:56	13/02/2020 09:24	13/02/2020 07:56	13/02/2020 09:24	1,46	34	49,60	CHI
20200264021	GOIANIA	GN12049397	ATLANTICO S3	13/02/2020 07:56	13/02/2020 10:05	13/02/2020 07:56	13/02/2020 09:20	1,39	345	477,92	CHI
20200264021	GOIANIA	GN12049397	ATLANTICO S3	13/02/2020 07:56	13/02/2020 10:05	13/02/2020 07:56	13/02/2020 10:05	2,15	62	133,16	CHI
20200264028	NOVA IGUACU DE GOIAS	NH12317131	CAMPINORTE	13/02/2020 07:56	13/02/2020 08:46	13/02/2020 07:56	13/02/2020 08:46	0,83	42	34,84	CHI
20200264027	ITUMBIARA	IT12257056	PARANAIBA	13/02/2020 07:58	13/02/2020 10:36	13/02/2020 07:58	13/02/2020 10:36	2,63	7	18,40	CHI
20200264033	SANTO ANTONIO DO DESCOBERTO	SN12330527	MARAJOARA	13/02/2020 07:59	13/02/2020 11:12	13/02/2020 07:59	13/02/2020 11:12	3,21	15	48,18	CHI
20200264037	PARAUNA	PU21356335	ACREUNA	13/02/2020 07:59	13/02/2020 10:31	13/02/2020 07:59	13/02/2020 10:31	2,52	1	2,52	CHI
20200264040	MORRINHOS	MR21417457	MORRINHOS	13/02/2020 08:01	13/02/2020 14:03	13/02/2020 08:01	13/02/2020 14:03	6,03	1	6,03	CHI
20200264573	PADRE BERNARDO	PB12336085	PADRE BERNARDO	13/02/2020 08:02	14/02/2020 00:16	13/02/2020 08:02	14/02/2020 00:16	16,23	12	194,79	CHI
20200264044	ANAPOLIS	20780291	ANAPOLIS UNIVERSITARIO S2	13/02/2020 08:03	13/02/2020 11:56	13/02/2020 08:03	13/02/2020 11:56	3,88	1	3,88	CHI
20200264053	BURITI ALEGRE	BG12000126	ITUMBIARA VELHA S2	13/02/2020 08:03	14/02/2020 14:20	13/02/2020 08:03	14/02/2020 14:20	30,27	6	181,62	CHI
20200264073	ALEXANIA	AX12319851	ALEXANIA	13/02/2020 08:03	14/02/2020 16:02	13/02/2020 08:03	13/02/2020 20:27	12,40	21	260,37	CHI
20200264073	ALEXANIA	03650224	ALEXANIA	13/02/2020 08:03	14/02/2020 16:02	14/02/2020 11:31	14/02/2020 16:02	4,53	66	298,78	CHI
20200264073	SANTO ANTONIO DO DESCOBERTO	03650224	ALEXANIA	13/02/2020 08:03	14/02/2020 16:02	14/02/2020 11:31	14/02/2020 16:02	4,53	181	819,38	CHI
20200264419	DAMIANOPOLIS	SI12295432	IACIARA S2	13/02/2020 08:03	14/02/2020 10:10	13/02/2020 08:03	14/02/2020 10:10	26,11	9	234,97	CHI

20200264063	SILVANIA	660040244	VIANOPOLIS	13/02/2020 08:05	13/02/2020 09:12	13/02/2020 08:05	13/02/2020 09:12	1,11	1	1,11	CHI
20200264064	SANTO ANTONIO DO DESCOBERTO	SN21139281	MARAJOARA	13/02/2020 08:05	13/02/2020 16:20	13/02/2020 08:05	13/02/2020 16:20	8,24	2	16,48	CHI
20200268209	CALDAS NOVAS	CN21318995	CALDAS NOVAS S1	13/02/2020 08:05	13/02/2020 15:20	13/02/2020 08:05	13/02/2020 15:20	7,24	1	7,24	CHI
20200264066	GOIANIA	15310220	REAL S1	13/02/2020 08:06	13/02/2020 10:22	13/02/2020 08:06	13/02/2020 10:22	2,26	1	2,26	CHI
20200264076	BURITI ALEGRE	BG12263593	ITUMBIARA VELHA S2	13/02/2020 08:08	14/02/2020 11:32	13/02/2020 08:08	14/02/2020 11:32	27,39	4	109,58	CHI
20200264088	COCALZINHO DE GOIAS	ZN21302498	COCALZINHO	13/02/2020 08:12	13/02/2020 14:09	13/02/2020 08:12	13/02/2020 14:09	5,94	1	5,94	CHI
20200264090	ABADIANIA	10000832217	ANAPOLIS UNIVERSITARIO S1	13/02/2020 08:13	13/02/2020 11:46	13/02/2020 08:13	13/02/2020 11:46	3,54	1	3,54	CHI
20200264093	FLORES DE GOIAS	FB21044975	IACIARA S2	13/02/2020 08:14	13/02/2020 10:58	13/02/2020 08:14	13/02/2020 10:58	2,73	1	2,73	CHI
20200264097	ORIZONA	OZ21307738	PIRES DO RIO S2	13/02/2020 08:15	13/02/2020 09:30	13/02/2020 08:15	13/02/2020 09:30	1,25	1	1,25	CHI
20200264099	NOVA AMERICA	8560000345	RUBIATABA	13/02/2020 08:15	13/02/2020 10:09	13/02/2020 08:15	13/02/2020 10:09	1,89	1	1,89	CHI
20200264105	BELA VISTA DE GOIAS	BV12042836	CEPAIGO S2	13/02/2020 08:16	13/02/2020 10:10	13/02/2020 08:16	13/02/2020 10:10	1,89	5	9,46	CHI
20200264122	NIQUELANDIA	2750048819	NIQUELANDIA SUBTRANSMISSAO	13/02/2020 08:20	13/02/2020 18:33	13/02/2020 08:20	13/02/2020 18:33	10,21	1	10,21	CHI
20200264201	GOIATUBA	140063330	GOIATUBA S2	13/02/2020 08:20	13/02/2020 11:17	13/02/2020 08:20	13/02/2020 11:17	2,94	1	2,94	CHI
20200264202	SANTO ANTONIO DO DESCOBERTO	SN12163756	AGUAS Lindas DE GOIAS S2	13/02/2020 08:20	13/02/2020 18:21	13/02/2020 08:20	13/02/2020 18:21	10,00	4	40,01	CHI
20200264207	MINACU	IH21192456	MINACU	13/02/2020 08:21	13/02/2020 16:12	13/02/2020 08:21	13/02/2020 16:12	7,85	2	15,69	CHI
20200264303	ARACU	AR12019252	ARACU	13/02/2020 08:22	13/02/2020 10:27	13/02/2020 08:22	13/02/2020 10:27	2,07	8	16,56	CHI
20200264304	CAMPINORTE	CR12398060	CAMPINORTE	13/02/2020 08:23	13/02/2020 10:27	13/02/2020 08:23	13/02/2020 10:27	2,07	121	250,03	CHI
20200264305	MONTE ALEGRE DE GOIAS	MA12236692	SAO DOMINGOS	13/02/2020 08:23	13/02/2020 11:27	13/02/2020 08:23	13/02/2020 11:27	3,07	5	15,33	CHI
20200264309	BOM JESUS DE GOIAS	BJ21000337	BOM JESUS DE GOIAS	13/02/2020 08:24	13/02/2020 12:38	13/02/2020 08:24	13/02/2020 12:38	4,22	1	4,22	CHI
20200264311	ANAPOLIS	21389615	ANAPOLIS UNIVERSITARIO S2	13/02/2020 08:24	13/02/2020 11:48	13/02/2020 08:24	13/02/2020 11:48	3,39	1	3,39	CHI
20200264500	CRISTALINA	IP12219725	CRISTALINA S2	13/02/2020 08:24	13/02/2020 10:40	13/02/2020 08:24	13/02/2020 10:40	2,25	2	4,50	CHI
20200264500	IPAMERI	IP12219725	CRISTALINA S2	13/02/2020 08:24	13/02/2020 10:40	13/02/2020 08:24	13/02/2020 10:40	2,25	3	6,75	CHI
20200264579	SAO DOMINGOS	SD12389277	SAO DOMINGOS	13/02/2020 08:24	13/02/2020 13:20	13/02/2020 08:24	13/02/2020 13:20	4,92	25	122,92	CHI
20200264317	VILA PROPICIO	PV21151980	GOIANESIA S1	13/02/2020 08:25	13/02/2020 15:15	13/02/2020 08:25	13/02/2020 15:15	6,84	1	6,84	CHI
20200264329	GOIANIA	GN12193191	CAMPINAS S1	13/02/2020 08:27	13/02/2020 10:16	13/02/2020 08:27	13/02/2020 10:16	1,81	109	197,80	CHI
20200264335	ARAGOIANIA	AO11048953	INDEPENDENCIA S2	13/02/2020 08:28	13/02/2020 10:58	13/02/2020 08:28	13/02/2020 10:58	2,49	16	39,88	CHI
20200264471	NOVA VENEZA	NR12009855	INHUMAS S1	13/02/2020 08:28	13/02/2020 11:53	13/02/2020 08:28	13/02/2020 11:53	3,42	4	13,67	CHI
20200264339	GOIATUBA	GT12048503	GOIATUBA S2	13/02/2020 08:29	13/02/2020 09:42	13/02/2020 08:29	13/02/2020 09:42	1,20	22	26,47	CHI
20200264346	MONTE ALEGRE DE GOIAS	1620000043	SAO DOMINGOS	13/02/2020 08:30	13/02/2020 12:59	13/02/2020 08:30	13/02/2020 12:59	4,48	1	4,48	CHI
20200264348	AGUA FRIA DE GOIAS	JL21164678	SAO JOAO D ALIANCA	13/02/2020 08:31	13/02/2020 10:35	13/02/2020 08:31	13/02/2020 10:35	2,05	1	2,05	CHI
20200264354	PLANALTINA	2960234322	PLANALTINA	13/02/2020 08:32	13/02/2020 10:40	13/02/2020 08:32	13/02/2020 10:40	2,12	1	2,12	CHI
20200264595	GOIANESIA	GE12215070	GOIANESIA S1	13/02/2020 08:32	13/02/2020 10:20	13/02/2020 08:32	13/02/2020 10:20	1,81	24	43,45	CHI
20200264403	AMARALINA	LC12230319	NOVA CRIXAS	13/02/2020 08:33	13/02/2020 11:35	13/02/2020 08:33	13/02/2020 11:35	3,03	3	9,09	CHI

20200271311	SANTA RITA DO NOVO DESTINO	DF12382137	BARRO ALTO	13/02/2020 08:33	13/02/2020 20:50	13/02/2020 08:33	13/02/2020 20:50	12,28	12	147,39	CHI
20200263359	CAVALCANTE	CJ12262441	FLORES DE GOIAS	13/02/2020 08:34	13/02/2020 09:00	13/02/2020 08:34	13/02/2020 09:00	0,42	15	6,31	CHI
20200263359	TERESINA DE GOIAS	CJ12262441	FLORES DE GOIAS	13/02/2020 08:34	13/02/2020 09:00	13/02/2020 08:34	13/02/2020 09:00	0,42	2	0,84	CHI
20200264408	GAMELEIRA DE GOIAS	SV12211132	VIANOPOLIS	13/02/2020 08:34	13/02/2020 12:03	13/02/2020 08:34	13/02/2020 12:03	3,48	19	66,09	CHI
20200264408	SILVANIA	SV12211132	VIANOPOLIS	13/02/2020 08:34	13/02/2020 12:03	13/02/2020 08:34	13/02/2020 12:03	3,48	44	153,06	CHI
20200264410	SERRANOPOLIS	3000003184	JATAI S1	13/02/2020 08:34	13/02/2020 15:58	13/02/2020 08:34	13/02/2020 15:58	7,40	1	7,40	CHI
20200264581	PIRACANJUBA	PJ12000119	PIRACANJUBA	13/02/2020 08:35	13/02/2020 12:51	13/02/2020 08:35	13/02/2020 12:51	4,27	5	21,35	CHI
20200268281	PIRACANJUBA	PJ21058649	PIRACANJUBA	13/02/2020 08:35	13/02/2020 14:58	13/02/2020 08:35	13/02/2020 14:58	6,39	1	6,39	CHI
20200264423	IPAMERI	IP21153089	IPAMERI	13/02/2020 08:37	14/02/2020 08:05	13/02/2020 08:37	14/02/2020 08:05	23,46	1	23,46	CHI
20200264426	BARRO ALTO	BA21157844	BARRO ALTO	13/02/2020 08:38	13/02/2020 16:01	13/02/2020 08:38	13/02/2020 16:01	7,38	1	7,38	CHI
20200264428	SILVANIA	660017817	VIANOPOLIS	13/02/2020 08:38	13/02/2020 09:51	13/02/2020 08:38	13/02/2020 09:51	1,21	1	1,21	CHI
20200264431	VALPARAISO DE GOIAS	10009588289	PACAEMBU S2	13/02/2020 08:38	13/02/2020 12:00	13/02/2020 08:38	13/02/2020 12:00	3,35	1	3,35	CHI
20200264583	BELA VISTA DE GOIAS	BV12068885	BELA VISTA S1	13/02/2020 08:38	13/02/2020 11:07	13/02/2020 08:38	13/02/2020 11:07	2,48	17	42,18	CHI
20200264439	TRINDADE	TR32001819	TRINDADE	13/02/2020 08:41	13/02/2020 10:44	13/02/2020 08:41	13/02/2020 10:44	2,04	2	4,09	CHI
20200264452	PIRACANJUBA	60087006	PIRACANJUBA	13/02/2020 08:44	13/02/2020 15:47	13/02/2020 08:44	13/02/2020 15:47	7,04	1	7,04	CHI
20200264453	GOIANIRA	GR11343098	MEIA PONTE	13/02/2020 08:45	13/02/2020 10:00	13/02/2020 08:45	13/02/2020 10:00	1,25	105	131,25	CHI
20200264477	PROFESSOR JAMIL SAFADY	10007648233	ROCHEDO	13/02/2020 08:45	13/02/2020 15:00	13/02/2020 08:45	13/02/2020 15:00	6,25	0	0,00	CHI
20200264460	JOVIANIA	JV12025366	GOIATUBA S1	13/02/2020 08:46	13/02/2020 11:06	13/02/2020 08:46	13/02/2020 11:06	2,32	3	6,97	CHI
20200264502	CARMO DO RIO VERDE	RB12069098LD	RUBIATABA	13/02/2020 08:46	13/02/2020 14:46	13/02/2020 08:46	13/02/2020 14:46	5,98	3	17,95	CHI
20200264502	CERES	RB12069098LD	RUBIATABA	13/02/2020 08:46	13/02/2020 14:46	13/02/2020 08:46	13/02/2020 14:46	5,98	12	71,81	CHI
20200264502	RUBIATABA	RB12069098LD	RUBIATABA	13/02/2020 08:46	13/02/2020 14:46	13/02/2020 08:46	13/02/2020 14:46	5,98	339	2028,63	CHI
20200264502	SAO PATRICIO	RB12069098LD	RUBIATABA	13/02/2020 08:46	13/02/2020 14:46	13/02/2020 08:46	13/02/2020 14:46	5,98	19	113,70	CHI
20200264465	CRISTALINA	KR12305252	PAMPLONA	13/02/2020 08:47	13/02/2020 12:12	13/02/2020 08:47	13/02/2020 12:12	3,41	6	20,46	CHI
20200264470	MORRINHOS	150029690	MORRINHOS	13/02/2020 08:47	13/02/2020 09:22	13/02/2020 08:47	13/02/2020 09:22	0,58	1	0,58	CHI
20200264479	SAO DOMINGOS	SD21224217	SAO DOMINGOS	13/02/2020 08:49	13/02/2020 14:47	13/02/2020 08:49	13/02/2020 14:47	5,95	2	11,91	CHI
20200264482	HIDROLANDIA	HD12024197	CEPAIGO S2	13/02/2020 08:50	13/02/2020 12:48	13/02/2020 08:50	13/02/2020 12:48	3,96	2	7,92	CHI
20200264485	EDEIA	EA12394399	EDEIA	13/02/2020 08:50	13/02/2020 10:06	13/02/2020 08:50	13/02/2020 10:06	1,25	53	66,43	CHI
20200264490	CRISTALINA	10016558446	CRISTALINA S1	13/02/2020 08:52	13/02/2020 11:53	13/02/2020 08:52	13/02/2020 11:53	3,01	1	3,01	CHI
20200264519	CRISTALINA	KR12237804	CRISTALINA S1	13/02/2020 08:53	13/02/2020 13:29	13/02/2020 08:53	13/02/2020 13:29	4,60	2	9,20	CHI
20200264503	MAURILANDIA	ML12303334	RIO DOS BOIS	13/02/2020 08:54	13/02/2020 13:54	13/02/2020 08:54	13/02/2020 13:54	5,00	14	69,99	CHI
20200264503	RIO VERDE	ML12303334	RIO DOS BOIS	13/02/2020 08:54	13/02/2020 13:54	13/02/2020 08:54	13/02/2020 13:54	5,00	2	10,00	CHI
20200264509	GUAPO	GA21000078	GUAPO S2	13/02/2020 08:54	13/02/2020 13:01	13/02/2020 08:54	13/02/2020 13:01	4,10	1	4,10	CHI
20200264512	IPAMERI	IP21309707	IPAMERI	13/02/2020 08:55	13/02/2020 12:22	13/02/2020 08:55	13/02/2020 12:22	3,45	1	3,45	CHI

20200266511	RIO VERDE	RV11000045	RIO VERDE S1	13/02/2020 08:55	13/02/2020 13:39	13/02/2020 08:55	13/02/2020 13:39	4,72	108	509,70	CHI
20200264525	RIO VERDE	RV21398965	RIO VERDE S2	13/02/2020 08:56	13/02/2020 13:07	13/02/2020 08:56	13/02/2020 13:07	4,17	1	4,17	CHI
20200264527	CALDAS NOVAS	CN12263369	CALDAS NOVAS S2	13/02/2020 08:57	13/02/2020 16:50	13/02/2020 08:57	13/02/2020 16:50	7,88	23	181,23	CHI
20200264530	MINACU	IH11182312	MINACU	13/02/2020 08:57	13/02/2020 16:25	13/02/2020 08:57	13/02/2020 16:25	7,46	1	7,46	CHI
20200264533	ANAPOLIS	10008030411	ANAPOLIS UNIVERSITARIO S2	13/02/2020 08:57	13/02/2020 11:39	13/02/2020 08:57	13/02/2020 11:39	2,69	1	2,69	CHI
20200264535	CACU	CC12235898	CACHOEIRA ALTA	13/02/2020 08:58	13/02/2020 11:44	13/02/2020 08:58	13/02/2020 11:44	2,76	2	5,52	CHI
20200264536	GOIANIA	10021355841	INDEPENDENCIA S2	13/02/2020 08:58	13/02/2020 09:56	13/02/2020 08:58	13/02/2020 09:56	0,96	1	0,96	CHI
20200264540	AGUA FRIA DE GOIAS	TL12164597	SAO JOAO D ALIANCA	13/02/2020 08:58	13/02/2020 11:34	13/02/2020 08:58	13/02/2020 11:34	2,58	536	1385,26	CHI
20200264551	URUACU	10010894185	CAMPINORTE	13/02/2020 09:00	13/02/2020 11:34	13/02/2020 09:00	13/02/2020 11:34	2,55	1	2,55	CHI
20200264552	SAO DOMINGOS	SD21160907	SAO DOMINGOS	13/02/2020 09:00	13/02/2020 15:33	13/02/2020 09:00	13/02/2020 15:33	6,54	1	6,54	CHI
20200264562	ANAPOLIS	20536082	ANAPOLIS UNIVERSITARIO S2	13/02/2020 09:02	13/02/2020 10:49	13/02/2020 09:02	13/02/2020 10:49	1,77	1	1,77	CHI
20200264567	MORRINHOS	150142900	MORRINHOS	13/02/2020 09:02	13/02/2020 15:10	13/02/2020 09:02	13/02/2020 15:10	6,12	1	6,12	CHI
20200264568	AGUAS LINDAS DE GOIAS	4830422258	AGUAS LINDAS DE GOIAS S2	13/02/2020 09:02	13/02/2020 11:22	13/02/2020 09:02	13/02/2020 11:22	2,32	1	2,32	CHI
20200264571	MINACU	IH21187826	MINACU	13/02/2020 09:03	13/02/2020 17:27	13/02/2020 09:03	13/02/2020 17:27	8,39	1	8,39	CHI
20200264574	MINACU	IH12236146	MINACU	13/02/2020 09:04	13/02/2020 17:24	13/02/2020 09:04	13/02/2020 17:24	8,33	2	16,67	CHI
20200264576	GOIANIA	10702003	ATLANTICO S2	13/02/2020 09:05	13/02/2020 10:36	13/02/2020 09:05	13/02/2020 10:36	1,51	1	1,51	CHI
20200264578	RIO VERDE	RV12345375LD	RIO VERDE S2	13/02/2020 09:05	13/02/2020 12:39	13/02/2020 09:05	13/02/2020 12:39	3,56	2	7,11	CHI
20200264585	ANAPOLIS	10011609972	ANAPOLIS UNIVERSITARIO S2	13/02/2020 09:07	13/02/2020 10:44	13/02/2020 09:07	13/02/2020 10:44	1,61	1	1,61	CHI
20200264596	MINEIROS	MY12385364	PARQUE DAS EMAS	13/02/2020 09:09	13/02/2020 14:00	13/02/2020 09:09	13/02/2020 14:00	4,84	1	4,84	CHI
20200264600	DOVERLANDIA	MY12209669	PARQUE DAS EMAS	13/02/2020 09:10	13/02/2020 14:40	13/02/2020 09:10	13/02/2020 14:40	5,49	12	65,82	CHI
20200264710	FORMOSA	FA12204761	ITUIQUIRA	13/02/2020 09:13	13/02/2020 15:30	13/02/2020 09:13	13/02/2020 15:30	6,28	48	301,55	CHI
20200264712	ITUMBIARA	IT12000103	PARANAIBA	13/02/2020 09:13	13/02/2020 11:37	13/02/2020 09:13	13/02/2020 11:37	2,40	3	7,20	CHI
20200264713	ANAPOLIS	20769210	ANAPOLIS UNIVERSITARIO S2	13/02/2020 09:13	13/02/2020 11:48	13/02/2020 09:13	13/02/2020 11:48	2,58	1	2,58	CHI
20200264719	TRINDADE	13973629	GOYA S2	13/02/2020 09:14	13/02/2020 11:00	13/02/2020 09:14	13/02/2020 11:00	1,75	1	1,75	CHI
20200264727	CAMPESTRE DE GOIAS	GC11276771	TRINDADE	13/02/2020 09:16	13/02/2020 12:43	13/02/2020 09:16	13/02/2020 12:43	3,44	1	3,44	CHI
20200264731	GOIANIA	14964387	FERROVIARIO S2	13/02/2020 09:17	13/02/2020 11:49	13/02/2020 09:17	13/02/2020 11:49	2,53	1	2,53	CHI
20200264736	EDEALINA	ED21161525	PONTALINA	13/02/2020 09:18	13/02/2020 10:09	13/02/2020 09:18	13/02/2020 10:09	0,84	1	0,84	CHI
20200264743	TEREZOPOLIS DE GOIAS	TJ21353407	DAIA S2	13/02/2020 09:19	13/02/2020 10:51	13/02/2020 09:19	13/02/2020 10:51	1,52	1	1,52	CHI
20200264744	SAO LUIZ DO NORTE	SZ21242770	ITAPACI	13/02/2020 09:19	13/02/2020 13:52	13/02/2020 09:19	13/02/2020 13:52	4,53	1	4,53	CHI
20200264745	SERRANOPOLIS	SX12365187	CHAPADAO DO CEU	13/02/2020 09:19	13/02/2020 11:55	13/02/2020 09:19	13/02/2020 11:55	2,58	1	2,58	CHI
20200267951	CAVALCANTE	CJ12047979	FLORES DE GOIAS	13/02/2020 09:19	13/02/2020 16:17	13/02/2020 09:19	13/02/2020 16:17	6,97	21	146,29	CHI
20200267951	TERESINA DE GOIAS	CJ12047979	FLORES DE GOIAS	13/02/2020 09:19	13/02/2020 16:17	13/02/2020 09:19	13/02/2020 16:17	6,97	2	13,93	CHI
20200266611	CATALAO	CT21287013	CATALAO S1	13/02/2020 09:20	13/02/2020 16:37	13/02/2020 09:20	13/02/2020 16:37	7,27	1	7,27	CHI

20200267206	CATALAO	CT21104210	CATALAO S1	13/02/2020 09:20	13/02/2020 18:00	13/02/2020 09:20	13/02/2020 18:00	8,65	1	8,65	CHI
20200264756	GOIANIA	12622552	GOIANIA LESTE S1	13/02/2020 09:21	13/02/2020 11:53	13/02/2020 09:21	13/02/2020 11:53	2,52	1	2,52	CHI
20200264757	CRISTALINA	KR12209482	CRISTALINA S1	13/02/2020 09:21	13/02/2020 13:11	13/02/2020 09:21	13/02/2020 13:11	3,82	1	3,82	CHI
20200264794	RIO VERDE	RV10396180	CABRIUVA S2	13/02/2020 09:21	13/02/2020 09:27	13/02/2020 09:21	13/02/2020 09:27	0,11	49	5,19	CHI
20200264760	MINEIROS	MY21264421	SANTA RITA DO ARAGUAIA	13/02/2020 09:22	13/02/2020 16:20	13/02/2020 09:22	13/02/2020 16:20	6,96	1	6,96	CHI
20200264763	LUZIANIA	LZ11170140	MARAJOARA	13/02/2020 09:22	13/02/2020 12:34	13/02/2020 09:22	13/02/2020 12:34	3,19	10	31,92	CHI
20200264767	CHAPADAO DO CEU	9880010352	CHAPADAO DO CEU	13/02/2020 09:22	13/02/2020 10:30	13/02/2020 09:22	13/02/2020 10:30	1,13	1	1,13	CHI
20200264769	ACREUNA	EU12090359	ACREUNA	13/02/2020 09:23	13/02/2020 14:41	13/02/2020 09:23	13/02/2020 14:41	5,30	2	10,59	CHI
20200264613	GOIANIA	GN11041345	REAL S2	13/02/2020 09:24	13/02/2020 15:30	13/02/2020 12:00	13/02/2020 15:30	3,50	65	227,50	CHI
20200264778	CACHOEIRA DOURADA	CD12000291	CACHOEIRA DOURADA	13/02/2020 09:24	13/02/2020 15:51	13/02/2020 09:24	13/02/2020 15:51	6,44	8	51,54	CHI
20200264780	CALDAS NOVAS	CN21186170	SERRA DE CALDAS	13/02/2020 09:24	13/02/2020 15:51	13/02/2020 09:24	13/02/2020 15:51	6,44	1	6,44	CHI
20200264782	ANAPOLIS	20658059	ANAPOLIS UNIVERSITARIO S1	13/02/2020 09:25	13/02/2020 15:37	13/02/2020 09:25	13/02/2020 15:37	6,20	1	6,20	CHI
202002191209	FLORES DE GOIAS	FB12302732LD	FLORES DE GOIAS	13/02/2020 09:25	14/02/2020 15:50	13/02/2020 09:25	14/02/2020 15:50	30,40	11	334,41	CHI
20200264795	RIO VERDE	RV12093099	RIO VERDE S1	13/02/2020 09:27	13/02/2020 15:53	13/02/2020 09:27	13/02/2020 15:53	6,43	7	45,01	CHI
20200264797	JATAI	JT21357066	JATAI S1	13/02/2020 09:27	13/02/2020 11:15	13/02/2020 09:27	13/02/2020 11:15	1,79	1	1,79	CHI
20200264801	URUACU	UR21405332	MARA ROSA	13/02/2020 09:28	14/02/2020 10:45	13/02/2020 09:28	14/02/2020 10:45	25,30	1	25,30	CHI
20200264810	MORRINHOS	MR21024278	MORRINHOS	13/02/2020 09:29	13/02/2020 10:16	13/02/2020 09:29	13/02/2020 10:16	0,77	1	0,77	CHI
20200264811	GOIANIA	GN11166128	FERROVIARIO S2	13/02/2020 09:30	13/02/2020 11:24	13/02/2020 09:30	13/02/2020 11:24	1,90	44	83,58	CHI
20200264812	ANAPOLIS	AN11217373	ANAPOLIS UNIVERSITARIO S2	13/02/2020 09:30	13/02/2020 11:33	13/02/2020 09:30	13/02/2020 11:33	2,06	70	144,01	CHI
20200264814	BARRO ALTO	BA12210738	BARRO ALTO	13/02/2020 09:30	13/02/2020 13:59	13/02/2020 09:30	13/02/2020 13:59	4,48	1	4,48	CHI
20200264817	GOUVELANDIA	QI31094293	QUIRINOPOLIS	13/02/2020 09:30	13/02/2020 13:40	13/02/2020 09:30	13/02/2020 13:40	4,16	1	4,16	CHI
20200264818	ORIZONA	OZ21035320	PIRES DO RIO S2	13/02/2020 09:30	13/02/2020 16:21	13/02/2020 09:30	13/02/2020 16:21	6,83	1	6,83	CHI
20200264821	PLANALTINA	10018500100	PLANALTINA	13/02/2020 09:31	13/02/2020 10:27	13/02/2020 09:31	13/02/2020 10:27	0,93	1	0,93	CHI
20200264832	MORRINHOS	150014284	MORRINHOS	13/02/2020 09:33	13/02/2020 17:12	13/02/2020 09:33	13/02/2020 17:12	7,64	1	7,64	CHI
20200264833	JATAI	JT12184065	JATAI S2	13/02/2020 09:33	13/02/2020 13:35	13/02/2020 09:33	13/02/2020 13:35	4,02	13	52,23	CHI
20200264849	COLINAS DO SUL	TL12355533	NIQUELANDIA SUBTRANSMISSAO	13/02/2020 09:34	13/02/2020 20:04	13/02/2020 09:34	13/02/2020 20:04	10,49	9	94,43	CHI
20200264839	CHAPADAO DO CEU	DJ21109637	CHAPADAO DO CEU	13/02/2020 09:35	13/02/2020 11:00	13/02/2020 09:35	13/02/2020 11:00	1,41	1	1,41	CHI
20200264845	COCALZINHO DE GOIAS	ZN12284334	COCALZINHO	13/02/2020 09:36	13/02/2020 14:59	13/02/2020 09:36	13/02/2020 14:59	5,37	1	5,37	CHI
20200264846	NIQUELANDIA	10015857954	NIQUELANDIA SUBTRANSMISSAO	13/02/2020 09:36	14/02/2020 01:58	13/02/2020 09:36	14/02/2020 01:58	16,36	1	16,36	CHI
20200264851	JATAI	290128961	JATAI S3	13/02/2020 09:37	13/02/2020 13:00	13/02/2020 09:37	13/02/2020 13:00	3,37	1	3,37	CHI
20200264861	JARAGUA	JA12112437	GOIANESIA S2	13/02/2020 09:41	13/02/2020 13:59	13/02/2020 09:41	13/02/2020 13:59	4,29	2	8,59	CHI
20200264866	ANAPOLIS	10026644655	ANAPOLIS UNIVERSITARIO S2	13/02/2020 09:42	13/02/2020 13:26	13/02/2020 09:42	13/02/2020 13:26	3,73	1	3,73	CHI
20200264868	GUAPO	GA12000164	GUAPO S1	13/02/2020 09:42	13/02/2020 10:49	13/02/2020 09:42	13/02/2020 10:49	1,11	7	7,74	CHI

20200264874	GOIANIA	14442000	ATLANTICO S1	13/02/2020 09:43	13/02/2020 11:09	13/02/2020 09:43	13/02/2020 11:09	1,42	1	1,42	CHI
20200267603	PADRE BERNARDO	PB12275401	PADRE BERNARDO	13/02/2020 09:45	13/02/2020 16:47	13/02/2020 09:45	13/02/2020 16:47	7,03	27	189,76	CHI
20200264883	PLANALTINA	PI21199855	PLANALTINA	13/02/2020 09:46	14/02/2020 14:54	13/02/2020 09:46	14/02/2020 14:54	29,12	2	58,25	CHI
20200264892	SITIO D ABADIA	FB11285720	IACIARA S2	13/02/2020 09:46	13/02/2020 20:30	13/02/2020 09:46	13/02/2020 20:30	10,74	1	10,74	CHI
20200264893	HIDROLANDIA	HD12288933	CEPAIGO S2	13/02/2020 09:46	13/02/2020 14:06	13/02/2020 09:46	13/02/2020 14:06	4,32	13	56,17	CHI
20200265020	BARRO ALTO	BA12210722	GOIANESIA S1	13/02/2020 09:47	13/02/2020 11:43	13/02/2020 09:47	13/02/2020 11:43	1,94	3	5,83	CHI
20200264900	PADRE BERNARDO	10006838330	PADRE BERNARDO	13/02/2020 09:48	13/02/2020 11:57	13/02/2020 09:48	13/02/2020 11:57	2,14	1	2,14	CHI
20200265001	MORRINHOS	MR12223297	MORRINHOS	13/02/2020 09:48	13/02/2020 13:39	13/02/2020 09:48	13/02/2020 13:39	3,84	3	11,52	CHI
20200265004	SAO JOAO D ALIANCA	JL21197429	SAO JOAO D ALIANCA	13/02/2020 09:48	13/02/2020 20:33	13/02/2020 09:48	13/02/2020 20:33	10,74	1	10,74	CHI
20200265005	PIREOPOLIS	PV21314185	CORUMBA	13/02/2020 09:48	13/02/2020 15:14	13/02/2020 09:48	13/02/2020 15:14	5,42	1	5,42	CHI
20200265007	MORRINHOS	150069650	MORRINHOS	13/02/2020 09:49	13/02/2020 12:44	13/02/2020 09:49	13/02/2020 12:44	2,92	1	2,92	CHI
20200265008	MORRINHOS	150081911	MORRINHOS	13/02/2020 09:49	13/02/2020 18:30	13/02/2020 09:49	13/02/2020 18:30	8,68	1	8,68	CHI
20200265012	NOVA ROMA	SD12067690	IACIARA S2	13/02/2020 09:50	13/02/2020 17:12	13/02/2020 09:50	13/02/2020 17:12	7,36	1	7,36	CHI
20200265012	SAO DOMINGOS	SD12067690	IACIARA S2	13/02/2020 09:50	13/02/2020 17:12	13/02/2020 09:50	13/02/2020 17:12	7,36	2	14,71	CHI
20200265029	QUIRINOPOLIS	QI21295737	QUIRINOPOLIS	13/02/2020 09:54	13/02/2020 19:35	13/02/2020 09:54	13/02/2020 19:35	9,70	1	9,70	CHI
20200265032	GOIANIA	10023950070	CARAJAS S1	13/02/2020 09:54	13/02/2020 11:50	13/02/2020 09:54	13/02/2020 11:50	1,92	1	1,92	CHI
20200265035	COCALZINHO DE GOIAS	ZN12313683LD	AGUAS LINDAS DE GOIAS S2	13/02/2020 09:55	13/02/2020 12:36	13/02/2020 11:00	13/02/2020 12:36	1,60	85	136,07	CHI
20200265035	CORUMBA DE GOIAS	ZN12313683LD	AGUAS LINDAS DE GOIAS S2	13/02/2020 09:55	13/02/2020 12:36	13/02/2020 11:00	13/02/2020 12:36	1,60	7	11,21	CHI
20200265035	SANTO ANTONIO DO DESCOBERTO	ZN12313683LD	AGUAS LINDAS DE GOIAS S2	13/02/2020 09:55	13/02/2020 12:36	13/02/2020 11:00	13/02/2020 12:36	1,60	82	131,27	CHI
20200265038	GOIANIA	14002190	AEROPORTO S2	13/02/2020 09:55	13/02/2020 11:39	13/02/2020 09:55	13/02/2020 11:39	1,73	1	1,73	CHI
20200265039	GOIANIA	GN11209264	CARAJAS S1	13/02/2020 09:55	13/02/2020 11:07	13/02/2020 09:55	13/02/2020 11:07	1,19	143	170,61	CHI
20200265041	APARECIDA DE GOIANIA	16242804	REAL S1	13/02/2020 09:55	13/02/2020 14:03	13/02/2020 09:55	13/02/2020 14:03	4,12	1	4,12	CHI
20200265044	GOIANIA	GN11002257	CAMPINAS S3	13/02/2020 09:55	13/02/2020 18:02	13/02/2020 09:55	13/02/2020 18:02	8,10	57	461,72	CHI
20200265045	GOIANIRA	390013500	GOIANIRA	13/02/2020 09:56	13/02/2020 12:12	13/02/2020 09:56	13/02/2020 12:12	2,27	1	2,27	CHI
20200265050	SANTA TEREZINHA DE GOIAS	SG21202039	SANTA TEREZINHA	13/02/2020 09:56	13/02/2020 11:07	13/02/2020 09:56	13/02/2020 11:07	1,18	1	1,18	CHI
20200268235	MINACU	IH12129795	MINACU	13/02/2020 09:57	13/02/2020 14:50	13/02/2020 09:57	13/02/2020 14:50	4,88	32	156,00	CHI
20200265065	MUNDO NOVO DE GOIAS	MH21037797	NOVA CRIXAS	13/02/2020 09:59	14/02/2020 09:57	13/02/2020 09:59	14/02/2020 09:57	23,96	1	23,96	CHI
20200265066	NIQUELANDIA	NQ13364088	BARRO ALTO	13/02/2020 09:59	14/02/2020 05:40	13/02/2020 09:59	14/02/2020 05:40	19,68	3	59,05	CHI
20200265066	MIMOSO DE GOIAS	NQ13364088	BARRO ALTO	13/02/2020 09:59	14/02/2020 05:40	13/02/2020 21:53	14/02/2020 05:40	7,78	4	31,14	CHI
20200265066	NIQUELANDIA	NQ13364088	BARRO ALTO	13/02/2020 09:59	14/02/2020 05:40	13/02/2020 21:53	14/02/2020 05:40	7,78	224	1743,84	CHI
20200265073	SANTO ANTONIO DO DESCOBERTO	2210040146	AGUAS LINDAS DE GOIAS S2	13/02/2020 10:00	13/02/2020 15:55	13/02/2020 10:00	13/02/2020 15:55	5,91	1	5,91	CHI
20200264928	ANAPOLIS	AN12000675	JUNDIAI S1	13/02/2020 10:01	13/02/2020 11:20	13/02/2020 10:01	13/02/2020 11:20	1,30	575	749,42	CHI
20200265079	CORUMBA DE GOIAS	260019770	CORUMBA	13/02/2020 10:01	13/02/2020 19:45	13/02/2020 10:01	13/02/2020 19:45	9,73	1	9,73	CHI

20200265085	CUMARI	CT21231651	CATALAO S2	13/02/2020 10:02	13/02/2020 11:48	13/02/2020 10:02	13/02/2020 11:48	1,77	1	1,77	CHI
20200265086	GOIANIA	13923729	ATLANTICO S2	13/02/2020 10:02	13/02/2020 15:40	13/02/2020 10:02	13/02/2020 15:40	5,64	1	5,64	CHI
20200265089	DAVINOPOLIS	IO21231429	CATALAO S1	13/02/2020 10:02	13/02/2020 11:49	13/02/2020 10:02	13/02/2020 11:49	1,77	1	1,77	CHI
20200265090	ITUMBIARA	690146929	ITUMBIARA NOVA	13/02/2020 10:03	13/02/2020 13:00	13/02/2020 10:03	13/02/2020 13:00	2,95	1	2,95	CHI
20200265095	CABECEIRAS	CW21144169	ITUIQUIRA	13/02/2020 10:04	13/02/2020 11:49	13/02/2020 10:04	13/02/2020 11:49	1,75	1	1,75	CHI
20200265096	CATALAO	CT21192690	CATALAO S2	13/02/2020 10:04	13/02/2020 12:18	13/02/2020 10:04	13/02/2020 12:18	2,22	1	2,22	CHI
20200265102	NOVA IGUACU DE GOIAS	NH21317119	SANTA TEREZINHA	13/02/2020 10:05	13/02/2020 15:01	13/02/2020 10:05	13/02/2020 15:01	4,92	1	4,92	CHI
20200265107	SAO FRANCISCO DE GOIAS	SF21381360	SAO FRANCISCO DE GOIAS	13/02/2020 10:05	13/02/2020 15:14	13/02/2020 10:05	13/02/2020 15:14	5,14	1	5,14	CHI
20200268432	PIRENOPOLIS	SF12017628	SAO FRANCISCO DE GOIAS	13/02/2020 10:07	13/02/2020 18:47	13/02/2020 10:07	13/02/2020 18:47	8,65	4	34,61	CHI
20200268432	SAO FRANCISCO DE GOIAS	SF12017628	SAO FRANCISCO DE GOIAS	13/02/2020 10:07	13/02/2020 18:47	13/02/2020 10:07	13/02/2020 18:47	8,65	8	69,21	CHI
20200265108	SANTO ANTONIO DO DESCOBERTO	SN12401713	ALEXANIA	13/02/2020 10:08	13/02/2020 11:20	13/02/2020 10:08	13/02/2020 11:20	1,20	3	3,60	CHI
20200265109	CORUMBAIBA	CI21098627	VILA CORUMBA	13/02/2020 10:08	13/02/2020 16:20	13/02/2020 10:08	13/02/2020 16:20	6,19	1	6,19	CHI
20200265111	ANAPOLIS	AN12093693	ANAPOLIS UNIVERSITARIO S2	13/02/2020 10:09	13/02/2020 11:33	13/02/2020 10:09	13/02/2020 11:33	1,41	253	355,82	CHI
20200270562	GOIATUBA	BJ12062735	BOM JESUS DE GOIAS	13/02/2020 10:12	13/02/2020 18:35	13/02/2020 10:12	13/02/2020 18:35	8,37	3	25,10	CHI
20200265131	CRISTALINA	KR21339712	CRISTALINA S1	13/02/2020 10:13	13/02/2020 18:35	13/02/2020 10:13	13/02/2020 18:35	8,36	1	8,36	CHI
20200265144	GOIANESIA	10026010443	GOIANESIA S2	13/02/2020 10:17	13/02/2020 12:55	13/02/2020 10:17	13/02/2020 12:55	2,64	1	2,64	CHI
20200265506	GOIANESIA	GE21317837	GOIANESIA S1	13/02/2020 10:20	13/02/2020 14:20	13/02/2020 10:20	13/02/2020 14:20	4,00	1	4,00	CHI
20200265510	VILA PROPICIO	PV12255981	GOIANESIA S1	13/02/2020 10:20	13/02/2020 15:17	13/02/2020 10:20	13/02/2020 15:17	4,94	3	14,82	CHI
20200265513	SANTA HELENA DE GOIAS	SH12024698	RIO VERDE S1	13/02/2020 10:22	13/02/2020 14:11	13/02/2020 10:22	13/02/2020 14:11	3,81	5	19,07	CHI
20200265524	NOVA CRIXAS	NA21321049	NOVA CRIXAS	13/02/2020 10:24	13/02/2020 14:00	13/02/2020 10:24	13/02/2020 14:00	3,59	1	3,59	CHI
20200265532	ALEXANIA	AX21302090	ALEXANIA	13/02/2020 10:26	13/02/2020 16:40	13/02/2020 10:26	13/02/2020 16:40	6,22	1	6,22	CHI
20200265534	SANTA TEREZINHA DE GOIAS	2480017790	SANTA TEREZINHA	13/02/2020 10:27	13/02/2020 16:49	13/02/2020 10:27	13/02/2020 16:49	6,36	1	6,36	CHI
20200265537	GOIANIA	10014725302	GOYA S1	13/02/2020 10:27	13/02/2020 14:48	13/02/2020 10:27	13/02/2020 14:48	4,33	1	4,33	CHI
20200267258	ITARUMA	IM12092329LD	CACHOEIRA ALTA	13/02/2020 10:27	13/02/2020 18:21	13/02/2020 10:27	13/02/2020 18:21	7,88	8	63,08	CHI
20200265539	CATALAO	CT21266326	CATALAO S1	13/02/2020 10:29	13/02/2020 16:54	13/02/2020 10:29	13/02/2020 16:54	6,41	1	6,41	CHI
20200265541	IPAMERI	IP12403328	PIRES DO RIO S2	13/02/2020 10:29	13/02/2020 18:44	13/02/2020 10:29	13/02/2020 18:44	8,24	7	57,69	CHI
20200265542	SANTA HELENA DE GOIAS	SH12301062	RIO DOS BOIS	13/02/2020 10:29	13/02/2020 15:07	13/02/2020 10:29	13/02/2020 15:07	4,62	3	13,87	CHI
20200265542	TURVELANDIA	SH12301062	RIO DOS BOIS	13/02/2020 10:29	13/02/2020 15:07	13/02/2020 10:29	13/02/2020 15:07	4,62	3	13,87	CHI
20200265543	JOVIANIA	570022083	GOIATUBA S1	13/02/2020 10:29	13/02/2020 17:25	13/02/2020 10:29	13/02/2020 17:25	6,92	1	6,92	CHI
20200265544	CRIXAS	CX12252911	SANTA TEREZINHA	13/02/2020 10:30	13/02/2020 20:48	13/02/2020 10:30	13/02/2020 20:48	10,30	13	133,94	CHI
20200265545	GOIATUBA	GT21326065	GOIATUBA S1	13/02/2020 10:30	13/02/2020 13:14	13/02/2020 10:30	13/02/2020 13:14	2,74	1	2,74	CHI
20200265547	GOIANIA	15917253	GOYA S2	13/02/2020 10:31	13/02/2020 12:08	13/02/2020 10:31	13/02/2020 12:08	1,62	1	1,62	CHI
20200265552	MORRINHOS	MR21048481	GOIATUBA S2	13/02/2020 10:32	13/02/2020 18:07	13/02/2020 10:32	13/02/2020 18:07	7,58	1	7,58	CHI

20200265553	LUZIANIA	LZ12245978	CRISTALINA S2	13/02/2020 10:32	13/02/2020 14:16	13/02/2020 10:32	13/02/2020 14:16	3,73	8	29,85	CHI
20200265554	APORE	AE12219486	ITAJA S1	13/02/2020 10:32	13/02/2020 12:38	13/02/2020 10:32	13/02/2020 12:38	2,09	2	4,19	CHI
20200265555	CATALAO	1990027407	CATALAO S2	13/02/2020 10:33	13/02/2020 18:38	13/02/2020 10:33	13/02/2020 18:38	8,08	1	8,08	CHI
20200265557	GOIANIA	15185618	GOIANIA LESTE S1	13/02/2020 10:33	13/02/2020 12:36	13/02/2020 10:33	13/02/2020 12:36	2,04	1	2,04	CHI
20200265558	PIRES DO RIO	PR11027087	PIRES DO RIO S1	13/02/2020 10:34	13/02/2020 16:06	13/02/2020 10:34	13/02/2020 16:06	5,53	5	27,65	CHI
20200265803	ORIZONA	OZ21031248	PIRES DO RIO S2	13/02/2020 10:34	13/02/2020 12:50	13/02/2020 10:34	13/02/2020 12:50	2,27	1	2,27	CHI
20200265571	AGUAS LINDAS DE GOIAS	10011635396	AGUAS LINDAS DE GOIAS S1	13/02/2020 10:37	13/02/2020 14:59	13/02/2020 10:37	13/02/2020 14:59	4,36	1	4,36	CHI
20200265572	RIO VERDE	630366871	CABRIUVA S1	13/02/2020 10:37	13/02/2020 13:39	13/02/2020 10:37	13/02/2020 13:39	3,04	1	3,04	CHI
20200265902	SANTA TEREZINHA DE GOIAS	SG21202100	SANTA TEREZINHA	13/02/2020 10:38	13/02/2020 16:16	13/02/2020 10:38	13/02/2020 16:16	5,63	1	5,63	CHI
20200265904	CABECEIRAS	CW21090893	ITIQUEIRA	13/02/2020 10:38	13/02/2020 14:41	13/02/2020 10:38	13/02/2020 14:41	4,04	1	4,04	CHI
20200265807	PLANALTINA	PI12326717	SAO JOAO D ALIANCA	13/02/2020 10:39	13/02/2020 14:54	13/02/2020 10:39	13/02/2020 14:54	4,24	1	4,24	CHI
20200265905	TRINDADE	40121768	TRINDADE	13/02/2020 10:40	13/02/2020 12:27	13/02/2020 10:40	13/02/2020 12:27	1,78	1	1,78	CHI
20200265908	FORMOSA	610283972	ITIQUEIRA	13/02/2020 10:42	14/02/2020 08:21	13/02/2020 10:42	14/02/2020 08:21	21,65	1	21,65	CHI
20200265915	CACHOEIRA ALTA	CA21154437	CACHOEIRA ALTA	13/02/2020 10:43	13/02/2020 13:57	13/02/2020 10:43	13/02/2020 13:57	3,23	1	3,23	CHI
20200266001	URUTAI	PR21328162	URUTAI	13/02/2020 10:43	13/02/2020 14:06	13/02/2020 10:43	13/02/2020 14:06	3,37	4	13,49	CHI
20200266101	QUIRINOPOLIS	QI12047654	CACHOEIRA ALTA	13/02/2020 10:43	13/02/2020 16:06	13/02/2020 10:43	13/02/2020 16:06	5,37	2	10,74	CHI
20200266401	GOIANESIA	550037573	GOIANESIA S2	13/02/2020 10:47	13/02/2020 17:45	13/02/2020 10:47	13/02/2020 17:45	6,97	1	6,97	CHI
20200266408	FLORES DE GOIAS	FB11211693	FLORES DE GOIAS	13/02/2020 10:48	13/02/2020 13:05	13/02/2020 10:48	13/02/2020 13:05	2,27	3	6,81	CHI
20200260602	PETROLINA DE GOIAS	PG12230708	PETROLINA	13/02/2020 10:49	13/02/2020 17:19	13/02/2020 10:49	13/02/2020 17:19	6,50	6	38,99	CHI
20200260602	SAO FRANCISCO DE GOIAS	PG12230708	PETROLINA	13/02/2020 10:49	13/02/2020 17:19	13/02/2020 10:49	13/02/2020 17:19	6,50	13	84,47	CHI
20200266804	MORRINHOS	MR12264053	MORRINHOS	13/02/2020 10:49	13/02/2020 16:17	13/02/2020 10:49	13/02/2020 16:17	5,46	9	49,17	CHI
20200266419	GOIANIA	10027376603	GOYA S1	13/02/2020 10:50	13/02/2020 12:35	13/02/2020 10:50	13/02/2020 12:35	1,75	1	1,75	CHI
20200266421	AGUA FRIA DE GOIAS	JL12261887	SAO JOAO D ALIANCA	13/02/2020 10:50	13/02/2020 12:29	13/02/2020 10:50	13/02/2020 12:29	1,64	2	3,29	CHI
20200266421	SAO JOAO D ALIANCA	JL12261887	SAO JOAO D ALIANCA	13/02/2020 10:50	13/02/2020 12:29	13/02/2020 10:50	13/02/2020 12:29	1,64	5	8,22	CHI
20200266425	CRISTALINA	1060110481	CRISTALINA S1	13/02/2020 10:50	13/02/2020 22:25	13/02/2020 10:50	13/02/2020 22:25	11,58	1	11,58	CHI
20200266426	GOIANESIA	550026812	GOIANESIA S2	13/02/2020 10:51	13/02/2020 19:15	13/02/2020 10:51	13/02/2020 19:15	8,41	1	8,41	CHI
20200266427	JARAGUA	70086618	JARAGUA	13/02/2020 10:51	13/02/2020 16:17	13/02/2020 10:51	13/02/2020 16:17	5,43	1	5,43	CHI
20200266606	CACU	CC21340779	CACHOEIRA ALTA	13/02/2020 10:56	13/02/2020 18:15	13/02/2020 10:56	13/02/2020 18:15	7,32	1	7,32	CHI
20200266608	COCALZINHO DE GOIAS	1200028240	COCALZINHO	13/02/2020 10:57	13/02/2020 14:52	13/02/2020 10:57	13/02/2020 14:52	3,91	1	3,91	CHI
20200266701	BONOPOLIS	4350004611	SAO MIGUEL DO ARAGUAIA	13/02/2020 10:57	13/02/2020 14:19	13/02/2020 10:57	13/02/2020 14:19	3,35	1	3,35	CHI
20200271201	PETROLINA DE GOIAS	PG32086638	SAO FRANCISCO DE GOIAS	13/02/2020 10:57	14/02/2020 00:20	13/02/2020 10:57	14/02/2020 00:20	13,40	40	535,82	CHI
20200266808	IPAMERI	IP21359965	PIRES DO RIO S2	13/02/2020 10:59	13/02/2020 19:10	13/02/2020 10:59	13/02/2020 19:10	8,18	1	8,18	CHI
20200266816	RIO QUENTE	2530001474	RIO QUENTE	13/02/2020 11:01	13/02/2020 17:36	13/02/2020 11:01	13/02/2020 17:36	6,58	1	6,58	CHI

20200265515	GOIANIA	GN12000797	GOYA S1	13/02/2020 11:02	13/02/2020 16:51	13/02/2020 11:02	13/02/2020 16:51	5,81	173	1004,79	CHI
20200267004	AGUA FRIA DE GOIAS	TL12096478	SAO JOAO D ALIANCA	13/02/2020 11:04	13/02/2020 14:10	13/02/2020 11:04	13/02/2020 14:10	3,10	2	6,19	CHI
20200267005	ANAPOLIS	AN11121967	JUNDAIA S1	13/02/2020 11:04	13/02/2020 13:16	13/02/2020 11:04	13/02/2020 13:16	2,19	124	270,97	CHI
20200267201	INHUMAS	10005528460	INHUMAS S2	13/02/2020 11:05	13/02/2020 15:40	13/02/2020 11:05	13/02/2020 15:40	4,57	1	4,57	CHI
20200267202	FORMOSA	610057789	ITUIQUIRA	13/02/2020 11:05	13/02/2020 17:29	13/02/2020 11:05	13/02/2020 17:29	6,39	1	6,39	CHI
20200265843	INACIOLANDIA	ID12128131	QUIRINOPOLIS	13/02/2020 11:06	13/02/2020 19:54	13/02/2020 13:54	13/02/2020 19:54	6,00	11	66,05	CHI
20200267205	GOIANESIA	GE21239034	GOIANESIA S1	13/02/2020 11:06	13/02/2020 18:05	13/02/2020 11:06	13/02/2020 18:05	6,98	2	13,95	CHI
20200265835	ITUMBIARA	690242232	ITUMBIARA NOVA	13/02/2020 11:09	13/02/2020 22:27	13/02/2020 11:09	13/02/2020 22:27	11,30	1	11,30	CHI
20200267213	CRISTALINA	KR12110413	CRISTALINA S2	13/02/2020 11:11	13/02/2020 17:09	13/02/2020 11:11	13/02/2020 17:09	5,97	6	35,80	CHI
20200267214	GOIANIA	11041560	GOYA S1	13/02/2020 11:11	13/02/2020 14:40	13/02/2020 11:11	13/02/2020 14:40	3,48	1	3,48	CHI
20200267215	GUARANI DE GOIAS	GY12265440	IACIARA S1	13/02/2020 11:11	13/02/2020 14:07	13/02/2020 11:11	13/02/2020 14:07	2,92	20	58,48	CHI
20200267228	GOIANIRA	10014556640	MEIA PONTE	13/02/2020 11:15	13/02/2020 19:39	13/02/2020 11:15	13/02/2020 19:39	8,39	1	8,39	CHI
20200267236	NIQUELANDIA	NQ12268706	NIQUELANDIA SUBTRANSMISSAO	13/02/2020 11:17	14/02/2020 08:48	13/02/2020 11:17	14/02/2020 08:48	21,51	1	21,51	CHI
20200267242	ITAJA	2300004210	ITAJA S2	13/02/2020 11:18	13/02/2020 12:40	13/02/2020 11:18	13/02/2020 12:40	1,36	1	1,36	CHI
20200267244	PLANALTINA	2960064404	PLANALTINA	13/02/2020 11:19	13/02/2020 13:00	13/02/2020 11:19	13/02/2020 13:00	1,68	1	1,68	CHI
20200267248	ANAPOLIS	10023560140	ANAPOLIS UNIVERSITARIO S2	13/02/2020 11:20	13/02/2020 14:20	13/02/2020 11:20	13/02/2020 14:20	2,99	1	2,99	CHI
20200267261	EDEIA	1120004382	EDEIA	13/02/2020 11:22	13/02/2020 12:45	13/02/2020 11:22	13/02/2020 12:45	1,37	1	1,37	CHI
20200267256	CACU	CC21322238	CACHOEIRA ALTA	13/02/2020 11:23	13/02/2020 16:31	13/02/2020 11:23	13/02/2020 16:31	5,13	1	5,13	CHI
20200267259	GOIANESIA	550180229	GOIANESIA S2	13/02/2020 11:24	13/02/2020 19:30	13/02/2020 11:24	13/02/2020 19:30	8,11	1	8,11	CHI
20200267406	BRAZABRANTES	03920224	NEROPOLIS S1	13/02/2020 11:24	13/02/2020 16:54	13/02/2020 11:24	13/02/2020 12:33	1,16	365	422,59	CHI
20200267406	NOVA VENEZA	03920224	NEROPOLIS S1	13/02/2020 11:24	13/02/2020 16:54	13/02/2020 11:24	13/02/2020 12:33	1,16	3	3,47	CHI
20200267406	BRAZABRANTES	03920224	NEROPOLIS S1	13/02/2020 11:24	13/02/2020 16:54	13/02/2020 11:24	13/02/2020 13:16	1,86	2	3,73	CHI
20200267406	GOIANIRA	03920224	NEROPOLIS S1	13/02/2020 11:24	13/02/2020 16:54	13/02/2020 11:24	13/02/2020 13:16	1,86	7	13,05	CHI
20200267406	BRAZABRANTES	03920224	NEROPOLIS S1	13/02/2020 11:24	13/02/2020 16:54	13/02/2020 11:24	13/02/2020 16:31	5,12	2	10,24	CHI
20200267406	GOIANIRA	03920224	NEROPOLIS S1	13/02/2020 11:24	13/02/2020 16:54	13/02/2020 11:24	13/02/2020 16:31	5,12	12	61,42	CHI
20200267406	GOIANIRA	03920224	NEROPOLIS S1	13/02/2020 11:24	13/02/2020 16:54	13/02/2020 11:24	13/02/2020 16:44	5,33	8	42,63	CHI
20200267406	BRAZABRANTES	03920224	NEROPOLIS S1	13/02/2020 11:24	13/02/2020 16:54	13/02/2020 11:24	13/02/2020 16:54	5,49	2	10,99	CHI
20200267406	GOIANIRA	03920224	NEROPOLIS S1	13/02/2020 11:24	13/02/2020 16:54	13/02/2020 11:24	13/02/2020 16:54	5,49	2	10,99	CHI
20200267263	GOIANIA	16450437	FERROVIARIO S1	13/02/2020 11:25	13/02/2020 16:47	13/02/2020 11:25	13/02/2020 16:47	5,38	1	5,38	CHI
20200267301	BARRO ALTO	10005957921	GOIANESIA S1	13/02/2020 11:26	14/02/2020 02:43	13/02/2020 11:26	14/02/2020 02:43	15,28	1	15,28	CHI
20200267407	CUMARI	CY12318863	CATALAO S1	13/02/2020 11:26	13/02/2020 11:55	13/02/2020 11:26	13/02/2020 11:55	0,47	1	0,47	CHI
20200267410	GOIANIA	11898963	GOIANIA LESTE S2	13/02/2020 11:27	13/02/2020 12:27	13/02/2020 11:27	13/02/2020 12:27	0,98	1	0,98	CHI
20200267411	VALPARAISO DE GOIAS	2860068620	PACAEMBU S1	13/02/2020 11:28	13/02/2020 18:07	13/02/2020 11:28	13/02/2020 18:07	6,64	1	6,64	CHI

20200267417	CALDAS NOVAS	10023226690	SERRA DE CALDAS	13/02/2020 11:30	13/02/2020 16:50	13/02/2020 11:30	13/02/2020 16:50	5,32	1	5,32	CHI
20200267706	FORMOSA	FA12218278	SAO JOAO D ALIANCA	13/02/2020 11:30	14/02/2020 09:13	13/02/2020 11:30	14/02/2020 09:13	21,71	3	65,13	CHI
20200267418	LUZIANIA	LZ12037192	RIO VERMELHO	13/02/2020 11:31	13/02/2020 19:16	13/02/2020 11:31	13/02/2020 19:16	7,75	6	46,50	CHI
20200267420	COLINAS DO SUL	TI21196542	MINACU	13/02/2020 11:31	13/02/2020 19:00	13/02/2020 11:31	13/02/2020 19:00	7,48	1	7,48	CHI
20200270731	LUZIANIA	LZ21091124	RIO VERMELHO	13/02/2020 11:31	13/02/2020 19:20	13/02/2020 11:31	13/02/2020 19:20	7,82	1	7,82	CHI
20200267429	NOVA AURORA	NE21082760	CATALAO S1	13/02/2020 11:33	13/02/2020 15:19	13/02/2020 11:33	13/02/2020 15:19	3,75	1	3,75	CHI
20200267431	AGUA FRIA DE GOIAS	TL21049168	SAO JOAO D ALIANCA	13/02/2020 11:34	14/02/2020 10:45	13/02/2020 11:34	14/02/2020 10:45	23,18	1	23,18	CHI
20200267432	IPAMERI	IP21138818	PIRES DO RIO S2	13/02/2020 11:34	14/02/2020 10:01	13/02/2020 11:34	14/02/2020 10:01	22,44	1	22,44	CHI
20200267433	VIANOPOLIS	VN21209136	VIANOPOLIS	13/02/2020 11:35	13/02/2020 12:24	13/02/2020 11:35	13/02/2020 12:24	0,82	2	1,63	CHI
20200267704	OURO VERDE DE GOIAS	OV12030093	NEROPOLIS S2	13/02/2020 11:37	13/02/2020 15:20	13/02/2020 11:37	13/02/2020 15:20	3,71	3	11,13	CHI
20200267708	CRISTALINA	KR21413854	CRISTALINA S1	13/02/2020 11:38	13/02/2020 14:49	13/02/2020 11:38	13/02/2020 14:49	3,17	1	3,17	CHI
20200267716	BELA VISTA DE GOIAS	BV31185851	BELA VISTA S1	13/02/2020 11:39	13/02/2020 13:05	13/02/2020 11:39	13/02/2020 13:05	1,42	1	1,42	CHI
20200268317	BURITI ALEGRE	BG12263620	ALTO BURITI	13/02/2020 11:39	14/02/2020 09:12	13/02/2020 11:39	14/02/2020 09:12	21,55	3	64,64	CHI
20200265848	TERESINA DE GOIAS	TE12328403	FLORES DE GOIAS	13/02/2020 11:40	13/02/2020 12:15	13/02/2020 11:40	13/02/2020 12:15	0,57	4	2,27	CHI
20200267718	INHUMAS	AR12247240	ARACU	13/02/2020 11:40	13/02/2020 14:51	13/02/2020 11:40	13/02/2020 14:51	3,18	8	25,44	CHI
20200267720	PIRES DO RIO	PR21100251	PIRES DO RIO S1	13/02/2020 11:40	13/02/2020 14:15	13/02/2020 11:40	13/02/2020 14:15	2,57	3	7,72	CHI
20200267722	PIRES DO RIO	BC21137530	PIRES DO RIO S2	13/02/2020 11:40	13/02/2020 12:19	13/02/2020 11:40	13/02/2020 12:19	0,64	1	0,64	CHI
20200267727	CATALAO	1990241703	CATALAO S2	13/02/2020 11:42	13/02/2020 15:51	13/02/2020 11:42	13/02/2020 15:51	4,15	1	4,15	CHI
20200267730	GOIATUBA	GT21033090	BOM JESUS DE GOIAS	13/02/2020 11:42	13/02/2020 14:34	13/02/2020 11:42	13/02/2020 14:34	2,85	1	2,85	CHI
20200267735	PADRE BERNARDO	PB12349199	PADRE BERNARDO	13/02/2020 11:43	13/02/2020 15:43	13/02/2020 11:43	13/02/2020 15:43	3,99	1	3,99	CHI
20200267756	CAMPINACU	UC12239728	PORANGATU	13/02/2020 11:43	13/02/2020 13:20	13/02/2020 11:43	13/02/2020 13:20	1,61	9	14,51	CHI
20200267744	GOIANIA	GN11283034	GOIANIA LESTE S2	13/02/2020 11:47	13/02/2020 16:43	13/02/2020 15:31	13/02/2020 16:43	1,21	85	102,83	CHI
20200267746	ARAGOIANIA	AO12291291	GUAPO S2	13/02/2020 11:47	13/02/2020 16:23	13/02/2020 11:47	13/02/2020 16:23	4,59	44	201,98	CHI
20200267746	HIDROLANDIA	AO12291291	GUAPO S2	13/02/2020 11:47	13/02/2020 16:23	13/02/2020 11:47	13/02/2020 16:23	4,59	2	9,18	CHI
20200267928	VICENTINOPOLIS	VI12218168	VICENTINOPOLIS	13/02/2020 11:47	13/02/2020 13:47	13/02/2020 11:47	13/02/2020 13:47	1,99	47	93,70	CHI
20200267758	HIDROLANDIA	HD12000295	CEPAIGO S2	13/02/2020 11:49	13/02/2020 15:11	13/02/2020 11:49	13/02/2020 15:11	3,35	13	43,60	CHI
20200267759	CATALAO	1990065445	CATALAO S2	13/02/2020 11:50	13/02/2020 14:16	13/02/2020 11:50	13/02/2020 14:16	2,43	1	2,43	CHI
20200268575	IPAMERI	IP21031356	IPAMERI	13/02/2020 11:50	13/02/2020 22:57	13/02/2020 11:50	13/02/2020 22:57	11,11	1	11,11	CHI
20200267766	MINACU	IH21187828	MINACU	13/02/2020 11:52	13/02/2020 19:25	13/02/2020 11:52	13/02/2020 19:25	7,55	1	7,55	CHI
20200267771	QUIRINOPOLIS	QI12239488	QUIRINOPOLIS	13/02/2020 11:54	13/02/2020 14:24	13/02/2020 11:54	13/02/2020 14:24	2,50	4	9,99	CHI
20200267773	ITARUMA	IM12160235	ITAJA S2	13/02/2020 11:54	13/02/2020 13:32	13/02/2020 11:54	13/02/2020 13:32	1,62	13	21,02	CHI
20200267775	RIO VERDE	RV21289892	RIO VERDE S1	13/02/2020 11:55	14/02/2020 05:01	13/02/2020 11:55	14/02/2020 05:01	17,09	1	17,09	CHI
20200267780	ORIZONA	OZ21326467	PIRES DO RIO S2	13/02/2020 11:56	14/02/2020 11:26	13/02/2020 11:56	14/02/2020 11:26	23,49	1	23,49	CHI

20200267781	CIDADE OCIDENTAL	10010791378	MARAJOARA	13/02/2020 11:56	13/02/2020 13:56	13/02/2020 11:56	13/02/2020 13:56	1,99	1	1,99	CHI
20200267782	SAO SIMAO	SO21049161	CACHOEIRA ALTA	13/02/2020 11:56	13/02/2020 15:23	13/02/2020 11:56	13/02/2020 15:23	3,44	1	3,44	CHI
20200267785	GOIANIA	17423120	GOYA S2	13/02/2020 11:57	13/02/2020 15:39	13/02/2020 11:57	13/02/2020 15:39	3,70	1	3,70	CHI
20200267790	CATALAO	1990032373	CATALAO S2	13/02/2020 11:59	13/02/2020 14:04	13/02/2020 11:59	13/02/2020 14:04	2,07	1	2,07	CHI
20200267795	AGUAS LINDAS DE GOIAS	10004739661	AGUAS LINDAS DE GOIAS S1	13/02/2020 12:01	13/02/2020 13:33	13/02/2020 12:01	13/02/2020 13:33	1,52	1	1,52	CHI
20200267801	INHUMAS	IN12325094	INHUMAS S1	13/02/2020 12:01	13/02/2020 13:42	13/02/2020 12:01	13/02/2020 13:42	1,67	2	3,34	CHI
20200267901	NOVA CRIXAS	NA12091638	NOVA CRIXAS	13/02/2020 12:02	14/02/2020 13:40	13/02/2020 12:02	14/02/2020 13:40	25,63	9	230,70	CHI
20200267902	APARECIDA DE GOIANIA	16918186	ANHANGUERA	13/02/2020 12:02	13/02/2020 15:29	13/02/2020 12:02	13/02/2020 15:29	3,45	1	3,45	CHI
20200267904	APARECIDA DE GOIANIA	AP11347529	ANHANGUERA	13/02/2020 12:02	13/02/2020 17:18	13/02/2020 12:02	13/02/2020 17:18	5,25	42	220,69	CHI
20200267910	GOIANIA	10517340	GOIANIA LESTE S2	13/02/2020 12:04	13/02/2020 14:15	13/02/2020 12:04	13/02/2020 14:15	2,17	1	2,17	CHI
20200267914	ALEXANIA	10008678136	ALEXANIA	13/02/2020 12:06	13/02/2020 13:19	13/02/2020 12:06	13/02/2020 13:19	1,21	1	1,21	CHI
20200267918	NIQUELANDIA	TL11162980	SAO JOAO D ALIANCA	13/02/2020 12:07	14/02/2020 11:19	13/02/2020 12:07	14/02/2020 11:19	23,20	53	1229,36	CHI
20200267919	OURO VERDE DE GOIAS	OV21028937	NEROPOLIS S2	13/02/2020 12:07	13/02/2020 15:53	13/02/2020 12:07	13/02/2020 15:53	3,75	1	3,75	CHI
20200267920	GOIANIA	14410333	CARAJAS S2	13/02/2020 12:08	13/02/2020 14:21	13/02/2020 12:08	13/02/2020 14:21	2,21	1	2,21	CHI
20200267922	SANTO ANTONIO DO DESCOBERTO	SN21381416	ALEXANIA	13/02/2020 12:08	13/02/2020 18:31	13/02/2020 12:08	13/02/2020 18:31	6,37	1	6,37	CHI
20200267923	IPAMERI	6930000962	PIRES DO RIO S2	13/02/2020 12:08	14/02/2020 10:51	13/02/2020 12:08	14/02/2020 10:51	22,70	1	22,70	CHI
20200267925	ALTO PARAISO DE GOIAS	BF21136633	FLORES DE GOIAS	13/02/2020 12:09	13/02/2020 15:08	13/02/2020 12:09	13/02/2020 15:08	2,98	1	2,98	CHI
20200267930	FORMOSA	610160436	ITUIQUIRA	13/02/2020 12:10	13/02/2020 18:04	13/02/2020 12:10	13/02/2020 18:04	5,89	1	5,89	CHI
20200267933	PORANGATU	PO21241962	NOVO PLANALTO	13/02/2020 12:11	13/02/2020 15:43	13/02/2020 12:11	13/02/2020 15:43	3,53	1	3,53	CHI
20200267934	ANAPOLIS	AN21270286	ANAPOLIS UNIVERSITARIO S2	13/02/2020 12:12	13/02/2020 18:08	13/02/2020 12:12	13/02/2020 18:08	5,93	2	11,86	CHI
20200267942	GUARINOS	3720006187	SANTA TEREZINHA	13/02/2020 12:14	13/02/2020 15:58	13/02/2020 12:14	13/02/2020 15:58	3,73	1	3,73	CHI
20200267943	APORE	AE21161262	ITAJA S1	13/02/2020 12:14	14/02/2020 07:58	13/02/2020 12:14	14/02/2020 07:58	19,73	1	19,73	CHI
20200267954	VICENTINOPOLIS	VI12042225	VICENTINOPOLIS	13/02/2020 12:15	13/02/2020 12:42	13/02/2020 12:15	13/02/2020 12:42	0,44	5	2,21	CHI
20200267952	ORIZONA	OZ11073421	PIRES DO RIO S2	13/02/2020 12:16	13/02/2020 20:44	13/02/2020 12:16	13/02/2020 20:44	8,46	23	194,53	CHI
20200267955	INDIARA	2710032606	EDEIA	13/02/2020 12:17	14/02/2020 07:23	13/02/2020 12:17	14/02/2020 07:23	19,10	1	19,10	CHI
20200267960	CAMPO ALEGRE DE GOIAS	CM21075566	CAMPO ALEGRE DE GOIAS	13/02/2020 12:18	14/02/2020 07:40	13/02/2020 12:18	14/02/2020 07:40	19,35	1	19,35	CHI
20200267961	PIRENOPOLIS	PV21258289	CORUMBA	13/02/2020 12:18	13/02/2020 22:41	13/02/2020 12:18	13/02/2020 22:41	10,37	2	20,74	CHI
20200267962	SAO MIGUEL DO ARAGUAIA	4650002073	SAO MIGUEL DO ARAGUAIA	13/02/2020 12:19	13/02/2020 14:50	13/02/2020 12:19	13/02/2020 14:50	2,53	1	2,53	CHI
20200267967	GOIANIA	10363531	CAMPINAS S1	13/02/2020 12:21	13/02/2020 14:46	13/02/2020 12:21	13/02/2020 14:46	2,41	1	2,41	CHI
20200263951	CATALAO	CT12093871	CATALAO S1	13/02/2020 12:23	13/02/2020 14:52	13/02/2020 12:23	13/02/2020 14:52	2,47	40	98,94	CHI
20200269930	GOIANESIA	GE12360273	GOIANESIA S2	13/02/2020 12:23	13/02/2020 22:50	13/02/2020 12:23	13/02/2020 22:50	10,46	19	198,69	CHI
20200267979	MINEIROS	MY12296347	PARQUE DAS EMAS	13/02/2020 12:26	14/02/2020 12:07	13/02/2020 12:26	14/02/2020 12:07	23,67	2	47,34	CHI
20200267986	BONFINOPOLIS	LB12258821	DAIA S2	13/02/2020 12:29	13/02/2020 17:22	13/02/2020 12:29	13/02/2020 17:22	4,88	1	4,88	CHI

20200267986	LEOPOLDO DE BULHOES	LB12258821	DAIA S2	13/02/2020 12:29	13/02/2020 17:22	13/02/2020 12:29	13/02/2020 17:22	4,88	6	29,28	CHI
20200268259	NOVA CRIXAS	NA12131934	NOVA CRIXAS	13/02/2020 12:29	13/02/2020 16:56	13/02/2020 12:29	13/02/2020 16:56	4,44	69	306,49	CHI
20200267991	FORMOSA	FA11359142	ITUIQUIRA	13/02/2020 12:30	13/02/2020 19:48	13/02/2020 12:30	13/02/2020 19:48	7,30	1	7,30	CHI
20200268104	TERESINA DE GOIAS	TE21117310	FLORES DE GOIAS	13/02/2020 12:30	13/02/2020 12:49	13/02/2020 12:30	13/02/2020 12:49	0,31	1	0,31	CHI
20200267999	ALEXANIA	10004045937	CORUMBA	13/02/2020 12:33	13/02/2020 14:44	13/02/2020 12:33	13/02/2020 14:44	2,18	1	2,18	CHI
20200268000	JATAI	JT12072680	JATAI S1	13/02/2020 12:34	13/02/2020 19:00	13/02/2020 12:34	13/02/2020 19:00	6,43	15	96,43	CHI
20200268202	JARAGUA	JA12298107	JARAGUA	13/02/2020 12:34	13/02/2020 14:25	13/02/2020 12:34	13/02/2020 14:25	1,84	3	5,51	CHI
20200268205	GOIANESIA	550131450	GOIANESIA S2	13/02/2020 12:35	13/02/2020 20:01	13/02/2020 12:35	13/02/2020 20:01	7,43	1	7,43	CHI
20200268207	CAMPOS VERDES	SG13330145	SANTA TEREZINHA	13/02/2020 12:35	13/02/2020 18:00	13/02/2020 12:35	13/02/2020 18:00	5,40	13	70,26	CHI
20200268207	SANTA TEREZINHA DE GOIAS	SG13330145	SANTA TEREZINHA	13/02/2020 12:35	13/02/2020 18:00	13/02/2020 12:35	13/02/2020 18:00	5,40	31	167,55	CHI
20200268207	UIRAPURU	SG13330145	SANTA TEREZINHA	13/02/2020 12:35	13/02/2020 18:00	13/02/2020 12:35	13/02/2020 18:00	5,40	12	64,86	CHI
20200268207	SANTA TEREZINHA DE GOIAS	SG13330145	SANTA TEREZINHA	13/02/2020 12:35	13/02/2020 18:00	13/02/2020 16:55	13/02/2020 18:00	1,07	33	35,24	CHI
20200268207	UIRAPURU	SG13330145	SANTA TEREZINHA	13/02/2020 12:35	13/02/2020 18:00	13/02/2020 16:55	13/02/2020 18:00	1,07	31	33,10	CHI
20200268215	PIRES DO RIO	PR21231422	PIRES DO RIO S1	13/02/2020 12:38	13/02/2020 18:57	13/02/2020 12:38	13/02/2020 18:57	6,32	1	6,32	CHI
20200268224	IACIARA	IA12286108LD	IACIARA S2	13/02/2020 12:40	13/02/2020 19:16	13/02/2020 12:40	13/02/2020 19:16	6,59	3	19,77	CHI
20200268365	NOVA ROMA	ND12325863	FLORES DE GOIAS	13/02/2020 12:42	13/02/2020 18:06	13/02/2020 12:42	13/02/2020 18:06	5,40	15	81,00	CHI
20200268230	GOIANIRA	10002258313	MEIA PONTE	13/02/2020 12:43	13/02/2020 20:38	13/02/2020 12:43	13/02/2020 20:38	7,91	1	7,91	CHI
20200268246	BELA VISTA DE GOIAS	BV12060163	CRISTIANOPOLIS	13/02/2020 12:50	13/02/2020 15:41	13/02/2020 12:50	13/02/2020 15:41	2,85	2	5,69	CHI
20200268249	IPAMERI	580052266	IPAMERI	13/02/2020 12:50	13/02/2020 17:09	13/02/2020 12:50	13/02/2020 17:09	4,30	1	4,30	CHI
20200272475	FORMOSA	FA12228229	SAO JOAO D ALIANCA	13/02/2020 12:52	14/02/2020 12:40	13/02/2020 17:03	14/02/2020 12:40	19,61	46	902,24	CHI
202002191272	FORMOSA	10005577444	SAO JOAO D ALIANCA	13/02/2020 12:52	13/02/2020 17:03	13/02/2020 12:52	13/02/2020 17:03	4,18	1	4,18	CHI
20200268384	VALPARAISO DE GOIAS	VA11067696	MARAJOARA	13/02/2020 12:53	13/02/2020 15:33	13/02/2020 12:53	13/02/2020 15:33	2,65	63	167,07	CHI
20200268258	CORUMBAIBA	CI21234688	VILA CORUMBA	13/02/2020 12:54	13/02/2020 15:40	13/02/2020 12:54	13/02/2020 15:40	2,76	1	2,76	CHI
20200268260	PETROLINA DE GOIAS	PG21221977	PETROLINA	13/02/2020 12:54	13/02/2020 15:22	13/02/2020 12:54	13/02/2020 15:22	2,45	1	2,45	CHI
20200268263	JARAGUA	JA21017435	SAO FRANCISCO DE GOIAS	13/02/2020 12:55	13/02/2020 22:00	13/02/2020 12:55	13/02/2020 22:00	9,07	1	9,07	CHI
20200268269	SANTO ANTONIO DO DESCOBERTO	SN21173015	ALEXANIA	13/02/2020 12:56	13/02/2020 19:30	13/02/2020 12:56	13/02/2020 19:30	6,56	2	13,12	CHI
20200268274	PIRENOPOLIS	220043838	CORUMBA	13/02/2020 12:58	14/02/2020 12:11	13/02/2020 12:58	14/02/2020 12:11	23,21	1	23,21	CHI
20200268275	ITAPACI	IW21379427	ITAPACI	13/02/2020 12:58	13/02/2020 16:12	13/02/2020 12:58	13/02/2020 16:12	3,23	1	3,23	CHI
20200268277	SANTO ANTONIO DO DESCOBERTO	2210145679	ALEXANIA	13/02/2020 12:59	13/02/2020 18:56	13/02/2020 12:59	13/02/2020 18:56	5,95	1	5,95	CHI
20200268278	POSSE	PS21235258	IACIARA S2	13/02/2020 12:59	13/02/2020 15:50	13/02/2020 12:59	13/02/2020 15:50	2,84	1	2,84	CHI
20200268284	SENADOR CANEDO	14890811	SENADOR CANEDO	13/02/2020 13:00	13/02/2020 17:08	13/02/2020 13:00	13/02/2020 17:08	4,13	1	4,13	CHI
20200268336	JARAGUA	JA21297921	JARAGUA	13/02/2020 13:01	13/02/2020 16:50	13/02/2020 13:01	13/02/2020 16:50	3,82	5	19,11	CHI
20200268289	SANTO ANTONIO DO DESCOBERTO	2210003009	AGUAS LINDAS DE GOIAS S2	13/02/2020 13:03	13/02/2020 16:47	13/02/2020 13:03	13/02/2020 16:47	3,73	1	3,73	CHI

20200268294	AGUAS LINDAS DE GOIAS	10010248941	AGUAS LINDAS DE GOIAS S1	13/02/2020 13:04	13/02/2020 14:14	13/02/2020 13:04	13/02/2020 14:14	1,16	1	1,16	CHI
20200268351	ITUMBIARA	IT12000308RE	PARANAIBA	13/02/2020 13:04	13/02/2020 22:49	13/02/2020 13:04	13/02/2020 17:48	4,73	20	94,60	CHI
20200268351	ITUMBIARA	IT12000308RE	PARANAIBA	13/02/2020 13:04	13/02/2020 22:49	13/02/2020 13:04	13/02/2020 20:29	7,42	41	304,32	CHI
20200268351	ITUMBIARA	IT12000308RE	PARANAIBA	13/02/2020 13:04	13/02/2020 22:49	13/02/2020 13:04	13/02/2020 21:58	8,90	11	97,89	CHI
20200268351	ITUMBIARA	IT12000308RE	PARANAIBA	13/02/2020 13:04	13/02/2020 22:49	13/02/2020 13:04	13/02/2020 22:49	9,75	20	195,08	CHI
20200268298	SENADOR CANEDO	190136443	SENADOR CANEDO	13/02/2020 13:06	13/02/2020 16:26	13/02/2020 13:06	13/02/2020 16:26	3,32	1	3,32	CHI
20200268304	TRES RANCHOS	2170008520	CATALAO S1	13/02/2020 13:06	13/02/2020 18:55	13/02/2020 13:06	13/02/2020 18:55	5,80	1	5,80	CHI
20200268301	MUTUNOPOLIS	MU21000005	MARA ROSA	13/02/2020 13:07	13/02/2020 14:54	13/02/2020 13:07	13/02/2020 14:54	1,78	1	1,78	CHI
20200268303	MONTE ALEGRE DE GOIAS	MA12236705	SAO DOMINGOS	13/02/2020 13:07	13/02/2020 19:23	13/02/2020 13:07	13/02/2020 19:23	6,26	11	68,82	CHI
20200268303	NOVA ROMA	MA12236705	SAO DOMINGOS	13/02/2020 13:07	13/02/2020 19:23	13/02/2020 13:07	13/02/2020 19:23	6,26	57	356,63	CHI
20200268307	GOIANIA	11349293	ATLANTICO S2	13/02/2020 13:08	13/02/2020 15:42	13/02/2020 13:08	13/02/2020 15:42	2,56	1	2,56	CHI
20200268312	FORMOSA	610324317	ITIQUEIRA	13/02/2020 13:10	13/02/2020 15:23	13/02/2020 13:10	13/02/2020 15:23	2,21	1	2,21	CHI
20200268313	NIQUELANDIA	NQ21055109	NIQUELANDIA SUBTRANSMISSAO	13/02/2020 13:10	14/02/2020 01:58	13/02/2020 13:10	14/02/2020 01:58	12,79	1	12,79	CHI
20200268322	RIO VERDE	630548754	RIO VERDE S2	13/02/2020 13:16	14/02/2020 12:07	13/02/2020 13:16	14/02/2020 12:07	22,85	1	22,85	CHI
20200268710	PORANGATU	PO12391671	PORANGATU	13/02/2020 13:17	14/02/2020 09:55	13/02/2020 13:17	14/02/2020 04:23	15,11	2	30,21	CHI
20200268710	PORANGATU	PO12391671	PORANGATU	13/02/2020 13:17	14/02/2020 09:55	13/02/2020 13:17	14/02/2020 09:55	20,63	21	433,28	CHI
20200268333	CEZARINA	CZ21366048	GUAPO S2	13/02/2020 13:18	14/02/2020 09:49	13/02/2020 13:18	14/02/2020 09:49	20,51	1	20,51	CHI
20200268334	IACIARA	1550024880	IACIARA S1	13/02/2020 13:18	13/02/2020 23:05	13/02/2020 13:18	13/02/2020 23:05	9,77	1	9,77	CHI
20200268335	CATALAO	1990117512	CATALAO S2	13/02/2020 13:19	13/02/2020 14:17	13/02/2020 13:19	13/02/2020 14:17	0,96	1	0,96	CHI
20200268337	OUVIDOR	OU21306717	CATALAO S1	13/02/2020 13:19	13/02/2020 17:34	13/02/2020 13:19	13/02/2020 17:34	4,24	1	4,24	CHI
20200268349	SAO SIMAO	2240051973	CACHOEIRA ALTA	13/02/2020 13:24	13/02/2020 16:45	13/02/2020 13:24	13/02/2020 16:45	3,35	1	3,35	CHI
20200268354	SANTA HELENA DE GOIAS	SH12296017	IPEGUARI	13/02/2020 13:26	13/02/2020 18:18	13/02/2020 13:26	13/02/2020 18:18	4,86	2	9,71	CHI
20200268504	CRISTALINA	KR12228851	CRISTALINA S2	13/02/2020 13:26	13/02/2020 18:29	13/02/2020 13:26	13/02/2020 18:29	5,05	6	30,29	CHI
20200268358	ITUMBIARA	IT21021381	PARANAIBA	13/02/2020 13:28	13/02/2020 17:50	13/02/2020 13:28	13/02/2020 17:50	4,36	1	4,36	CHI
20200268363	MORRINHOS	150117899	MORRINHOS	13/02/2020 13:29	13/02/2020 16:15	13/02/2020 13:29	13/02/2020 16:15	2,76	1	2,76	CHI
20200268364	GOIANESIA	550042301	GOIANESIA S2	13/02/2020 13:29	13/02/2020 20:29	13/02/2020 13:29	13/02/2020 20:29	6,99	1	6,99	CHI
20200268370	SAO FRANCISCO DE GOIAS	SF21094464	SAO FRANCISCO DE GOIAS	13/02/2020 13:33	13/02/2020 15:45	13/02/2020 13:33	13/02/2020 15:45	2,20	1	2,20	CHI
20200268375	GOIANIA	GN11002310	CAMPINAS S2	13/02/2020 13:34	13/02/2020 17:59	13/02/2020 16:19	13/02/2020 17:59	1,65	117	193,18	CHI
20200268382	RIO VERDE	RV21111073	CABRIUVA S2	13/02/2020 13:36	14/02/2020 14:36	13/02/2020 13:36	14/02/2020 14:36	24,99	1	24,99	CHI
20200268543	CATALAO	CT11065572	CATALAO S2	13/02/2020 13:39	13/02/2020 15:03	13/02/2020 13:39	13/02/2020 15:03	1,39	84	116,41	CHI
20200270530	GOIATUBA	GT12190913	GOIATUBA S1	13/02/2020 13:40	13/02/2020 20:12	13/02/2020 13:40	13/02/2020 20:12	6,53	4	26,10	CHI
20200268398	GOIANIA	AP11077026	INDEPENDENCIA S2	13/02/2020 13:41	13/02/2020 14:55	13/02/2020 13:41	13/02/2020 14:55	1,22	56	68,55	CHI
20200268505	CACHOEIRA ALTA	CA12305852	CACHOEIRA ALTA	13/02/2020 13:44	13/02/2020 17:37	13/02/2020 13:44	13/02/2020 17:37	3,87	3	11,62	CHI

20200268505	CACU	CA12305852	CACHOEIRA ALTA	13/02/2020 13:44	13/02/2020 17:37	13/02/2020 13:44	13/02/2020 17:37	3,87	1	3,87	CHI
20200268506	SILVANIA	10005163909	VIANOPOLIS	13/02/2020 13:44	13/02/2020 16:24	13/02/2020 13:44	13/02/2020 16:24	2,65	1	2,65	CHI
20200268508	URUACU	UR21118003	URUACU	13/02/2020 13:45	13/02/2020 15:38	13/02/2020 13:45	13/02/2020 15:38	1,88	1	1,88	CHI
20200268511	LUZIANIA	LZ21244629	CRISTALINA S2	13/02/2020 13:46	13/02/2020 21:05	13/02/2020 13:46	13/02/2020 21:05	7,31	1	7,31	CHI
20200268518	NOVO GAMA	10004507450	MARAJOARA	13/02/2020 13:47	13/02/2020 18:12	13/02/2020 13:47	13/02/2020 18:12	4,41	1	4,41	CHI
20200268519	PORTELANDIA	PW12205299	PARQUE DAS EMAS	13/02/2020 13:47	14/02/2020 16:30	13/02/2020 13:47	14/02/2020 16:30	26,71	10	267,05	CHI
20200268521	CATALAO	CT21278417	CATALAO S1	13/02/2020 13:48	13/02/2020 21:53	13/02/2020 13:48	13/02/2020 21:53	8,08	1	8,08	CHI
20200268528	BONFINOPOLIS	BO21281331	CEPAIGO S2	13/02/2020 13:48	13/02/2020 16:28	13/02/2020 13:48	13/02/2020 16:28	2,66	1	2,66	CHI
20200270308	CIDADE OCIDENTAL	DH12383008	MARAJOARA	13/02/2020 13:48	13/02/2020 23:19	13/02/2020 17:35	13/02/2020 20:00	2,43	32	77,71	CHI
20200270308	CIDADE OCIDENTAL	DH12376171	MARAJOARA	13/02/2020 13:48	13/02/2020 23:19	13/02/2020 13:48	13/02/2020 23:19	9,51	7	66,58	CHI
20200268525	PIRACANJUBA	PJ21039109	PIRACANJUBA	13/02/2020 13:49	13/02/2020 16:33	13/02/2020 13:49	13/02/2020 16:33	2,72	1	2,72	CHI
20200268526	CATALAO	CT21266265	CATALAO S1	13/02/2020 13:49	13/02/2020 16:26	13/02/2020 13:49	13/02/2020 16:26	2,61	1	2,61	CHI
20200271418	RIO VERDE	RV12240535	MONTIVIDIU T	13/02/2020 13:50	13/02/2020 22:27	13/02/2020 13:50	13/02/2020 22:27	8,60	3	25,81	CHI
20200268534	GUAPO	710016955	GUAPO S1	13/02/2020 13:51	13/02/2020 15:00	13/02/2020 13:51	13/02/2020 15:00	1,13	1	1,13	CHI
20200270549	POSSE	PS10408306	IACIARA S2	13/02/2020 13:51	13/02/2020 23:11	13/02/2020 22:21	13/02/2020 22:26	0,08	3999	327,70	CHI
20200270549	POSSE	PS12071349	IACIARA S2	13/02/2020 13:51	13/02/2020 23:11	13/02/2020 13:51	13/02/2020 23:11	9,33	411	3835,77	CHI
20200270549	POSSE	PS12071349	IACIARA S2	13/02/2020 13:51	13/02/2020 23:11	13/02/2020 22:13	13/02/2020 23:11	0,98	590	577,71	CHI
20200270549	POSSE	PS12071349	IACIARA S2	13/02/2020 13:51	13/02/2020 23:11	13/02/2020 22:42	13/02/2020 23:11	0,49	193	94,89	CHI
20200268538	GOIANIA	11719503	CAMPINAS S2	13/02/2020 13:52	13/02/2020 15:57	13/02/2020 13:52	13/02/2020 15:57	2,07	1	2,07	CHI
20200268539	CAMPO ALEGRE DE GOIAS	CM21285930	CAMPO ALEGRE DE GOIAS	13/02/2020 13:52	13/02/2020 20:28	13/02/2020 13:52	13/02/2020 20:28	6,59	1	6,59	CHI
20200268545	CATALAO	CT21064014	CATALAO S1	13/02/2020 13:53	13/02/2020 23:00	13/02/2020 13:53	13/02/2020 23:00	9,10	1	9,10	CHI
20200268552	PADRE BERNARDO	10010256774	PADRE BERNARDO	13/02/2020 13:55	13/02/2020 17:08	13/02/2020 13:55	13/02/2020 17:08	3,21	1	3,21	CHI
20200268553	JATAI	JT21234471	JATAI S2	13/02/2020 13:55	14/02/2020 08:30	13/02/2020 13:55	14/02/2020 08:30	18,57	1	18,57	CHI
20200268554	HIDROLANDIA	180053929	CEPAIGO S2	13/02/2020 13:56	13/02/2020 20:25	13/02/2020 13:56	13/02/2020 20:25	6,48	1	6,48	CHI
20200268555	INHUMAS	IX12355994	INHUMAS S1	13/02/2020 13:56	13/02/2020 17:22	13/02/2020 13:56	13/02/2020 17:22	3,42	12	41,08	CHI
20200278930	IPAMERI	KR21228575	CRISTALINA S2	13/02/2020 13:56	14/02/2020 11:46	13/02/2020 13:56	14/02/2020 11:46	21,82	1	21,82	CHI
20200268551	RIO VERDE	RV21322240	CABRIUVA S2	13/02/2020 13:58	13/02/2020 22:17	13/02/2020 13:58	13/02/2020 22:17	8,31	1	8,31	CHI
20200268577	ALTO HORIZONTE	AJ12375644	SANTA TEREZINHA	13/02/2020 14:01	13/02/2020 18:24	13/02/2020 14:01	13/02/2020 18:24	4,38	9	39,40	CHI
20200268577	PILAR DE GOIAS	AJ12375644	SANTA TEREZINHA	13/02/2020 14:01	13/02/2020 18:24	13/02/2020 14:01	13/02/2020 18:24	4,38	1	4,38	CHI
20200268580	GOIANIA	10015248311	GOIANIA LESTE S1	13/02/2020 14:01	13/02/2020 15:17	13/02/2020 14:01	13/02/2020 15:17	1,26	1	1,26	CHI
20200268581	SAO SIMAO	10003755396	CACHOEIRA ALTA	13/02/2020 14:01	13/02/2020 16:20	13/02/2020 14:01	13/02/2020 16:20	2,32	1	2,32	CHI
20200268585	JOVIANIA	JV12052736	VICENTINOPOLIS	13/02/2020 14:03	13/02/2020 17:46	13/02/2020 14:03	13/02/2020 17:46	3,71	1	3,71	CHI
20200268585	VICENTINOPOLIS	JV12052736	VICENTINOPOLIS	13/02/2020 14:03	13/02/2020 17:46	13/02/2020 14:03	13/02/2020 17:46	3,71	2	7,41	CHI

202002191212	BURITINOPOLIS	04990214	IACIARA S2	13/02/2020 14:05	13/02/2020 17:43	13/02/2020 14:05	13/02/2020 17:43	3,63	442	1605,81	CHI
202002191212	MAMBAI	04990214	IACIARA S2	13/02/2020 14:05	13/02/2020 17:43	13/02/2020 14:05	13/02/2020 17:43	3,63	2886	10485,00	CHI
202002191212	SITIO D ABADIA	04990214	IACIARA S2	13/02/2020 14:05	13/02/2020 17:43	13/02/2020 14:05	13/02/2020 17:43	3,63	1	3,63	CHI
20200268596	BOM JESUS DE GOIAS	BJ21026828	RIO DOS BOIS	13/02/2020 14:06	13/02/2020 20:04	13/02/2020 14:06	13/02/2020 20:04	5,95	1	5,95	CHI
20200268608	SERRANOPOLIS	SX21037682	JATAI S1	13/02/2020 14:11	14/02/2020 12:03	13/02/2020 14:11	14/02/2020 12:03	21,86	1	21,86	CHI
20200268708	ITUMBIARA	CD21000185	CACHOEIRA DOURADA	13/02/2020 14:12	14/02/2020 10:38	13/02/2020 14:12	14/02/2020 10:38	20,42	1	20,42	CHI
20200268703	PIRES DO RIO	PZ21231359	PIRES DO RIO S2	13/02/2020 14:13	13/02/2020 16:53	13/02/2020 14:13	13/02/2020 16:53	2,66	1	2,66	CHI
20200268709	GOIATUBA	140009012	GOIATUBA S2	13/02/2020 14:14	13/02/2020 18:57	13/02/2020 14:14	13/02/2020 18:57	4,71	1	4,71	CHI
20200268730	GOIANIRA	00550224	GOIANIRA	13/02/2020 14:14	13/02/2020 17:28	13/02/2020 14:14	13/02/2020 16:31	2,29	5605	12813,65	CHI
20200268730	TRINDADE	00550224	GOIANIRA	13/02/2020 14:14	13/02/2020 17:28	13/02/2020 14:14	13/02/2020 16:31	2,29	190	434,36	CHI
20200268730	GOIANIRA	GR12133799LD	GOIANIRA	13/02/2020 14:14	13/02/2020 17:28	13/02/2020 16:52	13/02/2020 17:13	0,35	435	152,13	CHI
20200268730	GOIANIRA	00550224	GOIANIRA	13/02/2020 14:14	13/02/2020 17:28	13/02/2020 14:14	13/02/2020 17:28	3,23	331	1070,33	CHI
202002191230	GOIANIRA	GR11016209	GOIANIRA	13/02/2020 14:14	13/02/2020 17:28	13/02/2020 14:14	13/02/2020 17:28	3,23	151	488,28	CHI
20200268722	BOM JESUS DE GOIAS	JV12222565RE	VICENTINOPOLIS	13/02/2020 14:16	13/02/2020 23:01	13/02/2020 14:16	13/02/2020 23:01	8,74	3	26,22	CHI
20200268722	GOIATUBA	JV12222565RE	VICENTINOPOLIS	13/02/2020 14:16	13/02/2020 23:01	13/02/2020 14:16	13/02/2020 23:01	8,74	15	131,10	CHI
20200268722	JOVIANIA	JV12222565RE	VICENTINOPOLIS	13/02/2020 14:16	13/02/2020 23:01	13/02/2020 14:16	13/02/2020 23:01	8,74	6	52,44	CHI
20200268722	VICENTINOPOLIS	JV12222565RE	VICENTINOPOLIS	13/02/2020 14:16	13/02/2020 23:01	13/02/2020 14:16	13/02/2020 23:01	8,74	2	17,48	CHI
20200270327	PADRE BERNARDO	PB12163217	PADRE BERNARDO	13/02/2020 14:16	13/02/2020 17:14	13/02/2020 14:16	13/02/2020 17:14	2,97	26	77,11	CHI
20200268725	ITUMBIARA	IT11378985	ITUMBIARA VELHA S1	13/02/2020 14:17	13/02/2020 17:28	13/02/2020 14:17	13/02/2020 17:28	3,18	19	60,45	CHI
20200268726	MONTIVIDIU	MV12295835	MONTIVIDIU T	13/02/2020 14:17	13/02/2020 19:12	13/02/2020 14:17	13/02/2020 19:12	4,91	1	4,91	CHI
20200268729	SILVANIA	SV21348693	BELA VISTA S2	13/02/2020 14:17	13/02/2020 16:56	13/02/2020 14:17	13/02/2020 16:56	2,64	1	2,64	CHI
20200268735	SANTA HELENA DE GOIAS	TD12213488	RIO DOS BOIS	13/02/2020 14:19	14/02/2020 20:39	13/02/2020 14:19	14/02/2020 14:13	23,91	3	71,72	CHI
20200268735	TURVELANDIA	TD12213488	RIO DOS BOIS	13/02/2020 14:19	14/02/2020 20:39	13/02/2020 14:19	14/02/2020 14:13	23,91	4	95,62	CHI
20200268735	TURVELANDIA	TD12213488	RIO DOS BOIS	13/02/2020 14:19	14/02/2020 20:39	13/02/2020 14:19	14/02/2020 20:38	30,32	1	30,32	CHI
20200268735	TURVELANDIA	TD12213488	RIO DOS BOIS	13/02/2020 14:19	14/02/2020 20:39	13/02/2020 14:19	14/02/2020 20:39	30,33	1	30,33	CHI
20200268739	CACHOEIRA ALTA	CA21154434	CACHOEIRA ALTA	13/02/2020 14:20	13/02/2020 19:18	13/02/2020 14:20	13/02/2020 19:18	4,97	1	4,97	CHI
20200268742	JATAI	JT21142796	JATAI S1	13/02/2020 14:20	13/02/2020 22:30	13/02/2020 14:20	13/02/2020 22:30	8,16	1	8,16	CHI
202002110309	CHAPADAO DO CEU	02430524	CHAPADAO DO CEU	13/02/2020 14:24	13/02/2020 14:27	13/02/2020 14:24	13/02/2020 14:27	0,05	2002	100,10	CHI
202002110309	CHAPADAO DO CEU	02430524	CHAPADAO DO CEU	13/02/2020 14:24	13/02/2020 14:27	13/02/2020 14:24	13/02/2020 14:27	0,05	2347	117,35	CHI
202002110309	CHAPADAO DO CEU	02430524	CHAPADAO DO CEU	13/02/2020 14:24	13/02/2020 14:27	13/02/2020 14:24	13/02/2020 14:27	0,05	11	0,55	CHI
202002110309	CHAPADAO DO CEU	02430524	CHAPADAO DO CEU	13/02/2020 14:24	13/02/2020 14:27	13/02/2020 14:24	13/02/2020 14:27	0,05	83	4,15	CHI
202002110309	MINEIROS	02430524	CHAPADAO DO CEU	13/02/2020 14:24	13/02/2020 14:27	13/02/2020 14:24	13/02/2020 14:27	0,05	8	0,40	CHI
202002110309	MINEIROS	02430524	CHAPADAO DO CEU	13/02/2020 14:24	13/02/2020 14:27	13/02/2020 14:24	13/02/2020 14:27	0,05	25	1,25	CHI

202002110309	SERRANOPOLIS	02430524	CHAPADAO DO CEU	13/02/2020 14:24	13/02/2020 14:27	13/02/2020 14:24	13/02/2020 14:27	0,05	76	3,80	CHI
202002110309	SERRANOPOLIS	02430524	JATAI S1	13/02/2020 14:24	13/02/2020 14:27	13/02/2020 14:24	13/02/2020 14:27	0,05	3	0,15	CHI
20200269404	INACIOLANDIA	ID21249182	QUIRINOPOLIS	13/02/2020 14:26	13/02/2020 20:18	13/02/2020 14:26	13/02/2020 20:18	5,86	6	35,17	CHI
20200269407	GOIANIA	10004968903	FERROVIARIO S1	13/02/2020 14:27	13/02/2020 15:23	13/02/2020 14:27	13/02/2020 15:23	0,92	1	0,92	CHI
20200269408	CRISTALINA	KR13242545	CRISTALINA S1	13/02/2020 14:28	13/02/2020 17:37	13/02/2020 16:44	13/02/2020 16:54	0,18	200	35,17	CHI
20200269408	CRISTALINA	KR13253160	CRISTALINA S1	13/02/2020 14:28	13/02/2020 17:37	13/02/2020 17:31	13/02/2020 17:37	0,11	289	31,63	CHI
20200269408	IPAMERI	KR13253160	CRISTALINA S1	13/02/2020 14:28	13/02/2020 17:37	13/02/2020 17:31	13/02/2020 17:37	0,11	5	0,55	CHI
20200269408	CRISTALINA	KR13253160	CRISTALINA S2	13/02/2020 14:28	13/02/2020 17:37	13/02/2020 17:31	13/02/2020 17:37	0,11	1	0,11	CHI
20200269411	ORIZONA	OZ21224114	PIRES DO RIO S2	13/02/2020 14:28	13/02/2020 17:30	13/02/2020 14:28	13/02/2020 17:30	3,03	1	3,03	CHI
20200269412	CRIXAS	CX21284788	RUBIATABA	13/02/2020 14:28	14/02/2020 13:36	13/02/2020 14:28	14/02/2020 13:36	23,12	1	23,12	CHI
20200270032	FORMOSA	FA12140789	ITUIQUIRA	13/02/2020 14:28	13/02/2020 20:30	13/02/2020 14:28	13/02/2020 20:30	6,02	14	84,24	CHI
20200269414	MONTIVIDIU DO NORTE	MX12088676	PORANGATU	13/02/2020 14:29	14/02/2020 01:38	13/02/2020 14:29	14/02/2020 01:38	11,15	2	22,29	CHI
20200269701	QUIRINOPOLIS	10018427047	QUIRINOPOLIS	13/02/2020 14:30	13/02/2020 15:50	13/02/2020 14:30	13/02/2020 15:50	1,33	1	1,33	CHI
20200269702	ANAPOLIS	21308858	ANAPOLIS UNIVERSITARIO S2	13/02/2020 14:30	13/02/2020 16:41	13/02/2020 14:30	13/02/2020 16:41	2,18	1	2,18	CHI
20200269704	ITUMBIARA	10020756427	ITUMBIARA VELHA S1	13/02/2020 14:31	13/02/2020 16:19	13/02/2020 14:31	13/02/2020 16:19	1,81	1	1,81	CHI
20200270069	CRIXAS	NM12194294	RUBIATABA	13/02/2020 14:32	13/02/2020 16:44	13/02/2020 14:32	13/02/2020 16:44	2,20	1	2,20	CHI
20200270069	NOVA AMERICA	NM12194294	RUBIATABA	13/02/2020 14:32	13/02/2020 16:44	13/02/2020 14:32	13/02/2020 16:44	2,20	156	343,16	CHI
20200270069	RUBIATABA	NM12194294	RUBIATABA	13/02/2020 14:32	13/02/2020 16:44	13/02/2020 14:32	13/02/2020 16:44	2,20	8	17,60	CHI
20200269720	CATALAO	CT21333727	CATALAO S1	13/02/2020 14:37	13/02/2020 15:44	13/02/2020 14:37	13/02/2020 15:44	1,11	1	1,11	CHI
20200269728	CAIAPONIA	CP12265311	MONTIVIDIU T	13/02/2020 14:39	14/02/2020 00:19	13/02/2020 14:39	14/02/2020 00:19	9,66	10	96,63	CHI
20200269906	SENADOR CANEDO	SW11350071	SENADOR CANEDO	13/02/2020 14:42	13/02/2020 17:20	13/02/2020 14:42	13/02/2020 17:20	2,63	4	10,52	CHI
20200269920	JATAI	JT12260447	JATAI S1	13/02/2020 14:45	13/02/2020 17:04	13/02/2020 14:45	13/02/2020 17:04	2,31	52	120,06	CHI
20200269922	VILA PROPICIO	PV21234056	GOIANESIA S1	13/02/2020 14:45	13/02/2020 21:10	13/02/2020 14:45	13/02/2020 21:10	6,41	1	6,41	CHI
20200269937	PORANGATU	PO21217375	PORANGATU	13/02/2020 14:50	13/02/2020 15:55	13/02/2020 14:50	13/02/2020 15:55	1,08	1	1,08	CHI
20200269947	VARJAO	VJ31066148	GUAPO S2	13/02/2020 14:51	13/02/2020 17:55	13/02/2020 14:51	13/02/2020 17:55	3,07	1	3,07	CHI
20200269951	NOVA AMERICA	2160008054	RUBIATABA	13/02/2020 14:51	13/02/2020 22:20	13/02/2020 14:51	13/02/2020 22:20	7,47	1	7,47	CHI
20200269952	SENADOR CANEDO	12877931	SENADOR CANEDO	13/02/2020 14:51	13/02/2020 17:45	13/02/2020 14:51	13/02/2020 17:45	2,89	1	2,89	CHI
20200269954	PETROLINA DE GOIAS	PG21215015	PETROLINA	13/02/2020 14:51	14/02/2020 01:57	13/02/2020 14:51	14/02/2020 01:57	11,08	2	22,17	CHI
20200269962	RIO VERDE	SH12273765	SANTA HELENA S1	13/02/2020 14:53	13/02/2020 17:48	13/02/2020 14:53	13/02/2020 17:48	2,91	3	8,72	CHI
20200269962	SANTA HELENA DE GOIAS	SH12273765	SANTA HELENA S1	13/02/2020 14:53	13/02/2020 17:48	13/02/2020 14:53	13/02/2020 17:48	2,91	12	34,88	CHI
20200269975	GOIANIA	GN11275684	GOYA S2	13/02/2020 14:54	13/02/2020 16:26	13/02/2020 14:54	13/02/2020 16:26	1,52	63	95,81	CHI
20200269973	COLINAS DO SUL	TI21196544	MINACU	13/02/2020 14:55	13/02/2020 18:34	13/02/2020 14:55	13/02/2020 18:34	3,65	1	3,65	CHI
20200269979	APARECIDA DE GOIANIA	13778031	ATLANTICO S2	13/02/2020 14:56	13/02/2020 18:37	13/02/2020 14:56	13/02/2020 18:37	3,67	1	3,67	CHI

20200269984	NIQUELANDIA	NQ12283445	NIQUELANDIA SUBTRANSMISSAO	13/02/2020 14:57	14/02/2020 01:21	13/02/2020 14:57	14/02/2020 01:21	10,40	4	41,59	CHI
20200269988	IPAMERI	IP21351594	PIRES DO RIO S2	13/02/2020 14:58	13/02/2020 21:39	13/02/2020 14:58	13/02/2020 21:39	6,68	1	6,68	CHI
20200269996	SITIO D ABADIA	FB11285688	IACIARA S2	13/02/2020 14:59	13/02/2020 21:58	13/02/2020 14:59	13/02/2020 21:58	6,97	1	6,97	CHI
20200270542	EDEIA	IY12399332	EDEIA	13/02/2020 14:59	13/02/2020 20:37	13/02/2020 14:59	13/02/2020 20:37	5,62	5	28,12	CHI
20200270542	INDIARA	IY12399332	EDEIA	13/02/2020 14:59	13/02/2020 20:37	13/02/2020 14:59	13/02/2020 20:37	5,62	453	2547,37	CHI
20200270542	JANDAIA	IY12399332	EDEIA	13/02/2020 14:59	13/02/2020 20:37	13/02/2020 14:59	13/02/2020 20:37	5,62	1	5,62	CHI
20200269997	ITUMBIARA	BG21000182	ITUMBIARA VELHA S2	13/02/2020 15:00	14/02/2020 11:02	13/02/2020 15:00	14/02/2020 11:02	20,03	1	20,03	CHI
20200270000	BELA VISTA DE GOIAS	BV21151664	BELA VISTA S2	13/02/2020 15:00	13/02/2020 17:49	13/02/2020 15:00	13/02/2020 17:49	2,80	1	2,80	CHI
20200270006	GOIANIA	10003973458	INDEPENDENCIA S2	13/02/2020 15:02	13/02/2020 17:04	13/02/2020 15:02	13/02/2020 17:04	2,02	1	2,02	CHI
20200270007	CATALAO	10008582260	CATALAO S2	13/02/2020 15:02	13/02/2020 20:15	13/02/2020 15:02	13/02/2020 20:15	5,21	1	5,21	CHI
20200270014	CALDAS NOVAS	10009165124	CALDAS NOVAS S2	13/02/2020 15:03	13/02/2020 18:38	13/02/2020 15:03	13/02/2020 18:38	3,58	1	3,58	CHI
20200270016	RIO VERDE	RV21306312	RIO VERDE S2	13/02/2020 15:04	14/02/2020 15:41	13/02/2020 15:04	14/02/2020 15:41	24,61	1	24,61	CHI
20200270021	FLORES DE GOIAS	3480024243	FLORES DE GOIAS	13/02/2020 15:04	13/02/2020 19:36	13/02/2020 15:04	13/02/2020 19:36	4,52	1	4,52	CHI
20200270034	CATALAO	10014471262	CATALAO S2	13/02/2020 15:09	14/02/2020 01:13	13/02/2020 15:09	14/02/2020 01:13	10,06	1	10,06	CHI
20200270042	ITUMBIARA	IT21081104	ITUMBIARA NOVA	13/02/2020 15:10	13/02/2020 17:41	13/02/2020 15:10	13/02/2020 17:41	2,51	1	2,51	CHI
20200270623	ORIZONA	OZ12404725	PIRES DO RIO S1	13/02/2020 15:10	13/02/2020 18:56	13/02/2020 15:10	13/02/2020 18:56	3,76	4	15,05	CHI
20200270046	ANAPOLIS	20475135	ANAPOLIS UNIVERSITARIO S2	13/02/2020 15:11	13/02/2020 17:18	13/02/2020 15:11	13/02/2020 17:18	2,11	1	2,11	CHI
20200270047	SANTA TEREZINHA DE GOIAS	SG21341905	SANTA TEREZINHA	13/02/2020 15:11	13/02/2020 18:07	13/02/2020 15:11	13/02/2020 18:07	2,93	1	2,93	CHI
20200270049	BOM JESUS DE GOIAS	1250051670	BOM JESUS DE GOIAS	13/02/2020 15:11	13/02/2020 16:42	13/02/2020 15:11	13/02/2020 16:42	1,50	1	1,50	CHI
20200270052	JATAI	JT12105219	JATAI S1	13/02/2020 15:12	14/02/2020 11:02	13/02/2020 15:12	14/02/2020 11:02	19,83	9	178,49	CHI
20200270060	IPAMERI	IP21230019	CAMPO ALEGRE DE GOIAS	13/02/2020 15:13	14/02/2020 09:13	13/02/2020 15:13	14/02/2020 09:13	17,99	1	17,99	CHI
20200270061	GOIATUBA	GT21050598	BOM JESUS DE GOIAS	13/02/2020 15:13	13/02/2020 21:30	13/02/2020 15:13	13/02/2020 21:30	6,29	1	6,29	CHI
20200270063	ORIZONA	OZ21339334	PIRES DO RIO S2	13/02/2020 15:14	13/02/2020 21:50	13/02/2020 15:14	13/02/2020 21:50	6,59	1	6,59	CHI
20200270065	NIQUELANDIA	NQ21353119	NIQUELANDIA SUBTRANSMISSAO	13/02/2020 15:14	14/02/2020 00:35	13/02/2020 15:14	13/02/2020 23:44	8,49	2	16,98	CHI
20200270065	NIQUELANDIA	NQ12396775	NIQUELANDIA SUBTRANSMISSAO	13/02/2020 15:14	14/02/2020 00:35	13/02/2020 22:25	14/02/2020 00:35	2,16	40	86,32	CHI
20200270071	ANAPOLIS	10004409360	ANAPOLIS UNIVERSITARIO S2	13/02/2020 15:15	13/02/2020 20:38	13/02/2020 15:15	13/02/2020 20:38	5,37	1	5,37	CHI
20200270072	CACU	CC21085731	CACHOEIRA ALTA	13/02/2020 15:16	14/02/2020 00:38	13/02/2020 15:16	14/02/2020 00:38	9,36	1	9,36	CHI
20200270073	GOIANIA	GN12001434	FERROVIARIO S1	13/02/2020 15:16	13/02/2020 18:26	13/02/2020 15:16	13/02/2020 18:26	3,16	93	293,54	CHI
20200270302	JATAI	290337173	JATAI S2	13/02/2020 15:17	14/02/2020 00:00	13/02/2020 15:17	14/02/2020 00:00	8,71	1	8,71	CHI
20200270519	CACHOEIRA DOURADA	IT12088560	CACHOEIRA DOURADA	13/02/2020 15:17	13/02/2020 17:50	13/02/2020 15:17	13/02/2020 17:50	2,54	1	2,54	CHI
20200270519	ITUMBIARA	IT12088560	CACHOEIRA DOURADA	13/02/2020 15:17	13/02/2020 17:50	13/02/2020 15:17	13/02/2020 17:50	2,54	4	10,15	CHI
20200270307	TURVELANDIA	TD12342212	SANTA HELENA S1	13/02/2020 15:19	14/02/2020 11:51	13/02/2020 15:19	14/02/2020 11:51	20,52	1	20,52	CHI
20200270397	CACU	04400214	CACHOEIRA ALTA	13/02/2020 15:19	14/02/2020 22:12	13/02/2020 15:19	13/02/2020 23:50	8,50	4	34,02	CHI

20200270397	ITAJA	04400214	CACHOEIRA ALTA	13/02/2020 15:19	14/02/2020 22:12	13/02/2020 15:19	13/02/2020 23:50	8,50	23	195,61	CHI
20200270397	ITARUMA	04400214	CACHOEIRA ALTA	13/02/2020 15:19	14/02/2020 22:12	13/02/2020 15:19	13/02/2020 23:50	8,50	102	867,48	CHI
20200270397	ITAJA	04400214	CACHOEIRA ALTA	13/02/2020 15:19	14/02/2020 22:12	13/02/2020 15:19	14/02/2020 12:47	21,46	8	171,70	CHI
20200270397	ITARUMA	04400214	CACHOEIRA ALTA	13/02/2020 15:19	14/02/2020 22:12	13/02/2020 15:19	14/02/2020 12:47	21,46	3	64,39	CHI
20200270397	ITARUMA	04400214	CACHOEIRA ALTA	13/02/2020 15:19	14/02/2020 22:12	13/02/2020 15:19	14/02/2020 21:14	29,91	15	448,66	CHI
20200270397	ITARUMA	04400214	CACHOEIRA ALTA	13/02/2020 15:19	14/02/2020 22:12	13/02/2020 15:19	14/02/2020 22:12	30,88	10	308,76	CHI
20200270316	GOIANIA	12307105	ATLANTICO S1	13/02/2020 15:21	13/02/2020 17:34	13/02/2020 15:21	13/02/2020 17:34	2,20	1	2,20	CHI
20200270317	GOIATUBA	GT21000218	GOIATUBA S2	13/02/2020 15:21	13/02/2020 19:06	13/02/2020 15:21	13/02/2020 19:06	3,74	1	3,74	CHI
20200270319	MUTUNOPOLIS	MU12086706	MARA ROSA	13/02/2020 15:21	13/02/2020 21:30	13/02/2020 15:21	13/02/2020 21:30	6,14	1	6,14	CHI
20200270324	CALDAS NOVAS	CN12298694	CALDAS NOVAS S1	13/02/2020 15:23	14/02/2020 17:32	13/02/2020 15:23	14/02/2020 17:32	26,15	1	26,15	CHI
20200270328	ITARUMA	IM12338003	ITAJA S2	13/02/2020 15:23	13/02/2020 16:28	13/02/2020 15:23	13/02/2020 16:28	1,07	2	2,14	CHI
20200270331	RIO VERDE	RV21213473	RIO VERDE S1	13/02/2020 15:24	14/02/2020 11:22	13/02/2020 15:24	14/02/2020 11:22	19,96	1	19,96	CHI
20200270334	SITIO D ABADIA	FB11285674	IACIARA S2	13/02/2020 15:25	13/02/2020 22:22	13/02/2020 15:25	13/02/2020 22:22	6,95	2	13,89	CHI
20200270337	CATALAO	10030116153	CATALAO S2	13/02/2020 15:25	13/02/2020 18:47	13/02/2020 15:25	13/02/2020 18:47	3,35	1	3,35	CHI
20200270338	CATALAO	CT12231540RE	CATALAO S1	13/02/2020 15:25	13/02/2020 19:50	13/02/2020 15:25	13/02/2020 19:50	4,40	11	48,45	CHI
20200271139	CRIXAS	CX12190201RE	SANTA TEREZINHA	13/02/2020 15:26	13/02/2020 21:49	13/02/2020 15:26	13/02/2020 21:49	6,38	50	319,06	CHI
20200270341	AGUAS LINDAS DE GOIAS	10029871342	AGUAS LINDAS DE GOIAS S1	13/02/2020 15:27	13/02/2020 17:00	13/02/2020 15:27	13/02/2020 17:00	1,54	1	1,54	CHI
20200270344	SANTA HELENA DE GOIAS	400032910	IPEGUARI	13/02/2020 15:28	13/02/2020 23:21	13/02/2020 15:28	13/02/2020 23:21	7,89	1	7,89	CHI
20200270345	MONTIVIDIU	MV12406530	MONTIVIDIU T	13/02/2020 15:28	13/02/2020 21:50	13/02/2020 15:28	13/02/2020 21:50	6,36	9	57,25	CHI
20200270347	CUMARI	CY21072258	CATALAO S1	13/02/2020 15:28	13/02/2020 18:21	13/02/2020 15:28	13/02/2020 18:21	2,87	1	2,87	CHI
20200270351	SANTA BARBARA DE GOIAS	TR12048114	TRINDADE	13/02/2020 15:29	14/02/2020 15:15	13/02/2020 15:29	14/02/2020 15:15	23,77	142	3375,73	CHI
20200270351	TRINDADE	TR12048114	TRINDADE	13/02/2020 15:29	14/02/2020 15:15	13/02/2020 15:29	14/02/2020 15:15	23,77	30	713,18	CHI
20200270357	JATAI	JT11172861	JATAI S3	13/02/2020 15:31	13/02/2020 16:49	13/02/2020 15:31	13/02/2020 16:49	1,29	82	106,10	CHI
20200270363	IPAMERI	580063008	IPAMERI	13/02/2020 15:33	13/02/2020 19:01	13/02/2020 15:33	13/02/2020 19:01	3,46	1	3,46	CHI
20200270364	PADRE BERNARDO	PB12377221	PADRE BERNARDO	13/02/2020 15:33	13/02/2020 22:05	13/02/2020 15:33	13/02/2020 22:05	6,52	1	6,52	CHI
20200270366	MONTE ALEGRE DE GOIAS	MA21236762	SAO DOMINGOS	13/02/2020 15:34	13/02/2020 20:10	13/02/2020 15:34	13/02/2020 20:10	4,59	1	4,59	CHI
20200270368	CALDAS NOVAS	760034199	SERRA DE CALDAS	13/02/2020 15:34	13/02/2020 20:58	13/02/2020 15:34	13/02/2020 20:58	5,39	1	5,39	CHI
20200270524	SAO DOMINGOS	SD12348648	SAO DOMINGOS	13/02/2020 15:34	14/02/2020 09:41	13/02/2020 15:34	14/02/2020 09:41	18,10	16	289,66	CHI
20200270378	APORE	AE21301924	ITAJA S1	13/02/2020 15:37	13/02/2020 22:32	13/02/2020 15:37	13/02/2020 22:32	6,92	1	6,92	CHI
20200270381	GAMELEIRA DE GOIAS	SV12382483	ANAPOLIS UNIVERSITARIO S1	13/02/2020 15:37	13/02/2020 20:58	13/02/2020 15:37	13/02/2020 20:58	5,34	17	90,85	CHI
20200272403	VILA PROPICIO	NP12298225	BARRO ALTO	13/02/2020 15:38	14/02/2020 10:07	13/02/2020 15:38	14/02/2020 10:07	18,47	14	258,58	CHI
20200270390	PORANGATU	PO21022449	PORANGATU	13/02/2020 15:39	13/02/2020 23:21	13/02/2020 15:39	13/02/2020 23:21	7,69	1	7,69	CHI
20200270391	SANTA RITA DO NOVO DESTINO	DF21168353	BARRO ALTO	13/02/2020 15:39	14/02/2020 12:20	13/02/2020 15:39	14/02/2020 12:20	20,68	1	20,68	CHI

20200270400	CALDAS NOVAS	760343380	SERRA DE CALDAS	13/02/2020 15:42	13/02/2020 22:26	13/02/2020 15:42	13/02/2020 22:26	6,72	1	6,72	CHI
20200270569	JATAI	04800414	JATAI S1	13/02/2020 15:56	13/02/2020 18:36	13/02/2020 15:56	13/02/2020 18:28	2,54	9	22,85	CHI
20200270569	JATAI	04800414	JATAI S1	13/02/2020 15:56	13/02/2020 18:36	13/02/2020 15:56	13/02/2020 18:36	2,67	19	50,65	CHI
20200270569	JATAI	JT13068117	JATAI S1	13/02/2020 15:56	13/02/2020 18:36	13/02/2020 16:00	13/02/2020 18:36	2,60	2	5,20	CHI
20200270552	CAMPO ALEGRE DE GOIAS	CM21122450	CAMPO ALEGRE DE GOIAS	13/02/2020 15:59	14/02/2020 01:11	13/02/2020 15:59	14/02/2020 01:11	9,20	1	9,20	CHI
20200270557	GAMELEIRA DE GOIAS	SV21045758	DAIA S2	13/02/2020 16:00	13/02/2020 23:37	13/02/2020 16:00	13/02/2020 23:37	7,61	1	7,61	CHI
20200270649	NOVA ROMA	ND12122038	IACIARA S2	13/02/2020 16:00	13/02/2020 20:42	13/02/2020 16:00	13/02/2020 20:42	4,68	5	23,42	CHI
20200270649	SAO JOAO D ALIANCA	ND12122038	IACIARA S2	13/02/2020 16:00	13/02/2020 20:42	13/02/2020 16:00	13/02/2020 20:42	4,68	15	70,26	CHI
20200270708	GOIANIA	GN11218937	GOYA S1	13/02/2020 16:00	13/02/2020 17:56	13/02/2020 16:00	13/02/2020 17:56	1,92	62	119,32	CHI
20200270572	BURITI ALEGRE	BG21242693	ALTO BURITI	13/02/2020 16:03	13/02/2020 23:40	13/02/2020 16:03	13/02/2020 23:40	7,61	1	7,61	CHI
20200270575	LUZIANIA	LZ21349119	VIANOPOLIS	13/02/2020 16:04	14/02/2020 09:33	13/02/2020 16:04	14/02/2020 09:33	17,48	1	17,48	CHI
20200270576	BOM JESUS DE GOIAS	BJ12263544	BOM JESUS DE GOIAS	13/02/2020 16:04	13/02/2020 22:06	13/02/2020 16:04	13/02/2020 22:06	6,03	6	36,16	CHI
20200270580	SILVANIA	SV12056341	VIANOPOLIS	13/02/2020 16:05	13/02/2020 19:57	13/02/2020 16:05	13/02/2020 19:57	3,86	17	65,63	CHI
20200270586	DIVINOPOLIS DE GOIAS	10005240741	SAO DOMINGOS	13/02/2020 16:06	13/02/2020 18:34	13/02/2020 16:06	13/02/2020 18:34	2,46	1	2,46	CHI
20200270587	AGUAS LINDAS DE GOIAS	10018440647	AGUAS LINDAS DE GOIAS S2	13/02/2020 16:06	13/02/2020 17:30	13/02/2020 16:06	13/02/2020 17:30	1,39	0	0,00	CHI
20200270589	MONTIVIDIU	MV12267612	MONTIVIDIU T	13/02/2020 16:07	13/02/2020 20:48	13/02/2020 16:07	13/02/2020 20:48	4,67	8	37,37	CHI
20200270593	RIO VERDE	630577705	CABRIUVA S1	13/02/2020 16:09	14/02/2020 11:54	13/02/2020 16:09	14/02/2020 11:54	19,74	1	19,74	CHI
20200270634	POSSE	PS12344204	IACIARA S2	13/02/2020 16:09	13/02/2020 17:05	13/02/2020 16:09	13/02/2020 17:05	0,93	130	120,39	CHI
20200270597	APARECIDA DE GOIANIA	AP11149572	ANHANGUERA	13/02/2020 16:10	13/02/2020 19:07	13/02/2020 16:10	13/02/2020 19:07	2,94	123	361,96	CHI
20200270599	MINEIROS	MY12149310	PARQUE DAS EMAS	13/02/2020 16:10	14/02/2020 19:48	13/02/2020 20:00	13/02/2020 21:05	1,08	47	50,71	CHI
20200270599	MINEIROS	MY12149315	PARQUE DAS EMAS	13/02/2020 16:10	14/02/2020 19:48	13/02/2020 16:10	14/02/2020 19:48	27,63	27	745,94	CHI
20200270602	CAMPINACU	IH12320899	MINACU	13/02/2020 16:11	13/02/2020 20:26	13/02/2020 16:11	13/02/2020 20:26	4,23	13	55,05	CHI
20200270602	MINACU	IH12320899	MINACU	13/02/2020 16:11	13/02/2020 20:26	13/02/2020 16:11	13/02/2020 20:26	4,23	9	38,11	CHI
20200270603	JARAGUA	JA21152215	SAO FRANCISCO DE GOIAS	13/02/2020 16:12	13/02/2020 22:52	13/02/2020 16:12	13/02/2020 22:52	6,66	2	13,33	CHI
20200270607	GOIANIA	14530454	GOYA S2	13/02/2020 16:13	13/02/2020 17:06	13/02/2020 16:13	13/02/2020 17:06	0,88	1	0,88	CHI
202002191216	GOUVELANDIA	GB12207219	QUIRINOPOLIS	13/02/2020 16:14	13/02/2020 19:20	13/02/2020 16:14	13/02/2020 19:20	3,09	1	3,09	CHI
20200270622	NIQUELANDIA	NQ21388231	URUACU	13/02/2020 16:18	13/02/2020 18:57	13/02/2020 16:18	13/02/2020 18:57	2,64	1	2,64	CHI
20200271005	PARAUNA	BZ13402205S	ACREUNA	13/02/2020 16:20	13/02/2020 23:00	13/02/2020 16:20	13/02/2020 23:00	6,65	159	1057,66	CHI
20200271005	RIO VERDE	BZ13402205S	ACREUNA	13/02/2020 16:20	13/02/2020 23:00	13/02/2020 16:20	13/02/2020 23:00	6,65	99	658,54	CHI
20200271005	SANTO ANTONIO DA BARRA	BZ13402205S	ACREUNA	13/02/2020 16:20	13/02/2020 23:00	13/02/2020 16:20	13/02/2020 23:00	6,65	4	26,61	CHI
20200270644	MORRINHOS	MR21240035	MORRINHOS	13/02/2020 16:23	13/02/2020 19:21	13/02/2020 16:23	13/02/2020 19:21	2,96	1	2,96	CHI
20200270648	CAMPOS BELOS	CH12375530	SAO DOMINGOS	13/02/2020 16:25	13/02/2020 21:32	13/02/2020 16:25	13/02/2020 21:32	5,12	8	40,92	CHI
20200270665	ARAGOIANIA	AO32064823	GUAPO S2	13/02/2020 16:25	13/02/2020 19:50	13/02/2020 16:25	13/02/2020 19:50	3,41	3	10,22	CHI

20200270445	CRIXAS	05630224	NOVA CRIXAS	13/02/2020 16:26	13/02/2020 18:37	13/02/2020 16:26	13/02/2020 18:37	2,19	1	2,19	CHI
20200270445	NOVA CRIXAS	05630224	NOVA CRIXAS	13/02/2020 16:26	13/02/2020 18:37	13/02/2020 16:26	13/02/2020 18:37	2,19	50	109,50	CHI
20200270445	CRIXAS	05630224	NOVA CRIXAS	13/02/2020 16:26	13/02/2020 18:37	13/02/2020 16:27	13/02/2020 18:37	2,17	2	4,33	CHI
20200270445	NOVA CRIXAS	05630224	NOVA CRIXAS	13/02/2020 16:26	13/02/2020 18:37	13/02/2020 16:27	13/02/2020 18:37	2,17	5	10,83	CHI
20200270654	FORMOSA	FA21204779	ITUIQUIRA	13/02/2020 16:26	14/02/2020 10:31	13/02/2020 16:26	14/02/2020 10:31	18,08	1	18,08	CHI
20200270655	CAMPOS BELOS	MA12211609	SAO DOMINGOS	13/02/2020 16:26	13/02/2020 17:50	13/02/2020 16:26	13/02/2020 17:50	1,39	8	11,15	CHI
20200270655	MONTE ALEGRE DE GOIAS	MA12211609	SAO DOMINGOS	13/02/2020 16:26	13/02/2020 17:50	13/02/2020 16:26	13/02/2020 17:50	1,39	7	9,75	CHI
20200270656	INDIARA	IY21377909	ACREUNA	13/02/2020 16:26	14/02/2020 00:10	13/02/2020 16:26	14/02/2020 00:10	7,73	1	7,73	CHI
20200270679	APARECIDA DE GOIANIA	AP11144772	REAL S2	13/02/2020 16:27	13/02/2020 18:26	13/02/2020 16:27	13/02/2020 18:26	1,98	99	195,72	CHI
20200270693	SENADOR CANEDO	SW12079060	CEPAIGO S2	13/02/2020 16:27	13/02/2020 18:53	13/02/2020 16:27	13/02/2020 18:53	2,42	107	258,64	CHI
20200270664	BURITI ALEGRE	00990404	ITUMBIARA VELHA S2	13/02/2020 16:28	14/02/2020 14:29	13/02/2020 23:19	13/02/2020 23:22	0,05	1	0,05	CHI
20200270664	ITUMBIARA	00990404	ITUMBIARA VELHA S2	13/02/2020 16:28	14/02/2020 14:29	13/02/2020 23:19	13/02/2020 23:22	0,05	74	4,01	CHI
20200270664	BURITI ALEGRE	BG12263537	ITUMBIARA VELHA S2	13/02/2020 16:28	14/02/2020 14:29	13/02/2020 16:28	14/02/2020 14:29	22,01	1	22,01	CHI
20200270664	ITUMBIARA	BG12263537	ITUMBIARA VELHA S2	13/02/2020 16:28	14/02/2020 14:29	13/02/2020 16:28	14/02/2020 14:29	22,01	7	154,08	CHI
20200270664	BURITI ALEGRE	BG12263537	ITUMBIARA VELHA S2	13/02/2020 16:28	14/02/2020 14:29	13/02/2020 23:19	14/02/2020 14:29	15,17	4	60,67	CHI
20200270666	ABADIA DE GOIAS	LG21335566	CARAJAS S1	13/02/2020 16:28	13/02/2020 20:23	13/02/2020 16:28	13/02/2020 20:23	3,90	1	3,90	CHI
20200270670	AGUAS LINDAS DE GOIAS	4830006251	AGUAS LINDAS DE GOIAS S1	13/02/2020 16:29	13/02/2020 18:10	13/02/2020 16:29	13/02/2020 18:10	1,68	1	1,68	CHI
20200270448	SANTA HELENA DE GOIAS	SH12279869	IPEGUARI	13/02/2020 16:31	13/02/2020 17:16	13/02/2020 16:31	13/02/2020 17:16	0,74	147	109,39	CHI
20200270680	RIO VERDE	RV21049092	ACREUNA	13/02/2020 16:31	13/02/2020 22:50	13/02/2020 16:31	13/02/2020 22:50	6,30	1	6,30	CHI
20200270682	AGUA FRIA DE GOIAS	TL21194763	SAO JOAO D ALIANCA	13/02/2020 16:32	13/02/2020 17:20	13/02/2020 16:32	13/02/2020 17:20	0,79	2	1,59	CHI
20200270686	GOIANESIA	550208951	GOIANESIA S2	13/02/2020 16:32	13/02/2020 21:44	13/02/2020 16:32	13/02/2020 21:44	5,19	1	5,19	CHI
20200270695	AGUAS LINDAS DE GOIAS	LA12050923	AGUAS LINDAS DE GOIAS S1	13/02/2020 16:35	13/02/2020 18:29	13/02/2020 16:35	13/02/2020 18:29	1,90	99	187,74	CHI
20200270696	GOIANIA	10006609862	GOYA S1	13/02/2020 16:35	13/02/2020 18:11	13/02/2020 16:35	13/02/2020 18:11	1,59	1	1,59	CHI
20200270698	RIO VERDE	RV12271578	MONTIVIDIU T	13/02/2020 16:35	14/02/2020 01:20	13/02/2020 16:35	14/02/2020 01:20	8,74	7	61,16	CHI
20200270709	VALPARAISO DE GOIAS	2860011499	PACAEMBU S1	13/02/2020 16:38	13/02/2020 18:53	13/02/2020 16:38	13/02/2020 18:53	2,25	1	2,25	CHI
20200272560	BURITI ALEGRE	MR12000170RE	MORRINHOS	13/02/2020 16:38	13/02/2020 22:41	13/02/2020 16:38	13/02/2020 22:41	6,04	1	6,04	CHI
20200272560	MORRINHOS	MR12000170RE	MORRINHOS	13/02/2020 16:38	13/02/2020 22:41	13/02/2020 16:38	13/02/2020 22:41	6,04	55	332,44	CHI
20200270715	JATAI	290322560	JATAI S2	13/02/2020 16:41	13/02/2020 19:15	13/02/2020 16:41	13/02/2020 19:15	2,56	1	2,56	CHI
20200271122	FLORES DE GOIAS	FB12249653	FLORES DE GOIAS	13/02/2020 16:41	13/02/2020 23:36	13/02/2020 16:41	13/02/2020 23:36	6,91	153	1057,87	CHI
20200270722	SANTA CRUZ DE GOIAS	BC21402513	PIRES DO RIO S2	13/02/2020 16:42	14/02/2020 08:57	13/02/2020 16:42	14/02/2020 08:57	16,24	1	16,24	CHI
20200270726	PIRACANJUBA	PJ21000174	PIRACANJUBA	13/02/2020 16:43	13/02/2020 18:00	13/02/2020 16:43	13/02/2020 18:00	1,27	1	1,27	CHI
20200270728	NIQUELANDIA	2750100271	NIQUELANDIA SUBTRANSMISSAO	13/02/2020 16:43	13/02/2020 23:40	13/02/2020 16:43	13/02/2020 23:40	6,93	1	6,93	CHI
202002191218	JARAGUA	JA12353176	JARAGUA	13/02/2020 16:44	14/02/2020 00:37	13/02/2020 16:44	14/02/2020 00:37	7,88	6	47,26	CHI

20200271441	MONTE ALEGRE DE GOIAS	MA12071358	SAO DOMINGOS	13/02/2020 16:45	13/02/2020 19:10	13/02/2020 16:45	13/02/2020 19:10	2,40	533	1279,35	CHI
20200272446	NIQUELANDIA	NQ12243514	BARRO ALTO	13/02/2020 16:45	14/02/2020 08:17	13/02/2020 16:45	14/02/2020 08:17	15,52	25	388,12	CHI
20200268576	MAURILANDIA	ML32191806	RIO DOS BOIS	13/02/2020 16:46	14/02/2020 13:36	13/02/2020 16:46	14/02/2020 01:31	8,75	37	323,61	CHI
20200268576	CASTELANDIA	ML32191806	RIO DOS BOIS	13/02/2020 16:46	14/02/2020 13:36	13/02/2020 16:46	14/02/2020 13:36	20,83	20	416,69	CHI
20200268576	MAURILANDIA	ML32191806	RIO DOS BOIS	13/02/2020 16:46	14/02/2020 13:36	13/02/2020 16:46	14/02/2020 13:36	20,83	35	729,21	CHI
20200268576	RIO VERDE	ML32191806	RIO DOS BOIS	13/02/2020 16:46	14/02/2020 13:36	13/02/2020 16:46	14/02/2020 13:36	20,83	22	458,36	CHI
20200268576	MAURILANDIA	ML32191806	RIO DOS BOIS	13/02/2020 16:46	14/02/2020 13:36	14/02/2020 09:20	14/02/2020 13:36	4,27	37	157,90	CHI
20200270804	MUNDO NOVO DE GOIAS	4240005979	NOVA CRIXAS	13/02/2020 16:46	13/02/2020 22:14	13/02/2020 16:46	13/02/2020 22:14	5,46	1	5,46	CHI
2020021300044	ANAPOLIS	AN16407942	JUNDIAI S1	13/02/2020 16:46	13/02/2020 17:20	13/02/2020 16:51	13/02/2020 16:54	0,06	3249	189,53	CHI
2020021300044	GOIANAPOLIS	AN16407942	JUNDIAI S1	13/02/2020 16:46	13/02/2020 17:20	13/02/2020 16:51	13/02/2020 16:54	0,06	195	11,38	CHI
2020021300044	LEOPOLDO DE BULHOES	AN16407942	JUNDIAI S1	13/02/2020 16:46	13/02/2020 17:20	13/02/2020 16:51	13/02/2020 16:54	0,06	5	0,29	CHI
2020021300044	TEREZOPOLIS DE GOIAS	AN16407942	JUNDIAI S1	13/02/2020 16:46	13/02/2020 17:20	13/02/2020 16:51	13/02/2020 16:54	0,06	43	2,51	CHI
2020021300044	ANAPOLIS	AN16407942	JUNDIAI S1	13/02/2020 16:46	13/02/2020 17:20	13/02/2020 16:51	13/02/2020 16:56	0,08	6429	500,03	CHI
2020021300044	TEREZOPOLIS DE GOIAS	AN16407942	JUNDIAI S1	13/02/2020 16:46	13/02/2020 17:20	13/02/2020 16:51	13/02/2020 16:56	0,08	11	0,86	CHI
2020021300044	ANAPOLIS	AN16407941	DAIA S1	13/02/2020 16:46	13/02/2020 17:20	13/02/2020 16:46	13/02/2020 17:00	0,23	15	3,44	CHI
2020021300044	ANAPOLIS	00032114	DAIA S1	13/02/2020 16:46	13/02/2020 17:20	13/02/2020 16:46	13/02/2020 17:19	0,55	8	4,42	CHI
2020021300044	ANAPOLIS	00032114	DAIA S1	13/02/2020 16:46	13/02/2020 17:20	13/02/2020 16:46	13/02/2020 17:19	0,55	28	15,46	CHI
2020021300044	ANAPOLIS	00032114	DAIA S1	13/02/2020 16:46	13/02/2020 17:20	13/02/2020 16:46	13/02/2020 17:19	0,55	67	37,00	CHI
2020021300044	ANAPOLIS	00032114	DAIA S1	13/02/2020 16:46	13/02/2020 17:20	13/02/2020 16:46	13/02/2020 17:19	0,55	19	10,49	CHI
2020021300044	ANAPOLIS	00032114	DAIA S1	13/02/2020 16:46	13/02/2020 17:20	13/02/2020 16:46	13/02/2020 17:19	0,55	371	204,87	CHI
2020021300044	ANAPOLIS	00032138	DAIA S1	13/02/2020 16:46	13/02/2020 17:20	13/02/2020 16:46	13/02/2020 17:20	0,57	7	3,98	CHI
2020021300044	ANAPOLIS	00032138	DAIA S1	13/02/2020 16:46	13/02/2020 17:20	13/02/2020 16:46	13/02/2020 17:20	0,57	74	42,08	CHI
2020021300044	ANAPOLIS	00032138	DAIA S1	13/02/2020 16:46	13/02/2020 17:20	13/02/2020 16:46	13/02/2020 17:20	0,57	3172	1803,63	CHI
2020021300044	ANAPOLIS	00032138	DAIA S1	13/02/2020 16:46	13/02/2020 17:20	13/02/2020 16:46	13/02/2020 17:20	0,57	12	6,82	CHI
2020021300044	ANAPOLIS	00032138	DAIA S1	13/02/2020 16:46	13/02/2020 17:20	13/02/2020 16:46	13/02/2020 17:20	0,57	1	0,57	CHI
2020021300044	GAMELEIRA DE GOIAS	00032138	DAIA S1	13/02/2020 16:46	13/02/2020 17:20	13/02/2020 16:46	13/02/2020 17:20	0,57	101	57,43	CHI
2020021300044	LEOPOLDO DE BULHOES	00032138	DAIA S1	13/02/2020 16:46	13/02/2020 17:20	13/02/2020 16:46	13/02/2020 17:20	0,57	66	37,53	CHI
2020021300044	SILVANIA	00032138	DAIA S1	13/02/2020 16:46	13/02/2020 17:20	13/02/2020 16:46	13/02/2020 17:20	0,57	21	11,94	CHI
2020021300044	SILVANIA	00032138	DAIA S1	13/02/2020 16:46	13/02/2020 17:20	13/02/2020 16:46	13/02/2020 17:20	0,57	22	12,51	CHI
2020021300044	ANAPOLIS	AN16407941	DAIA S1	13/02/2020 16:46	13/02/2020 17:20	13/02/2020 17:06	13/02/2020 17:20	0,25	15	3,70	CHI
20200270811	ALTO PARAISO DE GOIAS	BF11129977	FLORES DE GOIAS	13/02/2020 16:47	13/02/2020 17:53	13/02/2020 16:47	13/02/2020 17:53	1,09	150	162,92	CHI
20200270827	SANTO ANTONIO DE GOIAS	GR12090049	NEROPOLIS S1	13/02/2020 16:51	13/02/2020 21:47	13/02/2020 16:51	13/02/2020 21:47	4,92	2	9,84	CHI
20200270835	CRIXAS	CX21151969	RUBIATABA	13/02/2020 16:52	14/02/2020 10:59	13/02/2020 16:52	14/02/2020 10:59	18,11	1	18,11	CHI

20200270847	SILVANIA	SV21137400	DAIA S2	13/02/2020 16:53	13/02/2020 18:40	13/02/2020 16:53	13/02/2020 18:40	1,78	1	1,78	CHI
20200270850	ITAUCU	IX12013783	INHUMAS S2	13/02/2020 16:53	13/02/2020 19:31	13/02/2020 16:53	13/02/2020 19:31	2,62	7	18,33	CHI
20200270850	PETROLINA DE GOIAS	IX12013783	INHUMAS S2	13/02/2020 16:53	13/02/2020 19:31	13/02/2020 16:53	13/02/2020 19:31	2,62	2	5,24	CHI
20200270854	PORANGATU	PO12230403	PORANGATU	13/02/2020 16:54	13/02/2020 18:50	13/02/2020 16:54	13/02/2020 18:50	1,93	5	9,63	CHI
20200270863	GOIANIRA	10013055699	GOIANIRA	13/02/2020 16:55	13/02/2020 19:21	13/02/2020 16:55	13/02/2020 19:21	2,43	1	2,43	CHI
20200271007	GOIANIA	11974084	ATLANTICO S1	13/02/2020 16:57	13/02/2020 23:17	13/02/2020 16:57	13/02/2020 23:17	6,32	1	6,32	CHI
20200271704	GOIANIA	GN11092980	CARAJAS S2	13/02/2020 16:59	13/02/2020 19:43	13/02/2020 16:59	13/02/2020 19:43	2,72	87	237,03	CHI
20200271121	APARECIDA DE GOIANIA	16372300	INDEPENDENCIA S2	13/02/2020 17:01	13/02/2020 18:17	13/02/2020 17:01	13/02/2020 18:17	1,25	1	1,25	CHI
20200271141	GOIANIA	10757582	CAMPINAS S1	13/02/2020 17:04	13/02/2020 21:32	13/02/2020 17:04	13/02/2020 21:32	4,46	1	4,46	CHI
20200271205	GOIATUBA	GT11000026	GOIATUBA S2	13/02/2020 17:05	13/02/2020 18:11	13/02/2020 17:05	13/02/2020 18:11	1,10	234	256,94	CHI
20200271149	MONTIVIDIU DO NORTE	MX12203423	PORANGATU	13/02/2020 17:06	13/02/2020 20:47	13/02/2020 17:06	13/02/2020 20:47	3,67	16	58,72	CHI
20200271207	GOIANIA	10109924	XAVANTES	13/02/2020 17:12	13/02/2020 18:29	13/02/2020 17:12	13/02/2020 18:29	1,28	1	1,28	CHI
20200271212	FORMOSA	FA12270579	ITIQUEIRA	13/02/2020 17:13	13/02/2020 20:55	13/02/2020 17:13	13/02/2020 20:55	3,69	5	18,47	CHI
20200271223	GOIANIA	10340725	CAMPINAS S1	13/02/2020 17:17	13/02/2020 20:32	13/02/2020 17:17	13/02/2020 20:32	3,24	1	3,24	CHI
20200271226	CAMPOS BELOS	820027583	SAO DOMINGOS	13/02/2020 17:18	13/02/2020 22:50	13/02/2020 17:18	13/02/2020 22:50	5,52	1	5,52	CHI
20200271228	PIRES DO RIO	PR12359913	PIRES DO RIO S1	13/02/2020 17:19	13/02/2020 23:03	13/02/2020 17:19	13/02/2020 23:03	5,73	1	5,73	CHI
20200271229	SANTO ANTONIO DA BARRA	6621339	ACREUNA	13/02/2020 17:19	14/02/2020 01:00	13/02/2020 17:19	14/02/2020 01:00	7,68	3	23,03	CHI
20200271424	TEREZOPOLIS DE GOIAS	TJ12080977	JUNDIAI S2	13/02/2020 17:19	14/02/2020 08:58	13/02/2020 17:19	14/02/2020 08:58	15,64	4	62,57	CHI
20200271701	SANTO ANTONIO DA BARRA	BZ21302020	ACREUNA	13/02/2020 17:19	14/02/2020 02:20	13/02/2020 17:19	14/02/2020 02:20	9,01	1	9,01	CHI
20200271231	FORMOSA	FA12233564	ITIQUEIRA	13/02/2020 17:20	14/02/2020 09:48	13/02/2020 17:20	14/02/2020 09:48	16,46	3	49,39	CHI
20200271233	TEREZOPOLIS DE GOIAS	1370012096	DAIA S2	13/02/2020 17:20	13/02/2020 22:00	13/02/2020 17:20	13/02/2020 22:00	4,66	1	4,66	CHI
20200271305	PONTALINA	MI21181922	PONTALINA	13/02/2020 17:23	13/02/2020 20:59	13/02/2020 17:23	13/02/2020 20:59	3,60	1	3,60	CHI
20200271306	PIRENOPOLIS	PV21196874	SAO FRANCISCO DE GOIAS	13/02/2020 17:23	14/02/2020 08:16	13/02/2020 17:23	14/02/2020 08:16	14,87	2	29,75	CHI
20200271312	APARECIDA DE GOIANIA	AP21000327	CEPAIGO S1	13/02/2020 17:24	13/02/2020 18:58	13/02/2020 17:24	13/02/2020 18:58	1,56	2	3,12	CHI
20200271425	ANAPOLIS	AN11003273	JUNDIAI S1	13/02/2020 17:25	13/02/2020 21:24	13/02/2020 17:25	13/02/2020 21:24	3,97	123	488,79	CHI
20200271411	MINACU	IH11202506	MINACU	13/02/2020 17:28	13/02/2020 18:30	13/02/2020 17:28	13/02/2020 18:30	1,03	4	4,11	CHI
20200271419	ALEXANIA	AX21190652	ALEXANIA	13/02/2020 17:30	13/02/2020 18:50	13/02/2020 17:30	13/02/2020 18:50	1,33	4	5,32	CHI
20200271422	LUZIANIA	LZ21212000	MARAJOARA	13/02/2020 17:31	13/02/2020 21:53	13/02/2020 17:31	13/02/2020 21:53	4,37	2	8,74	CHI
20200271426	SANTA BARBARA DE GOIAS	1030011622	TRINDADE	13/02/2020 17:31	13/02/2020 22:57	13/02/2020 17:31	13/02/2020 22:57	5,42	1	5,42	CHI
20200271433	MONTIVIDIU DO NORTE	MX21139241	PORANGATU	13/02/2020 17:34	14/02/2020 11:07	13/02/2020 17:34	14/02/2020 11:07	17,54	1	17,54	CHI
20200271435	CUMARI	CY21327302	CATALAO S1	13/02/2020 17:34	14/02/2020 07:15	13/02/2020 17:34	14/02/2020 07:15	13,67	1	13,67	CHI
20200271440	PORANGATU	PO12265821	PORANGATU	13/02/2020 17:35	13/02/2020 22:41	13/02/2020 17:35	13/02/2020 22:41	5,09	5	25,43	CHI
20200271445	MONTIVIDIU DO NORTE	MX11203314	PORANGATU	13/02/2020 17:37	14/02/2020 09:48	13/02/2020 17:37	14/02/2020 09:48	16,17	2	32,35	CHI

20200272506	BURITI ALEGRE	BG12263567	ITUMBIARA VELHA S2	13/02/2020 17:37	14/02/2020 08:50	13/02/2020 17:37	14/02/2020 08:50	15,21	3	45,62	CHI
20200272506	ITUMBIARA	BG12263567	ITUMBIARA VELHA S2	13/02/2020 17:37	14/02/2020 08:50	13/02/2020 17:37	14/02/2020 08:50	15,21	18	273,74	CHI
20200271501	GOIANIA	GN11002918	REAL S1	13/02/2020 17:38	13/02/2020 19:53	13/02/2020 17:38	13/02/2020 19:53	2,24	3	6,73	CHI
20200263962	URUTAI	UT12095217	URUTAI	13/02/2020 17:39	14/02/2020 10:42	13/02/2020 17:39	14/02/2020 10:42	17,04	6	102,27	CHI
20200271703	GOIANESIA	550055678	GOIANESIA S2	13/02/2020 17:40	13/02/2020 20:14	13/02/2020 17:40	13/02/2020 20:14	2,58	1	2,58	CHI
20200271709	GOIANIA	10011401379	CAMPINAS S2	13/02/2020 17:41	13/02/2020 19:22	13/02/2020 17:41	13/02/2020 19:22	1,67	1	1,67	CHI
20200271710	BOM JESUS DE GOIAS	1250051670	BOM JESUS DE GOIAS	13/02/2020 17:42	13/02/2020 23:48	13/02/2020 17:42	13/02/2020 23:48	6,09	1	6,09	CHI
20200271714	QUIRINOPOLIS	80024075	QUIRINOPOLIS	13/02/2020 17:44	13/02/2020 23:32	13/02/2020 17:44	13/02/2020 23:32	5,80	1	5,80	CHI
20200271722	ANAPOLIS	20777875	ANAPOLIS UNIVERSITARIO S2	13/02/2020 17:46	13/02/2020 23:40	13/02/2020 17:46	13/02/2020 23:40	5,89	1	5,89	CHI
20200271733	NIQUELANDIA	NQ12232473	NIQUELANDIA SUBTRANSMISSAO	13/02/2020 17:50	13/02/2020 23:40	13/02/2020 17:50	13/02/2020 23:40	5,82	38	221,11	CHI
20200272761	DIVINOPOLIS DE GOIAS	GH12322683	SAO DOMINGOS	13/02/2020 17:51	13/02/2020 22:51	13/02/2020 17:51	13/02/2020 22:51	4,99	2	9,98	CHI
20200272761	SAO DOMINGOS	GH12322683	SAO DOMINGOS	13/02/2020 17:51	13/02/2020 22:51	13/02/2020 17:51	13/02/2020 22:51	4,99	4	19,97	CHI
20200271744	SAO JOAO D ALIANCA	JL12329788	SAO JOAO D ALIANCA	13/02/2020 17:53	13/02/2020 20:33	13/02/2020 17:53	13/02/2020 20:33	2,65	81	215,05	CHI
20200271752	AGUAS LINDAS DE GOIAS	4830285681	AGUAS LINDAS DE GOIAS S1	13/02/2020 17:57	13/02/2020 18:47	13/02/2020 17:57	13/02/2020 18:47	0,83	1	0,83	CHI
20200271801	BELA VISTA DE GOIAS	10026101856	BELA VISTA S1	13/02/2020 17:58	13/02/2020 19:57	13/02/2020 17:58	13/02/2020 19:57	1,97	1	1,97	CHI
20200272001	GOIANIA	10870489	GOIANIA LESTE S3	13/02/2020 17:59	13/02/2020 20:27	13/02/2020 17:59	13/02/2020 20:27	2,45	1	2,45	CHI
20200272003	GOIANESIA	10022083861	GOIANESIA S2	13/02/2020 18:00	14/02/2020 00:12	13/02/2020 18:00	14/02/2020 00:12	6,21	1	6,21	CHI
20200272471	ANAPOLIS	AN11091590	JUNDIAI S2	13/02/2020 18:00	13/02/2020 19:15	13/02/2020 18:00	13/02/2020 19:15	1,25	161	201,25	CHI
20200272101	CABECEIRAS	CW11287241	ITUIQUIRA	13/02/2020 18:01	13/02/2020 19:35	13/02/2020 18:01	13/02/2020 19:35	1,56	1	1,56	CHI
20200272102	NIQUELANDIA	NQ12310103	NIQUELANDIA SUBTRANSMISSAO	13/02/2020 18:01	14/02/2020 13:29	13/02/2020 18:01	14/02/2020 13:29	19,47	9	175,20	CHI
20200272103	PORANGATU	PO12192315	PORANGATU	13/02/2020 18:01	13/02/2020 22:36	13/02/2020 18:01	13/02/2020 22:36	4,57	19	86,78	CHI
20200272201	CRIXAS	CX12062047	SANTA TEREZINHA	13/02/2020 18:03	14/02/2020 01:19	13/02/2020 18:03	14/02/2020 01:19	7,25	9	65,28	CHI
20200272205	TRINDADE	10014265808	GOYA S1	13/02/2020 18:04	13/02/2020 20:41	13/02/2020 18:04	13/02/2020 20:41	2,60	1	2,60	CHI
20200272523	RIO VERDE	RV12256176LD	RIO VERDE S1	13/02/2020 18:08	13/02/2020 22:56	13/02/2020 18:08	13/02/2020 22:56	4,81	582	2797,97	CHI
20200270493	NEROPOLIS	10005035803	NEROPOLIS S1	13/02/2020 18:09	14/02/2020 00:18	13/02/2020 18:09	14/02/2020 00:18	6,14	1	6,14	CHI
20200272411	JARAGUA	JA21121664	JARAGUA	13/02/2020 18:11	14/02/2020 02:23	13/02/2020 18:11	14/02/2020 02:23	8,20	1	8,20	CHI
20200272479	PADRE BERNARDO	PB12284769	PADRE BERNARDO	13/02/2020 18:11	14/02/2020 00:40	13/02/2020 18:11	14/02/2020 00:31	6,32	66	417,10	CHI
20200272479	PADRE BERNARDO	PB11288562	PADRE BERNARDO	13/02/2020 18:11	14/02/2020 00:40	13/02/2020 18:11	14/02/2020 00:40	6,48	1	6,48	CHI
20200272415	LUZIANIA	3200081506	MARAJOARA	13/02/2020 18:12	13/02/2020 22:54	13/02/2020 18:12	13/02/2020 22:54	4,69	1	4,69	CHI
20200272416	PARAUNA	EU21000196	ACREUNA	13/02/2020 18:12	13/02/2020 21:19	13/02/2020 18:12	13/02/2020 21:19	3,11	1	3,11	CHI
20200272418	ORIZONA	OZ21272788	PIRES DO RIO S2	13/02/2020 18:13	13/02/2020 23:00	13/02/2020 18:13	13/02/2020 23:00	4,77	1	4,77	CHI
20200272419	AGUA FRIA DE GOIAS	TL12048061	SAO JOAO D ALIANCA	13/02/2020 18:13	14/02/2020 19:20	13/02/2020 18:13	14/02/2020 19:20	25,10	53	1330,37	CHI
20200272420	SAO DOMINGOS	SD11389115	SAO DOMINGOS	13/02/2020 18:14	14/02/2020 11:30	13/02/2020 18:14	14/02/2020 11:30	17,27	1	17,27	CHI

20200272421	LUZIANIA	10024828422	MARAJOARA	13/02/2020 18:14	13/02/2020 20:33	13/02/2020 18:14	13/02/2020 20:33	2,32	1	2,32	CHI
20200272422	NOVO GAMA	LZ21000397	PACAEMBU S1	13/02/2020 18:14	13/02/2020 22:59	13/02/2020 18:14	13/02/2020 22:59	4,73	1	4,73	CHI
20200272424	AGUA FRIA DE GOIAS	TL21270096	SAO JOAO D ALIANCA	13/02/2020 18:16	13/02/2020 21:36	13/02/2020 18:16	13/02/2020 21:36	3,33	1	3,33	CHI
20200272430	PIRENOPOLIS	PV21121613	SAO FRANCISCO DE GOIAS	13/02/2020 18:18	14/02/2020 10:49	13/02/2020 18:18	14/02/2020 10:49	16,51	1	16,51	CHI
20200272431	SAO SIMAO	2240035943	CACHOEIRA ALTA	13/02/2020 18:19	13/02/2020 21:48	13/02/2020 18:19	13/02/2020 21:48	3,48	1	3,48	CHI
20200272441	GOIANIA	17456940	GOIANIA LESTE S3	13/02/2020 18:22	13/02/2020 21:42	13/02/2020 18:22	13/02/2020 21:42	3,33	1	3,33	CHI
20200272448	GOIANESIA	550146088	GOIANESIA S2	13/02/2020 18:25	13/02/2020 21:49	13/02/2020 18:25	13/02/2020 21:49	3,40	1	3,40	CHI
20200272459	ALTO PARAISO DE GOIAS	BF12365282	SAO JOAO D ALIANCA	13/02/2020 18:28	13/02/2020 20:15	13/02/2020 18:28	13/02/2020 20:15	1,77	47	83,06	CHI
20200272463	ACREUNA	EU21317010	RIO DOS BOIS	13/02/2020 18:29	13/02/2020 22:33	13/02/2020 18:29	13/02/2020 22:33	4,06	1	4,06	CHI
20200272539	RIO VERDE	7114755	CABRIUVA S2	13/02/2020 18:31	14/02/2020 00:08	13/02/2020 18:31	14/02/2020 00:08	5,61	5	28,07	CHI
20200272474	GOIANIA	16980840	GOYA S1	13/02/2020 18:33	13/02/2020 19:45	13/02/2020 18:33	13/02/2020 19:45	1,20	1	1,20	CHI
20200272477	BELA VISTA DE GOIAS	BV21034809	BELA VISTA S2	13/02/2020 18:33	13/02/2020 21:12	13/02/2020 18:33	13/02/2020 21:12	2,64	1	2,64	CHI
20200272483	CACU	CC12080189	CACHOEIRA ALTA	13/02/2020 18:35	13/02/2020 20:45	13/02/2020 18:35	13/02/2020 20:45	2,16	16	34,63	CHI
20200272494	MUTUNOPOLIS	MU21262529	MARA ROSA	13/02/2020 18:35	13/02/2020 22:42	13/02/2020 18:35	13/02/2020 22:42	4,10	1	4,10	CHI
20200272496	ANAPOLIS	AN12382307	ANAPOLIS UNIVERSITARIO S2	13/02/2020 18:36	13/02/2020 22:45	13/02/2020 18:36	13/02/2020 22:45	4,14	40	165,76	CHI
20200272496	GAMELEIRA DE GOIAS	AN12382307	ANAPOLIS UNIVERSITARIO S2	13/02/2020 18:36	13/02/2020 22:45	13/02/2020 18:36	13/02/2020 22:45	4,14	31	128,46	CHI
20200270489	NOVA CRIXAS	NA13259652	MOZARLANDIA	13/02/2020 18:37	14/02/2020 00:08	13/02/2020 18:37	13/02/2020 22:52	4,25	20	85,07	CHI
20200270489	CRIXAS	NA12057420LD	MOZARLANDIA	13/02/2020 18:37	14/02/2020 00:08	13/02/2020 18:37	14/02/2020 00:08	5,51	1	5,51	CHI
20200270489	NOVA CRIXAS	NA12057420LD	MOZARLANDIA	13/02/2020 18:37	14/02/2020 00:08	13/02/2020 18:37	14/02/2020 00:08	5,51	39	214,88	CHI
20200270489	NOVA CRIXAS	NA12057420LD	NOVA CRIXAS	13/02/2020 18:37	14/02/2020 00:08	13/02/2020 18:37	14/02/2020 00:08	5,51	1	5,51	CHI
20200272499	SANTA BARBARA DE GOIAS	1030010411	TRINDADE	13/02/2020 18:37	13/02/2020 22:00	13/02/2020 18:37	13/02/2020 22:00	3,38	1	3,38	CHI
20200272503	GOIANIA	16028570	FERROVIARIO S1	13/02/2020 18:38	13/02/2020 21:52	13/02/2020 18:38	13/02/2020 21:52	3,23	1	3,23	CHI
20200272504	GUAPO	GA21133301	GUAPO S1	13/02/2020 18:39	14/02/2020 00:00	13/02/2020 18:39	14/02/2020 00:00	5,35	1	5,35	CHI
20200272508	MINACU	IH12307129	MINACU	13/02/2020 18:39	13/02/2020 21:27	13/02/2020 18:39	13/02/2020 21:27	2,79	12	33,50	CHI
20200272510	CATALAO	1990198378	CATALAO S2	13/02/2020 18:40	13/02/2020 23:52	13/02/2020 18:40	13/02/2020 23:52	5,19	1	5,19	CHI
20200272512	APARECIDA DE GOIANIA	16157588	REAL S2	13/02/2020 18:41	13/02/2020 19:56	13/02/2020 18:41	13/02/2020 19:56	1,26	1	1,26	CHI
20200272519	IACIARA	IA21232137	IACIARA S1	13/02/2020 18:43	14/02/2020 03:27	13/02/2020 18:43	14/02/2020 03:27	8,72	1	8,72	CHI
20200272520	PETROLINA DE GOIAS	PG12090243	PETROLINA	13/02/2020 18:43	13/02/2020 22:45	13/02/2020 18:43	13/02/2020 22:45	4,03	9	36,23	CHI
20200272526	APARECIDA DE GOIANIA	AP12321572	ANHANGUERA	13/02/2020 18:45	14/02/2020 12:07	13/02/2020 18:45	14/02/2020 12:07	17,37	3	52,12	CHI
20200272954	JARAGUA	JA11070675	JARAGUA	13/02/2020 18:46	13/02/2020 23:26	13/02/2020 18:46	13/02/2020 23:26	4,66	21	97,92	CHI
20200272544	RIO VERDE	RV12091975	MONTIVIDIU T	13/02/2020 18:50	14/02/2020 10:15	13/02/2020 18:50	14/02/2020 10:15	15,40	5	77,02	CHI
20200272549	MONTIVIDIU DO NORTE	MX21371817	PORANGATU	13/02/2020 18:53	14/02/2020 12:24	13/02/2020 18:53	14/02/2020 12:24	17,51	1	17,51	CHI
20200272559	QUIRINOPOLIS	QI21092926	QUIRINOPOLIS	13/02/2020 18:54	13/02/2020 21:46	13/02/2020 18:54	13/02/2020 21:46	2,85	3	8,56	CHI

20200272566	GOIANIA	16397435	GOYA S2	13/02/2020 18:56	13/02/2020 20:32	13/02/2020 18:56	13/02/2020 20:32	1,59	1	1,59	CHI
20200272570	PIRENOPOLIS	SF21146760	CORUMBA	13/02/2020 18:57	14/02/2020 09:08	13/02/2020 18:57	14/02/2020 09:08	14,17	1	14,17	CHI
20200272598	QUIRINOPOLIS	QI11015561	QUIRINOPOLIS	13/02/2020 18:57	13/02/2020 22:10	13/02/2020 18:57	13/02/2020 22:10	3,21	122	391,31	CHI
20200272575	SAO DOMINGOS	SD12344085	SAO DOMINGOS	13/02/2020 18:58	14/02/2020 09:27	13/02/2020 18:58	14/02/2020 09:27	14,47	3	43,40	CHI
20200272578	GOIANIA	14840339	GOYA S2	13/02/2020 18:59	13/02/2020 21:12	13/02/2020 18:59	13/02/2020 21:12	2,20	1	2,20	CHI
20200272583	SENADOR CANEDO	16650931	GOIANIA LESTE S1	13/02/2020 19:00	13/02/2020 19:57	13/02/2020 19:00	13/02/2020 19:57	0,94	1	0,94	CHI
20200272782	ANAPOLIS	OV12037464	NEROPOLIS S1	13/02/2020 19:00	14/02/2020 00:09	13/02/2020 19:00	14/02/2020 00:09	5,14	66	339,07	CHI
20200272782	OURO VERDE DE GOIAS	OV12037464	NEROPOLIS S1	13/02/2020 19:00	14/02/2020 00:09	13/02/2020 19:00	14/02/2020 00:09	5,14	9	46,24	CHI
20200272782	PETROLINA DE GOIAS	OV12037464	NEROPOLIS S1	13/02/2020 19:00	14/02/2020 00:09	13/02/2020 19:00	14/02/2020 00:09	5,14	10	51,37	CHI
20200272782	PIRENOPOLIS	OV12037464	NEROPOLIS S1	13/02/2020 19:00	14/02/2020 00:09	13/02/2020 19:00	14/02/2020 00:09	5,14	50	256,87	CHI
20200270490	ALEXANIA	AX21354213	ALEXANIA	13/02/2020 19:01	13/02/2020 21:12	13/02/2020 19:01	13/02/2020 21:12	2,18	1	2,18	CHI
20200272600	JARAGUA	70080057	JARAGUA	13/02/2020 19:03	14/02/2020 01:26	13/02/2020 19:03	14/02/2020 01:26	6,37	1	6,37	CHI
20200272604	JATAI	JT11152222	JATAI S2	13/02/2020 19:05	13/02/2020 20:10	13/02/2020 19:05	13/02/2020 20:10	1,08	112	120,96	CHI
20200272615	SAO FRANCISCO DE GOIAS	SF21071514	SAO FRANCISCO DE GOIAS	13/02/2020 19:08	13/02/2020 23:18	13/02/2020 19:08	13/02/2020 23:18	4,16	1	4,16	CHI
20200272616	VALPARAISO DE GOIAS	10018314277	MARAJOARA	13/02/2020 19:09	13/02/2020 21:37	13/02/2020 19:09	13/02/2020 21:37	2,46	1	2,46	CHI
20200272627	CRISTALINA	KR12245975	CRISTALINA S1	13/02/2020 19:11	14/02/2020 08:14	13/02/2020 19:11	14/02/2020 08:14	13,04	5	65,22	CHI
20200272647	BURITINOPOLIS	SU12374375	SANTA RITA DO ARAGUAIA	13/02/2020 19:13	13/02/2020 23:36	13/02/2020 19:13	13/02/2020 23:36	4,37	1	4,37	CHI
20200272647	SANTA RITA DO ARAGUAIA	SU12374375	SANTA RITA DO ARAGUAIA	13/02/2020 19:13	13/02/2020 23:36	13/02/2020 19:13	13/02/2020 23:36	4,37	5	21,87	CHI
20200272649	CHAPADAO DO CEU	DJ21121697	CHAPADAO DO CEU	13/02/2020 19:18	14/02/2020 09:41	13/02/2020 19:18	14/02/2020 09:41	14,37	2	28,75	CHI
20200272909	SERRANOPOLIS	SX12226484	JATAI S1	13/02/2020 19:18	13/02/2020 23:26	13/02/2020 19:18	13/02/2020 23:26	4,12	14	57,72	CHI
20200272670	ANAPOLIS	20549684	ANAPOLIS UNIVERSITARIO S2	13/02/2020 19:23	14/02/2020 00:34	13/02/2020 19:23	14/02/2020 00:34	5,18	1	5,18	CHI
20200272687	SIMOLANDIA	SA21246976	IACIARA S2	13/02/2020 19:27	14/02/2020 10:50	13/02/2020 19:27	14/02/2020 10:50	15,38	1	15,38	CHI
20200272697	GOIANESIA	GE11375680	GOIANESIA S2	13/02/2020 19:30	14/02/2020 01:15	13/02/2020 19:30	14/02/2020 01:15	5,75	1	5,75	CHI
20200272722	ANAPOLIS	AN11215206	ANAPOLIS UNIVERSITARIO S2	13/02/2020 19:31	13/02/2020 20:50	13/02/2020 19:31	13/02/2020 20:50	1,32	64	84,48	CHI
20200272710	MORRINHOS	MR12264053	MORRINHOS	13/02/2020 19:35	13/02/2020 23:08	13/02/2020 19:35	13/02/2020 23:08	3,55	9	31,93	CHI
20200272727	ANAPOLIS	10007659286	ANAPOLIS UNIVERSITARIO S2	13/02/2020 19:38	14/02/2020 00:22	13/02/2020 19:38	14/02/2020 00:22	4,72	1	4,72	CHI
20200272732	QUIRINOPOLIS	QI21298318	QUIRINOPOLIS	13/02/2020 19:39	14/02/2020 01:10	13/02/2020 19:39	14/02/2020 01:10	5,52	1	5,52	CHI
20200272738	CATALAO	1990062110	CATALAO S2	13/02/2020 19:41	13/02/2020 21:07	13/02/2020 19:41	13/02/2020 21:07	1,43	1	1,43	CHI
20200272757	SITIO D ABADIA	SI12131972	IACIARA S2	13/02/2020 19:46	14/02/2020 15:20	13/02/2020 19:46	14/02/2020 15:20	19,56	45	880,37	CHI
20200272760	PADRE BERNARDO	PB12092844	PADRE BERNARDO	13/02/2020 19:47	13/02/2020 23:52	13/02/2020 19:47	13/02/2020 23:52	4,08	5	20,41	CHI
20200272766	ITARUMA	IM12053047	CACHOEIRA ALTA	13/02/2020 19:48	13/02/2020 22:55	13/02/2020 19:48	13/02/2020 22:55	3,11	4	12,43	CHI
20200272771	RIO VERDE	RV21398965	RIO VERDE S2	13/02/2020 19:49	14/02/2020 02:25	13/02/2020 19:49	14/02/2020 01:40	5,84	1	5,84	CHI
20200272771	RIO VERDE	RV12384685	RIO VERDE S2	13/02/2020 19:49	14/02/2020 02:25	13/02/2020 23:56	14/02/2020 02:25	2,47	1	2,47	CHI

20200272783	CRISTALINA	KR21248643	CRISTALINA S1	13/02/2020 19:52	14/02/2020 02:40	13/02/2020 19:52	14/02/2020 02:40	6,78	2	13,57	CHI
20200272784	ITARUMA	IM12160235	ITAJA S2	13/02/2020 19:53	13/02/2020 22:39	13/02/2020 19:53	13/02/2020 22:39	2,76	13	35,92	CHI
20200272785	AGUAS LINDAS DE GOIAS	10007030515	AGUAS LINDAS DE GOIAS S1	13/02/2020 19:53	13/02/2020 22:19	13/02/2020 19:53	13/02/2020 22:19	2,43	1	2,43	CHI
20200272798	SANTO ANTONIO DO DESCOBERTO	2210190480	AGUAS LINDAS DE GOIAS S2	13/02/2020 19:58	13/02/2020 23:58	13/02/2020 19:58	13/02/2020 23:58	3,99	1	3,99	CHI
20200272817	RIO VERDE	BZ12211442	SANTA HELENA S1	13/02/2020 20:06	13/02/2020 22:38	13/02/2020 20:06	13/02/2020 22:38	2,53	4	10,10	CHI
20200272817	SANTO ANTONIO DA BARRA	BZ12211442	SANTA HELENA S1	13/02/2020 20:06	13/02/2020 22:38	13/02/2020 20:06	13/02/2020 22:38	2,53	20	50,50	CHI
20200272822	FORMOSA	610057789	ITUIQUIRA	13/02/2020 20:08	13/02/2020 20:55	13/02/2020 20:08	13/02/2020 20:55	0,77	1	0,77	CHI
20200272828	ORIZONA	OZ21111508	PIRES DO RIO S2	13/02/2020 20:10	14/02/2020 08:50	13/02/2020 20:10	14/02/2020 08:50	12,66	1	12,66	CHI
20200272836	ANAPOLIS	20828240	DAIA S1	13/02/2020 20:11	13/02/2020 23:12	13/02/2020 20:11	13/02/2020 23:12	3,02	1	3,02	CHI
20200272845	MINEIROS	MY12324340	PARQUE DAS EMAS	13/02/2020 20:13	14/02/2020 00:02	13/02/2020 20:13	14/02/2020 00:02	3,80	13	49,46	CHI
20200272846	FORMOSA	FA11359142	ITUIQUIRA	13/02/2020 20:14	13/02/2020 21:55	13/02/2020 20:14	13/02/2020 21:55	1,68	1	1,68	CHI
20200272856	JATAI	290229856	JATAI S2	13/02/2020 20:18	13/02/2020 22:12	13/02/2020 20:18	13/02/2020 22:12	1,89	1	1,89	CHI
20200272876	GOIANESIA	GE12000016	GOIANESIA S2	13/02/2020 20:19	13/02/2020 22:31	13/02/2020 20:19	13/02/2020 22:31	2,20	8	17,63	CHI
20200272876	VILA PROPICIO	GE12000016	GOIANESIA S2	13/02/2020 20:19	13/02/2020 22:31	13/02/2020 20:19	13/02/2020 22:31	2,20	5	11,02	CHI
20200272881	ITAJA	2300022704	ITAJA S2	13/02/2020 20:26	13/02/2020 22:36	13/02/2020 20:26	13/02/2020 22:36	2,16	1	2,16	CHI
20200272883	NOVA AURORA	NE21082760	CATALAO S1	13/02/2020 20:26	14/02/2020 08:08	13/02/2020 20:26	14/02/2020 08:08	11,69	1	11,69	CHI
20200272912	ITUMBIARA	IT11000019	ITUMBIARA VELHA S1	13/02/2020 20:26	13/02/2020 21:45	13/02/2020 20:26	13/02/2020 21:45	1,30	126	164,22	CHI
20200272933	CATALAO	CT12399850	CATALAO S1	13/02/2020 20:26	13/02/2020 21:53	13/02/2020 20:26	13/02/2020 21:53	1,44	54	77,70	CHI
20200272933	GOIANDIRA	CT12399850	CATALAO S1	13/02/2020 20:26	13/02/2020 21:53	13/02/2020 20:26	13/02/2020 21:53	1,44	41	58,99	CHI
20200272902	SAO FRANCISCO DE GOIAS	SF21084981	SAO FRANCISCO DE GOIAS	13/02/2020 20:31	13/02/2020 22:01	13/02/2020 20:31	13/02/2020 22:01	1,49	1	1,49	CHI
20200272916	SANTO ANTONIO DO DESCOBERTO	SN12338448	ALEXANIA	13/02/2020 20:34	14/02/2020 10:18	13/02/2020 20:34	14/02/2020 10:18	13,73	10	137,30	CHI
20200272917	EDEALINA	ED21142057	PONTALINA	13/02/2020 20:34	13/02/2020 22:31	13/02/2020 20:34	13/02/2020 22:31	1,93	1	1,93	CHI
20200272919	ITUMBIARA	690270471	ITUMBIARA NOVA	13/02/2020 20:35	14/02/2020 08:32	13/02/2020 20:35	14/02/2020 08:32	11,95	1	11,95	CHI
20200272928	PETROLINA DE GOIAS	PG12297936	PETROLINA	13/02/2020 20:38	14/02/2020 02:51	13/02/2020 20:38	14/02/2020 02:51	6,21	5	31,04	CHI
20200272940	BURITI ALEGRE	AL12041363	VILA CORUMBA	13/02/2020 20:42	14/02/2020 20:12	13/02/2020 20:42	14/02/2020 20:12	23,51	3	70,52	CHI
20200272952	FORMOSA	610321584	ITUIQUIRA	13/02/2020 20:45	13/02/2020 21:35	13/02/2020 20:45	13/02/2020 21:35	0,82	1	0,82	CHI
20200273157	PETROLINA DE GOIAS	PG12048641	PETROLINA	13/02/2020 20:49	14/02/2020 14:50	13/02/2020 20:49	14/02/2020 14:50	18,01	19	342,16	CHI
20200273330	SAO FRANCISCO DE GOIAS	SF12039351	SAO FRANCISCO DE GOIAS	13/02/2020 20:49	14/02/2020 00:41	13/02/2020 20:49	14/02/2020 00:41	3,86	20	77,18	CHI
20200272972	JARAGUA	JA11222205	JARAGUA	13/02/2020 20:52	14/02/2020 03:15	13/02/2020 20:52	14/02/2020 03:15	6,38	42	267,80	CHI
20200273105	SAO FRANCISCO DE GOIAS	JA21140687	SAO FRANCISCO DE GOIAS	13/02/2020 20:54	13/02/2020 22:50	13/02/2020 20:54	13/02/2020 22:50	1,93	3	5,78	CHI
20200273109	CATALAO	1990040424	CATALAO S2	13/02/2020 20:58	14/02/2020 00:05	13/02/2020 20:58	14/02/2020 00:05	3,11	1	3,11	CHI
20200273116	LUZIANIA	120286830	RIO VERMELHO	13/02/2020 21:01	14/02/2020 00:50	13/02/2020 21:01	14/02/2020 00:50	3,82	1	3,82	CHI
20200273141	VALPARAISO DE GOIAS	2860360603	MARAJOARA	13/02/2020 21:09	14/02/2020 00:49	13/02/2020 21:09	14/02/2020 00:49	3,67	1	3,67	CHI

20200273203	IPAMERI	IP12087055	PIRES DO RIO S2	13/02/2020 21:10	13/02/2020 23:08	13/02/2020 21:10	13/02/2020 23:08	1,96	13	25,52	CHI
20200273168	PIRES DO RIO	PR21051691	PIRES DO RIO S2	13/02/2020 21:14	14/02/2020 16:20	13/02/2020 21:14	14/02/2020 16:20	19,10	1	19,10	CHI
20200273178	PIRES DO RIO	PR21051682	PIRES DO RIO S2	13/02/2020 21:19	14/02/2020 17:00	13/02/2020 21:19	14/02/2020 17:00	19,68	1	19,68	CHI
20200273351	BURITINOPOLIS	MB12344322RE	IACIARA S2	13/02/2020 21:20	14/02/2020 08:16	13/02/2020 21:20	14/02/2020 08:16	10,94	30	328,31	CHI
20200273351	MAMBAI	MB12344322RE	IACIARA S2	13/02/2020 21:20	14/02/2020 08:16	13/02/2020 21:20	14/02/2020 08:16	10,94	126	1378,89	CHI
20200273189	ANAPOLIS	20107523	JUNDIAI S1	13/02/2020 21:24	14/02/2020 00:28	13/02/2020 21:24	14/02/2020 00:28	3,07	1	3,07	CHI
20200273216	SANTA CRUZ DE GOIAS	BC21280312	PIRES DO RIO S2	13/02/2020 21:36	14/02/2020 00:36	13/02/2020 21:36	14/02/2020 00:36	3,00	1	3,00	CHI
20200273236	CRISTALINA	KR12206642	PAMPLONA	13/02/2020 21:40	14/02/2020 00:00	13/02/2020 21:40	14/02/2020 00:00	2,33	3	7,00	CHI
20200273236	DISTRITO FEDERAL	KR12206642	PAMPLONA	13/02/2020 21:40	14/02/2020 00:00	13/02/2020 21:40	14/02/2020 00:00	2,33	2	4,66	CHI
20200273236	LUZIANIA	KR12206642	PAMPLONA	13/02/2020 21:40	14/02/2020 00:00	13/02/2020 21:40	14/02/2020 00:00	2,33	2	4,66	CHI
20200273223	GOIANESIA	550149582	GOIANESIA S2	13/02/2020 21:41	14/02/2020 04:40	13/02/2020 21:41	14/02/2020 04:40	6,99	1	6,99	CHI
20200273328	FORMOSA	FA11383386	ITIQUEIRA	13/02/2020 21:53	13/02/2020 22:42	13/02/2020 21:53	13/02/2020 22:42	0,80	122	97,67	CHI
20200273268	VILA PROPICIO	PV21115150	GOIANESIA S1	13/02/2020 21:55	14/02/2020 10:17	13/02/2020 21:55	14/02/2020 10:17	12,36	1	12,36	CHI
20200273361	SANTA RITA DO NOVO DESTINO	DF11315669	BARRO ALTO	13/02/2020 21:56	14/02/2020 01:28	13/02/2020 21:56	14/02/2020 01:28	3,52	1	3,52	CHI
20200273315	LUZIANIA	120198563	RIO VERMELHO	13/02/2020 22:10	13/02/2020 23:41	13/02/2020 22:10	13/02/2020 23:41	1,53	1	1,53	CHI
20200273353	ITUMBIARA	BG21293150	ITUMBIARA VELHA S2	13/02/2020 22:21	14/02/2020 13:01	13/02/2020 22:21	14/02/2020 13:01	14,66	1	14,66	CHI
20200273362	ITUMBIARA	IT21263963	PARANAIBA	13/02/2020 22:24	14/02/2020 13:44	13/02/2020 22:24	14/02/2020 13:44	15,32	1	15,32	CHI
20200273377	SAO MIGUEL DO PASSA QUATRO	SQ12070875	CRISTIANOPOLIS	13/02/2020 22:27	14/02/2020 01:45	13/02/2020 22:27	14/02/2020 01:45	3,29	8	26,31	CHI
20200273387	LUZIANIA	3200004913	MARAJOARA	13/02/2020 22:30	13/02/2020 23:41	13/02/2020 22:30	13/02/2020 23:41	1,18	1	1,18	CHI
20200273487	ITUMBIARA	IT12366589LD	ITUMBIARA NOVA	13/02/2020 22:33	14/02/2020 08:55	13/02/2020 22:33	14/02/2020 08:55	10,36	182	1885,42	CHI
20200273413	CALDAS NOVAS	10022495795	SERRA DE CALDAS	13/02/2020 22:39	14/02/2020 04:37	13/02/2020 22:39	14/02/2020 04:37	5,95	1	5,95	CHI
20200273528	ITUMBIARA	CD12000328	CACHOEIRA DOURADA	14/02/2020 00:34	14/02/2020 17:02	14/02/2020 00:34	14/02/2020 17:02	16,46	3	49,37	CHI
20200273535	SANTA CRUZ DE GOIAS	BC21280312	PIRES DO RIO S2	14/02/2020 00:57	14/02/2020 12:28	14/02/2020 00:57	14/02/2020 12:28	11,51	1	11,51	CHI
20200273724	BURITI ALEGRE	MR12000170RE	MORRINHOS	14/02/2020 01:10	14/02/2020 09:57	14/02/2020 01:10	14/02/2020 09:57	8,78	1	8,78	CHI
20200273724	MORRINHOS	MR12000170RE	MORRINHOS	14/02/2020 01:10	14/02/2020 09:57	14/02/2020 01:10	14/02/2020 09:57	8,78	54	474,25	CHI
20200273713	GUARANI DE GOIAS	GY12265440	IACIARA S1	14/02/2020 04:25	14/02/2020 09:54	14/02/2020 04:25	14/02/2020 09:54	5,48	20	109,63	CHI
20200273723	FLORES DE GOIAS	FB12106993	FLORES DE GOIAS	14/02/2020 05:17	14/02/2020 07:11	14/02/2020 05:17	14/02/2020 07:11	1,90	15	28,43	CHI
20200273723	FORMOSA	FB12106993	FLORES DE GOIAS	14/02/2020 05:17	14/02/2020 07:11	14/02/2020 05:17	14/02/2020 07:11	1,90	9	17,06	CHI
20200273723	SAO JOAO D ALIANCA	FB12106993	FLORES DE GOIAS	14/02/2020 05:17	14/02/2020 07:11	14/02/2020 05:17	14/02/2020 07:11	1,90	5	9,48	CHI
20200273736	ITUMBIARA	IT12273930	CACHOEIRA DOURADA	14/02/2020 05:45	14/02/2020 08:58	14/02/2020 05:45	14/02/2020 08:58	3,22	15	48,23	CHI
20200273738	NOVA ROMA	ND12392238	IACIARA S2	14/02/2020 05:49	14/02/2020 10:41	14/02/2020 05:49	14/02/2020 10:41	4,86	242	1175,85	CHI
20200274143	FORMOSA	FA12233756	SAO JOAO D ALIANCA	14/02/2020 06:03	14/02/2020 14:32	14/02/2020 06:03	14/02/2020 14:32	8,47	7	59,29	CHI
20200274111	FORMOSA	FA11396400	ITIQUEIRA	14/02/2020 06:18	14/02/2020 21:58	14/02/2020 06:18	14/02/2020 21:58	15,66	1	15,66	CHI

20200274114	PIRES DO RIO	BC12051685	PIRES DO RIO S2	14/02/2020 06:20	14/02/2020 11:25	14/02/2020 06:20	14/02/2020 11:25	5,08	2	10,15	CHI
20200274114	SANTA CRUZ DE GOIAS	BC12051685	PIRES DO RIO S2	14/02/2020 06:20	14/02/2020 11:25	14/02/2020 06:20	14/02/2020 11:25	5,08	5	25,38	CHI
20200274116	CRISTIANOPOLIS	CF12300616	CRISTIANOPOLIS	14/02/2020 06:22	14/02/2020 07:49	14/02/2020 06:22	14/02/2020 07:49	1,45	8	11,58	CHI
20200274120	FORMOSA	7194099	ITUIQUIRA	14/02/2020 06:26	14/02/2020 08:42	14/02/2020 06:26	14/02/2020 08:42	2,26	22	49,72	CHI
20200274197	GOIATUBA	GT12392084	GOIATUBA S2	14/02/2020 06:37	14/02/2020 08:50	14/02/2020 06:37	14/02/2020 08:50	2,21	18	39,78	CHI
20200274517	PIRACANJUBA	PJ12212152	PIRACANJUBA	14/02/2020 06:37	14/02/2020 09:12	14/02/2020 06:37	14/02/2020 09:12	2,59	37	95,75	CHI
20200274141	SAO MIGUEL DO PASSA QUATRO	SQ12070875	CRISTIANOPOLIS	14/02/2020 06:39	14/02/2020 09:30	14/02/2020 06:39	14/02/2020 09:30	2,85	8	22,79	CHI
20200274156	FORMOSA	FA21160212	ITUIQUIRA	14/02/2020 06:45	14/02/2020 13:39	14/02/2020 06:45	14/02/2020 13:39	6,90	1	6,90	CHI
20200274158	MONTE ALEGRE DE GOIAS	MA12233165	SAO DOMINGOS	14/02/2020 06:46	14/02/2020 10:11	14/02/2020 06:46	14/02/2020 10:11	3,41	6	20,48	CHI
20200274179	ALTO PARAISO DE GOIAS	BF12180923	FLORES DE GOIAS	14/02/2020 06:54	14/02/2020 08:58	14/02/2020 06:54	14/02/2020 08:58	2,06	7	14,44	CHI
20200274180	CABECEIRAS	FA12218558	ITUIQUIRA	14/02/2020 06:54	14/02/2020 11:40	14/02/2020 06:54	14/02/2020 11:40	4,77	19	90,66	CHI
20200274180	FORMOSA	FA12218558	ITUIQUIRA	14/02/2020 06:54	14/02/2020 11:40	14/02/2020 06:54	14/02/2020 11:40	4,77	12	57,26	CHI
20200274507	CORUMBAIBA	CI12064619	VILA CORUMBA	14/02/2020 06:55	14/02/2020 12:20	14/02/2020 06:55	14/02/2020 12:20	5,41	36	194,69	CHI
20200274185	NOVA ROMA	ND12242838	IACIARA S2	14/02/2020 06:56	14/02/2020 14:37	14/02/2020 06:56	14/02/2020 14:37	7,67	1	7,67	CHI
20200274645	GOIANDIRA	GD12078359	CATALAO S1	14/02/2020 07:03	14/02/2020 10:18	14/02/2020 07:03	14/02/2020 10:18	3,23	26	84,10	CHI
20200274502	ORIZONA	OZ21326458	PIRES DO RIO S2	14/02/2020 07:09	14/02/2020 15:36	14/02/2020 07:09	14/02/2020 15:36	8,44	1	8,44	CHI
20200274512	FORMOSA	FA21329692	ITUIQUIRA	14/02/2020 07:12	14/02/2020 08:56	14/02/2020 07:12	14/02/2020 08:56	1,74	1	1,74	CHI
20200274616	FORMOSA	FA12248883	ITUIQUIRA	14/02/2020 07:14	14/02/2020 13:32	14/02/2020 07:14	14/02/2020 13:32	6,30	18	113,34	CHI
20200274527	PONTALINA	JV21142233	GOIATUBA S1	14/02/2020 07:16	14/02/2020 09:05	14/02/2020 07:16	14/02/2020 09:05	1,81	1	1,81	CHI
20200274530	SIMOLANDIA	SA12180855	IACIARA S2	14/02/2020 07:17	14/02/2020 09:30	14/02/2020 07:17	14/02/2020 09:30	2,21	230	508,24	CHI
20200274532	FLORES DE GOIAS	FB12204157	FLORES DE GOIAS	14/02/2020 07:17	14/02/2020 09:37	14/02/2020 07:17	14/02/2020 09:37	2,32	13	30,20	CHI
20200274544	CACHOEIRA DOURADA	CD12316710	CACHOEIRA DOURADA	14/02/2020 07:20	14/02/2020 11:43	14/02/2020 07:20	14/02/2020 11:43	4,37	1	4,37	CHI
20200274570	FORMOSA	7678624	ITUIQUIRA	14/02/2020 07:27	14/02/2020 12:18	14/02/2020 07:27	14/02/2020 12:18	4,84	1	4,84	CHI
20200274573	FORMOSA	10009459012	ITUIQUIRA	14/02/2020 07:30	14/02/2020 10:22	14/02/2020 07:30	14/02/2020 10:22	2,87	1	2,87	CHI
20200274611	CATALAO	CT21164135	CATALAO S1	14/02/2020 07:38	14/02/2020 09:24	14/02/2020 07:38	14/02/2020 09:24	1,76	1	1,76	CHI
20200274619	BURITINOPOLIS	7090000484	IACIARA S2	14/02/2020 07:40	14/02/2020 09:44	14/02/2020 07:40	14/02/2020 09:44	2,07	1	2,07	CHI
20200274639	IPAMERI	UT12080881	URUTAI	14/02/2020 07:46	14/02/2020 16:57	14/02/2020 07:46	14/02/2020 16:57	9,18	3	27,53	CHI
20200274639	URUTAI	UT12080881	URUTAI	14/02/2020 07:46	14/02/2020 16:57	14/02/2020 07:46	14/02/2020 16:57	9,18	1	9,18	CHI
20200274655	CAVALCANTE	CJ11257477	FLORES DE GOIAS	14/02/2020 07:51	14/02/2020 09:02	14/02/2020 07:51	14/02/2020 09:02	1,18	85	100,44	CHI
20200274675	SAO DOMINGOS	SD12132214	SAO DOMINGOS	14/02/2020 07:56	14/02/2020 15:15	14/02/2020 07:56	14/02/2020 15:15	7,30	3	21,91	CHI
20200274688	AGUA LIMPA	AL12172363	VILA CORUMBA	14/02/2020 08:00	14/02/2020 11:35	14/02/2020 08:00	14/02/2020 11:35	3,58	7	25,08	CHI
20200274708	ITUMBIARA	10004405100	ITUMBIARA VELHA S1	14/02/2020 08:04	14/02/2020 10:38	14/02/2020 08:04	14/02/2020 10:38	2,57	1	2,57	CHI
20200274732	INDIARA	IY21010973	EDEIA	14/02/2020 08:08	14/02/2020 11:25	14/02/2020 08:08	14/02/2020 11:25	3,28	2	6,56	CHI

20200274755	CALDAS NOVAS	CN11354043	CALDAS NOVAS S1	14/02/2020 08:12	14/02/2020 13:47	14/02/2020 08:12	14/02/2020 13:47	5,57	2	11,14	CHI
20200274759	CATALAO	CT12093871	CATALAO S1	14/02/2020 08:13	14/02/2020 11:12	14/02/2020 08:13	14/02/2020 11:12	2,98	40	119,00	CHI
20200274781	PIRACANJUBA	60006547	PIRACANJUBA	14/02/2020 08:20	14/02/2020 11:58	14/02/2020 08:20	14/02/2020 11:58	3,63	1	3,63	CHI
20200274788	AGUA FRIA DE GOIAS	NQ12270128RE	SAO JOAO D ALIANCA	14/02/2020 08:21	14/02/2020 12:54	14/02/2020 08:21	14/02/2020 12:54	4,54	68	308,93	CHI
20200274788	NIQUELANDIA	NQ12270128RE	SAO JOAO D ALIANCA	14/02/2020 08:21	14/02/2020 12:54	14/02/2020 08:21	14/02/2020 12:54	4,54	15	68,15	CHI
20200274804	INDIARA	10030893990	EDEIA	14/02/2020 08:24	14/02/2020 13:10	14/02/2020 08:24	14/02/2020 13:10	4,78	1	4,78	CHI
20200274807	JOVIANIA	JV21208249	GOIATUBA S1	14/02/2020 08:24	14/02/2020 10:07	14/02/2020 08:24	14/02/2020 10:07	1,71	1	1,71	CHI
20200274812	URUTAI	UT21016965	URUTAI	14/02/2020 08:25	14/02/2020 14:56	14/02/2020 08:25	14/02/2020 14:56	6,51	1	6,51	CHI
20200274830	ITUMBIARA	690128332	ITUMBIARA NOVA	14/02/2020 08:29	14/02/2020 09:51	14/02/2020 08:29	14/02/2020 09:51	1,36	1	1,36	CHI
20200274840	CAVALCANTE	CJ12239935	FLORES DE GOIAS	14/02/2020 08:32	14/02/2020 13:28	14/02/2020 08:32	14/02/2020 13:28	4,93	122	601,49	CHI
20200274847	PROFESSOR JAMIL SAFADY	PJ21123652	ROCHEDO	14/02/2020 08:33	14/02/2020 10:30	14/02/2020 08:33	14/02/2020 10:30	1,94	1	1,94	CHI
20200274852	PIRES DO RIO	460102280	PIRES DO RIO S1	14/02/2020 08:34	14/02/2020 16:15	14/02/2020 08:34	14/02/2020 16:15	7,67	1	7,67	CHI
20200274870	CALDAS NOVAS	760085213	CALDAS NOVAS S1	14/02/2020 08:38	14/02/2020 10:00	14/02/2020 08:38	14/02/2020 10:00	1,36	1	1,36	CHI
20200274904	IACIARA	IA21232137	IACIARA S1	14/02/2020 08:43	14/02/2020 10:06	14/02/2020 08:43	14/02/2020 10:06	1,37	1	1,37	CHI
20200274931	GOIATUBA	10023567021	GOIATUBA S2	14/02/2020 08:49	14/02/2020 09:57	14/02/2020 08:49	14/02/2020 09:57	1,13	1	1,13	CHI
20200274937	ITUMBIARA	690357424	PARANAIBA	14/02/2020 08:51	14/02/2020 10:10	14/02/2020 08:51	14/02/2020 10:10	1,32	1	1,32	CHI

Plotagem das Ocorrências conforme a Espacialização das Chuvas

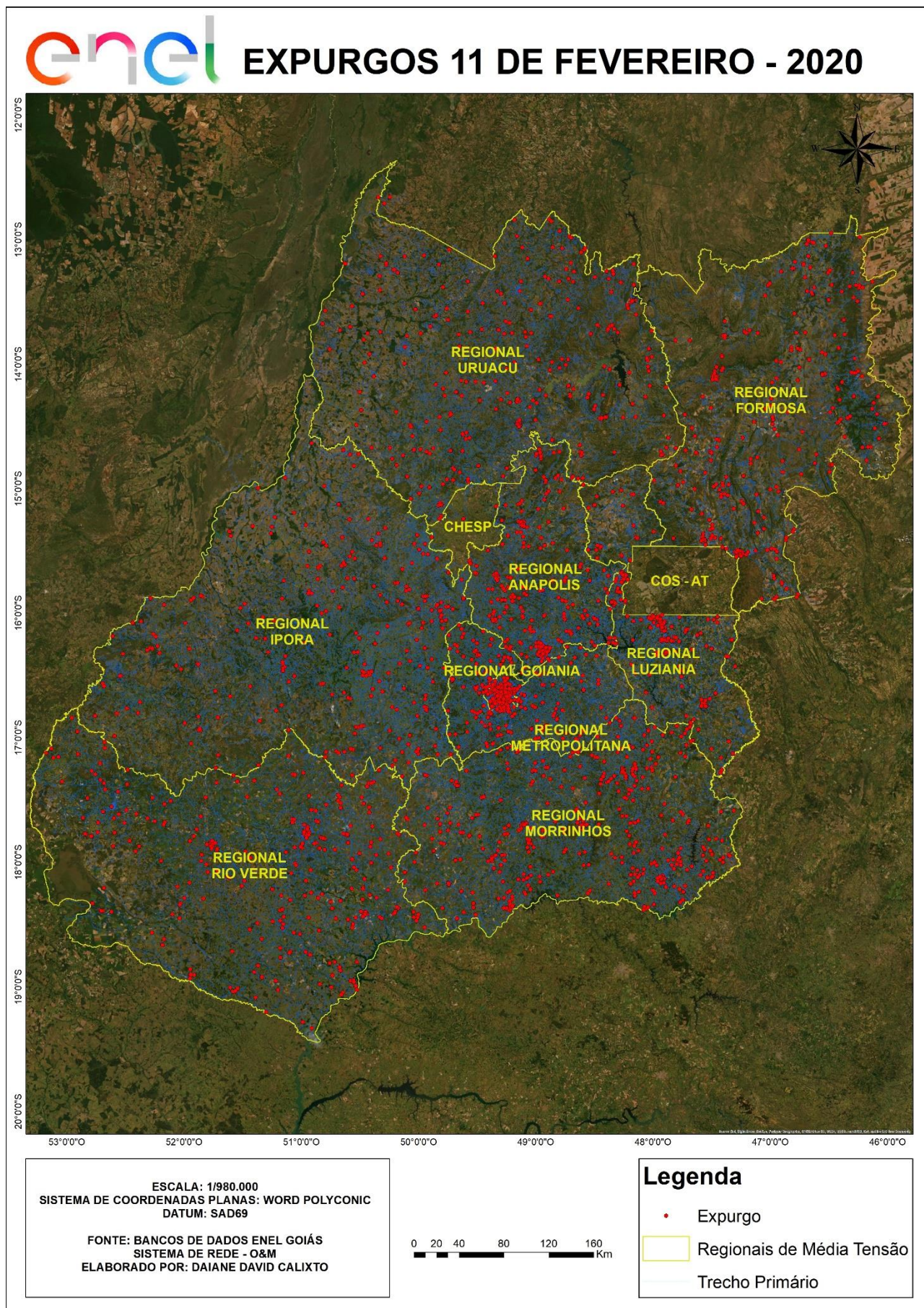

Diagramas Unifilares

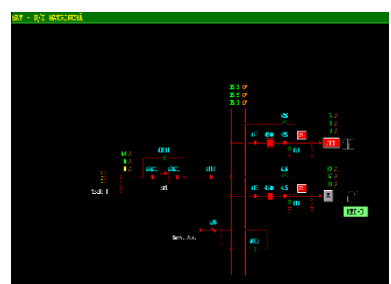
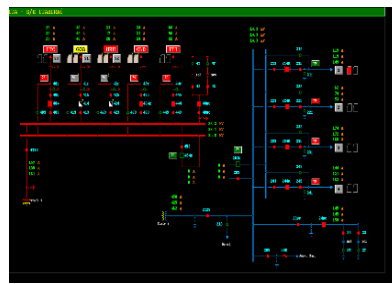
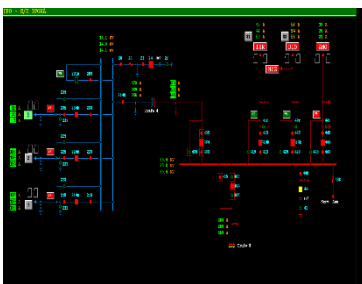
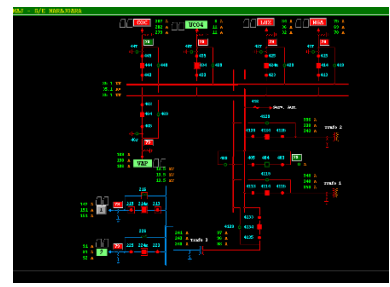
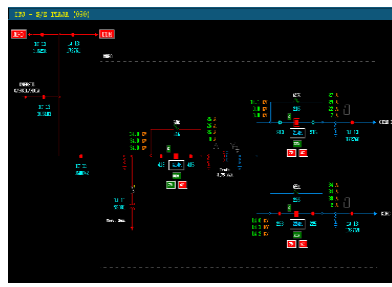
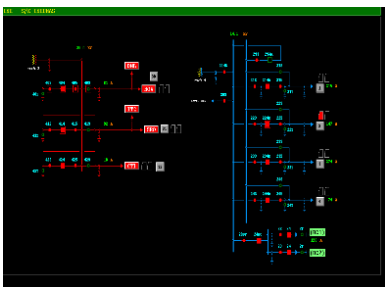
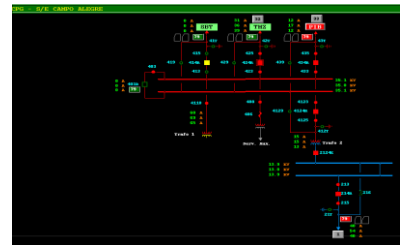
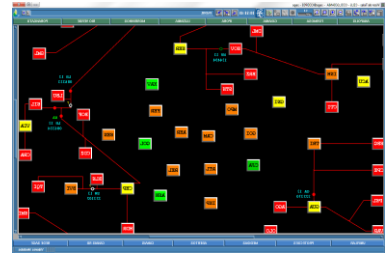
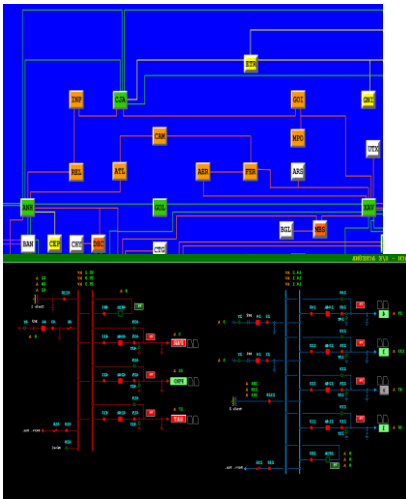

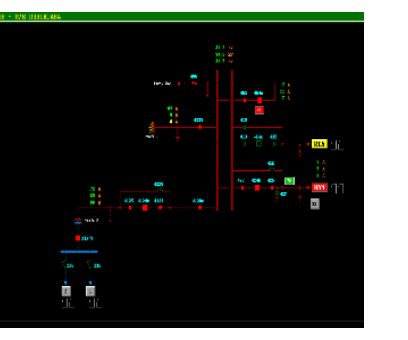
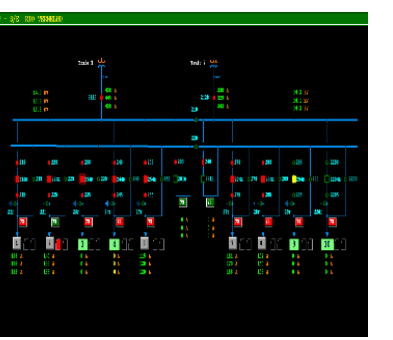
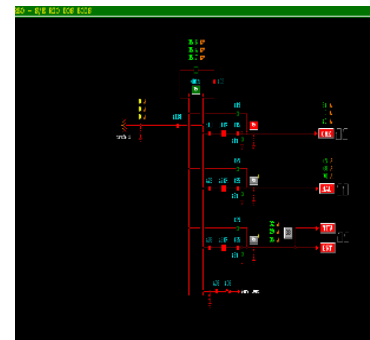
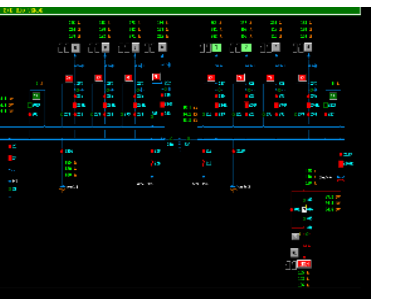
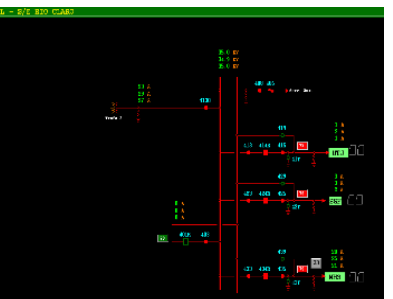
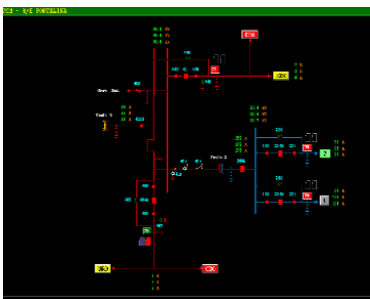
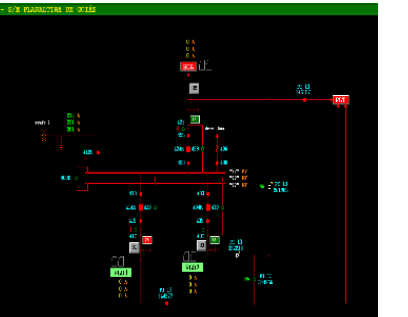
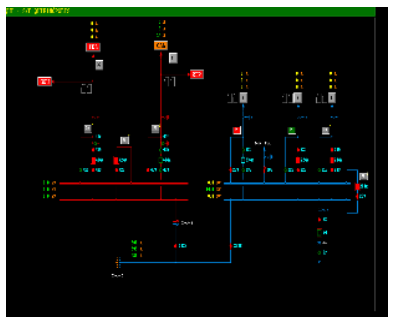
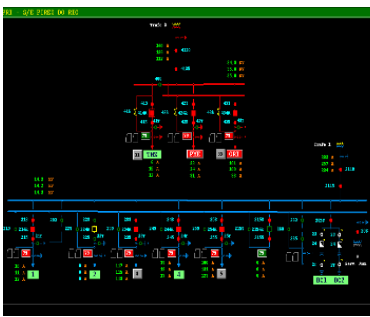
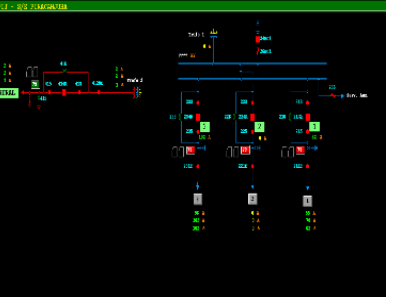
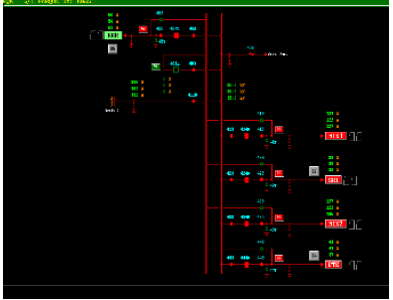
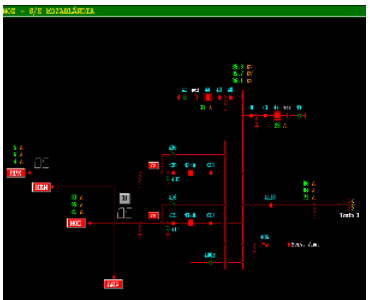
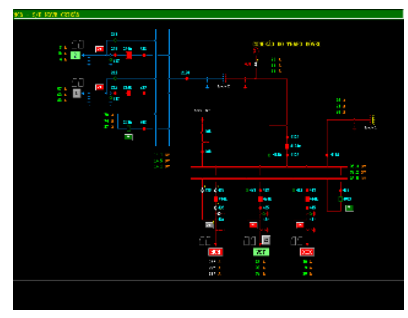
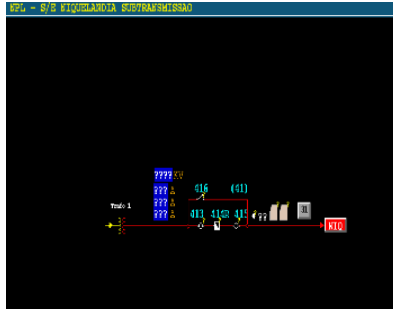

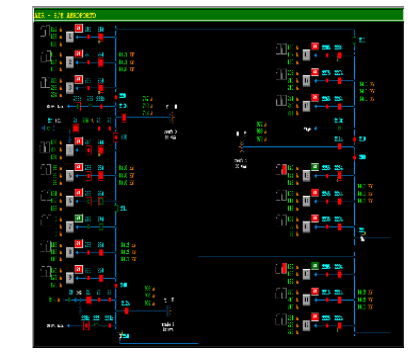
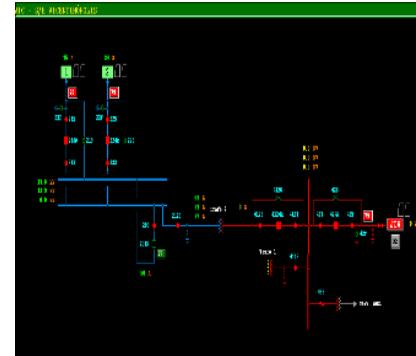
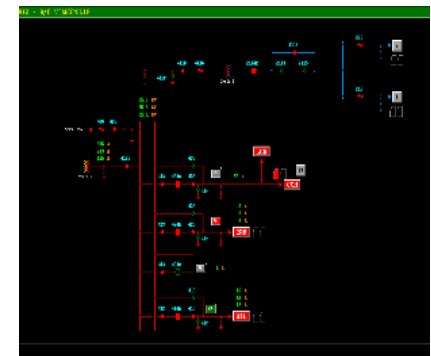
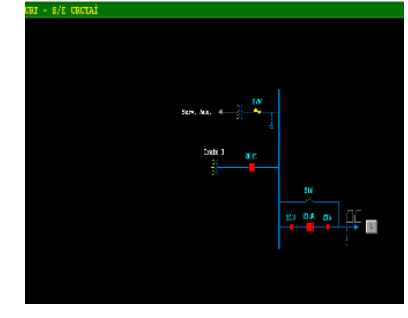
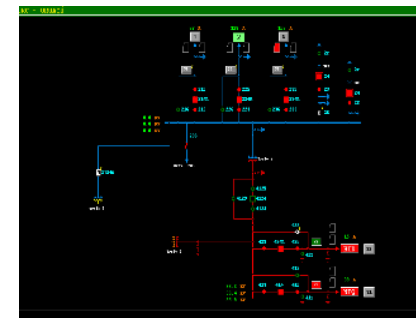
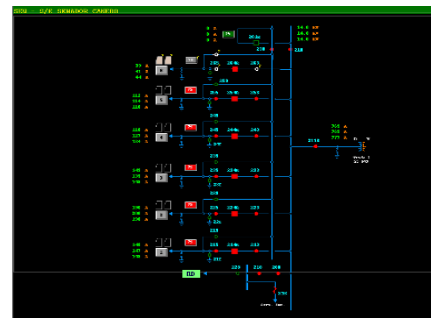
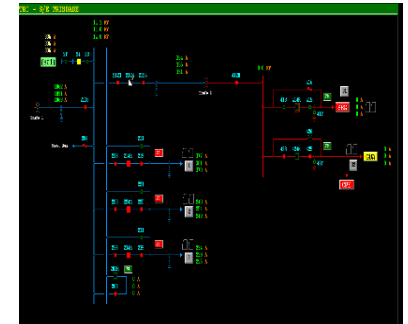
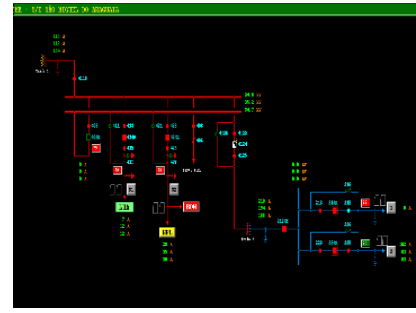
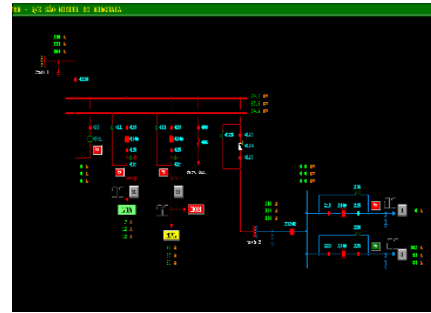
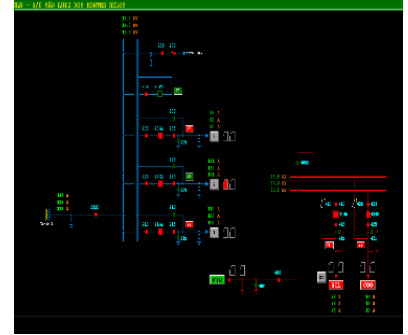
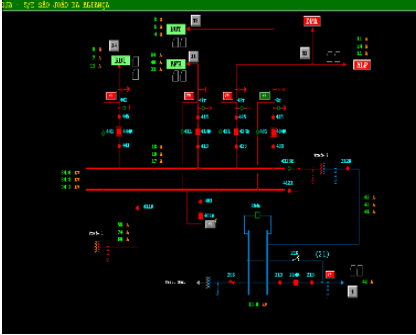
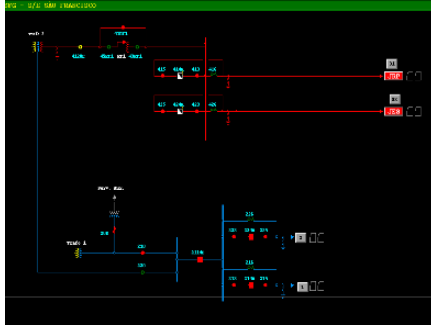
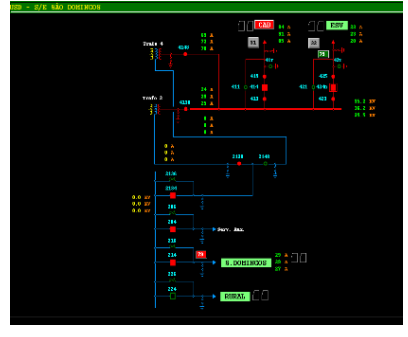
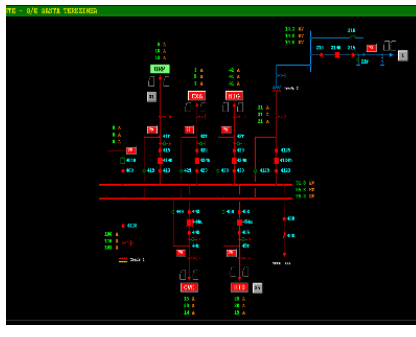
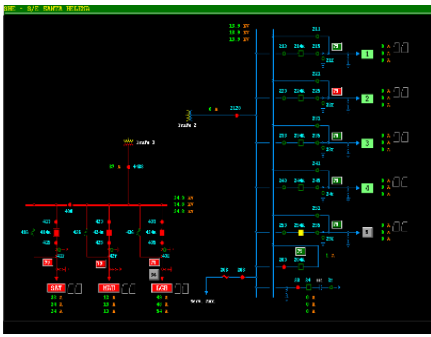

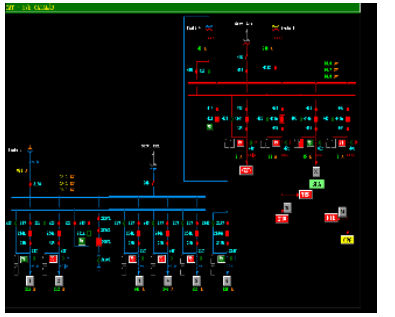
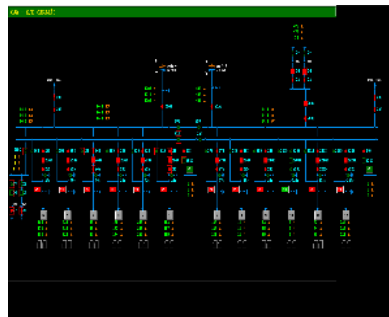
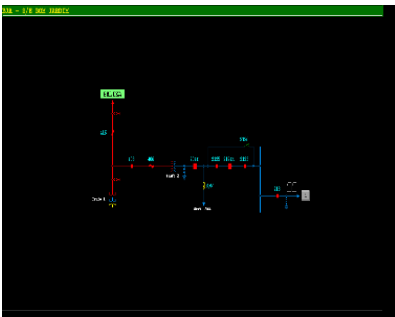
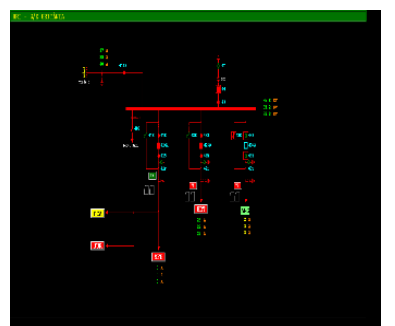
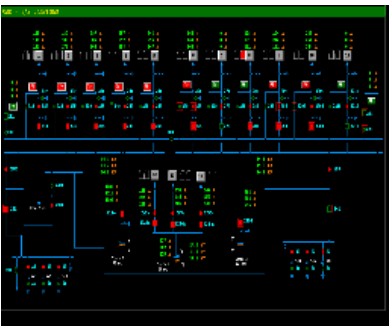
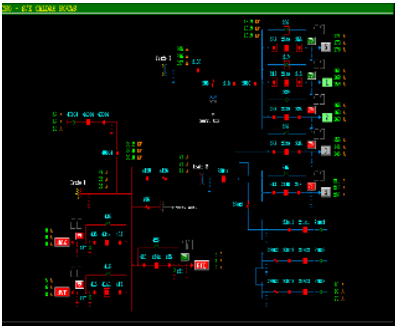
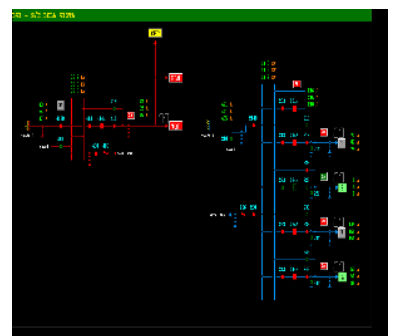
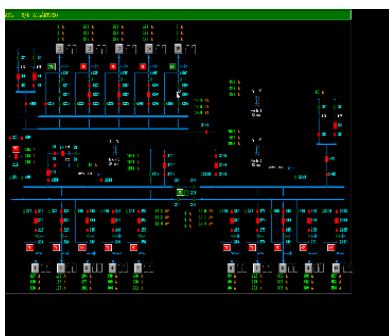
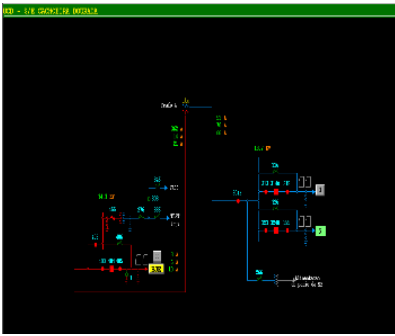
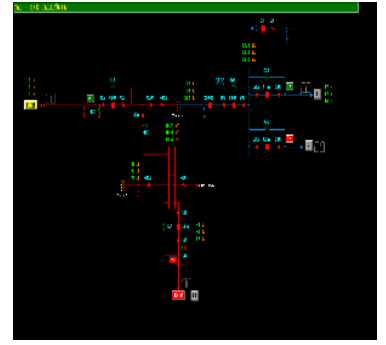
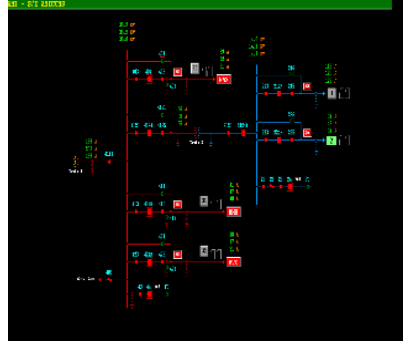
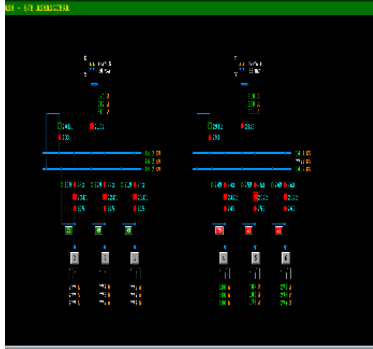
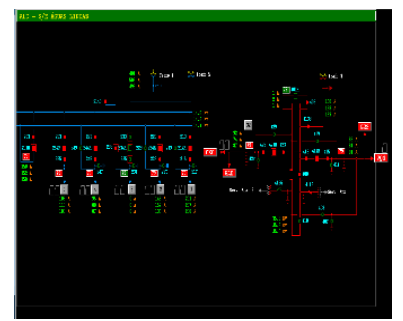
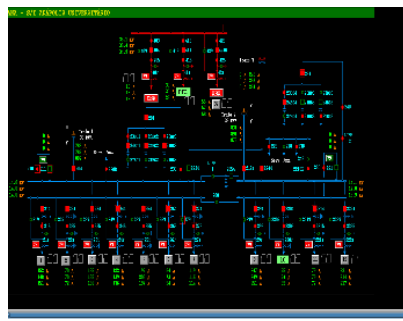
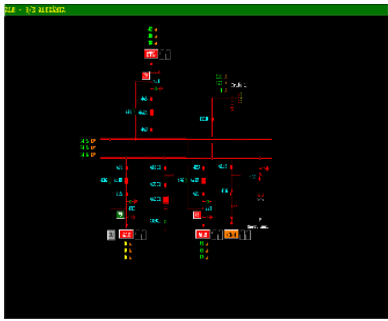

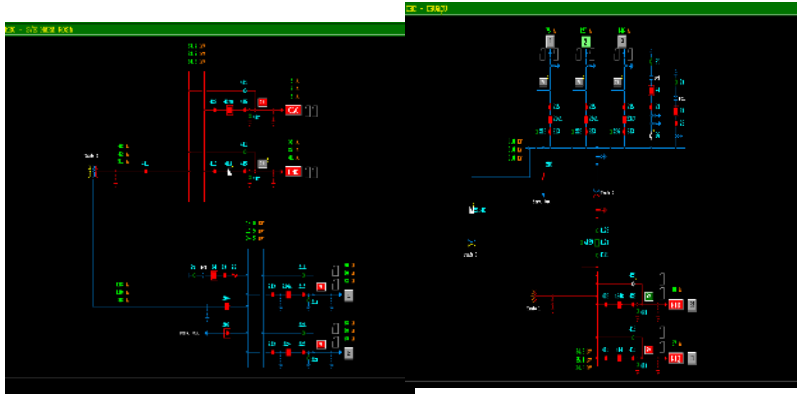
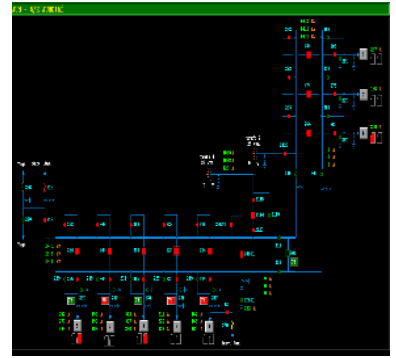
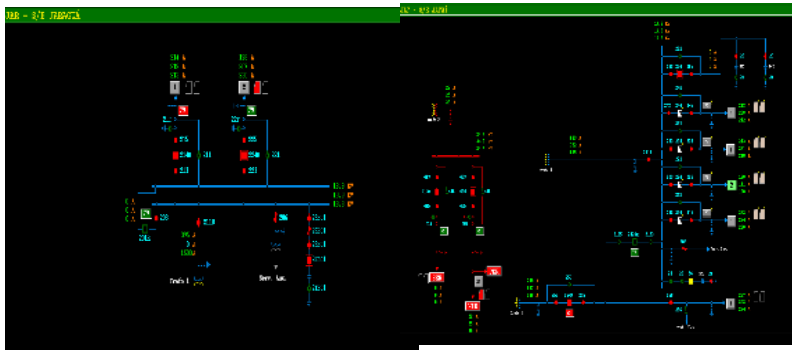

DEMAIS EVIDÊNCIAS

DADOS TÉCNICO - OPERACIONAIS ENEL GO

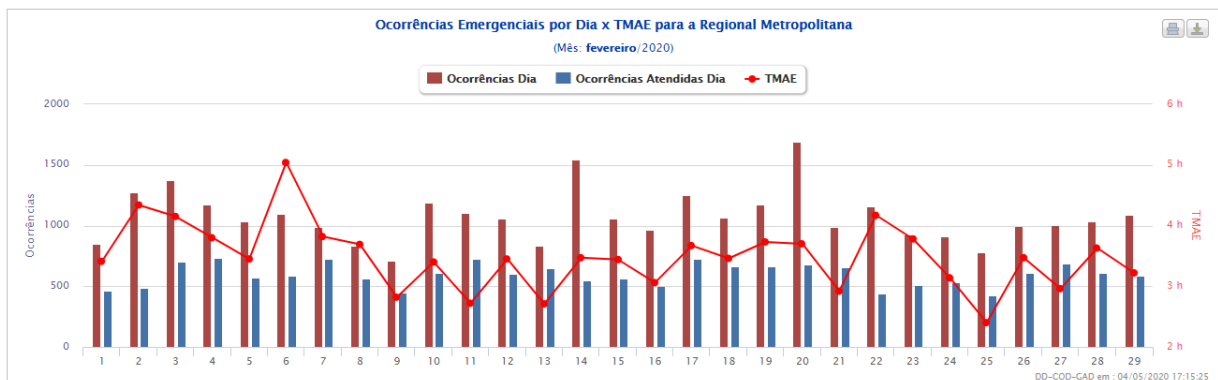
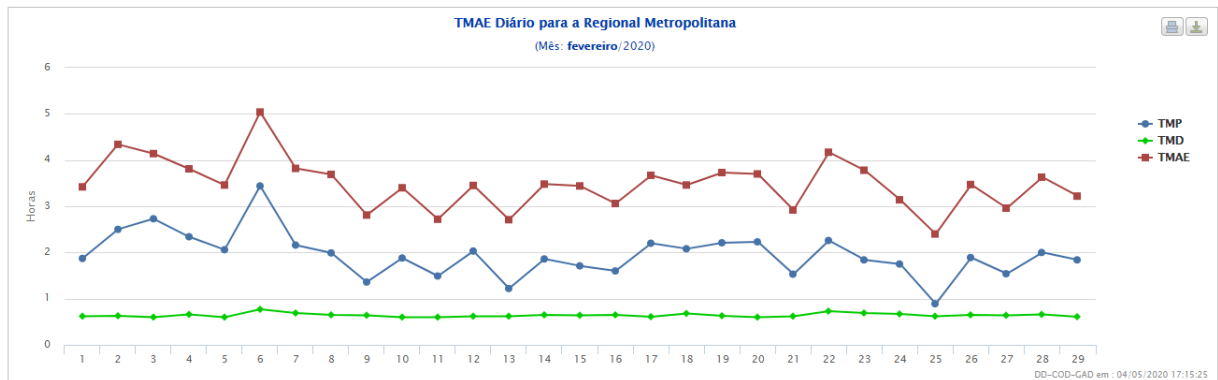
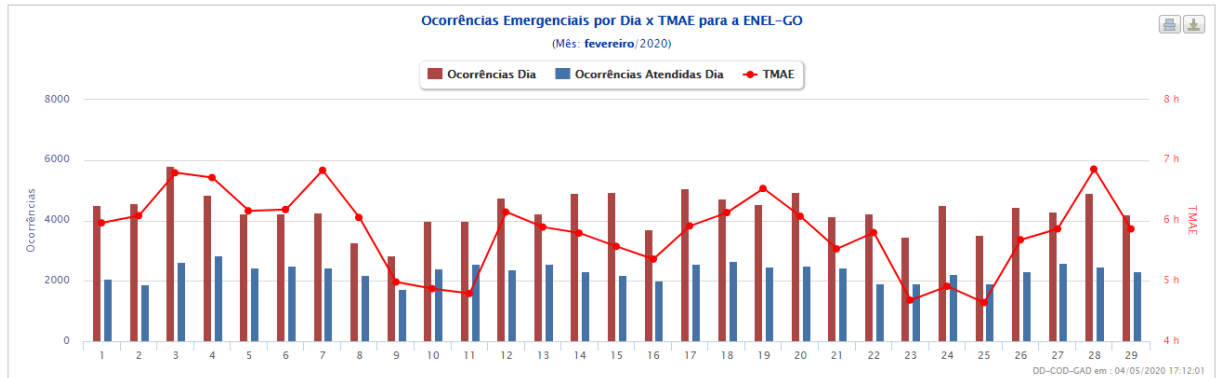
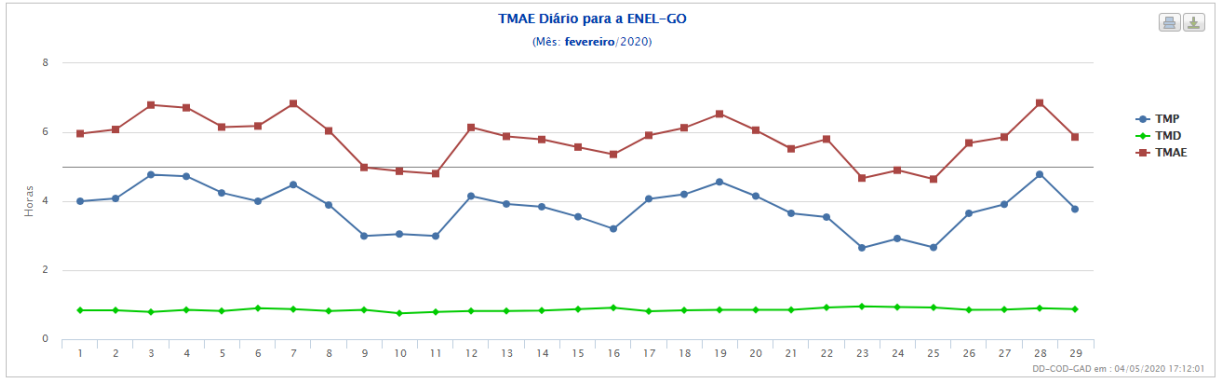

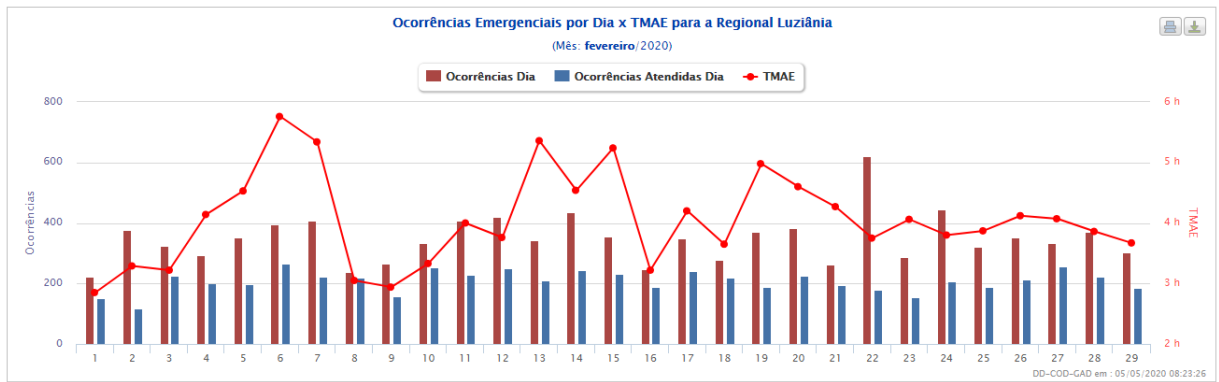
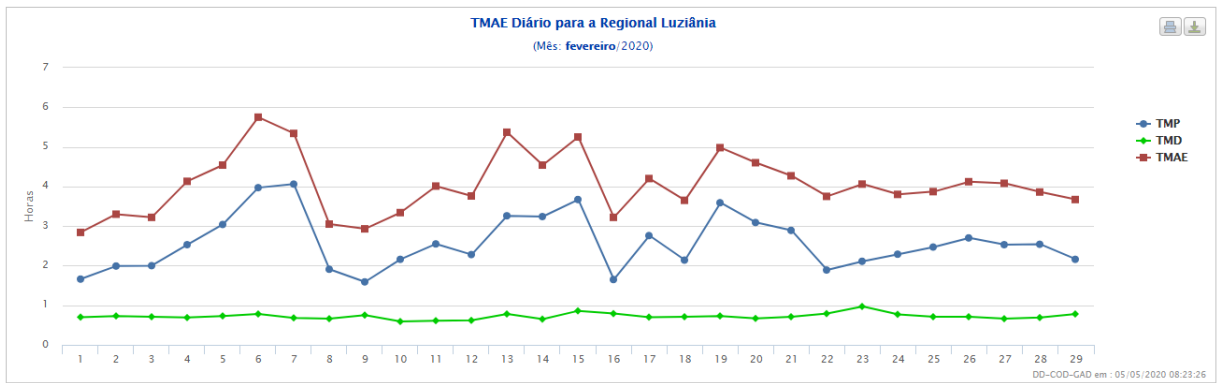
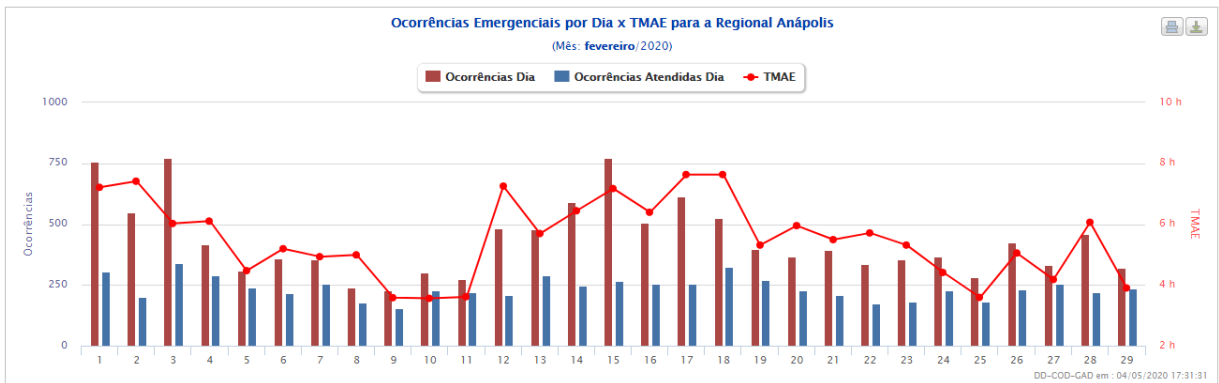
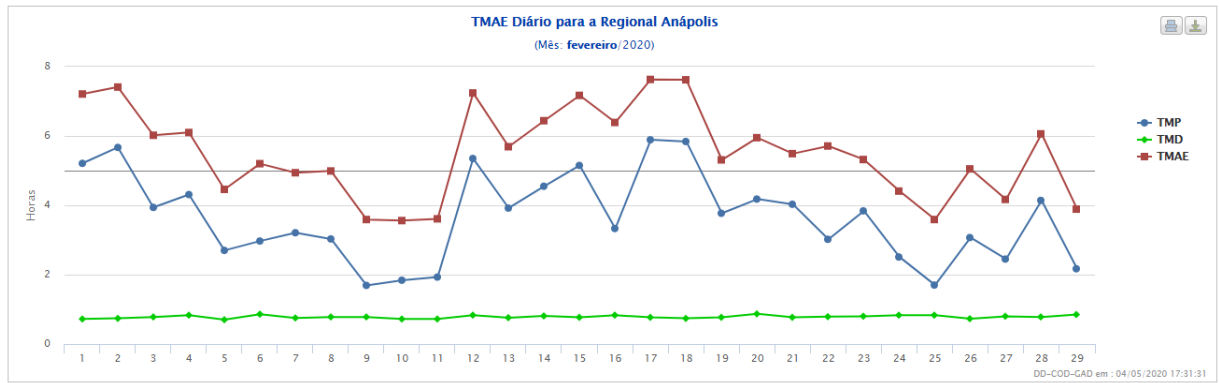

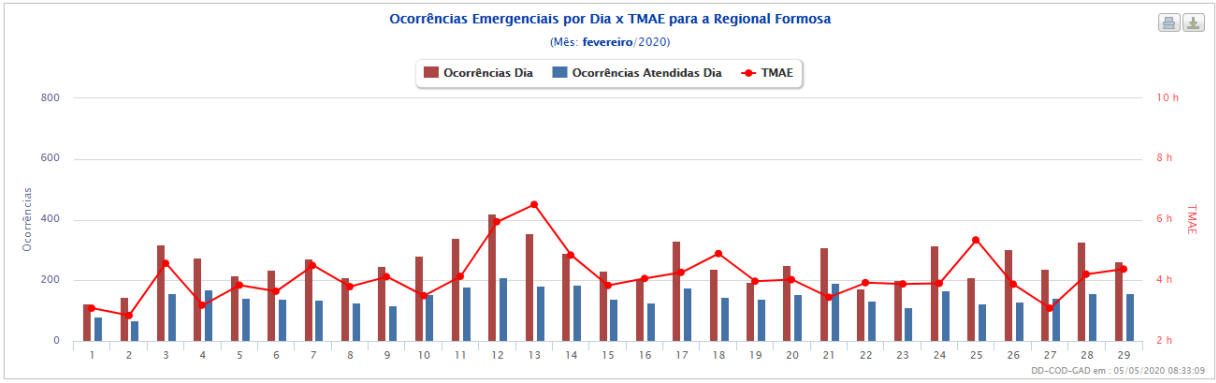
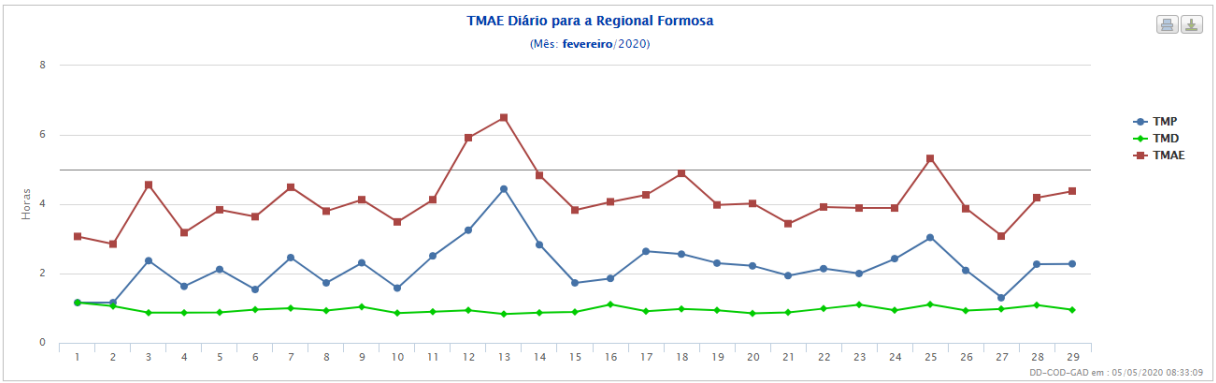
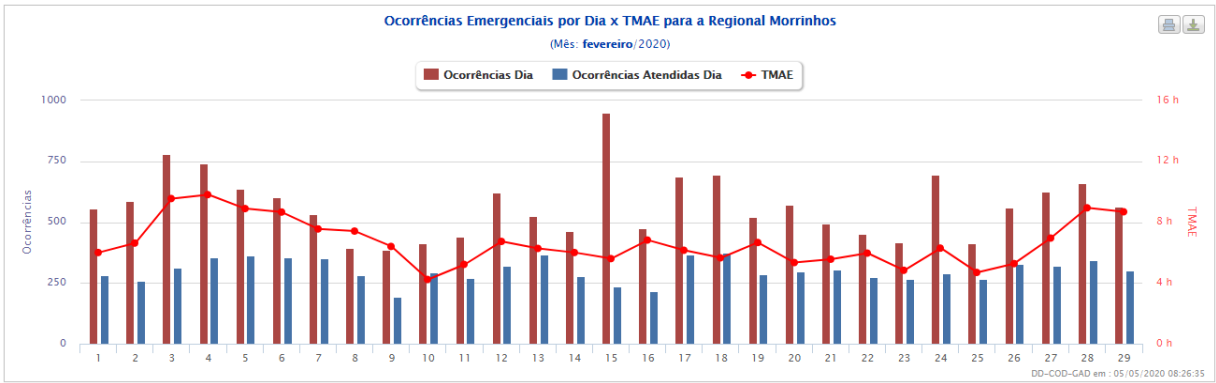
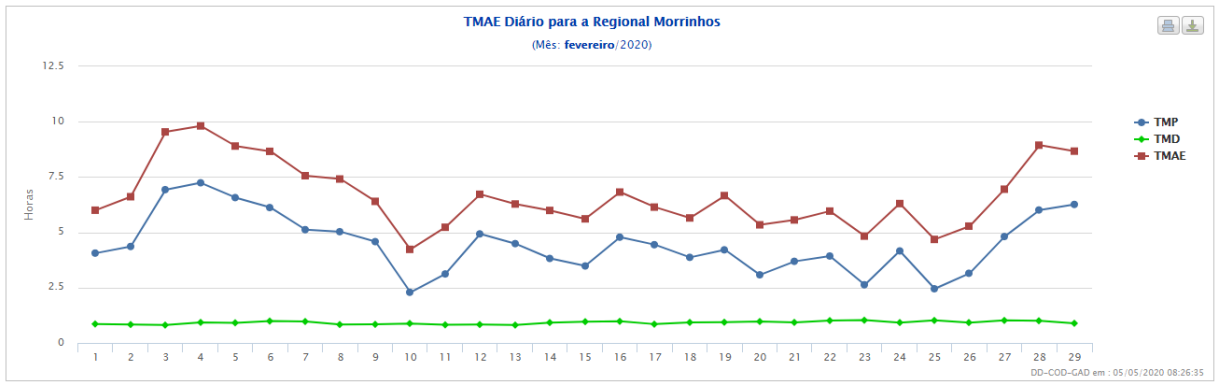

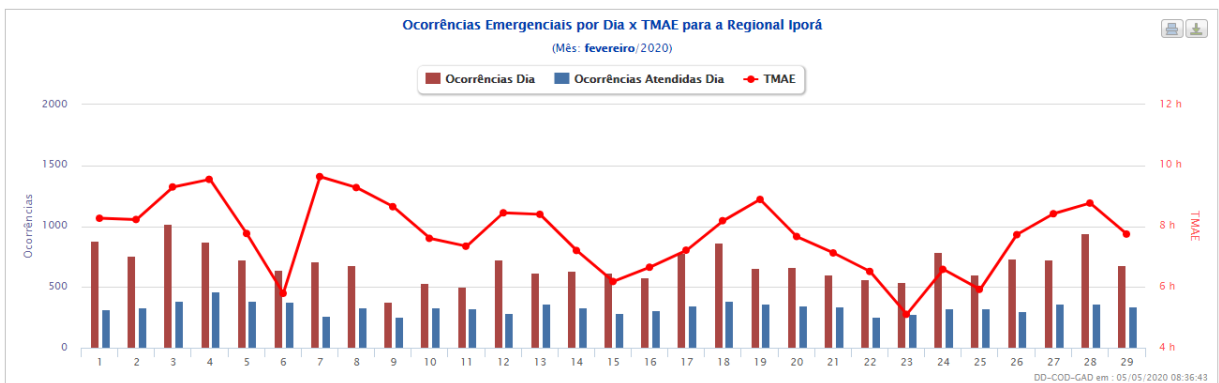
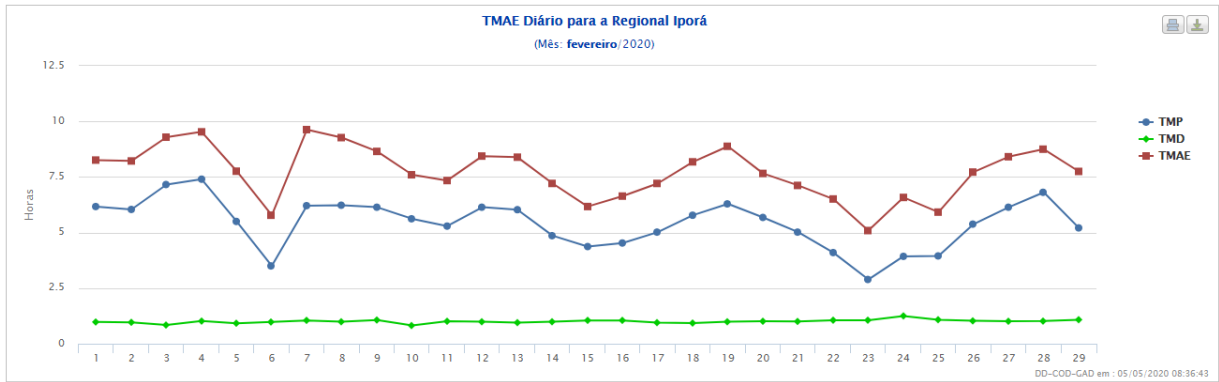
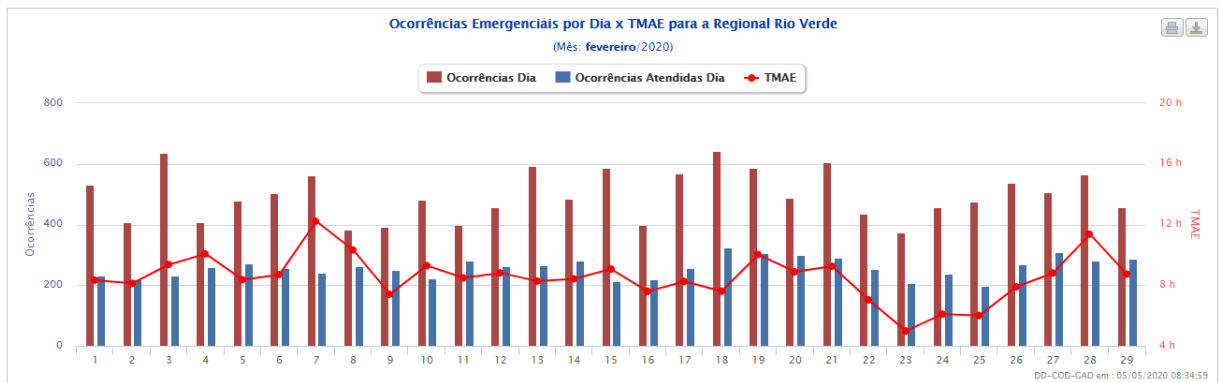
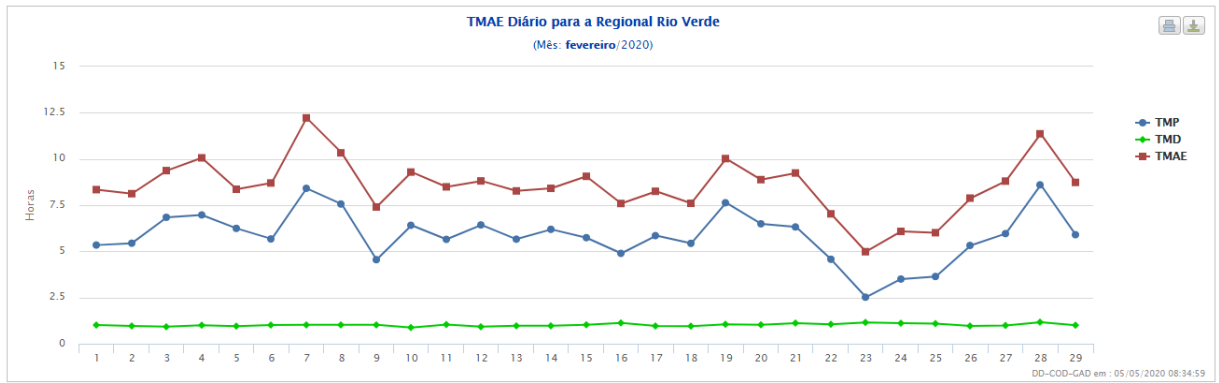

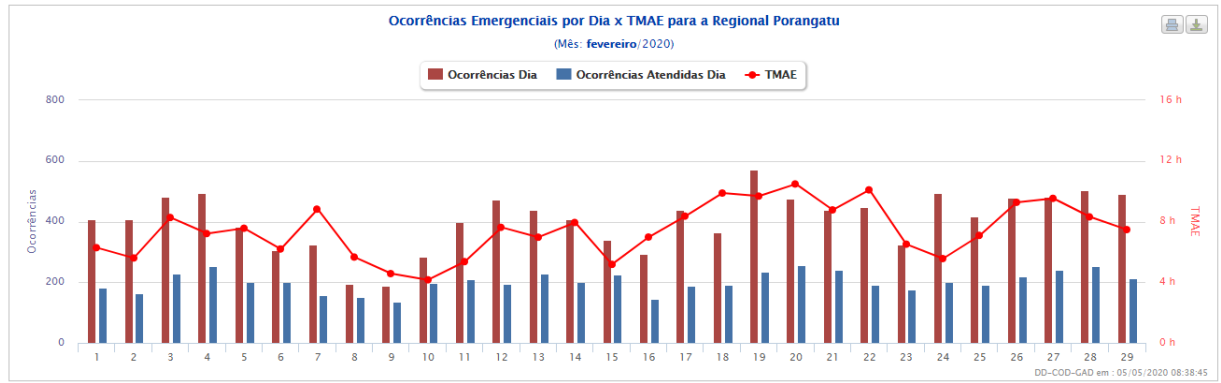
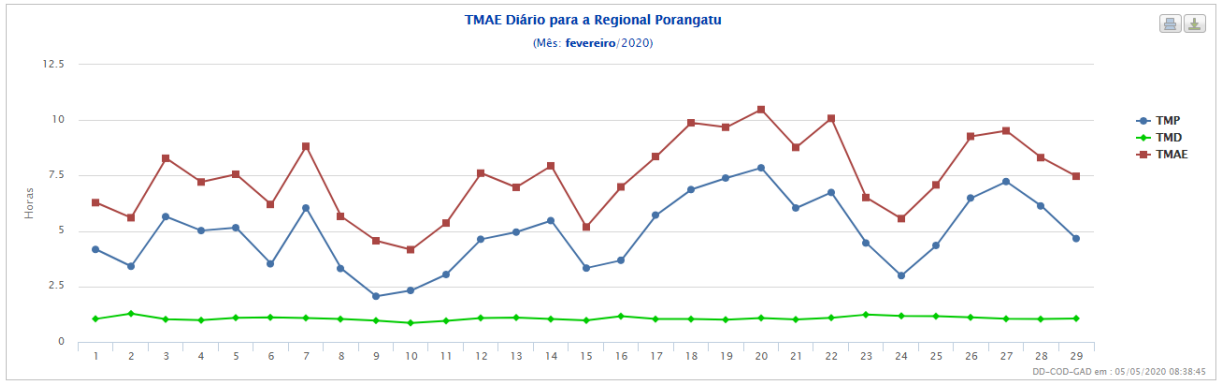

CLIMATEMPO

**Laudo Meteorológico de Evento Climático
- ENEL Goiás - 11 de Fevereiro de 2020**

São Paulo, SP, Brasil

Março de 2020

Sumário

1	ANÁLISE DE EVENTO METEOROLÓGICO	2
1.1	Descrição do Evento.....	2
1.2	Abrangência do Evento	5
2	CLASSIFICAÇÃO COBRADE	15
3	RESUMO DO EVENTO	16
4	REFERÊNCIAS.....	20

1 Análise de Evento Meteorológico

1.1 Descrição do Evento

Na figura a seguir é apresentada a área de concessão da ENEL DISTRIBUIÇÃO GOIÁS, dividida em regiões, a serem analisadas neste relatório.



Figura 1 – Regiões atendidas pela ENEL Goiás.

Áreas de instabilidade associadas à organização e manutenção de uma zona de convergência de umidade favoreceram a formação de nuvens de tempestade sobre o estado de Goiás a partir do dia 11 de fevereiro de 2020.

Nas Figuras 2 e 3 são apresentadas as descargas atmosféricas nuvem-solo (raios) e nuvem-nuvem detectadas pelo sistema Earth Networks. Entre as 11h00 do dia 11 e 01h45 do dia 14 de fevereiro de 2020 foram registrados 22019 raios nuvem-solo e 31013 descargas nuvem-nuvem sobre a área da ENEL DISTRIBUIÇÃO GOIÁS.

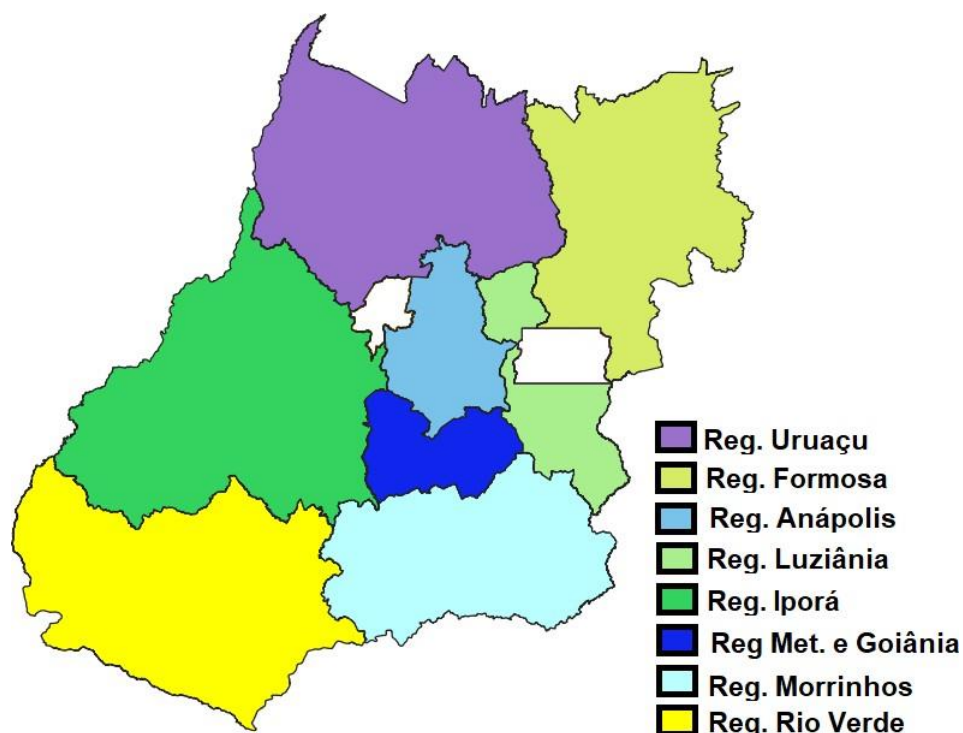

Figura 2 – Descargas atmosféricas nuvem-solo (em preto) detectadas pelo sistema Earth Networks entre 11h00 do dia 11 e 01h45 do dia 14 de fevereiro de 2020 sobre a área de concessão da CELG Distribuição.



Figura 3 – Descargas atmosféricas nuvem-nuvem (em vermelho) detectadas pelo sistema Earth Networks entre 11h00 do dia 11 e 01h45 do dia 14 de fevereiro de 2020 sobre a área de concessão da CELG Distribuição.

Estações do Instituto Nacional de Meteorologia (INMET), representativas da área de concessão da CELG Distribuição Goiás, registraram chuva forte (segundo a American Meteorological Society - Sociedade Meteorológica Americana -, chuvas com taxa entre 2,5mm a 7,6 mm por hora são consideradas moderadas e aquelas com taxa superior a 7,6 mm por hora são consideradas chuva forte). Na tabela 1 são apresentados os registros de acumulados horários superiores a 7,6 mm entre os dias 11 e 14 de fevereiro de 2020. Considerando os acumulados diários, entre as 09h00 do dia 12 e 09h00 do dia 13 foram acumulados 93,6 mm em Iporá, que corresponde a aproximadamente 47% da média climatológica para o mês de fevereiro na região. Entre as 09h00 do dia 13 e 09h00 do dia 14 de fevereiro foram acumulados 32,2 mm em Rio Verde, volume que corresponde a aproximadamente 15% da média do mês na região. Desse total, 30,6 mm se concentraram em apenas duas horas, entre as 17h e 19h do dia 13 de fevereiro.

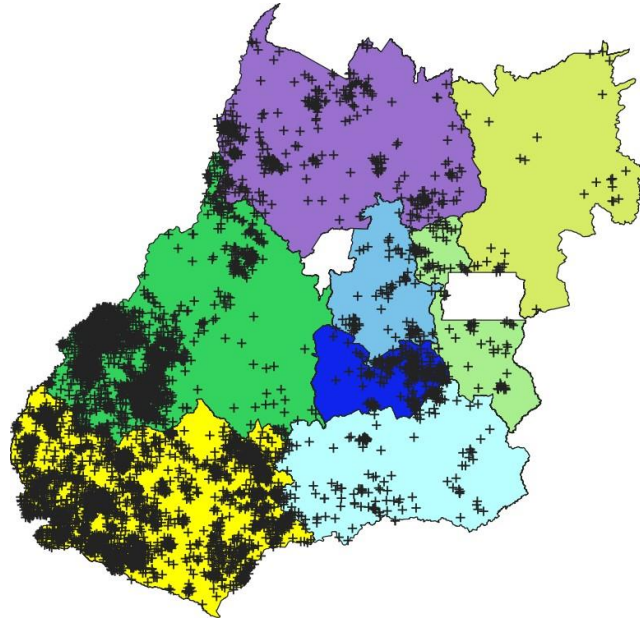
Na tabela 2 são apresentadas as rajadas de vento iguais ou superiores a 50 km/h registradas por estações do Instituto Nacional de Meteorologia (INMET) representativas da área de concessão da ENEL Distribuição Goiás. Como é possível observar, o maior valor registrado foi de 56,9 km/h na estação de Goiás entre as 14h e 15h do dia 12 de fevereiro, vento classificado como vento forte pela escala Beaufort.

Tabela 1 – Acumulado horário de chuva registrada pelo INMET.

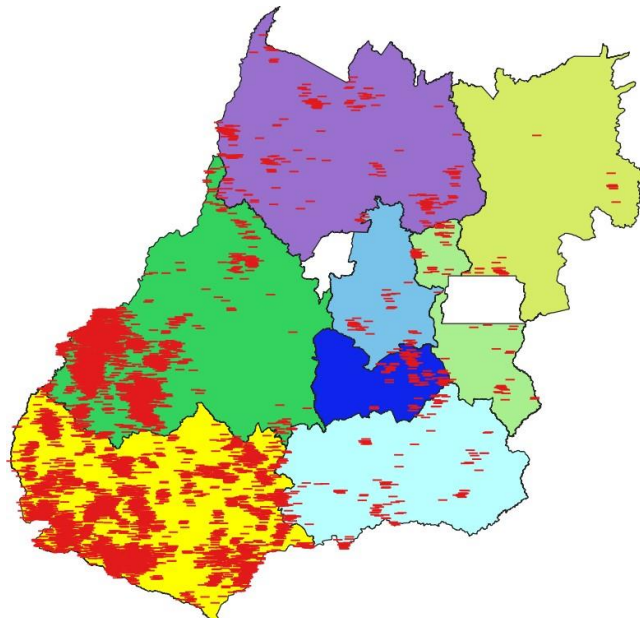
Estação	Horário	Precipitação (mm)
Aragarças	Entre 18h e 19h do dia 11/2/2020	9.6
Iporá	Entre 13h e 14h do dia 12/2/2020	13.8
Alto Araguaia	Entre 14h e 15h do dia 12/2/2020	14.6
Iporá	Entre 17h e 18h do dia 12/2/2020	12.2
Paraúna	Entre 17h e 18h do dia 12/2/2020	22.8
Goianésia	Entre 18h e 19h do dia 12/2/2020	14
Iporá	Entre 18h e 19h do dia 12/2/2020	46.4
Iporá	Entre 20h e 21h do dia 12/2/2020	11.4
Silvânia	Entre 22h e 23h do dia 12/2/2020	30.0
Monte Alegre de Goiás	Entre 16h e 17h do dia 13/2/2020	17.6
Alto Araguaia	Entre 17h e 18h do dia 13/2/2020	22.2
Rio Verde	Entre 17h e 18h do dia 13/2/2020	21.4
Rio Verde	Entre 18h e 19h do dia 13/2/2020	9.2

Tabela 2 – Rajadas de vento maiores ou iguais a 50 km/h registradas pelo INMET. Segundo a escala Beaufort, ventos entre 50 e 61 km/h são classificados como vento forte.

Estação	Horário	Rajada (km/h)
Goiás	Entre 14h e 15h do dia 12/2/2020	56.9
Goiás	Entre 15h e 16h do dia 12/2/2020	56.5
Itumbiara	Entre 19h e 20h do dia 12/2/2020	55.4

1.2 Abrangência do Evento

A seguir são apresentadas as imagens realçadas do satélite GOES-16 entre as 15h00 do dia 11 e 00h00 do dia 14 de fevereiro de 2020. Os tons em vermelho e preto indicam a presença de nuvens de grande desenvolvimento vertical, geralmente associadas à ocorrência de tempo severo.

15h00 - 11 de Fevereiro de 2020



Figura 4 – Imagens realçadas do satélite GOES-16 das 15h00 do dia 11 de Fevereiro de 2020.
FONTE: Cptec/INPE.

18h00 - 11 de Fevereiro de 2020

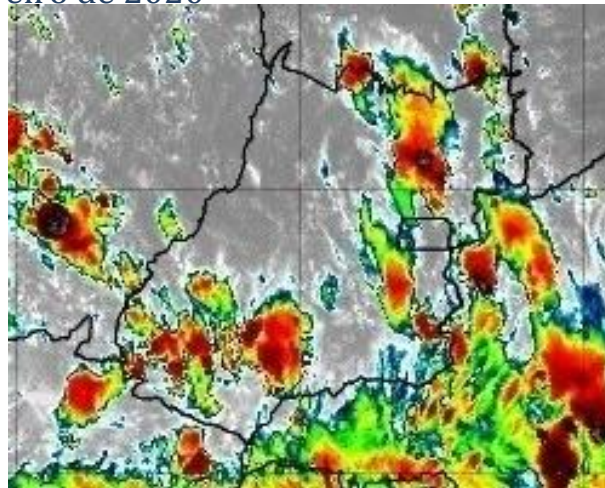

Figura 5 – Imagens realçadas do satélite GOES-16 das 18h00 do dia 11 de Fevereiro de 2020.
FONTE: Cptec/INPE.

21h00 - 11 de Fevereiro de 2020

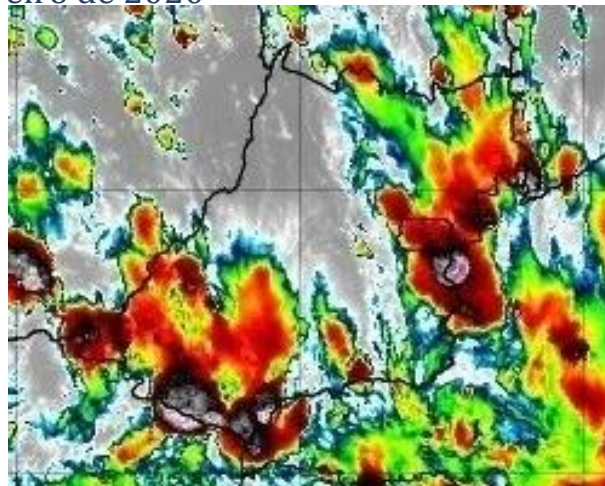

Figura 6 – Imagens realçadas do satélite GOES-16 das 21h00 do dia 11 de Fevereiro de 2020. FONTE: Cptec/INPE.

0h00 - 12 de Fevereiro de 2020

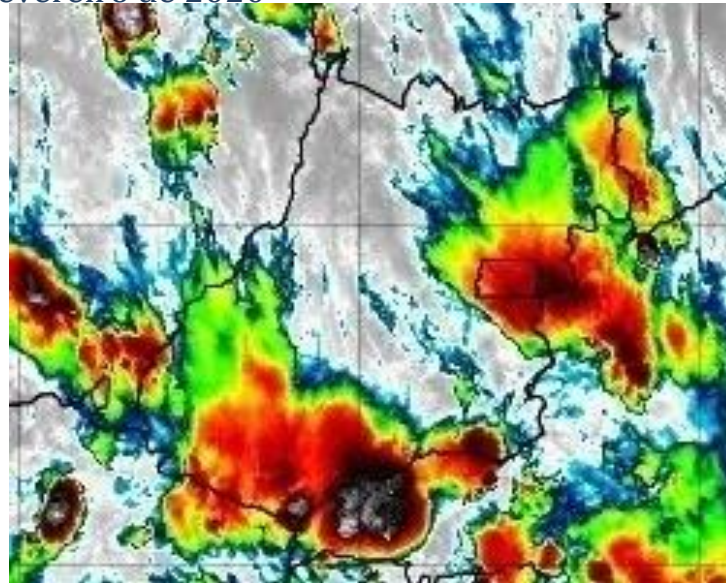

Figura 7 – Imagens realçadas do satélite GOES-16 das 0h00 do dia 12 de Fevereiro de 2020. FONTE: Cptec/INPE.

3h00 - 12 de Fevereiro de 2020

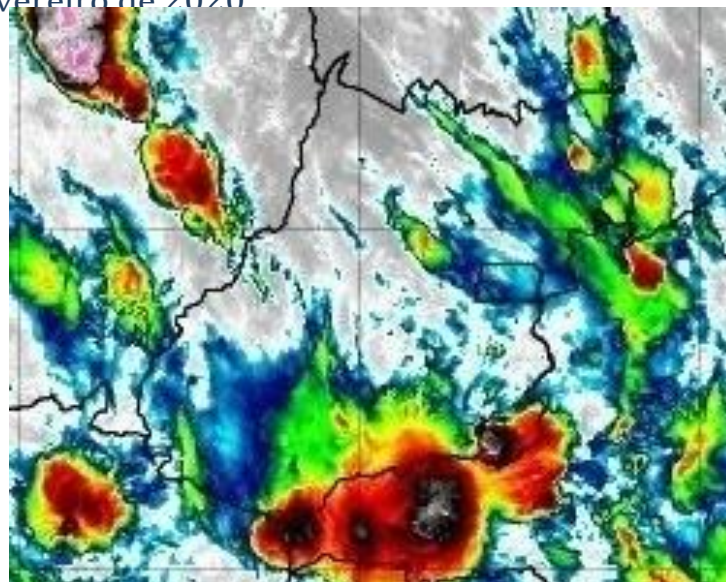

Figura 8 – Imagens realçadas do satélite GOES-16 das 3h00 do dia 12 de Fevereiro de 2020. FONTE: Cptec/INPE.

6h00 - 12 de Fevereiro de 2020

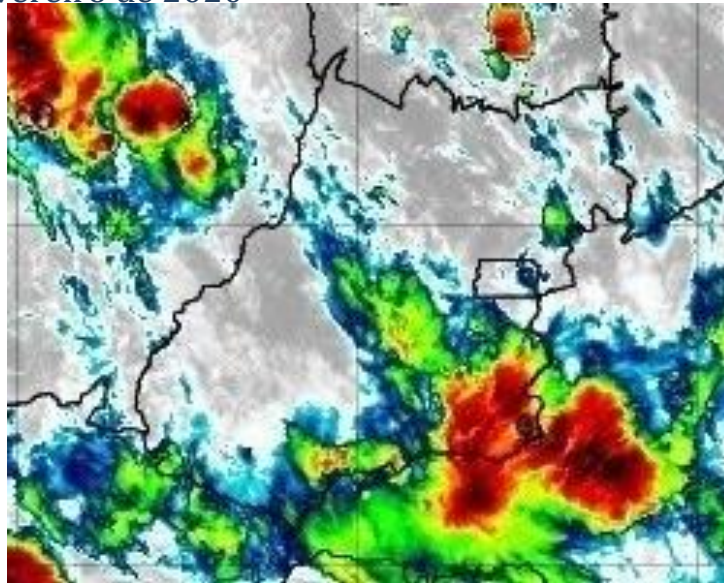

Figura 9 – Imagens realçadas do satélite GOES-16 das 6h00 do dia 12 de Fevereiro de 2020. FONTE: Cptec/INPE.

9h00 - 12 de Fevereiro de 2020

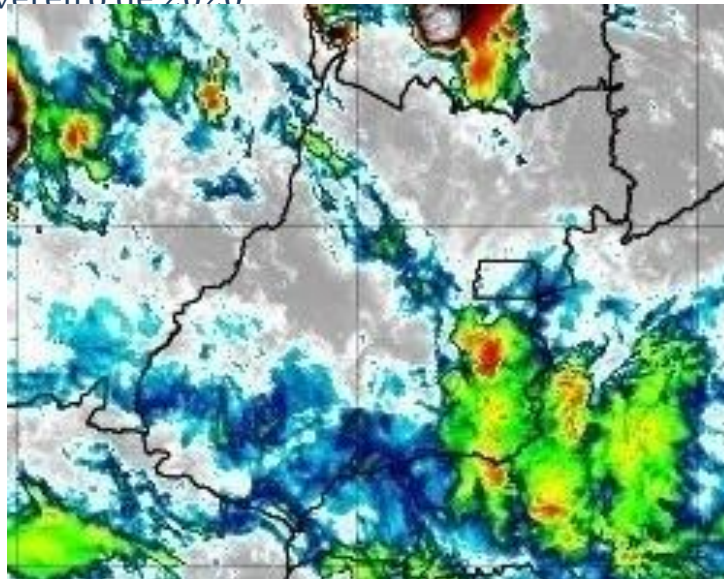

Figura 10 – Imagens realçadas do satélite GOES-16 das 9h00 do dia 12 de Fevereiro de 2020.
FONTE: Cptec/INPE.

12h00 - 12 de Fevereiro de 2020

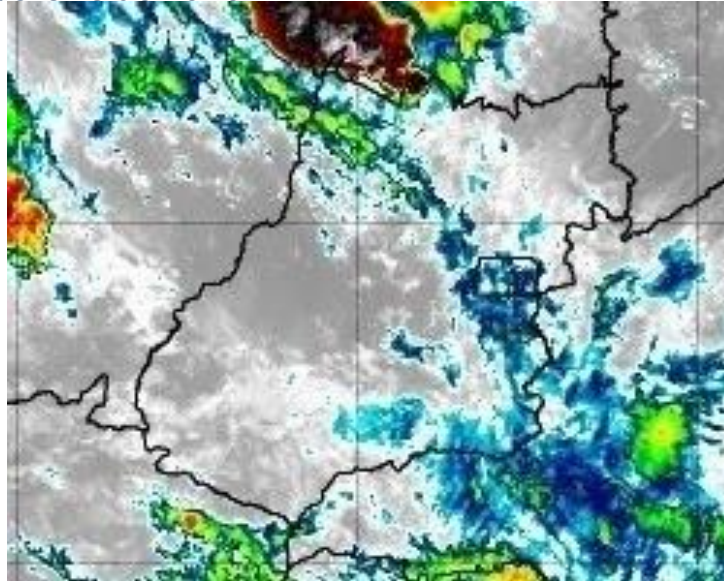

Figura 11 – Imagens realçadas do satélite GOES-16 das 12h00 do dia 12 de Fevereiro de 2020.
FONTE: Cptec/INPE.

15h00 - 12 de Fevereiro de 2020

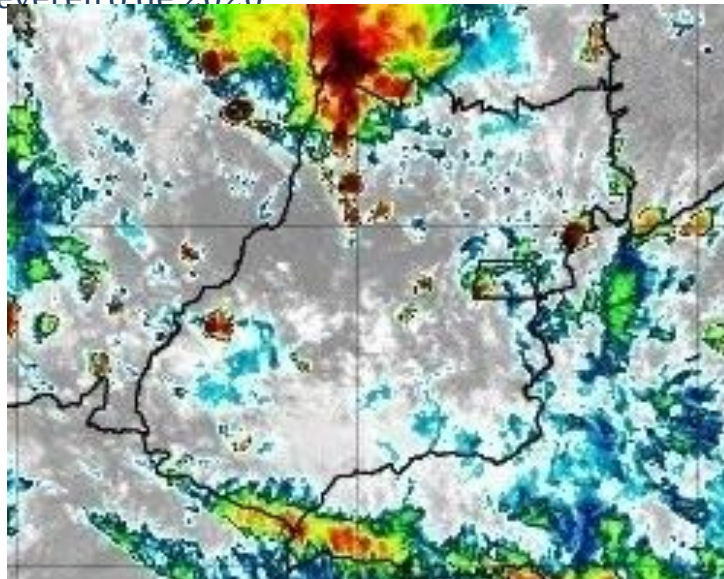

Figura 12 – Imagens realçadas do satélite GOES-16 das 15h00 do dia 12 de Fevereiro de 2020.
FONTE: Cptec/INPE.

18h00 - 12 de Fevereiro de 2020

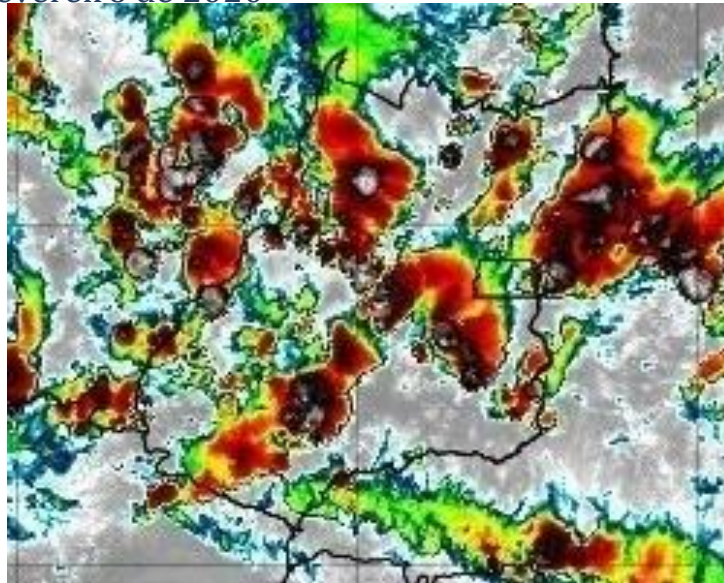

Figura 13 – Imagens realçadas do satélite GOES-16 das 18h00 do dia 12 de Fevereiro de 2020.
FONTE: Cptec/INPE.

21h00 - 12 de Fevereiro de 2020

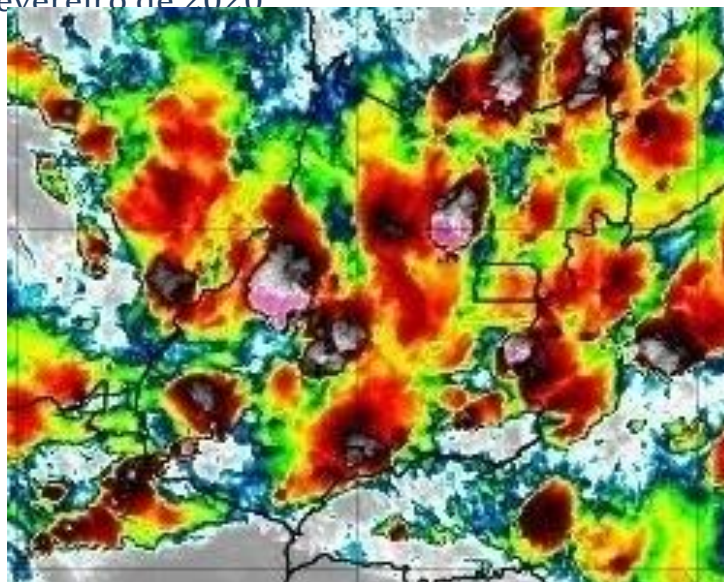

Figura 14 – Imagens realçadas do satélite GOES-16 das 21h00 do dia 12 de Fevereiro de 2020.
FONTE: Cptec/INPE.

0h00 - 13 de Fevereiro de 2020

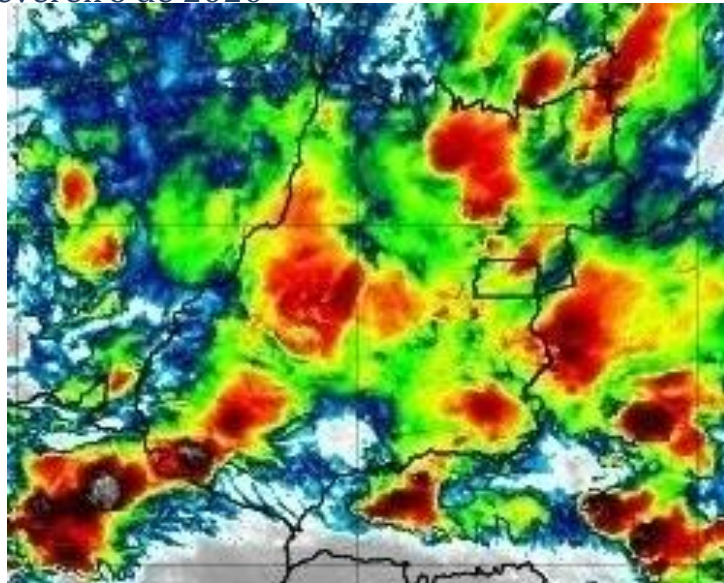

Figura 15 – Imagens realçadas do satélite GOES-16 das 0h00 do dia 13 de Fevereiro de 2020.
FONTE: Cptec/INPE.

3h00 - 13 de Fevereiro de 2020

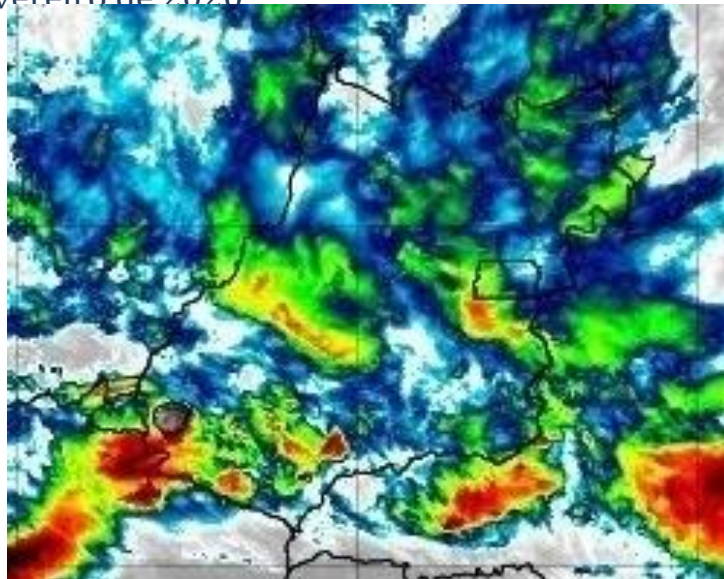

Figura 16 – Imagens realçadas do satélite GOES-16 das 3h00 do dia 13 de Fevereiro de 2020.
FONTE: Cptec/INPE.

6h00 - 13 de Fevereiro de 2020

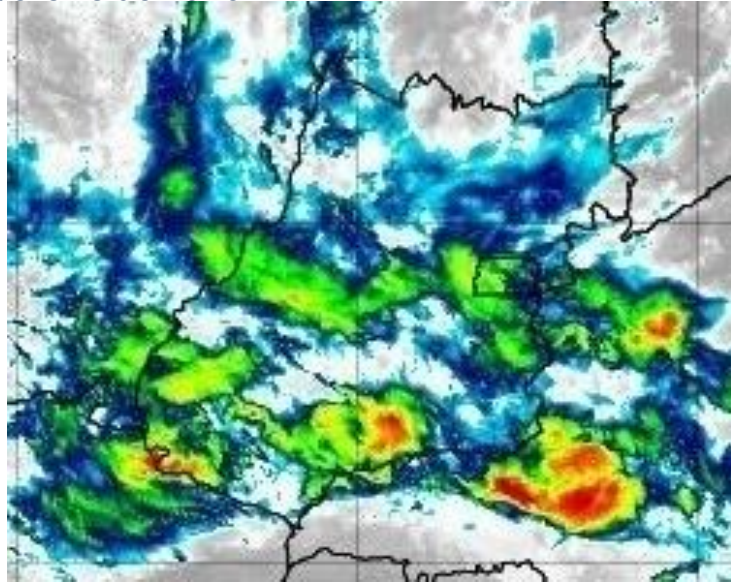

Figura 17 – Imagens realçadas do satélite GOES-16 das 6h00 do dia 13 de Fevereiro de 2020.
FONTE: Cptec/INPE.

9h00 - 13 de Fevereiro de 2020

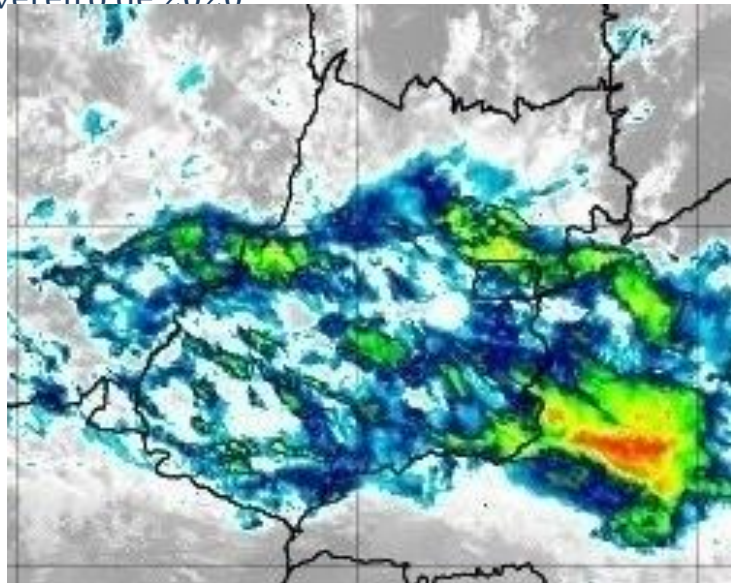

Figura 18 – Imagens realçadas do satélite GOES-16 das 9h00 do dia 13 de Fevereiro de 2020.
FONTE: Cptec/INPE.

12h00 - 13 de Fevereiro de 2020

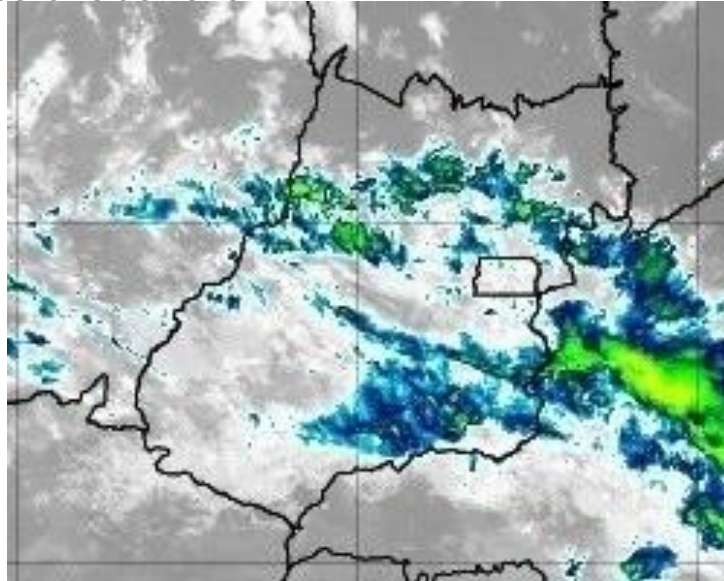

Figura 19 – Imagens realçadas do satélite GOES-16 das 12h00 do dia 13 de Fevereiro de 2020.
FONTE: Cptec/INPE.

15h00 - 13 de Fevereiro de 2020

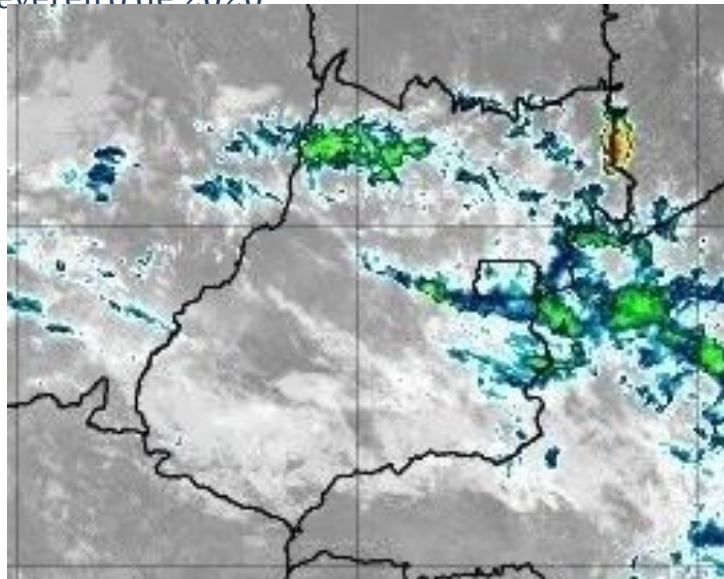

Figura 20 – Imagens realçadas do satélite GOES-16 das 15h00 do dia 13 de Fevereiro de 2020.
FONTE: Cptec/INPE.

18h00 - 13 de Fevereiro de 2020

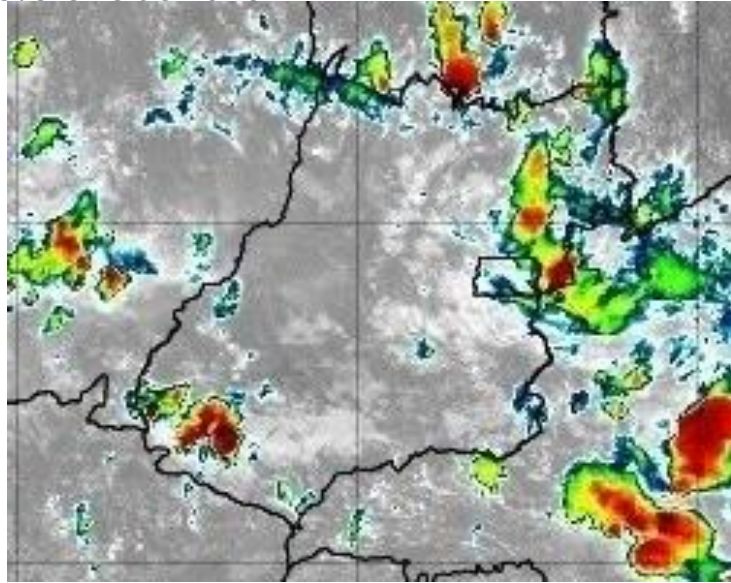

Figura 21 – Imagens realçadas do satélite GOES-16 das 18h00 do dia 13 de Fevereiro de 2020.
FONTE: Cptec/INPE.

21h00 - 13 de Fevereiro de 2020

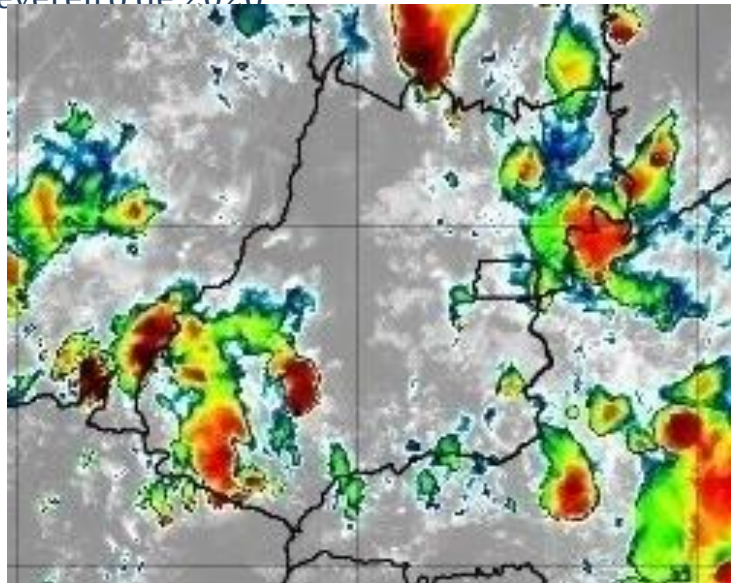

Figura 22 – Imagens realçadas do satélite GOES-16 das 21h00 do dia 13 de Fevereiro de 2020.
FONTE: Cptec/INPE.

0h00 - 14 de Fevereiro de 2020

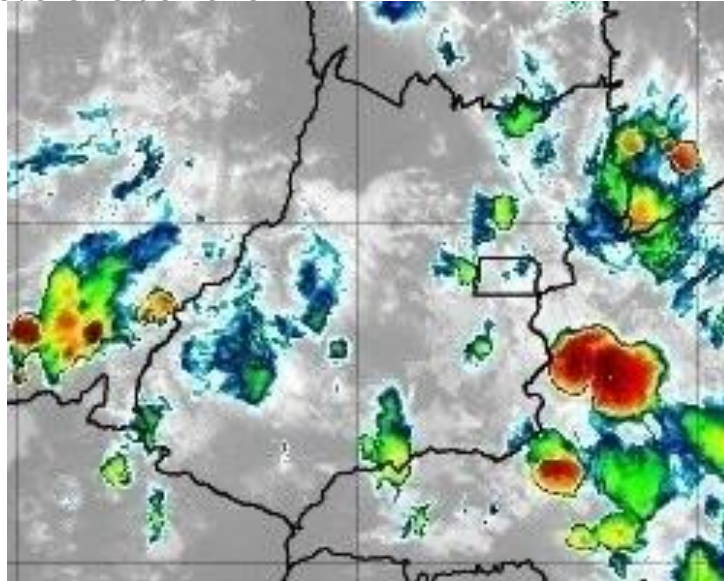

Figura 23 – Imagens realçadas do satélite GOES-16 das 0h00 do dia 14 de Fevereiro de 2020.
FONTE: Cptec/INPE.

2 Classificação COBRADE

O COBRADE (Classificação e Codificação Brasileira de Desastres) foi criado com o intuito de adequar a classificação brasileira à classificação utilizada pela ONU na classificação de desastres e nivelar o país aos demais organismos de gestão de desastres do mundo.

Baseados nos dados analisados nos itens anteriores, podemos classificar o evento ocorrido sobre a área de concessão da ENEL Distribuição Goiás como Zona de Convergência (Código 1.3.1.2.0).

3 Resumo do Evento

Uma zona de convergência de umidade favoreceu a formação de nuvens de tempestade sobre o estado de Goiás entre a manhã do dia 11 e a madrugada do dia 14 de fevereiro de 2020.

O sistema de detecção da EarthNetworks registrou 53032 descargas atmosféricas sobre a área de concessão da ENEL em Goiás entre as 11h00 do dia 11 e 01h45 do dia 14 de fevereiro de 2020.

Rajadas de vento forte foram registrados pelo INMET. Na cidade de Goiás ocorreram ventos de até 56,9 km/h entre as 14h e 15h do dia 12 de fevereiro de 2020.

Chuva forte e volumosa foi registrada pelo INMET em estações representativas da área de concessão da ENEL Distribuição Goiás. Na estação de Iporá foram acumulados 46,4 mm de chuva entre as 18h e 19h do dia 12 de fevereiro, volume que corresponde a aproximadamente 23% da média climatológica para o mês de fevereiro na região. Entre as 09h do dia 12 e 09h do dia 13 de fevereiro foram acumulados o correspondente a 47% da média climatológica para o mês na região. Em Rio Verde, entre as 09h00 do dia 13 e 09h00 do dia 14 de fevereiro foram acumulados 32,2 mm em Rio Verde, volume que corresponde a aproximadamente 15% da média do mês na região.

Tabela 3 – Resumo do evento Regional Rio Verde

Número/Código do Evento	
Número/Código do Relatório	
Descrição	Região ligada à tempestade causada por uma zona de baixa pressão atmosférica, provocando forte deslocamento de massas de ar, vendavais, chuvas intensa e possível queda de granizo.
Código COBRADE	1.3.1.2.0 – Zona de Convergência
Hora início do evento	12h30 do dia 11 de fevereiro de 2020
Hora de fim do evento	20h30 do dia 13 de fevereiro
Abrangência	Regional Rio Verde

Tabela 4 – Resumo do evento Regional Morrinhos

Número/Código do Evento	
Número/Código do Relatório	
Descrição	Região ligada à tempestade causada por uma zona de baixa pressão atmosférica, provocando forte deslocamento de massas de ar, vendavais, chuvas intensa e possível queda de granizo.
Código COBRADE	1.3.1.2.0 – Zona de Convergência
Hora início do evento	12h30 do dia 11 de fevereiro de 2020
Hora de fim do evento	00h00 do dia 14 de fevereiro
Abrangência	Regional Morrinhos

Tabela 5 – Resumo do evento Regional Metropolitana e Goiânia

Número/Código do Evento	
Número/Código do Relatório	
Descrição	Região ligada à tempestade causada por uma zona de baixa pressão atmosférica, provocando forte deslocamento de massas de ar, vendavais, chuvas intensa e possível queda de granizo.
Código COBRADE	1.3.1.2.0 – Zona de Convergência
Hora início do evento	14h20 do dia 11 de fevereiro de 2020
Hora de fim do evento	19h00 do dia 13 de fevereiro
Abrangência	Regional Metropolitana e Goiânia

Tabela 6 – Resumo do evento Regional Iporá

Número/Código do Evento	
Número/Código do Relatório	
Descrição	Região ligada à tempestade causada por uma zona de baixa pressão atmosférica, provocando forte deslocamento de massas de ar, vendavais, chuvas intensa e possível queda de granizo.
Código COBRADE	1.3.1.2.0 – Zona de Convergência
Hora início do evento	11h30 do dia 11 de fevereiro de 2020
Hora de fim do evento	20h00 do dia 12 de fevereiro
Abrangência	Regional Iporá

Tabela 7 – Resumo do evento Regional Luziânia

Número/Código do Evento	
Número/Código do Relatório	
Descrição	Região ligada à tempestade causada por uma zona de baixa pressão atmosférica, provocando forte deslocamento de massas de ar, vendavais, chuvas intensa e possível queda de granizo.
Código COBRADE	1.3.1.2.0 – Zona de Convergência
Hora início do evento	11h30 do dia 11 de fevereiro de 2020
Hora de fim do evento	22h30 do dia 13 de fevereiro
Abrangência	Regional Luziânia

Tabela 8 – Resumo do evento Regional Anápolis

Número/Código do Evento	
Número/Código do Relatório	
Descrição	Região ligada à tempestade causada por uma zona de baixa pressão atmosférica, provocando forte deslocamento de massas de ar, vendavais, chuvas intensa e possível queda de granizo.
Código COBRADE	1.3.1.2.0 – Zona de Convergência
Hora início do evento	11h00 do dia 11 de fevereiro de 2020
Hora de fim do evento	22h30 do dia 13 de fevereiro
Abrangência	Regional Anápolis

Tabela 9 – Resumo do evento Regional Uruaçu

Número/Código do Evento	
Número/Código do Relatório	
Descrição	Região ligada à tempestade causada por uma zona de baixa pressão atmosférica, provocando forte deslocamento de massas de ar, vendavais, chuvas intensa e possível queda de granizo.
Código COBRADE	1.3.1.2.0 – Zona de Convergência
Hora início do evento	12h00 do dia 11 de fevereiro de 2020
Hora de fim do evento	19h00 do dia 13 de fevereiro
Abrangência	Regional Uruaçu

Tabela 10 – Resumo do evento Regional Formosa

Número/Código do Evento	
Número/Código do Relatório	
Descrição	Região ligada à tempestade causada por uma zona de baixa pressão atmosférica, provocando forte deslocamento de massas de ar, vendavais, chuvas intensa e possível queda de granizo.
Código COBRADE	1.3.1.2.0 – Zona de Convergência
Hora início do evento	11h00 do dia 11 de fevereiro de 2020
Hora de fim do evento	02h00 do dia 14 de fevereiro
Abrangência	Regional Formosa

4 Referências

- RMetS Royal Meteorological Society – Beaufort Scale - <https://www.rmets.org/weather-and-climate/observing/beaufort-scale>

- Instituto Nacional de Meteorologia (INMET) - <http://www.inmet.gov.br>

- Cptec/INPE- <https://www.cptec.inpe.br/>

- Centro de Hidrografia da Marinha do Brasil - <https://www.marinha.mil.br/chm/>

- Meteorology Glossary - American Meteorological Society -
<http://glossary.ametsoc.org/>

Anexos

A.1 Carta Sinótica



Figura A1 - Carta sinótica para as 1200Z do dia 11 de fevereiro de 2020 (09h00 do dia 11 de fevereiro de 2020 hora local. FONTE: Marinha do Brasil).



Figura A2 - Carta sinótica para as 1200Z do dia 12 de fevereiro de 2020 (09h00 do dia 12 de fevereiro de 2020 hora local. FONTE: Marinha do Brasil).

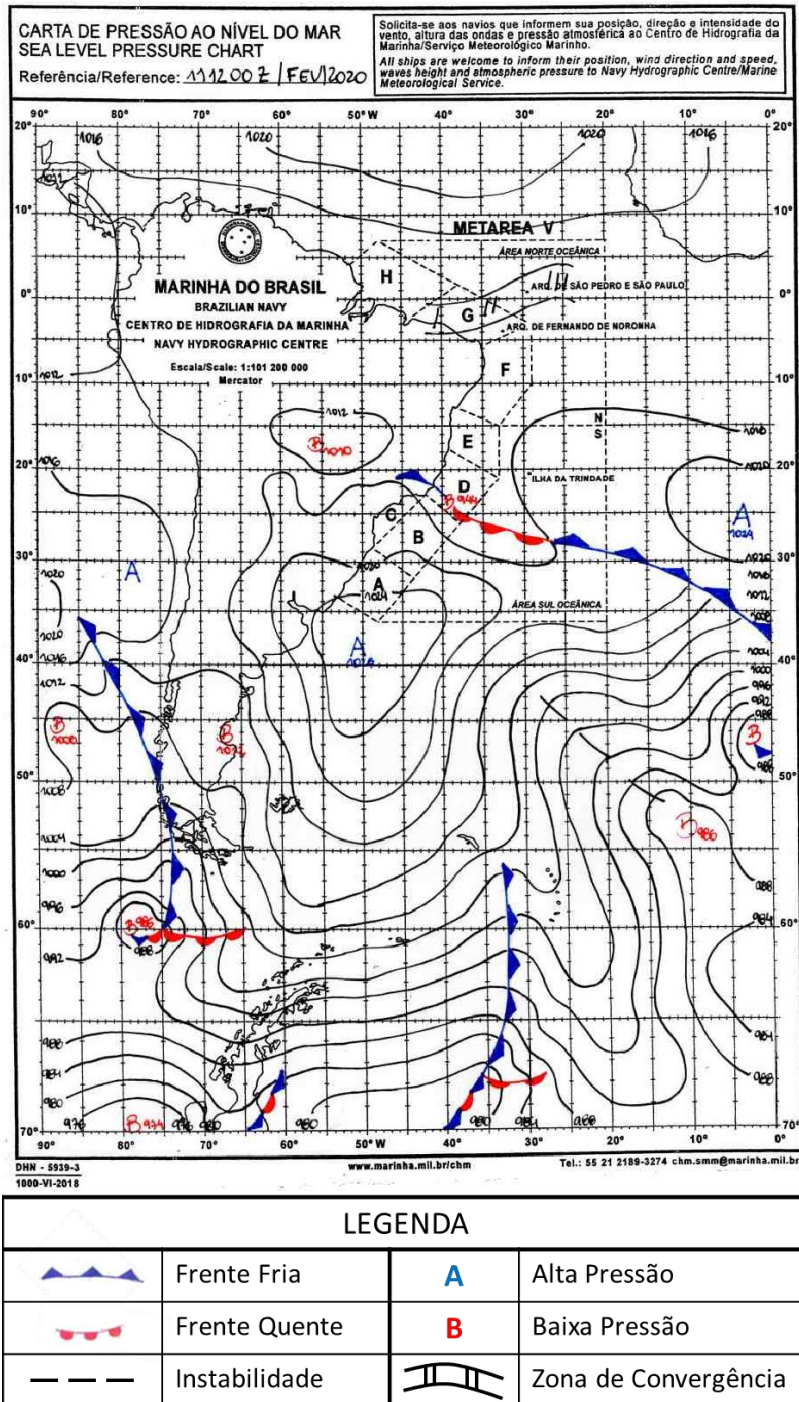

LEGENDA			
	Frente Fria	A	Alta Pressão
	Frente Quente	B	Baixa Pressão
	Instabilidade		Zona de Convergência

Figura A3 - Carta sinótica para as 1200Z do dia 13 de fevereiro de 2020 (09h00 do dia 13 de fevereiro de 2020 hora local. FONTE: Marinha do Brasil).

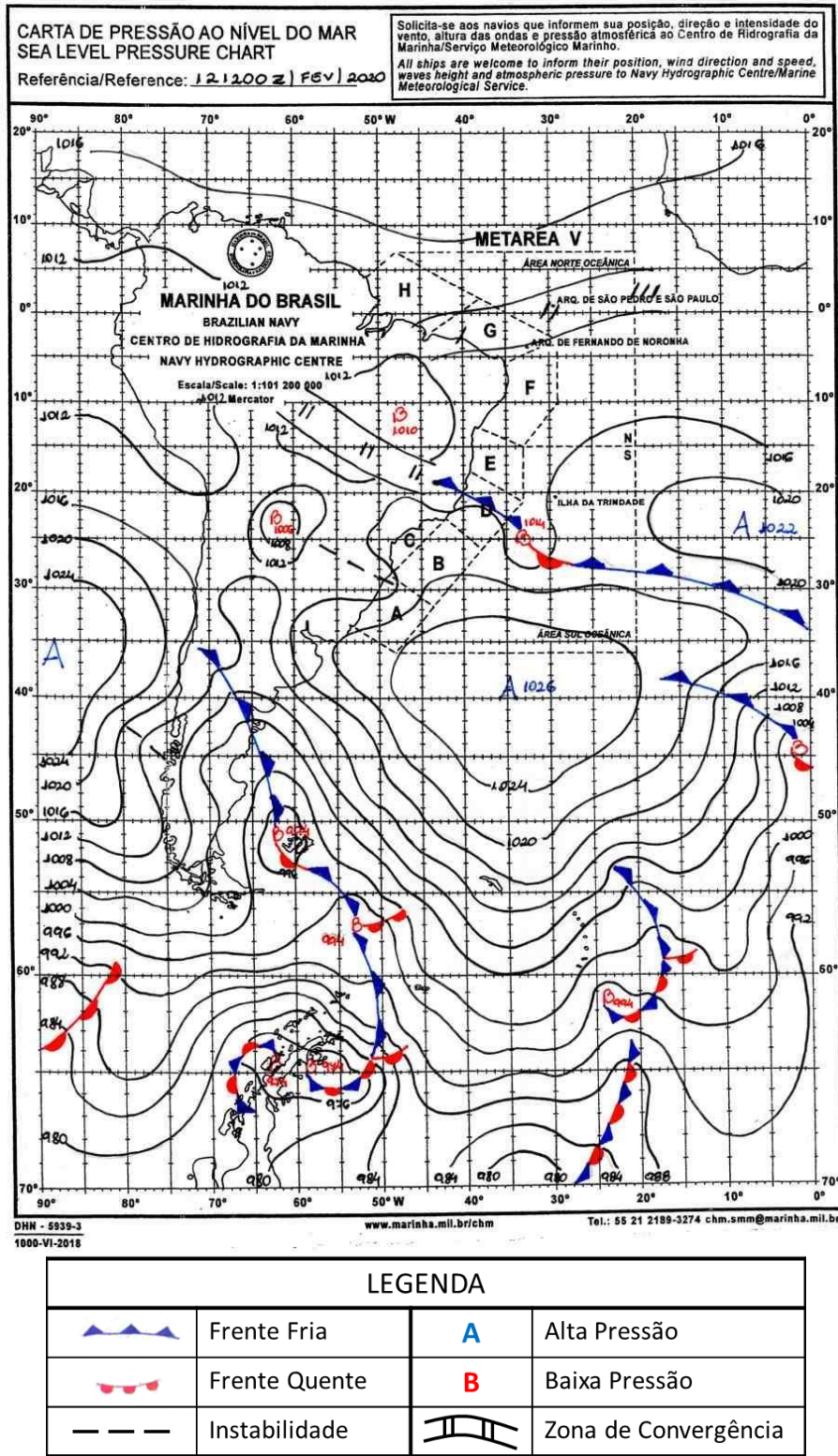
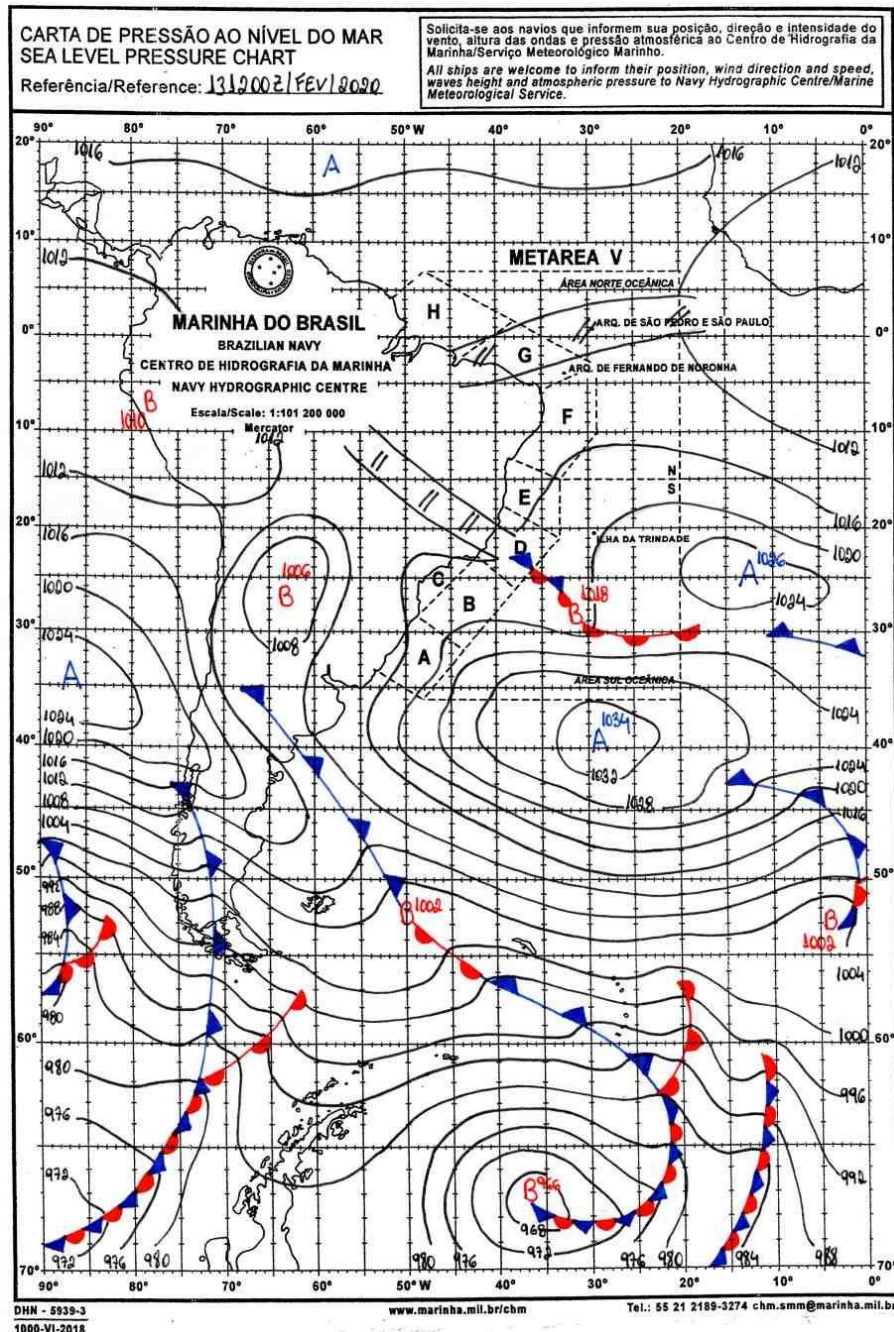
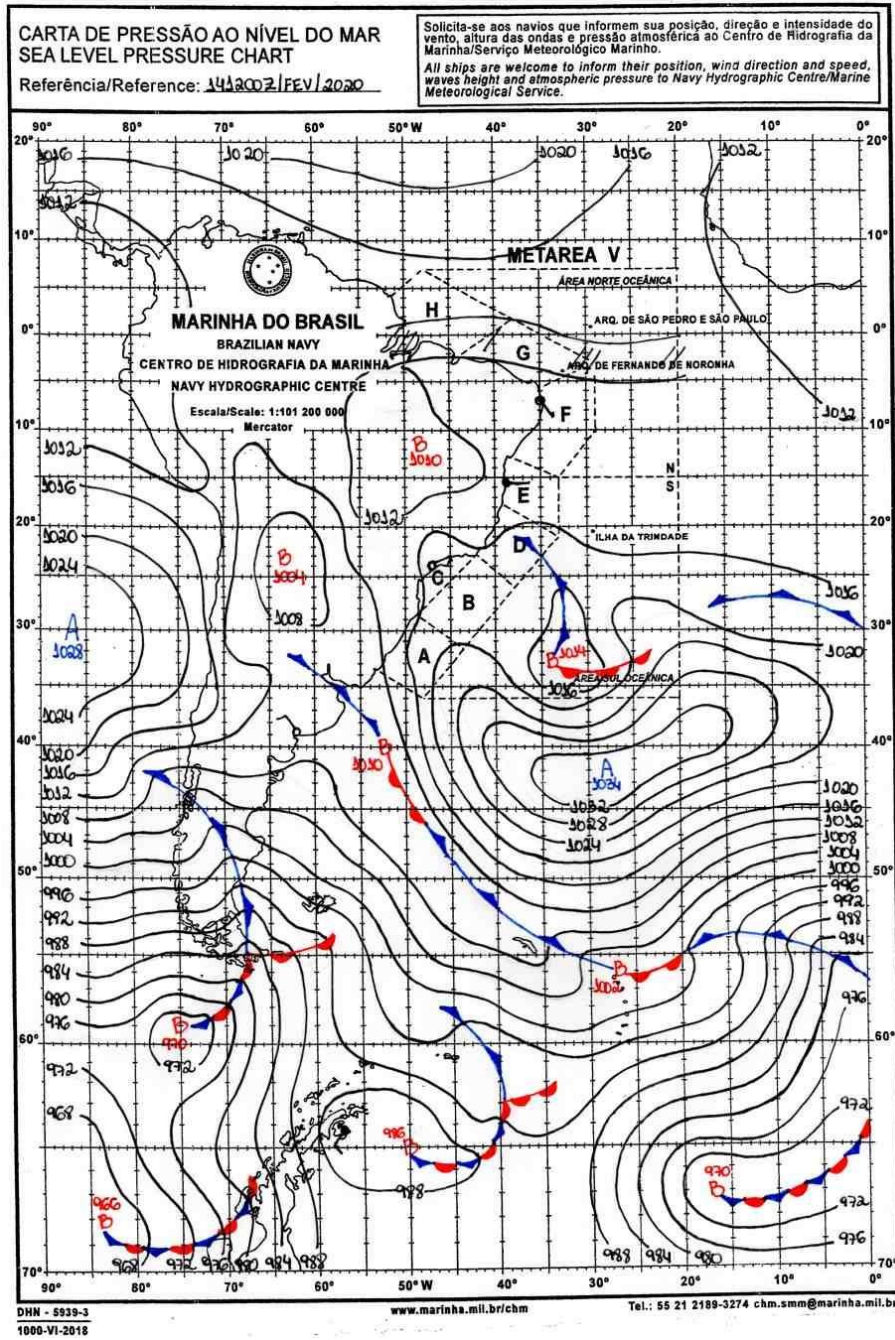

LEGENDA			
	Frente Fria	A	Alta Pressão
	Frente Quente	B	Baixa Pressão
	Instabilidade		Zona de Convergência

Figura A4 - Carta sinótica para as 1200Z do dia 14 de fevereiro de 2020 (09h00 do dia 14 de fevereiro de 2020 hora local. FONTE: Marinha do Brasil).

A.2 Notícias associadas

-Chuva provoca cheia do rio claro, moradores sofre prejuízos em condomínios em Montes Claros de Goiás.

<https://rioclaronews.com.br/noticia/388/chuva-provoca-cheia-do-rio-claro-moradores-sofre-prejuizos-em-condominios-em-montes-claros-de-goias.html>

- Carro com quatro pessoas é 'engolido' por cratera aberta pela chuva na Rodovia da Fé

<https://excelencianoticias.com.br/2020/02/13/carro-com-quatro-pessoas-e-engolido-por-cratera-aberta-pela-chuva-na-rodovia-da-fe/>

Instituto Nacional de Meteorologia - INMET

Chuva Acumulada 24h
Estação: ARAGARCAS - 02/2020



Instituto Nacional de Meteorologia - INMET

Chuva Acumulada 24h
Estação: CATALAO - 02/2020

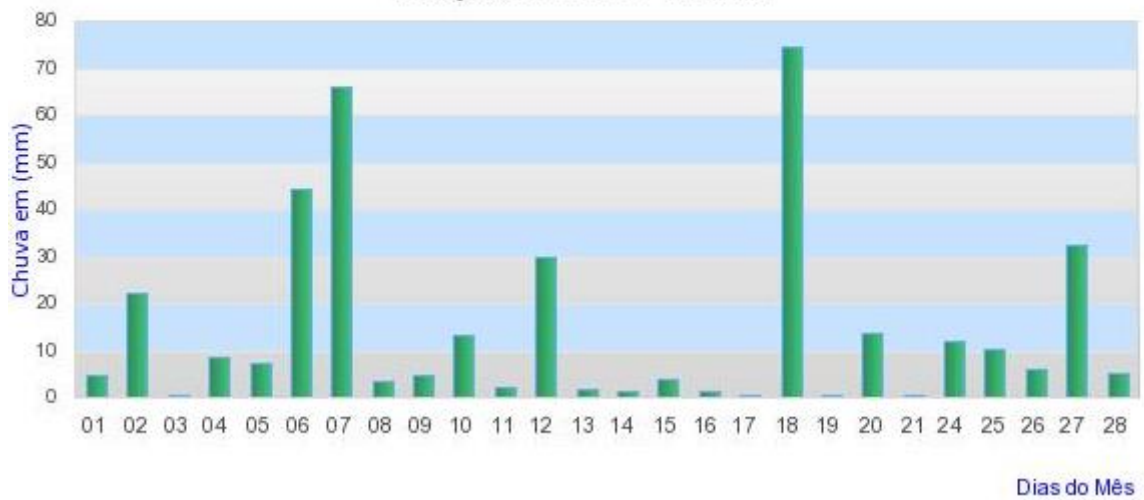

Instituto Nacional de Meteorologia - INMET

Chuva Acumulada 24h

Estação: FORMOSA - 02/2020

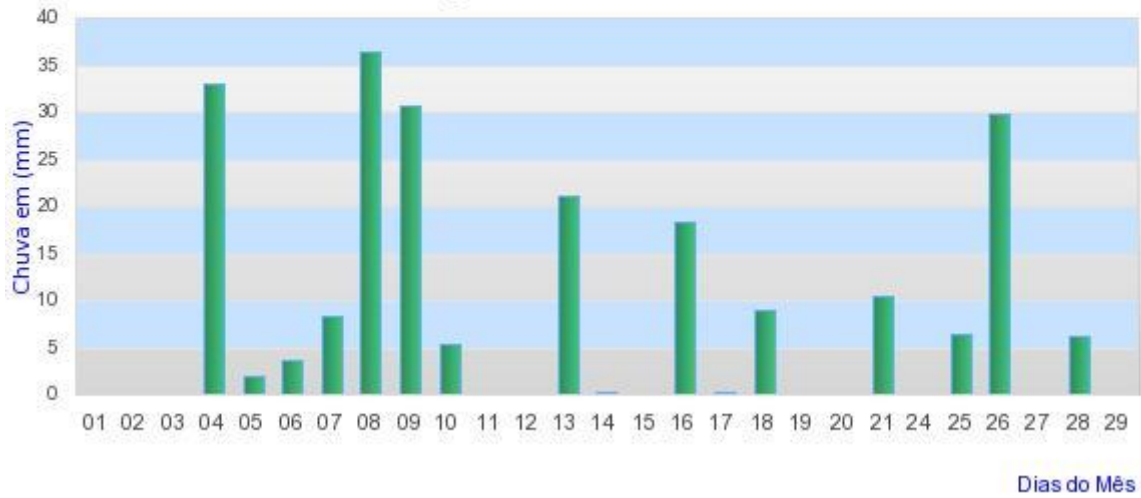

Instituto Nacional de Meteorologia - INMET

Chuva Acumulada 24h

Estação: GOIANIA - 02/2020



Instituto Nacional de Meteorologia - INMET

Chuva Acumulada 24h
Estação: IPAMERI - 02/2020



Instituto Nacional de Meteorologia - INMET

Chuva Acumulada 24h
Estação: JATAI - 02/2020

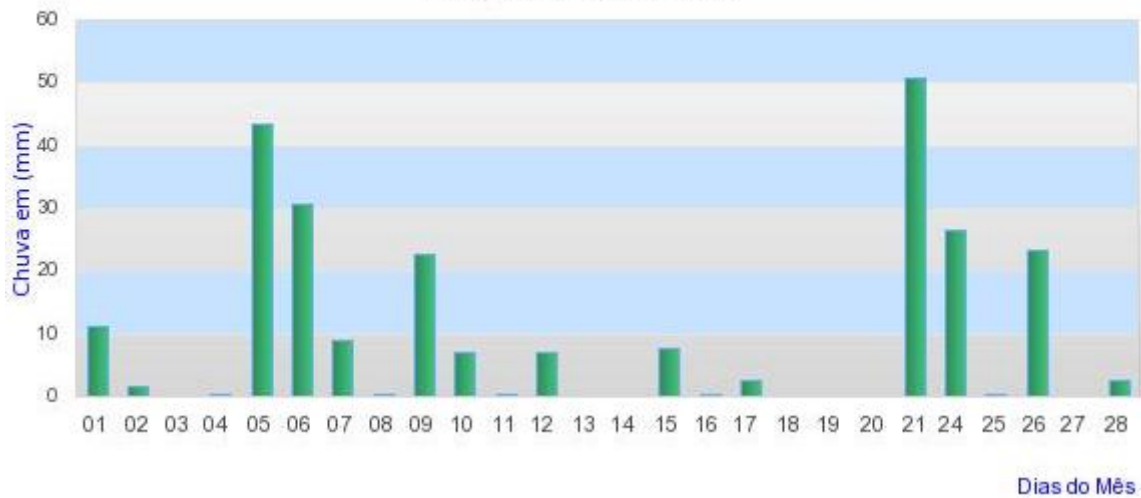

Instituto Nacional de Meteorologia - INMET

Chuva Acumulada 24h

Estação: PIRENOPOLIS - 02/2020

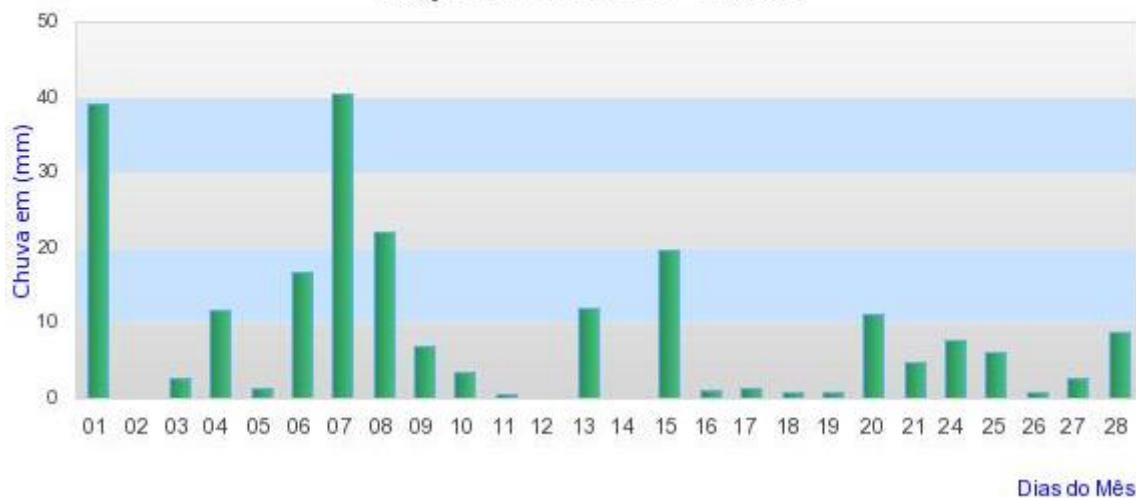

Instituto Nacional de Meteorologia - INMET

Chuva Acumulada 24h

Estação: POSSE - 02/2020

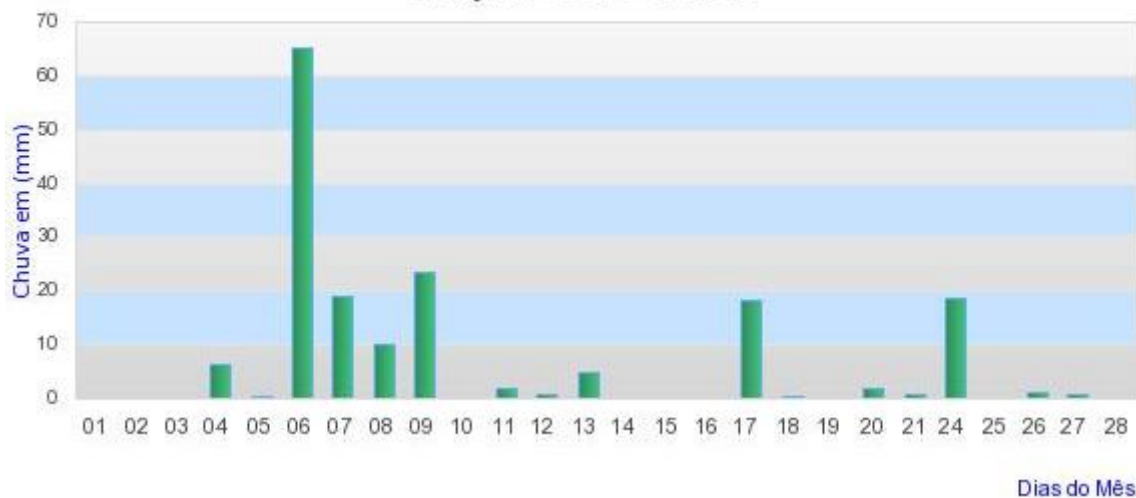

Instituto Nacional de Meteorologia - INMET

Chuva Acumulada 24h

Estação: RIO VERDE - 02/2020



NOTÍCIAS RELACIONADAS

<https://rioclaronews.com.br/noticia/388/chuva-provoca-cheia-do-rio-claro-moradores-sofre-prejuizos-em-condominios-em-montes-claros-de-goias.html>



Home

Notícias Local

Cidades ▾

Esportes

Entretenimento

Política

Economia

Educação

Chuva provoca cheia do rio claro, moradores sofre prejuízos em condomínios em Montes Claros de Goiás.

O Rio Claro que passa no Município de Montes Claros de Goiás transborda e esta causando prejuízos, aos moradores a suas margens

Por Thiago C. DRT 4029/GO em 13/02/2020 às 15:37:30



Fotos: WC PRODUÇÕES

O Rio Claro que passa no Município de Montes Claros de Goiás, esta causando preocupações aos moradores ribeirinhos e aos proprietários de condomínios as margens do rio. O acumulo das fortes chuvas que atingem a região de Montes Claros fez o nível do Rio Claro subir fora de sua caixa normal nesta segunda feira (10) e no começo da tarde desta quarta feira (12) as águas começaram a invadir as casas dos moradores, De acordo com a população ribeirinha o rio esta tendo inundações em vários pontos em suas margens.

CIDADE: DOVERLANDIA - GO

DIA: 11-02-2020

RELATO: PONTE CAI NA ZONA RURAL DE DOVERLÂNDIA, DEVIDO CÔRREGO TRANSBORDAR POR CAUSA DO VOLUME AUTO DE CHUVA E EQUIPES DE EMERGÊNCIA NÃO TEVE ACESSO À CLIENTES NO ATENDIMENTO, RETARDANDO A NORMALIZAÇÃO DA ENERGIA.

enei
REGIONAL DE IPORA



CIDADE: MOZARLÂNDIA -GO

DIA: 11-02-2020

RELATO: CONSTANTES CHUVAS EM MOZARLÂNDIA OCASIONOU O TRANSBORDAMENTO DE VÁRIOS CÔRREGOS NA REGIÃO, PREJUDICANDO O ACESSO E ATENDIMENTO DE OCORRÊNCIAS.



CIDADE: TAQUARAL-GO

DIA: 12-02-2020



RELATO: CHUVAS TORRENCIAIS CAUSARAM VÁRIOS DANOS NO MUNICÍPIO DE TAQUARAL, CORREGOS TRANSBORDARAM E PONTE CAIU, ATRAPALHANDO O DESLOCAMENTO NA ZONA RURAL E ATENDIMENTO DE EMERGÊNCIA.

**CIDADE: ARAGUAPAZ -GO
ARUANA**

DIA: 12-02-2020

RELATO: ATOLEIROS SURGIRAM DEVIDO MUITAS CHUVAS NOS MUNICÍPIOS DE ARAGUAPAZ E ARUANA RETARDANDO ATENDIMENTOS EMERGENCIAIS.





maisgoiás • Seguindo



maisgoiás Tempo: veja como ficou a Rua 87, no Setor Sul, após a chuva que caiu nessa tarde em Goiânia.

12 sem



gleyciele.sousa.5 @diegoaraujo.5



12 sem Responder



carlacristinadearaujo Parece que nesse trecho aí não tem solução pro escoamento da água



12 sem Responder



manganrazi



187.935 visualizações

14 DE FEVEREIRO

Adicione um comentário...

Publicar



maisgoiás • Seguindo



maisgoiás Mais do mesmo: situação nesse momento do viaduto do Flamboyant.

12 sem



reis.ribamar Todo ano é assim



12 sem Responder



viniustnandrade @drzaineborges olha aí Zainim... Renegate não passa nem em poça d'água



12 sem Responder



263.937 visualizações

14 DE FEVEREIRO

Adicione um comentário...

Publicar



maisgoias • Seguindo



maisgoias Tempo: chove forte em alguns bairros de Goiânia. Imagem registrada há pouco no viaduto do Flamboyant, no Jardim Goiás

12 sem



newriaraujo @felliipego



67.420 visualizações

14 DE FEVEREIRO

Adicione um comentário...

Publicar