

## Resumo Executivo

O Presente Relatório tem como objetivo a incorporação de informações que sejam relevantes para que se possa fazer a devida associação aos dados contidos no corpo do documento objeto da classificação de Situação de Emergência caracterizada pelo Módulo 8 do Prodist, que tem como foco o impacto do evento sobre determinada rede geoeletrica e cuja denominação é definida como CHI (Consumidor hora interrompido). O parâmetro para enquadramento nesta classificação de expurgo tem como premissa inicial o limite de Consumidor hora interrompido definido pela fórmula descrita no Módulo 01 do Prodist (Revisão - 9), acrescido de todos os outros informes e dados listados no Módulo 08 (Revisão 10) do Prodist. Este enquadramento se apresenta na maioria das vezes em condições climáticas adversas com severidade dos fatores inerentes a situação, caracterizado na maioria dos casos por fortes ventos e chuvas de grande intensidade e continuidade.

Entre a manhã do dia 22/02/2020 - sábado - e a noite do dia 24 de fevereiro de 2020. – Segunda-feira – Áreas de instabilidade associadas ao ar quente e úmido e a presença de uma frente fria no mar favoreceram a formação de nuvens de tempestade que avançaram sobre o estado de Goiás.

Conforme informações do Climatempo Meteorologia, o Instituto Nacional de Meteorologia (INMET) detectou rajadas de vento acima de 50km/h entre a manhã do dia 22 de fevereiro e a noite do dia 24 de fevereiro de 2020. Na cidade de Pires do Rio ocorreram ventos de até 53,3 km/h entre as 14h e 15h do dia 24 de fevereiro de 2020.

O sistema de detecção da EarthNetworks registrou 40334 descargas atmosféricas sobre a área de concessão da ENEL em Goiás entre as 09h40 do dia 22 e 23h40 do dia 24 de fevereiro de 2020, o que causou grande instabilidade na rede.

Chuva forte e volumosa foi registrada pelo INMET em estações representativas da área de concessão da ENEL Distribuição Goiás. Na estação de Goiás foram acumulados 35,6 mm de chuva entre as 09h e 11h do dia 24 de fevereiro. Entre as 09h do dia 23 e 09h do dia 24 de fevereiro foram acumulados o correspondente a 64% da média climatológica para o mês na região.

### **Em menos de uma semana, chuva já deixou vários sinais de destruição em Anápolis -**

Previsão é que mais água caia nos próximos dias, elevando o sinal de alerta na cidade. A chuva ganhou intensidade e provocou diversos incidentes em Anápolis nos últimos dias. Antes restritos apenas em regiões ainda carentes de equipamentos urbanos, como Sul e Oeste, os estragos tornaram-se mais visíveis ao alcançar também locais de maior circulação. Acesso em:

<https://portal6.com.br/2020/02/24/em-menos-de-uma-semana-chuva-ja-deixou-varios-sinais-de-destruicao-em-anapolis/>

## Relatório de Ocorrências do período

Em todo o Estado de Goiás verificou-se também que a intensidade da chuva e dos ventos danificaram a rede de distribuição de energia elétrica em diversos pontos, registrando aproximadamente 199 mil clientes com interrupção no fornecimento de energia elétrica devido a eventos relacionados ao temporal.

Para otimizar o volume de atendimentos e reduzir os tempos de interrupção foram mobilizados os recursos extras da empresa que aumentou o contingente em relação a situação normal de operação. O acompanhamento da quantidade de equipes e o Tempo Médio de Atendimento podem ser consultados na Pág.02 do Relatório em anexo.

O impacto e severidade do evento estão relatados em artigos de mídia, como fotos e reportagens que demonstram os danos na Rede de Distribuição, oriundos dos eventos climáticos no período. Eventos estes que afetaram 199.216 consumidores com CHI de 541.491,39 superior ao de 482.597,74 estabelecido como limite para definição de Situação de Emergência, conforme resumo das informações obrigatórias.

<b>Empresa</b>	ENEL DISTRIBUIÇÃO GOIÁS		
<b>Código do Relatório</b>	CHI-043 - ENEL DISTRIBUIÇÃO GOIÁS		
<b>Evento:</b>	TEMPORAL NA AREA DE CONCESSÃO DA ENEL DISTRIBUIÇÃO GOIAS		
<b>Código COBRADE:</b>	1.3.2.1.2, 1.3.2.1.4, 1.3.2.1.5	<b>Data Inicio</b>	22/02/2020
			<b>Hora início</b>
			09h40
<b>Código do Evento:</b>	CHI-043-ENEL GO	<b>Data Término</b>	24/02/2020
			<b>Hora Término</b>
			22h45
<b>Valor CHI (Limite e Real)</b>	482.597,74	541.491,39	
<b>Código do Decreto (Se Houver):</b>			
<b>Quantidade de Interrupções (Evento)</b>	3.279		
<b>Início 1ª Incidência (Data e Hora)</b>	22/02/2020 09:43		
	<b>Subestações Atingidas</b>	ABADIANIA / ABC / ACREUNA / ADELANDIA / AEROPORTO / AGUA LIMPA (MARZAGAO) / AGUAS LINDAS / ALEXANIA / ALEXANIA TRANSMISSAO / ALMERINDONOPOLIS / ALOANDIA / ALPHAVILLE / ALTO BURITI / ALTO HORIZONTE / ALTO PARAISO DE GOIAS / ALVORADA DO NORTE / AMERICANO DO BRASIL / AMORINOPOLIS / ANAPOLIS UNIVERSITARIA / ANHANGUERA / ANICUNS / ANTONIO DO VITTO / APORE / ARACU / ARAGARCAS / ARAGOIANIA / ARAGUAPAZ / ARARAS / AREIAS / ARENOPOLIS / ARUANA / ARUANA (TRANSMISSAO) / ASA BRANCA / ATLANTICO / AURILANDIA / AVELINOPOLIS / BACURI (RIO VERDE) / BARBOSELANDIA / BARCELONA / BARREIRO (PORANGATU) / BARRO ALTO / BELA VISTA (TRANSMISSAO) / BOA VISTA / BOM JARDIM / BOM JESUS DE GOIAS / BONFINOPOLIS / BONOPOLIS / BONSUCESSO (RIO VERDE) / BRAZABRANTES / BRITANIA / BRITANIA (TRANSMISSAO) / BURITI ALEGRE / BURITI DE GOIAS / BURITIZINHO / CABECEIRAS / CABRIUVA (RIO VERDE) / CACHOEIRA ALTA / CACHOEIRA DOURADA / CACHOEIRA NOVA / CACHOEIRINHA (ITARUMA) / CACU / CAIAPONIA / CALCILANDIA / CALDAS NOVAS / CALDAZINHA / CAMPESTRE / CAMPINAS / CAMPINORTE / CAMPO ALEGRE DE GOIAS / CAMPO LIMPO DE GOIAS / CAMPO NOVO / CAMPOS BELOS / CAMPOS VERDES / CARAIBAS / CARAJAS / CASTELANDIA / CATALAO / CATURAI / CEBRASA FABRICA DA AMBEV / CEMAT/BALIZA / CEPALGO / CEZARINA / CHAPADAO DO CEU / CIDADE OCIDENTAL / COCALZINHO / COLINACU / CORREGO DO OURO / CORUMBA / CORUMBAIBA / CRISTALINA / CRISTALINA TRANSMISSAO / CRISTIANOPOLIS / CRIXAS / CROMINIA / CUMARI / DAIA - ANAPOLIS / DAMOLANDIA / DAVINOPOLIS / DESFECHO / DESTILARIA BRASIL CENTRAL / DIMIC / DORCELINO PEIXOTO DE MORAES / DOVERLANDIA / EDEALINA / EDEIA / ENERSUL / ESTANIFERA / ESTRELA DO NORTE / FAINA / FAZENDA CANADA / FAZENDA NOVA / FERROVIARIO / FIRMINOPOLIS / FLORES DE GOIAS / FORMIGA / FORMOSO / FRONTEIRA / GAMELEIRA / GIRASSOL / GOIANAPOLIS / GOIANDIRA / GOIANESIA / GOIANIA LESTE / GOIANIRA / GOIAS / GOIATUBA / GOUVERLANDIA / GOYA / GUAPU / HEITORAI / HIDROLANDIA / IACIARA / INACIOLANDIA / INDEPENDENCIA / INDIARA / INHUMAS / IPAMERI / IPEGUARI / IPORA / ISRAELANDIA / ITABERAI / ITAGUARI / ITAGUARU / ITAJA / ITAPACI / ITAPIRAPUA / ITAPURANGA / ITARUMA / ITAUCU / ITIQUIRA (FORMOSA) / ITUMBIARA NOVA / ITUMBIARA VELHA / JACILANDIA / JANDAIA / JARAGUA / JARANAPOLIS / JATAI / JAUPACI / JESUPOLIS / JOVIANIA / JUNDIAI / JURUMIRIM / JUSCELANDIA / JUSSARA / LAGES / LAGOA DA SERRA / LAGOA DO BAUZINHO (RIO VERDE) / LEOPOLDO DE BULHOES / LUZIANIA INDUSTRIAL / MAIRIPOTABA / MAMBAI / MARA ROSA / MARAJOARA / MARCIANOPOLIS / MARIAPOLIS (PADRE BERNARDO) / MATO GRANDE / MATRINCHA / MAURILANDIA / MEIA PONTE / MINACU / MINEIROS / MINEIROS TRANSMISSAO / MOIPORA / MONTE ALEGRE / MONTES CLAROS DE GOIAS / MONTIVIDIU T / MORRINHOS / MORRO AGUDO / MOSSAMEDES / MOZARLANDIA / MOZARLANDIA (TRANSMISSAO) / MUNDO NOVO DE GOIAS / MUTUNOPOLIS / NAVESLANDIA ( JATAI ) / NAZARIO / NEROPOLIS / NIQUELANDIA / NOVA AMERICA / NOVA AURORA / NOVA CRIXAS (TRANSMISSAO) / NOVA IGUACU / NOVA VENEZA / NOVO BRASIL / NOVO GAMA / NOVO PLANALTO / OLHOS DAGUA / OLOANA / ORIZONA / OURO VERDE DE GOIAS / OUVIDOR / PACAEMBU (NOVO GAMA) / PADRE BERNARDO / PALESTINA / PALMEIRAS / PALMEIRAS DE GOIAS / PALMELO / PALMINOPOLIS / PAMPLONA / PANAMA / PARANA / PARANAIBA / PARANAIGUARA / PARAUNA SE ALTA TENSAO / PARQUE DAS EMAS (MINEIROS) / PARQUE DAS NACOES / PEROLANDIA / PETROLINA / PILAR / PIRACANJUBA / PIRANHAS T / PIRENOPOLIS / PIRES BELO / PIRES DO RIO / PLANALTINA / PLANALTINA (TRANSMISSAO) / PLANALTO / PONTALINA / PORANGATU / PORTEIRAO / PORTELANDIA / POSSE / POSSELANDIA / PROFESSOR JAMIL / QUEBRA LINHA / QUIRINOPOLIS / REAL / RETIRO / GOIAS / RIO CLARO JATAI MONTIVIDIU / RIO DO PEIXE / RIO DOS BOIS (MAURILANDIA) / RIO PRETO / RIO QUENTE / RIO VERDE / RIO VERMELHO / RIVERLANDIA (RIO VERDE) / RUBIATABA / SANCLERLANDIA / SANTA BARBARA / SANTA FE DE GOIAS / SANTA HELENA / SANTA RITA DO ARAGUAIA / SANTA ROSA / SANTA ROSA DE GOIAS / SANTA ROSA DO MEIA PONTE / SANTA TEREZA DE GOIAS / SANTA TEREZINHA / SANTANA / SANTO ANTONIO DA BARRA / SANTO ANTONIO DE GOIAS / SANTO ANTONIO DO DESCOBERTO / SAO BARTOLOMEU / SAO DOMINGOS / SAO FRANCISCO DE GOIAS / SAO JOAO D ALIANCA / SAO LUIZ DOS MONTES BELOS / SAO MIGUEL DO ARAGUAIA / SAO MIGUEL DO PASSA QUATRO / SENADOR CANEDO TRANSMISSAO / SERRA AZUL (JATAI) / SERRA DE CALDAS /	

			SERRANOPOLIS / SILVANIA / SOUZALANDIA / SUCURI / TAIOBA / TAQUARAL / TAQUARI / TEREZOPOLIS / TRES BARRAS / TRES RANCHOS / TRINDADE / TURVANIA / TURVELANDIA / URU / URUACU / URUTAI / USINA DE ACUCAR DE GOIANESIA / USINA MAMBAI / VALPARAISO / VARJAO / VENDA SECA / VIANOPOLIS / VICENTINOPOLIS / VILA CORUMBA / VILA PROPICIO / XAVANTES / XIXA / ZELANDIA
<b>Início Última Incidência (Data e Hora)</b>	24/02/2020 22:39		
<b>Média de Duração das Incidências (h)</b>	5,53		
<b>Duração da Incidência mais longa (h)</b>	57,45		
<b>Total de Clientes afetados</b>	199.216	<b>Municípios Atingidos</b>	ABADIA DE GOIAS / ABADIANIA / ACREUNA / ADELANDIA / AGUA FRIA DE GOIAS / AGUA LIMPA / AGUAS LINDAS DE GOIAS / ALEXANIA / ALOANDIA / ALTO HORIZONTE / ALTO PARAISO DE GOIAS / ALVORADA DO NORTE / AMARALINA / AMERICANO DO BRASIL / AMORINOPOLIS / ANAPOLIS / ANHANGUERA / ANICUNS / APARECIDA DE GOIANIA / APARECIDA DO RIO DOCE / APORE / ARACU / ARAGARCAS / ARAGOIANIA / ARAGUAPAZ / ARENOPOLIS / ARUANA / AURILANDIA / AVELINOPOLIS / BALIZA / BARRO ALTO / BELA VISTA DE GOIAS / BOM JARDIM DE GOIAS / BOM JESUS DE GOIAS / BONFINOPOLIS / BONOPOLIS / BRAZABRANTES / BRITANIA / BURITI ALEGRE / BURITI DE GOIAS / BURITINOPOLIS / CABECEIRAS / CACHOEIRA ALTA / CACHOEIRA DE GOIAS / CACHOEIRA DOURADA / CACU / CAIAPONIA / CALDAS NOVAS / CALDAZINHA / CAMPESTRE DE GOIAS / CAMPINACU / CAMPINORTE / CAMPO ALEGRE DE GOIAS / CAMPO LIMPO / CAMPOS BELOS / CAMPOS VERDES / CARMO DO RIO VERDE / CASTELANDIA / CATALAO / CATURAI / CAVALCANTE / CEZARINA / CHAPADAO DO CEU / CIDADE OCIDENTAL / COCALZINHO DE GOIAS / COLINAS DO SUL / CORREGO DO OURO / CORUMBA DE GOIAS / CORUMBAIBA / CRISTALINA / CRISTIANOPOLIS / CRIXAS / CROMINIA / CUMARI / DAMIANOPOLIS / DAMOLANDIA / DAVINOPOLIS / DIORAMA / DISTRITO FEDERAL / DIVINOPOLIS DE GOIAS / DOVERLANDIA / EDEALINA / EDEIA / ESTRELA DO NORTE / FAINA / FAZENDA NOVA / FIRMINOPOLIS / FLORES DE GOIAS / FORMOSA / FORMOSO / GAMELEIRA DE GOIAS / GOIANAPOLIS / GOIANDIRA / GOIANESIA / GOIANIA / GOIANIRA / GOIAS / GOIATUBA / GOUVELANDIA / GUAPO / GUARAITA / GUARANI DE GOIAS / GUARINOS / HEITORAI / HIDROLANDIA / IACIARA / INACIOLANDIA / INDIARA / INHUMAS / IPAMERI / IPIRANGA DE GOIAS / IPORA / ISRAELANDIA / ITABERAI / ITAGUARI / ITAGUARU / ITAJA / ITAPACI / ITAPIRAPUA / ITAPURANGA / ITARUMA / ITAUCU / ITUMBIARA / IVOLANDIA / JANDAIA / JARAGUA / JATAI / JAUPACI / JESUPOLIS / JOVIANIA / JUSSARA / LAGOA SANTA / LEOPOLDO DE BULHOES / LUZIANIA / MAIRIPOTABA / MAMBAI / MARA ROSA / MATRINCHA / MAURILANDIA / MIMOSO DE GOIAS / MINACU / MINEIROS / MOIPORA / MONTE ALEGRE DE GOIAS / MONTES CLAROS DE GOIAS / MONTIVIDIU / MONTIVIDIU DO NORTE / MORRINHOS / MORRO AGUDO DE GOIAS / MOSSAMEDES / MOZARLANDIA / MUNDO NOVO DE GOIAS / MUTUNOPOLIS / NAZARIO / NEROPOLIS / NIQUELANDIA / NOVA AMERICA / NOVA AURORA / NOVA CRIXAS / NOVA GLORIA / NOVA IGUACU DE GOIAS / NOVA ROMA / NOVA VENEZA / NOVO BRASIL / NOVO GAMA / NOVO PLANALTO / ORIZONA / OURO VERDE DE GOIAS / OUVIDOR / PADRE BERNARDO / PALESTINA DE GOIAS / PALMEIRAS DE GOIAS / PALMELO / PALMINOPOLIS / PANAMA / PARANAIGUARA / PARAUNA / PEROLANDIA / PETROLINA DE GOIAS / PILAR DE GOIAS / PIRACANJUBA / PIRANHAS / PIRENOPOLIS / PIRES DO RIO / PLANALTINA / PONTALINA / PORANGATU / PORTEIRAO / PORTELANDIA / POSSE / PROFESSOR JAMIL SAFADY / QUIRINOPOLIS / RIALMA / RIO QUENTE / RIO VERDE / RUBIATABA / SANCLERLANDIA / SANTA BARBARA DE GOIAS / SANTA CRUZ DE GOIAS / SANTA FE DE GOIAS / SANTA HELENA DE GOIAS / SANTA RITA DO ARAGUAIA / SANTA RITA DO NOVO DESTINO / SANTA TEREZA DE GOIAS / SANTA TEREZINHA DE GOIAS / SANTO ANTONIO DA BARRA / SANTO ANTONIO DE GOIAS / SANTO ANTONIO DO DESCOBERTO / SAO DOMINGOS / SAO FRANCISCO DE GOIAS / SAO JOAO D ALIANCA / SAO JOAO DA PARAUNA / SAO LUIS DE MONTES BELOS / SAO LUIZ DO NORTE / SAO MIGUEL DO ARAGUAIA / SAO MIGUEL DO PASSA QUATRO / SAO SIMAO / SENADOR CANEDO / SERRANOPOLIS / SILVANIA / SITIO D ABADIA / TAQUARAL DE GOIAS / TEREZOPOLIS DE GOIAS / TRES RANCHOS / TRINDADE / TROMBAS / TURVANIA / TURVELANDIA / UIRAPURU / URUACU / URUTAI / VALPARAISO DE GOIAS / VARJAO / VIANOPOLIS / VICENTINOPOLIS / VILA BOA / VILA PROPICIO

<b>DANOS CAUSADOS</b>			
<b>Equipamentos Danificado</b>	<b>Importância para o Sistema</b>	<b>Local</b>	<b>Quantidade</b>
Disjuntor/Religador Operado	Proteção do Alimentador	Área de Concessão	55
Chaves Fusíveis Operada	Proteção de Ramais de Alimentadores	Área de Concessão	1048
Transformador Operado	Proteção do Transformador	Área de Concessão	837

<b>Relato técnico sobre a Intervenção realizada em Goiânia e Região Metropolitana</b>				
<b>Informações sobre Equipes</b>	22/02	23/02	24/02	
<b>Quantidade Usual</b>	675	617	720	turmas
<b>Quantidade Adicional</b>	8	20	15	turmas
<b>Quantidade Total</b>	683	636	735	turmas
<b>Tempos Médios</b>				
<b>Preparação</b>	3,56	2,67	2,93	Horas
<b>Deslocamento</b>	0,93	0,97	0,95	Horas
<b>Execução</b>	1,30	0,95	0,95	Horas
<b>TMAE</b>	5,79	4,59	4,82	Horas

### **Principais Dificuldades Encontradas:**

Chuvas com ventos fortes provocaram muitos pontos de alagamento e enxurrada, trânsito impedido por vários semáforos desligados dificultando a chegada ao atendimento das ocorrências emergenciais. Em determinadas regiões, decorrente dos fortes ventos, houve o tombamento de árvores nas estruturas de alimentação de média tensão, danos em ramais de ligação dos clientes, impedimentos de acesso e atolamentos em estradas rurais.

<b>Empresa</b>	ENEL DISTRIBUIÇÃO GOIAS		
<b>Valor CHI (Limite e Real)</b>	<b>482.597,74</b>		<b>541.491,39</b>



DOC ORIGEM	MIUNICIPIO	EQP_ORIGEM	CONJUNTO	INI_OCORRENC	FIM_OCORRENC	DT_INI_EVENTO	DT_FIM_EVENTO	DURAÇ	UC INT	CHI	EXPURGO
202002150841	CAMPOS VERDES	VD12201664	SANTA TEREZINHA	22/02/2020 09:43	22/02/2020 11:15	22/02/2020 09:43	22/02/2020 11:15	1,53	106	162,50	CHI
202002150880	NOVA AMERICA	2160000122	RUBIATABA	22/02/2020 09:52	22/02/2020 11:56	22/02/2020 09:52	22/02/2020 11:56	2,06	1	2,06	CHI
202002150887	SAO JOAO D ALIANCA	JL21381818	SAO JOAO D ALIANCA	22/02/2020 09:54	22/02/2020 11:29	22/02/2020 09:54	22/02/2020 11:29	1,57	1	1,57	CHI
202002150934	PORANGATU	PO12390358	PORANGATU	22/02/2020 10:09	22/02/2020 12:07	22/02/2020 10:09	22/02/2020 12:07	1,96	7	13,74	CHI
202002150937	FORMOSA	FA11315285	ITIQUEIRA	22/02/2020 10:10	22/02/2020 11:25	22/02/2020 10:10	22/02/2020 11:25	1,25	7	8,75	CHI
202002150939	FORMOSA	FA11278193	ITIQUEIRA	22/02/2020 10:10	22/02/2020 11:58	22/02/2020 10:10	22/02/2020 11:58	1,79	1	1,79	CHI
202002150942	NIQUELANDIA	10004007229	NIQUELANDIA SUBTRANSMISSAO	22/02/2020 10:11	22/02/2020 18:27	22/02/2020 10:11	22/02/2020 18:27	8,26	1	8,26	CHI
202002150955	SAO MIGUEL DO ARAGUAIA	SM21170925	SAO MIGUEL DO ARAGUAIA	22/02/2020 10:14	22/02/2020 15:40	22/02/2020 10:14	22/02/2020 15:40	5,42	1	5,42	CHI
202002150984	CABECEIRAS	CW21381539	ITIQUEIRA	22/02/2020 10:23	22/02/2020 12:39	22/02/2020 10:23	22/02/2020 12:39	2,26	2	4,52	CHI
202002150997	SAO DOMINGOS	SD12170547	SAO DOMINGOS	22/02/2020 10:29	22/02/2020 17:36	22/02/2020 10:29	22/02/2020 17:36	7,11	13	92,49	CHI
202002151010	TEREZOPOLIS DE GOIAS	10000365929	DAIA S2	22/02/2020 10:33	22/02/2020 19:14	22/02/2020 10:33	22/02/2020 19:14	8,67	1	8,67	CHI
202002151022	FLORES DE GOIAS	FB11242870	FLORES DE GOIAS	22/02/2020 10:38	22/02/2020 17:53	22/02/2020 10:38	22/02/2020 17:53	7,24	1	7,24	CHI
202002151042	POSSE	PS11332774	IACIARA S2	22/02/2020 10:46	22/02/2020 12:15	22/02/2020 10:46	22/02/2020 12:15	1,48	1	1,48	CHI
202002151059	FORMOSA	FA21053565	ITIQUEIRA	22/02/2020 10:50	22/02/2020 13:30	22/02/2020 10:50	22/02/2020 13:30	2,65	1	2,65	CHI
202002151063	NOVA CRIXAS	NA12223941	NOVA CRIXAS	22/02/2020 10:52	23/02/2020 08:08	22/02/2020 10:52	23/02/2020 08:08	21,26	2	42,52	CHI
202002151075	GUARINOS	3720004129	SANTA TEREZINHA	22/02/2020 10:56	22/02/2020 17:57	22/02/2020 10:56	22/02/2020 17:57	7,00	1	7,00	CHI
202002151087	BONOPOLIS	BX12391924	SAO MIGUEL DO ARAGUAIA	22/02/2020 11:02	24/02/2020 10:09	22/02/2020 11:02	23/02/2020 00:58	13,94	13	181,21	CHI
202002151087	BONOPOLIS	BX12391924	SAO MIGUEL DO ARAGUAIA	22/02/2020 11:02	24/02/2020 10:09	22/02/2020 11:02	23/02/2020 09:48	22,77	6	136,62	CHI
202002151087	SAO MIGUEL DO ARAGUAIA	BX12391924	SAO MIGUEL DO ARAGUAIA	22/02/2020 11:02	24/02/2020 10:09	22/02/2020 11:02	23/02/2020 09:48	22,77	1	22,77	CHI
202002151087	BONOPOLIS	BX12391924	SAO MIGUEL DO ARAGUAIA	22/02/2020 11:02	24/02/2020 10:09	23/02/2020 10:04	23/02/2020 10:51	0,77	13	10,04	CHI
202002151087	BONOPOLIS	BX13380429	SAO MIGUEL DO ARAGUAIA	22/02/2020 11:02	24/02/2020 10:09	23/02/2020 10:04	23/02/2020 12:27	2,39	4	9,54	CHI
202002151087	SAO MIGUEL DO ARAGUAIA	BX13380429	SAO MIGUEL DO ARAGUAIA	22/02/2020 11:02	24/02/2020 10:09	23/02/2020 10:04	23/02/2020 12:27	2,39	1	2,39	CHI
202002151087	BONOPOLIS	BX12391924	SAO MIGUEL DO ARAGUAIA	22/02/2020 11:02	24/02/2020 10:09	22/02/2020 11:02	23/02/2020 19:06	32,06	8	256,50	CHI
202002151087	BONOPOLIS	BX12375327LD	SAO MIGUEL DO ARAGUAIA	22/02/2020 11:02	24/02/2020 10:09	23/02/2020 10:04	24/02/2020 09:47	23,71	2	47,43	CHI
202002151087	BONOPOLIS	BX12391924	SAO MIGUEL DO ARAGUAIA	22/02/2020 11:02	24/02/2020 10:09	24/02/2020 10:05	24/02/2020 10:09	0,08	27	2,04	CHI
202002151087	SAO MIGUEL DO ARAGUAIA	BX12391924	SAO MIGUEL DO ARAGUAIA	22/02/2020 11:02	24/02/2020 10:09	24/02/2020 10:05	24/02/2020 10:09	0,08	1	0,08	CHI
202002151094	AGUA FRIA DE GOIAS	TL12365109	SAO JOAO D ALIANCA	22/02/2020 11:05	22/02/2020 14:14	22/02/2020 11:05	22/02/2020 14:14	3,15	1	3,15	CHI
202002151095	IACIARA	IA21257584	IACIARA S1	22/02/2020 11:05	22/02/2020 13:28	22/02/2020 11:05	22/02/2020 13:28	2,37	1	2,37	CHI
202002151124	COCALZINHO DE GOIAS	ZN12258524RE	COCALZINHO	22/02/2020 13:00	22/02/2020 19:35	22/02/2020 13:00	22/02/2020 16:45	3,77	20	75,32	CHI
202002151124	COCALZINHO DE GOIAS	ZN13381224	COCALZINHO	22/02/2020 13:00	22/02/2020 19:35	22/02/2020 13:00	22/02/2020 19:35	6,58	35	230,43	CHI
202002151125	CATALAO	10010108643	CATALAO S2	22/02/2020 13:50	22/02/2020 14:58	22/02/2020 13:50	22/02/2020 14:58	1,13	1	1,13	CHI
202002151142	CALDAZINHA	DE12334874	CEPAIGO S2	22/02/2020 17:38	22/02/2020 18:31	22/02/2020 17:38	22/02/2020 18:31	0,88	15	13,15	CHI
202002151144	RIO VERDE	RV11216175	MONTIVIDIU T	22/02/2020 16:32	23/02/2020 08:06	22/02/2020 16:32	23/02/2020 08:06	15,57	1	15,57	CHI
202002151160	GOIANIA	GN11001721	GOIANIA LESTE S3	22/02/2020 20:07	23/02/2020 11:05	22/02/2020 20:07	23/02/2020 11:05	14,96	131	1960,12	CHI
202002151161	BRAZABRANTES	NV10383766	INHUMAS S1	22/02/2020 19:57	23/02/2020 08:52	22/02/2020 20:02	22/02/2020 20:59	0,95	67	63,65	CHI
202002151161	DAMOLANDIA	NV10383766	INHUMAS S1	22/02/2020 19:57	23/02/2020 08:52	22/02/2020 20:02	22/02/2020 20:59	0,95	3	2,85	CHI
202002151161	INHUMAS	NV10383766	INHUMAS S1	22/02/2020 19:57	23/02/2020 08:52	22/02/2020 20:02	22/02/2020 20:59	0,95	17	16,15	CHI
202002151161	NEROPOLIS	NV10383766	INHUMAS S1	22/02/2020 19:57	23/02/2020 08:52	22/02/2020 20:02	22/02/2020 20:59	0,95	8	7,60	CHI
202002151161	NOVA VENEZA	NV10383766	INHUMAS S1	22/02/2020 19:57	23/02/2020 08:52	22/02/2020 20:02	22/02/2020 20:59	0,95	1897	1802,15	CHI
202002151161	NOVA VENEZA	NV10383766	INHUMAS S1	22/02/2020 19:57	23/02/2020 08:52	22/02/2020 20:02	22/02/2020 20:59	0,95	1899	1804,05	CHI
202002151161	OURO VERDE DE GOIAS	NV10383766	INHUMAS S1	22/02/2020 19:57	23/02/2020 08:52	22/02/2020 20:02	22/02/2020 20:59	0,95	47	44,65	CHI
202002151161	SANTO ANTONIO DE GOIAS	NV10383766	INHUMAS S1	22/02/2020 19:57	23/02/2020 08:52	22/02/2020 20:02	22/02/2020 20:59	0,95	1	0,95	CHI
202002151161	GOIANIA	NV10383766	NEROPOLIS S1	22/02/2020 19:57	23/02/2020 08:52	22/02/2020 20:02	22/02/2020 22:23	2,36	131	309,41	CHI

202002151161	NEROPOLIS	NV10383766	NEROPOLIS S1	22/02/2020 19:57	23/02/2020 08:52	22/02/2020 20:02	22/02/2020 22:23	2,36	17	40,15	CHI
202002151161	NOVA VENEZA	NV10383766	NEROPOLIS S1	22/02/2020 19:57	23/02/2020 08:52	22/02/2020 20:02	22/02/2020 22:23	2,36	1	2,36	CHI
202002151161	NOVA VENEZA	NV10383766	NEROPOLIS S1	22/02/2020 19:57	23/02/2020 08:52	22/02/2020 20:02	22/02/2020 22:23	2,36	83	196,04	CHI
202002151161	SANTO ANTONIO DE GOIAS	NV10383766	NEROPOLIS S1	22/02/2020 19:57	23/02/2020 08:52	22/02/2020 20:02	22/02/2020 22:23	2,36	579	1367,57	CHI
202002151161	SANTO ANTONIO DE GOIAS	NV10383766	NEROPOLIS S1	22/02/2020 19:57	23/02/2020 08:52	22/02/2020 20:02	22/02/2020 22:23	2,36	2142	5059,28	CHI
202002151161	SANTO ANTONIO DE GOIAS	NV10383766	NEROPOLIS S1	22/02/2020 19:57	23/02/2020 08:52	22/02/2020 20:02	22/02/2020 22:23	2,36	164	387,36	CHI
202002151161	BRAZABRANTES	IN16407240	NEROPOLIS S1	22/02/2020 19:57	23/02/2020 08:52	22/02/2020 20:02	23/02/2020 02:15	6,23	371	2310,09	CHI
202002151161	GOIANIRA	IN16407240	NEROPOLIS S1	22/02/2020 19:57	23/02/2020 08:52	22/02/2020 20:02	23/02/2020 02:15	6,23	29	180,57	CHI
202002151161	NOVA VENEZA	IN16407240	NEROPOLIS S1	22/02/2020 19:57	23/02/2020 08:52	22/02/2020 20:02	23/02/2020 02:15	6,23	3	18,68	CHI
202002151161	BRAZABRANTES	BR13203588	NEROPOLIS S1	22/02/2020 19:57	23/02/2020 08:52	22/02/2020 20:02	23/02/2020 02:59	6,96	1175	8181,26	CHI
202002151161	BRAZABRANTES	BR13236506	NEROPOLIS S1	22/02/2020 19:57	23/02/2020 08:52	22/02/2020 20:02	23/02/2020 08:52	12,84	9	115,55	CHI
202002151164	CRISTALINA	KR10395376	CRISTALINA S1	22/02/2020 20:31	23/02/2020 01:36	22/02/2020 20:31	22/02/2020 22:38	2,12	28	59,31	CHI
202002151164	IPAMERI	KR10395376	CRISTALINA S1	22/02/2020 20:31	23/02/2020 01:36	22/02/2020 20:31	22/02/2020 22:38	2,12	5	10,59	CHI
202002151164	CRISTALINA	KR12246115LD	CRISTALINA S1	22/02/2020 20:31	23/02/2020 01:36	22/02/2020 20:31	23/02/2020 00:25	3,89	20	77,89	CHI
202002151164	CRISTALINA	KR10395376	CRISTALINA S1	22/02/2020 20:31	23/02/2020 01:36	22/02/2020 20:31	23/02/2020 01:36	5,09	200	1018,72	CHI
202002151173	GOIANIA	GN16413799	FERROVIARIO S3	23/02/2020 00:03	23/02/2020 00:09	23/02/2020 00:03	23/02/2020 00:07	0,07	5587	372,47	CHI
202002151173	GOIANIA	GN16404317	FERROVIARIO S3	23/02/2020 00:03	23/02/2020 00:09	23/02/2020 00:03	23/02/2020 00:09	0,10	4010	402,11	CHI
202002151181	SANTO ANTONIO DE GOIAS	BW12169731	NEROPOLIS S1	23/02/2020 02:06	23/02/2020 02:30	23/02/2020 02:06	23/02/2020 02:30	0,39	2	0,78	CHI
202002151192	TRINDADE	TR11230641	TRINDADE	23/02/2020 05:04	23/02/2020 16:20	23/02/2020 05:04	23/02/2020 16:20	11,26	91	1025,01	CHI
202002151195	PORANGATU	PO10396207	PORANGATU	23/02/2020 06:19	23/02/2020 13:24	23/02/2020 09:51	23/02/2020 10:20	0,49	163	79,33	CHI
202002151195	PORANGATU	PO12115502	PORANGATU	23/02/2020 06:19	23/02/2020 13:24	23/02/2020 06:19	23/02/2020 12:15	5,93	93	551,44	CHI
202002151195	MONTIVIDIU DO NORTE	PO12094115	PORANGATU	23/02/2020 06:19	23/02/2020 13:24	23/02/2020 06:19	23/02/2020 12:56	6,62	6	39,75	CHI
202002151195	PORANGATU	PO12094115	PORANGATU	23/02/2020 06:19	23/02/2020 13:24	23/02/2020 06:19	23/02/2020 12:56	6,62	72	476,96	CHI
202002151195	PORANGATU	PO12052522	PORANGATU	23/02/2020 06:19	23/02/2020 13:24	23/02/2020 06:19	23/02/2020 13:24	7,09	36	255,19	CHI
202002151205	AMARALINA	LC11270143	SAO MIGUEL DO ARAGUAIA	22/02/2020 11:11	22/02/2020 14:12	22/02/2020 11:11	22/02/2020 14:12	3,01	1	3,01	CHI
202002151206	URUACU	UR12322790	MARA ROSA	22/02/2020 11:11	22/02/2020 20:45	22/02/2020 11:11	22/02/2020 20:45	9,56	1	9,56	CHI
202002151218	BONOPOLIS	BX21333257	SAO MIGUEL DO ARAGUAIA	22/02/2020 11:15	23/02/2020 20:10	22/02/2020 11:15	23/02/2020 20:10	32,91	1	32,91	CHI
202002151224	PLANALTINA	3890004542	PLANALTINA	22/02/2020 11:18	22/02/2020 12:55	22/02/2020 11:18	22/02/2020 12:55	1,61	1	1,61	CHI
202002151235	URUACU	10009487776	URUACU	22/02/2020 11:22	22/02/2020 14:22	22/02/2020 11:22	22/02/2020 14:22	2,99	1	2,99	CHI
202002151258	SITIO D ABADIA	19650963	IACIARA S2	22/02/2020 11:29	22/02/2020 16:58	22/02/2020 11:29	22/02/2020 16:58	5,47	1	5,47	CHI
202002151273	FORMOSA	610297521	ITIQUEIRA	22/02/2020 11:36	22/02/2020 14:04	22/02/2020 11:36	22/02/2020 14:04	2,45	1	2,45	CHI
202002151276	CABECEIRAS	CW12233584	ITIQUEIRA	22/02/2020 11:37	22/02/2020 17:45	22/02/2020 11:37	22/02/2020 17:45	6,13	3	18,38	CHI
202002151289	PETROLINA DE GOIAS	PG12230708	PETROLINA	22/02/2020 11:42	22/02/2020 17:21	22/02/2020 11:42	22/02/2020 17:21	5,65	6	33,90	CHI
202002151289	SAO FRANCISCO DE GOIAS	PG12230708	PETROLINA	22/02/2020 11:42	22/02/2020 17:21	22/02/2020 11:42	22/02/2020 17:21	5,65	13	73,45	CHI
202002151290	DAMIANOPOLIS	8230000404	IACIARA S2	22/02/2020 11:42	22/02/2020 14:22	22/02/2020 11:42	22/02/2020 14:22	2,67	1	2,67	CHI
202002151297	SAO DOMINGOS	8680002114	SAO DOMINGOS	22/02/2020 11:43	22/02/2020 20:40	22/02/2020 11:43	22/02/2020 20:40	8,95	1	8,95	CHI
202002151311	MONTIVIDIU DO NORTE	MX12364218	PORANGATU	22/02/2020 11:34	22/02/2020 15:27	22/02/2020 11:34	22/02/2020 15:27	3,88	14	54,29	CHI
202002151324	CAMPINORTE	CR12291127	CAMPINORTE	22/02/2020 11:54	22/02/2020 15:45	22/02/2020 11:54	22/02/2020 15:45	3,84	0	0,00	CHI
202002151324	URUACU	CR12291127	CAMPINORTE	22/02/2020 11:54	22/02/2020 15:45	22/02/2020 11:54	22/02/2020 15:45	3,84	169	649,57	CHI
202002151331	UIRAPURU	UP12328026	NOVA CRIXAS	22/02/2020 11:56	22/02/2020 19:21	22/02/2020 11:56	22/02/2020 19:21	7,40	40	296,03	CHI
202002151334	CABECEIRAS	CW21218525	ITIQUEIRA	22/02/2020 11:57	22/02/2020 19:16	22/02/2020 11:57	22/02/2020 19:16	7,31	1	7,31	CHI
202002151337	JARAGUA	JA11065873	JARAGUA	22/02/2020 11:49	22/02/2020 19:11	22/02/2020 11:49	22/02/2020 19:11	7,37	118	869,53	CHI
202002151348	MONTE ALEGRE DE GOIAS	MA12405588	SAO DOMINGOS	22/02/2020 12:00	22/02/2020 18:38	22/02/2020 12:00	22/02/2020 18:38	6,63	1	6,63	CHI
202002151353	SAO JOAO D ALIANCA	JL21283738	FLORES DE GOIAS	22/02/2020 12:01	22/02/2020 19:38	22/02/2020 12:01	22/02/2020 19:38	7,60	1	7,60	CHI

202002151361	SILVANIA	SV12322411	DAIA S2	22/02/2020 11:45	22/02/2020 14:27	22/02/2020 11:45	22/02/2020 14:27	2,69	5	13,46	CHI
202002151393	SAO FRANCISCO DE GOIAS	490013831	SAO FRANCISCO DE GOIAS	22/02/2020 12:12	22/02/2020 17:26	22/02/2020 12:12	22/02/2020 17:26	5,24	0	0,00	CHI
202002151410	MARA ROSA	MQ21244251	MARA ROSA	22/02/2020 12:20	22/02/2020 23:38	22/02/2020 12:20	22/02/2020 23:38	11,28	1	11,28	CHI
202002151421	MINACU	4020084799	MINACU	22/02/2020 12:23	23/02/2020 07:13	22/02/2020 12:23	23/02/2020 07:13	18,83	1	18,83	CHI
202002151433	CABECEIRAS	CW21184643	ITUIQUIRA	22/02/2020 12:28	22/02/2020 20:25	22/02/2020 12:28	22/02/2020 20:25	7,94	1	7,94	CHI
202002151439	MINEIROS	SU12184133	SANTA RITA DO ARAGUAIA	22/02/2020 12:30	24/02/2020 18:13	22/02/2020 12:30	24/02/2020 18:13	53,71	11	590,78	CHI
202002151439	SANTA RITA DO ARAGUAIA	SU12184133	SANTA RITA DO ARAGUAIA	22/02/2020 12:30	24/02/2020 18:13	22/02/2020 12:30	24/02/2020 18:13	53,71	23	1235,27	CHI
202002151450	PEROLANDIA	JT21125865	JATAI S1	22/02/2020 12:33	22/02/2020 18:48	22/02/2020 12:33	22/02/2020 18:48	6,24	1	6,24	CHI
202002151454	APORE	AE21155312	ITAJA S2	22/02/2020 12:34	22/02/2020 17:17	22/02/2020 12:34	22/02/2020 17:17	4,71	1	4,71	CHI
202002151465	MINEIROS	MY21337072	SANTA RITA DO ARAGUAIA	22/02/2020 12:39	23/02/2020 12:39	22/02/2020 12:39	23/02/2020 12:39	23,99	1	23,99	CHI
202002151466	ALTO HORIZONTE	AJ21086260	SANTA TEREZINHA	22/02/2020 12:40	23/02/2020 00:40	22/02/2020 12:40	23/02/2020 00:40	12,00	1	12,00	CHI
202002151467	SILVANIA	SV21120471	DAIA S2	22/02/2020 12:40	22/02/2020 17:03	22/02/2020 12:40	22/02/2020 17:03	4,38	1	4,38	CHI
202002151469	MARA ROSA	MQ12062677	MARA ROSA	22/02/2020 12:41	22/02/2020 21:06	22/02/2020 12:41	22/02/2020 18:19	5,64	121	682,51	CHI
202002151469	MARA ROSA	MQ12062677	MARA ROSA	22/02/2020 12:41	22/02/2020 21:06	22/02/2020 12:41	22/02/2020 18:35	5,91	143	844,45	CHI
202002151469	MARA ROSA	MQ11062678	MARA ROSA	22/02/2020 12:41	22/02/2020 21:06	22/02/2020 18:21	22/02/2020 21:06	2,74	121	332,14	CHI
202002151488	POSSE	PS21232282	IACIARA S2	22/02/2020 12:49	22/02/2020 15:49	22/02/2020 12:49	22/02/2020 15:49	2,99	1	2,99	CHI
202002151489	ITAJA	IJ21031125	CACHOEIRA ALTA	22/02/2020 12:49	22/02/2020 23:39	22/02/2020 12:49	22/02/2020 23:39	10,82	1	10,82	CHI
202002151490	PORANGATU	PO12022348	PORANGATU	22/02/2020 12:50	22/02/2020 14:44	22/02/2020 12:50	22/02/2020 14:44	1,89	1	1,89	CHI
202002151500	NIQUELANDIA	NQ12275490	NIQUELANDIA SUBTRANSMISSAO	22/02/2020 12:55	22/02/2020 14:30	22/02/2020 12:55	22/02/2020 14:30	1,57	194	304,58	CHI
202002151505	SAO MIGUEL DO ARAGUAIA	SM21334307	SAO MIGUEL DO ARAGUAIA	22/02/2020 12:57	23/02/2020 10:50	22/02/2020 12:57	23/02/2020 10:50	21,88	1	21,88	CHI
202002151506	ANAPOLIS	TJ12353479	DAIA S2	22/02/2020 12:57	23/02/2020 20:28	22/02/2020 12:57	23/02/2020 20:28	31,51	1	31,51	CHI
202002151506	TEREZOPOLIS DE GOIAS	TJ12353479	DAIA S2	22/02/2020 12:57	23/02/2020 20:28	23/02/2020 17:48	23/02/2020 20:28	2,66	13	34,54	CHI
202002151507	CACHOEIRA ALTA	CA21000012	CACHOEIRA ALTA	22/02/2020 12:58	22/02/2020 16:01	22/02/2020 12:58	22/02/2020 16:01	3,06	1	3,06	CHI
202002151510	PORANGATU	PO21227056	PORANGATU	22/02/2020 12:59	22/02/2020 21:36	22/02/2020 12:59	22/02/2020 21:36	8,60	1	8,60	CHI
202002151521	JATAI	JT21361506	JATAI S1	22/02/2020 13:03	22/02/2020 20:57	22/02/2020 13:03	22/02/2020 20:57	7,89	1	7,89	CHI
202002151524	CORUMBAIBA	CI21028978	VILA CORUMBA	22/02/2020 13:03	22/02/2020 15:01	22/02/2020 13:03	22/02/2020 15:01	1,95	1	1,95	CHI
202002151530	PIRES DO RIO	10016775307	PIRES DO RIO S1	22/02/2020 13:08	22/02/2020 14:47	22/02/2020 13:08	22/02/2020 14:47	1,64	1	1,64	CHI
202002151535	EDEIA	EA21237746	EDEIA	22/02/2020 13:10	22/02/2020 18:19	22/02/2020 13:10	22/02/2020 18:19	5,14	1	5,14	CHI
202002151539	PONTALINA	PK21223285	VICENTINOPOLIS	22/02/2020 13:11	22/02/2020 16:28	22/02/2020 13:11	22/02/2020 16:28	3,28	1	3,28	CHI
202002151541	FLORES DE GOIAS	FB12252139	FLORES DE GOIAS	22/02/2020 13:11	22/02/2020 23:23	22/02/2020 13:11	22/02/2020 23:23	10,19	1	10,19	CHI
202002151564	UIRAPURU	UP21313379	SANTA TEREZINHA	22/02/2020 13:19	23/02/2020 00:49	22/02/2020 13:19	23/02/2020 00:49	11,49	1	11,49	CHI
202002151585	JATAI	290327945	JATAI S2	22/02/2020 13:27	22/02/2020 14:49	22/02/2020 13:27	22/02/2020 14:49	1,35	1	1,35	CHI
202002151588	CACU	CC12219251	CACHOEIRA ALTA	22/02/2020 13:29	22/02/2020 19:22	22/02/2020 13:29	22/02/2020 19:22	5,88	2	11,75	CHI
202002151609	EDEALINA	IY12103916	EDEIA	22/02/2020 13:32	22/02/2020 16:42	22/02/2020 13:32	22/02/2020 16:42	3,16	2	6,33	CHI
202002151612	PIRES DO RIO	PR21100018	PIRES DO RIO S1	22/02/2020 13:33	22/02/2020 15:22	22/02/2020 13:33	22/02/2020 15:22	1,81	1	1,81	CHI
202002151614	MINEIROS	PW12301784	PARQUE DAS EMAS	22/02/2020 13:33	23/02/2020 10:55	22/02/2020 13:33	23/02/2020 10:55	21,35	9	192,16	CHI
202002151620	COCALZINHO DE GOIAS	ZN12327452	GOIANESIA S1	22/02/2020 13:35	23/02/2020 10:28	22/02/2020 13:35	23/02/2020 10:28	20,90	9	188,06	CHI
202002151625	CAMPINACU	UC12197187	PORANGATU	22/02/2020 13:35	22/02/2020 17:15	22/02/2020 13:35	22/02/2020 17:15	3,65	28	102,28	CHI
202002151631	BARRO ALTO	1150008006	BARRO ALTO	22/02/2020 13:39	23/02/2020 17:04	22/02/2020 13:39	23/02/2020 17:04	27,41	1	27,41	CHI
202002151634	BONOPOLIS	BX12266004	NOVO PLANALTO	22/02/2020 12:05	23/02/2020 07:43	22/02/2020 12:05	23/02/2020 07:43	19,62	3	58,86	CHI
202002151638	BONOPOLIS	BX12079321	SAO MIGUEL DO ARAGUAIA	22/02/2020 13:41	24/02/2020 01:30	22/02/2020 13:41	22/02/2020 20:54	7,20	11	79,22	CHI
202002151638	BONOPOLIS	BX12079321	SAO MIGUEL DO ARAGUAIA	22/02/2020 13:41	24/02/2020 01:30	22/02/2020 23:15	22/02/2020 23:44	0,48	11	5,32	CHI
202002151638	BONOPOLIS	BX12079321	SAO MIGUEL DO ARAGUAIA	22/02/2020 13:41	24/02/2020 01:30	23/02/2020 01:02	23/02/2020 23:40	22,63	11	248,95	CHI
202002151638	BONOPOLIS	BX12079321	SAO MIGUEL DO ARAGUAIA	22/02/2020 13:41	24/02/2020 01:30	22/02/2020 13:41	24/02/2020 01:30	35,81	23	823,52	CHI

202002151638	BONOPOLIS	BX13182474	SAO MIGUEL DO ARAGUAIA	22/02/2020 13:41	24/02/2020 01:30	22/02/2020 13:41	24/02/2020 01:30	35,81	24	859,33	CHI
202002151655	ANAPOLIS	20678654	ANAPOLIS UNIVERSITARIO S1	22/02/2020 13:45	22/02/2020 15:05	22/02/2020 13:45	22/02/2020 15:05	1,32	1	1,32	CHI
202002151673	MINEIROS	1390155794	PARQUE DAS EMAS	22/02/2020 13:50	22/02/2020 17:28	22/02/2020 13:50	22/02/2020 17:28	3,63	1	3,63	CHI
202002151675	INACIOLANDIA	ID31128263	QUIRINOPOLIS	22/02/2020 13:51	22/02/2020 15:57	22/02/2020 13:51	22/02/2020 15:57	2,10	1	2,10	CHI
202002151682	PORANGATU	PO21245078	PORANGATU	22/02/2020 13:53	22/02/2020 15:24	22/02/2020 13:53	22/02/2020 15:24	1,52	1	1,52	CHI
202002151697	INACIOLANDIA	ID12306349	CACHOEIRA DOURADA	22/02/2020 13:15	22/02/2020 15:13	22/02/2020 13:15	22/02/2020 15:13	1,95	42	81,95	CHI
202002151699	TRINDADE	TR11111853	TRINDADE	22/02/2020 14:00	22/02/2020 16:21	22/02/2020 14:00	22/02/2020 16:21	2,34	143	334,42	CHI
202002151706	OUIDOR	IO12077644	CATALAO S1	22/02/2020 14:04	23/02/2020 09:03	22/02/2020 14:04	23/02/2020 09:03	18,98	5	94,89	CHI
202002151718	PORANGATU	PO12291266	PORANGATU	22/02/2020 14:09	22/02/2020 15:49	22/02/2020 14:09	22/02/2020 15:49	1,66	7	11,64	CHI
202002151720	SILVANIA	660073286	VIANOPOLIS	22/02/2020 14:09	22/02/2020 16:06	22/02/2020 14:09	22/02/2020 16:06	1,94	1	1,94	CHI
202002151721	CALDAZINHA	DE21334876	CEPAIGO S2	22/02/2020 14:10	22/02/2020 17:02	22/02/2020 14:10	22/02/2020 17:02	2,88	5	14,38	CHI
202002151728	VARJAO	VJ21196733	GUAPO S2	22/02/2020 14:11	22/02/2020 16:40	22/02/2020 14:11	22/02/2020 16:40	2,48	2	4,95	CHI
202002151733	ARUANA	AK21287766	MOZARLANDIA	22/02/2020 14:14	22/02/2020 17:21	22/02/2020 14:14	22/02/2020 17:21	3,10	1	3,10	CHI
202002151738	PIRACANJUBA	PJ21200028	BELA VISTA S1	22/02/2020 14:16	22/02/2020 18:13	22/02/2020 14:16	22/02/2020 18:13	3,95	1	3,95	CHI
202002151743	PORANGATU	PO11350147	PORANGATU	22/02/2020 14:17	23/02/2020 09:00	22/02/2020 14:17	23/02/2020 09:00	18,71	1	18,71	CHI
202002151744	QUIRINOPOLIS	80007132	QUIRINOPOLIS	22/02/2020 14:17	22/02/2020 16:31	22/02/2020 14:17	22/02/2020 16:31	2,22	1	2,22	CHI
202002151749	APORE	AE21391170	ITAJA S1	22/02/2020 14:19	22/02/2020 20:44	22/02/2020 14:19	22/02/2020 20:44	6,40	1	6,40	CHI
202002151756	GOIANIA	GN12111308	CARAJAS S1	22/02/2020 14:21	22/02/2020 15:32	22/02/2020 14:21	22/02/2020 15:32	1,18	420	493,73	CHI
202002151769	ITAPIRAPUA	IU21183154	MATRINCHA	22/02/2020 14:26	23/02/2020 07:07	22/02/2020 14:26	23/02/2020 07:07	16,68	1	16,68	CHI
202002151770	ORIZONA	OZ11077376	VIANOPOLIS	22/02/2020 14:26	23/02/2020 10:40	22/02/2020 14:26	23/02/2020 10:40	20,23	4	80,92	CHI
202002151774	CRIXAS	CX12287951	SERRA DO OURO	22/02/2020 14:27	22/02/2020 22:54	22/02/2020 14:27	22/02/2020 22:54	8,44	4	33,77	CHI
202002151775	SILVANIA	VN10400760	VIANOPOLIS	22/02/2020 14:27	22/02/2020 16:05	22/02/2020 14:27	22/02/2020 16:05	1,63	55	89,39	CHI
202002151775	VIANOPOLIS	VN10400760	VIANOPOLIS	22/02/2020 14:27	22/02/2020 16:05	22/02/2020 14:27	22/02/2020 16:05	1,63	30	48,76	CHI
202002151776	GOIANIA	13889590	MEIA PONTE	22/02/2020 14:27	22/02/2020 16:50	22/02/2020 14:27	22/02/2020 16:50	2,37	1	2,37	CHI
202002151777	CATALAO	CT12042326	CATALAO S1	22/02/2020 14:27	22/02/2020 23:42	22/02/2020 14:27	22/02/2020 23:42	9,24	8	73,92	CHI
202002151778	APARECIDA DE GOIANIA	AP11079021	INDEPENDENCIA S1	22/02/2020 14:22	22/02/2020 16:36	22/02/2020 14:22	22/02/2020 16:36	2,22	82	182,27	CHI
202002151780	GOIANIA	11572383	GOYA S2	22/02/2020 14:29	22/02/2020 18:42	22/02/2020 14:29	22/02/2020 18:42	4,22	1	4,22	CHI
202002151783	GOIATUBA	CL12295997	RIO DOS BOIS	22/02/2020 14:29	22/02/2020 18:21	22/02/2020 14:29	22/02/2020 18:21	3,85	17	65,48	CHI
202002151783	PORTEIRAO	CL12295997	RIO DOS BOIS	22/02/2020 14:29	22/02/2020 18:21	22/02/2020 14:29	22/02/2020 18:21	3,85	1	3,85	CHI
202002151797	ANAPOLIS	21229120	ANAPOLIS UNIVERSITARIO S2	22/02/2020 14:35	22/02/2020 17:46	22/02/2020 14:35	22/02/2020 17:46	3,17	1	3,17	CHI
202002151798	GOIANIA	GN11001785	AEROPORTO S3	22/02/2020 14:35	22/02/2020 17:41	22/02/2020 14:35	22/02/2020 17:41	3,09	51	157,39	CHI
202002151804	SAO FRANCISCO DE GOIAS	SF11107970	SAO FRANCISCO DE GOIAS	22/02/2020 14:24	22/02/2020 17:05	22/02/2020 14:24	22/02/2020 17:05	2,67	74	197,77	CHI
202002151807	CACHOEIRA DOURADA	CD12000273	CACHOEIRA DOURADA	22/02/2020 14:39	22/02/2020 17:54	22/02/2020 14:39	22/02/2020 17:54	3,25	1	3,25	CHI
202002151807	ITUMBIARA	CD12000273	CACHOEIRA DOURADA	22/02/2020 14:39	22/02/2020 17:54	22/02/2020 14:39	22/02/2020 17:54	3,25	8	25,98	CHI
202002151809	PORANGATU	PO11000018	PORANGATU	22/02/2020 14:38	22/02/2020 16:19	22/02/2020 15:43	22/02/2020 16:19	0,60	54	32,41	CHI
202002151811	ARUANA	O3200434	ARUANA	22/02/2020 14:36	22/02/2020 15:04	22/02/2020 14:36	22/02/2020 15:04	0,47	8	3,77	CHI
202002151817	SILVANIA	SV21216496	DAIA S2	22/02/2020 14:41	22/02/2020 18:48	22/02/2020 14:41	22/02/2020 18:48	4,11	1	4,11	CHI
202002151820	BARRO ALTO	BA21161160	BARRO ALTO	22/02/2020 14:42	22/02/2020 23:48	22/02/2020 14:42	22/02/2020 23:48	9,10	1	9,10	CHI
202002151831	FAZENDA NOVA	JR12156323	JUSSARA	22/02/2020 14:47	22/02/2020 15:55	22/02/2020 14:47	22/02/2020 15:55	1,12	6	6,74	CHI
202002151831	JUSSARA	JR12156323	JUSSARA	22/02/2020 14:47	22/02/2020 15:55	22/02/2020 14:47	22/02/2020 15:55	1,12	17	19,11	CHI
202002151833	URUTAI	UT21195369	URUTAI	22/02/2020 14:48	22/02/2020 22:51	22/02/2020 14:48	22/02/2020 22:51	8,04	1	8,04	CHI
202002151836	CAIAPONIA	CP12358785	CAIAPONIA	22/02/2020 14:48	23/02/2020 00:17	22/02/2020 14:48	23/02/2020 00:17	9,47	2	18,94	CHI
202002151838	FORMOSA	FA12394153	ITUIQUIRA	22/02/2020 14:48	22/02/2020 16:16	22/02/2020 14:48	22/02/2020 16:16	1,45	19	27,60	CHI
202002151841	JATAI	JT12000231	JATAI S1	22/02/2020 14:19	22/02/2020 22:40	22/02/2020 14:19	22/02/2020 22:40	8,34	73	608,54	CHI

202002151841	PEROLANDIA	JT12000231	JATAI S1	22/02/2020 14:19	22/02/2020 22:40	22/02/2020 14:19	22/02/2020 22:40	8,34	3	25,01	CHI
202002151842	APARECIDA DE GOIANIA	AP11193242	INDEPENDENCIA S2	22/02/2020 14:50	22/02/2020 15:55	22/02/2020 14:50	22/02/2020 15:55	1,08	181	195,68	CHI
202002151845	JUSSARA	JR12220051	JUSSARA	22/02/2020 14:52	22/02/2020 16:53	22/02/2020 14:52	22/02/2020 16:53	2,02	70	141,13	CHI
202002151847	DOVERLANDIA	MY21324381	PARQUE DAS EMAS	22/02/2020 14:52	23/02/2020 11:37	22/02/2020 14:52	23/02/2020 11:37	20,75	1	20,75	CHI
202002151848	CORUMBAIBA	560021926	VILA CORUMBA	22/02/2020 14:52	22/02/2020 16:11	22/02/2020 14:52	22/02/2020 16:11	1,31	1	1,31	CHI
202002151852	CRISTALINA	10027228035	CRISTALINA S1	22/02/2020 14:54	22/02/2020 17:40	22/02/2020 14:54	22/02/2020 17:40	2,76	1	2,76	CHI
202002151854	ITUMBIARA	IT12000128	PARANAIBA	22/02/2020 14:54	23/02/2020 14:20	22/02/2020 14:54	22/02/2020 16:20	1,42	281	399,96	CHI
202002151854	ITUMBIARA	IT12000128	PARANAIBA	22/02/2020 14:54	23/02/2020 14:20	22/02/2020 16:27	23/02/2020 12:27	19,99	171	3418,76	CHI
202002151854	ITUMBIARA	IT12222568	PARANAIBA	22/02/2020 14:54	23/02/2020 14:20	22/02/2020 16:27	23/02/2020 12:46	20,31	24	487,33	CHI
202002151854	ITUMBIARA	IT12000128	PARANAIBA	22/02/2020 14:54	23/02/2020 14:20	22/02/2020 16:27	23/02/2020 13:44	21,28	57	1212,71	CHI
202002151854	ITUMBIARA	IT12000128	PARANAIBA	22/02/2020 14:54	23/02/2020 14:20	22/02/2020 16:27	23/02/2020 14:20	21,88	30	656,48	CHI
202002151864	SANTO ANTONIO DE GOIAS	GR12002121	NEROPOLIS S1	22/02/2020 14:03	23/02/2020 02:30	22/02/2020 14:03	23/02/2020 02:30	12,45	30	373,43	CHI
202002151870	CALDAZINHA	SW21317427	SENADOR CANEDO	22/02/2020 14:58	22/02/2020 16:10	22/02/2020 14:58	22/02/2020 16:10	1,19	4	4,77	CHI
202002151935	ALEXANIA	AX12311876	ALEXANIA	22/02/2020 14:55	22/02/2020 16:41	22/02/2020 14:55	22/02/2020 16:41	1,75	109	190,84	CHI
202002151946	GOIATUBA	JV12208115RE	GOIATUBA S1	22/02/2020 15:03	22/02/2020 16:41	22/02/2020 15:03	22/02/2020 16:41	1,62	10	16,20	CHI
202002151946	JOVIANIA	JV12208115RE	GOIATUBA S1	22/02/2020 15:03	22/02/2020 16:41	22/02/2020 15:03	22/02/2020 16:41	1,62	18	29,16	CHI
202002151946	VICENTINOPOLIS	JV12208115RE	GOIATUBA S1	22/02/2020 15:03	22/02/2020 16:41	22/02/2020 15:03	22/02/2020 16:41	1,62	11	17,82	CHI
202002151994	FORMOSO	SE12170967	MARA ROSA	22/02/2020 09:46	22/02/2020 19:04	22/02/2020 09:46	22/02/2020 19:04	9,29	3	27,86	CHI
202002152008	AMORINOPOLIS	AM12104129	IPORA	22/02/2020 15:05	23/02/2020 03:39	22/02/2020 15:05	23/02/2020 03:39	12,55	3	37,66	CHI
202002152069	ARENOPOLIS	AY12390169	ARENOPOLIS	22/02/2020 15:08	22/02/2020 18:20	22/02/2020 15:08	22/02/2020 18:20	3,20	23	73,58	CHI
202002152069	DIORAMA	AY12390169	ARENOPOLIS	22/02/2020 15:08	22/02/2020 18:20	22/02/2020 15:08	22/02/2020 18:20	3,20	3	9,60	CHI
202002152113	ANAPOLIS	20877330	JUNDIAI S1	22/02/2020 15:09	22/02/2020 17:30	22/02/2020 15:09	22/02/2020 17:30	2,34	1	2,34	CHI
202002152123	SAO JOAO D ALIANCA	JL12404389	SAO JOAO D ALIANCA	22/02/2020 15:10	22/02/2020 17:14	22/02/2020 15:10	22/02/2020 17:14	2,06	7	14,39	CHI
202002152125	CACHOEIRA DOURADA	CD11166433	CACHOEIRA DOURADA	22/02/2020 14:26	22/02/2020 16:48	22/02/2020 14:26	22/02/2020 16:48	2,35	132	310,24	CHI
202002152147	VALPARAISO DE GOIAS	VA11092803	MARAJOARA	22/02/2020 15:13	22/02/2020 15:51	22/02/2020 15:13	22/02/2020 15:51	0,63	149	94,08	CHI
202002152159	MINACU	IH21242201	MINACU	22/02/2020 15:14	23/02/2020 13:14	22/02/2020 15:14	23/02/2020 13:14	21,99	1	21,99	CHI
202002152172	NIQUELANDIA	NQ21355508	NIQUELANDIA SUBTRANSMISSAO	22/02/2020 15:17	22/02/2020 21:13	22/02/2020 15:17	22/02/2020 21:13	5,93	1	5,93	CHI
202002152175	SAO JOAO D ALIANCA	JL21266374	SAO JOAO D ALIANCA	22/02/2020 15:19	22/02/2020 16:20	22/02/2020 15:19	22/02/2020 16:20	1,02	1	1,02	CHI
202002152186	PIRES DO RIO	PR21000065	PIRES DO RIO S1	22/02/2020 15:21	22/02/2020 19:08	22/02/2020 15:21	22/02/2020 19:08	3,77	1	3,77	CHI
202002152197	MINEIROS	1390175707	PARQUE DAS EMAS	22/02/2020 15:24	23/02/2020 02:26	22/02/2020 15:24	23/02/2020 02:26	11,03	1	11,03	CHI
202002152199	SILVANIA	SV21339184	VIANOPOLIS	22/02/2020 15:24	22/02/2020 18:08	22/02/2020 15:24	22/02/2020 18:08	2,72	1	2,72	CHI
202002152203	SERRANOPOLIS	SX12296463	JATAI S1	22/02/2020 15:25	23/02/2020 12:29	22/02/2020 15:25	23/02/2020 12:29	21,05	1	21,05	CHI
202002152204	MARA ROSA	MQ21187999	MARA ROSA	22/02/2020 15:25	22/02/2020 23:30	22/02/2020 15:25	22/02/2020 23:30	8,07	1	8,07	CHI
202002152210	SAO MIGUEL DO ARAGUAIA	830055022	NOVA CRIXAS	22/02/2020 15:29	23/02/2020 07:49	22/02/2020 15:29	23/02/2020 07:49	16,33	1	16,33	CHI
202002152212	LEOPOLDO DE BULHOES	LB11250068	DAIA S2	22/02/2020 15:29	22/02/2020 17:47	22/02/2020 15:29	22/02/2020 17:47	2,30	40	91,96	CHI
202002152214	JARAGUA	JA21339859	ITABERAI S1	22/02/2020 15:29	23/02/2020 14:34	22/02/2020 15:29	23/02/2020 14:34	23,07	1	23,07	CHI
202002152215	MUNDO NOVO DE GOIAS	MH12084354	NOVA CRIXAS	22/02/2020 15:29	22/02/2020 22:39	22/02/2020 15:29	22/02/2020 22:39	7,16	6	42,93	CHI
202002152218	GUARANI DE GOIAS	GY21218423	IACIARA S1	22/02/2020 15:30	22/02/2020 18:01	22/02/2020 15:30	22/02/2020 18:01	2,50	1	2,50	CHI
202002152220	JOVIANIA	JV21050283	GOIATUBA S1	22/02/2020 15:03	22/02/2020 17:08	22/02/2020 15:03	22/02/2020 17:08	2,07	1	2,07	CHI
202002152222	MARA ROSA	ET12256314	MARA ROSA	22/02/2020 15:27	22/02/2020 21:40	22/02/2020 15:27	22/02/2020 21:40	6,20	8	49,60	CHI
202002152223	GOIANIA	11752476	REAL S1	22/02/2020 15:32	22/02/2020 16:39	22/02/2020 15:32	22/02/2020 16:39	1,10	1	1,10	CHI
202002152224	NOVA GLORIA	IW21245606	RUBIATABA	22/02/2020 15:33	23/02/2020 01:05	22/02/2020 15:33	23/02/2020 01:05	9,53	2	19,06	CHI
202002152229	ANAPOLIS	AN12258963	ANAPOLIS UNIVERSITARIO S2	22/02/2020 15:35	22/02/2020 18:30	22/02/2020 15:35	22/02/2020 18:30	2,91	3	8,74	CHI
202002152230	SAO MIGUEL DO ARAGUAIA	SM12096096	SAO MIGUEL DO ARAGUAIA	22/02/2020 15:35	22/02/2020 19:23	22/02/2020 15:35	22/02/2020 19:23	3,80	13	49,39	CHI

202002152248	SERRANOPOLIS	SX12072421	JATAI S1	22/02/2020 15:41	22/02/2020 17:53	22/02/2020 15:41	22/02/2020 17:53	2,18	5	10,92	CHI
202002152249	ORIZONA	10011387805	PIRES DO RIO S2	22/02/2020 15:42	22/02/2020 22:17	22/02/2020 15:42	22/02/2020 22:17	6,57	1	6,57	CHI
202002152250	LUZIANIA	LZ21152836	MARAJOARA	22/02/2020 15:42	22/02/2020 17:25	22/02/2020 15:42	22/02/2020 17:25	1,70	1	1,70	CHI
202002152254	LUZIANIA	LZ12313611	VIANOPOLIS	22/02/2020 15:12	22/02/2020 17:39	22/02/2020 15:12	22/02/2020 17:39	2,44	13	31,72	CHI
202002152255	SILVANIA	LB21200904	DAIA S2	22/02/2020 15:43	23/02/2020 03:42	22/02/2020 15:43	23/02/2020 03:42	11,97	1	11,97	CHI
202002152267	GOIANIRA	GR11076749	GOIANIRA	22/02/2020 14:34	22/02/2020 18:07	22/02/2020 14:34	22/02/2020 18:07	3,53	209	738,58	CHI
202002152274	ANAPOLIS	21099730	JUNDIAI S1	22/02/2020 15:48	22/02/2020 18:19	22/02/2020 15:48	22/02/2020 18:19	2,50	1	2,50	CHI
202002152299	SANTA HELENA DE GOIAS	SH11207101	IPEGUARI	22/02/2020 15:50	22/02/2020 21:46	22/02/2020 15:50	22/02/2020 21:46	5,92	36	213,26	CHI
202002152300	GOIAS	GS21124736	GOIAS	22/02/2020 15:50	22/02/2020 17:13	22/02/2020 15:50	22/02/2020 17:13	1,37	1	1,37	CHI
202002152306	PALMINOPOLIS	PP21053912	PALMEIRAS	22/02/2020 15:51	22/02/2020 17:15	22/02/2020 15:51	22/02/2020 17:15	1,39	1	1,39	CHI
202002152308	MINEIROS	PW12301783	PARQUE DAS EMAS	22/02/2020 15:53	23/02/2020 10:55	22/02/2020 15:53	23/02/2020 10:55	19,03	35	666,09	CHI
202002152308	SANTA RITA DO ARAGUAIA	PW12301783	PARQUE DAS EMAS	22/02/2020 15:53	23/02/2020 10:55	22/02/2020 15:53	23/02/2020 10:55	19,03	15	285,47	CHI
202002152309	ITAGUARU	JA12027826	JARAGUA	22/02/2020 14:58	22/02/2020 18:19	22/02/2020 14:58	22/02/2020 18:19	3,35	9	30,12	CHI
202002152309	JARAGUA	JA12027826	JARAGUA	22/02/2020 14:58	22/02/2020 18:19	22/02/2020 14:58	22/02/2020 18:19	3,35	18	60,24	CHI
202002152341	NIQUELANDIA	NQ21181232	URUACU	22/02/2020 15:53	22/02/2020 23:20	22/02/2020 15:53	22/02/2020 23:20	7,44	2	14,88	CHI
202002152348	CATALAO	CT12266314	CATALAO S2	22/02/2020 15:55	22/02/2020 17:42	22/02/2020 15:55	22/02/2020 17:42	1,77	1	1,77	CHI
202002152348	CUMARI	CT12266314	CATALAO S2	22/02/2020 15:55	22/02/2020 17:42	22/02/2020 15:55	22/02/2020 17:42	1,77	1	1,77	CHI
202002152357	GOIATUBA	GT12044907	GOIATUBA S2	22/02/2020 15:58	22/02/2020 18:46	22/02/2020 15:58	22/02/2020 18:46	2,79	11	30,68	CHI
202002152358	BOM JARDIM DE GOIAS	BM12259509	BOM JARDIM	22/02/2020 15:59	23/02/2020 11:39	22/02/2020 15:59	23/02/2020 11:39	19,66	3	58,98	CHI
202002152360	ITUMBIARA	IT12273841	PARANAIBA	22/02/2020 16:00	22/02/2020 20:13	22/02/2020 16:00	22/02/2020 20:13	4,20	3	12,61	CHI
202002152364	JATAI	JT21361501	JATAI S1	22/02/2020 16:02	22/02/2020 20:22	22/02/2020 16:02	22/02/2020 20:22	4,33	1	4,33	CHI
202002152365	GOIANIA	12650640	ATLANTICO S1	22/02/2020 16:02	22/02/2020 18:16	22/02/2020 16:02	22/02/2020 18:16	2,22	1	2,22	CHI
202002152366	TURVANIA	TV12111578	FIRMINOPOLIS S1	22/02/2020 16:03	22/02/2020 19:25	22/02/2020 16:03	22/02/2020 19:25	3,36	4	13,43	CHI
202002152368	TRINDADE	TR32043437	TRINDADE	22/02/2020 16:04	22/02/2020 21:07	22/02/2020 16:04	22/02/2020 21:07	5,05	2	10,09	CHI
202002152369	CRIXAS	CX12190130	SANTA TEREZINHA	22/02/2020 12:02	23/02/2020 09:37	22/02/2020 12:02	23/02/2020 09:37	21,57	6	129,43	CHI
202002152373	LUZIANIA	LZ12245978	CRISTALINA S2	22/02/2020 16:04	22/02/2020 17:15	22/02/2020 16:04	22/02/2020 17:15	1,17	8	9,34	CHI
202002152374	ACREUNA	EU11000005	ACREUNA	22/02/2020 14:35	22/02/2020 19:33	22/02/2020 14:35	22/02/2020 19:33	4,96	71	351,92	CHI
202002152375	TURVANIA	TV21215885	FIRMINOPOLIS S1	22/02/2020 16:05	22/02/2020 20:51	22/02/2020 16:05	22/02/2020 20:51	4,76	1	4,76	CHI
202002152377	RIO VERDE	RV11371500	RIO VERDE S2	22/02/2020 16:05	22/02/2020 21:31	22/02/2020 16:05	22/02/2020 21:31	5,42	39	211,42	CHI
202002152381	MONTIVIDIU DO NORTE	MX12187848	PORANGATU	22/02/2020 15:54	22/02/2020 17:44	22/02/2020 15:54	22/02/2020 17:44	1,82	15	27,35	CHI
202002152381	TROMBAS	MX12187848	PORANGATU	22/02/2020 15:54	22/02/2020 17:44	22/02/2020 15:54	22/02/2020 17:44	1,82	1	1,82	CHI
202002152400	MORRINHOS	MR21306869	GOIATUBA S1	22/02/2020 16:12	23/02/2020 00:17	22/02/2020 16:12	23/02/2020 00:17	8,07	2	16,14	CHI
202002152403	NIQUELANDIA	NQ21316275	BARRO ALTO	22/02/2020 16:13	23/02/2020 01:55	22/02/2020 16:13	23/02/2020 01:55	9,69	1	9,69	CHI
202002152404	PADRE BERNARDO	PB12313941	PADRE BERNARDO	22/02/2020 16:14	22/02/2020 18:40	22/02/2020 16:14	22/02/2020 18:40	2,43	4	9,70	CHI
202002152416	APARECIDA DE GOIANIA	200408290	INDEPENDENCIA S2	22/02/2020 16:18	22/02/2020 18:58	22/02/2020 16:18	22/02/2020 18:58	2,66	1	2,66	CHI
202002152420	CRIXAS	CX12181532	SERRA DO OURO	22/02/2020 16:19	23/02/2020 11:38	22/02/2020 16:19	23/02/2020 11:38	19,32	10	193,15	CHI
202002152421	ORIZONA	OZ12094835	VIANOPOLIS	22/02/2020 16:19	22/02/2020 19:03	22/02/2020 16:19	22/02/2020 19:03	2,73	2	5,46	CHI
202002152421	VIANOPOLIS	OZ12094835	VIANOPOLIS	22/02/2020 16:19	22/02/2020 19:03	22/02/2020 16:19	22/02/2020 19:03	2,73	28	76,51	CHI
202002152422	PROFESSOR JAMIL SAFADY	JS21363825	ROCHEDO	22/02/2020 16:19	22/02/2020 19:15	22/02/2020 16:19	22/02/2020 19:15	2,93	1	2,93	CHI
202002152424	QUIRINOPOLIS	QI11371208	QUIRINOPOLIS	22/02/2020 16:16	22/02/2020 17:23	22/02/2020 16:16	22/02/2020 17:23	1,10	51	56,27	CHI
202002152436	ITAPURANGA	IK12023043	ITAPURANGA	22/02/2020 16:22	22/02/2020 19:12	22/02/2020 16:22	22/02/2020 19:12	2,82	89	251,05	CHI
202002152441	PALMEIRAS DE GOIAS	PL12000070	PALMEIRAS	22/02/2020 16:25	22/02/2020 17:25	22/02/2020 16:25	22/02/2020 17:25	0,99	19	18,90	CHI
202002152443	SANTO ANTONIO DO DESCOBERTO	2210027026	AGUAS LINDAS DE GOIAS S2	22/02/2020 16:25	22/02/2020 17:51	22/02/2020 16:25	22/02/2020 17:51	1,42	1	1,42	CHI
202002152452	CORUMBAIBA	NE12037329	CATALAO S1	22/02/2020 16:28	22/02/2020 18:57	22/02/2020 16:28	22/02/2020 18:57	2,47	15	37,12	CHI

202002152452	NOVA AURORA	NE12037329	CATALAO S1	22/02/2020 16:28	22/02/2020 18:57	22/02/2020 16:28	22/02/2020 18:57	2,47	70	173,21	CHI
202002152456	BRAZABRANTES	BR12238977	INHUMAS S1	22/02/2020 16:35	22/02/2020 19:00	22/02/2020 16:35	22/02/2020 19:00	2,40	43	103,41	CHI
202002152456	BRAZABRANTES	BR12238977	INHUMAS S1	22/02/2020 16:35	22/02/2020 19:00	22/02/2020 16:35	22/02/2020 19:00	2,40	1	2,40	CHI
202002152456	DAMOLANDIA	BR12238977	INHUMAS S1	22/02/2020 16:35	22/02/2020 19:00	22/02/2020 16:35	22/02/2020 19:00	2,40	701	1685,90	CHI
202002152456	DAMOLANDIA	BR12238977	INHUMAS S1	22/02/2020 16:35	22/02/2020 19:00	22/02/2020 16:35	22/02/2020 19:00	2,40	133	319,86	CHI
202002152456	INHUMAS	BR12238977	INHUMAS S1	22/02/2020 16:35	22/02/2020 19:00	22/02/2020 16:35	22/02/2020 19:00	2,40	102	245,31	CHI
202002152456	INHUMAS	BR12238977	INHUMAS S1	22/02/2020 16:35	22/02/2020 19:00	22/02/2020 16:35	22/02/2020 19:00	2,40	2	4,81	CHI
202002152456	NOVA VENEZA	BR12238977	INHUMAS S1	22/02/2020 16:35	22/02/2020 19:00	22/02/2020 16:35	22/02/2020 19:00	2,40	30	72,15	CHI
202002152456	OURO VERDE DE GOIAS	BR12238977	INHUMAS S1	22/02/2020 16:35	22/02/2020 19:00	22/02/2020 16:35	22/02/2020 19:00	2,40	136	327,08	CHI
202002152456	PETROLINA DE GOIAS	BR12238977	INHUMAS S1	22/02/2020 16:35	22/02/2020 19:00	22/02/2020 16:35	22/02/2020 19:00	2,40	5	12,02	CHI
202002152456	PETROLINA DE GOIAS	BR12238977	INHUMAS S1	22/02/2020 16:35	22/02/2020 19:00	22/02/2020 16:35	22/02/2020 19:00	2,40	6	14,43	CHI
202002152460	APARECIDA DE GOIANIA	10018221716	REAL S2	22/02/2020 16:30	22/02/2020 17:58	22/02/2020 16:30	22/02/2020 17:58	1,46	1	1,46	CHI
202002152472	GOIANIA	12607988	MEIA PONTE	22/02/2020 16:34	22/02/2020 18:15	22/02/2020 16:34	22/02/2020 18:15	1,67	1	1,67	CHI
202002152473	MOZARLANDIA	MZ12051179	MOZARLANDIA	22/02/2020 16:35	22/02/2020 20:36	22/02/2020 16:35	22/02/2020 20:36	4,01	15	60,15	CHI
202002152474	PALMEIRAS DE GOIAS	PL12277423	PALMEIRAS	22/02/2020 16:35	22/02/2020 19:33	22/02/2020 16:35	22/02/2020 19:33	2,97	24	71,21	CHI
202002152479	PORANGATU	PO12230423	NOVO PLANALTO	22/02/2020 16:36	23/02/2020 12:38	22/02/2020 16:36	23/02/2020 12:38	20,02	3	60,07	CHI
202002152480	PIRACANJUBA	PJ21406568	PIRACANJUBA	22/02/2020 16:36	22/02/2020 23:20	22/02/2020 16:36	22/02/2020 23:20	6,72	1	6,72	CHI
202002152489	LUZIANIA	LZ21237998	CRISTALINA S2	22/02/2020 16:39	22/02/2020 18:57	22/02/2020 16:39	22/02/2020 18:57	2,28	1	2,28	CHI
202002152492	PORANGATU	PO12022073	PORANGATU	23/02/2020 12:35	23/02/2020 23:48	23/02/2020 12:35	23/02/2020 23:48	11,22	3	33,65	CHI
202002152498	IPORA	IR21065106	IPORA	22/02/2020 16:42	23/02/2020 06:57	22/02/2020 16:42	23/02/2020 06:57	14,24	2	28,48	CHI
202002152499	MONTIVIDIU DO NORTE	MX12226413	PORANGATU	22/02/2020 16:42	23/02/2020 09:00	22/02/2020 16:42	23/02/2020 09:00	16,29	38	618,90	CHI
202002152501	PORANGATU	PO12020947	PORANGATU	22/02/2020 15:43	22/02/2020 18:11	22/02/2020 15:43	22/02/2020 18:11	2,47	44	108,52	CHI
202002152504	PALMEIRAS DE GOIAS	PL12109625	PALMEIRAS	22/02/2020 16:43	22/02/2020 19:35	22/02/2020 16:43	22/02/2020 19:35	2,86	30	85,75	CHI
202002152509	CALDAS NOVAS	CN21324649	SERRA DE CALDAS	22/02/2020 16:46	23/02/2020 08:35	22/02/2020 16:46	23/02/2020 08:35	15,81	1	15,81	CHI
202002152512	MOSSAMEDES	MD21024164	FIRMINOPOLIS S2	22/02/2020 16:46	22/02/2020 22:43	22/02/2020 16:46	22/02/2020 22:43	5,94	2	11,87	CHI
202002152518	VILA PROPICIO	NP12188681	GOIANESIA S1	22/02/2020 16:45	22/02/2020 19:10	22/02/2020 16:45	22/02/2020 19:10	2,42	87	210,71	CHI
202002152526	TEREZOPOLIS DE GOIAS	TJ21068717	NEROPOLIS S1	22/02/2020 16:49	23/02/2020 01:49	22/02/2020 16:49	23/02/2020 01:49	8,99	2	17,97	CHI
202002152528	PIRENOPOLIS	PV21185543	CORUMBA	22/02/2020 16:50	23/02/2020 07:37	22/02/2020 16:50	23/02/2020 07:37	14,78	1	14,78	CHI
202002152529	CRISTALINA	KR12412111	CRISTALINA S2	22/02/2020 16:50	23/02/2020 08:31	22/02/2020 16:50	23/02/2020 08:31	15,69	7	109,84	CHI
202002152535	BRAZABRANTES	IN21195709	INHUMAS S2	22/02/2020 16:52	23/02/2020 11:59	22/02/2020 16:52	23/02/2020 11:59	19,10	7	133,73	CHI
202002152538	ANAPOLIS	21017827	ANAPOLIS UNIVERSITARIO S2	22/02/2020 16:53	23/02/2020 00:16	22/02/2020 16:53	23/02/2020 00:16	7,38	1	7,38	CHI
202002152541	GUAPO	GA21220924	GUAPO S1	22/02/2020 16:53	22/02/2020 18:13	22/02/2020 16:53	22/02/2020 18:13	1,33	1	1,33	CHI
202002152546	GOIATUBA	GT21050349	GOIATUBA S1	22/02/2020 16:54	22/02/2020 19:23	22/02/2020 16:54	22/02/2020 19:23	2,48	1	2,48	CHI
202002152548	GOIATUBA	GT11038982	GOIATUBA S2	22/02/2020 16:23	22/02/2020 21:30	22/02/2020 16:23	22/02/2020 21:30	5,12	61	312,39	CHI
202002152550	SAO MIGUEL DO PASSA QUATRO	SQ12231382	CRISTIANOPOLIS	22/02/2020 16:55	22/02/2020 18:05	22/02/2020 16:55	22/02/2020 18:05	1,16	44	51,04	CHI
202002152551	MUNDO NOVO DE GOIAS	MH12391964	NOVA CRIXAS	22/02/2020 16:10	22/02/2020 19:42	22/02/2020 16:10	22/02/2020 19:42	3,52	9	31,69	CHI
202002152553	PIRENOPOLIS	PV21048282	NEROPOLIS S1	22/02/2020 16:55	23/02/2020 01:08	22/02/2020 16:55	23/02/2020 01:08	8,20	2	16,41	CHI
202002152554	LUZIANIA	LZ21264828	VIANOPOLIS	22/02/2020 16:55	23/02/2020 00:14	22/02/2020 16:55	23/02/2020 00:14	7,30	4	29,22	CHI
202002152563	MINEIROS	MY21324356	PARQUE DAS EMAS	22/02/2020 16:56	23/02/2020 03:38	22/02/2020 16:56	23/02/2020 03:38	10,68	1	10,68	CHI
202002152565	ORIZONA	2060010464	PIRES DO RIO S2	22/02/2020 16:57	22/02/2020 23:27	22/02/2020 16:57	22/02/2020 23:27	6,49	1	6,49	CHI
202002152568	ANAPOLIS	AN11000277	JUNDIAI S2	22/02/2020 16:58	22/02/2020 18:22	22/02/2020 16:58	22/02/2020 18:22	1,40	174	243,26	CHI
202002152570	BONFINOPOLIS	BO21243742	CEPAIGO S2	22/02/2020 16:58	22/02/2020 18:22	22/02/2020 16:58	22/02/2020 18:22	1,39	2	2,78	CHI
202002152575	NOVA CRIXAS	NA12380421	NOVA CRIXAS	22/02/2020 16:08	22/02/2020 23:57	22/02/2020 16:08	22/02/2020 23:57	7,80	47	366,70	CHI
202002152577	ANAPOLIS	10027512485	JUNDIAI S2	22/02/2020 17:00	22/02/2020 22:47	22/02/2020 17:00	22/02/2020 22:47	5,78	1	5,78	CHI

202002152578	CATALAO	CT12399850	CATALAO S1	22/02/2020 16:47	22/02/2020 21:20	22/02/2020 16:47	22/02/2020 21:20	4,55	54	245,49	CHI
202002152578	GOIANDIRA	CT12399850	CATALAO S1	22/02/2020 16:47	22/02/2020 21:20	22/02/2020 16:47	22/02/2020 21:20	4,55	41	186,39	CHI
202002152580	ANAPOLIS	10005733934	ANAPOLIS UNIVERSITARIO S2	22/02/2020 17:00	22/02/2020 18:27	22/02/2020 17:00	22/02/2020 18:27	1,44	1	1,44	CHI
202002152583	CROMINIA	CQ11000017	PONTALINA	22/02/2020 17:01	23/02/2020 00:11	22/02/2020 17:01	23/02/2020 00:11	7,16	172	1231,76	CHI
202002152585	CRISTALINA	KR21211933	CRISTALINA S2	22/02/2020 17:01	22/02/2020 21:19	22/02/2020 17:01	22/02/2020 21:19	4,28	1	4,28	CHI
202002152591	JATAI	JT12286459	CABRIUVA S2	22/02/2020 15:23	23/02/2020 08:31	22/02/2020 15:23	23/02/2020 08:31	17,13	10	171,31	CHI
202002152592	NIQUELANDIA	NQ21264225	NIQUELANDIA SUBTRANSMISSAO	22/02/2020 17:03	23/02/2020 16:02	22/02/2020 17:03	23/02/2020 16:02	22,98	1	22,98	CHI
202002152595	ISRAELANDIA	IS12101655	IPORA	22/02/2020 14:49	22/02/2020 21:45	22/02/2020 14:49	22/02/2020 21:45	6,93	5	34,64	CHI
202002152597	NIQUELANDIA	NQ21328643	NIQUELANDIA SUBTRANSMISSAO	22/02/2020 17:03	23/02/2020 09:13	22/02/2020 17:03	23/02/2020 09:13	16,15	1	16,15	CHI
202002152598	SANTO ANTONIO DO DESCOBERTO	SN21137735	MARAJOARA	22/02/2020 17:04	22/02/2020 18:13	22/02/2020 17:04	22/02/2020 18:13	1,14	1	1,14	CHI
202002152601	CALDAS NOVAS	CN21223717	CALDAS NOVAS S1	22/02/2020 17:06	23/02/2020 10:25	22/02/2020 17:06	23/02/2020 10:25	17,31	1	17,31	CHI
202002152602	CALDAS NOVAS	760222861	CALDAS NOVAS S1	22/02/2020 17:06	22/02/2020 18:07	22/02/2020 17:06	22/02/2020 18:07	1,01	1	1,01	CHI
202002152603	URUTAI	UT121274689	PIRES DO RIO S2	22/02/2020 17:07	23/02/2020 09:52	22/02/2020 17:07	23/02/2020 09:52	16,74	1	16,74	CHI
202002152608	NOVA CRIXAS	NA12391603	NOVA CRIXAS	22/02/2020 16:26	23/02/2020 09:29	22/02/2020 16:26	23/02/2020 09:29	17,04	41	698,44	CHI
202002152609	JATAI	JT12260443	JATAI S1	22/02/2020 17:09	22/02/2020 23:02	22/02/2020 17:09	22/02/2020 23:02	5,88	2	11,76	CHI
202002152624	AGUAS LINDAS DE GOIAS	10006958360	AGUAS LINDAS DE GOIAS S1	22/02/2020 17:12	22/02/2020 19:00	22/02/2020 17:12	22/02/2020 19:00	1,79	1	1,79	CHI
202002152636	URUACU	640062015	URUACU	22/02/2020 17:15	22/02/2020 19:00	22/02/2020 17:15	22/02/2020 19:00	1,74	1	1,74	CHI
202002152638	PALMEIRAS DE GOIAS	PL12399449	PALMEIRAS	22/02/2020 17:15	22/02/2020 23:07	22/02/2020 17:15	22/02/2020 23:07	5,85	2	11,70	CHI
202002152641	PALMEIRAS DE GOIAS	PL21061052	PALMEIRAS	22/02/2020 17:16	23/02/2020 07:10	22/02/2020 17:16	23/02/2020 07:10	13,91	1	13,91	CHI
202002152645	SENADOR CANEDO	13238700	SENADOR CANEDO	22/02/2020 17:16	22/02/2020 20:27	22/02/2020 17:16	22/02/2020 20:27	3,17	1	3,17	CHI
202002152646	CATALAO	GD12039654	CATALAO S1	22/02/2020 16:49	22/02/2020 20:06	22/02/2020 16:49	22/02/2020 20:06	3,28	4	13,10	CHI
202002152646	GOIANDIRA	GD12039654	CATALAO S1	22/02/2020 16:49	22/02/2020 20:06	22/02/2020 16:49	22/02/2020 20:06	3,28	6	19,65	CHI
202002152649	VARJAO	VJ31066148	GUAPO S2	22/02/2020 17:17	22/02/2020 19:21	22/02/2020 17:17	22/02/2020 19:21	2,06	1	2,06	CHI
202002152653	CATALAO	CT12215709RE	CATALAO S1	22/02/2020 17:09	22/02/2020 19:50	22/02/2020 17:09	22/02/2020 19:50	2,67	119	317,93	CHI
202002152655	BOM JESUS DE GOIAS	BJ12000202	CACHOEIRA DOURADA	22/02/2020 16:26	22/02/2020 22:33	22/02/2020 16:26	22/02/2020 22:33	6,11	23	140,51	CHI
202002152655	GOIATUBA	BJ12000202	CACHOEIRA DOURADA	22/02/2020 16:26	22/02/2020 22:33	22/02/2020 16:26	22/02/2020 22:33	6,11	7	42,76	CHI
202002152655	PANAMA	BJ12000202	CACHOEIRA DOURADA	22/02/2020 16:26	22/02/2020 22:33	22/02/2020 16:26	22/02/2020 22:33	6,11	2	12,22	CHI
202002152656	PADRE BERNARDO	PB21312692	PADRE BERNARDO	22/02/2020 17:18	22/02/2020 22:54	22/02/2020 17:18	22/02/2020 22:54	5,60	1	5,60	CHI
202002152658	RIO VERDE	630411426	RIO VERDE S1	22/02/2020 17:18	22/02/2020 20:38	22/02/2020 17:18	22/02/2020 20:38	3,32	1	3,32	CHI
202002152665	ITAUCU	IB21317396	INHUMAS S1	22/02/2020 17:20	23/02/2020 10:29	22/02/2020 17:20	23/02/2020 10:29	17,15	1	17,15	CHI
202002152668	GOIAS	GS21319398	GOIAS	22/02/2020 17:20	22/02/2020 20:22	22/02/2020 17:20	22/02/2020 20:22	3,03	1	3,03	CHI
202002152673	MARA ROSA	NQ12243364	URUACU	22/02/2020 14:24	22/02/2020 19:58	22/02/2020 14:24	22/02/2020 19:58	5,56	1	5,56	CHI
202002152673	NIQUELANDIA	NQ12243364	URUACU	22/02/2020 14:24	22/02/2020 19:58	22/02/2020 14:24	22/02/2020 19:58	5,56	21	116,76	CHI
202002152676	GOIATUBA	GT21326094	GOIATUBA S2	22/02/2020 17:22	23/02/2020 09:09	22/02/2020 17:22	23/02/2020 09:09	15,79	1	15,79	CHI
202002152678	ITAPURANGA	IK12299926	ITAPURANGA	22/02/2020 17:16	22/02/2020 20:26	22/02/2020 17:16	22/02/2020 20:26	3,15	19	59,91	CHI
202002152680	ABADIANIA	AA12348146	ANAPOLIS UNIVERSITARIO S2	22/02/2020 17:18	22/02/2020 19:54	22/02/2020 17:18	22/02/2020 19:54	2,59	208	538,20	CHI
202002152680	CORUMBA DE GOIAS	AA12348146	ANAPOLIS UNIVERSITARIO S2	22/02/2020 17:18	22/02/2020 19:54	22/02/2020 17:18	22/02/2020 19:54	2,59	1	2,59	CHI
202002152683	IPAMERI	10003545359	IPAMERI	22/02/2020 17:24	22/02/2020 20:18	22/02/2020 17:24	22/02/2020 20:18	2,90	1	2,90	CHI
202002152684	ITAPURANGA	IK12298543	ITAPURANGA	22/02/2020 17:07	22/02/2020 20:05	22/02/2020 17:07	22/02/2020 20:05	2,95	4	11,82	CHI
202002152687	NEROPOLIS	160049570	NEROPOLIS S2	22/02/2020 17:24	23/02/2020 11:38	22/02/2020 17:24	23/02/2020 11:38	18,23	1	18,23	CHI
202002152689	FORMOSA	10026645325	ITUIQUIRA	22/02/2020 17:24	22/02/2020 18:38	22/02/2020 17:24	22/02/2020 18:38	1,22	1	1,22	CHI
202002152690	ANAPOLIS	NR12268437	NEROPOLIS S2	22/02/2020 16:33	22/02/2020 20:53	22/02/2020 16:33	22/02/2020 20:53	4,32	13	56,20	CHI
202002152690	NEROPOLIS	NR12268437	NEROPOLIS S2	22/02/2020 16:33	22/02/2020 20:53	22/02/2020 16:33	22/02/2020 20:53	4,32	30	129,70	CHI
202002152690	OURO VERDE DE GOIAS	NR12268437	NEROPOLIS S2	22/02/2020 16:33	22/02/2020 20:53	22/02/2020 16:33	22/02/2020 20:53	4,32	1	4,32	CHI



202002152691	ITAPURANGA	IK12311030	ITAPURANGA	22/02/2020 17:25	23/02/2020 09:38	22/02/2020 17:25	23/02/2020 09:38	16,21	3	48,64	CHI
202002152692	CRISTALINA	1060117505	CRISTALINA S1	22/02/2020 17:26	22/02/2020 18:05	22/02/2020 17:26	22/02/2020 18:05	0,66	1	0,66	CHI
202002152693	GOIAS	GS12310416	ITABERAI S1	22/02/2020 17:02	22/02/2020 19:40	22/02/2020 17:02	22/02/2020 19:40	2,62	18	47,24	CHI
202002152697	PIRES DO RIO	460111565	PIRES DO RIO S1	22/02/2020 17:27	22/02/2020 20:53	22/02/2020 17:27	22/02/2020 20:53	3,43	1	3,43	CHI
202002152699	APARECIDA DE GOIANIA	200377012	INDEPENDENCIA S2	22/02/2020 17:27	22/02/2020 19:08	22/02/2020 17:27	22/02/2020 19:08	1,67	1	1,67	CHI
202002152702	COCALZINHO DE GOIAS	ZN12302401	COCALZINHO	22/02/2020 17:14	23/02/2020 09:41	22/02/2020 17:14	23/02/2020 09:41	16,45	4	65,78	CHI
202002152702	CORUMBA DE GOIAS	ZN12302401	COCALZINHO	22/02/2020 17:14	23/02/2020 09:41	22/02/2020 17:14	23/02/2020 09:41	16,45	22	361,81	CHI
202002152703	ACREUNA	EU12045197	ACREUNA	22/02/2020 16:52	22/02/2020 20:44	22/02/2020 16:52	22/02/2020 20:44	3,85	17	65,48	CHI
202002152707	PALMEIRAS DE GOIAS	PL21287723	PALMEIRAS	22/02/2020 17:33	22/02/2020 22:02	22/02/2020 17:33	22/02/2020 22:02	4,47	1	4,47	CHI
202002152709	PADRE BERNARDO	PB12053941	PADRE BERNARDO	22/02/2020 17:34	22/02/2020 22:54	22/02/2020 17:34	22/02/2020 22:54	5,33	1	5,33	CHI
202002152713	CATALAO	CT12042339	CATALAO S1	22/02/2020 15:50	22/02/2020 21:49	22/02/2020 15:50	22/02/2020 21:49	5,98	10	59,80	CHI
202002152714	SAO MIGUEL DO ARAGUAIA	SM12350501	SAO MIGUEL DO ARAGUAIA	22/02/2020 16:08	22/02/2020 21:30	22/02/2020 16:08	22/02/2020 21:30	5,36	6	32,18	CHI
202002152716	PARAUNA	PU12205936	PARAUNA	22/02/2020 17:36	22/02/2020 20:23	22/02/2020 17:36	22/02/2020 20:23	2,78	5	13,91	CHI
202002152719	SAO LUIS DE MONTES BELOS	SL12006949	SAO LUIZ DOS MONTES BELOS	22/02/2020 17:36	22/02/2020 21:53	22/02/2020 17:36	22/02/2020 21:53	4,28	41	175,30	CHI
202002152720	BELA VISTA DE GOIAS	BV12000030	BELA VISTA S1	22/02/2020 17:37	22/02/2020 21:15	22/02/2020 17:37	22/02/2020 21:15	3,64	9	32,77	CHI
202002152720	HIDROLANDIA	BV12000030	BELA VISTA S1	22/02/2020 17:37	22/02/2020 21:15	22/02/2020 17:37	22/02/2020 21:15	3,64	1	3,64	CHI
202002152720	PIRACANJUBA	BV12000030	BELA VISTA S1	22/02/2020 17:37	22/02/2020 21:15	22/02/2020 17:37	22/02/2020 21:15	3,64	2	7,28	CHI
202002152720	BELA VISTA DE GOIAS	BV12000030	BELA VISTA S1	22/02/2020 17:37	22/02/2020 21:15	22/02/2020 19:31	22/02/2020 21:15	1,74	4	6,94	CHI
202002152732	VALPARAISO DE GOIAS	10008046237	MARAJOARA	22/02/2020 17:40	22/02/2020 19:40	22/02/2020 17:40	22/02/2020 19:40	1,99	1	1,99	CHI
202002152741	GOIANIRA	390018880	GOIANIRA	22/02/2020 17:43	22/02/2020 20:13	22/02/2020 17:43	22/02/2020 20:13	2,50	1	2,50	CHI
202002152756	SENADOR CANEDO	12688009	GOIANIA LESTE S1	22/02/2020 17:44	22/02/2020 19:26	22/02/2020 17:44	22/02/2020 19:26	1,69	1	1,69	CHI
202002152757	JATAI	290242514	JATAI S2	22/02/2020 17:44	22/02/2020 19:19	22/02/2020 17:44	22/02/2020 19:19	1,58	1	1,58	CHI
202002152758	MONTIVIDIU	MV12303520	MONTIVIDIU T	22/02/2020 17:39	22/02/2020 21:25	22/02/2020 17:39	22/02/2020 21:25	3,77	3	11,30	CHI
202002152758	RIO VERDE	MV12303520	MONTIVIDIU T	22/02/2020 17:39	22/02/2020 21:25	22/02/2020 17:39	22/02/2020 21:25	3,77	1	3,77	CHI
202002152762	RIO VERDE	RV21207011	MONTIVIDIU T	22/02/2020 17:45	23/02/2020 09:28	22/02/2020 17:45	23/02/2020 09:28	15,70	1	15,70	CHI
202002152766	MOZARLANDIA	MZ12055655	MOZARLANDIA	22/02/2020 17:47	23/02/2020 08:22	22/02/2020 17:47	23/02/2020 08:22	14,58	2	29,15	CHI
202002152769	MAIRIPOTABA	MI31060577	PONTALINA	22/02/2020 17:48	22/02/2020 22:49	22/02/2020 17:48	22/02/2020 22:49	5,01	1	5,01	CHI
202002152770	IPIRANGA DE GOIAS	RB12194284	RUBIATABA	22/02/2020 17:37	22/02/2020 21:20	22/02/2020 17:37	22/02/2020 21:20	3,70	4	14,81	CHI
202002152777	CUMARI	CY21000308	CATALAO S1	22/02/2020 17:50	23/02/2020 02:21	22/02/2020 17:50	23/02/2020 02:21	8,50	1	8,50	CHI
202002152778	NOVO GAMA	NJ11203782	MARAJOARA	22/02/2020 17:51	22/02/2020 19:05	22/02/2020 17:51	22/02/2020 19:05	1,23	225	275,88	CHI
202002152780	ABADIANIA	AA12068686	ANAPOLIS UNIVERSITARIO S1	22/02/2020 17:20	23/02/2020 01:25	22/02/2020 17:20	23/02/2020 01:25	8,09	7	56,65	CHI
202002152781	ANAPOLIS	21032040	JUNDIAI S1	22/02/2020 17:53	22/02/2020 21:50	22/02/2020 17:53	22/02/2020 21:50	3,93	1	3,93	CHI
202002152782	CRISTIANOPOLIS	CF21300623	CRISTIANOPOLIS	22/02/2020 17:53	22/02/2020 19:39	22/02/2020 17:53	22/02/2020 19:39	1,75	1	1,75	CHI
202002152783	CRISTIANOPOLIS	CF21126406	CRISTIANOPOLIS	22/02/2020 17:55	22/02/2020 20:26	22/02/2020 17:55	22/02/2020 20:26	2,51	1	2,51	CHI
202002152794	BURITI ALEGRE	BG12263597	ITUMBIARA VELHA S2	22/02/2020 17:58	23/02/2020 10:11	22/02/2020 17:58	23/02/2020 10:11	16,21	4	64,85	CHI
202002152795	PARANAIGUARA	PC21098589	QUIRINOPOLIS	22/02/2020 17:58	22/02/2020 21:51	22/02/2020 17:58	22/02/2020 21:51	3,87	2	7,75	CHI
202002152806	ABADIANIA	AN12022159	ANAPOLIS UNIVERSITARIO S2	22/02/2020 18:00	22/02/2020 22:36	22/02/2020 18:00	22/02/2020 22:36	4,59	84	385,49	CHI
202002152812	ITAPURANGA	IK12300004	ITAPURANGA	22/02/2020 18:02	22/02/2020 19:42	22/02/2020 18:02	22/02/2020 19:42	1,65	9	14,86	CHI
202002152817	ACREUNA	EU12260931	ACREUNA	22/02/2020 18:04	22/02/2020 23:34	22/02/2020 18:04	22/02/2020 23:34	5,49	3	16,47	CHI
202002152821	CAMPINACU	UC12375372	PORANGATU	22/02/2020 18:04	23/02/2020 07:50	22/02/2020 18:04	23/02/2020 07:50	13,75	3	41,26	CHI
202002152825	NIQUELANDIA	2750060080	NIQUELANDIA SUBTRANSMISSAO	22/02/2020 18:06	22/02/2020 22:34	22/02/2020 18:06	22/02/2020 22:34	4,47	1	4,47	CHI
202002152826	MUNDO NOVO DE GOIAS	MH11269484	NOVA CRIXAS	22/02/2020 18:06	22/02/2020 23:40	22/02/2020 18:06	22/02/2020 23:40	5,57	1	5,57	CHI
202002152827	CALDAS NOVAS	CN11000017	SERRA DE CALDAS	22/02/2020 17:47	22/02/2020 22:18	22/02/2020 17:47	22/02/2020 22:18	4,50	151	680,00	CHI
202002152828	URUACU	UR21156474	CAMPINORTE	22/02/2020 18:07	22/02/2020 21:34	22/02/2020 18:07	22/02/2020 21:34	3,45	12	41,35	CHI

202002152834	PETROLINA DE GOIAS	PG12160898LD	SAO FRANCISCO DE GOIAS	22/02/2020 18:08	23/02/2020 22:18	23/02/2020 20:43	23/02/2020 22:18	1,59	2	3,19	CHI
202002152839	MONTIVIDIU	MV12160710	MONTIVIDIU T	22/02/2020 17:59	22/02/2020 20:39	22/02/2020 17:59	22/02/2020 20:39	2,66	21	55,85	CHI
202002152842	JATAI	JT12187731	JATAI S2	22/02/2020 18:10	22/02/2020 23:34	22/02/2020 18:10	22/02/2020 23:34	5,39	3	16,18	CHI
202002152845	IACIARA	IA12046295	IACIARA S2	22/02/2020 18:11	22/02/2020 18:54	22/02/2020 18:11	22/02/2020 18:54	0,71	47	33,50	CHI
202002152847	CACHOEIRA ALTA	CA12200649	CACHOEIRA ALTA	22/02/2020 18:12	22/02/2020 19:55	22/02/2020 18:12	22/02/2020 19:55	1,71	2	3,42	CHI
202002152851	CACU	1140002007	CACHOEIRA ALTA	22/02/2020 18:13	22/02/2020 23:51	22/02/2020 18:13	22/02/2020 23:51	5,62	1	5,62	CHI
202002152858	ANAPOLIS	21127517	ANAPOLIS UNIVERSITARIO S2	22/02/2020 18:16	22/02/2020 21:36	22/02/2020 18:16	22/02/2020 21:36	3,33	1	3,33	CHI
202002152862	SANTO ANTONIO DO DESCOBERTO	SN12314001	MARAJOARA	22/02/2020 18:17	22/02/2020 19:11	22/02/2020 18:17	22/02/2020 19:11	0,88	135	119,40	CHI
202002152872	PALMEIRAS DE GOIAS	PL12333051	PALMEIRAS	22/02/2020 18:19	23/02/2020 08:28	22/02/2020 18:19	23/02/2020 08:28	14,14	1	14,14	CHI
202002152874	PORANGATU	840039396	PORANGATU	22/02/2020 18:20	23/02/2020 14:07	22/02/2020 18:20	23/02/2020 14:07	19,78	1	19,78	CHI
202002152882	INACIOLANDIA	ID12305562	CACHOEIRA DOURADA	22/02/2020 18:22	23/02/2020 01:00	22/02/2020 18:22	23/02/2020 01:00	6,62	4	26,47	CHI
202002152886	MORRINHOS	MR13172966	MORRINHOS	22/02/2020 18:23	22/02/2020 19:28	22/02/2020 18:52	22/02/2020 19:28	0,58	255	149,03	CHI
202002152887	PALMINOPOLIS	PP12053968	PALMEIRAS	22/02/2020 18:24	22/02/2020 21:36	22/02/2020 18:24	22/02/2020 21:36	3,19	5	15,94	CHI
202002152888	APARECIDA DE GOIANIA	14026016	INDEPENDENCIA S2	22/02/2020 18:24	22/02/2020 19:44	22/02/2020 18:24	22/02/2020 19:44	1,32	1	1,32	CHI
202002152891	LUZIANIA	120419737	RIO VERMELHO	22/02/2020 18:26	22/02/2020 20:00	22/02/2020 18:26	22/02/2020 20:00	1,56	1	1,56	CHI
202002152894	LUZIANIA	LZ12320068	CRISTALINA S2	22/02/2020 18:26	22/02/2020 21:06	22/02/2020 18:26	22/02/2020 21:06	2,65	4	10,62	CHI
202002152896	PONTALINA	PK21074972	PONTALINA	22/02/2020 18:26	23/02/2020 07:56	22/02/2020 18:26	23/02/2020 07:56	13,49	1	13,49	CHI
202002152898	GOIANIRA	390103032	GOIANIRA	22/02/2020 18:27	23/02/2020 05:55	22/02/2020 18:27	23/02/2020 05:55	11,45	1	11,45	CHI
202002152902	LUZIANIA	120448385	RIO VERMELHO	22/02/2020 18:29	22/02/2020 20:51	22/02/2020 18:29	22/02/2020 20:51	2,36	1	2,36	CHI
202002152907	ABADIANIA	SV12158398	ANAPOLIS UNIVERSITARIO S1	22/02/2020 18:29	22/02/2020 23:52	22/02/2020 18:29	22/02/2020 23:52	5,37	5	26,87	CHI
202002152907	GAMELEIRA DE GOIAS	SV12158398	ANAPOLIS UNIVERSITARIO S1	22/02/2020 18:29	22/02/2020 23:52	22/02/2020 18:29	22/02/2020 23:52	5,37	6	32,24	CHI
202002152912	PIRES DO RIO	OZ12022847	PIRES DO RIO S2	22/02/2020 18:31	22/02/2020 20:58	22/02/2020 18:31	22/02/2020 20:58	2,45	9	22,04	CHI
202002152927	MORRINHOS	PJ12076912	MORRINHOS	22/02/2020 18:05	22/02/2020 19:56	22/02/2020 18:05	22/02/2020 19:56	1,85	4	7,39	CHI
202002152937	HEITORAI	HE21274497	ITAPURANGA	22/02/2020 18:37	23/02/2020 08:56	22/02/2020 18:37	23/02/2020 08:56	14,30	1	14,30	CHI
202002152943	SANTA CRUZ DE GOIAS	BC21186567	CRISTIANOPOLIS	22/02/2020 18:39	22/02/2020 21:50	22/02/2020 18:39	22/02/2020 21:50	3,18	1	3,18	CHI
202002152950	CATALAO	CT12266196	CATALAO S1	22/02/2020 18:40	23/02/2020 10:47	22/02/2020 18:40	23/02/2020 10:47	16,11	1	16,11	CHI
202002152952	GOIANIA	10003130698	REAL S1	22/02/2020 18:41	22/02/2020 20:01	22/02/2020 18:41	22/02/2020 20:01	1,33	1	1,33	CHI
202002152955	ANAPOLIS	20103270	JUNDIAI S2	22/02/2020 18:41	23/02/2020 02:37	22/02/2020 18:41	23/02/2020 02:37	7,92	1	7,92	CHI
202002152956	PALMEIRAS DE GOIAS	PL11000037	PALMEIRAS	22/02/2020 17:15	22/02/2020 19:01	22/02/2020 17:15	22/02/2020 19:01	1,76	117	205,76	CHI
202002152957	CATALAO	CT21166833	CATALAO S1	22/02/2020 18:42	23/02/2020 08:31	22/02/2020 18:42	23/02/2020 08:31	13,81	1	13,81	CHI
202002152960	CORUMBAIBA	CI12120810	VILA CORUMBA	22/02/2020 18:17	22/02/2020 22:08	22/02/2020 18:17	22/02/2020 22:08	3,84	51	195,73	CHI
202002152964	TRES RANCHOS	TH11165256	CATALAO S1	22/02/2020 18:13	23/02/2020 00:21	22/02/2020 18:13	23/02/2020 00:21	6,13	175	1073,38	CHI
202002152965	MINACU	IH12182453	MINACU	22/02/2020 18:43	23/02/2020 00:47	22/02/2020 18:43	23/02/2020 00:47	6,07	181	1098,32	CHI
202002152970	SANTO ANTONIO DO DESCOBERTO	2210046069	AGUAS LINDAS DE GOIAS S2	22/02/2020 18:46	22/02/2020 19:42	22/02/2020 18:46	22/02/2020 19:42	0,93	1	0,93	CHI
202002152973	GOIANESIA	GE12389757	GOIANESIA S2	22/02/2020 18:46	22/02/2020 23:00	22/02/2020 18:46	22/02/2020 23:00	4,23	1	4,23	CHI
202002152974	CATALAO	CT21266251	CATALAO S1	22/02/2020 18:46	23/02/2020 01:40	22/02/2020 18:46	23/02/2020 01:40	6,89	2	13,78	CHI
202002152975	VALPARAISO DE GOIAS	10014205570	MARAJOARA	22/02/2020 18:46	22/02/2020 20:41	22/02/2020 18:46	22/02/2020 20:41	1,90	1	1,90	CHI
202002152976	GOIATUBA	140063225	GOIATUBA S2	22/02/2020 18:47	22/02/2020 23:28	22/02/2020 18:47	22/02/2020 23:28	4,68	1	4,68	CHI
202002152979	CRISTALINA	KR12352836	CRISTALINA S1	22/02/2020 18:30	23/02/2020 04:19	22/02/2020 18:30	23/02/2020 04:19	9,81	62	608,50	CHI
202002152980	GOIANIRA	TR12015734	INHUMAS S1	22/02/2020 18:48	22/02/2020 21:59	22/02/2020 18:48	22/02/2020 21:59	3,18	16	50,92	CHI
202002152980	TRINDADE	TR12015734	INHUMAS S1	22/02/2020 18:48	22/02/2020 21:59	22/02/2020 18:48	22/02/2020 21:59	3,18	1	3,18	CHI
202002152981	SAO SIMAO	PC12361065	CACHOEIRA ALTA	22/02/2020 18:48	22/02/2020 20:08	22/02/2020 18:48	22/02/2020 20:08	1,33	1	1,33	CHI
202002152985	CALDAS NOVAS	CN11164890	CALDAS NOVAS S1	22/02/2020 18:50	22/02/2020 20:52	22/02/2020 18:50	22/02/2020 20:52	2,03	72	146,22	CHI
202002152993	CALDAS NOVAS	CN11213816	SERRA DE CALDAS	22/02/2020 18:52	22/02/2020 20:30	22/02/2020 18:52	22/02/2020 20:30	1,64	64	104,89	CHI

202002152994	MINEIROS	MY21306466	PARQUE DAS EMAS	22/02/2020 18:52	23/02/2020 09:41	22/02/2020 18:52	23/02/2020 09:41	14,82	1	14,82	CHI
202002152998	JARAGUA	JA12240112	JARAGUA	22/02/2020 16:30	23/02/2020 00:10	22/02/2020 16:30	23/02/2020 00:10	7,67	23	176,34	CHI
202002153001	ALEXANIA	AX12351026	ALEXANIA	22/02/2020 18:36	23/02/2020 10:16	22/02/2020 18:36	23/02/2020 10:16	15,66	77	1205,46	CHI
202002153003	GOIANIRA	390019823	GOIANIRA	22/02/2020 18:53	23/02/2020 10:30	22/02/2020 18:53	23/02/2020 10:30	15,61	1	15,61	CHI
202002153004	ANAPOLIS	10015198799	JUNDIAI S2	22/02/2020 18:53	22/02/2020 21:33	22/02/2020 18:53	22/02/2020 21:33	2,66	1	2,66	CHI
202002153009	APARECIDA DE GOIANIA	AP11209156	INDEPENDENCIA S1	22/02/2020 18:54	23/02/2020 11:31	22/02/2020 18:54	23/02/2020 11:31	16,62	82	1362,61	CHI
202002153011	PIRACANJUBA	60049881	PIRACANJUBA	22/02/2020 18:55	22/02/2020 21:31	22/02/2020 18:55	22/02/2020 21:31	2,59	1	2,59	CHI
202002153014	CRISTALINA	KR11149716	CRISTALINA S1	22/02/2020 18:51	22/02/2020 20:14	22/02/2020 18:51	22/02/2020 20:14	1,37	97	132,92	CHI
202002153019	INHUMAS	IN21110934	INHUMAS S2	22/02/2020 18:56	23/02/2020 12:44	22/02/2020 18:56	23/02/2020 12:44	17,79	1	17,79	CHI
202002153020	SENADOR CANEDO	SW31060139	GOIANIA LESTE S1	22/02/2020 18:56	22/02/2020 20:08	22/02/2020 18:56	22/02/2020 20:08	1,19	1	1,19	CHI
202002153026	PORANGATU	PO12252098	PORANGATU	22/02/2020 18:57	23/02/2020 19:56	22/02/2020 18:57	23/02/2020 19:56	24,97	5	124,83	CHI
202002153027	MOZARLANDIA	MZ21064163	MOZARLANDIA	22/02/2020 18:58	23/02/2020 08:58	22/02/2020 18:58	23/02/2020 08:58	14,00	1	14,00	CHI
202002153032	NOVO GAMA	2460195200	PACAEMBU S1	22/02/2020 18:59	22/02/2020 20:44	22/02/2020 18:59	22/02/2020 20:44	1,73	1	1,73	CHI
202002153036	ALTO PARAISO DE GOIAS	3870007537	FLORES DE GOIAS	22/02/2020 19:01	22/02/2020 21:24	22/02/2020 19:01	22/02/2020 21:24	2,38	1	2,38	CHI
202002153038	SANTA RITA DO ARAGUAIA	SU12302007	SANTA RITA DO ARAGUAIA	22/02/2020 18:44	24/02/2020 22:14	22/02/2020 18:44	24/02/2020 22:14	51,49	2	102,99	CHI
202002153043	SANCLERLANDIA	SC11259219	FIRMINOPOLIS S2	22/02/2020 19:02	22/02/2020 21:20	22/02/2020 19:02	22/02/2020 21:20	2,29	49	112,18	CHI
202002153045	LUZIANIA	LZ12336006	VIANOPOLIS	22/02/2020 18:52	22/02/2020 21:11	22/02/2020 18:52	22/02/2020 21:11	2,31	97	224,37	CHI
202002153049	CATALAO	1990098657	CATALAO S2	22/02/2020 19:04	22/02/2020 23:46	22/02/2020 19:04	22/02/2020 23:46	4,68	1	4,68	CHI
202002153054	GOIANIA	10967072	FERROVIARIO S3	22/02/2020 19:05	23/02/2020 09:06	22/02/2020 19:05	23/02/2020 09:06	14,01	1	14,01	CHI
202002153056	ORIZONA	OZ21389790	VIANOPOLIS	22/02/2020 19:05	23/02/2020 11:37	22/02/2020 19:05	23/02/2020 11:37	16,52	1	16,52	CHI
202002153058	ITAPIRAPUA	IU12073722	MATRINCHA	22/02/2020 15:08	23/02/2020 08:21	22/02/2020 15:08	23/02/2020 08:21	17,20	3	51,61	CHI
202002153074	FORMOSA	610221395	ITUIQUIRA	22/02/2020 19:11	22/02/2020 20:30	22/02/2020 19:11	22/02/2020 20:30	1,31	1	1,31	CHI
202002153077	CUMARI	CY21131102	CATALAO S1	22/02/2020 19:11	23/02/2020 04:55	22/02/2020 19:11	23/02/2020 04:55	9,72	1	9,72	CHI
202002153082	PLANALTINA	PI21359528	PLANALTINA	22/02/2020 19:13	22/02/2020 20:52	22/02/2020 19:13	22/02/2020 20:52	1,64	1	1,64	CHI
202002153083	LUZIANIA	OZ12402562RE	PIRES DO RIO S2	22/02/2020 18:52	23/02/2020 12:00	22/02/2020 18:52	23/02/2020 12:00	17,13	132	2261,64	CHI
202002153083	ORIZONA	OZ12402562RE	PIRES DO RIO S2	22/02/2020 18:52	23/02/2020 12:00	22/02/2020 18:52	23/02/2020 12:00	17,13	7	119,94	CHI
202002153089	APORE	3110012003	ITAJA S1	22/02/2020 19:16	23/02/2020 07:18	22/02/2020 19:16	23/02/2020 07:18	12,03	1	12,03	CHI
202002153090	IPAMERI	IP21199374	IPAMERI	22/02/2020 19:17	23/02/2020 08:30	22/02/2020 19:17	23/02/2020 08:30	13,22	1	13,22	CHI
202002153092	NOVO GAMA	10000619327	PACAEMBU S1	22/02/2020 19:17	22/02/2020 23:23	22/02/2020 19:17	22/02/2020 23:23	4,09	1	4,09	CHI
202002153093	PARAUNA	PU12007905LD	PARAUNA	22/02/2020 19:18	23/02/2020 12:39	22/02/2020 22:01	23/02/2020 12:39	14,65	1	14,65	CHI
202002153096	LUZIANIA	LZ12330783RE	MARAJOARA	22/02/2020 18:53	22/02/2020 23:46	22/02/2020 18:53	22/02/2020 23:46	4,87	204	994,44	CHI
202002153099	ANAPOLIS	AN21086629	ANAPOLIS UNIVERSITARIO S2	22/02/2020 19:19	22/02/2020 21:33	22/02/2020 19:19	22/02/2020 21:33	2,22	1	2,22	CHI
202002153100	LUZIANIA	120341086	RIO VERMELHO	22/02/2020 19:19	22/02/2020 21:00	22/02/2020 19:19	22/02/2020 21:00	1,67	1	1,67	CHI
202002153101	SANTO ANTONIO DO DESCOBERTO	SN21141205	AGUAS LINDAS DE GOIAS S2	22/02/2020 19:19	22/02/2020 23:18	22/02/2020 19:19	22/02/2020 23:18	3,97	1	3,97	CHI
202002153102	AGUAS LINDAS DE GOIAS	LA11346384	AGUAS LINDAS DE GOIAS S1	22/02/2020 19:20	22/02/2020 21:03	22/02/2020 19:20	22/02/2020 21:03	1,71	57	97,44	CHI
202002153103	ITAPURANGA	19637427	ITAPURANGA	22/02/2020 18:50	22/02/2020 22:14	22/02/2020 18:50	22/02/2020 22:14	3,39	107	363,00	CHI
202002153105	TRES RANCHOS	2170010203	CATALAO S1	22/02/2020 19:21	23/02/2020 08:22	22/02/2020 19:21	23/02/2020 08:22	13,01	1	13,01	CHI
202002153106	GOIANESIA	550185094	GOIANESIA S2	22/02/2020 19:21	22/02/2020 20:48	22/02/2020 19:21	22/02/2020 20:48	1,45	1	1,45	CHI
202002153113	DIVINOPOLIS DE GOIAS	GH12151237	SAO DOMINGOS	22/02/2020 19:23	22/02/2020 22:24	22/02/2020 19:23	22/02/2020 22:24	3,01	29	87,16	CHI
202002153113	SAO DOMINGOS	GH12151237	SAO DOMINGOS	22/02/2020 19:23	22/02/2020 22:24	22/02/2020 19:23	22/02/2020 22:24	3,01	21	63,12	CHI
202002153115	URUTAI	UT11000152	URUTAI	22/02/2020 19:22	22/02/2020 22:08	22/02/2020 19:22	22/02/2020 22:08	2,75	229	630,64	CHI
202002153117	TURVELANDIA	TD12213335	RIO DOS BOIS	22/02/2020 19:24	22/02/2020 23:00	22/02/2020 19:24	22/02/2020 23:00	3,60	2	7,19	CHI
202002153118	MONTIVIDIU	MV21260840	MONTIVIDIU T	22/02/2020 19:24	23/02/2020 09:54	22/02/2020 19:24	23/02/2020 09:54	14,49	1	14,49	CHI
202002153123	GOUVELANDIA	6966002	QUIRINOPOLIS	22/02/2020 19:25	23/02/2020 11:54	22/02/2020 19:25	23/02/2020 11:54	16,49	4	65,96	CHI

202002153125	TRINDADE	40301382	TRINDADE	22/02/2020 19:25	23/02/2020 00:45	22/02/2020 19:25	23/02/2020 00:45	5,33	1	5,33	CHI
202002153129	SAO MIGUEL DO PASSA QUATRO	SQ21128951	CRISTIANOPOLIS	22/02/2020 19:25	23/02/2020 10:43	22/02/2020 19:25	23/02/2020 10:43	15,29	1	15,29	CHI
202002153136	MOSSAMEDES	MD12206378	FIRMINOPOLIS S2	22/02/2020 19:26	22/02/2020 21:53	22/02/2020 19:26	22/02/2020 21:53	2,45	15	36,73	CHI
202002153150	VALPARAISO DE GOIAS	10008493950	MARAJOARA	22/02/2020 19:28	22/02/2020 21:06	22/02/2020 19:28	22/02/2020 21:06	1,62	1	1,62	CHI
202002153155	PALMEIRAS DE GOIAS	PL11314971	PALMEIRAS	22/02/2020 18:26	22/02/2020 20:29	22/02/2020 18:26	22/02/2020 20:29	2,03	91	185,06	CHI
202002153156	VALPARAISO DE GOIAS	VA11330581	PACAEMBU S1	22/02/2020 19:28	23/02/2020 10:26	22/02/2020 19:28	23/02/2020 10:26	14,96	56	837,67	CHI
202002153161	ITAGUARI	II11000033	ITABERAI S1	22/02/2020 18:38	22/02/2020 23:35	22/02/2020 18:38	22/02/2020 23:35	4,94	121	597,71	CHI
202002153175	BURITI ALEGRE	BG21048603	ITUMBIARA VELHA S2	22/02/2020 19:31	23/02/2020 10:17	22/02/2020 19:31	23/02/2020 10:17	14,76	3	44,28	CHI
202002153179	JATAI	290092218	JATAI S2	22/02/2020 19:31	22/02/2020 21:44	22/02/2020 19:31	22/02/2020 21:44	2,21	1	2,21	CHI
202002153181	ARAGOIANIA	AO31229559	GUAPO S2	22/02/2020 19:31	22/02/2020 21:40	22/02/2020 19:31	22/02/2020 21:40	2,14	1	2,14	CHI
202002153188	CRISTALINA	KR21237983	CRISTALINA S2	22/02/2020 19:32	23/02/2020 09:43	22/02/2020 19:32	23/02/2020 09:43	14,18	1	14,18	CHI
202002153195	PARAUNA	PU12314958	PARAUNA	22/02/2020 19:32	23/02/2020 02:03	22/02/2020 19:32	23/02/2020 02:03	6,51	8	52,06	CHI
202002153195	RIO VERDE	PU12314958	PARAUNA	22/02/2020 19:32	23/02/2020 02:03	22/02/2020 19:32	23/02/2020 02:03	6,51	2	13,01	CHI
202002153224	ITAJA	IJ21000008	ITAJA S2	22/02/2020 19:36	23/02/2020 09:45	22/02/2020 19:36	23/02/2020 09:45	14,15	1	14,15	CHI
202002153419	ITAGUARI	JA12300163	ITABERAI S1	22/02/2020 19:41	23/02/2020 08:27	22/02/2020 19:41	23/02/2020 08:27	12,77	12	153,20	CHI
202002153420	ALTO HORIZONTE	AJ21135563	SANTA TEREZINHA	22/02/2020 19:41	23/02/2020 00:04	22/02/2020 19:41	23/02/2020 00:04	4,38	1	4,38	CHI
202002153424	ANAPOLIS	20012147	ANAPOLIS UNIVERSITARIO S2	22/02/2020 19:41	22/02/2020 22:34	22/02/2020 19:41	22/02/2020 22:34	2,88	1	2,88	CHI
202002153427	CAMPO ALEGRE DE GOIAS	CM21279002	CAMPO ALEGRE DE GOIAS	22/02/2020 19:42	23/02/2020 09:48	22/02/2020 19:42	23/02/2020 09:48	14,09	1	14,09	CHI
202002153434	GUAPO	10015805016	GUAPO S1	22/02/2020 19:44	22/02/2020 23:07	22/02/2020 19:44	22/02/2020 23:07	3,38	1	3,38	CHI
202002153441	JUSSARA	JR21165320	BRITANIA	22/02/2020 19:44	23/02/2020 09:26	22/02/2020 19:44	23/02/2020 09:26	13,69	3	41,07	CHI
202002153445	SAO MIGUEL DO ARAGUAIA	SM12096096	SAO MIGUEL DO ARAGUAIA	22/02/2020 19:44	23/02/2020 10:45	22/02/2020 19:44	23/02/2020 10:45	15,01	13	195,09	CHI
202002153449	IPAMERI	IP21162508	CRISTALINA S2	22/02/2020 19:47	23/02/2020 11:10	22/02/2020 19:47	23/02/2020 11:10	15,38	1	15,38	CHI
202002153451	CEZARINA	CZ12339956	CEZARINA	22/02/2020 19:47	22/02/2020 21:41	22/02/2020 19:47	22/02/2020 21:41	1,89	2	3,79	CHI
202002153471	MONTES CLAROS DE GOIAS	ME10343348	IPORA	22/02/2020 19:47	23/02/2020 05:47	22/02/2020 19:47	23/02/2020 02:17	6,50	21	136,55	CHI
202002153471	ARAGARCAS	ME10343348	IPORA	22/02/2020 19:47	23/02/2020 05:47	22/02/2020 19:47	23/02/2020 05:47	9,99	49	489,69	CHI
202002153471	ARENOPOLIS	ME10343348	IPORA	22/02/2020 19:47	23/02/2020 05:47	22/02/2020 19:47	23/02/2020 05:47	9,99	106	1059,32	CHI
202002153471	ARENOPOLIS	ME10343348	IPORA	22/02/2020 19:47	23/02/2020 05:47	22/02/2020 19:47	23/02/2020 05:47	9,99	132	1319,16	CHI
202002153471	BOM JARDIM DE GOIAS	ME10343348	IPORA	22/02/2020 19:47	23/02/2020 05:47	22/02/2020 19:47	23/02/2020 05:47	9,99	19	189,88	CHI
202002153471	MONTES CLAROS DE GOIAS	ME10343348	IPORA	22/02/2020 19:47	23/02/2020 05:47	22/02/2020 19:47	23/02/2020 05:47	9,99	83	829,47	CHI
202002153471	MONTES CLAROS DE GOIAS	ME10343348	IPORA	22/02/2020 19:47	23/02/2020 05:47	22/02/2020 19:47	23/02/2020 05:47	9,99	803	8024,87	CHI
202002153471	PIRANHAS	ME10343348	IPORA	22/02/2020 19:47	23/02/2020 05:47	22/02/2020 19:47	23/02/2020 05:47	9,99	2	19,99	CHI
202002153471	MONTES CLAROS DE GOIAS	ME10343348	IPORA	22/02/2020 19:47	23/02/2020 05:47	22/02/2020 20:48	23/02/2020 05:47	8,98	4	35,92	CHI
202002153483	BRAZABRANTES	BR21228335	NEROPOLIS S1	22/02/2020 19:52	23/02/2020 09:25	22/02/2020 19:52	23/02/2020 09:25	13,54	1	13,54	CHI
202002153486	QUIRINOPOLIS	80026771	QUIRINOPOLIS	22/02/2020 19:52	22/02/2020 21:42	22/02/2020 19:52	22/02/2020 21:42	1,82	1	1,82	CHI
202002153489	FORMOSO	FO12328885	PORANGATU	22/02/2020 19:53	23/02/2020 09:57	22/02/2020 19:53	23/02/2020 09:57	14,05	4	56,21	CHI
202002153489	SANTA TEREZA DE GOIAS	FO12328885	PORANGATU	22/02/2020 19:53	23/02/2020 09:57	22/02/2020 19:53	23/02/2020 09:57	14,05	12	168,64	CHI
202002153495	MONTIVIDIU DO NORTE	MX12364202	PORANGATU	22/02/2020 19:54	23/02/2020 11:39	22/02/2020 19:54	23/02/2020 11:39	15,74	23	362,03	CHI
202002153509	MONTIVIDIU	MV12213365	MONTIVIDIU T	22/02/2020 18:45	22/02/2020 23:12	22/02/2020 18:45	22/02/2020 23:12	4,44	3	13,33	CHI
202002153522	NEROPOLIS	NV21275162	INHUMAS S1	22/02/2020 19:58	23/02/2020 07:30	22/02/2020 19:58	23/02/2020 07:30	11,52	2	23,05	CHI
202002153530	BELA VISTA DE GOIAS	BV32085133	BELA VISTA S1	22/02/2020 19:44	22/02/2020 21:55	22/02/2020 19:44	22/02/2020 21:55	2,18	101	220,49	CHI
202002153548	ANAPOLIS	21291627	JUNDIAI S1	22/02/2020 20:04	22/02/2020 22:43	22/02/2020 20:04	22/02/2020 22:43	2,63	1	2,63	CHI
202002153560	APARECIDA DE GOIANIA	AP12258426	INDEPENDENCIA S2	22/02/2020 19:50	23/02/2020 11:00	22/02/2020 19:50	23/02/2020 10:35	14,74	1007	14845,14	CHI
202002153560	APARECIDA DE GOIANIA	AP12258426	INDEPENDENCIA S2	22/02/2020 19:50	23/02/2020 11:00	22/02/2020 19:50	23/02/2020 10:49	14,97	33	494,17	CHI
202002153560	APARECIDA DE GOIANIA	AP12258426	INDEPENDENCIA S2	22/02/2020 19:50	23/02/2020 11:00	22/02/2020 19:50	23/02/2020 11:00	15,16	40	606,57	CHI

202002153584	LEOPOLDO DE BULHOES	LB11216337	DAIA S2	22/02/2020 20:13	23/02/2020 00:41	22/02/2020 20:13	23/02/2020 00:41	4,45	17	75,72	CHI
202002153588	GOIANIA	12845760	CAMPINAS S2	22/02/2020 20:15	22/02/2020 22:52	22/02/2020 20:15	22/02/2020 22:52	2,62	1	2,62	CHI
202002153599	MARA ROSA	MQ12028228	MARA ROSA	22/02/2020 20:18	23/02/2020 01:03	22/02/2020 20:18	23/02/2020 01:03	4,74	14	66,31	CHI
202002153624	ANAPOLIS	AN12000193RE	ANAPOLIS UNIVERSITARIO S2	22/02/2020 20:24	23/02/2020 11:48	22/02/2020 20:24	23/02/2020 11:48	15,39	15	230,88	CHI
202002153633	CACHOEIRA ALTA	CA12370065	CACHOEIRA ALTA	22/02/2020 20:26	22/02/2020 22:47	22/02/2020 20:26	22/02/2020 22:47	2,35	3	7,04	CHI
202002153643	GOIANIA	AP11169480	INDEPENDENCIA S2	22/02/2020 20:09	23/02/2020 11:16	22/02/2020 20:09	23/02/2020 11:16	15,11	69	1042,80	CHI
202002153646	ABADIANIA	AN12360334	ANAPOLIS UNIVERSITARIO S2	22/02/2020 18:28	22/02/2020 22:36	22/02/2020 18:28	22/02/2020 22:36	4,12	10	41,19	CHI
202002153646	ANAPOLIS	AN12360334	ANAPOLIS UNIVERSITARIO S2	22/02/2020 18:28	22/02/2020 22:36	22/02/2020 18:28	22/02/2020 22:36	4,12	415	1709,57	CHI
202002153647	APARECIDA DE GOIANIA	AP12000220	ANHANGUERA	22/02/2020 19:58	22/02/2020 23:14	22/02/2020 19:58	22/02/2020 23:14	3,25	343	1115,61	CHI
202002153655	MAURILANDIA	RV12315683	SANTA HELENA S1	22/02/2020 20:31	23/02/2020 00:10	22/02/2020 20:31	23/02/2020 00:10	3,64	4	14,54	CHI
202002153655	RIO VERDE	RV12315683	SANTA HELENA S1	22/02/2020 20:31	23/02/2020 00:10	22/02/2020 20:31	23/02/2020 00:10	3,64	7	25,45	CHI
202002153659	APORE	AE21296571	ITAJA S2	22/02/2020 20:32	23/02/2020 08:38	22/02/2020 20:32	23/02/2020 08:38	12,08	1	12,08	CHI
202002153672	BONFINOPOLIS	BV12205539	GOIANIA LESTE S2	23/02/2020 07:57	23/02/2020 10:13	23/02/2020 07:57	23/02/2020 10:13	2,26	12	27,07	CHI
202002153672	SENADOR CANEDO	BV12205539	GOIANIA LESTE S2	23/02/2020 07:57	23/02/2020 10:13	23/02/2020 07:57	23/02/2020 10:13	2,26	5	11,28	CHI
202002153681	EDEALINA	10024543959	PONTALINA	22/02/2020 20:39	22/02/2020 22:49	22/02/2020 20:39	22/02/2020 22:49	2,16	1	2,16	CHI
202002153686	AGUAS LINDAS DE GOIAS	10016972900	AGUAS LINDAS DE GOIAS S1	22/02/2020 20:40	22/02/2020 21:45	22/02/2020 20:40	22/02/2020 21:45	1,08	1	1,08	CHI
202002153688	GOIANIA	GN11042200	FERROVIARIO S2	22/02/2020 20:32	23/02/2020 14:16	22/02/2020 20:32	23/02/2020 14:16	17,74	105	1862,73	CHI
202002153689	INACIOLANDIA	ID12128116	QUIRINOPOLIS	22/02/2020 20:35	22/02/2020 22:08	22/02/2020 20:35	22/02/2020 22:08	1,54	27	41,71	CHI
202002153692	CATALAO	CT12250337	CATALAO S1	22/02/2020 20:41	22/02/2020 23:35	22/02/2020 20:41	22/02/2020 23:35	2,88	30	86,53	CHI
202002153693	GOIANIA	00630224	XAVANTES	22/02/2020 20:33	23/02/2020 11:13	22/02/2020 20:33	22/02/2020 20:37	0,06	562	31,22	CHI
202002153693	GOIANIA	GN16403897	XAVANTES	22/02/2020 20:33	23/02/2020 11:13	22/02/2020 20:33	22/02/2020 21:40	1,11	5287	5859,76	CHI
202002153693	GOIANIA	GN16403897	XAVANTES	22/02/2020 20:33	23/02/2020 11:13	22/02/2020 20:33	23/02/2020 05:34	9,02	748	6746,75	CHI
202002153693	GOIANIA	GN16401524	XAVANTES	22/02/2020 20:33	23/02/2020 11:13	23/02/2020 05:48	23/02/2020 05:56	0,13	748	97,86	CHI
202002153693	GOIANIA	GN16403897	XAVANTES	22/02/2020 20:33	23/02/2020 11:13	22/02/2020 20:33	23/02/2020 08:28	11,91	142	1691,89	CHI
202002153693	GOIANIA	GN16403897	XAVANTES	22/02/2020 20:33	23/02/2020 11:13	22/02/2020 20:33	23/02/2020 08:44	12,18	697	8491,40	CHI
202002153693	GOIANIA	GN16403897	XAVANTES	22/02/2020 20:33	23/02/2020 11:13	22/02/2020 20:33	23/02/2020 10:59	14,42	519	7486,29	CHI
202002153693	SANTO ANTONIO DE GOIAS	GN16403897	XAVANTES	22/02/2020 20:33	23/02/2020 11:13	22/02/2020 20:33	23/02/2020 10:59	14,42	4	57,70	CHI
202002153693	GOIANIA	GN16403897	XAVANTES	22/02/2020 20:33	23/02/2020 11:13	22/02/2020 20:33	23/02/2020 11:13	14,67	9	131,99	CHI
202002153693	SANTO ANTONIO DE GOIAS	GN16403897	XAVANTES	22/02/2020 20:33	23/02/2020 11:13	22/02/2020 20:33	23/02/2020 11:13	14,67	10	146,66	CHI
202002153700	APARECIDA DE GOIANIA	10014405839	INDEPENDENCIA S2	22/02/2020 20:44	23/02/2020 00:18	22/02/2020 20:44	23/02/2020 00:18	3,56	1	3,56	CHI
202002153701	RIO VERDE	630224869	RIO VERDE S1	22/02/2020 20:44	22/02/2020 23:18	22/02/2020 20:44	22/02/2020 23:18	2,55	1	2,55	CHI
202002153706	PIRANHAS	PH12170744	PIRANHAS	22/02/2020 20:47	23/02/2020 00:25	22/02/2020 20:47	23/02/2020 00:25	3,62	5	18,10	CHI
202002153707	PIRENOPOLIS	PV21222779	CORUMBA	22/02/2020 20:48	23/02/2020 00:26	22/02/2020 20:48	23/02/2020 00:26	3,63	2	7,27	CHI
202002153714	SENADOR CANEDO	15718440	CEPAIGO S1	22/02/2020 20:52	23/02/2020 04:01	22/02/2020 20:52	23/02/2020 04:01	7,14	1	7,14	CHI
202002153720	SENADOR CANEDO	SW21092677	SENADOR CANEDO	22/02/2020 20:51	22/02/2020 22:25	22/02/2020 20:51	22/02/2020 22:25	1,56	1	1,56	CHI
202002153722	SANTO ANTONIO DO DESCOBERTO	2210132466	AGUAS LINDAS DE GOIAS S2	22/02/2020 20:55	22/02/2020 23:31	22/02/2020 20:55	22/02/2020 23:31	2,60	1	2,60	CHI
202002153724	SENADOR CANEDO	SW12235055LD	SENADOR CANEDO	22/02/2020 20:51	23/02/2020 12:39	22/02/2020 20:51	23/02/2020 12:39	15,79	19	300,10	CHI
202002153727	ARUANA	AK11183261	ARUANA	22/02/2020 20:59	23/02/2020 00:49	22/02/2020 20:59	23/02/2020 00:49	3,83	102	390,80	CHI
202002153731	TRINDADE	TR32049465	TRINDADE	22/02/2020 20:59	23/02/2020 15:06	22/02/2020 20:59	23/02/2020 15:06	18,11	9	162,96	CHI
202002153733	RIO VERDE	10002875185	CABRIUVA S1	22/02/2020 21:01	22/02/2020 22:22	22/02/2020 21:01	22/02/2020 22:22	1,34	1	1,34	CHI
202002153736	INHUMAS	IN12098387	INHUMAS S2	22/02/2020 16:43	23/02/2020 00:34	22/02/2020 16:43	23/02/2020 00:34	7,85	15	117,75	CHI
202002153747	URUACU	640102657	URUACU	22/02/2020 21:09	22/02/2020 22:05	22/02/2020 21:09	22/02/2020 22:05	0,92	1	0,92	CHI
202002153751	DOVERLANDIA	DV12380977	CAIAPONIA	22/02/2020 21:11	22/02/2020 22:52	22/02/2020 21:11	22/02/2020 22:52	1,67	92	153,79	CHI
202002153761	GOIATUBA	VI12166490	VICENTINOPOLIS	22/02/2020 21:14	22/02/2020 22:24	22/02/2020 21:14	22/02/2020 22:24	1,17	4	4,66	CHI

202002153761	VICENTINOPOLIS	VI12166490	VICENTINOPOLIS	22/02/2020 21:14	22/02/2020 22:24	22/02/2020 21:14	22/02/2020 22:24	1,17	2	2,33	CHI
202002153773	APARECIDA DE GOIANIA	AP11093008	REAL S2	22/02/2020 21:19	23/02/2020 01:28	22/02/2020 21:19	23/02/2020 01:28	4,14	78	323,07	CHI
202002153780	PADRE BERNARDO	PB12163217	PADRE BERNARDO	22/02/2020 21:22	22/02/2020 21:58	22/02/2020 21:22	22/02/2020 21:58	0,60	114	68,72	CHI
202002153795	APARECIDA DE GOIANIA	AO10400701	GUAPO S2	22/02/2020 21:29	23/02/2020 08:42	22/02/2020 21:29	22/02/2020 23:30	2,01	2	4,03	CHI
202002153795	ARAGOIANIA	AO10400701	GUAPO S2	22/02/2020 21:29	23/02/2020 08:42	22/02/2020 21:29	22/02/2020 23:30	2,01	585	1178,12	CHI
202002153795	HIDROLANDIA	AO10400701	GUAPO S2	22/02/2020 21:29	23/02/2020 08:42	22/02/2020 21:29	22/02/2020 23:30	2,01	2	4,03	CHI
202002153795	ARAGOIANIA	AO12000105LD	GUAPO S2	22/02/2020 21:29	23/02/2020 08:42	22/02/2020 21:29	23/02/2020 03:00	5,51	2	11,02	CHI
202002153795	ARAGOIANIA	AO12031976	GUAPO S2	22/02/2020 21:29	23/02/2020 08:42	22/02/2020 21:29	23/02/2020 05:54	8,42	46	387,46	CHI
202002153795	ARAGOIANIA	AO12094644LD	GUAPO S2	22/02/2020 21:29	23/02/2020 08:42	22/02/2020 21:29	23/02/2020 08:42	11,22	3	33,67	CHI
202002153796	MARA ROSA	MQ12249312	SANTA TEREZINHA	22/02/2020 21:30	22/02/2020 21:42	22/02/2020 21:30	22/02/2020 21:42	0,18	11	2,03	CHI
202002153799	MINEIROS	DP12272501	JATAI S1	22/02/2020 21:31	23/02/2020 01:57	22/02/2020 21:31	23/02/2020 01:57	4,43	3	13,28	CHI
202002153799	PEROLANDIA	DP12272501	JATAI S1	22/02/2020 21:31	23/02/2020 01:57	22/02/2020 21:31	23/02/2020 01:57	4,43	50	221,37	CHI
202002153800	JARAGUA	JA12000210LD	JARAGUA	22/02/2020 21:31	23/02/2020 13:28	23/02/2020 09:33	23/02/2020 13:20	3,79	36	136,32	CHI
202002153800	JARAGUA	JA21293928	JARAGUA	22/02/2020 21:31	23/02/2020 13:28	22/02/2020 21:31	23/02/2020 13:28	15,95	1	15,95	CHI
202002153808	BONOPOLIS	BX12262762	SAO MIGUEL DO ARAGUAIA	22/02/2020 21:34	23/02/2020 14:33	22/02/2020 21:34	23/02/2020 14:33	16,98	5	84,89	CHI
202002153810	GOIANIA	11635733	ATLANTICO S3	22/02/2020 21:34	23/02/2020 02:09	22/02/2020 21:34	23/02/2020 02:09	4,57	1	4,57	CHI
202002153818	JUSSARA	JR12206881	JUSSARA	22/02/2020 21:41	23/02/2020 08:04	22/02/2020 21:41	23/02/2020 08:04	10,37	7	72,59	CHI
202002153833	CORUMBAIBA	NE12377067	CATALAO S1	22/02/2020 20:03	23/02/2020 08:14	22/02/2020 20:03	23/02/2020 08:14	12,18	15	182,65	CHI
202002153833	NOVA AURORA	NE12377067	CATALAO S1	22/02/2020 20:03	23/02/2020 08:14	22/02/2020 20:03	23/02/2020 08:14	12,18	10	121,76	CHI
202002153842	ABADIA DE GOIAS	GN31050566	TRINDADE	22/02/2020 21:52	23/02/2020 00:16	22/02/2020 21:52	23/02/2020 00:16	2,39	1	2,39	CHI
202002153860	NIQUELANDIA	NQ12227348	URUACU	22/02/2020 22:00	23/02/2020 03:09	22/02/2020 22:00	23/02/2020 03:09	5,14	45	231,50	CHI
202002153862	CAMPOS VERDES	VD12201660	SANTA TEREZINHA	22/02/2020 22:00	23/02/2020 09:40	22/02/2020 22:00	23/02/2020 08:36	10,59	9	95,35	CHI
202002153862	SANTA TEREZINHA DE GOIAS	VD12201660	SANTA TEREZINHA	22/02/2020 22:00	23/02/2020 09:40	22/02/2020 22:00	23/02/2020 08:36	10,59	47	497,93	CHI
202002153862	CAMPOS VERDES	VD12181203	SANTA TEREZINHA	22/02/2020 22:00	23/02/2020 09:40	22/02/2020 22:00	23/02/2020 09:40	11,66	12	139,86	CHI
202002153872	CAMPOS BELOS	MA12150372	SAO DOMINGOS	22/02/2020 22:03	23/02/2020 01:08	22/02/2020 22:03	23/02/2020 01:08	3,07	20	61,47	CHI
202002153872	MONTE ALEGRE DE GOIAS	MA12150372	SAO DOMINGOS	22/02/2020 22:03	23/02/2020 01:08	22/02/2020 22:03	23/02/2020 01:08	3,07	40	122,93	CHI
202002153887	ITAUCU	IX21330171	INHUMAS S1	22/02/2020 22:05	23/02/2020 09:59	22/02/2020 22:05	23/02/2020 09:59	11,88	1	11,88	CHI
202002153890	SAO LUIS DE MONTES BELOS	SL10394732	SAO LUIZ DOS MONTES BELOS	22/02/2020 22:06	23/02/2020 05:28	22/02/2020 22:06	22/02/2020 23:14	1,14	686	779,56	CHI
202002153890	SAO LUIS DE MONTES BELOS	SL11006848	SAO LUIZ DOS MONTES BELOS	22/02/2020 22:06	23/02/2020 05:28	22/02/2020 22:06	22/02/2020 23:22	1,27	163	207,06	CHI
202002153890	SAO LUIS DE MONTES BELOS	SL13186345	SAO LUIZ DOS MONTES BELOS	22/02/2020 22:06	23/02/2020 05:28	22/02/2020 22:06	23/02/2020 05:13	7,13	157	1119,58	CHI
202002153890	SAO LUIS DE MONTES BELOS	SL13232006	SAO LUIZ DOS MONTES BELOS	22/02/2020 22:06	23/02/2020 05:28	23/02/2020 01:03	23/02/2020 05:28	4,41	27	119,18	CHI
202002153896	GOIANIA	GN12000680	CAMPINAS S1	22/02/2020 21:56	23/02/2020 09:48	23/02/2020 03:02	23/02/2020 09:48	6,77	477	3228,36	CHI
202002153897	INDIARA	IY12391274	EDEIA	22/02/2020 22:07	23/02/2020 01:17	22/02/2020 22:07	23/02/2020 01:17	3,16	4	12,64	CHI
202002153901	LUZIANIA	LZ12313695	RIO VERMELHO	22/02/2020 22:08	23/02/2020 10:13	22/02/2020 22:08	23/02/2020 10:13	12,08	23	277,80	CHI
202002153908	NIQUELANDIA	NQ21255127	BARRO ALTO	22/02/2020 22:10	23/02/2020 02:02	22/02/2020 22:10	23/02/2020 02:02	3,87	1	3,87	CHI
202002153915	PALMEIRAS DE GOIAS	PL11361555	PALMEIRAS	22/02/2020 22:11	22/02/2020 23:01	22/02/2020 22:11	22/02/2020 23:01	0,83	35	28,89	CHI
202002153917	NEROPOLIS	NR12247250	NEROPOLIS S2	23/02/2020 06:18	23/02/2020 08:41	23/02/2020 06:18	23/02/2020 08:41	2,37	9	21,35	CHI
202002153934	PORANGATU	MU12094084	MARA ROSA	22/02/2020 22:14	23/02/2020 08:12	22/02/2020 22:14	23/02/2020 08:12	9,96	67	667,10	CHI
202002153947	BALIZA	BH12142110	BOM JARDIM	22/02/2020 22:07	22/02/2020 23:56	22/02/2020 22:07	22/02/2020 23:56	1,80	83	149,56	CHI
202002153950	URUACU	UR21145583	CAMPINORTE	22/02/2020 22:17	22/02/2020 23:55	22/02/2020 22:17	22/02/2020 23:55	1,63	2	3,25	CHI
202002153956	PIRES DO RIO	PR12337227	PIRES DO RIO S1	22/02/2020 22:18	23/02/2020 00:55	22/02/2020 22:18	23/02/2020 00:55	2,61	40	104,53	CHI
202002153956	SANTA CRUZ DE GOIAS	PR12337227	PIRES DO RIO S1	22/02/2020 22:18	23/02/2020 00:55	22/02/2020 22:18	23/02/2020 00:55	2,61	1	2,61	CHI
202002153956	URUTAI	PR12337227	PIRES DO RIO S1	22/02/2020 22:18	23/02/2020 00:55	22/02/2020 22:18	23/02/2020 00:55	2,61	1	2,61	CHI
202002153962	JATAI	JT21365083	JATAI S1	22/02/2020 22:20	22/02/2020 23:38	22/02/2020 22:20	22/02/2020 23:38	1,29	1	1,29	CHI

202002153975	RIO VERDE	RV11382627	CABRIUVA S1	22/02/2020 19:50	22/02/2020 23:01	22/02/2020 19:50	22/02/2020 23:01	3,18	6	19,10	CHI
202002153985	JATAI	JT12000096	JATAI S3	22/02/2020 22:26	23/02/2020 03:12	22/02/2020 22:26	23/02/2020 03:12	4,75	16	76,01	CHI
202002153992	ARAGOIANIA	HD12000186	CEPAIGO S2	23/02/2020 08:01	23/02/2020 11:55	23/02/2020 08:01	23/02/2020 11:55	3,89	14	54,45	CHI
202002153992	HIDROLANDIA	HD12000186	CEPAIGO S2	23/02/2020 08:01	23/02/2020 11:55	23/02/2020 08:01	23/02/2020 11:55	3,89	11	42,78	CHI
202002153993	INDIARA	IY12010956	EDEIA	22/02/2020 22:32	23/02/2020 08:31	22/02/2020 22:32	23/02/2020 08:31	9,98	4	39,92	CHI
202002153993	JANDAIA	IY12010956	EDEIA	22/02/2020 22:32	23/02/2020 08:31	22/02/2020 22:32	23/02/2020 08:31	9,98	1	9,98	CHI
202002154001	CAMPOS BELOS	CH12375530	SAO DOMINGOS	22/02/2020 22:34	23/02/2020 02:25	22/02/2020 22:34	23/02/2020 02:25	3,84	8	30,75	CHI
202002154007	GOIANIA	GN16404320	XAVANTES	22/02/2020 21:02	22/02/2020 22:44	22/02/2020 21:02	22/02/2020 22:42	1,67	4052	6784,85	CHI
202002154007	GOIANIA	00630244	XAVANTES	22/02/2020 21:02	22/02/2020 22:44	22/02/2020 21:02	22/02/2020 22:44	1,70	2919	4962,30	CHI
202002154008	CORREGO DO OURO	CO21087893	FIRMINOPOLIS S2	22/02/2020 22:38	23/02/2020 13:58	22/02/2020 22:38	23/02/2020 13:58	15,33	1	15,33	CHI
202002154009	MINEIROS	MY11036539	PARQUE DAS EMAS	22/02/2020 22:19	23/02/2020 00:28	22/02/2020 22:19	23/02/2020 00:28	2,13	138	294,55	CHI
202002154012	INDIARA	IY12067608	EDEIA	22/02/2020 22:39	23/02/2020 03:38	22/02/2020 22:39	23/02/2020 03:38	4,97	5	24,87	CHI
202002154012	PALMEIRAS DE GOIAS	IY12067608	EDEIA	22/02/2020 22:39	23/02/2020 03:38	22/02/2020 22:39	23/02/2020 03:38	4,97	4	19,89	CHI
202002154019	CRISTALINA	10007569384	CRISTALINA S1	22/02/2020 22:41	23/02/2020 09:01	22/02/2020 22:41	23/02/2020 09:01	10,33	1	10,33	CHI
202002154044	GOIANIRA	GR12353897	MEIA PONTE	22/02/2020 19:57	23/02/2020 02:45	22/02/2020 19:57	23/02/2020 02:45	6,80	317	2154,98	CHI
202002154047	CEZARINA	PL12028820	PALMEIRAS	22/02/2020 22:50	23/02/2020 08:38	22/02/2020 22:50	23/02/2020 08:38	9,79	3	29,36	CHI
202002154047	PALMEIRAS DE GOIAS	PL12028820	PALMEIRAS	22/02/2020 22:50	23/02/2020 08:38	22/02/2020 22:50	23/02/2020 08:38	9,79	7	68,51	CHI
202002154051	URUACU	CR21280281	CAMPINORTE	22/02/2020 22:53	23/02/2020 07:51	22/02/2020 22:53	23/02/2020 07:51	8,95	1	8,95	CHI
202002154053	FIRMINOPOLIS	FR21000042	FIRMINOPOLIS S1	22/02/2020 22:56	23/02/2020 12:12	22/02/2020 22:56	23/02/2020 12:12	13,25	1	13,25	CHI
202002154054	RIO VERDE	630188610	CABRIUVA S1	22/02/2020 22:57	23/02/2020 02:09	22/02/2020 22:57	23/02/2020 02:09	3,19	1	3,19	CHI
202002154059	ITAUCU	IX21013755	INHUMAS S2	22/02/2020 23:02	23/02/2020 14:16	22/02/2020 23:02	23/02/2020 14:16	15,22	1	15,22	CHI
202002154060	GOIANIA	14208295	ATLANTICO S3	22/02/2020 23:03	23/02/2020 04:43	22/02/2020 23:03	23/02/2020 04:43	5,66	1	5,66	CHI
202002154061	INHUMAS	IN11251732	INHUMAS S2	22/02/2020 21:13	23/02/2020 03:11	22/02/2020 21:13	23/02/2020 03:11	5,96	41	244,42	CHI
202002154063	SAO LUIS DE MONTES BELOS	SL32144895	SAO LUIZ DOS MONTES BELOS	22/02/2020 23:04	23/02/2020 07:26	22/02/2020 23:04	23/02/2020 07:26	8,36	5	41,81	CHI
202002154065	JANDAIA	JD12042808	PALMEIRAS	22/02/2020 23:04	23/02/2020 07:00	22/02/2020 23:04	23/02/2020 07:00	7,92	3	23,76	CHI
202002154065	PALMEIRAS DE GOIAS	JD12042808	PALMEIRAS	22/02/2020 23:04	23/02/2020 07:00	22/02/2020 23:04	23/02/2020 07:00	7,92	1	7,92	CHI
202002154071	NOVO GAMA	NU11084529	PACAEMBU S1	22/02/2020 23:11	23/02/2020 01:23	22/02/2020 23:11	23/02/2020 01:23	2,19	244	535,17	CHI
202002154074	CALDAS NOVAS	CN12000057	CALDAS NOVAS S2	22/02/2020 23:12	23/02/2020 09:33	22/02/2020 23:12	23/02/2020 09:33	10,34	40	413,63	CHI
202002154075	DIVINOPOLIS DE GOIAS	GH12322683	SAO DOMINGOS	22/02/2020 23:14	23/02/2020 08:19	22/02/2020 23:14	23/02/2020 08:19	9,08	2	18,16	CHI
202002154075	SAO DOMINGOS	GH12322683	SAO DOMINGOS	22/02/2020 23:14	23/02/2020 08:19	22/02/2020 23:14	23/02/2020 08:19	9,08	4	36,32	CHI
202002154081	BELA VISTA DE GOIAS	04180216	CEPAIGO S2	22/02/2020 21:33	23/02/2020 02:43	22/02/2020 21:33	23/02/2020 02:43	5,17	176	909,09	CHI
202002154081	CALDAZINHA	04180216	CEPAIGO S2	22/02/2020 21:33	23/02/2020 02:43	22/02/2020 21:33	23/02/2020 02:43	5,17	412	2128,09	CHI
202002154081	SENADOR CANEDO	04180216	CEPAIGO S2	22/02/2020 21:33	23/02/2020 02:43	22/02/2020 21:33	23/02/2020 02:43	5,17	1	5,17	CHI
202002154081	SILVANIA	04180216	CEPAIGO S2	22/02/2020 21:33	23/02/2020 02:43	22/02/2020 21:33	23/02/2020 02:43	5,17	1	5,17	CHI
202002154089	SANTA BARBARA DE GOIAS	10000934303	TRINDADE	22/02/2020 23:26	23/02/2020 08:33	22/02/2020 23:26	23/02/2020 08:33	9,10	1	9,10	CHI
202002154092	BRITANIA	04750224	MATRINCHA	22/02/2020 23:22	23/02/2020 05:28	22/02/2020 23:22	23/02/2020 05:28	6,09	6	36,54	CHI
202002154092	ITAPIRAPUA	04750224	MATRINCHA	22/02/2020 23:22	23/02/2020 05:28	22/02/2020 23:22	23/02/2020 05:28	6,09	92	560,36	CHI
202002154093	RIO VERDE	10002875185	CABRIUVA S1	22/02/2020 23:28	23/02/2020 01:00	22/02/2020 23:28	23/02/2020 01:00	1,52	1	1,52	CHI
202002154094	GOIANIA	10003891672	GOYA S1	22/02/2020 23:30	23/02/2020 08:10	22/02/2020 23:30	23/02/2020 08:10	8,66	1	8,66	CHI
202002154097	APARECIDA DE GOIANIA	AP11137117	INDEPENDENCIA S2	22/02/2020 23:33	23/02/2020 05:35	22/02/2020 23:33	23/02/2020 05:35	6,03	105	633,21	CHI
202002154099	EDEIA	CL12214130RE	RIO DOS BOIS	23/02/2020 06:05	23/02/2020 08:04	23/02/2020 06:05	23/02/2020 08:04	1,97	2	3,94	CHI
202002154099	GOIATUBA	CL12214130RE	RIO DOS BOIS	23/02/2020 06:05	23/02/2020 08:04	23/02/2020 06:05	23/02/2020 08:04	1,97	18	35,50	CHI
202002154099	PORTEIRAO	CL12214130RE	RIO DOS BOIS	23/02/2020 06:05	23/02/2020 08:04	23/02/2020 06:05	23/02/2020 08:04	1,97	24	47,33	CHI
202002154099	VICENTINOPOLIS	CL12214130RE	RIO DOS BOIS	23/02/2020 06:05	23/02/2020 08:04	23/02/2020 06:05	23/02/2020 08:04	1,97	4	7,89	CHI

202002154101	MONTIVIDIU	MV12260794	MONTIVIDIU T	22/02/2020 23:35	23/02/2020 10:00	22/02/2020 23:35	23/02/2020 10:00	10,42	1	10,42	CHI
202002154104	MIMOSO DE GOIAS	NQ12207364	BARRO ALTO	22/02/2020 23:36	23/02/2020 09:54	22/02/2020 23:36	23/02/2020 09:54	10,30	4	41,20	CHI
202002154104	NIQUELANDIA	NQ12207364	BARRO ALTO	22/02/2020 23:36	23/02/2020 09:54	22/02/2020 23:36	23/02/2020 09:54	10,30	26	267,79	CHI
202002154110	APARECIDA DE GOIANIA	AP12157727	INDEPENDENCIA S1	22/02/2020 23:41	23/02/2020 13:07	22/02/2020 23:41	23/02/2020 13:07	13,44	13	174,68	CHI
202002154112	GOIANIA	GN11337834	XAVANTES	22/02/2020 23:45	23/02/2020 02:30	22/02/2020 23:45	23/02/2020 02:30	2,74	7	19,17	CHI
202002154113	ALTO PARAISO DE GOIAS	BF12117405	SAO JOAO D ALIANCA	22/02/2020 23:45	23/02/2020 08:25	22/02/2020 23:45	23/02/2020 08:25	8,66	1	8,66	CHI
202002154119	CAMPINORTE	CR12101042	CAMPINORTE	22/02/2020 23:51	23/02/2020 04:51	22/02/2020 23:51	23/02/2020 04:51	4,99	7	34,92	CHI
202002154121	GAMELEIRA DE GOIAS	SV12153787	DAIA S2	22/02/2020 23:51	23/02/2020 12:39	22/02/2020 23:51	23/02/2020 12:39	12,79	4	51,16	CHI
202002154125	CATALAO	CT21344486	CATALAO S1	22/02/2020 23:59	23/02/2020 07:26	22/02/2020 23:59	23/02/2020 07:26	7,44	1	7,44	CHI
202002154126	BARRO ALTO	GE12000087	GOIANESIA S2	23/02/2020 00:01	23/02/2020 01:15	23/02/2020 00:01	23/02/2020 01:15	1,22	2	2,44	CHI
202002154126	GOIANESIA	GE12000087	GOIANESIA S2	23/02/2020 00:01	23/02/2020 01:15	23/02/2020 00:01	23/02/2020 01:15	1,22	14	17,11	CHI
202002154131	GOIANIA	GN11002782	CARAJAS S1	22/02/2020 23:59	23/02/2020 03:05	22/02/2020 23:59	23/02/2020 03:05	3,09	130	401,92	CHI
202002154137	GOIANIA	GN11041232	GOYA S1	23/02/2020 00:13	23/02/2020 04:35	23/02/2020 00:13	23/02/2020 04:35	4,37	2	8,73	CHI
202002154144	GOIAS	GS12021056	GOIAS	23/02/2020 00:19	23/02/2020 07:30	23/02/2020 00:19	23/02/2020 07:30	7,17	26	186,43	CHI
202002154157	LUZIANIA	LZ12349111	MARAJOARA	23/02/2020 00:39	23/02/2020 08:19	23/02/2020 00:39	23/02/2020 08:19	7,65	157	1201,22	CHI
202002154158	PALMINOPOLIS	TV12005542	FIRMINOPOLIS S2	23/02/2020 00:41	23/02/2020 08:10	23/02/2020 00:41	23/02/2020 08:10	7,47	22	164,34	CHI
202002154158	TURVANIA	TV12005542	FIRMINOPOLIS S2	23/02/2020 00:41	23/02/2020 08:10	23/02/2020 00:41	23/02/2020 08:10	7,47	52	388,44	CHI
202002154160	PADRE BERNARDO	10023052692	PADRE BERNARDO	23/02/2020 00:44	23/02/2020 02:24	23/02/2020 00:44	23/02/2020 02:24	1,65	1	1,65	CHI
202002154165	SANTA CRUZ DE GOIAS	BC12309602	CRISTIANOPOLIS	23/02/2020 01:00	23/02/2020 07:22	23/02/2020 01:00	23/02/2020 07:22	6,36	52	330,85	CHI
202002154201	ANAPOLIS	21314597	ANAPOLIS UNIVERSITARIO S2	23/02/2020 01:14	23/02/2020 08:28	23/02/2020 01:14	23/02/2020 08:28	7,23	1	7,23	CHI
202002154223	GOIANIA	200593353	INDEPENDENCIA S2	23/02/2020 01:33	23/02/2020 03:25	23/02/2020 01:33	23/02/2020 03:25	1,85	1	1,85	CHI
202002154255	CAIAPONIA	PY12040163	PALESTINA	23/02/2020 01:55	23/02/2020 07:52	23/02/2020 01:55	23/02/2020 07:52	5,94	45	267,15	CHI
202002154255	PALESTINA DE GOIAS	PY12040163	PALESTINA	23/02/2020 01:55	23/02/2020 07:52	23/02/2020 01:55	23/02/2020 07:52	5,94	103	611,48	CHI
202002154270	GOIANIA	GN16404346	FERROVIARIO S3	23/02/2020 01:23	23/02/2020 05:40	23/02/2020 01:23	23/02/2020 01:28	0,08	1895	158,44	CHI
202002154270	GOIANIA	GN16404346	XAVANTES	23/02/2020 01:23	23/02/2020 05:40	23/02/2020 01:23	23/02/2020 01:28	0,08	4543	379,85	CHI
202002154270	GOIANIA	00592264	AEROPORTO S1	23/02/2020 01:23	23/02/2020 05:40	23/02/2020 01:23	23/02/2020 01:40	0,30	1585	470,22	CHI
202002154270	GOIANIA	00592264	FERROVIARIO S3	23/02/2020 01:23	23/02/2020 05:40	23/02/2020 01:23	23/02/2020 01:40	0,30	9597	2847,11	CHI
202002154270	GOIANIA	00592264	FERROVIARIO S3	23/02/2020 01:23	23/02/2020 05:40	23/02/2020 01:23	23/02/2020 02:00	0,62	1892	1169,36	CHI
202002154270	GOIANIA	GN16404346	FERROVIARIO S3	23/02/2020 01:23	23/02/2020 05:40	23/02/2020 01:23	23/02/2020 02:00	0,62	1713	1058,73	CHI
202002154270	GOIANIA	00592264	AEROPORTO S2	23/02/2020 01:23	23/02/2020 05:40	23/02/2020 01:23	23/02/2020 02:03	0,68	1013	689,12	CHI
202002154270	GOIANIA	00592264	AEROPORTO S2	23/02/2020 01:23	23/02/2020 05:40	23/02/2020 01:23	23/02/2020 05:40	4,29	703	3015,87	CHI
202002154273	ALOANDIA	AD12402548	GOIATUBA S1	23/02/2020 02:17	23/02/2020 07:36	23/02/2020 02:17	23/02/2020 07:36	5,30	1	5,30	CHI
202002154273	MORRINHOS	AD12402548	GOIATUBA S1	23/02/2020 02:17	23/02/2020 07:36	23/02/2020 02:17	23/02/2020 07:36	5,30	1	5,30	CHI
202002154275	PALMEIRAS DE GOIAS	PL12000126	PALMEIRAS	22/02/2020 22:45	23/02/2020 07:44	22/02/2020 22:45	23/02/2020 07:44	8,98	14	125,70	CHI
202002154280	GOIANIA	GN11003128	FERROVIARIO S2	22/02/2020 23:04	23/02/2020 07:58	22/02/2020 23:04	23/02/2020 07:58	8,90	28	249,14	CHI
202002154284	NEROPOLIS	NR21010664	NEROPOLIS S2	23/02/2020 02:31	23/02/2020 04:30	23/02/2020 02:31	23/02/2020 04:30	1,97	1	1,97	CHI
202002154289	BOM JARDIM DE GOIAS	BM12231130	BOM JARDIM	23/02/2020 02:33	23/02/2020 08:44	23/02/2020 02:33	23/02/2020 08:44	6,18	10	61,81	CHI
202002154294	SAO LUIS DE MONTES BELOS	SL16407327	SAO LUIZ DOS MONTES BELOS	23/02/2020 02:29	23/02/2020 12:19	23/02/2020 02:29	23/02/2020 06:11	3,69	28	103,35	CHI
202002154294	SAO LUIS DE MONTES BELOS	SL10394730	SAO LUIZ DOS MONTES BELOS	23/02/2020 02:29	23/02/2020 12:19	23/02/2020 06:24	23/02/2020 11:04	4,66	19	88,50	CHI
202002154294	AURILANDIA	SL10403940	SAO LUIZ DOS MONTES BELOS	23/02/2020 02:29	23/02/2020 12:19	23/02/2020 02:29	23/02/2020 11:10	8,68	33	286,31	CHI
202002154294	CORREGO DO OURO	SL10403940	SAO LUIZ DOS MONTES BELOS	23/02/2020 02:29	23/02/2020 12:19	23/02/2020 02:29	23/02/2020 11:10	8,68	327	2837,09	CHI
202002154294	FIRMINOPOLIS	SL10403940	SAO LUIZ DOS MONTES BELOS	23/02/2020 02:29	23/02/2020 12:19	23/02/2020 02:29	23/02/2020 11:10	8,68	110	954,37	CHI
202002154294	MOIPORA	SL10403940	SAO LUIZ DOS MONTES BELOS	23/02/2020 02:29	23/02/2020 12:19	23/02/2020 02:29	23/02/2020 11:10	8,68	28	242,93	CHI
202002154294	SANCLERLANDIA	SL10403940	SAO LUIZ DOS MONTES BELOS	23/02/2020 02:29	23/02/2020 12:19	23/02/2020 02:29	23/02/2020 11:10	8,68	37	321,02	CHI



202002154294	SAO LUIS DE MONTES BELOS	SL10403940	SAO LUIZ DOS MONTES BELOS	23/02/2020 02:29	23/02/2020 12:19	23/02/2020 02:29	23/02/2020 11:10	8,68	295	2559,45	CHI
202002154294	SAO LUIS DE MONTES BELOS	SL12006949	SAO LUIZ DOS MONTES BELOS	23/02/2020 02:29	23/02/2020 12:19	23/02/2020 02:29	23/02/2020 11:52	9,38	41	384,61	CHI
202002154294	SAO LUIS DE MONTES BELOS	SL12373573	SAO LUIZ DOS MONTES BELOS	23/02/2020 02:29	23/02/2020 12:19	23/02/2020 06:24	23/02/2020 12:19	5,92	9	53,27	CHI
202002154299	JUSSARA	JR12220059	JUSSARA	22/02/2020 22:21	23/02/2020 08:34	22/02/2020 22:21	23/02/2020 08:34	10,21	12	122,54	CHI
202002154301	JUSSARA	JR11009934	JUSSARA	23/02/2020 02:57	23/02/2020 07:22	23/02/2020 02:57	23/02/2020 07:22	4,41	109	480,18	CHI
202002154302	TRINDADE	12664984	GOYA S2	23/02/2020 03:01	23/02/2020 04:55	23/02/2020 03:01	23/02/2020 04:55	1,90	1	1,90	CHI
202002154303	AGUA LIMPA	RQ12063059RE	VILA CORUMBA	23/02/2020 03:04	23/02/2020 12:38	23/02/2020 03:04	23/02/2020 12:38	9,56	16	153,00	CHI
202002154303	CALDAS NOVAS	RQ12063059RE	VILA CORUMBA	23/02/2020 03:04	23/02/2020 12:38	23/02/2020 03:04	23/02/2020 12:38	9,56	20	191,26	CHI
202002154303	MORRINHOS	RQ12063059RE	VILA CORUMBA	23/02/2020 03:04	23/02/2020 12:38	23/02/2020 03:04	23/02/2020 12:38	9,56	5	47,81	CHI
202002154303	RIO QUENTE	RQ12063059RE	VILA CORUMBA	23/02/2020 03:04	23/02/2020 12:38	23/02/2020 03:04	23/02/2020 12:38	9,56	112	1071,03	CHI
202002154306	GOIANIA	GN12042847	FERROVIARIO S2	23/02/2020 02:53	23/02/2020 05:52	23/02/2020 02:53	23/02/2020 05:52	2,97	507	1506,35	CHI
202002154312	GOIANIA	GN12164390	XAVANTES	22/02/2020 23:11	23/02/2020 08:36	22/02/2020 23:11	23/02/2020 08:36	9,41	744	7003,93	CHI
202002154315	MORRINHOS	MR12029813	MORRINHOS	23/02/2020 04:01	23/02/2020 08:57	23/02/2020 04:01	23/02/2020 08:57	4,92	14	68,89	CHI
202002154318	GUARANI DE GOIAS	GY12257673	IACIARA S1	23/02/2020 04:20	23/02/2020 08:12	23/02/2020 04:20	23/02/2020 08:12	3,86	95	366,73	CHI
202002154318	IACIARA	GY12257673	IACIARA S1	23/02/2020 04:20	23/02/2020 08:12	23/02/2020 04:20	23/02/2020 08:12	3,86	6	23,16	CHI
202002154319	APARECIDA DE GOIANIA	AP11150295	INDEPENDENCIA S2	23/02/2020 04:22	23/02/2020 09:46	23/02/2020 04:22	23/02/2020 09:46	5,39	14	75,47	CHI
202002154320	ANAPOLIS	AN12258136	ANAPOLIS UNIVERSITARIO S1	23/02/2020 04:24	23/02/2020 08:07	23/02/2020 04:24	23/02/2020 08:07	3,71	4	14,84	CHI
202002154324	SAO MIGUEL DO PASSA QUATRO	SQ12231522	CRISTIANOPOLIS	22/02/2020 23:40	23/02/2020 09:49	22/02/2020 23:40	23/02/2020 09:49	10,14	12	121,74	CHI
202002154324	VIANOPOLIS	SQ12231522	CRISTIANOPOLIS	22/02/2020 23:40	23/02/2020 09:49	22/02/2020 23:40	23/02/2020 09:49	10,14	18	182,61	CHI
202002154326	GOIAS	GS21116949	GOIAS	23/02/2020 04:50	23/02/2020 08:52	23/02/2020 04:50	23/02/2020 08:52	4,03	1	4,03	CHI
202002154327	MUTUNOPOLIS	MU12060992	MARA ROSA	23/02/2020 04:54	23/02/2020 08:55	23/02/2020 04:54	23/02/2020 08:55	4,02	3	12,05	CHI
202002154330	SAO LUIS DE MONTES BELOS	SL12383510	FIRMINOPOLIS S2	23/02/2020 05:00	23/02/2020 07:51	23/02/2020 05:00	23/02/2020 07:51	2,84	6	17,07	CHI
202002154333	PIRANHAS	PH12380878	PIRANHAS	23/02/2020 05:06	23/02/2020 07:26	23/02/2020 05:06	23/02/2020 07:26	2,33	11	25,61	CHI
202002154336	PLANALTIMA	PI12324338	SAO JOAO D ALIANCA	23/02/2020 05:09	23/02/2020 11:00	23/02/2020 05:09	23/02/2020 11:00	5,86	6	35,14	CHI
202002154338	DIORAMA	DI12063493	IPORA	23/02/2020 05:12	23/02/2020 09:04	23/02/2020 05:12	23/02/2020 09:04	3,85	39	150,31	CHI
202002154338	IPORA	DI12063493	IPORA	23/02/2020 05:12	23/02/2020 09:04	23/02/2020 05:12	23/02/2020 09:04	3,85	3	11,56	CHI
202002154338	MONTES CLAROS DE GOIAS	DI12063493	IPORA	23/02/2020 05:12	23/02/2020 09:04	23/02/2020 05:12	23/02/2020 09:04	3,85	7	26,98	CHI
202002154340	NOVA AMERICA	RB12251987	RUBIATABA	23/02/2020 04:01	23/02/2020 08:49	23/02/2020 04:01	23/02/2020 08:49	4,80	3	14,40	CHI
202002154340	RUBIATABA	RB12251987	RUBIATABA	23/02/2020 04:01	23/02/2020 08:49	23/02/2020 04:01	23/02/2020 08:49	4,80	6	28,80	CHI
202002154341	BALIZA	BH12079598	BOM JARDIM	23/02/2020 05:19	23/02/2020 08:03	23/02/2020 05:19	23/02/2020 08:03	2,73	25	68,26	CHI
202002154344	GOIANIA	15458120	CAMPINAS S2	23/02/2020 05:22	23/02/2020 08:03	23/02/2020 05:22	23/02/2020 08:03	2,67	1	2,67	CHI
202002154347	PONTALINA	PK12080060	PONTALINA	23/02/2020 05:23	23/02/2020 09:35	23/02/2020 05:23	23/02/2020 09:35	4,19	29	121,40	CHI
202002154351	PIRACANJUBA	PJ12384538	MORRINHOS	23/02/2020 05:33	23/02/2020 09:01	23/02/2020 05:33	23/02/2020 09:01	3,46	21	72,60	CHI
202002154354	ANICUNS	AC12020469	ANICUNS	23/02/2020 03:37	23/02/2020 08:18	23/02/2020 03:37	23/02/2020 08:18	4,67	19	88,79	CHI
202002154355	ITABERAI	IB12227139	ITABERAI S1	23/02/2020 05:36	23/02/2020 08:52	23/02/2020 05:36	23/02/2020 08:52	3,27	9	29,40	CHI
202002154357	IPAMERI	IP12031890	IPAMERI	23/02/2020 05:36	23/02/2020 08:02	23/02/2020 05:36	23/02/2020 08:02	2,42	66	160,03	CHI
202002154360	EDEIA	ED12000041	EDEIA	23/02/2020 05:39	23/02/2020 08:46	23/02/2020 05:39	23/02/2020 08:46	3,11	26	80,76	CHI
202002154361	GOIANIA	GN11001836	AEROPORTO S1	23/02/2020 05:42	23/02/2020 12:02	23/02/2020 09:30	23/02/2020 11:34	2,08	20	41,57	CHI
202002154361	GOIANIA	GN13400635B	AEROPORTO S2	23/02/2020 05:42	23/02/2020 12:02	23/02/2020 05:42	23/02/2020 12:02	6,33	703	4447,06	CHI
202002154363	GOIANDIRA	GD12078359	CATALAO S1	23/02/2020 05:43	23/02/2020 09:27	23/02/2020 05:43	23/02/2020 09:27	3,72	26	96,69	CHI
202002154365	JUSSARA	JR12198907	BRITANIA	23/02/2020 05:50	23/02/2020 15:16	23/02/2020 05:50	23/02/2020 15:16	9,44	36	339,88	CHI
202002154369	JARAGUA	JA12040435	SAO FRANCISCO DE GOIAS	22/02/2020 22:43	23/02/2020 09:29	22/02/2020 22:43	23/02/2020 09:29	10,77	3	32,30	CHI
202002154369	JESUPOLIS	JA12040435	SAO FRANCISCO DE GOIAS	22/02/2020 22:43	23/02/2020 09:29	22/02/2020 22:43	23/02/2020 09:29	10,77	19	204,57	CHI
202002154370	ORIZONA	VN12026007	VIANOPOLIS	23/02/2020 05:51	23/02/2020 08:55	23/02/2020 05:51	23/02/2020 08:55	3,05	20	61,09	CHI

202002154370	SILVANIA	VN12026007	VIANOPOLIS	23/02/2020 05:51	23/02/2020 08:55	23/02/2020 05:51	23/02/2020 08:55	3,05	1	3,05	CHI
202002154370	VIANOPOLIS	VN12026007	VIANOPOLIS	23/02/2020 05:51	23/02/2020 08:55	23/02/2020 05:51	23/02/2020 08:55	3,05	55	168,01	CHI
202002154372	NOVA CRIXAS	NA12334349	NOVA CRIXAS	23/02/2020 05:54	23/02/2020 09:06	23/02/2020 05:54	23/02/2020 09:06	3,20	86	275,03	CHI
202002154373	PARAUNA	PU12194225	FIRMINOPOLIS S2	23/02/2020 05:53	23/02/2020 07:25	23/02/2020 05:53	23/02/2020 07:25	1,52	13	19,74	CHI
202002154374	GOIANIA	GN11043396	CAMPINAS S1	23/02/2020 05:55	23/02/2020 09:11	23/02/2020 05:55	23/02/2020 09:11	3,26	34	110,89	CHI
202002154378	PIRENOPOLIS	PV11248856	CORUMBA	23/02/2020 06:01	23/02/2020 08:13	23/02/2020 06:01	23/02/2020 08:13	2,19	108	237,00	CHI
202002154381	MONTE ALEGRE DE GOIAS	MA12209855	SAO DOMINGOS	23/02/2020 06:03	23/02/2020 09:56	23/02/2020 06:03	23/02/2020 09:56	3,88	14	54,36	CHI
202002154383	PIRACANJUBA	PJ12212150RE	PIRACANJUBA	23/02/2020 06:04	23/02/2020 09:44	23/02/2020 06:04	23/02/2020 09:44	3,66	61	223,26	CHI
202002154385	JANDAIA	JD12005405	PALMEIRAS	23/02/2020 02:33	23/02/2020 08:37	23/02/2020 02:33	23/02/2020 08:37	6,06	7	42,40	CHI
202002154385	PALMEIRAS DE GOIAS	JD12005405	PALMEIRAS	23/02/2020 02:33	23/02/2020 08:37	23/02/2020 02:33	23/02/2020 08:37	6,06	53	321,02	CHI
202002154386	DISTRITO FEDERAL	SN12237830	MARAJOARA	23/02/2020 06:04	23/02/2020 12:30	23/02/2020 06:04	23/02/2020 12:30	6,42	3	19,26	CHI
202002154386	SANTO ANTONIO DO DESCOBERTO	SN12237830	MARAJOARA	23/02/2020 06:04	23/02/2020 12:30	23/02/2020 06:04	23/02/2020 12:30	6,42	24	154,07	CHI
202002154388	AMARALINA	LC12050751	MARA ROSA	23/02/2020 05:00	23/02/2020 09:31	23/02/2020 05:00	23/02/2020 09:31	4,51	12	54,10	CHI
202002154388	MARA ROSA	LC12050751	MARA ROSA	23/02/2020 05:00	23/02/2020 09:31	23/02/2020 05:00	23/02/2020 09:31	4,51	5	22,54	CHI
202002154389	CAMPOS BELOS	MA12150372	SAO DOMINGOS	23/02/2020 06:08	23/02/2020 09:56	23/02/2020 06:08	23/02/2020 09:56	3,80	20	75,90	CHI
202002154389	MONTE ALEGRE DE GOIAS	MA12150372	SAO DOMINGOS	23/02/2020 06:08	23/02/2020 09:56	23/02/2020 06:08	23/02/2020 09:56	3,80	26	98,67	CHI
202002154390	LAGOA SANTA	LS12131582	CACHOEIRA ALTA	23/02/2020 05:39	23/02/2020 08:50	23/02/2020 05:39	23/02/2020 08:50	3,18	18	57,26	CHI
202002154390	DISTRITO FEDERAL	LS12131582	ITAJA S2	23/02/2020 05:39	23/02/2020 08:50	23/02/2020 05:39	23/02/2020 08:50	3,18	1	3,18	CHI
202002154390	LAGOA SANTA	LS12131582	ITAJA S2	23/02/2020 05:39	23/02/2020 08:50	23/02/2020 05:39	23/02/2020 08:50	3,18	11	34,99	CHI
202002154392	CAMPOS BELOS	8563407	SAO DOMINGOS	23/02/2020 06:08	23/02/2020 08:34	23/02/2020 06:08	23/02/2020 08:34	2,42	2	4,84	CHI
202002154393	BRAZABRANTES	BR12166574	NEROPOLIS S1	22/02/2020 19:32	23/02/2020 08:57	22/02/2020 19:32	23/02/2020 08:57	13,41	2	26,83	CHI
202002154393	GOIANIRA	BR12166574	NEROPOLIS S1	22/02/2020 19:32	23/02/2020 08:57	22/02/2020 19:32	23/02/2020 08:57	13,41	22	295,12	CHI
202002154393	SANTO ANTONIO DE GOIAS	BR12166574	NEROPOLIS S1	22/02/2020 19:32	23/02/2020 08:57	22/02/2020 19:32	23/02/2020 08:57	13,41	5	67,07	CHI
202002154394	FORMOSO	FO12291195	PORANGATU	23/02/2020 06:09	23/02/2020 08:45	23/02/2020 06:09	23/02/2020 08:45	2,59	1	2,59	CHI
202002154395	MIMOSO DE GOIAS	PV12152505	BARRO ALTO	23/02/2020 06:09	23/02/2020 11:33	23/02/2020 06:09	23/02/2020 11:33	5,40	9	48,57	CHI
202002154395	NIQUELANDIA	PV12152505	BARRO ALTO	23/02/2020 06:09	23/02/2020 11:33	23/02/2020 06:09	23/02/2020 11:33	5,40	12	64,76	CHI
202002154395	VILA PROPICIO	PV12152505	BARRO ALTO	23/02/2020 06:09	23/02/2020 11:33	23/02/2020 06:09	23/02/2020 11:33	5,40	22	118,73	CHI
202002154396	PIRES DO RIO	PR21270797	PIRES DO RIO S1	23/02/2020 06:10	23/02/2020 10:13	23/02/2020 06:10	23/02/2020 10:13	4,04	2	8,09	CHI
202002154397	MARA ROSA	MQ12263046	MARA ROSA	23/02/2020 06:10	23/02/2020 07:11	23/02/2020 06:10	23/02/2020 07:11	1,00	7	7,02	CHI
202002154398	GUARANI DE GOIAS	GY21267990	IACIARA S1	23/02/2020 06:10	23/02/2020 09:30	23/02/2020 06:10	23/02/2020 09:30	3,32	1	3,32	CHI
202002154405	DOVERLANDIA	DV11253347	CAIAPONIA	23/02/2020 06:13	23/02/2020 10:47	23/02/2020 06:13	23/02/2020 10:47	4,56	1	4,56	CHI
202002154408	FIRMINOPOLIS	FR12000064	FIRMINOPOLIS S1	23/02/2020 06:14	23/02/2020 09:45	23/02/2020 06:14	23/02/2020 09:45	3,52	43	151,17	CHI
202002154409	EDEALINA	ED12293192	PONTALINA	22/02/2020 21:58	23/02/2020 07:43	22/02/2020 21:58	23/02/2020 07:43	9,74	17	165,51	CHI
202002154409	INDIARA	ED12293192	PONTALINA	22/02/2020 21:58	23/02/2020 07:43	22/02/2020 21:58	23/02/2020 07:43	9,74	2	19,47	CHI
202002154410	GAMELEIRA DE GOIAS	SV21089489	ANAPOLIS UNIVERSITARIO S2	23/02/2020 06:15	23/02/2020 11:43	23/02/2020 06:15	23/02/2020 11:43	5,46	1	5,46	CHI
202002154411	SITIO D ABADIA	SI12211381	IACIARA S2	23/02/2020 06:16	23/02/2020 08:43	23/02/2020 06:16	23/02/2020 08:43	2,45	28	68,58	CHI
202002154418	APARECIDA DE GOIANIA	10016749721	INDEPENDENCIA S1	23/02/2020 06:21	23/02/2020 08:20	23/02/2020 06:21	23/02/2020 08:20	1,98	1	1,98	CHI
202002154419	CAIAPONIA	CP12207905	PIRANHAS	23/02/2020 06:21	23/02/2020 08:02	23/02/2020 06:21	23/02/2020 08:02	1,67	1	1,67	CHI
202002154421	CORUMBAIBA	CI21000530	VILA CORUMBA	23/02/2020 06:22	23/02/2020 10:05	23/02/2020 06:22	23/02/2020 10:05	3,71	1	3,71	CHI
202002154426	BRITANIA	BT12005369LD	BRITANIA	23/02/2020 05:34	23/02/2020 16:38	23/02/2020 05:34	23/02/2020 16:38	11,06	12	132,69	CHI
202002154426	ITAPIRAPUA	BT12005369LD	BRITANIA	23/02/2020 05:34	23/02/2020 16:38	23/02/2020 05:34	23/02/2020 16:38	11,06	2	22,12	CHI
202002154430	MONTE ALEGRE DE GOIAS	MA21332993	SAO DOMINGOS	23/02/2020 06:28	23/02/2020 11:52	23/02/2020 06:28	23/02/2020 11:52	5,40	1	5,40	CHI
202002154434	ORIZONA	OZ12152754	PIRES DO RIO S2	22/02/2020 22:45	23/02/2020 09:40	22/02/2020 22:45	23/02/2020 09:40	10,91	18	196,45	CHI
202002154435	PIRENOPOLIS	PV12295641	SAO FRANCISCO DE GOIAS	23/02/2020 05:30	23/02/2020 09:58	23/02/2020 05:30	23/02/2020 09:58	4,46	182	811,67	CHI

202002154443	CRIXAS	CX12202134	SERRA DO OURO	23/02/2020 06:34	23/02/2020 10:54	23/02/2020 06:34	23/02/2020 10:54	4,33	44	190,39	CHI
202002154450	HEITORAI	HE12099418	ITAPURANGA	23/02/2020 06:36	23/02/2020 09:51	23/02/2020 06:36	23/02/2020 09:51	3,23	38	122,88	CHI
202002154454	PORANGATU	PO12139234	PORANGATU	22/02/2020 20:15	23/02/2020 07:51	22/02/2020 20:15	23/02/2020 07:51	11,58	3	34,75	CHI
202002154455	MONTES CLAROS DE GOIAS	ME21093562	IPORA	23/02/2020 06:38	23/02/2020 08:45	23/02/2020 06:38	23/02/2020 08:45	2,11	1	2,11	CHI
202002154457	SITIO D ABADIA	SI12302925	IACIARA S2	23/02/2020 06:38	23/02/2020 07:59	23/02/2020 06:38	23/02/2020 07:59	1,34	5	6,68	CHI
202002154461	SAO DOMINGOS	SD12170547	SAO DOMINGOS	23/02/2020 06:39	23/02/2020 09:58	23/02/2020 06:39	23/02/2020 09:58	3,31	13	43,03	CHI
202002154503	POSSE	PS12180838RE	IACIARA S2	23/02/2020 06:41	23/02/2020 09:43	23/02/2020 06:41	23/02/2020 09:43	3,03	72	218,30	CHI
202002154504	GOIANIA	GN12001048	CAMPINAS S1	23/02/2020 06:41	23/02/2020 07:56	23/02/2020 06:41	23/02/2020 07:56	1,24	511	634,21	CHI
202002154505	APARECIDA DO RIO DOCE	JT21234198	JATAI S1	23/02/2020 06:41	23/02/2020 08:53	23/02/2020 06:41	23/02/2020 08:53	2,19	1	2,19	CHI
202002154506	GUARINOS	GF12380720	SANTA TEREZINHA	23/02/2020 06:42	23/02/2020 13:52	23/02/2020 06:42	23/02/2020 13:52	7,17	17	121,83	CHI
202002154508	APARECIDA DO RIO DOCE	AW12191577	CACHOEIRA ALTA	23/02/2020 06:42	23/02/2020 09:56	23/02/2020 06:42	23/02/2020 09:56	3,24	10	32,43	CHI
202002154513	ACREUNA	EU12085779	ACREUNA	23/02/2020 06:45	23/02/2020 08:15	23/02/2020 06:45	23/02/2020 08:15	1,50	128	191,40	CHI
202002154515	CRIXAS	CX12392061	SANTA TEREZINHA	23/02/2020 06:46	23/02/2020 10:27	23/02/2020 06:46	23/02/2020 10:27	3,68	8	29,45	CHI
202002154516	BRITANIA	BT12013469	BRITANIA	23/02/2020 06:46	23/02/2020 09:21	23/02/2020 06:46	23/02/2020 09:21	2,60	5	12,98	CHI
202002154519	ITAPURANGA	IK12060514	ITAPURANGA	23/02/2020 06:13	23/02/2020 08:44	23/02/2020 06:13	23/02/2020 08:44	2,52	66	166,03	CHI
202002154520	NIQUELANDIA	6732096	URUACU	23/02/2020 06:46	23/02/2020 12:31	23/02/2020 06:46	23/02/2020 12:31	5,74	4	22,94	CHI
202002154524	PORANGATU	PO12100815	NOVO PLANALTO	23/02/2020 06:47	24/02/2020 00:09	23/02/2020 06:47	24/02/2020 00:09	17,36	3	52,07	CHI
202002154525	GOIANIRA	GR11038275	GOIANIRA	23/02/2020 06:48	23/02/2020 11:19	23/02/2020 06:48	23/02/2020 11:19	4,51	144	650,12	CHI
202002154535	CORUMBAIBA	CI21158133	CATALAO S1	23/02/2020 06:52	23/02/2020 10:39	23/02/2020 06:52	23/02/2020 10:39	3,77	1	3,77	CHI
202002154536	TRINDADE	TR32001819	TRINDADE	23/02/2020 06:54	23/02/2020 12:37	23/02/2020 06:54	23/02/2020 12:11	5,29	1	5,29	CHI
202002154536	TRINDADE	TR32001819	TRINDADE	23/02/2020 06:54	23/02/2020 12:37	23/02/2020 06:54	23/02/2020 12:37	5,72	1	5,72	CHI
202002154538	PIRENOPOLIS	PV21093298	SAO FRANCISCO DE GOIAS	23/02/2020 06:55	23/02/2020 10:59	23/02/2020 06:55	23/02/2020 10:59	4,06	1	4,06	CHI
202002154542	ALEXANIA	AX12000154	CORUMBA	23/02/2020 06:49	23/02/2020 10:50	23/02/2020 06:49	23/02/2020 10:50	4,02	21	84,33	CHI
202002154542	CORUMBA DE GOIAS	AX12000154	CORUMBA	23/02/2020 06:49	23/02/2020 10:50	23/02/2020 06:49	23/02/2020 10:50	4,02	4	16,06	CHI
202002154543	PIRACANJUBA	PJ21377903	PIRACANJUBA	23/02/2020 06:56	23/02/2020 09:27	23/02/2020 06:56	23/02/2020 09:27	2,51	6	15,07	CHI
202002154546	VARJAO	VJ11362507	GUAPO S2	23/02/2020 06:56	23/02/2020 09:48	23/02/2020 06:56	23/02/2020 09:48	2,85	1	2,85	CHI
202002154547	PADRE BERNARDO	PB12389380	PADRE BERNARDO	23/02/2020 06:57	23/02/2020 08:42	23/02/2020 06:57	23/02/2020 08:42	1,75	12	20,96	CHI
202002154551	ANAPOLIS	AN21285270	ANAPOLIS UNIVERSITARIO S1	23/02/2020 06:57	23/02/2020 08:31	23/02/2020 06:57	23/02/2020 08:31	1,55	1	1,55	CHI
202002154553	RIO VERDE	RV12020010	CABRIUVA S2	23/02/2020 06:59	23/02/2020 09:15	23/02/2020 06:59	23/02/2020 09:15	2,25	48	108,24	CHI
202002154574	NOVO BRASIL	NB12019355	JUSSARA	23/02/2020 07:04	23/02/2020 10:38	23/02/2020 07:04	23/02/2020 10:38	3,56	5	17,78	CHI
202002154575	LUZIANIA	LZ12336006	VIANOPOLIS	22/02/2020 21:52	23/02/2020 10:19	22/02/2020 21:52	23/02/2020 10:19	12,44	97	1206,76	CHI
202002154578	BOM JESUS DE GOIAS	BJ12000041RE	BOM JESUS DE GOIAS	23/02/2020 06:11	23/02/2020 09:32	23/02/2020 06:11	23/02/2020 09:32	3,34	45	150,18	CHI
202002154578	ITUMBIARA	BJ12000041RE	BOM JESUS DE GOIAS	23/02/2020 06:11	23/02/2020 09:32	23/02/2020 06:11	23/02/2020 09:32	3,34	2	6,67	CHI
202002154581	PORANGATU	PO12189630	PORANGATU	23/02/2020 07:06	24/02/2020 01:21	23/02/2020 07:06	24/02/2020 01:21	18,24	2	36,49	CHI
202002154585	MIMOSO DE GOIAS	MJ12377249	PADRE BERNARDO	23/02/2020 07:07	23/02/2020 13:45	23/02/2020 07:07	23/02/2020 13:45	6,62	18	119,23	CHI
202002154587	JATAI	JT21358881	JATAI S1	23/02/2020 07:07	23/02/2020 13:00	23/02/2020 07:07	23/02/2020 13:00	5,87	1	5,87	CHI
202002154593	OUVIDOR	OU12358360	CATALAO S1	23/02/2020 07:10	23/02/2020 08:34	23/02/2020 07:10	23/02/2020 08:34	1,40	4	5,59	CHI
202002154596	GOIANIRA	GR11202922	GOIANIRA	23/02/2020 07:10	23/02/2020 12:58	23/02/2020 07:10	23/02/2020 12:58	5,79	16	92,68	CHI
202002154597	JUSSARA	JR12204918	IPORA	23/02/2020 07:11	23/02/2020 12:51	23/02/2020 07:11	23/02/2020 12:51	5,67	35	198,28	CHI
202002154597	MONTES CLAROS DE GOIAS	JR12204918	IPORA	23/02/2020 07:11	23/02/2020 12:51	23/02/2020 07:11	23/02/2020 12:51	5,67	17	96,31	CHI
202002154600	ITABERAI	IB21105973	ITABERAI S2	23/02/2020 07:12	23/02/2020 08:22	23/02/2020 07:12	23/02/2020 08:22	1,17	1	1,17	CHI
202002154603	GOIANIA	14343629	CARAJAS S1	23/02/2020 07:13	23/02/2020 08:44	23/02/2020 07:13	23/02/2020 08:44	1,51	1	1,51	CHI
202002154608	PARANAIGUARA	PC12361065	CACHOEIRA ALTA	23/02/2020 07:15	23/02/2020 08:50	23/02/2020 07:15	23/02/2020 08:50	1,57	1	1,57	CHI
202002154608	SAO SIMAO	PC12361065	CACHOEIRA ALTA	23/02/2020 07:15	23/02/2020 08:50	23/02/2020 07:15	23/02/2020 08:50	1,57	2	3,14	CHI

202002154612	PORANGATU	PO12027986	PORANGATU	23/02/2020 05:52	23/02/2020 14:27	23/02/2020 05:52	23/02/2020 14:27	8,58	7	60,06	CHI
202002154702	SANTA CRUZ DE GOIAS	BC21300725	CRISTIANOPOLIS	23/02/2020 01:00	23/02/2020 09:01	23/02/2020 01:00	23/02/2020 09:01	8,01	2	16,03	CHI
202002154739	RIO VERDE	RV21306554	RIO VERDE S1	23/02/2020 09:07	23/02/2020 09:43	23/02/2020 09:07	23/02/2020 09:43	0,59	1	0,59	CHI
202002154747	JATAI	JT21286465	CABRIUVA S2	23/02/2020 09:37	23/02/2020 09:55	23/02/2020 09:37	23/02/2020 09:55	0,30	1	0,30	CHI
202002154766	RIO VERDE	630091560	RIO VERDE S2	23/02/2020 10:16	23/02/2020 12:00	23/02/2020 10:16	23/02/2020 12:00	1,73	1	1,73	CHI
202002154767	MONTIVIDIU	MV21260838	MONTIVIDIU T	23/02/2020 10:19	23/02/2020 15:22	23/02/2020 10:19	23/02/2020 15:22	5,04	1	5,04	CHI
202002154768	SAO JOAO D ALIANCA	TL12342355	SAO JOAO D ALIANCA	23/02/2020 10:25	23/02/2020 19:31	23/02/2020 10:57	23/02/2020 19:31	8,55	1	8,55	CHI
202002154776	SANTO ANTONIO DO DESCOBERTO	SN12010404	MARAJOARA	23/02/2020 05:07	23/02/2020 17:28	23/02/2020 05:07	23/02/2020 17:28	12,34	64	789,49	CHI
202002154795	CALDAS NOVAS	CN21128473	CALDAS NOVAS S2	23/02/2020 09:34	23/02/2020 17:07	23/02/2020 09:34	23/02/2020 17:07	7,54	1	7,54	CHI
202002154798	SANTO ANTONIO DE GOIAS	BW11291505	NEROPOLIS S1	23/02/2020 10:01	23/02/2020 17:00	23/02/2020 10:01	23/02/2020 17:00	6,98	260	1815,09	CHI
202002154800	GOIANIA	GN12048949	XAVANTES	23/02/2020 14:46	23/02/2020 15:37	23/02/2020 14:46	23/02/2020 15:37	0,84	1	0,84	CHI
202002154801	NOVA CRIXAS	NA12091692	NOVA CRIXAS	23/02/2020 07:17	23/02/2020 12:02	23/02/2020 07:17	23/02/2020 12:02	4,74	22	104,21	CHI
202002154803	ORIZONA	OZ12372377	PIRES DO RIO S2	23/02/2020 01:21	23/02/2020 10:24	23/02/2020 01:21	23/02/2020 10:24	9,04	27	244,14	CHI
202002154807	CRIXAS	UP12171811	SANTA TEREZINHA	23/02/2020 07:18	23/02/2020 09:35	23/02/2020 07:18	23/02/2020 09:35	2,27	6	13,63	CHI
202002154807	UIRAPURU	UP12171811	SANTA TEREZINHA	23/02/2020 07:18	23/02/2020 09:35	23/02/2020 07:18	23/02/2020 09:35	2,27	31	70,41	CHI
202002154808	MOSSAMEDES	SC12060904	FIRMINOPOLIS S2	23/02/2020 07:15	23/02/2020 10:08	23/02/2020 07:15	23/02/2020 10:08	2,87	2	5,73	CHI
202002154808	SANCLERLANDIA	SC12060904	FIRMINOPOLIS S2	23/02/2020 07:15	23/02/2020 10:08	23/02/2020 07:15	23/02/2020 10:08	2,87	23	65,95	CHI
202002154810	PIRENOPOLIS	PV31068632	SAO FRANCISCO DE GOIAS	23/02/2020 05:30	23/02/2020 12:59	23/02/2020 05:30	23/02/2020 12:59	7,48	1	7,48	CHI
202002154813	ITAPIRAPUA	IU12089757	MATRINCHA	23/02/2020 07:19	23/02/2020 08:29	23/02/2020 07:19	23/02/2020 08:29	1,16	9	10,46	CHI
202002154817	SAO MIGUEL DO ARAGUAIA	SM12151000	SAO MIGUEL DO ARAGUAIA	23/02/2020 02:08	23/02/2020 12:24	23/02/2020 02:08	23/02/2020 12:24	10,27	19	195,04	CHI
202002154822	MUNDO NOVO DE GOIAS	MH12297074	NOVA CRIXAS	23/02/2020 07:21	23/02/2020 10:08	23/02/2020 07:21	23/02/2020 10:08	2,77	3	8,32	CHI
202002154825	PIRES DO RIO	PR21186663	PIRES DO RIO S1	23/02/2020 07:22	23/02/2020 13:20	23/02/2020 07:22	23/02/2020 13:20	5,95	1	5,95	CHI
202002154827	MORRINHOS	MR12000214	MORRINHOS	23/02/2020 07:23	23/02/2020 09:38	23/02/2020 07:23	23/02/2020 09:38	2,25	4	9,00	CHI
202002154829	CACHOEIRA DOURADA	CD21038078	CACHOEIRA DOURADA	23/02/2020 07:23	23/02/2020 11:29	23/02/2020 07:23	23/02/2020 11:29	4,10	1	4,10	CHI
202002154831	PARAUNA	980008049	PARAUNA	23/02/2020 07:23	23/02/2020 09:01	23/02/2020 07:23	23/02/2020 09:01	1,62	1	1,62	CHI
202002154832	NOVA CRIXAS	MZ12055676	MOZARLANDIA	23/02/2020 07:22	23/02/2020 12:06	23/02/2020 07:22	23/02/2020 12:06	4,72	9	42,45	CHI
202002154835	BONFINOPOLIS	TA12247490	NOVO PLANALTO	23/02/2020 07:24	23/02/2020 20:24	23/02/2020 07:24	23/02/2020 20:24	13,01	1	13,01	CHI
202002154835	BONOPOLIS	TA12247490	NOVO PLANALTO	23/02/2020 07:24	23/02/2020 20:24	23/02/2020 07:24	23/02/2020 20:24	13,01	11	143,09	CHI
202002154835	PORANGATU	TA12247490	NOVO PLANALTO	23/02/2020 07:24	23/02/2020 20:24	23/02/2020 07:24	23/02/2020 20:24	13,01	2	26,02	CHI
202002154836	FORMOSO	TB12185306	PORANGATU	23/02/2020 07:10	23/02/2020 08:55	23/02/2020 07:10	23/02/2020 08:55	1,74	1	1,74	CHI
202002154836	TROMBAS	TB12185306	PORANGATU	23/02/2020 07:10	23/02/2020 08:55	23/02/2020 07:10	23/02/2020 08:55	1,74	10	17,40	CHI
202002154837	IACIARA	IA21218849	IACIARA S2	23/02/2020 07:25	23/02/2020 10:14	23/02/2020 07:25	23/02/2020 10:14	2,82	1	2,82	CHI
202002154842	COLINAS DO SUL	TI12236619	MINACU	23/02/2020 07:26	23/02/2020 09:00	23/02/2020 07:26	23/02/2020 09:00	1,55	3	4,66	CHI
202002154843	PALMEIRAS DE GOIAS	TV12005728	FIRMINOPOLIS S2	22/02/2020 23:09	23/02/2020 11:27	22/02/2020 23:09	23/02/2020 11:27	12,29	5	61,43	CHI
202002154843	TURVANIA	TV12005728	FIRMINOPOLIS S2	22/02/2020 23:09	23/02/2020 11:27	22/02/2020 23:09	23/02/2020 11:27	12,29	4	49,14	CHI
202002154847	IACIARA	IA12257594	IACIARA S2	23/02/2020 07:28	23/02/2020 09:21	23/02/2020 07:28	23/02/2020 09:21	1,87	5	9,36	CHI
202002154849	SANTA RITA DO NOVO DESTINO	DF12377521	BARRO ALTO	23/02/2020 06:39	23/02/2020 09:44	23/02/2020 06:39	23/02/2020 09:44	3,08	23	70,87	CHI
202002154850	CATALAO	CT21266251	CATALAO S1	23/02/2020 07:29	23/02/2020 11:23	23/02/2020 07:29	23/02/2020 11:23	3,89	2	7,77	CHI
202002154853	PARAUNA	PU12301167	ACREUNA	23/02/2020 07:30	23/02/2020 10:31	23/02/2020 07:30	23/02/2020 10:31	3,02	14	42,22	CHI
202002154854	ANAPOLIS	AN21248874	ANAPOLIS UNIVERSITARIO S2	23/02/2020 07:30	23/02/2020 09:00	23/02/2020 07:30	23/02/2020 09:00	1,49	2	2,99	CHI
202002154856	ITUMBIARA	IT21000267	ITUMBIARA NOVA	23/02/2020 07:30	23/02/2020 09:09	23/02/2020 07:30	23/02/2020 09:09	1,63	1	1,63	CHI
202002154858	MINEIROS	MY12153327RE	PARQUE DAS EMAS	23/02/2020 05:25	23/02/2020 09:27	23/02/2020 05:25	23/02/2020 09:27	4,03	170	684,49	CHI
202002154858	SANTA RITA DO ARAGUAIA	MY12153327RE	PARQUE DAS EMAS	23/02/2020 05:25	23/02/2020 09:27	23/02/2020 05:25	23/02/2020 09:27	4,03	4	16,11	CHI
202002154859	SAO MIGUEL DO ARAGUAIA	SM12000063	SAO MIGUEL DO ARAGUAIA	23/02/2020 07:03	23/02/2020 12:04	23/02/2020 07:03	23/02/2020 12:04	5,01	35	175,35	CHI

202002154860	VALPARAISO DE GOIAS	VA11353919	PACAEMBU S2	23/02/2020 07:31	23/02/2020 08:52	23/02/2020 07:31	23/02/2020 08:52	1,35	177	238,36	CHI
202002154862	MORRINHOS	MR12035905	MORRINHOS	23/02/2020 07:32	23/02/2020 08:48	23/02/2020 07:32	23/02/2020 08:48	1,26	57	71,60	CHI
202002154869	NOVA AURORA	NE12149259	CATALAO S1	23/02/2020 07:20	23/02/2020 09:14	23/02/2020 07:20	23/02/2020 09:14	1,90	6	11,37	CHI
202002154870	GOIANIA	GN21118433	XAVANTES	23/02/2020 07:33	23/02/2020 11:58	23/02/2020 07:33	23/02/2020 11:58	4,41	1	4,41	CHI
202002154874	HIDROLANDIA	HD11246651	CEPAIGO S2	23/02/2020 07:34	23/02/2020 09:29	23/02/2020 07:34	23/02/2020 09:29	1,92	10	19,16	CHI
202002154879	AGUA FRIA DE GOIAS	10011206185	SAO JOAO D ALIANCA	23/02/2020 07:34	23/02/2020 10:33	23/02/2020 07:34	23/02/2020 10:33	2,98	1	2,98	CHI
202002154886	MINEIROS	MY12390600	PARQUE DAS EMAS	23/02/2020 07:36	23/02/2020 13:40	23/02/2020 07:36	23/02/2020 11:12	3,60	13	46,80	CHI
202002154886	MINEIROS	MY12390600	PARQUE DAS EMAS	23/02/2020 07:36	23/02/2020 13:40	23/02/2020 07:36	23/02/2020 12:30	4,90	9	44,10	CHI
202002154886	DOVERLANDIA	MY12390600	PARQUE DAS EMAS	23/02/2020 07:36	23/02/2020 13:40	23/02/2020 07:36	23/02/2020 13:40	6,08	1	6,08	CHI
202002154886	MINEIROS	MY12390600	PARQUE DAS EMAS	23/02/2020 07:36	23/02/2020 13:40	23/02/2020 07:36	23/02/2020 13:40	6,08	2	12,16	CHI
202002154887	SANTA BARBARA DE GOIAS	1030015561	TRINDADE	23/02/2020 07:36	23/02/2020 10:59	23/02/2020 07:36	23/02/2020 10:59	3,38	1	3,38	CHI
202002154890	ITAPACI	100032060	ITAPACI	23/02/2020 07:36	23/02/2020 09:30	23/02/2020 07:36	23/02/2020 09:30	1,89	1	1,89	CHI
202002154891	GOIANIA	15723707	CARAJAS S1	23/02/2020 07:36	23/02/2020 09:30	23/02/2020 07:36	23/02/2020 09:30	1,89	1	1,89	CHI
202002154893	FORMOSA	FA12204623	SAO JOAO D ALIANCA	23/02/2020 07:37	23/02/2020 12:43	23/02/2020 07:37	23/02/2020 12:43	5,10	19	96,89	CHI
202002154894	COCALZINHO DE GOIAS	ZN12258986	COCALZINHO	23/02/2020 06:38	23/02/2020 10:39	23/02/2020 06:38	23/02/2020 10:39	4,00	21	84,06	CHI
202002154896	MONTES CLAROS DE GOIAS	ME11334793	IPORA	23/02/2020 07:32	23/02/2020 19:29	23/02/2020 07:32	23/02/2020 19:29	11,93	59	704,10	CHI
202002154901	GUARANI DE GOIAS	SD12262409	SAO DOMINGOS	23/02/2020 07:38	23/02/2020 09:49	23/02/2020 07:38	23/02/2020 09:49	2,17	3	6,51	CHI
202002154901	SAO DOMINGOS	SD12262409	SAO DOMINGOS	23/02/2020 07:38	23/02/2020 09:49	23/02/2020 07:38	23/02/2020 09:49	2,17	71	154,01	CHI
202002154905	GAMELEIRA DE GOIAS	SV12272205	DAIA S2	23/02/2020 09:38	23/02/2020 10:59	23/02/2020 09:38	23/02/2020 10:59	1,35	11	14,85	CHI
202002154910	FORMOSO	SE12170967	MARA ROSA	23/02/2020 07:40	23/02/2020 21:57	23/02/2020 07:40	23/02/2020 16:40	8,99	3	26,98	CHI
202002154910	FORMOSO	SE12170967	MARA ROSA	23/02/2020 07:40	23/02/2020 21:57	23/02/2020 20:26	23/02/2020 21:57	1,52	3	4,57	CHI
202002154911	CAMPOS BELOS	CH12218811	SAO DOMINGOS	23/02/2020 07:40	23/02/2020 09:37	23/02/2020 07:40	23/02/2020 09:37	1,96	12	23,47	CHI
202002154912	CORUMBAIBA	CI21110118	VILA CORUMBA	23/02/2020 07:40	23/02/2020 12:12	23/02/2020 07:40	23/02/2020 12:12	4,53	1	4,53	CHI
202002154918	CALDAZINHA	SW12017151	CEPAIGO S2	23/02/2020 07:17	23/02/2020 10:11	23/02/2020 07:17	23/02/2020 10:11	2,88	11	31,73	CHI
202002154929	ISRAELANDIA	IS21101647	IPORA	23/02/2020 07:43	23/02/2020 11:20	23/02/2020 07:43	23/02/2020 11:20	3,61	1	3,61	CHI
202002154934	CATALAO	CT21042323	CATALAO S1	23/02/2020 07:44	23/02/2020 13:56	23/02/2020 07:44	23/02/2020 13:56	6,19	1	6,19	CHI
202002154939	SAO LUIS DE MONTES BELOS	SL32145768	SAO LUIZ DOS MONTES BELOS	23/02/2020 06:36	23/02/2020 08:18	23/02/2020 06:36	23/02/2020 08:18	1,70	28	47,50	CHI
202002154940	NEROPOLIS	NR21141575	NEROPOLIS S2	23/02/2020 07:45	23/02/2020 15:01	23/02/2020 07:45	23/02/2020 15:01	7,25	2	14,50	CHI
202002154941	ITUMBIARA	BJ12000194	CACHOEIRA DOURADA	22/02/2020 22:47	23/02/2020 11:36	22/02/2020 22:47	23/02/2020 11:36	12,81	6	76,85	CHI
202002154943	IVOLANDIA	MO12193365	IPORA	23/02/2020 06:31	23/02/2020 10:45	23/02/2020 06:31	23/02/2020 10:45	4,23	0	0,00	CHI
202002154943	MOIPORA	MO12193365	IPORA	23/02/2020 06:31	23/02/2020 10:45	23/02/2020 06:31	23/02/2020 10:45	4,23	5	21,16	CHI
202002154945	GOIANIA	GN11041232	GOYA S1	23/02/2020 07:46	23/02/2020 09:18	23/02/2020 07:46	23/02/2020 09:18	1,52	2	3,04	CHI
202002154948	ACREUNA	EU12045200	ACREUNA	23/02/2020 07:44	23/02/2020 10:05	23/02/2020 07:44	23/02/2020 10:05	2,34	5	11,70	CHI
202002154951	JANDAIA	JD12308464	PALMEIRAS	23/02/2020 07:48	23/02/2020 09:49	23/02/2020 07:48	23/02/2020 09:49	2,01	12	24,16	CHI
202002154958	URUACU	UR12210930	URUACU	23/02/2020 07:49	23/02/2020 11:15	23/02/2020 07:49	23/02/2020 11:15	3,42	11	37,61	CHI
202002154959	GOIANIRA	GR31135428	TRINDADE	23/02/2020 07:49	23/02/2020 13:10	23/02/2020 07:49	23/02/2020 13:10	5,33	2	10,67	CHI
202002154960	SANTO ANTONIO DO DESCOBERTO	SN21201475	MARAJOARA	23/02/2020 07:50	23/02/2020 16:33	23/02/2020 07:50	23/02/2020 16:33	8,72	1	8,72	CHI
202002154966	GOIANESIA	GE21026066	GOIANESIA S1	23/02/2020 07:51	23/02/2020 09:11	23/02/2020 07:51	23/02/2020 09:11	1,33	2	2,67	CHI
202002154968	LUZIANIA	LZ12313611	VIANOPOLIS	23/02/2020 06:33	23/02/2020 13:03	23/02/2020 06:33	23/02/2020 13:03	6,49	13	84,36	CHI
202002154969	CAIAPONIA	CP12200875	CAIAPONIA	23/02/2020 07:51	23/02/2020 10:17	23/02/2020 07:51	23/02/2020 10:17	2,42	9	21,75	CHI
202002154974	GOIANIA	GN11001458	CAMPINAS S1	23/02/2020 07:53	23/02/2020 08:59	23/02/2020 07:53	23/02/2020 08:59	1,10	108	118,59	CHI
202002154976	MAIRIPOTABA	MI31060577	PONTALINA	23/02/2020 07:53	23/02/2020 16:32	23/02/2020 07:53	23/02/2020 16:32	8,65	1	8,65	CHI
202002154978	MINEIROS	MY21322116	PARQUE DAS EMAS	23/02/2020 07:55	23/02/2020 11:30	23/02/2020 07:55	23/02/2020 11:30	3,58	1	3,58	CHI
202002154979	ITARUMA	2310014509	CACHOEIRA ALTA	23/02/2020 07:55	23/02/2020 12:50	23/02/2020 07:55	23/02/2020 12:50	4,93	1	4,93	CHI

202002154981	MONTES CLAROS DE GOIAS	ME21228428	IPORA	23/02/2020 07:55	23/02/2020 15:16	23/02/2020 07:55	23/02/2020 15:16	7,34	1	7,34	CHI
202002154987	HIDROLANDIA	HD11251855	CEPAIGO S2	23/02/2020 07:57	23/02/2020 10:48	23/02/2020 07:57	23/02/2020 10:48	2,85	16	45,56	CHI
202002154989	CACU	CC12260993	CACHOEIRA ALTA	23/02/2020 07:57	23/02/2020 10:32	23/02/2020 07:57	23/02/2020 10:32	2,58	7	18,04	CHI
202002154992	PALMEIRAS DE GOIAS	TV12005723	FIRMINOPOLIS S2	23/02/2020 07:57	23/02/2020 10:37	23/02/2020 07:57	23/02/2020 10:37	2,65	4	10,61	CHI
202002154993	FORMOSO	FO12185313	PORANGATU	23/02/2020 07:57	23/02/2020 09:50	23/02/2020 07:57	23/02/2020 09:50	1,87	9	16,83	CHI
202002154995	CAMPO LIMPO	AN12258907	NEROPOLIS S1	23/02/2020 07:58	23/02/2020 10:09	23/02/2020 07:58	23/02/2020 10:09	2,17	1	2,17	CHI
202002154996	JATAI	JT12205195	JATAI S1	23/02/2020 07:44	23/02/2020 09:59	23/02/2020 07:44	23/02/2020 09:59	2,25	45	101,21	CHI
202002154997	ARAGARCAS	AG12234261	ARAGARCAS	23/02/2020 07:58	23/02/2020 11:46	23/02/2020 07:58	23/02/2020 11:46	3,79	4	15,14	CHI
202002154999	GOIANIA	GN21233060	XAVANTES	23/02/2020 07:59	23/02/2020 09:47	23/02/2020 07:59	23/02/2020 09:47	1,80	1	1,80	CHI
202002155003	ABADIANIA	AA21319622	DAIA S2	23/02/2020 08:00	23/02/2020 10:24	23/02/2020 08:00	23/02/2020 10:24	2,39	1	2,39	CHI
202002155011	PONTALINA	PK12047398	VICENTINOPOLIS	23/02/2020 07:50	23/02/2020 10:00	23/02/2020 07:50	23/02/2020 10:00	2,16	9	19,45	CHI
202002155014	ITABERAI	IB11326373	ITABERAI S2	23/02/2020 08:02	23/02/2020 09:10	23/02/2020 08:02	23/02/2020 09:10	1,12	66	74,14	CHI
202002155018	ISRAELANDIA	IS12018686	IPORA	23/02/2020 08:03	23/02/2020 10:28	23/02/2020 08:03	23/02/2020 10:28	2,41	3	7,24	CHI
202002155018	JAUPACI	IS12018686	IPORA	23/02/2020 08:03	23/02/2020 10:28	23/02/2020 08:03	23/02/2020 10:28	2,41	7	16,88	CHI
202002155019	SANTA HELENA DE GOIAS	SH12214104	ACREUNA	23/02/2020 08:03	23/02/2020 11:43	23/02/2020 08:03	23/02/2020 11:43	3,66	4	14,64	CHI
202002155021	FAINA	FC12147790	GOIAS	23/02/2020 08:03	23/02/2020 08:53	23/02/2020 08:03	23/02/2020 08:53	0,82	5	4,11	CHI
202002155023	TROMBAS	TB21052592	PORANGATU	23/02/2020 08:03	23/02/2020 17:45	23/02/2020 08:03	23/02/2020 17:45	9,69	1	9,69	CHI
202002155024	ANAPOLIS	AN12000193RE	ANAPOLIS UNIVERSITARIO S2	23/02/2020 06:51	23/02/2020 11:30	23/02/2020 06:51	23/02/2020 11:30	4,64	6	27,83	CHI
202002155024	PIRENOPOLIS	AN12000193RE	ANAPOLIS UNIVERSITARIO S2	23/02/2020 06:51	23/02/2020 11:30	23/02/2020 06:51	23/02/2020 11:30	4,64	7	32,47	CHI
202002155031	ANAPOLIS	AN11185112	ANAPOLIS UNIVERSITARIO S2	23/02/2020 08:04	23/02/2020 11:53	23/02/2020 08:04	23/02/2020 11:53	3,80	18	68,45	CHI
202002155032	ALTO PARAISO DE GOIAS	BF12244571	SAO JOAO D ALIANCA	23/02/2020 08:05	23/02/2020 09:37	23/02/2020 08:05	23/02/2020 09:37	1,53	25	38,28	CHI
202002155035	CAIAPONIA	CP12395453	PALESTINA	23/02/2020 08:06	23/02/2020 12:49	23/02/2020 08:06	23/02/2020 12:49	4,71	6	28,28	CHI
202002155038	NEROPOLIS	BW12100382	NEROPOLIS S1	23/02/2020 08:06	24/02/2020 18:35	23/02/2020 12:08	23/02/2020 17:08	5,00	14	70,00	CHI
202002155038	SANTO ANTONIO DE GOIAS	BW12100382	NEROPOLIS S1	23/02/2020 08:06	24/02/2020 18:35	23/02/2020 12:08	23/02/2020 17:08	5,00	11	55,00	CHI
202002155038	SANTO ANTONIO DE GOIAS	BW12100382	NEROPOLIS S1	23/02/2020 08:06	24/02/2020 18:35	23/02/2020 08:06	24/02/2020 18:25	34,30	16	548,86	CHI
202002155038	SANTO ANTONIO DE GOIAS	BW12100382	NEROPOLIS S1	23/02/2020 08:06	24/02/2020 18:35	23/02/2020 19:51	24/02/2020 18:25	22,57	3	67,70	CHI
202002155038	NEROPOLIS	BW12100382	NEROPOLIS S1	23/02/2020 08:06	24/02/2020 18:35	23/02/2020 08:06	24/02/2020 18:35	34,47	3	103,41	CHI
202002155038	NOVA VENEZA	BW12100382	NEROPOLIS S1	23/02/2020 08:06	24/02/2020 18:35	23/02/2020 08:06	24/02/2020 18:35	34,47	1	34,47	CHI
202002155038	SANTO ANTONIO DE GOIAS	BW12100382	NEROPOLIS S1	23/02/2020 08:06	24/02/2020 18:35	23/02/2020 08:06	24/02/2020 18:35	34,47	10	344,71	CHI
202002155038	SANTO ANTONIO DE GOIAS	BW12100382	NEROPOLIS S1	23/02/2020 08:06	24/02/2020 18:35	23/02/2020 12:08	24/02/2020 18:35	30,45	1	30,45	CHI
202002155038	NEROPOLIS	GR13100383	NEROPOLIS S1	23/02/2020 08:06	24/02/2020 18:35	23/02/2020 19:51	24/02/2020 18:35	22,73	14	318,24	CHI
202002155038	SANTO ANTONIO DE GOIAS	GR13100383	NEROPOLIS S1	23/02/2020 08:06	24/02/2020 18:35	23/02/2020 19:51	24/02/2020 18:35	22,73	8	181,85	CHI
202002155041	DISTRITO FEDERAL	PB12313905	PADRE BERNARDO	23/02/2020 08:07	23/02/2020 14:15	23/02/2020 08:07	23/02/2020 14:15	6,13	6	36,76	CHI
202002155041	ITARUMA	PB12313905	PADRE BERNARDO	23/02/2020 08:07	23/02/2020 14:15	23/02/2020 08:07	23/02/2020 14:15	6,13	1	6,13	CHI
202002155041	PADRE BERNARDO	PB12313905	PADRE BERNARDO	23/02/2020 08:07	23/02/2020 14:15	23/02/2020 08:07	23/02/2020 14:15	6,13	2	12,25	CHI
202002155041	PLANALTINA	PB12313905	PADRE BERNARDO	23/02/2020 08:07	23/02/2020 14:15	23/02/2020 08:07	23/02/2020 14:15	6,13	10	61,27	CHI
202002155042	IPIRANGA DE GOIAS	RB12194288	RUBIATABA	23/02/2020 07:36	23/02/2020 09:56	23/02/2020 07:36	23/02/2020 09:56	2,32	4	9,27	CHI
202002155052	MONTE ALEGRE DE GOIAS	MA12129802	SAO DOMINGOS	23/02/2020 08:09	23/02/2020 13:21	23/02/2020 08:09	23/02/2020 13:21	5,19	2	10,38	CHI
202002155054	GOIANIA	10018478768	GOYA S1	23/02/2020 08:10	23/02/2020 11:51	23/02/2020 08:10	23/02/2020 11:51	3,67	1	3,67	CHI
202002155057	APARECIDA DE GOIANIA	14971793	REAL S1	23/02/2020 08:11	23/02/2020 12:31	23/02/2020 08:11	23/02/2020 12:31	4,33	1	4,33	CHI
202002155058	INHUMAS	IN11276557	INHUMAS S2	23/02/2020 08:11	23/02/2020 13:30	23/02/2020 08:11	23/02/2020 13:30	5,31	88	467,11	CHI
202002155059	BOM JESUS DE GOIAS	BJ12000208	CACHOEIRA DOURADA	23/02/2020 08:11	23/02/2020 11:31	23/02/2020 08:11	23/02/2020 11:31	3,32	10	33,23	CHI
202002155064	AURILANDIA	AI12206461	FIRMINOPOLIS S2	23/02/2020 07:57	23/02/2020 11:22	23/02/2020 07:57	23/02/2020 11:22	3,41	14	47,76	CHI
202002155064	FIRMINOPOLIS	AI12206461	FIRMINOPOLIS S2	23/02/2020 07:57	23/02/2020 11:22	23/02/2020 07:57	23/02/2020 11:22	3,41	16	54,58	CHI

202002155065	CRISTALINA	KR12224215	PAMPLONA	23/02/2020 08:12	23/02/2020 14:50	23/02/2020 08:12	23/02/2020 14:50	6,62	4	26,48	CHI
202002155069	ABADIANIA	AA21291795	ANAPOLIS UNIVERSITARIO S2	23/02/2020 08:13	23/02/2020 09:31	23/02/2020 08:13	23/02/2020 09:31	1,29	1	1,29	CHI
202002155070	AMARALINA	LC12230319	NOVA CRIXAS	23/02/2020 07:21	23/02/2020 20:31	23/02/2020 07:21	23/02/2020 20:31	13,17	3	39,50	CHI
202002155071	ANICUNS	AC12020526	ANICUNS	23/02/2020 08:14	23/02/2020 09:54	23/02/2020 08:14	23/02/2020 09:54	1,67	8	13,33	CHI
202002155072	MORRINHOS	MR32076989	GOIATUBA S1	23/02/2020 08:14	23/02/2020 13:01	23/02/2020 08:14	23/02/2020 13:01	4,78	6	28,68	CHI
202002155075	GOIAS	GS12093357	MATRINCHA	23/02/2020 07:21	23/02/2020 13:21	23/02/2020 07:21	23/02/2020 10:32	3,20	5	15,99	CHI
202002155075	GOIAS	GS12093357	MATRINCHA	23/02/2020 07:21	23/02/2020 13:21	23/02/2020 07:21	23/02/2020 13:21	6,00	2	12,00	CHI
202002155078	LUZIANIA	LZ21264828	VIANOPOLIS	23/02/2020 08:15	23/02/2020 17:42	23/02/2020 08:15	23/02/2020 17:42	9,45	4	37,80	CHI
202002155079	INHUMAS	IN21098253	INHUMAS S2	23/02/2020 08:15	23/02/2020 13:01	23/02/2020 08:15	23/02/2020 13:01	4,76	1	4,76	CHI
202002155084	APARECIDA DE GOIANIA	13854860	REAL S1	23/02/2020 08:16	23/02/2020 11:52	23/02/2020 08:16	23/02/2020 11:52	3,59	1	3,59	CHI
202002155086	PIRANHAS	PH12381017	PIRANHAS	23/02/2020 08:16	23/02/2020 12:04	23/02/2020 08:16	23/02/2020 12:04	3,79	12	45,46	CHI
202002155096	JANDAIA	PL12000049	PALMEIRAS	23/02/2020 08:17	23/02/2020 11:00	23/02/2020 08:17	23/02/2020 11:00	2,71	8	21,68	CHI
202002155096	PALESTINA DE GOIAS	PL12000049	PALMEIRAS	23/02/2020 08:17	23/02/2020 11:00	23/02/2020 08:17	23/02/2020 11:00	2,71	1	2,71	CHI
202002155096	PALMEIRAS DE GOIAS	PL12000049	PALMEIRAS	23/02/2020 08:17	23/02/2020 11:00	23/02/2020 08:17	23/02/2020 11:00	2,71	28	75,89	CHI
202002155099	ITABERAI	IB12300330	ITABERAI S2	23/02/2020 08:08	23/02/2020 12:40	23/02/2020 08:08	23/02/2020 12:40	4,52	14	63,32	CHI
202002155101	NOVO GAMA	2460010613	PACAEMBU S1	23/02/2020 08:18	23/02/2020 10:26	23/02/2020 08:18	23/02/2020 10:26	2,13	1	2,13	CHI
202002155105	ALVORADA DO NORTE	AQ12160982	IACIARA S2	23/02/2020 08:18	23/02/2020 11:24	23/02/2020 08:18	23/02/2020 11:24	3,08	5	15,42	CHI
202002155112	MORRINHOS	MR21155465	MORRINHOS	23/02/2020 08:19	23/02/2020 09:44	23/02/2020 08:19	23/02/2020 09:44	1,40	1	1,40	CHI
202002155114	PORANGATU	PO12189555	PORANGATU	23/02/2020 03:59	23/02/2020 12:06	23/02/2020 03:59	23/02/2020 12:06	8,10	8	64,82	CHI
202002155117	CACU	CC12021384	CACHOEIRA ALTA	23/02/2020 08:20	23/02/2020 11:10	23/02/2020 08:20	23/02/2020 11:10	2,82	12	33,85	CHI
202002155118	PONTALINA	PK31045971	PONTALINA	23/02/2020 08:21	23/02/2020 12:58	23/02/2020 08:21	23/02/2020 12:58	4,61	1	4,61	CHI
202002155119	BARRO ALTO	BA12382485	BARRO ALTO	23/02/2020 08:21	23/02/2020 11:20	23/02/2020 08:21	23/02/2020 11:20	2,98	9	26,80	CHI
202002155121	IPAMERI	IP21083311	IPAMERI	23/02/2020 08:21	23/02/2020 09:45	23/02/2020 08:21	23/02/2020 09:45	1,39	1	1,39	CHI
202002155126	VICENTINOPOLIS	VI21257155	VICENTINOPOLIS	23/02/2020 08:22	23/02/2020 10:37	23/02/2020 08:22	23/02/2020 10:37	2,24	1	2,24	CHI
202002155127	ITUMBIARA	BJ21029998	BOM JESUS DE GOIAS	23/02/2020 08:22	23/02/2020 13:10	23/02/2020 08:22	23/02/2020 13:10	4,79	1	4,79	CHI
202002155128	PALMEIRAS DE GOIAS	PL12169788	PALMEIRAS	23/02/2020 08:23	23/02/2020 09:40	23/02/2020 08:23	23/02/2020 09:40	1,28	8	10,23	CHI
202002155131	INHUMAS	30121322	INHUMAS S2	23/02/2020 08:24	23/02/2020 16:17	23/02/2020 08:24	23/02/2020 16:17	7,89	1	7,89	CHI
202002155132	JATAI	JT12260457	JATAI S1	23/02/2020 08:24	23/02/2020 09:45	23/02/2020 08:24	23/02/2020 09:45	1,34	3	4,03	CHI
202002155134	PARANAIGUARA	PC21000112	CACHOEIRA ALTA	23/02/2020 08:25	23/02/2020 09:37	23/02/2020 08:25	23/02/2020 09:37	1,19	1	1,19	CHI
202002155135	JUSSARA	3150000711	IPORA	23/02/2020 08:25	23/02/2020 21:04	23/02/2020 08:25	23/02/2020 21:04	12,64	1	12,64	CHI
202002155137	ITAJA	IJ12194905	ITAJA S2	23/02/2020 06:02	23/02/2020 09:08	23/02/2020 06:02	23/02/2020 09:08	3,09	155	479,25	CHI
202002155138	PIRANHAS	PH12380983	PIRANHAS	23/02/2020 08:18	23/02/2020 15:29	23/02/2020 08:18	23/02/2020 15:29	7,17	6	43,05	CHI
202002155139	ITAUCU	10020212990	INHUMAS S1	23/02/2020 08:26	23/02/2020 11:04	23/02/2020 08:26	23/02/2020 11:04	2,62	1	2,62	CHI
202002155142	MORRINHOS	MR12263657	GOIATUBA S1	23/02/2020 07:36	23/02/2020 10:56	23/02/2020 07:36	23/02/2020 10:56	3,33	13	43,32	CHI
202002155151	AMARALINA	LC12245307	MARA ROSA	23/02/2020 08:30	23/02/2020 10:46	23/02/2020 08:30	23/02/2020 10:46	2,27	5	11,33	CHI
202002155158	GOIANIA	10023864484	GOYA S1	23/02/2020 08:31	23/02/2020 11:55	23/02/2020 08:31	23/02/2020 11:55	3,39	1	3,39	CHI
202002155164	GOIATUBA	GT21190979	GOIATUBA S2	23/02/2020 08:32	23/02/2020 09:43	23/02/2020 08:32	23/02/2020 09:43	1,17	1	1,17	CHI
202002155173	ANAPOLIS	AN12285315	ANAPOLIS UNIVERSITARIO S2	23/02/2020 06:44	23/02/2020 10:10	23/02/2020 06:44	23/02/2020 10:10	3,42	10	34,21	CHI
202002155180	BELA VISTA DE GOIAS	BV12321518	BELA VISTA S2	23/02/2020 07:44	23/02/2020 10:37	23/02/2020 07:44	23/02/2020 10:37	2,88	37	106,48	CHI
202002155182	GOUVELANDIA	GB31249148	QUIRINOPOLIS	23/02/2020 08:36	23/02/2020 13:33	23/02/2020 08:36	23/02/2020 13:33	4,95	3	14,85	CHI
202002155184	CAIAPONIA	CP12395939	PALESTINA	23/02/2020 08:37	24/02/2020 02:52	23/02/2020 08:37	24/02/2020 02:52	18,24	2	36,48	CHI
202002155190	CRISTALINA	KR12230156	PAMPLONA	23/02/2020 08:20	23/02/2020 12:47	23/02/2020 08:20	23/02/2020 12:47	4,44	21	93,22	CHI
202002155191	GOIANIA	GN11337834	XAVANTES	23/02/2020 08:39	23/02/2020 10:29	23/02/2020 08:39	23/02/2020 10:29	1,83	7	12,79	CHI
202002155196	MONTIVIDIU	MV12241236	MONTIVIDIU T	23/02/2020 08:40	23/02/2020 11:56	23/02/2020 08:40	23/02/2020 11:56	3,26	2	6,52	CHI

202002155198	ACREUNA	EU11085780	ACREUNA	23/02/2020 08:32	23/02/2020 16:12	23/02/2020 08:32	23/02/2020 16:12	7,66	128	980,09	CHI
202002155199	SANTO ANTONIO DO DESCOBERTO	2210139011	AGUAS LINDAS DE GOIAS S2	23/02/2020 08:40	23/02/2020 10:24	23/02/2020 08:40	23/02/2020 10:24	1,72	1	1,72	CHI
202002155207	APARECIDA DE GOIANIA	200223630	INDEPENDENCIA S2	23/02/2020 08:42	23/02/2020 10:37	23/02/2020 08:42	23/02/2020 10:37	1,91	1	1,91	CHI
202002155210	JANDAIA	JD21008222	PALMEIRAS	23/02/2020 08:43	23/02/2020 11:40	23/02/2020 08:43	23/02/2020 11:40	2,94	1	2,94	CHI
202002155214	PILAR DE GOIAS	GG12318450	URUACU	23/02/2020 08:44	23/02/2020 12:40	23/02/2020 08:44	23/02/2020 12:40	3,93	3	11,79	CHI
202002155217	SANTA CRUZ DE GOIAS	BC21012014	PIRES DO RIO S2	23/02/2020 08:45	23/02/2020 20:05	23/02/2020 08:45	23/02/2020 20:05	11,33	1	11,33	CHI
202002155218	RIO VERDE	RV21279463	CABRIUVA S2	23/02/2020 08:45	23/02/2020 11:16	23/02/2020 08:45	23/02/2020 11:16	2,50	1	2,50	CHI
202002155227	GOIANIA	11949119	FERROVIARIO S3	23/02/2020 08:46	23/02/2020 13:40	23/02/2020 08:46	23/02/2020 13:40	4,89	1	4,89	CHI
202002155228	JARAGUA	10006331201	JARAGUA	23/02/2020 08:48	23/02/2020 14:23	23/02/2020 08:48	23/02/2020 14:23	5,58	1	5,58	CHI
202002155230	JATAI	JT21214475	MONTIVIDIU T	23/02/2020 08:48	23/02/2020 10:58	23/02/2020 08:48	23/02/2020 10:58	2,17	1	2,17	CHI
202002155234	ARENOPOLIS	AY12000048	ARENOPOLIS	23/02/2020 07:55	23/02/2020 11:23	23/02/2020 07:55	23/02/2020 11:23	3,46	12	41,53	CHI
202002155234	DIORAMA	AY12000048	ARENOPOLIS	23/02/2020 07:55	23/02/2020 11:23	23/02/2020 07:55	23/02/2020 11:23	3,46	12	41,53	CHI
202002155239	SAO JOAO D ALIANCA	JL12211487	SAO JOAO D ALIANCA	23/02/2020 08:49	23/02/2020 14:00	23/02/2020 08:49	23/02/2020 14:00	5,17	18	93,11	CHI
202002155242	JATAI	JT12303488	JATAI S1	23/02/2020 08:49	23/02/2020 13:49	23/02/2020 08:49	23/02/2020 13:49	4,99	2	9,97	CHI
202002155244	PADRE BERNARDO	2760008405	PADRE BERNARDO	23/02/2020 08:49	23/02/2020 11:20	23/02/2020 08:49	23/02/2020 11:20	2,50	1	2,50	CHI
202002155249	LUZIANIA	LZ12372287	CRISTALINA S2	23/02/2020 08:51	23/02/2020 12:01	23/02/2020 08:51	23/02/2020 12:01	3,16	13	41,12	CHI
202002155250	MONTES CLAROS DE GOIAS	ME12074048	IPORA	23/02/2020 08:51	24/02/2020 01:45	23/02/2020 08:51	24/02/2020 01:45	16,89	1	16,89	CHI
202002155251	CATALAO	CT21112613	CATALAO S1	23/02/2020 08:51	23/02/2020 11:31	23/02/2020 08:51	23/02/2020 11:31	2,66	1	2,66	CHI
202002155255	QUIRINOPOLIS	QI12279796	QUIRINOPOLIS	23/02/2020 08:52	23/02/2020 12:59	23/02/2020 08:52	23/02/2020 12:59	4,11	13	53,40	CHI
202002155259	SANTA HELENA DE GOIAS	SH12279903	IPEGUARI	23/02/2020 08:29	23/02/2020 11:02	23/02/2020 08:29	23/02/2020 11:02	2,55	6	15,29	CHI
202002155260	ITAPACI	IW12267460	ITAPACI	23/02/2020 08:53	23/02/2020 11:34	23/02/2020 08:53	23/02/2020 11:34	2,68	8	21,44	CHI
202002155263	ANICUNS	AC12391419	ANICUNS	23/02/2020 08:53	23/02/2020 10:23	23/02/2020 08:53	23/02/2020 10:23	1,49	310	460,87	CHI
202002155266	GOIANIA	10005231300	MEIA PONTE	23/02/2020 08:54	23/02/2020 14:46	23/02/2020 08:54	23/02/2020 14:46	5,86	1	5,86	CHI
202002155268	MARA ROSA	MQ12287615	MARA ROSA	23/02/2020 07:35	23/02/2020 12:21	23/02/2020 07:35	23/02/2020 12:21	4,76	4	19,04	CHI
202002155269	APARECIDA DE GOIANIA	10016454241	REAL S1	23/02/2020 08:55	23/02/2020 11:18	23/02/2020 08:55	23/02/2020 11:18	2,37	1	2,37	CHI
202002155275	ANAPOLIS	AN21217561	ANAPOLIS UNIVERSITARIO S1	23/02/2020 08:57	23/02/2020 10:45	23/02/2020 08:57	23/02/2020 10:45	1,80	1	1,80	CHI
202002155277	CALDAS NOVAS	CN31060269	RIO QUENTE	23/02/2020 08:57	23/02/2020 11:31	23/02/2020 08:57	23/02/2020 11:31	2,56	1	2,56	CHI
202002155278	COLINAS DO SUL	TI21236615	MINACU	23/02/2020 08:57	23/02/2020 09:46	23/02/2020 08:57	23/02/2020 09:46	0,81	1	0,81	CHI
202002155279	ADELANDIA	MD21158367	FIRMINOPOLIS S2	23/02/2020 08:57	23/02/2020 12:42	23/02/2020 08:57	23/02/2020 12:42	3,74	1	3,74	CHI
202002155283	FORMOSA	FA12204709	ITUIQUIRA	23/02/2020 08:57	23/02/2020 11:29	23/02/2020 08:57	23/02/2020 11:29	2,52	5	12,60	CHI
202002155286	BARRO ALTO	BA21101506	GOIANESIA S1	23/02/2020 08:58	23/02/2020 15:05	23/02/2020 08:58	23/02/2020 15:05	6,12	1	6,12	CHI
202002155289	MINEIROS	MY21324356	PARQUE DAS EMAS	23/02/2020 08:59	23/02/2020 16:32	23/02/2020 08:59	23/02/2020 16:32	7,56	1	7,56	CHI
202002155293	GOIANIA	12436884	GOIANIA LESTE S3	23/02/2020 09:00	23/02/2020 10:14	23/02/2020 09:00	23/02/2020 10:14	1,23	1	1,23	CHI
202002155295	GOIANIA	GN12099668	XAVANTES	23/02/2020 07:37	23/02/2020 14:14	23/02/2020 07:37	23/02/2020 12:46	5,14	46	236,62	CHI
202002155295	GOIANIA	GN12099668	XAVANTES	23/02/2020 07:37	23/02/2020 14:14	23/02/2020 13:00	23/02/2020 14:14	1,23	46	56,62	CHI
202002155296	ANAPOLIS	10029919540	JUNDIAI S1	23/02/2020 09:00	23/02/2020 11:32	23/02/2020 09:00	23/02/2020 11:32	2,53	1	2,53	CHI
202002155300	MINEIROS	1390059513	PARQUE DAS EMAS	23/02/2020 09:02	23/02/2020 11:11	23/02/2020 09:02	23/02/2020 11:11	2,14	1	2,14	CHI
202002155301	ALEXANIA	AX12000099	ALEXANIA	23/02/2020 08:53	23/02/2020 12:43	23/02/2020 08:53	23/02/2020 12:43	3,82	11	42,00	CHI
202002155306	SAO MIGUEL DO ARAGUAIA	SM12291166	SAO MIGUEL DO ARAGUAIA	23/02/2020 09:03	23/02/2020 11:10	23/02/2020 09:03	23/02/2020 11:10	2,11	8	16,89	CHI
202002155315	RIO VERDE	630224869	RIO VERDE S1	23/02/2020 09:05	23/02/2020 10:14	23/02/2020 09:05	23/02/2020 10:14	1,16	1	1,16	CHI
202002155317	NIQUELANDIA	NQ21232484	BARRO ALTO	23/02/2020 09:05	23/02/2020 22:17	23/02/2020 09:05	23/02/2020 22:17	13,19	2	26,38	CHI
202002155319	ITAPURANGA	IK21300354	ITAPURANGA	23/02/2020 09:07	23/02/2020 11:04	23/02/2020 09:07	23/02/2020 11:04	1,95	3	5,85	CHI
202002155328	TRINDADE	TR21265439	TRINDADE	23/02/2020 09:09	23/02/2020 10:31	23/02/2020 09:09	23/02/2020 10:31	1,36	1	1,36	CHI
202002155331	SILVANIA	SV21160589	VIANOPOLIS	23/02/2020 09:09	23/02/2020 12:03	23/02/2020 09:09	23/02/2020 12:03	2,89	1	2,89	CHI



202002155334	SAO DOMINGOS	8680003465	SAO DOMINGOS	23/02/2020 09:10	23/02/2020 14:27	23/02/2020 09:10	23/02/2020 14:27	5,28	1	5,28	CHI
202002155335	CATALAO	CT21317603	CATALAO S1	23/02/2020 09:10	23/02/2020 12:20	23/02/2020 09:10	23/02/2020 12:20	3,16	1	3,16	CHI
202002155338	PEROLANDIA	DP12209680	JATAI S1	23/02/2020 08:51	23/02/2020 11:28	23/02/2020 08:51	23/02/2020 11:28	2,62	4	10,47	CHI
202002155340	JATAI	JT21326923	JATAI S1	23/02/2020 09:11	23/02/2020 11:40	23/02/2020 09:11	23/02/2020 11:40	2,47	1	2,47	CHI
202002155342	RIO VERDE	630091560	RIO VERDE S2	23/02/2020 09:12	23/02/2020 10:16	23/02/2020 09:12	23/02/2020 10:16	1,07	1	1,07	CHI
202002155344	SANTA TEREZINHA DE GOIAS	SG21283472	SANTA TEREZINHA	23/02/2020 09:11	23/02/2020 12:28	23/02/2020 09:11	23/02/2020 12:28	3,27	2	6,54	CHI
202002155350	BONOPOLIS	BX12233107	NOVO PLANALTO	23/02/2020 08:54	24/02/2020 01:19	23/02/2020 08:54	24/02/2020 01:19	16,41	8	131,27	CHI
202002155353	SANCLERLANDIA	SL10377155	SAO LUIZ DOS MONTES BELOS	23/02/2020 09:10	24/02/2020 15:45	23/02/2020 09:10	23/02/2020 10:24	1,22	28	34,11	CHI
202002155353	SAO LUIS DE MONTES BELOS	SL10377155	SAO LUIZ DOS MONTES BELOS	23/02/2020 09:10	24/02/2020 15:45	23/02/2020 09:10	23/02/2020 10:24	1,22	642	782,17	CHI
202002155353	BURITI DE GOIAS	SL10377155	FIRMINOPOLIS S2	23/02/2020 09:10	24/02/2020 15:45	23/02/2020 09:10	23/02/2020 10:37	1,44	61	87,81	CHI
202002155353	CORREGO DO OURO	SL10377155	FIRMINOPOLIS S2	23/02/2020 09:10	24/02/2020 15:45	23/02/2020 09:10	23/02/2020 10:37	1,44	129	185,69	CHI
202002155353	CORREGO DO OURO	SL10377155	FIRMINOPOLIS S2	23/02/2020 09:10	24/02/2020 15:45	23/02/2020 09:10	23/02/2020 10:37	1,44	6	8,64	CHI
202002155353	NOVO BRASIL	SL10377155	FIRMINOPOLIS S2	23/02/2020 09:10	24/02/2020 15:45	23/02/2020 09:10	23/02/2020 10:37	1,44	16	23,03	CHI
202002155353	SANCLERLANDIA	SL10377155	FIRMINOPOLIS S2	23/02/2020 09:10	24/02/2020 15:45	23/02/2020 09:10	23/02/2020 10:37	1,44	212	305,16	CHI
202002155353	SANCLERLANDIA	SL10377155	FIRMINOPOLIS S2	23/02/2020 09:10	24/02/2020 15:45	23/02/2020 09:10	23/02/2020 13:21	4,18	15	62,72	CHI
202002155353	SAO LUIS DE MONTES BELOS	SL10377155	FIRMINOPOLIS S2	23/02/2020 09:10	24/02/2020 15:45	23/02/2020 09:10	23/02/2020 13:21	4,18	32	133,81	CHI
202002155353	SAO LUIS DE MONTES BELOS	SL13003678	FIRMINOPOLIS S2	23/02/2020 09:10	24/02/2020 15:45	23/02/2020 09:10	23/02/2020 13:21	4,18	4	16,73	CHI
202002155353	SAO LUIS DE MONTES BELOS	SL13003678	FIRMINOPOLIS S2	23/02/2020 09:10	24/02/2020 15:45	23/02/2020 11:19	23/02/2020 13:21	2,05	17	34,79	CHI
202002155353	CORREGO DO OURO	SL10377155	FIRMINOPOLIS S2	23/02/2020 09:10	24/02/2020 15:45	23/02/2020 09:10	24/02/2020 15:45	30,57	1	30,57	CHI
202002155353	SANCLERLANDIA	SL10377155	FIRMINOPOLIS S2	23/02/2020 09:10	24/02/2020 15:45	23/02/2020 09:10	24/02/2020 15:45	30,57	19	580,88	CHI
202002155353	SAO LUIS DE MONTES BELOS	SL10377155	FIRMINOPOLIS S2	23/02/2020 09:10	24/02/2020 15:45	23/02/2020 09:10	24/02/2020 15:45	30,57	9	275,15	CHI
202002155354	SAO FRANCISCO DE GOIAS	SF21084980	SAO FRANCISCO DE GOIAS	23/02/2020 09:15	23/02/2020 11:01	23/02/2020 09:15	23/02/2020 11:01	1,75	1	1,75	CHI
202002155362	ITABERAÍ	IB12310540	ITABERAÍ S1	23/02/2020 09:17	23/02/2020 12:24	23/02/2020 09:17	23/02/2020 12:24	3,10	2	6,21	CHI
202002155364	MINACU	IH11348011	MINACU	23/02/2020 09:18	23/02/2020 17:50	23/02/2020 09:18	23/02/2020 17:50	8,53	1	8,53	CHI
202002155368	GOIAS	GS11223844	GOIAS	23/02/2020 09:19	23/02/2020 16:08	23/02/2020 09:19	23/02/2020 16:08	6,82	1	6,82	CHI
202002155369	IPAMERI	580016020	IPAMERI	23/02/2020 09:19	23/02/2020 12:17	23/02/2020 09:19	23/02/2020 12:17	2,97	1	2,97	CHI
202002155370	GOIANIA	GN11085951	REAL S1	23/02/2020 08:41	23/02/2020 10:52	23/02/2020 08:41	23/02/2020 10:52	2,18	70	152,76	CHI
202002155371	IVOLANDIA	IV11256515	IPORA	23/02/2020 09:21	23/02/2020 12:56	23/02/2020 09:21	23/02/2020 12:56	3,58	2	7,16	CHI
202002155378	ABADIANIA	AA21084579	ANAPOLIS UNIVERSITARIO S1	23/02/2020 09:22	23/02/2020 10:47	23/02/2020 09:22	23/02/2020 10:47	1,42	3	4,25	CHI
202002155379	VICENTINOPOLIS	VI12218216	VICENTINOPOLIS	23/02/2020 09:22	23/02/2020 12:12	23/02/2020 09:22	23/02/2020 12:12	2,83	3	8,49	CHI
202002155381	ABADIANIA	AA21393146	ANAPOLIS UNIVERSITARIO S1	23/02/2020 09:22	23/02/2020 13:25	23/02/2020 09:22	23/02/2020 13:25	4,04	2	8,07	CHI
202002155382	JOVIANIA	JV21000009	GOIATUBA S1	23/02/2020 09:22	23/02/2020 12:49	23/02/2020 09:22	23/02/2020 12:49	3,43	1	3,43	CHI
202002155383	APARECIDA DE GOIANIA	AP11291541	ATLANTICO S3	23/02/2020 09:23	23/02/2020 11:43	23/02/2020 09:23	23/02/2020 11:43	2,33	4	9,33	CHI
202002155385	BONOPOLIS	BX12168258	SAO MIGUEL DO ARAGUAIA	23/02/2020 06:42	23/02/2020 13:28	23/02/2020 06:42	23/02/2020 13:28	6,76	20	135,13	CHI
202002155385	CACU	BX12168258	SAO MIGUEL DO ARAGUAIA	23/02/2020 06:42	23/02/2020 13:28	23/02/2020 06:42	23/02/2020 13:28	6,76	1	6,76	CHI
202002155391	GOIANIA	GN11088484	REAL S1	23/02/2020 08:39	23/02/2020 11:32	23/02/2020 08:39	23/02/2020 11:32	2,88	83	238,90	CHI
202002155393	FORMOSA	FA11068107	ITUIQUIRA	23/02/2020 09:25	23/02/2020 10:39	23/02/2020 09:25	23/02/2020 10:39	1,22	161	196,46	CHI
202002155398	ITAGUARU	JA12027826	JARAGUA	23/02/2020 08:39	23/02/2020 10:41	23/02/2020 08:39	23/02/2020 10:41	2,02	9	18,22	CHI
202002155398	JARAGUA	JA12027826	JARAGUA	23/02/2020 08:39	23/02/2020 10:41	23/02/2020 08:39	23/02/2020 10:41	2,02	18	36,43	CHI
202002155399	PEROLANDIA	MY21301786	PARQUE DAS EMAS	23/02/2020 09:26	23/02/2020 13:57	23/02/2020 09:26	23/02/2020 13:57	4,51	1	4,51	CHI
202002155405	CALDAS NOVAS	CN21186896	SERRA DE CALDAS	23/02/2020 09:27	23/02/2020 11:47	23/02/2020 09:27	23/02/2020 11:47	2,32	10	23,23	CHI
202002155408	BARRO ALTO	BA21161150	BARRO ALTO	23/02/2020 09:30	23/02/2020 13:30	23/02/2020 09:30	23/02/2020 13:30	4,00	2	7,99	CHI
202002155416	SANCLERLANDIA	SC21005469	FIRMINOPOLIS S2	23/02/2020 09:33	23/02/2020 11:02	23/02/2020 09:33	23/02/2020 11:02	1,48	1	1,48	CHI
202002155417	ABADIANIA	AA11090354	ANAPOLIS UNIVERSITARIO S1	23/02/2020 09:33	23/02/2020 12:59	23/02/2020 09:33	23/02/2020 12:59	3,42	55	188,33	CHI

202002155420	ANAPOLIS	21222198	ANAPOLIS UNIVERSITARIO S1	23/02/2020 09:34	23/02/2020 10:46	23/02/2020 09:34	23/02/2020 10:46	1,19	1	1,19	CHI
202002155421	PIRACANJUBA	PJ21105765	MORRINHOS	23/02/2020 09:34	23/02/2020 11:26	23/02/2020 09:34	23/02/2020 11:26	1,85	1	1,85	CHI
202002155422	GOIAS	GS12061061	ITAPURANGA	23/02/2020 09:35	23/02/2020 11:49	23/02/2020 09:35	23/02/2020 11:49	2,22	36	79,96	CHI
202002155426	ANHANGUERA	AH21082024	CATALAO S1	23/02/2020 09:38	23/02/2020 11:12	23/02/2020 09:38	23/02/2020 11:12	1,56	1	1,56	CHI
202002155427	SANTA RITA DO NOVO DESTINO	BA12163300	BARRO ALTO	23/02/2020 09:38	23/02/2020 11:13	23/02/2020 09:38	23/02/2020 11:13	1,58	20	31,61	CHI
202002155429	GOIANESIA	GE21354271	GOIANESIA S1	23/02/2020 09:39	23/02/2020 14:15	23/02/2020 09:39	23/02/2020 14:15	4,59	1	4,59	CHI
202002155436	SAO MIGUEL DO ARAGUAIA	SM13377685	SAO MIGUEL DO ARAGUAIA	23/02/2020 06:34	23/02/2020 16:01	23/02/2020 06:34	23/02/2020 16:01	9,45	7	66,13	CHI
202002155438	PIRENOPOLIS	JA21121821	JARAGUA	23/02/2020 09:44	23/02/2020 17:10	23/02/2020 09:44	23/02/2020 17:10	7,42	1	7,42	CHI
202002155440	CATALAO	CT12266329	CATALAO S1	23/02/2020 09:45	23/02/2020 16:04	23/02/2020 09:45	23/02/2020 16:04	6,30	9	56,73	CHI
202002155444	ALEXANIA	AX11349392	ALEXANIA	23/02/2020 08:41	23/02/2020 14:47	23/02/2020 08:41	23/02/2020 14:47	6,09	14	85,23	CHI
202002155447	IACIARA	IA21286091	IACIARA S2	23/02/2020 09:47	23/02/2020 10:39	23/02/2020 09:47	23/02/2020 10:39	0,86	1	0,86	CHI
202002155448	LUZIANIA	LZ21335535	CRISTALINA S2	23/02/2020 09:47	23/02/2020 12:59	23/02/2020 09:47	23/02/2020 12:59	3,20	1	3,20	CHI
202002155449	PIRACANJUBA	PJ12082680	CALDAS NOVAS S1	23/02/2020 09:47	23/02/2020 17:40	23/02/2020 09:47	23/02/2020 17:40	7,88	4	31,53	CHI
202002155453	PARAUNA	MV21079573	MONTIVIDIU T	23/02/2020 09:48	23/02/2020 14:28	23/02/2020 09:48	23/02/2020 14:28	4,65	1	4,65	CHI
202002155454	QUIRINOPOLIS	QI12301490	QUIRINOPOLIS	23/02/2020 09:48	23/02/2020 16:23	23/02/2020 09:48	23/02/2020 16:23	6,57	8	52,54	CHI
202002155455	URUACU	CR21243558	MARA ROSA	23/02/2020 09:49	23/02/2020 13:09	23/02/2020 09:49	23/02/2020 13:09	3,33	1	3,33	CHI
202002155458	MARA ROSA	ET21252375	MARA ROSA	23/02/2020 09:50	23/02/2020 13:32	23/02/2020 09:50	23/02/2020 13:32	3,70	1	3,70	CHI
202002155460	PORANGATU	PO21193526	PORANGATU	23/02/2020 09:50	23/02/2020 17:01	23/02/2020 09:50	23/02/2020 17:01	7,18	1	7,18	CHI
202002155463	SAO LUIZ DO NORTE	SZ12258502	BARRO ALTO	23/02/2020 09:50	23/02/2020 16:45	23/02/2020 09:50	23/02/2020 16:45	6,91	1	6,91	CHI
202002155465	POSSE	PS12235404	IACIARA S2	23/02/2020 09:50	23/02/2020 10:51	23/02/2020 09:50	23/02/2020 10:51	1,00	32	32,02	CHI
202002155468	GOIANIA	13448821	CAMPINAS S3	23/02/2020 09:51	23/02/2020 11:20	23/02/2020 09:51	23/02/2020 11:20	1,47	1	1,47	CHI
202002155471	MAMBAI	MB12392204LD	IACIARA S2	23/02/2020 09:51	23/02/2020 12:43	23/02/2020 09:51	23/02/2020 12:43	2,87	152	435,61	CHI
202002155471	MAMBAI	MB12392204LD	IACIARA S2	23/02/2020 09:51	23/02/2020 12:43	23/02/2020 11:26	23/02/2020 12:43	1,29	1	1,29	CHI
202002155475	SAO MIGUEL DO ARAGUAIA	SM21328554	SAO MIGUEL DO ARAGUAIA	23/02/2020 09:53	23/02/2020 13:46	23/02/2020 09:53	23/02/2020 13:46	3,87	1	3,87	CHI
202002155478	JUSSARA	JR12229982	JUSSARA	23/02/2020 09:53	23/02/2020 12:43	23/02/2020 09:53	23/02/2020 12:43	2,82	6	16,91	CHI
202002155483	PORANGATU	PO21295153	PORANGATU	23/02/2020 09:55	23/02/2020 15:07	23/02/2020 09:55	23/02/2020 15:07	5,19	1	5,19	CHI
202002155487	SILVANIA	SV21254604	VIANOPOLIS	23/02/2020 09:56	23/02/2020 12:32	23/02/2020 09:56	23/02/2020 12:32	2,59	1	2,59	CHI
202002155488	CAMPOS BELOS	CH11046866	SAO DOMINGOS	23/02/2020 08:38	23/02/2020 10:37	23/02/2020 08:38	23/02/2020 10:37	1,98	133	263,56	CHI
202002155489	FAINA	MP12194509	MATRINCHA	23/02/2020 09:58	23/02/2020 12:43	23/02/2020 09:58	23/02/2020 12:43	2,75	3	8,25	CHI
202002155489	MATRINCHA	MP12194509	MATRINCHA	23/02/2020 09:58	23/02/2020 12:43	23/02/2020 09:58	23/02/2020 12:43	2,75	3	8,25	CHI
202002155494	SILVANIA	SV12319704	DAIA S2	23/02/2020 09:58	23/02/2020 11:52	23/02/2020 09:58	23/02/2020 11:52	1,89	5	9,44	CHI
202002155495	CABECEIRAS	CW21184643	ITUIQUIRA	23/02/2020 09:58	23/02/2020 11:30	23/02/2020 09:58	23/02/2020 11:30	1,52	1	1,52	CHI
202002155496	QUIRINOPOLIS	QI12295729	QUIRINOPOLIS	23/02/2020 09:59	23/02/2020 11:30	23/02/2020 09:59	23/02/2020 11:30	1,53	69	105,59	CHI
202002155508	PADRE BERNARDO	PB21148421	PADRE BERNARDO	23/02/2020 10:01	23/02/2020 17:45	23/02/2020 10:01	23/02/2020 17:45	7,72	2	15,44	CHI
202002155511	PARAUNA	PU12336650	ACREUNA	23/02/2020 10:02	23/02/2020 12:19	23/02/2020 10:02	23/02/2020 12:19	2,28	2	4,56	CHI
202002155513	UIRAPURU	UP12297241	SANTA TEREZINHA	23/02/2020 10:03	23/02/2020 11:48	23/02/2020 10:03	23/02/2020 11:48	1,74	3	5,23	CHI
202002155514	TRES RANCHOS	TH21327324	CATALAO S1	23/02/2020 10:03	23/02/2020 13:53	23/02/2020 10:03	23/02/2020 13:53	3,82	2	7,64	CHI
202002155516	ORIZONA	OZ12115280	VIANOPOLIS	23/02/2020 10:04	23/02/2020 18:34	23/02/2020 10:04	23/02/2020 18:34	8,49	7	59,46	CHI
202002155517	CAMPO ALEGRE DE GOIAS	CT12130977	CATALAO S1	23/02/2020 09:59	23/02/2020 13:14	23/02/2020 09:59	23/02/2020 13:14	3,24	2	6,48	CHI
202002155517	CATALAO	CT12130977	CATALAO S1	23/02/2020 09:59	23/02/2020 13:14	23/02/2020 09:59	23/02/2020 13:14	3,24	34	110,19	CHI
202002155520	CRISTALINA	KR12133609	CRISTALINA S1	23/02/2020 10:05	24/02/2020 02:24	23/02/2020 10:05	24/02/2020 02:24	16,31	6	97,89	CHI
202002155520	IPAMERI	KR12133609	CRISTALINA S1	23/02/2020 10:05	24/02/2020 02:24	23/02/2020 10:05	24/02/2020 02:24	16,31	1	16,31	CHI
202002155521	SANTO ANTONIO DE GOIAS	GR31073470	NEROPOLIS S1	23/02/2020 10:05	23/02/2020 15:37	23/02/2020 10:05	23/02/2020 15:37	5,53	1	5,53	CHI
202002155527	CACU	CC21198093	CACHOEIRA ALTA	23/02/2020 10:07	23/02/2020 20:24	23/02/2020 10:07	23/02/2020 20:24	10,27	1	10,27	CHI

202002155529	MONTE ALEGRE DE GOIAS	MA12209855	SAO DOMINGOS	23/02/2020 10:07	23/02/2020 11:47	23/02/2020 10:07	23/02/2020 11:47	1,66	14	23,19	CHI
202002155530	ALEXANIA	AX12211846	ALEXANIA	22/02/2020 23:53	23/02/2020 14:04	22/02/2020 23:53	23/02/2020 14:04	14,18	215	3049,48	CHI
202002155531	FAZENDA NOVA	FN12390138	IPORA	23/02/2020 10:08	23/02/2020 16:04	23/02/2020 10:08	23/02/2020 16:04	5,92	7	41,46	CHI
202002155536	NEROPOLIS	NR12029257	NEROPOLIS S2	23/02/2020 10:09	23/02/2020 15:22	23/02/2020 10:09	23/02/2020 15:22	5,20	11	57,23	CHI
202002155545	JANDAIA	JD21312556	PALMEIRAS	23/02/2020 10:12	23/02/2020 11:46	23/02/2020 10:12	23/02/2020 11:46	1,56	1	1,56	CHI
202002155546	INHUMAS	IX12013297	INHUMAS S2	23/02/2020 08:36	23/02/2020 12:52	23/02/2020 08:36	23/02/2020 12:52	4,25	13	55,29	CHI
202002155547	SAO MIGUEL DO PASSA QUATRO	SQ12231522	CRISTIANOPOLIS	23/02/2020 10:13	23/02/2020 12:19	23/02/2020 10:13	23/02/2020 12:19	2,10	12	25,19	CHI
202002155547	VIANOPOLIS	SQ12231522	CRISTIANOPOLIS	23/02/2020 10:13	23/02/2020 12:19	23/02/2020 10:13	23/02/2020 12:19	2,10	18	37,79	CHI
202002155548	CATALAO	CT21245080	CATALAO S1	23/02/2020 10:13	23/02/2020 14:12	23/02/2020 10:13	23/02/2020 14:12	3,98	1	3,98	CHI
202002155552	DIVINOPOLIS DE GOIAS	GH12151237	SAO DOMINGOS	23/02/2020 07:34	23/02/2020 12:39	23/02/2020 07:34	23/02/2020 12:39	5,08	29	147,27	CHI
202002155552	SAO DOMINGOS	GH12151237	SAO DOMINGOS	23/02/2020 07:34	23/02/2020 12:39	23/02/2020 07:34	23/02/2020 12:39	5,08	21	106,65	CHI
202002155557	MOSSAMEDES	MD21089224	ITABERAI S2	23/02/2020 10:14	23/02/2020 16:00	23/02/2020 10:14	23/02/2020 16:00	5,75	1	5,75	CHI
202002155571	VILA PROPICIO	PV21080661	GOIANESIA S1	23/02/2020 10:19	23/02/2020 12:21	23/02/2020 10:19	23/02/2020 12:21	2,04	3	6,13	CHI
202002155572	GOIANIA	GN11180081	XAVANTES	23/02/2020 08:19	23/02/2020 16:22	23/02/2020 08:19	23/02/2020 16:22	8,05	136	1094,20	CHI
202002155575	MINEIROS	MY12153327RE	PARQUE DAS EMAS	23/02/2020 10:17	23/02/2020 12:27	23/02/2020 10:17	23/02/2020 12:27	2,16	128	276,37	CHI
202002155575	SANTA RITA DO ARAGUAIA	MY12153327RE	PARQUE DAS EMAS	23/02/2020 10:17	23/02/2020 12:27	23/02/2020 10:17	23/02/2020 12:27	2,16	4	8,64	CHI
202002155577	BELA VISTA DE GOIAS	BV12086489	CEPAIGO S2	23/02/2020 10:05	23/02/2020 15:26	23/02/2020 10:05	23/02/2020 15:26	5,34	13	69,36	CHI
202002155577	SILVANIA	BV12086489	CEPAIGO S2	23/02/2020 10:05	23/02/2020 15:26	23/02/2020 10:05	23/02/2020 15:26	5,34	1	5,34	CHI
202002155583	GOIANESIA	GE12357342	GOIANESIA S2	23/02/2020 10:23	23/02/2020 14:38	23/02/2020 10:23	23/02/2020 14:38	4,25	18	76,48	CHI
202002155583	VILA PROPICIO	GE12357342	GOIANESIA S2	23/02/2020 10:23	23/02/2020 14:38	23/02/2020 10:23	23/02/2020 14:38	4,25	9	38,24	CHI
202002155587	CRIXAS	CX12281130	SERRA DO OURO	23/02/2020 10:23	23/02/2020 15:59	23/02/2020 10:23	23/02/2020 15:59	5,58	2	11,17	CHI
202002155600	COCALZINHO DE GOIAS	ZN12258524RE	COCALZINHO	23/02/2020 08:50	23/02/2020 12:45	23/02/2020 08:50	23/02/2020 12:45	3,92	54	211,48	CHI
202002155603	RIO VERDE	RV12123383	RIO VERDE S1	23/02/2020 10:27	23/02/2020 13:44	23/02/2020 10:27	23/02/2020 13:44	3,28	4	13,12	CHI
202002155604	DAVINOPOLIS	IO12266860RE	CATALAO S1	23/02/2020 09:55	23/02/2020 12:41	23/02/2020 09:55	23/02/2020 12:41	2,75	49	134,86	CHI
202002155604	DISTRITO FEDERAL	IO12266860RE	CATALAO S1	23/02/2020 09:55	23/02/2020 12:41	23/02/2020 09:55	23/02/2020 12:41	2,75	8	22,02	CHI
202002155605	GOIANIRA	GR31045883	TRINDADE	23/02/2020 10:27	23/02/2020 12:21	23/02/2020 10:27	23/02/2020 12:21	1,89	1	1,89	CHI
202002155610	PIRENOPOLIS	PV12014768	SAO FRANCISCO DE GOIAS	23/02/2020 10:29	23/02/2020 20:37	23/02/2020 10:29	23/02/2020 20:37	10,12	7	70,82	CHI
202002155612	CATURAI	CK12131268	ARACU	23/02/2020 10:30	23/02/2020 12:48	23/02/2020 10:30	23/02/2020 12:48	2,29	1	2,29	CHI
202002155615	ITABERAI	IB12206924	ITABERAI S2	23/02/2020 10:31	23/02/2020 11:36	23/02/2020 10:31	23/02/2020 11:36	1,07	7	7,50	CHI
202002155617	GOIANIA	GN11151908	ATLANTICO S3	23/02/2020 10:31	23/02/2020 12:53	23/02/2020 10:31	23/02/2020 12:53	2,35	20	47,06	CHI
202002155620	SILVANIA	LB21200904	DAIA S2	23/02/2020 10:34	23/02/2020 12:35	23/02/2020 10:34	23/02/2020 12:35	2,01	1	2,01	CHI
202002155623	MUTUNOPOLIS	2400004141	MARA ROSA	23/02/2020 10:34	23/02/2020 15:48	23/02/2020 10:34	23/02/2020 15:48	5,22	1	5,22	CHI
202002155624	ANAPOLIS	10013227317	ANAPOLIS UNIVERSITARIO S2	23/02/2020 10:35	23/02/2020 18:32	23/02/2020 10:35	23/02/2020 18:32	7,95	1	7,95	CHI
202002155627	INDIARA	IY21060961	EDEIA	23/02/2020 10:35	23/02/2020 14:46	23/02/2020 10:35	23/02/2020 14:46	4,18	1	4,18	CHI
202002155629	VIANOPOLIS	VN21060534	PIRES DO RIO S2	23/02/2020 10:36	23/02/2020 12:49	23/02/2020 10:36	23/02/2020 12:49	2,21	1	2,21	CHI
202002155634	BOM JESUS DE GOIAS	1250077701	BOM JESUS DE GOIAS	23/02/2020 10:37	23/02/2020 19:20	23/02/2020 10:37	23/02/2020 19:20	8,70	1	8,70	CHI
202002155636	GOIANIA	15014629	CARAJAS S2	23/02/2020 10:39	23/02/2020 15:41	23/02/2020 10:39	23/02/2020 15:41	5,03	1	5,03	CHI
202002155638	NOVA CRIXAS	NA21077118	NOVA CRIXAS	23/02/2020 10:39	23/02/2020 19:38	23/02/2020 10:39	23/02/2020 19:38	8,98	1	8,98	CHI
202002155641	IPAMERI	IP12200146	URUTAI	23/02/2020 10:40	23/02/2020 14:53	23/02/2020 10:40	23/02/2020 14:53	4,21	3	12,63	CHI
202002155644	SILVANIA	SV21152366	DAIA S2	23/02/2020 10:40	23/02/2020 15:03	23/02/2020 10:40	23/02/2020 15:03	4,37	1	4,37	CHI
202002155645	ITAPURANGA	IK21238869	ITAPURANGA	23/02/2020 10:41	23/02/2020 11:54	23/02/2020 10:41	23/02/2020 11:54	1,21	1	1,21	CHI
202002155646	CALDAZINHA	SV21311964	CEPAIGO S2	23/02/2020 10:41	23/02/2020 17:59	23/02/2020 10:41	23/02/2020 17:59	7,30	1	7,30	CHI
202002155647	CATALAO	CT21266168	CATALAO S1	23/02/2020 10:41	23/02/2020 13:18	23/02/2020 10:41	23/02/2020 13:18	2,61	1	2,61	CHI
202002155648	GOIAS	GS21094807	MATRINCHA	23/02/2020 10:41	23/02/2020 14:27	23/02/2020 10:41	23/02/2020 14:27	3,75	1	3,75	CHI

202002155654	BURITI ALEGRE	BG21278741	ITUMBIARA VELHA S2	23/02/2020 10:43	23/02/2020 12:56	23/02/2020 10:43	23/02/2020 12:56	2,21	1	2,21	CHI
202002155656	RIO VERDE	10023059999	RIO VERDE S2	23/02/2020 10:44	23/02/2020 12:52	23/02/2020 10:44	23/02/2020 12:52	2,13	1	2,13	CHI
202002155657	MINACU	IH11202507	MINACU	23/02/2020 06:11	23/02/2020 12:26	23/02/2020 06:11	23/02/2020 12:26	6,24	11	68,64	CHI
202002155659	GOIANIA	AP11169530	INDEPENDENCIA S2	23/02/2020 10:44	23/02/2020 11:39	23/02/2020 10:44	23/02/2020 11:39	0,92	85	77,80	CHI
202002155660	RIO VERDE	RV13279865	SANTA HELENA S1	23/02/2020 10:29	23/02/2020 12:38	23/02/2020 10:29	23/02/2020 12:38	2,14	3	6,43	CHI
202002155664	GOIANIA	15905949	GOIANIA LESTE S2	23/02/2020 10:45	23/02/2020 13:15	23/02/2020 10:45	23/02/2020 13:15	2,48	1	2,48	CHI
202002155668	PORTEIRAO	CL12230806	RIO DOS BOIS	23/02/2020 10:46	23/02/2020 17:22	23/02/2020 10:46	23/02/2020 17:22	6,59	4	26,35	CHI
202002155668	VICENTINOPOLIS	CL12230806	RIO DOS BOIS	23/02/2020 10:46	23/02/2020 17:22	23/02/2020 10:46	23/02/2020 17:22	6,59	4	26,35	CHI
202002155669	LEOPOLDO DE BULHOES	LB21248836	DAIA S2	23/02/2020 10:46	23/02/2020 15:38	23/02/2020 10:46	23/02/2020 15:38	4,85	1	4,85	CHI
202002155671	GOIANESIA	GE21026066	GOIANESIA S1	23/02/2020 10:47	23/02/2020 14:16	23/02/2020 10:47	23/02/2020 14:16	3,47	2	6,94	CHI
202002155672	MINEIROS	MY11035971	PARQUE DAS EMAS	23/02/2020 10:47	23/02/2020 13:56	23/02/2020 10:47	23/02/2020 13:56	3,14	168	526,91	CHI
202002155675	ORIZONA	3440000926	PIRES DO RIO S2	23/02/2020 10:47	23/02/2020 16:31	23/02/2020 10:47	23/02/2020 16:31	5,72	1	5,72	CHI
202002155676	PARAUNA	PU21348600	PARAUNA	23/02/2020 10:48	23/02/2020 16:43	23/02/2020 10:48	23/02/2020 16:43	5,91	1	5,91	CHI
202002155682	CALDAS NOVAS	CN12298752	CALDAS NOVAS S2	23/02/2020 10:01	23/02/2020 13:52	23/02/2020 10:01	23/02/2020 13:52	3,83	9	34,50	CHI
202002155685	SANTA CRUZ DE GOIAS	BC12309408	PIRES DO RIO S2	23/02/2020 10:50	23/02/2020 14:54	23/02/2020 10:50	23/02/2020 14:54	4,06	6	24,35	CHI
202002155688	GOIANIA	11175199	ATLANTICO S2	23/02/2020 10:50	23/02/2020 12:42	23/02/2020 10:50	23/02/2020 12:42	1,85	1	1,85	CHI
202002155690	GOIANIA	10018095168	CARAJAS S2	23/02/2020 10:51	23/02/2020 12:59	23/02/2020 10:51	23/02/2020 12:59	2,13	1	2,13	CHI
202002155692	BOM JARDIM DE GOIAS	BM12335395	BOM JARDIM	23/02/2020 10:51	23/02/2020 13:48	23/02/2020 10:51	23/02/2020 13:48	2,95	2	5,89	CHI
202002155694	MORRINHOS	MR21102224	MORRINHOS	23/02/2020 10:51	23/02/2020 16:31	23/02/2020 10:51	23/02/2020 16:31	5,66	2	11,31	CHI
202002155698	MONTES CLAROS DE GOIAS	ME21066175	IPORA	23/02/2020 10:51	24/02/2020 07:38	23/02/2020 10:51	24/02/2020 07:38	20,77	2	41,54	CHI
202002155699	ITAPURANGA	10013941400	ITAPURANGA	23/02/2020 10:52	23/02/2020 13:09	23/02/2020 10:52	23/02/2020 13:09	2,28	1	2,28	CHI
202002155707	GUARINOS	GF21314373	SANTA TEREZINHA	23/02/2020 10:56	23/02/2020 14:19	23/02/2020 10:56	23/02/2020 14:19	3,38	2	6,77	CHI
202002155708	MORRINHOS	OZ12064707	VIANOPOLIS	23/02/2020 09:22	23/02/2020 15:02	23/02/2020 09:22	23/02/2020 15:02	5,65	1	5,65	CHI
202002155708	ORIZONA	OZ12064707	VIANOPOLIS	23/02/2020 09:22	23/02/2020 15:02	23/02/2020 09:22	23/02/2020 15:02	5,65	30	169,61	CHI
202002155708	SILVANIA	OZ12064707	VIANOPOLIS	23/02/2020 09:22	23/02/2020 15:02	23/02/2020 09:22	23/02/2020 15:02	5,65	5	28,27	CHI
202002155709	JARAGUA	70023128	JARAGUA	23/02/2020 10:57	23/02/2020 12:52	23/02/2020 10:57	23/02/2020 12:52	1,91	1	1,91	CHI
202002155710	ABADIANIA	AA12085971	ANAPOLIS UNIVERSITARIO S1	23/02/2020 10:44	23/02/2020 12:19	23/02/2020 10:44	23/02/2020 12:19	1,57	12	18,88	CHI
202002155711	GOIANIA	GN12054915	XAVANTES	23/02/2020 10:58	23/02/2020 12:30	23/02/2020 10:58	23/02/2020 12:30	1,53	32	48,89	CHI
202002155718	JATAI	JT12000231	JATAI S1	23/02/2020 11:01	23/02/2020 23:08	23/02/2020 11:01	23/02/2020 13:32	2,51	54	135,73	CHI
202002155718	JATAI	JT12000231	JATAI S1	23/02/2020 11:01	23/02/2020 23:08	23/02/2020 11:01	23/02/2020 14:19	3,30	13	42,89	CHI
202002155718	PEROLANDIA	JT12000231	JATAI S1	23/02/2020 11:01	23/02/2020 23:08	23/02/2020 11:01	23/02/2020 14:19	3,30	3	9,90	CHI
202002155718	JATAI	JT12000231	JATAI S1	23/02/2020 11:01	23/02/2020 23:08	23/02/2020 17:33	23/02/2020 19:57	2,41	7	16,89	CHI
202002155718	JATAI	JT13336940	JATAI S1	23/02/2020 11:01	23/02/2020 23:08	23/02/2020 17:33	23/02/2020 20:38	3,09	44	135,89	CHI
202002155718	JATAI	JT12336942	JATAI S1	23/02/2020 11:01	23/02/2020 23:08	23/02/2020 17:33	23/02/2020 22:33	5,01	13	65,07	CHI
202002155718	PEROLANDIA	JT12336942	JATAI S1	23/02/2020 11:01	23/02/2020 23:08	23/02/2020 17:33	23/02/2020 22:33	5,01	3	15,02	CHI
202002155718	JATAI	JT12000231	JATAI S1	23/02/2020 11:01	23/02/2020 23:08	23/02/2020 11:01	23/02/2020 23:08	12,13	6	72,78	CHI
202002155726	CALDAZINHA	SV21302145	CEPAIGO S2	23/02/2020 11:02	23/02/2020 19:22	23/02/2020 11:02	23/02/2020 19:22	8,32	2	16,64	CHI
202002155728	SANCLERLANDIA	SC21278729	FIRMINOPOLIS S2	23/02/2020 11:03	23/02/2020 14:01	23/02/2020 11:03	23/02/2020 14:01	2,95	1	2,95	CHI
202002155734	PORANGATU	PO12230401	MARA ROSA	23/02/2020 10:15	23/02/2020 13:17	23/02/2020 10:15	23/02/2020 13:17	3,03	5	15,13	CHI
202002155736	SERRANOPOLIS	SX21156859	JATAI S1	23/02/2020 11:05	23/02/2020 14:48	23/02/2020 11:05	23/02/2020 14:48	3,70	1	3,70	CHI
202002155738	PARAUNA	PU21356335	ACREUNA	23/02/2020 11:07	23/02/2020 15:23	23/02/2020 11:07	23/02/2020 15:23	4,26	1	4,26	CHI
202002155739	JATAI	JT12196245	JATAI S1	23/02/2020 11:08	23/02/2020 14:49	23/02/2020 11:08	23/02/2020 14:49	3,68	4	14,73	CHI
202002155741	MINEIROS	1390077527	PARQUE DAS EMAS	23/02/2020 11:08	23/02/2020 13:01	23/02/2020 11:08	23/02/2020 13:01	1,88	1	1,88	CHI
202002155744	MONTIVIDIU DO NORTE	MX12244258	PORANGATU	23/02/2020 11:08	23/02/2020 13:57	23/02/2020 11:08	23/02/2020 13:57	2,81	18	50,53	CHI

202002155747	PALMEIRAS DE GOIAS	PL21382564	FIRMINOPOLIS S2	23/02/2020 11:09	23/02/2020 12:10	23/02/2020 11:09	23/02/2020 12:10	1,01	2	2,03	CHI
202002155748	PORTEIRAO	BJ12030830	RIO DOS BOIS	23/02/2020 11:09	23/02/2020 22:59	23/02/2020 11:09	23/02/2020 22:59	11,84	1	11,84	CHI
202002155748	GOIATUBA	BJ12030830	RIO DOS BOIS	23/02/2020 11:09	23/02/2020 22:59	23/02/2020 16:09	23/02/2020 22:59	6,85	1	6,85	CHI
202002155748	PORTEIRAO	BJ12030830	RIO DOS BOIS	23/02/2020 11:09	23/02/2020 22:59	23/02/2020 16:09	23/02/2020 22:59	6,85	1	6,85	CHI
202002155750	MINEIROS	PW12301783	PARQUE DAS EMAS	23/02/2020 11:09	23/02/2020 15:49	23/02/2020 11:09	23/02/2020 15:49	4,65	44	204,81	CHI
202002155750	SANTA RITA DO ARAGUAIA	PW12301783	PARQUE DAS EMAS	23/02/2020 11:09	23/02/2020 15:49	23/02/2020 11:09	23/02/2020 15:49	4,65	15	69,82	CHI
202002155751	JARAGUA	JA12156311	JARAGUA	23/02/2020 08:12	23/02/2020 15:50	23/02/2020 08:12	23/02/2020 15:50	7,63	19	144,91	CHI
202002155752	GOIANIA	17445152	GOIANIA LESTE S2	23/02/2020 11:10	23/02/2020 15:03	23/02/2020 11:10	23/02/2020 15:03	3,88	1	3,88	CHI
202002155753	HIDROLANDIA	HD21012592	CEPAIGO S2	23/02/2020 11:10	23/02/2020 14:52	23/02/2020 11:10	23/02/2020 14:52	3,69	2	7,39	CHI
202002155755	BARRO ALTO	BA21237503	BARRO ALTO	23/02/2020 11:11	23/02/2020 14:08	23/02/2020 11:11	23/02/2020 14:08	2,95	1	2,95	CHI
202002155757	CAIAPONIA	CP12354340	CAIAPONIA	23/02/2020 10:52	23/02/2020 13:00	23/02/2020 10:52	23/02/2020 13:00	2,13	13	27,65	CHI
202002155760	GOIANIA	GN11091333	GOIANIA LESTE S3	23/02/2020 10:53	23/02/2020 12:55	23/02/2020 10:53	23/02/2020 12:55	2,03	260	526,93	CHI
202002155762	DIORAMA	DI12138444	IPORA	23/02/2020 11:13	23/02/2020 16:02	23/02/2020 11:13	23/02/2020 16:02	4,81	2	9,63	CHI
202002155765	BRAZABRANTES	03920224	NEROPOLIS S1	23/02/2020 10:56	23/02/2020 13:06	23/02/2020 10:56	23/02/2020 12:14	1,29	365	469,63	CHI
202002155765	NOVA VENEZA	03920224	NEROPOLIS S1	23/02/2020 10:56	23/02/2020 13:06	23/02/2020 10:56	23/02/2020 12:14	1,29	3	3,86	CHI
202002155765	BRAZABRANTES	BR13016008	NEROPOLIS S1	23/02/2020 10:56	23/02/2020 13:06	23/02/2020 10:56	23/02/2020 12:34	1,63	2	3,25	CHI
202002155765	GOIANIRA	BR13016008	NEROPOLIS S1	23/02/2020 10:56	23/02/2020 13:06	23/02/2020 10:56	23/02/2020 12:34	1,63	7	11,38	CHI
202002155765	BRAZABRANTES	BR13016007	NEROPOLIS S1	23/02/2020 10:56	23/02/2020 13:06	23/02/2020 10:56	23/02/2020 13:06	2,16	4	8,64	CHI
202002155765	GOIANIRA	BR13016007	NEROPOLIS S1	23/02/2020 10:56	23/02/2020 13:06	23/02/2020 10:56	23/02/2020 13:06	2,16	22	47,54	CHI
202002155766	APORE	AE21391170	ITAJA S1	23/02/2020 11:15	23/02/2020 14:26	23/02/2020 11:15	23/02/2020 14:26	3,17	1	3,17	CHI
202002155773	CALDAZINHA	DE21113339	CEPAIGO S2	23/02/2020 11:17	23/02/2020 12:41	23/02/2020 11:17	23/02/2020 12:41	1,39	2	2,79	CHI
202002155774	ITACUCU	IX21013773	INHUMAS S2	23/02/2020 11:18	23/02/2020 14:46	23/02/2020 11:18	23/02/2020 14:46	3,45	1	3,45	CHI
202002155775	AMARALINA	LC12278480	MARA ROSA	23/02/2020 11:19	23/02/2020 16:47	23/02/2020 11:19	23/02/2020 16:47	5,45	3	16,36	CHI
202002155778	URUACU	UR12398055	URUACU	23/02/2020 11:20	23/02/2020 15:46	23/02/2020 11:20	23/02/2020 15:46	4,42	13	57,46	CHI
202002155779	SAO LUIS DE MONTES BELOS	SL21049621	SAO LUIZ DOS MONTES BELOS	23/02/2020 11:21	23/02/2020 14:07	23/02/2020 11:21	23/02/2020 14:07	2,76	1	2,76	CHI
202002155781	VALPARAISO DE GOIAS	10005973617	MARAJOARA	23/02/2020 11:21	23/02/2020 12:45	23/02/2020 11:21	23/02/2020 12:45	1,39	1	1,39	CHI
202002155783	MINACU	IH12317057	MINACU	23/02/2020 11:23	23/02/2020 15:22	23/02/2020 11:23	23/02/2020 15:22	3,99	5	19,94	CHI
202002155786	GOIANIA	GN11000611	AEROPORTO S2	23/02/2020 11:25	23/02/2020 14:43	23/02/2020 11:25	23/02/2020 14:43	3,29	43	141,42	CHI
202002155787	ANAPOLIS	20094851	ANAPOLIS UNIVERSITARIO S2	23/02/2020 11:26	23/02/2020 15:33	23/02/2020 11:26	23/02/2020 15:33	4,11	1	4,11	CHI
202002155794	SANTO ANTONIO DO DESCOBERTO	SN12275494	MARAJOARA	23/02/2020 07:26	23/02/2020 14:23	23/02/2020 07:26	23/02/2020 14:23	6,95	8	55,60	CHI
202002155797	JATAI	10016516743	JATAI S2	23/02/2020 11:28	23/02/2020 13:47	23/02/2020 11:28	23/02/2020 13:47	2,32	1	2,32	CHI
202002155803	PARANAIGUARA	PC12136019	CACHOEIRA ALTA	23/02/2020 11:32	23/02/2020 13:35	23/02/2020 11:32	23/02/2020 13:35	2,05	3	6,14	CHI
202002155805	PADRE BERNARDO	PB11042826	PADRE BERNARDO	23/02/2020 10:37	23/02/2020 15:36	23/02/2020 10:37	23/02/2020 15:36	4,98	38	189,38	CHI
202002155806	PORTELANDIA	PW12209812	PARQUE DAS EMAS	23/02/2020 11:26	23/02/2020 17:42	23/02/2020 11:26	23/02/2020 17:42	6,26	84	525,77	CHI
202002155815	CAMPO ALEGRE DE GOIAS	CM12131049LD	CAMPO ALEGRE DE GOIAS	23/02/2020 11:41	23/02/2020 12:47	23/02/2020 11:41	23/02/2020 12:47	1,10	6	6,58	CHI
202002155815	CATALAO	CM12131049LD	CAMPO ALEGRE DE GOIAS	23/02/2020 11:41	23/02/2020 12:47	23/02/2020 11:41	23/02/2020 12:47	1,10	4	4,39	CHI
202002155816	CACU	IM12234538	CACHOEIRA ALTA	23/02/2020 09:38	23/02/2020 14:45	23/02/2020 09:38	23/02/2020 14:45	5,12	60	307,22	CHI
202002155816	ITARUMA	IM12234538	CACHOEIRA ALTA	23/02/2020 09:38	23/02/2020 14:45	23/02/2020 09:38	23/02/2020 14:45	5,12	35	179,21	CHI
202002155816	JATAI	IM12234538	CACHOEIRA ALTA	23/02/2020 09:38	23/02/2020 14:45	23/02/2020 09:38	23/02/2020 14:45	5,12	20	102,41	CHI
202002155818	CABECEIRAS	CW12184623	ITUIQUIRA	23/02/2020 11:39	23/02/2020 13:06	23/02/2020 11:39	23/02/2020 13:06	1,44	7	10,11	CHI
202002155824	PIRES DO RIO	460081627	PIRES DO RIO S1	23/02/2020 11:41	23/02/2020 14:39	23/02/2020 11:41	23/02/2020 14:39	2,96	1	2,96	CHI
202002155827	ITAJA	IJ21160699	ITAJA S2	23/02/2020 11:41	23/02/2020 16:52	23/02/2020 11:41	23/02/2020 16:52	5,17	1	5,17	CHI
202002155828	SENADOR CANEDO	190020623	CEPAIGO S2	23/02/2020 11:43	23/02/2020 14:10	23/02/2020 11:43	23/02/2020 14:10	2,43	1	2,43	CHI
202002155831	GOIANIA	GN11068487	GOYA S2	23/02/2020 10:50	23/02/2020 13:43	23/02/2020 10:50	23/02/2020 13:43	2,87	19	54,49	CHI

202002155838	APARECIDA DE GOIANIA	200105980	INDEPENDENCIA S2	23/02/2020 11:47	23/02/2020 14:09	23/02/2020 11:47	23/02/2020 14:09	2,37	1	2,37	CHI
202002155839	MINEIROS	MY12385364	PARQUE DAS EMAS	23/02/2020 11:47	23/02/2020 16:43	23/02/2020 11:47	23/02/2020 16:43	4,94	1	4,94	CHI
202002155840	GOIANIA	15850924	CARAJAS S1	23/02/2020 11:47	23/02/2020 14:36	23/02/2020 11:47	23/02/2020 14:36	2,81	1	2,81	CHI
202002155847	NOVA ROMA	5600000253	IACIARA S2	23/02/2020 11:51	23/02/2020 13:21	23/02/2020 11:51	23/02/2020 13:21	1,49	1	1,49	CHI
202002155848	JARAGUA	JA12040435	SAO FRANCISCO DE GOIAS	23/02/2020 11:33	23/02/2020 18:33	23/02/2020 11:33	23/02/2020 18:33	6,99	2	13,98	CHI
202002155848	JESUPOLIS	JA12040435	SAO FRANCISCO DE GOIAS	23/02/2020 11:33	23/02/2020 18:33	23/02/2020 11:33	23/02/2020 18:33	6,99	19	132,84	CHI
202002155849	SAO MIGUEL DO ARAGUAIA	SM12334372	SAO MIGUEL DO ARAGUAIA	23/02/2020 11:53	23/02/2020 16:30	23/02/2020 11:53	23/02/2020 16:30	4,61	4	18,44	CHI
202002155853	ALEXANIA	AX21144013	ALEXANIA	23/02/2020 11:56	23/02/2020 15:11	23/02/2020 11:56	23/02/2020 15:11	3,24	1	3,24	CHI
202002155856	GOIANIA	14828224	REAL S1	23/02/2020 11:58	23/02/2020 14:29	23/02/2020 11:58	23/02/2020 14:29	2,51	1	2,51	CHI
202002155860	NIQUELANDIA	NQ21379798	URUACU	23/02/2020 12:00	23/02/2020 16:58	23/02/2020 12:00	23/02/2020 16:58	4,95	2	9,91	CHI
202002155863	TRINDADE	TR21089332	TRINDADE	23/02/2020 12:03	23/02/2020 15:59	23/02/2020 12:03	23/02/2020 15:59	3,93	2	7,86	CHI
202002155865	GOIANIA	10179951	FERROVIARIO S3	23/02/2020 12:04	23/02/2020 14:01	23/02/2020 12:04	23/02/2020 14:01	1,95	1	1,95	CHI
202002155866	POSSE	PS12122519	IACIARA S2	23/02/2020 12:04	23/02/2020 12:40	23/02/2020 12:04	23/02/2020 12:40	0,60	10	5,96	CHI
202002155869	SANTO ANTONIO DO DESCOBERTO	2210034640	AGUAS LINDAS DE GOIAS S2	23/02/2020 12:05	23/02/2020 12:46	23/02/2020 12:05	23/02/2020 12:46	0,68	1	0,68	CHI
202002155870	MONTES CLAROS DE GOIAS	ME21086436	IPORA	23/02/2020 12:05	23/02/2020 17:35	23/02/2020 12:05	23/02/2020 17:35	5,48	1	5,48	CHI
202002155871	BURITI ALEGRE	BG11143983	ITUMBIARA VELHA S2	23/02/2020 12:05	23/02/2020 20:16	23/02/2020 12:05	23/02/2020 20:16	8,17	53	432,88	CHI
202002155872	NEROPOLIS	NR21000090	NEROPOLIS S2	23/02/2020 12:06	23/02/2020 17:16	23/02/2020 12:06	23/02/2020 17:16	5,16	1	5,16	CHI
202002155876	PADRE BERNARDO	PB12347929	PADRE BERNARDO	23/02/2020 12:07	23/02/2020 15:21	23/02/2020 12:07	23/02/2020 15:21	3,22	5	16,09	CHI
202002155877	CORUMBA DE GOIAS	CB12161727	CORUMBA	23/02/2020 12:08	23/02/2020 14:14	23/02/2020 12:08	23/02/2020 14:14	2,10	305	639,82	CHI
202002155880	CAIAPONIA	CP12380880	CAIAPONIA	23/02/2020 12:10	23/02/2020 23:20	23/02/2020 12:10	23/02/2020 23:20	11,17	11	122,83	CHI
202002155886	GOIANIA	13489951	REAL S1	23/02/2020 12:11	23/02/2020 15:11	23/02/2020 12:11	23/02/2020 15:11	2,99	1	2,99	CHI
202002155891	CAMPOS VERDES	SG12318464	SANTA TEREZINHA	23/02/2020 11:46	23/02/2020 18:07	23/02/2020 11:46	23/02/2020 18:07	6,35	13	82,52	CHI
202002155891	SANTA TEREZINHA DE GOIAS	SG12318464	SANTA TEREZINHA	23/02/2020 11:46	23/02/2020 18:07	23/02/2020 11:46	23/02/2020 18:07	6,35	31	196,78	CHI
202002155891	UIRAPURU	SG12318464	SANTA TEREZINHA	23/02/2020 11:46	23/02/2020 18:07	23/02/2020 11:46	23/02/2020 18:07	6,35	12	76,17	CHI
202002155894	ORIZONA	OZ12152754	PIRES DO RIO S2	23/02/2020 12:17	23/02/2020 17:44	23/02/2020 12:17	23/02/2020 17:44	5,44	18	97,90	CHI
202002155896	ANAPOLIS	AN21258585	NEROPOLIS S1	23/02/2020 12:18	23/02/2020 14:40	23/02/2020 12:18	23/02/2020 14:40	2,37	1	2,37	CHI
202002155901	RIO VERDE	RV12111110	MONTIVIDIU T	23/02/2020 12:20	23/02/2020 17:51	23/02/2020 12:20	23/02/2020 17:51	5,51	5	27,54	CHI
202002155906	IPAMERI	580061206	IPAMERI	23/02/2020 12:24	23/02/2020 17:15	23/02/2020 12:24	23/02/2020 17:15	4,85	1	4,85	CHI
202002155908	ALTO PARAISO DE GOIAS	BF21399133	FLORES DE GOIAS	23/02/2020 12:26	23/02/2020 15:18	23/02/2020 12:26	23/02/2020 15:18	2,85	1	2,85	CHI
202002155910	ITUMBIARA	IT12000308RE	PARANAIBA	23/02/2020 12:27	23/02/2020 15:07	23/02/2020 12:27	23/02/2020 15:07	2,65	92	244,18	CHI
202002155911	GOIANIA	16730537	GOIANIA LESTE S3	23/02/2020 12:28	23/02/2020 14:18	23/02/2020 12:28	23/02/2020 14:18	1,83	1	1,83	CHI
202002155912	CAMPO ALEGRE DE GOIAS	CM12084693	CAMPO ALEGRE DE GOIAS	23/02/2020 12:28	23/02/2020 15:54	23/02/2020 12:28	23/02/2020 15:54	3,42	1	3,42	CHI
202002155915	EDEALINA	ED11108008	PONTALINA	23/02/2020 12:29	23/02/2020 15:07	23/02/2020 12:29	23/02/2020 15:07	2,62	115	301,56	CHI
202002155924	TURVELANDIA	TD21326928	RIO DOS BOIS	23/02/2020 12:34	23/02/2020 15:03	23/02/2020 12:34	23/02/2020 15:03	2,47	4	9,89	CHI
202002155925	JARAGUA	JA12070670	JARAGUA	23/02/2020 12:34	23/02/2020 15:36	23/02/2020 12:34	23/02/2020 15:36	3,02	9	27,19	CHI
202002155928	BELA VISTA DE GOIAS	BV21372161	BELA VISTA S1	23/02/2020 12:34	23/02/2020 14:18	23/02/2020 12:34	23/02/2020 14:18	1,72	1	1,72	CHI
202002155932	PARAUNA	PU21152650	PARAUNA	23/02/2020 12:35	23/02/2020 17:49	23/02/2020 12:35	23/02/2020 17:49	5,22	1	5,22	CHI
202002155934	FORMOSA	610268016	ITUIQUIRA	23/02/2020 12:36	23/02/2020 15:02	23/02/2020 12:36	23/02/2020 15:02	2,43	1	2,43	CHI
202002155936	GOIAS	IB12210550	ITABERAI S1	23/02/2020 12:37	23/02/2020 13:16	23/02/2020 12:37	23/02/2020 13:16	0,64	2	1,27	CHI
202002155936	ITABERAI	IB12210550	ITABERAI S1	23/02/2020 12:37	23/02/2020 13:16	23/02/2020 12:37	23/02/2020 13:16	0,64	36	22,90	CHI
202002155938	BRAZABRANTES	IN21195709	INHUMAS S2	23/02/2020 12:38	23/02/2020 14:51	23/02/2020 12:38	23/02/2020 14:51	2,21	7	15,46	CHI
202002155939	MINEIROS	MY12244676	PARQUE DAS EMAS	23/02/2020 12:31	23/02/2020 20:25	23/02/2020 12:31	23/02/2020 20:25	7,89	9	70,98	CHI
202002155941	RIO QUENTE	RQ12063401	RIO QUENTE	23/02/2020 12:39	23/02/2020 19:05	23/02/2020 12:39	23/02/2020 19:05	6,42	6	38,54	CHI
202002155942	GOIATUBA	GT21311373	GOIATUBA S1	23/02/2020 12:39	23/02/2020 15:28	23/02/2020 12:39	23/02/2020 15:28	2,81	1	2,81	CHI

202002155946	LUZIANIA	3200095955	MARAJOARA	23/02/2020 12:41	23/02/2020 13:08	23/02/2020 12:41	23/02/2020 13:08	0,45	1	0,45	CHI
202002155947	CATALAO	1990256779	CATALAO S2	23/02/2020 12:41	23/02/2020 15:08	23/02/2020 12:41	23/02/2020 15:08	2,44	1	2,44	CHI
202002155948	SANTO ANTONIO DO DESCOBERTO	SN21141205	AGUAS LINDAS DE GOIAS S2	23/02/2020 12:42	23/02/2020 15:03	23/02/2020 12:42	23/02/2020 15:03	2,34	1	2,34	CHI
202002155951	GOIANIA	10009966925	GOYA S2	23/02/2020 12:44	23/02/2020 16:33	23/02/2020 12:44	23/02/2020 16:33	3,81	1	3,81	CHI
202002155952	NEROPOLIS	10009555259	NEROPOLIS S2	23/02/2020 12:44	23/02/2020 14:58	23/02/2020 12:44	23/02/2020 14:58	2,22	1	2,22	CHI
202002155953	ANAPOLIS	10025621651	ANAPOLIS UNIVERSITARIO S2	23/02/2020 12:44	23/02/2020 18:17	23/02/2020 12:44	23/02/2020 18:17	5,54	1	5,54	CHI
202002155961	PONTALINA	PK21204455	PONTALINA	23/02/2020 12:47	23/02/2020 16:23	23/02/2020 12:47	23/02/2020 16:23	3,59	1	3,59	CHI
202002155964	CAIAPONIA	CP21357618	CAIAPONIA	23/02/2020 12:49	24/02/2020 11:18	23/02/2020 12:49	24/02/2020 11:18	22,48	1	22,48	CHI
202002155965	SANTO ANTONIO DO DESCOBERTO	SN12330527	MARAJOARA	23/02/2020 11:08	23/02/2020 19:57	23/02/2020 11:08	23/02/2020 19:57	8,80	15	132,02	CHI
202002155971	CRISTALINA	KR21348856	CRISTALINA S2	23/02/2020 12:51	24/02/2020 01:25	23/02/2020 12:51	24/02/2020 01:25	12,56	3	37,68	CHI
202002155973	ALEXANIA	AX21198223	ALEXANIA	23/02/2020 12:54	23/02/2020 15:26	23/02/2020 12:54	23/02/2020 15:26	2,53	1	2,53	CHI
202002155974	CRIXAS	CX21211394	SANTA TEREZINHA	23/02/2020 12:54	23/02/2020 15:34	23/02/2020 12:54	23/02/2020 15:34	2,66	1	2,66	CHI
202002155976	GOIANIA	11936915	GOYA S2	23/02/2020 12:55	23/02/2020 16:16	23/02/2020 12:55	23/02/2020 16:16	3,35	1	3,35	CHI
202002155977	ALEXANIA	AX21061852	ALEXANIA	23/02/2020 12:56	23/02/2020 17:01	23/02/2020 12:56	23/02/2020 17:01	4,08	1	4,08	CHI
202002155982	SANTO ANTONIO DE GOIAS	GN21150460	XAVANTES	23/02/2020 12:58	23/02/2020 22:40	23/02/2020 12:58	23/02/2020 22:40	9,69	1	9,69	CHI
202002155985	SENADOR CANEDO	SW12402763	SENADOR CANEDO	23/02/2020 13:01	23/02/2020 14:43	23/02/2020 13:01	23/02/2020 14:43	1,70	135	229,01	CHI
202002155986	APARECIDA DE GOIANIA	10012179807	INDEPENDENCIA S2	23/02/2020 13:02	23/02/2020 15:36	23/02/2020 13:02	23/02/2020 15:36	2,57	1	2,57	CHI
202002156007	PIRENOPOLIS	PV31090227	SAO FRANCISCO DE GOIAS	23/02/2020 13:11	23/02/2020 19:07	23/02/2020 13:11	23/02/2020 19:07	5,92	3	17,75	CHI
202002156010	FAZENDA NOVA	FN21259908	BRITANIA	23/02/2020 07:05	23/02/2020 15:32	23/02/2020 07:05	23/02/2020 15:32	8,44	34	286,98	CHI
202002156022	MIMOSO DE GOIAS	MJ12304747	PADRE BERNARDO	23/02/2020 11:08	23/02/2020 15:51	23/02/2020 11:08	23/02/2020 15:51	4,71	8	37,71	CHI
202002156026	GOIANIRA	390084426	GOIANIRA	23/02/2020 13:15	23/02/2020 16:41	23/02/2020 13:15	23/02/2020 16:41	3,42	1	3,42	CHI
202002156032	APARECIDA DE GOIANIA	10001198341	INDEPENDENCIA S2	23/02/2020 13:17	23/02/2020 17:45	23/02/2020 13:17	23/02/2020 17:45	4,46	1	4,46	CHI
202002156033	INACIOLANDIA	ID31128263	QUIRINOPOLIS	23/02/2020 13:17	23/02/2020 20:42	23/02/2020 13:17	23/02/2020 20:42	7,41	1	7,41	CHI
202002156034	FORMOSA	FA12392206	ITUIQUIRA	23/02/2020 13:18	23/02/2020 15:46	23/02/2020 13:18	23/02/2020 15:46	2,47	9	22,20	CHI
202002156036	MORRINHOS	MR21251021	GOIATUBA S1	23/02/2020 13:18	23/02/2020 16:02	23/02/2020 13:18	23/02/2020 16:02	2,73	1	2,73	CHI
202002156042	DIORAMA	DI21187459	ARENOPOLIS	23/02/2020 13:21	23/02/2020 15:17	23/02/2020 13:21	23/02/2020 15:17	1,92	1	1,92	CHI
202002156051	GOIANIA	10017852984	XAVANTES	23/02/2020 13:24	23/02/2020 15:45	23/02/2020 13:24	23/02/2020 15:45	2,35	1	2,35	CHI
202002156052	BELA VISTA DE GOIAS	BV21285563	BELA VISTA S1	23/02/2020 13:25	23/02/2020 15:55	23/02/2020 13:25	23/02/2020 15:55	2,49	1	2,49	CHI
202002156060	PETROLINA DE GOIAS	PG12230708	PETROLINA	23/02/2020 12:51	23/02/2020 19:26	23/02/2020 12:51	23/02/2020 19:26	6,58	6	39,45	CHI
202002156060	SAO FRANCISCO DE GOIAS	PG12230708	PETROLINA	23/02/2020 12:51	23/02/2020 19:26	23/02/2020 12:51	23/02/2020 19:26	6,58	13	85,49	CHI
202002156062	JUSSARA	JR12093790	JUSSARA	23/02/2020 13:29	23/02/2020 19:49	23/02/2020 13:29	23/02/2020 19:49	6,32	2	12,64	CHI
202002156068	COCALZINHO DE GOIAS	ZN12302401	COCALZINHO	23/02/2020 13:28	24/02/2020 16:21	23/02/2020 13:28	24/02/2020 16:21	26,88	4	107,51	CHI
202002156068	CORUMBA DE GOIAS	ZN12302401	COCALZINHO	23/02/2020 13:28	24/02/2020 16:21	23/02/2020 13:28	24/02/2020 16:21	26,88	22	591,29	CHI
202002156070	SAO DOMINGOS	SD12254354	SAO DOMINGOS	23/02/2020 13:32	23/02/2020 18:16	23/02/2020 13:32	23/02/2020 17:48	4,26	5	21,29	CHI
202002156070	DIVINOPOLIS DE GOIAS	GH12253952	SAO DOMINGOS	23/02/2020 13:32	23/02/2020 18:16	23/02/2020 17:49	23/02/2020 18:16	0,45	3	1,35	CHI
202002156071	QUIRINOPOLIS	QI12296596	QUIRINOPOLIS	23/02/2020 12:09	23/02/2020 14:44	23/02/2020 12:09	23/02/2020 14:44	2,58	53	136,71	CHI
202002156082	APARECIDA DE GOIANIA	200264199	CEPAIGO S1	23/02/2020 13:38	23/02/2020 14:43	23/02/2020 13:38	23/02/2020 14:43	1,08	1	1,08	CHI
202002156085	NOVA ROMA	ND21286027	IACIARA S2	23/02/2020 13:38	23/02/2020 17:22	23/02/2020 13:38	23/02/2020 17:22	3,72	2	7,45	CHI
202002156087	MOIPORA	MO21003694	SAO LUIZ DOS MONTES BELOS	23/02/2020 13:40	23/02/2020 15:44	23/02/2020 13:40	23/02/2020 15:44	2,06	1	2,06	CHI
202002156088	FIRMINOPOLIS	FR21275147	SAO LUIZ DOS MONTES BELOS	23/02/2020 13:40	23/02/2020 16:04	23/02/2020 13:40	23/02/2020 16:04	2,40	1	2,40	CHI
202002156092	SAO LUIS DE MONTES BELOS	SL12021470	SAO LUIZ DOS MONTES BELOS	23/02/2020 13:41	23/02/2020 16:50	23/02/2020 13:41	23/02/2020 16:50	3,14	36	113,12	CHI
202002156093	LUZIANIA	LZ21237833	MARAJOARA	23/02/2020 13:42	23/02/2020 20:46	23/02/2020 13:42	23/02/2020 20:46	7,07	1	7,07	CHI
202002156095	SAO LUIS DE MONTES BELOS	SC12019505	SAO LUIZ DOS MONTES BELOS	23/02/2020 13:18	23/02/2020 16:07	23/02/2020 13:18	23/02/2020 16:07	2,81	12	33,68	CHI
202002156102	CATALAO	CT21278949	CATALAO S1	23/02/2020 13:46	23/02/2020 16:42	23/02/2020 13:46	23/02/2020 16:42	2,93	4	11,72	CHI

202002156105	MINEIROS	MY21322116	PARQUE DAS EMAS	23/02/2020 13:48	23/02/2020 20:29	23/02/2020 13:48	23/02/2020 20:29	6,68	1	6,68	CHI
202002156112	BURITI DE GOIAS	BS21306852	FIRMINOPOLIS S2	23/02/2020 13:50	23/02/2020 17:42	23/02/2020 13:50	23/02/2020 17:42	3,85	1	3,85	CHI
202002156114	ANAPOLIS	21006106	ANAPOLIS UNIVERSITARIO S2	23/02/2020 13:51	23/02/2020 16:58	23/02/2020 13:51	23/02/2020 16:58	3,11	1	3,11	CHI
202002156115	CALDAZINHA	SW12317421	SENADOR CANEDO	23/02/2020 13:30	23/02/2020 15:45	23/02/2020 13:30	23/02/2020 15:45	2,26	25	56,60	CHI
202002156115	SENADOR CANEDO	SW12317421	SENADOR CANEDO	23/02/2020 13:30	23/02/2020 15:45	23/02/2020 13:30	23/02/2020 15:45	2,26	6	13,58	CHI
202002156118	SAO MIGUEL DO PASSA QUATRO	SQ21188508	CRISTIANOPOLIS	23/02/2020 13:53	23/02/2020 17:44	23/02/2020 13:53	23/02/2020 17:44	3,84	2	7,67	CHI
202002156120	JATAI	10010052850	JATAI S2	23/02/2020 13:55	23/02/2020 17:05	23/02/2020 13:55	23/02/2020 17:05	3,16	1	3,16	CHI
202002156122	COCALZINHO DE GOIAS	ZN21321419	COCALZINHO	23/02/2020 13:58	24/02/2020 13:55	23/02/2020 13:58	24/02/2020 13:55	23,94	1	23,94	CHI
202002156125	MORRO AGUDO DE GOIAS	MS12136795	ITAPURANGA	23/02/2020 13:58	23/02/2020 16:48	23/02/2020 13:58	23/02/2020 16:48	2,82	35	98,66	CHI
202002156128	NOVA ROMA	ND12392246B	IACIARA S2	23/02/2020 13:59	23/02/2020 17:22	23/02/2020 13:59	23/02/2020 17:22	3,37	6	20,22	CHI
202002156128	SAO DOMINGOS	ND12392246B	IACIARA S2	23/02/2020 13:59	23/02/2020 17:22	23/02/2020 13:59	23/02/2020 17:22	3,37	3	10,11	CHI
202002156131	ORIZONA	OZ12022880RE	PIRES DO RIO S2	23/02/2020 13:03	23/02/2020 17:05	23/02/2020 13:03	23/02/2020 17:05	4,03	58	233,95	CHI
202002156134	EDEIA	EA11056510	PONTALINA	23/02/2020 14:01	23/02/2020 18:06	23/02/2020 14:01	23/02/2020 18:06	4,07	60	244,12	CHI
202002156138	GOIANIA	14366204	INDEPENDENCIA S2	23/02/2020 14:02	23/02/2020 16:57	23/02/2020 14:02	23/02/2020 16:57	2,91	1	2,91	CHI
202002156139	HIDROLANDIA	HD11343157	CEPAIGO S2	23/02/2020 14:02	23/02/2020 23:19	23/02/2020 14:02	23/02/2020 23:05	9,04	14	126,57	CHI
202002156139	HIDROLANDIA	HD12276576	CEPAIGO S2	23/02/2020 14:02	23/02/2020 23:19	23/02/2020 21:55	23/02/2020 23:19	1,39	4	5,57	CHI
202002156142	PALMEIRAS DE GOIAS	PL21294918	PALMEIRAS	23/02/2020 14:03	23/02/2020 15:18	23/02/2020 14:03	23/02/2020 15:18	1,25	1	1,25	CHI
202002156148	PARAUNA	PU21364931	PARAUNA	23/02/2020 14:07	23/02/2020 20:07	23/02/2020 14:07	23/02/2020 20:07	5,98	1	5,98	CHI
202002156150	CRISTALINA	KR12230156	PAMPLONA	23/02/2020 13:58	23/02/2020 17:45	23/02/2020 13:58	23/02/2020 17:45	3,77	21	79,19	CHI
202002156152	SANTO ANTONIO DO DESCOBERTO	LZ31048862	MARAJOARA	23/02/2020 14:11	23/02/2020 16:35	23/02/2020 14:11	23/02/2020 16:35	2,38	1	2,38	CHI
202002156157	BARRO ALTO	BA12210734	BARRO ALTO	23/02/2020 12:43	23/02/2020 14:56	23/02/2020 12:43	23/02/2020 14:56	2,22	4	8,86	CHI
202002156158	CACHOEIRA DE GOIAS	CG12289761	FIRMINOPOLIS S2	23/02/2020 14:05	23/02/2020 17:02	23/02/2020 14:05	23/02/2020 17:02	2,95	17	50,08	CHI
202002156160	COCALZINHO DE GOIAS	ZN12285303	COCALZINHO	23/02/2020 12:02	23/02/2020 16:23	23/02/2020 12:02	23/02/2020 16:23	4,35	12	52,17	CHI
202002156162	SAO SIMAO	SO21000014	CACHOEIRA ALTA	23/02/2020 14:14	23/02/2020 15:31	23/02/2020 14:14	23/02/2020 15:31	1,27	1	1,27	CHI
202002156163	SAO MIGUEL DO ARAGUAIA	SM12000063	SAO MIGUEL DO ARAGUAIA	23/02/2020 13:28	24/02/2020 12:21	23/02/2020 21:20	24/02/2020 12:21	15,03	35	526,11	CHI
202002156168	JUSSARA	JR12220051	JUSSARA	23/02/2020 14:16	23/02/2020 16:20	23/02/2020 14:16	23/02/2020 16:20	2,06	70	144,51	CHI
202002156171	PIRENOPOLIS	PV21075594	SAO FRANCISCO DE GOIAS	23/02/2020 14:18	23/02/2020 17:38	23/02/2020 14:18	23/02/2020 17:38	3,33	1	3,33	CHI
202002156173	UIRAPURU	MH12391944	NOVA CRIXAS	23/02/2020 14:19	24/02/2020 00:00	23/02/2020 14:19	24/02/2020 00:00	9,68	6	58,07	CHI
202002156175	PORANGATU	PO11350147	PORANGATU	23/02/2020 14:20	24/02/2020 09:44	23/02/2020 14:20	24/02/2020 09:44	19,40	1	19,40	CHI
202002156177	BELA VISTA DE GOIAS	BV21060801	BELA VISTA S1	23/02/2020 14:21	23/02/2020 15:05	23/02/2020 14:21	23/02/2020 15:05	0,72	2	1,44	CHI
202002156178	SANTO ANTONIO DA BARRA	BZ21214090	SANTA HELENA S1	23/02/2020 14:21	23/02/2020 22:30	23/02/2020 14:21	23/02/2020 22:30	8,14	1	8,14	CHI
202002156181	CEZARINA	CZ21220919	GUAPO S2	23/02/2020 14:22	23/02/2020 16:49	23/02/2020 14:22	23/02/2020 16:49	2,44	2	4,87	CHI
202002156183	ITABERAI	IB21167823	ITABERAI S1	23/02/2020 14:24	23/02/2020 14:54	23/02/2020 14:24	23/02/2020 14:54	0,50	1	0,50	CHI
202002156187	INDIARA	IY12406245	ACREUNA	23/02/2020 14:24	23/02/2020 17:52	23/02/2020 14:24	23/02/2020 17:52	3,45	2	6,90	CHI
202002156188	LUZIANIA	LZ21120152	MARAJOARA	23/02/2020 14:25	23/02/2020 19:19	23/02/2020 14:25	23/02/2020 19:19	4,88	1	4,88	CHI
202002156193	PIRACANJUBA	PJ21043089	PIRACANJUBA	23/02/2020 14:29	23/02/2020 16:20	23/02/2020 14:29	23/02/2020 16:20	1,85	1	1,85	CHI
202002156197	CAMPOS BELOS	CH12375530	SAO DOMINGOS	23/02/2020 14:29	23/02/2020 16:14	23/02/2020 14:29	23/02/2020 16:14	1,74	8	13,93	CHI
202002156200	JATAI	JT21286464	CABRIUVA S2	23/02/2020 14:32	23/02/2020 20:28	23/02/2020 14:32	23/02/2020 20:28	5,92	1	5,92	CHI
202002156201	MORRINHOS	MR11255609	GOIATUBA S1	23/02/2020 14:32	23/02/2020 17:35	23/02/2020 14:32	23/02/2020 17:35	3,04	1	3,04	CHI
202002156203	ALEXANIA	AX12353115LD	ALEXANIA	23/02/2020 14:35	23/02/2020 21:08	23/02/2020 14:35	23/02/2020 21:08	6,56	215	1410,16	CHI
202002156203	ALEXANIA	AX12353115LD	ALEXANIA	23/02/2020 14:35	23/02/2020 21:08	23/02/2020 19:23	23/02/2020 21:08	1,76	68	119,43	CHI
202002156205	APARECIDA DE GOIANIA	11924214	REAL S1	23/02/2020 14:36	23/02/2020 16:16	23/02/2020 14:36	23/02/2020 16:16	1,66	1	1,66	CHI
202002156208	CRISTALINA	KR11315539	CRISTALINA S1	23/02/2020 14:40	24/02/2020 00:27	23/02/2020 14:40	24/02/2020 00:27	9,78	3	29,35	CHI
202002156210	SAO SIMAO	PC21306628	CACHOEIRA ALTA	23/02/2020 14:40	23/02/2020 15:06	23/02/2020 14:40	23/02/2020 15:06	0,44	1	0,44	CHI



202002156217	INACIOLANDIA	ID31122312	QUIRINOPOLIS	23/02/2020 14:45	23/02/2020 19:58	23/02/2020 14:45	23/02/2020 19:58	5,21	1	5,21	CHI
202002156218	AGUAS LINDAS DE GOIAS	4830131720	AGUAS LINDAS DE GOIAS S1	23/02/2020 14:46	23/02/2020 16:27	23/02/2020 14:46	23/02/2020 16:27	1,68	1	1,68	CHI
202002156220	BALIZA	BH12210020	BOM JARDIM	23/02/2020 14:44	23/02/2020 16:51	23/02/2020 14:44	23/02/2020 16:51	2,11	93	195,84	CHI
202002156221	GOIANIA	10003608830	XAVANTES	23/02/2020 14:47	23/02/2020 16:42	23/02/2020 14:47	23/02/2020 16:42	1,91	1	1,91	CHI
202002156225	APARECIDA DE GOIANIA	AP11000016	INDEPENDENCIA S1	23/02/2020 14:49	23/02/2020 16:08	23/02/2020 14:49	23/02/2020 16:08	1,32	122	160,60	CHI
202002156227	ARAGOIANA	680037858	GUAPO S2	23/02/2020 14:49	23/02/2020 18:36	23/02/2020 14:49	23/02/2020 18:36	3,77	1	3,77	CHI
202002156230	JUSSARA	JR21120636	JUSSARA	23/02/2020 14:50	23/02/2020 16:58	23/02/2020 14:50	23/02/2020 16:58	2,12	2	4,23	CHI
202002156238	COCALZINHO DE GOIAS	ZN12185681	COCALZINHO	23/02/2020 14:53	24/02/2020 09:07	23/02/2020 14:53	24/02/2020 09:07	18,23	7	127,61	CHI
202002156238	PIRENOPOLIS	ZN12185681	COCALZINHO	23/02/2020 14:53	24/02/2020 09:07	23/02/2020 14:53	24/02/2020 09:07	18,23	5	91,15	CHI
202002156240	FLORES DE GOIAS	FB12277979	IACIARA S2	23/02/2020 13:38	23/02/2020 17:31	23/02/2020 13:38	23/02/2020 17:31	3,87	2	7,74	CHI
202002156240	SITIO D ABADIA	FB12277979	IACIARA S2	23/02/2020 13:38	23/02/2020 17:31	23/02/2020 13:38	23/02/2020 17:31	3,87	8	30,96	CHI
202002156243	ARAGOIANA	AO32097638	GUAPO S2	23/02/2020 14:56	23/02/2020 20:02	23/02/2020 14:56	23/02/2020 20:02	5,09	6	30,57	CHI
202002156243	ARAGOIANA	03500214	GUAPO S2	23/02/2020 14:56	23/02/2020 20:02	23/02/2020 19:23	23/02/2020 20:02	0,65	1296	838,44	CHI
202002156243	HIDROLANDIA	03500214	GUAPO S2	23/02/2020 14:56	23/02/2020 20:02	23/02/2020 19:23	23/02/2020 20:02	0,65	111	71,81	CHI
202002156243	MAIRIPOTABA	03500214	GUAPO S2	23/02/2020 14:56	23/02/2020 20:02	23/02/2020 19:23	23/02/2020 20:02	0,65	2	1,29	CHI
202002156243	VARJAO	03500214	GUAPO S2	23/02/2020 14:56	23/02/2020 20:02	23/02/2020 19:23	23/02/2020 20:02	0,65	69	44,64	CHI
202002156246	URUACU	UR11221613	URUACU	23/02/2020 14:57	23/02/2020 18:22	23/02/2020 14:57	23/02/2020 18:22	3,41	33	112,44	CHI
202002156247	FORMOSA	FA21344271	ITUIQUIRA	23/02/2020 14:58	23/02/2020 18:07	23/02/2020 14:58	23/02/2020 18:07	3,15	3	9,44	CHI
202002156250	JATAI	JT10394711	JATAI S3	23/02/2020 14:57	23/02/2020 15:02	23/02/2020 14:57	23/02/2020 15:02	0,09	220	20,23	CHI
202002156250	RIO VERDE	JT10394711	JATAI S3	23/02/2020 14:57	23/02/2020 15:02	23/02/2020 14:57	23/02/2020 15:02	0,09	8	0,74	CHI
202002156253	DIORAMA	DI21341776	ARENOPOLIS	23/02/2020 15:00	23/02/2020 15:51	23/02/2020 15:00	23/02/2020 15:51	0,84	6	5,06	CHI
202002156254	CRISTALINA	KR12366452	PAMPLONA	23/02/2020 14:17	23/02/2020 18:31	23/02/2020 14:17	23/02/2020 18:31	4,23	10	42,29	CHI
202002156256	LUZIANIA	LZ21304854	PAMPLONA	23/02/2020 15:01	23/02/2020 17:21	23/02/2020 15:01	23/02/2020 17:21	2,33	2	4,65	CHI
202002156260	ORIZONA	OZ21186672	PIRES DO RIO S2	23/02/2020 15:02	23/02/2020 18:47	23/02/2020 15:02	23/02/2020 18:47	3,74	1	3,74	CHI
202002156262	SANCLERLANDIA	SL12114750	FIRMINOPOLIS S2	23/02/2020 15:03	23/02/2020 16:36	23/02/2020 15:03	23/02/2020 16:36	1,55	3	4,64	CHI
202002156262	SAO LUIS DE MONTES BELOS	SL12114750	FIRMINOPOLIS S2	23/02/2020 15:03	23/02/2020 16:36	23/02/2020 15:03	23/02/2020 16:36	1,55	5	7,73	CHI
202002156263	LUZIANIA	LZ12383009	MARAJOARA	23/02/2020 10:46	23/02/2020 18:21	23/02/2020 10:46	23/02/2020 18:21	7,57	12	90,84	CHI
202002156264	SERRANOPOLIS	SX12216602	JATAI S1	23/02/2020 15:03	24/02/2020 09:43	23/02/2020 15:03	24/02/2020 09:43	18,65	2	37,31	CHI
202002156266	CAMPOS BELOS	10025345190	SAO DOMINGOS	23/02/2020 15:03	23/02/2020 16:30	23/02/2020 15:03	23/02/2020 16:30	1,44	1	1,44	CHI
202002156269	DAMOLANDIA	IN12014342	INHUMAS S1	23/02/2020 15:04	23/02/2020 19:00	23/02/2020 15:04	23/02/2020 19:00	3,92	27	105,95	CHI
202002156269	INHUMAS	IN12014342	INHUMAS S1	23/02/2020 15:04	23/02/2020 19:00	23/02/2020 15:04	23/02/2020 19:00	3,92	18	70,64	CHI
202002156269	PETROLINA DE GOIAS	IN12014342	INHUMAS S1	23/02/2020 15:04	23/02/2020 19:00	23/02/2020 15:04	23/02/2020 19:00	3,92	5	19,62	CHI
202002156270	SAO DOMINGOS	SD12398397	SAO DOMINGOS	23/02/2020 14:59	23/02/2020 17:28	23/02/2020 14:59	23/02/2020 17:28	2,48	6	14,88	CHI
202002156273	GOIANIA	16119630	XAVANTES	23/02/2020 15:05	23/02/2020 16:34	23/02/2020 15:05	23/02/2020 16:34	1,47	1	1,47	CHI
202002156275	GOIAS	GS12299699	GOIAS	23/02/2020 15:06	23/02/2020 17:14	23/02/2020 15:06	23/02/2020 17:14	2,13	32	68,20	CHI
202002156279	MINEIROS	PW10406623	PARQUE DAS EMAS	23/02/2020 15:06	23/02/2020 15:33	23/02/2020 15:06	23/02/2020 15:33	0,46	77	35,46	CHI
202002156279	PORTELANDIA	PW10406623	PARQUE DAS EMAS	23/02/2020 15:06	23/02/2020 15:33	23/02/2020 15:06	23/02/2020 15:33	0,46	45	20,72	CHI
202002156279	SANTA RITA DO ARAGUAIA	PW10406623	PARQUE DAS EMAS	23/02/2020 15:06	23/02/2020 15:33	23/02/2020 15:06	23/02/2020 15:33	0,46	3	1,38	CHI
202002156281	APARECIDA DE GOIANIA	200106776	INDEPENDENCIA S1	23/02/2020 15:08	23/02/2020 18:23	23/02/2020 15:08	23/02/2020 18:23	3,24	1	3,24	CHI
202002156282	AMERICANO DO BRASIL	IB12000062	ITABERAI S2	23/02/2020 15:08	23/02/2020 17:52	23/02/2020 15:08	23/02/2020 17:52	2,72	11	29,96	CHI
202002156282	ITABERAI	IB12000062	ITABERAI S2	23/02/2020 15:08	23/02/2020 17:52	23/02/2020 15:08	23/02/2020 17:52	2,72	18	49,02	CHI
202002156290	ITAGUARI	IC12219941	ITABERAI S1	23/02/2020 15:12	23/02/2020 16:33	23/02/2020 15:12	23/02/2020 16:33	1,34	31	41,57	CHI
202002156290	ITAGUARU	IC12219941	ITABERAI S1	23/02/2020 15:12	23/02/2020 16:33	23/02/2020 15:12	23/02/2020 16:33	1,34	21	28,16	CHI
202002156291	SAO MIGUEL DO PASSA QUATRO	SQ31202929	CRISTIANOPOLIS	23/02/2020 15:12	23/02/2020 17:54	23/02/2020 15:12	23/02/2020 17:54	2,69	1	2,69	CHI

202002156298	MORRINHOS	MR21119785	MORRINHOS	23/02/2020 15:15	23/02/2020 17:30	23/02/2020 15:15	23/02/2020 17:30	2,24	1	2,24	CHI
202002156300	COCALZINHO DE GOIAS	ZN12258524RE	COCALZINHO	23/02/2020 13:11	23/02/2020 17:56	23/02/2020 13:11	23/02/2020 17:56	4,74	55	260,58	CHI
202002156317	GOIANIA	GN11229570	CAMPINAS S3	23/02/2020 19:18	23/02/2020 20:00	23/02/2020 19:18	23/02/2020 20:00	0,71	47	33,55	CHI
202002156412	PLANALTINA	PI12099511	PLANALTINA	23/02/2020 15:20	23/02/2020 20:08	23/02/2020 15:20	23/02/2020 20:08	4,79	17	81,41	CHI
202002156415	CAMPOS BELOS	CH12211230	SAO DOMINGOS	23/02/2020 15:18	23/02/2020 18:15	23/02/2020 15:18	23/02/2020 18:15	2,95	3	8,84	CHI
202002156416	JUSSARA	JR21129769	BRITANIA	23/02/2020 15:21	23/02/2020 19:59	23/02/2020 15:21	23/02/2020 19:59	4,62	1	4,62	CHI
202002156420	GOIANIA	10000104300	FERROVIARIO S1	23/02/2020 15:22	23/02/2020 17:33	23/02/2020 15:22	23/02/2020 17:33	2,17	1	2,17	CHI
202002156424	APARECIDA DE GOIANIA	12515267	INDEPENDENCIA S2	23/02/2020 15:25	23/02/2020 20:50	23/02/2020 15:25	23/02/2020 20:50	5,42	1	5,42	CHI
202002156428	JUSSARA	JR12341254	IPORA	23/02/2020 14:35	23/02/2020 19:41	23/02/2020 14:35	23/02/2020 19:41	5,08	149	757,50	CHI
202002156428	MONTES CLAROS DE GOIAS	JR12341254	IPORA	23/02/2020 14:35	23/02/2020 19:41	23/02/2020 14:35	23/02/2020 19:41	5,08	17	86,43	CHI
202002156437	CAIAPONIA	CP12247460	CAIAPONIA	23/02/2020 09:51	23/02/2020 20:42	23/02/2020 09:51	23/02/2020 20:42	10,84	3	32,52	CHI
202002156438	GOIANIA	16541315	ATLANTICO S1	23/02/2020 15:30	23/02/2020 17:50	23/02/2020 15:30	23/02/2020 17:50	2,33	1	2,33	CHI
202002156439	ITABERAI	IB11000041	ITABERAI S2	23/02/2020 15:30	23/02/2020 17:16	23/02/2020 15:30	23/02/2020 17:16	1,77	110	195,10	CHI
202002156444	SILVANIA	SV21087630	DAIA S2	23/02/2020 15:31	23/02/2020 17:14	23/02/2020 15:31	23/02/2020 17:14	1,71	1	1,71	CHI
202002156445	SAO LUIS DE MONTES BELOS	SL31145798	SAO LUIZ DOS MONTES BELOS	23/02/2020 15:31	23/02/2020 18:18	23/02/2020 15:31	23/02/2020 18:18	2,77	2	5,55	CHI
202002156447	VALPARAISO DE GOIAS	10009236463	PACAEMBU S1	23/02/2020 15:32	23/02/2020 20:07	23/02/2020 15:32	23/02/2020 20:07	4,58	1	4,58	CHI
202002156450	RIO VERDE	RV21260669	RIO VERDE S1	23/02/2020 15:34	23/02/2020 18:09	23/02/2020 15:34	23/02/2020 18:09	2,57	1	2,57	CHI
202002156452	GOIAS	GS12259678	ITABERAI S2	23/02/2020 15:33	23/02/2020 20:15	23/02/2020 15:33	23/02/2020 20:15	4,70	49	230,52	CHI
202002156453	NOVO GAMA	NJ12219816	PACAEMBU S1	23/02/2020 15:36	23/02/2020 18:29	23/02/2020 15:52	23/02/2020 18:29	2,63	183	481,49	CHI
202002156454	NIQUELANDIA	10000718457	NIQUELANDIA SUBTRANSMISSAO	23/02/2020 15:36	23/02/2020 17:48	23/02/2020 15:36	23/02/2020 17:48	2,19	1	2,19	CHI
202002156455	PARAUNA	PU21152648	PARAUNA	23/02/2020 15:36	23/02/2020 18:36	23/02/2020 15:36	23/02/2020 18:36	2,99	1	2,99	CHI
202002156459	IPAMERI	IP21000069	IPAMERI	23/02/2020 15:37	23/02/2020 19:08	23/02/2020 15:37	23/02/2020 19:08	3,50	1	3,50	CHI
202002156460	MONTE ALEGRE DE GOIAS	MA12129814	SAO DOMINGOS	23/02/2020 15:38	23/02/2020 20:48	23/02/2020 15:38	23/02/2020 20:48	5,16	31	160,07	CHI
202002156466	PORANGATU	PO12208558	PORANGATU	23/02/2020 14:15	23/02/2020 17:53	23/02/2020 14:15	23/02/2020 17:53	3,62	14	50,66	CHI
202002156468	TRINDADE	40100613	TRINDADE	23/02/2020 15:41	23/02/2020 17:53	23/02/2020 15:41	23/02/2020 17:53	2,20	1	2,20	CHI
202002156471	NOVA VENEZA	NV12200061	INHUMAS S1	23/02/2020 15:36	23/02/2020 16:03	23/02/2020 15:36	23/02/2020 16:03	0,44	276	120,37	CHI
202002156474	ANAPOLIS	21178471	JUNDIAI S2	23/02/2020 15:44	23/02/2020 23:16	23/02/2020 15:44	23/02/2020 23:16	7,52	1	7,52	CHI
202002156477	IVOLANDIA	IV21079425	ARENOPOLIS	23/02/2020 15:45	23/02/2020 17:08	23/02/2020 15:45	23/02/2020 17:08	1,38	1	1,38	CHI
202002156478	LUZIANIA	LZ11000011	RIO VERMELHO	23/02/2020 15:45	23/02/2020 18:10	23/02/2020 15:45	23/02/2020 18:10	2,41	151	363,62	CHI
202002156479	CAMPINACU	UC12312614	PORANGATU	23/02/2020 15:46	24/02/2020 02:00	23/02/2020 15:46	24/02/2020 02:00	10,23	8	81,85	CHI
202002156482	NOVA CRIXAS	NA12091692	NOVA CRIXAS	23/02/2020 20:36	24/02/2020 13:47	23/02/2020 20:36	24/02/2020 13:47	17,18	22	377,87	CHI
202002156483	DOVERLANDIA	MY12390600	PARQUE DAS EMAS	23/02/2020 15:48	23/02/2020 22:09	23/02/2020 15:48	23/02/2020 22:09	6,33	1	6,33	CHI
202002156483	MINEIROS	MY12390600	PARQUE DAS EMAS	23/02/2020 15:48	23/02/2020 22:09	23/02/2020 15:48	23/02/2020 22:09	6,33	24	152,03	CHI
202002156486	MOSSAMEDES	MD12311080	ITABERAI S2	23/02/2020 15:49	23/02/2020 17:52	23/02/2020 15:49	23/02/2020 17:52	2,03	15	30,51	CHI
202002156487	CAIAPONIA	IV12201977	IPORA	23/02/2020 15:22	23/02/2020 17:30	23/02/2020 15:22	23/02/2020 17:30	2,13	7	14,93	CHI
202002156487	IVOLANDIA	IV12201977	IPORA	23/02/2020 15:22	23/02/2020 17:30	23/02/2020 15:22	23/02/2020 17:30	2,13	8	17,06	CHI
202002156491	SILVANIA	SV21098394	DAIA S2	23/02/2020 15:52	23/02/2020 17:49	23/02/2020 15:52	23/02/2020 17:49	1,95	1	1,95	CHI
202002156492	CARMO DO RIO VERDE	IK12311305	ITAPURANGA	23/02/2020 15:52	23/02/2020 17:53	23/02/2020 15:52	23/02/2020 17:53	2,00	4	8,01	CHI
202002156492	ITAPURANGA	IK12311305	ITAPURANGA	23/02/2020 15:52	23/02/2020 17:53	23/02/2020 15:52	23/02/2020 17:53	2,00	33	66,11	CHI
202002156495	GUARANI DE GOIAS	GY12265440	IACIARA S1	23/02/2020 15:53	23/02/2020 17:26	23/02/2020 15:53	23/02/2020 17:26	1,53	20	30,69	CHI
202002156496	SANTA CRUZ DE GOIAS	BC21186567	CRISTIANOPOLIS	23/02/2020 15:54	23/02/2020 17:43	23/02/2020 15:54	23/02/2020 17:43	1,81	1	1,81	CHI
202002156497	MINEIROS	MY11360060	PARQUE DAS EMAS	23/02/2020 15:55	23/02/2020 18:25	23/02/2020 15:55	23/02/2020 18:25	2,49	36	89,74	CHI
202002156499	QUIRINOPOLIS	QI12054727	QUIRINOPOLIS	23/02/2020 15:56	23/02/2020 19:51	23/02/2020 15:56	23/02/2020 19:51	3,91	12	46,88	CHI
202002156500	ARACU	AR12104723	ARACU	23/02/2020 15:39	23/02/2020 18:39	23/02/2020 15:39	23/02/2020 18:39	3,00	22	65,95	CHI

202002156500	ITAUCU	AR12104723	ARACU	23/02/2020 15:39	23/02/2020 18:39	23/02/2020 15:39	23/02/2020 18:39	3,00	10	29,98	CHI
202002156501	CAMPINORTE	CR12050832	CAMPINORTE	23/02/2020 15:58	23/02/2020 17:14	23/02/2020 15:58	23/02/2020 17:14	1,25	6	7,52	CHI
202002156506	GOIANESIA	GE21194472	GOIANESIA S1	23/02/2020 16:00	23/02/2020 18:35	23/02/2020 16:00	23/02/2020 18:35	2,59	1	2,59	CHI
202002156507	GOIANIA	12299728	FERROVIARIO S2	23/02/2020 16:00	23/02/2020 18:33	23/02/2020 16:00	23/02/2020 18:33	2,54	1	2,54	CHI
202002156508	ALEXANIA	AX21190698	ALEXANIA	23/02/2020 16:01	23/02/2020 19:53	23/02/2020 16:01	23/02/2020 19:53	3,86	1	3,86	CHI
202002156602	CRISTALINA	KR21171016	CRISTALINA S1	23/02/2020 16:04	23/02/2020 23:20	23/02/2020 16:04	23/02/2020 22:49	6,74	2	13,49	CHI
202002156602	CRISTALINA	KR12168463	CRISTALINA S1	23/02/2020 16:04	23/02/2020 23:20	23/02/2020 20:30	23/02/2020 23:20	2,82	1	2,82	CHI
202002156603	CATALAO	CT21192558	CATALAO S1	23/02/2020 16:04	23/02/2020 22:34	23/02/2020 16:04	23/02/2020 22:34	6,49	1	6,49	CHI
202002156608	BURITI DE GOIAS	BS12304459	FIRMINOPOLIS S2	23/02/2020 16:06	23/02/2020 19:18	23/02/2020 16:06	23/02/2020 19:18	3,19	10	31,90	CHI
202002156608	MOSSAMEDES	BS12304459	FIRMINOPOLIS S2	23/02/2020 16:06	23/02/2020 19:18	23/02/2020 16:06	23/02/2020 19:18	3,19	5	15,95	CHI
202002156608	SANCLERLANDIA	BS12304459	FIRMINOPOLIS S2	23/02/2020 16:06	23/02/2020 19:18	23/02/2020 16:06	23/02/2020 19:18	3,19	1	3,19	CHI
202002156609	CAMPINORTE	CR21213060	CAMPINORTE	23/02/2020 16:06	23/02/2020 18:31	23/02/2020 16:06	23/02/2020 18:31	2,40	1	2,40	CHI
202002156610	MONTES CLAROS DE GOIAS	ME21139363	ARENOPOLIS	23/02/2020 16:06	24/02/2020 13:00	23/02/2020 16:06	24/02/2020 13:00	20,89	1	20,89	CHI
202002156612	APARECIDA DE GOIANIA	14690287	INDEPENDENCIA S2	23/02/2020 16:07	23/02/2020 17:00	23/02/2020 16:07	23/02/2020 17:00	0,88	1	0,88	CHI
202002156613	PIRACANJUBA	PJ21201546	MORRINHOS	23/02/2020 16:07	23/02/2020 17:32	23/02/2020 16:07	23/02/2020 17:32	1,40	1	1,40	CHI
202002156614	TURVANIA	TV21005755	FIRMINOPOLIS S2	23/02/2020 16:08	23/02/2020 17:57	23/02/2020 16:08	23/02/2020 17:57	1,81	1	1,81	CHI
202002156615	CABECEIRAS	CW21184524	ITUIQUIRA	23/02/2020 16:08	23/02/2020 17:37	23/02/2020 16:08	23/02/2020 17:37	1,47	1	1,47	CHI
202002156619	ALEXANIA	AX11326404	ALEXANIA	23/02/2020 16:10	24/02/2020 12:09	23/02/2020 16:10	24/02/2020 12:09	19,98	22	439,54	CHI
202002156621	GOIAS	GS12198785	GOIAS	23/02/2020 14:55	23/02/2020 19:20	23/02/2020 14:55	23/02/2020 19:20	4,41	8	35,26	CHI
202002156621	GUARAITA	GS12198785	GOIAS	23/02/2020 14:55	23/02/2020 19:20	23/02/2020 14:55	23/02/2020 19:20	4,41	2	8,82	CHI
202002156621	ITAPURANGA	GS12198785	GOIAS	23/02/2020 14:55	23/02/2020 19:20	23/02/2020 14:55	23/02/2020 19:20	4,41	2	8,82	CHI
202002156622	SANTO ANTONIO DO DESCOBERTO	2210143579	AGUAS LINDAS DE GOIAS S2	23/02/2020 16:11	23/02/2020 21:53	23/02/2020 16:11	23/02/2020 21:53	5,70	1	5,70	CHI
202002156625	QUIRINOPOLIS	QI12000241	QUIRINOPOLIS	23/02/2020 14:58	23/02/2020 17:53	23/02/2020 14:58	23/02/2020 17:53	2,91	9	26,16	CHI
202002156628	SANTA RITA DO NOVO DESTINO	BA12373973	BARRO ALTO	23/02/2020 16:13	23/02/2020 20:50	23/02/2020 16:13	23/02/2020 20:50	4,61	3	13,83	CHI
202002156629	RIO VERDE	RV12305858	RIO VERDE S2	23/02/2020 16:16	23/02/2020 19:01	23/02/2020 16:16	23/02/2020 19:01	2,75	5	13,74	CHI
202002156632	MONTE ALEGRE DE GOIAS	MA12261959	SAO DOMINGOS	23/02/2020 16:13	23/02/2020 20:57	23/02/2020 16:13	23/02/2020 20:57	4,73	28	132,47	CHI
202002156637	MINEIROS	MY12360786	PARQUE DAS EMAS	23/02/2020 16:20	23/02/2020 22:31	23/02/2020 16:20	23/02/2020 22:31	6,17	2	12,34	CHI
202002156640	SENADOR CANEDO	190026662	SENADOR CANEDO	23/02/2020 16:22	23/02/2020 17:31	23/02/2020 16:22	23/02/2020 17:31	1,14	1	1,14	CHI
202002156645	VIANOPOLIS	OZ21185999	PIRES DO RIO S2	23/02/2020 16:23	23/02/2020 19:10	23/02/2020 16:23	23/02/2020 19:10	2,77	1	2,77	CHI
202002156648	PARAUNA	10030652675	PARAUNA	23/02/2020 16:24	24/02/2020 06:46	23/02/2020 16:24	24/02/2020 06:46	14,35	1	14,35	CHI
202002156652	SERRANOPOLIS	6605383	JATAI S1	23/02/2020 16:25	23/02/2020 22:08	23/02/2020 16:25	23/02/2020 22:08	5,70	2	11,40	CHI
202002156653	CAVALCANTE	SD12389657	SAO DOMINGOS	23/02/2020 12:09	24/02/2020 12:01	23/02/2020 12:09	24/02/2020 12:01	23,85	39	930,29	CHI
202002156656	CUMARI	2000004046	CATALAO S1	23/02/2020 16:26	23/02/2020 17:43	23/02/2020 16:26	23/02/2020 17:43	1,27	1	1,27	CHI
202002156657	BARRO ALTO	BA21237503	BARRO ALTO	23/02/2020 16:27	23/02/2020 18:29	23/02/2020 16:27	23/02/2020 18:29	2,02	1	2,02	CHI
202002156659	MINEIROS	PW12301784	PARQUE DAS EMAS	23/02/2020 16:28	24/02/2020 10:45	23/02/2020 16:28	24/02/2020 10:45	18,28	9	164,54	CHI
202002156661	GUARINOS	GF21293521	SANTA TEREZINHA	23/02/2020 16:28	23/02/2020 20:24	23/02/2020 16:28	23/02/2020 20:24	3,92	1	3,92	CHI
202002156663	NEROPOLIS	10009555259	NEROPOLIS S2	23/02/2020 16:30	23/02/2020 17:44	23/02/2020 16:30	23/02/2020 17:44	1,23	1	1,23	CHI
202002156665	CRISTALINA	10003664900	CRISTALINA S1	23/02/2020 16:31	23/02/2020 18:39	23/02/2020 16:31	23/02/2020 18:39	2,13	1	2,13	CHI
202002156673	GOIANAPOLIS	GP21059091	DAIA S2	23/02/2020 16:35	23/02/2020 21:46	23/02/2020 16:35	23/02/2020 21:46	5,18	2	10,36	CHI
202002156677	CACHOEIRA ALTA	CA21322218	CACHOEIRA ALTA	23/02/2020 16:35	23/02/2020 20:02	23/02/2020 16:35	23/02/2020 20:02	3,44	1	3,44	CHI
202002156681	CRIXAS	CX12321023	SANTA TEREZINHA	23/02/2020 15:18	23/02/2020 22:49	23/02/2020 15:18	23/02/2020 22:49	7,52	12	90,19	CHI
202002156682	ARAGUAPAZ	1780014615	MOZARLANDIA	23/02/2020 16:38	23/02/2020 17:58	23/02/2020 16:38	23/02/2020 17:58	1,33	1	1,33	CHI
202002156683	ACREUNA	EU12085779	ACREUNA	23/02/2020 16:38	23/02/2020 16:58	23/02/2020 16:38	23/02/2020 16:58	0,33	128	41,74	CHI
202002156688	BONFINOPOLIS	LB12032331	GOIANIA LESTE S2	23/02/2020 16:40	23/02/2020 19:51	23/02/2020 16:40	23/02/2020 19:51	3,17	24	76,14	CHI

202002156700	CATURAI	CK12127990	INHUMAS S1	23/02/2020 16:44	24/02/2020 11:24	23/02/2020 16:44	24/02/2020 11:24	18,66	26	485,21	CHI
202002156700	INHUMAS	CK12127990	INHUMAS S1	23/02/2020 16:44	24/02/2020 11:24	23/02/2020 16:44	24/02/2020 11:24	18,66	3	55,99	CHI
202002156700	CATURAI	CK12127990	INHUMAS S1	23/02/2020 16:44	24/02/2020 11:24	24/02/2020 09:03	24/02/2020 11:24	2,35	1	2,35	CHI
202002156703	CACU	CC12293980	CACHOEIRA ALTA	23/02/2020 16:45	24/02/2020 16:06	23/02/2020 16:45	24/02/2020 16:06	23,34	6	140,05	CHI
202002156704	CAMPOS BELOS	CH12247435	SAO DOMINGOS	23/02/2020 16:45	23/02/2020 19:05	23/02/2020 16:45	23/02/2020 19:05	2,33	1	2,33	CHI
202002156706	SANTA BARBARA DE GOIAS	1030004757	TRINDADE	23/02/2020 16:46	23/02/2020 20:18	23/02/2020 16:46	23/02/2020 20:18	3,53	1	3,53	CHI
202002156708	SANTO ANTONIO DO DESCOBERTO	SN21246083	AGUAS LINDAS DE GOIAS S2	23/02/2020 16:46	23/02/2020 20:27	23/02/2020 16:46	23/02/2020 20:27	3,67	1	3,67	CHI
202002156709	SANTO ANTONIO DO DESCOBERTO	SN21201475	MARAJOARA	23/02/2020 16:47	23/02/2020 19:44	23/02/2020 16:47	23/02/2020 19:44	2,94	1	2,94	CHI
202002156710	GUARANI DE GOIAS	GY21255281	IACIARA S1	23/02/2020 16:47	23/02/2020 17:59	23/02/2020 16:47	23/02/2020 17:59	1,18	1	1,18	CHI
202002156711	MORRINHOS	MR21251021	GOIATUBA S1	23/02/2020 16:48	24/02/2020 14:36	23/02/2020 16:48	24/02/2020 14:36	21,79	1	21,79	CHI
202002156712	CAMPOS BELOS	8563407	SAO DOMINGOS	23/02/2020 16:49	23/02/2020 18:42	23/02/2020 16:49	23/02/2020 18:42	1,89	3	5,67	CHI
202002156718	SANTO ANTONIO DO DESCOBERTO	2210085907	AGUAS LINDAS DE GOIAS S2	23/02/2020 16:51	23/02/2020 22:59	23/02/2020 16:51	23/02/2020 22:59	6,13	1	6,13	CHI
202002156720	BOM JESUS DE GOIAS	BJ21026229	BOM JESUS DE GOIAS	23/02/2020 16:53	23/02/2020 20:40	23/02/2020 16:53	23/02/2020 20:40	3,78	1	3,78	CHI
202002156724	SANCLERLANDIA	SC21259976	SAO LUIZ DOS MONTES BELOS	23/02/2020 16:54	23/02/2020 20:14	23/02/2020 16:54	23/02/2020 20:14	3,33	1	3,33	CHI
202002156726	CACHOEIRA ALTA	CA21034865	CACHOEIRA ALTA	23/02/2020 16:54	24/02/2020 08:14	23/02/2020 16:54	24/02/2020 08:14	15,33	1	15,33	CHI
202002156736	AURILANDIA	AI21306954	FIRMINOPOLIS S2	23/02/2020 16:57	23/02/2020 22:01	23/02/2020 16:57	23/02/2020 22:01	5,06	1	5,06	CHI
202002156737	CORREGO DO OURO	CO21299150	FIRMINOPOLIS S2	23/02/2020 16:57	23/02/2020 18:35	23/02/2020 16:57	23/02/2020 18:35	1,62	2	3,24	CHI
202002156738	TEREZOPOLIS DE GOIAS	GP21094465	DAIA S2	23/02/2020 16:57	23/02/2020 20:18	23/02/2020 16:57	23/02/2020 20:18	3,34	1	3,34	CHI
202002156739	RIO VERDE	RV12273766	MONTIVIDIU T	23/02/2020 16:58	23/02/2020 19:10	23/02/2020 16:58	23/02/2020 19:10	2,20	3	6,60	CHI
202002156744	ORIZONA	OZ12084921RE	PIRES DO RIO S2	23/02/2020 17:00	23/02/2020 18:26	23/02/2020 17:00	23/02/2020 18:26	1,42	110	156,66	CHI
202002156744	VIANOPOLIS	OZ12084921RE	PIRES DO RIO S2	23/02/2020 17:00	23/02/2020 18:26	23/02/2020 17:00	23/02/2020 18:26	1,42	17	24,21	CHI
202002156747	RUBIATABA	RB12066220	RUBIATABA	23/02/2020 17:01	24/02/2020 10:08	23/02/2020 17:01	24/02/2020 10:08	17,12	5	85,58	CHI
202002156749	ARUANA	AK12184500	ARUANA	23/02/2020 17:01	23/02/2020 18:11	23/02/2020 17:01	23/02/2020 18:11	1,15	3	3,45	CHI
202002156757	MORRINHOS	MR21236942	GOIATUBA S2	23/02/2020 17:04	23/02/2020 20:01	23/02/2020 17:04	23/02/2020 20:01	2,94	1	2,94	CHI
202002156758	PIRACANJUBA	60020271	PIRACANJUBA	23/02/2020 17:04	23/02/2020 19:20	23/02/2020 17:04	23/02/2020 19:20	2,26	1	2,26	CHI
202002156760	ITAGUARI	IC12038617	ITABERAI S1	23/02/2020 17:04	23/02/2020 18:05	23/02/2020 17:04	23/02/2020 18:05	1,01	19	19,13	CHI
202002156760	ITAGUARU	IC12038617	ITABERAI S1	23/02/2020 17:04	23/02/2020 18:05	23/02/2020 17:04	23/02/2020 18:05	1,01	11	11,08	CHI
202002156763	LUZIANIA	LZ12217742	VIANOPOLIS	23/02/2020 14:39	23/02/2020 18:58	23/02/2020 14:39	23/02/2020 18:58	4,31	12	51,69	CHI
202002156766	GOIATUBA	GT12228827	BOM JESUS DE GOIAS	23/02/2020 17:06	23/02/2020 18:29	23/02/2020 17:06	23/02/2020 18:29	1,39	5	6,95	CHI
202002156776	ANAPOLIS	AN12258963	ANAPOLIS UNIVERSITARIO S2	23/02/2020 17:08	23/02/2020 19:07	23/02/2020 17:08	23/02/2020 19:07	1,97	3	5,91	CHI
202002156777	RUBIATABA	10025216129	RUBIATABA	23/02/2020 17:08	24/02/2020 03:00	23/02/2020 17:08	24/02/2020 03:00	9,85	1	9,85	CHI
202002156780	PALESTINA DE GOIAS	PY12040193	PALESTINA	23/02/2020 17:07	23/02/2020 20:49	23/02/2020 17:07	23/02/2020 20:49	3,69	81	298,96	CHI
202002156795	MONTE ALEGRE DE GOIAS	SD12322677	SAO DOMINGOS	23/02/2020 16:24	23/02/2020 19:54	23/02/2020 16:24	23/02/2020 19:54	3,48	2	6,97	CHI
202002156795	NOVA ROMA	SD12322677	SAO DOMINGOS	23/02/2020 16:24	23/02/2020 19:54	23/02/2020 16:24	23/02/2020 19:54	3,48	3	10,45	CHI
202002156795	SAO DOMINGOS	SD12322677	SAO DOMINGOS	23/02/2020 16:24	23/02/2020 19:54	23/02/2020 16:24	23/02/2020 19:54	3,48	35	121,93	CHI
202002156796	EDEALINA	1130010123	PONTALINA	23/02/2020 17:14	23/02/2020 22:54	23/02/2020 17:14	23/02/2020 22:54	5,66	1	5,66	CHI
202002156799	CRIXAS	CX12134501	RUBIATABA	23/02/2020 17:11	23/02/2020 23:08	23/02/2020 17:11	23/02/2020 23:08	5,95	56	333,18	CHI
202002156799	NOVA IGUACU DE GOIAS	CX12134501	RUBIATABA	23/02/2020 17:11	23/02/2020 23:08	23/02/2020 17:11	23/02/2020 23:08	5,95	1	5,95	CHI
202002156802	PARAUNA	PU21314942	PARAUNA	23/02/2020 17:16	23/02/2020 19:45	23/02/2020 17:16	23/02/2020 19:45	2,48	1	2,48	CHI
202002156804	BALIZA	BH11334510	BOM JARDIM	23/02/2020 17:16	23/02/2020 23:34	23/02/2020 17:16	23/02/2020 23:34	6,29	1	6,29	CHI
202002156808	BONOPOLIS	BX21334596	SAO MIGUEL DO ARAGUAIA	23/02/2020 17:18	24/02/2020 10:10	23/02/2020 17:18	24/02/2020 10:10	16,86	1	16,86	CHI
202002156813	ANAPOLIS	OV12037464	NEROPOLIS S1	23/02/2020 17:07	23/02/2020 20:39	23/02/2020 17:07	23/02/2020 20:39	3,53	66	232,80	CHI
202002156813	OURO VERDE DE GOIAS	OV12037464	NEROPOLIS S1	23/02/2020 17:07	23/02/2020 20:39	23/02/2020 17:07	23/02/2020 20:39	3,53	9	31,75	CHI
202002156813	PETROLINA DE GOIAS	OV12037464	NEROPOLIS S1	23/02/2020 17:07	23/02/2020 20:39	23/02/2020 17:07	23/02/2020 20:39	3,53	10	35,27	CHI

202002156813	PIRENOPOLIS	OV12037464	NEROPOLIS S1	23/02/2020 17:07	23/02/2020 20:39	23/02/2020 17:07	23/02/2020 20:39	3,53	50	176,36	CHI
202002156817	ITAUCU	IX12321508	INHUMAS S1	23/02/2020 16:32	24/02/2020 03:06	23/02/2020 16:32	24/02/2020 03:06	10,55	3	31,66	CHI
202002156820	FORMOSA	FA12397036	ITUIQUIRA	23/02/2020 17:21	23/02/2020 21:15	23/02/2020 17:21	23/02/2020 21:15	3,90	3	11,69	CHI
202002156829	INACIOLANDIA	02220214	QUIRINOPOLIS	23/02/2020 17:14	23/02/2020 17:21	23/02/2020 17:14	23/02/2020 17:18	0,06	1049	67,02	CHI
202002156829	INACIOLANDIA	02220214	QUIRINOPOLIS	23/02/2020 17:14	23/02/2020 17:21	23/02/2020 17:14	23/02/2020 17:19	0,08	886	70,14	CHI
202002156829	ITUMBIARA	02220214	QUIRINOPOLIS	23/02/2020 17:14	23/02/2020 17:21	23/02/2020 17:14	23/02/2020 17:19	0,08	4	0,32	CHI
202002156829	BOM JESUS DE GOIAS	02220214	QUIRINOPOLIS	23/02/2020 17:14	23/02/2020 17:21	23/02/2020 17:14	23/02/2020 17:20	0,09	69	6,13	CHI
202002156829	INACIOLANDIA	02220214	QUIRINOPOLIS	23/02/2020 17:14	23/02/2020 17:21	23/02/2020 17:14	23/02/2020 17:20	0,09	51	4,53	CHI
202002156829	ITUMBIARA	02220214	QUIRINOPOLIS	23/02/2020 17:14	23/02/2020 17:21	23/02/2020 17:14	23/02/2020 17:20	0,09	5	0,44	CHI
202002156829	INACIOLANDIA	02220214	QUIRINOPOLIS	23/02/2020 17:14	23/02/2020 17:21	23/02/2020 17:14	23/02/2020 17:21	0,11	669	71,55	CHI
202002156831	ARACU	AR12019598	ARACU	23/02/2020 17:20	23/02/2020 20:29	23/02/2020 17:20	23/02/2020 20:29	3,14	7	21,95	CHI
202002156831	ITABERAI	AR12019598	ARACU	23/02/2020 17:20	23/02/2020 20:29	23/02/2020 17:20	23/02/2020 20:29	3,14	12	37,62	CHI
202002156834	CATALAO	1990120080	CATALAO S2	23/02/2020 17:25	23/02/2020 19:44	23/02/2020 17:25	23/02/2020 19:44	2,31	1	2,31	CHI
202002156835	SERRANOPOLIS	SX12123303	ITAJA S1	23/02/2020 17:25	23/02/2020 21:18	23/02/2020 17:25	23/02/2020 21:18	3,87	35	135,62	CHI
202002156840	ITUMBIARA	IT12033043	BOM JESUS DE GOIAS	23/02/2020 17:27	23/02/2020 22:51	23/02/2020 17:27	23/02/2020 22:51	5,39	3	16,18	CHI
202002156841	GOIANIA	10028549536	XAVANTES	23/02/2020 17:27	23/02/2020 21:31	23/02/2020 17:27	23/02/2020 21:31	4,06	1	4,06	CHI
202002156843	GOIANAPOLIS	LB12205831	DAIA S2	23/02/2020 16:44	23/02/2020 19:15	23/02/2020 16:44	23/02/2020 19:15	2,50	1	2,50	CHI
202002156843	LEOPOLDO DE BULHOES	LB12205831	DAIA S2	23/02/2020 16:44	23/02/2020 19:15	23/02/2020 16:44	23/02/2020 19:15	2,50	23	57,54	CHI
202002156844	ITAJA	IJ21031125	CACHOEIRA ALTA	23/02/2020 17:28	23/02/2020 23:32	23/02/2020 17:28	23/02/2020 23:32	6,05	1	6,05	CHI
202002156846	RIO VERDE	RV12327004	RIO VERDE S2	23/02/2020 17:29	23/02/2020 20:08	23/02/2020 17:29	23/02/2020 20:08	2,64	2	5,29	CHI
202002156847	JARAGUA	JA21283554	JARAGUA	23/02/2020 17:29	23/02/2020 19:55	23/02/2020 17:29	23/02/2020 19:55	2,42	1	2,42	CHI
202002156854	CACHOEIRA ALTA	CA21095037	CACHOEIRA ALTA	23/02/2020 17:31	23/02/2020 22:49	23/02/2020 17:31	23/02/2020 22:49	5,29	1	5,29	CHI
202002156856	CRIXAS	CX12190207	SANTA TEREZINHA	23/02/2020 15:45	24/02/2020 00:25	23/02/2020 15:45	24/02/2020 00:25	8,67	8	69,33	CHI
202002156858	GOIANIA	10951131	FERROVIARIO S1	23/02/2020 17:32	23/02/2020 20:28	23/02/2020 17:32	23/02/2020 20:28	2,93	1	2,93	CHI
202002156860	BOM JARDIM DE GOIAS	BM12065619	BOM JARDIM	23/02/2020 17:32	23/02/2020 20:35	23/02/2020 17:32	23/02/2020 20:35	3,04	1	3,04	CHI
202002156862	VILA PROPICIO	NP12382345	GOIANESIA S1	23/02/2020 17:33	23/02/2020 20:45	23/02/2020 17:33	23/02/2020 20:45	3,20	6	19,20	CHI
202002156864	BELA VISTA DE GOIAS	BV21227032	BELA VISTA S2	23/02/2020 17:33	23/02/2020 20:44	23/02/2020 17:33	23/02/2020 20:44	3,17	2	6,35	CHI
202002156869	SAO DOMINGOS	SD12046231	SAO DOMINGOS	23/02/2020 15:15	23/02/2020 21:13	23/02/2020 15:15	23/02/2020 21:13	5,98	120	717,70	CHI
202002156870	BOM JARDIM DE GOIAS	BM12064260	BOM JARDIM	23/02/2020 17:23	23/02/2020 19:26	23/02/2020 17:23	23/02/2020 19:26	2,05	17	34,82	CHI
202002156872	JARAGUA	SF12000192	SAO FRANCISCO DE GOIAS	23/02/2020 17:35	23/02/2020 20:08	23/02/2020 17:35	23/02/2020 20:08	2,54	17	43,14	CHI
202002156872	JESUPOLIS	SF12000192	SAO FRANCISCO DE GOIAS	23/02/2020 17:35	23/02/2020 20:08	23/02/2020 17:35	23/02/2020 20:08	2,54	5	12,69	CHI
202002156873	CRISTALINA	KR21165556	CRISTALINA S2	23/02/2020 17:35	23/02/2020 23:29	23/02/2020 17:35	23/02/2020 23:29	5,89	1	5,89	CHI
202002156878	ITAJA	IJ21087656	CACHOEIRA ALTA	23/02/2020 17:37	24/02/2020 00:50	23/02/2020 17:37	24/02/2020 00:50	7,22	1	7,22	CHI
202002156881	IPAMERI	IP12027141	URUTAI	23/02/2020 17:38	24/02/2020 10:10	23/02/2020 17:38	24/02/2020 10:10	16,53	4	66,13	CHI
202002156881	URUTAI	IP12027141	URUTAI	23/02/2020 17:38	24/02/2020 10:10	23/02/2020 17:38	24/02/2020 10:10	16,53	1	16,53	CHI
202002156883	GOIANIA	GN12090090	GOIANIA LESTE S1	23/02/2020 17:39	23/02/2020 19:34	23/02/2020 17:39	23/02/2020 19:34	1,92	193	370,88	CHI
202002156887	CATALAO	CT12042327	CATALAO S2	23/02/2020 17:36	23/02/2020 18:42	23/02/2020 17:36	23/02/2020 18:42	1,09	5	5,43	CHI
202002156888	LUZIANIA	LZ21013823	VIANOPOLIS	23/02/2020 17:40	23/02/2020 19:45	23/02/2020 17:40	23/02/2020 19:45	2,08	1	2,08	CHI
202002156890	ITUMBIARA	IT11000019	ITUMBIARA VELHA S1	23/02/2020 17:40	23/02/2020 19:02	23/02/2020 17:40	23/02/2020 19:02	1,35	126	170,14	CHI
202002156893	FORMOSO	FO12145300	PORANGATU	23/02/2020 17:41	23/02/2020 19:28	23/02/2020 17:41	23/02/2020 19:28	1,78	11	19,61	CHI
202002156899	ADELANDIA	MD12304614	ANICUNS	23/02/2020 17:42	23/02/2020 20:46	23/02/2020 17:42	23/02/2020 20:46	3,06	2	6,12	CHI
202002156899	MOSSAMEDES	MD12304614	ANICUNS	23/02/2020 17:42	23/02/2020 20:46	23/02/2020 17:42	23/02/2020 20:46	3,06	7	21,41	CHI
202002156900	ANAPOLIS	AN11209025	JUNDIAI S1	23/02/2020 16:39	23/02/2020 19:18	23/02/2020 16:39	23/02/2020 19:18	2,65	108	285,81	CHI
202002156903	CATALAO	TH12394023RE	CATALAO S1	23/02/2020 16:39	25/02/2020 03:52	23/02/2020 16:39	23/02/2020 23:38	6,98	33	230,45	CHI

202002156903	TRES RANCHOS	TH12394023RE	CATALAO S1	23/02/2020 16:39	25/02/2020 03:52	23/02/2020 16:39	23/02/2020 23:38	6,98	1	6,98	CHI
202002156903	CATALAO	TH12394023RE	CATALAO S1	23/02/2020 16:39	25/02/2020 03:52	24/02/2020 02:13	24/02/2020 03:00	0,79	33	25,98	CHI
202002156903	TRES RANCHOS	TH12394023RE	CATALAO S1	23/02/2020 16:39	25/02/2020 03:52	24/02/2020 02:13	24/02/2020 03:00	0,79	1	0,79	CHI
202002156903	OUIDOR	02640214	CATALAO S1	23/02/2020 16:39	25/02/2020 03:52	24/02/2020 06:35	24/02/2020 06:57	0,37	1	0,37	CHI
202002156903	TRES RANCHOS	02640214	CATALAO S1	23/02/2020 16:39	25/02/2020 03:52	24/02/2020 06:35	24/02/2020 06:57	0,37	1915	703,23	CHI
202002156903	CATALAO	TH13269683	CATALAO S1	23/02/2020 16:39	25/02/2020 03:52	24/02/2020 04:10	24/02/2020 07:58	3,80	61	231,99	CHI
202002156903	TRES RANCHOS	TH13269683	CATALAO S1	23/02/2020 16:39	25/02/2020 03:52	24/02/2020 04:10	24/02/2020 07:58	3,80	384	1460,37	CHI
202002156903	CATALAO	TH12394023RE	CATALAO S1	23/02/2020 16:39	25/02/2020 03:52	23/02/2020 16:39	25/02/2020 03:52	35,21	161	5669,48	CHI
202002156903	CUMARI	TH12394023RE	CATALAO S1	23/02/2020 16:39	25/02/2020 03:52	23/02/2020 16:39	25/02/2020 03:52	35,21	1	35,21	CHI
202002156903	DISTRITO FEDERAL	TH12394023RE	CATALAO S1	23/02/2020 16:39	25/02/2020 03:52	23/02/2020 16:39	25/02/2020 03:52	35,21	1	35,21	CHI
202002156903	CATALAO	TH12394023RE	CATALAO S1	23/02/2020 16:39	25/02/2020 03:52	24/02/2020 13:00	25/02/2020 03:52	14,87	32	475,91	CHI
202002156903	TRES RANCHOS	TH12394023RE	CATALAO S1	23/02/2020 16:39	25/02/2020 03:52	24/02/2020 13:00	25/02/2020 03:52	14,87	1	14,87	CHI
202002156904	TRINDADE	TR12393570	GOIANIRA	23/02/2020 17:41	24/02/2020 10:15	23/02/2020 17:41	24/02/2020 08:52	15,18	10	151,78	CHI
202002156904	TRINDADE	TR121218404LD	GOIANIRA	23/02/2020 17:41	24/02/2020 10:15	23/02/2020 17:41	24/02/2020 10:15	16,56	2	33,12	CHI
202002156908	PALMINOPOLIS	PP12077093	PALMEIRAS	23/02/2020 17:45	23/02/2020 20:00	23/02/2020 17:45	23/02/2020 20:00	2,24	2	4,48	CHI
202002156919	NOVO GAMA	10022550095	PACAEMBU S1	23/02/2020 17:49	23/02/2020 20:58	23/02/2020 17:49	23/02/2020 20:58	3,14	1	3,14	CHI
202002156921	IPORA	IR12014024	IPORA	23/02/2020 17:16	23/02/2020 18:39	23/02/2020 17:16	23/02/2020 18:39	1,37	17	23,26	CHI
202002156923	PLANALTINA	PI11208657	PLANALTINA	23/02/2020 17:49	23/02/2020 18:47	23/02/2020 17:49	23/02/2020 18:47	0,95	157	149,32	CHI
202002156929	PADRE BERNARDO	PB12382263	PADRE BERNARDO	23/02/2020 17:51	23/02/2020 19:11	23/02/2020 17:51	23/02/2020 19:11	1,33	38	50,65	CHI
202002156933	JANDAIA	JD12289834	PALMEIRAS	23/02/2020 17:52	23/02/2020 20:48	23/02/2020 17:52	23/02/2020 20:48	2,93	2	5,85	CHI
202002156941	RIO VERDE	RV21306579	RIO VERDE S1	23/02/2020 17:54	23/02/2020 19:57	23/02/2020 17:54	23/02/2020 19:57	2,05	1	2,05	CHI
202002156942	AMERICANO DO BRASIL	KB21148855	ANICUNS	23/02/2020 17:54	23/02/2020 19:29	23/02/2020 17:54	23/02/2020 19:29	1,57	1	1,57	CHI
202002156951	CIDADE OCIDENTAL	2680119703	MARAJOARA	23/02/2020 17:57	23/02/2020 20:41	23/02/2020 17:57	23/02/2020 20:41	2,73	1	2,73	CHI
202002156957	SAO FRANCISCO DE GOIAS	PV21072530	SAO FRANCISCO DE GOIAS	23/02/2020 17:58	23/02/2020 21:47	23/02/2020 17:58	23/02/2020 21:47	3,80	1	3,80	CHI
202002156961	GOIANIA	GN12030546	CAMPINAS S3	23/02/2020 17:43	23/02/2020 19:03	23/02/2020 17:43	23/02/2020 19:03	1,33	356	473,68	CHI
202002156963	APARECIDA DE GOIANIA	AP11198313	INDEPENDENCIA S2	23/02/2020 17:54	23/02/2020 19:00	23/02/2020 17:54	23/02/2020 19:00	1,10	74	81,26	CHI
202002156967	MINACU	IH12317057	MINACU	23/02/2020 18:00	23/02/2020 22:03	23/02/2020 18:00	23/02/2020 22:03	4,04	5	20,18	CHI
202002156974	CORUMBA DE GOIAS	CB12058982	CORUMBA	23/02/2020 17:36	24/02/2020 01:27	23/02/2020 17:36	24/02/2020 01:27	7,85	9	70,63	CHI
202002156975	ARAGARCAS	AG21388293	ARAGARCAS	23/02/2020 18:03	23/02/2020 21:23	23/02/2020 18:03	23/02/2020 21:23	3,32	1	3,32	CHI
202002156980	SANTA RITA DO NOVO DESTINO	DF21267438	BARRO ALTO	23/02/2020 18:04	23/02/2020 22:13	23/02/2020 18:04	23/02/2020 22:13	4,13	1	4,13	CHI
202002156982	GOIANIA	GN11040729	AEROPORTO S1	23/02/2020 18:05	24/02/2020 01:02	23/02/2020 18:05	24/02/2020 01:02	6,94	28	194,30	CHI
202002156986	FORMOSA	FA12207282	ITUIQUIRA	23/02/2020 17:32	23/02/2020 20:30	23/02/2020 17:32	23/02/2020 20:30	2,96	15	44,36	CHI
202002156988	FORMOSA	FA21017451	ITUIQUIRA	23/02/2020 18:06	23/02/2020 23:05	23/02/2020 18:06	23/02/2020 23:05	4,97	1	4,97	CHI
202002156991	MOZARLANDIA	MZ12238850	MOZARLANDIA	23/02/2020 18:07	23/02/2020 19:50	23/02/2020 18:07	23/02/2020 19:50	1,71	4	6,84	CHI
202002156994	GOIANIA	AP11062675	INDEPENDENCIA S2	23/02/2020 18:00	23/02/2020 20:53	23/02/2020 18:00	23/02/2020 20:53	2,88	108	311,01	CHI
202002156995	CACU	CC21057586	CACHOEIRA ALTA	23/02/2020 18:08	23/02/2020 20:41	23/02/2020 18:08	23/02/2020 20:41	2,55	1	2,55	CHI
202002156996	BELA VISTA DE GOIAS	SV12319545	BELA VISTA S2	23/02/2020 17:46	23/02/2020 21:30	23/02/2020 17:46	23/02/2020 21:30	3,74	73	272,66	CHI
202002156996	CALDAZINHA	SV12319545	BELA VISTA S2	23/02/2020 17:46	23/02/2020 21:30	23/02/2020 17:46	23/02/2020 21:30	3,74	7	26,15	CHI
202002156996	SAO MIGUEL DO PASSA QUATRO	SV12319545	BELA VISTA S2	23/02/2020 17:46	23/02/2020 21:30	23/02/2020 17:46	23/02/2020 21:30	3,74	2	7,47	CHI
202002156996	SILVANIA	SV12319545	BELA VISTA S2	23/02/2020 17:46	23/02/2020 21:30	23/02/2020 17:46	23/02/2020 21:30	3,74	72	268,92	CHI
202002156997	SANTA HELENA DE GOIAS	400150268	IPEGUARI	23/02/2020 18:09	23/02/2020 19:57	23/02/2020 18:09	23/02/2020 19:57	1,80	1	1,80	CHI
202002157007	GOIATUBA	GT12190913	GOIATUBA S1	23/02/2020 18:12	24/02/2020 11:40	23/02/2020 18:12	24/02/2020 11:40	17,46	4	69,84	CHI
202002157010	CATALAO	1990177958	CATALAO S2	23/02/2020 18:13	23/02/2020 22:05	23/02/2020 18:13	23/02/2020 22:05	3,87	1	3,87	CHI
202002157015	CIDADE OCIDENTAL	10018250724	MARAJOARA	23/02/2020 18:16	23/02/2020 19:46	23/02/2020 18:16	23/02/2020 19:46	1,49	1	1,49	CHI

202002157016	ITUMBIARA	IT12305617	ITUMBIARA NOVA	23/02/2020 18:16	23/02/2020 20:19	23/02/2020 18:16	23/02/2020 20:19	2,04	8	16,30	CHI
202002157018	TRINDADE	TR11049496	GOYA S1	23/02/2020 18:10	23/02/2020 20:28	23/02/2020 18:10	23/02/2020 20:28	2,29	123	281,53	CHI
202002157020	CATALAO	CT21042398	CATALAO S1	23/02/2020 18:17	23/02/2020 20:01	23/02/2020 18:17	23/02/2020 20:01	1,72	1	1,72	CHI
202002157024	CACU	CC21322238	CACHOEIRA ALTA	23/02/2020 18:18	24/02/2020 00:43	23/02/2020 18:18	24/02/2020 00:43	6,42	1	6,42	CHI
202002157027	GOIANIA	11263441	ATLANTICO S3	23/02/2020 18:18	23/02/2020 19:34	23/02/2020 18:18	23/02/2020 19:34	1,25	1	1,25	CHI
202002157031	LUZIANIA	LZ12336006	VIANOPOLIS	23/02/2020 18:17	23/02/2020 20:52	23/02/2020 18:17	23/02/2020 20:52	2,57	97	249,61	CHI
202002157034	AGUAS LINDAS DE GOIAS	4830078390	AGUAS LINDAS DE GOIAS S1	23/02/2020 18:22	23/02/2020 20:46	23/02/2020 18:22	23/02/2020 20:46	2,40	1	2,40	CHI
202002157036	CATALAO	CT21266339	CATALAO S1	23/02/2020 18:22	24/02/2020 11:00	23/02/2020 18:22	24/02/2020 11:00	16,63	1	16,63	CHI
202002157042	FORMOSA	FA11042079	ITIQUEIRA	23/02/2020 18:17	24/02/2020 04:07	23/02/2020 18:17	24/02/2020 04:07	9,83	97	953,43	CHI
202002157049	SILVANIA	SV12389456	VIANOPOLIS	23/02/2020 18:10	24/02/2020 03:51	23/02/2020 18:10	24/02/2020 03:51	9,68	109	1055,09	CHI
202002157050	APARECIDA DE GOIANIA	16301080	REAL S1	23/02/2020 18:27	23/02/2020 21:10	23/02/2020 18:27	23/02/2020 21:10	2,72	1	2,72	CHI
202002157053	QUIRINOPOLIS	QI21091041	QUIRINOPOLIS	23/02/2020 18:27	23/02/2020 22:00	23/02/2020 18:27	23/02/2020 22:00	3,54	1	3,54	CHI
202002157056	IPAMERI	IP11077544	IPAMERI	23/02/2020 18:28	23/02/2020 21:30	23/02/2020 18:28	23/02/2020 21:30	3,02	10	30,22	CHI
202002157059	SAO DOMINGOS	SD21195978	SAO DOMINGOS	23/02/2020 18:29	23/02/2020 19:59	23/02/2020 18:29	23/02/2020 19:59	1,49	1	1,49	CHI
202002157062	ANAPOLIS	21291627	JUNDIAI S1	23/02/2020 18:29	24/02/2020 00:34	23/02/2020 18:29	24/02/2020 00:34	6,07	1	6,07	CHI
202002157072	IPAMERI	OZ12395554RE	PIRES DO RIO S2	23/02/2020 18:26	23/02/2020 21:16	23/02/2020 18:26	23/02/2020 21:16	2,83	9	25,44	CHI
202002157072	ORIZONA	OZ12395554RE	PIRES DO RIO S2	23/02/2020 18:26	23/02/2020 21:16	23/02/2020 18:26	23/02/2020 21:16	2,83	26	73,49	CHI
202002157081	ITAJA	IJ12194905	ITAJA S2	23/02/2020 18:34	23/02/2020 20:01	23/02/2020 18:34	23/02/2020 20:01	1,45	157	228,22	CHI
202002157082	BONFINOPOLIS	BO12400463	CEPAIGO S2	23/02/2020 17:20	23/02/2020 23:34	23/02/2020 17:20	23/02/2020 23:34	6,23	25	155,79	CHI
202002157082	LEOPOLDO DE BULHOES	BO12400463	CEPAIGO S2	23/02/2020 17:20	23/02/2020 23:34	23/02/2020 17:20	23/02/2020 23:34	6,23	12	74,78	CHI
202002157085	NOVO GAMA	NJ11183937	PACAEMBU S1	23/02/2020 18:29	23/02/2020 18:50	23/02/2020 18:29	23/02/2020 18:50	0,34	145	50,02	CHI
202002157086	ITABERAI	50002314	ITABERAI S2	23/02/2020 18:36	23/02/2020 20:22	23/02/2020 18:36	23/02/2020 20:22	1,76	1	1,76	CHI
202002157087	INDIARA	PL21016311	EDEIA	23/02/2020 18:36	23/02/2020 20:41	23/02/2020 18:36	23/02/2020 20:41	2,09	1	2,09	CHI
202002157088	BURITI ALEGRE	GT10408745	GOIATUBA S2	23/02/2020 18:35	24/02/2020 09:41	23/02/2020 18:35	24/02/2020 09:41	15,10	30	452,93	CHI
202002157088	GOIATUBA	GT10408745	GOIATUBA S2	23/02/2020 18:35	24/02/2020 09:41	23/02/2020 18:35	24/02/2020 09:41	15,10	104	1570,14	CHI
202002157088	MORRINHOS	GT10408745	GOIATUBA S2	23/02/2020 18:35	24/02/2020 09:41	23/02/2020 18:35	24/02/2020 09:41	15,10	26	392,54	CHI
202002157091	ALEXANIA	AX21091394	ALEXANIA	23/02/2020 18:37	24/02/2020 13:28	23/02/2020 18:37	24/02/2020 13:28	18,84	1	18,84	CHI
202002157092	GOIANIA	15021634	CARAJAS S1	23/02/2020 18:37	23/02/2020 20:33	23/02/2020 18:37	23/02/2020 20:33	1,92	1	1,92	CHI
202002157094	PARAUNA	PU12191978	MONTIVIDIU T	23/02/2020 18:35	23/02/2020 22:04	23/02/2020 18:35	23/02/2020 22:04	3,47	4	13,90	CHI
202002157101	BONFINOPOLIS	GP12241545	DAIA S2	23/02/2020 18:39	23/02/2020 21:43	23/02/2020 18:39	23/02/2020 21:43	3,05	1	3,05	CHI
202002157105	PLANALTINA	PI12324322	SAO JOAO D ALIANCA	23/02/2020 18:40	23/02/2020 22:00	23/02/2020 18:40	23/02/2020 22:00	3,32	7	23,22	CHI
202002157109	CACHOEIRA ALTA	CA21075278	CACHOEIRA ALTA	23/02/2020 18:41	24/02/2020 00:39	23/02/2020 18:41	24/02/2020 00:39	5,95	1	5,95	CHI
202002157110	CRISTALINA	KR21305007	PAMPLONA	23/02/2020 18:41	23/02/2020 19:51	23/02/2020 18:41	23/02/2020 19:51	1,17	1	1,17	CHI
202002157116	PIRES DO RIO	PR11186718	PIRES DO RIO S1	23/02/2020 18:14	23/02/2020 19:36	23/02/2020 18:14	23/02/2020 19:36	1,37	44	60,13	CHI
202002157201	ANAPOLIS	20123140	ANAPOLIS UNIVERSITARIO S2	23/02/2020 18:43	23/02/2020 23:03	23/02/2020 18:43	23/02/2020 23:03	4,32	1	4,32	CHI
202002157202	FORMOSA	FA12146111	ITIQUEIRA	23/02/2020 18:43	23/02/2020 20:35	23/02/2020 18:43	23/02/2020 20:35	1,85	11	20,39	CHI
202002157304	GOIANIA	14629940	GOYA S2	23/02/2020 18:44	23/02/2020 20:11	23/02/2020 18:44	23/02/2020 20:11	1,44	1	1,44	CHI
202002157308	ITUMBIARA	IT10404069	PARANAIBA	23/02/2020 18:44	24/02/2020 12:25	23/02/2020 18:44	23/02/2020 19:24	0,66	207	137,14	CHI
202002157308	ITUMBIARA	IT12222546	PARANAIBA	23/02/2020 18:44	24/02/2020 12:25	23/02/2020 18:44	24/02/2020 10:50	16,10	26	418,53	CHI
202002157308	ITUMBIARA	IT12222546	PARANAIBA	23/02/2020 18:44	24/02/2020 12:25	23/02/2020 18:44	24/02/2020 12:14	17,48	20	349,68	CHI
202002157308	ITUMBIARA	IT12222546	PARANAIBA	23/02/2020 18:44	24/02/2020 12:25	23/02/2020 18:44	24/02/2020 12:20	17,58	6	105,50	CHI
202002157308	ITUMBIARA	IT12222546	PARANAIBA	23/02/2020 18:44	24/02/2020 12:25	23/02/2020 18:44	24/02/2020 12:21	17,60	1	17,60	CHI
202002157308	ITUMBIARA	IT12222546	PARANAIBA	23/02/2020 18:44	24/02/2020 12:25	23/02/2020 19:24	24/02/2020 12:21	16,94	1	16,94	CHI
202002157308	ITUMBIARA	IT12222546	PARANAIBA	23/02/2020 18:44	24/02/2020 12:25	23/02/2020 18:44	24/02/2020 12:22	17,62	2	35,23	CHI

202002157308	ITUMBIARA	IT12222546	PARANAIBA	23/02/2020 18:44	24/02/2020 12:25	23/02/2020 18:44	24/02/2020 12:23	17,63	30	529,02	CHI
202002157308	ITUMBIARA	IT12222546	PARANAIBA	23/02/2020 18:44	24/02/2020 12:25	23/02/2020 18:44	24/02/2020 12:25	17,67	1	17,67	CHI
202002157310	ALEXANIA	AX12168328	ALEXANIA	23/02/2020 18:40	23/02/2020 22:14	23/02/2020 18:40	23/02/2020 22:14	3,56	16	56,99	CHI
202002157313	GOIANESIA	GE12063282	GOIANESIA S2	23/02/2020 18:46	24/02/2020 00:48	23/02/2020 18:46	24/02/2020 00:48	6,02	2	12,04	CHI
202002157313	VILA PROPICIO	GE12063282	GOIANESIA S2	23/02/2020 18:46	24/02/2020 00:48	23/02/2020 18:46	24/02/2020 00:48	6,02	2	12,04	CHI
202002157314	JATAI	JT12210073	JATAI S1	23/02/2020 18:47	23/02/2020 21:23	23/02/2020 18:47	23/02/2020 21:23	2,60	23	59,70	CHI
202002157322	ALTO PARAISO DE GOIAS	BF21140119	SAO JOAO D ALIANCA	23/02/2020 18:48	23/02/2020 20:24	23/02/2020 18:48	23/02/2020 20:24	1,59	1	1,59	CHI
202002157326	ABADIANIA	CB21135774	CORUMBA	23/02/2020 18:49	23/02/2020 21:51	23/02/2020 18:49	23/02/2020 21:51	3,02	1	3,02	CHI
202002157327	ITUMBIARA	IT12088642	ITUMBIARA NOVA	23/02/2020 18:49	23/02/2020 20:48	23/02/2020 18:49	23/02/2020 20:48	1,97	10	19,70	CHI
202002157329	GOIANIA	13947278	MEIA PONTE	23/02/2020 18:50	23/02/2020 20:39	23/02/2020 18:50	23/02/2020 20:39	1,81	1	1,81	CHI
202002157332	ITUMBIARA	IT12222359	PARANAIBA	23/02/2020 18:51	23/02/2020 20:56	23/02/2020 18:51	23/02/2020 20:56	2,07	20	41,50	CHI
202002157332	PANAMA	IT12222359	PARANAIBA	23/02/2020 18:51	23/02/2020 20:56	23/02/2020 18:51	23/02/2020 20:56	2,07	23	47,72	CHI
202002157335	ABADIANIA	05730216	DAIA S2	23/02/2020 18:52	24/02/2020 08:52	23/02/2020 18:52	24/02/2020 00:57	6,08	2	12,16	CHI
202002157335	ABADIANIA	05730216	DAIA S2	23/02/2020 18:52	24/02/2020 08:52	23/02/2020 18:52	24/02/2020 05:35	10,72	248	2657,60	CHI
202002157335	ABADIANIA	05730216	DAIA S2	23/02/2020 18:52	24/02/2020 08:52	23/02/2020 18:52	24/02/2020 06:10	11,30	19	214,62	CHI
202002157335	ABADIANIA	05730216	DAIA S2	23/02/2020 18:52	24/02/2020 08:52	23/02/2020 18:52	24/02/2020 08:52	14,01	119	1667,06	CHI
202002157335	ABADIANIA	AA12221505LD	DAIA S2	23/02/2020 18:52	24/02/2020 08:52	24/02/2020 00:57	24/02/2020 08:52	7,93	1	7,93	CHI
202002157342	PORANGATU	PO21115461	PORANGATU	23/02/2020 18:53	24/02/2020 11:43	23/02/2020 18:53	24/02/2020 11:43	16,83	1	16,83	CHI
202002157344	GOIANIA	14113715	REAL S2	23/02/2020 18:53	23/02/2020 22:41	23/02/2020 18:53	23/02/2020 22:41	3,80	1	3,80	CHI
202002157346	JARAGUA	JA21223857	JARAGUA	23/02/2020 18:53	23/02/2020 21:28	23/02/2020 18:53	23/02/2020 21:28	2,57	1	2,57	CHI
202002157347	CAIAPONIA	CP12354340	CAIAPONIA	23/02/2020 16:08	23/02/2020 21:44	23/02/2020 16:08	23/02/2020 21:44	5,58	13	72,59	CHI
202002157348	NOVO GAMA	10011400895	PACAEMBU S1	23/02/2020 18:54	23/02/2020 20:02	23/02/2020 18:54	23/02/2020 20:02	1,13	1	1,13	CHI
202002157349	PIRENOPOLIS	4330000247	CORUMBA	23/02/2020 18:54	24/02/2020 16:58	23/02/2020 18:54	24/02/2020 16:58	22,06	1	22,06	CHI
202002157353	FAZENDA NOVA	NB12061633	JUSSARA	23/02/2020 18:30	23/02/2020 20:35	23/02/2020 18:30	23/02/2020 20:35	2,08	1	2,08	CHI
202002157353	JUSSARA	NB12061633	JUSSARA	23/02/2020 18:30	23/02/2020 20:35	23/02/2020 18:30	23/02/2020 20:35	2,08	11	22,85	CHI
202002157353	NOVO BRASIL	NB12061633	JUSSARA	23/02/2020 18:30	23/02/2020 20:35	23/02/2020 18:30	23/02/2020 20:35	2,08	12	24,93	CHI
202002157356	SILVANIA	SV12011218	DAIA S2	23/02/2020 18:55	23/02/2020 21:42	23/02/2020 18:55	23/02/2020 21:42	2,78	19	52,88	CHI
202002157363	GOIANIA	11257246	GOIANIA LESTE S1	23/02/2020 18:56	23/02/2020 20:19	23/02/2020 18:56	23/02/2020 20:19	1,37	1	1,37	CHI
202002157369	ORIZONA	2060051065	PIRES DO RIO S2	23/02/2020 18:59	23/02/2020 20:23	23/02/2020 18:59	23/02/2020 20:23	1,39	1	1,39	CHI
202002157371	BOM JARDIM DE GOIAS	BM12184273	BOM JARDIM	23/02/2020 19:00	23/02/2020 21:58	23/02/2020 19:00	23/02/2020 21:58	2,97	4	11,86	CHI
202002157373	PALMINOPOLIS	PP21005761	FIRMINOPOLIS S2	23/02/2020 19:00	23/02/2020 20:37	23/02/2020 19:00	23/02/2020 20:37	1,61	3	4,83	CHI
202002157376	SANTA RITA DO NOVO DESTINO	DF11315626	BARRO ALTO	23/02/2020 19:01	23/02/2020 23:47	23/02/2020 19:01	23/02/2020 23:47	4,76	1	4,76	CHI
202002157377	CAMPO ALEGRE DE GOIAS	CM12281443	CAMPO ALEGRE DE GOIAS	23/02/2020 19:01	25/02/2020 20:05	23/02/2020 19:01	25/02/2020 20:05	49,06	14	686,86	CHI
202002157377	IPAMERI	CM12281443	CAMPO ALEGRE DE GOIAS	23/02/2020 19:01	25/02/2020 20:05	23/02/2020 19:01	25/02/2020 20:05	49,06	1	49,06	CHI
202002157389	PIRACANJUBA	60056976	PIRACANJUBA	23/02/2020 19:03	23/02/2020 22:32	23/02/2020 19:03	23/02/2020 22:32	3,47	1	3,47	CHI
202002157410	GOIANIA	10022100138	CARAJAS S2	23/02/2020 19:09	23/02/2020 22:11	23/02/2020 19:09	23/02/2020 22:11	3,02	1	3,02	CHI
202002157412	PIRACANJUBA	PJ11036150	PIRACANJUBA	23/02/2020 19:10	23/02/2020 20:35	23/02/2020 19:10	23/02/2020 20:35	1,40	143	200,72	CHI
202002157414	INHUMAS	IN21000100	INHUMAS S2	23/02/2020 19:11	23/02/2020 23:54	23/02/2020 19:11	23/02/2020 23:54	4,72	1	4,72	CHI
202002157417	GOIANIA	GN11068487	GOYA S2	23/02/2020 19:11	23/02/2020 21:12	23/02/2020 19:11	23/02/2020 21:12	2,01	19	38,14	CHI
202002157418	CRISTALINA	KR12349171	PAMPLONA	23/02/2020 19:11	23/02/2020 23:22	23/02/2020 19:11	23/02/2020 23:22	4,18	1	4,18	CHI
202002157418	LUZIANIA	KR12349171	PAMPLONA	23/02/2020 19:11	23/02/2020 23:22	23/02/2020 19:11	23/02/2020 23:22	4,18	30	125,47	CHI
202002157421	JUSSARA	JR21137156	JUSSARA	23/02/2020 19:12	23/02/2020 21:11	23/02/2020 19:12	23/02/2020 21:11	1,98	4	7,93	CHI
202002157426	BURITINOPOLIS	PS12189370	IACIARA S2	23/02/2020 19:12	23/02/2020 21:36	23/02/2020 19:12	23/02/2020 21:36	2,39	2	4,78	CHI
202002157426	MAMBAI	PS12189370	IACIARA S2	23/02/2020 19:12	23/02/2020 21:36	23/02/2020 19:12	23/02/2020 21:36	2,39	27	64,53	CHI



202002157426	POSSE	PS12189370	IACIARA S2	23/02/2020 19:12	23/02/2020 21:36	23/02/2020 19:12	23/02/2020 21:36	2,39	4	9,56	CHI
202002157434	CAMPO ALEGRE DE GOIAS	CM12358429	CAMPO ALEGRE DE GOIAS	23/02/2020 19:14	23/02/2020 20:45	23/02/2020 19:14	23/02/2020 20:45	1,51	9	13,59	CHI
202002157435	CAMPINORTE	CR12291120LD	MARA ROSA	23/02/2020 19:14	23/02/2020 21:48	23/02/2020 19:14	23/02/2020 21:48	2,56	16	40,92	CHI
202002157435	URUACU	CR12291120LD	MARA ROSA	23/02/2020 19:14	23/02/2020 21:48	23/02/2020 19:14	23/02/2020 21:48	2,56	57	145,78	CHI
202002157436	SILVANIA	SV12011149	DAIA S2	23/02/2020 19:14	24/02/2020 10:30	23/02/2020 19:14	24/02/2020 10:30	15,25	1	15,25	CHI
202002157438	GOIANIA	12214681	GOIANIA LESTE S3	23/02/2020 19:14	24/02/2020 10:19	23/02/2020 19:14	24/02/2020 10:19	15,08	1	15,08	CHI
202002157441	GOIANIA	12862599	GOIANIA LESTE S3	23/02/2020 19:16	24/02/2020 11:07	23/02/2020 19:16	24/02/2020 11:07	15,84	1	15,84	CHI
202002157442	PILAR DE GOIAS	UR12325185	URUACU	23/02/2020 19:16	24/02/2020 09:35	23/02/2020 19:16	24/02/2020 09:35	14,30	1	14,30	CHI
202002157442	URUACU	UR12325185	URUACU	23/02/2020 19:16	24/02/2020 09:35	23/02/2020 19:16	24/02/2020 09:35	14,30	24	343,29	CHI
202002157443	SANTO ANTONIO DO DESCOBERTO	SN12314001	MARAJOARA	23/02/2020 18:40	23/02/2020 21:31	23/02/2020 18:40	23/02/2020 21:31	2,84	133	377,83	CHI
202002157445	GOIANIA	14093534	GOIANIA LESTE S3	23/02/2020 19:17	24/02/2020 00:51	23/02/2020 19:17	24/02/2020 00:51	5,56	1	5,56	CHI
202002157448	GOIANIA	GN21031139	AEROPORTO S1	23/02/2020 19:18	23/02/2020 22:52	23/02/2020 19:18	23/02/2020 22:52	3,56	1	3,56	CHI
202002157450	PIRENOPOLIS	PV21171311	CORUMBA	23/02/2020 19:18	23/02/2020 21:21	23/02/2020 19:18	23/02/2020 21:21	2,04	1	2,04	CHI
202002157451	PIRENOPOLIS	PV21021313	CORUMBA	23/02/2020 19:18	23/02/2020 22:50	23/02/2020 19:18	23/02/2020 22:50	3,52	1	3,52	CHI
202002157458	CATALAO	CT21131044	CATALAO S1	23/02/2020 19:20	23/02/2020 22:01	23/02/2020 19:20	23/02/2020 22:01	2,67	1	2,67	CHI
202002157460	ANAPOLIS	21164113	JUNDIAI S1	23/02/2020 19:21	24/02/2020 07:44	23/02/2020 19:21	24/02/2020 07:44	12,38	1	12,38	CHI
202002157463	SENADOR CANEDO	10031100404	SENADOR CANEDO	23/02/2020 19:21	23/02/2020 20:38	23/02/2020 19:21	23/02/2020 20:38	1,28	1	1,28	CHI
202002157466	SERRANOPOLIS	SX21123271	ITAJA S1	23/02/2020 19:21	23/02/2020 21:48	23/02/2020 19:21	23/02/2020 21:48	2,44	1	2,44	CHI
202002157469	GOIANIA	GN12395188	GOYA S2	23/02/2020 19:21	23/02/2020 21:12	23/02/2020 19:21	23/02/2020 21:12	1,84	1	1,84	CHI
202002157472	URUACU	CR12375637	CAMPINORTE	23/02/2020 19:18	23/02/2020 23:57	23/02/2020 19:18	23/02/2020 23:57	4,65	117	543,89	CHI
202002157482	MINEIROS	MY10396070	PARQUE DAS EMAS	23/02/2020 19:20	23/02/2020 20:13	23/02/2020 19:20	23/02/2020 20:13	0,89	129	114,24	CHI
202002157482	SERRANOPOLIS	MY10396070	PARQUE DAS EMAS	23/02/2020 19:20	23/02/2020 20:13	23/02/2020 19:20	23/02/2020 20:13	0,89	7	6,20	CHI
202002157488	NOVA CRIXAS	NA12075890	MOZARLANDIA	23/02/2020 18:51	24/02/2020 07:30	23/02/2020 18:51	24/02/2020 07:30	12,64	6	75,83	CHI
202002157489	GOIAS	IK12299970	GOIAS	23/02/2020 19:21	23/02/2020 20:22	23/02/2020 19:21	23/02/2020 20:22	1,00	23	23,09	CHI
202002157489	HEITORAI	IK12299970	GOIAS	23/02/2020 19:21	23/02/2020 20:22	23/02/2020 19:21	23/02/2020 20:22	1,00	33	33,13	CHI
202002157489	ITABERAI	IK12299970	GOIAS	23/02/2020 19:21	23/02/2020 20:22	23/02/2020 19:21	23/02/2020 20:22	1,00	3	3,01	CHI
202002157489	ITAPURANGA	IK12299970	GOIAS	23/02/2020 19:21	23/02/2020 20:22	23/02/2020 19:21	23/02/2020 20:22	1,00	3	3,01	CHI
202002157499	APORE	AE12205140	ITAJA S2	23/02/2020 18:43	24/02/2020 08:55	23/02/2020 18:43	24/02/2020 08:55	14,20	19	269,72	CHI
202002157503	TRINDADE	TR11129538	GOYA S2	23/02/2020 19:16	23/02/2020 21:03	23/02/2020 19:16	23/02/2020 21:03	1,77	67	118,40	CHI
202002157506	PONTALINA	PK11048361	PONTALINA	23/02/2020 19:15	23/02/2020 21:49	23/02/2020 19:15	23/02/2020 21:49	2,56	145	371,04	CHI
202002157508	PADRE BERNARDO	PB12305212	PADRE BERNARDO	23/02/2020 19:28	24/02/2020 00:12	23/02/2020 19:28	24/02/2020 00:12	4,73	7	33,11	CHI
202002157509	BURITI ALEGRE	BG21263647	ALTO BURITI	23/02/2020 19:28	23/02/2020 22:03	23/02/2020 19:28	23/02/2020 22:03	2,57	1	2,57	CHI
202002157515	RUBIATABA	RB12246312	RUBIATABA	23/02/2020 19:28	23/02/2020 21:29	23/02/2020 19:28	23/02/2020 21:29	2,01	323	648,51	CHI
202002157520	PIRES DO RIO	460009357	PIRES DO RIO S1	23/02/2020 19:29	23/02/2020 22:43	23/02/2020 19:29	23/02/2020 22:43	3,23	1	3,23	CHI
202002157523	LUZIANIA	LZ12372241	PACAEMBU S1	23/02/2020 19:20	23/02/2020 20:53	23/02/2020 19:20	23/02/2020 20:53	1,54	344	531,38	CHI
202002157523	NOVO GAMA	LZ12372241	PACAEMBU S1	23/02/2020 19:20	23/02/2020 20:53	23/02/2020 19:20	23/02/2020 20:53	1,54	18	27,80	CHI
202002157529	NIQUELANDIA	NQ122384917	NIQUELANDIA SUBTRANSMISSAO	23/02/2020 19:29	23/02/2020 22:17	23/02/2020 19:29	23/02/2020 22:17	2,79	103	286,86	CHI
202002157531	ITUMBIARA	IT11349810	PARANAIBA	23/02/2020 19:29	23/02/2020 22:21	23/02/2020 19:29	23/02/2020 22:21	2,85	9	25,65	CHI
202002157547	ITUMBIARA	IT21309903	CACHOEIRA DOURADA	23/02/2020 19:31	23/02/2020 23:33	23/02/2020 19:31	23/02/2020 23:33	4,03	2	8,05	CHI
202002157564	SAO MIGUEL DO ARAGUAIA	SM12211095	SAO MIGUEL DO ARAGUAIA	23/02/2020 19:24	23/02/2020 22:57	23/02/2020 19:24	23/02/2020 22:57	3,54	130	460,78	CHI
202002157565	FAZENDA NOVA	NB12250852	JUSSARA	23/02/2020 19:33	23/02/2020 22:02	23/02/2020 19:33	23/02/2020 22:02	2,47	4	9,87	CHI
202002157565	NOVO BRASIL	NB12250852	JUSSARA	23/02/2020 19:33	23/02/2020 22:02	23/02/2020 19:33	23/02/2020 22:02	2,47	2	4,93	CHI
202002157569	PALESTINA DE GOIAS	PY21289536	PALESTINA	23/02/2020 19:34	24/02/2020 20:28	23/02/2020 19:34	24/02/2020 03:40	8,09	1	8,09	CHI
202002157569	PALESTINA DE GOIAS	PY12223087LD	PALESTINA	23/02/2020 19:34	24/02/2020 20:28	23/02/2020 19:34	24/02/2020 07:59	12,41	112	1389,70	CHI

202002157569	PALESTINA DE GOIAS	PY12223011	PALESTINA	23/02/2020 19:34	24/02/2020 20:28	24/02/2020 10:50	24/02/2020 12:18	1,47	1	1,47	CHI
202002157569	PALESTINA DE GOIAS	PY12223087LD	PALESTINA	23/02/2020 19:34	24/02/2020 20:28	24/02/2020 08:08	24/02/2020 14:21	6,23	57	355,06	CHI
202002157569	PALESTINA DE GOIAS	PY12026684LD	PALESTINA	23/02/2020 19:34	24/02/2020 20:28	24/02/2020 08:08	24/02/2020 16:30	8,37	55	460,50	CHI
202002157569	PALESTINA DE GOIAS	PY21223089	PALESTINA	23/02/2020 19:34	24/02/2020 20:28	23/02/2020 19:34	24/02/2020 16:30	20,94	1	20,94	CHI
202002157569	PALESTINA DE GOIAS	PY21116730	PALESTINA	23/02/2020 19:34	24/02/2020 20:28	23/02/2020 19:34	24/02/2020 16:50	21,27	1	21,27	CHI
202002157569	PALESTINA DE GOIAS	PY12223011	PALESTINA	23/02/2020 19:34	24/02/2020 20:28	24/02/2020 17:10	24/02/2020 20:18	3,13	113	354,19	CHI
202002157569	PALESTINA DE GOIAS	7714400	PALESTINA	23/02/2020 19:34	24/02/2020 20:28	24/02/2020 17:10	24/02/2020 20:28	3,30	1	3,30	CHI
202002157577	SANTA BARBARA DE GOIAS	SB21358068	TRINDADE	23/02/2020 19:35	23/02/2020 21:29	23/02/2020 19:35	23/02/2020 21:29	1,89	1	1,89	CHI
202002157579	SERRANOPOLIS	SX21318847	JATAI S1	23/02/2020 19:36	24/02/2020 07:36	23/02/2020 19:36	24/02/2020 07:36	12,00	1	12,00	CHI
202002157584	LUZIANIA	10003568464	MARAJOARA	23/02/2020 19:37	23/02/2020 21:23	23/02/2020 19:37	23/02/2020 21:23	1,77	1	1,77	CHI
202002157601	QUIRINOPOLIS	QI12296642	QUIRINOPOLIS	23/02/2020 16:43	23/02/2020 21:01	23/02/2020 16:43	23/02/2020 21:01	4,30	5	21,49	CHI
202002157605	ANAPOLIS	280002798	ANAPOLIS UNIVERSITARIO S2	23/02/2020 19:41	23/02/2020 21:29	23/02/2020 19:41	23/02/2020 21:29	1,80	1	1,80	CHI
202002157608	TURVANIA	TV21005790	FIRMINOPOLIS S2	23/02/2020 19:41	24/02/2020 08:11	23/02/2020 19:41	24/02/2020 08:11	12,49	2	24,97	CHI
202002157610	MOZARLANDIA	MZ12064157	MOZARLANDIA	23/02/2020 19:42	23/02/2020 22:27	23/02/2020 19:42	23/02/2020 22:27	2,75	14	38,48	CHI
202002157615	LUZIANIA	LZ21086762	VIANOPOLIS	23/02/2020 19:43	23/02/2020 21:29	23/02/2020 19:43	23/02/2020 21:29	1,76	1	1,76	CHI
202002157616	FAZENDA NOVA	FN12396248	JUSSARA	23/02/2020 19:43	24/02/2020 11:36	23/02/2020 19:43	24/02/2020 11:36	15,87	8	126,97	CHI
202002157617	CRISTALINA	KR12287383	CRISTALINA S1	23/02/2020 19:44	24/02/2020 04:07	23/02/2020 19:44	24/02/2020 04:07	8,38	78	653,75	CHI
202002157639	GOIANESIA	GE21115062	GOIANESIA S1	23/02/2020 19:51	24/02/2020 01:58	23/02/2020 19:51	24/02/2020 01:58	6,12	1	6,12	CHI
202002157641	IPAMERI	IP21000068	IPAMERI	23/02/2020 20:05	24/02/2020 10:32	23/02/2020 20:05	24/02/2020 10:32	14,45	1	14,45	CHI
202002157648	JATAI	10012349524	JATAI S2	23/02/2020 19:52	23/02/2020 22:49	23/02/2020 19:52	23/02/2020 22:49	2,93	1	2,93	CHI
202002157651	INDIARA	IY12406245	ACREUNA	23/02/2020 19:53	24/02/2020 13:20	23/02/2020 19:53	24/02/2020 13:20	17,45	2	34,90	CHI
202002157656	CAMPO LIMPO	AN21000533	JUNDIAI S1	23/02/2020 19:55	24/02/2020 01:29	23/02/2020 19:55	24/02/2020 01:29	5,57	3	16,70	CHI
202002157657	LUZIANIA	LZ11086766	VIANOPOLIS	23/02/2020 19:55	24/02/2020 01:47	23/02/2020 19:55	24/02/2020 01:47	5,86	24	140,60	CHI
202002157658	MORRINHOS	150163769	GOIATUBA S1	23/02/2020 19:56	24/02/2020 18:31	23/02/2020 19:56	24/02/2020 18:31	22,59	1	22,59	CHI
202002157666	AMORINOPOLIS	IV12390141	IPORA	23/02/2020 19:57	24/02/2020 01:09	23/02/2020 19:57	24/02/2020 01:09	5,19	6	31,12	CHI
202002157666	IVOLANDIA	IV12390141	IPORA	23/02/2020 19:57	24/02/2020 01:09	23/02/2020 19:57	24/02/2020 01:09	5,19	60	311,22	CHI
202002157668	CORUMBAIBA	CI11250396	VILA CORUMBA	23/02/2020 19:57	24/02/2020 03:03	23/02/2020 19:57	24/02/2020 03:03	7,09	86	609,67	CHI
202002157676	GOIANIA	12097846	GOYA S1	23/02/2020 19:59	23/02/2020 23:06	23/02/2020 19:59	23/02/2020 23:06	3,11	1	3,11	CHI
202002157690	ALEXANIA	AX12048218	ALEXANIA	23/02/2020 13:40	23/02/2020 22:27	23/02/2020 13:40	23/02/2020 22:27	8,77	3	26,32	CHI
202002157692	NOVA ROMA	ND12392238	IACIARA S2	23/02/2020 20:08	24/02/2020 09:03	23/02/2020 20:08	24/02/2020 09:03	12,92	234	3022,30	CHI
202002157693	CAMPESTRE DE GOIAS	GC12005182	TRINDADE	23/02/2020 20:08	23/02/2020 23:02	23/02/2020 20:08	23/02/2020 23:02	2,90	8	23,17	CHI
202002157694	CAIAPONIA	CP12200873	PALESTINA	23/02/2020 19:20	24/02/2020 08:21	23/02/2020 19:20	24/02/2020 08:21	13,01	85	1105,50	CHI
202002157700	CALDAS NOVAS	CN12142380	CALDAS NOVAS S2	23/02/2020 20:05	23/02/2020 21:37	23/02/2020 20:05	23/02/2020 21:37	1,52	1059	1607,91	CHI
202002157701	ITAPACI	IW12078035	ITAPACI	23/02/2020 20:10	23/02/2020 21:55	23/02/2020 20:10	23/02/2020 21:55	1,74	21	36,49	CHI
202002157701	NOVA GLORIA	IW12078035	ITAPACI	23/02/2020 20:10	23/02/2020 21:55	23/02/2020 20:10	23/02/2020 21:55	1,74	1	1,74	CHI
202002157705	HIDROLANDIA	180066080	CEPAIGO S2	23/02/2020 20:11	23/02/2020 22:17	23/02/2020 20:11	23/02/2020 22:17	2,10	1	2,10	CHI
202002157720	ARAGOIANIA	AO31021342	GUAPO S2	23/02/2020 20:15	23/02/2020 21:18	23/02/2020 20:15	23/02/2020 21:18	1,04	1	1,04	CHI
202002157724	FORMOSA	FA12042563	ITUIQUIRA	23/02/2020 20:16	23/02/2020 22:23	23/02/2020 20:16	23/02/2020 22:23	2,12	53	112,20	CHI
202002157738	CALDAS NOVAS	CN11000035	CALDAS NOVAS S2	23/02/2020 20:19	23/02/2020 20:59	23/02/2020 20:19	23/02/2020 20:59	0,66	156	103,65	CHI
202002157749	VARJAO	VJ31064206	GUAPO S2	23/02/2020 20:23	23/02/2020 22:15	23/02/2020 20:23	23/02/2020 22:15	1,86	1	1,86	CHI
202002157759	PLANALTINA	PI11164647	PLANALTINA	23/02/2020 20:23	23/02/2020 20:55	23/02/2020 20:23	23/02/2020 20:55	0,53	115	60,89	CHI
202002157765	JARAGUA	JA21237652	JARAGUA	23/02/2020 20:25	24/02/2020 00:13	23/02/2020 20:25	24/02/2020 00:13	3,79	1	3,79	CHI
202002157766	VARJAO	VJ31064205	GUAPO S2	23/02/2020 20:27	24/02/2020 09:40	23/02/2020 20:27	24/02/2020 09:40	13,21	1	13,21	CHI
202002157783	ORIZONA	VN12249992	VIANOPOLIS	23/02/2020 20:23	24/02/2020 05:54	23/02/2020 20:23	24/02/2020 05:54	9,50	10	95,00	CHI

202002157783	VIANOPOLIS	VN12249992	VIANOPOLIS	23/02/2020 20:23	24/02/2020 05:54	23/02/2020 20:23	24/02/2020 05:54	9,50	146	1387,04	CHI
202002157784	BOM JARDIM DE GOIAS	PH12193387	PIRANHAS	23/02/2020 20:09	23/02/2020 23:20	23/02/2020 20:09	23/02/2020 23:20	3,17	3	9,52	CHI
202002157784	PIRANHAS	PH12193387	PIRANHAS	23/02/2020 20:09	23/02/2020 23:20	23/02/2020 20:09	23/02/2020 23:20	3,17	5	15,87	CHI
202002157785	VILA PROPICIO	NP12298249	GOIANESIA S1	23/02/2020 20:34	24/02/2020 11:54	23/02/2020 20:34	24/02/2020 11:54	15,33	9	137,97	CHI
202002157789	MINEIROS	1390022435	PARQUE DAS EMAS	23/02/2020 20:37	23/02/2020 22:42	23/02/2020 20:37	23/02/2020 22:42	2,08	1	2,08	CHI
202002157795	GOIANIA	GN21159266	GOIANIA LESTE S2	23/02/2020 20:38	23/02/2020 23:20	23/02/2020 20:38	23/02/2020 23:20	2,69	2	5,39	CHI
202002157797	CASTELANDIA	DM12295950	RIO DOS BOIS	23/02/2020 20:38	23/02/2020 22:10	23/02/2020 20:38	23/02/2020 22:10	1,53	24	36,63	CHI
202002157797	MAURILANDIA	DM12295950	RIO DOS BOIS	23/02/2020 20:38	23/02/2020 22:10	23/02/2020 20:38	23/02/2020 22:10	1,53	1	1,53	CHI
202002157798	ARACU	AR12019445	ARACU	23/02/2020 20:38	23/02/2020 22:28	23/02/2020 20:38	23/02/2020 22:28	1,82	20	36,42	CHI
202002157798	ITABERAI	AR12019445	ARACU	23/02/2020 20:38	23/02/2020 22:28	23/02/2020 20:38	23/02/2020 22:28	1,82	12	21,85	CHI
202002157799	GOIATUBA	GT12000264	GOIATUBA S1	23/02/2020 19:29	24/02/2020 06:44	23/02/2020 19:29	24/02/2020 06:44	11,24	16	179,90	CHI
202002157799	PANAMA	GT12000264	GOIATUBA S1	23/02/2020 19:29	24/02/2020 06:44	23/02/2020 19:29	24/02/2020 06:44	11,24	1	11,24	CHI
202002157799	RUBIATABA	GT12000264	GOIATUBA S1	23/02/2020 19:29	24/02/2020 06:44	23/02/2020 19:29	24/02/2020 06:44	11,24	1	11,24	CHI
202002157814	GOIANIA	10005142480	XAVANTES	23/02/2020 20:45	23/02/2020 23:11	23/02/2020 20:45	23/02/2020 23:11	2,43	1	2,43	CHI
202002157822	FLORES DE GOIAS	FB21334129	FLORES DE GOIAS	23/02/2020 20:47	24/02/2020 00:25	23/02/2020 20:47	24/02/2020 00:25	3,64	1	3,64	CHI
202002157829	JUSSARA	JR12204918	IPORA	23/02/2020 20:50	24/02/2020 02:07	23/02/2020 20:50	24/02/2020 02:07	5,28	35	184,78	CHI
202002157829	MONTES CLAROS DE GOIAS	JR12204918	IPORA	23/02/2020 20:50	24/02/2020 02:07	23/02/2020 20:50	24/02/2020 02:07	5,28	17	89,75	CHI
202002157832	LUZIANIA	LZ21252632	MARAJOARA	23/02/2020 20:51	23/02/2020 23:20	23/02/2020 20:51	23/02/2020 23:20	2,48	1	2,48	CHI
202002157837	VICENTINOPOLIS	VI12166491	VICENTINOPOLIS	23/02/2020 20:52	24/02/2020 07:25	23/02/2020 20:52	24/02/2020 07:25	10,55	26	274,26	CHI
202002157840	CAIAPONIA	CP12151179	CAIAPONIA	23/02/2020 20:53	23/02/2020 22:28	23/02/2020 20:53	23/02/2020 22:28	1,58	80	126,13	CHI
202002157847	FAZENDA NOVA	FN12250532	JUSSARA	23/02/2020 20:56	24/02/2020 12:11	23/02/2020 20:56	24/02/2020 12:11	15,24	11	167,67	CHI
202002157850	PORANGATU	PO12038327	PORANGATU	23/02/2020 20:59	24/02/2020 08:33	23/02/2020 20:59	24/02/2020 08:33	11,57	2	23,14	CHI
202002157852	LUZIANIA	LZ12372241	PACAEMBU S1	23/02/2020 21:00	23/02/2020 22:53	23/02/2020 21:00	23/02/2020 22:53	1,87	344	643,38	CHI
202002157852	NOVO GAMA	LZ12372241	PACAEMBU S1	23/02/2020 21:00	23/02/2020 22:53	23/02/2020 21:00	23/02/2020 22:53	1,87	18	33,66	CHI
202002157853	NIQUELANDIA	NQ21117587	URUACU	23/02/2020 21:00	23/02/2020 23:12	23/02/2020 21:00	23/02/2020 23:12	2,19	1	2,19	CHI
202002157854	ANAPOLIS	20146413	JUNDIAI S2	23/02/2020 21:01	24/02/2020 09:55	23/02/2020 21:01	24/02/2020 09:55	12,90	1	12,90	CHI
202002157869	RIO VERDE	BZ12200724	ACREUNA	23/02/2020 20:48	24/02/2020 10:57	23/02/2020 20:48	24/02/2020 10:57	14,14	24	339,48	CHI
202002157869	SANTA HELENA DE GOIAS	BZ12200724	ACREUNA	23/02/2020 20:48	24/02/2020 10:57	23/02/2020 20:48	24/02/2020 10:57	14,14	5	70,72	CHI
202002157869	SANTO ANTONIO DA BARRA	BZ12200724	ACREUNA	23/02/2020 20:48	24/02/2020 10:57	23/02/2020 20:48	24/02/2020 10:57	14,14	139	1966,15	CHI
202002157876	GOIANIA	12076170	GOYA S1	23/02/2020 21:09	23/02/2020 22:59	23/02/2020 21:09	23/02/2020 22:59	1,82	1	1,82	CHI
202002157878	URUACU	640038426	URUACU	23/02/2020 21:10	23/02/2020 22:04	23/02/2020 21:10	23/02/2020 22:04	0,89	1	0,89	CHI
202002157880	PARAUNA	PU12304395	PARAUNA	23/02/2020 21:11	24/02/2020 09:47	23/02/2020 21:11	24/02/2020 09:47	12,59	4	50,37	CHI
202002157882	POSSE	PS12152680	IACIARA S2	23/02/2020 21:12	24/02/2020 08:27	23/02/2020 21:12	24/02/2020 08:27	11,24	9	101,18	CHI
202002157884	SANTA TEREZINHA DE GOIAS	SG12214548	SANTA TEREZINHA	23/02/2020 21:12	24/02/2020 00:33	23/02/2020 21:12	24/02/2020 00:33	3,34	11	36,70	CHI
202002157887	PIRENOPOLIS	PV11057886	CORUMBA	23/02/2020 21:13	23/02/2020 22:40	23/02/2020 21:13	23/02/2020 22:40	1,44	100	144,33	CHI
202002157888	ARUANA	AK11216406	ARUANA	23/02/2020 21:06	23/02/2020 23:04	23/02/2020 21:06	23/02/2020 23:04	1,95	71	138,55	CHI
202002157889	TRINDADE	TR31043435	TRINDADE	23/02/2020 21:14	24/02/2020 00:33	23/02/2020 21:14	24/02/2020 00:33	3,31	2	6,63	CHI
202002157901	CATALAO	1990048162	CATALAO S2	23/02/2020 21:19	24/02/2020 07:34	23/02/2020 21:19	24/02/2020 07:34	10,24	1	10,24	CHI
202002157902	PARAUNA	BZ10394760	ACREUNA	23/02/2020 21:18	25/02/2020 14:07	23/02/2020 21:18	23/02/2020 23:17	1,98	1	1,98	CHI
202002157902	PARAUNA	BZ10394760	ACREUNA	23/02/2020 21:18	25/02/2020 14:07	23/02/2020 21:18	24/02/2020 01:34	4,27	19	81,21	CHI
202002157902	RIO VERDE	BZ10394760	ACREUNA	23/02/2020 21:18	25/02/2020 14:07	23/02/2020 21:18	24/02/2020 01:34	4,27	42	179,51	CHI
202002157902	SANTO ANTONIO DA BARRA	BZ10394760	ACREUNA	23/02/2020 21:18	25/02/2020 14:07	23/02/2020 21:18	24/02/2020 01:34	4,27	93	397,50	CHI
202002157902	RIO VERDE	BZ10394760	ACREUNA	23/02/2020 21:18	25/02/2020 14:07	23/02/2020 21:18	24/02/2020 03:01	5,71	24	137,06	CHI
202002157902	PARAUNA	BZ10394760	ACREUNA	23/02/2020 21:18	25/02/2020 14:07	24/02/2020 11:00	24/02/2020 11:49	0,81	19	15,46	CHI

202002157902	RIO VERDE	BZ10394760	ACREUNA	23/02/2020 21:18	25/02/2020 14:07	24/02/2020 11:00	24/02/2020 11:49	0,81	63	51,26	CHI
202002157902	SANTO ANTONIO DA BARRA	BZ10394760	ACREUNA	23/02/2020 21:18	25/02/2020 14:07	24/02/2020 11:00	24/02/2020 11:49	0,81	84	68,34	CHI
202002157902	RIO VERDE	RV12219435LD	ACREUNA	23/02/2020 21:18	25/02/2020 14:07	23/02/2020 21:18	24/02/2020 14:31	17,22	3	51,65	CHI
202002157902	PARAUNA	RV12219435LD	ACREUNA	23/02/2020 21:18	25/02/2020 14:07	23/02/2020 21:18	24/02/2020 15:16	17,96	112	2011,58	CHI
202002157902	RIO VERDE	RV12219435LD	ACREUNA	23/02/2020 21:18	25/02/2020 14:07	23/02/2020 21:18	24/02/2020 15:16	17,96	1	17,96	CHI
202002157902	PARAUNA	BZ10394760	ACREUNA	23/02/2020 21:18	25/02/2020 14:07	23/02/2020 21:18	24/02/2020 17:08	19,83	27	535,50	CHI
202002157902	RIO VERDE	BZ10394760	ACREUNA	23/02/2020 21:18	25/02/2020 14:07	23/02/2020 21:18	24/02/2020 17:08	19,83	28	555,33	CHI
202002157902	RIO VERDE	RV12219435LD	ACREUNA	23/02/2020 21:18	25/02/2020 14:07	23/02/2020 21:18	25/02/2020 00:51	27,54	42	1156,88	CHI
202002157902	RIO VERDE	RV12219435LD	ACREUNA	23/02/2020 21:18	25/02/2020 14:07	23/02/2020 21:18	25/02/2020 14:07	40,82	1	40,82	CHI
202002157906	CEZARINA	CZ21138558	CEZARINA	23/02/2020 21:20	24/02/2020 07:47	23/02/2020 21:20	24/02/2020 07:47	10,43	1	10,43	CHI
202002157907	MORRO AGUDO DE GOIAS	MS12136795	ITAPURANGA	23/02/2020 21:09	24/02/2020 14:00	23/02/2020 21:09	24/02/2020 12:22	15,22	12	182,64	CHI
202002157907	MORRO AGUDO DE GOIAS	MS12136795	ITAPURANGA	23/02/2020 21:09	24/02/2020 14:00	23/02/2020 21:09	24/02/2020 14:00	16,86	23	387,70	CHI
202002157908	HIDROLANDIA	HD12046374	PONTALINA	23/02/2020 21:22	24/02/2020 01:51	23/02/2020 21:22	24/02/2020 01:51	4,47	10	44,71	CHI
202002157910	PADRE BERNARDO	PB12313941	PADRE BERNARDO	23/02/2020 21:24	24/02/2020 16:31	23/02/2020 21:24	24/02/2020 16:31	19,11	4	76,45	CHI
202002157911	GOIANIA	GN11374123	CARAJAS S2	23/02/2020 21:18	24/02/2020 00:57	23/02/2020 21:18	24/02/2020 00:57	3,65	120	437,47	CHI
202002157913	FORMOSA	FA12404501	ITUIQUIRA	23/02/2020 21:26	24/02/2020 00:05	23/02/2020 21:26	24/02/2020 00:05	2,65	53	140,33	CHI
202002157915	SAO MIGUEL DO PASSA QUATRO	SQ21099205	BELA VISTA S2	23/02/2020 21:29	23/02/2020 22:53	23/02/2020 21:29	23/02/2020 22:53	1,40	1	1,40	CHI
202002157920	PANAMA	PX11166410	GOIATUBA S1	23/02/2020 21:34	24/02/2020 14:42	23/02/2020 21:34	24/02/2020 14:42	17,13	1	17,13	CHI
202002157922	NIQUELANDIA	NQ12232438	BARRO ALTO	23/02/2020 21:35	24/02/2020 04:00	23/02/2020 21:35	24/02/2020 04:00	6,42	14	89,82	CHI
202002157924	ITUMBIARA	IT21305601	ITUMBIARA NOVA	23/02/2020 21:37	24/02/2020 00:16	23/02/2020 21:37	24/02/2020 00:16	2,64	2	5,27	CHI
202002157942	RIO VERDE	RV12260980	CABRIUVA S2	23/02/2020 21:53	24/02/2020 09:04	23/02/2020 21:53	24/02/2020 09:04	11,18	3	33,54	CHI
202002157944	MONTES CLAROS DE GOIAS	ME21014452	IPORA	23/02/2020 21:53	24/02/2020 17:18	23/02/2020 21:53	24/02/2020 17:18	19,41	1	19,41	CHI
202002157946	HIDROLANDIA	HD12006263	INDEPENDENCIA S1	23/02/2020 21:55	23/02/2020 23:59	23/02/2020 21:55	23/02/2020 23:59	2,07	6	12,39	CHI
202002157947	GOIANIA	14608947	ATLANTICO S2	23/02/2020 21:56	23/02/2020 23:23	23/02/2020 21:56	23/02/2020 23:23	1,45	1	1,45	CHI
202002157957	PONTALINA	PK11048361	PONTALINA	23/02/2020 22:02	23/02/2020 23:35	23/02/2020 22:02	23/02/2020 23:35	1,54	145	223,90	CHI
202002157959	GOIANIA	GN21193576	GOIANIA LESTE S3	23/02/2020 22:04	24/02/2020 00:24	23/02/2020 22:04	24/02/2020 00:24	2,33	1	2,33	CHI
202002157961	MIMOSO DE GOIAS	NQ12207364	BARRO ALTO	24/02/2020 06:53	24/02/2020 10:30	24/02/2020 06:53	24/02/2020 10:30	3,61	4	14,45	CHI
202002157961	NIQUELANDIA	NQ12207364	BARRO ALTO	24/02/2020 06:53	24/02/2020 10:30	24/02/2020 06:53	24/02/2020 10:30	3,61	26	93,90	CHI
202002157963	ITAPIRAPUA	IU12089742	MATRINCHA	23/02/2020 22:08	24/02/2020 00:16	23/02/2020 22:08	24/02/2020 00:16	2,13	6	12,75	CHI
202002157965	PIRACANJUBA	PJ12082228	CRISTIANOPOLIS	23/02/2020 22:08	24/02/2020 01:53	23/02/2020 22:08	24/02/2020 01:53	3,74	5	18,70	CHI
202002157966	ARACU	AR21363468	ARACU	23/02/2020 22:08	24/02/2020 00:54	23/02/2020 22:08	24/02/2020 00:54	2,75	1	2,75	CHI
202002157970	PONTALINA	PK12080060	PONTALINA	23/02/2020 22:11	24/02/2020 18:52	23/02/2020 22:11	24/02/2020 14:20	16,14	8	129,09	CHI
202002157970	PONTALINA	PK12189867LD	PONTALINA	23/02/2020 22:11	24/02/2020 18:52	23/02/2020 22:11	24/02/2020 16:07	17,92	2	35,84	CHI
202002157970	PONTALINA	PK12189868LD	PONTALINA	23/02/2020 22:11	24/02/2020 18:52	23/02/2020 22:11	24/02/2020 18:11	20,00	15	299,97	CHI
202002157970	PONTALINA	PK12189869LD	PONTALINA	23/02/2020 22:11	24/02/2020 18:52	23/02/2020 22:11	24/02/2020 18:52	20,68	4	82,74	CHI
202002157973	CACHOEIRA ALTA	00270214	CACHOEIRA ALTA	23/02/2020 22:13	24/02/2020 16:39	23/02/2020 22:13	23/02/2020 22:59	0,77	27	20,80	CHI
202002157973	CACU	00270214	CACHOEIRA ALTA	23/02/2020 22:13	24/02/2020 16:39	23/02/2020 22:13	23/02/2020 22:59	0,77	5	3,85	CHI
202002157973	CACHOEIRA ALTA	00270214	CACHOEIRA ALTA	23/02/2020 22:13	24/02/2020 16:39	23/02/2020 23:57	24/02/2020 00:03	0,09	27	2,52	CHI
202002157973	CACU	00270214	CACHOEIRA ALTA	23/02/2020 22:13	24/02/2020 16:39	23/02/2020 23:57	24/02/2020 00:03	0,09	5	0,47	CHI
202002157973	CACHOEIRA ALTA	CA13219249	CACHOEIRA ALTA	23/02/2020 22:13	24/02/2020 16:39	23/02/2020 22:13	24/02/2020 10:09	11,92	12	143,09	CHI
202002157973	CACHOEIRA ALTA	CA21013567	CACHOEIRA ALTA	23/02/2020 22:13	24/02/2020 16:39	23/02/2020 22:13	24/02/2020 16:28	18,25	2	36,50	CHI
202002157973	CACHOEIRA ALTA	CA12000077	CACHOEIRA ALTA	23/02/2020 22:13	24/02/2020 16:39	23/02/2020 22:13	24/02/2020 16:39	18,43	46	848,00	CHI
202002157999	GOIANIA	10324252	CAMPINAS S1	23/02/2020 22:20	23/02/2020 23:43	23/02/2020 22:20	23/02/2020 23:43	1,38	1	1,38	CHI
202002158000	BURITI ALEGRE	BG12263567	ITUMBIARA VELHA S2	23/02/2020 22:31	24/02/2020 10:18	23/02/2020 22:31	24/02/2020 10:18	11,80	3	35,39	CHI

202002158000	ITUMBIARA	BG12263567	ITUMBIARA VELHA S2	23/02/2020 22:31	24/02/2020 10:18	23/02/2020 22:31	24/02/2020 10:18	11,80	18	212,36	CHI
202002158001	AMERICANO DO BRASIL	IB12310616	ITABERAI S2	24/02/2020 06:13	24/02/2020 13:14	24/02/2020 06:13	24/02/2020 13:14	7,03	1	7,03	CHI
202002158001	ITABERAI	IB12310616	ITABERAI S2	24/02/2020 06:13	24/02/2020 13:14	24/02/2020 06:13	24/02/2020 13:14	7,03	6	42,15	CHI
202002158003	ITAUCU	IX12018278	INHUMAS S1	23/02/2020 22:16	24/02/2020 01:41	23/02/2020 22:16	24/02/2020 01:41	3,41	76	259,16	CHI
202002158006	ANAPOLIS	AN21325271	ANAPOLIS UNIVERSITARIO S2	23/02/2020 22:34	23/02/2020 23:49	23/02/2020 22:34	23/02/2020 23:49	1,25	1	1,25	CHI
202002158010	ARUANA	AK11183285	ARUANA	23/02/2020 22:04	24/02/2020 00:16	23/02/2020 22:04	24/02/2020 00:16	2,19	23	50,31	CHI
202002158015	SENADOR CANEDO	10021963825	SENADOR CANEDO	23/02/2020 22:43	24/02/2020 01:13	23/02/2020 22:43	24/02/2020 01:13	2,50	1	2,50	CHI
202002158016	ITAUCU	IX21000072	ARACU	23/02/2020 22:45	24/02/2020 09:26	23/02/2020 22:45	24/02/2020 09:26	10,68	2	21,37	CHI
202002158017	JARAGUA	JA12064317	JARAGUA	23/02/2020 22:45	24/02/2020 01:31	23/02/2020 22:45	24/02/2020 01:31	2,75	51	140,26	CHI
202002158018	PIRENOPOLIS	PV21294289	CORUMBA	23/02/2020 22:47	23/02/2020 23:43	23/02/2020 22:47	23/02/2020 23:43	0,93	1	0,93	CHI
202002158019	CATALAO	CT21127864	CATALAO S1	23/02/2020 22:48	24/02/2020 09:09	23/02/2020 22:48	24/02/2020 09:09	10,34	1	10,34	CHI
202002158020	QUIRINOPOLIS	QI12116546	QUIRINOPOLIS	23/02/2020 17:18	24/02/2020 09:47	23/02/2020 17:18	24/02/2020 09:47	16,48	22	362,54	CHI
202002158022	IPAMERI	IP12000088	IPAMERI	23/02/2020 22:53	24/02/2020 08:18	23/02/2020 22:53	24/02/2020 08:18	9,42	15	141,25	CHI
202002158030	FIRMINOPOLIS	FR12028946	FIRMINOPOLIS S1	23/02/2020 22:36	24/02/2020 07:32	23/02/2020 22:36	24/02/2020 07:32	8,92	21	187,32	CHI
202002158031	CAIAPONIA	CP12207858	PALESTINA	23/02/2020 23:06	24/02/2020 04:40	23/02/2020 23:06	24/02/2020 04:40	5,56	18	100,17	CHI
202002158031	PALESTINA DE GOIAS	CP12207858	PALESTINA	23/02/2020 23:06	24/02/2020 04:40	23/02/2020 23:06	24/02/2020 04:40	5,56	1	5,56	CHI
202002158033	BONOPOLIS	9900001156	SAO MIGUEL DO ARAGUAIA	23/02/2020 23:07	24/02/2020 04:13	23/02/2020 23:07	24/02/2020 04:13	5,10	1	5,10	CHI
202002158036	JUSSARA	JR12023506	IPORA	23/02/2020 23:09	24/02/2020 03:53	23/02/2020 23:09	24/02/2020 03:53	4,73	7	33,11	CHI
202002158037	DOVERLANDIA	MY12217015	PARQUE DAS EMAS	24/02/2020 06:20	24/02/2020 10:07	24/02/2020 06:20	24/02/2020 10:07	3,78	30	113,51	CHI
202002158037	MINEIROS	MY12217015	PARQUE DAS EMAS	24/02/2020 06:20	24/02/2020 10:07	24/02/2020 06:20	24/02/2020 10:07	3,78	9	34,05	CHI
202002158040	ARUANA	AK11183260	ARUANA	23/02/2020 23:11	24/02/2020 03:27	23/02/2020 23:11	24/02/2020 03:27	4,26	108	459,72	CHI
202002158041	VARJAO	VJ21395516	GUAPO S2	23/02/2020 23:13	24/02/2020 11:20	23/02/2020 23:13	24/02/2020 11:20	12,11	1	12,11	CHI
202002158043	MONTIVIDIU	MV12214244	MONTIVIDIU T	23/02/2020 23:16	24/02/2020 08:57	23/02/2020 23:16	24/02/2020 08:57	9,68	16	154,81	CHI
202002158043	RIO VERDE	MV12214244	MONTIVIDIU T	23/02/2020 23:16	24/02/2020 08:57	23/02/2020 23:16	24/02/2020 08:57	9,68	2	19,35	CHI
202002158049	BALIZA	BH11023495	BOM JARDIM	23/02/2020 23:26	24/02/2020 08:48	23/02/2020 23:26	24/02/2020 08:48	9,36	65	608,40	CHI
202002158052	GOIANIA	GN11002414	FERROVIARIO S1	23/02/2020 23:28	24/02/2020 04:54	23/02/2020 23:28	24/02/2020 04:54	5,42	73	395,68	CHI
202002158055	COCALZINHO DE GOIAS	CB12051786	GOIANESIA S1	24/02/2020 08:00	24/02/2020 09:17	24/02/2020 08:00	24/02/2020 09:17	1,28	99	126,39	CHI
202002158056	ITAPIRAPUA	IU12018777	JUSSARA	24/02/2020 05:19	24/02/2020 07:48	24/02/2020 05:19	24/02/2020 07:48	2,48	11	27,28	CHI
202002158057	GUAPO	710035536	GUAPO S1	23/02/2020 23:31	24/02/2020 07:22	23/02/2020 23:31	24/02/2020 07:22	7,85	1	7,85	CHI
202002158060	FORMOSA	610198397	ITUIQUIRA	23/02/2020 23:40	24/02/2020 01:18	23/02/2020 23:40	24/02/2020 01:18	1,63	1	1,63	CHI
202002158062	PANAMA	IT12000117	PARANAIBA	23/02/2020 23:46	24/02/2020 19:15	23/02/2020 23:46	24/02/2020 19:15	19,48	2	38,97	CHI
202002158065	ITUMBIARA	IT12038299	PARANAIBA	23/02/2020 23:51	24/02/2020 14:31	23/02/2020 23:51	24/02/2020 14:31	14,68	6	88,08	CHI
202002158070	SAO MIGUEL DO ARAGUAIA	SM12074411	SAO MIGUEL DO ARAGUAIA	23/02/2020 23:55	24/02/2020 06:25	23/02/2020 23:55	24/02/2020 06:25	6,50	10	64,97	CHI
202002158073	APARECIDA DE GOIANIA	AP11389470	INDEPENDENCIA S2	24/02/2020 00:04	24/02/2020 00:54	24/02/2020 00:04	24/02/2020 00:54	0,83	84	69,88	CHI
202002158076	HIDROLANDIA	HD12006263	INDEPENDENCIA S1	24/02/2020 00:05	24/02/2020 13:23	24/02/2020 00:05	24/02/2020 13:23	13,29	6	79,77	CHI
202002158079	TRINDADE	TR12402860	TRINDADE	24/02/2020 00:09	24/02/2020 03:23	24/02/2020 00:09	24/02/2020 03:23	3,24	44	142,66	CHI
202002158081	FLORES DE GOIAS	FB12302741	FLORES DE GOIAS	24/02/2020 00:11	24/02/2020 07:20	24/02/2020 00:11	24/02/2020 07:20	7,14	22	156,99	CHI
202002158083	DAMIANOPOLIS	DA12399316	IACIARA S2	24/02/2020 00:17	24/02/2020 00:54	24/02/2020 00:17	24/02/2020 00:54	0,61	1	0,61	CHI
202002158089	CALDAS NOVAS	CN12246675	SERRA DE CALDAS	24/02/2020 00:38	24/02/2020 08:53	24/02/2020 00:38	24/02/2020 08:53	8,23	4	32,94	CHI
202002158093	PALMEIRAS DE GOIAS	PL12063336	PALMEIRAS	24/02/2020 00:55	24/02/2020 08:45	24/02/2020 00:55	24/02/2020 08:45	7,83	10	78,27	CHI
202002158093	PALMINOPOLIS	PL12063336	PALMEIRAS	24/02/2020 00:55	24/02/2020 08:45	24/02/2020 00:55	24/02/2020 08:45	7,83	1	7,83	CHI
202002158095	QUIRINOPOLIS	QI12279796	QUIRINOPOLIS	24/02/2020 00:59	24/02/2020 08:58	24/02/2020 00:59	24/02/2020 08:58	7,98	13	103,71	CHI
202002158105	GOIANIA	GN11001731	GOIANIA LESTE S2	24/02/2020 01:22	24/02/2020 03:13	24/02/2020 01:22	24/02/2020 03:13	1,84	239	439,89	CHI
202002158109	PIRACANJUBA	PJ10378310	PIRACANJUBA	24/02/2020 01:49	24/02/2020 14:33	24/02/2020 01:49	24/02/2020 08:24	6,59	73	480,75	CHI

202002158109	CRISTIANOPOLIS	PJ10378310	PIRACANJUBA	24/02/2020 01:49	24/02/2020 14:33	24/02/2020 01:49	24/02/2020 14:33	12,74	9	114,67	CHI
202002158109	PIRACANJUBA	PJ10378310	PIRACANJUBA	24/02/2020 01:49	24/02/2020 14:33	24/02/2020 01:49	24/02/2020 14:33	12,74	200	2548,22	CHI
202002158109	SANTA CRUZ DE GOIAS	PJ10378310	PIRACANJUBA	24/02/2020 01:49	24/02/2020 14:33	24/02/2020 01:49	24/02/2020 14:33	12,74	106	1350,56	CHI
202002158112	LUZIANIA	LZ12336006	VIANOPOLIS	24/02/2020 01:00	24/02/2020 09:37	24/02/2020 01:00	24/02/2020 09:37	8,60	97	834,42	CHI
202002158114	CEZARINA	PJ10401415	PONTALINA	24/02/2020 01:58	24/02/2020 12:23	24/02/2020 01:58	24/02/2020 02:01	0,06	40	2,22	CHI
202002158114	CROMINIA	PJ10401415	PONTALINA	24/02/2020 01:58	24/02/2020 12:23	24/02/2020 01:58	24/02/2020 02:01	0,06	1788	99,33	CHI
202002158114	CROMINIA	PJ10401415	PONTALINA	24/02/2020 01:58	24/02/2020 12:23	24/02/2020 01:58	24/02/2020 02:01	0,06	20	1,11	CHI
202002158114	CROMINIA	PJ10401415	PONTALINA	24/02/2020 01:58	24/02/2020 12:23	24/02/2020 01:58	24/02/2020 02:01	0,06	2	0,11	CHI
202002158114	CROMINIA	PJ10401415	PONTALINA	24/02/2020 01:58	24/02/2020 12:23	24/02/2020 01:58	24/02/2020 02:01	0,06	18	1,00	CHI
202002158114	CROMINIA	PJ10401415	PONTALINA	24/02/2020 01:58	24/02/2020 12:23	24/02/2020 01:58	24/02/2020 02:01	0,06	43	2,39	CHI
202002158114	CROMINIA	PJ10401415	PONTALINA	24/02/2020 01:58	24/02/2020 12:23	24/02/2020 01:58	24/02/2020 02:01	0,06	12	0,67	CHI
202002158114	CROMINIA	PJ10401415	PONTALINA	24/02/2020 01:58	24/02/2020 12:23	24/02/2020 01:58	24/02/2020 02:01	0,06	10	0,56	CHI
202002158114	HIDROLANDIA	PJ10401415	PONTALINA	24/02/2020 01:58	24/02/2020 12:23	24/02/2020 01:58	24/02/2020 02:01	0,06	181	10,06	CHI
202002158114	HIDROLANDIA	PJ10401415	PONTALINA	24/02/2020 01:58	24/02/2020 12:23	24/02/2020 01:58	24/02/2020 02:01	0,06	75	4,17	CHI
202002158114	HIDROLANDIA	PJ10401415	PONTALINA	24/02/2020 01:58	24/02/2020 12:23	24/02/2020 01:58	24/02/2020 02:01	0,06	4	0,22	CHI
202002158114	MAIRIPOTABA	PJ10401415	PONTALINA	24/02/2020 01:58	24/02/2020 12:23	24/02/2020 01:58	24/02/2020 02:01	0,06	69	3,83	CHI
202002158114	MAIRIPOTABA	PJ10401415	PONTALINA	24/02/2020 01:58	24/02/2020 12:23	24/02/2020 01:58	24/02/2020 02:01	0,06	781	43,39	CHI
202002158114	MAIRIPOTABA	PJ10401415	PONTALINA	24/02/2020 01:58	24/02/2020 12:23	24/02/2020 01:58	24/02/2020 02:01	0,06	10	0,56	CHI
202002158114	MAIRIPOTABA	PJ10401415	PONTALINA	24/02/2020 01:58	24/02/2020 12:23	24/02/2020 01:58	24/02/2020 02:01	0,06	358	19,89	CHI
202002158114	MAIRIPOTABA	PJ10401415	PONTALINA	24/02/2020 01:58	24/02/2020 12:23	24/02/2020 01:58	24/02/2020 02:01	0,06	8	0,44	CHI
202002158114	MAIRIPOTABA	PJ10401415	PONTALINA	24/02/2020 01:58	24/02/2020 12:23	24/02/2020 01:58	24/02/2020 02:01	0,06	2	0,11	CHI
202002158114	MAIRIPOTABA	PJ10401415	PONTALINA	24/02/2020 01:58	24/02/2020 12:23	24/02/2020 01:58	24/02/2020 02:01	0,06	3	0,17	CHI
202002158114	PONTALINA	PJ10401415	PONTALINA	24/02/2020 01:58	24/02/2020 12:23	24/02/2020 01:58	24/02/2020 02:01	0,06	34	1,89	CHI
202002158114	PONTALINA	PJ10401415	PONTALINA	24/02/2020 01:58	24/02/2020 12:23	24/02/2020 01:58	24/02/2020 02:01	0,06	3	0,17	CHI
202002158114	PONTALINA	PJ10401415	PONTALINA	24/02/2020 01:58	24/02/2020 12:23	24/02/2020 01:58	24/02/2020 02:01	0,06	61	3,39	CHI
202002158114	PROFESSOR JAMIL SAFADY	PJ10401415	PONTALINA	24/02/2020 01:58	24/02/2020 12:23	24/02/2020 01:58	24/02/2020 02:01	0,06	14	0,78	CHI
202002158114	PROFESSOR JAMIL SAFADY	PJ10401415	PONTALINA	24/02/2020 01:58	24/02/2020 12:23	24/02/2020 01:58	24/02/2020 02:01	0,06	44	2,44	CHI
202002158114	VARJAO	PJ10401415	PONTALINA	24/02/2020 01:58	24/02/2020 12:23	24/02/2020 01:58	24/02/2020 02:01	0,06	1	0,06	CHI
202002158114	PROFESSOR JAMIL SAFADY	PJ10401415	PONTALINA	24/02/2020 01:58	24/02/2020 12:23	24/02/2020 02:15	24/02/2020 06:48	4,54	38	172,61	CHI
202002158114	PROFESSOR JAMIL SAFADY	01620404	PONTALINA	24/02/2020 01:58	24/02/2020 12:23	24/02/2020 06:52	24/02/2020 10:24	3,53	38	134,03	CHI
202002158114	PROFESSOR JAMIL SAFADY	01620404	PONTALINA	24/02/2020 01:58	24/02/2020 12:23	24/02/2020 11:32	24/02/2020 11:53	0,34	38	13,00	CHI
202002158114	CEZARINA	01510404	PONTALINA	24/02/2020 01:58	24/02/2020 12:23	24/02/2020 02:15	24/02/2020 11:53	9,63	40	385,04	CHI
202002158114	CROMINIA	01510404	PONTALINA	24/02/2020 01:58	24/02/2020 12:23	24/02/2020 02:15	24/02/2020 11:53	9,63	1788	17211,49	CHI
202002158114	CROMINIA	01510404	PONTALINA	24/02/2020 01:58	24/02/2020 12:23	24/02/2020 02:15	24/02/2020 11:53	9,63	20	192,52	CHI
202002158114	CROMINIA	01510404	PONTALINA	24/02/2020 01:58	24/02/2020 12:23	24/02/2020 02:15	24/02/2020 11:53	9,63	2	19,25	CHI
202002158114	CROMINIA	01510404	PONTALINA	24/02/2020 01:58	24/02/2020 12:23	24/02/2020 02:15	24/02/2020 11:53	9,63	18	173,27	CHI
202002158114	CROMINIA	PJ10401415	PONTALINA	24/02/2020 01:58	24/02/2020 12:23	24/02/2020 02:15	24/02/2020 11:53	9,63	43	413,92	CHI
202002158114	CROMINIA	01510404	PONTALINA	24/02/2020 01:58	24/02/2020 12:23	24/02/2020 02:15	24/02/2020 11:53	9,63	12	115,51	CHI
202002158114	CROMINIA	01510404	PONTALINA	24/02/2020 01:58	24/02/2020 12:23	24/02/2020 02:15	24/02/2020 11:53	9,63	10	96,26	CHI
202002158114	HIDROLANDIA	01510404	PONTALINA	24/02/2020 01:58	24/02/2020 12:23	24/02/2020 02:15	24/02/2020 11:53	9,63	181	1742,33	CHI
202002158114	HIDROLANDIA	01510404	PONTALINA	24/02/2020 01:58	24/02/2020 12:23	24/02/2020 02:15	24/02/2020 11:53	9,63	75	721,96	CHI
202002158114	HIDROLANDIA	01510404	PONTALINA	24/02/2020 01:58	24/02/2020 12:23	24/02/2020 02:15	24/02/2020 11:53	9,63	4	38,50	CHI
202002158114	MAIRIPOTABA	01510404	PONTALINA	24/02/2020 01:58	24/02/2020 12:23	24/02/2020 02:15	24/02/2020 11:53	9,63	69	664,20	CHI
202002158114	MAIRIPOTABA	01510404	PONTALINA	24/02/2020 01:58	24/02/2020 12:23	24/02/2020 02:15	24/02/2020 11:53	9,63	781	7517,99	CHI

202002158114	MAIRIPOTABA	01510404	PONTALINA	24/02/2020 01:58	24/02/2020 12:23	24/02/2020 02:15	24/02/2020 11:53	9,63	10	96,26	CHI
202002158114	MAIRIPOTABA	01510404	PONTALINA	24/02/2020 01:58	24/02/2020 12:23	24/02/2020 02:15	24/02/2020 11:53	9,63	358	3446,15	CHI
202002158114	MAIRIPOTABA	PJ10401415	PONTALINA	24/02/2020 01:58	24/02/2020 12:23	24/02/2020 02:15	24/02/2020 11:53	9,63	8	77,01	CHI
202002158114	MAIRIPOTABA	01510404	PONTALINA	24/02/2020 01:58	24/02/2020 12:23	24/02/2020 02:15	24/02/2020 11:53	9,63	2	19,25	CHI
202002158114	MAIRIPOTABA	01510404	PONTALINA	24/02/2020 01:58	24/02/2020 12:23	24/02/2020 02:15	24/02/2020 11:53	9,63	3	28,88	CHI
202002158114	PONTALINA	01510404	PONTALINA	24/02/2020 01:58	24/02/2020 12:23	24/02/2020 02:15	24/02/2020 11:53	9,63	34	327,29	CHI
202002158114	PONTALINA	01510404	PONTALINA	24/02/2020 01:58	24/02/2020 12:23	24/02/2020 02:15	24/02/2020 11:53	9,63	3	28,88	CHI
202002158114	PONTALINA	01510404	PONTALINA	24/02/2020 01:58	24/02/2020 12:23	24/02/2020 02:15	24/02/2020 11:53	9,63	61	587,19	CHI
202002158114	PROFESSOR JAMIL SAFADY	01510404	PONTALINA	24/02/2020 01:58	24/02/2020 12:23	24/02/2020 02:15	24/02/2020 11:53	9,63	14	134,77	CHI
202002158114	PROFESSOR JAMIL SAFADY	PJ10401415	PONTALINA	24/02/2020 01:58	24/02/2020 12:23	24/02/2020 02:15	24/02/2020 11:53	9,63	6	57,76	CHI
202002158114	VARJAO	01510404	PONTALINA	24/02/2020 01:58	24/02/2020 12:23	24/02/2020 02:15	24/02/2020 11:53	9,63	1	9,63	CHI
202002158114	CEZARINA	01620404	PONTALINA	24/02/2020 01:58	24/02/2020 12:23	24/02/2020 12:16	24/02/2020 12:23	0,12	40	4,74	CHI
202002158114	CROMINIA	01620404	PONTALINA	24/02/2020 01:58	24/02/2020 12:23	24/02/2020 12:16	24/02/2020 12:23	0,12	1788	212,08	CHI
202002158114	CROMINIA	01620404	PONTALINA	24/02/2020 01:58	24/02/2020 12:23	24/02/2020 12:16	24/02/2020 12:23	0,12	20	2,37	CHI
202002158114	CROMINIA	01620404	PONTALINA	24/02/2020 01:58	24/02/2020 12:23	24/02/2020 12:16	24/02/2020 12:23	0,12	2	0,24	CHI
202002158114	CROMINIA	01620404	PONTALINA	24/02/2020 01:58	24/02/2020 12:23	24/02/2020 12:16	24/02/2020 12:23	0,12	18	2,13	CHI
202002158114	CROMINIA	PJ13263311	PONTALINA	24/02/2020 01:58	24/02/2020 12:23	24/02/2020 12:16	24/02/2020 12:23	0,12	41	4,86	CHI
202002158114	CROMINIA	01620404	PONTALINA	24/02/2020 01:58	24/02/2020 12:23	24/02/2020 12:16	24/02/2020 12:23	0,12	12	1,42	CHI
202002158114	CROMINIA	01620404	PONTALINA	24/02/2020 01:58	24/02/2020 12:23	24/02/2020 12:16	24/02/2020 12:23	0,12	10	1,19	CHI
202002158114	HIDROLANDIA	01620404	PONTALINA	24/02/2020 01:58	24/02/2020 12:23	24/02/2020 12:16	24/02/2020 12:23	0,12	181	21,47	CHI
202002158114	HIDROLANDIA	01620404	PONTALINA	24/02/2020 01:58	24/02/2020 12:23	24/02/2020 12:16	24/02/2020 12:23	0,12	75	8,90	CHI
202002158114	HIDROLANDIA	01620404	PONTALINA	24/02/2020 01:58	24/02/2020 12:23	24/02/2020 12:16	24/02/2020 12:23	0,12	4	0,47	CHI
202002158114	MAIRIPOTABA	01620404	PONTALINA	24/02/2020 01:58	24/02/2020 12:23	24/02/2020 12:16	24/02/2020 12:23	0,12	69	8,18	CHI
202002158114	MAIRIPOTABA	01620404	PONTALINA	24/02/2020 01:58	24/02/2020 12:23	24/02/2020 12:16	24/02/2020 12:23	0,12	781	92,64	CHI
202002158114	MAIRIPOTABA	01620404	PONTALINA	24/02/2020 01:58	24/02/2020 12:23	24/02/2020 12:16	24/02/2020 12:23	0,12	10	1,19	CHI
202002158114	MAIRIPOTABA	01620404	PONTALINA	24/02/2020 01:58	24/02/2020 12:23	24/02/2020 12:16	24/02/2020 12:23	0,12	358	42,46	CHI
202002158114	MAIRIPOTABA	PJ13263311	PONTALINA	24/02/2020 01:58	24/02/2020 12:23	24/02/2020 12:16	24/02/2020 12:23	0,12	8	0,95	CHI
202002158114	MAIRIPOTABA	01620404	PONTALINA	24/02/2020 01:58	24/02/2020 12:23	24/02/2020 12:16	24/02/2020 12:23	0,12	2	0,24	CHI
202002158114	MAIRIPOTABA	01620404	PONTALINA	24/02/2020 01:58	24/02/2020 12:23	24/02/2020 12:16	24/02/2020 12:23	0,12	3	0,36	CHI
202002158114	PONTALINA	01620404	PONTALINA	24/02/2020 01:58	24/02/2020 12:23	24/02/2020 12:16	24/02/2020 12:23	0,12	34	4,03	CHI
202002158114	PONTALINA	01620404	PONTALINA	24/02/2020 01:58	24/02/2020 12:23	24/02/2020 12:16	24/02/2020 12:23	0,12	3	0,36	CHI
202002158114	PONTALINA	01620404	PONTALINA	24/02/2020 01:58	24/02/2020 12:23	24/02/2020 12:16	24/02/2020 12:23	0,12	61	7,24	CHI
202002158114	PROFESSOR JAMIL SAFADY	01620404	PONTALINA	24/02/2020 01:58	24/02/2020 12:23	24/02/2020 12:16	24/02/2020 12:23	0,12	14	1,66	CHI
202002158114	PROFESSOR JAMIL SAFADY	PJ13263311	PONTALINA	24/02/2020 01:58	24/02/2020 12:23	24/02/2020 12:16	24/02/2020 12:23	0,12	44	5,22	CHI
202002158114	VARJAO	01620404	PONTALINA	24/02/2020 01:58	24/02/2020 12:23	24/02/2020 12:16	24/02/2020 12:23	0,12	1	0,12	CHI
202002158116	AURILANDIA	AI12126017	FIRMINOPOLIS S2	24/02/2020 02:25	24/02/2020 11:31	24/02/2020 02:25	24/02/2020 11:31	9,10	5	45,49	CHI
202002158116	CACHOEIRA DE GOIAS	AI12126017	FIRMINOPOLIS S2	24/02/2020 02:25	24/02/2020 11:31	24/02/2020 02:25	24/02/2020 11:31	9,10	4	36,39	CHI
202002158121	ITUMBIARA	BG12257007	ITUMBIARA VELHA S2	24/02/2020 02:49	24/02/2020 11:15	24/02/2020 02:49	24/02/2020 11:15	8,44	6	50,63	CHI
202002158122	PARAUNA	PU12304549	PARAUNA	24/02/2020 02:49	24/02/2020 07:32	24/02/2020 02:49	24/02/2020 07:32	4,71	13	61,27	CHI
202002158124	CACHOEIRA DOURADA	00280314	CACHOEIRA DOURADA	24/02/2020 02:54	24/02/2020 18:09	24/02/2020 02:54	24/02/2020 08:50	5,94	67	397,76	CHI
202002158124	DISTRITO FEDERAL	00280314	CACHOEIRA DOURADA	24/02/2020 02:54	24/02/2020 18:09	24/02/2020 02:54	24/02/2020 08:50	5,94	1	5,94	CHI
202002158124	CACHOEIRA DOURADA	00280314	CACHOEIRA DOURADA	24/02/2020 02:54	24/02/2020 18:09	24/02/2020 02:54	24/02/2020 08:56	6,02	14	84,33	CHI
202002158124	ITUMBIARA	00280314	CACHOEIRA DOURADA	24/02/2020 02:54	24/02/2020 18:09	24/02/2020 02:54	24/02/2020 08:56	6,02	6	36,14	CHI
202002158124	CACHOEIRA DOURADA	CD13000006	CACHOEIRA DOURADA	24/02/2020 02:54	24/02/2020 18:09	24/02/2020 08:54	24/02/2020 11:18	2,40	20	48,05	CHI

202002158124	CACHOEIRA DOURADA	00280314	CACHOEIRA DOURADA	24/02/2020 02:54	24/02/2020 18:09	24/02/2020 08:54	24/02/2020 13:36	4,70	42	197,41	CHI
202002158124	DISTRITO FEDERAL	00280314	CACHOEIRA DOURADA	24/02/2020 02:54	24/02/2020 18:09	24/02/2020 08:54	24/02/2020 13:36	4,70	1	4,70	CHI
202002158124	CACHOEIRA DOURADA	CD10396181	CACHOEIRA DOURADA	24/02/2020 02:54	24/02/2020 18:09	24/02/2020 14:29	24/02/2020 14:40	0,19	34	6,57	CHI
202002158124	ITUMBIARA	CD10396181	CACHOEIRA DOURADA	24/02/2020 02:54	24/02/2020 18:09	24/02/2020 14:29	24/02/2020 14:40	0,19	6	1,16	CHI
202002158124	CACHOEIRA DOURADA	00280314	CACHOEIRA DOURADA	24/02/2020 02:54	24/02/2020 18:09	24/02/2020 14:29	24/02/2020 15:19	0,83	42	34,99	CHI
202002158124	DISTRITO FEDERAL	00280314	CACHOEIRA DOURADA	24/02/2020 02:54	24/02/2020 18:09	24/02/2020 14:29	24/02/2020 15:19	0,83	1	0,83	CHI
202002158124	CACHOEIRA DOURADA	00280314	CACHOEIRA DOURADA	24/02/2020 02:54	24/02/2020 18:09	24/02/2020 08:54	24/02/2020 18:09	9,26	4	37,02	CHI
202002158124	CACHOEIRA DOURADA	00280314	CACHOEIRA DOURADA	24/02/2020 02:54	24/02/2020 18:09	24/02/2020 18:04	24/02/2020 18:09	0,08	42	3,40	CHI
202002158124	DISTRITO FEDERAL	00280314	CACHOEIRA DOURADA	24/02/2020 02:54	24/02/2020 18:09	24/02/2020 18:04	24/02/2020 18:09	0,08	1	0,08	CHI
202002158124	CACHOEIRA DOURADA	CD10396181	CACHOEIRA DOURADA	24/02/2020 02:54	24/02/2020 18:09	24/02/2020 18:04	24/02/2020 18:09	0,08	34	2,70	CHI
202002158124	ITUMBIARA	CD10396181	CACHOEIRA DOURADA	24/02/2020 02:54	24/02/2020 18:09	24/02/2020 18:04	24/02/2020 18:09	0,08	6	0,48	CHI
202002158125	FLORES DE GOIAS	FB21334129	FLORES DE GOIAS	24/02/2020 03:10	24/02/2020 08:30	24/02/2020 03:10	24/02/2020 08:30	5,32	1	5,32	CHI
202002158127	CACHOEIRA DE GOIAS	CG12289761	FIRMINOPOLIS S2	24/02/2020 02:37	24/02/2020 09:30	24/02/2020 02:37	24/02/2020 09:30	6,87	18	123,70	CHI
202002158128	ITAUCU	IX11129742	INHUMAS S1	24/02/2020 03:28	24/02/2020 14:24	24/02/2020 03:28	24/02/2020 14:24	10,93	11	120,27	CHI
202002158130	QUIRINOPOLIS	QI12000274	QUIRINOPOLIS	24/02/2020 03:34	24/02/2020 09:14	24/02/2020 03:34	24/02/2020 09:14	5,66	4	22,66	CHI
202002158133	ORIZONA	OZ12022888	PIRES DO RIO S2	24/02/2020 03:48	24/02/2020 09:12	24/02/2020 03:48	24/02/2020 09:12	5,40	37	199,65	CHI
202002158134	ANAPOLIS	20770352	ANAPOLIS UNIVERSITARIO S1	24/02/2020 03:49	24/02/2020 07:20	24/02/2020 03:49	24/02/2020 07:20	3,51	1	3,51	CHI
202002158139	TURVELANDIA	SH12000251	IPEGUARI	24/02/2020 04:17	24/02/2020 09:23	24/02/2020 04:17	24/02/2020 09:23	5,09	9	45,83	CHI
202002158141	ITUMBIARA	BJ12000196	CACHOEIRA DOURADA	24/02/2020 04:21	24/02/2020 09:00	24/02/2020 04:21	24/02/2020 09:00	4,65	4	18,60	CHI
202002158142	ITAPURANGA	IK12023043	ITAPURANGA	24/02/2020 04:19	24/02/2020 05:34	24/02/2020 04:19	24/02/2020 05:34	1,24	89	110,26	CHI
202002158143	BONOPOLIS	BX12202593	SAO MIGUEL DO ARAGUAIA	24/02/2020 04:22	24/02/2020 22:49	24/02/2020 04:22	24/02/2020 13:56	9,55	1	9,55	CHI
202002158143	BONOPOLIS	BX12202593	SAO MIGUEL DO ARAGUAIA	24/02/2020 04:22	24/02/2020 22:49	24/02/2020 04:22	24/02/2020 22:49	18,44	3	55,33	CHI
202002158143	BONOPOLIS	BX12202593	SAO MIGUEL DO ARAGUAIA	24/02/2020 04:22	24/02/2020 22:49	24/02/2020 21:23	24/02/2020 22:49	1,42	1	1,42	CHI
202002158144	CAMPO ALEGRE DE GOIAS	O2250424	CAMPO ALEGRE DE GOIAS	24/02/2020 04:24	26/02/2020 13:51	24/02/2020 04:24	24/02/2020 10:09	5,75	70	402,48	CHI
202002158144	CAMPO ALEGRE DE GOIAS	O2250424	CAMPO ALEGRE DE GOIAS	24/02/2020 04:24	26/02/2020 13:51	24/02/2020 10:19	24/02/2020 10:32	0,22	70	15,67	CHI
202002158144	CAMPO ALEGRE DE GOIAS	IP10400416	PIRES DO RIO S2	24/02/2020 04:24	26/02/2020 13:51	24/02/2020 10:36	24/02/2020 12:01	1,41	21	29,64	CHI
202002158144	IPAMERI	IP10400416	PIRES DO RIO S2	24/02/2020 04:24	26/02/2020 13:51	24/02/2020 10:36	24/02/2020 12:01	1,41	39	55,05	CHI
202002158144	CAMPO ALEGRE DE GOIAS	O2250424	CAMPO ALEGRE DE GOIAS	24/02/2020 04:24	26/02/2020 13:51	24/02/2020 04:24	24/02/2020 12:29	8,08	29	234,18	CHI
202002158144	IPAMERI	O2250424	CAMPO ALEGRE DE GOIAS	24/02/2020 04:24	26/02/2020 13:51	24/02/2020 04:24	24/02/2020 12:29	8,08	20	161,50	CHI
202002158144	CAMPO ALEGRE DE GOIAS	IP10400416	PIRES DO RIO S2	24/02/2020 04:24	26/02/2020 13:51	24/02/2020 12:03	24/02/2020 13:16	1,23	16	19,67	CHI
202002158144	IPAMERI	IP10400416	PIRES DO RIO S2	24/02/2020 04:24	26/02/2020 13:51	24/02/2020 12:03	24/02/2020 13:16	1,23	23	28,28	CHI
202002158144	CAMPO ALEGRE DE GOIAS	IP10400416	CAMPO ALEGRE DE GOIAS	24/02/2020 04:24	26/02/2020 13:51	24/02/2020 10:36	24/02/2020 13:38	3,02	80	241,73	CHI
202002158144	IPAMERI	IP10400416	CAMPO ALEGRE DE GOIAS	24/02/2020 04:24	26/02/2020 13:51	24/02/2020 10:36	24/02/2020 13:38	3,02	19	57,41	CHI
202002158144	CAMPO ALEGRE DE GOIAS	O2250424	CAMPO ALEGRE DE GOIAS	24/02/2020 04:24	26/02/2020 13:51	24/02/2020 13:38	24/02/2020 14:02	0,39	98	38,57	CHI
202002158144	IPAMERI	O2250424	CAMPO ALEGRE DE GOIAS	24/02/2020 04:24	26/02/2020 13:51	24/02/2020 13:38	24/02/2020 14:02	0,39	20	7,87	CHI
202002158144	CAMPO ALEGRE DE GOIAS	O2250424	CAMPO ALEGRE DE GOIAS	24/02/2020 04:24	26/02/2020 13:51	24/02/2020 14:12	24/02/2020 14:39	0,46	98	45,24	CHI
202002158144	IPAMERI	O2250424	CAMPO ALEGRE DE GOIAS	24/02/2020 04:24	26/02/2020 13:51	24/02/2020 14:12	24/02/2020 14:39	0,46	20	9,23	CHI
202002158144	CAMPO ALEGRE DE GOIAS	IP10400416	CAMPO ALEGRE DE GOIAS	24/02/2020 04:24	26/02/2020 13:51	24/02/2020 15:10	24/02/2020 15:32	0,37	80	29,60	CHI
202002158144	IPAMERI	IP10400416	CAMPO ALEGRE DE GOIAS	24/02/2020 04:24	26/02/2020 13:51	24/02/2020 15:10	24/02/2020 15:32	0,37	19	7,03	CHI
202002158144	CAMPO ALEGRE DE GOIAS	IP10400416	PIRES DO RIO S2	24/02/2020 04:24	26/02/2020 13:51	24/02/2020 15:10	24/02/2020 15:32	0,37	16	5,92	CHI
202002158144	IPAMERI	IP10400416	PIRES DO RIO S2	24/02/2020 04:24	26/02/2020 13:51	24/02/2020 15:10	24/02/2020 15:32	0,37	23	8,51	CHI
202002158144	IPAMERI	O2250424	CAMPO ALEGRE DE GOIAS	24/02/2020 04:24	26/02/2020 13:51	24/02/2020 04:24	24/02/2020 18:02	13,62	43	585,77	CHI
202002158144	CAMPO ALEGRE DE GOIAS	IP10400416	CAMPO ALEGRE DE GOIAS	24/02/2020 04:24	26/02/2020 13:51	24/02/2020 16:57	24/02/2020 19:00	2,04	79	160,87	CHI
202002158144	IPAMERI	IP10400416	CAMPO ALEGRE DE GOIAS	24/02/2020 04:24	26/02/2020 13:51	24/02/2020 16:57	24/02/2020 19:00	2,04	19	38,69	CHI



202002158144	CAMPO ALEGRE DE GOIAS	IP10400416	PIRES DO RIO S2	24/02/2020 04:24	26/02/2020 13:51	24/02/2020 16:57	24/02/2020 19:00	2,04	16	32,58	CHI
202002158144	IPAMERI	IP10400416	PIRES DO RIO S2	24/02/2020 04:24	26/02/2020 13:51	24/02/2020 16:57	24/02/2020 19:00	2,04	24	48,87	CHI
202002158144	IPAMERI	IP10400416	CAMPO ALEGRE DE GOIAS	24/02/2020 04:24	26/02/2020 13:51	24/02/2020 18:26	24/02/2020 19:00	0,56	43	24,04	CHI
202002158144	CAMPO ALEGRE DE GOIAS	IP10400416	CAMPO ALEGRE DE GOIAS	24/02/2020 04:24	26/02/2020 13:51	24/02/2020 10:36	24/02/2020 20:09	9,55	15	143,25	CHI
202002158144	CAMPO ALEGRE DE GOIAS	IP13215578	PIRES DO RIO S2	24/02/2020 04:24	26/02/2020 13:51	24/02/2020 12:03	24/02/2020 20:49	8,77	4	35,07	CHI
202002158144	IPAMERI	IP13215578	PIRES DO RIO S2	24/02/2020 04:24	26/02/2020 13:51	24/02/2020 12:03	24/02/2020 20:49	8,77	11	96,43	CHI
202002158144	IPAMERI	02250424	CAMPO ALEGRE DE GOIAS	24/02/2020 04:24	26/02/2020 13:51	24/02/2020 04:24	24/02/2020 21:24	16,99	3	50,97	CHI
202002158144	CAMPO ALEGRE DE GOIAS	IP13277042	PIRES DO RIO S2	24/02/2020 04:24	26/02/2020 13:51	24/02/2020 12:03	24/02/2020 21:48	9,75	1	9,75	CHI
202002158144	CAMPO ALEGRE DE GOIAS	02250424	CAMPO ALEGRE DE GOIAS	24/02/2020 04:24	26/02/2020 13:51	24/02/2020 04:24	24/02/2020 21:50	17,44	4	69,74	CHI
202002158144	IPAMERI	02250424	CAMPO ALEGRE DE GOIAS	24/02/2020 04:24	26/02/2020 13:51	24/02/2020 04:24	24/02/2020 21:50	17,44	11	191,79	CHI
202002158144	CAMPO ALEGRE DE GOIAS	IP10400416	CAMPO ALEGRE DE GOIAS	24/02/2020 04:24	26/02/2020 13:51	25/02/2020 03:39	25/02/2020 03:55	0,27	88	23,74	CHI
202002158144	IPAMERI	IP10400416	CAMPO ALEGRE DE GOIAS	24/02/2020 04:24	26/02/2020 13:51	25/02/2020 03:39	25/02/2020 03:55	0,27	65	17,53	CHI
202002158144	CAMPO ALEGRE DE GOIAS	IP10400416	PIRES DO RIO S2	24/02/2020 04:24	26/02/2020 13:51	25/02/2020 03:39	25/02/2020 03:55	0,27	21	5,66	CHI
202002158144	IPAMERI	IP10400416	PIRES DO RIO S2	24/02/2020 04:24	26/02/2020 13:51	25/02/2020 03:39	25/02/2020 03:55	0,27	35	9,44	CHI
202002158144	CAMPO ALEGRE DE GOIAS	IP10400416	CAMPO ALEGRE DE GOIAS	24/02/2020 04:24	26/02/2020 13:51	24/02/2020 10:36	25/02/2020 09:00	22,40	3	67,19	CHI
202002158144	CAMPO ALEGRE DE GOIAS	IP10400416	CAMPO ALEGRE DE GOIAS	24/02/2020 04:24	26/02/2020 13:51	24/02/2020 10:36	25/02/2020 09:11	22,57	118	2663,46	CHI
202002158144	CATALAO	IP10400416	CAMPO ALEGRE DE GOIAS	24/02/2020 04:24	26/02/2020 13:51	24/02/2020 10:36	25/02/2020 09:11	22,57	21	474,00	CHI
202002158144	DISTRITO FEDERAL	IP10400416	CAMPO ALEGRE DE GOIAS	24/02/2020 04:24	26/02/2020 13:51	24/02/2020 10:36	25/02/2020 09:11	22,57	1	22,57	CHI
202002158144	IPAMERI	IP10400416	CAMPO ALEGRE DE GOIAS	24/02/2020 04:24	26/02/2020 13:51	24/02/2020 10:36	25/02/2020 09:11	22,57	10	225,72	CHI
202002158144	CAMPO ALEGRE DE GOIAS	IP10400416	CAMPO ALEGRE DE GOIAS	24/02/2020 04:24	26/02/2020 13:51	24/02/2020 10:36	25/02/2020 11:10	24,56	17	417,54	CHI
202002158144	CAMPO ALEGRE DE GOIAS	02250424	CAMPO ALEGRE DE GOIAS	24/02/2020 04:24	26/02/2020 13:51	25/02/2020 15:12	25/02/2020 15:31	0,32	255	81,60	CHI
202002158144	CATALAO	02250424	CAMPO ALEGRE DE GOIAS	24/02/2020 04:24	26/02/2020 13:51	25/02/2020 15:12	25/02/2020 15:31	0,32	21	6,72	CHI
202002158144	DISTRITO FEDERAL	02250424	CAMPO ALEGRE DE GOIAS	24/02/2020 04:24	26/02/2020 13:51	25/02/2020 15:12	25/02/2020 15:31	0,32	1	0,32	CHI
202002158144	IPAMERI	02250424	CAMPO ALEGRE DE GOIAS	24/02/2020 04:24	26/02/2020 13:51	25/02/2020 15:12	25/02/2020 15:31	0,32	41	13,12	CHI
202002158144	CAMPO ALEGRE DE GOIAS	IP10400416	CAMPO ALEGRE DE GOIAS	24/02/2020 04:24	26/02/2020 13:51	24/02/2020 10:36	25/02/2020 16:51	30,25	6	181,52	CHI
202002158144	IPAMERI	IP13272863	PIRES DO RIO S2	24/02/2020 04:24	26/02/2020 13:51	24/02/2020 12:03	25/02/2020 20:14	32,19	1	32,19	CHI
202002158144	CAMPO ALEGRE DE GOIAS	IP10400416	CAMPO ALEGRE DE GOIAS	24/02/2020 04:24	26/02/2020 13:51	24/02/2020 10:36	25/02/2020 23:01	36,41	2	72,81	CHI
202002158144	IPAMERI	02250424	CAMPO ALEGRE DE GOIAS	24/02/2020 04:24	26/02/2020 13:51	24/02/2020 04:24	25/02/2020 23:42	43,29	2	86,58	CHI
202002158144	IPAMERI	IP12337279	PIRES DO RIO S2	24/02/2020 04:24	26/02/2020 13:51	24/02/2020 12:03	26/02/2020 00:08	36,09	2	72,17	CHI
202002158144	IPAMERI	IP12316902	PIRES DO RIO S2	24/02/2020 04:24	26/02/2020 13:51	24/02/2020 12:03	26/02/2020 03:04	39,03	1	39,03	CHI
202002158144	CAMPO ALEGRE DE GOIAS	IP10400416	CAMPO ALEGRE DE GOIAS	24/02/2020 04:24	26/02/2020 13:51	26/02/2020 04:33	26/02/2020 04:43	0,17	89	15,23	CHI
202002158144	IPAMERI	IP10400416	CAMPO ALEGRE DE GOIAS	24/02/2020 04:24	26/02/2020 13:51	26/02/2020 04:33	26/02/2020 04:43	0,17	67	11,46	CHI
202002158144	CAMPO ALEGRE DE GOIAS	IP10400416	PIRES DO RIO S2	24/02/2020 04:24	26/02/2020 13:51	26/02/2020 04:33	26/02/2020 04:43	0,17	21	3,59	CHI
202002158144	IPAMERI	IP10400416	PIRES DO RIO S2	24/02/2020 04:24	26/02/2020 13:51	26/02/2020 04:33	26/02/2020 04:43	0,17	39	6,67	CHI
202002158144	IPAMERI	6439698	PIRES DO RIO S2	24/02/2020 04:24	26/02/2020 13:51	24/02/2020 12:03	26/02/2020 13:17	49,23	1	49,23	CHI
202002158144	IPAMERI	02250424	CAMPO ALEGRE DE GOIAS	24/02/2020 04:24	26/02/2020 13:51	24/02/2020 04:24	26/02/2020 13:51	57,45	1	57,45	CHI
202002158146	TRES RANCHOS	TH21195262	CATALAO S1	24/02/2020 04:37	24/02/2020 08:54	24/02/2020 04:37	24/02/2020 08:54	4,28	2	8,56	CHI
202002158152	CASTELANDIA	DM21246774	RIO DOS BOIS	24/02/2020 04:50	24/02/2020 11:56	24/02/2020 04:50	24/02/2020 11:56	7,10	1	7,10	CHI
202002158153	AMARALINA	MU12391672	MARA ROSA	24/02/2020 00:58	24/02/2020 07:31	24/02/2020 00:58	24/02/2020 07:31	6,55	101	661,21	CHI
202002158153	MUTUNOPOLIS	MU12391672	MARA ROSA	24/02/2020 00:58	24/02/2020 07:31	24/02/2020 00:58	24/02/2020 07:31	6,55	7	45,83	CHI
202002158156	TAQUARAL DE GOIAS	TQ12000087	ITABERAI S1	24/02/2020 04:57	24/02/2020 09:18	24/02/2020 04:57	24/02/2020 09:18	4,33	44	190,69	CHI
202002158157	GOIAS	GS12071232	GOIAS	24/02/2020 04:48	24/02/2020 16:03	24/02/2020 04:48	24/02/2020 16:03	11,24	38	427,07	CHI
202002158158	AMERICANO DO BRASIL	KB21107309	ANICUNS	24/02/2020 05:00	24/02/2020 07:15	24/02/2020 05:00	24/02/2020 07:15	2,25	1	2,25	CHI
202002158160	GOIANESIA	PV12312048RE	CORUMBA	24/02/2020 05:01	24/02/2020 11:42	24/02/2020 05:01	24/02/2020 11:42	6,68	10	66,81	CHI

202002158160	JARAGUA	PV12312048RE	CORUMBA	24/02/2020 05:01	24/02/2020 11:42	24/02/2020 05:01	24/02/2020 11:42	6,68	4	26,72	CHI
202002158160	PIRENOPOLIS	PV12312048RE	CORUMBA	24/02/2020 05:01	24/02/2020 11:42	24/02/2020 05:01	24/02/2020 11:42	6,68	57	380,81	CHI
202002158160	VILA PROPICIO	PV12312048RE	CORUMBA	24/02/2020 05:01	24/02/2020 11:42	24/02/2020 05:01	24/02/2020 11:42	6,68	3	20,04	CHI
202002158161	CATALAO	CT12011272	CATALAO S1	24/02/2020 05:06	24/02/2020 11:14	24/02/2020 05:06	24/02/2020 11:14	6,13	172	1053,69	CHI
202002158162	BURITI ALEGRE	BG12000023	ALTO BURITI	24/02/2020 05:13	24/02/2020 15:33	24/02/2020 05:13	24/02/2020 13:11	7,97	15	119,58	CHI
202002158162	BURITI ALEGRE	BG12000162	ALTO BURITI	24/02/2020 05:13	24/02/2020 15:33	24/02/2020 05:13	24/02/2020 14:19	9,10	7	63,68	CHI
202002158162	ITUMBIARA	BG12000162	ALTO BURITI	24/02/2020 05:13	24/02/2020 15:33	24/02/2020 05:13	24/02/2020 14:19	9,10	11	100,06	CHI
202002158162	BURITI ALEGRE	BG12256994	ALTO BURITI	24/02/2020 05:13	24/02/2020 15:33	24/02/2020 05:13	24/02/2020 15:33	10,33	5	51,65	CHI
202002158165	PARAUNA	RV12306606	MONTIVIDIU T	24/02/2020 05:21	24/02/2020 14:55	24/02/2020 05:21	24/02/2020 14:55	9,57	54	517,05	CHI
202002158167	NIQUELANDIA	NQ21293919	URUACU	24/02/2020 05:23	24/02/2020 09:44	24/02/2020 05:23	24/02/2020 09:44	4,34	2	8,67	CHI
202002158168	INDIARA	IY12009123	EDEIA	24/02/2020 05:24	24/02/2020 06:50	24/02/2020 05:24	24/02/2020 06:50	1,45	62	89,61	CHI
202002158170	MORRINHOS	MR12075101	MORRINHOS	24/02/2020 05:25	24/02/2020 08:28	24/02/2020 05:25	24/02/2020 08:28	3,05	43	131,02	CHI
202002158172	TRES RANCHOS	TH21154696	CATALAO S1	24/02/2020 05:28	24/02/2020 17:35	24/02/2020 05:28	24/02/2020 17:35	12,11	3	36,34	CHI
202002158175	INDIARA	IY12010956	EDEIA	24/02/2020 05:29	24/02/2020 08:00	24/02/2020 05:29	24/02/2020 08:00	2,51	2	5,01	CHI
202002158175	JANDAIA	IY12010956	EDEIA	24/02/2020 05:29	24/02/2020 08:00	24/02/2020 05:29	24/02/2020 08:00	2,51	1	2,51	CHI
202002158176	ISRAELANDIA	IS12108448	IPORA	24/02/2020 05:35	24/02/2020 10:59	24/02/2020 05:35	24/02/2020 10:59	5,39	13	70,08	CHI
202002158176	JAUPACI	IS12108448	IPORA	24/02/2020 05:35	24/02/2020 10:59	24/02/2020 05:35	24/02/2020 10:59	5,39	3	16,17	CHI
202002158177	MOZARLANDIA	MZ12307500	MOZARLANDIA	24/02/2020 05:39	24/02/2020 10:34	24/02/2020 05:39	24/02/2020 10:34	4,91	4	19,65	CHI
202002158178	PARAUNA	PU12194225	FIRMINOPOLIS S2	24/02/2020 05:39	25/02/2020 08:53	24/02/2020 05:39	25/02/2020 08:53	27,22	13	353,82	CHI
202002158179	NOVO PLANALTO	TA12369993	NOVO PLANALTO	24/02/2020 05:40	24/02/2020 11:20	24/02/2020 05:40	24/02/2020 11:20	5,67	36	203,98	CHI
202002158179	NOVO PLANALTO	TA12369993	NOVO PLANALTO	24/02/2020 05:40	24/02/2020 11:20	24/02/2020 05:40	24/02/2020 11:20	5,67	14	79,32	CHI
202002158183	FORMOSA	FA21149074	ITUIQUIRA	24/02/2020 05:45	24/02/2020 08:44	24/02/2020 05:45	24/02/2020 08:44	2,98	3	8,94	CHI
202002158186	ANICUNS	AC12126246	ANICUNS	24/02/2020 05:48	24/02/2020 07:05	24/02/2020 05:48	24/02/2020 07:05	1,28	8	10,22	CHI
202002158192	BOM JARDIM DE GOIAS	BM12064260	BOM JARDIM	24/02/2020 05:58	24/02/2020 08:39	24/02/2020 05:58	24/02/2020 08:39	2,67	17	45,46	CHI
202002158198	SANCLERLANDIA	SL12323580	SAO LUIZ DOS MONTES BELOS	23/02/2020 23:18	24/02/2020 07:45	23/02/2020 23:18	24/02/2020 07:45	8,44	28	236,28	CHI
202002158198	SAO LUIS DE MONTES BELOS	SL12323580	SAO LUIZ DOS MONTES BELOS	23/02/2020 23:18	24/02/2020 07:45	23/02/2020 23:18	24/02/2020 07:45	8,44	112	945,12	CHI
202002158199	MUNDO NOVO DE GOIAS	MH12034680	NOVA CRIXAS	24/02/2020 04:49	24/02/2020 07:29	24/02/2020 04:49	24/02/2020 07:29	2,65	29	76,91	CHI
202002158200	DIVINOPOLIS DE GOIAS	GH12074067	SAO DOMINGOS	24/02/2020 06:06	24/02/2020 08:10	24/02/2020 06:06	24/02/2020 08:10	2,06	365	752,41	CHI
202002158200	MONTE ALEGRE DE GOIAS	GH12074067	SAO DOMINGOS	24/02/2020 06:06	24/02/2020 08:10	24/02/2020 06:06	24/02/2020 08:10	2,06	15	30,92	CHI
202002158200	SAO DOMINGOS	GH12074067	SAO DOMINGOS	24/02/2020 06:06	24/02/2020 08:10	24/02/2020 06:06	24/02/2020 08:10	2,06	1	2,06	CHI
202002158303	ITAGUARI	IC12353098	ITABERAI S1	24/02/2020 06:04	24/02/2020 08:09	24/02/2020 06:04	24/02/2020 08:09	2,08	47	97,79	CHI
202002158303	ITAGUARU	IC12353098	ITABERAI S1	24/02/2020 06:04	24/02/2020 08:09	24/02/2020 06:04	24/02/2020 08:09	2,08	82	170,61	CHI
202002158303	JARAGUA	IC12353098	ITABERAI S1	24/02/2020 06:04	24/02/2020 08:09	24/02/2020 06:04	24/02/2020 08:09	2,08	128	266,31	CHI
202002158304	PALMINOPOLIS	PP12008241	PALMEIRAS	24/02/2020 06:07	24/02/2020 14:37	24/02/2020 06:07	24/02/2020 14:37	8,48	22	186,66	CHI
202002158307	MORRINHOS	150060208	MORRINHOS	24/02/2020 06:09	24/02/2020 08:32	24/02/2020 06:09	24/02/2020 08:32	2,38	1	2,38	CHI
202002158308	NIQUELANDIA	NQ21280340	NIQUELANDIA SUBTRANSMISSAO	24/02/2020 06:09	24/02/2020 08:08	24/02/2020 06:09	24/02/2020 08:08	1,98	1	1,98	CHI
202002158309	MINEIROS	MY12035970	PARQUE DAS EMAS	24/02/2020 06:10	24/02/2020 10:31	24/02/2020 06:10	24/02/2020 10:31	4,35	168	730,47	CHI
202002158313	JATAI	JT12000231	JATAI S1	24/02/2020 06:11	24/02/2020 08:51	24/02/2020 06:11	24/02/2020 08:51	2,66	73	194,46	CHI
202002158313	PEROLANDIA	JT12000231	JATAI S1	24/02/2020 06:11	24/02/2020 08:51	24/02/2020 06:11	24/02/2020 08:51	2,66	3	7,99	CHI
202002158315	CACHOEIRA DOURADA	CD12389722	CACHOEIRA DOURADA	24/02/2020 06:11	24/02/2020 08:52	24/02/2020 06:11	24/02/2020 08:52	2,67	138	368,88	CHI
202002158316	CRIXAS	CX21371997	SANTA TEREZINHA	24/02/2020 06:11	24/02/2020 09:30	24/02/2020 06:11	24/02/2020 09:30	3,30	1	3,30	CHI
202002158318	JATAI	JT12331838	JATAI S2	24/02/2020 06:13	24/02/2020 09:09	24/02/2020 06:13	24/02/2020 09:09	2,93	1	2,93	CHI
202002158319	GOIAS	IK12250721	GOIAS	24/02/2020 02:42	24/02/2020 10:28	24/02/2020 02:42	24/02/2020 10:28	7,76	14	108,59	CHI
202002158319	ITABERAI	IK12250721	GOIAS	24/02/2020 02:42	24/02/2020 10:28	24/02/2020 02:42	24/02/2020 10:28	7,76	3	23,27	CHI

202002158319	ITAPURANGA	IK12250721	GOIAS	24/02/2020 02:42	24/02/2020 10:28	24/02/2020 02:42	24/02/2020 10:28	7,76	3	23,27	CHI
202002158324	PORANGATU	PO12022073	PORANGATU	24/02/2020 02:35	24/02/2020 09:08	24/02/2020 02:35	24/02/2020 09:08	6,53	45	294,04	CHI
202002158325	BOM JESUS DE GOIAS	BJ12026228	BOM JESUS DE GOIAS	24/02/2020 06:16	24/02/2020 13:30	24/02/2020 06:16	24/02/2020 13:30	7,22	2	14,44	CHI
202002158327	JUSSARA	JR12364553	BRITANIA	24/02/2020 06:17	24/02/2020 08:43	24/02/2020 06:17	24/02/2020 08:43	2,43	18	43,71	CHI
202002158330	SILVANIA	SV12205355	DAIA S2	24/02/2020 06:18	24/02/2020 08:07	24/02/2020 06:18	24/02/2020 08:07	1,82	4	7,26	CHI
202002158336	MUTUNOPOLIS	MU12086730	MARA ROSA	24/02/2020 06:20	24/02/2020 19:05	24/02/2020 06:20	24/02/2020 19:05	12,74	31	394,89	CHI
202002158339	JUSSARA	JR12073378	BRITANIA	24/02/2020 06:21	24/02/2020 10:59	24/02/2020 06:21	24/02/2020 10:59	4,63	3	13,88	CHI
202002158340	IACIARA	IA21194776	IACIARA S2	24/02/2020 06:21	24/02/2020 09:21	24/02/2020 06:21	24/02/2020 09:21	2,99	1	2,99	CHI
202002158343	PARAUNA	PU12194227	PARAUNA	24/02/2020 06:22	24/02/2020 10:41	24/02/2020 06:22	24/02/2020 10:41	4,30	14	60,24	CHI
202002158343	SAO JOAO DA PARAUNA	PU12194227	PARAUNA	24/02/2020 06:22	24/02/2020 10:41	24/02/2020 06:22	24/02/2020 10:41	4,30	47	202,24	CHI
202002158344	ITAPURANGA	IK12187039	ITAPURANGA	24/02/2020 06:22	24/02/2020 07:10	24/02/2020 06:22	24/02/2020 07:10	0,79	21	16,51	CHI
202002158346	SANTA TEREZA DE GOIAS	SE12390458	MARA ROSA	24/02/2020 06:23	24/02/2020 09:37	24/02/2020 06:23	24/02/2020 09:37	3,23	11	35,57	CHI
202002158347	EDEALINA	ED12390279	PONTALINA	24/02/2020 06:24	24/02/2020 12:30	24/02/2020 06:24	24/02/2020 12:30	6,10	18	109,74	CHI
202002158348	BALIZA	BH12193416	BOM JARDIM	24/02/2020 06:26	24/02/2020 08:29	24/02/2020 06:26	24/02/2020 08:29	2,05	3	6,14	CHI
202002158348	BOM JARDIM DE GOIAS	BH12193416	BOM JARDIM	24/02/2020 06:26	24/02/2020 08:29	24/02/2020 06:26	24/02/2020 08:29	2,05	4	8,18	CHI
202002158350	PIRENOPOLIS	PV12362263	CORUMBA	24/02/2020 06:27	24/02/2020 15:31	24/02/2020 06:27	24/02/2020 15:31	9,05	13	117,68	CHI
202002158351	CRISTALINA	KR12349171	PAMPLONA	24/02/2020 06:28	24/02/2020 09:02	24/02/2020 06:28	24/02/2020 09:02	2,56	1	2,56	CHI
202002158351	LUZIANIA	KR12349171	PAMPLONA	24/02/2020 06:28	24/02/2020 09:02	24/02/2020 06:28	24/02/2020 09:02	2,56	30	76,82	CHI
202002158353	PROFESSOR JAMIL SAFADY	JS12000104	ROCHEDO	24/02/2020 05:28	24/02/2020 19:51	24/02/2020 05:28	24/02/2020 12:52	7,39	16	118,28	CHI
202002158353	PROFESSOR JAMIL SAFADY	JS21239627	ROCHEDO	24/02/2020 05:28	24/02/2020 19:51	24/02/2020 05:28	24/02/2020 19:50	14,37	1	14,37	CHI
202002158353	PROFESSOR JAMIL SAFADY	JS21320276	ROCHEDO	24/02/2020 05:28	24/02/2020 19:51	24/02/2020 05:28	24/02/2020 19:51	14,38	2	28,76	CHI
202002158356	GOIANIA	10797634	CARAJAS S1	24/02/2020 06:29	24/02/2020 08:22	24/02/2020 06:29	24/02/2020 08:22	1,87	1	1,87	CHI
202002158359	PADRE BERNARDO	PB12382213	PADRE BERNARDO	24/02/2020 06:31	24/02/2020 08:55	24/02/2020 06:31	24/02/2020 08:55	2,40	11	26,38	CHI
202002158360	ISRAELANDIA	MO12402985	IPORA	24/02/2020 06:31	24/02/2020 15:53	24/02/2020 06:31	24/02/2020 15:53	9,36	2	18,72	CHI
202002158360	MOIPORA	MO12402985	IPORA	24/02/2020 06:31	24/02/2020 15:53	24/02/2020 06:31	24/02/2020 15:53	9,36	15	140,41	CHI
202002158365	ARAGUAPAZ	RB12022187	ITAPURANGA	24/02/2020 06:32	24/02/2020 12:17	24/02/2020 06:32	24/02/2020 12:17	5,74	1	5,74	CHI
202002158365	MORRO AGUDO DE GOIAS	RB12022187	ITAPURANGA	24/02/2020 06:32	24/02/2020 12:17	24/02/2020 06:32	24/02/2020 12:17	5,74	1	5,74	CHI
202002158365	RUBIATABA	RB12022187	ITAPURANGA	24/02/2020 06:32	24/02/2020 12:17	24/02/2020 06:32	24/02/2020 12:17	5,74	9	51,67	CHI
202002158366	VILA BOA	6071706	IACIARA S2	24/02/2020 06:32	24/02/2020 07:56	24/02/2020 06:32	24/02/2020 07:56	1,39	3	4,17	CHI
202002158367	GOIANESIA	1380002361	GOIANESIA S1	24/02/2020 06:32	24/02/2020 08:55	24/02/2020 06:32	24/02/2020 08:55	2,38	1	2,38	CHI
202002158369	SAO LUIS DE MONTES BELOS	SL32145964	SAO LUIZ DOS MONTES BELOS	24/02/2020 00:45	24/02/2020 08:36	24/02/2020 00:45	24/02/2020 08:36	7,84	36	282,17	CHI
202002158370	FLORES DE GOIAS	FB12211536	IACIARA S2	24/02/2020 06:33	24/02/2020 09:38	24/02/2020 06:33	24/02/2020 09:38	3,08	14	43,14	CHI
202002158373	BONOPOLIS	BX12013030	SAO MIGUEL DO ARAGUAIA	24/02/2020 06:33	24/02/2020 10:42	24/02/2020 06:33	24/02/2020 10:42	4,13	5	20,67	CHI
202002158376	ARUANA	AK11253725	ARUANA	24/02/2020 06:34	24/02/2020 10:44	24/02/2020 06:34	24/02/2020 10:44	4,16	39	162,05	CHI
202002158377	ITAPIRAPUA	IU12073722	MATRINCHA	24/02/2020 06:35	24/02/2020 08:56	24/02/2020 06:35	24/02/2020 08:56	2,35	3	7,04	CHI
202002158378	SAO MIGUEL DO PASSA QUATRO	SV21012190	BELA VISTA S2	24/02/2020 06:35	24/02/2020 08:57	24/02/2020 06:35	24/02/2020 08:57	2,36	1	2,36	CHI
202002158379	CAIAPONIA	CP12241868	CAIAPONIA	24/02/2020 06:35	24/02/2020 07:28	24/02/2020 06:35	24/02/2020 07:28	0,88	6	5,27	CHI
202002158385	GOIANIA	GN12390233	CARAJAS S1	24/02/2020 06:34	24/02/2020 08:08	24/02/2020 06:34	24/02/2020 08:08	1,56	364	567,44	CHI
202002158386	IPORA	IR12251380	IPORA	24/02/2020 05:27	24/02/2020 09:22	24/02/2020 05:27	24/02/2020 09:22	3,90	58	226,47	CHI
202002158387	ITUMBIARA	IT12296860	CACHOEIRA DOURADA	24/02/2020 06:37	24/02/2020 11:51	24/02/2020 06:37	24/02/2020 11:51	5,22	1	5,22	CHI
202002158388	IPORA	IR12172534	IPORA	24/02/2020 06:38	24/02/2020 10:27	24/02/2020 06:38	24/02/2020 10:27	3,82	9	34,34	CHI
202002158388	IVOLANDIA	IR12172534	IPORA	24/02/2020 06:38	24/02/2020 10:27	24/02/2020 06:38	24/02/2020 10:27	3,82	1	3,82	CHI
202002158389	GOIANESIA	GE12016189	GOIANESIA S2	24/02/2020 06:38	24/02/2020 10:17	24/02/2020 06:38	24/02/2020 10:17	3,64	5	18,22	CHI
202002158390	ALTO HORIZONTE	AJ21137959	SANTA TEREZINHA	24/02/2020 06:38	24/02/2020 08:20	24/02/2020 06:38	24/02/2020 08:20	1,69	1	1,69	CHI

202002158394	MIMOSO DE GOIAS	MJ12313854	PADRE BERNARDO	24/02/2020 06:39	24/02/2020 11:14	24/02/2020 06:39	24/02/2020 11:14	4,58	19	86,99	CHI
202002158398	FLORES DE GOIAS	FB12218636	IACIARA S2	24/02/2020 06:40	24/02/2020 12:01	24/02/2020 06:40	24/02/2020 12:01	5,35	4	21,40	CHI
202002158400	SAO DOMINGOS	SD12170547	SAO DOMINGOS	24/02/2020 06:40	24/02/2020 11:33	24/02/2020 06:40	24/02/2020 11:33	4,88	13	63,50	CHI
202002158403	DOVERLANDIA	MY12390600	PARQUE DAS EMAS	24/02/2020 06:41	24/02/2020 12:24	24/02/2020 06:41	24/02/2020 12:24	5,71	1	5,71	CHI
202002158403	MINEIROS	MY12390600	PARQUE DAS EMAS	24/02/2020 06:41	24/02/2020 12:24	24/02/2020 06:41	24/02/2020 12:24	5,71	24	137,05	CHI
202002158404	LUZIANIA	LZ12336007	RIO VERMELHO	24/02/2020 06:41	24/02/2020 08:02	24/02/2020 06:41	24/02/2020 08:02	1,34	86	115,38	CHI
202002158405	GUAPO	GA12310191	GUAPO S2	24/02/2020 06:41	24/02/2020 10:52	24/02/2020 06:41	24/02/2020 10:52	4,17	7	29,18	CHI
202002158406	COCALZINHO DE GOIAS	ZN21112409	AGUAS LINDAS DE GOIAS S2	24/02/2020 06:42	24/02/2020 14:21	24/02/2020 06:42	24/02/2020 14:21	7,65	1	7,65	CHI
202002158407	CATURAI	CK11093363	GOIANIRA	24/02/2020 06:42	24/02/2020 08:51	24/02/2020 06:42	24/02/2020 08:51	2,15	58	124,43	CHI
202002158415	SANTA FE DE GOIAS	RN12055147	BRITANIA	24/02/2020 06:43	24/02/2020 11:55	24/02/2020 06:43	24/02/2020 11:55	5,19	1	5,19	CHI
202002158416	NOVA AURORA	NE12127548	CATALAO S1	24/02/2020 06:43	24/02/2020 09:40	24/02/2020 06:43	24/02/2020 09:40	2,94	39	114,65	CHI
202002158417	PORANGATU	PO12202421	PORANGATU	24/02/2020 06:44	24/02/2020 10:37	24/02/2020 06:44	24/02/2020 10:37	3,88	6	23,26	CHI
202002158418	GOIANESIA	GE12006474	BARRO ALTO	24/02/2020 06:45	24/02/2020 11:32	24/02/2020 06:45	24/02/2020 11:32	4,78	1	4,78	CHI
202002158418	SANTA RITA DO NOVO DESTINO	GE12006474	BARRO ALTO	24/02/2020 06:45	24/02/2020 11:32	24/02/2020 06:45	24/02/2020 11:32	4,78	6	28,68	CHI
202002158418	SAO LUIZ DO NORTE	GE12006474	BARRO ALTO	24/02/2020 06:45	24/02/2020 11:32	24/02/2020 06:45	24/02/2020 11:32	4,78	1	4,78	CHI
202002158419	NOVA CRIXAS	NA12380421	NOVA CRIXAS	24/02/2020 06:45	24/02/2020 09:03	24/02/2020 06:45	24/02/2020 09:03	2,30	48	110,23	CHI
202002158421	SAO MIGUEL DO ARAGUAIA	SM12393949	SAO MIGUEL DO ARAGUAIA	24/02/2020 06:45	24/02/2020 11:56	24/02/2020 06:45	24/02/2020 11:56	5,18	13	67,29	CHI
202002158422	IACIARA	IA12132252	IACIARA S2	24/02/2020 06:45	24/02/2020 14:21	24/02/2020 06:45	24/02/2020 14:21	7,59	2	15,18	CHI
202002158422	POSSE	IA12132252	IACIARA S2	24/02/2020 06:45	24/02/2020 14:21	24/02/2020 06:45	24/02/2020 14:21	7,59	1	7,59	CHI
202002158425	FORMOSA	7194099	ITUIQUIRA	24/02/2020 06:47	24/02/2020 10:10	24/02/2020 06:47	24/02/2020 10:10	3,38	22	74,42	CHI
202002158427	SAO LUIS DE MONTES BELOS	SL32125644	FIRMINOPOLIS S1	24/02/2020 06:47	24/02/2020 08:46	24/02/2020 06:47	24/02/2020 08:46	1,98	15	29,69	CHI
202002158428	PIRANHAS	PH12187444	PIRANHAS	24/02/2020 06:47	24/02/2020 09:31	24/02/2020 06:47	24/02/2020 09:31	2,73	1	2,73	CHI
202002158429	CRISTIANOPOLIS	CF12112079	CRISTIANOPOLIS	24/02/2020 06:47	24/02/2020 09:05	24/02/2020 06:47	24/02/2020 09:05	2,29	5	11,47	CHI
202002158431	SANTA TEREZA DE GOIAS	SE12094686	MARA ROSA	24/02/2020 06:48	24/02/2020 09:14	24/02/2020 06:48	24/02/2020 09:14	2,43	6	14,59	CHI
202002158432	BALIZA	BM12390150	BOM JARDIM	24/02/2020 06:48	24/02/2020 10:13	24/02/2020 06:48	24/02/2020 10:13	3,41	51	173,87	CHI
202002158432	BOM JARDIM DE GOIAS	BM12390150	BOM JARDIM	24/02/2020 06:48	24/02/2020 10:13	24/02/2020 06:48	24/02/2020 10:13	3,41	9	30,68	CHI
202002158433	ORIZONA	OZ21382069	PIRES DO RIO S2	24/02/2020 06:48	24/02/2020 09:20	24/02/2020 06:48	24/02/2020 09:20	2,53	3	7,58	CHI
202002158441	GOIANESIA	GE12000030	GOIANESIA S2	24/02/2020 06:40	24/02/2020 08:25	24/02/2020 06:40	24/02/2020 08:25	1,75	13	22,72	CHI
202002158447	ALTO PARAISO DE GOIAS	BF12245433	FLORES DE GOIAS	23/02/2020 23:10	24/02/2020 20:38	23/02/2020 23:10	24/02/2020 20:38	21,47	9	193,26	CHI
202002158451	AGUA FRIA DE GOIAS	TL21211516	SAO JOAO D ALIANCA	24/02/2020 06:52	24/02/2020 09:29	24/02/2020 06:52	24/02/2020 09:29	2,60	1	2,60	CHI
202002158456	ORIZONA	OZ12000353	PIRES DO RIO S1	24/02/2020 06:53	24/02/2020 09:53	24/02/2020 06:53	24/02/2020 09:53	2,99	34	101,58	CHI
202002158460	RIO VERDE	RV12279609	RIO VERDE S1	24/02/2020 06:54	24/02/2020 08:53	24/02/2020 06:54	24/02/2020 08:53	1,97	31	61,09	CHI
202002158462	IPAMERI	IP21360232	PIRES DO RIO S2	24/02/2020 06:55	24/02/2020 14:15	24/02/2020 06:55	24/02/2020 14:15	7,34	1	7,34	CHI
202002158464	JATAI	JT12378137	JATAI S2	24/02/2020 06:55	24/02/2020 11:34	24/02/2020 06:55	24/02/2020 11:34	4,63	8	37,08	CHI
202002158465	CAMPO ALEGRE DE GOIAS	CM21122428	CAMPO ALEGRE DE GOIAS	24/02/2020 06:56	24/02/2020 10:16	24/02/2020 06:56	24/02/2020 10:16	3,33	1	3,33	CHI
202002158466	BOM JESUS DE GOIAS	DM12303633LD	RIO DOS BOIS	24/02/2020 06:56	24/02/2020 15:20	24/02/2020 06:56	24/02/2020 15:20	8,40	7	58,78	CHI
202002158470	MORRINHOS	MR12212184	MORRINHOS	24/02/2020 06:57	24/02/2020 09:25	24/02/2020 06:57	24/02/2020 09:25	2,46	2	4,91	CHI
202002158472	ARAGUAPAZ	AZ12404519	MOZARLANDIA	24/02/2020 06:58	24/02/2020 11:33	24/02/2020 06:58	24/02/2020 11:33	4,57	10	45,70	CHI
202002158476	ABADIANIA	AA21201395	DAIA S2	24/02/2020 07:00	24/02/2020 10:20	24/02/2020 07:00	24/02/2020 10:20	3,33	2	6,65	CHI
202002158478	FAZENDA NOVA	IS13188399	IPORA	24/02/2020 07:00	24/02/2020 09:31	24/02/2020 07:00	24/02/2020 09:31	2,51	67	167,85	CHI
202002158478	ISRAELANDIA	IS13188399	IPORA	24/02/2020 07:00	24/02/2020 09:31	24/02/2020 07:00	24/02/2020 09:31	2,51	131	328,19	CHI
202002158478	JAUPACI	IS13188399	IPORA	24/02/2020 07:00	24/02/2020 09:31	24/02/2020 07:00	24/02/2020 09:31	2,51	4	10,02	CHI
202002158480	AGUA LIMPA	AL12075702	VILA CORUMBA	24/02/2020 07:01	24/02/2020 10:30	24/02/2020 07:01	24/02/2020 10:30	3,48	2	6,96	CHI
202002158481	AVELINOPOLIS	AV12033564	ANICUNS	24/02/2020 07:01	24/02/2020 11:12	24/02/2020 07:01	24/02/2020 11:12	4,17	4	16,69	CHI

202002158488	GOIAS	GS12071258	GOIAS	24/02/2020 07:02	24/02/2020 16:20	24/02/2020 07:02	24/02/2020 16:20	9,29	91	845,29	CHI
202002158491	PADRE BERNARDO	PB12321774	PADRE BERNARDO	24/02/2020 07:02	24/02/2020 12:53	24/02/2020 07:02	24/02/2020 12:53	5,84	4	23,34	CHI
202002158492	LEOPOLDO DE BULHOES	LB21078508	DAIA S2	24/02/2020 07:02	24/02/2020 09:18	24/02/2020 07:02	24/02/2020 09:18	2,25	2	4,50	CHI
202002158493	AMARALINA	LC12168855	MARA ROSA	24/02/2020 07:03	24/02/2020 10:56	24/02/2020 07:03	24/02/2020 10:56	3,88	35	135,88	CHI
202002158493	MARA ROSA	LC12168855	MARA ROSA	24/02/2020 07:03	24/02/2020 10:56	24/02/2020 07:03	24/02/2020 10:56	3,88	8	31,06	CHI
202002158499	SAO DOMINGOS	SD12389179	SAO DOMINGOS	24/02/2020 07:04	24/02/2020 11:07	24/02/2020 07:04	24/02/2020 11:07	4,05	10	40,47	CHI
202002158530	BURITINOPOLIS	BQ12194634	IACIARA S2	24/02/2020 07:46	24/02/2020 10:31	24/02/2020 07:46	24/02/2020 10:31	2,74	50	136,92	CHI
202002158530	MAMBAI	BQ12194634	IACIARA S2	24/02/2020 07:46	24/02/2020 10:31	24/02/2020 07:46	24/02/2020 10:31	2,74	1	2,74	CHI
202002158549	CAMPOS BELOS	CH21144723	SAO DOMINGOS	24/02/2020 09:18	24/02/2020 11:26	24/02/2020 09:18	24/02/2020 11:26	2,12	1	2,12	CHI
202002158580	VILA PROPICIO	NP21298256	GOIANESIA S1	24/02/2020 11:15	24/02/2020 11:18	24/02/2020 11:15	24/02/2020 11:18	0,06	1	0,06	CHI
202002158605	MOSSAMEDES	SC12376380	FIRMINOPOLIS S2	24/02/2020 07:06	24/02/2020 10:35	24/02/2020 07:06	24/02/2020 10:35	3,48	2	6,97	CHI
202002158605	SANCLERLANDIA	SC12376380	FIRMINOPOLIS S2	24/02/2020 07:06	24/02/2020 10:35	24/02/2020 07:06	24/02/2020 10:35	3,48	2	6,97	CHI
202002158607	SANTO ANTONIO DA BARRA	BZ12400189	ACREUNA	24/02/2020 07:06	24/02/2020 09:46	24/02/2020 07:06	24/02/2020 09:46	2,67	139	370,63	CHI
202002158613	PLANALTINA	PI21325616	PLANALTINA	24/02/2020 07:07	24/02/2020 09:14	24/02/2020 07:07	24/02/2020 09:14	2,11	1	2,11	CHI
202002158614	JATAI	JT21182213	JATAI S3	24/02/2020 07:07	24/02/2020 08:52	24/02/2020 07:07	24/02/2020 08:52	1,74	1	1,74	CHI
202002158615	ANAPOLIS	10012997453	JUNDIAI S2	24/02/2020 07:07	24/02/2020 09:24	24/02/2020 07:07	24/02/2020 09:24	2,27	1	2,27	CHI
202002158619	AMARALINA	LC12270741	SAO MIGUEL DO ARAGUAIA	24/02/2020 06:54	24/02/2020 10:37	24/02/2020 06:54	24/02/2020 10:37	3,71	10	37,08	CHI
202002158627	CACHOEIRA DOURADA	CD12000066	CACHOEIRA DOURADA	24/02/2020 06:49	24/02/2020 17:03	24/02/2020 06:49	24/02/2020 17:03	10,23	11	112,48	CHI
202002158629	FORMOSA	FA12394153	ITIQUEIRA	24/02/2020 07:11	24/02/2020 10:27	24/02/2020 07:11	24/02/2020 10:27	3,26	19	61,88	CHI
202002158637	IPORA	IR12014480	IPORA	24/02/2020 01:27	24/02/2020 08:00	24/02/2020 01:27	24/02/2020 08:00	6,55	13	85,11	CHI
202002158638	SANTA CRUZ DE GOIAS	BC12309408	PIRES DO RIO S2	24/02/2020 07:13	24/02/2020 09:56	24/02/2020 07:13	24/02/2020 09:56	2,71	6	16,28	CHI
202002158639	ITABERAI	IB12090330	ANICUNS	24/02/2020 07:13	24/02/2020 13:21	24/02/2020 07:13	24/02/2020 13:21	6,13	9	55,14	CHI
202002158641	SAO DOMINGOS	SD12161805	SAO DOMINGOS	24/02/2020 07:13	24/02/2020 10:03	24/02/2020 07:13	24/02/2020 10:03	2,82	47	132,75	CHI
202002158642	PALMEIRAS DE GOIAS	590075690	PALMEIRAS	24/02/2020 07:13	24/02/2020 09:08	24/02/2020 07:13	24/02/2020 09:08	1,91	1	1,91	CHI
202002158647	CALDAS NOVAS	CN12332905	CALDAS NOVAS S1	24/02/2020 07:14	24/02/2020 10:59	24/02/2020 07:14	24/02/2020 10:59	3,75	30	112,40	CHI
202002158648	SILVANIA	SV12389456	VIANOPOLIS	24/02/2020 06:32	24/02/2020 09:57	24/02/2020 06:32	24/02/2020 09:57	3,41	109	372,20	CHI
202002158650	ESTRELA DO NORTE	ET12256551	MARA ROSA	24/02/2020 07:15	24/02/2020 09:34	24/02/2020 07:15	24/02/2020 09:34	2,32	9	20,85	CHI
202002158652	SAO JOAO D ALIANCA	JL12269022	SAO JOAO D ALIANCA	24/02/2020 07:15	24/02/2020 09:42	24/02/2020 07:15	24/02/2020 09:42	2,44	1	2,44	CHI
202002158653	PIRACANJUBA	PJ21072759	PIRACANJUBA	24/02/2020 07:15	24/02/2020 08:42	24/02/2020 07:15	24/02/2020 08:42	1,44	1	1,44	CHI
202002158656	GOIATUBA	GT21257185	VICENTINOPOLIS	24/02/2020 07:16	24/02/2020 09:33	24/02/2020 07:16	24/02/2020 09:33	2,27	1	2,27	CHI
202002158659	ITABERAI	IB12300301	ITABERAI S2	24/02/2020 07:17	24/02/2020 15:26	24/02/2020 07:17	24/02/2020 15:26	8,15	2	16,30	CHI
202002158661	NAZARIO	NZ21308567	ANICUNS	24/02/2020 07:17	24/02/2020 09:04	24/02/2020 07:17	24/02/2020 09:04	1,77	1	1,77	CHI
202002158663	NIQUELANDIA	NQ12281264	NIQUELANDIA SUBTRANSMISSAO	24/02/2020 07:18	24/02/2020 09:23	24/02/2020 07:18	24/02/2020 09:23	2,08	32	66,52	CHI
202002158666	CAMPO LIMPO	AN21000533	JUNDIAI S1	24/02/2020 07:18	24/02/2020 08:21	24/02/2020 07:18	24/02/2020 08:21	1,03	3	3,10	CHI
202002158667	SANTO ANTONIO DA BARRA	BZ12301385	ACREUNA	24/02/2020 07:19	24/02/2020 21:05	24/02/2020 07:19	24/02/2020 21:05	13,78	9	124,01	CHI
202002158668	FORMOSA	FA21053565	ITIQUEIRA	24/02/2020 07:19	24/02/2020 09:55	24/02/2020 07:19	24/02/2020 09:55	2,60	1	2,60	CHI
202002158671	CAMPOS VERDES	SG12321954	SANTA TEREZINHA	24/02/2020 07:19	24/02/2020 13:32	24/02/2020 07:19	24/02/2020 13:32	6,20	1	6,20	CHI
202002158671	MARA ROSA	SG12321954	SANTA TEREZINHA	24/02/2020 07:19	24/02/2020 13:32	24/02/2020 07:19	24/02/2020 13:32	6,20	15	93,03	CHI
202002158671	SANTA TEREZINHA DE GOIAS	SG12321954	SANTA TEREZINHA	24/02/2020 07:19	24/02/2020 13:32	24/02/2020 07:19	24/02/2020 13:32	6,20	15	93,03	CHI
202002158676	TROMBAS	TB21052592	PORANGATU	24/02/2020 07:20	24/02/2020 11:37	24/02/2020 07:20	24/02/2020 11:37	4,27	1	4,27	CHI
202002158684	CHAPADAO DO CEU	DJ12131923	CHAPADAO DO CEU	24/02/2020 07:21	24/02/2020 09:36	24/02/2020 07:21	24/02/2020 09:36	2,25	10	22,46	CHI
202002158691	SANTA BARBARA DE GOIAS	6704336	TRINDADE	24/02/2020 07:22	24/02/2020 08:55	24/02/2020 07:22	24/02/2020 08:55	1,54	2	3,07	CHI
202002158692	ACREUNA	EU12045539	ACREUNA	24/02/2020 07:22	24/02/2020 11:57	24/02/2020 07:22	24/02/2020 11:57	4,57	1	4,57	CHI
202002158694	SANTA RITA DO ARAGUAIA	SU12306507	SANTA RITA DO ARAGUAIA	24/02/2020 07:23	26/02/2020 14:10	24/02/2020 07:23	26/02/2020 14:10	54,78	15	821,70	CHI

202002158698	FAINA	FC12158726	GOIAS	24/02/2020 07:23	24/02/2020 10:46	24/02/2020 07:23	24/02/2020 10:46	3,37	4	13,49	CHI
202002158699	GAMELEIRA DE GOIAS	SV12211132	VIANOPOLIS	24/02/2020 06:05	24/02/2020 11:01	24/02/2020 06:05	24/02/2020 11:01	4,93	20	98,63	CHI
202002158699	SILVANIA	SV12211132	VIANOPOLIS	24/02/2020 06:05	24/02/2020 11:01	24/02/2020 06:05	24/02/2020 11:01	4,93	43	212,06	CHI
202002158706	GOIAS	GS21234103	GOIAS	24/02/2020 07:24	24/02/2020 13:41	24/02/2020 07:24	24/02/2020 13:41	6,27	1	6,27	CHI
202002158713	NOVA ROMA	ND21218881	IACIARA S2	24/02/2020 07:25	24/02/2020 09:41	24/02/2020 07:25	24/02/2020 09:41	2,26	1	2,26	CHI
202002158715	SAO LUIS DE MONTES BELOS	SL21151317	SAO LUIZ DOS MONTES BELOS	24/02/2020 07:25	24/02/2020 08:59	24/02/2020 07:25	24/02/2020 08:59	1,55	2	3,11	CHI
202002158718	APARECIDA DE GOIANIA	AP11317630	INDEPENDENCIA S1	24/02/2020 07:02	24/02/2020 09:34	24/02/2020 07:02	24/02/2020 09:34	2,53	76	191,94	CHI
202002158720	GOIANIA	12549733	ATLANTICO S3	24/02/2020 07:26	24/02/2020 09:51	24/02/2020 07:26	24/02/2020 09:51	2,40	1	2,40	CHI
202002158728	RIO VERDE	RV12172877	CABRIUVA S2	24/02/2020 07:29	24/02/2020 09:08	24/02/2020 07:29	24/02/2020 09:08	1,65	12	19,75	CHI
202002158729	CAIAPONIA	CP12204882	CAIAPONIA	24/02/2020 07:29	24/02/2020 12:56	24/02/2020 07:29	24/02/2020 12:56	5,44	72	391,98	CHI
202002158729	DOVERLANDIA	CP12204882	CAIAPONIA	24/02/2020 07:29	24/02/2020 12:56	24/02/2020 07:29	24/02/2020 12:56	5,44	3	16,33	CHI
202002158733	SAO DOMINGOS	SD12132214	SAO DOMINGOS	24/02/2020 07:12	24/02/2020 10:28	24/02/2020 07:12	24/02/2020 10:28	3,27	3	9,80	CHI
202002158738	HIDROLANDIA	HD12034362	CEPAIGO S2	24/02/2020 07:13	24/02/2020 09:45	24/02/2020 07:13	24/02/2020 09:45	2,52	3	7,57	CHI
202002158740	CRIXAS	CX12276585	SERRA DO OURO	24/02/2020 07:31	24/02/2020 10:55	24/02/2020 07:31	24/02/2020 10:55	3,39	2	6,78	CHI
202002158745	ITAJA	IM12303219	CACHOEIRA ALTA	24/02/2020 07:32	24/02/2020 10:59	24/02/2020 07:32	24/02/2020 10:59	3,44	6	20,62	CHI
202002158745	ITARUMA	IM12303219	CACHOEIRA ALTA	24/02/2020 07:32	24/02/2020 10:59	24/02/2020 07:32	24/02/2020 10:59	3,44	2	6,87	CHI
202002158746	BELA VISTA DE GOIAS	BV21360011	BELA VISTA S2	24/02/2020 07:32	24/02/2020 09:42	24/02/2020 07:32	24/02/2020 09:42	2,15	1	2,15	CHI
202002158747	HIDROLANDIA	HD12034363	CEPAIGO S2	24/02/2020 07:04	24/02/2020 12:26	24/02/2020 07:04	24/02/2020 12:26	5,36	2	10,71	CHI
202002158748	HIDROLANDIA	HD1231836	CEPAIGO S2	24/02/2020 07:25	24/02/2020 12:28	24/02/2020 07:25	24/02/2020 12:28	5,05	1	5,05	CHI
202002158755	NOVA CRIXAS	NA12354849	NOVA CRIXAS	24/02/2020 07:34	24/02/2020 11:19	24/02/2020 07:34	24/02/2020 11:19	3,74	17	63,61	CHI
202002158756	CORUMBA DE GOIAS	CB12258175	CORUMBA	24/02/2020 07:34	24/02/2020 11:15	24/02/2020 07:34	24/02/2020 11:15	3,67	18	66,13	CHI
202002158765	PIRES DO RIO	PR21250259	PIRES DO RIO S1	24/02/2020 07:36	24/02/2020 11:57	24/02/2020 07:36	24/02/2020 11:57	4,34	1	4,34	CHI
202002158769	PONTALINA	PK12263505RE	PONTALINA	24/02/2020 07:37	24/02/2020 10:37	24/02/2020 07:37	24/02/2020 10:37	2,99	8	23,96	CHI
202002158772	CAVALCANTE	CJ11380482	SAO DOMINGOS	24/02/2020 07:37	24/02/2020 14:20	24/02/2020 07:37	24/02/2020 14:20	6,70	1	6,70	CHI
202002158776	TROMBAS	TB12288232	PORANGATU	24/02/2020 07:38	24/02/2020 10:30	24/02/2020 07:38	24/02/2020 10:30	2,85	21	59,90	CHI
202002158778	MUNDO NOVO DE GOIAS	MH21320978	NOVA CRIXAS	24/02/2020 07:39	24/02/2020 13:31	24/02/2020 07:39	24/02/2020 13:11	5,53	1	5,53	CHI
202002158778	MUNDO NOVO DE GOIAS	MH12170092	NOVA CRIXAS	24/02/2020 07:39	24/02/2020 13:31	24/02/2020 10:19	24/02/2020 13:31	3,20	14	44,74	CHI
202002158779	UPIRANGA DE GOIAS	CE12063327	RUBIATABA	24/02/2020 07:39	24/02/2020 11:14	24/02/2020 07:39	24/02/2020 11:14	3,57	4	14,30	CHI
202002158783	ITAPIRAPUA	IU12250533	MATRINCHA	24/02/2020 07:40	24/02/2020 13:40	24/02/2020 07:40	24/02/2020 13:40	6,00	1	6,00	CHI
202002158784	PARAUNA	PU12301167	ACREUNA	24/02/2020 06:33	24/02/2020 20:07	24/02/2020 06:33	24/02/2020 20:07	13,56	14	189,90	CHI
202002158789	ITAUCU	IB08618628	INHUMAS S1	24/02/2020 07:41	24/02/2020 12:40	24/02/2020 07:41	24/02/2020 12:40	4,97	2	9,94	CHI
202002158805	PIRACANJUBA	PJ21036130	PIRACANJUBA	24/02/2020 07:44	24/02/2020 08:55	24/02/2020 07:44	24/02/2020 08:55	1,17	1	1,17	CHI
202002158810	DOVERLANDIA	DV12207962	CAIAPONIA	24/02/2020 07:45	25/02/2020 00:04	24/02/2020 07:45	25/02/2020 00:04	16,31	7	114,17	CHI
202002158817	CATALAO	CT11333455	CATALAO S2	24/02/2020 07:46	24/02/2020 10:26	24/02/2020 07:46	24/02/2020 10:26	2,65	26	68,93	CHI
202002158818	APORE	AE21264308	ITAJA S1	24/02/2020 07:47	24/02/2020 10:57	24/02/2020 07:47	24/02/2020 10:57	3,17	2	6,33	CHI
202002158819	FORMOSO	FO12328885	PORANGATU	24/02/2020 07:47	24/02/2020 09:40	24/02/2020 07:47	24/02/2020 09:40	1,88	4	7,53	CHI
202002158819	SANTA TEREZA DE GOIAS	FO12328885	PORANGATU	24/02/2020 07:47	24/02/2020 09:40	24/02/2020 07:47	24/02/2020 09:40	1,88	12	22,58	CHI
202002158823	JATAI	JT12205173	JATAI S1	24/02/2020 07:47	24/02/2020 09:50	24/02/2020 07:47	24/02/2020 09:50	2,04	1	2,04	CHI
202002158826	MINEIROS	MY12296347	PARQUE DAS EMAS	24/02/2020 07:48	24/02/2020 10:45	24/02/2020 07:48	24/02/2020 10:45	2,95	2	5,90	CHI
202002158829	HIDROLANDIA	HD12400510	INDEPENDENCIA S1	24/02/2020 07:48	24/02/2020 12:17	24/02/2020 07:48	24/02/2020 12:17	4,48	2	8,96	CHI
202002158830	SANTO ANTONIO DO DESCOBERTO	2210193601	ALEXANIA	24/02/2020 07:48	24/02/2020 09:27	24/02/2020 07:48	24/02/2020 09:27	1,65	1	1,65	CHI
202002158831	COCALZINHO DE GOIAS	ZN12258524RE	COCALZINHO	24/02/2020 07:16	24/02/2020 19:50	24/02/2020 07:16	24/02/2020 19:50	12,57	54	678,55	CHI
202002158834	FORMOSA	FA21344271	ITUIQUIRA	24/02/2020 07:48	24/02/2020 12:31	24/02/2020 07:48	24/02/2020 12:31	4,71	3	14,12	CHI
202002158835	BARRO ALTO	BA12298193	BARRO ALTO	24/02/2020 07:48	24/02/2020 15:02	24/02/2020 07:48	24/02/2020 15:02	7,22	3	21,65	CHI

202002158837	BONFINOPOLIS	BO12400465	CEPAIGO S2	24/02/2020 07:44	24/02/2020 10:27	24/02/2020 07:44	24/02/2020 10:27	2,71	3	8,14	CHI
202002158837	LEOPOLDO DE BULHOES	BO12400465	CEPAIGO S2	24/02/2020 07:44	24/02/2020 10:27	24/02/2020 07:44	24/02/2020 10:27	2,71	12	32,54	CHI
202002158838	GOIAS	GS21021055	GOIAS	24/02/2020 07:49	24/02/2020 13:32	24/02/2020 07:49	24/02/2020 13:32	5,72	1	5,72	CHI
202002158839	MONTE ALEGRE DE GOIAS	MA21257575	SAO DOMINGOS	24/02/2020 07:49	24/02/2020 08:51	24/02/2020 07:49	24/02/2020 08:51	1,03	1	1,03	CHI
202002158844	PORTELANDIA	PW12209812	PARQUE DAS EMAS	24/02/2020 03:47	24/02/2020 15:01	24/02/2020 03:47	24/02/2020 15:01	11,23	83	931,97	CHI
202002158846	TRINDADE	TR21403323	TRINDADE	24/02/2020 07:50	24/02/2020 10:35	24/02/2020 07:50	24/02/2020 10:35	2,74	1	2,74	CHI
202002158848	SILVANIA	SV21012805	BELA VISTA S2	24/02/2020 07:50	24/02/2020 09:48	24/02/2020 07:50	24/02/2020 09:48	1,95	1	1,95	CHI
202002158854	CRIXAS	CX12190022	RUBIATABA	24/02/2020 07:51	24/02/2020 16:17	24/02/2020 07:51	24/02/2020 16:17	8,43	18	151,75	CHI
202002158855	RUBIATABA	RB12194747	RUBIATABA	24/02/2020 07:21	24/02/2020 11:19	24/02/2020 07:21	24/02/2020 11:19	3,96	12	47,50	CHI
202002158856	ANAPOLIS	21178471	JUNDIAI S2	24/02/2020 07:51	24/02/2020 10:45	24/02/2020 07:51	24/02/2020 10:45	2,89	1	2,89	CHI
202002158863	PARAUNA	PU21239448	PARAUNA	24/02/2020 07:52	25/02/2020 11:29	24/02/2020 07:52	25/02/2020 11:29	27,61	1	27,61	CHI
202002158866	BONOPOLIS	BX12316276	SAO MIGUEL DO ARAGUAIA	24/02/2020 07:01	24/02/2020 13:24	24/02/2020 07:01	24/02/2020 13:24	6,37	4	25,49	CHI
202002158869	RIO VERDE	RV12260575	RIO VERDE S1	24/02/2020 07:53	24/02/2020 10:34	24/02/2020 07:53	24/02/2020 10:34	2,68	2	5,36	CHI
202002158873	PORTEIRAO	CL12230806	RIO DOS BOIS	24/02/2020 07:53	24/02/2020 11:24	24/02/2020 07:53	24/02/2020 11:24	3,51	4	14,04	CHI
202002158873	VICENTINOPOLIS	CL12230806	RIO DOS BOIS	24/02/2020 07:53	24/02/2020 11:24	24/02/2020 07:53	24/02/2020 11:24	3,51	4	14,04	CHI
202002158874	ANAPOLIS	AN11000347	ANAPOLIS UNIVERSITARIO S2	24/02/2020 07:53	24/02/2020 11:28	24/02/2020 07:53	24/02/2020 11:28	3,58	27	96,74	CHI
202002158875	CAIAPONIA	CP12395438	PALESTINA	24/02/2020 07:54	24/02/2020 15:58	24/02/2020 07:54	24/02/2020 15:58	8,07	5	40,33	CHI
202002158875	PALESTINA DE GOIAS	CP12395438	PALESTINA	24/02/2020 07:54	24/02/2020 15:58	24/02/2020 07:54	24/02/2020 15:58	8,07	1	8,07	CHI
202002158878	MINEIROS	10017559284	PARQUE DAS EMAS	24/02/2020 07:54	24/02/2020 14:05	24/02/2020 07:54	24/02/2020 14:05	6,18	1	6,18	CHI
202002158880	CRIXAS	CX12318400	MOZARLANDIA	24/02/2020 07:54	24/02/2020 12:16	24/02/2020 07:54	24/02/2020 12:16	4,35	11	47,86	CHI
202002158884	PIRES DO RIO	PR12051693	PIRES DO RIO S2	24/02/2020 07:47	24/02/2020 12:17	24/02/2020 07:47	24/02/2020 12:17	4,48	14	62,77	CHI
202002158884	SANTA CRUZ DE GOIAS	PR12051693	PIRES DO RIO S2	24/02/2020 07:47	24/02/2020 12:17	24/02/2020 07:47	24/02/2020 12:17	4,48	2	8,97	CHI
202002158885	BOM JESUS DE GOIAS	1250077294	BOM JESUS DE GOIAS	24/02/2020 07:55	24/02/2020 14:47	24/02/2020 07:55	24/02/2020 14:47	6,86	1	6,86	CHI
202002158891	ISRAELANDIA	IS12101895	IPORA	24/02/2020 07:56	24/02/2020 12:03	24/02/2020 07:56	24/02/2020 12:03	4,10	6	24,61	CHI
202002158893	ITABERAI	IB12099038	ITABERAI S2	24/02/2020 07:57	24/02/2020 10:10	24/02/2020 07:57	24/02/2020 10:10	2,21	15	33,14	CHI
202002158897	DOVERLANDIA	DV12155481	CAIAPONIA	24/02/2020 07:59	24/02/2020 11:32	24/02/2020 07:59	24/02/2020 11:32	3,54	5	17,69	CHI
202002158898	GOIANIA	GN11329249	FERROVIARIO S1	24/02/2020 07:59	24/02/2020 09:02	24/02/2020 07:59	24/02/2020 09:02	1,04	23	23,82	CHI
202002158901	JUSSARA	JR12101970RE	BRITANIA	24/02/2020 08:00	24/02/2020 13:23	24/02/2020 08:00	24/02/2020 13:23	5,37	11	59,06	CHI
202002158903	GOIANIA	10628551	AEROPORTO S2	24/02/2020 08:00	24/02/2020 09:30	24/02/2020 08:00	24/02/2020 09:30	1,48	1	1,48	CHI
202002158904	ACREUNA	EU21189129	ACREUNA	24/02/2020 08:01	24/02/2020 19:44	24/02/2020 08:01	24/02/2020 19:44	11,72	1	11,72	CHI
202002158907	CRISTALINA	KR12219776	PAMPLONA	24/02/2020 08:01	24/02/2020 15:30	24/02/2020 08:01	24/02/2020 15:30	7,48	5	37,42	CHI
202002158919	ANICUNS	AC21075589	ANICUNS	24/02/2020 08:02	24/02/2020 09:53	24/02/2020 08:02	24/02/2020 09:53	1,83	1	1,83	CHI
202002158921	MINEIROS	MY12358869	PARQUE DAS EMAS	24/02/2020 05:44	24/02/2020 12:10	24/02/2020 05:44	24/02/2020 12:10	6,42	120	770,77	CHI
202002158921	SANTA RITA DO ARAGUAIA	MY12358869	PARQUE DAS EMAS	24/02/2020 05:44	24/02/2020 12:10	24/02/2020 05:44	24/02/2020 12:10	6,42	4	25,69	CHI
202002158929	MAURILANDIA	ML12303334	RIO DOS BOIS	24/02/2020 07:13	24/02/2020 11:15	24/02/2020 07:13	24/02/2020 11:15	4,02	14	56,29	CHI
202002158929	RIO VERDE	ML12303334	RIO DOS BOIS	24/02/2020 07:13	24/02/2020 11:15	24/02/2020 07:13	24/02/2020 11:15	4,02	2	8,04	CHI
202002158931	SAO FRANCISCO DE GOIAS	SF12084426	SAO FRANCISCO DE GOIAS	24/02/2020 08:03	24/02/2020 09:26	24/02/2020 08:03	24/02/2020 09:26	1,38	5	6,88	CHI
202002158933	MONTIVIDIU DO NORTE	MX12182382	PORANGATU	24/02/2020 08:04	24/02/2020 09:54	24/02/2020 08:04	24/02/2020 09:54	1,83	1	1,83	CHI
202002158934	RIO VERDE	RV21271509	CABRIUVA S2	24/02/2020 08:04	24/02/2020 10:00	24/02/2020 08:04	24/02/2020 10:00	1,92	1	1,92	CHI
202002158938	ALTO PARAISO DE GOIAS	BF12196490	NIQUELANDIA SUBTRANSMISSAO	24/02/2020 08:05	24/02/2020 12:30	24/02/2020 08:05	24/02/2020 12:30	4,41	9	39,71	CHI
202002158940	FAZENDA NOVA	FN12222899	JUSSARA	24/02/2020 08:05	24/02/2020 15:51	24/02/2020 08:05	24/02/2020 15:51	7,75	5	38,77	CHI
202002158943	CORUMBAIBA	CI12391595	VILA CORUMBA	24/02/2020 08:06	24/02/2020 13:36	24/02/2020 08:06	24/02/2020 13:36	5,50	299	1644,25	CHI
202002158944	SENADOR CANEDO	10011284941	SENADOR CANEDO	24/02/2020 08:06	24/02/2020 10:50	24/02/2020 08:06	24/02/2020 10:50	2,73	1	2,73	CHI
202002158948	VARJAO	VJ11000013	GUAPO S2	24/02/2020 08:06	24/02/2020 14:37	24/02/2020 08:06	24/02/2020 14:37	6,51	141	917,79	CHI

202002158951	GOIATUBA	GT12000084	GOIATUBA S2	24/02/2020 07:22	24/02/2020 10:13	24/02/2020 07:22	24/02/2020 10:13	2,85	6	17,07	CHI
202002158955	MINEIROS	MY12260468	PARQUE DAS EMAS	24/02/2020 08:07	24/02/2020 12:32	24/02/2020 08:07	24/02/2020 12:32	4,41	5	22,04	CHI
202002158956	NIQUELANDIA	NQ12294573	BARRO ALTO	24/02/2020 08:07	25/02/2020 00:40	24/02/2020 08:07	25/02/2020 00:40	16,54	3	49,63	CHI
202002158957	IPIRANGA DE GOIAS	RB12194284	RUBIATABA	24/02/2020 08:08	24/02/2020 10:54	24/02/2020 08:08	24/02/2020 10:54	2,77	8	22,13	CHI
202002158960	INDIARA	IY12057315	EDEIA	24/02/2020 08:08	24/02/2020 09:38	24/02/2020 08:08	24/02/2020 09:38	1,49	5	7,47	CHI
202002158961	ABADIANIA	AA21144049	ANAPOLIS UNIVERSITARIO S1	24/02/2020 08:08	24/02/2020 09:45	24/02/2020 08:08	24/02/2020 09:45	1,60	1	1,60	CHI
202002158963	PIRES DO RIO	PR11265546	PIRES DO RIO S1	24/02/2020 08:09	24/02/2020 09:29	24/02/2020 08:09	24/02/2020 09:29	1,34	5	6,72	CHI
202002158967	BELA VISTA DE GOIAS	BV31209923	BELA VISTA S1	24/02/2020 08:09	24/02/2020 09:42	24/02/2020 08:09	24/02/2020 09:42	1,54	1	1,54	CHI
202002158969	JUSSARA	JR21097827	IPORA	24/02/2020 08:09	24/02/2020 23:29	24/02/2020 08:09	24/02/2020 23:29	15,32	1	15,32	CHI
202002158970	BOM JESUS DE GOIAS	BJ12000300	BOM JESUS DE GOIAS	24/02/2020 08:09	24/02/2020 10:21	24/02/2020 08:09	24/02/2020 10:21	2,18	3	6,55	CHI
202002158974	CORUMBA DE GOIAS	CB12382397	CORUMBA	24/02/2020 08:10	24/02/2020 13:02	24/02/2020 08:10	24/02/2020 13:02	4,86	31	150,79	CHI
202002158978	CATALAO	CT12149194	CATALAO S1	24/02/2020 08:10	24/02/2020 10:18	24/02/2020 08:10	24/02/2020 10:18	2,12	8	16,95	CHI
202002158979	JATAI	JT21234383	JATAI S3	24/02/2020 08:11	24/02/2020 09:29	24/02/2020 08:11	24/02/2020 09:29	1,30	1	1,30	CHI
202002158982	GOIANIA	GN11000559	AEROPORTO S1	24/02/2020 08:11	24/02/2020 09:58	24/02/2020 08:11	24/02/2020 09:58	1,77	86	152,01	CHI
202002158985	NIQUELANDIA	10001687911	NIQUELANDIA SUBTRANSMISSAO	24/02/2020 00:53	24/02/2020 08:12	24/02/2020 00:53	24/02/2020 08:12	7,32	1	7,32	CHI
202002158986	CRISTALINA	10018058998	CRISTALINA S1	24/02/2020 08:12	24/02/2020 09:05	24/02/2020 08:12	24/02/2020 09:05	0,87	1	0,87	CHI
202002158994	CRISTALINA	KR12366452	PAMPLONA	24/02/2020 07:00	24/02/2020 11:02	24/02/2020 07:00	24/02/2020 11:02	4,03	10	40,32	CHI
202002158995	ITUMBIARA	IT12296859	CACHOEIRA DOURADA	24/02/2020 08:14	24/02/2020 13:27	24/02/2020 08:14	24/02/2020 13:27	5,20	4	20,81	CHI
202002158997	CATALAO	CT12250389	CATALAO S1	24/02/2020 08:14	24/02/2020 12:00	24/02/2020 08:14	24/02/2020 12:00	3,75	2	7,50	CHI
202002159002	LUZIANIA	LZ21219797	MARAJOARA	24/02/2020 08:15	24/02/2020 11:30	24/02/2020 08:15	24/02/2020 11:30	3,25	1	3,25	CHI
202002159004	JARAGUA	JA12297944	JARAGUA	24/02/2020 08:15	24/02/2020 10:23	24/02/2020 08:15	24/02/2020 10:23	2,12	11	23,37	CHI
202002159005	SAO MIGUEL DO ARAGUAIA	SM12128351	SAO MIGUEL DO ARAGUAIA	24/02/2020 08:15	24/02/2020 11:01	24/02/2020 08:15	24/02/2020 11:01	2,75	20	55,08	CHI
202002159014	MOSSAMEDES	MD21299586	ITABERAI S2	24/02/2020 08:17	24/02/2020 11:43	24/02/2020 08:17	24/02/2020 11:43	3,43	1	3,43	CHI
202002159017	CORUMBAIBA	CI12064619	VILA CORUMBA	24/02/2020 08:16	24/02/2020 12:56	24/02/2020 08:16	24/02/2020 12:56	4,67	36	168,08	CHI
202002159022	SAO LUIS DE MONTES BELOS	SL12306962	FIRMINOPOLIS S2	24/02/2020 06:40	24/02/2020 13:56	24/02/2020 06:40	24/02/2020 13:56	7,26	26	188,70	CHI
202002159031	GOIANIRA	390003967	GOIANIRA	24/02/2020 08:20	24/02/2020 10:32	24/02/2020 08:20	24/02/2020 10:32	2,19	1	2,19	CHI
202002159034	QUIRINOPOLIS	QI21091041	QUIRINOPOLIS	24/02/2020 08:20	24/02/2020 12:32	24/02/2020 08:20	24/02/2020 12:32	4,19	1	4,19	CHI
202002159035	AGUA FRIA DE GOIAS	TL21205644	SAO JOAO D ALIANCA	24/02/2020 08:20	24/02/2020 11:50	24/02/2020 08:20	24/02/2020 11:50	3,49	1	3,49	CHI
202002159038	GOIAS	GS12206865	MATRINCHA	24/02/2020 08:21	24/02/2020 14:28	24/02/2020 08:21	24/02/2020 14:28	6,11	68	415,80	CHI
202002159039	GOUVELANDIA	2250002960	QUIRINOPOLIS	24/02/2020 08:22	24/02/2020 09:50	24/02/2020 08:22	24/02/2020 09:50	1,46	1	1,46	CHI
202002159047	GOIAS	GS12068549	MATRINCHA	24/02/2020 06:32	24/02/2020 17:51	24/02/2020 06:32	24/02/2020 17:51	11,31	8	90,51	CHI
202002159049	ITAPURANGA	IK11000015	ITAPURANGA	24/02/2020 08:24	24/02/2020 16:31	24/02/2020 08:24	24/02/2020 16:31	8,13	131	1064,67	CHI
202002159050	CRIXAS	CX12190247	SANTA TEREZINHA	24/02/2020 07:20	24/02/2020 09:57	24/02/2020 07:20	24/02/2020 09:57	2,60	5	13,02	CHI
202002159052	APARECIDA DE GOIANIA	10021200490	INDEPENDENCIA S1	24/02/2020 08:24	24/02/2020 11:55	24/02/2020 08:24	24/02/2020 11:55	3,51	1	3,51	CHI
202002159053	SAO MIGUEL DO ARAGUAIA	SM12350501	SAO MIGUEL DO ARAGUAIA	24/02/2020 08:24	25/02/2020 05:52	24/02/2020 08:24	25/02/2020 05:52	21,46	6	128,78	CHI
202002159056	NOVA ROMA	6490000229	IACIARA S2	24/02/2020 08:25	24/02/2020 11:46	24/02/2020 08:25	24/02/2020 11:46	3,34	1	3,34	CHI
202002159062	SILVANIA	SV12389473	VIANOPOLIS	24/02/2020 08:26	24/02/2020 11:24	24/02/2020 08:26	24/02/2020 11:24	2,96	10	29,60	CHI
202002159068	MAIRIPOTABA	MR12000060RE	MORRINHOS	24/02/2020 06:11	24/02/2020 11:34	24/02/2020 06:11	24/02/2020 11:34	5,38	15	80,69	CHI
202002159068	MORRINHOS	MR12000060RE	MORRINHOS	24/02/2020 06:11	24/02/2020 11:34	24/02/2020 06:11	24/02/2020 11:34	5,38	32	172,13	CHI
202002159068	PIRACANJUBA	MR12000060RE	MORRINHOS	24/02/2020 06:11	24/02/2020 11:34	24/02/2020 06:11	24/02/2020 11:34	5,38	7	37,65	CHI
202002159068	PONTALINA	MR12000060RE	MORRINHOS	24/02/2020 06:11	24/02/2020 11:34	24/02/2020 06:11	24/02/2020 11:34	5,38	10	53,79	CHI
202002159071	CACU	CC21214267	CACHOEIRA ALTA	24/02/2020 08:27	24/02/2020 10:10	24/02/2020 08:27	24/02/2020 10:10	1,70	1	1,70	CHI
202002159091	PIRENOPOLIS	PV21113068	SAO FRANCISCO DE GOIAS	24/02/2020 08:32	24/02/2020 11:31	24/02/2020 08:32	24/02/2020 11:31	2,98	1	2,98	CHI
202002159092	ABADIANIA	AA12048248	ANAPOLIS UNIVERSITARIO S1	24/02/2020 08:32	24/02/2020 10:57	24/02/2020 08:32	24/02/2020 10:57	2,41	5	12,04	CHI



202002159100	LEOPOLDO DE BULHOES	LB21334094	CEPAIGO S2	24/02/2020 08:33	24/02/2020 12:35	24/02/2020 08:33	24/02/2020 12:35	4,03	4	16,10	CHI
202002159103	ITAJA	IJ12203996	ITAJA S2	24/02/2020 08:33	24/02/2020 13:44	24/02/2020 08:33	24/02/2020 13:44	5,17	2	10,34	CHI
202002159105	ITAPURANGA	IK12299926	ITAPURANGA	24/02/2020 08:33	24/02/2020 10:29	24/02/2020 08:33	24/02/2020 10:29	1,92	20	38,36	CHI
202002159112	CAIAPONIA	CP21204312	PALESTINA	24/02/2020 08:35	24/02/2020 18:38	24/02/2020 08:35	24/02/2020 18:38	10,04	1	10,04	CHI
202002159114	ALEXANIA	AX11398539	ALEXANIA	24/02/2020 08:06	24/02/2020 11:45	24/02/2020 08:06	24/02/2020 11:45	3,64	13	47,36	CHI
202002159125	SANTA CRUZ DE GOIAS	BC21186565	PIRES DO RIO S2	24/02/2020 08:36	24/02/2020 10:48	24/02/2020 08:36	24/02/2020 10:48	2,19	1	2,19	CHI
202002159126	DAVINOPOLIS	IO12037555	CATALAO S1	24/02/2020 08:34	24/02/2020 10:59	24/02/2020 08:34	24/02/2020 10:59	2,41	16	38,62	CHI
202002159126	DISTRITO FEDERAL	IO12037555	CATALAO S1	24/02/2020 08:34	24/02/2020 10:59	24/02/2020 08:34	24/02/2020 10:59	2,41	2	4,83	CHI
202002159127	CATALAO	CT12103631	CATALAO S1	24/02/2020 08:36	24/02/2020 11:22	24/02/2020 08:36	24/02/2020 11:22	2,76	8	22,06	CHI
202002159128	PARAUNA	PU12361896	PARAUNA	24/02/2020 06:32	24/02/2020 18:50	24/02/2020 06:32	24/02/2020 16:37	10,08	12	121,00	CHI
202002159128	PARAUNA	PU12233501LD	PARAUNA	24/02/2020 06:32	24/02/2020 18:50	24/02/2020 06:32	24/02/2020 17:29	10,94	4	43,77	CHI
202002159128	PARAUNA	PU12361896	PARAUNA	24/02/2020 06:32	24/02/2020 18:50	24/02/2020 06:32	24/02/2020 18:50	12,29	3	36,87	CHI
202002159130	GOIANIA	GN21158355	XAVANTES	24/02/2020 08:37	24/02/2020 10:11	24/02/2020 08:37	24/02/2020 10:11	1,57	1	1,57	CHI
202002159131	BARRO ALTO	BA21379422	BARRO ALTO	24/02/2020 08:37	24/02/2020 11:35	24/02/2020 08:37	24/02/2020 11:35	2,97	1	2,97	CHI
202002159135	SANTO ANTONIO DA BARRA	BZ21303297	ACREUNA	24/02/2020 11:16	24/02/2020 19:43	24/02/2020 11:16	24/02/2020 19:43	8,44	1	8,44	CHI
202002159136	PALESTINA DE GOIAS	PY21139071	ARENOPOLIS	24/02/2020 08:50	24/02/2020 12:24	24/02/2020 08:50	24/02/2020 12:24	3,56	1	3,56	CHI
202002159137	GOIAS	GS21116947	GOIAS	24/02/2020 08:38	25/02/2020 08:48	24/02/2020 08:38	25/02/2020 08:48	24,16	1	24,16	CHI
202002159141	CATURAI	CK12018892	INHUMAS S1	24/02/2020 07:43	24/02/2020 10:27	24/02/2020 07:43	24/02/2020 10:27	2,73	5	13,66	CHI
202002159142	DOVERLANDIA	MY12036563	PARQUE DAS EMAS	24/02/2020 07:08	24/02/2020 12:18	24/02/2020 07:08	24/02/2020 12:18	5,15	23	118,54	CHI
202002159143	ARENOPOLIS	DI12188377	ARENOPOLIS	24/02/2020 07:30	24/02/2020 13:11	24/02/2020 07:30	24/02/2020 13:11	5,67	1	5,67	CHI
202002159143	DIORAMA	DI12188377	ARENOPOLIS	24/02/2020 07:30	24/02/2020 13:11	24/02/2020 07:30	24/02/2020 13:11	5,67	12	68,08	CHI
202002159145	RIO VERDE	RV21000306	RIO VERDE S2	24/02/2020 08:39	24/02/2020 12:28	24/02/2020 08:39	24/02/2020 12:28	3,81	1	3,81	CHI
202002159150	SENADOR CANEDO	SW31095082	SENADOR CANEDO	24/02/2020 08:39	24/02/2020 10:31	24/02/2020 08:39	24/02/2020 10:31	1,86	1	1,86	CHI
202002159151	TRES RANCHOS	TH21195269	CATALAO S1	24/02/2020 08:39	24/02/2020 16:58	24/02/2020 08:39	24/02/2020 16:58	8,30	1	8,30	CHI
202002159152	AGUA FRIA DE GOIAS	TL21342470	SAO JOAO D ALIANCA	24/02/2020 08:39	24/02/2020 13:01	24/02/2020 08:39	24/02/2020 13:01	4,35	1	4,35	CHI
202002159155	ALEXANIA	AX12351025	ALEXANIA	24/02/2020 08:39	24/02/2020 13:14	24/02/2020 08:39	24/02/2020 13:14	4,57	21	95,93	CHI
202002159161	GOIANIA	15942387	FERROVIARIO S2	24/02/2020 08:40	24/02/2020 10:13	24/02/2020 08:40	24/02/2020 10:13	1,54	1	1,54	CHI
202002159163	ITAJA	IJ12200688	ITAJA S2	24/02/2020 08:40	24/02/2020 11:45	24/02/2020 08:40	24/02/2020 11:45	3,08	2	6,17	CHI
202002159167	PIRACANJUBA	PJ11148046	PIRACANJUBA	24/02/2020 08:41	24/02/2020 09:54	24/02/2020 08:41	24/02/2020 09:54	1,21	128	154,52	CHI
202002159168	HEITORAI	HE21347158	GOIAS	23/02/2020 20:44	24/02/2020 14:11	23/02/2020 20:44	24/02/2020 14:11	17,45	4	69,79	CHI
202002159169	PIRENOPOLIS	PV21311867	CORUMBA	24/02/2020 08:42	24/02/2020 11:19	24/02/2020 08:42	24/02/2020 11:19	2,61	3	7,84	CHI
202002159172	INACIOLANDIA	ID11305564	CACHOEIRA DOURADA	24/02/2020 08:42	24/02/2020 10:59	24/02/2020 08:42	24/02/2020 10:59	2,27	1	2,27	CHI
202002159183	SAO MIGUEL DO PASSA QUATRO	SQ21244738	CRISTIANOPOLIS	24/02/2020 08:44	24/02/2020 10:52	24/02/2020 08:44	24/02/2020 10:52	2,13	1	2,13	CHI
202002159190	PARAUNA	PU12304548	PARAUNA	24/02/2020 08:45	24/02/2020 19:48	24/02/2020 08:45	24/02/2020 19:48	11,04	3	33,12	CHI
202002159191	GOIANIA	17379064	CARAJAS S2	24/02/2020 08:45	24/02/2020 09:53	24/02/2020 08:45	24/02/2020 09:53	1,12	1	1,12	CHI
202002159205	CRIXAS	CX12235697	SERRA DO OURO	24/02/2020 08:48	24/02/2020 11:48	24/02/2020 08:48	24/02/2020 11:48	2,99	52	155,60	CHI
202002159206	ITABERAI	IB21230567	ITABERAI S1	24/02/2020 08:48	24/02/2020 11:25	24/02/2020 08:48	24/02/2020 11:25	2,61	1	2,61	CHI
202002159219	ALEXANIA	AX21370423	ALEXANIA	24/02/2020 08:49	24/02/2020 13:19	24/02/2020 08:49	24/02/2020 13:19	4,49	2	8,97	CHI
202002159221	ITAPACI	100081708	ITAPACI	24/02/2020 08:49	24/02/2020 14:40	24/02/2020 08:49	24/02/2020 14:40	5,84	1	5,84	CHI
202002159229	RIO VERDE	10020164686	RIO VERDE S2	24/02/2020 08:51	24/02/2020 10:46	24/02/2020 08:51	24/02/2020 10:46	1,91	1	1,91	CHI
202002159230	GOIAS	GS12220477	GOIAS	24/02/2020 07:05	24/02/2020 14:43	24/02/2020 07:05	24/02/2020 14:43	7,62	11	83,83	CHI
202002159246	QUIRINOPOLIS	RV12029069	SANTA HELENA S1	24/02/2020 08:52	24/02/2020 13:00	24/02/2020 08:52	24/02/2020 13:00	4,12	1	4,12	CHI
202002159247	GOIAS	10016177469	GOIAS	24/02/2020 08:52	24/02/2020 11:51	24/02/2020 08:52	24/02/2020 11:51	2,98	1	2,98	CHI
202002159249	PARAUNA	PU12295862	ACREUNA	24/02/2020 08:53	24/02/2020 18:49	24/02/2020 08:53	24/02/2020 18:49	9,93	1	9,93	CHI

202002159255	COCALZINHO DE GOIAS	ZN12302364	COCALZINHO	23/02/2020 15:16	24/02/2020 14:09	23/02/2020 15:16	24/02/2020 14:09	22,87	10	228,70	CHI
202002159262	MONTIVIDIU DO NORTE	MX21384465	PORANGATU	24/02/2020 08:56	24/02/2020 11:25	24/02/2020 08:56	24/02/2020 11:25	2,48	2	4,96	CHI
202002159271	APARECIDA DE GOIANIA	AP11169493	REAL S2	24/02/2020 08:57	24/02/2020 11:55	24/02/2020 08:57	24/02/2020 11:55	2,98	42	125,22	CHI
202002159274	JATAI	JT12260302	JATAI S3	24/02/2020 08:57	24/02/2020 11:37	24/02/2020 08:57	24/02/2020 11:37	2,66	3	7,98	CHI
202002159276	CATALAO	CT21104210	CATALAO S1	24/02/2020 08:57	25/02/2020 09:43	24/02/2020 08:57	25/02/2020 09:43	24,76	1	24,76	CHI
202002159280	ADELANDIA	2330007584	FIRMINOPOLIS S2	24/02/2020 08:58	24/02/2020 11:14	24/02/2020 08:58	24/02/2020 11:14	2,26	1	2,26	CHI
202002159283	LUZIANIA	3200018274	MARAJOARA	24/02/2020 08:58	24/02/2020 11:08	24/02/2020 08:58	24/02/2020 11:08	2,16	1	2,16	CHI
202002159287	CATALAO	CT21333727	CATALAO S1	24/02/2020 08:59	24/02/2020 21:24	24/02/2020 08:59	24/02/2020 21:24	12,42	1	12,42	CHI
202002159289	HEITORAI	03530224	ITAPURANGA	24/02/2020 08:52	24/02/2020 19:00	24/02/2020 08:52	24/02/2020 11:34	2,70	1	2,70	CHI
202002159289	HEITORAI	03530224	ITAPURANGA	24/02/2020 08:52	24/02/2020 19:00	24/02/2020 08:52	24/02/2020 11:54	3,03	43	130,22	CHI
202002159289	GOIAS	03530224	ITAPURANGA	24/02/2020 08:52	24/02/2020 19:00	24/02/2020 08:52	24/02/2020 18:24	9,53	65	619,22	CHI
202002159289	HEITORAI	03530224	ITAPURANGA	24/02/2020 08:52	24/02/2020 19:00	24/02/2020 08:52	24/02/2020 18:24	9,53	103	981,22	CHI
202002159289	ITAPURANGA	03530224	ITAPURANGA	24/02/2020 08:52	24/02/2020 19:00	24/02/2020 08:52	24/02/2020 18:24	9,53	18	171,47	CHI
202002159289	GOIAS	03530224	ITAPURANGA	24/02/2020 08:52	24/02/2020 19:00	24/02/2020 08:52	24/02/2020 19:00	10,13	11	111,41	CHI
202002159289	HEITORAI	03530224	ITAPURANGA	24/02/2020 08:52	24/02/2020 19:00	24/02/2020 08:52	24/02/2020 19:00	10,13	20	202,57	CHI
202002159289	ITAPURANGA	03530224	ITAPURANGA	24/02/2020 08:52	24/02/2020 19:00	24/02/2020 08:52	24/02/2020 19:00	10,13	66	668,49	CHI
202002159305	ITARUMA	IM21143041	CACHOEIRA ALTA	24/02/2020 08:59	24/02/2020 14:06	24/02/2020 08:59	24/02/2020 14:06	5,11	1	5,11	CHI
202002159306	GOIANIA	15360209	CARAJAS S1	24/02/2020 08:59	24/02/2020 10:56	24/02/2020 08:59	24/02/2020 10:56	1,93	1	1,93	CHI
202002159316	ITAGUARU	HE21310516	ITAPURANGA	24/02/2020 09:01	24/02/2020 12:40	24/02/2020 09:01	24/02/2020 12:40	3,65	1	3,65	CHI
202002159317	RIO VERDE	RV12338619	CABRIUVA S2	24/02/2020 09:01	24/02/2020 11:30	24/02/2020 09:01	24/02/2020 11:30	2,48	1	2,48	CHI
202002159318	ANAPOLIS	AN21267965	ANAPOLIS UNIVERSITARIO S2	24/02/2020 09:01	24/02/2020 13:52	24/02/2020 09:01	24/02/2020 13:52	4,84	2	9,68	CHI
202002159319	JARAGUA	JA12278873	JARAGUA	24/02/2020 09:01	24/02/2020 11:40	24/02/2020 09:01	24/02/2020 11:40	2,64	15	39,59	CHI
202002159324	CATALAO	CT12130955	CATALAO S1	24/02/2020 09:02	25/02/2020 08:36	24/02/2020 09:02	25/02/2020 08:36	23,56	5	117,81	CHI
202002159324	DISTRITO FEDERAL	CT12130955	CATALAO S1	24/02/2020 09:02	25/02/2020 08:36	24/02/2020 09:02	25/02/2020 08:36	23,56	1	23,56	CHI
202002159328	SANTA HELENA DE GOIAS	SH21034293	IPEGUARI	24/02/2020 09:03	24/02/2020 11:49	24/02/2020 09:03	24/02/2020 11:49	2,76	1	2,76	CHI
202002159329	APARECIDA DE GOIANIA	15868590	REAL S1	24/02/2020 09:03	24/02/2020 12:29	24/02/2020 09:03	24/02/2020 12:29	3,43	1	3,43	CHI
202002159330	NIQUELANDIA	NQ21262961	NIQUELANDIA SUBTRANSMISSAO	24/02/2020 09:03	24/02/2020 11:28	24/02/2020 09:03	24/02/2020 11:28	2,41	69	166,21	CHI
202002159331	PALMEIRAS DE GOIAS	PL21159052	PALMEIRAS	24/02/2020 09:03	24/02/2020 11:07	24/02/2020 09:03	24/02/2020 11:07	2,06	1	2,06	CHI
202002159339	ARUANA	AK11183260	ARUANA	24/02/2020 05:50	24/02/2020 11:06	24/02/2020 05:50	24/02/2020 11:06	5,26	108	567,75	CHI
202002159342	GOIANIA	12693637	FERROVIARIO S1	24/02/2020 09:05	24/02/2020 09:57	24/02/2020 09:05	24/02/2020 09:57	0,86	1	0,86	CHI
202002159344	RIO VERDE	630510076	RIO VERDE S1	24/02/2020 09:05	24/02/2020 10:49	24/02/2020 09:05	24/02/2020 10:49	1,74	1	1,74	CHI
202002159346	PIRENOPOLIS	220032907	CORUMBA	24/02/2020 09:05	24/02/2020 11:30	24/02/2020 09:05	24/02/2020 11:30	2,41	1	2,41	CHI
202002159351	ITAGUARI	II2220226	ITABERAI S1	24/02/2020 09:06	24/02/2020 10:33	24/02/2020 09:06	24/02/2020 10:33	1,44	7	10,10	CHI
202002159356	BALIZA	BH21358045	BOM JARDIM	24/02/2020 09:06	24/02/2020 10:35	24/02/2020 09:06	24/02/2020 10:35	1,47	1	1,47	CHI
202002159358	GOIANESIA	550134372	GOIANESIA S2	24/02/2020 09:07	24/02/2020 16:06	24/02/2020 09:07	24/02/2020 16:06	6,99	1	6,99	CHI
202002159359	HIDROLANDIA	HD31088355	CEPAIGO S2	24/02/2020 09:07	24/02/2020 11:59	24/02/2020 09:07	24/02/2020 11:59	2,86	1	2,86	CHI
202002159360	CAMPINORTE	10005801468	CAMPINORTE	24/02/2020 09:07	24/02/2020 11:24	24/02/2020 09:07	24/02/2020 11:24	2,28	1	2,28	CHI
202002159363	CALDAS NOVAS	CN12363792	SERRA DE CALDAS	24/02/2020 08:20	24/02/2020 12:11	24/02/2020 08:20	24/02/2020 12:11	3,84	125	479,62	CHI
202002159364	ORIZONA	OZ21186672	PIRES DO RIO S2	24/02/2020 09:07	24/02/2020 10:57	24/02/2020 09:07	24/02/2020 10:57	1,82	1	1,82	CHI
202002159368	ACREUNA	2440073216	ACREUNA	24/02/2020 09:08	24/02/2020 13:12	24/02/2020 09:08	24/02/2020 13:12	4,06	1	4,06	CHI
202002159374	CABECEIRAS	860010545	ITUIQUIRA	24/02/2020 09:09	24/02/2020 11:08	24/02/2020 09:09	24/02/2020 11:08	1,98	1	1,98	CHI
202002159375	MORRINHOS	MR12033194	MORRINHOS	24/02/2020 09:09	24/02/2020 12:08	24/02/2020 09:09	24/02/2020 12:08	2,98	15	44,68	CHI
202002159376	CACHOEIRA DOURADA	CD11273892	CACHOEIRA DOURADA	24/02/2020 09:09	24/02/2020 10:07	24/02/2020 09:09	24/02/2020 10:07	0,96	3	2,89	CHI
202002159380	PIRACANJUBA	PJ21154681	CALDAS NOVAS S1	24/02/2020 09:10	24/02/2020 11:11	24/02/2020 09:10	24/02/2020 11:11	2,01	1	2,01	CHI

202002159381	JATAI	JT12061503	JATAI S2	24/02/2020 09:10	24/02/2020 10:59	24/02/2020 09:10	24/02/2020 10:59	1,81	5	9,06	CHI
202002159384	CRISTALINA	KR21163150	CRISTALINA S1	24/02/2020 09:11	24/02/2020 11:00	24/02/2020 09:11	24/02/2020 11:00	1,82	1	1,82	CHI
202002159386	GOIATUBA	GT12000100	GOIATUBA S2	24/02/2020 08:27	24/02/2020 10:33	24/02/2020 08:27	24/02/2020 10:33	2,09	20	41,86	CHI
202002159389	ANAPOLIS	AN12080965	ANAPOLIS UNIVERSITARIO S1	24/02/2020 09:11	24/02/2020 13:02	24/02/2020 09:11	24/02/2020 13:02	3,84	14	53,73	CHI
202002159390	GOIANIA	13972595	MEIA PONTE	24/02/2020 09:11	24/02/2020 11:11	24/02/2020 09:11	24/02/2020 11:11	1,99	1	1,99	CHI
202002159392	TRINDADE	TR11382783	TRINDADE	24/02/2020 08:44	24/02/2020 11:32	24/02/2020 08:44	24/02/2020 11:32	2,80	64	179,02	CHI
202002159395	CACU	CC21033599	CACHOEIRA ALTA	24/02/2020 09:13	24/02/2020 11:50	24/02/2020 09:13	24/02/2020 11:50	2,62	2	5,25	CHI
202002159396	JATAI	JT12377889	JATAI S1	24/02/2020 09:13	24/02/2020 16:14	24/02/2020 09:13	24/02/2020 16:14	7,01	5	35,03	CHI
202002159398	ANAPOLIS	TJ21353473	DAIA S2	24/02/2020 09:13	24/02/2020 10:42	24/02/2020 09:13	24/02/2020 10:42	1,47	1	1,47	CHI
202002159401	ITAPURANGA	IK21310369	ITAPURANGA	24/02/2020 09:14	24/02/2020 17:46	24/02/2020 09:14	24/02/2020 17:43	8,49	1	8,49	CHI
202002159401	ITAPURANGA	IK12221196	ITAPURANGA	24/02/2020 09:14	24/02/2020 17:46	24/02/2020 17:06	24/02/2020 17:46	0,67	13	8,72	CHI
202002159402	DIORAMA	DI21065671	IPORA	24/02/2020 09:14	24/02/2020 21:48	24/02/2020 09:14	24/02/2020 21:48	12,56	1	12,56	CHI
202002159417	CORUMBAIBA	CI12035404	VILA CORUMBA	24/02/2020 07:13	24/02/2020 11:01	24/02/2020 07:13	24/02/2020 11:01	3,79	85	322,34	CHI
202002159422	GOIANIA	TR12082347	GOYA S2	24/02/2020 07:51	24/02/2020 10:07	24/02/2020 07:51	24/02/2020 10:07	2,25	48	108,13	CHI
202002159422	TRINDADE	TR12082347	GOYA S2	24/02/2020 07:51	24/02/2020 10:07	24/02/2020 07:51	24/02/2020 10:07	2,25	109	245,55	CHI
202002159433	CRISTALINA	KR12323377	PAMPLONA	24/02/2020 09:19	24/02/2020 15:11	24/02/2020 09:19	24/02/2020 15:11	5,86	1	5,86	CHI
202002159434	LUZIANIA	LZ11041555	RIO VERMELHO	24/02/2020 09:19	24/02/2020 09:49	24/02/2020 09:19	24/02/2020 09:49	0,49	173	85,44	CHI
202002159436	BURITI ALEGRE	BG12263593	ITUMBIARA VELHA S2	24/02/2020 09:19	24/02/2020 12:34	24/02/2020 09:19	24/02/2020 12:34	3,24	4	12,97	CHI
202002159438	ESTRELA DO NORTE	2420014917	MARA ROSA	24/02/2020 09:19	24/02/2020 10:39	24/02/2020 09:19	24/02/2020 10:39	1,32	1	1,32	CHI
202002159439	GOIANIA	GN12133742	GOYA S1	24/02/2020 09:04	24/02/2020 15:39	24/02/2020 09:04	24/02/2020 15:39	6,59	89	586,61	CHI
202002159441	SAO LUIS DE MONTES BELOS	SL32154604	FIRMINOPOLIS S2	24/02/2020 09:20	24/02/2020 10:28	24/02/2020 09:20	24/02/2020 10:28	1,12	2	2,24	CHI
202002159449	GOIANESIA	BA21063283	GOIANESIA S2	24/02/2020 09:23	24/02/2020 11:43	24/02/2020 09:23	24/02/2020 11:43	2,34	1	2,34	CHI
202002159456	FORMOSA	FA21322668	ITUIQUIRA	24/02/2020 09:24	24/02/2020 11:54	24/02/2020 09:24	24/02/2020 11:54	2,49	1	2,49	CHI
202002159464	VIANOPOLIS	VN21275110	VIANOPOLIS	24/02/2020 09:25	24/02/2020 11:17	24/02/2020 09:25	24/02/2020 11:17	1,85	1	1,85	CHI
202002159466	GOIANIA	GN11281853	REAL S2	24/02/2020 09:26	24/02/2020 11:40	24/02/2020 09:26	24/02/2020 11:40	2,23	94	209,28	CHI
202002159467	CRISTALINA	3490009160	PAMPLONA	24/02/2020 09:26	24/02/2020 11:28	24/02/2020 09:26	24/02/2020 11:28	2,03	1	2,03	CHI
202002159468	FAZENDA NOVA	FN12096201	JUSSARA	24/02/2020 09:26	25/02/2020 08:10	24/02/2020 09:26	25/02/2020 08:10	22,73	5	113,65	CHI
202002159470	SERRANOPOLIS	SX21166098	JATAI S1	24/02/2020 09:26	24/02/2020 15:15	24/02/2020 09:26	24/02/2020 15:15	5,80	1	5,80	CHI
202002159474	INACIOLANDIA	ID21015520	QUIRINOPOLIS	24/02/2020 09:27	24/02/2020 12:31	24/02/2020 09:27	24/02/2020 12:31	3,06	2	6,12	CHI
202002159475	ITUMBIARA	IT21373955	PARANAIBA	24/02/2020 09:27	24/02/2020 16:15	24/02/2020 09:27	24/02/2020 16:15	6,79	1	6,79	CHI
202002159479	JUSSARA	7754567	BRITANIA	24/02/2020 07:06	24/02/2020 16:00	24/02/2020 07:06	24/02/2020 16:00	8,90	1	8,90	CHI
202002159479	MONTES CLAROS DE GOIAS	7754567	BRITANIA	24/02/2020 07:06	24/02/2020 16:00	24/02/2020 07:06	24/02/2020 16:00	8,90	49	435,95	CHI
202002159481	CACU	CC21193985	CACHOEIRA ALTA	24/02/2020 09:28	25/02/2020 01:19	24/02/2020 09:28	25/02/2020 01:19	15,85	1	15,85	CHI
202002159483	GOIANIA	10996850	FERROVIARIO S2	24/02/2020 09:29	24/02/2020 11:47	24/02/2020 09:29	24/02/2020 11:47	2,30	1	2,30	CHI
202002159484	BELA VISTA DE GOIAS	10000477611	BELA VISTA S1	24/02/2020 09:29	24/02/2020 10:04	24/02/2020 09:29	24/02/2020 10:04	0,58	1	0,58	CHI
202002159489	ALVORADA DO NORTE	1510013092	IACIARA S2	24/02/2020 09:29	24/02/2020 11:28	24/02/2020 09:29	24/02/2020 11:28	1,97	1	1,97	CHI
202002159491	NEROPOLIS	NR21268874	NEROPOLIS S2	24/02/2020 09:29	24/02/2020 11:06	24/02/2020 09:29	24/02/2020 11:06	1,60	2	3,21	CHI
202002159494	SENADOR CANEDO	190120459	SENADOR CANEDO	24/02/2020 09:30	24/02/2020 12:27	24/02/2020 09:30	24/02/2020 12:27	2,94	1	2,94	CHI
202002159514	CAIAPONIA	IV12249611	IPORA	24/02/2020 09:31	25/02/2020 08:21	24/02/2020 09:31	25/02/2020 08:21	22,82	2	45,63	CHI
202002159514	IVOLANDIA	IV12249611	IPORA	24/02/2020 09:31	25/02/2020 08:21	24/02/2020 09:31	25/02/2020 08:21	22,82	7	159,72	CHI
202002159515	CAIAPONIA	CP12067935	CAIAPONIA	24/02/2020 08:54	24/02/2020 12:58	24/02/2020 08:54	24/02/2020 12:58	4,07	6	24,40	CHI
202002159521	IPORA	IR21031703	IPORA	24/02/2020 09:33	24/02/2020 11:32	24/02/2020 09:33	24/02/2020 11:32	1,98	1	1,98	CHI
202002159522	ANAPOLIS	20933824	JUNDIAI S1	24/02/2020 09:33	24/02/2020 11:58	24/02/2020 09:33	24/02/2020 11:58	2,41	1	2,41	CHI
202002159525	JATAI	JT12187731	JATAI S2	24/02/2020 09:34	24/02/2020 14:29	24/02/2020 09:34	24/02/2020 14:29	4,92	3	14,75	CHI

202002159526	JANDAIA	JD12308473	PALMEIRAS	24/02/2020 09:35	24/02/2020 10:59	24/02/2020 09:35	24/02/2020 10:59	1,40	7	9,78	CHI
202002159527	APARECIDA DE GOIANIA	11814937	INDEPENDENCIA S1	24/02/2020 09:35	24/02/2020 15:38	24/02/2020 09:35	24/02/2020 15:38	6,04	1	6,04	CHI
202002159528	SENADOR CANEDO	SW12079060	CEPAIGO S2	24/02/2020 09:36	24/02/2020 11:51	24/02/2020 09:36	24/02/2020 11:51	2,25	107	240,57	CHI
202002159531	CRISTALINA	KR11276430	CRISTALINA S2	24/02/2020 09:36	24/02/2020 17:30	24/02/2020 09:36	24/02/2020 17:30	7,89	1	7,89	CHI
202002159536	ANAPOLIS	21172328	ANAPOLIS UNIVERSITARIO S2	24/02/2020 09:38	24/02/2020 15:17	24/02/2020 09:38	24/02/2020 15:17	5,64	1	5,64	CHI
202002159541	GOIANIA	12234047	FERROVIARIO S1	24/02/2020 09:39	24/02/2020 10:48	24/02/2020 09:39	24/02/2020 10:48	1,14	1	1,14	CHI
202002159546	MONTES CLAROS DE GOIAS	ME21094773	IPORA	24/02/2020 09:40	24/02/2020 20:32	24/02/2020 09:40	24/02/2020 20:32	10,85	1	10,85	CHI
202002159549	BARRO ALTO	BA21239003	BARRO ALTO	24/02/2020 09:41	24/02/2020 15:42	24/02/2020 09:41	24/02/2020 15:42	6,01	1	6,01	CHI
202002159552	EDEIA	EA12043986	EDEIA	24/02/2020 09:42	24/02/2020 15:05	24/02/2020 09:42	24/02/2020 15:05	5,38	2	10,77	CHI
202002159554	NAZARIO	NZ12000054	ANICUNS	24/02/2020 09:25	24/02/2020 11:35	24/02/2020 09:25	24/02/2020 11:35	2,15	3	6,46	CHI
202002159554	PALMEIRAS DE GOIAS	NZ12000054	ANICUNS	24/02/2020 09:25	24/02/2020 11:35	24/02/2020 09:25	24/02/2020 11:35	2,15	18	38,78	CHI
202002159554	SANTA BARBARA DE GOIAS	NZ12000054	ANICUNS	24/02/2020 09:25	24/02/2020 11:35	24/02/2020 09:25	24/02/2020 11:35	2,15	20	43,09	CHI
202002159556	NOVO GAMA	10005053550	MARAJOARA	24/02/2020 09:42	24/02/2020 12:02	24/02/2020 09:42	24/02/2020 12:02	2,32	1	2,32	CHI
202002159557	APARECIDA DE GOIANIA	AP11137770	INDEPENDENCIA S2	24/02/2020 09:42	24/02/2020 11:03	24/02/2020 09:42	24/02/2020 11:03	1,34	29	38,77	CHI
202002159560	IPAMERI	IP12000066	IPAMERI	24/02/2020 09:43	24/02/2020 11:37	24/02/2020 09:43	24/02/2020 11:37	1,90	5	9,49	CHI
202002159561	GOIATUBA	MR21048483	GOIATUBA S2	24/02/2020 09:43	24/02/2020 17:17	24/02/2020 09:43	24/02/2020 17:17	7,56	1	7,56	CHI
202002159564	MUNDO NOVO DE GOIAS	MH12274898	NOVA CRIXAS	24/02/2020 09:37	24/02/2020 13:09	24/02/2020 09:37	24/02/2020 13:09	3,53	2	7,05	CHI
202002159566	ARUANA	AK11183262	ARUANA	24/02/2020 08:51	24/02/2020 13:25	24/02/2020 08:51	24/02/2020 13:25	4,55	87	395,90	CHI
202002159571	HIDROLANDIA	HD21007385	CEPAIGO S2	24/02/2020 09:45	24/02/2020 14:49	24/02/2020 09:45	24/02/2020 14:49	5,06	1	5,06	CHI
202002159572	TURVANIA	TV21028193	FIRMINOPOLIS S2	24/02/2020 09:45	24/02/2020 16:55	24/02/2020 09:45	24/02/2020 16:55	7,16	1	7,16	CHI
202002159578	GOIANIA	GN11226773	GOIANIA LESTE S3	24/02/2020 09:46	24/02/2020 11:44	24/02/2020 09:46	24/02/2020 11:44	1,96	53	104,04	CHI
202002159579	RIO VERDE	630207070	CABRIUVA S1	24/02/2020 09:46	24/02/2020 13:27	24/02/2020 09:46	24/02/2020 13:27	3,68	1	3,68	CHI
202002159580	SANTA FE DE GOIAS	RN12089861	BRITANIA	24/02/2020 09:46	24/02/2020 17:51	24/02/2020 09:46	24/02/2020 17:51	8,08	7	56,53	CHI
202002159582	GOIATUBA	GT12203427	BOM JESUS DE GOIAS	24/02/2020 09:46	24/02/2020 12:01	24/02/2020 09:46	24/02/2020 12:01	2,24	2	4,48	CHI
202002159585	PALESTINA DE GOIAS	PY12023472	PALESTINA	24/02/2020 09:33	24/02/2020 21:16	24/02/2020 09:33	24/02/2020 21:16	11,72	7	82,02	CHI
202002159588	ITUMBIARA	IT21305605	ITUMBIARA NOVA	24/02/2020 09:46	25/02/2020 09:21	24/02/2020 09:46	25/02/2020 09:21	23,57	2	47,14	CHI
202002159590	INHUMAS	IN12216381	INHUMAS S1	24/02/2020 09:47	24/02/2020 12:13	24/02/2020 09:47	24/02/2020 12:13	2,42	4	9,70	CHI
202002159592	TRES RANCHOS	TH11000132	CATALAO S1	24/02/2020 09:07	24/02/2020 14:06	24/02/2020 09:07	24/02/2020 14:06	4,98	91	452,80	CHI
202002159595	MINACU	IH12396739	MINACU	24/02/2020 07:24	24/02/2020 13:09	24/02/2020 07:24	24/02/2020 13:09	5,74	16	91,92	CHI
202002159599	TRES RANCHOS	TH11000133	CATALAO S1	24/02/2020 08:58	24/02/2020 13:45	24/02/2020 08:58	24/02/2020 13:45	4,77	75	357,65	CHI
202002159600	CATALAO	CT21152868	IPAMERI	24/02/2020 09:50	25/02/2020 08:49	24/02/2020 09:50	25/02/2020 08:49	22,98	1	22,98	CHI
202002159611	PORANGATU	PO12208396	PORANGATU	24/02/2020 09:53	24/02/2020 13:00	24/02/2020 09:53	24/02/2020 13:00	3,11	1	3,11	CHI
202002159614	MINEIROS	MY12156850	PARQUE DAS EMAS	24/02/2020 06:46	24/02/2020 13:57	24/02/2020 06:46	24/02/2020 13:57	7,18	30	215,32	CHI
202002159622	CAIAPONIA	CP12356629	PIRANHAS	24/02/2020 09:56	24/02/2020 17:37	24/02/2020 09:56	24/02/2020 17:37	7,67	1	7,67	CHI
202002159625	ARUANA	AK11216406	ARUANA	24/02/2020 09:57	24/02/2020 11:26	24/02/2020 09:57	24/02/2020 11:26	1,47	71	104,57	CHI
202002159626	APORE	AE21391170	ITAJA S1	24/02/2020 09:57	24/02/2020 16:39	24/02/2020 09:57	24/02/2020 16:39	6,69	1	6,69	CHI
202002159630	CACU	CC12085722	CACHOEIRA ALTA	24/02/2020 09:58	25/02/2020 11:59	24/02/2020 09:58	25/02/2020 11:59	26,00	4	104,01	CHI
202002159631	EDEALINA	ED21128654	PONTALINA	24/02/2020 09:58	24/02/2020 12:04	24/02/2020 09:58	24/02/2020 12:04	2,09	1	2,09	CHI
202002159633	ORIZONA	OZ21109809	PIRES DO RIO S2	24/02/2020 09:58	24/02/2020 14:00	24/02/2020 09:58	24/02/2020 14:00	4,02	1	4,02	CHI
202002159638	CEZARINA	CZ21363385	GUAPO S2	24/02/2020 10:00	24/02/2020 11:39	24/02/2020 10:00	24/02/2020 11:39	1,65	18	29,69	CHI
202002159651	QUIRINOPOLIS	QI31094258	QUIRINOPOLIS	24/02/2020 10:01	24/02/2020 13:36	24/02/2020 10:01	24/02/2020 13:36	3,58	1	3,58	CHI
202002159655	BRITANIA	BT12183239	BRITANIA	24/02/2020 10:02	25/02/2020 12:31	24/02/2020 10:02	25/02/2020 12:31	26,48	1	26,48	CHI
202002159657	ABADIA DE GOIAS	O1760424	TRINDADE	24/02/2020 09:53	24/02/2020 22:39	24/02/2020 09:53	24/02/2020 10:01	0,12	1	0,12	CHI
202002159657	GUAPO	O1760424	TRINDADE	24/02/2020 09:53	24/02/2020 22:39	24/02/2020 09:53	24/02/2020 10:01	0,12	21	2,54	CHI

202002159657	TRINDADE	01760424	TRINDADE	24/02/2020 09:53	24/02/2020 22:39	24/02/2020 09:53	24/02/2020 10:01	0,12	24	2,91	CHI
202002159657	ABADIA DE GOIAS	01760424	TRINDADE	24/02/2020 09:53	24/02/2020 22:39	24/02/2020 09:53	24/02/2020 11:58	2,07	6	12,41	CHI
202002159657	CAMPESTRE DE GOIAS	01760424	TRINDADE	24/02/2020 09:53	24/02/2020 22:39	24/02/2020 09:53	24/02/2020 11:58	2,07	1377	2848,10	CHI
202002159657	CAMPESTRE DE GOIAS	GC10383765	TRINDADE	24/02/2020 09:53	24/02/2020 22:39	24/02/2020 09:53	24/02/2020 11:58	2,07	7	14,48	CHI
202002159657	PALMEIRAS DE GOIAS	01760424	TRINDADE	24/02/2020 09:53	24/02/2020 22:39	24/02/2020 09:53	24/02/2020 11:58	2,07	13	26,89	CHI
202002159657	PALMEIRAS DE GOIAS	GC10383765	TRINDADE	24/02/2020 09:53	24/02/2020 22:39	24/02/2020 09:53	24/02/2020 11:58	2,07	1	2,07	CHI
202002159657	SANTA BARBARA DE GOIAS	01760424	TRINDADE	24/02/2020 09:53	24/02/2020 22:39	24/02/2020 09:53	24/02/2020 11:58	2,07	10	20,68	CHI
202002159657	TRINDADE	01760424	TRINDADE	24/02/2020 09:53	24/02/2020 22:39	24/02/2020 09:53	24/02/2020 11:58	2,07	464	959,71	CHI
202002159657	TRINDADE	01760424	TRINDADE	24/02/2020 09:53	24/02/2020 22:39	24/02/2020 09:53	24/02/2020 11:58	2,07	4	8,27	CHI
202002159657	TRINDADE	GC10383765	TRINDADE	24/02/2020 09:53	24/02/2020 22:39	24/02/2020 09:53	24/02/2020 11:58	2,07	31	64,12	CHI
202002159657	ABADIA DE GOIAS	01760424	TRINDADE	24/02/2020 09:53	24/02/2020 22:39	24/02/2020 09:53	24/02/2020 13:33	3,66	2	7,32	CHI
202002159657	TRINDADE	01760424	TRINDADE	24/02/2020 09:53	24/02/2020 22:39	24/02/2020 09:53	24/02/2020 13:33	3,66	31	113,39	CHI
202002159657	TRINDADE	01760424	TRINDADE	24/02/2020 09:53	24/02/2020 22:39	24/02/2020 09:53	24/02/2020 22:39	12,77	45	574,53	CHI
202002159661	CRISTALINA	KR21212026	PAMPLONA	24/02/2020 10:03	24/02/2020 13:13	24/02/2020 10:03	24/02/2020 13:13	3,16	2	6,32	CHI
202002159663	CATALAO	10026861540	CATALAO S2	24/02/2020 10:04	24/02/2020 13:35	24/02/2020 10:04	24/02/2020 13:35	3,52	1	3,52	CHI
202002159667	ANAPOLIS	AN21221320	ANAPOLIS UNIVERSITARIO S1	24/02/2020 10:04	24/02/2020 11:48	24/02/2020 10:04	24/02/2020 11:48	1,72	1	1,72	CHI
202002159670	TRINDADE	10011238001	GOYA S2	24/02/2020 10:05	24/02/2020 13:40	24/02/2020 10:05	24/02/2020 13:40	3,58	1	3,58	CHI
202002159677	FAINA	FC21196420	GOIAS	24/02/2020 10:06	25/02/2020 00:05	24/02/2020 10:06	25/02/2020 00:05	13,97	1	13,97	CHI
202002159678	NEROPOLIS	NR21009835	NEROPOLIS S2	24/02/2020 10:07	24/02/2020 13:24	24/02/2020 10:07	24/02/2020 13:24	3,28	2	6,56	CHI
202002159679	MONTIVIDIU	RV12384572B	MONTIVIDIU T	24/02/2020 10:02	24/02/2020 10:53	24/02/2020 10:02	24/02/2020 10:53	0,83	6	5,00	CHI
202002159680	CAMPINORTE	CR12309721	MARA ROSA	24/02/2020 08:44	24/02/2020 12:40	24/02/2020 08:44	24/02/2020 12:40	3,93	4	15,70	CHI
202002159680	NOVA IGUACU DE GOIAS	CR12309721	MARA ROSA	24/02/2020 08:44	24/02/2020 12:40	24/02/2020 08:44	24/02/2020 12:40	3,93	2	7,85	CHI
202002159683	GOIANIA	10028854452	CARAJAS S2	24/02/2020 10:08	24/02/2020 11:41	24/02/2020 10:08	24/02/2020 11:41	1,53	1	1,53	CHI
202002159684	EDEALINA	ED21182626	EDEIA	24/02/2020 10:09	24/02/2020 22:25	24/02/2020 10:09	24/02/2020 22:25	12,27	2	24,53	CHI
202002159685	CATALAO	CT21192558	CATALAO S1	24/02/2020 10:09	24/02/2020 15:34	24/02/2020 10:09	24/02/2020 15:34	5,41	1	5,41	CHI
202002159687	JATAI	JT12354973	JATAI S1	24/02/2020 09:53	24/02/2020 14:18	24/02/2020 09:53	24/02/2020 14:18	4,40	34	149,75	CHI
202002159689	JARAGUA	JA12298079	JARAGUA	24/02/2020 10:10	24/02/2020 11:35	24/02/2020 10:10	24/02/2020 11:35	1,41	10	14,07	CHI
202002159691	ORIZONA	OZ21114936	PIRES DO RIO S1	24/02/2020 10:10	24/02/2020 13:44	24/02/2020 10:10	24/02/2020 13:44	3,56	1	3,56	CHI
202002159694	PLANALTINA	PI11355768	PLANALTINA	24/02/2020 10:11	24/02/2020 11:28	24/02/2020 10:11	24/02/2020 11:28	1,27	1	1,27	CHI
202002159701	GOIANIRA	CK21247994	INHUMAS S1	24/02/2020 10:13	24/02/2020 15:00	24/02/2020 10:13	24/02/2020 15:00	4,77	1	4,77	CHI
202002159702	ITAPURANGA	170078668	ITAPURANGA	24/02/2020 10:13	24/02/2020 15:20	24/02/2020 10:13	24/02/2020 15:20	5,11	1	5,11	CHI
202002159709	VICENTINOPOLIS	VI12218196	VICENTINOPOLIS	24/02/2020 10:15	24/02/2020 13:42	24/02/2020 10:15	24/02/2020 13:42	3,44	5	17,22	CHI
202002159716	SAO JOAO DA PARAUNA	RP12404686	FIRMINOPOLIS S1	24/02/2020 10:04	24/02/2020 19:02	24/02/2020 10:04	24/02/2020 19:02	8,96	3	26,87	CHI
202002159718	CATALAO	1990067624	CATALAO S2	24/02/2020 10:18	24/02/2020 12:11	24/02/2020 10:18	24/02/2020 12:11	1,88	1	1,88	CHI
202002159726	CORUMBAIBA	CI21000464	VILA CORUMBA	24/02/2020 10:22	24/02/2020 16:12	24/02/2020 10:22	24/02/2020 16:12	5,82	1	5,82	CHI
202002159732	FORMOSA	FA12376671	ITUIQUIRA	24/02/2020 09:05	24/02/2020 12:27	24/02/2020 09:05	24/02/2020 12:27	3,37	24	80,79	CHI
202002159734	POSSE	10004136789	IACIARA S2	24/02/2020 10:25	24/02/2020 15:38	24/02/2020 10:25	24/02/2020 15:38	5,20	1	5,20	CHI
202002159738	RIO VERDE	RV12370287	MONTIVIDIU T	24/02/2020 10:26	24/02/2020 13:13	24/02/2020 10:26	24/02/2020 13:13	2,77	1	2,77	CHI
202002159743	MONTE ALEGRE DE GOIAS	MA12282329	SAO DOMINGOS	24/02/2020 10:27	24/02/2020 12:10	24/02/2020 10:27	24/02/2020 12:10	1,71	6	10,28	CHI
202002159746	ITAGUARU	IC12068838	ITABERAI S1	24/02/2020 09:58	24/02/2020 11:25	24/02/2020 09:58	24/02/2020 11:25	1,44	12	17,32	CHI
202002159749	POSSE	PS21235523	IACIARA S2	24/02/2020 10:28	24/02/2020 11:33	24/02/2020 10:28	24/02/2020 11:33	1,08	1	1,08	CHI
202002159752	JARAGUA	JA21331949	JARAGUA	24/02/2020 10:28	24/02/2020 18:39	24/02/2020 10:28	24/02/2020 18:39	8,17	2	16,35	CHI
202002159754	URUACU	UR12384347	URUACU	24/02/2020 10:29	24/02/2020 15:33	24/02/2020 10:29	24/02/2020 15:33	5,07	25	126,67	CHI
202002159758	IPAMERI	IP12068500	CRISTALINA S2	24/02/2020 10:30	24/02/2020 12:37	24/02/2020 10:30	24/02/2020 12:37	2,10	62	130,27	CHI

202002159759	GOIANESIA	GE21026149	GOIANESIA S1	24/02/2020 10:31	24/02/2020 14:44	24/02/2020 10:31	24/02/2020 14:44	4,22	2	8,45	CHI
202002159761	CAIAPONIA	CP12252503	CAIAPONIA	24/02/2020 10:05	24/02/2020 13:39	24/02/2020 10:05	24/02/2020 13:39	3,55	6	21,32	CHI
202002159763	GOIAS	GS12162491	GOIAS	24/02/2020 09:44	24/02/2020 17:28	24/02/2020 09:44	24/02/2020 17:28	7,72	51	393,93	CHI
202002159776	MUTUNOPOLIS	MU12214693	MARA ROSA	24/02/2020 10:34	24/02/2020 14:28	24/02/2020 10:34	24/02/2020 14:28	3,89	9	34,98	CHI
202002159780	URUTAI	600000722	URUTAI	24/02/2020 10:35	24/02/2020 17:43	24/02/2020 10:35	24/02/2020 17:43	7,13	1	7,13	CHI
202002159789	ANAPOLIS	AN12054413	ANAPOLIS UNIVERSITARIO S2	24/02/2020 10:38	24/02/2020 21:01	24/02/2020 10:38	24/02/2020 21:01	10,38	19	197,21	CHI
202002159790	GOIANIA	16128503	CAMPINAS S3	24/02/2020 10:39	24/02/2020 12:36	24/02/2020 10:39	24/02/2020 12:36	1,94	1	1,94	CHI
202002159795	PIRENOPOLIS	220054393	CORUMBA	24/02/2020 10:40	24/02/2020 14:15	24/02/2020 10:40	24/02/2020 14:15	3,57	1	3,57	CHI
202002159804	GOIANAPOLIS	GP12000043	DAIA S2	24/02/2020 10:43	24/02/2020 12:36	24/02/2020 10:43	24/02/2020 12:36	1,88	5	9,38	CHI
202002159807	SANTA BARBARA DE GOIAS	10016142100	TRINDADE	24/02/2020 10:44	24/02/2020 15:33	24/02/2020 10:44	24/02/2020 15:33	4,82	1	4,82	CHI
202002159810	SILVANIA	SV21012805	BELA VISTA S2	24/02/2020 10:44	24/02/2020 11:49	24/02/2020 10:44	24/02/2020 11:49	1,07	1	1,07	CHI
202002159815	SAO MIGUEL DO ARAGUAIA	SM12291166	SAO MIGUEL DO ARAGUAIA	24/02/2020 07:53	24/02/2020 12:11	24/02/2020 07:53	24/02/2020 12:11	4,30	8	34,36	CHI
202002159817	ITUMBIARA	690394652	ITUMBIARA VELHA S1	24/02/2020 10:46	24/02/2020 13:18	24/02/2020 10:46	24/02/2020 13:18	2,53	1	2,53	CHI
202002159819	BELA VISTA DE GOIAS	BV11269852	CEPAIGO S2	24/02/2020 10:46	24/02/2020 12:25	24/02/2020 10:46	24/02/2020 12:25	1,64	8	13,13	CHI
202002159820	JATAI	10013243355	JATAI S2	24/02/2020 10:46	24/02/2020 12:19	24/02/2020 10:46	24/02/2020 12:19	1,54	1	1,54	CHI
202002159841	SAO JOAO D ALIANCA	TL21342471	SAO JOAO D ALIANCA	24/02/2020 10:52	24/02/2020 13:15	24/02/2020 10:52	24/02/2020 13:15	2,37	1	2,37	CHI
202002159844	ORIZONA	OZ21113696	PIRES DO RIO S2	24/02/2020 10:53	24/02/2020 14:41	24/02/2020 10:53	24/02/2020 14:41	3,79	1	3,79	CHI
202002159846	DAMOLANDIA	DL12319228	INHUMAS S1	24/02/2020 10:53	24/02/2020 12:29	24/02/2020 10:53	24/02/2020 12:29	1,59	1	1,59	CHI
202002159846	OURO VERDE DE GOIAS	DL12319228	INHUMAS S1	24/02/2020 10:53	24/02/2020 12:29	24/02/2020 10:53	24/02/2020 12:29	1,59	4	6,35	CHI
202002159851	FORMOSA	FA11315285	ITIQUIRA	24/02/2020 10:54	24/02/2020 11:50	24/02/2020 10:54	24/02/2020 11:50	0,93	7	6,49	CHI
202002159854	LUZIANIA	120306025	RIO VERMELHO	24/02/2020 10:55	24/02/2020 11:41	24/02/2020 10:55	24/02/2020 11:41	0,76	1	0,76	CHI
202002159858	JARAGUA	SR21099292	INHUMAS S1	24/02/2020 10:56	24/02/2020 15:13	24/02/2020 10:56	24/02/2020 15:13	4,28	1	4,28	CHI
202002159863	GUAPO	AO21027603	GUAPO S1	24/02/2020 10:57	24/02/2020 14:10	24/02/2020 10:57	24/02/2020 14:10	3,21	1	3,21	CHI
202002159864	GOIANESIA	GE12384168	GOIANESIA S2	24/02/2020 10:58	25/02/2020 13:05	24/02/2020 10:58	25/02/2020 13:05	26,13	1	26,13	CHI
202002159865	NOVO GAMA	4990089365	PACAEMBU S1	24/02/2020 10:58	24/02/2020 12:38	24/02/2020 10:58	24/02/2020 12:38	1,66	1	1,66	CHI
202002159866	EDEIA	EA12084053	EDEIA	24/02/2020 08:20	24/02/2020 16:06	24/02/2020 08:20	24/02/2020 16:06	7,77	6	46,59	CHI
202002159867	APARECIDA DE GOIANIA	16629012	REAL S1	24/02/2020 10:58	24/02/2020 16:55	24/02/2020 10:58	24/02/2020 16:55	5,94	1	5,94	CHI
202002159870	PILAR DE GOIAS	GG12293454	URUACU	24/02/2020 11:00	24/02/2020 17:06	24/02/2020 11:00	24/02/2020 17:06	6,09	3	18,26	CHI
202002159874	BONOPOLIS	BX12115527	SAO MIGUEL DO ARAGUAIA	24/02/2020 07:50	24/02/2020 11:53	24/02/2020 07:50	24/02/2020 11:53	4,03	4	16,14	CHI
202002159876	GOIATUBA	GT21052726	GOIATUBA S2	24/02/2020 11:02	24/02/2020 15:58	24/02/2020 11:02	24/02/2020 15:58	4,92	1	4,92	CHI
202002159877	CAMPO LIMPO	960023422	NEROPOLIS S1	24/02/2020 11:02	24/02/2020 17:29	24/02/2020 11:02	24/02/2020 17:29	6,44	1	6,44	CHI
202002159880	GOIANIA	12764929	INDEPENDENCIA S1	24/02/2020 11:03	24/02/2020 12:06	24/02/2020 11:03	24/02/2020 12:06	1,05	1	1,05	CHI
202002159887	APORE	AE12205145	ITAJA S2	24/02/2020 10:16	25/02/2020 03:43	24/02/2020 10:16	25/02/2020 03:43	17,44	32	558,15	CHI
202002159888	PETROLINA DE GOIAS	PG11272955	PETROLINA	24/02/2020 10:42	24/02/2020 12:26	24/02/2020 10:42	24/02/2020 12:26	1,73	28	48,42	CHI
202002159891	GOIANESIA	GE12354272	GOIANESIA S1	24/02/2020 11:05	24/02/2020 23:25	24/02/2020 11:05	24/02/2020 23:25	12,32	6	73,93	CHI
202002159904	ANAPOLIS	AN21270423	ANAPOLIS UNIVERSITARIO S2	24/02/2020 11:10	24/02/2020 17:56	24/02/2020 11:10	24/02/2020 17:56	6,76	1	6,76	CHI
202002159907	MUNDO NOVO DE GOIAS	MH21037797	NOVA CRIXAS	24/02/2020 11:11	24/02/2020 17:33	24/02/2020 11:11	24/02/2020 17:33	6,36	1	6,36	CHI
202002159911	GOIANIA	10881074	GOIANIA LESTE S1	24/02/2020 11:13	24/02/2020 12:26	24/02/2020 11:13	24/02/2020 12:26	1,22	1	1,22	CHI
202002159913	PLANALTINA	2960155630	PLANALTINA	24/02/2020 11:13	24/02/2020 13:09	24/02/2020 11:13	24/02/2020 13:09	1,92	1	1,92	CHI
202002159917	RIO VERDE	RV21091968	RIO VERDE S1	24/02/2020 11:14	24/02/2020 16:30	24/02/2020 11:14	24/02/2020 16:30	5,26	1	5,26	CHI
202002159918	RIO VERDE	630507545	RIO VERDE S2	24/02/2020 11:14	24/02/2020 19:14	24/02/2020 11:14	24/02/2020 19:14	7,99	1	7,99	CHI
202002159921	GOIANESIA	GE21194472	GOIANESIA S1	24/02/2020 11:16	24/02/2020 20:40	24/02/2020 11:16	24/02/2020 20:40	9,41	1	9,41	CHI
202002159922	GOIANIA	GN11000723	GOIANIA LESTE S2	24/02/2020 11:16	24/02/2020 14:06	24/02/2020 11:16	24/02/2020 14:06	2,83	96	271,33	CHI
202002159925	LUZIANIA	120407942	RIO VERMELHO	24/02/2020 11:17	24/02/2020 12:56	24/02/2020 11:17	24/02/2020 12:56	1,65	1	1,65	CHI

202002159942	SANTA RITA DO NOVO DESTINO	BA12152769	BARRO ALTO	24/02/2020 11:04	24/02/2020 14:41	24/02/2020 11:04	24/02/2020 14:41	3,61	62	223,92	CHI
202002159955	NOVO BRASIL	NB12079555	JUSSARA	24/02/2020 07:45	24/02/2020 12:46	24/02/2020 07:45	24/02/2020 12:46	5,01	16	80,14	CHI
202002159956	RIO VERDE	630487480	CABRIUVA S1	24/02/2020 11:25	24/02/2020 18:10	24/02/2020 11:25	24/02/2020 18:10	6,75	1	6,75	CHI
202002159966	TRINDADE	TR21018406	GOIANIRA	24/02/2020 11:28	24/02/2020 12:28	24/02/2020 11:28	24/02/2020 12:28	0,99	1	0,99	CHI
202002159981	CACHOEIRA ALTA	CA12200647	CACHOEIRA ALTA	24/02/2020 11:31	24/02/2020 18:16	24/02/2020 11:31	24/02/2020 18:16	6,74	5	33,71	CHI
202002159984	FLORES DE GOIAS	FA12042061	ITUIQUIRA	24/02/2020 06:41	24/02/2020 14:42	24/02/2020 06:41	24/02/2020 14:42	8,01	1	8,01	CHI
202002159984	VILA BOA	FA12042061	ITUIQUIRA	24/02/2020 06:41	24/02/2020 14:42	24/02/2020 06:41	24/02/2020 14:42	8,01	1	8,01	CHI
202002159987	CACU	10019209949	CACHOEIRA ALTA	24/02/2020 11:34	24/02/2020 19:32	24/02/2020 11:34	24/02/2020 19:32	7,96	1	7,96	CHI
202002159996	GOIANIA	GN21149967	GOIANIA LESTE S3	24/02/2020 11:36	24/02/2020 16:40	24/02/2020 11:36	24/02/2020 16:40	5,07	1	5,07	CHI
202002159997	GOIANDIRA	2010021340	CATALAO S1	24/02/2020 11:36	24/02/2020 14:29	24/02/2020 11:36	24/02/2020 14:29	2,87	1	2,87	CHI
202002159999	CALDAS NOVAS	760341539	SERRA DE CALDAS	24/02/2020 11:37	24/02/2020 14:44	24/02/2020 11:37	24/02/2020 14:44	3,11	1	3,11	CHI
202002160001	ANAPOLIS	10002613253	ANAPOLIS UNIVERSITARIO S2	24/02/2020 11:37	24/02/2020 14:11	24/02/2020 11:37	24/02/2020 14:11	2,55	1	2,55	CHI
202002160006	PORANGATU	PO12390257	PORANGATU	24/02/2020 11:38	24/02/2020 13:47	24/02/2020 11:38	24/02/2020 13:47	2,13	4	8,54	CHI
202002160007	CALDAS NOVAS	CN21306706	CALDAS NOVAS S1	24/02/2020 11:39	24/02/2020 18:41	24/02/2020 11:39	24/02/2020 18:41	7,02	1	7,02	CHI
202002160010	MINEIROS	1390169161	PARQUE DAS EMAS	24/02/2020 11:40	24/02/2020 20:00	24/02/2020 11:40	24/02/2020 20:00	8,33	1	8,33	CHI
202002160012	CACU	CA12034600	CACHOEIRA ALTA	24/02/2020 11:40	24/02/2020 23:17	24/02/2020 11:40	24/02/2020 23:17	11,61	38	441,03	CHI
202002160012	CACHOEIRA ALTA	CA12034600	CACHOEIRA ALTA	24/02/2020 11:40	24/02/2020 23:17	24/02/2020 19:39	24/02/2020 23:17	3,63	3	10,90	CHI
202002160019	PORTELANDIA	PW21303435	PARQUE DAS EMAS	24/02/2020 11:42	24/02/2020 14:39	24/02/2020 11:42	24/02/2020 14:39	2,95	1	2,95	CHI
202002160020	CIDADE OCIDENTAL	2680021247	MARAJOARA	24/02/2020 11:42	24/02/2020 16:50	24/02/2020 11:42	24/02/2020 16:50	5,13	1	5,13	CHI
202002160029	MUTUNOPOLIS	MU12060992	MARA ROSA	24/02/2020 11:44	24/02/2020 15:50	24/02/2020 11:44	24/02/2020 15:50	4,08	3	12,25	CHI
202002160031	JARAGUA	JA21278874	JARAGUA	24/02/2020 12:55	25/02/2020 18:15	24/02/2020 12:55	25/02/2020 11:16	22,36	1	22,36	CHI
202002160031	JARAGUA	JA12273009	JARAGUA	24/02/2020 12:55	25/02/2020 18:15	25/02/2020 11:14	25/02/2020 18:15	7,00	4	28,01	CHI
202002160034	MORRINHOS	MR12075105	MORRINHOS	24/02/2020 11:47	24/02/2020 15:20	24/02/2020 11:47	24/02/2020 15:20	3,54	6	21,26	CHI
202002160035	MINACU	IH21240658	MINACU	24/02/2020 11:47	24/02/2020 15:11	24/02/2020 11:47	24/02/2020 15:11	3,39	1	3,39	CHI
202002160042	MORRINHOS	MR21223578	MORRINHOS	24/02/2020 11:49	24/02/2020 12:52	24/02/2020 11:49	24/02/2020 12:52	1,05	1	1,05	CHI
202002160049	FORMOSA	FA21106953	ITUIQUIRA	24/02/2020 11:51	24/02/2020 14:15	24/02/2020 11:51	24/02/2020 14:15	2,40	1	2,40	CHI
202002160050	CRISTALINA	KR21133577	CRISTALINA S2	24/02/2020 11:51	24/02/2020 17:37	24/02/2020 11:51	24/02/2020 17:37	5,76	1	5,76	CHI
202002160057	VIANOPOLIS	OZ21221829	PIRES DO RIO S2	24/02/2020 11:52	24/02/2020 15:33	24/02/2020 11:52	24/02/2020 15:33	3,67	1	3,67	CHI
202002160065	PADRE BERNARDO	10011145968	PADRE BERNARDO	24/02/2020 11:56	24/02/2020 15:07	24/02/2020 11:56	24/02/2020 15:07	3,18	1	3,18	CHI
202002160067	OURO VERDE DE GOIAS	OV12374484	NEROPOLIS S2	24/02/2020 11:19	24/02/2020 16:02	24/02/2020 11:19	24/02/2020 16:02	4,71	6	28,29	CHI
202002160069	CALDAS NOVAS	CN11051672	CALDAS NOVAS S2	24/02/2020 11:56	24/02/2020 14:32	24/02/2020 11:56	24/02/2020 14:32	2,59	103	266,68	CHI
202002160072	DAVINOPOLIS	IO21085120	CATALAO S1	24/02/2020 11:56	24/02/2020 13:51	24/02/2020 11:56	24/02/2020 13:51	1,90	1	1,90	CHI
202002160073	VILA PROPICIO	NP21294001	GOIANESIA S1	24/02/2020 11:57	24/02/2020 14:30	24/02/2020 11:57	24/02/2020 14:30	2,56	2	5,11	CHI
202002160074	VALPARAISO DE GOIAS	2860192640	PACAEMBU S1	24/02/2020 11:57	24/02/2020 17:52	24/02/2020 11:57	24/02/2020 17:52	5,91	1	5,91	CHI
202002160078	SAO DOMINGOS	SD12389179	SAO DOMINGOS	24/02/2020 11:58	24/02/2020 18:07	24/02/2020 11:58	24/02/2020 18:07	6,14	10	61,39	CHI
202002160079	GOIANIA	10967072	FERROVIARIO S3	24/02/2020 11:58	24/02/2020 13:16	24/02/2020 11:58	24/02/2020 13:16	1,29	1	1,29	CHI
202002160082	CRISTALINA	3490002384	PAMPLONA	24/02/2020 11:59	24/02/2020 19:53	24/02/2020 11:59	24/02/2020 19:53	7,91	1	7,91	CHI
202002160083	GOIANIA	GN12000607	CAMPINAS S3	24/02/2020 11:59	24/02/2020 13:17	24/02/2020 11:59	24/02/2020 13:17	1,29	215	278,19	CHI
202002160085	COCALZINHO DE GOIAS	ZN11230195	AGUAS LINDAS DE GOIAS S2	24/02/2020 12:00	24/02/2020 13:27	24/02/2020 12:00	24/02/2020 13:27	1,44	121	174,71	CHI
202002160097	SILVANIA	SV12084550	VIANOPOLIS	24/02/2020 12:00	24/02/2020 16:45	24/02/2020 12:00	24/02/2020 16:45	4,74	44	208,47	CHI
202002160097	SILVANIA	SV12084550	VIANOPOLIS	24/02/2020 12:00	24/02/2020 16:45	24/02/2020 16:05	24/02/2020 16:45	0,65	5	3,26	CHI
202002160098	ITUMBIARA	690332737	ITUMBIARA NOVA	24/02/2020 12:02	24/02/2020 15:10	24/02/2020 12:02	24/02/2020 15:10	3,12	1	3,12	CHI
202002160102	GOIANIA	GN21001246	GOYA S1	24/02/2020 12:03	24/02/2020 13:35	24/02/2020 12:03	24/02/2020 13:35	1,53	5	7,63	CHI
202002160103	JARAGUA	JA21114634	JARAGUA	24/02/2020 12:04	24/02/2020 14:46	24/02/2020 12:04	24/02/2020 14:46	2,70	1	2,70	CHI

202002160104	GOIANIA	GN11000488	CAMPINAS S3	24/02/2020 11:59	24/02/2020 14:08	24/02/2020 11:59	24/02/2020 14:08	2,14	112	240,15	CHI
202002160115	ABADIANIA	670003189	ANAPOLIS UNIVERSITARIO S1	24/02/2020 12:06	24/02/2020 21:39	24/02/2020 12:06	24/02/2020 21:39	9,54	1	9,54	CHI
202002160116	PIRACANJUBA	PJ12026702	PIRACANJUBA	24/02/2020 12:07	24/02/2020 15:52	24/02/2020 12:07	24/02/2020 15:52	3,74	2	7,49	CHI
202002160117	MONTIVIDIU	RV12384572B	MONTIVIDIU T	24/02/2020 12:08	24/02/2020 15:24	24/02/2020 12:08	24/02/2020 15:24	3,26	6	19,58	CHI
202002160124	CATALAO	CT21236882	CATALAO S1	24/02/2020 12:10	24/02/2020 16:24	24/02/2020 12:10	24/02/2020 16:24	4,22	1	4,22	CHI
202002160125	JATAI	290324713	JATAI S2	24/02/2020 12:10	24/02/2020 17:13	24/02/2020 12:10	24/02/2020 17:13	5,04	1	5,04	CHI
202002160132	ANAPOLIS	AN21216172	ANAPOLIS UNIVERSITARIO S1	24/02/2020 12:11	24/02/2020 13:51	24/02/2020 12:11	24/02/2020 13:51	1,66	1	1,66	CHI
202002160133	GOIANIA	13025168	ATLANTICO S1	24/02/2020 12:11	24/02/2020 15:08	24/02/2020 12:11	24/02/2020 15:08	2,94	1	2,94	CHI
202002160135	GOIANIA	13911582	FERROVIARIO S1	24/02/2020 12:11	24/02/2020 13:49	24/02/2020 12:11	24/02/2020 13:49	1,62	1	1,62	CHI
202002160147	PONTALINA	PK12000015	PONTALINA	24/02/2020 12:08	24/02/2020 14:41	24/02/2020 12:08	24/02/2020 14:41	2,55	99	252,01	CHI
202002160151	SAO MIGUEL DO ARAGUAIA	830078046	SAO MIGUEL DO ARAGUAIA	24/02/2020 12:13	24/02/2020 15:38	24/02/2020 12:13	24/02/2020 15:38	3,40	1	3,40	CHI
202002160152	PORANGATU	PO21079304	PORANGATU	24/02/2020 12:14	24/02/2020 16:08	24/02/2020 12:14	24/02/2020 16:08	3,90	1	3,90	CHI
202002160155	JATAI	290079070	JATAI S2	24/02/2020 12:15	24/02/2020 17:59	24/02/2020 12:15	24/02/2020 17:59	5,72	1	5,72	CHI
202002160156	QUIRINOPOLIS	QI21132854	QUIRINOPOLIS	24/02/2020 12:16	24/02/2020 14:49	24/02/2020 12:16	24/02/2020 14:49	2,55	1	2,55	CHI
202002160158	APARECIDA DE GOIANIA	AP12000220	ANHANGUERA	24/02/2020 12:12	24/02/2020 14:31	24/02/2020 12:12	24/02/2020 14:31	2,31	591	1364,88	CHI
202002160168	GOIANIA	GN12167804	GOIANIA LESTE S3	24/02/2020 12:22	24/02/2020 13:42	24/02/2020 12:22	24/02/2020 13:42	1,33	327	434,82	CHI
202002160171	GOIANIA	14113715	REAL S2	24/02/2020 12:18	24/02/2020 17:36	24/02/2020 12:18	24/02/2020 17:36	5,30	1	5,30	CHI
202002160174	MORRINHOS	10016229612	MORRINHOS	24/02/2020 12:18	24/02/2020 15:01	24/02/2020 12:18	24/02/2020 15:01	2,72	1	2,72	CHI
202002160178	LUZIANIA	LZ12383009	MARAJOARA	24/02/2020 12:19	24/02/2020 14:45	24/02/2020 12:19	24/02/2020 14:45	2,43	11	26,68	CHI
202002160182	GOIANIA	GN11000395	GOIANIA LESTE S3	24/02/2020 12:06	24/02/2020 18:10	24/02/2020 12:06	24/02/2020 18:10	6,07	26	157,69	CHI
202002160185	JATAI	JT21104655	JATAI S1	24/02/2020 12:22	24/02/2020 18:32	24/02/2020 12:22	24/02/2020 18:32	6,15	1	6,15	CHI
202002160186	MONTIVIDIU	MV21345991	MONTIVIDIU T	24/02/2020 12:23	24/02/2020 14:54	24/02/2020 12:23	24/02/2020 14:54	2,52	1	2,52	CHI
202002160189	VIANOPOLIS	VN32014647	VIANOPOLIS	24/02/2020 12:23	24/02/2020 15:46	24/02/2020 12:23	24/02/2020 15:46	3,38	4	13,50	CHI
202002160192	CRISTALINA	KR12163890	CRISTALINA S2	24/02/2020 12:24	24/02/2020 15:33	24/02/2020 12:24	24/02/2020 15:33	3,14	89	279,39	CHI
202002160192	LUZIANIA	KR12163890	CRISTALINA S2	24/02/2020 12:24	24/02/2020 15:33	24/02/2020 12:24	24/02/2020 15:33	3,14	8	25,11	CHI
202002160196	IPAMERI	IP21166966	IPAMERI	24/02/2020 12:25	24/02/2020 18:28	24/02/2020 12:25	24/02/2020 18:28	6,05	1	6,05	CHI
202002160203	CALDAS NOVAS	760201730	SERRA DE CALDAS	24/02/2020 12:27	24/02/2020 17:48	24/02/2020 12:27	24/02/2020 17:48	5,35	1	5,35	CHI
202002160205	SAO MIGUEL DO ARAGUAIA	SM12371084	SAO MIGUEL DO ARAGUAIA	24/02/2020 12:28	24/02/2020 14:05	24/02/2020 12:28	24/02/2020 14:05	1,62	3	4,85	CHI
202002160209	IPAMERI	UT10375990	URUTAI	24/02/2020 11:35	24/02/2020 15:38	24/02/2020 11:35	24/02/2020 15:38	4,04	74	299,14	CHI
202002160209	URUTAI	UT10375990	URUTAI	24/02/2020 11:35	24/02/2020 15:38	24/02/2020 11:35	24/02/2020 15:38	4,04	216	873,18	CHI
202002160215	LEOPOLDO DE BULHOES	BO12403039	CEPAIGO S2	24/02/2020 12:30	24/02/2020 15:23	24/02/2020 12:30	24/02/2020 15:23	2,88	18	51,80	CHI
202002160218	APARECIDA DE GOIANIA	10008906082	INDEPENDENCIA S2	24/02/2020 12:31	24/02/2020 17:28	24/02/2020 12:31	24/02/2020 17:28	4,95	1	4,95	CHI
202002160225	APARECIDA DE GOIANIA	10004825681	REAL S1	24/02/2020 12:31	24/02/2020 13:33	24/02/2020 12:31	24/02/2020 13:33	1,03	1	1,03	CHI
202002160235	GOIANIA	10824558	GOIANIA LESTE S2	24/02/2020 12:34	24/02/2020 15:19	24/02/2020 12:34	24/02/2020 15:19	2,74	1	2,74	CHI
202002160236	APORE	AE21112882	ITAJA S1	24/02/2020 12:34	24/02/2020 15:30	24/02/2020 12:34	24/02/2020 15:30	2,92	1	2,92	CHI
202002160248	CATALAO	CT12333402	CATALAO S1	24/02/2020 12:37	25/02/2020 13:47	24/02/2020 12:37	25/02/2020 13:47	25,15	2	50,30	CHI
202002160252	SAO JOAO D ALIANCA	JL12383340	SAO JOAO D ALIANCA	24/02/2020 12:38	24/02/2020 13:53	24/02/2020 12:38	24/02/2020 13:53	1,24	76	94,51	CHI
202002160253	ANAPOLIS	AN21221320	ANAPOLIS UNIVERSITARIO S1	24/02/2020 12:38	24/02/2020 15:47	24/02/2020 12:38	24/02/2020 15:47	3,13	1	3,13	CHI
202002160256	ALTO PARAISO DE GOIAS	BF12129915	FLORES DE GOIAS	24/02/2020 12:37	24/02/2020 22:32	24/02/2020 12:37	24/02/2020 22:32	9,91	23	228,04	CHI
202002160257	ALVORADA DO NORTE	SI12211393	IACIARA S2	24/02/2020 12:39	24/02/2020 15:14	24/02/2020 12:39	24/02/2020 15:14	2,57	3	7,71	CHI
202002160257	SITIO D ABADIA	SI12211393	IACIARA S2	24/02/2020 12:39	24/02/2020 15:14	24/02/2020 12:39	24/02/2020 15:14	2,57	1	2,57	CHI
202002160260	CIDADE OCIDENTAL	LZ12031093	RIO VERMELHO	24/02/2020 12:40	24/02/2020 17:58	24/02/2020 16:00	24/02/2020 17:58	1,97	7	13,77	CHI
202002160260	LUZIANIA	LZ12031093	RIO VERMELHO	24/02/2020 12:40	24/02/2020 17:58	24/02/2020 16:00	24/02/2020 17:58	1,97	41	80,64	CHI
202002160261	GOIANIA	12510178	GOIANIA LESTE S3	24/02/2020 12:40	24/02/2020 14:24	24/02/2020 12:40	24/02/2020 14:24	1,72	1	1,72	CHI



202002160271	GOIANIA	16774486	GOIANIA LESTE S3	24/02/2020 12:44	24/02/2020 15:20	24/02/2020 12:44	24/02/2020 15:20	2,61	1	2,61	CHI
202002160272	APARECIDA DE GOIANIA	13434779	REAL S1	24/02/2020 12:44	24/02/2020 15:56	24/02/2020 12:44	24/02/2020 15:56	3,19	1	3,19	CHI
202002160273	GOIANIA	GN12220945	GOYA S2	24/02/2020 11:18	24/02/2020 13:53	24/02/2020 11:18	24/02/2020 13:53	2,58	280	721,16	CHI
202002160274	NEROPOLIS	NR21239047	NEROPOLIS S2	24/02/2020 12:44	24/02/2020 20:39	24/02/2020 12:44	24/02/2020 20:39	7,91	1	7,91	CHI
202002160282	TRINDADE	10012553911	GOYA S2	24/02/2020 12:47	24/02/2020 23:45	24/02/2020 12:47	24/02/2020 23:45	10,97	1	10,97	CHI
202002160283	NIQUELANDIA	2750098940	NIQUELANDIA SUBTRANSMISSAO	24/02/2020 12:47	24/02/2020 20:33	24/02/2020 12:47	24/02/2020 20:33	7,76	1	7,76	CHI
202002160288	CATALAO	CT12209404	CATALAO S1	24/02/2020 12:47	25/02/2020 11:50	24/02/2020 12:47	25/02/2020 11:50	23,04	3	69,11	CHI
202002160289	CATURAI	CK21015373	INHUMAS S1	24/02/2020 12:47	24/02/2020 14:58	24/02/2020 12:47	24/02/2020 14:58	2,17	1	2,17	CHI
202002160297	CAIAPONIA	MY13306440	PARQUE DAS EMAS	24/02/2020 12:40	24/02/2020 19:43	24/02/2020 12:40	24/02/2020 19:43	7,04	5	35,19	CHI
202002160297	MINEIROS	MY13306440	PARQUE DAS EMAS	24/02/2020 12:40	24/02/2020 19:43	24/02/2020 12:40	24/02/2020 19:43	7,04	71	499,74	CHI
202002160297	PEROLANDIA	MY13306440	PARQUE DAS EMAS	24/02/2020 12:40	24/02/2020 19:43	24/02/2020 12:40	24/02/2020 19:43	7,04	8	56,31	CHI
202002160298	RIO VERDE	630065834	RIO VERDE S2	24/02/2020 12:50	24/02/2020 15:50	24/02/2020 12:50	24/02/2020 15:50	2,99	1	2,99	CHI
202002160305	CAVALCANTE	7474969	SAO DOMINGOS	24/02/2020 12:50	24/02/2020 14:30	24/02/2020 12:50	24/02/2020 14:30	1,65	2	3,31	CHI
202002160309	APARECIDA DE GOIANIA	13363529	REAL S1	24/02/2020 12:52	24/02/2020 13:55	24/02/2020 12:52	24/02/2020 13:55	1,04	1	1,04	CHI
202002160315	APARECIDA DE GOIANIA	AP11166245	REAL S1	24/02/2020 12:37	24/02/2020 15:01	24/02/2020 12:37	24/02/2020 15:01	2,39	82	195,62	CHI
202002160317	GOIANIA	10745830	CAMPINAS S1	24/02/2020 12:54	24/02/2020 14:15	24/02/2020 12:54	24/02/2020 14:15	1,35	1	1,35	CHI
202002160322	INACIOLANDIA	ID31122312	QUIRINOPOLIS	24/02/2020 12:55	24/02/2020 14:16	24/02/2020 12:55	24/02/2020 14:16	1,34	1	1,34	CHI
202002160325	GOIANIA	GN12059752	GOYA S1	24/02/2020 12:56	24/02/2020 15:11	24/02/2020 12:56	24/02/2020 15:11	2,24	70	156,94	CHI
202002160327	SILVANIA	SV21229183	DAIA S2	24/02/2020 12:56	24/02/2020 15:36	24/02/2020 12:56	24/02/2020 15:36	2,65	1	2,65	CHI
202002160328	JATAI	290323745	JATAI S2	24/02/2020 12:56	24/02/2020 16:15	24/02/2020 12:56	24/02/2020 16:15	3,30	1	3,30	CHI
202002160329	PIRENOPOLIS	PV21185610	CORUMBA	24/02/2020 12:57	24/02/2020 17:09	24/02/2020 12:57	24/02/2020 17:09	4,20	1	4,20	CHI
202002160334	OUVIDOR	IO21156373	CATALAO S1	24/02/2020 12:57	24/02/2020 16:49	24/02/2020 12:57	24/02/2020 16:49	3,86	2	7,71	CHI
202002160339	SANTO ANTONIO DO DESCOBERTO	SN12275480	MARAJOARA	24/02/2020 12:10	24/02/2020 15:47	24/02/2020 12:10	24/02/2020 15:47	3,61	13	46,98	CHI
202002160344	CAMPOS BELOS	820023334	SAO DOMINGOS	24/02/2020 13:00	24/02/2020 15:18	24/02/2020 13:00	24/02/2020 15:18	2,29	1	2,29	CHI
202002160346	DOVERLANDIA	DV12342637	PARQUE DAS EMAS	24/02/2020 13:00	25/02/2020 01:44	24/02/2020 13:00	25/02/2020 01:44	12,72	2	25,43	CHI
202002160348	URUACU	CR21068074	MARA ROSA	24/02/2020 13:01	24/02/2020 14:45	24/02/2020 14:36	24/02/2020 14:45	0,16	1	0,16	CHI
202002160349	MINEIROS	MY21372168	PARQUE DAS EMAS	24/02/2020 13:01	24/02/2020 22:47	24/02/2020 13:01	24/02/2020 22:47	9,76	2	19,52	CHI
202002160350	TRINDADE	TR31043435	TRINDADE	24/02/2020 13:01	24/02/2020 16:08	24/02/2020 13:01	24/02/2020 16:08	3,10	2	6,21	CHI
202002160353	CAMPOS BELOS	CH11077827	SAO DOMINGOS	24/02/2020 13:00	24/02/2020 15:53	24/02/2020 13:00	24/02/2020 15:53	2,88	107	307,98	CHI
202002160354	CORUMBA DE GOIAS	CB21058986	CORUMBA	24/02/2020 13:02	24/02/2020 18:21	24/02/2020 13:02	24/02/2020 18:21	5,31	1	5,31	CHI
202002160356	LUZIANIA	LZ12383059	CRISTALINA S2	24/02/2020 13:03	24/02/2020 16:02	24/02/2020 13:03	24/02/2020 16:02	2,98	112	333,67	CHI
202002160361	PLANALTINA	2960245861	PLANALTINA	24/02/2020 13:03	24/02/2020 14:11	24/02/2020 13:03	24/02/2020 14:11	1,12	1	1,12	CHI
202002160382	HIDROLANDIA	HD21373532	PONTALINA	24/02/2020 13:10	24/02/2020 16:46	24/02/2020 13:10	24/02/2020 16:46	3,59	2	7,19	CHI
202002160384	FLORES DE GOIAS	3480017421	FLORES DE GOIAS	24/02/2020 13:10	24/02/2020 19:53	24/02/2020 13:10	24/02/2020 19:53	6,71	1	6,71	CHI
202002160387	SAO MIGUEL DO ARAGUAIA	SM21000039	SAO MIGUEL DO ARAGUAIA	24/02/2020 13:10	24/02/2020 16:00	24/02/2020 13:10	24/02/2020 16:00	2,82	1	2,82	CHI
202002160393	IPAMERI	IP11216061	IPAMERI	24/02/2020 11:59	24/02/2020 22:44	24/02/2020 11:59	24/02/2020 22:44	10,74	90	966,40	CHI
202002160394	LUZIANIA	LZ11362621	RIO VERMELHO	24/02/2020 12:48	24/02/2020 15:12	24/02/2020 12:48	24/02/2020 15:12	2,38	72	171,68	CHI
202002160395	RIO VERDE	10003874590	RIO VERDE S1	24/02/2020 13:12	24/02/2020 15:20	24/02/2020 13:12	24/02/2020 15:20	2,14	1	2,14	CHI
202002160397	JARAGUA	JA21254075	JARAGUA	24/02/2020 13:12	24/02/2020 14:39	24/02/2020 13:12	24/02/2020 14:39	1,44	1	1,44	CHI
202002160400	SAO MIGUEL DO ARAGUAIA	SM21000040	SAO MIGUEL DO ARAGUAIA	24/02/2020 13:14	24/02/2020 16:30	24/02/2020 13:14	24/02/2020 16:30	3,27	1	3,27	CHI
202002160420	GOIANIA	GN11326265	GOIANIA LESTE S3	24/02/2020 13:58	24/02/2020 15:19	24/02/2020 13:58	24/02/2020 15:19	1,34	40	53,72	CHI
202002160431	FLORES DE GOIAS	FB10405178	FLORES DE GOIAS	24/02/2020 15:01	24/02/2020 15:13	24/02/2020 15:01	24/02/2020 15:13	0,21	589	121,24	CHI
202002160438	SAO SIMAO	SO11350049	CACHOEIRA ALTA	24/02/2020 15:28	24/02/2020 17:47	24/02/2020 15:28	24/02/2020 17:47	2,31	6	13,85	CHI
202002160442	PORTEIRAO	CL21301084	RIO DOS BOIS	24/02/2020 15:52	24/02/2020 17:44	24/02/2020 15:52	24/02/2020 17:44	1,87	1	1,87	CHI

202002160503	CROMINIA	CQ21378442	PONTALINA	24/02/2020 13:14	24/02/2020 15:49	24/02/2020 13:14	24/02/2020 15:49	2,58	1	2,58	CHI
202002160504	CROMINIA	CQ21079845	PONTALINA	24/02/2020 13:14	24/02/2020 17:22	24/02/2020 13:14	24/02/2020 17:22	4,12	2	8,24	CHI
202002160507	PADRE BERNARDO	PB12000028	PADRE BERNARDO	24/02/2020 13:15	24/02/2020 15:32	24/02/2020 13:15	24/02/2020 15:32	2,28	1	2,28	CHI
202002160514	VALPARAISO DE GOIAS	VA11349074	PACAEMBU S1	24/02/2020 13:03	24/02/2020 15:13	24/02/2020 13:03	24/02/2020 15:13	2,16	64	138,38	CHI
202002160519	GOIANIA	16216143	GOYA S2	24/02/2020 13:18	24/02/2020 15:11	24/02/2020 13:18	24/02/2020 15:11	1,87	1	1,87	CHI
202002160520	JARAGUA	JA21194258	JARAGUA	24/02/2020 13:18	24/02/2020 15:07	24/02/2020 13:18	24/02/2020 15:07	1,80	1	1,80	CHI
202002160525	BOM JESUS DE GOIAS	1250056291	BOM JESUS DE GOIAS	24/02/2020 13:19	24/02/2020 17:17	24/02/2020 13:19	24/02/2020 17:17	3,96	1	3,96	CHI
202002160528	FORMOSA	FA11000047	ITIQUEIRA	24/02/2020 13:21	24/02/2020 17:48	24/02/2020 13:21	24/02/2020 17:48	4,45	84	374,06	CHI
202002160529	MUTUNOPOLIS	MU21000011	MARA ROSA	24/02/2020 13:21	24/02/2020 16:08	24/02/2020 13:21	24/02/2020 16:08	2,78	1	2,78	CHI
202002160531	URUACU	10010000680	URUACU	24/02/2020 13:21	24/02/2020 14:58	24/02/2020 13:21	24/02/2020 14:58	1,60	1	1,60	CHI
202002160532	FORMOSA	FA12204612	ITIQUEIRA	24/02/2020 12:27	24/02/2020 14:29	24/02/2020 12:27	24/02/2020 14:29	2,03	11	22,37	CHI
202002160533	LUZIANIA	LZ12351266RE	MARAJOARA	24/02/2020 13:15	24/02/2020 15:43	24/02/2020 13:15	24/02/2020 15:43	2,46	37	91,14	CHI
202002160534	PIRACANJUBA	PJ12212173	PIRACANJUBA	24/02/2020 13:22	24/02/2020 15:45	24/02/2020 13:22	24/02/2020 15:45	2,37	19	44,98	CHI
202002160537	CATALAO	CT21143495	CATALAO S2	24/02/2020 13:23	25/02/2020 13:40	24/02/2020 13:23	25/02/2020 13:40	24,27	1	24,27	CHI
202002160543	LUZIANIA	LZ12112942	PAMPLONA	24/02/2020 13:23	24/02/2020 16:28	24/02/2020 13:23	24/02/2020 16:28	3,07	8	24,58	CHI
202002160545	LUZIANIA	10021894114	RIO VERMELHO	24/02/2020 13:25	24/02/2020 17:55	24/02/2020 13:25	24/02/2020 17:55	4,50	1	4,50	CHI
202002160546	HIDROLANDIA	HD21034366	CEPAIGO S2	24/02/2020 13:25	24/02/2020 16:10	24/02/2020 13:25	24/02/2020 16:10	2,75	1	2,75	CHI
202002160550	PIRACANJUBA	PJ21182710	PIRACANJUBA	24/02/2020 13:25	24/02/2020 15:47	24/02/2020 13:25	24/02/2020 15:47	2,35	1	2,35	CHI
202002160556	GOIANIA	GN11199218	FERROVIARIO S1	24/02/2020 12:49	24/02/2020 15:00	24/02/2020 12:49	24/02/2020 15:00	2,17	66	143,22	CHI
202002160557	GOIANIRA	10016824758	MEIA PONTE	24/02/2020 13:28	24/02/2020 16:46	24/02/2020 13:28	24/02/2020 16:46	3,29	1	3,29	CHI
202002160563	CROMINIA	10031081620	PONTALINA	24/02/2020 13:29	24/02/2020 16:28	24/02/2020 13:29	24/02/2020 16:28	2,98	1	2,98	CHI
202002160565	FORMOSA	FA12207282	ITIQUEIRA	24/02/2020 13:07	24/02/2020 16:11	24/02/2020 13:07	24/02/2020 16:11	3,05	15	45,80	CHI
202002160568	SANTA TEREZA DE GOIAS	SE12332803	MARA ROSA	24/02/2020 13:30	24/02/2020 18:36	24/02/2020 13:30	24/02/2020 18:36	5,09	4	20,37	CHI
202002160572	GOIANIA	15891835	REAL S2	24/02/2020 13:30	24/02/2020 15:52	24/02/2020 13:30	24/02/2020 15:52	2,35	1	2,35	CHI
202002160575	SENADOR CANEDO	10010359387	SENADOR CANEDO	24/02/2020 13:31	24/02/2020 16:21	24/02/2020 13:31	24/02/2020 16:21	2,83	1	2,83	CHI
202002160586	NOVA CRIXAS	10010836541	NOVA CRIXAS	24/02/2020 13:33	24/02/2020 17:34	24/02/2020 13:33	24/02/2020 17:34	4,00	1	4,00	CHI
202002160595	RIO VERDE	630545881	RIO VERDE S2	24/02/2020 13:36	24/02/2020 16:52	24/02/2020 13:36	24/02/2020 16:52	3,26	1	3,26	CHI
202002160598	CALDAZINHA	DE21378488	CEPAIGO S2	24/02/2020 13:36	24/02/2020 15:31	24/02/2020 13:36	24/02/2020 15:31	1,90	2	3,80	CHI
202002160601	URUACU	UR12234962	URUACU	24/02/2020 13:37	24/02/2020 18:03	24/02/2020 13:37	24/02/2020 18:03	4,43	1	4,43	CHI
202002160615	MONTE ALEGRE DE GOIAS	SD12115759	SAO DOMINGOS	24/02/2020 13:39	24/02/2020 15:05	24/02/2020 13:39	24/02/2020 15:05	1,42	2	2,84	CHI
202002160615	NOVA ROMA	SD12115759	SAO DOMINGOS	24/02/2020 13:39	24/02/2020 15:05	24/02/2020 13:39	24/02/2020 15:05	1,42	3	4,26	CHI
202002160615	SAO DOMINGOS	SD12115759	SAO DOMINGOS	24/02/2020 13:39	24/02/2020 15:05	24/02/2020 13:39	24/02/2020 15:05	1,42	179	254,23	CHI
202002160618	LUZIANIA	LZ12383015	VIANOPOLIS	24/02/2020 13:40	24/02/2020 17:11	24/02/2020 13:40	24/02/2020 17:11	3,51	48	168,65	CHI
202002160620	EDEALINA	1130010123	PONTALINA	24/02/2020 13:41	24/02/2020 18:14	24/02/2020 13:41	24/02/2020 18:14	4,55	1	4,55	CHI
202002160625	INHUMAS	IN21059826	INHUMAS S2	24/02/2020 13:42	24/02/2020 16:55	24/02/2020 13:42	24/02/2020 16:55	3,20	2	6,41	CHI
202002160627	GOIANIA	16906482	CAMPINAS S2	24/02/2020 13:42	24/02/2020 15:41	24/02/2020 13:42	24/02/2020 15:41	1,97	1	1,97	CHI
202002160628	POSSE	PS21268312	IACIARA S2	24/02/2020 13:43	24/02/2020 17:29	24/02/2020 13:43	24/02/2020 17:29	3,76	1	3,76	CHI
202002160629	LUZIANIA	LZ12092911	RIO VERMELHO	24/02/2020 13:43	24/02/2020 18:06	24/02/2020 13:43	24/02/2020 18:06	4,38	5	21,89	CHI
202002160630	SANTO ANTONIO DO DESCOBERTO	SN21064503	MARAJOARA	24/02/2020 13:43	24/02/2020 16:27	24/02/2020 13:43	24/02/2020 16:27	2,73	1	2,73	CHI
202002160642	PANAMA	IT12000120	PARANAIBA	24/02/2020 13:45	24/02/2020 20:20	24/02/2020 13:45	24/02/2020 20:20	6,58	2	13,16	CHI
202002160643	GOIANIA	GN11210430	GOIANIA LESTE S3	24/02/2020 13:43	24/02/2020 17:54	24/02/2020 13:43	24/02/2020 17:54	4,17	90	375,55	CHI
202002160645	VIANOPOLIS	VN12102959	VIANOPOLIS	24/02/2020 13:46	24/02/2020 16:19	24/02/2020 13:46	24/02/2020 16:19	2,54	4	10,18	CHI
202002160647	NOVA CRIXAS	NA12334349	NOVA CRIXAS	24/02/2020 13:46	24/02/2020 17:07	24/02/2020 13:46	24/02/2020 17:07	3,34	84	280,96	CHI
202002160654	BURITINOPOLIS	BQ11190571	IACIARA S2	24/02/2020 13:48	24/02/2020 16:35	24/02/2020 13:48	24/02/2020 16:35	2,77	4	11,08	CHI

202002160656	GOIANIA	GN12000882	GOIANIA LESTE S2	24/02/2020 13:37	24/02/2020 14:45	24/02/2020 13:37	24/02/2020 14:45	1,13	263	296,53	CHI
202002160657	CIDADE OCIDENTAL	10004394389	MARAJOA RA	24/02/2020 13:49	24/02/2020 18:05	24/02/2020 13:49	24/02/2020 18:05	4,26	1	4,26	CHI
202002160661	CRIXAS	CX11397437	SERRA DO OURO	24/02/2020 13:50	24/02/2020 16:45	24/02/2020 13:50	24/02/2020 16:45	2,91	1	2,91	CHI
202002160667	ACREUNA	EU12085777	ACREUNA	24/02/2020 10:48	24/02/2020 17:58	24/02/2020 10:48	24/02/2020 17:58	7,16	59	422,24	CHI
202002160671	ALTO PARAISO DE GOIAS	BF10395392	NIQUELANDIA SUBTRANSMISSAO	24/02/2020 13:46	24/02/2020 19:52	24/02/2020 13:46	24/02/2020 13:52	0,10	550	52,86	CHI
202002160671	CAVALCANTE	BF10395392	NIQUELANDIA SUBTRANSMISSAO	24/02/2020 13:46	24/02/2020 19:52	24/02/2020 13:46	24/02/2020 13:52	0,10	57	5,48	CHI
202002160671	COLINAS DO SUL	BF10395392	NIQUELANDIA SUBTRANSMISSAO	24/02/2020 13:46	24/02/2020 19:52	24/02/2020 13:46	24/02/2020 13:52	0,10	69	6,63	CHI
202002160671	NIQUELANDIA	BF10395392	NIQUELANDIA SUBTRANSMISSAO	24/02/2020 13:46	24/02/2020 19:52	24/02/2020 13:46	24/02/2020 13:52	0,10	4	0,38	CHI
202002160671	COLINAS DO SUL	TI10396052	NIQUELANDIA SUBTRANSMISSAO	24/02/2020 13:46	24/02/2020 19:52	24/02/2020 13:46	24/02/2020 13:54	0,12	1099	134,63	CHI
202002160671	ALTO PARAISO DE GOIAS	NQ10383169	NIQUELANDIA SUBTRANSMISSAO	24/02/2020 13:46	24/02/2020 19:52	24/02/2020 13:46	24/02/2020 17:15	3,47	12	41,68	CHI
202002160671	NIQUELANDIA	NQ10383169	NIQUELANDIA SUBTRANSMISSAO	24/02/2020 13:46	24/02/2020 19:52	24/02/2020 13:46	24/02/2020 17:15	3,47	219	760,72	CHI
202002160671	SAO JOAO D ALIANCA	NQ10383169	NIQUELANDIA SUBTRANSMISSAO	24/02/2020 13:46	24/02/2020 19:52	24/02/2020 13:46	24/02/2020 17:15	3,47	1	3,47	CHI
202002160671	COLINAS DO SUL	NQ10383169	NIQUELANDIA SUBTRANSMISSAO	24/02/2020 13:46	24/02/2020 19:52	24/02/2020 13:46	24/02/2020 19:52	6,10	18	109,77	CHI
202002160671	NIQUELANDIA	NQ10383169	NIQUELANDIA SUBTRANSMISSAO	24/02/2020 13:46	24/02/2020 19:52	24/02/2020 13:46	24/02/2020 19:52	6,10	175	1067,16	CHI
202002160681	LUZIANIA	LZ12320196	RIO VERMELHO	24/02/2020 13:53	24/02/2020 23:49	24/02/2020 13:53	24/02/2020 18:54	5,01	10	50,08	CHI
202002160681	LUZIANIA	LZ12320196	RIO VERMELHO	24/02/2020 13:53	24/02/2020 23:49	24/02/2020 13:53	24/02/2020 23:49	9,92	1	9,92	CHI
202002160684	MINACU	IH11202500	MINACU	24/02/2020 13:54	24/02/2020 17:40	24/02/2020 13:54	24/02/2020 17:40	3,76	12	45,16	CHI
202002160692	GOIANIA	GN11289510	CARAJAS S2	24/02/2020 13:56	24/02/2020 17:42	24/02/2020 13:56	24/02/2020 17:42	3,76	71	266,78	CHI
202002160700	IACIARA	IA12302910	IACIARA S1	24/02/2020 13:59	24/02/2020 14:25	24/02/2020 13:59	24/02/2020 14:25	0,42	11	4,63	CHI
202002160712	GOIANIA	13875681	CAMPINAS S1	24/02/2020 14:02	24/02/2020 15:13	24/02/2020 14:02	24/02/2020 15:13	1,17	1	1,17	CHI
202002160726	ORIZONA	VN12072138	VIANOPOLIS	24/02/2020 14:08	24/02/2020 16:39	24/02/2020 14:08	24/02/2020 16:39	2,51	23	57,71	CHI
202002160726	GOIANOPOLIS	VN12072138	VIANOPOLIS	24/02/2020 14:08	24/02/2020 16:39	24/02/2020 14:08	24/02/2020 16:39	2,51	85	213,28	CHI
202002160728	GIATUBA	BJ21273967	BOM JESUS DE GOIAS	24/02/2020 14:09	24/02/2020 18:24	24/02/2020 14:09	24/02/2020 18:24	4,24	1	4,24	CHI
202002160732	NOVA ROMA	ND21159882	IACIARA S2	24/02/2020 14:10	24/02/2020 16:46	24/02/2020 14:10	24/02/2020 16:46	2,61	1	2,61	CHI
202002160737	AGUAS LINDAS DE GOIAS	4830107158	AGUAS LINDAS DE GOIAS S1	24/02/2020 14:12	24/02/2020 16:34	24/02/2020 14:12	24/02/2020 16:34	2,35	1	2,35	CHI
202002160751	NOVO PLANALTO	SM12099146RE	SAO MIGUEL DO ARAGUAIA	24/02/2020 14:18	24/02/2020 20:48	24/02/2020 14:18	24/02/2020 20:48	6,50	0	0,00	CHI
202002160751	SAO MIGUEL DO ARAGUAIA	SM12099146RE	SAO MIGUEL DO ARAGUAIA	24/02/2020 14:18	24/02/2020 20:48	24/02/2020 14:18	24/02/2020 20:48	6,50	52	337,86	CHI
202002160757	MUNDO NOVO DE GOIAS	MH12391957	NOVA CRIXAS	24/02/2020 10:34	24/02/2020 15:56	24/02/2020 10:34	24/02/2020 15:56	5,35	8	42,81	CHI
202002160760	DISTRITO FEDERAL	FA12383392	ITIQUEIRA	24/02/2020 14:18	24/02/2020 17:39	24/02/2020 14:18	24/02/2020 17:39	3,33	2	6,67	CHI
202002160760	FORMOSA	FA12383392	ITIQUEIRA	24/02/2020 14:18	24/02/2020 17:39	24/02/2020 14:18	24/02/2020 17:39	3,33	1	3,33	CHI
202002160761	PADRE BERNARDO	PB12346973	PADRE BERNARDO	24/02/2020 14:19	24/02/2020 17:44	24/02/2020 14:19	24/02/2020 17:44	3,42	5	17,08	CHI
202002160763	MINACU	IH12396739	MINACU	24/02/2020 14:19	25/02/2020 09:11	24/02/2020 14:19	25/02/2020 09:11	18,86	16	301,83	CHI
202002160767	COCALZINHO DE GOIAS	PB21219627	AGUAS LINDAS DE GOIAS S2	24/02/2020 14:19	24/02/2020 20:26	24/02/2020 14:19	24/02/2020 20:26	6,10	1	6,10	CHI
202002160769	MORRINHOS	MR21029756	MORRINHOS	24/02/2020 14:20	24/02/2020 16:00	24/02/2020 14:20	24/02/2020 16:00	1,67	1	1,67	CHI
202002160771	MAURILANDIA	ML12303334	RIO DOS BOIS	24/02/2020 14:20	24/02/2020 18:22	24/02/2020 14:20	24/02/2020 18:22	4,03	14	56,36	CHI
202002160771	RIO VERDE	ML12303334	RIO DOS BOIS	24/02/2020 14:20	24/02/2020 18:22	24/02/2020 14:20	24/02/2020 18:22	4,03	2	8,05	CHI
202002160776	CALDAS NOVAS	760215091	SERRA DE CALDAS	24/02/2020 14:21	24/02/2020 16:52	24/02/2020 14:21	24/02/2020 16:52	2,52	1	2,52	CHI
202002160779	NIQUELANDIA	NQ12397472	NIQUELANDIA SUBTRANSMISSAO	24/02/2020 14:02	24/02/2020 19:08	24/02/2020 14:02	24/02/2020 19:08	5,09	16	81,50	CHI
202002160779	URUACU	NQ12397472	NIQUELANDIA SUBTRANSMISSAO	24/02/2020 14:02	24/02/2020 19:08	24/02/2020 14:02	24/02/2020 19:08	5,09	1	5,09	CHI
202002160783	CROMINIA	CQ12109249	PONTALINA	24/02/2020 14:24	24/02/2020 17:27	24/02/2020 14:24	24/02/2020 17:27	3,05	5	15,24	CHI
202002160785	FLORES DE GOIAS	6079455	IACIARA S2	24/02/2020 14:24	24/02/2020 17:07	24/02/2020 14:24	24/02/2020 17:07	2,71	15	40,63	CHI
202002160790	MINACU	IH12207388	MINACU	24/02/2020 14:04	24/02/2020 16:47	24/02/2020 14:04	24/02/2020 16:47	2,71	81	219,87	CHI
202002160794	CROMINIA	CQ21380588	PONTALINA	24/02/2020 14:26	24/02/2020 16:20	24/02/2020 14:26	24/02/2020 16:20	1,90	1	1,90	CHI
202002160803	PORANGATU	PO12363571	PORANGATU	24/02/2020 14:28	25/02/2020 08:15	24/02/2020 14:28	25/02/2020 08:15	17,78	1	17,78	CHI

202002160809	COCALZINHO DE GOIAS	ZN12375219	AGUAS LINDAS DE GOIAS S2	24/02/2020 14:29	24/02/2020 16:37	24/02/2020 14:29	24/02/2020 16:37	2,12	25	53,08	CHI
202002160810	IPAMERI	10030192488	IPAMERI	24/02/2020 14:29	24/02/2020 23:53	24/02/2020 14:29	24/02/2020 23:53	9,39	1	9,39	CHI
202002160815	SANTA TEREZINHA DE GOIAS	SG21221154	SANTA TEREZINHA	24/02/2020 14:30	24/02/2020 23:01	24/02/2020 14:30	24/02/2020 23:01	8,51	1	8,51	CHI
202002160816	CRISTALINA	KR12366452	PAMPLONA	24/02/2020 14:30	25/02/2020 12:08	24/02/2020 14:30	24/02/2020 20:22	5,86	10	58,62	CHI
202002160816	CRISTALINA	KR12366452	PAMPLONA	24/02/2020 14:30	25/02/2020 12:08	24/02/2020 20:24	25/02/2020 12:08	15,73	11	173,05	CHI
202002160819	NIQUELANDIA	NQ12245210	NIQUELANDIA SUBTRANSMISSAO	24/02/2020 14:30	24/02/2020 21:34	24/02/2020 14:30	24/02/2020 21:34	7,05	71	500,59	CHI
202002160820	PORANGATU	PO12230403	PORANGATU	24/02/2020 14:31	24/02/2020 16:53	24/02/2020 14:31	24/02/2020 16:53	2,36	5	11,82	CHI
202002160822	CAMPO ALEGRE DE GOIAS	CT12165146	CATALAO S1	24/02/2020 08:58	24/02/2020 17:56	24/02/2020 08:58	24/02/2020 17:56	8,96	2	17,92	CHI
202002160822	CATALAO	CT12165146	CATALAO S1	24/02/2020 08:58	24/02/2020 17:56	24/02/2020 08:58	24/02/2020 17:56	8,96	31	277,83	CHI
202002160829	GOUVELANDIA	GB12303256	QUIRINOPOLIS	24/02/2020 14:33	24/02/2020 17:08	24/02/2020 14:33	24/02/2020 17:08	2,58	99	255,17	CHI
202002160845	COCALZINHO DE GOIAS	9970029696	AGUAS LINDAS DE GOIAS S2	24/02/2020 14:36	24/02/2020 17:15	24/02/2020 14:36	24/02/2020 17:15	2,64	1	2,64	CHI
202002160846	ALTO PARAISO DE GOIAS	BF10400692	FLORES DE GOIAS	24/02/2020 14:26	24/02/2020 18:26	24/02/2020 14:26	24/02/2020 18:26	3,99	206	822,57	CHI
202002160846	SAO JOAO D ALIANCA	BF10400692	FLORES DE GOIAS	24/02/2020 14:26	24/02/2020 18:26	24/02/2020 14:26	24/02/2020 18:26	3,99	2	7,99	CHI
202002160847	AGUA FRIA DE GOIAS	TL21194804	SAO JOAO D ALIANCA	24/02/2020 14:37	24/02/2020 15:34	24/02/2020 14:37	24/02/2020 15:34	0,96	1	0,96	CHI
202002160848	AGUA FRIA DE GOIAS	TL21322494	SAO JOAO D ALIANCA	24/02/2020 14:37	25/02/2020 00:48	24/02/2020 14:37	25/02/2020 00:48	10,19	3	30,56	CHI
202002160850	NOVA ROMA	ND11322706	IACIARA S2	24/02/2020 14:38	24/02/2020 16:18	24/02/2020 14:38	24/02/2020 16:18	1,67	53	88,26	CHI
202002160863	GUARANI DE GOIAS	GY12375512	IACIARA S1	24/02/2020 14:42	24/02/2020 16:55	24/02/2020 14:42	24/02/2020 16:55	2,21	1	2,21	CHI
202002160865	FORMOSA	FA12051040	ITUIQUIRA	24/02/2020 14:43	24/02/2020 16:58	24/02/2020 14:43	24/02/2020 16:58	2,25	11	24,70	CHI
202002160871	AGUA FRIA DE GOIAS	NQ12140182	SAO JOAO D ALIANCA	24/02/2020 14:44	24/02/2020 20:56	24/02/2020 14:44	24/02/2020 20:56	6,19	67	414,64	CHI
202002160871	NIQUELANDIA	NQ12140182	SAO JOAO D ALIANCA	24/02/2020 14:44	24/02/2020 20:56	24/02/2020 14:44	24/02/2020 20:56	6,19	6	37,13	CHI
202002160872	ORIZONA	OZ12038929	PIRES DO RIO S2	24/02/2020 14:44	24/02/2020 17:47	24/02/2020 14:44	24/02/2020 17:47	3,04	11	33,40	CHI
202002160874	MAIRIPOTABA	MI21217817	PONTALINA	24/02/2020 14:45	24/02/2020 17:56	24/02/2020 14:45	24/02/2020 17:56	3,18	1	3,18	CHI
202002160883	PADRE BERNARDO	PB12163212	PADRE BERNARDO	24/02/2020 14:47	24/02/2020 19:16	24/02/2020 14:47	24/02/2020 19:16	4,48	30	134,40	CHI
202002160899	CATALAO	CT12104168	CATALAO S1	24/02/2020 14:51	24/02/2020 16:34	24/02/2020 14:51	24/02/2020 16:34	1,70	4	6,80	CHI
202002160905	NOVA IGUACU DE GOIAS	10003407100	SANTA TEREZINHA	24/02/2020 14:53	24/02/2020 18:52	24/02/2020 14:53	24/02/2020 18:52	3,98	1	3,98	CHI
202002160908	MONTE ALEGRE DE GOIAS	MA12233165	SAO DOMINGOS	24/02/2020 14:54	24/02/2020 17:54	24/02/2020 14:54	24/02/2020 17:54	2,99	6	17,96	CHI
202002160920	PLANALTINA	10015302901	PLANALTINA	24/02/2020 14:56	24/02/2020 20:19	24/02/2020 14:56	24/02/2020 20:19	5,37	1	5,37	CHI
202002160929	FLORES DE GOIAS	FB12321129	IACIARA S2	24/02/2020 14:58	24/02/2020 19:23	24/02/2020 14:58	24/02/2020 19:23	4,40	6	26,43	CHI
202002160929	FORMOSA	FB12321129	IACIARA S2	24/02/2020 14:58	24/02/2020 19:23	24/02/2020 14:58	24/02/2020 19:23	4,40	1	4,40	CHI
202002160929	VILA BOA	FB12321129	IACIARA S2	24/02/2020 14:58	24/02/2020 19:23	24/02/2020 14:58	24/02/2020 19:23	4,40	4	17,62	CHI
202002160935	GUARANI DE GOIAS	GY21215952	IACIARA S1	24/02/2020 15:00	24/02/2020 19:15	24/02/2020 15:00	24/02/2020 19:15	4,24	1	4,24	CHI
202002160940	SAO DOMINGOS	SD12170547	SAO DOMINGOS	24/02/2020 12:49	24/02/2020 20:18	24/02/2020 12:49	24/02/2020 20:18	7,48	13	97,19	CHI
202002160945	CACHOEIRA ALTA	QI12189166	CACHOEIRA ALTA	24/02/2020 13:34	24/02/2020 19:22	24/02/2020 13:34	24/02/2020 19:22	5,80	3	17,39	CHI
202002160945	QUIRINOPOLIS	QI12189166	CACHOEIRA ALTA	24/02/2020 13:34	24/02/2020 19:22	24/02/2020 13:34	24/02/2020 19:22	5,80	2	11,59	CHI
202002160946	PORANGATU	MU12094084	MARA ROSA	24/02/2020 14:46	24/02/2020 17:34	24/02/2020 14:46	24/02/2020 17:34	2,80	83	232,08	CHI
202002160958	CAMPO ALEGRE DE GOIAS	CM12166728	CAMPO ALEGRE DE GOIAS	24/02/2020 14:27	24/02/2020 18:17	24/02/2020 14:27	24/02/2020 18:17	3,82	35	133,83	CHI
202002160961	MORRINHOS	150055006	MORRINHOS	24/02/2020 15:06	24/02/2020 15:59	24/02/2020 15:06	24/02/2020 15:59	0,89	1	0,89	CHI
202002160967	DAVINOPOLIS	IO12037555	CATALAO S1	24/02/2020 15:07	24/02/2020 17:59	24/02/2020 15:07	24/02/2020 17:59	2,86	16	45,70	CHI
202002160967	DISTRITO FEDERAL	IO12037555	CATALAO S1	24/02/2020 15:07	24/02/2020 17:59	24/02/2020 15:07	24/02/2020 17:59	2,86	2	5,71	CHI
202002160970	HIDROLANDIA	HD21007664	PONTALINA	24/02/2020 15:07	24/02/2020 17:32	24/02/2020 15:07	24/02/2020 17:32	2,40	1	2,40	CHI
202002160979	DOVERLANDIA	DV21303658	PARQUE DAS EMAS	24/02/2020 15:10	25/02/2020 13:18	24/02/2020 15:10	25/02/2020 13:18	22,13	1	22,13	CHI
202002160990	MONTE ALEGRE DE GOIAS	MA21282324	SAO DOMINGOS	24/02/2020 15:14	24/02/2020 19:29	24/02/2020 15:14	24/02/2020 19:29	4,24	1	4,24	CHI
202002160992	LUZIANIA	LZ12051365	CRISTALINA S2	24/02/2020 15:14	24/02/2020 19:29	24/02/2020 15:14	24/02/2020 19:29	4,23	4	16,94	CHI
202002160998	IACIARA	IA12218830	IACIARA S2	24/02/2020 15:15	24/02/2020 21:44	24/02/2020 15:15	24/02/2020 21:44	6,47	1	6,47	CHI

202002160998	SAO DOMINGOS	IA12218830	IACIARA S2	24/02/2020 15:15	24/02/2020 21:44	24/02/2020 15:15	24/02/2020 21:44	6,47	1	6,47	CHI
202002160999	MORRO AGUDO DE GOIAS	RB12156092	RUBIATABA	24/02/2020 15:16	24/02/2020 18:23	24/02/2020 15:16	24/02/2020 18:23	3,12	10	31,17	CHI
202002161001	MORRINHOS	MR21171702	MORRINHOS	24/02/2020 15:16	24/02/2020 16:17	24/02/2020 15:16	24/02/2020 16:17	1,01	1	1,01	CHI
202002161006	MINEIROS	MY21212545	PARQUE DAS EMAS	24/02/2020 15:17	25/02/2020 14:39	24/02/2020 15:17	25/02/2020 14:39	23,36	1	23,36	CHI
202002161010	AMARALINA	MU12384317	MARA ROSA	24/02/2020 13:49	24/02/2020 17:01	24/02/2020 13:49	24/02/2020 17:01	3,19	4	12,76	CHI
202002161010	MUTUNOPOLIS	MU12384317	MARA ROSA	24/02/2020 13:49	24/02/2020 17:01	24/02/2020 13:49	24/02/2020 17:01	3,19	20	63,78	CHI
202002161014	OUIDOR	OU21161375	CATALAO S1	24/02/2020 15:19	24/02/2020 17:57	24/02/2020 15:19	24/02/2020 17:57	2,63	1	2,63	CHI
202002161026	PIRACANJUBA	PJ21000157	PIRACANJUBA	24/02/2020 15:21	24/02/2020 21:58	24/02/2020 15:21	24/02/2020 21:58	6,60	1	6,60	CHI
202002161031	FLORES DE GOIAS	FB12106993	FLORES DE GOIAS	24/02/2020 15:21	24/02/2020 17:52	24/02/2020 15:21	24/02/2020 17:52	2,50	15	37,55	CHI
202002161031	FORMOSA	FB12106993	FLORES DE GOIAS	24/02/2020 15:21	24/02/2020 17:52	24/02/2020 15:21	24/02/2020 17:52	2,50	135	337,95	CHI
202002161031	FORMOSO	FB12106993	FLORES DE GOIAS	24/02/2020 15:21	24/02/2020 17:52	24/02/2020 15:21	24/02/2020 17:52	2,50	1	2,50	CHI
202002161031	SAO JOAO D ALIANCA	FB12106993	FLORES DE GOIAS	24/02/2020 15:21	24/02/2020 17:52	24/02/2020 15:21	24/02/2020 17:52	2,50	5	12,52	CHI
202002161040	FLORES DE GOIAS	FB12248238	FLORES DE GOIAS	24/02/2020 15:23	24/02/2020 18:32	24/02/2020 15:23	24/02/2020 18:32	3,14	95	298,75	CHI
202002161040	SAO JOAO D ALIANCA	FB12248238	FLORES DE GOIAS	24/02/2020 15:23	24/02/2020 18:32	24/02/2020 15:23	24/02/2020 18:32	3,14	41	128,93	CHI
202002161042	CAIAPONIA	CP21243846	MONTIVIDIU T	24/02/2020 15:23	24/02/2020 22:35	24/02/2020 15:23	24/02/2020 22:35	7,18	1	7,18	CHI
202002161043	URUTAI	UT12300817LD	PIRES DO RIO S2	24/02/2020 15:24	24/02/2020 20:14	24/02/2020 15:24	24/02/2020 20:14	4,83	1	4,83	CHI
202002161071	RIO VERDE	RV12260980	CABRIUVA S2	24/02/2020 13:10	24/02/2020 17:35	24/02/2020 13:10	24/02/2020 17:35	4,41	3	13,22	CHI
202002161074	EDEALINA	ED21308023	PONTALINA	24/02/2020 15:31	24/02/2020 17:05	24/02/2020 15:31	24/02/2020 17:05	1,55	1	1,55	CHI
202002161076	IACIARA	IA21211657	IACIARA S1	24/02/2020 15:31	24/02/2020 16:45	24/02/2020 15:31	24/02/2020 16:45	1,22	1	1,22	CHI
202002161083	CALDAS NOVAS	CN12200806	SERRA DE CALDAS	24/02/2020 15:33	24/02/2020 18:07	24/02/2020 15:33	24/02/2020 18:07	2,55	5	12,76	CHI
202002161094	SAO JOAO D ALIANCA	JL12404385	SAO JOAO D ALIANCA	24/02/2020 15:34	24/02/2020 17:43	24/02/2020 15:34	24/02/2020 17:43	2,13	56	119,51	CHI
202002161104	VILA BOA	2880011160	IACIARA S2	24/02/2020 15:36	24/02/2020 17:24	24/02/2020 15:36	24/02/2020 17:24	1,80	1	1,80	CHI
202002161116	FLORES DE GOIAS	FB12302793	FLORES DE GOIAS	24/02/2020 15:38	24/02/2020 17:11	24/02/2020 15:38	24/02/2020 17:11	1,54	2	3,08	CHI
202002161123	URUACU	UR21212326	URUACU	24/02/2020 15:40	24/02/2020 20:49	24/02/2020 15:40	24/02/2020 20:49	5,15	1	5,15	CHI
202002161124	RIO VERDE	630463633	RIO VERDE S2	24/02/2020 15:40	24/02/2020 20:18	24/02/2020 15:40	24/02/2020 20:18	4,63	1	4,63	CHI
202002161125	POSSE	PS11262346	IACIARA S1	24/02/2020 15:40	24/02/2020 18:14	24/02/2020 15:40	24/02/2020 18:14	2,57	23	59,02	CHI
202002161132	CAMPO ALEGRE DE GOIAS	CM21133649	CAMPO ALEGRE DE GOIAS	24/02/2020 15:42	25/02/2020 16:13	24/02/2020 15:42	25/02/2020 16:13	24,51	1	24,51	CHI
202002161136	RIO VERDE	RV21074160	MONTIVIDIU T	24/02/2020 15:42	24/02/2020 20:38	24/02/2020 15:42	24/02/2020 20:38	4,93	2	9,86	CHI
202002161143	CAMPO ALEGRE DE GOIAS	CM21304128	CAMPO ALEGRE DE GOIAS	24/02/2020 15:44	25/02/2020 12:30	24/02/2020 15:44	25/02/2020 12:30	20,77	1	20,77	CHI
202002161147	MINACU	IH12207743	MINACU	24/02/2020 15:44	24/02/2020 17:50	24/02/2020 15:44	24/02/2020 17:50	2,09	18	37,55	CHI
202002161152	INDIARA	10031072974	EDEIA	24/02/2020 15:45	24/02/2020 19:18	24/02/2020 15:45	24/02/2020 19:18	3,55	0	0,00	CHI
202002161153	ORIZONA	OZ12372377	PIRES DO RIO S2	24/02/2020 09:27	24/02/2020 18:20	24/02/2020 09:27	24/02/2020 18:20	8,87	27	239,51	CHI
202002161157	CATALAO	CT12266222	CATALAO S1	24/02/2020 15:47	25/02/2020 10:24	24/02/2020 15:47	25/02/2020 10:24	18,61	1	18,61	CHI
202002161166	IPAMERI	IP21359061	PIRES DO RIO S2	24/02/2020 15:50	24/02/2020 20:40	24/02/2020 15:50	24/02/2020 20:40	4,83	1	4,83	CHI
202002161175	ITAJA	IJ21200689	ITAJA S2	24/02/2020 15:50	24/02/2020 21:20	24/02/2020 15:50	24/02/2020 20:52	5,04	1	5,04	CHI
202002161175	APORE	IJ13205155	ITAJA S2	24/02/2020 15:50	24/02/2020 21:20	24/02/2020 18:02	24/02/2020 21:20	3,30	4	13,19	CHI
202002161175	ITAJA	IJ13205155	ITAJA S2	24/02/2020 15:50	24/02/2020 21:20	24/02/2020 18:02	24/02/2020 21:20	3,30	17	56,05	CHI
202002161181	CRISTALINA	IP12165527	CRISTALINA S1	24/02/2020 15:25	24/02/2020 18:18	24/02/2020 15:25	24/02/2020 18:18	2,88	13	37,43	CHI
202002161188	CAMPINORTE	5750000544	MARA ROSA	24/02/2020 15:54	24/02/2020 20:02	24/02/2020 15:54	24/02/2020 20:02	4,12	1	4,12	CHI
202002161204	ITUMBIARA	IT12352663	ITUMBIARA VELHA S1	24/02/2020 15:45	24/02/2020 16:37	24/02/2020 15:45	24/02/2020 16:37	0,86	883	759,87	CHI
202002161212	IPAMERI	OZ21137552	PIRES DO RIO S2	24/02/2020 15:59	24/02/2020 21:21	24/02/2020 15:59	24/02/2020 21:21	5,36	1	5,36	CHI
202002161235	PORANGATU	PO12020580	PORANGATU	24/02/2020 15:49	24/02/2020 17:28	24/02/2020 15:49	24/02/2020 17:28	1,64	66	108,04	CHI
202002161237	ANAPOLIS	AN12370313LD	ANAPOLIS UNIVERSITARIO S2	24/02/2020 10:48	24/02/2020 21:01	24/02/2020 10:48	24/02/2020 21:01	10,21	43	439,15	CHI
202002161237	CAMPO LIMPO	AN12370313LD	ANAPOLIS UNIVERSITARIO S2	24/02/2020 10:48	24/02/2020 21:01	24/02/2020 10:48	24/02/2020 21:01	10,21	2	20,43	CHI

202002161237	ANAPOLIS	AN12370313LD	ANAPOLIS UNIVERSITARIO S2	24/02/2020 10:48	24/02/2020 21:01	24/02/2020 18:17	24/02/2020 21:01	2,73	14	38,24	CHI
202002161240	CAMPOS VERDES	SG12321954	SANTA TEREZINHA	24/02/2020 16:06	24/02/2020 21:48	24/02/2020 16:06	24/02/2020 21:48	5,70	1	5,70	CHI
202002161240	MARA ROSA	SG12321954	SANTA TEREZINHA	24/02/2020 16:06	24/02/2020 21:48	24/02/2020 16:06	24/02/2020 21:48	5,70	15	85,44	CHI
202002161240	SANTA TEREZINHA DE GOIAS	SG12321954	SANTA TEREZINHA	24/02/2020 16:06	24/02/2020 21:48	24/02/2020 16:06	24/02/2020 21:48	5,70	15	85,44	CHI
202002161246	ITUMBIARA	IT21000286	ITUMBIARA NOVA	24/02/2020 16:07	24/02/2020 17:36	24/02/2020 16:07	24/02/2020 17:36	1,47	2	2,94	CHI
202002161256	QUIRINOPOLIS	QI21091041	QUIRINOPOLIS	24/02/2020 16:09	25/02/2020 12:21	24/02/2020 16:09	25/02/2020 12:21	20,18	1	20,18	CHI
202002161260	IPAMERI	IP21200116	URUTAI	24/02/2020 16:10	24/02/2020 18:26	24/02/2020 16:10	24/02/2020 18:26	2,25	1	2,25	CHI
202002161264	ITUMBIARA	CD12000205	CACHOEIRA DOURADA	24/02/2020 16:11	24/02/2020 17:54	24/02/2020 16:11	24/02/2020 17:54	1,71	3	5,12	CHI
202002161267	ITAJA	IM12301779	CACHOEIRA ALTA	24/02/2020 16:12	24/02/2020 23:53	24/02/2020 16:12	24/02/2020 23:53	7,68	6	46,05	CHI
202002161295	RUBIATABA	RB21232708	RUBIATABA	24/02/2020 16:17	24/02/2020 18:56	24/02/2020 16:17	24/02/2020 18:56	2,64	2	5,29	CHI
202002161301	PANAMA	IT21166443	ITUMBIARA NOVA	24/02/2020 16:19	24/02/2020 18:57	24/02/2020 16:19	24/02/2020 18:57	2,63	2	5,25	CHI
202002161311	VICENTINOPOLIS	01810214	VICENTINOPOLIS	24/02/2020 16:20	24/02/2020 21:34	24/02/2020 16:20	24/02/2020 21:27	5,12	756	3869,88	CHI
202002161311	JOVIANIA	01810214	VICENTINOPOLIS	24/02/2020 16:20	24/02/2020 21:34	24/02/2020 16:20	24/02/2020 21:34	5,24	31	162,43	CHI
202002161311	PONTALINA	01810214	VICENTINOPOLIS	24/02/2020 16:20	24/02/2020 21:34	24/02/2020 16:20	24/02/2020 21:34	5,24	25	130,99	CHI
202002161311	VICENTINOPOLIS	01810214	VICENTINOPOLIS	24/02/2020 16:20	24/02/2020 21:34	24/02/2020 16:20	24/02/2020 21:34	5,24	1264	6623,01	CHI
202002161312	IPAMERI	IP12241882	IPAMERI	24/02/2020 16:22	25/02/2020 16:02	24/02/2020 16:22	25/02/2020 16:02	23,65	3	70,96	CHI
202002161316	FORMOSA	FA32042716	SAO JOAO D ALIANCA	24/02/2020 16:24	24/02/2020 21:41	24/02/2020 16:24	24/02/2020 21:41	5,27	1	5,27	CHI
202002161323	IACIARA	IA12046295	IACIARA S2	24/02/2020 16:26	24/02/2020 17:43	24/02/2020 16:26	24/02/2020 17:43	1,28	42	53,82	CHI
202002161331	PORANGATU	PO12241996	PORANGATU	24/02/2020 15:39	24/02/2020 18:25	24/02/2020 15:39	24/02/2020 18:25	2,76	81	223,87	CHI
202002161343	FORMOSA	FA11254247	ITIQUEIRA	24/02/2020 16:33	24/02/2020 17:48	24/02/2020 16:33	24/02/2020 17:48	1,25	1	1,25	CHI
202002161344	FORMOSA	FA12202282	ITIQUEIRA	24/02/2020 16:33	24/02/2020 19:00	24/02/2020 16:33	24/02/2020 19:00	2,45	5	12,23	CHI
202002161360	MAMBAI	1570000697	IACIARA S2	24/02/2020 16:37	24/02/2020 18:47	24/02/2020 16:37	24/02/2020 18:47	2,16	1	2,16	CHI
202002161369	IACIARA	IA21046256	IACIARA S2	24/02/2020 16:39	24/02/2020 18:49	24/02/2020 16:39	24/02/2020 18:49	2,16	1	2,16	CHI
202002161373	FLORES DE GOIAS	FB11255017	FLORES DE GOIAS	24/02/2020 16:40	25/02/2020 08:22	24/02/2020 16:40	25/02/2020 08:22	15,70	10	157,00	CHI
202002161377	HIDROLANDIA	HD21285820	PONTALINA	24/02/2020 16:40	24/02/2020 20:37	24/02/2020 16:40	24/02/2020 20:37	3,94	1	3,94	CHI
202002161385	MUNDO NOVO DE GOIAS	4240031693	NOVA CRIXAS	24/02/2020 16:42	24/02/2020 19:24	24/02/2020 16:42	24/02/2020 19:24	2,69	1	2,69	CHI
202002161395	IACIARA	IA21262075	IACIARA S2	24/02/2020 16:44	24/02/2020 19:04	24/02/2020 16:44	24/02/2020 19:04	2,32	1	2,32	CHI
202002161396	CACU	CC21072093	CACHOEIRA ALTA	24/02/2020 16:45	24/02/2020 20:33	24/02/2020 16:45	24/02/2020 20:33	3,80	1	3,80	CHI
202002161402	ORIZONA	OZ12390431	PIRES DO RIO S2	24/02/2020 14:55	24/02/2020 18:45	24/02/2020 14:55	24/02/2020 18:45	3,83	145	555,59	CHI
202002161406	ORIZONA	OZ12022983	PIRES DO RIO S2	24/02/2020 15:32	24/02/2020 19:25	24/02/2020 15:32	24/02/2020 19:25	3,88	11	42,63	CHI
202002161432	SANTO ANTONIO DA BARRA	BZ21027641	ACREUNA	24/02/2020 11:16	24/02/2020 20:52	24/02/2020 11:16	24/02/2020 20:52	9,59	1	9,59	CHI
202002161504	VILA BOA	2880009462	IACIARA S2	24/02/2020 16:46	24/02/2020 17:51	24/02/2020 16:46	24/02/2020 17:51	1,08	1	1,08	CHI
202002161512	AMARALINA	MU12391672	MARA ROSA	24/02/2020 16:30	24/02/2020 17:53	24/02/2020 16:30	24/02/2020 17:53	1,38	101	139,13	CHI
202002161512	MUTUNOPOLIS	MU12391672	MARA ROSA	24/02/2020 16:30	24/02/2020 17:53	24/02/2020 16:30	24/02/2020 17:53	1,38	7	9,64	CHI
202002161513	SAO MIGUEL DO ARAGUAIA	SM12371084	SAO MIGUEL DO ARAGUAIA	24/02/2020 16:43	24/02/2020 19:19	24/02/2020 16:43	24/02/2020 19:19	2,59	2	5,18	CHI
202002161522	QUIRINOPOLIS	QI21227773	SANTA HELENA S1	24/02/2020 16:49	25/02/2020 02:34	24/02/2020 16:49	25/02/2020 02:34	9,74	1	9,74	CHI
202002161531	PONTALINA	PK12393853	PONTALINA	24/02/2020 16:52	24/02/2020 18:18	24/02/2020 16:52	24/02/2020 18:18	1,43	3	4,29	CHI
202002161539	CORUMBAIBA	CI12049729	VILA CORUMBA	24/02/2020 16:39	24/02/2020 19:50	24/02/2020 16:39	24/02/2020 19:50	3,17	6	19,05	CHI
202002161548	ITUMBIARA	690119057	ITUMBIARA NOVA	24/02/2020 16:54	24/02/2020 18:04	24/02/2020 16:54	24/02/2020 18:04	1,15	1	1,15	CHI
202002161551	MORRINHOS	MR11171715	MORRINHOS	24/02/2020 16:55	24/02/2020 17:45	24/02/2020 16:55	24/02/2020 17:45	0,83	179	148,22	CHI
202002161559	NIQUELANDIA	NQ21285212	NIQUELANDIA SUBTRANSMISSAO	24/02/2020 16:57	25/02/2020 00:42	24/02/2020 16:57	25/02/2020 00:42	7,74	1	7,74	CHI
202002161560	NOVA CRIXAS	NA12091692	NOVA CRIXAS	24/02/2020 16:58	24/02/2020 21:56	24/02/2020 16:58	24/02/2020 21:56	4,96	22	109,04	CHI
202002161570	CATALAO	1990115783	CATALAO S2	24/02/2020 17:00	24/02/2020 22:10	24/02/2020 17:00	24/02/2020 22:10	5,16	1	5,16	CHI
202002161573	CACHOEIRA DOURADA	CD12000273	CACHOEIRA DOURADA	24/02/2020 08:28	24/02/2020 19:35	24/02/2020 08:28	24/02/2020 19:35	11,12	1	11,12	CHI

202002161573	ITUMBIARA	CD12000273	CACHOEIRA DOURADA	24/02/2020 08:28	24/02/2020 19:35	24/02/2020 08:28	24/02/2020 19:35	11,12	8	88,92	CHI
202002161584	ALTO PARAISO DE GOIAS	BF12375516	FLORES DE GOIAS	24/02/2020 17:01	24/02/2020 22:06	24/02/2020 17:01	24/02/2020 22:06	5,07	8	40,56	CHI
202002161585	CACU	CC12293980	CACHOEIRA ALTA	24/02/2020 17:02	25/02/2020 11:21	24/02/2020 17:02	25/02/2020 11:21	18,31	6	109,84	CHI
202002161587	IPAMERI	UT12016993	URUTAI	24/02/2020 17:00	24/02/2020 18:48	24/02/2020 17:00	24/02/2020 18:48	1,79	21	37,55	CHI
202002161587	URUTAI	UT12016993	URUTAI	24/02/2020 17:00	24/02/2020 18:48	24/02/2020 17:00	24/02/2020 18:48	1,79	5	8,94	CHI
202002161588	MINACU	4020029156	MINACU	24/02/2020 17:03	24/02/2020 20:24	24/02/2020 17:03	24/02/2020 20:24	3,35	1	3,35	CHI
202002161589	URUTAI	UT12309665	URUTAI	24/02/2020 17:03	24/02/2020 20:40	24/02/2020 17:03	24/02/2020 20:40	3,61	8	28,87	CHI
202002161596	CATALAO	CT12266116	CATALAO S1	24/02/2020 17:04	25/02/2020 12:49	24/02/2020 17:04	25/02/2020 12:49	19,73	3	59,20	CHI
202002161598	MINEIROS	1390084817	PARQUE DAS EMAS	24/02/2020 17:05	25/02/2020 00:14	24/02/2020 17:05	25/02/2020 00:14	7,14	1	7,14	CHI
202002161608	CALDAS NOVAS	CN12363988	CALDAS NOVAS S2	24/02/2020 16:54	24/02/2020 18:51	24/02/2020 16:54	24/02/2020 18:51	1,93	11	21,28	CHI
202002161613	PIRACANJUBA	PJ12212153	PIRACANJUBA	24/02/2020 16:55	24/02/2020 21:00	24/02/2020 16:55	24/02/2020 21:00	4,08	6	24,48	CHI
202002161616	CAMPO ALEGRE DE GOIAS	CM12231703	CAMPO ALEGRE DE GOIAS	24/02/2020 17:07	25/02/2020 11:27	24/02/2020 17:07	25/02/2020 11:27	18,32	10	183,18	CHI
202002161618	GUARINOS	GF12380720	SANTA TEREZINHA	24/02/2020 17:08	24/02/2020 19:07	24/02/2020 17:08	24/02/2020 19:07	1,98	17	33,63	CHI
202002161619	CATALAO	1990309681	CATALAO S2	24/02/2020 17:08	25/02/2020 00:09	24/02/2020 17:08	25/02/2020 00:09	7,01	1	7,01	CHI
202002161628	NIQUELANDIA	NQ12256599	NIQUELANDIA SUBTRANSMISSAO	24/02/2020 17:10	26/02/2020 17:20	24/02/2020 17:10	25/02/2020 22:56	29,76	3	89,28	CHI
202002161628	NIQUELANDIA	NQ12256599	NIQUELANDIA SUBTRANSMISSAO	24/02/2020 17:10	26/02/2020 17:20	24/02/2020 17:10	26/02/2020 17:20	48,17	1	48,17	CHI
202002161633	RIO VERDE	RV21260188	RIO VERDE S2	24/02/2020 17:11	24/02/2020 20:43	24/02/2020 17:11	24/02/2020 20:43	3,52	2	7,05	CHI
202002161639	SANTA HELENA DE GOIAS	400108586	IPEGUARI	24/02/2020 17:12	24/02/2020 19:06	24/02/2020 17:12	24/02/2020 19:06	1,89	1	1,89	CHI
202002161682	GOIATUBA	GT21190878	GOIATUBA S2	24/02/2020 17:20	24/02/2020 18:48	24/02/2020 17:20	24/02/2020 18:48	1,47	2	2,93	CHI
202002161685	CORUMBAIBA	IP10375985	IPAMERI	24/02/2020 17:13	25/02/2020 11:50	24/02/2020 17:13	24/02/2020 19:24	2,18	12	26,14	CHI
202002161685	IPAMERI	IP10375985	IPAMERI	24/02/2020 17:13	25/02/2020 11:50	24/02/2020 17:13	24/02/2020 19:24	2,18	191	416,06	CHI
202002161685	IPAMERI	IP10375985	IPAMERI	24/02/2020 17:13	25/02/2020 11:50	24/02/2020 17:13	24/02/2020 21:07	3,90	1	3,90	CHI
202002161685	CORUMBAIBA	IP10375985	IPAMERI	24/02/2020 17:13	25/02/2020 11:50	24/02/2020 20:50	24/02/2020 21:07	0,28	16	4,47	CHI
202002161685	IPAMERI	IP10375985	IPAMERI	24/02/2020 17:13	25/02/2020 11:50	24/02/2020 20:50	24/02/2020 21:07	0,28	209	58,40	CHI
202002161685	CORUMBAIBA	IP10375985	IPAMERI	24/02/2020 17:13	25/02/2020 11:50	24/02/2020 22:19	24/02/2020 22:28	0,14	16	2,29	CHI
202002161685	IPAMERI	IP10375985	IPAMERI	24/02/2020 17:13	25/02/2020 11:50	24/02/2020 22:19	24/02/2020 22:28	0,14	211	30,24	CHI
202002161685	CORUMBAIBA	IP10375985	IPAMERI	24/02/2020 17:13	25/02/2020 11:50	25/02/2020 08:02	25/02/2020 08:19	0,28	16	4,50	CHI
202002161685	IPAMERI	IP10375985	IPAMERI	24/02/2020 17:13	25/02/2020 11:50	25/02/2020 08:02	25/02/2020 08:19	0,28	215	60,44	CHI
202002161685	NOVA AURORA	IP10375985	IPAMERI	24/02/2020 17:13	25/02/2020 11:50	25/02/2020 08:02	25/02/2020 08:19	0,28	2	0,56	CHI
202002161685	CALDAS NOVAS	IP12000080LD	IPAMERI	24/02/2020 17:13	25/02/2020 11:50	24/02/2020 17:13	25/02/2020 11:32	18,31	10	183,07	CHI
202002161685	CORUMBAIBA	IP12000080LD	IPAMERI	24/02/2020 17:13	25/02/2020 11:50	24/02/2020 17:13	25/02/2020 11:32	18,31	3	54,92	CHI
202002161685	IPAMERI	IP12000080LD	IPAMERI	24/02/2020 17:13	25/02/2020 11:50	24/02/2020 17:13	25/02/2020 11:32	18,31	221	4045,83	CHI
202002161685	IPAMERI	IP12000080LD	IPAMERI	24/02/2020 17:13	25/02/2020 11:50	24/02/2020 17:13	25/02/2020 11:50	18,61	1	18,61	CHI
202002161703	FORMOSA	FA21393548	ITUIQUIRA	24/02/2020 17:23	24/02/2020 18:34	24/02/2020 17:23	24/02/2020 18:34	1,17	2	2,35	CHI
202002161711	ITUMBIARA	690201898	ITUMBIARA VELHA S1	24/02/2020 17:25	25/02/2020 07:07	24/02/2020 17:25	25/02/2020 07:07	13,69	1	13,69	CHI
202002161715	ORIZONA	OZ21152144	PIRES DO RIO S2	24/02/2020 17:25	24/02/2020 19:55	24/02/2020 17:25	24/02/2020 19:55	2,49	1	2,49	CHI
202002161717	BOM JESUS DE GOIAS	DM12153969	RIO DOS BOIS	24/02/2020 16:43	24/02/2020 19:27	24/02/2020 16:43	24/02/2020 19:27	2,72	1	2,72	CHI
202002161717	CASTELANDIA	DM12153969	RIO DOS BOIS	24/02/2020 16:43	24/02/2020 19:27	24/02/2020 16:43	24/02/2020 19:27	2,72	5	13,62	CHI
202002161717	QUIRINOPOLIS	DM12153969	RIO DOS BOIS	24/02/2020 16:43	24/02/2020 19:27	24/02/2020 16:43	24/02/2020 19:27	2,72	9	24,51	CHI
202002161725	CABECEIRAS	CW12316971	ITUIQUIRA	24/02/2020 17:27	24/02/2020 20:13	24/02/2020 17:27	24/02/2020 20:13	2,76	1	2,76	CHI
202002161727	PALMELO	PZ12063775RE	PIRES DO RIO S2	24/02/2020 17:27	24/02/2020 20:19	24/02/2020 17:27	24/02/2020 20:19	2,85	23	65,65	CHI
202002161727	PIRES DO RIO	PZ12063775RE	PIRES DO RIO S2	24/02/2020 17:27	24/02/2020 20:19	24/02/2020 17:27	24/02/2020 20:19	2,85	6	17,13	CHI
202002161727	SANTA CRUZ DE GOIAS	PZ12063775RE	PIRES DO RIO S2	24/02/2020 17:27	24/02/2020 20:19	24/02/2020 17:27	24/02/2020 20:19	2,85	26	74,22	CHI
202002161728	MINEIROS	MY21210416	PARQUE DAS EMAS	24/02/2020 17:27	25/02/2020 05:00	24/02/2020 17:27	25/02/2020 05:00	11,53	1	11,53	CHI

202002161729	JATAI	JT12361799	JATAI S2	24/02/2020 17:24	24/02/2020 20:03	24/02/2020 17:24	24/02/2020 20:03	2,64	32	84,62	CHI
202002161731	PORANGATU	PO11150798	PORANGATU	24/02/2020 17:28	25/02/2020 00:07	24/02/2020 17:28	24/02/2020 23:49	6,34	46	291,70	CHI
202002161731	PORANGATU	PO12103735	PORANGATU	24/02/2020 17:28	25/02/2020 00:07	24/02/2020 21:57	25/02/2020 00:07	2,17	98	212,80	CHI
202002161736	EDEALINA	ED12100591	PONTALINA	24/02/2020 17:28	25/02/2020 11:45	24/02/2020 17:28	24/02/2020 18:45	1,28	2	2,57	CHI
202002161736	EDEALINA	ED12100591	PONTALINA	24/02/2020 17:28	25/02/2020 11:45	24/02/2020 18:49	25/02/2020 11:45	16,92	2	33,84	CHI
202002161747	GOIATUBA	GT11000025	GOIATUBA S2	24/02/2020 17:32	25/02/2020 10:44	24/02/2020 17:32	25/02/2020 10:44	17,19	125	2148,89	CHI
202002161754	MINACU	IH12317057	MINACU	24/02/2020 16:00	24/02/2020 18:37	24/02/2020 16:00	24/02/2020 18:37	2,61	5	13,04	CHI
202002161772	CABECEIRAS	CW12184625	ITIQUEIRA	24/02/2020 17:37	24/02/2020 18:32	24/02/2020 17:37	24/02/2020 18:32	0,91	3	2,72	CHI
202002161775	PEROLANDIA	MY12324350	PARQUE DAS EMAS	24/02/2020 17:37	24/02/2020 19:20	24/02/2020 17:37	24/02/2020 19:20	1,70	2	3,40	CHI
202002161783	MAMBAI	MB11057996	IACIARA S2	24/02/2020 17:40	24/02/2020 19:25	24/02/2020 17:40	24/02/2020 19:25	1,75	28	48,89	CHI
202002161794	CALDAS NOVAS	10013558046	SERRA DE CALDAS	24/02/2020 17:42	24/02/2020 18:56	24/02/2020 17:42	24/02/2020 18:56	1,23	1	1,23	CHI
202002161801	AGUA FRIA DE GOIAS	PI21048035	SAO JOAO D ALIANCA	24/02/2020 17:44	24/02/2020 19:35	24/02/2020 17:44	24/02/2020 19:35	1,83	1	1,83	CHI
202002161807	PARAUNA	PU12303763	ACREUNA	24/02/2020 17:46	24/02/2020 21:40	24/02/2020 17:46	24/02/2020 21:40	3,90	3	11,71	CHI
202002161812	MINEIROS	MY12202613	PARQUE DAS EMAS	24/02/2020 17:47	25/02/2020 03:13	24/02/2020 17:47	25/02/2020 03:13	9,44	10	94,37	CHI
202002161816	MINEIROS	1390075233	PARQUE DAS EMAS	24/02/2020 17:49	24/02/2020 22:41	24/02/2020 17:49	24/02/2020 22:41	4,86	1	4,86	CHI
202002161819	MONTIVIDIU	MV12085688	MONTIVIDIU T	24/02/2020 17:50	24/02/2020 22:50	24/02/2020 17:50	24/02/2020 22:50	4,99	1	4,99	CHI
202002161823	CALDAS NOVAS	CN21254419	SERRA DE CALDAS	24/02/2020 17:50	24/02/2020 18:03	24/02/2020 17:50	24/02/2020 18:03	0,22	1	0,22	CHI
202002161825	ALTO PARAISO DE GOIAS	BF12224071	SAO JOAO D ALIANCA	24/02/2020 17:52	25/02/2020 10:01	24/02/2020 17:52	25/02/2020 10:01	16,15	5	80,73	CHI
202002161838	MINACU	IH12207388	MINACU	24/02/2020 17:19	24/02/2020 19:06	24/02/2020 17:19	24/02/2020 19:06	1,77	81	143,71	CHI
202002161839	ITAJA	IJ21154804	ITAJA S2	24/02/2020 17:56	25/02/2020 08:07	24/02/2020 17:56	25/02/2020 08:07	14,17	1	14,17	CHI
202002161871	DISTRITO FEDERAL	FA21180750	ITIQUEIRA	24/02/2020 18:03	24/02/2020 19:12	24/02/2020 18:03	24/02/2020 19:12	1,14	1	1,14	CHI
202002161873	GOIATUBA	140000460	GOIATUBA S2	24/02/2020 18:04	24/02/2020 22:15	24/02/2020 18:04	24/02/2020 22:15	4,19	1	4,19	CHI
202002161891	JATAI	JT21357719	JATAI S1	24/02/2020 18:12	24/02/2020 21:42	24/02/2020 18:12	24/02/2020 21:42	3,49	1	3,49	CHI
202002161895	CROMINIA	CQ21161582	PONTALINA	24/02/2020 18:12	24/02/2020 21:25	24/02/2020 18:12	24/02/2020 21:25	3,20	1	3,20	CHI
202002161897	CATALAO	CT21192558	CATALAO S1	24/02/2020 18:13	25/02/2020 08:21	24/02/2020 18:13	25/02/2020 08:21	14,12	1	14,12	CHI
202002161898	ITUMBIARA	CD21222294	CACHOEIRA DOURADA	24/02/2020 18:13	25/02/2020 09:02	24/02/2020 18:13	25/02/2020 09:02	14,80	1	14,80	CHI
202002161905	FORMOSA	FA12282335	ITIQUEIRA	24/02/2020 18:15	24/02/2020 19:37	24/02/2020 18:15	24/02/2020 19:37	1,36	5	6,80	CHI
202002161912	FORMOSA	FA12322753	ITIQUEIRA	24/02/2020 18:17	24/02/2020 20:20	24/02/2020 18:17	24/02/2020 20:20	2,05	2	4,09	CHI
202002161924	IACIARA	IA21134187	IACIARA S2	24/02/2020 18:22	24/02/2020 20:29	24/02/2020 18:22	24/02/2020 20:29	2,11	1	2,11	CHI
202002161927	JATAI	JT12007819	JATAI S2	24/02/2020 18:22	24/02/2020 22:33	24/02/2020 18:22	24/02/2020 22:33	4,17	1	4,17	CHI
202002161938	FORMOSA	FB12242937LD	FLORES DE GOIAS	24/02/2020 18:19	25/02/2020 00:03	24/02/2020 18:19	25/02/2020 00:03	5,73	129	739,49	CHI
202002161938	FORMOSO	FB12242937LD	FLORES DE GOIAS	24/02/2020 18:19	25/02/2020 00:03	24/02/2020 18:19	25/02/2020 00:03	5,73	1	5,73	CHI
202002161938	SAO JOAO D ALIANCA	FB12242937LD	FLORES DE GOIAS	24/02/2020 18:19	25/02/2020 00:03	24/02/2020 18:19	25/02/2020 00:03	5,73	5	28,66	CHI
202002161938	FLORES DE GOIAS	FB12242937LD	FLORES DE GOIAS	24/02/2020 18:19	25/02/2020 00:03	24/02/2020 21:45	25/02/2020 00:03	2,31	3	6,92	CHI
202002161938	FORMOSA	FB12242937LD	FLORES DE GOIAS	24/02/2020 18:19	25/02/2020 00:03	24/02/2020 21:45	25/02/2020 00:03	2,31	4	9,23	CHI
202002161940	CALDAS NOVAS	760280009	SERRA DE CALDAS	24/02/2020 18:24	24/02/2020 20:22	24/02/2020 18:24	24/02/2020 20:22	1,95	1	1,95	CHI
202002161956	CATALAO	10012413249	CATALAO S2	24/02/2020 18:30	25/02/2020 07:33	24/02/2020 18:30	25/02/2020 07:33	13,04	1	13,04	CHI
202002161963	EDEIA	EA12000039	EDEIA	24/02/2020 18:31	24/02/2020 21:17	24/02/2020 18:31	24/02/2020 21:17	2,75	20	55,01	CHI
202002161970	IPAMERI	IP21375812	IPAMERI	24/02/2020 18:32	25/02/2020 09:05	24/02/2020 18:32	25/02/2020 09:05	14,53	1	14,53	CHI
202002161981	BOM JESUS DE GOIAS	05210214	CACHOEIRA DOURADA	24/02/2020 18:04	24/02/2020 21:55	24/02/2020 18:04	24/02/2020 19:45	1,68	3	5,05	CHI
202002161981	ITUMBIARA	05210214	CACHOEIRA DOURADA	24/02/2020 18:04	24/02/2020 21:55	24/02/2020 18:04	24/02/2020 19:45	1,68	80	134,64	CHI
202002161981	BOM JESUS DE GOIAS	05210214	CACHOEIRA DOURADA	24/02/2020 18:04	24/02/2020 21:55	24/02/2020 18:04	24/02/2020 21:55	3,84	30	115,11	CHI
202002161981	GOIATUBA	05210214	CACHOEIRA DOURADA	24/02/2020 18:04	24/02/2020 21:55	24/02/2020 18:04	24/02/2020 21:55	3,84	7	26,86	CHI
202002161981	ITUMBIARA	05210214	CACHOEIRA DOURADA	24/02/2020 18:04	24/02/2020 21:55	24/02/2020 18:04	24/02/2020 21:55	3,84	106	406,72	CHI



202002161981	PANAMA	05210214	CACHOEIRA DOURADA	24/02/2020 18:04	24/02/2020 21:55	24/02/2020 18:04	24/02/2020 21:55	3,84	20	76,74	CHI
202002161982	VILA BOA	2880010142	IACIARA S2	24/02/2020 18:38	24/02/2020 21:06	24/02/2020 18:38	24/02/2020 21:06	2,46	1	2,46	CHI
202002161984	CALDAS NOVAS	10027391491	SERRA DE CALDAS	24/02/2020 18:39	24/02/2020 20:50	24/02/2020 18:39	24/02/2020 20:50	2,18	1	2,18	CHI
202002161990	SAO MIGUEL DO ARAGUAIA	SM12096089RE	SAO MIGUEL DO ARAGUAIA	24/02/2020 17:35	24/02/2020 21:42	24/02/2020 17:35	24/02/2020 21:42	4,12	27	111,11	CHI
202002161992	CAMPO ALEGRE DE GOIAS	CM12127532	CAMPO ALEGRE DE GOIAS	24/02/2020 18:40	25/02/2020 11:42	24/02/2020 18:40	25/02/2020 11:08	16,46	17	279,75	CHI
202002161992	CAMPO ALEGRE DE GOIAS	CM12266823	CAMPO ALEGRE DE GOIAS	24/02/2020 18:40	25/02/2020 11:42	24/02/2020 18:40	25/02/2020 11:42	17,03	43	732,18	CHI
202002162006	PIRES DO RIO	PR12255837	PIRES DO RIO S1	24/02/2020 17:49	24/02/2020 23:12	24/02/2020 17:49	24/02/2020 23:12	5,37	33	177,35	CHI
202002162023	CATALAO	1990157169	CATALAO S2	24/02/2020 18:50	24/02/2020 22:39	24/02/2020 18:50	24/02/2020 22:39	3,81	1	3,81	CHI
202002162031	MORRINHOS	1790000261	MORRINHOS	24/02/2020 18:52	24/02/2020 23:30	24/02/2020 18:52	24/02/2020 23:30	4,63	1	4,63	CHI
202002162036	PLANALTINA	PI12100878	PLANALTINA	24/02/2020 18:53	24/02/2020 22:43	24/02/2020 18:53	24/02/2020 22:43	3,82	23	87,95	CHI
202002162038	BURITI ALEGRE	420051077	ALTO BURITI	24/02/2020 18:53	24/02/2020 20:25	24/02/2020 18:53	24/02/2020 20:25	1,53	1	1,53	CHI
202002162046	IPAMERI	IP11332948	IPAMERI	24/02/2020 18:56	25/02/2020 11:30	24/02/2020 18:56	25/02/2020 11:30	16,56	1	16,56	CHI
202002162047	CABECEIRAS	CW21393777	ITUIQUIRA	24/02/2020 18:56	24/02/2020 21:08	24/02/2020 18:56	24/02/2020 21:08	2,19	1	2,19	CHI
202002162056	LAGOA SANTA	3900006086	ITAJA S2	24/02/2020 18:59	25/02/2020 07:33	24/02/2020 18:59	25/02/2020 07:33	12,56	1	12,56	CHI
202002162057	PORTELANDIA	PW10406623	PARQUE DAS EMAS	24/02/2020 18:59	25/02/2020 21:57	25/02/2020 19:00	25/02/2020 19:05	0,07	16	1,14	CHI
202002162057	MINEIROS	PW10406623	PARQUE DAS EMAS	24/02/2020 18:59	25/02/2020 21:57	25/02/2020 19:00	25/02/2020 21:57	2,95	121	356,51	CHI
202002162057	PORTELANDIA	PW10406623	PARQUE DAS EMAS	24/02/2020 18:59	25/02/2020 21:57	25/02/2020 19:00	25/02/2020 21:57	2,95	29	85,45	CHI
202002162057	SANTA RITA DO ARAGUAIA	PW10406623	PARQUE DAS EMAS	24/02/2020 18:59	25/02/2020 21:57	25/02/2020 19:00	25/02/2020 21:57	2,95	13	38,30	CHI
202002162081	ORIZONA	OZ11000126	PIRES DO RIO S2	24/02/2020 17:57	24/02/2020 21:57	24/02/2020 17:57	24/02/2020 21:57	3,99	120	479,37	CHI
202002162134	CACHOEIRA ALTA	CA21071627	CACHOEIRA ALTA	24/02/2020 19:17	25/02/2020 01:19	24/02/2020 19:17	25/02/2020 01:19	6,02	1	6,02	CHI
202002162145	MONTIVIDIU	2840025640	MONTIVIDIU T	24/02/2020 19:20	24/02/2020 22:25	24/02/2020 19:20	24/02/2020 22:25	3,08	1	3,08	CHI
202002162190	RIO VERDE	10005941740	RIO VERDE S1	24/02/2020 19:32	25/02/2020 01:02	24/02/2020 19:32	25/02/2020 01:02	5,50	1	5,50	CHI
202002162294	MINEIROS	MY12296347	PARQUE DAS EMAS	24/02/2020 19:56	25/02/2020 13:56	24/02/2020 19:56	25/02/2020 13:56	17,99	2	35,99	CHI
202002162315	GOIATUBA	10027232423	RIO DOS BOIS	24/02/2020 20:03	24/02/2020 23:42	24/02/2020 20:03	24/02/2020 23:42	3,65	1	3,65	CHI
202002162328	QUIRINOPOLIS	80029930	QUIRINOPOLIS	24/02/2020 20:06	24/02/2020 21:36	24/02/2020 20:06	24/02/2020 21:36	1,50	1	1,50	CHI
202002162339	ACREUNA	TD12025737	RIO DOS BOIS	24/02/2020 20:09	25/02/2020 10:19	24/02/2020 20:09	25/02/2020 10:19	14,16	13	184,04	CHI
202002162339	SANTA HELENA DE GOIAS	TD12025737	RIO DOS BOIS	24/02/2020 20:09	25/02/2020 10:19	24/02/2020 20:09	25/02/2020 10:19	14,16	18	254,82	CHI
202002162339	TURVELANDIA	TD12025737	RIO DOS BOIS	24/02/2020 20:09	25/02/2020 10:19	24/02/2020 20:09	25/02/2020 10:19	14,16	51	721,99	CHI
202002162351	CACU	CC11000025	CACHOEIRA ALTA	24/02/2020 20:08	24/02/2020 21:37	24/02/2020 20:08	24/02/2020 21:37	1,48	153	225,76	CHI
202002162440	JATAI	JT12036853	JATAI S3	24/02/2020 20:30	25/02/2020 07:35	24/02/2020 20:30	25/02/2020 07:35	11,07	1	11,07	CHI
202002162445	IPAMERI	IP12337216	IPAMERI	24/02/2020 05:00	25/02/2020 07:01	24/02/2020 05:00	25/02/2020 07:01	26,02	4	104,07	CHI
202002162445	NOVA AURORA	IP12337216	IPAMERI	24/02/2020 05:00	25/02/2020 07:01	24/02/2020 05:00	25/02/2020 07:01	26,02	2	52,03	CHI
202002162455	CACHOEIRA ALTA	CA21350893	CACHOEIRA ALTA	24/02/2020 20:35	24/02/2020 23:29	24/02/2020 20:35	24/02/2020 23:29	2,90	2	5,79	CHI
202002162497	ACREUNA	EU12026747	RIO DOS BOIS	24/02/2020 20:01	25/02/2020 10:19	24/02/2020 20:01	25/02/2020 10:19	14,29	11	157,21	CHI
202002162497	TURVELANDIA	EU12026747	RIO DOS BOIS	24/02/2020 20:01	25/02/2020 10:19	24/02/2020 20:01	25/02/2020 10:19	14,29	15	214,37	CHI
202002162557	CACU	CC12322236	CACHOEIRA ALTA	24/02/2020 21:17	25/02/2020 08:31	24/02/2020 21:17	25/02/2020 08:31	11,23	1	11,23	CHI
202002162601	JATAI	JT12274032	JATAI S2	24/02/2020 21:28	24/02/2020 23:30	24/02/2020 21:28	24/02/2020 23:30	2,02	11	22,20	CHI
202002162607	TURVELANDIA	SH12026451	RIO DOS BOIS	24/02/2020 21:32	25/02/2020 11:41	24/02/2020 21:32	25/02/2020 11:41	14,15	1	14,15	CHI
202002162616	CAIAPONIA	CP21303516	MONTIVIDIU T	24/02/2020 21:34	24/02/2020 23:41	24/02/2020 21:34	24/02/2020 23:41	2,11	1	2,11	CHI
202002162625	JATAI	JT21135403	JATAI S1	24/02/2020 21:36	25/02/2020 00:30	24/02/2020 21:36	25/02/2020 00:30	2,89	1	2,89	CHI
202002162679	ITAJA	IJ21191720	ITAJA S2	24/02/2020 22:02	25/02/2020 04:50	24/02/2020 22:02	25/02/2020 04:50	6,80	1	6,80	CHI
202002162728	MINEIROS	MY21332655	PARQUE DAS EMAS	24/02/2020 22:39	25/02/2020 12:03	24/02/2020 22:39	25/02/2020 12:03	13,40	1	13,40	CHI
202002162886	SERRANOPOLIS	SX12166082	JATAI S1	24/02/2020 22:14	25/02/2020 08:51	24/02/2020 22:14	25/02/2020 08:51	10,61	19	201,50	CHI
202002191109	CATALAO	GD12039654	CATALAO S1	23/02/2020 23:15	24/02/2020 08:18	23/02/2020 23:15	24/02/2020 08:18	9,04	4	36,14	CHI

202002191109	GOIANDIRA	GD12039654	CATALAO S1	23/02/2020 23:15	24/02/2020 08:18	23/02/2020 23:15	24/02/2020 08:18	9,04	6	54,21	CHI
202002191112	CUMARI	CY12038820	CATALAO S1	24/02/2020 05:57	24/02/2020 13:36	24/02/2020 05:57	24/02/2020 13:36	7,64	7	53,45	CHI
202002191130	BURITI ALEGRE	420039685	ITUMBIARA VELHA S2	22/02/2020 18:05	23/02/2020 09:07	22/02/2020 18:05	23/02/2020 09:07	15,03	1	15,03	CHI
2020022200049	SANTO ANTONIO DO DESCOBERTO	03190508	ALEXANIA	22/02/2020 19:22	24/02/2020 15:59	22/02/2020 19:22	22/02/2020 20:24	1,04	12315	12776,81	CHI
2020022200049	CORUMBA DE GOIAS	SN10395421	ALEXANIA	22/02/2020 19:22	24/02/2020 15:59	22/02/2020 19:22	22/02/2020 20:24	1,04	9	9,34	CHI
2020022200049	SANTO ANTONIO DO DESCOBERTO	SN10395421	ALEXANIA	22/02/2020 19:22	24/02/2020 15:59	22/02/2020 19:22	22/02/2020 20:24	1,04	169	175,38	CHI
2020022200049	ALEXANIA	CB13108434	ALEXANIA	22/02/2020 19:22	24/02/2020 15:59	22/02/2020 19:22	22/02/2020 21:01	1,66	39	64,61	CHI
2020022200049	ALEXANIA	03190508	ALEXANIA	22/02/2020 19:22	24/02/2020 15:59	22/02/2020 19:22	22/02/2020 21:01	1,66	285	472,15	CHI
2020022200049	CORUMBA DE GOIAS	CB13108434	ALEXANIA	22/02/2020 19:22	24/02/2020 15:59	22/02/2020 19:22	22/02/2020 21:01	1,66	15	24,85	CHI
2020022200049	SANTO ANTONIO DO DESCOBERTO	03190508	ALEXANIA	22/02/2020 19:22	24/02/2020 15:59	22/02/2020 19:22	22/02/2020 21:01	1,66	34	56,33	CHI
2020022200049	ALEXANIA	03190508	CORUMBA	22/02/2020 19:22	24/02/2020 15:59	22/02/2020 19:22	22/02/2020 21:01	1,66	854	1414,79	CHI
2020022200049	CORUMBA DE GOIAS	03190508	CORUMBA	22/02/2020 19:22	24/02/2020 15:59	22/02/2020 19:22	22/02/2020 21:01	1,66	363	601,37	CHI
2020022200049	ABADIANIA	03190508	ALEXANIA	22/02/2020 19:22	24/02/2020 15:59	22/02/2020 19:22	22/02/2020 21:28	2,11	17	35,79	CHI
2020022200049	ALEXANIA	03190508	ALEXANIA	22/02/2020 19:22	24/02/2020 15:59	22/02/2020 19:22	22/02/2020 21:28	2,11	4079	8588,56	CHI
2020022200049	ALEXANIA	AX10406655	ALEXANIA	22/02/2020 19:22	24/02/2020 15:59	22/02/2020 19:22	22/02/2020 21:28	2,11	2	4,21	CHI
2020022200049	CORUMBA DE GOIAS	03190508	ALEXANIA	22/02/2020 19:22	24/02/2020 15:59	22/02/2020 19:22	22/02/2020 21:28	2,11	119	250,56	CHI
2020022200049	JARAGUA	03190508	ALEXANIA	22/02/2020 19:22	24/02/2020 15:59	22/02/2020 19:22	22/02/2020 21:28	2,11	73	153,71	CHI
2020022200049	ALEXANIA	AX10406655	ALEXANIA	22/02/2020 19:22	24/02/2020 15:59	22/02/2020 21:10	22/02/2020 21:28	0,31	285	87,56	CHI
2020022200049	SANTO ANTONIO DO DESCOBERTO	AX10406655	ALEXANIA	22/02/2020 19:22	24/02/2020 15:59	22/02/2020 21:10	22/02/2020 21:28	0,31	34	10,45	CHI
2020022200049	ALEXANIA	03190508	ALEXANIA	22/02/2020 19:22	24/02/2020 15:59	22/02/2020 19:22	22/02/2020 21:33	2,19	4715	10308,82	CHI
2020022200049	SANTO ANTONIO DO DESCOBERTO	03190508	ALEXANIA	22/02/2020 19:22	24/02/2020 15:59	22/02/2020 19:22	22/02/2020 21:33	2,19	1	2,19	CHI
2020022200049	ALEXANIA	03190508	ALEXANIA	22/02/2020 19:22	24/02/2020 15:59	22/02/2020 19:22	22/02/2020 21:42	2,35	1524	3575,47	CHI
2020022200049	ALEXANIA	AX10394596	ALEXANIA	22/02/2020 19:22	24/02/2020 15:59	22/02/2020 19:22	22/02/2020 21:44	2,37	148	350,10	CHI
2020022200049	CORUMBA DE GOIAS	AX10394596	ALEXANIA	22/02/2020 19:22	24/02/2020 15:59	22/02/2020 19:22	22/02/2020 21:44	2,37	7	16,56	CHI
2020022200049	SANTO ANTONIO DO DESCOBERTO	AX10394596	ALEXANIA	22/02/2020 19:22	24/02/2020 15:59	22/02/2020 19:22	22/02/2020 21:44	2,37	4	9,46	CHI
2020022200049	ALEXANIA	03190508	ALEXANIA	22/02/2020 19:22	24/02/2020 15:59	22/02/2020 19:22	22/02/2020 22:24	3,04	418	1269,21	CHI
2020022200049	ALEXANIA	03190508	ALEXANIA	22/02/2020 19:22	24/02/2020 15:59	22/02/2020 19:22	22/02/2020 22:24	3,04	66	200,40	CHI
2020022200049	ALEXANIA	03190508	ALEXANIA	22/02/2020 19:22	24/02/2020 15:59	22/02/2020 19:22	22/02/2020 22:24	3,04	763	2316,76	CHI
2020022200049	ALEXANIA	03190508	ALEXANIA	22/02/2020 19:22	24/02/2020 15:59	22/02/2020 19:22	22/02/2020 22:24	3,04	27	81,98	CHI
2020022200049	BARRO ALTO	03190508	ALEXANIA	22/02/2020 19:22	24/02/2020 15:59	22/02/2020 19:22	22/02/2020 22:24	3,04	2	6,07	CHI
2020022200049	SANTO ANTONIO DO DESCOBERTO	03190508	ALEXANIA	22/02/2020 19:22	24/02/2020 15:59	22/02/2020 19:22	22/02/2020 22:24	3,04	1	3,04	CHI
2020022200049	SANTO ANTONIO DO DESCOBERTO	03190508	ALEXANIA	22/02/2020 19:22	24/02/2020 15:59	22/02/2020 19:22	22/02/2020 22:24	3,04	183	555,66	CHI
2020022200049	ALEXANIA	AX13196774	ALEXANIA	22/02/2020 19:22	24/02/2020 15:59	23/02/2020 11:36	23/02/2020 13:18	1,70	404	686,46	CHI
2020022200049	BARRO ALTO	AX13196774	ALEXANIA	22/02/2020 19:22	24/02/2020 15:59	23/02/2020 11:36	23/02/2020 13:18	1,70	2	3,40	CHI
2020022200049	SANTO ANTONIO DO DESCOBERTO	AX13196774	ALEXANIA	22/02/2020 19:22	24/02/2020 15:59	23/02/2020 11:36	23/02/2020 13:18	1,70	1	1,70	CHI
2020022200049	ALEXANIA	03650214	ALEXANIA	22/02/2020 19:22	24/02/2020 15:59	23/02/2020 13:12	23/02/2020 13:18	0,09	14	1,31	CHI
2020022200049	AGUAS LINDAS DE GOIAS	LA10400400	AGUAS LINDAS DE GOIAS S2	22/02/2020 19:22	24/02/2020 15:59	23/02/2020 18:57	23/02/2020 20:31	1,56	2	3,12	CHI
2020022200049	COCALZINHO DE GOIAS	LA10400400	AGUAS LINDAS DE GOIAS S2	22/02/2020 19:22	24/02/2020 15:59	23/02/2020 18:57	23/02/2020 20:31	1,56	186	290,01	CHI
2020022200049	COCALZINHO DE GOIAS	LA10400400	AGUAS LINDAS DE GOIAS S2	22/02/2020 19:22	24/02/2020 15:59	23/02/2020 18:57	23/02/2020 20:31	1,56	3026	4718,04	CHI
2020022200049	COCALZINHO DE GOIAS	LA10400400	AGUAS LINDAS DE GOIAS S2	22/02/2020 19:22	24/02/2020 15:59	23/02/2020 18:57	23/02/2020 20:31	1,56	8	12,47	CHI
2020022200049	CORUMBA DE GOIAS	LA10400400	AGUAS LINDAS DE GOIAS S2	22/02/2020 19:22	24/02/2020 15:59	23/02/2020 18:57	23/02/2020 20:31	1,56	7	10,91	CHI
2020022200049	PADRE BERNARDO	LA10400400	AGUAS LINDAS DE GOIAS S2	22/02/2020 19:22	24/02/2020 15:59	23/02/2020 18:57	23/02/2020 20:31	1,56	4	6,24	CHI
2020022200049	RIALMA	LA10400400	AGUAS LINDAS DE GOIAS S2	22/02/2020 19:22	24/02/2020 15:59	23/02/2020 18:57	23/02/2020 20:31	1,56	6	9,36	CHI
2020022200049	SANTO ANTONIO DO DESCOBERTO	LA10400400	AGUAS LINDAS DE GOIAS S2	22/02/2020 19:22	24/02/2020 15:59	23/02/2020 18:57	23/02/2020 20:31	1,56	99	154,36	CHI

2020022200049	AGUAS LINDAS DE GOIAS	ZN10398171	AGUAS LINDAS DE GOIAS S2	22/02/2020 19:22	24/02/2020 15:59	23/02/2020 20:47	23/02/2020 21:40	0,88	2	1,76	CHI
2020022200049	COCALZINHO DE GOIAS	ZN10398171	AGUAS LINDAS DE GOIAS S2	22/02/2020 19:22	24/02/2020 15:59	23/02/2020 20:47	23/02/2020 21:40	0,88	156	137,11	CHI
2020022200049	CORUMBA DE GOIAS	ZN10398171	AGUAS LINDAS DE GOIAS S2	22/02/2020 19:22	24/02/2020 15:59	23/02/2020 20:47	23/02/2020 21:40	0,88	7	6,15	CHI
2020022200049	SANTO ANTONIO DO DESCOBERTO	ZN10398171	AGUAS LINDAS DE GOIAS S2	22/02/2020 19:22	24/02/2020 15:59	23/02/2020 20:47	23/02/2020 21:40	0,88	99	87,01	CHI
2020022200049	ABADIANIA	AX10406655	ALEXANIA	22/02/2020 19:22	24/02/2020 15:59	24/02/2020 14:50	24/02/2020 14:58	0,13	17	2,29	CHI
2020022200049	ALEXANIA	AX10406655	ALEXANIA	22/02/2020 19:22	24/02/2020 15:59	24/02/2020 14:50	24/02/2020 14:58	0,13	4156	559,91	CHI
2020022200049	ALEXANIA	AX10406655	ALEXANIA	22/02/2020 19:22	24/02/2020 15:59	24/02/2020 14:50	24/02/2020 14:58	0,13	1672	225,26	CHI
2020022200049	ALEXANIA	AX10406655	ALEXANIA	22/02/2020 19:22	24/02/2020 15:59	24/02/2020 14:50	24/02/2020 14:58	0,13	4715	635,22	CHI
2020022200049	ALEXANIA	AX10406655	ALEXANIA	22/02/2020 19:22	24/02/2020 15:59	24/02/2020 14:50	24/02/2020 14:58	0,13	3	0,40	CHI
2020022200049	CORUMBA DE GOIAS	AX10406655	ALEXANIA	22/02/2020 19:22	24/02/2020 15:59	24/02/2020 14:50	24/02/2020 14:58	0,13	121	16,30	CHI
2020022200049	CORUMBA DE GOIAS	AX10406655	ALEXANIA	22/02/2020 19:22	24/02/2020 15:59	24/02/2020 14:50	24/02/2020 14:58	0,13	7	0,94	CHI
2020022200049	JARAGUA	AX10406655	ALEXANIA	22/02/2020 19:22	24/02/2020 15:59	24/02/2020 14:50	24/02/2020 14:58	0,13	73	9,83	CHI
2020022200049	SANTO ANTONIO DO DESCOBERTO	AX10406655	ALEXANIA	22/02/2020 19:22	24/02/2020 15:59	24/02/2020 14:50	24/02/2020 14:58	0,13	4	0,54	CHI
2020022200049	SANTO ANTONIO DO DESCOBERTO	AX10406655	ALEXANIA	22/02/2020 19:22	24/02/2020 15:59	24/02/2020 14:50	24/02/2020 14:58	0,13	1	0,13	CHI
2020022200049	ALEXANIA	AX10406655	ALEXANIA	22/02/2020 19:22	24/02/2020 15:59	24/02/2020 14:50	24/02/2020 14:58	0,14	13	1,76	CHI
2020022200049	ALEXANIA	AX10406655	ALEXANIA	22/02/2020 19:22	24/02/2020 15:59	24/02/2020 14:50	24/02/2020 14:59	0,15	418	61,66	CHI
2020022200049	ALEXANIA	AX10406655	ALEXANIA	22/02/2020 19:22	24/02/2020 15:59	24/02/2020 14:50	24/02/2020 14:59	0,15	66	9,74	CHI
2020022200049	ALEXANIA	AX10406655	ALEXANIA	22/02/2020 19:22	24/02/2020 15:59	24/02/2020 14:50	24/02/2020 14:59	0,15	727	107,23	CHI
2020022200049	ALEXANIA	AX13163280	ALEXANIA	22/02/2020 19:22	24/02/2020 15:59	24/02/2020 14:50	24/02/2020 14:59	0,15	14	2,07	CHI
2020022200049	BARRO ALTO	AX10406655	ALEXANIA	22/02/2020 19:22	24/02/2020 15:59	24/02/2020 14:50	24/02/2020 14:59	0,15	2	0,30	CHI
2020022200049	SANTO ANTONIO DO DESCOBERTO	AX10406655	ALEXANIA	22/02/2020 19:22	24/02/2020 15:59	24/02/2020 14:50	24/02/2020 14:59	0,15	1	0,15	CHI
2020022200049	SANTO ANTONIO DO DESCOBERTO	AX10406655	ALEXANIA	22/02/2020 19:22	24/02/2020 15:59	24/02/2020 14:50	24/02/2020 14:59	0,15	173	25,52	CHI
2020022200049	ALEXANIA	AX10406655	ALEXANIA	22/02/2020 19:22	24/02/2020 15:59	24/02/2020 14:50	24/02/2020 15:59	1,14	285	325,45	CHI
2020022200049	SANTO ANTONIO DO DESCOBERTO	AX10406655	ALEXANIA	22/02/2020 19:22	24/02/2020 15:59	24/02/2020 14:50	24/02/2020 15:59	1,14	34	38,83	CHI



# Plotagem das Ocorrências conforme a Espacialização das Chuvas

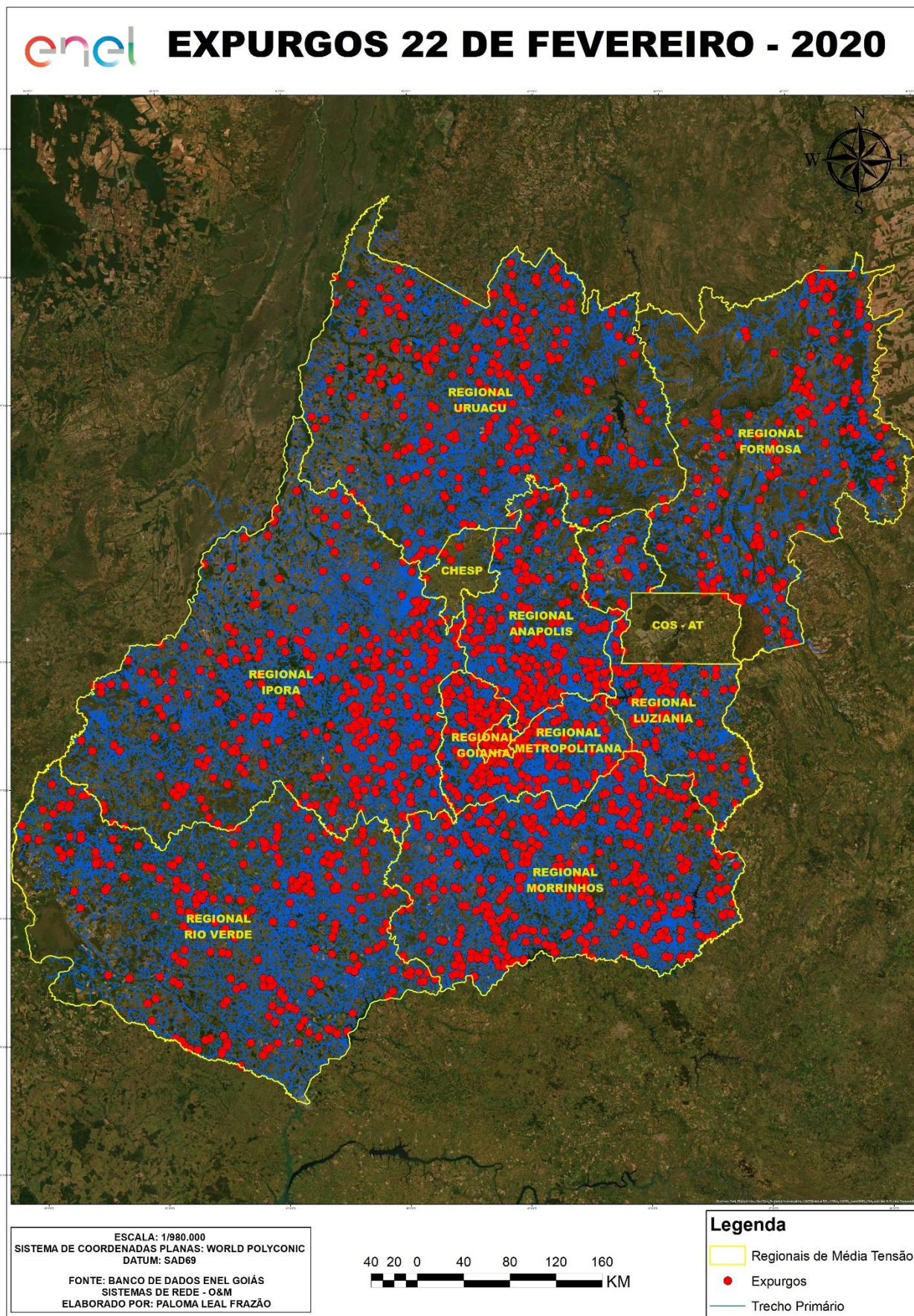

# Diagramas Unifilares

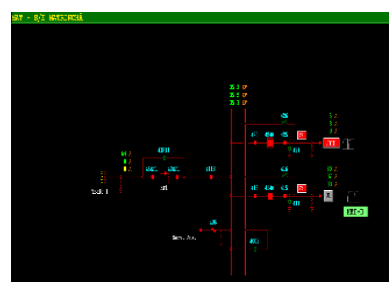
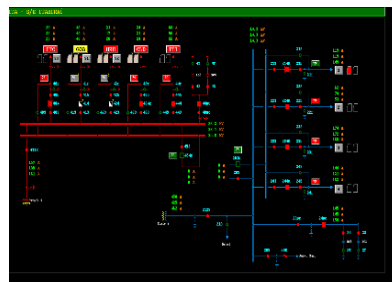
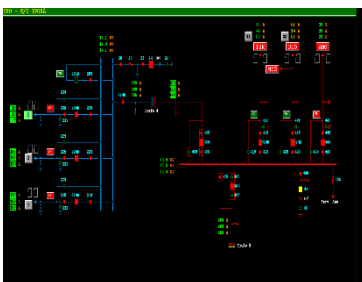
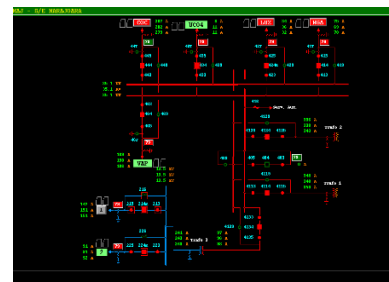
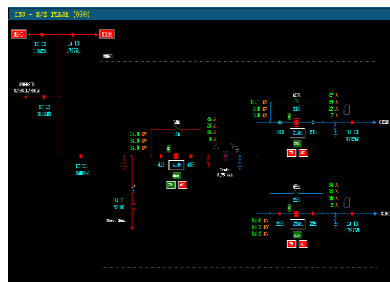
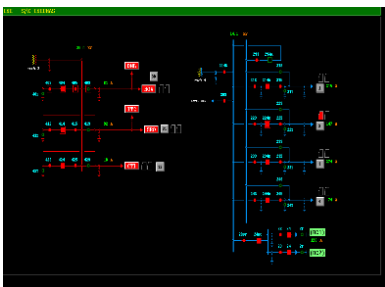
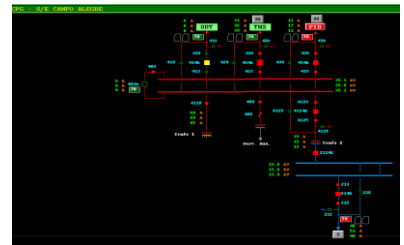
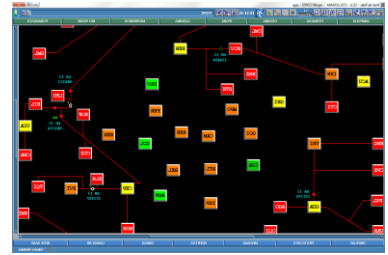
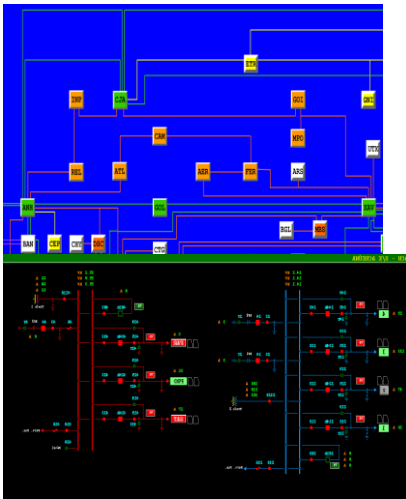



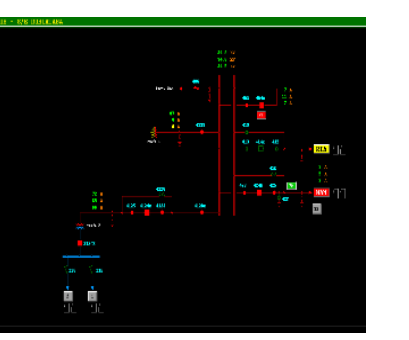
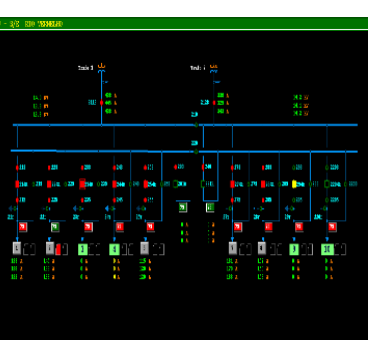
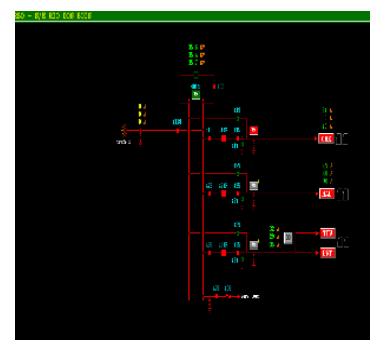
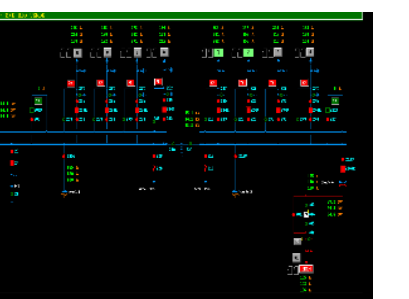
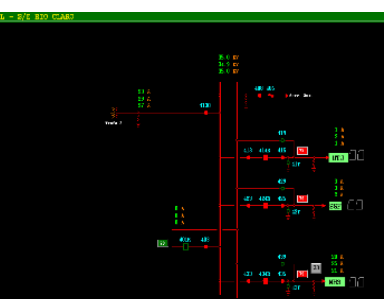
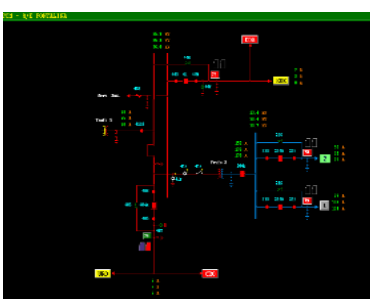
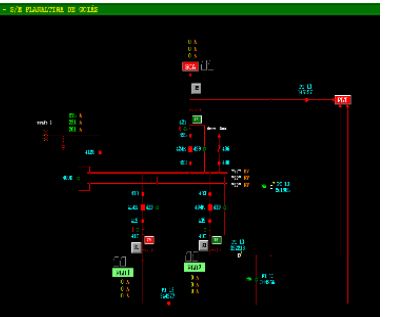
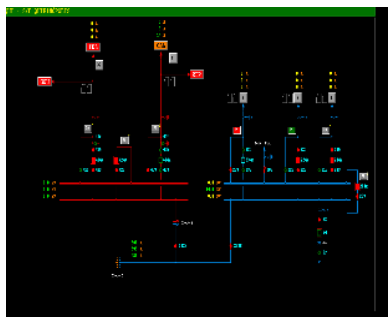
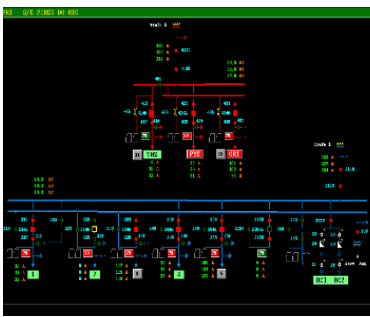
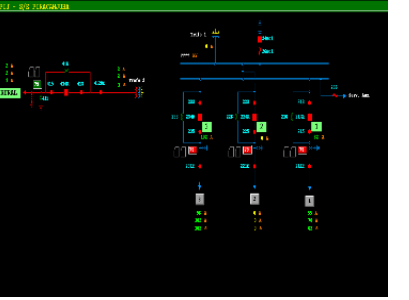
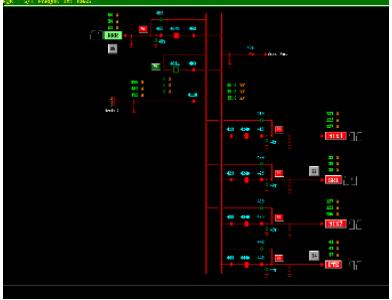
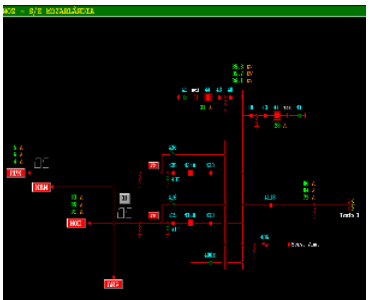
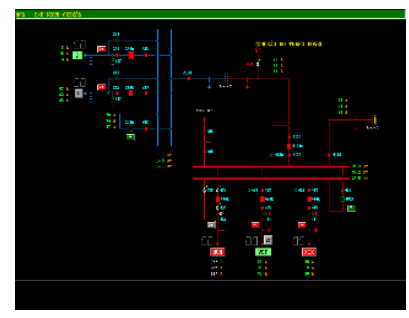
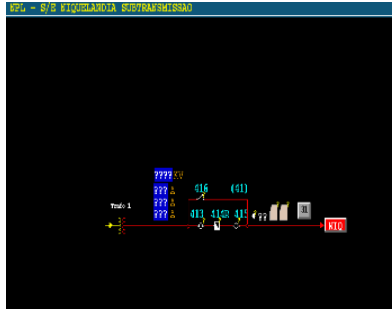

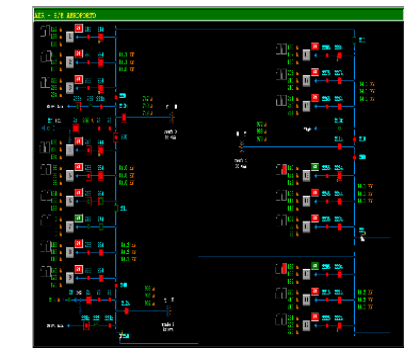
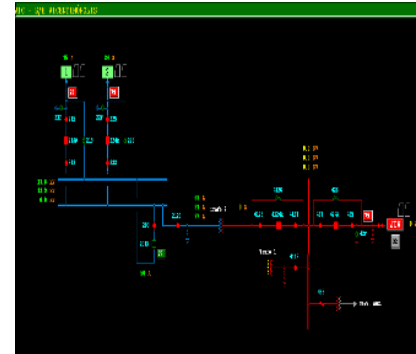
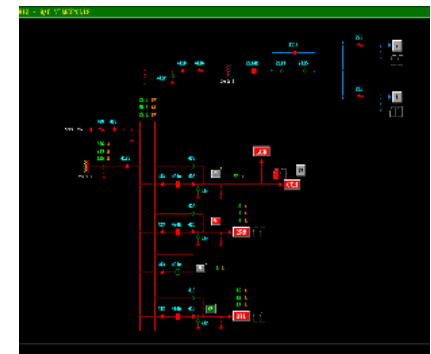
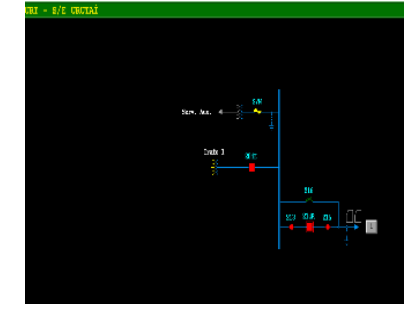
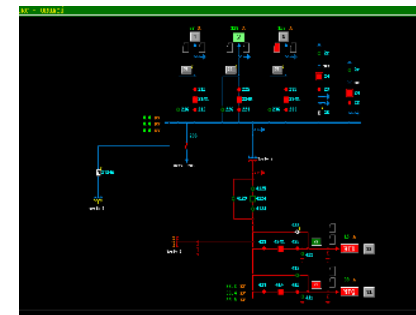
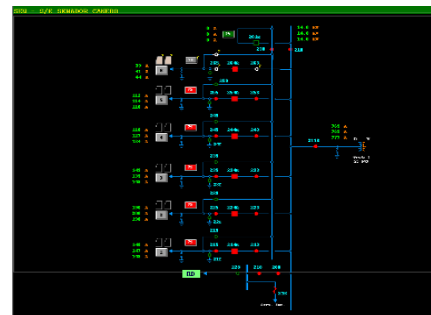
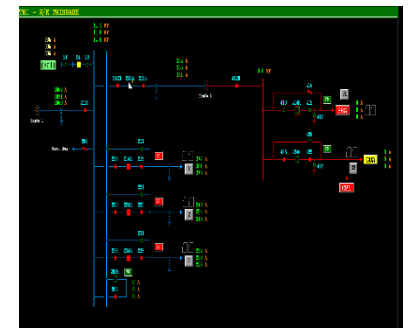
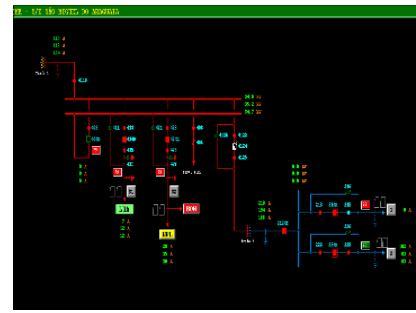
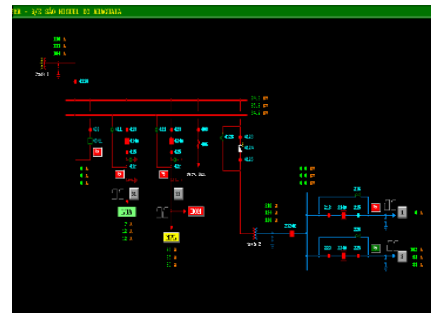
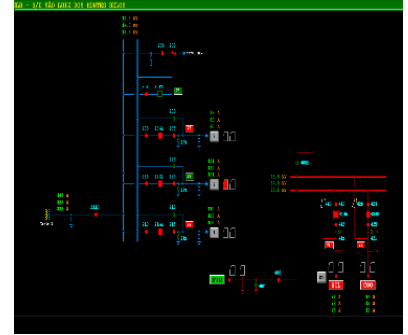
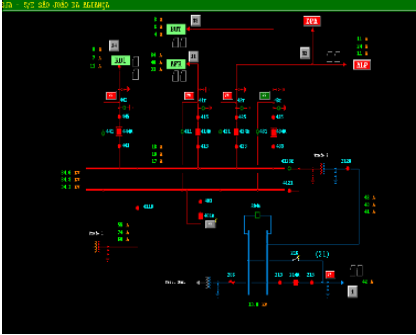
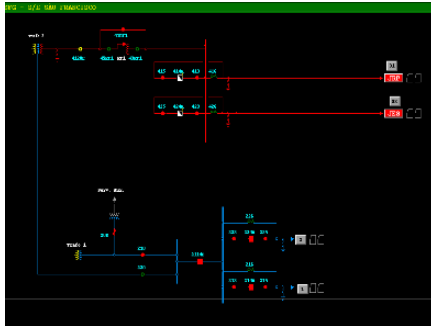
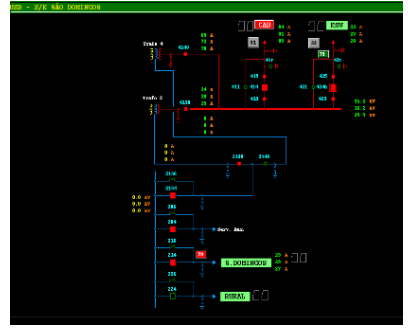
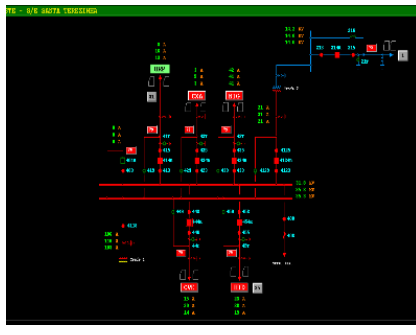
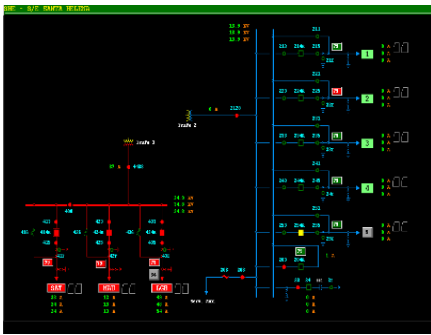

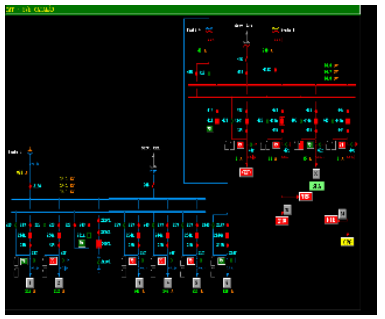
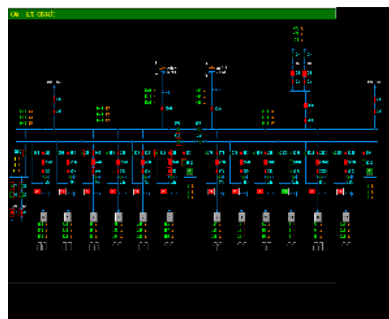
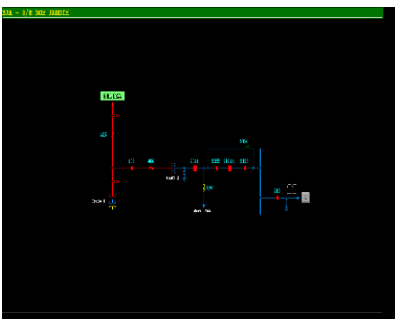
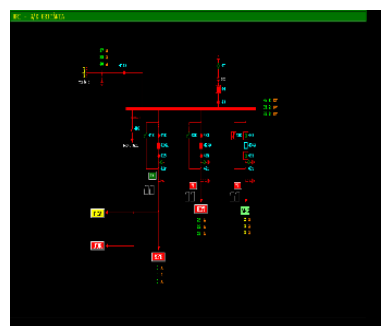
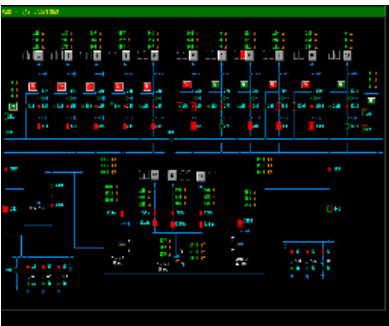
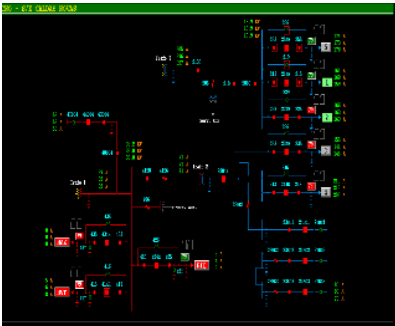
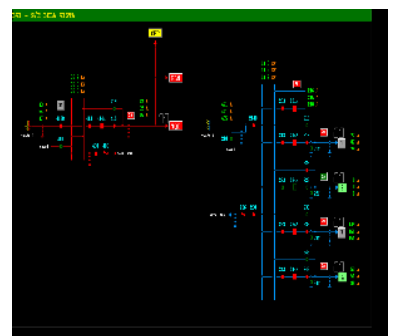
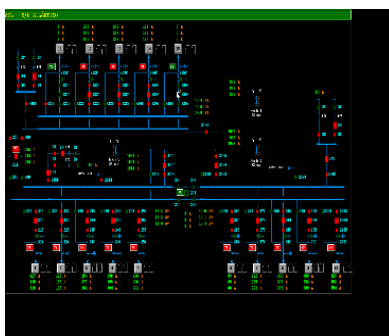
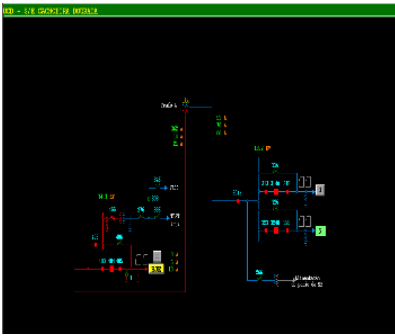
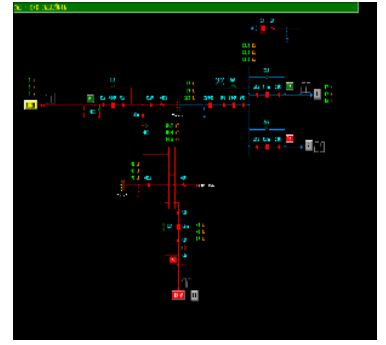
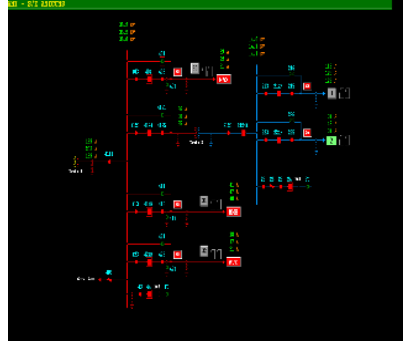
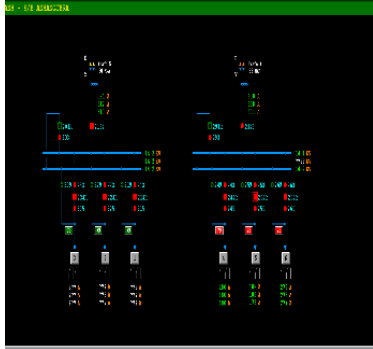
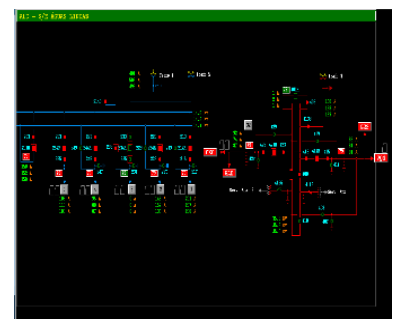
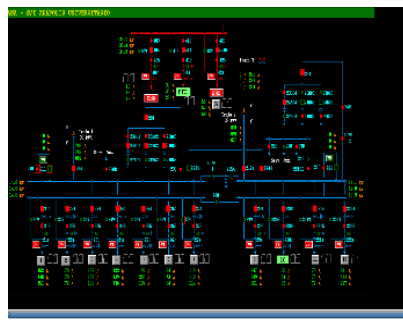
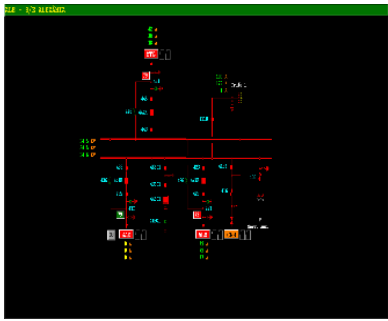





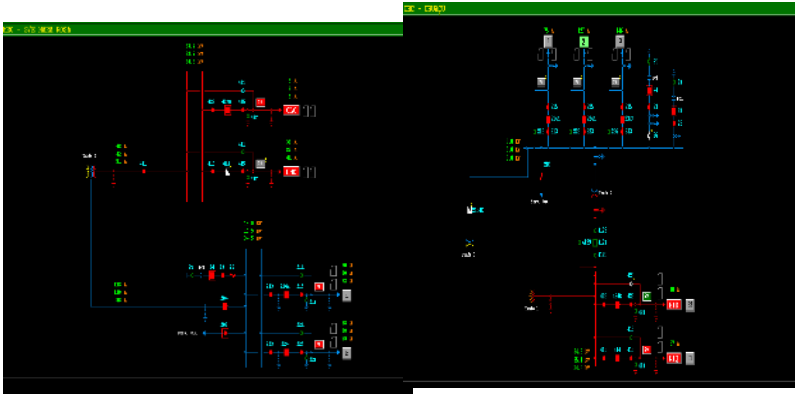
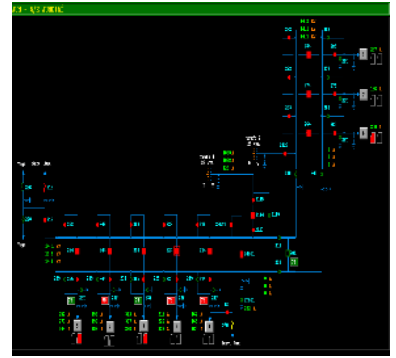
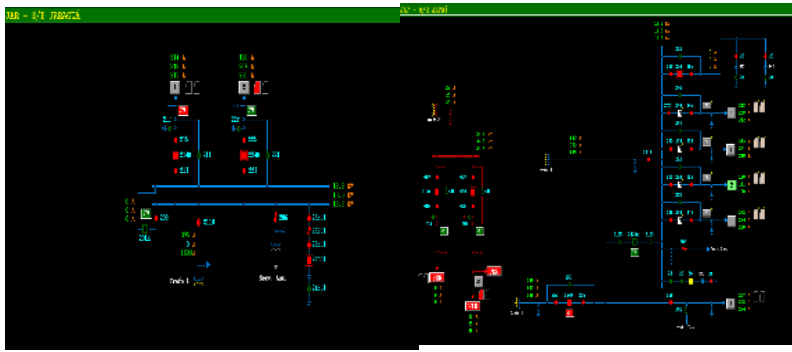

# DEMAIS EVIDÊNCIAS

## DADOS TÉCNICO - OPERACIONAIS ENEL GO

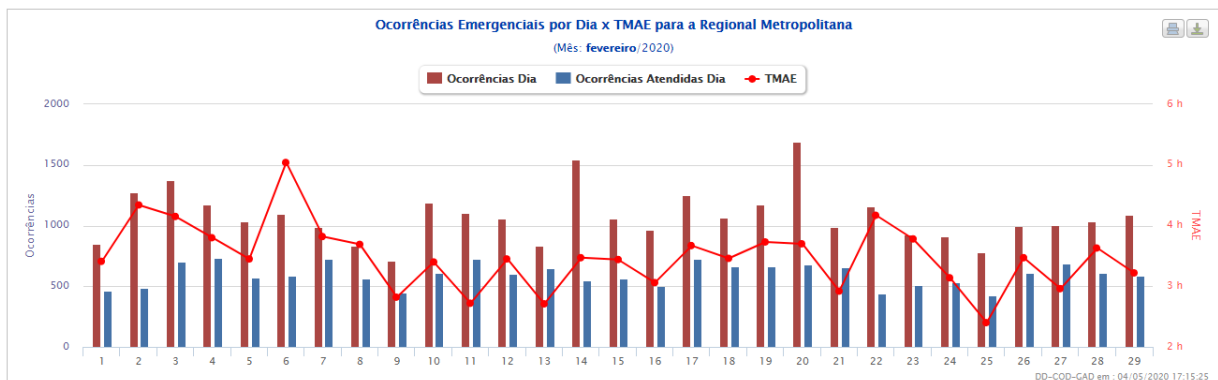
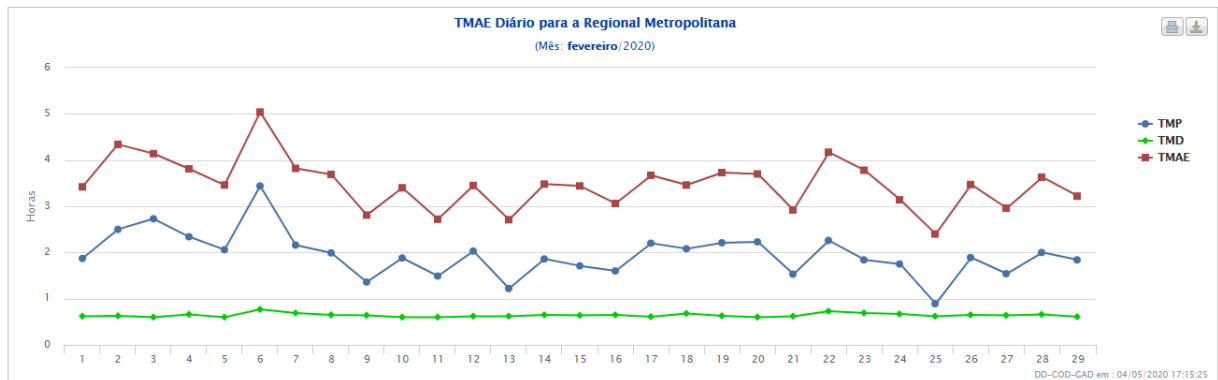
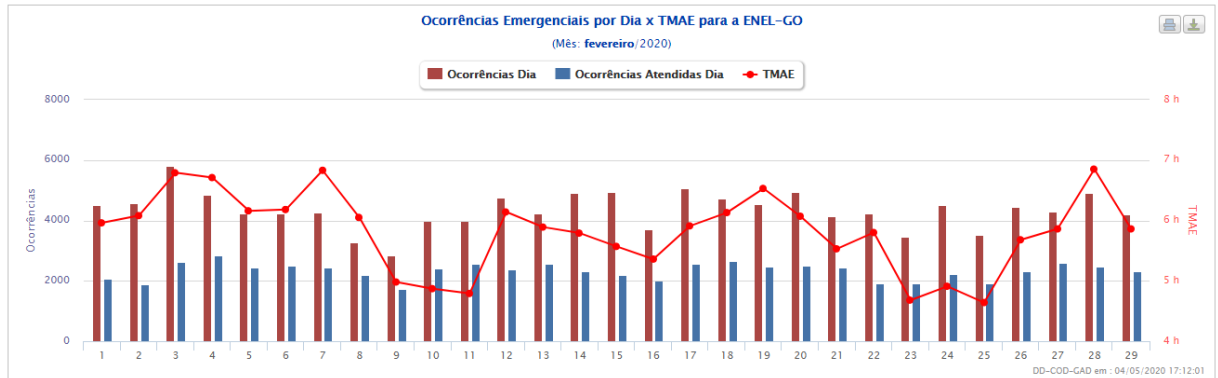
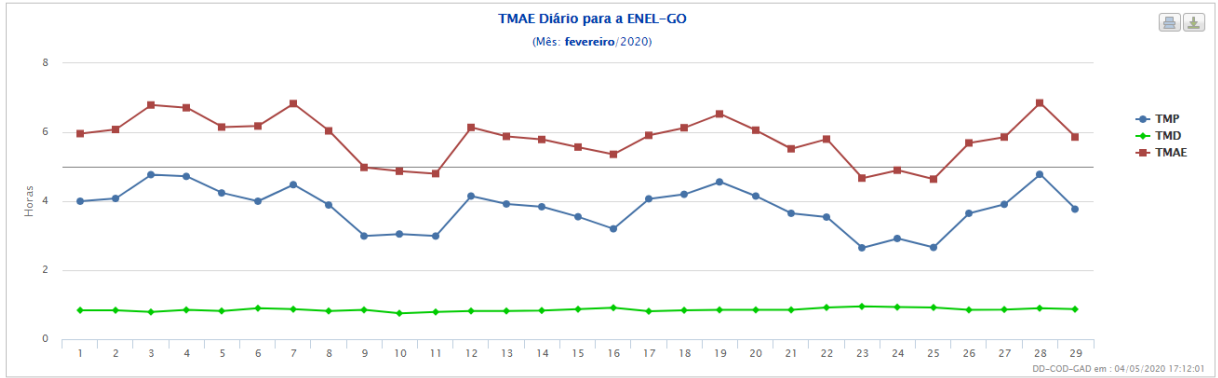

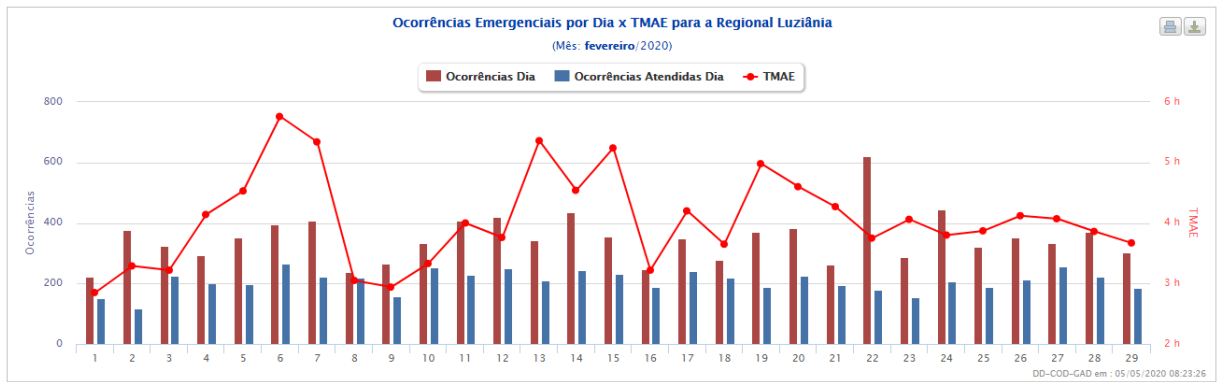
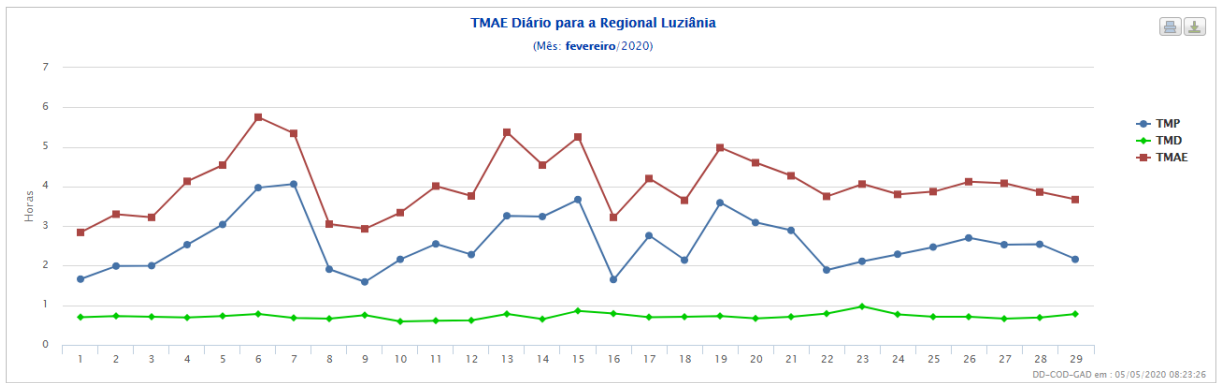
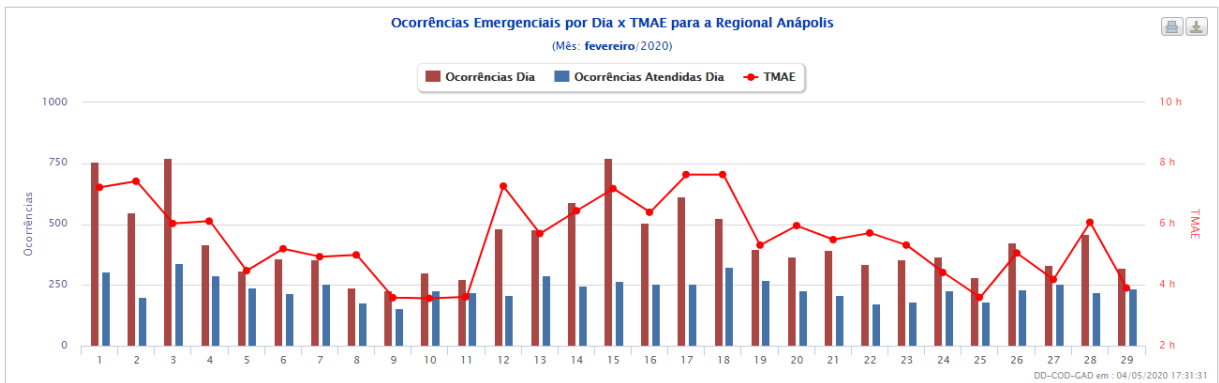
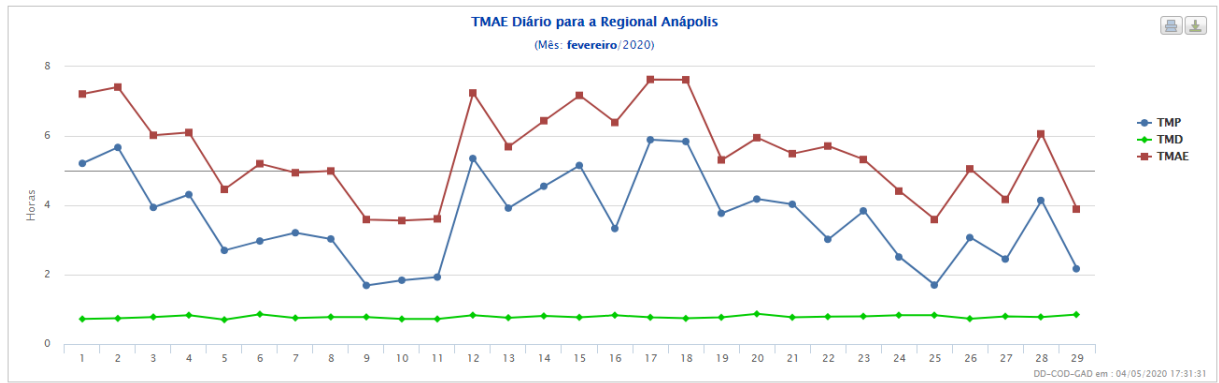

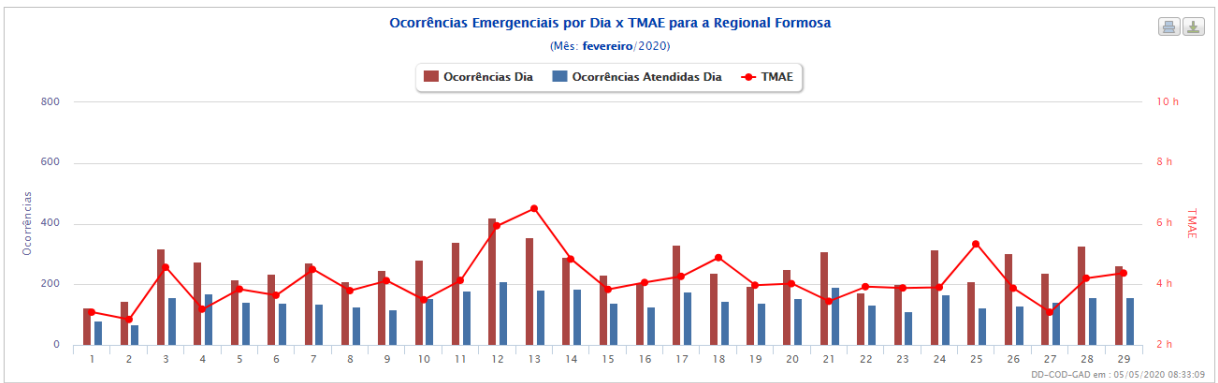
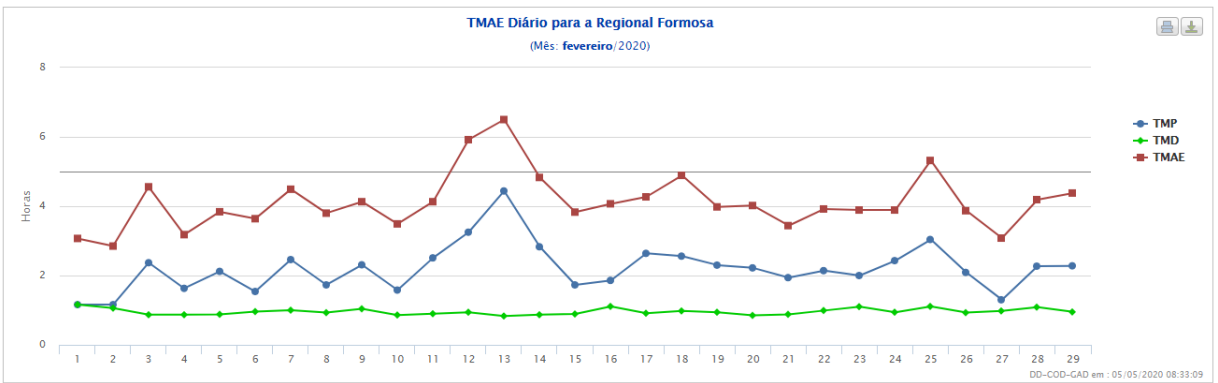
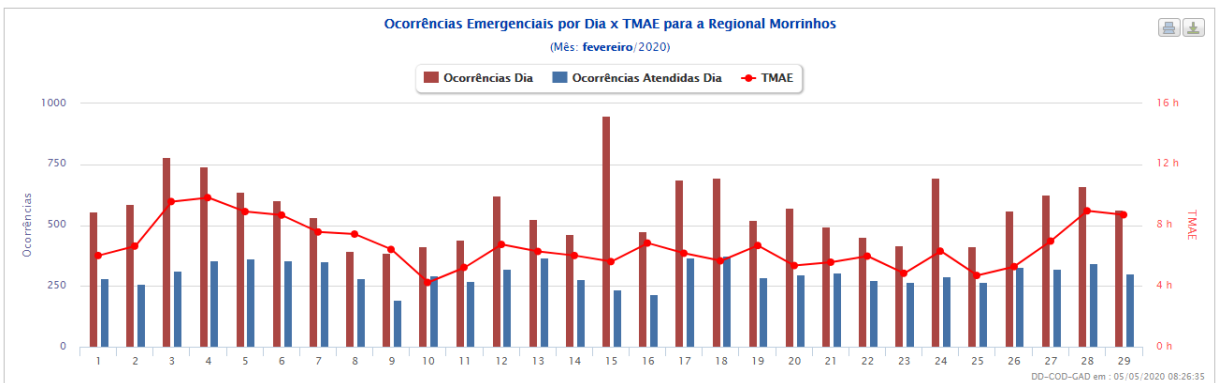
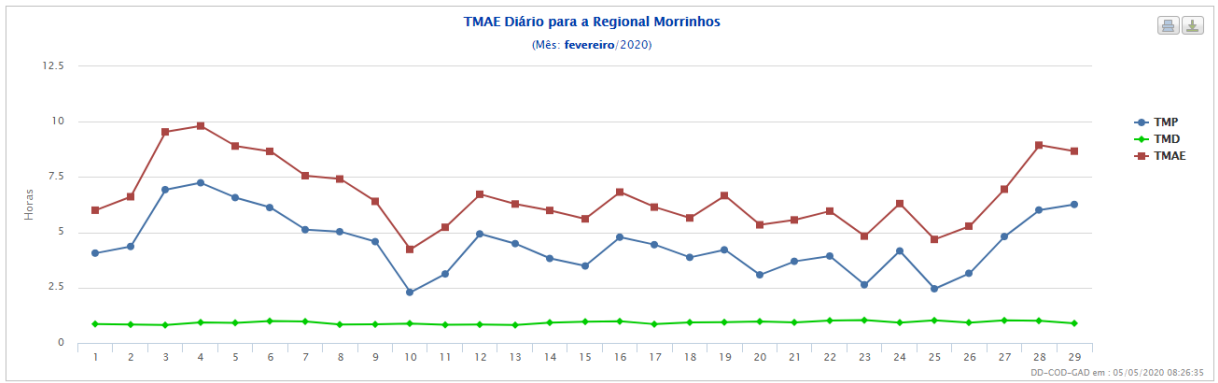

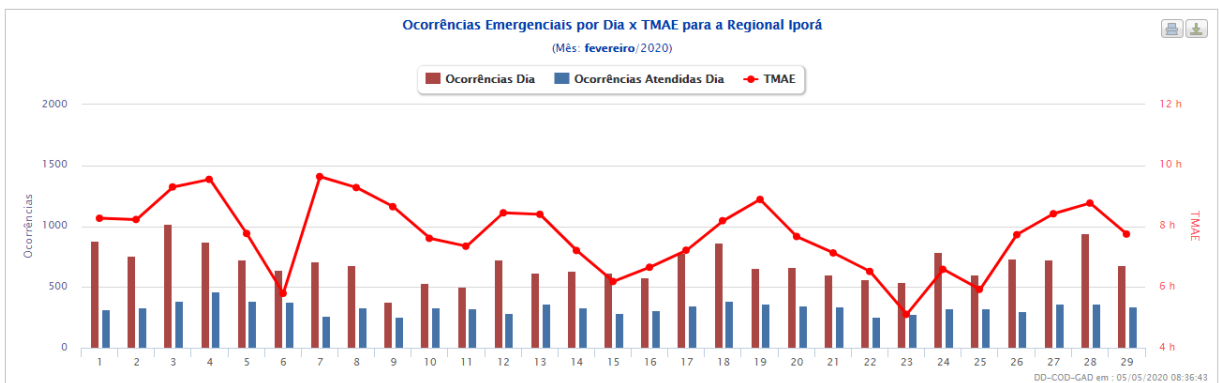
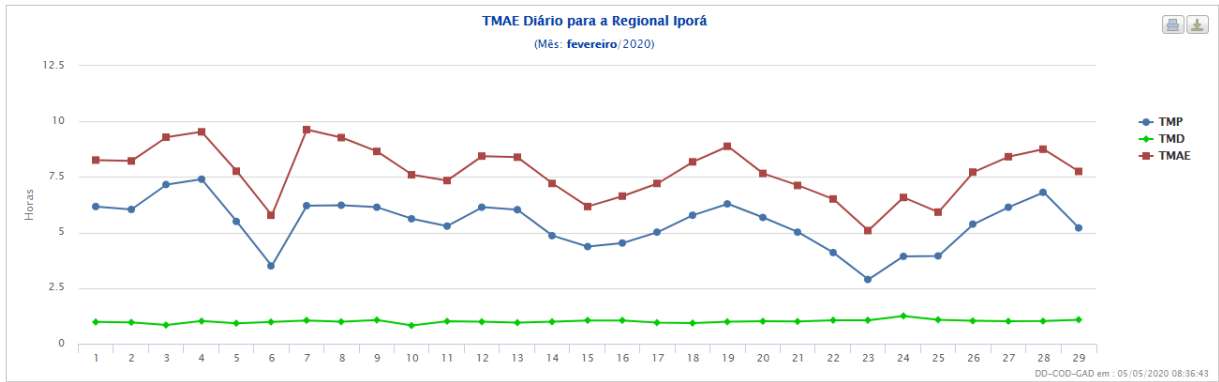
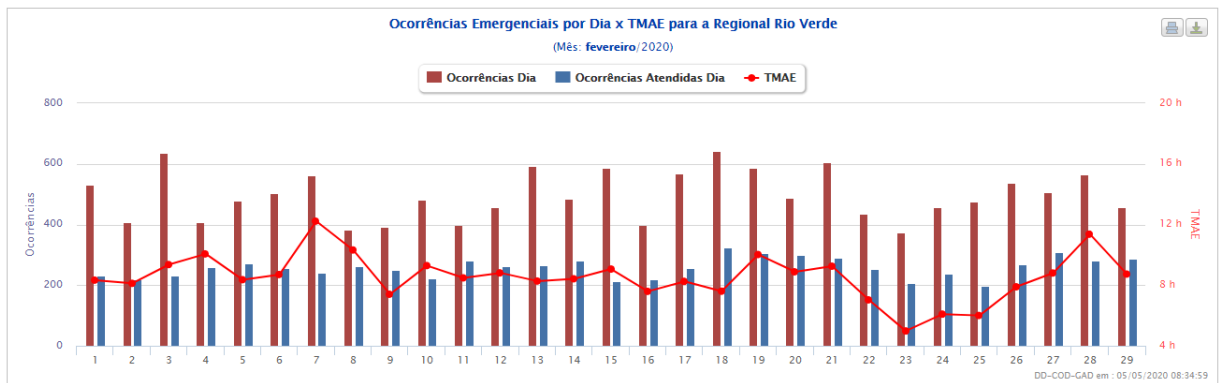
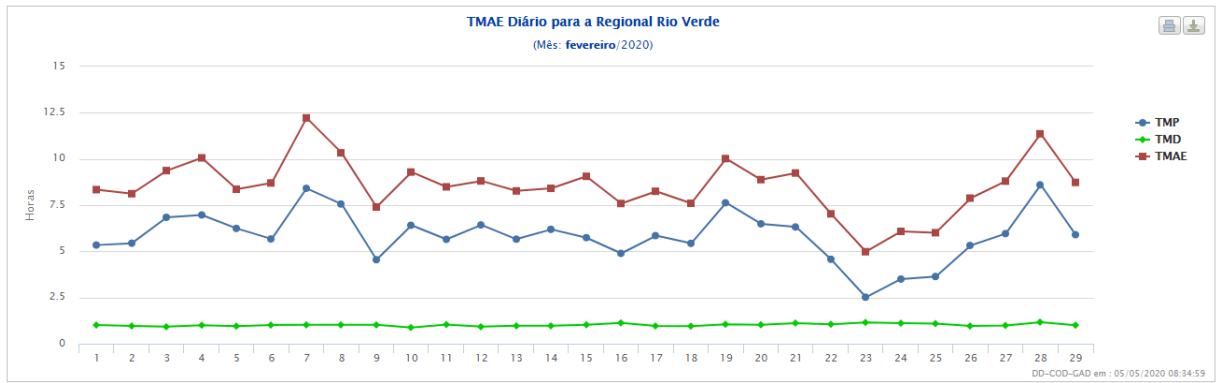

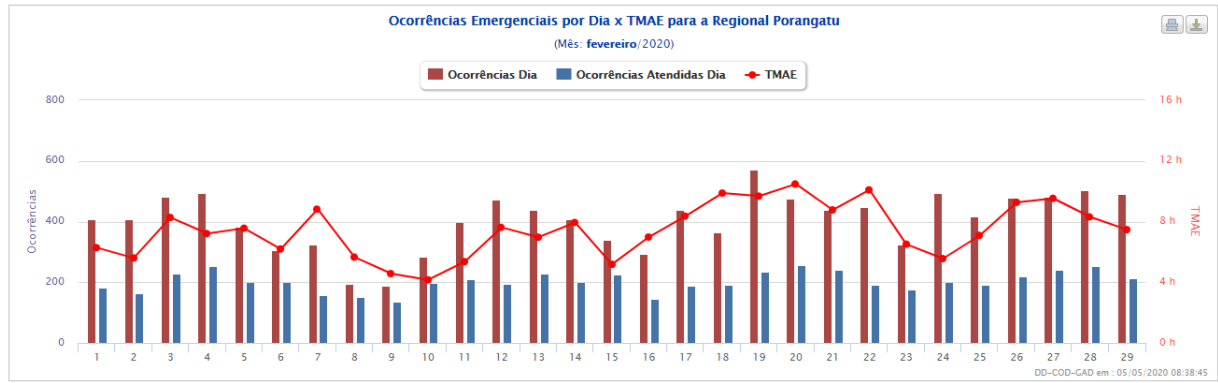
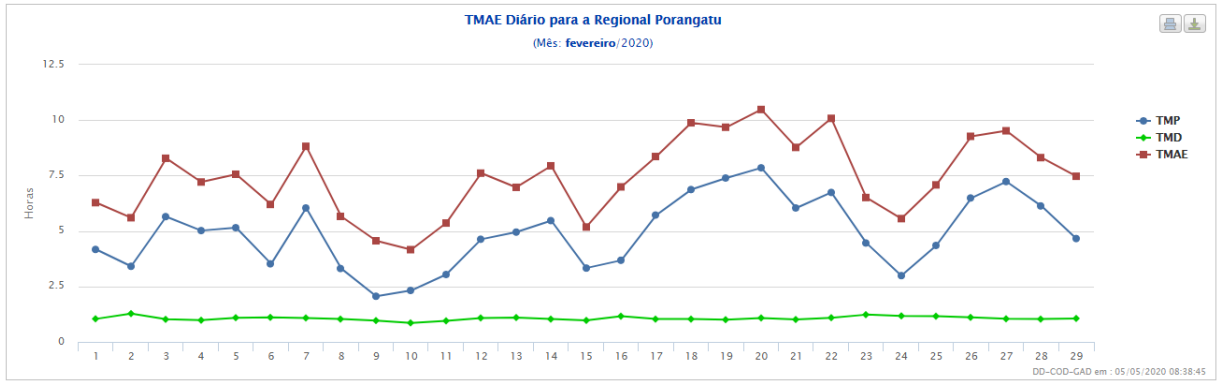

CLIMATEMPO

**Laudo Meteorológico de Evento Climático -  
ENEL Goiás - 22 de Fevereiro de 2020**

São Paulo, SP, Brasil Março de 2020



# Sumário

<b>1</b>	<b>ANÁLISE DE EVENTO METEOROLÓGICO .....</b>	<b>2</b>
<b>1.1</b>	<b>Descrição do Evento.....</b>	<b>2</b>
<b>1.2</b>	<b>Abrangência do Evento .....</b>	<b>6</b>
<b>2</b>	<b>CLASSIFICAÇÃO COBRADE .....</b>	<b>16</b>
<b>3</b>	<b>RESUMO DO EVENTO .....</b>	<b>17</b>
<b>4</b>	<b>REFERÊNCIAS.....</b>	<b>22</b>

# 1 Análise de Evento Meteorológico

## 1.1 Descrição do Evento

Na figura a seguir é apresentada a área de concessão da ENEL DISTRIBUIÇÃO GOIÁS, dividida em regiões, a serem analisadas neste relatório.



Figura 1 – Regiões atendidas pela ENEL Goiás.

O ar quente e úmido sobre a região e a presença de uma frente fria no mar ajudaram a organizar áreas de instabilidade sobre o estado de Goiás entre os dias 22 e 24 de dezembro de 2020.

Nas Figuras 2 e 3 são apresentadas as descargas atmosféricas nuvem-solo (raios) e nuvem-nuvem detectadas pelo sistema Earth Networks. Entre as 09h40 do dia 22 e 23h40 do dia 24 de fevereiro de 2020 foram registrados 14165 raios nuvem-solo e 26169 descargas nuvem-nuvem sobre a área da ENEL DISTRIBUIÇÃO GOIÁS.

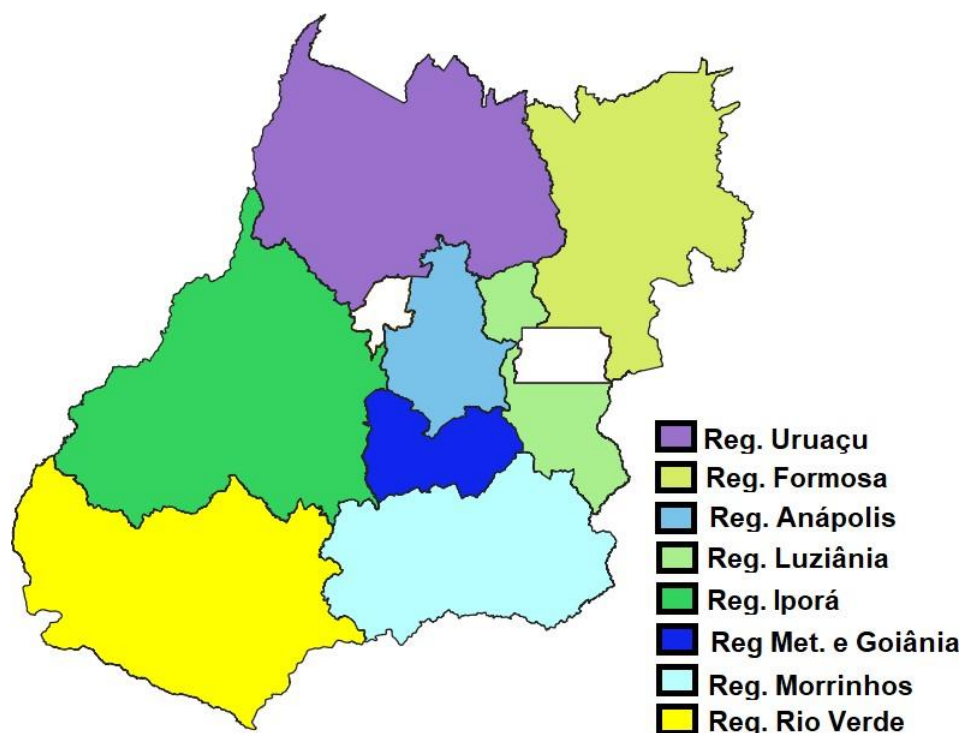

Figura 2 – Descargas atmosféricas nuvem-solo (em preto) detectadas pelo sistema Earth Networks entre 09h40 do dia 22 e 23h40 do dia 24 de fevereiro de 2020 sobre a área de concessão da CELG Distribuição.



Figura 3 – Descargas atmosféricas nuvem-nuvem (em vermelho) detectadas pelo sistema Earth Networks entre 09h40 do dia 22 e 23h40 do dia 24 de fevereiro de 2020 sobre a área de concessão da CELG Distribuição.

Estações do Instituto Nacional de Meteorologia (INMET), representativas da área de concessão da CELG Distribuição Goiás, registraram chuva forte (segundo a American Meteorological Society - Sociedade Meteorológica Americana -, chuvas com taxa entre 2,5mm a 7,6 mm por hora são consideradas moderadas e aquelas com taxa superior a 7,6 mm por hora são consideradas chuva forte). Na tabela 1 são apresentados os registros de acumulados horários superiores a 7,6 mm entre os dias 22 e 24 de fevereiro de 2020.

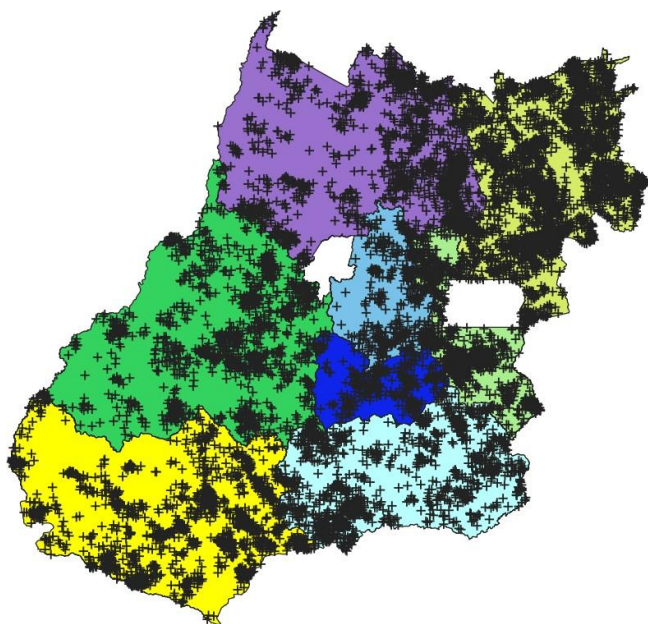
Nas tabelas 2, 3 e 4 são apresentados os acumulados registrados em períodos de 24 horas, entre os dias 22 e 24 de fevereiro de 2020. Em Ipameri foram acumulados 129,9 mm entre os dias 23 e 24 de fevereiro, valor que corresponde a aproximadamente 64% da média climatológica para o mês de fevereiro na região.

Na tabela 5 são apresentadas as rajadas de vento iguais ou superiores a 50 km/h registradas por estações do Instituto Nacional de Meteorologia (INMET) representativas da área de concessão da ENEL Distribuição Goiás. Como é possível observar, o maior valor registrado foi de 53,3 km/h na estação de Pires do Rio entre as 14h e 15h do dia 24 de fevereiro, vento classificado como vento forte pela escala Beaufort.

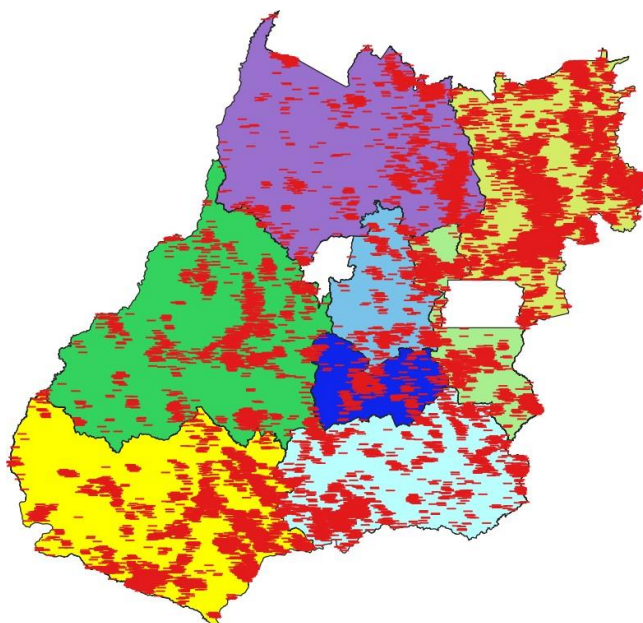
Tabela 1 – Acumulado horário de chuva registrada pelo INMET.

Estação	Horário	Precipitação (mm)
Goianésia	Entre 16h e 17h do dia 22/2/2020	7.8
Goiânia	Entre 18h e 19h do dia 22/2/2020	10.0
Goiânia	Entre 19h e 20h do dia 22/2/2020	36.2
Goiânia	Entre 20h e 21h do dia 22/2/2020	11.4
Silvânia	Entre 21h e 22h do dia 22/2/2020	10.4
Silvânia	Entre 22h e 23h do dia 22/2/2020	12.2
Alto Araguaia	Entre 17h e 18h do dia 23/2/2020	14.8
Silvânia	Entre 18h e 19h do dia 23/2/2020	16.0
Jataí	Entre 1h e 2h do dia 24/2/2020	16.6
Silvânia	Entre 2h e 3h do dia 24/2/2020	9.0
Iporá	Entre 3h e 4h do dia 24/2/2020	13.8
Iporá	Entre 4h e 5h do dia 24/2/2020	28.8
Cristalina	Entre 5h e 6h do dia 24/2/2020	10.0
Cristalina	Entre 6h e 7h do dia 24/2/2020	11.6
Goiás	Entre 9h e 10h do dia 24/2/2020	19.4
Goiás	Entre 10h e 11h do dia 24/2/2020	16.2
Silvânia	Entre 13h e 14h do dia 24/2/2020	7.8
Catalão	Entre 17h e 18h do dia 24/2/2020	17.4

Tabela 2 – Precipitação acumulada entre 09h do dia 22 e 09h do dia 23 de fevereiro de 2020. FONTE: INMET

Estação	Precipitação Acumulada(mm)
GOIANIA	68,0
SILVANIA	33,6

Tabela 3 – Precipitação acumulada entre 09h do dia 23 e 09h do dia 24 de fevereiro de 2020. FONTE: INMET

Estação	Precipitação Acumulada(mm)
IPAMERI	129,9
ARAGARCAS	81,0
SILVANIA	80,4
EDEIA	76,8
ARAGARÇAS	70,6
IPORÁ	64,0
RIO VERDE	54,4
CRISTALINA	34,6

Tabela 4 – Precipitação acumulada entre 09h do dia 24 e 09h do dia 25 de fevereiro de 2020. FONTE: INMET

Estação	Precipitação Acumulada(mm)
GOIÁS	40,6

Tabela 5 – Rajadas de vento maiores ou iguais a 50 km/h registradas pelo INMET. Segundo a escala Beaufort, ventos entre 50 e 61 km/h são classificados como vento forte.

Estação	Horário	Rajada (km/h)
Goianésia	Entre 15h e 16h do dia 22/2/2020	51.5
Goianésia	Entre 16h e 17h do dia 22/2/2020	51.5
Pires do Rio	Entre 14h e 15h do dia 24/2/2020	53.3

## 1.2 Abrangência do Evento

A seguir são apresentadas as imagens realçadas do satélite GOES-16 entre as 12h00 do dia 22 e 03h00 do dia 25 de fevereiro de 2020. Os tons em vermelho e preto indicam a presença de nuvens de grande desenvolvimento vertical, geralmente associadas à ocorrência de tempo severo.

**12h00 - 22 de Fevereiro de 2020**



Figura 4 – Imagens realçadas do satélite GOES-16 das 12h00 do dia 22 de Fevereiro de 2020. FONTE: Cptec/INPE.

**15h00 - 22 de Fevereiro de 2020**



Figura 5 – Imagens realçadas do satélite GOES-16 das 15h00 do dia 22 de Fevereiro de 2020. FONTE: Cptec/INPE.



**18h00 - 22 de Fevereiro de 2020**

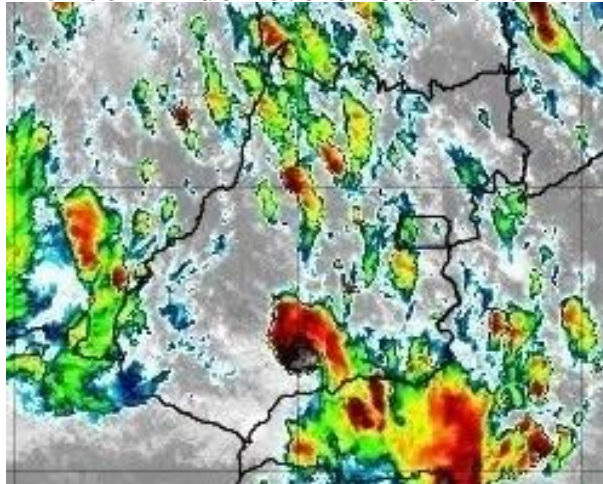

Figura 6 – Imagens realçadas do satélite GOES-16 das 18h00 do dia 22 de Fevereiro de 2020. FONTE: Cptec/INPE.

**21h00 - 22 de Fevereiro de 2020**

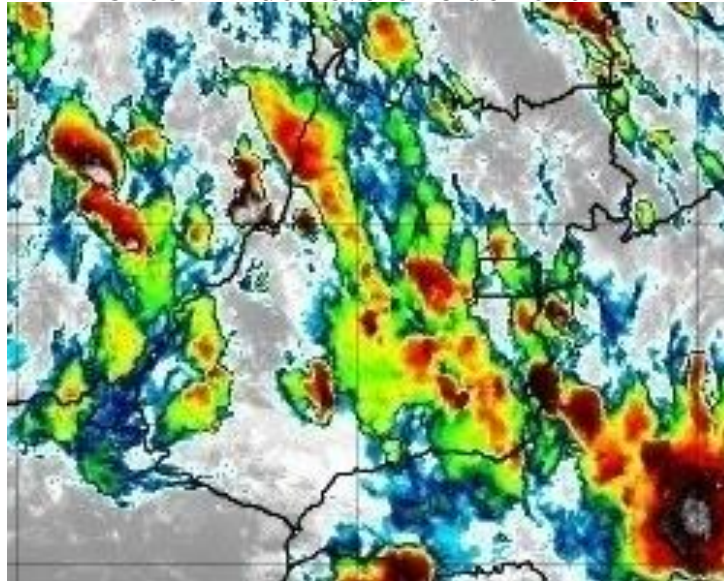

Figura 7 – Imagens realçadas do satélite GOES-16 das 21h00 do dia 22 de Fevereiro de 2020. FONTE: Cptec/INPE.

**0h00 - 23 de Fevereiro de 2020**

Figura 8 – Imagens realçadas do satélite GOES-16 das 0h00 do dia 23 de Fevereiro de 2020. FONTE: Cptec/INPE.

**3h00 - 23 de Fevereiro de 2020**

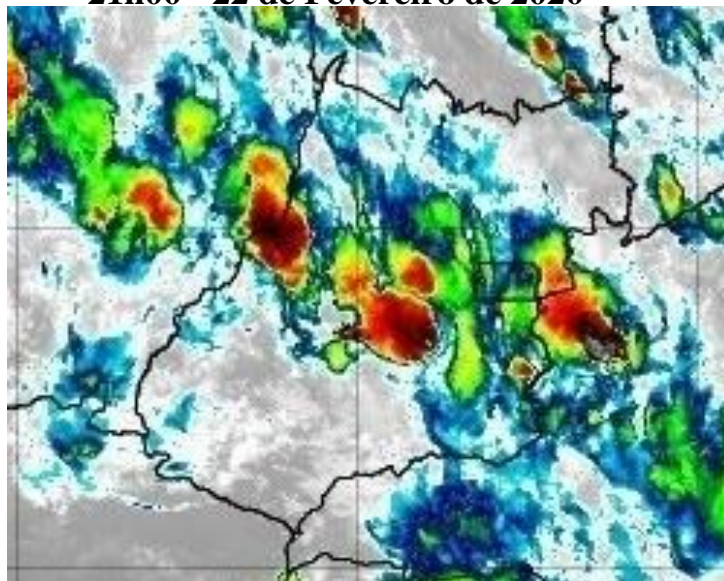
Figura 9 – Imagens realçadas do satélite GOES-16 das 3h00 do dia 23 de Fevereiro de 2020. FONTE: Cptec/INPE.

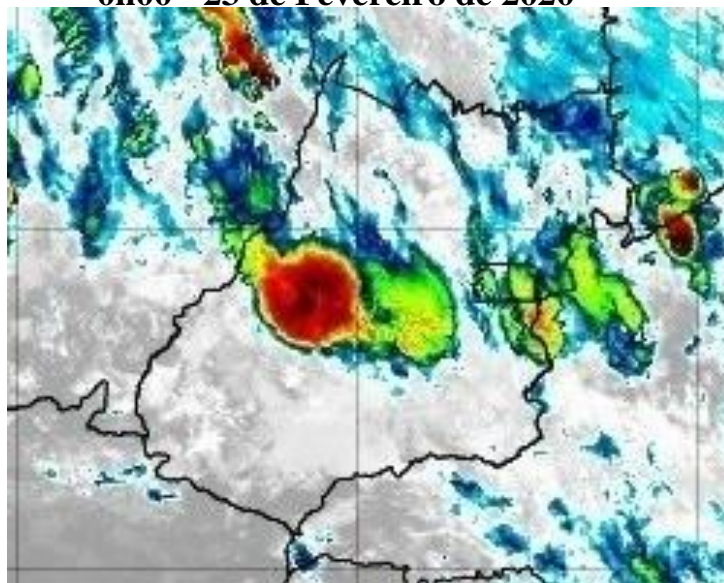

**6h00 - 23 de Fevereiro de 2020**

Figura 10 – Imagens realçadas do satélite GOES-16 das 6h00 do dia 23 de Fevereiro de 2020. FONTE: Cptec/INPE.

**9h00 - 23 de Fevereiro de 2020**

Figura 11 – Imagens realçadas do satélite GOES-16 das 9h00 do dia 23 de Fevereiro de 2020. FONTE: Cptec/INPE.

**12h00 - 23 de Fevereiro de 2020**

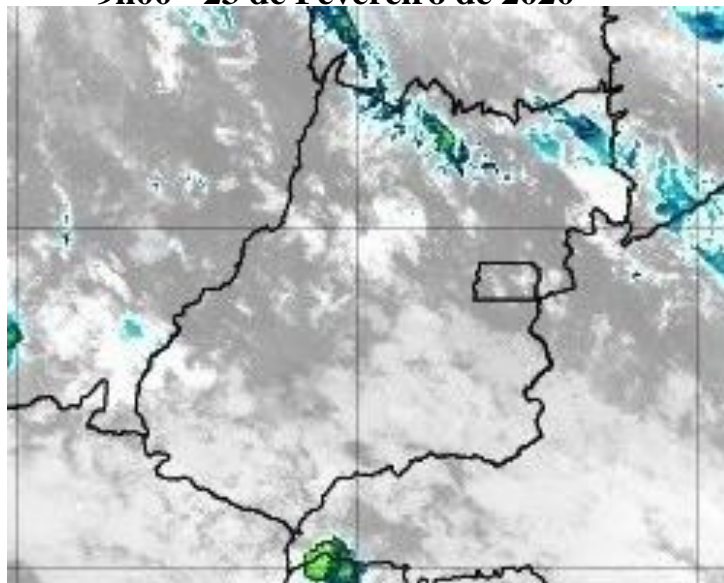

Figura 12 – Imagens realçadas do satélite GOES-16 das 12h00 do dia 23 de Fevereiro de 2020. FONTE: Cptec/INPE.

**15h00 - 23 de Fevereiro de 2020**



Figura 13 – Imagens realçadas do satélite GOES-16 das 15h00 do dia 23 de Fevereiro de 2020. FONTE: Cptec/INPE.

**18h00 - 23 de Fevereiro de 2020**

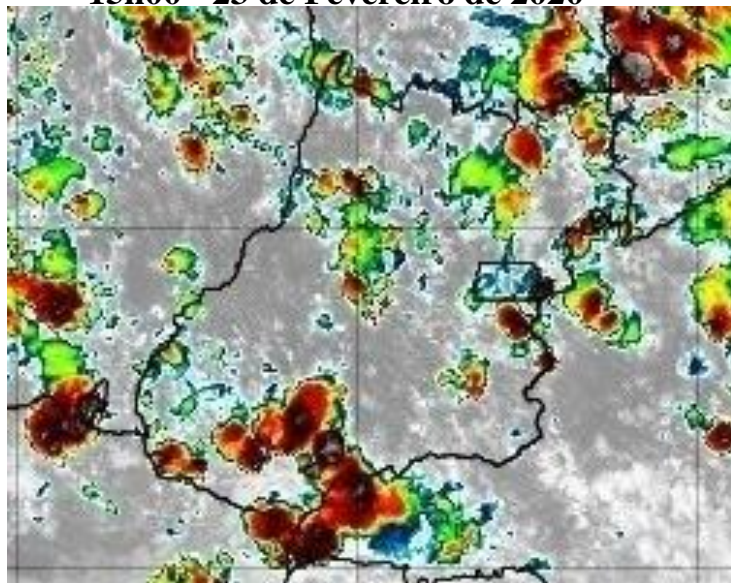

Figura 14 – Imagens realçadas do satélite GOES-16 das 18h00 do dia 23 de Fevereiro de 2020. FONTE: Cptec/INPE.

**21h00 - 23 de Fevereiro de 2020**



Figura 15 – Imagens realçadas do satélite GOES-16 das 21h00 do dia 23 de Fevereiro de 2020. FONTE: Cptec/INPE.

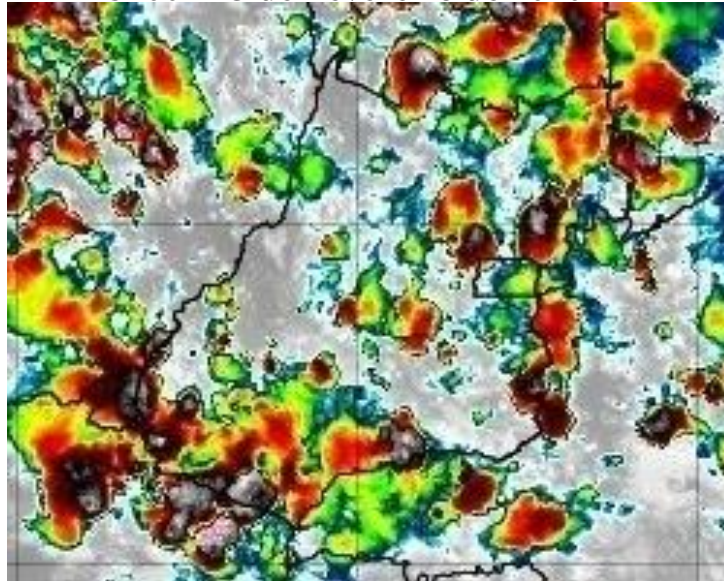

**0h00 - 24 de Fevereiro de 2020**

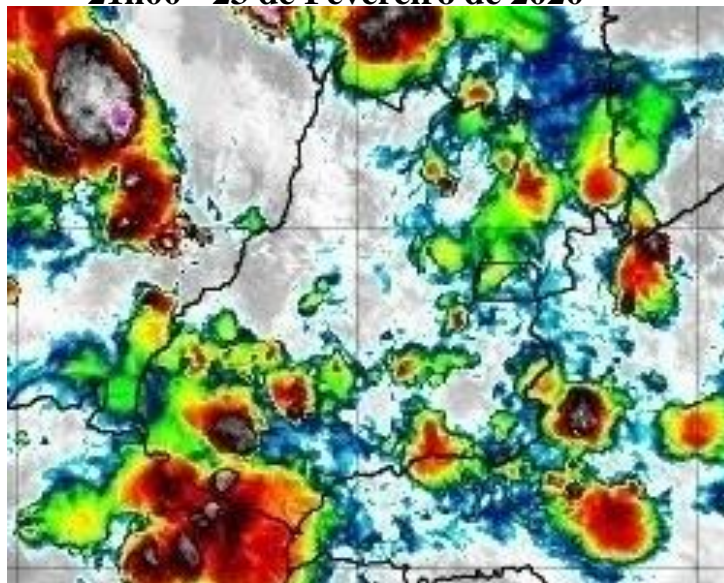

Figura 16 – Imagens realçadas do satélite GOES-16 das 0h00 do dia 24 de Fevereiro de 2020. FONTE: Cptec/INPE.

**3h00 - 24 de Fevereiro de 2020**

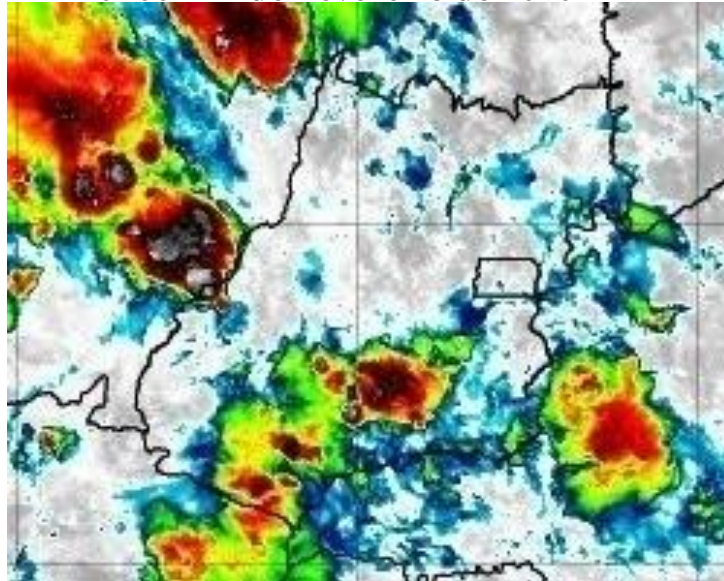

Figura 17 – Imagens realçadas do satélite GOES-16 das 3h00 do dia 24 de Fevereiro de 2020. FONTE: Cptec/INPE.

**9h00 - 24 de Fevereiro de 2020**

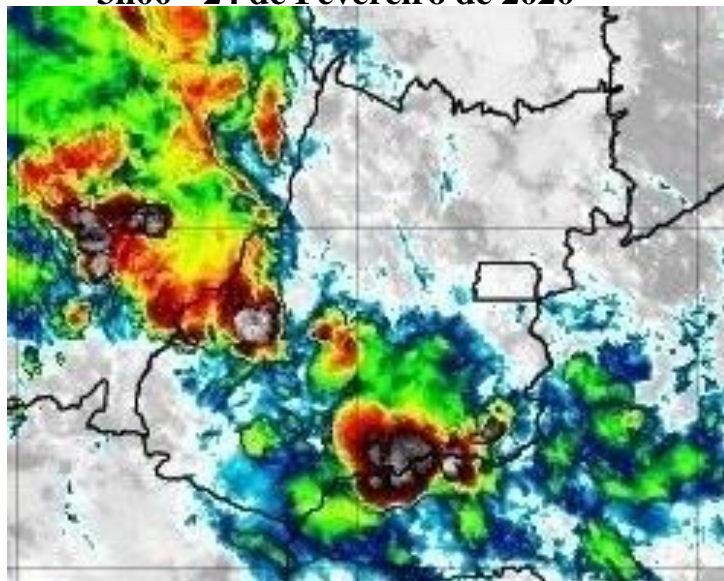

Figura 18 – Imagens realçadas do satélite GOES-16 das 9h00 do dia 24 de Fevereiro de 2020. FONTE: Cptec/INPE.

**12h00 - 24 de Fevereiro de 2020**



Figura 19 – Imagens realçadas do satélite GOES-16 das 12h00 do dia 24 de Fevereiro de 2020. FONTE: Cptec/INPE.

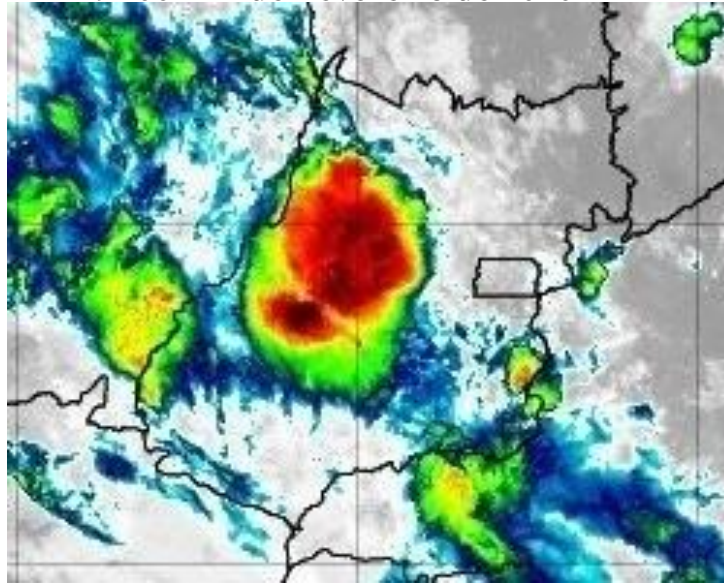

**15h00 - 24 de Fevereiro de 2020**

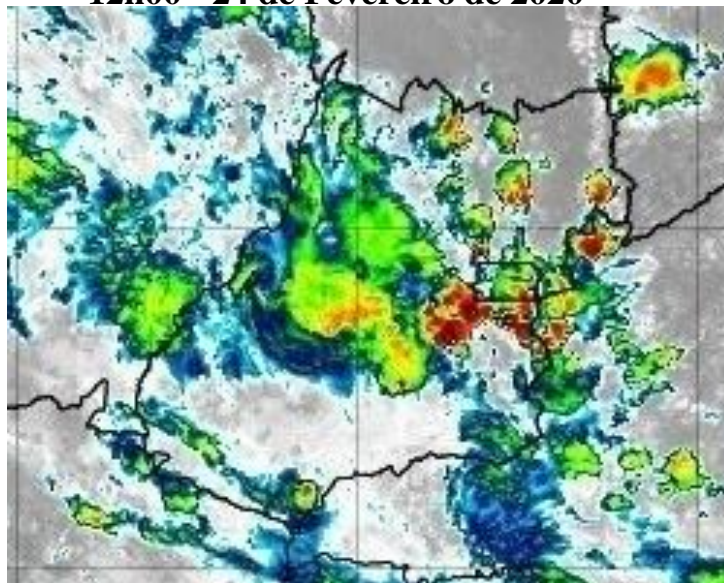

Figura 20 – Imagens realçadas do satélite GOES-16 das 15h00 do dia 24 de Fevereiro de 2020. FONTE: Cptec/INPE.

**18h00 - 24 de Fevereiro de 2020**

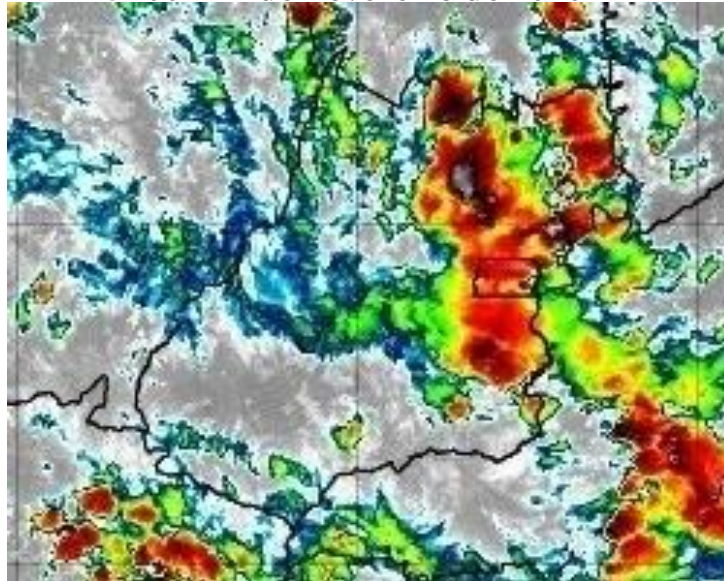

Figura 21 – Imagens realçadas do satélite GOES-16 das 18h00 do dia 24 de Fevereiro de 2020. FONTE: Cptec/INPE.

**0h00 - 25 de Fevereiro de 2020**

Figura 22 – Imagens realçadas do satélite GOES-16 das 0h00 do dia 25 de Fevereiro de 2020. FONTE: Cptec/INPE.

**3h00 - 25 de Fevereiro de 2020**

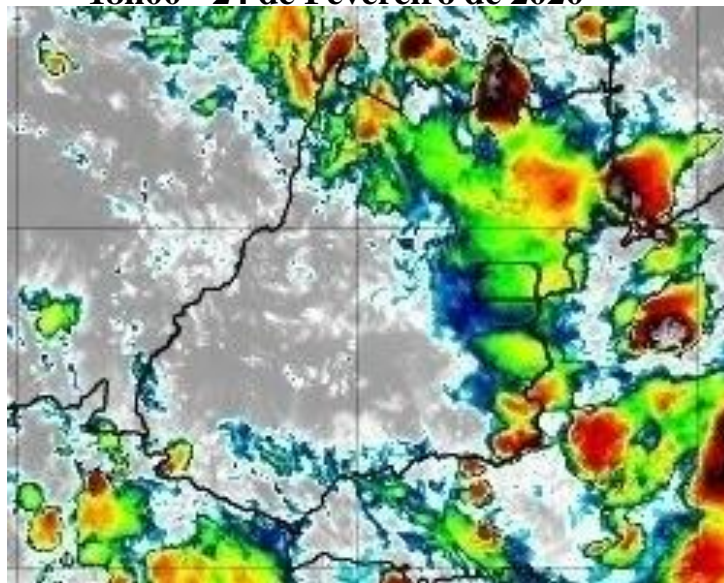
Figura 23 – Imagens realçadas do satélite GOES-16 das 3h00 do dia 25 de Fevereiro de 2020. FONTE: Cptec/INPE.

## 2 Classificação COBRADE

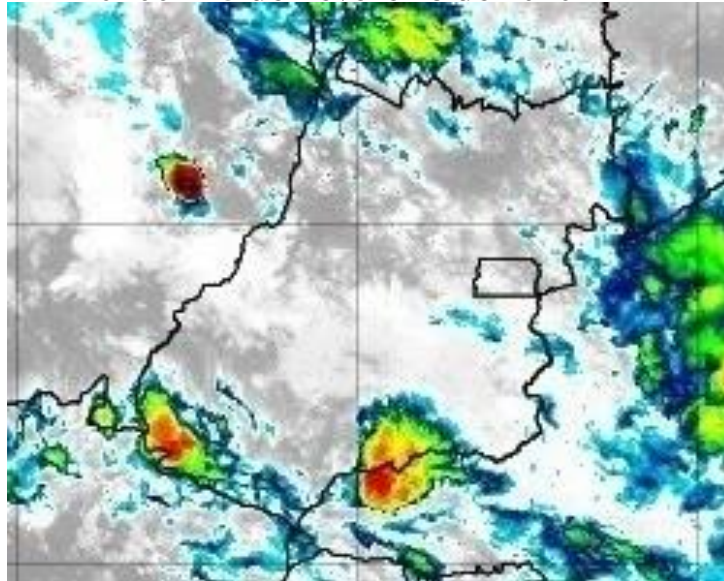
O COBRADE (Classificação e Codificação Brasileira de Desastres) foi criado com o intuito de adequar a classificação brasileira à classificação utilizada pela ONU na classificação de desastres e nivelar o país aos demais organismos de gestão de desastres do mundo.

Baseados nos dados analisados nos itens anteriores, podemos classificar o evento ocorrido sobre a área de concessão da ENEL Distribuição Goiás como Tempestade de raios (Código 1.3.2.1.2), Chuvas Intensas (Código 1.3.2.1.4) e Vendaval (Código 1.3.2.1.5).

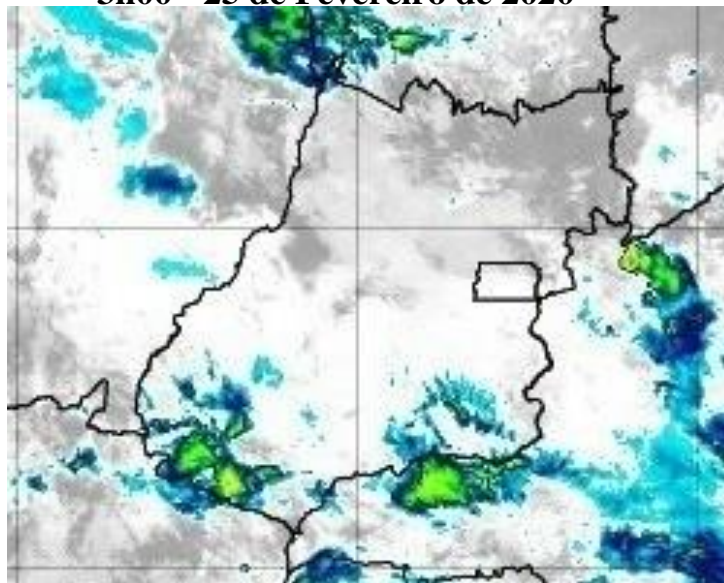

### 3 Resumo do Evento

Áreas de instabilidade associadas ao ar quente e úmido e a presença de uma frente fria no mar favoreceram a formação de nuvens de tempestade que avançaram sobre o estado de Goiás entre a manhã do dia 22 e a noite do dia 24 de fevereiro de 2020.

O sistema de detecção da EarthNetworks registrou 40334 descargas atmosféricas sobre a área de concessão da ENEL em Goiás entre as 09h40 do dia 22 e 23h40 do dia 24 de fevereiro de 2020.

Rajadas de vento forte foram registrados pelo INMET. Na cidade de Pires do Rio ocorreram ventos de até 53,3 km/h entre as 14h e 15h do dia 24 de fevereiro de 2020.

Chuva forte e volumosa foi registrada pelo INMET em estações representativas da área de concessão da ENEL Distribuição Goiás. Na estação de Goiás foram acumulados 35,6 mm de chuva entre as 09h e 11h do dia 24 de fevereiro. Entre as 09h do dia 23 e 09h do dia 24 de fevereiro foram acumulados o correspondente a 64% da média climatológica para o mês na região.

Tabela 6 – Resumo do evento Regional Rio Verde

Número/Código do Evento	
Número/Código do Relatório	
Descrição	Tempestade com intensa atividade elétrica no interior das nuvens, com grande desenvolvimento vertical. Chuvas com acumulados significativos. Forte deslocamento de uma massa de ar em uma região.
Código COBRADE	1.3.2.1.2 - Tempestade de raios, 1.3.2.1.4 - Chuvas intensas e 1.3.2.1.5 - Vendaval
Hora início do evento	12h30 do dia 22 de fevereiro de 2020
Hora de fim do evento	23h00 do dia 24 de fevereiro
Abrangência	Regional Rio Verde

Tabela 7 – Resumo do evento Regional Morrinhos

Número/Código do Evento	
Número/Código do Relatório	
Descrição	Tempestade com intensa atividade elétrica no interior das nuvens, com grande desenvolvimento vertical. Chuvas com acumulados significativos. Forte deslocamento de uma massa de ar em uma região.
Código COBRADE	1.3.2.1.2 - Tempestade de raios, 1.3.2.1.4 - Chuvas intensas e 1.3.2.1.5 - Vendaval
Hora início do evento	13h00 do dia 22 de fevereiro de 2020
Hora de fim do evento	19h00 do dia 24 de fevereiro
Abrangência	Regional Morrinhos

Tabela 8 – Resumo do evento Regional Metropolitana e Goiânia

Número/Código do Evento	
Número/Código do Relatório	
Descrição	Tempestade com intensa atividade elétrica no interior das nuvens, com grande desenvolvimento vertical. Chuvas com acumulados significativos. Forte deslocamento de uma massa de ar em uma região.
Código COBRADE	1.3.2.1.2 - Tempestade de raios, 1.3.2.1.4 - Chuvas intensas e 1.3.2.1.5 - Vendaval
Hora início do evento	14h00 do dia 22 de fevereiro de 2020
Hora de fim do evento	14h10 do dia 24 de fevereiro
Abrangência	Regional Metropolitana e Goiânia

Tabela 9 – Resumo do evento Regional Iporá

Número/Código do Evento	
Número/Código do Relatório	
Descrição	Tempestade com intensa atividade elétrica no interior das nuvens, com grande desenvolvimento vertical. Chuvas com acumulados significativos. Forte deslocamento de uma massa de ar em uma região.
Código COBRADE	1.3.2.1.2 - Tempestade de raios, 1.3.2.1.4 - Chuvas intensas e 1.3.2.1.5 - Vendaval
Hora início do evento	14h00 do dia 22 de fevereiro de 2020
Hora de fim do evento	10h20 do dia 24 de fevereiro
Abrangência	Regional Iporá

Tabela 10 – Resumo do evento Regional Luziânia

Número/Código do Evento	
Número/Código do Relatório	
Descrição	Tempestade com intensa atividade elétrica no interior das nuvens, com grande desenvolvimento vertical. Chuvas com acumulados significativos. Forte deslocamento de uma massa de ar em uma região.
Código COBRADE	1.3.2.1.2 - Tempestade de raios, 1.3.2.1.4 - Chuvas intensas e 1.3.2.1.5 - Vendaval
Hora início do evento	14h30 do dia 22 de fevereiro de 2020
Hora de fim do evento	15h30 do dia 24 de fevereiro
Abrangência	Regional Luziânia

Tabela 11 – Resumo do evento Regional Anápolis

Número/Código do Evento	
Número/Código do Relatório	
Descrição	Tempestade com intensa atividade elétrica no interior das nuvens, com grande desenvolvimento vertical. Chuvas com acumulados significativos. Forte deslocamento de uma massa de ar em uma região.
Código COBRADE	1.3.2.1.2 - Tempestade de raios, 1.3.2.1.4 - Chuvas intensas e 1.3.2.1.5 - Vendaval
Hora início do evento	10h30 do dia 22 de fevereiro de 2020
Hora de fim do evento	13h40 do dia 24 de fevereiro
Abrangência	Regional Anápolis

Tabela 12 – Resumo do evento Regional Uruaçu

Número/Código do Evento	
Número/Código do Relatório	
Descrição	Tempestade com intensa atividade elétrica no interior das nuvens, com grande desenvolvimento vertical. Chuvas com acumulados significativos. Forte deslocamento de uma massa de ar em uma região.
Código COBRADE	1.3.2.1.2 - Tempestade de raios, 1.3.2.1.4 - Chuvas intensas e 1.3.2.1.5 - Vendaval
Hora início do evento	09h40 do dia 22 de fevereiro de 2020
Hora de fim do evento	17h40 do dia 24 de fevereiro
Abrangência	Regional Uruaçu

Tabela 13 – Resumo do evento Regional Formosa

Número/Código do Evento	
Número/Código do Relatório	
Descrição	Tempestade com intensa atividade elétrica no interior das nuvens, com grande desenvolvimento vertical. Chuvas com acumulados significativos. Forte deslocamento de uma massa de ar em uma região.
Código COBRADE	1.3.2.1.2 - Tempestade de raios, 1.3.2.1.4 - Chuvas intensas e 1.3.2.1.5 - Vendaval
Hora início do evento	09h40 do dia 22 de fevereiro de 2020
Hora de fim do evento	19h00 do dia 24 de fevereiro
Abrangência	Regional Formosa

## 4 Referências

- RMets Royal Meteorological Society – Beaufort Scale - <https://www.rmets.org/weather-and-climate/observing/beaufort-scale>
- Instituto Nacional de Meteorologia (INMET) - <http://www.inmet.gov.br>
- Cptec/INPE- <https://www.cptec.inpe.br/>
- Centro de Hidrografia da Marinha do Brasil - <https://www.marinha.mil.br/chm/>
- Meteorology Glossary - American Meteorological Society - <http://glossary.ametsoc.org/>

# Anexos

## A.1 Carta Sinótica



Figura A1 - Carta sinótica para as 1200Z do dia 22 de fevereiro de 2020 (0900 do dia 22 de fevereiro de 2020 hora local). FONTE: Marinha do Brasil).



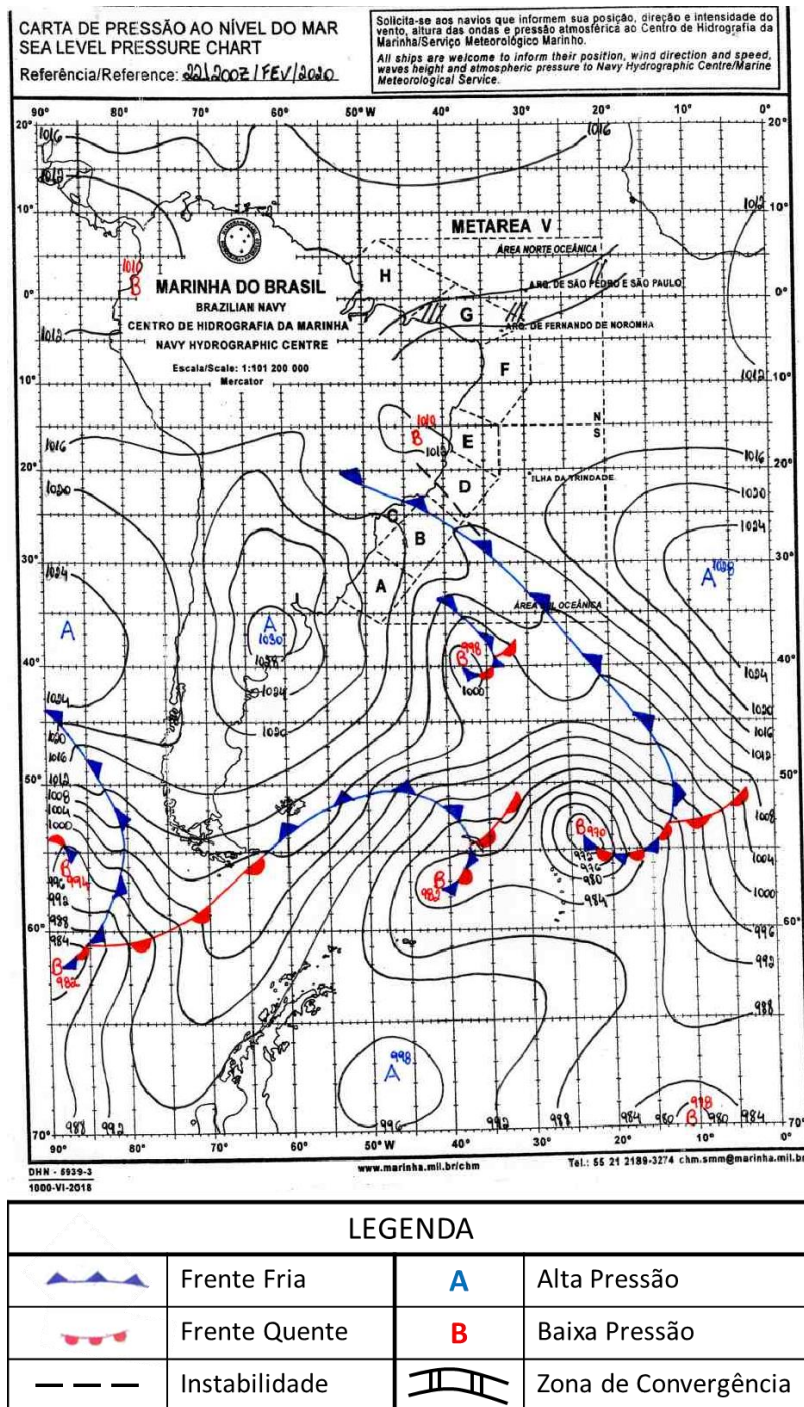
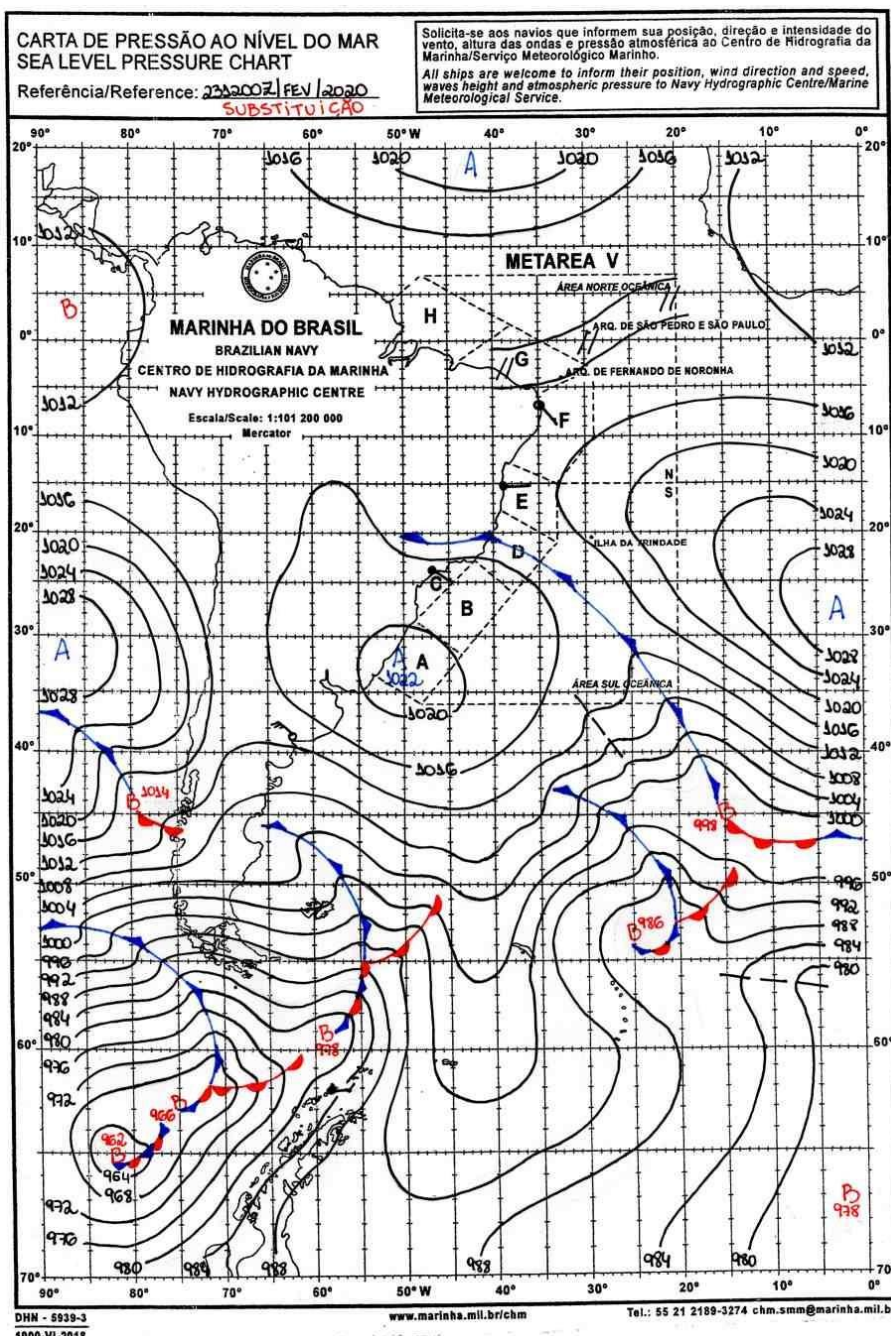

LEGENDA			
	Frente Fria	<b>A</b>	Alta Pressão
	Frente Quente	<b>B</b>	Baixa Pressão
	Instabilidade		Zona de Convergência

Figura A2 - Carta sinótica para as 1200Z do dia 23 de fevereiro de 2020 (09h00 do dia 23 de fevereiro de 2020 hora local). FONTE: Marinha do Brasil.





Figura A3 - Carta sinótica para as 1200Z do dia 24 de fevereiro de 2020 (09h00 do dia 24 de fevereiro de 2020 hora local). FONTE: Marinha do Brasil).

## A.2 Notícias associadas

- Enxurrada arrasta e invade carro em rua de Valparaíso de Goiás; vídeo  
<https://g1.globo.com/go/goias/noticia/2020/02/25/enxurrada-arrasta-e-invade-carro-em-rua-de-valparaiso-de-goias-video.ghtml>
- BR-040 é interditada devido a forte chuva  
<https://jornaldebrasil.com.br/cidades/br-040-e-interditada-devido-a-forte-chuva/>
- Em menos de uma semana, chuva já deixou vários sinais de destruição em Anápolis  
<https://portal6.com.br/2020/02/24/em-menos-de-uma-semana-chuva-ja-deixou-varios-sinais-de-destruicao-em-anapolis>

Bianca Lobo Silva

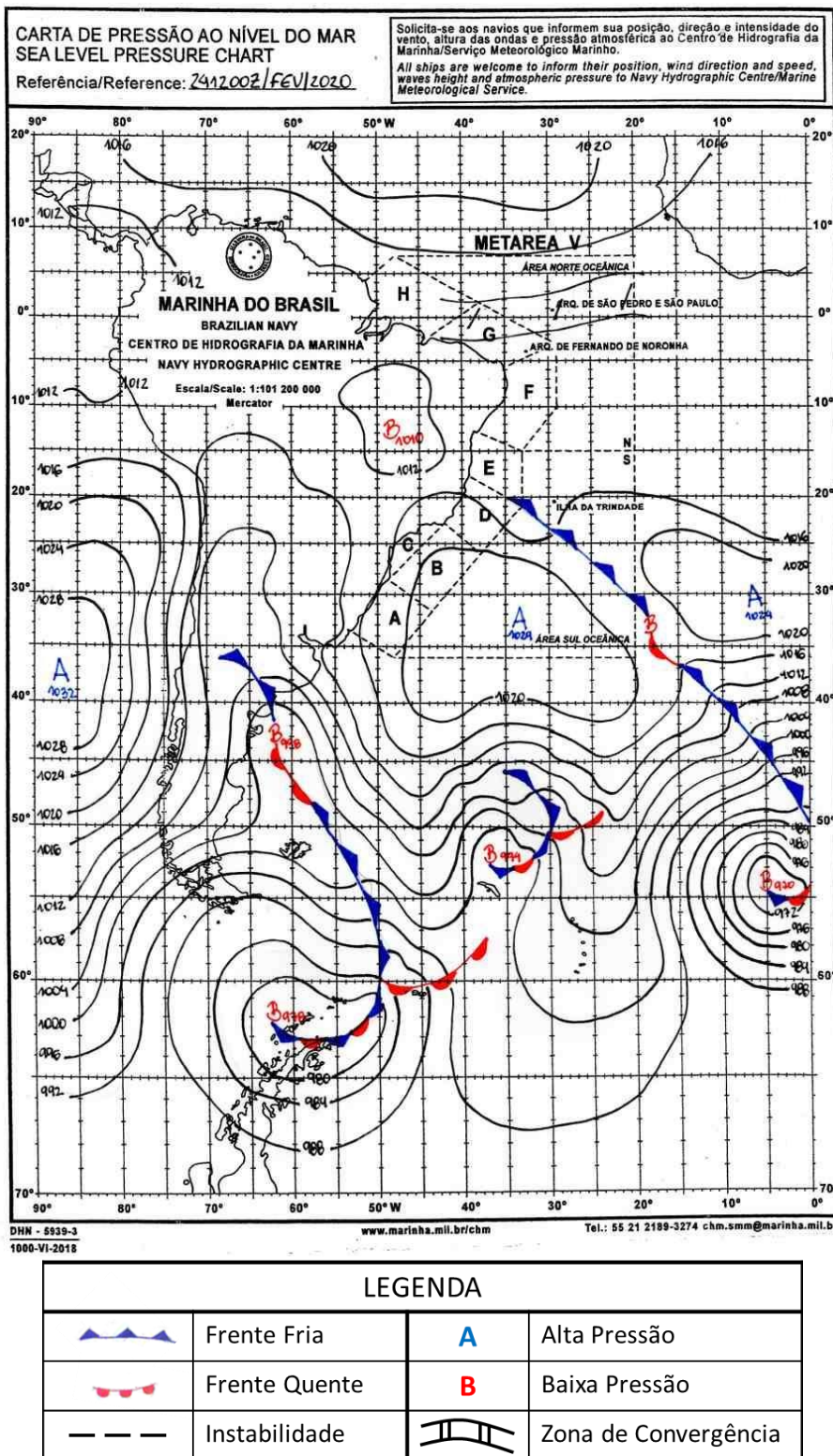
Meteorologista

CREA 5063840461

### Instituto Nacional de Meteorologia - INMET

Chuva Acumulada 24h

Estação: ARAGARCAS - 02/2020



### Instituto Nacional de Meteorologia - INMET

Chuva Acumulada 24h

Estação: CATALAO - 02/2020

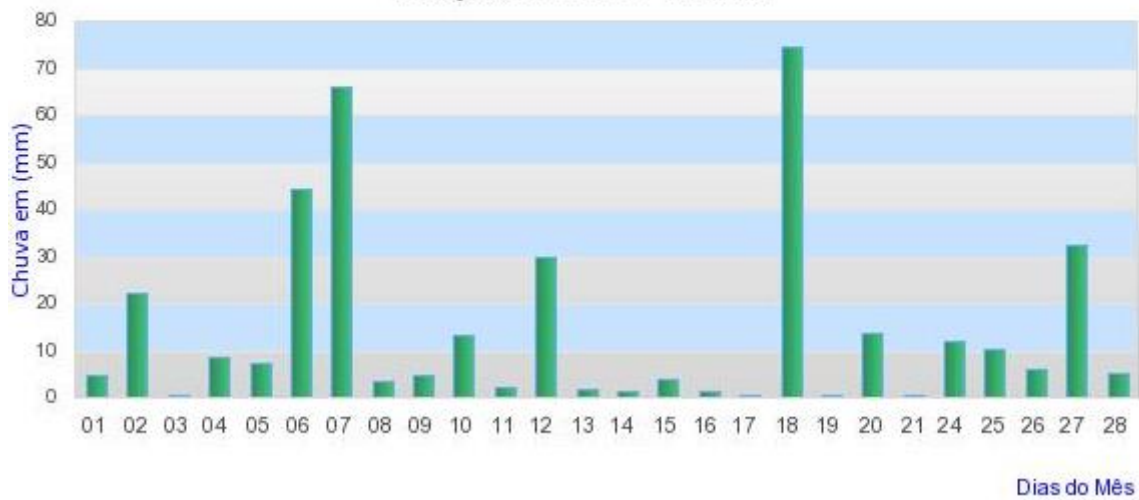

### Instituto Nacional de Meteorologia - INMET

Chuva Acumulada 24h

Estação: FORMOSA - 02/2020

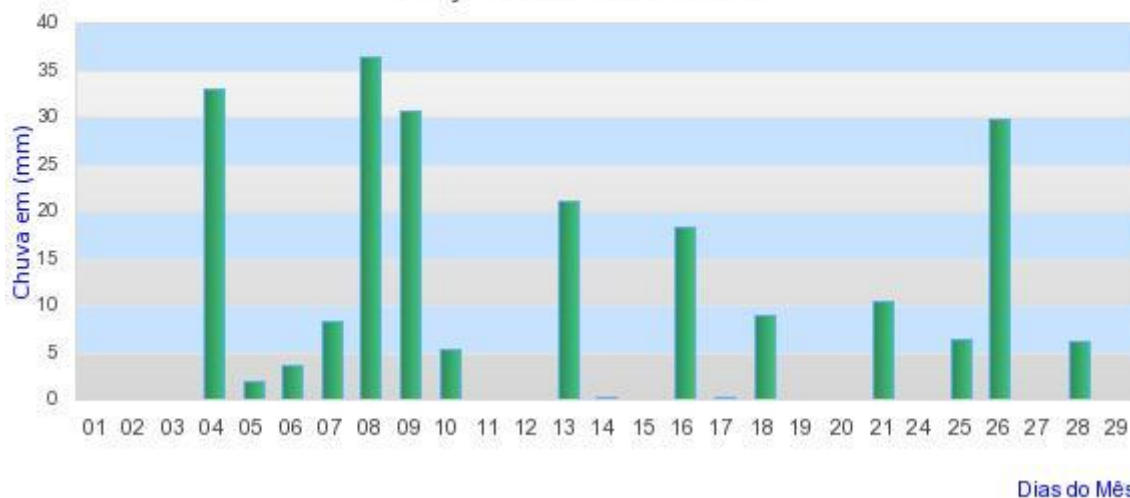

### Instituto Nacional de Meteorologia - INMET

Chuva Acumulada 24h

Estação: GOIANIA - 02/2020

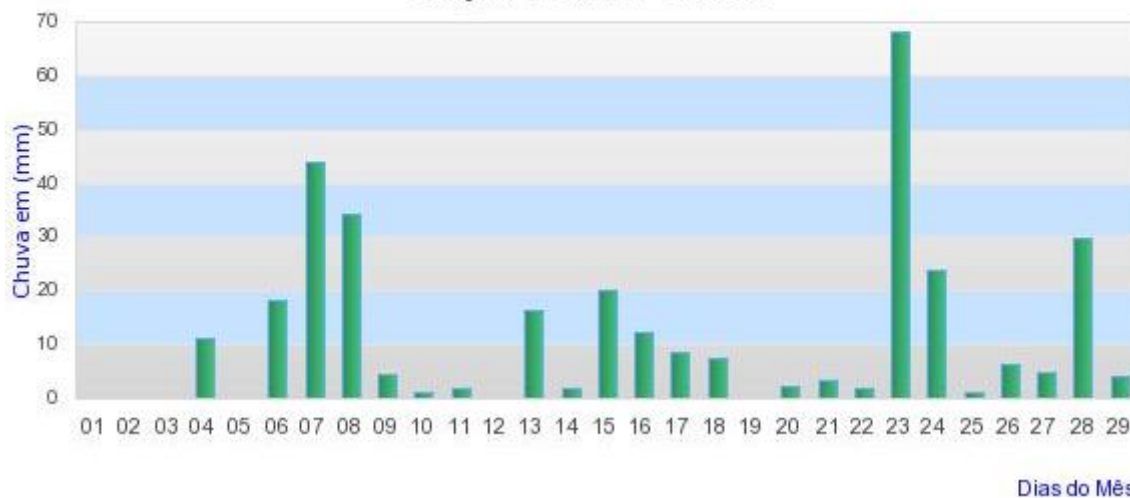

### Instituto Nacional de Meteorologia - INMET

Chuva Acumulada 24h  
Estação: IPAMERI - 02/2020



### Instituto Nacional de Meteorologia - INMET

Chuva Acumulada 24h  
Estação: JATAI - 02/2020

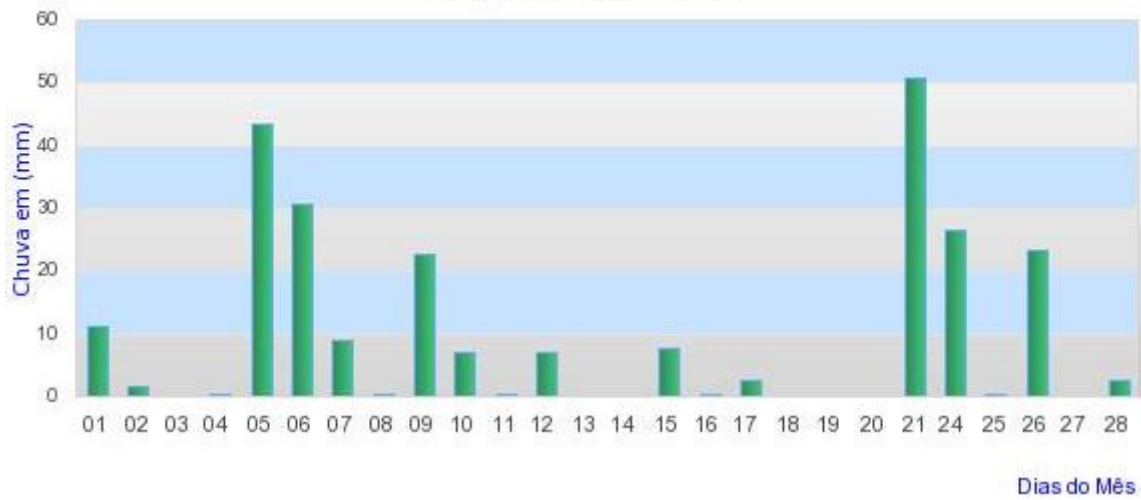



### Instituto Nacional de Meteorologia - INMET

Chuva Acumulada 24h

Estação: PIRENOPOLIS - 02/2020

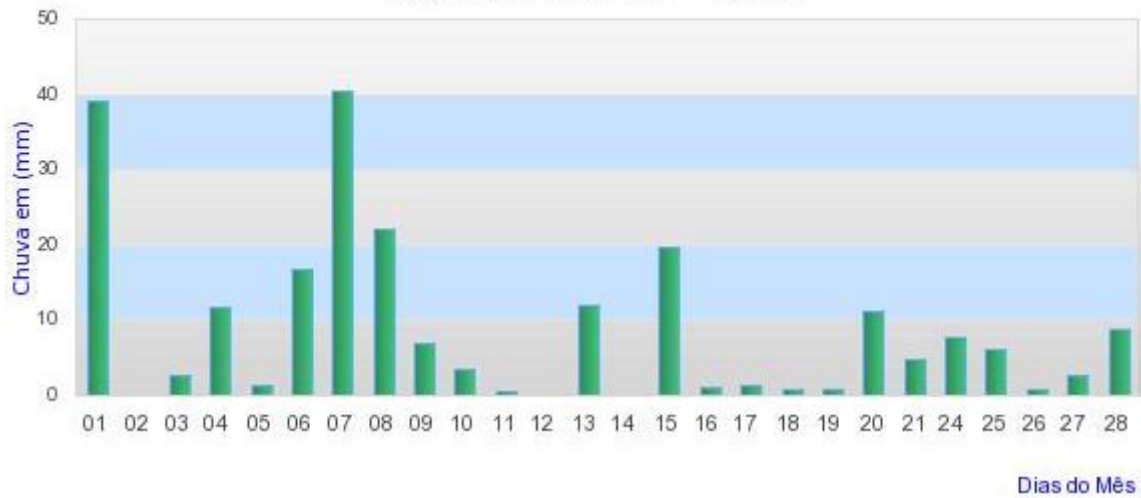

### Instituto Nacional de Meteorologia - INMET

Chuva Acumulada 24h

Estação: POSSE - 02/2020

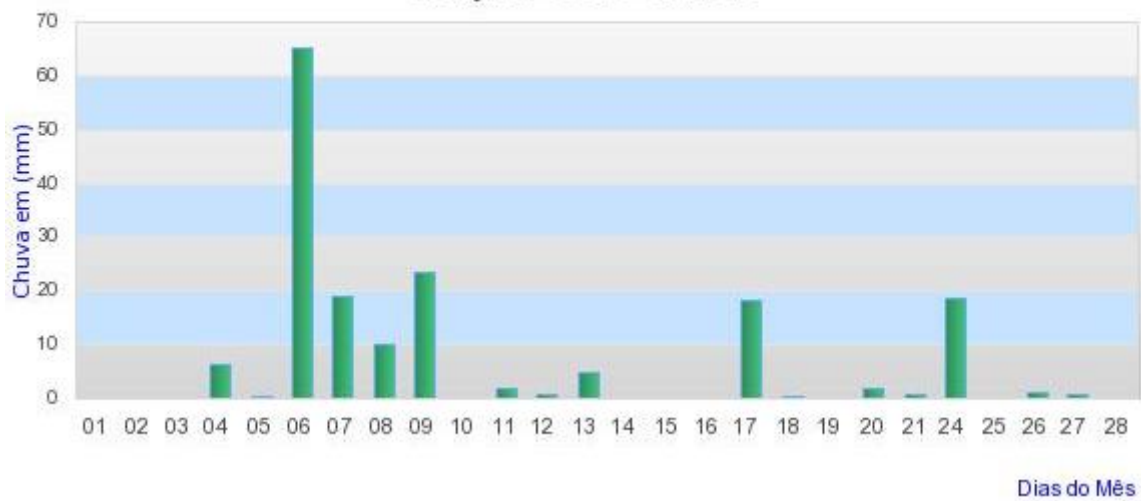

### Instituto Nacional de Meteorologia - INMET

Chuva Acumulada 24h

Estação: RIO VERDE - 02/2020

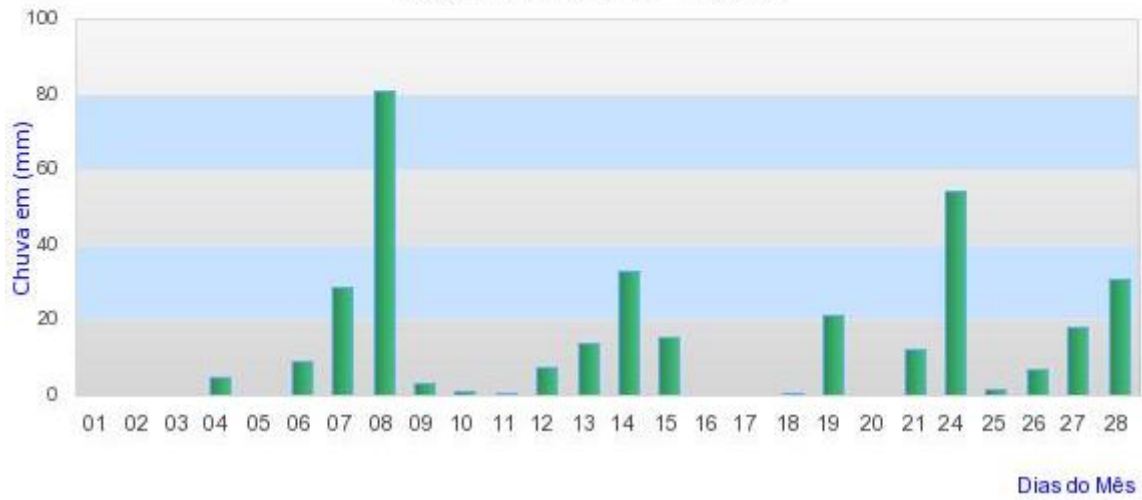

## NOTÍCIAS RELACIONADAS

<https://g1.globo.com/go/goias/noticia/2020/02/25/enxurrada-arrasta-e-invade-carro-em-rua-de-valparaiso-de-goias-video.ghtml>

<https://g1.globo.com/go/goias/noticia/2020/02/25/enxurrada-arrasta-e-invade-carro-em-rua-de-valparaiso-de-goias-video.ghtml>

MENU

G1

GOIÁS

# Enxurrada arrasta e invade carro em rua de Valparaíso de Goiás; vídeo

Imagens mostram água entrando no veículo. Vidros das portas tiveram de ser quebrados para escoar água.

Por **Silvio Túlio, G1 GO**

25/02/2020 10h17 - Atualizado há 2 meses



Dia: 22/02/2020  
Cidade: Goiânia

Relato: Chuva torrencial, grande dificuldade em substituição de poste quebrado





Jornal de Brasília

BR-040 é interditada devido a forte chuva

# BR-040 é interditada devido a forte chuva

Interdição durou cerca de 50 minutos



Publicado 2 meses atrás em 24/02/2020  
Por Willian Matos



Dia: 22/02/2020  
Cidade: Goiânia

Relato: Chuva torrencial, grande dificuldade em executar emendas em cabos partidos na se Xavantes

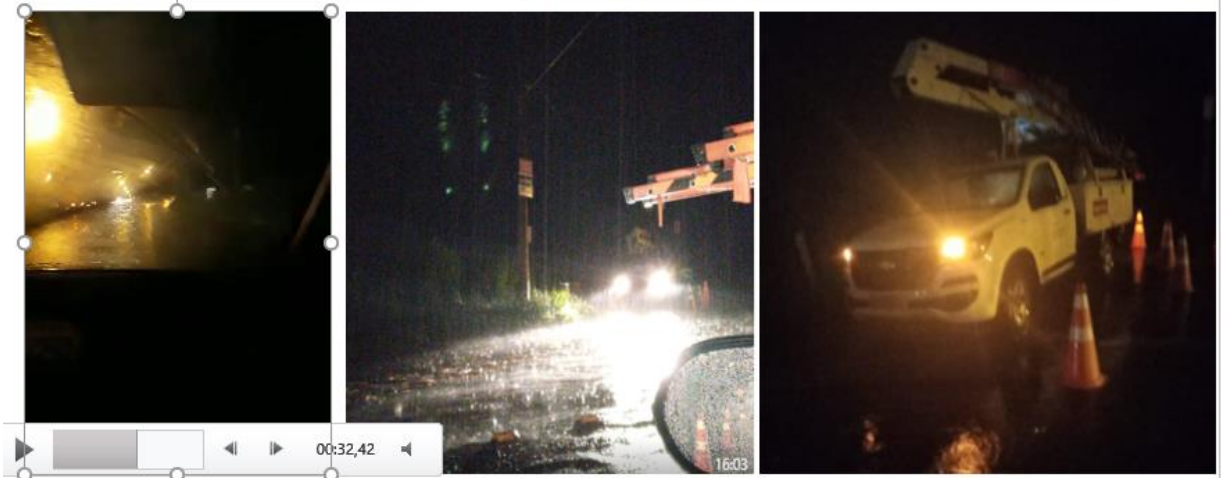

# Em menos de uma semana, chuva já deixou vários sinais de destruição em Anápolis

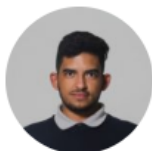

Denilson  
Boaventura



2 meses atrás

Previsão é que mais água caia nos próximos dias, elevando o sinal de alerta na cidade

A chuva ganhou intensidade e provocou diversos incidentes em Anápolis nos últimos dias. Antes restritos apenas em regiões ainda carentes de equipamentos urbanos, como Sul e Oeste, os estragos tornaram-se mais visíveis ao alcançar também locais de maior circulação.

O exemplo mais recente é um [buraco profundo que se abriu no asfalto da Avenida São Francisco](#) após o solo ceder, no último domingo (23). Mais movimentada do bairro Jundiá, a via foi sinalizada por populares e, mesmo com o mau tempo, recebeu reparos neste começo de fevereiro (24).

Chuva e vento, árvore caiu na rede retirando o alimentador 32 da S/E-85-Iporá em 22/02/2019





CHUVA EM PIRANHAS DESTRUIU BUEIRO 23/02/19



CHUVA EM PIRANHAS DESTRUIU BUEIRO 23/02/19





Chuva e vento forte,  
derrubou árvore na  
pista entre Piranhas e  
Arenópolis, ctos 01,02  
e 31 da S/E  
16(Arenópolis)  
24/02/19

<https://raddarmix.com.br/site/vendaval-derruba-torre-da-radio-de-arenopolis-go-e-causa-estragos-em-outras-cidades-da-regiao/>

Vendaval derruba torre da Rádio de Arenópolis-GO e causa estragos em outras cidades da região  
Por [RaddarMix Iporá](#)

Vendaval derruba torre da Rádio de Arenópolis-GO e causa estragos em outras cidades da região  
Ao menos três cidades da região sofreram prejuízos com o forte vendaval e chuva. Uma forte chuva neste final de semana, último sábado, **23/02**, causou estrago em algumas cidades da região. Casas foram destelhadas em **Piranhas, Arenópolis e Diorama** durante temporal neste último fim de semana. Em Arenópolis, o vendaval derrubou e danificou a torre de transmissão da rádio Comunitária ...







**CIDADE: SÃO LUIZ MONTES BELO**

**DIA: 22-02-2020**

**RELATO:** EQUIPE EM ATENDIMENTO NA ZONA RURAL DE SÃO LUIZ MONTES, DEVIDO GRANDE VOLUME DE CHUVA NA REGIÃO CÓRREGO TRANSBORDOU, NÃO TEVE COMO EQUIPE PASSAR PARA ATENDER OCORRÊNCIA.



**CIDADE: ITAGUARI - GO**

**DIA: 23-02-2020**

**RELATO:** PONTE NO MUNICÍPIO DE ITAGUARI CAIU EM CONSEQUÊNCIA DE CHUVAS NA REGIÃO, EQUIPE TEVE ATRASO NO ATENDIMENTO EMERGENCIAIS DEVIDO AOS INTEMPERES.

**CIDADE: IPORÁ - GO**

**DIA: 24-02-2020**

**RELATO: GO – 060 ENTRE O MUNICÍPIO DE IPORÁ E ISRAELÂNDIA TEVE O ROMPIMENTO DE UM BUEIRO CAUSANDO GRANDES TRANSTORNO NO DESLOCAMENTO DE EQUIPES DE EMERGÊNCIA ENTRE OS MUNICÍPIOS DE IPORÁ - ISRAELÂNDIA – JAUPACI - MOIPORÁ E IVOLANDIA**

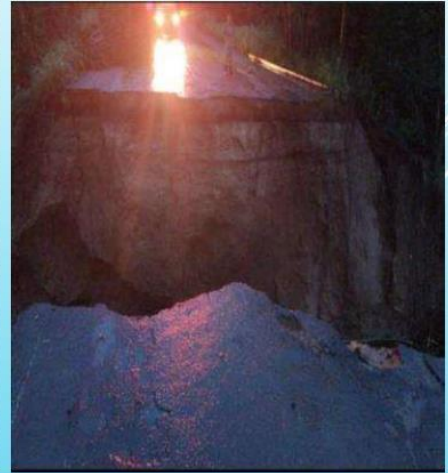

**CIDADE: IPORÁ - GO  
ISRAELÂNDIA – GO**

**DIA: 24-02-2020**



**RELATO: GO 060 TEVE O BUEIRO ROMPIDO E INTERROMPENDO O TRAFICO E NA ZONA RURAL DE IPORÁ E ISRAELÂNDIA RIO TRANSBORDOU DANIFICANDO A PONTE SOBRE O CÓRREGO DA LAJE.**



[https://www.instagram.com/p/B89h\\_06lEk/](https://www.instagram.com/p/B89h_06lEk/)



**maisgoias**

maisgoias • Seguir

maisgoias Segundo informações da Defesa Civil, a Secretaria de Meio Ambiente e Desenvolvimento Sustentável (Semad) sugeriu que fosse aberta uma vala na Avenida Samambaia, a fim de realizar a drenagem e evitar o rompimento da represa de uma fazenda particular. Esta será feita pela Secretaria de Infraestrutura (Seinfra). Dolzonan Mattos, titular da Seinfra, confirmou a ação e informou ao Mais Goiás que os gastos serão repassados ao proprietário da terra.

A via, próxima a Faculdade de Agronomia da Universidade Federal de Goiás, em Goiânia, foi interditada nesta manhã de segunda-feira (24)

Seinfra vai abrir vala de drenagem na Av. Samambaia para evitar rompimento de represa

Curtido por apaula0806 e outras 1.784 pessoas

24 DE FEVEREIRO

Adicione um comentário... [Publicar](#)

<https://www.instagram.com/p/B89qD8TICNI/>



**maisgoias**

maisgoias • Seguir

maisgoias Veja o momento em que populares tentam evitar que um carro seja levado pela enxurrada. O flagrante foi registrado no Bairro Ipiranga, em Valparaíso de Goiás, na manhã desta segunda-feira.

10 sem

antoniamk\_up Mi veio Uma pergunta pôr quanto vale sua vida ?

10 sem 2 curtidas Responder

amandabcnutri Jesus amado

Curtido por mestreivo e outras 11.325 pessoas

24 DE FEVEREIRO

Adicione um comentário... [Publicar](#)

<https://www.instagram.com/p/B89eJDAI02R/>



**maisgoiás**

**maisgoiás** • Seguir

**maisgoiás** A forte chuva que caiu no início da tarde desta segunda-feira (24) deixou a BR-040 interditada. O caso ocorreu no KM 2, em Valparaíso de Goiás, no Entorno do Distrito Federal. De acordo com a Polícia Rodoviária Federal do Distrito Federal (PRF- DF), o fechamento durou cerca de 50 minutos e resultou em congestionamento. Momento foi capturado em vídeo por pessoas que passaram pelo local (ASSISTA NO NOSSO SITE - LINK NOS STORIES!)

Fotos da região mostram que um forte correnteza se formou na região devido ao grande volume de chuva. Ainda de acordo com a PRF, o resultado foi um quilômetro de

♥️ 💬 📌

**Curtido por mestreivo e outras 3.450 pessoas**

24 DE FEVEREIRO

Adicione um comentário... [Publicar](#)

<https://www.instagram.com/p/B89JDqtlawv/>



**maisgoiás**

**maisgoiás** • Seguir

**maisgoiás** Um trecho da GO-060, em Iporá, precisou ser interditado após o rompimento de um bueiro. O incidente aconteceu no km 210 da rodovia durante forte chuva na madrugada desta segunda-feira (24). A via está completamente intrafegável já que toda os dois sentidos da pista ficaram destruídos. Não há informações de feridos.

Equipes do Corpo de Bombeiros foram acionadas e fizeram a interdição da rodovia. A corporação afirma que esta é a segunda vez que o bueiro se rompe e deixa a GO interditada. O primeiro caso ocorreu em 2019 e deixou parte da estrutura destruída. Desta vez, porém, o estrago

♥️ 💬 📌

**Curtido por mestreivo e outras 2.974 pessoas**

24 DE FEVEREIRO

Adicione um comentário... [Publicar](#)



<https://www.instagram.com/p/B889joVFeh/>



<https://www.instagram.com/p/B887PtmF799/>



<https://www.instagram.com/p/B8841DDDmWT/>



maisgoias • Seguir

maisgoias Tempo agora: E a segunda-feira de Carnaval amanheceu com muita chuva na cidade de Goiás. Vídeo @adisonutim

10 sem

+

batistasuelmarosa Graças a Deus. Chuva é muito bom 🙏🏻

10 sem 3 curtidas Responder

jenisan\_naves Carnaval e perca de tempo a chuva e coisa de Deus tomara que chova três dias sem parar kkkkkkk

49.196 visualizações

24 DE FEVEREIRO

Adicione um comentário... Publicar

<https://www.instagram.com/p/B8836RpF5jL/>



maisgoias • Seguir

maisgoias Tempo agora: chove forte nesse momento na cidade de Valparaíso de Goiás. Imagens registradas entres os bairros Valparaíso II e Rio Branco - as margens da BR-040

10 sem

rosanebessaa 🤔 @ebobessa

10 sem 1 curtida Responder

— Ver respostas (1)

claudiopsilva01 Vixi

10 sem Responder

daviblack645 Venha para Goiânia

40.692 visualizações

24 DE FEVEREIRO

Adicione um comentário... Publicar

<https://www.instagram.com/p/B88yuiXFUDL/>



maisgoias • Seguir

maisgoias ATENÇÃO MOTORISTAS: GO-060, entre Iporá e Israelândia, está interdita.

10 sem

layanebarbosa @andreeeelucas  
10 sem 2 curtidas Responder

lorenamonna @tania.elena2011  
10 sem 1 curtida Responder

aldineiadecastros Vamos ficar ilhados assim

27.990 visualizações  
24 DE FEVEREIRO

Adicione um comentário... Publicar

<https://www.instagram.com/p/B87HvtgFmZZ/>



maisgoias • Seguir

maisgoias Tempo: situação da Avenida Assis Chateaubriand, nas proximidades do Bosque dos Buritis.

10 sem

klesleybarbosa Num pode nem espirrar q Goiania alaga kkk  
10 sem Responder

1ftavares Que filmagem boa em  
10 sem Responder

eujessykar @renataaaaaf bem a Camila falou kkkk

125.217 visualizações  
23 DE FEVEREIRO

Adicione um comentário... Publicar



<https://www.instagram.com/p/B87GtHLFSOf/>



**maisgoias** • Seguir

**criss\_esteves** @giofesteves  
10 sem Responder

**closetmaria\_** Se  
10 sem Responder

**marcindaarcencio2101** 😞  
10 sem Responder

**danielecosta5220** 😞😞😞  
10 sem Responder

**jacky\_souto** @renatinhaty  
misericórdia  
10 sem Responder

168.084 visualizações  
23 DE FEVEREIRO

Adicione um comentário... **Publicar**

<https://www.instagram.com/p/B87GLIQFLEU/>



**maisgoias** • Seguir

**maisgoias** Agora: e a chuva deu uma atrapalhada no Carnaval na Praça Cívica. Para se abrigarem da chuva, os foliões correram para um posto de combustível. Vídeo @gusbaptista  
10 sem

**pudim\_emjj** Nutellas  
10 sem Responder

**mariaaparecida081016** Que maravilha!!Tomará que chova assim até quarta feira

Curtido por **albeert\_cp** e outras 19.324 pessoas  
23 DE FEVEREIRO

Adicione um comentário... **Publicar**

<https://www.instagram.com/p/B87FEm2IXWf/>



maisgoias • Seguir

maisgoias Tempo: chove forte nesse momento em alguns bairros de Goiânia. Imagem registrada há pouco nas proximidades do Cepal do Setor Sul. (Por @altemargo, do Mais Goiás) vídeo @michelencristinacampos

10 sem

gislennemartins\_ @mjchel\_m  
10 sem Responder

ormonddanielli @gleidsonjonas  
10 sem Responder

54.938 visualizações  
23 DE FEVEREIRO

Adicione um comentário... Publicar

<https://www.instagram.com/p/B84t4WXF88S/>



maisgoias • Seguir

maisgoias Tempo: situação da Avenida Rio Verde, nas proximidades do Cartório. Muita atenção ao passar pelo local.

10 sem

herculanofer.imoveis Avenida Rio você quis dizer ne literalmente falando 🤔🤔🤔

10 sem 1 curtida Responder

jovanijacomini Aqui é normal

10 sem Responder

57.735 visualizações  
22 DE FEVEREIRO

Adicione um comentário... Publicar



<https://www.instagram.com/p/B84s0sVIWSW/>

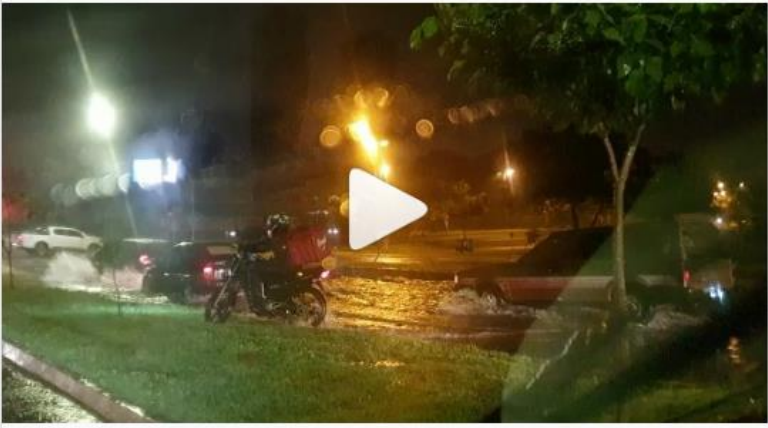

maisgoias • Seguir

maisgoias Tempo: situação nesse momento de Avenida Milão, sentido Terminal Bandeiras.

10 sem

danillorodrigues5686 @rhayllander

10 sem 1 curtida Responder

andriolacavalante

51.441 visualizações

22 DE FEVEREIRO

Adicione um comentário... Publicar

<https://www.instagram.com/p/B84sSr7lhw1/>

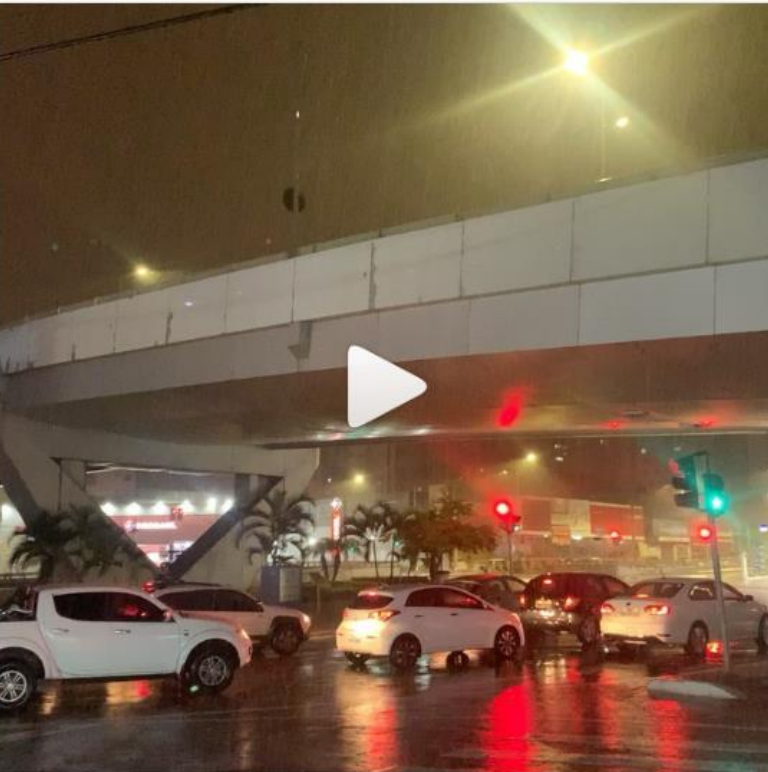

maisgoias • Seguir

Tadeu, chovendo muito agora 🙏

10 sem Responder

mariaconceicao2118 Finsocial chovendo

10 sem Responder

dalvalesp Carnaval com muita chuva, bom de mais 🙏🙏🙏🙏

10 sem Responder

marcianafogaca Chove nesse momento e já faz duas horas que estamos sem energia!!! O vida!!! Oh Enel!!!

10 sem Responder

41.209 visualizações

22 DE FEVEREIRO

Adicione um comentário... Publicar