

Resumo Executivo

O Presente Relatório tem como objetivo a incorporação de informações que sejam relevantes para que se possa fazer a devida associação aos dados contidos no corpo do documento objeto da classificação de Situação de Emergência caracterizada pelo Módulo 8 do Prodist, que tem como foco o impacto do evento sobre determinada rede geelétrica e cuja denominação é definida como CHI (Consumidor hora interrompido). O parâmetro para enquadramento nesta classificação de expurgo tem como premissa inicial o limite de Consumidor hora interrompido definido pela fórmula descrita no Módulo 01 do Prodist (Revisão - 9), acrescido de todos os outros informes e dados listados no Módulo 08 (Revisão 10) do Prodist. Este enquadramento se apresenta na maioria das vezes em condições climáticas adversas com severidade dos fatores inerentes a situação, caracterizado na maioria dos casos por fortes ventos e chuvas de grande intensidade e continuidade.

Entre a manhã do dia 27/02/2020 - sábado - e a noite do dia 9 de março de 2020. – segunda-feira – Áreas de instabilidade associadas à ZCAS favoreceram a ocorrência de chuva forte, raios e rajadas de vento sobre o estado de Goiás.

Conforme informações do Climatempo Meteorologia, o Instituto Nacional de Meteorologia (INMET) detectou rajadas de vento acima de 50km/h entre a manhã do dia 27 de fevereiro e a noite do dia 9 de março de 2020. Na cidade de Catalão ocorreram ventos de até 98,6 km/h entre as 16h e 17h do dia 05 de março de 2020, vento classificado como temporal pela escala Beaufort.

O sistema de detecção da EarthNetworks registrou 48207 descargas atmosféricas sobre a área de concessão da ENEL em Goiás entre as 11h0 do dia 27 de fevereiro e 21h00 do dia 09 de março de 2020, o que causou grande instabilidade na rede.

Estações do INMET também registraram chuva forte entre os dias 27 de fevereiro e 09 de março de 2020. O acumulado de chuva entre os dias 25 de fevereiro e 10 de março de 2020 corresponde às médias históricas tanto do mês de fevereiro, como do mês de março.

Bombeiros resgatam famílias que ficaram ilhadas após forte chuva em Planaltina de Goiás-

Cerca de 20 pessoas precisaram ser resgatadas pela corporação. Segundo bombeiro, água atingiu 2 metros de altura em seu ponto mais alto. Acesso em:

<https://g1.globo.com/go/goias/noticia/2020/03/01/bombeiros-resgatam-familias-que-ficaram-ilhadas-apos-forte-chuva-em-planaltina-de-goias.ghtml>

Relatório de Ocorrências do período

Em todo o Estado de Goiás verificou-se também que a intensidade da chuva e dos ventos danificaram a rede de distribuição de energia elétrica em diversos pontos, registrando aproximadamente 816 mil clientes com interrupção no fornecimento de energia elétrica devido a eventos relacionados ao temporal.

Para otimizar o volume de atendimentos e reduzir os tempos de interrupção foram mobilizados os recursos extras da empresa que aumentou o contingente em relação a situação normal de operação. O acompanhamento da quantidade de equipes e o Tempo Médio de Atendimento podem ser consultados na Pág.02 do Relatório em anexo.

O impacto e severidade do evento estão relatados em artigos de mídia, como fotos e reportagens que demonstram os danos na Rede de Distribuição, oriundos dos eventos climáticos no período. Eventos estes que afetaram 816.017 consumidores com CHI de 1.796.450,21 superior ao de 482.597,74 estabelecido como limite para definição de Situação de Emergência, conforme resumo das informações obrigatórias.

O impacto do evento climático em nossa rede se deu, em sua maioria, do dia 27/02 ao dia 06/03/2020. Por esta razão, limitamos o período de expurgo às ocorrências que se iniciaram nesses dias, e optamos por não utilizar o período definido pelo Laudo em sua totalidade.

Empresa	ENEL DISTRIBUIÇÃO GOIÁS							
Código do Relatório	CHI-044 - ENEL DISTRIBUIÇÃO GOIÁS							
Evento:	TEMPORAL NA AREA DE CONCESSÃO DA ENEL DISTRIBUIÇÃO GOIAS							
Código COBRADE:	1.3.1.2.0	Data Início	27/02/2020	Hora início	11h30			
Código do Evento:	CHI-044-ENEL GO	Data Término	06/03/2020	Hora Término	23h59			
Valor CHI (Limite e Real)	482.597,74	1.796.450,21	Subestações Atingidas ABADIANIA / ABC / ACREUNA / ADELANDIA / AEROPORTO / AGUA LIMPA (MARZAGAO) / AGUAS LINDAS / ALEXANIA / ALEXANIA TRANSMISSAO / ALMERINDONOPOLIS / ALOANDIA / ALPHAVILLE / ALTO BURITI / ALTO HORIZONTE / ALTO PARAISO DE GOIAS / ALVORADA DO NORTE / AMERICANO (RIO VERDE) / AMERICANO DO BRASIL / AMORINOPOLIS / ANAPOLIS UNIVERSITARIA / ANHANGUERA / ANICUNS / ANTONIO DO VITTO / APARECIDA DO RIO DOCE / APORE / ARACU / ARAGARCAS / ARAGOIANIA / ARAGUAPAZ / ARARAS / AREIAS / ARENOPOLIS / ARUANA / ARUANA (TRANSMISSAO) / ASA BRANCA / ATLANTICO / AURILANDIA / AVELINOPOLIS / BACURI (RIO VERDE) / BARBOSELANDIA / BARCELONA / BARREIRO (PORANGATU) / BARRO ALTO / BELA VISTA (TRANSMISSAO) / BOA VISTA / BOM JARDIM / BOM JESUS DE GOIAS / BONFINOPOLIS / BONITO / BONOPOLIS / BONSUCESSO (RIO VERDE) / BRAZABRANTES / BRITANIA / BRITANIA (TRANSMISSAO) / BURITI ALEGRE / BURITI DE GOIAS / BURITIZINHO / CABECEIRAS / CABRIUVA (RIO VERDE) / CACHOEIRA ALTA / CACHOEIRA DOURADA / CACHOEIRA NOVA / CACHOEIRINHA (ITARUMA) / CACU / CAIAPONIA / CALCILANDIA / CALDAS NOVAS / CALDAZINHA / CAMPESTRE / CAMPINAS / CAMPINORTE / CAMPO ALEGRE DE GOIAS / CAMPO LIMPO DE GOIAS / CAMPO NOVO / CAMPOS BELOS / CAMPOS VERDES / CARAIBAS / CARAJAS / CASTELANDIA / CATALAO / CATURAI / CEBRASA FABRICA DA AMBEV / CEMAT/BALIZA / CEPAIGO / CEZARINA / CHAPADAO DO CEU / CIDADE ECLETICA / CIDADE OCIDENTAL / COCALZINHO / COLINACU / CORREGO ALEGRE / CORREGO DO OURO / CORUMBA / CORUMBAIBA / CRISTALINA / CRISTALINA TRANSMISSAO / CRISTIANOPOLIS / CRIXAS / CROMINIA / CUMARI / DAIA - ANAPOLIS / DAMOLANDIA / DAVINOPOLIS / DESFECHO / DESTILARIA BRASIL CENTRAL / DIMIC / DIORAMA / DORCELINO PEIXOTO DE MORAES / DOVERLANDIA / EDEALINA / EDEIA / ENERSUL / ESTANIFERA / ESTRELA DO NORTE / FAINA / FAZENDA CANADA / FAZENDA NOVA / FERROVIARIO / FIRMINOPOLIS / FLORES DE GOIAS / FORMIGA / FORMOSO / FRONTEIRA / GAMELEIRA / GIRASSOL / GOIANAPOLIS / GOIANDIRA / GOIANESIA / GOIANIA LESTE / GOIANIRA / GOIAS / GOIATUBA / GOUVERLANDIA / GOYA / GUAPO / HEITORAI / HIDROLANDIA / HIDROLINA / IACIARA / INACIOLANDIA / INDEPENDENCIA / INDIARA / INHUMAS / IPAMERI / IPEGUARI / IPORA / ISRAELANDIA / ITABERAI / ITAGUARI / ITAGUARU / ITAJA / ITAPACI / ITAPACI (TRANSMISSAO) / ITAPIRAPUA / ITAPURANGA / ITAPURANGA (TRANSMISSAO) / ITARUMA / ITAUCU / ITIQUIRA (FORMOSA) / ITUMBIARA NOVA / ITUMBIARA VELHA / JACILANDIA / JANDAIA / JARAGUA / JARANAPOLIS / JATAI / JAUPACI / JESUPOLIS / JOVIANIA / JUNDIAI / JURUMIRIM / JUSCELANDIA / JUSSARA / LAGES / LAGOA DA SERRA / LAGOA DO BAUZINHO (RIO VERDE) / LEOPOLDO DE BULHOES / LUZIANIA / MAIRIPOTABA / MAMBAI / MARA ROSA / MARAJOARA / MARIAPOLIS (PADRE BERNARDO) / MARZAGAO / MATO GRANDE / MATRINCHA / MAURILANDIA / MEIA PONTE / MINACU / MINEIROS / MINEIROS TRANSMISSAO / MOIPORA / MONTE ALEGRE / MONTES CLAROS DE GOIAS / MONTIVIDIU T / MORRINHOS / MORRO AGUDO / MOSSAMEDES / MOZARLANDIA / MOZARLANDIA (TRANSMISSAO) / MUNDO NOVO DE GOIAS / MUTUNOPOLIS / NAVESLANDIA (JATAI) / NAZARIO / NEROPOLIS / NIQUELANDIA / NOVA AMERICA / NOVA AURORA / NOVA CRIXAS (TRANSMISSAO) / NOVA IGUACU / NOVA PONTE / NOVA VENEZA / NOVO BRASIL / NOVO GAMA / NOVO PLANALTO / OLHOS DAGUA / OLOANA / ORIZONA / OURO VERDE DE GOIAS / OUVIDOR / PACAEMBU (NOVO GAMA) / PADRE BERNARDO / PALESTINA / PALMEIRAS / PALMEIRAS DE GOIAS / PALMELO / PALMINOPOLIS / PAMPLONA / PANAMA / PARANA / PARANAIBA / PARANAIGUARA / PARAUNA SE ALTA TENSAO / PARQUE DAS EMAS (MINEIROS) / PARQUE DAS NACOES / PEROLANDIA / PETROLINA / PILAR / PILOANDIA / PIRACANJUBA / PIRANHAS T / PIRENOPOLIS / PIRES BELO / PIRES DO RIO / PLANALTINA / PLANALTINA (TRANSMISSAO) / PLANALTO / PONTALINA / PORANGATU / PORTEIRAO / PORTELANDIA / PORTO SAO SIMAO / POSSE / POSSELANDIA / PROFESSOR JAMIL / QUEBRA LINHA / QUIRINOPOLIS / REAL / RETIRO / GOIAS / RIO CLARO JATAI MONTIVIDIU / RIO DO PEIXE / RIO DOS BOIS (MAURILANDIA) / RIO PRETO / RIO QUENTE / RIO VERDE / RIO VERMELHO / RIVERLANDIA (RIO VERDE) / ROCHEDO (UEH) / RUBIATABA / SANCLERLANDIA / SANTA BARBARA / SANTA FE DE GOIAS / SANTA HELENA / SANTA RITA DO ARAGUAIA / SANTA ROSA / SANTA ROSA DE GOIAS / SANTA ROSA DO MEIA PONTE / SANTA TEREZA DE GOIAS / SANTA TEREZINHA / SANTANA / SANTO ANTONIO DA BARRA / SANTO ANTONIO DE GOIAS / SANTO ANTONIO DO DESCOBERTO / SAO BARTOLOMEU / SAO DOMINGOS / SAO					
Código do Decreto (Se Houver):								
Quantidade de Interrupções (Evento)	11.905							
Início 1ª Incidência (Data e Hora)	27/02/2020 11:31							

			FRANCISCO DE GOIAS / SAO GABRIEL DE GOIAS / SAO JOAO D ALIANCA / SAO JOAO DA PARAUNA / SAO JUDAS TADEU / SAO LUIZ DOS MONTES BELOS / SAO MIGUEL DO ARAGUAIA / SAO MIGUEL DO PASSA QUATRO / SAO SIMAO / SENADOR CANEDO TRANSMISSAO / SERRA AZUL (JATAI) / SERRA DE CALDAS / SERRA DO OURO / SERRANOPOLIS / SILVANIA / SITIO DABADIA / SOUZALANDIA / SUCURI / TAIOBA / TAQUARAL / TAQUARI / TEREZOPOLIS / TERRA VERMELHA / TRAJANOPOLIS (PADRE BERNARDO) / TRES BARRAS / TRES RANCHOS / TRINDADE / TUCUNARE / TURVANIA / TURVELANDIA / URU / URUACU / URUTAI / USINA DE ACUCAR DE GOIANESIA / USINA MAMBAI / VALPARAISO / VARJAO / VENDA SECA / VIANOPOLIS / VICENTINOPOLIS / VILA CORUMBA / VILA PROPICIO / XAVANTES / XIXA / ZELANDIA
Início Ultima Incidência (Data e Hora)	06/03/2020 23:37		
Média de Duração das Incidências (h)	6,19		
Duração da Incidência mais longa (h)	97,99		
Total de Clientes afetados	816.017	Municípios Atingidos	ABADIA DE GOIAS / ABADIANA / ACREUNA / ADELANDIA / AGUA FRIA DE GOIAS / AGUA LIMPA / AGUAS LINDAS DE GOIAS / ALEXANIA / ALOANDIA / ALTO HORIZONTE / ALTO PARAISO DE GOIAS / ALVORADA DO NORTE / AMARALINA / AMERICANO DO BRASIL / AMORINOPOLIS / ANAPOLIS / ANHANGUERA / ANICUNS / APARECIDA DE GOIANIA / APARECIDA DO RIO DOCE / APORE / ARACU / ARAGARCAS / ARAGOIANIA / ARAGUAPAZ / ARENOPOLIS / ARUANA / AURILANDIA / AVELINOPOLIS / BALIZA / BARRO ALTO / BELA VISTA DE GOIAS / BOM JARDIM DE GOIAS / BOM JESUS DE GOIAS / BONFINOPOLIS / BONOPOLIS / BRAZABRANTES / BRITANIA / BURITI ALEGRE / BURITI DE GOIAS / BURITINOPOLIS / CABECEIRAS / CACHOEIRA ALTA / CACHOEIRA DE GOIAS / CACHOEIRA DOURADA / CACU / CAIAPONIA / CALDAS NOVAS / CALDAZINHA / CAMPESTRE DE GOIAS / CAMPINACU / CAMPINORTE / CAMPO ALEGRE DE GOIAS / CAMPO LIMPO / CAMPOS BELOS / CAMPOS VERDES / CARMO DO RIO VERDE / CASTELANDIA / CATALAO / CATURAI / CAVALCANTE / CERES / CEZARINA / CHAPADAO DO CEU / CIDADE OCIDENTAL / COCALZINHO DE GOIAS / COLINAS DO SUL / CORREGO DO OURO / CORUMBA DE GOIAS / CORUMBAIBA / CRISTALINA / CRISTIANOPOLIS / CRIXAS / CROMINIA / CUMARI / DAMIANOPOLIS / DAMOLANDIA / DAVINOPOLIS / DIORAMA / DISTRITO FEDERAL / DIVINOPOLIS DE GOIAS / DOVERLANDIA / EDEALINA / EDEIA / ESTRELA DO NORTE / FAINA / FAZENDA NOVA / FIRMINOPOLIS / FLORES DE GOIAS / FORMOSA / FORMOSO / GAMELEIRA DE GOIAS / GOIANAPOLIS / GOIANDIRA / GOIANESIA / GOIANIA / GOIANIRA / GOIAS / GOIATUBA / GOUVELANDIA / GUAPO / GUARAITA / GUARANI DE GOIAS / GUARINOS / HEITORAI / HIDROLANDIA / HIDROLINA / IACIARA / INACIOLANDIA / INDIARA / INHUMAS / IPAMERI / IPIRANGA DE GOIAS / IPORA / ISRAELANDIA / ITABERAI / ITAGUARI / ITAGUARU / ITAJA / ITAPACI / ITAPIRAPUA / ITAPURANGA / ITARUMA / ITAUCU / ITUMBIARA / IVOLANDIA / JANDAIA / JARAGUA / JATAI / JAUPACI / JESUPOLIS / JOVIANIA / JUSSARA / LAGOA SANTA / LEOPOLDO DE BULHOES / LUZIANIA / MAIRIPOTABA / MAMBAI / MARA ROSA / MARZAGAO / MATRINCHA / MAURILANDIA / MIMOSO DE GOIAS / MINACU / MINEIROS / MOIPORA / MONTE ALEGRE DE GOIAS / MONTES CLAROS DE GOIAS / MONTIVIDIU / MONTIVIDIU DO NORTE / MORRINHOS / MORRO AGUDO DE GOIAS / MOSSAMEDES / MOZARLANDIA / MUNDO NOVO DE GOIAS / MUTUNOPOLIS / NAZARIO / NEROPOLIS / NIQUELANDIA / NOVA AMERICA / NOVA AURORA / NOVA CRIXAS / NOVA GLORIA / NOVA IGUACU DE GOIAS / NOVA ROMA / NOVA VENEZA / NOVO BRASIL / NOVO GAMA / NOVO PLANALTO / ORIZONA / OURO VERDE DE GOIAS / OUVIDOR / PADRE BERNARDO / PALESTINA DE GOIAS / PALMEIRAS DE GOIAS / PALMELO / PALMINOPOLIS / PANAMA / PARANAIGUARA / PARAUNA / PEROLANDIA / PETROLINA DE GOIAS / PILAR DE GOIAS / PIRACANJUBA / PIRANHAS / PIRENOPOLIS / PIRES DO RIO / PLANALTINA / PONTALINA / PORANGATU / PORTEIRAO / PORTELANDIA / POSSE / PROFESSOR JAMIL SAFADY / QUIRINOPOLIS / RIO QUENTE / RIO VERDE / RUBIATABA / SANCLERLANDIA / SANTA BARBARA DE GOIAS / SANTA CRUZ DE GOIAS / SANTA FE DE GOIAS / SANTA HELENA DE GOIAS / SANTA ISABEL / SANTA RITA DO ARAGUAIA / SANTA RITA DO NOVO DESTINO / SANTA ROSA DE GOIAS / SANTA TEREZA DE GOIAS / SANTA TEREZINHA DE GOIAS / SANTO ANTONIO DA BARRA / SANTO ANTONIO DE GOIAS / SANTO ANTONIO DO DESCOBERTO / SAO DOMINGOS / SAO FRANCISCO DE GOIAS / SAO JOAO D ALIANCA / SAO JOAO DA PARAUNA / SAO LUIS DE MONTES BELOS / SAO LUIZ DO NORTE / SAO MIGUEL DO ARAGUAIA / SAO MIGUEL DO PASSA QUATRO / SAO PATRICIO / SAO SIMAO / SENADOR CANEDO / SERRANOPOLIS / SILVANIA / SIMOLANDIA / SITIO D ABADIA / TAQUARAL DE GOIAS / TEREZOPOLIS DE GOIAS / TRES RANCHOS / TRINDADE / TROMBAS / TURVANIA / TURVELANDIA / UIRAPURU / URUACU / URUANA / URUTAI / VALPARAISO DE GOIAS / VARJAO / VIANOPOLIS / VICENTINOPOLIS / VILA BOA / VILA PROPICIO

DANOS CAUSADOS			
Equipamentos Danificado	Importância para o Sistema	Local	Quantidade
Disjuntor/Religador Operado	Proteção do Alimentador	Área de Concessão	223
Chaves Fusíveis Operada	Proteção de Ramais de Alimentadores	Área de Concessão	3212
Transformador Operado	Proteção do Transformador	Área de Concessão	2802

Relato técnico sobre a Intervenção realizada em Goiânia e Região Metropolitana										
Informações sobre Equipes	27/02	28/02	29/02	01/03	02/03	03/03	04/03	05/03	06/03	
Quantidade Usual	720	720	675	570	717	717	717	717	717	turmas
Quantidade Adicional	82	57	25	52	22	42	45	49	17	turmas
Quantidade Total	802	777	700	622	739	759	762	766	734	turmas
Tempos Médios										
Preparação	3,92	4,76	3,75	3,10	3,69	3,38	3,11	2,91	3,32	Horas
Deslocamento	0,88	0,92	0,89	0,95	0,91	0,90	0,84	0,89	0,87	Horas
Execução	1,02	1,04	1,12	1,11	1,03	1,08	1,03	1,26	1,00	Horas
TMAE	5,82	6,72	5,76	5,16	5,63	5,36	4,98	5,06	5,18	Horas

Principais Dificuldades Encontradas:

Chuvas com ventos fortes provocaram muitos pontos de alagamento e enxurrada, trânsito impedido por vários semáforos desligados dificultando a chegada ao atendimento das ocorrências emergenciais. Em determinadas regiões, decorrente dos fortes ventos, houve o tombamento de árvores nas estruturas de alimentação de média tensão, danos em ramais de ligação dos clientes, impedimentos de acesso e atolamentos em estradas rurais.

Empresa	ENEL DISTRIBUIÇÃO GOIAS		
Valor CHI (Limite e Real)	482.597,74		1.796.450,21

DOC ORIGEM	MIUNICIPIO	EQP_ORIGEM	CONJUNTO	INI_OCORRENC	FIM_OCORRENC	DT_INI_EVENTO	DT_FIM_EVENTO	DURAÇ	UC INT	CHI	EXPURGO
2020032	URUACU	UR16405071	URUACU	01/03/2020 00:05	01/03/2020 02:43	01/03/2020 00:05	01/03/2020 02:43	2,64	466	1228,30	CHI
20200310	AMARALINA	LC12270120	SAO MIGUEL DO ARAGUAIA	01/03/2020 07:56	01/03/2020 09:27	01/03/2020 07:56	01/03/2020 09:27	1,51	10	15,13	CHI
20200314	ANAPOLIS	20836181	ANAPOLIS UNIVERSITARIO S2	01/03/2020 00:24	01/03/2020 02:39	01/03/2020 00:24	01/03/2020 02:39	2,24	1	2,24	CHI
20200324	CAMPESTRE DE GOIAS	GC21005200	TRINDADE	01/03/2020 00:53	01/03/2020 06:18	01/03/2020 00:53	01/03/2020 06:18	5,41	1	5,41	CHI
20200325	MONTES CLAROS DE GOIAS	ME12140084	IPORA	01/03/2020 00:54	01/03/2020 17:56	01/03/2020 00:54	01/03/2020 17:56	17,02	5	85,11	CHI
20200326	RUBIATABA	6567988	RUBIATABA	01/03/2020 05:27	01/03/2020 09:43	01/03/2020 05:27	01/03/2020 09:43	4,26	15	63,93	CHI
20200327	ITABERAI	50078689	ITABERAI S2	01/03/2020 00:58	01/03/2020 04:40	01/03/2020 00:58	01/03/2020 04:40	3,69	1	3,69	CHI
20200332	OURO VERDE DE GOIAS	OV12036341	INHUMAS S1	01/03/2020 01:11	01/03/2020 03:38	01/03/2020 01:11	01/03/2020 03:38	2,43	20	48,69	CHI
20200338	JATAI	JT12378171	MONTIVIDIU T	01/03/2020 01:23	01/03/2020 11:40	01/03/2020 01:23	01/03/2020 11:40	10,28	5	51,41	CHI
20200343	NIQUELANDIA	NQ12086224	NIQUELANDIA SUBTRANSMISSAO	29/02/2020 22:01	01/03/2020 09:38	29/02/2020 22:01	01/03/2020 09:38	11,60	17	197,20	CHI
20200345	SANTO ANTONIO DO DESCOBERTO	SN21214785	MARAJOARA	01/03/2020 01:47	01/03/2020 07:03	01/03/2020 01:47	01/03/2020 07:03	5,25	1	5,25	CHI
20200347	GUARANI DE GOIAS	GY12265440	IACIARA S1	01/03/2020 01:52	01/03/2020 07:14	01/03/2020 01:52	01/03/2020 07:14	5,36	20	107,16	CHI
20200349	OURO VERDE DE GOIAS	OV21014208	INHUMAS S1	01/03/2020 01:58	01/03/2020 03:54	01/03/2020 01:58	01/03/2020 03:54	1,93	2	3,86	CHI
20200351	TURVELANDIA	TD12025685	RIO DOS BOIS	01/03/2020 02:17	01/03/2020 08:09	01/03/2020 02:17	01/03/2020 08:09	5,85	27	157,96	CHI
20200354	SAO MIGUEL DO ARAGUAIA	SM12000050	SAO MIGUEL DO ARAGUAIA	01/03/2020 02:49	01/03/2020 13:30	01/03/2020 02:49	01/03/2020 13:30	10,68	28	299,02	CHI
20200357	ITUMBIARA	IT12222359	PARANAIBA	01/03/2020 03:12	01/03/2020 08:53	01/03/2020 03:12	01/03/2020 08:53	5,68	20	113,55	CHI
20200357	PANAMA	IT12222359	PARANAIBA	01/03/2020 03:12	01/03/2020 08:53	01/03/2020 03:12	01/03/2020 08:53	5,68	23	130,58	CHI
20200358	GOIATUBA	GT21309912	GOIATUBA S2	01/03/2020 03:16	01/03/2020 07:57	01/03/2020 03:16	01/03/2020 07:57	4,67	1	4,67	CHI
20200362	IVOLANDIA	IV12011808	IPORA	01/03/2020 03:31	01/03/2020 16:28	01/03/2020 03:31	01/03/2020 16:28	12,93	22	284,54	CHI
20200364	ITABERAI	II12220232	ITABERAI S1	01/03/2020 03:41	01/03/2020 08:15	01/03/2020 03:41	01/03/2020 08:15	4,56	2	9,12	CHI
20200364	ITAGUARI	II12220232	ITABERAI S1	01/03/2020 03:41	01/03/2020 08:15	01/03/2020 03:41	01/03/2020 08:15	4,56	1	4,56	CHI
20200364	TAQUARAL DE GOIAS	II12220232	ITABERAI S1	01/03/2020 03:41	01/03/2020 08:15	01/03/2020 03:41	01/03/2020 08:15	4,56	32	145,92	CHI
20200365	EDEALINA	ED12293192	PONTALINA	01/03/2020 09:30	01/03/2020 14:06	01/03/2020 09:30	01/03/2020 14:06	4,59	17	78,05	CHI
20200365	INDIARA	ED12293192	PONTALINA	01/03/2020 09:30	01/03/2020 14:06	01/03/2020 09:30	01/03/2020 14:06	4,59	2	9,18	CHI
20200367	SANTA RITA DO ARAGUAIA	SU12306507	SANTA RITA DO ARAGUAIA	01/03/2020 04:04	01/03/2020 09:03	01/03/2020 04:04	01/03/2020 09:03	4,98	15	74,71	CHI
20200368	PADRE BERNARDO	PB12377248	PADRE BERNARDO	01/03/2020 04:05	01/03/2020 05:30	01/03/2020 04:05	01/03/2020 05:30	1,41	7	9,90	CHI
20200369	BELA VISTA DE GOIAS	BV31094241	CEPAIGO S2	01/03/2020 04:07	01/03/2020 09:14	01/03/2020 04:07	01/03/2020 09:14	5,11	1	5,11	CHI
20200372	RIO VERDE	RV12327049	CABRIUVA S2	01/03/2020 04:09	01/03/2020 10:20	01/03/2020 04:09	01/03/2020 10:20	6,17	3	18,51	CHI
20200374	CATALAO	CT21250462	CATALAO S1	01/03/2020 04:13	01/03/2020 07:33	01/03/2020 04:13	01/03/2020 07:33	3,32	1	3,32	CHI
20200377	AURILANDIA	AI12377180	FIRMINOPOLIS S2	01/03/2020 04:24	01/03/2020 08:37	01/03/2020 04:24	01/03/2020 08:37	4,21	6	25,29	CHI
20200378	PONTALINA	PK21046061	PONTALINA	01/03/2020 04:31	01/03/2020 09:34	01/03/2020 04:31	01/03/2020 09:34	5,04	2	10,07	CHI
20200383	IPAMERI	IP21359965	PIRES DO RIO S2	01/03/2020 04:47	01/03/2020 08:00	01/03/2020 04:47	01/03/2020 08:00	3,21	1	3,21	CHI
20200385	JUSSARA	JR12087424	JUSSARA	01/03/2020 01:06	01/03/2020 06:58	01/03/2020 01:06	01/03/2020 06:58	5,85	11	64,38	CHI
20200386	CAIAPONIA	CP12039210	CAIAPONIA	01/03/2020 05:01	01/03/2020 13:06	01/03/2020 05:01	01/03/2020 13:06	8,08	11	88,86	CHI
20200388	NOVO BRASIL	NB12378819	JUSSARA	01/03/2020 04:50	01/03/2020 22:35	01/03/2020 04:50	01/03/2020 22:35	17,75	4	70,99	CHI
20200389	MINEIROS	PW12219564	PARQUE DAS EMAS	01/03/2020 05:06	01/03/2020 10:30	01/03/2020 05:06	01/03/2020 10:30	5,39	7	37,70	CHI
20200389	PORTELANDIA	PW12219564	PARQUE DAS EMAS	01/03/2020 05:06	01/03/2020 10:30	01/03/2020 05:06	01/03/2020 10:30	5,39	12	64,63	CHI
20200398	CRIXAS	UP12171811	SANTA TEREZINHA	01/03/2020 05:15	01/03/2020 10:40	01/03/2020 05:15	01/03/2020 10:40	5,42	6	32,49	CHI
20200398	UIRAPURU	UP12171811	SANTA TEREZINHA	01/03/2020 05:15	01/03/2020 10:40	01/03/2020 05:15	01/03/2020 10:40	5,42	31	167,89	CHI
20200399	PIRACANJUBA	PJ12381140	PIRACANJUBA	01/03/2020 05:23	01/03/2020 09:22	01/03/2020 05:23	01/03/2020 09:22	3,97	9	35,76	CHI
202003201	ARAGARCAS	AG10396203	ARAGARCAS	01/03/2020 02:25	02/03/2020 19:51	01/03/2020 02:31	01/03/2020 07:55	5,40	47	253,59	CHI
202003201	BOM JARDIM DE GOIAS	AG10396203	ARAGARCAS	01/03/2020 02:25	02/03/2020 19:51	01/03/2020 02:31	01/03/2020 07:55	5,40	13	70,14	CHI
202003201	ARAGARCAS	AG10396203	ARAGARCAS	01/03/2020 02:25	02/03/2020 19:51	01/03/2020 10:37	01/03/2020 11:07	0,50	47	23,59	CHI

202003201	BOM JARDIM DE GOIAS	AG10396203	ARAGARCAS	01/03/2020 02:25	02/03/2020 19:51	01/03/2020 10:37	01/03/2020 11:07	0,50	13	6,53	CHI
202003201	ARAGARCAS	AG10396203	ARAGARCAS	01/03/2020 02:25	02/03/2020 19:51	02/03/2020 10:11	02/03/2020 10:30	0,32	47	15,11	CHI
202003201	BOM JARDIM DE GOIAS	AG10396203	ARAGARCAS	01/03/2020 02:25	02/03/2020 19:51	02/03/2020 10:11	02/03/2020 10:30	0,32	13	4,18	CHI
202003201	ARAGARCAS	AG13204830	ARAGARCAS	01/03/2020 02:25	02/03/2020 19:51	01/03/2020 02:31	02/03/2020 18:08	39,62	11	435,80	CHI
202003201	BOM JARDIM DE GOIAS	AG13204830	ARAGARCAS	01/03/2020 02:25	02/03/2020 19:51	01/03/2020 02:31	02/03/2020 18:08	39,62	3	118,85	CHI
202003201	ARAGARCAS	BM12316433	ARAGARCAS	01/03/2020 02:25	02/03/2020 19:51	01/03/2020 02:31	02/03/2020 19:37	41,09	47	1931,24	CHI
202003201	BOM JARDIM DE GOIAS	BM12316433	ARAGARCAS	01/03/2020 02:25	02/03/2020 19:51	01/03/2020 02:31	02/03/2020 19:37	41,09	2	82,18	CHI
202003201	BOM JARDIM DE GOIAS	BM12060899	ARAGARCAS	01/03/2020 02:25	02/03/2020 19:51	01/03/2020 02:31	02/03/2020 19:51	41,33	36	1487,88	CHI
202003203	AMORINOPOLIS	AM12402915	IPORA	29/02/2020 16:31	01/03/2020 11:25	29/02/2020 16:31	01/03/2020 11:25	18,89	2	37,79	CHI
202003204	AMORINOPOLIS	AM12091446	IPORA	29/02/2020 16:44	01/03/2020 11:56	29/02/2020 16:44	01/03/2020 11:56	19,19	2	38,39	CHI
202003205	AMORINOPOLIS	AM21193417	IPORA	29/02/2020 19:43	01/03/2020 10:25	29/02/2020 19:43	01/03/2020 10:25	14,69	1	14,69	CHI
202003252	JATAI	JT11274077	JATAI S3	01/03/2020 11:21	01/03/2020 13:23	01/03/2020 11:21	01/03/2020 13:23	2,02	103	208,29	CHI
202003284	MINEIROS	MY10401436	PARQUE DAS EMAS	01/03/2020 15:55	01/03/2020 23:58	01/03/2020 15:55	01/03/2020 15:59	0,07	29	1,93	CHI
202003284	MINEIROS	MY10401436	PARQUE DAS EMAS	01/03/2020 15:55	01/03/2020 23:58	01/03/2020 19:40	01/03/2020 20:03	0,39	28	10,79	CHI
202003284	MINEIROS	MY10401436	PARQUE DAS EMAS	01/03/2020 15:55	01/03/2020 23:58	01/03/2020 22:50	01/03/2020 23:04	0,24	28	6,74	CHI
202003284	MINEIROS	MY13324526	PARQUE DAS EMAS	01/03/2020 15:55	01/03/2020 23:58	01/03/2020 15:55	01/03/2020 23:58	8,05	7	56,37	CHI
202003287	RIO QUENTE	RQ12050875	VILA CORUMBA	01/03/2020 07:08	01/03/2020 19:21	01/03/2020 07:08	01/03/2020 19:21	12,21	13	158,77	CHI
202003299	TRINDADE	TR12071655	TRINDADE	01/03/2020 19:26	01/03/2020 22:41	01/03/2020 21:24	01/03/2020 22:41	1,29	59	76,03	CHI
202003302	JANDAIA	PP12307065	PALMEIRAS	01/03/2020 05:27	01/03/2020 07:04	01/03/2020 05:27	01/03/2020 07:04	1,61	15	24,13	CHI
202003302	PALMINOPOLIS	PP12307065	PALMEIRAS	01/03/2020 05:27	01/03/2020 07:04	01/03/2020 05:27	01/03/2020 07:04	1,61	6	9,65	CHI
202003305	ORIZONA	OZ12079958	VIANOPOLIS	01/03/2020 05:29	01/03/2020 12:43	01/03/2020 05:29	01/03/2020 12:43	7,23	5	36,15	CHI
202003305	VIANOPOLIS	OZ12079958	VIANOPOLIS	01/03/2020 05:29	01/03/2020 12:43	01/03/2020 05:29	01/03/2020 12:43	7,23	54	390,41	CHI
202003313	ITAPIRAPUA	NB21165498	JUSSARA	01/03/2020 05:38	01/03/2020 08:08	01/03/2020 05:38	01/03/2020 08:08	2,49	1	2,49	CHI
202003314	DOVERLANDIA	DV12138335	CAIAPONIA	01/03/2020 05:38	01/03/2020 08:12	01/03/2020 05:38	01/03/2020 08:12	2,55	37	94,39	CHI
202003315	NOVA AMERICA	RB12320982	RUBIATABA	01/03/2020 05:40	01/03/2020 09:41	01/03/2020 05:40	01/03/2020 09:41	4,00	4	16,02	CHI
202003315	RUBIATABA	RB12320982	RUBIATABA	01/03/2020 05:40	01/03/2020 09:41	01/03/2020 05:40	01/03/2020 09:41	4,00	23	92,09	CHI
202003316	PIRACANJUBA	PJ12000022	PIRACANJUBA	01/03/2020 05:41	01/03/2020 11:21	01/03/2020 05:41	01/03/2020 11:21	5,66	19	107,47	CHI
202003317	PONTALINA	PK12046042	PONTALINA	01/03/2020 05:43	01/03/2020 09:00	01/03/2020 05:43	01/03/2020 09:00	3,27	11	35,94	CHI
202003318	MINEIROS	MY12303820	PARQUE DAS EMAS	01/03/2020 05:45	01/03/2020 21:14	01/03/2020 05:45	01/03/2020 21:14	15,47	28	433,29	CHI
202003318	SANTA RITA DO ARAGUAIA	MY12303820	PARQUE DAS EMAS	01/03/2020 05:45	01/03/2020 21:14	01/03/2020 05:45	01/03/2020 21:14	15,47	2	30,95	CHI
202003320	GOIAS	GS12035930	GOIAS	01/03/2020 05:48	01/03/2020 08:36	01/03/2020 05:48	01/03/2020 08:36	2,80	41	114,66	CHI
202003320	HEITORAI	GS12035930	GOIAS	01/03/2020 05:48	01/03/2020 08:36	01/03/2020 05:48	01/03/2020 08:36	2,80	33	92,29	CHI
202003320	ITABERAI	GS12035930	GOIAS	01/03/2020 05:48	01/03/2020 08:36	01/03/2020 05:48	01/03/2020 08:36	2,80	3	8,39	CHI
202003320	ITAPURANGA	GS12035930	GOIAS	01/03/2020 05:48	01/03/2020 08:36	01/03/2020 05:48	01/03/2020 08:36	2,80	3	8,39	CHI
202003322	BONOPOLIS	BX12202590	SAO MIGUEL DO ARAGUAIA	01/03/2020 05:49	01/03/2020 10:38	01/03/2020 05:49	01/03/2020 10:38	4,81	11	52,96	CHI
202003325	FLORES DE GOIAS	FB12062351	FLORES DE GOIAS	01/03/2020 05:51	01/03/2020 07:23	01/03/2020 05:51	01/03/2020 07:23	1,53	2	3,05	CHI
202003326	CAIAPONIA	DV12332038	CAIAPONIA	01/03/2020 05:07	01/03/2020 07:05	01/03/2020 05:07	01/03/2020 07:05	1,96	22	43,11	CHI
202003326	DOVERLANDIA	DV12332038	CAIAPONIA	01/03/2020 05:07	01/03/2020 07:05	01/03/2020 05:07	01/03/2020 07:05	1,96	28	54,86	CHI
202003330	ALEXANIA	AX12061853	ALEXANIA	01/03/2020 05:57	01/03/2020 07:13	01/03/2020 05:57	01/03/2020 07:13	1,26	5	6,29	CHI
202003333	BONOPOLIS	BX12168258	SAO MIGUEL DO ARAGUAIA	01/03/2020 06:01	01/03/2020 08:16	01/03/2020 06:01	01/03/2020 08:16	2,25	20	45,06	CHI
202003333	CACU	BX12168258	SAO MIGUEL DO ARAGUAIA	01/03/2020 06:01	01/03/2020 08:16	01/03/2020 06:01	01/03/2020 08:16	2,25	1	2,25	CHI
202003338	JARAGUA	JA21188768	JARAGUA	01/03/2020 06:06	01/03/2020 08:05	01/03/2020 06:06	01/03/2020 08:05	1,98	1	1,98	CHI
202003339	JARAGUA	JA12353232	GOIANESIA S2	01/03/2020 06:06	01/03/2020 08:38	01/03/2020 06:06	01/03/2020 08:38	2,53	32	80,88	CHI
202003344	PORANGATU	PO12021172	PORANGATU	01/03/2020 06:08	01/03/2020 09:36	01/03/2020 06:08	01/03/2020 09:36	3,45	5	17,26	CHI

202003345	BOM JESUS DE GOIAS	JV12222565RE	VICENTINOPOLIS	01/03/2020 06:09	01/03/2020 11:43	01/03/2020 06:09	01/03/2020 11:43	5,57	3	16,70	CHI
202003345	GOIATUBA	JV12222565RE	VICENTINOPOLIS	01/03/2020 06:09	01/03/2020 11:43	01/03/2020 06:09	01/03/2020 11:43	5,57	14	77,92	CHI
202003345	JOVIANIA	JV12222565RE	VICENTINOPOLIS	01/03/2020 06:09	01/03/2020 11:43	01/03/2020 06:09	01/03/2020 11:43	5,57	6	33,39	CHI
202003345	VICENTINOPOLIS	JV12222565RE	VICENTINOPOLIS	01/03/2020 06:09	01/03/2020 11:43	01/03/2020 06:09	01/03/2020 11:43	5,57	2	11,13	CHI
202003347	CATALAO	7156994	CATALAO S1	01/03/2020 06:10	01/03/2020 07:53	01/03/2020 06:10	01/03/2020 07:53	1,71	7	11,98	CHI
202003347	OUVIDOR	7156994	CATALAO S1	01/03/2020 06:10	01/03/2020 07:53	01/03/2020 06:10	01/03/2020 07:53	1,71	22	37,64	CHI
202003351	CEZARINA	CZ12000020	CEZARINA	01/03/2020 06:11	01/03/2020 08:21	01/03/2020 06:11	01/03/2020 08:21	2,15	1	2,15	CHI
202003351	VARJAO	CZ12000020	CEZARINA	01/03/2020 06:11	01/03/2020 08:21	01/03/2020 06:11	01/03/2020 08:21	2,15	4	8,61	CHI
202003352	BALIZA	BM12390150	BOM JARDIM	01/03/2020 06:12	01/03/2020 10:35	01/03/2020 06:12	01/03/2020 10:35	4,38	51	223,46	CHI
202003352	BOM JARDIM DE GOIAS	BM12390150	BOM JARDIM	01/03/2020 06:12	01/03/2020 10:35	01/03/2020 06:12	01/03/2020 10:35	4,38	9	39,43	CHI
202003354	COCALZINHO DE GOIAS	ZN12302401	COCALZINHO	01/03/2020 01:16	01/03/2020 08:06	01/03/2020 01:16	01/03/2020 08:06	6,83	4	27,32	CHI
202003354	CORUMBA DE GOIAS	ZN12302401	COCALZINHO	01/03/2020 01:16	01/03/2020 08:06	01/03/2020 01:16	01/03/2020 08:06	6,83	22	150,28	CHI
202003355	FAZENDA NOVA	NB12396238	JUSSARA	01/03/2020 06:14	01/03/2020 10:06	01/03/2020 06:14	01/03/2020 10:06	3,87	1	3,87	CHI
202003355	NOVO BRASIL	NB12396238	JUSSARA	01/03/2020 06:14	01/03/2020 10:06	01/03/2020 06:14	01/03/2020 10:06	3,87	4	15,46	CHI
202003358	PIRENOPOLIS	PV12381260	CORUMBA	01/03/2020 06:19	01/03/2020 07:56	01/03/2020 06:19	01/03/2020 07:56	1,61	73	117,37	CHI
202003363	RIO VERDE	RV11113538	RIO VERDE S2	01/03/2020 01:52	01/03/2020 13:50	01/03/2020 01:52	01/03/2020 13:50	11,95	124	1482,28	CHI
202003364	VILA PROPICIO	GE12258997	GOIANESIA S2	01/03/2020 06:21	01/03/2020 09:58	01/03/2020 06:21	01/03/2020 09:58	3,61	10	36,06	CHI
202003370	PARAUNA	PU12010292	FIRMINOPOLIS S2	01/03/2020 06:25	01/03/2020 13:30	01/03/2020 06:25	01/03/2020 13:30	7,08	27	191,23	CHI
202003371	MORRINHOS	MR12212264RE	GOIATUBA S1	01/03/2020 06:25	01/03/2020 12:53	01/03/2020 06:25	01/03/2020 12:53	6,47	60	388,13	CHI
202003378	PLANALTINA	PI12355798	PLANALTINA	01/03/2020 06:27	01/03/2020 09:34	01/03/2020 06:27	01/03/2020 09:34	3,10	55	170,53	CHI
202003381	ITAJA	IJ12184028	ITAJA S2	01/03/2020 06:29	01/03/2020 08:50	01/03/2020 06:29	01/03/2020 08:50	2,35	1	2,35	CHI
202003382	MUTUNOPOLIS	PO12374520	PORANGATU	01/03/2020 05:08	01/03/2020 14:48	01/03/2020 05:08	01/03/2020 10:14	5,09	6	30,55	CHI
202003382	PORANGATU	PO12374520	PORANGATU	01/03/2020 05:08	01/03/2020 14:48	01/03/2020 05:08	01/03/2020 10:14	5,09	19	96,74	CHI
202003382	MUTUNOPOLIS	PO12374520	PORANGATU	01/03/2020 05:08	01/03/2020 14:48	01/03/2020 05:08	01/03/2020 14:48	9,67	12	116,07	CHI
202003382	MUTUNOPOLIS	PO12374520	PORANGATU	01/03/2020 05:08	01/03/2020 14:48	01/03/2020 11:41	01/03/2020 14:48	3,12	6	18,70	CHI
202003382	PORANGATU	PO12374520	PORANGATU	01/03/2020 05:08	01/03/2020 14:48	01/03/2020 11:41	01/03/2020 14:48	3,12	19	59,21	CHI
202003386	CRIXAS	NA12057181	MOZARLANDIA	01/03/2020 00:39	01/03/2020 08:52	01/03/2020 00:39	01/03/2020 08:52	8,20	2	16,41	CHI
202003386	NOVA CRIXAS	NA12057181	MOZARLANDIA	01/03/2020 00:39	01/03/2020 08:52	01/03/2020 00:39	01/03/2020 08:52	8,20	54	443,07	CHI
202003388	QUIRINOPOLIS	QI21119911	QUIRINOPOLIS	01/03/2020 06:30	01/03/2020 08:04	01/03/2020 06:30	01/03/2020 08:04	1,55	1	1,55	CHI
202003389	JOVIANIA	JV21208250	GOIATUBA S1	01/03/2020 06:31	01/03/2020 11:26	01/03/2020 06:31	01/03/2020 11:26	4,91	1	4,91	CHI
202003390	APORE	AE12000052	ITAJA S1	01/03/2020 06:31	01/03/2020 11:15	01/03/2020 06:31	01/03/2020 11:15	4,72	13	61,36	CHI
202003391	PADRE BERNARDO	PB11261452	PADRE BERNARDO	01/03/2020 06:32	01/03/2020 13:22	01/03/2020 06:32	01/03/2020 13:22	6,83	46	313,99	CHI
202003392	ITAPIRAPUA	IU12072503	JUSSARA	01/03/2020 06:33	01/03/2020 09:01	01/03/2020 06:33	01/03/2020 09:01	2,46	11	27,11	CHI
202003393	SILVANIA	VN12017544	VIANOPOLIS	01/03/2020 03:28	01/03/2020 09:21	01/03/2020 03:28	01/03/2020 09:21	5,87	118	692,50	CHI
202003393	VIANOPOLIS	VN12017544	VIANOPOLIS	01/03/2020 03:28	01/03/2020 09:21	01/03/2020 03:28	01/03/2020 09:21	5,87	48	281,69	CHI
202003394	HIDROLANDIA	HD11000143	ANHANGUERA	01/03/2020 06:33	01/03/2020 08:49	01/03/2020 06:33	01/03/2020 08:49	2,26	92	207,74	CHI
202003395	GOIANESIA	GE12384170	GOIANESIA S2	01/03/2020 06:33	01/03/2020 08:00	01/03/2020 06:33	01/03/2020 08:00	1,44	4	5,76	CHI
202003395	VILA PROPICIO	GE12384170	GOIANESIA S2	01/03/2020 06:33	01/03/2020 08:00	01/03/2020 06:33	01/03/2020 08:00	1,44	4	5,76	CHI
202003398	PILAR DE GOIAS	GG12284732	SANTA TEREZINHA	29/02/2020 19:56	01/03/2020 08:41	29/02/2020 19:56	01/03/2020 08:41	12,75	3	38,24	CHI
202003404	CAMPO LIMPO	OV12317357	NEROPOLIS S2	01/03/2020 06:37	01/03/2020 09:11	01/03/2020 06:37	01/03/2020 09:11	2,56	2	5,11	CHI
202003404	OURO VERDE DE GOIAS	OV12317357	NEROPOLIS S2	01/03/2020 06:37	01/03/2020 09:11	01/03/2020 06:37	01/03/2020 09:11	2,56	32	81,78	CHI
202003406	RIO VERDE	RV12296155	SANTA HELENA S1	01/03/2020 05:07	01/03/2020 12:46	01/03/2020 05:07	01/03/2020 12:46	7,64	69	527,49	CHI
202003406	SANTA HELENA DE GOIAS	RV12296155	SANTA HELENA S1	01/03/2020 05:07	01/03/2020 12:46	01/03/2020 05:07	01/03/2020 12:46	7,64	1	7,64	CHI
202003415	IACIARA	IA21399314	IACIARA S1	01/03/2020 06:41	01/03/2020 09:26	01/03/2020 06:41	01/03/2020 09:26	2,74	1	2,74	CHI

202003417	MONTE ALEGRE DE GOIAS	MA12211596	SAO DOMINGOS	01/03/2020 06:42	01/03/2020 08:44	01/03/2020 06:42	01/03/2020 08:44	2,03	6	12,18	CHI
202003418	VILA PROPICIO	NP12188681	GOIANESIA S1	01/03/2020 06:19	01/03/2020 10:55	01/03/2020 06:19	01/03/2020 10:55	4,59	87	398,92	CHI
202003420	SANTA RITA DO NOVO DESTINO	BA21155130	BARRO ALTO	01/03/2020 06:43	01/03/2020 11:35	01/03/2020 06:43	01/03/2020 11:35	4,87	2	9,74	CHI
202003421	CATALAO	CT12000107	CATALAO S1	01/03/2020 03:30	01/03/2020 07:53	01/03/2020 03:30	01/03/2020 07:53	4,37	16	69,96	CHI
202003421	OUVIDOR	CT12000107	CATALAO S1	01/03/2020 03:30	01/03/2020 07:53	01/03/2020 03:30	01/03/2020 07:53	4,37	11	48,09	CHI
202003422	ADELANDIA	DN12160971	FIRMINOPOLIS S2	01/03/2020 06:45	01/03/2020 09:06	01/03/2020 06:45	01/03/2020 09:06	2,35	43	100,95	CHI
202003425	BONOPOLIS	BX21233094	NOVO PLANALTO	01/03/2020 06:45	01/03/2020 20:59	01/03/2020 06:45	01/03/2020 20:59	14,22	1	14,22	CHI
202003426	JATAI	JT12182032RE	JATAI S3	01/03/2020 06:45	01/03/2020 09:13	01/03/2020 06:45	01/03/2020 09:13	2,45	5	12,25	CHI
202003428	ITAPACI	IW12044978	ITAPACI	01/03/2020 06:46	01/03/2020 10:53	01/03/2020 06:46	01/03/2020 10:53	4,11	6	24,65	CHI
202003439	MINEIROS	PW12360810	PARQUE DAS EMAS	01/03/2020 06:50	01/03/2020 12:23	01/03/2020 06:50	01/03/2020 12:23	5,55	8	44,40	CHI
202003439	PORTELANDIA	PW12360810	PARQUE DAS EMAS	01/03/2020 06:50	01/03/2020 12:23	01/03/2020 06:50	01/03/2020 12:23	5,55	1	5,55	CHI
202003440	ITAPURANGA	IK12250516	ITAPURANGA	01/03/2020 06:50	01/03/2020 09:05	01/03/2020 06:50	01/03/2020 09:05	2,25	15	33,73	CHI
202003442	DAVINOPOLIS	IO21151432	CATALAO S1	01/03/2020 06:50	01/03/2020 19:14	01/03/2020 06:50	01/03/2020 19:14	12,40	3	37,19	CHI
202003443	URUACU	UR12341322	URUACU	01/03/2020 06:52	01/03/2020 09:04	01/03/2020 06:52	01/03/2020 09:04	2,19	7	15,34	CHI
202003444	CAMPINACU	IH12360453	MINACU	01/03/2020 06:53	01/03/2020 09:57	01/03/2020 06:53	01/03/2020 09:57	3,07	5	15,33	CHI
202003444	MINACU	IH12360453	MINACU	01/03/2020 06:53	01/03/2020 09:57	01/03/2020 06:53	01/03/2020 09:57	3,07	72	220,74	CHI
202003448	CAMPOS BELOS	CH12243118	SAO DOMINGOS	01/03/2020 06:53	01/03/2020 08:22	01/03/2020 06:53	01/03/2020 08:22	1,48	6	8,87	CHI
202003448	MONTE ALEGRE DE GOIAS	CH12243118	SAO DOMINGOS	01/03/2020 06:53	01/03/2020 08:22	01/03/2020 06:53	01/03/2020 08:22	1,48	3	4,43	CHI
202003450	CORUMBA DE GOIAS	CB12302322	ANAPOLIS UNIVERSITARIO S1	01/03/2020 06:53	01/03/2020 09:27	01/03/2020 06:53	01/03/2020 09:27	2,56	20	51,13	CHI
202003451	CACHOEIRA ALTA	RV12227747	QUIRINOPOLIS	01/03/2020 06:54	01/03/2020 11:30	01/03/2020 06:54	01/03/2020 11:30	4,59	7	32,15	CHI
202003451	RIO VERDE	RV12227747	QUIRINOPOLIS	01/03/2020 06:54	01/03/2020 11:30	01/03/2020 06:54	01/03/2020 11:30	4,59	3	13,78	CHI
202003455	SERRANOPOLIS	SX12166082	JATAI S1	01/03/2020 05:49	01/03/2020 09:26	01/03/2020 05:49	01/03/2020 09:26	3,61	19	68,56	CHI
202003458	MINACU	IH12181712	MINACU	01/03/2020 06:41	01/03/2020 11:24	01/03/2020 06:41	01/03/2020 11:24	4,71	75	353,31	CHI
202003462	MINEIROS	PW12301784	PARQUE DAS EMAS	01/03/2020 06:17	01/03/2020 14:52	01/03/2020 06:17	01/03/2020 14:52	8,57	9	77,13	CHI
202003463	RIO VERDE	RV12098521	CABRIUVA S2	01/03/2020 06:39	01/03/2020 09:30	01/03/2020 06:39	01/03/2020 09:30	2,84	15	42,63	CHI
202003467	FORMOSA	10004078304	ITUIQUIRA	01/03/2020 07:00	01/03/2020 08:31	01/03/2020 07:00	01/03/2020 08:31	1,50	1	1,50	CHI
202003468	AMARALINA	LC12270122	SAO MIGUEL DO ARAGUAIA	01/03/2020 06:33	01/03/2020 09:00	01/03/2020 06:33	01/03/2020 09:00	2,44	11	26,81	CHI
202003469	POSSE	SA12211553	IACIARA S2	01/03/2020 06:53	01/03/2020 08:39	01/03/2020 06:53	01/03/2020 08:39	1,76	2	3,53	CHI
202003469	SIMOLANDIA	SA12211553	IACIARA S2	01/03/2020 06:53	01/03/2020 08:39	01/03/2020 06:53	01/03/2020 08:39	1,76	12	21,17	CHI
202003471	NIQUELANDIA	2750101470	NIQUELANDIA SUBTRANSMISSAO	01/03/2020 07:01	01/03/2020 12:03	01/03/2020 07:01	01/03/2020 12:03	5,03	1	5,03	CHI
202003480	PONTALINA	PK12293392	PONTALINA	01/03/2020 07:05	01/03/2020 17:15	01/03/2020 07:05	01/03/2020 17:15	10,16	13	132,12	CHI
202003482	PORANGATU	PO12139169	PORANGATU	01/03/2020 05:28	01/03/2020 08:45	01/03/2020 05:28	01/03/2020 08:45	3,27	106	346,80	CHI
202003485	LUZIANIA	LZ12396830	MARAJOARA	01/03/2020 07:06	01/03/2020 09:31	01/03/2020 07:06	01/03/2020 09:31	2,41	56	134,96	CHI
202003486	PETROLINA DE GOIAS	PV12062894	SAO FRANCISCO DE GOIAS	01/03/2020 06:36	01/03/2020 08:25	01/03/2020 06:36	01/03/2020 08:25	1,81	3	5,42	CHI
202003486	PIRENOPOLIS	PV12062894	SAO FRANCISCO DE GOIAS	01/03/2020 06:36	01/03/2020 08:25	01/03/2020 06:36	01/03/2020 08:25	1,81	21	37,93	CHI
202003488	CAMPINORTE	CR12094178	CAMPINORTE	01/03/2020 07:07	01/03/2020 10:13	01/03/2020 07:07	01/03/2020 10:13	3,10	10	30,95	CHI
202003494	BARRO ALTO	BA12068485	BARRO ALTO	01/03/2020 07:10	01/03/2020 13:04	01/03/2020 07:10	01/03/2020 10:15	3,08	1	3,08	CHI
202003494	SANTA RITA DO NOVO DESTINO	BA12068485	BARRO ALTO	01/03/2020 07:10	01/03/2020 13:04	01/03/2020 07:10	01/03/2020 10:15	3,08	16	49,28	CHI
202003494	SANTA RITA DO NOVO DESTINO	BA12068485	BARRO ALTO	01/03/2020 07:10	01/03/2020 13:04	01/03/2020 07:10	01/03/2020 13:04	5,90	14	82,56	CHI
202003496	CAMPO LIMPO	AN12258813	NEROPOLIS S1	01/03/2020 07:11	01/03/2020 09:54	01/03/2020 07:11	01/03/2020 09:54	2,72	23	62,48	CHI
202003499	SANTA RITA DO NOVO DESTINO	DF12382140	BARRO ALTO	01/03/2020 07:10	01/03/2020 13:04	01/03/2020 07:10	01/03/2020 13:04	5,89	1	5,89	CHI
202003500	SAO MIGUEL DO ARAGUAIA	SM12016662	SAO MIGUEL DO ARAGUAIA	01/03/2020 07:10	02/03/2020 14:59	01/03/2020 07:10	02/03/2020 09:42	26,53	2	53,07	CHI
202003500	SAO MIGUEL DO ARAGUAIA	SM12385035LD	SAO MIGUEL DO ARAGUAIA	01/03/2020 07:10	02/03/2020 14:59	01/03/2020 07:10	02/03/2020 14:59	31,81	1	31,81	CHI
202003501	CAIAPONIA	CP21154335	CAIAPONIA	01/03/2020 07:11	01/03/2020 09:58	01/03/2020 07:11	01/03/2020 09:58	2,77	1	2,77	CHI

202003502	SANTA CRUZ DE GOIAS	BC12231405	PIRES DO RIO S2	01/03/2020 07:11	01/03/2020 10:35	01/03/2020 07:11	01/03/2020 10:35	3,39	24	81,29	CHI
202003503	MORRINHOS	MR21292976	MORRINHOS	01/03/2020 07:11	01/03/2020 22:48	01/03/2020 07:11	01/03/2020 22:48	15,60	1	15,60	CHI
202003510	JANDAIA	PL12000049	PALMEIRAS	01/03/2020 07:13	01/03/2020 09:25	01/03/2020 07:13	01/03/2020 09:25	2,19	6	13,14	CHI
202003510	PALESTINA DE GOIAS	PL12000049	PALMEIRAS	01/03/2020 07:13	01/03/2020 09:25	01/03/2020 07:13	01/03/2020 09:25	2,19	1	2,19	CHI
202003510	PALMEIRAS DE GOIAS	PL12000049	PALMEIRAS	01/03/2020 07:13	01/03/2020 09:25	01/03/2020 07:13	01/03/2020 09:25	2,19	29	63,49	CHI
202003513	PADRE BERNARDO	PB12382236	PADRE BERNARDO	01/03/2020 07:14	01/03/2020 09:50	01/03/2020 07:14	01/03/2020 09:50	2,60	6	15,59	CHI
202003515	SAO LUIS DE MONTES BELOS	SL12373573	SAO LUIZ DOS MONTES BELOS	01/03/2020 07:14	01/03/2020 12:23	01/03/2020 07:14	01/03/2020 12:23	5,14	9	46,23	CHI
202003522	INHUMAS	IN12374035	INHUMAS S2	01/03/2020 07:18	01/03/2020 09:48	01/03/2020 07:18	01/03/2020 09:48	2,50	3	7,50	CHI
202003523	ANAPOLIS	OV21223921	NEROPOLIS S1	01/03/2020 07:18	01/03/2020 12:00	01/03/2020 07:18	01/03/2020 12:00	4,69	1	4,69	CHI
202003524	ANAPOLIS	20103943	JUNDIAI S2	01/03/2020 07:18	01/03/2020 08:34	01/03/2020 07:18	01/03/2020 08:34	1,26	1	1,26	CHI
202003529	PALMEIRAS DE GOIAS	PL11158607	PALMEIRAS	01/03/2020 07:19	01/03/2020 08:36	01/03/2020 07:19	01/03/2020 08:36	1,27	148	187,63	CHI
202003530	CRIXAS	CX12253967	SANTA TEREZINHA	01/03/2020 07:20	01/03/2020 11:17	01/03/2020 07:20	01/03/2020 11:17	3,94	2	7,89	CHI
202003531	SAO MIGUEL DO ARAGUAIA	SM12128351	SAO MIGUEL DO ARAGUAIA	01/03/2020 06:39	01/03/2020 09:33	01/03/2020 06:39	01/03/2020 09:33	2,90	20	58,00	CHI
202003537	ANICUNS	AC21216464	ANICUNS	01/03/2020 07:21	01/03/2020 10:06	01/03/2020 07:21	01/03/2020 10:06	2,74	2	5,47	CHI
202003538	ALTO HORIZONTE	NH12202110RE	SANTA TEREZINHA	01/03/2020 07:22	01/03/2020 17:00	01/03/2020 07:22	01/03/2020 17:00	9,63	12	115,59	CHI
202003538	NOVA IGUAQU DE GOIAS	NH12202110RE	SANTA TEREZINHA	01/03/2020 07:22	01/03/2020 17:00	01/03/2020 07:22	01/03/2020 17:00	9,63	1	9,63	CHI
202003538	PILAR DE GOIAS	NH12202110RE	SANTA TEREZINHA	01/03/2020 07:22	01/03/2020 17:00	01/03/2020 07:22	01/03/2020 17:00	9,63	17	163,75	CHI
202003538	SANTA TEREZINHA DE GOIAS	NH12202110RE	SANTA TEREZINHA	01/03/2020 07:22	01/03/2020 17:00	01/03/2020 07:22	01/03/2020 17:00	9,63	23	221,55	CHI
202003540	MINEIROS	MY12360756	PARQUE DAS EMAS	01/03/2020 07:22	01/03/2020 10:41	01/03/2020 07:22	01/03/2020 10:41	3,33	6	19,96	CHI
202003541	PLANALTINA	PI12085617RE	PLANALTINA	01/03/2020 07:24	01/03/2020 08:41	01/03/2020 07:24	01/03/2020 08:41	1,28	396	506,55	CHI
202003543	SERRANOPOLIS	SX12184212	CHAPADAO DO CEU	01/03/2020 07:24	01/03/2020 15:01	01/03/2020 07:24	01/03/2020 15:01	7,60	5	38,01	CHI
202003544	FAINA	FC12211092	GOIAS	01/03/2020 07:24	01/03/2020 09:01	01/03/2020 07:24	01/03/2020 09:01	1,60	24	38,44	CHI
202003551	BOM JARDIM DE GOIAS	BM12334813	IPORA	01/03/2020 07:19	01/03/2020 12:53	01/03/2020 07:19	01/03/2020 12:53	5,57	15	83,49	CHI
202003552	SAO JOAO D ALIANCA	JL12253236	SAO JOAO D ALIANCA	01/03/2020 07:26	01/03/2020 15:18	01/03/2020 07:26	01/03/2020 15:18	7,86	14	110,02	CHI
202003553	CAMPOS VERDES	VD12049799	SANTA TEREZINHA	01/03/2020 07:26	01/03/2020 10:25	01/03/2020 07:26	01/03/2020 10:25	2,97	21	62,31	CHI
202003553	PILAR DE GOIAS	VD12049799	SANTA TEREZINHA	01/03/2020 07:26	01/03/2020 10:25	01/03/2020 07:26	01/03/2020 10:25	2,97	6	17,80	CHI
202003553	SANTA TEREZINHA DE GOIAS	VD12049799	SANTA TEREZINHA	01/03/2020 07:26	01/03/2020 10:25	01/03/2020 07:26	01/03/2020 10:25	2,97	3	8,90	CHI
202003556	IPAMERI	IP21337242	URUTAI	01/03/2020 07:27	01/03/2020 10:06	01/03/2020 07:27	01/03/2020 10:06	2,63	1	2,63	CHI
202003560	PETROLINA DE GOIAS	PG12015821	PETROLINA	01/03/2020 07:16	01/03/2020 08:39	01/03/2020 07:16	01/03/2020 08:39	1,37	64	87,98	CHI
202003561	LEOPOLDO DE BULHOES	LB21277023	DAIA S2	01/03/2020 07:29	01/03/2020 08:56	01/03/2020 07:29	01/03/2020 08:56	1,44	11	15,88	CHI
202003562	PARAUNA	10015198616	PARAUNA	01/03/2020 07:29	02/03/2020 02:46	01/03/2020 07:29	02/03/2020 02:46	19,27	1	19,27	CHI
202003563	ADELANDIA	DN12391391	FIRMINOPOLIS S2	01/03/2020 07:29	01/03/2020 10:12	01/03/2020 07:29	01/03/2020 10:12	2,70	2	5,41	CHI
202003563	ANICUNS	DN12391391	FIRMINOPOLIS S2	01/03/2020 07:29	01/03/2020 10:12	01/03/2020 07:29	01/03/2020 10:12	2,70	2	5,41	CHI
202003564	SAO LUIS DE MONTES BELOS	SL11000036	SAO LUIZ DOS MONTES BELOS	01/03/2020 07:28	01/03/2020 12:30	01/03/2020 07:28	01/03/2020 12:30	5,02	148	743,04	CHI
202003565	SAO MIGUEL DO ARAGUAIA	SM12000063	SAO MIGUEL DO ARAGUAIA	01/03/2020 07:29	03/03/2020 01:02	01/03/2020 07:29	01/03/2020 14:30	7,01	20	140,11	CHI
202003565	SAO MIGUEL DO ARAGUAIA	SM12000063	SAO MIGUEL DO ARAGUAIA	01/03/2020 07:29	03/03/2020 01:02	01/03/2020 16:21	01/03/2020 17:53	1,53	20	30,67	CHI
202003565	SAO MIGUEL DO ARAGUAIA	SM12000063	SAO MIGUEL DO ARAGUAIA	01/03/2020 07:29	03/03/2020 01:02	01/03/2020 23:13	02/03/2020 00:17	1,06	20	21,13	CHI
202003565	SAO MIGUEL DO ARAGUAIA	SM12000063	SAO MIGUEL DO ARAGUAIA	01/03/2020 07:29	03/03/2020 01:02	02/03/2020 12:28	02/03/2020 12:56	0,47	20	9,33	CHI
202003565	SAO MIGUEL DO ARAGUAIA	SM12000063	SAO MIGUEL DO ARAGUAIA	01/03/2020 07:29	03/03/2020 01:02	01/03/2020 07:29	02/03/2020 19:04	35,59	14	498,20	CHI
202003565	SAO MIGUEL DO ARAGUAIA	SM12000063	SAO MIGUEL DO ARAGUAIA	01/03/2020 07:29	03/03/2020 01:02	01/03/2020 07:29	03/03/2020 01:02	41,55	1	41,55	CHI
202003567	URUTAI	UT21382048	PIRES DO RIO S2	01/03/2020 06:49	01/03/2020 10:57	01/03/2020 06:49	01/03/2020 10:57	4,13	1	4,13	CHI
202003568	PONTALINA	PK21063376	PONTALINA	01/03/2020 05:43	01/03/2020 09:20	01/03/2020 05:43	01/03/2020 09:20	3,60	1	3,60	CHI
202003569	JATAI	10012666856	JATAI S2	01/03/2020 07:30	01/03/2020 09:03	01/03/2020 07:30	01/03/2020 09:03	1,54	1	1,54	CHI
202003570	SILVANIA	SV21152127	DAIA S2	01/03/2020 07:31	01/03/2020 11:49	01/03/2020 07:31	01/03/2020 11:49	4,30	1	4,30	CHI

202003575	BONOPOLIS	BX12394407	SAO MIGUEL DO ARAGUAIA	01/03/2020 07:31	01/03/2020 19:29	01/03/2020 07:31	01/03/2020 19:29	11,96	6	71,75	CHI
202003579	JATAI	JT12241703	JATAI S1	01/03/2020 07:32	01/03/2020 10:19	01/03/2020 07:32	01/03/2020 10:19	2,77	4	11,07	CHI
202003588	RIO VERDE	RV12024714	RIO VERDE S1	01/03/2020 05:13	01/03/2020 12:40	01/03/2020 05:13	01/03/2020 12:40	7,45	24	178,75	CHI
202003591	NOVA AMERICA	RB21247621	RUBIATABA	01/03/2020 07:35	01/03/2020 11:02	01/03/2020 07:35	01/03/2020 11:02	3,45	1	3,45	CHI
202003592	RIO VERDE	630019861	RIO VERDE S2	01/03/2020 07:35	01/03/2020 18:24	01/03/2020 07:35	01/03/2020 18:24	10,81	1	10,81	CHI
202003594	JARAGUA	JA21029526	JARAGUA	01/03/2020 07:35	01/03/2020 10:30	01/03/2020 07:35	01/03/2020 10:30	2,90	3	8,71	CHI
202003596	PORANGATU	PO21230394	NOVO PLANALTO	01/03/2020 07:36	01/03/2020 10:28	01/03/2020 07:36	01/03/2020 10:28	2,87	1	2,87	CHI
202003598	MONTES CLAROS DE GOIAS	ME12334949	IPORA	01/03/2020 07:36	01/03/2020 18:28	01/03/2020 07:36	01/03/2020 18:28	10,86	7	76,01	CHI
202003600	DIVINOPOLIS DE GOIAS	MA12398387	SAO DOMINGOS	01/03/2020 06:57	01/03/2020 11:13	01/03/2020 06:57	01/03/2020 11:13	4,26	3	12,79	CHI
202003600	MONTE ALEGRE DE GOIAS	MA12398387	SAO DOMINGOS	01/03/2020 06:57	01/03/2020 11:13	01/03/2020 06:57	01/03/2020 11:13	4,26	16	68,23	CHI
202003606	VILA PROPICIO	NP12339454	GOIANESIA S1	01/03/2020 06:27	01/03/2020 10:20	01/03/2020 06:27	01/03/2020 10:20	3,87	113	437,06	CHI
202003612	DOVERLANDIA	DV12235070	PARQUE DAS EMAS	01/03/2020 07:40	02/03/2020 16:20	01/03/2020 07:40	02/03/2020 16:20	32,67	5	163,37	CHI
202003613	EDEIA	EA12087651	EDEIA	01/03/2020 07:39	01/03/2020 12:36	01/03/2020 07:39	01/03/2020 12:36	4,95	16	79,20	CHI
202003616	PORANGATU	PO12027986	PORANGATU	01/03/2020 05:09	01/03/2020 09:20	01/03/2020 05:09	01/03/2020 09:20	4,18	5	20,89	CHI
202003618	CEZARINA	CZ21237646	CEZARINA	01/03/2020 07:41	01/03/2020 13:01	01/03/2020 07:41	01/03/2020 13:01	5,32	1	5,32	CHI
202003620	SITIO D ABADIA	SI12131972	IACIARA S2	01/03/2020 06:57	01/03/2020 09:01	01/03/2020 06:57	01/03/2020 09:01	2,06	45	92,64	CHI
202003622	PORANGATU	PO12059923	PORANGATU	01/03/2020 07:17	01/03/2020 11:07	01/03/2020 07:17	01/03/2020 11:07	3,83	13	49,83	CHI
202003628	TAQUARAL DE GOIAS	IX21016030	INHUMAS S1	01/03/2020 07:44	01/03/2020 09:50	01/03/2020 07:44	01/03/2020 09:50	2,08	1	2,08	CHI
202003630	PORANGATU	PO12349234	MARA ROSA	01/03/2020 07:45	01/03/2020 09:34	01/03/2020 07:45	01/03/2020 09:34	1,81	16	28,93	CHI
202003640	PETROLINA DE GOIAS	PG10390335	PETROLINA	01/03/2020 07:48	01/03/2020 10:54	01/03/2020 10:51	01/03/2020 10:54	0,05	217	11,45	CHI
202003641	GOIANIRA	GR11016216	GOIANIRA	01/03/2020 07:48	01/03/2020 10:48	01/03/2020 07:48	01/03/2020 10:48	2,99	89	265,84	CHI
202003642	PORTEIRAO	CL12213422	RIO DOS BOIS	01/03/2020 07:49	01/03/2020 14:41	01/03/2020 07:49	01/03/2020 14:41	6,86	1	6,86	CHI
202003643	GOIANIA	GN12063665	GOYA S2	01/03/2020 07:49	01/03/2020 09:08	01/03/2020 07:49	01/03/2020 09:08	1,31	115	150,94	CHI
202003644	BELA VISTA DE GOIAS	BV21172621	BELA VISTA S1	01/03/2020 07:49	01/03/2020 08:59	01/03/2020 07:49	01/03/2020 08:59	1,16	2	2,32	CHI
202003652	URUACU	UR12202170	URUACU	01/03/2020 07:51	01/03/2020 10:39	01/03/2020 07:51	01/03/2020 10:39	2,80	5	14,00	CHI
202003653	CALDAS NOVAS	CN21238432	CALDAS NOVAS S1	01/03/2020 07:51	01/03/2020 19:09	01/03/2020 07:51	01/03/2020 19:09	11,30	2	22,59	CHI
202003664	QUIRINOPOLIS	QI21298305	QUIRINOPOLIS	01/03/2020 07:54	01/03/2020 08:50	01/03/2020 07:54	01/03/2020 08:50	0,93	2	1,86	CHI
202003668	DOVERLANDIA	DV21123923	CAIAPONIA	01/03/2020 07:55	01/03/2020 20:26	01/03/2020 07:55	01/03/2020 20:26	12,51	1	12,51	CHI
202003674	ITUMBIARA	CD12000231	CACHOEIRA DOURADA	01/03/2020 07:56	01/03/2020 11:48	01/03/2020 07:56	01/03/2020 11:48	3,86	2	7,72	CHI
202003675	ISRAELANDIA	IS12089375	IPORA	01/03/2020 06:22	02/03/2020 09:00	01/03/2020 06:22	02/03/2020 09:00	26,64	19	506,21	CHI
202003682	PADRE BERNARDO	PB12290547	PADRE BERNARDO	01/03/2020 07:39	01/03/2020 11:58	01/03/2020 07:39	01/03/2020 11:58	4,30	18	77,45	CHI
202003688	CAIAPONIA	CP12075032	CAIAPONIA	01/03/2020 07:59	01/03/2020 17:27	01/03/2020 07:59	01/03/2020 17:27	9,46	10	94,63	CHI
202003689	CAMPESTRE DE GOIAS	GA12011344	GUAPO S2	01/03/2020 07:40	01/03/2020 09:26	01/03/2020 07:40	01/03/2020 09:26	1,76	12	21,13	CHI
202003689	GUAPO	GA12011344	GUAPO S2	01/03/2020 07:40	01/03/2020 09:26	01/03/2020 07:40	01/03/2020 09:26	1,76	54	95,09	CHI
202003690	CACHOEIRA ALTA	PC12209796	CACHOEIRA ALTA	01/03/2020 07:59	01/03/2020 16:50	01/03/2020 07:59	01/03/2020 16:50	8,84	3	26,51	CHI
202003693	RUBIATABA	RB12262942	RUBIATABA	01/03/2020 08:00	01/03/2020 08:47	01/03/2020 08:00	01/03/2020 08:47	0,77	15	11,53	CHI
202003695	CRISTALINA	KR12366452	PAMPLONA	01/03/2020 08:01	01/03/2020 13:17	01/03/2020 08:01	01/03/2020 13:17	5,26	11	57,88	CHI
202003697	APARECIDA DE GOIANIA	10002309538	INDEPENDENCIA S2	01/03/2020 08:02	01/03/2020 09:56	01/03/2020 08:02	01/03/2020 09:56	1,90	1	1,90	CHI
202003701	AGUA FRIA DE GOIAS	PI21148629	SAO JOAO D ALIANCA	01/03/2020 08:02	01/03/2020 12:13	01/03/2020 08:02	01/03/2020 12:13	4,17	1	4,17	CHI
202003703	URUTAI	UT12075970	PIRES DO RIO S2	01/03/2020 08:03	01/03/2020 12:07	01/03/2020 08:03	01/03/2020 12:07	4,05	2	8,11	CHI
202003713	GOIANIA	GN12071845	GOIANIA LESTE S3	01/03/2020 08:05	01/03/2020 11:21	01/03/2020 08:05	01/03/2020 11:21	3,26	4	13,04	CHI
202003726	GOIAS	GS12091169	MATRINCHA	01/03/2020 08:08	01/03/2020 10:20	01/03/2020 08:08	01/03/2020 10:20	2,18	9	19,66	CHI
202003727	CAMPOS VERDES	VD12238510	SANTA TEREZINHA	01/03/2020 08:09	01/03/2020 13:10	01/03/2020 08:09	01/03/2020 13:10	5,00	6	30,02	CHI
202003729	EDEIA	1120028027	EDEIA	01/03/2020 08:10	01/03/2020 11:17	01/03/2020 08:10	01/03/2020 11:17	3,11	1	3,11	CHI

202003730	NIQUELANDIA	NQ12264207	NIQUELANDIA SUBTRANSMISSAO	01/03/2020 08:10	01/03/2020 12:38	01/03/2020 08:10	01/03/2020 12:38	4,46	13	57,93	CHI
202003739	PONTALINA	PK21108769	GOIATUBA S1	01/03/2020 08:12	01/03/2020 15:14	01/03/2020 08:12	01/03/2020 15:14	7,02	2	14,04	CHI
202003740	JUSSARA	JR12124817	BRITANIA	01/03/2020 08:11	01/03/2020 12:52	01/03/2020 08:11	01/03/2020 12:52	4,68	10	46,82	CHI
202003742	AGUA FRIA DE GOIAS	MJ12305238	PADRE BERNARDO	01/03/2020 07:49	01/03/2020 11:57	01/03/2020 07:49	01/03/2020 11:57	4,13	2	8,25	CHI
202003742	MIMOSO DE GOIAS	MJ12305238	PADRE BERNARDO	01/03/2020 07:49	01/03/2020 11:57	01/03/2020 07:49	01/03/2020 11:57	4,13	3	12,38	CHI
202003743	MOSSAMEDES	MD21132090	FIRMINOPOLIS S2	01/03/2020 08:13	01/03/2020 09:34	01/03/2020 08:13	01/03/2020 09:34	1,34	1	1,34	CHI
202003745	CAIAPONIA	CP12226867	CAIAPONIA	01/03/2020 08:13	01/03/2020 12:20	01/03/2020 08:13	01/03/2020 12:20	4,10	10	41,03	CHI
202003751	BONOPOLIS	BX12266016	SAO MIGUEL DO ARAGUAIA	01/03/2020 07:19	01/03/2020 11:13	01/03/2020 07:19	01/03/2020 11:13	3,89	9	35,04	CHI
202003755	PIRACANJUBA	MR12000203RE	MORRINHOS	01/03/2020 04:41	01/03/2020 14:17	01/03/2020 04:41	01/03/2020 14:17	9,60	19	182,38	CHI
202003756	NAZARIO	NZ12233489	ANICUNS	01/03/2020 08:16	01/03/2020 11:25	01/03/2020 08:16	01/03/2020 11:25	3,14	39	122,36	CHI
202003756	PALMEIRAS DE GOIAS	NZ12233489	ANICUNS	01/03/2020 08:16	01/03/2020 11:25	01/03/2020 08:16	01/03/2020 11:25	3,14	3	9,41	CHI
202003760	SAO DOMINGOS	SD12344106	SAO DOMINGOS	01/03/2020 08:18	01/03/2020 13:22	01/03/2020 08:18	01/03/2020 13:22	5,06	6	30,38	CHI
202003770	BOM JARDIM DE GOIAS	PH12317697	PIRANHAS	01/03/2020 08:19	02/03/2020 17:45	01/03/2020 08:19	02/03/2020 17:45	33,43	2	66,86	CHI
202003770	PIRANHAS	PH12317697	PIRANHAS	01/03/2020 08:19	02/03/2020 17:45	01/03/2020 08:19	02/03/2020 17:45	33,43	2	66,86	CHI
202003772	NOVA CRIXAS	NA12397493	NOVA CRIXAS	01/03/2020 06:11	01/03/2020 16:16	01/03/2020 06:11	01/03/2020 16:16	10,08	17	171,33	CHI
202003776	CRIXAS	CX12321941	SERRA DO OURO	01/03/2020 08:21	01/03/2020 15:42	01/03/2020 08:21	01/03/2020 15:42	7,35	18	132,21	CHI
202003776	NOVA CRIXAS	CX12321941	SERRA DO OURO	01/03/2020 08:21	01/03/2020 15:42	01/03/2020 08:21	01/03/2020 15:42	7,35	6	44,07	CHI
202003777	MINACU	IH21230307	MINACU	01/03/2020 08:21	01/03/2020 14:47	01/03/2020 08:21	01/03/2020 14:47	6,42	1	6,42	CHI
202003778	MINEIROS	MY11209671	PARQUE DAS EMAS	01/03/2020 08:22	01/03/2020 15:20	01/03/2020 08:22	01/03/2020 15:20	6,96	126	877,52	CHI
202003782	URUACU	UR12234962	URUACU	01/03/2020 08:22	01/03/2020 11:02	01/03/2020 08:22	01/03/2020 11:02	2,66	1	2,66	CHI
202003784	VIANOPOLIS	VN12127632	VIANOPOLIS	01/03/2020 08:23	01/03/2020 11:34	01/03/2020 08:23	01/03/2020 11:34	3,18	31	98,57	CHI
202003788	UIRAPURU	UP12243502	SANTA TEREZINHA	01/03/2020 08:24	01/03/2020 11:35	01/03/2020 08:24	01/03/2020 11:35	3,17	4	12,70	CHI
202003790	SENADOR CANEDO	190119421	SENADOR CANEDO	01/03/2020 08:25	01/03/2020 11:40	01/03/2020 08:25	01/03/2020 11:40	3,25	1	3,25	CHI
202003791	GOIANIA	10001981941	FERROVIARIO S1	01/03/2020 08:25	01/03/2020 09:40	01/03/2020 08:25	01/03/2020 09:40	1,25	1	1,25	CHI
202003792	PIRES DO RIO	460041605	PIRES DO RIO S1	01/03/2020 08:25	01/03/2020 12:31	01/03/2020 08:25	01/03/2020 12:31	4,10	1	4,10	CHI
202003795	MORRINHOS	MR21266593	MORRINHOS	01/03/2020 08:25	01/03/2020 17:37	01/03/2020 08:25	01/03/2020 17:37	9,19	1	9,19	CHI
202003802	ARAGARCAS	BM12372353	BOM JARDIM	01/03/2020 08:25	01/03/2020 12:25	01/03/2020 08:25	01/03/2020 12:25	4,00	12	48,00	CHI
202003808	BOM JARDIM DE GOIAS	1880009551	BOM JARDIM	01/03/2020 08:29	02/03/2020 07:10	01/03/2020 08:29	02/03/2020 07:10	22,67	1	22,67	CHI
202003809	APARECIDA DE GOIANIA	10019988433	INDEPENDENCIA S2	01/03/2020 08:29	01/03/2020 11:28	01/03/2020 08:29	01/03/2020 11:28	2,98	1	2,98	CHI
202003820	ACREUNA	SH12279542	SANTA HELENA S1	01/03/2020 08:26	01/03/2020 12:05	01/03/2020 08:26	01/03/2020 12:05	3,65	3	10,94	CHI
202003820	SANTA HELENA DE GOIAS	SH12279542	SANTA HELENA S1	01/03/2020 08:26	01/03/2020 12:05	01/03/2020 08:26	01/03/2020 12:05	3,65	8	29,17	CHI
202003820	SANTO ANTONIO DA BARRA	SH12279542	SANTA HELENA S1	01/03/2020 08:26	01/03/2020 12:05	01/03/2020 08:26	01/03/2020 12:05	3,65	1	3,65	CHI
202003821	GOIANIA	12025598	FERROVIARIO S3	01/03/2020 08:34	01/03/2020 09:38	01/03/2020 08:34	01/03/2020 09:38	1,06	1	1,06	CHI
202003824	VARJAO	VJ21126405	CEZARINA	01/03/2020 08:35	01/03/2020 11:13	01/03/2020 08:35	01/03/2020 11:13	2,63	1	2,63	CHI
202003825	CUMARI	AH12287032	CATALAO S1	01/03/2020 08:35	01/03/2020 14:41	01/03/2020 08:35	01/03/2020 14:41	6,09	14	85,32	CHI
202003828	NOVA AURORA	NE21311815	CATALAO S1	01/03/2020 08:36	01/03/2020 09:16	01/03/2020 08:36	01/03/2020 09:16	0,66	1	0,66	CHI
202003830	ITAPACI	IW12262868	ITAPACI	01/03/2020 08:18	01/03/2020 12:10	01/03/2020 08:18	01/03/2020 12:10	3,86	58	223,59	CHI
202003832	JUSSARA	JR21120975	JUSSARA	01/03/2020 08:36	01/03/2020 10:06	01/03/2020 08:36	01/03/2020 10:06	1,49	1	1,49	CHI
202003834	ITUMBIARA	IT21257127	PARANAIBA	01/03/2020 08:37	01/03/2020 10:09	01/03/2020 08:37	01/03/2020 10:09	1,53	1	1,53	CHI
202003835	GOIANIA	12012520	GOIANIA LESTE S2	01/03/2020 08:37	01/03/2020 09:06	01/03/2020 08:37	01/03/2020 09:06	0,48	1	0,48	CHI
202003840	SANTA HELENA DE GOIAS	SH21047495	SANTA HELENA S1	01/03/2020 08:38	01/03/2020 17:21	01/03/2020 08:38	01/03/2020 17:21	8,70	1	8,70	CHI
202003842	AMARALINA	LC12230319	NOVA CRIXAS	01/03/2020 08:04	01/03/2020 19:06	01/03/2020 08:04	01/03/2020 19:06	11,03	3	33,10	CHI
202003844	SAO SIMAO	SO21000082	CACHOEIRA ALTA	01/03/2020 08:40	01/03/2020 19:17	01/03/2020 08:40	01/03/2020 19:17	10,61	1	10,61	CHI
202003851	CORUMBA DE GOIAS	CB12017454	CORUMBA	01/03/2020 08:42	01/03/2020 10:52	01/03/2020 08:42	01/03/2020 10:52	2,15	10	21,53	CHI

202003856	GAMELEIRA DE GOIAS	SV12125444	DAIA S2	01/03/2020 08:44	01/03/2020 13:36	01/03/2020 08:44	01/03/2020 13:36	4,86	29	141,06	CHI
202003857	NIQUELANDIA	NQ12227348	URUACU	01/03/2020 08:44	01/03/2020 17:55	01/03/2020 08:44	01/03/2020 17:55	9,18	45	412,95	CHI
202003864	ARAGUAPAZ	AZ12329923	MOZARLANDIA	01/03/2020 08:45	01/03/2020 10:23	01/03/2020 08:45	01/03/2020 10:23	1,63	3	4,89	CHI
202003870	SITIO D ABADIA	SI12247434	IACIARA S2	01/03/2020 08:46	01/03/2020 09:52	01/03/2020 08:46	01/03/2020 09:52	1,09	5	5,44	CHI
202003872	GOIATUBA	JV12073049	GOIATUBA S1	01/03/2020 08:47	01/03/2020 11:42	01/03/2020 08:47	01/03/2020 11:42	2,91	2	5,81	CHI
202003872	JOVIANIA	JV12073049	GOIATUBA S1	01/03/2020 08:47	01/03/2020 11:42	01/03/2020 08:47	01/03/2020 11:42	2,91	4	11,62	CHI
202003876	FIRMINOPOLIS	FR12096758	FIRMINOPOLIS S1	01/03/2020 08:48	01/03/2020 13:58	01/03/2020 08:48	01/03/2020 13:58	5,15	6	30,90	CHI
202003879	RIO VERDE	SH21296219	RIO VERDE S1	01/03/2020 08:50	01/03/2020 19:02	01/03/2020 08:50	01/03/2020 19:02	10,20	2	20,40	CHI
202003881	ABADIANIA	AA21133698	CORUMBA	01/03/2020 08:50	01/03/2020 10:22	01/03/2020 08:50	01/03/2020 10:22	1,52	1	1,52	CHI
202003883	APARECIDA DE GOIANIA	13591782	INDEPENDENCIA S2	01/03/2020 08:50	01/03/2020 11:17	01/03/2020 08:50	01/03/2020 11:17	2,44	1	2,44	CHI
202003885	ARUANA	MZ12250762	MOZARLANDIA	01/03/2020 08:18	01/03/2020 11:59	01/03/2020 08:18	01/03/2020 11:59	3,68	8	29,45	CHI
202003885	MOZARLANDIA	MZ12250762	MOZARLANDIA	01/03/2020 08:18	01/03/2020 11:59	01/03/2020 08:18	01/03/2020 11:59	3,68	2	7,36	CHI
202003888	MIMOSO DE GOIAS	MJ12377249	PADRE BERNARDO	01/03/2020 08:03	01/03/2020 10:18	01/03/2020 08:03	01/03/2020 10:18	2,24	18	40,35	CHI
202003893	ARAGUAPAZ	AZ12404563	GOIAS	01/03/2020 08:50	01/03/2020 13:18	01/03/2020 08:50	01/03/2020 12:51	4,01	6	24,09	CHI
202003893	FAINA	AZ12404563	GOIAS	01/03/2020 08:50	01/03/2020 13:18	01/03/2020 08:50	01/03/2020 12:51	4,01	1	4,01	CHI
202003893	ARAGUAPAZ	AZ12329926LD	GOIAS	01/03/2020 08:50	01/03/2020 13:18	01/03/2020 08:50	01/03/2020 13:18	4,47	14	62,55	CHI
202003896	GOIANIA	15513336	CAMPINAS S1	01/03/2020 08:52	01/03/2020 10:32	01/03/2020 08:52	01/03/2020 10:32	1,65	1	1,65	CHI
202003898	ANAPOLIS	AN12080965	ANAPOLIS UNIVERSITARIO S1	01/03/2020 08:53	01/03/2020 10:51	01/03/2020 08:53	01/03/2020 10:51	1,96	14	27,49	CHI
202003902	FLORES DE GOIAS	FB21233548	FLORES DE GOIAS	01/03/2020 08:53	01/03/2020 09:49	01/03/2020 08:53	01/03/2020 09:49	0,92	2	1,84	CHI
202003908	JARAGUA	JA12097028	JARAGUA	01/03/2020 08:54	01/03/2020 10:33	01/03/2020 08:54	01/03/2020 10:33	1,65	24	39,55	CHI
202003909	MAIRIPOTABA	MI31060577	PONTALINA	01/03/2020 08:54	02/03/2020 10:53	01/03/2020 08:54	02/03/2020 10:53	25,97	1	25,97	CHI
202003910	SANTO ANTONIO DE GOIAS	GR12056290	NEROPOLIS S1	01/03/2020 08:55	01/03/2020 11:16	01/03/2020 08:55	01/03/2020 11:16	2,35	3	7,04	CHI
202003914	AMARALINA	LC21193514	MARA ROSA	01/03/2020 08:56	01/03/2020 09:54	01/03/2020 08:56	01/03/2020 09:54	0,96	1	0,96	CHI
202003915	QUIRINOPOLIS	80081101	QUIRINOPOLIS	01/03/2020 08:56	01/03/2020 10:27	01/03/2020 08:56	01/03/2020 10:27	1,51	1	1,51	CHI
202003924	CATALAO	10003953910	CATALAO S2	01/03/2020 08:59	01/03/2020 11:13	01/03/2020 08:59	01/03/2020 11:13	2,23	1	2,23	CHI
202003925	AGUAS LINDAS DE GOIAS	10013113540	AGUAS LINDAS DE GOIAS S1	01/03/2020 08:59	01/03/2020 10:01	01/03/2020 08:59	01/03/2020 10:01	1,02	1	1,02	CHI
202003929	GOIATUBA	JV12208104	GOIATUBA S1	01/03/2020 09:00	01/03/2020 21:19	01/03/2020 09:00	01/03/2020 21:19	12,31	14	172,36	CHI
202003929	JOVIANIA	JV12208104	GOIATUBA S1	01/03/2020 09:00	01/03/2020 21:19	01/03/2020 09:00	01/03/2020 21:19	12,31	4	49,25	CHI
202003930	MINACU	IH12252364	MINACU	01/03/2020 09:01	01/03/2020 11:43	01/03/2020 09:01	01/03/2020 11:43	2,70	9	24,29	CHI
202003932	FAZENDA NOVA	FN12073183	BRITANIA	01/03/2020 09:01	01/03/2020 13:22	01/03/2020 09:01	01/03/2020 13:22	4,34	67	291,10	CHI
202003934	GOIAS	IB12210550	ITABERAI S1	01/03/2020 09:01	01/03/2020 10:40	01/03/2020 09:01	01/03/2020 10:40	1,64	2	3,27	CHI
202003934	ITABERAI	IB12210550	ITABERAI S1	01/03/2020 09:01	01/03/2020 10:40	01/03/2020 09:01	01/03/2020 10:40	1,64	35	57,26	CHI
202003939	GOIANDIRA	GD21215577	CATALAO S1	01/03/2020 09:33	01/03/2020 13:00	01/03/2020 09:33	01/03/2020 13:00	3,44	2	6,89	CHI
202003942	CATALAO	CT21192692	CATALAO S2	01/03/2020 09:02	01/03/2020 12:38	01/03/2020 09:02	01/03/2020 12:38	3,58	1	3,58	CHI
202003944	LEOPOLDO DE BULHOES	LB12028215	DAIA S2	01/03/2020 09:03	01/03/2020 10:48	01/03/2020 09:03	01/03/2020 10:48	1,75	6	10,48	CHI
202003945	NIQUELANDIA	2750078514	NIQUELANDIA SUBTRANSMISSAO	01/03/2020 09:03	01/03/2020 10:09	01/03/2020 09:03	01/03/2020 10:09	1,09	1	1,09	CHI
202003948	URUACU	UR12003395	URUACU	01/03/2020 09:04	01/03/2020 10:57	01/03/2020 09:04	01/03/2020 10:57	1,88	8	15,01	CHI
202003954	CORUMBA DE GOIAS	CB21129324	COCALZINHO	01/03/2020 09:06	01/03/2020 11:55	01/03/2020 09:06	01/03/2020 11:55	2,81	2	5,62	CHI
202003957	BOM JESUS DE GOIAS	BJ12226866	RIO DOS BOIS	01/03/2020 09:06	01/03/2020 14:26	01/03/2020 09:06	01/03/2020 14:26	5,32	5	26,61	CHI
202003958	CATALAO	1990323525	CATALAO S2	01/03/2020 09:06	01/03/2020 10:39	01/03/2020 09:06	01/03/2020 10:39	1,54	1	1,54	CHI
202003960	RIO VERDE	10010028992	RIO VERDE S2	01/03/2020 09:07	01/03/2020 20:03	01/03/2020 09:07	01/03/2020 20:03	10,92	1	10,92	CHI
202003961	PALESTINA DE GOIAS	PY21374975	ARENOPOLIS	01/03/2020 09:07	01/03/2020 12:55	01/03/2020 09:07	01/03/2020 12:55	3,79	1	3,79	CHI
202003964	GOIAS	IK12299970	GOIAS	01/03/2020 08:59	01/03/2020 12:28	01/03/2020 08:59	01/03/2020 12:28	3,47	25	86,84	CHI
202003964	HEITORAI	IK12299970	GOIAS	01/03/2020 08:59	01/03/2020 12:28	01/03/2020 08:59	01/03/2020 12:28	3,47	33	114,63	CHI

202003964	ITABERAÍ	IK12299970	GOIÁS	01/03/2020 08:59	01/03/2020 12:28	01/03/2020 08:59	01/03/2020 12:28	3,47	3	10,42	CHI
202003964	ITAPURANGA	IK12299970	GOIÁS	01/03/2020 08:59	01/03/2020 12:28	01/03/2020 08:59	01/03/2020 12:28	3,47	3	10,42	CHI
202003966	CACHOEIRA ALTA	1090032770	CACHOEIRA ALTA	01/03/2020 09:08	01/03/2020 10:52	01/03/2020 09:08	01/03/2020 10:52	1,74	1	1,74	CHI
202003970	APARECIDA DE GOIANIA	10008217856	REAL S2	01/03/2020 09:08	01/03/2020 12:48	01/03/2020 09:08	01/03/2020 12:48	3,65	1	3,65	CHI
202003975	NOVA CRIXAS	NA12354854	NOVA CRIXAS	01/03/2020 06:42	01/03/2020 12:18	01/03/2020 06:42	01/03/2020 12:18	5,59	9	50,34	CHI
202003978	SAO MIGUEL DO PASSA QUATRO	SQ12231522	CRISTIANOPOLIS	01/03/2020 09:10	01/03/2020 12:24	01/03/2020 09:10	01/03/2020 12:24	3,23	12	38,73	CHI
202003978	VIANOPOLIS	SQ12231522	CRISTIANOPOLIS	01/03/2020 09:10	01/03/2020 12:24	01/03/2020 09:10	01/03/2020 12:24	3,23	18	58,09	CHI
202003980	PANAMA	IT12000094	PARANAIBA	01/03/2020 09:10	01/03/2020 11:03	01/03/2020 09:10	01/03/2020 11:03	1,87	21	39,31	CHI
202003985	PONTALINA	PK12293144	VICENTINOPOLIS	01/03/2020 09:11	01/03/2020 16:02	01/03/2020 09:11	01/03/2020 16:02	6,84	12	82,09	CHI
202003988	BURITI ALEGRE	BG12263642	ITUMBIARA VELHA S2	01/03/2020 09:12	02/03/2020 11:03	01/03/2020 09:12	02/03/2020 11:03	25,85	1	25,85	CHI
202003988	ITUMBIARA	BG12263642	ITUMBIARA VELHA S2	01/03/2020 09:12	02/03/2020 11:03	01/03/2020 09:12	02/03/2020 11:03	25,85	2	51,70	CHI
202003989	SAO DOMINGOS	SD12389194	SAO DOMINGOS	01/03/2020 09:12	01/03/2020 17:23	01/03/2020 09:12	01/03/2020 14:30	5,30	12	63,64	CHI
202003989	SAO DOMINGOS	SD12389194	SAO DOMINGOS	01/03/2020 09:12	01/03/2020 17:23	01/03/2020 09:12	01/03/2020 17:04	7,87	1	7,87	CHI
202003989	SAO DOMINGOS	SD12389194	SAO DOMINGOS	01/03/2020 09:12	01/03/2020 17:23	01/03/2020 09:12	01/03/2020 17:23	8,20	9	73,76	CHI
202003990	CAMPOS VERDES	SG12318464	SANTA TEREZINHA	01/03/2020 09:12	01/03/2020 14:13	01/03/2020 09:12	01/03/2020 14:13	5,01	13	65,15	CHI
202003990	SANTA TEREZINHA DE GOIAS	SG12318464	SANTA TEREZINHA	01/03/2020 09:12	01/03/2020 14:13	01/03/2020 09:12	01/03/2020 14:13	5,01	33	165,38	CHI
202003990	UIRAPURU	SG12318464	SANTA TEREZINHA	01/03/2020 09:12	01/03/2020 14:13	01/03/2020 09:12	01/03/2020 14:13	5,01	11	55,13	CHI
202003996	NOVA ROMA	ND12117611	IACIARA S2	01/03/2020 09:13	01/03/2020 11:50	01/03/2020 09:13	01/03/2020 11:50	2,61	8	20,91	CHI
2020031003	ITAPACI	IW21294812	ITAPACI	01/03/2020 09:14	01/03/2020 12:06	01/03/2020 09:14	01/03/2020 12:06	2,86	1	2,86	CHI
2020031007	MONTES CLAROS DE GOIAS	ME21086430	IPORA	01/03/2020 09:15	01/03/2020 10:14	01/03/2020 09:15	01/03/2020 10:14	0,97	1	0,97	CHI
2020031009	SAO LUIS DE MONTES BELOS	3930000633	SAO LUIZ DOS MONTES BELOS	01/03/2020 09:16	01/03/2020 16:43	01/03/2020 09:16	01/03/2020 16:43	7,44	1	7,44	CHI
2020031010	CORUMBA DE GOIAS	CB21236583	CORUMBA	01/03/2020 08:42	01/03/2020 12:25	01/03/2020 08:42	01/03/2020 12:25	3,70	1	3,70	CHI
2020031018	URUACU	UR21156461	CAMPINORTE	01/03/2020 09:21	01/03/2020 11:15	01/03/2020 09:21	01/03/2020 11:15	1,90	1	1,90	CHI
2020031019	MORRINHOS	MR21120840	MORRINHOS	01/03/2020 09:21	01/03/2020 18:20	01/03/2020 09:21	01/03/2020 18:20	9,00	1	9,00	CHI
2020031021	JATAI	290287420	JATAI S2	01/03/2020 09:21	01/03/2020 13:00	01/03/2020 09:21	01/03/2020 13:00	3,65	1	3,65	CHI
2020031026	CAMPO ALEGRE DE GOIAS	CM12333445RE	CAMPO ALEGRE DE GOIAS	01/03/2020 09:22	01/03/2020 12:53	01/03/2020 09:22	01/03/2020 12:53	3,51	63	220,92	CHI
2020031026	CATALAO	CM12333445RE	CAMPO ALEGRE DE GOIAS	01/03/2020 09:22	01/03/2020 12:53	01/03/2020 09:22	01/03/2020 12:53	3,51	19	66,63	CHI
2020031026	IPAMERI	CM12333445RE	CAMPO ALEGRE DE GOIAS	01/03/2020 09:22	01/03/2020 12:53	01/03/2020 09:22	01/03/2020 12:53	3,51	8	28,05	CHI
2020031027	SERRANOPOLIS	SX12216620	JATAI S1	01/03/2020 00:25	01/03/2020 11:32	01/03/2020 00:25	01/03/2020 11:32	11,11	5	55,53	CHI
2020031028	TRINDADE	40125920	TRINDADE	01/03/2020 09:23	01/03/2020 11:50	01/03/2020 09:23	01/03/2020 11:50	2,45	1	2,45	CHI
2020031031	BALIZA	BH12060671	BOM JARDIM	01/03/2020 09:24	01/03/2020 15:29	01/03/2020 09:24	01/03/2020 15:29	6,07	6	36,44	CHI
2020031032	BRITANIA	BT12101446	BRITANIA	01/03/2020 09:24	01/03/2020 14:01	01/03/2020 09:24	01/03/2020 14:01	4,62	47	217,14	CHI
2020031034	CACU	CC21080185	CACHOEIRA ALTA	01/03/2020 09:24	01/03/2020 13:58	01/03/2020 09:24	01/03/2020 13:58	4,56	1	4,56	CHI
2020031035	MAURILANDIA	RV12315683	SANTA HELENA S1	01/03/2020 00:28	01/03/2020 13:53	01/03/2020 00:28	01/03/2020 13:53	13,40	4	53,62	CHI
2020031035	RIO VERDE	RV12315683	SANTA HELENA S1	01/03/2020 00:28	01/03/2020 13:53	01/03/2020 00:28	01/03/2020 13:53	13,40	7	93,83	CHI
2020031039	GOIANIA	10004508457	INDEPENDENCIA S2	01/03/2020 09:26	01/03/2020 10:57	01/03/2020 09:26	01/03/2020 10:57	1,51	1	1,51	CHI
2020031049	QUIRINOPOLIS	80083511	QUIRINOPOLIS	01/03/2020 09:27	01/03/2020 12:43	01/03/2020 09:27	01/03/2020 12:43	3,25	1	3,25	CHI
2020031050	MONTES CLAROS DE GOIAS	ME21138678	IPORA	01/03/2020 09:27	01/03/2020 11:35	01/03/2020 09:27	01/03/2020 11:35	2,12	1	2,12	CHI
2020031053	CAMPESTRE DE GOIAS	GA12008543	GUAPO S2	01/03/2020 09:28	01/03/2020 10:05	01/03/2020 09:28	01/03/2020 10:05	0,60	11	6,64	CHI
2020031053	GUAPO	GA12008543	GUAPO S2	01/03/2020 09:28	01/03/2020 10:05	01/03/2020 09:28	01/03/2020 10:05	0,60	27	16,29	CHI
2020031054	PLANALTINA	2960049695	PLANALTINA	01/03/2020 09:29	02/03/2020 10:57	01/03/2020 09:29	02/03/2020 10:57	25,47	1	25,47	CHI
2020031056	SAO MIGUEL DO ARAGUAIA	SM12291166	SAO MIGUEL DO ARAGUAIA	01/03/2020 08:18	01/03/2020 18:35	01/03/2020 08:18	01/03/2020 18:35	10,27	8	82,18	CHI
2020031057	FAINA	GS12220409	GOIAS	01/03/2020 09:29	01/03/2020 13:50	01/03/2020 09:29	01/03/2020 13:50	4,34	1	4,34	CHI
2020031057	GOIAS	GS12220409	GOIAS	01/03/2020 09:29	01/03/2020 13:50	01/03/2020 09:29	01/03/2020 13:50	4,34	81	351,79	CHI

2020031060	IPORA	IR21188494	IPORA	01/03/2020 09:28	01/03/2020 14:15	01/03/2020 09:28	01/03/2020 14:15	4,77	1	4,77	CHI
2020031063	TRES RANCHOS	TH12068480	CATALAO S1	01/03/2020 09:31	01/03/2020 14:32	01/03/2020 09:31	01/03/2020 14:32	5,00	12	60,02	CHI
2020031069	MORRINHOS	MR21157276	MORRINHOS	01/03/2020 09:32	01/03/2020 16:55	01/03/2020 09:32	01/03/2020 16:55	7,37	1	7,37	CHI
2020031074	GOIANIA	14942690	MEIA PONTE	01/03/2020 09:34	01/03/2020 11:14	01/03/2020 09:34	01/03/2020 11:14	1,65	1	1,65	CHI
2020031076	PALESTINA DE GOIAS	PY12223085	ARENOPOLIS	01/03/2020 09:09	01/03/2020 12:10	01/03/2020 09:09	01/03/2020 12:10	3,01	6	18,07	CHI
2020031079	PLANALTINA	2960048186	PLANALTINA	01/03/2020 09:36	01/03/2020 11:03	01/03/2020 09:36	01/03/2020 11:03	1,46	1	1,46	CHI
2020031081	FORMOSA	610308816	ITUIQUIRA	01/03/2020 09:36	01/03/2020 11:06	01/03/2020 09:36	01/03/2020 11:06	1,49	1	1,49	CHI
2020031083	DIORAMA	DI21188378	ARENOPOLIS	01/03/2020 09:37	01/03/2020 20:50	01/03/2020 09:37	01/03/2020 20:50	11,21	1	11,21	CHI
2020031085	CRIXAS	CX12169995	SERRA DO OURO	01/03/2020 09:37	02/03/2020 11:48	01/03/2020 09:37	02/03/2020 11:48	26,17	3	78,52	CHI
2020031088	PLANALTINA	PI12326717	SAO JOAO D ALIANCA	01/03/2020 09:38	01/03/2020 14:47	01/03/2020 09:38	01/03/2020 14:47	5,14	1	5,14	CHI
2020031090	MINEIROS	SU12184123	SANTA RITA DO ARAGUAIA	01/03/2020 09:22	01/03/2020 11:47	01/03/2020 09:22	01/03/2020 11:47	2,41	15	36,16	CHI
2020031090	SANTA RITA DO ARAGUAIA	SU12184123	SANTA RITA DO ARAGUAIA	01/03/2020 09:22	01/03/2020 11:47	01/03/2020 09:22	01/03/2020 11:47	2,41	5	12,05	CHI
2020031091	PONTALINA	PK12000100	PONTALINA	01/03/2020 09:38	02/03/2020 08:59	01/03/2020 09:38	02/03/2020 08:59	23,33	11	256,68	CHI
2020031092	MINACU	4020059290	MINACU	01/03/2020 09:39	01/03/2020 13:29	01/03/2020 09:39	01/03/2020 13:29	3,83	1	3,83	CHI
2020031097	JUSSARA	JR12033380	BRITANIA	01/03/2020 09:40	01/03/2020 13:55	01/03/2020 09:40	01/03/2020 13:55	4,26	32	136,22	CHI
2020031098	PORANGATU	PO21151750	PORANGATU	01/03/2020 09:40	01/03/2020 12:05	01/03/2020 09:40	01/03/2020 12:05	2,40	1	2,40	CHI
2020031101	SAO MIGUEL DO ARAGUAIA	SM21170985	SAO MIGUEL DO ARAGUAIA	01/03/2020 09:41	02/03/2020 01:40	01/03/2020 09:41	02/03/2020 01:40	15,98	1	15,98	CHI
2020031103	MONTIVIDIU DO NORTE	MX12391928	PORANGATU	01/03/2020 09:41	01/03/2020 11:10	01/03/2020 09:41	01/03/2020 11:10	1,48	19	28,13	CHI
2020031105	INHUMAS	IN21132765	INHUMAS S2	01/03/2020 09:41	01/03/2020 11:17	01/03/2020 09:41	01/03/2020 11:17	1,59	1	1,59	CHI
2020031107	URUACU	UR12310334	URUACU	01/03/2020 09:41	01/03/2020 12:11	01/03/2020 09:41	01/03/2020 12:11	2,49	3	7,46	CHI
2020031109	ITAPACI	IW21227649	ITAPACI	01/03/2020 09:41	01/03/2020 15:00	01/03/2020 09:41	01/03/2020 15:00	5,30	1	5,30	CHI
2020031114	IPAMERI	IP21202982	PIRES DO RIO S2	01/03/2020 09:42	01/03/2020 16:14	01/03/2020 09:42	01/03/2020 16:14	6,52	3	19,56	CHI
2020031115	OUVIDOR	CT12266109	CATALAO S1	01/03/2020 09:42	01/03/2020 15:05	01/03/2020 09:42	01/03/2020 15:05	5,37	4	21,47	CHI
2020031116	ARUANA	AK12310706RE	MOZARLANDIA	01/03/2020 09:43	01/03/2020 16:30	01/03/2020 09:43	01/03/2020 16:30	6,77	9	60,92	CHI
2020031118	NIQUELANDIA	NQ21268973	URUACU	01/03/2020 09:44	01/03/2020 11:33	01/03/2020 09:44	01/03/2020 11:33	1,82	1	1,82	CHI
2020031120	GOIANIA	15436627	CARAIAS S2	01/03/2020 09:44	01/03/2020 11:36	01/03/2020 09:44	01/03/2020 11:36	1,86	1	1,86	CHI
2020031123	CORUMBA DE GOIAS	PV12295561	CORUMBA	01/03/2020 09:44	01/03/2020 11:51	01/03/2020 09:44	01/03/2020 11:51	2,10	4	8,40	CHI
2020031123	PIRENOPOLIS	PV12295561	CORUMBA	01/03/2020 09:44	01/03/2020 11:51	01/03/2020 09:44	01/03/2020 11:51	2,10	27	56,71	CHI
2020031130	PIRES DO RIO	PR21216043	PIRES DO RIO S1	01/03/2020 09:48	02/03/2020 12:42	01/03/2020 09:48	02/03/2020 12:42	26,89	1	26,89	CHI
2020031131	SANTO ANTONIO DO DESCOBERTO	SN21366477	MARAJOARA	01/03/2020 09:49	01/03/2020 12:43	01/03/2020 09:49	01/03/2020 12:43	2,89	1	2,89	CHI
2020031132	AGUA LIMPA	AL21265708	VILA CORUMBA	29/02/2020 15:58	02/03/2020 13:03	29/02/2020 15:58	02/03/2020 13:03	45,08	1	45,08	CHI
2020031135	CIDADE OCIDENTAL	DH21290896	MARAJOARA	01/03/2020 09:50	01/03/2020 12:11	01/03/2020 09:50	01/03/2020 12:11	2,35	1	2,35	CHI
2020031136	ITAPACI	IW12094089	ITAPACI	01/03/2020 09:51	01/03/2020 14:34	01/03/2020 09:51	01/03/2020 14:34	4,71	2	9,42	CHI
2020031139	CALDAZINHA	SV12202383	CEPAIGO S2	01/03/2020 09:52	01/03/2020 15:55	01/03/2020 09:52	01/03/2020 15:55	6,05	12	72,58	CHI
2020031141	NIQUELANDIA	NQ21117587	URUACU	01/03/2020 09:52	01/03/2020 14:54	01/03/2020 09:52	01/03/2020 14:54	5,02	1	5,02	CHI
2020031142	GOIANDIRA	GD21231691	CATALAO S1	01/03/2020 09:53	01/03/2020 10:43	01/03/2020 09:53	01/03/2020 10:43	0,83	3	2,50	CHI
2020031144	ITAGUARI	IC12038617	ITABERAI S1	01/03/2020 09:53	01/03/2020 12:11	01/03/2020 09:53	01/03/2020 12:11	2,29	19	43,58	CHI
2020031144	ITAGUARU	IC12038617	ITABERAI S1	01/03/2020 09:53	01/03/2020 12:11	01/03/2020 09:53	01/03/2020 12:11	2,29	11	25,23	CHI
2020031148	BOM JARDIM DE GOIAS	BM21198366	BOM JARDIM	01/03/2020 09:54	02/03/2020 14:01	01/03/2020 09:54	02/03/2020 14:01	28,11	1	28,11	CHI
2020031151	CRIXAS	NA12156613	MOZARLANDIA	01/03/2020 09:55	01/03/2020 20:38	01/03/2020 09:55	01/03/2020 20:38	10,71	2	21,42	CHI
2020031151	NOVA CRIXAS	NA12156613	MOZARLANDIA	01/03/2020 09:55	01/03/2020 20:38	01/03/2020 09:55	01/03/2020 20:38	10,71	34	364,15	CHI
2020031157	CORUMBA DE GOIAS	CB21102095	COCALZINHO	01/03/2020 09:56	01/03/2020 12:24	01/03/2020 09:56	01/03/2020 12:24	2,46	1	2,46	CHI
2020031159	MINACU	IH12288127	MINACU	01/03/2020 09:56	01/03/2020 12:33	01/03/2020 09:56	01/03/2020 12:33	2,60	6	15,62	CHI
2020031163	AGUA FRIA DE GOIAS	4440000734	SAO JOAO D ALIANCA	01/03/2020 09:57	01/03/2020 13:16	01/03/2020 09:57	01/03/2020 13:16	3,30	1	3,30	CHI

2020031164	CATALAO	CT11032135	CATALAO S2	01/03/2020 09:57	01/03/2020 12:41	01/03/2020 09:57	01/03/2020 12:41	2,72	99	268,98	CHI
2020031168	RIO VERDE	RV21255704	MONTIVIDIU T	01/03/2020 09:58	02/03/2020 08:46	01/03/2020 09:58	02/03/2020 08:46	22,78	4	91,14	CHI
2020031174	CAMPO LIMPO	AN21258061	NEROPOLIS S1	01/03/2020 09:59	01/03/2020 13:29	01/03/2020 09:59	01/03/2020 13:29	3,49	1	3,49	CHI
2020031175	DIORAMA	DI12065689	IPORA	01/03/2020 09:18	01/03/2020 17:34	01/03/2020 09:18	01/03/2020 17:34	8,26	16	132,13	CHI
2020031176	ARAGARCAS	AG12223202	ARAGARCAS	01/03/2020 07:51	01/03/2020 14:30	01/03/2020 07:51	01/03/2020 14:30	6,64	8	53,09	CHI
2020031179	RIO VERDE	630339223	RIO VERDE S2	01/03/2020 10:01	01/03/2020 22:51	01/03/2020 10:01	01/03/2020 22:51	12,83	1	12,83	CHI
2020031181	CAMPESTRE DE GOIAS	GA12008538	GUAPO S2	01/03/2020 10:02	01/03/2020 10:50	01/03/2020 10:02	01/03/2020 10:50	0,79	1	0,79	CHI
2020031181	GUAPO	GA12008538	GUAPO S2	01/03/2020 10:02	01/03/2020 10:50	01/03/2020 10:02	01/03/2020 10:50	0,79	11	8,72	CHI
2020031182	CAIAPONIA	CP12184786	CAIAPONIA	01/03/2020 10:02	01/03/2020 14:17	01/03/2020 10:02	01/03/2020 14:17	4,24	36	152,46	CHI
2020031182	DOVERLANDIA	CP12184786	CAIAPONIA	01/03/2020 10:02	01/03/2020 14:17	01/03/2020 10:02	01/03/2020 14:17	4,24	1	4,24	CHI
2020031187	JUSSARA	JR12076133	BRITANIA	01/03/2020 10:04	02/03/2020 08:54	01/03/2020 10:04	02/03/2020 08:54	22,82	3	68,47	CHI
2020031189	BURITI ALEGRE	BG12263620	ALTO BURITI	01/03/2020 08:54	01/03/2020 14:56	01/03/2020 08:54	01/03/2020 14:56	6,03	3	18,08	CHI
2020031191	JATAI	290247482	JATAI S2	01/03/2020 10:04	01/03/2020 12:31	01/03/2020 10:04	01/03/2020 12:31	2,44	1	2,44	CHI
2020031192	HIDROLANDIA	HD12000150	PONTALINA	01/03/2020 10:05	01/03/2020 14:08	01/03/2020 10:05	01/03/2020 14:08	4,04	1	4,04	CHI
2020031194	CRISTALINA	KR12168463	CRISTALINA S1	01/03/2020 10:06	01/03/2020 12:27	01/03/2020 10:06	01/03/2020 12:27	2,35	3	7,05	CHI
2020031200	LEOPOLDO DE BULHOES	LB21336903	DAIA S2	01/03/2020 10:07	01/03/2020 11:29	01/03/2020 10:07	01/03/2020 11:29	1,36	1	1,36	CHI
2020031201	PIRES DO RIO	PR21000072	PIRES DO RIO S1	01/03/2020 10:07	02/03/2020 12:40	01/03/2020 10:07	02/03/2020 12:40	26,54	1	26,54	CHI
2020031203	ANAPOLIS	10004094121	ANAPOLIS UNIVERSITARIO S2	01/03/2020 10:08	01/03/2020 13:11	01/03/2020 10:08	01/03/2020 13:11	3,04	1	3,04	CHI
2020031207	VILA BOA	VB11146246	IACIARA S2	01/03/2020 10:08	01/03/2020 11:39	01/03/2020 10:08	01/03/2020 11:39	1,52	211	319,90	CHI
2020031217	JATAI	JT21361511	JATAI S1	01/03/2020 10:13	01/03/2020 11:39	01/03/2020 10:13	01/03/2020 11:39	1,43	1	1,43	CHI
2020031218	APARECIDA DE GOIANIA	AP12200152	CEPAIGO S1	01/03/2020 10:13	01/03/2020 12:38	01/03/2020 10:13	01/03/2020 12:38	2,41	4	9,65	CHI
2020031219	BONFINOPOLIS	LB21032348	CEPAIGO S2	01/03/2020 10:13	01/03/2020 12:50	01/03/2020 10:13	01/03/2020 12:50	2,61	1	2,61	CHI
2020031220	HIDROLANDIA	HD32064193	GUAPO S2	01/03/2020 10:13	02/03/2020 17:20	01/03/2020 10:13	01/03/2020 16:19	6,10	2	12,20	CHI
2020031220	ARAGOIANIA	HD32064193	GUAPO S2	01/03/2020 10:13	02/03/2020 17:20	01/03/2020 10:13	02/03/2020 17:20	31,11	1	31,11	CHI
2020031220	HIDROLANDIA	HD32064193	GUAPO S2	01/03/2020 10:13	02/03/2020 17:20	01/03/2020 10:13	02/03/2020 17:20	31,11	1	31,11	CHI
2020031229	SANTO ANTONIO DA BARRA	BZ12295790	ACREUNA	01/03/2020 09:34	01/03/2020 13:29	01/03/2020 09:34	01/03/2020 13:29	3,91	6	23,44	CHI
2020031235	IPORA	730141524	IPORA	01/03/2020 10:18	01/03/2020 13:36	01/03/2020 10:18	01/03/2020 13:36	3,30	1	3,30	CHI
2020031237	ITAUCU	IX21172644	INHUMAS S1	01/03/2020 10:18	01/03/2020 13:44	01/03/2020 10:18	01/03/2020 13:44	3,42	1	3,42	CHI
2020031245	SAO MIGUEL DO ARAGUAIA	SM12013055	SAO MIGUEL DO ARAGUAIA	01/03/2020 10:20	02/03/2020 18:14	01/03/2020 10:20	02/03/2020 10:48	24,47	2	48,93	CHI
2020031245	SAO MIGUEL DO ARAGUAIA	SM12013055	SAO MIGUEL DO ARAGUAIA	01/03/2020 10:20	02/03/2020 18:14	01/03/2020 10:20	02/03/2020 18:14	31,89	2	63,78	CHI
2020031246	DOVERLANDIA	DV12139906	CAIAPONIA	01/03/2020 10:20	02/03/2020 07:49	01/03/2020 10:20	02/03/2020 07:49	21,47	10	214,69	CHI
2020031247	COCALZINHO DE GOIAS	ZN21068616	GOIANESIA S1	01/03/2020 10:21	01/03/2020 17:01	01/03/2020 10:21	01/03/2020 17:01	6,67	1	6,67	CHI
2020031248	LUZIANIA	LZ21209548	RIO VERMELHO	01/03/2020 10:21	01/03/2020 12:48	01/03/2020 10:21	01/03/2020 12:48	2,44	1	2,44	CHI
2020031252	ARUANA	AK12156743	ARUANA	01/03/2020 06:49	01/03/2020 12:20	01/03/2020 06:49	01/03/2020 12:20	5,50	7	38,53	CHI
2020031254	RIO VERDE	10010561267	RIO VERDE S1	01/03/2020 10:23	01/03/2020 23:52	01/03/2020 10:23	01/03/2020 23:52	13,48	1	13,48	CHI
2020031255	GOIANIA	15539325	MEIA PONTE	01/03/2020 10:23	01/03/2020 11:57	01/03/2020 10:23	01/03/2020 11:57	1,56	1	1,56	CHI
2020031256	SAO JOAO DA PARAUNA	RP21349327	FIRMINOPOLIS S1	01/03/2020 10:23	01/03/2020 19:14	01/03/2020 10:23	01/03/2020 19:14	8,84	2	17,68	CHI
2020031262	ANAPOLIS	10023592000	ANAPOLIS UNIVERSITARIO S2	01/03/2020 10:27	01/03/2020 14:18	01/03/2020 10:27	01/03/2020 14:18	3,84	1	3,84	CHI
2020031271	CEZARINA	CZ21228914	CEZARINA	01/03/2020 10:30	01/03/2020 18:50	01/03/2020 10:30	01/03/2020 18:50	8,33	1	8,33	CHI
2020031273	ALTO PARAISO DE GOIAS	3870000981	FLORES DE GOIAS	01/03/2020 10:30	01/03/2020 11:48	01/03/2020 10:30	01/03/2020 11:48	1,29	1	1,29	CHI
2020031274	MINEIROS	MY12324537	PARQUE DAS EMAS	01/03/2020 08:23	01/03/2020 14:20	01/03/2020 08:23	01/03/2020 14:20	5,94	10	59,40	CHI
2020031275	NEROPOLIS	NR21326139	NEROPOLIS S2	01/03/2020 10:31	01/03/2020 11:56	01/03/2020 10:31	01/03/2020 11:56	1,41	1	1,41	CHI
2020031276	GUAPO	GA11276622	GUAPO S2	01/03/2020 10:31	01/03/2020 11:49	01/03/2020 10:31	01/03/2020 11:49	1,29	3	3,88	CHI
2020031277	PIRANHAS	PH12231174	ARENOPOLIS	01/03/2020 10:32	01/03/2020 14:28	01/03/2020 10:32	01/03/2020 14:28	3,93	3	11,78	CHI

2020031279	SERRANOPOLIS	3000019519	JATAI S1	01/03/2020 10:32	01/03/2020 12:55	01/03/2020 10:32	01/03/2020 12:55	2,37	1	2,37	CHI
2020031283	ITAPIRAPUA	IU21147480	MATRINCHA	01/03/2020 10:33	01/03/2020 18:05	01/03/2020 10:33	01/03/2020 18:05	7,52	2	15,05	CHI
2020031285	CAMPINORTE	MQ12094074	MARA ROSA	01/03/2020 10:34	01/03/2020 18:15	01/03/2020 10:34	01/03/2020 18:15	7,68	9	69,10	CHI
2020031287	JATAI	290174030	JATAI S3	01/03/2020 10:34	01/03/2020 13:48	01/03/2020 10:34	01/03/2020 13:48	3,23	1	3,23	CHI
2020031289	BOM JARDIM DE GOIAS	BM12074235	PIRANHAS	01/03/2020 10:35	02/03/2020 09:14	01/03/2020 10:35	02/03/2020 09:14	22,65	12	271,76	CHI
2020031290	SILVANIA	SV12101286	VIANOPOLIS	01/03/2020 10:35	01/03/2020 14:34	01/03/2020 10:35	01/03/2020 14:34	3,98	17	67,59	CHI
2020031291	GOIANIA	GN12219050	NEROPOLIS S2	01/03/2020 10:35	01/03/2020 13:01	01/03/2020 10:35	01/03/2020 13:01	2,42	2	4,84	CHI
2020031291	NEROPOLIS	GN12219050	NEROPOLIS S2	01/03/2020 10:35	01/03/2020 13:01	01/03/2020 10:35	01/03/2020 13:01	2,42	6	14,53	CHI
2020031291	SANTO ANTONIO DE GOIAS	GN12219050	NEROPOLIS S2	01/03/2020 10:35	01/03/2020 13:01	01/03/2020 10:35	01/03/2020 13:01	2,42	25	60,56	CHI
2020031294	INACIOLANDIA	ID32128215	QUIRINOPOLIS	01/03/2020 10:36	01/03/2020 14:33	01/03/2020 10:36	01/03/2020 14:33	3,94	6	23,65	CHI
2020031297	PIRENOPOLIS	PV21194531	CORUMBA	01/03/2020 09:44	01/03/2020 13:29	01/03/2020 09:44	01/03/2020 13:29	3,73	4	14,94	CHI
2020031300	VIANOPOLIS	VN12040838	VIANOPOLIS	01/03/2020 10:40	01/03/2020 11:44	01/03/2020 10:40	01/03/2020 11:44	1,06	13	13,77	CHI
2020031303	GOIANIA	10022516369	MEIA PONTE	01/03/2020 10:40	01/03/2020 13:05	01/03/2020 10:40	01/03/2020 13:05	2,40	1	2,40	CHI
2020031304	PARAUNA	PU12301178	ACREUNA	01/03/2020 10:42	01/03/2020 20:10	01/03/2020 10:42	01/03/2020 16:19	5,62	1	5,62	CHI
2020031304	PARAUNA	PU12301178	ACREUNA	01/03/2020 10:42	01/03/2020 20:10	01/03/2020 10:42	01/03/2020 19:47	9,08	5	45,40	CHI
2020031304	PARAUNA	PU12301178	ACREUNA	01/03/2020 10:42	01/03/2020 20:10	01/03/2020 16:32	01/03/2020 19:47	3,24	1	3,24	CHI
2020031304	PARAUNA	PU12301178	ACREUNA	01/03/2020 10:42	01/03/2020 20:10	01/03/2020 10:42	01/03/2020 20:10	9,46	2	18,93	CHI
2020031309	NIQUELANDIA	NQ12397472	NIQUELANDIA SUBTRANSMISSAO	01/03/2020 10:43	01/03/2020 15:12	01/03/2020 10:43	01/03/2020 15:12	4,48	15	67,19	CHI
2020031309	URUACU	NQ12397472	NIQUELANDIA SUBTRANSMISSAO	01/03/2020 10:43	01/03/2020 15:12	01/03/2020 10:43	01/03/2020 15:12	4,48	1	4,48	CHI
2020031312	IVOLANDIA	IV21181753	IPORA	01/03/2020 10:43	01/03/2020 13:56	01/03/2020 10:43	01/03/2020 13:56	3,20	1	3,20	CHI
2020031313	APARECIDA DE GOIANIA	AP12000054	CEPAIGO S1	01/03/2020 10:44	01/03/2020 12:07	01/03/2020 10:44	01/03/2020 12:07	1,37	1	1,37	CHI
2020031319	NOVO PLANALTO	TA12121348	SAO MIGUEL DO ARAGUAIA	01/03/2020 10:46	01/03/2020 15:56	01/03/2020 10:46	01/03/2020 15:56	5,16	39	201,28	CHI
2020031323	CACU	CC12191544	CACHOEIRA ALTA	01/03/2020 10:46	01/03/2020 17:01	01/03/2020 10:46	01/03/2020 12:37	1,84	370	679,05	CHI
2020031323	CACU	CC11059774	CACHOEIRA ALTA	01/03/2020 10:46	01/03/2020 17:01	01/03/2020 10:46	01/03/2020 17:01	6,24	102	636,00	CHI
2020031328	DIVINOPOLIS DE GOIAS	GH12235979	SAO DOMINGOS	01/03/2020 10:49	01/03/2020 15:32	01/03/2020 10:49	01/03/2020 15:32	4,71	4	18,83	CHI
2020031339	JATAI	JT21061477	JATAI S1	01/03/2020 10:51	01/03/2020 13:00	01/03/2020 10:51	01/03/2020 13:00	2,14	1	2,14	CHI
2020031341	JATAI	JT21000126	JATAI S3	01/03/2020 10:51	01/03/2020 17:40	01/03/2020 10:51	01/03/2020 17:40	6,82	1	6,82	CHI
2020031345	CACU	1140051031	CACHOEIRA ALTA	01/03/2020 10:52	01/03/2020 12:25	01/03/2020 10:52	01/03/2020 12:25	1,56	1	1,56	CHI
2020031348	MONTES CLAROS DE GOIAS	ME12204886	IPORA	01/03/2020 10:32	01/03/2020 18:50	01/03/2020 10:32	01/03/2020 18:50	8,29	78	646,81	CHI
2020031350	NIQUELANDIA	NQ21332890	NIQUELANDIA SUBTRANSMISSAO	01/03/2020 10:53	01/03/2020 17:08	01/03/2020 10:53	01/03/2020 17:08	6,24	1	6,24	CHI
2020031354	GOIANAPOLIS	GP21392831	DAIA S2	01/03/2020 10:54	01/03/2020 13:11	01/03/2020 10:54	01/03/2020 13:11	2,27	1	2,27	CHI
2020031356	LUZIANIA	LZ11092920	RIO VERMELHO	01/03/2020 10:54	01/03/2020 12:25	01/03/2020 11:45	01/03/2020 12:25	0,67	98	65,39	CHI
2020031360	NOVO GAMA	2460105193	PACAEMBU S1	01/03/2020 10:56	01/03/2020 12:24	01/03/2020 10:56	01/03/2020 12:24	1,46	1	1,46	CHI
2020031363	JARAGUA	JA21277079	JARAGUA	01/03/2020 10:58	01/03/2020 12:59	01/03/2020 10:58	01/03/2020 12:59	2,01	1	2,01	CHI
2020031364	CAIAPONIA	CP11287648	PALESTINA	01/03/2020 10:58	02/03/2020 08:37	01/03/2020 10:58	02/03/2020 08:37	21,64	1	21,64	CHI
2020031366	QUIRINOPOLIS	QI21306065	QUIRINOPOLIS	01/03/2020 10:59	01/03/2020 12:29	01/03/2020 10:59	01/03/2020 12:29	1,49	1	1,49	CHI
2020031371	APARECIDA DE GOIANIA	10016793542	INDEPENDENCIA S2	01/03/2020 11:00	01/03/2020 14:03	01/03/2020 11:00	01/03/2020 14:03	3,04	1	3,04	CHI
2020031372	PIRENOPOLIS	PV21273400	SAO FRANCISCO DE GOIAS	01/03/2020 11:00	01/03/2020 15:45	01/03/2020 11:00	01/03/2020 15:45	4,74	2	9,47	CHI
2020031374	ABADIANIA	AA21238142	ANAPOLIS UNIVERSITARIO S1	01/03/2020 11:01	01/03/2020 15:39	01/03/2020 11:01	01/03/2020 15:39	4,63	1	4,63	CHI
2020031377	PONTALINA	PK21111929	PONTALINA	01/03/2020 11:02	01/03/2020 12:49	01/03/2020 11:02	01/03/2020 12:49	1,77	1	1,77	CHI
2020031378	ITABERAI	IB21167823	ITABERAI S1	01/03/2020 11:02	01/03/2020 12:00	01/03/2020 11:02	01/03/2020 12:00	0,96	1	0,96	CHI
2020031384	SAO LUIZ DO NORTE	GE12339967	ITAPACI	01/03/2020 10:50	02/03/2020 12:49	01/03/2020 10:50	01/03/2020 21:00	10,16	3	30,47	CHI
2020031384	SAO LUIZ DO NORTE	GE12339967	ITAPACI	01/03/2020 10:50	02/03/2020 12:49	01/03/2020 21:01	02/03/2020 12:49	15,81	3	47,42	CHI
2020031386	SAO MIGUEL DO PASSA QUATRO	SQ21375954	VIANOPOLIS	01/03/2020 11:04	01/03/2020 13:15	01/03/2020 11:04	01/03/2020 13:15	2,18	1	2,18	CHI

2020031388	CUMARI	2000005646	CATALAO S1	01/03/2020 11:05	01/03/2020 13:44	01/03/2020 11:05	01/03/2020 13:44	2,65	1	2,65	CHI
2020031394	GOIATUBA	GT12296902	BOM JESUS DE GOIAS	01/03/2020 11:08	01/03/2020 16:02	01/03/2020 11:08	01/03/2020 16:02	4,89	8	39,11	CHI
2020031395	PADRE BERNARDO	PB12330444	PADRE BERNARDO	01/03/2020 11:08	01/03/2020 17:23	01/03/2020 11:08	01/03/2020 17:23	6,24	3	18,71	CHI
2020031397	GOIANIA	11363332	FERROVIARIO S3	01/03/2020 11:08	01/03/2020 12:55	01/03/2020 11:08	01/03/2020 12:55	1,77	1	1,77	CHI
2020031404	TRINDADE	TR31004591	TRINDADE	28/02/2020 17:03	01/03/2020 18:10	28/02/2020 17:03	01/03/2020 18:10	49,11	1	49,11	CHI
2020031405	PONTALINA	PK21098670	PONTALINA	01/03/2020 11:12	01/03/2020 12:02	01/03/2020 11:12	01/03/2020 12:02	0,83	2	1,65	CHI
2020031406	DAMIANOPOLIS	DA12302922	IACIARA S2	01/03/2020 11:12	01/03/2020 13:32	01/03/2020 11:12	01/03/2020 13:32	2,32	1	2,32	CHI
2020031410	GOIANIA	GN11021072	ATLANTICO S1	01/03/2020 11:13	01/03/2020 14:15	01/03/2020 11:13	01/03/2020 14:15	3,03	73	220,99	CHI
2020031411	ITABERAI	IB21158791	ITABERAI S2	01/03/2020 11:14	01/03/2020 12:14	01/03/2020 11:14	01/03/2020 12:14	0,99	1	0,99	CHI
2020031420	GOIANIA	10028378871	ATLANTICO S3	01/03/2020 11:17	01/03/2020 12:01	01/03/2020 11:17	01/03/2020 12:01	0,73	1	0,73	CHI
2020031423	PORANGATU	PO12208614	PORANGATU	01/03/2020 08:57	01/03/2020 13:39	01/03/2020 08:57	01/03/2020 13:39	4,69	9	42,19	CHI
2020031424	IPAMERI	IP21114937	IPAMERI	01/03/2020 11:17	01/03/2020 14:36	01/03/2020 11:17	01/03/2020 14:36	3,31	1	3,31	CHI
2020031425	AGUAS LINDAS DE GOIAS	SN21096324	AGUAS LINDAS DE GOIAS S1	01/03/2020 11:17	01/03/2020 13:33	01/03/2020 11:17	01/03/2020 13:33	2,26	1	2,26	CHI
2020031430	BURITI DE GOIAS	SC12052751	FIRMINOPOLIS S2	01/03/2020 11:19	01/03/2020 21:29	01/03/2020 11:19	01/03/2020 21:29	10,17	3	30,52	CHI
2020031430	SANCLERLANDIA	SC12052751	FIRMINOPOLIS S2	01/03/2020 11:19	01/03/2020 21:29	01/03/2020 11:19	01/03/2020 21:29	10,17	19	193,29	CHI
2020031440	IPAMERI	NE21150933	CATALAO S1	01/03/2020 11:21	01/03/2020 15:59	01/03/2020 11:21	01/03/2020 15:59	4,63	1	4,63	CHI
2020031441	ITAPIRAPUA	IU12087963	MATRINCHA	01/03/2020 11:19	01/03/2020 14:14	01/03/2020 11:19	01/03/2020 14:14	2,91	43	124,93	CHI
2020031444	URUTAI	UT12115680	PIRES DO RIO S2	01/03/2020 11:23	01/03/2020 16:01	01/03/2020 11:23	01/03/2020 16:01	4,62	33	152,58	CHI
2020031445	AGUA LIMPA	AL21000260	VILA CORUMBA	01/03/2020 11:23	01/03/2020 13:10	01/03/2020 11:23	01/03/2020 13:10	1,77	1	1,77	CHI
2020031450	ALTO PARAISO DE GOIAS	BF21312327	FLORES DE GOIAS	01/03/2020 11:24	01/03/2020 14:40	01/03/2020 11:24	01/03/2020 14:40	3,25	1	3,25	CHI
2020031452	RIO VERDE	RV21249070	MONTIVIDIU T	01/03/2020 11:25	02/03/2020 02:07	01/03/2020 11:25	02/03/2020 02:07	14,69	2	29,37	CHI
2020031453	VALPARAISO DE GOIAS	2860215640	PACAEMBU S1	01/03/2020 11:26	01/03/2020 12:46	01/03/2020 11:26	01/03/2020 12:46	1,32	1	1,32	CHI
2020031455	TRINDADE	TR32050470	TRINDADE	01/03/2020 11:26	01/03/2020 15:24	01/03/2020 11:26	01/03/2020 15:24	3,95	3	11,86	CHI
2020031461	VICENTINOPOLIS	VI12128635	VICENTINOPOLIS	01/03/2020 11:26	01/03/2020 12:13	01/03/2020 11:26	01/03/2020 12:13	0,77	344	264,40	CHI
2020031464	BURITI ALEGRE	BG12229312	ALTO BURITI	01/03/2020 11:29	01/03/2020 19:28	01/03/2020 11:29	01/03/2020 19:28	7,97	3	23,90	CHI
2020031465	AURILANDIA	AI21287135	FIRMINOPOLIS S2	01/03/2020 11:31	01/03/2020 17:55	01/03/2020 11:31	01/03/2020 17:55	6,40	1	6,40	CHI
2020031468	ABADIANIA	AA12084772	ANAPOLIS UNIVERSITARIO S1	01/03/2020 11:32	01/03/2020 16:00	01/03/2020 11:32	01/03/2020 16:00	4,46	13	57,97	CHI
2020031471	DAMIANOPOLIS	DA21240257	IACIARA S2	01/03/2020 11:33	01/03/2020 14:34	01/03/2020 11:33	01/03/2020 14:34	3,02	1	3,02	CHI
2020031475	MONTIVIDIU	MV12267719	MONTIVIDIU T	01/03/2020 11:34	02/03/2020 08:27	01/03/2020 11:34	02/03/2020 08:27	20,88	2	41,76	CHI
2020031476	FORMOSA	FA31223595	SAO JOAO D ALIANCA	01/03/2020 11:34	01/03/2020 18:28	01/03/2020 11:34	01/03/2020 18:28	6,89	1	6,89	CHI
2020031479	NIQUELANDIA	NQ12232485	URUACU	01/03/2020 11:35	02/03/2020 00:33	01/03/2020 11:35	02/03/2020 00:33	12,96	2	25,91	CHI
2020031480	MINEIROS	MY21302951	PARQUE DAS EMAS	01/03/2020 11:35	02/03/2020 09:40	01/03/2020 11:35	02/03/2020 09:40	22,07	1	22,07	CHI
2020031484	VILA PROPICIO	GE12255985	GOIANESIA S1	01/03/2020 07:03	01/03/2020 13:54	01/03/2020 07:03	01/03/2020 13:54	6,85	8	54,84	CHI
2020031485	ARUANA	AK12292820	BRITANIA	01/03/2020 11:38	01/03/2020 14:45	01/03/2020 11:38	01/03/2020 14:45	3,12	4	12,46	CHI
2020031488	GOIANIA	12186764	CAMPINAS S1	01/03/2020 11:40	01/03/2020 13:06	01/03/2020 11:40	01/03/2020 13:06	1,42	1	1,42	CHI
2020031491	MONTES CLAROS DE GOIAS	ME21212962	IPORA	01/03/2020 11:42	01/03/2020 13:53	01/03/2020 11:42	01/03/2020 13:53	2,17	1	2,17	CHI
2020031492	BARRO ALTO	BA21095438	BARRO ALTO	01/03/2020 11:43	01/03/2020 23:16	01/03/2020 11:43	01/03/2020 23:16	11,55	1	11,55	CHI
2020031493	MINACU	IH21220672	MINACU	01/03/2020 11:44	01/03/2020 14:30	01/03/2020 11:44	01/03/2020 14:30	2,77	2	5,53	CHI
2020031494	CAMPO ALEGRE DE GOIAS	CM21215490	CAMPO ALEGRE DE GOIAS	01/03/2020 11:44	01/03/2020 20:52	01/03/2020 11:44	01/03/2020 20:52	9,13	1	9,13	CHI
2020031498	GUARINOS	9210000139	SANTA TEREZINHA	01/03/2020 11:45	01/03/2020 19:29	01/03/2020 11:45	01/03/2020 19:29	7,73	1	7,73	CHI
2020031499	CHAPADAO DO CEU	DJ21221934	CHAPADAO DO CEU	01/03/2020 11:45	01/03/2020 15:22	01/03/2020 11:45	01/03/2020 15:22	3,61	1	3,61	CHI
2020031503	PADRE BERNARDO	PB12163217	PADRE BERNARDO	01/03/2020 11:46	01/03/2020 19:20	01/03/2020 11:46	01/03/2020 19:20	7,55	114	860,95	CHI
2020031504	CIDADE OCIDENTAL	LZ21061791	MARAJOARA	01/03/2020 09:50	01/03/2020 13:29	01/03/2020 09:50	01/03/2020 13:29	3,64	1	3,64	CHI
2020031508	COCALZINHO DE GOIAS	ZN12345237	COCALZINHO	01/03/2020 11:48	01/03/2020 15:15	01/03/2020 11:48	01/03/2020 15:15	3,44	3	10,32	CHI

2020031513	CARMO DO RIO VERDE	RB12051013	RUBIATABA	01/03/2020 11:50	01/03/2020 17:20	01/03/2020 11:50	01/03/2020 17:20	5,49	3	16,47	CHI
2020031513	SAO PATRICIO	RB12051013	RUBIATABA	01/03/2020 11:50	01/03/2020 17:20	01/03/2020 11:50	01/03/2020 17:20	5,49	3	16,47	CHI
2020031526	PIRES DO RIO	PR21084117	PIRES DO RIO S1	01/03/2020 11:54	01/03/2020 15:50	01/03/2020 11:54	01/03/2020 15:50	3,93	1	3,93	CHI
2020031527	VALPARAISO DE GOIAS	2860095105	PACAEMBU S1	01/03/2020 11:54	01/03/2020 13:44	01/03/2020 11:54	01/03/2020 13:44	1,82	1	1,82	CHI
2020031528	CIDADE OCIDENTAL	LZ12078409	MARAJOARA	01/03/2020 11:55	01/03/2020 13:10	01/03/2020 11:55	01/03/2020 13:10	1,24	36	44,76	CHI
2020031535	LEOPOLDO DE BULHOES	LB21313046	DAIA S2	01/03/2020 11:58	01/03/2020 18:38	01/03/2020 11:58	01/03/2020 18:38	6,65	2	13,31	CHI
2020031538	SANTO ANTONIO DO DESCOBERTO	2210155387	ALEXANIA	01/03/2020 12:01	01/03/2020 13:47	01/03/2020 12:01	01/03/2020 13:47	1,76	1	1,76	CHI
2020031547	ARAGUAPAZ	AZ12234927	GOIAS	01/03/2020 12:03	01/03/2020 20:46	01/03/2020 12:03	01/03/2020 20:46	8,70	1	8,70	CHI
2020031550	DOVERLANDIA	DV21156755	CAIAPONIA	01/03/2020 12:04	02/03/2020 10:13	01/03/2020 12:04	02/03/2020 10:13	22,14	1	22,14	CHI
2020031553	SERRANOPOLIS	3000003214	JATAI S1	01/03/2020 12:05	01/03/2020 14:09	01/03/2020 12:05	01/03/2020 14:09	2,06	1	2,06	CHI
2020031556	RIO VERDE	RV12271525	CABRIUVA S2	01/03/2020 02:14	02/03/2020 08:33	01/03/2020 02:14	02/03/2020 08:33	30,32	7	212,21	CHI
2020031561	ANAPOLIS	GP12382434	DAIA S2	01/03/2020 11:53	01/03/2020 14:42	01/03/2020 11:53	01/03/2020 14:42	2,81	7	19,68	CHI
2020031561	GOIANAPOLIS	GP12382434	DAIA S2	01/03/2020 11:53	01/03/2020 14:42	01/03/2020 11:53	01/03/2020 14:42	2,81	1	2,81	CHI
2020031561	LEOPOLDO DE BULHOES	GP12382434	DAIA S2	01/03/2020 11:53	01/03/2020 14:42	01/03/2020 11:53	01/03/2020 14:42	2,81	185	520,11	CHI
2020031566	FIRMINOPOLIS	FR12312448	FIRMINOPOLIS S1	01/03/2020 12:06	01/03/2020 13:44	01/03/2020 12:06	01/03/2020 13:44	1,62	3	4,87	CHI
2020031567	BONFINOPOLIS	BO12265380	CEPAIGO S2	01/03/2020 12:08	01/03/2020 13:51	01/03/2020 12:08	01/03/2020 13:51	1,71	18	30,86	CHI
2020031574	UIRAPURU	UP12297241	SANTA TEREZINHA	01/03/2020 12:12	01/03/2020 15:00	01/03/2020 12:12	01/03/2020 15:00	2,79	3	8,36	CHI
2020031575	NOVA CRIXAS	NA12357679	NOVA CRIXAS	01/03/2020 06:54	01/03/2020 12:31	01/03/2020 06:54	01/03/2020 12:31	5,61	8	44,85	CHI
2020031580	LUZIANIA	120110179	RIO VERMELHO	01/03/2020 12:13	01/03/2020 13:15	01/03/2020 12:13	01/03/2020 13:15	1,04	1	1,04	CHI
2020031585	CAIAPONIA	CP12207767	CAIAPONIA	01/03/2020 12:17	01/03/2020 18:52	01/03/2020 12:17	01/03/2020 18:52	6,58	9	59,21	CHI
2020031586	GOIANDIRA	2010013342	CATALAO S1	01/03/2020 09:02	01/03/2020 16:44	01/03/2020 09:02	01/03/2020 16:44	7,69	1	7,69	CHI
2020031588	GOIANIA	15587782	MEIA PONTE	01/03/2020 12:17	01/03/2020 15:01	01/03/2020 12:17	01/03/2020 15:01	2,72	1	2,72	CHI
2020031589	MARA ROSA	MQ21301012	MARA ROSA	01/03/2020 12:17	02/03/2020 09:23	01/03/2020 12:17	02/03/2020 09:23	21,08	1	21,08	CHI
2020031591	TRINDADE	10011123778	TRINDADE	01/03/2020 12:19	01/03/2020 17:26	01/03/2020 12:19	01/03/2020 17:26	5,10	1	5,10	CHI
2020031593	ITABERAI	IB12364880	ITABERAI S2	01/03/2020 11:19	01/03/2020 14:20	01/03/2020 11:19	01/03/2020 14:20	3,01	3	9,03	CHI
2020031594	ARENOPOLIS	AY12331906	ARENOPOLIS	01/03/2020 12:20	01/03/2020 22:08	01/03/2020 12:20	01/03/2020 22:08	9,79	2	19,58	CHI
2020031597	POSSE	SA12268178	IACIARA S2	01/03/2020 12:22	01/03/2020 19:59	01/03/2020 12:22	01/03/2020 19:59	7,61	3	22,83	CHI
2020031599	SANTA TEREZINHA DE GOIAS	SG21129656	SANTA TEREZINHA	01/03/2020 12:23	02/03/2020 09:45	01/03/2020 12:23	02/03/2020 09:45	21,36	1	21,36	CHI
2020031605	CORUMBA DE GOIAS	CB21236606	CORUMBA	01/03/2020 12:26	01/03/2020 15:08	01/03/2020 12:26	01/03/2020 15:08	2,70	1	2,70	CHI
2020031613	SENADOR CANEDO	10013840361	SENADOR CANEDO	01/03/2020 12:28	01/03/2020 13:32	01/03/2020 12:28	01/03/2020 13:32	1,05	1	1,05	CHI
2020031616	NOVO GAMA	10024020441	PACAEMBU S1	01/03/2020 12:31	01/03/2020 16:59	01/03/2020 12:31	01/03/2020 16:59	4,46	1	4,46	CHI
2020031617	NOVO BRASIL	NB12378823	JUSSARA	01/03/2020 12:31	01/03/2020 16:00	01/03/2020 12:31	01/03/2020 16:00	3,48	1	3,48	CHI
2020031618	APARECIDA DE GOIANIA	AP11322995	ANHANGUERA	01/03/2020 12:26	01/03/2020 18:24	01/03/2020 15:28	01/03/2020 18:24	2,94	97	284,99	CHI
2020031619	VICENTINOPOLIS	VI11128634	VICENTINOPOLIS	01/03/2020 12:29	01/03/2020 15:33	01/03/2020 12:29	01/03/2020 15:33	3,07	150	459,79	CHI
2020031623	LUZIANIA	10015250391	MARAJOARA	01/03/2020 12:34	01/03/2020 14:55	01/03/2020 12:34	01/03/2020 14:55	2,35	1	2,35	CHI
2020031628	ABADIANIA	AA21191099	ANAPOLIS UNIVERSITARIO S1	01/03/2020 12:34	01/03/2020 17:17	01/03/2020 12:34	01/03/2020 17:17	4,70	1	4,70	CHI
2020031629	POSSE	PS12217661	IACIARA S2	01/03/2020 12:34	01/03/2020 14:52	01/03/2020 12:34	01/03/2020 14:52	2,29	44	100,69	CHI
2020031631	EDEIA	ED12000041	EDEIA	01/03/2020 11:46	01/03/2020 14:09	01/03/2020 11:46	01/03/2020 14:09	2,38	25	59,53	CHI
2020031633	INHUMAS	10026494467	INHUMAS S2	01/03/2020 12:35	01/03/2020 15:34	01/03/2020 12:35	01/03/2020 15:34	2,97	1	2,97	CHI
2020031635	GOIANIA	14107922	MEIA PONTE	01/03/2020 12:36	01/03/2020 14:35	01/03/2020 12:36	01/03/2020 14:35	1,98	1	1,98	CHI
2020031636	EDEALINA	EA12257919RE	EDEIA	01/03/2020 11:47	01/03/2020 14:41	01/03/2020 11:47	01/03/2020 14:41	2,89	1	2,89	CHI
2020031636	EDEIA	EA12257919RE	EDEIA	01/03/2020 11:47	01/03/2020 14:41	01/03/2020 11:47	01/03/2020 14:41	2,89	46	132,71	CHI
2020031639	MORRINHOS	MR12000033	MORRINHOS	01/03/2020 10:34	01/03/2020 14:36	01/03/2020 10:34	01/03/2020 14:36	4,03	191	769,78	CHI
2020031641	PARAUNA	PU12388915	PARAUNA	01/03/2020 12:38	01/03/2020 18:23	01/03/2020 12:38	01/03/2020 18:23	5,74	3	17,21	CHI

2020031646	BALIZA	BM12390150	BOM JARDIM	01/03/2020 17:07	02/03/2020 04:08	01/03/2020 17:07	02/03/2020 04:08	11,00	51	561,23	CHI
2020031646	BOM JARDIM DE GOIAS	BM12390150	BOM JARDIM	01/03/2020 17:07	02/03/2020 04:08	01/03/2020 17:07	02/03/2020 04:08	11,00	9	99,04	CHI
2020031647	VIANOPOLIS	VN12107887	VIANOPOLIS	01/03/2020 12:40	01/03/2020 20:44	01/03/2020 12:40	01/03/2020 20:44	8,07	10	80,65	CHI
2020031649	GUARINOS	SG12363548	SANTA TEREZINHA	01/03/2020 12:41	01/03/2020 16:44	01/03/2020 12:41	01/03/2020 16:44	4,05	3	12,15	CHI
2020031655	ITARUMA	2310004840	CACHOEIRA ALTA	01/03/2020 12:44	01/03/2020 15:15	01/03/2020 12:44	01/03/2020 15:15	2,52	1	2,52	CHI
2020031656	CALDAS NOVAS	RQ12063069	VILA CORUMBA	01/03/2020 06:56	01/03/2020 18:05	01/03/2020 06:56	01/03/2020 18:05	11,14	8	89,13	CHI
2020031659	RIO VERDE	RV21289520	ACREUNA	01/03/2020 12:45	02/03/2020 08:55	01/03/2020 12:45	02/03/2020 08:55	20,16	1	20,16	CHI
2020031666	SANTA HELENA DE GOIAS	SH12038291	RIO DOS BOIS	01/03/2020 08:22	01/03/2020 15:37	01/03/2020 08:22	01/03/2020 15:37	7,25	6	43,48	CHI
2020031666	TURVELANDIA	SH12038291	RIO DOS BOIS	01/03/2020 08:22	01/03/2020 15:37	01/03/2020 08:22	01/03/2020 15:37	7,25	5	36,24	CHI
2020031668	CIDADE OCIDENTAL	10005934182	MARAJOARA	01/03/2020 12:49	01/03/2020 16:22	01/03/2020 12:49	01/03/2020 16:22	3,54	1	3,54	CHI
2020031673	MONTE ALEGRE DE GOIAS	MA21214775	SAO DOMINGOS	01/03/2020 12:51	01/03/2020 16:12	01/03/2020 12:51	01/03/2020 16:12	3,35	1	3,35	CHI
2020031675	CAVALCANTE	CJ11384716	SAO DOMINGOS	01/03/2020 12:52	01/03/2020 16:37	01/03/2020 12:52	01/03/2020 16:37	3,74	1	3,74	CHI
2020031684	CIDADE OCIDENTAL	2680053613	MARAJOARA	01/03/2020 12:56	01/03/2020 14:28	01/03/2020 12:56	01/03/2020 14:28	1,52	1	1,52	CHI
2020031685	PETROLINA DE GOIAS	PG12017216	PETROLINA	01/03/2020 12:56	01/03/2020 18:06	01/03/2020 12:56	01/03/2020 18:06	5,16	66	340,27	CHI
2020031687	PLANALTINA	2960065706	PLANALTINA	01/03/2020 12:57	01/03/2020 13:35	01/03/2020 12:57	01/03/2020 13:35	0,63	1	0,63	CHI
2020031688	ANAPOLIS	20783358	ANAPOLIS UNIVERSITARIO S2	01/03/2020 12:57	01/03/2020 17:36	01/03/2020 12:57	01/03/2020 17:36	4,64	1	4,64	CHI
2020031695	URUACU	640013259	URUACU	01/03/2020 13:01	01/03/2020 15:25	01/03/2020 13:01	01/03/2020 15:25	2,40	1	2,40	CHI
2020031697	NOVO BRASIL	NB12113789	JUSSARA	01/03/2020 13:02	02/03/2020 00:32	01/03/2020 13:02	02/03/2020 00:32	11,50	1	11,50	CHI
2020031698	AGUAS LINDAS DE GOIAS	4830024083	AGUAS LINDAS DE GOIAS S2	01/03/2020 13:02	01/03/2020 15:41	01/03/2020 13:02	01/03/2020 15:41	2,64	1	2,64	CHI
2020031704	SAO MIGUEL DO ARAGUAIA	SM12039297	SAO MIGUEL DO ARAGUAIA	01/03/2020 13:07	02/03/2020 11:26	01/03/2020 13:07	02/03/2020 11:26	22,31	1	22,31	CHI
2020031705	GUARINOS	GF12164872	SANTA TEREZINHA	01/03/2020 13:07	01/03/2020 22:20	01/03/2020 13:07	01/03/2020 22:20	9,20	6	55,21	CHI
2020031708	PARAUNA	PU21133296	FIRMINOPOLIS S2	01/03/2020 13:10	02/03/2020 11:29	01/03/2020 13:10	02/03/2020 11:29	22,32	2	44,63	CHI
2020031709	RIO VERDE	630035945	RIO VERDE S2	01/03/2020 13:09	01/03/2020 21:29	01/03/2020 13:09	01/03/2020 21:29	8,32	1	8,32	CHI
2020031710	NIQUELANDIA	NQ12268706	NIQUELANDIA SUBTRANSMISSAO	01/03/2020 13:10	01/03/2020 19:39	01/03/2020 13:10	01/03/2020 19:39	6,47	1	6,47	CHI
2020031712	GOIAS	90073745	MATRINCHA	01/03/2020 13:10	01/03/2020 17:06	01/03/2020 13:10	01/03/2020 17:06	3,93	1	3,93	CHI
2020031715	CUMARI	CY21377056	CATALAO S1	01/03/2020 13:11	01/03/2020 16:54	01/03/2020 13:11	01/03/2020 16:54	3,71	1	3,71	CHI
2020031723	PIRACANJUBA	10001563015	PIRACANJUBA	01/03/2020 13:14	01/03/2020 21:35	01/03/2020 13:14	01/03/2020 21:35	8,35	1	8,35	CHI
2020031724	JATAI	JT12072680	JATAI S1	01/03/2020 13:14	01/03/2020 16:11	01/03/2020 13:14	01/03/2020 16:11	2,94	15	44,05	CHI
2020031730	APARECIDA DE GOIANIA	16820745	ATLANTICO S3	01/03/2020 13:16	01/03/2020 14:38	01/03/2020 13:16	01/03/2020 14:38	1,36	1	1,36	CHI
2020031732	CAMPOS VERDES	VD12049799	SANTA TEREZINHA	01/03/2020 12:45	01/03/2020 23:28	01/03/2020 12:45	01/03/2020 23:28	10,71	18	192,84	CHI
2020031732	CAMPOS VERDES	7118331	SANTA TEREZINHA	01/03/2020 12:45	01/03/2020 23:28	01/03/2020 12:45	01/03/2020 23:28	10,71	3	32,14	CHI
2020031732	PILAR DE GOIAS	7118331	SANTA TEREZINHA	01/03/2020 12:45	01/03/2020 23:28	01/03/2020 12:45	01/03/2020 23:28	10,71	6	64,28	CHI
2020031732	SANTA TEREZINHA DE GOIAS	7118331	SANTA TEREZINHA	01/03/2020 12:45	01/03/2020 23:28	01/03/2020 12:45	01/03/2020 23:28	10,71	3	32,14	CHI
2020031742	HIDROLANDIA	HD21240506	PONTALINA	01/03/2020 13:20	01/03/2020 20:07	01/03/2020 13:20	01/03/2020 20:07	6,77	1	6,77	CHI
2020031747	PIRACANJUBA	PJ21372887	PIRACANJUBA	01/03/2020 13:23	01/03/2020 17:11	01/03/2020 13:23	01/03/2020 17:11	3,80	1	3,80	CHI
2020031750	FAINA	FC12204586	GOIAS	01/03/2020 12:22	01/03/2020 17:20	01/03/2020 12:22	01/03/2020 17:20	4,96	3	14,88	CHI
2020031755	CAMPINACU	01120518	MARA ROSA	01/03/2020 13:14	01/03/2020 16:14	01/03/2020 13:14	01/03/2020 14:00	0,77	11	8,44	CHI
2020031755	CAMPINACU	01120518	MARA ROSA	01/03/2020 13:14	01/03/2020 16:14	01/03/2020 13:14	01/03/2020 14:00	0,77	281	215,59	CHI
2020031755	CAMPINORTE	01120518	MARA ROSA	01/03/2020 13:14	01/03/2020 16:14	01/03/2020 13:14	01/03/2020 14:00	0,77	283	217,12	CHI
2020031755	CAMPINORTE	01120518	MARA ROSA	01/03/2020 13:14	01/03/2020 16:14	01/03/2020 13:14	01/03/2020 14:00	0,77	200	153,44	CHI
2020031755	CAMPINORTE	01120518	MARA ROSA	01/03/2020 13:14	01/03/2020 16:14	01/03/2020 13:14	01/03/2020 14:00	0,77	2	1,53	CHI
2020031755	ESTRELA DO NORTE	01120518	MARA ROSA	01/03/2020 13:14	01/03/2020 16:14	01/03/2020 13:14	01/03/2020 14:00	0,77	17	13,04	CHI
2020031755	FORMOSO	01120518	MARA ROSA	01/03/2020 13:14	01/03/2020 16:14	01/03/2020 13:14	01/03/2020 14:00	0,77	3	2,30	CHI
2020031755	MARA ROSA	01120518	MARA ROSA	01/03/2020 13:14	01/03/2020 16:14	01/03/2020 13:14	01/03/2020 14:00	0,77	10	7,67	CHI

2020031755	MARA ROSA	01120518	MARA ROSA	01/03/2020 13:14	01/03/2020 16:14	01/03/2020 13:14	01/03/2020 14:00	0,77	73	56,01	CHI
2020031755	MARA ROSA	01120518	MARA ROSA	01/03/2020 13:14	01/03/2020 16:14	01/03/2020 13:14	01/03/2020 14:00	0,77	2	1,53	CHI
2020031755	URUACU	01120518	MARA ROSA	01/03/2020 13:14	01/03/2020 16:14	01/03/2020 13:14	01/03/2020 14:00	0,77	1	0,77	CHI
2020031755	URUACU	01120518	MARA ROSA	01/03/2020 13:14	01/03/2020 16:14	01/03/2020 13:14	01/03/2020 14:00	0,77	373	286,17	CHI
2020031755	URUACU	01120518	MARA ROSA	01/03/2020 13:14	01/03/2020 16:14	01/03/2020 13:14	01/03/2020 14:00	0,77	5	3,84	CHI
2020031755	CAMPINORTE	CR10404187	MARA ROSA	01/03/2020 13:14	01/03/2020 16:14	01/03/2020 13:30	01/03/2020 15:42	2,19	137	299,76	CHI
2020031755	MARA ROSA	CR10404187	MARA ROSA	01/03/2020 13:14	01/03/2020 16:14	01/03/2020 13:30	01/03/2020 15:42	2,19	6	13,13	CHI
2020031755	NOVA IGUACU DE GOIAS	CR10404187	MARA ROSA	01/03/2020 13:14	01/03/2020 16:14	01/03/2020 13:30	01/03/2020 15:42	2,19	15	32,82	CHI
2020031755	CAMPINORTE	01120214	MARA ROSA	01/03/2020 13:14	01/03/2020 16:14	01/03/2020 13:14	01/03/2020 15:56	2,71	34	92,20	CHI
2020031755	ESTRELA DO NORTE	01120214	MARA ROSA	01/03/2020 13:14	01/03/2020 16:14	01/03/2020 13:14	01/03/2020 15:56	2,71	7	18,98	CHI
2020031755	MARA ROSA	01120214	MARA ROSA	01/03/2020 13:14	01/03/2020 16:14	01/03/2020 13:14	01/03/2020 15:56	2,71	3957	10730,07	CHI
2020031755	ALTO HORIZONTE	MQ10403947	MARA ROSA	01/03/2020 13:14	01/03/2020 16:14	01/03/2020 13:30	01/03/2020 16:14	2,72	3	8,16	CHI
2020031755	AMARALINA	MQ10403947	MARA ROSA	01/03/2020 13:14	01/03/2020 16:14	01/03/2020 13:30	01/03/2020 16:14	2,72	1055	2869,89	CHI
2020031755	MARA ROSA	MQ10403947	MARA ROSA	01/03/2020 13:14	01/03/2020 16:14	01/03/2020 13:30	01/03/2020 16:14	2,72	371	1009,22	CHI
2020031755	MUTUNOPOLIS	MQ10403947	MARA ROSA	01/03/2020 13:14	01/03/2020 16:14	01/03/2020 13:30	01/03/2020 16:14	2,72	2	5,44	CHI
2020031760	CRISTALINA	KR12304800	CRISTALINA S2	01/03/2020 13:26	01/03/2020 15:05	01/03/2020 13:26	01/03/2020 15:05	1,63	66	107,85	CHI
2020031770	PADRE BERNARDO	PB12376763	PADRE BERNARDO	01/03/2020 13:29	01/03/2020 16:46	01/03/2020 13:29	01/03/2020 16:46	3,27	12	39,29	CHI
2020031775	NIQUELANDIA	NQ12262921	BARRO ALTO	01/03/2020 13:30	01/03/2020 16:53	01/03/2020 13:30	01/03/2020 16:53	3,39	6	20,35	CHI
2020031776	CRISTALINA	1060042815	CRISTALINA S1	01/03/2020 13:30	01/03/2020 15:07	01/03/2020 13:30	01/03/2020 15:07	1,61	1	1,61	CHI
2020031782	QUIRINOPOLIS	QI11380623	QUIRINOPOLIS	01/03/2020 13:12	01/03/2020 15:26	01/03/2020 13:12	01/03/2020 15:26	2,23	89	198,42	CHI
2020031791	ITAPIRAPUA	1420028343	MATRINCHA	01/03/2020 13:36	01/03/2020 16:50	01/03/2020 13:36	01/03/2020 16:50	3,24	1	3,24	CHI
2020031801	ITAJA	IJ21122571	ITAJA S2	01/03/2020 13:38	01/03/2020 14:57	01/03/2020 13:38	01/03/2020 14:57	1,31	1	1,31	CHI
2020031803	ANAPOLIS	AN11388780	JUNDIAI S2	01/03/2020 13:38	01/03/2020 17:59	01/03/2020 13:38	01/03/2020 17:59	4,35	50	217,36	CHI
2020031814	VICENTINOPOLIS	VI12218178	VICENTINOPOLIS	01/03/2020 13:41	02/03/2020 07:18	01/03/2020 13:41	02/03/2020 07:18	17,63	1	17,63	CHI
2020031816	MINEIROS	1390086425	PARQUE DAS EMAS	01/03/2020 13:42	01/03/2020 16:29	01/03/2020 13:42	01/03/2020 16:29	2,79	1	2,79	CHI
2020031824	ALEXANIA	AX10403918	ALEXANIA	01/03/2020 13:38	01/03/2020 17:08	01/03/2020 13:38	01/03/2020 13:41	0,06	978	55,69	CHI
2020031824	ALEXANIA	AX10403918	ALEXANIA	01/03/2020 13:38	01/03/2020 17:08	01/03/2020 13:38	01/03/2020 17:08	3,50	1517	5312,87	CHI
2020031824	SANTO ANTONIO DO DESCOBERTO	AX10403918	ALEXANIA	01/03/2020 13:38	01/03/2020 17:08	01/03/2020 13:38	01/03/2020 17:08	3,50	1	3,50	CHI
2020031825	ITAPURANGA	IK12000010	ITAPURANGA	01/03/2020 13:44	01/03/2020 14:29	01/03/2020 13:44	01/03/2020 14:29	0,74	187	138,17	CHI
2020031832	AGUAS LINDAS DE GOIAS	4830078766	AGUAS LINDAS DE GOIAS S1	01/03/2020 13:46	01/03/2020 15:03	01/03/2020 13:46	01/03/2020 15:03	1,28	1	1,28	CHI
2020031833	GOIANIA	15698166	CAMPINAS S2	01/03/2020 13:46	01/03/2020 15:34	01/03/2020 13:46	01/03/2020 15:34	1,78	1	1,78	CHI
2020031838	PIRES DO RIO	PR21278099	PIRES DO RIO S1	01/03/2020 13:48	01/03/2020 22:40	01/03/2020 13:48	01/03/2020 22:40	8,86	1	8,86	CHI
2020031839	AURILANDIA	AI21019757	FIRMINOPOLIS S2	01/03/2020 13:48	01/03/2020 18:57	01/03/2020 13:48	01/03/2020 18:57	5,14	1	5,14	CHI
2020031854	GAMELEIRA DE GOIAS	AN12390320	DAIA S1	01/03/2020 13:52	01/03/2020 15:35	01/03/2020 13:52	01/03/2020 15:35	1,70	1	1,70	CHI
2020031863	GOIANIA	GN12000394	CAMPINAS S3	01/03/2020 13:55	01/03/2020 18:29	01/03/2020 13:55	01/03/2020 16:17	2,36	58	137,07	CHI
2020031863	GOIANIA	GN12000394	CAMPINAS S3	01/03/2020 13:55	01/03/2020 18:29	01/03/2020 13:55	01/03/2020 18:29	4,57	54	246,58	CHI
2020031866	GOUVELANDIA	GB12144239	QUIRINOPOLIS	01/03/2020 13:56	01/03/2020 16:44	01/03/2020 13:56	01/03/2020 16:44	2,79	6	16,72	CHI
2020031869	DAMIANOPOLIS	DA12060858	IACIARA S2	01/03/2020 13:57	01/03/2020 14:02	01/03/2020 13:57	01/03/2020 14:02	0,08	2	0,15	CHI
2020031880	NEROPOLIS	NR12329594	NEROPOLIS S2	01/03/2020 13:59	01/03/2020 17:15	01/03/2020 13:59	01/03/2020 15:43	1,74	72	125,10	CHI
2020031880	NEROPOLIS	NR12349577LD	NEROPOLIS S2	01/03/2020 13:59	01/03/2020 17:15	01/03/2020 13:59	01/03/2020 17:15	3,27	979	3205,14	CHI
2020031881	APARECIDA DE GOIANIA	15084048	INDEPENDENCIA S1	01/03/2020 13:59	01/03/2020 14:46	01/03/2020 13:59	01/03/2020 14:46	0,78	1	0,78	CHI
2020031884	COLINAS DO SUL	TI21196544	MINACU	01/03/2020 14:00	01/03/2020 14:59	01/03/2020 14:00	01/03/2020 14:59	0,98	1	0,98	CHI
2020031888	GOIANIA	GN11097479	CAMPINAS S3	01/03/2020 14:00	01/03/2020 17:32	01/03/2020 14:00	01/03/2020 17:32	3,52	57	200,59	CHI
2020031897	CACU	CC12000088	CACHOEIRA ALTA	01/03/2020 12:07	01/03/2020 15:06	01/03/2020 12:07	01/03/2020 15:06	2,97	84	249,85	CHI

2020031901	GOIANIA	GN12043328	ATLANTICO S2	01/03/2020 14:04	01/03/2020 15:40	01/03/2020 14:04	01/03/2020 15:40	1,59	364	578,86	CHI
2020031903	BELA VISTA DE GOIAS	BV12010770	BELA VISTA S1	01/03/2020 14:06	01/03/2020 15:47	01/03/2020 14:06	01/03/2020 15:47	1,68	2	3,37	CHI
2020031904	NOVO PLANALTO	TA12192346	SAO MIGUEL DO ARAGUAIA	01/03/2020 14:03	02/03/2020 12:34	01/03/2020 14:03	01/03/2020 20:53	6,83	4	27,32	CHI
2020031904	NOVO PLANALTO	TA12192349LD	SAO MIGUEL DO ARAGUAIA	01/03/2020 14:03	02/03/2020 12:34	01/03/2020 14:03	01/03/2020 21:56	7,88	22	173,37	CHI
2020031904	NOVO PLANALTO	TA12293657	SAO MIGUEL DO ARAGUAIA	01/03/2020 14:03	02/03/2020 12:34	01/03/2020 14:03	01/03/2020 23:04	9,02	59	532,29	CHI
2020031904	NOVO PLANALTO	TA12293705	SAO MIGUEL DO ARAGUAIA	01/03/2020 14:03	02/03/2020 12:34	01/03/2020 14:03	02/03/2020 12:34	22,52	16	360,29	CHI
2020031907	GOIANIA	GN12001697	AEROPORTO S2	01/03/2020 14:08	01/03/2020 15:46	01/03/2020 14:08	01/03/2020 15:46	1,63	460	750,57	CHI
2020031910	AURILANDIA	AI12377180	FIRMINOPOLIS S2	01/03/2020 08:41	01/03/2020 17:58	01/03/2020 08:41	01/03/2020 17:58	9,28	6	55,67	CHI
2020031914	GOIANIA	GN12215900	GOIANIA LESTE S2	01/03/2020 14:10	01/03/2020 15:22	01/03/2020 14:10	01/03/2020 15:22	1,19	96	114,21	CHI
2020031919	GOIAS	GS21244019	GOIAS	01/03/2020 14:11	01/03/2020 18:17	01/03/2020 14:11	01/03/2020 18:17	4,10	1	4,10	CHI
2020031921	IPAMERI	IP12079464	CAMPO ALEGRE DE GOIAS	01/03/2020 14:11	01/03/2020 20:27	01/03/2020 14:11	01/03/2020 20:27	6,25	4	25,02	CHI
2020031924	VILA PROPICIO	NP12188681	GOIANESIA S1	01/03/2020 13:55	01/03/2020 17:25	01/03/2020 13:55	01/03/2020 17:25	3,50	87	304,28	CHI
2020031930	GOIANIA	10063950	CAMPINAS S3	01/03/2020 14:16	01/03/2020 17:20	01/03/2020 14:16	01/03/2020 17:20	3,05	1	3,05	CHI
2020031931	HIDROLANDIA	HD11275661	CEPAIGO S2	01/03/2020 14:17	01/03/2020 18:01	01/03/2020 14:17	01/03/2020 18:01	3,72	8	29,77	CHI
2020031932	OUIDOR	OU11215734	CATALAO S1	01/03/2020 14:17	01/03/2020 16:25	01/03/2020 14:17	01/03/2020 16:25	2,12	105	222,51	CHI
2020031933	GOIANIA	GN11238122	GOIANIA LESTE S2	01/03/2020 14:18	01/03/2020 15:45	01/03/2020 14:18	01/03/2020 15:45	1,44	83	119,89	CHI
2020031938	GOIANDIRA	CT21215587	CATALAO S1	01/03/2020 14:19	01/03/2020 18:32	01/03/2020 14:19	01/03/2020 18:32	4,21	1	4,21	CHI
2020031942	PLANALTINA	PI12248193	PLANALTINA	01/03/2020 14:19	01/03/2020 16:27	01/03/2020 14:19	01/03/2020 16:27	2,12	4	8,49	CHI
2020031945	ITAPACI	IW21079707	ITAPACI	01/03/2020 14:21	01/03/2020 17:45	01/03/2020 14:21	01/03/2020 17:45	3,39	1	3,39	CHI
2020031955	BRITANIA	BT21101442	BRITANIA	01/03/2020 14:27	01/03/2020 17:10	01/03/2020 14:27	01/03/2020 17:10	2,71	1	2,71	CHI
2020031958	AMORINOPOLIS	AM12362188	IPORA	01/03/2020 14:29	02/03/2020 02:29	01/03/2020 14:29	02/03/2020 02:29	11,98	4	47,94	CHI
2020031963	COCALZINHO DE GOIAS	ZN12302401	COCALZINHO	01/03/2020 13:43	01/03/2020 16:48	01/03/2020 13:43	01/03/2020 16:48	3,08	4	12,30	CHI
2020031963	CORUMBA DE GOIAS	ZN12302401	COCALZINHO	01/03/2020 13:43	01/03/2020 16:48	01/03/2020 13:43	01/03/2020 16:48	3,08	22	67,67	CHI
2020031975	MINEIROS	MY12274044	PARQUE DAS EMAS	01/03/2020 14:42	01/03/2020 20:30	01/03/2020 14:42	01/03/2020 20:30	5,79	2	11,58	CHI
2020031984	CATALAO	10007782975	CATALAO S2	01/03/2020 14:47	01/03/2020 16:00	01/03/2020 14:47	01/03/2020 16:00	1,22	1	1,22	CHI
2020031986	GOIANIA	GN11002633	AEROPORTO S1	01/03/2020 14:47	01/03/2020 17:30	01/03/2020 14:47	01/03/2020 15:20	0,54	63	34,14	CHI
2020031986	GOIANIA	GN11001960	AEROPORTO S1	01/03/2020 14:47	01/03/2020 17:30	01/03/2020 15:40	01/03/2020 17:30	1,82	31	56,45	CHI
2020031987	JAUPACI	JP12358470	IPORA	01/03/2020 14:47	02/03/2020 10:21	01/03/2020 14:47	02/03/2020 10:21	19,55	7	136,88	CHI
2020031990	CAIAPONIA	CP21381069	CAIAPONIA	01/03/2020 14:50	02/03/2020 00:19	01/03/2020 14:50	02/03/2020 00:19	9,48	1	9,48	CHI
2020031993	ANICUNS	910051938	ANICUNS	01/03/2020 14:51	01/03/2020 16:33	01/03/2020 14:51	01/03/2020 16:33	1,70	1	1,70	CHI
2020031998	VALPARAISO DE GOIAS	2860259059	PACAEMBU S2	01/03/2020 14:52	01/03/2020 16:48	01/03/2020 14:52	01/03/2020 16:48	1,93	1	1,93	CHI
2020032000	EDEALINA	ED21108473	EDEIA	01/03/2020 14:53	01/03/2020 20:23	01/03/2020 14:53	01/03/2020 20:23	5,50	1	5,50	CHI
2020032006	MONTIVIDIU	MV2121075459	MONTIVIDIU T	01/03/2020 14:54	02/03/2020 01:00	01/03/2020 14:54	02/03/2020 01:00	10,09	2	20,18	CHI
2020032008	BONOPOLIS	BX12202590	SAO MIGUEL DO ARAGUAIA	01/03/2020 14:38	01/03/2020 22:03	01/03/2020 14:38	01/03/2020 22:03	7,42	11	81,58	CHI
2020032012	MIMOSO DE GOIAS	MJ18376711TS	PADRE BERNARDO	01/03/2020 14:57	01/03/2020 16:45	01/03/2020 14:57	01/03/2020 16:45	1,80	372	669,08	CHI
2020032012	NIQUELANDIA	MJ18376711TS	PADRE BERNARDO	01/03/2020 14:57	01/03/2020 16:45	01/03/2020 14:57	01/03/2020 16:45	1,80	1	1,80	CHI
2020032013	AGUAS LINDAS DE GOIAS	LA11376792	AGUAS LINDAS DE GOIAS S1	01/03/2020 14:57	01/03/2020 18:02	01/03/2020 16:20	01/03/2020 18:02	1,70	97	164,42	CHI
2020032015	RIO VERDE	RV21213756	CABRIUVA S2	01/03/2020 14:57	01/03/2020 18:52	01/03/2020 14:57	01/03/2020 18:52	3,91	1	3,91	CHI
2020032016	LUZIANIA	10011348826	RIO VERMELHO	01/03/2020 14:57	01/03/2020 16:15	01/03/2020 14:57	01/03/2020 16:15	1,29	1	1,29	CHI
2020032017	SANTO ANTONIO DO DESCOBERTO	SN12382967	MARAJOARA	01/03/2020 14:58	03/03/2020 12:19	01/03/2020 14:58	01/03/2020 19:18	4,33	8	34,67	CHI
2020032017	SANTO ANTONIO DO DESCOBERTO	SN12075362LD	MARAJOARA	01/03/2020 14:58	03/03/2020 12:19	01/03/2020 14:58	01/03/2020 21:30	6,54	4	26,16	CHI
2020032017	SANTO ANTONIO DO DESCOBERTO	SN12382967	MARAJOARA	01/03/2020 14:58	03/03/2020 12:19	01/03/2020 22:43	01/03/2020 23:05	0,37	12	4,41	CHI
2020032017	SANTO ANTONIO DO DESCOBERTO	SN12382967	MARAJOARA	01/03/2020 14:58	03/03/2020 12:19	02/03/2020 11:10	02/03/2020 11:37	0,46	12	5,48	CHI
2020032017	ALEXANIA	SN12094510LD	MARAJOARA	01/03/2020 14:58	03/03/2020 12:19	01/03/2020 14:58	02/03/2020 12:45	21,78	1	21,78	CHI

2020032017	SANTO ANTONIO DO DESCOBERTO	SN12094510LD	MARAJOARA	01/03/2020 14:58	03/03/2020 12:19	01/03/2020 14:58	02/03/2020 12:45	21,78	4	87,13	CHI
2020032017	ALEXANIA	SN12382967	MARAJOARA	01/03/2020 14:58	03/03/2020 12:19	02/03/2020 15:28	02/03/2020 18:40	3,21	1	3,21	CHI
2020032017	SANTO ANTONIO DO DESCOBERTO	SN12382967	MARAJOARA	01/03/2020 14:58	03/03/2020 12:19	02/03/2020 15:28	02/03/2020 18:40	3,21	14	44,94	CHI
2020032017	ALEXANIA	SN13286432	MARAJOARA	01/03/2020 14:58	03/03/2020 12:19	02/03/2020 15:28	02/03/2020 18:40	3,20	4	12,80	CHI
2020032017	DISTRITO FEDERAL	SN13286432	MARAJOARA	01/03/2020 14:58	03/03/2020 12:19	02/03/2020 15:28	02/03/2020 18:40	3,20	3	9,60	CHI
2020032017	SANTO ANTONIO DO DESCOBERTO	SN13286432	MARAJOARA	01/03/2020 14:58	03/03/2020 12:19	02/03/2020 15:28	02/03/2020 18:40	3,20	495	1583,86	CHI
2020032017	SANTO ANTONIO DO DESCOBERTO	AX21075359	MARAJOARA	01/03/2020 14:58	03/03/2020 12:19	02/03/2020 12:48	03/03/2020 11:36	22,80	1	22,80	CHI
2020032017	SANTO ANTONIO DO DESCOBERTO	AX21075360	MARAJOARA	01/03/2020 14:58	03/03/2020 12:19	02/03/2020 12:48	03/03/2020 12:19	23,51	1	23,51	CHI
2020032021	TURVELANDIA	TD12213335	RIO DOS BOIS	01/03/2020 09:49	01/03/2020 16:50	01/03/2020 09:49	01/03/2020 16:50	7,00	2	14,00	CHI
2020032023	BOM JESUS DE GOIAS	BJ21205362	RIO DOS BOIS	01/03/2020 15:00	01/03/2020 17:49	01/03/2020 15:00	01/03/2020 17:49	2,80	2	5,61	CHI
2020032024	GOIANIA	GN11340638	AEROPORTO S3	01/03/2020 14:20	01/03/2020 16:59	01/03/2020 14:20	01/03/2020 16:59	2,64	106	279,99	CHI
2020032030	GOIANIA	GN11227525	ATLANTICO S2	01/03/2020 14:04	01/03/2020 16:25	01/03/2020 14:04	01/03/2020 16:25	2,34	11	25,74	CHI
2020032032	JATAI	JT12182190	JATAI S1	01/03/2020 15:03	01/03/2020 17:55	01/03/2020 15:03	01/03/2020 17:55	2,85	25	71,26	CHI
2020032035	FLORES DE GOIAS	3480010098	FLORES DE GOIAS	01/03/2020 15:07	01/03/2020 16:58	01/03/2020 15:07	01/03/2020 16:58	1,84	1	1,84	CHI
2020032036	PIRANHAS	PH12204954	PIRANHAS	01/03/2020 15:07	02/03/2020 23:53	01/03/2020 15:07	02/03/2020 23:53	32,76	1	32,76	CHI
2020032037	GOIANIA	GN11202314	AEROPORTO S3	01/03/2020 15:02	01/03/2020 17:21	01/03/2020 15:02	01/03/2020 17:21	2,31	90	207,92	CHI
2020032038	MUTUNOPOLIS	MU12060992	MARA ROSA	01/03/2020 15:09	01/03/2020 21:07	01/03/2020 15:09	01/03/2020 21:07	5,96	3	17,89	CHI
2020032044	SANTA TEREZINHA DE GOIAS	2480021677	SANTA TEREZINHA	01/03/2020 15:12	01/03/2020 17:59	01/03/2020 15:12	01/03/2020 17:59	2,77	1	2,77	CHI
2020032045	PLANALTINA	10025153569	PLANALTINA	01/03/2020 15:14	01/03/2020 17:01	01/03/2020 15:14	01/03/2020 17:01	1,78	1	1,78	CHI
2020032046	EDEIA	EA21084020	EDEIA	01/03/2020 15:14	01/03/2020 21:11	01/03/2020 15:14	01/03/2020 21:11	5,94	1	5,94	CHI
2020032048	PIRENOPOLIS	PV12392222	CORUMBA	01/03/2020 12:43	01/03/2020 16:47	01/03/2020 12:43	01/03/2020 16:47	4,05	10	40,50	CHI
2020032049	AGUAS LINDAS DE GOIAS	LA12044225	AGUAS LINDAS DE GOIAS S2	01/03/2020 15:15	01/03/2020 16:26	01/03/2020 15:15	01/03/2020 16:26	1,18	60	70,72	CHI
2020032050	SANTO ANTONIO DO DESCOBERTO	10011582098	ALEXANIA	01/03/2020 15:15	01/03/2020 16:45	01/03/2020 15:15	01/03/2020 16:45	1,49	1	1,49	CHI
2020032051	GOIANIA	GN11047721	ATLANTICO S2	01/03/2020 14:00	01/03/2020 17:54	01/03/2020 14:00	01/03/2020 17:54	3,89	53	205,95	CHI
2020032053	CACHOEIRA ALTA	CA21327438	CACHOEIRA ALTA	01/03/2020 15:17	01/03/2020 20:00	01/03/2020 15:17	01/03/2020 20:00	4,71	1	4,71	CHI
2020032055	SAO LUIS DE MONTES BELOS	SL12395108	FIRMINOPOLIS S1	01/03/2020 15:20	01/03/2020 18:13	01/03/2020 15:20	01/03/2020 18:13	2,88	2	5,77	CHI
2020032056	MINEIROS	MY12360756	PARQUE DAS EMAS	01/03/2020 15:20	01/03/2020 18:10	01/03/2020 15:20	01/03/2020 18:10	2,83	6	16,96	CHI
2020032059	BELA VISTA DE GOIAS	BV12030209	BELA VISTA S1	01/03/2020 15:20	01/03/2020 16:56	01/03/2020 15:20	01/03/2020 16:56	1,58	5	7,92	CHI
2020032060	GOIANIA	10739476	CAMPINAS S1	01/03/2020 15:21	01/03/2020 16:40	01/03/2020 15:21	01/03/2020 16:40	1,32	1	1,32	CHI
2020032062	PORANGATU	PO21192332	PORANGATU	01/03/2020 15:22	01/03/2020 21:18	01/03/2020 15:22	01/03/2020 21:18	5,93	1	5,93	CHI
2020032064	GOIANIA	GN11138192	ATLANTICO S1	01/03/2020 15:22	01/03/2020 17:45	01/03/2020 15:22	01/03/2020 17:45	2,37	19	45,06	CHI
2020032066	GOIAS	GS12206865	MATRINCHA	01/03/2020 15:24	01/03/2020 19:08	01/03/2020 15:24	01/03/2020 19:08	3,73	69	257,47	CHI
2020032070	GOIANIA	GN11291663	AEROPORTO S2	01/03/2020 14:54	01/03/2020 18:41	01/03/2020 14:54	01/03/2020 18:41	3,78	93	351,69	CHI
2020032076	ORIZONA	OZ21114456	PIRES DO RIO S2	01/03/2020 15:29	01/03/2020 17:18	01/03/2020 15:29	01/03/2020 17:18	1,81	1	1,81	CHI
2020032077	GOIANIA	10013091130	MEIA PONTE	01/03/2020 15:29	01/03/2020 17:18	01/03/2020 15:29	01/03/2020 17:18	1,81	1	1,81	CHI
2020032080	ITABERAÍ	IB21016895	INHUMAS S1	01/03/2020 15:31	01/03/2020 17:14	01/03/2020 15:31	01/03/2020 17:14	1,71	1	1,71	CHI
2020032082	TRINDADE	TR12393570	GOIANIRA	01/03/2020 15:31	01/03/2020 16:22	01/03/2020 15:31	01/03/2020 16:22	0,84	12	10,12	CHI
2020032085	CORUMBAIBA	CI12263343	VILA CORUMBA	01/03/2020 15:32	01/03/2020 19:10	01/03/2020 15:32	01/03/2020 19:10	3,63	4	14,54	CHI
2020032086	RIO VERDE	RV12360681	MONTIVIDIU T	02/03/2020 09:37	02/03/2020 11:11	02/03/2020 09:37	02/03/2020 11:11	1,56	2	3,12	CHI
2020032090	ANAPOLIS	GP12382434	DAIA S2	01/03/2020 15:24	01/03/2020 18:06	01/03/2020 15:24	01/03/2020 18:06	2,70	9	24,29	CHI
2020032090	GOIANAPOLIS	GP12382434	DAIA S2	01/03/2020 15:24	01/03/2020 18:06	01/03/2020 15:24	01/03/2020 18:06	2,70	3	8,10	CHI
2020032090	LEOPOLDO DE BULHOES	GP12382434	DAIA S2	01/03/2020 15:24	01/03/2020 18:06	01/03/2020 15:24	01/03/2020 18:06	2,70	128	345,39	CHI
2020032092	IACIARA	IA21399314	IACIARA S1	01/03/2020 15:34	01/03/2020 23:20	01/03/2020 15:34	01/03/2020 23:20	7,76	1	7,76	CHI
2020032093	PIRACANJUBA	PJ12212173	PIRACANJUBA	01/03/2020 15:34	02/03/2020 08:03	01/03/2020 15:34	02/03/2020 08:03	16,48	19	313,09	CHI

2020032101	SILVANIA	SV12087628	DAIA S2	01/03/2020 15:36	01/03/2020 16:56	01/03/2020 15:36	01/03/2020 16:56	1,33	61	81,01	CHI
2020032103	LUZIANIA	LZ11183668	MARAJOARA	01/03/2020 15:36	01/03/2020 16:37	01/03/2020 15:36	01/03/2020 16:37	1,01	34	34,29	CHI
2020032104	CEZARINA	1650019352	CEZARINA	01/03/2020 15:36	01/03/2020 20:18	01/03/2020 15:36	01/03/2020 20:18	4,70	1	4,70	CHI
2020032105	ANAPOLIS	AN21297644	ANAPOLIS UNIVERSITARIO S2	01/03/2020 15:37	01/03/2020 19:00	01/03/2020 15:37	01/03/2020 19:00	3,38	1	3,38	CHI
2020032108	BRAZABRANTES	BR21096020	INHUMAS S1	01/03/2020 15:38	01/03/2020 17:22	01/03/2020 15:38	01/03/2020 17:22	1,73	1	1,73	CHI
2020032112	CACHOEIRA DOURADA	CD11273892	CACHOEIRA DOURADA	01/03/2020 15:38	01/03/2020 22:35	01/03/2020 15:38	01/03/2020 22:35	6,95	3	20,86	CHI
2020032114	MORRINHOS	MR11389892	MORRINHOS	01/03/2020 15:40	01/03/2020 22:06	01/03/2020 15:40	01/03/2020 22:06	6,43	82	527,42	CHI
2020032119	FORMOSA	610059427	ITUIQUIRA	01/03/2020 15:43	01/03/2020 17:53	01/03/2020 15:43	01/03/2020 17:53	2,16	1	2,16	CHI
2020032120	BURITI ALEGRE	BG12263593	ITUMBIARA VELHA S2	01/03/2020 15:43	02/03/2020 15:39	01/03/2020 15:43	02/03/2020 15:39	23,92	4	95,69	CHI
2020032124	ARAGARCAS	AG21184387	ARAGARCAS	01/03/2020 15:47	01/03/2020 23:46	01/03/2020 15:47	01/03/2020 23:46	7,98	5	39,88	CHI
2020032125	JATAI	JT11274027	JATAI S2	01/03/2020 15:33	01/03/2020 17:35	01/03/2020 15:33	01/03/2020 17:35	2,02	69	139,30	CHI
2020032133	BOM JARDIM DE GOIAS	BM11209244	BOM JARDIM	01/03/2020 15:51	02/03/2020 11:05	01/03/2020 15:51	02/03/2020 11:05	19,22	1	19,22	CHI
2020032136	GOIANIA	10003533504	CARAJAS S1	01/03/2020 15:52	01/03/2020 17:11	01/03/2020 15:52	01/03/2020 17:11	1,30	1	1,30	CHI
2020032138	FIRMINOPOLIS	FR21096754	FIRMINOPOLIS S1	01/03/2020 15:54	01/03/2020 17:02	01/03/2020 15:54	01/03/2020 17:02	1,13	1	1,13	CHI
2020032139	SILVANIA	SV21192043	VIANOPOLIS	01/03/2020 15:54	02/03/2020 08:05	01/03/2020 15:54	02/03/2020 08:05	16,17	1	16,17	CHI
2020032142	GAMELEIRA DE GOIAS	AN21335142	DAIA S1	01/03/2020 15:55	01/03/2020 18:23	01/03/2020 15:55	01/03/2020 18:23	2,47	1	2,47	CHI
2020032147	LUZIANIA	LZ11090113	RIO VERMELHO	01/03/2020 15:57	01/03/2020 17:50	01/03/2020 17:15	01/03/2020 17:50	0,58	136	78,99	CHI
2020032149	AURILANDIA	RP12304543	FIRMINOPOLIS S2	01/03/2020 13:48	02/03/2020 08:59	01/03/2020 13:48	02/03/2020 08:59	19,17	3	57,52	CHI
2020032149	PARAUNA	RP12304543	FIRMINOPOLIS S2	01/03/2020 13:48	02/03/2020 08:59	01/03/2020 13:48	02/03/2020 08:59	19,17	35	671,12	CHI
2020032154	VIANOPOLIS	VN12168187	VIANOPOLIS	01/03/2020 15:58	01/03/2020 19:14	01/03/2020 15:58	01/03/2020 19:14	3,25	13	42,26	CHI
2020032155	FORMOSA	610330603	ITUIQUIRA	01/03/2020 15:59	02/03/2020 00:17	01/03/2020 15:59	02/03/2020 00:17	8,30	1	8,30	CHI
2020032159	ITAGUARI	10019194844	ITABERA S1	01/03/2020 16:03	01/03/2020 17:20	01/03/2020 16:03	01/03/2020 17:20	1,28	1	1,28	CHI
2020032160	PALESTINA DE GOIAS	PY21139071	ARENOPOLIS	01/03/2020 16:03	02/03/2020 09:21	01/03/2020 16:03	02/03/2020 09:21	17,30	1	17,30	CHI
2020032164	PIRACANJUBA	BV12402760	BELA VISTA S1	01/03/2020 16:03	03/03/2020 12:12	01/03/2020 16:03	01/03/2020 23:58	7,91	4	31,62	CHI
2020032164	PIRACANJUBA	PJ12320313	BELA VISTA S1	01/03/2020 16:03	03/03/2020 12:12	01/03/2020 16:03	02/03/2020 01:14	9,18	4	36,72	CHI
2020032164	PIRACANJUBA	BV12402760	BELA VISTA S1	01/03/2020 16:03	03/03/2020 12:12	01/03/2020 16:03	03/03/2020 10:02	41,98	1	41,98	CHI
2020032164	PIRACANJUBA	BV12402760	BELA VISTA S1	01/03/2020 16:03	03/03/2020 12:12	01/03/2020 16:03	03/03/2020 11:12	43,15	1	43,15	CHI
2020032164	PIRACANJUBA	BV12402760	BELA VISTA S1	01/03/2020 16:03	03/03/2020 12:12	01/03/2020 16:03	03/03/2020 12:12	44,14	8	353,09	CHI
2020032164	PIRACANJUBA	BV12402760	BELA VISTA S1	01/03/2020 16:03	03/03/2020 12:12	02/03/2020 13:57	03/03/2020 12:12	22,24	8	177,96	CHI
2020032167	LUZIANIA	3200163481	MARAJOARA	01/03/2020 16:05	01/03/2020 17:35	01/03/2020 16:05	01/03/2020 17:35	1,50	1	1,50	CHI
2020032173	DIVINOPOLIS DE GOIAS	SD12233559	SAO DOMINGOS	01/03/2020 16:06	01/03/2020 18:44	01/03/2020 16:06	01/03/2020 18:44	2,62	14	36,65	CHI
2020032173	SAO DOMINGOS	SD12233559	SAO DOMINGOS	01/03/2020 16:06	01/03/2020 18:44	01/03/2020 16:06	01/03/2020 18:44	2,62	4	10,47	CHI
2020032176	GOIANIA	10018860220	MEIA PONTE	01/03/2020 16:09	01/03/2020 17:19	01/03/2020 16:09	01/03/2020 17:19	1,16	1	1,16	CHI
2020032177	RIO VERDE	630398197	RIO VERDE S1	01/03/2020 16:10	01/03/2020 22:47	01/03/2020 16:10	01/03/2020 22:47	6,61	1	6,61	CHI
2020032181	AGUA LIMPA	RQ12050878	VILA CORUMBA	01/03/2020 09:34	01/03/2020 20:08	01/03/2020 09:34	01/03/2020 20:08	10,55	3	31,66	CHI
2020032183	MINEIROS	MY21234368	PARQUE DAS EMAS	01/03/2020 16:13	01/03/2020 23:51	01/03/2020 16:13	01/03/2020 23:51	7,63	1	7,63	CHI
2020032184	ALTO PARAISO DE GOIAS	BF12365234	SAO JOAO D ALIANCA	01/03/2020 16:13	01/03/2020 18:45	01/03/2020 16:13	01/03/2020 18:45	2,53	9	22,77	CHI
2020032186	FIRMINOPOLIS	FR12096809	FIRMINOPOLIS S1	01/03/2020 16:13	01/03/2020 21:07	01/03/2020 16:13	01/03/2020 21:07	4,89	5	24,45	CHI
2020032187	FAZENDA NOVA	NB12117290	JUSSARA	01/03/2020 15:37	01/03/2020 23:58	01/03/2020 15:37	01/03/2020 23:58	8,34	4	33,37	CHI
2020032187	NOVO BRASIL	NB12117290	JUSSARA	01/03/2020 15:37	01/03/2020 23:58	01/03/2020 15:37	01/03/2020 23:58	8,34	5	41,72	CHI
2020032190	VILA PROPICIO	NP11043764	GOIANESIA S1	01/03/2020 15:34	01/03/2020 22:18	01/03/2020 15:34	01/03/2020 22:18	6,73	90	605,78	CHI
2020032193	ITUMBIARA	690158579	ITUMBIARA NOVA	01/03/2020 16:17	01/03/2020 18:13	01/03/2020 16:17	01/03/2020 18:13	1,93	1	1,93	CHI
2020032197	RUBIATABA	RB21027500	RUBIATABA	01/03/2020 16:18	01/03/2020 19:03	01/03/2020 16:18	01/03/2020 19:03	2,74	1	2,74	CHI
2020032199	SAO LUIS DE MONTES BELOS	SL12006908	SAO LUIZ DOS MONTES BELOS	01/03/2020 16:19	01/03/2020 18:48	01/03/2020 16:19	01/03/2020 18:48	2,48	6	14,88	CHI

2020032202	MARA ROSA	MQ21338160	MARA ROSA	01/03/2020 16:21	02/03/2020 09:57	01/03/2020 16:21	02/03/2020 09:57	17,60	1	17,60	CHI
2020032209	NOVO PLANALTO	TA12391925	SAO MIGUEL DO ARAGUAIA	01/03/2020 16:23	01/03/2020 23:21	01/03/2020 16:23	01/03/2020 23:21	6,96	8	55,71	CHI
2020032210	GOIANIA	16014789	GOIANIA LESTE S3	01/03/2020 16:23	01/03/2020 19:31	01/03/2020 16:23	01/03/2020 19:31	3,12	1	3,12	CHI
2020032213	IPORA	IR21188494	IPORA	01/03/2020 16:26	02/03/2020 03:29	01/03/2020 16:26	02/03/2020 03:29	11,04	1	11,04	CHI
2020032217	MONTE ALEGRE DE GOIAS	MA21233140	SAO DOMINGOS	01/03/2020 16:28	01/03/2020 17:13	01/03/2020 16:28	01/03/2020 17:13	0,75	1	0,75	CHI
2020032219	OUVIDOR	OU21140981	CATALAO S1	01/03/2020 16:29	01/03/2020 19:21	01/03/2020 16:29	01/03/2020 19:21	2,87	1	2,87	CHI
2020032221	MONTES CLAROS DE GOIAS	1440001811	IPORA	01/03/2020 16:29	01/03/2020 23:59	01/03/2020 16:29	01/03/2020 23:59	7,49	1	7,49	CHI
2020032227	GOIANIA	GN11043074	GOIANIA LESTE S2	01/03/2020 16:33	01/03/2020 19:43	01/03/2020 16:33	01/03/2020 19:43	3,15	71	223,85	CHI
2020032233	PLANALTINA	PI12324319	SAO JOAO D ALIANCA	01/03/2020 16:38	01/03/2020 16:59	01/03/2020 16:38	01/03/2020 16:59	0,33	6	2,01	CHI
2020032235	SAO FRANCISCO DE GOIAS	SF21297419	SAO FRANCISCO DE GOIAS	01/03/2020 16:40	01/03/2020 19:03	01/03/2020 16:40	01/03/2020 19:03	2,37	1	2,37	CHI
2020032240	MONTE ALEGRE DE GOIAS	10000568978	SAO DOMINGOS	01/03/2020 16:45	01/03/2020 17:43	01/03/2020 16:45	01/03/2020 17:43	0,95	1	0,95	CHI
2020032242	CAMPINORTE	5750000726	MARA ROSA	01/03/2020 16:46	02/03/2020 05:32	01/03/2020 16:46	02/03/2020 05:32	12,75	1	12,75	CHI
2020032244	HEITORAI	HE12300120	ITAPURANGA	01/03/2020 16:47	01/03/2020 19:24	01/03/2020 16:47	01/03/2020 19:24	2,60	10	26,03	CHI
2020032245	MONTES CLAROS DE GOIAS	ME12203472	IPORA	01/03/2020 16:48	02/03/2020 08:16	01/03/2020 16:48	02/03/2020 08:16	15,46	8	123,66	CHI
2020032248	QUIRINOPOLIS	QI21101762	QUIRINOPOLIS	01/03/2020 16:49	01/03/2020 22:52	01/03/2020 16:49	01/03/2020 22:52	6,04	1	6,04	CHI
2020032253	ITABERAI	IB21000039	ITABERAI S2	01/03/2020 16:51	01/03/2020 17:52	01/03/2020 16:51	01/03/2020 17:52	1,02	1	1,02	CHI
2020032256	ANAPOLIS	AN11157953	ANAPOLIS UNIVERSITARIO S2	01/03/2020 16:51	01/03/2020 18:24	01/03/2020 16:51	01/03/2020 18:24	1,54	116	178,38	CHI
2020032258	QUIRINOPOLIS	80040603	QUIRINOPOLIS	01/03/2020 16:53	02/03/2020 00:31	01/03/2020 16:53	02/03/2020 00:31	7,64	1	7,64	CHI
2020032263	BONFINOPOLIS	BO21271202	CEPAIGO S2	01/03/2020 16:53	01/03/2020 18:25	01/03/2020 16:53	01/03/2020 18:25	1,52	2	3,04	CHI
2020032264	CATALAO	CT21152868	IPAMERI	01/03/2020 16:53	01/03/2020 18:05	01/03/2020 16:53	01/03/2020 18:05	1,19	1	1,19	CHI
2020032265	GOIANIA	GN11001731	GOIANIA LESTE S2	01/03/2020 16:54	01/03/2020 19:01	01/03/2020 16:54	01/03/2020 19:01	2,11	240	506,60	CHI
2020032270	CATALAO	CT21327320	IPAMERI	01/03/2020 16:54	01/03/2020 18:25	01/03/2020 16:54	01/03/2020 18:25	1,50	1	1,50	CHI
2020032274	VALPARAISO DE GOIAS	2860342911	PACAEMBU S1	01/03/2020 16:55	01/03/2020 18:55	01/03/2020 16:55	01/03/2020 18:55	1,99	1	1,99	CHI
2020032277	DIVINOPOLIS DE GOIAS	GH12199989	SAO DOMINGOS	01/03/2020 16:56	01/03/2020 20:22	01/03/2020 16:56	01/03/2020 20:22	3,43	5	17,16	CHI
2020032279	INHUMAS	IN21025246	INHUMAS S2	01/03/2020 16:56	01/03/2020 18:15	01/03/2020 16:56	01/03/2020 18:15	1,31	1	1,31	CHI
2020032281	AMARALINA	MH12391970LD	NOVA CRIXAS	01/03/2020 16:56	01/03/2020 23:50	01/03/2020 16:56	01/03/2020 23:50	6,88	1	6,88	CHI
2020032281	MUNDO NOVO DE GOIAS	MH12391970LD	NOVA CRIXAS	01/03/2020 16:56	01/03/2020 23:50	01/03/2020 16:56	01/03/2020 23:50	6,88	4	27,54	CHI
2020032288	ANAPOLIS	20226834	ANAPOLIS UNIVERSITARIO S2	01/03/2020 16:59	01/03/2020 18:05	01/03/2020 16:59	01/03/2020 18:05	1,10	1	1,10	CHI
2020032290	GOIANIA	10007878	AEROPORTO S3	01/03/2020 16:59	01/03/2020 19:39	01/03/2020 16:59	01/03/2020 19:39	2,66	1	2,66	CHI
2020032298	PARAUNA	PU12206469	ACREUNA	01/03/2020 16:05	01/03/2020 22:38	01/03/2020 16:05	01/03/2020 22:38	6,54	22	143,94	CHI
2020032301	PARAUNA	PU12361896	PARAUNA	01/03/2020 17:04	01/03/2020 20:45	01/03/2020 17:04	01/03/2020 20:45	3,68	19	69,89	CHI
2020032302	PARANAIGUARA	PC12209794	QUIRINOPOLIS	01/03/2020 17:04	01/03/2020 21:03	01/03/2020 17:04	01/03/2020 21:03	3,97	8	31,76	CHI
2020032303	GOIANIA	GN11162078	CAMPINAS S3	01/03/2020 16:44	01/03/2020 23:29	01/03/2020 16:44	01/03/2020 23:29	6,75	68	458,72	CHI
2020032304	CRISTIANOPOLIS	CF11217007	CRISTIANOPOLIS	01/03/2020 16:37	02/03/2020 08:37	01/03/2020 16:37	02/03/2020 08:37	15,99	79	1263,01	CHI
2020032307	GOIANIA	GN11001474	ATLANTICO S1	01/03/2020 17:02	01/03/2020 21:23	01/03/2020 17:02	01/03/2020 21:23	4,34	133	577,22	CHI
2020032311	CORUMBA DE GOIAS	CB21236606	CORUMBA	01/03/2020 17:08	01/03/2020 20:09	01/03/2020 17:08	01/03/2020 20:09	3,00	1	3,00	CHI
2020032317	PARAUNA	PU21348600	PARAUNA	01/03/2020 17:10	02/03/2020 09:27	01/03/2020 17:10	02/03/2020 09:27	16,27	1	16,27	CHI
2020032324	FORMOSA	FA12262305	ITUIQUIRA	01/03/2020 16:58	01/03/2020 20:24	01/03/2020 16:58	01/03/2020 19:20	2,36	563	1330,56	CHI
2020032324	FORMOSA	FA11254470	ITUIQUIRA	01/03/2020 16:58	01/03/2020 20:24	01/03/2020 16:58	01/03/2020 20:24	3,43	103	353,55	CHI
2020032325	ANAPOLIS	10028039279	ANAPOLIS UNIVERSITARIO S2	01/03/2020 17:13	01/03/2020 18:32	01/03/2020 17:13	01/03/2020 18:32	1,30	1	1,30	CHI
2020032326	BARRO ALTO	DF12382135	BARRO ALTO	01/03/2020 16:54	01/03/2020 20:03	01/03/2020 16:54	01/03/2020 20:03	3,14	34	106,64	CHI
2020032326	SANTA RITA DO NOVO DESTINO	DF12382135	BARRO ALTO	01/03/2020 16:54	01/03/2020 20:03	01/03/2020 16:54	01/03/2020 20:03	3,14	2	6,27	CHI
2020032328	CATALAO	CT21373656	CATALAO S2	01/03/2020 17:14	01/03/2020 20:08	01/03/2020 17:14	01/03/2020 20:08	2,89	1	2,89	CHI
2020032334	DIORAMA	DI12245747	IPORA	01/03/2020 17:16	02/03/2020 11:23	01/03/2020 17:16	02/03/2020 11:23	18,12	1	18,12	CHI

2020032336	NIQUELANDIA	NQ12374575	NIQUELANDIA SUBTRANSMISSAO	01/03/2020 12:58	01/03/2020 18:44	01/03/2020 12:58	01/03/2020 18:44	5,77	12	69,19	CHI
2020032344	IVOLANDIA	IV12206098	IPORA	01/03/2020 17:22	02/03/2020 10:43	01/03/2020 17:22	02/03/2020 10:43	17,35	2	34,70	CHI
2020032346	MUNDO NOVO DE GOIAS	MH21147311	NOVA CRIXAS	01/03/2020 17:23	01/03/2020 22:10	01/03/2020 17:23	01/03/2020 22:10	4,78	1	4,78	CHI
2020032353	APARECIDA DE GOIANIA	15162862	REAL S1	01/03/2020 17:26	01/03/2020 18:47	01/03/2020 17:26	01/03/2020 18:47	1,34	1	1,34	CHI
2020032355	ITAPIRAPUA	IU21018866	MATRINCHA	01/03/2020 17:27	02/03/2020 10:26	01/03/2020 17:27	02/03/2020 10:26	16,97	1	16,97	CHI
2020032356	RIO VERDE	RV21022607	CABRIUVA S2	01/03/2020 17:28	02/03/2020 04:38	01/03/2020 17:28	02/03/2020 04:38	11,16	1	11,16	CHI
2020032359	URUTAI	UT12115680	PIRES DO RIO S2	01/03/2020 17:30	02/03/2020 08:39	01/03/2020 17:30	02/03/2020 08:39	15,14	33	499,76	CHI
2020032361	SANTA TEREZA DE GOIAS	2430015992	MARA ROSA	01/03/2020 17:32	01/03/2020 19:54	01/03/2020 17:32	01/03/2020 19:54	2,37	1	2,37	CHI
2020032362	RIO VERDE	RV21213487	CABRIUVA S2	01/03/2020 07:49	01/03/2020 19:16	01/03/2020 07:49	01/03/2020 19:16	11,43	1	11,43	CHI
2020032375	CATALAO	10013385257	CATALAO S2	01/03/2020 17:38	02/03/2020 07:58	01/03/2020 17:38	02/03/2020 07:58	14,33	1	14,33	CHI
2020032376	BELA VISTA DE GOIAS	240062425	BELA VISTA S1	01/03/2020 17:38	01/03/2020 18:25	01/03/2020 17:38	01/03/2020 18:25	0,78	1	0,78	CHI
2020032382	EDEALINA	ED12007679	PONTALINA	01/03/2020 17:41	01/03/2020 19:45	01/03/2020 17:41	01/03/2020 19:45	2,05	16	32,82	CHI
2020032383	BOM JESUS DE GOIAS	BJ11163877	BOM JESUS DE GOIAS	01/03/2020 17:42	01/03/2020 19:02	01/03/2020 17:42	01/03/2020 19:02	1,33	86	113,95	CHI
2020032385	BRITANIA	BT21101969	BRITANIA	01/03/2020 17:42	01/03/2020 18:54	01/03/2020 17:42	01/03/2020 18:54	1,18	1	1,18	CHI
2020032387	SENADOR CANEDO	SW21125212	SENADOR CANEDO	01/03/2020 17:43	01/03/2020 18:38	01/03/2020 17:43	01/03/2020 18:38	0,91	2	1,82	CHI
2020032391	ACREUNA	EU12085776	ACREUNA	01/03/2020 17:44	01/03/2020 21:29	01/03/2020 17:44	01/03/2020 21:29	3,73	6	22,40	CHI
2020032392	HIDROLANDIA	HD31200335	CEPAIGO S2	01/03/2020 17:45	02/03/2020 00:50	01/03/2020 17:45	02/03/2020 00:50	7,08	2	14,16	CHI
2020032393	GOIANIA	GN11000200	FERROVIARIO S1	01/03/2020 17:45	01/03/2020 20:59	01/03/2020 17:45	01/03/2020 20:59	3,22	70	225,28	CHI
2020032394	SANTA BARBARA DE GOIAS	TR31047821	TRINDADE	01/03/2020 17:46	01/03/2020 20:03	01/03/2020 17:46	01/03/2020 20:03	2,28	2	4,56	CHI
2020032395	ORIZONA	OZ12205492	PIRES DO RIO S1	01/03/2020 17:47	01/03/2020 20:20	01/03/2020 17:47	01/03/2020 20:20	2,55	3	7,65	CHI
2020032397	CAMPINACU	UC21291185	PORANGATU	01/03/2020 17:49	02/03/2020 09:59	02/03/2020 07:55	02/03/2020 09:59	2,05	1	2,05	CHI
2020032398	GAMELEIRA DE GOIAS	SV21227743	DAIA S2	01/03/2020 17:50	02/03/2020 03:52	01/03/2020 17:50	02/03/2020 03:52	10,03	1	10,03	CHI
2020032402	RIO VERDE	630032725	RIO VERDE S1	01/03/2020 17:51	01/03/2020 22:59	01/03/2020 17:51	01/03/2020 22:59	5,12	1	5,12	CHI
2020032403	CAIAPONIA	CP21039211	CAIAPONIA	01/03/2020 17:52	01/03/2020 21:47	01/03/2020 17:52	01/03/2020 21:47	3,92	1	3,92	CHI
2020032405	CRIXAS	CX12276584	SERRA DO OURO	01/03/2020 17:54	02/03/2020 20:17	01/03/2020 17:54	02/03/2020 20:17	26,38	4	105,52	CHI
2020032406	DOVERLANDIA	DV21209147	CAIAPONIA	01/03/2020 17:56	01/03/2020 22:14	01/03/2020 17:56	01/03/2020 22:14	4,30	1	4,30	CHI
2020032407	MINEIROS	MY21322121	PARQUE DAS EMAS	01/03/2020 17:56	02/03/2020 19:10	01/03/2020 17:56	02/03/2020 19:10	25,24	1	25,24	CHI
2020032408	BONOPOLIS	BX21198520	NOVO PLANALTO	01/03/2020 17:57	01/03/2020 21:38	01/03/2020 17:57	01/03/2020 21:38	3,68	2	7,36	CHI
2020032409	GOIANESIA	GE12322006	GOIANESIA S1	01/03/2020 17:52	01/03/2020 20:30	01/03/2020 17:52	01/03/2020 20:30	2,62	7	18,37	CHI
2020032409	SANTA RITA DO NOVO DESTINO	GE12322006	GOIANESIA S1	01/03/2020 17:52	01/03/2020 20:30	01/03/2020 17:52	01/03/2020 20:30	2,62	7	18,37	CHI
2020032411	SAO LUIS DE MONTES BELOS	SL12289750	FIRMINOPOLIS S2	01/03/2020 17:59	01/03/2020 21:28	01/03/2020 17:59	01/03/2020 21:28	3,48	3	10,43	CHI
2020032411	TURVANIA	SL12289750	FIRMINOPOLIS S2	01/03/2020 17:59	01/03/2020 21:28	01/03/2020 17:59	01/03/2020 21:28	3,48	2	6,95	CHI
2020032412	GOIANESIA	GE12000018	GOIANESIA S2	01/03/2020 17:59	01/03/2020 22:10	01/03/2020 17:59	01/03/2020 22:10	4,18	2	8,36	CHI
2020032414	MINEIROS	MY11209671	PARQUE DAS EMAS	01/03/2020 18:01	01/03/2020 20:06	01/03/2020 18:01	01/03/2020 20:06	2,07	126	260,71	CHI
2020032416	GOIANIA	10028755136	GOIANIA LESTE S1	01/03/2020 18:02	01/03/2020 19:12	01/03/2020 18:02	01/03/2020 19:12	1,16	1	1,16	CHI
2020032418	MINACU	4020040310	MINACU	01/03/2020 18:04	01/03/2020 22:14	01/03/2020 18:04	01/03/2020 22:14	4,16	1	4,16	CHI
2020032420	JATAI	10010052583	JATAI S3	01/03/2020 18:05	01/03/2020 19:42	01/03/2020 18:05	01/03/2020 19:42	1,60	1	1,60	CHI
2020032422	POSSE	PS12195787	IACIARA S2	01/03/2020 18:06	01/03/2020 21:03	01/03/2020 18:06	01/03/2020 21:03	2,94	1	2,94	CHI
2020032427	ANAPOLIS	10006273660	JUNDIAI S2	01/03/2020 18:08	01/03/2020 19:02	01/03/2020 18:08	01/03/2020 19:02	0,89	1	0,89	CHI
2020032429	GOIANIA	10250967	AEROPORTO S1	01/03/2020 18:09	01/03/2020 19:34	01/03/2020 18:09	01/03/2020 19:34	1,40	1	1,40	CHI
2020032430	FORMOSA	610102333	ITUIQUIRA	01/03/2020 18:10	01/03/2020 21:15	01/03/2020 18:10	01/03/2020 21:15	3,07	1	3,07	CHI
2020032431	CATALAO	10020325973	CATALAO S2	01/03/2020 18:10	01/03/2020 20:57	01/03/2020 18:10	01/03/2020 20:57	2,77	1	2,77	CHI
2020032433	SAO MIGUEL DO ARAGUAIA	SM12393947	SAO MIGUEL DO ARAGUAIA	01/03/2020 18:11	02/03/2020 18:37	01/03/2020 18:11	02/03/2020 18:37	24,42	1	24,42	CHI
2020032438	VILA PROPICIO	NP12309704	BARRO ALTO	01/03/2020 18:14	02/03/2020 01:02	01/03/2020 18:14	02/03/2020 01:02	6,79	6	40,75	CHI

2020032440	GOIANIA	16302084	GOYA S2	01/03/2020 18:15	01/03/2020 20:43	01/03/2020 18:15	01/03/2020 20:43	2,46	1	2,46	CHI
2020032441	FLORES DE GOIAS	IA12046295	IACIARA S2	01/03/2020 18:16	01/03/2020 21:28	01/03/2020 18:16	01/03/2020 21:28	3,20	1	3,20	CHI
2020032441	IACIARA	IA12046295	IACIARA S2	01/03/2020 18:16	01/03/2020 21:28	01/03/2020 18:16	01/03/2020 21:28	3,20	58	185,45	CHI
2020032443	SANTO ANTONIO DO DESCOBERTO	10008394502	ALEXANIA	01/03/2020 18:16	01/03/2020 19:47	01/03/2020 18:16	01/03/2020 19:47	1,51	1	1,51	CHI
2020032444	VIANOPOLIS	VN21157263	VIANOPOLIS	01/03/2020 18:17	02/03/2020 09:22	01/03/2020 18:17	02/03/2020 09:22	15,08	1	15,08	CHI
2020032449	NOVO BRASIL	NB21254701	JUSSARA	01/03/2020 18:20	01/03/2020 22:27	01/03/2020 18:20	01/03/2020 22:27	4,11	1	4,11	CHI
2020032451	PADRE BERNARDO	PB21056412	PADRE BERNARDO	01/03/2020 18:20	01/03/2020 19:11	01/03/2020 18:20	01/03/2020 19:11	0,84	1	0,84	CHI
2020032453	EDEIA	EA12000001	EDEIA	01/03/2020 18:12	01/03/2020 19:55	01/03/2020 18:12	01/03/2020 19:55	1,71	19	32,47	CHI
2020032457	GOIANIA	GN12210367	AEROPORTO S3	01/03/2020 18:22	01/03/2020 22:42	01/03/2020 18:22	01/03/2020 22:42	4,32	11	47,56	CHI
2020032458	QUIRINOPOLIS	QI21000007	QUIRINOPOLIS	01/03/2020 18:22	01/03/2020 19:46	01/03/2020 18:22	01/03/2020 19:46	1,39	1	1,39	CHI
2020032459	MIMOSO DE GOIAS	NQ12251264	BARRO ALTO	01/03/2020 14:01	01/03/2020 21:13	01/03/2020 14:01	01/03/2020 21:13	7,20	7	50,40	CHI
2020032459	VILA PROPICIO	NQ12251264	BARRO ALTO	01/03/2020 14:01	01/03/2020 21:13	01/03/2020 14:01	01/03/2020 21:13	7,20	4	28,80	CHI
2020032460	PALMELO	450002640	PIRES DO RIO S2	01/03/2020 18:23	02/03/2020 11:49	01/03/2020 18:23	02/03/2020 11:49	17,43	1	17,43	CHI
2020032463	FORMOSA	FA11180623	ITIQUEIRA	01/03/2020 18:19	02/03/2020 00:08	01/03/2020 18:19	02/03/2020 00:08	5,82	206	1198,06	CHI
2020032464	ITABERAI	IB11054560	ITABERAI S2	01/03/2020 18:25	01/03/2020 19:32	01/03/2020 18:25	01/03/2020 19:32	1,11	140	155,75	CHI
2020032470	CORUMBAIBA	CI12180475	VILA CORUMBA	01/03/2020 18:29	02/03/2020 11:42	01/03/2020 18:29	02/03/2020 11:42	17,21	3	51,63	CHI
2020032474	ANAPOLIS	AN11329895	JUNDIAI S1	01/03/2020 18:07	02/03/2020 00:40	01/03/2020 18:07	02/03/2020 00:17	6,17	178	1098,06	CHI
2020032474	ANAPOLIS	AN16407092	JUNDIAI S1	01/03/2020 18:07	02/03/2020 00:40	01/03/2020 18:07	02/03/2020 00:40	6,55	1319	8644,95	CHI
2020032474	ANAPOLIS	AN16407092	JUNDIAI S1	01/03/2020 18:07	02/03/2020 00:40	02/03/2020 00:26	02/03/2020 00:40	0,24	693	165,74	CHI
2020032478	ANAPOLIS	20469810	DAIA S1	01/03/2020 18:32	01/03/2020 19:39	01/03/2020 18:32	01/03/2020 19:39	1,11	1	1,11	CHI
2020032480	DIORAMA	DI12065691	IPORA	01/03/2020 18:32	02/03/2020 10:05	01/03/2020 18:32	02/03/2020 10:05	15,55	8	124,43	CHI
2020032482	PLANALTINA	2960166869	PLANALTINA	01/03/2020 18:33	01/03/2020 20:48	01/03/2020 18:33	01/03/2020 20:48	2,24	1	2,24	CHI
2020032485	DOVERLANDIA	DV12354650	CAIAPONIA	01/03/2020 17:24	02/03/2020 02:01	01/03/2020 17:24	02/03/2020 02:01	8,62	129	1112,55	CHI
2020032498	IPAMERI	IP21380531	IPAMERI	01/03/2020 18:41	02/03/2020 14:52	01/03/2020 18:41	02/03/2020 14:52	20,17	1	20,17	CHI
2020032499	MONTE ALEGRE DE GOIAS	MA12284421	SAO DOMINGOS	01/03/2020 18:41	01/03/2020 21:01	01/03/2020 18:41	01/03/2020 21:01	2,32	3	6,96	CHI
2020032511	ITUMBIARA	IT11255160	ITUMBIARA NOVA	01/03/2020 18:45	01/03/2020 20:20	01/03/2020 18:45	01/03/2020 20:20	1,58	97	153,42	CHI
2020032516	PALESTINA DE GOIAS	AY12390161	ARENOPOLIS	01/03/2020 18:47	02/03/2020 11:31	01/03/2020 18:47	02/03/2020 11:31	16,73	5	83,63	CHI
2020032525	PALMEIRAS DE GOIAS	590022842	PALMEIRAS	01/03/2020 18:49	02/03/2020 09:27	01/03/2020 18:49	02/03/2020 09:27	14,63	1	14,63	CHI
2020032532	BARRO ALTO	BA21237503	BARRO ALTO	01/03/2020 18:51	01/03/2020 22:28	01/03/2020 18:51	01/03/2020 22:28	3,61	1	3,61	CHI
2020032538	IPAMERI	IP12000014	IPAMERI	01/03/2020 18:53	01/03/2020 20:47	01/03/2020 18:53	01/03/2020 20:47	1,90	23	43,70	CHI
2020032542	SENADOR CANEDO	SW11384961	SENADOR CANEDO	01/03/2020 18:51	01/03/2020 19:32	01/03/2020 18:51	01/03/2020 19:32	0,67	172	115,10	CHI
2020032548	GOIANIRA	390075530	GOIANIRA	01/03/2020 18:56	01/03/2020 21:12	01/03/2020 18:56	01/03/2020 21:12	2,26	1	2,26	CHI
2020032557	MONTE ALEGRE DE GOIAS	MA12114728	SAO DOMINGOS	01/03/2020 18:56	01/03/2020 20:35	01/03/2020 18:56	01/03/2020 20:35	1,65	35	57,83	CHI
2020032563	APARECIDA DE GOIANIA	13414045	INDEPENDENCIA S2	01/03/2020 18:59	01/03/2020 19:38	01/03/2020 18:59	01/03/2020 19:38	0,64	1	0,64	CHI
2020032566	PIRENOPOLIS	220077927	CORUMBA	01/03/2020 19:00	01/03/2020 21:05	01/03/2020 19:00	01/03/2020 21:05	2,08	1	2,08	CHI
2020032572	POSSE	PS12344204	IACIARA S2	01/03/2020 18:53	01/03/2020 19:54	01/03/2020 18:53	01/03/2020 19:54	1,01	131	132,02	CHI
2020032573	INHUMAS	30096820	INHUMAS S2	01/03/2020 19:00	01/03/2020 22:14	01/03/2020 19:00	01/03/2020 22:14	3,22	1	3,22	CHI
2020032574	MINACU	IH12252305	MINACU	01/03/2020 19:00	02/03/2020 00:11	01/03/2020 19:00	02/03/2020 00:11	5,17	4	20,67	CHI
2020032575	PIRACANJUBA	PJ11051177	PIRACANJUBA	01/03/2020 19:01	01/03/2020 20:59	01/03/2020 19:01	01/03/2020 20:59	1,95	188	367,28	CHI
2020032576	IPORA	IR11353736	IPORA	01/03/2020 19:01	02/03/2020 03:48	01/03/2020 19:01	02/03/2020 03:48	8,77	1	8,77	CHI
2020032583	AGUAS LINDAS DE GOIAS	4830176363	AGUAS LINDAS DE GOIAS S1	01/03/2020 19:03	01/03/2020 20:10	01/03/2020 19:03	01/03/2020 20:10	1,11	1	1,11	CHI
2020032585	FORMOSA	610049069	ITIQUEIRA	01/03/2020 19:03	01/03/2020 20:59	01/03/2020 19:03	01/03/2020 20:59	1,93	1	1,93	CHI
2020032589	IPAMERI	IP12027061	URUTAI	01/03/2020 19:04	02/03/2020 18:31	01/03/2020 19:04	02/03/2020 18:31	23,45	25	586,20	CHI
2020032597	JARAGUA	JA21029526	JARAGUA	01/03/2020 19:05	01/03/2020 21:20	01/03/2020 19:05	01/03/2020 21:20	2,25	3	6,74	CHI

2020032599	BRITANIA	BT21009720	BRITANIA	01/03/2020 19:06	01/03/2020 22:12	01/03/2020 19:06	01/03/2020 22:12	3,10	1	3,10	CHI
2020032608	GOIANIA	GN11271818	GOYA S2	01/03/2020 19:04	01/03/2020 20:21	01/03/2020 19:04	01/03/2020 20:21	1,28	173	221,78	CHI
2020032614	SANTA HELENA DE GOIAS	400111860	IPEGUARI	01/03/2020 19:08	02/03/2020 08:03	01/03/2020 19:08	02/03/2020 08:03	12,91	1	12,91	CHI
2020032615	PORANGATU	PO12064911	NOVO PLANALTO	01/03/2020 13:25	01/03/2020 22:04	01/03/2020 13:25	01/03/2020 22:04	8,64	133	1149,23	CHI
2020032618	ANAPOLIS	10013251960	ANAPOLIS UNIVERSITARIO S2	01/03/2020 19:10	01/03/2020 20:46	01/03/2020 19:10	01/03/2020 20:46	1,60	1	1,60	CHI
2020032624	MINEIROS	1390170151	PARQUE DAS EMAS	01/03/2020 19:11	01/03/2020 23:34	01/03/2020 19:11	01/03/2020 23:34	4,38	1	4,38	CHI
2020032626	PLANALTINA	PI11248798	PLANALTINA	01/03/2020 19:11	01/03/2020 21:48	01/03/2020 19:11	01/03/2020 21:48	2,61	1	2,61	CHI
2020032633	GOIANIA	15099660	AEROPORTO S3	01/03/2020 19:13	01/03/2020 20:42	01/03/2020 19:13	01/03/2020 20:42	1,47	1	1,47	CHI
2020032634	HIDROLANDIA	180059695	CEPAIGO S2	01/03/2020 19:14	01/03/2020 21:58	01/03/2020 19:14	01/03/2020 21:58	2,73	1	2,73	CHI
2020032635	GOIANIA	15994740	FERROVIARIO S3	01/03/2020 19:14	01/03/2020 21:52	01/03/2020 19:14	01/03/2020 21:52	2,62	1	2,62	CHI
2020032641	CATALAO	1990134716	CATALAO S2	01/03/2020 19:19	01/03/2020 20:46	01/03/2020 19:19	01/03/2020 20:46	1,45	1	1,45	CHI
2020032649	IPAMERI	IP12056133	IPAMERI	01/03/2020 18:54	01/03/2020 20:06	01/03/2020 18:54	01/03/2020 20:06	1,19	514	612,23	CHI
2020032650	ANAPOLIS	20523713	JUNDIAI S2	01/03/2020 19:21	01/03/2020 19:57	01/03/2020 19:21	01/03/2020 19:57	0,59	1	0,59	CHI
2020032654	OURO VERDE DE GOIAS	OV21311992	NEROPOLIS S1	01/03/2020 19:23	01/03/2020 20:52	01/03/2020 19:23	01/03/2020 20:52	1,48	1	1,48	CHI
2020032657	PIRACANJUBA	BV12076787	BELA VISTA S1	01/03/2020 17:44	02/03/2020 10:34	01/03/2020 17:44	02/03/2020 10:34	16,83	4	67,33	CHI
2020032659	IPAMERI	IP12335846	IPAMERI	01/03/2020 18:34	02/03/2020 10:55	01/03/2020 18:34	02/03/2020 10:55	16,34	4	65,34	CHI
2020032662	SILVANIA	SV21205398	VIANOPOLIS	01/03/2020 19:25	02/03/2020 10:57	01/03/2020 19:25	02/03/2020 10:57	15,52	2	31,04	CHI
2020032664	POSSE	PS21255366	IACIARA S2	01/03/2020 19:27	01/03/2020 21:31	01/03/2020 19:27	01/03/2020 21:31	2,06	1	2,06	CHI
2020032665	SAO MIGUEL DO PASSA QUATRO	SQ12020399	CRISTIANOPOLIS	01/03/2020 19:27	01/03/2020 22:36	01/03/2020 19:27	01/03/2020 22:36	3,16	1	3,16	CHI
2020032667	GOIANIA	10007910	AEROPORTO S3	01/03/2020 19:28	01/03/2020 20:02	01/03/2020 19:28	01/03/2020 20:02	0,57	1	0,57	CHI
2020032672	IPAMERI	IP12275812	IPAMERI	01/03/2020 18:58	01/03/2020 23:48	01/03/2020 18:58	01/03/2020 23:48	4,82	20	96,36	CHI
2020032681	PLANALTINA	PI11164647	PLANALTINA	01/03/2020 19:29	01/03/2020 21:22	01/03/2020 19:29	01/03/2020 21:22	1,88	116	217,73	CHI
2020032683	GOIANDIRA	GD21215577	CATALAO S1	01/03/2020 19:32	01/03/2020 20:57	01/03/2020 19:32	01/03/2020 20:57	1,41	2	2,81	CHI
2020032684	MORRINHOS	MR11009623	MORRINHOS	01/03/2020 19:07	02/03/2020 00:11	01/03/2020 19:07	02/03/2020 00:11	5,07	152	770,30	CHI
2020032688	GOIANIA	10655840	CAMPINAS S3	01/03/2020 19:34	01/03/2020 20:43	01/03/2020 19:34	01/03/2020 20:43	1,15	1	1,15	CHI
2020032691	CAMPOS VERDES	SG12181588	SANTA TEREZINHA	01/03/2020 14:30	01/03/2020 23:53	01/03/2020 14:30	01/03/2020 23:53	9,38	8	75,04	CHI
2020032691	SANTA TEREZINHA DE GOIAS	SG12181588	SANTA TEREZINHA	01/03/2020 14:30	01/03/2020 23:53	01/03/2020 14:30	01/03/2020 23:53	9,38	6	56,28	CHI
2020032697	ANAPOLIS	AN11003272	JUNDIAI S1	01/03/2020 19:38	01/03/2020 20:46	01/03/2020 19:38	01/03/2020 20:46	1,12	139	155,45	CHI
2020032701	SILVANIA	SV12131990	VIANOPOLIS	01/03/2020 18:55	02/03/2020 00:06	01/03/2020 18:55	02/03/2020 00:06	5,17	30	155,07	CHI
2020032702	LEOPOLDO DE BULHOES	LB21353339	DAIA S2	01/03/2020 19:40	01/03/2020 21:56	01/03/2020 19:40	01/03/2020 21:56	2,26	1	2,26	CHI
2020032703	VALPARAISO DE GOIAS	2860194480	PACAEMBU S1	01/03/2020 19:40	01/03/2020 20:48	01/03/2020 19:40	01/03/2020 20:48	1,13	1	1,13	CHI
2020032705	GOIATUBA	GT11296895	GOIATUBA S1	01/03/2020 19:40	01/03/2020 21:54	01/03/2020 19:40	01/03/2020 21:54	2,22	27	60,06	CHI
2020032707	PIRES DO RIO	460102710	PIRES DO RIO S1	01/03/2020 19:41	01/03/2020 23:12	01/03/2020 19:41	01/03/2020 23:12	3,52	1	3,52	CHI
2020032714	CALDAS NOVAS	CN12363792	SERRA DE CALDAS	01/03/2020 18:58	01/03/2020 23:21	01/03/2020 18:58	01/03/2020 23:21	4,37	125	546,53	CHI
2020032716	URUACU	UR21190229	URUACU	01/03/2020 19:43	01/03/2020 21:02	01/03/2020 19:43	01/03/2020 21:02	1,31	1	1,31	CHI
2020032717	BONOPOLIS	BX21233113	NOVO PLANALTO	01/03/2020 19:43	01/03/2020 21:10	01/03/2020 19:43	01/03/2020 21:10	1,44	1	1,44	CHI
2020032718	CATALAO	1990124929	CATALAO S2	01/03/2020 19:43	02/03/2020 11:00	01/03/2020 19:43	02/03/2020 11:00	15,27	1	15,27	CHI
2020032721	GOIANIA	GN12098874	AEROPORTO S3	01/03/2020 18:54	01/03/2020 23:31	01/03/2020 18:54	01/03/2020 21:11	2,28	50	114,18	CHI
2020032721	GOIANIA	GN11000625	AEROPORTO S3	01/03/2020 18:54	01/03/2020 23:31	01/03/2020 18:54	01/03/2020 23:31	4,61	51	235,05	CHI
2020032725	TRINDADE	TR11053494	TRINDADE	01/03/2020 19:41	01/03/2020 20:39	01/03/2020 19:41	01/03/2020 20:39	0,96	186	179,28	CHI
2020032726	GOIANIA	GN12025489LD	FERROVIARIO S3	01/03/2020 19:47	02/03/2020 01:01	01/03/2020 20:54	02/03/2020 01:01	4,12	142	584,41	CHI
2020032729	SILVANIA	SV12107843	VIANOPOLIS	01/03/2020 19:48	02/03/2020 09:50	01/03/2020 19:48	02/03/2020 09:50	14,02	1	14,02	CHI
2020032730	ITUMBIARA	IT12065311	CACHOEIRA DOURADA	01/03/2020 19:50	02/03/2020 13:39	01/03/2020 19:50	02/03/2020 13:39	17,81	3	53,44	CHI
2020032734	ITABERAÍ	IB11274344	ITABERAÍ S2	01/03/2020 19:52	01/03/2020 20:53	01/03/2020 19:52	01/03/2020 20:53	1,01	121	121,74	CHI

2020032736	CALDAS NOVAS	CN11198386	SERRA DE CALDAS	01/03/2020 19:53	02/03/2020 00:18	01/03/2020 19:53	02/03/2020 00:18	4,40	25	110,03	CHI
2020032737	NOVA CRIXAS	NA12375099	NOVA CRIXAS	01/03/2020 19:54	02/03/2020 22:07	01/03/2020 19:54	02/03/2020 12:05	16,19	2	32,38	CHI
2020032737	NOVA CRIXAS	NA12375099	NOVA CRIXAS	01/03/2020 19:54	02/03/2020 22:07	02/03/2020 20:01	02/03/2020 21:14	1,22	2	2,43	CHI
2020032737	NOVA CRIXAS	NA12375099	NOVA CRIXAS	01/03/2020 19:54	02/03/2020 22:07	01/03/2020 19:54	02/03/2020 22:07	26,23	3	78,68	CHI
2020032751	GOIANIA	12109587	CAMPINAS S2	01/03/2020 20:02	01/03/2020 22:31	01/03/2020 20:02	01/03/2020 22:31	2,48	1	2,48	CHI
2020032753	CORUMBA DE GOIAS	ZN21345231	COCALZINHO	01/03/2020 20:03	01/03/2020 21:28	01/03/2020 20:03	01/03/2020 21:28	1,40	1	1,40	CHI
2020032754	SANTO ANTONIO DO DESCOBERTO	2210036337	ALEXANIA	01/03/2020 20:04	01/03/2020 22:08	01/03/2020 20:04	01/03/2020 22:08	2,06	1	2,06	CHI
2020032755	TRINDADE	TR21391375	TRINDADE	01/03/2020 20:05	01/03/2020 21:56	01/03/2020 20:05	01/03/2020 21:56	1,85	1	1,85	CHI
2020032758	EDEALINA	1130016101	PONTALINA	01/03/2020 20:06	01/03/2020 22:42	01/03/2020 20:06	01/03/2020 22:42	2,59	1	2,59	CHI
2020032763	JARAGUA	JA21293773	JARAGUA	01/03/2020 20:08	01/03/2020 23:49	01/03/2020 20:08	01/03/2020 23:49	3,67	1	3,67	CHI
2020032767	PADRE BERNARDO	10013334920	PADRE BERNARDO	01/03/2020 20:11	01/03/2020 21:35	01/03/2020 20:11	01/03/2020 21:35	1,39	1	1,39	CHI
2020032772	INHUMAS	IN11251742	INHUMAS S2	01/03/2020 19:58	01/03/2020 21:21	01/03/2020 19:58	01/03/2020 21:21	1,38	102	140,51	CHI
2020032776	ITUMBIARA	690225428	ITUMBIARA NOVA	01/03/2020 20:14	01/03/2020 22:12	01/03/2020 20:14	01/03/2020 22:12	1,97	1	1,97	CHI
2020032779	CAMPOS BELOS	CH11000002	SAO DOMINGOS	01/03/2020 20:16	01/03/2020 23:11	01/03/2020 20:16	01/03/2020 23:11	2,91	120	349,53	CHI
2020032780	FIRMINOPOLIS	SL12206332	FIRMINOPOLIS S1	01/03/2020 20:16	01/03/2020 22:57	01/03/2020 20:16	01/03/2020 22:57	2,68	1	2,68	CHI
2020032780	SAO LUIS DE MONTES BELOS	SL12206332	FIRMINOPOLIS S1	01/03/2020 20:16	01/03/2020 22:57	01/03/2020 20:16	01/03/2020 22:57	2,68	15	40,13	CHI
2020032783	FORMOSA	FA12211252	ITUIQUIRA	01/03/2020 20:17	01/03/2020 23:00	01/03/2020 20:17	01/03/2020 23:00	2,71	16	43,28	CHI
2020032787	GOIANIA	10004981349	MEIA PONTE	01/03/2020 20:21	01/03/2020 22:32	01/03/2020 20:21	01/03/2020 22:32	2,17	1	2,17	CHI
2020032789	GOUVELANDIA	Q112053194	QUIRINOPOLIS	01/03/2020 20:23	02/03/2020 01:16	01/03/2020 20:23	02/03/2020 01:16	4,88	2	9,75	CHI
2020032789	QUIRINOPOLIS	Q112053194	QUIRINOPOLIS	01/03/2020 20:23	02/03/2020 01:16	01/03/2020 20:23	02/03/2020 01:16	4,88	50	243,83	CHI
2020032790	GOIANIA	GN11131188	FERROVIARIO S1	01/03/2020 20:23	01/03/2020 22:08	01/03/2020 20:23	01/03/2020 22:08	1,73	101	175,15	CHI
2020032791	VILA PROPICIO	NP21284279	GOIANESIA S2	01/03/2020 20:24	02/03/2020 02:00	01/03/2020 20:24	02/03/2020 02:00	5,61	3	16,82	CHI
2020032796	GOIANIA	GN11000256	AEROPORTO S3	01/03/2020 20:25	01/03/2020 22:28	01/03/2020 20:25	01/03/2020 22:28	2,04	19	38,75	CHI
2020032799	ARAGUAPAZ	AZ12188220	MOZARLANDIA	01/03/2020 20:27	02/03/2020 01:59	01/03/2020 20:27	02/03/2020 01:59	5,52	35	193,33	CHI
2020032799	MOZARLANDIA	AZ12188220	MOZARLANDIA	01/03/2020 20:27	02/03/2020 01:59	01/03/2020 20:27	02/03/2020 01:59	5,52	8	44,19	CHI
2020032901	GOIANIA	10097119	ATLANTICO S1	01/03/2020 20:27	01/03/2020 22:26	01/03/2020 20:27	01/03/2020 22:26	1,97	1	1,97	CHI
2020032903	LUZIANIA	10003198276	RIO VERMELHO	01/03/2020 20:29	01/03/2020 21:27	01/03/2020 20:29	01/03/2020 21:27	0,97	1	0,97	CHI
2020032914	DIORAMA	DI12188303	ARENOPOLIS	01/03/2020 20:29	03/03/2020 09:25	01/03/2020 20:29	03/03/2020 09:25	36,93	27	997,20	CHI
2020032914	MONTES CLAROS DE GOIAS	DI12188303	ARENOPOLIS	01/03/2020 20:29	03/03/2020 09:25	01/03/2020 20:29	03/03/2020 09:25	36,93	1	36,93	CHI
2020032923	VILA PROPICIO	NP12188681	GOIANESIA S1	01/03/2020 20:28	02/03/2020 15:57	01/03/2020 20:28	02/03/2020 10:24	13,93	44	613,03	CHI
2020032923	VILA PROPICIO	NP12188681	GOIANESIA S1	01/03/2020 20:28	02/03/2020 15:57	01/03/2020 20:28	02/03/2020 11:45	15,28	9	137,54	CHI
2020032923	VILA PROPICIO	NP12188681	GOIANESIA S1	01/03/2020 20:28	02/03/2020 15:57	01/03/2020 20:28	02/03/2020 14:00	17,53	27	473,38	CHI
2020032923	VILA PROPICIO	NP12188681	GOIANESIA S1	01/03/2020 20:28	02/03/2020 15:57	01/03/2020 20:28	02/03/2020 15:57	19,49	7	136,45	CHI
2020032925	GOUVELANDIA	GB12394808	QUIRINOPOLIS	01/03/2020 20:39	01/03/2020 22:17	01/03/2020 20:39	01/03/2020 22:17	1,63	2	3,25	CHI
2020032925	QUIRINOPOLIS	GB12394808	QUIRINOPOLIS	01/03/2020 20:39	01/03/2020 22:17	01/03/2020 20:39	01/03/2020 22:17	1,63	77	125,17	CHI
2020032937	JATAI	290338610	JATAI S2	01/03/2020 20:44	02/03/2020 07:28	01/03/2020 20:44	02/03/2020 07:28	10,73	1	10,73	CHI
2020032944	SANTA CRUZ DE GOIAS	BC21112759	PIRES DO RIO S2	01/03/2020 20:47	02/03/2020 10:48	01/03/2020 20:47	02/03/2020 10:48	14,00	2	28,00	CHI
2020032946	CATURAI	CK12326175	INHUMAS S1	01/03/2020 20:48	01/03/2020 22:58	01/03/2020 20:48	01/03/2020 22:58	2,16	3	6,48	CHI
2020032946	INHUMAS	CK12326175	INHUMAS S1	01/03/2020 20:48	01/03/2020 22:58	01/03/2020 20:48	01/03/2020 22:58	2,16	3	6,48	CHI
2020032951	CRIXAS	CX12330137	RUBIATABA	01/03/2020 20:44	02/03/2020 02:46	01/03/2020 20:44	02/03/2020 02:46	6,03	35	210,92	CHI
2020032954	NOVO GAMA	NJ11149844	PACAEMBU S1	01/03/2020 20:52	01/03/2020 22:40	01/03/2020 20:52	01/03/2020 22:40	1,79	120	215,03	CHI
2020032955	ARENOPOLIS	AY12180009	ARENOPOLIS	01/03/2020 20:52	02/03/2020 13:17	01/03/2020 20:52	02/03/2020 13:17	16,41	7	114,86	CHI
2020032956	GOIANIRA	GR11313224	MEIA PONTE	01/03/2020 20:41	02/03/2020 01:50	01/03/2020 20:41	02/03/2020 01:40	4,97	57	283,29	CHI
2020032956	GOIANIRA	GR12313284	MEIA PONTE	01/03/2020 20:41	02/03/2020 01:50	02/03/2020 01:04	02/03/2020 01:50	0,76	231	175,50	CHI

2020032958	CIDADE OCIDENTAL	10028029656	MARAJOARA	01/03/2020 20:55	01/03/2020 22:11	01/03/2020 20:55	01/03/2020 22:11	1,26	1	1,26	CHI
2020032961	ALTO HORIZONTE	MQ12181177	MARA ROSA	01/03/2020 20:41	02/03/2020 03:26	01/03/2020 20:41	02/03/2020 03:26	6,74	3	20,22	CHI
2020032961	MARA ROSA	MQ12181177	MARA ROSA	01/03/2020 20:41	02/03/2020 03:26	01/03/2020 20:41	02/03/2020 03:26	6,74	28	188,74	CHI
2020032961	URUACU	MQ12181177	MARA ROSA	01/03/2020 20:41	02/03/2020 03:26	01/03/2020 20:41	02/03/2020 03:26	6,74	1	6,74	CHI
2020032964	COLINAS DO SUL	TI21155526	MINACU	01/03/2020 21:00	02/03/2020 08:08	01/03/2020 21:00	02/03/2020 08:08	11,13	2	22,26	CHI
2020032968	DIORAMA	DI21188376	ARENOPOLIS	01/03/2020 21:02	01/03/2020 21:09	01/03/2020 21:02	01/03/2020 21:09	0,11	1	0,11	CHI
2020032969	JATAI	290157675	JATAI S3	01/03/2020 21:04	01/03/2020 23:42	01/03/2020 21:04	01/03/2020 23:42	2,63	1	2,63	CHI
2020032974	NOVA CRIXAS	NA12334349	NOVA CRIXAS	01/03/2020 21:08	02/03/2020 11:26	01/03/2020 21:08	02/03/2020 11:26	14,29	59	843,26	CHI
2020032976	CORUMBAIBA	CI21309419	VILA CORUMBA	01/03/2020 21:09	02/03/2020 12:46	01/03/2020 21:09	02/03/2020 12:46	15,61	1	15,61	CHI
2020032977	IPAMERI	IP12057877RE	PIRES DO RIO S2	01/03/2020 19:14	02/03/2020 02:25	01/03/2020 19:14	02/03/2020 02:25	7,17	28	200,76	CHI
2020032980	FAINA	FC12220907	GOIAS	01/03/2020 21:13	01/03/2020 23:21	01/03/2020 21:13	01/03/2020 23:21	2,12	11	23,37	CHI
2020032982	APARECIDA DE GOIANIA	14909479	ANHANGUERA	01/03/2020 21:14	01/03/2020 22:09	01/03/2020 21:14	01/03/2020 22:09	0,91	1	0,91	CHI
2020032983	PORANGATU	PO12239639	MARA ROSA	01/03/2020 21:18	02/03/2020 00:43	01/03/2020 21:18	02/03/2020 00:43	3,41	31	105,73	CHI
2020032992	QUIRINOPOLIS	QI11189167	QUIRINOPOLIS	01/03/2020 21:12	01/03/2020 23:32	01/03/2020 21:12	01/03/2020 23:32	2,33	111	258,32	CHI
2020032993	EDEALINA	VI12381142	VICENTINOPOLIS	02/03/2020 06:20	02/03/2020 08:02	02/03/2020 06:20	02/03/2020 08:02	1,70	15	25,46	CHI
2020032999	AGUAS LINDAS DE GOIAS	10008635399	AGUAS LINDAS DE GOIAS S2	01/03/2020 21:36	01/03/2020 23:01	01/03/2020 21:36	01/03/2020 23:01	1,41	1	1,41	CHI
2020033000	PIRACANJUBA	PJ21287336	PIRACANJUBA	01/03/2020 21:36	02/03/2020 08:15	01/03/2020 21:36	02/03/2020 08:15	10,64	1	10,64	CHI
2020033002	JUSSARA	1290072556	JUSSARA	01/03/2020 21:39	01/03/2020 22:46	01/03/2020 21:39	01/03/2020 22:46	1,10	1	1,10	CHI
2020033004	IPAMERI	IP21000030	IPAMERI	01/03/2020 21:42	02/03/2020 00:18	01/03/2020 21:42	02/03/2020 00:18	2,59	2	5,18	CHI
2020033006	CORUMBAIBA	CI21180476	VILA CORUMBA	01/03/2020 21:44	02/03/2020 13:16	01/03/2020 21:44	02/03/2020 13:16	15,52	1	15,52	CHI
2020033008	ITAPIRAPUA	IU12072503	JUSSARA	01/03/2020 21:45	01/03/2020 22:45	01/03/2020 21:45	01/03/2020 22:45	0,99	11	10,87	CHI
2020033013	GOIANIA	GN11386310	AEROPORTO S3	01/03/2020 21:22	01/03/2020 23:22	01/03/2020 21:22	01/03/2020 23:22	2,00	86	171,86	CHI
2020033019	FAZENDA NOVA	FN12113973	IPORA	01/03/2020 21:59	02/03/2020 12:20	01/03/2020 21:59	02/03/2020 12:20	14,34	10	143,39	CHI
2020033019	ISRAELANDIA	FN12113973	IPORA	01/03/2020 21:59	02/03/2020 12:20	01/03/2020 21:59	02/03/2020 12:20	14,34	2	28,68	CHI
2020033024	URUTAI	UT12337239	PIRES DO RIO S2	01/03/2020 22:02	03/03/2020 08:45	01/03/2020 22:02	02/03/2020 10:46	12,72	5	63,60	CHI
2020033024	CAMPO ALEGRE DE GOIAS	01480414	CAMPO ALEGRE DE GOIAS	01/03/2020 22:02	03/03/2020 08:45	03/03/2020 08:41	03/03/2020 08:45	0,06	89	5,44	CHI
2020033024	IPAMERI	01480414	CAMPO ALEGRE DE GOIAS	01/03/2020 22:02	03/03/2020 08:45	03/03/2020 08:41	03/03/2020 08:45	0,06	66	4,03	CHI
2020033024	CAMPO ALEGRE DE GOIAS	01480414	PIRES DO RIO S2	01/03/2020 22:02	03/03/2020 08:45	03/03/2020 08:41	03/03/2020 08:45	0,06	19	1,16	CHI
2020033024	IPAMERI	01480414	PIRES DO RIO S2	01/03/2020 22:02	03/03/2020 08:45	03/03/2020 08:41	03/03/2020 08:45	0,06	261	15,95	CHI
2020033024	ORIZONA	01480414	PIRES DO RIO S2	01/03/2020 22:02	03/03/2020 08:45	03/03/2020 08:41	03/03/2020 08:45	0,06	9	0,55	CHI
2020033024	PIRES DO RIO	01480414	PIRES DO RIO S2	01/03/2020 22:02	03/03/2020 08:45	03/03/2020 08:41	03/03/2020 08:45	0,06	10	0,61	CHI
2020033024	URUTAI	01480414	PIRES DO RIO S2	01/03/2020 22:02	03/03/2020 08:45	03/03/2020 08:41	03/03/2020 08:45	0,06	93	5,68	CHI
2020033024	URUTAI	UT12337239	PIRES DO RIO S2	01/03/2020 22:02	03/03/2020 08:45	01/03/2020 22:02	03/03/2020 08:45	34,71	5	173,54	CHI
2020033029	GOIANIA	10020303384	FERROVIARIO S3	01/03/2020 22:06	01/03/2020 23:12	01/03/2020 22:06	01/03/2020 23:12	1,09	1	1,09	CHI
2020033031	SANTA RITA DO NOVO DESTINO	DF11315625	BARRO ALTO	01/03/2020 22:06	02/03/2020 01:59	01/03/2020 22:06	02/03/2020 01:59	3,87	1	3,87	CHI
2020033032	ITUMBIARA	10002916230	ITUMBIARA NOVA	01/03/2020 22:07	01/03/2020 22:58	01/03/2020 22:07	01/03/2020 22:58	0,85	1	0,85	CHI
2020033034	SILVANIA	SV12247192	VIANOPOLIS	01/03/2020 22:09	02/03/2020 10:53	01/03/2020 22:09	02/03/2020 10:53	12,72	9	114,48	CHI
2020033036	SERRANOPOLIS	SX12324832	JATAI S1	01/03/2020 22:08	02/03/2020 10:06	01/03/2020 22:08	02/03/2020 10:06	11,96	13	155,51	CHI
2020033042	CHAPADAO DO CEU	DJ12284819	CHAPADAO DO CEU	01/03/2020 22:10	02/03/2020 13:11	01/03/2020 22:10	02/03/2020 13:11	15,01	1	15,01	CHI
2020033048	PIRES DO RIO	PR21300876	PIRES DO RIO S1	01/03/2020 22:33	02/03/2020 00:57	01/03/2020 22:33	02/03/2020 00:57	2,39	1	2,39	CHI
2020033050	PIRES DO RIO	PR12064876RE	PIRES DO RIO S1	02/03/2020 06:33	02/03/2020 09:45	02/03/2020 06:33	02/03/2020 09:45	3,19	33	105,28	CHI
2020033051	ORIZONA	OZ12015058	VIANOPOLIS	01/03/2020 22:43	02/03/2020 18:47	01/03/2020 22:43	02/03/2020 18:47	20,07	11	220,72	CHI
2020033053	GOIANIA	10014468245	GOIANIA LESTE S2	01/03/2020 22:47	02/03/2020 00:45	01/03/2020 22:47	02/03/2020 00:45	1,96	1	1,96	CHI
2020033054	ARAGARCAS	AG12334918	ARAGARCAS	01/03/2020 22:47	03/03/2020 09:25	01/03/2020 22:47	03/03/2020 09:25	34,63	3	103,89	CHI

2020033062	ALTO PARAISO DE GOIAS	NQ12234731	NIQUELANDIA SUBTRANSMISSAO	01/03/2020 22:54	03/03/2020 14:55	01/03/2020 22:54	03/03/2020 14:55	40,00	12	480,03	CHI
2020033062	NIQUELANDIA	NQ12234731	NIQUELANDIA SUBTRANSMISSAO	01/03/2020 22:54	03/03/2020 14:55	01/03/2020 22:54	03/03/2020 14:55	40,00	0	0,00	CHI
2020033062	SAO JOAO D ALIANCA	NQ12234731	NIQUELANDIA SUBTRANSMISSAO	01/03/2020 22:54	03/03/2020 14:55	01/03/2020 22:54	03/03/2020 14:55	40,00	1	40,00	CHI
2020033062	NIQUELANDIA	NQ12234731	NIQUELANDIA SUBTRANSMISSAO	01/03/2020 22:54	03/03/2020 14:55	03/03/2020 11:16	03/03/2020 14:55	3,64	13	47,31	CHI
2020033065	CACU	10000172330	CACHOEIRA ALTA	01/03/2020 22:56	02/03/2020 00:52	01/03/2020 22:56	02/03/2020 00:52	1,92	1	1,92	CHI
2020033071	GOIANIA	GN12000394	CAMPINAS S3	01/03/2020 23:03	02/03/2020 03:19	01/03/2020 23:03	02/03/2020 00:56	1,88	57	107,33	CHI
2020033071	GOIANIA	GN12000394	CAMPINAS S3	01/03/2020 23:03	02/03/2020 03:19	02/03/2020 02:46	02/03/2020 02:58	0,21	57	12,22	CHI
2020033071	GOIANIA	GN12185816LD	CAMPINAS S3	01/03/2020 23:03	02/03/2020 03:19	01/03/2020 23:03	02/03/2020 03:19	4,25	55	233,92	CHI
2020033077	AGUAS LINDAS DE GOIAS	10011134249	AGUAS LINDAS DE GOIAS S1	01/03/2020 23:12	02/03/2020 00:07	01/03/2020 23:12	02/03/2020 00:07	0,90	1	0,90	CHI
2020033082	AMARALINA	LC21058062	MARA ROSA	01/03/2020 23:16	02/03/2020 00:58	01/03/2020 23:16	02/03/2020 00:58	1,70	1	1,70	CHI
2020033083	ANAPOLIS	AN11003272	JUNDIAI S1	01/03/2020 23:17	02/03/2020 00:08	01/03/2020 23:17	02/03/2020 00:08	0,84	139	117,18	CHI
2020033087	ORIZONA	OZ12022850RE	PIRES DO RIO S2	01/03/2020 21:58	02/03/2020 07:40	01/03/2020 21:58	02/03/2020 07:40	9,69	9	87,24	CHI
2020033087	PIRES DO RIO	OZ12022850RE	PIRES DO RIO S2	01/03/2020 21:58	02/03/2020 07:40	01/03/2020 21:58	02/03/2020 07:40	9,69	56	542,86	CHI
2020033092	APARECIDA DE GOIANIA	200456623	INDEPENDENCIA S2	01/03/2020 23:43	02/03/2020 01:17	01/03/2020 23:43	02/03/2020 01:17	1,57	1	1,57	CHI
2020033098	PARAUNA	PU12412183	PARAUNA	02/03/2020 00:00	02/03/2020 08:45	02/03/2020 00:00	02/03/2020 08:45	8,74	3	26,21	CHI
2020033099	MUNDO NOVO DE GOIAS	NA12035650	NOVA CRIXAS	02/03/2020 00:05	02/03/2020 08:13	02/03/2020 00:05	02/03/2020 08:13	8,13	8	65,01	CHI
2020033099	NOVA CRIXAS	NA12035650	NOVA CRIXAS	02/03/2020 00:05	02/03/2020 08:13	02/03/2020 00:05	02/03/2020 08:13	8,13	24	195,03	CHI
2020033100	GOIAS	GS12087843	ITABERAI S1	02/03/2020 00:19	02/03/2020 02:23	02/03/2020 00:19	02/03/2020 02:23	2,07	7	14,46	CHI
2020033101	MAURILANDIA	ML12286251	RIO DOS BOIS	02/03/2020 00:22	02/03/2020 08:05	02/03/2020 00:22	02/03/2020 08:05	7,71	68	524,00	CHI
2020033106	NOVA CRIXAS	MZ12055676	MOZARLANDIA	02/03/2020 00:32	02/03/2020 07:56	02/03/2020 00:32	02/03/2020 07:56	7,39	10	73,93	CHI
2020033108	POSSE	PS12298947	FLORES DE GOIAS	02/03/2020 00:40	02/03/2020 14:38	02/03/2020 00:40	02/03/2020 14:38	13,96	1	13,96	CHI
2020033109	GOIANESIA	GE11372408	GOIANESIA S1	02/03/2020 00:47	02/03/2020 03:00	02/03/2020 00:47	02/03/2020 03:00	2,20	1	2,20	CHI
2020033119	GOIATUBA	GT21235346	GOIATUBA S2	02/03/2020 01:58	02/03/2020 08:31	02/03/2020 01:58	02/03/2020 08:31	6,54	1	6,54	CHI
2020033121	CACU	19875324	CACHOEIRA ALTA	02/03/2020 01:59	02/03/2020 08:10	02/03/2020 01:59	02/03/2020 08:10	6,17	280	1728,46	CHI
2020033124	CEZARINA	CZ13000001	CEZARINA	02/03/2020 01:59	02/03/2020 06:22	02/03/2020 01:59	02/03/2020 06:22	4,38	2954	12938,52	CHI
2020033124	INDIARA	CZ13000001	CEZARINA	02/03/2020 01:59	02/03/2020 06:22	02/03/2020 01:59	02/03/2020 06:22	4,38	9	39,42	CHI
2020033124	PALMEIRAS DE GOIAS	CZ13000001	CEZARINA	02/03/2020 01:59	02/03/2020 06:22	02/03/2020 01:59	02/03/2020 06:22	4,38	21	91,98	CHI
2020033124	VARJAO	CZ13000001	CEZARINA	02/03/2020 01:59	02/03/2020 06:22	02/03/2020 01:59	02/03/2020 06:22	4,38	12	52,56	CHI
2020033127	BOM JARDIM DE GOIAS	BM12395481	BOM JARDIM	02/03/2020 02:48	02/03/2020 14:34	02/03/2020 02:48	02/03/2020 14:34	11,75	4	47,01	CHI
2020033129	PORANGATU	PO10396207	PORANGATU	02/03/2020 03:04	02/03/2020 13:58	02/03/2020 03:04	02/03/2020 07:38	4,56	156	711,58	CHI
2020033129	PORANGATU	PO10396207	PORANGATU	02/03/2020 03:04	02/03/2020 13:58	02/03/2020 09:26	02/03/2020 09:46	0,34	155	52,18	CHI
2020033129	PORANGATU	PO10396207	PORANGATU	02/03/2020 03:04	02/03/2020 13:58	02/03/2020 10:14	02/03/2020 10:29	0,25	155	38,41	CHI
2020033129	PORANGATU	PO10396207	PORANGATU	02/03/2020 03:04	02/03/2020 13:58	02/03/2020 03:04	02/03/2020 13:15	10,17	8	81,38	CHI
2020033129	PORANGATU	PO10396207	PORANGATU	02/03/2020 03:04	02/03/2020 13:58	02/03/2020 03:04	02/03/2020 13:47	10,71	204	2185,18	CHI
2020033129	MONTIVIDIU DO NORTE	PO12094115	PORANGATU	02/03/2020 03:04	02/03/2020 13:58	02/03/2020 03:04	02/03/2020 13:58	10,90	6	65,42	CHI
2020033129	PORANGATU	PO12094115	PORANGATU	02/03/2020 03:04	02/03/2020 13:58	02/03/2020 03:04	02/03/2020 13:58	10,90	72	785,00	CHI
2020033131	RIO VERDE	RV12247299	CACHOEIRA ALTA	02/03/2020 03:14	02/03/2020 10:31	02/03/2020 03:14	02/03/2020 10:31	7,27	26	188,99	CHI
2020033132	SAO MIGUEL DO ARAGUAIA	SM13220856	SAO MIGUEL DO ARAGUAIA	02/03/2020 03:23	03/03/2020 00:02	02/03/2020 03:23	03/03/2020 00:02	20,63	11	226,98	CHI
2020033137	BELA VISTA DE GOIAS	BV11000015	BELA VISTA S1	02/03/2020 03:44	02/03/2020 05:36	02/03/2020 03:44	02/03/2020 05:36	1,86	54	100,45	CHI
2020033139	BOM JESUS DE GOIAS	IT12030006	BOM JESUS DE GOIAS	02/03/2020 03:50	02/03/2020 08:11	02/03/2020 03:50	02/03/2020 08:11	4,35	1	4,35	CHI
2020033139	ITUMBIARA	IT12030006	BOM JESUS DE GOIAS	02/03/2020 03:50	02/03/2020 08:11	02/03/2020 03:50	02/03/2020 08:11	4,35	10	43,50	CHI
2020033147	BURITI DE GOIAS	BS12304459	FIRMINOPOLIS S2	02/03/2020 04:05	02/03/2020 07:11	02/03/2020 04:05	02/03/2020 07:11	3,10	10	30,97	CHI
2020033147	MOSSAMEDES	BS12304459	FIRMINOPOLIS S2	02/03/2020 04:05	02/03/2020 07:11	02/03/2020 04:05	02/03/2020 07:11	3,10	4	12,39	CHI
2020033147	SANCLERLANDIA	BS12304459	FIRMINOPOLIS S2	02/03/2020 04:05	02/03/2020 07:11	02/03/2020 04:05	02/03/2020 07:11	3,10	1	3,10	CHI

2020033151	ARAGUAPAZ	AZ12404563	GOIAS	02/03/2020 04:20	02/03/2020 09:58	02/03/2020 04:20	02/03/2020 09:58	5,62	20	112,37	CHI
2020033151	FAINA	AZ12404563	GOIAS	02/03/2020 04:20	02/03/2020 09:58	02/03/2020 04:20	02/03/2020 09:58	5,62	1	5,62	CHI
2020033153	SAO LUIS DE MONTES BELOS	SL12125616	FIRMINOPOLIS S1	01/03/2020 23:38	02/03/2020 08:25	01/03/2020 23:38	02/03/2020 08:25	8,78	10	87,80	CHI
2020033154	ALEXANIA	AX21094515	ALEXANIA	02/03/2020 04:26	02/03/2020 08:25	02/03/2020 04:26	02/03/2020 08:25	3,97	1	3,97	CHI
2020033156	JOVIANIA	JV12050338	GOIATUBA S1	02/03/2020 04:35	02/03/2020 08:55	02/03/2020 04:35	02/03/2020 08:55	4,33	6	25,96	CHI
2020033156	PONTALINA	JV12050338	GOIATUBA S1	02/03/2020 04:35	02/03/2020 08:55	02/03/2020 04:35	02/03/2020 08:55	4,33	16	69,24	CHI
2020033158	VILA PROPICIO	NP21284279	GOIANESIA S2	02/03/2020 04:42	02/03/2020 08:36	02/03/2020 04:42	02/03/2020 08:36	3,90	3	11,70	CHI
2020033159	HIDROLINA	SZ12190057	ITAPACI	02/03/2020 04:44	02/03/2020 11:15	02/03/2020 04:44	02/03/2020 11:15	6,51	32	208,37	CHI
2020033159	SAO LUIZ DO NORTE	SZ12190057	ITAPACI	02/03/2020 04:44	02/03/2020 11:15	02/03/2020 04:44	02/03/2020 11:15	6,51	2	13,02	CHI
2020033162	ITAGUARI	II21172703	ITABERAI S1	02/03/2020 04:57	02/03/2020 07:41	02/03/2020 04:57	02/03/2020 07:41	2,72	1	2,72	CHI
2020033167	URUACU	CR12375637	CAMPINORTE	02/03/2020 06:59	02/03/2020 09:14	02/03/2020 06:59	02/03/2020 09:14	2,24	117	262,28	CHI
2020033171	PONTALINA	PK12047392	VICENTINOPOLIS	02/03/2020 05:22	02/03/2020 11:20	02/03/2020 05:22	02/03/2020 11:20	5,96	19	113,20	CHI
2020033172	FAZENDA NOVA	FN12078803	IPORA	02/03/2020 05:24	02/03/2020 12:14	02/03/2020 05:24	02/03/2020 12:14	6,83	16	109,29	CHI
2020033178	FORMOSA	FA12383233	ITUIQUIRA	02/03/2020 05:32	02/03/2020 08:21	02/03/2020 05:32	02/03/2020 08:21	2,81	63	177,06	CHI
2020033179	NOVA CRIXAS	NA12038063	MOZARLANDIA	02/03/2020 05:34	02/03/2020 09:55	02/03/2020 05:34	02/03/2020 09:55	4,35	3	13,05	CHI
2020033182	GUARANI DE GOIAS	GY12271764	IACIARA S1	02/03/2020 05:34	02/03/2020 08:44	02/03/2020 05:34	02/03/2020 08:44	3,15	4	12,61	CHI
2020033185	FIRMINOPOLIS	TV12098088	FIRMINOPOLIS S1	02/03/2020 05:38	02/03/2020 08:36	02/03/2020 05:38	02/03/2020 08:36	2,96	1	2,96	CHI
2020033185	TURVANIA	TV12098088	FIRMINOPOLIS S1	02/03/2020 05:38	02/03/2020 08:36	02/03/2020 05:38	02/03/2020 08:36	2,96	5	14,80	CHI
2020033186	CAMPINACU	IH12192447	MINACU	02/03/2020 05:38	02/03/2020 15:10	02/03/2020 05:38	02/03/2020 10:48	5,16	5	25,78	CHI
2020033186	MINACU	IH12192447	MINACU	02/03/2020 05:38	02/03/2020 15:10	02/03/2020 05:38	02/03/2020 10:48	5,16	13	67,03	CHI
2020033186	MINACU	IH12192447	MINACU	02/03/2020 05:38	02/03/2020 15:10	02/03/2020 05:38	02/03/2020 12:00	6,36	3	19,07	CHI
2020033186	MINACU	IH12192447	MINACU	02/03/2020 05:38	02/03/2020 15:10	02/03/2020 05:38	02/03/2020 13:29	7,84	5	39,20	CHI
2020033186	MINACU	IH12192447	MINACU	02/03/2020 05:38	02/03/2020 15:10	02/03/2020 05:38	02/03/2020 15:10	9,52	3	28,57	CHI
2020033187	SANCLERLANDIA	SL12019284	SAO LUIZ DOS MONTES BELOS	02/03/2020 00:24	02/03/2020 08:11	02/03/2020 00:24	02/03/2020 08:11	7,77	28	217,63	CHI
2020033187	SAO LUIS DE MONTES BELOS	SL12019284	SAO LUIZ DOS MONTES BELOS	02/03/2020 00:24	02/03/2020 08:11	02/03/2020 00:24	02/03/2020 08:11	7,77	58	450,80	CHI
2020033188	LUZIANIA	LZ12390016	MARAJOARA	02/03/2020 05:40	02/03/2020 07:53	02/03/2020 05:40	02/03/2020 07:53	2,21	118	261,24	CHI
2020033190	IPAMERI	IP12017029	IPAMERI	02/03/2020 05:40	02/03/2020 08:58	02/03/2020 05:40	02/03/2020 08:58	3,29	14	46,01	CHI
2020033193	PIRACANJUBA	PJ12068868	PIRACANJUBA	02/03/2020 05:42	02/03/2020 10:42	02/03/2020 05:42	02/03/2020 10:42	5,00	9	44,96	CHI
2020033196	FIRMINOPOLIS	SL12306929	SAO LUIZ DOS MONTES BELOS	02/03/2020 05:31	02/03/2020 07:03	02/03/2020 05:31	02/03/2020 07:03	1,52	39	59,28	CHI
2020033196	SAO LUIS DE MONTES BELOS	SL12306929	SAO LUIZ DOS MONTES BELOS	02/03/2020 05:31	02/03/2020 07:03	02/03/2020 05:31	02/03/2020 07:03	1,52	22	33,44	CHI
2020033198	FIRMINOPOLIS	FR12000056	FIRMINOPOLIS S1	02/03/2020 05:46	02/03/2020 10:28	02/03/2020 05:46	02/03/2020 10:28	4,69	19	89,07	CHI
2020033305	FORMOSA	FA12392208	ITUIQUIRA	02/03/2020 05:51	02/03/2020 09:12	02/03/2020 05:51	02/03/2020 09:12	3,34	13	43,43	CHI
2020033306	PALMEIRAS DE GOIAS	PL12143287	PALMEIRAS	02/03/2020 05:05	02/03/2020 08:34	02/03/2020 05:05	02/03/2020 08:34	3,47	39	135,25	CHI
2020033312	BURITINOPOLIS	SU12301950	SANTA RITA DO ARAGUAIA	02/03/2020 06:00	02/03/2020 09:19	02/03/2020 06:00	02/03/2020 09:19	3,31	1	3,31	CHI
2020033312	SANTA RITA DO ARAGUAIA	SU12301950	SANTA RITA DO ARAGUAIA	02/03/2020 06:00	02/03/2020 09:19	02/03/2020 06:00	02/03/2020 09:19	3,31	21	69,57	CHI
2020033313	AMARALINA	LC12270112	SAO MIGUEL DO ARAGUAIA	02/03/2020 06:00	02/03/2020 10:45	02/03/2020 06:00	02/03/2020 10:45	4,74	62	293,81	CHI
2020033314	SANTA TEREZA DE GOIAS	SE12262714	MARA ROSA	02/03/2020 06:02	02/03/2020 09:01	02/03/2020 06:02	02/03/2020 09:01	2,98	15	44,65	CHI
2020033315	NOVA CRIXAS	NA12158763	NOVA CRIXAS	03/03/2020 07:03	03/03/2020 11:53	03/03/2020 07:03	03/03/2020 11:53	4,84	17	82,22	CHI
2020033317	MOSSAMEDES	MD12000176	FIRMINOPOLIS S2	02/03/2020 06:03	02/03/2020 08:05	02/03/2020 06:03	02/03/2020 08:05	2,03	37	75,04	CHI
2020033319	CASTELANDIA	QI12296614	QUIRINOPOLIS	02/03/2020 06:04	02/03/2020 09:12	02/03/2020 06:04	02/03/2020 09:12	3,13	1	3,13	CHI
2020033319	QUIRINOPOLIS	QI12296614	QUIRINOPOLIS	02/03/2020 06:04	02/03/2020 09:12	02/03/2020 06:04	02/03/2020 09:12	3,13	11	34,39	CHI
2020033322	BALIZA	BH12334823	BOM JARDIM	02/03/2020 05:01	02/03/2020 13:28	02/03/2020 05:01	02/03/2020 13:28	8,45	200	1689,89	CHI
2020033324	NOVA CRIXAS	NA12158761	NOVA CRIXAS	02/03/2020 05:46	02/03/2020 07:14	02/03/2020 05:46	02/03/2020 07:14	1,46	6	8,75	CHI
2020033326	CALDAS NOVAS	CN12298650	SERRA DE CALDAS	01/03/2020 22:55	02/03/2020 07:32	01/03/2020 22:55	02/03/2020 07:32	8,61	5	43,03	CHI

2020033328	CAIAPONIA	CP12296476	JATAI S1	02/03/2020 06:11	02/03/2020 07:52	02/03/2020 06:11	02/03/2020 07:52	1,67	7	11,67	CHI
2020033329	COCALZINHO DE GOIAS	ZN12302401	COCALZINHO	01/03/2020 22:14	02/03/2020 08:14	01/03/2020 22:14	02/03/2020 08:14	10,00	4	39,99	CHI
2020033329	CORUMBA DE GOIAS	ZN12302401	COCALZINHO	01/03/2020 22:14	02/03/2020 08:14	01/03/2020 22:14	02/03/2020 08:14	10,00	22	219,93	CHI
2020033330	SANTA CRUZ DE GOIAS	CN21180308	CALDAS NOVAS S1	02/03/2020 06:14	02/03/2020 13:40	02/03/2020 06:14	02/03/2020 13:40	7,42	1	7,42	CHI
2020033331	ITUMBIARA	IT21198587	ITUMBIARA VELHA S2	02/03/2020 04:21	02/03/2020 12:29	02/03/2020 04:21	02/03/2020 12:29	8,13	2	16,26	CHI
2020033332	LUZIANIA	LZ11000039	RIO VERMELHO	02/03/2020 06:15	02/03/2020 11:55	02/03/2020 06:15	02/03/2020 11:55	5,67	162	917,77	CHI
2020033333	BURITI ALEGRE	BG12257082	ALTO BURITI	02/03/2020 06:16	02/03/2020 14:37	02/03/2020 06:16	02/03/2020 14:37	8,34	29	241,83	CHI
2020033333	MORRINHOS	BG12257082	ALTO BURITI	02/03/2020 06:16	02/03/2020 14:37	02/03/2020 06:16	02/03/2020 14:37	8,34	4	33,36	CHI
2020033334	LUZIANIA	OZ12402562RE	PIRES DO RIO S2	02/03/2020 06:16	02/03/2020 10:42	02/03/2020 06:16	02/03/2020 10:42	4,42	133	587,56	CHI
2020033334	ORIZONA	OZ12402562RE	PIRES DO RIO S2	02/03/2020 06:16	02/03/2020 10:42	02/03/2020 06:16	02/03/2020 10:42	4,42	7	30,92	CHI
2020033335	GOIAS	GS12203896	ITABERAI S2	02/03/2020 06:17	02/03/2020 07:54	02/03/2020 06:17	02/03/2020 07:54	1,61	40	64,51	CHI
2020033337	AGUA LIMPA	AL21046643	VILA CORUMBA	02/03/2020 06:18	02/03/2020 16:58	02/03/2020 06:18	02/03/2020 16:58	10,67	1	10,67	CHI
2020033342	LUZIANIA	LZ21041494	MARAJOARA	02/03/2020 06:19	02/03/2020 11:47	02/03/2020 06:19	02/03/2020 11:47	5,46	1	5,46	CHI
2020033347	CAMPO ALEGRE DE GOIAS	CM12338745	CAMPO ALEGRE DE GOIAS	02/03/2020 06:21	02/03/2020 09:08	02/03/2020 06:21	02/03/2020 09:08	2,77	6	16,63	CHI
2020033349	GOIATUBA	JV12026571	GOIATUBA S1	02/03/2020 06:23	02/03/2020 08:56	02/03/2020 06:23	02/03/2020 08:56	2,54	4	10,17	CHI
2020033350	BALIZA	BH12079598	BOM JARDIM	02/03/2020 06:23	02/03/2020 13:41	02/03/2020 06:23	02/03/2020 13:41	7,30	24	175,25	CHI
2020033351	INDIARA	PL12376414	PALMEIRAS	02/03/2020 06:23	02/03/2020 12:48	02/03/2020 06:23	02/03/2020 12:48	6,41	3	19,22	CHI
2020033351	PALMEIRAS DE GOIAS	PL12376414	PALMEIRAS	02/03/2020 06:23	02/03/2020 12:48	02/03/2020 06:23	02/03/2020 12:48	6,41	50	320,32	CHI
2020033352	BRITANIA	IU12020119	MATRINCHA	02/03/2020 06:24	02/03/2020 09:25	02/03/2020 06:24	02/03/2020 09:25	3,02	6	18,09	CHI
2020033352	ITAPIRAPUA	IU12020119	MATRINCHA	02/03/2020 06:24	02/03/2020 09:25	02/03/2020 06:24	02/03/2020 09:25	3,02	42	126,63	CHI
2020033357	ARENOPOLIS	AY12380961	ARENOPOLIS	02/03/2020 06:25	03/03/2020 01:46	02/03/2020 06:25	03/03/2020 01:46	19,34	2	38,68	CHI
2020033357	PALESTINA DE GOIAS	AY12380961	ARENOPOLIS	02/03/2020 06:25	03/03/2020 01:46	02/03/2020 06:25	03/03/2020 01:46	19,34	3	58,02	CHI
2020033358	MARA ROSA	MQ12262455	MARA ROSA	02/03/2020 06:25	02/03/2020 11:20	02/03/2020 06:25	02/03/2020 11:20	4,91	3	14,72	CHI
2020033359	COCALZINHO DE GOIAS	ZN12381218	COCALZINHO	02/03/2020 06:26	02/03/2020 09:59	02/03/2020 06:26	02/03/2020 09:59	3,54	13	46,06	CHI
2020033360	CACHOEIRA ALTA	QI12191652	CACHOEIRA ALTA	02/03/2020 06:26	02/03/2020 10:07	02/03/2020 06:26	02/03/2020 10:07	3,68	3	11,04	CHI
2020033360	QUIRINOPOLIS	QI12191652	CACHOEIRA ALTA	02/03/2020 06:26	02/03/2020 10:07	02/03/2020 06:26	02/03/2020 10:07	3,68	9	33,12	CHI
2020033361	IACIARA	IA12302910	IACIARA S1	02/03/2020 06:26	02/03/2020 09:22	02/03/2020 06:26	02/03/2020 09:22	2,92	12	35,02	CHI
2020033363	GOIANESIA	550120683	GOIANESIA S2	02/03/2020 06:28	02/03/2020 15:59	02/03/2020 06:28	02/03/2020 15:59	9,53	1	9,53	CHI
2020033364	BONOPOLIS	BX10403948	SAO MIGUEL DO ARAGUAIA	02/03/2020 06:29	02/03/2020 07:53	02/03/2020 07:49	02/03/2020 07:53	0,07	259	17,05	CHI
2020033368	GOIANIA	GN11166706	CAMPINAS S2	02/03/2020 06:30	02/03/2020 07:43	02/03/2020 06:30	02/03/2020 07:43	1,20	76	91,56	CHI
2020033369	GOIANIA	GN11001386	ATLANTICO S3	02/03/2020 06:31	02/03/2020 08:17	02/03/2020 06:31	02/03/2020 08:17	1,76	186	328,03	CHI
2020033370	BURITI ALEGRE	BG21066352	ITUMBIARA VELHA S2	02/03/2020 06:32	02/03/2020 12:17	02/03/2020 06:32	02/03/2020 12:17	5,75	1	5,75	CHI
2020033377	IVOLANDIA	IV12199875	IPORA	02/03/2020 06:34	02/03/2020 09:37	02/03/2020 06:34	02/03/2020 09:37	3,04	7	21,26	CHI
2020033381	JANDAIA	JD12308479	PALMEIRAS	02/03/2020 06:35	02/03/2020 09:26	02/03/2020 06:35	02/03/2020 09:26	2,84	6	17,07	CHI
2020033382	BELA VISTA DE GOIAS	BV12242097	BELA VISTA S1	02/03/2020 06:36	02/03/2020 10:44	02/03/2020 06:36	02/03/2020 10:44	4,12	10	41,20	CHI
2020033383	CAIAPONIA	CP12374976	PALESTINA	02/03/2020 06:37	02/03/2020 11:37	02/03/2020 06:37	02/03/2020 11:37	5,00	6	30,00	CHI
2020033385	VARJAO	VJ21113945	GUAPO S2	02/03/2020 06:37	02/03/2020 12:20	02/03/2020 06:37	02/03/2020 12:20	5,71	1	5,71	CHI
2020033386	PONTALINA	PK12047065	PONTALINA	02/03/2020 05:15	02/03/2020 08:45	02/03/2020 05:15	02/03/2020 08:45	3,48	10	34,84	CHI
2020033388	AURILANDIA	AI21125123	FIRMINOPOLIS S2	02/03/2020 06:38	02/03/2020 22:04	02/03/2020 06:38	02/03/2020 22:04	15,42	1	15,42	CHI
2020033392	CASTELANDIA	QI12053189	QUIRINOPOLIS	02/03/2020 06:39	02/03/2020 08:40	02/03/2020 06:39	02/03/2020 08:40	2,01	3	6,02	CHI
2020033392	QUIRINOPOLIS	QI12053189	QUIRINOPOLIS	02/03/2020 06:39	02/03/2020 08:40	02/03/2020 06:39	02/03/2020 08:40	2,01	15	30,10	CHI
2020033392	RIO VERDE	QI12053189	QUIRINOPOLIS	02/03/2020 06:39	02/03/2020 08:40	02/03/2020 06:39	02/03/2020 08:40	2,01	1	2,01	CHI
2020033399	ANAPOLIS	AN11071526	ANAPOLIS UNIVERSITARIO S2	02/03/2020 06:42	02/03/2020 08:03	02/03/2020 06:42	02/03/2020 08:03	1,34	185	247,49	CHI
2020033403	ARAGOIANIA	00750214	GUAPO S1	02/03/2020 06:37	02/03/2020 10:36	02/03/2020 06:37	02/03/2020 07:21	0,73	31	22,56	CHI

2020033403	GUAPO	00750214	GUAPO S1	02/03/2020 06:37	02/03/2020 10:36	02/03/2020 06:37	02/03/2020 07:21	0,73	213	155,02	CHI
2020033403	VARJAO	00750214	GUAPO S1	02/03/2020 06:37	02/03/2020 10:36	02/03/2020 06:37	02/03/2020 07:21	0,73	11	8,01	CHI
2020033403	GUAPO	00750214	GUAPO S1	02/03/2020 06:37	02/03/2020 10:36	02/03/2020 06:37	02/03/2020 08:03	1,42	215	306,26	CHI
2020033403	ARAGOIANIA	AO10400702	GUAPO S1	02/03/2020 06:37	02/03/2020 10:36	02/03/2020 07:52	02/03/2020 08:32	0,67	31	20,70	CHI
2020033403	GUAPO	AO10400702	GUAPO S1	02/03/2020 06:37	02/03/2020 10:36	02/03/2020 07:52	02/03/2020 08:32	0,67	209	139,57	CHI
2020033403	VARJAO	AO10400702	GUAPO S1	02/03/2020 06:37	02/03/2020 10:36	02/03/2020 07:52	02/03/2020 08:32	0,67	11	7,35	CHI
2020033403	ARAGOIANIA	AO10400702	GUAPO S2	02/03/2020 06:37	02/03/2020 10:36	02/03/2020 07:52	02/03/2020 08:32	0,67	19	12,69	CHI
2020033403	GUAPO	AO10400702	GUAPO S2	02/03/2020 06:37	02/03/2020 10:36	02/03/2020 07:52	02/03/2020 08:32	0,67	46	30,72	CHI
2020033403	ARAGOIANIA	AO16414496	GUAPO S1	02/03/2020 06:37	02/03/2020 10:36	02/03/2020 08:38	02/03/2020 09:08	0,51	31	15,70	CHI
2020033403	GUAPO	AO16414496	GUAPO S1	02/03/2020 06:37	02/03/2020 10:36	02/03/2020 08:38	02/03/2020 09:08	0,51	213	107,86	CHI
2020033403	VARJAO	AO16414496	GUAPO S1	02/03/2020 06:37	02/03/2020 10:36	02/03/2020 08:38	02/03/2020 09:08	0,51	11	5,57	CHI
2020033403	ARAGOIANIA	AO16414496	GUAPO S2	02/03/2020 06:37	02/03/2020 10:36	02/03/2020 08:38	02/03/2020 09:08	0,51	20	10,13	CHI
2020033403	GUAPO	AO16414496	GUAPO S2	02/03/2020 06:37	02/03/2020 10:36	02/03/2020 08:38	02/03/2020 09:08	0,51	46	23,29	CHI
2020033403	GUAPO	00750214	GUAPO S1	02/03/2020 06:37	02/03/2020 10:36	02/03/2020 06:37	02/03/2020 09:16	2,65	1171	3097,62	CHI
2020033403	GUAPO	00750214	GUAPO S1	02/03/2020 06:37	02/03/2020 10:36	02/03/2020 06:37	02/03/2020 10:36	3,97	820	3258,82	CHI
2020033437	IACIARA	AQ12257608	FLORES DE GOIAS	02/03/2020 08:53	02/03/2020 09:27	02/03/2020 08:53	02/03/2020 09:27	0,56	1	0,56	CHI
2020033450	HIDROLANDIA	02200234	CEPAIGO S2	02/03/2020 09:10	03/03/2020 05:38	02/03/2020 09:10	02/03/2020 11:04	1,91	556	1059,64	CHI
2020033450	HIDROLANDIA	02200234	CEPAIGO S2	02/03/2020 09:10	03/03/2020 05:38	02/03/2020 09:12	02/03/2020 11:04	1,88	2	3,76	CHI
2020033450	HIDROLANDIA	02200234	CEPAIGO S2	02/03/2020 09:10	03/03/2020 05:38	02/03/2020 09:10	02/03/2020 11:13	2,05	25	51,35	CHI
2020033450	HIDROLANDIA	HD13072710	CEPAIGO S2	02/03/2020 09:10	03/03/2020 05:38	02/03/2020 09:12	02/03/2020 11:13	2,03	79	160,41	CHI
2020033450	HIDROLANDIA	02200234	CEPAIGO S2	02/03/2020 09:10	03/03/2020 05:38	02/03/2020 11:53	02/03/2020 11:58	0,08	558	43,56	CHI
2020033450	BELA VISTA DE GOIAS	02200234	CEPAIGO S2	02/03/2020 09:10	03/03/2020 05:38	02/03/2020 09:10	02/03/2020 12:05	2,91	2	5,82	CHI
2020033450	HIDROLANDIA	02200234	CEPAIGO S2	02/03/2020 09:10	03/03/2020 05:38	02/03/2020 09:10	02/03/2020 12:05	2,91	37	107,59	CHI
2020033450	BELA VISTA DE GOIAS	02200234	CEPAIGO S2	02/03/2020 09:10	03/03/2020 05:38	02/03/2020 09:12	02/03/2020 12:05	2,88	6	17,30	CHI
2020033450	HIDROLANDIA	02200234	CEPAIGO S2	02/03/2020 09:10	03/03/2020 05:38	02/03/2020 09:12	02/03/2020 12:05	2,88	150	432,62	CHI
2020033450	HIDROLANDIA	HD10395394	CEPAIGO S2	02/03/2020 09:10	03/03/2020 05:38	02/03/2020 14:26	02/03/2020 15:39	1,23	61	74,84	CHI
2020033450	PIRACANJUBA	HD10395394	CEPAIGO S2	02/03/2020 09:10	03/03/2020 05:38	02/03/2020 14:26	02/03/2020 15:39	1,23	4	4,91	CHI
2020033450	HIDROLANDIA	PJ13200328	CEPAIGO S2	02/03/2020 09:10	03/03/2020 05:38	02/03/2020 14:27	02/03/2020 15:39	1,20	3	3,60	CHI
2020033450	PROFESSOR JAMIL SAFADY	PJ13200328	CEPAIGO S2	02/03/2020 09:10	03/03/2020 05:38	02/03/2020 14:27	02/03/2020 15:39	1,20	1	1,20	CHI
2020033450	HIDROLANDIA	HD10221925	CEPAIGO S2	02/03/2020 09:10	03/03/2020 05:38	02/03/2020 14:26	02/03/2020 16:30	2,06	232	477,47	CHI
2020033450	HIDROLANDIA	HD10221925	CEPAIGO S2	02/03/2020 09:10	03/03/2020 05:38	02/03/2020 14:28	02/03/2020 16:30	2,04	11	22,41	CHI
2020033450	HIDROLANDIA	02200234	CEPAIGO S2	02/03/2020 09:10	03/03/2020 05:38	02/03/2020 09:10	02/03/2020 17:28	8,31	33	274,09	CHI
2020033450	HIDROLANDIA	02200234	CEPAIGO S2	02/03/2020 09:10	03/03/2020 05:38	02/03/2020 09:12	02/03/2020 17:28	8,28	16	132,52	CHI
2020033450	HIDROLANDIA	HD10221925	CEPAIGO S2	02/03/2020 09:10	03/03/2020 05:38	02/03/2020 14:26	02/03/2020 20:05	5,64	52	293,02	CHI
2020033450	HIDROLANDIA	HD10221925	CEPAIGO S2	02/03/2020 09:10	03/03/2020 05:38	02/03/2020 14:28	02/03/2020 20:05	5,61	3	16,84	CHI
2020033450	HIDROLANDIA	HD10221925	CEPAIGO S2	02/03/2020 09:10	03/03/2020 05:38	02/03/2020 14:26	02/03/2020 20:39	6,20	70	434,18	CHI
2020033450	HIDROLANDIA	HD10221925	CEPAIGO S2	02/03/2020 09:10	03/03/2020 05:38	02/03/2020 14:28	02/03/2020 20:39	6,18	8	49,45	CHI
2020033450	HIDROLANDIA	HD10221925	CEPAIGO S2	02/03/2020 09:10	03/03/2020 05:38	02/03/2020 20:25	02/03/2020 20:39	0,23	296	69,15	CHI
2020033450	HIDROLANDIA	HD10221925	CEPAIGO S2	02/03/2020 09:10	03/03/2020 05:38	02/03/2020 14:26	02/03/2020 21:41	7,24	61	441,83	CHI
2020033450	HIDROLANDIA	HD10221925	CEPAIGO S2	02/03/2020 09:10	03/03/2020 05:38	02/03/2020 14:28	02/03/2020 21:41	7,22	5	36,11	CHI
2020033450	HIDROLANDIA	HD10395394	CEPAIGO S2	02/03/2020 09:10	03/03/2020 05:38	03/03/2020 02:25	03/03/2020 02:28	0,06	63	4,08	CHI
2020033450	PIRACANJUBA	HD10395394	CEPAIGO S2	02/03/2020 09:10	03/03/2020 05:38	03/03/2020 02:25	03/03/2020 02:28	0,06	4	0,26	CHI
2020033450	PROFESSOR JAMIL SAFADY	HD10395394	CEPAIGO S2	02/03/2020 09:10	03/03/2020 05:38	03/03/2020 02:25	03/03/2020 02:28	0,06	1	0,06	CHI
2020033450	BELA VISTA DE GOIAS	02200234	CEPAIGO S2	02/03/2020 09:10	03/03/2020 05:38	02/03/2020 09:10	03/03/2020 04:50	19,66	1	19,66	CHI

2020033450	HIDROLANDIA	02200234	CEPAIGO S2	02/03/2020 09:10	03/03/2020 05:38	02/03/2020 09:10	03/03/2020 04:50	19,66	13	255,53	CHI
2020033450	HIDROLANDIA	02200234	CEPAIGO S2	02/03/2020 09:10	03/03/2020 05:38	02/03/2020 09:12	03/03/2020 04:50	19,63	5	98,16	CHI
2020033450	HIDROLANDIA	HD10221925	CEPAIGO S2	02/03/2020 09:10	03/03/2020 05:38	02/03/2020 14:26	03/03/2020 05:38	15,19	39	592,30	CHI
2020033450	HIDROLANDIA	HD10221925	CEPAIGO S2	02/03/2020 09:10	03/03/2020 05:38	02/03/2020 14:28	03/03/2020 05:38	15,17	4	60,67	CHI
2020033476	CAMPO LIMPO	AN21360261	NEROPOLIS S1	02/03/2020 10:16	02/03/2020 11:09	02/03/2020 10:16	02/03/2020 11:09	0,87	1	0,87	CHI
2020033503	JUSSARA	JR12341198	JUSSARA	02/03/2020 06:44	02/03/2020 07:51	02/03/2020 06:44	02/03/2020 07:51	1,11	7	7,80	CHI
2020033504	PIRACANJUBA	PJ12040425	MORRINHOS	02/03/2020 06:40	02/03/2020 08:38	02/03/2020 06:40	02/03/2020 08:38	1,96	15	29,38	CHI
2020033510	ITUMBIARA	690046765	ITUMBIARA NOVA	02/03/2020 06:47	02/03/2020 08:50	02/03/2020 06:47	02/03/2020 08:50	2,05	1	2,05	CHI
2020033512	URUTAI	UT21337187	URUTAI	02/03/2020 06:47	02/03/2020 09:07	02/03/2020 06:47	02/03/2020 09:07	2,32	1	2,32	CHI
2020033514	ITAPIRAPUA	IU12018746	JUSSARA	02/03/2020 06:48	02/03/2020 11:26	02/03/2020 06:48	02/03/2020 11:26	4,64	3	13,92	CHI
2020033523	JATAI	JT12296503	JATAI S1	02/03/2020 06:51	02/03/2020 10:24	02/03/2020 06:51	02/03/2020 10:24	3,55	16	56,78	CHI
2020033523	PEROLANDIA	JT12296503	JATAI S1	02/03/2020 06:51	02/03/2020 10:24	02/03/2020 06:51	02/03/2020 10:24	3,55	3	10,65	CHI
2020033526	ALTO HORIZONTE	NH12202110RE	SANTA TEREZINHA	02/03/2020 06:20	02/03/2020 09:10	02/03/2020 06:20	02/03/2020 09:10	2,83	12	33,97	CHI
2020033526	NOVA IGUACU DE GOIAS	NH12202110RE	SANTA TEREZINHA	02/03/2020 06:20	02/03/2020 09:10	02/03/2020 06:20	02/03/2020 09:10	2,83	1	2,83	CHI
2020033526	PILAR DE GOIAS	NH12202110RE	SANTA TEREZINHA	02/03/2020 06:20	02/03/2020 09:10	02/03/2020 06:20	02/03/2020 09:10	2,83	17	48,12	CHI
2020033526	SANTA TEREZINHA DE GOIAS	NH12202110RE	SANTA TEREZINHA	02/03/2020 06:20	02/03/2020 09:10	02/03/2020 06:20	02/03/2020 09:10	2,83	23	65,10	CHI
2020033527	PORANGATU	PO12262596	PORANGATU	02/03/2020 06:52	02/03/2020 09:13	02/03/2020 06:52	02/03/2020 09:13	2,34	38	88,78	CHI
2020033530	MORRINHOS	MR12121217	MORRINHOS	02/03/2020 06:53	02/03/2020 11:00	02/03/2020 06:53	02/03/2020 11:00	4,11	15	61,64	CHI
2020033531	HIDROLANDIA	HD12310178	CEPAIGO S2	02/03/2020 06:54	02/03/2020 12:01	02/03/2020 06:54	02/03/2020 12:01	5,12	10	51,18	CHI
2020033532	PORTELANDIA	PW12302000	PARQUE DAS EMAS	02/03/2020 06:55	02/03/2020 09:45	02/03/2020 06:55	02/03/2020 09:45	2,83	3	8,50	CHI
2020033533	BALIZA	BM12390150	BOM JARDIM	02/03/2020 06:37	02/03/2020 08:51	02/03/2020 06:37	02/03/2020 08:51	2,23	51	113,89	CHI
2020033533	BOM JARDIM DE GOIAS	BM12390150	BOM JARDIM	02/03/2020 06:37	02/03/2020 08:51	02/03/2020 06:37	02/03/2020 08:51	2,23	9	20,10	CHI
2020033536	AMORINOPOLIS	AM12072349	IPORA	02/03/2020 06:56	02/03/2020 18:44	02/03/2020 06:56	02/03/2020 18:44	11,79	8	94,34	CHI
2020033541	CATALAO	CT12077435	CATALAO S2	02/03/2020 06:57	02/03/2020 08:28	02/03/2020 06:57	02/03/2020 08:28	1,51	6	9,07	CHI
2020033542	JATAI	JT12234457	JATAI S3	02/03/2020 06:57	02/03/2020 08:38	02/03/2020 06:57	02/03/2020 08:38	1,68	6	10,07	CHI
2020033546	ITARUMA	IM21048945	CACHOEIRA ALTA	02/03/2020 06:56	02/03/2020 12:30	02/03/2020 06:56	02/03/2020 11:54	4,96	1	4,96	CHI
2020033546	ITARUMA	IM12038174	CACHOEIRA ALTA	02/03/2020 06:56	02/03/2020 12:30	02/03/2020 10:25	02/03/2020 12:30	2,08	2	4,17	CHI
2020033547	BOM JARDIM DE GOIAS	8647473	IPORA	02/03/2020 06:58	03/03/2020 03:12	02/03/2020 06:58	03/03/2020 03:12	20,24	1	20,24	CHI
2020033556	PARAUNA	8578844	ACREUNA	02/03/2020 06:59	02/03/2020 21:48	02/03/2020 06:59	02/03/2020 21:48	14,81	7	103,64	CHI
2020033558	RIO VERDE	RV12279609	RIO VERDE S1	02/03/2020 07:00	02/03/2020 10:35	02/03/2020 07:00	02/03/2020 10:35	3,57	31	110,82	CHI
2020033559	JUSSARA	JR12027532	BRITANIA	02/03/2020 07:00	02/03/2020 16:15	02/03/2020 07:00	02/03/2020 16:15	9,24	39	360,23	CHI
2020033562	GOIAS	GS12054690	GOIAS	02/03/2020 07:02	02/03/2020 08:23	02/03/2020 07:02	02/03/2020 08:23	1,34	14	18,82	CHI
2020033567	APARECIDA DE GOIANIA	10005368802	ANHANGUERA	02/03/2020 07:04	02/03/2020 09:50	02/03/2020 07:04	02/03/2020 09:50	2,77	1	2,77	CHI
2020033570	CATALAO	CT11250213	CATALAO S1	02/03/2020 07:04	02/03/2020 13:22	02/03/2020 07:04	02/03/2020 13:22	6,30	102	642,54	CHI
2020033571	RIO VERDE	RV12303875	ACREUNA	02/03/2020 07:05	02/03/2020 10:44	02/03/2020 07:05	02/03/2020 10:44	3,65	5	18,24	CHI
2020033574	GOIANIA	GN11016164	CAMPINAS S1	02/03/2020 07:06	02/03/2020 13:09	02/03/2020 07:06	02/03/2020 13:09	6,05	1	6,05	CHI
2020033575	CRISTALINA	KR12261714	CRISTALINA S2	02/03/2020 07:06	02/03/2020 09:26	02/03/2020 07:06	02/03/2020 09:26	2,32	12	27,84	CHI
2020033581	CATURAI	CK12326175	INHUMAS S1	02/03/2020 07:08	02/03/2020 11:26	02/03/2020 07:08	02/03/2020 11:26	4,29	3	12,88	CHI
2020033581	INHUMAS	CK12326175	INHUMAS S1	02/03/2020 07:08	02/03/2020 11:26	02/03/2020 07:08	02/03/2020 11:26	4,29	3	12,88	CHI
2020033582	CACU	CC12019878	CACHOEIRA ALTA	02/03/2020 07:08	02/03/2020 12:32	02/03/2020 07:08	02/03/2020 12:32	5,39	29	156,22	CHI
2020033587	PORANGATU	PO12391648	NOVO PLANALTO	02/03/2020 07:09	02/03/2020 11:15	02/03/2020 07:09	02/03/2020 11:15	4,09	4	16,37	CHI
2020033588	JARAGUA	JA12059976	JARAGUA	02/03/2020 06:49	02/03/2020 09:06	02/03/2020 06:49	02/03/2020 09:06	2,28	2	4,55	CHI
2020033588	PIRENOPOLIS	JA12059976	JARAGUA	02/03/2020 06:49	02/03/2020 09:06	02/03/2020 06:49	02/03/2020 09:06	2,28	97	220,70	CHI
2020033589	CASTELANDIA	DM12000064	RIO DOS BOIS	02/03/2020 07:09	02/03/2020 12:52	02/03/2020 07:09	02/03/2020 12:52	5,71	10	57,06	CHI

2020033589	MAURILANDIA	DM12000064	RIO DOS BOIS	02/03/2020 07:09	02/03/2020 12:52	02/03/2020 07:09	02/03/2020 12:52	5,71	1	5,71	CHI
2020033593	EDEALINA	ED12293192	PONTALINA	01/03/2020 21:42	02/03/2020 09:47	01/03/2020 21:42	02/03/2020 09:47	12,08	17	205,41	CHI
2020033593	INDIARA	ED12293192	PONTALINA	01/03/2020 21:42	02/03/2020 09:47	01/03/2020 21:42	02/03/2020 09:47	12,08	2	24,17	CHI
2020033598	SANTA CRUZ DE GOIAS	BC12110028RE	PIRES DO RIO S2	02/03/2020 06:42	02/03/2020 09:58	02/03/2020 06:42	02/03/2020 09:58	3,25	19	61,82	CHI
2020033599	BOM JESUS DE GOIAS	IT12034458RE	CACHOEIRA DOURADA	02/03/2020 05:24	02/03/2020 11:23	02/03/2020 05:24	02/03/2020 11:23	5,99	3	17,98	CHI
2020033599	ITUMBIARA	IT12034458RE	CACHOEIRA DOURADA	02/03/2020 05:24	02/03/2020 11:23	02/03/2020 05:24	02/03/2020 11:23	5,99	65	389,51	CHI
2020033599	PANAMA	IT12034458RE	CACHOEIRA DOURADA	02/03/2020 05:24	02/03/2020 11:23	02/03/2020 05:24	02/03/2020 11:23	5,99	13	77,90	CHI
2020033603	BOM JARDIM DE GOIAS	BM12349615	BOM JARDIM	02/03/2020 07:13	02/03/2020 20:22	02/03/2020 07:13	02/03/2020 20:22	13,14	16	210,23	CHI
2020033608	MINEIROS	MY12360820	PARQUE DAS EMAS	02/03/2020 07:14	02/03/2020 10:12	02/03/2020 07:14	02/03/2020 10:12	2,96	9	26,61	CHI
2020033613	JANDAIA	JD12289834	PALMEIRAS	02/03/2020 07:16	02/03/2020 11:05	02/03/2020 07:16	02/03/2020 11:05	3,82	2	7,63	CHI
2020033614	SAO MIGUEL DO ARAGUAIA	SM21000026	SAO MIGUEL DO ARAGUAIA	02/03/2020 07:16	02/03/2020 20:38	02/03/2020 07:16	02/03/2020 20:38	13,37	1	13,37	CHI
2020033617	CAIAPONIA	CP12248981	CAIAPONIA	02/03/2020 07:16	02/03/2020 18:20	02/03/2020 07:16	02/03/2020 18:20	11,06	8	88,47	CHI
2020033618	PIRACANJUBA	PJ21134772	PIRACANJUBA	02/03/2020 07:16	02/03/2020 09:44	02/03/2020 07:16	02/03/2020 09:44	2,45	1	2,45	CHI
2020033619	BOM JARDIM DE GOIAS	BM12334785	BOM JARDIM	02/03/2020 05:01	02/03/2020 12:34	02/03/2020 05:01	02/03/2020 12:34	7,54	57	429,65	CHI
2020033621	CACHOEIRA DE GOIAS	CG12165601	FIRMINOPOLIS S2	02/03/2020 07:17	02/03/2020 11:21	02/03/2020 07:17	02/03/2020 11:21	4,07	3	12,20	CHI
2020033623	DOVERLANDIA	DV12324390	PARQUE DAS EMAS	02/03/2020 07:17	02/03/2020 20:30	02/03/2020 07:17	02/03/2020 20:30	13,22	11	145,37	CHI
2020033627	ALEXANIA	AX21255933	ALEXANIA	02/03/2020 07:17	02/03/2020 10:44	02/03/2020 07:17	02/03/2020 10:44	3,44	4	13,76	CHI
2020033634	NIQUELANDIA	NQ12374575	NIQUELANDIA SUBTRANSMISSAO	02/03/2020 07:20	02/03/2020 08:44	02/03/2020 07:20	02/03/2020 08:44	1,39	12	16,72	CHI
2020033635	PORANGATU	PO12354488	NOVO PLANALTO	02/03/2020 07:20	02/03/2020 10:05	02/03/2020 07:20	02/03/2020 10:05	2,74	15	41,06	CHI
2020033636	PADRE BERNARDO	PB12347929	PADRE BERNARDO	02/03/2020 07:20	02/03/2020 10:10	02/03/2020 07:20	02/03/2020 10:10	2,82	5	14,09	CHI
2020033637	SAO LUIS DE MONTES BELOS	SL12391445	FIRMINOPOLIS S1	02/03/2020 07:20	02/03/2020 10:21	02/03/2020 07:20	02/03/2020 10:21	3,00	6	18,00	CHI
2020033638	GOIANESIA	GE21115124	GOIANESIA S2	02/03/2020 07:21	03/03/2020 11:30	02/03/2020 07:21	03/03/2020 10:50	27,49	1	27,49	CHI
2020033638	GOIANESIA	GE12115053	GOIANESIA S2	02/03/2020 07:21	03/03/2020 11:30	02/03/2020 07:21	03/03/2020 11:11	27,85	1	27,85	CHI
2020033638	GOIANESIA	GE12384172	GOIANESIA S2	02/03/2020 07:21	03/03/2020 11:30	02/03/2020 07:21	03/03/2020 11:20	27,99	5	139,94	CHI
2020033638	GOIANESIA	GE21000029	GOIANESIA S2	02/03/2020 07:21	03/03/2020 11:30	02/03/2020 07:21	03/03/2020 11:30	28,16	1	28,16	CHI
2020033639	IPAMERI	IP12195237	IPAMERI	01/03/2020 20:51	02/03/2020 08:58	01/03/2020 20:51	02/03/2020 08:58	12,11	6	72,65	CHI
2020033640	TRES RANCHOS	TH12127698	CATALAO S1	02/03/2020 07:21	02/03/2020 10:31	02/03/2020 07:21	02/03/2020 10:31	3,16	3	9,47	CHI
2020033643	DOVERLANDIA	DV12207836	CAIAPONIA	02/03/2020 07:21	02/03/2020 10:39	02/03/2020 07:21	02/03/2020 10:39	3,29	11	36,20	CHI
2020033644	MUTUNOPOLIS	PO12242441	PORANGATU	02/03/2020 07:21	02/03/2020 15:39	02/03/2020 07:21	02/03/2020 15:39	8,28	2	16,57	CHI
2020033654	CORUMBAIBA	CI21149218	CATALAO S1	02/03/2020 07:22	02/03/2020 13:13	02/03/2020 07:22	02/03/2020 13:13	5,84	1	5,84	CHI
2020033657	RIO VERDE	630225059	CABRIUVA S1	02/03/2020 07:23	02/03/2020 10:04	02/03/2020 07:23	02/03/2020 10:04	2,67	1	2,67	CHI
2020033658	SANTO ANTONIO DO DESCOBERTO	SN11375247	ALEXANIA	02/03/2020 06:18	02/03/2020 10:43	02/03/2020 06:18	02/03/2020 10:43	4,41	58	255,97	CHI
2020033659	BRITANIA	BT12210599	BRITANIA	02/03/2020 07:09	02/03/2020 17:41	02/03/2020 07:09	02/03/2020 11:41	4,54	547	2481,56	CHI
2020033659	JUSSARA	BT12210599	BRITANIA	02/03/2020 07:09	02/03/2020 17:41	02/03/2020 07:09	02/03/2020 11:41	4,54	48	217,76	CHI
2020033659	BRITANIA	BT10400610	BRITANIA	02/03/2020 07:09	02/03/2020 17:41	02/03/2020 07:09	02/03/2020 16:17	9,13	113	1032,22	CHI
2020033659	BRITANIA	BT21101967	BRITANIA	02/03/2020 07:09	02/03/2020 17:41	02/03/2020 07:09	02/03/2020 16:58	9,82	1	9,82	CHI
2020033659	BRITANIA	BT12101446	BRITANIA	02/03/2020 07:09	02/03/2020 17:41	02/03/2020 07:09	02/03/2020 17:41	10,54	46	484,70	CHI
2020033661	JATAI	JT12234319	JATAI S3	02/03/2020 07:25	02/03/2020 09:56	02/03/2020 07:25	02/03/2020 09:56	2,51	4	10,04	CHI
2020033663	AURILANDIA	SL12003853	SAO LUIZ DOS MONTES BELOS	02/03/2020 07:25	02/03/2020 14:21	02/03/2020 07:25	02/03/2020 14:21	6,93	6	41,55	CHI
2020033663	FIRMINOPOLIS	SL12003853	SAO LUIZ DOS MONTES BELOS	02/03/2020 07:25	02/03/2020 14:21	02/03/2020 07:25	02/03/2020 14:21	6,93	2	13,85	CHI
2020033663	SANCLERLANDIA	SL12003853	SAO LUIZ DOS MONTES BELOS	02/03/2020 07:25	02/03/2020 14:21	02/03/2020 07:25	02/03/2020 14:21	6,93	1	6,93	CHI
2020033663	SAO LUIS DE MONTES BELOS	SL12003853	SAO LUIZ DOS MONTES BELOS	02/03/2020 07:25	02/03/2020 14:21	02/03/2020 07:25	02/03/2020 14:21	6,93	103	713,36	CHI
2020033664	FAZENDA NOVA	NB12396238	JUSSARA	02/03/2020 07:25	02/03/2020 15:18	02/03/2020 07:25	02/03/2020 15:18	7,87	1	7,87	CHI
2020033664	NOVO BRASIL	NB12396238	JUSSARA	02/03/2020 07:25	02/03/2020 15:18	02/03/2020 07:25	02/03/2020 15:18	7,87	4	31,50	CHI

2020033668	NOVA CRIXAS	NA12040307	NOVA CRIXAS	02/03/2020 07:26	03/03/2020 17:30	02/03/2020 07:26	03/03/2020 17:30	34,07	5	170,37	CHI
2020033675	INHUMAS	IN12247252	INHUMAS S1	02/03/2020 07:27	02/03/2020 09:53	02/03/2020 07:27	02/03/2020 09:53	2,43	4	9,72	CHI
2020033678	MONTIVIDIU	MV12160710	MONTIVIDIU T	02/03/2020 07:06	02/03/2020 15:10	02/03/2020 07:06	02/03/2020 15:10	8,05	21	169,09	CHI
2020033679	GOIANIA	GN12000242	GOIANIA LESTE S1	02/03/2020 07:27	02/03/2020 09:40	02/03/2020 07:27	02/03/2020 09:40	2,21	142	313,31	CHI
2020033687	PIRES DO RIO	PZ12114941	PIRES DO RIO S2	02/03/2020 07:29	02/03/2020 14:58	02/03/2020 07:29	02/03/2020 14:58	7,48	3	22,44	CHI
2020033687	SANTA CRUZ DE GOIAS	PZ12114941	PIRES DO RIO S2	02/03/2020 07:29	02/03/2020 14:58	02/03/2020 07:29	02/03/2020 14:58	7,48	30	224,43	CHI
2020033694	CACHOEIRA DOURADA	CD12032028	CACHOEIRA DOURADA	02/03/2020 06:51	02/03/2020 09:28	02/03/2020 06:51	02/03/2020 09:28	2,61	6	15,69	CHI
2020033694	ITUMBIARA	CD12032028	CACHOEIRA DOURADA	02/03/2020 06:51	02/03/2020 09:28	02/03/2020 06:51	02/03/2020 09:28	2,61	4	10,46	CHI
2020033695	RIO VERDE	RV12326798	SANTA HELENA S1	02/03/2020 07:30	02/03/2020 11:57	02/03/2020 07:30	02/03/2020 11:57	4,45	2	8,89	CHI
2020033698	MATRINCHA	MP12299780	MATRINCHA	02/03/2020 07:30	02/03/2020 12:38	02/03/2020 07:30	02/03/2020 12:38	5,12	2	10,25	CHI
2020033699	APARECIDA DE GOIANIA	200292389	INDEPENDENCIA S2	02/03/2020 07:30	02/03/2020 17:46	02/03/2020 07:30	02/03/2020 17:46	10,27	1	10,27	CHI
2020033706	GOIANDIRA	GD21270771	CATALAO S1	02/03/2020 07:32	02/03/2020 11:57	02/03/2020 07:32	02/03/2020 11:57	4,41	1	4,41	CHI
2020033709	ITUMBIARA	IT12282410	ITUMBIARA VELHA S1	02/03/2020 07:33	02/03/2020 09:40	02/03/2020 07:33	02/03/2020 09:40	2,12	103	217,93	CHI
2020033710	VIANOPOLIS	VN12249458	VIANOPOLIS	02/03/2020 07:33	02/03/2020 13:42	02/03/2020 07:33	02/03/2020 13:42	6,15	1	6,15	CHI
2020033711	DAVINOPOLIS	IO21151432	CATALAO S1	02/03/2020 07:33	02/03/2020 20:55	02/03/2020 07:33	02/03/2020 20:55	13,36	3	40,08	CHI
2020033713	GOIANIA	GN21313923	CAMPINAS S1	02/03/2020 07:33	02/03/2020 11:00	02/03/2020 07:33	02/03/2020 11:00	3,44	1	3,44	CHI
2020033714	CORUMBAIBA	CI21309343	CATALAO S1	02/03/2020 07:33	03/03/2020 09:48	02/03/2020 07:33	03/03/2020 09:48	26,24	1	26,24	CHI
2020033716	PROFESSOR JAMIL SAFADY	JS12308012	ROCHEDO	02/03/2020 07:34	02/03/2020 10:25	02/03/2020 07:34	02/03/2020 10:25	2,85	2	5,70	CHI
2020033718	ITAJA	Z300014112	ITAJA S2	02/03/2020 07:35	02/03/2020 09:20	02/03/2020 07:35	02/03/2020 09:20	1,75	1	1,75	CHI
2020033720	ITABERAI	IB21336510	ITABERAI S2	02/03/2020 07:35	02/03/2020 08:18	02/03/2020 07:35	02/03/2020 08:18	0,70	1	0,70	CHI
2020033721	EDEIA	EA12049531	EDEIA	02/03/2020 07:35	02/03/2020 10:38	02/03/2020 07:35	02/03/2020 10:38	3,03	2	6,07	CHI
2020033722	PALMEIRAS DE GOIAS	PL12076440	PALMEIRAS	02/03/2020 07:36	02/03/2020 10:35	02/03/2020 07:36	02/03/2020 10:35	2,98	1	2,98	CHI
2020033726	COCALZINHO DE GOIAS	ZN21185680	COCALZINHO	02/03/2020 07:37	02/03/2020 11:06	02/03/2020 07:37	02/03/2020 11:06	3,47	1	3,47	CHI
2020033729	APARECIDA DE GOIANIA	10560968	REAL S2	02/03/2020 07:37	02/03/2020 10:17	02/03/2020 07:37	02/03/2020 10:17	2,65	1	2,65	CHI
2020033731	ALEXANIA	AX12351026	ALEXANIA	02/03/2020 07:09	02/03/2020 09:39	02/03/2020 07:09	02/03/2020 09:39	2,50	77	192,14	CHI
2020033732	NIQUELANDIA	NQ21345059	NIQUELANDIA SUBTRANSMISSAO	02/03/2020 07:38	02/03/2020 10:16	02/03/2020 07:38	02/03/2020 10:16	2,62	1	2,62	CHI
2020033735	LUZIANIA	LZ21209515	RIO VERMELHO	02/03/2020 07:39	02/03/2020 15:46	02/03/2020 07:39	02/03/2020 15:00	7,35	1	7,35	CHI
2020033735	LUZIANIA	LZ12041476	RIO VERMELHO	02/03/2020 07:39	02/03/2020 15:46	02/03/2020 10:23	02/03/2020 15:46	5,39	20	107,81	CHI
2020033738	CATALAO	CT12316116	CATALAO S1	02/03/2020 07:39	02/03/2020 09:45	02/03/2020 07:39	02/03/2020 09:45	2,09	4	8,36	CHI
2020033743	SAO LUIS DE MONTES BELOS	SL12259053	SAO LUIZ DOS MONTES BELOS	02/03/2020 07:39	02/03/2020 17:58	02/03/2020 07:39	02/03/2020 17:58	10,30	3	30,90	CHI
2020033744	HIDROLANDIA	HD11251854	CEPAIGO S2	02/03/2020 07:40	02/03/2020 11:32	02/03/2020 07:40	02/03/2020 11:32	3,87	75	290,00	CHI
2020033745	FORMOSA	FA12146108	ITUIQUIRA	02/03/2020 07:40	02/03/2020 11:17	02/03/2020 07:40	02/03/2020 11:17	3,61	33	119,27	CHI
2020033755	CORUMBAIBA	CI12000499	VILA CORUMBA	02/03/2020 07:42	02/03/2020 10:40	02/03/2020 07:42	02/03/2020 10:40	2,96	5	14,80	CHI
2020033758	CROMINIA	CQ21038831	PONTALINA	02/03/2020 07:43	02/03/2020 09:46	02/03/2020 07:43	02/03/2020 09:46	2,05	1	2,05	CHI
2020033761	JOVIANIA	JV21103209	GOIATUBA S1	02/03/2020 07:44	02/03/2020 10:58	02/03/2020 07:44	02/03/2020 10:58	3,23	1	3,23	CHI
2020033763	MINEIROS	MY12324703	PARQUE DAS EMAS	02/03/2020 07:44	02/03/2020 18:30	02/03/2020 07:44	02/03/2020 18:30	10,76	1	10,76	CHI
2020033766	ANAPOLIS	AN11000135	ANAPOLIS UNIVERSITARIO S2	02/03/2020 07:45	02/03/2020 09:34	02/03/2020 07:45	02/03/2020 09:34	1,82	116	210,57	CHI
2020033768	BELA VISTA DE GOIAS	BV11000015	BELA VISTA S1	02/03/2020 07:45	02/03/2020 17:12	02/03/2020 12:39	02/03/2020 17:12	4,55	54	245,70	CHI
2020033769	MORRINHOS	PJ12076912	MORRINHOS	02/03/2020 07:45	02/03/2020 12:20	02/03/2020 07:45	02/03/2020 12:20	4,57	4	18,28	CHI
2020033771	PIRENOPOLIS	PV21060507	CORUMBA	02/03/2020 07:46	02/03/2020 18:33	02/03/2020 07:46	02/03/2020 18:33	10,78	1	10,78	CHI
2020033776	GOIAS	GS21145473	GOIAS	02/03/2020 07:47	02/03/2020 10:30	02/03/2020 07:47	02/03/2020 10:30	2,71	1	2,71	CHI
2020033778	PILAR DE GOIAS	GG21322615	URUACU	02/03/2020 07:47	02/03/2020 09:29	02/03/2020 07:47	02/03/2020 09:29	1,68	1	1,68	CHI
2020033782	CATALAO	CT12266779	CATALAO S1	02/03/2020 07:48	02/03/2020 10:06	02/03/2020 07:48	02/03/2020 10:06	2,29	2	4,59	CHI
2020033785	BURITI ALEGRE	BG12229312	ALTO BURITI	02/03/2020 07:48	02/03/2020 20:00	02/03/2020 07:48	02/03/2020 20:00	12,18	3	36,55	CHI

2020033786	FORMOSA	FA21180864	ITUIQUIRA	02/03/2020 07:48	02/03/2020 11:34	02/03/2020 07:48	02/03/2020 11:34	3,75	1	3,75	CHI
2020033794	PETROLINA DE GOIAS	PV12062894	SAO FRANCISCO DE GOIAS	02/03/2020 06:49	02/03/2020 10:23	02/03/2020 06:49	02/03/2020 10:23	3,55	3	10,66	CHI
2020033794	PIRENOPOLIS	PV12062894	SAO FRANCISCO DE GOIAS	02/03/2020 06:49	02/03/2020 10:23	02/03/2020 06:49	02/03/2020 10:23	3,55	21	74,63	CHI
2020033797	SANTA HELENA DE GOIAS	400035649	IPEGUARI	02/03/2020 07:51	02/03/2020 11:22	02/03/2020 07:51	02/03/2020 11:22	3,52	1	3,52	CHI
2020033799	CAMPO LIMPO	CV21244205	NEROPOLIS S1	02/03/2020 07:51	02/03/2020 10:22	02/03/2020 07:51	02/03/2020 10:22	2,51	1	2,51	CHI
2020033800	PONTALINA	PK12063352	PONTALINA	02/03/2020 06:39	02/03/2020 09:33	02/03/2020 06:39	02/03/2020 09:33	2,90	17	49,30	CHI
2020033801	FORMOSA	FA12404498	ITUIQUIRA	02/03/2020 07:51	02/03/2020 09:59	02/03/2020 07:51	02/03/2020 09:59	2,12	1	2,12	CHI
2020033808	DAVINOPOLIS	IO12333671	CATALAO S1	02/03/2020 07:52	02/03/2020 11:05	02/03/2020 07:52	02/03/2020 11:05	3,22	7	22,52	CHI
2020033808	OUIDOR	IO12333671	CATALAO S1	02/03/2020 07:52	02/03/2020 11:05	02/03/2020 07:52	02/03/2020 11:05	3,22	7	22,52	CHI
2020033813	PIRACANJUBA	PJ12228105	PIRACANJUBA	02/03/2020 07:53	02/03/2020 13:22	02/03/2020 07:53	02/03/2020 13:22	5,48	2	10,96	CHI
2020033816	RIO VERDE	RV12296153	SANTA HELENA S1	02/03/2020 07:53	02/03/2020 16:27	02/03/2020 07:53	02/03/2020 16:27	8,55	20	171,09	CHI
2020033817	LUZIANIA	10023715195	RIO VERMELHO	02/03/2020 07:54	02/03/2020 10:23	02/03/2020 07:54	02/03/2020 10:23	2,48	1	2,48	CHI
2020033821	ANAPOLIS	AN21255925	JUNDIAI S1	02/03/2020 07:55	02/03/2020 10:08	02/03/2020 07:55	02/03/2020 10:08	2,21	1	2,21	CHI
2020033823	CACU	CC12202706	CACHOEIRA ALTA	02/03/2020 07:55	02/03/2020 13:10	02/03/2020 07:55	02/03/2020 13:10	5,24	8	41,91	CHI
2020033825	RIO VERDE	RV21365431	RIO VERDE S2	02/03/2020 07:55	02/03/2020 10:05	02/03/2020 07:55	02/03/2020 10:05	2,15	1	2,15	CHI
2020033832	GOIANIA	GN12152082	SENADOR CANEDO	02/03/2020 07:56	02/03/2020 08:40	02/03/2020 08:24	02/03/2020 08:40	0,27	150	40,00	CHI
2020033836	CORUMBA DE GOIAS	260002823	CORUMBA	02/03/2020 07:57	02/03/2020 19:33	02/03/2020 07:57	02/03/2020 19:33	11,59	1	11,59	CHI
2020033837	PIRACANJUBA	BV21077148	BELA VISTA S1	02/03/2020 07:58	02/03/2020 10:53	02/03/2020 07:58	02/03/2020 10:53	2,92	1	2,92	CHI
2020033838	MONTES CLAROS DE GOIAS	ME21140224	IPORA	02/03/2020 07:58	02/03/2020 10:08	02/03/2020 07:58	02/03/2020 10:08	2,17	1	2,17	CHI
2020033840	GOIANIA	13948209	MEIA PONTE	02/03/2020 07:58	02/03/2020 12:59	02/03/2020 07:58	02/03/2020 12:59	5,01	1	5,01	CHI
2020033841	ALTO HORIZONTE	9640006639	SANTA TEREZINHA	02/03/2020 07:58	02/03/2020 10:38	02/03/2020 07:58	02/03/2020 10:38	2,66	1	2,66	CHI
2020033845	ANAPOLIS	AN11221273	ANAPOLIS UNIVERSITARIO S2	02/03/2020 07:59	02/03/2020 09:30	02/03/2020 07:59	02/03/2020 09:30	1,51	103	155,53	CHI
2020033846	PIRACANJUBA	PJ21072598	PIRACANJUBA	02/03/2020 07:59	02/03/2020 14:24	02/03/2020 07:59	02/03/2020 14:24	6,41	1	6,41	CHI
2020033847	AGUAS LINDAS DE GOIAS	LA12412176	AGUAS LINDAS DE GOIAS S1	02/03/2020 07:59	02/03/2020 11:38	02/03/2020 07:59	02/03/2020 11:38	3,63	1	3,63	CHI
2020033851	GOIANIA	10187686	AEROPORTO S2	02/03/2020 08:00	02/03/2020 10:31	02/03/2020 08:00	02/03/2020 10:31	2,51	1	2,51	CHI
2020033852	APARECIDA DE GOIANIA	12340923	REAL S1	02/03/2020 08:00	02/03/2020 11:18	02/03/2020 08:00	02/03/2020 11:18	3,29	1	3,29	CHI
2020033853	PROFESSOR JAMIL SAFADY	PJ12078744	ROCHEDO	02/03/2020 08:01	02/03/2020 11:42	02/03/2020 08:01	02/03/2020 11:42	3,68	4	14,73	CHI
2020033855	MINEIROS	MY21197245	PARQUE DAS EMAS	02/03/2020 08:01	02/03/2020 13:50	02/03/2020 08:01	02/03/2020 13:50	5,82	1	5,82	CHI
2020033856	IPAMERI	IP12404728	IPAMERI	02/03/2020 08:01	02/03/2020 12:00	02/03/2020 08:01	02/03/2020 12:00	3,98	10	39,76	CHI
2020033859	CORUMBA DE GOIAS	CB12058982	CORUMBA	02/03/2020 08:02	02/03/2020 11:58	02/03/2020 08:02	02/03/2020 11:58	3,93	8	31,45	CHI
2020033860	NEROPOLIS	NR12010648	NEROPOLIS S2	02/03/2020 08:02	02/03/2020 10:11	02/03/2020 08:02	02/03/2020 10:11	2,15	3	6,44	CHI
2020033863	CROMINIA	CQ12000237	PONTALINA	02/03/2020 08:02	02/03/2020 10:39	02/03/2020 08:02	02/03/2020 10:39	2,61	2	5,22	CHI
2020033864	PARAUNA	PU21303604	PARAUNA	02/03/2020 08:02	02/03/2020 11:50	02/03/2020 08:02	02/03/2020 11:00	2,96	1	2,96	CHI
2020033864	PARAUNA	PU12388915	PARAUNA	02/03/2020 08:02	02/03/2020 11:50	02/03/2020 08:02	02/03/2020 11:10	3,12	2	6,25	CHI
2020033864	PARAUNA	PU12388915	PARAUNA	02/03/2020 08:02	02/03/2020 11:50	02/03/2020 11:32	02/03/2020 11:50	0,31	2	0,63	CHI
2020033867	URUACU	640047543	URUACU	02/03/2020 08:02	02/03/2020 10:45	02/03/2020 08:02	02/03/2020 10:45	2,70	1	2,70	CHI
2020033868	SERRANOPOLIS	SX21403340	JATAI S1	02/03/2020 08:02	02/03/2020 11:45	02/03/2020 08:02	02/03/2020 11:45	3,70	1	3,70	CHI
2020033871	GOIATUBA	JV21157813	GOIATUBA S1	02/03/2020 08:03	02/03/2020 10:26	02/03/2020 08:03	02/03/2020 10:26	2,37	1	2,37	CHI
2020033873	BONOPOLIS	BX21229972	SAO MIGUEL DO ARAGUAIA	02/03/2020 08:03	03/03/2020 09:39	02/03/2020 08:03	03/03/2020 09:39	25,59	1	25,59	CHI
2020033877	PETROLINA DE GOIAS	PG12017759	PETROLINA	02/03/2020 08:04	02/03/2020 11:18	02/03/2020 08:04	02/03/2020 11:18	3,23	16	51,65	CHI
2020033881	SAO FRANCISCO DE GOIAS	SF12000177	SAO FRANCISCO DE GOIAS	02/03/2020 07:29	02/03/2020 09:21	02/03/2020 07:29	02/03/2020 09:21	1,86	4	7,44	CHI
2020033888	CORUMBA DE GOIAS	CB12161727	CORUMBA	02/03/2020 08:00	02/03/2020 09:34	02/03/2020 08:00	02/03/2020 09:34	1,56	305	476,65	CHI
2020033890	SAO LUIS DE MONTES BELOS	SL12003914	SAO LUIZ DOS MONTES BELOS	02/03/2020 08:04	02/03/2020 17:08	02/03/2020 08:04	02/03/2020 17:08	9,06	13	117,78	CHI
2020033891	SANTA FE DE GOIAS	RN12206755	BRITANIA	02/03/2020 08:06	02/03/2020 17:30	02/03/2020 08:06	02/03/2020 17:30	9,39	3	28,16	CHI

2020033896	SAO MIGUEL DO ARAGUAIA	SM12372634	SAO MIGUEL DO ARAGUAIA	02/03/2020 08:05	02/03/2020 11:43	02/03/2020 08:05	02/03/2020 11:43	3,63	23	83,57	CHI
2020033898	CRIXAS	GF12243493	SANTA TEREZINHA	02/03/2020 08:07	02/03/2020 16:45	02/03/2020 08:07	02/03/2020 16:45	8,62	3	25,86	CHI
2020033898	GUARINOS	GF12243493	SANTA TEREZINHA	02/03/2020 08:07	02/03/2020 16:45	02/03/2020 08:07	02/03/2020 16:45	8,62	13	112,07	CHI
2020033903	APARECIDA DE GOIANIA	14400110	ATLANTICO S2	02/03/2020 08:08	02/03/2020 10:40	02/03/2020 08:08	02/03/2020 10:40	2,53	1	2,53	CHI
2020033908	GOIANDIRA	GD12027441	CATALAO S1	02/03/2020 08:09	03/03/2020 18:44	02/03/2020 08:09	03/03/2020 17:51	33,70	3	101,11	CHI
2020033908	GOIANDIRA	GD12027441	CATALAO S1	02/03/2020 08:09	03/03/2020 18:44	03/03/2020 14:56	03/03/2020 17:51	2,92	3	8,76	CHI
2020033908	CATALAO	GD12039654	CATALAO S1	02/03/2020 08:09	03/03/2020 18:44	02/03/2020 08:09	03/03/2020 18:12	34,04	3	102,13	CHI
2020033908	GOIANDIRA	GD12039654	CATALAO S1	02/03/2020 08:09	03/03/2020 18:44	02/03/2020 08:09	03/03/2020 18:12	34,04	6	204,25	CHI
2020033908	GOIANDIRA	GD21035395	CATALAO S1	02/03/2020 08:09	03/03/2020 18:44	02/03/2020 08:09	03/03/2020 18:44	34,59	2	69,18	CHI
2020033909	APARECIDA DE GOIANIA	10005558547	ANHANGUERA	02/03/2020 08:09	02/03/2020 09:27	02/03/2020 08:09	02/03/2020 09:27	1,29	1	1,29	CHI
2020033915	SAO MIGUEL DO ARAGUAIA	SM12059999	SAO MIGUEL DO ARAGUAIA	02/03/2020 08:10	02/03/2020 18:35	02/03/2020 08:10	02/03/2020 18:35	10,41	9	93,68	CHI
2020033924	PORANGATU	840106385	PORANGATU	02/03/2020 08:11	02/03/2020 14:07	02/03/2020 08:11	02/03/2020 14:07	5,92	1	5,92	CHI
2020033927	RIO VERDE	630227597	RIO VERDE S1	02/03/2020 08:12	02/03/2020 10:46	02/03/2020 08:12	02/03/2020 10:46	2,56	1	2,56	CHI
2020033931	MONTES CLAROS DE GOIAS	ME21050104	IPORA	02/03/2020 08:12	02/03/2020 11:47	02/03/2020 08:12	02/03/2020 11:47	3,57	1	3,57	CHI
2020033936	CORUMBAIBA	CI12092099	VILA CORUMBA	02/03/2020 08:14	02/03/2020 17:57	02/03/2020 08:14	02/03/2020 17:57	9,71	2	19,43	CHI
2020033937	MOSSAMEDES	SC12164006	FIRMINOPOLIS S2	02/03/2020 08:14	02/03/2020 09:13	02/03/2020 08:14	02/03/2020 09:13	0,97	11	10,69	CHI
2020033938	JATAI	JT21248508	JATAI S3	02/03/2020 08:14	02/03/2020 10:37	02/03/2020 08:14	02/03/2020 10:37	2,37	1	2,37	CHI
2020033940	FAINA	FC12211270	GOIAS	02/03/2020 08:15	02/03/2020 10:34	02/03/2020 08:15	02/03/2020 10:34	2,31	8	18,47	CHI
2020033941	ARUANA	AK21198834	MOZARLANDIA	02/03/2020 08:15	02/03/2020 10:05	02/03/2020 08:15	02/03/2020 10:05	1,83	1	1,83	CHI
2020033942	SANTA RITA DO ARAGUAIA	SU12184139	SANTA RITA DO ARAGUAIA	02/03/2020 08:15	02/03/2020 11:35	02/03/2020 08:15	02/03/2020 11:35	3,32	1	3,32	CHI
2020033944	RIO VERDE	630468291	RIO VERDE S2	02/03/2020 08:15	02/03/2020 11:03	02/03/2020 08:15	02/03/2020 11:03	2,80	1	2,80	CHI
2020033946	CATALAO	CT12318869	CATALAO S1	02/03/2020 08:16	02/03/2020 13:21	02/03/2020 08:16	02/03/2020 13:21	5,08	5	25,41	CHI
2020033950	CRISTALINA	KR12304800	CRISTALINA S2	02/03/2020 08:16	02/03/2020 12:48	02/03/2020 08:16	02/03/2020 12:48	4,53	66	298,93	CHI
2020033954	ARUANA	AK12274205	MOZARLANDIA	02/03/2020 08:17	02/03/2020 09:35	02/03/2020 08:17	02/03/2020 09:35	1,30	1	1,30	CHI
2020033956	NOVA IGUACU DE GOIAS	NH12398059	CAMPINORTE	02/03/2020 08:17	02/03/2020 10:28	02/03/2020 08:17	02/03/2020 10:28	2,18	8	17,44	CHI
2020033958	INACIOLANDIA	ID11304157	CACHOEIRA DOURADA	02/03/2020 08:17	02/03/2020 11:52	02/03/2020 08:17	02/03/2020 11:52	3,57	1	3,57	CHI
2020033959	FORMOSA	VB12262281	ITUIQUIRA	02/03/2020 08:17	02/03/2020 09:40	02/03/2020 08:17	02/03/2020 09:40	1,37	16	21,90	CHI
2020033962	MONTIVIDIU DO NORTE	MX12270942	PORANGATU	02/03/2020 08:18	02/03/2020 12:36	02/03/2020 08:18	02/03/2020 12:36	4,30	50	214,83	CHI
2020033965	VIANOPOLIS	VN12107799	VIANOPOLIS	02/03/2020 08:19	02/03/2020 11:42	02/03/2020 08:19	02/03/2020 11:42	3,38	6	20,27	CHI
2020033966	JANDAIA	JD12008673	PALMEIRAS	02/03/2020 08:19	02/03/2020 13:49	02/03/2020 08:19	02/03/2020 13:49	5,49	13	71,36	CHI
2020033967	NOVA CRIXAS	NA12131934	NOVA CRIXAS	02/03/2020 08:19	02/03/2020 17:49	02/03/2020 08:19	02/03/2020 17:49	9,49	171	1622,31	CHI
2020033969	GOIAS	GS12056682	GOIAS	02/03/2020 08:19	02/03/2020 08:49	02/03/2020 08:19	02/03/2020 08:49	0,49	7	3,43	CHI
2020033971	JUSSARA	1290013953	JUSSARA	02/03/2020 08:20	02/03/2020 16:59	02/03/2020 08:20	02/03/2020 16:59	8,65	1	8,65	CHI
2020033974	GOIANIA	GN11001641	FERROVIARIO S1	02/03/2020 08:21	02/03/2020 16:59	02/03/2020 12:24	02/03/2020 16:59	4,58	133	609,62	CHI
2020033975	CEZARINA	CZ21132639	CEZARINA	02/03/2020 08:22	02/03/2020 09:01	02/03/2020 08:22	02/03/2020 09:01	0,63	1	0,63	CHI
2020033979	URUACU	640017125	URUACU	02/03/2020 08:23	02/03/2020 19:38	02/03/2020 08:23	02/03/2020 19:38	11,25	1	11,25	CHI
2020033990	SAO MIGUEL DO ARAGUAIA	SM12220658	SAO MIGUEL DO ARAGUAIA	02/03/2020 08:25	02/03/2020 14:58	02/03/2020 08:25	02/03/2020 14:58	6,54	4	26,17	CHI
2020033992	BELA VISTA DE GOIAS	BV21020408	BELA VISTA S2	02/03/2020 08:26	02/03/2020 14:47	02/03/2020 08:26	02/03/2020 14:47	6,34	1	6,34	CHI
2020033994	FIRMINOPOLIS	FR21362890	FIRMINOPOLIS S1	02/03/2020 08:26	02/03/2020 15:47	02/03/2020 08:26	02/03/2020 15:47	7,34	1	7,34	CHI
2020033997	PIRES DO RIO	PR21191532	PIRES DO RIO S2	02/03/2020 08:28	02/03/2020 16:52	02/03/2020 08:28	02/03/2020 16:52	8,39	1	8,39	CHI
2020034002	SANTA TEREZA DE GOIAS	SE12182470	MARA ROSA	02/03/2020 08:28	02/03/2020 13:08	02/03/2020 08:28	02/03/2020 13:08	4,66	7	32,59	CHI
2020034003	AGUAS LINDAS DE GOIAS	10003734283	AGUAS LINDAS DE GOIAS S1	02/03/2020 08:27	02/03/2020 09:59	02/03/2020 08:27	02/03/2020 09:59	1,52	1	1,52	CHI
2020034007	SILVANIA	SV21151525	VIANOPOLIS	02/03/2020 08:29	02/03/2020 12:03	02/03/2020 08:29	02/03/2020 12:03	3,56	1	3,56	CHI
2020034011	CRIXAS	CX21190110	SANTA TEREZINHA	02/03/2020 08:30	02/03/2020 15:15	02/03/2020 08:30	02/03/2020 15:15	6,74	1	6,74	CHI

2020034012	TRINDADE	TR31190548	TRINDADE	02/03/2020 08:30	02/03/2020 10:33	02/03/2020 08:30	02/03/2020 10:33	2,04	1	2,04	CHI
2020034014	PARAUNA	PU12206469	ACREUNA	02/03/2020 08:31	02/03/2020 10:29	02/03/2020 08:31	02/03/2020 10:29	1,96	22	43,20	CHI
2020034017	MONTES CLAROS DE GOIAS	ME12390172	IPORA	02/03/2020 08:23	02/03/2020 12:55	02/03/2020 08:23	02/03/2020 12:55	4,52	31	140,05	CHI
2020034018	CORUMBA DE GOIAS	260009520	CORUMBA	02/03/2020 08:31	02/03/2020 10:33	02/03/2020 08:31	02/03/2020 10:33	2,03	1	2,03	CHI
2020034022	AMARALINA	MQ12210288	NOVA CRIXAS	02/03/2020 08:32	02/03/2020 14:39	02/03/2020 08:32	02/03/2020 14:39	6,10	6	36,61	CHI
2020034023	MONTES CLAROS DE GOIAS	ME12381013	IPORA	02/03/2020 08:33	03/03/2020 16:42	02/03/2020 08:33	03/03/2020 16:42	32,15	3	96,45	CHI
2020034028	CAMPINORTE	CR12172326	MARA ROSA	02/03/2020 08:35	02/03/2020 13:10	02/03/2020 08:35	02/03/2020 13:10	4,58	4	18,33	CHI
2020034028	FORMOSO	CR12172326	MARA ROSA	02/03/2020 08:35	02/03/2020 13:10	02/03/2020 08:35	02/03/2020 13:10	4,58	3	13,75	CHI
2020034029	ITARUMA	IM12219246	CACHOEIRA ALTA	02/03/2020 08:35	02/03/2020 14:54	02/03/2020 08:35	02/03/2020 14:54	6,31	4	25,23	CHI
2020034032	VALPARAISO DE GOIAS	VA11376292	MARAJOARA	02/03/2020 08:35	02/03/2020 11:57	02/03/2020 08:35	02/03/2020 11:57	3,35	9	30,16	CHI
2020034041	FAINA	FC21219223	GOIAS	02/03/2020 08:37	02/03/2020 10:06	02/03/2020 08:37	02/03/2020 10:06	1,47	1	1,47	CHI
2020034045	ITUMBIARA	IT21290355	PARANAIBA	02/03/2020 08:38	02/03/2020 10:48	02/03/2020 08:38	02/03/2020 10:48	2,16	1	2,16	CHI
2020034048	SENADOR CANEDO	SW21171838	GOIANIA LESTE S2	02/03/2020 08:39	02/03/2020 10:28	02/03/2020 08:39	02/03/2020 10:28	1,80	2	3,60	CHI
2020034050	SILVANIA	SV12205374	VIANOPOLIS	02/03/2020 08:40	02/03/2020 11:45	02/03/2020 08:40	02/03/2020 11:45	3,08	2	6,17	CHI
2020034051	MORRINHOS	MR21128626	MORRINHOS	02/03/2020 08:40	02/03/2020 10:31	02/03/2020 08:40	02/03/2020 10:31	1,86	1	1,86	CHI
2020034055	GOIATUBA	140073401	GOIATUBA S2	02/03/2020 08:41	02/03/2020 09:38	02/03/2020 08:41	02/03/2020 09:38	0,96	1	0,96	CHI
2020034057	ITAUCU	IX21317392	INHUMAS S1	02/03/2020 08:41	02/03/2020 10:52	02/03/2020 08:41	02/03/2020 10:52	2,17	1	2,17	CHI
2020034063	PADRE BERNARDO	PB12375228	PADRE BERNARDO	02/03/2020 08:42	02/03/2020 12:56	02/03/2020 08:42	02/03/2020 12:56	4,22	1	4,22	CHI
2020034064	GOIAS	GS12206917	ITABERAI S1	02/03/2020 08:43	02/03/2020 12:00	02/03/2020 08:43	02/03/2020 12:00	3,28	14	45,96	CHI
2020034065	AMARALINA	MU12384317	MARA ROSA	02/03/2020 08:43	02/03/2020 15:07	02/03/2020 08:43	02/03/2020 15:07	6,39	4	25,57	CHI
2020034065	MUTUNOPOLIS	MU12384317	MARA ROSA	02/03/2020 08:43	02/03/2020 15:07	02/03/2020 08:43	02/03/2020 15:07	6,39	20	127,84	CHI
2020034068	CAMPINORTE	CR12291127	CAMPINORTE	02/03/2020 05:07	02/03/2020 10:56	02/03/2020 05:07	02/03/2020 10:56	5,81	0	0,00	CHI
2020034068	URUACU	CR12291127	CAMPINORTE	02/03/2020 05:07	02/03/2020 10:56	02/03/2020 05:07	02/03/2020 10:56	5,81	170	987,09	CHI
2020034072	POSSE	PS21132655	IACIARA S2	02/03/2020 08:44	02/03/2020 10:20	02/03/2020 08:44	02/03/2020 10:20	1,59	1	1,59	CHI
2020034073	PALMEIRAS DE GOIAS	PL21059942	CEZARINA	02/03/2020 08:44	02/03/2020 10:04	02/03/2020 08:44	02/03/2020 10:04	1,32	1	1,32	CHI
2020034076	GOIANIA	GN11002463	GOIANIA LESTE S2	02/03/2020 08:45	02/03/2020 10:09	02/03/2020 08:45	02/03/2020 10:09	1,40	40	55,82	CHI
2020034084	APARECIDA DE GOIANIA	14327430	ATLANTICO S3	02/03/2020 08:46	02/03/2020 10:48	02/03/2020 08:46	02/03/2020 10:48	2,02	1	2,02	CHI
2020034087	PIRENOPOLIS	PV21241580	CORUMBA	02/03/2020 08:47	02/03/2020 18:10	02/03/2020 08:47	02/03/2020 18:10	9,38	1	9,38	CHI
2020034088	CATALAO	1990003488	CATALAO S2	02/03/2020 08:47	02/03/2020 10:42	02/03/2020 08:47	02/03/2020 10:42	1,91	1	1,91	CHI
2020034089	GOIANIA	GN12034647	GOIANIA LESTE S1	02/03/2020 08:47	02/03/2020 12:07	02/03/2020 10:45	02/03/2020 12:07	1,37	1	1,37	CHI
2020034090	LUZIANIA	LZ21021415	MARAJOARA	02/03/2020 08:47	02/03/2020 10:28	02/03/2020 08:47	02/03/2020 10:28	1,68	1	1,68	CHI
2020034091	PORTELANDIA	PW12248465	PARQUE DAS EMAS	02/03/2020 08:08	02/03/2020 11:26	02/03/2020 08:08	02/03/2020 11:26	3,29	11	36,14	CHI
2020034095	SANTO ANTONIO DO DESCOBERTO	2210174734	AGUAS LINDAS DE GOIAS S2	02/03/2020 08:49	02/03/2020 12:59	02/03/2020 08:49	02/03/2020 12:59	4,16	1	4,16	CHI
2020034097	JATAI	JT12260439	JATAI S1	02/03/2020 08:49	02/03/2020 11:15	02/03/2020 08:49	02/03/2020 11:15	2,42	2	4,84	CHI
2020034098	BURITI ALEGRE	BG12294720	GOIATUBA S2	02/03/2020 08:50	02/03/2020 12:12	02/03/2020 08:50	02/03/2020 12:12	3,37	1	3,37	CHI
2020034098	GOIATUBA	BG12294720	GOIATUBA S2	02/03/2020 08:50	02/03/2020 12:12	02/03/2020 08:50	02/03/2020 12:12	3,37	1	3,37	CHI
2020034099	ANAPOLIS	20563024	JUNDIAI S2	02/03/2020 08:50	02/03/2020 12:42	02/03/2020 08:50	02/03/2020 12:42	3,85	1	3,85	CHI
2020034109	CRISTALINA	KR11315536	CRISTALINA S1	02/03/2020 08:53	02/03/2020 21:43	02/03/2020 08:53	02/03/2020 21:43	12,83	4	51,30	CHI
2020034113	AMARALINA	MU12390127	MARA ROSA	02/03/2020 08:51	02/03/2020 11:52	02/03/2020 08:51	02/03/2020 11:52	3,01	6	18,09	CHI
2020034114	SAO SIMAO	SO12219317	CACHOEIRA ALTA	02/03/2020 06:48	02/03/2020 09:25	02/03/2020 06:48	02/03/2020 09:25	2,61	126	329,00	CHI
2020034114	SAO SIMAO	SO12219317	CACHOEIRA ALTA	02/03/2020 06:48	02/03/2020 09:25	02/03/2020 08:43	02/03/2020 09:25	0,70	473	330,31	CHI
2020034115	ITUMBIARA	BG12000073	ITUMBIARA VELHA S2	02/03/2020 06:15	02/03/2020 12:29	02/03/2020 06:15	02/03/2020 12:29	6,23	13	81,02	CHI
2020034119	FAZENDA NOVA	NB12117290	JUSSARA	02/03/2020 08:56	02/03/2020 21:09	02/03/2020 08:56	02/03/2020 21:09	12,22	4	48,87	CHI
2020034119	NOVO BRASIL	NB12117290	JUSSARA	02/03/2020 08:56	02/03/2020 21:09	02/03/2020 08:56	02/03/2020 21:09	12,22	5	61,08	CHI

2020034123	CABECEIRAS	CW21381539	ITUIQUIRA	02/03/2020 08:56	02/03/2020 10:09	02/03/2020 08:56	02/03/2020 10:09	1,20	2	2,41	CHI
2020034124	CUMARI	CY21318868	CATALAO S2	02/03/2020 08:56	02/03/2020 15:20	02/03/2020 08:56	02/03/2020 15:20	6,39	1	6,39	CHI
2020034126	PADRE BERNARDO	PB11275430	PADRE BERNARDO	02/03/2020 08:56	02/03/2020 15:00	02/03/2020 08:56	02/03/2020 15:00	6,05	4	24,20	CHI
2020034129	FORMOSA	FA12085562	ITUIQUIRA	02/03/2020 08:58	02/03/2020 15:45	02/03/2020 08:58	02/03/2020 15:45	6,78	4	27,11	CHI
2020034130	ALTO PARAISO DE GOIAS	BF21232055	NIQUELANDIA SUBTRANSMISSAO	02/03/2020 08:58	02/03/2020 11:50	02/03/2020 08:58	02/03/2020 11:50	2,85	2	5,70	CHI
2020034132	CIDADE OCIDENTAL	2680041581	MARAJOARA	02/03/2020 08:59	02/03/2020 12:55	02/03/2020 08:59	02/03/2020 12:55	3,93	1	3,93	CHI
2020034134	ARUANA	MZ12057162	MOZARLANDIA	02/03/2020 08:55	02/03/2020 12:45	02/03/2020 08:55	02/03/2020 12:45	3,82	2	7,63	CHI
2020034134	MOZARLANDIA	MZ12057162	MOZARLANDIA	02/03/2020 08:55	02/03/2020 12:45	02/03/2020 08:55	02/03/2020 12:45	3,82	3	11,45	CHI
2020034135	JUSSARA	JR21144577	JUSSARA	02/03/2020 08:59	03/03/2020 10:03	02/03/2020 08:59	02/03/2020 14:02	5,05	1	5,05	CHI
2020034135	JUSSARA	JR21144577	JUSSARA	02/03/2020 08:59	03/03/2020 10:03	02/03/2020 14:52	03/03/2020 10:03	19,19	1	19,19	CHI
2020034136	ANICUNS	910079535	ANICUNS	02/03/2020 08:59	02/03/2020 11:29	02/03/2020 08:59	02/03/2020 11:29	2,49	1	2,49	CHI
2020034144	RIO VERDE	630339119	RIO VERDE S2	02/03/2020 09:01	02/03/2020 11:49	02/03/2020 09:01	02/03/2020 11:49	2,79	1	2,79	CHI
2020034148	PIRACANJUBA	PJ12045337	PIRACANJUBA	02/03/2020 09:03	02/03/2020 12:40	02/03/2020 09:03	02/03/2020 12:40	3,61	7	25,29	CHI
2020034152	JARAGUA	UA12078282	JARAGUA	02/03/2020 07:05	02/03/2020 12:00	02/03/2020 07:05	02/03/2020 12:00	4,91	3	14,72	CHI
2020034152	URUANA	UA12078282	JARAGUA	02/03/2020 07:05	02/03/2020 12:00	02/03/2020 07:05	02/03/2020 12:00	4,91	7	34,34	CHI
2020034157	IPAMERI	NE21150933	CATALAO S1	02/03/2020 09:04	03/03/2020 11:48	02/03/2020 09:04	03/03/2020 11:48	26,72	1	26,72	CHI
2020034165	IPORA	730104928	IPORA	02/03/2020 09:06	02/03/2020 15:07	02/03/2020 09:06	02/03/2020 15:07	6,01	1	6,01	CHI
2020034166	VIANOPOLIS	VN21117183	VIANOPOLIS	02/03/2020 09:06	02/03/2020 13:12	02/03/2020 09:06	02/03/2020 13:12	4,09	1	4,09	CHI
2020034171	ITABERAI	IB12310588	ITABERAI S2	02/03/2020 09:07	02/03/2020 10:40	02/03/2020 09:07	02/03/2020 10:40	1,54	4	6,15	CHI
2020034172	GOIANIA	10003905835	GOYA S1	02/03/2020 09:08	02/03/2020 13:06	02/03/2020 09:08	02/03/2020 13:06	3,96	1	3,96	CHI
2020034176	JANDAIA	3030002510	PALMEIRAS	02/03/2020 09:08	02/03/2020 15:20	02/03/2020 09:08	02/03/2020 15:20	6,19	1	6,19	CHI
2020034181	IPAMERI	IP21216022	CAMPO ALEGRE DE GOIAS	02/03/2020 09:09	03/03/2020 08:58	02/03/2020 09:09	03/03/2020 08:58	23,81	1	23,81	CHI
2020034187	RIO VERDE	RV12279861	CABRIUVA S2	02/03/2020 09:09	02/03/2020 21:38	02/03/2020 09:09	02/03/2020 21:38	12,47	1	12,47	CHI
2020034190	BURITI ALEGRE	BG12000111	ITUMBIARA VELHA S2	02/03/2020 09:10	02/03/2020 12:18	02/03/2020 09:10	02/03/2020 12:18	3,12	17	53,10	CHI
2020034191	GOIANIA	14959446	CAMPINAS S3	02/03/2020 09:10	02/03/2020 11:00	02/03/2020 09:10	02/03/2020 11:00	1,82	1	1,82	CHI
2020034202	EDEALINA	ED21284705	VICENTINOPOLIS	02/03/2020 09:11	02/03/2020 14:20	02/03/2020 09:11	02/03/2020 14:20	5,13	1	5,13	CHI
2020034204	RIO VERDE	630007998	RIO VERDE S2	02/03/2020 09:12	02/03/2020 12:30	02/03/2020 09:12	02/03/2020 12:30	3,31	1	3,31	CHI
2020034208	GOIANIA	14414685	MEIA PONTE	02/03/2020 09:12	02/03/2020 11:51	02/03/2020 09:12	02/03/2020 11:51	2,64	1	2,64	CHI
2020034210	EDEALINA	ED21218137	PONTALINA	02/03/2020 09:12	02/03/2020 11:12	02/03/2020 09:12	02/03/2020 11:12	1,99	1	1,99	CHI
2020034211	ACREUNA	EU21301571	ACREUNA	02/03/2020 09:13	02/03/2020 11:00	02/03/2020 09:13	02/03/2020 11:00	1,78	1	1,78	CHI
2020034214	SANTA FE DE GOIAS	RN21007851	BRITANIA	02/03/2020 09:13	03/03/2020 10:09	02/03/2020 09:13	03/03/2020 10:09	24,94	1	24,94	CHI
2020034215	CALDAS NOVAS	760305742	SERRA DE CALDAS	02/03/2020 09:13	02/03/2020 12:18	02/03/2020 09:13	02/03/2020 12:18	3,08	1	3,08	CHI
2020034218	BARRO ALTO	BA12382484	BARRO ALTO	02/03/2020 09:13	02/03/2020 15:06	02/03/2020 09:13	02/03/2020 15:06	5,87	17	99,76	CHI
2020034224	OURO VERDE DE GOIAS	OV12319823	NEROPOLIS S1	02/03/2020 09:15	02/03/2020 13:57	02/03/2020 09:15	02/03/2020 13:57	4,70	23	108,07	CHI
2020034225	RIO VERDE	RV11217653	MONTIVIDIU T	02/03/2020 09:15	02/03/2020 19:01	02/03/2020 09:15	02/03/2020 19:01	9,76	1	9,76	CHI
2020034226	IPAMERI	IP12267077	IPAMERI	02/03/2020 06:34	02/03/2020 11:01	02/03/2020 06:34	02/03/2020 11:01	4,45	5	22,25	CHI
2020034230	MONTIVIDIU DO NORTE	MX12270910	PORANGATU	02/03/2020 09:15	02/03/2020 13:47	02/03/2020 09:15	02/03/2020 13:47	4,52	7	31,63	CHI
2020034235	GOIAS	GS21135043	MATRINCHA	02/03/2020 09:16	02/03/2020 12:40	02/03/2020 09:16	02/03/2020 12:40	3,38	1	3,38	CHI
2020034241	SILVANIA	SV12160607	VIANOPOLIS	02/03/2020 09:17	02/03/2020 13:00	02/03/2020 09:17	02/03/2020 13:00	3,70	2	7,40	CHI
2020034244	JATAI	10005310146	JATAI S3	02/03/2020 09:18	02/03/2020 11:10	02/03/2020 09:18	02/03/2020 11:10	1,86	1	1,86	CHI
2020034247	RIO VERDE	630132288	RIO VERDE S2	02/03/2020 09:16	02/03/2020 15:58	02/03/2020 09:16	02/03/2020 15:58	6,69	1	6,69	CHI
2020034248	AMARALINA	LC12278479	MARA ROSA	02/03/2020 09:19	02/03/2020 11:14	02/03/2020 09:19	02/03/2020 11:14	1,91	1	1,91	CHI
2020034250	SAO JOAO D ALIANCA	JL21106967	SAO JOAO D ALIANCA	02/03/2020 09:19	02/03/2020 10:53	02/03/2020 09:19	02/03/2020 10:53	1,55	1	1,55	CHI
2020034256	PADRE BERNARDO	PB12376763	PADRE BERNARDO	02/03/2020 09:20	02/03/2020 19:13	02/03/2020 09:20	02/03/2020 19:13	9,88	12	118,51	CHI

2020034263	SANCLERLANDIA	1210028168	FIRMINOPOLIS S2	02/03/2020 09:21	02/03/2020 12:33	02/03/2020 09:21	02/03/2020 12:33	3,20	1	3,20	CHI
2020034264	SENADOR CANEDO	13255976	SENADOR CANEDO	02/03/2020 09:21	02/03/2020 10:37	02/03/2020 09:21	02/03/2020 10:37	1,25	1	1,25	CHI
2020034266	CATALAO	CT21231565	CATALAO S1	02/03/2020 09:22	02/03/2020 16:39	02/03/2020 09:22	02/03/2020 16:39	7,28	1	7,28	CHI
2020034269	URUACU	640015566	URUACU	02/03/2020 09:23	02/03/2020 20:11	02/03/2020 09:23	02/03/2020 20:11	10,80	1	10,80	CHI
2020034273	SANTA HELENA DE GOIAS	400111860	IPEGUARI	02/03/2020 09:24	02/03/2020 12:52	02/03/2020 09:24	02/03/2020 12:52	3,47	1	3,47	CHI
2020034278	PIRACANJUBA	PJ12040425	MORRINHOS	02/03/2020 09:12	02/03/2020 11:26	02/03/2020 09:12	02/03/2020 11:26	2,23	15	33,42	CHI
2020034282	PONTALINA	PK21257245	PONTALINA	02/03/2020 09:25	02/03/2020 13:12	02/03/2020 09:25	02/03/2020 13:12	3,77	1	3,77	CHI
2020034284	MINEIROS	MY12234339	PARQUE DAS EMAS	02/03/2020 09:06	02/03/2020 13:19	02/03/2020 09:06	02/03/2020 13:19	4,21	11	46,27	CHI
2020034286	JATAI	JT12036242LD	JATAI S2	02/03/2020 09:26	02/03/2020 12:56	02/03/2020 09:26	02/03/2020 12:56	3,50	4	13,99	CHI
2020034288	MORRINHOS	150137096	MORRINHOS	02/03/2020 09:26	02/03/2020 10:55	02/03/2020 09:26	02/03/2020 10:55	1,47	1	1,47	CHI
2020034289	BURITI ALEGRE	BG21143857	ITUMBIARA VELHA S2	02/03/2020 09:26	02/03/2020 21:49	02/03/2020 09:26	02/03/2020 21:49	12,37	1	12,37	CHI
2020034292	IACIARA	ND12218839	IACIARA S2	02/03/2020 09:27	02/03/2020 12:26	02/03/2020 09:27	02/03/2020 12:26	2,98	23	68,59	CHI
2020034292	SAO DOMINGOS	ND12218839	IACIARA S2	02/03/2020 09:27	02/03/2020 12:26	02/03/2020 09:27	02/03/2020 12:26	2,98	3	8,95	CHI
2020034303	RIO VERDE	RV31191874	QUIRINOPOLIS	02/03/2020 09:29	02/03/2020 19:39	02/03/2020 09:29	02/03/2020 19:39	10,16	2	20,33	CHI
2020034311	COCALZINHO DE GOIAS	ZN12302401	COCALZINHO	02/03/2020 08:37	02/03/2020 15:30	02/03/2020 08:37	02/03/2020 15:30	6,87	4	27,50	CHI
2020034311	CORUMBA DE GOIAS	ZN12302401	COCALZINHO	02/03/2020 08:37	02/03/2020 15:30	02/03/2020 08:37	02/03/2020 15:30	6,87	22	151,24	CHI
2020034314	SERRANOPOLIS	SX21365486	JATAI S1	02/03/2020 09:31	02/03/2020 14:22	02/03/2020 09:31	02/03/2020 14:22	4,84	3	14,51	CHI
2020034316	CEZARINA	1650019352	CEZARINA	02/03/2020 09:32	02/03/2020 12:23	02/03/2020 09:32	02/03/2020 12:23	2,85	1	2,85	CHI
2020034320	LUZIANIA	10002245483	RIO VERMELHO	02/03/2020 09:32	02/03/2020 11:24	02/03/2020 09:32	02/03/2020 11:24	1,86	1	1,86	CHI
2020034326	EDEIA	EA21182662	EDEIA	02/03/2020 09:34	02/03/2020 10:45	02/03/2020 09:34	02/03/2020 10:45	1,18	1	1,18	CHI
2020034334	JATAI	290128638	JATAI S3	02/03/2020 09:36	02/03/2020 11:11	02/03/2020 09:36	02/03/2020 11:11	1,60	1	1,60	CHI
2020034337	SANTA RITA DO ARAGUAIA	SU12188579	PARQUE DAS EMAS	02/03/2020 09:36	02/03/2020 14:53	02/03/2020 09:36	02/03/2020 14:53	5,28	5	26,39	CHI
2020034338	PIRES DO RIO	PR21107693	PIRES DO RIO S1	02/03/2020 09:36	03/03/2020 13:04	02/03/2020 09:36	03/03/2020 13:04	27,45	2	54,91	CHI
2020034349	SAO LUIS DE MONTES BELOS	SL21233517	FIRMINOPOLIS S1	02/03/2020 09:38	02/03/2020 12:41	02/03/2020 09:38	02/03/2020 12:41	3,05	2	6,09	CHI
2020034351	ALTO HORIZONTE	GG12136442	SANTA TEREZINHA	02/03/2020 09:39	02/03/2020 11:29	02/03/2020 09:39	02/03/2020 11:29	1,83	2	3,66	CHI
2020034352	DIVINOPOLIS DE GOIAS	GH12241928	SAO DOMINGOS	02/03/2020 09:39	02/03/2020 14:15	02/03/2020 09:39	02/03/2020 14:15	4,60	40	183,97	CHI
2020034352	MONTE ALEGRE DE GOIAS	GH12241928	SAO DOMINGOS	02/03/2020 09:39	02/03/2020 14:15	02/03/2020 09:39	02/03/2020 14:15	4,60	3	13,80	CHI
2020034352	SAO DOMINGOS	GH12241928	SAO DOMINGOS	02/03/2020 09:39	02/03/2020 14:15	02/03/2020 09:39	02/03/2020 14:15	4,60	12	55,19	CHI
2020034354	SAO DOMINGOS	SD21373508	IACIARA S2	02/03/2020 09:39	02/03/2020 12:36	02/03/2020 09:39	02/03/2020 12:36	2,94	1	2,94	CHI
2020034355	QUIRINOPOLIS	QI21091036	QUIRINOPOLIS	02/03/2020 09:39	02/03/2020 15:18	02/03/2020 09:39	02/03/2020 15:18	5,63	1	5,63	CHI
2020034359	MINEIROS	1390078623	PARQUE DAS EMAS	02/03/2020 09:41	02/03/2020 15:47	02/03/2020 09:41	02/03/2020 15:47	6,09	1	6,09	CHI
2020034363	APARECIDA DE GOIANIA	10024092868	INDEPENDENCIA S2	02/03/2020 09:42	02/03/2020 11:55	02/03/2020 09:42	02/03/2020 11:55	2,21	1	2,21	CHI
2020034364	SAO FRANCISCO DE GOIAS	SF12000173	SAO FRANCISCO DE GOIAS	02/03/2020 09:39	02/03/2020 11:36	02/03/2020 09:39	02/03/2020 11:36	1,94	12	23,27	CHI
2020034366	AGUA LIMPA	AL12172363	VILA CORUMBA	02/03/2020 09:45	03/03/2020 10:32	02/03/2020 09:45	03/03/2020 10:32	24,78	7	173,44	CHI
2020034372	MINEIROS	1390112916	PARQUE DAS EMAS	02/03/2020 09:46	02/03/2020 12:53	02/03/2020 09:46	02/03/2020 12:53	3,11	1	3,11	CHI
2020034374	AMARALINA	MH12391970LD	NOVA CRIXAS	02/03/2020 09:47	03/03/2020 08:32	02/03/2020 09:47	03/03/2020 08:32	22,75	1	22,75	CHI
2020034374	MUNDO NOVO DE GOIAS	MH12391970LD	NOVA CRIXAS	02/03/2020 09:47	03/03/2020 08:32	02/03/2020 09:47	03/03/2020 08:32	22,75	4	90,99	CHI
2020034377	GOIANIA	10314714	CAMPINAS S2	02/03/2020 09:47	02/03/2020 13:49	02/03/2020 09:47	02/03/2020 13:49	4,02	1	4,02	CHI
2020034382	LUZIANIA	LZ21261482	PAMPLONA	02/03/2020 09:48	02/03/2020 13:06	02/03/2020 09:48	02/03/2020 13:06	3,30	1	3,30	CHI
2020034383	IPORA	IR11080559	IPORA	02/03/2020 09:25	02/03/2020 12:50	02/03/2020 09:25	02/03/2020 12:50	3,41	142	484,89	CHI
2020034385	ITUMBIARA	10021914530	ITUMBIARA VELHA S1	02/03/2020 09:45	02/03/2020 17:11	02/03/2020 09:45	02/03/2020 17:11	7,42	1	7,42	CHI
2020034387	SANTA CRUZ DE GOIAS	BC21325018	PIRES DO RIO S2	02/03/2020 09:49	02/03/2020 14:50	02/03/2020 09:49	02/03/2020 14:50	5,01	2	10,02	CHI
2020034388	APARECIDA DE GOIANIA	AP21029888	ANHANGUERA	02/03/2020 09:49	02/03/2020 13:26	02/03/2020 09:49	02/03/2020 13:26	3,61	1	3,61	CHI
2020034390	MINEIROS	MY21348944	PARQUE DAS EMAS	02/03/2020 09:50	02/03/2020 13:23	02/03/2020 09:50	02/03/2020 13:23	3,55	1	3,55	CHI

2020034393	CATURAI	CK21098786	INHUMAS S1	02/03/2020 09:50	02/03/2020 12:13	02/03/2020 09:50	02/03/2020 12:13	2,37	1	2,37	CHI
2020034396	GOIANIA	11127028	GOYA S2	02/03/2020 09:51	02/03/2020 11:30	02/03/2020 09:51	02/03/2020 11:30	1,64	1	1,64	CHI
2020034400	SAO LUIS DE MONTES BELOS	SL21125654	FIRMINOPOLIS S1	02/03/2020 09:52	02/03/2020 11:01	02/03/2020 09:52	02/03/2020 11:01	1,13	1	1,13	CHI
2020034403	ANAPOLIS	AN21297638	ANAPOLIS UNIVERSITARIO S2	02/03/2020 09:53	02/03/2020 14:09	02/03/2020 09:53	02/03/2020 14:09	4,26	1	4,26	CHI
2020034404	PEROLANDIA	2370008319	JATAI S1	02/03/2020 09:53	02/03/2020 11:28	02/03/2020 09:53	02/03/2020 11:28	1,57	1	1,57	CHI
2020034411	PEROLANDIA	DP11254674	JATAI S1	02/03/2020 09:52	02/03/2020 11:32	02/03/2020 09:52	02/03/2020 11:32	1,65	1	1,65	CHI
2020034412	GOIAS	GS12307232	GOIAS	02/03/2020 09:54	02/03/2020 12:18	02/03/2020 09:54	02/03/2020 12:18	2,39	4	9,56	CHI
2020034413	ARUANA	AK21264062	MOZARLANDIA	02/03/2020 09:54	02/03/2020 13:20	02/03/2020 09:54	02/03/2020 13:20	3,42	1	3,42	CHI
2020034421	PIRENOPOLIS	220030820	CORUMBA	02/03/2020 09:55	02/03/2020 22:54	02/03/2020 09:55	02/03/2020 22:54	12,97	1	12,97	CHI
2020034423	APARECIDA DE GOIANIA	12487170	INDEPENDENCIA S2	02/03/2020 09:56	02/03/2020 12:02	02/03/2020 09:56	02/03/2020 12:02	2,09	1	2,09	CHI
2020034425	JUSSARA	JR12137858	BRITANIA	02/03/2020 09:54	02/03/2020 22:36	02/03/2020 09:54	02/03/2020 22:36	12,70	3	38,09	CHI
2020034427	BELA VISTA DE GOIAS	BV21092444	BELA VISTA S1	02/03/2020 09:57	02/03/2020 12:17	02/03/2020 09:57	02/03/2020 12:17	2,33	1	2,33	CHI
2020034428	DAMIANOPOLIS	DA11195993	IACIARA S2	02/03/2020 09:57	02/03/2020 11:43	02/03/2020 09:57	02/03/2020 11:43	1,77	72	127,10	CHI
2020034431	CRISTALINA	KR21351503	CRISTALINA S1	02/03/2020 09:57	02/03/2020 16:59	02/03/2020 09:57	02/03/2020 16:59	7,03	1	7,03	CHI
2020034432	RIO VERDE	RV12191875	CABRIUVA S2	02/03/2020 09:57	03/03/2020 09:33	02/03/2020 09:57	03/03/2020 09:33	23,59	1	23,59	CHI
2020034435	GOIANIA	17014979	GOYA S2	02/03/2020 09:58	02/03/2020 11:26	02/03/2020 09:58	02/03/2020 11:26	1,46	1	1,46	CHI
2020034440	ABADIA DE GOIAS	5580016170	CARAJAS S1	02/03/2020 09:59	02/03/2020 12:33	02/03/2020 09:59	02/03/2020 12:33	2,55	1	2,55	CHI
2020034444	MOSSAMEDES	SC21001679	FIRMINOPOLIS S2	02/03/2020 09:59	02/03/2020 10:44	02/03/2020 09:59	02/03/2020 10:44	0,73	1	0,73	CHI
2020034445	FAZENDA NOVA	FN11246040	IPORA	02/03/2020 09:59	02/03/2020 21:46	02/03/2020 09:59	02/03/2020 21:46	11,77	1	11,77	CHI
2020034450	CRISTALINA	KR11276383	CRISTALINA S2	02/03/2020 10:01	02/03/2020 15:29	02/03/2020 10:01	02/03/2020 15:29	5,47	1	5,47	CHI
2020034452	GOIANIA	17051630	CARAJAS S2	02/03/2020 10:01	02/03/2020 11:44	02/03/2020 10:01	02/03/2020 11:44	1,71	1	1,71	CHI
2020034459	JATAI	JT12334235	JATAI S3	02/03/2020 10:01	02/03/2020 13:29	02/03/2020 10:01	02/03/2020 13:29	3,45	2	6,90	CHI
2020034460	MIMOSO DE GOIAS	MJ12071960	PADRE BERNARDO	02/03/2020 10:02	03/03/2020 16:48	02/03/2020 10:02	02/03/2020 14:30	4,47	40	178,70	CHI
2020034460	MIMOSO DE GOIAS	MJ12390562LD	PADRE BERNARDO	02/03/2020 10:02	03/03/2020 16:48	02/03/2020 10:02	02/03/2020 16:38	6,60	39	257,41	CHI
2020034460	MIMOSO DE GOIAS	MJ12377230	PADRE BERNARDO	02/03/2020 10:02	03/03/2020 16:48	02/03/2020 10:02	02/03/2020 18:38	8,61	57	490,71	CHI
2020034460	NIQUELANDIA	MJ12377230	PADRE BERNARDO	02/03/2020 10:02	03/03/2020 16:48	02/03/2020 10:02	02/03/2020 18:38	8,61	1	8,61	CHI
2020034460	MIMOSO DE GOIAS	MJ12071960	PADRE BERNARDO	02/03/2020 10:02	03/03/2020 16:48	03/03/2020 12:26	03/03/2020 15:39	3,23	133	429,00	CHI
2020034460	NIQUELANDIA	MJ12071960	PADRE BERNARDO	02/03/2020 10:02	03/03/2020 16:48	03/03/2020 12:26	03/03/2020 15:39	3,23	1	3,23	CHI
2020034460	MIMOSO DE GOIAS	MJ12376705LD	PADRE BERNARDO	02/03/2020 10:02	03/03/2020 16:48	02/03/2020 10:02	03/03/2020 16:48	30,78	23	707,84	CHI
2020034461	CRIXAS	CX12302060	SERRA DO OURO	02/03/2020 10:02	03/03/2020 02:50	02/03/2020 10:02	03/03/2020 02:50	16,80	1	16,80	CHI
2020034462	FORMOSA	FA12383241	ITUIQUIRA	02/03/2020 10:02	02/03/2020 11:47	02/03/2020 10:02	02/03/2020 11:47	1,74	1	1,74	CHI
2020034465	JANDAIA	JD12134334	PALMEIRAS	02/03/2020 10:03	02/03/2020 13:13	02/03/2020 10:03	02/03/2020 13:13	3,16	11	34,77	CHI
2020034466	PALMEIRAS DE GOIAS	PL12391508	PALMEIRAS	02/03/2020 10:03	02/03/2020 12:47	02/03/2020 10:03	02/03/2020 12:47	2,73	3	8,20	CHI
2020034467	GOIANIA	GN21226678	GOIANIA LESTE S3	02/03/2020 10:03	02/03/2020 11:13	02/03/2020 10:03	02/03/2020 11:13	1,16	1	1,16	CHI
2020034468	GUARANI DE GOIAS	1580013305	IACIARA S1	02/03/2020 10:03	02/03/2020 12:22	02/03/2020 10:03	02/03/2020 12:22	2,31	1	2,31	CHI
2020034479	CACHOEIRA DOURADA	IT12088560	CACHOEIRA DOURADA	02/03/2020 10:06	02/03/2020 16:02	02/03/2020 10:06	02/03/2020 16:02	5,93	1	5,93	CHI
2020034479	ITUMBUIARA	IT12088560	CACHOEIRA DOURADA	02/03/2020 10:06	02/03/2020 16:02	02/03/2020 10:06	02/03/2020 16:02	5,93	4	23,70	CHI
2020034481	CRIXAS	CX12319094	SERRA DO OURO	02/03/2020 10:06	03/03/2020 10:06	02/03/2020 10:06	03/03/2020 10:06	23,98	5	119,92	CHI
2020034482	MORRINHOS	MR31075156	GOIATUBA S1	02/03/2020 10:07	02/03/2020 12:41	02/03/2020 10:07	02/03/2020 12:19	2,20	1	2,20	CHI
2020034482	MORRINHOS	MR12393855	GOIATUBA S1	02/03/2020 10:07	02/03/2020 12:41	02/03/2020 12:12	02/03/2020 12:41	0,49	2	0,98	CHI
2020034485	GOIANIA	GN11001657	GOIANIA LESTE S3	02/03/2020 10:07	02/03/2020 14:58	02/03/2020 10:07	02/03/2020 14:58	4,84	225	1088,81	CHI
2020034488	SANTA CRUZ DE GOIAS	CN21182809	CALDAS NOVAS S1	02/03/2020 10:08	02/03/2020 13:54	02/03/2020 10:08	02/03/2020 13:54	3,77	1	3,77	CHI
2020034489	PORANGATU	840082484	PORANGATU	02/03/2020 10:08	02/03/2020 15:22	02/03/2020 10:08	02/03/2020 15:22	5,23	1	5,23	CHI
2020034490	RIO VERDE	630423570	RIO VERDE S2	02/03/2020 10:08	02/03/2020 11:54	02/03/2020 10:08	02/03/2020 11:54	1,78	1	1,78	CHI

2020034498	CACHOEIRA ALTA	CA11143715	CACHOEIRA ALTA	02/03/2020 10:08	02/03/2020 11:40	02/03/2020 10:08	02/03/2020 11:40	1,53	153	233,62	CHI
2020034503	BRITANIA	04750406	MATRINCHA	02/03/2020 11:29	02/03/2020 13:50	02/03/2020 11:29	02/03/2020 13:50	2,35	6	14,09	CHI
2020034503	ITAPIRAPUA	04750406	MATRINCHA	02/03/2020 11:29	02/03/2020 13:50	02/03/2020 11:29	02/03/2020 13:50	2,35	434	1019,18	CHI
2020034503	ITAPIRAPUA	04750406	MATRINCHA	02/03/2020 11:29	02/03/2020 13:50	02/03/2020 11:29	02/03/2020 13:50	2,35	92	216,05	CHI
2020034503	JUSSARA	04750406	MATRINCHA	02/03/2020 11:29	02/03/2020 13:50	02/03/2020 11:29	02/03/2020 13:50	2,35	4	9,39	CHI
2020034503	SANTA FE DE GOIAS	04750406	MATRINCHA	02/03/2020 11:29	02/03/2020 13:50	02/03/2020 11:29	02/03/2020 13:50	2,35	12	28,18	CHI
2020034505	CAVALCANTE	CJ21339413	MINACU	02/03/2020 10:09	02/03/2020 17:07	02/03/2020 10:09	02/03/2020 17:07	6,95	1	6,95	CHI
2020034514	RIO VERDE	RV12030734	CABRIUVA S1	02/03/2020 10:12	02/03/2020 12:28	02/03/2020 10:12	02/03/2020 12:28	2,26	12	27,15	CHI
2020034515	ALEXANIA	AX12381241	ALEXANIA	02/03/2020 10:12	02/03/2020 12:31	02/03/2020 10:12	02/03/2020 12:31	2,31	3	6,93	CHI
2020034516	RIO VERDE	630515803	RIO VERDE S2	02/03/2020 10:12	02/03/2020 12:11	02/03/2020 10:12	02/03/2020 12:11	1,97	1	1,97	CHI
2020034517	TAQUARAL DE GOIAS	TQ11092189	ITABERAI S1	02/03/2020 10:12	02/03/2020 17:31	02/03/2020 10:12	02/03/2020 17:31	7,30	141	1029,57	CHI
2020034518	AGUA FRIA DE GOIAS	TL12394165	SAO JOAO D ALIANCA	02/03/2020 10:12	02/03/2020 15:30	02/03/2020 10:12	02/03/2020 15:30	5,29	19	100,43	CHI
2020034520	SAO SIMAO	SO13196183	CACHOEIRA ALTA	02/03/2020 10:13	02/03/2020 14:35	02/03/2020 11:11	02/03/2020 13:15	2,07	21	43,41	CHI
2020034520	SAO SIMAO	SO13303111	CACHOEIRA ALTA	02/03/2020 10:13	02/03/2020 14:35	02/03/2020 14:30	02/03/2020 14:35	0,08	51	4,18	CHI
2020034523	BOM JARDIM DE GOIAS	BM12064260	BOM JARDIM	02/03/2020 07:29	02/03/2020 17:18	02/03/2020 07:29	02/03/2020 17:18	9,82	17	166,87	CHI
2020034524	UIRAPURU	UP12328026	NOVA CRIXAS	02/03/2020 08:33	02/03/2020 16:17	02/03/2020 08:33	02/03/2020 16:17	7,72	40	308,78	CHI
2020034529	SANTO ANTONIO DO DESCOBERTO	SN12078145	MARAJOARA	02/03/2020 10:14	02/03/2020 18:48	02/03/2020 10:14	02/03/2020 18:48	8,55	2	17,10	CHI
2020034536	URUACU	UR21070401	URUACU	02/03/2020 10:16	02/03/2020 12:44	02/03/2020 10:16	02/03/2020 12:44	2,45	2	4,91	CHI
2020034540	NIQUELANDIA	NQ12201753LD	URUACU	02/03/2020 10:17	02/03/2020 14:53	02/03/2020 10:17	02/03/2020 14:53	4,59	71	325,65	CHI
2020034541	LUZIANIA	OZ12318971	PIRES DO RIO S2	02/03/2020 09:49	02/03/2020 14:41	02/03/2020 09:49	02/03/2020 14:41	4,86	5	24,31	CHI
2020034541	ORIZONA	OZ12318971	PIRES DO RIO S2	02/03/2020 09:49	02/03/2020 14:41	02/03/2020 09:49	02/03/2020 14:41	4,86	5	24,31	CHI
2020034544	CEZARINA	CZ21312457	CEZARINA	02/03/2020 10:18	02/03/2020 12:46	02/03/2020 10:18	02/03/2020 12:46	2,47	2	4,93	CHI
2020034547	VILA PROPICIO	NP21298243	GOIANESIA S1	02/03/2020 10:19	02/03/2020 18:06	02/03/2020 10:19	02/03/2020 18:06	7,80	1	7,80	CHI
2020034548	FORMOSA	610255290	ITUIQUIRA	02/03/2020 10:19	02/03/2020 18:54	02/03/2020 10:19	02/03/2020 18:54	8,59	1	8,59	CHI
2020034550	LUZIANIA	3200179087	MARAJOARA	02/03/2020 10:20	02/03/2020 16:30	02/03/2020 10:20	02/03/2020 16:30	6,17	1	6,17	CHI
2020034556	ALTO PARAISO DE GOIAS	BF21375517	FLORES DE GOIAS	02/03/2020 10:21	02/03/2020 14:16	02/03/2020 12:24	02/03/2020 14:16	1,87	1	1,87	CHI
2020034560	GOIANIA	15138288	CAMPINAS S2	02/03/2020 10:22	02/03/2020 14:12	02/03/2020 10:22	02/03/2020 14:12	3,83	1	3,83	CHI
2020034563	BALIZA	BH12358791	CAIAPONIA	02/03/2020 10:22	02/03/2020 21:12	02/03/2020 10:22	02/03/2020 21:12	10,82	5	54,11	CHI
2020034569	FORMOSA	FA12072571	ITUIQUIRA	02/03/2020 10:24	02/03/2020 12:37	02/03/2020 10:24	02/03/2020 12:37	2,21	10	22,08	CHI
2020034570	ACREUNA	SH12271266	SANTA HELENA S1	02/03/2020 10:24	02/03/2020 16:43	02/03/2020 10:24	02/03/2020 16:43	6,31	3	18,92	CHI
2020034570	SANTA HELENA DE GOIAS	SH12271266	SANTA HELENA S1	02/03/2020 10:24	02/03/2020 16:43	02/03/2020 10:24	02/03/2020 16:43	6,31	3	18,92	CHI
2020034572	ITUMBIARA	IT21097287	ITUMBIARA VELHA S1	02/03/2020 10:24	02/03/2020 14:50	02/03/2020 10:24	02/03/2020 14:50	4,42	10	44,19	CHI
2020034573	SERRANOPOLIS	SX12260308	JATAI S1	02/03/2020 10:24	02/03/2020 17:20	02/03/2020 10:24	02/03/2020 17:20	6,92	7	48,42	CHI
2020034576	SILVANIA	SV12035086	VIANOPOLIS	02/03/2020 09:03	02/03/2020 14:20	02/03/2020 09:03	02/03/2020 14:20	5,28	14	73,97	CHI
2020034578	GOIATUBA	GT12000131	GOIATUBA S2	02/03/2020 09:59	02/03/2020 15:00	02/03/2020 09:59	02/03/2020 15:00	5,01	6	30,08	CHI
2020034584	MORRO AGUDO DE GOIAS	MS12113249LD	ITAPURANGA	02/03/2020 10:26	03/03/2020 11:36	02/03/2020 10:26	03/03/2020 11:36	25,16	2	50,32	CHI
2020034584	FAINA	MS12113249LD	ITAPURANGA	02/03/2020 10:26	03/03/2020 11:36	03/03/2020 09:02	03/03/2020 11:36	2,55	11	28,08	CHI
2020034584	MORRO AGUDO DE GOIAS	MS12113249LD	ITAPURANGA	02/03/2020 10:26	03/03/2020 11:36	03/03/2020 09:02	03/03/2020 11:36	2,55	8	20,42	CHI
2020034589	PARAUNA	10015198616	PARAUNA	02/03/2020 10:27	02/03/2020 22:33	02/03/2020 10:27	02/03/2020 22:33	12,09	1	12,09	CHI
2020034590	JATAI	JT21134479	JATAI S1	02/03/2020 10:27	02/03/2020 11:27	02/03/2020 10:27	02/03/2020 11:27	0,99	1	0,99	CHI
2020034591	APARECIDA DE GOIANIA	AP12363031	INDEPENDENCIA S1	02/03/2020 09:53	02/03/2020 12:02	02/03/2020 09:53	02/03/2020 12:02	2,15	413	887,84	CHI
2020034592	CAMPESTRE DE GOIAS	GC21037350	TRINDADE	02/03/2020 10:27	02/03/2020 16:14	02/03/2020 10:27	02/03/2020 16:14	5,77	2	11,54	CHI
2020034593	PARAUNA	PU12079036	FIRMINOPOLIS S2	02/03/2020 10:28	02/03/2020 13:33	02/03/2020 10:28	02/03/2020 13:33	3,08	7	21,56	CHI
2020034597	VILA BOA	FA21042042	IACIARA S2	02/03/2020 10:29	02/03/2020 11:56	02/03/2020 10:29	02/03/2020 11:56	1,46	1	1,46	CHI

2020034605	PONTALINA	PK12046026	GOIATUBA S1	02/03/2020 10:31	02/03/2020 14:24	02/03/2020 10:31	02/03/2020 14:24	3,88	23	89,24	CHI
2020034607	MONTIVIDIU	MV21075459	MONTIVIDIU T	02/03/2020 10:31	02/03/2020 13:13	02/03/2020 10:31	02/03/2020 13:13	2,69	2	5,38	CHI
2020034610	ITAPURANGA	IK11051555	ITAPURANGA	02/03/2020 10:32	02/03/2020 19:44	02/03/2020 15:15	02/03/2020 19:44	4,48	170	762,17	CHI
2020034614	DIVINOPOLIS DE GOIAS	8170000119	SAO DOMINGOS	02/03/2020 10:33	02/03/2020 12:48	02/03/2020 10:33	02/03/2020 12:48	2,25	1	2,25	CHI
2020034619	APARECIDA DE GOIANIA	AP11229283	INDEPENDENCIA S2	02/03/2020 10:22	02/03/2020 12:39	02/03/2020 10:22	02/03/2020 12:39	2,28	130	295,97	CHI
2020034620	GOIANIA	10766730	ATLANTICO S1	02/03/2020 10:34	02/03/2020 11:57	02/03/2020 10:34	02/03/2020 11:57	1,38	1	1,38	CHI
2020034621	GOIAS	90049240	GOIAS	02/03/2020 10:34	02/03/2020 14:33	02/03/2020 10:34	02/03/2020 14:33	3,98	1	3,98	CHI
2020034623	SANCLERLANDIA	SC12154609	FIRMINOPOLIS S2	02/03/2020 10:35	02/03/2020 18:58	02/03/2020 10:35	02/03/2020 18:58	8,38	1	8,38	CHI
2020034624	MORRO AGUDO DE GOIAS	MS12318396	ITAPURANGA	02/03/2020 10:35	02/03/2020 16:34	02/03/2020 10:35	02/03/2020 16:34	5,98	4	23,92	CHI
2020034625	CRISTALINA	KR21305255	CRISTALINA S1	02/03/2020 10:35	02/03/2020 15:51	02/03/2020 10:35	02/03/2020 15:51	5,26	1	5,26	CHI
2020034628	GOIAS	GS21222050	GOIAS	02/03/2020 10:35	02/03/2020 15:32	02/03/2020 10:35	02/03/2020 15:32	4,94	1	4,94	CHI
2020034640	ITAPACI	IW11267263	ITAPACI	02/03/2020 10:35	02/03/2020 11:54	02/03/2020 10:35	02/03/2020 11:54	1,31	83	108,73	CHI
2020034641	JUSSARA	JR12101970RE	BRITANIA	02/03/2020 10:38	03/03/2020 12:40	02/03/2020 10:38	03/03/2020 12:40	26,02	11	286,23	CHI
2020034642	CACU	CC12130408	CACHOEIRA ALTA	02/03/2020 10:37	02/03/2020 20:22	02/03/2020 10:37	02/03/2020 20:22	9,74	1	9,74	CHI
2020034643	RIO VERDE	630264340	RIO VERDE S1	02/03/2020 10:38	02/03/2020 14:32	02/03/2020 10:38	02/03/2020 14:32	3,90	1	3,90	CHI
2020034646	PIRACANJUBA	PJ12000086	PIRACANJUBA	02/03/2020 10:40	02/03/2020 11:38	02/03/2020 10:40	02/03/2020 11:38	0,97	9	8,70	CHI
2020034647	CALDAS NOVAS	760292498	CALDAS NOVAS S1	02/03/2020 10:40	02/03/2020 14:43	02/03/2020 10:40	02/03/2020 14:43	4,05	1	4,05	CHI
2020034653	EDEIA	EA21182703	EDEIA	02/03/2020 10:40	02/03/2020 11:39	02/03/2020 10:40	02/03/2020 11:39	0,97	1	0,97	CHI
2020034655	PIRENOPOLIS	PV21273400	SAO FRANCISCO DE GOIAS	02/03/2020 10:42	02/03/2020 13:02	02/03/2020 10:42	02/03/2020 13:02	2,33	2	4,66	CHI
2020034662	ITUMBIARA	IT21000151	PARANAIBA	02/03/2020 10:43	02/03/2020 11:29	02/03/2020 10:43	02/03/2020 11:29	0,76	1	0,76	CHI
2020034663	CATALAO	CT21042513	CATALAO S1	02/03/2020 10:43	02/03/2020 16:55	02/03/2020 10:43	02/03/2020 16:55	6,20	1	6,20	CHI
2020034666	ITAPURANGA	IK12307575	ITAPURANGA	02/03/2020 10:43	02/03/2020 13:10	02/03/2020 10:43	02/03/2020 13:10	2,44	2	4,87	CHI
2020034670	JATAI	290036628	JATAI S3	02/03/2020 10:44	02/03/2020 11:51	02/03/2020 10:44	02/03/2020 11:51	1,11	1	1,11	CHI
2020034671	NAZARIO	NZ21167176	ANICUNS	02/03/2020 10:44	02/03/2020 19:24	02/03/2020 10:44	02/03/2020 18:58	8,22	1	8,22	CHI
2020034671	NAZARIO	NZ12003897	ANICUNS	02/03/2020 10:44	02/03/2020 19:24	02/03/2020 16:38	02/03/2020 19:24	2,75	17	46,81	CHI
2020034673	BONOPOLIS	PO21151759	NOVO PLANALTO	02/03/2020 10:45	02/03/2020 13:54	02/03/2020 10:45	02/03/2020 13:54	3,14	1	3,14	CHI
2020034676	TRINDADE	TR21119050	TRINDADE	02/03/2020 10:45	02/03/2020 16:22	02/03/2020 10:45	02/03/2020 16:22	5,61	1	5,61	CHI
2020034682	VARJAO	VJ31064208	GUAPO S2	02/03/2020 10:46	02/03/2020 15:45	02/03/2020 10:46	02/03/2020 15:45	4,97	1	4,97	CHI
2020034688	CATALAO	1990074185	CATALAO S2	02/03/2020 10:47	02/03/2020 20:58	02/03/2020 10:47	02/03/2020 20:58	10,18	1	10,18	CHI
2020034694	LUZIANIA	120415112	RIO VERMELHO	02/03/2020 10:49	02/03/2020 12:54	02/03/2020 10:49	02/03/2020 12:54	2,08	1	2,08	CHI
2020034695	GOIATUBA	10004125566	GOIATUBA S2	02/03/2020 10:49	02/03/2020 19:24	02/03/2020 10:49	02/03/2020 19:24	8,58	1	8,58	CHI
2020034803	BARRO ALTO	GE12000092	GOIANESIA S1	02/03/2020 10:01	02/03/2020 14:05	02/03/2020 10:01	02/03/2020 14:05	4,06	2	8,12	CHI
2020034803	GOIANESIA	GE12000092	GOIANESIA S1	02/03/2020 10:01	02/03/2020 14:05	02/03/2020 10:01	02/03/2020 14:05	4,06	19	77,12	CHI
2020034804	MONTES CLAROS DE GOIAS	ME12323757	IPORA	02/03/2020 10:50	02/03/2020 18:35	02/03/2020 10:50	02/03/2020 18:35	7,74	11	85,12	CHI
2020034805	NIQUELANDIA	NQ21254946	NIQUELANDIA SUBTRANSMISSAO	02/03/2020 10:51	02/03/2020 14:43	02/03/2020 10:51	02/03/2020 14:43	3,86	1	3,86	CHI
2020034811	CRISTALINA	KR12249257	CRISTALINA S1	02/03/2020 10:52	02/03/2020 13:58	02/03/2020 10:52	02/03/2020 13:58	3,09	5	15,47	CHI
2020034816	CAIAPONIA	JT12000216	JATAI S1	02/03/2020 10:53	02/03/2020 15:10	02/03/2020 10:53	02/03/2020 15:10	4,28	1	4,28	CHI
2020034817	LUZIANIA	3200085809	MARAJOARA	02/03/2020 10:54	02/03/2020 17:12	02/03/2020 10:54	02/03/2020 17:12	6,29	1	6,29	CHI
2020034818	GOIANESIA	550001591	GOIANESIA S2	02/03/2020 10:54	02/03/2020 15:01	02/03/2020 10:54	02/03/2020 15:01	4,12	1	4,12	CHI
2020034819	GOIATUBA	GT12043398	GOIATUBA S2	02/03/2020 10:54	02/03/2020 16:34	02/03/2020 10:54	02/03/2020 16:34	5,66	2	11,31	CHI
2020034820	MINEIROS	MY11209671	PARQUE DAS EMAS	02/03/2020 10:24	02/03/2020 13:32	02/03/2020 10:24	02/03/2020 13:32	3,12	126	393,47	CHI
2020034823	GOIAS	GS12203896	ITABERAI S2	02/03/2020 10:15	02/03/2020 12:18	02/03/2020 10:15	02/03/2020 12:18	2,04	40	81,74	CHI
2020034825	JUSSARA	1290019207	JUSSARA	02/03/2020 10:56	03/03/2020 10:07	02/03/2020 10:56	03/03/2020 10:07	23,17	1	23,17	CHI
2020034831	GOIANIA	10002023103	INDEPENDENCIA S2	02/03/2020 10:57	02/03/2020 13:20	02/03/2020 10:57	02/03/2020 13:20	2,38	1	2,38	CHI

2020034835	PIRENOPOLIS	4330000946	CORUMBA	02/03/2020 10:58	02/03/2020 16:26	02/03/2020 10:58	02/03/2020 16:26	5,46	1	5,46	CHI
2020034838	ALVORADA DO NORTE	SI12302708	IACIARA S2	02/03/2020 10:58	02/03/2020 13:17	02/03/2020 10:58	02/03/2020 13:17	2,31	1	2,31	CHI
2020034838	SITIO D ABADIA	SI12302708	IACIARA S2	02/03/2020 10:58	02/03/2020 13:17	02/03/2020 10:58	02/03/2020 13:17	2,31	1	2,31	CHI
2020034839	SANCLERLANDIA	1210025477	FIRMINOPOLIS S2	02/03/2020 10:58	02/03/2020 14:51	02/03/2020 10:58	02/03/2020 14:51	3,87	1	3,87	CHI
2020034840	PLANALTINA	10002763310	PLANALTINA	02/03/2020 10:59	02/03/2020 12:10	02/03/2020 10:59	02/03/2020 12:10	1,19	1	1,19	CHI
2020034842	SAO LUIS DE MONTES BELOS	SL21019471	SAO LUIZ DOS MONTES BELOS	02/03/2020 10:59	02/03/2020 12:55	02/03/2020 10:59	02/03/2020 12:55	1,92	1	1,92	CHI
2020034848	BELA VISTA DE GOIAS	BV21010095	CRISTIANOPOLIS	02/03/2020 11:01	02/03/2020 20:04	02/03/2020 11:01	02/03/2020 20:04	9,05	2	18,09	CHI
2020034849	GOIANIRA	GR12053239	NEROPOLIS S1	02/03/2020 09:24	02/03/2020 14:55	02/03/2020 09:24	02/03/2020 14:55	5,51	6	33,08	CHI
2020034856	PARAUNA	10021607875	PARAUNA	02/03/2020 11:02	02/03/2020 20:57	02/03/2020 11:02	02/03/2020 20:57	9,91	1	9,91	CHI
2020034857	APARECIDA DE GOIANIA	10018794686	INDEPENDENCIA S2	02/03/2020 11:03	02/03/2020 15:03	02/03/2020 11:03	02/03/2020 15:03	4,00	1	4,00	CHI
2020034859	JATAI	10014485204	JATAI S3	02/03/2020 11:03	02/03/2020 12:41	02/03/2020 11:03	02/03/2020 12:41	1,63	1	1,63	CHI
2020034863	VICENTINOPOLIS	VI12218227	VICENTINOPOLIS	02/03/2020 11:00	02/03/2020 16:49	02/03/2020 11:00	02/03/2020 16:49	5,81	3	17,42	CHI
2020034864	QUIRINOPOLIS	80040603	QUIRINOPOLIS	02/03/2020 11:04	02/03/2020 17:42	02/03/2020 11:04	02/03/2020 17:42	6,63	1	6,63	CHI
2020034866	FORMOSA	610120591	ITIQUEIRA	02/03/2020 11:05	02/03/2020 12:49	02/03/2020 11:05	02/03/2020 12:49	1,73	1	1,73	CHI
2020034868	TRINDADE	TR21320405	TRINDADE	02/03/2020 11:05	02/03/2020 19:28	02/03/2020 11:05	02/03/2020 19:28	8,37	6	50,23	CHI
2020034869	EDEIA	1120051220	EDEIA	02/03/2020 11:05	03/03/2020 13:23	02/03/2020 11:05	03/03/2020 13:23	26,29	1	26,29	CHI
2020034871	TRINDADE	TR12323273	TRINDADE	02/03/2020 09:54	02/03/2020 12:28	02/03/2020 09:54	02/03/2020 12:28	2,57	145	371,97	CHI
2020034872	PALMEIRAS DE GOIAS	10006606049	PALMEIRAS	02/03/2020 11:06	02/03/2020 12:24	02/03/2020 11:06	02/03/2020 12:24	1,30	1	1,30	CHI
2020034875	CUMARI	CT21067741	CATALAO S2	02/03/2020 11:07	02/03/2020 16:50	02/03/2020 11:07	02/03/2020 16:50	5,71	1	5,71	CHI
2020034877	CRIXAS	CX21151969	RUBIATABA	02/03/2020 11:08	03/03/2020 12:56	02/03/2020 11:08	03/03/2020 12:56	25,80	1	25,80	CHI
2020034879	RIO VERDE	RV12360702	MONTIVIDIU T	02/03/2020 09:37	02/03/2020 11:31	02/03/2020 09:37	02/03/2020 11:31	1,89	12	22,67	CHI
2020034881	PIRACANJUBA	PJ21105655	MORRINHOS	02/03/2020 11:08	02/03/2020 14:36	02/03/2020 11:08	02/03/2020 14:36	3,46	1	3,46	CHI
2020034882	GOIANIA	16515365	GOYA S1	02/03/2020 11:09	02/03/2020 12:29	02/03/2020 11:09	02/03/2020 12:29	1,33	1	1,33	CHI
2020034883	PORANGATU	PO12228609	PORANGATU	02/03/2020 07:51	02/03/2020 16:57	02/03/2020 07:51	02/03/2020 16:57	9,09	16	145,36	CHI
2020034884	CORUMBAIBA	CI12000521	VILA CORUMBA	02/03/2020 11:09	02/03/2020 20:20	02/03/2020 11:09	02/03/2020 20:20	9,18	141	1294,89	CHI
2020034890	CALDAS NOVAS	CN21182592	CALDAS NOVAS S1	02/03/2020 11:11	02/03/2020 15:24	02/03/2020 11:11	02/03/2020 15:24	4,21	1	4,21	CHI
2020034892	MONTES CLAROS DE GOIAS	ME12204903	IPORA	02/03/2020 09:14	03/03/2020 08:13	02/03/2020 09:14	03/03/2020 08:13	22,98	3	68,93	CHI
2020034897	TROMBAS	TB21146512	PORANGATU	02/03/2020 11:12	02/03/2020 18:45	02/03/2020 11:12	02/03/2020 18:45	7,54	1	7,54	CHI
2020034901	MAURILANDIA	ML31028050	RIO DOS BOIS	02/03/2020 11:14	02/03/2020 17:32	02/03/2020 11:14	02/03/2020 17:32	6,29	1	6,29	CHI
2020034908	CASTELANDIA	QI12053189	QUIRINOPOLIS	03/03/2020 06:25	03/03/2020 07:46	03/03/2020 06:25	03/03/2020 07:46	1,33	19	25,35	CHI
2020034908	QUIRINOPOLIS	QI12053189	QUIRINOPOLIS	03/03/2020 06:25	03/03/2020 07:46	03/03/2020 06:25	03/03/2020 07:46	1,33	34	45,36	CHI
2020034908	RIO VERDE	QI12053189	QUIRINOPOLIS	03/03/2020 06:25	03/03/2020 07:46	03/03/2020 06:25	03/03/2020 07:46	1,33	1	1,33	CHI
2020034915	BURITI ALEGRE	BG12263597	ITUMBIARA VELHA S2	02/03/2020 11:18	03/03/2020 08:26	02/03/2020 11:18	03/03/2020 08:26	21,13	4	84,53	CHI
2020034920	ITUMBIARA	690348411	PARANAIBA	02/03/2020 11:19	02/03/2020 14:50	02/03/2020 11:19	02/03/2020 14:50	3,51	1	3,51	CHI
2020034922	TRINDADE	TR12001811	GOYA S1	02/03/2020 11:17	02/03/2020 12:59	02/03/2020 11:17	02/03/2020 12:59	1,69	24	40,57	CHI
2020034923	CAMPESTRE DE GOIAS	GC21281543	TRINDADE	02/03/2020 11:19	02/03/2020 17:45	02/03/2020 11:19	02/03/2020 17:45	6,42	1	6,42	CHI
2020034925	DAVINOPOLIS	IO12394013	CATALAO S1	02/03/2020 11:20	02/03/2020 16:41	02/03/2020 11:20	02/03/2020 16:41	5,34	11	58,79	CHI
2020034925	DISTRITO FEDERAL	IO12394013	CATALAO S1	02/03/2020 11:20	02/03/2020 16:41	02/03/2020 11:20	02/03/2020 16:41	5,34	2	10,69	CHI
2020034926	SANTA HELENA DE GOIAS	10024885140	IPEGUARI	02/03/2020 11:20	02/03/2020 19:12	02/03/2020 11:20	02/03/2020 19:12	7,86	1	7,86	CHI
2020034927	MINEIROS	PW21206292	PARQUE DAS EMAS	02/03/2020 11:20	02/03/2020 21:40	02/03/2020 11:20	02/03/2020 21:40	10,33	1	10,33	CHI
2020034928	CATALAO	CT21281457	CATALAO S1	02/03/2020 11:20	02/03/2020 14:40	02/03/2020 11:20	02/03/2020 14:40	3,32	2	6,64	CHI
2020034929	GOIANIA	10004193537	GOIANIA LESTE S3	02/03/2020 11:21	02/03/2020 12:47	02/03/2020 11:21	02/03/2020 12:47	1,43	1	1,43	CHI
2020034931	PIRENOPOLIS	PV12297712	CORUMBA	02/03/2020 11:21	02/03/2020 17:27	02/03/2020 11:21	02/03/2020 17:27	6,09	14	85,23	CHI
2020034946	SILVANIA	SV12168792	VIANOPOLIS	02/03/2020 11:25	02/03/2020 14:56	02/03/2020 11:25	02/03/2020 14:56	3,51	3	10,52	CHI

2020034950	ITAPURANGA	IK12310824	ITAPURANGA	02/03/2020 10:31	02/03/2020 17:38	02/03/2020 10:31	02/03/2020 17:38	7,10	6	42,63	CHI
2020034954	PIRACANJUBA	PJ12032054	CRISTIANOPOLIS	02/03/2020 11:26	02/03/2020 22:40	02/03/2020 11:26	02/03/2020 22:40	11,22	3	33,66	CHI
2020034956	AGUA FRIA DE GOIAS	PI12067431	SAO JOAO D ALIANCA	02/03/2020 11:27	02/03/2020 18:35	02/03/2020 11:27	02/03/2020 18:35	7,13	11	78,46	CHI
2020034967	CATALAO	10003888035	CATALAO S2	02/03/2020 11:29	02/03/2020 15:35	02/03/2020 11:29	02/03/2020 15:35	4,10	1	4,10	CHI
2020034971	GOIANESIA	550113447	GOIANESIA S2	02/03/2020 11:29	03/03/2020 01:22	02/03/2020 11:29	03/03/2020 01:22	13,87	1	13,87	CHI
2020034972	CUMARI	CY12333314	CATALAO S1	02/03/2020 11:29	03/03/2020 16:45	02/03/2020 11:29	03/03/2020 16:45	29,25	2	58,50	CHI
2020034978	NOVO PLANALTO	TA21170089	SAO MIGUEL DO ARAGUAIA	02/03/2020 11:31	02/03/2020 23:31	02/03/2020 11:31	02/03/2020 23:31	11,99	1	11,99	CHI
2020034989	CATALAO	CT11333586	CATALAO S1	02/03/2020 11:33	02/03/2020 16:47	02/03/2020 11:33	02/03/2020 16:47	5,23	61	318,88	CHI
2020034993	GAMELEIRA DE GOIAS	SV12056396	DAIA S2	02/03/2020 10:40	02/03/2020 15:03	02/03/2020 10:40	02/03/2020 15:03	4,38	104	455,72	CHI
2020034993	SILVANIA	SV12056396	DAIA S2	02/03/2020 10:40	02/03/2020 15:03	02/03/2020 10:40	02/03/2020 15:03	4,38	1	4,38	CHI
2020034994	PONTALINA	PK12047217	PONTALINA	02/03/2020 11:34	02/03/2020 15:56	02/03/2020 11:34	02/03/2020 15:56	4,36	80	348,82	CHI
2020034995	JATAI	10029913673	JATAI S3	02/03/2020 11:34	02/03/2020 16:52	02/03/2020 11:34	02/03/2020 16:52	5,30	1	5,30	CHI
2020034996	PONTALINA	PK21074609	PONTALINA	02/03/2020 11:35	02/03/2020 13:46	02/03/2020 11:35	02/03/2020 13:46	2,18	1	2,18	CHI
2020035008	TRINDADE	TR12185475	TRINDADE	02/03/2020 11:23	02/03/2020 15:09	02/03/2020 11:23	02/03/2020 15:09	3,77	85	320,05	CHI
2020035013	ANAPOLIS	20755259	ANAPOLIS UNIVERSITARIO S2	02/03/2020 11:37	02/03/2020 14:23	02/03/2020 11:37	02/03/2020 14:23	2,75	1	2,75	CHI
2020035017	INACIOLANDIA	CD12000114	CACHOEIRA DOURADA	02/03/2020 11:39	02/03/2020 12:48	02/03/2020 11:39	02/03/2020 12:48	1,15	2	2,29	CHI
2020035019	CATALAO	CT11333662	CATALAO S2	02/03/2020 10:36	02/03/2020 14:56	02/03/2020 10:36	02/03/2020 14:56	4,32	12	51,87	CHI
2020035022	PIRACANJUBA	PJ12000042RE	PIRACANJUBA	02/03/2020 11:39	02/03/2020 23:11	02/03/2020 11:39	02/03/2020 23:11	11,52	10	115,22	CHI
2020035024	APARECIDA DE GOIANIA	10024822211	ANHANGUERA	02/03/2020 11:41	02/03/2020 13:54	02/03/2020 11:41	02/03/2020 13:54	2,21	1	2,21	CHI
2020035032	MUTUNOPOLIS	MU12060992	MARA ROSA	02/03/2020 11:45	02/03/2020 19:12	02/03/2020 11:45	02/03/2020 19:12	7,43	3	22,30	CHI
2020035038	URUACU	UR12317135	URUACU	02/03/2020 11:47	02/03/2020 14:16	02/03/2020 11:47	02/03/2020 14:16	2,47	11	27,18	CHI
2020035039	GOIANIA	10088891	GOYA S2	02/03/2020 11:47	02/03/2020 13:59	02/03/2020 11:47	02/03/2020 13:59	2,20	1	2,20	CHI
2020035041	CAMPESTRE DE GOIAS	GA12008538	GUAPO S2	02/03/2020 11:48	02/03/2020 15:04	02/03/2020 11:48	02/03/2020 15:04	3,26	1	3,26	CHI
2020035041	GUAPO	GA12008538	GUAPO S2	02/03/2020 11:48	02/03/2020 15:04	02/03/2020 11:48	02/03/2020 15:04	3,26	11	35,84	CHI
2020035043	TURVANIA	TV12005559	FIRMINOPOLIS S1	02/03/2020 11:49	02/03/2020 14:58	02/03/2020 11:49	02/03/2020 14:58	3,15	2	6,30	CHI
2020035047	VILA BOA	2880005950	IACIARA S2	02/03/2020 11:49	02/03/2020 14:56	02/03/2020 11:49	02/03/2020 14:56	3,11	1	3,11	CHI
2020035049	CATURAI	CK21132748	INHUMAS S1	02/03/2020 11:49	02/03/2020 13:04	02/03/2020 11:49	02/03/2020 13:04	1,24	1	1,24	CHI
2020035054	ARAGOIANIA	AO32000287	GUAPO S2	02/03/2020 11:45	02/03/2020 13:50	02/03/2020 11:45	02/03/2020 13:50	2,07	16	33,08	CHI
2020035060	CRISTALINA	KR21304809	CRISTALINA S2	02/03/2020 11:52	02/03/2020 18:31	02/03/2020 11:52	02/03/2020 18:31	6,64	1	6,64	CHI
2020035061	BOM JESUS DE GOIAS	1250062114	BOM JESUS DE GOIAS	02/03/2020 11:52	02/03/2020 15:09	02/03/2020 11:52	02/03/2020 15:09	3,28	1	3,28	CHI
2020035066	MORRINHOS	MR12080320	VILA CORUMBA	02/03/2020 11:55	02/03/2020 22:57	02/03/2020 11:55	02/03/2020 22:57	11,03	3	33,10	CHI
2020035067	FAZENDA NOVA	FN11242289	IPORA	02/03/2020 11:56	02/03/2020 22:30	02/03/2020 11:56	02/03/2020 22:30	10,57	1	10,57	CHI
2020035070	IPAMERI	IP21308247	IPAMERI	02/03/2020 11:56	03/03/2020 09:48	02/03/2020 11:56	03/03/2020 09:48	21,86	1	21,86	CHI
2020035071	SAO FRANCISCO DE GOIAS	SF21186956	SAO FRANCISCO DE GOIAS	02/03/2020 11:56	02/03/2020 14:48	02/03/2020 11:56	02/03/2020 14:48	2,86	1	2,86	CHI
2020035074	CACU	CC12235900	CACHOEIRA ALTA	02/03/2020 11:57	02/03/2020 13:15	02/03/2020 11:57	02/03/2020 13:15	1,29	1	1,29	CHI
2020035081	JARAGUA	10029771364	JARAGUA	02/03/2020 12:00	02/03/2020 13:52	02/03/2020 12:00	02/03/2020 13:52	1,86	1	1,86	CHI
2020035082	APORE	AE21301905	ITAJA S1	02/03/2020 12:01	02/03/2020 15:35	02/03/2020 12:01	02/03/2020 15:35	3,56	1	3,56	CHI
2020035083	GOIANIA	10481461	GOIANIA LESTE S2	02/03/2020 12:01	02/03/2020 15:53	02/03/2020 12:01	02/03/2020 15:53	3,86	1	3,86	CHI
2020035090	PIRENOPOLIS	PV12319787	CORUMBA	02/03/2020 10:05	02/03/2020 13:43	02/03/2020 10:05	02/03/2020 13:43	3,63	8	29,03	CHI
2020035094	FAZENDA NOVA	FN21277914	JUSSARA	02/03/2020 12:03	03/03/2020 15:56	02/03/2020 12:03	03/03/2020 15:56	27,87	1	27,87	CHI
2020035097	SAO MIGUEL DO ARAGUAIA	SM12350501	SAO MIGUEL DO ARAGUAIA	02/03/2020 12:04	02/03/2020 15:17	02/03/2020 12:04	02/03/2020 15:17	3,20	6	19,21	CHI
2020035099	BELA VISTA DE GOIAS	240060908	BELA VISTA S1	02/03/2020 12:05	02/03/2020 13:24	02/03/2020 12:05	02/03/2020 13:24	1,31	1	1,31	CHI
2020035113	NOVA ROMA	SD12067690	IACIARA S2	02/03/2020 12:52	02/03/2020 13:19	02/03/2020 12:52	02/03/2020 13:19	0,45	1	0,45	CHI
2020035113	SAO DOMINGOS	SD12067690	IACIARA S2	02/03/2020 12:52	02/03/2020 13:19	02/03/2020 12:52	02/03/2020 13:19	0,45	2	0,89	CHI

2020035138	MINEIROS	MY10401436	PARQUE DAS EMAS	02/03/2020 14:32	04/03/2020 23:08	02/03/2020 14:32	02/03/2020 17:06	2,57	28	71,93	CHI
2020035138	MINEIROS	MY10401436	PARQUE DAS EMAS	02/03/2020 14:32	04/03/2020 23:08	02/03/2020 19:42	02/03/2020 19:49	0,12	28	3,39	CHI
2020035138	MINEIROS	MY10401436	PARQUE DAS EMAS	02/03/2020 14:32	04/03/2020 23:08	03/03/2020 10:07	03/03/2020 10:16	0,14	29	4,03	CHI
2020035138	MINEIROS	MY10401436	PARQUE DAS EMAS	02/03/2020 14:32	04/03/2020 23:08	03/03/2020 10:40	03/03/2020 21:23	10,71	2	21,42	CHI
2020035138	MINEIROS	MY10401436	PARQUE DAS EMAS	02/03/2020 14:32	04/03/2020 23:08	03/03/2020 23:23	04/03/2020 00:05	0,70	2	1,40	CHI
2020035138	MINEIROS	MY10401436	PARQUE DAS EMAS	02/03/2020 14:32	04/03/2020 23:08	03/03/2020 10:40	04/03/2020 17:26	30,76	6	184,57	CHI
2020035138	MINEIROS	MY10401436	PARQUE DAS EMAS	02/03/2020 14:32	04/03/2020 23:08	03/03/2020 10:40	04/03/2020 18:10	31,50	6	188,99	CHI
2020035138	MINEIROS	MY13303915	PARQUE DAS EMAS	02/03/2020 14:32	04/03/2020 23:08	03/03/2020 10:40	04/03/2020 18:10	31,50	15	472,48	CHI
2020035138	MINEIROS	MY10401436	PARQUE DAS EMAS	02/03/2020 14:32	04/03/2020 23:08	02/03/2020 14:32	04/03/2020 18:15	51,71	2	103,42	CHI
2020035138	MINEIROS	MY10401436	PARQUE DAS EMAS	02/03/2020 14:32	04/03/2020 23:08	04/03/2020 20:27	04/03/2020 20:31	0,05	29	1,57	CHI
2020035138	MINEIROS	MY13324529	PARQUE DAS EMAS	02/03/2020 14:32	04/03/2020 23:08	04/03/2020 18:17	04/03/2020 20:59	2,69	1	2,69	CHI
2020035138	MINEIROS	MY13324529	PARQUE DAS EMAS	02/03/2020 14:32	04/03/2020 23:08	04/03/2020 21:55	04/03/2020 22:05	0,16	1	0,16	CHI
2020035138	MINEIROS	MY13324529	PARQUE DAS EMAS	02/03/2020 14:32	04/03/2020 23:08	04/03/2020 18:17	04/03/2020 22:45	4,46	1	4,46	CHI
2020035138	MINEIROS	MY13324529	PARQUE DAS EMAS	02/03/2020 14:32	04/03/2020 23:08	04/03/2020 22:10	04/03/2020 22:45	0,57	1	0,57	CHI
2020035138	MINEIROS	MY10401436	PARQUE DAS EMAS	02/03/2020 14:32	04/03/2020 23:08	02/03/2020 14:32	04/03/2020 23:08	56,60	5	283,01	CHI
2020035201	PILAR DE GOIAS	GG12100377	SANTA TEREZINHA	02/03/2020 12:05	02/03/2020 21:14	02/03/2020 12:05	02/03/2020 21:14	9,13	2	18,27	CHI
2020035202	FLORES DE GOIAS	FB11255038	FLORES DE GOIAS	02/03/2020 12:06	02/03/2020 15:17	02/03/2020 12:06	02/03/2020 15:17	3,18	8	25,44	CHI
2020035206	NOVA ROMA	ND21242942	IACIARA S2	02/03/2020 12:06	02/03/2020 15:17	02/03/2020 12:06	02/03/2020 15:17	3,17	1	3,17	CHI
2020035211	INDIARA	2710022856	EDEIA	02/03/2020 12:08	02/03/2020 17:09	02/03/2020 12:08	02/03/2020 17:09	5,01	1	5,01	CHI
2020035221	NIQUELANDIA	2750070886	NIQUELANDIA SUBTRANSMISSAO	02/03/2020 12:11	02/03/2020 13:10	02/03/2020 12:11	02/03/2020 13:10	0,98	1	0,98	CHI
2020035224	ITABERAI	IB12022008	ITABERAI S2	02/03/2020 12:13	02/03/2020 14:06	02/03/2020 12:13	02/03/2020 14:06	1,88	28	52,68	CHI
2020035228	IPORA	730079399	IPORA	02/03/2020 12:15	03/03/2020 03:21	02/03/2020 12:15	03/03/2020 03:21	15,10	1	15,10	CHI
2020035229	RUBIATABA	780035100	RUBIATABA	02/03/2020 12:15	02/03/2020 14:04	02/03/2020 12:15	02/03/2020 14:04	1,81	1	1,81	CHI
2020035236	SILVANIA	SV21133524	VIANOPOLIS	02/03/2020 12:17	02/03/2020 17:24	02/03/2020 12:17	02/03/2020 17:24	5,11	1	5,11	CHI
2020035239	GOIANIA	15296246	GOIANIA LESTE S3	02/03/2020 12:18	02/03/2020 13:33	02/03/2020 12:18	02/03/2020 13:33	1,24	1	1,24	CHI
2020035241	SAO LUIS DE MONTES BELOS	SL21259062	SAO LUIZ DOS MONTES BELOS	02/03/2020 12:19	02/03/2020 14:33	02/03/2020 12:19	02/03/2020 14:33	2,23	2	4,45	CHI
2020035244	MUNDO NOVO DE GOIAS	MH12170094	NOVA CRIXAS	02/03/2020 07:08	02/03/2020 15:54	02/03/2020 07:08	02/03/2020 15:54	8,76	4	35,04	CHI
2020035246	ITAPURANGA	IK21300023	ITAPURANGA	02/03/2020 12:20	02/03/2020 15:27	02/03/2020 12:20	02/03/2020 15:27	3,11	1	3,11	CHI
2020035264	AMARALINA	MU21156447	MARA ROSA	02/03/2020 12:27	02/03/2020 20:04	02/03/2020 12:27	02/03/2020 20:04	7,61	1	7,61	CHI
2020035265	ALEXANIA	AX12095958	CORUMBA	02/03/2020 12:27	02/03/2020 17:16	02/03/2020 12:27	02/03/2020 17:16	4,81	6	28,87	CHI
2020035265	CORUMBA DE GOIAS	AX12095958	CORUMBA	02/03/2020 12:27	02/03/2020 17:16	02/03/2020 12:27	02/03/2020 17:16	4,81	3	14,44	CHI
2020035272	IPAMERI	IP12215692	PIRES DO RIO S2	02/03/2020 09:53	03/03/2020 00:53	02/03/2020 09:53	03/03/2020 00:53	14,99	3	44,97	CHI
2020035274	CALDAS NOVAS	CN12332905	CALDAS NOVAS S1	02/03/2020 12:28	02/03/2020 23:30	02/03/2020 12:28	02/03/2020 23:30	11,02	29	319,55	CHI
2020035275	SILVANIA	SV21348693	BELA VISTA S2	02/03/2020 12:28	02/03/2020 15:09	02/03/2020 12:28	02/03/2020 15:09	2,67	1	2,67	CHI
2020035279	CALDAS NOVAS	RQ21103101	VILA CORUMBA	02/03/2020 12:30	02/03/2020 17:47	02/03/2020 12:30	02/03/2020 17:47	5,27	1	5,27	CHI
2020035280	LEOPOLDO DE BULHOES	LB21254201	DAIA S2	02/03/2020 12:30	02/03/2020 15:19	02/03/2020 12:30	02/03/2020 15:19	2,80	1	2,80	CHI
2020035288	JATAI	JT21280097	JATAI S1	02/03/2020 12:33	02/03/2020 15:41	02/03/2020 12:33	02/03/2020 15:41	3,13	1	3,13	CHI
2020035289	IACIARA	IA21090934	IACIARA S2	02/03/2020 12:33	02/03/2020 13:07	02/03/2020 12:33	02/03/2020 13:07	0,56	1	0,56	CHI
2020035290	SILVANIA	SV12070054	CEPAIGO S2	02/03/2020 12:33	02/03/2020 17:26	02/03/2020 12:33	02/03/2020 17:26	4,87	2	9,74	CHI
2020035291	CEZARINA	CZ12000034	CEZARINA	02/03/2020 12:29	02/03/2020 16:14	02/03/2020 12:29	02/03/2020 16:14	3,74	21	78,45	CHI
2020035291	INDIARA	CZ12000034	CEZARINA	02/03/2020 12:29	02/03/2020 16:14	02/03/2020 12:29	02/03/2020 16:14	3,74	9	33,62	CHI
2020035294	PORANGATU	840101065	PORANGATU	02/03/2020 12:34	02/03/2020 15:24	02/03/2020 12:34	02/03/2020 15:24	2,82	1	2,82	CHI
2020035295	RIO VERDE	630291329	RIO VERDE S1	02/03/2020 12:35	02/03/2020 17:27	02/03/2020 12:35	02/03/2020 17:27	4,86	1	4,86	CHI
2020035297	TRINDADE	TR21344885	TRINDADE	02/03/2020 12:36	02/03/2020 17:40	02/03/2020 12:36	02/03/2020 17:40	5,05	1	5,05	CHI

2020035299	JATAI	JT11104951	JATAI S3	02/03/2020 12:07	02/03/2020 13:40	02/03/2020 12:07	02/03/2020 13:40	1,54	106	163,65	CHI
2020035300	ITABERAI	50099796	ITABERAI S2	02/03/2020 12:38	02/03/2020 16:02	02/03/2020 12:38	02/03/2020 16:02	3,40	1	3,40	CHI
2020035301	SAO SIMAO	2240026309	CACHOEIRA ALTA	02/03/2020 12:38	02/03/2020 23:20	02/03/2020 12:38	02/03/2020 23:20	10,69	1	10,69	CHI
2020035318	PIRACANJUBA	PJ21287336	PIRACANJUBA	02/03/2020 12:43	02/03/2020 21:11	02/03/2020 12:43	02/03/2020 21:11	8,47	1	8,47	CHI
2020035321	JATAI	JT12099233	JATAI S1	02/03/2020 12:43	02/03/2020 17:07	02/03/2020 12:43	02/03/2020 17:07	4,39	3	13,17	CHI
2020035324	PANAMA	PX21293038	PARANAIBA	02/03/2020 12:44	02/03/2020 17:52	02/03/2020 12:44	02/03/2020 17:52	5,14	1	5,14	CHI
2020035327	GOIANIA	16733848	ATLANTICO S3	02/03/2020 12:45	02/03/2020 15:47	02/03/2020 12:45	02/03/2020 15:47	3,02	1	3,02	CHI
2020035330	CATURAI	CK21401014	INHUMAS S1	02/03/2020 12:47	02/03/2020 16:56	02/03/2020 12:47	02/03/2020 16:56	4,15	2	8,29	CHI
2020035338	URUACU	UR11221613	URUACU	02/03/2020 12:49	02/03/2020 13:38	02/03/2020 12:49	02/03/2020 13:38	0,81	34	27,37	CHI
2020035345	GOIANIA	14103746	ATLANTICO S3	02/03/2020 12:51	02/03/2020 14:21	02/03/2020 12:51	02/03/2020 14:21	1,49	1	1,49	CHI
2020035347	DOVERLANDIA	DV21123980	CAIAPONIA	02/03/2020 12:52	02/03/2020 18:12	02/03/2020 12:52	02/03/2020 18:12	5,33	1	5,33	CHI
2020035361	CATALAO	CT12042366	CATALAO S1	02/03/2020 11:30	02/03/2020 20:53	02/03/2020 11:30	02/03/2020 20:53	9,37	19	178,08	CHI
2020035364	JATAI	JT12191724	JATAI S2	02/03/2020 12:28	02/03/2020 13:54	02/03/2020 12:28	02/03/2020 13:54	1,43	7	10,03	CHI
2020035365	SANTA RITA DO ARAGUAIA	SU12184129	SANTA RITA DO ARAGUAIA	02/03/2020 12:56	02/03/2020 22:36	02/03/2020 12:56	02/03/2020 22:36	9,65	2	19,30	CHI
2020035370	SANTA TEREZA DE GOIAS	SE21012482	MARA ROSA	02/03/2020 12:57	03/03/2020 10:29	02/03/2020 12:57	03/03/2020 10:29	21,52	1	21,52	CHI
2020035374	PARAUNA	EU12000131LD	ACREUNA	02/03/2020 12:53	02/03/2020 17:16	02/03/2020 12:53	02/03/2020 17:16	4,37	16	69,97	CHI
2020035387	RIO VERDE	RV12018100	SANTA HELENA S1	02/03/2020 13:01	02/03/2020 18:53	02/03/2020 13:01	02/03/2020 18:53	5,85	11	64,38	CHI
2020035389	CRIXAS	CX12283275	SERRA DO OURO	02/03/2020 13:02	03/03/2020 17:21	02/03/2020 13:02	03/03/2020 17:21	28,31	2	56,62	CHI
2020035392	RIO VERDE	630513788	RIO VERDE S2	02/03/2020 13:03	02/03/2020 19:01	02/03/2020 13:03	02/03/2020 19:01	5,95	1	5,95	CHI
2020035393	MOSSAMEDES	MD21157123	FIRMINOPOLIS S2	02/03/2020 13:04	02/03/2020 15:14	02/03/2020 13:04	02/03/2020 15:14	2,16	2	4,32	CHI
2020035395	NIQUELANDIA	NQ11353784	URUACU	02/03/2020 13:05	02/03/2020 23:40	02/03/2020 13:05	02/03/2020 23:40	10,58	1	10,58	CHI
2020035403	ABADIANIA	AN21144048	ANAPOLIS UNIVERSITARIO S2	02/03/2020 13:08	02/03/2020 17:48	02/03/2020 13:08	02/03/2020 17:48	4,68	1	4,68	CHI
2020035404	NIQUELANDIA	NQ12274742	BARRO ALTO	02/03/2020 11:02	02/03/2020 15:46	02/03/2020 11:02	02/03/2020 15:46	4,73	17	80,37	CHI
2020035405	ITAPACI	IW11267263	ITAPACI	02/03/2020 13:08	02/03/2020 18:09	02/03/2020 13:08	02/03/2020 18:09	5,00	83	415,39	CHI
2020035409	CRIXAS	CX12213047	SANTA TEREZINHA	02/03/2020 13:10	02/03/2020 19:15	02/03/2020 13:10	02/03/2020 19:15	6,08	41	249,41	CHI
2020035409	SANTA TEREZINHA DE GOIAS	CX12213047	SANTA TEREZINHA	02/03/2020 13:10	02/03/2020 19:15	02/03/2020 13:10	02/03/2020 19:15	6,08	4	24,33	CHI
2020035418	BONOPOLIS	BX10403948	SAO MIGUEL DO ARAGUAIA	02/03/2020 13:12	02/03/2020 23:08	02/03/2020 13:12	02/03/2020 15:15	2,05	17	34,78	CHI
2020035418	BONOPOLIS	BX10403944	SAO MIGUEL DO ARAGUAIA	02/03/2020 13:12	02/03/2020 23:08	02/03/2020 13:12	02/03/2020 15:42	2,50	196	489,46	CHI
2020035418	BONOPOLIS	BX13064902	SAO MIGUEL DO ARAGUAIA	02/03/2020 13:12	02/03/2020 23:08	02/03/2020 13:12	02/03/2020 22:34	9,36	57	533,73	CHI
2020035418	BONOPOLIS	BX13168252	SAO MIGUEL DO ARAGUAIA	02/03/2020 13:12	02/03/2020 23:08	02/03/2020 22:54	02/03/2020 23:08	0,24	196	46,93	CHI
2020035425	CATALAO	7457524	CATALAO S1	02/03/2020 13:14	02/03/2020 15:31	02/03/2020 13:14	02/03/2020 15:31	2,28	1	2,28	CHI
2020035426	PONTALINA	PK12033340	PONTALINA	02/03/2020 13:15	03/03/2020 15:56	02/03/2020 13:15	03/03/2020 15:56	26,68	1	26,68	CHI
2020035428	PONTALINA	PK21189865	PONTALINA	02/03/2020 13:16	02/03/2020 14:33	02/03/2020 13:16	02/03/2020 14:33	1,28	1	1,28	CHI
2020035429	GOIANIA	10000351383	INDEPENDENCIA S2	02/03/2020 13:16	02/03/2020 14:50	02/03/2020 13:16	02/03/2020 14:50	1,56	1	1,56	CHI
2020035438	MAURILANDIA	ML21000001	RIO DOS BOIS	02/03/2020 13:19	02/03/2020 20:14	02/03/2020 13:19	02/03/2020 20:14	6,91	1	6,91	CHI
2020035445	JARAGUA	JA12273193	JARAGUA	02/03/2020 13:20	02/03/2020 14:33	02/03/2020 13:20	02/03/2020 14:33	1,21	2	2,41	CHI
2020035446	POSSE	10000028884	IACIARA S2	02/03/2020 13:20	02/03/2020 15:53	02/03/2020 13:20	02/03/2020 15:53	2,54	1	2,54	CHI
2020035447	SAO JOAO D ALIANCA	JL31198426	SAO JOAO D ALIANCA	02/03/2020 13:21	02/03/2020 19:01	02/03/2020 13:21	02/03/2020 19:01	5,67	1	5,67	CHI
2020035450	LUZIANIA	120264146	RIO VERMELHO	02/03/2020 13:22	02/03/2020 15:46	02/03/2020 13:22	02/03/2020 15:46	2,41	1	2,41	CHI
2020035458	ORIZONA	OZ21114456	PIRES DO RIO S2	02/03/2020 13:23	03/03/2020 09:01	02/03/2020 13:23	03/03/2020 09:01	19,62	1	19,62	CHI
2020035463	SANTA RITA DO NOVO DESTINO	DF11315645	BARRO ALTO	02/03/2020 13:25	02/03/2020 20:18	02/03/2020 13:25	02/03/2020 20:18	6,88	1	6,88	CHI
2020035465	GOIANIA	10222236	AEROPORTO S2	02/03/2020 13:26	02/03/2020 16:14	02/03/2020 13:26	02/03/2020 16:14	2,79	1	2,79	CHI
2020035467	MINEIROS	10010916049	PARQUE DAS EMAS	02/03/2020 13:26	02/03/2020 16:37	02/03/2020 13:26	02/03/2020 16:37	3,18	1	3,18	CHI
2020035469	GOIANIA	10009182436	ATLANTICO S3	02/03/2020 13:27	02/03/2020 16:16	02/03/2020 13:27	02/03/2020 16:16	2,80	1	2,80	CHI

2020035474	FLORES DE GOIAS	IA12361389	IACIARA S2	02/03/2020 13:29	02/03/2020 16:03	02/03/2020 13:29	02/03/2020 16:03	2,55	1	2,55	CHI
2020035474	IACIARA	IA12361389	IACIARA S2	02/03/2020 13:29	02/03/2020 16:03	02/03/2020 13:29	02/03/2020 16:03	2,55	41	104,74	CHI
2020035477	GOIANIA	10361248	CAMPINAS S1	02/03/2020 13:29	02/03/2020 14:40	02/03/2020 13:29	02/03/2020 14:40	1,17	1	1,17	CHI
2020035479	SENADOR CANEDO	13340578	SENADOR CANEDO	02/03/2020 13:30	02/03/2020 14:25	02/03/2020 13:30	02/03/2020 14:25	0,91	1	0,91	CHI
2020035480	BOM JARDIM DE GOIAS	BM12201516	BOM JARDIM	02/03/2020 13:30	02/03/2020 16:05	02/03/2020 13:30	02/03/2020 16:05	2,57	38	97,74	CHI
2020035488	APARECIDA DE GOIANIA	15925456	REAL S1	02/03/2020 13:33	02/03/2020 17:38	02/03/2020 13:33	02/03/2020 17:38	4,07	1	4,07	CHI
2020035491	CAIAPONIA	CP12389845	CAIAPONIA	02/03/2020 13:34	02/03/2020 20:27	02/03/2020 13:34	02/03/2020 20:27	6,87	5	34,35	CHI
2020035498	ANAPOLIS	20642040	ANAPOLIS UNIVERSITARIO S2	02/03/2020 13:36	02/03/2020 15:31	02/03/2020 13:36	02/03/2020 15:31	1,91	1	1,91	CHI
2020035499	NEROPOLIS	NR12009253	NEROPOLIS S2	02/03/2020 13:36	02/03/2020 15:07	02/03/2020 13:36	02/03/2020 15:07	1,51	2	3,01	CHI
2020035500	IPAMERI	IP12300882	IPAMERI	02/03/2020 13:37	02/03/2020 19:08	02/03/2020 13:37	02/03/2020 19:08	5,52	3	16,55	CHI
2020035506	ANAPOLIS	AN21302358	DAIA S1	02/03/2020 13:38	02/03/2020 14:40	02/03/2020 13:38	02/03/2020 14:40	1,03	1	1,03	CHI
2020035514	COCALZINHO DE GOIAS	9970017840	AGUAS LINDAS DE GOIAS S1	02/03/2020 13:42	02/03/2020 15:23	02/03/2020 13:42	02/03/2020 15:23	1,68	1	1,68	CHI
2020035520	PIRES DO RIO	PR12255829	PIRES DO RIO S1	02/03/2020 13:43	02/03/2020 17:26	02/03/2020 13:43	02/03/2020 17:26	3,71	8	29,67	CHI
2020035527	SILVANIA	VN12400021	VIANOPOLIS	02/03/2020 13:39	02/03/2020 16:10	02/03/2020 13:39	02/03/2020 16:10	2,50	22	55,05	CHI
2020035527	VIANOPOLIS	VN12400021	VIANOPOLIS	02/03/2020 13:39	02/03/2020 16:10	02/03/2020 13:39	02/03/2020 16:10	2,50	113	282,75	CHI
2020035529	JATAI	JT11036756	JATAI S2	02/03/2020 12:51	02/03/2020 15:06	02/03/2020 12:51	02/03/2020 15:06	2,25	82	184,16	CHI
2020035531	CACHOEIRA ALTA	CA21036998	CACHOEIRA ALTA	02/03/2020 13:47	02/03/2020 16:20	02/03/2020 13:47	02/03/2020 16:20	2,56	1	2,56	CHI
2020035535	CACU	CC12202706	CACHOEIRA ALTA	02/03/2020 13:47	02/03/2020 16:45	02/03/2020 13:47	02/03/2020 16:45	2,95	8	23,62	CHI
2020035539	ESTRELA DO NORTE	MQ12150566	MARA ROSA	02/03/2020 13:17	02/03/2020 16:06	02/03/2020 13:17	02/03/2020 16:06	2,80	7	19,62	CHI
2020035539	MARA ROSA	MQ12150566	MARA ROSA	02/03/2020 13:17	02/03/2020 16:06	02/03/2020 13:17	02/03/2020 16:06	2,80	7	19,62	CHI
2020035546	SENADOR CANEDO	SW12025377	SENADOR CANEDO	02/03/2020 13:51	02/03/2020 16:14	02/03/2020 13:51	02/03/2020 16:14	2,38	3	7,13	CHI
2020035547	ARAGOIANIA	AO21111920	GUAPO S2	02/03/2020 13:52	02/03/2020 14:59	02/03/2020 13:52	02/03/2020 14:59	1,12	1	1,12	CHI
2020035550	CACU	CC21086138	CACHOEIRA ALTA	02/03/2020 13:52	02/03/2020 22:05	02/03/2020 13:52	02/03/2020 22:05	8,21	1	8,21	CHI
2020035553	IPORA	IR21097734	IPORA	02/03/2020 09:12	02/03/2020 20:19	02/03/2020 09:12	02/03/2020 20:19	11,10	2	22,20	CHI
2020035557	GOIANIA	10004981349	MEIA PONTE	02/03/2020 13:53	02/03/2020 16:07	02/03/2020 13:53	02/03/2020 16:07	2,23	1	2,23	CHI
2020035561	RIO VERDE	RV21033133	CABRIUVA S2	02/03/2020 13:54	03/03/2020 09:01	02/03/2020 13:54	03/03/2020 09:01	19,11	1	19,11	CHI
2020035562	GOIANIA	GN11000625	AEROPORTO S3	02/03/2020 13:54	02/03/2020 16:28	02/03/2020 13:54	02/03/2020 16:28	2,56	51	130,46	CHI
2020035563	TRES RANCHOS	TH21294956	CATALAO S1	02/03/2020 13:54	02/03/2020 16:58	02/03/2020 13:54	02/03/2020 16:58	3,06	1	3,06	CHI
2020035564	BOM JARDIM DE GOIAS	BM12212797	BOM JARDIM	02/03/2020 11:25	02/03/2020 20:22	02/03/2020 11:25	02/03/2020 20:22	8,93	70	625,35	CHI
2020035564	PIRANHAS	BM12212797	BOM JARDIM	02/03/2020 11:25	02/03/2020 20:22	02/03/2020 11:25	02/03/2020 20:22	8,93	2	17,87	CHI
2020035565	ABADIANIA	AA12377756	ANAPOLIS UNIVERSITARIO S1	02/03/2020 13:54	02/03/2020 16:49	02/03/2020 13:54	02/03/2020 16:49	2,90	19	55,13	CHI
2020035566	SERRANOPOLIS	SX21318838	JATAI S1	02/03/2020 13:56	03/03/2020 07:49	02/03/2020 13:56	03/03/2020 07:49	17,88	1	17,88	CHI
2020035578	JATAI	JT12072680	JATAI S1	02/03/2020 13:28	02/03/2020 16:15	02/03/2020 13:28	02/03/2020 16:15	2,78	15	41,75	CHI
2020035583	AGUA FRIA DE GOIAS	PI12048046	SAO JOAO D ALIANCA	02/03/2020 14:00	02/03/2020 17:52	02/03/2020 14:00	02/03/2020 17:52	3,86	5	19,28	CHI
2020035584	NOVO PLANALTO	SM12074646	SAO MIGUEL DO ARAGUAIA	02/03/2020 13:59	02/03/2020 18:59	02/03/2020 13:59	02/03/2020 18:59	4,99	6	29,91	CHI
2020035584	SAO MIGUEL DO ARAGUAIA	SM12074646	SAO MIGUEL DO ARAGUAIA	02/03/2020 13:59	02/03/2020 18:59	02/03/2020 13:59	02/03/2020 18:59	4,99	376	1874,36	CHI
2020035585	CROMINIA	CQ21079837	PONTALINA	02/03/2020 14:00	02/03/2020 14:43	02/03/2020 14:00	02/03/2020 14:43	0,70	1	0,70	CHI
2020035586	FORMOSA	10021822814	ITUIQUIRA	02/03/2020 14:01	02/03/2020 15:55	02/03/2020 14:01	02/03/2020 15:55	1,91	1	1,91	CHI
2020035593	JUSSARA	JR21158988	BRITANIA	02/03/2020 14:03	02/03/2020 18:57	02/03/2020 14:03	02/03/2020 18:57	4,89	1	4,89	CHI
2020035600	NOVO BRASIL	NB12061645	JUSSARA	02/03/2020 07:18	02/03/2020 21:51	02/03/2020 07:18	02/03/2020 21:51	14,54	2	29,07	CHI
2020035601	ITUMBIARA	690205661	PARANAIBA	02/03/2020 14:05	02/03/2020 18:13	02/03/2020 14:05	02/03/2020 18:13	4,12	1	4,12	CHI
2020035602	PARANAIGUARA	PC21235071	CACHOEIRA ALTA	02/03/2020 14:05	02/03/2020 18:40	02/03/2020 14:05	02/03/2020 18:40	4,57	1	4,57	CHI
2020035605	GOIANESIA	SJ21006513	GOIANESIA S1	02/03/2020 14:07	02/03/2020 16:00	02/03/2020 14:07	02/03/2020 16:00	1,90	1	1,90	CHI
2020035606	AGUA FRIA DE GOIAS	JL12270093	SAO JOAO D ALIANCA	02/03/2020 14:07	02/03/2020 18:59	02/03/2020 14:07	02/03/2020 18:59	4,86	1	4,86	CHI

2020035615	PILAR DE GOIAS	SG12390506	SANTA TEREZINHA	02/03/2020 13:24	02/03/2020 17:01	02/03/2020 13:24	02/03/2020 17:01	3,61	3	10,84	CHI
2020035615	SANTA TEREZINHA DE GOIAS	SG12390506	SANTA TEREZINHA	02/03/2020 13:24	02/03/2020 17:01	02/03/2020 13:24	02/03/2020 17:01	3,61	50	180,71	CHI
2020035616	ITABERAI	IB12066172	ITABERAI S1	02/03/2020 14:12	02/03/2020 15:12	02/03/2020 14:12	02/03/2020 15:12	1,00	11	10,98	CHI
2020035618	NIQUELANDIA	NQ12374766	URUACU	02/03/2020 14:13	02/03/2020 22:37	02/03/2020 14:13	02/03/2020 22:37	8,39	2	16,79	CHI
2020035622	FORMOSO	FO12208460	MARA ROSA	02/03/2020 14:14	02/03/2020 17:12	02/03/2020 14:14	02/03/2020 17:12	2,97	11	32,62	CHI
2020035628	FORMOSO	FO12328885	PORANGATU	02/03/2020 14:15	02/03/2020 20:35	02/03/2020 14:15	02/03/2020 20:35	6,33	4	25,32	CHI
2020035628	SANTA TEREZA DE GOIAS	FO12328885	PORANGATU	02/03/2020 14:15	02/03/2020 20:35	02/03/2020 14:15	02/03/2020 20:35	6,33	12	75,95	CHI
2020035630	JARAGUA	UA12078282	JARAGUA	02/03/2020 14:15	02/03/2020 16:49	02/03/2020 14:15	02/03/2020 16:49	2,56	3	7,67	CHI
2020035630	URUANA	UA12078282	JARAGUA	02/03/2020 14:15	02/03/2020 16:49	02/03/2020 14:15	02/03/2020 16:49	2,56	7	17,89	CHI
2020035633	CATALAO	1990180519	CATALAO S2	02/03/2020 14:16	03/03/2020 07:36	02/03/2020 14:16	03/03/2020 07:36	17,32	1	17,32	CHI
2020035635	CACU	1140035177	CACHOEIRA ALTA	02/03/2020 14:16	02/03/2020 22:38	02/03/2020 14:16	02/03/2020 22:38	8,35	1	8,35	CHI
2020035638	PARAUNA	10018553212	PARAUNA	02/03/2020 14:17	02/03/2020 16:04	02/03/2020 14:17	02/03/2020 16:04	1,78	1	1,78	CHI
2020035646	AMORINOPOLIS	AM21362194	IPORA	02/03/2020 14:18	02/03/2020 21:59	02/03/2020 14:18	02/03/2020 21:59	7,67	1	7,67	CHI
2020035647	CRISTALINA	KR12304816	CRISTALINA S2	02/03/2020 13:57	02/03/2020 15:51	02/03/2020 13:57	02/03/2020 15:51	1,90	15	28,47	CHI
2020035651	ANAPOLIS	AN11339368	JUNDIAI S2	02/03/2020 14:20	02/03/2020 15:27	02/03/2020 14:20	02/03/2020 15:27	1,10	85	93,83	CHI
2020035661	FORMOSO	FO12185319	PORANGATU	02/03/2020 14:22	02/03/2020 15:07	02/03/2020 14:22	02/03/2020 15:07	0,74	31	23,04	CHI
2020035665	PONTALINA	PK32047393	VICENTINOPOLIS	02/03/2020 14:23	02/03/2020 16:30	02/03/2020 14:23	02/03/2020 16:30	2,11	6	12,69	CHI
2020035667	PIRACANJUBA	BV12210350	BELA VISTA S1	02/03/2020 12:54	02/03/2020 18:06	02/03/2020 12:54	02/03/2020 18:06	5,20	11	57,20	CHI
2020035669	NIQUELANDIA	NQ11057935	NIQUELANDIA SUBTRANSMISSAO	02/03/2020 14:23	02/03/2020 19:51	02/03/2020 14:23	02/03/2020 19:51	5,45	116	632,30	CHI
2020035670	JARAGUA	JA11070675	JARAGUA	02/03/2020 14:24	02/03/2020 22:27	02/03/2020 14:24	02/03/2020 22:27	8,06	20	161,27	CHI
2020035671	SAO MIGUEL DO ARAGUAIA	SM13349178	SAO MIGUEL DO ARAGUAIA	02/03/2020 14:21	03/03/2020 08:13	02/03/2020 14:21	03/03/2020 08:13	17,86	84	1500,12	CHI
2020035672	FAZENDA NOVA	FN21113916	IPORA	02/03/2020 14:24	03/03/2020 12:18	02/03/2020 14:24	03/03/2020 12:18	21,90	1	21,90	CHI
2020035675	APARECIDA DE GOIANIA	14299598	INDEPENDENCIA S1	02/03/2020 14:24	02/03/2020 16:48	02/03/2020 14:24	02/03/2020 16:48	2,39	1	2,39	CHI
2020035676	MINEIROS	MY21278378	PARQUE DAS EMAS	02/03/2020 14:25	03/03/2020 03:39	02/03/2020 14:25	03/03/2020 03:39	13,23	1	13,23	CHI
2020035677	CAMPOS BELOS	CH12046871	SAO DOMINGOS	02/03/2020 14:25	02/03/2020 16:18	02/03/2020 14:25	02/03/2020 16:18	1,88	113	212,47	CHI
2020035680	SAO SIMAO	2240039420	CACHOEIRA ALTA	02/03/2020 14:23	03/03/2020 00:25	02/03/2020 14:23	03/03/2020 00:25	10,03	1	10,03	CHI
2020035684	PARAUNA	PU21110526	PARAUNA	02/03/2020 14:26	02/03/2020 19:02	02/03/2020 14:26	02/03/2020 19:02	4,59	1	4,59	CHI
2020035685	AGUAS LINDAS DE GOIAS	4830367235	AGUAS LINDAS DE GOIAS S1	02/03/2020 14:26	02/03/2020 15:52	02/03/2020 14:26	02/03/2020 15:52	1,42	1	1,42	CHI
2020035686	MORRINHOS	150088863	MORRINHOS	02/03/2020 14:26	02/03/2020 17:20	02/03/2020 14:26	02/03/2020 17:20	2,89	1	2,89	CHI
2020035691	AGUAS LINDAS DE GOIAS	LA12044225	AGUAS LINDAS DE GOIAS S2	02/03/2020 14:28	02/03/2020 16:35	02/03/2020 14:28	02/03/2020 16:35	2,11	60	126,58	CHI
2020035693	GOIAS	GS11299663	GOIAS	02/03/2020 14:28	02/03/2020 17:27	02/03/2020 14:28	02/03/2020 17:27	2,97	1	2,97	CHI
2020035700	PROFESSOR JAMIL SAFADY	JS12297257	ROCHEDO	02/03/2020 14:29	02/03/2020 16:53	02/03/2020 14:29	02/03/2020 16:53	2,38	8	19,08	CHI
2020035711	PIRANHAS	PH12273643	PIRANHAS	02/03/2020 14:14	03/03/2020 07:44	02/03/2020 14:14	03/03/2020 07:44	17,49	15	262,28	CHI
2020035720	FAZENDA NOVA	NB12099378	JUSSARA	02/03/2020 14:33	03/03/2020 11:51	02/03/2020 14:33	03/03/2020 11:51	21,30	3	63,91	CHI
2020035720	NOVO BRASIL	NB12099378	JUSSARA	02/03/2020 14:33	03/03/2020 11:51	02/03/2020 14:33	03/03/2020 11:51	21,30	1	21,30	CHI
2020035722	AGUAS LINDAS DE GOIAS	LA12412178	AGUAS LINDAS DE GOIAS S1	02/03/2020 14:33	02/03/2020 17:19	02/03/2020 14:33	02/03/2020 17:19	2,75	10	27,54	CHI
2020035727	GOIANIA	12378379	FERROVIARIO S2	02/03/2020 14:34	02/03/2020 16:58	02/03/2020 14:34	02/03/2020 16:58	2,39	1	2,39	CHI
2020035734	GUARANI DE GOIAS	IA12117792	IACIARA S1	02/03/2020 14:35	02/03/2020 15:47	02/03/2020 14:35	02/03/2020 15:47	1,18	18	21,32	CHI
2020035734	IACIARA	IA12117792	IACIARA S1	02/03/2020 14:35	02/03/2020 15:47	02/03/2020 14:35	02/03/2020 15:47	1,18	24	28,43	CHI
2020035734	SAO DOMINGOS	IA12117792	IACIARA S1	02/03/2020 14:35	02/03/2020 15:47	02/03/2020 14:35	02/03/2020 15:47	1,18	1	1,18	CHI
2020035737	GOIAS	GS21058286	GOIAS	02/03/2020 14:36	02/03/2020 17:31	02/03/2020 14:36	02/03/2020 17:31	2,90	1	2,90	CHI
2020035741	GOIANIA	16963556	INDEPENDENCIA S2	02/03/2020 14:36	02/03/2020 16:20	02/03/2020 14:36	02/03/2020 16:20	1,72	1	1,72	CHI
2020035742	NIQUELANDIA	NQ21146143	URUACU	02/03/2020 14:37	02/03/2020 16:25	02/03/2020 14:37	02/03/2020 16:25	1,79	6	10,72	CHI
2020035745	QUIRINOPOLIS	QI32038053	QUIRINOPOLIS	02/03/2020 10:08	02/03/2020 19:56	02/03/2020 10:08	02/03/2020 19:56	9,79	3	29,37	CHI

2020035747	FORMOSA	FA12000175	ITUIQUIRA	02/03/2020 14:39	03/03/2020 02:14	02/03/2020 14:39	03/03/2020 02:14	11,58	43	497,86	CHI
2020035751	JATAI	JT21134479	JATAI S1	02/03/2020 14:40	02/03/2020 21:28	02/03/2020 14:40	02/03/2020 21:28	6,79	1	6,79	CHI
2020035752	JARAGUA	JA21090442	JARAGUA	02/03/2020 14:41	02/03/2020 16:56	02/03/2020 14:41	02/03/2020 16:56	2,24	1	2,24	CHI
2020035753	LEOPOLDO DE BULHOES	LB12032416	DAIA S2	02/03/2020 13:25	02/03/2020 20:41	02/03/2020 13:25	02/03/2020 20:41	7,26	53	384,81	CHI
2020035755	JARAGUA	70033389	JARAGUA	02/03/2020 14:42	02/03/2020 16:39	02/03/2020 14:42	02/03/2020 16:39	1,95	1	1,95	CHI
2020035763	JARAGUA	JA21339855	ITABERAI S1	02/03/2020 14:44	03/03/2020 00:01	02/03/2020 14:44	03/03/2020 00:01	9,28	1	9,28	CHI
2020035764	CALDAS NOVAS	760374120	CALDAS NOVAS S1	02/03/2020 14:44	02/03/2020 18:02	02/03/2020 14:44	02/03/2020 18:02	3,29	1	3,29	CHI
2020035768	APARECIDA DE GOIANIA	14435998	ATLANTICO S1	02/03/2020 14:45	02/03/2020 22:30	02/03/2020 14:45	02/03/2020 22:30	7,76	1	7,76	CHI
2020035770	LUZIANIA	LZ21116036	MARAJOARA	02/03/2020 14:45	02/03/2020 17:02	02/03/2020 14:45	02/03/2020 17:02	2,27	2	4,55	CHI
2020035777	VARJAO	10008814420	GUAPO S2	02/03/2020 14:45	02/03/2020 17:58	02/03/2020 14:45	02/03/2020 17:58	3,23	1	3,23	CHI
2020035781	CAMPO ALEGRE DE GOIAS	CM12352547	CAMPO ALEGRE DE GOIAS	02/03/2020 14:47	02/03/2020 16:32	02/03/2020 14:47	02/03/2020 16:32	1,74	1	1,74	CHI
2020035788	DOVERLANDIA	DV12086876	CAIAPONIA	02/03/2020 14:49	02/03/2020 17:41	02/03/2020 14:49	02/03/2020 17:41	2,85	9	25,69	CHI
2020035795	LUZIANIA	LZ21149902	CRISTALINA S2	02/03/2020 14:51	02/03/2020 18:49	02/03/2020 14:51	02/03/2020 18:49	3,96	1	3,96	CHI
2020035799	FORMOSA	10019963457	ITUIQUIRA	02/03/2020 14:53	02/03/2020 16:50	02/03/2020 14:53	02/03/2020 16:50	1,96	1	1,96	CHI
2020035801	BELA VISTA DE GOIAS	BV12045925	BELA VISTA S1	02/03/2020 14:53	02/03/2020 16:13	02/03/2020 14:53	02/03/2020 16:13	1,32	228	300,33	CHI
2020035804	SANTA BARBARA DE GOIAS	1030004538	TRINDADE	02/03/2020 14:52	02/03/2020 19:51	02/03/2020 14:52	02/03/2020 19:51	4,98	1	4,98	CHI
2020035811	FLORES DE GOIAS	FB12249653	FLORES DE GOIAS	02/03/2020 14:55	02/03/2020 19:26	02/03/2020 14:55	02/03/2020 19:26	4,50	149	670,75	CHI
2020035815	SANTA TEREZA DE GOIAS	SE12262714	MARA ROSA	02/03/2020 14:56	02/03/2020 18:54	02/03/2020 14:56	02/03/2020 18:54	3,95	15	59,29	CHI
2020035816	CATALAO	1990107993	CATALAO S2	02/03/2020 14:56	03/03/2020 07:26	02/03/2020 14:56	03/03/2020 07:26	16,48	1	16,48	CHI
2020035820	FORMOSA	FA11270028	ITUIQUIRA	02/03/2020 14:58	02/03/2020 16:13	02/03/2020 14:58	02/03/2020 16:13	1,24	1	1,24	CHI
2020035822	VIANOPOLIS	VN21117183	VIANOPOLIS	02/03/2020 14:58	03/03/2020 09:20	02/03/2020 14:58	03/03/2020 09:20	18,36	1	18,36	CHI
2020035824	GOIAS	90023134	GOIAS	02/03/2020 14:59	02/03/2020 17:52	02/03/2020 14:59	02/03/2020 17:52	2,87	1	2,87	CHI
2020035826	CABECEIRAS	FA10410993	ITUIQUIRA	02/03/2020 14:55	02/03/2020 21:43	02/03/2020 14:55	02/03/2020 14:59	0,07	21	1,46	CHI
2020035826	DISTRITO FEDERAL	FA10410993	ITUIQUIRA	02/03/2020 14:55	02/03/2020 21:43	02/03/2020 14:55	02/03/2020 14:59	0,07	1	0,07	CHI
2020035826	CABECEIRAS	FA10410993	ITUIQUIRA	02/03/2020 14:55	02/03/2020 21:43	02/03/2020 14:56	02/03/2020 14:59	0,05	3	0,16	CHI
2020035826	CABECEIRAS	FA10410993	ITUIQUIRA	02/03/2020 14:55	02/03/2020 21:43	02/03/2020 14:55	02/03/2020 16:50	1,92	2	3,84	CHI
2020035826	CABECEIRAS	FA10410993	ITUIQUIRA	02/03/2020 14:55	02/03/2020 21:43	02/03/2020 14:56	02/03/2020 16:50	1,90	5	9,51	CHI
2020035826	FORMOSA	FA10410993	ITUIQUIRA	02/03/2020 14:55	02/03/2020 21:43	02/03/2020 14:55	02/03/2020 21:43	6,81	1	6,81	CHI
2020035826	FORMOSA	FA10410993	ITUIQUIRA	02/03/2020 14:55	02/03/2020 21:43	02/03/2020 14:56	02/03/2020 21:43	6,79	1	6,79	CHI
2020035836	SAO DOMINGOS	SD12170547	SAO DOMINGOS	02/03/2020 13:14	02/03/2020 18:36	02/03/2020 13:14	02/03/2020 18:36	5,36	13	69,72	CHI
2020035840	URUACU	UR21310127	URUACU	02/03/2020 15:03	02/03/2020 16:00	02/03/2020 15:03	02/03/2020 16:00	0,94	1	0,94	CHI
2020035841	COCALZINHO DE GOIAS	ZN12258524RE	COCALZINHO	02/03/2020 14:13	02/03/2020 23:13	02/03/2020 14:13	02/03/2020 23:13	8,99	53	476,57	CHI
2020035842	ITARUMA	CC12000108	CACHOEIRA ALTA	02/03/2020 15:03	02/03/2020 23:10	02/03/2020 15:03	02/03/2020 23:10	8,10	19	153,94	CHI
2020035843	CORREGO DO OURO	CO21126238	SAO LUIZ DOS MONTES BELOS	02/03/2020 15:04	02/03/2020 22:05	02/03/2020 15:04	02/03/2020 22:05	7,01	2	14,03	CHI
2020035847	ARAGUAPAZ	AZ12274481	GOIAS	02/03/2020 15:05	02/03/2020 16:35	02/03/2020 15:05	02/03/2020 16:35	1,49	1	1,49	CHI
2020035859	SANTA TEREZA DE GOIAS	SE12061012	MARA ROSA	02/03/2020 15:08	02/03/2020 20:31	02/03/2020 15:08	02/03/2020 20:31	5,37	2	10,74	CHI
2020035861	FORMOSA	FA11062210	ITUIQUIRA	02/03/2020 15:10	03/03/2020 12:32	02/03/2020 15:10	03/03/2020 12:32	21,36	3	64,09	CHI
2020035862	SANTA CRUZ DE GOIAS	BC21309653	PIRES DO RIO S2	02/03/2020 15:10	02/03/2020 18:42	02/03/2020 15:10	02/03/2020 18:42	3,53	1	3,53	CHI
2020035864	GOIANIA	15880072	CAMPINAS S2	02/03/2020 15:10	02/03/2020 16:33	02/03/2020 15:10	02/03/2020 16:33	1,37	1	1,37	CHI
2020035867	CUMARI	CY12038820	CATALAO S1	02/03/2020 15:04	02/03/2020 18:56	02/03/2020 15:04	02/03/2020 18:56	3,86	5	19,31	CHI
2020035873	ITABERAI	II12168368	ITABERAI S1	02/03/2020 15:12	02/03/2020 17:49	02/03/2020 15:12	02/03/2020 17:49	2,60	1	2,60	CHI
2020035874	ITABERAI	IB21105982	ITABERAI S2	02/03/2020 15:13	02/03/2020 18:36	02/03/2020 15:13	02/03/2020 18:36	3,38	1	3,38	CHI
2020035875	GOIANESIA	550197424	GOIANESIA S2	02/03/2020 15:13	03/03/2020 00:50	02/03/2020 15:13	03/03/2020 00:50	9,63	1	9,63	CHI
2020035880	MONTIVIDIU	MV21075459	MONTIVIDIU T	02/03/2020 15:14	02/03/2020 22:29	02/03/2020 15:14	02/03/2020 22:29	7,25	2	14,50	CHI

2020035894	JARAGUA	JA12059976	JARAGUA	02/03/2020 14:06	02/03/2020 19:33	02/03/2020 14:06	02/03/2020 19:33	5,44	2	10,89	CHI
2020035894	PIRENOPOLIS	JA12059976	JARAGUA	02/03/2020 14:06	02/03/2020 19:33	02/03/2020 14:06	02/03/2020 19:33	5,44	97	527,98	CHI
2020035895	NOVO BRASIL	NB12378883	JUSSARA	02/03/2020 08:46	03/03/2020 08:38	02/03/2020 08:46	03/03/2020 08:38	23,87	5	119,34	CHI
2020035896	MINEIROS	MY12197100	PARQUE DAS EMAS	02/03/2020 15:17	02/03/2020 22:44	02/03/2020 15:17	02/03/2020 22:44	7,45	6	44,68	CHI
2020035897	MONTIVIDIU	MV21260822	MONTIVIDIU T	02/03/2020 15:17	03/03/2020 14:15	03/03/2020 10:29	03/03/2020 13:43	3,22	1	3,22	CHI
2020035897	MONTIVIDIU	MV21054379	MONTIVIDIU T	02/03/2020 15:17	03/03/2020 14:15	02/03/2020 15:17	03/03/2020 14:00	22,73	1	22,73	CHI
2020035897	MONTIVIDIU	MV21260819	MONTIVIDIU T	02/03/2020 15:17	03/03/2020 14:15	02/03/2020 15:17	03/03/2020 14:15	22,97	1	22,97	CHI
2020036008	GOIANESIA	GE21169991	GOIANESIA S1	02/03/2020 08:42	02/03/2020 14:48	02/03/2020 08:42	02/03/2020 14:48	6,11	1	6,11	CHI
2020036013	BRAZABRANTES	03920224	NEROPOLIS S1	02/03/2020 15:35	02/03/2020 17:36	02/03/2020 15:35	02/03/2020 17:16	1,68	366	615,29	CHI
2020036013	GOIANIRA	03920224	NEROPOLIS S1	02/03/2020 15:35	02/03/2020 17:36	02/03/2020 15:35	02/03/2020 17:16	1,68	7	11,77	CHI
2020036013	NOVA VENEZA	03920224	NEROPOLIS S1	02/03/2020 15:35	02/03/2020 17:36	02/03/2020 15:35	02/03/2020 17:16	1,68	3	5,04	CHI
2020036013	BRAZABRANTES	03920224	NEROPOLIS S1	02/03/2020 15:35	02/03/2020 17:36	02/03/2020 15:35	02/03/2020 17:36	2,01	4	8,06	CHI
2020036013	GOIANIRA	03920224	NEROPOLIS S1	02/03/2020 15:35	02/03/2020 17:36	02/03/2020 15:35	02/03/2020 17:36	2,01	23	46,34	CHI
2020036102	ITAPURANGA	170043319	ITAPURANGA	02/03/2020 15:18	02/03/2020 18:36	02/03/2020 15:18	02/03/2020 18:36	3,30	1	3,30	CHI
2020036109	RUBIATABA	RB21114298	RUBIATABA	02/03/2020 15:19	02/03/2020 17:57	02/03/2020 15:19	02/03/2020 17:57	2,62	1	2,62	CHI
2020036111	IPAMERI	IP12107644	IPAMERI	02/03/2020 09:17	03/03/2020 07:49	02/03/2020 09:17	03/03/2020 07:49	22,53	9	202,73	CHI
2020036114	GUARANI DE GOIAS	GY11262278	IACIARA S1	02/03/2020 15:21	02/03/2020 17:50	02/03/2020 17:10	02/03/2020 17:50	0,67	86	57,36	CHI
2020036117	IACIARA	IA12253250	IACIARA S1	02/03/2020 15:21	02/03/2020 17:15	02/03/2020 15:21	02/03/2020 17:15	1,89	7	13,22	CHI
2020036121	RIO QUENTE	RQ21100194	VILA CORUMBA	02/03/2020 13:37	03/03/2020 12:33	02/03/2020 13:37	03/03/2020 12:33	22,92	1	22,92	CHI
2020036123	BELA VISTA DE GOIAS	BV12082045RE	CRISTIANOPOLIS	02/03/2020 15:02	02/03/2020 17:22	02/03/2020 15:02	02/03/2020 17:22	2,32	4	9,28	CHI
2020036123	CRISTIANOPOLIS	BV12082045RE	CRISTIANOPOLIS	02/03/2020 15:02	02/03/2020 17:22	02/03/2020 15:02	02/03/2020 17:22	2,32	19	44,10	CHI
2020036124	TRINDADE	TR11185434	TRINDADE	02/03/2020 15:23	02/03/2020 15:28	02/03/2020 15:23	02/03/2020 15:28	0,07	85	6,37	CHI
2020036130	ORIZONA	OZ21127793	PIRES DO RIO S2	02/03/2020 15:25	02/03/2020 17:43	02/03/2020 15:25	02/03/2020 17:43	2,29	1	2,29	CHI
2020036133	RIO VERDE	RV12260980	CABRIUVA S2	02/03/2020 15:26	02/03/2020 17:33	02/03/2020 15:26	02/03/2020 17:33	2,12	2	4,23	CHI
2020036134	BELA VISTA DE GOIAS	BV21012797	BELA VISTA S1	02/03/2020 15:26	02/03/2020 17:38	02/03/2020 15:26	02/03/2020 17:38	2,20	1	2,20	CHI
2020036135	APARECIDA DE GOIANIA	AP11073163	INDEPENDENCIA S2	02/03/2020 15:06	02/03/2020 16:39	02/03/2020 15:06	02/03/2020 16:39	1,54	168	258,39	CHI
2020036141	FORMOSA	03740444	ITUIQUIRA	02/03/2020 15:27	02/03/2020 15:48	02/03/2020 15:27	02/03/2020 15:48	0,35	2	0,71	CHI
2020036144	SERRANOPOLIS	SX12166082	JATAI S1	02/03/2020 15:29	03/03/2020 00:28	02/03/2020 15:29	03/03/2020 00:28	8,98	19	170,55	CHI
2020036145	TURVELANDIA	TD21118506	SANTA HELENA S1	02/03/2020 15:29	02/03/2020 17:45	02/03/2020 15:29	02/03/2020 17:45	2,26	1	2,26	CHI
2020036146	SANTA TEREZINHA DE GOIAS	2480021677	SANTA TEREZINHA	02/03/2020 15:29	03/03/2020 17:58	02/03/2020 15:29	03/03/2020 17:58	26,47	1	26,47	CHI
2020036148	SENADOR CANEDO	190037131	SENADOR CANEDO	02/03/2020 15:29	03/03/2020 11:42	02/03/2020 15:29	03/03/2020 11:42	20,20	1	20,20	CHI
2020036150	PARAUNA	10025785387	PARAUNA	02/03/2020 15:30	02/03/2020 17:59	02/03/2020 15:30	02/03/2020 17:59	2,47	1	2,47	CHI
2020036152	GOIANIA	13502803	GOIANIA LESTE S3	02/03/2020 15:30	02/03/2020 20:12	02/03/2020 15:30	02/03/2020 20:12	4,69	1	4,69	CHI
2020036156	PARAUNA	PU12391518	PARAUNA	02/03/2020 12:07	02/03/2020 18:40	02/03/2020 12:07	02/03/2020 18:40	6,54	24	157,01	CHI
2020036159	MINACU	IH12313441	MINACU	02/03/2020 15:33	02/03/2020 18:18	02/03/2020 15:33	02/03/2020 18:18	2,75	4	10,99	CHI
2020036160	MUTUNOPOLIS	PO12297025	PORANGATU	02/03/2020 15:33	02/03/2020 18:03	02/03/2020 15:33	02/03/2020 18:03	2,50	1	2,50	CHI
2020036163	GOIANIA	11633888	CAMPINAS S1	02/03/2020 15:33	02/03/2020 17:30	02/03/2020 15:33	02/03/2020 17:30	1,94	1	1,94	CHI
2020036169	SAO MIGUEL DO ARAGUAIA	SM21013553	SAO MIGUEL DO ARAGUAIA	02/03/2020 15:35	03/03/2020 10:15	02/03/2020 15:35	03/03/2020 10:15	18,67	2	37,33	CHI
2020036175	ANAPOLIS	AN21219207	DAIA S1	02/03/2020 15:35	02/03/2020 18:45	02/03/2020 15:35	02/03/2020 18:45	3,15	1	3,15	CHI
2020036176	ESTRELA DO NORTE	ET12094692	MARA ROSA	02/03/2020 15:35	02/03/2020 18:47	02/03/2020 15:35	02/03/2020 18:47	3,19	13	41,42	CHI
2020036176	SANTA TEREZA DE GOIAS	ET12094692	MARA ROSA	02/03/2020 15:35	02/03/2020 18:47	02/03/2020 15:35	02/03/2020 18:47	3,19	4	12,75	CHI
2020036206	PEROLANDIA	JT21125865	JATAI S1	02/03/2020 15:44	02/03/2020 17:19	02/03/2020 15:44	02/03/2020 17:19	1,57	1	1,57	CHI
2020036208	VIANOPOLIS	VN21406514	VIANOPOLIS	02/03/2020 15:46	02/03/2020 18:52	02/03/2020 15:46	02/03/2020 18:52	3,10	1	3,10	CHI
2020036213	GOIANDIRA	GD21270771	CATALAO S1	02/03/2020 15:46	02/03/2020 18:52	02/03/2020 15:46	02/03/2020 18:52	3,09	1	3,09	CHI

2020036216	URUACU	UR12213102	URUACU	02/03/2020 15:47	02/03/2020 21:22	02/03/2020 15:47	02/03/2020 21:22	5,58	9	50,18	CHI
2020036218	INDIARA	JD12005508	PALMEIRAS	02/03/2020 15:32	02/03/2020 19:15	02/03/2020 15:32	02/03/2020 19:15	3,70	46	170,40	CHI
2020036218	JANDAIA	JD12005508	PALMEIRAS	02/03/2020 15:32	02/03/2020 19:15	02/03/2020 15:32	02/03/2020 19:15	3,70	16	59,27	CHI
2020036219	URUACU	CR12271956	MARA ROSA	02/03/2020 15:48	03/03/2020 12:02	02/03/2020 15:48	03/03/2020 12:02	20,22	2	40,45	CHI
2020036230	MORRINHOS	MR21041267	MORRINHOS	02/03/2020 15:51	02/03/2020 17:26	02/03/2020 15:51	02/03/2020 17:26	1,58	1	1,58	CHI
2020036233	PARAUNA	PU21136112	FIRMINOPOLIS S2	02/03/2020 15:51	03/03/2020 07:46	02/03/2020 15:51	03/03/2020 07:46	15,90	1	15,90	CHI
2020036242	GOIANIRA	390098759	MEIA PONTE	02/03/2020 15:54	02/03/2020 17:58	02/03/2020 15:54	02/03/2020 17:58	2,06	1	2,06	CHI
2020036253	DIVINOPOLIS DE GOIAS	GH12256132	SAO DOMINGOS	02/03/2020 15:58	03/03/2020 10:31	02/03/2020 15:58	03/03/2020 10:31	18,55	19	352,42	CHI
2020036258	POSSE	PS12195787	IACIARA S2	02/03/2020 15:59	02/03/2020 17:32	02/03/2020 15:59	02/03/2020 17:32	1,54	1	1,54	CHI
2020036265	MONTE ALEGRE DE GOIAS	MA11405737	SAO DOMINGOS	02/03/2020 16:02	02/03/2020 20:13	02/03/2020 16:02	02/03/2020 18:53	2,86	1	2,86	CHI
2020036265	MONTE ALEGRE DE GOIAS	MA12233174	SAO DOMINGOS	02/03/2020 16:02	02/03/2020 20:13	02/03/2020 18:41	02/03/2020 18:53	0,20	15	3,06	CHI
2020036265	MONTE ALEGRE DE GOIAS	MA11405737	SAO DOMINGOS	02/03/2020 16:02	02/03/2020 20:13	02/03/2020 19:09	02/03/2020 20:13	1,06	1	1,06	CHI
2020036269	AURILANDIA	AI12289760	FIRMINOPOLIS S2	02/03/2020 08:23	02/03/2020 18:55	02/03/2020 08:23	02/03/2020 18:55	10,52	6	63,12	CHI
2020036271	VILA PROPICIO	NP12169962	GOIANESIA S1	02/03/2020 16:02	03/03/2020 02:53	02/03/2020 16:02	03/03/2020 02:53	10,84	1	10,84	CHI
2020036272	MINACU	IH12088797	MINACU	02/03/2020 16:03	02/03/2020 17:13	02/03/2020 16:03	02/03/2020 17:13	1,17	163	190,03	CHI
2020036282	CRIXAS	2490043773	SERRA DO OURO	02/03/2020 16:05	02/03/2020 21:25	02/03/2020 16:05	02/03/2020 21:25	5,33	1	5,33	CHI
2020036285	GOIAS	GS12210548	GOIAS	02/03/2020 16:05	02/03/2020 21:54	02/03/2020 16:05	02/03/2020 21:54	5,80	218	1265,49	CHI
2020036286	MARA ROSA	MQ12125574	MARA ROSA	02/03/2020 16:06	02/03/2020 18:15	02/03/2020 16:06	02/03/2020 18:15	2,14	14	29,95	CHI
2020036300	ANAPOLIS	20971576	ANAPOLIS UNIVERSITARIO S1	02/03/2020 16:10	02/03/2020 21:18	02/03/2020 16:10	02/03/2020 21:18	5,12	1	5,12	CHI
2020036303	MINEIROS	MY12048095	PARQUE DAS EMAS	02/03/2020 15:07	02/03/2020 23:17	02/03/2020 15:07	02/03/2020 23:17	8,17	22	179,80	CHI
2020036312	JARAGUA	JA12278873	JARAGUA	02/03/2020 16:14	02/03/2020 22:39	02/03/2020 16:14	02/03/2020 22:39	6,41	11	70,49	CHI
2020036317	CALDAS NOVAS	CN21182856	CALDAS NOVAS S1	02/03/2020 16:14	03/03/2020 09:41	02/03/2020 16:14	03/03/2020 09:41	17,44	1	17,44	CHI
2020036334	NOVA CRIXAS	NA12181597	NOVA CRIXAS	02/03/2020 16:19	03/03/2020 13:34	02/03/2020 16:19	03/03/2020 13:34	21,25	3	63,75	CHI
2020036337	GAMELEIRA DE GOIAS	SV21374406	DAIA S2	02/03/2020 16:20	03/03/2020 03:33	02/03/2020 16:20	03/03/2020 03:33	11,21	1	11,21	CHI
2020036338	ANAPOLIS	AN31196825	ANAPOLIS UNIVERSITARIO S2	02/03/2020 16:20	02/03/2020 17:20	02/03/2020 16:20	02/03/2020 17:20	0,99	2	1,99	CHI
2020036341	CRIXAS	CX12190201RE	SANTA TEREZINHA	02/03/2020 15:36	02/03/2020 22:01	02/03/2020 15:36	02/03/2020 22:01	6,41	50	320,29	CHI
2020036343	FORMOSA	FA12041992	ITUIQUIRA	02/03/2020 16:21	03/03/2020 15:21	02/03/2020 16:21	03/03/2020 15:21	23,00	1	23,00	CHI
2020036345	ALEXANIA	AX12319851	ALEXANIA	02/03/2020 15:34	02/03/2020 18:17	02/03/2020 15:34	02/03/2020 18:17	2,71	20	54,13	CHI
2020036346	PLANALTINA	2960150230	PLANALTINA	02/03/2020 16:21	02/03/2020 17:21	02/03/2020 16:21	02/03/2020 17:21	1,00	1	1,00	CHI
2020036352	VILA PROPICIO	NP12382314	GOIANESIA S1	02/03/2020 15:40	02/03/2020 19:26	02/03/2020 15:40	02/03/2020 19:26	3,75	12	45,04	CHI
2020036354	LUZANIA	10027393770	MARAJOARA	02/03/2020 16:25	02/03/2020 20:16	02/03/2020 16:25	02/03/2020 20:16	3,85	1	3,85	CHI
2020036356	ESTRELA DO NORTE	SE12314443	MARA ROSA	02/03/2020 16:25	02/03/2020 20:03	02/03/2020 16:25	02/03/2020 20:03	3,62	1	3,62	CHI
2020036356	SANTA TEREZA DE GOIAS	SE12314443	MARA ROSA	02/03/2020 16:25	02/03/2020 20:03	02/03/2020 16:25	02/03/2020 20:03	3,62	2	7,24	CHI
2020036361	PLANALTINA	PI12243006	PLANALTINA	02/03/2020 16:26	02/03/2020 17:45	02/03/2020 16:26	02/03/2020 17:45	1,30	34	44,30	CHI
2020036363	VILA PROPICIO	NP11228416	GOIANESIA S1	02/03/2020 16:27	02/03/2020 18:16	02/03/2020 16:27	02/03/2020 18:16	1,81	1	1,81	CHI
2020036366	GOIAS	GS21299669	GOIAS	02/03/2020 16:27	02/03/2020 19:34	02/03/2020 16:27	02/03/2020 19:34	3,11	1	3,11	CHI
2020036368	ANAPOLIS	21294914	ANAPOLIS UNIVERSITARIO S2	02/03/2020 16:27	02/03/2020 20:11	02/03/2020 16:27	02/03/2020 20:11	3,72	1	3,72	CHI
2020036369	MARA ROSA	NQ12400312	MARA ROSA	02/03/2020 16:28	02/03/2020 23:43	02/03/2020 16:28	02/03/2020 23:43	7,24	5	36,22	CHI
2020036372	GOIANIA	14181800	FERROVIARIO S1	02/03/2020 16:29	02/03/2020 18:16	02/03/2020 16:29	02/03/2020 18:16	1,78	1	1,78	CHI
2020036379	FORMOSO	FO12185319	PORANGATU	02/03/2020 16:31	03/03/2020 00:25	02/03/2020 16:31	03/03/2020 00:25	7,89	31	244,48	CHI
2020036381	COCALZINHO DE GOIAS	ZN21141559	COCALZINHO	02/03/2020 16:31	03/03/2020 04:29	02/03/2020 16:31	03/03/2020 04:29	11,97	1	11,97	CHI
2020036382	GOIANIA	GN11001366	AEROPORTO S1	02/03/2020 16:32	02/03/2020 20:17	02/03/2020 16:32	02/03/2020 20:17	3,75	19	71,19	CHI
2020036384	ANAPOLIS	20652495	JUNDIAI S1	02/03/2020 16:32	02/03/2020 21:30	02/03/2020 16:32	02/03/2020 21:30	4,95	1	4,95	CHI
2020036387	GOIANESIA	GE12000018	GOIANESIA S2	02/03/2020 16:33	03/03/2020 01:50	02/03/2020 16:33	03/03/2020 01:50	9,29	2	18,58	CHI

2020036388	CACU	CC12196047	CACHOEIRA ALTA	02/03/2020 16:33	02/03/2020 23:48	02/03/2020 16:33	02/03/2020 23:48	7,24	11	79,68	CHI
2020036390	RIO VERDE	RV12271282	CABRIUVA S2	02/03/2020 16:08	02/03/2020 18:28	02/03/2020 16:08	02/03/2020 18:28	2,33	30	69,85	CHI
2020036397	CALDAS NOVAS	760417568	CALDAS NOVAS S2	02/03/2020 16:36	02/03/2020 22:07	02/03/2020 16:36	02/03/2020 22:07	5,52	1	5,52	CHI
2020036398	CALDAS NOVAS	760068938	CALDAS NOVAS S1	02/03/2020 16:36	02/03/2020 18:24	02/03/2020 16:36	02/03/2020 18:24	1,79	1	1,79	CHI
2020036399	HIDROLANDIA	HD11275661	CEPAIGO S2	02/03/2020 16:36	03/03/2020 01:01	02/03/2020 16:36	03/03/2020 01:01	8,40	8	67,23	CHI
2020036410	ARACU	AR10400568	ARACU	02/03/2020 16:43	02/03/2020 21:45	02/03/2020 16:43	02/03/2020 17:53	1,16	1	1,16	CHI
2020036410	CATURAI	AR10400568	ARACU	02/03/2020 16:43	02/03/2020 21:45	02/03/2020 16:43	02/03/2020 17:53	1,16	7	8,13	CHI
2020036410	INHUMAS	AR10400568	ARACU	02/03/2020 16:43	02/03/2020 21:45	02/03/2020 16:43	02/03/2020 17:53	1,16	36	41,83	CHI
2020036410	CATURAI	AR10400568	ARACU	02/03/2020 16:43	02/03/2020 21:45	02/03/2020 16:43	02/03/2020 18:33	1,84	25	45,94	CHI
2020036410	INHUMAS	AR10400568	ARACU	02/03/2020 16:43	02/03/2020 21:45	02/03/2020 16:43	02/03/2020 18:33	1,84	39	71,67	CHI
2020036410	CATURAI	AR10400568	ARACU	02/03/2020 16:43	02/03/2020 21:45	02/03/2020 16:43	02/03/2020 21:45	5,03	69	347,28	CHI
2020036410	INHUMAS	AR10400568	ARACU	02/03/2020 16:43	02/03/2020 21:45	02/03/2020 16:43	02/03/2020 21:45	5,03	27	135,89	CHI
2020036425	RIO VERDE	RV12200774	CABRIUVA S2	02/03/2020 13:28	02/03/2020 20:28	02/03/2020 13:28	02/03/2020 20:28	7,00	13	90,99	CHI
2020036502	JUSSARA	1290077840	JUSSARA	02/03/2020 16:38	02/03/2020 19:38	02/03/2020 16:38	02/03/2020 19:38	3,00	1	3,00	CHI
2020036505	ALTO HORIZONTE	AJ12398008	SANTA TEREZINHA	02/03/2020 16:38	03/03/2020 00:54	02/03/2020 16:38	03/03/2020 00:54	8,27	47	388,77	CHI
2020036505	ALTO HORIZONTE	AJ12398008	SANTA TEREZINHA	02/03/2020 16:38	03/03/2020 00:54	02/03/2020 16:38	03/03/2020 00:54	8,27	7	57,90	CHI
2020036508	CAMPOS VERDES	SG12181588	SANTA TEREZINHA	02/03/2020 16:36	02/03/2020 21:41	02/03/2020 16:36	02/03/2020 21:41	5,08	8	40,63	CHI
2020036508	SANTA TEREZINHA DE GOIAS	SG12181588	SANTA TEREZINHA	02/03/2020 16:36	02/03/2020 21:41	02/03/2020 16:36	02/03/2020 21:41	5,08	6	30,47	CHI
2020036511	SANTO ANTONIO DO DESCOBERTO	SN12382252	ALEXANIA	02/03/2020 15:01	02/03/2020 19:27	02/03/2020 15:01	02/03/2020 19:27	4,42	10	44,18	CHI
2020036512	SENADOR CANEDO	12880700	SENADOR CANEDO	02/03/2020 16:39	02/03/2020 18:49	02/03/2020 16:39	02/03/2020 18:49	2,16	1	2,16	CHI
2020036516	ANICUNS	AC21000078	ANICUNS	02/03/2020 16:40	03/03/2020 06:57	02/03/2020 16:40	03/03/2020 06:57	14,27	1	14,27	CHI
2020036523	BELA VISTA DE GOIAS	BV21323321	BELA VISTA S1	02/03/2020 16:41	02/03/2020 18:12	02/03/2020 16:41	02/03/2020 18:12	1,50	1	1,50	CHI
2020036527	LUZIANIA	LZ21031681	CRISTALINA S2	02/03/2020 16:43	02/03/2020 21:11	02/03/2020 16:43	02/03/2020 21:11	4,46	1	4,46	CHI
2020036528	MINACU	IH12375476	MINACU	02/03/2020 16:20	02/03/2020 18:01	02/03/2020 16:20	02/03/2020 18:01	1,68	49	82,48	CHI
2020036535	ANAPOLIS	AN12054439	ANAPOLIS UNIVERSITARIO S2	02/03/2020 16:46	02/03/2020 23:28	02/03/2020 16:46	02/03/2020 23:28	6,70	1	6,70	CHI
2020036541	INHUMAS	30038893	INHUMAS S2	02/03/2020 16:47	02/03/2020 19:21	02/03/2020 16:47	02/03/2020 19:21	2,56	1	2,56	CHI
2020036542	CATALAO	CT12077605	CATALAO S1	02/03/2020 16:47	02/03/2020 22:03	02/03/2020 16:47	02/03/2020 22:03	5,25	9	47,27	CHI
2020036543	SAO LUIS DE MONTES BELOS	500065226	SAO LUIZ DOS MONTES BELOS	02/03/2020 16:48	02/03/2020 18:11	02/03/2020 16:48	02/03/2020 18:11	1,38	1	1,38	CHI
2020036545	UIRAPURU	4210000049	NOVA CRIXAS	02/03/2020 16:49	03/03/2020 12:13	02/03/2020 16:49	03/03/2020 12:13	19,39	1	19,39	CHI
2020036551	ALTO HORIZONTE	MQ12181177	MARA ROSA	02/03/2020 16:52	03/03/2020 08:01	02/03/2020 16:52	03/03/2020 08:01	15,15	3	45,44	CHI
2020036551	MARA ROSA	MQ12181177	MARA ROSA	02/03/2020 16:52	03/03/2020 08:01	02/03/2020 16:52	03/03/2020 08:01	15,15	28	424,10	CHI
2020036551	URUACU	MQ12181177	MARA ROSA	02/03/2020 16:52	03/03/2020 08:01	02/03/2020 16:52	03/03/2020 08:01	15,15	1	15,15	CHI
2020036559	CAMPO ALEGRE DE GOIAS	IP21192514	PIRES DO RIO S2	02/03/2020 16:53	03/03/2020 12:11	02/03/2020 16:53	03/03/2020 12:11	19,29	2	38,59	CHI
2020036561	GOIANIRA	GR21011986	NEROPOLIS S1	02/03/2020 16:53	02/03/2020 20:24	02/03/2020 16:53	02/03/2020 20:24	3,51	1	3,51	CHI
2020036566	NOVA ROMA	ND12117611	IACIARA S2	02/03/2020 16:54	02/03/2020 18:15	02/03/2020 16:54	02/03/2020 18:15	1,34	8	10,73	CHI
2020036567	PIRACANJUBA	PJ21000072	PIRACANJUBA	02/03/2020 16:55	03/03/2020 07:53	02/03/2020 16:55	03/03/2020 07:53	14,96	1	14,96	CHI
2020036570	CEZARINA	CZ12308499	CEZARINA	02/03/2020 16:57	02/03/2020 21:42	02/03/2020 16:57	02/03/2020 21:42	4,74	2	9,48	CHI
2020036570	INDIARA	CZ12308499	CEZARINA	02/03/2020 16:57	02/03/2020 21:42	02/03/2020 16:57	02/03/2020 21:42	4,74	9	42,65	CHI
2020036577	BURITI ALEGRE	BG12000111	ITUMBIARA VELHA S2	02/03/2020 14:48	02/03/2020 20:33	02/03/2020 14:48	02/03/2020 20:33	5,75	17	97,72	CHI
2020036580	RIO VERDE	630287661	CABRIUVA S1	02/03/2020 13:34	02/03/2020 22:42	02/03/2020 13:34	02/03/2020 22:42	9,12	1	9,12	CHI
2020036582	JATAI	290150206	JATAI S2	02/03/2020 17:00	02/03/2020 20:33	02/03/2020 17:00	02/03/2020 20:33	3,54	1	3,54	CHI
2020036587	BONFINOPOLIS	10030010371	CEPAIGO S2	02/03/2020 17:02	02/03/2020 18:29	02/03/2020 17:02	02/03/2020 18:29	1,44	1	1,44	CHI
2020036591	CRIXAS	2490028231	SERRA DO OURO	02/03/2020 17:04	02/03/2020 22:00	02/03/2020 17:04	02/03/2020 22:00	4,93	1	4,93	CHI
2020036592	ANAPOLIS	10012606667	ANAPOLIS UNIVERSITARIO S2	02/03/2020 17:04	02/03/2020 19:50	02/03/2020 17:04	02/03/2020 19:50	2,75	1	2,75	CHI

2020036593	ALTO HORIZONTE	AJ12321045	SANTA TEREZINHA	02/03/2020 16:41	03/03/2020 01:02	02/03/2020 16:41	03/03/2020 01:02	8,35	15	125,20	CHI
2020036605	MUNDO NOVO DE GOIAS	MH12269056	NOVA CRIXAS	02/03/2020 13:44	03/03/2020 01:55	02/03/2020 13:44	03/03/2020 01:55	12,17	22	267,67	CHI
2020036609	GOIANIA	10003409480	CAMPINAS S2	02/03/2020 17:08	02/03/2020 19:36	02/03/2020 17:08	02/03/2020 19:36	2,47	1	2,47	CHI
2020036616	RIO VERDE	RV12303492	MONTIVIDIU T	02/03/2020 16:14	02/03/2020 19:57	02/03/2020 16:14	02/03/2020 19:57	3,71	4	14,82	CHI
2020036625	AMERICANO DO BRASIL	1410010809	ANICUNS	02/03/2020 17:12	02/03/2020 18:48	02/03/2020 17:12	02/03/2020 18:48	1,60	1	1,60	CHI
2020036627	GOIANIA	15395250	GOYA S2	02/03/2020 17:12	02/03/2020 19:22	02/03/2020 17:12	02/03/2020 19:22	2,15	1	2,15	CHI
2020036629	GOIATUBA	VI12329055	VICENTINOPOLIS	02/03/2020 17:13	02/03/2020 21:21	02/03/2020 17:13	02/03/2020 21:21	4,12	12	49,49	CHI
2020036629	VICENTINOPOLIS	VI12329055	VICENTINOPOLIS	02/03/2020 17:13	02/03/2020 21:21	02/03/2020 17:13	02/03/2020 21:21	4,12	28	115,48	CHI
2020036633	GUARINOS	IW12201636	ITAPACI	02/03/2020 15:54	03/03/2020 07:00	02/03/2020 15:54	03/03/2020 07:00	15,10	7	105,68	CHI
2020036633	ITAPACI	IW12201636	ITAPACI	02/03/2020 15:54	03/03/2020 07:00	02/03/2020 15:54	03/03/2020 07:00	15,10	244	3683,59	CHI
2020036633	PILAR DE GOIAS	IW12201636	ITAPACI	02/03/2020 15:54	03/03/2020 07:00	02/03/2020 15:54	03/03/2020 07:00	15,10	1	15,10	CHI
2020036636	APARECIDA DE GOIANIA	10012332850	INDEPENDENCIA S1	02/03/2020 17:14	02/03/2020 20:03	02/03/2020 17:14	02/03/2020 20:03	2,81	1	2,81	CHI
2020036637	AGUAS LINDAS DE GOIAS	10001215416	AGUAS LINDAS DE GOIAS S1	02/03/2020 17:14	02/03/2020 18:14	02/03/2020 17:14	02/03/2020 18:14	0,99	1	0,99	CHI
2020036639	SAO DOMINGOS	SD12115759	SAO DOMINGOS	02/03/2020 17:14	02/03/2020 20:42	02/03/2020 17:14	02/03/2020 20:42	3,45	45	155,40	CHI
2020036645	AMARALINA	LC12170975	MARA ROSA	02/03/2020 17:18	02/03/2020 20:26	02/03/2020 17:18	02/03/2020 20:26	3,13	11	34,39	CHI
2020036650	CRISTALINA	1060103798	CRISTALINA S1	02/03/2020 17:19	02/03/2020 20:05	02/03/2020 17:19	02/03/2020 20:05	2,76	1	2,76	CHI
2020036654	NOVA CRIXAS	NA12115792	NOVA CRIXAS	02/03/2020 17:21	03/03/2020 14:20	02/03/2020 17:21	03/03/2020 14:20	20,98	4	83,92	CHI
2020036658	GOIANIA	17307065	AEROPORTO S3	02/03/2020 17:22	02/03/2020 18:47	02/03/2020 17:22	02/03/2020 18:47	1,42	1	1,42	CHI
2020036666	CACHOEIRA ALTA	1090006746	CACHOEIRA ALTA	02/03/2020 17:24	03/03/2020 07:12	02/03/2020 17:24	03/03/2020 07:12	13,81	1	13,81	CHI
2020036675	ANAPOLIS	10018059765	JUNDIAI S2	02/03/2020 17:25	03/03/2020 10:33	02/03/2020 17:25	03/03/2020 10:33	17,12	1	17,12	CHI
2020036676	ITUMBIARA	690092180	ITUMBIARA NOVA	02/03/2020 17:26	02/03/2020 19:55	02/03/2020 17:26	02/03/2020 19:55	2,48	1	2,48	CHI
2020036682	AMORINOPOLIS	AM12091215LD	IPORA	02/03/2020 17:26	03/03/2020 10:53	02/03/2020 17:26	03/03/2020 10:53	17,44	1	17,44	CHI
2020036686	GOIANIA	10790512	CARAJAS S1	02/03/2020 17:27	02/03/2020 18:28	02/03/2020 17:27	02/03/2020 18:28	1,01	1	1,01	CHI
2020036691	GOIANIA	GN12196741	GOYA S2	02/03/2020 17:28	02/03/2020 19:02	02/03/2020 17:28	02/03/2020 19:02	1,56	452	704,37	CHI
2020036698	EDEALINA	EA21047546	VICENTINOPOLIS	02/03/2020 17:29	03/03/2020 10:30	02/03/2020 17:29	03/03/2020 10:30	17,00	1	17,00	CHI
2020036700	ARUANA	AK12250809	ARUANA	02/03/2020 17:30	02/03/2020 18:46	02/03/2020 17:30	02/03/2020 18:46	1,26	2	2,53	CHI
2020036701	ARENOPOLIS	1920012804	ARENOPOLIS	02/03/2020 17:30	03/03/2020 05:18	02/03/2020 17:30	03/03/2020 05:18	11,80	1	11,80	CHI
2020036707	NOVA IGUACU DE GOIAS	NH12317131	CAMPINORTE	02/03/2020 17:30	03/03/2020 12:37	02/03/2020 17:30	03/03/2020 09:06	15,60	40	624,00	CHI
2020036707	NOVA IGUACU DE GOIAS	NH12317131	CAMPINORTE	02/03/2020 17:30	03/03/2020 12:37	03/03/2020 09:08	03/03/2020 09:20	0,20	40	8,17	CHI
2020036707	NOVA IGUACU DE GOIAS	NH12214529LD	CAMPINORTE	02/03/2020 17:30	03/03/2020 12:37	02/03/2020 17:30	03/03/2020 09:36	16,10	2	32,19	CHI
2020036707	NOVA IGUACU DE GOIAS	NH12317131	CAMPINORTE	02/03/2020 17:30	03/03/2020 12:37	03/03/2020 10:05	03/03/2020 10:17	0,20	40	8,12	CHI
2020036707	NOVA IGUACU DE GOIAS	NH12214529LD	CAMPINORTE	02/03/2020 17:30	03/03/2020 12:37	03/03/2020 09:40	03/03/2020 12:37	2,96	2	5,92	CHI
2020036713	GOIATUBA	JV12073049	GOIATUBA S1	02/03/2020 17:06	02/03/2020 23:20	02/03/2020 17:06	02/03/2020 23:20	6,23	2	12,45	CHI
2020036713	JOVIANIA	JV12073049	GOIATUBA S1	02/03/2020 17:06	02/03/2020 23:20	02/03/2020 17:06	02/03/2020 23:20	6,23	4	24,90	CHI
2020036714	CAMPESTRE DE GOIAS	GC12053740	GUAPO S1	02/03/2020 17:17	03/03/2020 09:28	02/03/2020 17:17	03/03/2020 09:28	16,17	3	48,51	CHI
2020036717	CRIXAS	CX21266382	SANTA TEREZINHA	02/03/2020 17:32	03/03/2020 01:41	02/03/2020 17:32	03/03/2020 01:41	8,14	2	16,28	CHI
2020036724	GOIANIA	10942944	FERROVIARIO S2	02/03/2020 17:34	03/03/2020 01:43	02/03/2020 17:34	03/03/2020 01:43	8,14	1	8,14	CHI
2020036725	CEZARINA	10023740076	CEZARINA	02/03/2020 17:34	02/03/2020 20:48	02/03/2020 17:34	02/03/2020 20:48	3,22	1	3,22	CHI
2020036726	MINACU	4020119376	MINACU	02/03/2020 17:35	02/03/2020 20:10	02/03/2020 17:35	02/03/2020 20:10	2,58	1	2,58	CHI
2020036735	CEZARINA	1650023872	CEZARINA	02/03/2020 17:36	02/03/2020 20:05	02/03/2020 17:36	02/03/2020 20:05	2,48	1	2,48	CHI
2020036737	CAVALCANTE	TI12162624	NIQUELANDIA SUBTRANSMISSAO	02/03/2020 17:29	02/03/2020 18:56	02/03/2020 17:29	02/03/2020 18:56	1,44	31	44,57	CHI
2020036737	COLINAS DO SUL	TI12162624	NIQUELANDIA SUBTRANSMISSAO	02/03/2020 17:29	02/03/2020 18:56	02/03/2020 17:29	02/03/2020 18:56	1,44	10	14,38	CHI
2020036744	BRAZABRANTES	GR21016118	NEROPOLIS S1	02/03/2020 17:38	02/03/2020 19:22	02/03/2020 17:38	02/03/2020 19:22	1,73	1	1,73	CHI
2020036745	MUNDO NOVO DE GOIAS	NA12050943LD	NOVA CRIXAS	02/03/2020 16:31	02/03/2020 21:28	02/03/2020 16:31	02/03/2020 21:28	4,95	8	39,59	CHI

2020036745	NOVA CRIXAS	NA12050943LD	NOVA CRIXAS	02/03/2020 16:31	02/03/2020 21:28	02/03/2020 16:31	02/03/2020 21:28	4,95	13	64,34	CHI
2020036748	GUAPO	GC12000274	GUAPO S1	02/03/2020 17:39	02/03/2020 21:40	02/03/2020 17:39	02/03/2020 21:40	4,01	39	156,30	CHI
2020036748	TRINDADE	GC12000274	GUAPO S1	02/03/2020 17:39	02/03/2020 21:40	02/03/2020 17:39	02/03/2020 21:40	4,01	34	136,26	CHI
2020036754	EDEALINA	10027989443	PONTALINA	02/03/2020 17:41	02/03/2020 22:22	02/03/2020 17:41	02/03/2020 22:22	4,68	1	4,68	CHI
2020036757	DOVERLANDIA	DV11253347	CAIAPONIA	02/03/2020 17:41	03/03/2020 02:22	02/03/2020 17:41	03/03/2020 02:22	8,68	1	8,68	CHI
2020036765	PLANALTINA	PI12049937	PLANALTINA	02/03/2020 17:25	02/03/2020 18:35	02/03/2020 17:25	02/03/2020 18:35	1,16	278	322,87	CHI
2020036769	GOIAS	GS12362376	MATRINCHA	02/03/2020 17:14	03/03/2020 00:50	02/03/2020 17:14	03/03/2020 00:50	7,60	1	7,60	CHI
2020036769	ITAPIRAPUA	GS12362376	MATRINCHA	02/03/2020 17:14	03/03/2020 00:50	02/03/2020 17:14	03/03/2020 00:50	7,60	10	75,97	CHI
2020036771	GOIANIA	14121050	GOIANIA LESTE S1	02/03/2020 17:43	02/03/2020 23:47	02/03/2020 17:43	02/03/2020 23:47	6,06	1	6,06	CHI
2020036779	FLORES DE GOIAS	FB12211535	IACIARA S2	02/03/2020 17:44	02/03/2020 20:28	02/03/2020 17:44	02/03/2020 20:28	2,72	54	147,02	CHI
2020036780	ANAPOLIS	AN11273308	ANAPOLIS UNIVERSITARIO S2	02/03/2020 17:44	02/03/2020 23:34	02/03/2020 17:44	02/03/2020 23:34	5,82	3	17,46	CHI
2020036781	MONTES CLAROS DE GOIAS	ME12132529	IPORA	02/03/2020 17:45	03/03/2020 17:20	03/03/2020 07:40	03/03/2020 17:20	9,67	31	299,66	CHI
2020036784	PARAUNA	PU12314958	PARAUNA	02/03/2020 17:45	02/03/2020 22:39	02/03/2020 17:45	02/03/2020 22:39	4,89	8	39,10	CHI
2020036784	RIO VERDE	PU12314958	PARAUNA	02/03/2020 17:45	02/03/2020 22:39	02/03/2020 17:45	02/03/2020 22:39	4,89	2	9,78	CHI
2020036786	ALEXANIA	AX21094513	ALEXANIA	02/03/2020 17:46	02/03/2020 18:48	02/03/2020 17:46	02/03/2020 18:48	1,03	2	2,07	CHI
2020036790	INHUMAS	IN12162096	INHUMAS S2	02/03/2020 17:08	02/03/2020 18:36	02/03/2020 17:08	02/03/2020 18:36	1,46	952	1386,22	CHI
2020036792	SAO MIGUEL DO ARAGUAIA	SM12089544	SAO MIGUEL DO ARAGUAIA	02/03/2020 17:46	02/03/2020 22:14	02/03/2020 17:46	02/03/2020 22:14	4,45	3	13,36	CHI
2020036796	CALDAS NOVAS	760355836	SERRA DE CALDAS	02/03/2020 17:47	02/03/2020 19:15	02/03/2020 17:47	02/03/2020 19:15	1,47	1	1,47	CHI
2020036810	FORMOSA	02820204	ITIQUEIRA	02/03/2020 17:42	03/03/2020 12:39	02/03/2020 17:42	03/03/2020 12:15	18,55	45	834,71	CHI
2020036810	FORMOSA	02820204	ITIQUEIRA	02/03/2020 17:42	03/03/2020 12:39	02/03/2020 17:42	03/03/2020 12:39	18,95	750	14214,38	CHI
2020036810	VILA BOA	02820204	ITIQUEIRA	02/03/2020 17:42	03/03/2020 12:39	02/03/2020 17:42	03/03/2020 12:39	18,95	4	75,81	CHI
2020036813	GUAPO	710003043	GUAPO S1	02/03/2020 17:50	02/03/2020 20:00	02/03/2020 17:50	02/03/2020 20:00	2,15	1	2,15	CHI
2020036814	LUZIANIA	LZ21237854	VIANOPOLIS	02/03/2020 17:51	03/03/2020 00:11	02/03/2020 17:51	03/03/2020 00:11	6,33	1	6,33	CHI
2020036821	GOIANESIA	550088568	GOIANESIA S2	02/03/2020 17:52	03/03/2020 01:48	02/03/2020 17:52	03/03/2020 01:48	7,93	1	7,93	CHI
2020036825	MARA ROSA	MQ21182378	MARA ROSA	02/03/2020 17:53	02/03/2020 22:53	02/03/2020 17:53	02/03/2020 22:53	4,99	1	4,99	CHI
2020036826	BELA VISTA DE GOIAS	BV21092444	BELA VISTA S1	02/03/2020 17:54	03/03/2020 12:16	02/03/2020 17:54	03/03/2020 12:16	18,36	1	18,36	CHI
2020036827	SENADOR CANEDO	SW12291669	CEPAIGO S1	02/03/2020 17:54	02/03/2020 23:36	02/03/2020 17:54	02/03/2020 23:36	5,69	69	392,65	CHI
2020036843	AMERICANO DO BRASIL	AC21304499	ANICUNS	02/03/2020 17:59	03/03/2020 09:27	02/03/2020 17:59	03/03/2020 09:27	15,46	1	15,46	CHI
2020036846	LUZIANIA	LZ12320207	CRISTALINA S2	02/03/2020 18:00	03/03/2020 11:21	02/03/2020 18:00	03/03/2020 11:21	17,34	2	34,69	CHI
2020036850	SILVANIA	SV12389456	VIANOPOLIS	02/03/2020 16:39	02/03/2020 21:20	02/03/2020 16:39	02/03/2020 21:20	4,67	109	509,00	CHI
2020036853	LUZIANIA	LZ12353712	VIANOPOLIS	02/03/2020 18:02	02/03/2020 22:20	02/03/2020 18:02	02/03/2020 22:20	4,29	29	124,55	CHI
2020036861	MORRINHOS	MR21190256	MORRINHOS	02/03/2020 18:04	02/03/2020 21:04	02/03/2020 18:04	02/03/2020 21:04	3,00	1	3,00	CHI
2020036868	IPORA	IR21188494	IPORA	02/03/2020 18:05	03/03/2020 05:32	02/03/2020 18:05	03/03/2020 05:32	11,44	1	11,44	CHI
2020036874	ACREUNA	2440066820	ACREUNA	02/03/2020 18:07	02/03/2020 23:06	02/03/2020 18:07	02/03/2020 23:06	4,98	1	4,98	CHI
2020036877	COLINAS DO SUL	TI12355503	MINACU	02/03/2020 18:08	02/03/2020 20:31	02/03/2020 18:08	02/03/2020 20:31	2,38	9	21,40	CHI
2020036879	ITAGUARI	II13110946	ITABERAI S1	02/03/2020 17:19	02/03/2020 22:20	02/03/2020 17:19	02/03/2020 22:20	5,01	151	756,43	CHI
2020036880	MINEIROS	MY21244670	PARQUE DAS EMAS	02/03/2020 18:08	03/03/2020 11:47	02/03/2020 18:08	03/03/2020 11:47	17,64	2	35,27	CHI
2020036906	AMARALINA	LC12231661	MARA ROSA	02/03/2020 18:13	03/03/2020 10:42	02/03/2020 18:13	03/03/2020 10:42	16,47	1	16,47	CHI
2020036907	AGUA FRIA DE GOIAS	TL12202266	SAO JOAO D ALIANCA	02/03/2020 18:13	02/03/2020 20:46	02/03/2020 18:13	02/03/2020 20:46	2,54	11	27,92	CHI
2020036909	TRINDADE	40137442	TRINDADE	02/03/2020 18:14	02/03/2020 23:06	02/03/2020 18:14	02/03/2020 23:06	4,86	1	4,86	CHI
2020036931	GOUVELANDIA	GB12296587	QUIRINOPOLIS	02/03/2020 18:19	03/03/2020 12:12	02/03/2020 18:19	03/03/2020 12:12	17,88	6	107,26	CHI
2020036933	NIQUELANDIA	NQ12375602	URUACU	02/03/2020 15:14	02/03/2020 21:32	02/03/2020 15:14	02/03/2020 21:32	6,28	34	213,68	CHI
2020036937	ANAPOLIS	AN12390204	ANAPOLIS UNIVERSITARIO S1	02/03/2020 18:20	02/03/2020 19:40	02/03/2020 18:20	02/03/2020 19:40	1,32	2	2,65	CHI
2020036944	GOIANIA	16437263	CAMPINAS S2	02/03/2020 18:21	03/03/2020 00:33	02/03/2020 18:21	03/03/2020 00:33	6,18	1	6,18	CHI

2020036945	CATALAO	1990073880	CATALAO S2	02/03/2020 18:21	03/03/2020 08:09	02/03/2020 18:21	03/03/2020 08:09	13,78	1	13,78	CHI
2020036946	POSSE	PS11000010	IACIARA S2	02/03/2020 18:22	02/03/2020 19:44	02/03/2020 18:22	02/03/2020 19:44	1,36	22	29,96	CHI
2020036951	PADRE BERNARDO	9980007375	PADRE BERNARDO	02/03/2020 18:22	03/03/2020 17:27	02/03/2020 18:22	03/03/2020 17:27	23,07	1	23,07	CHI
2020036952	MINACU	IH21240658	MINACU	02/03/2020 18:22	02/03/2020 22:18	02/03/2020 18:22	02/03/2020 22:18	3,92	1	3,92	CHI
2020036953	FORMOSO	FO12145300	PORANGATU	02/03/2020 16:59	02/03/2020 21:31	02/03/2020 16:59	02/03/2020 21:31	4,52	11	49,77	CHI
2020036956	PLANALTINA	PI21385668	PLANALTINA	02/03/2020 18:23	02/03/2020 19:28	02/03/2020 18:23	02/03/2020 19:28	1,08	1	1,08	CHI
2020036958	APARECIDA DE GOIANIA	200544550	ANHANGUERA	02/03/2020 18:23	02/03/2020 20:05	02/03/2020 18:23	02/03/2020 20:05	1,69	1	1,69	CHI
2020036964	CRISTALINA	10030780630	PAMPLONA	02/03/2020 18:24	02/03/2020 20:45	02/03/2020 18:24	02/03/2020 20:45	2,36	1	2,36	CHI
2020036965	ALTO PARAISO DE GOIAS	BF11376612	NIQUELANDIA SUBTRANSMISSAO	02/03/2020 18:24	03/03/2020 12:59	02/03/2020 18:24	03/03/2020 12:59	18,57	18	334,30	CHI
2020036966	APARECIDA DE GOIANIA	AP11251485	INDEPENDENCIA S2	02/03/2020 18:16	02/03/2020 21:16	02/03/2020 18:16	02/03/2020 21:16	3,00	137	410,70	CHI
2020036967	CIDADE OCIDENTAL	10013981143	MARAJOARA	02/03/2020 18:06	02/03/2020 20:05	02/03/2020 18:06	02/03/2020 20:05	1,99	1	1,99	CHI
2020036974	GOIANESIA	GE12256007	GOIANESIA S2	02/03/2020 18:11	02/03/2020 23:10	02/03/2020 18:11	02/03/2020 23:10	4,99	6	29,93	CHI
2020036981	BARRO ALTO	1150026902	BARRO ALTO	02/03/2020 18:30	03/03/2020 04:37	02/03/2020 18:30	03/03/2020 04:37	10,11	1	10,11	CHI
2020036986	CRIXAS	CX12297042	SERRA DO OURO	02/03/2020 18:32	03/03/2020 04:03	02/03/2020 18:32	03/03/2020 04:03	9,51	1	9,51	CHI
2020037004	COCALZINHO DE GOIAS	ZN12377435	COCALZINHO	02/03/2020 18:18	02/03/2020 21:20	02/03/2020 18:18	02/03/2020 21:20	3,04	54	164,04	CHI
2020037006	PLANALTINA	PI11071397	PLANALTINA	02/03/2020 17:41	02/03/2020 19:34	02/03/2020 17:41	02/03/2020 19:34	1,87	137	256,46	CHI
2020037009	RIO VERDE	RV12052177	MONTIVIDIU T	02/03/2020 18:37	03/03/2020 00:35	02/03/2020 18:37	03/03/2020 00:35	5,96	1	5,96	CHI
2020037010	CRIXAS	CX21132272	SERRA DO OURO	02/03/2020 18:37	03/03/2020 06:09	02/03/2020 18:37	03/03/2020 06:09	11,53	1	11,53	CHI
2020037013	CIDADE OCIDENTAL	10007311506	MARAJOARA	02/03/2020 18:38	02/03/2020 22:23	02/03/2020 18:38	02/03/2020 22:23	3,74	1	3,74	CHI
2020037014	AGUAS LINDAS DE GOIAS	10015720886	AGUAS LINDAS DE GOIAS S2	02/03/2020 18:38	03/03/2020 09:22	02/03/2020 18:38	03/03/2020 09:22	14,72	1	14,72	CHI
2020037019	PLANALTINA	PI21099509	PLANALTINA	02/03/2020 18:40	02/03/2020 21:58	02/03/2020 18:40	02/03/2020 21:58	3,29	1	3,29	CHI
2020037020	FIRMINOPOLIS	10001172520	FIRMINOPOLIS S1	02/03/2020 18:40	02/03/2020 19:58	02/03/2020 18:40	02/03/2020 19:58	1,29	1	1,29	CHI
2020037022	PIRENOPOLIS	PV12355148	CORUMBA	02/03/2020 18:01	02/03/2020 20:02	02/03/2020 18:01	02/03/2020 20:02	2,02	24	48,37	CHI
2020037029	GOIANIRA	GR31135474	NEROPOLIS S1	02/03/2020 18:42	02/03/2020 23:29	02/03/2020 18:42	02/03/2020 23:29	4,78	1	4,78	CHI
2020037037	NOVA IGUACU DE GOIAS	UR12000054RE	CAMPINORTE	02/03/2020 18:00	02/03/2020 19:44	02/03/2020 18:00	02/03/2020 19:44	1,73	15	25,99	CHI
2020037037	URUACU	UR12000054RE	CAMPINORTE	02/03/2020 18:00	02/03/2020 19:44	02/03/2020 18:00	02/03/2020 19:44	1,73	91	157,68	CHI
2020037039	SANTA CRUZ DE GOIAS	BC21207665	PIRES DO RIO S2	02/03/2020 16:14	02/03/2020 20:30	02/03/2020 16:14	02/03/2020 20:30	4,27	1	4,27	CHI
2020037042	ANAPOLIS	10012488320	ANAPOLIS UNIVERSITARIO S2	02/03/2020 18:45	02/03/2020 23:41	02/03/2020 18:45	02/03/2020 23:41	4,92	1	4,92	CHI
2020037044	CATALAO	1990124929	CATALAO S2	02/03/2020 18:47	03/03/2020 08:55	02/03/2020 18:47	03/03/2020 08:55	14,13	1	14,13	CHI
2020037045	ESTRELA DO NORTE	ET12256551	MARA ROSA	02/03/2020 18:47	02/03/2020 22:37	02/03/2020 18:47	02/03/2020 22:37	3,83	9	34,47	CHI
2020037046	IACIARA	IA12211664	IACIARA S2	02/03/2020 18:47	02/03/2020 20:03	02/03/2020 18:47	02/03/2020 20:03	1,26	9	11,36	CHI
2020037047	COCALZINHO DE GOIAS	ZN12258078	COCALZINHO	02/03/2020 18:45	02/03/2020 21:54	02/03/2020 18:45	02/03/2020 21:54	3,13	56	175,51	CHI
2020037048	SANTO ANTONIO DO DESCOBERTO	SN21139297	ALEXANIA	02/03/2020 18:47	02/03/2020 20:20	02/03/2020 18:47	02/03/2020 20:20	1,54	1	1,54	CHI
2020037058	NIQUELANDIA	NQ12333066	NIQUELANDIA SUBTRANSMISSAO	02/03/2020 18:50	03/03/2020 13:31	02/03/2020 18:50	03/03/2020 13:31	18,68	5	93,39	CHI
2020037059	MONTIVIDIU DO NORTE	MX12143686	PORANGATU	02/03/2020 18:36	02/03/2020 23:20	02/03/2020 18:36	02/03/2020 23:20	4,72	102	481,69	CHI
2020037060	ITABERAÍ	IB11336801	ITABERAÍ S2	02/03/2020 18:50	02/03/2020 21:06	02/03/2020 18:50	02/03/2020 21:06	2,26	64	144,69	CHI
2020037066	GOIANIA	11487240	REAL S2	02/03/2020 18:52	02/03/2020 22:07	02/03/2020 18:52	02/03/2020 22:07	3,25	1	3,25	CHI
2020037071	MINACU	IH12396737	MINACU	02/03/2020 18:53	02/03/2020 21:26	02/03/2020 18:53	02/03/2020 21:26	2,54	14	35,51	CHI
2020037075	ADELANDIA	DN21291932	FIRMINOPOLIS S2	02/03/2020 18:54	03/03/2020 08:15	02/03/2020 18:54	03/03/2020 08:15	13,33	1	13,33	CHI
2020037086	SENADOR CANEDO	10021904578	SENADOR CANEDO	02/03/2020 18:58	02/03/2020 19:57	02/03/2020 18:58	02/03/2020 19:57	0,98	1	0,98	CHI
2020037091	ALEXANIA	AX12000154	CORUMBA	02/03/2020 18:56	02/03/2020 20:48	02/03/2020 18:56	02/03/2020 20:48	1,86	21	39,12	CHI
2020037091	CORUMBA DE GOIAS	AX12000154	CORUMBA	02/03/2020 18:56	02/03/2020 20:48	02/03/2020 18:56	02/03/2020 20:48	1,86	4	7,45	CHI
2020037092	ITUMBIARA	IT21296920	PARANAIBA	02/03/2020 19:01	03/03/2020 08:02	02/03/2020 19:01	03/03/2020 08:02	13,01	1	13,01	CHI
2020037095	GUARANI DE GOIAS	GY12257673	IACIARA S1	02/03/2020 19:03	02/03/2020 21:00	02/03/2020 19:03	02/03/2020 21:00	1,95	95	185,20	CHI

2020037095	IACIARA	GY12257673	IACIARA S1	02/03/2020 19:03	02/03/2020 21:00	02/03/2020 19:03	02/03/2020 21:00	1,95	6	11,70	CHI
2020037097	PIRACANJUBA	60010629	PIRACANJUBA	02/03/2020 19:03	03/03/2020 11:00	02/03/2020 19:03	03/03/2020 11:00	15,94	1	15,94	CHI
2020037099	PIRENOPOLIS	PV21302212	CORUMBA	02/03/2020 19:04	02/03/2020 21:26	02/03/2020 19:04	02/03/2020 21:26	2,36	1	2,36	CHI
2020037106	FORMOSA	FA11264682	ITIQUEIRA	02/03/2020 19:05	02/03/2020 23:55	02/03/2020 23:45	02/03/2020 23:55	0,17	135	22,43	CHI
2020037111	PLANALTINA	PI12390968	PLANALTINA	02/03/2020 19:06	03/03/2020 09:14	02/03/2020 19:06	03/03/2020 09:14	14,12	3	42,36	CHI
2020037113	CATALAO	CT12318869	CATALAO S1	02/03/2020 19:07	03/03/2020 09:10	02/03/2020 19:07	03/03/2020 09:10	14,04	5	70,21	CHI
2020037124	GOIANIA	GN11265328	AEROPORTO S3	02/03/2020 19:09	02/03/2020 22:41	02/03/2020 19:09	02/03/2020 22:41	3,52	74	260,67	CHI
2020037131	FIRMINOPOLIS	FR21283580	FIRMINOPOLIS S1	02/03/2020 19:11	02/03/2020 21:51	02/03/2020 19:11	02/03/2020 21:51	2,65	1	2,65	CHI
2020037134	TROMBAS	TB21185258	PORANGATU	02/03/2020 19:12	03/03/2020 01:49	02/03/2020 19:12	03/03/2020 01:49	6,61	1	6,61	CHI
2020037136	FORMOSA	10018560227	ITIQUEIRA	02/03/2020 19:12	02/03/2020 21:11	02/03/2020 19:12	02/03/2020 21:11	1,97	1	1,97	CHI
2020037138	ALEXANIA	AX12382326	ALEXANIA	02/03/2020 19:13	02/03/2020 23:09	02/03/2020 19:13	02/03/2020 23:09	3,93	299	1175,32	CHI
2020037140	ANAPOLIS	21194968	JUNDIAI S1	02/03/2020 19:13	03/03/2020 01:46	02/03/2020 19:13	03/03/2020 01:46	6,54	1	6,54	CHI
2020037142	SANTO ANTONIO DO DESCOBERTO	SN21103505	ALEXANIA	02/03/2020 19:13	02/03/2020 21:25	02/03/2020 19:13	02/03/2020 21:25	2,19	1	2,19	CHI
2020037144	CACU	CC12340974	CACHOEIRA ALTA	02/03/2020 19:13	03/03/2020 00:45	02/03/2020 19:13	03/03/2020 00:45	5,53	5	27,65	CHI
2020037145	GAMELEIRA DE GOIAS	SV12077017	DAIA S2	02/03/2020 17:41	02/03/2020 23:50	02/03/2020 17:41	02/03/2020 23:50	6,15	2	12,30	CHI
2020037145	SILVANIA	SV12077017	DAIA S2	02/03/2020 17:41	02/03/2020 23:50	02/03/2020 17:41	02/03/2020 23:50	6,15	3	18,44	CHI
2020037156	EDEIA	EA12352545	EDEIA	02/03/2020 19:13	02/03/2020 20:32	02/03/2020 19:13	02/03/2020 20:32	1,30	3	3,91	CHI
2020037156	INDIARA	EA12352545	EDEIA	02/03/2020 19:13	02/03/2020 20:32	02/03/2020 19:13	02/03/2020 20:32	1,30	20	26,10	CHI
2020037165	QUIRINOPOLIS	QI11341055	QUIRINOPOLIS	02/03/2020 19:14	02/03/2020 20:32	02/03/2020 19:14	02/03/2020 20:32	1,28	168	215,69	CHI
2020037166	SILVANIA	SV12131990	VIANOPOLIS	02/03/2020 18:47	02/03/2020 22:45	02/03/2020 18:47	02/03/2020 22:45	3,95	30	118,60	CHI
2020037168	RIO VERDE	RV12038460	MONTIVIDIU T	02/03/2020 17:22	03/03/2020 04:51	02/03/2020 17:22	03/03/2020 04:51	11,47	9	103,23	CHI
2020037169	ARUANA	AK21066582	ARUANA	02/03/2020 19:21	02/03/2020 22:17	02/03/2020 19:21	02/03/2020 22:17	2,93	1	2,93	CHI
2020037171	TRINDADE	40146868	TRINDADE	02/03/2020 19:21	03/03/2020 00:40	02/03/2020 19:21	03/03/2020 00:40	5,31	1	5,31	CHI
2020037173	CRIXAS	CX12392063	SANTA TEREZINHA	02/03/2020 19:21	03/03/2020 19:49	02/03/2020 19:21	03/03/2020 19:49	24,45	28	684,63	CHI
2020037173	ITAPACI	CX12392063	SANTA TEREZINHA	02/03/2020 19:21	03/03/2020 19:49	02/03/2020 19:21	03/03/2020 19:49	24,45	4	97,80	CHI
2020037174	PIRACANJUBA	PJ21076774	BELA VISTA S1	02/03/2020 19:22	02/03/2020 23:39	02/03/2020 19:22	02/03/2020 23:39	4,27	1	4,27	CHI
2020037176	CACHOEIRA DOURADA	CD12000067	CACHOEIRA DOURADA	02/03/2020 17:12	02/03/2020 22:48	02/03/2020 17:12	02/03/2020 22:48	5,58	48	268,08	CHI
2020037176	INACIOLANDIA	CD12000067	CACHOEIRA DOURADA	02/03/2020 17:12	02/03/2020 22:48	02/03/2020 17:12	02/03/2020 22:48	5,58	103	575,25	CHI
2020037176	ITUMBIARA	CD12000067	CACHOEIRA DOURADA	02/03/2020 17:12	02/03/2020 22:48	02/03/2020 17:12	02/03/2020 22:48	5,58	13	72,60	CHI
2020037179	VALPARAISO DE GOIAS	3350050631	PACAEMBU S1	02/03/2020 19:24	03/03/2020 10:55	02/03/2020 19:24	03/03/2020 10:55	15,51	1	15,51	CHI
2020037181	LEOPOLDO DE BULHOES	LB12384848	DAIA S2	02/03/2020 19:24	03/03/2020 02:19	02/03/2020 19:24	03/03/2020 02:19	6,90	1	6,90	CHI
2020037184	SANTO ANTONIO DO DESCOBERTO	10014006675	AGUAS LINDAS DE GOIAS S2	02/03/2020 19:25	02/03/2020 23:07	02/03/2020 19:25	02/03/2020 23:07	3,69	1	3,69	CHI
2020037185	MATRINCHA	MP12250740	MATRINCHA	02/03/2020 19:21	03/03/2020 07:40	02/03/2020 19:21	03/03/2020 07:40	12,31	9	110,78	CHI
2020037186	INHUMAS	IN12311189	INHUMAS S2	02/03/2020 16:37	02/03/2020 23:12	02/03/2020 16:37	02/03/2020 23:12	6,57	43	282,50	CHI
2020037189	GOIANIA	GN11050818	GOYA S2	02/03/2020 19:27	02/03/2020 22:14	02/03/2020 20:11	02/03/2020 22:14	2,05	23	47,16	CHI
2020037190	URUTAI	UT21222676	URUTAI	02/03/2020 19:27	02/03/2020 22:42	02/03/2020 19:27	02/03/2020 22:42	3,25	1	3,25	CHI
2020037193	SENADOR CANEDO	SW12392773	SENADOR CANEDO	02/03/2020 17:21	02/03/2020 20:25	02/03/2020 17:21	02/03/2020 20:25	3,06	347	1061,82	CHI
2020037197	ORIZONA	OZ21043237	PIRES DO RIO S2	02/03/2020 19:28	02/03/2020 21:37	02/03/2020 19:28	02/03/2020 21:37	2,14	1	2,14	CHI
2020037200	UIRAPURU	UP11396309	NOVA CRIXAS	02/03/2020 19:29	03/03/2020 11:33	02/03/2020 19:29	03/03/2020 11:33	16,06	1	16,06	CHI
2020037204	ANAPOLIS	20924665	ANAPOLIS UNIVERSITARIO S2	02/03/2020 19:30	03/03/2020 01:06	02/03/2020 19:30	03/03/2020 01:06	5,59	1	5,59	CHI
2020037206	ITAPACI	IW13097491	ITAPACI	02/03/2020 19:22	03/03/2020 14:29	02/03/2020 21:34	02/03/2020 22:31	0,94	16	14,99	CHI
2020037206	ITAPACI	IW13333920	ITAPACI	02/03/2020 19:22	03/03/2020 14:29	03/03/2020 00:44	03/03/2020 03:40	2,95	16	47,18	CHI
2020037206	ITAPACI	IW13333920	ITAPACI	02/03/2020 19:22	03/03/2020 14:29	02/03/2020 22:28	03/03/2020 14:29	16,02	25	400,48	CHI
2020037207	GAMELEIRA DE GOIAS	SV12214543	DAIA S2	02/03/2020 19:31	03/03/2020 00:30	02/03/2020 19:31	03/03/2020 00:30	4,98	7	34,88	CHI

2020037208	SANTO ANTONIO DO DESCOBERTO	SN12351060	ALEXANIA	02/03/2020 19:31	02/03/2020 22:08	02/03/2020 19:31	02/03/2020 22:08	2,60	3	7,81	CHI
2020037211	MINEIROS	PW12219564	PARQUE DAS EMAS	02/03/2020 19:32	03/03/2020 08:39	02/03/2020 19:32	03/03/2020 08:39	13,11	7	91,75	CHI
2020037211	PORTELANDIA	PW12219564	PARQUE DAS EMAS	02/03/2020 19:32	03/03/2020 08:39	02/03/2020 19:32	03/03/2020 08:39	13,11	12	157,28	CHI
2020037212	ACREUNA	2440079437	ACREUNA	02/03/2020 19:32	03/03/2020 00:09	02/03/2020 19:32	03/03/2020 00:09	4,61	1	4,61	CHI
2020037214	CALDAZINHA	BV21164331	CEPAIGO S2	02/03/2020 19:32	02/03/2020 22:31	02/03/2020 19:32	02/03/2020 22:31	2,97	1	2,97	CHI
2020037217	ITUMBIARA	690102380	ITUMBIARA VELHA S1	02/03/2020 19:33	04/03/2020 09:49	02/03/2020 19:33	04/03/2020 09:49	38,26	1	38,26	CHI
2020037221	AGUA FRIA DE GOIAS	PI21049173	SAO JOAO D ALIANCA	02/03/2020 19:34	02/03/2020 20:21	02/03/2020 19:34	02/03/2020 20:21	0,78	1	0,78	CHI
2020037227	SAO MIGUEL DO ARAGUAIA	SM12096096	SAO MIGUEL DO ARAGUAIA	02/03/2020 19:36	03/03/2020 10:18	02/03/2020 19:36	03/03/2020 10:18	14,69	13	190,94	CHI
2020037229	ANAPOLIS	AN12273408RE	ANAPOLIS UNIVERSITARIO S2	02/03/2020 18:15	04/03/2020 00:23	02/03/2020 18:15	02/03/2020 23:28	5,21	7	36,50	CHI
2020037229	PIRENOPOLIS	AN12273408RE	ANAPOLIS UNIVERSITARIO S2	02/03/2020 18:15	04/03/2020 00:23	02/03/2020 18:15	04/03/2020 00:23	30,12	5	150,60	CHI
2020037233	SIMOLANDIA	SA11398190	IACIARA S2	02/03/2020 19:37	02/03/2020 21:57	02/03/2020 19:37	02/03/2020 21:57	2,32	1	2,32	CHI
2020037237	SANTA ROSA DE GOIAS	SR12346425	INHUMAS S1	02/03/2020 18:42	02/03/2020 21:32	02/03/2020 18:42	02/03/2020 21:32	2,83	3	8,50	CHI
2020037237	TUARAL DE GOIAS	SR12346425	INHUMAS S1	02/03/2020 18:42	02/03/2020 21:32	02/03/2020 18:42	02/03/2020 21:32	2,83	5	14,16	CHI
2020037239	PARAUNA	RP21102381	PARAUNA	02/03/2020 19:40	03/03/2020 12:52	02/03/2020 19:40	03/03/2020 12:52	17,19	1	17,19	CHI
2020037240	BALIZA	BH12334535	BOM JARDIM	02/03/2020 17:35	02/03/2020 23:25	02/03/2020 17:35	02/03/2020 23:25	5,83	18	104,98	CHI
2020037243	PORANGATU	PO12252098	PORANGATU	02/03/2020 17:35	02/03/2020 22:42	02/03/2020 17:35	02/03/2020 22:42	5,11	5	25,57	CHI
2020037246	CORUMBAIBA	CI12000093RE	VILA CORUMBA	02/03/2020 17:23	04/03/2020 10:42	02/03/2020 17:23	03/03/2020 11:51	18,46	7	129,21	CHI
2020037246	CORUMBAIBA	CI12000093RE	VILA CORUMBA	02/03/2020 17:23	04/03/2020 10:42	03/03/2020 10:30	03/03/2020 11:51	1,36	2	2,72	CHI
2020037246	CORUMBAIBA	CI12000093RE	VILA CORUMBA	02/03/2020 17:23	04/03/2020 10:42	02/03/2020 17:23	03/03/2020 12:37	19,22	34	653,43	CHI
2020037246	CORUMBAIBA	CI12228811LD	VILA CORUMBA	02/03/2020 17:23	04/03/2020 10:42	03/03/2020 10:30	03/03/2020 12:37	2,12	5	10,59	CHI
2020037246	CORUMBAIBA	CI12000093RE	VILA CORUMBA	02/03/2020 17:23	04/03/2020 10:42	02/03/2020 17:23	03/03/2020 14:17	20,89	7	146,20	CHI
2020037246	CORUMBAIBA	CI13161363	VILA CORUMBA	02/03/2020 17:23	04/03/2020 10:42	03/03/2020 10:30	03/03/2020 14:17	3,78	1	3,78	CHI
2020037246	CORUMBAIBA	CI12000093RE	VILA CORUMBA	02/03/2020 17:23	04/03/2020 10:42	02/03/2020 17:23	03/03/2020 23:30	30,11	54	1625,84	CHI
2020037246	CORUMBAIBA	CI13215565	VILA CORUMBA	02/03/2020 17:23	04/03/2020 10:42	03/03/2020 10:30	03/03/2020 23:30	13,01	35	455,23	CHI
2020037246	CORUMBAIBA	CI12000093RE	VILA CORUMBA	02/03/2020 17:23	04/03/2020 10:42	02/03/2020 17:23	04/03/2020 10:42	41,31	2	82,62	CHI
2020037250	GOIANIA	10006351849	MEIA PONTE	02/03/2020 19:43	02/03/2020 23:57	02/03/2020 19:43	02/03/2020 23:57	4,22	1	4,22	CHI
2020037256	GOIANIRA	10002998325	MEIA PONTE	02/03/2020 19:45	02/03/2020 23:57	02/03/2020 19:45	02/03/2020 23:57	4,19	1	4,19	CHI
2020037257	MINACU	IH11202506	MINACU	02/03/2020 19:46	03/03/2020 07:24	02/03/2020 19:46	03/03/2020 07:24	11,63	4	46,51	CHI
2020037262	BURITI ALEGRE	BG21110223	ITUMBIARA VELHA S2	02/03/2020 19:46	03/03/2020 11:10	02/03/2020 19:46	03/03/2020 11:10	15,38	1	15,38	CHI
2020037270	GOUVELANDIA	GB12394808	QUIRINOPOLIS	02/03/2020 19:49	02/03/2020 22:50	02/03/2020 19:49	02/03/2020 22:50	3,01	2	6,03	CHI
2020037270	QUIRINOPOLIS	GB12394808	QUIRINOPOLIS	02/03/2020 19:49	02/03/2020 22:50	02/03/2020 19:49	02/03/2020 22:50	3,01	77	231,98	CHI
2020037280	PIRACANJUBA	60044287	PIRACANJUBA	02/03/2020 19:51	02/03/2020 22:26	02/03/2020 19:51	02/03/2020 22:26	2,58	1	2,58	CHI
2020037281	CRIXAS	CX21249605	SANTA TEREZINHA	02/03/2020 19:51	03/03/2020 04:35	02/03/2020 19:51	03/03/2020 04:35	8,72	1	8,72	CHI
2020037287	MATRINCHA	MP12070337	MATRINCHA	02/03/2020 17:07	03/03/2020 09:47	02/03/2020 17:07	03/03/2020 09:47	16,66	71	1182,64	CHI
2020037288	GOIANIA	10044656	GOYA S2	02/03/2020 19:52	02/03/2020 21:35	02/03/2020 19:52	02/03/2020 21:35	1,70	1	1,70	CHI
2020037290	HIDROLANDIA	HD21269028	CEPAIGO S2	02/03/2020 19:53	03/03/2020 01:22	02/03/2020 19:53	03/03/2020 01:22	5,47	3	16,42	CHI
2020037292	ITUMBIARA	10015719144	PARANAIBA	02/03/2020 19:54	02/03/2020 21:57	02/03/2020 19:54	02/03/2020 21:57	2,05	1	2,05	CHI
2020037293	GOIANIRA	390101138	MEIA PONTE	02/03/2020 19:54	03/03/2020 01:59	02/03/2020 19:54	03/03/2020 01:59	6,07	1	6,07	CHI
2020037298	BRITANIA	BT12131110	BRITANIA	02/03/2020 19:56	03/03/2020 12:19	02/03/2020 19:56	03/03/2020 12:19	16,38	30	491,47	CHI
2020037299	GOIANIA	10006256374	MEIA PONTE	02/03/2020 19:56	02/03/2020 21:09	02/03/2020 19:56	02/03/2020 21:09	1,21	1	1,21	CHI
2020037301	NEROPOLIS	NR12029257	NEROPOLIS S2	02/03/2020 19:56	02/03/2020 22:18	02/03/2020 19:56	02/03/2020 22:18	2,36	11	25,92	CHI
2020037309	JARAGUA	JA12266573	JARAGUA	02/03/2020 19:58	02/03/2020 21:46	02/03/2020 19:58	02/03/2020 21:46	1,80	201	361,41	CHI
2020037310	BELA VISTA DE GOIAS	BV31247463	BELA VISTA S1	02/03/2020 19:58	03/03/2020 10:26	02/03/2020 19:58	03/03/2020 10:26	14,46	3	43,39	CHI
2020037311	DOVERLANDIA	DV11229582	CAIAPONIA	02/03/2020 19:58	02/03/2020 22:16	02/03/2020 19:58	02/03/2020 22:16	2,29	1	2,29	CHI

2020037314	GOIANESIA	GE12322006	GOIANESIA S1	03/03/2020 06:43	03/03/2020 09:19	03/03/2020 06:43	03/03/2020 09:19	2,61	7	18,27	CHI
2020037314	SANTA RITA DO NOVO DESTINO	GE12322006	GOIANESIA S1	03/03/2020 06:43	03/03/2020 09:19	03/03/2020 06:43	03/03/2020 09:19	2,61	7	18,27	CHI
2020037324	APARECIDA DE GOIANIA	10025420770	INDEPENDENCIA S2	02/03/2020 20:01	02/03/2020 21:31	02/03/2020 20:01	02/03/2020 21:31	1,50	1	1,50	CHI
2020037327	NIQUELANDIA	NQ12295506	NIQUELANDIA SUBTRANSMISSAO	02/03/2020 20:03	03/03/2020 18:33	02/03/2020 20:03	03/03/2020 18:33	22,50	19	427,46	CHI
2020037333	TRINDADE	TR11053494	TRINDADE	02/03/2020 20:03	02/03/2020 21:04	02/03/2020 20:03	02/03/2020 21:04	1,01	186	188,58	CHI
2020037337	FORMOSA	FA32042715	SAO JOAO D ALIANCA	02/03/2020 20:05	03/03/2020 13:56	02/03/2020 20:05	03/03/2020 13:56	17,84	3	53,52	CHI
2020037339	APARECIDA DE GOIANIA	200445716	ANHANGUERA	02/03/2020 20:06	02/03/2020 22:11	02/03/2020 20:06	02/03/2020 22:11	2,07	1	2,07	CHI
2020037341	MAIRIPOTABA	PK12293392	PONTALINA	02/03/2020 20:07	02/03/2020 22:57	02/03/2020 20:07	02/03/2020 22:57	2,83	1	2,83	CHI
2020037341	PONTALINA	PK12293392	PONTALINA	02/03/2020 20:07	02/03/2020 22:57	02/03/2020 20:07	02/03/2020 22:57	2,83	13	36,75	CHI
2020037346	COCALZINHO DE GOIAS	ZN12041395	COCALZINHO	02/03/2020 19:57	02/03/2020 22:23	02/03/2020 19:57	02/03/2020 22:23	2,42	43	104,25	CHI
2020037346	CORUMBA DE GOIAS	ZN12041395	COCALZINHO	02/03/2020 19:57	02/03/2020 22:23	02/03/2020 19:57	02/03/2020 22:23	2,42	75	181,83	CHI
2020037349	HIDROLANDIA	HD21090158	CEPAIGO S2	02/03/2020 09:10	03/03/2020 10:38	02/03/2020 14:26	03/03/2020 10:38	20,18	1	20,18	CHI
2020037352	EDEIA	1120019749	EDEIA	02/03/2020 20:12	03/03/2020 07:48	02/03/2020 20:12	03/03/2020 07:48	11,59	1	11,59	CHI
2020037360	COLINAS DO SUL	TI21309771	NIQUELANDIA SUBTRANSMISSAO	02/03/2020 20:14	02/03/2020 23:06	02/03/2020 20:14	02/03/2020 23:06	2,87	1	2,87	CHI
2020037362	ANAPOLIS	AN11107975	ANAPOLIS UNIVERSITARIO S2	02/03/2020 20:13	02/03/2020 21:38	02/03/2020 20:13	02/03/2020 21:38	1,41	107	150,87	CHI
2020037365	GOIAS	90029422	GOIAS	02/03/2020 20:14	02/03/2020 21:31	02/03/2020 20:14	02/03/2020 21:31	1,27	1	1,27	CHI
2020037369	IPORA	10021830604	IPORA	02/03/2020 20:15	03/03/2020 16:20	02/03/2020 20:15	03/03/2020 16:20	20,08	1	20,08	CHI
2020037373	RUBIATABA	780040533	RUBIATABA	02/03/2020 20:16	03/03/2020 15:44	02/03/2020 20:16	03/03/2020 15:44	19,46	1	19,46	CHI
2020037375	FAZENDA NOVA	FN21183349	IPORA	02/03/2020 20:16	02/03/2020 21:52	02/03/2020 20:16	02/03/2020 21:52	1,58	1	1,58	CHI
2020037377	CAMPINORTE	2040001494	CAMPINORTE	02/03/2020 20:17	03/03/2020 09:40	02/03/2020 20:17	03/03/2020 09:40	13,37	1	13,37	CHI
2020037380	IPORA	730113486	IPORA	02/03/2020 20:18	03/03/2020 17:25	02/03/2020 20:18	03/03/2020 17:25	21,11	1	21,11	CHI
2020037384	CIDADE OCIDENTAL	2680141186	MARAJOARA	02/03/2020 20:20	03/03/2020 08:19	02/03/2020 20:20	03/03/2020 08:19	11,98	1	11,98	CHI
2020037388	FORMOSA	FA12087475	ITUIQUIRA	02/03/2020 20:22	03/03/2020 11:39	02/03/2020 20:22	03/03/2020 11:39	15,28	2	30,57	CHI
2020037389	PARAUNA	980037438	PARAUNA	02/03/2020 20:22	03/03/2020 13:25	02/03/2020 20:22	03/03/2020 13:25	17,05	1	17,05	CHI
2020037391	GOIANIA	13280703	REAL S1	02/03/2020 20:22	03/03/2020 00:01	02/03/2020 20:22	03/03/2020 00:01	3,65	1	3,65	CHI
2020037398	GOIANIA	11637511	CAMPINAS S3	02/03/2020 20:26	02/03/2020 23:37	02/03/2020 20:26	02/03/2020 23:37	3,18	1	3,18	CHI
2020037400	SAO JOAO D ALIANCA	JL12270138	SAO JOAO D ALIANCA	02/03/2020 20:26	03/03/2020 10:36	02/03/2020 20:26	03/03/2020 10:36	14,15	1	14,15	CHI
2020037506	TRINDADE	10028385703	TRINDADE	02/03/2020 20:28	02/03/2020 22:04	02/03/2020 20:28	02/03/2020 22:04	1,59	1	1,59	CHI
2020037510	ITUMBIARA	690188638	ITUMBIARA NOVA	02/03/2020 20:29	04/03/2020 10:28	02/03/2020 20:29	04/03/2020 10:28	37,97	1	37,97	CHI
2020037516	COCALZINHO DE GOIAS	10021377632	COCALZINHO	02/03/2020 20:31	03/03/2020 07:24	02/03/2020 20:31	03/03/2020 07:24	10,88	1	10,88	CHI
2020037521	ITABERAI	IB12310600	ITABERAI S2	02/03/2020 20:24	03/03/2020 13:21	02/03/2020 20:24	03/03/2020 07:20	10,93	78	852,19	CHI
2020037521	ITABERAI	IB12310600	ITABERAI S2	02/03/2020 20:24	03/03/2020 13:21	03/03/2020 07:29	03/03/2020 12:44	5,26	37	194,51	CHI
2020037521	ITABERAI	IB12124895	ITABERAI S2	02/03/2020 20:24	03/03/2020 13:21	03/03/2020 07:29	03/03/2020 13:21	5,87	41	240,87	CHI
2020037525	ACREUNA	2440076102	ACREUNA	02/03/2020 20:33	02/03/2020 23:20	02/03/2020 20:33	02/03/2020 23:20	2,77	1	2,77	CHI
2020037526	GOIANIA	10012752221	CAMPINAS S3	02/03/2020 20:34	02/03/2020 22:18	02/03/2020 20:34	02/03/2020 22:18	1,73	1	1,73	CHI
2020037528	CAIAPONIA	CP12241867	CAIAPONIA	02/03/2020 17:38	02/03/2020 23:47	02/03/2020 17:38	02/03/2020 23:47	6,15	20	122,93	CHI
2020037530	IPORA	IR21097735	IPORA	02/03/2020 09:48	03/03/2020 09:14	02/03/2020 09:48	03/03/2020 09:14	23,43	1	23,43	CHI
2020037532	IPAMERI	IP12275809	IPAMERI	03/03/2020 06:29	03/03/2020 08:48	03/03/2020 06:29	03/03/2020 08:48	2,31	149	343,45	CHI
2020037534	IPAMERI	IP12068500	CRISTALINA S2	02/03/2020 19:37	03/03/2020 00:45	02/03/2020 19:37	03/03/2020 00:45	5,12	61	312,34	CHI
2020037537	NOVO PLANALTO	TA21187832	SAO MIGUEL DO ARAGUAIA	02/03/2020 20:36	04/03/2020 19:15	02/03/2020 20:36	04/03/2020 19:15	46,64	1	46,64	CHI
2020037539	GOIANIA	10011789164	ATLANTICO S1	02/03/2020 20:36	02/03/2020 22:23	02/03/2020 20:36	02/03/2020 22:23	1,77	1	1,77	CHI
2020037543	COCALZINHO DE GOIAS	ZN12261437	AGUAS LINDAS DE GOIAS S2	02/03/2020 17:58	03/03/2020 03:53	02/03/2020 17:58	03/03/2020 03:53	9,91	6	59,46	CHI
2020037543	CORUMBA DE GOIAS	ZN12261437	AGUAS LINDAS DE GOIAS S2	02/03/2020 17:58	03/03/2020 03:53	02/03/2020 17:58	03/03/2020 03:53	9,91	5	49,55	CHI
2020037548	GOIANIA	10596641	AEROPORTO S3	02/03/2020 20:41	03/03/2020 00:40	02/03/2020 20:41	03/03/2020 00:40	3,97	1	3,97	CHI

2020037551	TRINDADE	TR11073625	TRINDADE	02/03/2020 20:34	03/03/2020 00:31	02/03/2020 20:34	03/03/2020 00:31	3,95	174	686,48	CHI
2020037555	RIO VERDE	10005176938	CABRIUVA S1	02/03/2020 20:42	02/03/2020 23:20	02/03/2020 20:42	02/03/2020 23:20	2,63	1	2,63	CHI
2020037566	GOIANIA	GN11002299	GOIANIA LESTE S3	02/03/2020 20:44	03/03/2020 00:14	02/03/2020 20:44	03/03/2020 00:14	3,50	6	20,99	CHI
2020037584	GOIANIA	GN12098425	CEPAIGO S1	02/03/2020 18:41	02/03/2020 22:46	02/03/2020 18:41	02/03/2020 22:46	4,08	111	452,66	CHI
2020037587	ANAPOLIS	AN11003275	JUNDIAI S1	02/03/2020 20:48	02/03/2020 22:05	02/03/2020 20:48	02/03/2020 22:05	1,28	154	196,61	CHI
2020037589	ITUMBIARA	10023113586	ITUMBIARA VELHA S1	02/03/2020 20:53	03/03/2020 00:03	02/03/2020 20:53	03/03/2020 00:03	3,16	1	3,16	CHI
2020037592	MONTES CLAROS DE GOIAS	ME12380990	IPORA	02/03/2020 20:55	03/03/2020 08:35	02/03/2020 20:55	03/03/2020 08:35	11,66	5	58,32	CHI
2020037594	SAO LUIS DE MONTES BELOS	SL12021470	SAO LUIZ DOS MONTES BELOS	02/03/2020 20:56	02/03/2020 21:42	02/03/2020 20:56	02/03/2020 21:42	0,76	36	27,38	CHI
2020037596	AGUAS LINDAS DE GOIAS	10013133894	AGUAS LINDAS DE GOIAS S1	02/03/2020 20:56	02/03/2020 22:27	02/03/2020 20:56	02/03/2020 22:27	1,50	1	1,50	CHI
2020037597	QUIRINOPOLIS	80056696	QUIRINOPOLIS	02/03/2020 20:57	02/03/2020 23:32	02/03/2020 20:57	02/03/2020 23:32	2,58	1	2,58	CHI
2020037603	OUIDOR	OU12250288	CATALAO S1	02/03/2020 21:02	03/03/2020 11:50	02/03/2020 21:02	03/03/2020 11:50	14,80	3	44,39	CHI
2020037604	CAMPESTRE DE GOIAS	GC12037349	TRINDADE	02/03/2020 21:02	03/03/2020 00:49	02/03/2020 21:02	03/03/2020 00:49	3,77	4	15,08	CHI
2020037606	SAO LUIS DE MONTES BELOS	SL11158902	SAO LUIZ DOS MONTES BELOS	02/03/2020 20:13	02/03/2020 21:45	02/03/2020 20:13	02/03/2020 21:45	1,52	167	253,65	CHI
2020037607	CRIXAS	CX21151927	RUBIATABA	02/03/2020 21:03	03/03/2020 15:15	02/03/2020 21:03	03/03/2020 15:15	18,19	2	36,39	CHI
2020037612	MORRINHOS	MR12000166	MORRINHOS	02/03/2020 20:25	02/03/2020 23:01	02/03/2020 20:25	02/03/2020 23:01	2,60	5	13,02	CHI
2020037614	GAMELEIRA DE GOIAS	LB12000008	DAIA S2	02/03/2020 20:49	02/03/2020 23:25	02/03/2020 20:49	02/03/2020 23:25	2,59	15	38,86	CHI
2020037614	LEOPOLDO DE BULHOES	LB12000008	DAIA S2	02/03/2020 20:49	02/03/2020 23:25	02/03/2020 20:49	02/03/2020 23:25	2,59	152	393,76	CHI
2020037614	SILVANIA	LB12000008	DAIA S2	02/03/2020 20:49	02/03/2020 23:25	02/03/2020 20:49	02/03/2020 23:25	2,59	92	238,33	CHI
2020037616	CORUMBAIBA	CI21130857	VILA CORUMBA	02/03/2020 21:10	02/03/2020 23:10	02/03/2020 21:10	02/03/2020 23:10	2,00	1	2,00	CHI
2020037617	APARECIDA DE GOIANIA	AP11038682	INDEPENDENCIA S1	02/03/2020 21:10	02/03/2020 23:16	02/03/2020 21:10	02/03/2020 23:16	2,09	88	184,16	CHI
2020037622	CATALAO	CT11331364	CATALAO S1	02/03/2020 16:59	03/03/2020 00:05	02/03/2020 16:59	03/03/2020 00:05	7,10	94	667,01	CHI
2020037623	DAVINOPOLIS	IO21151432	CATALAO S1	02/03/2020 21:15	02/03/2020 21:24	02/03/2020 21:15	02/03/2020 21:24	0,15	3	0,45	CHI
2020037624	GOIANIA	GN11041888	SENADOR CANEDO	02/03/2020 17:26	03/03/2020 00:09	02/03/2020 17:26	03/03/2020 00:09	6,71	129	866,13	CHI
2020037628	PIRACANJUBA	PJ21076775	BELA VISTA S1	02/03/2020 21:17	03/03/2020 08:01	02/03/2020 21:17	03/03/2020 08:01	10,73	1	10,73	CHI
2020037629	URUTAI	UT21337188	PIRES DO RIO S2	02/03/2020 21:18	03/03/2020 10:02	02/03/2020 21:18	03/03/2020 10:02	12,73	1	12,73	CHI
2020037630	MONTIVIDIU	MV12207099	MONTIVIDIU T	02/03/2020 21:20	03/03/2020 18:10	02/03/2020 21:20	03/03/2020 18:10	20,84	2	41,69	CHI
2020037630	RIO VERDE	MV12207099	MONTIVIDIU T	02/03/2020 21:20	03/03/2020 18:10	02/03/2020 21:20	03/03/2020 18:10	20,84	1	20,84	CHI
2020037636	JUSSARA	JR12090187	JUSSARA	02/03/2020 21:22	03/03/2020 11:15	02/03/2020 21:22	03/03/2020 11:15	13,87	3	41,61	CHI
2020037639	CRISTALINA	KR11376976	CRISTALINA S2	02/03/2020 21:24	03/03/2020 08:25	02/03/2020 21:24	03/03/2020 08:25	11,01	1	11,01	CHI
2020037641	AGUA FRIA DE GOIAS	TL21270371	SAO JOAO D ALIANCA	02/03/2020 21:24	03/03/2020 10:21	02/03/2020 21:24	03/03/2020 10:21	12,95	1	12,95	CHI
2020037647	MONTES CLAROS DE GOIAS	ME12204886	IPORA	02/03/2020 21:26	03/03/2020 00:52	02/03/2020 21:26	03/03/2020 00:52	3,42	75	256,35	CHI
2020037654	SAO MIGUEL DO ARAGUAIA	SM12238713	SAO MIGUEL DO ARAGUAIA	02/03/2020 21:30	03/03/2020 08:26	02/03/2020 21:30	03/03/2020 08:26	10,93	2	21,86	CHI
2020037657	GOIANIA	GN11131188	FERROVIARIO S1	02/03/2020 21:21	02/03/2020 22:52	02/03/2020 21:21	02/03/2020 22:52	1,51	101	152,82	CHI
2020037668	APARECIDA DE GOIANIA	200646930	INDEPENDENCIA S1	02/03/2020 21:33	02/03/2020 23:16	02/03/2020 21:33	02/03/2020 23:16	1,71	1	1,71	CHI
2020037675	CRISTALINA	03470464	CRISTALINA S2	02/03/2020 21:20	03/03/2020 14:39	02/03/2020 21:20	02/03/2020 22:51	1,53	170	260,15	CHI
2020037675	CRISTALINA	03470464	CRISTALINA S2	02/03/2020 21:20	03/03/2020 14:39	02/03/2020 21:20	02/03/2020 22:54	1,57	415	651,78	CHI
2020037675	CRISTALINA	KR10400735	CRISTALINA S2	02/03/2020 21:20	03/03/2020 14:39	02/03/2020 21:20	02/03/2020 22:54	1,57	1	1,57	CHI
2020037675	LUZIANIA	03470464	CRISTALINA S2	02/03/2020 21:20	03/03/2020 14:39	02/03/2020 21:20	02/03/2020 22:54	1,57	250	392,64	CHI
2020037675	LUZIANIA	KR10400735	CRISTALINA S2	02/03/2020 21:20	03/03/2020 14:39	02/03/2020 21:20	02/03/2020 22:54	1,57	202	317,25	CHI
2020037675	CRISTALINA	03470464	CRISTALINA S2	02/03/2020 21:20	03/03/2020 14:39	02/03/2020 23:05	03/03/2020 01:06	2,02	130	262,71	CHI
2020037675	CRISTALINA	KR13408332B	CRISTALINA S2	02/03/2020 21:20	03/03/2020 14:39	02/03/2020 23:05	03/03/2020 01:24	2,32	40	92,99	CHI
2020037675	CRISTALINA	03470464	CRISTALINA S2	02/03/2020 21:20	03/03/2020 14:39	03/03/2020 02:22	03/03/2020 04:35	2,21	93	205,19	CHI
2020037675	CRISTALINA	03470464	CRISTALINA S2	02/03/2020 21:20	03/03/2020 14:39	03/03/2020 06:30	03/03/2020 10:16	3,78	73	275,62	CHI
2020037675	CRISTALINA	03470464	CRISTALINA S2	02/03/2020 21:20	03/03/2020 14:39	03/03/2020 02:22	03/03/2020 13:42	11,33	37	419,26	CHI

2020037675	CRISTALINA	03470464	CRISTALINA S2	02/03/2020 21:20	03/03/2020 14:39	03/03/2020 10:50	03/03/2020 13:42	2,86	73	209,04	CHI
2020037675	CRISTALINA	KR10400735	CRISTALINA S2	02/03/2020 21:20	03/03/2020 14:39	03/03/2020 14:30	03/03/2020 14:39	0,14	438	61,44	CHI
2020037675	CRISTALINA	KR13414277B	CRISTALINA S2	02/03/2020 21:20	03/03/2020 14:39	03/03/2020 14:30	03/03/2020 14:39	0,14	127	17,82	CHI
2020037675	LUZIANIA	KR10400735	CRISTALINA S2	02/03/2020 21:20	03/03/2020 14:39	03/03/2020 14:30	03/03/2020 14:39	0,14	253	35,49	CHI
2020037675	LUZIANIA	KR13414277B	CRISTALINA S2	02/03/2020 21:20	03/03/2020 14:39	03/03/2020 14:30	03/03/2020 14:39	0,14	212	29,74	CHI
2020037689	NEROPOLIS	10000602424	NEROPOLIS S2	02/03/2020 21:45	02/03/2020 23:23	02/03/2020 21:45	02/03/2020 23:23	1,63	1	1,63	CHI
2020037694	APARECIDA DE GOIANIA	AP11063769	REAL S1	02/03/2020 21:42	02/03/2020 22:50	02/03/2020 21:42	02/03/2020 22:50	1,12	142	158,80	CHI
2020037697	ARAGUAPAZ	1780009644	MOZARLANDIA	02/03/2020 21:51	02/03/2020 23:28	02/03/2020 21:51	02/03/2020 23:28	1,60	1	1,60	CHI
2020037712	GOIANIA	AP11169516	INDEPENDENCIA S1	02/03/2020 21:57	02/03/2020 22:54	02/03/2020 22:41	02/03/2020 22:54	0,21	62	13,24	CHI
2020037720	FORMOSA	FA21130095	ITUIQUIRA	02/03/2020 22:03	03/03/2020 13:00	02/03/2020 22:03	03/03/2020 13:00	14,96	2	29,91	CHI
2020037722	GOIATUBA	140110185	GOIATUBA S2	02/03/2020 22:04	02/03/2020 23:22	02/03/2020 22:04	02/03/2020 23:22	1,30	1	1,30	CHI
2020037726	CACHOEIRA DOURADA	CD11273892	CACHOEIRA DOURADA	02/03/2020 22:05	03/03/2020 01:00	02/03/2020 22:05	03/03/2020 01:00	2,92	3	8,75	CHI
2020037728	CATURAI	CK21321438	ARACU	02/03/2020 22:08	03/03/2020 01:00	02/03/2020 22:08	03/03/2020 01:00	2,87	1	2,87	CHI
2020037731	GOIANESIA	GE21210832	GOIANESIA S2	02/03/2020 22:10	03/03/2020 11:27	02/03/2020 22:10	03/03/2020 11:27	13,30	1	13,30	CHI
2020037738	IPORA	IR21354436	ARENOPOLIS	02/03/2020 22:18	03/03/2020 12:27	02/03/2020 22:18	03/03/2020 12:27	14,14	1	14,14	CHI
2020037742	QUIRINOPOLIS	Q111341055	QUIRINOPOLIS	02/03/2020 22:18	03/03/2020 02:30	02/03/2020 22:18	03/03/2020 02:30	4,19	168	703,36	CHI
2020037746	UIRAPURU	UP12243590	NOVA CRIXAS	02/03/2020 17:26	03/03/2020 10:06	02/03/2020 17:26	03/03/2020 10:06	16,65	5	83,26	CHI
2020037749	ANAPOLIS	AN12000026	ANAPOLIS UNIVERSITARIO S2	02/03/2020 22:30	03/03/2020 01:12	02/03/2020 22:30	03/03/2020 01:12	2,70	225	607,13	CHI
2020037752	COCALZINHO DE GOIAS	9970036287	AGUAS LINDAS DE GOIAS S2	02/03/2020 22:34	03/03/2020 11:38	02/03/2020 22:34	03/03/2020 11:38	13,06	1	13,06	CHI
2020037755	GOIANIA	15518620	GOIANIA LESTE S1	02/03/2020 22:38	03/03/2020 00:21	02/03/2020 22:38	03/03/2020 00:21	1,72	1	1,72	CHI
2020037759	CATALAO	CT11131007	CATALAO S2	02/03/2020 22:35	03/03/2020 01:01	02/03/2020 22:35	03/03/2020 01:01	2,43	113	274,43	CHI
2020037761	BELA VISTA DE GOIAS	BV12012781	BELA VISTA S2	02/03/2020 22:46	03/03/2020 04:23	02/03/2020 22:46	03/03/2020 04:23	5,60	85	476,28	CHI
2020037765	GOIANIA	10005090278	CARAJAS S1	02/03/2020 22:51	03/03/2020 00:29	02/03/2020 22:51	03/03/2020 00:29	1,63	1	1,63	CHI
2020037767	BALIZA	BH12369819	BOM JARDIM	02/03/2020 21:39	03/03/2020 08:18	02/03/2020 21:39	03/03/2020 08:18	10,64	1	10,64	CHI
2020037770	CAIAPONIA	CP12395452	PALESTINA	02/03/2020 21:51	03/03/2020 08:49	02/03/2020 21:51	03/03/2020 08:49	10,97	71	778,57	CHI
2020037771	BURITI ALEGRE	420037871	ITUMBIARA VELHA S2	02/03/2020 23:00	03/03/2020 11:00	02/03/2020 23:00	03/03/2020 11:00	11,99	1	11,99	CHI
2020037773	RIO VERDE	RV21237115	CABRIUVA S2	02/03/2020 23:07	03/03/2020 11:15	02/03/2020 23:07	03/03/2020 11:15	12,12	1	12,12	CHI
2020037774	GOIANIA	GN11200265	REAL S1	02/03/2020 23:08	03/03/2020 02:56	02/03/2020 23:08	03/03/2020 02:56	3,80	42	159,40	CHI
2020037782	ANAPOLIS	AN12258395	JUNDIAI S2	02/03/2020 22:52	03/03/2020 00:26	02/03/2020 22:52	03/03/2020 00:26	1,56	13	20,30	CHI
2020037784	ALEXANIA	AX12095958	CORUMBA	02/03/2020 23:20	03/03/2020 08:30	02/03/2020 23:20	03/03/2020 08:30	9,16	6	54,97	CHI
2020037784	CORUMBA DE GOIAS	AX12095958	CORUMBA	02/03/2020 23:20	03/03/2020 08:30	02/03/2020 23:20	03/03/2020 08:30	9,16	3	27,48	CHI
2020037788	IPAMERI	IP12071425	URUTAI	02/03/2020 23:24	03/03/2020 11:47	02/03/2020 23:24	03/03/2020 11:47	12,38	12	148,56	CHI
2020037795	PLANALTINA	PI21243161	PLANALTINA	02/03/2020 23:38	03/03/2020 08:25	02/03/2020 23:38	03/03/2020 08:25	8,77	1	8,77	CHI
2020037797	SANTA HELENA DE GOIAS	10011584252	IPEGUARI	02/03/2020 23:44	03/03/2020 04:00	02/03/2020 23:44	03/03/2020 04:00	4,26	1	4,26	CHI
2020037799	PIRENOPOLIS	220021107	CORUMBA	02/03/2020 23:48	03/03/2020 04:17	02/03/2020 23:48	03/03/2020 04:17	4,47	1	4,47	CHI
2020037801	PADRE BERNARDO	PB12290558	PADRE BERNARDO	02/03/2020 23:56	03/03/2020 01:57	02/03/2020 23:56	03/03/2020 01:57	2,00	13	26,03	CHI
2020037803	AMORINOPOLIS	AM21109012	IPORA	03/03/2020 00:04	03/03/2020 11:40	03/03/2020 00:04	03/03/2020 11:40	11,59	1	11,59	CHI
2020037804	SAO DOMINGOS	SD11151619	SAO DOMINGOS	02/03/2020 23:14	03/03/2020 12:51	02/03/2020 23:14	03/03/2020 12:51	13,61	336	4574,55	CHI
2020037828	TURVANIA	TV12259061	FIRMINOPOLIS S2	03/03/2020 00:35	03/03/2020 09:22	03/03/2020 00:35	03/03/2020 08:06	7,51	3	22,52	CHI
2020037828	TURVANIA	TV12259061	FIRMINOPOLIS S2	03/03/2020 00:35	03/03/2020 09:22	03/03/2020 00:35	03/03/2020 09:22	8,77	6	52,63	CHI
2020037833	RUBIATABA	RB21191311	RUBIATABA	03/03/2020 01:34	03/03/2020 10:16	03/03/2020 01:34	03/03/2020 10:16	8,70	1	8,70	CHI
2020037834	ITAUCU	IX12016021	INHUMAS S1	03/03/2020 01:35	03/03/2020 02:54	03/03/2020 01:35	03/03/2020 02:54	1,31	50	65,68	CHI
2020037834	TAQUARAL DE GOIAS	IX12016021	INHUMAS S1	03/03/2020 01:35	03/03/2020 02:54	03/03/2020 01:35	03/03/2020 02:54	1,31	48	63,05	CHI
2020037840	APARECIDA DE GOIANIA	13554190	INDEPENDENCIA S1	03/03/2020 02:26	03/03/2020 03:56	03/03/2020 02:26	03/03/2020 03:56	1,49	1	1,49	CHI

2020037842	SANTO ANTONIO DO DESCOBERTO	SN21308925	ALEXANIA	02/03/2020 16:04	03/03/2020 11:55	02/03/2020 16:04	03/03/2020 11:55	19,84	2	39,67	CHI
2020037845	GOIAS	GS12217234	MATRINCHA	03/03/2020 03:01	03/03/2020 08:42	03/03/2020 03:01	03/03/2020 08:42	5,67	83	470,54	CHI
2020037845	ITAPIRAPUA	GS12217234	MATRINCHA	03/03/2020 03:01	03/03/2020 08:42	03/03/2020 03:01	03/03/2020 08:42	5,67	1	5,67	CHI
2020037845	NOVO BRASIL	GS12217234	MATRINCHA	03/03/2020 03:01	03/03/2020 08:42	03/03/2020 03:01	03/03/2020 08:42	5,67	36	204,09	CHI
2020037846	CAMPINACU	IH12192447	MINACU	03/03/2020 03:09	03/03/2020 10:04	03/03/2020 03:09	03/03/2020 10:04	6,91	5	34,57	CHI
2020037846	MINACU	IH12192447	MINACU	03/03/2020 03:09	03/03/2020 10:04	03/03/2020 03:09	03/03/2020 10:04	6,91	24	165,93	CHI
2020037853	CACU	CC12075913	CACHOEIRA ALTA	03/03/2020 03:32	03/03/2020 08:36	03/03/2020 03:32	03/03/2020 08:36	5,05	13	65,71	CHI
2020037853	ITARUMA	CC12075913	CACHOEIRA ALTA	03/03/2020 03:32	03/03/2020 08:36	03/03/2020 03:32	03/03/2020 08:36	5,05	32	161,75	CHI
2020037856	ITAPIRAPUA	IU12250535	JUSSARA	03/03/2020 03:36	03/03/2020 07:20	03/03/2020 03:36	03/03/2020 07:20	3,73	16	59,73	CHI
2020037856	JUSSARA	IU12250535	JUSSARA	03/03/2020 03:36	03/03/2020 07:20	03/03/2020 03:36	03/03/2020 07:20	3,73	9	33,60	CHI
2020037859	CALDAZINHA	BV12070808	CEPAIGO S2	03/03/2020 03:51	03/03/2020 10:36	03/03/2020 03:51	03/03/2020 10:36	6,73	11	74,08	CHI
2020037863	PLANALTINA	PI12056840	PLANALTINA	03/03/2020 04:01	03/03/2020 06:08	03/03/2020 04:01	03/03/2020 06:08	2,11	1444	3040,02	CHI
2020037866	ARAGARCAS	BM12204860	BOM JARDIM	03/03/2020 04:10	03/03/2020 13:39	03/03/2020 04:10	03/03/2020 13:39	9,48	1	9,48	CHI
2020037866	BOM JARDIM DE GOIAS	BM12204860	BOM JARDIM	03/03/2020 04:10	03/03/2020 13:39	03/03/2020 04:10	03/03/2020 13:39	9,48	7	66,35	CHI
2020037869	FAINA	FC12378894	MATRINCHA	03/03/2020 04:14	03/03/2020 07:07	03/03/2020 04:14	03/03/2020 07:07	2,87	13	37,36	CHI
2020037869	MATRINCHA	FC12378894	MATRINCHA	03/03/2020 04:14	03/03/2020 07:07	03/03/2020 04:14	03/03/2020 07:07	2,87	7	20,12	CHI
2020037873	SILVANIA	SV12101286	VIANOPOLIS	03/03/2020 04:26	03/03/2020 07:58	03/03/2020 04:26	03/03/2020 07:58	3,52	17	59,84	CHI
2020037876	JUSSARA	JR12009949	JUSSARA	03/03/2020 04:29	03/03/2020 08:28	03/03/2020 04:29	03/03/2020 08:28	3,97	5	19,85	CHI
2020037877	AGUA LIMPA	AL11273798	VILA CORUMBA	02/03/2020 20:57	03/03/2020 09:17	02/03/2020 20:57	03/03/2020 09:17	12,33	23	283,55	CHI
2020037878	LUZIANIA	OZ12186208	PIRES DO RIO S2	03/03/2020 04:30	03/03/2020 10:40	03/03/2020 04:30	03/03/2020 10:40	6,16	32	197,26	CHI
2020037881	NOVA AMERICA	NM12318470	RUBIATABA	03/03/2020 04:35	03/03/2020 11:39	03/03/2020 04:35	03/03/2020 11:39	7,06	16	112,99	CHI
2020037883	PONTALINA	PK12293374	PONTALINA	03/03/2020 04:40	03/03/2020 07:58	03/03/2020 04:40	03/03/2020 07:58	3,29	19	62,60	CHI
2020037886	ITAPIRAPUA	IU12087963	MATRINCHA	03/03/2020 04:44	03/03/2020 08:05	03/03/2020 04:44	03/03/2020 08:05	3,34	43	143,69	CHI
2020037887	JANDAIA	PP12307069	PALMEIRAS	03/03/2020 04:48	03/03/2020 07:35	03/03/2020 04:48	03/03/2020 07:35	2,78	10	27,83	CHI
2020037889	GOIANIA	GN11043954	CAMPINAS S3	03/03/2020 04:57	03/03/2020 10:55	03/03/2020 04:57	03/03/2020 10:55	5,95	94	559,35	CHI
2020037893	ARENOPOLIS	AY12188398	ARENOPOLIS	03/03/2020 05:03	03/03/2020 10:00	03/03/2020 05:03	03/03/2020 10:00	4,94	10	49,38	CHI
2020037893	DIORAMA	AY12188398	ARENOPOLIS	03/03/2020 05:03	03/03/2020 10:00	03/03/2020 05:03	03/03/2020 10:00	4,94	7	34,57	CHI
2020037899	ITABERAI	IB12274270	ITABERAI S1	03/03/2020 03:36	03/03/2020 09:19	03/03/2020 03:36	03/03/2020 09:19	5,70	49	279,45	CHI
2020037905	CHAPADAO DO CEU	DJ10395373	CHAPADAO DO CEU	03/03/2020 03:30	03/03/2020 12:24	03/03/2020 03:30	03/03/2020 12:07	8,60	5	43,02	CHI
2020037905	CHAPADAO DO CEU	DJ12214397	CHAPADAO DO CEU	03/03/2020 03:30	03/03/2020 12:24	03/03/2020 03:30	03/03/2020 12:24	8,89	7	62,23	CHI
2020037905	MINEIROS	DJ12214397	CHAPADAO DO CEU	03/03/2020 03:30	03/03/2020 12:24	03/03/2020 03:30	03/03/2020 12:24	8,89	3	26,67	CHI
2020037911	NOVO GAMA	NJ12261817	MARAJOARA	03/03/2020 06:27	03/03/2020 10:02	03/03/2020 07:59	03/03/2020 10:02	2,04	191	390,54	CHI
2020037914	MONTE ALEGRE DE GOIAS	MA12233174	SAO DOMINGOS	03/03/2020 06:51	03/03/2020 14:01	03/03/2020 10:40	03/03/2020 13:51	3,18	16	50,93	CHI
2020037914	MONTE ALEGRE DE GOIAS	MA11405737	SAO DOMINGOS	03/03/2020 06:51	03/03/2020 14:01	03/03/2020 06:51	03/03/2020 14:01	7,16	1	7,16	CHI
2020037918	CAVALCANTE	CJ12412387	MINACU	03/03/2020 08:14	03/03/2020 15:40	03/03/2020 08:14	03/03/2020 15:40	7,43	14	103,98	CHI
2020037953	SANTA RITA DO NOVO DESTINO	GE12006536	GOIANESIA S1	02/03/2020 19:36	03/03/2020 10:01	02/03/2020 19:36	03/03/2020 10:01	14,42	6	86,52	CHI
2020037995	CAMPESTRE DE GOIAS	GC31053742	GUAPO S1	02/03/2020 17:17	03/03/2020 10:17	02/03/2020 17:17	03/03/2020 10:17	16,99	1	16,99	CHI
2020038005	PONTALINA	PK12074323	VICENTINOPOLIS	03/03/2020 05:18	03/03/2020 08:11	03/03/2020 05:18	03/03/2020 08:11	2,88	6	17,25	CHI
2020038006	HIDROLANDIA	HD21006311	CEPAIGO S2	03/03/2020 05:19	03/03/2020 09:46	03/03/2020 05:19	03/03/2020 09:46	4,43	1	4,43	CHI
2020038007	JUSSARA	RN12250752	BRITANIA	03/03/2020 05:21	03/03/2020 12:00	03/03/2020 05:21	03/03/2020 12:00	6,65	19	126,29	CHI
2020038007	SANTA FE DE GOIAS	RN12250752	BRITANIA	03/03/2020 05:21	03/03/2020 12:00	03/03/2020 05:21	03/03/2020 12:00	6,65	39	259,23	CHI
2020038010	JUSSARA	JR12198907	BRITANIA	03/03/2020 05:26	04/03/2020 08:56	03/03/2020 05:26	03/03/2020 17:13	11,78	7	82,47	CHI
2020038010	JUSSARA	JR12198907	BRITANIA	03/03/2020 05:26	04/03/2020 08:56	03/03/2020 05:26	04/03/2020 08:05	26,65	19	506,29	CHI
2020038010	JUSSARA	JR12198907	BRITANIA	03/03/2020 05:26	04/03/2020 08:56	03/03/2020 05:26	04/03/2020 08:32	27,10	3	81,29	CHI

2020038010	JUSSARA	JR12198907	BRITANIA	03/03/2020 05:26	04/03/2020 08:56	03/03/2020 05:26	04/03/2020 08:56	27,51	7	192,57	CHI
2020038011	RUBIATABA	RB12003316	RUBIATABA	03/03/2020 05:26	03/03/2020 08:46	03/03/2020 05:26	03/03/2020 08:46	3,33	44	146,39	CHI
2020038013	HIDROLANDIA	HD21000252	CEPAIGO S2	03/03/2020 05:27	03/03/2020 09:28	03/03/2020 05:27	03/03/2020 09:28	4,01	1	4,01	CHI
2020038014	BONOPOLIS	BX12202593	SAO MIGUEL DO ARAGUAIA	03/03/2020 05:16	03/03/2020 08:45	03/03/2020 05:16	03/03/2020 08:45	3,48	4	13,91	CHI
2020038015	CORREGO DO OURO	CO12004043	FIRMINOPOLIS S2	03/03/2020 05:29	03/03/2020 08:41	03/03/2020 05:29	03/03/2020 08:41	3,20	11	35,17	CHI
2020038016	BALIZA	BM12156550	BOM JARDIM	03/03/2020 04:40	03/03/2020 07:47	03/03/2020 04:40	03/03/2020 07:47	3,11	1	3,11	CHI
2020038016	BOM JARDIM DE GOIAS	BM12156550	BOM JARDIM	03/03/2020 04:40	03/03/2020 07:47	03/03/2020 04:40	03/03/2020 07:47	3,11	94	292,03	CHI
2020038017	JANDAIA	JD12391440	PALMEIRAS	03/03/2020 05:31	03/03/2020 08:31	03/03/2020 05:31	03/03/2020 08:31	3,00	25	74,93	CHI
2020038020	AGUA FRIA DE GOIAS	TL12279981	SAO JOAO D ALIANCA	03/03/2020 02:03	03/03/2020 10:00	03/03/2020 02:03	03/03/2020 10:00	7,94	41	325,62	CHI
2020038022	CROMINIA	JS12000108RE	ROCHEDO	03/03/2020 05:33	03/03/2020 09:20	03/03/2020 05:33	03/03/2020 09:20	3,77	4	15,08	CHI
2020038022	HIDROLANDIA	JS12000108RE	ROCHEDO	03/03/2020 05:33	03/03/2020 09:20	03/03/2020 05:33	03/03/2020 09:20	3,77	9	33,92	CHI
2020038022	PIRACANJUBA	JS12000108RE	ROCHEDO	03/03/2020 05:33	03/03/2020 09:20	03/03/2020 05:33	03/03/2020 09:20	3,77	281	1059,06	CHI
2020038022	PROFESSOR JAMIL SAFADY	JS12000108RE	ROCHEDO	03/03/2020 05:33	03/03/2020 09:20	03/03/2020 05:33	03/03/2020 09:20	3,77	181	682,17	CHI
2020038026	FORMOSO	TB12372648	PORANGATU	03/03/2020 02:37	03/03/2020 07:21	03/03/2020 02:37	03/03/2020 07:21	4,72	1	4,72	CHI
2020038026	TROMBAS	TB12372648	PORANGATU	03/03/2020 02:37	03/03/2020 07:21	03/03/2020 02:37	03/03/2020 07:21	4,72	66	311,45	CHI
2020038028	INHUMAS	IN12028765	INHUMAS S2	03/03/2020 05:45	03/03/2020 08:10	03/03/2020 05:45	03/03/2020 08:10	2,41	2	4,82	CHI
2020038028	ITAUCU	IN12028765	INHUMAS S2	03/03/2020 05:45	03/03/2020 08:10	03/03/2020 05:45	03/03/2020 08:10	2,41	34	81,96	CHI
2020038028	SANTA ROSA DE GOIAS	IN12028765	INHUMAS S2	03/03/2020 05:45	03/03/2020 08:10	03/03/2020 05:45	03/03/2020 08:10	2,41	10	24,11	CHI
2020038033	ESTRELA DO NORTE	MU12076698	MARA ROSA	03/03/2020 04:24	03/03/2020 07:11	03/03/2020 04:24	03/03/2020 07:11	2,77	1	2,77	CHI
2020038033	MUTUNOPOLIS	MU12076698	MARA ROSA	03/03/2020 04:24	03/03/2020 07:11	03/03/2020 04:24	03/03/2020 07:11	2,77	31	85,88	CHI
2020038035	GOIAS	GK12220543	ITAPURANGA	03/03/2020 03:41	03/03/2020 09:57	03/03/2020 03:41	03/03/2020 09:57	6,27	11	68,93	CHI
2020038035	GUARAITA	GK12220543	ITAPURANGA	03/03/2020 03:41	03/03/2020 09:57	03/03/2020 03:41	03/03/2020 09:57	6,27	22	137,86	CHI
2020038036	FORMOSA	FA21257561	ITUIQUIRA	03/03/2020 05:55	03/03/2020 12:37	03/03/2020 05:55	03/03/2020 12:37	6,69	1	6,69	CHI
2020038037	BURITI DE GOIAS	BS21079943	FIRMINOPOLIS S2	03/03/2020 05:55	03/03/2020 10:23	03/03/2020 05:55	03/03/2020 10:23	4,46	1	4,46	CHI
2020038044	JATAI	JT12034816	JATAI S3	03/03/2020 05:59	03/03/2020 07:41	03/03/2020 05:59	03/03/2020 07:41	1,69	3	5,08	CHI
2020038049	BELA VISTA DE GOIAS	BV31097921	BELA VISTA S2	03/03/2020 06:01	03/03/2020 17:04	03/03/2020 06:01	03/03/2020 17:04	11,04	1	11,04	CHI
2020038051	ACREUNA	EU12037883	ACREUNA	03/03/2020 06:02	03/03/2020 07:04	03/03/2020 06:02	03/03/2020 07:04	1,03	6	6,16	CHI
2020038052	PIRENOPOLIS	PV12381257	CORUMBA	03/03/2020 06:02	03/03/2020 08:07	03/03/2020 06:02	03/03/2020 08:07	2,07	124	257,20	CHI
2020038055	MINEIROS	PW12303388	PARQUE DAS EMAS	03/03/2020 06:03	03/03/2020 16:25	03/03/2020 06:03	03/03/2020 16:25	10,36	4	41,42	CHI
2020038055	PORTELANDIA	PW12303388	PARQUE DAS EMAS	03/03/2020 06:03	03/03/2020 16:25	03/03/2020 06:03	03/03/2020 16:25	10,36	4	41,42	CHI
2020038056	BELA VISTA DE GOIAS	05240214	CRISTIANOPOLIS	03/03/2020 06:03	03/03/2020 08:34	03/03/2020 06:03	03/03/2020 08:34	2,50	85	212,59	CHI
2020038056	CRISTIANOPOLIS	05240214	CRISTIANOPOLIS	03/03/2020 06:03	03/03/2020 08:34	03/03/2020 06:03	03/03/2020 08:34	2,50	22	55,02	CHI
2020038056	SAO MIGUEL DO PASSA QUATRO	05240214	CRISTIANOPOLIS	03/03/2020 06:03	03/03/2020 08:34	03/03/2020 06:03	03/03/2020 08:34	2,50	279	697,81	CHI
2020038056	VIANOPOLIS	05240214	CRISTIANOPOLIS	03/03/2020 06:03	03/03/2020 08:34	03/03/2020 06:03	03/03/2020 08:34	2,50	3	7,50	CHI
2020038057	RUBIATABA	RB12114265	RUBIATABA	03/03/2020 00:32	03/03/2020 21:30	03/03/2020 00:32	03/03/2020 19:30	18,96	22	417,12	CHI
2020038057	RUBIATABA	RB12114265	RUBIATABA	03/03/2020 00:32	03/03/2020 21:30	03/03/2020 00:32	03/03/2020 20:20	19,80	30	593,99	CHI
2020038057	CRIXAS	NM12187169LD	RUBIATABA	03/03/2020 00:32	03/03/2020 21:30	03/03/2020 00:32	03/03/2020 21:30	20,96	1	20,96	CHI
2020038057	NOVA AMERICA	NM12187169LD	RUBIATABA	03/03/2020 00:32	03/03/2020 21:30	03/03/2020 00:32	03/03/2020 21:30	20,96	18	377,28	CHI
2020038057	RUBIATABA	NM12187169LD	RUBIATABA	03/03/2020 00:32	03/03/2020 21:30	03/03/2020 00:32	03/03/2020 21:30	20,96	30	628,80	CHI
2020038062	RIO QUENTE	RQ12100101RE	RIO QUENTE	03/03/2020 05:40	03/03/2020 10:42	03/03/2020 05:40	03/03/2020 10:42	5,04	42	211,47	CHI
2020038064	GOIANIA	10027623805	CEPAIGO S1	03/03/2020 06:08	03/03/2020 12:43	03/03/2020 06:08	03/03/2020 12:43	6,57	1	6,57	CHI
2020038065	LUZIANIA	LZ11041513	RIO VERMELHO	03/03/2020 04:56	03/03/2020 10:36	03/03/2020 04:56	03/03/2020 10:36	5,66	165	934,36	CHI
2020038066	BURITI ALEGRE	BG12000126	ITUMBIARA VELHA S2	03/03/2020 06:09	03/03/2020 09:21	03/03/2020 06:09	03/03/2020 09:21	3,20	6	19,19	CHI
2020038070	GOUVELANDIA	GB12394808	QUIRINOPOLIS	03/03/2020 06:10	03/03/2020 08:03	03/03/2020 06:10	03/03/2020 08:03	1,87	2	3,74	CHI

2020038070	QUIRINOPOLIS	GB12394808	QUIRINOPOLIS	03/03/2020 06:10	03/03/2020 08:03	03/03/2020 06:10	03/03/2020 08:03	1,87	77	143,86	CHI
2020038074	CAMPOS BELOS	CH12243118	SAO DOMINGOS	03/03/2020 06:12	03/03/2020 10:05	03/03/2020 06:12	03/03/2020 10:05	3,87	6	23,25	CHI
2020038074	MONTE ALEGRE DE GOIAS	CH12243118	SAO DOMINGOS	03/03/2020 06:12	03/03/2020 10:05	03/03/2020 06:12	03/03/2020 10:05	3,87	3	11,62	CHI
2020038078	MORRINHOS	MR21064833	GOIATUBA S1	03/03/2020 06:13	03/03/2020 08:25	03/03/2020 06:13	03/03/2020 08:25	2,19	1	2,19	CHI
2020038083	INDIARA	PL12376414	PALMEIRAS	03/03/2020 06:15	03/03/2020 08:14	03/03/2020 06:15	03/03/2020 08:14	1,97	3	5,91	CHI
2020038083	PALMEIRAS DE GOIAS	PL12376414	PALMEIRAS	03/03/2020 06:15	03/03/2020 08:14	03/03/2020 06:15	03/03/2020 08:14	1,97	50	98,43	CHI
2020038084	ITAPIRAPUA	IU12206870	MATRINCHA	03/03/2020 06:16	03/03/2020 06:50	03/03/2020 06:16	03/03/2020 06:50	0,56	8	4,52	CHI
2020038089	GOIANIRA	GR31019801	NEROPOLIS S1	03/03/2020 06:18	03/03/2020 11:19	03/03/2020 06:18	03/03/2020 11:19	5,01	1	5,01	CHI
2020038092	ITAPACI	IW12044978	ITAPACI	03/03/2020 06:19	03/03/2020 09:49	03/03/2020 06:19	03/03/2020 09:49	3,49	6	20,91	CHI
2020038093	MINEIROS	MY12149300	PARQUE DAS EMAS	03/03/2020 03:27	03/03/2020 10:14	03/03/2020 03:27	03/03/2020 10:14	6,78	88	596,71	CHI
2020038094	CAIAPONIA	CP12342210	CAIAPONIA	03/03/2020 06:21	03/03/2020 08:45	03/03/2020 06:21	03/03/2020 08:45	2,40	47	112,81	CHI
2020038095	JATAI	JT12260431	JATAI S1	03/03/2020 06:21	03/03/2020 08:52	03/03/2020 06:21	03/03/2020 08:52	2,51	23	57,82	CHI
2020038095	SERRANOPOLIS	JT12260431	JATAI S1	03/03/2020 06:21	03/03/2020 08:52	03/03/2020 06:21	03/03/2020 08:52	2,51	19	47,76	CHI
2020038097	BRITANIA	BT12250825	BRITANIA	02/03/2020 20:19	03/03/2020 09:00	02/03/2020 20:19	03/03/2020 09:00	12,69	4	50,74	CHI
2020038100	ACREUNA	EU12044258	ACREUNA	03/03/2020 05:44	03/03/2020 08:29	03/03/2020 05:44	03/03/2020 08:29	2,74	33	90,34	CHI
2020038100	JANDAIA	EU12044258	ACREUNA	03/03/2020 05:44	03/03/2020 08:29	03/03/2020 05:44	03/03/2020 08:29	2,74	7	19,16	CHI
2020038100	PARAUNA	EU12044258	ACREUNA	03/03/2020 05:44	03/03/2020 08:29	03/03/2020 05:44	03/03/2020 08:29	2,74	39	106,76	CHI
2020038102	MOSSAMEDES	MD10395291	FIRMINOPOLIS S2	03/03/2020 05:16	03/03/2020 07:45	03/03/2020 05:16	03/03/2020 07:45	2,48	59	146,21	CHI
2020038108	ITABERAI	IB21310639	ITABERAI S2	03/03/2020 06:27	03/03/2020 07:39	03/03/2020 06:27	03/03/2020 07:39	1,19	1	1,19	CHI
2020038112	BELA VISTA DE GOIAS	BV32060162	BELA VISTA S1	03/03/2020 06:28	03/03/2020 09:49	03/03/2020 06:28	03/03/2020 09:49	3,35	3	10,04	CHI
2020038114	BONOPOLIS	BX12316276	SAO MIGUEL DO ARAGUAIA	03/03/2020 06:28	03/03/2020 11:47	03/03/2020 06:28	03/03/2020 11:47	5,31	4	21,23	CHI
2020038122	MINACU	IH12339952	MINACU	03/03/2020 06:31	03/03/2020 14:11	03/03/2020 06:31	03/03/2020 14:11	7,66	16	122,63	CHI
2020038137	ITAPIRAPUA	IU12018750	MATRINCHA	03/03/2020 06:36	04/03/2020 09:48	03/03/2020 06:36	04/03/2020 09:48	27,20	3	81,60	CHI
2020038140	PONTALINA	PK12080063	PONTALINA	03/03/2020 06:36	03/03/2020 08:47	03/03/2020 06:36	03/03/2020 08:47	2,17	38	82,40	CHI
2020038141	JANDAIA	JD12055081	PALMEIRAS	03/03/2020 06:36	03/03/2020 08:49	03/03/2020 06:36	03/03/2020 08:49	2,20	12	26,46	CHI
2020038150	CACU	CC21321077	CACHOEIRA ALTA	03/03/2020 06:38	03/03/2020 09:24	03/03/2020 06:38	03/03/2020 09:24	2,76	1	2,76	CHI
2020038153	GOIANIA	GN11329140	GOIANIA LESTE S1	03/03/2020 06:39	03/03/2020 08:49	03/03/2020 06:39	03/03/2020 08:49	2,16	33	71,35	CHI
2020038155	UIRAPURU	UP12190132	NOVA CRIXAS	03/03/2020 06:40	03/03/2020 13:58	03/03/2020 06:40	03/03/2020 13:58	7,30	1	7,30	CHI
2020038156	BURITINOPOLIS	3610002930	IACIARA S2	03/03/2020 06:39	03/03/2020 11:46	03/03/2020 06:39	03/03/2020 11:46	5,11	1	5,11	CHI
2020038157	BRAZABRANTES	DL12012174	INHUMAS S1	03/03/2020 06:40	03/03/2020 08:43	03/03/2020 06:40	03/03/2020 08:43	2,04	2	4,08	CHI
2020038157	DAMOLANDIA	DL12012174	INHUMAS S1	03/03/2020 06:40	03/03/2020 08:43	03/03/2020 06:40	03/03/2020 08:43	2,04	32	65,26	CHI
2020038157	INHUMAS	DL12012174	INHUMAS S1	03/03/2020 06:40	03/03/2020 08:43	03/03/2020 06:40	03/03/2020 08:43	2,04	20	40,79	CHI
2020038158	GOIANDIRA	10006515949	CATALAO S1	03/03/2020 06:40	03/03/2020 09:10	03/03/2020 06:40	03/03/2020 09:10	2,50	1	2,50	CHI
2020038161	POSSE	PS12180838RE	IACIARA S2	03/03/2020 06:38	03/03/2020 08:31	03/03/2020 06:38	03/03/2020 08:31	1,88	72	135,24	CHI
2020038165	PORANGATU	PO12104347	PORANGATU	03/03/2020 06:42	03/03/2020 08:55	03/03/2020 06:42	03/03/2020 08:55	2,21	8	17,71	CHI
2020038166	ITAGUARI	IC12219937	ITABERAI S1	03/03/2020 05:58	03/03/2020 08:16	03/03/2020 05:58	03/03/2020 08:16	2,30	25	57,40	CHI
2020038166	ITAGUARU	IC12219937	ITABERAI S1	03/03/2020 05:58	03/03/2020 08:16	03/03/2020 05:58	03/03/2020 08:16	2,30	2	4,59	CHI
2020038167	ARAGARCAS	AG12341726	IPORA	03/03/2020 06:42	03/03/2020 15:33	03/03/2020 06:42	03/03/2020 15:33	8,83	28	247,36	CHI
2020038170	FORMOSO	FO12328885	PORANGATU	03/03/2020 06:43	03/03/2020 08:24	03/03/2020 06:43	03/03/2020 08:24	1,67	4	6,69	CHI
2020038170	SANTA TEREZA DE GOIAS	FO12328885	PORANGATU	03/03/2020 06:43	03/03/2020 08:24	03/03/2020 06:43	03/03/2020 08:24	1,67	12	20,06	CHI
2020038172	JARAGUA	JA21029526	JARAGUA	03/03/2020 06:43	03/03/2020 07:59	03/03/2020 06:43	03/03/2020 07:59	1,26	3	3,77	CHI
2020038173	FORMOSA	FA12000175	ITUIQUIRA	03/03/2020 06:44	03/03/2020 09:57	03/03/2020 06:44	03/03/2020 09:57	3,21	27	86,66	CHI
2020038179	URUACU	UR12066508	URUACU	03/03/2020 04:44	03/03/2020 09:18	03/03/2020 04:44	03/03/2020 09:18	4,56	13	59,29	CHI
2020038180	PARAUNA	PU21312314	MONTIVIDIU T	03/03/2020 06:45	03/03/2020 12:17	03/03/2020 06:45	03/03/2020 12:17	5,53	1	5,53	CHI

2020038188	GOIANDIRA	GD12216033	CATALAO S1	03/03/2020 06:41	03/03/2020 08:15	03/03/2020 06:41	03/03/2020 08:15	1,55	52	80,80	CHI
2020038190	SAO LUIS DE MONTES BELOS	SL11006854	SAO LUIZ DOS MONTES BELOS	03/03/2020 06:49	03/03/2020 11:13	03/03/2020 06:49	03/03/2020 11:13	4,40	221	971,79	CHI
2020038192	IACIARA	IA12218688	IACIARA S2	03/03/2020 06:50	03/03/2020 11:24	03/03/2020 06:50	03/03/2020 11:24	4,56	3	13,69	CHI
2020038195	PADRE BERNARDO	PB12290529	PADRE BERNARDO	03/03/2020 06:51	03/03/2020 11:47	03/03/2020 06:51	03/03/2020 11:47	4,93	16	78,92	CHI
2020038197	MONTE ALEGRE DE GOIAS	MA12211597	SAO DOMINGOS	03/03/2020 06:51	03/03/2020 21:10	03/03/2020 06:51	03/03/2020 14:58	8,13	2	16,25	CHI
2020038197	MONTE ALEGRE DE GOIAS	MA12211597	SAO DOMINGOS	03/03/2020 06:51	03/03/2020 21:10	03/03/2020 06:51	03/03/2020 16:40	9,82	4	39,30	CHI
2020038197	MONTE ALEGRE DE GOIAS	MA12211597	SAO DOMINGOS	03/03/2020 06:51	03/03/2020 21:10	03/03/2020 06:51	03/03/2020 17:07	10,27	2	20,53	CHI
2020038197	MONTE ALEGRE DE GOIAS	MA12211597	SAO DOMINGOS	03/03/2020 06:51	03/03/2020 21:10	03/03/2020 06:51	03/03/2020 21:10	14,31	1	14,31	CHI
2020038198	LEOPOLDO DE BULHOES	LB12100600	DAIA S2	03/03/2020 06:51	03/03/2020 09:02	03/03/2020 06:51	03/03/2020 09:02	2,18	49	106,62	CHI
2020038199	CAMPINACU	IH12132432	MINACU	03/03/2020 05:59	03/03/2020 08:48	03/03/2020 05:59	03/03/2020 08:48	2,82	22	61,95	CHI
2020038199	MINACU	IH12132432	MINACU	03/03/2020 05:59	03/03/2020 08:48	03/03/2020 05:59	03/03/2020 08:48	2,82	109	306,96	CHI
2020038200	CALDAS NOVAS	CN12034796	CALDAS NOVAS S2	03/03/2020 06:51	03/03/2020 08:28	03/03/2020 06:51	03/03/2020 08:28	1,60	12	19,22	CHI
2020038201	CRISTALINA	KR12133610	CRISTALINA S2	03/03/2020 06:52	03/03/2020 13:35	03/03/2020 06:52	03/03/2020 13:35	6,71	12	80,56	CHI
2020038208	CRIXAS	CX12318400	MOZARLANDIA	03/03/2020 06:53	03/03/2020 12:54	03/03/2020 06:53	03/03/2020 12:54	6,01	11	66,15	CHI
2020038209	EDEIA	EA12394173	EDEIA	03/03/2020 06:53	03/03/2020 09:15	03/03/2020 06:53	03/03/2020 09:15	2,36	6	14,16	CHI
2020038213	GOIAS	GS12076721	GOIAS	03/03/2020 06:54	03/03/2020 10:51	03/03/2020 06:54	03/03/2020 10:51	3,94	23	90,68	CHI
2020038215	ALEXANIA	AX21144103	ALEXANIA	03/03/2020 06:54	03/03/2020 10:29	03/03/2020 06:54	03/03/2020 10:29	3,57	1	3,57	CHI
2020038217	ANAPOLIS	AN11130801	JUNDIAI S2	03/03/2020 06:55	03/03/2020 07:50	03/03/2020 06:55	03/03/2020 07:50	0,91	123	111,66	CHI
2020038218	GOIAS	GS12058298	MATRINCHA	03/03/2020 05:11	03/03/2020 11:35	03/03/2020 05:11	03/03/2020 11:35	6,39	26	166,22	CHI
2020038222	ANAPOLIS	20559100	JUNDIAI S1	03/03/2020 06:57	03/03/2020 08:57	03/03/2020 06:57	03/03/2020 08:57	2,00	1	2,00	CHI
2020038224	BONOPOLIS	BX12246493	SAO MIGUEL DO ARAGUAIA	03/03/2020 06:47	03/03/2020 11:52	03/03/2020 06:47	03/03/2020 11:52	5,08	4	20,33	CHI
2020038225	PALMEIRAS DE GOIAS	PL12034684	PALMEIRAS	03/03/2020 06:57	03/03/2020 09:15	03/03/2020 06:57	03/03/2020 09:15	2,29	13	29,77	CHI
2020038226	PIRACANJUBA	PJ21142477	ROCHEDO	03/03/2020 06:57	03/03/2020 08:17	03/03/2020 06:57	03/03/2020 08:17	1,32	1	1,32	CHI
2020038230	CORUMBAIBA	CI12039772	VILA CORUMBA	03/03/2020 06:59	03/03/2020 09:34	03/03/2020 06:59	03/03/2020 09:34	2,58	7	18,06	CHI
2020038231	CEZARINA	CZ12064280	CEZARINA	03/03/2020 06:59	03/03/2020 10:46	03/03/2020 06:59	03/03/2020 10:46	3,79	47	178,01	CHI
2020038231	INDIARA	CZ12064280	CEZARINA	03/03/2020 06:59	03/03/2020 10:46	03/03/2020 06:59	03/03/2020 10:46	3,79	15	56,81	CHI
2020038233	ARENOPOLIS	AY12243745	ARENOPOLIS	03/03/2020 07:00	03/03/2020 13:15	03/03/2020 07:00	03/03/2020 13:15	6,24	2	12,49	CHI
2020038235	ORIZONA	OZ21185980	PIRES DO RIO S2	03/03/2020 07:00	03/03/2020 12:10	03/03/2020 07:00	03/03/2020 12:10	5,15	1	5,15	CHI
2020038240	PIRENOPOLIS	JA12080571	JARAGUA	03/03/2020 06:44	03/03/2020 13:44	03/03/2020 06:44	03/03/2020 13:44	6,99	13	90,93	CHI
2020038243	PORANGATU	PO12391670	PORANGATU	03/03/2020 07:03	03/03/2020 11:42	03/03/2020 07:03	03/03/2020 11:42	4,64	5	23,22	CHI
2020038244	ITUMBIARA	BJ21068948	BOM JESUS DE GOIAS	03/03/2020 07:03	03/03/2020 08:30	03/03/2020 07:03	03/03/2020 08:30	1,45	1	1,45	CHI
2020038245	GOIANIA	GN21385654	FERROVIARIO S1	03/03/2020 07:03	03/03/2020 10:33	03/03/2020 09:38	03/03/2020 10:33	0,92	1	0,92	CHI
2020038247	FORMOSA	FA12085742	ITUIQUIRA	03/03/2020 07:04	03/03/2020 14:11	03/03/2020 07:04	03/03/2020 14:11	7,12	3	21,35	CHI
2020038248	MOZARLANDIA	MZ12057146	MOZARLANDIA	03/03/2020 07:04	03/03/2020 09:03	03/03/2020 07:04	03/03/2020 09:03	1,98	6	11,86	CHI
2020038248	NOVA CRIXAS	MZ12057146	MOZARLANDIA	03/03/2020 07:04	03/03/2020 09:03	03/03/2020 07:04	03/03/2020 09:03	1,98	25	49,41	CHI
2020038249	POSSE	SA12211553	IACIARA S2	03/03/2020 07:04	03/03/2020 08:40	03/03/2020 07:04	03/03/2020 08:40	1,58	2	3,17	CHI
2020038249	SIMOLANDIA	SA12211553	IACIARA S2	03/03/2020 07:04	03/03/2020 08:40	03/03/2020 07:04	03/03/2020 08:40	1,58	12	19,02	CHI
2020038252	FORMOSO	FO21291207	PORANGATU	03/03/2020 07:05	03/03/2020 10:17	03/03/2020 07:05	03/03/2020 10:17	3,19	0	0,00	CHI
2020038254	IPORA	IR12222975	IPORA	03/03/2020 05:07	03/03/2020 09:45	03/03/2020 05:07	03/03/2020 09:45	4,62	68	314,42	CHI
2020038254	IVOLANDIA	IR12222975	IPORA	03/03/2020 05:07	03/03/2020 09:45	03/03/2020 05:07	03/03/2020 09:45	4,62	6	27,74	CHI
2020038254	MOIPORA	IR12222975	IPORA	03/03/2020 05:07	03/03/2020 09:45	03/03/2020 05:07	03/03/2020 09:45	4,62	20	92,48	CHI
2020038255	PORANGATU	PO12141124	NOVO PLANALTO	03/03/2020 06:04	03/03/2020 14:45	03/03/2020 06:04	03/03/2020 14:45	8,67	20	173,48	CHI
2020038256	NIQUELANDIA	NQ12171108	BARRO ALTO	03/03/2020 07:05	03/03/2020 09:40	03/03/2020 07:05	03/03/2020 09:40	2,58	8	20,63	CHI
2020038260	JOVIANIA	JV12028556	GOIATUBA S1	03/03/2020 07:07	03/03/2020 08:04	03/03/2020 07:07	03/03/2020 08:04	0,94	2	1,89	CHI

2020038261	ITAPACI	IW12379430	ITAPACI	03/03/2020 07:07	03/03/2020 18:39	03/03/2020 07:07	03/03/2020 18:39	11,52	2	23,04	CHI
2020038263	ANICUNS	2320001226	FIRMINOPOLIS S2	03/03/2020 07:07	03/03/2020 17:44	03/03/2020 07:07	03/03/2020 17:44	10,60	1	10,60	CHI
2020038265	PORANGATU	PO12104342	PORANGATU	03/03/2020 06:52	03/03/2020 14:06	03/03/2020 06:52	03/03/2020 14:06	7,22	2	14,43	CHI
2020038268	AGUA FRIA DE GOIAS	TL12204677	SAO JOAO D ALIANCA	03/03/2020 07:09	03/03/2020 11:16	03/03/2020 07:09	03/03/2020 11:16	4,10	5	20,52	CHI
2020038270	CRISTALINA	IP21168495	CRISTALINA S2	03/03/2020 07:11	03/03/2020 14:14	03/03/2020 07:11	03/03/2020 14:14	7,04	1	7,04	CHI
2020038272	PADRE BERNARDO	PB12249535	PADRE BERNARDO	02/03/2020 20:43	03/03/2020 12:25	02/03/2020 20:43	03/03/2020 12:25	15,69	14	219,61	CHI
2020038275	GOIAS	GS12068546	MATRINCHA	03/03/2020 07:12	03/03/2020 14:00	03/03/2020 07:12	03/03/2020 14:00	6,80	16	108,76	CHI
2020038278	CRISTALINA	KR21133600	PAMPLONA	03/03/2020 07:12	03/03/2020 11:50	03/03/2020 07:12	03/03/2020 11:50	4,64	3	13,91	CHI
2020038279	GOIAS	GS12336438	GOIAS	03/03/2020 06:38	03/03/2020 08:52	03/03/2020 06:38	03/03/2020 08:52	2,22	36	80,00	CHI
2020038281	QUIRINOPOLIS	80112778	QUIRINOPOLIS	03/03/2020 07:13	03/03/2020 08:37	03/03/2020 07:13	03/03/2020 08:37	1,40	1	1,40	CHI
2020038282	SANTO ANTONIO DO DESCOBERTO	SN21087350	MARAJOARA	03/03/2020 07:13	03/03/2020 13:38	03/03/2020 07:13	03/03/2020 13:38	6,41	4	25,63	CHI
2020038291	COCALZINHO DE GOIAS	ZN12330505	AGUAS LINDAS DE GOIAS S2	03/03/2020 06:44	03/03/2020 10:22	03/03/2020 06:44	03/03/2020 10:22	3,62	28	101,42	CHI
2020038291	PADRE BERNARDO	ZN12330505	AGUAS LINDAS DE GOIAS S2	03/03/2020 06:44	03/03/2020 10:22	03/03/2020 06:44	03/03/2020 10:22	3,62	4	14,49	CHI
2020038292	MAIRIPOTABA	MI12000426	PONTALINA	03/03/2020 07:15	03/03/2020 08:46	03/03/2020 07:15	03/03/2020 08:46	1,51	9	13,63	CHI
2020038293	APARECIDA DE GOIANIA	AP11137770	INDEPENDENCIA S2	03/03/2020 07:16	03/03/2020 12:55	03/03/2020 08:06	03/03/2020 12:55	4,81	29	139,55	CHI
2020038294	ALTO HORIZONTE	AJ12321035	SANTA TEREZINHA	03/03/2020 07:16	03/03/2020 09:49	03/03/2020 07:16	03/03/2020 09:49	2,54	15	38,16	CHI
2020038295	ITABERAI	10013686990	ITABERAI S2	03/03/2020 07:16	03/03/2020 08:50	03/03/2020 07:16	03/03/2020 08:50	1,57	1	1,57	CHI
2020038296	CORUMBA DE GOIAS	CB11351483	CORUMBA	03/03/2020 07:16	03/03/2020 08:19	03/03/2020 07:16	03/03/2020 08:19	1,04	47	49,00	CHI
2020038303	CRISTALINA	KR12025856	PAMPLONA	03/03/2020 07:18	03/03/2020 15:52	03/03/2020 07:18	03/03/2020 15:52	8,56	7	59,91	CHI
2020038309	CACHOEIRA DOURADA	CD11273796	CACHOEIRA DOURADA	03/03/2020 07:19	03/03/2020 10:28	03/03/2020 07:19	03/03/2020 10:28	3,14	170	534,04	CHI
2020038314	GOIANIA	16729833	MEIA PONTE	03/03/2020 07:20	03/03/2020 10:19	03/03/2020 07:20	03/03/2020 10:19	2,98	1	2,98	CHI
2020038320	GOIAS	10022383580	GOIAS	03/03/2020 07:21	03/03/2020 10:03	03/03/2020 07:21	03/03/2020 10:03	2,69	1	2,69	CHI
2020038325	CRIXAS	20010112	SERRA DO OURO	03/03/2020 07:22	03/03/2020 16:44	03/03/2020 07:22	03/03/2020 16:44	9,36	5	46,78	CHI
2020038328	SAO LUIZ DO NORTE	3090004523	BARRO ALTO	03/03/2020 07:24	03/03/2020 15:30	03/03/2020 07:24	03/03/2020 15:30	8,09	1	8,09	CHI
2020038331	CAMPESTRE DE GOIAS	GC12048402	TRINDADE	03/03/2020 06:35	03/03/2020 08:43	03/03/2020 06:35	03/03/2020 08:43	2,12	13	27,60	CHI
2020038331	TRINDADE	GC12048402	TRINDADE	03/03/2020 06:35	03/03/2020 08:43	03/03/2020 06:35	03/03/2020 08:43	2,12	5	10,61	CHI
2020038332	PARAUNA	980016976	PARAUNA	03/03/2020 07:25	03/03/2020 15:15	03/03/2020 07:25	03/03/2020 15:15	7,83	1	7,83	CHI
2020038333	SAO JOAO DA PARAUNA	FR12040685	FIRMINOPOLIS S2	03/03/2020 07:25	03/03/2020 10:52	03/03/2020 07:25	03/03/2020 10:52	3,44	6	20,65	CHI
2020038334	CORUMBA DE GOIAS	CB21062142	CORUMBA	03/03/2020 07:25	03/03/2020 09:05	03/03/2020 07:25	03/03/2020 09:05	1,66	1	1,66	CHI
2020038335	PIRES DO RIO	PR12337227	PIRES DO RIO S1	03/03/2020 07:25	03/03/2020 09:54	03/03/2020 07:25	03/03/2020 09:54	2,47	40	98,99	CHI
2020038335	SANTA CRUZ DE GOIAS	PR12337227	PIRES DO RIO S1	03/03/2020 07:25	03/03/2020 09:54	03/03/2020 07:25	03/03/2020 09:54	2,47	1	2,47	CHI
2020038335	URUTAI	PR12337227	PIRES DO RIO S1	03/03/2020 07:25	03/03/2020 09:54	03/03/2020 07:25	03/03/2020 09:54	2,47	1	2,47	CHI
2020038336	EDEIA	10001177581	EDEIA	03/03/2020 07:26	03/03/2020 11:35	03/03/2020 07:26	03/03/2020 11:35	4,14	1	4,14	CHI
2020038343	INDIARA	PL12158923	EDEIA	03/03/2020 07:28	03/03/2020 09:21	03/03/2020 07:28	03/03/2020 09:21	1,88	1	1,88	CHI
2020038343	PALMEIRAS DE GOIAS	PL12158923	EDEIA	03/03/2020 07:28	03/03/2020 09:21	03/03/2020 07:28	03/03/2020 09:21	1,88	3	5,63	CHI
2020038344	ITAPACI	IW21094098	ITAPACI	03/03/2020 07:28	03/03/2020 08:10	03/03/2020 07:28	03/03/2020 08:10	0,69	2	1,38	CHI
2020038345	PALMEIRAS DE GOIAS	PL12000070	PALMEIRAS	03/03/2020 07:28	03/03/2020 09:55	03/03/2020 07:28	03/03/2020 09:55	2,44	19	46,32	CHI
2020038347	PORANGATU	PO12282160	PORANGATU	03/03/2020 06:52	03/03/2020 08:39	03/03/2020 06:52	03/03/2020 08:39	1,77	11	19,44	CHI
2020038348	SAO MIGUEL DO ARAGUAIA	SM12137060	SAO MIGUEL DO ARAGUAIA	03/03/2020 07:29	04/03/2020 09:19	03/03/2020 07:29	04/03/2020 09:19	25,83	2	51,65	CHI
2020038352	MONTE ALEGRE DE GOIAS	MA12233169	SAO DOMINGOS	03/03/2020 07:30	03/03/2020 16:18	03/03/2020 07:30	03/03/2020 16:18	8,79	18	158,16	CHI
2020038353	LUZIANIA	LZ21264828	VIANOPOLIS	03/03/2020 07:30	03/03/2020 11:16	03/03/2020 07:30	03/03/2020 11:16	3,75	4	15,01	CHI
2020038354	PIRACANJUBA	PJ12072600	PIRACANJUBA	03/03/2020 07:30	03/03/2020 09:50	03/03/2020 07:30	03/03/2020 09:50	2,32	4	9,27	CHI
2020038355	COLINAS DO SUL	TI21309771	NIQUELANDIA SUBTRANSMISSAO	03/03/2020 07:31	04/03/2020 09:58	03/03/2020 07:31	04/03/2020 09:58	26,45	1	26,45	CHI
2020038358	JARAGUA	JA12283464	JARAGUA	03/03/2020 08:20	03/03/2020 10:49	03/03/2020 08:20	03/03/2020 10:49	2,47	13	32,10	CHI

2020038362	LUZIANIA	LZ12313611	VIANOPOLIS	03/03/2020 07:10	03/03/2020 10:08	03/03/2020 07:10	03/03/2020 10:08	2,96	13	38,44	CHI
2020038364	SANTA TEREZA DE GOIAS	SE21152485	MARA ROSA	03/03/2020 07:31	03/03/2020 10:55	03/03/2020 07:31	03/03/2020 10:55	3,39	1	3,39	CHI
2020038371	CRIXAS	CX12321941	SERRA DO OURO	03/03/2020 07:32	03/03/2020 14:35	03/03/2020 07:32	03/03/2020 14:35	7,04	18	126,64	CHI
2020038371	NOVA CRIXAS	CX12321941	SERRA DO OURO	03/03/2020 07:32	03/03/2020 14:35	03/03/2020 07:32	03/03/2020 14:35	7,04	5	35,18	CHI
2020038377	CRIXAS	CX21320874	SERRA DO OURO	03/03/2020 07:34	03/03/2020 18:22	03/03/2020 07:34	03/03/2020 18:22	10,79	1	10,79	CHI
2020038379	DOVERLANDIA	DV12144429	CAIAPONIA	03/03/2020 07:34	03/03/2020 08:58	03/03/2020 07:34	03/03/2020 08:58	1,38	1	1,38	CHI
2020038382	CAIAPONIA	CP12269004	CAIAPONIA	03/03/2020 07:34	03/03/2020 11:52	03/03/2020 07:34	03/03/2020 11:52	4,28	4	17,13	CHI
2020038383	SERRANOPOLIS	DJ21164263	CHAPADAO DO CEU	03/03/2020 07:35	03/03/2020 10:01	03/03/2020 07:35	03/03/2020 10:01	2,43	1	2,43	CHI
2020038384	JANDAIA	JD12233369	PALMEIRAS	03/03/2020 07:35	03/03/2020 10:00	03/03/2020 07:35	03/03/2020 10:00	2,42	5	12,08	CHI
2020038386	ANAPOLIS	AN12189910	ANAPOLIS UNIVERSITARIO S2	03/03/2020 07:35	03/03/2020 10:31	03/03/2020 07:35	03/03/2020 10:31	2,93	241	705,39	CHI
2020038388	RIO VERDE	RV12260699	CABRIUVA S1	03/03/2020 07:36	03/03/2020 15:24	03/03/2020 07:36	03/03/2020 15:24	7,81	19	148,30	CHI
2020038394	PALMEIRAS DE GOIAS	PL12169788	PALMEIRAS	03/03/2020 07:36	03/03/2020 13:29	03/03/2020 07:36	03/03/2020 13:29	5,88	9	52,89	CHI
2020038400	IVOLANDIA	IV12015643	IPORA	03/03/2020 07:37	03/03/2020 11:29	03/03/2020 07:37	03/03/2020 11:29	3,86	65	250,86	CHI
2020038404	PADRE BERNARDO	PB12163217	PADRE BERNARDO	03/03/2020 06:35	03/03/2020 10:32	03/03/2020 06:35	03/03/2020 10:32	3,94	113	444,72	CHI
2020038406	CORUMBA DE GOIAS	CB12065715	CORUMBA	03/03/2020 06:12	03/03/2020 09:36	03/03/2020 06:12	03/03/2020 09:36	3,40	32	108,74	CHI
2020038411	GOIANESIA	GE21285433	GOIANESIA S2	03/03/2020 07:39	03/03/2020 09:53	03/03/2020 07:39	03/03/2020 09:53	2,23	2	4,47	CHI
2020038412	NIQUELANDIA	NQ12398048	URUACU	03/03/2020 06:51	03/03/2020 11:40	03/03/2020 06:51	03/03/2020 11:40	4,81	103	495,80	CHI
2020038417	VILA PROPICIO	9290001555	GOIANESIA S1	03/03/2020 07:40	03/03/2020 11:55	03/03/2020 07:40	03/03/2020 11:55	4,24	1	4,24	CHI
2020038418	GOIAS	GS12220300LD	GOIAS	03/03/2020 07:40	03/03/2020 10:57	03/03/2020 07:40	03/03/2020 10:57	3,28	7	22,93	CHI
2020038425	PARAUNA	PU12301185LD	ACREUNA	03/03/2020 07:20	03/03/2020 11:05	03/03/2020 07:20	03/03/2020 11:05	3,74	68	254,26	CHI
2020038427	COCALZINHO DE GOIAS	ZN12302401	COCALZINHO	03/03/2020 06:47	03/03/2020 11:14	03/03/2020 06:47	03/03/2020 11:14	4,44	4	17,77	CHI
2020038427	CORUMBA DE GOIAS	ZN12302401	COCALZINHO	03/03/2020 06:47	03/03/2020 11:14	03/03/2020 06:47	03/03/2020 11:14	4,44	22	97,73	CHI
2020038428	MORRINHOS	MR12269745	MORRINHOS	03/03/2020 07:41	03/03/2020 08:29	03/03/2020 07:41	03/03/2020 08:29	0,79	11	8,70	CHI
2020038429	FLORES DE GOIAS	FB21218594	FLORES DE GOIAS	03/03/2020 07:41	03/03/2020 10:05	03/03/2020 07:41	03/03/2020 10:05	2,39	1	2,39	CHI
2020038431	IVOLANDIA	IV12108126	IPORA	03/03/2020 05:26	03/03/2020 15:14	03/03/2020 05:26	03/03/2020 15:14	9,79	16	156,65	CHI
2020038431	PALESTINA DE GOIAS	IV12108126	IPORA	03/03/2020 05:26	03/03/2020 15:14	03/03/2020 05:26	03/03/2020 15:14	9,79	33	323,10	CHI
2020038433	FAZENDA NOVA	NB12117290	JUSSARA	03/03/2020 07:43	03/03/2020 10:29	03/03/2020 07:43	03/03/2020 10:29	2,76	4	11,03	CHI
2020038433	NOVO BRASIL	NB12117290	JUSSARA	03/03/2020 07:43	03/03/2020 10:29	03/03/2020 07:43	03/03/2020 10:29	2,76	5	13,78	CHI
2020038435	SAO FRANCISCO DE GOIAS	SF21040439	SAO FRANCISCO DE GOIAS	03/03/2020 07:43	03/03/2020 10:46	03/03/2020 07:43	03/03/2020 10:46	3,04	1	3,04	CHI
2020038443	CACU	CC21226518	CACHOEIRA ALTA	03/03/2020 07:44	03/03/2020 12:05	03/03/2020 07:44	03/03/2020 12:05	4,34	1	4,34	CHI
2020038444	SAO LUIS DE MONTES BELOS	SL31100369	SAO LUIZ DOS MONTES BELOS	03/03/2020 07:44	03/03/2020 09:27	03/03/2020 07:44	03/03/2020 09:27	1,70	1	1,70	CHI
2020038446	GOIATUBA	GT12000178	BOM JESUS DE GOIAS	03/03/2020 07:45	03/03/2020 10:47	03/03/2020 07:45	03/03/2020 10:47	3,03	29	87,88	CHI
2020038447	RUBIATABA	RB12292125	RUBIATABA	03/03/2020 07:45	04/03/2020 10:33	03/03/2020 07:45	04/03/2020 10:33	26,79	3	80,37	CHI
2020038448	MATRINCHA	MP21165369	MATRINCHA	03/03/2020 07:45	03/03/2020 14:20	03/03/2020 07:45	03/03/2020 14:20	6,57	1	6,57	CHI
2020038449	MIMOSO DE GOIAS	NQ12213063	BARRO ALTO	03/03/2020 06:32	03/03/2020 11:15	03/03/2020 06:32	03/03/2020 11:15	4,73	9	42,54	CHI
2020038449	NIQUELANDIA	NQ12213063	BARRO ALTO	03/03/2020 06:32	03/03/2020 11:15	03/03/2020 06:32	03/03/2020 11:15	4,73	1	4,73	CHI
2020038449	VILA PROPICIO	NQ12213063	BARRO ALTO	03/03/2020 06:32	03/03/2020 11:15	03/03/2020 06:32	03/03/2020 11:15	4,73	12	56,71	CHI
2020038452	MORRO AGUDO DE GOIAS	MS12088842	ITAPURANGA	03/03/2020 07:46	03/03/2020 10:47	03/03/2020 07:46	03/03/2020 10:47	3,00	4	12,01	CHI
2020038463	ABADIA DE GOIAS	5580012991	INDEPENDENCIA S2	03/03/2020 07:50	03/03/2020 09:57	03/03/2020 07:50	03/03/2020 09:57	2,11	1	2,11	CHI
2020038466	ALEXANIA	SN12389385	MARAJOARA	02/03/2020 19:49	03/03/2020 11:33	02/03/2020 19:49	03/03/2020 11:33	15,72	3	47,16	CHI
2020038466	DISTRITO FEDERAL	SN12389385	MARAJOARA	02/03/2020 19:49	03/03/2020 11:33	02/03/2020 19:49	03/03/2020 11:33	15,72	3	47,16	CHI
2020038466	SANTO ANTONIO DO DESCOBERTO	SN12389385	MARAJOARA	02/03/2020 19:49	03/03/2020 11:33	02/03/2020 19:49	03/03/2020 11:33	15,72	79	1241,86	CHI
2020038467	ARAGUAPAZ	1780016120	MOZARLANDIA	03/03/2020 07:50	03/03/2020 11:40	03/03/2020 07:50	03/03/2020 11:40	3,83	1	3,83	CHI
2020038469	CRISTALINA	KR21163630	PAMPLONA	03/03/2020 07:51	03/03/2020 14:14	03/03/2020 07:51	03/03/2020 14:14	6,39	1	6,39	CHI

2020038472	RIO VERDE	RV21322316	CABRIUVA S2	03/03/2020 07:51	03/03/2020 11:15	03/03/2020 07:51	03/03/2020 11:15	3,39	1	3,39	CHI
2020038474	SANTA BARBARA DE GOIAS	TR12048114	TRINDADE	03/03/2020 07:52	04/03/2020 00:34	03/03/2020 07:52	04/03/2020 00:34	16,70	117	1953,70	CHI
2020038474	TRINDADE	TR12048114	TRINDADE	03/03/2020 07:52	04/03/2020 00:34	03/03/2020 07:52	04/03/2020 00:34	16,70	11	183,68	CHI
2020038474	SANTA BARBARA DE GOIAS	TR12048114	TRINDADE	03/03/2020 07:52	04/03/2020 00:34	03/03/2020 11:13	04/03/2020 00:34	13,35	3	40,05	CHI
2020038474	TRINDADE	TR12048114	TRINDADE	03/03/2020 07:52	04/03/2020 00:34	03/03/2020 11:13	04/03/2020 00:34	13,35	6	80,10	CHI
2020038478	AGUA FRIA DE GOIAS	TL12365112	SAO JOAO D ALIANCA	03/03/2020 07:52	03/03/2020 14:48	03/03/2020 07:52	03/03/2020 14:48	6,92	39	269,89	CHI
2020038480	MUTUNOPOLIS	MU11268755	MARA ROSA	03/03/2020 07:53	03/03/2020 16:09	03/03/2020 07:53	03/03/2020 16:09	8,26	1	8,26	CHI
2020038481	MUTUNOPOLIS	MU11057915	MARA ROSA	03/03/2020 07:53	03/03/2020 11:25	03/03/2020 10:00	03/03/2020 11:25	1,42	79	111,92	CHI
2020038482	IPAMERI	10020438212	CRISTALINA S2	03/03/2020 07:53	03/03/2020 17:52	03/03/2020 07:53	03/03/2020 17:52	9,98	1	9,98	CHI
2020038483	PANAMA	PX21134536	ITUMBIARA NOVA	03/03/2020 07:54	03/03/2020 11:35	03/03/2020 07:54	03/03/2020 11:35	3,68	2	7,37	CHI
2020038486	SAO MIGUEL DO ARAGUAIA	SM12017268	SAO MIGUEL DO ARAGUAIA	03/03/2020 07:00	03/03/2020 10:58	03/03/2020 07:00	03/03/2020 10:58	3,95	9	35,57	CHI
2020038488	CAMPO LIMPO	AN21258616	NEROPOLIS S1	03/03/2020 07:54	03/03/2020 12:26	03/03/2020 07:54	03/03/2020 12:26	4,52	1	4,52	CHI
2020038496	PONTALINA	PK12335172	PONTALINA	03/03/2020 07:56	04/03/2020 16:36	03/03/2020 07:56	04/03/2020 16:36	32,66	3	97,97	CHI
2020038498	LUZIANIA	LZ12118949	MARAJOARA	03/03/2020 07:57	03/03/2020 12:33	03/03/2020 07:57	03/03/2020 12:33	4,60	11	50,55	CHI
2020038500	SERRANOPOLIS	SX12226484	JATAI S1	03/03/2020 07:22	03/03/2020 09:30	03/03/2020 07:22	03/03/2020 09:30	2,13	14	29,86	CHI
2020038505	NOVA IGUAQU DE GOIAS	MQ21026542	CAMPINORTE	03/03/2020 07:57	03/03/2020 15:49	03/03/2020 07:57	03/03/2020 15:49	7,85	1	7,85	CHI
2020038507	MOSSAMEDES	MD21343844	FIRMINOPOLIS S2	03/03/2020 07:58	03/03/2020 09:01	03/03/2020 07:58	03/03/2020 09:01	1,04	1	1,04	CHI
2020038510	RIO VERDE	RV12076338	RIO VERDE S1	03/03/2020 07:59	03/03/2020 11:44	03/03/2020 07:59	03/03/2020 11:44	3,74	8	29,90	CHI
2020038515	ITAPACI	IW12081353	ITAPACI	03/03/2020 08:00	03/03/2020 17:35	03/03/2020 08:00	03/03/2020 17:35	9,58	23	220,31	CHI
2020038516	COCALZINHO DE GOIAS	ZN12320107	AGUAS LINDAS DE GOIAS S1	02/03/2020 21:26	03/03/2020 10:40	02/03/2020 21:26	03/03/2020 10:40	13,23	12	158,78	CHI
2020038517	SENADOR CANEDO	GN21001409	GOIANIA LESTE S2	03/03/2020 08:01	03/03/2020 10:21	03/03/2020 08:01	03/03/2020 10:21	2,32	2	4,65	CHI
2020038520	MUTUNOPOLIS	MU12357192	MARA ROSA	03/03/2020 08:01	03/03/2020 11:41	03/03/2020 08:01	03/03/2020 11:41	3,65	2	7,31	CHI
2020038524	IPAMERI	IP21275735	IPAMERI	03/03/2020 08:01	03/03/2020 08:37	03/03/2020 08:01	03/03/2020 08:37	0,59	1	0,59	CHI
2020038525	SANTO ANTONIO DO DESCOBERTO	SN12314001	MARAJOARA	03/03/2020 06:27	03/03/2020 09:03	03/03/2020 06:27	03/03/2020 09:03	2,59	135	349,42	CHI
2020038528	PLANALTINA	PI21088240	PLANALTINA	03/03/2020 08:02	03/03/2020 11:03	03/03/2020 08:02	03/03/2020 11:03	3,01	1	3,01	CHI
2020038532	ACREUNA	EU12090359	ACREUNA	03/03/2020 08:03	03/03/2020 08:46	03/03/2020 08:03	03/03/2020 08:46	0,71	2	1,43	CHI
2020038533	ARENOPOLIS	AY12000048	ARENOPOLIS	03/03/2020 07:52	03/03/2020 09:19	03/03/2020 07:52	03/03/2020 09:19	1,45	12	17,37	CHI
2020038533	DIORAMA	AY12000048	ARENOPOLIS	03/03/2020 07:52	03/03/2020 09:19	03/03/2020 07:52	03/03/2020 09:19	1,45	12	17,37	CHI
2020038538	GOIANIA	16201772	GOYA S2	03/03/2020 08:03	03/03/2020 09:47	03/03/2020 08:03	03/03/2020 09:47	1,72	1	1,72	CHI
2020038539	PLANALTINA	PI12400941	PLANALTINA	03/03/2020 08:03	03/03/2020 09:22	03/03/2020 08:03	03/03/2020 09:22	1,30	6	7,81	CHI
2020038542	ORIZONA	OZ12115280	VIANOPOLIS	03/03/2020 08:04	03/03/2020 22:46	03/03/2020 08:04	03/03/2020 22:46	14,69	7	102,85	CHI
2020038543	SERRANOPOLIS	SX12260467	JATAI S1	03/03/2020 07:39	03/03/2020 11:49	03/03/2020 07:39	03/03/2020 11:49	4,16	7	29,14	CHI
2020038548	CATALAO	CT12333401	CATALAO S1	03/03/2020 08:06	03/03/2020 09:27	03/03/2020 08:06	03/03/2020 09:27	1,36	7	9,51	CHI
2020038550	MINACU	IH12240767	MINACU	03/03/2020 08:07	03/03/2020 13:41	03/03/2020 08:07	03/03/2020 13:41	5,57	20	111,33	CHI
2020038552	ITAPIRAPUA	IU21089778	MATRINCHA	03/03/2020 08:07	03/03/2020 13:20	03/03/2020 08:07	03/03/2020 13:20	5,21	1	5,21	CHI
2020038556	GOIANESIA	GE12382313	GOIANESIA S2	03/03/2020 08:03	03/03/2020 10:20	03/03/2020 08:03	03/03/2020 10:20	2,29	18	41,22	CHI
2020038557	MINACU	4020018821	MINACU	03/03/2020 08:07	03/03/2020 11:47	03/03/2020 08:07	03/03/2020 11:47	3,66	1	3,66	CHI
2020038567	PORANGATU	PO12049340	PORANGATU	03/03/2020 06:16	03/03/2020 09:31	03/03/2020 06:16	03/03/2020 09:31	3,24	7	22,65	CHI
2020038574	INHUMAS	IN21063061	INHUMAS S1	03/03/2020 08:10	03/03/2020 11:21	03/03/2020 08:10	03/03/2020 11:21	3,17	1	3,17	CHI
2020038577	SANTO ANTONIO DA BARRA	6621339	ACREUNA	03/03/2020 08:11	03/03/2020 11:30	03/03/2020 08:11	03/03/2020 11:30	3,30	4	13,21	CHI
2020038579	RIO VERDE	630190800	RIO VERDE S1	03/03/2020 08:11	04/03/2020 09:59	03/03/2020 08:11	04/03/2020 09:59	25,78	1	25,78	CHI
2020038580	LUZIANIA	LZ21084513	CRISTALINA S2	03/03/2020 08:12	03/03/2020 10:47	03/03/2020 08:12	03/03/2020 10:47	2,59	1	2,59	CHI
2020038592	COCALZINHO DE GOIAS	CB12090420	COCALZINHO	03/03/2020 08:13	03/03/2020 13:35	03/03/2020 08:13	03/03/2020 13:35	5,36	13	69,71	CHI
2020038595	BURITI ALEGRE	BG12222285	ALTO BURITI	03/03/2020 08:13	03/03/2020 10:35	03/03/2020 08:13	03/03/2020 10:35	2,35	2	4,71	CHI

2020038596	GOIANIA	14317175	CAMPINAS S2	03/03/2020 08:13	03/03/2020 10:09	03/03/2020 08:13	03/03/2020 10:09	1,92	1	1,92	CHI
2020038597	GAMELEIRA DE GOIAS	SV12116679	DAIA S2	03/03/2020 08:14	03/03/2020 12:21	03/03/2020 08:14	03/03/2020 12:21	4,11	15	61,69	CHI
2020038597	SILVANIA	SV12116679	DAIA S2	03/03/2020 08:14	03/03/2020 12:21	03/03/2020 08:14	03/03/2020 12:21	4,11	6	24,67	CHI
2020038601	SANTO ANTONIO DO DESCOBERTO	SN12313461	MARAJOARA	03/03/2020 08:14	03/03/2020 13:13	03/03/2020 08:14	03/03/2020 13:13	4,97	7	34,80	CHI
2020038603	SAO MIGUEL DO ARAGUAIA	SM12059987	SAO MIGUEL DO ARAGUAIA	03/03/2020 08:14	04/03/2020 08:08	03/03/2020 08:14	04/03/2020 08:08	23,88	4	95,54	CHI
2020038604	PADRE BERNARDO	PB12163218	PADRE BERNARDO	03/03/2020 08:15	04/03/2020 00:03	03/03/2020 08:15	04/03/2020 00:03	15,80	1	15,80	CHI
2020038607	SANTA TEREZA DE GOIAS	SE21051940	MARA ROSA	03/03/2020 08:15	03/03/2020 10:24	03/03/2020 08:15	03/03/2020 10:24	2,14	1	2,14	CHI
2020038611	CORUMBAIBA	CI21307791	VILA CORUMBA	03/03/2020 08:16	03/03/2020 23:40	03/03/2020 08:16	03/03/2020 23:40	15,40	1	15,40	CHI
2020038618	VILA PROPICIO	NP12169962	GOIANESIA S1	03/03/2020 08:18	03/03/2020 10:23	03/03/2020 08:18	03/03/2020 10:23	2,08	1	2,08	CHI
2020038619	GOIANESIA	BA12036611	GOIANESIA S1	03/03/2020 07:57	03/03/2020 11:38	03/03/2020 07:57	03/03/2020 11:38	3,69	7	25,83	CHI
2020038627	CRISTALINA	KR12200024	CRISTALINA S2	03/03/2020 08:19	03/03/2020 17:02	03/03/2020 08:19	03/03/2020 17:02	8,71	1	8,71	CHI
2020038628	CABECEIRAS	FA13154418	ITUIQUIRA	03/03/2020 08:18	03/03/2020 19:49	03/03/2020 08:18	03/03/2020 19:49	11,51	7	80,55	CHI
2020038633	ARAGUAPAZ	AZ12404563	GOIAS	03/03/2020 08:20	03/03/2020 11:00	03/03/2020 08:20	03/03/2020 11:00	2,66	20	53,10	CHI
2020038633	FAINA	AZ12404563	GOIAS	03/03/2020 08:20	03/03/2020 11:00	03/03/2020 08:20	03/03/2020 11:00	2,66	1	2,66	CHI
2020038636	NOVO PLANALTO	TA21170089	SAO MIGUEL DO ARAGUAIA	03/03/2020 08:21	03/03/2020 12:19	03/03/2020 08:21	03/03/2020 12:19	3,96	1	3,96	CHI
2020038637	SAO FRANCISCO DE GOIAS	SF21000093	SAO FRANCISCO DE GOIAS	03/03/2020 08:21	03/03/2020 09:52	03/03/2020 08:21	03/03/2020 09:52	1,51	2	3,01	CHI
2020038638	NOVA ROMA	ND12392238	IACIARA S2	03/03/2020 06:21	03/03/2020 09:48	03/03/2020 06:21	03/03/2020 09:48	3,45	232	799,50	CHI
2020038639	MONTIVIDIU	MV21260840	MONTIVIDIU T	03/03/2020 08:21	03/03/2020 10:32	03/03/2020 08:21	03/03/2020 10:32	2,17	1	2,17	CHI
2020038641	NOVA ROMA	6250151	IACIARA S2	03/03/2020 08:21	03/03/2020 12:36	03/03/2020 08:21	03/03/2020 12:36	4,24	5	21,18	CHI
2020038650	ITAPIRAPUA	IU12121382	MATRINCHA	03/03/2020 08:24	03/03/2020 09:15	03/03/2020 08:24	03/03/2020 09:15	0,84	14	11,76	CHI
2020038652	CACHOEIRA DOURADA	CD21304168	CACHOEIRA DOURADA	03/03/2020 08:24	03/03/2020 10:40	03/03/2020 08:24	03/03/2020 10:40	2,26	1	2,26	CHI
2020038657	QUIRINOPOLIS	QI21022114	QUIRINOPOLIS	03/03/2020 08:25	03/03/2020 09:06	03/03/2020 08:25	03/03/2020 09:06	0,68	1	0,68	CHI
2020038661	MINEIROS	JT21260428	PARQUE DAS EMAS	03/03/2020 08:25	03/03/2020 10:28	03/03/2020 08:25	03/03/2020 10:28	2,04	1	2,04	CHI
2020038664	JANDAIA	JD12308473	PALMEIRAS	03/03/2020 08:25	03/03/2020 10:33	03/03/2020 08:25	03/03/2020 10:33	2,12	7	14,84	CHI
2020038671	AGUAS LINDAS DE GOIAS	LA12245671	AGUAS LINDAS DE GOIAS S1	03/03/2020 08:26	03/03/2020 11:44	03/03/2020 08:26	03/03/2020 11:44	3,31	6	19,83	CHI
2020038672	MIMOSO DE GOIAS	MJ12376709	PADRE BERNARDO	03/03/2020 07:18	03/03/2020 15:07	03/03/2020 07:18	03/03/2020 15:07	7,81	3	23,43	CHI
2020038675	GOIANIA	14786667	MEIA PONTE	03/03/2020 08:26	03/03/2020 10:03	03/03/2020 08:26	03/03/2020 10:03	1,60	1	1,60	CHI
2020038676	SILVANIA	20685722	ANAPOLIS UNIVERSITARIO S2	03/03/2020 08:27	03/03/2020 21:07	03/03/2020 08:27	03/03/2020 21:07	12,66	17	215,25	CHI
2020038679	ITAPIRAPUA	IU12020184	JUSSARA	03/03/2020 08:27	03/03/2020 11:09	03/03/2020 08:27	03/03/2020 11:09	2,69	6	16,13	CHI
2020038690	MINEIROS	MY21324439	PARQUE DAS EMAS	03/03/2020 08:29	03/03/2020 13:48	03/03/2020 08:29	03/03/2020 13:48	5,31	1	5,31	CHI
2020038692	COCALZINHO DE GOIAS	ZN12353427	COCALZINHO	03/03/2020 08:29	03/03/2020 21:48	03/03/2020 08:29	03/03/2020 21:48	13,31	6	79,83	CHI
2020038695	DAVINOPOLIS	CT12266103	CATALAO S1	03/03/2020 07:40	03/03/2020 11:35	03/03/2020 07:40	03/03/2020 11:35	3,90	44	171,66	CHI
2020038695	OUVIDOR	CT12266103	CATALAO S1	03/03/2020 07:40	03/03/2020 11:35	03/03/2020 07:40	03/03/2020 11:35	3,90	5	19,51	CHI
2020038699	TRINDADE	40074067	TRINDADE	03/03/2020 08:30	03/03/2020 10:08	03/03/2020 08:30	03/03/2020 10:08	1,62	1	1,62	CHI
2020038701	CORUMBAIBA	CI12081002	VILA CORUMBA	03/03/2020 08:31	04/03/2020 10:54	03/03/2020 08:31	04/03/2020 10:54	26,37	5	131,85	CHI
2020038710	JARAGUA	480033912	ALEXANIA	03/03/2020 08:33	04/03/2020 04:41	03/03/2020 08:33	04/03/2020 04:41	20,13	1	20,13	CHI
2020038712	SANTA ISABEL	GE12000139	GOIANESIA S1	03/03/2020 06:33	03/03/2020 13:59	03/03/2020 06:33	03/03/2020 13:59	7,43	14	104,00	CHI
2020038714	CRISTALINA	KR12287399	CRISTALINA S1	03/03/2020 08:33	03/03/2020 18:43	03/03/2020 08:33	03/03/2020 18:43	10,16	10	101,64	CHI
2020038715	POSSE	PS12212366	IACIARA S1	03/03/2020 08:34	03/03/2020 11:00	03/03/2020 08:34	03/03/2020 11:00	2,43	38	92,47	CHI
2020038718	CAIAPONIA	CP12252503	CAIAPONIA	03/03/2020 08:34	03/03/2020 12:15	03/03/2020 08:34	03/03/2020 12:15	3,67	6	22,01	CHI
2020038725	UIRAPURU	UP12328026	NOVA CRIXAS	03/03/2020 08:35	03/03/2020 14:44	03/03/2020 08:35	03/03/2020 14:44	6,14	40	245,46	CHI
2020038727	LUZIANIA	LZ21065580	CRISTALINA S2	03/03/2020 08:36	03/03/2020 12:45	03/03/2020 08:36	03/03/2020 12:45	4,15	1	4,15	CHI
2020038730	MAMBAI	4580000019	IACIARA S2	03/03/2020 08:36	03/03/2020 09:57	03/03/2020 08:36	03/03/2020 09:57	1,34	1	1,34	CHI
2020038731	CORUMBAIBA	CI21298711	VILA CORUMBA	03/03/2020 08:36	03/03/2020 12:27	03/03/2020 08:36	03/03/2020 12:27	3,84	1	3,84	CHI

2020038733	VILA BOA	VB11270057	ITUIQUIRA	03/03/2020 08:36	03/03/2020 14:52	03/03/2020 08:36	03/03/2020 14:52	6,25	5	31,27	CHI
2020038741	GOIAS	GS12140275	MATRINCHA	03/03/2020 08:29	03/03/2020 10:40	03/03/2020 08:29	03/03/2020 10:40	2,19	13	28,52	CHI
2020038742	MORRINHOS	MR21249758	MORRINHOS	03/03/2020 08:39	03/03/2020 11:08	03/03/2020 08:39	03/03/2020 11:08	2,48	1	2,48	CHI
2020038747	PETROLINA DE GOIAS	PG12015850	PETROLINA	03/03/2020 08:40	03/03/2020 10:49	03/03/2020 08:40	03/03/2020 10:49	2,14	66	141,20	CHI
2020038749	SANTA RITA DO NOVO DESTINO	DF21326044	GOIANESIA S1	03/03/2020 08:41	03/03/2020 14:20	03/03/2020 08:41	03/03/2020 14:20	5,66	1	5,66	CHI
2020038750	SAO MIGUEL DO PASSA QUATRO	1490013900	CRISTIANOPOLIS	03/03/2020 08:41	03/03/2020 11:09	03/03/2020 08:41	03/03/2020 11:09	2,46	1	2,46	CHI
2020038752	MONTIVIDIU DO NORTE	MX12391928	PORANGATU	03/03/2020 08:29	03/03/2020 11:34	03/03/2020 08:29	03/03/2020 11:34	3,07	19	58,36	CHI
2020038753	CACU	CC12204140	CACHOEIRA ALTA	03/03/2020 07:43	03/03/2020 11:43	03/03/2020 07:43	03/03/2020 11:43	3,99	8	31,94	CHI
2020038757	APARECIDA DE GOIANIA	12954743	INDEPENDENCIA S2	03/03/2020 08:42	03/03/2020 11:01	03/03/2020 08:42	03/03/2020 11:01	2,30	1	2,30	CHI
2020038761	SANTA TEREZINHA DE GOIAS	SG12291239	SANTA TEREZINHA	03/03/2020 07:18	03/03/2020 19:19	03/03/2020 07:18	03/03/2020 19:19	12,01	33	396,43	CHI
2020038763	ACREUNA	EU12301058	ACREUNA	03/03/2020 08:43	03/03/2020 10:35	03/03/2020 08:43	03/03/2020 10:35	1,85	2	3,70	CHI
2020038771	CAMPOS BELOS	CH21078787	SAO DOMINGOS	03/03/2020 08:45	03/03/2020 11:15	03/03/2020 08:45	03/03/2020 11:15	2,49	2	4,97	CHI
2020038772	GOIANIA	10808190	GOIANIA LESTE S1	03/03/2020 08:45	03/03/2020 14:18	03/03/2020 08:45	03/03/2020 14:18	5,54	1	5,54	CHI
2020038778	SANTA TEREZINHA DE GOIAS	2480030666	SANTA TEREZINHA	03/03/2020 08:47	04/03/2020 01:53	03/03/2020 08:47	04/03/2020 01:53	17,10	1	17,10	CHI
2020038783	ORIZONA	OZ12186216	PIRES DO RIO S2	03/03/2020 08:14	03/03/2020 12:08	03/03/2020 08:14	03/03/2020 12:08	3,89	10	38,93	CHI
2020038786	GOIANESIA	550155508	GOIANESIA S2	03/03/2020 08:48	03/03/2020 11:12	03/03/2020 08:48	03/03/2020 11:12	2,40	1	2,40	CHI
2020038788	CRIXAS	CX12166640	SANTA TEREZINHA	03/03/2020 08:49	03/03/2020 20:54	03/03/2020 08:49	03/03/2020 20:54	12,08	26	313,98	CHI
2020038790	BURITINOPOLIS	MB11190559	IACIARA S2	03/03/2020 08:49	03/03/2020 12:52	03/03/2020 08:49	03/03/2020 12:52	4,04	2	8,08	CHI
2020038793	RUBIATABA	780010243	RUBIATABA	03/03/2020 08:50	03/03/2020 15:03	03/03/2020 08:50	03/03/2020 15:03	6,21	1	6,21	CHI
2020038794	NOVA ROMA	FB12314707	FLORES DE GOIAS	03/03/2020 08:48	03/03/2020 17:35	03/03/2020 08:48	03/03/2020 17:35	8,78	2	17,55	CHI
2020038794	SAO JOAO D ALIANCA	FB12314707	FLORES DE GOIAS	03/03/2020 08:48	03/03/2020 17:35	03/03/2020 08:48	03/03/2020 17:35	8,78	45	394,93	CHI
2020038803	CRIXAS	CX12064145	SANTA TEREZINHA	03/03/2020 08:52	03/03/2020 11:47	03/03/2020 08:52	03/03/2020 11:47	2,91	25	72,85	CHI
2020038803	UIRAPURU	CX12064145	SANTA TEREZINHA	03/03/2020 08:52	03/03/2020 11:47	03/03/2020 08:52	03/03/2020 11:47	2,91	7	20,40	CHI
2020038808	BELA VISTA DE GOIAS	BV12199077	BELA VISTA S2	03/03/2020 08:52	03/03/2020 11:25	03/03/2020 08:52	03/03/2020 11:25	2,53	105	266,09	CHI
2020038814	FAZENDA NOVA	9680000934	IPORA	03/03/2020 08:53	04/03/2020 10:10	03/03/2020 08:53	04/03/2020 10:10	25,28	1	25,28	CHI
2020038815	PADRE BERNARDO	PB12163215	PADRE BERNARDO	03/03/2020 08:21	03/03/2020 19:53	03/03/2020 08:21	03/03/2020 12:56	4,58	32	146,52	CHI
2020038815	DISTRITO FEDERAL	PB13275455	PADRE BERNARDO	03/03/2020 08:21	03/03/2020 19:53	03/03/2020 08:21	03/03/2020 18:39	10,30	3	30,89	CHI
2020038815	PADRE BERNARDO	PB13275455	PADRE BERNARDO	03/03/2020 08:21	03/03/2020 19:53	03/03/2020 08:21	03/03/2020 18:39	10,30	197	2028,22	CHI
2020038815	PADRE BERNARDO	PB12275514	PADRE BERNARDO	03/03/2020 08:21	03/03/2020 19:53	03/03/2020 08:21	03/03/2020 19:28	11,10	27	299,81	CHI
2020038815	PADRE BERNARDO	PB12275499	PADRE BERNARDO	03/03/2020 08:21	03/03/2020 19:53	03/03/2020 08:21	03/03/2020 19:53	11,52	22	253,45	CHI
2020038818	CALDAS NOVAS	10015522812	CALDAS NOVAS S1	03/03/2020 08:54	03/03/2020 10:43	03/03/2020 08:54	03/03/2020 10:43	1,81	1	1,81	CHI
2020038820	POSSE	PS21046206	IACIARA S2	03/03/2020 08:54	03/03/2020 10:33	03/03/2020 08:54	03/03/2020 10:33	1,64	1	1,64	CHI
2020038823	SAO LUIS DE MONTES BELOS	500035246	SAO LUIZ DOS MONTES BELOS	03/03/2020 08:55	03/03/2020 12:22	03/03/2020 08:55	03/03/2020 12:22	3,45	1	3,45	CHI
2020038824	COCALZINHO DE GOIAS	ZN21210665	AGUAS LINDAS DE GOIAS S2	03/03/2020 08:55	03/03/2020 12:48	03/03/2020 08:55	03/03/2020 12:48	3,88	1	3,88	CHI
2020038829	ITAJA	IJ12202670	CACHOEIRA ALTA	03/03/2020 08:56	03/03/2020 15:16	03/03/2020 08:56	03/03/2020 15:16	6,33	2	12,66	CHI
2020038830	GOIANIA	14678445	AEROPORTO S1	03/03/2020 08:56	03/03/2020 12:26	03/03/2020 08:56	03/03/2020 12:26	3,50	1	3,50	CHI
2020038833	ORIZONA	OZ21095379	PIRES DO RIO S2	03/03/2020 08:56	03/03/2020 14:24	03/03/2020 08:56	03/03/2020 14:24	5,46	1	5,46	CHI
2020038835	ALTO HORIZONTE	9640000728	SANTA TEREZINHA	03/03/2020 08:57	03/03/2020 11:03	03/03/2020 08:57	03/03/2020 11:03	2,09	1	2,09	CHI
2020038836	CAMPO ALEGRE DE GOIAS	CM21285931	CAMPO ALEGRE DE GOIAS	03/03/2020 08:58	03/03/2020 15:52	03/03/2020 08:58	03/03/2020 15:52	6,90	2	13,80	CHI
2020038837	IPORA	IR12014024	IPORA	03/03/2020 07:27	03/03/2020 15:55	03/03/2020 07:27	03/03/2020 15:55	8,46	17	143,80	CHI
2020038847	JARAGUA	JA21370465	GOIANESIA S2	03/03/2020 09:00	03/03/2020 13:31	03/03/2020 09:00	03/03/2020 13:31	4,51	1	4,51	CHI
2020038851	MUNDO NOVO DE GOIAS	MH12242017	NOVA CRIXAS	03/03/2020 09:00	03/03/2020 19:40	03/03/2020 09:00	03/03/2020 19:40	10,65	3	31,96	CHI
2020038852	JARAGUA	JA12047472	JARAGUA	03/03/2020 09:01	03/03/2020 13:18	03/03/2020 09:01	03/03/2020 13:18	4,28	10	42,79	CHI
2020038857	ALTO HORIZONTE	AJ12204148	SANTA TEREZINHA	03/03/2020 09:02	03/03/2020 12:18	03/03/2020 09:02	03/03/2020 12:18	3,27	14	45,73	CHI

2020038858	FORMOSA	610161209	ITUIQUIRA	03/03/2020 09:02	03/03/2020 16:20	03/03/2020 09:02	03/03/2020 16:20	7,30	1	7,30	CHI
2020038862	RIO VERDE	RV21147692	SANTA HELENA S1	03/03/2020 09:02	03/03/2020 11:08	03/03/2020 09:02	03/03/2020 11:08	2,09	1	2,09	CHI
2020038866	PADRE BERNARDO	PB21109511	PADRE BERNARDO	03/03/2020 09:03	04/03/2020 11:12	03/03/2020 09:03	04/03/2020 11:12	26,15	1	26,15	CHI
2020038868	CORREGO DO OURO	CO12004043	FIRMINOPOLIS S2	03/03/2020 09:03	03/03/2020 11:21	03/03/2020 09:03	03/03/2020 11:21	2,30	11	25,26	CHI
2020038877	GOIANIA	GN21213534	CARAJAS S2	03/03/2020 09:05	03/03/2020 12:30	03/03/2020 09:05	03/03/2020 12:30	3,41	3	10,22	CHI
2020038877	GOIANIA	7982709	CARAJAS S2	03/03/2020 09:05	03/03/2020 12:30	03/03/2020 09:05	03/03/2020 12:30	3,41	3	10,22	CHI
2020038878	GOIANIA	13145502	GOIANIA LESTE S2	03/03/2020 09:06	03/03/2020 12:17	03/03/2020 09:06	03/03/2020 12:17	3,18	1	3,18	CHI
2020038879	MINEIROS	MY12260468	PARQUE DAS EMAS	03/03/2020 09:06	03/03/2020 12:14	03/03/2020 09:06	03/03/2020 12:14	3,13	5	15,64	CHI
2020038880	CATALAO	CT12318674	CATALAO S1	03/03/2020 09:06	03/03/2020 15:50	03/03/2020 09:06	03/03/2020 15:50	6,73	2	13,45	CHI
2020038880	DAVINOPOLIS	CT12318674	CATALAO S1	03/03/2020 09:06	03/03/2020 15:50	03/03/2020 09:06	03/03/2020 15:50	6,73	3	20,18	CHI
2020038887	SANTA RITA DO ARAGUAIA	SU21184143	SANTA RITA DO ARAGUAIA	03/03/2020 09:07	04/03/2020 12:55	03/03/2020 09:07	04/03/2020 12:55	27,80	1	27,80	CHI
2020038893	LUZIANIA	LZ21261245	CRISTALINA S2	03/03/2020 09:07	03/03/2020 11:35	03/03/2020 09:07	03/03/2020 11:35	2,47	1	2,47	CHI
2020038903	PLANALTINA	PI12375541	PLANALTINA	03/03/2020 09:09	03/03/2020 11:43	03/03/2020 09:09	03/03/2020 11:43	2,56	177	453,41	CHI
2020038908	PIRENOPOLIS	PV21284936	CORUMBA	03/03/2020 09:10	03/03/2020 19:34	03/03/2020 09:10	03/03/2020 19:34	10,39	1	10,39	CHI
2020038909	ITAPURANGA	IK12310859	ITAPURANGA	03/03/2020 09:10	03/03/2020 12:24	03/03/2020 09:10	03/03/2020 12:24	3,22	7	22,56	CHI
2020038911	BELA VISTA DE GOIAS	BV12009527	BELA VISTA S1	03/03/2020 09:10	03/03/2020 12:32	03/03/2020 09:10	03/03/2020 12:32	3,35	12	40,24	CHI
2020038912	CRIXAS	CX12391661	SANTA TEREZINHA	03/03/2020 09:10	03/03/2020 22:30	03/03/2020 09:10	03/03/2020 22:30	13,32	30	399,52	CHI
2020038917	SAO MIGUEL DO ARAGUAIA	SM21262469	SAO MIGUEL DO ARAGUAIA	03/03/2020 09:11	03/03/2020 11:13	03/03/2020 09:11	03/03/2020 11:13	2,02	1	2,02	CHI
2020038925	SANTA RITA DO NOVO DESTINO	BA12163300	BARRO ALTO	03/03/2020 09:12	03/03/2020 15:08	03/03/2020 09:12	03/03/2020 15:08	5,92	8	47,35	CHI
2020038926	UIRAPURU	UP12321028	SANTA TEREZINHA	03/03/2020 07:31	03/03/2020 16:18	03/03/2020 07:31	03/03/2020 16:18	8,77	7	61,39	CHI
2020038928	FORMOSA	FA12257708	ITUIQUIRA	03/03/2020 09:13	03/03/2020 16:25	03/03/2020 09:13	03/03/2020 16:25	7,21	1	7,21	CHI
2020038931	CATALAO	10007541390	CATALAO S1	03/03/2020 09:14	03/03/2020 10:59	03/03/2020 09:14	03/03/2020 10:59	1,75	1	1,75	CHI
2020038933	MINEIROS	MY12402482	PARQUE DAS EMAS	03/03/2020 09:14	03/03/2020 15:05	03/03/2020 09:14	03/03/2020 15:05	5,84	2	11,68	CHI
2020038938	NOVA VENEZA	NV12272479	INHUMAS S1	03/03/2020 09:14	03/03/2020 16:18	03/03/2020 09:14	03/03/2020 16:18	7,05	5	35,26	CHI
2020038942	ANAPOLIS	21298828	JUNDIAI S2	03/03/2020 09:15	03/03/2020 20:13	03/03/2020 09:15	03/03/2020 20:13	10,95	1	10,95	CHI
2020038951	MINEIROS	1390063784	PARQUE DAS EMAS	03/03/2020 09:17	03/03/2020 10:56	03/03/2020 09:17	03/03/2020 10:56	1,65	1	1,65	CHI
2020038952	CAIAPONIA	CP12395452	PALESTINA	03/03/2020 16:47	05/03/2020 03:30	03/03/2020 16:47	03/03/2020 23:21	6,56	27	177,00	CHI
2020038952	CAIAPONIA	CP12395452	PALESTINA	03/03/2020 16:47	05/03/2020 03:30	03/03/2020 16:47	04/03/2020 11:16	18,47	1	18,47	CHI
2020038952	CAIAPONIA	CP13414563	PALESTINA	03/03/2020 16:47	05/03/2020 03:30	03/03/2020 16:47	05/03/2020 03:30	34,70	43	1492,24	CHI
2020038955	CATALAO	CT12075528	CATALAO S2	03/03/2020 09:18	03/03/2020 12:43	03/03/2020 09:18	03/03/2020 12:43	3,42	1	3,42	CHI
2020038955	CUMARI	CT12075528	CATALAO S2	03/03/2020 09:18	03/03/2020 12:43	03/03/2020 09:18	03/03/2020 12:43	3,42	4	13,66	CHI
2020038957	CIDADE OCIDENTAL	DH11248726	MARAJOARA	03/03/2020 09:18	03/03/2020 11:53	03/03/2020 09:18	03/03/2020 11:53	2,58	69	177,96	CHI
2020038959	GOIANIA	14052271	GOIANIA LESTE S3	03/03/2020 09:18	04/03/2020 01:56	03/03/2020 09:18	04/03/2020 01:56	16,63	1	16,63	CHI
2020038964	COCALZINHO DE GOIAS	1200014392	COCALZINHO	03/03/2020 09:19	03/03/2020 23:39	03/03/2020 09:19	03/03/2020 23:39	14,34	1	14,34	CHI
2020038968	BOM JESUS DE GOIAS	10007741128	BOM JESUS DE GOIAS	03/03/2020 09:20	03/03/2020 11:40	03/03/2020 09:20	03/03/2020 11:40	2,34	1	2,34	CHI
2020038975	IPAMERI	IP21308240	IPAMERI	03/03/2020 09:22	03/03/2020 15:01	03/03/2020 09:22	03/03/2020 15:01	5,65	1	5,65	CHI
2020038981	PIRENOPOLIS	PV12093290	SAO FRANCISCO DE GOIAS	03/03/2020 09:23	03/03/2020 14:57	03/03/2020 09:23	03/03/2020 14:57	5,56	2	11,13	CHI
2020038984	MINEIROS	1390116211	PARQUE DAS EMAS	03/03/2020 09:24	03/03/2020 12:54	03/03/2020 09:24	03/03/2020 12:54	3,49	1	3,49	CHI
2020038987	EDEALINA	ED21281320	VICENTINOPOLIS	03/03/2020 09:24	03/03/2020 11:00	03/03/2020 09:24	03/03/2020 11:00	1,59	1	1,59	CHI
2020038991	ARAGOIANIA	AO11189573	GUAPO S2	03/03/2020 09:25	03/03/2020 10:18	03/03/2020 09:25	03/03/2020 10:18	0,87	23	20,12	CHI
2020038995	TROMBAS	TB12187857	PORANGATU	03/03/2020 09:25	03/03/2020 11:38	03/03/2020 09:25	03/03/2020 11:38	2,20	8	17,61	CHI
2020038997	MONTIVIDIU DO NORTE	MX12187848	PORANGATU	03/03/2020 09:26	03/03/2020 14:38	03/03/2020 09:26	03/03/2020 14:38	5,19	15	77,90	CHI
2020038997	TROMBAS	MX12187848	PORANGATU	03/03/2020 09:26	03/03/2020 14:38	03/03/2020 09:26	03/03/2020 14:38	5,19	1	5,19	CHI
2020039011	COCALZINHO DE GOIAS	CB12075828	COCALZINHO	03/03/2020 09:15	03/03/2020 13:04	03/03/2020 09:15	03/03/2020 13:04	3,81	11	41,87	CHI

2020039013	ITABERAI	50068921	ITABERAI S2	03/03/2020 09:28	03/03/2020 13:24	03/03/2020 09:28	03/03/2020 13:24	3,93	1	3,93	CHI
2020039017	ITAPACI	IW12275237	ITAPACI	03/03/2020 09:29	03/03/2020 18:39	03/03/2020 09:29	03/03/2020 18:39	9,16	1	9,16	CHI
2020039020	CORUMBA DE GOIAS	PV12377711	CORUMBA	03/03/2020 09:30	03/03/2020 13:04	03/03/2020 09:30	03/03/2020 13:04	3,57	18	64,20	CHI
2020039020	PIRENOPOLIS	PV12377711	CORUMBA	03/03/2020 09:30	03/03/2020 13:04	03/03/2020 09:30	03/03/2020 13:04	3,57	15	53,50	CHI
2020039022	MONTIVIDIU	MV21144624	MONTIVIDIU T	03/03/2020 09:30	03/03/2020 15:19	03/03/2020 09:30	03/03/2020 15:19	5,81	2	11,62	CHI
2020039026	RIO VERDE	630232489	RIO VERDE S1	03/03/2020 09:32	03/03/2020 14:30	03/03/2020 09:32	03/03/2020 14:30	4,96	1	4,96	CHI
2020039027	CAMPOS VERDES	VD11029478	SANTA TEREZINHA	03/03/2020 09:24	03/03/2020 12:28	03/03/2020 09:24	03/03/2020 12:28	3,06	50	153,19	CHI
2020039030	GOIANDIRA	GD21215577	CATALAO S1	03/03/2020 09:33	03/03/2020 11:19	03/03/2020 09:33	03/03/2020 11:19	1,76	2	3,53	CHI
2020039046	RIO VERDE	10010129160	RIO VERDE S1	03/03/2020 09:35	03/03/2020 13:00	03/03/2020 09:35	03/03/2020 13:00	3,41	1	3,41	CHI
2020039047	QUIRINOPOLIS	QI21143192	QUIRINOPOLIS	03/03/2020 09:35	03/03/2020 10:24	03/03/2020 09:35	03/03/2020 10:24	0,81	1	0,81	CHI
2020039059	MONTIVIDIU	MV21214148	MONTIVIDIU T	03/03/2020 09:38	03/03/2020 17:48	03/03/2020 09:38	03/03/2020 17:48	8,16	1	8,16	CHI
2020039061	PEROLANDIA	DP21375083	JATAI S1	03/03/2020 09:37	03/03/2020 13:03	03/03/2020 09:37	03/03/2020 13:03	3,43	1	3,43	CHI
2020039063	MARA ROSA	ET12208257	MARA ROSA	03/03/2020 08:32	03/03/2020 18:09	03/03/2020 08:32	03/03/2020 18:09	9,61	2	19,22	CHI
2020039070	GOIANIA	11213887	GOYA S2	03/03/2020 09:41	03/03/2020 12:24	03/03/2020 09:41	03/03/2020 12:24	2,70	1	2,70	CHI
2020039075	JATAI	JT11228779	JATAI S3	03/03/2020 09:42	03/03/2020 12:30	03/03/2020 09:42	03/03/2020 12:30	2,80	1	2,80	CHI
2020039076	ANAPOLIS	AN11096679	JUNDIAI S2	03/03/2020 09:42	03/03/2020 13:06	03/03/2020 09:42	03/03/2020 13:06	3,39	98	332,63	CHI
2020039077	CAMPOS BELOS	CH12264902	SAO DOMINGOS	03/03/2020 09:42	03/03/2020 12:46	03/03/2020 09:42	03/03/2020 12:46	3,06	4	12,24	CHI
2020039078	INACIOLANDIA	ID12305562	CACHOEIRA DOURADA	03/03/2020 09:42	03/03/2020 17:52	03/03/2020 09:42	03/03/2020 17:52	8,15	4	32,62	CHI
2020039082	NEROPOLIS	NR12000052	NEROPOLIS S2	03/03/2020 08:47	03/03/2020 10:54	03/03/2020 08:47	03/03/2020 10:54	2,11	2	4,21	CHI
2020039082	NOVA VENEZA	NR12000052	NEROPOLIS S2	03/03/2020 08:47	03/03/2020 10:54	03/03/2020 08:47	03/03/2020 10:54	2,11	1	2,11	CHI
2020039082	OURO VERDE DE GOIAS	NR12000052	NEROPOLIS S2	03/03/2020 08:47	03/03/2020 10:54	03/03/2020 08:47	03/03/2020 10:54	2,11	1	2,11	CHI
2020039083	LUZIANIA	LZ21276299	PIRES DO RIO S2	03/03/2020 09:43	03/03/2020 17:20	03/03/2020 09:43	03/03/2020 17:20	7,61	1	7,61	CHI
2020039091	FORMOSO	SE12053856	MARA ROSA	03/03/2020 07:34	03/03/2020 12:26	03/03/2020 07:34	03/03/2020 12:26	4,85	6	29,13	CHI
2020039091	SANTA TEREZA DE GOIAS	SE12053856	MARA ROSA	03/03/2020 07:34	03/03/2020 12:26	03/03/2020 07:34	03/03/2020 12:26	4,85	3	14,56	CHI
2020039095	PLANALTINA	PI12302908	PLANALTINA	03/03/2020 09:45	03/03/2020 13:50	03/03/2020 09:45	03/03/2020 13:50	4,08	40	163,24	CHI
2020039096	LUZIANIA	120179507	RIO VERMELHO	03/03/2020 09:46	03/03/2020 10:58	03/03/2020 09:46	03/03/2020 10:58	1,20	1	1,20	CHI
2020039098	CATALAO	10003888035	CATALAO S2	03/03/2020 09:46	03/03/2020 10:34	03/03/2020 09:46	03/03/2020 10:34	0,80	1	0,80	CHI
2020039114	SILVANIA	VN12400027	VIANOPOLIS	03/03/2020 10:00	03/03/2020 20:07	03/03/2020 16:51	03/03/2020 20:07	3,27	1	3,27	CHI
2020039114	VIANOPOLIS	VN12400027	VIANOPOLIS	03/03/2020 10:00	03/03/2020 20:07	03/03/2020 16:51	03/03/2020 20:07	3,27	8	26,17	CHI
2020039139	FLORES DE GOIAS	FB12211536	IACIARA S2	03/03/2020 07:19	03/03/2020 12:59	03/03/2020 07:19	03/03/2020 12:59	5,66	14	79,21	CHI
2020039142	BRITANIA	BT12106209	BRITANIA	03/03/2020 06:16	04/03/2020 14:04	03/03/2020 06:16	04/03/2020 14:04	31,80	13	413,41	CHI
2020039145	BRITANIA	BT12055124	BRITANIA	03/03/2020 09:43	03/03/2020 12:19	03/03/2020 09:43	03/03/2020 12:19	2,59	107	277,46	CHI
2020039148	IPORA	IR21091994	IPORA	03/03/2020 10:51	03/03/2020 11:48	03/03/2020 10:51	03/03/2020 11:48	0,94	1	0,94	CHI
2020039202	LUZIANIA	LZ21097175	VIANOPOLIS	03/03/2020 09:46	03/03/2020 14:26	03/03/2020 09:46	03/03/2020 14:26	4,65	1	4,65	CHI
2020039209	PLANALTINA	PI21100873	PLANALTINA	03/03/2020 09:48	04/03/2020 12:58	04/03/2020 08:59	04/03/2020 12:35	3,59	3	10,77	CHI
2020039209	PLANALTINA	PI21261985	PLANALTINA	03/03/2020 09:48	04/03/2020 12:58	03/03/2020 09:48	04/03/2020 12:55	27,13	1	27,13	CHI
2020039209	PLANALTINA	PI21241914	PLANALTINA	03/03/2020 09:48	04/03/2020 12:58	03/03/2020 09:48	04/03/2020 12:58	27,16	1	27,16	CHI
2020039210	NOVO BRASIL	NB12378883	JUSSARA	03/03/2020 11:01	04/03/2020 03:01	03/03/2020 11:01	04/03/2020 03:01	15,99	2	31,97	CHI
2020039210	NOVO BRASIL	NB12378883	JUSSARA	03/03/2020 11:01	04/03/2020 03:01	04/03/2020 00:26	04/03/2020 03:01	2,58	3	7,73	CHI
2020039212	ANICUNS	AC21031007	ANICUNS	03/03/2020 09:48	03/03/2020 11:05	03/03/2020 09:48	03/03/2020 11:05	1,27	2	2,54	CHI
2020039217	PIRENOPOLIS	PV21000722	SAO FRANCISCO DE GOIAS	03/03/2020 09:23	03/03/2020 15:45	03/03/2020 09:23	03/03/2020 15:45	6,36	1	6,36	CHI
2020039220	FLORES DE GOIAS	FB12106993	FLORES DE GOIAS	03/03/2020 09:51	03/03/2020 11:13	03/03/2020 09:51	03/03/2020 11:13	1,36	15	20,45	CHI
2020039220	FORMOSA	FB12106993	FLORES DE GOIAS	03/03/2020 09:51	03/03/2020 11:13	03/03/2020 09:51	03/03/2020 11:13	1,36	137	186,74	CHI
2020039220	FORMOSO	FB12106993	FLORES DE GOIAS	03/03/2020 09:51	03/03/2020 11:13	03/03/2020 09:51	03/03/2020 11:13	1,36	1	1,36	CHI

2020039220	SAO JOAO D ALIANCA	FB12106993	FLORES DE GOIAS	03/03/2020 09:51	03/03/2020 11:13	03/03/2020 09:51	03/03/2020 11:13	1,36	5	6,82	CHI
2020039222	ANAPOLIS	NR12291552	NEROPOLIS S2	03/03/2020 09:44	03/03/2020 10:54	03/03/2020 09:44	03/03/2020 10:54	1,16	13	15,10	CHI
2020039222	NEROPOLIS	NR12291552	NEROPOLIS S2	03/03/2020 09:44	03/03/2020 10:54	03/03/2020 09:44	03/03/2020 10:54	1,16	4	4,65	CHI
2020039222	OURO VERDE DE GOIAS	NR12291552	NEROPOLIS S2	03/03/2020 09:44	03/03/2020 10:54	03/03/2020 09:44	03/03/2020 10:54	1,16	1	1,16	CHI
2020039224	NEROPOLIS	NR12009262	NEROPOLIS S2	03/03/2020 09:51	03/03/2020 15:47	03/03/2020 12:51	03/03/2020 15:47	2,92	1	2,92	CHI
2020039229	GUARANI DE GOIAS	GY12195884	IACIARA S1	03/03/2020 09:52	03/03/2020 14:52	03/03/2020 09:52	03/03/2020 14:52	4,99	10	49,87	CHI
2020039236	EDEALINA	IY12103916	EDEIA	03/03/2020 09:54	03/03/2020 11:53	03/03/2020 09:54	03/03/2020 11:53	1,97	2	3,94	CHI
2020039240	GOIANIA	12203830	GOIANIA LESTE S1	03/03/2020 09:55	03/03/2020 13:29	03/03/2020 09:55	03/03/2020 13:29	3,55	1	3,55	CHI
2020039244	MOZARLANDIA	MZ21057098	MOZARLANDIA	03/03/2020 09:56	03/03/2020 17:54	03/03/2020 09:56	03/03/2020 17:54	7,97	1	7,97	CHI
2020039245	GOIANIA	BW12151470	NEROPOLIS S1	03/03/2020 09:56	03/03/2020 13:48	03/03/2020 09:56	03/03/2020 13:48	3,87	130	502,56	CHI
2020039245	SANTO ANTONIO DE GOIAS	BW12151470	NEROPOLIS S1	03/03/2020 09:56	03/03/2020 13:48	03/03/2020 09:56	03/03/2020 13:48	3,87	2	7,73	CHI
2020039250	AGUAS LINDAS DE GOIAS	10016274910	AGUAS LINDAS DE GOIAS S1	03/03/2020 09:57	03/03/2020 15:01	03/03/2020 09:57	03/03/2020 15:01	5,06	1	5,06	CHI
2020039251	ALTO HORIZONTE	AJ12320994	SANTA TEREZINHA	03/03/2020 09:57	04/03/2020 12:07	03/03/2020 09:57	04/03/2020 12:07	26,16	5	130,82	CHI
2020039252	ALEXANIA	AX12319851	ALEXANIA	03/03/2020 09:57	03/03/2020 12:04	03/03/2020 09:57	03/03/2020 12:04	2,11	21	44,29	CHI
2020039254	GOIANIA	17102820	CARAJAS S1	03/03/2020 09:57	03/03/2020 12:06	03/03/2020 09:57	03/03/2020 12:06	2,14	1	2,14	CHI
2020039256	SITIO D ABADIA	SI12325441	IACIARA S2	03/03/2020 09:58	03/03/2020 15:33	03/03/2020 09:58	03/03/2020 15:33	5,58	4	22,31	CHI
2020039257	SANTO ANTONIO DO DESCOBERTO	SN21342100	MARAJOARA	03/03/2020 09:58	03/03/2020 15:10	03/03/2020 09:58	03/03/2020 15:10	5,19	1	5,19	CHI
2020039259	PIRES DO RIO	460073930	PIRES DO RIO S1	03/03/2020 09:59	03/03/2020 11:01	03/03/2020 09:59	03/03/2020 11:01	1,05	1	1,05	CHI
2020039262	JUSSARA	IU21223821	JUSSARA	03/03/2020 09:59	04/03/2020 12:14	03/03/2020 09:59	04/03/2020 12:14	26,24	1	26,24	CHI
2020039268	PADRE BERNARDO	PB12313941	PADRE BERNARDO	02/03/2020 21:46	03/03/2020 14:17	02/03/2020 21:46	03/03/2020 14:17	16,51	4	66,05	CHI
2020039280	INHUMAS	30083540	INHUMAS S2	03/03/2020 10:03	03/03/2020 21:10	03/03/2020 10:03	03/03/2020 21:10	11,12	1	11,12	CHI
2020039288	MINACU	4020114287	MINACU	03/03/2020 10:05	03/03/2020 15:00	03/03/2020 10:05	03/03/2020 15:00	4,91	1	4,91	CHI
2020039292	GOIAS	GS21310671	GOIAS	03/03/2020 08:02	03/03/2020 11:31	03/03/2020 08:02	03/03/2020 11:31	3,47	2	6,94	CHI
2020039295	CATALAO	1990200970	CATALAO S2	03/03/2020 10:07	03/03/2020 12:50	03/03/2020 10:07	03/03/2020 12:50	2,71	1	2,71	CHI
2020039308	ARAGOIANIA	AO11198357	GUAPO S2	03/03/2020 10:03	03/03/2020 22:40	03/03/2020 10:03	03/03/2020 22:40	12,61	21	264,83	CHI
2020039316	GOIANIA	10013197752	MEIA PONTE	03/03/2020 10:11	03/03/2020 17:56	03/03/2020 10:11	03/03/2020 17:56	7,75	1	7,75	CHI
2020039322	CRIXAS	2490050005	SERRA DO OURO	03/03/2020 10:12	04/03/2020 08:55	03/03/2020 10:12	04/03/2020 08:55	22,71	1	22,71	CHI
2020039324	CALDAS NOVAS	CN21182856	CALDAS NOVAS S1	03/03/2020 10:12	03/03/2020 11:28	03/03/2020 10:12	03/03/2020 11:28	1,26	1	1,26	CHI
2020039330	JARAGUA	JA12059983	JARAGUA	03/03/2020 05:49	03/03/2020 15:10	03/03/2020 05:49	03/03/2020 15:10	9,34	89	831,56	CHI
2020039331	RIO VERDE	630173412	RIO VERDE S2	03/03/2020 10:14	04/03/2020 10:59	03/03/2020 10:14	04/03/2020 10:59	24,75	1	24,75	CHI
2020039339	SERRANOPOLIS	SX21241854	JATAI S1	03/03/2020 10:15	03/03/2020 16:23	03/03/2020 10:15	03/03/2020 16:23	6,13	1	6,13	CHI
2020039343	RUBIATABA	780020935	RUBIATABA	03/03/2020 10:16	03/03/2020 14:21	03/03/2020 10:16	03/03/2020 14:21	4,08	1	4,08	CHI
2020039344	NIQUELANDIA	NQ12235663	URUACU	03/03/2020 10:16	03/03/2020 12:45	03/03/2020 10:16	03/03/2020 12:45	2,47	7	17,30	CHI
2020039346	PROFESSOR JAMIL SAFADY	850002369	ROCHEDO	03/03/2020 10:17	03/03/2020 12:28	03/03/2020 10:17	03/03/2020 12:28	2,18	1	2,18	CHI
2020039348	LUZIANIA	LZ12313723	PIRES DO RIO S2	03/03/2020 10:18	04/03/2020 10:42	03/03/2020 10:18	04/03/2020 10:42	24,40	1	24,40	CHI
2020039351	MINEIROS	MY12149310	PARQUE DAS EMAS	03/03/2020 10:18	03/03/2020 12:17	03/03/2020 10:18	03/03/2020 12:17	1,97	74	145,59	CHI
2020039353	CRIXAS	CX12390497	SERRA DO OURO	03/03/2020 10:19	04/03/2020 11:55	03/03/2020 10:19	04/03/2020 11:55	25,60	3	76,80	CHI
2020039354	NOVA ROMA	ND12161820	IACIARA S2	03/03/2020 10:19	04/03/2020 22:09	03/03/2020 10:19	03/03/2020 19:10	8,85	7	61,98	CHI
2020039354	NOVA ROMA	ND12161820	IACIARA S2	03/03/2020 10:19	04/03/2020 22:09	03/03/2020 17:25	03/03/2020 19:10	1,75	18	31,44	CHI
2020039354	NOVA ROMA	ND12161820	IACIARA S2	03/03/2020 10:19	04/03/2020 22:09	03/03/2020 10:19	03/03/2020 21:43	11,40	1	11,40	CHI
2020039354	NOVA ROMA	ND13164499	IACIARA S2	03/03/2020 10:19	04/03/2020 22:09	03/03/2020 17:25	03/03/2020 21:43	4,29	44	188,86	CHI
2020039354	NOVA ROMA	ND12161820	IACIARA S2	03/03/2020 10:19	04/03/2020 22:09	03/03/2020 22:35	03/03/2020 23:26	0,86	70	60,43	CHI
2020039354	NOVA ROMA	ND12161820	IACIARA S2	03/03/2020 10:19	04/03/2020 22:09	04/03/2020 13:30	04/03/2020 15:08	1,63	70	114,16	CHI
2020039354	NOVA ROMA	ND12161820	IACIARA S2	03/03/2020 10:19	04/03/2020 22:09	03/03/2020 10:19	04/03/2020 22:06	35,79	1	35,79	CHI

2020039354	NOVA ROMA	ND13162969	IACIARA S2	03/03/2020 10:19	04/03/2020 22:09	03/03/2020 17:25	04/03/2020 22:06	28,68	1	28,68	CHI
2020039354	NOVA ROMA	ND12161820	IACIARA S2	03/03/2020 10:19	04/03/2020 22:09	03/03/2020 10:19	04/03/2020 22:09	35,84	54	1935,57	CHI
2020039354	NOVA ROMA	ND12162968LD	IACIARA S2	03/03/2020 10:19	04/03/2020 22:09	03/03/2020 17:25	04/03/2020 22:09	28,74	7	201,15	CHI
2020039358	RIO VERDE	630041910	RIO VERDE S1	03/03/2020 10:19	04/03/2020 10:39	03/03/2020 10:19	04/03/2020 10:39	24,32	1	24,32	CHI
2020039360	ALVORADA DO NORTE	10027054819	IACIARA S2	03/03/2020 10:20	03/03/2020 11:52	03/03/2020 10:20	03/03/2020 11:52	1,53	1	1,53	CHI
2020039369	HIDROLANDIA	HD21000247	CEPAIGO S2	03/03/2020 10:21	03/03/2020 12:45	03/03/2020 10:21	03/03/2020 12:45	2,40	1	2,40	CHI
2020039370	APARECIDA DE GOIANIA	200482592	ANHANGUERA	03/03/2020 10:22	03/03/2020 13:17	03/03/2020 10:22	03/03/2020 13:17	2,92	1	2,92	CHI
2020039373	QUIRINOPOLIS	QI21306065	QUIRINOPOLIS	03/03/2020 10:22	03/03/2020 11:35	03/03/2020 10:22	03/03/2020 11:35	1,21	1	1,21	CHI
2020039378	IPORA	IR12097730	IPORA	03/03/2020 10:20	03/03/2020 11:14	03/03/2020 10:20	03/03/2020 11:14	0,90	11	9,86	CHI
2020039385	BALIZA	BH12064258	BOM JARDIM	03/03/2020 10:23	03/03/2020 11:17	03/03/2020 10:23	03/03/2020 11:17	0,89	11	9,83	CHI
2020039392	GOIAS	GS12217234	MATRINCHA	03/03/2020 09:55	03/03/2020 12:42	03/03/2020 09:55	03/03/2020 12:42	2,77	83	229,75	CHI
2020039392	ITAPIRAPUA	GS12217234	MATRINCHA	03/03/2020 09:55	03/03/2020 12:42	03/03/2020 09:55	03/03/2020 12:42	2,77	1	2,77	CHI
2020039392	NOVO BRASIL	GS12217234	MATRINCHA	03/03/2020 09:55	03/03/2020 12:42	03/03/2020 09:55	03/03/2020 12:42	2,77	36	99,65	CHI
2020039395	LUZIANIA	10029894210	RIO VERMELHO	03/03/2020 10:27	03/03/2020 12:10	03/03/2020 10:27	03/03/2020 12:10	1,72	1	1,72	CHI
2020039397	BURITI ALEGRE	BG21103238	ITUMBIARA VELHA S2	03/03/2020 10:27	03/03/2020 13:38	03/03/2020 10:27	03/03/2020 13:38	3,18	1	3,18	CHI
2020039398	PIRANHAS	1930042611	PIRANHAS	03/03/2020 10:27	03/03/2020 17:30	03/03/2020 10:27	03/03/2020 17:30	7,06	1	7,06	CHI
2020039400	GOIANESIA	550092304	GOIANESIA S2	03/03/2020 10:27	03/03/2020 12:25	03/03/2020 10:27	03/03/2020 12:25	1,95	1	1,95	CHI
2020039401	BURITI DE GOIAS	BS21308404	FIRMINOPOLIS S2	03/03/2020 10:28	03/03/2020 13:21	03/03/2020 10:28	03/03/2020 13:21	2,87	1	2,87	CHI
2020039409	CATALAO	1990124929	CATALAO S2	03/03/2020 10:29	03/03/2020 12:55	03/03/2020 10:29	03/03/2020 12:55	2,42	1	2,42	CHI
2020039416	CATALAO	1990109527	CATALAO S2	03/03/2020 10:31	03/03/2020 12:38	03/03/2020 10:31	03/03/2020 12:38	2,10	1	2,10	CHI
2020039419	CRISTALINA	KR21320121	CRISTALINA S2	03/03/2020 10:32	03/03/2020 16:55	03/03/2020 10:32	03/03/2020 16:55	6,38	2	12,75	CHI
2020039422	CAIAPONIA	CP12247460	CAIAPONIA	03/03/2020 10:18	03/03/2020 13:25	03/03/2020 10:18	03/03/2020 13:25	3,12	3	9,35	CHI
2020039425	GOIANIA	GN11002594	MEIA PONTE	03/03/2020 10:20	03/03/2020 16:48	03/03/2020 10:20	03/03/2020 16:48	6,46	189	1220,68	CHI
2020039443	CORUMBA DE GOIAS	CB21204400	AGUAS LINDAS DE GOIAS S2	03/03/2020 09:15	03/03/2020 16:34	03/03/2020 09:15	03/03/2020 16:34	7,31	1	7,31	CHI
2020039448	CORUMBAIBA	560013292	VILA CORUMBA	03/03/2020 10:38	03/03/2020 21:38	03/03/2020 10:38	03/03/2020 21:38	11,00	1	11,00	CHI
2020039451	ARAGARCAS	BM12204862	IPORA	03/03/2020 10:40	03/03/2020 14:17	03/03/2020 10:40	03/03/2020 14:17	3,63	2	7,25	CHI
2020039455	FORMOSA	10005660082	ITUIQUIRA	03/03/2020 10:41	03/03/2020 13:17	03/03/2020 10:41	03/03/2020 13:17	2,59	1	2,59	CHI
2020039457	FORMOSA	610109807	ITUIQUIRA	03/03/2020 10:42	03/03/2020 18:53	03/03/2020 10:42	03/03/2020 18:53	8,17	1	8,17	CHI
2020039458	NIQUELANDIA	NQ21345032	NIQUELANDIA SUBTRANSMISSAO	03/03/2020 10:42	03/03/2020 23:20	03/03/2020 10:42	03/03/2020 23:20	12,62	1	12,62	CHI
2020039460	PARAUNA	PU12279674	ACREUNA	03/03/2020 10:43	03/03/2020 14:02	03/03/2020 10:43	03/03/2020 14:02	3,31	4	13,24	CHI
2020039461	ITABERAI	IB12220108	ITABERAI S1	03/03/2020 10:43	03/03/2020 20:07	03/03/2020 10:43	03/03/2020 15:37	4,90	2	9,80	CHI
2020039461	ITABERAI	IB12412562	ITABERAI S1	03/03/2020 10:43	03/03/2020 20:07	03/03/2020 10:43	03/03/2020 20:07	9,41	1	9,41	CHI
2020039464	AGUAS LINDAS DE GOIAS	10004342788	AGUAS LINDAS DE GOIAS S1	03/03/2020 10:43	03/03/2020 15:08	03/03/2020 10:43	03/03/2020 15:08	4,40	1	4,40	CHI
2020039470	PORANGATU	MU12266664	MARA ROSA	03/03/2020 09:56	03/03/2020 18:29	03/03/2020 09:56	03/03/2020 18:29	8,55	48	410,25	CHI
2020039472	JATAI	290220208	JATAI S3	03/03/2020 10:45	03/03/2020 14:46	03/03/2020 10:45	03/03/2020 14:46	4,00	1	4,00	CHI
2020039473	GUAPO	GA21373731	GUAPO S2	03/03/2020 10:46	03/03/2020 13:19	03/03/2020 10:46	03/03/2020 13:19	2,55	1	2,55	CHI
2020039474	GOIANIA	GN12000475	FERROVIARIO S1	03/03/2020 10:46	03/03/2020 11:45	03/03/2020 10:46	03/03/2020 11:45	0,98	1	0,98	CHI
2020039475	VILA PROPICIO	NP12239017	BARRO ALTO	03/03/2020 10:46	03/03/2020 23:34	03/03/2020 10:46	03/03/2020 23:34	12,79	1	12,79	CHI
2020039481	PIRES DO RIO	PR21229532	PIRES DO RIO S1	03/03/2020 10:47	03/03/2020 14:58	03/03/2020 10:47	03/03/2020 14:58	4,18	1	4,18	CHI
2020039486	CAMPINORTE	MQ12380774	MARA ROSA	03/03/2020 10:48	03/03/2020 19:30	03/03/2020 10:48	03/03/2020 19:30	8,69	1	8,69	CHI
2020039486	MARA ROSA	MQ12380774	MARA ROSA	03/03/2020 10:48	03/03/2020 19:30	03/03/2020 10:48	03/03/2020 19:30	8,69	2	17,38	CHI
2020039490	QUIRINOPOLIS	QI21214057	QUIRINOPOLIS	03/03/2020 10:49	03/03/2020 15:53	03/03/2020 10:49	03/03/2020 15:53	5,06	7	35,43	CHI
2020039491	SAO MIGUEL DO ARAGUAIA	SM11073065	SAO MIGUEL DO ARAGUAIA	03/03/2020 10:49	03/03/2020 23:58	03/03/2020 10:49	03/03/2020 23:58	13,14	2	26,28	CHI
2020039492	PARAUNA	PU12388915	PARAUNA	03/03/2020 10:51	04/03/2020 09:56	03/03/2020 10:51	04/03/2020 09:56	23,08	1	23,08	CHI

2020039493	MOSSAMEDES	MD21343844	FIRMINOPOLIS S2	03/03/2020 10:51	03/03/2020 15:51	03/03/2020 10:51	03/03/2020 15:51	5,00	1	5,00	CHI
2020039496	FLORES DE GOIAS	FB21106996	FLORES DE GOIAS	03/03/2020 10:51	03/03/2020 11:42	03/03/2020 10:51	03/03/2020 11:42	0,84	1	0,84	CHI
2020039497	CAVALCANTE	BF21063196	FLORES DE GOIAS	03/03/2020 10:51	03/03/2020 12:18	03/03/2020 10:51	03/03/2020 12:18	1,44	1	1,44	CHI
2020039499	ALTO HORIZONTE	9640003523	SANTA TEREZINHA	03/03/2020 10:53	03/03/2020 16:23	03/03/2020 10:53	03/03/2020 16:23	5,49	1	5,49	CHI
2020039505	OURO VERDE DE GOIAS	OV21037468	NEROPOLIS S1	03/03/2020 10:54	03/03/2020 17:20	03/03/2020 10:54	03/03/2020 17:20	6,43	1	6,43	CHI
2020039511	ANAPOLIS	20522915	ANAPOLIS UNIVERSITARIO S1	03/03/2020 10:54	03/03/2020 17:10	03/03/2020 10:54	03/03/2020 17:10	6,25	1	6,25	CHI
2020039513	NIQUELANDIA	NQ21141687	SAO JOAO D ALIANCA	03/03/2020 10:55	03/03/2020 19:40	03/03/2020 10:55	03/03/2020 19:40	8,75	1	8,75	CHI
2020039527	PLANALTINA	PI12214338	PLANALTINA	03/03/2020 10:58	03/03/2020 20:07	03/03/2020 10:58	03/03/2020 20:07	9,15	12	109,80	CHI
2020039530	NIQUELANDIA	NQ21363262	NIQUELANDIA SUBTRANSMISSAO	03/03/2020 10:58	03/03/2020 23:44	03/03/2020 10:58	03/03/2020 23:44	12,76	2	25,52	CHI
2020039534	ITABERAI	IB12022048	ITABERAI S2	03/03/2020 10:58	03/03/2020 12:37	03/03/2020 10:58	03/03/2020 12:37	1,64	12	19,67	CHI
2020039535	DOVERLANDIA	4220010982	CAIAPONIA	03/03/2020 10:57	03/03/2020 12:35	03/03/2020 10:57	03/03/2020 12:35	1,62	1	1,62	CHI
2020039537	FIRMINOPOLIS	FR21186490	FIRMINOPOLIS S1	03/03/2020 10:58	03/03/2020 14:09	03/03/2020 10:58	03/03/2020 14:09	3,17	1	3,17	CHI
2020039541	POSSE	PS12143770	IACIARA S2	03/03/2020 10:55	03/03/2020 14:16	03/03/2020 10:55	03/03/2020 14:16	3,35	109	365,12	CHI
2020039544	MUNDO NOVO DE GOIAS	MH11274983	NOVA CRIXAS	03/03/2020 11:00	03/03/2020 20:45	03/03/2020 11:00	03/03/2020 20:45	9,74	1	9,74	CHI
2020039546	ANAPOLIS	AN21258576	ANAPOLIS UNIVERSITARIO S2	03/03/2020 11:00	03/03/2020 12:04	03/03/2020 11:00	03/03/2020 12:04	1,05	1	1,05	CHI
2020039551	PLANALTINA	PB12377242	PADRE BERNARDO	03/03/2020 11:01	03/03/2020 15:00	03/03/2020 11:01	03/03/2020 15:00	3,98	4	15,90	CHI
2020039555	JATAI	290021686	JATAI S2	03/03/2020 11:02	03/03/2020 12:52	03/03/2020 11:02	03/03/2020 12:52	1,83	1	1,83	CHI
2020039565	FAZENDA NOVA	NB21116397	JUSSARA	03/03/2020 15:09	04/03/2020 07:59	03/03/2020 15:09	04/03/2020 07:59	16,83	1	16,83	CHI
2020039566	GOIANIA	GN11267319	CEPAIGO S1	03/03/2020 11:03	03/03/2020 14:05	03/03/2020 11:03	03/03/2020 14:05	3,02	26	78,64	CHI
2020039567	CATALAO	10007580361	CATALAO S1	03/03/2020 11:04	03/03/2020 15:14	03/03/2020 11:04	03/03/2020 15:14	4,17	1	4,17	CHI
2020039570	HEITORAI	HE12390849	ITAPURANGA	03/03/2020 09:37	03/03/2020 15:44	03/03/2020 09:37	03/03/2020 15:44	6,11	29	177,12	CHI
2020039570	ITAPURANGA	HE12390849	ITAPURANGA	03/03/2020 09:37	03/03/2020 15:44	03/03/2020 09:37	03/03/2020 15:44	6,11	1	6,11	CHI
2020039574	CRISTALINA	KR12305009	PAMPLONA	03/03/2020 11:05	03/03/2020 11:50	03/03/2020 11:05	03/03/2020 11:50	0,76	3	2,29	CHI
2020039582	SANTA RITA DO NOVO DESTINO	GE21000330	GOIANESIA S1	03/03/2020 11:06	03/03/2020 15:05	03/03/2020 11:06	03/03/2020 15:05	3,98	1	3,98	CHI
2020039583	PLANALTINA	2960038480	PLANALTINA	03/03/2020 11:06	03/03/2020 12:29	03/03/2020 11:06	03/03/2020 12:29	1,38	1	1,38	CHI
2020039584	FLORES DE GOIAS	FB21253046	FLORES DE GOIAS	03/03/2020 11:06	03/03/2020 13:59	03/03/2020 11:06	03/03/2020 13:59	2,87	1	2,87	CHI
2020039586	SANTA TEREZINHA DE GOIAS	SG12246311	SANTA TEREZINHA	03/03/2020 08:16	03/03/2020 13:23	03/03/2020 08:16	03/03/2020 13:23	5,11	4	20,45	CHI
2020039587	MIMOSO DE GOIAS	MU12377249	PADRE BERNARDO	03/03/2020 10:29	03/03/2020 21:05	03/03/2020 10:29	03/03/2020 21:05	10,60	18	190,83	CHI
2020039588	JUSSARA	1290078510	JUSSARA	03/03/2020 11:08	03/03/2020 16:17	03/03/2020 11:08	03/03/2020 16:17	5,15	1	5,15	CHI
2020039589	APARECIDA DE GOIANIA	13838908	ATLANTICO S2	03/03/2020 11:09	03/03/2020 12:12	03/03/2020 11:09	03/03/2020 12:12	1,04	1	1,04	CHI
2020039594	RIO VERDE	RV21306380	CABRIUVA S2	03/03/2020 11:10	04/03/2020 09:21	03/03/2020 11:10	04/03/2020 09:21	22,17	1	22,17	CHI
2020039595	HIDROLANDIA	HD21215963	CEPAIGO S2	03/03/2020 11:10	03/03/2020 14:25	03/03/2020 11:10	03/03/2020 14:25	3,24	1	3,24	CHI
2020039596	CALDAS NOVAS	10027384703	SERRA DE CALDAS	03/03/2020 11:11	03/03/2020 12:21	03/03/2020 11:11	03/03/2020 12:21	1,16	1	1,16	CHI
2020039599	PARANAIGUARA	PC12191508	CACHOEIRA ALTA	03/03/2020 11:11	03/03/2020 12:58	03/03/2020 11:11	03/03/2020 12:58	1,77	3	5,31	CHI
2020039603	NOVA VENEZA	OV12043221	NEROPOLIS S2	03/03/2020 11:12	03/03/2020 22:48	03/03/2020 11:12	03/03/2020 22:48	11,59	8	92,74	CHI
2020039603	OURO VERDE DE GOIAS	OV12043221	NEROPOLIS S2	03/03/2020 11:12	03/03/2020 22:48	03/03/2020 11:12	03/03/2020 22:48	11,59	14	162,29	CHI
2020039614	MUTUNOPOLIS	MU12060992	MARA ROSA	03/03/2020 11:15	03/03/2020 13:43	03/03/2020 11:15	03/03/2020 13:43	2,46	3	7,38	CHI
2020039621	NOVO GAMA	2460013950	PACAEMBU S1	03/03/2020 11:16	03/03/2020 13:09	03/03/2020 11:16	03/03/2020 13:09	1,87	1	1,87	CHI
2020039626	ABADIANIA	10031092622	CORUMBA	03/03/2020 11:18	03/03/2020 22:33	03/03/2020 11:18	03/03/2020 22:33	11,24	1	11,24	CHI
2020039631	FAZENDA NOVA	FN21199831	JUSSARA	03/03/2020 11:20	04/03/2020 09:15	03/03/2020 11:20	04/03/2020 09:15	21,91	1	21,91	CHI
2020039634	DOVERLANDIA	DV21259469	CAIAPONIA	03/03/2020 11:22	03/03/2020 13:28	03/03/2020 11:22	03/03/2020 13:28	2,09	1	2,09	CHI
2020039639	ALVORADA DO NORTE	AQ12347002	IACIARA S2	03/03/2020 11:24	03/03/2020 19:12	03/03/2020 11:24	03/03/2020 19:12	7,79	5	38,96	CHI
2020039640	SAO FRANCISCO DE GOIAS	SF21009996	SAO FRANCISCO DE GOIAS	03/03/2020 11:24	03/03/2020 14:35	03/03/2020 11:24	03/03/2020 14:35	3,17	1	3,17	CHI
2020039642	BURITI ALEGRE	BG21075771	ITUMBIARA VELHA S2	03/03/2020 11:25	03/03/2020 16:36	03/03/2020 11:25	03/03/2020 16:36	5,17	1	5,17	CHI

2020039645	CACHOEIRA ALTA	CA21011517	CACHOEIRA ALTA	03/03/2020 11:26	03/03/2020 14:05	03/03/2020 11:26	03/03/2020 14:05	2,64	2	5,29	CHI
2020039652	BONOPOLIS	PO21151082	NOVO PLANALTO	03/03/2020 11:27	03/03/2020 12:58	03/03/2020 11:27	03/03/2020 12:58	1,50	1	1,50	CHI
2020039657	AGUAS LINDAS DE GOIAS	10003047570	AGUAS LINDAS DE GOIAS S1	03/03/2020 11:28	03/03/2020 14:48	03/03/2020 11:28	03/03/2020 14:48	3,32	1	3,32	CHI
2020039659	GOIATUBA	6800000020	BOM JESUS DE GOIAS	03/03/2020 11:12	03/03/2020 14:05	03/03/2020 11:12	03/03/2020 14:05	2,87	1	2,87	CHI
2020039665	SAO LUIS DE MONTES BELOS	10016531866	SAO LUIZ DOS MONTES BELOS	03/03/2020 10:55	03/03/2020 12:25	03/03/2020 10:55	03/03/2020 12:25	1,50	1	1,50	CHI
2020039669	PLANALTINA	PI12326712	SAO JOAO D ALIANCA	03/03/2020 11:31	04/03/2020 03:05	03/03/2020 11:31	04/03/2020 03:05	15,56	4	62,26	CHI
2020039679	GOIANIA	13823711	FERROVIARIO S1	03/03/2020 11:32	03/03/2020 13:39	03/03/2020 11:32	03/03/2020 13:39	2,10	1	2,10	CHI
2020039680	GOIANIA	GN11366634	CEPAIGO S1	03/03/2020 11:33	04/03/2020 00:33	03/03/2020 11:33	04/03/2020 00:33	12,99	48	623,67	CHI
2020039683	NOVO PLANALTO	TA12192346	SAO MIGUEL DO ARAGUAIA	03/03/2020 11:11	03/03/2020 13:31	03/03/2020 11:11	03/03/2020 13:31	2,33	100	232,83	CHI
2020039685	ANAPOLIS	20108667	ANAPOLIS UNIVERSITARIO S2	03/03/2020 11:34	03/03/2020 13:56	03/03/2020 11:34	03/03/2020 13:56	2,36	1	2,36	CHI
2020039687	JOVIANIA	JV12030312	GOIATUBA S1	03/03/2020 11:35	03/03/2020 13:19	03/03/2020 11:35	03/03/2020 13:19	1,73	4	6,93	CHI
2020039687	VICENTINOPOLIS	JV12030312	GOIATUBA S1	03/03/2020 11:35	03/03/2020 13:19	03/03/2020 11:35	03/03/2020 13:19	1,73	4	6,93	CHI
2020039688	GOIANIA	GN11167633	ATLANTICO S1	03/03/2020 11:35	03/03/2020 14:54	03/03/2020 13:55	03/03/2020 14:54	0,98	70	68,83	CHI
2020039689	JARAGUA	70016525	JARAGUA	03/03/2020 11:35	03/03/2020 13:40	03/03/2020 11:35	03/03/2020 13:40	2,07	1	2,07	CHI
2020039694	SAO MIGUEL DO PASSA QUATRO	SQ21274193	VIANOPOLIS	03/03/2020 11:36	03/03/2020 14:11	03/03/2020 11:36	03/03/2020 14:11	2,57	1	2,57	CHI
2020039698	NOVA IGUACU DE GOIAS	NH21333055	CAMPINORTE	03/03/2020 11:37	04/03/2020 09:05	03/03/2020 11:37	04/03/2020 09:05	21,45	1	21,45	CHI
2020039702	HIDROLANDIA	HD10395394	CEPAIGO S2	03/03/2020 11:17	03/03/2020 19:47	03/03/2020 11:17	03/03/2020 12:50	1,54	58	89,19	CHI
2020039702	PIRACANJUBA	HD10395394	CEPAIGO S2	03/03/2020 11:17	03/03/2020 19:47	03/03/2020 11:17	03/03/2020 12:50	1,54	4	6,15	CHI
2020039702	PROFESSOR JAMIL SAFADY	HD10395394	CEPAIGO S2	03/03/2020 11:17	03/03/2020 19:47	03/03/2020 11:17	03/03/2020 12:50	1,54	1	1,54	CHI
2020039702	HIDROLANDIA	HD12130624	CEPAIGO S2	03/03/2020 11:17	03/03/2020 19:47	03/03/2020 11:17	03/03/2020 19:47	8,49	6	50,94	CHI
2020039717	ITABERAI	IB11333986	ITABERAI S2	03/03/2020 12:28	03/03/2020 15:31	03/03/2020 12:28	03/03/2020 15:31	3,05	22	67,05	CHI
2020039753	RIO VERDE	RV13322249	RIO VERDE S1	03/03/2020 14:47	04/03/2020 00:02	03/03/2020 18:07	03/03/2020 18:16	0,15	6462	998,02	CHI
2020039753	RIO VERDE	RV11043376	RIO VERDE S1	03/03/2020 14:47	04/03/2020 00:02	03/03/2020 18:39	03/03/2020 23:23	4,74	129	611,28	CHI
2020039753	RIO VERDE	RV13189228	RIO VERDE S1	03/03/2020 14:47	04/03/2020 00:02	03/03/2020 19:45	03/03/2020 23:53	4,14	1	4,14	CHI
2020039753	RIO VERDE	RV16407158	RIO VERDE S1	03/03/2020 14:47	04/03/2020 00:02	03/03/2020 23:59	04/03/2020 00:02	0,06	1847	102,61	CHI
2020039803	MINEIROS	MY11360060	PARQUE DAS EMAS	03/03/2020 11:36	03/03/2020 14:30	03/03/2020 11:36	03/03/2020 14:30	2,90	36	104,26	CHI
2020039805	PONTALINA	PK12293374	PONTALINA	03/03/2020 11:39	03/03/2020 23:21	03/03/2020 11:39	03/03/2020 23:21	11,70	3	35,11	CHI
2020039805	PONTALINA	PK12293374	PONTALINA	03/03/2020 11:39	03/03/2020 23:21	03/03/2020 21:11	03/03/2020 23:21	2,17	12	26,03	CHI
2020039810	PLANALTINA	PI12344170	PLANALTINA	03/03/2020 11:40	03/03/2020 20:36	03/03/2020 11:40	03/03/2020 20:36	8,93	1	8,93	CHI
2020039811	INHUMAS	30016526	INHUMAS S2	03/03/2020 11:40	03/03/2020 15:55	03/03/2020 11:40	03/03/2020 15:55	4,25	1	4,25	CHI
2020039812	ALTO HORIZONTE	AJ21084353	SANTA TEREZINHA	03/03/2020 11:41	03/03/2020 13:19	03/03/2020 11:41	03/03/2020 13:19	1,62	1	1,62	CHI
2020039823	PETROLINA DE GOIAS	PG11016086	PETROLINA	03/03/2020 11:44	03/03/2020 15:03	03/03/2020 11:44	03/03/2020 15:03	3,30	85	280,57	CHI
2020039824	CACU	CC12196048	CACHOEIRA ALTA	03/03/2020 19:45	03/03/2020 22:10	03/03/2020 19:45	03/03/2020 22:10	2,42	6	14,51	CHI
2020039824	CACU	CC12196048	CACHOEIRA ALTA	03/03/2020 19:45	03/03/2020 22:10	03/03/2020 20:40	03/03/2020 22:10	1,51	13	19,65	CHI
2020039826	SENADOR CANEDO	190056400	SENADOR CANEDO	03/03/2020 11:46	03/03/2020 13:33	03/03/2020 11:46	03/03/2020 13:33	1,78	1	1,78	CHI
2020039827	GOIAS	GS21090850	ITAPURANGA	03/03/2020 11:46	03/03/2020 13:33	03/03/2020 11:46	03/03/2020 13:33	1,77	1	1,77	CHI
2020039834	GOIANIA	GN12054915	XAVANTES	03/03/2020 11:38	03/03/2020 16:19	03/03/2020 11:38	03/03/2020 16:19	4,68	32	149,80	CHI
2020039840	PLANALTINA	PI12211502	PLANALTINA	03/03/2020 11:49	03/03/2020 15:23	03/03/2020 11:49	03/03/2020 15:23	3,56	177	629,83	CHI
2020039842	SITIO D ABADIA	SI11159875	IACIARA S2	03/03/2020 11:50	03/03/2020 14:56	03/03/2020 11:50	03/03/2020 14:56	3,10	1	3,10	CHI
2020039845	APORE	AE21041745	ITAJA S1	03/03/2020 11:52	03/03/2020 15:18	03/03/2020 11:52	03/03/2020 15:18	3,43	1	3,43	CHI
2020039865	NOVO GAMA	2460000700	PACAEMBU S1	03/03/2020 11:55	03/03/2020 12:51	03/03/2020 11:55	03/03/2020 12:51	0,92	1	0,92	CHI
2020039866	GOIANIA	GN11139669	CAMPINAS S3	03/03/2020 11:52	03/03/2020 12:20	03/03/2020 11:52	03/03/2020 12:20	0,47	66	30,76	CHI
2020039872	ABADIANIA	AA12388803	DAIA S2	03/03/2020 11:56	03/03/2020 15:29	03/03/2020 11:56	03/03/2020 15:29	3,54	34	120,19	CHI
2020039873	BARRO ALTO	BA21027565	BARRO ALTO	03/03/2020 11:56	03/03/2020 19:24	03/03/2020 11:56	03/03/2020 19:24	7,45	1	7,45	CHI

2020039874	ITABERAÍ	IB21065218	ANICUNS	03/03/2020 11:57	03/03/2020 14:00	03/03/2020 11:57	03/03/2020 14:00	2,04	1	2,04	CHI
2020039875	IPAMERI	IP12275809	IPAMERI	03/03/2020 11:45	03/03/2020 14:14	03/03/2020 11:45	03/03/2020 14:14	2,47	149	367,74	CHI
2020039877	CALDAZINHA	DE21113341	CEPAIGO S2	03/03/2020 11:59	03/03/2020 16:52	03/03/2020 11:59	03/03/2020 16:52	4,88	2	9,76	CHI
2020039880	CRISTALINA	KR12405474LD	CRISTALINA S1	03/03/2020 12:00	03/03/2020 19:10	03/03/2020 12:00	03/03/2020 19:10	7,16	6	42,99	CHI
2020039881	SAO LUIZ DO NORTE	SZ21063294	BARRO ALTO	03/03/2020 12:00	04/03/2020 01:02	03/03/2020 12:00	04/03/2020 01:02	13,03	1	13,03	CHI
2020039882	FIRMINOPOLIS	SL31186301	SAO LUIZ DOS MONTES BELOS	03/03/2020 12:00	03/03/2020 13:57	03/03/2020 12:00	03/03/2020 13:57	1,94	1	1,94	CHI
2020039885	IACIARA	IA12392240	FLORES DE GOIAS	03/03/2020 12:01	04/03/2020 10:02	03/03/2020 12:01	04/03/2020 10:02	22,00	7	154,00	CHI
2020039889	CEZARINA	CZ12000034	CEZARINA	03/03/2020 11:47	04/03/2020 08:32	03/03/2020 11:47	03/03/2020 20:04	8,29	8	66,31	CHI
2020039889	CEZARINA	CZ12233497LD	CEZARINA	03/03/2020 11:47	04/03/2020 08:32	03/03/2020 11:47	04/03/2020 08:32	20,75	13	269,77	CHI
2020039889	INDIARA	CZ12233497LD	CEZARINA	03/03/2020 11:47	04/03/2020 08:32	03/03/2020 11:47	04/03/2020 08:32	20,75	9	186,76	CHI
2020039892	FLORES DE GOIAS	FB21211654	IACIARA S2	03/03/2020 12:04	03/03/2020 13:48	03/03/2020 12:04	03/03/2020 13:48	1,73	1	1,73	CHI
2020039894	CATURAI	CK12326309	INHUMAS S1	03/03/2020 11:31	03/03/2020 14:22	03/03/2020 11:31	03/03/2020 14:22	2,84	27	76,68	CHI
2020039894	INHUMAS	CK12326309	INHUMAS S1	03/03/2020 11:31	03/03/2020 14:22	03/03/2020 11:31	03/03/2020 14:22	2,84	3	8,52	CHI
2020039896	NIQUELANDIA	NQ21243620	NIQUELANDIA SUBTRANSMISSAO	03/03/2020 12:05	04/03/2020 02:19	03/03/2020 12:05	04/03/2020 02:19	14,23	2	28,45	CHI
2020039898	ANICUNS	910073636	ANICUNS	03/03/2020 12:05	03/03/2020 16:20	03/03/2020 12:05	03/03/2020 16:20	4,24	1	4,24	CHI
2020039901	BELA VISTA DE GOIAS	BV21309592	CRISTIANOPOLIS	03/03/2020 12:07	03/03/2020 14:53	03/03/2020 12:07	03/03/2020 14:53	2,76	1	2,76	CHI
2020039902	ANAPOLIS	AN12340035	DAIA S1	03/03/2020 12:07	03/03/2020 13:08	03/03/2020 12:07	03/03/2020 13:08	1,01	27	27,28	CHI
2020039909	MIMOSO DE GOIAS	04560224	BARRO ALTO	03/03/2020 11:49	03/03/2020 15:01	03/03/2020 11:49	03/03/2020 15:01	3,19	4	12,76	CHI
2020039909	NIQUELANDIA	04560224	BARRO ALTO	03/03/2020 11:49	03/03/2020 15:01	03/03/2020 11:49	03/03/2020 15:01	3,19	1006	3209,14	CHI
2020039909	VILA PROPICIO	04560224	BARRO ALTO	03/03/2020 11:49	03/03/2020 15:01	03/03/2020 11:49	03/03/2020 15:01	3,19	32	102,08	CHI
2020039913	MARA ROSA	MQ11088478	MARA ROSA	03/03/2020 12:13	03/03/2020 16:08	03/03/2020 12:13	03/03/2020 16:08	3,91	100	391,47	CHI
2020039927	ITUMBIARA	IT21000127	PARANAIBA	03/03/2020 12:16	03/03/2020 16:18	03/03/2020 12:16	03/03/2020 16:18	4,03	3	12,09	CHI
2020039931	SANTA TEREZA DE GOIAS	SE12046189	MARA ROSA	03/03/2020 12:17	03/03/2020 21:42	03/03/2020 12:17	03/03/2020 21:00	8,71	1	8,71	CHI
2020039931	SANTA TEREZA DE GOIAS	SE21012482	MARA ROSA	03/03/2020 12:17	03/03/2020 21:42	03/03/2020 21:01	03/03/2020 21:42	0,68	1	0,68	CHI
2020039941	MAMBAI	MB11302672	IACIARA S2	03/03/2020 12:20	03/03/2020 14:05	03/03/2020 12:20	03/03/2020 14:05	1,73	79	136,96	CHI
2020039942	CRISTALINA	KR11315536	CRISTALINA S1	03/03/2020 12:21	03/03/2020 17:09	03/03/2020 12:21	03/03/2020 17:09	4,80	4	19,20	CHI
2020039946	ALVORADA DO NORTE	AQ12257608	FLORES DE GOIAS	03/03/2020 10:03	03/03/2020 17:37	03/03/2020 10:03	03/03/2020 17:37	7,56	9	68,01	CHI
2020039946	IACIARA	AQ12257608	FLORES DE GOIAS	03/03/2020 10:03	03/03/2020 17:37	03/03/2020 10:03	03/03/2020 17:37	7,56	4	30,23	CHI
2020039946	POSSE	AQ12257608	FLORES DE GOIAS	03/03/2020 10:03	03/03/2020 17:37	03/03/2020 10:03	03/03/2020 17:37	7,56	2	15,11	CHI
2020039947	ACREUNA	EU12077053	ACREUNA	03/03/2020 12:23	03/03/2020 16:08	03/03/2020 12:23	03/03/2020 16:08	3,74	26	97,29	CHI
2020039948	SERRANOPOLIS	3000009149	JATAI S1	03/03/2020 12:23	03/03/2020 14:49	03/03/2020 12:23	03/03/2020 14:49	2,42	1	2,42	CHI
2020039951	PIRENOPOLIS	PV12196720	CORUMBA	03/03/2020 11:52	03/03/2020 17:22	03/03/2020 11:52	03/03/2020 17:22	5,50	312	1714,70	CHI
2020039961	ANAPOLIS	20893590	ANAPOLIS UNIVERSITARIO S2	03/03/2020 12:28	03/03/2020 17:07	03/03/2020 12:28	03/03/2020 17:07	4,65	1	4,65	CHI
2020039964	GUAPO	GC12000274	GUAPO S1	03/03/2020 12:28	03/03/2020 15:34	03/03/2020 12:28	03/03/2020 15:34	3,09	39	120,60	CHI
2020039964	TRINDADE	GC12000274	GUAPO S1	03/03/2020 12:28	03/03/2020 15:34	03/03/2020 12:28	03/03/2020 15:34	3,09	36	111,32	CHI
2020039966	ITAUCU	IX21102104	INHUMAS S1	03/03/2020 12:28	03/03/2020 23:15	03/03/2020 12:28	03/03/2020 23:15	10,77	1	10,77	CHI
2020039976	AGUAS LINDAS DE GOIAS	10009329720	AGUAS LINDAS DE GOIAS S1	03/03/2020 12:31	03/03/2020 16:41	03/03/2020 12:31	03/03/2020 16:41	4,16	1	4,16	CHI
2020039981	ITABERAÍ	IB12227141	ITABERAÍ S1	03/03/2020 12:31	03/03/2020 15:25	03/03/2020 12:31	03/03/2020 15:25	2,89	6	17,36	CHI
2020039984	GOIANIA	GN12283013	GOYA S1	03/03/2020 12:15	03/03/2020 13:24	03/03/2020 12:15	03/03/2020 13:24	1,14	163	185,96	CHI
2020039994	PARANAIGUARA	PC21214451	QUIRINOPOLIS	03/03/2020 12:33	03/03/2020 14:09	03/03/2020 12:33	03/03/2020 14:09	1,58	1	1,58	CHI
2020039999	CALDAS NOVAS	760301864	CALDAS NOVAS S2	03/03/2020 12:35	03/03/2020 16:22	03/03/2020 12:35	03/03/2020 16:22	3,79	1	3,79	CHI
20200310005	BOM JARDIM DE GOIAS	BM12212797	BOM JARDIM	03/03/2020 12:30	03/03/2020 23:14	03/03/2020 12:30	03/03/2020 16:22	3,88	25	96,91	CHI
20200310005	PIRANHAS	BM12212797	BOM JARDIM	03/03/2020 12:30	03/03/2020 23:14	03/03/2020 12:30	03/03/2020 16:22	3,88	2	7,75	CHI
20200310005	BOM JARDIM DE GOIAS	BM12212797	BOM JARDIM	03/03/2020 12:30	03/03/2020 23:14	03/03/2020 12:30	03/03/2020 18:04	5,57	29	161,67	CHI

20200310005	BOM JARDIM DE GOIAS	BM12212797	BOM JARDIM	03/03/2020 12:30	03/03/2020 23:14	03/03/2020 12:30	03/03/2020 22:08	9,63	22	211,86	CHI
20200310005	BOM JARDIM DE GOIAS	BM12349615	BOM JARDIM	03/03/2020 12:30	03/03/2020 23:14	03/03/2020 22:08	03/03/2020 22:30	0,38	14	5,27	CHI
20200310005	BOM JARDIM DE GOIAS	BM12212797	BOM JARDIM	03/03/2020 12:30	03/03/2020 23:14	03/03/2020 12:30	03/03/2020 23:14	10,74	10	107,40	CHI
20200310007	VILA PROPICIO	GE12236840	GOIANESIA S2	03/03/2020 10:53	03/03/2020 16:20	03/03/2020 10:53	03/03/2020 16:20	5,44	27	146,87	CHI
20200310013	URUACU	UR21271951	MARA ROSA	03/03/2020 12:39	03/03/2020 16:01	03/03/2020 12:39	03/03/2020 16:01	3,37	2	6,73	CHI
20200310014	SANTO ANTONIO DO DESCOBERTO	SN12085981	MARAJOARA	03/03/2020 12:39	03/03/2020 20:59	03/03/2020 12:39	03/03/2020 17:59	5,34	3	16,02	CHI
20200310014	SANTO ANTONIO DO DESCOBERTO	SN12085981	MARAJOARA	03/03/2020 12:39	03/03/2020 20:59	03/03/2020 12:39	03/03/2020 19:35	6,94	15	104,05	CHI
20200310014	SANTO ANTONIO DO DESCOBERTO	SN12085981	MARAJOARA	03/03/2020 12:39	03/03/2020 20:59	03/03/2020 12:39	03/03/2020 20:15	7,61	6	45,67	CHI
20200310014	SANTO ANTONIO DO DESCOBERTO	SN12085981	MARAJOARA	03/03/2020 12:39	03/03/2020 20:59	03/03/2020 20:54	03/03/2020 20:59	0,08	24	1,91	CHI
20200310017	LAGOA SANTA	LS21095830	CACHOEIRA ALTA	03/03/2020 12:39	03/03/2020 18:02	03/03/2020 12:39	03/03/2020 18:02	5,37	1	5,37	CHI
20200310020	PANAMA	PX21021435	ITUMBIARA NOVA	03/03/2020 12:41	03/03/2020 14:53	03/03/2020 12:41	03/03/2020 14:53	2,21	1	2,21	CHI
20200310021	ANAPOLIS	AN11072945	JUNDIAI S1	03/03/2020 12:41	03/03/2020 13:35	03/03/2020 12:41	03/03/2020 13:35	0,89	119	106,31	CHI
20200310023	ARACU	AR12019445	ARACU	03/03/2020 11:49	03/03/2020 15:15	03/03/2020 11:49	03/03/2020 15:15	3,43	19	65,11	CHI
20200310023	ITABERAI	AR12019445	ARACU	03/03/2020 11:49	03/03/2020 15:15	03/03/2020 11:49	03/03/2020 15:15	3,43	12	41,12	CHI
20200310024	GOIANDIRA	GD12127593	CATALAO S1	03/03/2020 12:33	03/03/2020 19:12	03/03/2020 12:33	03/03/2020 19:12	6,64	21	139,41	CHI
20200310030	FORMOSA	FA21264666	ITUIQUIRA	03/03/2020 12:42	03/03/2020 16:59	03/03/2020 12:42	03/03/2020 16:59	4,28	1	4,28	CHI
20200310034	PIRENOPOLIS	PV12334636	CORUMBA	03/03/2020 12:43	03/03/2020 16:41	03/03/2020 12:43	03/03/2020 16:41	3,95	13	51,39	CHI
20200310042	ACREUNA	10026429037	ACREUNA	03/03/2020 12:45	03/03/2020 18:30	03/03/2020 12:45	03/03/2020 18:30	5,75	1	5,75	CHI
20200310051	GOIAS	GS11162299	GOIAS	03/03/2020 12:48	03/03/2020 23:15	03/03/2020 12:48	03/03/2020 23:15	10,44	2	20,89	CHI
20200310059	SAO MIGUEL DO ARAGUAIA	SM12099591	SAO MIGUEL DO ARAGUAIA	03/03/2020 12:50	04/03/2020 15:24	03/03/2020 12:50	04/03/2020 15:24	26,55	6	159,32	CHI
20200310063	SAO JOAO D ALIANCA	JL11280297	SAO JOAO D ALIANCA	03/03/2020 12:52	03/03/2020 16:54	03/03/2020 12:52	03/03/2020 16:54	4,02	9	36,18	CHI
20200310064	CATALAO	CT12134367	CATALAO S1	03/03/2020 12:52	03/03/2020 18:33	03/03/2020 12:52	03/03/2020 18:33	5,67	11	62,34	CHI
20200310070	SERRANOPOLIS	SX21249612	JATAI S1	03/03/2020 12:54	04/03/2020 08:33	03/03/2020 12:54	04/03/2020 08:33	19,64	1	19,64	CHI
20200310073	SANTA CRUZ DE GOIAS	BC12012000	PIRES DO RIO S2	03/03/2020 12:55	03/03/2020 14:35	03/03/2020 12:55	03/03/2020 14:35	1,67	86	143,36	CHI
20200310076	RIO VERDE	RV12322315	CABRIUVA S2	03/03/2020 12:56	04/03/2020 08:41	03/03/2020 12:56	04/03/2020 08:41	19,74	1	19,74	CHI
20200310077	GOIANIA	12626004	MEIA PONTE	03/03/2020 12:57	03/03/2020 15:27	03/03/2020 12:57	03/03/2020 15:27	2,49	1	2,49	CHI
20200310086	ANAPOLIS	10028314342	JUNDIAI S2	03/03/2020 13:00	03/03/2020 18:31	03/03/2020 13:00	03/03/2020 18:31	5,51	1	5,51	CHI
20200310101	POSSE	PS21237079	IACIARA S2	03/03/2020 13:05	03/03/2020 15:11	03/03/2020 13:05	03/03/2020 15:11	2,10	3	6,29	CHI
20200310111	NOVA IGUACU DE GOIAS	MQ21026544	CAMPINORTE	03/03/2020 13:07	03/03/2020 16:23	03/03/2020 13:07	03/03/2020 16:23	3,26	1	3,26	CHI
20200310112	PORANGATU	PO12020618	PORANGATU	03/03/2020 13:08	03/03/2020 15:13	03/03/2020 13:08	03/03/2020 15:13	2,07	24	49,79	CHI
20200310116	ITAJA	IJ21138062	ITAJA S2	03/03/2020 13:11	03/03/2020 19:22	03/03/2020 13:11	03/03/2020 19:22	6,18	1	6,18	CHI
20200310121	CABECEIRAS	CW21157333	ITUIQUIRA	03/03/2020 13:13	03/03/2020 14:27	03/03/2020 13:13	03/03/2020 14:27	1,22	1	1,22	CHI
20200310125	MINEIROS	MY21302933	PARQUE DAS EMAS	03/03/2020 13:15	03/03/2020 19:26	03/03/2020 13:15	03/03/2020 19:26	6,18	1	6,18	CHI
20200310126	RIO VERDE	RV12260132	CABRIUVA S2	03/03/2020 13:11	03/03/2020 17:30	03/03/2020 13:11	03/03/2020 17:30	4,32	19	82,10	CHI
20200310131	CRISTALINA	1060004279	CRISTALINA S1	03/03/2020 13:16	03/03/2020 15:41	03/03/2020 13:16	03/03/2020 15:41	2,41	1	2,41	CHI
20200310134	ITARUMA	IM21062395	CACHOEIRA ALTA	03/03/2020 13:17	03/03/2020 16:33	03/03/2020 13:17	03/03/2020 16:33	3,25	1	3,25	CHI
20200310138	PARAUNA	PU12301167	ACREUNA	03/03/2020 13:20	03/03/2020 17:02	03/03/2020 13:20	03/03/2020 17:02	3,71	15	55,66	CHI
20200310142	JATAI	JT21216743	JATAI S1	03/03/2020 13:21	03/03/2020 19:07	03/03/2020 13:21	03/03/2020 19:07	5,76	1	5,76	CHI
20200310150	FORMOSA	FA21257647	ITUIQUIRA	03/03/2020 13:23	03/03/2020 17:40	03/03/2020 13:23	03/03/2020 17:40	4,27	1	4,27	CHI
20200310152	NAZARIO	NZ21326677	ANICUNS	03/03/2020 13:24	03/03/2020 18:28	03/03/2020 13:24	03/03/2020 18:28	5,06	1	5,06	CHI
20200310159	APARECIDA DE GOIANIA	10022145476	ANHANGUERA	03/03/2020 13:26	03/03/2020 19:31	03/03/2020 13:26	03/03/2020 19:31	6,07	1	6,07	CHI
20200310161	PORANGATU	PO21035619	PORANGATU	03/03/2020 13:27	03/03/2020 16:22	03/03/2020 13:27	03/03/2020 16:22	2,92	1	2,92	CHI
20200310163	ITAPURANGA	IK12250508	ITAPURANGA	03/03/2020 13:27	03/03/2020 23:51	03/03/2020 13:27	03/03/2020 23:51	10,39	3	31,17	CHI
20200310164	VILA PROPICIO	NP12298198	GOIANESIA S1	03/03/2020 07:07	03/03/2020 20:30	03/03/2020 07:07	03/03/2020 20:30	13,38	4	53,53	CHI

20200310165	MINEIROS	MY21301881	PARQUE DAS EMAS	03/03/2020 13:28	04/03/2020 09:05	03/03/2020 13:28	04/03/2020 09:05	19,60	1	19,60	CHI
20200310166	GOIANESIA	GE12322006	GOIANESIA S1	03/03/2020 10:38	03/03/2020 19:25	03/03/2020 10:38	03/03/2020 19:25	8,78	7	61,48	CHI
20200310166	SANTA RITA DO NOVO DESTINO	GE12322006	GOIANESIA S1	03/03/2020 10:38	03/03/2020 19:25	03/03/2020 10:38	03/03/2020 19:25	8,78	7	61,48	CHI
20200310167	SENADOR CANEDO	190079836	SENADOR CANEDO	03/03/2020 13:29	03/03/2020 14:55	03/03/2020 13:29	03/03/2020 14:55	1,43	1	1,43	CHI
20200310176	CACHOEIRA ALTA	CA21094398	CACHOEIRA ALTA	03/03/2020 13:31	03/03/2020 15:26	03/03/2020 13:31	03/03/2020 15:26	1,90	1	1,90	CHI
20200310178	IACIARA	IA21254267	IACIARA S2	03/03/2020 13:32	03/03/2020 17:28	03/03/2020 13:32	03/03/2020 17:28	3,93	1	3,93	CHI
20200310185	GOIANIA	GN11155695	CAMPINAS S2	03/03/2020 13:00	03/03/2020 16:09	03/03/2020 13:00	03/03/2020 16:09	3,14	159	499,53	CHI
20200310188	EDEALINA	ED12007679	PONTALINA	03/03/2020 13:35	03/03/2020 14:57	03/03/2020 13:35	03/03/2020 14:57	1,37	16	21,98	CHI
20200310189	SAO LUIS DE MONTES BELOS	SL21259062	SAO LUIZ DOS MONTES BELOS	03/03/2020 13:35	03/03/2020 15:45	03/03/2020 13:35	03/03/2020 15:45	2,16	2	4,32	CHI
20200310191	GOIANIA	13703936	AEROPORTO S2	03/03/2020 13:35	03/03/2020 16:51	03/03/2020 13:35	03/03/2020 16:51	3,25	1	3,25	CHI
20200310192	SANTA CRUZ DE GOIAS	BC12389809	PIRES DO RIO S2	03/03/2020 11:12	03/03/2020 20:42	03/03/2020 11:12	03/03/2020 20:42	9,50	8	75,97	CHI
20200310195	VALPARAISO DE GOIAS	3350019351	PACAEMBU S1	03/03/2020 13:37	03/03/2020 17:25	03/03/2020 13:37	03/03/2020 17:25	3,80	1	3,80	CHI
20200310196	CORUMBA DE GOIAS	CB21114961	CORUMBA	03/03/2020 13:37	03/03/2020 18:16	03/03/2020 13:37	03/03/2020 18:16	4,64	1	4,64	CHI
20200310197	IACIARA	IA12062299	IACIARA S2	03/03/2020 13:37	03/03/2020 16:26	03/03/2020 13:37	03/03/2020 16:26	2,81	14	39,29	CHI
20200310197	POSSE	IA12062299	IACIARA S2	03/03/2020 13:37	03/03/2020 16:26	03/03/2020 13:37	03/03/2020 16:26	2,81	1	2,81	CHI
20200310205	CALDAS NOVAS	CN11000047	CALDAS NOVAS S1	03/03/2020 13:39	03/03/2020 16:41	03/03/2020 13:39	03/03/2020 16:41	3,02	6	18,12	CHI
20200310210	PARAUNA	PU12301178	ACREUNA	03/03/2020 13:41	03/03/2020 19:01	03/03/2020 13:41	03/03/2020 19:01	5,33	8	42,64	CHI
20200310211	NIQUELANDIA	NQ21255461	NIQUELANDIA SUBTRANSMISSAO	03/03/2020 13:42	03/03/2020 17:50	03/03/2020 13:42	03/03/2020 17:50	4,13	2	8,27	CHI
20200310216	ITABERAI	IB11250620	ITABERAI S1	03/03/2020 13:42	03/03/2020 18:24	03/03/2020 13:42	03/03/2020 18:24	4,69	53	248,45	CHI
20200310218	INHUMAS	IN12066343	INHUMAS S2	03/03/2020 13:43	03/03/2020 22:23	03/03/2020 13:43	03/03/2020 22:23	8,65	2	17,30	CHI
20200310219	VIANOPOLIS	510041541	VIANOPOLIS	03/03/2020 13:41	03/03/2020 15:44	03/03/2020 13:41	03/03/2020 15:44	2,04	1	2,04	CHI
20200310221	LUZIANIA	LZ21228583	CRISTALINA S2	03/03/2020 13:44	03/03/2020 19:08	03/03/2020 13:44	03/03/2020 19:08	5,39	1	5,39	CHI
20200310222	COCALZINHO DE GOIAS	ZN12375219	AGUAS LINDAS DE GOIAS S2	03/03/2020 13:44	03/03/2020 16:41	03/03/2020 13:44	03/03/2020 16:41	2,93	25	73,34	CHI
20200310224	AGUA FRIA DE GOIAS	4140005465	SAO JOAO D ALIANCA	03/03/2020 13:45	03/03/2020 18:00	03/03/2020 13:45	03/03/2020 18:00	4,26	1	4,26	CHI
20200310226	CEZARINA	CZ12404092	CEZARINA	03/03/2020 13:45	03/03/2020 15:45	03/03/2020 13:45	03/03/2020 15:45	2,00	2	4,00	CHI
20200310227	VILA PROPICIO	NP12231823	GOIANESIA S1	03/03/2020 10:11	03/03/2020 17:44	03/03/2020 10:11	03/03/2020 17:44	7,54	18	135,73	CHI
20200310229	SAO FRANCISCO DE GOIAS	SF12335087	SAO FRANCISCO DE GOIAS	03/03/2020 13:47	03/03/2020 17:01	03/03/2020 13:47	03/03/2020 17:01	3,23	12	38,77	CHI
20200310233	ALTO HORIZONTE	AJ12143571	MARA ROSA	03/03/2020 13:33	03/03/2020 17:11	03/03/2020 13:33	03/03/2020 17:11	3,63	37	134,40	CHI
20200310233	MARA ROSA	AJ12143571	MARA ROSA	03/03/2020 13:33	03/03/2020 17:11	03/03/2020 13:33	03/03/2020 17:11	3,63	5	18,16	CHI
20200310233	NOVA IGUACU DE GOIAS	AJ12143571	MARA ROSA	03/03/2020 13:33	03/03/2020 17:11	03/03/2020 13:33	03/03/2020 17:11	3,63	12	43,59	CHI
20200310238	ALEXANIA	AX10394596	ALEXANIA	03/03/2020 13:44	03/03/2020 22:16	03/03/2020 13:44	03/03/2020 15:18	1,56	47	73,37	CHI
20200310238	CORUMBA DE GOIAS	AX10394596	ALEXANIA	03/03/2020 13:44	03/03/2020 22:16	03/03/2020 13:44	03/03/2020 15:18	1,56	5	7,81	CHI
20200310238	ALEXANIA	AX12211853LD	ALEXANIA	03/03/2020 13:44	03/03/2020 22:16	03/03/2020 13:44	03/03/2020 18:05	4,35	38	165,43	CHI
20200310238	CORUMBA DE GOIAS	AX12211853LD	ALEXANIA	03/03/2020 13:44	03/03/2020 22:16	03/03/2020 13:44	03/03/2020 18:05	4,35	2	8,71	CHI
20200310238	ALEXANIA	AX12351040LD	ALEXANIA	03/03/2020 13:44	03/03/2020 22:16	03/03/2020 13:44	03/03/2020 21:37	7,89	29	228,72	CHI
20200310238	ALEXANIA	AX12362272LD	ALEXANIA	03/03/2020 13:44	03/03/2020 22:16	03/03/2020 13:44	03/03/2020 22:16	8,53	34	290,07	CHI
20200310238	SANTO ANTONIO DO DESCOBERTO	AX12362272LD	ALEXANIA	03/03/2020 13:44	03/03/2020 22:16	03/03/2020 13:44	03/03/2020 22:16	8,53	4	34,13	CHI
20200310241	MINEIROS	PW12301997LD	PARQUE DAS EMAS	03/03/2020 13:49	03/03/2020 21:40	03/03/2020 13:49	03/03/2020 21:40	7,85	5	39,26	CHI
20200310241	PORTELANDIA	PW12301997LD	PARQUE DAS EMAS	03/03/2020 13:49	03/03/2020 21:40	03/03/2020 13:49	03/03/2020 21:40	7,85	12	94,21	CHI
20200310241	PORTELANDIA	PW12301997LD	PARQUE DAS EMAS	03/03/2020 13:49	03/03/2020 21:40	03/03/2020 19:10	03/03/2020 21:40	2,50	31	77,41	CHI
20200310247	ALEXANIA	AX12211859	ALEXANIA	03/03/2020 11:30	03/03/2020 16:50	03/03/2020 11:30	03/03/2020 15:35	4,08	58	236,62	CHI
20200310247	ALEXANIA	AX11185675	ALEXANIA	03/03/2020 11:30	03/03/2020 16:50	03/03/2020 11:30	03/03/2020 16:50	5,33	34	181,35	CHI
20200310253	SAO MIGUEL DO ARAGUAIA	SM12192357	SAO MIGUEL DO ARAGUAIA	03/03/2020 13:51	04/03/2020 14:14	03/03/2020 13:51	04/03/2020 14:14	24,38	1	24,38	CHI
20200310256	PADRE BERNARDO	PB21137764	PADRE BERNARDO	03/03/2020 13:52	03/03/2020 21:04	03/03/2020 13:52	03/03/2020 21:04	7,20	2	14,39	CHI

20200310268	GOIANIA	11465773	GOYA S2	03/03/2020 13:54	03/03/2020 16:25	03/03/2020 13:54	03/03/2020 16:25	2,51	1	2,51	CHI
20200310270	MONTIVIDIU	MV12267611	MONTIVIDIU T	03/03/2020 13:55	03/03/2020 16:47	03/03/2020 13:55	03/03/2020 16:47	2,86	5	14,31	CHI
20200310273	JARAGUA	JA21297422	JARAGUA	03/03/2020 13:56	03/03/2020 18:31	03/03/2020 13:56	03/03/2020 18:31	4,57	1	4,57	CHI
20200310280	NIQUELANDIA	2750079178	NIQUELANDIA SUBTRANSMISSAO	03/03/2020 13:59	03/03/2020 15:55	03/03/2020 13:59	03/03/2020 15:55	1,93	1	1,93	CHI
20200310282	AGUAS LINDAS DE GOIAS	4830382182	AGUAS LINDAS DE GOIAS S1	03/03/2020 13:59	03/03/2020 19:44	03/03/2020 13:59	03/03/2020 19:44	5,74	1	5,74	CHI
20200310288	CORUMBA DE GOIAS	CB21115010	CORUMBA	03/03/2020 13:59	03/03/2020 17:03	03/03/2020 13:59	03/03/2020 17:03	3,05	1	3,05	CHI
20200310291	ORIZONA	OZ12372377	PIRES DO RIO S2	03/03/2020 14:01	03/03/2020 19:14	03/03/2020 14:01	03/03/2020 19:14	5,20	25	130,01	CHI
20200310299	SANTO ANTONIO DO DESCOBERTO	SN21084681	MARAJOARA	03/03/2020 14:04	03/03/2020 16:36	03/03/2020 14:04	03/03/2020 16:36	2,53	1	2,53	CHI
20200310302	CALDAS NOVAS	CN12332905	CALDAS NOVAS S1	03/03/2020 14:05	04/03/2020 08:49	03/03/2020 14:05	04/03/2020 08:49	18,73	30	561,83	CHI
20200310314	MUNDO NOVO DE GOIAS	MH12391949	NOVA CRIXAS	03/03/2020 13:11	03/03/2020 17:41	03/03/2020 13:11	03/03/2020 17:41	4,49	42	188,64	CHI
20200310319	VALPARAISO DE GOIAS	10016399968	MARAJOARA	03/03/2020 14:09	03/03/2020 15:39	03/03/2020 14:09	03/03/2020 15:39	1,50	1	1,50	CHI
20200310328	MOSSAMEDES	MD12119449	ANICUNS	03/03/2020 09:33	03/03/2020 18:57	03/03/2020 09:33	03/03/2020 18:57	9,39	15	140,92	CHI
20200310329	PARAUNA	PU12273594	PARAUNA	03/03/2020 14:11	03/03/2020 17:42	03/03/2020 14:11	03/03/2020 17:42	3,50	8	28,04	CHI
20200310337	PONTALINA	210017570	PONTALINA	03/03/2020 14:12	03/03/2020 16:46	03/03/2020 14:12	03/03/2020 16:46	2,57	1	2,57	CHI
20200310345	GOIANIA	GN11001984	ATLANTICO S1	03/03/2020 12:53	03/03/2020 16:24	03/03/2020 12:53	03/03/2020 16:24	3,50	109	381,83	CHI
20200310346	FORMOSA	FA12085474	ITUIQUIRA	03/03/2020 14:13	03/03/2020 16:21	03/03/2020 14:13	03/03/2020 16:21	2,12	29	61,58	CHI
20200310356	LAGOA SANTA	3900002718	ITAJA S2	03/03/2020 14:17	03/03/2020 16:35	03/03/2020 14:17	03/03/2020 16:35	2,29	1	2,29	CHI
20200310363	SAO LUIS DE MONTES BELOS	500084178	SAO LUIZ DOS MONTES BELOS	03/03/2020 14:18	03/03/2020 18:00	03/03/2020 14:18	03/03/2020 18:00	3,69	1	3,69	CHI
20200310366	GOIANIA	GN11001268	CAMPINAS S3	03/03/2020 14:17	03/03/2020 15:49	03/03/2020 14:17	03/03/2020 15:49	1,53	162	247,14	CHI
20200310375	PORANGATU	PO12241996	PORANGATU	03/03/2020 14:22	03/03/2020 18:18	03/03/2020 14:22	03/03/2020 18:18	3,92	81	317,81	CHI
20200310376	QUIRINOPOLIS	QI21101743	QUIRINOPOLIS	03/03/2020 14:22	03/03/2020 22:52	03/03/2020 14:22	03/03/2020 22:52	8,49	1	8,49	CHI
20200310385	POSSE	PS21312630	IACIARA S2	03/03/2020 14:23	03/03/2020 16:40	03/03/2020 14:23	03/03/2020 16:40	2,27	2	4,54	CHI
20200310399	CAMPOS VERDES	VD11055150	SANTA TEREZINHA	03/03/2020 13:31	04/03/2020 11:30	03/03/2020 13:31	04/03/2020 11:30	21,98	125	2747,99	CHI
20200310401	GOIANESIA	GE11297283	GOIANESIA S1	03/03/2020 14:29	03/03/2020 23:00	03/03/2020 14:29	03/03/2020 23:00	8,51	1	8,51	CHI
20200310404	NOVA CRIXAS	NA21080463	NOVA CRIXAS	03/03/2020 14:30	04/03/2020 12:44	03/03/2020 14:30	04/03/2020 12:44	22,22	5	111,11	CHI
20200310405	GOIAS	NB12064413	MATRINCHA	03/03/2020 14:31	03/03/2020 19:52	03/03/2020 14:31	03/03/2020 19:52	5,35	1	5,35	CHI
20200310405	NOVO BRASIL	NB12064413	MATRINCHA	03/03/2020 14:31	03/03/2020 19:52	03/03/2020 14:31	03/03/2020 19:52	5,35	30	160,48	CHI
20200310406	FORMOSA	FA21309102	ITUIQUIRA	03/03/2020 14:31	03/03/2020 17:34	03/03/2020 14:31	03/03/2020 17:34	3,05	1	3,05	CHI
20200310418	NOVO PLANALTO	TA12141118	NOVO PLANALTO	03/03/2020 14:35	03/03/2020 21:52	03/03/2020 14:35	03/03/2020 21:52	7,28	1	7,28	CHI
20200310418	PORANGATU	TA12141118	NOVO PLANALTO	03/03/2020 14:35	03/03/2020 21:52	03/03/2020 14:35	03/03/2020 21:52	7,28	1	7,28	CHI
20200310419	NOVA VENEZA	NV11246259	INHUMAS S1	03/03/2020 14:26	03/03/2020 19:08	03/03/2020 14:26	03/03/2020 19:08	4,69	131	614,68	CHI
20200310420	APARECIDA DE GOIANIA	AP12029887	ANHANGUERA	03/03/2020 14:36	03/03/2020 19:16	03/03/2020 14:36	03/03/2020 19:16	4,67	1	4,67	CHI
20200310424	CALDAS NOVAS	10017841036	SERRA DE CALDAS	03/03/2020 14:38	03/03/2020 17:28	03/03/2020 14:38	03/03/2020 17:28	2,83	1	2,83	CHI
20200310426	SANTO ANTONIO DE GOIAS	BW11343448	NEROPOLIS S1	03/03/2020 14:38	03/03/2020 17:32	03/03/2020 14:38	03/03/2020 17:32	2,90	21	60,80	CHI
20200310427	IPORA	10027399492	IPORA	03/03/2020 14:38	03/03/2020 19:50	03/03/2020 14:38	03/03/2020 19:50	5,19	1	5,19	CHI
20200310428	NAZARIO	NZ12000046	ANICUNS	03/03/2020 14:38	03/03/2020 18:22	03/03/2020 14:38	03/03/2020 18:22	3,72	1	3,72	CHI
20200310432	CAMPESTRE DE GOIAS	TR21000081	TRINDADE	03/03/2020 14:39	03/03/2020 17:24	03/03/2020 14:39	03/03/2020 17:24	2,74	1	2,74	CHI
20200310433	JATAI	JT12000231	JATAI S1	03/03/2020 14:27	03/03/2020 16:51	03/03/2020 14:27	03/03/2020 16:51	2,39	56	133,62	CHI
20200310433	PEROLANDIA	JT12000231	JATAI S1	03/03/2020 14:27	03/03/2020 16:51	03/03/2020 14:27	03/03/2020 16:51	2,39	3	7,16	CHI
20200310441	BONOPOLIS	BX21353563	SAO MIGUEL DO ARAGUAIA	03/03/2020 14:42	03/03/2020 21:31	03/03/2020 14:42	03/03/2020 21:31	6,80	1	6,80	CHI
20200310442	MONTIVIDIU DO NORTE	MX11364164	PORANGATU	03/03/2020 14:43	03/03/2020 16:42	03/03/2020 14:43	03/03/2020 16:42	1,98	1	1,98	CHI
20200310452	CRISTALINA	KR12133633	PAMPLONA	03/03/2020 14:45	03/03/2020 19:23	03/03/2020 14:45	03/03/2020 19:23	4,62	3	13,87	CHI
20200310457	JUSSARA	JR21137864	BRITANIA	03/03/2020 14:48	03/03/2020 16:52	03/03/2020 14:48	03/03/2020 16:52	2,06	1	2,06	CHI
20200310459	GOIAS	90035094	GOIAS	03/03/2020 14:48	03/03/2020 16:30	03/03/2020 14:48	03/03/2020 16:30	1,70	1	1,70	CHI

20200310460	APARECIDA DE GOIANIA	10005913827	INDEPENDENCIA S1	03/03/2020 14:48	03/03/2020 17:17	03/03/2020 14:48	03/03/2020 17:17	2,47	1	2,47	CHI
20200310466	ITUMBIARA	690246160	ITUMBIARA NOVA	03/03/2020 14:51	03/03/2020 16:49	03/03/2020 14:51	03/03/2020 16:49	1,97	1	1,97	CHI
20200310467	GOIANESIA	550097480	GOIANESIA S1	03/03/2020 14:51	04/03/2020 00:34	03/03/2020 14:51	04/03/2020 00:34	9,71	1	9,71	CHI
20200310468	GOIAS	GS21248145	ITABERAI S1	03/03/2020 14:51	03/03/2020 17:13	03/03/2020 14:51	03/03/2020 17:13	2,35	1	2,35	CHI
20200310473	URUACU	UR12317135	URUACU	03/03/2020 14:53	03/03/2020 18:58	03/03/2020 14:53	03/03/2020 18:58	4,07	11	44,76	CHI
20200310474	DIVINOPOLIS DE GOIAS	GH12156343RE	SAO DOMINGOS	03/03/2020 14:54	03/03/2020 17:50	03/03/2020 14:54	03/03/2020 17:50	2,93	127	372,36	CHI
20200310474	MONTE ALEGRE DE GOIAS	GH12156343RE	SAO DOMINGOS	03/03/2020 14:54	03/03/2020 17:50	03/03/2020 14:54	03/03/2020 17:50	2,93	15	43,98	CHI
20200310474	SAO DOMINGOS	GH12156343RE	SAO DOMINGOS	03/03/2020 14:54	03/03/2020 17:50	03/03/2020 14:54	03/03/2020 17:50	2,93	1	2,93	CHI
20200310476	JATAI	JT21348475	JATAI S2	03/03/2020 14:54	03/03/2020 20:37	03/03/2020 14:54	03/03/2020 20:37	5,71	1	5,71	CHI
20200310483	VALPARAISO DE GOIAS	3350006071	PACAEMBU S1	03/03/2020 14:56	03/03/2020 18:12	03/03/2020 14:56	03/03/2020 18:12	3,26	1	3,26	CHI
20200310484	CAMPOS VERDES	SG12202098	SANTA TEREZINHA	03/03/2020 14:57	03/03/2020 16:40	03/03/2020 14:57	03/03/2020 16:40	1,72	40	68,96	CHI
20200310484	SANTA TEREZINHA DE GOIAS	SG12202098	SANTA TEREZINHA	03/03/2020 14:57	03/03/2020 16:40	03/03/2020 14:57	03/03/2020 16:40	1,72	131	225,83	CHI
20200310484	UIRAPURU	SG12202098	SANTA TEREZINHA	03/03/2020 14:57	03/03/2020 16:40	03/03/2020 14:57	03/03/2020 16:40	1,72	56	96,54	CHI
20200310488	GOIANIA	GN12001199	CARAJAS S1	03/03/2020 14:58	03/03/2020 16:47	03/03/2020 14:58	03/03/2020 16:47	1,82	276	501,02	CHI
20200310489	CRISTALINA	KR11276465	CRISTALINA S2	03/03/2020 14:58	03/03/2020 20:10	03/03/2020 14:58	03/03/2020 20:10	5,20	1	5,20	CHI
20200310492	QUIRINOPOLIS	10021279789	QUIRINOPOLIS	03/03/2020 15:00	03/03/2020 17:04	03/03/2020 15:00	03/03/2020 17:04	2,06	1	2,06	CHI
20200310493	PLANALTINA	PI12100878	PLANALTINA	03/03/2020 14:44	03/03/2020 16:57	03/03/2020 14:44	03/03/2020 16:57	2,21	23	50,93	CHI
20200310504	GOIANIA	00580264	GOIANIA LESTE S1	03/03/2020 15:02	03/03/2020 19:57	03/03/2020 15:02	03/03/2020 15:44	0,69	4273	2951,93	CHI
20200310504	GOIANIA	00580264	GOIANIA LESTE S1	03/03/2020 15:02	03/03/2020 19:57	03/03/2020 15:02	03/03/2020 16:13	1,18	91	107,30	CHI
20200310504	GOIANIA	00580264	GOIANIA LESTE S1	03/03/2020 15:02	03/03/2020 19:57	03/03/2020 15:02	03/03/2020 16:18	1,26	2773	3504,76	CHI
20200310504	GOIANIA	GN13000309	GOIANIA LESTE S1	03/03/2020 15:02	03/03/2020 19:57	03/03/2020 16:17	03/03/2020 19:57	3,67	91	333,57	CHI
20200310605	GOIANIA	13965463	MEIA PONTE	03/03/2020 15:02	03/03/2020 16:12	03/03/2020 15:02	03/03/2020 16:12	1,15	1	1,15	CHI
20200310607	LUZIANIA	LZ12304865	MARAJOARA	03/03/2020 15:04	03/03/2020 17:14	03/03/2020 15:04	03/03/2020 17:14	2,17	5	10,83	CHI
20200310627	VALPARAISO DE GOIAS	2860192330	PACAEMBU S2	03/03/2020 15:08	03/03/2020 18:02	03/03/2020 15:08	03/03/2020 18:02	2,89	1	2,89	CHI
20200310628	PADRE BERNARDO	PB12336085	PADRE BERNARDO	03/03/2020 16:33	04/03/2020 14:45	03/03/2020 16:33	04/03/2020 14:45	22,19	12	266,33	CHI
20200310651	GOIANIA	GN11021067	XAVANTES	03/03/2020 15:12	03/03/2020 17:26	03/03/2020 17:13	03/03/2020 17:26	0,22	27	5,85	CHI
20200310656	FORMOSA	2870003785	ITUIQUIRA	03/03/2020 15:14	03/03/2020 18:42	03/03/2020 15:14	03/03/2020 18:42	3,46	1	3,46	CHI
20200310658	ITAPIRAPUA	IU12072448	MATRINCHA	03/03/2020 15:14	04/03/2020 14:40	03/03/2020 15:14	04/03/2020 14:40	23,42	1	23,42	CHI
20200310660	VILA PROPICIO	PV21150315	GOIANESIA S1	03/03/2020 15:15	03/03/2020 22:00	03/03/2020 15:15	03/03/2020 22:00	6,75	1	6,75	CHI
20200310661	CRISTIANOPOLIS	CF11000003	CRISTIANOPOLIS	03/03/2020 13:45	04/03/2020 00:18	03/03/2020 13:45	04/03/2020 00:18	10,54	95	1001,54	CHI
20200310662	SILVANIA	SV12247188	VIANOPOLIS	03/03/2020 15:15	03/03/2020 19:05	03/03/2020 15:15	03/03/2020 19:05	3,83	15	57,40	CHI
20200310665	ORIZONA	OZ12300909	PIRES DO RIO S2	03/03/2020 15:15	03/03/2020 18:42	03/03/2020 15:15	03/03/2020 18:42	3,44	13	44,73	CHI
20200310669	GOIAS	90007177	GOIAS	03/03/2020 15:16	03/03/2020 18:07	03/03/2020 15:16	03/03/2020 18:07	2,84	1	2,84	CHI
20200310676	ITAJA	2300010027	ITAJA S2	03/03/2020 15:17	03/03/2020 19:43	03/03/2020 15:17	03/03/2020 19:43	4,42	1	4,42	CHI
20200310677	SAO DOMINGOS	SD12317850	SAO DOMINGOS	03/03/2020 15:18	03/03/2020 17:45	03/03/2020 15:18	03/03/2020 17:45	2,45	69	168,84	CHI
20200310678	APARECIDA DE GOIANIA	15404330	INDEPENDENCIA S2	03/03/2020 15:18	03/03/2020 17:24	03/03/2020 15:18	03/03/2020 17:24	2,10	1	2,10	CHI
20200310683	GOIANIA	GN12396183	GOYA S1	03/03/2020 15:19	03/03/2020 17:11	03/03/2020 15:19	03/03/2020 17:11	1,85	63	116,73	CHI
20200310688	AGUAS LINDAS DE GOIAS	4830315624	AGUAS LINDAS DE GOIAS S1	03/03/2020 15:21	03/03/2020 16:51	03/03/2020 15:21	03/03/2020 16:51	1,49	1	1,49	CHI
20200310690	FORMOSA	FA21257706	ITUIQUIRA	03/03/2020 15:22	03/03/2020 16:54	03/03/2020 15:22	03/03/2020 16:54	1,53	1	1,53	CHI
20200310693	MORRINHOS	150039244	MORRINHOS	03/03/2020 15:23	03/03/2020 18:17	03/03/2020 15:23	03/03/2020 18:17	2,90	1	2,90	CHI
20200310704	GOIANIA	GN11001921	GOIANIA LESTE S3	03/03/2020 15:15	03/03/2020 18:55	03/03/2020 15:15	03/03/2020 18:55	3,66	55	201,16	CHI
20200310705	NOVA GLORIA	8700511	ITAPACI	03/03/2020 15:27	04/03/2020 08:43	03/03/2020 15:27	04/03/2020 08:43	17,27	6	103,59	CHI
20200310706	CAVALCANTE	CJ12409496	MINACU	03/03/2020 09:02	03/03/2020 21:37	03/03/2020 09:02	03/03/2020 21:37	12,58	116	1459,28	CHI
20200310716	LUZIANIA	120383550	RIO VERMELHO	03/03/2020 15:28	03/03/2020 16:31	03/03/2020 15:28	03/03/2020 16:31	1,04	1	1,04	CHI

20200310717	GOIANIA	GN12047147	AEROPORTO S1	03/03/2020 15:20	03/03/2020 17:25	03/03/2020 15:20	03/03/2020 17:25	2,07	170	351,90	CHI
20200310718	GOIANIA	12192570	GOIANIA LESTE S2	03/03/2020 15:28	04/03/2020 01:00	03/03/2020 15:28	04/03/2020 01:00	9,52	1	9,52	CHI
20200310726	SAO JOAO D ALIANCA	JL12383340	SAO JOAO D ALIANCA	03/03/2020 15:29	03/03/2020 17:29	03/03/2020 15:29	03/03/2020 17:29	1,98	76	150,75	CHI
20200310729	GOIANIA	GN12000085	CAMPINAS S1	03/03/2020 15:31	03/03/2020 16:53	03/03/2020 15:31	03/03/2020 16:53	1,36	97	132,22	CHI
20200310732	BOM JARDIM DE GOIAS	BM12360371	BOM JARDIM	03/03/2020 15:32	04/03/2020 03:16	03/03/2020 15:32	04/03/2020 03:16	11,73	2	23,46	CHI
20200310733	SERRANOPOLIS	SX12166082	JATAI S1	03/03/2020 15:04	03/03/2020 17:26	03/03/2020 15:04	03/03/2020 17:26	2,36	19	44,75	CHI
20200310737	SANTA TEREZINHA DE GOIAS	VD11094177	SANTA TEREZINHA	03/03/2020 15:33	03/03/2020 22:39	03/03/2020 15:33	03/03/2020 22:39	7,10	49	347,71	CHI
20200310740	MONTE ALEGRE DE GOIAS	MA12233165	SAO DOMINGOS	03/03/2020 15:33	03/03/2020 17:30	03/03/2020 15:33	03/03/2020 17:30	1,94	6	11,63	CHI
20200310748	JESUPOLIS	SF12000163	SAO FRANCISCO DE GOIAS	03/03/2020 15:15	03/03/2020 19:09	03/03/2020 15:15	03/03/2020 19:09	3,89	25	97,26	CHI
20200310753	PETROLINA DE GOIAS	PG12297931	PETROLINA	03/03/2020 15:04	03/03/2020 20:49	03/03/2020 15:04	03/03/2020 20:49	5,74	117	671,74	CHI
20200310753	SAO FRANCISCO DE GOIAS	PG12297931	PETROLINA	03/03/2020 15:04	03/03/2020 20:49	03/03/2020 15:04	03/03/2020 20:49	5,74	1	5,74	CHI
20200310755	APARECIDA DE GOIANIA	10000463491	REAL S2	03/03/2020 15:37	03/03/2020 17:27	03/03/2020 15:37	03/03/2020 17:27	1,83	1	1,83	CHI
20200310756	PLANALTINA	2960110074	PLANALTINA	03/03/2020 15:37	03/03/2020 17:29	03/03/2020 15:37	03/03/2020 17:29	1,86	1	1,86	CHI
20200310759	GOIANIA	10267232	CAMPINAS S3	03/03/2020 15:37	03/03/2020 17:54	03/03/2020 15:37	03/03/2020 17:54	2,27	1	2,27	CHI
20200310762	GOIANIA	GN11000668	ATLANTICO S2	03/03/2020 15:38	03/03/2020 17:09	03/03/2020 15:38	03/03/2020 17:09	1,50	99	148,89	CHI
20200310764	ALEXANIA	AX21302177	ALEXANIA	03/03/2020 15:39	04/03/2020 11:35	03/03/2020 15:39	04/03/2020 11:35	19,93	4	79,73	CHI
20200310765	MAMBAI	1570010277	IACIARA S2	03/03/2020 15:39	03/03/2020 17:06	03/03/2020 15:39	03/03/2020 17:06	1,44	1	1,44	CHI
20200310767	GOIANIA	10659717	AEROPORTO S2	03/03/2020 15:40	03/03/2020 18:52	03/03/2020 15:40	03/03/2020 18:52	3,20	1	3,20	CHI
20200310770	SILVANIA	SV21137423	VIANOPOLIS	03/03/2020 15:41	03/03/2020 16:54	03/03/2020 15:41	03/03/2020 16:54	1,21	1	1,21	CHI
20200310771	ITABERAI	IX21332280	ITABERAI S1	03/03/2020 15:42	03/03/2020 20:50	03/03/2020 15:42	03/03/2020 20:31	4,83	2	9,65	CHI
20200310771	ITAUCU	IB21154942	ITABERAI S1	03/03/2020 15:42	03/03/2020 20:50	03/03/2020 15:42	03/03/2020 20:50	5,13	1	5,13	CHI
20200310772	LUZIANIA	LZ21360112	RIO VERMELHO	03/03/2020 15:42	03/03/2020 17:54	03/03/2020 15:42	03/03/2020 17:54	2,19	1	2,19	CHI
20200310778	LEOPOLDO DE BULHOES	LB11105043	CEPAIGO S2	03/03/2020 15:43	03/03/2020 18:57	03/03/2020 15:43	03/03/2020 18:57	3,22	25	80,56	CHI
20200310779	JARAGUA	JA12298079	JARAGUA	03/03/2020 15:43	03/03/2020 20:45	03/03/2020 15:43	03/03/2020 20:45	5,02	10	50,22	CHI
20200310780	HIDROLANDIA	180007403	CEPAIGO S2	03/03/2020 15:43	03/03/2020 18:31	03/03/2020 15:43	03/03/2020 18:31	2,79	1	2,79	CHI
20200310791	GOIANIA	GN11041230	ATLANTICO S2	03/03/2020 15:45	03/03/2020 16:55	03/03/2020 15:45	03/03/2020 16:55	1,16	105	121,74	CHI
20200310792	BONOPOLIS	BX21245115	SAO MIGUEL DO ARAGUAIA	03/03/2020 15:45	03/03/2020 22:02	03/03/2020 15:45	03/03/2020 22:02	6,27	1	6,27	CHI
20200310794	INDIARA	IY12056564	EDEIA	03/03/2020 15:45	03/03/2020 19:14	03/03/2020 15:45	03/03/2020 19:14	3,47	1	3,47	CHI
20200310799	GOIANIA	GN11000540	CAMPINAS S3	03/03/2020 15:47	03/03/2020 21:34	03/03/2020 15:47	03/03/2020 21:34	5,77	17	98,09	CHI
20200310800	LUZIANIA	LZ12261749	CRISTALINA S2	03/03/2020 15:48	03/03/2020 23:08	03/03/2020 15:48	03/03/2020 23:08	7,33	3	21,99	CHI
20200310803	CATALAO	CT12103430	CATALAO S1	03/03/2020 15:49	03/03/2020 20:15	03/03/2020 15:49	03/03/2020 20:15	4,43	2	8,86	CHI
20200310811	ITAPIRAPUA	IU12014779	MATRINCHA	03/03/2020 15:07	03/03/2020 21:33	03/03/2020 15:07	03/03/2020 21:33	6,42	12	77,09	CHI
20200310815	CORUMBAIBA	CI21076934	VILA CORUMBA	03/03/2020 15:49	04/03/2020 16:50	03/03/2020 15:49	04/03/2020 16:50	25,00	1	25,00	CHI
20200310817	PORANGATU	PO21308167	PORANGATU	03/03/2020 15:50	03/03/2020 23:52	03/03/2020 15:50	03/03/2020 23:52	8,02	1	8,02	CHI
20200310818	DAVINOPOLIS	IO12073927	CATALAO S1	03/03/2020 15:28	03/03/2020 18:08	03/03/2020 15:28	03/03/2020 18:08	2,66	48	127,80	CHI
20200310821	CRIXAS	CX12321941	SERRA DO OURO	03/03/2020 15:45	03/03/2020 22:00	03/03/2020 15:45	03/03/2020 22:00	6,25	18	112,49	CHI
20200310821	NOVA CRIXAS	CX12321941	SERRA DO OURO	03/03/2020 15:45	03/03/2020 22:00	03/03/2020 15:45	03/03/2020 22:00	6,25	5	31,25	CHI
20200310829	GOIANESIA	GE11215135	GOIANESIA S2	03/03/2020 15:53	03/03/2020 17:00	03/03/2020 15:53	03/03/2020 17:00	1,12	96	107,20	CHI
20200310835	RIO QUENTE	RQ12063401	RIO QUENTE	03/03/2020 15:54	03/03/2020 20:48	03/03/2020 15:54	03/03/2020 20:48	4,90	6	29,41	CHI
20200310836	LUZIANIA	LZ12052693	CRISTALINA S2	03/03/2020 15:54	03/03/2020 17:52	03/03/2020 15:54	03/03/2020 17:52	1,96	1	1,96	CHI
20200310843	GOIANIA	GN11001626	CAMPINAS S1	03/03/2020 15:52	03/03/2020 19:35	03/03/2020 15:52	03/03/2020 19:35	3,70	85	314,88	CHI
20200310846	PORANGATU	PO12297141	PORANGATU	03/03/2020 15:57	03/03/2020 20:09	03/03/2020 15:57	03/03/2020 20:09	4,19	19	79,62	CHI
20200310847	MUNDO NOVO DE GOIAS	MH21220652	NOVA CRIXAS	03/03/2020 15:58	03/03/2020 20:18	03/03/2020 15:58	03/03/2020 20:18	4,32	1	4,32	CHI
20200310858	ANAPOLIS	20814148	ANAPOLIS UNIVERSITARIO S2	03/03/2020 16:01	04/03/2020 10:33	03/03/2020 16:01	04/03/2020 10:33	18,52	1	18,52	CHI

20200310864	GOIANIA	GN12001063	FERROVIARIO S3	03/03/2020 15:19	03/03/2020 17:51	03/03/2020 15:19	03/03/2020 17:51	2,53	234	591,82	CHI
20200310868	NIQUELANDIA	NQ21141840	NIQUELANDIA SUBTRANSMISSAO	03/03/2020 16:04	04/03/2020 01:32	03/03/2020 16:04	04/03/2020 01:32	9,45	1	9,45	CHI
20200310873	LUZIANIA	10031176060	RIO VERMELHO	03/03/2020 16:04	03/03/2020 18:26	03/03/2020 16:04	03/03/2020 18:26	2,35	1	2,35	CHI
20200310879	ANAPOLIS	AN12302127	ANAPOLIS UNIVERSITARIO S2	03/03/2020 16:06	04/03/2020 07:18	03/03/2020 16:06	04/03/2020 07:18	15,20	3	45,59	CHI
20200310881	URUACU	UR21000022	URUACU	03/03/2020 16:07	03/03/2020 19:56	03/03/2020 16:07	03/03/2020 19:56	3,81	2	7,63	CHI
20200310886	JATAI	JT11254109	JATAI S1	03/03/2020 14:27	03/03/2020 19:17	03/03/2020 14:27	03/03/2020 19:17	4,82	1	4,82	CHI
20200310887	PALMEIRAS DE GOIAS	PL21200214	PALMEIRAS	03/03/2020 16:09	03/03/2020 16:59	03/03/2020 16:09	03/03/2020 16:59	0,83	1	0,83	CHI
20200310889	TRINDADE	40235798	TRINDADE	03/03/2020 16:10	03/03/2020 17:58	03/03/2020 16:10	03/03/2020 17:58	1,80	1	1,80	CHI
20200310891	MORRINHOS	150037594	MORRINHOS	03/03/2020 16:10	03/03/2020 19:30	03/03/2020 16:10	03/03/2020 19:30	3,32	1	3,32	CHI
20200310899	IACIARA	IA12204746LD	IACIARA S1	03/03/2020 16:12	03/03/2020 21:05	03/03/2020 16:12	03/03/2020 21:05	4,88	112	547,09	CHI
20200310899	IACIARA	IA12204746LD	IACIARA S1	03/03/2020 16:12	03/03/2020 21:05	03/03/2020 20:22	03/03/2020 21:05	0,71	299	211,54	CHI
20200311101	ITUMBIARA	IT10408204	PARANAIBA	03/03/2020 15:46	03/03/2020 21:19	03/03/2020 15:54	03/03/2020 16:33	0,65	43	27,78	CHI
20200311101	ITUMBIARA	IT10408204	PARANAIBA	03/03/2020 15:46	03/03/2020 21:19	03/03/2020 16:39	03/03/2020 20:59	4,34	43	186,50	CHI
20200311101	BURITI ALEGRE	IT10408204	PARANAIBA	03/03/2020 15:46	03/03/2020 21:19	03/03/2020 15:54	03/03/2020 21:19	5,41	8	43,28	CHI
20200311101	GOIATUBA	IT10408204	PARANAIBA	03/03/2020 15:46	03/03/2020 21:19	03/03/2020 15:54	03/03/2020 21:19	5,41	6	32,46	CHI
20200311101	ITUMBIARA	IT10408204	PARANAIBA	03/03/2020 15:46	03/03/2020 21:19	03/03/2020 15:54	03/03/2020 21:19	5,41	66	357,06	CHI
20200311101	PANAMA	IT10408204	PARANAIBA	03/03/2020 15:46	03/03/2020 21:19	03/03/2020 15:54	03/03/2020 21:19	5,41	40	216,40	CHI
20200311101	ITUMBIARA	IT13273784	PARANAIBA	03/03/2020 15:46	03/03/2020 21:19	03/03/2020 17:14	03/03/2020 21:19	4,08	3	12,23	CHI
20200311101	PANAMA	IT13273784	PARANAIBA	03/03/2020 15:46	03/03/2020 21:19	03/03/2020 17:14	03/03/2020 21:19	4,08	1	4,08	CHI
20200311114	JUSSARA	JR10408237	BRITANIA	03/03/2020 17:16	04/03/2020 13:06	03/03/2020 17:16	04/03/2020 10:21	17,08	3	51,24	CHI
20200311114	JUSSARA	JR10408237	BRITANIA	03/03/2020 17:16	04/03/2020 13:06	03/03/2020 17:16	04/03/2020 11:53	18,61	3	55,84	CHI
20200311114	MONTES CLAROS DE GOIAS	JR10408237	BRITANIA	03/03/2020 17:16	04/03/2020 13:06	03/03/2020 17:16	04/03/2020 11:53	18,61	113	2103,46	CHI
20200311114	JUSSARA	JR10408237	BRITANIA	03/03/2020 17:16	04/03/2020 13:06	04/03/2020 11:37	04/03/2020 11:53	0,27	3	0,80	CHI
20200311114	JUSSARA	JR12121207	BRITANIA	03/03/2020 17:16	04/03/2020 13:06	03/03/2020 17:16	04/03/2020 13:06	19,84	68	1348,99	CHI
20200311114	MONTES CLAROS DE GOIAS	JR12121207	BRITANIA	03/03/2020 17:16	04/03/2020 13:06	03/03/2020 17:16	04/03/2020 13:06	19,84	49	972,06	CHI
20200311114	JUSSARA	JR12121207	BRITANIA	03/03/2020 17:16	04/03/2020 13:06	04/03/2020 10:12	04/03/2020 13:06	2,91	3	8,74	CHI
20200311116	SANTA HELENA DE GOIAS	SH13000013	IPEGUARI	03/03/2020 17:51	03/03/2020 19:28	03/03/2020 17:51	03/03/2020 18:38	0,79	1750	1380,56	CHI
20200311116	SANTA HELENA DE GOIAS	SH10404083	IPEGUARI	03/03/2020 17:51	03/03/2020 19:28	03/03/2020 17:51	03/03/2020 19:28	1,62	569	921,31	CHI
20200311202	NEROPOLIS	NR12029257	NEROPOLIS S2	03/03/2020 16:13	04/03/2020 02:01	03/03/2020 16:13	04/03/2020 02:01	9,80	11	107,75	CHI
20200311205	DOVERLANDIA	DV12212826	CAIAPONIA	03/03/2020 16:14	03/03/2020 19:27	03/03/2020 16:14	03/03/2020 19:27	3,22	10	32,16	CHI
20200311210	ANAPOLIS	10018856509	ANAPOLIS UNIVERSITARIO S2	03/03/2020 16:14	04/03/2020 02:06	03/03/2020 16:14	04/03/2020 02:06	9,85	1	9,85	CHI
20200311211	JUSSARA	JR21144577	JUSSARA	03/03/2020 16:14	04/03/2020 17:02	03/03/2020 16:14	04/03/2020 17:02	24,78	1	24,78	CHI
20200311219	FORMOSA	FA21120086	ITUIQUIRA	03/03/2020 16:18	03/03/2020 19:29	03/03/2020 16:18	03/03/2020 19:29	3,18	1	3,18	CHI
20200311220	GOIANIA	15993772	ATLANTICO S2	03/03/2020 16:18	03/03/2020 18:28	03/03/2020 16:18	03/03/2020 18:28	2,17	1	2,17	CHI
20200311225	URUACU	640097790	URUACU	03/03/2020 16:19	03/03/2020 20:38	03/03/2020 16:19	03/03/2020 20:38	4,31	1	4,31	CHI
20200311228	SANTO ANTONIO DO DESCOBERTO	10019069519	ALEXANIA	03/03/2020 16:19	03/03/2020 17:48	03/03/2020 16:19	03/03/2020 17:48	1,47	1	1,47	CHI
20200311229	CROMINIA	520007505	PONTALINA	03/03/2020 16:19	03/03/2020 16:50	03/03/2020 16:19	03/03/2020 16:50	0,50	1	0,50	CHI
20200311230	SANTO ANTONIO DO DESCOBERTO	SN21313931	MARAJOARA	03/03/2020 16:19	03/03/2020 19:00	03/03/2020 16:19	03/03/2020 19:00	2,67	4	10,67	CHI
20200311234	GOIANIA	GN12038757	ATLANTICO S2	03/03/2020 16:20	04/03/2020 00:47	03/03/2020 16:20	03/03/2020 19:37	3,28	107	350,48	CHI
20200311234	GOIANIA	GN11063200	ATLANTICO S2	03/03/2020 16:20	04/03/2020 00:47	03/03/2020 16:20	04/03/2020 00:33	8,21	52	426,83	CHI
20200311234	GOIANIA	GN11162198	ATLANTICO S2	03/03/2020 16:20	04/03/2020 00:47	03/03/2020 21:41	04/03/2020 00:47	3,09	91	281,22	CHI
20200311243	NOVA IGUACU DE GOIAS	NH12202113	SANTA TEREZINHA	03/03/2020 16:22	03/03/2020 20:49	03/03/2020 16:22	03/03/2020 20:49	4,44	63	279,90	CHI
20200311245	MUNDO NOVO DE GOIAS	MH11269571	NOVA CRIXAS	03/03/2020 13:36	03/03/2020 22:49	03/03/2020 13:36	03/03/2020 22:49	9,21	1	9,21	CHI
20200311250	ABADIANIA	AA12370449	ANAPOLIS UNIVERSITARIO S1	03/03/2020 16:21	04/03/2020 02:25	04/03/2020 01:28	04/03/2020 02:25	0,94	188	176,46	CHI

20200311261	ITUMBIARA	IT21000001	ITUMBIARA VELHA S1	03/03/2020 16:23	03/03/2020 17:43	03/03/2020 16:23	03/03/2020 17:43	1,33	1	1,33	CHI
20200311270	SAO DOMINGOS	SD12170547	SAO DOMINGOS	03/03/2020 16:24	03/03/2020 20:18	03/03/2020 16:24	03/03/2020 20:18	3,89	13	50,58	CHI
20200311284	IACIARA	IA12257594	IACIARA S2	03/03/2020 16:27	04/03/2020 08:45	03/03/2020 16:27	04/03/2020 08:45	16,29	5	81,44	CHI
20200311293	PADRE BERNARDO	PB12376763	PADRE BERNARDO	03/03/2020 11:27	03/03/2020 21:51	03/03/2020 11:27	03/03/2020 21:51	10,39	12	124,65	CHI
20200311298	COLINAS DO SUL	TI12355513	NIQUELANDIA SUBTRANSMISSAO	03/03/2020 16:29	04/03/2020 02:09	03/03/2020 16:29	04/03/2020 02:09	9,65	8	77,22	CHI
20200311302	LUZIANIA	LZ21230089	PACAEMBU S1	03/03/2020 16:30	03/03/2020 17:00	03/03/2020 16:30	03/03/2020 17:00	0,49	1	0,49	CHI
20200311307	AGUA FRIA DE GOIAS	TL11279968	SAO JOAO D ALIANCA	03/03/2020 16:31	03/03/2020 20:19	03/03/2020 16:31	03/03/2020 20:19	3,79	1	3,79	CHI
20200311310	SILVANIA	BV21090647	BELA VISTA S2	03/03/2020 16:30	03/03/2020 18:29	03/03/2020 16:30	03/03/2020 18:29	1,97	1	1,97	CHI
20200311318	LEOPOLDO DE BULHOES	LB12322348	DAIA S2	03/03/2020 16:14	03/03/2020 18:42	03/03/2020 16:14	03/03/2020 18:42	2,47	15	37,00	CHI
20200311320	BONFINOPOLIS	TA12247490	NOVO PLANALTO	03/03/2020 16:33	03/03/2020 22:56	03/03/2020 16:33	03/03/2020 22:56	6,37	1	6,37	CHI
20200311320	BONOPOLIS	TA12247490	NOVO PLANALTO	03/03/2020 16:33	03/03/2020 22:56	03/03/2020 16:33	03/03/2020 22:56	6,37	11	70,05	CHI
20200311320	PORANGATU	TA12247490	NOVO PLANALTO	03/03/2020 16:33	03/03/2020 22:56	03/03/2020 16:33	03/03/2020 22:56	6,37	2	12,74	CHI
20200311330	GOIANIA	15471998	CARAJAS S1	03/03/2020 16:36	03/03/2020 18:27	03/03/2020 16:36	03/03/2020 18:27	1,85	1	1,85	CHI
20200311334	PIRENOPOLIS	10026917740	CORUMBA	03/03/2020 12:43	03/03/2020 21:10	03/03/2020 12:43	03/03/2020 21:10	8,44	1	8,44	CHI
20200311337	BOM JARDIM DE GOIAS	BM21335400	BOM JARDIM	03/03/2020 16:37	04/03/2020 03:38	03/03/2020 16:37	04/03/2020 03:38	11,00	1	11,00	CHI
20200311354	ALEXANIA	AX10406655	ALEXANIA	03/03/2020 16:10	05/03/2020 11:26	03/03/2020 16:10	03/03/2020 19:35	3,41	28	95,43	CHI
20200311354	ALEXANIA	03190414	CORUMBA	03/03/2020 16:10	05/03/2020 11:26	03/03/2020 16:10	03/03/2020 19:35	3,41	838	2856,18	CHI
20200311354	CORUMBA DE GOIAS	03190414	CORUMBA	03/03/2020 16:10	05/03/2020 11:26	03/03/2020 16:10	03/03/2020 19:35	3,41	357	1216,77	CHI
20200311354	ALEXANIA	AX10406655	ALEXANIA	03/03/2020 16:10	05/03/2020 11:26	03/03/2020 16:13	03/03/2020 19:35	3,36	2	6,71	CHI
20200311354	ALEXANIA	03190414	CORUMBA	03/03/2020 16:10	05/03/2020 11:26	03/03/2020 16:13	03/03/2020 19:35	3,36	1	3,36	CHI
20200311354	CORUMBA DE GOIAS	03190414	CORUMBA	03/03/2020 16:10	05/03/2020 11:26	03/03/2020 16:13	03/03/2020 19:35	3,36	1	3,36	CHI
20200311354	ALEXANIA	03190414	ALEXANIA	03/03/2020 16:10	05/03/2020 11:26	03/03/2020 20:32	03/03/2020 20:38	0,10	30	2,90	CHI
20200311354	ALEXANIA	03190414	CORUMBA	03/03/2020 16:10	05/03/2020 11:26	03/03/2020 20:32	03/03/2020 20:38	0,10	838	81,01	CHI
20200311354	CORUMBA DE GOIAS	03190414	CORUMBA	03/03/2020 16:10	05/03/2020 11:26	03/03/2020 20:32	03/03/2020 20:38	0,10	354	34,22	CHI
20200311354	CORUMBA DE GOIAS	AX10406655	ALEXANIA	03/03/2020 16:10	05/03/2020 11:26	03/03/2020 16:10	03/03/2020 20:50	4,66	12	55,90	CHI
20200311354	ALEXANIA	AX10406655	ALEXANIA	03/03/2020 16:10	05/03/2020 11:26	03/03/2020 16:10	03/03/2020 22:46	6,59	9	59,35	CHI
20200311354	CORUMBA DE GOIAS	AX10406655	ALEXANIA	03/03/2020 16:10	05/03/2020 11:26	03/03/2020 16:10	03/03/2020 22:46	6,59	1	6,59	CHI
20200311354	CORUMBA DE GOIAS	AX10406655	ALEXANIA	03/03/2020 16:10	05/03/2020 11:26	03/03/2020 16:10	04/03/2020 11:04	18,90	2	37,80	CHI
20200311354	CORUMBA DE GOIAS	CB13370331	ALEXANIA	03/03/2020 16:10	05/03/2020 11:26	05/03/2020 11:21	05/03/2020 11:26	0,08	12	0,94	CHI
20200311357	DOVERLANDIA	DV21156756	CAIAPONIA	03/03/2020 16:41	04/03/2020 08:42	03/03/2020 16:41	04/03/2020 08:42	16,01	1	16,01	CHI
20200311361	ITUMBIARA	IT21081060	CACHOEIRA DOURADA	03/03/2020 16:42	03/03/2020 19:13	03/03/2020 16:42	03/03/2020 19:13	2,51	1	2,51	CHI
20200311368	BURITINOPOLIS	BQ11190593	IACIARA S2	03/03/2020 16:43	03/03/2020 18:30	03/03/2020 16:43	03/03/2020 18:30	1,77	5	8,84	CHI
20200311376	GOIANESIA	GE12000016	GOIANESIA S2	03/03/2020 16:25	03/03/2020 22:50	03/03/2020 16:25	03/03/2020 22:50	6,40	8	51,24	CHI
20200311376	VILA PROPICIO	GE12000016	GOIANESIA S2	03/03/2020 16:25	03/03/2020 22:50	03/03/2020 16:25	03/03/2020 22:50	6,40	5	32,02	CHI
20200311390	IPAMERI	IP12275809	IPAMERI	03/03/2020 16:46	03/03/2020 19:13	03/03/2020 16:46	03/03/2020 19:13	2,45	150	367,21	CHI
20200311396	POSSE	PS12257684	IACIARA S2	03/03/2020 16:30	03/03/2020 18:30	03/03/2020 16:30	03/03/2020 18:30	1,99	5	9,96	CHI
20200311397	JATAI	JT21134479	JATAI S1	03/03/2020 16:48	03/03/2020 22:38	03/03/2020 16:48	03/03/2020 22:38	5,83	1	5,83	CHI
20200311409	RIO VERDE	RV21029160	SANTA HELENA S1	03/03/2020 16:51	03/03/2020 18:52	03/03/2020 16:51	03/03/2020 18:52	2,01	0	0,00	CHI
20200311411	GOIANESIA	GE12000018	GOIANESIA S2	03/03/2020 16:51	04/03/2020 00:45	03/03/2020 16:51	04/03/2020 00:45	7,89	2	15,77	CHI
20200311414	CATALAO	CT21250462	CATALAO S1	03/03/2020 16:52	03/03/2020 20:19	03/03/2020 16:52	03/03/2020 20:19	3,45	1	3,45	CHI
20200311417	AGUAS LINDAS DE GOIAS	10008763508	AGUAS LINDAS DE GOIAS S1	03/03/2020 16:53	03/03/2020 20:52	03/03/2020 16:53	03/03/2020 20:52	3,98	1	3,98	CHI
20200311422	GOIANIRA	390054744	GOIANIRA	03/03/2020 16:54	03/03/2020 18:03	03/03/2020 16:54	03/03/2020 18:03	1,14	1	1,14	CHI
20200311423	NIQUELANDIA	NQ12311494	BARRO ALTO	03/03/2020 16:54	03/03/2020 21:16	03/03/2020 16:54	03/03/2020 21:16	4,35	18	78,36	CHI
20200311438	ANAPOLIS	AN11264480	ANAPOLIS UNIVERSITARIO S2	03/03/2020 16:30	04/03/2020 12:40	03/03/2020 18:16	03/03/2020 22:35	4,32	109	470,73	CHI

20200311438	ANAPOLIS	AN11000751	ANAPOLIS UNIVERSITARIO S2	03/03/2020 16:30	04/03/2020 12:40	03/03/2020 18:16	03/03/2020 22:41	4,41	154	679,05	CHI
20200311438	ANAPOLIS	AN13093766	ANAPOLIS UNIVERSITARIO S2	03/03/2020 16:30	04/03/2020 12:40	03/03/2020 18:16	03/03/2020 23:17	5,01	3266	16365,38	CHI
20200311438	ANAPOLIS	AN13000229	ANAPOLIS UNIVERSITARIO S2	03/03/2020 16:30	04/03/2020 12:40	03/03/2020 16:30	04/03/2020 12:40	20,16	1	20,16	CHI
20200311441	CATALAO	10019499823	CATALAO S2	03/03/2020 16:59	03/03/2020 22:58	03/03/2020 16:59	03/03/2020 22:58	5,97	1	5,97	CHI
20200311444	CRISTALINA	KR21230250	CRISTALINA S2	03/03/2020 17:00	03/03/2020 18:42	03/03/2020 17:00	03/03/2020 18:42	1,69	1	1,69	CHI
20200311449	LEOPOLDO DE BULHOES	LB21365887	DAIA S2	03/03/2020 17:00	03/03/2020 19:58	03/03/2020 17:00	03/03/2020 19:58	2,95	3	8,86	CHI
20200311455	NOVA IGUACU DE GOIAS	NH21148277	CAMPINORTE	03/03/2020 17:02	04/03/2020 12:35	03/03/2020 17:02	04/03/2020 12:35	19,55	1	19,55	CHI
20200311457	AGUAS LINDAS DE GOIAS	LA12044225	AGUAS LINDAS DE GOIAS S2	03/03/2020 16:29	03/03/2020 18:59	03/03/2020 16:29	03/03/2020 18:59	2,50	60	149,98	CHI
20200311459	RIO VERDE	RV21260771	CABRIUVA S1	03/03/2020 17:03	04/03/2020 10:54	03/03/2020 17:03	04/03/2020 10:54	17,85	1	17,85	CHI
20200311460	CATALAO	10027574073	CATALAO S2	03/03/2020 17:03	03/03/2020 21:46	03/03/2020 17:03	03/03/2020 21:46	4,71	1	4,71	CHI
20200311465	FLORES DE GOIAS	FB21253046	FLORES DE GOIAS	03/03/2020 17:04	03/03/2020 20:05	03/03/2020 17:04	03/03/2020 20:05	3,01	1	3,01	CHI
20200311466	CRISTALINA	KR21025857	PAMPLONA	03/03/2020 17:04	04/03/2020 08:37	03/03/2020 17:04	04/03/2020 08:37	15,54	1	15,54	CHI
20200311477	NOVA IGUACU DE GOIAS	NH12255661	CAMPINORTE	03/03/2020 17:07	04/03/2020 11:31	03/03/2020 17:07	04/03/2020 11:31	18,39	5	91,94	CHI
20200311482	PIRES DO RIO	460124262	PIRES DO RIO S1	03/03/2020 17:08	03/03/2020 20:54	03/03/2020 17:08	03/03/2020 20:54	3,75	1	3,75	CHI
20200311484	GOIANIA	10024225728	GOYA S1	03/03/2020 17:09	03/03/2020 18:15	03/03/2020 17:09	03/03/2020 18:15	1,09	1	1,09	CHI
20200311490	GOIANIA	17378345	XAVANTES	03/03/2020 17:11	03/03/2020 21:47	03/03/2020 17:11	03/03/2020 21:47	4,60	1	4,60	CHI
20200311492	ALOANDIA	AD21384517	GOIATUBA S1	03/03/2020 17:11	03/03/2020 18:53	03/03/2020 17:11	03/03/2020 18:53	1,69	1	1,69	CHI
20200311497	NEROPOLIS	NR12000048	NEROPOLIS S2	03/03/2020 16:57	04/03/2020 12:50	03/03/2020 16:57	03/03/2020 20:58	4,02	6	24,09	CHI
20200311497	NEROPOLIS	NR12000048	NEROPOLIS S2	03/03/2020 16:57	04/03/2020 12:50	03/03/2020 16:57	03/03/2020 22:00	5,06	2	10,12	CHI
20200311497	NEROPOLIS	NR12000048	NEROPOLIS S2	03/03/2020 16:57	04/03/2020 12:50	04/03/2020 07:38	04/03/2020 10:28	2,83	8	22,67	CHI
20200311497	NEROPOLIS	NR12000048	NEROPOLIS S2	03/03/2020 16:57	04/03/2020 12:50	03/03/2020 16:57	04/03/2020 11:48	18,85	3	56,55	CHI
20200311497	NEROPOLIS	NR12000048	NEROPOLIS S2	03/03/2020 16:57	04/03/2020 12:50	03/03/2020 16:57	04/03/2020 12:50	19,88	5	99,42	CHI
20200311500	BRITANIA	BT12131110	BRITANIA	03/03/2020 17:13	05/03/2020 19:01	03/03/2020 17:13	04/03/2020 17:04	23,84	8	190,73	CHI
20200311500	BRITANIA	BT12210599	BRITANIA	03/03/2020 17:13	05/03/2020 19:01	05/03/2020 08:05	05/03/2020 10:42	2,63	61	160,23	CHI
20200311500	BRITANIA	BT12210599	BRITANIA	03/03/2020 17:13	05/03/2020 19:01	05/03/2020 12:17	05/03/2020 12:50	0,54	61	32,72	CHI
20200311500	BRITANIA	BT12210599	BRITANIA	03/03/2020 17:13	05/03/2020 19:01	05/03/2020 08:05	05/03/2020 15:14	7,16	479	3428,71	CHI
20200311500	BRITANIA	BT13249637	BRITANIA	03/03/2020 17:13	05/03/2020 19:01	05/03/2020 17:13	05/03/2020 19:01	49,79	22	1095,32	CHI
20200311500	BRITANIA	BT12210599	BRITANIA	03/03/2020 17:13	05/03/2020 19:01	05/03/2020 08:05	05/03/2020 19:01	10,93	2	21,87	CHI
20200311500	BRITANIA	BT13249637	BRITANIA	03/03/2020 17:13	05/03/2020 19:01	05/03/2020 08:05	05/03/2020 19:01	10,93	143	1563,43	CHI
20200311500	JUSSARA	BT13249637	BRITANIA	03/03/2020 17:13	05/03/2020 19:01	05/03/2020 08:05	05/03/2020 19:01	10,93	48	524,79	CHI
20200311508	CAMPINORTE	10014453698	CAMPINORTE	03/03/2020 17:15	04/03/2020 09:41	03/03/2020 17:15	04/03/2020 09:41	16,43	1	16,43	CHI
20200311518	BURITINOPOLIS	PS12189370	IACIARA S2	03/03/2020 17:17	03/03/2020 19:50	03/03/2020 17:17	03/03/2020 19:50	2,55	2	5,10	CHI
20200311518	MAMBAI	PS12189370	IACIARA S2	03/03/2020 17:17	03/03/2020 19:50	03/03/2020 17:17	03/03/2020 19:50	2,55	28	71,40	CHI
20200311518	POSSE	PS12189370	IACIARA S2	03/03/2020 17:17	03/03/2020 19:50	03/03/2020 17:17	03/03/2020 19:50	2,55	4	10,20	CHI
20200311526	CAMPO ALEGRE DE GOIAS	CM21164130	CAMPO ALEGRE DE GOIAS	03/03/2020 17:18	03/03/2020 20:42	03/03/2020 17:18	03/03/2020 20:42	3,40	1	3,40	CHI
20200311538	NOVA IGUACU DE GOIAS	NH21270887	MARA ROSA	03/03/2020 17:20	04/03/2020 09:55	03/03/2020 17:20	04/03/2020 09:55	16,58	1	16,58	CHI
20200311539	LUZIANIA	LZ21335497	MARAJOARA	03/03/2020 17:20	03/03/2020 18:59	03/03/2020 17:20	03/03/2020 18:59	1,64	1	1,64	CHI
20200311541	GOIANIA	GN12161846	ATLANTICO S2	03/03/2020 17:20	03/03/2020 19:27	03/03/2020 17:20	03/03/2020 19:27	2,10	65	136,70	CHI
20200311547	ALEXANIA	SN12382967	MARAJOARA	03/03/2020 17:22	03/03/2020 20:52	03/03/2020 17:22	03/03/2020 20:52	3,49	1	3,49	CHI
20200311547	SANTO ANTONIO DO DESCOBERTO	SN12382967	MARAJOARA	03/03/2020 17:22	03/03/2020 20:52	03/03/2020 17:22	03/03/2020 20:52	3,49	16	55,89	CHI
20200311550	JUSSARA	JR12341254	IPORA	03/03/2020 17:23	04/03/2020 03:15	03/03/2020 17:23	04/03/2020 03:15	9,86	89	877,79	CHI
20200311550	MONTES CLAROS DE GOIAS	JR12341254	IPORA	03/03/2020 17:23	04/03/2020 03:15	03/03/2020 17:23	04/03/2020 03:15	9,86	4	39,45	CHI
20200311555	FORMOSA	FA11062210	ITUIQUIRA	03/03/2020 17:24	03/03/2020 18:09	03/03/2020 17:24	03/03/2020 18:09	0,75	3	2,25	CHI
20200311576	JANDAIA	JD12008614	PALMEIRAS	03/03/2020 17:21	04/03/2020 11:45	03/03/2020 17:21	04/03/2020 01:18	7,95	4	31,81	CHI

20200311576	JANDAIA	JD12008614	PALMEIRAS	03/03/2020 17:21	04/03/2020 11:45	03/03/2020 17:21	04/03/2020 10:40	17,32	14	242,51	CHI
20200311576	JANDAIA	JD12008614	PALMEIRAS	03/03/2020 17:21	04/03/2020 11:45	04/03/2020 09:01	04/03/2020 10:40	1,66	4	6,63	CHI
20200311576	JANDAIA	JD12008614	PALMEIRAS	03/03/2020 17:21	04/03/2020 11:45	03/03/2020 17:21	04/03/2020 11:45	18,40	1	18,40	CHI
20200311576	PARAUNA	JD12008614	PALMEIRAS	03/03/2020 17:21	04/03/2020 11:45	03/03/2020 17:21	04/03/2020 11:45	18,40	6	110,41	CHI
20200311576	JANDAIA	JD12008614	PALMEIRAS	03/03/2020 17:21	04/03/2020 11:45	04/03/2020 10:59	04/03/2020 11:45	0,77	18	13,83	CHI
20200311586	BELA VISTA DE GOIAS	SV12317629	DAIA S2	03/03/2020 17:05	03/03/2020 19:30	03/03/2020 17:05	03/03/2020 19:30	2,41	7	16,84	CHI
20200311586	SILVANIA	SV12317629	DAIA S2	03/03/2020 17:05	03/03/2020 19:30	03/03/2020 17:05	03/03/2020 19:30	2,41	13	31,28	CHI
20200311587	ANAPOLIS	AN11090379	ANAPOLIS UNIVERSITARIO S2	03/03/2020 17:15	04/03/2020 00:57	03/03/2020 17:15	04/03/2020 00:57	7,69	135	1037,74	CHI
20200311589	JAUPACI	JP12287872	IPORA	03/03/2020 15:57	03/03/2020 22:35	03/03/2020 15:57	03/03/2020 22:35	6,63	14	92,80	CHI
20200311603	SANTA HELENA DE GOIAS	SH12296134	IPEGUARI	03/03/2020 17:33	03/03/2020 22:47	03/03/2020 17:33	03/03/2020 22:47	5,22	9	46,96	CHI
20200311604	IPAMERI	IP21158139	CRISTALINA S2	03/03/2020 17:33	04/03/2020 00:39	03/03/2020 17:33	04/03/2020 00:39	7,08	1	7,08	CHI
20200311606	ARAGOIANIA	AO21000128	GUAPO S2	03/03/2020 17:34	03/03/2020 23:12	03/03/2020 17:34	03/03/2020 23:12	5,63	2	11,26	CHI
20200311607	PONTALINA	210042047	PONTALINA	03/03/2020 17:34	03/03/2020 19:43	03/03/2020 17:34	03/03/2020 19:43	2,15	1	2,15	CHI
20200311612	GOIANIA	GN11002039	CAMPINAS S3	03/03/2020 17:35	03/03/2020 20:56	03/03/2020 17:35	03/03/2020 20:56	3,34	71	237,04	CHI
20200311619	SANTO ANTONIO DO DESCOBERTO	SN12330527	MARAJOARA	03/03/2020 17:37	03/03/2020 23:12	03/03/2020 17:37	03/03/2020 23:12	5,57	15	83,55	CHI
20200311624	APARECIDA DE GOIANIA	12222276	ATLANTICO S1	03/03/2020 17:38	03/03/2020 18:59	03/03/2020 17:38	03/03/2020 18:59	1,34	1	1,34	CHI
20200311628	JATAI	JT12260412	JATAI S1	03/03/2020 17:40	03/03/2020 20:42	03/03/2020 17:40	03/03/2020 20:42	3,03	1	3,03	CHI
20200311637	NOVO GAMA	4990069378	PACAEMBU S1	03/03/2020 17:42	03/03/2020 19:53	03/03/2020 17:42	03/03/2020 19:53	2,18	1	2,18	CHI
20200311639	SANTA HELENA DE GOIAS	SH21000259	IPEGUARI	03/03/2020 17:43	03/03/2020 20:03	03/03/2020 17:43	03/03/2020 20:03	2,33	1	2,33	CHI
20200311643	GOIANIA	11848030	CAMPINAS S1	03/03/2020 17:44	03/03/2020 19:03	03/03/2020 17:44	03/03/2020 19:03	1,31	1	1,31	CHI
20200311645	SANTO ANTONIO DA BARRA	BZ11383974	ACREUNA	03/03/2020 17:45	03/03/2020 21:00	03/03/2020 17:45	03/03/2020 21:00	3,26	68	221,34	CHI
20200311653	PADRE BERNARDO	PB21283895	PADRE BERNARDO	03/03/2020 17:47	04/03/2020 01:21	03/03/2020 17:47	04/03/2020 01:21	7,57	1	7,57	CHI
20200311654	BELA VISTA DE GOIAS	7548369	PIRES DO RIO S2	03/03/2020 16:41	03/03/2020 20:42	03/03/2020 16:41	03/03/2020 20:42	4,00	2	8,01	CHI
20200311654	CRISTIANOPOLIS	7548369	PIRES DO RIO S2	03/03/2020 16:41	03/03/2020 20:42	03/03/2020 16:41	03/03/2020 20:42	4,00	29	116,13	CHI
20200311654	PALMELO	7548369	PIRES DO RIO S2	03/03/2020 16:41	03/03/2020 20:42	03/03/2020 16:41	03/03/2020 20:42	4,00	869	3479,86	CHI
20200311654	PIRES DO RIO	7548369	PIRES DO RIO S2	03/03/2020 16:41	03/03/2020 20:42	03/03/2020 16:41	03/03/2020 20:42	4,00	90	360,40	CHI
20200311654	SANTA CRUZ DE GOIAS	7548369	PIRES DO RIO S2	03/03/2020 16:41	03/03/2020 20:42	03/03/2020 16:41	03/03/2020 20:42	4,00	1271	5089,65	CHI
20200311654	SANTA CRUZ DE GOIAS	03540214	PIRES DO RIO S2	03/03/2020 16:41	03/03/2020 20:42	03/03/2020 20:25	03/03/2020 20:42	0,28	42	11,87	CHI
20200311657	JATAI	10011966910	JATAI S2	03/03/2020 17:47	03/03/2020 19:06	03/03/2020 17:47	03/03/2020 19:06	1,31	0	0,00	CHI
20200311660	PARAUNA	PU12295907	ACREUNA	03/03/2020 17:47	04/03/2020 08:48	03/03/2020 17:47	04/03/2020 08:48	15,02	6	90,13	CHI
20200311666	NIQUELANDIA	NQ12295228	NIQUELANDIA SUBTRANSMISSAO	03/03/2020 17:49	04/03/2020 04:13	03/03/2020 17:49	04/03/2020 04:13	10,40	108	1122,75	CHI
20200311670	GOIANIA	10014215070	CARAJAS S1	03/03/2020 17:49	03/03/2020 22:55	03/03/2020 17:49	03/03/2020 22:55	5,09	1	5,09	CHI
20200311671	MATRINCHA	MP12299698	MATRINCHA	03/03/2020 17:49	04/03/2020 15:00	03/03/2020 17:49	04/03/2020 15:00	21,17	2	42,34	CHI
20200311674	GOIAS	GS12068546	MATRINCHA	03/03/2020 17:47	03/03/2020 20:26	03/03/2020 17:47	03/03/2020 20:26	2,65	16	42,38	CHI
20200311676	SENADOR CANEDO	13340578	SENADOR CANEDO	03/03/2020 17:51	03/03/2020 19:51	03/03/2020 17:51	03/03/2020 19:51	2,00	1	2,00	CHI
20200311685	NOVO BRASIL	NB12019396	JUSSARA	03/03/2020 17:53	04/03/2020 09:26	03/03/2020 17:53	04/03/2020 09:26	15,55	41	637,52	CHI
20200311691	DOVERLANDIA	DV21156482	CAIAPONIA	03/03/2020 17:55	03/03/2020 20:36	03/03/2020 17:55	03/03/2020 20:36	2,67	1	2,67	CHI
20200311707	SAO LUIS DE MONTES BELOS	SL21146336	SAO LUIZ DOS MONTES BELOS	03/03/2020 17:58	03/03/2020 22:11	03/03/2020 17:58	03/03/2020 22:11	4,22	1	4,22	CHI
20200311708	ANAPOLIS	AN11000433	JUNDIAI S1	03/03/2020 17:56	03/03/2020 19:10	03/03/2020 17:56	03/03/2020 19:10	1,22	163	198,86	CHI
20200311714	ANAPOLIS	AN11189928	ANAPOLIS UNIVERSITARIO S1	03/03/2020 17:13	04/03/2020 00:32	03/03/2020 17:13	04/03/2020 00:32	7,31	95	694,11	CHI
20200311715	LUZIANIA	LZ11219848	RIO VERMELHO	03/03/2020 17:55	03/03/2020 18:50	03/03/2020 17:55	03/03/2020 18:50	0,91	103	93,56	CHI
20200311716	LUZIANIA	LZ21075048	MARAJOARA	03/03/2020 18:00	03/03/2020 20:44	03/03/2020 18:00	03/03/2020 20:44	2,72	1	2,72	CHI
20200311729	GOIANIA	16746430	CAMPINAS S2	03/03/2020 18:03	03/03/2020 21:34	03/03/2020 18:03	03/03/2020 21:34	3,52	1	3,52	CHI
20200311737	ORIZONA	OZ21300553	PIRES DO RIO S2	03/03/2020 18:04	03/03/2020 18:50	03/03/2020 18:04	03/03/2020 18:50	0,76	1	0,76	CHI

20200311742	NIQUELANDIA	NQ21354581	NIQUELANDIA SUBTRANSMISSAO	03/03/2020 18:05	03/03/2020 22:13	03/03/2020 18:05	03/03/2020 22:13	4,12	1	4,12	CHI
20200311744	PIRES DO RIO	PR12166937	PIRES DO RIO S1	03/03/2020 18:05	03/03/2020 20:34	03/03/2020 18:05	03/03/2020 20:34	2,47	111	274,54	CHI
20200311745	QUIRINOPOLIS	80019924	QUIRINOPOLIS	03/03/2020 18:06	03/03/2020 19:04	03/03/2020 18:06	03/03/2020 19:04	0,97	1	0,97	CHI
20200311747	GOIANIA	13070587	GOYA S1	03/03/2020 18:06	03/03/2020 19:34	03/03/2020 18:06	03/03/2020 19:34	1,46	1	1,46	CHI
20200311751	TRINDADE	TR12027284	TRINDADE	03/03/2020 18:07	03/03/2020 19:52	03/03/2020 18:07	03/03/2020 19:52	1,74	11	19,16	CHI
20200311754	ABADIANIA	AA12050405	ANAPOLIS UNIVERSITARIO S1	03/03/2020 18:05	04/03/2020 09:13	03/03/2020 18:05	04/03/2020 09:13	15,13	15	226,92	CHI
20200311760	BONFINOPOLIS	920019705	CEPAIGO S2	03/03/2020 18:08	03/03/2020 19:26	03/03/2020 18:08	03/03/2020 19:26	1,29	1	1,29	CHI
20200311763	MATRINCHA	MP21187651	MATRINCHA	03/03/2020 18:09	04/03/2020 09:19	03/03/2020 18:09	04/03/2020 09:19	15,16	1	15,16	CHI
20200311769	IPAMERI	IP21140122	CRISTALINA S2	03/03/2020 18:09	04/03/2020 00:03	03/03/2020 18:09	04/03/2020 00:03	5,88	1	5,88	CHI
20200311771	PIRES DO RIO	PR11186712	PIRES DO RIO S1	03/03/2020 17:31	03/03/2020 19:45	03/03/2020 17:31	03/03/2020 19:45	2,22	111	246,11	CHI
20200311773	GOIANIA	GN11002181	GOIANIA LESTE S2	03/03/2020 18:01	04/03/2020 01:44	03/03/2020 18:01	04/03/2020 01:44	7,71	77	593,71	CHI
20200311780	PADRE BERNARDO	PB11042827	PADRE BERNARDO	03/03/2020 18:12	04/03/2020 02:09	03/03/2020 18:12	04/03/2020 02:09	7,93	90	714,10	CHI
20200311796	ANAPOLIS	AN12413939	ANAPOLIS UNIVERSITARIO S2	03/03/2020 17:56	03/03/2020 19:42	03/03/2020 17:56	03/03/2020 19:42	1,77	163	287,79	CHI
20200311805	PETROLINA DE GOIAS	PG21059928	PETROLINA	03/03/2020 18:14	03/03/2020 20:54	03/03/2020 18:14	03/03/2020 20:54	2,66	1	2,66	CHI
20200311810	GOIANIA	GN21162060	XAVANTES	03/03/2020 18:15	04/03/2020 04:03	03/03/2020 18:15	04/03/2020 04:03	9,80	1	9,80	CHI
20200311816	SAO MIGUEL DO PASSA QUATRO	SV21022807	CRISTIANOPOLIS	03/03/2020 18:16	04/03/2020 15:12	03/03/2020 18:16	04/03/2020 15:12	20,93	1	20,93	CHI
20200311821	GOIAS	GS12073642	MATRINCHA	03/03/2020 17:52	04/03/2020 00:20	03/03/2020 17:52	04/03/2020 00:20	6,46	26	167,97	CHI
20200311822	GOIANIA	16437263	CAMPINAS S2	03/03/2020 18:19	04/03/2020 02:26	03/03/2020 18:19	04/03/2020 02:26	8,11	1	8,11	CHI
20200311827	IACIARA	IA12257569	IACIARA S1	03/03/2020 18:20	03/03/2020 23:20	03/03/2020 18:20	03/03/2020 23:20	5,00	19	94,95	CHI
20200311840	CORUMBA DE GOIAS	CB12382199	CORUMBA	03/03/2020 18:23	03/03/2020 19:32	03/03/2020 18:23	03/03/2020 19:32	1,15	7	8,03	CHI
20200311844	ITUMBIARA	690372980	ITUMBIARA NOVA	03/03/2020 18:24	03/03/2020 19:34	03/03/2020 18:24	03/03/2020 19:34	1,16	1	1,16	CHI
20200311846	SAO MIGUEL DO ARAGUAIA	SM12020668	SAO MIGUEL DO ARAGUAIA	03/03/2020 18:25	04/03/2020 14:02	03/03/2020 18:25	04/03/2020 14:02	19,61	10	196,07	CHI
20200311847	APARECIDA DE GOIANIA	14464550	ATLANTICO S3	03/03/2020 18:25	03/03/2020 19:36	03/03/2020 18:25	03/03/2020 19:36	1,17	1	1,17	CHI
20200311853	GOIANIA	GN11189268	FERROVIARIO S1	03/03/2020 18:11	03/03/2020 20:41	03/03/2020 18:11	03/03/2020 20:41	2,49	138	344,08	CHI
20200311855	MINACU	4020029636	MINACU	03/03/2020 18:27	03/03/2020 22:54	03/03/2020 18:27	03/03/2020 22:54	4,44	1	4,44	CHI
20200311866	JATAI	JT21304387	JATAI S1	03/03/2020 18:30	03/03/2020 23:19	03/03/2020 18:30	03/03/2020 23:19	4,81	1	4,81	CHI
20200311870	NIQUELANDIA	2750137348	NIQUELANDIA SUBTRANSMISSAO	03/03/2020 18:30	03/03/2020 21:09	03/03/2020 18:30	03/03/2020 21:09	2,64	1	2,64	CHI
20200311873	LUZIANIA	120155461	RIO VERMELHO	03/03/2020 18:30	03/03/2020 20:44	03/03/2020 18:30	03/03/2020 20:44	2,22	1	2,22	CHI
20200311875	APARECIDA DE GOIANIA	13761845	REAL S1	03/03/2020 18:31	03/03/2020 20:22	03/03/2020 18:31	03/03/2020 20:22	1,85	1	1,85	CHI
20200311876	GOIANIA	11521727	GOYA S1	03/03/2020 18:31	03/03/2020 20:32	03/03/2020 18:31	03/03/2020 20:32	2,01	1	2,01	CHI
20200311877	BRITANIA	BT11252613	BRITANIA	03/03/2020 18:12	04/03/2020 02:00	03/03/2020 18:12	04/03/2020 02:00	7,80	86	670,82	CHI
20200311878	ADELANDIA	MD12277722	ANICUNS	03/03/2020 18:31	03/03/2020 23:42	03/03/2020 18:31	03/03/2020 23:42	5,17	2	10,34	CHI
20200311878	MOSSAMEDES	MD12277722	ANICUNS	03/03/2020 18:31	03/03/2020 23:42	03/03/2020 18:31	03/03/2020 23:42	5,17	5	25,85	CHI
20200311884	AGUAS LINDAS DE GOIAS	4830429940	AGUAS LINDAS DE GOIAS S1	03/03/2020 18:33	03/03/2020 20:08	03/03/2020 18:33	03/03/2020 20:08	1,58	1	1,58	CHI
20200311885	POSSE	PS12143770	IACIARA S2	03/03/2020 18:30	03/03/2020 20:40	03/03/2020 18:30	03/03/2020 20:40	2,16	109	234,93	CHI
20200311890	BELA VISTA DE GOIAS	HD12323100	CEPAIGO S2	03/03/2020 18:35	03/03/2020 21:16	03/03/2020 18:35	03/03/2020 21:16	2,68	8	21,46	CHI
20200311890	HIDROLANDIA	HD12323100	CEPAIGO S2	03/03/2020 18:35	03/03/2020 21:16	03/03/2020 18:35	03/03/2020 21:16	2,68	100	268,25	CHI
20200311896	GOIANIA	GN12045276	GOYA S1	03/03/2020 18:20	03/03/2020 21:38	03/03/2020 18:20	03/03/2020 21:38	3,29	26	85,56	CHI
20200311897	GOIANIA	10581005	ATLANTICO S3	03/03/2020 18:36	03/03/2020 23:55	03/03/2020 18:36	03/03/2020 23:55	5,31	1	5,31	CHI
20200311904	CACU	CC21305851	CACHOEIRA ALTA	03/03/2020 18:37	04/03/2020 00:01	03/03/2020 18:37	04/03/2020 00:01	5,39	1	5,39	CHI
20200311910	MINEIROS	MY21216691	PARQUE DAS EMAS	03/03/2020 18:39	03/03/2020 21:42	03/03/2020 18:39	03/03/2020 21:42	3,05	1	3,05	CHI
20200311918	CRISTALINA	KR12162511	CRISTALINA S2	03/03/2020 18:38	03/03/2020 21:37	03/03/2020 18:38	03/03/2020 21:37	2,98	9	26,81	CHI
20200311920	GOIANIA	10518915	GOIANIA LESTE S2	03/03/2020 18:41	03/03/2020 20:30	03/03/2020 18:41	03/03/2020 20:30	1,81	1	1,81	CHI
20200311922	ALEXANIA	AX21302416	ALEXANIA	03/03/2020 18:41	04/03/2020 12:18	03/03/2020 18:41	04/03/2020 12:18	17,61	1	17,61	CHI

20200311928	ACREUNA	EU21247383	ACREUNA	03/03/2020 18:42	03/03/2020 22:32	03/03/2020 18:42	03/03/2020 22:32	3,83	1	3,83	CHI
20200311931	BRITANIA	BT12009771	BRITANIA	03/03/2020 18:42	04/03/2020 09:00	03/03/2020 18:42	04/03/2020 09:00	14,30	18	257,33	CHI
20200311938	BONOPOLIS	TA21233100	SAO MIGUEL DO ARAGUAIA	03/03/2020 18:43	04/03/2020 00:12	03/03/2020 18:43	04/03/2020 00:12	5,47	1	5,47	CHI
20200311944	RIO QUENTE	RQ21153456	VILA CORUMBA	03/03/2020 18:44	04/03/2020 10:10	03/03/2020 18:44	04/03/2020 10:10	15,45	1	15,45	CHI
20200311950	JATAI	290091913	JATAI S3	03/03/2020 18:45	03/03/2020 22:55	03/03/2020 18:45	03/03/2020 22:55	4,16	1	4,16	CHI
20200311953	LUZIANIA	LZ12290851	MARAJOARA	03/03/2020 18:45	03/03/2020 21:28	03/03/2020 18:45	03/03/2020 21:28	2,70	23	62,21	CHI
20200311955	CAMPINORTE	2040006911	CAMPINORTE	03/03/2020 18:46	04/03/2020 11:21	03/03/2020 18:46	04/03/2020 11:21	16,58	1	16,58	CHI
20200311956	URUACU	UR12361495	URUACU	03/03/2020 17:10	03/03/2020 21:22	03/03/2020 17:10	03/03/2020 21:22	4,20	11	46,17	CHI
20200311958	APARECIDA DE GOIANIA	200116356	INDEPENDENCIA S2	03/03/2020 18:47	03/03/2020 21:34	03/03/2020 18:47	03/03/2020 21:34	2,77	1	2,77	CHI
20200311960	GOIANIA	14324090	ATLANTICO S1	03/03/2020 18:48	03/03/2020 20:51	03/03/2020 18:48	03/03/2020 20:51	2,05	1	2,05	CHI
20200311961	GOIANESIA	GE21185212	GOIANESIA S1	03/03/2020 18:48	04/03/2020 00:50	03/03/2020 18:48	04/03/2020 00:50	6,04	1	6,04	CHI
20200311964	GAMELEIRA DE GOIAS	AN11273412	DAIA S1	03/03/2020 18:49	03/03/2020 19:30	03/03/2020 18:49	03/03/2020 19:30	0,68	31	21,10	CHI
20200311969	ALTO HORIZONTE	AJ12040664	SANTA TEREZINHA	03/03/2020 18:29	04/03/2020 08:47	03/03/2020 18:29	04/03/2020 08:47	14,29	5	71,47	CHI
20200311969	NOVA IGUACU DE GOIAS	AJ12040664	SANTA TEREZINHA	03/03/2020 18:29	04/03/2020 08:47	03/03/2020 18:29	04/03/2020 08:47	14,29	2	28,59	CHI
20200311972	PIRANHAS	PH11052932	PIRANHAS	03/03/2020 18:32	03/03/2020 20:40	03/03/2020 18:32	03/03/2020 20:40	2,12	174	369,17	CHI
20200311982	MOSSAMEDES	MD21144864	FIRMINOPOLIS S2	03/03/2020 18:52	03/03/2020 21:04	03/03/2020 18:52	03/03/2020 21:04	2,20	1	2,20	CHI
20200311984	SILVANIA	SV12131990	VIANOPOLIS	03/03/2020 18:49	03/03/2020 20:38	03/03/2020 18:49	03/03/2020 20:38	1,80	30	54,13	CHI
20200311986	UIRAPURU	UP21147330	SANTA TEREZINHA	03/03/2020 18:52	04/03/2020 12:40	03/03/2020 18:52	04/03/2020 12:40	17,79	1	17,79	CHI
20200311987	APARECIDA DE GOIANIA	11652962	INDEPENDENCIA S2	03/03/2020 18:52	03/03/2020 21:25	03/03/2020 18:52	03/03/2020 21:25	2,54	1	2,54	CHI
20200311988	CATALAO	1990133359	CATALAO S2	03/03/2020 18:52	04/03/2020 00:14	03/03/2020 18:52	04/03/2020 00:14	5,35	1	5,35	CHI
20200311991	PIRES DO RIO	PR12399182	PIRES DO RIO S2	03/03/2020 18:53	04/03/2020 00:34	03/03/2020 18:53	04/03/2020 00:34	5,68	1	5,68	CHI
20200311995	ANAPOLIS	AN12258920	JUNDIAI S1	03/03/2020 18:53	04/03/2020 14:05	03/03/2020 18:53	04/03/2020 14:05	19,20	6	115,20	CHI
20200311999	CAMPINORTE	CR12109072	MARA ROSA	03/03/2020 18:54	04/03/2020 11:28	03/03/2020 18:54	04/03/2020 11:28	16,57	2	33,13	CHI
20200312009	GOIANIA	14782364	ATLANTICO S3	03/03/2020 18:55	04/03/2020 00:30	03/03/2020 18:55	04/03/2020 00:30	5,57	1	5,57	CHI
20200312013	SAO MIGUEL DO ARAGUAIA	SM12096096	SAO MIGUEL DO ARAGUAIA	03/03/2020 16:41	04/03/2020 11:52	03/03/2020 16:41	04/03/2020 11:52	19,18	13	249,38	CHI
20200312016	URUACU	UR12398066	CAMPINORTE	03/03/2020 18:57	03/03/2020 21:30	03/03/2020 18:57	03/03/2020 21:30	2,54	6	15,26	CHI
20200312019	MINACU	4020038406	MINACU	03/03/2020 18:57	04/03/2020 00:03	03/03/2020 18:57	04/03/2020 00:03	5,09	1	5,09	CHI
20200312029	AMORINOPOLIS	IV12165613	IPORA	03/03/2020 18:51	03/03/2020 23:01	03/03/2020 18:51	03/03/2020 23:01	4,16	6	24,98	CHI
20200312029	IVOLANDIA	IV12165613	IPORA	03/03/2020 18:51	03/03/2020 23:01	03/03/2020 18:51	03/03/2020 23:01	4,16	6	24,98	CHI
20200312032	ITAPACI	IW12379430	ITAPACI	03/03/2020 19:00	04/03/2020 12:43	03/03/2020 19:00	04/03/2020 12:43	17,71	2	35,43	CHI
20200312047	PIRACANJUBA	10019351060	PIRACANJUBA	03/03/2020 19:01	03/03/2020 22:02	03/03/2020 19:01	03/03/2020 22:02	3,00	1	3,00	CHI
20200312049	ANICUNS	TV21027806	FIRMINOPOLIS S2	03/03/2020 19:03	03/03/2020 21:34	03/03/2020 19:03	03/03/2020 21:34	2,51	1	2,51	CHI
20200312054	GOIANIA	14162106	GOYA S1	03/03/2020 19:04	03/03/2020 20:40	03/03/2020 19:04	03/03/2020 20:40	1,60	1	1,60	CHI
20200312059	ITAPURANGA	IK11000001	ITAPURANGA	03/03/2020 18:47	03/03/2020 21:33	03/03/2020 18:47	03/03/2020 21:33	2,76	92	253,59	CHI
20200312060	APARECIDA DE GOIANIA	10009239772	ANHANGUERA	03/03/2020 19:05	03/03/2020 21:26	03/03/2020 19:05	03/03/2020 21:26	2,35	1	2,35	CHI
20200312062	ANICUNS	AC12035306	ANICUNS	03/03/2020 19:01	03/03/2020 21:29	03/03/2020 19:01	03/03/2020 21:29	2,46	20	49,28	CHI
20200312065	MUNDO NOVO DE GOIAS	MH12269054	NOVA CRIXAS	03/03/2020 18:59	03/03/2020 21:41	03/03/2020 18:59	03/03/2020 21:41	2,69	8	21,55	CHI
20200312074	GOUVELANDIA	GB12394808	QUIRINOPOLIS	03/03/2020 19:08	03/03/2020 20:04	03/03/2020 19:08	03/03/2020 20:04	0,92	2	1,84	CHI
20200312074	QUIRINOPOLIS	GB12394808	QUIRINOPOLIS	03/03/2020 19:08	03/03/2020 20:04	03/03/2020 19:08	03/03/2020 20:04	0,92	77	70,78	CHI
20200312076	BOM JESUS DE GOIAS	BJ21021407	CACHOEIRA DOURADA	03/03/2020 19:09	03/03/2020 22:10	03/03/2020 19:09	03/03/2020 22:10	3,01	1	3,01	CHI
20200312078	CAVALCANTE	TI12156216RE	MINACU	03/03/2020 08:25	03/03/2020 23:59	03/03/2020 08:25	03/03/2020 23:59	15,56	2	31,11	CHI
20200312078	COLINAS DO SUL	TI12156216RE	MINACU	03/03/2020 08:25	03/03/2020 23:59	03/03/2020 08:25	03/03/2020 23:59	15,56	5	77,78	CHI
20200312084	GOIANIA	GN11000507	CAMPINAS S3	03/03/2020 18:27	03/03/2020 20:30	03/03/2020 18:27	03/03/2020 20:30	2,04	131	267,42	CHI
20200312088	CAIAPONIA	CP12241867	CAIAPONIA	03/03/2020 19:12	04/03/2020 02:04	03/03/2020 19:12	04/03/2020 02:04	6,86	19	130,43	CHI

20200312096	GOIANIA	14920530	GOIANIA LESTE S3	03/03/2020 19:13	03/03/2020 23:53	03/03/2020 19:13	03/03/2020 23:53	4,66	1	4,66	CHI
20200312099	CATALAO	10019008803	CATALAO S2	03/03/2020 19:13	03/03/2020 20:55	03/03/2020 19:13	03/03/2020 20:55	1,69	1	1,69	CHI
20200312100	LUZIANIA	LZ12230289	PACAEMBU S1	03/03/2020 19:13	03/03/2020 22:40	03/03/2020 19:13	03/03/2020 22:40	3,43	1	3,43	CHI
20200312117	PORANGATU	PO12239639	MARA ROSA	03/03/2020 19:19	04/03/2020 01:47	03/03/2020 19:19	04/03/2020 01:47	6,45	31	200,05	CHI
20200312122	PARAUNA	PU12205943	PARAUNA	04/03/2020 08:23	04/03/2020 12:59	04/03/2020 08:23	04/03/2020 12:59	4,60	4	18,40	CHI
20200312138	APARECIDA DE GOIANIA	AP11150287	INDEPENDENCIA S2	03/03/2020 19:10	04/03/2020 05:17	03/03/2020 19:10	04/03/2020 05:17	10,12	10	101,16	CHI
20200312143	INACIOLANDIA	ID12128131	QUIRINOPOLIS	03/03/2020 19:23	03/03/2020 22:50	03/03/2020 19:23	03/03/2020 22:50	3,44	11	37,81	CHI
20200312146	ITUMBIARA	IT12273935	ITUMBIARA NOVA	03/03/2020 19:24	05/03/2020 00:01	03/03/2020 23:54	04/03/2020 00:32	0,62	558	348,13	CHI
20200312146	ITUMBIARA	IT11352721	ITUMBIARA NOVA	03/03/2020 19:24	05/03/2020 00:01	03/03/2020 19:24	05/03/2020 00:01	28,63	115	3292,29	CHI
20200312148	ITABERAI	IB21325031	ITABERAI S2	03/03/2020 19:24	04/03/2020 02:07	03/03/2020 19:24	04/03/2020 02:07	6,72	1	6,72	CHI
20200312148	ITABERAI	IB12021852	ITABERAI S2	03/03/2020 19:24	04/03/2020 02:07	03/03/2020 22:45	04/03/2020 02:07	3,37	76	256,46	CHI
20200312149	DIORAMA	DI21307514	ARENOPOLIS	03/03/2020 19:25	04/03/2020 11:29	03/03/2020 19:25	04/03/2020 11:29	16,06	1	16,06	CHI
20200312153	COCALZINHO DE GOIAS	9970000281	AGUAS LINDAS DE GOIAS S2	03/03/2020 19:25	03/03/2020 22:15	03/03/2020 19:25	03/03/2020 22:15	2,82	1	2,82	CHI
20200312155	SILVANIA	GL21338881	DAIA S2	03/03/2020 19:26	04/03/2020 01:33	03/03/2020 19:26	04/03/2020 01:33	6,11	2	12,23	CHI
20200312168	ANAPOLIS	10017061693	ANAPOLIS UNIVERSITARIO S2	03/03/2020 19:28	04/03/2020 08:59	03/03/2020 19:28	04/03/2020 08:59	13,51	1	13,51	CHI
20200312173	ANAPOLIS	AN11135790	ANAPOLIS UNIVERSITARIO S1	03/03/2020 19:20	03/03/2020 23:30	03/03/2020 19:20	03/03/2020 23:30	4,15	74	307,14	CHI
20200312178	ANAPOLIS	AN11000433	JUNDIAI S1	03/03/2020 19:17	04/03/2020 03:24	03/03/2020 19:17	04/03/2020 03:24	8,11	163	1321,48	CHI
20200312183	ITAGUARU	IC21250486	ITAPURANGA	03/03/2020 19:32	04/03/2020 12:29	03/03/2020 19:32	04/03/2020 12:29	16,94	1	16,94	CHI
20200312192	LEOPOLDO DE BULHOES	LB12270649	DAIA S2	03/03/2020 19:21	04/03/2020 01:48	03/03/2020 19:21	04/03/2020 01:48	6,44	70	450,80	CHI
20200312199	GOIATUBA	GT11081136	GOIATUBA S2	03/03/2020 19:37	03/03/2020 22:28	03/03/2020 19:37	03/03/2020 22:28	2,84	119	337,89	CHI
20200312202	MUNDO NOVO DE GOIAS	MH12164492	NOVA CRIXAS	03/03/2020 19:01	03/03/2020 23:13	03/03/2020 19:01	03/03/2020 23:13	4,19	3	12,56	CHI
20200312206	PARAUNA	BZ10394760	ACREUNA	03/03/2020 19:51	04/03/2020 12:47	03/03/2020 19:51	03/03/2020 23:12	3,35	19	63,61	CHI
20200312206	RIO VERDE	BZ10394760	ACREUNA	03/03/2020 19:51	04/03/2020 12:47	03/03/2020 19:51	03/03/2020 23:12	3,35	24	80,35	CHI
20200312206	SANTO ANTONIO DA BARRA	BZ10394760	ACREUNA	03/03/2020 19:51	04/03/2020 12:47	03/03/2020 19:51	03/03/2020 23:12	3,35	57	190,84	CHI
20200312206	RIO VERDE	BZ10394760	ACREUNA	03/03/2020 19:51	04/03/2020 12:47	03/03/2020 23:07	03/03/2020 23:12	0,07	42	3,09	CHI
20200312206	SANTO ANTONIO DA BARRA	BZ10394760	ACREUNA	03/03/2020 19:51	04/03/2020 12:47	03/03/2020 23:07	03/03/2020 23:12	0,07	34	2,50	CHI
20200312206	PARAUNA	RV12219435LD	ACREUNA	03/03/2020 19:51	04/03/2020 12:47	03/03/2020 19:51	04/03/2020 12:47	16,93	138	2336,45	CHI
20200312206	RIO VERDE	RV12219435LD	ACREUNA	03/03/2020 19:51	04/03/2020 12:47	03/03/2020 19:51	04/03/2020 12:47	16,93	75	1269,81	CHI
20200312210	ALEXANIA	AX12095958	CORUMBA	03/03/2020 11:14	04/03/2020 09:00	03/03/2020 11:14	04/03/2020 09:00	21,77	5	108,83	CHI
20200312210	CORUMBA DE GOIAS	AX12095958	CORUMBA	03/03/2020 11:14	04/03/2020 09:00	03/03/2020 11:14	04/03/2020 09:00	21,77	3	65,30	CHI
20200312217	SANTA TEREZA DE GOIAS	SE21012482	MARA ROSA	03/03/2020 21:57	04/03/2020 12:23	03/03/2020 21:57	04/03/2020 12:23	14,42	1	14,42	CHI
20200312302	ITUMBIARA	690155463	ITUMBIARA VELHA S1	03/03/2020 19:38	04/03/2020 12:09	03/03/2020 19:38	04/03/2020 12:09	16,50	1	16,50	CHI
20200312303	GOIANIRA	10000734312	GOIANIRA	03/03/2020 19:38	04/03/2020 00:37	03/03/2020 19:38	04/03/2020 00:37	4,98	1	4,98	CHI
20200312322	CORUMBA DE GOIAS	CB12078301	CORUMBA	03/03/2020 19:41	04/03/2020 10:27	03/03/2020 19:41	04/03/2020 10:27	14,76	4	59,05	CHI
20200312325	CAMPOS VERDES	VD21252838	SANTA TEREZINHA	03/03/2020 19:46	04/03/2020 18:59	03/03/2020 19:46	04/03/2020 18:59	23,21	1	23,21	CHI
20200312331	ORIZONA	OZ12114511	PIRES DO RIO S2	03/03/2020 19:37	03/03/2020 22:09	03/03/2020 19:37	03/03/2020 22:09	2,53	12	30,40	CHI
20200312337	SANTO ANTONIO DO DESCOBERTO	2210068363	ALEXANIA	03/03/2020 19:48	03/03/2020 23:32	03/03/2020 19:48	03/03/2020 23:32	3,72	1	3,72	CHI
20200312355	CIDADE OCIDENTAL	2680122854	MARAJOARA	03/03/2020 19:52	03/03/2020 22:20	03/03/2020 19:52	03/03/2020 22:20	2,45	1	2,45	CHI
20200312374	DISTRITO FEDERAL	10002239564	MARAJOARA	03/03/2020 19:58	03/03/2020 21:55	03/03/2020 19:58	03/03/2020 21:55	1,95	1	1,95	CHI
20200312375	GOIANIA	GN12001185	CAMPINAS S1	03/03/2020 19:42	03/03/2020 22:23	03/03/2020 19:42	03/03/2020 22:23	2,68	532	1425,91	CHI
20200312380	PADRE BERNARDO	PB21377280	PADRE BERNARDO	03/03/2020 19:59	04/03/2020 00:14	03/03/2020 19:59	04/03/2020 00:14	4,24	2	8,48	CHI
20200312384	GUARANI DE GOIAS	1580001108	IACIARA S1	03/03/2020 20:00	03/03/2020 23:44	03/03/2020 20:00	03/03/2020 23:44	3,72	1	3,72	CHI
20200312392	SANTO ANTONIO DO DESCOBERTO	SN12390560	AGUAS LINDAS DE GOIAS S2	03/03/2020 20:02	04/03/2020 06:54	03/03/2020 20:02	04/03/2020 06:54	10,86	12	130,35	CHI
20200312394	VILA PROPICIO	NP21326106	BARRO ALTO	03/03/2020 20:02	04/03/2020 08:55	03/03/2020 20:02	04/03/2020 08:55	12,87	2	25,75	CHI

20200312400	TRINDADE	TR11053494	TRINDADE	03/03/2020 20:02	03/03/2020 20:53	03/03/2020 20:02	03/03/2020 20:53	0,83	186	155,26	CHI
20200312401	SENADOR CANEDO	190052168	SENADOR CANEDO	03/03/2020 20:03	03/03/2020 21:36	03/03/2020 20:03	03/03/2020 21:36	1,53	1	1,53	CHI
20200312407	MINEIROS	MY11360832	PARQUE DAS EMAS	03/03/2020 19:48	03/03/2020 22:18	03/03/2020 19:48	03/03/2020 22:18	2,49	66	164,34	CHI
20200312415	CAIAPONIA	CP12340095	CAIAPONIA	03/03/2020 20:06	04/03/2020 01:00	03/03/2020 20:06	04/03/2020 01:00	4,89	6	29,31	CHI
20200312420	GOUVELANDIA	GB11348171	QUIRINOPOLIS	03/03/2020 20:08	04/03/2020 02:46	03/03/2020 20:08	04/03/2020 02:46	6,62	20	132,48	CHI
20200312439	GOIANIA	GN11336796	GOYA S2	03/03/2020 19:46	03/03/2020 22:49	03/03/2020 19:46	03/03/2020 22:49	3,04	87	264,53	CHI
20200312440	RIO VERDE	RV21105896	RIO VERDE S1	03/03/2020 20:12	04/03/2020 13:42	03/03/2020 20:12	04/03/2020 13:42	17,49	2	34,98	CHI
20200312447	GOIANIA	GN21057651	AEROPORTO S1	03/03/2020 20:13	03/03/2020 23:07	03/03/2020 20:13	03/03/2020 23:07	2,89	22	63,51	CHI
20200312450	TRINDADE	15403944	GOYA S2	03/03/2020 20:14	03/03/2020 21:54	03/03/2020 20:14	03/03/2020 21:54	1,66	1	1,66	CHI
20200312451	SANTO ANTONIO DO DESCOBERTO	SN21212123	ALEXANIA	03/03/2020 20:14	04/03/2020 12:39	03/03/2020 20:14	04/03/2020 12:39	16,40	5	82,02	CHI
20200312452	JATAI	290178710	JATAI S3	03/03/2020 20:15	03/03/2020 23:54	03/03/2020 20:15	03/03/2020 23:54	3,65	1	3,65	CHI
20200312454	APARECIDA DE GOIANIA	200004803	ANHANGUERA	03/03/2020 20:15	03/03/2020 21:56	03/03/2020 20:15	03/03/2020 21:56	1,67	1	1,67	CHI
20200312455	ITUMBIARA	690398992	ITUMBIARA VELHA S1	03/03/2020 20:15	04/03/2020 03:16	03/03/2020 20:15	04/03/2020 03:16	7,00	1	7,00	CHI
20200312462	SAO MIGUEL DO ARAGUAIA	SM10371101	SAO MIGUEL DO ARAGUAIA	03/03/2020 20:12	05/03/2020 01:49	03/03/2020 20:12	03/03/2020 23:09	2,96	115	340,05	CHI
20200312462	SAO MIGUEL DO ARAGUAIA	SM13374526	SAO MIGUEL DO ARAGUAIA	03/03/2020 20:12	05/03/2020 01:49	03/03/2020 20:12	04/03/2020 00:28	4,27	1	4,27	CHI
20200312462	SAO MIGUEL DO ARAGUAIA	SM10371101	SAO MIGUEL DO ARAGUAIA	03/03/2020 20:12	05/03/2020 01:49	04/03/2020 02:30	04/03/2020 02:50	0,33	116	38,57	CHI
20200312462	SAO MIGUEL DO ARAGUAIA	SM10371101	SAO MIGUEL DO ARAGUAIA	03/03/2020 20:12	05/03/2020 01:49	04/03/2020 06:06	04/03/2020 11:27	5,35	116	621,15	CHI
20200312462	SAO MIGUEL DO ARAGUAIA	SM13274816	SAO MIGUEL DO ARAGUAIA	03/03/2020 20:12	05/03/2020 01:49	03/03/2020 20:12	04/03/2020 20:20	24,13	4	96,53	CHI
20200312462	SAO MIGUEL DO ARAGUAIA	SM13334366	SAO MIGUEL DO ARAGUAIA	03/03/2020 20:12	05/03/2020 01:49	03/03/2020 20:12	05/03/2020 00:31	28,32	104	2945,11	CHI
20200312462	SAO MIGUEL DO ARAGUAIA	SM12334418	SAO MIGUEL DO ARAGUAIA	03/03/2020 20:12	05/03/2020 01:49	03/03/2020 20:12	05/03/2020 01:02	28,84	16	461,45	CHI
20200312462	SAO MIGUEL DO ARAGUAIA	SM12334372	SAO MIGUEL DO ARAGUAIA	03/03/2020 20:12	05/03/2020 01:49	03/03/2020 20:12	05/03/2020 01:49	29,62	4	118,46	CHI
20200312471	CRISTALINA	KR21041576	CRISTALINA S2	03/03/2020 20:20	04/03/2020 08:28	03/03/2020 20:20	04/03/2020 08:28	12,13	1	12,13	CHI
20200312477	NIQUELANDIA	2750014226	NIQUELANDIA SUBTRANSMISSAO	03/03/2020 20:22	03/03/2020 23:51	03/03/2020 20:22	03/03/2020 23:51	3,49	1	3,49	CHI
20200312482	TRINDADE	TR12071591	TRINDADE	03/03/2020 20:25	04/03/2020 00:13	03/03/2020 20:25	04/03/2020 00:13	3,80	10	37,97	CHI
20200312497	FIRMINOPOLIS	FR12323491	FIRMINOPOLIS S2	03/03/2020 19:30	04/03/2020 04:41	03/03/2020 19:30	04/03/2020 04:41	9,17	3	27,51	CHI
20200312504	VILA PROPICIO	GE21149473	GOIANESIA S2	03/03/2020 20:34	03/03/2020 23:05	03/03/2020 20:34	03/03/2020 23:05	2,51	1	2,51	CHI
20200312514	CIDADE OCIDENTAL	2680014280	MARAJOARA	03/03/2020 20:37	03/03/2020 23:34	03/03/2020 20:37	03/03/2020 23:34	2,94	1	2,94	CHI
20200312517	PIRES DO RIO	PR12404727	PIRES DO RIO S1	03/03/2020 20:38	04/03/2020 00:21	03/03/2020 20:38	04/03/2020 00:21	3,71	4	14,85	CHI
20200312534	MIMOSO DE GOIAS	MJ12251065	PADRE BERNARDO	03/03/2020 09:33	04/03/2020 10:25	03/03/2020 09:33	04/03/2020 10:25	24,87	10	248,68	CHI
20200312539	EDEALINA	10013914454	PONTALINA	03/03/2020 20:43	03/03/2020 22:46	03/03/2020 20:43	03/03/2020 22:46	2,04	1	2,04	CHI
20200312549	GOIANIA	15586420	XAVANTES	03/03/2020 20:48	04/03/2020 04:30	03/03/2020 20:48	04/03/2020 04:30	7,70	1	7,70	CHI
20200312551	CRISTALINA	KR21245993	CRISTALINA S2	03/03/2020 20:48	04/03/2020 04:19	03/03/2020 20:48	04/03/2020 04:19	7,50	1	7,50	CHI
20200312559	SANTA TEREZINHA DE GOIAS	SG12181455	SANTA TEREZINHA	03/03/2020 20:50	04/03/2020 13:45	03/03/2020 20:50	04/03/2020 13:45	16,91	18	304,31	CHI
20200312564	ARAGOIANIA	680016739	GUAPO S2	03/03/2020 20:53	04/03/2020 01:10	03/03/2020 20:53	04/03/2020 01:10	4,28	1	4,28	CHI
20200312565	TRINDADE	TR31063630	TRINDADE	03/03/2020 20:53	04/03/2020 00:12	03/03/2020 20:53	04/03/2020 00:12	3,31	1	3,31	CHI
20200312567	ANAPOLIS	10009113337	JUNDIAI S1	03/03/2020 20:54	04/03/2020 00:48	03/03/2020 20:54	04/03/2020 00:48	3,89	1	3,89	CHI
20200312570	CRISTALINA	KR12248700	CRISTALINA S2	03/03/2020 19:58	03/03/2020 23:01	03/03/2020 19:58	03/03/2020 23:01	3,04	17	51,71	CHI
20200312571	MINEIROS	1390108962	PARQUE DAS EMAS	03/03/2020 20:56	04/03/2020 01:11	03/03/2020 20:56	04/03/2020 01:11	4,24	1	4,24	CHI
20200312574	APARECIDA DE GOIANIA	10003679630	INDEPENDENCIA S2	03/03/2020 20:57	03/03/2020 22:30	03/03/2020 20:57	03/03/2020 22:30	1,54	1	1,54	CHI
20200312577	SANTA TEREZA DE GOIAS	SE21039890	MARA ROSA	03/03/2020 20:59	04/03/2020 13:24	03/03/2020 20:59	04/03/2020 13:24	16,41	1	16,41	CHI
20200312578	CRISTALINA	KR12389576	CRISTALINA S2	03/03/2020 20:50	05/03/2020 16:20	03/03/2020 20:50	04/03/2020 11:22	14,54	13	188,99	CHI
20200312578	CRISTALINA	KR12408889LD	CRISTALINA S2	03/03/2020 20:50	05/03/2020 16:20	03/03/2020 20:50	04/03/2020 12:27	15,61	13	202,99	CHI
20200312578	CRISTALINA	KR13320215	CRISTALINA S2	03/03/2020 20:50	05/03/2020 16:20	03/03/2020 20:50	04/03/2020 16:50	20,00	14	280,05	CHI
20200312578	CRISTALINA	KR12389576	CRISTALINA S2	03/03/2020 20:50	05/03/2020 16:20	04/03/2020 16:50	04/03/2020 17:44	0,90	26	23,40	CHI

20200312578	CRISTALINA	KR13320215	CRISTALINA S2	03/03/2020 20:50	05/03/2020 16:20	04/03/2020 17:15	04/03/2020 21:50	4,59	7	32,10	CHI
20200312578	CRISTALINA	KR12389576	CRISTALINA S2	03/03/2020 20:50	05/03/2020 16:20	04/03/2020 22:18	04/03/2020 22:59	0,68	26	17,69	CHI
20200312578	CRISTALINA	KR13320215	CRISTALINA S2	03/03/2020 20:50	05/03/2020 16:20	04/03/2020 17:15	05/03/2020 16:20	23,09	8	184,70	CHI
20200312578	CRISTALINA	KR13320215	CRISTALINA S2	03/03/2020 20:50	05/03/2020 16:20	04/03/2020 22:18	05/03/2020 16:20	18,03	7	126,23	CHI
20200312579	FAZENDA NOVA	FN21141452	JUSSARA	03/03/2020 20:59	04/03/2020 10:40	03/03/2020 20:59	04/03/2020 10:40	13,68	1	13,68	CHI
20200312587	VALPARAISO DE GOIAS	10026889550	MARAJOARA	03/03/2020 21:04	03/03/2020 23:04	03/03/2020 21:04	03/03/2020 23:04	1,99	1	1,99	CHI
20200312589	PIRES DO RIO	460020596	PIRES DO RIO S1	03/03/2020 21:05	03/03/2020 22:48	03/03/2020 21:05	03/03/2020 22:48	1,71	1	1,71	CHI
20200312590	BARRO ALTO	BA12035658	BARRO ALTO	03/03/2020 21:00	04/03/2020 09:34	03/03/2020 21:00	04/03/2020 09:34	12,56	6	75,34	CHI
20200312595	GOIANIA	11136285	XAVANTES	03/03/2020 21:09	04/03/2020 05:47	03/03/2020 21:09	04/03/2020 05:47	8,63	1	8,63	CHI
20200312599	NOVO GAMA	2460082132	PACAEMBU S1	03/03/2020 21:11	03/03/2020 22:44	03/03/2020 21:11	03/03/2020 22:44	1,55	1	1,55	CHI
20200312601	SAO DOMINGOS	SD12254355	SAO DOMINGOS	03/03/2020 18:40	04/03/2020 10:43	03/03/2020 18:40	04/03/2020 10:43	16,05	9	144,41	CHI
20200312603	CUMARI	CT21160919	CATALAO S1	03/03/2020 21:14	04/03/2020 00:30	03/03/2020 21:14	04/03/2020 00:30	3,27	3	9,80	CHI
20200312607	QUIRINOPOLIS	Q111018008	QUIRINOPOLIS	03/03/2020 21:16	03/03/2020 22:53	03/03/2020 21:16	03/03/2020 22:53	1,62	88	142,27	CHI
20200312608	SAO MIGUEL DO ARAGUAIA	830074247	SAO MIGUEL DO ARAGUAIA	03/03/2020 21:16	04/03/2020 11:05	03/03/2020 21:16	04/03/2020 11:05	13,81	1	13,81	CHI
20200312612	PETROLINA DE GOIAS	PG21140688	INHUMAS S1	03/03/2020 21:17	04/03/2020 00:48	03/03/2020 21:17	04/03/2020 00:48	3,51	1	3,51	CHI
20200312613	PALMEIRAS DE GOIAS	PL11314971	PALMEIRAS	03/03/2020 21:15	04/03/2020 08:46	03/03/2020 21:15	04/03/2020 08:46	11,51	91	1047,01	CHI
20200312616	NIQUELANDIA	NQ21317669	BARRO ALTO	03/03/2020 21:20	04/03/2020 12:30	03/03/2020 21:20	04/03/2020 12:30	15,17	2	30,35	CHI
20200312622	ITUMBIARA	10024885540	PARANAIBA	03/03/2020 21:23	03/03/2020 23:33	03/03/2020 21:23	03/03/2020 23:33	2,15	1	2,15	CHI
20200312625	GOIANIA	10637990	AEROPORTO S3	03/03/2020 21:25	04/03/2020 01:06	03/03/2020 21:25	04/03/2020 01:06	3,67	1	3,67	CHI
20200312629	CATALAO	CT12149116	CATALAO S1	03/03/2020 21:29	04/03/2020 18:00	03/03/2020 21:29	04/03/2020 18:00	20,53	1	20,53	CHI
20200312640	CORUMBA DE GOIAS	260007225	CORUMBA	03/03/2020 21:37	04/03/2020 11:54	03/03/2020 21:37	04/03/2020 11:54	14,27	1	14,27	CHI
20200312644	CACHOEIRA ALTA	10022783804	CACHOEIRA ALTA	03/03/2020 21:40	04/03/2020 00:51	03/03/2020 21:40	04/03/2020 00:51	3,18	1	3,18	CHI
20200312649	APARECIDA DE GOIANIA	12138137	INDEPENDENCIA S2	03/03/2020 21:46	03/03/2020 23:21	03/03/2020 21:46	03/03/2020 23:21	1,58	1	1,58	CHI
20200312652	JATAI	290319481	JATAI S3	03/03/2020 21:48	04/03/2020 01:26	03/03/2020 21:48	04/03/2020 01:26	3,63	1	3,63	CHI
20200312653	SERRANOPOLIS	SX11147545	JATAI S1	03/03/2020 20:43	04/03/2020 00:34	03/03/2020 20:43	04/03/2020 00:34	3,85	81	311,76	CHI
20200312665	ANAPOLIS	20189576	JUNDIAI S1	03/03/2020 22:02	04/03/2020 04:34	03/03/2020 22:02	04/03/2020 04:34	6,53	1	6,53	CHI
20200312666	INHUMAS	IN11292129	INHUMAS S2	03/03/2020 21:55	03/03/2020 23:51	03/03/2020 21:55	03/03/2020 23:51	1,92	139	267,27	CHI
20200312671	LUZIANIA	LZ11084543	RIO VERMELHO	03/03/2020 22:10	04/03/2020 00:57	03/03/2020 22:10	04/03/2020 00:57	2,78	171	475,43	CHI
20200312682	PORTELANDIA	1470003081	PARQUE DAS EMAS	03/03/2020 22:20	04/03/2020 01:22	03/03/2020 22:20	04/03/2020 01:22	3,02	1	3,02	CHI
20200312695	ARAGUAPAZ	AZ12238246	GOIAS	03/03/2020 22:32	04/03/2020 00:03	03/03/2020 22:32	04/03/2020 00:03	1,52	3	4,55	CHI
20200312700	BOM JESUS DE GOIAS	DM12153969	RIO DOS BOIS	03/03/2020 22:31	04/03/2020 02:30	03/03/2020 22:31	04/03/2020 02:30	3,98	1	3,98	CHI
20200312700	CASTELANDIA	DM12153969	RIO DOS BOIS	03/03/2020 22:31	04/03/2020 02:30	03/03/2020 22:31	04/03/2020 02:30	3,98	5	19,88	CHI
20200312700	QUIRINOPOLIS	DM12153969	RIO DOS BOIS	03/03/2020 22:31	04/03/2020 02:30	03/03/2020 22:31	04/03/2020 02:30	3,98	9	35,78	CHI
20200312702	PETROLINA DE GOIAS	PG12322380	INHUMAS S1	03/03/2020 22:26	04/03/2020 00:14	03/03/2020 22:26	04/03/2020 00:14	1,80	18	32,39	CHI
20200312705	IVOLANDIA	IV12098459	IPORA	03/03/2020 22:41	04/03/2020 11:10	03/03/2020 22:41	04/03/2020 11:10	12,48	4	49,90	CHI
20200312706	IVOLANDIA	IV21129859	IPORA	03/03/2020 22:42	04/03/2020 12:09	03/03/2020 22:42	04/03/2020 12:09	13,44	1	13,44	CHI
20200312707	NOVO PLANALTO	2500006070	NOVO PLANALTO	03/03/2020 22:44	04/03/2020 01:35	03/03/2020 22:44	04/03/2020 01:35	2,85	1	2,85	CHI
20200312713	GOIANIA	14652523	MEIA PONTE	03/03/2020 23:10	04/03/2020 02:49	03/03/2020 23:10	04/03/2020 02:49	3,65	1	3,65	CHI
20200312717	RIO VERDE	RV11113541	RIO VERDE S1	03/03/2020 22:33	04/03/2020 07:35	03/03/2020 22:33	04/03/2020 07:35	9,02	218	1966,84	CHI
20200312718	JATAI	JT12244304	JATAI S1	03/03/2020 23:15	04/03/2020 03:26	03/03/2020 23:15	04/03/2020 03:26	4,17	9	37,53	CHI
20200312718	SERRANOPOLIS	JT12244304	JATAI S1	03/03/2020 23:15	04/03/2020 03:26	03/03/2020 23:15	04/03/2020 03:26	4,17	2	8,34	CHI
20200312719	ALTO PARAISO DE GOIAS	BF12129943	FLORES DE GOIAS	03/03/2020 23:17	04/03/2020 08:32	03/03/2020 23:17	04/03/2020 08:32	9,25	1	9,25	CHI
20200312728	BRAZABRANTES	BR11265087	NEROPOLIS S1	03/03/2020 23:28	04/03/2020 05:26	03/03/2020 23:28	04/03/2020 05:26	5,96	39	232,53	CHI
20200312731	SAO LUIS DE MONTES BELOS	SL12289750	FIRMINOPOLIS S2	03/03/2020 23:34	04/03/2020 08:20	03/03/2020 23:34	04/03/2020 08:20	8,75	3	26,26	CHI

20200312731	TURVANIA	SL12289750	FIRMINOPOLIS S2	03/03/2020 23:34	04/03/2020 08:20	03/03/2020 23:34	04/03/2020 08:20	8,75	2	17,51	CHI
20200312746	GOIANIA	GN11001668	REAL S1	04/03/2020 00:16	04/03/2020 01:58	04/03/2020 00:16	04/03/2020 01:58	1,69	91	154,09	CHI
20200312747	GOIANIA	GN12000805	XAVANTES	04/03/2020 00:16	04/03/2020 04:21	04/03/2020 00:16	04/03/2020 04:21	4,07	15	61,08	CHI
20200312751	NIQUELANDIA	NQ12227348	URUACU	03/03/2020 15:11	04/03/2020 10:04	03/03/2020 15:11	04/03/2020 10:04	18,87	45	849,19	CHI
20200312755	GOIANIA	GN11000540	CAMPINAS S3	04/03/2020 00:42	04/03/2020 09:28	04/03/2020 00:42	04/03/2020 09:28	8,76	17	148,88	CHI
20200312762	ARACU	AR21167440	ARACU	04/03/2020 01:25	04/03/2020 12:27	04/03/2020 01:25	04/03/2020 12:27	11,03	4	44,10	CHI
20200312763	LUZIANIA	LZ11084543	RIO VERMELHO	04/03/2020 01:25	04/03/2020 02:37	04/03/2020 01:25	04/03/2020 02:37	1,19	171	203,96	CHI
20200312766	GUAPO	GA21122846	GUAPO S2	04/03/2020 01:32	04/03/2020 02:21	04/03/2020 01:32	04/03/2020 02:21	0,81	1	0,81	CHI
20200312768	PORANGATU	PO12139169	PORANGATU	04/03/2020 01:55	04/03/2020 16:35	04/03/2020 01:55	04/03/2020 09:53	7,96	19	151,17	CHI
20200312768	PORANGATU	PO13375448	PORANGATU	04/03/2020 01:55	04/03/2020 16:35	04/03/2020 01:55	04/03/2020 16:35	14,67	87	1275,95	CHI
20200312769	MARA ROSA	MQ12192427	MARA ROSA	04/03/2020 01:57	04/03/2020 07:15	04/03/2020 01:57	04/03/2020 07:15	5,30	3	15,89	CHI
20200312781	MUNDO NOVO DE GOIAS	O1590204	NOVA CRIXAS	04/03/2020 02:54	04/03/2020 09:56	04/03/2020 02:54	04/03/2020 03:24	0,50	1748	875,46	CHI
20200312781	MUNDO NOVO DE GOIAS	MH13255528	NOVA CRIXAS	04/03/2020 02:54	04/03/2020 09:56	04/03/2020 02:54	04/03/2020 09:56	7,03	129	907,30	CHI
20200312782	CRIXAS	CX10394718	SERRA DO OURO	04/03/2020 02:56	05/03/2020 16:31	04/03/2020 02:56	04/03/2020 06:27	3,53	81	285,73	CHI
20200312782	CRIXAS	CX12201615LD	SERRA DO OURO	04/03/2020 02:56	05/03/2020 16:31	04/03/2020 02:56	04/03/2020 09:39	6,71	7	46,99	CHI
20200312782	CRIXAS	CX12132683LD	SERRA DO OURO	04/03/2020 02:56	05/03/2020 16:31	04/03/2020 02:56	04/03/2020 11:52	8,93	42	375,08	CHI
20200312782	CRIXAS	CX10394718	SERRA DO OURO	04/03/2020 02:56	05/03/2020 16:31	04/03/2020 11:53	04/03/2020 11:58	0,09	87	7,85	CHI
20200312782	CRIXAS	CX12132683LD	SERRA DO OURO	04/03/2020 02:56	05/03/2020 16:31	04/03/2020 11:53	04/03/2020 15:56	4,05	26	105,37	CHI
20200312782	CRIXAS	CX12295212	SERRA DO OURO	04/03/2020 02:56	05/03/2020 16:31	04/03/2020 02:56	04/03/2020 16:36	13,67	28	382,85	CHI
20200312782	CRIXAS	CX10394718	SERRA DO OURO	04/03/2020 02:56	05/03/2020 16:31	05/03/2020 02:59	05/03/2020 07:52	4,88	17	82,88	CHI
20200312782	CRIXAS	CX12201615LD	SERRA DO OURO	04/03/2020 02:56	05/03/2020 16:31	05/03/2020 02:59	05/03/2020 08:01	5,02	60	301,47	CHI
20200312782	CRIXAS	CX13262870	SERRA DO OURO	04/03/2020 02:56	05/03/2020 16:31	05/03/2020 02:59	05/03/2020 09:30	6,51	16	104,20	CHI
20200312782	CRIXAS	CX10394718	SERRA DO OURO	04/03/2020 02:56	05/03/2020 16:31	04/03/2020 11:53	05/03/2020 12:16	24,39	7	170,71	CHI
20200312782	CRIXAS	CX10394718	SERRA DO OURO	04/03/2020 02:56	05/03/2020 16:31	05/03/2020 12:09	05/03/2020 12:16	0,11	95	10,56	CHI
20200312782	CRIXAS	CX12190041LD	SERRA DO OURO	04/03/2020 02:56	05/03/2020 16:31	04/03/2020 02:56	05/03/2020 13:55	34,99	5	174,95	CHI
20200312782	CRIXAS	CX10394718	SERRA DO OURO	04/03/2020 02:56	05/03/2020 16:31	04/03/2020 02:56	05/03/2020 15:00	36,07	59	2127,85	CHI
20200312782	NOVA CRIXAS	CX10394718	SERRA DO OURO	04/03/2020 02:56	05/03/2020 16:31	04/03/2020 02:56	05/03/2020 15:00	36,07	6	216,39	CHI
20200312782	CRIXAS	CX12146977LD	SERRA DO OURO	04/03/2020 02:56	05/03/2020 16:31	05/03/2020 02:59	05/03/2020 15:46	12,78	48	613,64	CHI
20200312782	CRIXAS	CX12190045	SERRA DO OURO	04/03/2020 02:56	05/03/2020 16:31	04/03/2020 11:53	05/03/2020 16:31	28,63	9	257,71	CHI
20200312785	VALPARAISO DE GOIAS	VA12345917	PACAEMBU S2	04/03/2020 03:21	04/03/2020 12:03	04/03/2020 10:36	04/03/2020 12:03	1,46	260	379,31	CHI
20200312787	ARAGUAPAZ	AZ12271926	MOZARLANDIA	04/03/2020 03:38	04/03/2020 05:09	04/03/2020 03:38	04/03/2020 05:09	1,50	7	10,53	CHI
20200312792	CAIAPONIA	CP12223099	PALESTINA	04/03/2020 03:42	04/03/2020 21:32	04/03/2020 03:42	04/03/2020 21:32	17,83	20	356,68	CHI
20200312794	BELA VISTA DE GOIAS	BV12308991	BELA VISTA S1	04/03/2020 03:45	04/03/2020 08:10	04/03/2020 03:45	04/03/2020 08:10	4,40	83	365,50	CHI
20200312794	CALDAZINHA	BV12308991	BELA VISTA S1	04/03/2020 03:45	04/03/2020 08:10	04/03/2020 03:45	04/03/2020 08:10	4,40	20	88,07	CHI
20200312799	IVOLANDIA	IV12390185	IPORA	04/03/2020 04:00	04/03/2020 08:47	04/03/2020 04:00	04/03/2020 08:47	4,77	13	62,05	CHI
20200312800	GOIAS	GS12071232	GOIAS	04/03/2020 04:01	05/03/2020 13:30	04/03/2020 04:01	04/03/2020 19:25	15,41	8	123,29	CHI
20200312800	GOIAS	GS12071232	GOIAS	04/03/2020 04:01	05/03/2020 13:30	04/03/2020 19:49	05/03/2020 11:30	15,68	8	125,46	CHI
20200312800	GOIAS	GS12071232	GOIAS	04/03/2020 04:01	05/03/2020 13:30	04/03/2020 04:01	05/03/2020 12:45	32,73	21	687,41	CHI
20200312800	GOIAS	GS12071232	GOIAS	04/03/2020 04:01	05/03/2020 13:30	04/03/2020 04:01	05/03/2020 13:30	33,49	10	334,95	CHI
20200312801	EDEALINA	VI10400586	VICENTINOPOLIS	04/03/2020 01:43	04/03/2020 02:54	04/03/2020 01:43	04/03/2020 02:54	1,18	15	17,76	CHI
20200312801	EDEALINA	VI10400586	VICENTINOPOLIS	04/03/2020 01:43	04/03/2020 02:54	04/03/2020 01:43	04/03/2020 02:54	1,18	34	40,25	CHI
20200312801	EDEIA	VI10400586	VICENTINOPOLIS	04/03/2020 01:43	04/03/2020 02:54	04/03/2020 01:43	04/03/2020 02:54	1,18	11	13,02	CHI
20200312801	EDEIA	VI10400586	VICENTINOPOLIS	04/03/2020 01:43	04/03/2020 02:54	04/03/2020 01:43	04/03/2020 02:54	1,18	33	39,07	CHI
20200312801	EDEIA	VI10400586	VICENTINOPOLIS	04/03/2020 01:43	04/03/2020 02:54	04/03/2020 01:43	04/03/2020 02:54	1,18	10	11,84	CHI

20200312801	GOIATUBA	VI10400586	VICENTINOPOLIS	04/03/2020 01:43	04/03/2020 02:54	04/03/2020 01:43	04/03/2020 02:54	1,18	12	14,21	CHI
20200312801	PONTALINA	VI10400586	VICENTINOPOLIS	04/03/2020 01:43	04/03/2020 02:54	04/03/2020 01:43	04/03/2020 02:54	1,18	1	1,18	CHI
20200312801	VICENTINOPOLIS	VI10400586	VICENTINOPOLIS	04/03/2020 01:43	04/03/2020 02:54	04/03/2020 01:43	04/03/2020 02:54	1,18	1	1,18	CHI
20200312801	VICENTINOPOLIS	VI10400586	VICENTINOPOLIS	04/03/2020 01:43	04/03/2020 02:54	04/03/2020 01:43	04/03/2020 02:54	1,18	2	2,37	CHI
20200312801	VICENTINOPOLIS	VI10400586	VICENTINOPOLIS	04/03/2020 01:43	04/03/2020 02:54	04/03/2020 01:43	04/03/2020 02:54	1,18	109	129,04	CHI
20200312901	CEZARINA	CZ12000015	CEZARINA	04/03/2020 02:00	04/03/2020 08:44	04/03/2020 02:00	04/03/2020 08:44	6,72	61	409,97	CHI
20200312901	INDIARA	CZ12000015	CEZARINA	04/03/2020 02:00	04/03/2020 08:44	04/03/2020 02:00	04/03/2020 08:44	6,72	37	248,67	CHI
20200312903	ORIZONA	OZ12094962	VIANOPOLIS	04/03/2020 04:11	04/03/2020 08:34	04/03/2020 04:11	04/03/2020 08:34	4,37	1	4,37	CHI
20200312903	VIANOPOLIS	OZ12094962	VIANOPOLIS	04/03/2020 04:11	04/03/2020 08:34	04/03/2020 04:11	04/03/2020 08:34	4,37	19	83,07	CHI
20200312905	CACU	CC12075913	CACHOEIRA ALTA	04/03/2020 04:16	04/03/2020 08:34	04/03/2020 04:16	04/03/2020 08:34	4,29	13	55,72	CHI
20200312905	ITARUMA	CC12075913	CACHOEIRA ALTA	04/03/2020 04:16	04/03/2020 08:34	04/03/2020 04:16	04/03/2020 08:34	4,29	32	137,16	CHI
20200312906	ARAGARCAS	BH12162960	BOM JARDIM	04/03/2020 04:16	04/03/2020 11:07	04/03/2020 04:16	04/03/2020 11:07	6,84	11	75,19	CHI
20200312906	BALIZA	BH12162960	BOM JARDIM	04/03/2020 04:16	04/03/2020 11:07	04/03/2020 04:16	04/03/2020 11:07	6,84	15	102,53	CHI
20200312908	CRIXAS	MZ12055650	MOZARLANDIA	04/03/2020 04:28	04/03/2020 07:19	04/03/2020 04:28	04/03/2020 07:19	2,84	74	210,49	CHI
20200312908	MOZARLANDIA	MZ12055650	MOZARLANDIA	04/03/2020 04:28	04/03/2020 07:19	04/03/2020 04:28	04/03/2020 07:19	2,84	5	14,22	CHI
20200312908	NOVA CRIXAS	MZ12055650	MOZARLANDIA	04/03/2020 04:28	04/03/2020 07:19	04/03/2020 04:28	04/03/2020 07:19	2,84	28	79,64	CHI
20200312909	SAO MIGUEL DO ARAGUAIA	SM21263007	SAO MIGUEL DO ARAGUAIA	04/03/2020 04:33	04/03/2020 11:42	04/03/2020 04:33	04/03/2020 11:42	7,14	1	7,14	CHI
20200312919	FORMOSA	FA12206251	ITUIQUIRA	03/03/2020 23:21	04/03/2020 07:24	03/03/2020 23:21	04/03/2020 07:24	8,04	10	80,37	CHI
20200312921	EDEALINA	ED12223495	PONTALINA	04/03/2020 05:05	04/03/2020 08:27	04/03/2020 05:05	04/03/2020 08:27	3,36	4	13,46	CHI
20200312922	MOSSAMEDES	MD12057741	FIRMINOPOLIS S2	04/03/2020 05:09	04/03/2020 07:11	04/03/2020 05:09	04/03/2020 07:11	2,02	18	36,32	CHI
20200312922	SANCLERLANDIA	MD12057741	FIRMINOPOLIS S2	04/03/2020 05:09	04/03/2020 07:11	04/03/2020 05:09	04/03/2020 07:11	2,02	1	2,02	CHI
20200312924	CAIAPONIA	CP12207858	PALESTINA	04/03/2020 05:12	04/03/2020 18:26	04/03/2020 05:12	04/03/2020 18:26	13,23	18	238,15	CHI
20200312924	PALESTINA DE GOIAS	CP12207858	PALESTINA	04/03/2020 05:12	04/03/2020 18:26	04/03/2020 05:12	04/03/2020 18:26	13,23	1	13,23	CHI
20200312927	RIO VERDE	RV12249024	SANTA HELENA S1	04/03/2020 05:20	04/03/2020 09:44	04/03/2020 05:20	04/03/2020 09:44	4,39	4	17,55	CHI
20200312933	ARUANA	AK12183184	BRITANIA	04/03/2020 05:28	04/03/2020 19:05	04/03/2020 05:28	04/03/2020 18:43	13,25	7	92,74	CHI
20200312933	ARUANA	AK12183184	BRITANIA	04/03/2020 05:28	04/03/2020 19:05	04/03/2020 05:28	04/03/2020 19:05	13,62	6	81,72	CHI
20200312938	ARENOPOLIS	AY12139436	ARENOPOLIS	04/03/2020 05:44	04/03/2020 09:40	04/03/2020 05:44	04/03/2020 09:40	3,93	16	62,93	CHI
20200312938	IPORA	AY12139436	ARENOPOLIS	04/03/2020 05:44	04/03/2020 09:40	04/03/2020 05:44	04/03/2020 09:40	3,93	11	43,27	CHI
20200312939	VIANOPOLIS	VN12114852	VIANOPOLIS	04/03/2020 05:44	04/03/2020 08:56	04/03/2020 05:44	04/03/2020 08:56	3,19	46	146,57	CHI
20200312940	BOM JARDIM DE GOIAS	BM12212797	BOM JARDIM	04/03/2020 04:13	04/03/2020 08:00	04/03/2020 04:13	04/03/2020 08:00	3,78	86	325,10	CHI
20200312940	PIRANHAS	BM12212797	BOM JARDIM	04/03/2020 04:13	04/03/2020 08:00	04/03/2020 04:13	04/03/2020 08:00	3,78	2	7,56	CHI
20200312941	ARAGUAPAZ	AZ12404563	GOIAS	04/03/2020 06:36	04/03/2020 08:36	04/03/2020 06:36	04/03/2020 08:36	2,00	20	39,95	CHI
20200312941	FAINA	AZ12404563	GOIAS	04/03/2020 06:36	04/03/2020 08:36	04/03/2020 06:36	04/03/2020 08:36	2,00	1	2,00	CHI
20200312945	URUACU	UR12341322	URUACU	04/03/2020 05:51	04/03/2020 08:11	04/03/2020 05:51	04/03/2020 08:11	2,32	7	16,25	CHI
20200312949	BURITINOPOLIS	SU12248425	SANTA RITA DO ARAGUAIA	04/03/2020 06:01	04/03/2020 10:30	04/03/2020 06:01	04/03/2020 10:30	4,47	1	4,47	CHI
20200312949	MINEIROS	SU12248425	SANTA RITA DO ARAGUAIA	04/03/2020 06:01	04/03/2020 10:30	04/03/2020 06:01	04/03/2020 10:30	4,47	11	49,21	CHI
20200312949	SANTA RITA DO ARAGUAIA	SU12248425	SANTA RITA DO ARAGUAIA	04/03/2020 06:01	04/03/2020 10:30	04/03/2020 06:01	04/03/2020 10:30	4,47	130	581,57	CHI
20200312950	CORREGO DO OURO	CO12004043	FIRMINOPOLIS S2	04/03/2020 05:42	04/03/2020 07:37	04/03/2020 05:42	04/03/2020 07:37	1,90	11	20,92	CHI
20200312953	CACU	CC21226518	CACHOEIRA ALTA	04/03/2020 06:02	04/03/2020 09:36	04/03/2020 06:02	04/03/2020 09:36	3,56	1	3,56	CHI
20200312961	BOM JARDIM DE GOIAS	BM21212986	BOM JARDIM	04/03/2020 06:08	04/03/2020 08:57	04/03/2020 06:08	04/03/2020 08:57	2,81	1	2,81	CHI
20200312962	LEOPOLDO DE BULHOES	LB12032456	DAIA S2	04/03/2020 06:08	04/03/2020 10:25	04/03/2020 06:08	04/03/2020 10:25	4,28	7	29,93	CHI
20200312964	BOM JARDIM DE GOIAS	BM21153197	BOM JARDIM	04/03/2020 06:09	04/03/2020 14:22	04/03/2020 06:09	04/03/2020 14:22	8,21	1	8,21	CHI
20200312966	CAMPINACU	UC12316380	MARA ROSA	04/03/2020 06:09	04/03/2020 09:07	04/03/2020 06:09	04/03/2020 09:07	2,96	55	162,68	CHI
20200312968	QUIRINOPOLIS	QI12295729	QUIRINOPOLIS	04/03/2020 06:11	04/03/2020 07:54	04/03/2020 06:11	04/03/2020 07:54	1,72	69	118,43	CHI

20200312970	ITABERAÍ	IB12206934	ITABERAÍ S2	04/03/2020 06:12	04/03/2020 10:50	04/03/2020 06:12	04/03/2020 10:50	4,63	19	87,99	CHI
20200312974	PLANALTINA	PI21334052	PLANALTINA	04/03/2020 06:12	04/03/2020 07:01	04/03/2020 06:12	04/03/2020 07:01	0,80	1	0,80	CHI
20200312975	FIRMINÓPOLIS	FR12000064	FIRMINÓPOLIS S1	04/03/2020 06:13	04/03/2020 08:09	04/03/2020 06:13	04/03/2020 08:09	1,92	43	82,77	CHI
20200312979	CAMPINACU	IH12360453	MINACU	04/03/2020 06:19	04/03/2020 08:21	04/03/2020 06:19	04/03/2020 08:21	2,03	5	10,16	CHI
20200312979	MINACU	IH12360453	MINACU	04/03/2020 06:19	04/03/2020 08:21	04/03/2020 06:19	04/03/2020 08:21	2,03	72	146,28	CHI
20200312980	GOIANIA	10813871	GOIANIA LESTE S2	04/03/2020 06:19	04/03/2020 08:56	04/03/2020 06:19	04/03/2020 08:56	2,61	1	2,61	CHI
20200312984	NOVO BRASIL	NB12378881	JUSSARA	04/03/2020 06:08	04/03/2020 12:20	04/03/2020 06:08	04/03/2020 12:20	6,19	12	74,26	CHI
20200312986	GOIANAPÓLIS	GP21392831	DAIA S2	04/03/2020 06:21	04/03/2020 08:50	04/03/2020 06:21	04/03/2020 08:50	2,47	1	2,47	CHI
20200312988	CALDAZINHA	BV12022081	CEPAIGO S2	04/03/2020 06:21	04/03/2020 10:18	04/03/2020 06:21	04/03/2020 10:18	3,93	2	7,87	CHI
20200312995	CRISTALINA	KR21246100	CRISTALINA S2	04/03/2020 06:24	04/03/2020 17:01	04/03/2020 06:24	04/03/2020 17:01	10,60	1	10,60	CHI
20200312997	ACREUNA	EU12301163	ACREUNA	04/03/2020 06:25	04/03/2020 11:26	04/03/2020 06:25	04/03/2020 11:26	5,00	1	5,00	CHI
20200313002	PORTELANDIA	PW10406623	PARQUE DAS EMAS	04/03/2020 05:54	04/03/2020 15:28	04/03/2020 05:54	04/03/2020 08:23	2,47	23	56,81	CHI
20200313002	MINEIROS	PW10406623	PARQUE DAS EMAS	04/03/2020 05:54	04/03/2020 15:28	04/03/2020 05:54	04/03/2020 15:28	9,56	121	1156,22	CHI
20200313002	PORTELANDIA	PW10406623	PARQUE DAS EMAS	04/03/2020 05:54	04/03/2020 15:28	04/03/2020 05:54	04/03/2020 15:28	9,56	22	210,22	CHI
20200313002	SANTA RITA DO ARAGUAIA	PW10406623	PARQUE DAS EMAS	04/03/2020 05:54	04/03/2020 15:28	04/03/2020 05:54	04/03/2020 15:28	9,56	18	172,00	CHI
20200313002	PORTELANDIA	PW10406623	PARQUE DAS EMAS	04/03/2020 05:54	04/03/2020 15:28	04/03/2020 08:27	04/03/2020 15:28	7,01	23	161,14	CHI
20200313007	ITABERAÍ	00880434	ITABERAÍ S1	04/03/2020 06:08	04/03/2020 09:24	04/03/2020 06:08	04/03/2020 07:02	0,91	29	26,45	CHI
20200313007	ITABERAÍ	00880434	ITABERAÍ S1	04/03/2020 06:08	04/03/2020 09:24	04/03/2020 07:17	04/03/2020 07:25	0,14	29	3,96	CHI
20200313007	GOIAS	00880434	ITABERAÍ S1	04/03/2020 06:08	04/03/2020 09:24	04/03/2020 06:08	04/03/2020 09:24	3,28	177	580,22	CHI
20200313007	GOIAS	00880434	ITABERAÍ S1	04/03/2020 06:08	04/03/2020 09:24	04/03/2020 06:08	04/03/2020 09:24	3,28	75	245,85	CHI
20200313007	GOIAS	00880434	ITABERAÍ S1	04/03/2020 06:08	04/03/2020 09:24	04/03/2020 06:08	04/03/2020 09:24	3,28	2	6,56	CHI
20200313007	GOIAS	IB13200314	ITABERAÍ S1	04/03/2020 06:08	04/03/2020 09:24	04/03/2020 06:08	04/03/2020 09:24	3,28	47	154,07	CHI
20200313007	ITABERAÍ	00880434	ITABERAÍ S1	04/03/2020 06:08	04/03/2020 09:24	04/03/2020 06:08	04/03/2020 09:24	3,28	3	9,83	CHI
20200313007	ITABERAÍ	00880434	ITABERAÍ S1	04/03/2020 06:08	04/03/2020 09:24	04/03/2020 06:08	04/03/2020 09:24	3,28	26	85,23	CHI
20200313007	ITABERAÍ	IB13200314	ITABERAÍ S1	04/03/2020 06:08	04/03/2020 09:24	04/03/2020 06:08	04/03/2020 09:24	3,28	36	118,01	CHI
20200313012	JATAÍ	SX12013892	JATAÍ S1	04/03/2020 05:01	04/03/2020 09:11	04/03/2020 05:01	04/03/2020 09:11	4,16	13	54,06	CHI
20200313012	SERRANÓPOLIS	SX12013892	JATAÍ S1	04/03/2020 05:01	04/03/2020 09:11	04/03/2020 05:01	04/03/2020 09:11	4,16	141	586,32	CHI
20200313040	PADRE BERNARDO	PB21121783	PADRE BERNARDO	04/03/2020 07:52	04/03/2020 14:11	04/03/2020 07:52	04/03/2020 14:11	6,31	1	6,31	CHI
20200313046	CALDAZINHA	DE12008325	CEPAIGO S2	04/03/2020 08:04	04/03/2020 11:20	04/03/2020 09:50	04/03/2020 11:20	1,48	35	51,95	CHI
20200313046	SENADOR CANEDO	DE12008325	CEPAIGO S2	04/03/2020 08:04	04/03/2020 11:20	04/03/2020 09:50	04/03/2020 11:20	1,48	1	1,48	CHI
20200313106	NOVA ROMA	ND12117611	IACIARA S2	04/03/2020 03:39	04/03/2020 17:04	04/03/2020 03:39	04/03/2020 17:04	13,42	8	107,39	CHI
20200313110	LEOPOLDO DE BULHOES	LB21351018	DAIA S2	04/03/2020 06:31	04/03/2020 09:39	04/03/2020 06:31	04/03/2020 09:39	3,13	1	3,13	CHI
20200313114	ARAGUAPAZ	AZ12248246	GOIAS	04/03/2020 06:33	04/03/2020 08:15	04/03/2020 06:33	04/03/2020 08:15	1,70	9	15,28	CHI
20200313116	GOIANIA	10614692	AEROPORTO S2	04/03/2020 06:34	04/03/2020 07:35	04/03/2020 06:34	04/03/2020 07:35	1,01	1	1,01	CHI
20200313119	ADELANDIA	SL12306949	ANICUNS	04/03/2020 06:35	04/03/2020 08:36	04/03/2020 06:35	04/03/2020 08:36	2,01	28	56,40	CHI
20200313119	MOSSAMEDES	SL12306949	ANICUNS	04/03/2020 06:35	04/03/2020 08:36	04/03/2020 06:35	04/03/2020 08:36	2,01	2	4,03	CHI
20200313119	ADELANDIA	SL12306949	FIRMINÓPOLIS S2	04/03/2020 06:35	04/03/2020 08:36	04/03/2020 06:35	04/03/2020 08:36	2,01	5	10,07	CHI
20200313122	FORMOSO	FO12328885	PORANGATU	04/03/2020 05:43	07/03/2020 18:56	04/03/2020 05:43	04/03/2020 15:50	10,13	4	40,50	CHI
20200313122	SANTA TEREZA DE GOIAS	FO13384307	PORANGATU	04/03/2020 05:43	07/03/2020 18:56	04/03/2020 05:43	07/03/2020 18:56	85,21	12	1022,57	CHI
20200313125	CATALAO	CM21195284	CATALAO S1	04/03/2020 06:37	04/03/2020 09:53	04/03/2020 06:37	04/03/2020 09:53	3,26	1	3,26	CHI
20200313126	NOVA CRIXAS	NA12038063	MOZARLANDIA	04/03/2020 06:37	04/03/2020 14:21	04/03/2020 06:37	04/03/2020 14:21	7,74	3	23,22	CHI
20200313127	CORREGO DO OURO	CO21316883	FIRMINÓPOLIS S2	04/03/2020 06:37	04/03/2020 09:32	04/03/2020 06:37	04/03/2020 09:32	2,91	1	2,91	CHI
20200313129	ANICUNS	IX12200037	ARACU	04/03/2020 05:10	04/03/2020 08:43	04/03/2020 05:10	04/03/2020 08:43	3,55	1	3,55	CHI
20200313129	ITABERAÍ	IX12200037	ARACU	04/03/2020 05:10	04/03/2020 08:43	04/03/2020 05:10	04/03/2020 08:43	3,55	12	42,60	CHI

20200313130	COCALZINHO DE GOIAS	ZN12313874	PADRE BERNARDO	04/03/2020 06:38	04/03/2020 13:16	04/03/2020 06:38	04/03/2020 13:16	6,63	1	6,63	CHI
20200313132	SAO PATRICIO	RB21255944	RUBIATABA	04/03/2020 06:38	04/03/2020 11:20	04/03/2020 06:38	04/03/2020 11:20	4,69	1	4,69	CHI
20200313134	CRIXAS	CX12190201RE	SANTA TEREZINHA	04/03/2020 05:32	04/03/2020 10:25	04/03/2020 05:32	04/03/2020 10:25	4,88	50	243,83	CHI
20200313136	CAIAPONIA	CP12380880	CAIAPONIA	04/03/2020 06:39	04/03/2020 15:42	04/03/2020 06:39	04/03/2020 15:42	9,04	10	90,43	CHI
20200313138	CAIAPONIA	CP12160772	MONTIVIDIU T	04/03/2020 06:40	04/03/2020 09:47	04/03/2020 06:40	04/03/2020 09:47	3,12	2	6,23	CHI
20200313138	JATAI	CP12160772	MONTIVIDIU T	04/03/2020 06:40	04/03/2020 09:47	04/03/2020 06:40	04/03/2020 09:47	3,12	1	3,12	CHI
20200313138	RIO VERDE	CP12160772	MONTIVIDIU T	04/03/2020 06:40	04/03/2020 09:47	04/03/2020 06:40	04/03/2020 09:47	3,12	1	3,12	CHI
20200313140	ALTO PARAISO DE GOIAS	ND12302636	IACIARA S2	04/03/2020 05:48	04/03/2020 10:02	04/03/2020 05:48	04/03/2020 10:02	4,23	18	76,18	CHI
20200313140	NOVA ROMA	ND12302636	IACIARA S2	04/03/2020 05:48	04/03/2020 10:02	04/03/2020 05:48	04/03/2020 10:02	4,23	97	410,53	CHI
20200313140	SAO JOAO D ALIANCA	ND12302636	IACIARA S2	04/03/2020 05:48	04/03/2020 10:02	04/03/2020 05:48	04/03/2020 10:02	4,23	12	50,79	CHI
20200313142	ORIZONA	OZ12115280	VIANOPOLIS	04/03/2020 06:40	04/03/2020 12:00	04/03/2020 06:40	04/03/2020 12:00	5,34	7	37,35	CHI
20200313146	ITAJA	IJ12155331	ITAJA S2	04/03/2020 06:42	04/03/2020 09:20	04/03/2020 06:42	04/03/2020 09:20	2,63	21	55,31	CHI
20200313146	LAGOA SANTA	IJ12155331	ITAJA S2	04/03/2020 06:42	04/03/2020 09:20	04/03/2020 06:42	04/03/2020 09:20	2,63	5	13,17	CHI
20200313147	INHUMAS	IN21033431	ARACU	04/03/2020 06:42	04/03/2020 11:10	04/03/2020 06:42	04/03/2020 11:10	4,46	3	13,38	CHI
20200313150	JATAI	JT21358881	JATAI S1	04/03/2020 06:44	04/03/2020 09:10	04/03/2020 06:44	04/03/2020 09:10	2,43	1	2,43	CHI
20200313156	ACREUNA	EU21301170	ACREUNA	04/03/2020 06:48	04/03/2020 10:11	04/03/2020 06:48	04/03/2020 10:11	3,38	1	3,38	CHI
20200313157	ANAPOLIS	AN12319607	DAIA S1	04/03/2020 06:31	04/03/2020 08:08	04/03/2020 06:31	04/03/2020 08:08	1,61	4	6,44	CHI
20200313157	LEOPOLDO DE BULHOES	AN12319607	DAIA S1	04/03/2020 06:31	04/03/2020 08:08	04/03/2020 06:31	04/03/2020 08:08	1,61	6	9,67	CHI
20200313158	SANTA TEREZINHA DE GOIAS	SG12350024	SANTA TEREZINHA	04/03/2020 06:49	04/03/2020 21:40	04/03/2020 06:49	04/03/2020 21:40	14,85	14	207,89	CHI
20200313161	ITAGUARI	IC12353098	ITABERAI S1	04/03/2020 06:27	05/03/2020 15:39	04/03/2020 06:27	04/03/2020 11:23	4,92	47	231,42	CHI
20200313161	ITAGUARU	IC12353098	ITABERAI S1	04/03/2020 06:27	05/03/2020 15:39	04/03/2020 06:27	04/03/2020 11:23	4,92	82	403,76	CHI
20200313161	JARAGUA	IC12353098	ITABERAI S1	04/03/2020 06:27	05/03/2020 15:39	04/03/2020 06:27	04/03/2020 11:23	4,92	124	610,56	CHI
20200313161	JARAGUA	JA12063036	ITABERAI S1	04/03/2020 06:27	05/03/2020 15:39	04/03/2020 06:27	05/03/2020 15:39	33,20	4	132,79	CHI
20200313163	UIRAPURU	UP12321930	SANTA TEREZINHA	04/03/2020 06:50	04/03/2020 10:56	04/03/2020 06:50	04/03/2020 10:56	4,09	3	12,27	CHI
20200313165	RIO VERDE	RV12240290	MONTIVIDIU T	04/03/2020 06:51	04/03/2020 13:03	04/03/2020 06:51	04/03/2020 13:03	6,19	14	86,70	CHI
20200313166	SILVANIA	SV12239452	DAIA S2	04/03/2020 06:52	04/03/2020 08:06	04/03/2020 06:52	04/03/2020 08:06	1,23	7	8,63	CHI
20200313168	PALMEIRAS DE GOIAS	PL11102106	PALMEIRAS	04/03/2020 05:48	04/03/2020 09:45	04/03/2020 05:48	04/03/2020 09:45	3,94	146	575,89	CHI
20200313170	CACHOEIRA ALTA	CA12020034	CACHOEIRA ALTA	04/03/2020 06:52	04/03/2020 12:10	04/03/2020 06:52	04/03/2020 12:10	5,29	56	296,24	CHI
20200313171	MUTUNOPOLIS	PO12374520	PORANGATU	04/03/2020 05:28	04/03/2020 08:13	04/03/2020 05:28	04/03/2020 08:13	2,74	18	49,39	CHI
20200313171	PORANGATU	PO12374520	PORANGATU	04/03/2020 05:28	04/03/2020 08:13	04/03/2020 05:28	04/03/2020 08:13	2,74	19	52,13	CHI
20200313172	CRISTALINA	KR12037184	CRISTALINA S1	04/03/2020 06:53	04/03/2020 11:13	04/03/2020 06:53	04/03/2020 11:13	4,33	3	12,99	CHI
20200313175	IPORA	IR21364494	IPORA	04/03/2020 06:54	04/03/2020 11:04	04/03/2020 06:54	04/03/2020 11:04	4,17	1	4,17	CHI
20200313177	CRIXAS	NA21034661	MOZARLANDIA	04/03/2020 06:55	04/03/2020 08:13	04/03/2020 06:55	04/03/2020 08:13	1,30	1	1,30	CHI
20200313179	JATAI	JT12248490	JATAI S1	04/03/2020 06:55	04/03/2020 09:02	04/03/2020 06:55	04/03/2020 09:02	2,11	6	12,69	CHI
20200313181	SANTA RITA DO ARAGUAIA	SU12374325	SANTA RITA DO ARAGUAIA	04/03/2020 06:21	04/03/2020 15:55	04/03/2020 06:21	04/03/2020 15:55	9,55	28	267,44	CHI
20200313186	HIDROLINA	UR12374572	URUACU	04/03/2020 06:58	04/03/2020 09:36	04/03/2020 06:58	04/03/2020 09:36	2,62	2	5,25	CHI
20200313186	URUACU	UR12374572	URUACU	04/03/2020 06:58	04/03/2020 09:36	04/03/2020 06:58	04/03/2020 09:36	2,62	6	15,74	CHI
20200313187	PORANGATU	PO12390255	PORANGATU	04/03/2020 06:58	04/03/2020 12:03	04/03/2020 06:58	04/03/2020 12:03	5,07	4	20,29	CHI
20200313189	CABECEIRAS	CW21163621	ITUIQUIRA	04/03/2020 07:00	04/03/2020 08:26	04/03/2020 07:00	04/03/2020 08:26	1,43	1	1,43	CHI
20200313190	BALIZA	BH12358780	BOM JARDIM	04/03/2020 07:00	04/03/2020 11:08	04/03/2020 07:00	04/03/2020 11:08	4,13	19	78,53	CHI
20200313192	NOVA CRIXAS	NA12213190	MOZARLANDIA	04/03/2020 07:01	04/03/2020 10:54	04/03/2020 07:01	04/03/2020 10:54	3,88	23	89,30	CHI
20200313198	SAO MIGUEL DO ARAGUAIA	SM12086469	SAO MIGUEL DO ARAGUAIA	04/03/2020 03:39	04/03/2020 12:20	04/03/2020 03:39	04/03/2020 12:20	8,68	461	4001,48	CHI
20200313201	AMORINOPOLIS	AM21000034	IPORA	04/03/2020 07:03	04/03/2020 09:35	04/03/2020 07:03	04/03/2020 09:35	2,52	1	2,52	CHI
20200313202	ITABERAI	IB11227378	ITABERAI S1	04/03/2020 07:03	04/03/2020 19:30	04/03/2020 07:03	04/03/2020 19:30	12,44	1	12,44	CHI

20200313206	RIO VERDE	JT12340898	CABRIUVA S2	04/03/2020 06:53	04/03/2020 09:12	04/03/2020 06:53	04/03/2020 09:12	2,31	7	16,19	CHI
20200313210	CAVALCANTE	TE21262440	FLORES DE GOIAS	04/03/2020 07:05	04/03/2020 10:21	04/03/2020 07:05	04/03/2020 10:21	3,26	1	3,26	CHI
20200313212	POSSE	PS21164583	IACIARA S2	04/03/2020 07:06	04/03/2020 09:51	04/03/2020 07:06	04/03/2020 09:51	2,75	1	2,75	CHI
20200313216	GUARANI DE GOIAS	GY12257655	SAO DOMINGOS	04/03/2020 07:07	04/03/2020 09:50	04/03/2020 07:07	04/03/2020 09:50	2,71	19	51,50	CHI
20200313216	SAO DOMINGOS	GY12257655	SAO DOMINGOS	04/03/2020 07:07	04/03/2020 09:50	04/03/2020 07:07	04/03/2020 09:50	2,71	13	35,23	CHI
20200313218	MONTES CLAROS DE GOIAS	ME21140229	IPORA	04/03/2020 07:07	04/03/2020 12:53	04/03/2020 07:07	04/03/2020 12:53	5,75	1	5,75	CHI
20200313219	RIO VERDE	RV12249020	CABRIUVA S2	04/03/2020 07:06	04/03/2020 09:25	04/03/2020 07:06	04/03/2020 09:25	2,32	17	39,37	CHI
20200313223	PORANGATU	TA12114216	NOVO PLANALTO	04/03/2020 07:08	04/03/2020 09:46	04/03/2020 07:08	04/03/2020 09:46	2,62	6	15,74	CHI
20200313224	TRINDADE	TR12218023	TRINDADE	04/03/2020 07:09	04/03/2020 10:44	04/03/2020 07:09	04/03/2020 10:44	3,57	7	25,01	CHI
20200313226	ANAPOLIS	20541168	ANAPOLIS UNIVERSITARIO S2	04/03/2020 07:10	04/03/2020 11:15	04/03/2020 07:10	04/03/2020 11:15	4,07	1	4,07	CHI
20200313232	CRIXAS	NA12078447	NOVA CRIXAS	04/03/2020 04:43	04/03/2020 08:10	04/03/2020 04:43	04/03/2020 08:10	3,45	18	62,06	CHI
20200313232	NOVA CRIXAS	NA12078447	NOVA CRIXAS	04/03/2020 04:43	04/03/2020 08:10	04/03/2020 04:43	04/03/2020 08:10	3,45	19	65,51	CHI
20200313237	BELA VISTA DE GOIAS	BV21020430	BELA VISTA S2	04/03/2020 07:12	04/03/2020 08:54	04/03/2020 07:12	04/03/2020 08:54	1,70	1	1,70	CHI
20200313247	MINEIROS	1390040814	PARQUE DAS EMAS	04/03/2020 07:14	04/03/2020 10:50	04/03/2020 07:14	04/03/2020 10:50	3,59	1	3,59	CHI
20200313250	QUIRINOPOLIS	QI12058198	QUIRINOPOLIS	04/03/2020 07:15	04/03/2020 09:08	04/03/2020 07:15	04/03/2020 09:08	1,88	16	30,08	CHI
20200313253	PADRE BERNARDO	PB12347929	PADRE BERNARDO	03/03/2020 19:40	04/03/2020 10:32	03/03/2020 19:40	04/03/2020 10:32	14,86	5	74,29	CHI
20200313255	GOIAS	GS12220578	GOIAS	04/03/2020 07:17	04/03/2020 08:57	04/03/2020 07:17	04/03/2020 08:57	1,66	11	18,24	CHI
20200313256	CRISTALINA	KR21332528	CRISTALINA S1	04/03/2020 07:17	04/03/2020 16:31	04/03/2020 07:17	04/03/2020 16:31	9,22	1	9,22	CHI
20200313258	GOIANIA	10008053241	GOYA S1	04/03/2020 07:17	04/03/2020 09:42	04/03/2020 07:17	04/03/2020 09:42	2,40	1	2,40	CHI
20200313261	SANTA FE DE GOIAS	RN12362415	BRITANIA	04/03/2020 07:20	04/03/2020 11:25	04/03/2020 07:20	04/03/2020 11:25	4,09	18	73,58	CHI
20200313263	GOIAS	GS12408674	MATRINCHA	04/03/2020 05:34	04/03/2020 13:48	04/03/2020 05:34	04/03/2020 13:48	8,22	18	147,94	CHI
20200313268	PORANGATU	PO12239639	MARA ROSA	04/03/2020 07:22	04/03/2020 09:18	04/03/2020 07:22	04/03/2020 09:18	1,93	31	59,75	CHI
20200313269	LEOPOLDO DE BULHOES	LB12012179	DAIA S2	04/03/2020 07:22	04/03/2020 11:36	04/03/2020 07:22	04/03/2020 11:36	4,23	10	42,27	CHI
20200313273	JUSSARA	JR12018743	JUSSARA	04/03/2020 07:23	04/03/2020 14:00	04/03/2020 07:23	04/03/2020 14:00	6,61	5	33,07	CHI
20200313275	BOM JARDIM DE GOIAS	BM12065611	BOM JARDIM	04/03/2020 07:23	04/03/2020 10:11	04/03/2020 07:23	04/03/2020 10:11	2,79	4	11,15	CHI
20200313276	FAINA	GS12362364	MATRINCHA	04/03/2020 07:08	04/03/2020 12:55	04/03/2020 07:08	04/03/2020 12:55	5,78	11	63,60	CHI
20200313276	GOIAS	GS12362364	MATRINCHA	04/03/2020 07:08	04/03/2020 12:55	04/03/2020 07:08	04/03/2020 12:55	5,78	8	46,25	CHI
20200313276	MATRINCHA	GS12362364	MATRINCHA	04/03/2020 07:08	04/03/2020 12:55	04/03/2020 07:08	04/03/2020 12:55	5,78	1	5,78	CHI
20200313278	BONOPOLIS	TA12263013	NOVO PLANALTO	04/03/2020 04:49	04/03/2020 11:12	04/03/2020 04:49	04/03/2020 11:12	6,37	31	197,45	CHI
20200313279	TRINDADE	TR12388750	TRINDADE	04/03/2020 07:24	04/03/2020 09:57	04/03/2020 07:24	04/03/2020 09:57	2,54	1	2,54	CHI
20200313281	BRITANIA	BT12250825	BRITANIA	04/03/2020 07:08	04/03/2020 09:55	04/03/2020 07:08	04/03/2020 09:55	2,79	4	11,15	CHI
20200313284	RIO VERDE	RV21326799	SANTA HELENA S1	04/03/2020 07:26	04/03/2020 21:32	04/03/2020 07:26	04/03/2020 21:32	14,09	1	14,09	CHI
20200313286	FAZENDA NOVA	NB12117290	JUSSARA	04/03/2020 10:04	04/03/2020 14:11	04/03/2020 10:04	04/03/2020 14:11	4,11	4	16,43	CHI
20200313286	NOVO BRASIL	NB12117290	JUSSARA	04/03/2020 10:04	04/03/2020 14:11	04/03/2020 10:04	04/03/2020 14:11	4,11	5	20,54	CHI
20200313289	MORRINHOS	MR12363942	MORRINHOS	04/03/2020 07:26	04/03/2020 09:41	04/03/2020 07:26	04/03/2020 09:41	2,23	4	8,94	CHI
20200313298	GOIANIRA	GR12291555	NEROPOLIS S1	04/03/2020 07:29	04/03/2020 09:14	04/03/2020 07:29	04/03/2020 09:14	1,75	5	8,73	CHI
20200313301	MINACU	IH12230480	MINACU	04/03/2020 07:30	04/03/2020 10:02	04/03/2020 07:30	04/03/2020 10:02	2,53	17	43,05	CHI
20200313305	COLINAS DO SUL	TI12355513	NIQUELANDIA SUBTRANSMISSAO	04/03/2020 06:50	04/03/2020 11:57	04/03/2020 06:50	04/03/2020 11:57	5,10	11	56,15	CHI
20200313306	CORUMBA DE GOIAS	CB21204400	AGUAS LINDAS DE GOIAS S2	04/03/2020 07:30	04/03/2020 12:15	04/03/2020 07:30	04/03/2020 12:15	4,74	1	4,74	CHI
20200313307	SILVANIA	SV21078267	DAIA S2	04/03/2020 07:30	04/03/2020 09:16	04/03/2020 07:30	04/03/2020 09:16	1,75	1	1,75	CHI
20200313311	FORMOSO	ET12143681	MARA ROSA	04/03/2020 06:02	04/03/2020 11:45	04/03/2020 06:02	04/03/2020 11:45	5,71	13	74,27	CHI
20200313312	MINACU	IH12396739	MINACU	04/03/2020 07:31	04/03/2020 16:32	04/03/2020 07:31	04/03/2020 16:32	9,00	16	144,08	CHI
20200313314	PIRES DO RIO	460106624	PIRES DO RIO S1	04/03/2020 07:32	04/03/2020 09:03	04/03/2020 07:32	04/03/2020 09:03	1,50	1	1,50	CHI
20200313321	NEROPOLIS	NR12029257	NEROPOLIS S2	04/03/2020 07:34	04/03/2020 14:26	04/03/2020 07:34	04/03/2020 14:26	6,87	11	75,53	CHI

20200313322	FLORES DE GOIAS	FB12204157	FLORES DE GOIAS	04/03/2020 07:34	04/03/2020 13:00	04/03/2020 07:34	04/03/2020 13:00	5,43	13	70,62	CHI
20200313325	ABADIANIA	AA21254123	ANAPOLIS UNIVERSITARIO S1	04/03/2020 07:34	04/03/2020 10:34	04/03/2020 07:34	04/03/2020 10:34	2,99	1	2,99	CHI
20200313326	NOVO GAMA	NJ11163765	PACAEMBU S1	04/03/2020 07:32	04/03/2020 12:20	04/03/2020 10:15	04/03/2020 12:20	2,08	127	264,62	CHI
20200313327	RIO VERDE	RV21271243	CABRIUVA S2	04/03/2020 07:34	04/03/2020 12:14	04/03/2020 07:34	04/03/2020 12:14	4,65	1	4,65	CHI
20200313328	JUSSARA	RN12079527	BRITANIA	04/03/2020 07:35	04/03/2020 11:11	04/03/2020 07:35	04/03/2020 11:11	3,61	2	7,22	CHI
20200313328	SANTA FE DE GOIAS	RN12079527	BRITANIA	04/03/2020 07:35	04/03/2020 11:11	04/03/2020 07:35	04/03/2020 11:11	3,61	11	39,73	CHI
20200313330	MAIRIPOTABA	MI31060577	PONTALINA	04/03/2020 07:35	04/03/2020 09:05	04/03/2020 07:35	04/03/2020 09:05	1,50	1	1,50	CHI
20200313331	JOVIANIA	MR12263821	GOIATUBA S1	04/03/2020 07:33	04/03/2020 09:35	04/03/2020 07:33	04/03/2020 09:35	2,03	5	10,15	CHI
20200313331	MORRINHOS	MR12263821	GOIATUBA S1	04/03/2020 07:33	04/03/2020 09:35	04/03/2020 07:33	04/03/2020 09:35	2,03	12	24,36	CHI
20200313333	BURITINOPOLIS	BQ12262077	IACIARA S2	04/03/2020 07:36	04/03/2020 11:11	04/03/2020 07:36	04/03/2020 11:11	3,57	53	189,11	CHI
20200313335	FAZENDA NOVA	FN21153790	JUSSARA	04/03/2020 07:37	04/03/2020 15:34	04/03/2020 07:37	04/03/2020 15:34	7,94	1	7,94	CHI
20200313336	PORTELANDIA	PW21205286	PARQUE DAS EMAS	04/03/2020 07:37	04/03/2020 22:49	04/03/2020 07:37	04/03/2020 22:49	15,19	1	15,19	CHI
20200313339	ALTO PARAISO DE GOIAS	BF12105397LD	SAO JOAO D ALIANCA	04/03/2020 07:14	04/03/2020 10:45	04/03/2020 07:14	04/03/2020 10:45	3,51	224	787,05	CHI
20200313343	LUZIANIA	LZ12383009	MARAJOARA	04/03/2020 07:39	04/03/2020 10:25	04/03/2020 07:39	04/03/2020 10:25	2,76	11	30,31	CHI
20200313345	INACIOLANDIA	2810000433	QUIRINOPOLIS	04/03/2020 07:40	04/03/2020 09:10	04/03/2020 07:40	04/03/2020 09:10	1,49	1	1,49	CHI
20200313356	APARECIDA DE GOIANIA	15391863	ATLANTICO S1	04/03/2020 07:42	04/03/2020 09:34	04/03/2020 07:42	04/03/2020 09:34	1,86	1	1,86	CHI
20200313365	PIRANHAS	PH12341825	PIRANHAS	04/03/2020 07:44	04/03/2020 09:44	04/03/2020 07:44	04/03/2020 09:44	2,00	4	7,98	CHI
20200313367	SANTA CRUZ DE GOIAS	BC21159572	CRISTIANOPOLIS	04/03/2020 07:45	04/03/2020 13:01	04/03/2020 07:45	04/03/2020 13:01	5,26	1	5,26	CHI
20200313370	ITARUMA	IM21084253	CACHOEIRA ALTA	04/03/2020 07:46	05/03/2020 04:18	04/03/2020 07:46	05/03/2020 04:18	20,53	1	20,53	CHI
20200313371	TRINDADE	10011948068	TRINDADE	04/03/2020 07:46	04/03/2020 11:36	04/03/2020 07:46	04/03/2020 11:36	3,82	1	3,82	CHI
20200313372	ITUMBIARA	IT12033043	BOM JESUS DE GOIAS	04/03/2020 07:46	04/03/2020 12:51	04/03/2020 07:46	04/03/2020 12:51	5,07	3	15,20	CHI
20200313373	GOIANIA	10215517	FERROVIARIO S3	04/03/2020 07:47	04/03/2020 09:20	04/03/2020 07:47	04/03/2020 09:20	1,55	1	1,55	CHI
20200313374	MINEIROS	SU21157173	SANTA RITA DO ARAGUAIA	04/03/2020 07:47	04/03/2020 15:30	04/03/2020 07:47	04/03/2020 15:30	7,72	1	7,72	CHI
20200313379	GOIAS	90084445	GOIAS	04/03/2020 07:48	04/03/2020 09:00	04/03/2020 07:48	04/03/2020 09:00	1,20	1	1,20	CHI
20200313381	LUZIANIA	LZ12253523	VIANOPOLIS	04/03/2020 07:48	04/03/2020 12:05	04/03/2020 07:48	04/03/2020 12:05	4,28	14	59,87	CHI
20200313382	JATAI	JT12244770	JATAI S1	04/03/2020 07:48	04/03/2020 09:03	04/03/2020 07:48	04/03/2020 09:03	1,24	12	14,87	CHI
20200313384	JARAGUA	JA21029526	JARAGUA	04/03/2020 07:48	04/03/2020 09:29	04/03/2020 07:48	04/03/2020 09:29	1,67	3	5,00	CHI
20200313385	SAO MIGUEL DO ARAGUAIA	SM12350501	SAO MIGUEL DO ARAGUAIA	04/03/2020 07:05	04/03/2020 13:35	04/03/2020 07:05	04/03/2020 13:35	6,50	6	38,98	CHI
20200313390	COLINAS DO SUL	TI21196532	MINACU	04/03/2020 07:50	04/03/2020 09:32	04/03/2020 07:50	04/03/2020 09:32	1,69	1	1,69	CHI
20200313393	ALEXANIA	AX12319443	ALEXANIA	04/03/2020 07:20	04/03/2020 12:18	04/03/2020 07:20	04/03/2020 12:18	4,96	2	9,91	CHI
20200313394	PALMEIRAS DE GOIAS	PL12050550	PALMEIRAS	04/03/2020 07:51	04/03/2020 09:49	04/03/2020 07:51	04/03/2020 09:49	1,96	3	5,87	CHI
20200313398	GOIANIA	GN11001881	GOIANIA LESTE S2	04/03/2020 07:52	04/03/2020 14:17	04/03/2020 09:25	04/03/2020 14:17	4,88	65	317,09	CHI
20200313401	CORUMBAIBA	CI12363778	VILA CORUMBA	04/03/2020 07:53	04/03/2020 15:58	04/03/2020 07:53	04/03/2020 15:58	8,07	3	24,21	CHI
20200313403	GOIANIA	11286684	GOIANIA LESTE S2	04/03/2020 07:54	04/03/2020 10:10	04/03/2020 07:54	04/03/2020 10:10	2,26	1	2,26	CHI
20200313405	PLANALTINA	10014705689	PLANALTINA	04/03/2020 07:55	04/03/2020 10:17	04/03/2020 07:55	04/03/2020 10:17	2,36	1	2,36	CHI
20200313410	JATAI	JT12377889	JATAI S1	04/03/2020 07:55	04/03/2020 15:37	04/03/2020 07:55	04/03/2020 15:37	7,68	5	38,42	CHI
20200313415	ALVORADA DO NORTE	AQ12085499	IACIARA S2	04/03/2020 07:58	04/03/2020 10:56	04/03/2020 07:58	04/03/2020 10:56	2,96	1	2,96	CHI
20200313415	FLORES DE GOIAS	AQ12085499	IACIARA S2	04/03/2020 07:58	04/03/2020 10:56	04/03/2020 07:58	04/03/2020 10:56	2,96	2	5,92	CHI
20200313424	PEROLANDIA	DP12013860	JATAI S1	04/03/2020 08:00	04/03/2020 11:11	04/03/2020 08:00	04/03/2020 11:11	3,17	8	25,39	CHI
20200313425	PIRACANJUBA	10018770299	PIRACANJUBA	04/03/2020 08:00	04/03/2020 12:31	04/03/2020 08:00	04/03/2020 12:31	4,50	1	4,50	CHI
20200313427	SANTA TEREZINHA DE GOIAS	SG21371047	SANTA TEREZINHA	04/03/2020 08:00	04/03/2020 22:59	04/03/2020 08:00	04/03/2020 22:59	14,97	1	14,97	CHI
20200313431	ITAPIRAPUA	IU12016406	MATRINCHA	04/03/2020 07:45	04/03/2020 10:30	04/03/2020 07:45	04/03/2020 10:30	2,73	12	32,81	CHI
20200313434	QUIRINOPOLIS	QI12326658	QUIRINOPOLIS	04/03/2020 08:01	04/03/2020 11:21	04/03/2020 08:01	04/03/2020 11:21	3,33	1	3,33	CHI
20200313436	PORANGATU	PO12141124	NOVO PLANALTO	04/03/2020 06:27	04/03/2020 09:43	04/03/2020 06:27	04/03/2020 09:43	3,28	20	65,52	CHI

20200313438	JAUPACI	JP21184759	IPORA	04/03/2020 08:01	04/03/2020 20:51	04/03/2020 08:01	04/03/2020 20:51	12,82	1	12,82	CHI
20200313443	PORANGATU	PO12390257	PORANGATU	04/03/2020 08:02	04/03/2020 12:32	04/03/2020 08:02	04/03/2020 12:32	4,49	4	17,96	CHI
20200313444	ITAPIRAPUA	IU12073521	MATRINCHA	04/03/2020 08:03	04/03/2020 14:12	04/03/2020 08:03	04/03/2020 14:12	6,15	4	24,59	CHI
20200313445	PIRES DO RIO	PR21399181	PIRES DO RIO S2	04/03/2020 08:03	04/03/2020 09:45	04/03/2020 08:03	04/03/2020 09:45	1,69	1	1,69	CHI
20200313447	FORMOSO	FO21313419	MARA ROSA	04/03/2020 08:04	04/03/2020 15:14	04/03/2020 08:04	04/03/2020 15:14	7,16	1	7,16	CHI
20200313449	INDIARA	2710016650	EDEIA	04/03/2020 08:04	04/03/2020 10:40	04/03/2020 08:04	04/03/2020 10:40	2,60	1	2,60	CHI
20200313456	GOIATUBA	GT21389720	GOIATUBA S2	04/03/2020 08:05	04/03/2020 09:13	04/03/2020 08:05	04/03/2020 09:13	1,14	1	1,14	CHI
20200313458	COLINAS DO SUL	9700007576	NIQUELANDIA SUBTRANSMISSAO	04/03/2020 08:06	04/03/2020 10:43	04/03/2020 08:06	04/03/2020 10:43	2,61	1	2,61	CHI
20200313460	GOIANIA	GN11362575	CARAJAS S2	04/03/2020 08:06	04/03/2020 12:14	04/03/2020 08:06	04/03/2020 12:14	4,12	2	8,24	CHI
20200313462	ABADIA DE GOIAS	GN16407637	CARAJAS S1	04/03/2020 08:07	04/03/2020 18:08	04/03/2020 17:10	04/03/2020 17:15	0,08	3307	270,99	CHI
20200313462	GOIANIA	GN16407637	CARAJAS S1	04/03/2020 08:07	04/03/2020 18:08	04/03/2020 17:10	04/03/2020 17:15	0,08	17	1,39	CHI
20200313462	GOIANIA	GN10401635	CARAJAS S1	04/03/2020 08:07	04/03/2020 18:08	04/03/2020 17:10	04/03/2020 17:27	0,28	14	3,90	CHI
20200313462	ABADIA DE GOIAS	GN10391537	CARAJAS S1	04/03/2020 08:07	04/03/2020 18:08	04/03/2020 17:17	04/03/2020 17:27	0,17	1	0,17	CHI
20200313462	GOIANIA	GN10391537	CARAJAS S1	04/03/2020 08:07	04/03/2020 18:08	04/03/2020 17:17	04/03/2020 17:27	0,17	3841	646,57	CHI
20200313462	ABADIA DE GOIAS	GN10391537	CARAJAS S1	04/03/2020 08:07	04/03/2020 18:08	04/03/2020 17:18	04/03/2020 17:27	0,14	3307	474,00	CHI
20200313462	GOIANIA	GN10391537	CARAJAS S1	04/03/2020 08:07	04/03/2020 18:08	04/03/2020 17:18	04/03/2020 17:27	0,14	17	2,44	CHI
20200313462	ABADIA DE GOIAS	GN10391537	TRINDADE	04/03/2020 08:07	04/03/2020 18:08	04/03/2020 17:18	04/03/2020 17:27	0,14	631	90,44	CHI
20200313462	GOIANIA	GN10391537	TRINDADE	04/03/2020 08:07	04/03/2020 18:08	04/03/2020 17:18	04/03/2020 17:27	0,14	32	4,59	CHI
20200313462	TRINDADE	GN10391537	TRINDADE	04/03/2020 08:07	04/03/2020 18:08	04/03/2020 17:18	04/03/2020 17:27	0,14	3323	476,30	CHI
20200313462	ABADIA DE GOIAS	TR10396028	CARAJAS S1	04/03/2020 08:07	04/03/2020 18:08	04/03/2020 17:28	04/03/2020 17:33	0,08	3307	270,99	CHI
20200313462	GOIANIA	TR10396028	CARAJAS S1	04/03/2020 08:07	04/03/2020 18:08	04/03/2020 17:28	04/03/2020 17:33	0,08	17	1,39	CHI
20200313462	ABADIA DE GOIAS	TR10396028	TRINDADE	04/03/2020 08:07	04/03/2020 18:08	04/03/2020 17:28	04/03/2020 17:33	0,08	631	51,71	CHI
20200313462	GOIANIA	TR10396028	TRINDADE	04/03/2020 08:07	04/03/2020 18:08	04/03/2020 17:28	04/03/2020 17:33	0,08	32	2,62	CHI
20200313462	TRINDADE	TR10396028	TRINDADE	04/03/2020 08:07	04/03/2020 18:08	04/03/2020 17:28	04/03/2020 17:33	0,08	3323	272,30	CHI
20200313462	GOIANIA	GN10404129	CARAJAS S1	04/03/2020 08:07	04/03/2020 18:08	04/03/2020 17:29	04/03/2020 17:34	0,08	14	1,13	CHI
20200313462	GOIANIA	GN10401635	CARAJAS S1	04/03/2020 08:07	04/03/2020 18:08	04/03/2020 17:10	04/03/2020 18:00	0,83	3642	3029,94	CHI
20200313462	GOIANIA	GN16413217	CARAJAS S1	04/03/2020 08:07	04/03/2020 18:08	04/03/2020 17:18	04/03/2020 18:00	0,70	2	1,39	CHI
20200313462	GOIANIA	GN21347789	CARAJAS S1	04/03/2020 08:07	04/03/2020 18:08	04/03/2020 08:07	04/03/2020 18:08	10,02	1	10,02	CHI
20200313466	JUSSARA	JR12101204	JUSSARA	04/03/2020 08:08	04/03/2020 11:05	04/03/2020 08:08	04/03/2020 11:05	2,95	29	85,43	CHI
20200313470	RIO VERDE	630463463	RIO VERDE S1	04/03/2020 08:09	04/03/2020 12:05	04/03/2020 08:09	04/03/2020 12:05	3,93	1	3,93	CHI
20200313474	GOIATUBA	GT21222328	GOIATUBA S1	04/03/2020 08:09	06/03/2020 13:12	04/03/2020 08:09	06/03/2020 13:12	53,04	1	53,04	CHI
20200313479	CRISTALINA	KR12029221	CRISTALINA S1	04/03/2020 07:05	04/03/2020 10:00	04/03/2020 07:05	04/03/2020 10:00	2,91	4	11,65	CHI
20200313482	BONOPOLIS	BX12364670	SAO MIGUEL DO ARAGUAIA	04/03/2020 08:11	04/03/2020 14:22	04/03/2020 08:11	04/03/2020 14:22	6,18	3	18,55	CHI
20200313490	SANTA FE DE GOIAS	RN12378850	BRITANIA	04/03/2020 08:12	04/03/2020 10:59	04/03/2020 08:12	04/03/2020 10:59	2,79	19	52,92	CHI
20200313492	CORUMBAIBA	CI21081007	VILA CORUMBA	04/03/2020 08:12	04/03/2020 17:01	04/03/2020 08:12	04/03/2020 17:01	8,81	1	8,81	CHI
20200313494	MUNDO NOVO DE GOIAS	MH12391950	NOVA CRIXAS	04/03/2020 07:50	04/03/2020 10:26	04/03/2020 07:50	04/03/2020 10:26	2,59	100	258,83	CHI
20200313495	CAMPOS VERDES	VD12251082	SANTA TEREZINHA	04/03/2020 07:40	04/03/2020 15:21	04/03/2020 07:40	04/03/2020 15:21	7,67	4	30,69	CHI
20200313495	SANTA TEREZINHA DE GOIAS	VD12251082	SANTA TEREZINHA	04/03/2020 07:40	04/03/2020 15:21	04/03/2020 07:40	04/03/2020 15:21	7,67	17	130,43	CHI
20200313498	JARAGUA	JA21124470	JARAGUA	04/03/2020 08:13	04/03/2020 09:37	04/03/2020 08:13	04/03/2020 09:37	1,39	3	4,17	CHI
20200313499	CATALAO	CT21000023	CATALAO S2	04/03/2020 08:13	04/03/2020 11:12	04/03/2020 08:13	04/03/2020 11:12	2,97	1	2,97	CHI
20200313500	SAO LUIZ DO NORTE	DF12241242	BARRO ALTO	04/03/2020 08:01	04/03/2020 11:30	04/03/2020 08:01	04/03/2020 11:30	3,48	5	17,41	CHI
20200313502	HIDROLINA	GE12382134	BARRO ALTO	04/03/2020 06:49	04/03/2020 12:23	04/03/2020 06:49	04/03/2020 12:23	5,56	1	5,56	CHI
20200313502	SAO LUIZ DO NORTE	GE12382134	BARRO ALTO	04/03/2020 06:49	04/03/2020 12:23	04/03/2020 06:49	04/03/2020 12:23	5,56	8	44,47	CHI
20200313503	PLANALTINA	10009875237	PLANALTINA	04/03/2020 08:13	04/03/2020 10:39	04/03/2020 08:13	04/03/2020 10:39	2,42	1	2,42	CHI

20200313506	FORMOSA	FA12254301	ITUIQUIRA	04/03/2020 08:15	04/03/2020 09:32	04/03/2020 08:15	04/03/2020 09:32	1,28	8	10,25	CHI
20200313517	MONTE ALEGRE DE GOIAS	MA21233202	SAO DOMINGOS	04/03/2020 08:17	04/03/2020 10:45	04/03/2020 08:17	04/03/2020 10:45	2,45	1	2,45	CHI
20200313519	RUBIATABA	RB21353642	RUBIATABA	04/03/2020 08:18	04/03/2020 16:39	04/03/2020 08:18	04/03/2020 16:39	8,35	1	8,35	CHI
20200313529	FIRMINOPOLIS	FR21000058	FIRMINOPOLIS S1	04/03/2020 08:20	04/03/2020 09:05	04/03/2020 08:20	04/03/2020 09:05	0,74	1	0,74	CHI
20200313534	GOIANIA	GN11074908	GOYA S1	04/03/2020 08:21	04/03/2020 11:48	04/03/2020 08:21	04/03/2020 11:48	3,44	141	485,04	CHI
20200313535	GOIANIRA	10000734312	GOIANIRA	04/03/2020 08:21	04/03/2020 12:29	04/03/2020 08:21	04/03/2020 12:29	4,12	1	4,12	CHI
20200313536	PLANALTINA	2960078105	PLANALTINA	04/03/2020 08:22	04/03/2020 09:58	04/03/2020 08:22	04/03/2020 09:58	1,61	1	1,61	CHI
20200313541	PIRACANJUBA	PJ21182517	PIRACANJUBA	04/03/2020 08:22	04/03/2020 11:15	04/03/2020 08:22	04/03/2020 11:15	2,87	1	2,87	CHI
20200313546	DISTRITO FEDERAL	IO21332218	CATALAO S1	04/03/2020 08:23	04/03/2020 16:54	04/03/2020 08:23	04/03/2020 16:54	8,51	1	8,51	CHI
20200313547	ITABERAI	IB12310560	ITABERAI S2	04/03/2020 08:23	04/03/2020 16:09	04/03/2020 08:23	04/03/2020 16:09	7,76	7	54,30	CHI
20200313549	ITAPACI	10016429484	ITAPACI	04/03/2020 08:24	05/03/2020 01:20	04/03/2020 08:24	05/03/2020 01:20	16,93	1	16,93	CHI
20200313552	JATAI	JT12348474LD	JATAI S2	04/03/2020 08:24	04/03/2020 14:26	04/03/2020 08:24	04/03/2020 14:26	6,02	1	6,02	CHI
20200313555	ITUMBIARA	IT21305378	BOM JESUS DE GOIAS	04/03/2020 08:25	04/03/2020 11:31	04/03/2020 08:25	04/03/2020 11:31	3,09	1	3,09	CHI
20200313557	BURITI ALEGRE	BG21102572	ITUMBIARA VELHA S2	04/03/2020 08:25	04/03/2020 20:32	04/03/2020 08:25	04/03/2020 20:32	12,10	1	12,10	CHI
20200313561	VALPARAISO DE GOIAS	VA11192841	PACAEMBU S1	04/03/2020 08:26	04/03/2020 15:57	04/03/2020 14:35	04/03/2020 15:57	1,37	165	225,36	CHI
20200313563	VICENTINOPOLIS	1970030103	VICENTINOPOLIS	04/03/2020 08:26	04/03/2020 09:42	04/03/2020 08:26	04/03/2020 09:42	1,26	1	1,26	CHI
20200313567	MINACU	IH12088795	MINACU	04/03/2020 08:27	04/03/2020 13:53	04/03/2020 08:27	04/03/2020 13:53	5,43	1	5,43	CHI
20200313573	JANDAIA	JD12308473	PALMEIRAS	04/03/2020 07:02	04/03/2020 14:17	04/03/2020 07:02	04/03/2020 14:17	7,25	7	50,75	CHI
20200313581	SANTA RITA DO ARAGUAIA	SU21142744	SANTA RITA DO ARAGUAIA	04/03/2020 08:30	04/03/2020 14:30	04/03/2020 08:30	04/03/2020 14:30	6,00	1	6,00	CHI
20200313582	ITUMBIARA	IT12000033	ITUMBIARA VELHA S1	04/03/2020 08:30	04/03/2020 12:01	04/03/2020 08:30	04/03/2020 12:01	3,50	3	10,51	CHI
20200313583	ITUMBIARA	690224217	ITUMBIARA VELHA S1	04/03/2020 08:31	04/03/2020 10:50	04/03/2020 08:31	04/03/2020 10:50	2,32	1	2,32	CHI
20200313591	MINEIROS	6210195	PARQUE DAS EMAS	04/03/2020 08:31	04/03/2020 11:35	04/03/2020 08:31	04/03/2020 11:35	3,05	1	3,05	CHI
20200313594	JARAGUA	JA12307662LD	ITABERAI S1	04/03/2020 08:32	04/03/2020 11:42	04/03/2020 08:32	04/03/2020 11:42	3,16	2	6,33	CHI
20200313597	COCALZINHO DE GOIAS	ZN21302488	COCALZINHO	04/03/2020 08:32	04/03/2020 11:14	04/03/2020 08:32	04/03/2020 11:14	2,69	1	2,69	CHI
20200313605	OUVIDOR	OU11000122	CATALAO S1	04/03/2020 08:19	04/03/2020 12:24	04/03/2020 09:57	04/03/2020 12:24	2,46	109	267,81	CHI
20200313625	GOIANIA	GN21002507	AEROPORTO S1	04/03/2020 08:39	04/03/2020 11:10	04/03/2020 08:39	04/03/2020 11:10	2,52	1	2,52	CHI
20200313703	SERRANOPOLIS	SX21308123	CHAPADAO DO CEU	04/03/2020 08:34	04/03/2020 12:23	04/03/2020 08:34	04/03/2020 12:23	3,81	1	3,81	CHI
20200313704	GOIANIA	10013148484	CAMPINAS S1	04/03/2020 08:34	04/03/2020 12:34	04/03/2020 08:34	04/03/2020 12:34	3,99	1	3,99	CHI
20200313708	URUACU	UR1237450	URUACU	04/03/2020 08:35	04/03/2020 11:26	04/03/2020 08:35	04/03/2020 11:26	2,85	5	14,23	CHI
20200313713	APARECIDA DE GOIANIA	17077187	INDEPENDENCIA S1	04/03/2020 08:35	04/03/2020 11:20	04/03/2020 08:35	04/03/2020 11:20	2,73	1	2,73	CHI
20200313714	NIQUELANDIA	NQ21274800	BARRO ALTO	04/03/2020 08:36	04/03/2020 10:38	04/03/2020 08:36	04/03/2020 10:38	2,03	1	2,03	CHI
20200313715	EDEALINA	1130004779	PONTALINA	04/03/2020 08:36	04/03/2020 10:38	04/03/2020 08:36	04/03/2020 10:38	2,03	1	2,03	CHI
20200313718	TRINDADE	TR31063630	TRINDADE	04/03/2020 08:36	04/03/2020 10:57	04/03/2020 08:36	04/03/2020 10:57	2,34	1	2,34	CHI
20200313723	ARAGARCAS	10020783246	ARAGARCAS	04/03/2020 08:37	04/03/2020 10:58	04/03/2020 08:37	04/03/2020 10:58	2,34	1	2,34	CHI
20200313726	PIRANHAS	BM21358759	BOM JARDIM	04/03/2020 08:38	04/03/2020 19:56	04/03/2020 08:38	04/03/2020 19:56	11,30	2	22,59	CHI
20200313734	GOIANIA	GN11042132	XAVANTES	04/03/2020 08:41	04/03/2020 17:56	04/03/2020 15:15	04/03/2020 17:56	2,68	148	397,13	CHI
20200313739	PIRACANJUBA	PJ21199384	PIRACANJUBA	04/03/2020 08:41	04/03/2020 13:05	04/03/2020 08:41	04/03/2020 13:05	4,39	1	4,39	CHI
20200313741	OURO VERDE DE GOIAS	OV21037468	NEROPOLIS S1	04/03/2020 08:43	04/03/2020 10:43	04/03/2020 08:43	04/03/2020 10:43	2,00	1	2,00	CHI
20200313743	POSSE	PS12256208	IACIARA S2	04/03/2020 08:44	04/03/2020 15:38	04/03/2020 08:44	04/03/2020 15:38	6,90	3	20,70	CHI
20200313746	DAMIANOPOLIS	MB12180675	IACIARA S2	04/03/2020 08:45	04/03/2020 09:52	04/03/2020 08:45	04/03/2020 09:52	1,11	8	8,88	CHI
20200313747	ANAPOLIS	AN21191461	DAIA S1	04/03/2020 08:45	04/03/2020 11:06	04/03/2020 08:45	04/03/2020 11:06	2,34	1	2,34	CHI
20200313748	ALEXANIA	AX21302095	ALEXANIA	04/03/2020 08:45	04/03/2020 12:54	04/03/2020 08:45	04/03/2020 12:54	4,14	1	4,14	CHI
20200313750	ANICUNS	910055956	ANICUNS	04/03/2020 08:46	04/03/2020 11:00	04/03/2020 08:46	04/03/2020 11:00	2,23	1	2,23	CHI
20200313757	SANTA FE DE GOIAS	2070019439	BRITANIA	04/03/2020 08:47	04/03/2020 15:25	04/03/2020 08:47	04/03/2020 15:25	6,64	1	6,64	CHI

20200313758	ARAGARCAS	1820024298	ARAGARCAS	04/03/2020 08:48	04/03/2020 18:32	04/03/2020 08:48	04/03/2020 18:32	9,73	1	9,73	CHI
20200313759	CRISTALINA	KR21118465	PAMPLONA	04/03/2020 08:48	04/03/2020 11:40	04/03/2020 08:48	04/03/2020 11:40	2,87	1	2,87	CHI
20200313760	LUZIANIA	120075295	RIO VERMELHO	04/03/2020 08:48	04/03/2020 11:48	04/03/2020 08:48	04/03/2020 11:48	2,99	1	2,99	CHI
20200313761	MUNDO NOVO DE GOIAS	MH12035583	NOVA CRIXAS	04/03/2020 08:49	04/03/2020 12:55	04/03/2020 08:49	04/03/2020 12:55	4,10	53	217,23	CHI
20200313765	NOVA IGUACU DE GOIAS	NH12236585	CAMPINORTE	03/03/2020 14:52	04/03/2020 10:19	03/03/2020 14:52	04/03/2020 10:19	19,44	6	116,62	CHI
20200313770	PIRENOPOLIS	PV21272029	CORUMBA	04/03/2020 08:52	04/03/2020 16:57	04/03/2020 08:52	04/03/2020 16:57	8,08	2	16,17	CHI
20200313771	SAO FRANCISCO DE GOIAS	SF12000106	SAO FRANCISCO DE GOIAS	04/03/2020 08:52	04/03/2020 10:09	04/03/2020 08:52	04/03/2020 10:09	1,28	9	11,50	CHI
20200313775	GOIANIA	GN11000559	AEROPORTO S1	04/03/2020 08:54	04/03/2020 10:41	04/03/2020 09:58	04/03/2020 10:41	0,72	87	62,35	CHI
20200313777	ACREUNA	BZ12240318	ACREUNA	04/03/2020 06:12	04/03/2020 13:05	04/03/2020 06:12	04/03/2020 13:05	6,88	2	13,75	CHI
20200313777	RIO VERDE	BZ12240318	ACREUNA	04/03/2020 06:12	04/03/2020 13:05	04/03/2020 06:12	04/03/2020 13:05	6,88	1	6,88	CHI
20200313777	SANTO ANTONIO DA BARRA	BZ12240318	ACREUNA	04/03/2020 06:12	04/03/2020 13:05	04/03/2020 06:12	04/03/2020 13:05	6,88	21	144,42	CHI
20200313780	RUBIATABA	RB12156045	RUBIATABA	04/03/2020 08:55	04/03/2020 14:37	04/03/2020 08:55	04/03/2020 14:37	5,69	2	11,38	CHI
20200313781	GOIANIA	10019418432	CARAJAS S1	04/03/2020 08:55	04/03/2020 11:18	04/03/2020 08:55	04/03/2020 11:18	2,37	1	2,37	CHI
20200313782	ITABERAI	IB12412562	ITABERAI S1	04/03/2020 08:56	04/03/2020 11:07	04/03/2020 08:56	04/03/2020 11:07	2,18	1	2,18	CHI
20200313785	NOVA IGUACU DE GOIAS	NH21148288	SANTA TEREZINHA	04/03/2020 08:56	04/03/2020 15:03	04/03/2020 08:56	04/03/2020 15:03	6,10	1	6,10	CHI
20200313788	ITAPACI	IW11055163	ITAPACI	04/03/2020 08:57	05/03/2020 03:00	04/03/2020 08:57	05/03/2020 03:00	18,04	183	3302,18	CHI
20200313789	VILA BOA	VB12265366	ITUIQUIRA	04/03/2020 08:57	04/03/2020 10:41	04/03/2020 08:57	04/03/2020 10:41	1,72	53	91,04	CHI
20200313793	GOIANIA	GN21060169	GOIANIA LESTE S3	04/03/2020 08:58	04/03/2020 11:41	04/03/2020 08:58	04/03/2020 11:41	2,71	1	2,71	CHI
20200313798	NOVO BRASIL	NB12396218	JUSSARA	04/03/2020 08:59	04/03/2020 19:52	04/03/2020 08:59	04/03/2020 19:52	10,88	2	21,75	CHI
20200313805	SAO MIGUEL DO ARAGUAIA	SM12298978	SAO MIGUEL DO ARAGUAIA	04/03/2020 08:02	04/03/2020 14:44	04/03/2020 08:02	04/03/2020 14:44	6,69	3	20,08	CHI
20200313813	NOVA AMERICA	RB21247621	RUBIATABA	04/03/2020 09:06	04/03/2020 16:06	04/03/2020 09:06	04/03/2020 16:06	7,00	1	7,00	CHI
20200313815	JATAI	JT12241744	JATAI S3	04/03/2020 09:06	04/03/2020 10:59	04/03/2020 09:06	04/03/2020 10:59	1,87	4	7,48	CHI
20200313816	SAO MIGUEL DO ARAGUAIA	10006546852	SAO MIGUEL DO ARAGUAIA	04/03/2020 09:07	04/03/2020 11:58	04/03/2020 09:07	04/03/2020 11:58	2,84	1	2,84	CHI
20200313820	HIDROLANDIA	1900001503	INDEPENDENCIA S1	04/03/2020 09:08	04/03/2020 12:41	04/03/2020 09:08	04/03/2020 12:41	3,54	1	3,54	CHI
20200313829	FAZENDA NOVA	NB12061633	JUSSARA	04/03/2020 09:09	04/03/2020 14:02	04/03/2020 09:09	04/03/2020 14:02	4,89	1	4,89	CHI
20200313829	JUSSARA	NB12061633	JUSSARA	04/03/2020 09:09	04/03/2020 14:02	04/03/2020 09:09	04/03/2020 14:02	4,89	11	53,83	CHI
20200313829	NOVO BRASIL	NB12061633	JUSSARA	04/03/2020 09:09	04/03/2020 14:02	04/03/2020 09:09	04/03/2020 14:02	4,89	12	58,72	CHI
20200313835	SANTO ANTONIO DO DESCOBERTO	SN12345926	MARAJOARA	04/03/2020 09:10	04/03/2020 16:17	04/03/2020 09:10	04/03/2020 16:17	7,10	2	14,21	CHI
20200313837	GOIANIA	12420761	ATLANTICO S1	04/03/2020 09:11	04/03/2020 12:20	04/03/2020 09:11	04/03/2020 12:20	3,15	1	3,15	CHI
20200313838	BELA VISTA DE GOIAS	10027124990	BELA VISTA S1	04/03/2020 09:12	04/03/2020 10:17	04/03/2020 09:12	04/03/2020 10:17	1,08	1	1,08	CHI
20200313842	MUTUNOPOLIS	MU12192453	MARA ROSA	04/03/2020 09:13	04/03/2020 15:19	04/03/2020 09:13	04/03/2020 15:19	6,10	1	6,10	CHI
20200313842	PORANGATU	MU12192453	MARA ROSA	04/03/2020 09:13	04/03/2020 15:19	04/03/2020 09:13	04/03/2020 15:19	6,10	1	6,10	CHI
20200313844	CACHOEIRA ALTA	CA21210068	CACHOEIRA ALTA	04/03/2020 09:13	04/03/2020 10:32	04/03/2020 09:13	04/03/2020 10:32	1,30	1	1,30	CHI
20200313845	CALDAS NOVAS	CN12142352	CALDAS NOVAS S1	04/03/2020 09:13	04/03/2020 18:24	04/03/2020 09:13	04/03/2020 18:24	9,17	9	82,53	CHI
20200313846	CATALAO	CT21273137	CATALAO S1	04/03/2020 09:14	04/03/2020 11:23	04/03/2020 09:14	04/03/2020 11:23	2,14	1	2,14	CHI
20200313847	JATAI	JT121359765	JATAI S1	04/03/2020 09:14	04/03/2020 11:00	04/03/2020 09:14	04/03/2020 11:00	1,75	2	3,51	CHI
20200313859	PIRES DO RIO	460052720	PIRES DO RIO S1	04/03/2020 09:17	04/03/2020 10:36	04/03/2020 09:17	04/03/2020 10:36	1,31	1	1,31	CHI
20200313860	GUARINOS	IW12209961	ITAPACI	04/03/2020 08:17	04/03/2020 17:44	04/03/2020 08:17	04/03/2020 17:44	9,45	7	66,14	CHI
20200313860	ITAPACI	IW12209961	ITAPACI	04/03/2020 08:17	04/03/2020 17:44	04/03/2020 08:17	04/03/2020 17:44	9,45	13	122,84	CHI
20200313860	PILAR DE GOIAS	IW12209961	ITAPACI	04/03/2020 08:17	04/03/2020 17:44	04/03/2020 08:17	04/03/2020 17:44	9,45	1	9,45	CHI
20200313861	JATAI	290174326	JATAI S2	04/03/2020 09:17	04/03/2020 11:22	04/03/2020 09:17	04/03/2020 11:22	2,07	1	2,07	CHI
20200313873	IACIARA	IA21286073	FLORES DE GOIAS	04/03/2020 09:20	04/03/2020 21:53	04/03/2020 09:20	04/03/2020 21:53	12,54	1	12,54	CHI
20200313881	PADRE BERNARDO	PB12376756	PADRE BERNARDO	04/03/2020 09:24	04/03/2020 18:55	04/03/2020 09:24	04/03/2020 18:55	9,52	5	47,58	CHI
20200313883	URUACU	640081587	URUACU	04/03/2020 09:24	04/03/2020 12:21	04/03/2020 09:24	04/03/2020 12:21	2,94	1	2,94	CHI

20200313884	BELA VISTA DE GOIAS	BV21020430	BELA VISTA S2	04/03/2020 09:24	04/03/2020 10:35	04/03/2020 09:24	04/03/2020 10:35	1,17	1	1,17	CHI
20200313887	GOIANESIA	GE21185708	GOIANESIA S1	04/03/2020 09:24	04/03/2020 12:54	04/03/2020 09:24	04/03/2020 12:54	3,49	1	3,49	CHI
20200313890	NOVA CRIXAS	NA12334349	NOVA CRIXAS	04/03/2020 07:08	04/03/2020 11:49	04/03/2020 07:08	04/03/2020 11:49	4,68	86	402,05	CHI
20200313893	MIMOSO DE GOIAS	MJ12377229	PADRE BERNARDO	04/03/2020 09:28	04/03/2020 12:30	04/03/2020 09:28	04/03/2020 12:30	3,04	7	21,29	CHI
20200313901	MONTIVIDIU	MV21075459	MONTIVIDIU T	04/03/2020 09:30	04/03/2020 17:22	04/03/2020 09:30	04/03/2020 17:22	7,86	2	15,72	CHI
20200313902	EDEALINA	1130009182	PONTALINA	04/03/2020 09:30	04/03/2020 11:49	04/03/2020 09:30	04/03/2020 11:49	2,31	1	2,31	CHI
20200313907	FAZENDA NOVA	FN12390140	IPORA	04/03/2020 09:08	04/03/2020 15:41	04/03/2020 09:08	04/03/2020 15:41	6,54	11	71,93	CHI
20200313909	GOIANIA	11211015	ATLANTICO S2	04/03/2020 09:32	04/03/2020 11:49	04/03/2020 09:32	04/03/2020 11:49	2,28	1	2,28	CHI
20200313910	PIRENOPOLIS	PV21093299	SAO FRANCISCO DE GOIAS	04/03/2020 09:32	05/03/2020 12:51	04/03/2020 09:32	05/03/2020 11:50	26,30	1	26,30	CHI
20200313910	PIRENOPOLIS	PV12093290	SAO FRANCISCO DE GOIAS	04/03/2020 09:32	05/03/2020 12:51	05/03/2020 08:50	05/03/2020 12:09	3,33	2	6,66	CHI
20200313910	PIRENOPOLIS	PV21093299	SAO FRANCISCO DE GOIAS	04/03/2020 09:32	05/03/2020 12:51	05/03/2020 12:09	05/03/2020 12:51	0,69	1	0,69	CHI
20200313912	MOZARLANDIA	10014955936	MOZARLANDIA	04/03/2020 09:30	04/03/2020 10:55	04/03/2020 09:30	04/03/2020 10:55	1,42	0	0,00	CHI
20200313913	NOVA IGUACU DE GOIAS	NH12202119	CAMPINORTE	04/03/2020 06:48	04/03/2020 23:27	04/03/2020 06:48	04/03/2020 23:27	16,65	8	133,20	CHI
20200313915	TRES RANCHOS	2170018410	CATALAO S1	04/03/2020 09:32	04/03/2020 13:22	04/03/2020 09:32	04/03/2020 13:22	3,82	1	3,82	CHI
20200313916	PEROLANDIA	DP12324473	JATAI S1	04/03/2020 09:32	04/03/2020 12:16	04/03/2020 09:32	04/03/2020 12:16	2,72	1	2,72	CHI
20200313917	CALDAS NOVAS	CN16404326	CALDAS NOVAS S2	04/03/2020 09:33	04/03/2020 14:16	04/03/2020 09:33	04/03/2020 14:16	4,72	1594	7518,81	CHI
20200313917	PIRACANJUBA	CN16404326	CALDAS NOVAS S2	04/03/2020 09:33	04/03/2020 14:16	04/03/2020 09:33	04/03/2020 14:16	4,72	2	9,43	CHI
20200313917	CALDAS NOVAS	CN16404326	CALDAS NOVAS S2	04/03/2020 09:33	04/03/2020 14:16	04/03/2020 14:11	04/03/2020 14:16	0,08	3049	229,52	CHI
20200313918	ALEXANIA	AX11398539	ALEXANIA	04/03/2020 09:33	04/03/2020 17:24	04/03/2020 09:33	04/03/2020 17:24	7,84	13	101,91	CHI
20200313922	RIO VERDE	630525109	RIO VERDE S1	04/03/2020 09:34	04/03/2020 11:27	04/03/2020 09:34	04/03/2020 11:27	1,88	1	1,88	CHI
20200313934	DOVERLANDIA	DV12400429	CAIAPONIA	04/03/2020 09:37	04/03/2020 13:14	04/03/2020 09:37	04/03/2020 13:14	3,61	66	238,48	CHI
20200313935	APARECIDA DE GOIANIA	200369544	INDEPENDENCIA S2	04/03/2020 09:37	04/03/2020 11:37	04/03/2020 09:37	04/03/2020 11:37	1,99	1	1,99	CHI
20200313938	GOIANIA	12649934	FERROVIARIO S3	04/03/2020 09:38	04/03/2020 12:18	04/03/2020 09:38	04/03/2020 12:18	2,67	1	2,67	CHI
20200313939	APARECIDA DE GOIANIA	14432894	INDEPENDENCIA S1	04/03/2020 09:38	04/03/2020 10:59	04/03/2020 09:38	04/03/2020 10:59	1,34	1	1,34	CHI
20200313940	GOIAS	GS21310614	ITABERAI S1	04/03/2020 09:38	04/03/2020 10:50	04/03/2020 09:38	04/03/2020 10:50	1,19	1	1,19	CHI
20200313945	GAMELEIRA DE GOIAS	GL12216197	ANAPOLIS UNIVERSITARIO S2	04/03/2020 09:03	04/03/2020 11:53	04/03/2020 09:03	04/03/2020 11:53	2,82	8	22,56	CHI
20200313947	ANAPOLIS	AN21374637	ANAPOLIS UNIVERSITARIO S2	04/03/2020 09:40	04/03/2020 12:02	04/03/2020 09:40	04/03/2020 12:02	2,36	1	2,36	CHI
20200313960	SANTA TEREZA DE GOIAS	2430002470	MARA ROSA	04/03/2020 09:42	04/03/2020 13:01	04/03/2020 09:42	04/03/2020 13:01	3,31	1	3,31	CHI
20200313962	NIQUELANDIA	NQ21235484	NIQUELANDIA SUBTRANSMISSAO	04/03/2020 09:43	04/03/2020 14:53	04/03/2020 09:43	04/03/2020 14:53	5,15	1	5,15	CHI
20200313968	SAO MIGUEL DO ARAGUAIA	SM12151032	SAO MIGUEL DO ARAGUAIA	03/03/2020 19:59	04/03/2020 13:53	03/03/2020 19:59	04/03/2020 13:53	17,90	10	178,97	CHI
20200313969	NIQUELANDIA	NQ12235634	URUACU	04/03/2020 09:45	04/03/2020 16:30	04/03/2020 09:45	04/03/2020 16:30	6,74	76	512,47	CHI
20200313970	GOIANESIA	GE21107728	GOIANESIA S2	04/03/2020 09:45	04/03/2020 11:55	04/03/2020 09:45	04/03/2020 11:55	2,16	1	2,16	CHI
20200313971	RIO QUENTE	RQ21124200	RIO QUENTE	04/03/2020 09:45	04/03/2020 12:45	04/03/2020 09:45	04/03/2020 12:45	2,99	2	5,97	CHI
20200313972	VILA PROPICIO	NP21298202	GOIANESIA S1	04/03/2020 09:44	04/03/2020 11:40	04/03/2020 09:44	04/03/2020 11:40	1,94	1	1,94	CHI
20200313973	ARAGUAPAZ	AZ21238247	GOIAS	04/03/2020 09:46	04/03/2020 10:46	04/03/2020 09:46	04/03/2020 10:46	1,00	1	1,00	CHI
20200313974	ALEXANIA	10024136776	ALEXANIA	04/03/2020 09:46	04/03/2020 21:08	04/03/2020 09:46	04/03/2020 21:08	11,35	1	11,35	CHI
20200313975	INDIARA	PL12376414	PALMEIRAS	04/03/2020 09:47	04/03/2020 11:24	04/03/2020 09:47	04/03/2020 11:24	1,62	3	4,85	CHI
20200313975	PALMEIRAS DE GOIAS	PL12376414	PALMEIRAS	04/03/2020 09:47	04/03/2020 11:24	04/03/2020 09:47	04/03/2020 11:24	1,62	50	80,82	CHI
20200313980	PROFESSOR JAMIL SAFADY	PJ21000400	ROCHEDO	04/03/2020 09:48	04/03/2020 14:43	04/03/2020 09:48	04/03/2020 14:43	4,91	1	4,91	CHI
20200313984	AGUAS LINDAS DE GOIAS	ZN12067366	AGUAS LINDAS DE GOIAS S1	04/03/2020 09:49	04/03/2020 21:51	04/03/2020 09:49	04/03/2020 21:51	12,03	50	601,36	CHI
20200313984	COCALZINHO DE GOIAS	ZN12067366	AGUAS LINDAS DE GOIAS S1	04/03/2020 09:49	04/03/2020 21:51	04/03/2020 09:49	04/03/2020 21:51	12,03	93	1118,53	CHI
20200313986	SAO DOMINGOS	SD12170547	SAO DOMINGOS	04/03/2020 09:50	04/03/2020 12:44	04/03/2020 09:50	04/03/2020 12:44	2,90	13	37,70	CHI
20200313988	ITABERAI	IB12099038	ITABERAI S2	04/03/2020 09:43	04/03/2020 10:12	04/03/2020 09:43	04/03/2020 10:12	0,47	15	7,07	CHI
20200313989	FLORES DE GOIAS	9620003773	IACIARA S2	04/03/2020 09:50	04/03/2020 13:57	04/03/2020 09:50	04/03/2020 13:57	4,10	1	4,10	CHI

20200313996	PIRENOPOLIS	220008450	CORUMBA	04/03/2020 09:52	04/03/2020 17:00	04/03/2020 09:52	04/03/2020 17:00	7,13	1	7,13	CHI
20200314016	PIRACANJUBA	PJ12000042RE	PIRACANJUBA	04/03/2020 09:58	04/03/2020 12:35	04/03/2020 09:58	04/03/2020 12:35	2,62	8	20,99	CHI
20200314043	BRAZABRANTES	03920224	NEROPOLIS S1	04/03/2020 10:51	04/03/2020 14:32	04/03/2020 10:51	04/03/2020 11:53	1,03	364	373,20	CHI
20200314043	NOVA VENEZA	03920224	NEROPOLIS S1	04/03/2020 10:51	04/03/2020 14:32	04/03/2020 10:51	04/03/2020 11:53	1,03	3	3,08	CHI
20200314043	BRAZABRANTES	03920224	NEROPOLIS S1	04/03/2020 10:51	04/03/2020 14:32	04/03/2020 10:51	04/03/2020 12:56	2,08	6	12,46	CHI
20200314043	GOIANIRA	03920224	NEROPOLIS S1	04/03/2020 10:51	04/03/2020 14:32	04/03/2020 10:51	04/03/2020 12:56	2,08	30	62,31	CHI
20200314043	BRAZABRANTES	03920224	NEROPOLIS S1	04/03/2020 10:51	04/03/2020 14:32	04/03/2020 12:00	04/03/2020 12:56	0,93	287	265,48	CHI
20200314043	BRAZABRANTES	03920224	NEROPOLIS S1	04/03/2020 10:51	04/03/2020 14:32	04/03/2020 12:00	04/03/2020 14:15	2,25	4	9,02	CHI
20200314043	BRAZABRANTES	03920224	NEROPOLIS S1	04/03/2020 10:51	04/03/2020 14:32	04/03/2020 12:00	04/03/2020 14:24	2,40	54	129,83	CHI
20200314043	NOVA VENEZA	03920224	NEROPOLIS S1	04/03/2020 10:51	04/03/2020 14:32	04/03/2020 12:00	04/03/2020 14:24	2,40	1	2,40	CHI
20200314043	BRAZABRANTES	03920224	NEROPOLIS S1	04/03/2020 10:51	04/03/2020 14:32	04/03/2020 12:00	04/03/2020 14:32	2,53	19	48,10	CHI
20200314043	NOVA VENEZA	03920224	NEROPOLIS S1	04/03/2020 10:51	04/03/2020 14:32	04/03/2020 12:00	04/03/2020 14:32	2,53	2	5,06	CHI
20200314050	POSSE	PS12257684	IACIARA S2	04/03/2020 11:16	04/03/2020 11:25	04/03/2020 11:16	04/03/2020 11:25	0,14	4	0,54	CHI
20200314067	ALEXANIA	AX21384804	ALEXANIA	04/03/2020 12:23	04/03/2020 12:44	04/03/2020 12:23	04/03/2020 12:44	0,33	1	0,33	CHI
20200314079	SERRANOPOLIS	SX21308100	CHAPADAO DO CEU	04/03/2020 12:49	04/03/2020 23:06	04/03/2020 12:49	04/03/2020 23:06	10,28	1	10,28	CHI
20200314101	LUZIANIA	120052015	RIO VERMELHO	04/03/2020 09:53	04/03/2020 11:44	04/03/2020 09:53	04/03/2020 11:44	1,85	1	1,85	CHI
20200314102	CRIXAS	NM12027453	RUBIATABA	04/03/2020 09:51	04/03/2020 11:49	04/03/2020 09:51	04/03/2020 11:49	1,96	6	11,73	CHI
20200314102	ITAPACI	NM12027453	RUBIATABA	04/03/2020 09:51	04/03/2020 11:49	04/03/2020 09:51	04/03/2020 11:49	1,96	2	3,91	CHI
20200314102	NOVA AMERICA	NM12027453	RUBIATABA	04/03/2020 09:51	04/03/2020 11:49	04/03/2020 09:51	04/03/2020 11:49	1,96	9	17,60	CHI
20200314105	MOZARLANDIA	10030825197	MOZARLANDIA	04/03/2020 09:54	04/03/2020 11:29	04/03/2020 09:54	04/03/2020 11:29	1,58	1	1,58	CHI
20200314108	CRISTALINA	KR11276413	CRISTALINA S2	04/03/2020 09:54	04/03/2020 18:23	04/03/2020 09:54	04/03/2020 18:23	8,48	1	8,48	CHI
20200314109	BARRO ALTO	BA21000035	BARRO ALTO	04/03/2020 09:54	04/03/2020 10:54	04/03/2020 09:54	04/03/2020 10:54	0,99	1	0,99	CHI
20200314110	DOVERLANDIA	DV12139906	CAIAPONIA	04/03/2020 09:54	04/03/2020 13:42	04/03/2020 09:54	04/03/2020 13:42	3,79	10	37,92	CHI
20200314120	URUACU	CR12101069	MARA ROSA	04/03/2020 09:44	05/03/2020 09:53	04/03/2020 09:44	05/03/2020 09:53	24,15	8	193,18	CHI
20200314125	EDEIA	EA12257969	RIO DOS BOIS	04/03/2020 08:37	04/03/2020 11:34	04/03/2020 08:37	04/03/2020 11:34	2,95	2	5,90	CHI
20200314130	JUSSARA	JR12085863	BRITANIA	04/03/2020 10:00	04/03/2020 13:20	04/03/2020 10:00	04/03/2020 13:20	3,32	4	13,30	CHI
20200314132	ADELANDIA	DN21352464	ANICUNS	04/03/2020 10:01	04/03/2020 13:44	04/03/2020 10:01	04/03/2020 13:44	3,71	1	3,71	CHI
20200314135	FORMOSA	610268296	ITUIQUIRA	04/03/2020 10:01	04/03/2020 12:12	04/03/2020 10:01	04/03/2020 12:12	2,17	1	2,17	CHI
20200314142	VIANOPOLIS	VN21190409	VIANOPOLIS	04/03/2020 10:02	04/03/2020 11:22	04/03/2020 10:02	04/03/2020 11:22	1,33	1	1,33	CHI
20200314148	ITABERAI	IB21364838	ITABERAI S1	04/03/2020 10:05	04/03/2020 15:07	04/03/2020 10:05	04/03/2020 15:07	5,03	2	10,06	CHI
20200314156	CAMPINACU	UC12341458	MARA ROSA	04/03/2020 10:07	04/03/2020 14:49	04/03/2020 10:07	04/03/2020 14:49	4,70	7	32,87	CHI
20200314158	IPORA	730053611	IPORA	04/03/2020 10:07	05/03/2020 03:45	04/03/2020 10:07	05/03/2020 03:45	17,62	1	17,62	CHI
20200314162	LUZIANIA	120093029	RIO VERMELHO	04/03/2020 10:09	04/03/2020 12:11	04/03/2020 10:09	04/03/2020 12:11	2,03	1	2,03	CHI
20200314167	BOM JESUS DE GOIAS	BJ21305404	BOM JESUS DE GOIAS	04/03/2020 10:11	04/03/2020 13:38	04/03/2020 10:11	04/03/2020 13:38	3,45	2	6,89	CHI
20200314171	PADRE BERNARDO	PB21163189	PADRE BERNARDO	04/03/2020 10:14	04/03/2020 16:35	04/03/2020 10:14	04/03/2020 16:35	6,35	1	6,35	CHI
20200314173	JATAI	JT12248490	JATAI S1	04/03/2020 10:14	04/03/2020 16:05	04/03/2020 10:14	04/03/2020 16:05	5,84	6	35,07	CHI
20200314180	CRISTALINA	KR21249278	PAMPLONA	04/03/2020 10:15	04/03/2020 13:55	04/03/2020 10:15	04/03/2020 13:55	3,66	1	3,66	CHI
20200314185	GOIAS	GS12310670	GOIAS	04/03/2020 10:17	04/03/2020 12:00	04/03/2020 10:17	04/03/2020 12:00	1,70	6	10,22	CHI
20200314188	AMARALINA	MU12357189	MARA ROSA	04/03/2020 10:17	04/03/2020 20:05	04/03/2020 10:17	04/03/2020 20:05	9,78	1	9,78	CHI
20200314188	MUTUNOPOLIS	MU12357189	MARA ROSA	04/03/2020 10:17	04/03/2020 20:05	04/03/2020 10:17	04/03/2020 20:05	9,78	2	19,57	CHI
20200314193	PADRE BERNARDO	PB21148882	PADRE BERNARDO	04/03/2020 10:18	04/03/2020 13:21	04/03/2020 10:18	04/03/2020 13:21	3,04	1	3,04	CHI
20200314196	BELA VISTA DE GOIAS	BV31010049	BELA VISTA S1	04/03/2020 10:19	04/03/2020 11:40	04/03/2020 10:19	04/03/2020 11:40	1,34	1	1,34	CHI
20200314199	PLANALTINA	2960021764	PLANALTINA	04/03/2020 10:19	04/03/2020 12:46	04/03/2020 10:19	04/03/2020 12:46	2,45	1	2,45	CHI
20200314201	CALDAZINHA	LB12095842	CEPAIGO S2	04/03/2020 10:20	04/03/2020 19:10	04/03/2020 10:20	04/03/2020 19:10	8,83	3	26,49	CHI

20200314202	RIO VERDE	RV11159382	RIO VERDE S1	04/03/2020 10:16	04/03/2020 22:37	04/03/2020 10:16	04/03/2020 22:37	12,34	141	1739,63	CHI
20200314215	ARENOPOLIS	AY12341229	ARENOPOLIS	04/03/2020 10:22	04/03/2020 21:35	04/03/2020 10:22	04/03/2020 21:35	11,20	27	302,43	CHI
20200314216	GOIAS	GS11090343	GOIAS	04/03/2020 10:22	04/03/2020 10:51	04/03/2020 10:22	04/03/2020 10:51	0,47	1	0,47	CHI
20200314218	SAO MIGUEL DO ARAGUAIA	SM21083879	SAO MIGUEL DO ARAGUAIA	04/03/2020 10:23	04/03/2020 12:33	04/03/2020 10:23	04/03/2020 12:33	2,16	1	2,16	CHI
20200314219	SAO LUIS DE MONTES BELOS	500012842	SAO LUIZ DOS MONTES BELOS	04/03/2020 10:23	04/03/2020 11:21	04/03/2020 10:23	04/03/2020 11:21	0,96	1	0,96	CHI
20200314220	RIO VERDE	630424305	RIO VERDE S2	04/03/2020 10:23	04/03/2020 22:10	04/03/2020 10:23	04/03/2020 22:10	11,78	1	11,78	CHI
20200314221	BURITI ALEGRE	420028717	ALTO BURITI	04/03/2020 10:23	04/03/2020 12:05	04/03/2020 10:23	04/03/2020 12:05	1,69	1	1,69	CHI
20200314223	CRIXAS	CX12392296	SANTA TEREZINHA	04/03/2020 08:29	04/03/2020 15:52	04/03/2020 08:29	04/03/2020 15:52	7,37	5	36,85	CHI
20200314223	SANTA TEREZINHA DE GOIAS	CX12392296	SANTA TEREZINHA	04/03/2020 08:29	04/03/2020 15:52	04/03/2020 08:29	04/03/2020 15:52	7,37	3	22,11	CHI
20200314231	POSSE	PS12212366	IACIARA S1	04/03/2020 08:38	04/03/2020 14:38	04/03/2020 08:38	04/03/2020 14:38	5,99	38	227,70	CHI
20200314234	NEROPOLIS	10012999030	NEROPOLIS S2	04/03/2020 10:25	04/03/2020 15:27	04/03/2020 10:25	04/03/2020 15:27	5,03	1	5,03	CHI
20200314238	LEOPOLDO DE BULHOES	SV21011171	DAIA S2	04/03/2020 10:26	04/03/2020 11:31	04/03/2020 10:26	04/03/2020 11:31	1,08	2	2,15	CHI
20200314243	PIRES DO RIO	460053577	PIRES DO RIO S1	04/03/2020 10:27	04/03/2020 11:58	04/03/2020 10:27	04/03/2020 11:58	1,51	1	1,51	CHI
20200314244	EDEIA	EA21086960	EDEIA	04/03/2020 10:26	04/03/2020 15:05	04/03/2020 10:26	04/03/2020 15:05	4,64	1	4,64	CHI
20200314245	CAMPOS VERDES	SG12181588	SANTA TEREZINHA	04/03/2020 07:23	04/03/2020 20:43	04/03/2020 07:23	04/03/2020 20:43	13,33	8	106,60	CHI
20200314245	SANTA TEREZINHA DE GOIAS	SG12181588	SANTA TEREZINHA	04/03/2020 07:23	04/03/2020 20:43	04/03/2020 07:23	04/03/2020 20:43	13,33	5	66,63	CHI
20200314248	PALMEIRAS DE GOIAS	PL12085225	PALMEIRAS	04/03/2020 10:28	04/03/2020 12:34	04/03/2020 10:28	04/03/2020 12:34	2,09	2	4,19	CHI
20200314249	CALDAS NOVAS	760263954	SERRA DE CALDAS	04/03/2020 10:28	04/03/2020 18:28	04/03/2020 10:28	04/03/2020 18:28	7,99	1	7,99	CHI
20200314258	VIANOPOLIS	VN12114854	VIANOPOLIS	04/03/2020 10:29	04/03/2020 14:21	04/03/2020 10:29	04/03/2020 14:21	3,86	18	69,48	CHI
20200314259	APARECIDA DE GOIANIA	200057820	INDEPENDENCIA S1	04/03/2020 10:32	04/03/2020 14:32	04/03/2020 10:32	04/03/2020 14:32	4,00	1	4,00	CHI
20200314264	ANAPOLIS	21085171	JUNDIAI S2	04/03/2020 10:34	04/03/2020 15:54	04/03/2020 10:34	04/03/2020 15:54	5,33	1	5,33	CHI
20200314265	SANTA HELENA DE GOIAS	10030315865	IPEGUARI	04/03/2020 10:34	05/03/2020 01:55	04/03/2020 10:34	05/03/2020 01:55	15,35	1	15,35	CHI
20200314273	JATAI	10003862532	JATAI S2	04/03/2020 10:35	04/03/2020 13:14	04/03/2020 10:35	04/03/2020 13:14	2,65	1	2,65	CHI
20200314279	PALMINOPOLIS	PP12215299	PALMEIRAS	04/03/2020 10:37	04/03/2020 13:06	04/03/2020 10:37	04/03/2020 13:06	2,48	1	2,48	CHI
20200314284	ARAGUAPAZ	AZ12248246	GOIAS	04/03/2020 10:38	04/03/2020 13:07	04/03/2020 10:38	04/03/2020 13:07	2,47	9	22,26	CHI
20200314285	CRISTALINA	1060124078	CRISTALINA S1	04/03/2020 10:39	05/03/2020 01:40	04/03/2020 10:39	05/03/2020 01:40	15,02	1	15,02	CHI
20200314287	FORMOSA	FA12392206	ITUIQUIRA	04/03/2020 10:40	04/03/2020 12:03	04/03/2020 10:40	04/03/2020 12:03	1,38	9	12,44	CHI
20200314288	ITAJA	IJ21351534	CACHOEIRA ALTA	04/03/2020 10:40	04/03/2020 15:17	04/03/2020 10:40	04/03/2020 15:17	4,61	1	4,61	CHI
20200314290	MAMBAI	4970000579	IACIARA S2	04/03/2020 10:38	04/03/2020 11:50	04/03/2020 10:38	04/03/2020 11:50	1,19	1	1,19	CHI
20200314292	ORIZONA	OZ21113156	VIANOPOLIS	04/03/2020 10:41	04/03/2020 22:16	04/03/2020 10:41	04/03/2020 22:16	11,57	1	11,57	CHI
20200314298	RIO VERDE	RV12018184	RIO VERDE S2	04/03/2020 10:44	05/03/2020 19:03	04/03/2020 10:44	05/03/2020 19:03	32,32	3	96,95	CHI
20200314298	RIO VERDE	RV12018184	RIO VERDE S2	04/03/2020 10:44	05/03/2020 19:03	05/03/2020 16:47	05/03/2020 19:03	2,26	6	13,57	CHI
20200314299	IPAMERI	NE21150933	CATALAO S1	04/03/2020 10:44	04/03/2020 16:07	04/03/2020 10:44	04/03/2020 16:07	5,37	1	5,37	CHI
20200314300	CRIXAS	CX11397152	SERRA DO OURO	04/03/2020 10:44	05/03/2020 09:54	04/03/2020 10:44	05/03/2020 09:54	23,16	1	23,16	CHI
20200314308	PALMEIRAS DE GOIAS	PL12391507	PALMEIRAS	04/03/2020 10:15	04/03/2020 12:29	04/03/2020 10:15	04/03/2020 12:29	2,23	7	15,58	CHI
20200314310	IACIARA	IA21351553	FLORES DE GOIAS	04/03/2020 10:47	04/03/2020 13:51	04/03/2020 10:47	04/03/2020 13:51	3,06	1	3,06	CHI
20200314312	NIQUELANDIA	NQ21139051	URUACU	04/03/2020 10:47	04/03/2020 20:00	04/03/2020 10:47	04/03/2020 20:00	9,20	1	9,20	CHI
20200314333	TRINDADE	TR21320405	TRINDADE	04/03/2020 10:52	04/03/2020 13:05	04/03/2020 10:52	04/03/2020 13:05	2,21	6	13,27	CHI
20200314334	JATAI	JT12234396	JATAI S1	04/03/2020 10:34	04/03/2020 17:03	04/03/2020 10:34	04/03/2020 17:03	6,47	9	58,27	CHI
20200314343	QUIRINOPOLIS	80051145	QUIRINOPOLIS	04/03/2020 10:56	04/03/2020 12:11	04/03/2020 10:56	04/03/2020 12:11	1,25	1	1,25	CHI
20200314344	ARUANA	2380034236	ARUANA	04/03/2020 10:54	04/03/2020 14:51	04/03/2020 10:54	04/03/2020 14:51	3,95	1	3,95	CHI
20200314345	GOIANESIA	GE12000198	GOIANESIA S2	04/03/2020 10:56	04/03/2020 14:50	04/03/2020 10:56	04/03/2020 14:50	3,89	1	3,89	CHI
20200314352	ARUANA	AK12250809	ARUANA	04/03/2020 11:01	04/03/2020 15:09	04/03/2020 11:01	04/03/2020 15:09	4,15	2	8,29	CHI
20200314353	VIANOPOLIS	VN21289086	VIANOPOLIS	04/03/2020 11:01	04/03/2020 12:43	04/03/2020 11:01	04/03/2020 12:43	1,70	1	1,70	CHI

20200314363	GUAPO	10000697131	GUAPO S1	04/03/2020 11:03	04/03/2020 13:19	04/03/2020 11:03	04/03/2020 13:19	2,26	1	2,26	CHI
20200314367	PARAUNA	PU12332611	PARAUNA	04/03/2020 11:04	04/03/2020 16:11	04/03/2020 11:04	04/03/2020 16:11	5,10	5	25,52	CHI
20200314373	IVOLANDIA	IV21097800	ARENOPOLIS	04/03/2020 11:05	04/03/2020 16:10	04/03/2020 11:05	04/03/2020 16:10	5,07	2	10,15	CHI
20200314376	BONOPOLIS	BX12316276	SAO MIGUEL DO ARAGUAIA	04/03/2020 11:05	04/03/2020 13:06	04/03/2020 11:05	04/03/2020 13:06	2,00	4	8,01	CHI
20200314378	ACREUNA	EU21114118	ACREUNA	04/03/2020 11:06	05/03/2020 01:15	04/03/2020 11:06	05/03/2020 01:15	14,14	2	28,29	CHI
20200314381	FAZENDA NOVA	FN12237035	JUSSARA	04/03/2020 08:19	04/03/2020 15:48	04/03/2020 08:19	04/03/2020 15:48	7,49	7	52,45	CHI
20200314387	ANAPOLIS	AN11285327	ANAPOLIS UNIVERSITARIO S1	04/03/2020 11:07	04/03/2020 12:59	04/03/2020 11:07	04/03/2020 12:20	1,21	1	1,21	CHI
20200314387	ANAPOLIS	AN12258767	ANAPOLIS UNIVERSITARIO S1	04/03/2020 11:07	04/03/2020 12:59	04/03/2020 11:08	04/03/2020 12:59	1,86	4	7,43	CHI
20200314389	APARECIDA DE GOIANIA	10002882688	INDEPENDENCIA S1	04/03/2020 11:07	04/03/2020 12:14	04/03/2020 11:07	04/03/2020 12:14	1,11	1	1,11	CHI
20200314392	ABADIANIA	AA21374687	ANAPOLIS UNIVERSITARIO S1	04/03/2020 11:07	04/03/2020 13:06	04/03/2020 11:07	04/03/2020 13:06	1,97	1	1,97	CHI
20200314394	MATRINCHA	MP21231901	MATRINCHA	04/03/2020 11:08	04/03/2020 16:40	04/03/2020 11:08	04/03/2020 16:40	5,53	1	5,53	CHI
20200314396	GOIANESIA	GE11043767	GOIANESIA S1	04/03/2020 11:09	04/03/2020 19:15	04/03/2020 11:09	04/03/2020 19:15	8,10	119	964,00	CHI
20200314400	VILA PROPICIO	NP11327895	GOIANESIA S1	04/03/2020 11:09	04/03/2020 14:50	04/03/2020 11:09	04/03/2020 14:50	3,68	1	3,68	CHI
20200314403	BOM JARDIM DE GOIAS	BM11209244	BOM JARDIM	04/03/2020 11:10	05/03/2020 03:18	04/03/2020 11:10	05/03/2020 03:18	16,13	1	16,13	CHI
20200314406	POSSE	PS11071364	IACIARA S2	04/03/2020 11:11	04/03/2020 12:41	04/03/2020 11:11	04/03/2020 12:41	1,50	83	124,27	CHI
20200314413	CABECEIRAS	CW21320508	ITIQUEIRA	04/03/2020 11:13	04/03/2020 14:31	04/03/2020 11:13	04/03/2020 14:31	3,30	1	3,30	CHI
20200314423	SANTO ANTONIO DO DESCOBERTO	10011823710	ALEXANIA	04/03/2020 11:17	04/03/2020 18:11	04/03/2020 11:17	04/03/2020 18:11	6,90	1	6,90	CHI
20200314428	POSSE	PS21160036	IACIARA S2	04/03/2020 11:18	04/03/2020 16:15	04/03/2020 11:18	04/03/2020 16:15	4,94	1	4,94	CHI
20200314431	PADRE BERNARDO	PB11314032	PADRE BERNARDO	04/03/2020 11:19	04/03/2020 16:30	04/03/2020 11:19	04/03/2020 16:30	5,17	6	31,01	CHI
20200314433	EDEIA	EA21044052	EDEIA	04/03/2020 11:20	04/03/2020 16:38	04/03/2020 11:20	04/03/2020 16:38	5,30	1	5,30	CHI
20200314445	GOIANIA	10021867524	FERROVIARIO S3	04/03/2020 11:22	04/03/2020 18:04	04/03/2020 11:22	04/03/2020 18:04	6,69	1	6,69	CHI
20200314448	SERRANOPOLIS	SX21267765	JATAI S1	04/03/2020 11:23	05/03/2020 09:13	04/03/2020 11:23	05/03/2020 09:13	21,83	1	21,83	CHI
20200314453	GOIANIA	12389080	AEROPORTO S1	04/03/2020 11:24	04/03/2020 19:23	04/03/2020 11:24	04/03/2020 19:23	7,97	1	7,97	CHI
20200314460	MINEIROS	MY12197173	PARQUE DAS EMAS	04/03/2020 11:23	04/03/2020 19:54	04/03/2020 11:23	04/03/2020 19:54	8,50	21	178,51	CHI
20200314462	GOIANIA	11329439	GOIANIA LESTE S3	04/03/2020 11:26	04/03/2020 14:36	04/03/2020 11:26	04/03/2020 14:36	3,16	1	3,16	CHI
20200314468	ABADIANIA	AA21302394	DAIA S2	04/03/2020 11:29	05/03/2020 16:30	04/03/2020 11:29	05/03/2020 16:30	29,02	6	174,09	CHI
20200314476	TURVELANDIA	TD12303745	RIO DOS BOIS	04/03/2020 11:31	04/03/2020 18:19	04/03/2020 11:31	04/03/2020 18:19	6,80	2	13,60	CHI
20200314478	EDEIA	IY12205924	EDEIA	04/03/2020 10:50	04/03/2020 15:29	04/03/2020 10:50	04/03/2020 13:21	2,52	5	12,58	CHI
20200314478	INDIARA	IY12205924	EDEIA	04/03/2020 10:50	04/03/2020 15:29	04/03/2020 10:50	04/03/2020 13:21	2,52	415	1044,19	CHI
20200314478	JANDAIA	IY12205924	EDEIA	04/03/2020 10:50	04/03/2020 15:29	04/03/2020 10:50	04/03/2020 13:21	2,52	1	2,52	CHI
20200314478	INDIARA	IY12299111	EDEIA	04/03/2020 10:50	04/03/2020 15:29	04/03/2020 10:50	04/03/2020 15:29	4,66	10	46,57	CHI
20200314483	RIO VERDE	RV12222616	RIO VERDE S2	04/03/2020 11:33	04/03/2020 19:48	04/03/2020 11:33	04/03/2020 19:48	8,25	13	107,25	CHI
20200314484	ACREUNA	2440013050	ACREUNA	04/03/2020 11:28	04/03/2020 14:20	04/03/2020 11:28	04/03/2020 14:20	2,85	0	0,00	CHI
20200314489	SANCLERLANDIA	SC21190733	FIRMINOPOLIS S2	04/03/2020 11:34	04/03/2020 16:09	04/03/2020 11:34	04/03/2020 16:09	4,58	1	4,58	CHI
20200314491	URUACU	UR21136491	URUACU	04/03/2020 11:36	04/03/2020 15:40	04/03/2020 11:36	04/03/2020 15:40	4,07	1	4,07	CHI
20200314492	RIO VERDE	RV11326123	RIO VERDE S1	04/03/2020 11:36	04/03/2020 11:40	04/03/2020 11:36	04/03/2020 11:40	0,06	83	5,10	CHI
20200314496	GOIANIA	16352658	MEIA PONTE	04/03/2020 11:37	04/03/2020 14:38	04/03/2020 11:37	04/03/2020 14:38	3,00	1	3,00	CHI
20200314501	PIRACANJUBA	PJ21025315	BELA VISTA S1	04/03/2020 11:38	04/03/2020 12:37	04/03/2020 11:38	04/03/2020 12:37	0,97	1	0,97	CHI
20200314503	GOIANIA	10011989708	GOIANIA LESTE S2	04/03/2020 11:39	04/03/2020 21:17	04/03/2020 11:39	04/03/2020 21:17	9,63	1	9,63	CHI
20200314505	SERRANOPOLIS	DJ21267756	CHAPADAO DO CEU	04/03/2020 11:39	04/03/2020 18:21	04/03/2020 11:39	04/03/2020 18:21	6,69	1	6,69	CHI
20200314516	VILA PROPICIO	NP12312761	GOIANESIA S1	04/03/2020 11:41	04/03/2020 16:47	04/03/2020 11:41	04/03/2020 16:47	5,09	5	25,43	CHI
20200314518	MIMOSO DE GOIAS	MJ12382208	PADRE BERNARDO	04/03/2020 11:33	04/03/2020 15:33	04/03/2020 11:33	04/03/2020 15:33	4,00	9	35,98	CHI
20200314518	PADRE BERNARDO	MJ12382208	PADRE BERNARDO	04/03/2020 11:33	04/03/2020 15:33	04/03/2020 11:33	04/03/2020 15:33	4,00	5	19,99	CHI
20200314520	ARAGARCAS	AG21234238	ARAGARCAS	04/03/2020 11:42	04/03/2020 20:50	04/03/2020 11:42	04/03/2020 20:50	9,13	1	9,13	CHI

20200314524	BARRO ALTO	GE12006481	BARRO ALTO	04/03/2020 11:29	04/03/2020 14:05	04/03/2020 11:29	04/03/2020 14:05	2,59	21	54,40	CHI
20200314524	SANTA RITA DO NOVO DESTINO	GE12006481	BARRO ALTO	04/03/2020 11:29	04/03/2020 14:05	04/03/2020 11:29	04/03/2020 14:05	2,59	10	25,90	CHI
20200314526	SENADOR CANEDO	12328674	SENADOR CANEDO	04/03/2020 11:44	04/03/2020 13:28	04/03/2020 11:44	04/03/2020 13:28	1,73	0	0,00	CHI
20200314527	GOIAS	10016411925	GOIAS	04/03/2020 11:44	04/03/2020 15:05	04/03/2020 11:44	04/03/2020 15:05	3,36	1	3,36	CHI
20200314529	LUZIANIA	10019198904	RIO VERMELHO	04/03/2020 11:44	04/03/2020 18:05	04/03/2020 11:44	04/03/2020 18:05	6,34	1	6,34	CHI
20200314531	JUSSARA	JR12220051	JUSSARA	04/03/2020 11:45	04/03/2020 15:35	04/03/2020 11:45	04/03/2020 15:35	3,83	69	264,42	CHI
20200314532	SERRANOPOLIS	SX12260467	JATAI S1	05/03/2020 07:29	05/03/2020 08:33	05/03/2020 07:29	05/03/2020 08:33	1,05	6	6,30	CHI
20200314534	FORMOSA	610151411	ITIQUEIRA	04/03/2020 11:47	04/03/2020 13:27	04/03/2020 11:47	04/03/2020 13:27	1,66	1	1,66	CHI
20200314535	RIO VERDE	RV12322213	RIO VERDE S1	04/03/2020 11:47	04/03/2020 14:47	04/03/2020 11:47	04/03/2020 14:47	2,99	581	1737,84	CHI
20200314536	OUVIDOR	OU12042451	CATALAO S1	04/03/2020 11:48	04/03/2020 22:03	04/03/2020 11:48	04/03/2020 22:03	10,24	3	30,72	CHI
20200314538	CALDAS NOVAS	CN12186164	CALDAS NOVAS S2	04/03/2020 11:48	04/03/2020 16:19	04/03/2020 11:48	04/03/2020 16:19	4,50	18	81,02	CHI
20200314544	ITAGUARU	IC21250502	ITABERAI S1	04/03/2020 11:49	04/03/2020 23:03	04/03/2020 11:49	04/03/2020 23:03	11,22	1	11,22	CHI
20200314545	INHUMAS	IN21383458	ARACU	04/03/2020 11:49	04/03/2020 13:01	04/03/2020 11:49	04/03/2020 13:01	1,19	2	2,37	CHI
20200314553	PIRES DO RIO	10003598940	PIRES DO RIO S1	04/03/2020 11:52	04/03/2020 15:08	04/03/2020 11:52	04/03/2020 15:08	3,26	1	3,26	CHI
20200314556	CRISTALINA	KR12305271	CRISTALINA S2	04/03/2020 10:34	04/03/2020 16:23	04/03/2020 10:34	04/03/2020 16:23	5,81	5	29,06	CHI
20200314558	PALMEIRAS DE GOIAS	590062724	PALMEIRAS	04/03/2020 11:54	04/03/2020 14:21	04/03/2020 11:54	04/03/2020 14:21	2,43	1	2,43	CHI
20200314559	GUARANI DE GOIAS	GY12271725	IACIARA S1	04/03/2020 11:55	04/03/2020 16:55	04/03/2020 11:55	04/03/2020 16:55	4,99	3	14,98	CHI
20200314563	CATALAO	CT11000046	CATALAO S2	04/03/2020 11:56	04/03/2020 16:05	04/03/2020 11:56	04/03/2020 16:05	4,15	79	327,65	CHI
20200314564	MUNDO NOVO DE GOIAS	MH12189540	NOVA CRIXAS	04/03/2020 08:25	04/03/2020 12:55	04/03/2020 08:25	04/03/2020 12:55	4,48	5	22,42	CHI
20200314575	VALPARAISO DE GOIAS	3350029990	PACAEMBU S2	04/03/2020 11:58	04/03/2020 16:50	04/03/2020 11:58	04/03/2020 16:50	4,86	1	4,86	CHI
20200314580	MIMOSO DE GOIAS	04560224	BARRO ALTO	04/03/2020 11:05	04/03/2020 12:31	04/03/2020 11:05	04/03/2020 12:31	1,43	4	5,73	CHI
20200314580	NIQUELANDIA	04560224	BARRO ALTO	04/03/2020 11:05	04/03/2020 12:31	04/03/2020 11:05	04/03/2020 12:31	1,43	1022	1462,88	CHI
20200314580	VILA PROPICIO	04560224	BARRO ALTO	04/03/2020 11:05	04/03/2020 12:31	04/03/2020 11:05	04/03/2020 12:31	1,43	32	45,80	CHI
20200314583	SANTA HELENA DE GOIAS	10028700854	IPEGUARI	04/03/2020 11:59	04/03/2020 19:44	04/03/2020 11:59	04/03/2020 19:44	7,74	1	7,74	CHI
20200314584	APARECIDA DE GOIANIA	16362998	INDEPENDENCIA S2	04/03/2020 11:59	04/03/2020 13:12	04/03/2020 11:59	04/03/2020 13:12	1,20	1	1,20	CHI
20200314590	GOIAS	GS21183458	GOIAS	04/03/2020 12:01	04/03/2020 15:52	04/03/2020 12:01	04/03/2020 15:52	3,84	1	3,84	CHI
20200314595	CATALAO	CT11000027	CATALAO S2	04/03/2020 11:55	04/03/2020 14:07	04/03/2020 11:55	04/03/2020 14:07	2,19	115	251,88	CHI
20200314596	NOVO BRASIL	NB21112724	JUSSARA	04/03/2020 12:03	04/03/2020 20:05	04/03/2020 12:03	04/03/2020 20:05	8,02	1	8,02	CHI
20200314612	PALMINOPOLIS	PP12013618	PALMEIRAS	04/03/2020 10:57	04/03/2020 13:22	04/03/2020 10:57	04/03/2020 13:22	2,42	14	33,82	CHI
20200314614	PIRES DO RIO	460079694	PIRES DO RIO S1	04/03/2020 12:10	04/03/2020 15:44	04/03/2020 12:10	04/03/2020 15:44	3,56	1	3,56	CHI
20200314618	ANAPOLIS	21196898	ANAPOLIS UNIVERSITARIO S2	04/03/2020 12:13	04/03/2020 17:08	04/03/2020 12:13	04/03/2020 17:08	4,91	1	4,91	CHI
20200314622	NIQUELANDIA	NQ12088704	URUACU	04/03/2020 12:14	04/03/2020 17:19	04/03/2020 12:14	04/03/2020 17:19	5,08	21	106,69	CHI
20200314623	NOVO GAMA	10000553334	PACAEMBU S1	04/03/2020 12:14	04/03/2020 15:44	04/03/2020 12:14	04/03/2020 15:44	3,49	1	3,49	CHI
20200314628	GOIAS	GS12091169	MATRINCHA	04/03/2020 11:59	04/03/2020 18:24	04/03/2020 11:59	04/03/2020 18:24	6,40	9	57,61	CHI
20200314629	TRINDADE	11567466	GOYA S2	04/03/2020 12:16	04/03/2020 13:24	04/03/2020 12:16	04/03/2020 13:24	1,13	1	1,13	CHI
20200314630	BELA VISTA DE GOIAS	BV21092444	BELA VISTA S1	04/03/2020 12:16	04/03/2020 13:19	04/03/2020 12:16	04/03/2020 13:19	1,04	1	1,04	CHI
20200314638	CALDAZINHA	LB21200297	CEPAIGO S2	04/03/2020 12:17	04/03/2020 20:57	04/03/2020 12:17	04/03/2020 20:57	8,66	1	8,66	CHI
20200314639	VALPARAISO DE GOIAS	10002010850	PACAEMBU S2	04/03/2020 12:17	04/03/2020 12:48	04/03/2020 12:17	04/03/2020 12:48	0,51	1	0,51	CHI
20200314643	CAMPO ALEGRE DE GOIAS	CM21077542	CAMPO ALEGRE DE GOIAS	04/03/2020 12:18	04/03/2020 14:42	04/03/2020 12:18	04/03/2020 14:42	2,40	1	2,40	CHI
20200314644	AMORINOPOLIS	IR12188430	IPORA	04/03/2020 12:18	04/03/2020 15:32	04/03/2020 12:18	04/03/2020 15:32	3,23	42	135,61	CHI
20200314644	IPORA	IR12188430	IPORA	04/03/2020 12:18	04/03/2020 15:32	04/03/2020 12:18	04/03/2020 15:32	3,23	23	74,26	CHI
20200314644	IVOLANDIA	IR12188430	IPORA	04/03/2020 12:18	04/03/2020 15:32	04/03/2020 12:18	04/03/2020 15:32	3,23	101	326,12	CHI
20200314644	PALESTINA DE GOIAS	IR12188430	IPORA	04/03/2020 12:18	04/03/2020 15:32	04/03/2020 12:18	04/03/2020 15:32	3,23	2	6,46	CHI
20200314651	FLORES DE GOIAS	02830414	FLORES DE GOIAS	04/03/2020 12:13	04/03/2020 12:16	04/03/2020 12:13	04/03/2020 12:16	0,05	2190	118,63	CHI

20200314651	NOVA ROMA	02830414	FLORES DE GOIAS	04/03/2020 12:13	04/03/2020 12:16	04/03/2020 12:13	04/03/2020 12:16	0,05	2	0,11	CHI
20200314651	SAO JOAO D ALIANCA	02830414	FLORES DE GOIAS	04/03/2020 12:13	04/03/2020 12:16	04/03/2020 12:13	04/03/2020 12:16	0,05	106	5,74	CHI
20200314651	ALVORADA DO NORTE	FB10401476	FLORES DE GOIAS	04/03/2020 12:13	04/03/2020 12:16	04/03/2020 12:13	04/03/2020 12:16	0,06	56	3,34	CHI
20200314651	FLORES DE GOIAS	FB10401476	FLORES DE GOIAS	04/03/2020 12:13	04/03/2020 12:16	04/03/2020 12:13	04/03/2020 12:16	0,06	258	15,41	CHI
20200314651	FORMOSA	FB10401476	FLORES DE GOIAS	04/03/2020 12:13	04/03/2020 12:16	04/03/2020 12:13	04/03/2020 12:16	0,06	137	8,18	CHI
20200314651	FORMOSO	FB10401476	FLORES DE GOIAS	04/03/2020 12:13	04/03/2020 12:16	04/03/2020 12:13	04/03/2020 12:16	0,06	1	0,06	CHI
20200314651	IACIARA	FB10401476	FLORES DE GOIAS	04/03/2020 12:13	04/03/2020 12:16	04/03/2020 12:13	04/03/2020 12:16	0,06	14	0,84	CHI
20200314651	POSSE	FB10401476	FLORES DE GOIAS	04/03/2020 12:13	04/03/2020 12:16	04/03/2020 12:13	04/03/2020 12:16	0,06	2	0,12	CHI
20200314651	SAO JOAO D ALIANCA	FB10401476	FLORES DE GOIAS	04/03/2020 12:13	04/03/2020 12:16	04/03/2020 12:13	04/03/2020 12:16	0,06	5	0,30	CHI
20200314655	LUZIANIA	120052015	RIO VERMELHO	04/03/2020 12:21	04/03/2020 14:12	04/03/2020 12:21	04/03/2020 14:12	1,85	1	1,85	CHI
20200314660	SANTA RITA DO NOVO DESTINO	DF21287203	BARRO ALTO	04/03/2020 12:22	04/03/2020 20:28	04/03/2020 12:22	04/03/2020 20:28	8,09	2	16,18	CHI
20200314679	GOIANIRA	10003579083	MEIA PONTE	04/03/2020 12:27	04/03/2020 16:29	04/03/2020 12:27	04/03/2020 16:29	4,03	1	4,03	CHI
20200314680	ADELANDIA	DN12391391	FIRMINOPOLIS S2	04/03/2020 12:27	04/03/2020 15:07	04/03/2020 14:03	04/03/2020 15:07	1,07	2	2,13	CHI
20200314680	ANICUNS	DN12391391	FIRMINOPOLIS S2	04/03/2020 12:27	04/03/2020 15:07	04/03/2020 14:03	04/03/2020 15:07	1,07	2	2,13	CHI
20200314689	DAVINOPOLIS	IO21085110	CATALAO S1	04/03/2020 12:29	04/03/2020 19:33	04/03/2020 12:29	04/03/2020 19:33	7,06	1	7,06	CHI
20200314693	PIRES DO RIO	PR12255829	PIRES DO RIO S1	04/03/2020 12:31	04/03/2020 18:21	04/03/2020 12:31	04/03/2020 18:21	5,82	8	46,60	CHI
20200314696	MARA ROSA	MQ21187985	MARA ROSA	04/03/2020 12:31	04/03/2020 16:34	04/03/2020 12:31	04/03/2020 16:34	4,04	1	4,04	CHI
20200314697	ITAPACI	IW21123084	ITAPACI	04/03/2020 12:32	05/03/2020 00:02	04/03/2020 22:30	05/03/2020 00:02	1,54	1	1,54	CHI
20200314698	QUIRINOPOLIS	QI21298273	QUIRINOPOLIS	04/03/2020 12:32	04/03/2020 15:03	04/03/2020 12:32	04/03/2020 15:03	2,51	1	2,51	CHI
20200314699	PARAUNA	PU12295862	ACREUNA	04/03/2020 12:32	04/03/2020 21:20	04/03/2020 12:32	04/03/2020 21:20	8,80	1	8,80	CHI
20200314700	CAMPOS VERDES	SG12321954	SANTA TEREZINHA	04/03/2020 12:32	04/03/2020 23:17	04/03/2020 12:32	04/03/2020 23:17	10,74	1	10,74	CHI
20200314700	MARA ROSA	SG12321954	SANTA TEREZINHA	04/03/2020 12:32	04/03/2020 23:17	04/03/2020 12:32	04/03/2020 23:17	10,74	15	161,04	CHI
20200314700	SANTA TEREZINHA DE GOIAS	SG12321954	SANTA TEREZINHA	04/03/2020 12:32	04/03/2020 23:17	04/03/2020 12:32	04/03/2020 23:17	10,74	15	161,04	CHI
20200314701	GOIANIA	14800950	GOIANIA LESTE S1	04/03/2020 12:32	04/03/2020 15:34	04/03/2020 12:32	04/03/2020 15:34	3,02	1	3,02	CHI
20200314706	RIO VERDE	10006975818	RIO VERDE S1	04/03/2020 12:34	04/03/2020 13:38	04/03/2020 12:34	04/03/2020 13:38	1,06	1	1,06	CHI
20200314713	ANAPOLIS	AN21091560	DAIA S1	04/03/2020 12:37	04/03/2020 14:21	04/03/2020 12:37	04/03/2020 14:21	1,72	1	1,72	CHI
20200314715	ORIZONA	OZ12143761	PIRES DO RIO S2	04/03/2020 11:50	04/03/2020 18:24	04/03/2020 11:50	04/03/2020 18:24	6,56	10	65,63	CHI
20200314717	BOM JARDIM DE GOIAS	BM12212797	BOM JARDIM	04/03/2020 11:29	04/03/2020 19:56	04/03/2020 11:29	04/03/2020 17:27	5,97	9	53,73	CHI
20200314717	BOM JARDIM DE GOIAS	BM12212797	BOM JARDIM	04/03/2020 11:29	04/03/2020 19:56	04/03/2020 11:29	04/03/2020 19:56	8,44	77	650,14	CHI
20200314723	AGUAS LINDAS DE GOIAS	10002254563	AGUAS LINDAS DE GOIAS S1	04/03/2020 12:40	04/03/2020 15:26	04/03/2020 12:40	04/03/2020 15:26	2,76	1	2,76	CHI
20200314728	PLANALTINA	10014962681	PLANALTINA	04/03/2020 12:42	04/03/2020 13:48	04/03/2020 12:42	04/03/2020 13:48	1,09	1	1,09	CHI
20200314729	CRISTALINA	KR21240981	CRISTALINA S1	04/03/2020 12:43	05/03/2020 00:30	04/03/2020 12:43	05/03/2020 00:30	11,80	1	11,80	CHI
20200314732	GOIANIA	12517069	GOIANIA LESTE S1	04/03/2020 12:43	04/03/2020 15:01	04/03/2020 12:43	04/03/2020 15:01	2,29	1	2,29	CHI
20200314733	ANAPOLIS	20746842	ANAPOLIS UNIVERSITARIO S2	04/03/2020 12:44	04/03/2020 14:59	04/03/2020 12:44	04/03/2020 14:59	2,24	1	2,24	CHI
20200314734	CATURAI	CK12321539	INHUMAS S1	04/03/2020 12:45	04/03/2020 17:06	04/03/2020 12:45	04/03/2020 17:06	4,35	1	4,35	CHI
20200314737	BRAZABRANTES	IN21195709	INHUMAS S2	04/03/2020 12:45	04/03/2020 15:46	04/03/2020 12:45	04/03/2020 15:46	3,01	7	21,06	CHI
20200314738	ORIZONA	2060035461	PIRES DO RIO S2	04/03/2020 12:45	04/03/2020 15:14	04/03/2020 12:45	04/03/2020 15:14	2,47	1	2,47	CHI
20200314739	GOUVELANDIA	GB12116577	QUIRINOPOLIS	04/03/2020 12:47	04/03/2020 14:11	04/03/2020 12:47	04/03/2020 14:11	1,40	35	48,91	CHI
20200314739	QUIRINOPOLIS	GB12116577	QUIRINOPOLIS	04/03/2020 12:47	04/03/2020 14:11	04/03/2020 12:47	04/03/2020 14:11	1,40	13	18,17	CHI
20200314740	FORMOSA	10023441290	ITUIQUIRA	04/03/2020 12:47	04/03/2020 15:18	04/03/2020 12:47	04/03/2020 15:18	2,51	1	2,51	CHI
20200314741	TRINDADE	40106500	TRINDADE	04/03/2020 12:47	04/03/2020 15:59	04/03/2020 12:47	04/03/2020 15:59	3,20	1	3,20	CHI
20200314743	JATAI	JT12000231	JATAI S1	04/03/2020 12:47	04/03/2020 16:05	04/03/2020 12:47	04/03/2020 16:05	3,29	67	220,15	CHI
20200314743	PEROLANDIA	JT12000231	JATAI S1	04/03/2020 12:47	04/03/2020 16:05	04/03/2020 12:47	04/03/2020 16:05	3,29	3	9,86	CHI
20200314745	LUZIANIA	LZ11000283	MARAJOARA	04/03/2020 12:49	04/03/2020 19:30	04/03/2020 17:49	04/03/2020 19:30	1,68	15	25,15	CHI

20200314747	PONTALINA	PK21204455	PONTALINA	04/03/2020 12:50	04/03/2020 16:29	04/03/2020 12:50	04/03/2020 16:29	3,64	1	3,64	CHI
20200314750	SAO DOMINGOS	SD12317850	SAO DOMINGOS	04/03/2020 12:51	04/03/2020 16:36	04/03/2020 12:51	04/03/2020 16:36	3,74	69	258,21	CHI
20200314761	APARECIDA DE GOIANIA	200610594	INDEPENDENCIA S1	04/03/2020 12:57	04/03/2020 14:44	04/03/2020 12:57	04/03/2020 14:44	1,77	1	1,77	CHI
20200314762	NOVO GAMA	2900065120	MARAJOARA	04/03/2020 12:58	04/03/2020 18:41	04/03/2020 12:58	04/03/2020 18:41	5,72	1	5,72	CHI
20200314763	FORMOSA	FA21106984	ITUIQUIRA	04/03/2020 12:58	04/03/2020 15:35	04/03/2020 12:58	04/03/2020 15:35	2,61	1	2,61	CHI
20200314764	NOVO BRASIL	NB21324071	JUSSARA	04/03/2020 12:58	04/03/2020 17:05	04/03/2020 12:58	04/03/2020 17:05	4,12	1	4,12	CHI
20200314765	JESUPOLIS	SF21101921	SAO FRANCISCO DE GOIAS	04/03/2020 12:58	04/03/2020 16:09	04/03/2020 12:58	04/03/2020 16:09	3,17	1	3,17	CHI
20200314776	VIANOPOLIS	VN21037575	VIANOPOLIS	04/03/2020 13:01	04/03/2020 14:15	04/03/2020 13:01	04/03/2020 14:15	1,23	1	1,23	CHI
20200314778	CAVALCANTE	CJ12397409	SAO DOMINGOS	04/03/2020 13:01	04/03/2020 18:00	04/03/2020 13:01	04/03/2020 18:00	4,97	12	59,61	CHI
20200314779	BRITANIA	9870000570	BRITANIA	04/03/2020 13:02	04/03/2020 19:42	04/03/2020 13:02	04/03/2020 19:42	6,67	1	6,67	CHI
20200314781	IPORA	730109483	IPORA	04/03/2020 13:03	04/03/2020 17:56	04/03/2020 13:03	04/03/2020 17:56	4,88	1	4,88	CHI
20200314789	GOIANIA	10007955136	REAL S1	04/03/2020 13:05	04/03/2020 16:57	04/03/2020 13:05	04/03/2020 16:57	3,85	1	3,85	CHI
20200314790	ITUMBIARA	690205879	ITUMBIARA VELHA S1	04/03/2020 13:06	04/03/2020 15:55	04/03/2020 13:06	04/03/2020 15:55	2,81	1	2,81	CHI
20200314791	AMARALINA	LC12270121	SAO MIGUEL DO ARAGUAIA	04/03/2020 13:06	04/03/2020 23:23	04/03/2020 13:06	04/03/2020 23:23	10,27	5	51,34	CHI
20200314793	SAO MIGUEL DO ARAGUAIA	SM12000050	SAO MIGUEL DO ARAGUAIA	04/03/2020 13:07	04/03/2020 19:20	04/03/2020 13:07	04/03/2020 19:20	6,21	28	173,76	CHI
20200314798	URUACU	UR21310099	CAMPINORTE	04/03/2020 13:08	04/03/2020 15:11	04/03/2020 13:08	04/03/2020 15:11	2,04	2	4,08	CHI
20200314806	FORMOSA	FA12383241	ITUIQUIRA	04/03/2020 13:11	04/03/2020 16:26	04/03/2020 13:11	04/03/2020 16:26	3,25	1	3,25	CHI
20200314807	MONTIVIDIU DO NORTE	PO12391673	PORANGATU	04/03/2020 09:49	05/03/2020 01:58	04/03/2020 09:49	05/03/2020 01:58	16,16	5	80,78	CHI
20200314807	PORANGATU	PO12391673	PORANGATU	04/03/2020 09:49	05/03/2020 01:58	05/03/2020 00:53	05/03/2020 01:58	1,09	10	10,89	CHI
20200314809	MORRINHOS	MR12252186	GOIATUBA S1	04/03/2020 13:12	04/03/2020 16:03	04/03/2020 13:12	04/03/2020 16:03	2,84	3	8,53	CHI
20200314814	ALEXANIA	AX12095958	CORUMBA	04/03/2020 13:14	04/03/2020 16:42	04/03/2020 13:14	04/03/2020 16:42	3,46	6	20,73	CHI
20200314814	CORUMBA DE GOIAS	AX12095958	CORUMBA	04/03/2020 13:14	04/03/2020 16:42	04/03/2020 13:14	04/03/2020 16:42	3,46	3	10,37	CHI
20200314821	ARAGUAPAZ	AZ12404563	GOIAS	04/03/2020 13:18	04/03/2020 16:55	04/03/2020 13:18	04/03/2020 16:55	3,61	20	72,18	CHI
20200314821	FAINA	AZ12404563	GOIAS	04/03/2020 13:18	04/03/2020 16:55	04/03/2020 13:18	04/03/2020 16:55	3,61	1	3,61	CHI
20200314833	CACHOEIRA DE GOIAS	CG12188668	FIRMINOPOLIS S2	04/03/2020 11:19	04/03/2020 18:38	04/03/2020 11:19	04/03/2020 18:38	7,31	3	21,92	CHI
20200314835	NOVO GAMA	2460054768	PACAEMBU S1	04/03/2020 13:22	04/03/2020 20:26	04/03/2020 13:22	04/03/2020 20:26	7,06	1	7,06	CHI
20200314836	PADRE BERNARDO	PB21393114	PADRE BERNARDO	04/03/2020 13:22	04/03/2020 14:41	04/03/2020 13:22	04/03/2020 14:41	1,31	1	1,31	CHI
20200314840	QUIRINOPOLIS	QI12163448	SANTA HELENA S1	04/03/2020 13:22	04/03/2020 15:01	04/03/2020 13:22	04/03/2020 15:01	1,64	10	16,43	CHI
20200314840	RIO VERDE	QI12163448	SANTA HELENA S1	04/03/2020 13:22	04/03/2020 15:01	04/03/2020 13:22	04/03/2020 15:01	1,64	1	1,64	CHI
20200314843	ARAGARCAS	1820057085	ARAGARCAS	04/03/2020 13:24	04/03/2020 17:45	04/03/2020 13:24	04/03/2020 17:45	4,34	1	4,34	CHI
20200314850	MIMOSO DE GOIAS	NQ12251264	BARRO ALTO	04/03/2020 13:27	04/03/2020 19:29	04/03/2020 13:27	04/03/2020 19:29	6,03	7	42,21	CHI
20200314850	VILA PROPICIO	NQ12251264	BARRO ALTO	04/03/2020 13:27	04/03/2020 19:29	04/03/2020 13:27	04/03/2020 19:29	6,03	4	24,12	CHI
20200314851	PANAMA	GT12249848	GOIATUBA S1	04/03/2020 13:27	05/03/2020 02:52	04/03/2020 23:34	05/03/2020 02:52	3,30	9	29,70	CHI
20200314852	CAIAPONIA	CP12251347	CAIAPONIA	04/03/2020 11:38	04/03/2020 22:23	04/03/2020 11:38	04/03/2020 22:23	10,75	8	85,97	CHI
20200314855	CALDAS NOVAS	760372652	CALDAS NOVAS S2	04/03/2020 13:28	04/03/2020 17:47	04/03/2020 13:28	04/03/2020 17:47	4,31	1	4,31	CHI
20200314858	RIO VERDE	630558139	RIO VERDE S2	04/03/2020 13:28	05/03/2020 22:20	04/03/2020 13:28	05/03/2020 22:20	32,85	1	32,85	CHI
20200314860	CHAPADAO DO CEU	DJ11339799	CHAPADAO DO CEU	04/03/2020 13:30	04/03/2020 16:41	04/03/2020 13:30	04/03/2020 16:41	3,18	45	143,00	CHI
20200314870	CAVALCANTE	TI12162624	NIQUELANDIA SUBTRANSMISSAO	04/03/2020 13:36	04/03/2020 18:48	04/03/2020 13:36	04/03/2020 18:48	5,19	1	5,19	CHI
20200314870	COLINAS DO SUL	TI12162624	NIQUELANDIA SUBTRANSMISSAO	04/03/2020 13:36	04/03/2020 18:48	04/03/2020 13:36	04/03/2020 18:48	5,19	7	36,33	CHI
20200314879	NOVA CRIXAS	NA12334349	NOVA CRIXAS	04/03/2020 13:08	04/03/2020 16:49	04/03/2020 13:08	04/03/2020 16:49	3,67	86	316,05	CHI
20200314885	GOIANIA	GN12047147	AEROPORTO S1	04/03/2020 13:37	04/03/2020 16:11	04/03/2020 13:37	04/03/2020 16:02	2,42	148	358,00	CHI
20200314885	GOIANIA	GN21057651	AEROPORTO S1	04/03/2020 13:37	04/03/2020 16:11	04/03/2020 13:37	04/03/2020 16:11	2,56	22	56,33	CHI
20200314889	SANTO ANTONIO DA BARRA	BZ12301380	ACREUNA	04/03/2020 13:40	04/03/2020 17:33	04/03/2020 13:40	04/03/2020 17:33	3,87	4	15,49	CHI
20200314894	GOIANESIA	GE12000241	GOIANESIA S2	04/03/2020 13:42	04/03/2020 15:28	04/03/2020 13:42	04/03/2020 15:28	1,75	3	5,26	CHI

20200314894	JARAGUA	GE12000241	GOIANESIA S2	04/03/2020 13:42	04/03/2020 15:28	04/03/2020 13:42	04/03/2020 15:28	1,75	22	38,58	CHI
20200314899	APARECIDA DE GOIANIA	AP11345614	CEPAIGO S1	04/03/2020 13:45	04/03/2020 16:38	04/03/2020 13:45	04/03/2020 16:38	2,88	161	463,99	CHI
20200314915	ARAGARCAS	DI13139476	IPORA	04/03/2020 14:22	04/03/2020 20:17	04/03/2020 14:22	04/03/2020 20:17	5,91	49	289,36	CHI
20200314915	ARENOPOLIS	DI10401419	IPORA	04/03/2020 14:22	04/03/2020 20:17	04/03/2020 14:22	04/03/2020 20:17	5,91	104	614,15	CHI
20200314915	ARENOPOLIS	DI10401419	IPORA	04/03/2020 14:22	04/03/2020 20:17	04/03/2020 14:22	04/03/2020 20:17	5,91	128	755,88	CHI
20200314915	BOM JARDIM DE GOIAS	DI13139476	IPORA	04/03/2020 14:22	04/03/2020 20:17	04/03/2020 14:22	04/03/2020 20:17	5,91	20	118,11	CHI
20200314915	DIORAMA	DI10401419	IPORA	04/03/2020 14:22	04/03/2020 20:17	04/03/2020 14:22	04/03/2020 20:17	5,91	11	64,96	CHI
20200314915	DIORAMA	DI10401419	IPORA	04/03/2020 14:22	04/03/2020 20:17	04/03/2020 14:22	04/03/2020 20:17	5,91	66	389,75	CHI
20200314915	FAZENDA NOVA	DI10401419	IPORA	04/03/2020 14:22	04/03/2020 20:17	04/03/2020 14:22	04/03/2020 20:17	5,91	6	35,43	CHI
20200314915	IPORA	DI10401419	IPORA	04/03/2020 14:22	04/03/2020 20:17	04/03/2020 14:22	04/03/2020 20:17	5,91	3	17,72	CHI
20200314915	JAUPACI	DI10401419	IPORA	04/03/2020 14:22	04/03/2020 20:17	04/03/2020 14:22	04/03/2020 20:17	5,91	7	41,34	CHI
20200314915	JUSSARA	DI10401419	IPORA	04/03/2020 14:22	04/03/2020 20:17	04/03/2020 14:22	04/03/2020 20:17	5,91	417	2462,50	CHI
20200314915	MONTE ALEGRE DE GOIAS	DI10401419	IPORA	04/03/2020 14:22	04/03/2020 20:17	04/03/2020 14:22	04/03/2020 20:17	5,91	2	11,81	CHI
20200314915	MONTES CLAROS DE GOIAS	DI10401419	IPORA	04/03/2020 14:22	04/03/2020 20:17	04/03/2020 14:22	04/03/2020 20:17	5,91	3214	18979,56	CHI
20200314915	MONTES CLAROS DE GOIAS	DI10401419	IPORA	04/03/2020 14:22	04/03/2020 20:17	04/03/2020 14:22	04/03/2020 20:17	5,91	84	496,04	CHI
20200314915	MONTES CLAROS DE GOIAS	DI10401419	IPORA	04/03/2020 14:22	04/03/2020 20:17	04/03/2020 14:22	04/03/2020 20:17	5,91	248	1464,51	CHI
20200314915	MONTES CLAROS DE GOIAS	DI13139476	IPORA	04/03/2020 14:22	04/03/2020 20:17	04/03/2020 14:22	04/03/2020 20:17	5,91	824	4865,95	CHI
20200314915	ORIZONA	DI10401419	IPORA	04/03/2020 14:22	04/03/2020 20:17	04/03/2020 14:22	04/03/2020 20:17	5,91	38	224,40	CHI
20200314915	PIRANHAS	DI10401419	IPORA	04/03/2020 14:22	04/03/2020 20:17	04/03/2020 14:22	04/03/2020 20:17	5,91	2	11,81	CHI
20200314922	ANAPOLIS	10005333618	JUNDIAI S1	04/03/2020 14:51	04/03/2020 16:37	04/03/2020 14:51	04/03/2020 16:37	1,77	1	1,77	CHI
20200315002	MUNDO NOVO DE GOIAS	MH12044733	NOVA CRIXAS	04/03/2020 13:45	05/03/2020 01:27	04/03/2020 13:45	05/03/2020 01:27	11,69	1	11,69	CHI
20200315007	VILA BOA	VB21317514	IACIARA S2	04/03/2020 13:46	04/03/2020 14:34	04/03/2020 13:46	04/03/2020 14:34	0,79	1	0,79	CHI
20200315010	PIRACANJUBA	PJ21316307	PIRACANJUBA	04/03/2020 13:47	04/03/2020 16:43	04/03/2020 13:47	04/03/2020 16:43	2,93	2	5,86	CHI
20200315012	MUNDO NOVO DE GOIAS	MH12034680	NOVA CRIXAS	04/03/2020 13:47	04/03/2020 18:17	04/03/2020 13:47	04/03/2020 18:17	4,49	29	130,24	CHI
20200315013	NOVA AURORA	NE21337555	CATALAO S1	04/03/2020 13:47	05/03/2020 08:44	04/03/2020 13:47	05/03/2020 08:44	18,94	1	18,94	CHI
20200315016	GOIANIA	10868689	GOIANIA LESTE S3	04/03/2020 13:48	04/03/2020 18:33	04/03/2020 13:48	04/03/2020 18:33	4,74	1	4,74	CHI
20200315018	GOIAS	GS11037752	GOIAS	04/03/2020 13:49	04/03/2020 14:57	04/03/2020 13:49	04/03/2020 14:57	1,13	67	75,60	CHI
20200315022	AGUAS LINDAS DE GOIAS	4830274282	AGUAS LINDAS DE GOIAS S1	04/03/2020 13:50	04/03/2020 20:11	04/03/2020 13:50	04/03/2020 20:11	6,35	1	6,35	CHI
20200315027	NEROPOLIS	NR21151406	NEROPOLIS S2	04/03/2020 13:51	04/03/2020 17:26	04/03/2020 13:51	04/03/2020 17:26	3,57	1	3,57	CHI
20200315029	ORIZONA	OZ12300909	PIRES DO RIO S2	04/03/2020 13:52	04/03/2020 18:05	04/03/2020 13:52	04/03/2020 18:05	4,21	13	54,76	CHI
20200315044	ITAGUARI	II11049701	ITABERAI S1	04/03/2020 13:55	04/03/2020 15:47	04/03/2020 15:10	04/03/2020 15:47	0,62	196	120,87	CHI
20200315049	NOVA IGUACU DE GOIAS	NH21070610	CAMPINORTE	04/03/2020 13:55	05/03/2020 08:31	04/03/2020 13:55	05/03/2020 08:31	18,59	1	18,59	CHI
20200315050	CACHOEIRA ALTA	CA12200630	CACHOEIRA ALTA	04/03/2020 13:56	04/03/2020 17:20	04/03/2020 13:56	04/03/2020 17:20	3,40	15	50,97	CHI
20200315056	MUTUNOPOLIS	MU12214690	MARA ROSA	04/03/2020 13:56	04/03/2020 18:08	04/03/2020 13:56	04/03/2020 18:08	4,18	1	4,18	CHI
20200315057	ARAGUAPAZ	AZ21299822	GOIAS	04/03/2020 13:57	04/03/2020 17:27	04/03/2020 13:57	04/03/2020 17:27	3,51	3	10,53	CHI
20200315063	SANTO ANTONIO DO DESCOBERTO	SN11199579	ALEXANIA	04/03/2020 13:56	04/03/2020 14:54	04/03/2020 13:56	04/03/2020 14:54	0,95	142	135,45	CHI
20200315068	ABADIANIA	AA12271855	ANAPOLIS UNIVERSITARIO S1	04/03/2020 14:00	04/03/2020 16:27	04/03/2020 14:00	04/03/2020 16:27	2,45	8	19,56	CHI
20200315069	ITABERAI	II21118740	ITABERAI S1	04/03/2020 14:00	04/03/2020 16:47	04/03/2020 14:00	04/03/2020 16:47	2,78	1	2,78	CHI
20200315070	FORMOSO	TB12051886	PORANGATU	04/03/2020 12:47	04/03/2020 15:03	04/03/2020 12:47	04/03/2020 15:03	2,26	2	4,52	CHI
20200315070	TROMBAS	TB12051886	PORANGATU	04/03/2020 12:47	04/03/2020 15:03	04/03/2020 12:47	04/03/2020 15:03	2,26	24	54,19	CHI
20200315073	FORMOSA	10029667982	ITUIQUIRA	04/03/2020 14:01	04/03/2020 16:22	04/03/2020 14:01	04/03/2020 16:22	2,35	1	2,35	CHI
20200315074	PONTALINA	PK12057483	VICENTINOPOLIS	04/03/2020 14:01	04/03/2020 18:44	04/03/2020 14:01	04/03/2020 18:44	4,71	7	32,95	CHI
20200315076	MATRINCHA	MP12098851	MATRINCHA	04/03/2020 14:02	04/03/2020 21:32	04/03/2020 14:02	04/03/2020 21:32	7,50	77	577,16	CHI
20200315084	PADRE BERNARDO	PB12163212	PADRE BERNARDO	04/03/2020 11:39	04/03/2020 16:52	04/03/2020 11:39	04/03/2020 16:52	5,21	23	119,86	CHI

20200315092	BONOPOLIS	BX12202593	SAO MIGUEL DO ARAGUAIA	04/03/2020 14:05	05/03/2020 10:21	04/03/2020 14:05	04/03/2020 21:32	7,46	1	7,46	CHI
20200315092	BONOPOLIS	BX12202593	SAO MIGUEL DO ARAGUAIA	04/03/2020 14:05	05/03/2020 10:21	04/03/2020 14:05	05/03/2020 10:21	20,27	3	60,81	CHI
20200315092	BONOPOLIS	BX12202593	SAO MIGUEL DO ARAGUAIA	04/03/2020 14:05	05/03/2020 10:21	05/03/2020 08:17	05/03/2020 10:21	2,06	1	2,06	CHI
20200315095	MINEIROS	MY21043886	PARQUE DAS EMAS	04/03/2020 14:08	04/03/2020 16:13	04/03/2020 14:08	04/03/2020 16:13	2,08	1	2,08	CHI
20200315097	APARECIDA DE GOIANIA	10004099778	INDEPENDENCIA S2	04/03/2020 14:08	04/03/2020 15:13	04/03/2020 14:08	04/03/2020 15:13	1,07	1	1,07	CHI
20200315101	JARAGUA	JA16411465	JARAGUA	04/03/2020 14:09	04/03/2020 19:40	04/03/2020 14:09	04/03/2020 19:40	5,52	555	3062,67	CHI
20200315101	JARAGUA	JA16411465	JARAGUA	04/03/2020 14:09	04/03/2020 19:40	04/03/2020 18:48	04/03/2020 19:40	0,88	808	712,61	CHI
20200315108	JUSSARA	1290038780	JUSSARA	04/03/2020 14:11	05/03/2020 01:00	04/03/2020 14:11	05/03/2020 01:00	10,81	1	10,81	CHI
20200315110	JANDAIA	JD12008614	PALMEIRAS	04/03/2020 13:49	04/03/2020 16:32	04/03/2020 13:49	04/03/2020 16:32	2,71	19	51,51	CHI
20200315110	PARAUNA	JD12008614	PALMEIRAS	04/03/2020 13:49	04/03/2020 16:32	04/03/2020 13:49	04/03/2020 16:32	2,71	6	16,27	CHI
20200315111	TRINDADE	10003748462	GOYA S1	04/03/2020 14:12	04/03/2020 15:48	04/03/2020 14:12	04/03/2020 15:48	1,60	1	1,60	CHI
20200315113	NOVA CRIXAS	NA21277415	MOZARLANDIA	04/03/2020 14:12	04/03/2020 19:16	04/03/2020 14:12	04/03/2020 19:16	5,06	1	5,06	CHI
20200315117	SAO DOMINGOS	SD21254358	SAO DOMINGOS	04/03/2020 14:13	04/03/2020 17:27	04/03/2020 14:13	04/03/2020 17:27	3,22	2	6,44	CHI
20200315118	FLORES DE GOIAS	IA12361389	IACIARA S2	04/03/2020 14:14	04/03/2020 16:18	04/03/2020 14:14	04/03/2020 16:18	2,06	1	2,06	CHI
20200315118	IACIARA	IA12361389	IACIARA S2	04/03/2020 14:14	04/03/2020 16:18	04/03/2020 14:14	04/03/2020 16:18	2,06	41	84,56	CHI
20200315119	SAO LUIZ DO NORTE	SZ21063294	BARRO ALTO	04/03/2020 14:15	04/03/2020 23:06	04/03/2020 14:15	04/03/2020 23:06	8,85	1	8,85	CHI
20200315126	SANTA HELENA DE GOIAS	SH12296230	IPEGUARI	04/03/2020 14:16	04/03/2020 22:45	04/03/2020 14:16	04/03/2020 22:45	8,47	5	42,34	CHI
20200315128	TURVELANDIA	TD21301553	RIO DOS BOIS	04/03/2020 14:17	04/03/2020 19:38	04/03/2020 14:17	04/03/2020 19:38	5,35	1	5,35	CHI
20200315130	VILA PROPICIO	GE12255985	GOIANESIA S1	04/03/2020 14:17	05/03/2020 00:01	04/03/2020 14:17	05/03/2020 00:01	9,73	8	77,82	CHI
20200315134	CAVALCANTE	CJ11397412	SAO DOMINGOS	04/03/2020 14:17	04/03/2020 18:55	04/03/2020 14:17	04/03/2020 18:55	4,62	2	9,24	CHI
20200315140	INHUMAS	IN11292129	INHUMAS S2	04/03/2020 13:40	04/03/2020 15:44	04/03/2020 13:40	04/03/2020 15:44	2,07	139	287,07	CHI
20200315144	NOVA CRIXAS	NA12091692	NOVA CRIXAS	04/03/2020 14:20	04/03/2020 18:56	04/03/2020 14:20	04/03/2020 18:56	4,60	22	101,11	CHI
20200315145	ITABERAI	IB12250715	ITABERAI S2	04/03/2020 14:20	04/03/2020 16:15	04/03/2020 14:20	04/03/2020 16:15	1,91	1	1,91	CHI
20200315149	NOVA CRIXAS	NA21080463	NOVA CRIXAS	04/03/2020 14:21	04/03/2020 22:33	04/03/2020 14:21	04/03/2020 22:33	8,20	5	40,98	CHI
20200315155	JATAI	JT12264399	JATAI S1	04/03/2020 14:22	04/03/2020 19:08	04/03/2020 14:22	04/03/2020 19:08	4,76	5	23,81	CHI
20200315159	SANTA BARBARA DE GOIAS	SB12215253	TRINDADE	04/03/2020 14:22	04/03/2020 16:33	04/03/2020 14:22	04/03/2020 16:33	2,18	3	6,53	CHI
20200315160	ITUMBIARA	IT11000039	ITUMBIARA VELHA S1	04/03/2020 14:21	04/03/2020 17:25	04/03/2020 14:21	04/03/2020 17:25	3,07	125	383,82	CHI
20200315165	ANICUNS	910041258	ANICUNS	04/03/2020 14:24	04/03/2020 16:46	04/03/2020 14:24	04/03/2020 16:46	2,36	1	2,36	CHI
20200315166	APARECIDA DE GOIANIA	10016564772	CARAJAS S1	04/03/2020 14:25	04/03/2020 15:35	04/03/2020 14:25	04/03/2020 15:35	1,16	1	1,16	CHI
20200315167	GOIANESIA	GE12357342	GOIANESIA S2	04/03/2020 14:25	04/03/2020 20:45	04/03/2020 14:25	04/03/2020 20:45	6,33	18	113,87	CHI
20200315167	VILA PROPICIO	GE12357342	GOIANESIA S2	04/03/2020 14:25	04/03/2020 20:45	04/03/2020 14:25	04/03/2020 20:45	6,33	9	56,94	CHI
20200315171	MONTIVIDIU	RV12062709	MONTIVIDIU T	04/03/2020 14:25	04/03/2020 20:48	04/03/2020 14:25	04/03/2020 20:48	6,37	18	114,67	CHI
20200315174	JARAGUA	JA21191322	JARAGUA	04/03/2020 14:27	04/03/2020 18:47	04/03/2020 14:27	04/03/2020 18:47	4,33	1	4,33	CHI
20200315191	GOIANIA	GN11117115	ATLANTICO S1	04/03/2020 14:33	04/03/2020 18:17	04/03/2020 14:33	04/03/2020 18:17	3,73	166	619,46	CHI
20200315194	APARECIDA DE GOIANIA	200339928	INDEPENDENCIA S2	04/03/2020 14:34	04/03/2020 16:50	04/03/2020 14:34	04/03/2020 16:50	2,27	1	2,27	CHI
20200315200	SAO DOMINGOS	SD12170547	SAO DOMINGOS	04/03/2020 14:34	04/03/2020 18:44	04/03/2020 14:34	04/03/2020 18:44	4,15	13	53,99	CHI
20200315203	VALPARAISO DE GOIAS	10001147658	MARAJOARA	04/03/2020 14:35	04/03/2020 16:57	04/03/2020 14:35	04/03/2020 16:57	2,35	1	2,35	CHI
20200315215	NEROPOLIS	NR21010661	NEROPOLIS S2	04/03/2020 14:37	04/03/2020 21:38	04/03/2020 14:37	04/03/2020 21:38	7,01	1	7,01	CHI
20200315217	GOIANIA	GN11042200	FERROVIARIO S2	04/03/2020 14:38	04/03/2020 16:20	04/03/2020 15:38	04/03/2020 16:20	0,70	103	72,10	CHI
20200315222	SANCLERLANDIA	1210017651	FIRMINOPOLIS S2	04/03/2020 14:39	04/03/2020 16:10	04/03/2020 14:39	04/03/2020 16:10	1,52	1	1,52	CHI
20200315224	SAO FRANCISCO DE GOIAS	SF11074693	SAO FRANCISCO DE GOIAS	04/03/2020 14:32	04/03/2020 16:14	04/03/2020 14:32	04/03/2020 16:14	1,70	226	383,20	CHI
20200315227	DOVERLANDIA	DV12131595	CAIAPONIA	04/03/2020 14:40	04/03/2020 21:59	04/03/2020 14:40	04/03/2020 21:59	7,31	2	14,61	CHI
20200315233	NOVA IGUAQU DE GOIAS	NH21140474	SANTA TEREZINHA	04/03/2020 14:42	04/03/2020 15:49	04/03/2020 14:42	04/03/2020 15:49	1,11	1	1,11	CHI
20200315239	GOIANIA	10021032376	CARAJAS S2	04/03/2020 14:43	04/03/2020 16:12	04/03/2020 14:43	04/03/2020 16:12	1,47	1	1,47	CHI

20200315242	NOVA CRIXAS	NA21138296	MOZARLANDIA	04/03/2020 14:45	04/03/2020 21:09	04/03/2020 14:45	04/03/2020 21:09	6,39	1	6,39	CHI
20200315243	GOIANESIA	GE12384166	GOIANESIA S2	04/03/2020 14:45	05/03/2020 07:57	04/03/2020 14:45	05/03/2020 07:57	17,19	2	34,38	CHI
20200315243	VILA PROPICIO	GE12384166	GOIANESIA S2	04/03/2020 14:45	05/03/2020 07:57	04/03/2020 14:45	05/03/2020 07:57	17,19	1	17,19	CHI
20200315244	CAMPINORTE	CR12109072	MARA ROSA	04/03/2020 14:45	04/03/2020 18:37	04/03/2020 14:45	04/03/2020 18:37	3,85	2	7,70	CHI
20200315246	FORMOSO	FO21281760	PORANGATU	04/03/2020 14:46	04/03/2020 16:49	04/03/2020 14:46	04/03/2020 16:49	2,04	1	2,04	CHI
20200315248	PIRANHAS	1930039752	PIRANHAS	04/03/2020 14:45	04/03/2020 17:09	04/03/2020 14:45	04/03/2020 17:09	2,39	1	2,39	CHI
20200315251	QUIRINOPOLIS	QI11047561	QUIRINOPOLIS	04/03/2020 14:11	04/03/2020 15:53	04/03/2020 14:11	04/03/2020 15:53	1,70	146	247,79	CHI
20200315254	RIO VERDE	RV12172877	CABRIUVA S2	04/03/2020 14:21	04/03/2020 16:28	04/03/2020 14:21	04/03/2020 16:28	2,10	11	23,11	CHI
20200315258	CAMPINORTE	UR21243263	MARA ROSA	04/03/2020 14:50	05/03/2020 09:09	04/03/2020 14:50	05/03/2020 09:09	18,31	1	18,31	CHI
20200315259	SAO DOMINGOS	SD21144393	SAO DOMINGOS	04/03/2020 14:50	04/03/2020 17:29	04/03/2020 14:50	04/03/2020 17:29	2,64	1	2,64	CHI
20200315267	CATALAO	CT11358393	CATALAO S2	04/03/2020 14:52	04/03/2020 18:05	04/03/2020 14:52	04/03/2020 18:05	3,21	52	166,75	CHI
20200315272	ITABERAI	IB21412605	ITABERAI S1	04/03/2020 14:53	04/03/2020 19:45	04/03/2020 14:53	04/03/2020 19:45	4,86	1	4,86	CHI
20200315281	GOIANIA	GN11000507	CAMPINAS S3	04/03/2020 14:55	04/03/2020 16:11	04/03/2020 14:55	04/03/2020 16:11	1,26	131	165,31	CHI
20200315284	GOUVELANDIA	2250005005	QUIRINOPOLIS	04/03/2020 14:55	05/03/2020 12:23	04/03/2020 14:55	05/03/2020 12:23	21,45	1	21,45	CHI
20200315290	JUSSARA	JR12204874	BRITANIA	04/03/2020 14:57	05/03/2020 11:25	04/03/2020 14:57	05/03/2020 11:25	20,46	3	61,37	CHI
20200315297	MINEIROS	1390116211	PARQUE DAS EMAS	04/03/2020 15:00	04/03/2020 18:13	04/03/2020 15:00	04/03/2020 18:13	3,20	1	3,20	CHI
20200315298	QUIRINOPOLIS	QI32036491	QUIRINOPOLIS	04/03/2020 15:01	04/03/2020 17:29	04/03/2020 15:01	04/03/2020 17:29	2,47	5	12,33	CHI
20200315306	CAMPO ALEGRE DE GOIAS	02250434	CAMPO ALEGRE DE GOIAS	04/03/2020 15:16	05/03/2020 13:41	04/03/2020 15:16	04/03/2020 16:10	0,91	100	90,72	CHI
20200315306	CAMPO ALEGRE DE GOIAS	CM13203185	CAMPO ALEGRE DE GOIAS	04/03/2020 15:16	05/03/2020 13:41	04/03/2020 15:16	04/03/2020 17:36	2,34	121	282,60	CHI
20200315306	CAMPO ALEGRE DE GOIAS	02250434	CAMPO ALEGRE DE GOIAS	04/03/2020 15:16	05/03/2020 13:41	04/03/2020 18:26	04/03/2020 18:43	0,28	221	62,06	CHI
20200315306	CAMPO ALEGRE DE GOIAS	02250434	CAMPO ALEGRE DE GOIAS	04/03/2020 15:16	05/03/2020 13:41	04/03/2020 19:53	04/03/2020 20:08	0,24	221	53,16	CHI
20200315306	CATALAO	CM13363409	CAMPO ALEGRE DE GOIAS	04/03/2020 15:16	05/03/2020 13:41	04/03/2020 15:16	04/03/2020 20:08	4,87	27	131,54	CHI
20200315306	CAMPO ALEGRE DE GOIAS	CM13363409	CAMPO ALEGRE DE GOIAS	04/03/2020 15:16	05/03/2020 13:41	04/03/2020 15:16	05/03/2020 13:41	22,42	4	89,69	CHI
20200315306	CATALAO	CM13363409	CAMPO ALEGRE DE GOIAS	04/03/2020 15:16	05/03/2020 13:41	04/03/2020 15:16	05/03/2020 13:41	22,42	32	717,54	CHI
20200315307	CACHOEIRA DOURADA	02670214	CACHOEIRA DOURADA	04/03/2020 15:14	05/03/2020 22:01	04/03/2020 15:14	04/03/2020 15:27	0,22	41	8,89	CHI
20200315307	CACHOEIRA DOURADA	02670214	CACHOEIRA DOURADA	04/03/2020 15:14	05/03/2020 22:01	04/03/2020 15:14	04/03/2020 18:13	2,98	586	1744,00	CHI
20200315307	CACHOEIRA DOURADA	02670214	CACHOEIRA DOURADA	04/03/2020 15:14	05/03/2020 22:01	04/03/2020 15:14	04/03/2020 19:26	4,19	17	71,29	CHI
20200315307	CACHOEIRA DOURADA	02670214	CACHOEIRA DOURADA	04/03/2020 15:14	05/03/2020 22:01	04/03/2020 15:14	04/03/2020 20:45	5,51	30	165,34	CHI
20200315307	INACIOLANDIA	02670214	CACHOEIRA DOURADA	04/03/2020 15:14	05/03/2020 22:01	04/03/2020 15:14	04/03/2020 20:45	5,51	1	5,51	CHI
20200315307	CACHOEIRA DOURADA	02670214	CACHOEIRA DOURADA	04/03/2020 15:14	05/03/2020 22:01	04/03/2020 22:01	04/03/2020 22:15	0,23	696	160,66	CHI
20200315307	INACIOLANDIA	02670214	CACHOEIRA DOURADA	04/03/2020 15:14	05/03/2020 22:01	04/03/2020 22:01	04/03/2020 22:15	0,23	1	0,23	CHI
20200315307	CACHOEIRA DOURADA	02670214	CACHOEIRA DOURADA	04/03/2020 15:14	05/03/2020 22:01	04/03/2020 15:14	04/03/2020 23:36	8,37	1	8,37	CHI
20200315307	INACIOLANDIA	02670214	CACHOEIRA DOURADA	04/03/2020 15:14	05/03/2020 22:01	04/03/2020 15:14	04/03/2020 23:36	8,37	20	167,40	CHI
20200315307	ITUMBIARA	02670214	CACHOEIRA DOURADA	04/03/2020 15:14	05/03/2020 22:01	04/03/2020 15:14	04/03/2020 23:36	8,37	13	108,81	CHI
20200315307	INACIOLANDIA	02670214	CACHOEIRA DOURADA	04/03/2020 15:14	05/03/2020 22:01	04/03/2020 15:14	05/03/2020 05:19	14,08	6	84,45	CHI
20200315307	INACIOLANDIA	02670214	CACHOEIRA DOURADA	04/03/2020 15:14	05/03/2020 22:01	04/03/2020 15:14	05/03/2020 09:49	18,58	16	297,26	CHI
20200315307	INACIOLANDIA	02670214	CACHOEIRA DOURADA	04/03/2020 15:14	05/03/2020 22:01	04/03/2020 15:18	05/03/2020 09:49	18,52	1	18,52	CHI
20200315307	CACHOEIRA DOURADA	02670214	CACHOEIRA DOURADA	04/03/2020 15:14	05/03/2020 22:01	05/03/2020 11:18	05/03/2020 11:44	0,42	697	294,48	CHI
20200315307	INACIOLANDIA	02670214	CACHOEIRA DOURADA	04/03/2020 15:14	05/03/2020 22:01	05/03/2020 11:18	05/03/2020 11:44	0,42	44	18,59	CHI
20200315307	ITUMBIARA	02670214	CACHOEIRA DOURADA	04/03/2020 15:14	05/03/2020 22:01	05/03/2020 11:18	05/03/2020 11:44	0,42	13	5,49	CHI
20200315307	INACIOLANDIA	02670214	CACHOEIRA DOURADA	04/03/2020 15:14	05/03/2020 22:01	04/03/2020 15:14	05/03/2020 13:24	22,16	29	642,65	CHI
20200315307	INACIOLANDIA	02670214	CACHOEIRA DOURADA	04/03/2020 15:14	05/03/2020 22:01	04/03/2020 15:14	05/03/2020 19:12	27,96	9	251,61	CHI
20200315307	INACIOLANDIA	02670214	CACHOEIRA DOURADA	04/03/2020 15:14	05/03/2020 22:01	04/03/2020 15:14	05/03/2020 20:24	29,16	2	58,32	CHI
20200315307	CACHOEIRA DOURADA	02670214	CACHOEIRA DOURADA	04/03/2020 15:14	05/03/2020 22:01	05/03/2020 21:24	05/03/2020 21:39	0,25	689	173,40	CHI

20200315307	INACIOLANDIA	02670214	CACHOEIRA DOURADA	04/03/2020 15:14	05/03/2020 22:01	05/03/2020 21:24	05/03/2020 21:39	0,25	84	21,14	CHI
20200315307	ITUMBIRA	02670214	CACHOEIRA DOURADA	04/03/2020 15:14	05/03/2020 22:01	05/03/2020 21:24	05/03/2020 21:39	0,25	13	3,27	CHI
20200315307	INACIOLANDIA	02670214	CACHOEIRA DOURADA	04/03/2020 15:14	05/03/2020 22:01	04/03/2020 15:14	05/03/2020 22:01	30,77	19	584,66	CHI
20200315312	ALTO PARAISO DE GOIAS	3870015911	FLORES DE GOIAS	04/03/2020 15:33	04/03/2020 16:24	04/03/2020 15:33	04/03/2020 16:24	0,84	1	0,84	CHI
20200315409	APARECIDA DE GOIANIA	11088084	REAL S2	04/03/2020 15:04	04/03/2020 16:35	04/03/2020 15:04	04/03/2020 16:35	1,51	1	1,51	CHI
20200315411	CATALAO	CT21192558	CATALAO S1	04/03/2020 15:05	05/03/2020 10:59	04/03/2020 15:05	05/03/2020 10:59	19,90	1	19,90	CHI
20200315421	SAO FRANCISCO DE GOIAS	SF12203678	SAO FRANCISCO DE GOIAS	04/03/2020 15:07	04/03/2020 18:00	04/03/2020 15:07	04/03/2020 18:00	2,87	5	14,37	CHI
20200315427	GOIANESIA	10008767899	GOIANESIA S2	04/03/2020 15:08	04/03/2020 17:01	04/03/2020 15:08	04/03/2020 17:01	1,88	1	1,88	CHI
20200315436	EDEIA	IY12010954	EDEIA	04/03/2020 14:48	04/03/2020 19:18	04/03/2020 14:48	04/03/2020 19:18	4,49	5	22,47	CHI
20200315436	INDIARA	IY12010954	EDEIA	04/03/2020 14:48	04/03/2020 19:18	04/03/2020 14:48	04/03/2020 19:18	4,49	46	206,69	CHI
20200315437	APARECIDA DE GOIANIA	AP11004998	REAL S2	04/03/2020 15:12	04/03/2020 19:00	04/03/2020 15:12	04/03/2020 19:00	3,80	109	413,81	CHI
20200315439	VILA BOA	VB21317514	IACIARA S2	04/03/2020 15:12	04/03/2020 17:50	04/03/2020 15:12	04/03/2020 17:50	2,62	1	2,62	CHI
20200315440	JESUPOLIS	SF21196923	SAO FRANCISCO DE GOIAS	04/03/2020 15:12	04/03/2020 17:19	04/03/2020 15:12	04/03/2020 17:19	2,10	1	2,10	CHI
20200315445	DOVERLANDIA	4220004910	CAIAPONIA	04/03/2020 15:13	04/03/2020 17:34	04/03/2020 15:13	04/03/2020 17:34	2,34	1	2,34	CHI
20200315449	SANTA HELENA DE GOIAS	SH21022695	SANTA HELENA S1	04/03/2020 15:14	05/03/2020 00:35	04/03/2020 15:14	05/03/2020 00:35	9,34	1	9,34	CHI
20200315451	INHUMAS	IN12051947	INHUMAS S1	04/03/2020 15:14	05/03/2020 02:10	04/03/2020 15:14	05/03/2020 02:10	10,92	1	10,92	CHI
20200315457	CORUMBAIBA	CI21309397	VILA CORUMBA	04/03/2020 15:17	04/03/2020 17:50	04/03/2020 15:17	04/03/2020 17:50	2,54	1	2,54	CHI
20200315458	COCALZINHO DE GOIAS	ZN12201365	COCALZINHO	04/03/2020 14:58	04/03/2020 20:29	04/03/2020 14:58	04/03/2020 20:29	5,51	3	16,52	CHI
20200315458	CORUMBA DE GOIAS	ZN12201365	COCALZINHO	04/03/2020 14:58	04/03/2020 20:29	04/03/2020 14:58	04/03/2020 20:29	5,51	16	88,13	CHI
20200315462	ARAGUAPAZ	1780030529	MOZARLANDIA	04/03/2020 15:18	04/03/2020 17:56	04/03/2020 15:18	04/03/2020 17:56	2,62	1	2,62	CHI
20200315465	GOIANIA	10641403	AEROPORTO S2	04/03/2020 15:18	04/03/2020 17:25	04/03/2020 15:18	04/03/2020 17:25	2,10	1	2,10	CHI
20200315466	COCALZINHO DE GOIAS	ZN12375219	AGUAS LINDAS DE GOIAS S2	04/03/2020 15:19	05/03/2020 08:00	04/03/2020 15:19	05/03/2020 08:00	16,68	25	417,08	CHI
20200315480	PLANALTINA	2960255623	PLANALTINA	04/03/2020 15:22	04/03/2020 15:58	04/03/2020 15:22	04/03/2020 15:58	0,60	1	0,60	CHI
20200315481	TRINDADE	40046734	TRINDADE	04/03/2020 15:22	04/03/2020 17:45	04/03/2020 15:22	04/03/2020 17:45	2,37	1	2,37	CHI
20200315484	IACIARA	IA12262204	IACIARA S2	04/03/2020 15:23	04/03/2020 18:10	04/03/2020 15:23	04/03/2020 18:10	2,78	10	27,78	CHI
20200315485	JATAI	JT11184025	JATAI S2	04/03/2020 15:23	04/03/2020 21:46	04/03/2020 15:23	04/03/2020 21:46	6,37	84	535,31	CHI
20200315486	FLORES DE GOIAS	FB21180632	FLORES DE GOIAS	04/03/2020 15:23	04/03/2020 16:50	04/03/2020 15:23	04/03/2020 16:50	1,44	1	1,44	CHI
20200315492	IPORA	IR12259868	ARENOPOLIS	04/03/2020 15:25	04/03/2020 21:44	04/03/2020 15:25	04/03/2020 21:44	6,31	15	94,58	CHI
20200315494	GOIANIRA	10016666915	GOIANIRA	04/03/2020 15:26	04/03/2020 17:59	04/03/2020 15:26	04/03/2020 17:59	2,55	1	2,55	CHI
20200315496	TEREZOPOLIS DE GOIAS	TJ12389766	DAIA S2	04/03/2020 14:21	05/03/2020 10:14	04/03/2020 14:21	05/03/2020 10:14	19,88	9	178,91	CHI
20200315497	CATALAO	CT11000027	CATALAO S2	04/03/2020 14:37	04/03/2020 17:48	04/03/2020 14:37	04/03/2020 17:48	3,18	115	365,38	CHI
20200315499	GOIANIA	10917780	GOIANIA LESTE S1	04/03/2020 15:27	04/03/2020 22:54	04/03/2020 15:27	04/03/2020 22:54	7,44	1	7,44	CHI
20200315500	PALMEIRAS DE GOIAS	PL21118648	PALMEIRAS	04/03/2020 15:28	04/03/2020 16:59	04/03/2020 15:28	04/03/2020 16:59	1,51	1	1,51	CHI
20200315504	QUIRINOPOLIS	QI21014276	QUIRINOPOLIS	04/03/2020 15:29	04/03/2020 17:39	04/03/2020 15:29	04/03/2020 17:39	2,16	1	2,16	CHI
20200315507	ARAGARCAS	1820003210	ARAGARCAS	04/03/2020 15:29	05/03/2020 07:36	04/03/2020 15:29	05/03/2020 07:36	16,10	1	16,10	CHI
20200315512	FORMOSA	610268480	ITUIQUIRA	04/03/2020 15:32	04/03/2020 17:00	04/03/2020 15:32	04/03/2020 17:00	1,46	1	1,46	CHI
20200315514	PARAUNA	PU12289841	PARAUNA	04/03/2020 15:33	04/03/2020 19:15	04/03/2020 15:33	04/03/2020 19:15	3,69	10	36,87	CHI
20200315517	BOM JESUS DE GOIAS	BJ21000136	BOM JESUS DE GOIAS	04/03/2020 15:34	05/03/2020 11:58	04/03/2020 15:34	05/03/2020 10:00	18,43	1	18,43	CHI
20200315517	BOM JESUS DE GOIAS	BJ21000131	BOM JESUS DE GOIAS	04/03/2020 15:34	05/03/2020 11:58	05/03/2020 09:59	05/03/2020 11:58	1,98	1	1,98	CHI
20200315518	CATALAO	CT11000040	CATALAO S2	04/03/2020 15:05	04/03/2020 19:42	04/03/2020 15:05	04/03/2020 19:42	4,60	43	198,01	CHI
20200315519	SANTO ANTONIO DA BARRA	BZ21301411	ACREUNA	04/03/2020 15:35	04/03/2020 23:41	04/03/2020 15:35	04/03/2020 23:41	8,10	1	8,10	CHI
20200315520	MINACU	4020075701	MINACU	04/03/2020 15:35	04/03/2020 20:27	04/03/2020 15:35	04/03/2020 20:27	4,86	1	4,86	CHI
20200315524	GOIANIA	15207821	GOIANIA LESTE S1	04/03/2020 15:36	04/03/2020 19:03	04/03/2020 15:36	04/03/2020 19:03	3,43	1	3,43	CHI
20200315535	FORMOSA	FA12051040	ITUIQUIRA	04/03/2020 15:41	04/03/2020 16:59	04/03/2020 15:41	04/03/2020 16:59	1,30	11	14,25	CHI

20200315537	RIO VERDE	RV12111052	CABRIUVA S2	04/03/2020 14:54	04/03/2020 18:28	04/03/2020 14:54	04/03/2020 18:28	3,56	25	88,98	CHI
20200315541	CATALAO	CT12077474	CATALAO S1	04/03/2020 15:42	05/03/2020 11:09	04/03/2020 15:42	05/03/2020 11:09	19,45	4	77,79	CHI
20200315544	IPORA	730001775	IPORA	04/03/2020 15:42	05/03/2020 07:11	04/03/2020 15:42	05/03/2020 07:11	15,47	1	15,47	CHI
20200315552	BELA VISTA DE GOIAS	240083982	BELA VISTA S1	04/03/2020 15:47	04/03/2020 16:39	04/03/2020 15:47	04/03/2020 16:39	0,86	1	0,86	CHI
20200315559	SANTA HELENA DE GOIAS	SH21382611	SANTA HELENA S1	04/03/2020 15:50	05/03/2020 02:38	04/03/2020 15:50	05/03/2020 02:38	10,79	1	10,79	CHI
20200315560	PONTALINA	210004320	PONTALINA	04/03/2020 15:51	04/03/2020 18:22	04/03/2020 15:51	04/03/2020 18:22	2,52	1	2,52	CHI
20200315576	LUZIANIA	LZ12313611	VIANOPOLIS	04/03/2020 15:57	04/03/2020 20:48	04/03/2020 15:57	04/03/2020 20:48	4,84	13	62,91	CHI
20200315581	DOVERLANDIA	DV12138342	CAIAPONIA	04/03/2020 15:59	04/03/2020 18:51	04/03/2020 15:59	04/03/2020 18:51	2,85	8	22,81	CHI
20200315587	MINACU	4020010690	MINACU	04/03/2020 16:02	04/03/2020 21:55	04/03/2020 16:02	04/03/2020 21:55	5,87	1	5,87	CHI
20200315592	ORIZONA	OZ12079958	VIANOPOLIS	04/03/2020 16:04	04/03/2020 19:18	04/03/2020 16:04	04/03/2020 19:18	3,23	5	16,16	CHI
20200315592	VIANOPOLIS	OZ12079958	VIANOPOLIS	04/03/2020 16:04	04/03/2020 19:18	04/03/2020 16:04	04/03/2020 19:18	3,23	54	174,57	CHI
20200315596	FORMOSA	FA12381543	ITIQUEIRA	04/03/2020 16:06	04/03/2020 18:10	04/03/2020 16:06	04/03/2020 18:10	2,06	4	8,25	CHI
20200315603	NIQUELANDIA	NQ21197663	BARRO ALTO	04/03/2020 16:09	04/03/2020 18:27	04/03/2020 16:09	04/03/2020 18:27	2,30	1	2,30	CHI
20200315605	PIRACANJUBA	PJ12352525	PIRACANJUBA	04/03/2020 15:57	04/03/2020 18:18	04/03/2020 15:57	04/03/2020 18:18	2,35	14	32,86	CHI
20200315607	GOIANIA	10846220	GOIANIA LESTE S1	04/03/2020 16:11	04/03/2020 21:54	04/03/2020 16:11	04/03/2020 21:54	5,70	1	5,70	CHI
20200315608	MOSSAMEDES	MD21295010	FIRMINOPOLIS S2	04/03/2020 16:12	04/03/2020 17:34	04/03/2020 16:12	04/03/2020 17:34	1,36	1	1,36	CHI
20200315615	APARECIDA DE GOIANIA	10004957359	ANHANGUERA	04/03/2020 16:14	04/03/2020 17:21	04/03/2020 16:14	04/03/2020 17:21	1,11	1	1,11	CHI
20200315616	LEOPOLDO DE BULHOES	LB21336904	DAIA S2	04/03/2020 16:10	04/03/2020 18:14	04/03/2020 16:10	04/03/2020 18:14	2,05	2	4,11	CHI
20200315618	SANTO ANTONIO DE GOIAS	GN21150460	XAVANTES	04/03/2020 16:15	04/03/2020 21:53	04/03/2020 16:15	04/03/2020 21:53	5,63	1	5,63	CHI
20200315620	SANTO ANTONIO DO DESCOBERTO	10002832702	ALEXANIA	04/03/2020 16:15	04/03/2020 17:31	04/03/2020 16:15	04/03/2020 17:31	1,26	1	1,26	CHI
20200315622	INHUMAS	IN11292129	INHUMAS S2	04/03/2020 16:42	04/03/2020 19:47	04/03/2020 18:47	04/03/2020 19:47	1,00	139	139,00	CHI
20200315628	LUZIANIA	LZ12230289	PACAEMBU S1	04/03/2020 16:17	04/03/2020 21:40	04/03/2020 16:17	04/03/2020 21:40	5,37	1	5,37	CHI
20200315629	RIO VERDE	10024886740	CABRIUVA S1	04/03/2020 16:16	04/03/2020 23:42	04/03/2020 16:16	04/03/2020 23:42	7,42	1	7,42	CHI
20200315631	RIO VERDE	RV21255787	RIO VERDE S1	04/03/2020 16:17	05/03/2020 14:24	04/03/2020 16:17	05/03/2020 14:24	22,10	3	66,31	CHI
20200315632	ARAGOIANIA	AO21244156	GUAPO S2	04/03/2020 16:18	04/03/2020 20:16	04/03/2020 16:18	04/03/2020 20:16	3,97	1	3,97	CHI
20200315633	NEROPOLIS	NR12029257	NEROPOLIS S2	04/03/2020 16:18	05/03/2020 00:17	04/03/2020 16:18	05/03/2020 00:17	7,98	11	87,79	CHI
20200315645	ORIZONA	OZ21022860	PIRES DO RIO S2	04/03/2020 16:25	04/03/2020 21:39	04/03/2020 16:25	04/03/2020 21:39	5,22	2	10,44	CHI
20200315655	FORMOSO	FO12290979	MARA ROSA	04/03/2020 16:29	04/03/2020 20:37	04/03/2020 16:29	04/03/2020 20:37	4,13	5	20,65	CHI
20200315657	RIO VERDE	RV12018092	SANTA HELENA S1	04/03/2020 16:30	04/03/2020 20:15	04/03/2020 16:30	04/03/2020 20:15	3,74	14	52,41	CHI
20200315664	CAIAPONIA	CP12252503	CAIAPONIA	04/03/2020 16:31	05/03/2020 08:32	04/03/2020 16:31	05/03/2020 08:32	16,00	6	96,02	CHI
20200315668	NOVA CRIXAS	NA12262740	NOVA CRIXAS	04/03/2020 16:15	04/03/2020 20:21	04/03/2020 16:15	04/03/2020 20:21	4,10	102	417,75	CHI
20200315669	FORMOSA	FA12000175	ITIQUEIRA	04/03/2020 16:34	04/03/2020 19:28	04/03/2020 16:34	04/03/2020 19:28	2,89	51	147,22	CHI
20200315670	SANTA HELENA DE GOIAS	TD12226264	RIO DOS BOIS	04/03/2020 16:27	04/03/2020 19:35	04/03/2020 16:27	04/03/2020 19:35	3,13	3	9,39	CHI
20200315670	TURVELANDIA	TD12226264	RIO DOS BOIS	04/03/2020 16:27	04/03/2020 19:35	04/03/2020 16:27	04/03/2020 19:35	3,13	78	244,10	CHI
20200315673	INDIARA	IY21047094	EDEIA	04/03/2020 16:35	04/03/2020 18:06	04/03/2020 16:35	04/03/2020 18:06	1,50	1	1,50	CHI
20200315674	JATAI	JT21358123	JATAI S1	04/03/2020 16:37	04/03/2020 19:26	04/03/2020 16:37	04/03/2020 19:26	2,82	1	2,82	CHI
20200315676	CAMPOS VERDES	VD12251079	SANTA TEREZINHA	04/03/2020 15:56	04/03/2020 19:43	04/03/2020 15:56	04/03/2020 19:43	3,78	3	11,33	CHI
20200315676	SANTA TEREZINHA DE GOIAS	VD12251079	SANTA TEREZINHA	04/03/2020 15:56	04/03/2020 19:43	04/03/2020 15:56	04/03/2020 19:43	3,78	3	11,33	CHI
20200315677	SANTA BARBARA DE GOIAS	10002114770	TRINDADE	04/03/2020 16:37	04/03/2020 19:58	04/03/2020 16:37	04/03/2020 19:58	3,34	1	3,34	CHI
20200315678	ANAPOLIS	21379580	JUNDIAI S1	04/03/2020 16:37	04/03/2020 18:12	04/03/2020 16:37	04/03/2020 18:12	1,57	1	1,57	CHI
20200315680	BARRO ALTO	GE12006481	BARRO ALTO	04/03/2020 14:35	05/03/2020 20:40	04/03/2020 14:35	05/03/2020 20:40	30,08	16	481,27	CHI
20200315680	SANTA RITA DO NOVO DESTINO	GE12006481	BARRO ALTO	04/03/2020 14:35	05/03/2020 20:40	04/03/2020 14:35	05/03/2020 20:40	30,08	5	150,40	CHI
20200315680	BARRO ALTO	GE12006481	BARRO ALTO	04/03/2020 14:35	05/03/2020 20:40	05/03/2020 15:30	05/03/2020 20:40	5,17	5	25,85	CHI
20200315680	SANTA RITA DO NOVO DESTINO	GE12006481	BARRO ALTO	04/03/2020 14:35	05/03/2020 20:40	05/03/2020 15:30	05/03/2020 20:40	5,17	5	25,85	CHI

20200315687	GOIANAPOLIS	GP11029286	JUNDIAI S1	04/03/2020 16:41	04/03/2020 20:17	04/03/2020 16:41	04/03/2020 20:17	3,60	45	161,90	CHI
20200315693	CATALAO	1990007615	CATALAO S2	04/03/2020 16:42	05/03/2020 10:28	04/03/2020 16:42	05/03/2020 10:28	17,76	1	17,76	CHI
20200315704	MARA ROSA	MQ11000006	MARA ROSA	04/03/2020 16:38	04/03/2020 17:51	04/03/2020 16:38	04/03/2020 17:51	1,21	110	133,59	CHI
20200315801	ITAGUARU	IC21250486	ITAPURANGA	04/03/2020 16:45	04/03/2020 18:00	04/03/2020 16:45	04/03/2020 18:00	1,24	1	1,24	CHI
20200315805	ACREUNA	SH12301267	ACREUNA	04/03/2020 16:23	04/03/2020 19:09	04/03/2020 16:23	04/03/2020 19:09	2,76	5	13,80	CHI
20200315805	SANTA HELENA DE GOIAS	SH12301267	ACREUNA	04/03/2020 16:23	04/03/2020 19:09	04/03/2020 16:23	04/03/2020 19:09	2,76	1	2,76	CHI
20200315805	SANTO ANTONIO DA BARRA	SH12301267	ACREUNA	04/03/2020 16:23	04/03/2020 19:09	04/03/2020 16:23	04/03/2020 19:09	2,76	16	44,17	CHI
20200315810	CABECEIRAS	CW12383348	ITIQUEIRA	04/03/2020 16:47	04/03/2020 22:09	04/03/2020 16:47	04/03/2020 22:09	5,36	117	627,28	CHI
20200315816	IPAMERI	IP21318941	CAMPO ALEGRE DE GOIAS	04/03/2020 16:49	04/03/2020 22:31	04/03/2020 16:49	04/03/2020 22:31	5,69	1	5,69	CHI
20200315820	COLINAS DO SUL	9700006780	NIQUELANDIA SUBTRANSMISSAO	04/03/2020 16:50	04/03/2020 18:04	04/03/2020 16:50	04/03/2020 18:04	1,23	1	1,23	CHI
20200315829	NIQUELANDIA	NQ21243548	URUACU	04/03/2020 16:51	04/03/2020 20:46	04/03/2020 16:51	04/03/2020 20:46	3,90	1	3,90	CHI
20200315830	APARECIDA DE GOIANIA	200656120	ANHANGUERA	04/03/2020 16:52	04/03/2020 17:54	04/03/2020 16:52	04/03/2020 17:54	1,03	1	1,03	CHI
20200315831	NIQUELANDIA	NQ12237510	URUACU	04/03/2020 16:53	04/03/2020 22:15	04/03/2020 16:53	04/03/2020 22:15	5,36	1	5,36	CHI
20200315832	SANTA HELENA DE GOIAS	SH11000021	IPEGUARI	04/03/2020 16:31	04/03/2020 20:48	04/03/2020 16:31	04/03/2020 20:48	4,28	30	128,27	CHI
20200315835	LUZIANIA	LZ21084502	MARAJOARA	04/03/2020 16:54	04/03/2020 21:05	04/03/2020 16:54	04/03/2020 21:05	4,18	1	4,18	CHI
20200315839	MOZARLANDIA	410034575	MOZARLANDIA	04/03/2020 16:55	04/03/2020 17:55	04/03/2020 16:55	04/03/2020 17:55	0,98	1	0,98	CHI
20200315841	LUZIANIA	LZ11230265	RIO VERMELHO	04/03/2020 16:56	04/03/2020 18:25	04/03/2020 17:56	04/03/2020 18:25	0,47	11	5,22	CHI
20200315845	MORRINHOS	MR21302606	MORRINHOS	04/03/2020 16:57	04/03/2020 19:30	04/03/2020 16:57	04/03/2020 19:30	2,55	1	2,55	CHI
20200315849	GOIANIA	10015005834	CARAJAS S2	04/03/2020 16:58	04/03/2020 17:58	04/03/2020 16:58	04/03/2020 17:58	0,99	1	0,99	CHI
20200315855	CALDAS NOVAS	CN12139717LD	CALDAS NOVAS S2	04/03/2020 17:02	05/03/2020 00:04	04/03/2020 23:35	05/03/2020 00:03	0,47	1386	649,88	CHI
20200315855	CALDAS NOVAS	CN12200059LD	CALDAS NOVAS S2	04/03/2020 17:02	05/03/2020 00:04	04/03/2020 17:02	05/03/2020 00:04	7,03	57	400,95	CHI
20200315856	VILA BOA	2880014330	ITIQUEIRA	04/03/2020 17:03	04/03/2020 19:18	04/03/2020 17:03	04/03/2020 19:18	2,26	1	2,26	CHI
20200315866	ORIZONA	2060035461	PIRES DO RIO S2	04/03/2020 17:05	04/03/2020 19:46	04/03/2020 17:05	04/03/2020 19:46	2,67	1	2,67	CHI
20200315869	APARECIDA DE GOIANIA	AP11078317	CEPAIGO S1	04/03/2020 17:06	04/03/2020 18:41	04/03/2020 17:06	04/03/2020 18:41	1,58	164	259,12	CHI
20200315871	PARAUNA	980047353	PARAUNA	04/03/2020 17:07	05/03/2020 07:26	04/03/2020 17:07	05/03/2020 07:26	14,31	1	14,31	CHI
20200315875	INACIOLANDIA	ID12128128	QUIRINOPOLIS	04/03/2020 17:10	05/03/2020 11:50	04/03/2020 17:10	05/03/2020 11:50	18,65	6	111,92	CHI
20200315877	LUZIANIA	10030350369	RIO VERMELHO	04/03/2020 17:11	04/03/2020 20:49	04/03/2020 17:11	04/03/2020 20:49	3,63	1	3,63	CHI
20200315878	MOSSAMEDES	MD12399626	FIRMINOPOLIS S2	04/03/2020 17:11	04/03/2020 18:27	04/03/2020 17:11	04/03/2020 18:27	1,26	1	1,26	CHI
20200315880	SANTA TEREZINHA DE GOIAS	SG12371051	SANTA TEREZINHA	04/03/2020 07:27	04/03/2020 21:55	04/03/2020 07:27	04/03/2020 21:55	14,46	5	72,32	CHI
20200315882	GOIANAPOLIS	GP12000094	DAIA S2	04/03/2020 16:51	04/03/2020 19:31	04/03/2020 16:51	04/03/2020 19:31	2,65	4	10,61	CHI
20200315882	TEREZOPOLIS DE GOIAS	GP12000094	DAIA S2	04/03/2020 16:51	04/03/2020 19:31	04/03/2020 16:51	04/03/2020 19:31	2,65	21	55,68	CHI
20200315896	PLANALTINA	PI21281776	PADRE BERNARDO	04/03/2020 17:15	05/03/2020 12:45	04/03/2020 17:15	05/03/2020 12:45	19,50	4	78,00	CHI
20200315898	NOVO GAMA	2460195091	PACAEMBU S1	04/03/2020 17:15	04/03/2020 21:20	04/03/2020 17:15	04/03/2020 21:20	4,08	1	4,08	CHI
20200315899	ANAPOLIS	AN12000209	ANAPOLIS UNIVERSITARIO S2	04/03/2020 17:12	04/03/2020 18:24	04/03/2020 17:12	04/03/2020 18:24	1,18	1471	1742,32	CHI
20200315900	CERES	CE21140596	RUBIATABA	04/03/2020 17:15	05/03/2020 10:16	04/03/2020 17:15	05/03/2020 10:16	17,01	1	17,01	CHI
20200315908	GOIAS	GS21172079	GOIAS	04/03/2020 17:16	04/03/2020 23:47	04/03/2020 17:16	04/03/2020 23:47	6,50	1	6,50	CHI
20200315917	PEROLANDIA	DP21209844	JATAI S1	04/03/2020 17:17	04/03/2020 18:43	04/03/2020 17:17	04/03/2020 18:43	1,42	1	1,42	CHI
20200315920	CUMARI	CY11215559	CATALAO S1	04/03/2020 16:50	04/03/2020 21:34	04/03/2020 16:50	04/03/2020 21:34	4,72	116	547,52	CHI
20200315925	CRISTALINA	1060031994	CRISTALINA S1	04/03/2020 17:18	04/03/2020 22:04	04/03/2020 17:18	04/03/2020 22:04	4,76	1	4,76	CHI
20200315930	MONTIVIDIU	MV12295830	MONTIVIDIU T	04/03/2020 15:42	04/03/2020 19:51	04/03/2020 15:42	04/03/2020 19:51	4,14	19	78,73	CHI
20200315938	GOIANIA	GN12395188	GOYA S2	04/03/2020 17:21	04/03/2020 18:56	04/03/2020 17:21	04/03/2020 18:56	1,58	1	1,58	CHI
20200315945	LEOPOLDO DE BULHOES	LB12200132	CEPAIGO S2	04/03/2020 17:22	04/03/2020 22:12	04/03/2020 17:22	04/03/2020 22:12	4,83	3	14,49	CHI
20200315961	SANTO ANTONIO DO DESCOBERTO	SN11109102	ALEXANIA	04/03/2020 17:23	04/03/2020 20:37	04/03/2020 17:23	04/03/2020 20:37	3,22	10	32,22	CHI
20200315969	CABECEIRAS	CW12403588	ITIQUEIRA	04/03/2020 17:24	04/03/2020 20:15	04/03/2020 17:24	04/03/2020 20:15	2,84	1	2,84	CHI

20200315971	TRINDADE	TR11185438	TRINDADE	04/03/2020 16:49	04/03/2020 18:51	04/03/2020 16:49	04/03/2020 18:51	2,02	55	110,93	CHI
20200315978	ITARUMA	IM21122710	CACHOEIRA ALTA	04/03/2020 17:25	04/03/2020 23:18	04/03/2020 17:25	04/03/2020 23:18	5,87	1	5,87	CHI
20200315985	GOIANIA	11083219	AEROPORTO S1	04/03/2020 17:27	04/03/2020 19:56	04/03/2020 17:27	04/03/2020 19:56	2,48	1	2,48	CHI
20200315987	GOIANIA	GN11001960	AEROPORTO S1	04/03/2020 17:27	04/03/2020 19:38	04/03/2020 17:27	04/03/2020 19:38	2,17	31	67,42	CHI
20200315990	ITAGUARI	IC21068812	ITABERAI S1	04/03/2020 17:27	04/03/2020 23:30	04/03/2020 17:27	04/03/2020 23:30	6,04	1	6,04	CHI
20200315998	PORTEIRAO	CL21260969	RIO DOS BOIS	04/03/2020 17:28	06/03/2020 20:53	04/03/2020 17:28	06/03/2020 20:53	51,40	2	102,80	CHI
20200315998	PORTEIRAO	CL12030933LD	RIO DOS BOIS	04/03/2020 17:28	06/03/2020 20:53	06/03/2020 14:35	06/03/2020 20:53	6,30	2	12,60	CHI
20200316123	PLANALTINA	PI16404271	PLANALTINA	04/03/2020 17:32	04/03/2020 19:48	04/03/2020 19:36	04/03/2020 19:39	0,06	2513	147,29	CHI
20200316123	PLANALTINA	PI12056837	PLANALTINA	04/03/2020 17:32	04/03/2020 19:48	04/03/2020 17:32	04/03/2020 19:48	2,26	855	1928,26	CHI
20200316124	GOIANIA	GN12167624	GOIANIA LESTE S3	04/03/2020 17:32	04/03/2020 19:52	04/03/2020 17:32	04/03/2020 19:52	2,32	18	41,72	CHI
20200316141	FIRMINOPOLIS	FR11076437	FIRMINOPOLIS S1	04/03/2020 17:35	04/03/2020 19:24	04/03/2020 17:35	04/03/2020 19:24	1,81	120	216,80	CHI
20200316143	POSSE	PS11199471	IACIARA S2	04/03/2020 17:34	04/03/2020 18:22	04/03/2020 17:34	04/03/2020 18:22	0,79	32	25,37	CHI
20200316144	PALMINOPOLIS	PP21221178	PALMEIRAS	04/03/2020 17:36	04/03/2020 19:36	04/03/2020 17:36	04/03/2020 19:36	1,99	1	1,99	CHI
20200316157	SAO JOAO D ALIANCA	FB12254528	FLORES DE GOIAS	04/03/2020 17:38	05/03/2020 01:18	04/03/2020 17:38	05/03/2020 01:18	7,66	7	53,61	CHI
20200316165	RIO VERDE	RV21000215	RIO VERDE S1	04/03/2020 17:39	05/03/2020 05:42	04/03/2020 17:39	05/03/2020 05:42	12,04	1	12,04	CHI
20200316166	IPAMERI	IP12275733	IPAMERI	04/03/2020 17:39	05/03/2020 16:47	04/03/2020 17:39	05/03/2020 16:47	23,13	2	46,26	CHI
20200316168	TRINDADE	TR11000036	TRINDADE	04/03/2020 15:30	04/03/2020 18:59	04/03/2020 15:30	04/03/2020 18:59	3,48	102	354,71	CHI
20200316172	QUIRINOPOLIS	QI10396886	QUIRINOPOLIS	04/03/2020 17:11	05/03/2020 03:02	04/03/2020 17:11	04/03/2020 20:02	2,86	762	2176,36	CHI
20200316172	QUIRINOPOLIS	QI12034381	QUIRINOPOLIS	04/03/2020 17:11	05/03/2020 03:02	04/03/2020 17:11	04/03/2020 21:06	3,91	366	1432,89	CHI
20200316172	QUIRINOPOLIS	QI12240357	QUIRINOPOLIS	04/03/2020 17:11	05/03/2020 03:02	04/03/2020 17:11	04/03/2020 21:06	3,92	623	2442,33	CHI
20200316172	QUIRINOPOLIS	QI10396886	QUIRINOPOLIS	04/03/2020 17:11	05/03/2020 03:02	04/03/2020 17:11	05/03/2020 00:10	6,98	106	739,62	CHI
20200316172	QUIRINOPOLIS	QI10396886	QUIRINOPOLIS	04/03/2020 17:11	05/03/2020 03:02	04/03/2020 17:11	05/03/2020 03:02	9,85	714	7029,73	CHI
20200316173	ABADIANIA	AA11374466	CORUMBA	04/03/2020 17:40	04/03/2020 20:30	04/03/2020 17:40	04/03/2020 20:30	2,83	41	116,23	CHI
20200316178	EDEIA	CL12230806	RIO DOS BOIS	04/03/2020 17:30	04/03/2020 21:17	04/03/2020 17:30	04/03/2020 21:17	3,77	2	7,55	CHI
20200316178	PORTEIRAO	CL12230806	RIO DOS BOIS	04/03/2020 17:30	04/03/2020 21:17	04/03/2020 17:30	04/03/2020 21:17	3,77	4	15,09	CHI
20200316178	VICENTINOPOLIS	CL12230806	RIO DOS BOIS	04/03/2020 17:30	04/03/2020 21:17	04/03/2020 17:30	04/03/2020 21:17	3,77	4	15,09	CHI
20200316183	LUZIANIA	LZ12200111	VIANOPOLIS	04/03/2020 17:42	04/03/2020 22:00	04/03/2020 17:42	04/03/2020 22:00	4,30	10	42,99	CHI
20200316190	GOIAS	GS11239245	GOIAS	04/03/2020 17:43	04/03/2020 20:33	04/03/2020 17:43	04/03/2020 20:33	2,84	1	2,84	CHI
20200316192	TRINDADE	40290244	TRINDADE	04/03/2020 17:44	04/03/2020 20:14	04/03/2020 17:44	04/03/2020 20:14	2,50	1	2,50	CHI
20200316196	IVOLANDIA	IV21165793	IPORA	04/03/2020 17:44	05/03/2020 11:01	04/03/2020 17:44	05/03/2020 11:01	17,27	1	17,27	CHI
20200316201	VICENTINOPOLIS	VI10400586	VICENTINOPOLIS	04/03/2020 17:24	05/03/2020 01:42	04/03/2020 17:24	04/03/2020 20:46	3,37	1	3,37	CHI
20200316201	GOIATUBA	VI10400586	VICENTINOPOLIS	04/03/2020 17:24	05/03/2020 01:42	04/03/2020 17:24	04/03/2020 22:19	4,92	12	59,01	CHI
20200316201	VICENTINOPOLIS	VI10400586	VICENTINOPOLIS	04/03/2020 17:24	05/03/2020 01:42	04/03/2020 17:24	04/03/2020 22:19	4,92	32	157,35	CHI
20200316201	EDEIA	VI10400586	VICENTINOPOLIS	04/03/2020 17:24	05/03/2020 01:42	04/03/2020 17:24	04/03/2020 22:59	5,57	8	44,56	CHI
20200316201	VICENTINOPOLIS	VI10400586	VICENTINOPOLIS	04/03/2020 17:24	05/03/2020 01:42	04/03/2020 17:24	04/03/2020 22:59	5,57	43	239,49	CHI
20200316201	EDEALINA	VI10400586	VICENTINOPOLIS	04/03/2020 17:24	05/03/2020 01:42	04/03/2020 17:24	04/03/2020 23:29	6,08	15	91,16	CHI
20200316201	EDEIA	VI10400586	VICENTINOPOLIS	04/03/2020 17:24	05/03/2020 01:42	04/03/2020 17:24	04/03/2020 23:29	6,08	11	66,85	CHI
20200316201	EDEIA	VI10400586	VICENTINOPOLIS	04/03/2020 17:24	05/03/2020 01:42	04/03/2020 17:24	04/03/2020 23:29	6,08	33	200,56	CHI
20200316201	EDEIA	VI10400586	VICENTINOPOLIS	04/03/2020 17:24	05/03/2020 01:42	04/03/2020 17:24	04/03/2020 23:29	6,08	1	6,08	CHI
20200316201	PONTALINA	VI10400586	VICENTINOPOLIS	04/03/2020 17:24	05/03/2020 01:42	04/03/2020 17:24	04/03/2020 23:29	6,08	1	6,08	CHI
20200316201	VICENTINOPOLIS	VI10400586	VICENTINOPOLIS	04/03/2020 17:24	05/03/2020 01:42	04/03/2020 17:24	04/03/2020 23:29	6,08	1	6,08	CHI
20200316201	VICENTINOPOLIS	VI10400586	VICENTINOPOLIS	04/03/2020 17:24	05/03/2020 01:42	04/03/2020 17:24	04/03/2020 23:29	6,08	2	12,15	CHI
20200316201	VICENTINOPOLIS	VI10400586	VICENTINOPOLIS	04/03/2020 17:24	05/03/2020 01:42	04/03/2020 17:24	04/03/2020 23:29	6,08	12	72,93	CHI
20200316201	EDEALINA	VI12218171LD	VICENTINOPOLIS	04/03/2020 17:24	05/03/2020 01:42	04/03/2020 17:24	05/03/2020 01:42	8,30	34	282,22	CHI

20200316201	EDEIA	VI12218171LD	VICENTINOPOLIS	04/03/2020 17:24	05/03/2020 01:42	04/03/2020 17:24	05/03/2020 01:42	8,30	1	8,30	CHI
20200316201	VICENTINOPOLIS	VI12218171LD	VICENTINOPOLIS	04/03/2020 17:24	05/03/2020 01:42	04/03/2020 17:24	05/03/2020 01:42	8,30	20	166,01	CHI
20200316302	QUIRINOPOLIS	QI10395333	QUIRINOPOLIS	04/03/2020 17:06	05/03/2020 01:08	04/03/2020 17:06	04/03/2020 17:12	0,10	621	62,27	CHI
20200316302	QUIRINOPOLIS	QI10406833	QUIRINOPOLIS	04/03/2020 17:06	05/03/2020 01:08	04/03/2020 17:06	04/03/2020 17:21	0,25	1187	300,71	CHI
20200316302	QUIRINOPOLIS	QI12017984	QUIRINOPOLIS	04/03/2020 17:06	05/03/2020 01:08	04/03/2020 19:00	04/03/2020 20:00	1,01	53	53,50	CHI
20200316302	QUIRINOPOLIS	QI10403958	QUIRINOPOLIS	04/03/2020 17:06	05/03/2020 01:08	04/03/2020 20:10	04/03/2020 20:13	0,05	762	38,10	CHI
20200316302	QUIRINOPOLIS	QI10404159	QUIRINOPOLIS	04/03/2020 17:06	05/03/2020 01:08	04/03/2020 17:10	04/03/2020 20:45	3,58	1700	6087,42	CHI
20200316302	QUIRINOPOLIS	QI10402323	QUIRINOPOLIS	04/03/2020 17:06	05/03/2020 01:08	04/03/2020 17:06	04/03/2020 21:17	4,19	90	377,40	CHI
20200316302	QUIRINOPOLIS	QI10402323	QUIRINOPOLIS	04/03/2020 17:06	05/03/2020 01:08	04/03/2020 17:09	04/03/2020 21:17	4,14	3	12,43	CHI
20200316302	QUIRINOPOLIS	QI10402323	QUIRINOPOLIS	04/03/2020 17:06	05/03/2020 01:08	04/03/2020 17:06	04/03/2020 22:30	5,41	288	1558,08	CHI
20200316302	QUIRINOPOLIS	QI13370012	QUIRINOPOLIS	04/03/2020 17:06	05/03/2020 01:08	04/03/2020 17:10	04/03/2020 23:10	6,00	687	4120,09	CHI
20200316302	QUIRINOPOLIS	QI10402323	QUIRINOPOLIS	04/03/2020 17:06	05/03/2020 01:08	04/03/2020 17:06	04/03/2020 23:53	6,79	100	678,69	CHI
20200316302	QUIRINOPOLIS	QI10402323	QUIRINOPOLIS	04/03/2020 17:06	05/03/2020 01:08	04/03/2020 17:09	04/03/2020 23:53	6,74	270	1818,90	CHI
20200316302	QUIRINOPOLIS	QI16409325	QUIRINOPOLIS	04/03/2020 17:06	05/03/2020 01:08	04/03/2020 17:10	05/03/2020 00:41	7,51	201	1510,35	CHI
20200316302	QUIRINOPOLIS	QI13380618	QUIRINOPOLIS	04/03/2020 17:06	05/03/2020 01:08	04/03/2020 18:53	05/03/2020 00:41	5,79	1	5,79	CHI
20200316302	QUIRINOPOLIS	QI12365729	QUIRINOPOLIS	04/03/2020 17:06	05/03/2020 01:08	05/03/2020 00:47	05/03/2020 01:08	0,35	381	134,83	CHI
20200316414	SILVANIA	SV21137453	VIANOPOLIS	04/03/2020 17:49	04/03/2020 19:51	04/03/2020 17:49	04/03/2020 19:51	2,02	1	2,02	CHI
20200316419	MOZARLANDIA	MZ21188037	MOZARLANDIA	04/03/2020 17:51	04/03/2020 20:35	04/03/2020 17:51	04/03/2020 20:35	2,73	1	2,73	CHI
20200316420	APARECIDA DE GOIANIA	10014890028	INDEPENDENCIA S2	04/03/2020 17:52	04/03/2020 19:48	04/03/2020 17:52	04/03/2020 19:48	1,93	1	1,93	CHI
20200316422	LUZIANA	120093029	RIO VERMELHO	04/03/2020 17:52	04/03/2020 19:18	04/03/2020 17:52	04/03/2020 19:18	1,43	1	1,43	CHI
20200316428	COCALZINHO DE GOIAS	10013459013	AGUAS LINDAS DE GOIAS S2	04/03/2020 17:54	04/03/2020 21:12	04/03/2020 17:54	04/03/2020 21:12	3,30	1	3,30	CHI
20200316429	AMORINOPOLIS	AM12035305	IPORA	04/03/2020 17:54	05/03/2020 04:09	04/03/2020 17:54	05/03/2020 04:09	10,25	12	122,94	CHI
20200316438	ITAPURANGA	IK21034373	ITAPURANGA	04/03/2020 17:58	04/03/2020 19:05	04/03/2020 17:58	04/03/2020 19:05	1,11	1	1,11	CHI
20200316440	JARAGUA	JA21360290	GOIANESIA S2	04/03/2020 17:58	04/03/2020 20:53	04/03/2020 17:58	04/03/2020 20:53	2,91	1	2,91	CHI
20200316442	INDIARA	IY21205933	EDEIA	04/03/2020 17:59	04/03/2020 19:49	04/03/2020 17:59	04/03/2020 19:49	1,83	1	1,83	CHI
20200316449	PALMEIRAS DE GOIAS	PL12000070	PALMEIRAS	04/03/2020 17:35	04/03/2020 22:44	04/03/2020 17:35	04/03/2020 22:44	5,15	19	97,84	CHI
20200316450	MINEIROS	MY12195521	PARQUE DAS EMAS	04/03/2020 18:00	05/03/2020 10:48	04/03/2020 18:00	05/03/2020 10:48	16,79	7	117,53	CHI
20200316459	GOIANIA	13547264	CARAJAS S1	04/03/2020 18:02	04/03/2020 19:45	04/03/2020 18:02	04/03/2020 19:45	1,72	1	1,72	CHI
20200316464	ITAPURANGA	170069930	ITAPURANGA	04/03/2020 18:03	04/03/2020 20:29	04/03/2020 18:03	04/03/2020 20:29	2,43	1	2,43	CHI
20200316469	APARECIDA DE GOIANIA	13562782	REAL S1	04/03/2020 18:04	04/03/2020 19:09	04/03/2020 18:04	04/03/2020 19:09	1,08	1	1,08	CHI
20200316471	BRITANIA	BT12210599	BRITANIA	04/03/2020 17:37	05/03/2020 07:59	04/03/2020 17:37	04/03/2020 20:33	2,93	1	2,93	CHI
20200316471	BRITANIA	BT12210599	BRITANIA	04/03/2020 17:37	05/03/2020 07:59	04/03/2020 17:44	04/03/2020 20:33	2,81	9	25,29	CHI
20200316471	JUSSARA	BT12210599	BRITANIA	04/03/2020 17:37	05/03/2020 07:59	04/03/2020 17:44	04/03/2020 20:33	2,81	2	5,62	CHI
20200316471	BRITANIA	BT12210599	BRITANIA	04/03/2020 17:37	05/03/2020 07:59	04/03/2020 17:37	05/03/2020 07:59	14,37	134	1925,58	CHI
20200316471	BRITANIA	BT12210599	BRITANIA	04/03/2020 17:37	05/03/2020 07:59	04/03/2020 17:44	05/03/2020 07:59	14,25	541	7710,75	CHI
20200316471	JUSSARA	BT12210599	BRITANIA	04/03/2020 17:37	05/03/2020 07:59	04/03/2020 17:44	05/03/2020 07:59	14,25	46	655,63	CHI
20200316472	RIO VERDE	630540342	RIO VERDE S2	04/03/2020 18:06	05/03/2020 20:15	04/03/2020 18:06	05/03/2020 20:15	26,14	1	26,14	CHI
20200316474	BELA VISTA DE GOIAS	240044162	BELA VISTA S1	04/03/2020 18:08	04/03/2020 20:28	04/03/2020 18:08	04/03/2020 20:28	2,32	1	2,32	CHI
20200316481	GOIANIA	11816600	GOIANIA LESTE S3	04/03/2020 18:10	04/03/2020 22:49	04/03/2020 18:10	04/03/2020 22:49	4,64	1	4,64	CHI
20200316487	GUARINOS	IW21267462	ITAPACI	04/03/2020 18:13	05/03/2020 03:45	04/03/2020 18:13	05/03/2020 03:45	9,54	1	9,54	CHI
20200316488	MORRINHOS	MR12204554	MORRINHOS	04/03/2020 18:13	04/03/2020 21:25	04/03/2020 18:13	04/03/2020 21:25	3,20	5	15,98	CHI
20200316497	PIRES DO RIO	460042683	PIRES DO RIO S1	04/03/2020 18:15	05/03/2020 01:14	04/03/2020 18:15	05/03/2020 01:14	6,97	1	6,97	CHI
20200316500	JATAI	290330750	JATAI S2	04/03/2020 18:17	04/03/2020 23:46	04/03/2020 18:17	04/03/2020 23:46	5,48	1	5,48	CHI
20200316515	CAVALCANTE	CJ12389930	SAO DOMINGOS	04/03/2020 19:43	04/03/2020 20:13	04/03/2020 19:43	04/03/2020 20:13	0,50	28	13,89	CHI

20200316531	RIO VERDE	630094809	RIO VERDE S2	04/03/2020 20:03	04/03/2020 23:13	04/03/2020 20:03	04/03/2020 23:13	3,16	1	3,16	CHI
20200316536	RIO VERDE	02450414	CABRIUVA S2	04/03/2020 23:02	05/03/2020 17:46	04/03/2020 23:02	04/03/2020 23:11	0,14	122	17,66	CHI
20200316536	RIO VERDE	02450414	CABRIUVA S2	04/03/2020 23:02	05/03/2020 17:46	04/03/2020 23:02	05/03/2020 00:55	1,88	118	222,07	CHI
20200316536	RIO VERDE	02450414	CABRIUVA S2	04/03/2020 23:02	05/03/2020 17:46	04/03/2020 23:03	05/03/2020 00:55	1,87	2	3,75	CHI
20200316536	RIO VERDE	02450414	CABRIUVA S2	04/03/2020 23:02	05/03/2020 17:46	04/03/2020 23:02	05/03/2020 08:21	9,32	59	549,73	CHI
20200316536	RIO VERDE	02450414	CABRIUVA S2	04/03/2020 23:02	05/03/2020 17:46	04/03/2020 23:02	05/03/2020 10:40	11,63	7	81,38	CHI
20200316536	RIO VERDE	02450414	CABRIUVA S2	04/03/2020 23:02	05/03/2020 17:46	04/03/2020 23:02	05/03/2020 13:46	14,74	8	117,89	CHI
20200316536	RIO VERDE	RV13191884	CABRIUVA S2	04/03/2020 23:02	05/03/2020 17:46	05/03/2020 17:28	05/03/2020 17:46	0,29	120	34,50	CHI
20200316601	JUSSARA	JR21274294	JUSSARA	04/03/2020 18:17	05/03/2020 02:21	04/03/2020 18:17	05/03/2020 02:21	8,06	1	8,06	CHI
20200316603	GOIANIA	14605430	CARAJAS S2	04/03/2020 18:18	04/03/2020 20:27	04/03/2020 18:18	04/03/2020 20:27	2,15	1	2,15	CHI
20200316605	IPORA	IR21188494	IPORA	04/03/2020 18:18	05/03/2020 09:07	04/03/2020 18:18	05/03/2020 09:07	14,80	1	14,80	CHI
20200316616	ABADIA DE GOIAS	LG31190616	TRINDADE	04/03/2020 18:20	04/03/2020 19:59	04/03/2020 18:20	04/03/2020 19:59	1,63	5	8,17	CHI
20200316621	PADRE BERNARDO	PB21339966	PADRE BERNARDO	04/03/2020 18:21	04/03/2020 20:26	04/03/2020 18:21	04/03/2020 20:26	2,07	1	2,07	CHI
20200316622	JATAI	10004182497	JATAI S3	04/03/2020 18:21	04/03/2020 21:43	04/03/2020 18:21	04/03/2020 21:43	3,35	1	3,35	CHI
20200316627	ITUMBIARA	690046005	ITUMBIARA NOVA	04/03/2020 18:24	04/03/2020 19:15	04/03/2020 18:24	04/03/2020 19:15	0,84	1	0,84	CHI
20200316628	ANAPOLIS	20532180	ANAPOLIS UNIVERSITARIO S2	04/03/2020 18:25	04/03/2020 19:48	04/03/2020 18:25	04/03/2020 19:48	1,38	1	1,38	CHI
20200316631	ITAPURANGA	IK12300232	ITAPURANGA	04/03/2020 18:26	04/03/2020 21:51	04/03/2020 18:26	04/03/2020 21:51	3,41	14	47,72	CHI
20200316643	ALEXANIA	AX12000154	CORUMBA	04/03/2020 18:28	05/03/2020 00:16	04/03/2020 18:28	05/03/2020 00:16	5,81	21	121,96	CHI
20200316643	CORUMBA DE GOIAS	AX12000154	CORUMBA	04/03/2020 18:28	05/03/2020 00:16	04/03/2020 18:28	05/03/2020 00:16	5,81	4	23,23	CHI
20200316648	NOVA CRIXAS	NA21351976	NOVA CRIXAS	04/03/2020 18:30	05/03/2020 10:54	04/03/2020 18:30	05/03/2020 10:54	16,40	1	16,40	CHI
20200316650	NIQUELANDIA	NQ12088704	URUACU	04/03/2020 18:32	04/03/2020 20:11	04/03/2020 18:32	04/03/2020 20:11	1,65	21	34,61	CHI
20200316652	LUZIANIA	LZ21264828	VIANOPOLIS	04/03/2020 18:33	04/03/2020 23:08	04/03/2020 18:33	04/03/2020 23:08	4,57	4	18,28	CHI
20200316658	SILVANIA	SV12131990	VIANOPOLIS	04/03/2020 18:34	04/03/2020 22:47	04/03/2020 18:34	04/03/2020 22:47	4,21	30	126,18	CHI
20200316659	SANTA RITA DO ARAGUAIA	SU21188566	PARQUE DAS EMAS	04/03/2020 18:35	05/03/2020 10:55	04/03/2020 18:35	05/03/2020 10:55	16,32	1	16,32	CHI
20200316663	JATAI	290346850	JATAI S2	04/03/2020 18:36	04/03/2020 20:33	04/03/2020 18:36	04/03/2020 20:33	1,94	1	1,94	CHI
20200316666	GOIANIA	GN21000705	CAMPINAS S2	04/03/2020 18:37	04/03/2020 19:36	04/03/2020 18:37	04/03/2020 19:36	0,98	1	0,98	CHI
20200316669	SAO JOAO D ALIANCA	JL12211635	SAO JOAO D ALIANCA	04/03/2020 18:37	04/03/2020 20:00	04/03/2020 18:37	04/03/2020 20:00	1,37	222	305,00	CHI
20200316671	PORANGATU	TB12262770	PORANGATU	04/03/2020 18:16	04/03/2020 22:36	04/03/2020 18:16	04/03/2020 22:36	4,33	1	4,33	CHI
20200316671	SANTA TEREZA DE GOIAS	TB12262770	PORANGATU	04/03/2020 18:16	04/03/2020 22:36	04/03/2020 18:16	04/03/2020 22:36	4,33	5	21,67	CHI
20200316671	TROMBAS	TB12262770	PORANGATU	04/03/2020 18:16	04/03/2020 22:36	04/03/2020 18:16	04/03/2020 22:36	4,33	13	56,33	CHI
20200316673	FORMOSA	610086868	ITUIQUIRA	04/03/2020 18:38	04/03/2020 19:45	04/03/2020 18:38	04/03/2020 19:45	1,12	1	1,12	CHI
20200316678	NOVA ROMA	8720006319	IACIARA S2	04/03/2020 18:40	04/03/2020 23:28	04/03/2020 18:40	04/03/2020 23:28	4,79	1	4,79	CHI
20200316679	PARANAIGUARA	PC21100537	QUIRINOPOLIS	04/03/2020 18:41	04/03/2020 21:58	04/03/2020 18:41	04/03/2020 21:58	3,28	1	3,28	CHI
20200316680	PONTALINA	210019700	PONTALINA	04/03/2020 18:42	05/03/2020 12:10	04/03/2020 18:42	05/03/2020 12:10	17,46	1	17,46	CHI
20200316681	NIQUELANDIA	NQ12398048	URUACU	04/03/2020 18:42	04/03/2020 22:38	04/03/2020 18:42	04/03/2020 22:38	3,93	103	404,30	CHI
20200316683	SANTO ANTONIO DO DESCOBERTO	10002503431	MARAJOARA	04/03/2020 18:42	04/03/2020 21:50	04/03/2020 18:42	04/03/2020 21:50	3,12	1	3,12	CHI
20200316686	APARECIDA DE GOIANIA	14030597	ANHANGUERA	04/03/2020 18:43	04/03/2020 20:17	04/03/2020 18:43	04/03/2020 20:17	1,56	1	1,56	CHI
20200316691	IACIARA	IA12211664	IACIARA S2	04/03/2020 18:44	04/03/2020 23:41	04/03/2020 18:44	04/03/2020 23:41	4,94	9	44,44	CHI
20200316693	GOIANIA	16716152	CARAJAS S1	04/03/2020 18:45	04/03/2020 21:33	04/03/2020 18:45	04/03/2020 21:33	2,80	1	2,80	CHI
20200316703	AVELINOPOLIS	AV12020312	ANICUNS	04/03/2020 18:47	04/03/2020 21:00	04/03/2020 18:47	04/03/2020 21:00	2,21	7	15,49	CHI
20200316704	QUIRINOPOLIS	QI12000017	QUIRINOPOLIS	04/03/2020 18:01	04/03/2020 22:56	04/03/2020 18:01	04/03/2020 22:56	4,90	97	475,76	CHI
20200316705	PARANAIGUARA	PC21230896	QUIRINOPOLIS	04/03/2020 18:47	05/03/2020 08:25	04/03/2020 18:47	05/03/2020 08:25	13,63	1	13,63	CHI
20200316709	IACIARA	IA21317966	IACIARA S2	04/03/2020 18:48	05/03/2020 03:48	04/03/2020 18:48	05/03/2020 03:48	8,99	1	8,99	CHI
20200316710	JATAI	JT21205252	JATAI S1	04/03/2020 18:49	05/03/2020 11:53	04/03/2020 18:49	05/03/2020 11:53	17,05	1	17,05	CHI

20200316718	PIRACANJUBA	PJ21000174	PIRACANJUBA	04/03/2020 18:52	04/03/2020 20:04	04/03/2020 18:52	04/03/2020 20:04	1,20	1	1,20	CHI
20200316719	CIDADE OCIDENTAL	DH11199621	MARAJOARA	04/03/2020 18:52	04/03/2020 19:50	04/03/2020 18:52	04/03/2020 19:50	0,96	36	34,72	CHI
20200316720	ANAPOLIS	20944287	JUNDIAI S2	04/03/2020 18:52	04/03/2020 22:09	04/03/2020 18:52	04/03/2020 22:09	3,28	1	3,28	CHI
20200316721	LUZIANIA	120132680	RIO VERMELHO	04/03/2020 18:52	04/03/2020 20:48	04/03/2020 18:52	04/03/2020 20:48	1,92	1	1,92	CHI
20200316723	IPORA	IR21188351	ARENOPOLIS	04/03/2020 18:53	05/03/2020 11:34	04/03/2020 18:53	05/03/2020 11:34	16,68	1	16,68	CHI
20200316727	SANTA HELENA DE GOIAS	SH11214111	ACREUNA	04/03/2020 18:53	04/03/2020 21:52	04/03/2020 18:53	04/03/2020 21:52	2,97	1	2,97	CHI
20200316731	ALEXANIA	AX21190665	ALEXANIA	04/03/2020 18:54	05/03/2020 13:59	04/03/2020 18:54	05/03/2020 13:59	19,07	1	19,07	CHI
20200316736	ITUMBIARA	690137503	ITUMBIARA NOVA	04/03/2020 18:56	04/03/2020 19:45	04/03/2020 18:56	04/03/2020 19:45	0,81	1	0,81	CHI
20200316746	QUIRINOPOLIS	QI11091105	QUIRINOPOLIS	04/03/2020 18:59	04/03/2020 22:18	04/03/2020 18:59	04/03/2020 22:18	3,32	128	424,46	CHI
20200316751	SANTA TEREZA DE GOIAS	TB12170075	PORANGATU	04/03/2020 18:59	04/03/2020 23:17	04/03/2020 18:59	04/03/2020 23:17	4,28	3	12,85	CHI
20200316758	ARAGARCAS	AG12212838	ARAGARCAS	04/03/2020 18:45	04/03/2020 22:07	04/03/2020 18:45	04/03/2020 22:07	3,36	89	298,77	CHI
20200316759	APARECIDA DE GOIANIA	AP12051715	ATLANTICO S2	04/03/2020 18:47	04/03/2020 21:47	04/03/2020 18:47	04/03/2020 21:47	3,00	401	1204,89	CHI
20200316761	ANAPOLIS	AN11000433	JUNDIAI S1	04/03/2020 18:56	04/03/2020 19:56	04/03/2020 18:56	04/03/2020 19:56	0,99	163	161,42	CHI
20200316762	GOIANIA	7054503	AEROPORTO S3	04/03/2020 18:24	04/03/2020 21:21	04/03/2020 18:24	04/03/2020 21:21	2,96	199	588,49	CHI
20200316762	GOIANIA	02402284	AEROPORTO S3	04/03/2020 18:24	04/03/2020 21:21	04/03/2020 21:14	04/03/2020 21:21	0,11	1789	196,79	CHI
20200316763	SANTA HELENA DE GOIAS	SH12345542	SANTA HELENA S1	05/03/2020 08:00	06/03/2020 18:15	05/03/2020 11:27	06/03/2020 18:15	30,80	1	30,80	CHI
20200316771	AGUAS LINDAS DE GOIAS	LA11261061	AGUAS LINDAS DE GOIAS S1	04/03/2020 19:02	04/03/2020 20:33	04/03/2020 19:02	04/03/2020 20:33	1,51	127	191,31	CHI
20200316775	ITAJA	IJ21154809	ITAJA S2	04/03/2020 19:03	04/03/2020 21:42	04/03/2020 19:03	04/03/2020 21:42	2,65	1	2,65	CHI
20200316777	JATAI	SX12080873	JATAI S1	04/03/2020 19:03	05/03/2020 10:48	04/03/2020 19:03	05/03/2020 10:48	15,74	75	1180,48	CHI
20200316777	SERRANOPOLIS	SX12080873	JATAI S1	04/03/2020 19:03	05/03/2020 10:48	04/03/2020 19:03	05/03/2020 10:48	15,74	25	393,49	CHI
20200316782	FORMOSO	TB12051886	PORANGATU	04/03/2020 18:37	04/03/2020 22:54	04/03/2020 18:37	04/03/2020 22:54	4,28	2	8,57	CHI
20200316782	TROMBAS	TB12051886	PORANGATU	04/03/2020 18:37	04/03/2020 22:54	04/03/2020 18:37	04/03/2020 22:54	4,28	24	102,80	CHI
20200316783	ISRAELANDIA	IV12011798	IPORA	04/03/2020 19:00	04/03/2020 22:59	04/03/2020 19:00	04/03/2020 22:59	3,98	4	15,91	CHI
20200316783	IVOLANDIA	IV12011798	IPORA	04/03/2020 19:00	04/03/2020 22:59	04/03/2020 19:00	04/03/2020 22:59	3,98	22	87,52	CHI
20200316783	MOIPORA	IV12011798	IPORA	04/03/2020 19:00	04/03/2020 22:59	04/03/2020 19:00	04/03/2020 22:59	3,98	21	83,54	CHI
20200316787	ANAPOLIS	20910289	ANAPOLIS UNIVERSITARIO S2	04/03/2020 19:05	04/03/2020 23:09	04/03/2020 19:05	04/03/2020 23:09	4,06	1	4,06	CHI
20200316788	SANTO ANTONIO DO DESCOBERTO	SN12330527	MARAJOARA	04/03/2020 19:05	05/03/2020 01:17	04/03/2020 19:05	05/03/2020 01:17	6,21	6	37,23	CHI
20200316800	CAMPO LIMPO	AN11210757	NEROPOLIS S1	04/03/2020 19:01	04/03/2020 19:33	04/03/2020 19:01	04/03/2020 19:33	0,52	153	79,43	CHI
20200316808	JATAI	10029563451	JATAI S3	04/03/2020 19:09	05/03/2020 00:17	04/03/2020 19:09	05/03/2020 00:17	5,13	1	5,13	CHI
20200316809	QUIRINOPOLIS	QI32058080	QUIRINOPOLIS	04/03/2020 19:09	05/03/2020 13:32	04/03/2020 19:09	05/03/2020 13:32	18,38	10	183,79	CHI
20200316813	RIO VERDE	RV12111052	CABRIUVA S2	04/03/2020 21:44	06/03/2020 07:31	04/03/2020 21:44	06/03/2020 07:31	33,79	16	540,63	CHI
20200316813	RIO VERDE	RV12111052	CABRIUVA S2	04/03/2020 21:44	06/03/2020 07:31	06/03/2020 03:13	06/03/2020 07:31	4,31	13	55,97	CHI
20200316815	GOIANIA	10019450212	CARAJAS S1	04/03/2020 19:11	04/03/2020 21:38	04/03/2020 19:11	04/03/2020 21:38	2,44	1	2,44	CHI
20200316817	ANAPOLIS	AN21267799	NEROPOLIS S1	04/03/2020 19:12	04/03/2020 21:13	04/03/2020 19:12	04/03/2020 21:13	2,01	1	2,01	CHI
20200316818	ITAPURANGA	IK12124739	ITAPURANGA	04/03/2020 19:02	04/03/2020 21:09	04/03/2020 19:02	04/03/2020 21:09	2,11	188	396,00	CHI
20200316819	BOM JESUS DE GOIAS	1250033187	BOM JESUS DE GOIAS	04/03/2020 19:13	05/03/2020 07:08	04/03/2020 19:13	05/03/2020 07:08	11,91	1	11,91	CHI
20200316820	BONOPOLIS	BX21324126	SAO MIGUEL DO ARAGUAIA	04/03/2020 19:13	05/03/2020 01:00	04/03/2020 19:13	05/03/2020 01:00	5,77	1	5,77	CHI
20200316826	SAO DOMINGOS	8680009856	SAO DOMINGOS	04/03/2020 19:14	04/03/2020 21:03	04/03/2020 19:14	04/03/2020 21:03	1,80	1	1,80	CHI
20200316831	FLORES DE GOIAS	FB12344375	FLORES DE GOIAS	04/03/2020 19:15	05/03/2020 13:36	05/03/2020 09:35	05/03/2020 13:36	4,02	1	4,02	CHI
20200316834	ANHANGUERA	AH11333425	CATALAO S1	04/03/2020 18:19	04/03/2020 22:57	04/03/2020 18:19	04/03/2020 22:57	4,63	79	365,95	CHI
20200316835	GOIANIA	10746535	CAMPINAS S1	04/03/2020 19:16	04/03/2020 21:01	04/03/2020 19:16	04/03/2020 21:01	1,74	1	1,74	CHI
20200316836	PLANALTINA	2960183478	PLANALTINA	04/03/2020 19:16	04/03/2020 20:50	04/03/2020 19:16	04/03/2020 20:50	1,57	1	1,57	CHI
20200316843	QUIRINOPOLIS	QI21306072	QUIRINOPOLIS	04/03/2020 19:17	05/03/2020 11:24	04/03/2020 19:17	05/03/2020 11:24	16,10	1	16,10	CHI
20200316845	SAO MIGUEL DO ARAGUAIA	SM12020668	SAO MIGUEL DO ARAGUAIA	04/03/2020 19:19	04/03/2020 22:37	04/03/2020 19:19	04/03/2020 22:37	3,30	13	42,90	CHI

20200316854	MUNDO NOVO DE GOIAS	NA12090018	NOVA CRIXAS	04/03/2020 19:22	05/03/2020 08:25	04/03/2020 19:22	05/03/2020 08:25	13,04	1	13,04	CHI
20200316854	NOVA CRIXAS	NA12090018	NOVA CRIXAS	04/03/2020 19:22	05/03/2020 08:25	04/03/2020 19:22	05/03/2020 08:25	13,04	1	13,04	CHI
20200316855	GOIANIA	GN21347789	CARAJAS S1	04/03/2020 19:22	04/03/2020 20:15	04/03/2020 20:04	04/03/2020 20:15	0,18	1	0,18	CHI
20200316869	RIO VERDE	RV11256149	RIO VERDE S1	04/03/2020 19:26	04/03/2020 20:53	04/03/2020 19:26	04/03/2020 20:53	1,44	49	70,34	CHI
20200316873	GOUVELANDIA	GB12394808	QUIRINOPOLIS	04/03/2020 18:54	05/03/2020 08:12	04/03/2020 18:54	05/03/2020 08:12	13,29	2	26,58	CHI
20200316873	QUIRINOPOLIS	GB12394808	QUIRINOPOLIS	04/03/2020 18:54	05/03/2020 08:12	04/03/2020 18:54	05/03/2020 08:12	13,29	77	1023,50	CHI
20200316878	GOIANIA	GN11043926	ATLANTICO S2	04/03/2020 19:28	04/03/2020 20:56	04/03/2020 19:28	04/03/2020 20:56	1,46	192	281,01	CHI
20200316881	APARECIDA DE GOIANIA	12545004	ATLANTICO S1	04/03/2020 19:29	04/03/2020 20:05	04/03/2020 19:29	04/03/2020 20:05	0,59	1	0,59	CHI
20200316883	ANAPOLIS	AN11135792	ANAPOLIS UNIVERSITARIO S1	04/03/2020 19:20	04/03/2020 21:27	04/03/2020 19:20	04/03/2020 21:27	2,11	128	270,47	CHI
20200316890	MORRINHOS	MR11381113	MORRINHOS	04/03/2020 19:25	04/03/2020 23:00	04/03/2020 19:25	04/03/2020 23:00	3,58	58	207,74	CHI
20200316891	ITUMBIARA	IT11000019	ITUMBIARA VELHA S1	04/03/2020 19:29	04/03/2020 20:17	04/03/2020 19:29	04/03/2020 20:17	0,79	126	99,75	CHI
20200316894	ITAPIRAPUA	10023761405	MATRINCHA	04/03/2020 19:32	04/03/2020 23:05	04/03/2020 19:32	04/03/2020 23:05	3,55	1	3,55	CHI
20200316899	SAO LUIS DE MONTES BELOS	SL21361910	FIRMINOPOLIS S2	04/03/2020 19:34	04/03/2020 20:52	04/03/2020 19:34	04/03/2020 20:52	1,29	1	1,29	CHI
20200316900	APARECIDA DE GOIANIA	14036939	INDEPENDENCIA S2	04/03/2020 19:34	04/03/2020 20:16	04/03/2020 19:34	04/03/2020 20:16	0,69	1	0,69	CHI
20200316907	SAO LUIS DE MONTES BELOS	SL11259146	SAO LUIZ DOS MONTES BELOS	04/03/2020 19:35	04/03/2020 21:32	04/03/2020 19:35	04/03/2020 21:32	1,94	28	54,46	CHI
20200316912	NIQUELANDIA	NQ12396793	NIQUELANDIA SUBTRANSMISSAO	04/03/2020 19:35	04/03/2020 21:44	04/03/2020 19:35	04/03/2020 21:44	2,14	5	10,70	CHI
20200316914	MORRINHOS	MR11000042	MORRINHOS	04/03/2020 19:26	04/03/2020 23:09	04/03/2020 19:26	04/03/2020 23:09	3,71	132	490,12	CHI
20200316915	MORRINHOS	MR12031171	MORRINHOS	04/03/2020 19:23	04/03/2020 21:11	04/03/2020 19:23	04/03/2020 21:11	1,79	101	181,18	CHI
20200316921	VILA PROPICIO	NP21370405	GOIANESIA S1	04/03/2020 19:37	05/03/2020 01:00	04/03/2020 19:37	05/03/2020 01:00	5,38	1	5,38	CHI
20200316936	LUZIANIA	LZ12389578	VIANOPOLIS	04/03/2020 19:42	05/03/2020 07:31	04/03/2020 19:42	05/03/2020 07:31	11,81	19	224,45	CHI
20200316937	TRINDADE	40315782	TRINDADE	04/03/2020 19:42	04/03/2020 23:08	04/03/2020 19:42	04/03/2020 23:08	3,43	1	3,43	CHI
20200316938	GOIANIA	17436930	GOIANIA LESTE S3	04/03/2020 19:42	04/03/2020 22:40	04/03/2020 19:42	04/03/2020 22:40	2,96	1	2,96	CHI
20200316939	APARECIDA DE GOIANIA	17286359	REAL S1	04/03/2020 19:43	04/03/2020 21:25	04/03/2020 19:43	04/03/2020 21:25	1,70	1	1,70	CHI
20200316952	MORRINHOS	MR11076850	MORRINHOS	04/03/2020 19:43	04/03/2020 23:00	04/03/2020 19:43	04/03/2020 23:00	3,29	126	414,86	CHI
20200316953	SAO LUIS DE MONTES BELOS	500008097	SAO LUIZ DOS MONTES BELOS	04/03/2020 19:45	04/03/2020 22:15	04/03/2020 19:45	04/03/2020 22:15	2,50	1	2,50	CHI
20200316956	MINEIROS	MY11034225	PARQUE DAS EMAS	04/03/2020 19:41	04/03/2020 22:06	04/03/2020 19:41	04/03/2020 22:06	2,41	125	301,46	CHI
20200316957	GOIANIA	GN11000562	AEROPORTO S2	04/03/2020 18:13	04/03/2020 21:24	04/03/2020 18:13	04/03/2020 21:24	3,17	103	326,77	CHI
20200316969	IPIRANGA DE GOIAS	RB21114318	RUBIATABA	04/03/2020 19:50	05/03/2020 09:03	04/03/2020 19:50	05/03/2020 09:03	13,21	1	13,21	CHI
20200316973	FLORES DE GOIAS	FB12062351	FLORES DE GOIAS	04/03/2020 19:50	05/03/2020 07:03	04/03/2020 19:50	05/03/2020 07:03	11,21	2	22,42	CHI
20200316977	TRINDADE	TR11073625	TRINDADE	04/03/2020 19:47	04/03/2020 21:34	04/03/2020 19:47	04/03/2020 21:34	1,78	174	309,38	CHI
20200316985	MORRINHOS	MR11000030	MORRINHOS	04/03/2020 19:37	04/03/2020 21:30	04/03/2020 19:37	04/03/2020 21:30	1,89	184	347,50	CHI
20200316988	MORRINHOS	RQ12257962	VILA CORUMBA	04/03/2020 19:05	05/03/2020 08:43	04/03/2020 19:05	05/03/2020 08:43	13,62	1	13,62	CHI
20200316988	RIO QUENTE	RQ12257962	VILA CORUMBA	04/03/2020 19:05	05/03/2020 08:43	04/03/2020 19:05	05/03/2020 08:43	13,62	9	122,57	CHI
20200316989	ITAPURANGA	IK21210642	ITAPURANGA	04/03/2020 19:53	04/03/2020 23:21	04/03/2020 19:53	04/03/2020 23:21	3,46	1	3,46	CHI
20200316990	MORRINHOS	MR21172946	MORRINHOS	04/03/2020 19:53	05/03/2020 09:03	04/03/2020 19:53	05/03/2020 09:03	13,16	1	13,16	CHI
20200316993	ORIZONA	OZ21151668	VIANOPOLIS	04/03/2020 19:54	04/03/2020 21:01	04/03/2020 19:54	04/03/2020 21:01	1,11	1	1,11	CHI
20200316997	CALDAS NOVAS	CN11309417	CALDAS NOVAS S1	04/03/2020 19:43	05/03/2020 08:29	04/03/2020 19:43	05/03/2020 08:29	12,76	79	1007,65	CHI
20200317005	CACHOEIRA ALTA	CA12200638	CACHOEIRA ALTA	04/03/2020 19:58	04/03/2020 22:13	04/03/2020 19:58	04/03/2020 22:13	2,24	9	20,15	CHI
20200317005	CACU	CA12200638	CACHOEIRA ALTA	04/03/2020 19:58	04/03/2020 22:13	04/03/2020 19:58	04/03/2020 22:13	2,24	5	11,19	CHI
20200317010	PARANAIGUARA	PC12306052	QUIRINOPOLIS	04/03/2020 14:36	04/03/2020 21:31	04/03/2020 14:36	04/03/2020 21:31	6,90	6	41,42	CHI
20200317010	QUIRINOPOLIS	PC12306052	QUIRINOPOLIS	04/03/2020 14:36	04/03/2020 21:31	04/03/2020 14:36	04/03/2020 21:31	6,90	3	20,71	CHI
20200317011	FAZENDA NOVA	FN21141452	JUSSARA	04/03/2020 20:00	05/03/2020 11:14	04/03/2020 20:00	05/03/2020 11:14	15,22	1	15,22	CHI
20200317017	POSSE	PS11279954	IACIARA S2	04/03/2020 20:03	04/03/2020 21:55	04/03/2020 20:03	04/03/2020 21:55	1,86	145	269,62	CHI
20200317019	FORMOSA	10000373484	ITUIQUIRA	04/03/2020 20:03	04/03/2020 20:54	04/03/2020 20:03	04/03/2020 20:54	0,84	1	0,84	CHI

20200317021	ABADIANIA	AA12333151	DAIA S2	04/03/2020 13:19	04/03/2020 23:59	04/03/2020 13:19	04/03/2020 23:59	10,66	21	223,96	CHI
20200317022	IPORA	730060135	IPORA	04/03/2020 20:04	05/03/2020 08:27	04/03/2020 20:04	05/03/2020 08:27	12,37	1	12,37	CHI
20200317035	FORMOSA	10007627724	ITUIQUIRA	04/03/2020 20:09	04/03/2020 21:27	04/03/2020 20:09	04/03/2020 21:27	1,30	1	1,30	CHI
20200317044	TRINDADE	TR11160661	TRINDADE	04/03/2020 20:01	04/03/2020 21:49	04/03/2020 20:01	04/03/2020 21:49	1,78	101	180,20	CHI
20200317046	IPORA	IR21040227	IPORA	04/03/2020 20:14	05/03/2020 00:33	04/03/2020 20:14	05/03/2020 00:33	4,31	1	4,31	CHI
20200317048	QUIRINOPOLIS	QI11000023	QUIRINOPOLIS	04/03/2020 19:15	04/03/2020 21:54	04/03/2020 19:15	04/03/2020 21:54	2,65	60	159,12	CHI
20200317051	BOM JARDIM DE GOIAS	BM12231130	BOM JARDIM	04/03/2020 20:17	05/03/2020 08:26	04/03/2020 20:17	05/03/2020 08:26	12,14	9	109,24	CHI
20200317052	SAO JOAO DA PARAUNA	RP11076379	FIRMINOPOLIS S2	04/03/2020 20:18	04/03/2020 23:16	04/03/2020 20:18	04/03/2020 23:16	2,96	206	608,90	CHI
20200317057	MONTIVIDIU	MV21267646	MONTIVIDIU T	04/03/2020 20:21	05/03/2020 12:03	04/03/2020 20:21	05/03/2020 11:07	14,76	1	14,76	CHI
20200317057	MONTIVIDIU	MV12267613	MONTIVIDIU T	04/03/2020 20:21	05/03/2020 12:03	05/03/2020 08:48	05/03/2020 12:03	3,25	2	6,50	CHI
20200317057	MONTIVIDIU	MV12267613	MONTIVIDIU T	04/03/2020 20:21	05/03/2020 12:03	05/03/2020 11:07	05/03/2020 12:03	0,92	1	0,92	CHI
20200317058	ITUMBIARA	10004325590	ITUMBIARA NOVA	04/03/2020 20:21	04/03/2020 21:10	04/03/2020 20:21	04/03/2020 21:10	0,81	1	0,81	CHI
20200317061	APARECIDA DE GOIANIA	10024951380	INDEPENDENCIA S2	04/03/2020 20:22	04/03/2020 22:06	04/03/2020 20:22	04/03/2020 22:06	1,73	1	1,73	CHI
20200317063	AMARALINA	LC12168861	MARA ROSA	04/03/2020 20:23	05/03/2020 00:12	04/03/2020 20:23	05/03/2020 00:12	3,81	4	15,23	CHI
20200317070	QUIRINOPOLIS	QI11226325	QUIRINOPOLIS	04/03/2020 19:51	05/03/2020 00:06	04/03/2020 19:51	05/03/2020 00:06	4,25	150	637,29	CHI
20200317073	SENADOR CANEDO	14093911	GOIANIA LESTE S1	04/03/2020 20:28	04/03/2020 23:51	04/03/2020 20:28	04/03/2020 23:51	3,38	1	3,38	CHI
20200317074	CORREGO DO OURO	CO21087893	FIRMINOPOLIS S2	04/03/2020 20:28	04/03/2020 21:09	04/03/2020 20:28	04/03/2020 21:09	0,67	1	0,67	CHI
20200317075	ALTO HORIZONTE	AJ21210310	MARA ROSA	04/03/2020 20:29	05/03/2020 10:28	04/03/2020 20:29	05/03/2020 10:28	13,98	1	13,98	CHI
20200317078	CALDAZINHA	LB21164013	CEPAIGO S2	04/03/2020 20:29	05/03/2020 02:48	04/03/2020 20:29	05/03/2020 02:48	6,30	1	6,30	CHI
20200317084	RIO VERDE	RV21246782	RIO VERDE S2	04/03/2020 20:31	04/03/2020 22:38	04/03/2020 20:31	04/03/2020 22:38	2,11	2	4,22	CHI
20200317085	NEROPOLIS	NR21009275	NEROPOLIS S2	04/03/2020 20:32	05/03/2020 01:03	04/03/2020 20:32	05/03/2020 01:03	4,51	2	9,02	CHI
20200317087	GOIANIA	13439911	REAL S1	04/03/2020 20:33	04/03/2020 23:59	04/03/2020 20:33	04/03/2020 23:59	3,42	1	3,42	CHI
20200317089	URUACU	640051893	URUACU	04/03/2020 20:34	04/03/2020 23:00	04/03/2020 20:34	04/03/2020 23:00	2,42	1	2,42	CHI
20200317094	AGUAS LINDAS DE GOIAS	LA11349021	AGUAS LINDAS DE GOIAS S1	04/03/2020 20:36	04/03/2020 23:31	04/03/2020 20:36	04/03/2020 23:31	2,91	76	220,99	CHI
20200317102	ANAPOLIS	AN11130759	ANAPOLIS UNIVERSITARIO S2	04/03/2020 20:36	04/03/2020 22:31	04/03/2020 20:36	04/03/2020 22:31	1,90	130	247,36	CHI
20200317103	RIO QUENTE	RQ21236866	VILA CORUMBA	04/03/2020 20:39	05/03/2020 09:48	04/03/2020 20:39	05/03/2020 09:48	13,14	1	13,14	CHI
20200317107	ANAPOLIS	10011202007	ANAPOLIS UNIVERSITARIO S2	04/03/2020 20:40	04/03/2020 23:46	04/03/2020 20:40	04/03/2020 23:46	3,09	1	3,09	CHI
20200317109	ITAPURANGA	IK21364889	ITAPURANGA	04/03/2020 20:41	05/03/2020 01:38	04/03/2020 20:41	05/03/2020 01:38	4,94	1	4,94	CHI
20200317111	GUAPO	GA12276655	GUAPO S2	04/03/2020 20:42	05/03/2020 02:32	04/03/2020 20:42	05/03/2020 02:32	5,83	44	256,51	CHI
20200317112	GOIAS	GS12058305	GOIAS	04/03/2020 17:28	05/03/2020 11:16	04/03/2020 17:28	05/03/2020 11:16	17,81	5	89,03	CHI
20200317113	AGUAS LINDAS DE GOIAS	10023496604	AGUAS LINDAS DE GOIAS S1	04/03/2020 20:44	05/03/2020 00:01	04/03/2020 20:44	05/03/2020 00:01	3,27	1	3,27	CHI
20200317120	GOIANIA	16735377	XAVANTES	04/03/2020 20:49	05/03/2020 01:14	04/03/2020 20:49	05/03/2020 01:14	4,40	1	4,40	CHI
20200317127	CORUMBAIBA	CI21025126	VILA CORUMBA	04/03/2020 20:52	05/03/2020 08:42	04/03/2020 20:52	05/03/2020 08:42	11,83	1	11,83	CHI
20200317129	COCALZINHO DE GOIAS	ZN11350338	AGUAS LINDAS DE GOIAS S2	04/03/2020 20:44	04/03/2020 22:01	04/03/2020 20:44	04/03/2020 22:01	1,27	28	35,56	CHI
20200317131	SANTA BARBARA DE GOIAS	10002114770	TRINDADE	04/03/2020 20:53	05/03/2020 02:34	04/03/2020 20:53	05/03/2020 02:34	5,68	1	5,68	CHI
20200317133	VIANOPOLIS	510020513	VIANOPOLIS	04/03/2020 20:55	04/03/2020 22:40	04/03/2020 20:55	04/03/2020 22:40	1,74	1	1,74	CHI
20200317136	AMORINOPOLIS	AM12039409	IPORA	04/03/2020 20:55	05/03/2020 09:35	04/03/2020 20:55	05/03/2020 09:35	12,65	5	63,25	CHI
20200317136	IPORA	AM12039409	IPORA	04/03/2020 20:55	05/03/2020 09:35	04/03/2020 20:55	05/03/2020 09:35	12,65	1	12,65	CHI
20200317141	SAO MIGUEL DO ARAGUAIA	SM21152385	SAO MIGUEL DO ARAGUAIA	04/03/2020 21:01	04/03/2020 23:49	04/03/2020 21:01	04/03/2020 23:49	2,79	1	2,79	CHI
20200317142	GUAPO	GA11276637	GUAPO S2	04/03/2020 21:01	05/03/2020 02:43	04/03/2020 21:01	05/03/2020 02:43	5,70	1	5,70	CHI
20200317151	CABECEIRAS	CW11106106	ITUIQUIRA	04/03/2020 18:37	04/03/2020 22:46	04/03/2020 18:37	04/03/2020 22:46	4,15	57	236,27	CHI
20200317154	NOVO GAMA	2460070816	PACAEMBU S1	04/03/2020 21:07	04/03/2020 23:10	04/03/2020 21:07	04/03/2020 23:10	2,04	1	2,04	CHI
20200317155	JUSSARA	JR11023510	IPORA	04/03/2020 20:38	04/03/2020 23:07	04/03/2020 20:38	04/03/2020 23:07	2,48	55	136,16	CHI
20200317161	MINACU	IH12377674	MINACU	04/03/2020 21:11	05/03/2020 11:08	04/03/2020 21:11	05/03/2020 11:08	13,96	18	251,24	CHI

20200317163	ITABERAÍ	50007907	ITABERAÍ S2	04/03/2020 21:12	05/03/2020 12:14	04/03/2020 21:12	05/03/2020 12:14	15,03	1	15,03	CHI
20200317164	NIQUELANDIA	NQ21330288	NIQUELANDIA SUBTRANSMISSAO	04/03/2020 21:12	04/03/2020 22:23	04/03/2020 21:12	04/03/2020 22:23	1,18	1	1,18	CHI
20200317166	INHUMAS	IN21106221	INHUMAS S2	04/03/2020 21:13	04/03/2020 22:34	04/03/2020 21:13	04/03/2020 22:34	1,35	2	2,70	CHI
20200317167	ITAPURANGA	170100418	ITAPURANGA	04/03/2020 21:13	05/03/2020 02:27	04/03/2020 21:13	05/03/2020 02:27	5,22	1	5,22	CHI
20200317169	RIO VERDE	630043449	RIO VERDE S2	04/03/2020 21:14	05/03/2020 16:46	04/03/2020 21:14	05/03/2020 16:46	19,54	1	19,54	CHI
20200317170	AVELINOPOLIS	AV12039027	ANICUNS	04/03/2020 21:03	04/03/2020 22:40	04/03/2020 21:03	04/03/2020 22:40	1,61	3	4,84	CHI
20200317173	JANDAIA	JD12003211	PALMEIRAS	04/03/2020 21:15	05/03/2020 00:19	04/03/2020 21:15	05/03/2020 00:19	3,06	10	30,62	CHI
20200317173	PALMEIRAS DE GOIAS	JD12003211	PALMEIRAS	04/03/2020 21:15	05/03/2020 00:19	04/03/2020 21:15	05/03/2020 00:19	3,06	4	12,25	CHI
20200317173	PALMINOPOLIS	JD12003211	PALMEIRAS	04/03/2020 21:15	05/03/2020 00:19	04/03/2020 21:15	05/03/2020 00:19	3,06	15	45,93	CHI
20200317180	ITAPACI	IW21144974	ITAPACI	04/03/2020 21:20	05/03/2020 04:07	04/03/2020 21:20	05/03/2020 04:07	6,78	2	13,56	CHI
20200317181	CATALAO	CT12166743RE	CATALAO S1	04/03/2020 21:20	05/03/2020 10:01	04/03/2020 21:20	05/03/2020 10:01	12,68	34	430,99	CHI
20200317182	PIRES DO RIO	PR12202877	PIRES DO RIO S1	04/03/2020 21:20	05/03/2020 00:36	04/03/2020 21:20	05/03/2020 00:36	3,25	208	676,98	CHI
20200317187	PALMEIRAS DE GOIAS	PL12000143	PALMEIRAS	04/03/2020 21:23	05/03/2020 08:02	04/03/2020 21:23	05/03/2020 08:02	10,64	36	383,04	CHI
20200317190	APARECIDA DE GOIANIA	AP11157653	INDEPENDENCIA S2	04/03/2020 21:22	04/03/2020 23:18	04/03/2020 21:22	04/03/2020 23:18	1,93	149	287,49	CHI
20200317191	ANAPOLIS	20991186	ANAPOLIS UNIVERSITARIO S2	04/03/2020 21:26	05/03/2020 00:32	04/03/2020 21:26	05/03/2020 00:32	3,09	1	3,09	CHI
20200317198	SANTA RITA DO ARAGUAIA	2130003832	SANTA RITA DO ARAGUAIA	04/03/2020 21:28	04/03/2020 23:35	04/03/2020 21:28	04/03/2020 23:35	2,10	1	2,10	CHI
20200317199	NOVA CRIXAS	8273612	NOVA CRIXAS	04/03/2020 21:29	05/03/2020 15:32	04/03/2020 21:29	05/03/2020 15:32	18,04	1	18,04	CHI
20200317200	GOUVELANDIA	GB12402364	QUIRINOPOLIS	04/03/2020 20:49	05/03/2020 11:06	04/03/2020 20:49	05/03/2020 11:06	14,28	10	142,76	CHI
20200317201	GOIANIA	13519451	XAVANTES	04/03/2020 21:31	05/03/2020 00:29	04/03/2020 21:31	05/03/2020 00:29	2,95	1	2,95	CHI
20200317203	IACIARA	ND12046258	IACIARA S2	04/03/2020 21:34	05/03/2020 02:29	04/03/2020 21:34	05/03/2020 02:29	4,90	2	9,80	CHI
20200317205	JATAI	JT11182019	JATAI S2	04/03/2020 21:34	04/03/2020 23:27	04/03/2020 21:34	04/03/2020 23:27	1,87	116	217,05	CHI
20200317214	GOIANIA	GN11001900	GOIANIA LESTE S3	04/03/2020 21:38	05/03/2020 01:19	04/03/2020 21:38	05/03/2020 01:19	3,68	17	62,59	CHI
20200317217	NOVA CRIXAS	NA12091693	NOVA CRIXAS	04/03/2020 21:38	05/03/2020 00:38	04/03/2020 21:38	05/03/2020 00:38	3,00	2	6,00	CHI
20200317218	HIDROLINA	1020005145	URUACU	04/03/2020 21:39	05/03/2020 10:02	04/03/2020 21:39	05/03/2020 10:02	12,38	1	12,38	CHI
20200317221	APARECIDA DE GOIANIA	AP11141264	ANHANGUERA	04/03/2020 21:41	04/03/2020 23:57	04/03/2020 21:41	04/03/2020 23:57	2,26	91	205,38	CHI
20200317225	AGUAS LINDAS DE GOIAS	10008043432	AGUAS LINDAS DE GOIAS S1	04/03/2020 21:43	05/03/2020 08:17	04/03/2020 21:43	05/03/2020 08:17	10,55	1	10,55	CHI
20200317232	PALMEIRAS DE GOIAS	PL11361555	PALMEIRAS	04/03/2020 21:34	04/03/2020 23:59	04/03/2020 21:34	04/03/2020 23:59	2,41	34	81,81	CHI
20200317242	QUIRINOPOLIS	QI11384076	QUIRINOPOLIS	04/03/2020 20:13	05/03/2020 00:39	04/03/2020 20:13	05/03/2020 00:39	4,43	91	403,18	CHI
20200317248	PONTALINA	PK11048361	PONTALINA	04/03/2020 21:49	04/03/2020 23:44	04/03/2020 21:49	04/03/2020 23:44	1,90	145	275,58	CHI
20200317250	JATAI	10008044056	JATAI S2	04/03/2020 22:00	04/03/2020 23:52	04/03/2020 22:00	04/03/2020 23:52	1,86	1	1,86	CHI
20200317254	SANTO ANTONIO DE GOIAS	BW11161024	NEROPOLIS S1	04/03/2020 21:44	04/03/2020 23:22	04/03/2020 21:44	04/03/2020 23:22	1,63	89	144,65	CHI
20200317255	GOIANIA	13822731	GOYA S1	04/03/2020 22:05	04/03/2020 23:31	04/03/2020 22:05	04/03/2020 23:31	1,43	1	1,43	CHI
20200317257	ESTRELA DO NORTE	00470204	MARA ROSA	04/03/2020 22:05	05/03/2020 07:43	04/03/2020 23:14	04/03/2020 23:17	0,06	1175	71,81	CHI
20200317257	FORMOSO	00470204	MARA ROSA	04/03/2020 22:05	05/03/2020 07:43	04/03/2020 23:14	04/03/2020 23:17	0,06	74	4,52	CHI
20200317257	MARA ROSA	00470204	MARA ROSA	04/03/2020 22:05	05/03/2020 07:43	04/03/2020 23:14	04/03/2020 23:17	0,06	103	6,29	CHI
20200317257	ESTRELA DO NORTE	ET12012489LD	MARA ROSA	04/03/2020 22:05	05/03/2020 07:43	05/03/2020 02:09	05/03/2020 04:43	2,57	342	878,94	CHI
20200317257	ESTRELA DO NORTE	ET12105649	MARA ROSA	04/03/2020 22:05	05/03/2020 07:43	04/03/2020 22:05	05/03/2020 07:43	9,63	246	2369,25	CHI
20200317270	ANICUNS	AC11098894	ANICUNS	04/03/2020 22:18	05/03/2020 00:52	04/03/2020 22:18	05/03/2020 00:52	2,56	147	375,59	CHI
20200317271	ANAPOLIS	21294069	JUNDIAI S1	04/03/2020 22:19	05/03/2020 01:15	04/03/2020 22:19	05/03/2020 01:15	2,93	1	2,93	CHI
20200317274	RIO VERDE	10001304591	RIO VERDE S1	04/03/2020 22:20	05/03/2020 22:38	04/03/2020 22:20	05/03/2020 22:38	24,30	1	24,30	CHI
20200317285	BOM JARDIM DE GOIAS	1880004462	BOM JARDIM	04/03/2020 22:33	04/03/2020 23:46	04/03/2020 22:33	04/03/2020 23:46	1,21	1	1,21	CHI
20200317289	GOIANESIA	GE21185731	GOIANESIA S2	04/03/2020 22:45	05/03/2020 01:07	04/03/2020 22:45	05/03/2020 01:07	2,36	2	4,71	CHI
20200317296	APARECIDA DE GOIANIA	AP11078317	CEPAIGO S1	04/03/2020 22:52	05/03/2020 04:38	04/03/2020 22:52	05/03/2020 04:38	5,76	164	944,32	CHI
20200317300	CIDADE OCIDENTAL	10001476074	MARAJOARA	04/03/2020 22:55	05/03/2020 07:34	04/03/2020 22:55	05/03/2020 07:34	8,64	1	8,64	CHI

20200317306	APARECIDA DE GOIANIA	15835819	ATLANTICO S2	04/03/2020 23:01	05/03/2020 00:00	04/03/2020 23:01	05/03/2020 00:00	0,97	1	0,97	CHI
20200317308	QUIRINOPOLIS	QI11000013	QUIRINOPOLIS	04/03/2020 23:03	05/03/2020 19:15	04/03/2020 23:03	05/03/2020 19:15	20,20	97	1959,24	CHI
20200317320	RIO VERDE	RV21062723	RIO VERDE S2	04/03/2020 23:19	05/03/2020 02:31	04/03/2020 23:19	05/03/2020 02:31	3,18	1	3,18	CHI
20200317324	GUAPO	GA11276629	GUAPO S2	04/03/2020 23:36	05/03/2020 03:05	04/03/2020 23:36	05/03/2020 03:05	3,48	1	3,48	CHI
20200317334	GOIANIA	GN11189940	GOYA S2	04/03/2020 23:41	05/03/2020 02:27	04/03/2020 23:41	05/03/2020 02:27	2,76	89	246,08	CHI
20200317339	ABADIANIA	AA21248831	ANAPOLIS UNIVERSITARIO S1	04/03/2020 23:44	05/03/2020 03:56	04/03/2020 23:44	05/03/2020 03:56	4,20	1	4,20	CHI
20200317343	ARAGUAPAZ	MS12113246	ITAPURANGA	04/03/2020 14:57	05/03/2020 07:45	04/03/2020 14:57	05/03/2020 07:45	16,79	2	33,58	CHI
20200317343	FAINA	MS12113246	ITAPURANGA	04/03/2020 14:57	05/03/2020 07:45	04/03/2020 14:57	05/03/2020 07:45	16,79	7	117,55	CHI
20200317343	MORRO AGUDO DE GOIAS	MS12113246	ITAPURANGA	04/03/2020 14:57	05/03/2020 07:45	04/03/2020 14:57	05/03/2020 07:45	16,79	7	117,55	CHI
20200317344	CATALAO	CT11000070	CATALAO S2	04/03/2020 22:22	05/03/2020 01:38	04/03/2020 22:22	05/03/2020 01:38	3,26	150	489,71	CHI
20200317347	GOIANIA	GN12047147	AEROPORTO S1	05/03/2020 00:04	05/03/2020 02:10	05/03/2020 00:04	05/03/2020 02:10	2,10	170	356,81	CHI
20200317348	APARECIDA DE GOIANIA	AP11137289	INDEPENDENCIA S2	05/03/2020 00:04	05/03/2020 01:32	05/03/2020 00:04	05/03/2020 01:32	1,46	156	228,37	CHI
20200317360	PONTALINA	PK11048361	PONTALINA	05/03/2020 00:04	05/03/2020 09:47	05/03/2020 00:04	05/03/2020 09:47	9,71	145	1408,15	CHI
20200317361	CRISTALINA	KR12164793	PAMPLONA	05/03/2020 00:21	05/03/2020 02:49	05/03/2020 00:21	05/03/2020 02:49	2,46	1	2,46	CHI
20200317362	CORUMBA DE GOIAS	PV12295561	CORUMBA	04/03/2020 23:43	05/03/2020 09:20	04/03/2020 23:44	05/03/2020 09:20	9,60	4	38,39	CHI
20200317362	PIRENOPOLIS	PV12295561	CORUMBA	04/03/2020 23:43	05/03/2020 09:20	04/03/2020 23:44	05/03/2020 09:20	9,60	31	297,53	CHI
20200317363	GOIANIA	GN11399271	GOIANIA LESTE S1	05/03/2020 00:23	05/03/2020 01:56	05/03/2020 00:23	05/03/2020 01:56	1,54	43	66,39	CHI
20200317393	ANAPOLIS	AN11130759	ANAPOLIS UNIVERSITARIO S2	05/03/2020 02:25	05/03/2020 05:21	05/03/2020 02:25	05/03/2020 05:21	2,93	130	380,79	CHI
20200317402	GOIANIA	GN10403965	FERROVIARIO S1	05/03/2020 00:01	05/03/2020 04:30	05/03/2020 00:01	05/03/2020 01:09	1,13	1081	1222,43	CHI
20200317402	GOIANIA	GN10403965	FERROVIARIO S1	05/03/2020 00:01	05/03/2020 04:30	05/03/2020 03:51	05/03/2020 04:14	0,39	1081	416,49	CHI
20200317402	GOIANIA	GN10403965	FERROVIARIO S1	05/03/2020 00:01	05/03/2020 04:30	05/03/2020 00:01	05/03/2020 04:30	4,47	148	662,01	CHI
20200317501	APARECIDA DE GOIANIA	AP10402779	ANHANGUERA	05/03/2020 01:23	05/03/2020 04:21	05/03/2020 01:23	05/03/2020 01:27	0,06	457	29,32	CHI
20200317501	APARECIDA DE GOIANIA	AP13000020	ANHANGUERA	05/03/2020 01:23	05/03/2020 04:21	05/03/2020 01:23	05/03/2020 02:15	0,87	56	48,89	CHI
20200317501	APARECIDA DE GOIANIA	AP10383621	ANHANGUERA	05/03/2020 01:23	05/03/2020 04:21	05/03/2020 01:26	05/03/2020 02:47	1,36	2102	2856,38	CHI
20200317501	APARECIDA DE GOIANIA	AP10383682	ANHANGUERA	05/03/2020 01:23	05/03/2020 04:21	05/03/2020 01:26	05/03/2020 04:21	2,92	198	578,33	CHI
20200317563	QUIRINOPOLIS	QI32053165	QUIRINOPOLIS	05/03/2020 06:32	05/03/2020 10:03	05/03/2020 06:32	05/03/2020 10:03	3,52	8	28,13	CHI
20200317586	ITAPURANGA	IK21298524	ITAPURANGA	05/03/2020 08:28	05/03/2020 13:33	05/03/2020 13:25	05/03/2020 13:33	0,13	1	0,13	CHI
20200317598	ORIZONA	OZ21185890	PIRES DO RIO S2	05/03/2020 09:01	05/03/2020 10:30	05/03/2020 09:01	05/03/2020 10:30	1,48	1	1,48	CHI
20200317600	GOIANIA	O2400254	AEROPORTO S1	05/03/2020 09:03	05/03/2020 12:30	05/03/2020 09:03	05/03/2020 09:06	0,05	392	19,60	CHI
20200317600	GOIANIA	GN10380042	AEROPORTO S1	05/03/2020 09:03	05/03/2020 12:30	05/03/2020 09:17	05/03/2020 09:57	0,68	447	303,59	CHI
20200317600	GOIANIA	GN16415878	AEROPORTO S1	05/03/2020 09:03	05/03/2020 12:30	05/03/2020 09:17	05/03/2020 09:58	0,68	918	627,30	CHI
20200317600	GOIANIA	GN13000171	AEROPORTO S1	05/03/2020 09:03	05/03/2020 12:30	05/03/2020 09:17	05/03/2020 12:30	3,22	441	1421,49	CHI
20200317605	MORRINHOS	MR11160446	MORRINHOS	05/03/2020 03:28	05/03/2020 08:16	05/03/2020 03:28	05/03/2020 08:16	4,79	61	292,46	CHI
20200317606	MORRINHOS	MR21293159	MORRINHOS	05/03/2020 03:29	05/03/2020 11:13	05/03/2020 03:29	05/03/2020 11:13	7,73	1	7,73	CHI
20200317607	GOIATUBA	GT12048503	GOIATUBA S2	05/03/2020 03:36	05/03/2020 07:42	05/03/2020 03:36	05/03/2020 07:42	4,08	22	89,84	CHI
20200317611	MOZARLANDIA	MZ12220375	MOZARLANDIA	05/03/2020 03:49	05/03/2020 08:26	05/03/2020 03:49	05/03/2020 08:26	4,61	31	142,82	CHI
20200317612	GOIAS	NB12092962	MATRINCHA	05/03/2020 03:53	05/03/2020 11:07	05/03/2020 03:53	05/03/2020 11:07	7,23	3	21,69	CHI
20200317612	ITAPIRAPUA	NB12092962	MATRINCHA	05/03/2020 03:53	05/03/2020 11:07	05/03/2020 03:53	05/03/2020 11:07	7,23	1	7,23	CHI
20200317612	NOVO BRASIL	NB12092962	MATRINCHA	05/03/2020 03:53	05/03/2020 11:07	05/03/2020 03:53	05/03/2020 11:07	7,23	5	36,15	CHI
20200317614	GOIANIRA	GR21277191	NEROPOLIS S1	05/03/2020 04:04	05/03/2020 07:23	05/03/2020 04:04	05/03/2020 07:23	3,30	1	3,30	CHI
20200317616	PARAUNA	PU12357332	PARAUNA	05/03/2020 04:25	05/03/2020 13:30	05/03/2020 04:25	05/03/2020 10:15	5,83	1	5,83	CHI
20200317616	PARAUNA	PU12357332	PARAUNA	05/03/2020 04:25	05/03/2020 13:30	05/03/2020 04:25	05/03/2020 13:30	9,08	25	227,10	CHI
20200317616	PARAUNA	PU13361636	PARAUNA	05/03/2020 04:25	05/03/2020 13:30	05/03/2020 09:07	05/03/2020 13:30	4,38	1	4,38	CHI
20200317620	NOVA AURORA	NE21157524	CATALAO S1	05/03/2020 04:35	05/03/2020 10:39	05/03/2020 04:35	05/03/2020 10:39	6,05	1	6,05	CHI

20200317622	MOSSAMEDES	MD12005317	FIRMINOPOLIS S2	05/03/2020 04:43	05/03/2020 06:44	05/03/2020 04:43	05/03/2020 06:44	2,01	16	32,24	CHI
20200317623	NOVA IGUAÇU DE GOIAS	NH12202113	SANTA TEREZINHA	05/03/2020 04:46	05/03/2020 09:00	05/03/2020 04:46	05/03/2020 09:00	4,23	63	266,39	CHI
20200317625	BONOPOLIS	BX12168258	SAO MIGUEL DO ARAGUAIA	05/03/2020 04:52	05/03/2020 11:14	05/03/2020 04:52	05/03/2020 11:14	6,35	20	127,01	CHI
20200317625	CACU	BX12168258	SAO MIGUEL DO ARAGUAIA	05/03/2020 04:52	05/03/2020 11:14	05/03/2020 04:52	05/03/2020 11:14	6,35	1	6,35	CHI
20200317627	NOVA CRIXAS	NA12158761	NOVA CRIXAS	05/03/2020 04:55	05/03/2020 06:47	05/03/2020 04:55	05/03/2020 06:47	1,86	6	11,19	CHI
20200317628	SAO MIGUEL DO ARAGUAIA	SM12228636	SAO MIGUEL DO ARAGUAIA	05/03/2020 04:59	05/03/2020 09:34	05/03/2020 04:59	05/03/2020 09:34	4,57	57	260,60	CHI
20200317629	GAMELEIRA DE GOIAS	SV21227714	DAIA S2	05/03/2020 05:02	05/03/2020 10:01	05/03/2020 05:02	05/03/2020 10:01	4,97	1	4,97	CHI
20200317630	MIMOSO DE GOIAS	NQ12207364	BARRO ALTO	05/03/2020 05:07	05/03/2020 09:10	05/03/2020 05:07	05/03/2020 09:10	4,06	4	16,24	CHI
20200317630	NIQUELANDIA	NQ12207364	BARRO ALTO	05/03/2020 05:07	05/03/2020 09:10	05/03/2020 05:07	05/03/2020 09:10	4,06	26	105,58	CHI
20200317635	CRIXAS	NM21143581	RUBIATABA	05/03/2020 05:22	05/03/2020 08:18	05/03/2020 05:22	05/03/2020 08:18	2,93	2	5,86	CHI
20200317636	DOVERLANDIA	DV12380977	CAIAPONIA	05/03/2020 04:07	05/03/2020 07:43	05/03/2020 04:07	05/03/2020 07:43	3,59	91	326,59	CHI
20200317637	ITABERAI	IB12310600	ITABERAI S2	05/03/2020 05:23	05/03/2020 13:53	05/03/2020 05:23	05/03/2020 10:39	5,27	37	195,11	CHI
20200317637	ITABERAI	IB12124895	ITABERAI S2	05/03/2020 05:23	05/03/2020 13:53	05/03/2020 05:23	05/03/2020 13:53	8,51	41	348,81	CHI
20200317640	NIQUELANDIA	NQ12265692	URUACU	05/03/2020 05:26	05/03/2020 09:25	05/03/2020 05:26	05/03/2020 09:25	3,98	6	23,88	CHI
20200317641	RIO VERDE	RV12025925	MONTIVIDIU T	05/03/2020 05:26	05/03/2020 22:06	05/03/2020 05:26	05/03/2020 22:06	16,66	14	233,24	CHI
20200317642	BELA VISTA DE GOIAS	BV12084793	BELA VISTA S1	05/03/2020 05:28	05/03/2020 11:21	05/03/2020 05:28	05/03/2020 11:21	5,88	4	23,53	CHI
20200317646	PARAUNA	PU12007910	PARAUNA	05/03/2020 05:36	05/03/2020 06:40	05/03/2020 05:36	05/03/2020 06:40	1,06	3	3,19	CHI
20200317647	MINACU	IH12088797	MINACU	05/03/2020 05:36	05/03/2020 08:17	05/03/2020 05:36	05/03/2020 08:17	2,68	163	437,07	CHI
20200317648	NOVA IGUAÇU DE GOIAS	NH21040663	SANTA TEREZINHA	05/03/2020 05:37	05/03/2020 11:09	05/03/2020 05:37	05/03/2020 11:09	5,53	1	5,53	CHI
20200317649	SAO MIGUEL DO ARAGUAIA	SM12096096	SAO MIGUEL DO ARAGUAIA	04/03/2020 21:19	05/03/2020 08:03	04/03/2020 21:19	05/03/2020 08:03	10,73	13	139,46	CHI
20200317650	BONFINOPOLIS	GP12195715	GOIANIA LESTE S2	05/03/2020 05:42	05/03/2020 09:44	05/03/2020 05:42	05/03/2020 09:44	4,02	1	4,02	CHI
20200317650	GOIANAPOLIS	GP12195715	GOIANIA LESTE S2	05/03/2020 05:42	05/03/2020 09:44	05/03/2020 05:42	05/03/2020 09:44	4,02	1	4,02	CHI
20200317653	ABADIANIA	AA12241539	ANAPOLIS UNIVERSITARIO S1	05/03/2020 05:51	05/03/2020 09:29	05/03/2020 05:51	05/03/2020 09:29	3,63	33	119,88	CHI
20200317653	CORUMBA DE GOIAS	AA12241539	ANAPOLIS UNIVERSITARIO S1	05/03/2020 05:51	05/03/2020 09:29	05/03/2020 05:51	05/03/2020 09:29	3,63	2	7,27	CHI
20200317658	CAMPESTRE DE GOIAS	GA12008543	GUAPO S2	05/03/2020 05:52	05/03/2020 08:46	05/03/2020 05:52	05/03/2020 08:46	2,89	11	31,77	CHI
20200317658	GUAPO	GA12008543	GUAPO S2	05/03/2020 05:52	05/03/2020 08:46	05/03/2020 05:52	05/03/2020 08:46	2,89	27	77,98	CHI
20200317659	INHUMAS	IN21066016	INHUMAS S1	05/03/2020 05:53	05/03/2020 11:13	05/03/2020 05:53	05/03/2020 11:13	5,32	1	5,32	CHI
20200317662	ARAGUAPAZ	AZ12042979	MOZARLANDIA	05/03/2020 05:54	05/03/2020 07:46	05/03/2020 05:54	05/03/2020 07:46	1,86	10	18,61	CHI
20200317667	INDIARA	IY12395106	EDEIA	04/03/2020 23:15	06/03/2020 00:48	05/03/2020 05:58	05/03/2020 14:32	8,58	2	17,15	CHI
20200317667	INDIARA	IY12395106	EDEIA	04/03/2020 23:15	06/03/2020 00:48	05/03/2020 08:22	05/03/2020 14:32	6,17	10	61,66	CHI
20200317667	INDIARA	IY12395106	EDEIA	04/03/2020 23:15	06/03/2020 00:48	05/03/2020 05:58	05/03/2020 15:04	9,10	258	2348,59	CHI
20200317667	INDIARA	IY12395106	EDEIA	04/03/2020 23:15	06/03/2020 00:48	05/03/2020 05:58	06/03/2020 00:48	18,83	1	18,83	CHI
20200317668	BELA VISTA DE GOIAS	BV12202366	BELA VISTA S2	05/03/2020 06:01	05/03/2020 10:10	05/03/2020 06:01	05/03/2020 10:10	4,15	9	37,34	CHI
20200317669	CALDAS NOVAS	CN12213834	CALDAS NOVAS S1	05/03/2020 06:01	05/03/2020 17:38	05/03/2020 13:30	05/03/2020 17:37	4,13	2	8,25	CHI
20200317669	CALDAS NOVAS	CN21213845	CALDAS NOVAS S1	05/03/2020 06:01	05/03/2020 17:38	05/03/2020 06:01	05/03/2020 17:38	11,63	2	23,25	CHI
20200317670	PALMEIRAS DE GOIAS	PL12046351	PALMEIRAS	05/03/2020 06:01	05/03/2020 07:46	05/03/2020 06:01	05/03/2020 07:46	1,74	4	6,98	CHI
20200317671	CRIXAS	IW12211868	RUBIATABA	05/03/2020 06:01	05/03/2020 11:19	05/03/2020 06:01	05/03/2020 11:19	5,29	12	63,48	CHI
20200317671	GUARINOS	IW12211868	RUBIATABA	05/03/2020 06:01	05/03/2020 11:19	05/03/2020 06:01	05/03/2020 11:19	5,29	5	26,45	CHI
20200317671	ITAPACI	IW12211868	RUBIATABA	05/03/2020 06:01	05/03/2020 11:19	05/03/2020 06:01	05/03/2020 11:19	5,29	19	100,50	CHI
20200317673	BURITI DE GOIAS	BS12079946	FIRMINOPOLIS S2	05/03/2020 06:02	05/03/2020 08:12	05/03/2020 06:02	05/03/2020 08:12	2,15	3	6,46	CHI
20200317675	CIDADE OCIDENTAL	DH21128821	MARAJOARA	05/03/2020 06:06	05/03/2020 08:14	05/03/2020 06:06	05/03/2020 08:14	2,12	6	12,70	CHI
20200317676	CEZARINA	PL12304466	PALMEIRAS	05/03/2020 06:06	05/03/2020 07:50	05/03/2020 06:06	05/03/2020 07:50	1,72	1	1,72	CHI
20200317676	PALMEIRAS DE GOIAS	PL12304466	PALMEIRAS	05/03/2020 06:06	05/03/2020 07:50	05/03/2020 06:06	05/03/2020 07:50	1,72	12	20,61	CHI
20200317677	IPAMERI	UT12027069RE	URUTAI	05/03/2020 06:07	05/03/2020 09:02	05/03/2020 06:07	05/03/2020 09:02	2,91	32	93,16	CHI

20200317677	URUTAI	UT12027069RE	URUTAI	05/03/2020 06:07	05/03/2020 09:02	05/03/2020 06:07	05/03/2020 09:02	2,91	47	136,84	CHI
20200317680	PALMINOPOLIS	PP12299141	FIRMINOPOLIS S2	05/03/2020 06:07	05/03/2020 08:17	05/03/2020 06:07	05/03/2020 08:17	2,15	15	32,32	CHI
20200317681	BURITI ALEGRE	BG12263568RE	ITUMBIARA VELHA S2	05/03/2020 06:08	05/03/2020 08:44	05/03/2020 06:08	05/03/2020 08:44	2,59	12	31,13	CHI
20200317681	ITUMBIARA	BG12263568RE	ITUMBIARA VELHA S2	05/03/2020 06:08	05/03/2020 08:44	05/03/2020 06:08	05/03/2020 08:44	2,59	118	306,11	CHI
20200317682	VARJAO	VJ12346703	GUAPO S2	05/03/2020 06:08	05/03/2020 11:06	05/03/2020 06:08	05/03/2020 11:06	4,95	4	19,81	CHI
20200317683	PONTALINA	PK12263503	PONTALINA	05/03/2020 06:09	05/03/2020 08:51	05/03/2020 06:09	05/03/2020 08:51	2,69	14	37,71	CHI
20200317684	FORMOSO	FO21313419	MARA ROSA	05/03/2020 06:09	05/03/2020 14:57	05/03/2020 06:09	05/03/2020 14:57	8,79	1	8,79	CHI
20200317686	LUZIANIA	LZ21156585	CRISTALINA S1	05/03/2020 06:10	05/03/2020 12:23	05/03/2020 06:10	05/03/2020 12:23	6,21	3	18,63	CHI
20200317690	CATALAO	CT12067787	CATALAO S2	05/03/2020 03:08	05/03/2020 07:56	05/03/2020 03:08	05/03/2020 07:56	4,79	337	1612,64	CHI
20200317693	CAIAPONIA	CP12395440	PALESTINA	05/03/2020 06:14	05/03/2020 11:23	05/03/2020 06:14	05/03/2020 11:23	5,15	18	92,64	CHI
20200317694	PARAUNA	PU21237780	PALMEIRAS	05/03/2020 06:14	05/03/2020 14:40	05/03/2020 06:14	05/03/2020 14:40	8,42	1	8,42	CHI
20200317695	GOIATUBA	CL12214130RE	RIO DOS BOIS	05/03/2020 06:15	07/03/2020 20:04	05/03/2020 10:40	05/03/2020 11:09	0,49	18	8,73	CHI
20200317695	PORTEIRAO	CL12214130RE	RIO DOS BOIS	05/03/2020 06:15	07/03/2020 20:04	05/03/2020 10:40	05/03/2020 11:09	0,49	27	13,10	CHI
20200317695	EDEIA	CL12230806	RIO DOS BOIS	05/03/2020 06:15	07/03/2020 20:04	05/03/2020 06:15	07/03/2020 00:04	41,81	1	41,81	CHI
20200317695	PORTEIRAO	CL12230806	RIO DOS BOIS	05/03/2020 06:15	07/03/2020 20:04	05/03/2020 06:15	07/03/2020 00:04	41,81	4	167,25	CHI
20200317695	VICENTINOPOLIS	CL12230806	RIO DOS BOIS	05/03/2020 06:15	07/03/2020 20:04	05/03/2020 06:15	07/03/2020 00:04	41,81	4	167,25	CHI
20200317695	EDEIA	CL12230806	RIO DOS BOIS	05/03/2020 06:15	07/03/2020 20:04	07/03/2020 00:32	07/03/2020 20:04	19,54	2	39,08	CHI
20200317695	PORTEIRAO	CL12230806	RIO DOS BOIS	05/03/2020 06:15	07/03/2020 20:04	07/03/2020 00:32	07/03/2020 20:04	19,54	4	78,16	CHI
20200317695	VICENTINOPOLIS	CL12230806	RIO DOS BOIS	05/03/2020 06:15	07/03/2020 20:04	07/03/2020 00:32	07/03/2020 20:04	19,54	4	78,16	CHI
20200317696	CAVALCANTE	TI12162624	NIQUELANDIA SUBTRANSMISSAO	05/03/2020 06:15	05/03/2020 13:33	05/03/2020 08:30	05/03/2020 09:38	1,14	58	66,12	CHI
20200317696	COLINAS DO SUL	TI12162624	NIQUELANDIA SUBTRANSMISSAO	05/03/2020 06:15	05/03/2020 13:33	05/03/2020 08:30	05/03/2020 09:38	1,14	6	6,84	CHI
20200317696	COLINAS DO SUL	TI12355513	NIQUELANDIA SUBTRANSMISSAO	05/03/2020 06:15	05/03/2020 13:33	05/03/2020 06:15	05/03/2020 11:11	4,92	9	44,31	CHI
20200317696	COLINAS DO SUL	TI12355513	NIQUELANDIA SUBTRANSMISSAO	05/03/2020 06:15	05/03/2020 13:33	05/03/2020 06:15	05/03/2020 13:33	7,29	2	14,58	CHI
20200317698	ITUMBIARA	IT12075764	ITUMBIARA VELHA S2	05/03/2020 06:17	05/03/2020 11:05	05/03/2020 06:17	05/03/2020 11:05	4,78	8	38,27	CHI
20200317699	TROMBAS	TB12391646	PORANGATU	05/03/2020 06:18	05/03/2020 09:30	05/03/2020 06:18	05/03/2020 09:30	3,20	6	19,17	CHI
20200317700	CEZARINA	CZ12314868	CEZARINA	05/03/2020 06:19	05/03/2020 10:23	05/03/2020 06:19	05/03/2020 10:23	4,07	19	77,26	CHI
20200317701	GOIANIA	10000209641	CAMPINAS S2	05/03/2020 06:19	05/03/2020 07:07	05/03/2020 06:19	05/03/2020 07:07	0,79	1	0,79	CHI
20200317704	SAO DOMINGOS	SD12170547	SAO DOMINGOS	05/03/2020 06:20	05/03/2020 11:21	05/03/2020 06:20	05/03/2020 11:21	5,01	13	65,07	CHI
20200317707	APARECIDA DE GOIANIA	16862041	REAL S1	05/03/2020 06:22	05/03/2020 07:33	05/03/2020 06:22	05/03/2020 07:33	1,18	1	1,18	CHI
20200317709	TRINDADE	TR11160661	TRINDADE	05/03/2020 06:22	05/03/2020 11:57	05/03/2020 06:22	05/03/2020 11:57	5,57	101	562,40	CHI
20200317710	CACHOEIRA DOURADA	CD21000071	CACHOEIRA DOURADA	05/03/2020 06:23	05/03/2020 09:27	05/03/2020 06:23	05/03/2020 09:27	3,07	1	3,07	CHI
20200317711	ANAPOLIS	AN12000193RE	ANAPOLIS UNIVERSITARIO S2	05/03/2020 06:23	05/03/2020 08:36	05/03/2020 06:23	05/03/2020 08:36	2,20	48	105,77	CHI
20200317711	PIRENOPOLIS	AN12000193RE	ANAPOLIS UNIVERSITARIO S2	05/03/2020 06:23	05/03/2020 08:36	05/03/2020 06:23	05/03/2020 08:36	2,20	17	37,46	CHI
20200317712	BOM JARDIM DE GOIAS	BM12335391	BOM JARDIM	05/03/2020 06:24	05/03/2020 14:47	05/03/2020 06:24	05/03/2020 14:47	8,38	2	16,75	CHI
20200317714	MONTES CLAROS DE GOIAS	ME12207822	IPORA	05/03/2020 06:26	05/03/2020 10:22	05/03/2020 06:26	05/03/2020 10:22	3,93	28	110,10	CHI
20200317715	MINEIROS	PW12219564	PARQUE DAS EMAS	05/03/2020 05:13	05/03/2020 08:42	05/03/2020 05:13	05/03/2020 08:42	3,47	7	24,27	CHI
20200317715	PORTELANDIA	PW12219564	PARQUE DAS EMAS	05/03/2020 05:13	05/03/2020 08:42	05/03/2020 05:13	05/03/2020 08:42	3,47	11	38,14	CHI
20200317716	TURVANIA	TV21026474	FIRMINOPOLIS S1	05/03/2020 06:26	05/03/2020 10:14	05/03/2020 06:26	05/03/2020 10:14	3,79	1	3,79	CHI
20200317717	ORIZONA	OZ12300563	PIRES DO RIO S2	05/03/2020 06:27	05/03/2020 13:30	05/03/2020 06:27	05/03/2020 13:30	7,06	30	211,83	CHI
20200317720	JATAI	JT12248490	JATAI S1	05/03/2020 06:28	05/03/2020 09:45	05/03/2020 06:28	05/03/2020 09:45	3,27	6	19,61	CHI
20200317722	GOIANESIA	GE12357342	GOIANESIA S2	05/03/2020 06:29	05/03/2020 10:08	05/03/2020 06:29	05/03/2020 10:08	3,64	18	65,60	CHI
20200317722	VILA PROPICIO	GE12357342	GOIANESIA S2	05/03/2020 06:29	05/03/2020 10:08	05/03/2020 06:29	05/03/2020 10:08	3,64	9	32,80	CHI
20200317723	GOIAS	IU12089755	MATRINCHA	05/03/2020 06:20	05/03/2020 08:30	05/03/2020 06:20	05/03/2020 08:30	2,15	1	2,15	CHI
20200317723	ITAPIRAPUA	IU12089755	MATRINCHA	05/03/2020 06:20	05/03/2020 08:30	05/03/2020 06:20	05/03/2020 08:30	2,15	56	120,46	CHI

20200317724	ANAPOLIS	AN31037461	NEROPOLIS S1	05/03/2020 06:30	05/03/2020 11:56	05/03/2020 06:30	05/03/2020 11:56	5,42	1	5,42	CHI
20200317725	NIQUELANDIA	NQ12280419	NIQUELANDIA SUBTRANSMISSAO	05/03/2020 06:30	05/03/2020 08:54	05/03/2020 06:30	05/03/2020 08:54	2,39	64	152,76	CHI
20200317730	MINEIROS	MY12114029	PARQUE DAS EMAS	05/03/2020 06:12	05/03/2020 09:14	05/03/2020 06:12	05/03/2020 09:14	3,03	7	21,18	CHI
20200317733	BOM JESUS DE GOIAS	DM12153969	RIO DOS BOIS	05/03/2020 06:34	05/03/2020 12:59	05/03/2020 06:34	05/03/2020 12:59	6,40	1	6,40	CHI
20200317733	CASTELANDIA	DM12153969	RIO DOS BOIS	05/03/2020 06:34	05/03/2020 12:59	05/03/2020 06:34	05/03/2020 12:59	6,40	5	32,02	CHI
20200317733	QUIRINOPOLIS	DM12153969	RIO DOS BOIS	05/03/2020 06:34	05/03/2020 12:59	05/03/2020 06:34	05/03/2020 12:59	6,40	9	57,64	CHI
20200317736	ALEXANIA	AX12095958	CORUMBA	05/03/2020 05:54	05/03/2020 13:22	05/03/2020 05:54	05/03/2020 13:22	7,46	6	44,73	CHI
20200317736	CORUMBA DE GOIAS	AX12095958	CORUMBA	05/03/2020 05:54	05/03/2020 13:22	05/03/2020 05:54	05/03/2020 13:22	7,46	3	22,37	CHI
20200317737	ANAPOLIS	AN21258099	NEROPOLIS S1	05/03/2020 14:06	05/03/2020 18:54	05/03/2020 14:06	05/03/2020 18:54	4,79	1	4,79	CHI
20200317739	AURILANDIA	RP12304543	FIRMINOPOLIS S2	05/03/2020 06:38	05/03/2020 10:18	05/03/2020 06:38	05/03/2020 10:18	3,65	3	10,96	CHI
20200317739	PARAUNA	RP12304543	FIRMINOPOLIS S2	05/03/2020 06:38	05/03/2020 10:18	05/03/2020 06:38	05/03/2020 10:18	3,65	35	127,92	CHI
20200317740	SANCLERLANDIA	SC21299155	FIRMINOPOLIS S2	05/03/2020 06:38	05/03/2020 10:15	05/03/2020 06:38	05/03/2020 10:15	3,60	1	3,60	CHI
20200317741	ABADIANIA	AA12384293	ANAPOLIS UNIVERSITARIO S1	05/03/2020 06:38	05/03/2020 11:23	05/03/2020 06:38	05/03/2020 11:23	4,74	4	18,94	CHI
20200317747	PARAUNA	PU12159023	PARAUNA	05/03/2020 06:40	05/03/2020 11:54	05/03/2020 06:40	05/03/2020 11:54	5,23	4	20,92	CHI
20200317748	HIDROLANDIA	HD12006204	INDEPENDENCIA S1	05/03/2020 06:40	05/03/2020 08:59	05/03/2020 06:40	05/03/2020 08:59	2,31	26	60,18	CHI
20200317750	PILAR DE GOIAS	GG12166533	SANTA TEREZINHA	05/03/2020 06:40	05/03/2020 12:08	05/03/2020 06:40	05/03/2020 12:08	5,45	9	49,09	CHI
20200317750	SANTA TEREZINHA DE GOIAS	GG12166533	SANTA TEREZINHA	05/03/2020 06:40	05/03/2020 12:08	05/03/2020 06:40	05/03/2020 12:08	5,45	6	32,73	CHI
20200317751	FORMOSA	FA11233671	SAO JOAO D ALIANCA	05/03/2020 06:40	05/03/2020 10:17	05/03/2020 06:40	05/03/2020 10:17	3,60	1	3,60	CHI
20200317753	FAZENDA NOVA	FN12082334	IPORA	05/03/2020 05:08	05/03/2020 18:42	05/03/2020 05:08	05/03/2020 18:42	13,57	12	162,78	CHI
20200317753	ISRAELANDIA	FN12082334	IPORA	05/03/2020 05:08	05/03/2020 18:42	05/03/2020 05:08	05/03/2020 18:42	13,57	2	27,13	CHI
20200317755	CAMPINACU	UC12237456	MARA ROSA	05/03/2020 06:41	05/03/2020 11:20	05/03/2020 06:41	05/03/2020 11:20	4,64	7	32,47	CHI
20200317755	URUACU	UC12237456	MARA ROSA	05/03/2020 06:41	05/03/2020 11:20	05/03/2020 06:41	05/03/2020 11:20	4,64	5	23,19	CHI
20200317757	IACIARA	ND12046258	IACIARA S2	05/03/2020 06:42	05/03/2020 11:14	05/03/2020 10:35	05/03/2020 11:14	0,65	2	1,30	CHI
20200317760	MIMOSO DE GOIAS	MJ12376736	PADRE BERNARDO	05/03/2020 06:43	05/03/2020 18:47	05/03/2020 06:43	05/03/2020 18:47	12,08	26	314,14	CHI
20200317762	HIDROLANDIA	HD12034363	CEPAIGO S2	05/03/2020 06:43	05/03/2020 11:08	05/03/2020 06:43	05/03/2020 11:08	4,41	2	8,82	CHI
20200317767	GOIAS	GS21116950	GOIAS	05/03/2020 06:44	05/03/2020 11:56	05/03/2020 06:44	05/03/2020 11:56	5,19	1	5,19	CHI
20200317772	JATAI	290172410	JATAI S3	05/03/2020 06:46	05/03/2020 08:41	05/03/2020 06:46	05/03/2020 08:41	1,92	1	1,92	CHI
20200317779	FLORES DE GOIAS	FB12211536	IACIARA S2	05/03/2020 06:49	05/03/2020 11:54	05/03/2020 06:49	05/03/2020 11:54	5,07	14	71,02	CHI
20200317783	LUZIANIA	LZ12304995	VIANOPOLIS	05/03/2020 06:52	05/03/2020 10:25	05/03/2020 06:52	05/03/2020 10:25	3,54	8	28,33	CHI
20200317783	ORIZONA	LZ12304995	VIANOPOLIS	05/03/2020 06:52	05/03/2020 10:25	05/03/2020 06:52	05/03/2020 10:25	3,54	86	304,58	CHI
20200317784	BALIZA	BH12358791	CAIAPONIA	05/03/2020 06:42	05/03/2020 10:08	05/03/2020 06:42	05/03/2020 10:08	3,42	5	17,09	CHI
20200317785	IVOLANDIA	IV12231193	ARENOPOLIS	05/03/2020 05:09	05/03/2020 09:49	05/03/2020 05:09	05/03/2020 09:49	4,66	9	41,97	CHI
20200317785	PALESTINA DE GOIAS	IV12231193	ARENOPOLIS	05/03/2020 05:09	05/03/2020 09:49	05/03/2020 05:09	05/03/2020 09:49	4,66	13	60,63	CHI
20200317786	EDEIA	EA12043985	EDEIA	05/03/2020 06:53	05/03/2020 08:53	05/03/2020 06:53	05/03/2020 08:53	1,99	5	9,96	CHI
20200317787	ARUANA	AK12250808	ARUANA	05/03/2020 06:53	05/03/2020 08:07	05/03/2020 06:53	05/03/2020 08:07	1,22	4	4,90	CHI
20200317788	CALDAS NOVAS	CN11162998	SERRA DE CALDAS	05/03/2020 00:51	05/03/2020 08:58	05/03/2020 00:51	05/03/2020 08:58	8,11	264	2140,31	CHI
20200317789	MONTES CLAROS DE GOIAS	ME12184484	IPORA	05/03/2020 06:53	05/03/2020 10:23	05/03/2020 06:53	05/03/2020 10:23	3,49	33	115,03	CHI
20200317794	GOIANIA	10012638356	CARAJAS S1	05/03/2020 06:54	05/03/2020 08:18	05/03/2020 06:54	05/03/2020 08:18	1,39	1	1,39	CHI
20200317799	AMARALINA	LC12182475	SAO MIGUEL DO ARAGUAIA	05/03/2020 06:55	05/03/2020 11:07	05/03/2020 06:55	05/03/2020 11:07	4,18	78	326,32	CHI
20200317803	ITAGUARI	IC12219937	ITABERAI S1	05/03/2020 06:02	05/03/2020 08:08	05/03/2020 06:02	05/03/2020 08:08	2,09	25	52,28	CHI
20200317803	ITAGUARU	IC12219937	ITABERAI S1	05/03/2020 06:02	05/03/2020 08:08	05/03/2020 06:02	05/03/2020 08:08	2,09	2	4,18	CHI
20200317813	EDEALINA	ED12007679	PONTALINA	05/03/2020 06:58	05/03/2020 10:10	05/03/2020 06:58	05/03/2020 10:10	3,19	16	51,04	CHI
20200317814	GOIANESIA	GE12253807	GOIANESIA S2	05/03/2020 06:58	05/03/2020 13:45	05/03/2020 06:58	05/03/2020 13:45	6,77	7	47,41	CHI
20200317816	GOUVELANDIA	GB21303168	QUIRINOPOLIS	05/03/2020 06:59	05/03/2020 11:10	05/03/2020 06:59	05/03/2020 11:10	4,18	2	8,37	CHI

20200317818	MINEIROS	MY12390605	PARQUE DAS EMAS	05/03/2020 06:59	05/03/2020 12:03	05/03/2020 06:59	05/03/2020 12:03	5,06	15	75,84	CHI
20200317821	AGUAS LINDAS DE GOIAS	10006319597	AGUAS LINDAS DE GOIAS S1	05/03/2020 07:00	05/03/2020 09:17	05/03/2020 07:00	05/03/2020 09:17	2,28	1	2,28	CHI
20200317824	HIDROLANDIA	AO21277406	GUAPO S2	05/03/2020 07:00	05/03/2020 10:03	05/03/2020 07:00	05/03/2020 10:03	3,03	1	3,03	CHI
20200317830	SAO MIGUEL DO ARAGUAIA	SM12151032	SAO MIGUEL DO ARAGUAIA	05/03/2020 06:58	05/03/2020 08:20	05/03/2020 06:58	05/03/2020 08:20	1,36	9	12,23	CHI
20200317835	DOVERLANDIA	DV12207929	CAIAPONIA	05/03/2020 07:03	05/03/2020 13:19	05/03/2020 07:03	05/03/2020 13:19	6,26	5	31,28	CHI
20200317840	ORIZONA	2060032812	VIANOPOLIS	05/03/2020 07:04	05/03/2020 12:07	05/03/2020 07:04	05/03/2020 12:07	5,05	1	5,05	CHI
20200317845	ACREUNA	EU21044330	ACREUNA	05/03/2020 07:05	05/03/2020 08:36	05/03/2020 07:05	05/03/2020 08:36	1,50	1	1,50	CHI
20200317848	APARECIDA DE GOIANIA	200163450	INDEPENDENCIA S1	05/03/2020 07:06	05/03/2020 08:42	05/03/2020 07:06	05/03/2020 08:42	1,59	1	1,59	CHI
20200317849	MORRINHOS	10002879040	MORRINHOS	05/03/2020 07:06	05/03/2020 08:45	05/03/2020 07:06	05/03/2020 08:45	1,64	1	1,64	CHI
20200317852	AGUAS LINDAS DE GOIAS	LA11164956	AGUAS LINDAS DE GOIAS S1	05/03/2020 07:07	05/03/2020 10:51	05/03/2020 07:07	05/03/2020 10:51	3,73	175	652,17	CHI
20200317853	QUIRINOPOLIS	QI12000040	QUIRINOPOLIS	05/03/2020 05:51	05/03/2020 11:25	05/03/2020 05:51	05/03/2020 10:10	4,31	17	73,33	CHI
20200317853	QUIRINOPOLIS	QI12000040	QUIRINOPOLIS	05/03/2020 05:51	05/03/2020 11:25	05/03/2020 09:05	05/03/2020 10:10	1,07	66	70,55	CHI
20200317853	QUIRINOPOLIS	QI12000040	QUIRINOPOLIS	05/03/2020 05:51	05/03/2020 11:25	05/03/2020 05:51	05/03/2020 11:25	5,58	6	33,47	CHI
20200317853	QUIRINOPOLIS	QI13301522	QUIRINOPOLIS	05/03/2020 05:51	05/03/2020 11:25	05/03/2020 09:05	05/03/2020 11:25	2,33	1	2,33	CHI
20200317855	ITABERAI	IB12026084	ITABERAI S2	05/03/2020 07:07	05/03/2020 10:32	05/03/2020 07:07	05/03/2020 10:32	3,40	4	13,62	CHI
20200317860	MORRINHOS	MR12098214	MORRINHOS	05/03/2020 07:08	05/03/2020 09:42	05/03/2020 07:08	05/03/2020 09:42	2,56	15	38,47	CHI
20200317866	GUARANI DE GOIAS	GY12267340	IACIARA S2	05/03/2020 07:10	05/03/2020 08:26	05/03/2020 07:10	05/03/2020 08:26	1,26	63	79,42	CHI
20200317867	GUARANI DE GOIAS	GY12393812	IACIARA S1	05/03/2020 07:11	05/03/2020 09:01	05/03/2020 07:11	05/03/2020 09:01	1,83	22	40,21	CHI
20200317874	MOSSAMEDES	MD21157127	FIRMINOPOLIS S2	05/03/2020 07:12	05/03/2020 09:21	05/03/2020 07:12	05/03/2020 09:21	2,14	1	2,14	CHI
20200317879	PALESTINA DE GOIAS	CP12395427	PALESTINA	05/03/2020 06:50	05/03/2020 09:11	05/03/2020 06:50	05/03/2020 09:11	2,35	6	14,07	CHI
20200317880	GOIANIA	13328803	CARAJAS S1	05/03/2020 07:14	05/03/2020 09:30	05/03/2020 07:14	05/03/2020 09:30	2,26	1	2,26	CHI
20200317882	SERRANOPOLIS	SX12296514	JATAI S1	05/03/2020 06:48	05/03/2020 09:35	05/03/2020 06:48	05/03/2020 09:35	2,78	23	63,96	CHI
20200317887	AMORINOPOLIS	AM21035304	IPORA	05/03/2020 07:16	05/03/2020 14:18	05/03/2020 07:16	05/03/2020 14:18	7,03	1	7,03	CHI
20200317888	ARUANA	AK12396237	BRITANIA	05/03/2020 07:16	05/03/2020 10:17	05/03/2020 07:16	05/03/2020 10:17	3,01	4	12,06	CHI
20200317893	PLANALTINA	2960027365	PLANALTINA	05/03/2020 07:17	05/03/2020 08:14	05/03/2020 07:17	05/03/2020 08:14	0,94	1	0,94	CHI
20200317896	PIRES DO RIO	UT12300798	URUTAI	05/03/2020 07:18	05/03/2020 10:23	05/03/2020 07:18	05/03/2020 10:23	3,07	2	6,15	CHI
20200317896	URUTAI	UT12300798	URUTAI	05/03/2020 07:18	05/03/2020 10:23	05/03/2020 07:18	05/03/2020 10:23	3,07	25	76,84	CHI
20200317897	SANCLERLANDIA	SC12102362	FIRMINOPOLIS S2	05/03/2020 06:39	05/03/2020 09:46	05/03/2020 06:39	05/03/2020 09:46	3,11	207	643,94	CHI
20200317898	MINACU	TB12256991	PORANGATU	05/03/2020 05:34	05/03/2020 10:30	05/03/2020 05:34	05/03/2020 10:30	4,93	12	59,16	CHI
20200317898	TROMBAS	TB12256991	PORANGATU	05/03/2020 05:34	05/03/2020 10:30	05/03/2020 05:34	05/03/2020 10:30	4,93	22	108,45	CHI
20200317902	GOIATUBA	VI12329055	VICENTINOPOLIS	05/03/2020 07:19	05/03/2020 11:10	05/03/2020 07:19	05/03/2020 11:10	3,84	7	26,90	CHI
20200317902	VICENTINOPOLIS	VI12329055	VICENTINOPOLIS	05/03/2020 07:19	05/03/2020 11:10	05/03/2020 07:19	05/03/2020 11:10	3,84	11	42,27	CHI
20200317904	GUAPO	GA21004949	GUAPO S1	05/03/2020 07:19	05/03/2020 14:04	05/03/2020 07:19	05/03/2020 14:04	6,74	1	6,74	CHI
20200317907	COCALZINHO DE GOIAS	PB12382249	PADRE BERNARDO	05/03/2020 05:51	05/03/2020 09:32	05/03/2020 05:51	05/03/2020 09:32	3,68	7	25,74	CHI
20200317913	CATURAI	CK21132748	INHUMAS S1	05/03/2020 07:20	05/03/2020 09:55	05/03/2020 07:20	05/03/2020 09:55	2,57	1	2,57	CHI
20200317916	SAO DOMINGOS	SD11208703	SAO DOMINGOS	05/03/2020 07:21	05/03/2020 08:43	05/03/2020 07:21	05/03/2020 08:43	1,36	17	23,14	CHI
20200317919	ITUMBIARA	IT11000003	ITUMBIARA VELHA S1	05/03/2020 07:21	05/03/2020 17:02	05/03/2020 07:21	05/03/2020 17:02	9,67	126	1218,74	CHI
20200317920	SANTA TEREZINHA DE GOIAS	SG21322074	SANTA TEREZINHA	05/03/2020 07:22	05/03/2020 12:30	05/03/2020 07:22	05/03/2020 12:30	5,13	1	5,13	CHI
20200317922	MINEIROS	10016109641	PARQUE DAS EMAS	05/03/2020 07:22	05/03/2020 09:30	05/03/2020 07:22	05/03/2020 09:30	2,13	1	2,13	CHI
20200317924	MOZARLANDIA	MZ12058584	MOZARLANDIA	05/03/2020 07:23	05/03/2020 11:51	05/03/2020 07:23	05/03/2020 11:51	4,46	13	58,03	CHI
20200317927	ANAPOLIS	AN21000135	JUNDIAI S2	05/03/2020 07:24	05/03/2020 12:11	05/03/2020 07:24	05/03/2020 12:11	4,79	1	4,79	CHI
20200317941	SANTA HELENA DE GOIAS	SH21296168	IPEGUARI	05/03/2020 07:27	05/03/2020 12:36	05/03/2020 07:27	05/03/2020 12:36	5,15	2	10,29	CHI
20200317942	CALDAZINHA	LB12095842	CEPAIGO S2	05/03/2020 07:27	05/03/2020 12:38	05/03/2020 07:27	05/03/2020 12:38	5,18	3	15,53	CHI
20200317950	NEROPOLIS	NR21099182	NEROPOLIS S2	05/03/2020 07:29	05/03/2020 08:52	05/03/2020 07:29	05/03/2020 08:52	1,38	2	2,75	CHI

20200317953	CRISTALINA	KR12276500	CRISTALINA S2	05/03/2020 07:22	05/03/2020 16:43	05/03/2020 07:22	05/03/2020 16:43	9,33	17	158,69	CHI
20200317954	RIO VERDE	RV12071620	MONTIVIDIU T	05/03/2020 07:30	05/03/2020 10:45	05/03/2020 07:30	05/03/2020 10:45	3,25	3	9,75	CHI
20200317955	QUIRINOPOLIS	80138433	QUIRINOPOLIS	05/03/2020 07:30	05/03/2020 16:11	05/03/2020 07:30	05/03/2020 16:11	8,68	1	8,68	CHI
20200317956	CRISTALINA	KR12168463	CRISTALINA S1	05/03/2020 07:30	05/03/2020 12:48	05/03/2020 07:30	05/03/2020 12:48	5,31	3	15,94	CHI
20200317957	PARAUNA	PU12007910	PARAUNA	05/03/2020 07:30	05/03/2020 13:55	05/03/2020 07:30	05/03/2020 13:55	6,41	3	19,24	CHI
20200317958	BELA VISTA DE GOIAS	SV12389414	DAIA S2	05/03/2020 07:30	05/03/2020 11:23	05/03/2020 07:30	05/03/2020 11:23	3,88	1	3,88	CHI
20200317958	SILVANIA	SV12389414	DAIA S2	05/03/2020 07:30	05/03/2020 11:23	05/03/2020 07:30	05/03/2020 11:23	3,88	12	46,55	CHI
20200317960	MOSSAMEDES	1310013898	FIRMINOPOLIS S2	05/03/2020 07:30	05/03/2020 10:47	05/03/2020 07:30	05/03/2020 10:47	3,27	1	3,27	CHI
20200317962	GOIAS	GS12091169	MATRINCHA	05/03/2020 07:24	05/03/2020 10:01	05/03/2020 07:24	05/03/2020 10:01	2,60	9	23,43	CHI
20200317963	INACIOLANDIA	ID21088519	QUIRINOPOLIS	05/03/2020 07:31	05/03/2020 10:40	05/03/2020 07:31	05/03/2020 10:40	3,15	1	3,15	CHI
20200317969	ITAJA	IM12301779	CACHOEIRA ALTA	05/03/2020 07:32	05/03/2020 16:25	05/03/2020 07:32	05/03/2020 16:25	8,87	5	44,36	CHI
20200317970	EDEIA	EA21212267	EDEIA	05/03/2020 07:33	05/03/2020 09:51	05/03/2020 07:33	05/03/2020 09:51	2,30	1	2,30	CHI
20200317971	GOIATUBA	GT12295929	RIO DOS BOIS	05/03/2020 07:33	05/03/2020 13:58	05/03/2020 07:33	05/03/2020 13:58	6,41	2	12,82	CHI
20200317973	ACREUNA	EU12026747	RIO DOS BOIS	05/03/2020 07:08	05/03/2020 15:03	05/03/2020 07:08	05/03/2020 15:03	7,91	11	86,96	CHI
20200317973	TURVELANDIA	EU12026747	RIO DOS BOIS	05/03/2020 07:08	05/03/2020 15:03	05/03/2020 07:08	05/03/2020 15:03	7,91	15	118,58	CHI
20200317975	NAZARIO	NZ12003900	ANICUNS	05/03/2020 07:34	05/03/2020 10:05	05/03/2020 07:34	05/03/2020 10:05	2,51	12	30,09	CHI
20200317976	NAZARIO	440002850	ANICUNS	05/03/2020 07:34	05/03/2020 08:42	05/03/2020 07:34	05/03/2020 08:42	1,12	1	1,12	CHI
20200317982	SAO MIGUEL DO ARAGUAIA	SM12350501	SAO MIGUEL DO ARAGUAIA	05/03/2020 07:36	05/03/2020 17:15	05/03/2020 07:36	05/03/2020 17:15	9,64	6	57,82	CHI
20200317985	GOIAS	GS12188167	GOIAS	05/03/2020 02:27	05/03/2020 13:55	05/03/2020 02:27	05/03/2020 13:55	11,45	70	801,62	CHI
20200317985	GOIAS	GS12188167	MATRINCHA	05/03/2020 02:27	05/03/2020 13:55	05/03/2020 02:27	05/03/2020 13:55	11,45	21	240,48	CHI
20200317988	SANTA RITA DO NOVO DESTINO	DF21266618	BARRO ALTO	05/03/2020 07:38	05/03/2020 18:55	05/03/2020 07:38	05/03/2020 18:55	11,27	1	11,27	CHI
20200317991	LUZIANIA	LZ11053458	RIO VERMELHO	05/03/2020 07:39	05/03/2020 10:25	05/03/2020 07:39	05/03/2020 10:25	2,77	143	396,15	CHI
20200317992	PIRACANJUBA	PJ12072600	PIRACANJUBA	05/03/2020 07:39	05/03/2020 11:11	05/03/2020 07:39	05/03/2020 11:11	3,53	4	14,11	CHI
20200317994	PONTALINA	PK12063349	PONTALINA	05/03/2020 07:17	05/03/2020 12:44	05/03/2020 07:17	05/03/2020 12:44	5,45	7	38,12	CHI
20200317995	CAIAPONIA	CP12075032	CAIAPONIA	05/03/2020 07:40	05/03/2020 12:07	05/03/2020 07:40	05/03/2020 12:07	4,45	10	44,46	CHI
20200317997	ORIZONA	OZ21113156	VIANOPOLIS	05/03/2020 07:40	05/03/2020 17:46	05/03/2020 07:40	05/03/2020 17:46	10,09	1	10,09	CHI
20200317998	JANDAIA	PP12126013	PALMEIRAS	05/03/2020 07:40	05/03/2020 08:47	05/03/2020 07:40	05/03/2020 08:47	1,10	30	33,07	CHI
20200317998	PALMINOPOLIS	PP12126013	PALMEIRAS	05/03/2020 07:40	05/03/2020 08:47	05/03/2020 07:40	05/03/2020 08:47	1,10	15	16,54	CHI
20200318000	GAMELEIRA DE GOIAS	SV32056363	DAIA S2	05/03/2020 06:54	05/03/2020 10:18	05/03/2020 06:54	05/03/2020 10:18	3,39	18	61,05	CHI
20200318000	SILVANIA	SV32056363	DAIA S2	05/03/2020 06:54	05/03/2020 10:18	05/03/2020 06:54	05/03/2020 10:18	3,39	1	3,39	CHI
20200318006	MOZARLANDIA	MZ12065623	MOZARLANDIA	05/03/2020 07:44	05/03/2020 14:40	05/03/2020 07:44	05/03/2020 14:40	6,95	14	97,23	CHI
20200318007	JATAI	4010000431	JATAI S1	05/03/2020 07:44	05/03/2020 10:28	05/03/2020 07:44	05/03/2020 10:28	2,74	1	2,74	CHI
20200318009	SERRANOPOLIS	SX21137463	CACHOEIRA ALTA	05/03/2020 07:44	06/03/2020 16:49	05/03/2020 07:44	06/03/2020 16:49	33,08	1	33,08	CHI
20200318014	IACIARA	IA21286083	IACIARA S2	05/03/2020 07:46	05/03/2020 09:18	05/03/2020 07:46	05/03/2020 09:18	1,52	1	1,52	CHI
20200318016	FORMOSO	2410004629	PORANGATU	05/03/2020 07:47	05/03/2020 11:40	05/03/2020 07:47	05/03/2020 11:40	3,88	1	3,88	CHI
20200318017	JOVIANIA	JV12079673	GOIATUBA S1	05/03/2020 07:47	05/03/2020 16:08	05/03/2020 07:47	05/03/2020 16:08	8,34	2	16,69	CHI
20200318025	CAMPINORTE	CR21101034	CAMPINORTE	05/03/2020 07:50	05/03/2020 09:02	05/03/2020 07:50	05/03/2020 09:02	1,19	1	1,19	CHI
20200318026	SANTO ANTONIO DO DESCOBERTO	SN12330527	MARAJOARA	05/03/2020 07:51	05/03/2020 10:34	05/03/2020 07:51	05/03/2020 10:34	2,72	6	16,30	CHI
20200318028	GOIANESIA	GE21000250	GOIANESIA S2	05/03/2020 07:51	05/03/2020 12:18	05/03/2020 07:51	05/03/2020 12:18	4,44	2	8,88	CHI
20200318030	SANTA HELENA DE GOIAS	SH21022692	IPEGUARI	05/03/2020 07:51	05/03/2020 11:26	05/03/2020 07:51	05/03/2020 11:26	3,57	1	3,57	CHI
20200318033	APARECIDA DE GOIANIA	AP11167085	INDEPENDENCIA S1	05/03/2020 07:52	05/03/2020 09:15	05/03/2020 07:52	05/03/2020 09:15	1,38	89	123,02	CHI
20200318035	MORRINHOS	MR21101306	MORRINHOS	05/03/2020 07:52	05/03/2020 10:36	05/03/2020 07:52	05/03/2020 10:36	2,72	1	2,72	CHI
20200318036	BELA VISTA DE GOIAS	BV12082045RE	CRISTIANOPOLIS	05/03/2020 06:57	05/03/2020 09:11	05/03/2020 06:57	05/03/2020 09:11	2,23	4	8,92	CHI
20200318036	CRISTIANOPOLIS	BV12082045RE	CRISTIANOPOLIS	05/03/2020 06:57	05/03/2020 09:11	05/03/2020 06:57	05/03/2020 09:11	2,23	19	42,38	CHI

20200318041	GUARANI DE GOIAS	GY12271764	IACIARA S1	05/03/2020 07:54	05/03/2020 09:43	05/03/2020 07:54	05/03/2020 09:43	1,81	4	7,23	CHI
20200318049	NOVA CRIXAS	NA12091692	NOVA CRIXAS	05/03/2020 05:54	05/03/2020 17:27	05/03/2020 05:54	05/03/2020 17:27	11,55	22	254,06	CHI
20200318050	DOVERLANDIA	MY12217015	PARQUE DAS EMAS	05/03/2020 06:57	05/03/2020 17:05	05/03/2020 06:57	05/03/2020 17:05	10,13	20	202,56	CHI
20200318050	MINEIROS	MY12217015	PARQUE DAS EMAS	05/03/2020 06:57	05/03/2020 17:05	05/03/2020 06:57	05/03/2020 17:05	10,13	9	91,15	CHI
20200318054	FAINA	GS12362364	MATRINCHA	05/03/2020 07:56	05/03/2020 10:49	05/03/2020 07:56	05/03/2020 10:49	2,87	11	31,56	CHI
20200318054	GOIAS	GS12362364	MATRINCHA	05/03/2020 07:56	05/03/2020 10:49	05/03/2020 07:56	05/03/2020 10:49	2,87	8	22,95	CHI
20200318054	MATRINCHA	GS12362364	MATRINCHA	05/03/2020 07:56	05/03/2020 10:49	05/03/2020 07:56	05/03/2020 10:49	2,87	1	2,87	CHI
20200318057	SANTA TEREZINHA DE GOIAS	SG12197603	SANTA TEREZINHA	05/03/2020 07:57	05/03/2020 14:40	05/03/2020 07:57	05/03/2020 14:40	6,71	2	13,42	CHI
20200318059	MIMOSO DE GOIAS	MJ12251065	PADRE BERNARDO	05/03/2020 07:26	05/03/2020 12:18	05/03/2020 07:26	05/03/2020 12:18	4,86	10	48,56	CHI
20200318061	TRINDADE	TR12390004	GOYA S2	05/03/2020 07:58	05/03/2020 09:25	05/03/2020 07:58	05/03/2020 09:25	1,44	343	492,68	CHI
20200318065	PALMINOPOLIS	PP21259849	PALMEIRAS	05/03/2020 08:00	05/03/2020 12:09	05/03/2020 08:00	05/03/2020 12:09	4,14	1	4,14	CHI
20200318073	MUTUNOPOLIS	MU12127951	MARA ROSA	05/03/2020 08:03	05/03/2020 10:48	05/03/2020 08:03	05/03/2020 10:48	2,75	4	10,98	CHI
20200318080	BONOPOLIS	BX21375452	SAO MIGUEL DO ARAGUAIA	05/03/2020 08:04	05/03/2020 11:47	05/03/2020 08:04	05/03/2020 11:47	3,70	1	3,70	CHI
20200318083	ITABERAI	50048235	ITABERAI S2	05/03/2020 08:05	05/03/2020 10:56	05/03/2020 08:05	05/03/2020 10:56	2,84	1	2,84	CHI
20200318087	CATALAO	1990093908	CATALAO S2	05/03/2020 08:06	05/03/2020 09:33	05/03/2020 08:06	05/03/2020 09:33	1,44	1	1,44	CHI
20200318089	INHUMAS	30014360	INHUMAS S2	05/03/2020 08:07	05/03/2020 10:37	05/03/2020 08:07	05/03/2020 10:37	2,50	1	2,50	CHI
20200318092	PARAUNA	PU12233382	PARAUNA	05/03/2020 08:08	05/03/2020 15:56	05/03/2020 08:08	05/03/2020 15:56	7,79	1	7,79	CHI
20200318093	GOIANIA	GN11000907	CAMPINAS S2	05/03/2020 08:09	05/03/2020 10:56	05/03/2020 08:09	05/03/2020 10:56	2,77	86	238,60	CHI
20200318094	VALPARAISO DE GOIAS	10000504716	MARAJOARA	05/03/2020 08:09	05/03/2020 09:31	05/03/2020 08:09	05/03/2020 09:31	1,36	1	1,36	CHI
20200318099	MONTIVIDIU	MV21075459	MONTIVIDIU T	05/03/2020 08:10	05/03/2020 15:10	05/03/2020 08:10	05/03/2020 15:10	6,99	2	13,99	CHI
20200318103	MORRINHOS	MR12204554	MORRINHOS	05/03/2020 08:11	05/03/2020 10:56	05/03/2020 08:11	05/03/2020 10:56	2,75	6	16,48	CHI
20200318104	ARAGUAPAZ	MP12355886	MATRINCHA	05/03/2020 08:11	05/03/2020 17:56	05/03/2020 08:11	05/03/2020 17:56	9,75	1	9,75	CHI
20200318104	FAINA	MP12355886	MATRINCHA	05/03/2020 08:11	05/03/2020 17:56	05/03/2020 08:11	05/03/2020 17:56	9,75	2	19,49	CHI
20200318108	ITAUCU	110012240	INHUMAS S1	05/03/2020 08:11	05/03/2020 13:18	05/03/2020 08:11	05/03/2020 13:18	5,10	1	5,10	CHI
20200318111	GOIANIA	10649610	CAMPINAS S1	05/03/2020 08:12	05/03/2020 09:36	05/03/2020 08:12	05/03/2020 09:36	1,39	1	1,39	CHI
20200318112	MORRINHOS	MR21093176	GOIATUBA S1	05/03/2020 08:12	05/03/2020 11:00	05/03/2020 08:12	05/03/2020 11:00	2,79	1	2,79	CHI
20200318115	CAMPESTRE DE GOIAS	GA12008538	GUAPO S2	05/03/2020 08:12	05/03/2020 09:15	05/03/2020 08:12	05/03/2020 09:15	1,04	1	1,04	CHI
20200318115	GUAPO	GA12008538	GUAPO S2	05/03/2020 08:12	05/03/2020 09:15	05/03/2020 08:12	05/03/2020 09:15	1,04	11	11,45	CHI
20200318116	AGUAS LINDAS DE GOIAS	4830202696	AGUAS LINDAS DE GOIAS S1	05/03/2020 08:12	05/03/2020 10:00	05/03/2020 08:12	05/03/2020 10:00	1,79	1	1,79	CHI
20200318119	FORMOSA	FA21322749	ITIQUEIRA	05/03/2020 08:13	05/03/2020 10:25	05/03/2020 08:13	05/03/2020 10:25	2,19	1	2,19	CHI
20200318121	MINEIROS	SU12302010	SANTA RITA DO ARAGUAIA	05/03/2020 08:13	05/03/2020 15:20	05/03/2020 08:13	05/03/2020 15:20	7,11	1	7,11	CHI
20200318121	SANTA RITA DO ARAGUAIA	SU12302010	SANTA RITA DO ARAGUAIA	05/03/2020 08:13	05/03/2020 15:20	05/03/2020 08:13	05/03/2020 15:20	7,11	5	35,54	CHI
20200318126	GOIANIRA	GR11291674	MEIA PONTE	05/03/2020 07:29	05/03/2020 09:29	05/03/2020 07:29	05/03/2020 09:29	1,99	64	127,52	CHI
20200318127	QUIRINOPOLIS	80042259	QUIRINOPOLIS	05/03/2020 08:14	05/03/2020 12:43	05/03/2020 08:14	05/03/2020 12:43	4,48	1	4,48	CHI
20200318128	ITAPIRAPUA	IU12189999	MATRINCHA	05/03/2020 08:14	05/03/2020 13:16	05/03/2020 08:14	05/03/2020 13:16	5,03	3	15,08	CHI
20200318137	POSSE	PS12298947	FLORES DE GOIAS	05/03/2020 08:15	05/03/2020 11:34	05/03/2020 08:15	05/03/2020 11:34	3,30	1	3,30	CHI
20200318139	NEROPOLIS	160065793	NEROPOLIS S2	05/03/2020 08:16	05/03/2020 11:24	05/03/2020 08:16	05/03/2020 11:24	3,13	1	3,13	CHI
20200318140	SAO MIGUEL DO ARAGUAIA	SM12013236	SAO MIGUEL DO ARAGUAIA	05/03/2020 05:52	05/03/2020 11:06	05/03/2020 05:52	05/03/2020 11:06	5,22	7	36,56	CHI
20200318141	DAMOLANDIA	DL21213607	INHUMAS S1	05/03/2020 08:16	05/03/2020 10:48	05/03/2020 08:16	05/03/2020 10:48	2,52	2	5,05	CHI
20200318144	MIMOSO DE GOIAS	MJ12071960	PADRE BERNARDO	05/03/2020 08:16	05/03/2020 16:02	05/03/2020 15:01	05/03/2020 16:02	1,01	159	160,63	CHI
20200318144	NIQUELANDIA	MJ12071960	PADRE BERNARDO	05/03/2020 08:16	05/03/2020 16:02	05/03/2020 15:01	05/03/2020 16:02	1,01	1	1,01	CHI
20200318148	FORMOSA	FA12206255	ITIQUEIRA	05/03/2020 08:18	05/03/2020 14:20	05/03/2020 08:18	05/03/2020 14:20	6,03	2	12,07	CHI
20200318152	FORMOSA	FA11062203	ITIQUEIRA	05/03/2020 08:19	05/03/2020 10:33	05/03/2020 08:19	05/03/2020 10:33	2,23	3	6,69	CHI
20200318154	BOM JESUS DE GOIAS	BJ12000363	BOM JESUS DE GOIAS	05/03/2020 08:19	05/03/2020 19:24	05/03/2020 08:19	05/03/2020 19:24	11,07	3	33,21	CHI

20200318160	COLINAS DO SUL	TI21138222	MINACU	05/03/2020 08:22	05/03/2020 10:01	05/03/2020 08:22	05/03/2020 10:01	1,64	2	3,29	CHI
20200318161	ANAPOLIS	20059760	JUNDIAI S1	05/03/2020 08:22	05/03/2020 16:51	05/03/2020 08:22	05/03/2020 16:51	8,47	1	8,47	CHI
20200318164	ACREUNA	BZ21289547	ACREUNA	05/03/2020 08:22	05/03/2020 10:24	05/03/2020 08:22	05/03/2020 10:24	2,02	3	6,05	CHI
20200318166	GOIAS	90029422	GOIAS	05/03/2020 08:23	05/03/2020 10:55	05/03/2020 08:23	05/03/2020 10:55	2,53	1	2,53	CHI
20200318171	SANTA HELENA DE GOIAS	SH12301343	IPEGUARI	05/03/2020 08:23	05/03/2020 22:32	05/03/2020 08:23	05/03/2020 22:32	14,14	6	84,86	CHI
20200318171	TURVELANDIA	SH12301343	IPEGUARI	05/03/2020 08:23	05/03/2020 22:32	05/03/2020 08:23	05/03/2020 22:32	14,14	3	42,43	CHI
20200318173	CHAPADAO DO CEU	DJ21124326	CHAPADAO DO CEU	05/03/2020 08:24	05/03/2020 10:28	05/03/2020 08:24	05/03/2020 10:28	2,05	1	2,05	CHI
20200318174	CRISTALINA	KR12230276	CRISTALINA S2	05/03/2020 08:24	05/03/2020 13:56	05/03/2020 08:24	05/03/2020 13:56	5,52	13	71,74	CHI
20200318175	PALMEIRAS DE GOIAS	PL21000025	PALMEIRAS	05/03/2020 08:25	05/03/2020 10:23	05/03/2020 08:25	05/03/2020 10:23	1,96	2	3,93	CHI
20200318178	NOVA IGUACU DE GOIAS	NH21181196	SANTA TEREZINHA	05/03/2020 08:25	05/03/2020 18:40	05/03/2020 08:25	05/03/2020 18:40	10,24	1	10,24	CHI
20200318187	FORMOSO	FO21185340	PORANGATU	05/03/2020 08:28	05/03/2020 14:52	05/03/2020 08:28	05/03/2020 14:52	6,40	1	6,40	CHI
20200318198	FLORES DE GOIAS	FB21106996	FLORES DE GOIAS	05/03/2020 08:29	05/03/2020 17:33	05/03/2020 08:29	05/03/2020 17:33	9,05	1	9,05	CHI
20200318206	PORTELANDIA	PW13326733	PARQUE DAS EMAS	05/03/2020 08:31	05/03/2020 16:10	05/03/2020 15:02	05/03/2020 16:10	1,12	3	3,37	CHI
20200318215	BRAZABRANTES	BV12381466	NEROPOLIS S1	05/03/2020 08:34	05/03/2020 11:39	05/03/2020 08:34	05/03/2020 11:39	3,08	7	21,53	CHI
20200318216	PIRES DO RIO	PR21272871	PIRES DO RIO S1	05/03/2020 08:34	05/03/2020 10:42	05/03/2020 08:34	05/03/2020 10:42	2,13	1	2,13	CHI
20200318218	CORUMBAIBA	CI12180475	VILA CORUMBA	05/03/2020 08:34	05/03/2020 09:50	05/03/2020 08:34	05/03/2020 09:50	1,25	3	3,75	CHI
20200318222	SAO SIMAO	2240043150	CACHOEIRA ALTA	05/03/2020 08:34	05/03/2020 10:13	05/03/2020 08:34	05/03/2020 10:13	1,64	1	1,64	CHI
20200318223	ESTRELA DO NORTE	ET11100731	MARA ROSA	05/03/2020 08:35	05/03/2020 11:27	05/03/2020 08:35	05/03/2020 11:27	2,85	132	376,79	CHI
20200318232	ABADIANIA	AA12385390	DAIA S2	05/03/2020 08:19	05/03/2020 11:27	05/03/2020 08:19	05/03/2020 11:27	3,13	10	31,31	CHI
20200318235	SAO LUIS DE MONTES BELOS	SL12080631	SAO LUIZ DOS MONTES BELOS	05/03/2020 06:58	05/03/2020 11:48	05/03/2020 06:58	05/03/2020 11:48	4,82	3	14,47	CHI
20200318238	MINACU	4020000208	MINACU	05/03/2020 08:38	05/03/2020 19:03	05/03/2020 08:38	05/03/2020 19:03	10,41	1	10,41	CHI
20200318239	ABADIANIA	AA21127479	ANAPOLIS UNIVERSITARIO S1	05/03/2020 08:38	05/03/2020 15:53	05/03/2020 08:38	05/03/2020 15:53	7,24	1	7,24	CHI
20200318240	GOIANAPOLIS	GP21387297	GOIANIA LESTE S2	05/03/2020 05:42	05/03/2020 10:24	05/03/2020 05:42	05/03/2020 10:24	4,69	1	4,69	CHI
20200318247	SAO DOMINGOS	SD12383369	SAO DOMINGOS	05/03/2020 08:40	05/03/2020 09:58	05/03/2020 08:40	05/03/2020 09:58	1,30	1	1,30	CHI
20200318249	FORMOSO	FO21190388	PORANGATU	05/03/2020 08:40	05/03/2020 12:23	05/03/2020 08:40	05/03/2020 12:23	3,71	1	3,71	CHI
20200318250	CATALAO	CT21104196	CATALAO S1	05/03/2020 08:40	05/03/2020 17:56	05/03/2020 08:40	05/03/2020 17:56	9,26	1	9,26	CHI
20200318251	QUIRINOPOLIS	QI11041280	QUIRINOPOLIS	05/03/2020 07:29	05/03/2020 13:45	05/03/2020 07:29	05/03/2020 13:45	6,26	106	663,44	CHI
20200318253	LUZIANIA	10002121725	RIO VERMELHO	05/03/2020 08:40	05/03/2020 10:54	05/03/2020 08:40	05/03/2020 10:54	2,22	1	2,22	CHI
20200318256	INHUMAS	30045137	INHUMAS S2	05/03/2020 08:41	05/03/2020 13:27	05/03/2020 08:41	05/03/2020 13:27	4,76	1	4,76	CHI
20200318262	NOVA CRIXAS	NA12328118	NOVA CRIXAS	05/03/2020 08:43	05/03/2020 15:27	05/03/2020 08:43	05/03/2020 15:27	6,73	2	13,45	CHI
20200318269	QUIRINOPOLIS	80006103	QUIRINOPOLIS	05/03/2020 08:44	05/03/2020 11:30	05/03/2020 08:44	05/03/2020 11:30	2,76	1	2,76	CHI
20200318270	GUAPO	GA11276690	GUAPO S2	05/03/2020 08:44	05/03/2020 14:26	05/03/2020 08:44	05/03/2020 14:26	5,69	1	5,69	CHI
20200318272	CORUMBA DE GOIAS	CB21280099	AGUAS LINDAS DE GOIAS S2	05/03/2020 08:45	05/03/2020 19:01	05/03/2020 08:45	05/03/2020 19:01	10,25	2	20,50	CHI
20200318275	CATALAO	CT12000043	CATALAO S2	05/03/2020 08:46	05/03/2020 11:40	05/03/2020 08:46	05/03/2020 11:40	2,89	39	112,68	CHI
20200318276	CABECEIRAS	CW21342458	ITUIQUIRA	05/03/2020 08:46	05/03/2020 10:07	05/03/2020 08:46	05/03/2020 10:07	1,34	1	1,34	CHI
20200318277	GOIANIA	10005505729	CARAJAS S1	05/03/2020 08:47	05/03/2020 10:05	05/03/2020 08:47	05/03/2020 10:05	1,29	1	1,29	CHI
20200318280	PARAUNA	PU21332612	PARAUNA	05/03/2020 08:49	05/03/2020 15:59	05/03/2020 08:49	05/03/2020 15:59	7,17	1	7,17	CHI
20200318281	ACREUNA	EU21301434	ACREUNA	05/03/2020 08:49	05/03/2020 13:58	05/03/2020 08:49	05/03/2020 13:58	5,14	1	5,14	CHI
20200318287	CIDADE OCIDENTAL	10014575157	MARAJOARA	05/03/2020 08:49	05/03/2020 10:02	05/03/2020 08:49	05/03/2020 10:02	1,20	1	1,20	CHI
20200318293	MONTES CLAROS DE GOIAS	8010001810	IPORA	05/03/2020 08:50	05/03/2020 12:10	05/03/2020 08:50	05/03/2020 12:10	3,32	1	3,32	CHI
20200318295	ABADIANIA	AA21130266	DAIA S2	05/03/2020 08:51	05/03/2020 16:41	05/03/2020 08:51	05/03/2020 16:41	7,82	1	7,82	CHI
20200318296	QUIRINOPOLIS	QI21230894	QUIRINOPOLIS	05/03/2020 08:52	05/03/2020 11:00	05/03/2020 08:52	05/03/2020 11:00	2,13	1	2,13	CHI
20200318297	GOIAS	90103701	GOIAS	05/03/2020 08:52	05/03/2020 12:03	05/03/2020 08:52	05/03/2020 12:03	3,17	1	3,17	CHI
20200318301	GOIANAPOLIS	GN12060168	GOIANIA LESTE S3	05/03/2020 08:53	05/03/2020 11:23	05/03/2020 08:53	05/03/2020 11:23	2,50	1	2,50	CHI

20200318301	GOIANIA	GN12060168	GOIANIA LESTE S3	05/03/2020 08:53	05/03/2020 11:23	05/03/2020 08:53	05/03/2020 11:23	2,50	3	7,49	CHI
20200318305	MONTES CLAROS DE GOIAS	1440013631	IPORA	05/03/2020 08:53	05/03/2020 12:15	05/03/2020 08:53	05/03/2020 12:15	3,36	1	3,36	CHI
20200318307	PIRENOPOLIS	PV21090278	ANAPOLIS UNIVERSITARIO S2	05/03/2020 08:54	05/03/2020 14:39	05/03/2020 08:54	05/03/2020 14:39	5,74	1	5,74	CHI
20200318308	NEROPOLIS	NR12321531	NEROPOLIS S2	05/03/2020 08:54	05/03/2020 11:39	05/03/2020 08:54	05/03/2020 11:39	2,73	5	13,67	CHI
20200318308	SANTO ANTONIO DE GOIAS	NR12321531	NEROPOLIS S2	05/03/2020 08:54	05/03/2020 11:39	05/03/2020 08:54	05/03/2020 11:39	2,73	4	10,94	CHI
20200318311	PARANAIGUARA	PC12306052	QUIRINOPOLIS	05/03/2020 08:56	05/03/2020 23:03	05/03/2020 08:56	05/03/2020 23:03	14,12	6	84,70	CHI
20200318311	QUIRINOPOLIS	PC12306052	QUIRINOPOLIS	05/03/2020 08:56	05/03/2020 23:03	05/03/2020 08:56	05/03/2020 23:03	14,12	3	42,35	CHI
20200318313	GOIANIA	10015702829	CAMPINAS S3	05/03/2020 08:56	05/03/2020 10:41	05/03/2020 08:56	05/03/2020 10:41	1,75	1	1,75	CHI
20200318314	CATALAO	CT21267040	CATALAO S2	05/03/2020 08:56	05/03/2020 13:34	05/03/2020 08:56	05/03/2020 13:34	4,63	1	4,63	CHI
20200318320	NOVA VENEZA	NV12402751	INHUMAS S1	05/03/2020 08:57	05/03/2020 11:13	05/03/2020 08:57	05/03/2020 11:13	2,26	11	24,88	CHI
20200318321	BURITI ALEGRE	BG21000031	ITUMBIARA VELHA S2	05/03/2020 08:57	05/03/2020 12:11	05/03/2020 08:57	05/03/2020 12:11	3,22	1	3,22	CHI
20200318325	NIQUELANDIA	NQ21371135	SAO JOAO D ALIANCA	05/03/2020 08:58	05/03/2020 19:51	05/03/2020 08:58	05/03/2020 19:51	10,87	1	10,87	CHI
20200318327	CAIAPONIA	CP12247446	PALESTINA	05/03/2020 09:00	05/03/2020 19:18	05/03/2020 09:00	05/03/2020 19:18	10,30	3	30,89	CHI
20200318331	CACHOEIRA DOURADA	CD12000291	CACHOEIRA DOURADA	05/03/2020 08:14	05/03/2020 10:44	05/03/2020 08:14	05/03/2020 10:44	2,49	2	4,98	CHI
20200318333	JUSSARA	JR21259914	JUSSARA	05/03/2020 09:01	05/03/2020 13:03	05/03/2020 09:01	05/03/2020 13:03	4,03	1	4,03	CHI
20200318335	GOIANIRA	GR21366619	NEROPOLIS S1	05/03/2020 09:01	05/03/2020 11:02	05/03/2020 09:01	05/03/2020 11:02	2,00	1	2,00	CHI
20200318338	FAINA	FC12026041	GOIAS	05/03/2020 09:01	05/03/2020 10:24	05/03/2020 09:01	05/03/2020 10:24	1,37	2	2,73	CHI
20200318341	ANAPOLIS	AN12382441LD	ANAPOLIS UNIVERSITARIO S2	05/03/2020 08:29	05/03/2020 15:28	05/03/2020 08:29	05/03/2020 15:28	7,00	54	377,78	CHI
20200318345	CORREGO DO OURO	CO12321872	FIRMINOPOLIS S2	05/03/2020 09:03	05/03/2020 14:30	05/03/2020 09:03	05/03/2020 14:30	5,44	11	59,81	CHI
20200318346	ABADIANIA	AA21122888	DAIA S2	05/03/2020 09:03	05/03/2020 12:47	05/03/2020 09:03	05/03/2020 12:47	3,72	1	3,72	CHI
20200318352	CAIAPONIA	CP12204876	CAIAPONIA	05/03/2020 06:43	05/03/2020 10:40	05/03/2020 06:43	05/03/2020 10:40	3,95	12	47,35	CHI
20200318354	GOIATUBA	GT21000206	GOIATUBA S2	05/03/2020 09:05	05/03/2020 11:27	05/03/2020 09:05	05/03/2020 11:27	2,36	1	2,36	CHI
20200318359	INHUMAS	IN21086351	INHUMAS S1	05/03/2020 09:06	05/03/2020 13:10	05/03/2020 09:06	05/03/2020 12:20	3,22	1	3,22	CHI
20200318359	INHUMAS	IN12088651	INHUMAS S1	05/03/2020 09:06	05/03/2020 13:10	05/03/2020 09:06	05/03/2020 13:10	4,05	1	4,05	CHI
20200318365	CALDAS NOVAS	760203155	SERRA DE CALDAS	05/03/2020 09:07	05/03/2020 11:56	05/03/2020 09:07	05/03/2020 11:56	2,82	1	2,82	CHI
20200318368	IVOLANDIA	IV12390185	IPORA	04/03/2020 20:53	05/03/2020 10:48	04/03/2020 20:53	05/03/2020 10:48	13,91	13	180,81	CHI
20200318372	APARECIDA DE GOIANIA	15521710	INDEPENDENCIA S2	05/03/2020 09:08	05/03/2020 11:25	05/03/2020 09:08	05/03/2020 11:25	2,28	1	2,28	CHI
20200318373	ALVORADA DO NORTE	1510018004	IACIARA S2	05/03/2020 09:08	05/03/2020 11:08	05/03/2020 09:08	05/03/2020 11:08	1,99	1	1,99	CHI
20200318374	GOIANIA	17384722	AEROPORTO S2	05/03/2020 09:09	05/03/2020 11:16	05/03/2020 09:09	05/03/2020 11:16	2,11	1	2,11	CHI
20200318376	CAMPO ALEGRE DE GOIAS	CM21203039	CAMPO ALEGRE DE GOIAS	05/03/2020 09:10	05/03/2020 16:42	05/03/2020 09:10	05/03/2020 16:42	7,54	1	7,54	CHI
20200318380	QUIRINOPOLIS	80013995	QUIRINOPOLIS	05/03/2020 09:11	05/03/2020 15:22	05/03/2020 09:11	05/03/2020 15:22	6,17	1	6,17	CHI
20200318383	CALDAS NOVAS	760027511	CALDAS NOVAS S2	05/03/2020 12:30	05/03/2020 15:41	05/03/2020 12:30	05/03/2020 15:41	3,19	1	3,19	CHI
20200318391	PIRES DO RIO	BC21311736	PIRES DO RIO S2	05/03/2020 09:13	05/03/2020 12:46	05/03/2020 09:13	05/03/2020 12:46	3,54	1	3,54	CHI
20200318394	NOVA ROMA	8720000410	IACIARA S2	05/03/2020 09:14	05/03/2020 12:45	05/03/2020 09:14	05/03/2020 12:45	3,52	1	3,52	CHI
20200318398	MUTUNOPOLIS	MU12395764	MARA ROSA	05/03/2020 09:15	05/03/2020 14:33	05/03/2020 09:15	05/03/2020 14:33	5,29	9	47,64	CHI
20200318400	PLANALTINA	PI12149010	PLANALTINA	05/03/2020 09:15	05/03/2020 10:08	05/03/2020 09:15	05/03/2020 10:08	0,87	169	147,73	CHI
20200318501	GOIANIRA	GR11131273	GOIANIRA	05/03/2020 09:13	05/03/2020 12:47	05/03/2020 11:46	05/03/2020 12:47	1,02	131	133,29	CHI
20200318502	HEITORAI	03530214	ITAPURANGA	05/03/2020 09:16	06/03/2020 04:19	05/03/2020 09:32	05/03/2020 10:00	0,47	1434	670,39	CHI
20200318502	ITAGUARU	03530214	ITAPURANGA	05/03/2020 09:16	06/03/2020 04:19	05/03/2020 09:32	05/03/2020 10:00	0,47	56	26,18	CHI
20200318502	ITAPURANGA	03530214	ITAPURANGA	05/03/2020 09:16	06/03/2020 04:19	05/03/2020 09:32	05/03/2020 10:00	0,47	76	35,53	CHI
20200318502	URUANA	03530214	ITAPURANGA	05/03/2020 09:16	06/03/2020 04:19	05/03/2020 09:32	05/03/2020 10:00	0,47	1	0,47	CHI
20200318502	GOIAS	00880424	ITABERAI S1	05/03/2020 09:16	06/03/2020 04:19	05/03/2020 09:38	05/03/2020 10:49	1,18	39	45,86	CHI
20200318502	HEITORAI	00880424	ITABERAI S1	05/03/2020 09:16	06/03/2020 04:19	05/03/2020 09:38	05/03/2020 10:49	1,18	2	2,35	CHI
20200318502	ITABERAI	00880424	ITABERAI S1	05/03/2020 09:16	06/03/2020 04:19	05/03/2020 09:38	05/03/2020 10:49	1,18	149	175,20	CHI

20200318502	ITABERAI	00880424	ITABERAI S1	05/03/2020 09:16	06/03/2020 04:19	05/03/2020 09:38	05/03/2020 10:49	1,18	547	643,18	CHI
20200318502	HEITORAI	HE13220377	ITABERAI S1	05/03/2020 09:16	06/03/2020 04:19	05/03/2020 09:38	05/03/2020 13:44	4,10	22	90,19	CHI
20200318502	ITABERAI	HE13220377	ITABERAI S1	05/03/2020 09:16	06/03/2020 04:19	05/03/2020 09:38	05/03/2020 13:44	4,10	2	8,20	CHI
20200318502	GOIAS	IB13144319	ITABERAI S1	05/03/2020 09:16	06/03/2020 04:19	05/03/2020 09:38	05/03/2020 13:45	4,11	39	160,11	CHI
20200318502	HEITORAI	IB13144319	ITABERAI S1	05/03/2020 09:16	06/03/2020 04:19	05/03/2020 09:38	05/03/2020 13:45	4,11	2	8,21	CHI
20200318502	ITABERAI	IB13144319	ITABERAI S1	05/03/2020 09:16	06/03/2020 04:19	05/03/2020 09:38	05/03/2020 13:45	4,11	64	262,74	CHI
20200318502	HEITORAI	HE13220377	ITABERAI S1	05/03/2020 09:16	06/03/2020 04:19	05/03/2020 09:38	06/03/2020 04:19	18,67	1	18,67	CHI
20200318502	ITABERAI	HE13220377	ITABERAI S1	05/03/2020 09:16	06/03/2020 04:19	05/03/2020 09:38	06/03/2020 04:19	18,67	8	149,37	CHI
20200318502	HEITORAI	HE13220377	ITABERAI S1	05/03/2020 09:16	06/03/2020 04:19	05/03/2020 23:52	06/03/2020 04:19	4,44	22	97,58	CHI
20200318502	ITABERAI	HE13220377	ITABERAI S1	05/03/2020 09:16	06/03/2020 04:19	05/03/2020 23:52	06/03/2020 04:19	4,44	2	8,87	CHI
20200318506	MINACU	IH12088797	MINACU	05/03/2020 08:39	05/03/2020 13:05	05/03/2020 08:39	05/03/2020 13:05	4,42	163	720,51	CHI
20200318508	CATURAI	CK21015400	INHUMAS S1	05/03/2020 09:17	05/03/2020 11:33	05/03/2020 09:17	05/03/2020 11:33	2,27	1	2,27	CHI
20200318517	SERRANOPOLIS	SX12337003	JATAI S1	05/03/2020 09:18	05/03/2020 17:41	05/03/2020 09:18	05/03/2020 17:41	8,38	2	16,77	CHI
20200318518	EDEIA	EA21182701	EDEIA	05/03/2020 09:18	05/03/2020 13:39	05/03/2020 09:18	05/03/2020 13:39	4,34	1	4,34	CHI
20200318519	MORRINHOS	150016785	MORRINHOS	05/03/2020 09:19	05/03/2020 12:10	05/03/2020 09:19	05/03/2020 12:10	2,85	1	2,85	CHI
20200318520	VALPARAISO DE GOIAS	VA11183578	PACAEMBU S1	05/03/2020 09:19	05/03/2020 11:35	05/03/2020 09:19	05/03/2020 11:35	2,26	123	278,46	CHI
20200318523	GOIANIA	10005248653	XAVANTES	05/03/2020 09:19	05/03/2020 10:20	05/03/2020 09:19	05/03/2020 10:20	1,01	1	1,01	CHI
20200318542	ANICUNS	AC11159072	ANICUNS	05/03/2020 09:22	05/03/2020 13:07	05/03/2020 09:22	05/03/2020 13:07	3,75	106	396,97	CHI
20200318545	JOVIANIA	JV12030312	GOIATUBA S1	05/03/2020 09:23	05/03/2020 16:56	05/03/2020 09:23	05/03/2020 16:56	7,54	4	30,17	CHI
20200318545	VICENTINOPOLIS	JV12030312	GOIATUBA S1	05/03/2020 09:23	05/03/2020 16:56	05/03/2020 09:23	05/03/2020 16:56	7,54	4	30,17	CHI
20200318551	NIQUELANDIA	10024275210	BARRO ALTO	05/03/2020 09:24	05/03/2020 13:20	05/03/2020 09:24	05/03/2020 13:20	3,94	1	3,94	CHI
20200318553	ABADIA DE GOIAS	TR12027281	TRINDADE	05/03/2020 09:24	05/03/2020 15:15	05/03/2020 09:24	05/03/2020 15:15	5,84	1	5,84	CHI
20200318553	TRINDADE	TR12027281	TRINDADE	05/03/2020 09:24	05/03/2020 15:15	05/03/2020 09:24	05/03/2020 15:15	5,84	2	11,68	CHI
20200318554	ITAPIRAPUA	IU12089733	MATRINCHA	05/03/2020 09:22	05/03/2020 11:11	05/03/2020 09:22	05/03/2020 11:11	1,82	24	43,58	CHI
20200318557	ITABERAI	IB21158791	ITABERAI S2	05/03/2020 09:25	05/03/2020 19:02	05/03/2020 09:25	05/03/2020 19:02	9,61	1	9,61	CHI
20200318566	PARAUNA	PU12361641	MONTIVIDIU T	05/03/2020 07:28	06/03/2020 08:49	05/03/2020 07:28	06/03/2020 08:49	25,35	35	887,24	CHI
20200318574	ALVORADA DO NORTE	AQ12184985	IACIARA S2	05/03/2020 09:28	05/03/2020 12:28	05/03/2020 09:28	05/03/2020 12:28	2,99	5	14,96	CHI
20200318580	PALMEIRAS DE GOIAS	PL12026608	PALMEIRAS	05/03/2020 09:30	05/03/2020 12:20	05/03/2020 09:30	05/03/2020 12:20	2,83	8	22,62	CHI
20200318581	CATALAO	CT11000055	CATALAO S2	05/03/2020 08:52	05/03/2020 10:36	05/03/2020 08:52	05/03/2020 10:36	1,73	29	50,15	CHI
20200318583	PETROLINA DE GOIAS	PG12073221	PETROLINA	05/03/2020 09:30	05/03/2020 11:19	05/03/2020 09:30	05/03/2020 11:19	1,81	2	3,61	CHI
20200318588	FORMOSA	FA11269969	ITUIQUIRA	05/03/2020 09:32	05/03/2020 12:11	05/03/2020 09:32	05/03/2020 12:11	2,64	1	2,64	CHI
20200318590	APARECIDA DE GOIANIA	14808857	ANHANGUERA	05/03/2020 09:32	05/03/2020 10:31	05/03/2020 09:32	05/03/2020 10:31	0,97	1	0,97	CHI
20200318591	RIO VERDE	RV11030697	RIO VERDE S1	05/03/2020 09:20	05/03/2020 16:35	05/03/2020 09:20	05/03/2020 16:35	7,25	146	1057,81	CHI
20200318595	PADRE BERNARDO	PB12290579	PADRE BERNARDO	05/03/2020 09:34	05/03/2020 16:17	05/03/2020 09:34	05/03/2020 16:17	6,72	6	40,30	CHI
20200318597	PONTALINA	PK21235035	PONTALINA	05/03/2020 09:34	05/03/2020 14:29	05/03/2020 09:34	05/03/2020 14:29	4,91	1	4,91	CHI
20200318598	EDEIA	EA12390301	EDEIA	05/03/2020 09:34	05/03/2020 16:41	05/03/2020 09:34	05/03/2020 16:41	7,11	5	35,53	CHI
20200318599	GOIAS	GS21073693	MATRINCHA	05/03/2020 09:35	05/03/2020 15:04	05/03/2020 09:35	05/03/2020 15:04	5,48	2	10,96	CHI
20200318714	CAIAPONIA	CP11287650	PALESTINA	05/03/2020 09:39	05/03/2020 16:32	05/03/2020 09:39	05/03/2020 16:32	6,88	1	6,88	CHI
20200318715	GOIANIA	GN21044159	GOYA S1	05/03/2020 09:39	05/03/2020 10:53	05/03/2020 09:39	05/03/2020 10:53	1,23	1	1,23	CHI
20200318718	ITUMBIARA	10000600855	ITUMBIARA NOVA	05/03/2020 09:40	05/03/2020 14:04	05/03/2020 09:40	05/03/2020 14:04	4,40	1	4,40	CHI
20200318721	ESTRELA DO NORTE	MU12075219	MARA ROSA	05/03/2020 09:40	05/03/2020 12:57	05/03/2020 09:40	05/03/2020 12:57	3,28	1	3,28	CHI
20200318721	MUTUNOPOLIS	MU12075219	MARA ROSA	05/03/2020 09:40	05/03/2020 12:57	05/03/2020 09:40	05/03/2020 12:57	3,28	8	26,22	CHI
20200318723	GOIANIA	16766805	FERROVIARIO S1	05/03/2020 09:40	05/03/2020 11:34	05/03/2020 09:40	05/03/2020 11:34	1,89	1	1,89	CHI
20200318725	SENADOR CANEDO	190139766	SENADOR CANEDO	05/03/2020 09:40	05/03/2020 10:55	05/03/2020 09:40	05/03/2020 10:55	1,24	1	1,24	CHI

20200318726	HIDROLINA	GE12382134	BARRO ALTO	05/03/2020 07:20	05/03/2020 15:23	05/03/2020 07:20	05/03/2020 15:23	8,04	1	8,04	CHI
20200318726	SAO LUIZ DO NORTE	GE12382134	BARRO ALTO	05/03/2020 07:20	05/03/2020 15:23	05/03/2020 07:20	05/03/2020 15:23	8,04	8	64,32	CHI
20200318727	QUIRINOPOLIS	80153264	QUIRINOPOLIS	05/03/2020 09:41	05/03/2020 11:54	05/03/2020 09:41	05/03/2020 11:54	2,21	1	2,21	CHI
20200318728	INHUMAS	IN12343069	INHUMAS S2	05/03/2020 09:41	05/03/2020 12:31	05/03/2020 09:41	05/03/2020 12:31	2,83	14	39,58	CHI
20200318730	IPAMERI	IP21359965	PIRES DO RIO S2	05/03/2020 09:41	05/03/2020 18:06	05/03/2020 09:41	05/03/2020 18:06	8,40	1	8,40	CHI
20200318731	VICENTINOPOLIS	VI21222497	VICENTINOPOLIS	05/03/2020 09:42	05/03/2020 11:50	05/03/2020 09:42	05/03/2020 11:50	2,13	1	2,13	CHI
20200318733	GOIANIA	12398433	FERROVIARIO S1	05/03/2020 09:42	05/03/2020 11:23	05/03/2020 09:42	05/03/2020 11:23	1,67	1	1,67	CHI
20200318746	CORUMBAIBA	CI21081013	VILA CORUMBA	05/03/2020 09:47	05/03/2020 11:16	05/03/2020 09:47	05/03/2020 11:16	1,48	1	1,48	CHI
20200318750	MORRINHOS	150023297	MORRINHOS	05/03/2020 09:47	05/03/2020 14:48	05/03/2020 09:47	05/03/2020 14:48	5,01	1	5,01	CHI
20200318754	MINEIROS	MY12195522	PARQUE DAS EMAS	05/03/2020 09:48	05/03/2020 20:15	05/03/2020 09:48	05/03/2020 20:15	10,45	1	10,45	CHI
20200318757	PORANGATU	PO12343296	PORANGATU	05/03/2020 09:48	05/03/2020 11:10	05/03/2020 09:48	05/03/2020 11:10	1,35	5	6,77	CHI
20200318759	APARECIDA DE GOIANIA	10004840893	INDEPENDENCIA S1	05/03/2020 09:49	05/03/2020 11:22	05/03/2020 09:49	05/03/2020 11:22	1,53	1	1,53	CHI
20200318763	NAZARIO	PL21314960	PALMEIRAS	05/03/2020 09:51	05/03/2020 11:34	05/03/2020 09:51	05/03/2020 11:34	1,71	1	1,71	CHI
20200318769	RIO VERDE	RV21000135	RIO VERDE S1	05/03/2020 09:52	06/03/2020 12:40	05/03/2020 09:52	06/03/2020 12:40	26,80	1	26,80	CHI
20200318775	BOM JARDIM DE GOIAS	BM12381018	ARAGARCAS	05/03/2020 09:53	05/03/2020 16:20	05/03/2020 09:53	05/03/2020 16:20	6,45	2	12,90	CHI
20200318776	SANTA FE DE GOIAS	10006678317	BRITANIA	05/03/2020 09:53	05/03/2020 14:13	05/03/2020 09:53	05/03/2020 14:13	4,34	1	4,34	CHI
20200318784	SANTA RITA DO NOVO DESTINO	DF11200453	BARRO ALTO	05/03/2020 09:56	05/03/2020 18:11	05/03/2020 09:56	05/03/2020 18:11	8,25	1	8,25	CHI
20200318787	HIDROLANDIA	HD21261851	CEPAIGO S1	05/03/2020 09:56	05/03/2020 11:24	05/03/2020 09:56	05/03/2020 11:24	1,46	1	1,46	CHI
20200318788	APARECIDA DE GOIANIA	AP12200191	REAL S1	05/03/2020 09:56	05/03/2020 15:50	05/03/2020 09:56	05/03/2020 15:50	5,89	640	3766,93	CHI
20200318796	HIDROLANDIA	HD21200013	CEPAIGO S2	05/03/2020 09:58	05/03/2020 11:50	05/03/2020 09:58	05/03/2020 11:50	1,85	1	1,85	CHI
20200318797	PORANGATU	PO12265511	PORANGATU	05/03/2020 09:58	05/03/2020 15:30	05/03/2020 09:58	05/03/2020 15:30	5,52	1	5,52	CHI
20200318798	APARECIDA DE GOIANIA	13841944	REAL S2	05/03/2020 09:59	05/03/2020 11:28	05/03/2020 09:59	05/03/2020 11:28	1,48	1	1,48	CHI
20200318903	GOIANIA	16468788	CARAJAS S1	05/03/2020 10:01	05/03/2020 11:11	05/03/2020 10:01	05/03/2020 11:11	1,16	1	1,16	CHI
20200318907	AGUAS LINDAS DE GOIAS	10002963564	AGUAS LINDAS DE GOIAS S1	05/03/2020 10:01	05/03/2020 11:44	05/03/2020 10:01	05/03/2020 11:44	1,70	1	1,70	CHI
20200318913	HIDROLANDIA	HD21072708	CEPAIGO S2	05/03/2020 10:04	05/03/2020 12:24	05/03/2020 10:04	05/03/2020 12:24	2,33	1	2,33	CHI
20200318914	CALDAS NOVAS	10010376648	CALDAS NOVAS S1	05/03/2020 10:05	05/03/2020 15:21	05/03/2020 10:05	05/03/2020 15:21	5,27	1	5,27	CHI
20200318915	GOIANIA	GN11374045	ATLANTICO S1	05/03/2020 10:04	05/03/2020 10:58	05/03/2020 10:04	05/03/2020 10:58	0,89	192	169,97	CHI
20200318916	ACREUNA	BZ12322216	ACREUNA	05/03/2020 10:06	05/03/2020 11:52	05/03/2020 10:06	05/03/2020 11:52	1,76	2	3,53	CHI
20200318916	SANTO ANTONIO DA BARRA	BZ12322216	ACREUNA	05/03/2020 10:06	05/03/2020 11:52	05/03/2020 10:06	05/03/2020 11:52	1,76	5	8,82	CHI
20200318922	JUSSARA	1290063543	JUSSARA	05/03/2020 10:09	05/03/2020 16:46	05/03/2020 10:09	05/03/2020 16:46	6,62	1	6,62	CHI
20200318923	PALMELO	450013339	PIRES DO RIO S2	05/03/2020 10:09	05/03/2020 12:59	05/03/2020 10:09	05/03/2020 12:59	2,83	1	2,83	CHI
20200318926	URUACU	UR21243611	URUACU	05/03/2020 10:11	05/03/2020 11:51	05/03/2020 10:11	05/03/2020 11:51	1,67	1	1,67	CHI
20200318927	APARECIDA DE GOIANIA	14331263	REAL S1	05/03/2020 10:11	05/03/2020 14:44	05/03/2020 10:11	05/03/2020 14:44	4,53	1	4,53	CHI
20200318930	RIO VERDE	RV11000163	CABRIUVA S1	05/03/2020 10:12	06/03/2020 17:37	05/03/2020 17:02	06/03/2020 17:37	24,58	3	73,75	CHI
20200318933	INHUMAS	IN21010455	INHUMAS S2	05/03/2020 10:12	05/03/2020 14:36	05/03/2020 10:12	05/03/2020 14:36	4,39	1	4,39	CHI
20200318934	SANTA ROSA DE GOIAS	SR21216368	INHUMAS S1	05/03/2020 10:12	05/03/2020 13:50	05/03/2020 10:12	05/03/2020 13:50	3,62	1	3,62	CHI
20200318936	FORMOSA	10008811278	ITUIQUIRA	05/03/2020 10:13	05/03/2020 13:21	05/03/2020 10:13	05/03/2020 13:21	3,14	1	3,14	CHI
20200318937	GOIATUBA	GT21190845	GOIATUBA S2	05/03/2020 10:13	05/03/2020 12:13	05/03/2020 10:13	05/03/2020 12:13	2,00	1	2,00	CHI
20200318943	LUZIANIA	10011884094	RIO VERMELHO	05/03/2020 10:13	05/03/2020 11:54	05/03/2020 10:13	05/03/2020 11:54	1,67	1	1,67	CHI
20200318944	ITAPACI	IW21237427	ITAPACI	05/03/2020 10:14	05/03/2020 13:59	05/03/2020 10:14	05/03/2020 13:59	3,74	1	3,74	CHI
20200318945	ANAPOLIS	AN12089415	ANAPOLIS UNIVERSITARIO S2	05/03/2020 09:25	05/03/2020 11:23	05/03/2020 09:25	05/03/2020 11:23	1,96	274	536,36	CHI
20200318951	ARUANA	AK21220351	MOZARLANDIA	05/03/2020 10:16	05/03/2020 14:37	05/03/2020 10:16	05/03/2020 14:37	4,34	1	4,34	CHI
20200318953	OUVIDOR	OU21141022	CATALAO S1	05/03/2020 10:15	05/03/2020 16:50	05/03/2020 10:15	05/03/2020 16:50	6,57	2	13,14	CHI
20200318954	RIO VERDE	RV12026370	RIO VERDE S1	05/03/2020 10:16	06/03/2020 08:40	05/03/2020 10:16	06/03/2020 08:40	22,38	23	514,84	CHI

20200318959	MAIRIPOTABA	MI12060664	PONTALINA	05/03/2020 10:17	05/03/2020 15:37	05/03/2020 10:17	05/03/2020 15:37	5,32	2	10,65	CHI
20200318964	CORUMBAIBA	CI11298604	VILA CORUMBA	05/03/2020 10:18	05/03/2020 15:49	05/03/2020 10:18	05/03/2020 15:49	5,50	8	44,03	CHI
20200318965	NIQUELANDIA	2750079075	NIQUELANDIA SUBTRANSMISSAO	05/03/2020 10:19	05/03/2020 14:42	05/03/2020 10:19	05/03/2020 14:42	4,38	1	4,38	CHI
20200318970	CRISTALINA	KR21249250	CRISTALINA S1	05/03/2020 10:20	06/03/2020 01:54	05/03/2020 10:20	06/03/2020 01:54	15,56	1	15,56	CHI
20200318971	CAMPESTRE DE GOIAS	GA12276639	GUAPO S2	05/03/2020 10:20	05/03/2020 19:45	05/03/2020 10:20	05/03/2020 19:45	9,42	11	103,64	CHI
20200318971	GUAPO	GA12276639	GUAPO S2	05/03/2020 10:20	05/03/2020 19:45	05/03/2020 10:20	05/03/2020 19:45	9,42	1	9,42	CHI
20200318980	PIRENOPOLIS	220048629	CORUMBA	05/03/2020 10:23	05/03/2020 13:12	05/03/2020 10:23	05/03/2020 13:12	2,80	1	2,80	CHI
20200318985	URUACU	UR12317135	URUACU	05/03/2020 10:17	05/03/2020 12:22	05/03/2020 10:17	05/03/2020 12:22	2,08	11	22,84	CHI
20200318992	FORMOSA	FA21400958	ITIQUEIRA	05/03/2020 10:27	05/03/2020 22:04	05/03/2020 10:27	05/03/2020 22:04	11,62	1	11,62	CHI
20200318998	CAMPOS BELOS	CH21242827	SAO DOMINGOS	05/03/2020 10:28	05/03/2020 11:29	05/03/2020 10:28	05/03/2020 11:29	1,01	1	1,01	CHI
20200319016	PALMEIRAS DE GOIAS	PL12000134	PALMEIRAS	05/03/2020 10:32	05/03/2020 14:01	05/03/2020 10:32	05/03/2020 14:01	3,47	3	10,40	CHI
20200319020	ORIZONA	OZ12079955	VIANOPOLIS	05/03/2020 10:33	05/03/2020 14:01	05/03/2020 10:33	05/03/2020 14:01	3,46	15	51,93	CHI
20200319020	VIANOPOLIS	OZ12079955	VIANOPOLIS	05/03/2020 10:33	05/03/2020 14:01	05/03/2020 10:33	05/03/2020 14:01	3,46	11	38,08	CHI
20200319034	BRITANIA	BT21009198	BRITANIA	05/03/2020 10:34	05/03/2020 13:00	05/03/2020 10:34	05/03/2020 13:00	2,42	1	2,42	CHI
20200319040	MINEIROS	10004023771	PARQUE DAS EMAS	05/03/2020 10:36	05/03/2020 13:30	05/03/2020 10:36	05/03/2020 13:30	2,91	1	2,91	CHI
20200319043	ACREUNA	JD12296089	ACREUNA	05/03/2020 14:21	05/03/2020 19:06	05/03/2020 14:21	05/03/2020 19:06	4,74	9	42,68	CHI
20200319046	QUIRINOPOLIS	80051704	QUIRINOPOLIS	05/03/2020 10:37	05/03/2020 13:53	05/03/2020 10:37	05/03/2020 13:53	3,25	1	3,25	CHI
20200319048	RIO VERDE	RV12093081	RIO VERDE S1	05/03/2020 10:38	06/03/2020 13:31	05/03/2020 10:38	06/03/2020 13:31	26,88	1	26,88	CHI
20200319054	TRINDADE	40150033	MEIA PONTE	05/03/2020 10:40	05/03/2020 12:56	05/03/2020 10:40	05/03/2020 12:56	2,27	1	2,27	CHI
20200319061	CRISTALINA	KR21304945	CRISTALINA S2	05/03/2020 10:41	05/03/2020 15:46	05/03/2020 10:41	05/03/2020 15:46	5,07	1	5,07	CHI
20200319068	MONTIVIDIU	MV21306283	MONTIVIDIU T	05/03/2020 10:43	05/03/2020 13:54	05/03/2020 10:43	05/03/2020 13:54	3,17	1	3,17	CHI
20200319070	NOVO BRASIL	NB21116398	JUSSARA	05/03/2020 10:39	05/03/2020 11:33	05/03/2020 10:39	05/03/2020 11:33	0,92	1	0,92	CHI
20200319072	NOVO GAMA	10004419063	MARAJOARA	05/03/2020 10:44	05/03/2020 15:29	05/03/2020 10:44	05/03/2020 15:29	4,74	1	4,74	CHI
20200319081	MOZARLANDIA	MZ12057123	MOZARLANDIA	05/03/2020 10:46	05/03/2020 14:49	05/03/2020 10:46	05/03/2020 14:49	4,04	3	12,12	CHI
20200319086	TEREZOPOLIS DE GOIAS	1370017148	DAIA S2	05/03/2020 10:48	05/03/2020 18:22	05/03/2020 10:48	05/03/2020 18:22	7,55	1	7,55	CHI
20200319094	CORUMBAIBA	CI21193613	VILA CORUMBA	05/03/2020 10:50	05/03/2020 17:32	05/03/2020 10:50	05/03/2020 17:32	6,70	1	6,70	CHI
20200319103	SAO MIGUEL DO ARAGUAIA	SM21099585	SAO MIGUEL DO ARAGUAIA	05/03/2020 10:31	05/03/2020 14:48	05/03/2020 10:31	05/03/2020 14:48	4,28	4	17,13	CHI
20200319129	GOIANIA	GN10383781	AEROPORTO S2	05/03/2020 11:20	05/03/2020 11:42	05/03/2020 11:23	05/03/2020 11:42	0,32	1607	518,70	CHI
20200319202	GOIANIA	10022706028	REAL S2	05/03/2020 10:52	05/03/2020 14:32	05/03/2020 10:52	05/03/2020 14:32	3,66	1	3,66	CHI
20200319211	PIRACANJUBA	PJ31097396	BELA VISTA S1	05/03/2020 10:55	05/03/2020 14:01	05/03/2020 10:55	05/03/2020 14:01	3,10	1	3,10	CHI
20200319213	FLORES DE GOIAS	FB11282061	IACIARA S2	05/03/2020 10:55	05/03/2020 14:41	05/03/2020 10:55	05/03/2020 14:41	3,75	7	26,28	CHI
20200319214	ITABERAI	IX12018271	INHUMAS S1	05/03/2020 10:56	05/03/2020 14:54	05/03/2020 10:56	05/03/2020 14:54	3,96	14	55,49	CHI
20200319214	ITAUCU	IX12018271	INHUMAS S1	05/03/2020 10:56	05/03/2020 14:54	05/03/2020 10:56	05/03/2020 14:54	3,96	16	63,42	CHI
20200319217	PADRE BERNARDO	PB12347929	PADRE BERNARDO	05/03/2020 10:56	05/03/2020 13:07	05/03/2020 10:56	05/03/2020 13:07	2,17	5	10,85	CHI
20200319219	ITABERAI	IB21336294	ITABERAI S1	05/03/2020 10:57	05/03/2020 14:17	05/03/2020 10:57	05/03/2020 14:17	3,33	1	3,33	CHI
20200319226	GOIANIA	GN11000871	FERROVIARIO S1	05/03/2020 10:59	05/03/2020 12:40	05/03/2020 11:41	05/03/2020 12:40	0,98	44	43,27	CHI
20200319234	IACIARA	IA21318093	FLORES DE GOIAS	05/03/2020 11:01	05/03/2020 18:15	05/03/2020 11:01	05/03/2020 18:15	7,23	1	7,23	CHI
20200319235	JATAI	JT12334223	JATAI S1	05/03/2020 11:01	05/03/2020 15:40	05/03/2020 11:01	05/03/2020 15:40	4,64	1	4,64	CHI
20200319240	ARENOPOLIS	10020926160	ARENOPOLIS	05/03/2020 11:02	05/03/2020 17:34	05/03/2020 11:02	05/03/2020 17:34	6,54	1	6,54	CHI
20200319242	GOIANIA	14906909	FERROVIARIO S1	05/03/2020 11:04	05/03/2020 13:40	05/03/2020 11:04	05/03/2020 13:40	2,58	1	2,58	CHI
20200319244	PARAUNA	PU21303603	PARAUNA	05/03/2020 11:05	05/03/2020 16:56	05/03/2020 11:05	05/03/2020 16:56	5,84	1	5,84	CHI
20200319245	PIRENOPOLIS	10008644460	CORUMBA	05/03/2020 11:05	05/03/2020 17:36	05/03/2020 11:05	05/03/2020 17:36	6,50	1	6,50	CHI
20200319251	LUZIANIA	LZ21344830	MARAJOARA	05/03/2020 11:07	05/03/2020 17:12	05/03/2020 11:07	05/03/2020 17:12	6,07	1	6,07	CHI
20200319261	BOM JARDIM DE GOIAS	BM12187492	BOM JARDIM	05/03/2020 10:01	05/03/2020 15:57	05/03/2020 10:01	05/03/2020 15:57	5,92	76	449,94	CHI

20200319265	ANAPOLIS	10024157129	ANAPOLIS UNIVERSITARIO S2	05/03/2020 11:12	05/03/2020 16:22	05/03/2020 11:12	05/03/2020 16:22	5,16	1	5,16	CHI
20200319268	PONTALINA	PK21352962	MORRINHOS	05/03/2020 11:13	05/03/2020 14:33	05/03/2020 11:13	05/03/2020 14:33	3,33	1	3,33	CHI
20200319270	HEITORAI	UA12189658	ITAPURANGA	05/03/2020 11:14	05/03/2020 17:45	05/03/2020 11:14	05/03/2020 17:45	6,50	2	13,01	CHI
20200319273	OURO VERDE DE GOIAS	OV12353393RE	NEROPOLIS S1	05/03/2020 11:15	05/03/2020 16:01	05/03/2020 11:15	05/03/2020 16:01	4,77	30	143,01	CHI
20200319275	PADRE BERNARDO	ZN21342166	PADRE BERNARDO	05/03/2020 11:15	06/03/2020 12:26	05/03/2020 11:15	06/03/2020 12:26	25,18	2	50,35	CHI
20200319276	IPAMERI	IP21157756	CRISTALINA S2	05/03/2020 11:15	06/03/2020 01:06	05/03/2020 11:15	06/03/2020 01:06	13,83	1	13,83	CHI
20200319281	ANAPOLIS	AN11000126	ANAPOLIS UNIVERSITARIO S2	05/03/2020 11:17	06/03/2020 01:50	05/03/2020 11:17	05/03/2020 12:33	1,27	57	72,28	CHI
20200319281	ANAPOLIS	AN12000006	ANAPOLIS UNIVERSITARIO S2	05/03/2020 11:17	06/03/2020 01:50	05/03/2020 12:28	06/03/2020 01:50	13,35	156	2082,90	CHI
20200319282	NIQUELANDIA	NQ12208518	NIQUELANDIA SUBTRANSMISSAO	05/03/2020 11:17	05/03/2020 13:26	05/03/2020 11:17	05/03/2020 13:26	2,14	96	205,76	CHI
20200319285	CUMARI	CY21000303	CATALAO S1	05/03/2020 11:18	05/03/2020 15:43	05/03/2020 11:18	05/03/2020 15:43	4,42	2	8,83	CHI
20200319286	SERRANOPOLIS	SX21216645	JATAI S1	05/03/2020 11:18	06/03/2020 12:00	05/03/2020 11:18	06/03/2020 12:00	24,69	1	24,69	CHI
20200319287	EDEALINA	10021932350	PONTALINA	05/03/2020 11:18	05/03/2020 13:44	05/03/2020 11:18	05/03/2020 13:44	2,43	1	2,43	CHI
20200319311	AMARALINA	MU12391672	MARA ROSA	05/03/2020 11:03	05/03/2020 13:53	05/03/2020 11:03	05/03/2020 13:53	2,83	101	285,91	CHI
20200319311	MUTUNOPOLIS	MU12391672	MARA ROSA	05/03/2020 11:03	05/03/2020 13:53	05/03/2020 11:03	05/03/2020 13:53	2,83	7	19,82	CHI
20200319319	PONTALINA	PK21384542	PONTALINA	05/03/2020 11:29	05/03/2020 18:53	05/03/2020 11:29	05/03/2020 18:53	7,39	2	14,78	CHI
20200319322	COCALZINHO DE GOIAS	10006311758	AGUAS LINDAS DE GOIAS S2	05/03/2020 11:30	05/03/2020 13:51	05/03/2020 11:30	05/03/2020 13:51	2,34	1	2,34	CHI
20200319325	MOZARLANDIA	MZ12015614	MOZARLANDIA	05/03/2020 11:32	05/03/2020 18:54	05/03/2020 11:32	05/03/2020 18:54	7,35	14	102,96	CHI
20200319332	SAO MIGUEL DO ARAGUAIA	SM12252091	SAO MIGUEL DO ARAGUAIA	05/03/2020 11:34	05/03/2020 15:36	05/03/2020 11:34	05/03/2020 15:36	4,02	61	245,19	CHI
20200319340	AGUAS LINDAS DE GOIAS	4830258422	AGUAS LINDAS DE GOIAS S2	05/03/2020 11:38	05/03/2020 13:47	05/03/2020 11:38	05/03/2020 13:47	2,15	1	2,15	CHI
20200319351	JATAI	JT21152403	JATAI S3	05/03/2020 11:40	05/03/2020 18:30	05/03/2020 11:40	05/03/2020 18:30	6,83	1	6,83	CHI
20200319357	GOIANIA	10010487067	XAVANTES	05/03/2020 11:41	05/03/2020 13:52	05/03/2020 11:41	05/03/2020 13:52	2,17	1	2,17	CHI
20200319359	LUZIANIA	LZ12290851	MARAJOARA	05/03/2020 11:42	05/03/2020 18:18	05/03/2020 11:42	05/03/2020 18:18	6,59	23	151,65	CHI
20200319361	LUZIANIA	LZ11169061	MARAJOARA	05/03/2020 11:42	05/03/2020 12:48	05/03/2020 11:42	05/03/2020 12:48	1,08	59	63,93	CHI
20200319363	MONTES CLAROS DE GOIAS	ME12270281	IPORA	05/03/2020 11:43	05/03/2020 21:17	05/03/2020 11:43	05/03/2020 21:17	9,56	1	9,56	CHI
20200319364	SANTA HELENA DE GOIAS	TD12213488	RIO DOS BOIS	05/03/2020 11:16	05/03/2020 18:34	05/03/2020 11:16	05/03/2020 18:34	7,29	3	21,86	CHI
20200319364	TURVELANDIA	TD12213488	RIO DOS BOIS	05/03/2020 11:16	05/03/2020 18:34	05/03/2020 11:16	05/03/2020 18:34	7,29	6	43,72	CHI
20200319365	SAO JOAO D ALIANCA	JL21184919	SAO JOAO D ALIANCA	05/03/2020 11:44	05/03/2020 12:39	05/03/2020 11:44	05/03/2020 12:39	0,91	3	2,73	CHI
20200319368	ITABERAI	IB12364880	ITABERAI S2	05/03/2020 11:44	05/03/2020 18:40	05/03/2020 11:44	05/03/2020 18:40	6,92	3	20,77	CHI
20200319373	ALTO PARAISO DE GOIAS	BF21047995	FLORES DE GOIAS	05/03/2020 11:46	05/03/2020 13:19	05/03/2020 11:46	05/03/2020 13:19	1,54	2	3,07	CHI
20200319381	SAO MIGUEL DO ARAGUAIA	SM12081437	SAO MIGUEL DO ARAGUAIA	05/03/2020 11:47	05/03/2020 15:12	05/03/2020 11:47	05/03/2020 15:12	3,40	23	78,22	CHI
20200319383	GOIANIA	GN11157951	GOIANIA LESTE S3	05/03/2020 11:48	05/03/2020 13:12	05/03/2020 12:48	05/03/2020 13:12	0,39	15	5,90	CHI
20200319390	ANAPOLIS	AN11000426	JUNDIAI S1	05/03/2020 11:50	05/03/2020 15:12	05/03/2020 11:50	05/03/2020 15:12	3,36	164	550,54	CHI
20200319407	CHAPADAO DO CEU	DJ12196240	CHAPADAO DO CEU	05/03/2020 12:04	05/03/2020 15:42	05/03/2020 12:04	05/03/2020 15:42	3,63	1	3,63	CHI
20200319422	EDEIA	EA21162595	EDEIA	05/03/2020 09:18	05/03/2020 14:04	05/03/2020 09:18	05/03/2020 14:04	4,75	1	4,75	CHI
20200319503	CABECEIRAS	CW21257768	ITUIQUIRA	05/03/2020 11:51	05/03/2020 14:55	05/03/2020 11:51	05/03/2020 14:55	3,06	1	3,06	CHI
20200319504	GOIANIA	12363078	FERROVIARIO S1	05/03/2020 11:51	05/03/2020 13:25	05/03/2020 11:51	05/03/2020 13:25	1,56	1	1,56	CHI
20200319510	ACREUNA	2440058422	ACREUNA	05/03/2020 11:52	05/03/2020 22:44	05/03/2020 11:52	05/03/2020 22:44	10,85	1	10,85	CHI
20200319515	PEROLANDIA	MY12348932	PARQUE DAS EMAS	05/03/2020 10:49	05/03/2020 15:29	05/03/2020 10:49	05/03/2020 15:29	4,66	3	13,99	CHI
20200319521	APARECIDA DE GOIANIA	AP12004993	REAL S2	05/03/2020 11:33	05/03/2020 13:18	05/03/2020 11:33	05/03/2020 13:10	1,61	144	231,68	CHI
20200319521	APARECIDA DE GOIANIA	AP11167870	REAL S2	05/03/2020 11:33	05/03/2020 13:18	05/03/2020 11:33	05/03/2020 13:18	1,74	48	83,61	CHI
20200319527	GUAPO	10003950547	GUAPO S1	05/03/2020 11:56	05/03/2020 15:04	05/03/2020 11:56	05/03/2020 15:04	3,12	1	3,12	CHI
20200319533	RIO VERDE	630214098	RIO VERDE S1	05/03/2020 11:59	06/03/2020 21:18	05/03/2020 11:59	06/03/2020 21:18	33,31	1	33,31	CHI
20200319541	INHUMAS	IN21106221	INHUMAS S2	05/03/2020 12:01	06/03/2020 14:53	05/03/2020 12:01	06/03/2020 14:44	26,73	2	53,45	CHI
20200319541	INHUMAS	IN12326242	INHUMAS S2	05/03/2020 12:01	06/03/2020 14:53	06/03/2020 09:48	06/03/2020 14:53	5,07	11	55,80	CHI

20200319548	DOVERLANDIA	DV12188470	PARQUE DAS EMAS	05/03/2020 07:26	05/03/2020 22:43	05/03/2020 07:26	05/03/2020 22:43	15,28	1	15,28	CHI
20200319550	DOVERLANDIA	MY12390600	PARQUE DAS EMAS	05/03/2020 06:46	05/03/2020 13:11	05/03/2020 06:46	05/03/2020 13:11	6,40	1	6,40	CHI
20200319550	MINEIROS	MY12390600	PARQUE DAS EMAS	05/03/2020 06:46	05/03/2020 13:11	05/03/2020 06:46	05/03/2020 13:11	6,40	24	153,65	CHI
20200319561	QUIRINOPOLIS	QI11365697	QUIRINOPOLIS	05/03/2020 12:05	05/03/2020 17:29	05/03/2020 12:05	05/03/2020 17:29	5,40	29	156,50	CHI
20200319563	NOVO GAMA	10005126450	PACAEMBU S1	05/03/2020 12:05	05/03/2020 19:09	05/03/2020 12:05	05/03/2020 19:09	7,06	1	7,06	CHI
20200319567	PLANALTINA	PI12394160	SAO JOAO D ALIANCA	05/03/2020 12:06	05/03/2020 17:20	05/03/2020 12:06	05/03/2020 17:20	5,22	7	36,56	CHI
20200319573	ABADIA DE GOIAS	TR31050565	TRINDADE	05/03/2020 12:08	05/03/2020 14:05	05/03/2020 12:08	05/03/2020 14:05	1,94	1	1,94	CHI
20200319578	INDIARA	JD12005508	PALMEIRAS	05/03/2020 10:30	06/03/2020 01:11	05/03/2020 10:30	06/03/2020 01:11	14,67	43	630,76	CHI
20200319578	JANDAIA	JD12005508	PALMEIRAS	05/03/2020 10:30	06/03/2020 01:11	05/03/2020 10:30	06/03/2020 01:11	14,67	7	102,68	CHI
20200319580	CRIXAS	RB12114265	RUBIATABA	05/03/2020 12:12	06/03/2020 13:45	05/03/2020 12:12	06/03/2020 13:45	25,55	1	25,55	CHI
20200319580	NOVA AMERICA	RB12114265	RUBIATABA	05/03/2020 12:12	06/03/2020 13:45	05/03/2020 12:12	06/03/2020 13:45	25,55	18	459,86	CHI
20200319580	RUBIATABA	RB12114265	RUBIATABA	05/03/2020 12:12	06/03/2020 13:45	05/03/2020 12:12	06/03/2020 13:45	25,55	82	2094,94	CHI
20200319582	MORRINHOS	150133200	MORRINHOS	05/03/2020 12:11	05/03/2020 12:53	05/03/2020 12:11	05/03/2020 12:53	0,69	1	0,69	CHI
20200319586	CAMPOS VERDES	SG12335777	SANTA TEREZINHA	05/03/2020 12:13	06/03/2020 12:00	05/03/2020 12:13	06/03/2020 12:00	23,77	1	23,77	CHI
20200319587	NOVA CRIXAS	NA12262740	NOVA CRIXAS	05/03/2020 12:13	05/03/2020 17:14	05/03/2020 12:13	05/03/2020 17:14	5,01	102	510,93	CHI
20200319588	RIO QUENTE	RQ12316156	VILA CORUMBA	05/03/2020 12:14	05/03/2020 19:03	05/03/2020 12:14	05/03/2020 19:03	6,82	2	13,65	CHI
20200319594	NIQUELANDIA	NQ21334144	BARRO ALTO	05/03/2020 12:16	05/03/2020 21:05	05/03/2020 12:16	05/03/2020 21:05	8,80	1	8,80	CHI
20200319595	BOM JESUS DE GOIAS	BJ12000024LD	BOM JESUS DE GOIAS	05/03/2020 11:05	06/03/2020 16:27	05/03/2020 11:05	06/03/2020 16:27	29,35	2	58,71	CHI
20200319595	ITUMBIARA	BJ12000024LD	BOM JESUS DE GOIAS	05/03/2020 11:05	06/03/2020 16:27	05/03/2020 11:05	06/03/2020 16:27	29,35	67	1966,77	CHI
20200319599	GOIAS	GS21058302	GOIAS	05/03/2020 12:18	05/03/2020 14:02	05/03/2020 12:18	05/03/2020 14:02	1,72	1	1,72	CHI
20200319602	MINEIROS	PW12205289	PARQUE DAS EMAS	05/03/2020 12:05	05/03/2020 18:54	05/03/2020 12:05	05/03/2020 18:54	6,81	3	20,44	CHI
20200319602	PORTELANDIA	PW12205289	PARQUE DAS EMAS	05/03/2020 12:05	05/03/2020 18:54	05/03/2020 12:05	05/03/2020 18:54	6,81	3	20,44	CHI
20200319605	LUZIANIA	LZ11031098	RIO VERMELHO	05/03/2020 12:20	05/03/2020 13:11	05/03/2020 12:20	05/03/2020 13:11	0,85	9	7,61	CHI
20200319607	SAO DOMINGOS	SD12170547	SAO DOMINGOS	05/03/2020 12:21	05/03/2020 13:44	05/03/2020 12:21	05/03/2020 13:44	1,37	13	17,84	CHI
20200319608	LEOPOLDO DE BULHOES	LB12090924	DAIA S2	05/03/2020 12:21	05/03/2020 15:20	05/03/2020 12:21	05/03/2020 15:20	2,97	1	2,97	CHI
20200319610	MAMBAI	MB12239963	IACIARA S2	05/03/2020 12:23	05/03/2020 13:39	05/03/2020 12:23	05/03/2020 13:39	1,27	7	8,86	CHI
20200319615	TRINDADE	40305405	TRINDADE	05/03/2020 12:24	05/03/2020 14:45	05/03/2020 12:24	05/03/2020 14:45	2,34	1	2,34	CHI
20200319624	ARENOPOLIS	AY12000051	ARENOPOLIS	05/03/2020 12:26	05/03/2020 18:35	05/03/2020 12:26	05/03/2020 18:35	6,14	4	24,54	CHI
20200319624	DIORAMA	AY12000051	ARENOPOLIS	05/03/2020 12:26	05/03/2020 18:35	05/03/2020 12:26	05/03/2020 18:35	6,14	2	12,27	CHI
20200319632	INHUMAS	IN21320343	INHUMAS S1	05/03/2020 12:31	05/03/2020 14:02	05/03/2020 12:31	05/03/2020 14:02	1,51	2	3,03	CHI
20200319637	FLORES DE GOIAS	FB12287910LD	IACIARA S2	05/03/2020 12:32	05/03/2020 16:29	05/03/2020 12:32	05/03/2020 16:29	3,94	4	15,74	CHI
20200319641	GOIAS	GS12065878	MATRINCHA	05/03/2020 12:34	05/03/2020 14:44	05/03/2020 12:34	05/03/2020 14:44	2,16	1	2,16	CHI
20200319647	GOIANIA	10028456	ATLANTICO S3	05/03/2020 12:35	05/03/2020 16:36	05/03/2020 12:35	05/03/2020 16:36	4,00	1	4,00	CHI
20200319649	RIO VERDE	RV12305757	MONTIVIDIU T	05/03/2020 12:36	06/03/2020 00:32	05/03/2020 12:36	06/03/2020 00:32	11,93	5	59,65	CHI
20200319652	SANTA TEREZA DE GOIAS	SE21288214	MARA ROSA	05/03/2020 12:37	05/03/2020 14:22	05/03/2020 12:37	05/03/2020 14:22	1,75	1	1,75	CHI
20200319662	BURITI DE GOIAS	1680000746	FIRMINOPOLIS S2	05/03/2020 12:42	05/03/2020 19:12	05/03/2020 12:42	05/03/2020 19:12	6,49	1	6,49	CHI
20200319669	APARECIDA DE GOIANIA	AP11372450	ANHANGUERA	05/03/2020 12:44	05/03/2020 16:40	05/03/2020 12:44	05/03/2020 16:40	3,93	71	278,93	CHI
20200319671	JATAI	JT12000118	JATAI S2	05/03/2020 12:45	06/03/2020 14:05	05/03/2020 12:45	05/03/2020 17:44	4,98	74	368,40	CHI
20200319671	JATAI	JT12000118	JATAI S2	05/03/2020 12:45	06/03/2020 14:05	05/03/2020 18:15	05/03/2020 21:19	3,08	59	181,79	CHI
20200319671	JATAI	JT13226566	JATAI S2	05/03/2020 12:45	06/03/2020 14:05	05/03/2020 18:15	05/03/2020 23:09	4,90	3	14,70	CHI
20200319671	JATAI	JT13214341	JATAI S2	05/03/2020 12:45	06/03/2020 14:05	05/03/2020 12:45	06/03/2020 00:03	11,29	1	11,29	CHI
20200319671	JATAI	JT13214341	JATAI S2	05/03/2020 12:45	06/03/2020 14:05	05/03/2020 18:15	06/03/2020 00:03	5,80	4	23,20	CHI
20200319671	JATAI	JT12036891LD	JATAI S2	05/03/2020 12:45	06/03/2020 14:05	05/03/2020 18:15	06/03/2020 14:05	19,83	4	79,33	CHI
20200319678	NIQUELANDIA	NQ12374779	URUACU	05/03/2020 11:24	05/03/2020 17:34	05/03/2020 11:24	05/03/2020 17:34	6,16	29	178,75	CHI

20200319680	GOIANESIA	GE21387155	GOIANESIA S1	05/03/2020 12:47	05/03/2020 16:02	05/03/2020 12:47	05/03/2020 16:02	3,26	1	3,26	CHI
20200319681	PIRANHAS	PH12201806	PIRANHAS	05/03/2020 12:47	05/03/2020 14:46	05/03/2020 12:47	05/03/2020 14:46	1,97	40	78,94	CHI
20200319682	URUACU	UR21059832	URUACU	05/03/2020 12:48	05/03/2020 14:30	05/03/2020 12:48	05/03/2020 14:30	1,70	1	1,70	CHI
20200319684	URUACU	UR12310098	URUACU	05/03/2020 12:49	05/03/2020 15:46	05/03/2020 12:49	05/03/2020 15:46	2,95	3	8,85	CHI
20200319685	GOIANESIA	550091221	GOIANESIA S2	05/03/2020 12:49	05/03/2020 14:36	05/03/2020 12:49	05/03/2020 14:36	1,78	1	1,78	CHI
20200319686	FLORES DE GOIAS	FB11286789	FLORES DE GOIAS	05/03/2020 12:49	05/03/2020 18:28	05/03/2020 12:49	05/03/2020 18:28	5,64	1	5,64	CHI
20200319693	GOIANAPOLIS	GN21030303	GOIANIA LESTE S3	05/03/2020 12:52	05/03/2020 15:17	05/03/2020 12:52	05/03/2020 15:17	2,41	1	2,41	CHI
20200319694	QUIRINOPOLIS	QI12017983	QUIRINOPOLIS	05/03/2020 12:42	05/03/2020 15:37	05/03/2020 12:42	05/03/2020 15:37	2,91	3	8,73	CHI
20200319695	MATRINCHA	MP12199954	MATRINCHA	05/03/2020 12:52	05/03/2020 21:48	05/03/2020 12:52	05/03/2020 21:48	8,93	4	35,71	CHI
20200319702	MORRINHOS	10021510375	MORRINHOS	05/03/2020 12:55	05/03/2020 16:30	05/03/2020 12:55	05/03/2020 16:30	3,59	1	3,59	CHI
20200319715	NOVA VENEZA	NV21275158	INHUMAS S1	05/03/2020 13:00	05/03/2020 16:21	05/03/2020 13:00	05/03/2020 16:21	3,35	1	3,35	CHI
20200319716	ALTO PARAISO DE GOIAS	BF12105397LD	SAO JOAO D ALIANCA	05/03/2020 13:00	05/03/2020 14:48	05/03/2020 13:00	05/03/2020 14:48	1,79	209	374,57	CHI
20200319723	PETROLINA DE GOIAS	PG21222703	PETROLINA	05/03/2020 13:03	05/03/2020 20:28	05/03/2020 13:03	05/03/2020 20:28	7,41	1	7,41	CHI
20200319726	DIVINOPOLIS DE GOIAS	GH12228817	SAO DOMINGOS	05/03/2020 12:46	05/03/2020 15:26	05/03/2020 12:46	05/03/2020 15:26	2,66	13	34,63	CHI
20200319729	GOIAS	GS12073642	MATRINCHA	05/03/2020 13:06	05/03/2020 16:37	05/03/2020 13:06	05/03/2020 16:37	3,51	26	91,20	CHI
20200319734	GOIAS	90029422	GOIAS	05/03/2020 13:08	05/03/2020 16:47	05/03/2020 13:08	05/03/2020 16:47	3,65	1	3,65	CHI
20200319738	GOIANIA	10521896	GOIANIA LESTE S2	05/03/2020 13:10	05/03/2020 15:26	05/03/2020 13:10	05/03/2020 15:26	2,27	1	2,27	CHI
20200319747	GOIAS	GS21319356	GOIAS	05/03/2020 13:15	05/03/2020 16:45	05/03/2020 13:15	05/03/2020 16:45	3,50	1	3,50	CHI
20200319759	CALDAS NOVAS	CN11111405	CALDAS NOVAS S1	05/03/2020 13:17	05/03/2020 19:17	05/03/2020 13:17	05/03/2020 19:17	5,99	187	1119,56	CHI
20200319760	PIRENOPOLIS	AN21325268	ANAPOLIS UNIVERSITARIO S2	05/03/2020 13:18	05/03/2020 15:51	05/03/2020 13:18	05/03/2020 15:51	2,54	2	5,08	CHI
20200319761	ISRAELANDIA	IS11005035	IPORA	05/03/2020 13:18	05/03/2020 16:11	05/03/2020 13:18	05/03/2020 16:11	2,87	73	209,85	CHI
20200319768	GOIANIA	10009030261	XAVANTES	05/03/2020 13:19	05/03/2020 14:09	05/03/2020 13:19	05/03/2020 14:09	0,82	1	0,82	CHI
20200319772	MINEIROS	MY12195613LD	PARQUE DAS EMAS	05/03/2020 13:21	07/03/2020 18:30	05/03/2020 13:21	07/03/2020 18:30	53,16	2	106,31	CHI
20200319774	LUZIANIA	LZ12320064	MARAJOARA	05/03/2020 13:21	06/03/2020 10:29	05/03/2020 13:21	06/03/2020 10:29	21,13	3	63,38	CHI
20200319775	FORMOSA	10006378143	ITUIQUIRA	05/03/2020 13:22	05/03/2020 15:14	05/03/2020 13:22	05/03/2020 15:14	1,87	1	1,87	CHI
20200319776	GOIANIA	10327370	CAMPINAS S1	05/03/2020 13:22	05/03/2020 15:39	05/03/2020 13:22	05/03/2020 15:39	2,28	1	2,28	CHI
20200319777	NOVO GAMA	2460028721	PACAEMBU S1	05/03/2020 13:22	05/03/2020 16:14	05/03/2020 13:22	05/03/2020 16:14	2,86	1	2,86	CHI
20200319779	ANAPOLIS	AN21229838	NEROPOLIS S1	05/03/2020 13:22	05/03/2020 17:28	05/03/2020 13:22	05/03/2020 17:28	4,09	1	4,09	CHI
20200319788	PIRES DO RIO	BC21311736	PIRES DO RIO S2	05/03/2020 13:27	05/03/2020 15:03	05/03/2020 13:27	05/03/2020 15:03	1,60	1	1,60	CHI
20200319796	SAO MIGUEL DO ARAGUAIA	SM12096089RE	SAO MIGUEL DO ARAGUAIA	05/03/2020 13:21	05/03/2020 16:27	05/03/2020 13:21	05/03/2020 16:27	3,10	27	83,62	CHI
20200319805	ANAPOLIS	AN12000524	ANAPOLIS UNIVERSITARIO S2	05/03/2020 13:32	05/03/2020 15:41	05/03/2020 13:32	05/03/2020 15:41	2,14	5	10,70	CHI
20200319809	GOIANIA	10010839176	XAVANTES	05/03/2020 13:34	05/03/2020 15:07	05/03/2020 13:34	05/03/2020 15:07	1,54	1	1,54	CHI
20200319817	GOIAS	IK12250614	ITAPURANGA	05/03/2020 13:34	05/03/2020 16:14	05/03/2020 13:34	05/03/2020 16:14	2,66	2	5,32	CHI
20200319817	GUARAITA	IK12250614	ITAPURANGA	05/03/2020 13:34	05/03/2020 16:14	05/03/2020 13:34	05/03/2020 16:14	2,66	18	47,84	CHI
20200319817	ITAPURANGA	IK12250614	ITAPURANGA	05/03/2020 13:34	05/03/2020 16:14	05/03/2020 13:34	05/03/2020 16:14	2,66	21	55,81	CHI
20200319824	FAZENDA NOVA	FN21113491	JUSSARA	05/03/2020 13:37	05/03/2020 15:31	05/03/2020 13:37	05/03/2020 15:31	1,88	1	1,88	CHI
20200319831	AGUAS LINDAS DE GOIAS	10004994130	AGUAS LINDAS DE GOIAS S1	05/03/2020 13:39	05/03/2020 15:15	05/03/2020 13:39	05/03/2020 15:15	1,60	1	1,60	CHI
20200319833	ITAPIRAPUA	IU12121510	MATRINCHA	05/03/2020 13:40	05/03/2020 16:29	05/03/2020 13:40	05/03/2020 16:29	2,81	3	8,43	CHI
20200319848	ANAPOLIS	21083666	ANAPOLIS UNIVERSITARIO S2	05/03/2020 13:45	06/03/2020 16:18	05/03/2020 13:45	06/03/2020 16:18	26,54	1	26,54	CHI
20200319850	ARAGOIANIA	680017379	GUAPO S2	05/03/2020 13:46	05/03/2020 16:24	05/03/2020 13:46	05/03/2020 16:24	2,63	1	2,63	CHI
20200319853	BONOPOLIS	BX12328842	NOVO PLANALTO	05/03/2020 13:47	05/03/2020 17:02	05/03/2020 13:47	05/03/2020 17:02	3,24	1	3,24	CHI
20200319857	JATAI	JT12182138	JATAI S1	05/03/2020 12:35	05/03/2020 20:36	05/03/2020 12:35	05/03/2020 20:36	8,01	10	80,10	CHI
20200319860	ANAPOLIS	10028431047	ANAPOLIS UNIVERSITARIO S2	05/03/2020 13:50	06/03/2020 03:42	05/03/2020 13:50	06/03/2020 03:42	13,87	1	13,87	CHI
20200319861	RUBIATABA	6571708	RUBIATABA	05/03/2020 13:50	05/03/2020 16:29	05/03/2020 13:50	05/03/2020 16:29	2,65	3	7,94	CHI

20200319863	FAZENDA NOVA	FN12217146	JUSSARA	05/03/2020 13:50	05/03/2020 17:28	05/03/2020 13:50	05/03/2020 17:28	3,62	14	50,73	CHI
20200319869	CAIAPONIA	CP11292059	CAIAPONIA	05/03/2020 13:53	05/03/2020 20:04	05/03/2020 13:53	05/03/2020 20:04	6,17	1	6,17	CHI
20200319871	VILA PROPICIO	GE12196931	GOIANESIA S1	05/03/2020 12:53	05/03/2020 18:00	05/03/2020 12:53	05/03/2020 18:00	5,12	9	46,11	CHI
20200319873	ITAPIRAPUA	IU21227285	MATRINCHA	05/03/2020 13:54	05/03/2020 17:17	05/03/2020 13:54	05/03/2020 17:17	3,38	1	3,38	CHI
20200319874	ESTRELA DO NORTE	ET12256551	MARA ROSA	05/03/2020 13:54	05/03/2020 16:39	05/03/2020 13:54	05/03/2020 16:39	2,74	9	24,67	CHI
20200319875	NIQUELANDIA	NQ11057931	NIQUELANDIA SUBTRANSMISSAO	05/03/2020 13:55	05/03/2020 17:38	05/03/2020 13:55	05/03/2020 17:38	3,71	155	574,75	CHI
20200319877	QUIRINOPOLIS	QI12064766	QUIRINOPOLIS	05/03/2020 13:57	06/03/2020 01:45	05/03/2020 13:57	05/03/2020 18:10	4,22	3	12,66	CHI
20200319877	PARANAIGUARA	QI12064766	QUIRINOPOLIS	05/03/2020 13:57	06/03/2020 01:45	05/03/2020 13:57	06/03/2020 01:45	11,80	2	23,59	CHI
20200319877	QUIRINOPOLIS	QI12064766	QUIRINOPOLIS	05/03/2020 13:57	06/03/2020 01:45	05/03/2020 13:57	06/03/2020 01:45	11,80	2	23,59	CHI
20200319878	LUZIANIA	LZ21163816	RIO VERMELHO	05/03/2020 13:57	05/03/2020 15:55	05/03/2020 13:57	05/03/2020 15:55	1,96	1	1,96	CHI
20200319880	EDEIA	1120040982	EDEIA	05/03/2020 13:55	05/03/2020 17:49	05/03/2020 13:55	05/03/2020 17:49	3,90	1	3,90	CHI
20200319881	SERRANOPOLIS	SX12296463	JATAI S1	05/03/2020 13:57	05/03/2020 19:21	05/03/2020 13:57	05/03/2020 19:21	5,39	1	5,39	CHI
20200319889	PADRE BERNARDO	9980000605	PADRE BERNARDO	05/03/2020 14:01	05/03/2020 17:37	05/03/2020 14:01	05/03/2020 17:37	3,58	1	3,58	CHI
20200319890	LUZIANIA	LZ12376129	CRISTALINA S2	05/03/2020 14:02	05/03/2020 22:01	05/03/2020 14:02	05/03/2020 22:01	7,97	55	438,40	CHI
20200319894	ORIZONA	OZ21115031	VIANOPOLIS	05/03/2020 14:04	05/03/2020 18:31	05/03/2020 14:04	05/03/2020 18:31	4,45	1	4,45	CHI
20200319896	JATAI	JT11063433	JATAI S3	05/03/2020 13:49	05/03/2020 15:34	05/03/2020 13:49	05/03/2020 15:34	1,75	118	206,47	CHI
20200319907	ACREUNA	02650216	RIO DOS BOIS	05/03/2020 13:12	06/03/2020 03:25	05/03/2020 13:12	06/03/2020 03:25	14,21	14	198,89	CHI
20200319907	EDEIA	02650216	RIO DOS BOIS	05/03/2020 13:12	06/03/2020 03:25	05/03/2020 13:12	06/03/2020 03:25	14,21	49	696,13	CHI
20200319907	GOIATUBA	02650216	RIO DOS BOIS	05/03/2020 13:12	06/03/2020 03:25	05/03/2020 13:12	06/03/2020 03:25	14,21	18	255,72	CHI
20200319907	PORTEIRAO	02650216	RIO DOS BOIS	05/03/2020 13:12	06/03/2020 03:25	05/03/2020 13:12	06/03/2020 03:25	14,21	35	497,23	CHI
20200319907	TURVELANDIA	02650216	RIO DOS BOIS	05/03/2020 13:12	06/03/2020 03:25	05/03/2020 13:12	06/03/2020 03:25	14,21	8	113,65	CHI
20200319909	ORIZONA	OZ21114456	PIRES DO RIO S2	05/03/2020 14:09	05/03/2020 18:01	05/03/2020 14:09	05/03/2020 18:01	3,87	1	3,87	CHI
20200319916	GOIANIA	11182222	CAMPINAS S1	05/03/2020 14:11	05/03/2020 16:11	05/03/2020 14:11	05/03/2020 16:11	1,99	1	1,99	CHI
20200319918	CORREGO DO OURO	CO12040666	FIRMINOPOLIS S2	05/03/2020 13:55	05/03/2020 16:57	05/03/2020 13:55	05/03/2020 16:57	3,02	12	36,25	CHI
20200319918	FAZENDA NOVA	CO12040666	FIRMINOPOLIS S2	05/03/2020 13:55	05/03/2020 16:57	05/03/2020 13:55	05/03/2020 16:57	3,02	8	24,17	CHI
20200319919	ITAPACI	IW21335708	ITAPACI	05/03/2020 14:12	05/03/2020 18:12	05/03/2020 14:12	05/03/2020 18:12	3,99	1	3,99	CHI
20200319929	GOIANIA	GN11218937	GOYA S1	05/03/2020 14:18	05/03/2020 15:37	05/03/2020 14:18	05/03/2020 15:37	1,32	62	81,55	CHI
20200319931	CRISTALINA	KR21240981	CRISTALINA S1	05/03/2020 14:19	05/03/2020 22:00	05/03/2020 14:19	05/03/2020 22:00	7,68	1	7,68	CHI
20200319940	LUZIANIA	LZ12313611	VIANOPOLIS	05/03/2020 14:21	05/03/2020 22:20	05/03/2020 14:21	05/03/2020 22:20	7,98	13	103,76	CHI
20200319943	FORMOSA	FA31233562	SAO JOAO D ALIANCA	05/03/2020 14:21	05/03/2020 20:02	05/03/2020 14:21	05/03/2020 20:02	5,67	1	5,67	CHI
20200319944	CAMPOS BELOS	CH12261966	SAO DOMINGOS	05/03/2020 14:21	05/03/2020 15:58	05/03/2020 14:21	05/03/2020 15:58	1,60	7	11,22	CHI
20200319945	CATALAO	CT12287068	CATALAO S1	05/03/2020 14:22	05/03/2020 20:23	05/03/2020 14:22	05/03/2020 20:23	6,02	1	6,02	CHI
20200319946	PADRE BERNARDO	PB12163211	PADRE BERNARDO	05/03/2020 14:22	06/03/2020 11:09	05/03/2020 14:22	06/03/2020 11:09	20,78	3	62,33	CHI
20200319953	RIO VERDE	RV12326798	SANTA HELENA S1	05/03/2020 14:24	05/03/2020 22:11	05/03/2020 14:24	05/03/2020 22:11	7,78	2	15,57	CHI
20200319954	JATAI	JT12210073	JATAI S1	05/03/2020 14:24	05/03/2020 19:13	05/03/2020 14:24	05/03/2020 19:13	4,81	23	110,74	CHI
20200319955	ITAJA	IJ12162692	ITAJA S2	05/03/2020 14:25	05/03/2020 15:48	05/03/2020 14:25	05/03/2020 15:48	1,38	6	8,27	CHI
20200319956	GOIANIA	10062269	GOYA S2	05/03/2020 14:25	05/03/2020 15:41	05/03/2020 14:25	05/03/2020 15:41	1,26	1	1,26	CHI
20200319963	CAIAPONIA	CP12243821	CAIAPONIA	05/03/2020 14:28	06/03/2020 03:18	05/03/2020 14:28	06/03/2020 03:18	12,82	14	179,50	CHI
20200319976	PIRACANJUBA	PJ12019736	PIRACANJUBA	05/03/2020 14:32	05/03/2020 16:31	05/03/2020 14:32	05/03/2020 16:31	1,98	8	15,86	CHI
20200319980	GOIANIA	11714724	ATLANTICO S3	05/03/2020 14:33	05/03/2020 15:43	05/03/2020 14:33	05/03/2020 15:43	1,16	1	1,16	CHI
20200319984	BONOPOLIS	BX12266016	SAO MIGUEL DO ARAGUAIA	05/03/2020 14:34	05/03/2020 17:44	05/03/2020 14:34	05/03/2020 17:44	3,16	9	28,46	CHI
20200319985	FORMOSA	FA12383259	ITUIQUIRA	05/03/2020 14:34	05/03/2020 17:22	05/03/2020 14:34	05/03/2020 17:22	2,79	2	5,57	CHI
20200319987	ALEXANIA	AX21000106	CORUMBA	05/03/2020 14:35	05/03/2020 19:26	05/03/2020 14:35	05/03/2020 19:26	4,84	1	4,84	CHI
20200319991	APARECIDA DE GOIANIA	200255083	INDEPENDENCIA S1	05/03/2020 14:37	05/03/2020 16:11	05/03/2020 14:37	05/03/2020 16:11	1,56	1	1,56	CHI

20200319992	MINEIROS	1390023166	PARQUE DAS EMAS	05/03/2020 14:38	05/03/2020 17:41	05/03/2020 14:38	05/03/2020 17:41	3,05	1	3,05	CHI
20200319993	SANTA TEREZA DE GOIAS	SE12143626	MARA ROSA	05/03/2020 14:38	06/03/2020 01:09	05/03/2020 14:38	05/03/2020 21:14	6,59	2	13,18	CHI
20200319993	SANTA TEREZA DE GOIAS	SE12053817LD	MARA ROSA	05/03/2020 14:38	06/03/2020 01:09	05/03/2020 14:38	05/03/2020 23:59	9,35	2	18,70	CHI
20200319993	SANTA TEREZA DE GOIAS	SE12242568	MARA ROSA	05/03/2020 14:38	06/03/2020 01:09	05/03/2020 14:38	06/03/2020 00:59	10,35	1	10,35	CHI
20200319993	SANTA TEREZA DE GOIAS	SE12242574	MARA ROSA	05/03/2020 14:38	06/03/2020 01:09	05/03/2020 14:38	06/03/2020 01:09	10,52	1	10,52	CHI
20200319994	JANDAIA	JD12008614	PALMEIRAS	05/03/2020 13:15	05/03/2020 17:00	05/03/2020 13:15	05/03/2020 17:00	3,74	19	71,05	CHI
20200319994	PARAUNA	JD12008614	PALMEIRAS	05/03/2020 13:15	05/03/2020 17:00	05/03/2020 13:15	05/03/2020 17:00	3,74	5	18,70	CHI
20200319997	ANAPOLIS	20544364	JUNDIAI S1	05/03/2020 14:40	05/03/2020 17:26	05/03/2020 14:40	05/03/2020 17:26	2,76	1	2,76	CHI
20200320000	VILA PROPICIO	PV21035850	GOIANESIA S1	05/03/2020 14:41	05/03/2020 21:13	05/03/2020 14:41	05/03/2020 21:13	6,52	1	6,52	CHI
20200320122	GOIANIA	GN10394634	FERROVIARIO S2	05/03/2020 15:26	05/03/2020 15:57	05/03/2020 15:26	05/03/2020 15:57	0,51	1455	742,86	CHI
20200320202	GOIATUBA	GT12392085	GOIATUBA S2	05/03/2020 14:41	05/03/2020 23:49	05/03/2020 14:41	05/03/2020 23:49	9,12	3	27,36	CHI
20200320203	CORUMBA DE GOIAS	CB21171921	CORUMBA	05/03/2020 14:42	05/03/2020 18:48	05/03/2020 14:42	05/03/2020 18:48	4,10	1	4,10	CHI
20200320205	CRISTALINA	LZ21080546	PAMPLONA	05/03/2020 14:42	05/03/2020 17:56	05/03/2020 14:42	05/03/2020 17:56	3,22	3	9,65	CHI
20200320207	GOIANAPOLIS	GP11029286	JUNDIAI S1	05/03/2020 14:46	05/03/2020 17:14	05/03/2020 14:46	05/03/2020 17:14	2,46	45	110,92	CHI
20200320211	GUARINOS	GF21323904	SANTA TEREZINHA	05/03/2020 14:45	05/03/2020 20:41	05/03/2020 14:45	05/03/2020 20:41	5,92	1	5,92	CHI
20200320222	PLANALTINA	2960191645	PLANALTINA	05/03/2020 14:49	05/03/2020 18:15	05/03/2020 14:49	05/03/2020 18:15	3,44	1	3,44	CHI
20200320228	IPORA	IR21294010	IPORA	05/03/2020 14:54	05/03/2020 20:05	05/03/2020 14:54	05/03/2020 20:05	5,17	1	5,17	CHI
20200320232	SANTA HELENA DE GOIAS	400114320	IPEGUARI	05/03/2020 14:55	05/03/2020 18:25	05/03/2020 14:55	05/03/2020 18:25	3,48	1	3,48	CHI
20200320233	TRINDADE	TR21119003	TRINDADE	05/03/2020 14:56	05/03/2020 15:35	05/03/2020 14:56	05/03/2020 15:35	0,64	1	0,64	CHI
20200320237	MORRINHOS	MR12417456	MORRINHOS	05/03/2020 14:58	06/03/2020 09:31	05/03/2020 14:58	06/03/2020 09:31	18,56	1	18,56	CHI
20200320239	GUAPO	GA31033255	GUAPO S2	05/03/2020 14:59	05/03/2020 16:08	05/03/2020 14:59	05/03/2020 16:08	1,15	1	1,15	CHI
20200320249	MOSSAMEDES	KB12382583	ANICUNS	05/03/2020 14:59	05/03/2020 18:25	05/03/2020 14:59	05/03/2020 18:25	3,43	17	58,34	CHI
20200320250	PADRE BERNARDO	PB12246199	PADRE BERNARDO	05/03/2020 15:01	06/03/2020 10:20	05/03/2020 15:01	06/03/2020 10:20	19,30	1	19,30	CHI
20200320258	MINACU	IH21242011	MINACU	05/03/2020 15:05	05/03/2020 16:37	05/03/2020 15:05	05/03/2020 16:37	1,53	2	3,06	CHI
20200320260	TURVELANDIA	TD12226264	RIO DOS BOIS	05/03/2020 15:01	05/03/2020 18:34	05/03/2020 15:01	05/03/2020 18:34	3,54	71	251,40	CHI
20200320264	JANDAIA	JD12199849	ACREUNA	05/03/2020 15:08	05/03/2020 20:38	05/03/2020 15:08	05/03/2020 20:38	5,49	4	21,95	CHI
20200320266	GOUVELANDIA	2250005005	QUIRINOPOLIS	05/03/2020 15:08	05/03/2020 19:41	05/03/2020 15:08	05/03/2020 19:41	4,54	1	4,54	CHI
20200320267	MINACU	IH12392285	MINACU	05/03/2020 15:09	05/03/2020 18:59	05/03/2020 15:09	05/03/2020 18:59	3,82	3	11,45	CHI
20200320268	ITUMBIARA	BG21000092	ITUMBIARA VELHA S2	05/03/2020 15:10	05/03/2020 23:18	05/03/2020 15:10	05/03/2020 23:18	8,13	1	8,13	CHI
20200320269	HIDROLANDIA	HD21402808	INDEPENDENCIA S1	05/03/2020 15:10	05/03/2020 17:02	05/03/2020 15:10	05/03/2020 17:02	1,86	1	1,86	CHI
20200320273	RIO VERDE	RV21026918	RIO DOS BOIS	05/03/2020 15:11	06/03/2020 18:20	05/03/2020 15:11	06/03/2020 18:20	27,14	1	27,14	CHI
20200320281	JATAI	JT21008873	JATAI S1	05/03/2020 15:13	05/03/2020 20:15	05/03/2020 15:13	05/03/2020 20:15	5,02	1	5,02	CHI
20200320282	MOIPORA	MO21003692	SAO LUIZ DOS MONTES BELOS	05/03/2020 15:13	05/03/2020 22:08	05/03/2020 15:13	05/03/2020 22:08	6,90	1	6,90	CHI
20200320287	GOUVELANDIA	GB21158171	QUIRINOPOLIS	05/03/2020 15:15	05/03/2020 18:43	05/03/2020 15:15	05/03/2020 18:43	3,45	1	3,45	CHI
20200320293	QUIRINOPOLIS	QI21119905	QUIRINOPOLIS	05/03/2020 15:17	05/03/2020 18:14	05/03/2020 15:17	05/03/2020 18:14	2,93	1	2,93	CHI
20200320295	RIO VERDE	RV12245473	CABRIUVA S2	05/03/2020 14:41	05/03/2020 18:49	05/03/2020 14:41	05/03/2020 18:49	4,13	7	28,91	CHI
20200320298	DOVERLANDIA	DV11138407	CAIAPONIA	05/03/2020 15:19	05/03/2020 18:22	05/03/2020 15:19	05/03/2020 18:22	3,04	2	6,08	CHI
20200320299	NOVA ROMA	ND21255065	IACIARA S2	05/03/2020 15:20	05/03/2020 16:10	05/03/2020 15:20	05/03/2020 16:10	0,83	1	0,83	CHI
20200320310	CAMPOS VERDES	UP10401404	SANTA TEREZINHA	05/03/2020 15:10	06/03/2020 18:36	05/03/2020 18:38	06/03/2020 14:17	19,64	1	19,64	CHI
20200320310	MARA ROSA	UP10401404	SANTA TEREZINHA	05/03/2020 15:10	06/03/2020 18:36	05/03/2020 18:38	06/03/2020 14:17	19,64	15	294,66	CHI
20200320310	SANTA TEREZINHA DE GOIAS	UP10401404	SANTA TEREZINHA	05/03/2020 15:10	06/03/2020 18:36	05/03/2020 18:38	06/03/2020 14:17	19,64	52	1021,50	CHI
20200320310	UIRAPURU	UP10401404	SANTA TEREZINHA	05/03/2020 15:10	06/03/2020 18:36	05/03/2020 18:38	06/03/2020 14:17	19,64	73	1434,02	CHI
20200320310	CRIXAS	UP10401404	SANTA TEREZINHA	05/03/2020 15:10	06/03/2020 18:36	05/03/2020 15:10	06/03/2020 18:36	27,42	5	137,11	CHI
20200320310	UIRAPURU	UP10401404	SANTA TEREZINHA	05/03/2020 15:10	06/03/2020 18:36	05/03/2020 15:10	06/03/2020 18:36	27,42	45	1233,96	CHI

20200320310	CAMPOS VERDES	UP10401404	SANTA TEREZINHA	05/03/2020 15:10	06/03/2020 18:36	06/03/2020 18:25	06/03/2020 18:36	0,18	1	0,18	CHI
20200320310	CRIXAS	UP10401404	SANTA TEREZINHA	05/03/2020 15:10	06/03/2020 18:36	06/03/2020 18:25	06/03/2020 18:36	0,18	12	2,15	CHI
20200320310	MARA ROSA	UP10401404	SANTA TEREZINHA	05/03/2020 15:10	06/03/2020 18:36	06/03/2020 18:25	06/03/2020 18:36	0,18	76	13,64	CHI
20200320310	SANTA TEREZINHA DE GOIAS	UP10401404	SANTA TEREZINHA	05/03/2020 15:10	06/03/2020 18:36	06/03/2020 18:25	06/03/2020 18:36	0,18	119	21,35	CHI
20200320310	UIRAPURU	UP10401404	SANTA TEREZINHA	05/03/2020 15:10	06/03/2020 18:36	06/03/2020 18:25	06/03/2020 18:36	0,18	116	20,82	CHI
20200320315	GOIANIA	13726675	GOIANIA LESTE S1	05/03/2020 15:25	05/03/2020 17:38	05/03/2020 15:25	05/03/2020 17:38	2,22	1	2,22	CHI
20200320316	ISRAELANDIA	IS12048170	IPORA	05/03/2020 15:25	05/03/2020 17:08	05/03/2020 15:25	05/03/2020 17:08	1,70	85	144,90	CHI
20200320321	RIO QUENTE	RQ21103122	VILA CORUMBA	05/03/2020 15:26	05/03/2020 17:59	05/03/2020 15:26	05/03/2020 17:59	2,54	1	2,54	CHI
20200320322	CALDAZINHA	LB12095842	CEPAIGO S2	05/03/2020 15:27	06/03/2020 23:15	05/03/2020 15:27	06/03/2020 23:15	31,81	3	95,42	CHI
20200320323	JATAI	JT11000092	JATAI S3	05/03/2020 15:12	05/03/2020 19:20	05/03/2020 15:12	05/03/2020 19:20	4,13	103	425,08	CHI
20200320326	ABADIANIA	AA12390214	ANAPOLIS UNIVERSITARIO S1	05/03/2020 14:28	05/03/2020 16:35	05/03/2020 14:28	05/03/2020 16:35	2,11	41	86,67	CHI
20200320327	GUARINOS	GF21294708	SANTA TEREZINHA	05/03/2020 15:29	05/03/2020 18:23	05/03/2020 15:29	05/03/2020 18:23	2,89	1	2,89	CHI
20200320328	CRISTALINA	1060084950	CRISTALINA S1	05/03/2020 15:29	05/03/2020 19:26	05/03/2020 15:29	05/03/2020 19:26	3,94	1	3,94	CHI
20200320329	ABADIA DE GOIAS	TR12052077	TRINDADE	05/03/2020 15:29	05/03/2020 16:16	05/03/2020 15:29	05/03/2020 16:16	0,78	2	1,56	CHI
20200320329	TRINDADE	TR12052077	TRINDADE	05/03/2020 15:29	05/03/2020 16:16	05/03/2020 15:29	05/03/2020 16:16	0,78	1	0,78	CHI
20200320330	JARAGUA	UA12078282	JARAGUA	05/03/2020 15:30	05/03/2020 18:46	05/03/2020 15:30	05/03/2020 18:46	3,27	3	9,80	CHI
20200320330	URUANA	UA12078282	JARAGUA	05/03/2020 15:30	05/03/2020 18:46	05/03/2020 15:30	05/03/2020 18:46	3,27	6	19,60	CHI
20200320332	PARAUNA	PU21309546	MONTIVIDIU T	05/03/2020 15:30	06/03/2020 13:22	05/03/2020 15:30	06/03/2020 13:22	21,85	1	21,85	CHI
20200320336	JARAGUA	JA12278873	JARAGUA	05/03/2020 15:31	05/03/2020 17:12	05/03/2020 15:31	05/03/2020 17:12	1,68	15	25,17	CHI
20200320340	ALEXANIA	AX12095958	CORUMBA	05/03/2020 13:33	05/03/2020 18:15	05/03/2020 13:33	05/03/2020 18:15	4,69	6	28,12	CHI
20200320340	CORUMBA DE GOIAS	AX12095958	CORUMBA	05/03/2020 13:33	05/03/2020 18:15	05/03/2020 13:33	05/03/2020 18:15	4,69	3	14,06	CHI
20200320341	SANTO ANTONIO DO DESCOBERTO	SN12345926	MARAJOARA	05/03/2020 15:31	05/03/2020 19:38	05/03/2020 15:31	05/03/2020 19:38	4,10	2	8,21	CHI
20200320342	ABADIANIA	AA12382337	CORUMBA	05/03/2020 15:31	05/03/2020 19:15	05/03/2020 15:31	05/03/2020 19:15	3,72	42	156,16	CHI
20200320346	LUZIANIA	LZ11400538	RIO VERMELHO	05/03/2020 15:32	05/03/2020 17:55	05/03/2020 17:35	05/03/2020 17:55	0,34	54	18,48	CHI
20200320354	MONTES CLAROS DE GOIAS	ME11091486	IPORA	05/03/2020 15:36	05/03/2020 17:23	05/03/2020 15:36	05/03/2020 17:23	1,78	74	131,74	CHI
20200320357	MINEIROS	MY21123134	PARQUE DAS EMAS	05/03/2020 15:36	05/03/2020 18:41	05/03/2020 15:36	05/03/2020 18:41	3,07	1	3,07	CHI
20200320359	CUMARI	CT21266982	CATALAO S2	05/03/2020 15:37	05/03/2020 18:06	05/03/2020 15:37	05/03/2020 18:06	2,48	1	2,48	CHI
20200320392	ITUMBIARA	IT12000308RE	PARANAIBA	05/03/2020 15:32	05/03/2020 16:20	05/03/2020 15:32	05/03/2020 16:20	0,79	92	72,68	CHI
20200320394	RIO VERDE	RV11273564	SANTA HELENA S1	05/03/2020 08:32	06/03/2020 04:38	05/03/2020 08:32	06/03/2020 04:38	20,10	1	20,10	CHI
20200320396	GOIANIA	GN11140498	GOIANIA LESTE S3	05/03/2020 15:40	05/03/2020 22:39	05/03/2020 15:40	05/03/2020 22:39	6,98	94	655,65	CHI
20200320397	BOM JESUS DE GOIAS	BJ12305426	BOM JESUS DE GOIAS	05/03/2020 10:49	05/03/2020 18:04	05/03/2020 10:49	05/03/2020 18:04	7,24	19	137,48	CHI
20200320399	VALPARAISO DE GOIAS	2860065680	PACAEMBU S1	05/03/2020 15:41	05/03/2020 19:34	05/03/2020 15:41	05/03/2020 19:34	3,88	1	3,88	CHI
20200320404	AGUAS LINDAS DE GOIAS	4830214613	AGUAS LINDAS DE GOIAS S1	05/03/2020 15:44	05/03/2020 17:40	05/03/2020 15:44	05/03/2020 17:40	1,92	1	1,92	CHI
20200320405	MINEIROS	MY21126357	PARQUE DAS EMAS	05/03/2020 15:44	06/03/2020 08:47	05/03/2020 15:44	06/03/2020 08:47	17,04	1	17,04	CHI
20200320407	GOIANIA	GN11283037	GOIANIA LESTE S2	05/03/2020 15:14	05/03/2020 18:28	05/03/2020 15:14	05/03/2020 18:28	3,23	92	297,03	CHI
20200320412	GOIANIA	GN11165737	CAMPINAS S2	05/03/2020 15:49	05/03/2020 19:51	05/03/2020 15:49	05/03/2020 19:51	4,03	119	479,97	CHI
20200320415	JATAI	JT21135344	JATAI S3	05/03/2020 15:49	05/03/2020 20:26	05/03/2020 15:49	05/03/2020 20:26	4,60	1	4,60	CHI
20200320422	LUZIANIA	120106395	RIO VERMELHO	05/03/2020 15:51	05/03/2020 17:35	05/03/2020 15:51	05/03/2020 17:35	1,73	1	1,73	CHI
20200320425	PILAR DE GOIAS	GG21267287	URUACU	05/03/2020 15:51	06/03/2020 11:18	05/03/2020 15:51	06/03/2020 11:18	19,44	1	19,44	CHI
20200320430	GOIAS	GS21073693	MATRINCHA	05/03/2020 15:52	05/03/2020 20:01	05/03/2020 15:52	05/03/2020 20:01	4,13	2	8,27	CHI
20200320441	ITUMBIARA	690160392	ITUMBIARA NOVA	05/03/2020 15:54	05/03/2020 17:30	05/03/2020 15:54	05/03/2020 17:30	1,59	1	1,59	CHI
20200320451	LUZIANIA	LZ21209621	PACAEMBU S1	05/03/2020 15:58	05/03/2020 19:54	05/03/2020 15:58	05/03/2020 19:54	3,93	1	3,93	CHI
20200320452	JATAI	JT21234378	JATAI S3	05/03/2020 15:58	05/03/2020 19:14	05/03/2020 15:58	05/03/2020 19:14	3,26	1	3,26	CHI
20200320456	INDIARA	IY21386428	EDEIA	05/03/2020 15:59	05/03/2020 19:14	05/03/2020 15:59	05/03/2020 19:14	3,24	1	3,24	CHI

20200320457	APARECIDA DE GOIANIA	15191801	INDEPENDENCIA S2	05/03/2020 15:59	05/03/2020 17:38	05/03/2020 15:59	05/03/2020 17:38	1,63	1	1,63	CHI
20200320462	SANTA TEREZINHA DE GOIAS	VD11094177	SANTA TEREZINHA	05/03/2020 16:01	05/03/2020 22:55	05/03/2020 22:25	05/03/2020 22:55	0,51	49	25,13	CHI
20200320465	CRIXAS	CX12202134	SERRA DO OURO	05/03/2020 16:02	05/03/2020 21:01	05/03/2020 16:02	05/03/2020 21:01	4,98	44	219,24	CHI
20200320468	SAO DOMINGOS	SD12317850	SAO DOMINGOS	05/03/2020 16:02	05/03/2020 18:36	05/03/2020 16:02	05/03/2020 18:36	2,56	69	176,49	CHI
20200320469	CORUMBA DE GOIAS	PV12377711	CORUMBA	05/03/2020 16:02	05/03/2020 17:18	05/03/2020 16:02	05/03/2020 17:18	1,26	18	22,60	CHI
20200320469	PIRENOPOLIS	PV12377711	CORUMBA	05/03/2020 16:02	05/03/2020 17:18	05/03/2020 16:02	05/03/2020 17:18	1,26	15	18,83	CHI
20200320472	PORANGATU	PO11390130	PORANGATU	05/03/2020 16:03	05/03/2020 21:52	05/03/2020 16:03	05/03/2020 21:52	5,81	22	127,83	CHI
20200320482	GOIANIA	GN12002497	GOIANIA LESTE S3	05/03/2020 15:48	05/03/2020 18:09	05/03/2020 15:48	05/03/2020 18:09	2,34	396	928,07	CHI
20200320483	TRINDADE	40289515	TRINDADE	05/03/2020 16:05	05/03/2020 17:30	05/03/2020 16:05	05/03/2020 17:30	1,41	1	1,41	CHI
20200320487	MARA ROSA	MQ21168858	MARA ROSA	05/03/2020 16:05	05/03/2020 18:17	05/03/2020 16:05	05/03/2020 18:17	2,19	1	2,19	CHI
20200320490	TRES RANCHOS	2170006753	CATALAO S1	05/03/2020 16:06	05/03/2020 20:40	05/03/2020 16:06	05/03/2020 20:40	4,56	1	4,56	CHI
20200320493	GOIAS	GS21145619	GOIAS	05/03/2020 16:06	05/03/2020 18:17	05/03/2020 16:06	05/03/2020 18:17	2,17	1	2,17	CHI
20200320500	CORUMBA DE GOIAS	CB12121725	CORUMBA	05/03/2020 16:07	05/03/2020 18:36	05/03/2020 16:07	05/03/2020 18:36	2,47	6	14,82	CHI
20200320501	ABADIANIA	AA21388585	ANAPOLIS UNIVERSITARIO S1	05/03/2020 08:21	05/03/2020 21:11	05/03/2020 08:21	05/03/2020 21:11	12,82	1	12,82	CHI
20200320502	ABADIANIA	AA12327987	ANAPOLIS UNIVERSITARIO S1	05/03/2020 14:20	05/03/2020 22:53	05/03/2020 14:20	05/03/2020 22:53	8,54	1	8,54	CHI
20200320508	ITAPURANGA	IK21023088	ITAPURANGA	05/03/2020 15:51	05/03/2020 17:37	05/03/2020 16:53	05/03/2020 17:37	0,73	1	0,73	CHI
20200320512	CATALAO	00340434	CATALAO S1	05/03/2020 15:57	06/03/2020 12:00	05/03/2020 15:57	05/03/2020 16:00	0,06	25	1,58	CHI
20200320512	GOIANDIRA	00340434	CATALAO S1	05/03/2020 15:57	06/03/2020 12:00	05/03/2020 15:57	05/03/2020 16:00	0,06	12	0,76	CHI
20200320512	ANHANGUERA	00340434	CATALAO S1	05/03/2020 15:57	06/03/2020 12:00	05/03/2020 15:57	05/03/2020 16:11	0,24	578	139,52	CHI
20200320512	CATALAO	00340434	CATALAO S1	05/03/2020 15:57	06/03/2020 12:00	05/03/2020 15:57	05/03/2020 16:11	0,24	6	1,45	CHI
20200320512	CORUMBAIBA	00340434	CATALAO S1	05/03/2020 15:57	06/03/2020 12:00	05/03/2020 15:57	05/03/2020 16:11	0,24	137	33,07	CHI
20200320512	CORUMBAIBA	00340434	CATALAO S1	05/03/2020 15:57	06/03/2020 12:00	05/03/2020 15:57	05/03/2020 16:11	0,24	4	0,97	CHI
20200320512	CUMARI	00340434	CATALAO S1	05/03/2020 15:57	06/03/2020 12:00	05/03/2020 15:57	05/03/2020 16:11	0,24	1202	290,15	CHI
20200320512	CUMARI	00340434	CATALAO S1	05/03/2020 15:57	06/03/2020 12:00	05/03/2020 15:57	05/03/2020 16:11	0,24	312	75,31	CHI
20200320512	CUMARI	00340434	CATALAO S1	05/03/2020 15:57	06/03/2020 12:00	05/03/2020 15:57	05/03/2020 16:11	0,24	5	1,21	CHI
20200320512	GOIANDIRA	00340434	CATALAO S1	05/03/2020 15:57	06/03/2020 12:00	05/03/2020 15:57	05/03/2020 16:11	0,24	2171	524,06	CHI
20200320512	GOIANDIRA	00340434	CATALAO S1	05/03/2020 15:57	06/03/2020 12:00	05/03/2020 15:57	05/03/2020 16:11	0,24	1	0,24	CHI
20200320512	GOIANDIRA	00340434	CATALAO S1	05/03/2020 15:57	06/03/2020 12:00	05/03/2020 15:57	05/03/2020 16:11	0,24	13	3,14	CHI
20200320512	GOIANDIRA	00340434	CATALAO S1	05/03/2020 15:57	06/03/2020 12:00	05/03/2020 15:57	05/03/2020 16:11	0,24	7	1,69	CHI
20200320512	GOIANDIRA	00340434	CATALAO S1	05/03/2020 15:57	06/03/2020 12:00	05/03/2020 15:57	05/03/2020 16:11	0,24	35	8,45	CHI
20200320512	GOIANDIRA	00340434	CATALAO S1	05/03/2020 15:57	06/03/2020 12:00	05/03/2020 15:57	05/03/2020 16:11	0,24	19	4,59	CHI
20200320512	IPAMERI	00340434	CATALAO S1	05/03/2020 15:57	06/03/2020 12:00	05/03/2020 15:57	05/03/2020 16:11	0,24	15	3,62	CHI
20200320512	MORRINHOS	00340434	CATALAO S1	05/03/2020 15:57	06/03/2020 12:00	05/03/2020 15:57	05/03/2020 16:11	0,24	1	0,24	CHI
20200320512	NOVA AURORA	00340434	CATALAO S1	05/03/2020 15:57	06/03/2020 12:00	05/03/2020 15:57	05/03/2020 16:11	0,24	1112	268,42	CHI
20200320512	NOVA AURORA	00340434	CATALAO S1	05/03/2020 15:57	06/03/2020 12:00	05/03/2020 15:57	05/03/2020 16:11	0,24	1	0,24	CHI
20200320512	NOVA AURORA	00340434	CATALAO S1	05/03/2020 15:57	06/03/2020 12:00	05/03/2020 15:57	05/03/2020 16:11	0,24	13	3,14	CHI
20200320512	NOVA AURORA	00340434	CATALAO S1	05/03/2020 15:57	06/03/2020 12:00	05/03/2020 15:57	05/03/2020 16:11	0,24	3	0,72	CHI
20200320512	CATALAO	00340434	CATALAO S1	05/03/2020 15:57	06/03/2020 12:00	05/03/2020 15:57	05/03/2020 16:14	0,29	1	0,29	CHI
20200320512	GOIANDIRA	00340434	CATALAO S1	05/03/2020 15:57	06/03/2020 12:00	05/03/2020 15:57	05/03/2020 16:14	0,29	2	0,58	CHI
20200320512	NOVA AURORA	00340434	CATALAO S1	05/03/2020 15:57	06/03/2020 12:00	05/03/2020 15:57	05/03/2020 16:14	0,29	1	0,29	CHI
20200320512	CATALAO	00340434	CATALAO S1	05/03/2020 15:57	06/03/2020 12:00	05/03/2020 15:57	05/03/2020 18:35	2,63	8	21,07	CHI
20200320512	GOIANDIRA	00340434	CATALAO S1	05/03/2020 15:57	06/03/2020 12:00	05/03/2020 15:57	05/03/2020 18:35	2,63	263	692,71	CHI
20200320512	NOVA AURORA	00340434	CATALAO S1	05/03/2020 15:57	06/03/2020 12:00	05/03/2020 15:57	05/03/2020 18:35	2,63	13	34,24	CHI
20200320512	CATALAO	00340434	CATALAO S1	05/03/2020 15:57	06/03/2020 12:00	05/03/2020 15:57	05/03/2020 19:45	3,80	16	60,80	CHI

20200320512	GOIANDIRA	00340434	CATALAO S1	05/03/2020 15:57	06/03/2020 12:00	05/03/2020 15:57	05/03/2020 19:45	3,80	68	258,42	CHI
20200320512	GOIANDIRA	00340434	CATALAO S1	05/03/2020 15:57	06/03/2020 12:00	05/03/2020 15:57	05/03/2020 23:09	7,20	9	64,83	CHI
20200320512	CATALAO	00340434	CATALAO S1	05/03/2020 15:57	06/03/2020 12:00	05/03/2020 15:57	06/03/2020 01:25	9,48	13	123,24	CHI
20200320512	GOIANDIRA	00340434	CATALAO S1	05/03/2020 15:57	06/03/2020 12:00	05/03/2020 15:57	06/03/2020 01:25	9,48	97	919,59	CHI
20200320512	IPAMERI	00340434	CATALAO S1	05/03/2020 15:57	06/03/2020 12:00	05/03/2020 15:57	06/03/2020 01:25	9,48	7	66,36	CHI
20200320512	CATALAO	00340434	CATALAO S1	05/03/2020 15:57	06/03/2020 12:00	05/03/2020 15:57	06/03/2020 11:10	19,22	2	38,45	CHI
20200320512	GOIANDIRA	00340434	CATALAO S1	05/03/2020 15:57	06/03/2020 12:00	05/03/2020 15:57	06/03/2020 11:10	19,22	29	557,49	CHI
20200320512	GOIANDIRA	00340434	CATALAO S1	05/03/2020 15:57	06/03/2020 12:00	05/03/2020 15:57	06/03/2020 12:00	20,07	93	1866,07	CHI
20200320517	SENADOR CANEDO	12235155	SENADOR CANEDO	05/03/2020 16:20	05/03/2020 18:35	05/03/2020 16:20	05/03/2020 18:35	2,24	1	2,24	CHI
20200320602	SAO MIGUEL DO ARAGUAIA	SM12384276	SAO MIGUEL DO ARAGUAIA	05/03/2020 16:08	06/03/2020 13:05	05/03/2020 16:08	06/03/2020 13:05	20,95	3	62,85	CHI
20200320607	MONTIVIDIU	MV12249172	MONTIVIDIU T	05/03/2020 16:10	06/03/2020 08:37	05/03/2020 16:10	06/03/2020 08:37	16,44	3	49,31	CHI
20200320619	CATALAO	CT21165122	CATALAO S1	05/03/2020 16:13	05/03/2020 17:42	05/03/2020 16:13	05/03/2020 17:42	1,48	2	2,96	CHI
20200320621	EDEIA	1120013530	EDEIA	05/03/2020 16:14	05/03/2020 18:54	05/03/2020 16:14	05/03/2020 18:54	2,65	1	2,65	CHI
20200320631	GOIANDIRA	GD12127588LD	CATALAO S1	05/03/2020 16:11	05/03/2020 19:45	05/03/2020 16:14	05/03/2020 19:45	3,51	1	3,51	CHI
20200320633	CABECEIRAS	CW21181824	ITUIQUIRA	05/03/2020 16:13	06/03/2020 07:20	05/03/2020 16:13	06/03/2020 07:20	15,12	1	15,12	CHI
20200320637	ANAPOLIS	AN12285273	ANAPOLIS UNIVERSITARIO S2	05/03/2020 16:17	05/03/2020 19:44	05/03/2020 16:17	05/03/2020 19:44	3,45	63	217,40	CHI
20200320637	ANAPOLIS	AN12285273	ANAPOLIS UNIVERSITARIO S2	05/03/2020 16:17	05/03/2020 19:44	05/03/2020 17:31	05/03/2020 19:44	2,23	29	64,60	CHI
20200320639	IACIARA	IA21361275	IACIARA S2	05/03/2020 16:17	05/03/2020 18:39	05/03/2020 16:17	05/03/2020 18:39	2,36	1	2,36	CHI
20200320640	JATAI	290288435	JATAI S3	05/03/2020 16:18	05/03/2020 21:25	05/03/2020 16:18	05/03/2020 21:25	5,13	1	5,13	CHI
20200320641	DOVERLANDIA	DV12193276	CAIAPONIA	05/03/2020 15:38	05/03/2020 17:34	05/03/2020 15:38	05/03/2020 17:34	1,92	50	96,10	CHI
20200320647	ANAPOLIS	20900454	JUNDIAI S2	05/03/2020 16:20	05/03/2020 17:36	05/03/2020 16:20	05/03/2020 17:36	1,25	1	1,25	CHI
20200320653	DISTRITO FEDERAL	FA21131708	ITUIQUIRA	05/03/2020 16:21	05/03/2020 17:47	05/03/2020 16:21	05/03/2020 17:47	1,42	1	1,42	CHI
20200320654	GOIANIA	GN11166128	FERROVIARIO S2	05/03/2020 16:21	05/03/2020 17:26	05/03/2020 16:53	05/03/2020 17:26	0,55	43	23,65	CHI
20200320656	NOVO PLANALTO	TA11292348	NOVO PLANALTO	05/03/2020 16:22	05/03/2020 19:52	05/03/2020 16:22	05/03/2020 19:52	3,49	59	205,71	CHI
20200320658	RIO VERDE	630339958	RIO VERDE S2	05/03/2020 16:23	06/03/2020 11:43	05/03/2020 16:23	06/03/2020 11:43	19,34	1	19,34	CHI
20200320662	GOIAS	GS12029627	GOIAS	05/03/2020 16:23	05/03/2020 18:04	05/03/2020 16:23	05/03/2020 18:04	1,67	10	16,67	CHI
20200320665	CAMPOS VERDES	SG12202098	SANTA TEREZINHA	05/03/2020 15:53	07/03/2020 18:27	05/03/2020 15:53	06/03/2020 00:04	8,18	18	147,19	CHI
20200320665	SANTA TEREZINHA DE GOIAS	SG12202098	SANTA TEREZINHA	05/03/2020 15:53	07/03/2020 18:27	05/03/2020 15:53	06/03/2020 00:04	8,18	45	367,97	CHI
20200320665	CAMPOS VERDES	SG12202098	SANTA TEREZINHA	05/03/2020 15:53	07/03/2020 18:27	05/03/2020 15:53	06/03/2020 01:57	10,06	9	90,51	CHI
20200320665	SANTA TEREZINHA DE GOIAS	SG12202098	SANTA TEREZINHA	05/03/2020 15:53	07/03/2020 18:27	05/03/2020 15:53	06/03/2020 01:57	10,06	23	231,31	CHI
20200320665	UIRAPURU	SG12202098	SANTA TEREZINHA	05/03/2020 15:53	07/03/2020 18:27	05/03/2020 15:53	06/03/2020 01:57	10,06	12	120,68	CHI
20200320665	CAMPOS VERDES	SG12202098	SANTA TEREZINHA	05/03/2020 15:53	07/03/2020 18:27	06/03/2020 02:15	06/03/2020 03:03	0,79	18	14,15	CHI
20200320665	SANTA TEREZINHA DE GOIAS	SG12202098	SANTA TEREZINHA	05/03/2020 15:53	07/03/2020 18:27	06/03/2020 02:15	06/03/2020 03:03	0,79	45	35,39	CHI
20200320665	CAMPOS VERDES	SG12202098	SANTA TEREZINHA	05/03/2020 15:53	07/03/2020 18:27	05/03/2020 15:53	07/03/2020 18:27	50,55	13	657,15	CHI
20200320665	SANTA TEREZINHA DE GOIAS	SG12202098	SANTA TEREZINHA	05/03/2020 15:53	07/03/2020 18:27	05/03/2020 15:53	07/03/2020 18:27	50,55	64	3235,22	CHI
20200320665	UIRAPURU	SG12202098	SANTA TEREZINHA	05/03/2020 15:53	07/03/2020 18:27	05/03/2020 15:53	07/03/2020 18:27	50,55	43	2173,66	CHI
20200320665	CAMPOS VERDES	SG13330123	SANTA TEREZINHA	05/03/2020 15:53	07/03/2020 18:27	06/03/2020 02:15	07/03/2020 18:27	40,19	9	361,67	CHI
20200320665	SANTA TEREZINHA DE GOIAS	SG13330123	SANTA TEREZINHA	05/03/2020 15:53	07/03/2020 18:27	06/03/2020 02:15	07/03/2020 18:27	40,19	23	924,27	CHI
20200320665	UIRAPURU	SG13330123	SANTA TEREZINHA	05/03/2020 15:53	07/03/2020 18:27	06/03/2020 02:15	07/03/2020 18:27	40,19	13	522,41	CHI
20200320666	INHUMAS	IN32066319	INHUMAS S2	05/03/2020 16:23	05/03/2020 20:21	05/03/2020 16:23	05/03/2020 20:21	3,95	23	90,90	CHI
20200320669	PETROLINA DE GOIAS	PG21399183	PETROLINA	05/03/2020 16:26	05/03/2020 19:50	05/03/2020 16:26	05/03/2020 19:50	3,40	1	3,40	CHI
20200320672	ALTO HORIZONTE	VD12390494	SANTA TEREZINHA	05/03/2020 16:27	05/03/2020 20:00	05/03/2020 16:27	05/03/2020 20:00	3,54	9	31,88	CHI
20200320672	CAMPOS VERDES	VD12390494	SANTA TEREZINHA	05/03/2020 16:27	05/03/2020 20:00	05/03/2020 16:27	05/03/2020 20:00	3,54	1	3,54	CHI
20200320672	MARA ROSA	VD12390494	SANTA TEREZINHA	05/03/2020 16:27	05/03/2020 20:00	05/03/2020 16:27	05/03/2020 20:00	3,54	66	233,75	CHI

20200320676	GOIANIA	16016750	GOIANIA LESTE S1	05/03/2020 16:28	05/03/2020 19:31	05/03/2020 16:28	05/03/2020 19:31	3,04	1	3,04	CHI
20200320677	LUZIANIA	LZ21264828	VIANOPOLIS	05/03/2020 16:29	05/03/2020 23:06	05/03/2020 16:29	05/03/2020 23:06	6,62	4	26,46	CHI
20200320679	CRISTIANOPOLIS	PJ10396076	PIRACANJUBA	05/03/2020 16:25	06/03/2020 22:42	05/03/2020 16:25	05/03/2020 18:15	1,82	5	9,11	CHI
20200320679	PIRACANJUBA	PJ10396076	PIRACANJUBA	05/03/2020 16:25	06/03/2020 22:42	05/03/2020 16:25	05/03/2020 18:15	1,82	42	76,54	CHI
20200320679	CRISTIANOPOLIS	PJ10396076	PIRACANJUBA	05/03/2020 16:25	06/03/2020 22:42	05/03/2020 16:25	05/03/2020 21:15	4,82	4	19,29	CHI
20200320679	PIRACANJUBA	PJ10396076	PIRACANJUBA	05/03/2020 16:25	06/03/2020 22:42	05/03/2020 16:25	05/03/2020 21:15	4,82	49	236,30	CHI
20200320679	SANTA CRUZ DE GOIAS	PJ10396076	PIRACANJUBA	05/03/2020 16:25	06/03/2020 22:42	05/03/2020 16:25	05/03/2020 21:15	4,82	73	352,04	CHI
20200320679	CRISTIANOPOLIS	PJ10396076	PIRACANJUBA	05/03/2020 16:25	06/03/2020 22:42	05/03/2020 21:16	05/03/2020 21:46	0,50	5	2,50	CHI
20200320679	PIRACANJUBA	PJ10396076	PIRACANJUBA	05/03/2020 16:25	06/03/2020 22:42	05/03/2020 21:16	05/03/2020 21:46	0,50	41	20,48	CHI
20200320679	PIRACANJUBA	PJ13067540	PIRACANJUBA	05/03/2020 16:25	06/03/2020 22:42	05/03/2020 21:16	05/03/2020 23:36	2,33	16	37,30	CHI
20200320679	PIRACANJUBA	PJ10396076	PIRACANJUBA	05/03/2020 16:25	06/03/2020 22:42	05/03/2020 16:25	06/03/2020 00:23	7,96	15	119,37	CHI
20200320679	SANTA CRUZ DE GOIAS	PJ10396076	PIRACANJUBA	05/03/2020 16:25	06/03/2020 22:42	05/03/2020 16:25	06/03/2020 00:23	7,96	33	262,62	CHI
20200320679	PIRACANJUBA	PJ12000022	PIRACANJUBA	05/03/2020 16:25	06/03/2020 22:42	05/03/2020 21:16	06/03/2020 10:09	12,88	19	244,80	CHI
20200320679	CRISTIANOPOLIS	PJ12212176RE	PIRACANJUBA	05/03/2020 16:25	06/03/2020 22:42	05/03/2020 21:16	06/03/2020 22:12	24,93	4	99,74	CHI
20200320679	PIRACANJUBA	PJ12212176RE	PIRACANJUBA	05/03/2020 16:25	06/03/2020 22:42	05/03/2020 21:16	06/03/2020 22:12	24,93	14	349,09	CHI
20200320679	SANTA CRUZ DE GOIAS	PJ12212176RE	PIRACANJUBA	05/03/2020 16:25	06/03/2020 22:42	05/03/2020 21:16	06/03/2020 22:12	24,93	73	1820,23	CHI
20200320679	PIRACANJUBA	PJ12249794	CALDAS NOVAS S1	05/03/2020 16:25	06/03/2020 22:42	06/03/2020 18:51	06/03/2020 22:42	3,83	2	7,67	CHI
20200320682	CAMPOS BELOS	CH21325627	SAO DOMINGOS	05/03/2020 16:30	05/03/2020 17:37	05/03/2020 16:30	05/03/2020 17:37	1,11	1	1,11	CHI
20200320704	CACHOEIRA DOURADA	CD12191000	CACHOEIRA DOURADA	05/03/2020 16:36	06/03/2020 00:14	05/03/2020 16:36	06/03/2020 00:14	7,63	7	53,39	CHI
20200320707	MINEIROS	MY12390605	PARQUE DAS EMAS	05/03/2020 16:37	06/03/2020 12:11	05/03/2020 16:37	06/03/2020 09:48	17,18	9	154,61	CHI
20200320707	MINEIROS	MY12390605	PARQUE DAS EMAS	05/03/2020 16:37	06/03/2020 12:11	05/03/2020 16:37	06/03/2020 12:11	19,56	5	97,81	CHI
20200320714	FORMOSA	FA11315285	ITUIQUIRA	05/03/2020 16:38	05/03/2020 19:44	05/03/2020 16:38	05/03/2020 19:44	3,10	7	21,68	CHI
20200320721	MARA ROSA	2260002852	MARA ROSA	05/03/2020 16:40	05/03/2020 19:19	05/03/2020 16:40	05/03/2020 19:19	2,65	1	2,65	CHI
20200320723	GOIANIRA	390051019	GOIANIRA	05/03/2020 16:40	05/03/2020 18:11	05/03/2020 16:40	05/03/2020 18:11	1,51	1	1,51	CHI
20200320733	ACREUNA	EU21026773	RIO DOS BOIS	05/03/2020 16:42	06/03/2020 02:59	05/03/2020 16:42	06/03/2020 02:59	10,28	1	10,28	CHI
20200320736	PALMEIRAS DE GOIAS	TV21005398	FIRMINOPOLIS S2	05/03/2020 16:42	05/03/2020 20:11	05/03/2020 16:42	05/03/2020 20:11	3,47	2	6,94	CHI
20200320747	RIO VERDE	RV10400562	CABRIUVA S2	05/03/2020 16:26	06/03/2020 10:59	05/03/2020 16:26	05/03/2020 17:05	0,65	1	0,65	CHI
20200320747	RIO VERDE	RV10400562	CABRIUVA S2	05/03/2020 16:26	06/03/2020 10:59	05/03/2020 16:26	05/03/2020 17:46	1,33	79	105,05	CHI
20200320747	RIO VERDE	RV10400562	CABRIUVA S2	05/03/2020 16:26	06/03/2020 10:59	05/03/2020 16:26	06/03/2020 08:19	15,88	8	127,08	CHI
20200320747	RIO VERDE	RV10400562	CABRIUVA S2	05/03/2020 16:26	06/03/2020 10:59	05/03/2020 16:26	06/03/2020 09:30	17,07	38	648,60	CHI
20200320747	RIO VERDE	RV13360739	CABRIUVA S2	05/03/2020 16:26	06/03/2020 10:59	05/03/2020 17:07	06/03/2020 09:30	16,39	1	16,39	CHI
20200320747	RIO VERDE	RV12402229LD	CABRIUVA S2	05/03/2020 16:26	06/03/2020 10:59	05/03/2020 16:26	06/03/2020 10:30	18,07	4	72,27	CHI
20200320747	APARECIDA DO RIO DOCE	RV12402230LD	CABRIUVA S2	05/03/2020 16:26	06/03/2020 10:59	05/03/2020 16:26	06/03/2020 10:59	18,55	6	111,27	CHI
20200320747	RIO VERDE	RV12402230LD	CABRIUVA S2	05/03/2020 16:26	06/03/2020 10:59	05/03/2020 16:26	06/03/2020 10:59	18,55	3	55,64	CHI
20200320749	LUZIANIA	LZ11000038	RIO VERMELHO	05/03/2020 16:41	05/03/2020 17:42	05/03/2020 16:41	05/03/2020 17:42	1,02	172	174,58	CHI
20200320752	CRIXAS	MZ12055628	MOZARLANDIA	05/03/2020 16:45	05/03/2020 18:54	05/03/2020 16:45	05/03/2020 18:54	2,14	25	53,52	CHI
20200320752	MOZARLANDIA	MZ12055628	MOZARLANDIA	05/03/2020 16:45	05/03/2020 18:54	05/03/2020 16:45	05/03/2020 18:54	2,14	25	53,52	CHI
20200320764	ABADIANIA	AA12241539	ANAPOLIS UNIVERSITARIO S1	05/03/2020 16:43	05/03/2020 19:37	05/03/2020 16:43	05/03/2020 19:37	2,90	36	104,26	CHI
20200320764	CORUMBA DE GOIAS	AA12241539	ANAPOLIS UNIVERSITARIO S1	05/03/2020 16:43	05/03/2020 19:37	05/03/2020 16:43	05/03/2020 19:37	2,90	2	5,79	CHI
20200320766	APARECIDA DE GOIANIA	AP11095595	INDEPENDENCIA S1	05/03/2020 16:43	05/03/2020 19:43	05/03/2020 16:43	05/03/2020 19:43	2,98	116	346,26	CHI
20200320770	BURITI ALEGRE	BG12263593	ITUMBIARA VELHA S2	05/03/2020 16:48	06/03/2020 09:21	05/03/2020 16:48	06/03/2020 09:21	16,54	4	66,16	CHI
20200320774	FAZENDA NOVA	FN21169386	JUSSARA	05/03/2020 16:47	06/03/2020 12:15	05/03/2020 16:47	06/03/2020 12:15	19,46	1	19,46	CHI
20200320776	CRISTIANOPOLIS	BC12300653	CRISTIANOPOLIS	05/03/2020 16:49	05/03/2020 21:40	05/03/2020 16:49	05/03/2020 21:40	4,86	11	53,41	CHI
20200320776	SANTA CRUZ DE GOIAS	BC12300653	CRISTIANOPOLIS	05/03/2020 16:49	05/03/2020 21:40	05/03/2020 16:49	05/03/2020 21:40	4,86	23	111,68	CHI

20200320784	PADRE BERNARDO	PB11377259	PADRE BERNARDO	05/03/2020 16:50	05/03/2020 20:04	05/03/2020 16:50	05/03/2020 20:04	3,22	55	176,96	CHI
20200320790	UIRAPURU	MH12391944	NOVA CRIXAS	05/03/2020 16:52	05/03/2020 23:54	05/03/2020 16:52	05/03/2020 23:54	7,03	6	42,18	CHI
20200320804	PARAUNA	PU21301130	ACREUNA	05/03/2020 16:56	05/03/2020 19:24	05/03/2020 16:56	05/03/2020 19:24	2,45	1	2,45	CHI
20200320805	NOVO GAMA	03860224	PACAEMBU S1	05/03/2020 16:48	05/03/2020 17:12	05/03/2020 16:49	05/03/2020 16:52	0,06	3158	197,37	CHI
20200320805	NOVO GAMA	03860224	PACAEMBU S1	05/03/2020 16:48	05/03/2020 17:12	05/03/2020 16:49	05/03/2020 16:54	0,08	10630	888,79	CHI
20200320805	SANTO ANTONIO DO DESCOBERTO	03860224	PACAEMBU S1	05/03/2020 16:48	05/03/2020 17:12	05/03/2020 16:49	05/03/2020 16:54	0,08	28	2,34	CHI
20200320805	NOVO GAMA	03860224	PACAEMBU S1	05/03/2020 16:48	05/03/2020 17:12	05/03/2020 16:49	05/03/2020 16:55	0,10	586	61,20	CHI
20200320805	VALPARAISO DE GOIAS	03860254	PACAEMBU S1	05/03/2020 16:48	05/03/2020 17:12	05/03/2020 16:48	05/03/2020 17:12	0,39	7238	2818,80	CHI
20200320806	FORMOSA	FA12397043	ITUIQUIRA	05/03/2020 16:57	05/03/2020 21:22	05/03/2020 16:57	05/03/2020 21:22	4,40	15	66,07	CHI
20200320808	CUMARI	CT12266841	CATALAO S2	05/03/2020 16:57	06/03/2020 07:52	05/03/2020 16:57	06/03/2020 07:52	14,90	1	14,90	CHI
20200320810	NOVO PLANALTO	TA12083734	NOVO PLANALTO	05/03/2020 16:40	05/03/2020 21:44	05/03/2020 16:40	05/03/2020 21:44	5,06	36	182,32	CHI
20200320811	SANTO ANTONIO DO DESCOBERTO	SN12275480	MARAJOARA	05/03/2020 16:58	05/03/2020 22:59	05/03/2020 16:58	05/03/2020 22:59	6,02	13	78,21	CHI
20200320814	GOIANIA	13760774	CARAJAS S1	05/03/2020 16:59	05/03/2020 19:23	05/03/2020 16:59	05/03/2020 19:23	2,40	1	2,40	CHI
20200320816	INACIOLANDIA	ID12094301	QUIRINOPOLIS	05/03/2020 16:59	05/03/2020 22:40	05/03/2020 16:59	05/03/2020 22:40	5,67	1	5,67	CHI
20200320817	GOIAS	GS11188182	GOIAS	05/03/2020 16:59	05/03/2020 18:42	05/03/2020 16:59	05/03/2020 18:42	1,70	2	3,41	CHI
20200320820	NIQUELANDIA	NQ12398036	NIQUELANDIA SUBTRANSMISSAO	05/03/2020 17:01	05/03/2020 21:18	05/03/2020 17:01	05/03/2020 21:18	4,28	3	12,85	CHI
20200320821	FLORES DE GOIAS	FB12204157	FLORES DE GOIAS	05/03/2020 17:01	05/03/2020 20:26	05/03/2020 17:01	05/03/2020 20:26	3,42	13	44,40	CHI
20200320830	ITUMBIARA	IT21293056	PARANAIBA	05/03/2020 17:05	05/03/2020 20:22	05/03/2020 17:05	05/03/2020 20:22	3,28	2	6,56	CHI
20200320839	CEZARINA	CZ12404092	CEZARINA	05/03/2020 17:07	06/03/2020 01:49	05/03/2020 17:07	06/03/2020 01:49	8,69	2	17,37	CHI
20200320840	BONOPOLIS	BX12168258	SAO MIGUEL DO ARAGUAIA	05/03/2020 16:06	05/03/2020 18:41	05/03/2020 16:06	05/03/2020 18:41	2,58	20	51,66	CHI
20200320840	CACU	BX12168258	SAO MIGUEL DO ARAGUAIA	05/03/2020 16:06	05/03/2020 18:41	05/03/2020 16:06	05/03/2020 18:41	2,58	1	2,58	CHI
20200320842	ABADIA DE GOIAS	5580006292	CARAJAS S1	05/03/2020 17:08	05/03/2020 18:54	05/03/2020 17:08	05/03/2020 18:54	1,76	1	1,76	CHI
20200320851	MONTE ALEGRE DE GOIAS	SD12322677	SAO DOMINGOS	05/03/2020 17:11	05/03/2020 19:51	05/03/2020 17:11	05/03/2020 19:51	2,66	2	5,31	CHI
20200320851	NOVA ROMA	SD12322677	SAO DOMINGOS	05/03/2020 17:11	05/03/2020 19:51	05/03/2020 17:11	05/03/2020 19:51	2,66	3	7,97	CHI
20200320851	SAO DOMINGOS	SD12322677	SAO DOMINGOS	05/03/2020 17:11	05/03/2020 19:51	05/03/2020 17:11	05/03/2020 19:51	2,66	35	92,99	CHI
20200320856	ITUMBIARA	690008600	ITUMBIARA VELHA S1	05/03/2020 17:13	05/03/2020 18:50	05/03/2020 17:13	05/03/2020 18:50	1,62	1	1,62	CHI
20200320860	ITABERAI	TQ21029854	ITABERAI S2	05/03/2020 17:14	05/03/2020 18:59	05/03/2020 17:14	05/03/2020 18:59	1,74	2	3,48	CHI
20200320861	BURITI ALEGRE	BG12263567	ITUMBIARA VELHA S2	05/03/2020 17:14	05/03/2020 21:13	05/03/2020 17:14	05/03/2020 21:13	3,97	3	11,92	CHI
20200320861	ITUMBIARA	BG12263567	ITUMBIARA VELHA S2	05/03/2020 17:14	05/03/2020 21:13	05/03/2020 17:14	05/03/2020 21:13	3,97	18	71,51	CHI
20200320864	PORANGATU	PO12020947	PORANGATU	05/03/2020 17:15	05/03/2020 21:52	05/03/2020 17:15	05/03/2020 21:52	4,61	44	202,89	CHI
20200320865	GOIATUBA	140030487	GOIATUBA S2	05/03/2020 17:15	05/03/2020 22:36	05/03/2020 17:15	05/03/2020 22:36	5,34	1	5,34	CHI
20200320869	DIVINOPOLIS DE GOIAS	SD12090135	SAO DOMINGOS	05/03/2020 17:17	05/03/2020 19:03	05/03/2020 17:17	05/03/2020 19:03	1,75	24	42,12	CHI
20200320869	SAO DOMINGOS	SD12090135	SAO DOMINGOS	05/03/2020 17:17	05/03/2020 19:03	05/03/2020 17:17	05/03/2020 19:03	1,75	66	115,83	CHI
20200320882	POSSE	SA12144805	IACIARA S2	05/03/2020 17:13	05/03/2020 18:55	05/03/2020 17:13	05/03/2020 18:55	1,70	17	28,90	CHI
20200320882	SIMOLANDIA	SA12144805	IACIARA S2	05/03/2020 17:13	05/03/2020 18:55	05/03/2020 17:13	05/03/2020 18:55	1,70	71	120,70	CHI
20200320887	GOIAS	GS12408674	MATRINCHA	05/03/2020 17:20	05/03/2020 19:52	05/03/2020 17:20	05/03/2020 19:52	2,53	18	45,51	CHI
20200320891	SAO JOAO DA PARAUNA	RP12076381	FIRMINOPOLIS S2	05/03/2020 16:51	06/03/2020 14:31	05/03/2020 16:51	05/03/2020 22:41	5,84	5	29,18	CHI
20200320891	AURILANDIA	RP12076381	FIRMINOPOLIS S2	05/03/2020 16:51	06/03/2020 14:31	05/03/2020 16:51	06/03/2020 00:00	7,15	4	28,58	CHI
20200320891	SAO JOAO DA PARAUNA	RP12076381	FIRMINOPOLIS S2	05/03/2020 16:51	06/03/2020 14:31	05/03/2020 16:51	06/03/2020 00:00	7,15	21	150,06	CHI
20200320891	SAO JOAO DA PARAUNA	RP12076381	FIRMINOPOLIS S2	05/03/2020 16:51	06/03/2020 14:31	05/03/2020 23:54	06/03/2020 00:00	0,10	5	0,50	CHI
20200320891	SAO JOAO DA PARAUNA	RP12076381	FIRMINOPOLIS S2	05/03/2020 16:51	06/03/2020 14:31	05/03/2020 16:51	06/03/2020 14:31	21,66	6	129,98	CHI
20200320897	JATAI	290229431	JATAI S2	05/03/2020 17:24	05/03/2020 22:44	05/03/2020 17:24	05/03/2020 22:44	5,33	1	5,33	CHI
20200320904	SANTA ROSA DE GOIAS	SR21078950	INHUMAS S1	05/03/2020 17:18	05/03/2020 17:53	05/03/2020 17:18	05/03/2020 17:53	0,58	1	0,58	CHI
20200320905	MIMOSO DE GOIAS	MJ12071960	PADRE BERNARDO	05/03/2020 17:20	05/03/2020 18:06	05/03/2020 17:20	05/03/2020 18:06	0,76	159	121,11	CHI

20200320905	NIQUELANDIA	MJ12071960	PADRE BERNARDO	05/03/2020 17:20	05/03/2020 18:06	05/03/2020 17:20	05/03/2020 18:06	0,76	1	0,76	CHI
20200320911	RIO VERDE	RV10212406	CABRIUVA S2	05/03/2020 17:42	06/03/2020 17:02	05/03/2020 17:44	05/03/2020 20:12	2,46	25	61,52	CHI
20200320911	RIO VERDE	RV13350911	CABRIUVA S2	05/03/2020 17:42	06/03/2020 17:02	05/03/2020 17:44	05/03/2020 20:45	3,01	27	81,19	CHI
20200320911	RIO VERDE	RV13350911	MONTIVIDIU T	05/03/2020 17:42	06/03/2020 17:02	05/03/2020 17:44	05/03/2020 20:45	3,01	39	117,28	CHI
20200320911	MONTIVIDIU	05700414	MONTIVIDIU T	05/03/2020 17:42	06/03/2020 17:02	05/03/2020 17:44	05/03/2020 23:36	5,86	2	11,71	CHI
20200320911	RIO VERDE	05700414	MONTIVIDIU T	05/03/2020 17:42	06/03/2020 17:02	05/03/2020 17:44	05/03/2020 23:36	5,86	21	123,00	CHI
20200320911	RIO VERDE	RV13383488	MONTIVIDIU T	05/03/2020 17:42	06/03/2020 17:02	05/03/2020 17:44	06/03/2020 03:48	10,07	4	40,27	CHI
20200320911	RIO VERDE	RV13271657	MONTIVIDIU T	05/03/2020 17:42	06/03/2020 17:02	05/03/2020 17:44	06/03/2020 17:02	23,29	10	232,94	CHI
20200321033	PORANGATU	PO12057986	PORANGATU	05/03/2020 17:24	05/03/2020 20:59	05/03/2020 17:24	05/03/2020 20:59	3,58	51	182,37	CHI
20200321036	VALPARAISO DE GOIAS	VA12199713	PACAEMBU S1	05/03/2020 17:24	05/03/2020 18:46	05/03/2020 17:24	05/03/2020 18:46	1,35	71	95,89	CHI
20200321039	NOVA CRIXAS	8570018747	NOVA CRIXAS	05/03/2020 17:26	05/03/2020 20:29	05/03/2020 17:26	05/03/2020 20:29	3,05	1	3,05	CHI
20200321041	IVOLANDIA	IV11256520	IPORA	05/03/2020 17:26	06/03/2020 09:50	05/03/2020 17:26	06/03/2020 09:50	16,40	2	32,79	CHI
20200321042	BELA VISTA DE GOIAS	BV21108064	BELA VISTA S1	05/03/2020 17:26	06/03/2020 10:20	05/03/2020 17:26	06/03/2020 10:20	16,89	2	33,79	CHI
20200321044	SAO MIGUEL DO ARAGUAIA	SM21081436	SAO MIGUEL DO ARAGUAIA	05/03/2020 17:27	05/03/2020 23:34	05/03/2020 17:27	05/03/2020 23:34	6,12	1	6,12	CHI
20200321045	NAZARIO	NZ12233489	ANICUNS	05/03/2020 16:49	05/03/2020 19:11	05/03/2020 16:49	05/03/2020 19:11	2,36	39	92,07	CHI
20200321045	PALMEIRAS DE GOIAS	NZ12233489	ANICUNS	05/03/2020 16:49	05/03/2020 19:11	05/03/2020 16:49	05/03/2020 19:11	2,36	3	7,08	CHI
20200321046	SANTO ANTONIO DO DESCOBERTO	10003518769	ALEXANIA	05/03/2020 17:27	05/03/2020 22:08	05/03/2020 17:27	05/03/2020 22:08	4,68	1	4,68	CHI
20200321047	CRIXAS	SG12291237	SANTA TEREZINHA	05/03/2020 17:12	05/03/2020 18:51	05/03/2020 17:12	05/03/2020 18:51	1,64	13	21,37	CHI
20200321047	GUARINOS	SG12291237	SANTA TEREZINHA	05/03/2020 17:12	05/03/2020 18:51	05/03/2020 17:12	05/03/2020 18:51	1,64	5	8,22	CHI
20200321049	ANAPOLIS	20852599	ANAPOLIS UNIVERSITARIO S1	05/03/2020 17:28	05/03/2020 22:59	05/03/2020 17:28	05/03/2020 22:59	5,52	1	5,52	CHI
20200321053	OUVIDOR	OU21231788	CATALAO S1	05/03/2020 17:29	06/03/2020 08:48	05/03/2020 17:29	06/03/2020 08:48	15,32	1	15,32	CHI
20200321055	VIANOPOLIS	VN12040854	VIANOPOLIS	05/03/2020 17:29	05/03/2020 18:30	05/03/2020 17:29	05/03/2020 18:30	1,01	36	36,48	CHI
20200321057	SANTO ANTONIO DO DESCOBERTO	SN12401712	ALEXANIA	05/03/2020 17:29	06/03/2020 10:30	05/03/2020 17:29	06/03/2020 10:30	17,01	5	85,05	CHI
20200321058	CHAPADAO DO CEU	DJ21191691	CHAPADAO DO CEU	05/03/2020 17:29	05/03/2020 19:22	05/03/2020 17:29	05/03/2020 19:22	1,88	1	1,88	CHI
20200321061	SANTO ANTONIO DO DESCOBERTO	SN12305157	MARAJOARA	05/03/2020 17:29	05/03/2020 21:28	05/03/2020 17:29	05/03/2020 21:28	3,97	14	55,60	CHI
20200321066	CATURAI	IN12015933	INHUMAS S2	05/03/2020 17:32	05/03/2020 23:50	05/03/2020 17:32	05/03/2020 23:50	6,29	1	6,29	CHI
20200321066	INHUMAS	IN12015933	INHUMAS S2	05/03/2020 17:32	05/03/2020 23:50	05/03/2020 17:32	05/03/2020 23:50	6,29	20	125,77	CHI
20200321089	PORANGATU	TA12114216	NOVO PLANALTO	05/03/2020 17:37	06/03/2020 12:15	05/03/2020 17:37	05/03/2020 21:54	4,27	1	4,27	CHI
20200321089	PORANGATU	TA12114216	NOVO PLANALTO	05/03/2020 17:37	06/03/2020 12:15	05/03/2020 17:37	06/03/2020 12:15	18,62	5	93,11	CHI
20200321096	ALTO PARAISO DE GOIAS	BF12349123	FLORES DE GOIAS	05/03/2020 17:39	05/03/2020 19:54	05/03/2020 17:39	05/03/2020 19:54	2,24	4	8,96	CHI
20200321096	SAO JOAO D ALIANCA	BF12349123	FLORES DE GOIAS	05/03/2020 17:39	05/03/2020 19:54	05/03/2020 17:39	05/03/2020 19:54	2,24	3	6,72	CHI
20200321107	ALEXANIA	AX11200558	ALEXANIA	05/03/2020 16:47	05/03/2020 21:46	05/03/2020 16:47	05/03/2020 21:46	4,98	129	641,81	CHI
20200321115	CABECEIRAS	CW21280653	ITUIQUIRA	05/03/2020 17:44	05/03/2020 22:59	05/03/2020 17:44	05/03/2020 22:59	5,25	2	10,49	CHI
20200321128	CERES	01630414	RUBIATABA	05/03/2020 17:41	07/03/2020 00:58	05/03/2020 17:41	05/03/2020 21:36	3,93	15	58,88	CHI
20200321128	IPIRANGA DE GOIAS	01630414	RUBIATABA	05/03/2020 17:41	07/03/2020 00:58	05/03/2020 17:41	05/03/2020 21:36	3,93	45	176,64	CHI
20200321128	ITAPACI	01630414	RUBIATABA	05/03/2020 17:41	07/03/2020 00:58	05/03/2020 17:41	05/03/2020 21:36	3,93	10	39,25	CHI
20200321128	RUBIATABA	01630414	RUBIATABA	05/03/2020 17:41	07/03/2020 00:58	05/03/2020 17:41	05/03/2020 21:36	3,93	149	584,87	CHI
20200321128	GUARINOS	00910434	ITAPACI	05/03/2020 17:41	07/03/2020 00:58	06/03/2020 00:02	06/03/2020 00:10	0,13	20	2,62	CHI
20200321128	ITAPACI	00910434	ITAPACI	05/03/2020 17:41	07/03/2020 00:58	06/03/2020 00:02	06/03/2020 00:10	0,13	175	22,90	CHI
20200321128	ITAPACI	00910434	ITAPACI	05/03/2020 17:41	07/03/2020 00:58	06/03/2020 00:02	06/03/2020 00:10	0,13	8	1,05	CHI
20200321128	NOVA GLORIA	00910434	ITAPACI	05/03/2020 17:41	07/03/2020 00:58	06/03/2020 00:02	06/03/2020 00:10	0,13	2	0,26	CHI
20200321128	NOVA GLORIA	00910434	ITAPACI	05/03/2020 17:41	07/03/2020 00:58	06/03/2020 00:02	06/03/2020 00:10	0,13	14	1,83	CHI
20200321128	NOVA GLORIA	IW13146314	RUBIATABA	05/03/2020 17:41	07/03/2020 00:58	05/03/2020 17:41	06/03/2020 02:09	8,47	49	415,00	CHI
20200321128	CERES	CE13290999	RUBIATABA	05/03/2020 17:41	07/03/2020 00:58	05/03/2020 17:41	06/03/2020 02:10	8,48	3	25,43	CHI

20200321128	CERES	RB13203654	RUBIATABA	05/03/2020 17:41	07/03/2020 00:58	05/03/2020 17:41	06/03/2020 02:42	9,02	2	18,05	CHI
20200321128	IPIRANGA DE GOIAS	RB13203654	RUBIATABA	05/03/2020 17:41	07/03/2020 00:58	05/03/2020 17:41	06/03/2020 02:42	9,02	2	18,05	CHI
20200321128	NOVA GLORIA	RB13203654	RUBIATABA	05/03/2020 17:41	07/03/2020 00:58	05/03/2020 17:41	06/03/2020 02:42	9,02	3	27,07	CHI
20200321128	RUBIATABA	RB13203654	RUBIATABA	05/03/2020 17:41	07/03/2020 00:58	05/03/2020 17:41	06/03/2020 02:42	9,02	2	18,05	CHI
20200321128	NOVA GLORIA	IW13146314	RUBIATABA	05/03/2020 17:41	07/03/2020 00:58	05/03/2020 17:41	07/03/2020 00:58	31,28	24	750,78	CHI
20200321128	CERES	01630414	RUBIATABA	05/03/2020 17:41	07/03/2020 00:58	07/03/2020 00:55	07/03/2020 00:58	0,05	20	1,01	CHI
20200321128	IPIRANGA DE GOIAS	01630414	RUBIATABA	05/03/2020 17:41	07/03/2020 00:58	07/03/2020 00:55	07/03/2020 00:58	0,05	46	2,31	CHI
20200321128	ITAPACI	01630414	RUBIATABA	05/03/2020 17:41	07/03/2020 00:58	07/03/2020 00:55	07/03/2020 00:58	0,05	10	0,50	CHI
20200321128	NOVA GLORIA	01630414	RUBIATABA	05/03/2020 17:41	07/03/2020 00:58	07/03/2020 00:55	07/03/2020 00:58	0,05	3	0,15	CHI
20200321128	RUBIATABA	01630414	RUBIATABA	05/03/2020 17:41	07/03/2020 00:58	07/03/2020 00:55	07/03/2020 00:58	0,05	148	7,44	CHI
20200321131	GUARANI DE GOIAS	GY12255301	IACIARA S1	05/03/2020 17:50	05/03/2020 19:47	05/03/2020 17:50	05/03/2020 19:47	1,95	11	21,43	CHI
20200321136	TURVELANDIA	10017596481	RIO DOS BOIS	05/03/2020 17:50	05/03/2020 21:08	05/03/2020 17:50	05/03/2020 21:08	3,29	1	3,29	CHI
20200321137	GOIAS	GS12250582	GOIAS	05/03/2020 17:51	05/03/2020 19:15	05/03/2020 17:51	05/03/2020 19:15	1,40	10	14,00	CHI
20200321142	CATALAO	CT12389855	CATALAO S2	05/03/2020 16:54	05/03/2020 19:22	05/03/2020 16:54	05/03/2020 19:22	2,45	407	999,07	CHI
20200321143	PARAUNA	PU12332611	PARAUNA	05/03/2020 17:51	06/03/2020 13:36	05/03/2020 17:51	06/03/2020 13:36	19,74	6	118,43	CHI
20200321146	APARECIDA DE GOIANIA	AP11102854	REAL S1	05/03/2020 17:37	05/03/2020 21:14	05/03/2020 17:37	05/03/2020 21:14	3,60	135	486,53	CHI
20200321157	CATALAO	1990072267	CATALAO S2	05/03/2020 17:55	06/03/2020 01:25	05/03/2020 17:55	06/03/2020 01:25	7,50	1	7,50	CHI
20200321158	ABADIANIA	AA12221425	ANAPOLIS UNIVERSITARIO S1	05/03/2020 17:38	05/03/2020 19:57	05/03/2020 17:38	05/03/2020 19:57	2,32	45	104,20	CHI
20200321158	GAMELEIRA DE GOIAS	AA12221425	ANAPOLIS UNIVERSITARIO S1	05/03/2020 17:38	05/03/2020 19:57	05/03/2020 17:38	05/03/2020 19:57	2,32	1	2,32	CHI
20200321159	ORIZONA	OZ12300563	PIRES DO RIO S2	05/03/2020 14:10	06/03/2020 12:50	05/03/2020 14:10	06/03/2020 12:50	22,66	30	679,85	CHI
20200321161	PONTALINA	PK32045966	PONTALINA	05/03/2020 17:57	05/03/2020 19:58	05/03/2020 17:57	05/03/2020 19:58	2,02	2	4,05	CHI
20200321168	NOVA VENEZA	10029834790	INHUMAS S1	05/03/2020 17:58	05/03/2020 19:30	05/03/2020 17:58	05/03/2020 19:30	1,53	1	1,53	CHI
20200321171	SILVANIA	SV12400029	VIANOPOLIS	05/03/2020 17:58	05/03/2020 23:00	05/03/2020 17:58	05/03/2020 23:00	5,02	97	487,10	CHI
20200321174	QUIRINOPOLIS	80073220	QUIRINOPOLIS	05/03/2020 17:58	05/03/2020 19:34	05/03/2020 17:58	05/03/2020 19:34	1,59	1	1,59	CHI
20200321177	GOIANIA	10009946037	CARAJAS S1	05/03/2020 17:59	05/03/2020 22:15	05/03/2020 17:59	05/03/2020 22:15	4,26	1	4,26	CHI
20200321182	CATALAO	CT11166785	CATALAO S2	05/03/2020 17:36	05/03/2020 20:32	05/03/2020 17:36	05/03/2020 20:32	2,92	94	274,77	CHI
20200321183	CRISTALINA	KR21249980	CRISTALINA S2	05/03/2020 18:00	06/03/2020 02:03	05/03/2020 18:00	06/03/2020 02:03	8,04	1	8,04	CHI
20200321195	PORANGATU	PO12049340	PORANGATU	05/03/2020 18:03	05/03/2020 22:27	05/03/2020 18:03	05/03/2020 22:27	4,40	3	13,19	CHI
20200321197	CRIXAS	CX21319106	SERRA DO OURO	05/03/2020 18:03	06/03/2020 01:44	05/03/2020 18:03	06/03/2020 01:44	7,68	1	7,68	CHI
20200321204	PORANGATU	PO12320999	PORANGATU	05/03/2020 18:05	05/03/2020 20:21	05/03/2020 18:05	05/03/2020 20:21	2,26	6	13,56	CHI
20200321207	GOIAS	GS12334023	GOIAS	05/03/2020 18:05	05/03/2020 20:58	05/03/2020 18:05	05/03/2020 20:58	2,87	2	5,73	CHI
20200321208	DIORAMA	DI12380801	IPORA	05/03/2020 18:06	06/03/2020 01:30	05/03/2020 18:06	06/03/2020 01:30	7,40	8	59,19	CHI
20200321209	RIO VERDE	RV11241423	RIO VERDE S2	05/03/2020 17:49	05/03/2020 19:50	05/03/2020 17:49	05/03/2020 19:50	2,01	122	244,81	CHI
20200321215	SENADOR CANEDO	10015231370	SENADOR CANEDO	05/03/2020 18:07	05/03/2020 19:06	05/03/2020 18:07	05/03/2020 19:06	0,97	1	0,97	CHI
20200321218	SAO MIGUEL DO ARAGUAIA	SM21298983	SAO MIGUEL DO ARAGUAIA	05/03/2020 18:08	06/03/2020 01:03	05/03/2020 18:08	06/03/2020 01:03	6,91	1	6,91	CHI
20200321221	NOVA CRIXAS	NA12115792	NOVA CRIXAS	05/03/2020 18:08	06/03/2020 15:47	05/03/2020 18:08	06/03/2020 15:47	21,64	4	86,56	CHI
20200321223	ITUMBIARA	690225428	ITUMBIARA NOVA	05/03/2020 18:08	05/03/2020 20:23	05/03/2020 18:08	05/03/2020 20:23	2,23	1	2,23	CHI
20200321226	JOVIANIA	JV21027527	GOIATUBA S1	05/03/2020 18:09	05/03/2020 21:50	05/03/2020 18:09	05/03/2020 21:50	3,67	2	7,34	CHI
20200321228	MORRINHOS	10006759260	MORRINHOS	05/03/2020 18:09	05/03/2020 19:19	05/03/2020 18:09	05/03/2020 19:19	1,17	1	1,17	CHI
20200321232	MAMBAI	MB11190510	IACIARA S2	05/03/2020 18:11	05/03/2020 18:51	05/03/2020 18:11	05/03/2020 18:51	0,66	11	7,22	CHI
20200321233	APARECIDA DE GOIANIA	10012826381	INDEPENDENCIA S2	05/03/2020 18:11	05/03/2020 19:45	05/03/2020 18:11	05/03/2020 19:45	1,55	1	1,55	CHI
20200321243	CEZARINA	CZ12206465	CEZARINA	05/03/2020 18:16	06/03/2020 08:10	05/03/2020 18:16	06/03/2020 08:10	13,90	2	27,79	CHI
20200321244	JATAI	JT21334224	JATAI S3	05/03/2020 18:16	06/03/2020 08:02	05/03/2020 18:16	06/03/2020 08:02	13,76	1	13,76	CHI
20200321245	PIRACANJUBA	PJ12249878	PIRACANJUBA	05/03/2020 17:34	05/03/2020 23:08	05/03/2020 17:34	05/03/2020 23:08	5,56	6	33,34	CHI

20200321253	GOIANIA	13596421	ATLANTICO S2	05/03/2020 18:17	05/03/2020 21:16	05/03/2020 18:17	05/03/2020 21:16	2,98	1	2,98	CHI
20200321254	APARECIDA DE GOIANIA	10013920543	INDEPENDENCIA S2	05/03/2020 18:17	05/03/2020 21:55	05/03/2020 18:17	05/03/2020 21:55	3,63	1	3,63	CHI
20200321260	ITAPACI	IW12333893	ITAPACI	05/03/2020 18:18	05/03/2020 21:10	05/03/2020 18:18	05/03/2020 21:10	2,87	27	77,36	CHI
20200321260	PILAR DE GOIAS	IW12333893	ITAPACI	05/03/2020 18:18	05/03/2020 21:10	05/03/2020 18:18	05/03/2020 21:10	2,87	37	106,02	CHI
20200321262	APARECIDA DE GOIANIA	200239296	INDEPENDENCIA S1	05/03/2020 18:18	05/03/2020 23:10	05/03/2020 18:18	05/03/2020 23:10	4,85	1	4,85	CHI
20200321264	SAO JOAO D ALIANCA	JL12383340	SAO JOAO D ALIANCA	05/03/2020 18:16	05/03/2020 20:01	05/03/2020 18:16	05/03/2020 20:01	1,74	76	132,09	CHI
20200321265	PARAUNA	PU12090181	MONTIVIDIU T	05/03/2020 18:20	06/03/2020 10:58	05/03/2020 18:20	06/03/2020 10:58	16,62	5	83,12	CHI
20200321271	SANTO ANTONIO DO DESCOBERTO	2210035795	ALEXANIA	05/03/2020 18:21	06/03/2020 00:31	05/03/2020 18:21	06/03/2020 00:31	6,15	1	6,15	CHI
20200321273	MONTES CLAROS DE GOIAS	ME21069024	IPORA	05/03/2020 18:22	05/03/2020 23:59	05/03/2020 18:22	05/03/2020 23:59	5,61	1	5,61	CHI
20200321276	COCALZINHO DE GOIAS	NP12402058	GOIANESIA S1	05/03/2020 18:24	06/03/2020 00:59	05/03/2020 18:24	06/03/2020 00:59	6,58	1	6,58	CHI
20200321276	PADRE BERNARDO	NP12402058	GOIANESIA S1	05/03/2020 18:24	06/03/2020 00:59	05/03/2020 18:24	06/03/2020 00:59	6,58	10	65,82	CHI
20200321276	VILA PROPICIO	NP12402058	GOIANESIA S1	05/03/2020 18:24	06/03/2020 00:59	05/03/2020 18:24	06/03/2020 00:59	6,58	96	631,84	CHI
20200321277	EDEALINA	ED12307998	PONTALINA	05/03/2020 18:26	06/03/2020 16:14	05/03/2020 18:26	06/03/2020 14:56	20,50	1	20,50	CHI
20200321277	EDEALINA	ED12307998	PONTALINA	05/03/2020 18:26	06/03/2020 16:14	05/03/2020 18:26	06/03/2020 15:06	20,67	1	20,67	CHI
20200321277	EDEALINA	ED12307998	PONTALINA	05/03/2020 18:26	06/03/2020 16:14	05/03/2020 18:26	06/03/2020 16:14	21,79	2	43,58	CHI
20200321277	EDEALINA	ED12307998	PONTALINA	05/03/2020 18:26	06/03/2020 16:14	06/03/2020 15:29	06/03/2020 16:14	0,74	2	1,48	CHI
20200321278	APARECIDA DE GOIANIA	10022462170	INDEPENDENCIA S1	05/03/2020 18:26	05/03/2020 21:43	05/03/2020 18:26	05/03/2020 21:43	3,27	1	3,27	CHI
20200321282	NOVA CRIXAS	8570014183	NOVA CRIXAS	05/03/2020 18:29	05/03/2020 21:34	05/03/2020 18:29	05/03/2020 21:34	3,08	1	3,08	CHI
20200321283	NOVO PLANALTO	TA12391903	NOVO PLANALTO	05/03/2020 18:29	06/03/2020 11:03	05/03/2020 18:29	06/03/2020 11:03	16,56	1	16,56	CHI
20200321287	PIRES DO RIO	PR12166937	PIRES DO RIO S1	05/03/2020 18:29	06/03/2020 09:05	05/03/2020 18:29	05/03/2020 22:04	3,57	105	374,67	CHI
20200321287	PIRES DO RIO	PR12166937	PIRES DO RIO S1	05/03/2020 18:29	06/03/2020 09:05	05/03/2020 18:29	06/03/2020 09:05	14,60	13	189,75	CHI
20200321288	PONTALINA	PK21212249	PONTALINA	05/03/2020 18:29	06/03/2020 07:50	05/03/2020 18:29	06/03/2020 07:50	13,33	2	26,67	CHI
20200321289	IPORA	IR11107563	IPORA	05/03/2020 18:30	05/03/2020 20:36	05/03/2020 18:30	05/03/2020 20:36	2,10	95	199,47	CHI
20200321318	JATAI	O1030214	JATAI S2	05/03/2020 18:50	05/03/2020 20:19	05/03/2020 18:50	05/03/2020 18:55	0,08	1967	167,19	CHI
20200321318	JATAI	O1030234	JATAI S2	05/03/2020 18:50	05/03/2020 20:19	05/03/2020 18:50	05/03/2020 19:00	0,16	2392	392,69	CHI
20200321318	RIO VERDE	O1030234	JATAI S2	05/03/2020 18:50	05/03/2020 20:19	05/03/2020 18:50	05/03/2020 19:00	0,16	32	5,25	CHI
20200321318	JATAI	O1030214	JATAI S2	05/03/2020 18:50	05/03/2020 20:19	05/03/2020 19:06	05/03/2020 20:19	1,22	1967	2393,18	CHI
20200321318	JATAI	O1030234	JATAI S2	05/03/2020 18:50	05/03/2020 20:19	05/03/2020 18:50	05/03/2020 20:19	1,47	5315	7827,81	CHI
20200321318	RIO VERDE	O1030234	JATAI S2	05/03/2020 18:50	05/03/2020 20:19	05/03/2020 18:50	05/03/2020 20:19	1,47	1	1,47	CHI
20200321318	JATAI	O1030234	JATAI S2	05/03/2020 18:50	05/03/2020 20:19	05/03/2020 19:09	05/03/2020 20:19	1,16	2392	2780,70	CHI
20200321318	RIO VERDE	O1030234	JATAI S2	05/03/2020 18:50	05/03/2020 20:19	05/03/2020 19:09	05/03/2020 20:19	1,16	32	37,20	CHI
20200321330	SAO DOMINGOS	SD21211279	SAO DOMINGOS	05/03/2020 19:10	06/03/2020 12:28	05/03/2020 19:10	06/03/2020 12:28	17,29	1	17,29	CHI
20200321337	CACHOEIRA DE GOIAS	CG21165610	FIRMINOPOLIS S2	05/03/2020 19:59	06/03/2020 09:59	05/03/2020 19:59	06/03/2020 09:59	13,99	1	13,99	CHI
20200321349	CATALAO	CT12318667	CATALAO S1	05/03/2020 18:56	06/03/2020 11:21	05/03/2020 18:56	06/03/2020 11:21	16,41	3	49,22	CHI
20200321349	DAVINOPOLIS	CT12318667	CATALAO S1	05/03/2020 18:56	06/03/2020 11:21	05/03/2020 18:56	06/03/2020 11:21	16,41	4	65,63	CHI
20200321409	CALDAS NOVAS	CN12207615RE	CALDAS NOVAS S1	05/03/2020 18:29	05/03/2020 20:33	05/03/2020 18:29	05/03/2020 20:33	2,06	16	32,95	CHI
20200321409	SANTA CRUZ DE GOIAS	CN12207615RE	CALDAS NOVAS S1	05/03/2020 18:29	05/03/2020 20:33	05/03/2020 18:29	05/03/2020 20:33	2,06	2	4,12	CHI
20200321410	SAO LUIS DE MONTES BELOS	SL11039166	SAO LUIZ DOS MONTES BELOS	05/03/2020 18:32	05/03/2020 20:20	05/03/2020 18:32	05/03/2020 20:20	1,79	136	243,78	CHI
20200321413	LUZIANIA	LZ21168158	CRISTALINA S2	05/03/2020 18:37	05/03/2020 22:01	05/03/2020 18:37	05/03/2020 22:01	3,39	1	3,39	CHI
20200321414	ANAPOLIS	AN21130438	NEROPOLIS S1	05/03/2020 18:37	06/03/2020 01:39	05/03/2020 18:37	06/03/2020 01:39	7,02	2	14,04	CHI
20200321423	BOM JARDIM DE GOIAS	BM12334785	BOM JARDIM	05/03/2020 18:40	06/03/2020 02:04	05/03/2020 18:40	06/03/2020 02:04	7,39	58	428,52	CHI
20200321427	PIRACANJUBA	PJ21000183	PIRACANJUBA	05/03/2020 18:42	06/03/2020 10:02	05/03/2020 18:42	06/03/2020 10:02	15,33	1	15,33	CHI
20200321433	CRISTALINA	KR11287413	CRISTALINA S1	05/03/2020 18:43	06/03/2020 12:33	05/03/2020 18:43	06/03/2020 12:33	17,82	5	89,09	CHI
20200321435	CEZARINA	CZ21382558	CEZARINA	05/03/2020 18:44	06/03/2020 08:57	05/03/2020 18:44	06/03/2020 08:57	14,21	1	14,21	CHI

20200321443	PORANGATU	PO12064910	NOVO PLANALTO	05/03/2020 18:47	06/03/2020 11:50	05/03/2020 18:47	06/03/2020 11:50	17,04	2	34,07	CHI
20200321445	GOIANESIA	GE21240126	GOIANESIA S2	05/03/2020 18:47	05/03/2020 23:10	05/03/2020 18:47	05/03/2020 23:10	4,37	1	4,37	CHI
20200321449	ITABERAI	IB12026084	ITABERAI S2	05/03/2020 18:48	05/03/2020 20:35	05/03/2020 18:48	05/03/2020 20:35	1,77	4	7,08	CHI
20200321452	PIRACANJUBA	BV12036142	BELA VISTA S1	05/03/2020 18:34	05/03/2020 21:01	05/03/2020 18:34	05/03/2020 21:01	2,44	87	212,59	CHI
20200321454	GOUVELANDIA	GB12394808	QUIRINOPOLIS	05/03/2020 18:50	05/03/2020 20:40	05/03/2020 18:50	05/03/2020 20:40	1,83	2	3,66	CHI
20200321454	QUIRINOPOLIS	GB12394808	QUIRINOPOLIS	05/03/2020 18:50	05/03/2020 20:40	05/03/2020 18:50	05/03/2020 20:40	1,83	77	140,93	CHI
20200321457	CORUMBA DE GOIAS	CB12377445	CORUMBA	05/03/2020 18:50	05/03/2020 20:18	05/03/2020 18:50	05/03/2020 20:18	1,46	20	29,14	CHI
20200321460	CAMPOS BELOS	CH12218811	SAO DOMINGOS	05/03/2020 18:51	05/03/2020 20:08	05/03/2020 18:51	05/03/2020 20:08	1,27	11	13,99	CHI
20200321466	NOVA ROMA	ND12392238	IACIARA S2	05/03/2020 18:52	05/03/2020 23:46	05/03/2020 18:52	05/03/2020 23:46	4,89	232	1133,96	CHI
20200321471	GOIANESIA	GE12215070	GOIANESIA S1	05/03/2020 18:54	05/03/2020 23:50	05/03/2020 18:54	05/03/2020 23:50	4,92	24	118,15	CHI
20200321474	APARECIDA DE GOIANIA	200543600	INDEPENDENCIA S1	05/03/2020 18:56	05/03/2020 21:14	05/03/2020 18:56	05/03/2020 21:14	2,30	1	2,30	CHI
20200321478	PIRENOPOLIS	PV11289629	CORUMBA	05/03/2020 18:34	05/03/2020 20:24	05/03/2020 18:34	05/03/2020 20:24	1,83	93	170,24	CHI
20200321482	JATAI	290332369	JATAI S2	05/03/2020 18:58	05/03/2020 23:25	05/03/2020 18:58	05/03/2020 23:25	4,44	1	4,44	CHI
20200321483	GOIANIA	12133747	GOIANIA LESTE S3	05/03/2020 18:58	05/03/2020 22:17	05/03/2020 18:58	05/03/2020 22:17	3,31	1	3,31	CHI
20200321484	PORANGATU	PO11307157	PORANGATU	05/03/2020 18:59	05/03/2020 22:10	05/03/2020 18:59	05/03/2020 22:10	3,18	4	12,71	CHI
20200321489	AGUA FRIA DE GOIAS	PI12048039	SAO JOAO D ALIANCA	05/03/2020 18:59	05/03/2020 22:54	05/03/2020 18:59	05/03/2020 22:54	3,90	6	23,41	CHI
20200321490	PALMEIRAS DE GOIAS	PL12276992	PALMEIRAS	05/03/2020 18:36	05/03/2020 22:13	05/03/2020 18:36	05/03/2020 22:13	3,61	4	14,43	CHI
20200321493	ANAPOLIS	AN11000106	ANAPOLIS UNIVERSITARIO S1	05/03/2020 18:49	05/03/2020 19:54	05/03/2020 18:49	05/03/2020 19:54	1,07	137	147,12	CHI
20200321497	JATAI	JT12092386	JATAI S1	05/03/2020 18:43	05/03/2020 23:12	05/03/2020 18:43	05/03/2020 23:12	4,48	44	197,18	CHI
20200321497	SERRANOPOLIS	JT12092386	JATAI S1	05/03/2020 18:43	05/03/2020 23:12	05/03/2020 18:43	05/03/2020 23:12	4,48	4	17,93	CHI
20200321500	RIO VERDE	RV12076323	CACHOEIRA ALTA	05/03/2020 17:06	08/03/2020 15:33	05/03/2020 17:06	07/03/2020 23:02	53,94	5	269,71	CHI
20200321500	RIO VERDE	RV12076323	CACHOEIRA ALTA	05/03/2020 17:06	08/03/2020 15:33	05/03/2020 17:06	08/03/2020 15:33	70,46	37	2607,08	CHI
20200321500	RIO VERDE	RV12076323	CACHOEIRA ALTA	05/03/2020 17:06	08/03/2020 15:33	08/03/2020 09:29	08/03/2020 15:33	6,07	5	30,36	CHI
20200321501	ARAGUAPAZ	AZ12404563	GOIAS	05/03/2020 18:59	05/03/2020 20:18	05/03/2020 18:59	05/03/2020 20:18	1,31	20	26,16	CHI
20200321501	FAINA	AZ12404563	GOIAS	05/03/2020 18:59	05/03/2020 20:18	05/03/2020 18:59	05/03/2020 20:18	1,31	1	1,31	CHI
20200321511	ITABERAI	IB21066173	ITABERAI S1	05/03/2020 19:05	05/03/2020 21:21	05/03/2020 19:05	05/03/2020 21:21	2,26	1	2,26	CHI
20200321517	PORANGATU	PO11208365	PORANGATU	05/03/2020 17:24	05/03/2020 19:54	05/03/2020 17:24	05/03/2020 19:54	2,49	48	119,47	CHI
20200321528	CALDAS NOVAS	760092898	CALDAS NOVAS S2	05/03/2020 19:08	05/03/2020 20:52	05/03/2020 19:08	05/03/2020 20:52	1,73	1	1,73	CHI
20200321531	OUVIDOR	OU21000302	CATALAO S1	05/03/2020 19:09	05/03/2020 21:36	05/03/2020 19:09	05/03/2020 21:36	2,45	1	2,45	CHI
20200321536	GOIANIRA	390005873	GOIANIRA	05/03/2020 19:10	06/03/2020 00:27	05/03/2020 19:10	06/03/2020 00:27	5,28	1	5,28	CHI
20200321538	GOIANIA	16562525	GOYA S2	05/03/2020 19:10	05/03/2020 20:08	05/03/2020 19:10	05/03/2020 20:08	0,96	1	0,96	CHI
20200321541	GOIANIA	10013178642	GOIANIA LESTE S3	05/03/2020 19:11	05/03/2020 21:20	05/03/2020 19:11	05/03/2020 21:20	2,14	1	2,14	CHI
20200321543	GOIANIA	GN11200572	CARAJAS S1	05/03/2020 19:09	05/03/2020 20:18	05/03/2020 19:09	05/03/2020 20:18	1,14	150	170,83	CHI
20200321546	TRINDADE	TR11053305	GOYA S2	05/03/2020 19:13	05/03/2020 20:54	05/03/2020 19:13	05/03/2020 20:54	1,67	184	307,38	CHI
20200321555	BALIZA	BH12243875	CAIAPONIA	05/03/2020 19:16	05/03/2020 23:38	05/03/2020 19:16	05/03/2020 23:38	4,35	4	17,40	CHI
20200321567	ITAPIRAPUA	IU12189999	MATRINCHA	05/03/2020 19:19	06/03/2020 14:37	05/03/2020 19:19	06/03/2020 14:37	19,30	3	57,91	CHI
20200321572	LEOPOLDO DE BULHOES	10004242252	DAIA S2	05/03/2020 19:21	05/03/2020 22:30	05/03/2020 19:21	05/03/2020 22:30	3,15	1	3,15	CHI
20200321573	CALDAS NOVAS	CN21060309	RIO QUENTE	05/03/2020 19:21	05/03/2020 20:41	05/03/2020 19:21	05/03/2020 20:41	1,32	1	1,32	CHI
20200321581	GUARANI DE GOIAS	SD12262409	SAO DOMINGOS	05/03/2020 19:23	06/03/2020 10:04	05/03/2020 19:23	06/03/2020 10:04	14,68	3	44,03	CHI
20200321581	SAO DOMINGOS	SD12262409	SAO DOMINGOS	05/03/2020 19:23	06/03/2020 10:04	05/03/2020 19:23	06/03/2020 10:04	14,68	71	1041,98	CHI
20200321583	PORANGATU	PO12291265	PORANGATU	05/03/2020 19:24	06/03/2020 02:09	05/03/2020 19:24	06/03/2020 02:09	6,75	3	20,25	CHI
20200321589	CROMINIA	520006628	PONTALINA	05/03/2020 19:26	06/03/2020 11:00	05/03/2020 19:26	06/03/2020 11:00	15,57	1	15,57	CHI
20200321590	PORANGATU	PO11227245	PORANGATU	06/03/2020 08:15	06/03/2020 10:53	06/03/2020 08:15	06/03/2020 10:53	2,62	1	2,62	CHI
20200321593	APARECIDA DE GOIANIA	200492469	ANHANGUERA	05/03/2020 19:27	05/03/2020 20:59	05/03/2020 19:27	05/03/2020 20:59	1,52	1	1,52	CHI

20200321601	SANTA TEREZINHA DE GOIAS	SG12181455	SANTA TEREZINHA	05/03/2020 17:30	06/03/2020 01:35	05/03/2020 17:30	06/03/2020 01:35	8,07	18	145,24	CHI
20200321605	ALEXANIA	AX12327814	ALEXANIA	05/03/2020 17:51	05/03/2020 21:46	05/03/2020 17:51	05/03/2020 21:46	3,92	66	258,44	CHI
20200321609	PIRACANJUBA	PJ12212173	PIRACANJUBA	05/03/2020 19:05	06/03/2020 01:01	05/03/2020 19:05	06/03/2020 01:01	5,93	19	112,59	CHI
20200321610	TRINDADE	TR11162122	TRINDADE	05/03/2020 19:29	05/03/2020 21:58	05/03/2020 19:29	05/03/2020 21:58	2,47	160	395,11	CHI
20200321613	MONTES CLAROS DE GOIAS	ME21242228	BRITANIA	05/03/2020 19:33	05/03/2020 23:14	05/03/2020 19:33	05/03/2020 23:14	3,68	5	18,38	CHI
20200321614	GOIANIA	13419808	CARAJAS S1	05/03/2020 19:33	05/03/2020 21:50	05/03/2020 19:33	05/03/2020 21:50	2,27	1	2,27	CHI
20200321615	NOVA CRIXAS	NA21142596	NOVA CRIXAS	05/03/2020 19:34	06/03/2020 23:29	05/03/2020 19:34	06/03/2020 23:29	27,92	1	27,92	CHI
20200321616	LUZIANIA	10009350819	RIO VERMELHO	05/03/2020 19:34	05/03/2020 20:49	05/03/2020 19:34	05/03/2020 20:49	1,25	1	1,25	CHI
20200321620	CATURAI	CK11052290	INHUMAS S1	05/03/2020 19:34	05/03/2020 21:12	05/03/2020 19:34	05/03/2020 21:12	1,63	141	229,83	CHI
20200321623	SAO MIGUEL DO ARAGUAIA	SM12096089RE	SAO MIGUEL DO ARAGUAIA	05/03/2020 19:05	06/03/2020 01:11	05/03/2020 19:05	06/03/2020 01:11	6,10	27	164,66	CHI
20200321627	SAO DOMINGOS	SD12268132	SAO DOMINGOS	05/03/2020 19:39	06/03/2020 13:05	05/03/2020 19:39	06/03/2020 13:05	17,43	2	34,86	CHI
20200321629	AGUA FRIA DE GOIAS	TL21067452	SAO JOAO D ALIANCA	05/03/2020 19:39	06/03/2020 12:27	05/03/2020 19:39	06/03/2020 12:27	16,80	1	16,80	CHI
20200321634	VALPARAISO DE GOIAS	3350055951	PACAEMBU S1	05/03/2020 19:40	05/03/2020 22:28	05/03/2020 19:40	05/03/2020 22:28	2,79	1	2,79	CHI
20200321637	LUZIANIA	LZ21312090	VIANOPOLIS	05/03/2020 19:41	05/03/2020 23:57	05/03/2020 19:41	05/03/2020 23:57	4,25	1	4,25	CHI
20200321640	GOIANIA	10009660915	INDEPENDENCIA S2	05/03/2020 19:44	05/03/2020 23:44	05/03/2020 19:44	05/03/2020 23:44	4,00	1	4,00	CHI
20200321644	CAMPO ALEGRE DE GOIAS	CM21215490	CAMPO ALEGRE DE GOIAS	05/03/2020 19:44	06/03/2020 08:41	05/03/2020 19:44	06/03/2020 08:41	12,93	1	12,93	CHI
20200321647	FIRMINOPOLIS	FR13194205	FIRMINOPOLIS S1	05/03/2020 19:10	06/03/2020 11:49	05/03/2020 19:10	06/03/2020 11:49	16,65	269	4479,82	CHI
20200321647	FIRMINOPOLIS	FR13194205	FIRMINOPOLIS S1	05/03/2020 19:10	06/03/2020 11:49	06/03/2020 08:23	06/03/2020 11:49	3,43	58	199,13	CHI
20200321651	CRISTALINA	KR21133668	CRISTALINA S2	05/03/2020 19:47	05/03/2020 22:08	05/03/2020 19:47	05/03/2020 22:08	2,34	1	2,34	CHI
20200321655	ANAPOLIS	AN12000688	JUNDIAI S1	05/03/2020 19:47	05/03/2020 22:11	05/03/2020 19:47	05/03/2020 22:11	2,39	415	993,69	CHI
20200321657	PALMEIRAS DE GOIAS	590047486	PALMEIRAS	05/03/2020 19:49	06/03/2020 06:34	05/03/2020 19:49	06/03/2020 06:34	10,76	1	10,76	CHI
20200321660	GOIANIA	GN11162162	CARAJAS S1	05/03/2020 19:50	05/03/2020 22:26	05/03/2020 19:50	05/03/2020 22:26	2,59	53	137,23	CHI
20200321669	ITUMBIARA	690081650	ITUMBIARA VELHA S1	05/03/2020 19:54	05/03/2020 21:18	05/03/2020 19:54	05/03/2020 21:18	1,41	1	1,41	CHI
20200321674	GOIAS	GS21148819	GOIAS	05/03/2020 19:54	05/03/2020 22:43	05/03/2020 19:54	05/03/2020 22:43	2,81	1	2,81	CHI
20200321678	GOIANIA	16751887	GOYA S1	05/03/2020 19:56	05/03/2020 20:55	05/03/2020 19:56	05/03/2020 20:55	0,98	1	0,98	CHI
20200321683	SAO FRANCISCO DE GOIAS	490018439	SAO FRANCISCO DE GOIAS	05/03/2020 19:57	05/03/2020 23:16	05/03/2020 19:57	05/03/2020 23:16	3,31	1	3,31	CHI
20200321685	SANTA RITA DO ARAGUAIA	10020367030	SANTA RITA DO ARAGUAIA	05/03/2020 19:58	06/03/2020 08:28	05/03/2020 19:58	06/03/2020 08:28	12,49	1	12,49	CHI
20200321690	MORRINHOS	150148641	MORRINHOS	05/03/2020 19:59	05/03/2020 22:05	05/03/2020 19:59	05/03/2020 22:05	2,08	1	2,08	CHI
20200321691	ANAPOLIS	AN11215206	ANAPOLIS UNIVERSITARIO S2	05/03/2020 20:01	05/03/2020 21:20	05/03/2020 20:01	05/03/2020 21:20	1,32	56	73,66	CHI
20200321692	CACHOEIRA DE GOIAS	CG21308862	FIRMINOPOLIS S2	05/03/2020 20:01	06/03/2020 10:17	05/03/2020 20:01	06/03/2020 10:17	14,25	1	14,25	CHI
20200321694	ARENOPOLIS	PH12233032	PIRANHAS	05/03/2020 20:01	05/03/2020 23:18	05/03/2020 20:01	05/03/2020 23:18	3,27	3	9,80	CHI
20200321694	PIRANHAS	PH12233032	PIRANHAS	05/03/2020 20:01	05/03/2020 23:18	05/03/2020 20:01	05/03/2020 23:18	3,27	4	13,07	CHI
20200321695	BRITANIA	BT12101446	BRITANIA	05/03/2020 20:02	06/03/2020 11:17	05/03/2020 20:02	06/03/2020 11:17	15,25	47	716,70	CHI
20200321696	AGUAS LINDAS DE GOIAS	10000074037	AGUAS LINDAS DE GOIAS S1	05/03/2020 20:02	05/03/2020 22:16	05/03/2020 20:02	05/03/2020 22:16	2,23	1	2,23	CHI
20200321703	MINEIROS	MY12303860	PARQUE DAS EMAS	05/03/2020 20:04	06/03/2020 12:11	05/03/2020 20:04	06/03/2020 12:11	16,11	1	16,11	CHI
20200321707	PARAUNA	PU12336650	ACREUNA	05/03/2020 20:07	06/03/2020 21:17	05/03/2020 20:07	06/03/2020 21:17	25,16	2	50,32	CHI
20200321710	MINEIROS	MY21197092	PARQUE DAS EMAS	05/03/2020 20:08	06/03/2020 01:10	05/03/2020 20:08	06/03/2020 01:10	5,03	1	5,03	CHI
20200321715	ARAGOIANIA	AO21098701	GUAPO S2	05/03/2020 20:10	05/03/2020 22:01	05/03/2020 20:10	05/03/2020 22:01	1,84	1	1,84	CHI
20200321719	SAO JOAO D ALIANCA	JL21268115	SAO JOAO D ALIANCA	05/03/2020 20:11	05/03/2020 20:27	05/03/2020 20:11	05/03/2020 20:27	0,25	2	0,50	CHI
20200321724	GOIANIA	10002748574	CARAJAS S2	05/03/2020 20:12	05/03/2020 22:18	05/03/2020 20:12	05/03/2020 22:18	2,09	1	2,09	CHI
20200321725	ARACU	750002086	ARACU	05/03/2020 20:13	06/03/2020 04:45	05/03/2020 20:13	06/03/2020 04:45	8,53	1	8,53	CHI
20200321728	AGUA FRIA DE GOIAS	TL21393107	SAO JOAO D ALIANCA	05/03/2020 20:14	06/03/2020 00:05	05/03/2020 20:14	06/03/2020 00:05	3,85	1	3,85	CHI
20200321731	NOVA CRIXAS	NA21158704	NOVA CRIXAS	05/03/2020 20:15	06/03/2020 00:32	05/03/2020 20:15	06/03/2020 00:32	4,28	1	4,28	CHI
20200321732	MUNDO NOVO DE GOIAS	MH12391968	NOVA CRIXAS	05/03/2020 20:16	06/03/2020 17:17	05/03/2020 20:16	06/03/2020 17:17	21,01	5	105,07	CHI

20200321735	NEROPOLIS	160059641	NEROPOLIS S2	05/03/2020 20:17	05/03/2020 21:52	05/03/2020 20:17	05/03/2020 21:52	1,58	1	1,58	CHI
20200321736	MORRINHOS	150023005	MORRINHOS	05/03/2020 20:17	05/03/2020 23:28	05/03/2020 20:17	05/03/2020 23:28	3,17	1	3,17	CHI
20200321744	ITUMBIARA	IT11309928	ITUMBIARA NOVA	05/03/2020 20:08	05/03/2020 21:29	05/03/2020 20:08	05/03/2020 21:29	1,35	104	139,94	CHI
20200321746	CATURAI	CK21180066	ARACU	05/03/2020 20:20	06/03/2020 03:14	05/03/2020 20:20	06/03/2020 03:14	6,90	1	6,90	CHI
20200321748	VALPARAISO DE GOIAS	VA11333234	PACAEMBU S1	05/03/2020 20:12	05/03/2020 23:20	05/03/2020 20:12	05/03/2020 23:20	3,12	99	309,29	CHI
20200321756	AGUA FRIA DE GOIAS	TL12196495	SAO JOAO D ALIANCA	05/03/2020 20:23	06/03/2020 14:17	05/03/2020 20:23	06/03/2020 14:17	17,88	1	17,88	CHI
20200321762	APORE	AE21155312	ITAJA S2	05/03/2020 20:30	05/03/2020 22:53	05/03/2020 20:30	05/03/2020 22:53	2,37	1	2,37	CHI
20200321771	INDIARA	IY12206402	CEZARINA	05/03/2020 20:34	06/03/2020 22:45	06/03/2020 11:35	06/03/2020 22:08	10,56	3	31,67	CHI
20200321771	INDIARA	IY21137887	CEZARINA	05/03/2020 20:34	06/03/2020 22:45	05/03/2020 20:34	06/03/2020 22:45	26,19	1	26,19	CHI
20200321782	MINEIROS	MY21348518	PARQUE DAS EMAS	05/03/2020 20:35	06/03/2020 04:24	05/03/2020 20:35	06/03/2020 04:24	7,81	1	7,81	CHI
20200321787	BONOPOLIS	BX12168258	SAO MIGUEL DO ARAGUAIA	05/03/2020 20:43	06/03/2020 09:19	05/03/2020 20:43	06/03/2020 09:19	12,60	20	251,97	CHI
20200321787	CACU	BX12168258	SAO MIGUEL DO ARAGUAIA	05/03/2020 20:43	06/03/2020 09:19	05/03/2020 20:43	06/03/2020 09:19	12,60	1	12,60	CHI
20200321789	MONTIVIDIU	MV12230886	MONTIVIDIU T	05/03/2020 19:55	06/03/2020 08:02	05/03/2020 19:55	06/03/2020 08:02	12,11	8	96,90	CHI
20200321789	RIO VERDE	MV12230886	MONTIVIDIU T	05/03/2020 19:55	06/03/2020 08:02	05/03/2020 19:55	06/03/2020 08:02	12,11	39	472,37	CHI
20200321792	IACIARA	ND12218839	IACIARA S2	05/03/2020 20:43	05/03/2020 22:28	05/03/2020 20:43	05/03/2020 22:28	1,74	23	39,95	CHI
20200321792	SAO DOMINGOS	ND12218839	IACIARA S2	05/03/2020 20:43	05/03/2020 22:28	05/03/2020 20:43	05/03/2020 22:28	1,74	3	5,21	CHI
20200321799	CRISTALINA	10020332619	CRISTALINA S2	05/03/2020 20:46	05/03/2020 22:36	05/03/2020 20:46	05/03/2020 22:36	1,82	1	1,82	CHI
20200321803	JARAGUA	10004729682	JARAGUA	05/03/2020 20:47	05/03/2020 22:20	05/03/2020 20:47	05/03/2020 22:20	1,56	1	1,56	CHI
20200321804	NOVO BRASIL	NB21353088	JUSSARA	05/03/2020 20:47	06/03/2020 02:53	05/03/2020 20:47	06/03/2020 02:53	6,09	1	6,09	CHI
20200321805	MONTES CLAROS DE GOIAS	ME21357463	IPORA	05/03/2020 20:47	06/03/2020 02:37	05/03/2020 20:47	06/03/2020 02:37	5,82	1	5,82	CHI
20200321807	CACHOEIRA ALTA	CA11182116	CACHOEIRA ALTA	05/03/2020 20:48	05/03/2020 22:01	05/03/2020 20:48	05/03/2020 22:01	1,21	57	68,81	CHI
20200321816	ABADIANIA	AA21090315	ANAPOLIS UNIVERSITARIO S1	05/03/2020 20:53	06/03/2020 01:05	05/03/2020 20:53	06/03/2020 01:05	4,18	1	4,18	CHI
20200321820	MORRINHOS	MR12035913	MORRINHOS	05/03/2020 20:11	05/03/2020 22:30	05/03/2020 20:11	05/03/2020 22:30	2,32	11	25,50	CHI
20200321822	CIDADE OCIDENTAL	DH11335959	MARAJOARA	05/03/2020 20:08	05/03/2020 21:51	05/03/2020 20:08	05/03/2020 21:51	1,70	126	214,52	CHI
20200321826	GOIANIA	10870726	GOIANIA LESTE S3	05/03/2020 20:59	05/03/2020 23:01	05/03/2020 20:59	05/03/2020 23:01	2,02	1	2,02	CHI
20200321827	CAMPESTRE DE GOIAS	GC12005180	TRINDADE	05/03/2020 21:00	06/03/2020 02:21	05/03/2020 21:00	06/03/2020 02:21	5,34	2	10,68	CHI
20200321829	ITAUCU	IX21333094	INHUMAS S1	05/03/2020 21:01	06/03/2020 01:00	05/03/2020 21:01	06/03/2020 01:00	3,98	2	7,96	CHI
20200321833	MONTES CLAROS DE GOIAS	ME12334949	IPORA	05/03/2020 21:01	06/03/2020 08:43	05/03/2020 21:01	06/03/2020 08:43	11,69	7	81,82	CHI
20200321834	CATALAO	1990076339	CATALAO S2	05/03/2020 21:01	06/03/2020 09:56	05/03/2020 21:01	06/03/2020 09:56	12,91	1	12,91	CHI
20200321837	MORRINHOS	MR12080320	VILA CORUMBA	05/03/2020 21:04	06/03/2020 11:05	05/03/2020 21:04	06/03/2020 11:05	14,00	3	42,00	CHI
20200321838	QUIRINOPOLIS	QI32050379	QUIRINOPOLIS	05/03/2020 21:05	06/03/2020 00:36	05/03/2020 21:05	06/03/2020 00:36	3,51	9	31,60	CHI
20200321839	ITABERAI	IB21355875	ITABERAI S1	05/03/2020 21:05	05/03/2020 21:38	05/03/2020 21:05	05/03/2020 21:38	0,54	2	1,08	CHI
20200321844	ANAPOLIS	21176917	ANAPOLIS UNIVERSITARIO S2	05/03/2020 21:08	06/03/2020 00:35	05/03/2020 21:08	06/03/2020 00:35	3,46	1	3,46	CHI
20200321845	CROMINIA	520006380	PONTALINA	05/03/2020 21:08	05/03/2020 22:46	05/03/2020 21:08	05/03/2020 22:46	1,62	1	1,62	CHI
20200321846	APORE	AE12000050	ITAJA S1	05/03/2020 19:15	06/03/2020 07:20	05/03/2020 19:15	06/03/2020 07:20	12,07	3	36,22	CHI
20200321852	SAO LUIS DE MONTES BELOS	SL12071351	SAO LUIZ DOS MONTES BELOS	05/03/2020 20:31	05/03/2020 23:15	05/03/2020 20:31	05/03/2020 23:15	2,72	531	1442,85	CHI
20200321853	LUZIANIA	LZ21329091	VIANOPOLIS	05/03/2020 21:12	06/03/2020 00:36	05/03/2020 21:12	06/03/2020 00:36	3,39	2	6,78	CHI
20200321856	INDIARA	2710015876	EDEIA	05/03/2020 21:14	06/03/2020 07:10	05/03/2020 21:14	06/03/2020 07:10	9,93	1	9,93	CHI
20200321866	VALPARAISO DE GOIAS	VA11067696	MARAJOARA	05/03/2020 21:14	05/03/2020 22:30	05/03/2020 21:14	05/03/2020 22:30	1,27	63	79,80	CHI
20200321872	IPAMERI	IP12068500	CRISTALINA S2	05/03/2020 21:23	06/03/2020 01:47	05/03/2020 21:23	06/03/2020 01:47	4,40	62	272,73	CHI
20200321882	VALPARAISO DE GOIAS	VA11355891	MARAJOARA	05/03/2020 21:31	05/03/2020 23:44	05/03/2020 21:31	05/03/2020 23:44	2,22	71	157,30	CHI
20200321887	CRIXAS	CX12321941	SERRA DO OURO	05/03/2020 18:44	06/03/2020 00:01	05/03/2020 18:44	06/03/2020 00:01	5,27	18	94,90	CHI
20200321887	NOVA CRIXAS	CX12321941	SERRA DO OURO	05/03/2020 18:44	06/03/2020 00:01	05/03/2020 18:44	06/03/2020 00:01	5,27	5	26,36	CHI
20200321888	GOIANIA	13448821	CAMPINAS S3	05/03/2020 21:33	05/03/2020 23:13	05/03/2020 21:33	05/03/2020 23:13	1,65	1	1,65	CHI

20200321889	GOIANIA	10013841325	FERROVIARIO S2	05/03/2020 21:34	05/03/2020 22:31	05/03/2020 21:34	05/03/2020 22:31	0,93	1	0,93	CHI
20200321890	RIO VERDE	RV21303613	MONTIVIDIU T	05/03/2020 21:36	06/03/2020 12:05	05/03/2020 21:36	06/03/2020 12:05	14,48	1	14,48	CHI
20200321893	JARAGUA	JA12353217	GOIANESIA S2	05/03/2020 20:38	06/03/2020 02:20	05/03/2020 20:38	06/03/2020 02:20	5,70	7	39,88	CHI
20200321895	APARECIDA DE GOIANIA	11066386	REAL S1	05/03/2020 21:39	05/03/2020 22:54	05/03/2020 21:39	05/03/2020 22:54	1,24	1	1,24	CHI
20200321904	MINACU	IH12307129	MINACU	05/03/2020 21:25	05/03/2020 23:53	05/03/2020 21:25	05/03/2020 23:53	2,46	13	31,99	CHI
20200321905	EDEIA	EA21198066	EDEIA	05/03/2020 21:47	05/03/2020 22:49	05/03/2020 21:47	05/03/2020 22:49	1,02	1	1,02	CHI
20200321907	ANAPOLIS	10013881025	ANAPOLIS UNIVERSITARIO S2	05/03/2020 21:50	06/03/2020 00:40	05/03/2020 21:50	06/03/2020 00:40	2,83	1	2,83	CHI
20200321915	CRISTALINA	KR21248625	CRISTALINA S1	05/03/2020 21:57	06/03/2020 10:42	05/03/2020 21:57	06/03/2020 10:42	12,74	1	12,74	CHI
20200321925	GOIANIA	10006934755	MEIA PONTE	05/03/2020 21:59	06/03/2020 00:29	05/03/2020 21:59	06/03/2020 00:29	2,49	1	2,49	CHI
20200321926	JARAGUA	JA11266569	JARAGUA	05/03/2020 21:38	05/03/2020 23:25	05/03/2020 21:38	05/03/2020 23:25	1,79	79	141,30	CHI
20200321927	QUIRINOPOLIS	80006103	QUIRINOPOLIS	05/03/2020 22:02	06/03/2020 02:40	05/03/2020 22:02	06/03/2020 02:40	4,63	1	4,63	CHI
20200321936	GOIANESIA	GE12372623	GOIANESIA S1	05/03/2020 19:56	06/03/2020 08:22	05/03/2020 19:56	06/03/2020 08:22	12,43	6	74,60	CHI
20200321939	PIRACANJUBA	BV12036142	BELA VISTA S1	05/03/2020 22:16	06/03/2020 12:06	05/03/2020 22:16	06/03/2020 08:48	10,53	41	431,83	CHI
20200321939	PIRACANJUBA	BV12036142	BELA VISTA S1	05/03/2020 22:16	06/03/2020 12:06	05/03/2020 22:16	06/03/2020 10:50	12,57	7	88,02	CHI
20200321939	PIRACANJUBA	BV12036142	BELA VISTA S1	05/03/2020 22:16	06/03/2020 12:06	05/03/2020 22:16	06/03/2020 11:02	12,77	18	229,79	CHI
20200321939	PIRACANJUBA	BV12036142	BELA VISTA S1	05/03/2020 22:16	06/03/2020 12:06	05/03/2020 22:16	06/03/2020 11:54	13,64	10	136,39	CHI
20200321939	PIRACANJUBA	BV12036142	BELA VISTA S1	05/03/2020 22:16	06/03/2020 12:06	05/03/2020 22:16	06/03/2020 12:06	13,84	11	152,26	CHI
20200321941	GOIANIA	8519025	XAVANTES	05/03/2020 22:17	06/03/2020 01:15	05/03/2020 22:17	06/03/2020 01:15	2,96	16	47,28	CHI
20200321942	ANAPOLIS	AN12285273	ANAPOLIS UNIVERSITARIO S2	05/03/2020 20:14	05/03/2020 23:24	05/03/2020 20:14	05/03/2020 23:24	3,16	79	249,38	CHI
20200321955	JANDAIA	JD12308457	PALMEIRAS	05/03/2020 20:18	06/03/2020 03:14	05/03/2020 20:18	06/03/2020 03:14	6,92	18	124,55	CHI
20200321957	APARECIDA DE GOIANIA	10024032571	INDEPENDENCIA S1	05/03/2020 22:38	06/03/2020 00:09	05/03/2020 22:38	06/03/2020 00:09	1,50	1	1,50	CHI
20200321958	NOVO GAMA	NJ11073455	PACAEMBU S1	05/03/2020 22:39	06/03/2020 07:50	05/03/2020 22:39	06/03/2020 07:50	9,18	172	1578,82	CHI
20200321961	PALMEIRAS DE GOIAS	PL11076753	PALMEIRAS	05/03/2020 22:41	06/03/2020 09:49	05/03/2020 22:41	06/03/2020 09:35	10,90	73	795,44	CHI
20200321961	PALMEIRAS DE GOIAS	PL12377190	PALMEIRAS	05/03/2020 22:41	06/03/2020 09:49	06/03/2020 07:01	06/03/2020 09:49	2,79	154	430,17	CHI
20200321964	FAINA	2580005426	GOIAS	05/03/2020 22:47	06/03/2020 03:42	05/03/2020 22:47	06/03/2020 03:42	4,91	1	4,91	CHI
20200321966	FORMOSA	10005649763	ITUIQUIRA	05/03/2020 22:51	06/03/2020 00:22	05/03/2020 22:51	06/03/2020 00:22	1,51	1	1,51	CHI
20200321975	NOVO PLANALTO	TA11292348	NOVO PLANALTO	05/03/2020 23:08	06/03/2020 10:50	05/03/2020 23:08	06/03/2020 10:50	11,69	59	689,79	CHI
20200321976	CABECEIRAS	CW12150013LD	ITUIQUIRA	05/03/2020 23:05	06/03/2020 11:46	06/03/2020 09:12	06/03/2020 11:46	2,56	51	130,47	CHI
20200321978	JUSSARA	JR12212887	IPORA	05/03/2020 23:15	06/03/2020 09:14	05/03/2020 23:15	06/03/2020 09:14	9,98	22	219,55	CHI
20200321978	MONTES CLAROS DE GOIAS	JR12212887	IPORA	05/03/2020 23:15	06/03/2020 09:14	05/03/2020 23:15	06/03/2020 09:14	9,98	7	69,86	CHI
20200321981	ANAPOLIS	AN11077943	ANAPOLIS UNIVERSITARIO S2	05/03/2020 23:26	06/03/2020 00:34	05/03/2020 23:26	06/03/2020 00:34	1,12	70	78,22	CHI
20200321984	ALEXANIA	AX12095958	CORUMBA	05/03/2020 23:29	06/03/2020 16:25	05/03/2020 23:29	06/03/2020 16:25	16,93	6	101,55	CHI
20200321984	CORUMBA DE GOIAS	AX12095958	CORUMBA	05/03/2020 23:29	06/03/2020 16:25	05/03/2020 23:29	06/03/2020 16:25	16,93	3	50,78	CHI
20200321994	GOIANESIA	GE12302383	GOIANESIA S1	05/03/2020 23:55	06/03/2020 08:30	05/03/2020 23:55	06/03/2020 08:30	8,57	3	25,72	CHI
20200321994	SANTA ISABEL	GE12302383	GOIANESIA S1	05/03/2020 23:55	06/03/2020 08:30	05/03/2020 23:55	06/03/2020 08:30	8,57	1	8,57	CHI
20200322001	APARECIDA DE GOIANIA	17392342	INDEPENDENCIA S1	06/03/2020 00:29	06/03/2020 01:43	06/03/2020 00:29	06/03/2020 01:43	1,22	1	1,22	CHI
20200322004	GOIANIA	GN11039226	GOIANIA LESTE S2	06/03/2020 00:49	06/03/2020 01:42	06/03/2020 00:49	06/03/2020 01:42	0,87	136	117,98	CHI
20200322007	VIANOPOLIS	VN21245058	PIRES DO RIO S2	06/03/2020 01:34	06/03/2020 19:18	06/03/2020 01:34	06/03/2020 19:18	17,73	1	17,73	CHI
20200322016	GOIAS	GS12408673LD	MATRINCHA	06/03/2020 02:52	06/03/2020 11:57	06/03/2020 02:52	06/03/2020 11:57	9,07	22	199,57	CHI
20200322019	CACHOEIRA DOURADA	CD12000050	CACHOEIRA DOURADA	06/03/2020 02:59	06/03/2020 09:14	06/03/2020 02:59	06/03/2020 09:14	6,24	5	31,21	CHI
20200322019	ITUMBIARA	CD12000050	CACHOEIRA DOURADA	06/03/2020 02:59	06/03/2020 09:14	06/03/2020 02:59	06/03/2020 09:14	6,24	2	12,48	CHI
20200322020	NOVA CRIXAS	NA12213190	MOZARLANDIA	06/03/2020 03:06	06/03/2020 11:45	06/03/2020 03:06	06/03/2020 11:45	8,64	23	198,69	CHI
20200322021	VILA PROPICIO	NP12307145	BARRO ALTO	06/03/2020 03:20	06/03/2020 09:28	06/03/2020 03:20	06/03/2020 09:28	6,13	15	91,95	CHI
20200322024	APARECIDA DE GOIANIA	10017066881	INDEPENDENCIA S2	06/03/2020 03:28	06/03/2020 05:24	06/03/2020 03:28	06/03/2020 05:24	1,92	1	1,92	CHI

20200322025	JATAI	JT12072680	JATAI S1	06/03/2020 03:34	06/03/2020 12:53	06/03/2020 03:34	06/03/2020 12:53	9,32	16	149,05	CHI
20200322026	SANTO ANTONIO DO DESCOBERTO	SN11199579	ALEXANIA	05/03/2020 23:49	06/03/2020 08:39	05/03/2020 23:49	06/03/2020 08:39	8,83	142	1254,06	CHI
20200322028	RIO VERDE	RV12260699	CABRIUVA S1	06/03/2020 03:38	06/03/2020 17:12	06/03/2020 03:38	06/03/2020 17:12	13,56	2	27,13	CHI
20200322034	ITABERAI	IB12310490	ITABERAI S2	06/03/2020 04:03	06/03/2020 07:32	06/03/2020 04:03	06/03/2020 07:32	3,48	4	13,93	CHI
20200322035	AGUAS LINDAS DE GOIAS	LA21351439	AGUAS LINDAS DE GOIAS S1	06/03/2020 04:14	06/03/2020 14:45	06/03/2020 04:14	06/03/2020 12:30	8,28	13	107,58	CHI
20200322035	AGUAS LINDAS DE GOIAS	LA12089112LD	AGUAS LINDAS DE GOIAS S1	06/03/2020 04:14	06/03/2020 14:45	06/03/2020 04:14	06/03/2020 14:45	10,51	11	115,65	CHI
20200322036	BALIZA	BH12142110	BOM JARDIM	06/03/2020 04:01	06/03/2020 07:42	06/03/2020 04:01	06/03/2020 07:42	3,68	83	305,19	CHI
20200322037	SANCLERLANDIA	SC12005400	FIRMINOPOLIS S2	06/03/2020 04:16	06/03/2020 07:19	06/03/2020 04:16	06/03/2020 07:19	3,04	42	127,49	CHI
20200322037	SAO LUIS DE MONTES BELOS	SC12005400	FIRMINOPOLIS S2	06/03/2020 04:16	06/03/2020 07:19	06/03/2020 04:16	06/03/2020 07:19	3,04	2	6,07	CHI
20200322040	CRIXAS	MZ12055628	MOZARLANDIA	06/03/2020 04:02	06/03/2020 08:15	06/03/2020 04:02	06/03/2020 08:15	4,21	26	109,58	CHI
20200322040	MOZARLANDIA	MZ12055628	MOZARLANDIA	06/03/2020 04:02	06/03/2020 08:15	06/03/2020 04:02	06/03/2020 08:15	4,21	39	164,36	CHI
20200322041	GAMELEIRA DE GOIAS	SV12056396	DAIA S2	06/03/2020 04:49	06/03/2020 12:29	06/03/2020 04:49	06/03/2020 09:41	4,86	103	500,98	CHI
20200322041	SILVANIA	SV12056396	DAIA S2	06/03/2020 04:49	06/03/2020 12:29	06/03/2020 04:49	06/03/2020 09:41	4,86	1	4,86	CHI
20200322041	GAMELEIRA DE GOIAS	SV21328278	DAIA S2	06/03/2020 04:49	06/03/2020 12:29	06/03/2020 04:49	06/03/2020 12:29	7,67	1	7,67	CHI
20200322044	BARRO ALTO	SJ12006466	GOIANESIA S1	06/03/2020 03:24	06/03/2020 10:15	06/03/2020 03:24	06/03/2020 10:15	6,84	1	6,84	CHI
20200322044	GOIANESIA	SJ12006466	GOIANESIA S1	06/03/2020 03:24	06/03/2020 10:15	06/03/2020 03:24	06/03/2020 10:15	6,84	7	47,90	CHI
20200322044	VILA PROPICIO	SJ12006466	GOIANESIA S1	06/03/2020 03:24	06/03/2020 10:15	06/03/2020 03:24	06/03/2020 10:15	6,84	1	6,84	CHI
20200322045	ANAPOLIS	AN12270460	ANAPOLIS UNIVERSITARIO S2	06/03/2020 04:52	06/03/2020 09:03	06/03/2020 04:52	06/03/2020 09:03	4,17	70	292,15	CHI
20200322047	CAMPOS BELOS	CH12382277	SAO DOMINGOS	06/03/2020 04:54	06/03/2020 09:09	06/03/2020 04:54	06/03/2020 09:09	4,24	1	4,24	CHI
20200322051	BURITI DE GOIAS	SC12052751	FIRMINOPOLIS S2	06/03/2020 05:05	06/03/2020 08:07	06/03/2020 05:05	06/03/2020 08:07	3,02	3	9,06	CHI
20200322051	SANCLERLANDIA	SC12052751	FIRMINOPOLIS S2	06/03/2020 05:05	06/03/2020 08:07	06/03/2020 05:05	06/03/2020 08:07	3,02	19	57,40	CHI
20200322052	ITAPACI	IW12081353	ITAPACI	06/03/2020 05:06	06/03/2020 15:41	06/03/2020 05:06	06/03/2020 15:41	10,57	23	243,13	CHI
20200322055	PONTALINA	PK12090553	VICENTINOPOLIS	06/03/2020 05:14	06/03/2020 08:04	06/03/2020 05:14	06/03/2020 08:04	2,83	16	45,23	CHI
20200322056	IACIARA	IA12085526	IACIARA S1	06/03/2020 05:14	06/03/2020 10:26	06/03/2020 05:14	06/03/2020 10:26	5,19	35	181,74	CHI
20200322057	ORIZONA	OZ12085014RE	PIRES DO RIO S2	06/03/2020 05:15	06/03/2020 20:04	06/03/2020 05:15	06/03/2020 09:48	4,55	13	59,18	CHI
20200322057	VIANOPOLIS	OZ12085014RE	PIRES DO RIO S2	06/03/2020 05:15	06/03/2020 20:04	06/03/2020 05:15	06/03/2020 09:48	4,55	8	36,42	CHI
20200322057	ORIZONA	OZ12085014RE	PIRES DO RIO S2	06/03/2020 05:15	06/03/2020 20:04	06/03/2020 05:15	06/03/2020 20:04	14,82	21	311,16	CHI
20200322057	ORIZONA	OZ12085014RE	PIRES DO RIO S2	06/03/2020 05:15	06/03/2020 20:04	06/03/2020 09:59	06/03/2020 20:04	10,08	13	131,08	CHI
20200322057	VIANOPOLIS	OZ12085014RE	PIRES DO RIO S2	06/03/2020 05:15	06/03/2020 20:04	06/03/2020 09:59	06/03/2020 20:04	10,08	8	80,67	CHI
20200322059	CACHOEIRA ALTA	CA12371227	CACHOEIRA ALTA	06/03/2020 05:19	06/03/2020 11:23	06/03/2020 05:19	06/03/2020 11:23	6,06	10	60,64	CHI
20200322060	FLORES DE GOIAS	FB10401475	FLORES DE GOIAS	06/03/2020 05:17	07/03/2020 14:50	06/03/2020 05:17	06/03/2020 07:13	1,94	21	40,73	CHI
20200322060	FLORES DE GOIAS	FB10401475	FLORES DE GOIAS	06/03/2020 05:17	07/03/2020 14:50	06/03/2020 07:20	06/03/2020 07:35	0,25	21	5,26	CHI
20200322060	ALVORADA DO NORTE	FB10401475	FLORES DE GOIAS	06/03/2020 05:17	07/03/2020 14:50	06/03/2020 05:17	06/03/2020 10:35	5,30	18	95,41	CHI
20200322060	FLORES DE GOIAS	FB10401475	FLORES DE GOIAS	06/03/2020 05:17	07/03/2020 14:50	06/03/2020 05:17	06/03/2020 10:35	5,30	17	90,10	CHI
20200322060	ALVORADA DO NORTE	FB12068785LD	FLORES DE GOIAS	06/03/2020 05:17	07/03/2020 14:50	06/03/2020 05:17	06/03/2020 14:26	9,15	4	36,59	CHI
20200322060	ALVORADA DO NORTE	AQ12320591	FLORES DE GOIAS	06/03/2020 05:17	07/03/2020 14:50	06/03/2020 05:17	06/03/2020 15:53	10,60	20	211,97	CHI
20200322060	ALVORADA DO NORTE	AQ12257608	FLORES DE GOIAS	06/03/2020 05:17	07/03/2020 14:50	06/03/2020 05:17	06/03/2020 19:16	13,99	10	139,91	CHI
20200322060	IACIARA	AQ12257608	FLORES DE GOIAS	06/03/2020 05:17	07/03/2020 14:50	06/03/2020 05:17	06/03/2020 19:16	13,99	4	55,96	CHI
20200322060	POSSE	AQ12257608	FLORES DE GOIAS	06/03/2020 05:17	07/03/2020 14:50	06/03/2020 05:17	06/03/2020 19:16	13,99	2	27,98	CHI
20200322060	ALVORADA DO NORTE	FB10401475	FLORES DE GOIAS	06/03/2020 05:17	07/03/2020 14:50	06/03/2020 22:58	06/03/2020 23:05	0,10	18	1,88	CHI
20200322060	FLORES DE GOIAS	FB10401475	FLORES DE GOIAS	06/03/2020 05:17	07/03/2020 14:50	06/03/2020 22:58	06/03/2020 23:05	0,10	38	3,96	CHI
20200322060	ALVORADA DO NORTE	FB12068785LD	FLORES DE GOIAS	06/03/2020 05:17	07/03/2020 14:50	06/03/2020 20:52	07/03/2020 00:08	3,27	34	111,31	CHI
20200322060	IACIARA	FB12068785LD	FLORES DE GOIAS	06/03/2020 05:17	07/03/2020 14:50	06/03/2020 20:52	07/03/2020 00:08	3,27	4	13,10	CHI
20200322060	POSSE	FB12068785LD	FLORES DE GOIAS	06/03/2020 05:17	07/03/2020 14:50	06/03/2020 20:52	07/03/2020 00:08	3,27	2	6,55	CHI

20200322060	ALVORADA DO NORTE	FB12068785LD	FLORES DE GOIAS	06/03/2020 05:17	07/03/2020 14:50	06/03/2020 05:17	07/03/2020 14:50	33,56	4	134,23	CHI
20200322060	IACIARA	FB12068785LD	FLORES DE GOIAS	06/03/2020 05:17	07/03/2020 14:50	06/03/2020 05:17	07/03/2020 14:50	33,56	12	402,70	CHI
20200322060	ALVORADA DO NORTE	FB12068785LD	FLORES DE GOIAS	06/03/2020 05:17	07/03/2020 14:50	07/03/2020 14:16	07/03/2020 14:50	0,57	34	19,37	CHI
20200322060	IACIARA	FB12068785LD	FLORES DE GOIAS	06/03/2020 05:17	07/03/2020 14:50	07/03/2020 14:16	07/03/2020 14:50	0,57	4	2,28	CHI
20200322060	POSSE	FB12068785LD	FLORES DE GOIAS	06/03/2020 05:17	07/03/2020 14:50	07/03/2020 14:16	07/03/2020 14:50	0,57	2	1,14	CHI
20200322062	PIRACANJUBA	PJ12249878	PIRACANJUBA	06/03/2020 05:23	06/03/2020 11:27	06/03/2020 05:23	06/03/2020 11:27	6,06	6	36,36	CHI
20200322063	JATAI	JT11000092	JATAI S3	06/03/2020 05:23	06/03/2020 11:09	06/03/2020 09:10	06/03/2020 11:09	1,98	103	204,28	CHI
20200322066	MINEIROS	MY21154705	PARQUE DAS EMAS	06/03/2020 05:27	06/03/2020 11:37	06/03/2020 05:27	06/03/2020 11:37	6,16	1	6,16	CHI
20200322067	ANAPOLIS	AN12262499	ANAPOLIS UNIVERSITARIO S1	06/03/2020 05:32	06/03/2020 15:39	06/03/2020 05:32	06/03/2020 15:39	10,11	11	111,25	CHI
20200322072	SAO LUIS DE MONTES BELOS	SL11039166	SAO LUIZ DOS MONTES BELOS	06/03/2020 05:36	06/03/2020 08:25	06/03/2020 05:36	06/03/2020 08:25	2,81	136	382,65	CHI
20200322076	ITABERAI	IB12310505	ITABERAI S2	06/03/2020 05:40	06/03/2020 09:07	06/03/2020 05:40	06/03/2020 09:07	3,44	14	48,18	CHI
20200322077	ESTRELA DO NORTE	ET12012492	MARA ROSA	06/03/2020 05:40	06/03/2020 08:59	06/03/2020 05:40	06/03/2020 08:59	3,31	8	26,46	CHI
20200322080	JARAGUA	JA12298032	JARAGUA	06/03/2020 05:41	06/03/2020 08:27	06/03/2020 05:41	06/03/2020 08:27	2,76	137	378,80	CHI
20200322082	ITUMBIARA	BG12000073	ITUMBIARA VELHA S2	06/03/2020 05:44	06/03/2020 10:53	06/03/2020 05:44	06/03/2020 10:53	5,15	15	77,25	CHI
20200322084	PIRACANJUBA	PJ12044993	PIRACANJUBA	06/03/2020 05:47	06/03/2020 10:14	06/03/2020 05:47	06/03/2020 10:14	4,45	5	22,23	CHI
20200322086	MINACU	IH12397473	MINACU	06/03/2020 05:50	06/03/2020 07:50	06/03/2020 05:50	06/03/2020 07:50	1,99	8	15,88	CHI
20200322088	ALTO HORIZONTE	NH12202112RE	SANTA TEREZINHA	06/03/2020 05:04	07/03/2020 14:22	06/03/2020 05:04	06/03/2020 15:20	10,27	9	92,42	CHI
20200322088	NOVA IGUACU DE GOIAS	NH12202112RE	SANTA TEREZINHA	06/03/2020 05:04	07/03/2020 14:22	06/03/2020 05:04	06/03/2020 15:20	10,27	6	61,61	CHI
20200322088	ALTO HORIZONTE	NH12202112RE	SANTA TEREZINHA	06/03/2020 05:04	07/03/2020 14:22	06/03/2020 05:04	07/03/2020 13:22	32,30	18	581,43	CHI
20200322088	ALTO HORIZONTE	NH12202112RE	SANTA TEREZINHA	06/03/2020 05:04	07/03/2020 14:22	07/03/2020 00:53	07/03/2020 13:22	12,49	8	99,94	CHI
20200322088	NOVA IGUACU DE GOIAS	NH12202112RE	SANTA TEREZINHA	06/03/2020 05:04	07/03/2020 14:22	07/03/2020 00:53	07/03/2020 13:22	12,49	5	62,46	CHI
20200322088	ALTO HORIZONTE	NH12202112RE	SANTA TEREZINHA	06/03/2020 05:04	07/03/2020 14:22	07/03/2020 01:03	07/03/2020 13:22	12,33	1	12,33	CHI
20200322088	NOVA IGUACU DE GOIAS	NH12202112RE	SANTA TEREZINHA	06/03/2020 05:04	07/03/2020 14:22	07/03/2020 01:03	07/03/2020 13:22	12,33	1	12,33	CHI
20200322088	ALTO HORIZONTE	AJ13237525	SANTA TEREZINHA	06/03/2020 05:04	07/03/2020 14:22	06/03/2020 05:04	07/03/2020 14:22	33,30	31	1032,38	CHI
20200322088	CAMPOS VERDES	AJ13237525	SANTA TEREZINHA	06/03/2020 05:04	07/03/2020 14:22	06/03/2020 05:04	07/03/2020 14:22	33,30	9	299,72	CHI
20200322088	PILAR DE GOIAS	AJ13237525	SANTA TEREZINHA	06/03/2020 05:04	07/03/2020 14:22	06/03/2020 05:04	07/03/2020 14:22	33,30	1	33,30	CHI
20200322090	MAIRIPOTABA	MI12000233	PONTALINA	06/03/2020 05:53	06/03/2020 09:31	06/03/2020 05:53	06/03/2020 09:31	3,63	14	50,84	CHI
20200322096	CAMPINORTE	UR12243278	MARA ROSA	06/03/2020 05:59	06/03/2020 11:40	06/03/2020 05:59	06/03/2020 11:40	5,68	7	39,77	CHI
20200322096	URUACU	UR12243278	MARA ROSA	06/03/2020 05:59	06/03/2020 11:40	06/03/2020 05:59	06/03/2020 11:40	5,68	14	79,54	CHI
20200322097	PORANGATU	PO21208484	PORANGATU	06/03/2020 05:59	06/03/2020 07:01	06/03/2020 05:59	06/03/2020 07:01	1,03	1	1,03	CHI
20200322099	CATALAO	CT21077506	CATALAO S1	06/03/2020 06:00	06/03/2020 13:27	06/03/2020 06:00	06/03/2020 13:27	7,44	1	7,44	CHI
20200322100	GOIAS	GS12310480	ITABERAI S2	06/03/2020 06:01	06/03/2020 07:59	06/03/2020 06:01	06/03/2020 07:59	1,97	2	3,93	CHI
20200322100	ITABERAI	GS12310480	ITABERAI S2	06/03/2020 06:01	06/03/2020 07:59	06/03/2020 06:01	06/03/2020 07:59	1,97	10	19,65	CHI
20200322214	DOVERLANDIA	PW10341001	PARQUE DAS EMAS	06/03/2020 06:52	06/03/2020 14:36	06/03/2020 06:52	06/03/2020 14:36	7,73	104	804,18	CHI
20200322214	MINEIROS	PW10341001	PARQUE DAS EMAS	06/03/2020 06:52	06/03/2020 14:36	06/03/2020 06:52	06/03/2020 14:36	7,73	361	2791,43	CHI
20200322214	PORTELANDIA	PW10341001	PARQUE DAS EMAS	06/03/2020 06:52	06/03/2020 14:36	06/03/2020 06:52	06/03/2020 14:36	7,73	149	1152,14	CHI
20200322214	SANTA RITA DO ARAGUAIA	PW10341001	PARQUE DAS EMAS	06/03/2020 06:52	06/03/2020 14:36	06/03/2020 06:52	06/03/2020 14:36	7,73	4	30,93	CHI
20200322224	PIRACANJUBA	PJ12000075	PIRACANJUBA	06/03/2020 06:02	06/03/2020 18:25	06/03/2020 06:02	06/03/2020 18:25	12,39	50	619,33	CHI
20200322301	RIO VERDE	RV12260606	CABRIUVA S1	06/03/2020 06:01	06/03/2020 14:22	06/03/2020 06:01	06/03/2020 14:22	8,35	3	25,04	CHI
20200322302	IACIARA	IA21286104	IACIARA S2	06/03/2020 06:01	06/03/2020 12:31	06/03/2020 06:01	06/03/2020 12:31	6,49	1	6,49	CHI
20200322307	APARECIDA DE GOIANIA	AP11375179	REAL S1	06/03/2020 06:02	06/03/2020 08:00	06/03/2020 06:02	06/03/2020 08:00	1,95	10	19,54	CHI
20200322308	GOIANIA	GN11214765	CAMPINAS S2	06/03/2020 05:45	06/03/2020 10:05	06/03/2020 05:45	06/03/2020 10:05	4,33	110	475,81	CHI
20200322309	LUZIANIA	LZ21161339	CRISTALINA S2	06/03/2020 06:05	06/03/2020 14:18	06/03/2020 06:05	06/03/2020 14:18	8,21	1	8,21	CHI
20200322312	PALMELO	PZ12073341RE	PIRES DO RIO S2	06/03/2020 02:54	06/03/2020 07:49	06/03/2020 02:54	06/03/2020 07:49	4,91	23	113,01	CHI

20200322312	PIRES DO RIO	PZ12073341RE	PIRES DO RIO S2	06/03/2020 02:54	06/03/2020 07:49	06/03/2020 02:54	06/03/2020 07:49	4,91	6	29,48	CHI
20200322312	SANTA CRUZ DE GOIAS	PZ12073341RE	PIRES DO RIO S2	06/03/2020 02:54	06/03/2020 07:49	06/03/2020 02:54	06/03/2020 07:49	4,91	62	304,64	CHI
20200322314	ANAPOLIS	PV12024149	CORUMBA	06/03/2020 06:08	06/03/2020 10:57	06/03/2020 06:08	06/03/2020 10:57	4,81	1	4,81	CHI
20200322314	PIRENOPOLIS	PV12024149	CORUMBA	06/03/2020 06:08	06/03/2020 10:57	06/03/2020 06:08	06/03/2020 10:57	4,81	23	110,53	CHI
20200322315	PARAUNA	PU12045175	ACREUNA	06/03/2020 06:11	06/03/2020 10:50	06/03/2020 06:11	06/03/2020 10:50	4,64	2	9,28	CHI
20200322319	MONTES CLAROS DE GOIAS	ME12132529	IPORA	06/03/2020 06:14	06/03/2020 10:30	06/03/2020 06:14	06/03/2020 10:30	4,26	31	131,99	CHI
20200322322	NOVA IGUACU DE GOIAS	NH12243460RE	SANTA TEREZINHA	06/03/2020 06:16	06/03/2020 10:45	06/03/2020 06:16	06/03/2020 10:45	4,48	37	165,63	CHI
20200322323	GOIANIA	16122720	CARAJAS S2	06/03/2020 06:17	06/03/2020 07:19	06/03/2020 06:17	06/03/2020 07:19	1,03	1	1,03	CHI
20200322325	PETROLINA DE GOIAS	PG12322380	INHUMAS S1	06/03/2020 06:17	06/03/2020 07:43	06/03/2020 06:17	06/03/2020 07:43	1,42	19	27,03	CHI
20200322326	RIO VERDE	RV21123294	CACHOEIRA ALTA	06/03/2020 06:17	06/03/2020 07:33	06/03/2020 06:17	06/03/2020 07:33	1,25	1	1,25	CHI
20200322327	SAO DOMINGOS	SD21134762	SAO DOMINGOS	06/03/2020 06:18	06/03/2020 09:11	06/03/2020 06:18	06/03/2020 09:11	2,88	1	2,88	CHI
20200322328	INACIOLANDIA	ID32128215	QUIRINOPOLIS	06/03/2020 06:19	06/03/2020 11:39	06/03/2020 06:19	06/03/2020 11:39	5,32	6	31,91	CHI
20200322330	NOVA CRIXAS	NA21121151	NOVA CRIXAS	06/03/2020 06:20	07/03/2020 00:28	06/03/2020 06:20	07/03/2020 00:28	18,13	1	18,13	CHI
20200322336	ALVORADA DO NORTE	1510009581	IACIARA S2	06/03/2020 06:27	06/03/2020 08:43	06/03/2020 06:27	06/03/2020 08:43	2,27	1	2,27	CHI
20200322341	SIMOLANDIA	1940022505	IACIARA S2	06/03/2020 06:30	06/03/2020 08:50	06/03/2020 06:30	06/03/2020 08:50	2,34	1	2,34	CHI
20200322353	ITAGUARI	II12220229LD	ITABERAI S1	06/03/2020 06:32	06/03/2020 08:36	06/03/2020 06:32	06/03/2020 08:36	2,05	25	51,31	CHI
20200322357	BONOPOLIS	BX12266016	SAO MIGUEL DO ARAGUAIA	06/03/2020 06:34	06/03/2020 12:22	06/03/2020 06:34	06/03/2020 12:22	5,79	9	52,12	CHI
20200322359	NOVA ROMA	ND12117611	IACIARA S2	06/03/2020 06:35	06/03/2020 11:38	06/03/2020 06:35	06/03/2020 11:38	5,05	8	40,37	CHI
20200322361	PLANALTINA	PI11194814	PLANALTINA	06/03/2020 06:36	06/03/2020 10:17	06/03/2020 06:36	06/03/2020 10:17	3,67	111	407,06	CHI
20200322362	SAO MIGUEL DO ARAGUAIA	830007076	SAO MIGUEL DO ARAGUAIA	06/03/2020 06:37	06/03/2020 08:16	06/03/2020 06:37	06/03/2020 08:16	1,65	1	1,65	CHI
20200322367	ITAGUARI	IC12219937	ITABERAI S1	06/03/2020 06:14	06/03/2020 09:35	06/03/2020 06:14	06/03/2020 09:35	3,33	25	83,35	CHI
20200322367	ITAGUARU	IC12219937	ITABERAI S1	06/03/2020 06:14	06/03/2020 09:35	06/03/2020 06:14	06/03/2020 09:35	3,33	2	6,67	CHI
20200322368	PETROLINA DE GOIAS	PV12062894	SAO FRANCISCO DE GOIAS	06/03/2020 06:38	06/03/2020 10:16	06/03/2020 06:38	06/03/2020 10:16	3,62	3	10,87	CHI
20200322368	PIRENOPOLIS	PV12062894	SAO FRANCISCO DE GOIAS	06/03/2020 06:38	06/03/2020 10:16	06/03/2020 06:38	06/03/2020 10:16	3,62	21	76,09	CHI
20200322369	INDIARA	IY12033386	EDEIA	06/03/2020 06:39	06/03/2020 09:40	06/03/2020 06:39	06/03/2020 09:40	3,03	1	3,03	CHI
20200322371	MINEIROS	MY12126392	PARQUE DAS EMAS	06/03/2020 06:40	06/03/2020 10:47	06/03/2020 06:40	06/03/2020 10:47	4,11	13	53,47	CHI
20200322373	INHUMAS	IN21105193	INHUMAS S1	06/03/2020 06:40	06/03/2020 09:08	06/03/2020 06:40	06/03/2020 09:08	2,46	1	2,46	CHI
20200322375	VIANOPOLIS	VN12115153	VIANOPOLIS	06/03/2020 06:41	06/03/2020 09:26	06/03/2020 06:41	06/03/2020 09:26	2,73	329	899,72	CHI
20200322376	PALMINOPOLIS	RP12259184	FIRMINOPOLIS S2	06/03/2020 04:59	06/03/2020 17:51	06/03/2020 04:59	06/03/2020 17:51	12,86	2	25,73	CHI
20200322376	SAO JOAO DA PARAUNA	RP12259184	FIRMINOPOLIS S2	06/03/2020 04:59	06/03/2020 17:51	06/03/2020 04:59	06/03/2020 17:51	12,86	6	77,18	CHI
20200322380	COLINAS DO SUL	TI21238179	MINACU	06/03/2020 06:43	06/03/2020 09:44	06/03/2020 06:43	06/03/2020 09:44	3,02	1	3,02	CHI
20200322387	AMARALINA	LC12168855	MARA ROSA	06/03/2020 06:44	06/03/2020 10:59	06/03/2020 06:44	06/03/2020 10:59	4,25	35	148,66	CHI
20200322387	MARA ROSA	LC12168855	MARA ROSA	06/03/2020 06:44	06/03/2020 10:59	06/03/2020 06:44	06/03/2020 10:59	4,25	8	33,98	CHI
20200322393	BONOPOLIS	BX12334597	NOVO PLANALTO	06/03/2020 06:46	06/03/2020 14:49	06/03/2020 06:46	06/03/2020 14:49	8,05	3	24,14	CHI
20200322397	NIQUELANDIA	NQ21181118	NIQUELANDIA SUBTRANSMISSAO	06/03/2020 06:47	06/03/2020 09:14	06/03/2020 06:47	06/03/2020 09:14	2,45	1	2,45	CHI
20200322399	SAO LUIS DE MONTES BELOS	SL12306962	FIRMINOPOLIS S2	06/03/2020 06:42	06/03/2020 09:25	06/03/2020 06:42	06/03/2020 09:25	2,71	26	70,42	CHI
20200322400	FORMOSA	610199274	ITUIQUIRA	06/03/2020 06:49	06/03/2020 07:55	06/03/2020 06:49	06/03/2020 07:55	1,09	1	1,09	CHI
20200322405	VIANOPOLIS	VN21275110	VIANOPOLIS	06/03/2020 06:51	06/03/2020 10:02	06/03/2020 06:51	06/03/2020 10:02	3,17	1	3,17	CHI
20200322406	GOIATUBA	GT12044903	GOIATUBA S2	06/03/2020 06:52	06/03/2020 08:10	06/03/2020 06:52	06/03/2020 08:10	1,30	8	10,39	CHI
20200322406	MORRINHOS	GT12044903	GOIATUBA S2	06/03/2020 06:52	06/03/2020 08:10	06/03/2020 06:52	06/03/2020 08:10	1,30	3	3,90	CHI
20200322408	JUSSARA	JR12198907	BRITANIA	06/03/2020 03:57	06/03/2020 11:44	06/03/2020 03:57	06/03/2020 11:44	7,77	36	279,67	CHI
20200322413	ITABERAI	IB12021840	ITABERAI S2	06/03/2020 06:54	06/03/2020 09:51	06/03/2020 06:54	06/03/2020 09:51	2,94	12	35,30	CHI
20200322414	SAO MIGUEL DO ARAGUAIA	SM12350501	SAO MIGUEL DO ARAGUAIA	06/03/2020 06:42	06/03/2020 08:56	06/03/2020 06:42	06/03/2020 08:56	2,23	6	13,35	CHI
20200322419	MONTIVIDIU DO NORTE	MX12192270	PORANGATU	06/03/2020 06:55	06/03/2020 12:42	06/03/2020 06:55	06/03/2020 12:42	5,77	106	611,36	CHI

20200322421	LUZIANIA	LZ12071096	CRISTALINA S2	06/03/2020 06:33	06/03/2020 10:10	06/03/2020 06:33	06/03/2020 10:10	3,62	4	14,46	CHI
20200322423	CATALAO	CT12127882	CATALAO S1	06/03/2020 06:57	06/03/2020 13:27	06/03/2020 06:57	06/03/2020 13:27	6,49	18	116,84	CHI
20200322427	CAIAPONIA	CP12253788	CAIAPONIA	06/03/2020 06:58	06/03/2020 09:00	06/03/2020 06:58	06/03/2020 09:00	2,02	22	44,49	CHI
20200322429	CROMINIA	MI12011352	PONTALINA	06/03/2020 06:58	06/03/2020 09:11	06/03/2020 06:58	06/03/2020 09:11	2,20	1	2,20	CHI
20200322429	MAIRIPOTABA	MI12011352	PONTALINA	06/03/2020 06:58	06/03/2020 09:11	06/03/2020 06:58	06/03/2020 09:11	2,20	2	4,40	CHI
20200322431	SITIO D ABADIA	SI12211381	IACIARA S2	06/03/2020 06:59	06/03/2020 09:13	06/03/2020 06:59	06/03/2020 09:13	2,23	28	62,32	CHI
20200322437	RIO VERDE	04150214	CABRIUVA S2	06/03/2020 06:01	06/03/2020 21:19	06/03/2020 06:01	06/03/2020 09:58	3,94	86	338,51	CHI
20200322437	RIO VERDE	RV12271283	CABRIUVA S2	06/03/2020 06:01	06/03/2020 21:19	06/03/2020 06:01	06/03/2020 21:19	15,30	20	305,97	CHI
20200322440	CALDAS NOVAS	CN11333129	SERRA DE CALDAS	06/03/2020 07:03	06/03/2020 08:20	06/03/2020 07:03	06/03/2020 08:20	1,29	150	193,29	CHI
20200322441	IPORA	730024908	IPORA	06/03/2020 07:03	06/03/2020 09:05	06/03/2020 07:03	06/03/2020 09:05	2,03	1	2,03	CHI
20200322443	ACREUNA	3330005796	ACREUNA	06/03/2020 07:03	06/03/2020 13:18	06/03/2020 07:03	06/03/2020 13:18	6,24	1	6,24	CHI
20200322444	ITAPACI	02600424	ITAPACI	06/03/2020 06:55	06/03/2020 16:32	06/03/2020 06:55	06/03/2020 07:01	0,09	47	4,24	CHI
20200322444	PILAR DE GOIAS	02600424	ITAPACI	06/03/2020 06:55	06/03/2020 16:32	06/03/2020 06:55	06/03/2020 07:01	0,09	2	0,18	CHI
20200322444	SAO LUIZ DO NORTE	02600424	ITAPACI	06/03/2020 06:55	06/03/2020 16:32	06/03/2020 06:55	06/03/2020 07:01	0,09	3	0,27	CHI
20200322444	ITAPACI	02600424	ITAPACI	06/03/2020 06:55	06/03/2020 16:32	06/03/2020 06:57	06/03/2020 07:01	0,05	12	0,65	CHI
20200322444	PILAR DE GOIAS	02600424	ITAPACI	06/03/2020 06:55	06/03/2020 16:32	06/03/2020 06:57	06/03/2020 07:01	0,05	1	0,05	CHI
20200322444	SAO LUIZ DO NORTE	02600424	ITAPACI	06/03/2020 06:55	06/03/2020 16:32	06/03/2020 06:57	06/03/2020 07:01	0,05	5	0,27	CHI
20200322444	ITAPACI	SZ10408364	ITAPACI	06/03/2020 06:55	06/03/2020 16:32	06/03/2020 16:27	06/03/2020 16:32	0,08	57	4,69	CHI
20200322444	PILAR DE GOIAS	SZ10408364	ITAPACI	06/03/2020 06:55	06/03/2020 16:32	06/03/2020 16:27	06/03/2020 16:32	0,08	3	0,25	CHI
20200322444	SAO LUIZ DO NORTE	SZ10408364	ITAPACI	06/03/2020 06:55	06/03/2020 16:32	06/03/2020 16:27	06/03/2020 16:32	0,08	8	0,66	CHI
20200322447	CRISTALINA	KR21168502	CRISTALINA S2	06/03/2020 07:04	06/03/2020 14:54	06/03/2020 07:04	06/03/2020 14:54	7,82	1	7,82	CHI
20200322448	SILVANIA	SV12287460	VIANOPOLIS	06/03/2020 05:43	06/03/2020 09:04	06/03/2020 05:43	06/03/2020 09:04	3,35	87	291,33	CHI
20200322449	HIDROLANDIA	HD21402808	INDEPENDENCIA S1	06/03/2020 07:05	06/03/2020 08:48	06/03/2020 07:05	06/03/2020 08:48	1,70	1	1,70	CHI
20200322451	ARUANA	AK12250808	ARUANA	06/03/2020 07:06	06/03/2020 08:10	06/03/2020 07:06	06/03/2020 08:10	1,05	4	4,22	CHI
20200322457	GOIATUBA	GT12000178	BOM JESUS DE GOIAS	06/03/2020 07:08	06/03/2020 10:08	06/03/2020 07:08	06/03/2020 10:08	2,99	27	80,61	CHI
20200322461	NOVA IGUACU DE GOIAS	GG12375656	SANTA TEREZINHA	06/03/2020 06:41	06/03/2020 11:36	06/03/2020 06:41	06/03/2020 11:36	4,91	6	29,48	CHI
20200322461	PILAR DE GOIAS	GG12375656	SANTA TEREZINHA	06/03/2020 06:41	06/03/2020 11:36	06/03/2020 06:41	06/03/2020 11:36	4,91	14	68,79	CHI
20200322463	GOIANIA	GN12000805	XAVANTES	06/03/2020 07:10	06/03/2020 09:30	06/03/2020 07:10	06/03/2020 09:30	2,33	15	34,98	CHI
20200322466	ANAPOLIS	AN11129383	JUNDIAI S1	06/03/2020 07:11	06/03/2020 07:58	06/03/2020 07:11	06/03/2020 07:58	0,78	154	120,50	CHI
20200322470	ITAUCU	IX12326187	INHUMAS S1	06/03/2020 07:11	06/03/2020 09:06	06/03/2020 07:11	06/03/2020 09:06	1,91	7	13,35	CHI
20200322471	SANTA RITA DO ARAGUAIA	SU21188572	SANTA RITA DO ARAGUAIA	06/03/2020 07:11	06/03/2020 10:48	06/03/2020 07:11	06/03/2020 10:48	3,60	1	3,60	CHI
20200322472	CORREGO DO OURO	CO12062738	FIRMINOPOLIS S2	06/03/2020 07:12	06/03/2020 09:16	06/03/2020 07:12	06/03/2020 09:16	2,06	4	8,25	CHI
20200322477	NIQUELANDIA	NQ12374779	URUACU	06/03/2020 06:25	06/03/2020 09:29	06/03/2020 06:25	06/03/2020 09:29	3,06	29	88,64	CHI
20200322491	VARJAO	VJ32066168	GUAPO S2	06/03/2020 07:15	06/03/2020 13:10	06/03/2020 07:15	06/03/2020 13:10	5,91	7	41,37	CHI
20200322493	PORANGATU	PO21265800	PORANGATU	06/03/2020 07:16	06/03/2020 14:45	06/03/2020 07:16	06/03/2020 14:45	7,48	1	7,48	CHI
20200322494	RIO VERDE	RV21398809	CABRIUVA S2	06/03/2020 07:16	07/03/2020 16:29	06/03/2020 07:16	07/03/2020 16:29	33,20	1	33,20	CHI
20200322495	AMORINOPOLIS	AM12333113	IPORA	06/03/2020 07:17	06/03/2020 10:41	06/03/2020 07:17	06/03/2020 10:41	3,39	7	23,75	CHI
20200322497	INDIARA	2710016194	EDEIA	06/03/2020 07:17	06/03/2020 09:21	06/03/2020 07:17	06/03/2020 09:21	2,07	1	2,07	CHI
20200322499	BRITANIA	BT12259804	BRITANIA	06/03/2020 07:18	06/03/2020 14:06	06/03/2020 07:18	06/03/2020 14:06	6,80	2	13,59	CHI
20200322500	CRIXAS	CX12322603	SANTA TEREZINHA	06/03/2020 07:19	06/03/2020 23:29	06/03/2020 07:19	06/03/2020 23:29	16,17	1	16,17	CHI
20200322500	GUARINOS	CX12322603	SANTA TEREZINHA	06/03/2020 07:19	06/03/2020 23:29	06/03/2020 07:19	06/03/2020 23:29	16,17	3	48,50	CHI
20200322501	PIRACANJUBA	PJ21150367	CRISTIANOPOLIS	06/03/2020 07:19	06/03/2020 09:10	06/03/2020 07:19	06/03/2020 09:10	1,86	1	1,86	CHI
20200322504	GOIANIA	14503141	ATLANTICO S1	06/03/2020 07:19	06/03/2020 08:43	06/03/2020 07:19	06/03/2020 08:43	1,40	1	1,40	CHI
20200322507	RIO VERDE	RV21398734	RIO VERDE S2	06/03/2020 07:20	06/03/2020 18:18	06/03/2020 07:20	06/03/2020 18:18	10,97	1	10,97	CHI

20200322509	JANDAIA	JD12005508	PALMEIRAS	06/03/2020 07:07	07/03/2020 07:33	06/03/2020 07:07	06/03/2020 13:07	6,01	6	36,04	CHI
20200322509	JANDAIA	JD12005508	PALMEIRAS	06/03/2020 07:07	07/03/2020 07:33	06/03/2020 09:30	06/03/2020 13:07	3,63	7	25,38	CHI
20200322509	INDIARA	JD12005508	PALMEIRAS	06/03/2020 07:07	07/03/2020 07:33	06/03/2020 07:07	06/03/2020 18:19	11,20	4	44,82	CHI
20200322509	JANDAIA	JD12005508	PALMEIRAS	06/03/2020 07:07	07/03/2020 07:33	06/03/2020 07:07	06/03/2020 18:19	11,20	1	11,20	CHI
20200322509	INDIARA	JD13158940	PALMEIRAS	06/03/2020 07:07	07/03/2020 07:33	06/03/2020 09:30	06/03/2020 18:19	8,82	1	8,82	CHI
20200322509	JANDAIA	JD13158940	PALMEIRAS	06/03/2020 07:07	07/03/2020 07:33	06/03/2020 09:30	06/03/2020 18:19	8,82	1	8,82	CHI
20200322509	INDIARA	JD12005508	PALMEIRAS	06/03/2020 07:07	07/03/2020 07:33	06/03/2020 07:07	07/03/2020 07:33	24,44	24	586,65	CHI
20200322509	INDIARA	IY13206464	PALMEIRAS	06/03/2020 07:07	07/03/2020 07:33	06/03/2020 09:30	07/03/2020 07:33	22,06	17	375,06	CHI
20200322509	JANDAIA	IY13206464	PALMEIRAS	06/03/2020 07:07	07/03/2020 07:33	06/03/2020 09:30	07/03/2020 07:33	22,06	1	22,06	CHI
20200322511	LUZIANIA	LZ12370854	MARAJOARA	06/03/2020 07:19	06/03/2020 11:06	06/03/2020 07:19	06/03/2020 11:06	3,78	5	18,91	CHI
20200322512	LUZIANIA	LZ12375907	VIANOPOLIS	06/03/2020 07:21	06/03/2020 13:27	06/03/2020 07:21	06/03/2020 13:27	6,09	2	12,17	CHI
20200322520	GOIANESIA	550144687	GOIANESIA S2	06/03/2020 07:23	06/03/2020 11:41	06/03/2020 07:23	06/03/2020 11:41	4,30	1	4,30	CHI
20200322522	ITAUCU	IX12346365	INHUMAS S1	06/03/2020 07:23	06/03/2020 11:40	06/03/2020 07:23	06/03/2020 11:40	4,27	5	21,35	CHI
20200322523	PETROLINA DE GOIAS	PG32086638	SAO FRANCISCO DE GOIAS	06/03/2020 07:06	06/03/2020 10:56	06/03/2020 07:06	06/03/2020 10:56	3,84	40	153,47	CHI
20200322524	SANTA HELENA DE GOIAS	SH12213299	IPEGUARI	06/03/2020 07:24	06/03/2020 09:37	06/03/2020 07:24	06/03/2020 09:37	2,21	3	6,63	CHI
20200322528	JANDAIA	JD12260012	PALMEIRAS	06/03/2020 07:24	06/03/2020 10:15	06/03/2020 07:24	06/03/2020 10:15	2,85	13	37,05	CHI
20200322529	ITAJA	IJ12326958	CACHOEIRA ALTA	06/03/2020 07:23	06/03/2020 10:50	06/03/2020 07:23	06/03/2020 10:50	3,45	9	31,03	CHI
20200322531	CATALAO	CT11000019	CATALAO S2	06/03/2020 06:46	06/03/2020 10:02	06/03/2020 06:46	06/03/2020 10:02	3,26	196	639,07	CHI
20200322534	APARECIDA DE GOIANIA	200547057	ANHANGUERA	06/03/2020 07:25	06/03/2020 08:49	06/03/2020 07:25	06/03/2020 08:49	1,39	1	1,39	CHI
20200322536	NOVA CRIXAS	NA21228264	MOZARLANDIA	06/03/2020 07:26	06/03/2020 10:59	06/03/2020 07:26	06/03/2020 10:59	3,54	1	3,54	CHI
20200322537	PORANGATU	TA12114216	NOVO PLANALTO	06/03/2020 07:26	06/03/2020 12:15	06/03/2020 07:26	06/03/2020 12:15	4,81	1	4,81	CHI
20200322538	VALPARAISO DE GOIAS	2860256708	MARAJOARA	06/03/2020 07:26	06/03/2020 09:00	06/03/2020 07:26	06/03/2020 09:00	1,56	1	1,56	CHI
20200322560	SAO DOMINGOS	SD12389179	SAO DOMINGOS	06/03/2020 07:30	06/03/2020 12:19	06/03/2020 07:30	06/03/2020 12:19	4,80	10	48,05	CHI
20200322566	GOIANIA	15980017	XAVANTES	06/03/2020 07:32	06/03/2020 09:52	06/03/2020 07:32	06/03/2020 09:52	2,32	1	2,32	CHI
20200322572	SANTO ANTONIO DE GOIAS	BW21133468	NEROPOLIS S1	06/03/2020 07:35	06/03/2020 10:07	06/03/2020 07:35	06/03/2020 10:07	2,52	1	2,52	CHI
20200322574	ACREUNA	JD12255748	ACREUNA	06/03/2020 07:01	06/03/2020 11:44	06/03/2020 07:01	06/03/2020 11:44	4,71	2	9,43	CHI
20200322574	JANDAIA	JD12255748	ACREUNA	06/03/2020 07:01	06/03/2020 11:44	06/03/2020 07:01	06/03/2020 11:44	4,71	1	4,71	CHI
20200322576	FLORES DE GOIAS	FB21211533	IACIARA S2	06/03/2020 07:36	06/03/2020 10:18	06/03/2020 07:36	06/03/2020 10:18	2,70	1	2,70	CHI
20200322581	NOVO BRASIL	NB12396208	JUSSARA	06/03/2020 07:36	06/03/2020 10:43	06/03/2020 07:36	06/03/2020 10:43	3,11	1	3,11	CHI
20200322585	LUZIANIA	LZ21388445	CRISTALINA S2	06/03/2020 07:38	06/03/2020 12:01	06/03/2020 07:38	06/03/2020 12:01	4,38	1	4,38	CHI
20200322589	JATAI	JT12165942	JATAI S2	06/03/2020 07:26	06/03/2020 09:31	06/03/2020 07:26	06/03/2020 09:31	2,07	444	919,33	CHI
20200322592	NOVA ROMA	ND12218709	IACIARA S2	06/03/2020 07:39	06/03/2020 15:09	06/03/2020 07:39	06/03/2020 15:09	7,49	1	7,49	CHI
20200322593	EDEALINA	ED12047062	PONTALINA	06/03/2020 06:24	06/03/2020 16:29	06/03/2020 06:24	06/03/2020 16:29	10,07	5	50,36	CHI
20200322594	ARENOPOLIS	AY21334521	ARENOPOLIS	06/03/2020 07:39	06/03/2020 10:45	06/03/2020 07:39	06/03/2020 10:45	3,09	1	3,09	CHI
20200322595	ITUMBIARA	BG21313095	ITUMBIARA VELHA S2	06/03/2020 07:39	06/03/2020 13:04	06/03/2020 07:39	06/03/2020 13:04	5,40	1	5,40	CHI
20200322597	GOIATUBA	GT21134615	BOM JESUS DE GOIAS	06/03/2020 07:08	06/03/2020 11:13	06/03/2020 07:08	06/03/2020 11:13	4,07	1	4,07	CHI
20200322599	MONTIVIDIU DO NORTE	MX11226403	PORANGATU	06/03/2020 07:40	06/03/2020 15:19	06/03/2020 07:40	06/03/2020 15:19	7,64	1	7,64	CHI
20200322707	CALDAZINHA	SW12217284	CEPAIGO S2	06/03/2020 07:42	06/03/2020 09:43	06/03/2020 07:42	06/03/2020 09:43	2,00	6	12,01	CHI
20200322707	LEOPOLDO DE BULHOES	SW12217284	CEPAIGO S2	06/03/2020 07:42	06/03/2020 09:43	06/03/2020 07:42	06/03/2020 09:43	2,00	51	102,11	CHI
20200322710	MARZAGAO	MG21182554	VILA CORUMBA	06/03/2020 07:43	06/03/2020 10:34	06/03/2020 07:43	06/03/2020 10:34	2,85	1	2,85	CHI
20200322716	ABADIANIA	AA10394593	ANAPOLIS UNIVERSITARIO S1	06/03/2020 07:41	06/03/2020 13:59	06/03/2020 07:41	06/03/2020 09:05	1,39	113	156,98	CHI
20200322716	CORUMBA DE GOIAS	AA10394593	ANAPOLIS UNIVERSITARIO S1	06/03/2020 07:41	06/03/2020 13:59	06/03/2020 07:41	06/03/2020 09:05	1,39	4	5,56	CHI
20200322716	ABADIANIA	AA10394593	ANAPOLIS UNIVERSITARIO S1	06/03/2020 07:41	06/03/2020 13:59	06/03/2020 07:41	06/03/2020 13:50	6,14	120	736,97	CHI
20200322716	GAMELEIRA DE GOIAS	AA10394593	ANAPOLIS UNIVERSITARIO S1	06/03/2020 07:41	06/03/2020 13:59	06/03/2020 07:41	06/03/2020 13:50	6,14	1	6,14	CHI

20200322716	ABADIANIA	AA12258343LD	ANAPOLIS UNIVERSITARIO S1	06/03/2020 07:41	06/03/2020 13:59	06/03/2020 07:41	06/03/2020 13:59	6,29	58	365,01	CHI
20200322718	PONTALINA	PK32045966	PONTALINA	06/03/2020 07:44	06/03/2020 10:01	06/03/2020 07:44	06/03/2020 10:01	2,27	2	4,54	CHI
20200322726	SAO MIGUEL DO ARAGUAIA	SM12096096	SAO MIGUEL DO ARAGUAIA	06/03/2020 05:38	06/03/2020 11:24	06/03/2020 05:38	06/03/2020 11:24	5,75	13	74,77	CHI
20200322735	ANAPOLIS	10008296497	ANAPOLIS UNIVERSITARIO S2	06/03/2020 07:49	06/03/2020 10:27	06/03/2020 07:49	06/03/2020 10:27	2,63	1	2,63	CHI
20200322740	PORANGATU	PO12349234	MARA ROSA	06/03/2020 07:50	06/03/2020 12:19	06/03/2020 07:50	06/03/2020 12:19	4,48	16	71,64	CHI
20200322741	RIO VERDE	RV12249020	CABRIUVA S2	06/03/2020 07:35	06/03/2020 18:45	06/03/2020 07:35	06/03/2020 14:00	6,41	18	115,39	CHI
20200322741	RIO VERDE	RV12207053LD	CABRIUVA S2	06/03/2020 07:35	06/03/2020 18:45	06/03/2020 13:46	06/03/2020 18:45	4,97	7	34,82	CHI
20200322744	ALEXANIA	AX12000154	CORUMBA	06/03/2020 07:14	06/03/2020 11:53	06/03/2020 07:14	06/03/2020 11:53	4,64	15	69,65	CHI
20200322744	CORUMBA DE GOIAS	AX12000154	CORUMBA	06/03/2020 07:14	06/03/2020 11:53	06/03/2020 07:14	06/03/2020 11:53	4,64	1	4,64	CHI
20200322748	ABADIANIA	AA21101468	ANAPOLIS UNIVERSITARIO S1	06/03/2020 07:52	06/03/2020 17:30	06/03/2020 07:52	06/03/2020 17:30	9,63	1	9,63	CHI
20200322751	RIO VERDE	RV12306377	CABRIUVA S2	06/03/2020 07:20	06/03/2020 11:38	06/03/2020 07:20	06/03/2020 11:38	4,30	21	90,26	CHI
20200322754	EDEALINA	ED12293380	PONTALINA	06/03/2020 07:52	06/03/2020 09:47	06/03/2020 07:52	06/03/2020 09:47	1,90	8	15,23	CHI
20200322756	NOVA IGUACU DE GOIAS	NH12232436	SANTA TEREZINHA	06/03/2020 07:53	07/03/2020 12:20	06/03/2020 07:53	07/03/2020 12:20	28,45	20	568,91	CHI
20200322761	BURITI ALEGRE	BG21263603	ITUMBIARA VELHA S2	06/03/2020 07:55	06/03/2020 12:55	06/03/2020 07:55	06/03/2020 12:55	5,00	1	5,00	CHI
20200322763	PORANGATU	PO12286007	PORANGATU	06/03/2020 07:55	06/03/2020 10:27	06/03/2020 07:55	06/03/2020 10:27	2,53	8	20,26	CHI
20200322764	SANTA HELENA DE GOIAS	SH11048103	IPEGUARI	06/03/2020 07:55	06/03/2020 12:13	06/03/2020 07:55	06/03/2020 12:13	4,30	149	640,00	CHI
20200322766	GUARAITA	IK12299949	ITAPURANGA	06/03/2020 07:55	06/03/2020 10:03	06/03/2020 07:55	06/03/2020 10:03	2,13	1	2,13	CHI
20200322766	ITAPURANGA	IK12299949	ITAPURANGA	06/03/2020 07:55	06/03/2020 10:03	06/03/2020 07:55	06/03/2020 10:03	2,13	17	36,15	CHI
20200322769	ITAPIRAPUA	1420002858	MATRINCHA	06/03/2020 07:56	06/03/2020 09:54	06/03/2020 07:56	06/03/2020 09:54	1,96	1	1,96	CHI
20200322776	BELA VISTA DE GOIAS	BV12012075	BELA VISTA S2	06/03/2020 06:15	06/03/2020 10:35	06/03/2020 06:15	06/03/2020 10:35	4,32	31	133,88	CHI
20200322776	CALDAZINHA	BV12012075	BELA VISTA S2	06/03/2020 06:15	06/03/2020 10:35	06/03/2020 06:15	06/03/2020 10:35	4,32	7	30,23	CHI
20200322776	SILVANIA	BV12012075	BELA VISTA S2	06/03/2020 06:15	06/03/2020 10:35	06/03/2020 06:15	06/03/2020 10:35	4,32	25	107,97	CHI
20200322779	PONTALINA	JV12208107	GOIATUBA S1	06/03/2020 08:00	06/03/2020 13:22	06/03/2020 08:00	06/03/2020 13:22	5,36	4	21,43	CHI
20200322782	RIO VERDE	RV21022355	MONTIVIDIU T	06/03/2020 08:00	07/03/2020 10:25	06/03/2020 08:00	07/03/2020 10:25	26,42	1	26,42	CHI
20200322788	LUZIANIA	LZ16410048	RIO VERMELHO	06/03/2020 07:58	06/03/2020 13:25	06/03/2020 07:58	06/03/2020 08:16	0,29	1935	568,14	CHI
20200322788	LUZIANIA	XX28425170	RIO VERMELHO	06/03/2020 07:58	06/03/2020 13:25	06/03/2020 07:58	06/03/2020 09:15	1,28	600	769,67	CHI
20200322788	LUZIANIA	XX01446939	RIO VERMELHO	06/03/2020 07:58	06/03/2020 13:25	06/03/2020 07:58	06/03/2020 09:41	1,71	868	1487,90	CHI
20200322788	LUZIANIA	LZ12003715LD	RIO VERMELHO	06/03/2020 07:58	06/03/2020 13:25	06/03/2020 07:58	06/03/2020 13:23	5,41	223	1205,81	CHI
20200322788	LUZIANIA	LZ11162869	RIO VERMELHO	06/03/2020 07:58	06/03/2020 13:25	06/03/2020 10:00	06/03/2020 13:25	3,42	102	348,50	CHI
20200322790	CATALAO	CT12755322	CAMPO ALEGRE DE GOIAS	06/03/2020 08:03	06/03/2020 15:00	06/03/2020 08:03	06/03/2020 15:00	6,95	2	13,90	CHI
20200322792	SAO MIGUEL DO ARAGUAIA	SM12128351	SAO MIGUEL DO ARAGUAIA	06/03/2020 08:03	06/03/2020 11:34	06/03/2020 08:03	06/03/2020 11:34	3,50	20	70,04	CHI
20200322794	SANCLERLANDIA	SL12145801	FIRMINOPOLIS S2	06/03/2020 08:04	06/03/2020 11:52	06/03/2020 08:04	06/03/2020 11:52	3,79	3	11,38	CHI
20200322796	JOVIANIA	JV21329072	GOIATUBA S1	06/03/2020 08:04	06/03/2020 11:22	06/03/2020 08:04	06/03/2020 11:22	3,29	1	3,29	CHI
20200322803	NOVA AURORA	NE21311815	CATALAO S1	06/03/2020 08:05	06/03/2020 11:20	06/03/2020 08:05	06/03/2020 11:20	3,24	1	3,24	CHI
20200322805	TRES RANCHOS	TH12394022	CATALAO S1	06/03/2020 08:05	06/03/2020 09:28	06/03/2020 08:05	06/03/2020 09:28	1,37	13	17,86	CHI
20200322806	PLANALTINA	10010236986	PLANALTINA	06/03/2020 08:05	06/03/2020 09:56	06/03/2020 08:05	06/03/2020 09:56	1,84	1	1,84	CHI
20200322807	PADRE BERNARDO	PB21141200	PADRE BERNARDO	06/03/2020 12:34	06/03/2020 16:21	06/03/2020 12:34	06/03/2020 16:21	3,77	1	3,77	CHI
20200322808	LUZIANIA	LZ21075048	MARAJOARA	06/03/2020 08:05	06/03/2020 11:53	06/03/2020 08:05	06/03/2020 11:53	3,79	1	3,79	CHI
20200322810	PILAR DE GOIAS	GG21131420	SANTA TEREZINHA	06/03/2020 08:06	06/03/2020 13:12	06/03/2020 08:06	06/03/2020 13:12	5,09	1	5,09	CHI
20200322812	ANAPOLIS	AN21000135	JUNDIAI S2	06/03/2020 08:07	06/03/2020 11:17	06/03/2020 08:07	06/03/2020 11:17	3,16	1	3,16	CHI
20200322813	CORUMBAIBA	10008558920	VILA CORUMBA	06/03/2020 08:07	06/03/2020 11:06	06/03/2020 08:07	06/03/2020 11:06	2,98	1	2,98	CHI
20200322825	PONTALINA	PK12335172	PONTALINA	06/03/2020 08:11	06/03/2020 09:33	06/03/2020 08:11	06/03/2020 09:33	1,37	3	4,10	CHI
20200322826	NIQUELANDIA	NQ21158618	NIQUELANDIA SUBTRANSMISSAO	06/03/2020 08:11	06/03/2020 10:26	06/03/2020 08:11	06/03/2020 10:26	2,25	1	2,25	CHI
20200322834	SAO DOMINGOS	SD12161805	SAO DOMINGOS	06/03/2020 07:51	06/03/2020 13:50	06/03/2020 07:51	06/03/2020 13:50	5,98	49	292,79	CHI

20200322835	BONFINOPOLIS	BO12200129	CEPAIGO S2	06/03/2020 08:13	06/03/2020 09:56	06/03/2020 08:13	06/03/2020 09:56	1,70	12	20,44	CHI
20200322835	CALDAZINHA	BO12200129	CEPAIGO S2	06/03/2020 08:13	06/03/2020 09:56	06/03/2020 08:13	06/03/2020 09:56	1,70	2	3,41	CHI
20200322835	LEOPOLDO DE BULHOES	BO12200129	CEPAIGO S2	06/03/2020 08:13	06/03/2020 09:56	06/03/2020 08:13	06/03/2020 09:56	1,70	34	57,91	CHI
20200322835	SENADOR CANEDO	BO12200129	CEPAIGO S2	06/03/2020 08:13	06/03/2020 09:56	06/03/2020 08:13	06/03/2020 09:56	1,70	1	1,70	CHI
20200322838	PIRACANJUBA	PJ12032540	PIRACANJUBA	06/03/2020 06:43	06/03/2020 12:04	06/03/2020 06:43	06/03/2020 12:04	5,34	6	32,06	CHI
20200322842	SAO MIGUEL DO ARAGUAIA	SM12228636	SAO MIGUEL DO ARAGUAIA	06/03/2020 07:57	06/03/2020 12:19	06/03/2020 07:57	06/03/2020 12:19	4,37	54	235,77	CHI
20200322845	SANTA HELENA DE GOIAS	SH12048102	IPEGUARI	06/03/2020 07:56	06/03/2020 10:59	06/03/2020 07:56	06/03/2020 10:59	3,04	108	328,23	CHI
20200322848	CORUMBAIBA	CI12027816	VILA CORUMBA	06/03/2020 08:41	06/03/2020 20:29	06/03/2020 08:41	06/03/2020 20:29	11,80	23	271,44	CHI
20200322854	CHAPADAO DO CEU	9880004352	CHAPADAO DO CEU	06/03/2020 08:18	06/03/2020 19:56	06/03/2020 08:18	06/03/2020 19:56	11,63	1	11,63	CHI
20200322855	PIRACANJUBA	PJ12045336	PIRACANJUBA	06/03/2020 08:18	06/03/2020 10:50	06/03/2020 08:18	06/03/2020 10:50	2,53	18	45,47	CHI
20200322856	CALDAS NOVAS	CN11000004	CALDAS NOVAS S2	06/03/2020 08:18	06/03/2020 09:50	06/03/2020 08:18	06/03/2020 09:50	1,52	96	146,13	CHI
20200322858	PORTEIRAO	2470020160	RIO DOS BOIS	06/03/2020 08:16	06/03/2020 20:00	06/03/2020 08:16	06/03/2020 20:00	11,72	1	11,72	CHI
20200322859	PIRACANJUBA	6417375	PIRACANJUBA	06/03/2020 08:19	06/03/2020 16:14	06/03/2020 08:19	06/03/2020 16:14	7,91	8	63,31	CHI
20200322860	MINACU	IH21129793	MINACU	06/03/2020 08:19	06/03/2020 15:13	06/03/2020 08:19	06/03/2020 15:13	6,90	1	6,90	CHI
20200322875	CRISTALINA	KR21163630	PAMPLONA	06/03/2020 08:20	06/03/2020 14:06	06/03/2020 08:20	06/03/2020 14:06	5,76	1	5,76	CHI
20200322876	VIANOPOLIS	10014379145	VIANOPOLIS	06/03/2020 08:20	06/03/2020 10:01	06/03/2020 08:20	06/03/2020 10:01	1,68	1	1,68	CHI
20200322877	CAMPINORTE	CR11257436	PORANGATU	06/03/2020 08:20	06/03/2020 13:09	06/03/2020 08:20	06/03/2020 13:09	4,81	1	4,81	CHI
20200322890	CABECEIRAS	CW12108845	ITUIQUIRA	06/03/2020 08:22	06/03/2020 12:41	06/03/2020 08:22	06/03/2020 12:41	4,30	11	47,32	CHI
20200322891	IPORA	IR21334806	IPORA	06/03/2020 08:22	06/03/2020 09:38	06/03/2020 08:22	06/03/2020 09:38	1,25	1	1,25	CHI
20200322895	VICENTINOPOLIS	1970014420	VICENTINOPOLIS	06/03/2020 08:20	06/03/2020 10:18	06/03/2020 08:20	06/03/2020 10:18	1,96	1	1,96	CHI
20200322928	IPAMERI	IP12275733	IPAMERI	06/03/2020 08:41	06/03/2020 13:38	06/03/2020 10:52	06/03/2020 13:38	2,77	2	5,53	CHI
20200322937	PIRES DO RIO	PR21232196	PIRES DO RIO S1	06/03/2020 08:53	06/03/2020 11:42	06/03/2020 08:53	06/03/2020 11:42	2,82	1	2,82	CHI
20200322938	PIRES DO RIO	460116599	PIRES DO RIO S1	06/03/2020 08:58	06/03/2020 11:04	06/03/2020 08:58	06/03/2020 11:04	2,10	1	2,10	CHI
20200322944	GOIAS	IB13144319	ITABERAI S1	06/03/2020 09:06	06/03/2020 19:32	06/03/2020 15:26	06/03/2020 19:32	4,11	37	152,19	CHI
20200322944	HEITORAI	IB13144319	ITABERAI S1	06/03/2020 09:06	06/03/2020 19:32	06/03/2020 15:26	06/03/2020 19:32	4,11	1	4,11	CHI
20200322944	ITABERAI	IB13144319	ITABERAI S1	06/03/2020 09:06	06/03/2020 19:32	06/03/2020 15:26	06/03/2020 19:32	4,11	63	259,14	CHI
20200322949	URUTAI	10003715980	URUTAI	06/03/2020 09:08	06/03/2020 11:36	06/03/2020 09:08	06/03/2020 11:36	2,46	1	2,46	CHI
20200323005	SANTA RITA DO NOVO DESTINO	BA12163300	BARRO ALTO	06/03/2020 05:32	06/03/2020 12:15	06/03/2020 05:32	06/03/2020 12:15	6,70	20	134,03	CHI
20200323006	CATALAO	CT212266071	CATALAO S1	06/03/2020 08:26	06/03/2020 15:39	06/03/2020 08:26	06/03/2020 15:39	7,22	1	7,22	CHI
20200323009	MOIPORA	1450000785	IPORA	06/03/2020 08:22	06/03/2020 11:33	06/03/2020 08:22	06/03/2020 11:33	3,18	1	3,18	CHI
20200323017	MOZARLANDIA	MZ12055640	MOZARLANDIA	06/03/2020 08:28	06/03/2020 12:10	06/03/2020 08:28	06/03/2020 12:10	3,69	9	33,19	CHI
20200323019	FORMOSA	FA11397060	ITUIQUIRA	06/03/2020 08:29	06/03/2020 12:10	06/03/2020 08:29	06/03/2020 12:10	3,68	1	3,68	CHI
20200323021	MONTES CLAROS DE GOIAS	ME11077848	IPORA	06/03/2020 08:25	06/03/2020 09:20	06/03/2020 08:25	06/03/2020 09:20	0,93	78	72,26	CHI
20200323028	CATALAO	1990332848	CATALAO S2	06/03/2020 08:32	06/03/2020 12:01	06/03/2020 08:32	06/03/2020 12:01	3,47	1	3,47	CHI
20200323034	ABADIANIA	AA12413563	DAIA S2	06/03/2020 07:42	06/03/2020 12:29	06/03/2020 07:42	06/03/2020 12:29	4,78	77	367,93	CHI
20200323036	SAO MIGUEL DO ARAGUAIA	10025417183	SAO MIGUEL DO ARAGUAIA	06/03/2020 08:35	06/03/2020 15:17	06/03/2020 08:35	06/03/2020 15:17	6,70	1	6,70	CHI
20200323038	RIO VERDE	RV11273557	SANTA HELENA S1	06/03/2020 08:35	07/03/2020 01:39	06/03/2020 08:35	07/03/2020 01:39	17,06	1	17,06	CHI
20200323039	BONOPOLIS	BX12013030	SAO MIGUEL DO ARAGUAIA	06/03/2020 06:28	06/03/2020 11:03	06/03/2020 06:28	06/03/2020 11:03	4,58	5	22,91	CHI
20200323041	RIO VERDE	RV21000271	CABRIUVA S1	06/03/2020 08:37	06/03/2020 15:46	06/03/2020 08:37	06/03/2020 15:46	7,15	24	171,61	CHI
20200323042	RIO VERDE	RV21123294	CACHOEIRA ALTA	06/03/2020 08:37	06/03/2020 15:19	06/03/2020 08:37	06/03/2020 15:19	6,69	1	6,69	CHI
20200323043	RIO VERDE	RV21213260	MONTIVIDIU T	06/03/2020 08:37	06/03/2020 12:53	06/03/2020 08:37	06/03/2020 12:53	4,25	1	4,25	CHI
20200323044	FAZENDA NOVA	FN12220464	JUSSARA	06/03/2020 08:37	06/03/2020 12:53	06/03/2020 08:37	06/03/2020 12:53	4,25	29	123,39	CHI
20200323047	MOIPORA	MO12157683	IPORA	06/03/2020 08:38	06/03/2020 14:38	06/03/2020 08:38	06/03/2020 14:38	6,00	5	29,99	CHI
20200323048	CATALAO	CT21215629	CATALAO S1	06/03/2020 08:38	06/03/2020 10:14	06/03/2020 08:38	06/03/2020 10:14	1,59	1	1,59	CHI

20200323049	ARAGUAPAZ	AZ12404563	GOIAS	06/03/2020 08:37	06/03/2020 14:57	06/03/2020 08:37	06/03/2020 14:57	6,32	20	126,42	CHI
20200323049	FAINA	AZ12404563	GOIAS	06/03/2020 08:37	06/03/2020 14:57	06/03/2020 08:37	06/03/2020 14:57	6,32	1	6,32	CHI
20200323053	MORRINHOS	MR21122111	MORRINHOS	06/03/2020 08:40	06/03/2020 09:57	06/03/2020 08:40	06/03/2020 09:57	1,28	1	1,28	CHI
20200323058	NOVO GAMA	2460029830	PACAEMBU S1	06/03/2020 08:40	06/03/2020 14:19	06/03/2020 08:40	06/03/2020 14:19	5,64	1	5,64	CHI
20200323060	ARAGOIANIA	AO32000287	GUAPO S2	06/03/2020 08:40	06/03/2020 10:03	06/03/2020 08:40	06/03/2020 10:03	1,37	16	21,91	CHI
20200323061	PARAUNA	PU12079036	FIRMINOPOLIS S2	06/03/2020 07:28	06/03/2020 16:21	06/03/2020 07:28	06/03/2020 16:21	8,88	7	62,18	CHI
20200323066	PLANALTINA	2960206624	PLANALTINA	06/03/2020 08:41	06/03/2020 20:27	06/03/2020 08:41	06/03/2020 20:27	11,76	1	11,76	CHI
20200323074	CRISTIANOPOLIS	CF21290019	CRISTIANOPOLIS	06/03/2020 08:43	06/03/2020 10:23	06/03/2020 08:43	06/03/2020 10:23	1,66	1	1,66	CHI
20200323079	CORUMBAIBA	CI12180475	VILA CORUMBA	06/03/2020 08:44	06/03/2020 12:11	06/03/2020 08:44	06/03/2020 12:11	3,45	3	10,34	CHI
20200323080	PORANGATU	PO12252098	PORANGATU	06/03/2020 08:20	06/03/2020 12:17	06/03/2020 08:20	06/03/2020 12:17	3,95	5	19,75	CHI
20200323081	CALDAS NOVAS	CN21119175	CALDAS NOVAS S2	06/03/2020 08:44	06/03/2020 09:55	06/03/2020 08:44	06/03/2020 09:55	1,18	2	2,36	CHI
20200323092	GOIANESIA	GE21240126	GOIANESIA S2	06/03/2020 08:47	06/03/2020 13:25	06/03/2020 08:47	06/03/2020 13:25	4,64	1	4,64	CHI
20200323093	GOIANIRA	GR12393579	GOIANIRA	06/03/2020 08:47	06/03/2020 11:38	06/03/2020 08:47	06/03/2020 11:38	2,84	2	5,68	CHI
20200323095	AURILANDIA	AI12142530	FIRMINOPOLIS S2	06/03/2020 08:48	06/03/2020 14:01	06/03/2020 08:48	06/03/2020 14:01	5,21	3	15,63	CHI
20200323095	FIRMINOPOLIS	AI12142530	FIRMINOPOLIS S2	06/03/2020 08:48	06/03/2020 14:01	06/03/2020 08:48	06/03/2020 14:01	5,21	3	15,63	CHI
20200323097	ANAPOLIS	AN11327855	JUNDIAI S1	06/03/2020 08:48	06/03/2020 09:52	06/03/2020 08:48	06/03/2020 09:52	1,05	40	42,16	CHI
20200323099	NIQUELANDIA	NQ12232473	NIQUELANDIA SUBTRANSMISSAO	06/03/2020 08:49	07/03/2020 08:27	06/03/2020 08:49	07/03/2020 08:27	23,62	43	1015,83	CHI
20200323114	PEROLANDIA	2370002494	JATAI S1	06/03/2020 08:51	06/03/2020 15:04	06/03/2020 08:51	06/03/2020 15:04	6,21	1	6,21	CHI
20200323116	GOIANIA	GN21163927	XAVANTES	06/03/2020 08:51	06/03/2020 10:47	06/03/2020 08:51	06/03/2020 10:47	1,92	1	1,92	CHI
20200323117	MIMOSO DE GOIAS	MJ12251065	PADRE BERNARDO	06/03/2020 08:51	06/03/2020 13:12	06/03/2020 08:51	06/03/2020 13:12	4,33	10	43,34	CHI
20200323119	APARECIDA DE GOIANIA	AP11167942	INDEPENDENCIA S1	06/03/2020 08:41	06/03/2020 11:26	06/03/2020 08:41	06/03/2020 11:26	2,74	98	268,47	CHI
20200323122	PONTALINA	10013371892	PONTALINA	06/03/2020 08:53	06/03/2020 10:22	06/03/2020 08:53	06/03/2020 10:22	1,48	1	1,48	CHI
20200323123	PEROLANDIA	2370007741	JATAI S1	06/03/2020 08:53	06/03/2020 15:00	06/03/2020 08:53	06/03/2020 15:00	6,13	1	6,13	CHI
20200323131	CAMPINORTE	UR21243263	MARA ROSA	06/03/2020 08:55	06/03/2020 15:18	06/03/2020 08:55	06/03/2020 15:18	6,38	1	6,38	CHI
20200323132	QUIRINOPOLIS	QI21129256	QUIRINOPOLIS	06/03/2020 08:55	06/03/2020 11:03	06/03/2020 08:55	06/03/2020 11:03	2,13	1	2,13	CHI
20200323143	GOIANIA	10015740500	CARAIAS S2	06/03/2020 08:56	06/03/2020 11:03	06/03/2020 08:56	06/03/2020 11:03	2,10	1	2,10	CHI
20200323147	CHAPADAO DO CEU	DI12226970	CHAPADAO DO CEU	06/03/2020 08:58	06/03/2020 19:06	06/03/2020 08:58	06/03/2020 19:06	10,13	2	20,26	CHI
20200323153	COCALZINHO DE GOIAS	ZN12327436	GOIANESIA S1	06/03/2020 09:00	06/03/2020 17:18	06/03/2020 09:00	06/03/2020 17:18	8,30	14	116,20	CHI
20200323154	MONTIVIDIU	MV12200062	MONTIVIDIU T	06/03/2020 09:00	06/03/2020 16:35	06/03/2020 09:00	06/03/2020 16:35	7,58	3	22,74	CHI
20200323154	RIO VERDE	MV12200062	MONTIVIDIU T	06/03/2020 09:00	06/03/2020 16:35	06/03/2020 09:00	06/03/2020 16:35	7,58	1	7,58	CHI
20200323160	ITAPACI	IW12396759	ITAPACI	06/03/2020 09:00	06/03/2020 11:08	06/03/2020 09:00	06/03/2020 11:08	2,12	8	16,97	CHI
20200323160	PILAR DE GOIAS	IW12396759	ITAPACI	06/03/2020 09:00	06/03/2020 11:08	06/03/2020 09:00	06/03/2020 11:08	2,12	1	2,12	CHI
20200323164	APARECIDA DE GOIANIA	17392342	INDEPENDENCIA S1	06/03/2020 09:02	06/03/2020 13:20	06/03/2020 09:02	06/03/2020 13:20	4,30	1	4,30	CHI
20200323167	ANAPOLIS	AN21382460	ANAPOLIS UNIVERSITARIO S2	06/03/2020 09:02	06/03/2020 11:02	06/03/2020 09:02	06/03/2020 11:02	1,99	2	3,98	CHI
20200323168	SANTA HELENA DE GOIAS	SH21033709	IPEGUARI	06/03/2020 09:03	06/03/2020 12:38	06/03/2020 09:03	06/03/2020 12:38	3,58	1	3,58	CHI
20200323169	SAO DOMINGOS	SD12398397	SAO DOMINGOS	06/03/2020 07:35	06/03/2020 12:15	06/03/2020 07:35	06/03/2020 12:15	4,66	6	27,95	CHI
20200323175	NOVO BRASIL	NB21123871	JUSSARA	06/03/2020 09:05	06/03/2020 16:00	06/03/2020 09:05	06/03/2020 16:00	6,92	1	6,92	CHI
20200323176	MORRINHOS	150056620	MORRINHOS	06/03/2020 09:06	06/03/2020 11:37	06/03/2020 09:06	06/03/2020 11:37	2,51	1	2,51	CHI
20200323177	PIRENOPOLIS	PV12370311	CORUMBA	06/03/2020 07:36	06/03/2020 11:24	06/03/2020 07:36	06/03/2020 11:24	3,78	3	11,35	CHI
20200323178	CALDAS NOVAS	CN12213834	CALDAS NOVAS S1	06/03/2020 09:06	06/03/2020 12:15	06/03/2020 09:06	06/03/2020 12:15	3,14	5	15,72	CHI
20200323180	ORIZONA	OZ21338070	PIRES DO RIO S2	06/03/2020 09:05	06/03/2020 23:10	06/03/2020 09:05	06/03/2020 23:10	14,08	1	14,08	CHI
20200323188	PALMEIRAS DE GOIAS	590026630	PALMEIRAS	06/03/2020 09:09	06/03/2020 13:11	06/03/2020 09:09	06/03/2020 13:11	4,03	1	4,03	CHI
20200323190	ITABERAÍ	IB21387679	ITABERAÍ S1	06/03/2020 09:09	06/03/2020 13:55	06/03/2020 09:09	06/03/2020 13:55	4,75	1	4,75	CHI
20200323191	JANDAIA	PU12205943	PARAUNA	06/03/2020 09:10	06/03/2020 18:23	06/03/2020 09:10	06/03/2020 18:23	9,21	4	36,86	CHI

20200323191	PARAUNA	PU12205943	PARAUNA	06/03/2020 09:10	06/03/2020 18:23	06/03/2020 09:10	06/03/2020 18:23	9,21	27	248,79	CHI
20200323194	GOIANIA	10007946897	CAMPINAS S2	06/03/2020 09:10	06/03/2020 12:24	06/03/2020 09:10	06/03/2020 12:24	3,22	1	3,22	CHI
20200323196	GOIANIA	17232624	CARAJAS S2	06/03/2020 09:12	06/03/2020 10:31	06/03/2020 09:12	06/03/2020 10:31	1,32	1	1,32	CHI
20200323199	SAO DOMINGOS	SD12302841	SAO DOMINGOS	06/03/2020 09:12	06/03/2020 14:51	06/03/2020 09:12	06/03/2020 14:51	5,65	45	254,11	CHI
20200323207	MARA ROSA	MQ12380741	SANTA TEREZINHA	06/03/2020 06:57	06/03/2020 16:49	06/03/2020 06:57	06/03/2020 16:49	9,86	12	118,27	CHI
20200323209	COCALZINHO DE GOIAS	ZN21153760	COCALZINHO	06/03/2020 09:15	06/03/2020 18:51	06/03/2020 09:15	06/03/2020 18:51	9,59	1	9,59	CHI
20200323212	ITUMBIARA	IT21296924	PARANAIBA	06/03/2020 09:17	06/03/2020 10:18	06/03/2020 09:17	06/03/2020 10:18	1,00	1	1,00	CHI
20200323219	SENADOR CANEDO	SW11366024	SENADOR CANEDO	06/03/2020 09:18	06/03/2020 11:40	06/03/2020 09:18	06/03/2020 11:40	2,36	96	226,45	CHI
20200323220	SAO JOAO D ALIANCA	JL12268121	SAO JOAO D ALIANCA	06/03/2020 08:27	06/03/2020 11:40	06/03/2020 08:27	06/03/2020 11:40	3,20	7	22,42	CHI
20200323223	ANAPOLIS	AN12285273	ANAPOLIS UNIVERSITARIO S2	06/03/2020 07:22	06/03/2020 15:35	06/03/2020 07:22	06/03/2020 15:35	8,20	79	648,15	CHI
20200323226	GOIANIA	11195101	ATLANTICO S1	06/03/2020 09:20	06/03/2020 10:42	06/03/2020 09:20	06/03/2020 10:42	1,36	1	1,36	CHI
20200323228	COCALZINHO DE GOIAS	LA12261431	AGUAS LINDAS DE GOIAS S1	06/03/2020 07:26	06/03/2020 13:12	06/03/2020 07:26	06/03/2020 13:12	5,76	29	166,94	CHI
20200323230	PIRES DO RIO	PR21318953	PIRES DO RIO S1	06/03/2020 09:20	06/03/2020 10:09	06/03/2020 09:20	06/03/2020 10:09	0,80	1	0,80	CHI
20200323231	SERRANOPOLIS	3000012665	JATAI S1	06/03/2020 09:20	06/03/2020 11:36	06/03/2020 09:20	06/03/2020 11:36	2,25	1	2,25	CHI
20200323233	URUACU	UR21221679	URUACU	06/03/2020 09:21	06/03/2020 15:34	06/03/2020 09:21	06/03/2020 15:34	6,21	6	37,27	CHI
20200323236	ORIZONA	OZ12352240	PIRES DO RIO S2	06/03/2020 09:21	06/03/2020 13:41	06/03/2020 09:21	06/03/2020 13:41	4,32	14	60,47	CHI
20200323238	ABADIA DE GOIAS	5580006292	CARAJAS S1	06/03/2020 09:21	06/03/2020 16:27	06/03/2020 09:21	06/03/2020 16:27	7,08	1	7,08	CHI
20200323240	CATALAO	CT12376055	CATALAO S2	06/03/2020 09:22	06/03/2020 11:00	06/03/2020 09:22	06/03/2020 11:00	1,63	4	6,52	CHI
20200323248	SANTA TEREZINHA DE GOIAS	SG21087953	SANTA TEREZINHA	06/03/2020 09:24	06/03/2020 21:00	06/03/2020 09:24	06/03/2020 21:00	11,61	1	11,61	CHI
20200323250	ARENOPOLIS	AY12331924	ARENOPOLIS	06/03/2020 09:25	06/03/2020 15:31	06/03/2020 09:25	06/03/2020 15:31	6,10	1	6,10	CHI
20200323252	FORMOSA	FA12233612	ITIQUEIRA	06/03/2020 09:25	06/03/2020 14:42	06/03/2020 09:25	06/03/2020 14:42	5,28	60	316,82	CHI
20200323256	JARAGUA	JA11007205	JARAGUA	06/03/2020 09:25	06/03/2020 16:19	06/03/2020 09:25	06/03/2020 16:19	6,90	43	296,49	CHI
20200323258	BOM JARDIM DE GOIAS	BM12236571	BOM JARDIM	06/03/2020 09:26	06/03/2020 15:33	06/03/2020 09:26	06/03/2020 15:33	6,11	4	24,43	CHI
20200323266	JATAI	JT12072427	JATAI S1	06/03/2020 09:28	06/03/2020 12:04	06/03/2020 09:28	06/03/2020 12:04	2,59	4	10,37	CHI
20200323267	JUSSARA	JR12085863	BRITANIA	06/03/2020 09:28	06/03/2020 14:21	06/03/2020 09:28	06/03/2020 14:21	4,89	4	19,56	CHI
20200323269	RIO VERDE	RV12190361	CABRIUVA S2	06/03/2020 09:27	07/03/2020 10:30	06/03/2020 09:27	07/03/2020 10:30	25,05	11	275,53	CHI
20200323273	ALTO HORIZONTE	20612316	SANTA TEREZINHA	06/03/2020 16:42	07/03/2020 17:36	06/03/2020 16:42	07/03/2020 17:36	24,90	4	99,59	CHI
20200323274	CRIXAS	CX21252941	SANTA TEREZINHA	06/03/2020 09:29	06/03/2020 14:29	06/03/2020 09:29	06/03/2020 14:29	4,99	1	4,99	CHI
20200323280	AGUA FRIA DE GOIAS	TL12404390	SAO JOAO D ALIANCA	06/03/2020 09:00	06/03/2020 18:13	06/03/2020 09:00	06/03/2020 18:13	9,23	8	73,80	CHI
20200323297	SANTA RITA DO ARAGUAIA	SU12324789	SANTA RITA DO ARAGUAIA	06/03/2020 09:36	06/03/2020 14:41	06/03/2020 09:36	06/03/2020 14:41	5,08	4	20,32	CHI
20200323300	FORMOSA	610132921	ITIQUEIRA	06/03/2020 09:37	06/03/2020 11:15	06/03/2020 09:37	06/03/2020 11:15	1,63	1	1,63	CHI
20200323401	CAMPOS VERDES	VD21252839	SANTA TEREZINHA	06/03/2020 09:37	06/03/2020 17:58	06/03/2020 09:37	06/03/2020 17:58	8,34	1	8,34	CHI
20200323409	VALPARAISO DE GOIAS	VA21353906	PACAEMBU S2	06/03/2020 09:38	06/03/2020 10:58	06/03/2020 09:38	06/03/2020 10:58	1,32	2	2,65	CHI
20200323410	VIANOPOLIS	SV12329170	VIANOPOLIS	06/03/2020 09:38	06/03/2020 11:25	06/03/2020 09:38	06/03/2020 11:25	1,77	3	5,31	CHI
20200323412	PILAR DE GOIAS	GG21372652	SANTA TEREZINHA	06/03/2020 09:38	06/03/2020 19:57	06/03/2020 09:38	06/03/2020 19:57	10,30	1	10,30	CHI
20200323413	GOIAS	10016957898	GOIAS	06/03/2020 09:39	06/03/2020 11:18	06/03/2020 09:39	06/03/2020 11:18	1,65	1	1,65	CHI
20200323421	SILVANIA	LZ12114043	VIANOPOLIS	06/03/2020 09:40	06/03/2020 13:45	06/03/2020 09:40	06/03/2020 13:45	4,08	3	12,23	CHI
20200323425	RIO VERDE	RV21076262	CABRIUVA S2	06/03/2020 09:41	07/03/2020 14:27	06/03/2020 09:41	07/03/2020 14:27	28,77	1	28,77	CHI
20200323429	FORMOSA	FA21309079	ITIQUEIRA	06/03/2020 09:41	06/03/2020 13:40	06/03/2020 09:41	06/03/2020 13:40	3,97	1	3,97	CHI
20200323432	BOM JARDIM DE GOIAS	BM12097834	BOM JARDIM	06/03/2020 09:41	06/03/2020 12:16	06/03/2020 09:41	06/03/2020 12:16	2,57	2	5,14	CHI
20200323433	GOIANIA	GN11378630	CAMPINAS S2	06/03/2020 09:42	06/03/2020 13:03	06/03/2020 09:42	06/03/2020 13:03	3,35	44	147,28	CHI
20200323434	IPIRANGA DE GOIAS	780038812	RUBIATABA	06/03/2020 09:42	07/03/2020 17:59	06/03/2020 09:42	07/03/2020 17:59	32,29	1	32,29	CHI
20200323435	EDEIA	EA21305968	RIO DOS BOIS	06/03/2020 09:42	06/03/2020 20:37	06/03/2020 09:42	06/03/2020 20:37	10,91	1	10,91	CHI
20200323437	GOIANIA	12046164	AEROPORTO S1	06/03/2020 09:43	06/03/2020 11:00	06/03/2020 09:43	06/03/2020 11:00	1,28	1	1,28	CHI

20200323438	POSSE	1480077474	IACIARA S2	06/03/2020 09:43	06/03/2020 11:47	06/03/2020 09:43	06/03/2020 11:47	2,06	1	2,06	CHI
20200323441	ANAPOLIS	OV12384197	NEROPOLIS S1	06/03/2020 09:00	06/03/2020 12:20	06/03/2020 09:00	06/03/2020 12:20	3,32	5	16,61	CHI
20200323441	OURO VERDE DE GOIAS	OV12384197	NEROPOLIS S1	06/03/2020 09:00	06/03/2020 12:20	06/03/2020 09:00	06/03/2020 12:20	3,32	2	6,64	CHI
20200323447	RIO VERDE	RV21191966	MONTIVIDIU T	06/03/2020 09:45	07/03/2020 05:52	06/03/2020 09:45	07/03/2020 05:52	20,11	1	20,11	CHI
20200323451	PONTALINA	PK21236050	VICENTINOPOLIS	06/03/2020 09:46	06/03/2020 12:59	06/03/2020 09:46	06/03/2020 12:59	3,22	1	3,22	CHI
20200323453	ABADIANIA	AA21201386	CORUMBA	06/03/2020 09:47	06/03/2020 13:31	06/03/2020 09:47	06/03/2020 13:31	3,73	1	3,73	CHI
20200323457	VALPARAISO DE GOIAS	10007973649	MARAJOARA	06/03/2020 09:48	06/03/2020 17:45	06/03/2020 09:48	06/03/2020 17:45	7,94	1	7,94	CHI
20200323460	VILA PROPICIO	PV21252379	CORUMBA	06/03/2020 09:49	06/03/2020 13:36	06/03/2020 09:49	06/03/2020 13:36	3,79	1	3,79	CHI
20200323462	NIQUELANDIA	NQ12236707	NIQUELANDIA SUBTRANSMISSAO	06/03/2020 09:26	06/03/2020 19:23	06/03/2020 09:26	06/03/2020 19:23	9,95	6	59,69	CHI
20200323466	ARENOPOLIS	AY11193265	ARENOPOLIS	06/03/2020 09:50	06/03/2020 13:33	06/03/2020 09:50	06/03/2020 13:33	3,71	70	259,82	CHI
20200323482	PLANALTINA	PI12375541	PLANALTINA	06/03/2020 09:55	06/03/2020 12:18	06/03/2020 09:55	06/03/2020 12:18	2,38	177	420,96	CHI
20200323483	PADRE BERNARDO	10008812959	PADRE BERNARDO	06/03/2020 09:55	06/03/2020 16:44	06/03/2020 09:55	06/03/2020 16:44	6,81	1	6,81	CHI
20200323487	ANAPOLIS	20754115	JUNDIAI S2	06/03/2020 09:56	06/03/2020 11:44	06/03/2020 09:56	06/03/2020 11:44	1,79	1	1,79	CHI
20200323493	SILVANIA	SV12080218	VIANOPOLIS	06/03/2020 09:58	06/03/2020 12:47	06/03/2020 09:58	06/03/2020 12:47	2,81	13	36,56	CHI
20200323495	JUSSARA	JR21259706	BRITANIA	06/03/2020 09:59	06/03/2020 22:43	06/03/2020 09:59	06/03/2020 21:37	11,63	1	11,63	CHI
20200323495	JUSSARA	JR12018571LD	BRITANIA	06/03/2020 09:59	06/03/2020 22:43	06/03/2020 17:16	06/03/2020 22:43	5,44	31	168,67	CHI
20200323498	LUZIANIA	LZ12414272	VIANOPOLIS	06/03/2020 06:52	06/03/2020 12:06	06/03/2020 06:52	06/03/2020 12:06	5,23	6	31,39	CHI
20200323500	GOIAS	GS12064392	MATRINCHA	06/03/2020 10:00	06/03/2020 15:01	06/03/2020 10:00	06/03/2020 15:01	5,00	4	20,02	CHI
20200323802	ORIZONA	460094336	PIRES DO RIO S1	06/03/2020 09:50	06/03/2020 12:37	06/03/2020 09:50	06/03/2020 12:37	2,77	1	2,77	CHI
20200323812	IPAMERI	IP21377016	IPAMERI	06/03/2020 10:07	06/03/2020 15:50	06/03/2020 10:07	06/03/2020 15:50	5,71	1	5,71	CHI
20200323902	IVOLANDIA	IV21337730	IPORA	06/03/2020 10:00	06/03/2020 11:55	06/03/2020 10:00	06/03/2020 11:55	1,90	1	1,90	CHI
20200323907	GOIANIA	15858303	GOIANIA LESTE S1	06/03/2020 10:04	06/03/2020 11:42	06/03/2020 10:04	06/03/2020 11:42	1,63	1	1,63	CHI
20200323912	GOIANESIA	GE21334009	GOIANESIA S1	06/03/2020 10:05	06/03/2020 14:25	06/03/2020 10:05	06/03/2020 14:25	4,33	1	4,33	CHI
20200323916	GOIANIA	14184011	CARAJAS S2	06/03/2020 10:06	06/03/2020 11:58	06/03/2020 10:06	06/03/2020 11:58	1,86	1	1,86	CHI
20200323919	IPAMERI	580052278	IPAMERI	06/03/2020 10:06	06/03/2020 11:28	06/03/2020 10:06	06/03/2020 11:28	1,35	1	1,35	CHI
20200323921	JATAI	JT12234313	JATAI S1	06/03/2020 10:07	06/03/2020 15:11	06/03/2020 10:07	06/03/2020 15:11	5,06	7	35,42	CHI
20200323922	UIRAPURU	UP12333204	SANTA TEREZINHA	06/03/2020 10:05	07/03/2020 12:30	06/03/2020 10:05	07/03/2020 12:30	26,42	1	26,42	CHI
20200323923	MORRINHOS	MR12239042	MORRINHOS	06/03/2020 10:08	06/03/2020 12:19	06/03/2020 10:08	06/03/2020 12:19	2,18	3	6,54	CHI
20200323925	SAO MIGUEL DO ARAGUAIA	SM21170925	SAO MIGUEL DO ARAGUAIA	06/03/2020 10:08	06/03/2020 14:29	06/03/2020 10:08	06/03/2020 14:29	4,34	1	4,34	CHI
20200323926	LUZIANIA	LZ21183847	CRISTALINA S2	06/03/2020 10:08	06/03/2020 19:38	06/03/2020 10:08	06/03/2020 19:38	9,49	1	9,49	CHI
20200323934	AGUA FRIA DE GOIAS	TL12157642	SAO JOAO D ALIANCA	06/03/2020 10:09	06/03/2020 13:34	06/03/2020 10:09	06/03/2020 13:34	3,40	3	10,21	CHI
20200323937	ANAPOLIS	10018798916	JUNDIAI S2	06/03/2020 10:10	06/03/2020 12:06	06/03/2020 10:10	06/03/2020 12:06	1,93	1	1,93	CHI
20200323955	ANHANGUERA	CY12317615	CATALAO S1	06/03/2020 10:13	06/03/2020 12:55	06/03/2020 10:13	06/03/2020 12:55	2,68	3	8,05	CHI
20200323955	CUMARI	CY12317615	CATALAO S1	06/03/2020 10:13	06/03/2020 12:55	06/03/2020 10:13	06/03/2020 12:55	2,68	2	5,37	CHI
20200323962	MONTIVIDIU DO NORTE	MX12243327	PORANGATU	06/03/2020 09:22	06/03/2020 14:19	06/03/2020 09:22	06/03/2020 14:19	4,95	7	34,62	CHI
20200323964	GOIAS	GS12299699	GOIAS	06/03/2020 10:17	06/03/2020 12:46	06/03/2020 10:17	06/03/2020 12:46	2,47	32	79,02	CHI
20200323965	HIDROLANDIA	HD11167933	CEPAIGO S2	06/03/2020 10:18	06/03/2020 16:40	06/03/2020 10:18	06/03/2020 16:40	6,37	146	930,59	CHI
20200323969	GOIANIA	15022092	CAMPINAS S2	06/03/2020 10:19	06/03/2020 11:13	06/03/2020 10:19	06/03/2020 11:13	0,90	1	0,90	CHI
20200323971	GUARINOS	GG12237782	URUACU	06/03/2020 10:19	07/03/2020 08:36	06/03/2020 10:19	07/03/2020 08:36	22,27	4	89,09	CHI
20200323971	SANTA TEREZINHA DE GOIAS	GG12237782	URUACU	06/03/2020 10:19	07/03/2020 08:36	06/03/2020 10:19	07/03/2020 08:36	22,27	1	22,27	CHI
20200323974	GOIANESIA	550030487	GOIANESIA S2	06/03/2020 10:21	06/03/2020 14:03	06/03/2020 10:21	06/03/2020 14:03	3,71	1	3,71	CHI
20200323976	GOIATUBA	GT12044924	GOIATUBA S2	06/03/2020 10:21	06/03/2020 11:30	06/03/2020 10:21	06/03/2020 11:30	1,14	3	3,43	CHI
20200323976	MORRINHOS	GT12044924	GOIATUBA S2	06/03/2020 10:21	06/03/2020 11:30	06/03/2020 10:21	06/03/2020 11:30	1,14	3	3,43	CHI
20200323977	CRISTALINA	KR21261611	CRISTALINA S2	06/03/2020 10:21	06/03/2020 14:56	06/03/2020 10:21	06/03/2020 14:56	4,57	1	4,57	CHI

20200323983	BALIZA	BM12390150	BOM JARDIM	06/03/2020 10:22	06/03/2020 13:47	06/03/2020 10:22	06/03/2020 13:47	3,40	51	173,41	CHI
20200323983	BOM JARDIM DE GOIAS	BM12390150	BOM JARDIM	06/03/2020 10:22	06/03/2020 13:47	06/03/2020 10:22	06/03/2020 13:47	3,40	9	30,60	CHI
20200323985	ANAPOLIS	AN11090384	ANAPOLIS UNIVERSITARIO S1	06/03/2020 09:38	06/03/2020 13:06	06/03/2020 09:38	06/03/2020 13:06	3,45	97	334,84	CHI
20200323988	CAMPO LIMPO	960014410	NEROPOLIS S1	06/03/2020 10:24	06/03/2020 13:03	06/03/2020 10:24	06/03/2020 13:03	2,64	1	2,64	CHI
20200323990	PARAUNA	PU21303604	PARAUNA	06/03/2020 10:24	06/03/2020 18:35	06/03/2020 10:24	06/03/2020 18:35	8,17	1	8,17	CHI
20200323993	PORANGATU	840015628	PORANGATU	06/03/2020 10:25	06/03/2020 15:17	06/03/2020 10:25	06/03/2020 15:17	4,86	1	4,86	CHI
20200323995	CALDAS NOVAS	10021020874	SERRA DE CALDAS	06/03/2020 10:25	06/03/2020 11:30	06/03/2020 10:25	06/03/2020 11:30	1,07	1	1,07	CHI
20200323999	CALDAS NOVAS	760374120	CALDAS NOVAS S1	06/03/2020 10:26	06/03/2020 12:27	06/03/2020 10:26	06/03/2020 12:27	2,01	1	2,01	CHI
20200324002	JUSSARA	JR21067734	BRITANIA	06/03/2020 10:17	06/03/2020 11:39	06/03/2020 10:17	06/03/2020 11:39	1,36	1	1,36	CHI
20200324205	GOIANIA	12625619	CAMPINAS S1	06/03/2020 10:27	06/03/2020 13:01	06/03/2020 10:27	06/03/2020 13:01	2,55	1	2,55	CHI
20200324214	BURITI ALEGRE	420046938	ALTO BURITI	06/03/2020 10:30	06/03/2020 12:25	06/03/2020 10:30	06/03/2020 12:25	1,90	1	1,90	CHI
20200324215	MINACU	IH11202492	MINACU	06/03/2020 10:31	06/03/2020 16:37	06/03/2020 10:31	06/03/2020 16:37	6,10	10	60,95	CHI
20200324220	SANTA BARBARA DE GOIAS	SB11403707	TRINDADE	06/03/2020 10:32	06/03/2020 12:26	06/03/2020 10:32	06/03/2020 12:26	1,89	27	51,04	CHI
20200324223	CACHOEIRA ALTA	1090008391	CACHOEIRA ALTA	06/03/2020 10:33	06/03/2020 12:00	06/03/2020 10:33	06/03/2020 12:00	1,45	1	1,45	CHI
20200324239	LUZIANIA	LZ12320196	RIO VERMELHO	06/03/2020 10:38	06/03/2020 14:22	06/03/2020 10:38	06/03/2020 14:22	3,73	11	41,01	CHI
20200324240	CACHOEIRA ALTA	CA21182119	CACHOEIRA ALTA	06/03/2020 10:38	06/03/2020 17:40	06/03/2020 10:38	06/03/2020 17:40	7,02	1	7,02	CHI
20200324241	RIO VERDE	630371659	RIO VERDE S1	06/03/2020 10:39	07/03/2020 08:59	06/03/2020 10:39	07/03/2020 08:59	22,33	1	22,33	CHI
20200324244	VIANOPOLIS	VN21117183	VIANOPOLIS	06/03/2020 10:39	06/03/2020 20:56	06/03/2020 10:39	06/03/2020 20:56	10,28	1	10,28	CHI
20200324250	PEROLANDIA	MY12348932	PARQUE DAS EMAS	06/03/2020 10:41	06/03/2020 20:15	06/03/2020 10:41	06/03/2020 20:15	9,56	3	28,69	CHI
20200324251	PIRES DO RIO	PR12064874	PIRES DO RIO S1	06/03/2020 10:41	06/03/2020 15:00	06/03/2020 10:41	06/03/2020 15:00	4,31	124	534,65	CHI
20200324255	QUIRINOPOLIS	QI21296581	QUIRINOPOLIS	06/03/2020 10:42	06/03/2020 11:39	06/03/2020 10:42	06/03/2020 11:39	0,94	4	3,76	CHI
20200324258	PIRANHAS	1930030360	PIRANHAS	06/03/2020 10:41	06/03/2020 20:22	06/03/2020 10:41	06/03/2020 20:22	9,67	1	9,67	CHI
20200324275	CRISTALINA	KR12245975	CRISTALINA S1	06/03/2020 10:10	06/03/2020 14:07	06/03/2020 10:10	06/03/2020 14:07	3,94	5	19,70	CHI
20200324279	GOIANIA	13290964	GOIANIA LESTE S3	06/03/2020 10:48	06/03/2020 13:36	06/03/2020 10:48	06/03/2020 13:36	2,79	1	2,79	CHI
20200324284	CACU	CC12021384	CACHOEIRA ALTA	06/03/2020 10:49	06/03/2020 16:08	06/03/2020 10:49	06/03/2020 16:08	5,30	12	63,66	CHI
20200324290	TRINDADE	XX09693506	TRINDADE	06/03/2020 10:51	06/03/2020 14:26	06/03/2020 10:51	06/03/2020 14:26	3,58	1	3,58	CHI
20200324298	ITUMBIARA	IT21143902	CACHOEIRA DOURADA	06/03/2020 10:53	06/03/2020 12:25	06/03/2020 10:53	06/03/2020 12:25	1,53	1	1,53	CHI
20200324300	GOIANIA	10031208175	CAMPINAS S3	06/03/2020 10:53	06/03/2020 16:13	06/03/2020 10:53	06/03/2020 16:13	5,32	0	0,00	CHI
20200324312	JATAI	290008037	JATAI S2	06/03/2020 10:57	06/03/2020 16:40	06/03/2020 10:57	06/03/2020 16:40	5,72	1	5,72	CHI
20200324317	FORMOSO	FO21145130	PORANGATU	06/03/2020 10:58	06/03/2020 17:38	06/03/2020 10:58	06/03/2020 17:38	6,65	1	6,65	CHI
20200324322	EDEIA	10030233508	EDEIA	06/03/2020 11:00	06/03/2020 17:55	06/03/2020 11:00	06/03/2020 17:55	6,91	1	6,91	CHI
20200324323	MARA ROSA	ET12208267	MARA ROSA	06/03/2020 11:01	06/03/2020 14:01	06/03/2020 11:01	06/03/2020 14:01	2,98	1	2,98	CHI
20200324331	FORMOSA	FA12376671	ITUIQUIRA	06/03/2020 10:52	06/03/2020 14:50	06/03/2020 10:52	06/03/2020 14:50	3,96	33	130,62	CHI
20200324333	ITAPACI	IW12405204	ITAPACI	06/03/2020 07:00	07/03/2020 10:31	06/03/2020 07:00	07/03/2020 10:31	27,52	17	467,81	CHI
20200324336	SAO DOMINGOS	SD11170570	SAO DOMINGOS	06/03/2020 11:06	06/03/2020 18:25	06/03/2020 11:06	06/03/2020 17:34	6,46	3	19,39	CHI
20200324336	SAO DOMINGOS	SD12170552	SAO DOMINGOS	06/03/2020 11:06	06/03/2020 18:25	06/03/2020 14:51	06/03/2020 18:25	3,57	11	39,24	CHI
20200324337	LUZIANIA	KR12261706	PAMPLONA	06/03/2020 11:06	06/03/2020 13:20	06/03/2020 11:06	06/03/2020 13:20	2,22	4	8,89	CHI
20200324339	CALDAS NOVAS	CN11111405	CALDAS NOVAS S1	06/03/2020 10:54	06/03/2020 12:30	06/03/2020 10:54	06/03/2020 12:30	1,60	187	298,94	CHI
20200324340	APARECIDA DE GOIANIA	15955813	REAL S2	06/03/2020 11:07	06/03/2020 12:34	06/03/2020 11:07	06/03/2020 12:34	1,44	1	1,44	CHI
20200324343	ANICUNS	AC12228150LD	ANICUNS	06/03/2020 10:54	06/03/2020 16:59	06/03/2020 10:54	06/03/2020 13:37	2,71	108	293,16	CHI
20200324343	AVELINOPOLIS	AC12228150LD	ANICUNS	06/03/2020 10:54	06/03/2020 16:59	06/03/2020 10:54	06/03/2020 13:37	2,71	1	2,71	CHI
20200324343	ANICUNS	AC21318613	ANICUNS	06/03/2020 10:54	06/03/2020 16:59	06/03/2020 10:54	06/03/2020 16:59	6,08	1	6,08	CHI
20200324347	GOIAS	90050230	GOIAS	06/03/2020 11:08	06/03/2020 17:45	06/03/2020 11:08	06/03/2020 17:45	6,61	1	6,61	CHI
20200324349	UIRAPURU	UP21257292	SANTA TEREZINHA	06/03/2020 11:09	07/03/2020 02:53	06/03/2020 11:09	07/03/2020 02:53	15,72	2	31,45	CHI

20200324358	ANAPOLIS	20004461	JUNDIAI S2	06/03/2020 11:11	06/03/2020 18:02	06/03/2020 11:11	06/03/2020 18:02	6,83	1	6,83	CHI
20200324363	ITAPACI	RB12417752	RUBIATABA	06/03/2020 07:36	06/03/2020 17:27	06/03/2020 07:36	06/03/2020 17:27	9,85	10	98,52	CHI
20200324363	RUBIATABA	RB12417752	RUBIATABA	06/03/2020 07:36	06/03/2020 17:27	06/03/2020 07:36	06/03/2020 17:27	9,85	96	945,84	CHI
20200324365	RIO VERDE	RV12152700	QUIRINOPOLIS	06/03/2020 05:07	06/03/2020 23:11	06/03/2020 05:07	06/03/2020 23:11	18,06	15	270,83	CHI
20200324369	MAIRIPOTABA	MI21244384	PONTALINA	06/03/2020 11:14	06/03/2020 18:24	06/03/2020 11:14	06/03/2020 18:24	7,16	1	7,16	CHI
20200324373	CATALAO	1990023256	CATALAO S2	06/03/2020 11:14	06/03/2020 15:37	06/03/2020 11:14	06/03/2020 15:37	4,37	1	4,37	CHI
20200324376	ITAPIRAPUA	IU12014855LD	MATRINCHA	06/03/2020 11:15	06/03/2020 14:36	06/03/2020 11:15	06/03/2020 14:36	3,35	5	16,74	CHI
20200324377	CATALAO	CT21192591	CATALAO S1	06/03/2020 11:15	06/03/2020 19:58	06/03/2020 11:15	06/03/2020 19:58	8,71	1	8,71	CHI
20200324381	PIRENOPOLIS	PV12381262	CORUMBA	06/03/2020 11:16	06/03/2020 13:50	06/03/2020 11:16	06/03/2020 13:50	2,57	5	12,83	CHI
20200324382	NIQUELANDIA	NQ12374779	URUACU	06/03/2020 11:11	06/03/2020 15:02	06/03/2020 11:11	06/03/2020 15:02	3,84	29	111,26	CHI
20200324392	GOIANIA	17071707	XAVANTES	06/03/2020 11:18	06/03/2020 13:07	06/03/2020 11:18	06/03/2020 13:07	1,81	1	1,81	CHI
20200324393	MORRINHOS	MR11372888	MORRINHOS	06/03/2020 11:18	06/03/2020 16:47	06/03/2020 11:18	06/03/2020 16:47	5,47	59	322,91	CHI
20200324396	JATAI	JT11067041	JATAI S2	06/03/2020 11:19	06/03/2020 16:13	06/03/2020 11:19	06/03/2020 16:13	4,89	60	293,18	CHI
20200324399	GOIANIA	15156000	FERROVIARIO S1	06/03/2020 11:21	06/03/2020 12:53	06/03/2020 11:21	06/03/2020 12:53	1,53	1	1,53	CHI
20200324610	GOIANIA	15978059	ATLANTICO S2	06/03/2020 11:23	06/03/2020 14:21	06/03/2020 11:23	06/03/2020 14:21	2,96	1	2,96	CHI
20200324611	GOIANIA	15168530	MEIA PONTE	06/03/2020 11:24	06/03/2020 13:20	06/03/2020 11:24	06/03/2020 13:20	1,93	1	1,93	CHI
20200324612	MONTIVIDIU	MV21075459	MONTIVIDIU T	06/03/2020 11:23	06/03/2020 16:17	06/03/2020 11:23	06/03/2020 16:17	4,90	2	9,79	CHI
20200324615	PORANGATU	PO21335451	MARA ROSA	06/03/2020 11:25	06/03/2020 14:17	06/03/2020 11:25	06/03/2020 14:17	2,86	1	2,86	CHI
20200324617	APARECIDA DE GOIANIA	11418400	REAL S2	06/03/2020 11:25	06/03/2020 17:06	06/03/2020 11:25	06/03/2020 17:06	5,68	1	5,68	CHI
20200324619	CRISTALINA	KR12244309	CRISTALINA S1	06/03/2020 11:15	06/03/2020 13:17	06/03/2020 11:15	06/03/2020 13:17	2,03	85	172,29	CHI
20200324620	CRIXAS	CX11360419	RUBIATABA	06/03/2020 11:26	07/03/2020 12:37	06/03/2020 11:26	07/03/2020 12:37	25,18	1	25,18	CHI
20200324621	HEITORAI	HE21310521	ITAPURANGA	06/03/2020 11:20	06/03/2020 17:14	06/03/2020 16:50	06/03/2020 17:14	0,40	1	0,40	CHI
20200324626	MORRINHOS	150031014	MORRINHOS	06/03/2020 11:27	06/03/2020 15:01	06/03/2020 11:27	06/03/2020 15:01	3,57	1	3,57	CHI
20200324632	AGUA FRIA DE GOIAS	TL21337508	SAO JOAO D ALIANCA	06/03/2020 11:28	06/03/2020 23:36	06/03/2020 11:28	06/03/2020 23:36	12,13	1	12,13	CHI
20200324637	LUZIANIA	LZ21246078	MARAJOARA	06/03/2020 11:29	06/03/2020 14:20	06/03/2020 11:29	06/03/2020 14:20	2,84	1	2,84	CHI
20200324641	GOIAS	IU12198548	MATRINCHA	06/03/2020 11:31	06/03/2020 18:51	06/03/2020 11:31	06/03/2020 18:51	7,33	1	7,33	CHI
20200324641	ITAPIRAPUA	IU12198548	MATRINCHA	06/03/2020 11:31	06/03/2020 18:51	06/03/2020 11:31	06/03/2020 18:51	7,33	2	14,65	CHI
20200324642	PEROLANDIA	DP12378134	PARQUE DAS EMAS	06/03/2020 11:31	06/03/2020 18:51	06/03/2020 11:31	06/03/2020 18:51	7,32	3	21,96	CHI
20200324659	ITAGUARI	II12333043	ITABERAI S1	06/03/2020 11:33	06/03/2020 12:07	06/03/2020 11:33	06/03/2020 12:07	0,55	2	1,11	CHI
20200324665	LUZIANIA	120078089	RIO VERMELHO	06/03/2020 11:40	06/03/2020 13:43	06/03/2020 11:40	06/03/2020 13:43	2,05	1	2,05	CHI
20200324670	ARAGUAPAZ	AZ21135181	MOZARLANDIA	06/03/2020 11:42	06/03/2020 13:37	06/03/2020 11:42	06/03/2020 13:37	1,92	1	1,92	CHI
20200324677	INACIOLANDIA	ID21004159	CACHOEIRA DOURADA	06/03/2020 11:45	06/03/2020 16:31	06/03/2020 11:45	06/03/2020 16:31	4,76	1	4,76	CHI
20200324678	GOIANIA	11630036	GOIANIA LESTE S1	06/03/2020 11:45	06/03/2020 13:58	06/03/2020 11:45	06/03/2020 13:58	2,21	1	2,21	CHI
20200324680	MINEIROS	MY12248372LD	PARQUE DAS EMAS	06/03/2020 11:45	06/03/2020 17:32	06/03/2020 11:45	06/03/2020 17:32	5,77	1	5,77	CHI
20200324686	AGUAS LINDAS DE GOIAS	LA12087830	AGUAS LINDAS DE GOIAS S1	06/03/2020 10:14	06/03/2020 12:15	06/03/2020 10:14	06/03/2020 12:15	2,00	123	246,44	CHI
20200324687	RIO VERDE	630339958	RIO VERDE S2	06/03/2020 11:43	07/03/2020 12:46	06/03/2020 11:43	07/03/2020 12:46	25,04	1	25,04	CHI
20200324696	NOVA CRIXAS	NA12106708	NOVA CRIXAS	06/03/2020 10:44	06/03/2020 21:18	06/03/2020 10:44	06/03/2020 21:18	10,56	3	31,68	CHI
20200324698	PADRE BERNARDO	10007017462	PADRE BERNARDO	06/03/2020 11:49	06/03/2020 18:09	06/03/2020 11:49	06/03/2020 18:09	6,32	1	6,32	CHI
20200324699	JATAI	JT11172863	JATAI S2	06/03/2020 10:42	06/03/2020 14:08	06/03/2020 10:42	06/03/2020 14:08	3,42	130	444,49	CHI
20200324700	BURITI ALEGRE	BG21229313	ITUMBIARA VELHA S2	06/03/2020 11:50	06/03/2020 14:01	06/03/2020 11:50	06/03/2020 14:01	2,18	1	2,18	CHI
20200324720	IACIARA	IA12257594	IACIARA S2	06/03/2020 12:45	06/03/2020 13:34	06/03/2020 12:45	06/03/2020 13:34	0,81	5	4,05	CHI
20200324801	ITABERAI	IB12300089	ITABERAI S2	06/03/2020 11:50	06/03/2020 15:45	06/03/2020 11:50	06/03/2020 15:45	3,91	1	3,91	CHI
20200324806	GOIANIA	GN11111861	MEIA PONTE	06/03/2020 11:51	06/03/2020 15:11	06/03/2020 13:56	06/03/2020 15:11	1,25	228	285,00	CHI
20200324807	CALDAS NOVAS	CN21160351	CALDAS NOVAS S1	06/03/2020 11:52	06/03/2020 15:53	06/03/2020 11:52	06/03/2020 15:53	4,02	1	4,02	CHI

20200324809	PORTELANDIA	PW21303438	PARQUE DAS EMAS	06/03/2020 11:52	06/03/2020 22:46	06/03/2020 11:52	06/03/2020 22:46	10,89	1	10,89	CHI
20200324811	CACHOEIRA DOURADA	CD21000153	CACHOEIRA DOURADA	06/03/2020 11:52	06/03/2020 15:19	06/03/2020 11:52	06/03/2020 15:19	3,44	1	3,44	CHI
20200324816	GOIANIA	12046164	AEROPORTO S1	06/03/2020 11:54	06/03/2020 15:54	06/03/2020 11:54	06/03/2020 15:54	3,99	1	3,99	CHI
20200324822	VILA PROPICIO	PV21315738	GOIANESIA S1	06/03/2020 11:55	06/03/2020 16:11	06/03/2020 11:55	06/03/2020 16:11	4,25	1	4,25	CHI
20200324828	MINEIROS	MY21274160	PARQUE DAS EMAS	06/03/2020 11:58	06/03/2020 17:35	06/03/2020 11:58	06/03/2020 17:35	5,61	1	5,61	CHI
20200324830	GOIANIA	10017493135	REAL S2	06/03/2020 11:59	06/03/2020 13:57	06/03/2020 11:59	06/03/2020 13:57	1,95	1	1,95	CHI
20200324834	TRINDADE	10014280335	TRINDADE	06/03/2020 12:01	06/03/2020 16:08	06/03/2020 12:01	06/03/2020 16:08	4,11	1	4,11	CHI
20200324838	GUAPO	8556404	GUAPO S1	06/03/2020 12:05	06/03/2020 14:56	06/03/2020 12:05	06/03/2020 14:56	2,85	4	11,39	CHI
20200324839	ARUANA	AK12220039	ARUANA	06/03/2020 09:13	06/03/2020 14:39	06/03/2020 09:13	06/03/2020 14:39	5,42	2	10,85	CHI
20200324841	JUSSARA	JR11025093	JUSSARA	06/03/2020 12:06	06/03/2020 14:31	06/03/2020 12:06	06/03/2020 14:31	2,42	81	195,66	CHI
20200324845	SENADOR CANEDO	SW11101879	SENADOR CANEDO	06/03/2020 10:48	06/03/2020 12:56	06/03/2020 10:48	06/03/2020 12:56	2,12	196	416,28	CHI
20200324847	SAO JOAO D ALIANCA	JL12016102	SAO JOAO D ALIANCA	06/03/2020 12:07	06/03/2020 13:02	06/03/2020 12:07	06/03/2020 13:02	0,91	304	276,13	CHI
20200324851	CAMPO ALEGRE DE GOIAS	CM21215490	CAMPO ALEGRE DE GOIAS	06/03/2020 12:10	06/03/2020 13:37	06/03/2020 12:10	06/03/2020 13:37	1,44	1	1,44	CHI
20200324855	CABECEIRAS	CW21151402	ITUIQUIRA	06/03/2020 12:11	06/03/2020 15:05	06/03/2020 12:11	06/03/2020 15:05	2,89	1	2,89	CHI
20200324856	NIQUELANDIA	4640001679	BARRO ALTO	06/03/2020 12:11	06/03/2020 21:47	06/03/2020 12:11	06/03/2020 21:47	9,59	1	9,59	CHI
20200324857	MORRINHOS	150067082	MORRINHOS	06/03/2020 12:11	06/03/2020 14:49	06/03/2020 12:11	06/03/2020 14:49	2,63	1	2,63	CHI
20200324858	NEROPOLIS	NR12000010	NEROPOLIS S2	06/03/2020 12:11	06/03/2020 17:44	06/03/2020 12:11	06/03/2020 17:44	5,54	3	16,61	CHI
20200324860	ARAGOIANIA	AO21326544	GUAPO S2	06/03/2020 12:12	06/03/2020 17:43	06/03/2020 12:12	06/03/2020 17:43	5,51	3	16,54	CHI
20200324862	CATALAO	CT21306685	CATALAO S1	06/03/2020 12:13	06/03/2020 18:52	06/03/2020 12:13	06/03/2020 18:52	6,65	1	6,65	CHI
20200324863	FIRMINOPOLIS	FR12308490	FIRMINOPOLIS S1	06/03/2020 12:13	06/03/2020 14:39	06/03/2020 12:13	06/03/2020 14:39	2,42	13	31,44	CHI
20200324874	LUZIANIA	LZ21203470	VIANOPOLIS	06/03/2020 12:20	06/03/2020 19:12	06/03/2020 12:20	06/03/2020 19:12	6,86	1	6,86	CHI
20200324880	CALDAS NOVAS	CN21055063	VILA CORUMBA	06/03/2020 12:23	06/03/2020 15:19	06/03/2020 12:23	06/03/2020 15:19	2,93	1	2,93	CHI
20200324881	SAO LUIZ DO NORTE	SZ21290397	ITAPACI	06/03/2020 12:24	07/03/2020 08:40	06/03/2020 12:24	07/03/2020 08:40	20,25	1	20,25	CHI
20200324887	PIRACANJUBA	PJ12045336	PIRACANJUBA	06/03/2020 11:15	06/03/2020 15:44	06/03/2020 11:15	06/03/2020 15:44	4,47	19	85,02	CHI
20200324893	ANAPOLIS	20182077	JUNDIAI S1	06/03/2020 12:30	06/03/2020 18:14	06/03/2020 12:30	06/03/2020 18:14	5,72	1	5,72	CHI
20200324894	FORMOSO	2410002013	PORANGATU	06/03/2020 12:30	06/03/2020 18:38	06/03/2020 12:30	06/03/2020 18:38	6,12	1	6,12	CHI
20200324896	CIDADE OCIDENTAL	LZ12060260	MARAJOARA	06/03/2020 12:32	06/03/2020 15:27	06/03/2020 12:32	06/03/2020 15:27	2,91	7	20,38	CHI
20200324904	JARAGUA	JA21169846	JARAGUA	06/03/2020 12:34	06/03/2020 18:07	06/03/2020 12:34	06/03/2020 18:07	5,54	1	5,54	CHI
20200324910	ABADIANIA	AA12258344	ANAPOLIS UNIVERSITARIO S1	06/03/2020 12:36	06/03/2020 20:00	06/03/2020 12:36	06/03/2020 20:00	7,40	93	688,28	CHI
20200324910	GAMELEIRA DE GOIAS	AA12258344	ANAPOLIS UNIVERSITARIO S1	06/03/2020 12:36	06/03/2020 20:00	06/03/2020 12:36	06/03/2020 20:00	7,40	10	74,01	CHI
20200324911	GOIANIA	15129573	REAL S1	06/03/2020 12:36	06/03/2020 15:29	06/03/2020 12:36	06/03/2020 15:29	2,87	1	2,87	CHI
20200324914	FLORES DE GOIAS	FB12250123	FLORES DE GOIAS	06/03/2020 12:37	06/03/2020 14:34	06/03/2020 12:37	06/03/2020 14:34	1,94	80	155,53	CHI
20200324914	SAO JOAO D ALIANCA	FB12250123	FLORES DE GOIAS	06/03/2020 12:37	06/03/2020 14:34	06/03/2020 12:37	06/03/2020 14:34	1,94	20	38,88	CHI
20200324916	INHUMAS	10006720739	INHUMAS S2	06/03/2020 12:37	06/03/2020 14:00	06/03/2020 12:37	06/03/2020 14:00	1,37	1	1,37	CHI
20200324917	SANTA RITA DO NOVO DESTINO	DF12377521	BARRO ALTO	06/03/2020 12:39	06/03/2020 19:35	06/03/2020 12:39	06/03/2020 19:35	6,93	23	159,40	CHI
20200324925	SENADOR CANEDO	16653968	GOIANIA LESTE S1	06/03/2020 12:41	06/03/2020 15:35	06/03/2020 12:41	06/03/2020 15:35	2,89	1	2,89	CHI
20200324926	ANAPOLIS	21096521	ANAPOLIS UNIVERSITARIO S2	06/03/2020 12:42	06/03/2020 20:26	06/03/2020 12:42	06/03/2020 20:26	7,73	1	7,73	CHI
20200324930	SANTO ANTONIO DA BARRA	BZ21207512	ACREUNA	06/03/2020 12:43	06/03/2020 18:31	06/03/2020 12:43	06/03/2020 18:31	5,78	2	11,57	CHI
20200324932	ANAPOLIS	10013974015	ANAPOLIS UNIVERSITARIO S2	06/03/2020 12:44	06/03/2020 15:53	06/03/2020 12:44	06/03/2020 15:53	3,15	1	3,15	CHI
20200324940	GOIANIA	15238532	ATLANTICO S1	06/03/2020 12:47	06/03/2020 14:47	06/03/2020 12:47	06/03/2020 14:47	2,00	1	2,00	CHI
20200324941	SERRANOPOLIS	SX21153208	JATAI S1	06/03/2020 12:47	07/03/2020 08:57	06/03/2020 12:47	07/03/2020 08:57	20,16	1	20,16	CHI
20200324945	CATALAO	10008631687	CATALAO S2	06/03/2020 12:48	06/03/2020 16:22	06/03/2020 12:48	06/03/2020 16:22	3,56	1	3,56	CHI
20200324946	SAO FRANCISCO DE GOIAS	SF12297994	SAO FRANCISCO DE GOIAS	06/03/2020 11:46	06/03/2020 15:16	06/03/2020 11:46	06/03/2020 15:16	3,50	19	66,48	CHI
20200324949	SAO LUIS DE MONTES BELOS	SL12011302	FIRMINOPOLIS S2	06/03/2020 11:51	06/03/2020 16:46	06/03/2020 11:51	06/03/2020 16:46	4,92	11	54,07	CHI

20200324951	VALPARAISO DE GOIAS	2860042447	MARAJOARA	06/03/2020 12:50	06/03/2020 15:14	06/03/2020 12:50	06/03/2020 15:14	2,39	1	2,39	CHI
20200324957	PONTALINA	10030938331	PONTALINA	06/03/2020 12:53	06/03/2020 14:27	06/03/2020 12:53	06/03/2020 14:27	1,55	1	1,55	CHI
20200324958	MOZARLANDIA	MZ12063703	MOZARLANDIA	06/03/2020 12:55	06/03/2020 21:58	06/03/2020 12:55	06/03/2020 21:58	9,04	10	90,41	CHI
20200324963	PLANALTINA	PI12355791	PLANALTINA	06/03/2020 12:57	06/03/2020 15:57	06/03/2020 12:57	06/03/2020 15:57	2,99	1	2,99	CHI
20200324969	BOM JARDIM DE GOIAS	BM12212797	BOM JARDIM	06/03/2020 13:00	06/03/2020 15:30	06/03/2020 13:00	06/03/2020 15:30	2,50	86	214,69	CHI
20200324969	PIRANHAS	BM12212797	BOM JARDIM	06/03/2020 13:00	06/03/2020 15:30	06/03/2020 13:00	06/03/2020 15:30	2,50	2	4,99	CHI
20200324972	ITABERAI	IB21027641	ITABERAI S2	06/03/2020 13:00	06/03/2020 21:10	06/03/2020 13:00	06/03/2020 21:10	8,16	1	8,16	CHI
20200324977	MOZARLANDIA	MZ21183495	MOZARLANDIA	06/03/2020 13:01	06/03/2020 16:55	06/03/2020 13:01	06/03/2020 16:55	3,89	1	3,89	CHI
20200324978	FIRMINOPOLIS	FR21206036	FIRMINOPOLIS S1	06/03/2020 13:02	06/03/2020 19:57	06/03/2020 13:02	06/03/2020 19:57	6,91	1	6,91	CHI
20200324980	APARECIDA DE GOIANIA	10029468190	INDEPENDENCIA S2	06/03/2020 13:02	06/03/2020 14:25	06/03/2020 13:02	06/03/2020 14:25	1,38	1	1,38	CHI
20200324981	APARECIDA DO RIO DOCE	AW21122544	JATAI S1	06/03/2020 13:02	06/03/2020 16:33	06/03/2020 13:02	06/03/2020 16:33	3,51	1	3,51	CHI
20200324982	SAO JOAO D ALIANCA	JL12383340	SAO JOAO D ALIANCA	06/03/2020 13:02	06/03/2020 16:53	06/03/2020 13:02	06/03/2020 16:53	3,84	76	291,65	CHI
20200324986	MAURILANDIA	ML11036529	RIO DOS BOIS	06/03/2020 09:28	06/03/2020 20:53	06/03/2020 09:28	06/03/2020 20:53	11,42	83	947,56	CHI
20200324991	VILA PROPICIO	NP21370405	GOIANESIA S1	06/03/2020 13:04	06/03/2020 19:13	06/03/2020 13:04	06/03/2020 19:13	6,14	1	6,14	CHI
20200324998	VIANOPOLIS	VN21060534	PIRES DO RIO S2	06/03/2020 13:08	06/03/2020 17:45	06/03/2020 13:08	06/03/2020 17:45	4,61	1	4,61	CHI
20200325001	FLORES DE GOIAS	3480007646	FLORES DE GOIAS	06/03/2020 13:09	07/03/2020 10:29	06/03/2020 13:09	07/03/2020 10:29	21,32	1	21,32	CHI
20200325005	QUIRINOPOLIS	QI12017983	QUIRINOPOLIS	06/03/2020 13:04	06/03/2020 15:08	06/03/2020 13:04	06/03/2020 15:08	2,06	3	6,19	CHI
20200325011	CATALAO	CT21042485	CATALAO S1	06/03/2020 13:13	06/03/2020 17:45	06/03/2020 13:13	06/03/2020 17:45	4,53	2	9,05	CHI
20200325016	GOIANIA	13441061	CAMPINAS S2	06/03/2020 13:15	06/03/2020 15:07	06/03/2020 13:15	06/03/2020 15:07	1,86	1	1,86	CHI
20200325018	MUNDO NOVO DE GOIAS	MH12391948	NOVA CRIXAS	06/03/2020 09:23	06/03/2020 15:36	06/03/2020 09:23	06/03/2020 15:36	6,21	14	86,99	CHI
20200325019	SENADOR CANEDO	10029626968	SENADOR CANEDO	06/03/2020 13:16	06/03/2020 14:32	06/03/2020 13:16	06/03/2020 14:32	1,25	1	1,25	CHI
20200325020	CIDADE OCIDENTAL	LZ21000293	MARAJOARA	06/03/2020 13:16	06/03/2020 15:33	06/03/2020 13:16	06/03/2020 15:33	2,27	1	2,27	CHI
20200325023	FAZENDA NOVA	FN21221803	IPORA	06/03/2020 13:17	07/03/2020 09:15	06/03/2020 13:17	07/03/2020 09:15	19,95	1	19,95	CHI
20200325024	ABADIANIA	AN12379943	ANAPOLIS UNIVERSITARIO S2	06/03/2020 13:17	06/03/2020 17:22	06/03/2020 13:17	06/03/2020 17:22	4,07	6	24,42	CHI
20200325027	URUACU	CR21237434	CAMPINORTE	06/03/2020 13:17	06/03/2020 21:40	06/03/2020 13:17	06/03/2020 21:40	8,37	10	83,68	CHI
20200325029	PIRENOPOLIS	PV12381258	CORUMBA	06/03/2020 09:23	06/03/2020 16:39	06/03/2020 09:23	06/03/2020 16:39	7,25	7	50,75	CHI
20200325032	APARECIDA DE GOIANIA	200011080	INDEPENDENCIA S1	06/03/2020 13:20	06/03/2020 15:09	06/03/2020 13:20	06/03/2020 15:09	1,82	1	1,82	CHI
20200325036	GOIANIA	GN12001527	GOYA S1	06/03/2020 13:19	06/03/2020 14:56	06/03/2020 13:19	06/03/2020 14:56	1,60	61	97,82	CHI
20200325037	JATAI	JT12007819	JATAI S2	06/03/2020 13:23	06/03/2020 15:46	06/03/2020 13:23	06/03/2020 15:46	2,38	1	2,38	CHI
20200325050	VIANOPOLIS	510047488	VIANOPOLIS	06/03/2020 13:27	06/03/2020 15:56	06/03/2020 13:27	06/03/2020 15:56	2,48	1	2,48	CHI
20200325051	NOVA ROMA	ND11071371	IACIARA S2	06/03/2020 13:28	06/03/2020 15:34	06/03/2020 13:28	06/03/2020 15:34	2,10	52	109,03	CHI
20200325052	BELA VISTA DE GOIAS	BV21222673	BELA VISTA S1	06/03/2020 13:28	06/03/2020 14:27	06/03/2020 13:28	06/03/2020 14:27	0,98	1	0,98	CHI
20200325057	LUZIANIA	LZ21219758	PAMPLONA	06/03/2020 13:30	06/03/2020 17:00	06/03/2020 13:30	06/03/2020 17:00	3,52	1	3,52	CHI
20200325062	MORRINHOS	MR12035910	MORRINHOS	06/03/2020 13:32	06/03/2020 17:58	06/03/2020 13:32	06/03/2020 17:58	4,43	6	26,59	CHI
20200325063	IACIARA	IA12262079	IACIARA S1	06/03/2020 13:32	06/03/2020 16:17	06/03/2020 13:32	06/03/2020 16:17	2,75	21	57,70	CHI
20200325065	CORUMBAIBA	CI12140329	CATALAO S1	06/03/2020 13:33	07/03/2020 09:14	06/03/2020 13:33	07/03/2020 09:14	19,68	8	157,47	CHI
20200325066	RIO QUENTE	RQ11265127	RIO QUENTE	06/03/2020 13:31	06/03/2020 17:05	06/03/2020 13:31	06/03/2020 17:05	3,56	3	10,67	CHI
20200325072	LUZIANIA	LZ21149528	MARAJOARA	06/03/2020 13:37	06/03/2020 17:21	06/03/2020 13:37	06/03/2020 17:21	3,72	2	7,45	CHI
20200325080	NAZARIO	440002394	ANICUNS	06/03/2020 13:39	06/03/2020 20:27	06/03/2020 13:39	06/03/2020 20:27	6,79	1	6,79	CHI
20200325081	SAO JOAO DA PARAUNA	RP21008027	FIRMINOPOLIS S1	06/03/2020 13:39	06/03/2020 20:25	06/03/2020 13:39	06/03/2020 20:25	6,75	1	6,75	CHI
20200325086	IPAMERI	CM21195342	CAMPO ALEGRE DE GOIAS	06/03/2020 13:41	07/03/2020 11:27	06/03/2020 13:41	07/03/2020 11:27	21,75	1	21,75	CHI
20200325087	COCALZINHO DE GOIAS	ZN21221481	AGUAS LINDAS DE GOIAS S1	06/03/2020 13:42	06/03/2020 17:37	06/03/2020 13:42	06/03/2020 17:37	3,91	1	3,91	CHI
20200325090	JUSSARA	1290032005	JUSSARA	06/03/2020 13:44	06/03/2020 15:19	06/03/2020 13:44	06/03/2020 15:19	1,58	1	1,58	CHI
20200325092	APARECIDA DE GOIANIA	12372640	CARAJAS S1	06/03/2020 13:45	06/03/2020 15:27	06/03/2020 13:45	06/03/2020 15:27	1,69	1	1,69	CHI

20200325094	JATAI	JT21105140	JATAI S1	06/03/2020 10:07	06/03/2020 15:30	06/03/2020 10:07	06/03/2020 15:30	5,38	2	10,75	CHI
20200325095	GOIANIA	GN11001773	GOIANIA LESTE S1	06/03/2020 13:47	06/03/2020 15:33	06/03/2020 14:58	06/03/2020 15:33	0,58	91	53,08	CHI
20200325202	QUIRINOPOLIS	10009712370	QUIRINOPOLIS	06/03/2020 13:50	06/03/2020 14:51	06/03/2020 13:50	06/03/2020 14:51	1,03	1	1,03	CHI
20200325217	NOVO GAMA	4990069378	PACAEMBU S1	06/03/2020 13:55	06/03/2020 17:07	06/03/2020 13:55	06/03/2020 17:07	3,20	1	3,20	CHI
20200325218	PILAR DE GOIAS	GG21284733	SANTA TEREZINHA	06/03/2020 13:55	07/03/2020 10:00	06/03/2020 13:55	07/03/2020 10:00	20,08	1	20,08	CHI
20200325219	BELA VISTA DE GOIAS	240046900	BELA VISTA S1	06/03/2020 13:56	06/03/2020 15:32	06/03/2020 13:56	06/03/2020 15:32	1,60	1	1,60	CHI
20200325220	GUAPO	TR12006367	GUAPO S1	06/03/2020 13:56	06/03/2020 15:29	06/03/2020 13:56	06/03/2020 15:29	1,54	39	60,21	CHI
20200325220	TRINDADE	TR12006367	GUAPO S1	06/03/2020 13:56	06/03/2020 15:29	06/03/2020 13:56	06/03/2020 15:29	1,54	5	7,72	CHI
20200325221	GOIANESIA	GE21115062	GOIANESIA S1	06/03/2020 13:56	06/03/2020 17:03	06/03/2020 13:56	06/03/2020 17:03	3,12	1	3,12	CHI
20200325223	ITAPURANGA	IK12220544	ITAPURANGA	06/03/2020 13:32	06/03/2020 15:21	06/03/2020 13:32	06/03/2020 15:21	1,80	27	48,61	CHI
20200325228	RUBIATABA	780030643	RUBIATABA	06/03/2020 13:58	07/03/2020 10:38	06/03/2020 13:58	07/03/2020 10:38	20,66	1	20,66	CHI
20200325229	ANAPOLIS	20045864	JUNDIAI S2	06/03/2020 13:58	06/03/2020 19:36	06/03/2020 13:58	06/03/2020 19:36	5,62	1	5,62	CHI
20200325231	JARAGUA	JA21297905	JARAGUA	06/03/2020 13:58	06/03/2020 20:15	06/03/2020 13:58	06/03/2020 20:15	6,27	2	12,54	CHI
20200325232	CAMPESTRE DE GOIAS	GA12008538	GUAPO S2	06/03/2020 13:59	06/03/2020 17:09	06/03/2020 13:59	06/03/2020 17:09	3,16	1	3,16	CHI
20200325232	GUAPO	GA12008538	GUAPO S2	06/03/2020 13:59	06/03/2020 17:09	06/03/2020 13:59	06/03/2020 17:09	3,16	11	34,75	CHI
20200325242	AGUAS LINDAS DE GOIAS	10000913942	AGUAS LINDAS DE GOIAS S1	06/03/2020 14:02	06/03/2020 15:10	06/03/2020 14:02	06/03/2020 15:10	1,13	1	1,13	CHI
20200325245	SANTA CRUZ DE GOIAS	BC12027030	PIRES DO RIO S2	06/03/2020 14:02	06/03/2020 16:00	06/03/2020 14:02	06/03/2020 16:00	1,95	24	46,91	CHI
20200325249	DAMOLANDIA	DL21013120	INHUMAS S1	06/03/2020 14:04	06/03/2020 23:34	06/03/2020 14:04	06/03/2020 23:34	9,50	2	18,99	CHI
20200325255	GOIATUBA	GT21000065	GOIATUBA S2	06/03/2020 14:07	06/03/2020 20:14	06/03/2020 14:07	06/03/2020 20:14	6,11	2	12,22	CHI
20200325259	MIMOSO DE GOIAS	MJ12071960	PADRE BERNARDO	06/03/2020 14:09	06/03/2020 18:41	06/03/2020 14:09	06/03/2020 18:41	4,53	159	719,87	CHI
20200325259	NIQUELANDIA	MJ12071960	PADRE BERNARDO	06/03/2020 14:09	06/03/2020 18:41	06/03/2020 14:09	06/03/2020 18:41	4,53	1	4,53	CHI
20200325270	GOIANDIRA	GD12237091	CATALAO S1	06/03/2020 14:11	07/03/2020 08:51	06/03/2020 14:11	07/03/2020 08:51	18,67	2	37,33	CHI
20200325274	ANAPOLIS	20575385	ANAPOLIS UNIVERSITARIO S1	06/03/2020 14:12	06/03/2020 19:17	06/03/2020 14:12	06/03/2020 19:17	5,07	1	5,07	CHI
20200325276	PARAUNA	RV12206011	ACREUNA	06/03/2020 13:07	06/03/2020 21:20	06/03/2020 13:07	06/03/2020 21:20	8,21	99	812,63	CHI
20200325278	MAIRIPOTABA	PK12010178	PONTALINA	06/03/2020 14:13	06/03/2020 15:41	06/03/2020 14:13	06/03/2020 15:41	1,46	10	14,62	CHI
20200325278	PONTALINA	PK12010178	PONTALINA	06/03/2020 14:13	06/03/2020 15:41	06/03/2020 14:13	06/03/2020 15:41	1,46	16	23,39	CHI
20200325284	LUZIANIA	LZ21032017	PACAEMBU S1	06/03/2020 14:15	06/03/2020 20:50	06/03/2020 14:15	06/03/2020 20:50	6,58	2	13,15	CHI
20200325292	INHUMAS	30134031	INHUMAS S2	06/03/2020 14:19	06/03/2020 23:11	06/03/2020 14:19	06/03/2020 23:11	8,86	1	8,86	CHI
20200325296	URUTAI	UT12255833	PIRES DO RIO S2	06/03/2020 14:20	06/03/2020 15:28	06/03/2020 14:20	06/03/2020 15:28	1,13	12	13,58	CHI
20200325300	CACU	1140010429	CACHOEIRA ALTA	06/03/2020 14:20	06/03/2020 16:13	06/03/2020 14:20	06/03/2020 16:13	1,87	1	1,87	CHI
20200325401	MUTUNOPOLIS	MU12391656	MARA ROSA	06/03/2020 14:21	06/03/2020 15:01	06/03/2020 14:21	06/03/2020 15:01	0,65	4	2,61	CHI
20200325406	GOIANIA	GN11374184	GOIANIA LESTE S1	06/03/2020 14:23	06/03/2020 16:16	06/03/2020 15:35	06/03/2020 16:16	0,68	15	10,25	CHI
20200325412	VIANOPOLIS	510020513	VIANOPOLIS	06/03/2020 14:26	06/03/2020 18:41	06/03/2020 14:26	06/03/2020 18:41	4,24	1	4,24	CHI
20200325414	FAZENDA NOVA	FN12060710	IPORA	06/03/2020 14:28	06/03/2020 16:57	06/03/2020 14:28	06/03/2020 16:57	2,48	47	116,48	CHI
20200325418	MAMBAI	MB11190510	IACIARA S2	06/03/2020 14:28	06/03/2020 15:30	06/03/2020 14:28	06/03/2020 15:30	1,02	11	11,26	CHI
20200325432	RUBIATABA	RB21170302	RUBIATABA	06/03/2020 14:31	07/03/2020 14:40	06/03/2020 14:31	07/03/2020 14:40	24,14	1	24,14	CHI
20200325433	ABADIANIA	AA21291813	ANAPOLIS UNIVERSITARIO S1	06/03/2020 14:31	06/03/2020 22:02	06/03/2020 14:31	06/03/2020 22:02	7,50	1	7,50	CHI
20200325434	URUACU	10027425353	URUACU	06/03/2020 14:32	07/03/2020 00:38	06/03/2020 14:32	07/03/2020 00:38	10,10	1	10,10	CHI
20200325446	SANTA TEREZINHA DE GOIAS	2480010576	SANTA TEREZINHA	06/03/2020 14:35	06/03/2020 17:45	06/03/2020 14:35	06/03/2020 17:45	3,16	1	3,16	CHI
20200325460	HIDROLANDIA	AO21277406	GUAPO S2	06/03/2020 14:38	06/03/2020 21:47	06/03/2020 14:38	06/03/2020 21:47	7,14	1	7,14	CHI
20200325461	BELA VISTA DE GOIAS	10010549615	BELA VISTA S1	06/03/2020 14:38	06/03/2020 16:10	06/03/2020 14:38	06/03/2020 16:10	1,52	1	1,52	CHI
20200325462	RIO VERDE	RV21040102	SANTA HELENA S1	06/03/2020 14:39	06/03/2020 23:36	06/03/2020 14:39	06/03/2020 23:36	8,95	1	8,95	CHI
20200325465	FORMOSA	FA12085494	ITIQUEIRA	06/03/2020 14:40	06/03/2020 16:11	06/03/2020 14:40	06/03/2020 16:11	1,51	4	6,04	CHI
20200325467	FORMOSA	FA21135133	ITIQUEIRA	06/03/2020 14:40	06/03/2020 19:33	06/03/2020 14:40	06/03/2020 19:33	4,87	1	4,87	CHI

20200325470	CATALAO	CT21318669	CATALAO S1	06/03/2020 14:41	06/03/2020 20:39	06/03/2020 14:41	06/03/2020 20:39	5,96	1	5,96	CHI
20200325474	ITAPACI	IW21140612	ITAPACI	06/03/2020 14:41	07/03/2020 10:06	06/03/2020 14:41	07/03/2020 10:06	19,40	1	19,40	CHI
20200325475	DOVERLANDIA	DV11204077	CAIAPONIA	06/03/2020 14:42	06/03/2020 19:06	06/03/2020 14:42	06/03/2020 19:06	4,40	3	13,20	CHI
20200325479	JATAI	JT12248490	JATAI S1	06/03/2020 14:43	06/03/2020 18:16	06/03/2020 14:43	06/03/2020 18:16	3,55	6	21,28	CHI
20200325480	BONOPOLIS	BX12266016	SAO MIGUEL DO ARAGUAIA	06/03/2020 14:43	06/03/2020 20:58	06/03/2020 14:43	06/03/2020 20:58	6,24	9	56,13	CHI
20200325481	MORRINHOS	MR12000014	MORRINHOS	06/03/2020 14:30	06/03/2020 18:08	06/03/2020 14:30	06/03/2020 18:08	3,62	251	908,90	CHI
20200325482	ORIZONA	OZ12113707	PIRES DO RIO S2	06/03/2020 14:39	06/03/2020 20:34	06/03/2020 14:39	06/03/2020 20:34	5,91	4	23,65	CHI
20200325483	ANICUNS	910043486	ANICUNS	06/03/2020 14:44	06/03/2020 17:15	06/03/2020 14:44	06/03/2020 17:15	2,51	1	2,51	CHI
20200325485	GOIANIA	10010143317	CARAJAS S2	06/03/2020 14:44	06/03/2020 15:33	06/03/2020 14:44	06/03/2020 15:33	0,80	1	0,80	CHI
20200325487	CALDAS NOVAS	CN21298757	CALDAS NOVAS S1	06/03/2020 14:42	06/03/2020 15:30	06/03/2020 14:42	06/03/2020 15:30	0,80	1	0,80	CHI
20200325491	LUZIANIA	LZ21345895	MARAJOARA	06/03/2020 14:46	06/03/2020 18:31	06/03/2020 14:46	06/03/2020 18:31	3,74	1	3,74	CHI
20200325493	ABADIANIA	10001560288	CORUMBA	06/03/2020 14:46	06/03/2020 20:01	06/03/2020 14:46	06/03/2020 20:01	5,24	1	5,24	CHI
20200325494	GOIANIA	10016751661	XAVANTES	06/03/2020 14:47	06/03/2020 16:46	06/03/2020 14:47	06/03/2020 16:46	1,98	1	1,98	CHI
20200325495	VIANOPOLIS	VN21386636	VIANOPOLIS	06/03/2020 14:48	06/03/2020 18:45	06/03/2020 14:48	06/03/2020 18:45	3,95	1	3,95	CHI
20200325497	GOIANIA	10197217	AEROPORTO S1	06/03/2020 14:48	06/03/2020 17:16	06/03/2020 14:48	06/03/2020 17:16	2,46	1	2,46	CHI
20200325501	SENADOR CANEDO	SW11092646	SENADOR CANEDO	06/03/2020 14:46	06/03/2020 21:14	06/03/2020 19:15	06/03/2020 21:14	1,98	113	224,15	CHI
20200325502	SIMOLANDIA	SA11195827	IACIARA S2	06/03/2020 14:55	06/03/2020 17:54	06/03/2020 14:55	06/03/2020 17:54	2,98	1	2,98	CHI
20200325604	PLANALTINA	2960026439	PLANALTINA	06/03/2020 14:49	06/03/2020 17:50	06/03/2020 14:49	06/03/2020 17:50	3,00	1	3,00	CHI
20200325608	ITUMBIARA	IT11000152	ITUMBIARA VELHA S1	06/03/2020 14:51	06/03/2020 18:27	06/03/2020 14:51	06/03/2020 18:27	3,60	162	583,70	CHI
20200325618	ITAPIRAPUA	IU21137839	JUSSARA	06/03/2020 14:53	06/03/2020 16:10	06/03/2020 14:53	06/03/2020 16:10	1,27	1	1,27	CHI
20200325621	AGUAS LINDAS DE GOIAS	4830138726	AGUAS LINDAS DE GOIAS S1	06/03/2020 14:54	06/03/2020 16:46	06/03/2020 14:54	06/03/2020 16:46	1,87	1	1,87	CHI
20200325628	AMARALINA	MH12391965	NOVA CRIXAS	06/03/2020 14:58	07/03/2020 12:22	06/03/2020 14:58	07/03/2020 12:22	21,41	1	21,41	CHI
20200325628	MUNDO NOVO DE GOIAS	MH12391965	NOVA CRIXAS	06/03/2020 14:58	07/03/2020 12:22	06/03/2020 14:58	07/03/2020 12:22	21,41	12	256,91	CHI
20200325629	RIO VERDE	630214360	RIO VERDE S1	06/03/2020 14:58	07/03/2020 10:59	06/03/2020 14:58	07/03/2020 10:59	20,00	1	20,00	CHI
20200325633	SILVANIA	SV21011233	DAIA S2	06/03/2020 15:00	06/03/2020 17:31	06/03/2020 15:00	06/03/2020 17:31	2,51	1	2,51	CHI
20200325640	PIRENOPOLIS	GE12185195	GOIANESIA S1	06/03/2020 09:54	06/03/2020 20:13	06/03/2020 09:54	06/03/2020 20:13	10,31	30	309,26	CHI
20200325642	QUIRINOPOLIS	QI12101226	QUIRINOPOLIS	06/03/2020 15:02	06/03/2020 22:30	06/03/2020 15:02	06/03/2020 22:30	7,47	18	134,39	CHI
20200325644	ABADIANIA	AA21146385	ANAPOLIS UNIVERSITARIO S1	06/03/2020 15:03	06/03/2020 20:58	06/03/2020 15:03	06/03/2020 20:58	5,92	1	5,92	CHI
20200325645	FLORES DE GOIAS	1510018764	IACIARA S2	06/03/2020 15:03	06/03/2020 18:24	06/03/2020 15:03	06/03/2020 18:24	3,35	1	3,35	CHI
20200325646	SAO MIGUEL DO ARAGUAIA	SM11216499	SAO MIGUEL DO ARAGUAIA	06/03/2020 14:10	06/03/2020 17:37	06/03/2020 14:10	06/03/2020 17:37	3,45	75	258,56	CHI
20200325660	SAO DOMINGOS	SD12346473	SAO DOMINGOS	06/03/2020 15:05	06/03/2020 18:25	06/03/2020 15:05	06/03/2020 18:25	3,33	24	80,00	CHI
20200325664	PONTALINA	210044585	PONTALINA	06/03/2020 15:08	07/03/2020 11:20	06/03/2020 15:08	07/03/2020 11:20	20,19	1	20,19	CHI
20200325665	RIO VERDE	RV12111052	CABRIUVA S2	06/03/2020 15:09	07/03/2020 04:55	06/03/2020 15:09	07/03/2020 04:55	13,78	1	13,78	CHI
20200325665	RIO VERDE	RV12111052	CABRIUVA S2	06/03/2020 15:09	07/03/2020 04:55	07/03/2020 01:07	07/03/2020 04:55	3,81	28	106,76	CHI
20200325668	CAIAPONIA	CP12251568	CAIAPONIA	06/03/2020 15:09	06/03/2020 21:03	06/03/2020 15:09	06/03/2020 21:03	5,89	21	123,77	CHI
20200325669	PIRES DO RIO	460101377	PIRES DO RIO S1	06/03/2020 15:09	06/03/2020 19:27	06/03/2020 15:09	06/03/2020 19:27	4,29	1	4,29	CHI
20200325675	MORRINHOS	MR21394373	MORRINHOS	06/03/2020 15:12	06/03/2020 22:38	06/03/2020 15:12	06/03/2020 22:38	7,44	1	7,44	CHI
20200325677	RIO VERDE	RV21383975	CABRIUVA S2	06/03/2020 15:12	07/03/2020 13:30	06/03/2020 15:12	07/03/2020 13:30	22,29	1	22,29	CHI
20200325682	SANTA CRUZ DE GOIAS	BC12300693	PIRES DO RIO S2	06/03/2020 15:14	07/03/2020 09:46	06/03/2020 15:14	07/03/2020 09:46	18,52	5	92,62	CHI
20200325683	ANICUNS	AC12259103	FIRMINOPOLIS S2	06/03/2020 13:52	06/03/2020 17:42	06/03/2020 13:52	06/03/2020 17:42	3,83	19	72,83	CHI
20200325697	CATALAO	CT21266678	CAMPO ALEGRE DE GOIAS	06/03/2020 15:18	06/03/2020 18:29	06/03/2020 15:18	06/03/2020 18:29	3,17	1	3,17	CHI
20200325805	PLANALTINA	2960225849	PLANALTINA	06/03/2020 15:19	06/03/2020 18:19	06/03/2020 15:19	06/03/2020 18:19	2,99	1	2,99	CHI
20200325806	GOIANESIA	550144687	GOIANESIA S2	06/03/2020 15:19	06/03/2020 23:25	06/03/2020 15:19	06/03/2020 23:25	8,09	1	8,09	CHI
20200325807	APARECIDA DE GOIANIA	200407170	ANHANGUERA	06/03/2020 15:19	06/03/2020 17:51	06/03/2020 15:19	06/03/2020 17:51	2,52	1	2,52	CHI

20200325812	JANDAIA	JD21358578	PALMEIRAS	06/03/2020 15:20	07/03/2020 09:40	06/03/2020 15:20	07/03/2020 09:40	18,33	1	18,33	CHI
20200325817	CRISTALINA	KR12244309	CRISTALINA S1	06/03/2020 15:21	07/03/2020 05:29	06/03/2020 15:21	07/03/2020 05:29	14,12	87	1228,17	CHI
20200325826	RIO VERDE	RV21010276	RIO VERDE S2	06/03/2020 15:25	06/03/2020 19:14	06/03/2020 15:25	06/03/2020 19:14	3,80	2	7,61	CHI
20200325832	CAIAPONIA	CP12241867	CAIAPONIA	06/03/2020 15:26	06/03/2020 17:39	06/03/2020 15:26	06/03/2020 17:39	2,20	20	44,05	CHI
20200325833	PEROLANDIA	MY12324350	PARQUE DAS EMAS	06/03/2020 15:26	06/03/2020 20:47	06/03/2020 15:26	06/03/2020 20:47	5,34	2	10,67	CHI
20200325835	PARANAIGUARA	QI21139101	QUIRINOPOLIS	06/03/2020 14:16	07/03/2020 00:49	06/03/2020 14:16	07/03/2020 00:49	10,55	1	10,55	CHI
20200325840	PIRENOPOLIS	PV12381262	CORUMBA	06/03/2020 15:03	06/03/2020 19:51	06/03/2020 15:03	06/03/2020 19:51	4,79	5	23,95	CHI
20200325842	QUIRINOPOLIS	QI21022114	QUIRINOPOLIS	06/03/2020 15:28	07/03/2020 00:44	06/03/2020 15:28	07/03/2020 00:44	9,25	1	9,25	CHI
20200325843	ORIZONA	OZ21017089	PIRES DO RIO S2	06/03/2020 15:28	07/03/2020 08:28	06/03/2020 15:28	07/03/2020 08:28	16,99	1	16,99	CHI
20200325844	APARECIDA DE GOIANIA	10011390687	REAL S1	06/03/2020 15:28	06/03/2020 16:56	06/03/2020 15:28	06/03/2020 16:56	1,45	1	1,45	CHI
20200325845	QUIRINOPOLIS	QI31052520	QUIRINOPOLIS	06/03/2020 15:29	06/03/2020 23:49	06/03/2020 15:29	06/03/2020 23:49	8,33	1	8,33	CHI
20200325846	CRIXAS	CX12325183	RUBIATABA	06/03/2020 10:18	07/03/2020 08:32	06/03/2020 10:18	07/03/2020 08:32	22,22	28	622,11	CHI
20200325851	ORIZONA	2060039326	PIRES DO RIO S2	06/03/2020 15:30	06/03/2020 21:58	06/03/2020 15:30	06/03/2020 21:58	6,47	1	6,47	CHI
20200325865	PORANGATU	PO12027986	PORANGATU	06/03/2020 15:18	06/03/2020 16:41	06/03/2020 15:18	06/03/2020 16:41	1,37	23	31,44	CHI
20200325866	ORIZONA	2060003526	PIRES DO RIO S2	06/03/2020 15:35	06/03/2020 23:18	06/03/2020 15:35	06/03/2020 23:18	7,71	1	7,71	CHI
20200325874	SAO LUIS DE MONTES BELOS	SL21180383	SAO LUIZ DOS MONTES BELOS	06/03/2020 15:38	06/03/2020 18:09	06/03/2020 15:38	06/03/2020 18:09	2,51	1	2,51	CHI
20200325882	PADRE BERNARDO	3160005699	PADRE BERNARDO	06/03/2020 15:40	06/03/2020 22:44	06/03/2020 15:40	06/03/2020 22:44	7,06	1	7,06	CHI
20200325887	ITAPURANGA	IK11387472	ITAPURANGA	06/03/2020 15:41	06/03/2020 17:15	06/03/2020 15:41	06/03/2020 17:15	1,55	6	9,31	CHI
20200325890	MONTES CLAROS DE GOIAS	ME12184484	IPORA	06/03/2020 14:01	06/03/2020 17:31	06/03/2020 14:01	06/03/2020 17:31	3,49	33	115,05	CHI
20200325894	JATAI	10010667383	JATAI S3	06/03/2020 15:44	06/03/2020 18:29	06/03/2020 15:44	06/03/2020 18:29	2,73	1	2,73	CHI
20200325895	CRISTALINA	KR21171017	CRISTALINA S1	06/03/2020 15:45	07/03/2020 01:42	06/03/2020 15:45	07/03/2020 01:42	9,95	1	9,95	CHI
20200325897	AGUA FRIA DE GOIAS	TL12233976	SAO JOAO D ALIANCA	06/03/2020 15:23	06/03/2020 17:11	06/03/2020 15:23	06/03/2020 17:11	1,80	23	41,32	CHI
20200325903	CAMPO ALEGRE DE GOIAS	CM21122428	CAMPO ALEGRE DE GOIAS	06/03/2020 15:44	06/03/2020 16:50	06/03/2020 15:44	06/03/2020 16:50	1,10	1	1,10	CHI
20200326004	CABECEIRAS	CW21154406	ITUIQUIRA	06/03/2020 15:46	06/03/2020 17:10	06/03/2020 15:46	06/03/2020 17:10	1,39	1	1,39	CHI
20200326008	GOIANIA	11335087	CAMPINAS S1	06/03/2020 15:47	06/03/2020 17:23	06/03/2020 15:47	06/03/2020 17:23	1,59	1	1,59	CHI
20200326009	NIQUELANDIA	4640001680	BARRO ALTO	06/03/2020 15:47	06/03/2020 22:03	06/03/2020 15:47	06/03/2020 22:03	6,26	1	6,26	CHI
20200326015	COLINAS DO SUL	TI12237626	MINACU	06/03/2020 13:47	06/03/2020 18:51	06/03/2020 13:47	06/03/2020 18:51	5,05	53	267,75	CHI
20200326015	NIQUELANDIA	TI12237626	MINACU	06/03/2020 13:47	06/03/2020 18:51	06/03/2020 13:47	06/03/2020 18:51	5,05	1	5,05	CHI
20200326015	URUACU	TI12237626	MINACU	06/03/2020 13:47	06/03/2020 18:51	06/03/2020 13:47	06/03/2020 18:51	5,05	1	5,05	CHI
20200326025	DOVERLANDIA	MY12390600	PARQUE DAS EMAS	06/03/2020 15:51	07/03/2020 10:22	06/03/2020 15:51	07/03/2020 10:22	18,50	1	18,50	CHI
20200326025	MINEIROS	MY12390600	PARQUE DAS EMAS	06/03/2020 15:51	07/03/2020 10:22	06/03/2020 15:51	07/03/2020 10:22	18,50	24	444,08	CHI
20200326027	QUIRINOPOLIS	QI11226325	QUIRINOPOLIS	06/03/2020 15:52	06/03/2020 19:34	06/03/2020 17:45	06/03/2020 19:34	1,82	150	272,50	CHI
20200326030	MIMOSO DE GOIAS	MJ21269018	PADRE BERNARDO	06/03/2020 15:53	06/03/2020 22:56	06/03/2020 15:53	06/03/2020 22:56	7,04	1	7,04	CHI
20200326031	LUZIANIA	LZ21000395	PACAEMBU S1	06/03/2020 15:54	06/03/2020 20:53	06/03/2020 15:54	06/03/2020 20:53	4,98	1	4,98	CHI
20200326032	JARAGUA	JA12273193	JARAGUA	06/03/2020 15:54	06/03/2020 23:44	06/03/2020 15:54	06/03/2020 23:44	7,82	2	15,64	CHI
20200326033	CACHOEIRA ALTA	QI12191652	CACHOEIRA ALTA	06/03/2020 15:39	06/03/2020 23:00	06/03/2020 15:39	06/03/2020 23:00	7,34	3	22,01	CHI
20200326033	QUIRINOPOLIS	QI12191652	CACHOEIRA ALTA	06/03/2020 15:39	06/03/2020 23:00	06/03/2020 15:39	06/03/2020 23:00	7,34	9	66,04	CHI
20200326035	CATALAO	1990012295	CATALAO S2	06/03/2020 15:55	07/03/2020 09:43	06/03/2020 15:55	07/03/2020 09:43	17,79	1	17,79	CHI
20200326039	CIDADE OCIDENTAL	10010547779	MARAJOARA	06/03/2020 15:56	06/03/2020 18:24	06/03/2020 15:56	06/03/2020 18:24	2,46	1	2,46	CHI
20200326041	RIO VERDE	10027859159	RIO VERDE S2	06/03/2020 15:56	07/03/2020 08:17	06/03/2020 15:56	07/03/2020 08:17	16,33	1	16,33	CHI
20200326045	ANAPOLIS	20032810	JUNDIAI S2	06/03/2020 15:57	06/03/2020 20:54	06/03/2020 15:57	06/03/2020 20:54	4,93	1	4,93	CHI
20200326056	LUZIANIA	LZ21290710	PACAEMBU S1	06/03/2020 16:01	06/03/2020 17:55	06/03/2020 16:01	06/03/2020 17:55	1,89	1	1,89	CHI
20200326058	INHUMAS	30035120	INHUMAS S2	06/03/2020 16:03	06/03/2020 21:43	06/03/2020 16:03	06/03/2020 21:43	5,66	1	5,66	CHI
20200326059	LUZIANIA	LZ21209459	PACAEMBU S1	06/03/2020 16:03	06/03/2020 20:22	06/03/2020 16:03	06/03/2020 20:22	4,31	1	4,31	CHI

20200326060	SANTA BARBARA DE GOIAS	10004191895	TRINDADE	06/03/2020 15:59	06/03/2020 17:54	06/03/2020 15:59	06/03/2020 17:54	1,90	1	1,90	CHI
20200326061	ITUMBIARA	IT11349802	ITUMBIARA VELHA S1	06/03/2020 16:03	06/03/2020 19:08	06/03/2020 16:03	06/03/2020 19:08	3,07	11	33,79	CHI
20200326062	VALPARAISO DE GOIAS	10010628078	MARAJOAARA	06/03/2020 16:04	06/03/2020 23:00	06/03/2020 16:04	06/03/2020 23:00	6,92	1	6,92	CHI
20200326066	URUTAI	UT12115680	PIRES DO RIO S2	06/03/2020 16:05	06/03/2020 18:20	06/03/2020 16:05	06/03/2020 18:20	2,25	33	74,10	CHI
20200326069	PORTELANDIA	PW11000033	PARQUE DAS EMAS	06/03/2020 16:01	06/03/2020 21:58	06/03/2020 16:01	06/03/2020 21:58	5,95	81	481,75	CHI
20200326070	FORMOSA	FA12207282	ITUIQUIRA	06/03/2020 16:06	06/03/2020 20:08	06/03/2020 16:06	06/03/2020 20:08	4,02	14	56,29	CHI
20200326071	CALDAS NOVAS	CN11105157	SERRA DE CALDAS	06/03/2020 14:13	06/03/2020 17:11	06/03/2020 14:13	06/03/2020 17:11	2,96	92	272,58	CHI
20200326072	BONOPOLIS	BX12292423	SAO MIGUEL DO ARAGUAIA	06/03/2020 16:08	06/03/2020 22:22	06/03/2020 16:08	06/03/2020 22:22	6,23	2	12,46	CHI
20200326074	MINEIROS	MY12195522	PARQUE DAS EMAS	06/03/2020 16:09	06/03/2020 20:39	06/03/2020 16:09	06/03/2020 20:39	4,49	1	4,49	CHI
20200326075	FORMOSO	FO21158486	MARA ROSA	06/03/2020 16:09	06/03/2020 17:57	06/03/2020 16:09	06/03/2020 17:57	1,79	1	1,79	CHI
20200326076	DIVINOPOLIS DE GOIAS	GH12398369	SAO DOMINGOS	06/03/2020 15:18	06/03/2020 20:00	06/03/2020 15:18	06/03/2020 20:00	4,69	20	93,71	CHI
20200326076	SAO DOMINGOS	GH12398369	SAO DOMINGOS	06/03/2020 15:18	06/03/2020 20:00	06/03/2020 15:18	06/03/2020 20:00	4,69	18	84,34	CHI
20200326078	GOIANIA	15755691	REAL S1	06/03/2020 16:10	06/03/2020 19:08	06/03/2020 16:10	06/03/2020 19:08	2,96	1	2,96	CHI
20200326079	FAINA	FC12158852	GOIAS	06/03/2020 16:10	06/03/2020 23:15	06/03/2020 16:10	06/03/2020 23:15	7,08	2	14,16	CHI
20200326080	ARAGUAPAZ	AZ12042863	MOZARLANDIA	06/03/2020 16:08	07/03/2020 08:47	06/03/2020 16:08	07/03/2020 08:47	16,64	1	16,64	CHI
20200326080	MOZARLANDIA	AZ12042863	MOZARLANDIA	06/03/2020 16:08	07/03/2020 08:47	06/03/2020 16:08	07/03/2020 08:47	16,64	2	33,27	CHI
20200326082	BOM JARDIM DE GOIAS	BM21136762	BOM JARDIM	06/03/2020 16:10	07/03/2020 01:05	06/03/2020 16:10	07/03/2020 01:05	8,91	1	8,91	CHI
20200326085	SENADOR CANEDO	190061492	SENADOR CANEDO	06/03/2020 16:11	06/03/2020 17:47	06/03/2020 16:11	06/03/2020 17:47	1,59	1	1,59	CHI
20200326087	PORANGATU	PO12230365	PORANGATU	06/03/2020 16:11	06/03/2020 19:39	06/03/2020 16:11	06/03/2020 19:39	3,45	2	6,90	CHI
20200326089	JATAI	10003719365	JATAI S3	06/03/2020 16:13	06/03/2020 22:31	06/03/2020 16:13	06/03/2020 22:31	6,30	1	6,30	CHI
20200326093	CAMPOS BELOS	CH21047950	SAO DOMINGOS	06/03/2020 16:14	06/03/2020 18:13	06/03/2020 16:14	06/03/2020 18:13	1,98	1	1,98	CHI
20200326096	CRIXAS	2490050005	SERRA DO OURO	06/03/2020 16:15	06/03/2020 22:42	06/03/2020 16:15	06/03/2020 22:42	6,44	1	6,44	CHI
20200326097	ITAJA	2300016820	ITAJA S2	06/03/2020 16:16	06/03/2020 18:22	06/03/2020 16:16	06/03/2020 18:22	2,09	1	2,09	CHI
20200326100	GOIANIA	GN11000303	GOIANIA LESTE S2	06/03/2020 16:18	06/03/2020 21:49	06/03/2020 16:18	06/03/2020 21:49	5,51	17	93,73	CHI
20200326102	ITAPIRAPUA	IU12020119	MATRINCHA	06/03/2020 16:19	06/03/2020 19:21	06/03/2020 16:19	06/03/2020 19:21	3,03	9	27,29	CHI
20200326107	MONTES CLAROS DE GOIAS	ME12029537	BRITANIA	06/03/2020 16:20	07/03/2020 08:44	06/03/2020 16:20	07/03/2020 08:44	16,40	12	196,77	CHI
20200326109	COCALZINHO DE GOIAS	LA12377201	AGUAS LINDAS DE GOIAS S2	06/03/2020 15:31	07/03/2020 12:17	06/03/2020 15:31	07/03/2020 12:17	20,75	4	83,01	CHI
20200326117	ARUANA	AK21088371	MOZARLANDIA	06/03/2020 16:24	07/03/2020 08:37	06/03/2020 16:24	07/03/2020 08:37	16,21	1	16,21	CHI
20200326119	ITUMBIARA	IT12263732	CACHOEIRA DOURADA	06/03/2020 16:24	06/03/2020 18:38	06/03/2020 16:24	06/03/2020 18:38	2,22	4	8,87	CHI
20200326137	URUACU	10012662230	URUACU	06/03/2020 16:28	06/03/2020 21:13	06/03/2020 16:28	06/03/2020 21:13	4,75	1	4,75	CHI
20200326141	JARAGUA	JA12278873	JARAGUA	06/03/2020 16:28	07/03/2020 07:43	06/03/2020 16:28	07/03/2020 07:43	15,24	15	228,55	CHI
20200326144	AGUAS LINDAS DE GOIAS	LA11095853	AGUAS LINDAS DE GOIAS S1	06/03/2020 16:29	06/03/2020 20:30	06/03/2020 16:29	06/03/2020 20:30	4,01	4	16,05	CHI
20200326148	ANAPOLIS	20370659	ANAPOLIS UNIVERSITARIO S1	06/03/2020 16:30	06/03/2020 22:43	06/03/2020 16:30	06/03/2020 22:43	6,21	1	6,21	CHI
20200326149	CRISTALINA	KR21261610	CRISTALINA S2	06/03/2020 16:30	06/03/2020 23:35	06/03/2020 16:30	06/03/2020 23:35	7,08	3	21,23	CHI
20200326150	CALDAS NOVAS	CN12404748	CALDAS NOVAS S1	06/03/2020 16:30	06/03/2020 17:40	06/03/2020 16:30	06/03/2020 17:40	1,16	6	6,94	CHI
20200326150	RIO QUENTE	CN12404748	CALDAS NOVAS S1	06/03/2020 16:30	06/03/2020 17:40	06/03/2020 16:30	06/03/2020 17:40	1,16	40	46,27	CHI
20200326151	CAMPO ALEGRE DE GOIAS	CM12376046	CAMPO ALEGRE DE GOIAS	06/03/2020 16:27	07/03/2020 14:11	06/03/2020 16:27	07/03/2020 14:11	21,74	7	152,19	CHI
20200326151	CATALAO	CM12376046	CAMPO ALEGRE DE GOIAS	06/03/2020 16:27	07/03/2020 14:11	06/03/2020 16:27	07/03/2020 14:11	21,74	3	65,22	CHI
20200326152	ANAPOLIS	AN21216172	ANAPOLIS UNIVERSITARIO S1	06/03/2020 16:32	06/03/2020 17:45	06/03/2020 16:32	06/03/2020 17:45	1,21	1	1,21	CHI
20200326153	PIRENOPOLIS	NP21342860	GOIANESIA S1	06/03/2020 16:32	06/03/2020 21:15	06/03/2020 16:32	06/03/2020 21:15	4,71	1	4,71	CHI
20200326155	AGUA FRIA DE GOIAS	PI21206206	SAO JOAO D ALIANCA	06/03/2020 16:32	06/03/2020 22:22	06/03/2020 16:32	06/03/2020 22:22	5,84	1	5,84	CHI
20200326162	LUZIANIA	LZ12112930	RIO VERMELHO	06/03/2020 16:36	06/03/2020 17:50	06/03/2020 16:36	06/03/2020 17:50	1,23	10	12,27	CHI
20200326164	MORRINHOS	10014936940	MORRINHOS	06/03/2020 16:37	06/03/2020 17:55	06/03/2020 16:37	06/03/2020 17:55	1,30	1	1,30	CHI
20200326166	SANTO ANTONIO DO DESCOBERTO	10017210281	ALEXANIA	06/03/2020 16:37	06/03/2020 18:48	06/03/2020 16:37	06/03/2020 18:48	2,17	1	2,17	CHI

20200326168	ARENOPOLIS	PH12024549RE	PIRANHAS	06/03/2020 15:50	06/03/2020 19:28	06/03/2020 15:50	06/03/2020 19:28	3,62	1	3,62	CHI
20200326168	PIRANHAS	PH12024549RE	PIRANHAS	06/03/2020 15:50	06/03/2020 19:28	06/03/2020 15:50	06/03/2020 19:28	3,62	110	398,32	CHI
20200326170	ITAPURANGA	IK21227277	ITAPURANGA	06/03/2020 16:39	07/03/2020 01:05	06/03/2020 16:39	07/03/2020 01:05	8,42	1	8,42	CHI
20200326171	FORMOSA	610289068	ITIQUEIRA	06/03/2020 16:40	06/03/2020 18:20	06/03/2020 16:40	06/03/2020 18:20	1,67	1	1,67	CHI
20200326175	FORMOSA	FA11085491	ITIQUEIRA	06/03/2020 16:41	06/03/2020 17:00	06/03/2020 16:41	06/03/2020 17:00	0,31	2	0,63	CHI
20200326179	CAMPO ALEGRE DE GOIAS	CM12084693	CAMPO ALEGRE DE GOIAS	06/03/2020 16:42	06/03/2020 20:28	06/03/2020 16:42	06/03/2020 20:28	3,76	1	3,76	CHI
20200326180	PILAR DE GOIAS	GG21322618	URUACU	06/03/2020 16:42	07/03/2020 11:32	06/03/2020 16:42	07/03/2020 11:32	18,82	1	18,82	CHI
20200326188	GOIANIA	GN11167476	ATLANTICO S2	06/03/2020 16:43	06/03/2020 19:19	06/03/2020 16:43	06/03/2020 19:19	2,60	168	436,33	CHI
20200326189	PORANGATU	PO11352193	PORANGATU	06/03/2020 16:45	06/03/2020 18:12	06/03/2020 16:45	06/03/2020 18:12	1,44	1	1,44	CHI
20200326190	SITIO D ABADIA	SI12211621	IACIARA S2	06/03/2020 16:45	06/03/2020 18:08	06/03/2020 16:45	06/03/2020 18:08	1,37	4	5,47	CHI
20200326193	GOIANIA	12070592	CAMPINAS S3	06/03/2020 16:47	06/03/2020 18:45	06/03/2020 16:47	06/03/2020 18:45	1,96	1	1,96	CHI
20200326194	BOM JARDIM DE GOIAS	BM12060899	ARAGARCAS	06/03/2020 16:48	06/03/2020 19:05	06/03/2020 16:48	06/03/2020 19:05	2,28	36	82,12	CHI
20200326199	CORUMBA DE GOIAS	ZN12302530	COCALZINHO	06/03/2020 15:32	06/03/2020 21:30	06/03/2020 15:32	06/03/2020 21:30	5,95	7	41,67	CHI
20200326307	CORUMBAIBA	CI12131032	VILA CORUMBA	06/03/2020 16:23	06/03/2020 21:20	06/03/2020 16:23	06/03/2020 21:20	4,94	21	103,73	CHI
20200326308	LUZIANIA	LZ21209490	MARAJOARA	06/03/2020 16:52	06/03/2020 22:29	06/03/2020 16:52	06/03/2020 22:29	5,61	2	11,21	CHI
20200326313	MONTIVIDIU	MV21139264	MONTIVIDIU T	06/03/2020 16:53	06/03/2020 19:38	06/03/2020 16:53	06/03/2020 19:38	2,74	1	2,74	CHI
20200326318	PIRACANJUBA	BV12036142	BELA VISTA S1	06/03/2020 16:54	06/03/2020 19:26	06/03/2020 16:54	06/03/2020 19:26	2,52	87	219,26	CHI
20200326330	BOM JESUS DE GOIAS	BJ12000024LD	BOM JESUS DE GOIAS	06/03/2020 16:56	06/03/2020 20:52	06/03/2020 16:56	06/03/2020 20:52	3,93	2	7,87	CHI
20200326330	ITUMBIARA	BJ12000024LD	BOM JESUS DE GOIAS	06/03/2020 16:56	06/03/2020 20:52	06/03/2020 16:56	06/03/2020 20:52	3,93	67	263,63	CHI
20200326332	JUSSARA	JR12229982	JUSSARA	06/03/2020 16:58	06/03/2020 19:59	06/03/2020 16:58	06/03/2020 19:59	3,00	6	18,02	CHI
20200326335	PIRACANJUBA	PJ12082177	MORRINHOS	06/03/2020 16:52	06/03/2020 21:36	06/03/2020 16:52	06/03/2020 21:36	4,72	16	75,50	CHI
20200326343	SANCLERLANDIA	SC21150812	FIRMINOPOLIS S2	06/03/2020 17:01	06/03/2020 17:49	06/03/2020 17:01	06/03/2020 17:49	0,79	1	0,79	CHI
20200326346	GOIANIA	10779735	CARAJAS S1	06/03/2020 17:02	06/03/2020 23:30	06/03/2020 17:02	06/03/2020 23:30	6,45	1	6,45	CHI
20200326355	GUAMARI	CT21195306	CATALAO S2	06/03/2020 17:04	06/03/2020 19:31	06/03/2020 17:04	06/03/2020 19:31	2,44	1	2,44	CHI
20200326359	JATAI	JT12398520	JATAI S1	06/03/2020 17:07	06/03/2020 20:35	06/03/2020 17:07	06/03/2020 20:35	3,45	9	31,06	CHI
20200326360	CACHOEIRA ALTA	CA21000012	CACHOEIRA ALTA	06/03/2020 17:08	06/03/2020 22:16	06/03/2020 17:08	06/03/2020 22:16	5,13	1	5,13	CHI
20200326367	SAO MIGUEL DO ARAGUAIA	SM12350501	SAO MIGUEL DO ARAGUAIA	06/03/2020 14:30	07/03/2020 05:33	06/03/2020 14:30	07/03/2020 05:33	15,04	6	90,23	CHI
20200326376	GOIANIA	GN11166128	FERROVIARIO S2	06/03/2020 17:12	06/03/2020 19:04	06/03/2020 17:12	06/03/2020 19:04	1,85	43	79,65	CHI
20200326378	RUBIATABA	RB21211759	RUBIATABA	06/03/2020 17:13	07/03/2020 15:35	06/03/2020 17:13	07/03/2020 15:35	22,35	1	22,35	CHI
20200326389	JATAI	290162270	JATAI S3	06/03/2020 17:19	06/03/2020 18:51	06/03/2020 17:19	06/03/2020 18:51	1,53	1	1,53	CHI
20200326390	GOIANIRA	10001234240	MEIA PONTE	06/03/2020 17:19	06/03/2020 20:13	06/03/2020 17:19	06/03/2020 20:13	2,92	1	2,92	CHI
20200326393	PONTALINA	PK12263486	PONTALINA	06/03/2020 17:19	07/03/2020 08:44	06/03/2020 17:19	07/03/2020 08:44	15,41	2	30,82	CHI
20200326394	GOIANDIRA	GD21161086	CATALAO S1	06/03/2020 17:19	06/03/2020 22:43	06/03/2020 17:19	06/03/2020 22:43	5,39	1	5,39	CHI
20200326395	CALDAZINHA	SW12218045	CEPAIGO S2	06/03/2020 17:10	06/03/2020 19:20	06/03/2020 17:10	06/03/2020 19:20	2,16	3	6,48	CHI
20200326398	PARAUNA	PU12205939	PARAUNA	06/03/2020 17:21	07/03/2020 10:05	06/03/2020 17:21	07/03/2020 10:05	16,73	8	133,87	CHI
20200326501	CAIAPONIA	CP12252503	CAIAPONIA	06/03/2020 17:21	07/03/2020 14:15	06/03/2020 17:21	07/03/2020 01:40	8,31	3	24,94	CHI
20200326501	CAIAPONIA	CP12252503	CAIAPONIA	06/03/2020 17:21	07/03/2020 14:15	06/03/2020 17:21	07/03/2020 14:15	20,91	3	62,72	CHI
20200326501	CAIAPONIA	CP12252503	CAIAPONIA	06/03/2020 17:21	07/03/2020 14:15	07/03/2020 12:21	07/03/2020 14:15	1,91	3	5,73	CHI
20200326506	BALIZA	BH12331370	CAIAPONIA	06/03/2020 16:25	06/03/2020 19:04	06/03/2020 16:25	06/03/2020 19:04	2,64	13	34,32	CHI
20200326508	INHUMAS	IN21086351	INHUMAS S1	06/03/2020 17:23	06/03/2020 20:22	06/03/2020 17:23	06/03/2020 20:22	2,98	1	2,98	CHI
20200326515	SANTO ANTONIO DO DESCOBERTO	SN12168727	ALEXANIA	06/03/2020 17:25	06/03/2020 22:51	06/03/2020 17:25	06/03/2020 22:51	5,43	71	385,59	CHI
20200326518	MINEIROS	10021456621	PARQUE DAS EMAS	06/03/2020 17:26	07/03/2020 15:24	06/03/2020 17:26	07/03/2020 15:24	21,97	1	21,97	CHI
20200326523	PADRE BERNARDO	PB12284769	PADRE BERNARDO	06/03/2020 13:08	06/03/2020 20:41	06/03/2020 13:08	06/03/2020 20:41	7,54	66	497,55	CHI
20200326529	MOSSAMEDES	KB12382583	ANICUNS	06/03/2020 13:25	06/03/2020 19:43	06/03/2020 13:25	06/03/2020 19:43	6,29	17	107,00	CHI

20200326532	MINEIROS	MY11349073	PARQUE DAS EMAS	06/03/2020 17:30	07/03/2020 02:42	06/03/2020 17:30	07/03/2020 02:42	9,19	1	9,19	CHI
20200326534	URUTAI	UT21274689	PIRES DO RIO S2	06/03/2020 17:31	06/03/2020 21:16	06/03/2020 17:31	06/03/2020 21:16	3,75	1	3,75	CHI
20200326537	AGUAS LINDAS DE GOIAS	10007024434	AGUAS LINDAS DE GOIAS S1	06/03/2020 17:32	06/03/2020 18:47	06/03/2020 17:32	06/03/2020 18:47	1,25	1	1,25	CHI
20200326539	GOIATUBA	GT12000349	GOIATUBA S2	06/03/2020 13:35	06/03/2020 19:21	06/03/2020 13:35	06/03/2020 19:21	5,76	2	11,53	CHI
20200326541	GOIANIA	13941434	GOIANIA LESTE S1	06/03/2020 17:34	06/03/2020 19:43	06/03/2020 17:34	06/03/2020 19:43	2,15	1	2,15	CHI
20200326542	CORUMBA DE GOIAS	CB12203649	CORUMBA	06/03/2020 17:34	07/03/2020 08:28	06/03/2020 17:34	07/03/2020 08:28	14,90	7	104,27	CHI
20200326542	PIRENOPOLIS	CB12203649	CORUMBA	06/03/2020 17:34	07/03/2020 08:28	06/03/2020 17:34	07/03/2020 08:28	14,90	2	29,79	CHI
20200326547	GOIANIA	11398942	AEROPORTO S1	06/03/2020 17:34	06/03/2020 20:13	06/03/2020 17:34	06/03/2020 20:13	2,64	1	2,64	CHI
20200326548	APARECIDA DO RIO DOCE	AW21360724	CABRIUVA S2	06/03/2020 17:35	07/03/2020 00:14	06/03/2020 17:35	07/03/2020 00:14	6,65	1	6,65	CHI
20200326551	CALDAS NOVAS	10021020874	SERRA DE CALDAS	06/03/2020 17:36	06/03/2020 18:51	06/03/2020 17:36	06/03/2020 18:51	1,25	1	1,25	CHI
20200326552	VILA BOA	VB12235747	IACIARA S2	06/03/2020 15:28	06/03/2020 22:04	06/03/2020 15:28	06/03/2020 22:04	6,59	14	92,26	CHI
20200326558	VICENTINOPOLIS	VI12352541	VICENTINOPOLIS	06/03/2020 17:39	07/03/2020 07:28	06/03/2020 17:39	07/03/2020 07:28	13,81	4	55,25	CHI
20200326568	DIORAMA	JP12316474RE	IPORA	06/03/2020 17:43	06/03/2020 22:32	06/03/2020 17:43	06/03/2020 22:32	4,82	12	57,89	CHI
20200326568	JAUPACI	JP12316474RE	IPORA	06/03/2020 17:43	06/03/2020 22:32	06/03/2020 17:43	06/03/2020 22:32	4,82	47	226,75	CHI
20200326571	ANAPOLIS	AN21388765	ANAPOLIS UNIVERSITARIO S2	06/03/2020 17:45	06/03/2020 21:45	06/03/2020 17:45	06/03/2020 21:45	3,99	1	3,99	CHI
20200326575	NOVA CRIXAS	NA12307371	MOZARLANDIA	06/03/2020 13:56	06/03/2020 23:43	06/03/2020 13:56	06/03/2020 23:43	9,77	7	68,39	CHI
20200326582	IACIARA	IA21218849	IACIARA S2	06/03/2020 17:49	06/03/2020 20:11	06/03/2020 17:49	06/03/2020 20:11	2,36	1	2,36	CHI
20200326583	ANAPOLIS	AN21258576	ANAPOLIS UNIVERSITARIO S2	06/03/2020 17:49	06/03/2020 18:45	06/03/2020 17:49	06/03/2020 18:45	0,92	1	0,92	CHI
20200326593	QUIRINOPOLIS	QI31000024	QUIRINOPOLIS	06/03/2020 17:51	06/03/2020 20:55	06/03/2020 17:51	06/03/2020 20:55	3,06	1	3,06	CHI
20200326597	SILVANIA	SV11168987	VIANOPOLIS	06/03/2020 17:42	06/03/2020 20:26	06/03/2020 17:42	06/03/2020 20:26	2,72	132	359,52	CHI
20200326602	HEITORAI	IK13307408	ITAPURANGA	06/03/2020 17:31	07/03/2020 11:22	07/03/2020 07:40	07/03/2020 10:50	3,17	34	107,66	CHI
20200326602	ITAPURANGA	IK13307408	ITAPURANGA	06/03/2020 17:31	07/03/2020 11:22	07/03/2020 07:40	07/03/2020 10:50	3,17	55	174,15	CHI
20200326602	GOIAS	HE10400387	ITAPURANGA	06/03/2020 17:31	07/03/2020 11:22	07/03/2020 10:29	07/03/2020 11:22	0,87	75	65,33	CHI
20200326602	HEITORAI	HE10400387	ITAPURANGA	06/03/2020 17:31	07/03/2020 11:22	07/03/2020 10:29	07/03/2020 11:22	0,87	1431	1246,56	CHI
20200326602	HEITORAI	HE10400387	ITAPURANGA	06/03/2020 17:31	07/03/2020 11:22	07/03/2020 10:29	07/03/2020 11:22	0,87	167	145,48	CHI
20200326602	ITAGUARU	HE10400387	ITAPURANGA	06/03/2020 17:31	07/03/2020 11:22	07/03/2020 10:29	07/03/2020 11:22	0,87	56	48,78	CHI
20200326602	ITAPURANGA	HE10400387	ITAPURANGA	06/03/2020 17:31	07/03/2020 11:22	07/03/2020 10:29	07/03/2020 11:22	0,87	76	66,20	CHI
20200326602	ITAPURANGA	HE10400387	ITAPURANGA	06/03/2020 17:31	07/03/2020 11:22	07/03/2020 10:29	07/03/2020 11:22	0,87	84	73,17	CHI
20200326602	URUANA	HE10400387	ITAPURANGA	06/03/2020 17:31	07/03/2020 11:22	07/03/2020 10:29	07/03/2020 11:22	0,87	1	0,87	CHI
20200326802	LUZIANIA	LZ11162869	RIO VERMELHO	06/03/2020 17:53	06/03/2020 21:02	06/03/2020 20:00	06/03/2020 21:02	1,03	102	105,43	CHI
20200326805	MORRINHOS	MR11378315	MORRINHOS	06/03/2020 17:54	06/03/2020 18:45	06/03/2020 17:54	06/03/2020 18:45	0,84	14	11,79	CHI
20200326807	LEOPOLDO DE BULHOES	LB21037888	DAIA S1	06/03/2020 17:55	06/03/2020 21:04	06/03/2020 17:55	06/03/2020 21:04	3,15	2	6,29	CHI
20200326819	LUZIANIA	3200101980	MARAJOARA	06/03/2020 18:00	06/03/2020 21:03	06/03/2020 18:00	06/03/2020 21:03	3,04	1	3,04	CHI
20200326820	PIRANHAS	1930022569	PIRANHAS	06/03/2020 18:00	06/03/2020 22:34	06/03/2020 18:00	06/03/2020 22:34	4,56	1	4,56	CHI
20200326822	PORANGATU	840143242	PORANGATU	06/03/2020 18:01	06/03/2020 23:26	06/03/2020 18:01	06/03/2020 23:26	5,42	1	5,42	CHI
20200326823	GOIANIA	13443914	GOYA S1	06/03/2020 18:01	06/03/2020 19:45	06/03/2020 18:01	06/03/2020 19:45	1,72	1	1,72	CHI
20200326826	SAO LUIS DE MONTES BELOS	SL21154576	FIRMINOPOLIS S2	06/03/2020 18:02	06/03/2020 19:48	06/03/2020 18:02	06/03/2020 19:48	1,76	2	3,52	CHI
20200326827	PIRACANJUBA	PJ21040824	PIRACANJUBA	06/03/2020 18:02	07/03/2020 09:38	06/03/2020 18:02	07/03/2020 09:38	15,59	2	31,18	CHI
20200326828	SAO JOAO D ALIANCA	JL12268121	SAO JOAO D ALIANCA	06/03/2020 18:02	07/03/2020 16:47	06/03/2020 18:02	07/03/2020 16:47	22,74	7	159,17	CHI
20200326837	APARECIDA DE GOIANIA	12122671	INDEPENDENCIA S2	06/03/2020 18:05	06/03/2020 19:07	06/03/2020 18:05	06/03/2020 19:07	1,02	1	1,02	CHI
20200326843	JATAI	10021072866	JATAI S2	06/03/2020 18:06	06/03/2020 20:48	06/03/2020 18:06	06/03/2020 20:48	2,69	1	2,69	CHI
20200326844	TURVANIA	TV12026469	FIRMINOPOLIS S1	06/03/2020 18:05	06/03/2020 20:23	06/03/2020 18:05	06/03/2020 20:23	2,30	7	16,09	CHI
20200326848	BOM JARDIM DE GOIAS	ME12251375	IPORA	06/03/2020 16:26	07/03/2020 10:45	06/03/2020 16:26	07/03/2020 10:45	18,31	18	329,59	CHI
20200326848	MONTES CLAROS DE GOIAS	ME12251375	IPORA	06/03/2020 16:26	07/03/2020 10:45	06/03/2020 16:26	07/03/2020 10:45	18,31	7	128,17	CHI

20200326850	MARA ROSA	MQ12318474	SANTA TEREZINHA	06/03/2020 18:07	06/03/2020 20:33	06/03/2020 18:07	06/03/2020 20:33	2,43	6	14,57	CHI
20200326855	ITARUMA	IM21340976	CACHOEIRA ALTA	06/03/2020 18:10	07/03/2020 03:16	06/03/2020 18:10	07/03/2020 03:16	9,09	1	9,09	CHI
20200326856	HEITORAI	HE21336543	ITAPURANGA	06/03/2020 18:11	06/03/2020 22:21	06/03/2020 18:11	06/03/2020 22:21	4,15	13	53,96	CHI
20200326860	PALMINOPOLIS	10001870546	PALMEIRAS	06/03/2020 18:12	06/03/2020 20:17	06/03/2020 18:12	06/03/2020 20:17	2,08	1	2,08	CHI
20200326863	CIDADE OCIDENTAL	DH11183892	MARAJOARA	06/03/2020 18:13	06/03/2020 22:12	06/03/2020 18:13	06/03/2020 22:12	3,98	149	592,65	CHI
20200326864	CRISTIANOPOLIS	CF21107205	CRISTIANOPOLIS	06/03/2020 18:13	06/03/2020 19:41	06/03/2020 18:13	06/03/2020 19:41	1,45	2	2,91	CHI
20200326868	MORRINHOS	MR21153631	MORRINHOS	06/03/2020 17:50	06/03/2020 20:50	06/03/2020 17:50	06/03/2020 20:50	2,99	1	2,99	CHI
20200326873	CALDAS NOVAS	CN12099537RE	RIO QUENTE	06/03/2020 16:57	07/03/2020 22:15	06/03/2020 16:57	07/03/2020 01:17	8,33	98	816,01	CHI
20200326873	MORRINHOS	CN12099537RE	RIO QUENTE	06/03/2020 16:57	07/03/2020 22:15	06/03/2020 16:57	07/03/2020 01:17	8,33	8	66,61	CHI
20200326873	PIRACANJUBA	CN12099537RE	RIO QUENTE	06/03/2020 16:57	07/03/2020 22:15	06/03/2020 16:57	07/03/2020 01:17	8,33	1	8,33	CHI
20200326873	RIO QUENTE	CN12099537RE	RIO QUENTE	06/03/2020 16:57	07/03/2020 22:15	06/03/2020 16:57	07/03/2020 01:17	8,33	2	16,65	CHI
20200326873	CALDAS NOVAS	CN12099537RE	RIO QUENTE	06/03/2020 16:57	07/03/2020 22:15	07/03/2020 01:18	07/03/2020 02:15	0,94	18	16,95	CHI
20200326873	RIO QUENTE	CN12099537RE	RIO QUENTE	06/03/2020 16:57	07/03/2020 22:15	07/03/2020 01:18	07/03/2020 02:15	0,94	2	1,88	CHI
20200326873	CALDAS NOVAS	CN13309364	RIO QUENTE	06/03/2020 16:57	07/03/2020 22:15	07/03/2020 01:18	07/03/2020 03:13	1,92	24	46,02	CHI
20200326873	MORRINHOS	CN13309364	RIO QUENTE	06/03/2020 16:57	07/03/2020 22:15	07/03/2020 01:18	07/03/2020 03:13	1,92	7	13,42	CHI
20200326873	CALDAS NOVAS	CN13298740	RIO QUENTE	06/03/2020 16:57	07/03/2020 22:15	07/03/2020 01:18	07/03/2020 11:03	9,74	8	77,95	CHI
20200326873	CALDAS NOVAS	CN12099537RE	RIO QUENTE	06/03/2020 16:57	07/03/2020 22:15	07/03/2020 11:47	07/03/2020 12:51	1,06	41	43,38	CHI
20200326873	MORRINHOS	CN12099537RE	RIO QUENTE	06/03/2020 16:57	07/03/2020 22:15	07/03/2020 11:47	07/03/2020 12:51	1,06	7	7,41	CHI
20200326873	RIO QUENTE	CN12099537RE	RIO QUENTE	06/03/2020 16:57	07/03/2020 22:15	07/03/2020 11:47	07/03/2020 12:51	1,06	2	2,12	CHI
20200326873	CALDAS NOVAS	MR13249888	RIO QUENTE	06/03/2020 16:57	07/03/2020 22:15	07/03/2020 01:18	07/03/2020 15:35	14,28	48	685,32	CHI
20200326873	MORRINHOS	MR13249888	RIO QUENTE	06/03/2020 16:57	07/03/2020 22:15	07/03/2020 01:18	07/03/2020 15:35	14,28	1	14,28	CHI
20200326873	PIRACANJUBA	MR13249888	RIO QUENTE	06/03/2020 16:57	07/03/2020 22:15	07/03/2020 01:18	07/03/2020 15:35	14,28	1	14,28	CHI
20200326873	CALDAS NOVAS	CN13298740	RIO QUENTE	06/03/2020 16:57	07/03/2020 22:15	07/03/2020 11:47	07/03/2020 21:12	9,42	8	75,33	CHI
20200326873	CALDAS NOVAS	CN13298630	RIO QUENTE	06/03/2020 16:57	07/03/2020 22:15	07/03/2020 21:48	07/03/2020 22:15	0,44	48	21,01	CHI
20200326873	MORRINHOS	CN13298630	RIO QUENTE	06/03/2020 16:57	07/03/2020 22:15	07/03/2020 21:48	07/03/2020 22:15	0,44	1	0,44	CHI
20200326873	PIRACANJUBA	CN13298630	RIO QUENTE	06/03/2020 16:57	07/03/2020 22:15	07/03/2020 21:48	07/03/2020 22:15	0,44	1	0,44	CHI
20200326879	QUIRINOPOLIS	80115056	QUIRINOPOLIS	06/03/2020 18:18	06/03/2020 22:28	06/03/2020 18:18	06/03/2020 22:28	4,15	1	4,15	CHI
20200326884	AMORINOPOLIS	IV12390141	IPORA	06/03/2020 18:14	07/03/2020 10:09	06/03/2020 18:14	07/03/2020 10:09	15,91	6	95,46	CHI
20200326884	IVOLANDIA	IV12390141	IPORA	06/03/2020 18:14	07/03/2020 10:09	06/03/2020 18:14	07/03/2020 10:09	15,91	60	954,60	CHI
20200326885	MARZAGAO	MG12000365	VILA CORUMBA	06/03/2020 18:21	07/03/2020 08:35	06/03/2020 18:21	07/03/2020 08:35	14,22	5	71,12	CHI
20200326889	GOIANIA	GN11213735	GOYA S1	06/03/2020 18:23	06/03/2020 20:40	06/03/2020 18:23	06/03/2020 20:40	2,27	137	311,22	CHI
20200326890	PALMEIRAS DE GOIAS	PL11277000	PALMEIRAS	06/03/2020 18:23	07/03/2020 07:43	06/03/2020 18:23	07/03/2020 07:43	13,32	1	13,32	CHI
20200326898	PLANALTINA	2960044971	PLANALTINA	06/03/2020 18:27	06/03/2020 22:48	06/03/2020 18:27	06/03/2020 22:48	4,35	1	4,35	CHI
20200326901	GOIANIA	15462717	FERROVIARIO S1	06/03/2020 18:27	06/03/2020 23:04	06/03/2020 18:27	06/03/2020 23:04	4,60	1	4,60	CHI
20200326902	GOIANIA	13156251	ATLANTICO S1	06/03/2020 18:28	06/03/2020 20:11	06/03/2020 18:28	06/03/2020 20:11	1,71	1	1,71	CHI
20200326904	ALTO PARAISO DE GOIAS	BF12206279	NIQUELANDIA SUBTRANSMISSAO	06/03/2020 18:29	07/03/2020 11:55	06/03/2020 18:29	07/03/2020 11:55	17,43	7	122,03	CHI
20200326904	SAO JOAO D ALIANCA	BF12206279	NIQUELANDIA SUBTRANSMISSAO	06/03/2020 18:29	07/03/2020 11:55	06/03/2020 18:29	07/03/2020 11:55	17,43	1	17,43	CHI
20200326906	PARANAIGUARA	PC11000009	CACHOEIRA ALTA	06/03/2020 18:29	06/03/2020 22:01	06/03/2020 18:29	06/03/2020 22:01	3,53	153	539,79	CHI
20200326908	SAO MIGUEL DO ARAGUAIA	SM12334361	SAO MIGUEL DO ARAGUAIA	06/03/2020 18:29	07/03/2020 00:13	06/03/2020 18:29	07/03/2020 00:13	5,72	4	22,88	CHI
20200326926	APARECIDA DE GOIANIA	200106028	INDEPENDENCIA S2	06/03/2020 18:35	06/03/2020 19:33	06/03/2020 18:35	06/03/2020 19:33	0,95	1	0,95	CHI
20200326928	GOIANIA	13241849	SENADOR CANEDO	06/03/2020 18:35	06/03/2020 23:30	06/03/2020 18:35	06/03/2020 23:30	4,90	1	4,90	CHI
20200326931	PARANAIGUARA	PC21235071	CACHOEIRA ALTA	06/03/2020 18:37	06/03/2020 23:58	06/03/2020 18:37	06/03/2020 23:58	5,34	1	5,34	CHI
20200326936	APARECIDA DE GOIANIA	AP11401264	INDEPENDENCIA S2	06/03/2020 18:30	06/03/2020 20:57	06/03/2020 18:30	06/03/2020 20:57	2,43	81	197,19	CHI
20200326940	GOIANIA	10643990	AEROPORTO S3	06/03/2020 18:39	06/03/2020 19:51	06/03/2020 18:39	06/03/2020 19:51	1,19	1	1,19	CHI

20200326942	VIANOPOLIS	SV21060825	VIANOPOLIS	06/03/2020 18:40	07/03/2020 01:51	06/03/2020 18:40	07/03/2020 01:51	7,18	1	7,18	CHI
20200326946	VIANOPOLIS	VN21036444	VIANOPOLIS	06/03/2020 18:41	06/03/2020 22:43	06/03/2020 18:41	06/03/2020 22:43	4,03	1	4,03	CHI
20200326948	MINACU	IH12063612	MINACU	06/03/2020 18:42	06/03/2020 20:25	06/03/2020 18:42	06/03/2020 20:25	1,71	407	697,44	CHI
20200326954	LUZIANIA	120063104	RIO VERMELHO	06/03/2020 18:44	06/03/2020 19:55	06/03/2020 18:44	06/03/2020 19:55	1,18	1	1,18	CHI
20200326956	RIO VERDE	RV21029160	SANTA HELENA S1	06/03/2020 18:44	07/03/2020 10:16	06/03/2020 18:44	07/03/2020 10:16	15,52	0	0,00	CHI
20200326965	ANAPOLIS	AN11129497	JUNDIAI S1	06/03/2020 18:34	06/03/2020 19:43	06/03/2020 18:34	06/03/2020 19:43	1,14	97	110,26	CHI
20200326968	JUSSARA	ME12094784	IPORA	06/03/2020 18:32	06/03/2020 19:55	06/03/2020 18:32	06/03/2020 19:55	1,37	2	2,75	CHI
20200326968	MONTE ALEGRE DE GOIAS	ME12094784	IPORA	06/03/2020 18:32	06/03/2020 19:55	06/03/2020 18:32	06/03/2020 19:55	1,37	2	2,75	CHI
20200326968	MONTES CLAROS DE GOIAS	ME12094784	IPORA	06/03/2020 18:32	06/03/2020 19:55	06/03/2020 18:32	06/03/2020 19:55	1,37	10	13,74	CHI
20200326972	NIQUELANDIA	NQ12375652	URUACU	06/03/2020 14:06	06/03/2020 21:07	06/03/2020 14:06	06/03/2020 21:07	7,00	207	1449,46	CHI
20200326977	PONTALINA	210061157	PONTALINA	06/03/2020 18:52	07/03/2020 09:11	06/03/2020 18:52	07/03/2020 09:11	14,30	1	14,30	CHI
20200326979	GOIANIA	16228390	GOYA S1	06/03/2020 18:52	06/03/2020 21:46	06/03/2020 18:52	06/03/2020 21:46	2,89	1	2,89	CHI
20200326981	BOM JARDIM DE GOIAS	BM12180008	BOM JARDIM	06/03/2020 17:29	06/03/2020 20:09	06/03/2020 17:29	06/03/2020 20:09	2,67	170	453,33	CHI
20200326982	CAMPO LIMPO	AN12011924	NEROPOLIS S1	06/03/2020 18:18	06/03/2020 23:41	06/03/2020 18:18	06/03/2020 23:41	5,37	46	246,94	CHI
20200326982	CAMPO LIMPO	AN12011924	NEROPOLIS S1	06/03/2020 18:18	06/03/2020 23:41	06/03/2020 20:33	06/03/2020 23:41	3,12	1	3,12	CHI
20200326987	DIVINOPOLIS DE GOIAS	2570010565	SAO DOMINGOS	06/03/2020 18:55	06/03/2020 21:16	06/03/2020 18:55	06/03/2020 21:16	2,35	1	2,35	CHI
20200326990	SAO LUIS DE MONTES BELOS	10005082941	SAO LUIZ DOS MONTES BELOS	06/03/2020 18:57	07/03/2020 11:02	06/03/2020 18:57	07/03/2020 11:02	16,08	1	16,08	CHI
20200326999	FORMOSA	FA12131868	ITIQUEIRA	06/03/2020 19:00	06/03/2020 19:52	06/03/2020 19:00	06/03/2020 19:52	0,86	683	586,81	CHI
20200327109	GOIANIA	10012978300	CAMPINAS S2	06/03/2020 19:02	06/03/2020 20:30	06/03/2020 19:02	06/03/2020 20:30	1,46	1	1,46	CHI
20200327120	GOUVELANDIA	GB12394808	QUIRINOPOLIS	06/03/2020 18:51	06/03/2020 20:03	06/03/2020 18:51	06/03/2020 20:03	1,19	2	2,37	CHI
20200327120	QUIRINOPOLIS	GB12394808	QUIRINOPOLIS	06/03/2020 18:51	06/03/2020 20:03	06/03/2020 18:51	06/03/2020 20:03	1,19	77	91,35	CHI
20200327129	RUBIATABA	RB21247673	RUBIATABA	06/03/2020 19:07	08/03/2020 01:08	06/03/2020 19:07	08/03/2020 01:08	30,02	2	60,03	CHI
20200327130	GOIANIA	14917051	XAVANTES	06/03/2020 19:08	07/03/2020 00:34	06/03/2020 19:08	07/03/2020 00:34	5,42	1	5,42	CHI
20200327132	APARECIDA DE GOIANIA	200661218	INDEPENDENCIA S1	06/03/2020 19:08	06/03/2020 20:30	06/03/2020 19:08	06/03/2020 20:30	1,35	1	1,35	CHI
20200327134	FORMOSO	2410023351	PORANGATU	06/03/2020 19:08	06/03/2020 22:09	06/03/2020 19:08	06/03/2020 22:09	3,00	1	3,00	CHI
20200327135	JUSSARA	JR12341198	JUSSARA	06/03/2020 19:04	06/03/2020 21:01	06/03/2020 19:04	06/03/2020 21:01	1,95	7	13,64	CHI
20200327141	ITAPACI	IW21168008	ITAPACI	06/03/2020 19:11	07/03/2020 17:45	06/03/2020 19:11	07/03/2020 17:45	22,56	1	22,56	CHI
20200327143	MORRINHOS	RQ21352583	MORRINHOS	06/03/2020 19:11	07/03/2020 10:20	07/03/2020 08:20	07/03/2020 09:40	1,34	3	4,02	CHI
20200327143	RIO QUENTE	MR21359678	MORRINHOS	06/03/2020 19:11	07/03/2020 10:20	07/03/2020 08:29	07/03/2020 09:49	1,34	1	1,34	CHI
20200327143	RIO QUENTE	RQ21381101	MORRINHOS	06/03/2020 19:11	07/03/2020 10:20	07/03/2020 08:12	07/03/2020 10:14	2,04	2	4,08	CHI
20200327143	MORRINHOS	RQ21349814	MORRINHOS	06/03/2020 19:11	07/03/2020 10:20	06/03/2020 19:11	07/03/2020 10:20	15,14	2	30,29	CHI
20200327150	PONTALINA	PK12074320	VICENTINOPOLIS	06/03/2020 19:13	07/03/2020 11:26	06/03/2020 19:13	07/03/2020 11:26	16,22	7	113,57	CHI
20200327150	PONTALINA	PK12074320	VICENTINOPOLIS	06/03/2020 19:13	07/03/2020 11:26	07/03/2020 09:21	07/03/2020 11:26	2,09	10	20,92	CHI
20200327158	CRISTALINA	KR11039214	CRISTALINA S1	06/03/2020 18:33	06/03/2020 23:29	06/03/2020 18:33	06/03/2020 23:29	4,93	112	552,50	CHI
20200327159	CAMPOS VERDES	SG12171809	SANTA TEREZINHA	06/03/2020 16:39	06/03/2020 21:26	06/03/2020 16:39	06/03/2020 21:26	4,78	13	62,10	CHI
20200327161	URUTAI	UT12115680	PIRES DO RIO S2	06/03/2020 19:13	06/03/2020 22:52	06/03/2020 19:13	06/03/2020 22:25	3,20	21	67,19	CHI
20200327161	URUTAI	UT12115680	PIRES DO RIO S2	06/03/2020 19:13	06/03/2020 22:52	06/03/2020 19:13	06/03/2020 22:52	3,65	12	43,80	CHI
20200327165	GOIANIA	12050271	REAL S1	06/03/2020 19:17	06/03/2020 22:01	06/03/2020 19:17	06/03/2020 22:01	2,72	1	2,72	CHI
20200327167	VILA BOA	2880005419	IACIARA S2	06/03/2020 19:18	06/03/2020 23:21	06/03/2020 19:18	06/03/2020 23:21	4,04	1	4,04	CHI
20200327172	HIDROLANDIA	10026514921	CEPAIGO S2	06/03/2020 19:19	06/03/2020 20:44	06/03/2020 19:19	06/03/2020 20:44	1,41	1	1,41	CHI
20200327173	PIRACANJUBA	PJ21119792	PIRACANJUBA	06/03/2020 19:20	07/03/2020 08:23	06/03/2020 19:20	07/03/2020 08:23	13,05	1	13,05	CHI
20200327177	APARECIDA DE GOIANIA	14690305	ATLANTICO S3	06/03/2020 19:21	06/03/2020 20:31	06/03/2020 19:21	06/03/2020 20:31	1,17	1	1,17	CHI
20200327179	FORMOSA	FA12397036	ITIQUEIRA	06/03/2020 19:22	07/03/2020 10:10	06/03/2020 19:22	07/03/2020 10:10	14,79	3	44,37	CHI
20200327181	RIO VERDE	RV12371443	CABRIUVA S1	06/03/2020 19:21	06/03/2020 22:14	06/03/2020 19:49	06/03/2020 22:14	2,41	9	21,71	CHI

20200327189	ACREUNA	EU12044291	ACREUNA	06/03/2020 13:31	08/03/2020 03:18	06/03/2020 19:05	07/03/2020 09:05	14,00	4	55,98	CHI
20200327189	ACREUNA	EU12044291	ACREUNA	06/03/2020 13:31	08/03/2020 03:18	07/03/2020 00:04	07/03/2020 09:05	9,00	9	81,02	CHI
20200327189	ACREUNA	EU12044291	ACREUNA	06/03/2020 13:31	08/03/2020 03:18	06/03/2020 19:05	07/03/2020 10:32	15,45	3	46,36	CHI
20200327189	PARAUNA	EU12044291	ACREUNA	06/03/2020 13:31	08/03/2020 03:18	06/03/2020 19:05	07/03/2020 10:32	15,45	1	15,45	CHI
20200327189	ACREUNA	EU12044291	ACREUNA	06/03/2020 13:31	08/03/2020 03:18	07/03/2020 00:04	07/03/2020 10:32	10,46	4	41,84	CHI
20200327189	PARAUNA	EU12044291	ACREUNA	06/03/2020 13:31	08/03/2020 03:18	07/03/2020 00:04	07/03/2020 10:32	10,46	14	146,45	CHI
20200327189	ACREUNA	EU12044291	ACREUNA	06/03/2020 13:31	08/03/2020 03:18	06/03/2020 13:31	07/03/2020 14:08	24,61	1	24,61	CHI
20200327189	ACREUNA	EU12044291	ACREUNA	06/03/2020 13:31	08/03/2020 03:18	07/03/2020 12:20	07/03/2020 14:08	1,80	18	32,40	CHI
20200327189	PARAUNA	EU12044291	ACREUNA	06/03/2020 13:31	08/03/2020 03:18	07/03/2020 12:20	07/03/2020 14:08	1,80	1	1,80	CHI
20200327189	ACREUNA	EU12044291	ACREUNA	06/03/2020 13:31	08/03/2020 03:18	07/03/2020 17:55	07/03/2020 19:35	1,66	14	23,19	CHI
20200327189	ACREUNA	EU12044291	ACREUNA	06/03/2020 13:31	08/03/2020 03:18	07/03/2020 21:23	07/03/2020 23:44	2,35	13	30,54	CHI
20200327189	ACREUNA	EU12044291	ACREUNA	06/03/2020 13:31	08/03/2020 03:18	06/03/2020 19:05	08/03/2020 03:01	31,93	6	191,59	CHI
20200327189	PARAUNA	EU12044291	ACREUNA	06/03/2020 13:31	08/03/2020 03:18	06/03/2020 19:05	08/03/2020 03:01	31,93	22	702,48	CHI
20200327189	ACREUNA	EU12044291	ACREUNA	06/03/2020 13:31	08/03/2020 03:18	07/03/2020 00:04	08/03/2020 03:01	26,94	6	161,62	CHI
20200327189	ACREUNA	EU13044322	ACREUNA	06/03/2020 13:31	08/03/2020 03:18	07/03/2020 00:04	08/03/2020 03:01	26,94	2	53,87	CHI
20200327189	PARAUNA	EU13044322	ACREUNA	06/03/2020 13:31	08/03/2020 03:18	07/03/2020 00:04	08/03/2020 03:01	26,94	119	3205,53	CHI
20200327189	ACREUNA	EU13044322	ACREUNA	06/03/2020 13:31	08/03/2020 03:18	07/03/2020 17:55	08/03/2020 03:01	9,09	6	54,55	CHI
20200327189	PARAUNA	EU13044322	ACREUNA	06/03/2020 13:31	08/03/2020 03:18	07/03/2020 21:23	08/03/2020 03:01	5,62	1	5,62	CHI
20200327189	ACREUNA	EU12044291	ACREUNA	06/03/2020 13:31	08/03/2020 03:18	07/03/2020 00:04	08/03/2020 03:18	27,22	27	734,90	CHI
20200327189	JANDAIA	EU12044291	ACREUNA	06/03/2020 13:31	08/03/2020 03:18	07/03/2020 00:04	08/03/2020 03:18	27,22	6	163,31	CHI
20200327189	PARAUNA	EU12044291	ACREUNA	06/03/2020 13:31	08/03/2020 03:18	07/03/2020 00:04	08/03/2020 03:18	27,22	26	707,68	CHI
20200327189	ACREUNA	EU12044258	ACREUNA	06/03/2020 13:31	08/03/2020 03:18	07/03/2020 04:38	08/03/2020 03:18	22,66	5	113,31	CHI
20200327189	JANDAIA	EU12044258	ACREUNA	06/03/2020 13:31	08/03/2020 03:18	07/03/2020 04:38	08/03/2020 03:18	22,66	1	22,66	CHI
20200327189	ACREUNA	EU12044258	ACREUNA	06/03/2020 13:31	08/03/2020 03:18	07/03/2020 12:20	08/03/2020 03:18	14,96	1	14,96	CHI
20200327189	PARAUNA	EU12044258	ACREUNA	06/03/2020 13:31	08/03/2020 03:18	07/03/2020 12:20	08/03/2020 03:18	14,96	14	209,49	CHI
20200327195	NIQUELANDIA	NQ12222646	URUACU	06/03/2020 15:53	06/03/2020 22:07	06/03/2020 15:53	06/03/2020 22:07	6,22	8	49,75	CHI
20200327214	ANAPOLIS	AN11003272	JUNDIAI S1	06/03/2020 19:28	06/03/2020 20:12	06/03/2020 19:28	06/03/2020 20:12	0,72	139	100,58	CHI
20200327217	GOIANIA	13715781	ATLANTICO S2	06/03/2020 19:31	06/03/2020 21:02	06/03/2020 19:31	06/03/2020 21:02	1,51	1	1,51	CHI
20200327218	MINACU	IH11207728	MINACU	06/03/2020 19:31	07/03/2020 08:51	06/03/2020 19:31	07/03/2020 08:51	13,32	3	39,97	CHI
20200327221	MORRINHOS	MR21223274	MORRINHOS	06/03/2020 19:33	06/03/2020 22:59	06/03/2020 19:33	06/03/2020 22:59	3,43	1	3,43	CHI
20200327225	ACREUNA	EU11279450	ACREUNA	06/03/2020 17:25	06/03/2020 23:10	06/03/2020 17:25	06/03/2020 23:10	5,74	41	235,45	CHI
20200327231	LUZIANIA	120419737	RIO VERMELHO	06/03/2020 19:35	06/03/2020 22:09	06/03/2020 19:35	06/03/2020 22:09	2,56	1	2,56	CHI
20200327232	ITAPURANGA	IK11124735	ITAPURANGA	06/03/2020 18:44	07/03/2020 01:31	06/03/2020 18:44	07/03/2020 01:31	6,78	61	413,80	CHI
20200327234	LUZIANIA	LZ21084474	MARAJOARA	06/03/2020 19:37	06/03/2020 21:30	06/03/2020 19:37	06/03/2020 21:30	1,88	3	5,64	CHI
20200327236	MORRINHOS	MR12031182	MORRINHOS	06/03/2020 19:37	07/03/2020 13:20	06/03/2020 19:37	07/03/2020 13:20	17,71	2	35,42	CHI
20200327237	JATAI	JT21135914	JATAI S2	06/03/2020 19:37	06/03/2020 21:43	06/03/2020 19:37	06/03/2020 21:43	2,09	1	2,09	CHI
20200327240	GUAPO	GA21238909	GUAPO S1	06/03/2020 19:38	06/03/2020 23:16	06/03/2020 19:38	06/03/2020 23:16	3,63	2	7,25	CHI
20200327244	CEZARINA	CZ21355951	GUAPO S2	06/03/2020 19:39	07/03/2020 08:06	06/03/2020 19:39	07/03/2020 08:06	12,44	1	12,44	CHI
20200327255	AGUAS LINDAS DE GOIAS	LA11165004	AGUAS LINDAS DE GOIAS S2	06/03/2020 19:43	06/03/2020 21:44	06/03/2020 19:43	06/03/2020 21:44	2,00	143	286,12	CHI
20200327259	ESTRELA DO NORTE	2420000098	MARA ROSA	06/03/2020 19:45	06/03/2020 22:36	06/03/2020 19:45	06/03/2020 22:36	2,84	1	2,84	CHI
20200327260	PALESTINA DE GOIAS	PY12395457	PALESTINA	06/03/2020 18:44	07/03/2020 08:18	06/03/2020 18:44	07/03/2020 08:18	13,56	4	54,23	CHI
20200327261	AGUAS LINDAS DE GOIAS	LA11305234	AGUAS LINDAS DE GOIAS S2	06/03/2020 19:43	06/03/2020 20:47	06/03/2020 19:43	06/03/2020 20:47	1,06	217	230,68	CHI
20200327262	BELA VISTA DE GOIAS	BV32097909	BELA VISTA S2	06/03/2020 19:34	07/03/2020 02:20	06/03/2020 19:34	07/03/2020 02:20	6,75	5	33,77	CHI
20200327262	SAO MIGUEL DO PASSA QUATRO	BV32097909	BELA VISTA S2	06/03/2020 19:34	07/03/2020 02:20	06/03/2020 19:34	07/03/2020 02:20	6,75	14	94,56	CHI

20200327263	ITAPIRAPUA	IU21189981	MATRINCHA	06/03/2020 19:47	06/03/2020 21:41	06/03/2020 19:47	06/03/2020 21:41	1,90	2	3,80	CHI
20200327266	ANAPOLIS	AN10384353	JUNDIAI S2	06/03/2020 19:23	06/03/2020 19:27	06/03/2020 19:23	06/03/2020 19:26	0,06	3926	215,93	CHI
20200327266	ANAPOLIS	AN10384353	JUNDIAI S2	06/03/2020 19:23	06/03/2020 19:27	06/03/2020 19:23	06/03/2020 19:27	0,07	2070	144,33	CHI
20200327268	IPORA	730022225	IPORA	06/03/2020 19:49	07/03/2020 08:07	06/03/2020 19:49	07/03/2020 08:07	12,29	1	12,29	CHI
20200327270	GOIANIA	GN11340496	GOIANIA LESTE S2	06/03/2020 19:52	06/03/2020 22:10	06/03/2020 19:52	06/03/2020 22:10	2,30	206	473,80	CHI
20200327282	NOVO PLANALTO	TA21094580	SAO MIGUEL DO ARAGUAIA	06/03/2020 19:56	06/03/2020 23:31	06/03/2020 19:56	06/03/2020 23:31	3,58	1	3,58	CHI
20200327284	GOIANIA	12858286	GOIANIA LESTE S1	06/03/2020 19:57	06/03/2020 21:07	06/03/2020 19:57	06/03/2020 21:07	1,16	1	1,16	CHI
20200327298	NOVO BRASIL	NB11289174	JUSSARA	06/03/2020 19:48	07/03/2020 03:51	06/03/2020 19:48	07/03/2020 03:51	8,04	117	941,04	CHI
20200327304	POSSE	1480048024	IACIARA S2	06/03/2020 19:50	06/03/2020 20:44	06/03/2020 19:50	06/03/2020 20:44	0,88	1	0,88	CHI
20200327306	DIORAMA	00850424	IPORA	06/03/2020 20:01	07/03/2020 04:07	06/03/2020 20:01	06/03/2020 21:33	1,53	10	15,27	CHI
20200327306	IPORA	00850424	IPORA	06/03/2020 20:01	07/03/2020 04:07	06/03/2020 20:01	06/03/2020 21:33	1,53	65	99,23	CHI
20200327306	ISRAELANDIA	00850424	IPORA	06/03/2020 20:01	07/03/2020 04:07	06/03/2020 20:01	06/03/2020 21:33	1,53	3	4,58	CHI
20200327306	JAUPACI	00850424	IPORA	06/03/2020 20:01	07/03/2020 04:07	06/03/2020 20:01	06/03/2020 21:33	1,53	17	25,95	CHI
20200327306	DIORAMA	00850424	IPORA	06/03/2020 20:01	07/03/2020 04:07	06/03/2020 20:01	06/03/2020 23:35	3,56	5	17,82	CHI
20200327306	IPORA	00850424	IPORA	06/03/2020 20:01	07/03/2020 04:07	06/03/2020 20:01	06/03/2020 23:35	3,56	11	39,21	CHI
20200327306	DIORAMA	00850424	IPORA	06/03/2020 20:01	07/03/2020 04:07	06/03/2020 20:01	07/03/2020 03:55	7,89	71	560,23	CHI
20200327306	IPORA	00850424	IPORA	06/03/2020 20:01	07/03/2020 04:07	06/03/2020 20:01	07/03/2020 03:55	7,89	2	15,78	CHI
20200327306	JAUPACI	00850424	IPORA	06/03/2020 20:01	07/03/2020 04:07	06/03/2020 20:01	07/03/2020 03:55	7,89	7	55,23	CHI
20200327306	ARENOPOLIS	00850424	IPORA	06/03/2020 20:01	07/03/2020 04:07	06/03/2020 20:01	07/03/2020 04:03	8,03	103	827,29	CHI
20200327306	ARENOPOLIS	00850424	IPORA	06/03/2020 20:01	07/03/2020 04:07	06/03/2020 20:01	07/03/2020 04:03	8,03	128	1028,09	CHI
20200327306	DIORAMA	00850424	IPORA	06/03/2020 20:01	07/03/2020 04:07	06/03/2020 20:01	07/03/2020 04:03	8,03	11	88,35	CHI
20200327306	DIORAMA	00850424	IPORA	06/03/2020 20:01	07/03/2020 04:07	06/03/2020 20:01	07/03/2020 04:03	8,03	768	6168,53	CHI
20200327306	DIORAMA	00850424	IPORA	06/03/2020 20:01	07/03/2020 04:07	06/03/2020 20:01	07/03/2020 04:03	8,03	87	698,78	CHI
20200327306	FAZENDA NOVA	00850424	IPORA	06/03/2020 20:01	07/03/2020 04:07	06/03/2020 20:01	07/03/2020 04:03	8,03	6	48,19	CHI
20200327306	IPORA	00850424	IPORA	06/03/2020 20:01	07/03/2020 04:07	06/03/2020 20:01	07/03/2020 04:03	8,03	17	136,54	CHI
20200327306	IPORA	00850424	IPORA	06/03/2020 20:01	07/03/2020 04:07	06/03/2020 20:01	07/03/2020 04:03	8,03	3	24,10	CHI
20200327306	JAUPACI	00850424	IPORA	06/03/2020 20:01	07/03/2020 04:07	06/03/2020 20:01	07/03/2020 04:03	8,03	7	56,22	CHI
20200327306	JUSSARA	00850424	IPORA	06/03/2020 20:01	07/03/2020 04:07	06/03/2020 20:01	07/03/2020 04:03	8,03	416	3341,29	CHI
20200327306	MONTE ALEGRE DE GOIAS	00850424	IPORA	06/03/2020 20:01	07/03/2020 04:07	06/03/2020 20:01	07/03/2020 04:03	8,03	2	16,06	CHI
20200327306	MONTES CLAROS DE GOIAS	00850424	IPORA	06/03/2020 20:01	07/03/2020 04:07	06/03/2020 20:01	07/03/2020 04:03	8,03	3155	25340,78	CHI
20200327306	MONTES CLAROS DE GOIAS	00850424	IPORA	06/03/2020 20:01	07/03/2020 04:07	06/03/2020 20:01	07/03/2020 04:03	8,03	82	658,62	CHI
20200327306	MONTES CLAROS DE GOIAS	00850424	IPORA	06/03/2020 20:01	07/03/2020 04:07	06/03/2020 20:01	07/03/2020 04:03	8,03	482	3871,40	CHI
20200327306	ORIZONA	00850424	IPORA	06/03/2020 20:01	07/03/2020 04:07	06/03/2020 20:01	07/03/2020 04:03	8,03	38	305,21	CHI
20200327306	PIRANHAS	00850424	IPORA	06/03/2020 20:01	07/03/2020 04:07	06/03/2020 20:01	07/03/2020 04:03	8,03	2	16,06	CHI
20200327306	ARENOPOLIS	00850424	IPORA	06/03/2020 20:01	07/03/2020 04:07	06/03/2020 20:01	07/03/2020 04:03	8,03	1	8,03	CHI
20200327306	MONTES CLAROS DE GOIAS	00850424	IPORA	06/03/2020 20:01	07/03/2020 04:07	06/03/2020 20:03	07/03/2020 04:03	8,00	1	8,00	CHI
20200327306	MONTES CLAROS DE GOIAS	00850424	IPORA	06/03/2020 20:01	07/03/2020 04:07	06/03/2020 20:03	07/03/2020 04:03	8,00	1	8,00	CHI
20200327306	JUSSARA	00850424	IPORA	06/03/2020 20:01	07/03/2020 04:07	06/03/2020 20:07	07/03/2020 04:03	7,93	1	7,93	CHI
20200327306	MONTES CLAROS DE GOIAS	00850424	IPORA	06/03/2020 20:01	07/03/2020 04:07	06/03/2020 20:07	07/03/2020 04:03	7,93	59	467,85	CHI
20200327306	MONTES CLAROS DE GOIAS	DI13341798	IPORA	06/03/2020 20:01	07/03/2020 04:07	06/03/2020 20:07	07/03/2020 04:03	7,93	1	7,93	CHI
20200327306	ARAGARCAS	00850424	IPORA	06/03/2020 20:01	07/03/2020 04:07	06/03/2020 20:01	07/03/2020 04:07	8,09	49	396,55	CHI
20200327306	BOM JARDIM DE GOIAS	00850424	IPORA	06/03/2020 20:01	07/03/2020 04:07	06/03/2020 20:01	07/03/2020 04:07	8,09	2	16,19	CHI
20200327306	MONTES CLAROS DE GOIAS	00850424	IPORA	06/03/2020 20:01	07/03/2020 04:07	06/03/2020 20:01	07/03/2020 04:07	8,09	582	4710,00	CHI
20200327402	PIRES DO RIO	PR21095360	PIRES DO RIO S1	06/03/2020 20:08	06/03/2020 23:45	06/03/2020 20:08	06/03/2020 23:45	3,61	1	3,61	CHI

20200327411	CAMPOS BELOS	CH11028138	SAO DOMINGOS	06/03/2020 20:11	07/03/2020 04:15	06/03/2020 20:11	07/03/2020 04:15	8,06	73	588,16	CHI
20200327418	GOIANIA	11533675	FERROVIARIO S2	06/03/2020 20:15	06/03/2020 21:37	06/03/2020 20:15	06/03/2020 21:37	1,36	1	1,36	CHI
20200327420	PARANAIGUARA	PC12191538	CACHOEIRA ALTA	06/03/2020 18:41	06/03/2020 22:01	06/03/2020 18:41	06/03/2020 22:01	3,33	356	1185,38	CHI
20200327431	ANICUNS	AC21000086	ANICUNS	06/03/2020 20:22	06/03/2020 23:43	06/03/2020 20:22	06/03/2020 23:43	3,34	1	3,34	CHI
20200327441	GOIANIA	GN11000853	FERROVIARIO S2	06/03/2020 20:24	06/03/2020 21:49	06/03/2020 20:24	06/03/2020 21:49	1,42	217	307,36	CHI
20200327444	LUZIANIA	LZ11149779	MARAJOARA	06/03/2020 20:27	06/03/2020 22:22	06/03/2020 20:27	06/03/2020 22:22	1,91	174	332,68	CHI
20200327452	PIRACANJUBA	BV12036142	BELA VISTA S1	06/03/2020 19:34	07/03/2020 10:59	06/03/2020 19:34	07/03/2020 09:42	14,14	41	579,54	CHI
20200327452	PIRACANJUBA	CF12257742LD	BELA VISTA S1	06/03/2020 19:34	07/03/2020 10:59	06/03/2020 19:34	07/03/2020 10:59	15,42	46	709,32	CHI
20200327468	SAO LUIS DE MONTES BELOS	SL12401199	FIRMINOPOLIS S1	06/03/2020 20:43	06/03/2020 22:32	06/03/2020 20:43	06/03/2020 22:32	1,81	5	9,07	CHI
20200327472	CRIXAS	CX21284404	SERRA DO OURO	06/03/2020 10:52	07/03/2020 10:56	06/03/2020 10:52	07/03/2020 10:56	24,05	1	24,05	CHI
20200327476	GOIANIA	16688284	XAVANTES	06/03/2020 20:47	06/03/2020 23:16	06/03/2020 20:47	06/03/2020 23:16	2,48	1	2,48	CHI
20200327477	GOIANIA	15814208	AEROPORTO S1	06/03/2020 20:47	06/03/2020 23:12	06/03/2020 20:47	06/03/2020 23:12	2,40	1	2,40	CHI
20200327483	ABADIANIA	AA21066490	ANAPOLIS UNIVERSITARIO S1	06/03/2020 20:52	07/03/2020 08:12	06/03/2020 20:52	07/03/2020 08:12	11,33	1	11,33	CHI
20200327485	ACREUNA	2440026007	ACREUNA	06/03/2020 20:53	06/03/2020 22:58	06/03/2020 20:53	06/03/2020 22:58	2,08	1	2,08	CHI
20200327490	ANAPOLIS	AN11215206	ANAPOLIS UNIVERSITARIO S2	06/03/2020 20:41	06/03/2020 22:15	06/03/2020 20:41	06/03/2020 22:15	1,56	56	87,28	CHI
20200327493	PARAUNA	PU12303601	PARAUNA	06/03/2020 21:02	07/03/2020 09:06	06/03/2020 21:02	07/03/2020 09:06	12,06	5	60,31	CHI
20200327495	PORANGATU	PO12000039	PORANGATU	06/03/2020 21:03	06/03/2020 23:43	06/03/2020 21:03	06/03/2020 23:00	1,94	4	7,77	CHI
20200327495	PORANGATU	PO12000039	PORANGATU	06/03/2020 21:03	06/03/2020 23:43	06/03/2020 23:01	06/03/2020 23:43	0,70	4	2,80	CHI
20200327498	FAINA	FC11250739	GOIAS	06/03/2020 20:20	06/03/2020 22:20	06/03/2020 20:20	06/03/2020 22:20	2,00	124	247,69	CHI
20200327507	PETROLINA DE GOIAS	PV12062894	SAO FRANCISCO DE GOIAS	06/03/2020 20:58	07/03/2020 01:00	06/03/2020 20:58	07/03/2020 01:00	4,03	3	12,10	CHI
20200327507	PIRENOPOLIS	PV12062894	SAO FRANCISCO DE GOIAS	06/03/2020 20:58	07/03/2020 01:00	06/03/2020 20:58	07/03/2020 01:00	4,03	19	76,61	CHI
20200327509	ANAPOLIS	AN12000006	ANAPOLIS UNIVERSITARIO S2	06/03/2020 21:04	06/03/2020 23:02	06/03/2020 21:04	06/03/2020 23:02	1,96	351	687,57	CHI
20200327510	URUACU	UR11221613	URUACU	06/03/2020 21:07	07/03/2020 03:33	06/03/2020 21:07	07/03/2020 03:33	6,43	34	218,49	CHI
20200327511	GOUVELANDIA	QI12000254	QUIRINOPOLIS	06/03/2020 21:08	07/03/2020 09:06	06/03/2020 21:08	07/03/2020 09:06	11,96	2	23,93	CHI
20200327511	QUIRINOPOLIS	QI12000254	QUIRINOPOLIS	06/03/2020 21:08	07/03/2020 09:06	06/03/2020 21:08	07/03/2020 09:06	11,96	6	71,79	CHI
20200327513	MONTE ALEGRE DE GOIAS	SD12322677	SAO DOMINGOS	06/03/2020 19:04	07/03/2020 09:32	06/03/2020 19:04	07/03/2020 09:32	14,46	2	28,92	CHI
20200327513	NOVA ROMA	SD12322677	SAO DOMINGOS	06/03/2020 19:04	07/03/2020 09:32	06/03/2020 19:04	07/03/2020 09:32	14,46	3	43,38	CHI
20200327513	SAO DOMINGOS	SD12322677	SAO DOMINGOS	06/03/2020 19:04	07/03/2020 09:32	06/03/2020 19:04	07/03/2020 09:32	14,46	35	506,15	CHI
20200327514	ANAPOLIS	AN11135792	ANAPOLIS UNIVERSITARIO S1	06/03/2020 21:04	06/03/2020 21:55	06/03/2020 21:04	06/03/2020 21:55	0,84	128	107,98	CHI
20200327515	APARECIDA DE GOIANIA	10007614932	REAL S2	06/03/2020 21:09	06/03/2020 22:27	06/03/2020 21:09	06/03/2020 22:27	1,29	1	1,29	CHI
20200327516	APARECIDA DE GOIANIA	10010793877	INDEPENDENCIA S1	06/03/2020 21:10	06/03/2020 22:59	06/03/2020 21:10	06/03/2020 22:59	1,82	1	1,82	CHI
20200327518	NOVO BRASIL	NB21123869	JUSSARA	06/03/2020 21:10	07/03/2020 13:32	06/03/2020 21:10	07/03/2020 13:32	16,35	1	16,35	CHI
20200327519	SANTO ANTONIO DO DESCOBERTO	10022989607	AGUAS LINDAS DE GOIAS S2	06/03/2020 21:11	06/03/2020 23:57	06/03/2020 21:11	06/03/2020 23:57	2,76	1	2,76	CHI
20200327523	CATALAO	CT21075574	CAMPO ALEGRE DE GOIAS	06/03/2020 21:18	07/03/2020 08:45	06/03/2020 21:18	07/03/2020 08:45	11,44	1	11,44	CHI
20200327529	LUZIANIA	120065800	RIO VERMELHO	06/03/2020 21:24	06/03/2020 22:56	06/03/2020 21:24	06/03/2020 22:56	1,53	1	1,53	CHI
20200327531	FORMOSO	TB12051886	PORANGATU	06/03/2020 21:25	06/03/2020 23:33	06/03/2020 21:25	06/03/2020 23:33	2,12	2	4,24	CHI
20200327531	TROMBAS	TB12051886	PORANGATU	06/03/2020 21:25	06/03/2020 23:33	06/03/2020 21:25	06/03/2020 23:33	2,12	24	50,85	CHI
20200327538	ANAPOLIS	AN11003272	JUNDIAI S1	06/03/2020 21:27	06/03/2020 22:29	06/03/2020 21:27	06/03/2020 22:29	1,02	139	141,43	CHI
20200327545	SAO LUIS DE MONTES BELOS	SL31145919	SAO LUIZ DOS MONTES BELOS	06/03/2020 21:38	07/03/2020 07:29	06/03/2020 21:38	07/03/2020 07:29	9,84	2	19,68	CHI
20200327551	SENADOR CANEDO	SW21337615	SENADOR CANEDO	06/03/2020 21:42	06/03/2020 22:16	06/03/2020 21:42	06/03/2020 22:16	0,56	3	1,68	CHI
20200327552	GOIANIA	15129573	REAL S1	06/03/2020 21:42	07/03/2020 00:36	06/03/2020 21:42	07/03/2020 00:36	2,89	1	2,89	CHI
20200327554	CALDAS NOVAS	CN11000046	CALDAS NOVAS S1	06/03/2020 21:43	06/03/2020 23:53	06/03/2020 23:33	06/03/2020 23:53	0,34	122	41,41	CHI
20200327557	CORUMBAIBA	CI21132314	VILA CORUMBA	06/03/2020 21:45	07/03/2020 10:32	06/03/2020 21:45	07/03/2020 10:32	12,78	1	12,78	CHI
20200327561	NOVO GAMA	NJ11201186	PACAEMBU S1	06/03/2020 21:47	06/03/2020 23:48	06/03/2020 21:47	06/03/2020 23:48	2,01	10	20,09	CHI

20200327565	TRINDADE	TR11053494	TRINDADE	06/03/2020 21:46	07/03/2020 05:08	06/03/2020 21:46	07/03/2020 05:08	7,36	186	1368,96	CHI
20200327566	BONOPOLIS	BX12266016	SAO MIGUEL DO ARAGUAIA	06/03/2020 21:51	07/03/2020 00:23	06/03/2020 21:51	07/03/2020 00:23	2,52	9	22,72	CHI
20200327573	GOIANIA	GN11134323	ATLANTICO S1	06/03/2020 21:56	06/03/2020 23:10	06/03/2020 21:56	06/03/2020 23:10	1,22	94	114,45	CHI
20200327577	SANTA HELENA DE GOIAS	TD12213488	RIO DOS BOIS	06/03/2020 21:28	06/03/2020 23:37	06/03/2020 21:28	06/03/2020 23:37	2,15	3	6,44	CHI
20200327577	TURVELANDIA	TD12213488	RIO DOS BOIS	06/03/2020 21:28	06/03/2020 23:37	06/03/2020 21:28	06/03/2020 23:37	2,15	5	10,74	CHI
20200327580	APARECIDA DO RIO DOCE	10015815542	CABRIUVA S2	06/03/2020 17:30	07/03/2020 15:00	06/03/2020 17:30	07/03/2020 15:00	21,51	1	21,51	CHI
20200327591	GOIANIA	10005102411	ATLANTICO S1	06/03/2020 22:19	06/03/2020 23:06	06/03/2020 22:19	06/03/2020 23:06	0,78	1	0,78	CHI
20200327592	RIO VERDE	630501506	RIO VERDE S1	06/03/2020 22:19	07/03/2020 09:57	06/03/2020 22:19	07/03/2020 09:57	11,63	1	11,63	CHI
20200327595	APARECIDA DE GOIANIA	10007348507	REAL S1	06/03/2020 22:24	06/03/2020 23:15	06/03/2020 22:24	06/03/2020 23:15	0,85	1	0,85	CHI
20200327600	PLANALTINA	10026094108	PLANALTINA	06/03/2020 22:33	07/03/2020 03:45	06/03/2020 22:33	07/03/2020 03:45	5,19	1	5,19	CHI
20200327603	SANTA TEREZINHA DE GOIAS	SG12237481	SANTA TEREZINHA	06/03/2020 22:38	07/03/2020 02:52	06/03/2020 22:38	07/03/2020 02:52	4,22	15	63,26	CHI
20200327604	CATALAO	7434601	CATALAO S1	06/03/2020 22:41	07/03/2020 11:45	06/03/2020 22:41	07/03/2020 11:45	13,07	2	26,13	CHI
20200327605	MONTES CLAROS DE GOIAS	ME11242244	BRITANIA	06/03/2020 22:43	07/03/2020 11:34	06/03/2020 22:43	07/03/2020 11:34	12,83	1	12,83	CHI
20200327609	ARAGOIANIA	AO32000285	GUAPO S2	06/03/2020 22:49	07/03/2020 00:57	06/03/2020 22:49	07/03/2020 00:57	2,13	51	108,62	CHI
20200327609	HIDROLANDIA	AO32000285	GUAPO S2	06/03/2020 22:49	07/03/2020 00:57	06/03/2020 22:49	07/03/2020 00:57	2,13	108	230,01	CHI
20200327609	MAIRIPOTABA	AO32000285	GUAPO S2	06/03/2020 22:49	07/03/2020 00:57	06/03/2020 22:49	07/03/2020 00:57	2,13	2	4,26	CHI
20200327609	VARJAO	AO32000285	GUAPO S2	06/03/2020 22:49	07/03/2020 00:57	06/03/2020 22:49	07/03/2020 00:57	2,13	70	149,08	CHI
20200327621	FAINA	FC12124752	GOIAS	06/03/2020 23:04	06/03/2020 23:56	06/03/2020 23:04	06/03/2020 23:56	0,86	26	22,35	CHI
20200327631	BOM JESUS DE GOIAS	BJ12256996	BOM JESUS DE GOIAS	06/03/2020 23:35	07/03/2020 08:05	06/03/2020 23:35	07/03/2020 08:05	8,49	14	118,89	CHI
20200327631	GOIATUBA	BJ12256996	BOM JESUS DE GOIAS	06/03/2020 23:35	07/03/2020 08:05	06/03/2020 23:35	07/03/2020 08:05	8,49	50	424,60	CHI
20200327633	APARECIDA DE GOIANIA	AP11047181	INDEPENDENCIA S1	06/03/2020 23:37	07/03/2020 00:26	06/03/2020 23:37	07/03/2020 00:26	0,81	81	65,61	CHI
20200327639	ANAPOLIS	AN11000209	JUNDIAI S1	06/03/2020 23:35	07/03/2020 01:09	06/03/2020 23:35	07/03/2020 01:09	1,57	92	144,26	CHI
20200328749	CATALAO	10001892442	CATALAO S1	06/03/2020 22:24	07/03/2020 12:16	06/03/2020 22:24	07/03/2020 12:16	13,86	1	13,86	CHI
202002171470	MINACU	IH12134994	MINACU	27/02/2020 13:25	27/02/2020 17:28	27/02/2020 13:25	27/02/2020 17:28	4,04	11	44,42	CHI
202002172396	TRINDADE	TR12036568	TRINDADE	27/02/2020 14:48	27/02/2020 17:13	27/02/2020 14:48	27/02/2020 17:13	2,41	8	19,32	CHI
202002174683	CACU	IM12371219	CACHOEIRA ALTA	27/02/2020 19:24	28/02/2020 10:04	27/02/2020 19:24	28/02/2020 10:04	14,66	29	425,22	CHI
202002174683	ITARUMA	IM12371219	CACHOEIRA ALTA	27/02/2020 19:24	28/02/2020 10:04	27/02/2020 19:24	28/02/2020 10:04	14,66	21	307,92	CHI
202002174683	JATAI	IM12371219	CACHOEIRA ALTA	27/02/2020 19:24	28/02/2020 10:04	27/02/2020 19:24	28/02/2020 10:04	14,66	19	278,59	CHI
202002174749	ITABERAI	IB11000041	ITABERAI S2	27/02/2020 11:31	27/02/2020 13:10	27/02/2020 11:31	27/02/2020 13:10	1,65	110	181,10	CHI
202002174757	ARENOPOLIS	1920001922	ARENOPOLIS	27/02/2020 11:33	27/02/2020 18:40	27/02/2020 11:33	27/02/2020 18:40	7,11	1	7,11	CHI
202002174763	APARECIDA DE GOIANIA	10006938076	INDEPENDENCIA S2	27/02/2020 11:34	27/02/2020 15:24	27/02/2020 11:34	27/02/2020 15:24	3,82	1	3,82	CHI
202002174768	GOIANIA	GN11080302	FERROVIARIO S2	27/02/2020 11:36	27/02/2020 16:27	27/02/2020 11:36	27/02/2020 16:27	4,84	29	140,25	CHI
202002174769	SILVANIA	SV21161973	VIANOPOLIS	27/02/2020 11:36	27/02/2020 14:45	27/02/2020 11:36	27/02/2020 14:45	3,14	2	6,27	CHI
202002174781	AGUAS LINDAS DE GOIAS	10012642515	AGUAS LINDAS DE GOIAS S1	27/02/2020 11:40	27/02/2020 15:00	27/02/2020 11:40	27/02/2020 15:00	3,33	1	3,33	CHI
202002174785	CATURAI	CK21108232	INHUMAS S1	27/02/2020 11:41	27/02/2020 13:32	27/02/2020 11:41	27/02/2020 13:32	1,83	1	1,83	CHI
202002174802	VIANOPOLIS	VN12249458	VIANOPOLIS	27/02/2020 11:46	27/02/2020 11:57	27/02/2020 11:46	27/02/2020 11:57	0,17	1	0,17	CHI
202002174806	ANAPOLIS	AN21258649	NEROPOLIS S1	27/02/2020 11:47	27/02/2020 16:35	27/02/2020 11:47	27/02/2020 16:35	4,79	1	4,79	CHI
202002174807	GOIANIA	14934152	MEIA PONTE	27/02/2020 11:47	27/02/2020 15:28	27/02/2020 11:47	27/02/2020 15:28	3,68	1	3,68	CHI
202002174813	GUAPO	3040002865	GUAPO S2	27/02/2020 11:49	27/02/2020 15:37	27/02/2020 11:49	27/02/2020 15:37	3,79	1	3,79	CHI
202002174840	GOIANIA	GN11340376	CAMPINAS S1	27/02/2020 11:51	27/02/2020 13:57	27/02/2020 12:00	27/02/2020 13:57	1,95	33	64,36	CHI
202002174841	APARECIDA DE GOIANIA	200369880	INDEPENDENCIA S2	27/02/2020 11:55	27/02/2020 14:55	27/02/2020 11:55	27/02/2020 14:55	3,00	1	3,00	CHI
202002174845	VALPARAISO DE GOIAS	VA11381880	MARAJOARA	27/02/2020 11:55	27/02/2020 16:41	27/02/2020 11:55	27/02/2020 16:41	4,76	85	404,51	CHI
202002174849	APARECIDA DE GOIANIA	10011536975	REAL S1	27/02/2020 11:57	27/02/2020 14:19	27/02/2020 11:57	27/02/2020 14:19	2,36	1	2,36	CHI
202002174856	GOIANIA	GN11001112	CAMPINAS S3	27/02/2020 11:58	27/02/2020 15:08	27/02/2020 11:58	27/02/2020 15:08	3,15	107	337,58	CHI

202002174862	GOIANIA	10010426505	CARAJAS S2	27/02/2020 11:59	27/02/2020 15:42	27/02/2020 11:59	27/02/2020 15:42	3,70	1	3,70	CHI
202002174864	PARAUNA	PU12301185LD	ACREUNA	27/02/2020 12:01	28/02/2020 22:45	27/02/2020 12:01	27/02/2020 17:23	5,36	32	171,42	CHI
202002174864	PARAUNA	PU12301185LD	ACREUNA	27/02/2020 12:01	28/02/2020 22:45	27/02/2020 12:01	28/02/2020 22:45	34,74	37	1285,32	CHI
202002174903	QUIRINOPOLIS	80003837	QUIRINOPOLIS	27/02/2020 12:04	27/02/2020 14:43	27/02/2020 12:04	27/02/2020 14:43	2,64	1	2,64	CHI
202002174909	AGUAS LINDAS DE GOIAS	10003793832	AGUAS LINDAS DE GOIAS S1	27/02/2020 12:07	27/02/2020 14:03	27/02/2020 12:07	27/02/2020 14:03	1,93	1	1,93	CHI
202002174911	GOIANIA	GN21251624	AEROPORTO S3	27/02/2020 12:07	27/02/2020 13:44	27/02/2020 12:07	27/02/2020 13:44	1,61	1	1,61	CHI
202002174913	ANICUNS	10005055294	ANICUNS	27/02/2020 12:07	27/02/2020 18:05	27/02/2020 12:07	27/02/2020 18:05	5,95	1	5,95	CHI
202002174914	GOIANIA	GN12002215	CAMPINAS S3	27/02/2020 12:07	27/02/2020 13:54	27/02/2020 12:07	27/02/2020 13:54	1,78	932	1662,84	CHI
202002174927	APORE	AE12000051	ITAJA S1	27/02/2020 12:10	27/02/2020 18:42	27/02/2020 12:10	27/02/2020 18:42	6,52	34	221,77	CHI
202002174935	ARAGOIANIA	AO32030329	GUAPO S2	27/02/2020 12:14	27/02/2020 15:17	27/02/2020 12:14	27/02/2020 15:17	3,05	10	30,48	CHI
202002174967	QUIRINOPOLIS	80077286	QUIRINOPOLIS	27/02/2020 12:24	27/02/2020 14:23	27/02/2020 12:24	27/02/2020 14:23	1,98	1	1,98	CHI
202002174975	ARUANA	AK12078438	MOZARLANDIA	27/02/2020 12:29	28/02/2020 13:05	27/02/2020 12:29	28/02/2020 13:05	24,60	80	1968,36	CHI
202002174980	ANAPOLIS	AN21325297	ANAPOLIS UNIVERSITARIO S2	27/02/2020 12:32	27/02/2020 14:19	27/02/2020 12:32	27/02/2020 14:19	1,78	2	3,56	CHI
202002174994	CAIAPONIA	CP12403685	CAIAPONIA	27/02/2020 12:37	28/02/2020 17:31	27/02/2020 12:37	28/02/2020 17:31	28,90	1	28,90	CHI
202002175008	GOIANESIA	550051259	GOIANESIA S2	27/02/2020 12:41	27/02/2020 19:33	27/02/2020 12:41	27/02/2020 19:33	6,86	1	6,86	CHI
202002175017	GOUVELANDIA	GB21248256	QUIRINOPOLIS	27/02/2020 12:43	27/02/2020 20:13	27/02/2020 12:43	27/02/2020 20:13	7,49	1	7,49	CHI
202002175020	ESTRELA DO NORTE	ET12256551	MARA ROSA	27/02/2020 12:44	27/02/2020 20:05	27/02/2020 12:44	27/02/2020 20:05	7,34	9	66,08	CHI
202002175032	AGUAS LINDAS DE GOIAS	LA11346463	AGUAS LINDAS DE GOIAS S1	27/02/2020 12:09	27/02/2020 14:22	27/02/2020 12:09	27/02/2020 14:22	2,21	206	455,37	CHI
202002175044	PIRENOPOLIS	PV21278855	CORUMBA	27/02/2020 12:51	27/02/2020 15:56	27/02/2020 12:51	27/02/2020 15:56	3,08	1	3,08	CHI
202002175055	NOVO PLANALTO	TA12293712	SAO MIGUEL DO ARAGUAIA	27/02/2020 12:57	27/02/2020 16:02	27/02/2020 12:57	27/02/2020 16:02	3,08	10	30,83	CHI
202002175058	URUTAI	UT121207645	URUTAI	27/02/2020 12:58	27/02/2020 15:18	27/02/2020 12:58	27/02/2020 15:18	2,33	1	2,33	CHI
202002175062	PIRACANJUBA	PJ12212173	PIRACANJUBA	27/02/2020 12:58	27/02/2020 14:40	27/02/2020 12:58	27/02/2020 14:40	1,70	19	32,22	CHI
202002175065	GOIAS	GS12198785	GOIAS	27/02/2020 12:59	27/02/2020 17:29	27/02/2020 12:59	27/02/2020 17:29	4,49	8	35,91	CHI
202002175065	GUARAITA	GS12198785	GOIAS	27/02/2020 12:59	27/02/2020 17:29	27/02/2020 12:59	27/02/2020 17:29	4,49	2	8,98	CHI
202002175065	ITAPURANGA	GS12198785	GOIAS	27/02/2020 12:59	27/02/2020 17:29	27/02/2020 12:59	27/02/2020 17:29	4,49	2	8,98	CHI
202002175079	NOVA CRIXAS	NA12057181	MOZARLANDIA	27/02/2020 13:04	28/02/2020 12:36	27/02/2020 13:04	28/02/2020 12:36	23,55	6	141,28	CHI
202002175079	CRIXAS	NA12057181	MOZARLANDIA	27/02/2020 13:04	28/02/2020 12:36	28/02/2020 11:15	28/02/2020 12:36	1,36	2	2,73	CHI
202002175079	NOVA CRIXAS	NA12057181	MOZARLANDIA	27/02/2020 13:04	28/02/2020 12:36	28/02/2020 11:15	28/02/2020 12:36	1,36	48	65,51	CHI
202002175089	NOVA CRIXAS	NA12057201	MOZARLANDIA	27/02/2020 13:08	27/02/2020 15:40	27/02/2020 13:08	27/02/2020 15:40	2,53	11	27,82	CHI
202002175090	GOIANESIA	550007088	GOIANESIA S2	27/02/2020 13:08	27/02/2020 19:34	27/02/2020 13:08	27/02/2020 19:34	6,43	1	6,43	CHI
202002175093	CEZARINA	CZ11076512	CEZARINA	27/02/2020 13:03	27/02/2020 16:21	27/02/2020 13:03	27/02/2020 16:21	3,29	270	887,10	CHI
202002175096	SILVANIA	SV12287460	VIANOPOLIS	27/02/2020 13:10	27/02/2020 16:28	27/02/2020 13:10	27/02/2020 16:28	0,98	84	81,92	CHI
202002175098	APARECIDA DE GOIANIA	AP11138923	REAL S1	27/02/2020 12:47	27/02/2020 15:43	27/02/2020 12:47	27/02/2020 15:43	2,93	179	524,27	CHI
202002175104	UIRAPURU	UP21333195	SANTA TEREZINHA	27/02/2020 13:09	27/02/2020 16:09	27/02/2020 13:09	27/02/2020 16:09	2,99	1	2,99	CHI
202002175105	TRINDADE	TR12093220LD	TRINDADE	27/02/2020 13:11	27/02/2020 16:51	27/02/2020 13:11	27/02/2020 16:51	3,66	1996	7298,71	CHI
202002175109	BARRO ALTO	BA21210771	GOIANESIA S1	27/02/2020 13:12	27/02/2020 17:38	27/02/2020 13:12	27/02/2020 17:38	4,42	1	4,42	CHI
202002175115	CRISTALINA	KR11276403	CRISTALINA S2	27/02/2020 13:13	27/02/2020 15:29	27/02/2020 13:13	27/02/2020 15:29	2,25	1	2,25	CHI
202002175120	JARAGUA	JA21124470	JARAGUA	27/02/2020 13:15	27/02/2020 17:01	27/02/2020 13:15	27/02/2020 17:01	3,76	3	11,28	CHI
202002175123	PETROLINA DE GOIAS	PG12070558	PETROLINA	27/02/2020 13:16	27/02/2020 16:57	27/02/2020 13:16	27/02/2020 16:57	3,68	1	3,68	CHI
202002175127	LUZIANIA	3200016976	MARAJOARA	27/02/2020 13:16	27/02/2020 16:51	27/02/2020 13:16	27/02/2020 16:51	3,57	1	3,57	CHI
202002175128	JATAI	JT21156143	JATAI S1	27/02/2020 13:17	27/02/2020 16:05	27/02/2020 13:17	27/02/2020 16:05	2,80	1	2,80	CHI
202002175135	JATAI	JT21378122	JATAI S1	27/02/2020 13:18	27/02/2020 17:09	27/02/2020 13:18	27/02/2020 17:09	3,85	1	3,85	CHI
202002175136	GOIANIA	15478774	GOIANIA LESTE S2	27/02/2020 13:18	27/02/2020 16:24	27/02/2020 13:18	27/02/2020 16:24	3,09	1	3,09	CHI
202002175141	PARANAIGUARA	PC21193920	QUIRINOPOLIS	27/02/2020 13:19	28/02/2020 00:35	27/02/2020 13:19	28/02/2020 00:35	11,25	1	11,25	CHI

202002175143	EDEIA	TD21191948	ACREUNA	27/02/2020 13:20	28/02/2020 10:52	27/02/2020 13:20	28/02/2020 10:52	21,52	5	107,61	CHI
202002175146	CALDAS NOVAS	CN12263369	CALDAS NOVAS S2	27/02/2020 13:21	27/02/2020 16:01	27/02/2020 13:21	27/02/2020 16:01	2,66	23	61,20	CHI
202002175157	RIO VERDE	630489488	RIO VERDE S2	27/02/2020 13:25	28/02/2020 17:06	27/02/2020 13:25	28/02/2020 17:06	27,67	1	27,67	CHI
202002175158	GOIANIA	GN11216354	CAMPINAS S2	27/02/2020 13:27	27/02/2020 14:38	27/02/2020 13:27	27/02/2020 14:38	1,18	82	96,60	CHI
202002175160	SANCLERLANDIA	SC21315011	FIRMINOPOLIS S2	27/02/2020 13:27	27/02/2020 17:07	27/02/2020 13:27	27/02/2020 17:07	3,66	1	3,66	CHI
202002175164	APARECIDA DE GOIANIA	15433638	INDEPENDENCIA S1	27/02/2020 13:28	27/02/2020 15:39	27/02/2020 13:28	27/02/2020 15:39	2,17	1	2,17	CHI
202002175168	ANAPOLIS	20027795	ANAPOLIS UNIVERSITARIO S2	27/02/2020 13:29	27/02/2020 17:15	27/02/2020 13:29	27/02/2020 17:15	3,75	1	3,75	CHI
202002175172	QUIRINOPOLIS	10025248608	QUIRINOPOLIS	27/02/2020 13:30	27/02/2020 14:57	27/02/2020 13:30	27/02/2020 14:57	1,44	1	1,44	CHI
202002175173	ARUANA	10024747082	ARUANA	27/02/2020 13:29	27/02/2020 16:21	27/02/2020 13:29	27/02/2020 16:21	2,86	1	2,86	CHI
202002175174	GOIANIA	GN11326265	GOIANIA LESTE S3	27/02/2020 13:31	27/02/2020 15:49	27/02/2020 15:45	27/02/2020 15:49	0,07	40	2,67	CHI
202002175175	GOIANIA	GN12234934	CARAJAS S1	27/02/2020 13:31	27/02/2020 15:03	27/02/2020 13:31	27/02/2020 15:03	1,52	3	4,55	CHI
202002175176	DISTRITO FEDERAL	SN12053556	MARAJOARA	27/02/2020 13:32	27/02/2020 17:38	27/02/2020 13:32	27/02/2020 17:38	4,09	49	200,60	CHI
202002175176	SANTO ANTONIO DO DESCOBERTO	SN12053556	MARAJOARA	27/02/2020 13:32	27/02/2020 17:38	27/02/2020 13:32	27/02/2020 17:38	4,09	21	85,97	CHI
202002175189	GOIANIA	GN12034152LD	CAMPINAS S2	27/02/2020 13:27	27/02/2020 15:04	27/02/2020 13:27	27/02/2020 15:04	1,61	437	702,72	CHI
202002175192	JATAI	JT21211181	JATAI S1	27/02/2020 13:35	27/02/2020 22:13	27/02/2020 13:35	27/02/2020 22:13	8,62	2	17,24	CHI
202002175195	MAURILANDIA	ML11286253	RIO DOS BOIS	27/02/2020 12:56	27/02/2020 17:48	27/02/2020 12:56	27/02/2020 17:48	4,87	96	467,15	CHI
202002175197	SANTO ANTONIO DO DESCOBERTO	SN21253957	ALEXANIA	27/02/2020 13:37	27/02/2020 15:54	27/02/2020 13:37	27/02/2020 15:54	2,28	1	2,28	CHI
202002175199	BELA VISTA DE GOIAS	BV21117053	BELA VISTA S1	27/02/2020 13:37	27/02/2020 16:17	27/02/2020 13:37	27/02/2020 16:17	2,65	3	7,96	CHI
202002175200	CRISTALINA	KR21385519	CRISTALINA S2	27/02/2020 13:37	27/02/2020 15:00	27/02/2020 13:37	27/02/2020 15:00	1,37	2	2,74	CHI
202002175201	BURITI ALEGRE	BG12263593	ITUMBIARA VELHA S2	27/02/2020 13:37	27/02/2020 18:10	27/02/2020 13:37	27/02/2020 18:10	4,53	4	18,14	CHI
202002175202	FORMOSA	FA12041996	ITUIQUIRA	27/02/2020 13:38	27/02/2020 14:41	27/02/2020 13:38	27/02/2020 14:41	1,05	412	432,26	CHI
202002175205	ANAPOLIS	20285267	ANAPOLIS UNIVERSITARIO S2	27/02/2020 13:38	27/02/2020 20:51	27/02/2020 13:38	27/02/2020 20:51	7,20	1	7,20	CHI
202002175211	SANTO ANTONIO DO DESCOBERTO	2210000215	AGUAS LINDAS DE GOIAS S2	27/02/2020 13:40	27/02/2020 15:49	27/02/2020 13:40	27/02/2020 15:49	2,14	1	2,14	CHI
202002175218	RIO VERDE	RV21190701	CABRIUVA S2	27/02/2020 13:41	27/02/2020 21:18	27/02/2020 13:41	27/02/2020 21:18	7,60	2	15,21	CHI
202002175219	GOIAS	GS21090859	GOIAS	27/02/2020 13:41	27/02/2020 15:09	27/02/2020 13:41	27/02/2020 15:09	1,45	1	1,45	CHI
202002175221	GOIANIA	GN11170689	INDEPENDENCIA S2	27/02/2020 13:39	27/02/2020 15:38	27/02/2020 13:39	27/02/2020 15:38	1,98	247	488,10	CHI
202002175222	INHUMAS	IN11365551	INHUMAS S2	27/02/2020 13:12	27/02/2020 15:02	27/02/2020 13:12	27/02/2020 15:02	1,82	76	138,49	CHI
202002175227	CHAPADAO DO CEU	DJ21136030	CHAPADAO DO CEU	27/02/2020 13:44	27/02/2020 19:13	27/02/2020 13:44	27/02/2020 19:13	5,47	2	10,94	CHI
202002175228	AMERICANO DO BRASIL	KB11000004	ANICUNS	27/02/2020 11:48	27/02/2020 16:08	27/02/2020 11:48	27/02/2020 16:08	4,32	58	250,53	CHI
202002175229	PIRANHAS	PH12245929	ARENOPOLIS	27/02/2020 13:45	27/02/2020 17:20	27/02/2020 13:45	27/02/2020 17:20	3,58	8	28,64	CHI
202002175230	CALDAS NOVAS	CN11309401	CALDAS NOVAS S2	27/02/2020 13:21	27/02/2020 15:56	27/02/2020 13:21	27/02/2020 15:56	2,58	49	126,53	CHI
202002175232	ALEXANIA	SN12382967	MARAJOARA	27/02/2020 12:51	27/02/2020 15:13	27/02/2020 12:51	27/02/2020 15:13	2,36	1	2,36	CHI
202002175232	SANTO ANTONIO DO DESCOBERTO	SN12382967	MARAJOARA	27/02/2020 12:51	27/02/2020 15:13	27/02/2020 12:51	27/02/2020 15:13	2,36	15	35,35	CHI
202002175236	GOIATUBA	GT12057603	GOIATUBA S2	27/02/2020 13:46	27/02/2020 17:07	27/02/2020 13:46	27/02/2020 17:07	3,35	2	6,69	CHI
202002175237	TRINDADE	TR31050484	TRINDADE	27/02/2020 13:46	27/02/2020 17:34	27/02/2020 13:46	27/02/2020 17:34	3,79	1	3,79	CHI
202002175242	TEREZOPOLIS DE GOIAS	TJ21327828	JUNDIAI S2	27/02/2020 13:47	27/02/2020 18:49	27/02/2020 13:47	27/02/2020 18:49	5,02	1	5,02	CHI
202002175246	PALMEIRAS DE GOIAS	PL21168174	PALMEIRAS	27/02/2020 13:47	27/02/2020 17:41	27/02/2020 13:47	27/02/2020 17:41	3,89	1	3,89	CHI
202002175249	ITAJA	IJ21154804	ITAJA S2	27/02/2020 13:48	27/02/2020 20:30	27/02/2020 13:48	27/02/2020 20:30	6,69	1	6,69	CHI
202002175256	APARECIDA DE GOIANIA	AP12029887	ANHANGUERA	27/02/2020 13:50	27/02/2020 16:15	27/02/2020 13:50	27/02/2020 16:15	2,41	1	2,41	CHI
202002175261	SANTO ANTONIO DO DESCOBERTO	SN12275494	MARAJOARA	27/02/2020 13:52	28/02/2020 17:40	27/02/2020 13:52	28/02/2020 09:16	19,40	3	58,19	CHI
202002175261	SANTO ANTONIO DO DESCOBERTO	SN12275494	MARAJOARA	27/02/2020 13:52	28/02/2020 17:40	27/02/2020 13:52	28/02/2020 13:45	23,89	4	95,55	CHI
202002175261	SANTO ANTONIO DO DESCOBERTO	SN12275494	MARAJOARA	27/02/2020 13:52	28/02/2020 17:40	28/02/2020 13:00	28/02/2020 13:45	0,75	3	2,24	CHI
202002175261	SANTO ANTONIO DO DESCOBERTO	SN32082892	MARAJOARA	27/02/2020 13:52	28/02/2020 17:40	27/02/2020 13:52	28/02/2020 17:40	27,80	1	27,80	CHI
202002175264	ORIZONA	6771772	PIRES DO RIO S2	27/02/2020 13:52	28/02/2020 13:24	27/02/2020 13:52	28/02/2020 13:24	23,52	2	47,04	CHI

202002175266	MINEIROS	1390015728	PARQUE DAS EMAS	27/02/2020 13:53	28/02/2020 09:30	27/02/2020 13:53	28/02/2020 09:30	19,61	1	19,61	CHI
202002175269	CIDADE OCIDENTAL	LZ21061791	MARAJOARA	27/02/2020 13:54	27/02/2020 18:24	27/02/2020 13:54	27/02/2020 18:24	4,50	1	4,50	CHI
202002175272	ANAPOLIS	20831523	ANAPOLIS UNIVERSITARIO S2	27/02/2020 13:54	27/02/2020 21:26	27/02/2020 13:54	27/02/2020 21:26	7,52	1	7,52	CHI
202002175275	ITAPIRAPUA	IU12073722	MATRINCHA	27/02/2020 12:39	27/02/2020 18:59	27/02/2020 12:39	27/02/2020 18:59	6,33	3	18,98	CHI
202002175283	JATAI	JT12109029	JATAI S1	27/02/2020 13:51	27/02/2020 19:03	27/02/2020 13:51	27/02/2020 19:03	5,19	28	145,21	CHI
202002175290	DOVERLANDIA	DV11193282	CAIAPONIA	27/02/2020 13:58	27/02/2020 18:23	27/02/2020 17:25	27/02/2020 18:23	0,97	40	38,67	CHI
202002175291	CAMPO ALEGRE DE GOIAS	CM21231726	CAMPO ALEGRE DE GOIAS	27/02/2020 13:59	28/02/2020 11:10	27/02/2020 13:59	28/02/2020 11:10	21,18	1	21,18	CHI
202002175294	GOIANIA	16027437	INDEPENDENCIA S2	27/02/2020 14:00	27/02/2020 16:29	27/02/2020 14:00	27/02/2020 16:29	2,48	1	2,48	CHI
202002175295	APORE	AE21296571	ITAJA S2	27/02/2020 14:00	27/02/2020 20:01	27/02/2020 14:00	27/02/2020 20:01	6,01	1	6,01	CHI
202002175303	GOIANIA	GN11129562	CAMPINAS S2	27/02/2020 13:47	27/02/2020 17:08	27/02/2020 13:47	27/02/2020 17:08	3,34	78	260,87	CHI
202002175307	GOIATUBA	GT21048486	GOIATUBA S1	27/02/2020 14:04	27/02/2020 19:02	27/02/2020 14:04	27/02/2020 19:02	4,96	2	9,92	CHI
202002175315	EDEIA	1120046560	EDEIA	27/02/2020 14:07	27/02/2020 19:34	27/02/2020 14:07	27/02/2020 19:34	5,43	1	5,43	CHI
202002175320	MINEIROS	1390067881	PARQUE DAS EMAS	27/02/2020 14:09	27/02/2020 18:35	27/02/2020 14:09	27/02/2020 18:35	4,45	1	4,45	CHI
202002175329	ORIZONA	2060031054	PIRES DO RIO S2	27/02/2020 14:12	27/02/2020 19:32	27/02/2020 14:12	27/02/2020 19:32	5,34	1	5,34	CHI
202002175602	QUIRINOPOLIS	QI31035318	QUIRINOPOLIS	27/02/2020 14:13	27/02/2020 17:05	27/02/2020 14:13	27/02/2020 17:05	2,86	1	2,86	CHI
202002175603	SANTO ANTONIO DO DESCOBERTO	SN21078143	MARAJOARA	27/02/2020 14:13	27/02/2020 19:14	27/02/2020 14:13	27/02/2020 19:14	5,02	1	5,02	CHI
202002175607	ITAPIRAPUA	IU12018846	MATRINCHA	27/02/2020 13:01	27/02/2020 19:13	27/02/2020 13:01	27/02/2020 19:13	6,19	4	24,76	CHI
202002175609	VALPARAISO DE GOIAS	2860097680	MARAJOARA	27/02/2020 14:16	27/02/2020 19:09	27/02/2020 14:16	27/02/2020 19:09	4,87	1	4,87	CHI
202002175611	HIDROLANDIA	HD12007391	CEPAIGO S2	27/02/2020 14:16	27/02/2020 18:23	27/02/2020 14:16	27/02/2020 18:23	4,10	11	45,13	CHI
202002175625	RIO VERDE	630411591	RIO VERDE S1	27/02/2020 14:19	28/02/2020 12:46	27/02/2020 14:19	28/02/2020 12:46	22,45	1	22,45	CHI
202002175627	CATURAI	CK21037991	ARACU	27/02/2020 14:19	27/02/2020 16:54	27/02/2020 14:19	27/02/2020 16:54	2,58	1	2,58	CHI
202002175631	ITAPURANGA	170022754	ITAPURANGA	27/02/2020 14:20	27/02/2020 15:54	27/02/2020 14:20	27/02/2020 15:54	1,56	1	1,56	CHI
202002175633	IPAMERI	IP21013492	URUTAI	27/02/2020 14:20	27/02/2020 22:51	27/02/2020 14:20	27/02/2020 22:51	8,51	1	8,51	CHI
202002175638	SENADOR CANEDO	10013544266	GOIANIA LESTE S1	27/02/2020 14:22	27/02/2020 16:30	27/02/2020 14:22	27/02/2020 16:30	2,13	1	2,13	CHI
202002175639	BRITANIA	2110022500	BRITANIA	27/02/2020 14:22	28/02/2020 07:24	27/02/2020 14:22	28/02/2020 07:24	17,02	1	17,02	CHI
202002175647	URUTAI	UT12107860	URUTAI	27/02/2020 14:23	27/02/2020 21:17	27/02/2020 14:23	27/02/2020 21:17	6,89	1	6,89	CHI
202002175650	GOIANESIA	GE12115090	GOIANESIA S2	27/02/2020 14:24	27/02/2020 16:35	27/02/2020 14:24	27/02/2020 16:35	2,18	295	644,00	CHI
202002175653	CABECEIRAS	CW21342458	ITUIQUIRA	27/02/2020 14:24	27/02/2020 16:24	27/02/2020 14:24	27/02/2020 16:24	2,00	1	2,00	CHI
202002175656	GOIANIA	SW12343204	GOIANIA LESTE S2	27/02/2020 14:24	27/02/2020 17:46	27/02/2020 14:24	27/02/2020 17:46	3,35	4	13,41	CHI
202002175658	GOIANESIA	10020926713	GOIANESIA S2	27/02/2020 14:25	27/02/2020 20:48	27/02/2020 14:25	27/02/2020 20:48	6,39	1	6,39	CHI
202002175660	ALTO HORIZONTE	AJ12143571	MARA ROSA	27/02/2020 14:26	27/02/2020 16:40	27/02/2020 14:26	27/02/2020 16:40	2,23	37	82,60	CHI
202002175660	MARA ROSA	AJ12143571	MARA ROSA	27/02/2020 14:26	27/02/2020 16:40	27/02/2020 14:26	27/02/2020 16:40	2,23	5	11,16	CHI
202002175660	NOVA IGUACU DE GOIAS	AJ12143571	MARA ROSA	27/02/2020 14:26	27/02/2020 16:40	27/02/2020 14:26	27/02/2020 16:40	2,23	12	26,79	CHI
202002175661	AGUAS LINDAS DE GOIAS	10001995683	AGUAS LINDAS DE GOIAS S1	27/02/2020 14:27	27/02/2020 15:40	27/02/2020 14:27	27/02/2020 15:40	1,21	1	1,21	CHI
202002175662	INHUMAS	IN21247255	INHUMAS S2	27/02/2020 14:27	27/02/2020 18:53	27/02/2020 14:27	27/02/2020 18:53	4,43	1	4,43	CHI
202002175667	GUAPO	GA11382711	GUAPO S1	27/02/2020 14:28	28/02/2020 09:57	27/02/2020 14:28	28/02/2020 09:57	19,48	5	97,41	CHI
202002175669	GOIANIA	GN12002215	CAMPINAS S3	27/02/2020 14:06	27/02/2020 15:08	27/02/2020 14:06	27/02/2020 15:08	1,02	932	953,49	CHI
202002175673	CROMINIA	CQ21100127	PONTALINA	27/02/2020 14:29	27/02/2020 16:40	27/02/2020 14:29	27/02/2020 16:40	2,17	2	4,34	CHI
202002175677	GUARAITA	GK21289032	ITAPURANGA	27/02/2020 14:31	27/02/2020 20:17	27/02/2020 14:31	27/02/2020 20:17	5,77	1	5,77	CHI
202002175678	FORMOSA	610026124	ITUIQUIRA	27/02/2020 14:31	27/02/2020 16:58	27/02/2020 14:31	27/02/2020 16:58	2,45	1	2,45	CHI
202002175679	PORANGATU	PO21100746	PORANGATU	27/02/2020 14:31	27/02/2020 23:43	27/02/2020 14:31	27/02/2020 23:43	9,19	1	9,19	CHI
202002175681	MAMBAI	MB11302664	IACIARA S2	27/02/2020 14:31	27/02/2020 18:35	27/02/2020 14:31	27/02/2020 18:35	4,05	12	48,62	CHI
202002175682	JATAI	JT12234494	JATAI S3	27/02/2020 14:32	27/02/2020 17:14	27/02/2020 14:32	27/02/2020 17:14	2,70	4	10,78	CHI
202002175684	GOIANIA	17324543	GOYA S1	27/02/2020 14:32	27/02/2020 15:45	27/02/2020 14:32	27/02/2020 15:45	1,20	1	1,20	CHI

202002175685	SILVANIA	SV21339144	VIANOPOLIS	27/02/2020 14:33	27/02/2020 17:03	27/02/2020 14:33	27/02/2020 17:03	2,49	2	4,99	CHI
202002175696	PLANALTINA	PI11130059	PLANALTINA	27/02/2020 14:29	27/02/2020 16:10	27/02/2020 14:29	27/02/2020 16:10	1,67	159	265,66	CHI
202002175699	TRINDADE	TR32001819	TRINDADE	27/02/2020 14:37	27/02/2020 16:57	27/02/2020 14:37	27/02/2020 16:57	2,32	2	4,65	CHI
202002175700	MOZARLANDIA	MZ12058538	MOZARLANDIA	27/02/2020 12:22	27/02/2020 19:03	27/02/2020 12:22	27/02/2020 19:03	6,68	7	46,77	CHI
202002175704	EDEALINA	EA13282645	VICENTINOPOLIS	27/02/2020 14:30	27/02/2020 17:58	27/02/2020 14:30	27/02/2020 17:58	3,46	15	51,92	CHI
202002175704	EDEIA	EA13282645	VICENTINOPOLIS	27/02/2020 14:30	27/02/2020 17:58	27/02/2020 14:30	27/02/2020 17:58	3,46	32	110,76	CHI
202002175704	PONTALINA	EA13282645	VICENTINOPOLIS	27/02/2020 14:30	27/02/2020 17:58	27/02/2020 14:30	27/02/2020 17:58	3,46	1	3,46	CHI
202002175704	VICENTINOPOLIS	EA13282645	VICENTINOPOLIS	27/02/2020 14:30	27/02/2020 17:58	27/02/2020 14:30	27/02/2020 17:58	3,46	2	6,92	CHI
202002175706	VIANOPOLIS	VN21280813	VIANOPOLIS	27/02/2020 14:38	27/02/2020 18:07	27/02/2020 14:38	27/02/2020 18:07	3,47	1	3,47	CHI
202002175707	ITABERAI	IB21299032	ANICUNS	27/02/2020 14:39	27/02/2020 20:40	27/02/2020 14:39	27/02/2020 20:40	6,01	1	6,01	CHI
202002175708	FORMOSA	FA21207285	ITIQUEIRA	27/02/2020 14:39	27/02/2020 18:20	27/02/2020 14:39	27/02/2020 18:20	3,67	3	11,02	CHI
202002175710	RIO VERDE	RV12214126	RIO VERDE S1	27/02/2020 13:37	28/02/2020 17:23	27/02/2020 13:37	28/02/2020 02:30	12,87	42	540,49	CHI
202002175710	SANTA HELENA DE GOIAS	RV12214126	RIO VERDE S1	27/02/2020 13:37	28/02/2020 17:23	27/02/2020 13:37	28/02/2020 02:30	12,87	25	321,72	CHI
202002175710	RIO VERDE	SH32159320LD	RIO VERDE S1	27/02/2020 13:37	28/02/2020 17:23	27/02/2020 13:37	28/02/2020 17:23	27,76	29	805,12	CHI
202002175710	SANTA HELENA DE GOIAS	SH32159320LD	RIO VERDE S1	27/02/2020 13:37	28/02/2020 17:23	27/02/2020 13:37	28/02/2020 17:23	27,76	20	555,26	CHI
202002175722	JUSSARA	JR21120636	JUSSARA	27/02/2020 14:42	28/02/2020 00:32	27/02/2020 14:42	28/02/2020 00:32	9,83	2	19,67	CHI
202002175725	ALEXANIA	7850002695	ALEXANIA	27/02/2020 14:42	27/02/2020 16:45	27/02/2020 14:42	27/02/2020 16:45	2,03	1	2,03	CHI
202002175730	CAIAPONIA	CP11287562	PALESTINA	27/02/2020 14:44	28/02/2020 16:29	27/02/2020 14:44	28/02/2020 16:29	25,75	1	25,75	CHI
202002175732	CACHOEIRA DOURADA	CD21000310	CACHOEIRA DOURADA	27/02/2020 14:44	27/02/2020 17:41	27/02/2020 14:44	27/02/2020 17:41	2,94	1	2,94	CHI
202002175742	SAO MIGUEL DO ARAGUAIA	SM12262623	SAO MIGUEL DO ARAGUAIA	27/02/2020 14:48	27/02/2020 20:27	27/02/2020 14:48	27/02/2020 20:27	5,65	3	16,95	CHI
202002175744	BRAZABRANTES	BR21324982	INHUMAS S2	27/02/2020 14:48	27/02/2020 16:57	27/02/2020 14:48	27/02/2020 16:57	2,14	1	2,14	CHI
202002175746	QUIRINOPOLIS	QI21143161	QUIRINOPOLIS	27/02/2020 14:49	27/02/2020 16:13	27/02/2020 14:49	27/02/2020 16:13	1,40	1	1,40	CHI
202002175748	IPAMERI	IP12112268	PIRES DO RIO S2	27/02/2020 13:53	28/02/2020 12:17	27/02/2020 13:53	28/02/2020 12:17	22,40	20	447,92	CHI
202002175749	GOIANESIA	550119310	GOIANESIA S2	27/02/2020 14:49	27/02/2020 19:13	27/02/2020 14:49	27/02/2020 19:13	4,39	1	4,39	CHI
202002175752	SANTA CRUZ DE GOIAS	BC12040850	PIRES DO RIO S2	27/02/2020 14:49	27/02/2020 18:28	27/02/2020 14:49	27/02/2020 18:28	3,65	1	3,65	CHI
202002175754	APARECIDA DE GOIANIA	200360115	INDEPENDENCIA S1	27/02/2020 14:49	27/02/2020 16:15	27/02/2020 14:49	27/02/2020 16:15	1,42	1	1,42	CHI
202002175755	ITAPURANGA	IK21024757	ITAPURANGA	27/02/2020 14:49	27/02/2020 18:28	27/02/2020 14:49	27/02/2020 18:28	3,64	1	3,64	CHI
202002175759	SAO DOMINGOS	SD12218814	SAO DOMINGOS	27/02/2020 14:48	27/02/2020 18:40	27/02/2020 14:48	27/02/2020 18:40	3,86	7	26,99	CHI
202002175764	FORMOSA	FA11000043	ITIQUEIRA	27/02/2020 14:50	27/02/2020 18:50	27/02/2020 14:50	27/02/2020 17:11	2,33	71	165,77	CHI
202002175764	FORMOSA	FA11000043	ITIQUEIRA	27/02/2020 14:50	27/02/2020 18:50	27/02/2020 17:12	27/02/2020 18:50	1,62	71	115,34	CHI
202002175765	CAMPINORTE	CR12172326	MARA ROSA	27/02/2020 14:51	28/02/2020 15:58	27/02/2020 14:51	28/02/2020 15:58	25,11	4	100,45	CHI
202002175765	FORMOSO	CR12172326	MARA ROSA	27/02/2020 14:51	28/02/2020 15:58	27/02/2020 14:51	28/02/2020 15:58	25,11	3	75,34	CHI
202002175773	ITABERAI	IB21018339	ITABERAI S2	27/02/2020 14:52	27/02/2020 19:47	27/02/2020 14:52	27/02/2020 19:47	4,90	3	14,71	CHI
202002175776	MONTE ALEGRE DE GOIAS	MA12211597	SAO DOMINGOS	27/02/2020 14:53	27/02/2020 16:47	27/02/2020 14:53	27/02/2020 16:47	1,90	10	18,95	CHI
202002175777	IPAMERI	IP21332847	URUTAI	27/02/2020 14:53	27/02/2020 23:16	27/02/2020 14:53	27/02/2020 23:16	8,37	1	8,37	CHI
202002175779	COCALZINHO DE GOIAS	ZN12302401	COCALZINHO	27/02/2020 14:50	27/02/2020 17:04	27/02/2020 14:50	27/02/2020 17:04	2,22	4	8,87	CHI
202002175779	CORUMBA DE GOIAS	ZN12302401	COCALZINHO	27/02/2020 14:50	27/02/2020 17:04	27/02/2020 14:50	27/02/2020 17:04	2,22	22	48,80	CHI
202002175780	RUBIATABA	780031362	RUBIATABA	27/02/2020 14:54	27/02/2020 16:54	27/02/2020 14:54	27/02/2020 16:54	1,99	1	1,99	CHI
202002175781	CAMPINORTE	2040001433	CAMPINORTE	27/02/2020 14:55	27/02/2020 16:49	27/02/2020 14:55	27/02/2020 16:49	1,90	1	1,90	CHI
202002175790	PIRES DO RIO	PR12337227	PIRES DO RIO S1	27/02/2020 14:58	27/02/2020 19:35	27/02/2020 14:58	27/02/2020 19:35	4,60	40	184,04	CHI
202002175790	SANTA CRUZ DE GOIAS	PR12337227	PIRES DO RIO S1	27/02/2020 14:58	27/02/2020 19:35	27/02/2020 14:58	27/02/2020 19:35	4,60	1	4,60	CHI
202002175790	URUTAI	PR12337227	PIRES DO RIO S1	27/02/2020 14:58	27/02/2020 19:35	27/02/2020 14:58	27/02/2020 19:35	4,60	1	4,60	CHI
202002175792	MINACU	IH21132464	MINACU	27/02/2020 14:59	28/02/2020 09:08	27/02/2020 14:59	28/02/2020 09:08	18,14	1	18,14	CHI
202002175793	GOIANIA	17289180	GOYA S2	27/02/2020 14:59	27/02/2020 16:21	27/02/2020 14:59	27/02/2020 16:21	1,36	1	1,36	CHI

202002175794	CAMPO ALEGRE DE GOIAS	CM21077542	CAMPO ALEGRE DE GOIAS	27/02/2020 14:59	27/02/2020 16:22	27/02/2020 14:59	27/02/2020 16:22	1,37	1	1,37	CHI
202002175797	ITABERAÍ	50130468	ITABERAÍ S2	27/02/2020 15:00	27/02/2020 16:06	27/02/2020 15:00	27/02/2020 16:06	1,09	1	1,09	CHI
202002175802	NOVA CRIXAS	NA21213039	NOVA CRIXAS	27/02/2020 15:01	28/02/2020 13:31	27/02/2020 15:01	28/02/2020 13:31	22,50	1	22,50	CHI
202002175811	GOIANIA	10014617909	FERROVIARIO S2	27/02/2020 15:03	27/02/2020 17:39	27/02/2020 15:03	27/02/2020 17:39	2,59	1	2,59	CHI
202002175813	MORRINHOS	10030631910	MORRINHOS	27/02/2020 15:03	27/02/2020 17:05	27/02/2020 15:03	27/02/2020 17:05	2,03	1	2,03	CHI
202002175821	BELA VISTA DE GOIAS	BV12402717	BELA VISTA S1	27/02/2020 15:07	27/02/2020 17:44	27/02/2020 15:07	27/02/2020 17:44	2,61	1	2,61	CHI
202002175827	NOVA ROMA	ND21159882	IACIARA S2	27/02/2020 15:09	27/02/2020 17:04	27/02/2020 15:09	27/02/2020 17:04	1,91	1	1,91	CHI
202002175834	SAO LUIS DE MONTES BELOS	SL10400789	SAO LUIZ DOS MONTES BELOS	27/02/2020 15:06	29/02/2020 16:30	27/02/2020 15:06	28/02/2020 19:47	28,69	5	143,44	CHI
202002175834	AURILANDIA	SL12003839	SAO LUIZ DOS MONTES BELOS	27/02/2020 15:06	29/02/2020 16:30	27/02/2020 15:06	28/02/2020 20:10	29,06	16	465,01	CHI
202002175834	SAO LUIS DE MONTES BELOS	SL12003839	SAO LUIZ DOS MONTES BELOS	27/02/2020 15:06	29/02/2020 16:30	27/02/2020 15:06	28/02/2020 20:10	29,06	9	261,57	CHI
202002175834	AURILANDIA	SL10400789	SAO LUIZ DOS MONTES BELOS	27/02/2020 15:06	29/02/2020 16:30	27/02/2020 15:06	29/02/2020 00:27	33,35	8	266,82	CHI
202002175834	SAO LUIS DE MONTES BELOS	SL10400789	SAO LUIZ DOS MONTES BELOS	27/02/2020 15:06	29/02/2020 16:30	27/02/2020 15:06	29/02/2020 00:27	33,35	2	66,70	CHI
202002175834	AURILANDIA	SL10400789	SAO LUIZ DOS MONTES BELOS	27/02/2020 15:06	29/02/2020 16:30	28/02/2020 21:53	29/02/2020 00:27	2,56	16	40,91	CHI
202002175834	SAO LUIS DE MONTES BELOS	SL10400789	SAO LUIZ DOS MONTES BELOS	27/02/2020 15:06	29/02/2020 16:30	28/02/2020 21:53	29/02/2020 00:27	2,56	14	35,80	CHI
202002175834	AURILANDIA	SL10400789	SAO LUIZ DOS MONTES BELOS	27/02/2020 15:06	29/02/2020 16:30	27/02/2020 15:06	29/02/2020 15:25	48,33	3	144,99	CHI
202002175834	MOIPORA	SL10400789	SAO LUIZ DOS MONTES BELOS	27/02/2020 15:06	29/02/2020 16:30	27/02/2020 15:06	29/02/2020 15:25	48,33	1	48,33	CHI
202002175834	AURILANDIA	SL10400789	SAO LUIZ DOS MONTES BELOS	27/02/2020 15:06	29/02/2020 16:30	29/02/2020 13:36	29/02/2020 15:25	1,82	24	43,70	CHI
202002175834	SAO LUIS DE MONTES BELOS	SL10400789	SAO LUIZ DOS MONTES BELOS	27/02/2020 15:06	29/02/2020 16:30	29/02/2020 13:36	29/02/2020 15:25	1,82	16	29,13	CHI
202002175834	MOIPORA	AI12206335	SAO LUIZ DOS MONTES BELOS	27/02/2020 15:06	29/02/2020 16:30	27/02/2020 15:06	29/02/2020 15:35	48,48	2	96,96	CHI
202002175834	MOIPORA	MO12259051	SAO LUIZ DOS MONTES BELOS	27/02/2020 15:06	29/02/2020 16:30	27/02/2020 15:06	29/02/2020 15:50	48,73	2	97,46	CHI
202002175834	CORREGO DO OURO	MO12003717LD	SAO LUIZ DOS MONTES BELOS	27/02/2020 15:06	29/02/2020 16:30	27/02/2020 15:06	29/02/2020 15:55	48,81	69	3368,10	CHI
202002175834	MOIPORA	MO12003717LD	SAO LUIZ DOS MONTES BELOS	27/02/2020 15:06	29/02/2020 16:30	27/02/2020 15:06	29/02/2020 15:55	48,81	11	536,94	CHI
202002175834	MOIPORA	MO12003718	SAO LUIZ DOS MONTES BELOS	27/02/2020 15:06	29/02/2020 16:30	27/02/2020 15:06	29/02/2020 16:05	48,98	8	391,84	CHI
202002175834	MOIPORA	MO31193322	SAO LUIZ DOS MONTES BELOS	27/02/2020 15:06	29/02/2020 16:30	27/02/2020 15:06	29/02/2020 16:30	49,41	1	49,41	CHI
202002175835	NOVA ROMA	ND21302759	IACIARA S2	27/02/2020 15:10	27/02/2020 17:20	27/02/2020 15:10	27/02/2020 17:20	2,15	1	2,15	CHI
202002175838	SILVANIA	SV12060971	VIANOPOLIS	27/02/2020 15:11	28/02/2020 10:18	27/02/2020 15:11	28/02/2020 10:18	19,11	4	76,43	CHI
202002175841	GOIANIA	13403965	ATLANTICO S2	27/02/2020 15:12	27/02/2020 18:22	27/02/2020 15:12	27/02/2020 18:22	3,15	1	3,15	CHI
202002175842	JARAGUA	JA12278873	JARAGUA	27/02/2020 15:13	27/02/2020 20:01	27/02/2020 15:13	27/02/2020 20:01	4,80	15	71,98	CHI
202002175847	PIRACANJUBA	PJ12223259	ROCHEDO	27/02/2020 15:14	27/02/2020 17:06	27/02/2020 15:14	27/02/2020 17:06	1,86	47	87,59	CHI
202002175849	OURO VERDE DE GOIAS	370005119	NEROPOLIS S1	27/02/2020 15:09	27/02/2020 17:56	27/02/2020 15:09	27/02/2020 17:56	2,78	1	2,78	CHI
202002175851	AGUAS LINDAS DE GOIAS	LA11375215	AGUAS LINDAS DE GOIAS S1	27/02/2020 15:15	27/02/2020 17:49	27/02/2020 15:15	27/02/2020 17:49	2,57	97	248,97	CHI
202002175852	AGUAS LINDAS DE GOIAS	10008373955	AGUAS LINDAS DE GOIAS S1	27/02/2020 15:15	27/02/2020 16:40	27/02/2020 15:15	27/02/2020 16:40	1,42	1	1,42	CHI
202002175858	GOIANESIA	550147135	GOIANESIA S2	27/02/2020 15:16	27/02/2020 22:40	27/02/2020 15:16	27/02/2020 22:40	7,39	1	7,39	CHI
202002175860	MOIPORA	MO12015679	IPORA	27/02/2020 15:17	28/02/2020 11:00	27/02/2020 15:17	28/02/2020 11:00	19,71	5	98,56	CHI
202002175868	MINACU	IH11202506	MINACU	27/02/2020 15:19	28/02/2020 09:30	27/02/2020 15:19	28/02/2020 09:30	18,18	4	72,73	CHI
202002175870	FORMOSA	FA21062356	ITUIQUIRA	27/02/2020 15:19	27/02/2020 16:47	27/02/2020 15:19	27/02/2020 16:47	1,45	1	1,45	CHI
202002175874	SANTA ISABEL	GE21000152	GOIANESIA S1	27/02/2020 15:20	27/02/2020 21:55	27/02/2020 15:20	27/02/2020 21:55	6,58	1	6,58	CHI
202002175875	URUACU	640057858	URUACU	27/02/2020 15:21	27/02/2020 17:13	27/02/2020 15:21	27/02/2020 17:13	1,86	1	1,86	CHI
202002175881	APARECIDA DE GOIANIA	14237131	INDEPENDENCIA S2	27/02/2020 15:22	27/02/2020 17:23	27/02/2020 15:22	27/02/2020 17:23	2,01	1	2,01	CHI
202002175886	SAO MIGUEL DO PASSA QUATRO	SQ21133375	CRISTIANOPOLIS	27/02/2020 15:23	27/02/2020 20:39	27/02/2020 15:23	27/02/2020 20:39	5,26	1	5,26	CHI
202002175887	CATURAI	250017015	INHUMAS S1	27/02/2020 15:23	28/02/2020 08:11	27/02/2020 15:23	28/02/2020 08:11	16,79	1	16,79	CHI
202002175898	GOIANIA	16885296	GOYA S1	27/02/2020 15:24	27/02/2020 16:39	27/02/2020 15:24	27/02/2020 16:39	1,24	1	1,24	CHI
202002176104	FLORES DE GOIAS	3480002016	FLORES DE GOIAS	27/02/2020 15:25	27/02/2020 17:41	27/02/2020 15:25	27/02/2020 17:41	2,25	1	2,25	CHI
202002176105	ACREUNA	EU21301169	ACREUNA	27/02/2020 15:26	28/02/2020 11:35	27/02/2020 15:26	28/02/2020 11:35	20,15	1	20,15	CHI

202002176107	ARAGUAPAZ	AZ21355890	MATRINCHA	27/02/2020 15:26	27/02/2020 21:41	27/02/2020 15:26	27/02/2020 21:41	6,24	1	6,24	CHI
202002176108	AVELINOPOLIS	AV12299225	TRINDADE	27/02/2020 15:26	28/02/2020 09:21	27/02/2020 15:26	28/02/2020 09:21	17,91	3	53,74	CHI
202002176108	NAZARIO	AV12299225	TRINDADE	27/02/2020 15:26	28/02/2020 09:21	27/02/2020 15:26	28/02/2020 09:21	17,91	7	125,40	CHI
202002176109	CRISTALINA	KR21214806	PAMPLONA	27/02/2020 15:27	28/02/2020 13:30	27/02/2020 15:27	28/02/2020 13:30	22,05	1	22,05	CHI
202002176110	INDIARA	IY12312487	CEZARINA	27/02/2020 15:27	27/02/2020 19:22	27/02/2020 15:27	27/02/2020 19:22	3,91	7	27,40	CHI
202002176111	POSSE	SA21226723	IACIARA S2	27/02/2020 15:27	27/02/2020 19:24	27/02/2020 15:27	27/02/2020 19:24	3,94	5	19,71	CHI
202002176112	JUSSARA	JR12101970RE	BRITANIA	27/02/2020 15:27	28/02/2020 08:54	27/02/2020 15:27	28/02/2020 08:54	17,44	11	191,86	CHI
202002176115	CATALAO	CT21287013	CATALAO S1	27/02/2020 15:28	28/02/2020 10:25	27/02/2020 15:28	28/02/2020 10:25	18,95	1	18,95	CHI
202002176127	CATALAO	GD12127538	CATALAO S1	27/02/2020 15:23	27/02/2020 23:03	27/02/2020 15:23	27/02/2020 23:03	7,65	5	38,27	CHI
202002176127	GOIANDIRA	GD12127538	CATALAO S1	27/02/2020 15:23	27/02/2020 23:03	27/02/2020 15:23	27/02/2020 23:03	7,65	13	99,49	CHI
202002176128	CATALAO	10021561042	CATALAO S2	27/02/2020 15:30	28/02/2020 08:07	27/02/2020 15:30	28/02/2020 08:07	16,62	1	16,62	CHI
202002176132	CATALAO	CT21273137	CATALAO S1	27/02/2020 15:31	28/02/2020 08:29	27/02/2020 15:31	28/02/2020 08:29	16,97	1	16,97	CHI
202002176138	JANDAIA	1180014094	PALMEIRAS	27/02/2020 16:14	27/02/2020 19:57	27/02/2020 16:14	27/02/2020 19:57	3,72	1	3,72	CHI
202002176143	BELA VISTA DE GOIAS	BV21075692	BELA VISTA S1	27/02/2020 15:33	27/02/2020 19:35	27/02/2020 15:33	27/02/2020 19:35	4,02	3	12,06	CHI
202002176147	ABADIANIA	SV12265211	DAIA S2	27/02/2020 15:34	28/02/2020 15:48	27/02/2020 15:34	28/02/2020 15:48	24,24	4	96,96	CHI
202002176147	ANAPOLIS	SV12265211	DAIA S2	27/02/2020 15:34	28/02/2020 15:48	27/02/2020 15:34	28/02/2020 15:48	24,24	4	96,96	CHI
202002176147	GAMELEIRA DE GOIAS	SV12265211	DAIA S2	27/02/2020 15:34	28/02/2020 15:48	27/02/2020 15:34	28/02/2020 15:48	24,24	120	2908,73	CHI
202002176148	SAO LUIS DE MONTES BELOS	SL21083409	FIRMINOPOLIS S2	27/02/2020 15:34	27/02/2020 16:48	27/02/2020 15:34	27/02/2020 16:48	1,22	2	2,45	CHI
202002176149	URUACU	UR11003374	URUACU	27/02/2020 15:34	27/02/2020 19:36	27/02/2020 15:34	27/02/2020 19:36	4,02	102	410,27	CHI
202002176170	ARAGUAPAZ	AZ12404563	GOIAS	27/02/2020 14:43	27/02/2020 17:36	27/02/2020 14:43	27/02/2020 17:36	2,87	20	57,39	CHI
202002176170	FAINA	AZ12404563	GOIAS	27/02/2020 14:43	27/02/2020 17:36	27/02/2020 14:43	27/02/2020 17:36	2,87	1	2,87	CHI
202002176172	URUTAI	UT12016984RE	URUTAI	27/02/2020 15:04	27/02/2020 19:50	27/02/2020 15:04	27/02/2020 19:50	4,76	10	47,62	CHI
202002176174	CROMINIA	CQ21000244	PONTALINA	27/02/2020 15:39	27/02/2020 16:52	27/02/2020 15:39	27/02/2020 16:52	1,21	1	1,21	CHI
202002176179	POSSE	SA11180528	IACIARA S2	27/02/2020 15:40	27/02/2020 20:32	27/02/2020 15:40	27/02/2020 20:32	4,86	4	19,45	CHI
202002176181	QUIRINOPOLIS	QI21213340	QUIRINOPOLIS	27/02/2020 15:40	27/02/2020 20:05	27/02/2020 15:40	27/02/2020 20:05	4,40	1	4,40	CHI
202002176185	SAO MIGUEL DO PASSA QUATRO	SQ12074827	CRISTIANOPOLIS	27/02/2020 15:41	27/02/2020 19:23	27/02/2020 15:41	27/02/2020 19:23	3,69	8	29,54	CHI
202002176191	SAO LUIS DE MONTES BELOS	SL31154603	FIRMINOPOLIS S2	27/02/2020 15:43	28/02/2020 07:24	27/02/2020 15:43	28/02/2020 07:24	15,67	1	15,67	CHI
202002176305	PIRENOPOLIS	PV21334686	CORUMBA	27/02/2020 15:46	27/02/2020 17:53	27/02/2020 15:46	27/02/2020 17:53	2,11	2	4,21	CHI
202002176311	ALTO PARAISO DE GOIAS	BF12129915	FLORES DE GOIAS	27/02/2020 15:48	27/02/2020 16:50	27/02/2020 15:48	27/02/2020 16:50	1,03	23	23,62	CHI
202002176313	PIRACANJUBA	60027678	PIRACANJUBA	27/02/2020 15:48	27/02/2020 18:27	27/02/2020 15:48	27/02/2020 18:27	2,64	1	2,64	CHI
202002176315	COCALZINHO DE GOIAS	1200036594	COCALZINHO	27/02/2020 15:49	27/02/2020 21:21	27/02/2020 15:49	27/02/2020 21:21	5,54	1	5,54	CHI
202002176316	GOIANIA	GN11166128	FERROVIARIO S2	27/02/2020 15:49	27/02/2020 17:39	27/02/2020 15:49	27/02/2020 17:39	1,83	44	80,64	CHI
202002176319	CAIAPONIA	2840017393	MONTIVIDIU T	27/02/2020 15:49	28/02/2020 06:32	27/02/2020 15:49	28/02/2020 06:32	14,72	1	14,72	CHI
202002176321	OURO VERDE DE GOIAS	OV12037463	NEROPOLIS S1	27/02/2020 15:50	27/02/2020 19:03	27/02/2020 15:50	27/02/2020 19:03	3,21	1	3,21	CHI
202002176323	PIRES DO RIO	PR21154622	PIRES DO RIO S1	27/02/2020 15:50	27/02/2020 18:11	27/02/2020 15:50	27/02/2020 18:11	2,34	1	2,34	CHI
202002176327	PORANGATU	PO21265800	PORANGATU	27/02/2020 15:51	28/02/2020 00:55	27/02/2020 15:51	28/02/2020 00:55	9,06	1	9,06	CHI
202002176401	VALPARAISO DE GOIAS	3350031442	PACAEMBU S1	27/02/2020 15:51	27/02/2020 18:41	27/02/2020 15:51	27/02/2020 18:41	2,82	1	2,82	CHI
202002176403	GOIANIA	GN11160637	ATLANTICO S1	27/02/2020 15:52	27/02/2020 17:34	27/02/2020 15:52	27/02/2020 17:34	1,69	17	28,73	CHI
202002176404	ANAPOLIS	AN11000014	JUNDIAI S1	27/02/2020 15:25	27/02/2020 16:55	27/02/2020 15:25	27/02/2020 16:55	1,49	78	116,03	CHI
202002176406	BARRO ALTO	3380002742	GOIANESIA S1	27/02/2020 15:53	27/02/2020 20:17	27/02/2020 15:53	27/02/2020 20:17	4,39	1	4,39	CHI
202002176415	ITAUCU	IX12013157	INHUMAS S2	27/02/2020 14:46	27/02/2020 20:32	27/02/2020 14:46	27/02/2020 20:32	5,76	5	28,79	CHI
202002176415	SANTA ROSA DE GOIAS	IX12013157	INHUMAS S2	27/02/2020 14:46	27/02/2020 20:32	27/02/2020 14:46	27/02/2020 20:32	5,76	10	57,58	CHI
202002176422	SAO LUIZ DO NORTE	GE12339967	ITAPACI	27/02/2020 15:55	27/02/2020 22:42	27/02/2020 15:55	27/02/2020 22:42	6,78	3	20,34	CHI
202002176426	PADRE BERNARDO	PB11313942	PADRE BERNARDO	27/02/2020 15:28	27/02/2020 17:50	27/02/2020 15:28	27/02/2020 17:50	2,36	12	28,29	CHI

202002176434	GOIAS	GS12336386	GOIAS	27/02/2020 15:55	28/02/2020 12:12	27/02/2020 15:55	28/02/2020 12:12	20,28	4	81,12	CHI
202002176434	GOIAS	GS12336386	GOIAS	27/02/2020 15:55	28/02/2020 12:12	28/02/2020 08:54	28/02/2020 12:12	3,29	6	19,74	CHI
202002176439	IPAMERI	IP12099279	PIRES DO RIO S2	27/02/2020 13:48	28/02/2020 18:45	27/02/2020 13:48	28/02/2020 18:45	28,95	2	57,89	CHI
202002176442	CRISTALINA	KR21165879	CRISTALINA S2	27/02/2020 16:02	27/02/2020 17:39	27/02/2020 16:02	27/02/2020 17:39	1,61	2	3,22	CHI
202002176448	NOVO BRASIL	NB12396223	JUSSARA	27/02/2020 16:04	28/02/2020 01:51	27/02/2020 16:04	28/02/2020 01:51	9,77	4	39,10	CHI
202002176450	NIQUELANDIA	NQ11353891	NIQUELANDIA SUBTRANSMISSAO	27/02/2020 14:41	27/02/2020 21:12	27/02/2020 14:41	27/02/2020 21:12	6,52	36	234,58	CHI
202002176451	HIDROLANDIA	10023824725	CEPAIGO S2	27/02/2020 16:05	27/02/2020 16:35	27/02/2020 16:05	27/02/2020 16:35	0,49	1	0,49	CHI
202002176456	SAO MIGUEL DO ARAGUAIA	SM12292394	SAO MIGUEL DO ARAGUAIA	27/02/2020 14:36	27/02/2020 19:26	27/02/2020 14:36	27/02/2020 19:26	4,83	4	19,30	CHI
202002176459	CATURAI	CK21030198	ARACU	27/02/2020 16:09	27/02/2020 18:16	27/02/2020 16:09	27/02/2020 18:16	2,11	1	2,11	CHI
202002176460	RIO VERDE	RV16407166	RIO VERDE S2	27/02/2020 16:05	27/02/2020 23:39	27/02/2020 19:47	27/02/2020 19:51	0,07	3910	287,82	CHI
202002176460	RIO VERDE	RV16402460	RIO VERDE S2	27/02/2020 16:05	27/02/2020 23:39	27/02/2020 16:21	27/02/2020 19:57	3,60	1118	4025,11	CHI
202002176460	RIO VERDE	RV16409384	RIO VERDE S2	27/02/2020 16:05	27/02/2020 23:39	27/02/2020 16:17	27/02/2020 23:39	7,37	932	6865,73	CHI
202002176460	RIO VERDE	RV16406926	RIO VERDE S2	27/02/2020 16:05	27/02/2020 23:39	27/02/2020 16:17	27/02/2020 23:39	7,37	1741	12836,01	CHI
202002176461	LUZIANIA	LZ12383009	MARAJOARA	27/02/2020 16:09	27/02/2020 23:20	27/02/2020 16:09	27/02/2020 23:20	7,17	12	86,07	CHI
202002176465	RIO VERDE	RV12172877	CABRIUVA S2	27/02/2020 15:41	28/02/2020 09:21	27/02/2020 15:41	28/02/2020 09:21	17,68	12	212,12	CHI
202002176468	CALDAS NOVAS	CN12000046	CALDAS NOVAS S2	27/02/2020 16:10	28/02/2020 06:44	27/02/2020 16:10	28/02/2020 06:44	14,56	13	189,22	CHI
202002176472	PONTALINA	PK12392168	PONTALINA	27/02/2020 15:38	27/02/2020 17:01	27/02/2020 15:38	27/02/2020 17:01	1,37	164	224,50	CHI
202002176476	ARAGOIANIA	GA32098705	GUAPO S2	27/02/2020 15:11	27/02/2020 19:30	27/02/2020 15:11	27/02/2020 19:30	4,30	4	17,22	CHI
202002176482	APARECIDA DE GOIANIA	10010760154	INDEPENDENCIA S2	27/02/2020 16:12	27/02/2020 17:17	27/02/2020 16:12	27/02/2020 17:17	1,08	1	1,08	CHI
202002176483	ITABERAI	IB21021845	ITABERAI S2	27/02/2020 16:12	28/02/2020 08:32	27/02/2020 16:12	28/02/2020 08:32	16,33	1	16,33	CHI
202002176489	JATAI	AW21342532	CACHOEIRA ALTA	27/02/2020 16:13	28/02/2020 09:21	27/02/2020 16:13	28/02/2020 09:21	17,12	1	17,12	CHI
202002176490	CACU	CC21198074	CACHOEIRA ALTA	27/02/2020 16:13	28/02/2020 08:11	27/02/2020 16:13	28/02/2020 08:11	15,96	1	15,96	CHI
202002176498	TURVANIA	TV12259061	FIRMINOPOLIS S2	27/02/2020 16:15	27/02/2020 21:42	27/02/2020 16:15	27/02/2020 21:42	5,45	8	43,60	CHI
202002176501	RIO VERDE	RV21000043	CABRIUVA S1	27/02/2020 16:15	27/02/2020 19:42	27/02/2020 16:15	27/02/2020 19:42	3,45	1	3,45	CHI
202002176605	CALDAS NOVAS	CN21333022	CALDAS NOVAS S1	27/02/2020 16:16	28/02/2020 08:47	27/02/2020 16:16	28/02/2020 08:47	16,51	2	33,01	CHI
202002176613	FIRMINOPOLIS	FR11076500	FIRMINOPOLIS S1	27/02/2020 16:19	27/02/2020 19:41	27/02/2020 16:19	27/02/2020 19:41	3,37	66	222,18	CHI
202002176629	ORIZONA	PR12000068RE	PIRES DO RIO S1	27/02/2020 14:13	27/02/2020 21:20	27/02/2020 14:13	27/02/2020 21:20	7,11	78	554,84	CHI
202002176629	PIRES DO RIO	PR12000068RE	PIRES DO RIO S1	27/02/2020 14:13	27/02/2020 21:20	27/02/2020 14:13	27/02/2020 21:20	7,11	21	149,38	CHI
202002176629	URUTAI	PR12000068RE	PIRES DO RIO S1	27/02/2020 14:13	27/02/2020 21:20	27/02/2020 14:13	27/02/2020 21:20	7,11	1	7,11	CHI
202002176630	APARECIDA DE GOIANIA	10003239568	INDEPENDENCIA S2	27/02/2020 16:22	27/02/2020 17:29	27/02/2020 16:22	27/02/2020 17:29	1,12	1	1,12	CHI
202002176634	GOIAS	GS21148732	ITABERAI S2	27/02/2020 16:23	27/02/2020 18:16	27/02/2020 16:23	27/02/2020 18:16	1,88	1	1,88	CHI
202002176638	COLINAS DO SUL	10018768634	NIQUELANDIA SUBTRANSMISSAO	27/02/2020 16:23	27/02/2020 19:11	27/02/2020 16:23	27/02/2020 19:11	2,80	1	2,80	CHI
202002176646	CAIAPONIA	930060787	CAIAPONIA	27/02/2020 16:26	28/02/2020 00:33	27/02/2020 16:26	28/02/2020 00:33	8,12	1	8,12	CHI
202002176654	AGUAS LINDAS DE GOIAS	LA12313663	AGUAS LINDAS DE GOIAS S2	27/02/2020 16:26	27/02/2020 17:50	27/02/2020 16:26	27/02/2020 17:50	1,39	9	12,47	CHI
202002176656	SANTA HELENA DE GOIAS	SH11361017	IPEGUARI	27/02/2020 14:21	27/02/2020 17:54	27/02/2020 14:21	27/02/2020 17:54	3,55	110	390,04	CHI
202002176659	CATALAO	CT12104183	CATALAO S1	27/02/2020 16:27	28/02/2020 08:15	27/02/2020 16:27	28/02/2020 08:15	15,78	6	94,70	CHI
202002176660	GOIATUBA	GT11128590	BOM JESUS DE GOIAS	27/02/2020 16:28	28/02/2020 08:20	27/02/2020 16:28	28/02/2020 08:20	15,86	11	174,51	CHI
202002176661	CALDAS NOVAS	CN11162476	CALDAS NOVAS S1	27/02/2020 16:28	27/02/2020 17:34	27/02/2020 16:28	27/02/2020 17:34	1,09	47	51,11	CHI
202002176663	MONTE ALEGRE DE GOIAS	MA12212608	SAO DOMINGOS	27/02/2020 16:28	27/02/2020 19:23	27/02/2020 16:28	27/02/2020 17:41	1,20	27	32,41	CHI
202002176663	MONTE ALEGRE DE GOIAS	MA12212608	SAO DOMINGOS	27/02/2020 16:28	27/02/2020 19:23	27/02/2020 16:28	27/02/2020 19:23	2,90	27	78,31	CHI
202002176666	APARECIDA DE GOIANIA	200037365	INDEPENDENCIA S1	27/02/2020 16:29	27/02/2020 17:33	27/02/2020 16:29	27/02/2020 17:33	1,05	1	1,05	CHI
202002176669	SITIO D ABADIA	FB11285754	IACIARA S2	27/02/2020 16:30	27/02/2020 18:08	27/02/2020 16:30	27/02/2020 18:08	1,63	1	1,63	CHI
202002176670	CACHOEIRA DOURADA	CD12000060	CACHOEIRA DOURADA	27/02/2020 16:30	28/02/2020 00:02	27/02/2020 16:30	28/02/2020 00:02	7,53	2	15,06	CHI
202002176672	APARECIDA DE GOIANIA	200664839	ANHANGUERA	27/02/2020 16:30	27/02/2020 19:12	27/02/2020 16:30	27/02/2020 19:12	2,69	1	2,69	CHI

202002176673	APARECIDA DE GOIANIA	14571377	REAL S1	27/02/2020 16:30	27/02/2020 20:18	27/02/2020 16:30	27/02/2020 20:18	3,79	1	3,79	CHI
202002176677	CATALAO	10010626059	CATALAO S2	27/02/2020 16:31	28/02/2020 09:06	27/02/2020 16:31	28/02/2020 09:06	16,58	1	16,58	CHI
202002176678	GOIANIA	10017551453	CARAJAS S2	27/02/2020 16:31	27/02/2020 17:25	27/02/2020 16:31	27/02/2020 17:25	0,89	1	0,89	CHI
202002176682	CAIAPONIA	CP12207864	CAIAPONIA	27/02/2020 16:33	28/02/2020 09:30	27/02/2020 16:33	28/02/2020 09:30	16,95	45	762,61	CHI
202002176684	RIO VERDE	RV12246766	ACREUNA	27/02/2020 16:26	28/02/2020 09:42	27/02/2020 16:26	28/02/2020 09:42	17,26	2	34,52	CHI
202002176685	NEROPOLIS	NR21161904	NEROPOLIS S2	27/02/2020 16:33	27/02/2020 19:41	27/02/2020 16:33	27/02/2020 19:41	3,12	2	6,24	CHI
202002176686	TURVANIA	TV21060048	FIRMINOPOLIS S2	27/02/2020 16:34	27/02/2020 21:28	27/02/2020 16:34	27/02/2020 21:28	4,90	1	4,90	CHI
202002176689	SILVANIA	10001045413	VIANOPOLIS	27/02/2020 16:35	27/02/2020 18:18	27/02/2020 16:35	27/02/2020 18:18	1,72	1	1,72	CHI
202002176692	PIRES DO RIO	PR12064876RE	PIRES DO RIO S1	27/02/2020 15:35	27/02/2020 21:25	27/02/2020 15:35	27/02/2020 21:25	5,83	33	192,43	CHI
202002176701	RIO QUENTE	RQ21316157	VILA CORUMBA	27/02/2020 16:38	28/02/2020 10:52	27/02/2020 16:38	28/02/2020 10:52	18,23	1	18,23	CHI
202002176703	ACREUNA	TD12226265	RIO DOS BOIS	27/02/2020 16:38	28/02/2020 00:27	27/02/2020 16:38	28/02/2020 00:27	7,81	2	15,63	CHI
202002176703	PORTEIRAO	TD12226265	RIO DOS BOIS	27/02/2020 16:38	28/02/2020 00:27	27/02/2020 16:38	28/02/2020 00:27	7,81	1	7,81	CHI
202002176703	SANTA HELENA DE GOIAS	TD12226265	RIO DOS BOIS	27/02/2020 16:38	28/02/2020 00:27	27/02/2020 16:38	28/02/2020 00:27	7,81	2	15,63	CHI
202002176703	TURVELANDIA	TD12226265	RIO DOS BOIS	27/02/2020 16:38	28/02/2020 00:27	27/02/2020 16:38	28/02/2020 00:27	7,81	99	773,46	CHI
202002176705	GOIANIA	10011017218	CARAJAS S1	27/02/2020 16:38	27/02/2020 18:10	27/02/2020 16:38	27/02/2020 18:10	1,52	1	1,52	CHI
202002176706	CAIAPONIA	DP12296462	JATAI S1	27/02/2020 15:28	27/02/2020 20:26	27/02/2020 15:28	27/02/2020 20:26	4,96	36	178,55	CHI
202002176706	MINEIROS	DP12296462	JATAI S1	27/02/2020 15:28	27/02/2020 20:26	27/02/2020 15:28	27/02/2020 20:26	4,96	2	9,92	CHI
202002176706	PEROLANDIA	DP12296462	JATAI S1	27/02/2020 15:28	27/02/2020 20:26	27/02/2020 15:28	27/02/2020 20:26	4,96	10	49,60	CHI
202002176710	DOVERLANDIA	DV12207928	CAIAPONIA	27/02/2020 16:40	27/02/2020 23:35	27/02/2020 16:40	27/02/2020 23:35	6,91	6	41,49	CHI
202002176712	MONTIVIDIU DO NORTE	MX11276707	PORANGATU	27/02/2020 16:41	28/02/2020 17:27	27/02/2020 16:41	28/02/2020 17:27	24,76	1	24,76	CHI
202002176713	CRISTALINA	KR12249615	CRISTALINA S2	27/02/2020 16:41	28/02/2020 07:57	27/02/2020 16:41	28/02/2020 07:57	15,26	12	183,12	CHI
202002176716	SERRANOPOLIS	SX21260503	JATAI S1	27/02/2020 16:42	27/02/2020 21:41	27/02/2020 16:42	27/02/2020 21:41	4,98	1	4,98	CHI
202002176719	ANAPOLIS	21077976	JUNDIAI S2	27/02/2020 16:42	27/02/2020 21:05	27/02/2020 16:42	27/02/2020 21:05	4,38	1	4,38	CHI
202002176720	GOIATUBA	GT12000265	GOIATUBA S2	27/02/2020 16:43	28/02/2020 14:59	27/02/2020 16:43	27/02/2020 18:21	1,63	2	3,27	CHI
202002176720	GOIATUBA	GT12000265	GOIATUBA S2	27/02/2020 16:43	28/02/2020 14:59	27/02/2020 16:43	28/02/2020 14:59	22,27	6	133,63	CHI
202002176723	GOIAS	90058793	GOIAS	27/02/2020 16:44	28/02/2020 10:30	27/02/2020 16:44	28/02/2020 10:30	17,78	1	17,78	CHI
202002176724	MOSSAMEDES	SC12395118	FIRMINOPOLIS S2	27/02/2020 16:44	27/02/2020 18:27	27/02/2020 16:44	27/02/2020 18:27	1,71	28	47,88	CHI
202002176724	SANCLERLANDIA	SC12395118	FIRMINOPOLIS S2	27/02/2020 16:44	27/02/2020 18:27	27/02/2020 16:44	27/02/2020 18:27	1,71	3	5,13	CHI
202002176727	QUIRINOPOLIS	QI21155580	QUIRINOPOLIS	27/02/2020 16:45	28/02/2020 11:04	27/02/2020 16:45	28/02/2020 11:04	18,31	1	18,31	CHI
202002176730	SILVANIA	SV21238643	VIANOPOLIS	27/02/2020 16:46	27/02/2020 22:25	27/02/2020 16:46	27/02/2020 22:25	5,64	1	5,64	CHI
202002176734	PADRE BERNARDO	2760052510	PADRE BERNARDO	27/02/2020 16:47	27/02/2020 18:36	27/02/2020 16:47	27/02/2020 18:36	1,82	1	1,82	CHI
202002176902	BOM JARDIM DE GOIAS	BM12286263	BOM JARDIM	27/02/2020 16:50	27/02/2020 18:58	27/02/2020 16:50	27/02/2020 18:58	2,13	4	8,51	CHI
202002176903	BURITI ALEGRE	BG12263597	ITUMBIRA VELHA S2	27/02/2020 15:25	28/02/2020 00:36	27/02/2020 15:25	28/02/2020 00:36	9,18	4	36,71	CHI
202002177103	EDEALINA	ED21008800	PONTALINA	27/02/2020 16:52	27/02/2020 23:22	27/02/2020 16:52	27/02/2020 23:22	6,50	1	6,50	CHI
202002177111	NOVA IGUACU DE GOIAS	NH21333082	MARA ROSA	27/02/2020 16:55	27/02/2020 18:45	27/02/2020 16:55	27/02/2020 18:45	1,82	1	1,82	CHI
202002177120	LUZIANIA	LZ21264828	VIANOPOLIS	27/02/2020 16:57	27/02/2020 20:16	27/02/2020 16:57	27/02/2020 20:16	3,31	4	13,25	CHI
202002177123	TROMBAS	TB12286019	PORANGATU	27/02/2020 16:57	27/02/2020 21:55	27/02/2020 16:57	27/02/2020 21:55	4,95	1	4,95	CHI
202002177129	FAINA	FC21061050	GOIAS	27/02/2020 16:58	28/02/2020 21:05	27/02/2020 16:58	28/02/2020 21:05	28,11	1	28,11	CHI
202002177131	MORRINHOS	MR21041911	MORRINHOS	27/02/2020 16:58	27/02/2020 22:10	27/02/2020 16:58	27/02/2020 22:10	5,20	1	5,20	CHI
202002177133	BALIZA	BH12207585	BOM JARDIM	27/02/2020 16:59	27/02/2020 23:14	27/02/2020 16:59	27/02/2020 23:14	6,25	6	37,47	CHI
202002177133	BOM JARDIM DE GOIAS	BH12207585	BOM JARDIM	27/02/2020 16:59	27/02/2020 23:14	27/02/2020 16:59	27/02/2020 23:14	6,25	1	6,25	CHI
202002177139	FORMOSA	610235473	ITUIQUIRA	27/02/2020 16:59	27/02/2020 18:29	27/02/2020 16:59	27/02/2020 18:29	1,49	1	1,49	CHI
202002177142	LUZIANIA	120202270	RIO VERMELHO	27/02/2020 17:00	27/02/2020 23:16	27/02/2020 17:00	27/02/2020 23:16	6,26	1	6,26	CHI
202002177148	TRES RANCHOS	TH12068477	CATALAO S1	27/02/2020 17:01	28/02/2020 01:21	27/02/2020 17:01	28/02/2020 01:21	8,32	19	158,10	CHI

202002177153	GOIANIA	GN12144781	ATLANTICO S3	27/02/2020 16:53	27/02/2020 17:43	27/02/2020 16:53	27/02/2020 17:43	0,83	862	717,38	CHI
202002177160	ANAPOLIS	AN21001148	JUNDIAI S1	27/02/2020 17:03	27/02/2020 18:51	27/02/2020 17:03	27/02/2020 18:51	1,79	1	1,79	CHI
202002177161	GOIANIA	11118910	ATLANTICO S2	27/02/2020 17:03	27/02/2020 22:54	27/02/2020 17:03	27/02/2020 22:54	5,84	1	5,84	CHI
202002177164	APARECIDA DE GOIANIA	AP11038685	CEPAIGO S1	27/02/2020 17:04	27/02/2020 19:25	27/02/2020 17:04	27/02/2020 19:25	2,35	22	51,70	CHI
202002177166	NIQUELANDIA	NQ21292550	URUACU	27/02/2020 17:04	27/02/2020 22:18	27/02/2020 17:04	27/02/2020 22:18	5,23	3	15,69	CHI
202002177168	BALIZA	BH12396127	BOM JARDIM	27/02/2020 17:04	28/02/2020 00:57	27/02/2020 17:04	28/02/2020 00:57	7,88	1	7,88	CHI
202002177168	BOM JARDIM DE GOIAS	BH12396127	BOM JARDIM	27/02/2020 17:04	28/02/2020 00:57	27/02/2020 17:04	28/02/2020 00:57	7,88	1	7,88	CHI
202002177170	CAMPOS VERDES	SG12181588	SANTA TEREZINHA	27/02/2020 17:04	27/02/2020 22:04	27/02/2020 17:04	27/02/2020 22:04	4,99	8	39,89	CHI
202002177170	SANTA TEREZINHA DE GOIAS	SG12181588	SANTA TEREZINHA	27/02/2020 17:04	27/02/2020 22:04	27/02/2020 17:04	27/02/2020 22:04	4,99	6	29,92	CHI
202002177171	MONTE ALEGRE DE GOIAS	MA12217827	SAO DOMINGOS	27/02/2020 17:04	27/02/2020 19:23	27/02/2020 17:04	27/02/2020 19:23	2,30	1	2,30	CHI
202002177172	AURILANDIA	AI12126019	FIRMINOPOLIS S2	27/02/2020 15:36	27/02/2020 20:50	27/02/2020 15:36	27/02/2020 20:50	5,22	9	46,97	CHI
202002177172	FIRMINOPOLIS	AI12126019	FIRMINOPOLIS S2	27/02/2020 15:36	27/02/2020 20:50	27/02/2020 15:36	27/02/2020 20:50	5,22	3	15,66	CHI
202002177173	TURVANIA	TV12005554	FIRMINOPOLIS S1	27/02/2020 16:19	27/02/2020 21:06	27/02/2020 16:19	27/02/2020 21:06	4,77	3	14,30	CHI
202002177174	BOM JARDIM DE GOIAS	BM12342030	BOM JARDIM	27/02/2020 17:06	28/02/2020 14:59	27/02/2020 17:06	28/02/2020 14:59	21,88	6	131,26	CHI
202002177186	CRISTIANOPOLIS	SQ12309675	CRISTIANOPOLIS	27/02/2020 16:55	28/02/2020 09:45	27/02/2020 16:55	28/02/2020 09:45	16,83	1	16,83	CHI
202002177186	SAO MIGUEL DO PASSA QUATRO	SQ12309675	CRISTIANOPOLIS	27/02/2020 16:55	28/02/2020 09:45	27/02/2020 16:55	28/02/2020 09:45	16,83	14	235,59	CHI
202002177190	POSSE	PS12124654	IACIARA S2	27/02/2020 17:09	27/02/2020 19:35	27/02/2020 17:09	27/02/2020 19:35	2,43	7	16,99	CHI
202002177191	NIQUELANDIA	NQ21262876	URUACU	27/02/2020 17:09	27/02/2020 21:47	27/02/2020 17:09	27/02/2020 21:47	4,63	1	4,63	CHI
202002177192	GOIANDIRA	GD12127586	CATALAO S1	27/02/2020 17:09	28/02/2020 15:37	27/02/2020 17:09	28/02/2020 15:37	22,46	1	22,46	CHI
202002177192	NOVA AURORA	GD12127586	CATALAO S1	27/02/2020 17:09	28/02/2020 15:37	27/02/2020 17:09	28/02/2020 15:37	22,46	1	22,46	CHI
202002177204	BELA VISTA DE GOIAS	240052950	BELA VISTA S1	27/02/2020 16:11	27/02/2020 18:25	27/02/2020 16:11	27/02/2020 18:25	2,22	1	2,22	CHI
202002177207	BELA VISTA DE GOIAS	BC12382052	PIRES DO RIO S2	27/02/2020 15:31	27/02/2020 19:57	27/02/2020 15:31	27/02/2020 19:57	4,42	2	8,85	CHI
202002177207	CRISTIANOPOLIS	BC12382052	PIRES DO RIO S2	27/02/2020 15:31	27/02/2020 19:57	27/02/2020 15:31	27/02/2020 19:57	4,42	24	106,19	CHI
202002177207	PIRES DO RIO	BC12382052	PIRES DO RIO S2	27/02/2020 15:31	27/02/2020 19:57	27/02/2020 15:31	27/02/2020 19:57	4,42	67	296,46	CHI
202002177207	SANTA CRUZ DE GOIAS	BC12382052	PIRES DO RIO S2	27/02/2020 15:31	27/02/2020 19:57	27/02/2020 15:31	27/02/2020 19:57	4,42	35	154,87	CHI
202002177210	SANTA CRUZ DE GOIAS	BC12389805	PIRES DO RIO S2	27/02/2020 16:04	27/02/2020 21:14	27/02/2020 16:04	27/02/2020 21:14	5,16	9	46,48	CHI
202002177228	INHUMAS	IN10403990	INHUMAS S2	27/02/2020 19:27	27/02/2020 19:32	27/02/2020 19:27	27/02/2020 19:32	0,09	1850	161,88	CHI
202002177244	PIRACANJUBA	PJ12223255	ROCHEDO	27/02/2020 17:59	28/02/2020 08:33	27/02/2020 17:59	28/02/2020 08:33	14,56	23	334,80	CHI
202002177250	AGUA FRIA DE GOIAS	TL21096451	SAO JOAO D ALIANCA	27/02/2020 16:00	28/02/2020 09:10	27/02/2020 16:00	28/02/2020 09:10	17,17	1	17,17	CHI
202002177254	CAVALCANTE	CJ12319260	MINACU	27/02/2020 23:55	28/02/2020 16:36	27/02/2020 23:56	28/02/2020 14:52	14,95	15	224,21	CHI
202002177254	CAVALCANTE	CJ12340539	MINACU	27/02/2020 23:55	28/02/2020 16:36	27/02/2020 23:56	28/02/2020 16:14	16,30	1	16,30	CHI
202002177254	CAVALCANTE	CJ13343191	MINACU	27/02/2020 23:55	28/02/2020 16:36	27/02/2020 23:55	28/02/2020 16:36	16,67	225	3751,19	CHI
202002177257	TRES RANCHOS	TH21294967	CATALAO S1	27/02/2020 17:23	28/02/2020 02:24	27/02/2020 17:23	28/02/2020 02:24	9,01	2	18,02	CHI
202002177262	ITAPACI	O2600424	ITAPACI	28/02/2020 04:45	28/02/2020 12:57	28/02/2020 04:45	28/02/2020 12:45	8,00	15	120,06	CHI
202002177262	ITAPACI	O2600424	ITAPACI	28/02/2020 04:45	28/02/2020 12:57	28/02/2020 04:50	28/02/2020 12:45	7,93	2	15,86	CHI
202002177262	HIDROLINA	IW13333920	ITAPACI	28/02/2020 04:45	28/02/2020 12:57	28/02/2020 04:45	28/02/2020 12:57	8,20	162	1328,31	CHI
202002177262	ITAPACI	O2600424	ITAPACI	28/02/2020 04:45	28/02/2020 12:57	28/02/2020 04:45	28/02/2020 12:57	8,20	42	344,38	CHI
202002177262	ITAPACI	IW13333920	ITAPACI	28/02/2020 04:45	28/02/2020 12:57	28/02/2020 04:45	28/02/2020 12:57	8,20	3	24,60	CHI
202002177262	NOVA GLORIA	IW13333920	ITAPACI	28/02/2020 04:45	28/02/2020 12:57	28/02/2020 04:45	28/02/2020 12:57	8,20	1	8,20	CHI
202002177262	PILAR DE GOIAS	O2600424	ITAPACI	28/02/2020 04:45	28/02/2020 12:57	28/02/2020 04:45	28/02/2020 12:57	8,20	3	24,60	CHI
202002177262	SAO LUIZ DO NORTE	O2600424	ITAPACI	28/02/2020 04:45	28/02/2020 12:57	28/02/2020 04:45	28/02/2020 12:57	8,20	8	65,60	CHI
202002177262	SAO LUIZ DO NORTE	IW13333920	ITAPACI	28/02/2020 04:45	28/02/2020 12:57	28/02/2020 04:45	28/02/2020 12:57	8,20	2107	17276,23	CHI
202002177263	URUACU	CR21197604	CAMPINORTE	28/02/2020 05:24	28/02/2020 09:50	28/02/2020 05:24	28/02/2020 09:50	4,43	4	17,70	CHI
202002177301	ITAPIRAPUA	IU12018753	MATRINCHA	27/02/2020 13:59	27/02/2020 19:55	27/02/2020 13:59	27/02/2020 19:55	5,92	239	1414,68	CHI

202002177310	MINEIROS	MY12202613	PARQUE DAS EMAS	27/02/2020 17:13	01/03/2020 10:30	27/02/2020 17:13	01/03/2020 10:30	65,27	10	652,73	CHI
202002177317	BRITANIA	BT12210599	BRITANIA	27/02/2020 17:16	28/02/2020 06:15	27/02/2020 17:16	27/02/2020 21:26	4,16	187	777,66	CHI
202002177317	JUSSARA	BT12210599	BRITANIA	27/02/2020 17:16	28/02/2020 06:15	27/02/2020 17:16	27/02/2020 21:26	4,16	44	182,98	CHI
202002177317	BRITANIA	BT12210599	BRITANIA	27/02/2020 17:16	28/02/2020 06:15	27/02/2020 17:16	27/02/2020 21:26	4,16	13	54,06	CHI
202002177317	JUSSARA	BT12210599	BRITANIA	27/02/2020 17:16	28/02/2020 06:15	27/02/2020 17:16	27/02/2020 21:26	4,16	4	16,63	CHI
202002177317	BRITANIA	BT13400611B	BRITANIA	27/02/2020 17:16	28/02/2020 06:15	27/02/2020 17:16	27/02/2020 23:40	6,40	118	755,23	CHI
202002177317	BRITANIA	BT12220391	BRITANIA	27/02/2020 17:16	28/02/2020 06:15	27/02/2020 17:16	28/02/2020 06:15	12,97	348	4515,01	CHI
202002177321	CRIXAS	CX11394452	SERRA DO OURO	27/02/2020 17:18	28/02/2020 02:57	27/02/2020 17:18	28/02/2020 02:57	9,65	1	9,65	CHI
202002177330	SANTO ANTONIO DO DESCOBERTO	2900098630	MARAJOARA	27/02/2020 17:20	27/02/2020 20:44	27/02/2020 17:20	27/02/2020 20:44	3,39	1	3,39	CHI
202002177342	ACREUNA	EU12301594	ACREUNA	27/02/2020 16:49	27/02/2020 23:07	27/02/2020 16:49	27/02/2020 23:07	6,29	3	18,87	CHI
202002177343	SANTO ANTONIO DA BARRA	BZ12240570	ACREUNA	27/02/2020 17:22	28/02/2020 10:00	27/02/2020 17:22	28/02/2020 10:00	16,62	4	66,49	CHI
202002177346	MUTUNOPOLIS	MU12060992	MARA ROSA	27/02/2020 17:23	27/02/2020 23:38	27/02/2020 17:23	27/02/2020 23:38	6,24	3	18,73	CHI
202002177351	BOM JARDIM DE GOIAS	BM12245130	BOM JARDIM	27/02/2020 17:24	28/02/2020 04:09	27/02/2020 17:24	28/02/2020 04:09	10,74	6	64,47	CHI
202002177351	PIRANHAS	BM12245130	BOM JARDIM	27/02/2020 17:24	28/02/2020 04:09	27/02/2020 17:24	28/02/2020 04:09	10,74	4	42,98	CHI
202002177352	GOIANESIA	GE21101813	GOIANESIA S2	27/02/2020 17:24	27/02/2020 22:35	27/02/2020 17:24	27/02/2020 22:35	5,19	1	5,19	CHI
202002177353	CIDADE OCIDENTAL	10000891841	MARAJOARA	27/02/2020 17:24	27/02/2020 19:20	27/02/2020 17:24	27/02/2020 19:20	1,92	1	1,92	CHI
202002177355	CATALAO	CT12203164	CATALAO S1	27/02/2020 16:58	27/02/2020 20:20	27/02/2020 16:58	27/02/2020 20:20	3,36	1113	3743,39	CHI
202002177357	CALDAS NOVAS	CN12000047	CALDAS NOVAS S2	27/02/2020 17:26	28/02/2020 07:08	27/02/2020 17:26	28/02/2020 07:08	13,70	7	95,87	CHI
202002177362	CATALAO	CT21127695	CATALAO S1	27/02/2020 17:27	27/02/2020 21:22	27/02/2020 17:27	27/02/2020 21:22	3,91	1	3,91	CHI
202002177363	CACU	CC12196048	CACHOEIRA ALTA	27/02/2020 17:28	28/02/2020 00:17	27/02/2020 17:28	28/02/2020 00:17	6,82	19	129,50	CHI
202002177365	LUZIANIA	LZ12313611	VIANOPOLIS	27/02/2020 17:28	27/02/2020 21:51	27/02/2020 17:28	27/02/2020 21:51	4,37	13	56,78	CHI
202002177370	BOM JESUS DE GOIAS	BJ12316774	BOM JESUS DE GOIAS	27/02/2020 17:29	27/02/2020 23:43	27/02/2020 17:29	27/02/2020 23:43	6,22	2	12,45	CHI
202002177374	QUIRINOPOLIS	QI31094258	QUIRINOPOLIS	27/02/2020 17:29	28/02/2020 01:17	27/02/2020 17:29	28/02/2020 01:17	7,79	1	7,79	CHI
202002177378	QUIRINOPOLIS	QI32053157	QUIRINOPOLIS	27/02/2020 17:31	28/02/2020 08:19	27/02/2020 17:31	28/02/2020 08:19	14,80	3	44,40	CHI
202002177380	PANAMA	PX12378952	GOIATUBA S1	27/02/2020 15:10	28/02/2020 08:24	27/02/2020 15:10	28/02/2020 08:24	17,22	4	68,90	CHI
202002177386	ITUMBIARA	IT21046810	BOM JESUS DE GOIAS	27/02/2020 17:33	27/02/2020 23:32	27/02/2020 17:33	27/02/2020 23:32	5,98	1	5,98	CHI
202002177393	SAO LUIS DE MONTES BELOS	SL12098057	SAO LUIZ DOS MONTES BELOS	27/02/2020 16:33	27/02/2020 18:39	27/02/2020 16:33	27/02/2020 18:39	2,10	282	591,02	CHI
202002177396	LEOPOLDO DE BULHOES	10021775760	DAIA S2	27/02/2020 17:35	27/02/2020 19:37	27/02/2020 17:35	27/02/2020 19:37	2,02	1	2,02	CHI
202002177399	LUZIANIA	LZ12000547	MARAJOARA	27/02/2020 17:27	27/02/2020 19:59	27/02/2020 17:27	27/02/2020 19:59	2,53	5	12,66	CHI
202002177400	ITAGUARI	7279625	ITABERAI S1	27/02/2020 17:36	27/02/2020 18:24	27/02/2020 17:36	27/02/2020 18:24	0,79	56	44,32	CHI
202002177400	ITAGUARU	7279625	ITABERAI S1	27/02/2020 17:36	27/02/2020 18:24	27/02/2020 17:36	27/02/2020 18:24	0,79	28	22,16	CHI
202002177403	CATALAO	CT12134367	CATALAO S1	27/02/2020 17:36	28/02/2020 07:34	27/02/2020 17:36	28/02/2020 07:34	13,95	10	139,51	CHI
202002177405	VALPARAISO DE GOIAS	3350043328	PACAEMBU S2	27/02/2020 17:37	27/02/2020 23:00	27/02/2020 17:37	27/02/2020 23:00	5,38	1	5,38	CHI
202002177410	BELA VISTA DE GOIAS	BV11085134	BELA VISTA S1	27/02/2020 16:46	27/02/2020 23:55	27/02/2020 16:46	27/02/2020 23:55	7,14	148	1057,34	CHI
202002177415	DIVINOPOLIS DE GOIAS	GH12156343RE	SAO DOMINGOS	27/02/2020 17:40	27/02/2020 18:54	27/02/2020 17:40	27/02/2020 18:54	1,22	127	154,90	CHI
202002177415	MONTE ALEGRE DE GOIAS	GH12156343RE	SAO DOMINGOS	27/02/2020 17:40	27/02/2020 18:54	27/02/2020 17:40	27/02/2020 18:54	1,22	15	18,30	CHI
202002177415	SAO DOMINGOS	GH12156343RE	SAO DOMINGOS	27/02/2020 17:40	27/02/2020 18:54	27/02/2020 17:40	27/02/2020 18:54	1,22	1	1,22	CHI
202002177418	RIO VERDE	630245940	RIO VERDE S1	27/02/2020 17:42	27/02/2020 22:31	27/02/2020 17:42	27/02/2020 22:31	4,81	1	4,81	CHI
202002177430	CORUMBAIBA	CI12060020	CATALAO S1	27/02/2020 17:21	27/02/2020 20:33	27/02/2020 17:21	27/02/2020 20:33	3,20	117	374,24	CHI
202002177430	MORRINHOS	CI12060020	CATALAO S1	27/02/2020 17:21	27/02/2020 20:33	27/02/2020 17:21	27/02/2020 20:33	3,20	1	3,20	CHI
202002177430	NOVA AURORA	CI12060020	CATALAO S1	27/02/2020 17:21	27/02/2020 20:33	27/02/2020 17:21	27/02/2020 20:33	3,20	9	28,79	CHI
202002177431	APARECIDA DE GOIANIA	15188310	REAL S1	27/02/2020 17:45	27/02/2020 20:32	27/02/2020 17:45	27/02/2020 20:32	2,77	1	2,77	CHI
202002177451	COCALZINHO DE GOIAS	ZN12067363	AGUAS LINDAS DE GOIAS S1	27/02/2020 16:59	27/02/2020 19:28	27/02/2020 16:59	27/02/2020 19:28	2,47	39	96,48	CHI
202002177457	GOIANIA	16695446	XAVANTES	27/02/2020 17:50	27/02/2020 19:58	27/02/2020 17:50	27/02/2020 19:58	2,12	1	2,12	CHI

202002177467	COLINAS DO SUL	970000855	NIQUELANDIA SUBTRANSMISSAO	27/02/2020 17:52	27/02/2020 20:33	27/02/2020 17:52	27/02/2020 20:33	2,68	1	2,68	CHI
202002177475	HEITORAI	HE21336474	ITAPURANGA	27/02/2020 17:54	28/02/2020 02:47	27/02/2020 17:54	28/02/2020 02:47	8,88	1	8,88	CHI
202002177479	RIO VERDE	RV21301278	SANTA HELENA S1	27/02/2020 17:55	28/02/2020 10:49	27/02/2020 17:55	28/02/2020 10:49	16,89	1	16,89	CHI
202002177485	VIANOPOLIS	VN12194266	VIANOPOLIS	27/02/2020 17:56	28/02/2020 06:00	27/02/2020 17:56	28/02/2020 06:00	12,06	5	60,29	CHI
202002177486	TURVELANDIA	TD12344903	RIO DOS BOIS	27/02/2020 16:37	27/02/2020 21:04	27/02/2020 16:37	27/02/2020 21:04	4,45	179	796,05	CHI
202002177489	JUSSARA	JR11259688	JUSSARA	27/02/2020 17:57	28/02/2020 00:45	27/02/2020 20:48	28/02/2020 00:45	3,96	81	321,01	CHI
202002177491	GOIANIA	10795080	CARAJAS S1	27/02/2020 17:58	27/02/2020 19:06	27/02/2020 17:58	27/02/2020 19:06	1,13	1	1,13	CHI
202002177496	NEROPOLIS	160015546	NEROPOLIS S2	27/02/2020 17:59	27/02/2020 20:46	27/02/2020 17:59	27/02/2020 20:46	2,78	1	2,78	CHI
202002177497	RIO QUENTE	RQ11064800	RIO QUENTE	27/02/2020 17:59	28/02/2020 09:38	27/02/2020 17:59	28/02/2020 09:38	15,64	12	187,70	CHI
202002177498	SAO FRANCISCO DE GOIAS	JA21140687	SAO FRANCISCO DE GOIAS	27/02/2020 17:59	27/02/2020 20:42	27/02/2020 17:59	27/02/2020 20:42	2,71	3	8,13	CHI
202002177503	MOSSAMEDES	MD21304685	ANICUNS	27/02/2020 18:00	27/02/2020 21:25	27/02/2020 18:00	27/02/2020 21:25	3,40	1	3,40	CHI
202002177505	DOVERLANDIA	DV12297286	CAIAPONIA	27/02/2020 18:01	28/02/2020 14:15	27/02/2020 18:01	28/02/2020 14:15	20,23	1	20,23	CHI
202002177506	ITABERAI	IB12310620	ITABERAI S1	27/02/2020 18:01	27/02/2020 20:10	27/02/2020 18:01	27/02/2020 20:10	2,14	2	4,29	CHI
202002177507	PLANALTINA	10006295434	PLANALTINA	27/02/2020 18:01	27/02/2020 19:26	27/02/2020 18:01	27/02/2020 19:26	1,40	1	1,40	CHI
202002177509	NOVO PLANALTO	TA12391903	NOVO PLANALTO	27/02/2020 18:02	28/02/2020 04:58	27/02/2020 18:02	28/02/2020 04:58	10,93	1	10,93	CHI
202002177512	JATAI	JT21296406	JATAI S1	27/02/2020 18:02	28/02/2020 00:07	27/02/2020 18:02	28/02/2020 00:07	6,07	1	6,07	CHI
202002177515	AMORINOPOLIS	AM12000028	IPORA	27/02/2020 18:03	28/02/2020 10:55	27/02/2020 18:03	28/02/2020 10:55	16,86	5	84,30	CHI
202002177516	APARECIDA DE GOIANIA	AP11007579	INDEPENDENCIA S2	27/02/2020 18:03	27/02/2020 20:12	27/02/2020 18:03	27/02/2020 20:12	2,14	289	618,54	CHI
202002177519	GUARAITA	IK12300356	ITAPURANGA	27/02/2020 17:33	27/02/2020 19:17	27/02/2020 17:33	27/02/2020 19:17	1,72	36	61,95	CHI
202002177519	ITAPURANGA	IK12300356	ITAPURANGA	27/02/2020 17:33	27/02/2020 19:17	27/02/2020 17:33	27/02/2020 19:17	1,72	83	142,83	CHI
202002177526	BELA VISTA DE GOIAS	BV21197959	CEPAIGO S2	27/02/2020 18:04	27/02/2020 23:31	27/02/2020 18:04	27/02/2020 23:31	5,43	1	5,43	CHI
202002177527	HIDROLANDIA	HD21358986	GUAPO S2	27/02/2020 18:05	27/02/2020 19:10	27/02/2020 18:05	27/02/2020 19:10	1,08	1	1,08	CHI
202002177531	CEZARINA	CZ12074810	CEZARINA	27/02/2020 16:51	27/02/2020 20:40	27/02/2020 16:51	27/02/2020 20:40	3,81	945	3600,19	CHI
202002177535	GOIANIA	10002197527	CARAJAS S1	27/02/2020 18:07	27/02/2020 19:17	27/02/2020 18:07	27/02/2020 19:17	1,16	1	1,16	CHI
202002177537	ANAPOLIS	20934932	ANAPOLIS UNIVERSITARIO S2	27/02/2020 18:07	27/02/2020 21:28	27/02/2020 18:07	27/02/2020 21:28	3,34	1	3,34	CHI
202002177544	BONOPOLIS	BX12292423	SAO MIGUEL DO ARAGUAIA	27/02/2020 18:09	28/02/2020 08:51	27/02/2020 18:09	28/02/2020 08:51	14,70	1	14,70	CHI
202002177545	JATAI	290206479	JATAI S3	27/02/2020 18:09	27/02/2020 22:23	27/02/2020 18:09	27/02/2020 22:23	4,22	1	4,22	CHI
202002177547	HEITORAI	IC12065281	ITABERAI S1	27/02/2020 17:47	27/02/2020 19:11	27/02/2020 17:47	27/02/2020 19:11	1,40	6	8,37	CHI
202002177547	ITAGUARU	IC12065281	ITABERAI S1	27/02/2020 17:47	27/02/2020 19:11	27/02/2020 17:47	27/02/2020 19:11	1,40	3	4,19	CHI
202002177548	SAO MIGUEL DO ARAGUAIA	SM12350501	SAO MIGUEL DO ARAGUAIA	27/02/2020 16:47	28/02/2020 00:56	27/02/2020 16:47	28/02/2020 00:56	8,14	6	48,86	CHI
202002177555	RIO VERDE	RV12303497	MONTIVIDIU T	27/02/2020 18:12	27/02/2020 21:50	27/02/2020 18:12	27/02/2020 21:50	3,63	3	10,88	CHI
202002177560	CALDAS NOVAS	CN11213803	SERRA DE CALDAS	27/02/2020 18:12	28/02/2020 04:47	27/02/2020 18:12	28/02/2020 04:47	10,57	2	21,13	CHI
202002177565	BURITINOPOLIS	BQ12228969	IACIARA S2	27/02/2020 18:14	27/02/2020 20:24	27/02/2020 18:14	27/02/2020 20:24	2,16	1	2,16	CHI
202002177569	BALIZA	BH12210020	BOM JARDIM	27/02/2020 16:49	27/02/2020 20:02	27/02/2020 16:49	27/02/2020 20:02	3,21	91	291,71	CHI
202002177571	RIO VERDE	RV12260699	CABRIUVA S1	27/02/2020 18:15	28/02/2020 19:00	27/02/2020 18:15	28/02/2020 19:00	24,74	1	24,74	CHI
202002177804	CRISTALINA	10010877574	CRISTALINA S1	27/02/2020 18:17	27/02/2020 20:09	27/02/2020 18:17	27/02/2020 20:09	1,86	1	1,86	CHI
202002177811	ITAPIRAPUA	IU12073729	MATRINCHA	27/02/2020 18:18	28/02/2020 00:04	27/02/2020 18:18	28/02/2020 00:04	5,76	3	17,28	CHI
202002177814	SAO LUIS DE MONTES BELOS	SL12019499	SAO LUIZ DOS MONTES BELOS	27/02/2020 18:18	28/02/2020 12:07	27/02/2020 18:18	28/02/2020 12:07	17,80	24	427,27	CHI
202002177820	ITAPURANGA	IK11000005	ITAPURANGA	27/02/2020 18:11	28/02/2020 05:42	27/02/2020 18:11	28/02/2020 05:42	11,51	57	656,10	CHI
202002177828	GOIANIA	14399763	XAVANTES	27/02/2020 18:22	27/02/2020 20:03	27/02/2020 18:22	27/02/2020 20:03	1,68	1	1,68	CHI
202002177832	GUARANI DE GOIAS	GY12267340	IACIARA S2	27/02/2020 18:22	27/02/2020 19:52	27/02/2020 18:22	27/02/2020 19:52	1,49	62	92,29	CHI
202002177833	JARAGUA	JA12025642	ITABERAI S1	27/02/2020 18:22	28/02/2020 08:41	27/02/2020 18:22	28/02/2020 08:41	14,30	60	858,28	CHI
202002177840	FORMOSA	FA11233692	SAO JOAO D ALIANCA	27/02/2020 18:23	27/02/2020 21:20	27/02/2020 18:23	27/02/2020 21:20	2,95	1	2,95	CHI
202002177841	PIRACANJUBA	PJ12223377	ROCHEDO	27/02/2020 17:30	28/02/2020 08:54	27/02/2020 17:30	28/02/2020 08:54	15,39	13	200,10	CHI

202002177842	GOIAS	HE12250706	ITABERAI S1	27/02/2020 18:03	27/02/2020 22:39	27/02/2020 18:03	27/02/2020 22:39	4,59	16	73,50	CHI
202002177850	ANAPOLIS	10017266430	JUNDIAI S2	27/02/2020 18:24	27/02/2020 23:28	27/02/2020 18:24	27/02/2020 23:28	5,06	1	5,06	CHI
202002177853	FORMOSA	FA21256451	ITIQUEIRA	27/02/2020 18:24	27/02/2020 20:31	27/02/2020 18:24	27/02/2020 20:31	2,11	2	4,21	CHI
202002177873	AGUA LIMPA	AL12309321	VILA CORUMBA	27/02/2020 18:28	28/02/2020 12:03	27/02/2020 18:28	28/02/2020 12:03	17,58	3	52,74	CHI
202002177877	ARAGOIANA	AO21022308	GUAPO S1	27/02/2020 18:29	27/02/2020 23:57	27/02/2020 18:29	27/02/2020 23:57	5,46	2	10,92	CHI
202002177878	SANTO ANTONIO DE GOIAS	BW12232189	NEROPOLIS S1	27/02/2020 18:18	27/02/2020 19:47	27/02/2020 18:18	27/02/2020 19:47	1,48	360	534,20	CHI
202002177883	GOIAS	GS11224166	GOIAS	27/02/2020 17:58	27/02/2020 22:20	27/02/2020 17:58	27/02/2020 22:20	4,36	29	126,46	CHI
202002177884	VIANOPOLIS	VN21151106	VIANOPOLIS	27/02/2020 18:30	28/02/2020 08:33	27/02/2020 18:30	28/02/2020 08:33	14,04	1	14,04	CHI
202002177893	RIO VERDE	RV21260188	RIO VERDE S2	27/02/2020 18:31	28/02/2020 12:12	27/02/2020 18:31	28/02/2020 12:12	17,67	2	35,34	CHI
202002177896	CAIAPONIA	CP12346563	MONTIVIDIU T	27/02/2020 18:32	28/02/2020 11:59	27/02/2020 18:32	28/02/2020 11:59	17,44	5	87,19	CHI
202002177897	IPORA	IR12060655	IPORA	27/02/2020 17:53	28/02/2020 02:58	27/02/2020 17:53	28/02/2020 02:58	9,07	63	571,22	CHI
202002177897	IVOLANDIA	IR12060655	IPORA	27/02/2020 17:53	28/02/2020 02:58	27/02/2020 17:53	28/02/2020 02:58	9,07	36	326,41	CHI
202002177897	MOIPORA	IR12060655	IPORA	27/02/2020 17:53	28/02/2020 02:58	27/02/2020 17:53	28/02/2020 02:58	9,07	5	45,33	CHI
202002177902	GOIAS	GS21070332	GOIAS	27/02/2020 18:34	28/02/2020 09:06	27/02/2020 18:34	28/02/2020 09:06	14,53	1	14,53	CHI
202002177911	APARECIDA DE GOIANIA	AP12168594	INDEPENDENCIA S1	27/02/2020 18:34	27/02/2020 19:37	27/02/2020 18:34	27/02/2020 19:37	1,04	103	107,18	CHI
202002177912	INHUMAS	30065320	INHUMAS S2	27/02/2020 18:36	28/02/2020 09:03	27/02/2020 18:36	28/02/2020 09:03	14,44	1	14,44	CHI
202002177913	CORUMBAIBA	CI12000463RE	VILA CORUMBA	27/02/2020 17:45	27/02/2020 22:54	27/02/2020 17:45	27/02/2020 22:54	5,17	122	630,20	CHI
202002177915	CUMARI	CT21229966	CATALAO S2	27/02/2020 18:37	28/02/2020 11:32	27/02/2020 18:37	28/02/2020 11:32	16,91	1	16,91	CHI
202002177919	BRITANIA	BT11043375	BRITANIA	27/02/2020 18:31	28/02/2020 02:27	27/02/2020 18:31	28/02/2020 02:27	7,93	199	1578,01	CHI
202002177922	GOIAS	GS21310394	ITABERAI S1	27/02/2020 18:38	27/02/2020 19:08	27/02/2020 18:38	27/02/2020 19:08	0,49	1	0,49	CHI
202002177924	GOIANIA	10012944724	GOYA S1	27/02/2020 18:38	27/02/2020 21:23	27/02/2020 18:38	27/02/2020 21:23	2,74	1	2,74	CHI
202002177925	AGUA LIMPA	AL12392133	VILA CORUMBA	27/02/2020 18:16	28/02/2020 10:05	27/02/2020 18:16	28/02/2020 10:05	15,82	45	711,75	CHI
202002177929	SANTO ANTONIO DO DESCOBERTO	SN21148954	MARAJOARA	27/02/2020 18:38	27/02/2020 20:35	27/02/2020 18:38	27/02/2020 20:35	1,93	2	3,87	CHI
202002177931	FORMOSA	10003644810	ITIQUEIRA	27/02/2020 18:39	28/02/2020 00:12	27/02/2020 18:39	28/02/2020 00:12	5,55	1	5,55	CHI
202002177935	JUSSARA	JR11165396	JUSSARA	27/02/2020 18:39	28/02/2020 00:01	27/02/2020 18:39	28/02/2020 00:01	5,37	78	419,19	CHI
202002177942	LUZIANIA	LZ12000276RE	MARAJOARA	27/02/2020 16:59	27/02/2020 20:45	27/02/2020 16:59	27/02/2020 20:45	3,75	32	120,16	CHI
202002177946	VALPARAISO DE GOIAS	3350048200	PACAEMBU S1	27/02/2020 18:42	27/02/2020 22:48	27/02/2020 18:42	27/02/2020 22:48	4,09	1	4,09	CHI
202002177951	SANTO ANTONIO DO DESCOBERTO	SN12078187	MARAJOARA	27/02/2020 18:41	28/02/2020 11:39	27/02/2020 18:41	28/02/2020 11:39	16,96	33	559,59	CHI
202002177955	ITABERAI	IB21310482	ITABERAI S2	27/02/2020 18:44	28/02/2020 18:44	27/02/2020 18:44	28/02/2020 18:44	23,99	1	23,99	CHI
202002177956	QUIRINOPOLIS	QI21143161	QUIRINOPOLIS	27/02/2020 18:44	27/02/2020 23:20	27/02/2020 18:44	27/02/2020 23:20	4,59	1	4,59	CHI
202002177957	CAMPINORTE	2040004446	CAMPINORTE	27/02/2020 18:44	28/02/2020 08:07	27/02/2020 18:44	28/02/2020 08:07	13,39	1	13,39	CHI
202002177959	GOIANIA	17404332	XAVANTES	27/02/2020 18:45	27/02/2020 23:32	27/02/2020 18:45	27/02/2020 23:32	4,78	1	4,78	CHI
202002177967	ITABERAI	IB12300044	ITABERAI S1	27/02/2020 18:17	27/02/2020 21:37	27/02/2020 18:17	27/02/2020 21:37	3,33	8	26,64	CHI
202002177969	MARA ROSA	MQ12249544	MARA ROSA	27/02/2020 18:46	28/02/2020 07:48	27/02/2020 18:46	28/02/2020 07:48	13,03	2	26,05	CHI
202002177973	TRINDADE	16831664	GOYA S2	27/02/2020 18:47	27/02/2020 20:17	27/02/2020 18:47	27/02/2020 20:17	1,49	1	1,49	CHI
202002177979	CATALAO	CT12061234	CATALAO S1	27/02/2020 16:36	27/02/2020 22:57	27/02/2020 16:36	27/02/2020 22:57	6,34	16	101,49	CHI
202002177982	CORUMBAIBA	CI10407944	VILA CORUMBA	27/02/2020 18:03	27/02/2020 22:00	27/02/2020 18:04	27/02/2020 22:00	3,94	247	972,63	CHI
202002177983	ITABERAI	IB12274355	ITABERAI S2	27/02/2020 18:51	28/02/2020 10:41	27/02/2020 18:51	28/02/2020 10:41	15,83	2	31,66	CHI
202002177990	GOIANIA	GN11040692	FERROVIARIO S2	27/02/2020 18:52	28/02/2020 09:43	28/02/2020 09:15	28/02/2020 09:43	0,47	74	34,55	CHI
202002177994	GOIANIA	10014349815	CARAJAS S1	27/02/2020 18:53	27/02/2020 20:53	27/02/2020 18:53	27/02/2020 20:53	2,00	1	2,00	CHI
202002177995	ANAPOLIS	20687060	JUNDIAI S2	27/02/2020 18:54	27/02/2020 21:58	27/02/2020 18:54	27/02/2020 21:58	3,06	1	3,06	CHI
202002177998	CORUMBAIBA	CI12027816	VILA CORUMBA	27/02/2020 18:29	28/02/2020 01:10	27/02/2020 18:29	28/02/2020 01:10	6,67	23	153,47	CHI
202002178000	ACREUNA	EU11189157	ACREUNA	27/02/2020 17:54	27/02/2020 22:55	27/02/2020 17:54	27/02/2020 22:55	5,00	170	850,52	CHI
202002178002	NIQUELANDIA	NQ12221620	URUACU	27/02/2020 18:55	27/02/2020 22:56	27/02/2020 18:55	27/02/2020 22:56	4,01	147	589,06	CHI

202002178007	GOIANIA	GN11390053	ATLANTICO S3	27/02/2020 18:48	27/02/2020 19:40	27/02/2020 18:48	27/02/2020 19:40	0,85	12	10,22	CHI
202002178008	ANAPOLIS	20714210	JUNDIAI S2	27/02/2020 18:57	27/02/2020 21:34	27/02/2020 18:57	27/02/2020 21:34	2,62	1	2,62	CHI
202002178012	IPAMERI	IP12404735	IPAMERI	27/02/2020 18:57	28/02/2020 08:20	27/02/2020 18:57	28/02/2020 08:20	13,38	2	26,75	CHI
202002178014	CATALAO	CT12338733	CATALAO S1	27/02/2020 18:38	27/02/2020 22:56	27/02/2020 18:38	27/02/2020 22:56	4,29	3	12,87	CHI
202002178019	PLANALTINA	PI12211522	PADRE BERNARDO	27/02/2020 18:58	28/02/2020 02:21	27/02/2020 18:58	28/02/2020 02:21	7,37	23	169,61	CHI
202002178020	PIRES DO RIO	PR12083163	PIRES DO RIO S1	27/02/2020 18:58	28/02/2020 08:28	27/02/2020 18:58	28/02/2020 08:28	13,49	5	67,45	CHI
202002178021	ITAUCU	IX12016023	INHUMAS S1	27/02/2020 18:59	28/02/2020 08:30	27/02/2020 18:59	28/02/2020 08:30	13,51	5	67,53	CHI
202002178024	ACREUNA	2440033577	ACREUNA	27/02/2020 19:00	28/02/2020 00:27	27/02/2020 19:00	28/02/2020 00:27	5,44	1	5,44	CHI
202002178025	PIRENOPOLIS	PV12316006	CORUMBA	27/02/2020 19:00	27/02/2020 22:41	27/02/2020 19:00	27/02/2020 22:41	3,67	3	11,02	CHI
202002178026	CAIAPONIA	CP12243821	CAIAPONIA	27/02/2020 15:01	28/02/2020 04:46	27/02/2020 15:01	28/02/2020 04:46	13,75	14	192,47	CHI
202002178028	TRINDADE	12279511	GOYA S2	27/02/2020 19:00	27/02/2020 20:51	27/02/2020 19:00	27/02/2020 20:51	1,84	1	1,84	CHI
202002178032	SANTO ANTONIO DA BARRA	2270008280	ACREUNA	27/02/2020 19:01	28/02/2020 01:20	27/02/2020 19:01	28/02/2020 01:20	6,31	1	6,31	CHI
202002178034	BELA VISTA DE GOIAS	BV12402719	BELA VISTA S1	27/02/2020 19:01	27/02/2020 21:58	27/02/2020 19:01	27/02/2020 21:58	2,94	169	496,25	CHI
202002178040	JARAGUA	PV12370304	CORUMBA	27/02/2020 19:03	28/02/2020 00:12	27/02/2020 19:03	28/02/2020 00:12	5,15	3	15,44	CHI
202002178043	CALDAS NOVAS	760167060	SERRA DE CALDAS	27/02/2020 19:03	28/02/2020 05:04	27/02/2020 19:03	28/02/2020 05:04	10,02	1	10,02	CHI
202002178047	FORMOSA	FA11180623	ITUIQUIRA	27/02/2020 19:03	27/02/2020 19:27	27/02/2020 19:03	27/02/2020 19:27	0,39	208	81,76	CHI
202002178077	MINACU	10001333419	MINACU	27/02/2020 19:12	28/02/2020 08:02	27/02/2020 19:12	28/02/2020 08:02	12,83	1	12,83	CHI
202002178082	ANAPOLIS	AN11129404	ANAPOLIS UNIVERSITARIO S2	27/02/2020 19:08	27/02/2020 22:46	27/02/2020 19:08	27/02/2020 22:46	3,63	164	595,59	CHI
202002178087	LUZIANIA	LZ11261251	RIO VERMELHO	27/02/2020 19:01	27/02/2020 22:29	27/02/2020 19:01	27/02/2020 22:29	3,46	149	515,33	CHI
202002178099	INHUMAS	IX10403955	INHUMAS S1	27/02/2020 19:14	28/02/2020 02:20	27/02/2020 19:14	27/02/2020 21:51	2,63	1	2,63	CHI
202002178099	ITAUCU	IX12018279LD	INHUMAS S1	27/02/2020 19:14	28/02/2020 02:20	28/02/2020 00:22	28/02/2020 02:18	1,93	150	289,25	CHI
202002178099	INHUMAS	IX10403955	INHUMAS S1	27/02/2020 19:14	28/02/2020 02:20	27/02/2020 19:14	28/02/2020 02:20	7,10	71	504,10	CHI
202002178099	INHUMAS	IX13016042	INHUMAS S1	27/02/2020 19:14	28/02/2020 02:20	27/02/2020 19:14	28/02/2020 02:20	7,10	79	560,90	CHI
202002178099	ITAUCU	IX10403955	INHUMAS S1	27/02/2020 19:14	28/02/2020 02:20	27/02/2020 19:14	28/02/2020 02:20	7,10	44	312,40	CHI
202002178104	RIO VERDE	RV21301280	SANTA HELENA S1	27/02/2020 19:19	28/02/2020 09:50	27/02/2020 19:19	28/02/2020 09:50	14,51	1	14,51	CHI
202002178105	ITABERAI	IB12079203	ITABERAI S1	27/02/2020 19:12	28/02/2020 15:20	27/02/2020 19:12	28/02/2020 12:43	17,51	17	297,74	CHI
202002178105	ITABERAI	IB12079207	ITABERAI S1	27/02/2020 19:12	28/02/2020 15:20	27/02/2020 19:12	28/02/2020 14:31	19,30	2	38,61	CHI
202002178105	ITABERAI	IB12172691LD	ITABERAI S1	27/02/2020 19:12	28/02/2020 15:20	27/02/2020 19:12	28/02/2020 15:20	20,12	4	80,48	CHI
202002178110	VILA BOA	2880001827	IACIARA S2	27/02/2020 19:20	27/02/2020 21:40	27/02/2020 19:20	27/02/2020 21:40	2,32	1	2,32	CHI
202002178111	GOIANIA	10631756	AEROPORTO S2	27/02/2020 19:21	28/02/2020 01:05	27/02/2020 19:21	28/02/2020 01:05	5,72	1	5,72	CHI
202002178113	GOIANIA	10025957927	GOYA S2	27/02/2020 19:22	27/02/2020 20:30	27/02/2020 19:22	27/02/2020 20:30	1,12	1	1,12	CHI
202002178115	URUTAI	UT12083186	URUTAI	27/02/2020 19:23	28/02/2020 00:46	27/02/2020 19:23	28/02/2020 00:46	5,38	3	16,14	CHI
202002178117	INDIARA	IY21385129	ACREUNA	27/02/2020 19:23	28/02/2020 08:38	27/02/2020 19:23	28/02/2020 08:38	13,24	1	13,24	CHI
202002178120	SITIO D ABADIA	AQ12240882	IACIARA S2	27/02/2020 19:24	27/02/2020 21:47	27/02/2020 19:24	27/02/2020 21:47	2,37	2	4,74	CHI
202002178121	FORMOSA	FA11257641	ITUIQUIRA	27/02/2020 19:23	27/02/2020 19:56	27/02/2020 19:23	27/02/2020 19:56	0,55	155	84,60	CHI
202002178124	SAO SIMAO	2240046539	CACHOEIRA ALTA	27/02/2020 19:26	27/02/2020 23:02	27/02/2020 19:26	27/02/2020 23:02	3,60	1	3,60	CHI
202002178125	CACU	CC12027354	CACHOEIRA ALTA	27/02/2020 19:26	28/02/2020 12:28	27/02/2020 19:26	28/02/2020 12:28	17,02	6	102,14	CHI
202002178130	ITAUCU	IB21317394	INHUMAS S1	27/02/2020 19:28	28/02/2020 10:54	27/02/2020 19:28	28/02/2020 10:54	15,43	3	46,28	CHI
202002178131	IPORA	IR12060703	IPORA	27/02/2020 18:04	28/02/2020 11:44	27/02/2020 18:04	28/02/2020 11:44	17,66	6	105,96	CHI
202002178139	MAIRIPOTABA	MI31060577	PONTALINA	27/02/2020 19:30	28/02/2020 08:46	27/02/2020 19:30	28/02/2020 08:46	13,26	1	13,26	CHI
202002178140	GOIANIA	GN12164390	XAVANTES	27/02/2020 19:27	27/02/2020 23:45	27/02/2020 22:00	27/02/2020 22:50	0,82	621	511,98	CHI
202002178140	GOIANIA	GN12164390	XAVANTES	27/02/2020 19:27	27/02/2020 23:45	27/02/2020 22:00	27/02/2020 23:45	1,74	123	214,19	CHI
202002178142	JATAI	290306474	JATAI S2	27/02/2020 19:31	28/02/2020 00:25	27/02/2020 19:31	28/02/2020 00:25	4,89	1	4,89	CHI
202002178150	LUZIANIA	120252880	RIO VERMELHO	27/02/2020 19:35	27/02/2020 21:49	27/02/2020 19:35	27/02/2020 21:49	2,22	1	2,22	CHI

202002178158	DOVERLANDIA	DV11204249	CAIAPONIA	27/02/2020 19:38	28/02/2020 18:47	27/02/2020 19:38	28/02/2020 18:47	23,14	1	23,14	CHI
202002178161	SANTO ANTONIO DO DESCOBERTO	SN21214799	ALEXANIA	27/02/2020 19:39	28/02/2020 10:16	27/02/2020 19:39	28/02/2020 10:16	14,60	1	14,60	CHI
202002178163	ITAGUARI	IC12219937	ITABERAI S1	27/02/2020 19:29	27/02/2020 21:56	27/02/2020 19:29	27/02/2020 21:56	2,45	25	61,13	CHI
202002178163	ITAGUARU	IC12219937	ITABERAI S1	27/02/2020 19:29	27/02/2020 21:56	27/02/2020 19:29	27/02/2020 21:56	2,45	2	4,89	CHI
202002178170	PONTALINA	PK12263505RE	PONTALINA	27/02/2020 19:42	28/02/2020 11:28	27/02/2020 19:42	28/02/2020 11:28	15,76	8	126,10	CHI
202002178171	PIRES DO RIO	PR21095281	PIRES DO RIO S1	27/02/2020 19:42	28/02/2020 07:54	27/02/2020 19:42	28/02/2020 07:54	12,20	1	12,20	CHI
202002178173	ITABERAI	IB12336270	ITABERAI S1	27/02/2020 19:42	28/02/2020 03:59	27/02/2020 19:42	28/02/2020 03:59	8,27	3	24,80	CHI
202002178176	ARAGARCAS	AG12380911	ARAGARCAS	27/02/2020 19:43	28/02/2020 10:38	27/02/2020 19:43	28/02/2020 10:38	14,91	1	14,91	CHI
202002178178	FORMOSA	FA11257764	ITIQUEIRA	27/02/2020 19:45	27/02/2020 21:24	27/02/2020 19:45	27/02/2020 21:24	1,65	3	4,95	CHI
202002178179	COCALZINHO DE GOIAS	ZN12067363	AGUAS LINDAS DE GOIAS S1	27/02/2020 19:45	27/02/2020 22:42	27/02/2020 19:45	27/02/2020 22:42	2,95	39	115,01	CHI
202002178180	FORMOSA	610101316	ITIQUEIRA	27/02/2020 19:45	27/02/2020 21:31	27/02/2020 19:45	27/02/2020 21:31	1,76	1	1,76	CHI
202002178182	GOIAS	IU12089736	MATRINCHA	27/02/2020 16:02	27/02/2020 18:20	27/02/2020 16:02	27/02/2020 18:20	2,30	1	2,30	CHI
202002178194	GOIANIA	10031197874	MEIA PONTE	27/02/2020 19:47	27/02/2020 21:37	27/02/2020 19:47	27/02/2020 21:37	1,83	0	0,00	CHI
202002178197	MINACU	IH21236211	MINACU	27/02/2020 19:47	28/02/2020 15:06	27/02/2020 19:47	28/02/2020 15:06	19,30	1	19,30	CHI
202002178198	GOIANIA	GN11136790	FERROVIARIO S1	27/02/2020 19:47	28/02/2020 00:49	27/02/2020 19:47	28/02/2020 00:49	5,03	110	553,33	CHI
202002178199	PLANALTINA	2960096168	PLANALTINA	27/02/2020 19:48	27/02/2020 21:23	27/02/2020 19:48	27/02/2020 21:23	1,59	1	1,59	CHI
202002178209	SAO MIGUEL DO ARAGUAIA	SM12384276	SAO MIGUEL DO ARAGUAIA	27/02/2020 19:51	28/02/2020 01:08	27/02/2020 19:51	28/02/2020 01:08	5,27	3	15,81	CHI
202002178213	CAMPO ALEGRE DE GOIAS	CM21074080	CAMPO ALEGRE DE GOIAS	27/02/2020 19:54	29/02/2020 10:02	27/02/2020 19:54	29/02/2020 10:02	38,13	1	38,13	CHI
202002178217	MONTES CLAROS DE GOIAS	ME12380972	IPORA	27/02/2020 19:54	28/02/2020 00:08	27/02/2020 19:54	28/02/2020 00:08	4,22	8	33,77	CHI
202002178224	TAUARAL DE GOIAS	TQ12171611	INHUMAS S1	27/02/2020 19:52	27/02/2020 21:31	27/02/2020 19:52	27/02/2020 21:31	1,64	4	6,56	CHI
202002178225	BONOPOLIS	BX12202590	SAO MIGUEL DO ARAGUAIA	27/02/2020 19:56	27/02/2020 20:48	27/02/2020 19:56	27/02/2020 20:48	0,85	11	9,40	CHI
202002178232	CORUMBAIBA	19979750	VILA CORUMBA	27/02/2020 19:00	28/02/2020 00:23	27/02/2020 19:00	28/02/2020 00:23	5,37	137	735,92	CHI
202002178236	SENADOR CANEDO	SW11384961	SENADOR CANEDO	27/02/2020 19:58	27/02/2020 20:52	27/02/2020 19:58	27/02/2020 20:52	0,89	169	150,69	CHI
202002178238	ITAPACI	100080236	ITAPACI	27/02/2020 19:59	27/02/2020 21:47	27/02/2020 19:59	27/02/2020 21:47	1,80	1	1,80	CHI
202002178240	APARECIDA DO RIO DOCE	RV12074685	CACHOEIRA ALTA	27/02/2020 19:59	28/02/2020 23:06	27/02/2020 19:59	28/02/2020 23:06	27,11	5	135,53	CHI
202002178240	RIO VERDE	RV12074685	CACHOEIRA ALTA	27/02/2020 19:59	28/02/2020 23:06	27/02/2020 19:59	28/02/2020 23:06	27,11	5	135,53	CHI
202002178244	GOIANIA	GN11390053	ATLANTICO S3	27/02/2020 20:02	27/02/2020 21:22	27/02/2020 20:26	27/02/2020 21:22	0,93	12	11,20	CHI
202002178245	FORMOSA	FA12131868	ITIQUEIRA	27/02/2020 19:57	27/02/2020 21:55	27/02/2020 19:57	27/02/2020 21:55	1,96	684	1338,55	CHI
202002178247	BONOPOLIS	BX12391924	SAO MIGUEL DO ARAGUAIA	27/02/2020 20:03	27/02/2020 22:45	27/02/2020 20:03	27/02/2020 22:45	2,70	27	72,88	CHI
202002178247	SAO MIGUEL DO ARAGUAIA	BX12391924	SAO MIGUEL DO ARAGUAIA	27/02/2020 20:03	27/02/2020 22:45	27/02/2020 20:03	27/02/2020 22:45	2,70	1	2,70	CHI
202002178248	GUAPO	710001459	GUAPO S1	27/02/2020 20:03	28/02/2020 02:24	27/02/2020 20:03	28/02/2020 02:24	6,35	1	6,35	CHI
202002178253	QUIRINOPOLIS	QI21000259	QUIRINOPOLIS	27/02/2020 20:04	27/02/2020 23:28	27/02/2020 20:04	27/02/2020 23:28	3,39	1	3,39	CHI
202002178255	ITAUCU	IX12319550	ITABERAI S1	27/02/2020 20:03	28/02/2020 09:35	27/02/2020 20:03	28/02/2020 09:35	13,53	5	67,64	CHI
202002178257	CACU	CC21322238	CACHOEIRA ALTA	27/02/2020 20:06	28/02/2020 00:09	27/02/2020 20:06	28/02/2020 00:09	4,03	1	4,03	CHI
202002178260	GOIAS	GS21307432	GOIAS	27/02/2020 20:07	28/02/2020 09:09	27/02/2020 20:07	28/02/2020 09:09	13,04	1	13,04	CHI
202002178267	AGUAS LINDAS DE GOIAS	4830152759	AGUAS LINDAS DE GOIAS S1	27/02/2020 20:10	27/02/2020 21:27	27/02/2020 20:10	27/02/2020 21:27	1,28	1	1,28	CHI
202002178268	SIMOLANDIA	10009356400	IACIARA S2	27/02/2020 20:10	27/02/2020 22:38	27/02/2020 20:10	27/02/2020 22:38	2,46	1	2,46	CHI
202002178271	PIRANHAS	PH12023593	PIRANHAS	27/02/2020 20:12	28/02/2020 07:17	27/02/2020 20:12	28/02/2020 07:17	11,08	27	299,20	CHI
202002178274	MONTIVIDIU	MV21075459	MONTIVIDIU T	27/02/2020 20:13	27/02/2020 23:32	27/02/2020 20:13	27/02/2020 23:32	3,31	2	6,62	CHI
202002178276	PORTEIRAO	CL12214128	RIO DOS BOIS	27/02/2020 20:13	28/02/2020 03:06	27/02/2020 20:13	28/02/2020 03:06	6,87	3	20,61	CHI
202002178278	AMARALINA	LC12189854	MARA ROSA	27/02/2020 20:15	28/02/2020 02:02	27/02/2020 20:15	28/02/2020 02:02	5,77	6	34,65	CHI
202002178278	MARA ROSA	LC12189854	MARA ROSA	27/02/2020 20:15	28/02/2020 02:02	27/02/2020 20:15	28/02/2020 02:02	5,77	2	11,55	CHI
202002178285	JATAI	JT12109029	JATAI S1	28/02/2020 06:41	28/02/2020 22:51	28/02/2020 06:41	28/02/2020 14:08	7,45	24	178,83	CHI
202002178285	JATAI	JT21164200	JATAI S1	28/02/2020 06:41	28/02/2020 22:51	28/02/2020 06:41	28/02/2020 22:11	15,51	2	31,02	CHI

202002178285	JATAI	JT21304384	JATAI S1	28/02/2020 06:41	28/02/2020 22:51	28/02/2020 06:41	28/02/2020 22:37	15,94	1	15,94	CHI
202002178285	JATAI	JT21358090	JATAI S1	28/02/2020 06:41	28/02/2020 22:51	28/02/2020 06:41	28/02/2020 22:51	16,18	1	16,18	CHI
202002178298	COLINAS DO SUL	TI21372304	MINACU	27/02/2020 20:22	28/02/2020 01:05	27/02/2020 20:22	28/02/2020 01:05	4,70	1	4,70	CHI
202002178301	CRISTIANOPOLIS	PJ12212176RE	PIRACANJUBA	27/02/2020 19:58	28/02/2020 00:37	27/02/2020 19:58	28/02/2020 00:37	4,63	4	18,54	CHI
202002178301	PIRACANJUBA	PJ12212176RE	PIRACANJUBA	27/02/2020 19:58	28/02/2020 00:37	27/02/2020 19:58	28/02/2020 00:37	4,63	14	64,88	CHI
202002178301	SANTA CRUZ DE GOIAS	PJ12212176RE	PIRACANJUBA	27/02/2020 19:58	28/02/2020 00:37	27/02/2020 19:58	28/02/2020 00:37	4,63	73	338,29	CHI
202002178303	ANAPOLIS	20565793	ANAPOLIS UNIVERSITARIO S2	27/02/2020 20:24	27/02/2020 22:33	27/02/2020 20:24	27/02/2020 22:33	2,14	1	2,14	CHI
202002178310	GOIANIA	GN12001501	XAVANTES	27/02/2020 20:28	27/02/2020 23:06	27/02/2020 20:28	27/02/2020 23:06	2,63	215	565,21	CHI
202002178315	ARAGARCAS	1820001432	ARAGARCAS	27/02/2020 20:30	28/02/2020 08:00	27/02/2020 20:30	28/02/2020 08:00	11,50	1	11,50	CHI
202002178318	SANTO ANTONIO DO DESCOBERTO	03560406	AGUAS LINDAS DE GOIAS S2	27/02/2020 20:30	27/02/2020 21:40	27/02/2020 20:30	27/02/2020 21:40	1,16	284	330,47	CHI
202002178337	SILVANIA	SV11104311	VIANOPOLIS	27/02/2020 20:31	27/02/2020 22:18	27/02/2020 20:31	27/02/2020 22:18	1,78	71	126,44	CHI
202002178337	SILVANIA	SV12104310	VIANOPOLIS	27/02/2020 20:31	27/02/2020 22:18	27/02/2020 22:00	27/02/2020 22:18	0,31	145	44,67	CHI
202002178338	ITABERAI	IB12210464	ITABERAI S1	27/02/2020 19:56	28/02/2020 03:33	27/02/2020 19:56	28/02/2020 03:33	7,62	7	53,32	CHI
202002178339	CROMINIA	CQ12000245	PONTALINA	27/02/2020 18:13	28/02/2020 09:08	27/02/2020 18:13	28/02/2020 09:08	14,92	9	134,29	CHI
202002178340	ANICUNS	AC11092553	ANICUNS	27/02/2020 20:29	27/02/2020 22:24	27/02/2020 20:29	27/02/2020 22:24	1,91	256	488,25	CHI
202002178342	ANICUNS	910046037	ANICUNS	27/02/2020 20:39	28/02/2020 00:05	27/02/2020 20:39	28/02/2020 00:05	3,42	1	3,42	CHI
202002178343	VALPARAISO DE GOIAS	2860306979	PACAEMBU S1	27/02/2020 20:39	27/02/2020 22:04	27/02/2020 20:39	27/02/2020 22:04	1,40	1	1,40	CHI
202002178345	MINEIROS	MY10396070	PARQUE DAS EMAS	27/02/2020 20:40	28/02/2020 19:30	27/02/2020 20:40	28/02/2020 02:32	5,87	37	217,01	CHI
202002178345	MINEIROS	MY12341117LD	PARQUE DAS EMAS	27/02/2020 20:40	28/02/2020 19:30	27/02/2020 20:40	28/02/2020 09:40	13,01	14	182,15	CHI
202002178345	MINEIROS	MY10396070	PARQUE DAS EMAS	27/02/2020 20:40	28/02/2020 19:30	27/02/2020 20:40	28/02/2020 15:45	19,08	27	515,16	CHI
202002178345	MINEIROS	MY10396070	PARQUE DAS EMAS	27/02/2020 20:40	28/02/2020 19:30	27/02/2020 20:40	28/02/2020 16:39	19,99	21	419,70	CHI
202002178345	MINEIROS	MY10396070	PARQUE DAS EMAS	27/02/2020 20:40	28/02/2020 19:30	27/02/2020 20:40	28/02/2020 18:53	22,23	17	377,86	CHI
202002178345	SERRANOPOLIS	MY10396070	PARQUE DAS EMAS	27/02/2020 20:40	28/02/2020 19:30	27/02/2020 20:40	28/02/2020 18:53	22,23	7	155,59	CHI
202002178345	MINEIROS	MY10396070	PARQUE DAS EMAS	27/02/2020 20:40	28/02/2020 19:30	27/02/2020 20:40	28/02/2020 19:30	22,84	13	296,87	CHI
202002178353	ITABERAI	IB12250711	ITABERAI S1	27/02/2020 20:12	28/02/2020 04:11	27/02/2020 20:12	28/02/2020 04:11	7,98	3	23,93	CHI
202002178356	ARAGARCAS	AG12316281	ARAGARCAS	27/02/2020 20:43	28/02/2020 11:03	27/02/2020 20:43	28/02/2020 11:03	14,32	2	28,64	CHI
202002178360	SAO DOMINGOS	SD12389179	SAO DOMINGOS	27/02/2020 20:45	28/02/2020 10:41	27/02/2020 20:45	28/02/2020 10:41	13,92	10	139,24	CHI
202002178367	GUAPO	GA12000164	GUAPO S1	27/02/2020 17:26	27/02/2020 22:29	27/02/2020 17:26	27/02/2020 22:29	5,05	7	35,35	CHI
202002178369	GOIANIA	13964501	MEIA PONTE	27/02/2020 20:47	28/02/2020 04:54	27/02/2020 20:47	28/02/2020 04:54	8,11	1	8,11	CHI
202002178370	PONTALINA	PK21181926	PONTALINA	27/02/2020 20:47	28/02/2020 10:51	27/02/2020 20:47	28/02/2020 10:51	14,06	1	14,06	CHI
202002178383	VIANOPOLIS	VN21228250	VIANOPOLIS	27/02/2020 20:49	28/02/2020 17:14	27/02/2020 20:49	28/02/2020 17:14	20,42	1	20,42	CHI
202002178384	CABECEIRAS	CW12108845	ITUIQUIRA	27/02/2020 20:49	27/02/2020 22:20	27/02/2020 20:49	27/02/2020 22:20	1,51	11	16,65	CHI
202002178385	APARECIDA DE GOIANIA	AP10383687	REAL S1	27/02/2020 20:42	28/02/2020 01:07	27/02/2020 20:46	28/02/2020 00:46	4,01	3551	14224,71	CHI
202002178385	APARECIDA DE GOIANIA	AP16401589	REAL S1	27/02/2020 20:42	28/02/2020 01:07	27/02/2020 20:46	28/02/2020 01:07	4,34	1626	7063,61	CHI
202002178389	MINACU	IH12230295	MINACU	27/02/2020 18:33	28/02/2020 13:54	27/02/2020 18:33	28/02/2020 13:54	19,33	5	96,67	CHI
202002178408	ANAPOLIS	20374860	JUNDIAI S1	27/02/2020 20:59	28/02/2020 00:20	27/02/2020 20:59	28/02/2020 00:20	3,34	1	3,34	CHI
202002178409	GOIANIA	16061354	MEIA PONTE	27/02/2020 21:00	27/02/2020 22:28	27/02/2020 21:00	27/02/2020 22:28	1,46	1	1,46	CHI
202002178415	MINEIROS	MY12148260	PARQUE DAS EMAS	27/02/2020 21:01	28/02/2020 13:50	27/02/2020 21:01	28/02/2020 13:50	16,81	6	100,83	CHI
202002178426	CATALAO	1990136373	CATALAO S2	27/02/2020 21:04	27/02/2020 23:46	27/02/2020 21:04	27/02/2020 23:46	2,70	1	2,70	CHI
202002178430	BOM JESUS DE GOIAS	BJ21310054	BOM JESUS DE GOIAS	27/02/2020 21:05	28/02/2020 08:20	27/02/2020 21:05	28/02/2020 08:20	11,24	1	11,24	CHI
202002178434	MONTE ALEGRE DE GOIAS	MA12261959	SAO DOMINGOS	27/02/2020 21:05	28/02/2020 00:39	27/02/2020 21:05	28/02/2020 00:39	3,56	28	99,63	CHI
202002178436	SANTA FE DE GOIAS	RN21275851	BRITANIA	27/02/2020 21:06	28/02/2020 09:57	27/02/2020 21:06	28/02/2020 09:57	12,84	1	12,84	CHI
202002178440	CAMPINORTE	CR12070384	CAMPINORTE	27/02/2020 18:54	28/02/2020 18:16	27/02/2020 18:54	28/02/2020 10:44	15,84	5	79,18	CHI
202002178440	NOVA IGUACU DE GOIAS	CR12070384	CAMPINORTE	27/02/2020 18:54	28/02/2020 18:16	27/02/2020 18:54	28/02/2020 10:44	15,84	13	205,87	CHI

202002178440	CAMPINORTE	CR12070384	CAMPINORTE	27/02/2020 18:54	28/02/2020 18:16	27/02/2020 18:54	28/02/2020 11:53	16,99	1	16,99	CHI
202002178440	NOVA IGUACU DE GOIAS	CR12070384	CAMPINORTE	27/02/2020 18:54	28/02/2020 18:16	27/02/2020 18:54	28/02/2020 11:53	16,99	2	33,98	CHI
202002178440	NOVA IGUACU DE GOIAS	CR12070384	CAMPINORTE	27/02/2020 18:54	28/02/2020 18:16	27/02/2020 18:54	28/02/2020 18:16	23,37	6	140,21	CHI
202002178443	PIRACANJUBA	PJ21106676	CALDAS NOVAS S1	27/02/2020 21:09	28/02/2020 08:35	27/02/2020 21:09	28/02/2020 08:35	11,43	1	11,43	CHI
202002178449	MATRINCHA	MP12299750	MATRINCHA	27/02/2020 21:11	28/02/2020 07:07	27/02/2020 21:11	28/02/2020 07:07	9,93	19	188,73	CHI
202002178456	EDEALINA	04970226	VICENTINOPOLIS	27/02/2020 21:14	28/02/2020 13:23	28/02/2020 06:31	28/02/2020 10:56	4,40	11	48,45	CHI
202002178456	EDEIA	04970226	VICENTINOPOLIS	27/02/2020 21:14	28/02/2020 13:23	28/02/2020 06:31	28/02/2020 10:56	4,40	32	140,94	CHI
202002178456	PONTALINA	04970226	VICENTINOPOLIS	27/02/2020 21:14	28/02/2020 13:23	28/02/2020 06:31	28/02/2020 10:56	4,40	1	4,40	CHI
202002178456	VICENTINOPOLIS	04970226	VICENTINOPOLIS	27/02/2020 21:14	28/02/2020 13:23	28/02/2020 06:31	28/02/2020 10:56	4,40	2	8,81	CHI
202002178456	EDEALINA	04970226	VICENTINOPOLIS	27/02/2020 21:14	28/02/2020 13:23	28/02/2020 06:31	28/02/2020 13:23	6,85	3	20,56	CHI
202002178457	AMARALINA	MQ12391953	NOVA CRIXAS	27/02/2020 15:04	28/02/2020 11:16	27/02/2020 15:04	28/02/2020 11:16	20,19	7	141,34	CHI
202002178457	MARA ROSA	MQ12391953	NOVA CRIXAS	27/02/2020 15:04	28/02/2020 11:16	27/02/2020 15:04	28/02/2020 11:16	20,19	15	302,87	CHI
202002178458	ORIZONA	OZ21127793	PIRES DO RIO S2	27/02/2020 21:15	28/02/2020 00:19	27/02/2020 21:15	28/02/2020 00:19	3,07	1	3,07	CHI
202002178464	LUZIANIA	LZ11061747	MARAJOARA	27/02/2020 21:19	27/02/2020 22:32	27/02/2020 21:19	27/02/2020 22:32	1,21	17	20,65	CHI
202002178466	PIRANHAS	PH12390165	PIRANHAS	27/02/2020 21:19	27/02/2020 22:22	27/02/2020 21:19	27/02/2020 22:22	1,04	4	4,16	CHI
202002178474	PIRENOPOLIS	PV21196784	CORUMBA	27/02/2020 21:23	27/02/2020 22:56	27/02/2020 21:23	27/02/2020 22:56	1,55	1	1,55	CHI
202002178476	LAGOA SANTA	IJ21154807	CACHOEIRA ALTA	27/02/2020 21:23	28/02/2020 03:35	27/02/2020 21:23	28/02/2020 03:35	6,18	1	6,18	CHI
202002178477	BOM JARDIM DE GOIAS	PH12201913	PIRANHAS	27/02/2020 21:23	28/02/2020 08:44	27/02/2020 21:23	28/02/2020 08:44	11,34	2	22,68	CHI
202002178477	PIRANHAS	PH12201913	PIRANHAS	27/02/2020 21:23	28/02/2020 08:44	27/02/2020 21:23	28/02/2020 08:44	11,34	11	124,76	CHI
202002178482	ADELANDIA	DN12039706	FIRMINOPOLIS S2	27/02/2020 21:26	28/02/2020 07:07	27/02/2020 21:26	28/02/2020 07:07	9,68	4	38,73	CHI
202002178482	AURILANDIA	DN12039706	FIRMINOPOLIS S2	27/02/2020 21:26	28/02/2020 07:07	27/02/2020 21:26	28/02/2020 07:07	9,68	1	9,68	CHI
202002178482	SAO LUIS DE MONTES BELOS	DN12039706	FIRMINOPOLIS S2	27/02/2020 21:26	28/02/2020 07:07	27/02/2020 21:26	28/02/2020 07:07	9,68	39	377,65	CHI
202002178482	TURVANIA	DN12039706	FIRMINOPOLIS S2	27/02/2020 21:26	28/02/2020 07:07	27/02/2020 21:26	28/02/2020 07:07	9,68	2	19,37	CHI
202002178483	SANTO ANTONIO DO DESCOBERTO	SN12330527	MARAJOARA	27/02/2020 21:25	27/02/2020 23:13	27/02/2020 21:25	27/02/2020 23:13	1,79	13	23,27	CHI
202002178484	GOIANIA	GN11001147	REAL S1	27/02/2020 21:26	27/02/2020 23:29	27/02/2020 23:23	27/02/2020 23:29	0,09	124	10,64	CHI
202002178485	TRINDADE	10025260934	TRINDADE	27/02/2020 21:26	27/02/2020 22:45	27/02/2020 21:26	27/02/2020 22:45	1,30	1	1,30	CHI
202002178494	CATURAI	CK21283804	INHUMAS S1	27/02/2020 21:30	28/02/2020 09:51	27/02/2020 21:30	28/02/2020 09:51	12,34	1	12,34	CHI
202002178496	CRISTALINA	KR12027635	PAMPLONA	27/02/2020 21:32	28/02/2020 01:05	27/02/2020 21:32	28/02/2020 01:05	3,54	3	10,62	CHI
202002178505	GOIANIA	10966158	CAMPINAS S3	27/02/2020 21:40	27/02/2020 22:56	27/02/2020 21:40	27/02/2020 22:56	1,26	1	1,26	CHI
202002178511	SILVANIA	SV12141337	VIANOPOLIS	27/02/2020 18:00	28/02/2020 15:08	27/02/2020 18:00	28/02/2020 15:08	21,13	11	232,38	CHI
202002178513	SILVANIA	SV21133523	VIANOPOLIS	27/02/2020 18:46	28/02/2020 00:20	27/02/2020 18:46	28/02/2020 00:20	5,57	1	5,57	CHI
202002178515	GOIATUBA	GT21316663	GOIATUBA S2	27/02/2020 21:45	28/02/2020 07:29	27/02/2020 21:45	28/02/2020 07:29	9,73	1	9,73	CHI
202002178517	SANTO ANTONIO DO DESCOBERTO	10005134038	ALEXANIA	27/02/2020 21:45	27/02/2020 23:18	27/02/2020 21:45	27/02/2020 23:18	1,54	1	1,54	CHI
202002178518	CAIAPONIA	CP12075058	CAIAPONIA	27/02/2020 21:30	28/02/2020 11:10	27/02/2020 21:30	28/02/2020 11:10	13,66	23	314,26	CHI
202002178518	JATAI	CP12075058	CAIAPONIA	27/02/2020 21:30	28/02/2020 11:10	27/02/2020 21:30	28/02/2020 11:10	13,66	3	40,99	CHI
202002178518	RIO VERDE	CP12075058	CAIAPONIA	27/02/2020 21:30	28/02/2020 11:10	27/02/2020 21:30	28/02/2020 11:10	13,66	4	54,65	CHI
202002178524	ANAPOLIS	AN11000499	JUNDIAI S2	27/02/2020 21:43	27/02/2020 22:47	27/02/2020 21:43	27/02/2020 22:47	1,06	149	158,06	CHI
202002178525	ITAPACI	IW12210233	ITAPACI	27/02/2020 21:45	28/02/2020 00:18	27/02/2020 21:45	28/02/2020 00:18	2,54	109	277,31	CHI
202002178526	VALPARAISO DE GOIAS	2860139923	PACAEMBU S2	27/02/2020 21:49	28/02/2020 01:40	27/02/2020 21:49	28/02/2020 01:40	3,84	1	3,84	CHI
202002178530	GOIANIA	14668713	ATLANTICO S2	27/02/2020 21:50	28/02/2020 00:54	27/02/2020 21:50	28/02/2020 00:54	3,05	1	3,05	CHI
202002178532	FAZENDA NOVA	2290000249	IPORA	27/02/2020 21:51	28/02/2020 15:59	27/02/2020 21:51	28/02/2020 15:59	18,13	1	18,13	CHI
202002178533	ITABERAI	IB12310620	ITABERAI S1	27/02/2020 21:52	27/02/2020 23:40	27/02/2020 21:52	27/02/2020 23:40	1,79	2	3,59	CHI
202002178539	CASTELANDIA	DM11000010	RIO DOS BOIS	27/02/2020 21:47	28/02/2020 01:59	27/02/2020 21:47	28/02/2020 01:59	4,18	81	338,96	CHI
202002178546	IPORA	IR12013991	IPORA	27/02/2020 21:59	28/02/2020 11:21	27/02/2020 21:59	28/02/2020 11:21	13,36	44	588,02	CHI

202002178550	MARZAGAO	MG21120771	VILA CORUMBA	27/02/2020 22:01	28/02/2020 10:05	27/02/2020 22:01	28/02/2020 10:05	12,06	1	12,06	CHI
202002178555	PORANGATU	PO12141124	NOVO PLANALTO	27/02/2020 21:52	28/02/2020 10:51	27/02/2020 21:52	28/02/2020 10:51	12,97	20	259,42	CHI
202002178556	GOIANESIA	GE11379072	GOIANESIA S2	27/02/2020 22:04	27/02/2020 23:10	27/02/2020 22:04	27/02/2020 23:10	1,10	27	29,63	CHI
202002178561	GOIANIA	16092946	GOYA S1	27/02/2020 22:09	28/02/2020 00:29	27/02/2020 22:09	28/02/2020 00:29	2,33	1	2,33	CHI
202002178563	NOVO BRASIL	NB12378883	JUSSARA	27/02/2020 22:09	28/02/2020 17:32	27/02/2020 22:09	28/02/2020 17:32	19,37	5	96,87	CHI
202002178564	JANDAIA	JD12005405	PALMEIRAS	27/02/2020 22:09	28/02/2020 00:44	27/02/2020 22:09	28/02/2020 00:44	2,58	11	28,42	CHI
202002178564	PALMEIRAS DE GOIAS	JD12005405	PALMEIRAS	27/02/2020 22:09	28/02/2020 00:44	27/02/2020 22:09	28/02/2020 00:44	2,58	55	142,10	CHI
202002178569	PORANGATU	PO11374534	PORANGATU	27/02/2020 21:58	28/02/2020 02:28	27/02/2020 21:58	28/02/2020 02:28	4,48	47	210,77	CHI
202002178571	BALIZA	BH12210020	BOM JARDIM	27/02/2020 22:13	28/02/2020 07:39	27/02/2020 22:13	28/02/2020 07:39	9,42	93	875,93	CHI
202002178574	EDEIA	EA12223551RE	EDEIA	28/02/2020 06:16	28/02/2020 09:58	28/02/2020 06:16	28/02/2020 09:58	3,69	62	228,57	CHI
202002178574	INDIARA	EA12223551RE	EDEIA	28/02/2020 06:16	28/02/2020 09:58	28/02/2020 06:16	28/02/2020 09:58	3,69	4	14,75	CHI
202002178574	PONTALINA	EA12223551RE	EDEIA	28/02/2020 06:16	28/02/2020 09:58	28/02/2020 06:16	28/02/2020 09:58	3,69	1	3,69	CHI
202002178581	GOIATUBA	VI12329055	VICENTINOPOLIS	27/02/2020 22:21	28/02/2020 07:24	27/02/2020 22:21	28/02/2020 07:24	9,04	11	99,44	CHI
202002178581	VICENTINOPOLIS	VI12329055	VICENTINOPOLIS	27/02/2020 22:21	28/02/2020 07:24	27/02/2020 22:21	28/02/2020 07:24	9,04	22	198,89	CHI
202002178584	ITAPIRAPUA	IU12020119	MATRINCHA	27/02/2020 22:22	28/02/2020 14:04	27/02/2020 22:22	28/02/2020 14:04	15,69	14	219,70	CHI
202002178586	CABECEIRAS	CW12042559	ITUIQUIRA	27/02/2020 22:23	27/02/2020 23:03	27/02/2020 22:23	27/02/2020 23:03	0,66	1	0,66	CHI
202002178596	FORMOSA	FA11180623	ITUIQUIRA	27/02/2020 22:09	27/02/2020 23:17	27/02/2020 22:09	27/02/2020 23:17	1,13	208	235,04	CHI
202002178602	CATALAO	10022901980	CATALAO S2	27/02/2020 22:33	28/02/2020 11:11	27/02/2020 22:33	28/02/2020 11:11	12,63	1	12,63	CHI
202002178614	ANAPOLIS	AN11352371	ANAPOLIS UNIVERSITARIO S2	27/02/2020 22:42	28/02/2020 03:41	27/02/2020 22:42	28/02/2020 03:40	4,96	65	322,67	CHI
202002178614	ANAPOLIS	AN11353529	ANAPOLIS UNIVERSITARIO S2	27/02/2020 22:42	28/02/2020 03:41	27/02/2020 22:42	28/02/2020 03:41	4,99	44	219,66	CHI
202002178616	GOIAS	GS12408674	MATRINCHA	27/02/2020 22:42	28/02/2020 09:07	27/02/2020 22:42	28/02/2020 09:07	10,40	18	187,23	CHI
202002178621	BONFINOPOLIS	TA12247490	NOVO PLANALTO	27/02/2020 22:20	28/02/2020 01:31	27/02/2020 22:20	28/02/2020 01:31	3,18	1	3,18	CHI
202002178621	BONOPOLIS	TA12247490	NOVO PLANALTO	27/02/2020 22:20	28/02/2020 01:31	27/02/2020 22:20	28/02/2020 01:31	3,18	11	34,98	CHI
202002178621	PORANGATU	TA12247490	NOVO PLANALTO	27/02/2020 22:20	28/02/2020 01:31	27/02/2020 22:20	28/02/2020 01:31	3,18	2	6,36	CHI
202002178622	ITAPACI	IW12078035	ITAPACI	27/02/2020 22:47	28/02/2020 04:56	27/02/2020 22:47	28/02/2020 04:56	6,15	21	129,11	CHI
202002178622	NOVA GLORIA	IW12078035	ITAPACI	27/02/2020 22:47	28/02/2020 04:56	27/02/2020 22:47	28/02/2020 04:56	6,15	1	6,15	CHI
202002178624	BONOPOLIS	BX12263014	SAO MIGUEL DO ARAGUAIA	27/02/2020 22:49	28/02/2020 19:20	27/02/2020 22:49	28/02/2020 19:20	20,51	4	82,05	CHI
202002178625	SAO MIGUEL DO PASSA QUATRO	SQ12088066	CRISTIANOPOLIS	27/02/2020 22:49	28/02/2020 09:24	27/02/2020 22:49	28/02/2020 09:24	10,58	3	31,73	CHI
202002178626	TRES RANCHOS	TH11077457	CATALAO S1	27/02/2020 22:49	28/02/2020 11:05	27/02/2020 22:49	28/02/2020 11:05	12,26	16	196,11	CHI
202002178628	COCALZINHO DE GOIAS	ZN11067364	AGUAS LINDAS DE GOIAS S1	27/02/2020 22:49	28/02/2020 01:08	27/02/2020 22:49	28/02/2020 01:08	2,30	20	46,08	CHI
202002178636	HIDROLANDIA	AO31240949	GUAPO S2	27/02/2020 22:58	28/02/2020 02:37	27/02/2020 22:58	28/02/2020 02:37	3,65	2	7,30	CHI
202002178641	CORUMBAIBA	CI21110121	VILA CORUMBA	27/02/2020 23:02	28/02/2020 18:51	27/02/2020 23:02	28/02/2020 18:51	19,82	2	39,64	CHI
202002178646	PIRENOPOLIS	PV21060504	CORUMBA	27/02/2020 23:08	27/02/2020 23:31	27/02/2020 23:08	27/02/2020 23:31	0,38	1	0,38	CHI
202002178647	MINEIROS	MY12252703	PARQUE DAS EMAS	27/02/2020 23:11	28/02/2020 16:00	27/02/2020 23:11	28/02/2020 16:00	16,82	2	33,65	CHI
202002178649	GOIANIA	10059477	GOIANIA LESTE S1	27/02/2020 23:18	28/02/2020 00:08	27/02/2020 23:18	28/02/2020 00:08	0,83	1	0,83	CHI
202002178655	ALEXANIA	10013801102	ALEXANIA	27/02/2020 23:25	28/02/2020 01:04	27/02/2020 23:25	28/02/2020 01:04	1,64	1	1,64	CHI
202002178656	ITAPIRAPUA	IU12027352	MATRINCHA	27/02/2020 17:01	28/02/2020 08:47	27/02/2020 17:01	28/02/2020 08:47	15,77	3	47,30	CHI
202002178668	BRITANIA	BT12396220	BRITANIA	27/02/2020 23:34	28/02/2020 09:39	27/02/2020 23:34	28/02/2020 09:39	10,07	2	20,14	CHI
202002178668	JUSSARA	BT12396220	BRITANIA	27/02/2020 23:34	28/02/2020 09:39	27/02/2020 23:34	28/02/2020 09:39	10,07	9	90,62	CHI
202002178669	GOIANIA	GN11363179	GOIANIA LESTE S2	27/02/2020 23:36	28/02/2020 00:14	27/02/2020 23:36	28/02/2020 00:14	0,63	151	94,75	CHI
202002178671	GOIANIA	10000052041	XAVANTES	27/02/2020 23:36	28/02/2020 00:44	27/02/2020 23:36	28/02/2020 00:44	1,12	1	1,12	CHI
202002178673	GOIANIA	GN11001147	REAL S1	27/02/2020 23:36	28/02/2020 03:24	27/02/2020 23:36	28/02/2020 03:24	3,80	124	471,75	CHI
202002178676	PORANGATU	PO12015887	PORANGATU	27/02/2020 23:30	28/02/2020 02:01	27/02/2020 23:30	28/02/2020 02:01	2,51	420	1056,18	CHI
202002178678	PORANGATU	PO21139111	NOVO PLANALTO	27/02/2020 23:41	28/02/2020 09:38	27/02/2020 23:41	28/02/2020 09:38	9,93	1	9,93	CHI

202002178685	VALPARAISO DE GOIAS	VA11067696	MARAJOARA	27/02/2020 23:51	28/02/2020 01:03	27/02/2020 23:51	28/02/2020 01:03	1,20	63	75,42	CHI
202002178686	NIQUELANDIA	NQ12171084	BARRO ALTO	27/02/2020 23:52	28/02/2020 03:53	27/02/2020 23:52	28/02/2020 03:53	4,01	1	4,01	CHI
202002178687	GOIANIA	GN21001945	AEROPORTO S1	28/02/2020 00:00	28/02/2020 01:15	28/02/2020 00:00	28/02/2020 01:15	1,25	56	69,91	CHI
202002178688	POSSE	PS12132043	IACIARA S2	28/02/2020 00:01	28/02/2020 09:10	28/02/2020 00:01	28/02/2020 09:10	9,15	36	329,32	CHI
202002178690	SANTO ANTONIO DO DESCOBERTO	2210089690	AGUAS LINDAS DE GOIAS S2	28/02/2020 00:02	28/02/2020 01:24	28/02/2020 00:02	28/02/2020 01:24	1,35	1	1,35	CHI
202002178698	GOIANIA	GN11000969	CAMPINAS S1	28/02/2020 00:26	28/02/2020 02:41	28/02/2020 01:26	28/02/2020 02:41	1,25	128	159,47	CHI
202002178802	POSSE	PS11180899	IACIARA S2	28/02/2020 01:09	28/02/2020 05:25	28/02/2020 01:09	28/02/2020 05:25	4,26	12	51,14	CHI
202002178803	GOIANIA	GN11000913	GOYA S2	28/02/2020 01:10	28/02/2020 03:10	28/02/2020 02:06	28/02/2020 03:10	1,07	182	194,69	CHI
202002178804	ARAGUAPAZ	AZ12198622	GOIAS	28/02/2020 01:21	28/02/2020 08:24	28/02/2020 01:21	28/02/2020 08:24	7,03	14	98,49	CHI
202002178804	FAINA	AZ12198622	GOIAS	28/02/2020 01:21	28/02/2020 08:24	28/02/2020 01:21	28/02/2020 08:24	7,03	1	7,03	CHI
202002178817	JUSSARA	JR12017178	JUSSARA	28/02/2020 02:32	28/02/2020 11:35	28/02/2020 02:32	28/02/2020 11:35	9,05	15	135,75	CHI
202002178821	FIRMINOPOLIS	FR12382556	FIRMINOPOLIS S1	28/02/2020 02:52	28/02/2020 09:16	28/02/2020 02:52	28/02/2020 08:37	5,74	2	11,48	CHI
202002178821	FIRMINOPOLIS	FR12382556	FIRMINOPOLIS S1	28/02/2020 02:52	28/02/2020 09:16	28/02/2020 02:52	28/02/2020 09:16	6,39	20	127,77	CHI
202002178821	SAO LUIS DE MONTES BELOS	FR12382556	FIRMINOPOLIS S1	28/02/2020 02:52	28/02/2020 09:16	28/02/2020 02:52	28/02/2020 09:16	6,39	7	44,72	CHI
202002178822	AMARALINA	MU12391672	MARA ROSA	28/02/2020 03:06	28/02/2020 08:26	28/02/2020 03:06	28/02/2020 08:26	5,32	101	537,29	CHI
202002178822	MUTUNOPOLIS	MU12391672	MARA ROSA	28/02/2020 03:06	28/02/2020 08:26	28/02/2020 03:06	28/02/2020 08:26	5,32	7	37,24	CHI
202002178823	FAINA	FC11250739	GOIAS	28/02/2020 03:22	29/02/2020 01:23	28/02/2020 03:22	29/02/2020 01:23	22,01	125	2751,74	CHI
202002178824	VILA PROPICIO	GE12243252	GOIANESIA S1	28/02/2020 03:27	28/02/2020 08:28	28/02/2020 03:27	28/02/2020 08:28	5,01	11	55,10	CHI
202002178826	CRIXAS	CX12235697	SERRA DO OURO	28/02/2020 03:30	28/02/2020 16:12	28/02/2020 03:30	28/02/2020 14:27	10,95	39	427,15	CHI
202002178826	CRIXAS	CX12235697	SERRA DO OURO	28/02/2020 03:30	28/02/2020 16:12	28/02/2020 03:30	28/02/2020 16:12	12,69	13	164,98	CHI
202002178830	CACU	CC12293980	CACHOEIRA ALTA	28/02/2020 03:44	28/02/2020 10:20	28/02/2020 03:44	28/02/2020 10:20	6,59	5	32,97	CHI
202002178834	CATURAI	CK12066127	INHUMAS S1	28/02/2020 04:22	28/02/2020 09:31	28/02/2020 04:22	28/02/2020 09:31	5,14	3	15,43	CHI
202002178835	CAIAPONIA	CP12200868	CAIAPONIA	28/02/2020 04:24	28/02/2020 08:07	28/02/2020 04:24	28/02/2020 08:07	3,71	6	22,27	CHI
202002178837	CAMPOS VERDES	SG12202098	SANTA TEREZINHA	28/02/2020 04:28	28/02/2020 07:10	28/02/2020 04:28	28/02/2020 07:10	2,69	40	107,54	CHI
202002178837	SANTA TEREZINHA DE GOIAS	SG12202098	SANTA TEREZINHA	28/02/2020 04:28	28/02/2020 07:10	28/02/2020 04:28	28/02/2020 07:10	2,69	132	354,90	CHI
202002178837	UIRAPURU	SG12202098	SANTA TEREZINHA	28/02/2020 04:28	28/02/2020 07:10	28/02/2020 04:28	28/02/2020 07:10	2,69	57	153,25	CHI
202002178839	BURITI ALEGRE	BG12294720	GOIATUBA S2	28/02/2020 04:36	28/02/2020 14:39	28/02/2020 04:36	28/02/2020 14:39	10,05	1	10,05	CHI
202002178839	GOIATUBA	BG12294720	GOIATUBA S2	28/02/2020 04:36	28/02/2020 14:39	28/02/2020 04:36	28/02/2020 14:39	10,05	1	10,05	CHI
202002178842	GOIAS	GS12378857	MATRINCHA	28/02/2020 04:49	28/02/2020 07:06	28/02/2020 04:49	28/02/2020 07:06	2,27	7	15,87	CHI
202002178843	BOM JARDIM DE GOIAS	BM12212797	BOM JARDIM	28/02/2020 02:49	28/02/2020 08:20	28/02/2020 02:49	28/02/2020 08:20	5,52	87	479,90	CHI
202002178843	PIRANHAS	BM12212797	BOM JARDIM	28/02/2020 02:49	28/02/2020 08:20	28/02/2020 02:49	28/02/2020 08:20	5,52	2	11,03	CHI
202002178849	ORIZONA	OZ12022850RE	PIRES DO RIO S2	28/02/2020 04:56	28/02/2020 08:28	28/02/2020 04:56	28/02/2020 08:28	3,52	9	31,69	CHI
202002178849	PIRES DO RIO	OZ12022850RE	PIRES DO RIO S2	28/02/2020 04:56	28/02/2020 08:28	28/02/2020 04:56	28/02/2020 08:28	3,52	56	197,18	CHI
202002178850	URUTAI	UT12080794	URUTAI	28/02/2020 04:41	28/02/2020 09:22	28/02/2020 04:41	28/02/2020 09:22	4,68	11	51,47	CHI
202002178852	MARA ROSA	MQ12249312	SANTA TEREZINHA	28/02/2020 05:03	28/02/2020 09:14	28/02/2020 05:03	28/02/2020 09:14	4,17	11	45,88	CHI
202002178853	MUNDO NOVO DE GOIAS	NA12035650	NOVA CRIXAS	28/02/2020 05:03	28/02/2020 20:44	28/02/2020 05:03	28/02/2020 17:50	12,78	2	25,55	CHI
202002178853	NOVA CRIXAS	NA12035650	NOVA CRIXAS	28/02/2020 05:03	28/02/2020 20:44	28/02/2020 05:03	28/02/2020 17:50	12,78	12	153,31	CHI
202002178853	NOVA CRIXAS	NA13110897	NOVA CRIXAS	28/02/2020 05:03	28/02/2020 20:44	28/02/2020 05:03	28/02/2020 20:14	15,18	12	182,17	CHI
202002178853	MUNDO NOVO DE GOIAS	NA12059971	NOVA CRIXAS	28/02/2020 05:03	28/02/2020 20:44	28/02/2020 05:03	28/02/2020 20:44	15,68	2	31,37	CHI
202002178853	MUNDO NOVO DE GOIAS	NA12059971	NOVA CRIXAS	28/02/2020 05:03	28/02/2020 20:44	28/02/2020 11:51	28/02/2020 20:44	8,90	4	35,59	CHI
202002178854	SERRANOPOLIS	SX12390596	JATAI S1	28/02/2020 05:03	28/02/2020 08:13	28/02/2020 05:03	28/02/2020 08:13	3,15	33	104,06	CHI
202002178862	PETROLINA DE GOIAS	SF12016175	SAO FRANCISCO DE GOIAS	28/02/2020 05:28	28/02/2020 08:41	28/02/2020 05:28	28/02/2020 08:41	3,20	1	3,20	CHI
202002178862	SAO FRANCISCO DE GOIAS	SF12016175	SAO FRANCISCO DE GOIAS	28/02/2020 05:28	28/02/2020 08:41	28/02/2020 05:28	28/02/2020 08:41	3,20	17	54,46	CHI
202002178864	FORMOSA	FA31042114	ITUIQUIRA	28/02/2020 05:29	28/02/2020 11:00	28/02/2020 05:29	28/02/2020 11:00	5,52	1	5,52	CHI

202002178865	RUBIATABA	RB12114296	RUBIATABA	28/02/2020 05:30	28/02/2020 10:56	28/02/2020 05:30	28/02/2020 10:56	5,42	1	5,42	CHI
202002178867	PIRENOPOLIS	10001037330	CORUMBA	28/02/2020 05:31	28/02/2020 08:51	28/02/2020 05:31	28/02/2020 08:51	3,33	1	3,33	CHI
202002178868	PIRENOPOLIS	PV12381260	CORUMBA	28/02/2020 02:43	28/02/2020 07:59	28/02/2020 02:43	28/02/2020 07:59	5,26	73	384,22	CHI
202002178872	NOVA CRIXAS	NA12091692	NOVA CRIXAS	28/02/2020 05:33	29/02/2020 12:01	28/02/2020 05:33	29/02/2020 12:01	30,46	22	670,22	CHI
202002178878	BURITI DE GOIAS	SC12052751	FIRMINOPOLIS S2	28/02/2020 05:41	28/02/2020 08:03	28/02/2020 05:41	28/02/2020 08:03	2,35	3	7,05	CHI
202002178878	SANCLERLANDIA	SC12052751	FIRMINOPOLIS S2	28/02/2020 05:41	28/02/2020 08:03	28/02/2020 05:41	28/02/2020 08:03	2,35	19	44,68	CHI
202002178882	BURITINOPOLIS	BQ12344370RE	IACIARA S2	28/02/2020 05:46	28/02/2020 07:37	28/02/2020 05:46	28/02/2020 07:37	1,85	256	472,89	CHI
202002178882	MAMBAI	BQ12344370RE	IACIARA S2	28/02/2020 05:46	28/02/2020 07:37	28/02/2020 05:46	28/02/2020 07:37	1,85	1	1,85	CHI
202002178893	ADELANDIA	SL12306949	FIRMINOPOLIS S2	28/02/2020 05:50	28/02/2020 09:20	28/02/2020 05:50	28/02/2020 09:20	3,48	5	17,42	CHI
202002178895	URUACU	UR12405303	MARA ROSA	27/02/2020 23:27	28/02/2020 11:29	27/02/2020 23:27	28/02/2020 11:29	12,02	32	384,68	CHI
202002178896	COCALZINHO DE GOIAS	ZN12297780	COCALZINHO	28/02/2020 05:54	28/02/2020 11:41	28/02/2020 05:54	28/02/2020 11:41	5,78	9	51,99	CHI
202002178898	ALTO HORIZONTE	AJ12375644	SANTA TEREZINHA	28/02/2020 08:42	28/02/2020 10:50	28/02/2020 08:42	28/02/2020 10:50	2,13	9	19,20	CHI
202002178898	PILAR DE GOIAS	AJ12375644	SANTA TEREZINHA	28/02/2020 08:42	28/02/2020 10:50	28/02/2020 08:42	28/02/2020 10:50	2,13	1	2,13	CHI
202002178900	AGUA LIMPA	AL12000251	VILA CORUMBA	28/02/2020 05:55	28/02/2020 08:52	28/02/2020 05:55	28/02/2020 08:52	2,94	7	20,55	CHI
202002178900	BURITI ALEGRE	AL12000251	VILA CORUMBA	28/02/2020 05:55	28/02/2020 08:52	28/02/2020 05:55	28/02/2020 08:52	2,94	3	8,81	CHI
202002178900	MORRINHOS	AL12000251	VILA CORUMBA	28/02/2020 05:55	28/02/2020 08:52	28/02/2020 05:55	28/02/2020 08:52	2,94	2	5,87	CHI
202002178913	ITAPIRAPUA	IU12250542	MATRINCHA	28/02/2020 06:01	28/02/2020 08:21	28/02/2020 06:01	28/02/2020 08:21	2,32	9	20,85	CHI
202002178914	COCALZINHO DE GOIAS	ZN12302401	COCALZINHO	28/02/2020 05:58	28/02/2020 08:15	28/02/2020 05:58	28/02/2020 08:15	2,28	4	9,11	CHI
202002178914	CORUMBA DE GOIAS	ZN12302401	COCALZINHO	28/02/2020 05:58	28/02/2020 08:15	28/02/2020 05:58	28/02/2020 08:15	2,28	22	50,11	CHI
202002178920	ITUMBIARA	BG12384546	ITUMBIARA VELHA S2	28/02/2020 05:50	28/02/2020 08:36	28/02/2020 05:50	28/02/2020 08:36	2,76	11	30,39	CHI
202002178925	ARENOPOLIS	AY12316423	ARENOPOLIS	28/02/2020 06:07	28/02/2020 11:12	28/02/2020 06:07	28/02/2020 11:12	5,08	5	25,39	CHI
202002178926	NOVO BRASIL	NB21167302	MATRINCHA	28/02/2020 06:07	28/02/2020 11:09	28/02/2020 06:07	28/02/2020 11:09	5,02	1	5,02	CHI
202002178927	ANAPOLIS	AN21071891	ANAPOLIS UNIVERSITARIO S2	28/02/2020 06:07	28/02/2020 07:54	28/02/2020 06:07	28/02/2020 07:54	1,77	1	1,77	CHI
202002178930	ORIZONA	PR12000068RE	PIRES DO RIO S1	28/02/2020 08:22	28/02/2020 14:53	28/02/2020 08:22	28/02/2020 14:53	6,50	75	487,77	CHI
202002178930	PIRES DO RIO	PR12000068RE	PIRES DO RIO S1	28/02/2020 08:22	28/02/2020 14:53	28/02/2020 08:22	28/02/2020 14:53	6,50	21	136,58	CHI
202002178930	URUTAI	PR12000068RE	PIRES DO RIO S1	28/02/2020 08:22	28/02/2020 14:53	28/02/2020 08:22	28/02/2020 14:53	6,50	1	6,50	CHI
202002178932	CRIXAS	IW12032522	RUBIATABA	27/02/2020 22:32	28/02/2020 09:26	27/02/2020 22:32	28/02/2020 09:26	10,89	12	130,69	CHI
202002178932	GUARINOS	IW12032522	RUBIATABA	27/02/2020 22:32	28/02/2020 09:26	27/02/2020 22:32	28/02/2020 09:26	10,89	11	119,80	CHI
202002178932	ITAPACI	IW12032522	RUBIATABA	27/02/2020 22:32	28/02/2020 09:26	27/02/2020 22:32	28/02/2020 09:26	10,89	33	359,41	CHI
202002178935	PADRE BERNARDO	PB12249535	PADRE BERNARDO	28/02/2020 06:11	28/02/2020 08:30	28/02/2020 06:11	28/02/2020 08:30	2,31	14	32,38	CHI
202002178937	CAMPOS VERDES	VD21181192	SANTA TEREZINHA	28/02/2020 06:11	28/02/2020 09:43	28/02/2020 06:11	28/02/2020 09:43	3,52	1	3,52	CHI
202002178942	MONTE ALEGRE DE GOIAS	SD12322677	SAO DOMINGOS	28/02/2020 06:14	28/02/2020 11:53	28/02/2020 06:14	28/02/2020 11:53	5,64	2	11,27	CHI
202002178942	NOVA ROMA	SD12322677	SAO DOMINGOS	28/02/2020 06:14	28/02/2020 11:53	28/02/2020 06:14	28/02/2020 11:53	5,64	3	16,91	CHI
202002178942	SAO DOMINGOS	SD12322677	SAO DOMINGOS	28/02/2020 06:14	28/02/2020 11:53	28/02/2020 06:14	28/02/2020 11:53	5,64	35	197,25	CHI
202002178943	CAMPOS VERDES	VD12049799	SANTA TEREZINHA	28/02/2020 06:15	28/02/2020 13:38	28/02/2020 06:15	28/02/2020 13:38	7,37	21	154,84	CHI
202002178943	PILAR DE GOIAS	VD12049799	SANTA TEREZINHA	28/02/2020 06:15	28/02/2020 13:38	28/02/2020 06:15	28/02/2020 13:38	7,37	6	44,24	CHI
202002178943	SANTA TEREZINHA DE GOIAS	VD12049799	SANTA TEREZINHA	28/02/2020 06:15	28/02/2020 13:38	28/02/2020 06:15	28/02/2020 13:38	7,37	3	22,12	CHI
202002178948	PIRES DO RIO	BC12051685	PIRES DO RIO S2	28/02/2020 06:17	28/02/2020 10:27	28/02/2020 06:17	28/02/2020 10:27	4,17	15	62,53	CHI
202002178949	CACHOEIRA DOURADA	CD12190754	CACHOEIRA DOURADA	28/02/2020 06:13	28/02/2020 10:46	28/02/2020 06:13	28/02/2020 10:46	4,54	1	4,54	CHI
202002178949	ITUMBIARA	CD12190754	CACHOEIRA DOURADA	28/02/2020 06:13	28/02/2020 10:46	28/02/2020 06:13	28/02/2020 10:46	4,54	16	72,69	CHI
202002178951	GOIAS	GS12058298	MATRINCHA	28/02/2020 06:17	28/02/2020 13:01	28/02/2020 06:17	28/02/2020 13:01	6,72	27	181,38	CHI
202002178954	CASTELANDIA	DM12417231	RIO DOS BOIS	28/02/2020 06:08	28/02/2020 12:04	28/02/2020 06:08	28/02/2020 12:04	5,92	23	136,23	CHI
202002178954	QUIRINOPOLIS	DM12417231	RIO DOS BOIS	28/02/2020 06:08	28/02/2020 12:04	28/02/2020 06:08	28/02/2020 12:04	5,92	14	82,92	CHI
202002178957	EDEIA	1120008272	EDEIA	28/02/2020 06:20	28/02/2020 23:29	28/02/2020 06:20	28/02/2020 23:29	17,14	1	17,14	CHI

202002178964	MUNDO NOVO DE GOIAS	MH21315444	NOVA CRIXAS	28/02/2020 06:24	28/02/2020 20:31	28/02/2020 06:24	28/02/2020 20:31	14,12	1	14,12	CHI
202002178966	VIANOPOLIS	VN11048844	VIANOPOLIS	28/02/2020 05:49	28/02/2020 10:09	28/02/2020 05:49	28/02/2020 10:09	4,33	125	541,18	CHI
202002178968	CORREGO DO OURO	CO12299163	FIRMINOPOLIS S2	28/02/2020 06:25	28/02/2020 09:40	28/02/2020 06:25	28/02/2020 09:40	3,24	13	42,07	CHI
202002178971	CORUMBAIBA	CI12060020	CATALAO S1	28/02/2020 06:00	28/02/2020 13:20	28/02/2020 06:00	28/02/2020 13:20	7,34	116	850,89	CHI
202002178971	MORRINHOS	CI12060020	CATALAO S1	28/02/2020 06:00	28/02/2020 13:20	28/02/2020 06:00	28/02/2020 13:20	7,34	1	7,34	CHI
202002178971	NOVA AURORA	CI12060020	CATALAO S1	28/02/2020 06:00	28/02/2020 13:20	28/02/2020 06:00	28/02/2020 13:20	7,34	9	66,02	CHI
202002178971	CORUMBAIBA	CI12060020	CATALAO S1	28/02/2020 06:00	28/02/2020 13:20	28/02/2020 10:17	28/02/2020 13:20	3,05	1	3,05	CHI
202002178977	JATAI	JT12331838	JATAI S2	28/02/2020 06:29	28/02/2020 09:02	28/02/2020 06:29	28/02/2020 09:02	2,54	5	12,71	CHI
202002178987	BELA VISTA DE GOIAS	CF12195129RE	CRISTIANOPOLIS	28/02/2020 03:38	28/02/2020 07:29	28/02/2020 03:38	28/02/2020 07:29	3,85	21	80,85	CHI
202002178987	CRISTIANOPOLIS	CF12195129RE	CRISTIANOPOLIS	28/02/2020 03:38	28/02/2020 07:29	28/02/2020 03:38	28/02/2020 07:29	3,85	6	23,10	CHI
202002178988	SAO MIGUEL DO ARAGUAIA	SM12000063	SAO MIGUEL DO ARAGUAIA	28/02/2020 05:41	28/02/2020 10:35	28/02/2020 05:41	28/02/2020 10:35	4,89	35	171,27	CHI
202002178991	GOIAS	GS21219920	GOIAS	28/02/2020 06:33	28/02/2020 12:00	28/02/2020 06:33	28/02/2020 12:00	5,45	1	5,45	CHI
202002178993	CAIAPONIA	CP12342210	CAIAPONIA	28/02/2020 06:34	28/02/2020 12:10	28/02/2020 06:34	28/02/2020 12:10	5,60	46	257,47	CHI
202002178994	DOVERLANDIA	DV12395478	CAIAPONIA	28/02/2020 05:29	28/02/2020 12:53	28/02/2020 05:29	28/02/2020 12:53	7,40	29	214,48	CHI
202002178995	NOVA CRIXAS	NA12034763	NOVA CRIXAS	28/02/2020 06:26	28/02/2020 09:07	28/02/2020 06:26	28/02/2020 09:07	2,68	6	16,06	CHI
202002179008	IPIRANGA DE GOIAS	RB21194517	RUBIATABA	28/02/2020 06:36	28/02/2020 07:50	28/02/2020 06:36	28/02/2020 07:50	1,23	1	1,23	CHI
202002179009	ADELANDIA	DN12053892	FIRMINOPOLIS S2	28/02/2020 03:52	28/02/2020 07:38	28/02/2020 03:52	28/02/2020 07:38	3,76	9	33,84	CHI
202002179014	PARAUNA	PU12194225	FIRMINOPOLIS S2	28/02/2020 06:38	28/02/2020 22:07	28/02/2020 06:38	28/02/2020 22:07	15,47	13	201,13	CHI
202002179018	CHAPADAO DO CEU	DJ12365007	CHAPADAO DO CEU	28/02/2020 06:39	28/02/2020 08:24	28/02/2020 06:39	28/02/2020 08:24	1,74	8	13,92	CHI
202002179018	MINEIROS	DJ12365007	CHAPADAO DO CEU	28/02/2020 06:39	28/02/2020 08:24	28/02/2020 06:39	28/02/2020 08:24	1,74	2	3,48	CHI
202002179020	JATAI	JT12211164	JATAI S2	28/02/2020 06:40	28/02/2020 10:14	28/02/2020 06:40	28/02/2020 10:14	3,56	9	32,06	CHI
202002179021	MARA ROSA	MQ21385697	MARA ROSA	28/02/2020 06:40	28/02/2020 11:57	28/02/2020 06:40	28/02/2020 11:57	5,28	1	5,28	CHI
202002179024	OUVIDOR	OU12308656	CATALAO S1	28/02/2020 06:41	28/02/2020 10:15	28/02/2020 06:41	28/02/2020 10:15	3,57	72	256,82	CHI
202002179026	TRINDADE	TR11376881	TRINDADE	28/02/2020 06:42	28/02/2020 17:30	28/02/2020 06:42	28/02/2020 14:52	8,16	47	383,49	CHI
202002179026	TRINDADE	TR11376881	TRINDADE	28/02/2020 06:42	28/02/2020 17:30	28/02/2020 14:53	28/02/2020 17:30	2,62	47	123,11	CHI
202002179034	RUBIATABA	RB12156088	RUBIATABA	28/02/2020 06:44	28/02/2020 11:41	28/02/2020 06:44	28/02/2020 11:41	4,94	12	59,24	CHI
202002179039	AMARALINA	LC12270120	SAO MIGUEL DO ARAGUAIA	28/02/2020 06:18	28/02/2020 12:15	28/02/2020 06:18	28/02/2020 12:15	5,95	10	59,46	CHI
202002179041	CRISTALINA	KR12228851	CRISTALINA S2	28/02/2020 06:46	28/02/2020 09:34	28/02/2020 06:46	28/02/2020 09:34	2,79	6	16,74	CHI
202002179042	GOIANAPOLIS	TJ21242542	DAIA S2	28/02/2020 06:46	28/02/2020 09:17	28/02/2020 06:46	28/02/2020 09:17	2,51	1	2,51	CHI
202002179043	CAMPO ALEGRE DE GOIAS	CM21122457	CAMPO ALEGRE DE GOIAS	28/02/2020 06:46	28/02/2020 14:50	28/02/2020 06:46	28/02/2020 14:50	8,05	2	16,11	CHI
202002179046	DAMOLANDIA	DL12272347	INHUMAS S1	28/02/2020 05:59	28/02/2020 09:39	28/02/2020 05:59	28/02/2020 09:39	3,65	14	51,14	CHI
202002179046	OURO VERDE DE GOIAS	DL12272347	INHUMAS S1	28/02/2020 05:59	28/02/2020 09:39	28/02/2020 05:59	28/02/2020 09:39	3,65	108	394,50	CHI
202002179050	ITARUMA	IM12340984	CACHOEIRA ALTA	28/02/2020 06:48	28/02/2020 08:42	28/02/2020 06:48	28/02/2020 08:42	1,89	20	37,89	CHI
202002179053	FAINA	FC21219222	GOIAS	28/02/2020 06:48	28/02/2020 15:37	28/02/2020 06:48	28/02/2020 15:37	8,81	1	8,81	CHI
202002179056	CAIAPONIA	DV12023480	CAIAPONIA	28/02/2020 06:49	28/02/2020 11:01	28/02/2020 06:49	28/02/2020 11:01	4,19	6	25,16	CHI
202002179056	DOVERLANDIA	DV12023480	CAIAPONIA	28/02/2020 06:49	28/02/2020 11:01	28/02/2020 06:49	28/02/2020 11:01	4,19	4	16,78	CHI
202002179056	PIRANHAS	DV12023480	CAIAPONIA	28/02/2020 06:49	28/02/2020 11:01	28/02/2020 06:49	28/02/2020 11:01	4,19	9	37,74	CHI
202002179059	PIRENOPOLIS	PV12285256	CORUMBA	28/02/2020 06:50	28/02/2020 14:59	28/02/2020 06:50	28/02/2020 14:59	8,15	12	97,76	CHI
202002179061	PORTEIRAO	CL12295983	RIO DOS BOIS	28/02/2020 06:50	28/02/2020 12:44	28/02/2020 06:50	28/02/2020 12:44	5,89	1	5,89	CHI
202002179062	DOVERLANDIA	DV12156199	PARQUE DAS EMAS	28/02/2020 06:51	28/02/2020 14:35	28/02/2020 06:51	28/02/2020 14:35	7,73	11	85,05	CHI
202002179064	GOIANIA	14991263	XAVANTES	28/02/2020 06:51	28/02/2020 09:44	28/02/2020 06:51	28/02/2020 09:44	2,87	1	2,87	CHI
202002179065	PIRENOPOLIS	PV12000073	CORUMBA	28/02/2020 06:51	28/02/2020 11:26	28/02/2020 06:51	28/02/2020 11:26	4,57	10	45,68	CHI
202002179069	GAMELEIRA DE GOIAS	SV12278872	DAIA S2	28/02/2020 06:16	28/02/2020 11:10	28/02/2020 06:16	28/02/2020 11:10	4,90	7	34,29	CHI
202002179074	GOIANESIA	GE21114630	GOIANESIA S2	28/02/2020 06:54	28/02/2020 10:46	28/02/2020 06:54	28/02/2020 10:46	3,87	1	3,87	CHI

202002179075	ITABERAÍ	50024292	ITABERAÍ S2	28/02/2020 06:54	28/02/2020 07:54	28/02/2020 06:54	28/02/2020 07:54	0,99	1	0,99	CHI
202002179077	NIQUELANDIA	NQ12171084	BARRO ALTO	28/02/2020 06:55	28/02/2020 09:31	28/02/2020 06:55	28/02/2020 09:31	2,59	44	114,01	CHI
202002179084	GOIANIA	GN16413637	AEROPORTO S2	28/02/2020 06:56	28/02/2020 11:08	28/02/2020 06:56	28/02/2020 07:22	0,42	448	190,03	CHI
202002179084	GOIANIA	GN10400634	AEROPORTO S1	28/02/2020 06:56	28/02/2020 11:08	28/02/2020 06:56	28/02/2020 07:24	0,47	3800	1791,28	CHI
202002179084	GOIANIA	GN10400634	CAMPINAS S3	28/02/2020 06:56	28/02/2020 11:08	28/02/2020 06:56	28/02/2020 07:24	0,47	2257	1063,92	CHI
202002179084	GOIANIA	GN16409449	CAMPINAS S3	28/02/2020 06:56	28/02/2020 11:08	28/02/2020 06:56	28/02/2020 07:29	0,55	251	137,14	CHI
202002179084	GOIANIA	GN13377942	CAMPINAS S3	28/02/2020 06:56	28/02/2020 11:08	28/02/2020 10:35	28/02/2020 11:08	0,55	417	228,31	CHI
202002179086	GOIANIA	GN21144340	CARAJAS S1	28/02/2020 06:56	28/02/2020 08:34	28/02/2020 06:56	28/02/2020 08:34	1,62	1	1,62	CHI
202002179091	SENADOR CANEDO	SW12402764	SENADOR CANEDO	28/02/2020 06:57	28/02/2020 08:45	28/02/2020 06:57	28/02/2020 08:45	1,80	364	654,59	CHI
202002179103	PIRACANJUBA	PJ32057770	PIRACANJUBA	28/02/2020 06:58	28/02/2020 08:38	28/02/2020 06:58	28/02/2020 08:38	1,65	14	23,12	CHI
202002179108	COCALZINHO DE GOIAS	1200024014	PADRE BERNARDO	28/02/2020 07:00	28/02/2020 12:19	28/02/2020 07:00	28/02/2020 12:19	5,30	1	5,30	CHI
202002179109	SAO MIGUEL DO ARAGUAIA	SM12371095	SAO MIGUEL DO ARAGUAIA	28/02/2020 07:00	28/02/2020 16:41	28/02/2020 07:00	28/02/2020 16:41	9,68	1	9,68	CHI
202002179112	ANICUNS	AC12021676	ANICUNS	28/02/2020 07:01	28/02/2020 12:27	28/02/2020 07:01	28/02/2020 12:27	5,43	2	10,86	CHI
202002179117	SAO MIGUEL DO ARAGUAIA	SM12032000	SAO MIGUEL DO ARAGUAIA	28/02/2020 07:02	28/02/2020 11:04	28/02/2020 07:02	28/02/2020 11:04	4,03	5	20,14	CHI
202002179118	IPORA	IR21102698	IPORA	28/02/2020 07:02	28/02/2020 16:04	28/02/2020 07:02	28/02/2020 16:04	9,03	1	9,03	CHI
202002179122	MARA ROSA	MQ21192430	MARA ROSA	28/02/2020 07:02	28/02/2020 13:20	28/02/2020 07:02	28/02/2020 13:20	6,29	1	6,29	CHI
202002179126	GOIANIA	GN12133717	CARAJAS S1	28/02/2020 07:03	28/02/2020 09:42	28/02/2020 07:03	28/02/2020 09:42	2,65	3	7,95	CHI
202002179127	CACHOEIRA ALTA	QI12191652	CACHOEIRA ALTA	28/02/2020 07:03	28/02/2020 16:21	28/02/2020 07:03	28/02/2020 16:21	9,29	3	27,88	CHI
202002179127	QUIRINOPOLIS	QI12191652	CACHOEIRA ALTA	28/02/2020 07:03	28/02/2020 16:21	28/02/2020 07:03	28/02/2020 16:21	9,29	9	83,63	CHI
202002179132	MUNDO NOVO DE GOIAS	MH12034680	NOVA CRIXAS	28/02/2020 07:04	28/02/2020 09:42	28/02/2020 07:04	28/02/2020 09:42	2,63	29	76,29	CHI
202002179134	NIQUELANDIA	NQ21142236	SAO JOAO D ALIANCA	28/02/2020 07:05	28/02/2020 08:04	28/02/2020 07:05	28/02/2020 08:04	0,98	2	1,96	CHI
202002179135	NEROPOLIS	NR21215200	NEROPOLIS S2	28/02/2020 07:05	28/02/2020 08:41	28/02/2020 07:05	28/02/2020 08:41	1,60	1	1,60	CHI
202002179138	MORRINHOS	MR12264053	MORRINHOS	28/02/2020 06:51	28/02/2020 09:27	28/02/2020 06:51	28/02/2020 09:27	2,60	8	20,78	CHI
202002179141	TURVANIA	TV12026469	FIRMINOPOLIS S1	28/02/2020 05:44	28/02/2020 09:23	28/02/2020 05:44	28/02/2020 09:23	3,63	7	25,44	CHI
202002179147	PIRACANJUBA	PJ12223405RE	PIRACANJUBA	28/02/2020 06:52	29/02/2020 15:03	28/02/2020 06:52	29/02/2020 15:03	32,17	6	193,03	CHI
202002179147	SANTA CRUZ DE GOIAS	PJ12223405RE	PIRACANJUBA	28/02/2020 06:52	29/02/2020 15:03	28/02/2020 06:52	29/02/2020 15:03	32,17	33	1061,67	CHI
202002179148	GUARAITA	IK12023097	ITAPURANGA	28/02/2020 07:02	28/02/2020 08:43	28/02/2020 07:02	28/02/2020 08:43	1,68	36	60,31	CHI
202002179148	ITAPURANGA	IK12023097	ITAPURANGA	28/02/2020 07:02	28/02/2020 08:43	28/02/2020 07:02	28/02/2020 08:43	1,68	5	8,38	CHI
202002179150	MINEIROS	MY12126392	PARQUE DAS EMAS	28/02/2020 06:22	28/02/2020 14:49	28/02/2020 06:22	28/02/2020 14:49	8,45	14	118,29	CHI
202002179153	ITABERAÍ	IB11037808	ITABERAÍ S2	28/02/2020 07:06	28/02/2020 10:04	28/02/2020 07:06	28/02/2020 10:04	2,95	88	259,72	CHI
202002179154	ALTO PARAISO DE GOIAS	BF12264707	FLORES DE GOIAS	28/02/2020 07:07	28/02/2020 08:33	28/02/2020 07:07	28/02/2020 08:33	1,43	23	32,88	CHI
202002179171	JATAI	JT12000151	JATAI S3	28/02/2020 07:09	28/02/2020 09:00	28/02/2020 07:09	28/02/2020 09:00	1,86	159	295,78	CHI
202002179172	FAZENDA NOVA	FN12073782	IPORA	28/02/2020 07:09	28/02/2020 16:20	28/02/2020 07:09	28/02/2020 16:20	9,18	21	192,87	CHI
202002179172	ISRAELANDIA	FN12073782	IPORA	28/02/2020 07:09	28/02/2020 16:20	28/02/2020 07:09	28/02/2020 16:20	9,18	2	18,37	CHI
202002179177	SAO LUIS DE MONTES BELOS	SL12388874	SAO LUIZ DOS MONTES BELOS	28/02/2020 06:12	28/02/2020 10:27	28/02/2020 06:12	28/02/2020 10:27	4,24	24	101,81	CHI
202002179183	AMERICANO DO BRASIL	KB12391521	ANICUNS	28/02/2020 07:10	28/02/2020 11:18	28/02/2020 07:10	28/02/2020 11:18	4,13	11	45,40	CHI
202002179183	MOSSAMEDES	KB12391521	ANICUNS	28/02/2020 07:10	28/02/2020 11:18	28/02/2020 07:10	28/02/2020 11:18	4,13	10	41,27	CHI
202002179184	SAO MIGUEL DO ARAGUAIA	SM12350501	SAO MIGUEL DO ARAGUAIA	28/02/2020 07:10	28/02/2020 12:11	28/02/2020 07:10	28/02/2020 12:11	5,00	6	30,01	CHI
202002179188	ACREUNA	TD12213318	RIO DOS BOIS	28/02/2020 04:31	28/02/2020 10:15	28/02/2020 04:31	28/02/2020 10:15	5,72	24	137,37	CHI
202002179188	SANTA HELENA DE GOIAS	TD12213318	RIO DOS BOIS	28/02/2020 04:31	28/02/2020 10:15	28/02/2020 04:31	28/02/2020 10:15	5,72	18	103,03	CHI
202002179188	TURVELANDIA	TD12213318	RIO DOS BOIS	28/02/2020 04:31	28/02/2020 10:15	28/02/2020 04:31	28/02/2020 10:15	5,72	84	480,81	CHI
202002179189	ITUMBIARA	CD12000284	CACHOEIRA DOURADA	28/02/2020 07:11	28/02/2020 15:08	28/02/2020 07:11	28/02/2020 15:08	7,94	19	150,92	CHI
202002179190	BELA VISTA DE GOIAS	XX10185264	BELA VISTA S1	28/02/2020 07:11	28/02/2020 09:33	28/02/2020 07:11	28/02/2020 09:33	2,36	3	7,08	CHI
202002179195	MOIPORA	MO12157683	IPORA	28/02/2020 06:30	28/02/2020 12:49	28/02/2020 06:30	28/02/2020 12:49	6,31	5	31,53	CHI

202002179198	SAO MIGUEL DO ARAGUAIA	SM12096089RE	SAO MIGUEL DO ARAGUAIA	28/02/2020 07:09	28/02/2020 20:18	28/02/2020 07:09	28/02/2020 20:18	13,15	27	354,96	CHI
202002179200	CRIXAS	CX12221633	RUBIATABA	28/02/2020 06:20	28/02/2020 13:18	28/02/2020 06:20	28/02/2020 13:18	6,97	130	905,63	CHI
202002179200	NOVA CRIXAS	CX12221633	RUBIATABA	28/02/2020 06:20	28/02/2020 13:18	28/02/2020 06:20	28/02/2020 13:18	6,97	1	6,97	CHI
202002179201	CACU	1090038619	CACHOEIRA ALTA	28/02/2020 07:15	28/02/2020 10:39	28/02/2020 07:15	28/02/2020 10:39	3,41	1	3,41	CHI
202002179202	RIO VERDE	RV21271668	MONTIVIDIU T	28/02/2020 07:15	28/02/2020 09:54	28/02/2020 07:15	28/02/2020 09:54	2,65	1	2,65	CHI
202002179206	PALMEIRAS DE GOIAS	PL12048169	PALMEIRAS	28/02/2020 07:15	28/02/2020 09:11	28/02/2020 07:15	28/02/2020 09:11	1,92	19	36,44	CHI
202002179213	SANTA CRUZ DE GOIAS	BC21080764	CRISTIANOPOLIS	28/02/2020 07:17	28/02/2020 11:46	28/02/2020 07:17	28/02/2020 11:46	4,47	2	8,94	CHI
202002179215	JATAI	JT11184090	JATAI S3	28/02/2020 07:18	28/02/2020 09:03	28/02/2020 07:18	28/02/2020 09:03	1,75	80	139,87	CHI
202002179225	SANTA CRUZ DE GOIAS	BC12389805	PIRES DO RIO S2	28/02/2020 06:35	28/02/2020 09:18	28/02/2020 06:35	28/02/2020 09:18	2,71	9	24,41	CHI
202002179229	JATAI	JT21150347	CACHOEIRA ALTA	27/02/2020 19:24	28/02/2020 16:33	27/02/2020 19:24	28/02/2020 16:33	21,15	1	21,15	CHI
202002179231	ITARUMA	IM21084243	CACHOEIRA ALTA	28/02/2020 07:20	28/02/2020 10:30	28/02/2020 07:20	28/02/2020 10:30	3,16	1	3,16	CHI
202002179233	RIO VERDE	RV12273766	MONTIVIDIU T	28/02/2020 07:17	28/02/2020 09:07	28/02/2020 07:17	28/02/2020 09:07	1,83	3	5,48	CHI
202002179242	CATALAO	CT12093871	CATALAO S1	28/02/2020 06:37	28/02/2020 13:52	28/02/2020 06:37	28/02/2020 13:52	7,25	40	289,96	CHI
202002179245	NIQUELANDIA	NQ21232650	URUACU	28/02/2020 07:22	28/02/2020 11:26	28/02/2020 07:22	28/02/2020 11:26	4,07	1	4,07	CHI
202002179246	BURITINOPOLIS	SU12301950	SANTA RITA DO ARAGUAIA	28/02/2020 06:48	28/02/2020 11:42	28/02/2020 06:48	28/02/2020 11:42	4,89	1	4,89	CHI
202002179246	SANTA RITA DO ARAGUAIA	SU12301950	SANTA RITA DO ARAGUAIA	28/02/2020 06:48	28/02/2020 11:42	28/02/2020 06:48	28/02/2020 11:42	4,89	21	102,71	CHI
202002179248	GOIANIA	14840595	GOYA S2	28/02/2020 07:22	28/02/2020 09:03	28/02/2020 07:22	28/02/2020 09:03	1,67	1	1,67	CHI
202002179253	MATRINCHA	MP12122364	MATRINCHA	28/02/2020 07:23	28/02/2020 10:34	28/02/2020 07:23	28/02/2020 10:34	3,18	10	31,79	CHI
202002179263	TURVELANDIA	TD11341627	RIO DOS BOIS	27/02/2020 21:50	28/02/2020 10:01	27/02/2020 21:50	28/02/2020 10:01	12,18	139	1693,29	CHI
202002179269	ITAPIRAPUA	IU12018852	MATRINCHA	28/02/2020 07:14	28/02/2020 11:38	28/02/2020 07:14	28/02/2020 11:38	4,40	35	153,87	CHI
202002179276	ITAPACI	IW12275237	ITAPACI	28/02/2020 07:29	28/02/2020 11:19	28/02/2020 07:29	28/02/2020 11:19	3,83	2	7,66	CHI
202002179279	ITABERAI	IB21000130	ITABERAI S2	28/02/2020 07:29	28/02/2020 11:13	28/02/2020 07:29	28/02/2020 11:13	3,73	1	3,73	CHI
202002179281	ITABERAI	340006948	ITABERAI S2	28/02/2020 07:29	28/02/2020 13:27	28/02/2020 07:29	28/02/2020 13:27	5,95	1	5,95	CHI
202002179283	CRIXAS	NM12027453	RUBIATABA	28/02/2020 06:27	28/02/2020 11:37	28/02/2020 06:27	28/02/2020 11:37	5,16	6	30,99	CHI
202002179283	ITAPACI	NM12027453	RUBIATABA	28/02/2020 06:27	28/02/2020 11:37	28/02/2020 06:27	28/02/2020 11:37	5,16	2	10,33	CHI
202002179283	NOVA AMERICA	NM12027453	RUBIATABA	28/02/2020 06:27	28/02/2020 11:37	28/02/2020 06:27	28/02/2020 11:37	5,16	9	46,48	CHI
202002179284	PARANAIGUARA	PC12093843	QUIRINOPOLIS	28/02/2020 07:25	29/02/2020 00:29	28/02/2020 07:25	29/02/2020 00:29	17,06	2	34,12	CHI
202002179294	CUMARI	CY12000305RE	CATALAO S1	28/02/2020 07:07	28/02/2020 11:48	28/02/2020 07:07	28/02/2020 11:48	4,68	175	818,56	CHI
202002179296	JATAI	JT21296399	JATAI S1	28/02/2020 07:32	28/02/2020 09:34	28/02/2020 07:32	28/02/2020 09:34	2,02	1	2,02	CHI
202002179306	IPAMERI	IP12266897	IPAMERI	28/02/2020 07:34	28/02/2020 10:56	28/02/2020 07:34	28/02/2020 10:56	3,36	6	20,18	CHI
202002179307	BONOPOLIS	BX12013030	SAO MIGUEL DO ARAGUAIA	28/02/2020 06:26	28/02/2020 23:02	28/02/2020 06:26	28/02/2020 23:02	16,60	5	82,98	CHI
202002179309	ARAGUAPAZ	AZ12299824LD	GOIAS	28/02/2020 07:00	28/02/2020 13:46	28/02/2020 07:00	28/02/2020 13:46	6,76	27	182,56	CHI
202002179309	FAINA	AZ12299824LD	GOIAS	28/02/2020 07:00	28/02/2020 13:46	28/02/2020 07:00	28/02/2020 13:46	6,76	4	27,05	CHI
202002179314	VIANOPOLIS	VN12009490	VIANOPOLIS	28/02/2020 07:35	28/02/2020 17:39	28/02/2020 07:35	28/02/2020 17:39	10,06	2	20,12	CHI
202002179315	AMARALINA	3590000427	MARA ROSA	28/02/2020 07:35	28/02/2020 15:22	28/02/2020 07:35	28/02/2020 15:22	7,77	1	7,77	CHI
202002179316	JANDAIA	JD12102347	ACREUNA	28/02/2020 07:36	28/02/2020 10:52	28/02/2020 07:36	28/02/2020 10:52	3,27	1	3,27	CHI
202002179317	QUIRINOPOLIS	QI12000344	QUIRINOPOLIS	28/02/2020 07:36	28/02/2020 09:32	28/02/2020 07:36	28/02/2020 09:32	1,93	8	15,45	CHI
202002179318	AGUA FRIA DE GOIAS	TL21211516	SAO JOAO D ALIANCA	28/02/2020 07:36	28/02/2020 10:40	28/02/2020 07:36	28/02/2020 10:40	3,08	1	3,08	CHI
202002179320	LUZIANIA	10023715195	RIO VERMELHO	28/02/2020 07:37	28/02/2020 10:03	28/02/2020 07:37	28/02/2020 10:03	2,43	1	2,43	CHI
202002179323	NOVA CRIXAS	NA12334349	NOVA CRIXAS	28/02/2020 06:30	28/02/2020 11:34	28/02/2020 06:30	28/02/2020 11:34	5,06	84	424,67	CHI
202002179335	GOIANESIA	GE11297289	GOIANESIA S1	28/02/2020 07:37	28/02/2020 21:03	28/02/2020 07:37	28/02/2020 21:03	13,42	1	13,42	CHI
202002179336	GOIANIA	10016466	CAMPINAS S2	28/02/2020 07:37	28/02/2020 09:34	28/02/2020 07:37	28/02/2020 09:34	1,94	1	1,94	CHI
202002179339	CACU	CC12295769	CACHOEIRA ALTA	28/02/2020 07:37	28/02/2020 23:38	28/02/2020 07:37	28/02/2020 23:38	16,01	4	64,04	CHI
202002179339	CACU	CC12295769	CACHOEIRA ALTA	28/02/2020 07:37	28/02/2020 23:38	28/02/2020 12:40	28/02/2020 23:38	10,97	3	32,91	CHI

202002179339	CACHOEIRA ALTA	CC12226533	CACHOEIRA ALTA	28/02/2020 07:37	28/02/2020 23:38	28/02/2020 18:16	28/02/2020 23:38	5,37	6	32,24	CHI
202002179339	CACU	CC12226533	CACHOEIRA ALTA	28/02/2020 07:37	28/02/2020 23:38	28/02/2020 18:16	28/02/2020 23:38	5,37	15	80,60	CHI
202002179341	CRISTALINA	KR12366452	PAMPLONA	28/02/2020 07:30	28/02/2020 11:01	28/02/2020 07:30	28/02/2020 11:01	3,51	11	38,65	CHI
202002179345	FORMOSO	FO12145406	PORANGATU	28/02/2020 07:26	28/02/2020 11:21	28/02/2020 07:26	28/02/2020 11:21	3,91	71	277,53	CHI
202002179350	MINEIROS	MY12234366	PARQUE DAS EMAS	28/02/2020 07:39	28/02/2020 13:12	28/02/2020 07:39	28/02/2020 13:12	5,54	1	5,54	CHI
202002179351	MINACU	IH12088797	MINACU	28/02/2020 00:25	28/02/2020 10:30	28/02/2020 00:25	28/02/2020 10:30	10,07	164	1651,57	CHI
202002179352	ITAPACI	IW122268794	RUBIATABA	28/02/2020 07:39	28/02/2020 10:54	28/02/2020 07:39	28/02/2020 10:54	3,24	11	35,60	CHI
202002179357	MINEIROS	MY12156850	PARQUE DAS EMAS	28/02/2020 07:02	29/02/2020 00:08	28/02/2020 07:02	29/02/2020 00:08	17,10	30	512,87	CHI
202002179358	DIVINOPOLIS DE GOIAS	GH12156343RE	SAO DOMINGOS	28/02/2020 07:02	28/02/2020 11:23	28/02/2020 07:02	28/02/2020 11:23	4,34	127	551,29	CHI
202002179358	MONTE ALEGRE DE GOIAS	GH12156343RE	SAO DOMINGOS	28/02/2020 07:02	28/02/2020 11:23	28/02/2020 07:02	28/02/2020 11:23	4,34	15	65,11	CHI
202002179358	SAO DOMINGOS	GH12156343RE	SAO DOMINGOS	28/02/2020 07:02	28/02/2020 11:23	28/02/2020 07:02	28/02/2020 11:23	4,34	1	4,34	CHI
202002179365	LUZIANIA	LZ21156995	MARAJOARA	28/02/2020 07:41	28/02/2020 09:04	28/02/2020 07:41	28/02/2020 09:04	1,38	2	2,75	CHI
202002179372	PORANGATU	PO12391655	NOVO PLANALTO	28/02/2020 07:42	28/02/2020 10:49	28/02/2020 07:42	28/02/2020 10:49	3,10	4	12,42	CHI
202002179373	ITAPACI	IW21379427	ITAPACI	28/02/2020 07:29	28/02/2020 15:32	28/02/2020 07:29	28/02/2020 15:32	8,05	1	8,05	CHI
202002179377	CALDAS NOVAS	CN12363988	CALDAS NOVAS S2	28/02/2020 07:43	28/02/2020 10:31	28/02/2020 07:43	28/02/2020 10:31	2,79	11	30,67	CHI
202002179381	ITUMBIARA	BG12263575	ITUMBIARA VELHA S2	28/02/2020 07:45	28/02/2020 14:20	28/02/2020 07:45	28/02/2020 14:20	6,58	3	19,75	CHI
202002179389	ANAPOLIS	OV12384197	NEROPOLIS S1	28/02/2020 07:45	28/02/2020 10:45	28/02/2020 07:45	28/02/2020 10:45	2,99	5	14,93	CHI
202002179389	OURO VERDE DE GOIAS	OV12384197	NEROPOLIS S1	28/02/2020 07:45	28/02/2020 10:45	28/02/2020 07:45	28/02/2020 10:45	2,99	2	5,97	CHI
202002179390	AGUA LIMPA	AL12075701	VILA CORUMBA	28/02/2020 07:06	28/02/2020 10:55	28/02/2020 07:06	28/02/2020 10:55	3,81	5	19,06	CHI
202002179391	BOM JARDIM DE GOIAS	BM12334813	IPORA	28/02/2020 07:46	28/02/2020 14:15	28/02/2020 07:46	28/02/2020 14:15	6,48	14	90,66	CHI
202002179392	IACIARA	IA21000008	IACIARA S1	28/02/2020 07:46	28/02/2020 15:37	28/02/2020 07:46	28/02/2020 15:37	7,84	2	15,67	CHI
202002179393	URUTAI	UT21266216	PIRES DO RIO S2	28/02/2020 07:46	28/02/2020 13:08	28/02/2020 07:46	28/02/2020 13:08	5,35	1	5,35	CHI
202002179396	ANAPOLIS	AN21258650	ANAPOLIS UNIVERSITARIO S2	28/02/2020 07:47	28/02/2020 10:07	28/02/2020 07:47	28/02/2020 10:07	2,33	1	2,33	CHI
202002179397	GOIANIA	15920343	REAL S2	28/02/2020 07:47	28/02/2020 09:15	28/02/2020 07:47	28/02/2020 09:15	1,46	1	1,46	CHI
202002179400	ITARUMA	IM21086392	CACHOEIRA ALTA	28/02/2020 06:48	28/02/2020 09:33	28/02/2020 06:48	28/02/2020 09:33	2,74	1	2,74	CHI
202002179406	CORUMBAIBA	CI21389812	VILA CORUMBA	28/02/2020 07:49	28/02/2020 15:45	28/02/2020 07:49	28/02/2020 15:45	7,92	1	7,92	CHI
202002179407	ITABERAI	IB12250711	ITABERAI S1	28/02/2020 06:02	28/02/2020 10:35	28/02/2020 06:02	28/02/2020 10:35	4,54	3	13,62	CHI
202002179408	BARRO ALTO	BA12382485	BARRO ALTO	28/02/2020 07:49	28/02/2020 09:50	28/02/2020 07:49	28/02/2020 09:50	2,00	9	18,02	CHI
202002179409	TURVANIA	TV21259081	FIRMINOPOLIS S2	28/02/2020 07:50	28/02/2020 09:50	28/02/2020 07:50	28/02/2020 09:50	2,00	1	2,00	CHI
202002179410	IACIARA	IA11195766	IACIARA S1	28/02/2020 07:42	28/02/2020 11:29	28/02/2020 07:42	28/02/2020 11:29	3,77	52	196,26	CHI
202002179412	DOVERLANDIA	DV11193272	CAIAPONIA	28/02/2020 07:50	28/02/2020 09:42	28/02/2020 07:50	28/02/2020 09:42	1,85	71	131,55	CHI
202002179413	FAZENDA NOVA	FN21096219	JUSSARA	28/02/2020 07:51	28/02/2020 21:53	28/02/2020 07:51	28/02/2020 21:53	14,03	1	14,03	CHI
202002179417	RIO VERDE	RV12123383	RIO VERDE S1	28/02/2020 06:24	28/02/2020 08:46	28/02/2020 06:24	28/02/2020 08:46	2,36	4	9,43	CHI
202002179420	BONOPOLIS	BX12079321	SAO MIGUEL DO ARAGUAIA	28/02/2020 07:27	28/02/2020 10:20	28/02/2020 07:27	28/02/2020 10:20	2,88	58	166,90	CHI
202002179424	ORIZONA	OZ32052342	PIRES DO RIO S2	28/02/2020 07:52	28/02/2020 09:34	28/02/2020 07:52	28/02/2020 09:34	1,69	5	8,44	CHI
202002179428	CATALAO	CT21042523	CATALAO S1	28/02/2020 07:53	28/02/2020 09:03	28/02/2020 07:53	28/02/2020 09:03	1,15	1	1,15	CHI
202002179430	SANTA TEREZINHA DE GOIAS	VD21253047	SANTA TEREZINHA	28/02/2020 07:54	28/02/2020 10:02	28/02/2020 07:54	28/02/2020 10:02	2,13	1	2,13	CHI
202002179434	CAIAPONIA	CP12020900	PIRANHAS	28/02/2020 07:54	28/02/2020 14:42	28/02/2020 07:54	28/02/2020 14:42	6,78	3	20,35	CHI
202002179438	GOIATUBA	JV12222364	GOIATUBA S1	28/02/2020 07:55	28/02/2020 11:49	28/02/2020 07:55	28/02/2020 11:49	3,90	2	7,80	CHI
202002179439	MONTIVIDIU	RV12100300	MONTIVIDIU T	28/02/2020 07:55	28/02/2020 11:23	28/02/2020 07:55	28/02/2020 11:23	3,46	3	10,38	CHI
202002179439	RIO VERDE	RV12100300	MONTIVIDIU T	28/02/2020 07:55	28/02/2020 11:23	28/02/2020 07:55	28/02/2020 11:23	3,46	1	3,46	CHI
202002179441	SAO MIGUEL DO ARAGUAIA	SM21246530	SAO MIGUEL DO ARAGUAIA	28/02/2020 07:55	29/02/2020 02:30	28/02/2020 07:55	29/02/2020 02:30	18,57	6	111,43	CHI
202002179443	CORUMBAIBA	CI21060349	VILA CORUMBA	28/02/2020 07:55	28/02/2020 12:19	28/02/2020 07:55	28/02/2020 12:19	4,39	1	4,39	CHI
202002179445	GOIANIA	10019293621	CAMPINAS S2	28/02/2020 07:56	28/02/2020 10:21	28/02/2020 07:56	28/02/2020 10:21	2,40	1	2,40	CHI

202002179447	CATALAO	CT21344427	CATALAO S1	28/02/2020 07:56	28/02/2020 10:58	28/02/2020 07:56	28/02/2020 10:58	3,02	1	3,02	CHI
202002179450	HIDROLANDIA	180044229	ANHANGUERA	28/02/2020 07:57	28/02/2020 11:55	28/02/2020 07:57	28/02/2020 11:55	3,95	1	3,95	CHI
202002179454	LUZIANIA	LZ11059707	RIO VERMELHO	28/02/2020 07:58	28/02/2020 10:02	28/02/2020 08:50	28/02/2020 10:02	1,20	93	111,68	CHI
202002179455	JUSSARA	1290068267	JUSSARA	28/02/2020 07:58	28/02/2020 12:11	28/02/2020 07:58	28/02/2020 12:11	4,21	1	4,21	CHI
202002179468	SAO DOMINGOS	SD12170547	SAO DOMINGOS	28/02/2020 08:00	28/02/2020 13:59	28/02/2020 08:00	28/02/2020 13:59	5,98	13	77,75	CHI
202002179470	BELA VISTA DE GOIAS	CF21152556	CRISTIANOPOLIS	28/02/2020 08:00	28/02/2020 09:53	28/02/2020 08:00	28/02/2020 09:53	1,87	1	1,87	CHI
202002179471	CORUMBAIBA	CI11203092	VILA CORUMBA	27/02/2020 19:00	28/02/2020 09:01	28/02/2020 00:00	28/02/2020 09:01	9,02	79	712,32	CHI
202002179502	VILA BOA	VB11270064	ITIQUEIRA	28/02/2020 08:01	28/02/2020 09:40	28/02/2020 08:01	28/02/2020 09:40	1,64	7	11,47	CHI
202002179601	AMARALINA	MQ12197505	NOVA CRIXAS	28/02/2020 08:01	28/02/2020 19:38	28/02/2020 08:01	28/02/2020 19:38	11,61	6	69,68	CHI
202002179601	UIRAPURU	MQ12197505	NOVA CRIXAS	28/02/2020 08:01	28/02/2020 19:38	28/02/2020 08:01	28/02/2020 19:38	11,61	3	34,84	CHI
202002179608	APARECIDA DO RIO DOCE	AW21122555	CACHOEIRA ALTA	28/02/2020 08:02	29/02/2020 09:33	28/02/2020 08:02	29/02/2020 09:33	25,50	1	25,50	CHI
202002179612	GOIANIA	16249367	CAMPINAS S2	28/02/2020 08:03	28/02/2020 11:25	28/02/2020 08:03	28/02/2020 11:25	3,36	1	3,36	CHI
202002179616	ITABERAI	IB21300138	ITABERAI S1	28/02/2020 08:04	29/02/2020 11:33	28/02/2020 08:04	29/02/2020 11:33	27,47	1	27,47	CHI
202002179620	JARAGUA	JA12273193	JARAGUA	28/02/2020 08:05	28/02/2020 09:44	28/02/2020 08:05	28/02/2020 09:44	1,64	2	3,28	CHI
202002179621	SAO MIGUEL DO ARAGUAIA	SM12253876	SAO MIGUEL DO ARAGUAIA	28/02/2020 08:05	28/02/2020 22:52	28/02/2020 08:05	28/02/2020 22:52	14,77	3	44,31	CHI
202002179622	FAINA	FC12272611	GOIAS	28/02/2020 08:05	28/02/2020 11:44	28/02/2020 08:05	28/02/2020 11:44	3,64	25	90,94	CHI
202002179635	GOIAS	GS11162378	MATRINCHA	28/02/2020 08:07	29/02/2020 08:18	28/02/2020 08:07	29/02/2020 08:18	24,18	1	24,18	CHI
202002179638	PIRES DO RIO	PR12409073	PIRES DO RIO S2	28/02/2020 08:07	28/02/2020 17:49	28/02/2020 08:07	28/02/2020 17:49	9,71	3	29,12	CHI
202002179642	URUTAI	UT12115680	PIRES DO RIO S2	28/02/2020 08:08	28/02/2020 11:13	28/02/2020 08:08	28/02/2020 11:13	3,08	32	98,63	CHI
202002179645	DIORAMA	JP12316474RE	IPORA	28/02/2020 06:27	28/02/2020 11:50	28/02/2020 06:27	28/02/2020 11:50	5,38	12	64,60	CHI
202002179645	JAUPACI	JP12316474RE	IPORA	28/02/2020 06:27	28/02/2020 11:50	28/02/2020 06:27	28/02/2020 11:50	5,38	47	253,02	CHI
202002179646	FAZENDA NOVA	FN12217146	JUSSARA	28/02/2020 08:03	28/02/2020 17:34	28/02/2020 08:03	28/02/2020 17:34	9,50	13	123,53	CHI
202002179650	AMORINOPOLIS	IR12402986	IPORA	28/02/2020 07:48	28/02/2020 14:02	28/02/2020 07:48	28/02/2020 14:02	6,22	1	6,22	CHI
202002179650	IPORA	IR12402986	IPORA	28/02/2020 07:48	28/02/2020 14:02	28/02/2020 07:48	28/02/2020 14:02	6,22	6	37,33	CHI
202002179654	PLANALTINA	PI11071308	PLANALTINA	28/02/2020 08:09	28/02/2020 09:37	28/02/2020 08:09	28/02/2020 09:37	1,46	27	39,43	CHI
202002179661	EDEIA	EA21380549	EDEIA	28/02/2020 08:10	28/02/2020 12:19	28/02/2020 08:10	28/02/2020 12:19	4,15	1	4,15	CHI
202002179663	CALDAS NOVAS	760195742	SERRA DE CALDAS	28/02/2020 08:10	28/02/2020 09:22	28/02/2020 08:10	28/02/2020 09:22	1,21	1	1,21	CHI
202002179667	GOIANESIA	GE12000231	GOIANESIA S2	28/02/2020 08:11	28/02/2020 12:05	28/02/2020 08:11	28/02/2020 12:05	3,90	4	15,60	CHI
202002179677	PIRES DO RIO	PR12255829	PIRES DO RIO S1	28/02/2020 08:13	28/02/2020 15:30	28/02/2020 08:13	28/02/2020 15:30	7,27	8	58,18	CHI
202002179683	GOIANIA	10015326800	MEIA PONTE	28/02/2020 08:14	28/02/2020 09:18	28/02/2020 08:14	28/02/2020 09:18	1,05	1	1,05	CHI
202002179684	CORUMBAIBA	CI21107521	VILA CORUMBA	28/02/2020 08:15	28/02/2020 10:15	28/02/2020 08:15	28/02/2020 10:15	2,00	1	2,00	CHI
202002179685	GOIATUBA	BJ21273967	BOM JESUS DE GOIAS	28/02/2020 08:15	28/02/2020 09:49	28/02/2020 08:15	28/02/2020 09:49	1,56	1	1,56	CHI
202002179687	PORANGATU	840073392	PORANGATU	28/02/2020 08:15	28/02/2020 09:31	28/02/2020 08:15	28/02/2020 09:31	1,26	1	1,26	CHI
202002179697	QUIRINOPOLIS	QI12271540	QUIRINOPOLIS	28/02/2020 08:15	28/02/2020 10:22	28/02/2020 08:15	28/02/2020 10:22	2,10	3	6,31	CHI
202002179698	GOIANIA	GN12044797	GOIANIA LESTE S3	28/02/2020 08:18	28/02/2020 10:05	28/02/2020 08:18	28/02/2020 10:05	1,78	342	608,19	CHI
202002179736	FAZENDA NOVA	FN21311836	IPORA	27/02/2020 21:21	28/02/2020 16:18	27/02/2020 21:21	28/02/2020 16:18	18,95	1	18,95	CHI
202002179772	GOIANIA	13932305	XAVANTES	28/02/2020 09:43	28/02/2020 12:07	28/02/2020 09:43	28/02/2020 12:07	2,38	1	2,38	CHI
202002179794	RIO VERDE	RV21205437	MONTIVIDIU T	28/02/2020 11:27	28/02/2020 12:11	28/02/2020 11:27	28/02/2020 12:11	0,72	13	9,36	CHI
202002179798	MARA ROSA	MQ12391917	MARA ROSA	27/02/2020 21:38	28/02/2020 15:27	27/02/2020 21:38	28/02/2020 15:27	17,82	6	106,90	CHI
202002179803	CRIXAS	CX12380748	SERRA DO OURO	28/02/2020 08:18	28/02/2020 17:31	28/02/2020 08:18	28/02/2020 17:31	9,21	25	230,22	CHI
202002179813	PIRACANJUBA	60069636	PIRACANJUBA	28/02/2020 08:20	28/02/2020 11:48	28/02/2020 08:20	28/02/2020 11:48	3,46	1	3,46	CHI
202002179815	SILVANIA	SV21241101	VIANOPOLIS	28/02/2020 08:20	28/02/2020 15:50	28/02/2020 08:20	28/02/2020 15:50	7,49	1	7,49	CHI
202002179818	MATRINCHA	AK21387201	MATRINCHA	28/02/2020 08:21	28/02/2020 14:13	28/02/2020 08:21	28/02/2020 14:13	5,86	1	5,86	CHI
202002179819	SANTA CRUZ DE GOIAS	PZ12311653	PIRES DO RIO S2	28/02/2020 08:22	29/02/2020 12:33	28/02/2020 08:22	29/02/2020 12:33	28,19	7	197,30	CHI

202002179822	SENADOR CANEDO	20027826	SENADOR CANEDO	28/02/2020 08:22	28/02/2020 10:00	28/02/2020 08:22	28/02/2020 09:40	1,30	415	538,00	CHI
202002179822	SENADOR CANEDO	SW11375181	SENADOR CANEDO	28/02/2020 08:22	28/02/2020 10:00	28/02/2020 08:22	28/02/2020 10:00	1,63	70	114,08	CHI
202002179823	MINACU	IH12307129	MINACU	28/02/2020 08:17	28/02/2020 12:30	28/02/2020 08:17	28/02/2020 12:30	4,21	12	50,55	CHI
202002179827	CALDAS NOVAS	760207756	SERRA DE CALDAS	28/02/2020 08:23	28/02/2020 10:36	28/02/2020 08:23	28/02/2020 10:36	2,22	1	2,22	CHI
202002179831	BOM JARDIM DE GOIAS	BM12190379	BOM JARDIM	28/02/2020 08:23	29/02/2020 07:41	28/02/2020 08:23	29/02/2020 07:41	23,29	3	69,86	CHI
202002179832	CRISTALINA	7501667	PAMPLONA	28/02/2020 08:23	28/02/2020 13:27	28/02/2020 08:23	28/02/2020 13:27	5,05	1	5,05	CHI
202002179833	POSSE	PS12332778	IACIARA S2	28/02/2020 08:24	28/02/2020 11:06	28/02/2020 08:24	28/02/2020 11:06	2,70	13	35,06	CHI
202002179835	SAO JOAO D ALIANCA	JL12266381	SAO JOAO D ALIANCA	28/02/2020 08:24	28/02/2020 10:16	28/02/2020 08:24	28/02/2020 10:16	1,86	1	1,86	CHI
202002179836	AGUA FRIA DE GOIAS	TL21232756	SAO JOAO D ALIANCA	28/02/2020 08:24	28/02/2020 12:36	28/02/2020 08:24	28/02/2020 12:36	4,19	5	20,97	CHI
202002179837	NOVA IGUAQU DE GOIAS	NH12232436	SANTA TEREZINHA	28/02/2020 08:24	28/02/2020 13:43	28/02/2020 08:24	28/02/2020 13:43	5,31	19	100,84	CHI
202002179839	CATALAO	CT12149164RE	CATALAO S1	28/02/2020 06:35	28/02/2020 09:40	28/02/2020 06:35	28/02/2020 09:40	3,08	145	446,44	CHI
202002179842	GOIANIA	15980145	CAMPINAS S1	28/02/2020 08:25	28/02/2020 10:39	28/02/2020 08:25	28/02/2020 10:39	2,23	1	2,23	CHI
202002179845	SAO JOAO DA PARAUNA	RP21035195	PARAUNA	28/02/2020 08:25	28/02/2020 15:55	28/02/2020 08:25	28/02/2020 15:55	7,49	1	7,49	CHI
202002179846	BONOPOLIS	BX12202590	SAO MIGUEL DO ARAGUAIA	28/02/2020 05:32	28/02/2020 15:03	28/02/2020 05:32	28/02/2020 15:03	9,50	11	104,52	CHI
202002179847	CATALAO	1990314664	CATALAO S2	28/02/2020 08:25	28/02/2020 09:56	28/02/2020 08:25	28/02/2020 09:56	1,51	1	1,51	CHI
202002179848	JUSSARA	1290019797	JUSSARA	28/02/2020 08:25	28/02/2020 11:40	28/02/2020 08:25	28/02/2020 11:40	3,24	1	3,24	CHI
202002179852	GOIANESIA	GE21000037	GOIANESIA S2	28/02/2020 08:25	28/02/2020 11:00	28/02/2020 09:55	28/02/2020 11:00	1,09	1	1,09	CHI
202002179858	SILVANIA	SV31013355	ANAPOLIS UNIVERSITARIO S2	28/02/2020 08:28	28/02/2020 11:51	28/02/2020 08:28	28/02/2020 11:51	3,38	1	3,38	CHI
202002179860	RIO VERDE	630095826	RIO VERDE S1	28/02/2020 08:28	28/02/2020 14:29	28/02/2020 08:28	28/02/2020 14:29	6,00	1	6,00	CHI
202002179865	ADELANDIA	DN12021716	ANICUNS	28/02/2020 08:29	28/02/2020 10:48	28/02/2020 08:29	28/02/2020 10:48	2,31	18	41,55	CHI
202002179865	MOSSAMEDES	DN12021716	ANICUNS	28/02/2020 08:29	28/02/2020 10:48	28/02/2020 08:29	28/02/2020 10:48	2,31	2	4,62	CHI
202002179867	URUACU	UR11221613	URUACU	28/02/2020 08:29	28/02/2020 10:35	28/02/2020 08:29	28/02/2020 10:35	2,09	33	68,92	CHI
202002179869	DIORAMA	DI12023266	IPORA	28/02/2020 07:33	28/02/2020 14:24	28/02/2020 07:33	28/02/2020 14:24	6,85	63	431,50	CHI
202002179869	JAUPACI	DI12023266	IPORA	28/02/2020 07:33	28/02/2020 14:24	28/02/2020 07:33	28/02/2020 14:24	6,85	9	61,64	CHI
202002179871	CATALAO	CT12104183	CATALAO S1	28/02/2020 08:30	28/02/2020 14:53	28/02/2020 08:30	28/02/2020 14:53	6,38	6	38,26	CHI
202002179883	INDIARA	00500424	EDEIA	28/02/2020 08:20	28/02/2020 18:56	28/02/2020 08:20	28/02/2020 10:00	1,65	5	8,26	CHI
202002179883	ACREUNA	00505114	EDEIA	28/02/2020 08:20	28/02/2020 18:56	28/02/2020 10:19	28/02/2020 10:25	0,10	19	1,90	CHI
202002179883	EDEALINA	00505114	EDEIA	28/02/2020 08:20	28/02/2020 18:56	28/02/2020 10:19	28/02/2020 10:25	0,10	1	0,10	CHI
202002179883	EDEALINA	00505114	EDEIA	28/02/2020 08:20	28/02/2020 18:56	28/02/2020 10:19	28/02/2020 10:25	0,10	47	4,70	CHI
202002179883	EDEALINA	00505114	EDEIA	28/02/2020 08:20	28/02/2020 18:56	28/02/2020 10:19	28/02/2020 10:25	0,10	3	0,30	CHI
202002179883	EDEIA	00505114	EDEIA	28/02/2020 08:20	28/02/2020 18:56	28/02/2020 10:19	28/02/2020 10:25	0,10	2998	299,80	CHI
202002179883	EDEIA	00505114	EDEIA	28/02/2020 08:20	28/02/2020 18:56	28/02/2020 10:19	28/02/2020 10:25	0,10	2005	200,50	CHI
202002179883	EDEIA	00505114	EDEIA	28/02/2020 08:20	28/02/2020 18:56	28/02/2020 10:19	28/02/2020 10:25	0,10	20	2,00	CHI
202002179883	INDIARA	00505114	EDEIA	28/02/2020 08:20	28/02/2020 18:56	28/02/2020 10:19	28/02/2020 10:25	0,10	43	4,30	CHI
202002179883	INDIARA	00505114	EDEIA	28/02/2020 08:20	28/02/2020 18:56	28/02/2020 10:19	28/02/2020 10:25	0,10	11	1,10	CHI
202002179883	PONTALINA	00505114	EDEIA	28/02/2020 08:20	28/02/2020 18:56	28/02/2020 10:19	28/02/2020 10:25	0,10	1	0,10	CHI
202002179883	CEZARINA	00505114	PONTALINA	28/02/2020 08:20	28/02/2020 18:56	28/02/2020 10:19	28/02/2020 10:25	0,10	4	0,40	CHI
202002179883	EDEALINA	00505114	PONTALINA	28/02/2020 08:20	28/02/2020 18:56	28/02/2020 10:19	28/02/2020 10:25	0,10	2013	201,30	CHI
202002179883	EDEIA	00505114	PONTALINA	28/02/2020 08:20	28/02/2020 18:56	28/02/2020 10:19	28/02/2020 10:25	0,10	131	13,10	CHI
202002179883	INDIARA	00505114	PONTALINA	28/02/2020 08:20	28/02/2020 18:56	28/02/2020 10:19	28/02/2020 10:25	0,10	2	0,20	CHI
202002179883	PONTALINA	00505114	PONTALINA	28/02/2020 08:20	28/02/2020 18:56	28/02/2020 10:19	28/02/2020 10:25	0,10	22	2,20	CHI
202002179883	INDIARA	00500424	EDEIA	28/02/2020 08:20	28/02/2020 18:56	28/02/2020 08:20	28/02/2020 15:00	6,66	9	59,98	CHI
202002179883	EDEIA	00500424	EDEIA	28/02/2020 08:20	28/02/2020 18:56	28/02/2020 08:20	28/02/2020 18:04	9,74	440	4283,52	CHI
202002179883	EDEIA	EA13206450	EDEIA	28/02/2020 08:20	28/02/2020 18:56	28/02/2020 18:45	28/02/2020 18:56	0,19	440	81,89	CHI

202002179884	BELA VISTA DE GOIAS	BV12207502	BELA VISTA S1	28/02/2020 07:47	28/02/2020 11:00	28/02/2020 07:47	28/02/2020 11:00	3,21	11	35,31	CHI
202002179894	JARAGUA	JA21200838	JARAGUA	28/02/2020 08:32	28/02/2020 11:29	28/02/2020 08:32	28/02/2020 11:29	2,95	1	2,95	CHI
202002179902	ARUANA	AK12250808	ARUANA	28/02/2020 07:51	28/02/2020 09:26	28/02/2020 07:51	28/02/2020 09:26	1,57	3	4,72	CHI
202002180103	GOIANIA	10026714866	CAMPINAS S1	28/02/2020 08:33	28/02/2020 11:17	28/02/2020 08:33	28/02/2020 11:17	2,72	1	2,72	CHI
202002180109	JATAI	JT12365031LD	JATAI S2	28/02/2020 08:34	28/02/2020 12:05	28/02/2020 08:34	28/02/2020 12:05	3,52	19	66,80	CHI
202002180110	GOIANIA	14808948	FERROVIARIO S3	28/02/2020 08:34	28/02/2020 10:26	28/02/2020 08:34	28/02/2020 10:26	1,86	1	1,86	CHI
202002180118	MONTIVIDIU DO NORTE	TB21157251	PORANGATU	28/02/2020 08:35	29/02/2020 12:47	28/02/2020 08:35	29/02/2020 12:47	28,20	1	28,20	CHI
202002180124	ITABERAI	10007927175	ITABERAI S2	28/02/2020 08:36	28/02/2020 13:10	28/02/2020 08:36	28/02/2020 13:10	4,57	1	4,57	CHI
202002180131	GOIANIA	16433130	MEIA PONTE	28/02/2020 08:37	28/02/2020 10:19	28/02/2020 08:37	28/02/2020 10:19	1,70	1	1,70	CHI
202002180132	SILVANIA	SV12022221	DAIA S2	28/02/2020 08:37	28/02/2020 11:44	28/02/2020 08:37	28/02/2020 11:44	3,11	3	9,34	CHI
202002180136	CATURAI	CK21226551	GOIANIRA	28/02/2020 08:38	28/02/2020 14:59	28/02/2020 08:38	28/02/2020 14:59	6,35	2	12,70	CHI
202002180137	FORMOSA	VB12164674	ITIQUEIRA	28/02/2020 08:38	28/02/2020 11:54	28/02/2020 08:38	28/02/2020 11:54	3,26	44	143,64	CHI
202002180137	VILA BOA	VB12164674	ITIQUEIRA	28/02/2020 08:38	28/02/2020 11:54	28/02/2020 08:38	28/02/2020 11:54	3,26	6	19,59	CHI
202002180142	CRISTALINA	KR21184977	CRISTALINA S1	28/02/2020 08:38	28/02/2020 16:02	28/02/2020 08:38	28/02/2020 16:02	7,39	1	7,39	CHI
202002180146	CHAPADAO DO CEU	DJ11226962	CHAPADAO DO CEU	28/02/2020 08:39	28/02/2020 09:35	28/02/2020 08:39	28/02/2020 09:35	0,92	1	0,92	CHI
202002180150	SAO JOAO D ALIANCA	JL121256460	ITIQUEIRA	28/02/2020 08:39	28/02/2020 16:41	28/02/2020 08:39	28/02/2020 16:41	8,02	2	16,04	CHI
202002180153	TRINDADE	TR11251469	TRINDADE	28/02/2020 08:40	28/02/2020 15:25	28/02/2020 08:40	28/02/2020 15:25	6,75	111	748,88	CHI
202002180155	RIO VERDE	630187411	RIO VERDE S1	28/02/2020 08:40	28/02/2020 17:30	28/02/2020 08:40	28/02/2020 17:30	8,84	1	8,84	CHI
202002180156	CRISTALINA	KR21203335	PAMPLONA	28/02/2020 08:40	28/02/2020 12:32	28/02/2020 08:40	28/02/2020 12:32	3,87	2	7,75	CHI
202002180157	SAO LUIS DE MONTES BELOS	500024145	SAO LUIZ DOS MONTES BELOS	28/02/2020 08:40	28/02/2020 16:38	28/02/2020 08:40	28/02/2020 16:38	7,96	1	7,96	CHI
202002180161	GOIANESIA	GE12353207	GOIANESIA S1	28/02/2020 08:41	28/02/2020 14:45	28/02/2020 08:41	28/02/2020 14:45	6,08	1	6,08	CHI
202002180167	ITABERAI	IB21373129	ITABERAI S1	28/02/2020 08:41	28/02/2020 18:49	28/02/2020 08:41	28/02/2020 18:49	10,12	1	10,12	CHI
202002180168	SAO FRANCISCO DE GOIAS	SF21008962	SAO FRANCISCO DE GOIAS	28/02/2020 08:41	28/02/2020 15:10	28/02/2020 08:41	28/02/2020 15:10	6,47	1	6,47	CHI
202002180176	FLORES DE GOIAS	IA12046295	IACIARA S2	28/02/2020 08:07	28/02/2020 09:25	28/02/2020 08:07	28/02/2020 09:25	1,30	1	1,30	CHI
202002180176	IACIARA	IA12046295	IACIARA S2	28/02/2020 08:07	28/02/2020 09:25	28/02/2020 08:07	28/02/2020 09:25	1,30	88	114,33	CHI
202002180180	CORUMBAIBA	CI12363795	VILA CORUMBA	28/02/2020 08:43	28/02/2020 12:16	28/02/2020 08:43	28/02/2020 12:16	3,54	3	10,63	CHI
202002180190	INHUMAS	10009093808	INHUMAS S2	28/02/2020 08:44	28/02/2020 11:41	28/02/2020 08:44	28/02/2020 11:41	2,95	1	2,95	CHI
202002180191	ANAPOLIS	AN21068670	JUNDAI S2	28/02/2020 08:44	28/02/2020 11:44	28/02/2020 08:44	28/02/2020 11:44	2,99	1	2,99	CHI
202002180192	IACIARA	IA12392240	FLORES DE GOIAS	28/02/2020 08:44	28/02/2020 13:36	28/02/2020 08:44	28/02/2020 13:36	4,86	7	34,01	CHI
202002180195	SILVANIA	SV21372235	VIANOPOLIS	28/02/2020 09:03	28/02/2020 13:18	28/02/2020 09:03	28/02/2020 13:18	4,24	1	4,24	CHI
202002180199	COCALZINHO DE GOIAS	LA12194977LD	AGUAS LINDAS DE GOIAS S2	28/02/2020 08:45	28/02/2020 17:14	28/02/2020 08:45	28/02/2020 17:14	8,47	62	525,45	CHI
202002180199	PADRE BERNARDO	LA12194977LD	AGUAS LINDAS DE GOIAS S2	28/02/2020 08:45	28/02/2020 17:14	28/02/2020 08:45	28/02/2020 17:14	8,47	2	16,95	CHI
202002180220	AMARALINA	MU12391672	MARA ROSA	28/02/2020 08:49	28/02/2020 11:08	28/02/2020 08:49	28/02/2020 11:08	2,32	101	234,52	CHI
202002180220	MUTUNOPOLIS	MU12391672	MARA ROSA	28/02/2020 08:49	28/02/2020 11:08	28/02/2020 08:49	28/02/2020 11:08	2,32	7	16,25	CHI
202002180225	SAO JOAO DA PARAUNA	RP21008144	FIRMINOPOLIS S2	28/02/2020 08:50	28/02/2020 12:36	28/02/2020 08:50	28/02/2020 12:36	3,76	2	7,51	CHI
202002180228	FLORES DE GOIAS	3480015151	FLORES DE GOIAS	28/02/2020 08:50	28/02/2020 10:57	28/02/2020 08:50	28/02/2020 10:57	2,10	1	2,10	CHI
202002180235	PARAUNA	PU21227976	FIRMINOPOLIS S2	28/02/2020 08:51	28/02/2020 17:04	28/02/2020 08:51	28/02/2020 17:04	8,21	1	8,21	CHI
202002180241	ITUMBIARA	IT21198607	ITUMBIARA VELHA S2	28/02/2020 08:52	28/02/2020 15:04	28/02/2020 08:52	28/02/2020 15:04	6,20	1	6,20	CHI
202002180244	PIRENOPOLIS	PV21283863	CORUMBA	28/02/2020 08:52	28/02/2020 13:17	28/02/2020 08:52	28/02/2020 13:17	4,40	2	8,81	CHI
202002180248	MIMOSO DE GOIAS	3170001964	PADRE BERNARDO	28/02/2020 08:54	28/02/2020 12:52	28/02/2020 08:54	28/02/2020 12:52	3,96	1	3,96	CHI
202002180249	CORUMBAIBA	CI11165243	VILA CORUMBA	28/02/2020 08:40	28/02/2020 13:00	28/02/2020 08:40	28/02/2020 13:00	4,32	137	592,14	CHI
202002180251	ITAPIRAPUA	IU12089735	MATRINCHA	28/02/2020 08:55	28/02/2020 09:56	28/02/2020 08:55	28/02/2020 09:56	1,01	8	8,09	CHI
202002180256	FORMOSA	FA12302847	ITIQUEIRA	28/02/2020 08:56	28/02/2020 13:35	28/02/2020 08:56	28/02/2020 13:35	4,65	1	4,65	CHI
202002180257	MINACU	IH12182357	MINACU	28/02/2020 08:56	28/02/2020 11:55	28/02/2020 08:56	28/02/2020 11:55	2,98	3	8,94	CHI

202002180279	APARECIDA DO RIO DOCE	JT12081470	JATAI S1	28/02/2020 07:53	28/02/2020 16:19	28/02/2020 07:53	28/02/2020 16:19	8,42	12	101,08	CHI
202002180283	ORIZONA	3440000460	PIRES DO RIO S2	28/02/2020 08:58	28/02/2020 11:31	28/02/2020 08:58	28/02/2020 11:31	2,54	1	2,54	CHI
202002180287	ACREUNA	2440010577	ACREUNA	28/02/2020 08:59	28/02/2020 13:24	28/02/2020 08:59	28/02/2020 13:24	4,40	1	4,40	CHI
202002180295	IPORA	730133047	IPORA	28/02/2020 09:01	28/02/2020 16:28	28/02/2020 09:01	28/02/2020 16:28	7,45	1	7,45	CHI
202002180296	CROMINIA	520006951	PONTALINA	28/02/2020 09:01	28/02/2020 13:35	28/02/2020 09:01	28/02/2020 13:35	4,56	1	4,56	CHI
202002180297	JANDAIA	PP12233311	PALMEIRAS	28/02/2020 09:01	28/02/2020 21:20	28/02/2020 09:01	28/02/2020 21:20	12,31	19	233,86	CHI
202002180297	PALMINOPOLIS	PP12233311	PALMEIRAS	28/02/2020 09:01	28/02/2020 21:20	28/02/2020 09:01	28/02/2020 21:20	12,31	39	480,04	CHI
202002180298	ALVORADA DO NORTE	AQ21309468	IACIARA S2	28/02/2020 09:01	28/02/2020 11:57	28/02/2020 09:01	28/02/2020 11:57	2,93	1	2,93	CHI
202002180301	GOIANESIA	550147135	GOIANESIA S2	28/02/2020 09:02	29/02/2020 10:33	28/02/2020 09:02	29/02/2020 10:33	25,52	1	25,52	CHI
202002180305	PORANGATU	PO12192371	PORANGATU	28/02/2020 09:02	29/02/2020 14:09	28/02/2020 09:02	29/02/2020 14:09	29,11	12	349,35	CHI
202002180311	ARAGUAPAZ	AZ12234927	GOIAS	28/02/2020 09:03	28/02/2020 15:31	28/02/2020 09:03	28/02/2020 15:31	6,46	1	6,46	CHI
202002180312	AMARALINA	LC12270742	SAO MIGUEL DO ARAGUAIA	28/02/2020 09:03	28/02/2020 15:51	28/02/2020 09:03	28/02/2020 15:51	6,79	4	27,17	CHI
202002180324	PALMEIRAS DE GOIAS	PL12011094	PALMEIRAS	28/02/2020 09:04	28/02/2020 12:03	28/02/2020 09:04	28/02/2020 12:03	2,97	3	8,92	CHI
202002180327	CHAPADAO DO CEU	9880006221	CHAPADAO DO CEU	28/02/2020 09:04	28/02/2020 11:05	28/02/2020 09:04	28/02/2020 11:05	2,01	1	2,01	CHI
202002180329	ITUMBIARA	IT12273841	PARANAIBA	28/02/2020 09:04	28/02/2020 11:57	28/02/2020 09:04	28/02/2020 11:57	2,87	3	8,61	CHI
202002180330	GAMELEIRA DE GOIAS	3830003375	DAIA S2	28/02/2020 09:04	28/02/2020 11:54	28/02/2020 09:04	28/02/2020 11:54	2,82	1	2,82	CHI
202002180332	PIRES DO RIO	PR21309164	PIRES DO RIO S1	28/02/2020 09:05	28/02/2020 10:24	28/02/2020 09:05	28/02/2020 10:24	1,31	1	1,31	CHI
202002180333	POSSE	PS12195956	IACIARA S2	28/02/2020 09:05	28/02/2020 10:43	28/02/2020 09:05	28/02/2020 10:43	1,63	3	4,89	CHI
202002180347	CIDADE OCIDENTAL	2680000098	MARAJOARA	28/02/2020 09:07	28/02/2020 11:07	28/02/2020 09:07	28/02/2020 11:07	1,99	1	1,99	CHI
202002180351	TURVELANDIA	TD12025685	RIO DOS BOIS	28/02/2020 08:07	28/02/2020 14:30	28/02/2020 08:07	28/02/2020 14:30	6,38	30	191,28	CHI
202002180352	NOVA CRIXAS	NA12321769	MOZARLANDIA	28/02/2020 09:07	28/02/2020 16:24	28/02/2020 09:07	28/02/2020 16:24	7,27	11	79,98	CHI
202002180358	ITAGUARI	IC21206953	ITABERAI S1	28/02/2020 09:08	28/02/2020 16:15	28/02/2020 09:08	28/02/2020 16:15	7,11	2	14,22	CHI
202002180361	ABADIANIA	AA12382362	CORUMBA	28/02/2020 09:09	28/02/2020 10:24	28/02/2020 09:09	28/02/2020 10:24	1,25	12	15,00	CHI
202002180362	INHUMAS	IN21021338	INHUMAS S2	28/02/2020 09:09	28/02/2020 12:37	28/02/2020 09:09	28/02/2020 12:37	3,46	1	3,46	CHI
202002180364	CATURAI	CK21027518	INHUMAS S1	28/02/2020 09:09	28/02/2020 11:27	28/02/2020 09:09	28/02/2020 11:27	2,29	1	2,29	CHI
202002180365	CACHOEIRA DOURADA	CD21305506	CACHOEIRA DOURADA	28/02/2020 09:09	28/02/2020 11:13	28/02/2020 09:09	28/02/2020 11:13	2,05	2	4,11	CHI
202002180369	BELA VISTA DE GOIAS	BV21000053	BELA VISTA S1	28/02/2020 09:10	28/02/2020 10:31	28/02/2020 09:10	28/02/2020 10:31	1,35	1	1,35	CHI
202002180377	CUMARI	CY21236645	CATALAO S1	28/02/2020 09:09	28/02/2020 12:25	28/02/2020 09:09	28/02/2020 12:25	3,26	1	3,26	CHI
202002180383	PETROLINA DE GOIAS	PG12116272	PETROLINA	28/02/2020 08:29	28/02/2020 10:54	28/02/2020 08:29	28/02/2020 10:54	2,41	8	19,30	CHI
202002180386	GOIANIA	14186779	GOIANIA LESTE S1	28/02/2020 09:12	28/02/2020 13:18	28/02/2020 09:12	28/02/2020 13:18	4,09	1	4,09	CHI
202002180395	CATURAI	TR12045912	TRINDADE	28/02/2020 09:13	28/02/2020 11:32	28/02/2020 09:13	28/02/2020 11:32	2,31	1	2,31	CHI
202002180395	TRINDADE	TR12045912	TRINDADE	28/02/2020 09:13	28/02/2020 11:32	28/02/2020 09:13	28/02/2020 11:32	2,31	2	4,62	CHI
202002180396	NEROPOLIS	160020888	NEROPOLIS S2	28/02/2020 09:13	28/02/2020 10:39	28/02/2020 09:13	28/02/2020 10:39	1,43	1	1,43	CHI
202002180397	IVOLANDIA	IV12381057	IPORA	28/02/2020 08:52	28/02/2020 21:33	28/02/2020 08:52	28/02/2020 21:33	12,68	8	101,41	CHI
202002180404	SAO MIGUEL DO PASSA QUATRO	SQ21216207	CRISTIANOPOLIS	28/02/2020 09:14	28/02/2020 10:42	28/02/2020 09:14	28/02/2020 10:42	1,46	1	1,46	CHI
202002180406	INHUMAS	30044110	INHUMAS S2	28/02/2020 09:15	28/02/2020 15:21	28/02/2020 09:15	28/02/2020 15:21	6,10	1	6,10	CHI
202002180413	IPAMERI	IP12272804	IPAMERI	28/02/2020 09:15	28/02/2020 11:52	28/02/2020 09:15	28/02/2020 11:52	2,60	2	5,20	CHI
202002180414	JARAGUA	70050764	JARAGUA	28/02/2020 09:16	28/02/2020 16:57	28/02/2020 09:16	28/02/2020 16:57	7,68	1	7,68	CHI
202002180415	TRINDADE	TR12343758	TRINDADE	28/02/2020 09:16	28/02/2020 21:03	28/02/2020 09:16	28/02/2020 18:15	8,98	16	143,70	CHI
202002180415	TRINDADE	TR21288925	TRINDADE	28/02/2020 09:16	28/02/2020 21:03	28/02/2020 18:59	28/02/2020 21:03	2,06	16	32,89	CHI
202002180418	CORUMBAIBA	CI12180475	VILA CORUMBA	28/02/2020 09:16	28/02/2020 11:42	28/02/2020 09:16	28/02/2020 11:42	2,42	3	7,26	CHI
202002180424	ITABERAI	TQ12376477	ITABERAI S1	28/02/2020 08:24	28/02/2020 11:54	28/02/2020 08:24	28/02/2020 11:54	3,50	3	10,50	CHI
202002180424	TAQUARAL DE GOIAS	TQ12376477	ITABERAI S1	28/02/2020 08:24	28/02/2020 11:54	28/02/2020 08:24	28/02/2020 11:54	3,50	52	182,04	CHI
202002180429	GOIANIA	13983647	MEIA PONTE	28/02/2020 09:18	28/02/2020 11:57	28/02/2020 09:18	28/02/2020 11:57	2,64	1	2,64	CHI

202002180446	ITAUCU	IX21380018	ITABERAÍ S1	28/02/2020 09:21	28/02/2020 22:53	28/02/2020 09:21	28/02/2020 22:53	13,53	1	13,53	CHI
202002180448	HIDROLANDIA	HD31088355	CEPAIGO S2	28/02/2020 09:21	28/02/2020 12:54	28/02/2020 09:21	28/02/2020 12:54	3,55	1	3,55	CHI
202002180449	CHAPADAO DO CEU	DJ121336990	CHAPADAO DO CEU	28/02/2020 09:21	28/02/2020 11:00	28/02/2020 09:21	28/02/2020 11:00	1,64	1	1,64	CHI
202002180501	OURO VERDE DE GOIAS	NR21324184	NEROPOLIS S2	28/02/2020 09:21	28/02/2020 12:33	28/02/2020 09:21	28/02/2020 12:33	3,19	1	3,19	CHI
202002180502	CRISTALINA	KR11315552	CRISTALINA S1	28/02/2020 09:21	28/02/2020 11:16	28/02/2020 09:21	28/02/2020 11:16	1,91	3	5,72	CHI
202002180505	GOIANIA	16666380	CARAJAS S1	28/02/2020 09:21	28/02/2020 13:02	28/02/2020 09:21	28/02/2020 13:02	3,67	1	3,67	CHI
202002180506	APARECIDA DE GOIANIA	11046661	REAL S2	28/02/2020 09:22	28/02/2020 11:36	28/02/2020 09:22	28/02/2020 11:36	2,23	1	2,23	CHI
202002180510	ITABERAÍ	IB12101173	ITABERAÍ S1	28/02/2020 09:22	28/02/2020 20:43	28/02/2020 09:22	28/02/2020 20:43	11,34	2	22,69	CHI
202002180519	ABADIANIA	AA21406235	ANAPOLIS UNIVERSITARIO S2	28/02/2020 09:23	28/02/2020 12:35	28/02/2020 09:23	28/02/2020 12:35	3,19	2	6,38	CHI
202002180521	SANTO ANTONIO DO DESCOBERTO	2210029011	AGUAS LINDAS DE GOIAS S2	28/02/2020 09:23	28/02/2020 12:09	28/02/2020 09:23	28/02/2020 12:09	2,75	1	2,75	CHI
202002180523	QUIRINOPOLIS	80129055	QUIRINOPOLIS	28/02/2020 09:24	28/02/2020 10:50	28/02/2020 09:24	28/02/2020 10:50	1,44	1	1,44	CHI
202002180524	SILVANIA	SV21137414	VIANOPOLIS	28/02/2020 09:24	28/02/2020 11:49	28/02/2020 09:24	28/02/2020 11:49	2,41	1	2,41	CHI
202002180531	GOIANIA	10865287	GOIANIA LESTE S3	28/02/2020 09:25	28/02/2020 11:40	28/02/2020 09:25	28/02/2020 11:40	2,25	1	2,25	CHI
202002180532	BURITI ALEGRE	BG21000131	ITUMBIARA VELHA S2	28/02/2020 09:25	28/02/2020 19:15	28/02/2020 09:25	28/02/2020 19:15	9,83	1	9,83	CHI
202002180533	SAO JOAO D ALIANCA	JL12170300	ITUIQUIRA	28/02/2020 09:25	28/02/2020 12:25	28/02/2020 09:25	28/02/2020 12:25	3,00	23	68,90	CHI
202002180536	NEROPOLIS	NR12319494	NEROPOLIS S2	28/02/2020 09:24	28/02/2020 10:35	28/02/2020 09:24	28/02/2020 10:35	1,17	1	1,17	CHI
202002180536	OURO VERDE DE GOIAS	NR12319494	NEROPOLIS S2	28/02/2020 09:24	28/02/2020 10:35	28/02/2020 09:24	28/02/2020 10:35	1,17	20	23,39	CHI
202002180550	SILVANIA	SV12012741	VIANOPOLIS	28/02/2020 09:26	28/02/2020 17:26	28/02/2020 09:26	28/02/2020 17:26	7,99	4	31,94	CHI
202002180559	PIRES DO RIO	PR21083232	PIRES DO RIO S1	28/02/2020 09:27	28/02/2020 17:05	28/02/2020 09:27	28/02/2020 17:05	7,63	1	7,63	CHI
202002180566	CIDADE OCIDENTAL	10000625637	MARAJOARA	28/02/2020 09:29	28/02/2020 11:39	28/02/2020 09:29	28/02/2020 11:39	2,17	1	2,17	CHI
202002180568	MINACU	IH12288091	MINACU	28/02/2020 09:29	28/02/2020 15:01	28/02/2020 09:29	28/02/2020 15:01	5,53	2	11,06	CHI
202002180571	MINACU	10025437036	MINACU	28/02/2020 09:29	28/02/2020 15:33	28/02/2020 09:29	28/02/2020 15:33	6,06	1	6,06	CHI
202002180573	CAIAPONIA	CP12186860	MONTIVIDIU T	28/02/2020 08:59	28/02/2020 22:17	28/02/2020 08:59	28/02/2020 22:17	13,29	10	132,88	CHI
202002180574	GOIANIA	GN11199235	REAL S2	28/02/2020 09:30	28/02/2020 11:27	28/02/2020 09:30	28/02/2020 11:27	1,95	55	107,11	CHI
202002180579	CALDAS NOVAS	760036421	CALDAS NOVAS S2	28/02/2020 09:30	28/02/2020 13:18	28/02/2020 09:30	28/02/2020 13:18	3,79	1	3,79	CHI
202002180583	NIQUELANDIA	NQ12292649	NIQUELANDIA SUBTRANSMISSAO	28/02/2020 09:31	28/02/2020 16:49	28/02/2020 09:31	28/02/2020 16:49	7,29	2	14,57	CHI
202002180589	PONTALINA	PK21223585	PONTALINA	28/02/2020 09:32	28/02/2020 11:02	28/02/2020 09:32	28/02/2020 11:02	1,48	1	1,48	CHI
202002180592	NIQUELANDIA	NQ12317141	NIQUELANDIA SUBTRANSMISSAO	28/02/2020 09:33	28/02/2020 16:33	28/02/2020 09:33	28/02/2020 16:33	6,99	1	6,99	CHI
202002180593	BARRO ALTO	BA11055045	BARRO ALTO	28/02/2020 09:33	28/02/2020 17:05	28/02/2020 15:00	28/02/2020 17:05	2,08	165	343,66	CHI
202002180596	ALTO PARAISO DE GOIAS	BF12206283	FLORES DE GOIAS	28/02/2020 09:34	28/02/2020 11:00	28/02/2020 09:34	28/02/2020 11:00	1,43	4	5,71	CHI
202002180603	PALMEIRAS DE GOIAS	PL21089373	PALMEIRAS	28/02/2020 09:34	28/02/2020 18:55	28/02/2020 09:34	28/02/2020 18:55	9,34	1	9,34	CHI
202002180609	MUNDO NOVO DE GOIAS	MH21375318	NOVA CRIXAS	28/02/2020 09:35	29/02/2020 06:41	28/02/2020 09:35	29/02/2020 06:41	21,08	1	21,08	CHI
202002180612	FAZENDA NOVA	FN12380955	IPORA	28/02/2020 09:36	29/02/2020 10:35	28/02/2020 09:36	29/02/2020 10:35	24,97	2	49,94	CHI
202002180628	TURVANIA	TV21186389	FIRMINOPOLIS S1	28/02/2020 09:38	28/02/2020 18:31	28/02/2020 09:38	28/02/2020 18:31	8,87	1	8,87	CHI
202002180637	SAO MIGUEL DO PASSA QUATRO	SQ21088035	CRISTIANOPOLIS	27/02/2020 17:58	28/02/2020 11:26	27/02/2020 17:58	28/02/2020 11:26	17,47	1	17,47	CHI
202002180638	CRISTIANOPOLIS	SQ12309689	CRISTIANOPOLIS	28/02/2020 05:50	28/02/2020 13:34	28/02/2020 05:50	28/02/2020 13:34	7,73	5	38,64	CHI
202002180638	SAO MIGUEL DO PASSA QUATRO	SQ12309689	CRISTIANOPOLIS	28/02/2020 05:50	28/02/2020 13:34	28/02/2020 05:50	28/02/2020 13:34	7,73	1	7,73	CHI
202002180640	ITARUMA	IM21214258	CACHOEIRA ALTA	28/02/2020 09:40	29/02/2020 13:21	28/02/2020 09:40	29/02/2020 13:21	27,68	1	27,68	CHI
202002180643	MORRINHOS	MR12249892	VILA CORUMBA	28/02/2020 09:40	28/02/2020 11:33	28/02/2020 09:40	28/02/2020 11:33	1,87	7	13,09	CHI
202002180648	FAINA	FC12029557	GOIAS	28/02/2020 09:41	28/02/2020 18:14	28/02/2020 09:41	28/02/2020 18:14	8,53	4	34,14	CHI
202002180656	GOIANIA	10015248800	CAMPINAS S3	28/02/2020 09:43	28/02/2020 14:21	28/02/2020 09:43	28/02/2020 14:21	4,63	1	4,63	CHI
202002180659	PADRE BERNARDO	PB21056412	PADRE BERNARDO	28/02/2020 09:43	28/02/2020 18:01	28/02/2020 09:43	28/02/2020 18:01	8,30	1	8,30	CHI
202002180660	INHUMAS	IN21131939	INHUMAS S2	28/02/2020 09:43	28/02/2020 11:11	28/02/2020 09:43	28/02/2020 11:11	1,46	1	1,46	CHI
202002180666	GOIANIA	GN12159195	XAVANTES	28/02/2020 09:43	28/02/2020 11:30	28/02/2020 09:43	28/02/2020 11:30	1,77	26	45,95	CHI

202002180672	POSSE	5140000627	IACIARA S2	28/02/2020 09:45	28/02/2020 12:26	28/02/2020 09:45	28/02/2020 12:26	2,68	1	2,68	CHI
202002180674	JARAGUA	JA21059951	JARAGUA	28/02/2020 09:46	28/02/2020 18:19	28/02/2020 09:46	28/02/2020 18:19	8,55	1	8,55	CHI
202002180676	GOIANIA	10339619	CAMPINAS S1	28/02/2020 09:46	28/02/2020 14:56	28/02/2020 09:46	28/02/2020 14:56	5,15	1	5,15	CHI
202002180679	NIQUELANDIA	2750045831	NIQUELANDIA SUBTRANSMISSAO	28/02/2020 09:47	28/02/2020 13:30	28/02/2020 09:47	28/02/2020 13:30	3,72	1	3,72	CHI
202002180692	CRISTALINA	KR12251692LD	CRISTALINA S1	28/02/2020 09:48	28/02/2020 23:29	28/02/2020 09:48	28/02/2020 23:29	13,69	194	2654,89	CHI
202002180697	BOM JARDIM DE GOIAS	BM12065733	BOM JARDIM	28/02/2020 08:06	28/02/2020 21:12	28/02/2020 08:06	28/02/2020 21:12	13,09	5	65,44	CHI
202002180697	PIRANHAS	BM12065733	BOM JARDIM	28/02/2020 08:06	28/02/2020 21:12	28/02/2020 08:06	28/02/2020 21:12	13,09	3	39,27	CHI
202002180703	RIO VERDE	RV21147856	MONTIVIDIU T	28/02/2020 09:49	29/02/2020 08:38	28/02/2020 09:49	29/02/2020 08:38	22,80	1	22,80	CHI
202002180705	MINEIROS	MY12303343	PARQUE DAS EMAS	28/02/2020 09:50	28/02/2020 19:01	28/02/2020 09:50	28/02/2020 19:01	9,18	19	174,39	CHI
202002180708	GOIANDIRA	10020540009	CATALAO S1	28/02/2020 09:50	28/02/2020 13:44	28/02/2020 09:50	28/02/2020 13:44	3,89	1	3,89	CHI
202002180714	SANTO ANTONIO DO DESCOBERTO	SN11109102	ALEXANIA	28/02/2020 09:52	28/02/2020 15:18	28/02/2020 09:52	28/02/2020 15:18	5,43	10	54,30	CHI
202002180716	APARECIDA DE GOIANIA	AP21000019	REAL S1	28/02/2020 09:52	28/02/2020 11:25	28/02/2020 09:52	28/02/2020 11:25	1,54	1	1,54	CHI
202002180723	MINACU	IH12134994	MINACU	28/02/2020 09:54	28/02/2020 12:24	28/02/2020 09:54	28/02/2020 12:24	2,50	11	27,50	CHI
202002180725	PILAR DE GOIAS	IW21243561	ITAPACI	28/02/2020 09:54	28/02/2020 12:52	28/02/2020 09:54	28/02/2020 12:52	2,96	1	2,96	CHI
202002180727	ALVORADA DO NORTE	10028541071	IACIARA S2	28/02/2020 09:54	28/02/2020 11:40	28/02/2020 09:54	28/02/2020 11:40	1,76	1	1,76	CHI
202002180728	CABECEIRAS	CW21342468	ITUIQUIRA	28/02/2020 09:54	28/02/2020 11:32	28/02/2020 09:54	28/02/2020 11:32	1,62	1	1,62	CHI
202002180739	JUSSARA	JR21120636	JUSSARA	28/02/2020 09:58	28/02/2020 15:23	28/02/2020 09:58	28/02/2020 15:23	5,41	2	10,83	CHI
202002180742	BELA VISTA DE GOIAS	10006566705	BELA VISTA S1	28/02/2020 09:58	28/02/2020 13:44	28/02/2020 09:58	28/02/2020 13:44	3,76	1	3,76	CHI
202002180744	URUACU	UR12398055	URUACU	28/02/2020 09:59	28/02/2020 12:15	28/02/2020 09:59	28/02/2020 12:15	2,26	13	29,41	CHI
202002180747	TRES RANCHOS	2170002980	CATALAO S1	28/02/2020 09:59	28/02/2020 12:10	28/02/2020 09:59	28/02/2020 12:10	2,18	1	2,18	CHI
202002180750	PLANALTINA	PI11105046	PLANALTINA	28/02/2020 09:59	28/02/2020 12:38	28/02/2020 09:59	28/02/2020 12:38	2,63	104	273,98	CHI
202002180752	TURVELANDIA	TD12360990	RIO DOS BOIS	28/02/2020 10:01	28/02/2020 19:28	28/02/2020 10:01	28/02/2020 19:28	9,45	1	9,45	CHI
202002180759	GOIANIA	GN11165056	ATLANTICO S1	28/02/2020 10:04	28/02/2020 14:11	28/02/2020 10:04	28/02/2020 14:11	4,11	134	550,26	CHI
202002180764	MALPARAISO DE GOIAS	VA11169042	MARAJOARA	28/02/2020 10:03	28/02/2020 16:20	28/02/2020 13:10	28/02/2020 16:20	3,17	182	576,38	CHI
202002180803	MATRINCHA	MP12089424	MOZARLANDIA	28/02/2020 10:07	28/02/2020 16:32	28/02/2020 10:07	28/02/2020 16:32	6,40	2	12,81	CHI
202002180805	RIO VERDE	RV21033133	CABRIUVA S2	28/02/2020 10:07	29/02/2020 09:16	28/02/2020 10:07	29/02/2020 09:16	23,14	1	23,14	CHI
202002180810	GOIANESIA	GE11185187	GOIANESIA S2	28/02/2020 10:09	28/02/2020 16:09	28/02/2020 10:09	28/02/2020 16:09	6,00	108	647,55	CHI
202002180812	BELA VISTA DE GOIAS	XX02686983	BELA VISTA S1	28/02/2020 10:09	28/02/2020 11:13	28/02/2020 10:09	28/02/2020 11:13	1,06	1	1,06	CHI
202002180815	URUTAI	UT21115663	URUTAI	28/02/2020 10:10	28/02/2020 12:07	28/02/2020 10:10	28/02/2020 12:07	1,94	1	1,94	CHI
202002180820	BURITINOPOLIS	BQ21302795	IACIARA S2	28/02/2020 10:10	28/02/2020 10:43	28/02/2020 10:10	28/02/2020 10:43	0,54	4	2,15	CHI
202002180821	GOIAS	GS21148732	ITABERAI S2	28/02/2020 10:11	28/02/2020 18:40	28/02/2020 10:11	28/02/2020 18:40	8,48	1	8,48	CHI
202002180823	PARANAIGUARA	PC12069008	QUIRINOPOLIS	28/02/2020 10:11	29/02/2020 17:40	28/02/2020 10:11	29/02/2020 17:40	31,48	1	31,48	CHI
202002180827	CRISTALINA	KR12261714	CRISTALINA S2	28/02/2020 10:11	28/02/2020 11:53	28/02/2020 10:11	28/02/2020 11:53	1,69	12	20,25	CHI
202002180831	RIO VERDE	RV21371425	MONTIVIDIU T	28/02/2020 10:14	29/02/2020 10:32	28/02/2020 10:14	29/02/2020 10:32	24,29	1	24,29	CHI
202002180832	JARAGUA	JA12035312	JARAGUA	28/02/2020 10:14	28/02/2020 19:40	28/02/2020 10:14	28/02/2020 19:40	9,42	6	56,53	CHI
202002180834	ANAPOLIS	10018552798	ANAPOLIS UNIVERSITARIO S2	28/02/2020 10:06	28/02/2020 12:46	28/02/2020 10:06	28/02/2020 12:46	2,65	1	2,65	CHI
202002180835	CHAPADAO DO CEU	10029692111	CHAPADAO DO CEU	28/02/2020 10:14	28/02/2020 11:55	28/02/2020 10:14	28/02/2020 11:55	1,68	1	1,68	CHI
202002180837	GUARANI DE GOIAS	SD12262409	SAO DOMINGOS	28/02/2020 10:14	28/02/2020 16:49	28/02/2020 10:14	28/02/2020 16:49	6,57	3	19,70	CHI
202002180837	SAO DOMINGOS	SD12262409	SAO DOMINGOS	28/02/2020 10:14	28/02/2020 16:49	28/02/2020 10:14	28/02/2020 16:49	6,57	71	466,29	CHI
202002180839	SANTO ANTONIO DA BARRA	630404203	ACREUNA	28/02/2020 10:15	29/02/2020 10:26	28/02/2020 10:15	29/02/2020 10:26	24,19	1	24,19	CHI
202002180840	GOIANESIA	GE21000250	GOIANESIA S2	28/02/2020 10:16	28/02/2020 19:01	28/02/2020 10:16	28/02/2020 19:01	8,75	2	17,50	CHI
202002180843	JUSSARA	BT12292746	BRITANIA	28/02/2020 10:16	28/02/2020 10:44	28/02/2020 10:16	28/02/2020 10:44	0,46	1	0,46	CHI
202002180846	INHUMAS	10001218016	INHUMAS S2	28/02/2020 10:18	28/02/2020 15:20	28/02/2020 10:18	28/02/2020 15:20	5,03	1	5,03	CHI
202002180849	CACU	CC21063056	CACHOEIRA ALTA	28/02/2020 10:20	28/02/2020 14:38	28/02/2020 10:20	28/02/2020 14:38	4,30	1	4,30	CHI

202002180850	GOIANIA	10391101	GOIANIA LESTE S2	28/02/2020 10:20	28/02/2020 19:40	28/02/2020 10:20	28/02/2020 19:40	9,33	1	9,33	CHI
202002180853	ITAPIRAPUA	IU12183438	MATRINCHA	28/02/2020 10:21	28/02/2020 17:05	28/02/2020 10:21	28/02/2020 17:05	6,73	1	6,73	CHI
202002180854	AGUA FRIA DE GOIAS	TL21321706	SAO JOAO D ALIANCA	28/02/2020 10:21	28/02/2020 17:48	28/02/2020 10:21	28/02/2020 17:48	7,45	1	7,45	CHI
202002180865	CRIXAS	MZ12055628	MOZARLANDIA	28/02/2020 10:23	28/02/2020 13:04	28/02/2020 10:23	28/02/2020 13:04	2,68	26	69,75	CHI
202002180865	MOZARLANDIA	MZ12055628	MOZARLANDIA	28/02/2020 10:23	28/02/2020 13:04	28/02/2020 10:23	28/02/2020 13:04	2,68	38	101,95	CHI
202002180871	MINEIROS	MY12061437	PARQUE DAS EMAS	28/02/2020 10:24	29/02/2020 20:16	28/02/2020 10:24	29/02/2020 20:16	33,85	2	67,70	CHI
202002180876	JARAGUA	10005439033	JARAGUA	28/02/2020 10:25	28/02/2020 13:20	28/02/2020 10:25	28/02/2020 13:20	2,91	1	2,91	CHI
202002180879	GOIAS	GS21169205	MATRINCHA	28/02/2020 10:26	28/02/2020 14:14	28/02/2020 10:26	28/02/2020 14:14	3,79	1	3,79	CHI
202002180880	NIQUELANDIA	NQ12363553	BARRO ALTO	28/02/2020 10:26	28/02/2020 15:26	28/02/2020 10:26	28/02/2020 15:26	4,99	5	24,94	CHI
202002180880	VILA PROPICIO	NQ12363553	BARRO ALTO	28/02/2020 10:26	28/02/2020 15:26	28/02/2020 10:26	28/02/2020 15:26	4,99	5	24,94	CHI
202002180881	IPORA	IR21091472	IPORA	28/02/2020 10:26	29/02/2020 09:54	28/02/2020 10:26	29/02/2020 09:54	23,46	2	46,91	CHI
202002180883	CACHOEIRA ALTA	10013046150	CACHOEIRA ALTA	28/02/2020 10:26	28/02/2020 15:10	28/02/2020 10:26	28/02/2020 15:10	4,73	1	4,73	CHI
202002180887	URUACU	UR12201688	URUACU	28/02/2020 10:27	28/02/2020 12:20	28/02/2020 10:27	28/02/2020 12:20	1,87	4	7,48	CHI
202002180889	MIMOSO DE GOIAS	NQ12251264	BARRO ALTO	28/02/2020 10:14	28/02/2020 21:17	28/02/2020 10:14	28/02/2020 21:17	11,05	7	77,33	CHI
202002180889	VILA PROPICIO	NQ12251264	BARRO ALTO	28/02/2020 10:14	28/02/2020 21:17	28/02/2020 10:14	28/02/2020 21:17	11,05	4	44,19	CHI
202002180891	MONTIVIDIU	MV21295837	MONTIVIDIU T	28/02/2020 10:28	28/02/2020 14:09	28/02/2020 10:28	28/02/2020 14:09	3,67	2	7,35	CHI
202002180901	ANAPOLIS	AN11000132	JUNDIAI S2	28/02/2020 10:30	28/02/2020 16:43	28/02/2020 10:30	28/02/2020 16:43	6,21	99	614,87	CHI
202002180904	FORMOSA	10000389887	ITUIQUIRA	28/02/2020 10:30	28/02/2020 17:10	28/02/2020 10:30	28/02/2020 17:10	6,67	1	6,67	CHI
202002180906	GUARANI DE GOIAS	GY12393812	IACIARA S1	28/02/2020 10:30	28/02/2020 12:16	28/02/2020 10:30	28/02/2020 12:16	1,75	22	38,51	CHI
202002180909	MONTIVIDIU	RV12384572B	MONTIVIDIU T	28/02/2020 10:29	28/02/2020 12:45	28/02/2020 10:29	28/02/2020 12:45	2,26	18	40,63	CHI
202002180915	CAMPOS BELOS	820037345	SAO DOMINGOS	28/02/2020 10:32	28/02/2020 12:04	28/02/2020 10:32	28/02/2020 12:04	1,52	1	1,52	CHI
202002180919	CALDAS NOVAS	MG12263102	VILA CORUMBA	28/02/2020 10:33	28/02/2020 15:21	28/02/2020 10:33	28/02/2020 15:21	4,79	2	9,59	CHI
202002180921	SAO MIGUEL DO PASSA QUATRO	SQ21111713	CRISTIANOPOLIS	28/02/2020 10:33	28/02/2020 12:00	28/02/2020 10:33	28/02/2020 12:00	1,44	1	1,44	CHI
202002180922	CAMPOS VERDES	VD21257338	SANTA TEREZINHA	28/02/2020 10:34	29/02/2020 04:47	28/02/2020 10:34	29/02/2020 04:47	18,21	1	18,21	CHI
202002180924	PIRACANJUBA	PJ21199382	PIRACANJUBA	28/02/2020 10:34	28/02/2020 12:29	28/02/2020 10:34	28/02/2020 12:29	1,91	2	3,82	CHI
202002180929	CALDAS NOVAS	760356932	CALDAS NOVAS S2	28/02/2020 10:34	28/02/2020 11:21	28/02/2020 10:34	28/02/2020 11:21	0,77	1	0,77	CHI
202002180932	ORIZONA	OZ21114456	PIRES DO RIO S2	28/02/2020 10:35	28/02/2020 14:46	28/02/2020 10:35	28/02/2020 14:46	4,18	1	4,18	CHI
202002181001	ITAPACI	IW21181316	ITAPACI	28/02/2020 10:36	28/02/2020 16:16	28/02/2020 10:36	28/02/2020 16:16	5,67	1	5,67	CHI
202002181102	MINACU	10001333419	MINACU	28/02/2020 10:36	28/02/2020 11:51	28/02/2020 10:36	28/02/2020 11:51	1,24	1	1,24	CHI
202002181401	HIDROLANDIA	HD12058749	CEPAIGO S2	28/02/2020 10:38	28/02/2020 13:48	28/02/2020 10:38	28/02/2020 13:48	3,16	11	34,79	CHI
202002181604	PILAR DE GOIAS	GG21171802	SANTA TEREZINHA	28/02/2020 10:39	28/02/2020 15:47	28/02/2020 10:39	28/02/2020 15:47	5,12	1	5,12	CHI
202002181606	JATAI	JT12182089	JATAI S1	28/02/2020 10:06	29/02/2020 22:55	28/02/2020 10:06	29/02/2020 00:20	14,24	6	85,41	CHI
202002181606	JATAI	JT12182089	JATAI S1	28/02/2020 10:06	29/02/2020 22:55	28/02/2020 10:06	29/02/2020 22:55	36,83	2	73,66	CHI
202002181606	JATAI	JT12182089	JATAI S1	28/02/2020 10:06	29/02/2020 22:55	28/02/2020 13:31	29/02/2020 22:55	33,41	1	33,41	CHI
202002181606	JATAI	JT12182089	JATAI S1	28/02/2020 10:06	29/02/2020 22:55	29/02/2020 21:11	29/02/2020 22:55	1,73	6	10,41	CHI
202002181608	POSSE	PS11329722	IACIARA S2	28/02/2020 10:40	28/02/2020 13:53	28/02/2020 10:40	28/02/2020 13:53	3,21	81	259,69	CHI
202002181609	PIRES DO RIO	PR21000082	PIRES DO RIO S1	28/02/2020 10:40	28/02/2020 15:20	28/02/2020 10:40	28/02/2020 15:20	4,66	2	9,31	CHI
202002181616	SANTA RITA DO ARAGUAIA	SU21142732	SANTA RITA DO ARAGUAIA	28/02/2020 10:42	29/02/2020 08:08	28/02/2020 10:42	29/02/2020 08:08	21,42	1	21,42	CHI
202002181617	GOIAS	90081316	GOIAS	28/02/2020 10:43	29/02/2020 11:48	28/02/2020 10:43	29/02/2020 11:48	25,08	1	25,08	CHI
202002181621	MOZARLANDIA	MZ12064157	MOZARLANDIA	28/02/2020 10:45	28/02/2020 22:30	28/02/2020 10:45	28/02/2020 22:30	11,75	14	164,47	CHI
202002181629	JARAGUA	JA12000117	JARAGUA	28/02/2020 07:21	28/02/2020 13:28	28/02/2020 07:21	28/02/2020 13:28	6,11	2	12,22	CHI
202002181635	SANTA HELENA DE GOIAS	SH21196643	SANTA HELENA S1	28/02/2020 10:47	28/02/2020 23:06	28/02/2020 10:47	28/02/2020 23:06	12,30	1	12,30	CHI
202002181636	JARAGUA	70015065	JARAGUA	28/02/2020 10:48	28/02/2020 14:39	28/02/2020 10:48	28/02/2020 14:39	3,86	1	3,86	CHI
202002181637	SAO MIGUEL DO PASSA QUATRO	SV21022809	CRISTIANOPOLIS	28/02/2020 10:48	28/02/2020 14:32	28/02/2020 10:48	28/02/2020 14:32	3,73	1	3,73	CHI

202002181641	ITAUCU	IX12043820	INHUMAS S1	28/02/2020 12:21	28/02/2020 17:39	28/02/2020 12:21	28/02/2020 17:39	5,31	1	5,31	CHI
202002181644	PIRACANJUBA	PJ12000202	PIRACANJUBA	28/02/2020 10:49	28/02/2020 14:50	28/02/2020 10:49	28/02/2020 14:50	4,00	4	16,00	CHI
202002181648	ITABERAI	IB11183164	ITABERAI S2	28/02/2020 10:51	28/02/2020 13:38	28/02/2020 10:51	28/02/2020 13:38	2,77	105	291,23	CHI
202002181650	SENADOR CANEDO	190155875	SENADOR CANEDO	28/02/2020 10:52	28/02/2020 12:03	28/02/2020 10:52	28/02/2020 12:03	1,18	1	1,18	CHI
202002181653	ARAGARCAS	AG12234256	ARAGARCAS	28/02/2020 10:04	28/02/2020 15:02	28/02/2020 10:04	28/02/2020 15:02	4,95	17	84,23	CHI
202002181657	JUSSARA	JR12396256	JUSSARA	28/02/2020 07:01	28/02/2020 14:03	28/02/2020 07:01	28/02/2020 14:03	7,02	5	35,12	CHI
202002181660	ALOANDIA	AD21199490	GOIATUBA S1	28/02/2020 10:53	28/02/2020 13:48	28/02/2020 10:53	28/02/2020 13:48	2,91	1	2,91	CHI
202002181661	MUNDO NOVO DE GOIAS	MH21147203	NOVA CRIXAS	28/02/2020 10:54	28/02/2020 17:44	28/02/2020 10:54	28/02/2020 17:44	6,82	1	6,82	CHI
202002181666	SANTO ANTONIO DO DESCOBERTO	SN21078142	MARAJOARA	28/02/2020 10:55	28/02/2020 20:51	28/02/2020 10:55	28/02/2020 20:51	9,94	1	9,94	CHI
202002181673	SERRANOPOLIS	SX12092350	JATAI S1	28/02/2020 10:57	28/02/2020 14:22	28/02/2020 10:57	28/02/2020 14:22	3,41	1	3,41	CHI
202002181685	CIDADE OCIDENTAL	2680062110	MARAJOARA	28/02/2020 11:00	28/02/2020 11:54	28/02/2020 11:00	28/02/2020 11:54	0,90	1	0,90	CHI
202002181686	GOIANIA	15701232	CAMPINAS S1	28/02/2020 11:00	28/02/2020 14:04	28/02/2020 11:00	28/02/2020 14:04	3,06	1	3,06	CHI
202002181692	NOVA CRIXAS	NA12158761	NOVA CRIXAS	28/02/2020 11:01	28/02/2020 16:09	28/02/2020 11:01	28/02/2020 16:09	5,12	6	30,71	CHI
202002181697	SAO MIGUEL DO ARAGUAIA	SM12351125	SAO MIGUEL DO ARAGUAIA	28/02/2020 08:29	28/02/2020 15:58	28/02/2020 08:29	28/02/2020 15:58	7,48	5	37,39	CHI
202002181699	GOIANIA	10021857960	GOYA S2	28/02/2020 11:03	28/02/2020 14:38	28/02/2020 11:03	28/02/2020 14:38	3,57	1	3,57	CHI
202002181700	GOIANIA	10300776	CAMPINAS S2	28/02/2020 11:04	28/02/2020 12:46	28/02/2020 11:04	28/02/2020 12:46	1,69	1	1,69	CHI
202002181701	ACREUNA	2440005818	ACREUNA	28/02/2020 11:04	29/02/2020 13:00	28/02/2020 11:04	29/02/2020 13:00	25,92	1	25,92	CHI
202002181702	IACIARA	IA12218688	IACIARA S2	28/02/2020 11:04	28/02/2020 15:46	28/02/2020 11:04	28/02/2020 15:46	4,69	3	14,07	CHI
202002181703	CAIAPONIA	CP12251344	CAIAPONIA	28/02/2020 11:04	29/02/2020 01:11	28/02/2020 11:04	29/02/2020 01:11	14,10	1	14,10	CHI
202002181706	NIQUELANDIA	NQ12292134	NIQUELANDIA SUBTRANSMISSAO	28/02/2020 07:25	28/02/2020 15:50	28/02/2020 07:25	28/02/2020 15:50	8,40	28	235,21	CHI
202002181708	GOIANIA	11111732	GOIANIA LESTE S3	28/02/2020 11:06	28/02/2020 12:27	28/02/2020 11:06	28/02/2020 12:27	1,34	1	1,34	CHI
202002181711	RIO VERDE	630523289	RIO VERDE S1	28/02/2020 11:06	28/02/2020 21:00	28/02/2020 11:06	28/02/2020 21:00	9,88	1	9,88	CHI
202002181712	NIQUELANDIA	NQ12235641	URUACU	28/02/2020 10:49	28/02/2020 17:31	28/02/2020 10:49	28/02/2020 17:31	6,68	27	180,47	CHI
202002181717	CRIXAS	SG21142134	SANTA TEREZINHA	28/02/2020 11:08	28/02/2020 18:09	28/02/2020 11:08	28/02/2020 18:09	7,01	1	7,01	CHI
202002181721	LUZIANIA	LZ12336006	VIANOPOLIS	28/02/2020 11:08	28/02/2020 14:20	28/02/2020 11:08	28/02/2020 14:20	3,18	96	305,68	CHI
202002181721	LUZIANIA	8203274	VIANOPOLIS	28/02/2020 11:08	28/02/2020 14:20	28/02/2020 11:08	28/02/2020 14:20	3,18	1	3,18	CHI
202002181722	IPIRANGA DE GOIAS	RB12003338	RUBIATABA	28/02/2020 11:03	28/02/2020 13:59	28/02/2020 11:03	28/02/2020 13:59	2,93	1	2,93	CHI
202002181722	ITAPACI	RB12003338	RUBIATABA	28/02/2020 11:03	28/02/2020 13:59	28/02/2020 11:03	28/02/2020 13:59	2,93	10	29,34	CHI
202002181722	RUBIATABA	RB12003338	RUBIATABA	28/02/2020 11:03	28/02/2020 13:59	28/02/2020 11:03	28/02/2020 13:59	2,93	127	372,57	CHI
202002181728	SENADOR CANEDO	13316989	GOIANIA LESTE S2	28/02/2020 11:11	28/02/2020 12:24	28/02/2020 11:11	28/02/2020 12:24	1,21	1	1,21	CHI
202002181738	FORMOSA	FA12218278	SAO JOAO D ALIANCA	28/02/2020 11:13	28/02/2020 14:14	28/02/2020 11:13	28/02/2020 14:14	3,01	3	9,02	CHI
202002181744	QUIRINOPOLIS	QI21125820	QUIRINOPOLIS	28/02/2020 11:15	28/02/2020 15:10	28/02/2020 11:15	28/02/2020 15:10	3,91	1	3,91	CHI
202002181804	CAIAPONIA	CP12409807	CAIAPONIA	28/02/2020 11:16	29/02/2020 09:19	28/02/2020 11:16	29/02/2020 09:19	22,04	1	22,04	CHI
202002181810	RIO VERDE	RV12322328	CABRIUVA S2	28/02/2020 11:18	28/02/2020 19:47	28/02/2020 11:18	28/02/2020 19:47	8,48	4	33,92	CHI
202002181811	GOUVELANDIA	GB21152563	QUIRINOPOLIS	28/02/2020 11:18	28/02/2020 13:55	28/02/2020 11:18	28/02/2020 13:55	2,61	4	10,43	CHI
202002181814	BELA VISTA DE GOIAS	BV21108607	BELA VISTA S1	28/02/2020 11:19	28/02/2020 15:54	28/02/2020 11:19	28/02/2020 15:54	4,58	2	9,17	CHI
202002181816	CEZARINA	CZ12000034	CEZARINA	28/02/2020 11:14	28/02/2020 12:25	28/02/2020 11:14	28/02/2020 12:25	1,17	21	24,67	CHI
202002181816	INDIARA	CZ12000034	CEZARINA	28/02/2020 11:14	28/02/2020 12:25	28/02/2020 11:14	28/02/2020 12:25	1,17	9	10,57	CHI
202002181817	SAO DOMINGOS	SD12384774	SAO DOMINGOS	28/02/2020 11:19	28/02/2020 14:19	28/02/2020 11:19	28/02/2020 14:19	3,00	40	119,88	CHI
202002181820	SANTO ANTONIO DE GOIAS	10006430170	NEROPOLIS S1	28/02/2020 11:20	28/02/2020 14:30	28/02/2020 11:20	28/02/2020 14:30	3,16	1	3,16	CHI
202002181824	JATAI	290162841	JATAI S1	28/02/2020 11:20	29/02/2020 13:24	28/02/2020 11:20	29/02/2020 13:24	26,06	1	26,06	CHI
202002181828	OUVIDOR	OU21161375	CATALAO S1	28/02/2020 11:21	28/02/2020 12:25	28/02/2020 11:21	28/02/2020 12:25	1,07	1	1,07	CHI
202002181829	ABADIANIA	AN12261177	ANAPOLIS UNIVERSITARIO S2	28/02/2020 11:12	28/02/2020 12:12	28/02/2020 11:12	28/02/2020 12:12	1,00	60	59,82	CHI
202002181831	ITUMBIARA	10030239042	PARANAIBA	28/02/2020 11:21	28/02/2020 14:40	28/02/2020 11:21	28/02/2020 14:40	3,30	1	3,30	CHI

202002181832	CATALAO	1990084531	CATALAO S2	28/02/2020 11:22	28/02/2020 14:09	28/02/2020 11:22	28/02/2020 14:09	2,77	1	2,77	CHI
202002181834	SAO LUIS DE MONTES BELOS	500120596	SAO LUIZ DOS MONTES BELOS	28/02/2020 11:22	28/02/2020 15:13	28/02/2020 11:22	28/02/2020 15:13	3,84	1	3,84	CHI
202002181836	ITABERAI	10021676001	ITABERAI S2	28/02/2020 11:23	28/02/2020 16:30	28/02/2020 11:23	28/02/2020 16:30	5,13	1	5,13	CHI
202002181837	SAO LUIZ DO NORTE	SZ21073503	BARRO ALTO	28/02/2020 11:23	28/02/2020 23:06	28/02/2020 11:23	28/02/2020 23:06	11,71	1	11,71	CHI
202002181838	MOZARLANDIA	MZ12063693	MOZARLANDIA	28/02/2020 11:23	28/02/2020 14:30	28/02/2020 11:23	28/02/2020 14:30	3,12	1	3,12	CHI
202002181839	ANAPOLIS	21347529	ANAPOLIS UNIVERSITARIO S2	28/02/2020 11:23	28/02/2020 12:33	28/02/2020 11:23	28/02/2020 12:33	1,16	1	1,16	CHI
202002181841	FORMOSA	FA11252144	ITIQUEIRA	28/02/2020 11:24	28/02/2020 15:58	28/02/2020 11:24	28/02/2020 15:58	4,56	1	4,56	CHI
202002181842	JATAI	JT21296399	JATAI S1	28/02/2020 11:25	28/02/2020 18:33	28/02/2020 11:25	28/02/2020 18:33	7,12	1	7,12	CHI
202002181844	IPAMERI	IP21311648	IPAMERI	28/02/2020 11:26	28/02/2020 18:27	28/02/2020 11:26	28/02/2020 18:27	7,01	1	7,01	CHI
202002181849	NOVA CRIXAS	8580006821	NOVA CRIXAS	28/02/2020 11:27	29/02/2020 11:17	28/02/2020 11:27	29/02/2020 11:17	23,82	1	23,82	CHI
202002181852	TAQUARAL DE GOIAS	TQ12171611	INHUMAS S1	28/02/2020 11:28	28/02/2020 13:00	28/02/2020 11:28	28/02/2020 13:00	1,53	4	6,11	CHI
202002181861	PORTELANDIA	PW21209802	PARQUE DAS EMAS	28/02/2020 11:32	28/02/2020 21:30	28/02/2020 11:32	28/02/2020 21:30	9,96	1	9,96	CHI
202002181867	URUACU	UR11065510	URUACU	28/02/2020 11:33	28/02/2020 16:21	28/02/2020 11:33	28/02/2020 16:21	4,79	49	234,79	CHI
202002181868	CRIXAS	MZ12055650	MOZARLANDIA	28/02/2020 10:32	28/02/2020 13:24	28/02/2020 10:32	28/02/2020 13:24	2,86	75	214,54	CHI
202002181868	MOZARLANDIA	MZ12055650	MOZARLANDIA	28/02/2020 10:32	28/02/2020 13:24	28/02/2020 10:32	28/02/2020 13:24	2,86	5	14,30	CHI
202002181868	NOVA CRIXAS	MZ12055650	MOZARLANDIA	28/02/2020 10:32	28/02/2020 13:24	28/02/2020 10:32	28/02/2020 13:24	2,86	28	80,10	CHI
202002181870	CAIAPONIA	CP12252503	CAIAPONIA	28/02/2020 11:34	29/02/2020 02:17	28/02/2020 11:34	29/02/2020 02:17	14,71	6	88,28	CHI
202002181877	GOIAS	GS11162314	GOIAS	28/02/2020 11:36	28/02/2020 16:20	28/02/2020 11:36	28/02/2020 16:20	4,72	1	4,72	CHI
202002181879	AGUA FRIA DE GOIAS	TL21194581	SAO JOAO D ALIANCA	28/02/2020 11:37	28/02/2020 14:03	28/02/2020 11:37	28/02/2020 14:03	2,43	1	2,43	CHI
202002181880	PORANGATU	PO12141124	NOVO PLANALTO	28/02/2020 11:37	28/02/2020 16:37	28/02/2020 11:37	28/02/2020 16:37	4,99	20	99,76	CHI
202002181881	SANTA TEREZA DE GOIAS	TB12170075	PORANGATU	28/02/2020 11:38	28/02/2020 22:38	28/02/2020 11:38	28/02/2020 22:38	10,99	3	32,97	CHI
202002181886	ARUANA	AK12404549	MOZARLANDIA	28/02/2020 11:39	28/02/2020 14:57	28/02/2020 11:39	28/02/2020 14:57	3,31	9	29,76	CHI
202002181887	MOZARLANDIA	410034563	MOZARLANDIA	28/02/2020 11:39	28/02/2020 16:54	28/02/2020 11:39	28/02/2020 16:54	5,25	1	5,25	CHI
202002181890	CATALAO	GD12127538	CATALAO S1	28/02/2020 08:55	28/02/2020 17:16	28/02/2020 08:55	28/02/2020 17:16	8,34	5	41,71	CHI
202002181890	GOIANDIRA	GD12127538	CATALAO S1	28/02/2020 08:55	28/02/2020 17:16	28/02/2020 08:55	28/02/2020 17:16	8,34	13	108,43	CHI
202002181891	NIQUELANDIA	NQ12213117	NIQUELANDIA SUBTRANSMISSAO	28/02/2020 10:31	29/02/2020 09:46	28/02/2020 10:31	29/02/2020 09:46	23,24	18	418,36	CHI
202002181892	QUIRINOPOLIS	QI21067498	QUIRINOPOLIS	28/02/2020 11:40	28/02/2020 13:10	28/02/2020 11:40	28/02/2020 13:10	1,49	1	1,49	CHI
202002181893	ITABERAI	IB11259681	ITABERAI S2	28/02/2020 09:10	28/02/2020 13:20	28/02/2020 09:10	28/02/2020 13:20	4,16	85	353,41	CHI
202002181900	NIQUELANDIA	NQ12197539	NIQUELANDIA SUBTRANSMISSAO	28/02/2020 10:48	28/02/2020 12:53	28/02/2020 10:48	28/02/2020 12:53	2,07	4	8,30	CHI
202002181903	VALPARAISO DE GOIAS	VA11192802	MARAJOARA	28/02/2020 11:42	28/02/2020 13:09	28/02/2020 11:42	28/02/2020 13:09	1,43	68	97,49	CHI
202002181904	MINEIROS	MY12303860	PARQUE DAS EMAS	28/02/2020 11:43	28/02/2020 16:18	28/02/2020 11:43	28/02/2020 16:18	4,58	6	27,46	CHI
202002181908	SANTA BARBARA DE GOIAS	SB12215253	TRINDADE	28/02/2020 11:45	28/02/2020 15:51	28/02/2020 11:45	28/02/2020 15:51	4,09	3	12,26	CHI
202002181909	MINACU	IH21240770	MINACU	28/02/2020 11:45	28/02/2020 15:00	28/02/2020 11:45	28/02/2020 15:00	3,23	2	6,47	CHI
202002181911	PIRES DO RIO	BC12051685	PIRES DO RIO S2	28/02/2020 11:46	29/02/2020 11:22	28/02/2020 11:46	29/02/2020 11:22	23,60	54	1274,37	CHI
202002181911	SANTA CRUZ DE GOIAS	BC12051685	PIRES DO RIO S2	28/02/2020 11:46	29/02/2020 11:22	28/02/2020 11:46	29/02/2020 11:22	23,60	26	613,59	CHI
202002181913	FORMOSO	FO12145300	PORANGATU	28/02/2020 11:32	28/02/2020 16:20	28/02/2020 11:32	28/02/2020 16:20	4,79	11	52,72	CHI
202002181915	JARAGUA	UA12078282	JARAGUA	28/02/2020 06:23	28/02/2020 15:52	28/02/2020 06:23	28/02/2020 15:52	9,47	3	28,42	CHI
202002181915	URUANA	UA12078282	JARAGUA	28/02/2020 06:23	28/02/2020 15:52	28/02/2020 06:23	28/02/2020 15:52	9,47	8	75,80	CHI
202002181916	CAIAPONIA	CP21075034	CAIAPONIA	28/02/2020 11:46	29/02/2020 10:29	28/02/2020 11:46	29/02/2020 10:29	22,70	1	22,70	CHI
202002181921	SAO JOAO D ALIANCA	JL12049201	SAO JOAO D ALIANCA	28/02/2020 11:48	28/02/2020 14:59	28/02/2020 11:48	28/02/2020 14:59	3,20	96	306,93	CHI
202002181923	URUTAI	UT21075965	PIRES DO RIO S2	28/02/2020 11:49	29/02/2020 11:42	28/02/2020 11:49	29/02/2020 11:42	23,88	1	23,88	CHI
202002181924	PIRENOPOLIS	220030820	CORUMBA	28/02/2020 11:49	28/02/2020 14:29	28/02/2020 11:49	28/02/2020 14:29	2,65	1	2,65	CHI
202002181927	ALTO PARAISO DE GOIAS	3870003027	FLORES DE GOIAS	28/02/2020 11:50	28/02/2020 15:39	28/02/2020 11:50	28/02/2020 15:39	3,82	1	3,82	CHI
202002181930	CACU	19875324	CACHOEIRA ALTA	28/02/2020 11:50	28/02/2020 15:24	28/02/2020 11:50	28/02/2020 15:24	3,56	286	1017,68	CHI

202002181931	MINEIROS	MY12216687	PARQUE DAS EMAS	28/02/2020 07:51	29/02/2020 19:12	28/02/2020 07:51	29/02/2020 19:12	35,34	4	141,36	CHI
202002181932	APARECIDA DE GOIANIA	10024337003	INDEPENDENCIA S1	28/02/2020 11:51	28/02/2020 13:22	28/02/2020 11:51	28/02/2020 13:22	1,50	1	1,50	CHI
202002181935	APARECIDA DE GOIANIA	AP11067637	REAL S2	28/02/2020 11:52	28/02/2020 13:31	28/02/2020 11:52	28/02/2020 13:31	1,64	147	241,32	CHI
202002181937	ARAGARCAS	AG12223202	ARAGARCAS	28/02/2020 11:52	28/02/2020 18:34	28/02/2020 11:52	28/02/2020 18:34	6,69	8	53,50	CHI
202002181943	FORMOSO	FO12071138	PORANGATU	28/02/2020 11:55	28/02/2020 15:13	28/02/2020 11:55	28/02/2020 15:13	3,30	3	9,89	CHI
202002181949	GAMELEIRA DE GOIAS	SV21127405	DAIA S2	28/02/2020 11:56	28/02/2020 19:50	28/02/2020 11:56	28/02/2020 19:50	7,89	1	7,89	CHI
202002181952	SAO JOAO D ALIANCA	JL12049197	SAO JOAO D ALIANCA	28/02/2020 11:56	28/02/2020 15:28	28/02/2020 11:56	28/02/2020 15:28	3,54	6	21,24	CHI
202002181953	SAO SIMAO	2240056983	CACHOEIRA ALTA	28/02/2020 11:56	29/02/2020 14:22	28/02/2020 11:56	29/02/2020 14:22	26,42	1	26,42	CHI
202002181954	PORANGATU	840125021	PORANGATU	28/02/2020 11:56	28/02/2020 16:23	28/02/2020 11:56	28/02/2020 16:23	4,43	1	4,43	CHI
202002181956	ANICUNS	AC10396902	ANICUNS	28/02/2020 11:56	28/02/2020 15:06	28/02/2020 11:56	28/02/2020 13:49	1,89	45	84,83	CHI
202002181956	ANICUNS	AC12382504	ANICUNS	28/02/2020 11:56	28/02/2020 15:06	28/02/2020 11:56	28/02/2020 14:01	2,09	28	58,47	CHI
202002181956	ANICUNS	AC12000051	ANICUNS	28/02/2020 11:56	28/02/2020 15:06	28/02/2020 11:56	28/02/2020 15:06	3,18	50	159,03	CHI
202002181956	AVELINOPOLIS	AC12000051	ANICUNS	28/02/2020 11:56	28/02/2020 15:06	28/02/2020 11:56	28/02/2020 15:06	3,18	1	3,18	CHI
202002181957	BARRO ALTO	BA21169570	GOIANESIA S1	28/02/2020 11:57	28/02/2020 13:00	28/02/2020 11:57	28/02/2020 13:00	1,04	1	1,04	CHI
202002181959	PIRES DO RIO	PR21359930	PIRES DO RIO S1	28/02/2020 11:58	28/02/2020 20:44	28/02/2020 11:58	28/02/2020 20:44	8,76	1	8,76	CHI
202002181960	CIDADE OCIDENTAL	DH11199612	MARAJOARA	28/02/2020 11:46	28/02/2020 12:58	28/02/2020 11:46	28/02/2020 12:58	1,18	117	138,58	CHI
202002181970	JAUPACI	JP12123940	IPORA	28/02/2020 12:01	28/02/2020 16:42	28/02/2020 12:01	28/02/2020 16:42	4,67	12	56,03	CHI
202002181976	PADRE BERNARDO	10029334339	PADRE BERNARDO	28/02/2020 12:02	28/02/2020 17:42	28/02/2020 12:02	28/02/2020 17:42	5,65	1	5,65	CHI
202002181978	AGUAS LINDAS DE GOIAS	10029649461	AGUAS LINDAS DE GOIAS S1	28/02/2020 12:02	28/02/2020 15:26	28/02/2020 12:02	28/02/2020 15:26	3,39	1	3,39	CHI
202002181988	FORMOSO	FO12052572	PORANGATU	28/02/2020 10:06	28/02/2020 19:53	28/02/2020 10:06	28/02/2020 19:53	9,77	3	29,32	CHI
202002182000	VIANOPOLIS	VN21221256	VIANOPOLIS	28/02/2020 12:09	29/02/2020 04:50	28/02/2020 12:09	29/02/2020 04:50	16,69	1	16,69	CHI
202002182017	ANAPOLIS	AN12273056	ANAPOLIS UNIVERSITARIO S2	28/02/2020 12:57	28/02/2020 14:25	28/02/2020 12:57	28/02/2020 14:25	1,47	15	22,01	CHI
202002182018	BRITANIA	BT12020168	BRITANIA	28/02/2020 07:12	29/02/2020 10:21	28/02/2020 07:12	29/02/2020 10:21	27,15	137	3718,94	CHI
202002182018	BRITANIA	BT12020168	BRITANIA	28/02/2020 07:12	29/02/2020 10:21	29/02/2020 01:43	29/02/2020 10:21	8,64	17	146,80	CHI
202002182026	ITABERAI	TQ21029854	ITABERAI S2	28/02/2020 09:30	28/02/2020 21:28	28/02/2020 09:30	28/02/2020 21:28	11,96	2	23,92	CHI
202002182028	VALPARAISO DE GOIAS	VA11192802	MARAJOARA	28/02/2020 13:16	28/02/2020 13:20	28/02/2020 13:16	28/02/2020 13:20	0,07	68	4,50	CHI
202002182033	AGUA FRIA DE GOIAS	TL12211505	SAO JOAO D ALIANCA	28/02/2020 13:49	29/02/2020 02:49	28/02/2020 13:49	29/02/2020 02:49	13,00	4	51,99	CHI
202002182039	CABECEIRAS	03740424	ITIQUEIRA	28/02/2020 14:20	28/02/2020 18:20	28/02/2020 14:20	28/02/2020 18:20	4,00	48	192,17	CHI
202002182039	FORMOSA	03740424	ITIQUEIRA	28/02/2020 14:20	28/02/2020 18:20	28/02/2020 14:20	28/02/2020 18:20	4,00	7	28,03	CHI
202002182039	CABECEIRAS	03740424	ITIQUEIRA	28/02/2020 14:20	28/02/2020 18:20	28/02/2020 14:23	28/02/2020 18:20	3,96	1	3,96	CHI
202002182040	JATAI	JT12260451	JATAI S1	28/02/2020 19:01	29/02/2020 10:55	28/02/2020 19:01	29/02/2020 10:55	15,89	4	63,57	CHI
202002182040	SERRANOPOLIS	JT12260451	JATAI S1	28/02/2020 19:01	29/02/2020 10:55	28/02/2020 19:01	29/02/2020 10:55	15,89	1	15,89	CHI
202002182056	SAO JOAO D ALIANCA	02160214	SAO JOAO D ALIANCA	28/02/2020 14:51	28/02/2020 20:23	28/02/2020 14:51	28/02/2020 15:11	0,34	3151	1059,96	CHI
202002182056	SAO JOAO D ALIANCA	JL10400661	SAO JOAO D ALIANCA	28/02/2020 14:51	28/02/2020 20:23	28/02/2020 14:51	28/02/2020 20:23	5,54	17	94,26	CHI
202002182066	MUNDO NOVO DE GOIAS	MH12084354	NOVA CRIXAS	28/02/2020 14:51	29/02/2020 15:38	28/02/2020 14:51	29/02/2020 15:38	24,77	3	74,30	CHI
202002182070	CACU	CC12191544	CACHOEIRA ALTA	28/02/2020 15:37	28/02/2020 15:50	28/02/2020 15:37	28/02/2020 15:50	0,20	375	75,10	CHI
202002182105	LUZIANIA	03720224	VIANOPOLIS	28/02/2020 12:08	28/02/2020 16:23	28/02/2020 12:08	28/02/2020 16:23	4,25	244	1037,00	CHI
202002182105	ORIZONA	03720224	VIANOPOLIS	28/02/2020 12:08	28/02/2020 16:23	28/02/2020 12:08	28/02/2020 16:23	4,25	91	386,75	CHI
202002182105	SILVANIA	03720224	VIANOPOLIS	28/02/2020 12:08	28/02/2020 16:23	28/02/2020 12:08	28/02/2020 16:23	4,25	98	416,50	CHI
202002182122	CATALAO	1990131960	CATALAO S2	28/02/2020 12:15	29/02/2020 00:46	28/02/2020 12:15	29/02/2020 00:46	12,50	1	12,50	CHI
202002182136	LUZIANIA	10030974923	RIO VERMELHO	28/02/2020 12:18	28/02/2020 14:09	28/02/2020 12:18	28/02/2020 14:09	1,85	1	1,85	CHI
202002182139	ANAPOLIS	AN12270323	ANAPOLIS UNIVERSITARIO S2	28/02/2020 11:39	28/02/2020 13:54	28/02/2020 11:39	28/02/2020 13:54	2,25	7	15,74	CHI
202002182139	PIRENOPOLIS	AN12270323	ANAPOLIS UNIVERSITARIO S2	28/02/2020 11:39	28/02/2020 13:54	28/02/2020 11:39	28/02/2020 13:54	2,25	42	94,47	CHI
202002182141	CRIXAS	CX12213047	SANTA TEREZINHA	28/02/2020 12:19	28/02/2020 21:01	28/02/2020 12:19	28/02/2020 21:01	8,69	41	356,40	CHI

202002182141	SANTA TEREZINHA DE GOIAS	CX12213047	SANTA TEREZINHA	28/02/2020 12:19	28/02/2020 21:01	28/02/2020 12:19	28/02/2020 21:01	8,69	4	34,77	CHI
202002182142	IPAMERI	IP21041052	IPAMERI	28/02/2020 12:19	29/02/2020 06:17	28/02/2020 12:19	29/02/2020 06:17	17,97	1	17,97	CHI
202002182147	ARAGOIANIA	AO32024098	GUAPO S2	28/02/2020 12:20	28/02/2020 17:45	28/02/2020 12:20	28/02/2020 17:45	5,41	4	21,64	CHI
202002182147	HIDROLANDIA	AO32024098	GUAPO S2	28/02/2020 12:20	28/02/2020 17:45	28/02/2020 12:20	28/02/2020 17:45	5,41	3	16,23	CHI
202002182155	CRISTALINA	KR10400736	CRISTALINA S2	28/02/2020 06:48	29/02/2020 02:18	28/02/2020 23:15	28/02/2020 23:43	0,46	43	19,74	CHI
202002182155	IPAMERI	KR10400736	CRISTALINA S2	28/02/2020 06:48	29/02/2020 02:18	28/02/2020 23:15	28/02/2020 23:43	0,46	5	2,30	CHI
202002182155	IPAMERI	IP13401324	CRISTALINA S2	28/02/2020 06:48	29/02/2020 02:18	28/02/2020 06:48	29/02/2020 02:18	19,49	12	233,93	CHI
202002182155	CRISTALINA	IP13401324	CRISTALINA S2	28/02/2020 06:48	29/02/2020 02:18	28/02/2020 23:15	29/02/2020 02:18	3,04	34	103,52	CHI
202002182155	IPAMERI	IP13401324	CRISTALINA S2	28/02/2020 06:48	29/02/2020 02:18	28/02/2020 23:15	29/02/2020 02:18	3,04	38	115,70	CHI
202002182156	NOVA CRIXAS	NA12320912	NOVA CRIXAS	28/02/2020 08:36	28/02/2020 22:44	28/02/2020 08:36	28/02/2020 22:44	14,13	2	28,26	CHI
202002182157	GOIAS	GS12014796	MATRINCHA	28/02/2020 10:11	28/02/2020 13:20	28/02/2020 10:11	28/02/2020 13:20	3,14	94	295,21	CHI
202002182158	ITUMBIARA	690009604	ITUMBIARA VELHA S1	28/02/2020 12:22	28/02/2020 15:26	28/02/2020 12:22	28/02/2020 15:26	3,06	1	3,06	CHI
202002182174	DISTRITO FEDERAL	2900047487	MARAJOARA	28/02/2020 12:26	28/02/2020 18:49	28/02/2020 12:26	28/02/2020 18:49	6,37	1	6,37	CHI
202002182175	ANAPOLIS	21296200	ANAPOLIS UNIVERSITARIO S2	28/02/2020 12:26	28/02/2020 15:39	28/02/2020 12:26	28/02/2020 15:39	3,21	1	3,21	CHI
202002182177	TRINDADE	40037708	GOYA S1	28/02/2020 12:27	28/02/2020 16:53	28/02/2020 12:27	28/02/2020 16:53	4,43	1	4,43	CHI
202002182183	BONOPOLIS	BX12292422	SAO MIGUEL DO ARAGUAIA	28/02/2020 12:27	28/02/2020 20:17	28/02/2020 12:27	28/02/2020 20:17	7,83	32	250,41	CHI
202002182183	PORANGATU	BX12292422	SAO MIGUEL DO ARAGUAIA	28/02/2020 12:27	28/02/2020 20:17	28/02/2020 12:27	28/02/2020 20:17	7,83	1	7,83	CHI
202002182185	CRIXAS	CX12319125	SANTA TEREZINHA	28/02/2020 12:28	29/02/2020 09:45	28/02/2020 12:28	29/02/2020 09:45	21,28	1	21,28	CHI
202002182186	NIQUELANDIA	NQ21208794	SAO JOAO D ALIANCA	28/02/2020 12:28	29/02/2020 08:00	28/02/2020 12:28	29/02/2020 08:00	19,53	1	19,53	CHI
202002182190	TURVELANDIA	TD12277621	RIO DOS BOIS	28/02/2020 12:30	29/02/2020 05:17	28/02/2020 12:30	29/02/2020 05:17	16,78	2	33,56	CHI
202002182196	ITUMBIARA	IT21000255	PARANAIBA	28/02/2020 12:31	28/02/2020 17:40	28/02/2020 12:31	28/02/2020 17:40	5,14	1	5,14	CHI
202002182199	CAIAPONIA	CP12308689	PALESTINA	28/02/2020 09:13	29/02/2020 07:44	28/02/2020 09:13	29/02/2020 07:44	22,50	7	157,50	CHI
202002182220	POSSE	PS11272127	IACIARA S2	28/02/2020 12:36	28/02/2020 16:09	28/02/2020 12:36	28/02/2020 16:09	3,54	189	669,43	CHI
202002182227	RIO VERDE	10010028992	RIO VERDE S2	28/02/2020 12:37	29/02/2020 09:29	28/02/2020 12:37	29/02/2020 09:29	20,86	1	20,86	CHI
202002182229	NOVA AMERICA	NM21143582	RUBIATABA	28/02/2020 12:37	28/02/2020 16:57	28/02/2020 12:37	28/02/2020 16:57	4,32	1	4,32	CHI
202002182236	NOVA AURORA	NE21311815	CATALAO S1	28/02/2020 12:41	28/02/2020 14:35	28/02/2020 12:41	28/02/2020 14:35	1,90	1	1,90	CHI
202002182242	ANICUNS	AC12061366	ANICUNS	28/02/2020 12:23	28/02/2020 16:07	28/02/2020 12:23	28/02/2020 16:07	3,73	14	52,23	CHI
202002182243	NAZARIO	AV12299225	TRINDADE	28/02/2020 12:25	29/02/2020 00:00	28/02/2020 12:25	28/02/2020 23:09	10,74	1	10,74	CHI
202002182243	AVELINOPOLIS	AV12299225	TRINDADE	28/02/2020 12:25	29/02/2020 00:00	28/02/2020 12:25	29/02/2020 00:00	11,58	3	34,74	CHI
202002182243	NAZARIO	AV12299225	TRINDADE	28/02/2020 12:25	29/02/2020 00:00	28/02/2020 12:25	29/02/2020 00:00	11,58	6	69,49	CHI
202002182251	SAO SIMAO	SO21329034	CACHOEIRA ALTA	28/02/2020 12:45	29/02/2020 16:47	28/02/2020 12:45	29/02/2020 16:47	28,02	1	28,02	CHI
202002182253	LUZIANIA	3200006806	MARAJOARA	28/02/2020 12:46	28/02/2020 17:24	28/02/2020 12:46	28/02/2020 17:24	4,63	1	4,63	CHI
202002182256	FAZENDA NOVA	NB12117290	JUSSARA	28/02/2020 12:12	28/02/2020 17:15	28/02/2020 12:12	28/02/2020 17:15	5,05	4	20,20	CHI
202002182256	NOVO BRASIL	NB12117290	JUSSARA	28/02/2020 12:12	28/02/2020 17:15	28/02/2020 12:12	28/02/2020 17:15	5,05	4	20,20	CHI
202002182267	EDEIA	EA12394173	EDEIA	28/02/2020 12:49	28/02/2020 22:14	28/02/2020 12:49	28/02/2020 22:14	9,41	6	56,49	CHI
202002182272	GOIANIA	GN12063665	GOYA S2	28/02/2020 12:46	28/02/2020 17:11	28/02/2020 12:47	28/02/2020 17:11	4,42	67	295,81	CHI
202002182275	JUSSARA	JR21104998	BRITANIA	28/02/2020 12:51	28/02/2020 15:45	28/02/2020 12:51	28/02/2020 15:45	2,88	1	2,88	CHI
202002182276	CALDAZINHA	LB12270648	DAIA S2	28/02/2020 12:52	28/02/2020 15:23	28/02/2020 12:52	28/02/2020 15:23	2,51	1	2,51	CHI
202002182276	LEOPOLDO DE BULHOES	LB12270648	DAIA S2	28/02/2020 12:52	28/02/2020 15:23	28/02/2020 12:52	28/02/2020 15:23	2,51	18	45,27	CHI
202002182278	VILA PROPICIO	NP12403817	GOIANESIA S1	28/02/2020 12:52	28/02/2020 18:10	28/02/2020 12:52	28/02/2020 18:10	5,29	1	5,29	CHI
202002182281	APARECIDA DE GOIANIA	12313919	REAL S1	28/02/2020 12:54	28/02/2020 16:58	28/02/2020 12:54	28/02/2020 16:58	4,06	1	4,06	CHI
202002182291	FORMOSA	10000621470	ITUIQUIRA	28/02/2020 12:55	28/02/2020 14:50	28/02/2020 12:55	28/02/2020 14:50	1,91	1	1,91	CHI
202002182297	GOIANESIA	GE11091173	GOIANESIA S2	28/02/2020 12:40	28/02/2020 14:43	28/02/2020 12:40	28/02/2020 14:43	2,05	179	367,20	CHI
202002182298	APARECIDA DE GOIANIA	17034437	ATLANTICO S3	28/02/2020 12:56	28/02/2020 15:17	28/02/2020 12:56	28/02/2020 15:17	2,35	1	2,35	CHI

202002182301	CATALAO	CT12399850	CATALAO S1	28/02/2020 12:56	28/02/2020 23:04	28/02/2020 12:56	28/02/2020 23:04	10,12	54	546,45	CHI
202002182301	GOIANDIRA	CT12399850	CATALAO S1	28/02/2020 12:56	28/02/2020 23:04	28/02/2020 12:56	28/02/2020 23:04	10,12	41	414,90	CHI
202002182305	SAO JOAO D ALIANCA	JL21218395	SAO JOAO D ALIANCA	28/02/2020 12:57	28/02/2020 20:58	28/02/2020 12:57	28/02/2020 20:58	8,00	1	8,00	CHI
202002182307	GOIANIA	10774592	ATLANTICO S1	28/02/2020 12:58	28/02/2020 14:41	28/02/2020 12:58	28/02/2020 14:41	1,71	1	1,71	CHI
202002182319	CUMARI	CY12203045RE	CATALAO S1	28/02/2020 12:47	29/02/2020 13:32	28/02/2020 12:47	28/02/2020 15:40	2,87	29	83,29	CHI
202002182319	CUMARI	CY12203045RE	CATALAO S1	28/02/2020 12:47	29/02/2020 13:32	28/02/2020 12:47	29/02/2020 13:32	24,75	7	173,25	CHI
202002182319	CUMARI	CY12203045RE	CATALAO S1	28/02/2020 12:47	29/02/2020 13:32	29/02/2020 10:37	29/02/2020 13:32	2,93	29	84,87	CHI
202002182323	JATAI	JT21167840	JATAI S1	28/02/2020 13:01	28/02/2020 23:21	28/02/2020 13:01	28/02/2020 23:21	10,32	1	10,32	CHI
202002182326	ITUMBIARA	IT21081104	ITUMBIARA NOVA	28/02/2020 13:02	28/02/2020 22:44	28/02/2020 13:02	28/02/2020 22:44	9,70	1	9,70	CHI
202002182327	GOIANIA	16543683	CAMPINAS S3	28/02/2020 13:02	28/02/2020 14:02	28/02/2020 13:02	28/02/2020 14:02	0,99	1	0,99	CHI
202002182328	PADRE BERNARDO	PB12382216	PADRE BERNARDO	28/02/2020 13:02	28/02/2020 19:57	28/02/2020 13:02	28/02/2020 19:57	6,91	6	41,45	CHI
202002182330	APARECIDA DE GOIANIA	AP11168458	ANHANGUERA	28/02/2020 12:56	28/02/2020 17:39	28/02/2020 12:56	28/02/2020 17:39	4,71	58	272,97	CHI
202002182331	NIQUELANDIA	NQ12197740RE	NIQUELANDIA SUBTRANSMISSAO	28/02/2020 13:03	28/02/2020 16:15	28/02/2020 13:03	28/02/2020 16:15	3,20	261	834,98	CHI
202002182334	NOVA CRIXAS	NA11357704	NOVA CRIXAS	28/02/2020 13:03	29/02/2020 05:53	28/02/2020 13:03	29/02/2020 05:53	16,82	1	16,82	CHI
202002182335	ANICUNS	AC12266584	ANICUNS	28/02/2020 13:04	28/02/2020 20:41	28/02/2020 13:04	28/02/2020 20:41	7,62	1	7,62	CHI
202002182335	TURVANIA	AC12266584	ANICUNS	28/02/2020 13:04	28/02/2020 20:41	28/02/2020 13:04	28/02/2020 20:41	7,62	5	38,08	CHI
202002182340	SAO MIGUEL DO ARAGUAIA	SM21081427	SAO MIGUEL DO ARAGUAIA	28/02/2020 13:05	28/02/2020 22:09	28/02/2020 13:05	28/02/2020 22:09	9,05	1	9,05	CHI
202002182341	PIRENOPOLIS	220076212	CORUMBA	28/02/2020 13:05	28/02/2020 14:43	28/02/2020 13:05	28/02/2020 14:43	1,63	1	1,63	CHI
202002182353	GOIANIA	11843019	GOIANIA LESTE S2	28/02/2020 13:09	28/02/2020 14:51	28/02/2020 13:09	28/02/2020 14:51	1,70	1	1,70	CHI
202002182354	GOIANIA	GN11074247	GOYA S2	28/02/2020 12:32	28/02/2020 17:40	28/02/2020 12:32	28/02/2020 17:40	5,13	49	251,41	CHI
202002182359	INDIARA	IY11035273	EDEIA	28/02/2020 13:10	28/02/2020 14:22	28/02/2020 13:10	28/02/2020 14:22	1,19	166	197,59	CHI
202002182361	CAIAPONIA	930024886	CAIAPONIA	28/02/2020 13:11	28/02/2020 21:22	28/02/2020 13:11	28/02/2020 21:22	8,18	1	8,18	CHI
202002182362	GOIANIA	GN11155955	ATLANTICO S2	28/02/2020 13:11	28/02/2020 14:56	28/02/2020 13:11	28/02/2020 14:56	1,74	25	43,46	CHI
202002182369	OURO VERDE DE GOIAS	OV12374484	NEROPOLIS S2	28/02/2020 13:13	29/02/2020 04:20	28/02/2020 13:13	29/02/2020 04:20	15,11	6	90,66	CHI
202002182377	ANAPOLIS	AN11210652	JUNDIAI S1	28/02/2020 13:05	28/02/2020 14:48	28/02/2020 13:05	28/02/2020 14:48	1,72	55	94,43	CHI
202002182382	IPORA	IR21399475	IPORA	28/02/2020 13:16	29/02/2020 13:52	28/02/2020 13:16	29/02/2020 13:52	24,59	1	24,59	CHI
202002182395	MINACU	4020058612	MINACU	28/02/2020 13:19	28/02/2020 15:27	28/02/2020 13:19	28/02/2020 15:27	2,12	1	2,12	CHI
202002182402	GOIANIRA	GR32045901	TRINDADE	28/02/2020 13:20	28/02/2020 21:42	28/02/2020 13:20	28/02/2020 21:42	8,35	5	41,76	CHI
202002182403	ARAGUAPAZ	AZ21329914	MOZARLANDIA	28/02/2020 13:21	28/02/2020 19:38	28/02/2020 13:21	28/02/2020 19:38	6,28	1	6,28	CHI
202002182404	IPAMERI	GD21075522	IPAMERI	28/02/2020 13:21	29/02/2020 16:38	28/02/2020 13:21	29/02/2020 16:38	27,28	2	54,56	CHI
202002182407	CAIAPONIA	MV21191991	MONTIVIDIU T	28/02/2020 13:22	29/02/2020 11:32	28/02/2020 13:22	29/02/2020 11:32	22,17	1	22,17	CHI
202002182413	JATAI	10031154180	JATAI S3	28/02/2020 13:22	28/02/2020 15:58	28/02/2020 13:22	28/02/2020 15:58	2,59	0	0,00	CHI
202002182419	CEZARINA	00370226	CEZARINA	28/02/2020 12:40	28/02/2020 16:32	28/02/2020 12:40	28/02/2020 16:32	3,86	2848	10982,20	CHI
202002182419	INDIARA	00370226	CEZARINA	28/02/2020 12:40	28/02/2020 16:32	28/02/2020 12:40	28/02/2020 16:32	3,86	9	34,71	CHI
202002182419	VARJAO	00370226	CEZARINA	28/02/2020 12:40	28/02/2020 16:32	28/02/2020 12:40	28/02/2020 16:32	3,86	7	26,99	CHI
202002182420	LUZIANIA	LZ12313802LD	PACAEMBU S1	28/02/2020 13:20	28/02/2020 16:15	28/02/2020 13:20	28/02/2020 16:15	2,91	67	194,82	CHI
202002182425	BOM JARDIM DE GOIAS	BM21334892	BOM JARDIM	28/02/2020 11:38	01/03/2020 01:16	28/02/2020 11:38	01/03/2020 01:16	37,62	2	75,24	CHI
202002182433	ANAPOLIS	20754711	JUNDIAI S1	28/02/2020 13:28	28/02/2020 18:42	28/02/2020 13:28	28/02/2020 18:42	5,23	1	5,23	CHI
202002182435	ORIZONA	OZ12372377	PIRES DO RIO S2	28/02/2020 11:56	28/02/2020 17:18	28/02/2020 11:56	28/02/2020 17:18	5,37	27	144,96	CHI
202002182437	MINACU	IH21208313	MINACU	28/02/2020 13:28	28/02/2020 18:09	28/02/2020 13:28	28/02/2020 18:09	4,67	1	4,67	CHI
202002182442	LUZIANIA	LZ12320196	RIO VERMELHO	28/02/2020 13:29	28/02/2020 20:37	28/02/2020 13:29	28/02/2020 20:37	7,13	11	78,38	CHI
202002182443	PLANALTINA	PI12107001	PLANALTINA	28/02/2020 13:29	28/02/2020 15:13	28/02/2020 13:29	28/02/2020 15:13	1,72	154	265,56	CHI
202002182445	CAMPESTRE DE GOIAS	GC12033580	TRINDADE	28/02/2020 13:29	28/02/2020 20:12	28/02/2020 13:29	28/02/2020 20:12	6,71	37	248,10	CHI
202002182445	TRINDADE	GC12033580	TRINDADE	28/02/2020 13:29	28/02/2020 20:12	28/02/2020 13:29	28/02/2020 20:12	6,71	5	33,53	CHI

202002182448	CATALAO	CT12266314	CATALAO S2	28/02/2020 13:30	28/02/2020 15:14	28/02/2020 13:30	28/02/2020 15:14	1,72	1	1,72	CHI
202002182448	CUMARI	CT12266314	CATALAO S2	28/02/2020 13:30	28/02/2020 15:14	28/02/2020 13:30	28/02/2020 15:14	1,72	1	1,72	CHI
202002182449	FORMOSA	FA11316959	ITUIQUIRA	28/02/2020 13:30	28/02/2020 16:34	28/02/2020 13:30	28/02/2020 16:34	3,05	29	88,55	CHI
202002182450	APARECIDA DE GOIANIA	10004540253	REAL S1	28/02/2020 13:30	28/02/2020 18:20	28/02/2020 13:30	28/02/2020 18:20	4,82	1	4,82	CHI
202002182458	JARAGUA	JA11000020	JARAGUA	28/02/2020 13:23	28/02/2020 16:30	28/02/2020 13:23	28/02/2020 16:30	3,12	106	331,10	CHI
202002182463	ABADIA DE GOIAS	TR12391385	GUAPO S1	28/02/2020 13:32	28/02/2020 19:58	28/02/2020 13:32	28/02/2020 19:58	6,43	106	681,40	CHI
202002182463	GUAPO	TR12391385	GUAPO S1	28/02/2020 13:32	28/02/2020 19:58	28/02/2020 13:32	28/02/2020 19:58	6,43	4	25,71	CHI
202002182470	ABADIA DE GOIAS	GN31052067	CARAJAS S1	28/02/2020 13:34	29/02/2020 02:15	28/02/2020 13:34	29/02/2020 02:15	12,68	3	38,03	CHI
202002182472	ITAPIRAPUA	IU21121461	MATRINCHA	28/02/2020 13:34	28/02/2020 15:45	28/02/2020 13:34	28/02/2020 15:45	2,17	1	2,17	CHI
202002182475	CROMINIA	10029203048	PONTALINA	28/02/2020 13:35	28/02/2020 16:11	28/02/2020 13:35	28/02/2020 16:11	2,60	1	2,60	CHI
202002182477	OUIDOR	OU21000303	CATALAO S1	28/02/2020 13:35	28/02/2020 15:20	28/02/2020 13:35	28/02/2020 15:20	1,74	1	1,74	CHI
202002182479	VILA PROPICIO	NP11253328	GOIANESIA S1	28/02/2020 13:36	28/02/2020 16:29	28/02/2020 13:36	28/02/2020 16:29	2,88	2	5,76	CHI
202002182501	ANAPOLIS	AN12191041	ANAPOLIS UNIVERSITARIO S2	28/02/2020 13:37	28/02/2020 15:48	28/02/2020 13:37	28/02/2020 15:48	2,17	69	149,63	CHI
202002182506	ANAPOLIS	20952545	JUNDIAI S1	28/02/2020 13:39	28/02/2020 19:13	28/02/2020 13:39	28/02/2020 19:13	5,56	1	5,56	CHI
202002182507	CAMPESTRE DE GOIAS	GC12248061	TRINDADE	28/02/2020 13:39	28/02/2020 17:56	28/02/2020 13:39	28/02/2020 16:31	2,86	130	372,45	CHI
202002182507	CAMPESTRE DE GOIAS	GC12000124	TRINDADE	28/02/2020 13:39	28/02/2020 17:56	28/02/2020 13:39	28/02/2020 17:20	3,67	10	36,73	CHI
202002182507	CAMPESTRE DE GOIAS	GC12000124	TRINDADE	28/02/2020 13:39	28/02/2020 17:56	28/02/2020 13:39	28/02/2020 17:56	4,27	5	21,36	CHI
202002182510	SENADOR CANEDO	SW21076757	CEPAIGO S1	28/02/2020 13:40	28/02/2020 15:02	28/02/2020 13:40	28/02/2020 15:02	1,36	1	1,36	CHI
202002182511	GOIANIA	11875070	REAL S1	28/02/2020 13:40	28/02/2020 16:51	28/02/2020 13:40	28/02/2020 16:51	3,17	1	3,17	CHI
202002182514	URUTAI	600002240	URUTAI	28/02/2020 13:40	29/02/2020 00:52	28/02/2020 13:40	29/02/2020 00:52	11,18	1	11,18	CHI
202002182515	AGUAS LINDAS DE GOIAS	LA12313663	AGUAS LINDAS DE GOIAS S2	28/02/2020 13:41	28/02/2020 16:09	28/02/2020 13:41	28/02/2020 16:09	2,47	9	22,19	CHI
202002182519	HIDROLANDIA	HD11164284	ANHANGUERA	28/02/2020 13:33	28/02/2020 18:10	28/02/2020 13:33	28/02/2020 18:10	4,62	20	92,33	CHI
202002182521	JARAGUA	SF12377528	SAO FRANCISCO DE GOIAS	28/02/2020 13:42	29/02/2020 09:15	28/02/2020 13:42	29/02/2020 09:15	19,54	1	19,54	CHI
202002182536	PLANALTINA	PI12085617RE	PLANALTINA	28/02/2020 13:26	28/02/2020 15:28	28/02/2020 13:26	28/02/2020 15:28	2,02	393	793,42	CHI
202002182539	AGUAS LINDAS DE GOIAS	LA11108704	AGUAS LINDAS DE GOIAS S1	28/02/2020 13:45	28/02/2020 17:31	28/02/2020 13:45	28/02/2020 17:31	3,75	92	345,15	CHI
202002182544	CAMPESTRE DE GOIAS	GC12050512	TRINDADE	28/02/2020 10:07	28/02/2020 16:53	28/02/2020 10:07	28/02/2020 16:53	6,75	10	67,54	CHI
202002182545	RIO VERDE	RV12240290	MONTIVIDIU T	28/02/2020 09:47	29/02/2020 10:17	28/02/2020 09:47	29/02/2020 10:17	24,48	14	342,77	CHI
202002182546	PONTALINA	PK21076928	PONTALINA	28/02/2020 13:47	28/02/2020 15:25	28/02/2020 13:47	28/02/2020 15:25	1,62	1	1,62	CHI
202002182547	ABADIA DE GOIAS	LG11272064	CARAJAS S1	28/02/2020 13:00	28/02/2020 19:31	28/02/2020 13:37	28/02/2020 19:31	5,90	167	985,11	CHI
202002182549	COCALZINHO DE GOIAS	ZN21319189	COCALZINHO	28/02/2020 13:47	28/02/2020 16:08	28/02/2020 13:47	28/02/2020 16:08	2,33	1	2,33	CHI
202002182551	NOVA AMERICA	NM12363582	RUBIATABA	28/02/2020 13:48	29/02/2020 16:07	28/02/2020 13:48	29/02/2020 16:07	26,32	3	78,97	CHI
202002182557	AGUAS LINDAS DE GOIAS	LA12389408	AGUAS LINDAS DE GOIAS S2	28/02/2020 13:48	28/02/2020 16:01	28/02/2020 13:48	28/02/2020 16:01	2,20	125	275,28	CHI
202002182558	SANTA RITA DO NOVO DESTINO	BA21146821	GOIANESIA S1	28/02/2020 13:49	29/02/2020 08:47	28/02/2020 13:49	29/02/2020 08:47	18,96	1	18,96	CHI
202002182561	APARECIDA DE GOIANIA	200266240	ANHANGUERA	28/02/2020 13:50	28/02/2020 15:15	28/02/2020 13:50	28/02/2020 15:15	1,41	1	1,41	CHI
202002182571	COCALZINHO DE GOIAS	ZN21104970	AGUAS LINDAS DE GOIAS S2	28/02/2020 13:52	28/02/2020 19:40	28/02/2020 13:52	28/02/2020 19:40	5,80	1	5,80	CHI
202002182580	MONTES CLAROS DE GOIAS	ME12215841	IPORA	28/02/2020 08:13	28/02/2020 17:18	28/02/2020 08:13	28/02/2020 17:18	9,08	17	154,31	CHI
202002182594	ITABERAI	IB12406608	ITABERAI S1	28/02/2020 13:56	28/02/2020 17:01	28/02/2020 13:56	28/02/2020 17:01	3,08	1	3,08	CHI
202002182596	MINACU	IH21245136	MINACU	28/02/2020 13:56	28/02/2020 19:34	28/02/2020 13:56	28/02/2020 19:34	5,63	1	5,63	CHI
202002182604	CAMPESTRE DE GOIAS	GC12322913	TRINDADE	28/02/2020 13:57	28/02/2020 19:58	28/02/2020 13:57	28/02/2020 19:58	6,00	3	18,01	CHI
202002182607	CEZARINA	CZ13343242	CEZARINA	28/02/2020 13:58	28/02/2020 22:44	28/02/2020 13:58	28/02/2020 22:17	8,30	24	199,25	CHI
202002182607	CEZARINA	CZ13343242	CEZARINA	28/02/2020 13:58	28/02/2020 22:44	28/02/2020 18:53	28/02/2020 22:17	3,39	4	13,55	CHI
202002182607	CEZARINA	CZ13343238	CEZARINA	28/02/2020 13:58	28/02/2020 22:44	28/02/2020 13:58	28/02/2020 22:44	8,77	118	1034,37	CHI
202002182607	INDIARA	CZ13343238	CEZARINA	28/02/2020 13:58	28/02/2020 22:44	28/02/2020 13:58	28/02/2020 22:44	8,77	30	262,97	CHI
202002182608	MOZARLANDIA	MZ12181320	MOZARLANDIA	28/02/2020 13:59	28/02/2020 18:17	28/02/2020 13:59	28/02/2020 18:17	4,30	21	90,28	CHI

202002182609	CATALAO	IP12000097	IPAMERI	28/02/2020 13:59	01/03/2020 10:50	28/02/2020 13:59	01/03/2020 10:50	44,86	19	852,42	CHI
202002182609	IPAMERI	IP12000097	IPAMERI	28/02/2020 13:59	01/03/2020 10:50	28/02/2020 13:59	01/03/2020 10:50	44,86	5	224,32	CHI
202002182610	NAZARIO	NZ11018619	ANICUNS	28/02/2020 12:59	28/02/2020 20:56	28/02/2020 12:59	28/02/2020 20:56	7,94	105	833,20	CHI
202002182615	PADRE BERNARDO	PB21283895	PADRE BERNARDO	28/02/2020 14:00	28/02/2020 19:15	28/02/2020 14:00	28/02/2020 19:15	5,25	1	5,25	CHI
202002182616	MOSSAMEDES	MD21188746	ANICUNS	28/02/2020 14:00	28/02/2020 17:04	28/02/2020 14:00	28/02/2020 17:04	3,06	1	3,06	CHI
202002182618	TURVANIA	TV12004804	ANICUNS	28/02/2020 13:31	28/02/2020 17:21	28/02/2020 13:31	28/02/2020 17:21	3,83	9	34,46	CHI
202002182622	ARAGOIANIA	AO12291291	GUAPO S2	28/02/2020 13:54	28/02/2020 19:20	28/02/2020 13:54	28/02/2020 19:20	5,42	44	238,60	CHI
202002182622	HIDROLANDIA	AO12291291	GUAPO S2	28/02/2020 13:54	28/02/2020 19:20	28/02/2020 13:54	28/02/2020 19:20	5,42	2	10,85	CHI
202002182625	ANAPOLIS	AN11167587	ANAPOLIS UNIVERSITARIO S2	28/02/2020 14:02	28/02/2020 18:17	28/02/2020 17:00	28/02/2020 18:17	1,28	111	142,42	CHI
202002182626	MONTES CLAROS DE GOIAS	ME12204903	IPORA	28/02/2020 11:18	28/02/2020 17:05	28/02/2020 11:18	28/02/2020 17:05	5,77	3	17,31	CHI
202002182637	INDIARA	IY12312487	CEZARINA	28/02/2020 08:19	29/02/2020 00:41	28/02/2020 08:19	29/02/2020 00:41	16,36	7	114,50	CHI
202002182639	LUZIANIA	LZ21084513	CRISTALINA S2	28/02/2020 14:04	29/02/2020 01:14	28/02/2020 14:04	29/02/2020 01:14	11,16	1	11,16	CHI
202002182642	SAO MIGUEL DO PASSA QUATRO	SQ21111713	CRISTIANOPOLIS	28/02/2020 14:05	28/02/2020 16:56	28/02/2020 14:05	28/02/2020 16:56	2,84	1	2,84	CHI
202002182646	CRISTALINA	KR12163676	PAMPLONA	28/02/2020 12:38	28/02/2020 15:35	28/02/2020 12:38	28/02/2020 15:35	2,96	26	76,88	CHI
202002182646	DISTRITO FEDERAL	KR12163676	PAMPLONA	28/02/2020 12:38	28/02/2020 15:35	28/02/2020 12:38	28/02/2020 15:35	2,96	4	11,83	CHI
202002182646	LUZIANIA	KR12163676	PAMPLONA	28/02/2020 12:38	28/02/2020 15:35	28/02/2020 12:38	28/02/2020 15:35	2,96	2	5,91	CHI
202002182648	RIO VERDE	RV12355047	RIO VERDE S1	28/02/2020 14:06	29/02/2020 09:40	28/02/2020 14:06	29/02/2020 09:40	19,56	2	39,11	CHI
202002182649	PLANALTINA	PI21072301	PLANALTINA	28/02/2020 14:06	28/02/2020 16:32	28/02/2020 14:06	28/02/2020 16:32	2,43	3	7,28	CHI
202002182651	PLANALTINA	PI11316972	PLANALTINA	28/02/2020 14:07	28/02/2020 16:37	28/02/2020 14:07	28/02/2020 16:37	2,50	86	214,93	CHI
202002182654	IPORA	IR12014531	IPORA	28/02/2020 14:07	29/02/2020 13:16	28/02/2020 14:07	29/02/2020 13:16	23,14	3	69,43	CHI
202002182656	NEROPOLIS	10029457996	NEROPOLIS S2	28/02/2020 14:07	28/02/2020 17:10	28/02/2020 14:07	28/02/2020 17:10	3,04	1	3,04	CHI
202002182657	ALEXANIA	SN12382967	MARAJOARA	28/02/2020 14:04	28/02/2020 17:32	28/02/2020 14:04	28/02/2020 17:32	3,45	1	3,45	CHI
202002182657	SANTO ANTONIO DO DESCOBERTO	SN12382967	MARAJOARA	28/02/2020 14:04	28/02/2020 17:32	28/02/2020 14:04	28/02/2020 17:32	3,45	16	55,23	CHI
202002182708	GOIANIA	GN11203352	CARAJAS S2	28/02/2020 14:10	28/02/2020 16:03	28/02/2020 14:10	28/02/2020 16:03	1,88	70	131,39	CHI
202002182709	MINACU	IH21230460	MINACU	28/02/2020 14:11	28/02/2020 17:55	28/02/2020 14:11	28/02/2020 17:55	3,73	1	3,73	CHI
202002182710	CAMPO ALEGRE DE GOIAS	CM12393725RE	CAMPO ALEGRE DE GOIAS	28/02/2020 14:11	29/02/2020 00:55	28/02/2020 21:26	29/02/2020 00:26	3,00	23	69,11	CHI
202002182710	CAMPO ALEGRE DE GOIAS	6944084	CAMPO ALEGRE DE GOIAS	28/02/2020 14:11	29/02/2020 00:55	28/02/2020 14:11	29/02/2020 00:55	10,73	2	21,47	CHI
202002182723	TROMBAS	TB12288281	PORANGATU	28/02/2020 14:14	29/02/2020 09:07	28/02/2020 14:14	29/02/2020 09:07	18,88	5	94,40	CHI
202002182724	CORUMBAIBA	CI12127541	CATALAO S1	28/02/2020 14:07	28/02/2020 20:20	28/02/2020 14:07	28/02/2020 20:20	6,21	24	149,13	CHI
202002182724	NOVA AURORA	CI12127541	CATALAO S1	28/02/2020 14:07	28/02/2020 20:20	28/02/2020 14:07	28/02/2020 20:20	6,21	8	49,71	CHI
202002182726	ITABERAI	IB21210487	ITABERAI S1	28/02/2020 14:14	28/02/2020 19:30	28/02/2020 14:14	28/02/2020 19:30	5,27	1	5,27	CHI
202002182728	SENADOR CANEDO	SW11291670	CEPAIGO S1	28/02/2020 14:14	28/02/2020 19:44	28/02/2020 14:14	28/02/2020 19:44	5,49	30	164,57	CHI
202002182732	FORMOSA	FA21330302	PLANALTINA	28/02/2020 14:15	28/02/2020 18:03	28/02/2020 14:15	28/02/2020 18:03	3,79	1	3,79	CHI
202002182738	PILAR DE GOIAS	GG21340022	SANTA TEREZINHA	28/02/2020 14:16	29/02/2020 08:43	28/02/2020 14:16	29/02/2020 08:43	18,44	1	18,44	CHI
202002182741	GOIANESIA	550111165	GOIANESIA S2	28/02/2020 14:17	28/02/2020 21:15	28/02/2020 14:17	28/02/2020 21:15	6,98	1	6,98	CHI
202002182743	ARENOPOLIS	AY12358539	ARENOPOLIS	28/02/2020 14:17	29/02/2020 11:56	28/02/2020 14:17	29/02/2020 11:56	21,64	1	21,64	CHI
202002182743	PALESTINA DE GOIAS	AY12358539	ARENOPOLIS	28/02/2020 14:17	29/02/2020 11:56	28/02/2020 14:17	29/02/2020 11:56	21,64	5	108,22	CHI
202002182744	FAINA	FC21324311	GOIAS	28/02/2020 14:16	29/02/2020 19:00	28/02/2020 14:16	29/02/2020 19:00	28,72	1	28,72	CHI
202002182750	ORIZONA	OZ12205492	PIRES DO RIO S1	28/02/2020 07:05	29/02/2020 12:02	28/02/2020 07:05	29/02/2020 12:02	28,94	3	86,82	CHI
202002182758	SANTA TEREZINHA DE GOIAS	2480037107	SANTA TEREZINHA	28/02/2020 14:19	28/02/2020 19:19	28/02/2020 14:19	28/02/2020 19:19	4,99	1	4,99	CHI
202002182760	VILA PROPICIO	NP12339454	GOIANESIA S1	28/02/2020 12:17	28/02/2020 16:03	28/02/2020 12:17	28/02/2020 16:03	3,76	113	425,10	CHI
202002182761	JARAGUA	JA12298079	JARAGUA	28/02/2020 14:20	28/02/2020 16:27	28/02/2020 14:20	28/02/2020 16:27	2,11	10	21,12	CHI
202002182762	PIRENOPOLIS	PV12297712	CORUMBA	28/02/2020 14:20	28/02/2020 18:06	28/02/2020 14:20	28/02/2020 18:06	3,76	14	52,67	CHI
202002182764	ANAPOLIS	10004886958	JUNDIAI S2	28/02/2020 14:20	29/02/2020 10:58	28/02/2020 14:20	29/02/2020 10:58	20,63	1	20,63	CHI

202002182766	SANTO ANTONIO DA BARRA	BZ21295805	ACREUNA	28/02/2020 14:20	29/02/2020 01:16	28/02/2020 14:20	29/02/2020 01:16	10,92	1	10,92	CHI
202002182767	QUIRINOPOLIS	QI31067434	QUIRINOPOLIS	28/02/2020 14:20	28/02/2020 19:23	28/02/2020 14:20	28/02/2020 19:23	5,04	1	5,04	CHI
202002182775	VALPARAISO DE GOIAS	3350017226	PACAEMBU S1	28/02/2020 14:22	28/02/2020 23:00	28/02/2020 14:22	28/02/2020 23:00	8,62	1	8,62	CHI
202002182782	ITARUMA	IM21139756	CACHOEIRA ALTA	28/02/2020 14:24	29/02/2020 14:42	28/02/2020 14:24	29/02/2020 14:42	24,29	1	24,29	CHI
202002182785	JUSSARA	JR21120646	JUSSARA	28/02/2020 14:25	28/02/2020 17:10	28/02/2020 14:25	28/02/2020 17:10	2,74	1	2,74	CHI
202002182786	SAO JOAO D ALIANCA	JL21268118	SAO JOAO D ALIANCA	28/02/2020 14:25	29/02/2020 10:09	28/02/2020 14:25	29/02/2020 10:09	19,73	1	19,73	CHI
202002182796	PALMEIRAS DE GOIAS	PL12277480	PALMEIRAS	28/02/2020 14:13	28/02/2020 18:12	28/02/2020 14:13	28/02/2020 18:12	3,97	19	75,45	CHI
202002182797	SENADOR CANEDO	190009421	SENADOR CANEDO	28/02/2020 14:27	28/02/2020 16:53	28/02/2020 14:27	28/02/2020 16:53	2,43	1	2,43	CHI
202002182798	AGUAS LINDAS DE GOIAS	LA12412179	AGUAS LINDAS DE GOIAS S1	28/02/2020 14:27	28/02/2020 17:02	28/02/2020 14:27	28/02/2020 17:02	2,58	1	2,58	CHI
202002182800	CACU	CC21026105	CACHOEIRA ALTA	28/02/2020 14:28	01/03/2020 08:24	28/02/2020 14:28	01/03/2020 08:24	41,93	1	41,93	CHI
202002182802	ACREUNA	EU12403890	ACREUNA	28/02/2020 12:59	28/02/2020 18:26	28/02/2020 12:59	28/02/2020 18:26	5,44	13	70,69	CHI
202002182805	JARAGUA	JA11070675	JARAGUA	28/02/2020 14:29	28/02/2020 23:40	28/02/2020 14:29	28/02/2020 23:40	9,18	21	192,69	CHI
202002182806	LUZIANIA	LZ11209614	MARAJOARA	28/02/2020 12:55	28/02/2020 16:10	28/02/2020 12:55	28/02/2020 16:10	3,24	32	103,83	CHI
202002182808	SAO FRANCISCO DE GOIAS	PV21337623	SAO FRANCISCO DE GOIAS	28/02/2020 14:30	28/02/2020 21:08	28/02/2020 14:30	28/02/2020 21:08	6,63	1	6,63	CHI
202002182812	PALMEIRAS DE GOIAS	590006990	PALMEIRAS	28/02/2020 14:30	28/02/2020 22:24	28/02/2020 14:30	28/02/2020 22:24	7,89	1	7,89	CHI
202002182818	BOM JARDIM DE GOIAS	BM12070982	BOM JARDIM	28/02/2020 09:34	28/02/2020 23:18	28/02/2020 09:34	28/02/2020 23:18	13,74	5	68,68	CHI
202002182819	IACIARA	IA12392240	FLORES DE GOIAS	28/02/2020 14:31	28/02/2020 17:45	28/02/2020 14:31	28/02/2020 17:45	3,22	7	22,57	CHI
202002182824	VALPARAISO DE GOIAS	2860143963	PACAEMBU S2	28/02/2020 14:32	28/02/2020 19:07	28/02/2020 14:32	28/02/2020 19:07	4,58	1	4,58	CHI
202002182825	CATURAI	TR32036669	TRINDADE	28/02/2020 12:42	28/02/2020 16:22	28/02/2020 12:42	28/02/2020 16:22	3,66	8	29,28	CHI
202002182825	SANTA BARBARA DE GOIAS	TR32036669	TRINDADE	28/02/2020 12:42	28/02/2020 16:22	28/02/2020 12:42	28/02/2020 16:22	3,66	22	80,52	CHI
202002182825	TRINDADE	TR32036669	TRINDADE	28/02/2020 12:42	28/02/2020 16:22	28/02/2020 12:42	28/02/2020 16:22	3,66	11	40,26	CHI
202002182829	GOIANESIA	GE21115124	GOIANESIA S2	28/02/2020 14:33	28/02/2020 23:10	28/02/2020 14:33	28/02/2020 23:10	8,62	1	8,62	CHI
202002182837	AGUAS LINDAS DE GOIAS	10003426643	AGUAS LINDAS DE GOIAS S1	28/02/2020 14:35	28/02/2020 16:39	28/02/2020 14:35	28/02/2020 16:39	2,06	1	2,06	CHI
202002182844	NEROPOLIS	NR21161904	NEROPOLIS S2	28/02/2020 14:37	28/02/2020 17:57	28/02/2020 14:37	28/02/2020 17:57	3,33	2	6,66	CHI
202002182845	CALDAS NOVAS	CN12363794	SERRA DE CALDAS	28/02/2020 14:37	29/02/2020 11:20	28/02/2020 14:37	29/02/2020 11:20	20,71	4	82,84	CHI
202002182848	PETROLINA DE GOIAS	PG12015831RE	PETROLINA	28/02/2020 14:07	28/02/2020 17:53	28/02/2020 14:07	28/02/2020 17:53	3,78	228	861,33	CHI
202002182848	SAO FRANCISCO DE GOIAS	PG12015831RE	PETROLINA	28/02/2020 14:07	28/02/2020 17:53	28/02/2020 14:07	28/02/2020 17:53	3,78	34	128,44	CHI
202002182852	TURVANIA	1220007083	FIRMINOPOLIS S2	28/02/2020 14:38	28/02/2020 17:06	28/02/2020 14:38	28/02/2020 17:06	2,46	1	2,46	CHI
202002182856	ITUMBIARA	00980234	ITUMBIARA NOVA	28/02/2020 14:37	28/02/2020 17:54	28/02/2020 14:37	28/02/2020 15:12	0,58	4806	2808,84	CHI
202002182856	PANAMA	00980234	ITUMBIARA NOVA	28/02/2020 14:37	28/02/2020 17:54	28/02/2020 14:37	28/02/2020 15:12	0,58	105	61,37	CHI
202002182856	ITUMBIARA	00980234	ITUMBIARA NOVA	28/02/2020 14:37	28/02/2020 17:54	28/02/2020 14:37	28/02/2020 15:50	1,21	2067	2507,96	CHI
202002182856	ITUMBIARA	00980234	ITUMBIARA NOVA	28/02/2020 14:37	28/02/2020 17:54	28/02/2020 14:37	28/02/2020 17:54	3,28	1352	4440,19	CHI
202002182861	FORMOSA	FA12211252	ITUIQUIRA	28/02/2020 14:40	28/02/2020 19:14	28/02/2020 14:40	28/02/2020 19:14	4,55	16	72,88	CHI
202002182863	SANTO ANTONIO DO DESCOBERTO	SN12382951	MARAJOARA	28/02/2020 14:41	28/02/2020 20:51	28/02/2020 14:41	28/02/2020 20:51	6,18	57	352,09	CHI
202002182864	HIDROLANDIA	HD12402898	CEPAIGO S2	28/02/2020 14:41	28/02/2020 18:43	28/02/2020 14:41	28/02/2020 18:43	4,03	43	173,25	CHI
202002182865	SANTA TEREZINHA DE GOIAS	SG12243403	SANTA TEREZINHA	28/02/2020 14:41	28/02/2020 19:17	28/02/2020 14:41	28/02/2020 19:17	4,60	1	4,60	CHI
202002182866	ALEXANIA	AX12095958	CORUMBA	28/02/2020 14:41	28/02/2020 18:59	28/02/2020 14:41	28/02/2020 18:59	4,29	6	25,74	CHI
202002182866	CORUMBA DE GOIAS	AX12095958	CORUMBA	28/02/2020 14:41	28/02/2020 18:59	28/02/2020 14:41	28/02/2020 18:59	4,29	3	12,87	CHI
202002182873	SANTO ANTONIO DO DESCOBERTO	SN12330527	MARAJOARA	28/02/2020 14:42	28/02/2020 20:02	28/02/2020 14:42	28/02/2020 20:02	5,32	6	31,94	CHI
202002182883	PIRENOPOLIS	SF12017628	SAO FRANCISCO DE GOIAS	28/02/2020 14:42	28/02/2020 17:50	28/02/2020 14:42	28/02/2020 17:50	3,13	4	12,50	CHI
202002182883	SAO FRANCISCO DE GOIAS	SF12017628	SAO FRANCISCO DE GOIAS	28/02/2020 14:42	28/02/2020 17:50	28/02/2020 14:42	28/02/2020 17:50	3,13	8	25,01	CHI
202002182884	JATAI	JT21106071	JATAI S1	28/02/2020 14:44	29/02/2020 08:12	28/02/2020 14:44	29/02/2020 08:12	17,46	2	34,92	CHI
202002182885	AVELINOPOLIS	AV21348471	ANICUNS	28/02/2020 14:44	28/02/2020 19:33	28/02/2020 14:44	28/02/2020 19:33	4,81	1	4,81	CHI
202002182890	BOM JARDIM DE GOIAS	BM12212797	BOM JARDIM	28/02/2020 13:32	28/02/2020 21:32	28/02/2020 13:32	28/02/2020 21:32	7,99	87	695,01	CHI

202002182890	PIRANHAS	BM12212797	BOM JARDIM	28/02/2020 13:32	28/02/2020 21:32	28/02/2020 13:32	28/02/2020 21:32	7,99	2	15,98	CHI
202002182892	ABADIANIA	350001777	ANAPOLIS UNIVERSITARIO S1	28/02/2020 14:45	28/02/2020 16:56	28/02/2020 14:45	28/02/2020 16:56	2,17	1	2,17	CHI
202002182893	ITARUMA	IM12038174	CACHOEIRA ALTA	28/02/2020 14:46	01/03/2020 05:10	28/02/2020 14:46	01/03/2020 05:10	38,40	2	76,79	CHI
202002182896	SANTO ANTONIO DA BARRA	BZ21301712	ACREUNA	28/02/2020 14:46	29/02/2020 12:35	28/02/2020 14:46	29/02/2020 12:35	21,81	1	21,81	CHI
202002182897	RIO VERDE	RV12326798	SANTA HELENA S1	28/02/2020 14:46	01/03/2020 10:55	28/02/2020 14:46	01/03/2020 10:55	44,14	2	88,28	CHI
202002182898	CATALAO	CT12093871	CATALAO S1	28/02/2020 14:46	28/02/2020 18:27	28/02/2020 14:46	28/02/2020 18:27	3,67	35	128,62	CHI
202002182907	ARUANA	AK21093998	ARUANA	28/02/2020 14:48	28/02/2020 16:39	28/02/2020 14:48	28/02/2020 16:39	1,85	1	1,85	CHI
202002182914	MINACU	IH12220694	MINACU	28/02/2020 14:48	28/02/2020 16:18	28/02/2020 14:48	28/02/2020 16:18	1,48	5	7,42	CHI
202002182917	OURO VERDE DE GOIAS	370014297	NEROPOLIS S1	28/02/2020 14:49	29/02/2020 01:06	28/02/2020 14:49	29/02/2020 01:06	10,27	1	10,27	CHI
202002182921	EDEIA	EA12000001	EDEIA	28/02/2020 14:50	28/02/2020 17:23	28/02/2020 14:50	28/02/2020 17:23	2,54	19	48,32	CHI
202002182924	GOIANIA	GN11131381	MEIA PONTE	28/02/2020 14:50	29/02/2020 01:32	28/02/2020 14:50	28/02/2020 15:19	0,49	145	70,81	CHI
202002182924	GOIANIA	GN11213539	MEIA PONTE	28/02/2020 14:50	29/02/2020 01:32	28/02/2020 16:03	29/02/2020 01:32	9,48	73	692,18	CHI
202002182927	ARUANA	10005720026	ARUANA	28/02/2020 14:51	28/02/2020 16:30	28/02/2020 14:51	28/02/2020 16:30	1,65	1	1,65	CHI
202002182929	NIQUELANDIA	NQ21197663	BARRO ALTO	28/02/2020 14:51	29/02/2020 08:31	28/02/2020 14:51	29/02/2020 08:31	17,66	1	17,66	CHI
202002182934	RIO VERDE	RV12136250	MONTIVIDIU T	28/02/2020 09:38	28/02/2020 20:36	28/02/2020 09:38	28/02/2020 20:36	10,97	5	54,83	CHI
202002182935	BARRO ALTO	10005030704	BARRO ALTO	28/02/2020 14:52	28/02/2020 19:49	28/02/2020 14:52	28/02/2020 19:49	4,95	1	4,95	CHI
202002182939	SAO MIGUEL DO PASSA QUATRO	SQ21116220	CRISTIANOPOLIS	28/02/2020 14:52	28/02/2020 19:57	28/02/2020 14:52	28/02/2020 19:57	5,07	1	5,07	CHI
202002182940	CAIAPONIA	CP21342198	CAIAPONIA	28/02/2020 14:52	28/02/2020 22:05	28/02/2020 14:52	28/02/2020 22:05	7,21	1	7,21	CHI
202002182943	ARAGOIANIA	AO32060753	GUAPO S2	28/02/2020 14:07	28/02/2020 17:32	28/02/2020 14:07	28/02/2020 17:32	3,41	4	13,63	CHI
202002182946	SAO SIMAO	2240050440	CACHOEIRA ALTA	28/02/2020 14:53	29/02/2020 10:10	28/02/2020 14:53	29/02/2020 10:10	19,29	1	19,29	CHI
202002182949	PIRACANJUBA	PJ12212173	PIRACANJUBA	28/02/2020 14:53	28/02/2020 21:01	28/02/2020 14:53	28/02/2020 21:01	6,12	19	116,33	CHI
202002182953	NOVO GAMA	2900105372	MARAJOARA	28/02/2020 14:55	28/02/2020 18:33	28/02/2020 14:55	28/02/2020 18:33	3,63	1	3,63	CHI
202002182956	CRISTALINA	KR12366452	PAMPLONA	28/02/2020 14:48	28/02/2020 17:05	28/02/2020 14:48	28/02/2020 17:05	2,28	10	22,81	CHI
202002182960	VICENTINOPOLIS	VI12293191	VICENTINOPOLIS	28/02/2020 14:39	01/03/2020 02:00	28/02/2020 14:39	01/03/2020 17:34	2,91	2	5,83	CHI
202002182960	VICENTINOPOLIS	VI12293191	VICENTINOPOLIS	28/02/2020 14:39	01/03/2020 02:00	28/02/2020 14:39	01/03/2020 02:00	35,36	16	565,74	CHI
202002182973	MONTE ALEGRE DE GOIAS	SD12322677	SAO DOMINGOS	28/02/2020 14:58	28/02/2020 18:11	28/02/2020 14:58	28/02/2020 18:11	3,20	2	6,40	CHI
202002182973	NOVA ROMA	SD12322677	SAO DOMINGOS	28/02/2020 14:58	28/02/2020 18:11	28/02/2020 14:58	28/02/2020 18:11	3,20	3	9,60	CHI
202002182973	SAO DOMINGOS	SD12322677	SAO DOMINGOS	28/02/2020 14:58	28/02/2020 18:11	28/02/2020 14:58	28/02/2020 18:11	3,20	35	112,03	CHI
202002182974	CRISTALINA	KR21248625	CRISTALINA S1	28/02/2020 14:58	28/02/2020 16:53	28/02/2020 14:58	28/02/2020 16:53	1,90	1	1,90	CHI
202002182980	CABECEIRAS	CW21366182	ITIQUEIRA	28/02/2020 15:01	28/02/2020 17:50	28/02/2020 15:01	28/02/2020 17:50	2,82	1	2,82	CHI
202002182986	VILA PROPICIO	PV21119826	GOIANESIA S1	28/02/2020 15:02	28/02/2020 19:01	28/02/2020 15:02	28/02/2020 19:01	3,97	1	3,97	CHI
202002182988	BELA VISTA DE GOIAS	BV12067601LD	BELA VISTA S1	28/02/2020 14:50	28/02/2020 15:59	28/02/2020 14:50	28/02/2020 15:59	1,14	157	179,37	CHI
202002182996	PIRENOPOLIS	PV11057879	CORUMBA	28/02/2020 14:38	28/02/2020 16:52	28/02/2020 14:38	28/02/2020 16:52	2,23	93	207,57	CHI
202002183002	GOIANIA	12335824	GOYA S2	28/02/2020 15:06	28/02/2020 17:37	28/02/2020 15:06	28/02/2020 17:37	2,51	1	2,51	CHI
202002183006	CATALAO	CT21360051	CATALAO S1	28/02/2020 15:07	29/02/2020 08:44	28/02/2020 15:07	29/02/2020 08:44	17,61	1	17,61	CHI
202002183009	SANTA FE DE GOIAS	RN21010492	BRITANIA	28/02/2020 15:05	29/02/2020 17:10	28/02/2020 15:05	29/02/2020 16:50	25,75	1	25,75	CHI
202002183009	SANTA FE DE GOIAS	RN12123453	BRITANIA	28/02/2020 15:05	29/02/2020 17:10	29/02/2020 15:20	29/02/2020 17:10	1,83	1	1,83	CHI
202002183011	JATAI	JT12211164	JATAI S2	28/02/2020 13:38	28/02/2020 19:47	28/02/2020 13:38	28/02/2020 19:47	6,14	10	61,39	CHI
202002183017	SANTO ANTONIO DA BARRA	BZ21340869	ACREUNA	28/02/2020 11:03	28/02/2020 23:05	28/02/2020 11:03	28/02/2020 23:05	12,02	1	12,02	CHI
202002183023	CRISTALINA	KR12305054	PAMPLONA	28/02/2020 15:10	28/02/2020 17:55	28/02/2020 15:10	28/02/2020 17:55	2,74	138	377,85	CHI
202002183024	COCALZINHO DE GOIAS	ZN12000096	COCALZINHO	28/02/2020 14:35	28/02/2020 19:19	28/02/2020 14:35	28/02/2020 19:19	4,73	24	113,49	CHI
202002183036	JARAGUA	JA12070670	JARAGUA	28/02/2020 14:59	28/02/2020 19:59	28/02/2020 14:59	28/02/2020 19:59	4,99	9	44,90	CHI
202002183052	LUZIANIA	LZ21156965	MARAJOARA	28/02/2020 15:16	28/02/2020 23:54	28/02/2020 15:16	28/02/2020 23:54	8,63	2	17,27	CHI
202002183055	PIRACANJUBA	60050986	PIRACANJUBA	28/02/2020 15:16	01/03/2020 10:03	28/02/2020 15:16	01/03/2020 10:03	42,77	1	42,77	CHI

202002183057	VALPARAISO DE GOIAS	10027830169	PACAEMBU S1	28/02/2020 15:17	28/02/2020 17:17	28/02/2020 15:17	28/02/2020 17:17	2,00	1	2,00	CHI
202002183064	PONTALINA	PK32046001	PONTALINA	28/02/2020 15:17	28/02/2020 19:00	28/02/2020 15:17	28/02/2020 19:00	3,70	19	70,32	CHI
202002183076	PROFESSOR JAMIL SAFADY	JS21337202	PIRACANJUBA	28/02/2020 15:19	01/03/2020 03:04	28/02/2020 15:19	01/03/2020 03:04	35,75	1	35,75	CHI
202002183077	HIDROLANDIA	HD12006326	CEPAIGO S2	28/02/2020 14:51	28/02/2020 16:25	28/02/2020 14:51	28/02/2020 16:25	1,55	21	32,60	CHI
202002183079	GOIANIA	11933320	FERROVIARIO S2	28/02/2020 15:20	28/02/2020 16:57	28/02/2020 15:20	28/02/2020 16:57	1,62	1	1,62	CHI
202002183084	PALMEIRAS DE GOIAS	PL21304478	PALMEIRAS	28/02/2020 15:20	29/02/2020 02:20	28/02/2020 15:20	29/02/2020 02:20	11,00	1	11,00	CHI
202002183092	PIRENOPOLIS	PV11200598	CORUMBA	28/02/2020 14:52	28/02/2020 17:33	28/02/2020 14:52	28/02/2020 17:33	2,67	87	232,17	CHI
202002183097	CAIAPONIA	CP11243822	CAIAPONIA	28/02/2020 15:23	29/02/2020 13:33	28/02/2020 15:23	29/02/2020 13:33	22,15	2	44,31	CHI
202002183101	PIRENOPOLIS	PV12382113	SAO FRANCISCO DE GOIAS	28/02/2020 14:43	28/02/2020 18:07	28/02/2020 14:43	28/02/2020 18:07	3,39	285	965,60	CHI
202002183104	FAZENDA NOVA	IS12381080	IPORA	28/02/2020 15:26	28/02/2020 19:59	28/02/2020 15:26	28/02/2020 19:59	4,54	9	40,90	CHI
202002183104	ISRAELANDIA	IS12381080	IPORA	28/02/2020 15:26	28/02/2020 19:59	28/02/2020 15:26	28/02/2020 19:59	4,54	2	9,09	CHI
202002183107	MORRINHOS	10017725117	MORRINHOS	28/02/2020 15:27	28/02/2020 16:25	28/02/2020 15:27	28/02/2020 16:25	0,97	1	0,97	CHI
202002183108	SAO FRANCISCO DE GOIAS	490022753	SAO FRANCISCO DE GOIAS	28/02/2020 15:27	29/02/2020 08:16	28/02/2020 15:27	29/02/2020 08:16	16,82	1	16,82	CHI
202002183110	CABECEIRAS	CW21157344	ITUIQUIRA	28/02/2020 15:27	28/02/2020 17:16	28/02/2020 15:27	28/02/2020 17:16	1,81	1	1,81	CHI
202002183112	CRISTIANOPOLIS	BC12311662	PIRES DO RIO S2	28/02/2020 15:27	28/02/2020 23:52	28/02/2020 15:27	28/02/2020 23:52	8,40	3	25,20	CHI
202002183112	PIRES DO RIO	BC12311662	PIRES DO RIO S2	28/02/2020 15:27	28/02/2020 23:52	28/02/2020 15:27	28/02/2020 23:52	8,40	3	25,20	CHI
202002183115	MINEIROS	MY21340076	PARQUE DAS EMAS	28/02/2020 15:28	29/02/2020 10:33	28/02/2020 15:28	29/02/2020 10:33	19,07	1	19,07	CHI
202002183116	GOIANIA	10251431	AEROPORTO S1	28/02/2020 15:28	28/02/2020 16:41	28/02/2020 15:28	28/02/2020 16:41	1,21	1	1,21	CHI
202002183117	TURVANIA	TV11052101	FIRMINOPOLIS S2	28/02/2020 15:28	28/02/2020 18:57	28/02/2020 15:28	28/02/2020 18:57	3,47	13	45,12	CHI
202002183120	PILAR DE GOIAS	GG21100624	SANTA TEREZINHA	28/02/2020 15:26	29/02/2020 18:41	28/02/2020 15:26	29/02/2020 18:41	27,23	1	27,23	CHI
202002183124	DISTRITO FEDERAL	PB12163215	PADRE BERNARDO	28/02/2020 13:07	28/02/2020 16:34	28/02/2020 13:07	28/02/2020 16:34	3,44	3	10,33	CHI
202002183124	PADRE BERNARDO	PB12163215	PADRE BERNARDO	28/02/2020 13:07	28/02/2020 16:34	28/02/2020 13:07	28/02/2020 16:34	3,44	276	950,82	CHI
202002183130	AGUAS LINDAS DE GOIAS	4830260945	AGUAS LINDAS DE GOIAS S1	28/02/2020 15:30	28/02/2020 17:13	28/02/2020 15:30	28/02/2020 17:13	1,71	1	1,71	CHI
202002183132	PIRACANJUBA	PJ12263474	PIRACANJUBA	28/02/2020 15:30	28/02/2020 19:39	28/02/2020 15:30	28/02/2020 19:39	4,14	27	111,86	CHI
202002183133	GOIANIA	16735420	XAVANTES	28/02/2020 15:30	28/02/2020 16:54	28/02/2020 15:30	28/02/2020 16:54	1,39	0	0,00	CHI
202002183135	CIDADE OCIDENTAL	LZ21082933	MARAJOARA	28/02/2020 15:30	28/02/2020 18:33	28/02/2020 15:30	28/02/2020 18:33	3,05	2	6,09	CHI
202002183142	ARAGOIANIA	AO32000285	GUAPO S2	28/02/2020 14:42	28/02/2020 16:59	28/02/2020 14:42	28/02/2020 16:59	2,27	51	116,01	CHI
202002183142	HIDROLANDIA	AO32000285	GUAPO S2	28/02/2020 14:42	28/02/2020 16:59	28/02/2020 14:42	28/02/2020 16:59	2,27	107	243,40	CHI
202002183142	MAIRIPOTABA	AO32000285	GUAPO S2	28/02/2020 14:42	28/02/2020 16:59	28/02/2020 14:42	28/02/2020 16:59	2,27	2	4,55	CHI
202002183142	VARJAO	AO32000285	GUAPO S2	28/02/2020 14:42	28/02/2020 16:59	28/02/2020 14:42	28/02/2020 16:59	2,27	71	161,51	CHI
202002183144	PIRES DO RIO	PR12337227	PIRES DO RIO S1	28/02/2020 15:27	28/02/2020 16:45	28/02/2020 15:27	28/02/2020 16:45	1,30	39	50,59	CHI
202002183144	SANTA CRUZ DE GOIAS	PR12337227	PIRES DO RIO S1	28/02/2020 15:27	28/02/2020 16:45	28/02/2020 15:27	28/02/2020 16:45	1,30	1	1,30	CHI
202002183144	URUTAI	PR12337227	PIRES DO RIO S1	28/02/2020 15:27	28/02/2020 16:45	28/02/2020 15:27	28/02/2020 16:45	1,30	1	1,30	CHI
202002183145	CAMPINACU	IH12132432	MINACU	28/02/2020 15:13	28/02/2020 18:07	28/02/2020 15:13	28/02/2020 18:07	2,88	22	63,46	CHI
202002183145	MINACU	IH12132432	MINACU	28/02/2020 15:13	28/02/2020 18:07	28/02/2020 15:13	28/02/2020 18:07	2,88	110	317,32	CHI
202002183149	ORIZONA	PR12063767	PIRES DO RIO S2	28/02/2020 15:33	29/02/2020 11:08	28/02/2020 15:33	29/02/2020 11:08	19,57	12	234,85	CHI
202002183151	CAMPOS BELOS	CH21047950	SAO DOMINGOS	28/02/2020 15:34	28/02/2020 17:44	28/02/2020 15:34	28/02/2020 17:44	2,17	1	2,17	CHI
202002183153	SAO FRANCISCO DE GOIAS	SF12377527	SAO FRANCISCO DE GOIAS	28/02/2020 15:34	28/02/2020 19:03	28/02/2020 15:34	28/02/2020 19:03	3,48	2	6,95	CHI
202002183156	ANICUNS	AV12282415	ANICUNS	28/02/2020 12:37	28/02/2020 18:05	28/02/2020 12:37	28/02/2020 18:05	5,46	48	261,91	CHI
202002183156	AVELINOPOLIS	AV12282415	ANICUNS	28/02/2020 12:37	28/02/2020 18:05	28/02/2020 12:37	28/02/2020 18:05	5,46	4	21,83	CHI
202002183160	GOIATUBA	GT12048503	GOIATUBA S2	28/02/2020 15:35	28/02/2020 17:24	28/02/2020 15:35	28/02/2020 17:24	1,81	22	39,74	CHI
202002183164	NIQUELANDIA	NQ11083005	BARRO ALTO	28/02/2020 15:29	29/02/2020 14:24	28/02/2020 15:29	29/02/2020 14:24	22,91	37	847,70	CHI
202002183166	AGUA LIMPA	AL12257036	VILA CORUMBA	28/02/2020 11:52	28/02/2020 21:59	28/02/2020 11:52	28/02/2020 21:59	10,11	70	707,35	CHI
202002183166	CORUMBAIBA	AL12257036	VILA CORUMBA	28/02/2020 11:52	28/02/2020 21:59	28/02/2020 11:52	28/02/2020 21:59	10,11	1	10,11	CHI

202002183174	ABADIANIA	AA12335610	ANAPOLIS UNIVERSITARIO S1	28/02/2020 14:49	28/02/2020 23:14	28/02/2020 14:49	28/02/2020 23:14	8,42	1	8,42	CHI
202002183175	EDEALINA	ED12063150	PONTALINA	28/02/2020 15:38	28/02/2020 20:26	28/02/2020 15:38	28/02/2020 20:26	4,79	10	47,91	CHI
202002183176	APARECIDA DE GOIANIA	200260790	INDEPENDENCIA S1	28/02/2020 15:38	28/02/2020 17:31	28/02/2020 15:38	28/02/2020 17:31	1,87	1	1,87	CHI
202002183178	PIRACANJUBA	BV32051418	BELA VISTA S1	28/02/2020 15:20	28/02/2020 17:01	28/02/2020 15:20	28/02/2020 17:01	1,67	18	30,06	CHI
202002183183	CORUMBA DE GOIAS	CB21171921	CORUMBA	28/02/2020 15:39	28/02/2020 22:36	28/02/2020 15:39	28/02/2020 22:36	6,94	1	6,94	CHI
202002183185	PETROLINA DE GOIAS	PV12062894	SAO FRANCISCO DE GOIAS	28/02/2020 15:38	28/02/2020 22:21	28/02/2020 15:38	28/02/2020 22:21	6,72	3	20,15	CHI
202002183185	PIRENOPOLIS	PV12062894	SAO FRANCISCO DE GOIAS	28/02/2020 15:38	28/02/2020 22:21	28/02/2020 15:38	28/02/2020 22:21	6,72	21	141,03	CHI
202002183189	HIDROLANDIA	HD12288933	CEPAIGO S2	28/02/2020 15:40	29/02/2020 08:51	28/02/2020 15:40	29/02/2020 08:51	17,18	13	223,34	CHI
202002183194	PIRACANJUBA	PJ21056106	PIRACANJUBA	28/02/2020 15:41	29/02/2020 16:53	28/02/2020 15:41	29/02/2020 16:53	25,19	1	25,19	CHI
202002183198	CALDAZINHA	LB21160592	DAIA S2	28/02/2020 15:41	28/02/2020 17:46	28/02/2020 15:41	28/02/2020 17:46	2,07	2	4,15	CHI
202002183204	NOVO GAMA	2460056509	PACAEMBU S1	28/02/2020 15:43	28/02/2020 19:40	28/02/2020 15:43	28/02/2020 19:40	3,94	1	3,94	CHI
202002183208	ACREUNA	EU12045539	ACREUNA	28/02/2020 15:45	29/02/2020 11:53	28/02/2020 15:45	29/02/2020 11:53	20,13	1	20,13	CHI
202002183209	MINACU	IH21208274	MINACU	28/02/2020 15:45	28/02/2020 18:12	28/02/2020 15:45	28/02/2020 18:12	2,44	1	2,44	CHI
202002183210	MORRINHOS	MR12080320	VILA CORUMBA	28/02/2020 15:45	29/02/2020 08:28	28/02/2020 15:45	29/02/2020 08:28	16,71	3	50,12	CHI
202002183220	CATALAO	CT21318737	CATALAO S1	28/02/2020 15:47	29/02/2020 19:26	28/02/2020 15:47	29/02/2020 19:26	27,64	1	27,64	CHI
202002183226	MATRINCHA	MP21237235	MOZARLANDIA	28/02/2020 15:48	29/02/2020 10:25	28/02/2020 15:48	29/02/2020 10:25	18,63	1	18,63	CHI
202002183227	SAO LUIS DE MONTES BELOS	500006945	SAO LUIZ DOS MONTES BELOS	28/02/2020 15:48	28/02/2020 20:10	28/02/2020 15:48	28/02/2020 20:10	4,36	1	4,36	CHI
202002183232	PETROLINA DE GOIAS	10004019910	PETROLINA	28/02/2020 15:50	28/02/2020 19:16	28/02/2020 15:50	28/02/2020 19:16	3,43	1	3,43	CHI
202002183237	ITARUMA	IM21122634	CACHOEIRA ALTA	28/02/2020 15:51	29/02/2020 15:50	28/02/2020 15:51	29/02/2020 15:50	23,97	1	23,97	CHI
202002183239	JARAGUA	JA12104703	JARAGUA	28/02/2020 07:51	28/02/2020 19:59	28/02/2020 07:51	28/02/2020 19:59	12,13	3	36,38	CHI
202002183240	LUZIANIA	LZ12376168	CRISTALINA S2	28/02/2020 14:33	28/02/2020 23:50	28/02/2020 14:33	28/02/2020 23:50	9,27	14	129,79	CHI
202002183249	APARECIDA DE GOIANIA	15894800	REAL S1	28/02/2020 15:54	28/02/2020 17:21	28/02/2020 15:54	28/02/2020 17:21	1,45	1	1,45	CHI
202002183253	PIRACANJUBA	PJ21118724	PIRACANJUBA	28/02/2020 15:55	29/02/2020 17:46	28/02/2020 15:55	29/02/2020 17:46	25,85	1	25,85	CHI
202002183254	COCALZINHO DE GOIAS	ZN12000140	COCALZINHO	28/02/2020 14:34	28/02/2020 18:10	28/02/2020 14:34	28/02/2020 18:10	3,59	11	39,47	CHI
202002183255	CAMPOS BELOS	10002606273	SAO DOMINGOS	28/02/2020 15:55	28/02/2020 17:31	28/02/2020 15:55	28/02/2020 17:31	1,60	1	1,60	CHI
202002183257	POSSE	PS12123497	IACIARA S2	28/02/2020 15:55	28/02/2020 17:51	28/02/2020 15:55	28/02/2020 17:51	1,93	15	28,90	CHI
202002183259	GOIATUBA	140036064	GOIATUBA S2	28/02/2020 15:55	28/02/2020 18:58	28/02/2020 15:55	28/02/2020 18:58	3,04	1	3,04	CHI
202002183261	ANAPOLIS	21296200	ANAPOLIS UNIVERSITARIO S2	28/02/2020 15:55	28/02/2020 16:46	28/02/2020 15:55	28/02/2020 16:46	0,84	1	0,84	CHI
202002183264	ACREUNA	EU12214051	ACREUNA	28/02/2020 15:56	29/02/2020 13:41	28/02/2020 15:56	29/02/2020 13:41	21,74	1	21,74	CHI
202002183268	ALOANDIA	AD12150204	GOIATUBA S1	28/02/2020 15:58	28/02/2020 18:56	28/02/2020 15:58	28/02/2020 18:56	2,96	21	62,21	CHI
202002183269	CABECEIRAS	860006580	ITUIQUIRA	28/02/2020 15:58	28/02/2020 18:42	28/02/2020 15:58	28/02/2020 18:42	2,73	1	2,73	CHI
202002183276	CATALAO	CT12013670	CATALAO S1	28/02/2020 15:59	28/02/2020 21:01	28/02/2020 15:59	28/02/2020 21:01	5,03	5	25,13	CHI
202002183279	CACHOEIRA DOURADA	CD12000085	CACHOEIRA DOURADA	28/02/2020 15:40	28/02/2020 21:43	28/02/2020 15:40	28/02/2020 21:43	6,05	14	84,65	CHI
202002183287	SAO MIGUEL DO PASSA QUATRO	SQ21340606	CRISTIANOPOLIS	28/02/2020 16:00	28/02/2020 18:54	28/02/2020 16:00	28/02/2020 18:54	2,88	1	2,88	CHI
202002183288	BELA VISTA DE GOIAS	BV32060709	BELA VISTA S1	28/02/2020 16:01	28/02/2020 18:59	28/02/2020 16:01	28/02/2020 18:59	2,96	12	35,57	CHI
202002183294	TAQUARAL DE GOIAS	TQ21213680	INHUMAS S1	28/02/2020 16:01	29/02/2020 09:57	28/02/2020 16:01	29/02/2020 09:57	17,92	1	17,92	CHI
202002183305	ITAUCU	IX21317392	INHUMAS S1	29/02/2020 07:32	01/03/2020 12:10	29/02/2020 07:32	01/03/2020 11:49	28,28	1	28,28	CHI
202002183305	ITAUCU	IX12016023	INHUMAS S1	29/02/2020 07:32	01/03/2020 12:10	01/03/2020 09:55	01/03/2020 12:10	2,26	6	13,54	CHI
202002183602	PONTALINA	PK12118100RE	PONTALINA	28/02/2020 16:03	28/02/2020 19:30	28/02/2020 16:03	28/02/2020 19:30	3,44	41	141,18	CHI
202002183611	CACU	10019209949	CACHOEIRA ALTA	28/02/2020 16:05	28/02/2020 20:18	28/02/2020 16:05	28/02/2020 20:18	4,22	1	4,22	CHI
202002183612	CRIXAS	CX12330139	RUBIATABA	28/02/2020 15:40	29/02/2020 00:04	28/02/2020 15:40	29/02/2020 00:04	8,40	23	193,19	CHI
202002183612	NOVA CRIXAS	CX12330139	RUBIATABA	28/02/2020 15:40	29/02/2020 00:04	28/02/2020 15:40	29/02/2020 00:04	8,40	1	8,40	CHI
202002183613	MINEIROS	SU21157165	SANTA RITA DO ARAGUAIA	28/02/2020 16:04	28/02/2020 23:25	28/02/2020 16:04	28/02/2020 23:25	7,34	1	7,34	CHI
202002183616	SANTO ANTONIO DA BARRA	BZ21380455	ACREUNA	28/02/2020 16:04	29/02/2020 10:30	28/02/2020 16:04	29/02/2020 10:30	18,42	1	18,42	CHI

202002183618	BURITINOPOLIS	01230434	IACIARA S2	28/02/2020 16:06	28/02/2020 21:12	28/02/2020 17:07	28/02/2020 17:27	0,34	2	0,68	CHI
202002183618	IACIARA	01230434	IACIARA S2	28/02/2020 16:06	28/02/2020 21:12	28/02/2020 17:07	28/02/2020 17:27	0,34	1	0,34	CHI
202002183618	IACIARA	01230434	IACIARA S2	28/02/2020 16:06	28/02/2020 21:12	28/02/2020 17:07	28/02/2020 17:27	0,34	103	35,22	CHI
202002183618	MAMBAL	01230434	IACIARA S2	28/02/2020 16:06	28/02/2020 21:12	28/02/2020 17:07	28/02/2020 17:27	0,34	27	9,23	CHI
202002183618	POSSE	01230434	IACIARA S2	28/02/2020 16:06	28/02/2020 21:12	28/02/2020 17:07	28/02/2020 17:27	0,34	6783	2319,41	CHI
202002183618	POSSE	01230434	IACIARA S2	28/02/2020 16:06	28/02/2020 21:12	28/02/2020 17:07	28/02/2020 17:27	0,34	944	322,80	CHI
202002183618	POSSE	01230434	IACIARA S2	28/02/2020 16:06	28/02/2020 21:12	28/02/2020 17:07	28/02/2020 17:27	0,34	3396	1161,24	CHI
202002183618	POSSE	01230434	IACIARA S2	28/02/2020 16:06	28/02/2020 21:12	28/02/2020 17:07	28/02/2020 17:27	0,34	86	29,41	CHI
202002183618	POSSE	01230434	IACIARA S2	28/02/2020 16:06	28/02/2020 21:12	28/02/2020 17:07	28/02/2020 17:27	0,34	1439	492,06	CHI
202002183618	POSSE	PS11386178	IACIARA S2	28/02/2020 16:06	28/02/2020 21:12	28/02/2020 16:06	28/02/2020 17:27	1,35	77	104,08	CHI
202002183618	POSSE	PS12218767	IACIARA S2	28/02/2020 16:06	28/02/2020 21:12	28/02/2020 19:01	28/02/2020 20:04	1,06	386	411,09	CHI
202002183618	POSSE	PS12194558	IACIARA S2	28/02/2020 16:06	28/02/2020 21:12	28/02/2020 18:59	28/02/2020 20:51	1,86	1036	1922,36	CHI
202002183618	GUARANI DE GOIAS	PS13132340	IACIARA S2	28/02/2020 16:06	28/02/2020 21:12	28/02/2020 17:07	28/02/2020 21:12	4,09	99	405,05	CHI
202002183618	POSSE	PS13132340	IACIARA S2	28/02/2020 16:06	28/02/2020 21:12	28/02/2020 17:07	28/02/2020 21:12	4,09	62	253,67	CHI
202002183620	SAO JOAO DA PARAUNA	RP12384674	FIRMINOPOLIS S2	28/02/2020 16:06	28/02/2020 17:20	28/02/2020 16:06	28/02/2020 17:20	1,22	1	1,22	CHI
202002183621	MARA ROSA	MQ12313418	MARA ROSA	28/02/2020 16:07	28/02/2020 22:23	28/02/2020 16:07	28/02/2020 22:23	6,26	6	37,54	CHI
202002183623	ACREUNA	EA12257973	EDEIA	28/02/2020 14:47	28/02/2020 21:09	28/02/2020 14:47	28/02/2020 21:09	6,36	13	82,68	CHI
202002183623	EDEIA	EA12257973	EDEIA	28/02/2020 14:47	28/02/2020 21:09	28/02/2020 14:47	28/02/2020 21:09	6,36	25	159,00	CHI
202002183623	INDIARA	EA12257973	EDEIA	28/02/2020 14:47	28/02/2020 21:09	28/02/2020 14:47	28/02/2020 21:09	6,36	7	44,52	CHI
202002183630	CIDADE OCIDENTAL	DH11199612	MARAJOARA	28/02/2020 15:17	28/02/2020 19:40	28/02/2020 15:17	28/02/2020 19:40	4,38	117	513,01	CHI
202002183634	PADRE BERNARDO	PB12321774	PADRE BERNARDO	28/02/2020 16:09	28/02/2020 20:12	28/02/2020 16:09	28/02/2020 20:12	4,04	4	16,14	CHI
202002183636	SANTO ANTONIO DO DESCOBERTO	SN12010404	MARAJOARA	28/02/2020 16:10	28/02/2020 18:03	28/02/2020 16:10	28/02/2020 18:03	1,88	64	120,32	CHI
202002183637	GOIAS	GS21131414	MATRINCHA	28/02/2020 16:10	29/02/2020 10:00	28/02/2020 16:10	29/02/2020 10:00	17,82	2	35,65	CHI
202002183639	GOIANIA	GN11000685	REAL S2	28/02/2020 16:11	28/02/2020 20:00	28/02/2020 16:11	28/02/2020 20:00	3,81	37	140,91	CHI
202002183641	JARAGUA	JA21273335	JARAGUA	28/02/2020 16:11	28/02/2020 22:37	28/02/2020 16:11	28/02/2020 22:37	6,42	1	6,42	CHI
202002183646	AGUA LIMPA	AL12024213	VILA CORUMBA	28/02/2020 16:13	29/02/2020 10:47	28/02/2020 16:13	29/02/2020 10:47	18,57	2	37,13	CHI
202002183652	CACHOEIRA ALTA	CA12013266	CACHOEIRA ALTA	28/02/2020 16:14	29/02/2020 01:24	28/02/2020 16:14	29/02/2020 01:24	9,15	16	146,47	CHI
202002183701	PETROLINA DE GOIAS	PG12075851	PETROLINA	28/02/2020 16:14	28/02/2020 20:35	28/02/2020 16:14	28/02/2020 20:35	4,33	17	73,69	CHI
202002183709	VIANOPOLIS	VN12168187	VIANOPOLIS	28/02/2020 16:15	29/02/2020 12:52	28/02/2020 16:15	29/02/2020 12:52	20,61	12	247,28	CHI
202002183709	VIANOPOLIS	VN12168187	VIANOPOLIS	28/02/2020 16:15	29/02/2020 12:52	28/02/2020 18:25	29/02/2020 12:52	18,45	1	18,45	CHI
202002183717	GOIAS	GS11162299	GOIAS	28/02/2020 16:17	29/02/2020 11:00	28/02/2020 16:17	29/02/2020 11:00	18,71	2	37,42	CHI
202002183720	EDEIA	EA21031113	RIO DOS BOIS	28/02/2020 16:18	29/02/2020 10:27	28/02/2020 16:18	29/02/2020 10:27	18,14	1	18,14	CHI
202002183721	LUZIANIA	LZ12313611	VIANOPOLIS	28/02/2020 12:16	28/02/2020 17:26	28/02/2020 12:16	28/02/2020 17:26	5,17	13	67,15	CHI
202002183724	RIO QUENTE	RQ12087020	RIO QUENTE	28/02/2020 16:19	29/02/2020 00:07	28/02/2020 16:19	29/02/2020 00:07	7,79	10	77,93	CHI
202002183737	ABADIANIA	SV12265211	DAIA S2	28/02/2020 16:10	28/02/2020 18:20	28/02/2020 16:10	28/02/2020 18:20	2,16	4	8,65	CHI
202002183737	ANAPOLIS	SV12265211	DAIA S2	28/02/2020 16:10	28/02/2020 18:20	28/02/2020 16:10	28/02/2020 18:20	2,16	4	8,65	CHI
202002183737	GAMELEIRA DE GOIAS	SV12265211	DAIA S2	28/02/2020 16:10	28/02/2020 18:20	28/02/2020 16:10	28/02/2020 18:20	2,16	119	257,47	CHI
202002183743	ANAPOLIS	AN21267920	ANAPOLIS UNIVERSITARIO S2	28/02/2020 16:23	28/02/2020 18:24	28/02/2020 16:23	28/02/2020 18:24	2,01	3	6,02	CHI
202002183745	BELA VISTA DE GOIAS	BV21060727	CEPAIGO S2	28/02/2020 16:24	28/02/2020 18:55	28/02/2020 16:24	28/02/2020 18:55	2,51	1	2,51	CHI
202002183759	GOIAS	GS21124365	GOIAS	28/02/2020 16:25	28/02/2020 21:54	28/02/2020 16:25	28/02/2020 21:54	5,48	2	10,96	CHI
202002183762	BELA VISTA DE GOIAS	BV12131458	BELA VISTA S1	28/02/2020 16:25	28/02/2020 22:31	28/02/2020 16:25	28/02/2020 22:31	6,09	53	322,52	CHI
202002183766	AURILANDIA	AI12232979	FIRMINOPOLIS S2	28/02/2020 16:26	29/02/2020 08:48	28/02/2020 16:26	29/02/2020 08:48	16,35	5	81,77	CHI
202002183772	PIRACANJUBA	PJ12223396	ROCHEDO	28/02/2020 16:16	29/02/2020 09:48	28/02/2020 16:16	29/02/2020 09:48	17,52	3	52,56	CHI
202002183779	NOVO BRASIL	NB12396223	JUSSARA	28/02/2020 16:28	29/02/2020 15:33	28/02/2020 16:28	29/02/2020 15:33	23,07	4	92,27	CHI

202002183786	NOVO GAMA	NJ11201128	PACAEMBU S1	28/02/2020 16:30	28/02/2020 21:29	28/02/2020 16:30	28/02/2020 21:29	4,97	257	1277,00	CHI
202002183787	ITARUMA	IM12296697	CACHOEIRA ALTA	28/02/2020 16:31	28/02/2020 22:19	28/02/2020 16:31	28/02/2020 22:19	5,80	13	75,37	CHI
202002183788	ARAGUAPAZ	AZ21143347	GOIAS	28/02/2020 16:31	28/02/2020 20:42	28/02/2020 16:31	28/02/2020 20:42	4,18	1	4,18	CHI
202002183789	SAO JOAO D ALIANCA	JL12218373	SAO JOAO D ALIANCA	28/02/2020 16:31	29/02/2020 01:52	28/02/2020 16:31	29/02/2020 01:52	9,34	134	1251,56	CHI
202002183790	SAO JOAO DA PARAUNA	RP21349327	FIRMINOPOLIS S1	28/02/2020 16:31	28/02/2020 19:59	28/02/2020 16:31	28/02/2020 19:59	3,46	2	6,91	CHI
202002183791	ANAPOLIS	AN12258749	JUNDIAI S1	28/02/2020 15:18	28/02/2020 18:29	28/02/2020 15:18	28/02/2020 18:29	3,18	46	146,06	CHI
202002183793	BURITI ALEGRE	BG21134586	ITUMBIARA VELHA S2	28/02/2020 16:32	28/02/2020 20:33	28/02/2020 16:32	28/02/2020 20:33	4,01	1	4,01	CHI
202002183794	ANAPOLIS	21222484	JUNDIAI S1	28/02/2020 16:32	29/02/2020 08:20	28/02/2020 16:32	29/02/2020 08:20	15,79	1	15,79	CHI
202002183797	PIRACANJUBA	PJ12000119	PIRACANJUBA	28/02/2020 15:33	28/02/2020 23:06	28/02/2020 15:33	28/02/2020 23:06	7,54	6	45,25	CHI
202002183799	FAINA	FC12272620	GOIAS	28/02/2020 15:13	28/02/2020 18:48	28/02/2020 15:13	28/02/2020 18:48	3,59	4	14,35	CHI
202002183800	NOVA CRIXAS	NA12334349	NOVA CRIXAS	28/02/2020 13:17	29/02/2020 07:45	28/02/2020 13:17	29/02/2020 07:45	18,45	86	1586,75	CHI
202002183801	VILA PROPICIO	PV21196945	GOIANESIA S1	28/02/2020 16:34	29/02/2020 10:00	28/02/2020 16:34	29/02/2020 10:00	17,42	1	17,42	CHI
202002183802	FORMOSA	FA11262428	ITUIQUIRA	28/02/2020 16:34	28/02/2020 18:35	28/02/2020 16:34	28/02/2020 18:35	2,01	23	46,28	CHI
202002183805	BURITINOPOLIS	BQ11180926	IACIARA S2	28/02/2020 16:35	28/02/2020 18:40	28/02/2020 16:35	28/02/2020 18:40	2,07	140	289,37	CHI
202002183808	GOIANIA	12534560	ATLANTICO S2	28/02/2020 16:37	28/02/2020 18:35	28/02/2020 16:37	28/02/2020 18:35	1,96	1	1,96	CHI
202002183810	GOIANIA	10730904	ATLANTICO S2	28/02/2020 16:37	28/02/2020 20:40	28/02/2020 16:37	28/02/2020 20:40	4,04	1	4,04	CHI
202002183817	ITAGUARI	II21327356	ITABERAI S1	28/02/2020 16:39	29/02/2020 08:09	28/02/2020 16:39	29/02/2020 08:09	15,49	1	15,49	CHI
202002183818	CALDAS NOVAS	CN11162476	CALDAS NOVAS S1	28/02/2020 15:24	28/02/2020 21:58	28/02/2020 15:24	28/02/2020 21:58	6,57	47	308,59	CHI
202002183819	CATALAO	CT12104183	CATALAO S1	28/02/2020 16:40	28/02/2020 23:27	28/02/2020 16:40	28/02/2020 23:27	6,78	6	40,70	CHI
202002183826	CEZARINA	CZ21154057	CEZARINA	28/02/2020 16:41	29/02/2020 08:16	28/02/2020 16:41	29/02/2020 08:16	15,59	1	15,59	CHI
202002183828	DAMIANOPOLIS	SI2202236	IACIARA S2	28/02/2020 16:42	28/02/2020 17:54	28/02/2020 16:42	28/02/2020 17:54	1,19	27	32,26	CHI
202002183828	SITIO D ABADIA	SI2202236	IACIARA S2	28/02/2020 16:42	28/02/2020 17:54	28/02/2020 16:42	28/02/2020 17:54	1,19	1	1,19	CHI
202002183834	AGUAS LINDAS DE GOIAS	4830034714	AGUAS LINDAS DE GOIAS S2	28/02/2020 16:43	28/02/2020 18:07	28/02/2020 16:43	28/02/2020 18:07	1,39	0	0,00	CHI
202002183836	AGUA LIMPA	RQ12257962	VILA CORUMBA	28/02/2020 16:15	28/02/2020 18:27	28/02/2020 16:15	28/02/2020 18:27	2,21	9	19,88	CHI
202002183836	MORRINHOS	RQ12257962	VILA CORUMBA	28/02/2020 16:15	28/02/2020 18:27	28/02/2020 16:15	28/02/2020 18:27	2,21	5	11,05	CHI
202002183836	RIO QUENTE	RQ12257962	VILA CORUMBA	28/02/2020 16:15	28/02/2020 18:27	28/02/2020 16:15	28/02/2020 18:27	2,21	55	121,50	CHI
202002183840	VILA PROPICIO	NP12339454	GOIANESIA S1	28/02/2020 16:44	29/02/2020 10:41	28/02/2020 16:44	29/02/2020 10:00	17,26	14	241,65	CHI
202002183840	VILA PROPICIO	NP12339454	GOIANESIA S1	28/02/2020 16:44	29/02/2020 10:41	28/02/2020 16:44	29/02/2020 10:41	17,94	98	1758,53	CHI
202002183846	CALDAS NOVAS	CN12257954	SERRA DE CALDAS	28/02/2020 15:46	28/02/2020 19:56	28/02/2020 15:46	28/02/2020 19:56	4,15	69	286,43	CHI
202002183847	SENADOR CANEDO	SW12402764	SENADOR CANEDO	28/02/2020 16:08	28/02/2020 23:57	28/02/2020 16:08	28/02/2020 19:20	3,20	364	1163,99	CHI
202002183847	SENADOR CANEDO	SW12402764	SENADOR CANEDO	28/02/2020 16:08	28/02/2020 23:57	28/02/2020 19:25	28/02/2020 20:12	0,77	279	215,84	CHI
202002183847	SENADOR CANEDO	SW12402764	SENADOR CANEDO	28/02/2020 16:08	28/02/2020 23:57	28/02/2020 20:51	28/02/2020 21:10	0,33	279	90,91	CHI
202002183847	SENADOR CANEDO	SW21350094	SENADOR CANEDO	28/02/2020 16:08	28/02/2020 23:57	28/02/2020 19:25	28/02/2020 23:32	4,11	1	4,11	CHI
202002183847	SENADOR CANEDO	20238893	SENADOR CANEDO	28/02/2020 16:08	28/02/2020 23:57	28/02/2020 19:25	28/02/2020 23:46	4,34	79	342,82	CHI
202002183847	SENADOR CANEDO	20238893	SENADOR CANEDO	28/02/2020 16:08	28/02/2020 23:57	28/02/2020 19:25	28/02/2020 23:53	4,46	3	13,38	CHI
202002183847	SENADOR CANEDO	20238893	SENADOR CANEDO	28/02/2020 16:08	28/02/2020 23:57	28/02/2020 19:25	28/02/2020 23:57	4,52	2	9,04	CHI
202002183848	BARRO ALTO	BA12258276	GOIANESIA S1	28/02/2020 10:49	28/02/2020 19:05	28/02/2020 10:49	28/02/2020 19:05	8,25	15	123,80	CHI
202002183848	GOIANESIA	BA12258276	GOIANESIA S1	28/02/2020 10:49	28/02/2020 19:05	28/02/2020 10:49	28/02/2020 19:05	8,25	112	924,34	CHI
202002183848	VILA PROPICIO	BA12258276	GOIANESIA S1	28/02/2020 10:49	28/02/2020 19:05	28/02/2020 10:49	28/02/2020 19:05	8,25	12	99,04	CHI
202002183854	PARAUNA	PU21312549	PARAUNA	28/02/2020 16:47	28/02/2020 23:41	28/02/2020 16:47	28/02/2020 23:41	6,90	1	6,90	CHI
202002183858	CACHOEIRA ALTA	CA21081289	CACHOEIRA ALTA	28/02/2020 16:47	29/02/2020 10:07	28/02/2020 16:47	29/02/2020 10:07	17,33	1	17,33	CHI
202002183861	SAO FRANCISCO DE GOIAS	SF12000106	SAO FRANCISCO DE GOIAS	28/02/2020 16:17	28/02/2020 19:08	28/02/2020 16:17	28/02/2020 19:08	2,85	9	25,62	CHI
202002183871	BURITI ALEGRE	BG12090571	ITUMBIARA VELHA S2	28/02/2020 16:52	29/02/2020 11:20	28/02/2020 16:52	29/02/2020 11:20	18,46	1	18,46	CHI
202002183874	NOVA CRIXAS	NA11357654	NOVA CRIXAS	28/02/2020 16:53	29/02/2020 17:21	28/02/2020 16:53	29/02/2020 17:21	24,46	1	24,46	CHI

202002183875	HIDROLANDIA	HD21291462	CEPAIGO S2	28/02/2020 16:53	28/02/2020 21:36	28/02/2020 16:53	28/02/2020 21:36	4,71	1	4,71	CHI
202002183888	CAMPESTRE DE GOIAS	GC12000122	TRINDADE	28/02/2020 16:56	28/02/2020 23:17	28/02/2020 16:56	28/02/2020 23:17	6,36	1	6,36	CHI
202002183891	FORMOSA	610159392	ITUIQUIRA	28/02/2020 16:56	28/02/2020 18:36	28/02/2020 16:56	28/02/2020 18:36	1,65	1	1,65	CHI
202002183895	CACHOEIRA DOURADA	CD12000044	CACHOEIRA DOURADA	28/02/2020 14:59	28/02/2020 17:56	28/02/2020 14:59	28/02/2020 17:56	2,94	8	23,50	CHI
202002183901	MARA ROSA	ET21208327	MARA ROSA	28/02/2020 16:58	29/02/2020 18:11	28/02/2020 16:58	29/02/2020 18:11	25,20	1	25,20	CHI
202002183903	GOIANESIA	GE21000009	GOIANESIA S2	28/02/2020 17:00	28/02/2020 23:10	28/02/2020 17:00	28/02/2020 23:10	6,16	1	6,16	CHI
202002183905	PIRACANJUBA	PJ12263529	PIRACANJUBA	28/02/2020 17:01	28/02/2020 23:51	28/02/2020 17:01	28/02/2020 23:51	6,83	2	13,66	CHI
202002183907	NOVA CRIXAS	NA12321769	MOZARLANDIA	28/02/2020 17:01	29/02/2020 09:10	28/02/2020 17:01	29/02/2020 09:10	16,16	11	177,75	CHI
202002183908	CRISTALINA	3490003868	PAMPLONA	28/02/2020 17:01	28/02/2020 20:49	28/02/2020 17:01	28/02/2020 20:49	3,80	1	3,80	CHI
202002183909	GOIANIA	13984184	MEIA PONTE	28/02/2020 17:01	28/02/2020 19:10	28/02/2020 17:01	28/02/2020 19:10	2,14	1	2,14	CHI
202002183911	SAO JOAO D ALIANCA	JL12253236	SAO JOAO D ALIANCA	28/02/2020 13:06	29/02/2020 11:20	28/02/2020 13:06	29/02/2020 11:20	22,25	14	311,48	CHI
202002183913	COCALZINHO DE GOIAS	ZN12302401	COCALZINHO	28/02/2020 14:26	28/02/2020 21:11	28/02/2020 14:26	28/02/2020 21:11	6,74	4	26,95	CHI
202002183913	CORUMBA DE GOIAS	ZN12302401	COCALZINHO	28/02/2020 14:26	28/02/2020 21:11	28/02/2020 14:26	28/02/2020 21:11	6,74	22	148,23	CHI
202002183914	CATURAI	TR32036669	TRINDADE	28/02/2020 17:03	01/03/2020 16:10	28/02/2020 17:03	29/02/2020 01:50	8,78	2	17,55	CHI
202002183914	CATURAI	TR32036669	TRINDADE	28/02/2020 17:03	01/03/2020 16:10	28/02/2020 17:03	29/02/2020 09:30	16,46	2	32,91	CHI
202002183914	CATURAI	TR32036669	TRINDADE	28/02/2020 17:03	01/03/2020 16:10	28/02/2020 17:03	01/03/2020 14:05	45,04	3	135,11	CHI
202002183914	SANTA BARBARA DE GOIAS	TR32036669	TRINDADE	28/02/2020 17:03	01/03/2020 16:10	28/02/2020 17:03	01/03/2020 14:05	45,04	11	495,41	CHI
202002183914	TRINDADE	TR32036669	TRINDADE	28/02/2020 17:03	01/03/2020 16:10	28/02/2020 17:03	01/03/2020 14:05	45,04	6	270,23	CHI
202002183914	CATURAI	TR32036669	TRINDADE	28/02/2020 17:03	01/03/2020 16:10	01/03/2020 12:20	01/03/2020 14:05	1,75	4	7,00	CHI
202002183914	SANTA BARBARA DE GOIAS	TR32036669	TRINDADE	28/02/2020 17:03	01/03/2020 16:10	28/02/2020 17:03	01/03/2020 14:59	45,94	10	459,35	CHI
202002183914	TRINDADE	TR32036669	TRINDADE	28/02/2020 17:03	01/03/2020 16:10	28/02/2020 17:03	01/03/2020 14:59	45,94	1	45,94	CHI
202002183914	SANTA BARBARA DE GOIAS	SB12234175	TRINDADE	28/02/2020 17:03	01/03/2020 16:10	28/02/2020 21:03	01/03/2020 14:59	41,94	1	41,94	CHI
202002183914	CATURAI	TR32036669	TRINDADE	28/02/2020 17:03	01/03/2020 16:10	28/02/2020 17:03	01/03/2020 15:13	46,17	1	46,17	CHI
202002183914	TRINDADE	TR32036669	TRINDADE	28/02/2020 17:03	01/03/2020 16:10	28/02/2020 17:03	01/03/2020 15:13	46,17	2	92,34	CHI
202002183914	TRINDADE	TR32036669	TRINDADE	28/02/2020 17:03	01/03/2020 16:10	28/02/2020 17:03	01/03/2020 16:10	47,12	2	94,25	CHI
202002183917	IPAMERI	IP12114851	PIRES DO RIO S2	28/02/2020 12:37	28/02/2020 19:13	28/02/2020 12:37	28/02/2020 19:13	6,59	8	52,71	CHI
202002183919	IPAMERI	IP21152027	PIRES DO RIO S2	28/02/2020 14:48	28/02/2020 20:25	28/02/2020 14:48	28/02/2020 20:25	5,61	1	5,61	CHI
202002183927	ITABERAI	AC12382721	ARACU	28/02/2020 17:05	29/02/2020 11:24	28/02/2020 17:05	29/02/2020 11:24	18,31	1	18,31	CHI
202002183928	JANDAIA	JD12055081	PALMEIRAS	28/02/2020 15:19	28/02/2020 19:12	28/02/2020 15:19	28/02/2020 19:12	3,88	12	46,57	CHI
202002183930	ALEXANIA	AX12071331	ALEXANIA	28/02/2020 17:07	28/02/2020 18:35	28/02/2020 17:07	28/02/2020 18:35	1,46	8	11,69	CHI
202002183930	SANTO ANTONIO DO DESCOBERTO	AX12071331	ALEXANIA	28/02/2020 17:07	28/02/2020 18:35	28/02/2020 17:07	28/02/2020 18:35	1,46	3	4,38	CHI
202002183932	ALTO PARAISO DE GOIAS	10016246630	NIQUELANDIA SUBTRANSMISSAO	28/02/2020 17:07	28/02/2020 20:35	28/02/2020 17:07	28/02/2020 20:35	3,45	1	3,45	CHI
202002183933	ITABERAI	IB12267321	ITABERAI S2	28/02/2020 17:07	28/02/2020 18:21	28/02/2020 17:07	28/02/2020 18:21	1,22	180	219,55	CHI
202002183934	PARAUNA	PU12167339	PARAUNA	28/02/2020 17:07	28/02/2020 19:24	28/02/2020 17:07	28/02/2020 19:24	2,27	10	22,68	CHI
202002183940	CAMPESTRE DE GOIAS	GC11277373	TRINDADE	28/02/2020 17:09	28/02/2020 19:13	28/02/2020 17:09	28/02/2020 19:13	2,07	1	2,07	CHI
202002183945	TRINDADE	TR12193149	GOYA S2	28/02/2020 17:09	28/02/2020 17:56	28/02/2020 17:09	28/02/2020 17:56	0,77	68	52,40	CHI
202002183949	GOIANIRA	GR11131273	GOIANIRA	28/02/2020 17:10	28/02/2020 19:03	28/02/2020 17:10	28/02/2020 19:03	1,87	131	244,57	CHI
202002183955	IPAMERI	IP21300591	IPAMERI	28/02/2020 17:13	29/02/2020 18:05	28/02/2020 17:13	29/02/2020 18:05	24,86	1	24,86	CHI
202002183956	GOIANESIA	GE21000007	GOIANESIA S2	28/02/2020 17:13	29/02/2020 00:54	28/02/2020 17:13	29/02/2020 00:54	7,68	1	7,68	CHI
202002183962	SILVANIA	SV12205354	DAIA S2	28/02/2020 16:08	01/03/2020 03:52	28/02/2020 16:08	28/02/2020 22:36	6,47	12	77,59	CHI
202002183962	SILVANIA	SV12205354	DAIA S2	28/02/2020 16:08	01/03/2020 03:52	28/02/2020 16:08	01/03/2020 03:52	35,74	26	929,22	CHI
202002183962	SILVANIA	SV12205354	DAIA S2	28/02/2020 16:08	01/03/2020 03:52	01/03/2020 01:08	01/03/2020 03:52	2,74	12	32,86	CHI
202002183967	AGUAS LINDAS DE GOIAS	4830406927	AGUAS LINDAS DE GOIAS S1	28/02/2020 17:16	28/02/2020 19:38	28/02/2020 17:16	28/02/2020 19:38	2,37	1	2,37	CHI
202002183971	ITAPIRAPUA	IU12020125	MATRINCHA	28/02/2020 16:12	28/02/2020 19:52	28/02/2020 16:12	28/02/2020 19:52	3,65	14	51,17	CHI

202002183972	GUAPO	GA11276690	GUAPO S2	28/02/2020 17:17	29/02/2020 09:39	28/02/2020 17:17	29/02/2020 09:39	16,37	1	16,37	CHI
202002183973	ITABERAI	IB11183038	ITABERAI S2	28/02/2020 17:17	28/02/2020 22:55	28/02/2020 17:17	28/02/2020 22:55	5,63	30	168,85	CHI
202002183983	CATALAO	10008632284	CATALAO S2	28/02/2020 17:19	29/02/2020 00:01	28/02/2020 17:19	29/02/2020 00:01	6,69	1	6,69	CHI
202002183987	CALDAS NOVAS	CN21204423	SERRA DE CALDAS	28/02/2020 17:20	29/02/2020 19:59	28/02/2020 17:20	29/02/2020 19:59	26,65	1	26,65	CHI
202002183992	MINACU	IH12230469	MINACU	28/02/2020 17:20	28/02/2020 20:16	28/02/2020 17:20	28/02/2020 20:16	2,93	22	64,35	CHI
202002183994	CACHOEIRA ALTA	CA12075132	CACHOEIRA ALTA	28/02/2020 17:20	29/02/2020 07:52	28/02/2020 17:20	29/02/2020 07:52	14,53	22	319,59	CHI
202002184000	ITUMBIARA	IT12000414	ITUMBIARA NOVA	28/02/2020 17:21	29/02/2020 02:05	28/02/2020 17:21	29/02/2020 02:05	8,73	7	61,11	CHI
202002184001	IPAMERI	IP12183820	PIRES DO RIO S2	28/02/2020 17:06	28/02/2020 19:36	28/02/2020 17:06	28/02/2020 19:36	2,50	1	2,50	CHI
202002184110	SAO MIGUEL DO PASSA QUATRO	SQ21216988	CRISTIANOPOLIS	28/02/2020 17:25	29/02/2020 08:02	28/02/2020 17:25	29/02/2020 08:02	14,62	1	14,62	CHI
202002184112	SAO LUIS DE MONTES BELOS	500036299	SAO LUIZ DOS MONTES BELOS	28/02/2020 17:25	28/02/2020 20:19	28/02/2020 17:25	28/02/2020 20:19	2,89	1	2,89	CHI
202002184116	NOVA ROMA	ND11272104	IACIARA S2	28/02/2020 17:27	28/02/2020 18:27	28/02/2020 17:27	28/02/2020 18:27	1,00	3	3,00	CHI
202002184126	CALDAS NOVAS	CN11213907	SERRA DE CALDAS	28/02/2020 17:29	29/02/2020 02:35	28/02/2020 17:29	29/02/2020 02:35	9,10	5	45,49	CHI
202002184127	GOIANIA	14876190	MEIA PONTE	28/02/2020 17:30	28/02/2020 19:06	28/02/2020 17:30	28/02/2020 19:06	1,59	1	1,59	CHI
202002184132	MARA ROSA	MQ12125574	MARA ROSA	28/02/2020 17:18	28/02/2020 22:52	28/02/2020 17:18	28/02/2020 22:52	5,56	14	77,85	CHI
202002184133	CRISTIANOPOLIS	SQ12154764	CRISTIANOPOLIS	28/02/2020 17:31	29/02/2020 12:04	28/02/2020 17:31	29/02/2020 12:04	18,54	2	37,07	CHI
202002184135	HIDROLANDIA	HD12320393	PONTALINA	28/02/2020 17:32	29/02/2020 00:12	28/02/2020 17:32	29/02/2020 00:12	6,67	9	59,99	CHI
202002184135	VARJAO	HD12320393	PONTALINA	28/02/2020 17:32	29/02/2020 00:12	28/02/2020 17:32	29/02/2020 00:12	6,67	1	6,67	CHI
202002184136	LUZIANIA	10023715195	RIO VERMELHO	28/02/2020 17:32	28/02/2020 20:56	28/02/2020 17:32	28/02/2020 20:56	3,40	1	3,40	CHI
202002184138	ITABERAI	TQ21021974	ITABERAI S2	28/02/2020 17:32	28/02/2020 19:22	28/02/2020 17:32	28/02/2020 19:22	1,82	3	5,47	CHI
202002184139	SITIO D ABADIA	AQ21240901	IACIARA S2	28/02/2020 17:32	28/02/2020 19:28	28/02/2020 17:32	28/02/2020 19:28	1,92	1	1,92	CHI
202002184140	EDEALINA	EA12034059	VICENTINOPOLIS	28/02/2020 14:08	28/02/2020 20:36	28/02/2020 14:08	28/02/2020 20:36	6,46	4	25,85	CHI
202002184144	CEZARINA	CZ21310224	GUAPO S2	28/02/2020 17:33	29/02/2020 08:20	28/02/2020 17:33	29/02/2020 08:20	14,78	3	44,33	CHI
202002184147	NAZARIO	440018432	ANICUNS	28/02/2020 17:33	28/02/2020 23:16	28/02/2020 17:33	28/02/2020 23:16	5,70	1	5,70	CHI
202002184152	JATAI	10011246454	JATAI S2	28/02/2020 17:34	28/02/2020 21:04	28/02/2020 17:34	28/02/2020 21:04	3,49	1	3,49	CHI
202002184159	GOIANIA	GN12338048	FERROVIARIO S3	28/02/2020 17:35	28/02/2020 19:48	28/02/2020 17:35	28/02/2020 19:48	2,21	924	2038,96	CHI
202002184161	PADRE BERNARDO	PB21330890	PADRE BERNARDO	28/02/2020 17:36	28/02/2020 21:43	28/02/2020 17:36	28/02/2020 21:43	4,11	1	4,11	CHI
202002184163	LUZIANIA	LZ21379601	VIANOPOLIS	28/02/2020 17:36	28/02/2020 21:15	28/02/2020 17:36	28/02/2020 21:15	3,64	1	3,64	CHI
202002184166	LUZIANIA	LZ21086762	VIANOPOLIS	28/02/2020 17:37	29/02/2020 01:04	28/02/2020 17:37	29/02/2020 01:04	7,46	1	7,46	CHI
202002184167	PARAUNA	980007768	PARAUNA	28/02/2020 17:37	29/02/2020 01:03	28/02/2020 17:37	29/02/2020 01:03	7,42	1	7,42	CHI
202002184177	ABADIA DE GOIAS	LG11170643	CARAJAS S1	28/02/2020 13:43	28/02/2020 20:12	28/02/2020 13:43	28/02/2020 20:12	6,47	102	660,37	CHI
202002184178	MOIPORA	1450003830	IPORA	28/02/2020 17:40	28/02/2020 22:42	28/02/2020 17:40	28/02/2020 22:42	5,03	1	5,03	CHI
202002184183	MORRINHOS	MR21158092	MORRINHOS	28/02/2020 17:41	29/02/2020 09:40	28/02/2020 17:41	29/02/2020 09:40	15,99	1	15,99	CHI
202002184184	BELA VISTA DE GOIAS	BV12011061	BELA VISTA S1	28/02/2020 17:41	29/02/2020 05:40	28/02/2020 17:41	29/02/2020 05:40	11,98	28	335,32	CHI
202002184190	CACU	CC12338616	CACHOEIRA ALTA	28/02/2020 17:32	29/02/2020 00:14	28/02/2020 17:32	29/02/2020 00:14	6,69	32	214,15	CHI
202002184191	CUMARI	CY21000320	CATALAO S1	28/02/2020 17:43	29/02/2020 09:49	28/02/2020 17:43	29/02/2020 09:49	16,09	1	16,09	CHI
202002184195	SANTA TEREZINHA DE GOIAS	SG12188672LD	SANTA TEREZINHA	28/02/2020 17:44	29/02/2020 00:22	28/02/2020 17:44	29/02/2020 00:22	6,63	1	6,63	CHI
202002184195	SANTA TEREZINHA DE GOIAS	SG12188672LD	SANTA TEREZINHA	28/02/2020 17:44	29/02/2020 00:22	28/02/2020 21:46	29/02/2020 00:22	2,60	1	2,60	CHI
202002184203	MORRINHOS	150156133	MORRINHOS	28/02/2020 17:42	29/02/2020 03:23	28/02/2020 17:42	29/02/2020 03:23	9,68	1	9,68	CHI
202002184215	TAQUARAL DE GOIAS	TQ12171611	INHUMAS S1	28/02/2020 16:01	29/02/2020 09:57	28/02/2020 16:01	29/02/2020 09:57	17,92	3	53,76	CHI
202002184218	SAO SIMAO	01410424	CACHOEIRA ALTA	28/02/2020 19:20	29/02/2020 03:17	28/02/2020 19:23	28/02/2020 23:50	4,44	3	13,31	CHI
202002184218	SAO SIMAO	SO13322243	CACHOEIRA ALTA	28/02/2020 19:20	29/02/2020 03:17	28/02/2020 19:23	29/02/2020 00:57	5,56	1	5,56	CHI
202002184218	CACU	SO13322244	CACHOEIRA ALTA	28/02/2020 19:20	29/02/2020 03:17	28/02/2020 19:23	29/02/2020 01:47	6,40	1	6,40	CHI
202002184218	SAO SIMAO	SO13322244	CACHOEIRA ALTA	28/02/2020 19:20	29/02/2020 03:17	28/02/2020 19:23	29/02/2020 01:47	6,40	3	19,20	CHI
202002184218	SAO SIMAO	SO13303109	CACHOEIRA ALTA	28/02/2020 19:20	29/02/2020 03:17	28/02/2020 19:23	29/02/2020 03:17	7,89	1	7,89	CHI

202002184228	GAMELEIRA DE GOIAS	05720224	DAIA S2	28/02/2020 20:18	01/03/2020 15:12	28/02/2020 20:18	29/02/2020 00:41	4,38	96	420,40	CHI
202002184228	ABADIANIA	05720224	DAIA S2	28/02/2020 20:18	01/03/2020 15:12	28/02/2020 20:18	29/02/2020 02:02	5,72	2	11,45	CHI
202002184228	GAMELEIRA DE GOIAS	05720224	DAIA S2	28/02/2020 20:18	01/03/2020 15:12	28/02/2020 20:18	29/02/2020 02:02	5,72	43	246,12	CHI
202002184228	GAMELEIRA DE GOIAS	05720224	DAIA S2	28/02/2020 20:18	01/03/2020 15:12	28/02/2020 20:18	29/02/2020 14:24	18,09	22	397,94	CHI
202002184228	ABADIANIA	05720224	DAIA S2	28/02/2020 20:18	01/03/2020 15:12	29/02/2020 02:03	29/02/2020 14:24	12,34	2	24,68	CHI
202002184228	GAMELEIRA DE GOIAS	05720224	DAIA S2	28/02/2020 20:18	01/03/2020 15:12	29/02/2020 02:03	29/02/2020 14:24	12,34	42	518,36	CHI
202002184228	GAMELEIRA DE GOIAS	05720224	DAIA S2	28/02/2020 20:18	01/03/2020 15:12	29/02/2020 02:03	01/03/2020 15:12	37,15	1	37,15	CHI
202002184302	BOM JESUS DE GOIAS	IT12309820	CACHOEIRA DOURADA	28/02/2020 17:45	28/02/2020 20:28	28/02/2020 17:45	28/02/2020 20:28	2,72	3	8,15	CHI
202002184302	ITUMBIARA	IT12309820	CACHOEIRA DOURADA	28/02/2020 17:45	28/02/2020 20:28	28/02/2020 17:45	28/02/2020 20:28	2,72	7	19,01	CHI
202002184309	CHAPADAO DO CEU	DJ21131949	CHAPADAO DO CEU	28/02/2020 17:46	28/02/2020 20:35	28/02/2020 17:46	28/02/2020 20:35	2,82	1	2,82	CHI
202002184310	GOIANESIA	GE12241509	GOIANESIA S1	28/02/2020 17:46	29/02/2020 08:05	28/02/2020 17:46	29/02/2020 08:05	14,32	2	28,63	CHI
202002184310	NOVA GLORIA	GE12241509	GOIANESIA S1	28/02/2020 17:46	29/02/2020 08:05	28/02/2020 17:46	29/02/2020 08:05	14,32	2	28,63	CHI
202002184310	SANTA ISABEL	GE12241509	GOIANESIA S1	28/02/2020 17:46	29/02/2020 08:05	28/02/2020 17:46	29/02/2020 08:05	14,32	2	28,63	CHI
202002184312	MARZAGAO	MG21331860	VILA CORUMBA	28/02/2020 17:46	29/02/2020 12:20	28/02/2020 17:46	29/02/2020 12:20	18,56	2	37,11	CHI
202002184321	CRISTALINA	KR12171073	CRISTALINA S2	28/02/2020 16:28	29/02/2020 08:01	28/02/2020 16:28	29/02/2020 08:01	15,54	5	77,69	CHI
202002184504	LUZIANIA	SV12013810	VIANOPOLIS	28/02/2020 17:31	28/02/2020 19:58	28/02/2020 17:31	28/02/2020 19:58	2,45	64	156,73	CHI
202002184504	ORIZONA	SV12013810	VIANOPOLIS	28/02/2020 17:31	28/02/2020 19:58	28/02/2020 17:31	28/02/2020 19:58	2,45	60	146,93	CHI
202002184504	SILVANIA	SV12013810	VIANOPOLIS	28/02/2020 17:31	28/02/2020 19:58	28/02/2020 17:31	28/02/2020 19:58	2,45	16	39,18	CHI
202002184515	PILAR DE GOIAS	GG12309338	SANTA TEREZINHA	28/02/2020 17:29	28/02/2020 23:01	28/02/2020 17:29	28/02/2020 23:01	5,52	7	38,65	CHI
202002184517	DOVERLANDIA	DV12235070	PARQUE DAS EMAS	28/02/2020 17:54	29/02/2020 20:38	28/02/2020 17:54	29/02/2020 20:38	26,73	5	133,66	CHI
202002184519	FAZENDA NOVA	JR12156323	JUSSARA	28/02/2020 17:48	29/02/2020 00:01	28/02/2020 17:48	29/02/2020 00:01	6,22	6	37,33	CHI
202002184519	JUSSARA	JR12156323	JUSSARA	28/02/2020 17:48	29/02/2020 00:01	28/02/2020 17:48	29/02/2020 00:01	6,22	17	105,77	CHI
202002184525	URUACU	UR12317135	URUACU	28/02/2020 17:57	28/02/2020 19:24	28/02/2020 17:57	28/02/2020 19:24	1,43	11	15,78	CHI
202002184530	TURVELANDIA	TD12025685	RIO DOS BOIS	28/02/2020 17:59	28/02/2020 20:03	28/02/2020 17:59	28/02/2020 20:03	2,06	30	61,82	CHI
202002184538	HIDROLANDIA	HD12007513	PONTALINA	29/02/2020 08:22	29/02/2020 13:32	29/02/2020 08:22	29/02/2020 13:32	5,15	52	267,90	CHI
202002184601	RIO VERDE	10008742519	RIO VERDE S1	28/02/2020 18:03	29/02/2020 03:26	28/02/2020 18:03	29/02/2020 03:26	9,37	1	9,37	CHI
202002184605	ARAGUAPAZ	AZ21034578	GOIAS	28/02/2020 18:05	29/02/2020 08:23	28/02/2020 18:05	29/02/2020 08:23	14,30	1	14,30	CHI
202002184607	JANDAIA	JD12008638	PALMEIRAS	28/02/2020 17:33	28/02/2020 20:07	28/02/2020 17:33	28/02/2020 20:07	2,55	90	229,70	CHI
202002184607	PALMEIRAS DE GOIAS	JD12008638	PALMEIRAS	28/02/2020 17:33	28/02/2020 20:07	28/02/2020 17:33	28/02/2020 20:07	2,55	63	160,79	CHI
202002184607	PALMINOPOLIS	JD12008638	PALMEIRAS	28/02/2020 17:33	28/02/2020 20:07	28/02/2020 17:33	28/02/2020 20:07	2,55	14	35,73	CHI
202002184618	ORIZONA	OZ21136907	PIRES DO RIO S1	28/02/2020 18:06	29/02/2020 09:32	28/02/2020 18:06	29/02/2020 09:32	15,42	1	15,42	CHI
202002184620	CEZARINA	CZ12000034	CEZARINA	28/02/2020 16:50	28/02/2020 22:45	28/02/2020 16:50	28/02/2020 22:45	5,91	21	124,02	CHI
202002184620	INDIARA	CZ12000034	CEZARINA	28/02/2020 16:50	28/02/2020 22:45	28/02/2020 16:50	28/02/2020 22:45	5,91	9	53,15	CHI
202002184627	CACHOEIRA ALTA	CA12191598	CACHOEIRA ALTA	28/02/2020 18:08	28/02/2020 21:24	28/02/2020 18:08	28/02/2020 21:24	3,28	28	91,71	CHI
202002184627	CACU	CA12191598	CACHOEIRA ALTA	28/02/2020 18:08	28/02/2020 21:24	28/02/2020 18:08	28/02/2020 21:24	3,28	5	16,38	CHI
202002184628	CAMPESTRE DE GOIAS	GC12010283	TRINDADE	28/02/2020 18:08	28/02/2020 18:50	28/02/2020 18:08	28/02/2020 18:50	0,68	3	2,05	CHI
202002184630	POSSE	PS11204606	IACIARA S2	28/02/2020 18:03	28/02/2020 20:04	28/02/2020 18:03	28/02/2020 20:04	2,03	281	569,42	CHI
202002184632	CAMPO LIMPO	960022077	NEROPOLIS S1	28/02/2020 18:09	29/02/2020 02:28	28/02/2020 18:09	29/02/2020 02:28	8,30	1	8,30	CHI
202002184633	PADRE BERNARDO	PB12275509	PADRE BERNARDO	28/02/2020 17:21	28/02/2020 19:03	28/02/2020 17:21	28/02/2020 19:03	1,69	16	27,11	CHI
202002184634	AMARALINA	LC12270120	SAO MIGUEL DO ARAGUAIA	28/02/2020 17:37	29/02/2020 00:52	28/02/2020 17:37	29/02/2020 00:52	7,23	10	72,34	CHI
202002184638	ANAPOLIS	AN12089153	ANAPOLIS UNIVERSITARIO S2	28/02/2020 14:59	29/02/2020 00:41	28/02/2020 14:59	29/02/2020 00:41	9,69	1	9,69	CHI
202002184638	PIRENOPOLIS	AN12089153	ANAPOLIS UNIVERSITARIO S2	28/02/2020 14:59	29/02/2020 00:41	28/02/2020 14:59	29/02/2020 00:41	9,69	12	116,29	CHI
202002184643	MARA ROSA	MQ12065841	MARA ROSA	28/02/2020 18:11	28/02/2020 23:56	28/02/2020 18:11	28/02/2020 23:56	5,74	1	5,74	CHI
202002184645	MORRINHOS	150134721	MORRINHOS	28/02/2020 18:12	28/02/2020 19:52	28/02/2020 18:12	28/02/2020 19:52	1,67	1	1,67	CHI

202002184646	CAMPINORTE	CR21181238	MARA ROSA	28/02/2020 18:12	29/02/2020 14:31	28/02/2020 18:12	29/02/2020 14:31	20,31	2	40,62	CHI
202002184649	ORIZONA	OZ12216015	VIANOPOLIS	28/02/2020 18:05	28/02/2020 18:54	28/02/2020 18:05	28/02/2020 18:54	0,80	22	17,63	CHI
202002184653	SAO JOAO D ALIANCA	JL12242767LD	SAO JOAO D ALIANCA	28/02/2020 17:31	28/02/2020 23:42	28/02/2020 17:31	28/02/2020 23:42	6,17	5	30,86	CHI
202002184654	FIRMINOPOLIS	FR21000042	FIRMINOPOLIS S1	28/02/2020 18:14	28/02/2020 21:41	28/02/2020 18:14	28/02/2020 21:41	3,44	1	3,44	CHI
202002184660	OURO VERDE DE GOIAS	OV21332133	NEROPOLIS S2	28/02/2020 18:16	28/02/2020 22:31	28/02/2020 18:16	28/02/2020 22:31	4,25	2	8,49	CHI
202002184666	RIO QUENTE	RQ21098224	VILA CORUMBA	28/02/2020 18:17	29/02/2020 13:35	28/02/2020 18:17	29/02/2020 13:35	19,29	1	19,29	CHI
202002184668	NOVA CRIXAS	NA12158761	NOVA CRIXAS	28/02/2020 17:09	28/02/2020 22:12	28/02/2020 17:09	28/02/2020 22:12	5,05	3	15,15	CHI
202002184671	ACREUNA	10016221794	ACREUNA	28/02/2020 18:18	29/02/2020 08:35	28/02/2020 18:18	29/02/2020 08:35	14,27	1	14,27	CHI
202002184681	SANTA HELENA DE GOIAS	SH12295844	IPEGUARI	28/02/2020 09:25	28/02/2020 20:39	28/02/2020 09:25	28/02/2020 20:39	11,22	18	202,04	CHI
202002184692	GUAPO	10008331934	GUAPO S1	28/02/2020 18:23	29/02/2020 11:00	28/02/2020 18:23	29/02/2020 11:00	16,60	1	16,60	CHI
202002184694	CORUMBAIBA	CI12377064	CATALAO S1	28/02/2020 15:55	28/02/2020 21:41	28/02/2020 15:55	28/02/2020 21:41	5,77	12	69,20	CHI
202002184697	HIDROLANDIA	HD12130624	CEPAIGO S2	28/02/2020 18:25	28/02/2020 21:47	28/02/2020 18:25	28/02/2020 21:47	3,36	6	20,16	CHI
202002184699	GAMELEIRA DE GOIAS	AN11273412	DAIA S1	28/02/2020 18:26	28/02/2020 19:30	28/02/2020 18:26	28/02/2020 19:30	1,06	31	32,73	CHI
202002184701	GOIANDIRA	GD12127685	CATALAO S1	29/02/2020 06:17	29/02/2020 10:15	29/02/2020 06:17	29/02/2020 10:15	3,96	10	39,61	CHI
202002184701	NOVA AURORA	GD12127685	CATALAO S1	29/02/2020 06:17	29/02/2020 10:15	29/02/2020 06:17	29/02/2020 10:15	3,96	12	47,53	CHI
202002184705	GUAPO	TR12040839	GUAPO S1	28/02/2020 18:27	28/02/2020 22:15	28/02/2020 18:27	28/02/2020 22:15	3,79	5	18,97	CHI
202002184708	CAMPOS VERDES	VD12264097	SANTA TEREZINHA	28/02/2020 18:27	28/02/2020 23:08	28/02/2020 18:27	28/02/2020 23:08	4,67	6	28,01	CHI
202002184709	JARAGUA	70094949	JARAGUA	28/02/2020 18:28	28/02/2020 22:33	28/02/2020 18:28	28/02/2020 22:33	4,08	1	4,08	CHI
202002184712	ARENOPOLIS	DI12188377	ARENOPOLIS	28/02/2020 18:15	29/02/2020 14:28	28/02/2020 18:15	29/02/2020 14:28	20,22	1	20,22	CHI
202002184712	DIORAMA	DI12188377	ARENOPOLIS	28/02/2020 18:15	29/02/2020 14:28	28/02/2020 18:15	29/02/2020 14:28	20,22	12	242,60	CHI
202002184719	NOVA IGUACU DE GOIAS	NH12317131	CAMPINORTE	28/02/2020 17:45	28/02/2020 20:44	28/02/2020 17:45	28/02/2020 20:44	2,97	42	124,76	CHI
202002184720	CHAPADAO DO CEU	DJ21131309	CHAPADAO DO CEU	28/02/2020 18:31	28/02/2020 19:41	28/02/2020 18:31	28/02/2020 19:41	1,17	1	1,17	CHI
202002184731	ALTO HORIZONTE	NH12202110RE	SANTA TEREZINHA	28/02/2020 18:33	28/02/2020 21:34	28/02/2020 18:33	28/02/2020 21:34	3,00	12	36,05	CHI
202002184731	PILAR DE GOIAS	NH12202110RE	SANTA TEREZINHA	28/02/2020 18:33	28/02/2020 21:34	28/02/2020 18:33	28/02/2020 21:34	3,00	9	27,03	CHI
202002184731	SANTA TEREZINHA DE GOIAS	NH12202110RE	SANTA TEREZINHA	28/02/2020 18:33	28/02/2020 21:34	28/02/2020 18:33	28/02/2020 21:34	3,00	23	69,09	CHI
202002184732	BOM JARDIM DE GOIAS	BM12342030	BOM JARDIM	28/02/2020 18:33	29/02/2020 20:22	28/02/2020 18:33	29/02/2020 20:22	25,80	6	154,82	CHI
202002184734	AMORINOPOLIS	AM12000028	IPORA	28/02/2020 18:33	29/02/2020 17:34	28/02/2020 18:33	29/02/2020 17:34	23,00	5	115,01	CHI
202002184739	LUZIANIA	LZ21149730	RIO VERMELHO	28/02/2020 18:34	28/02/2020 21:17	28/02/2020 18:34	28/02/2020 21:17	2,71	1	2,71	CHI
202002184747	PIRENOPOLIS	220078427	CORUMBA	28/02/2020 18:35	28/02/2020 23:42	28/02/2020 18:35	28/02/2020 23:42	5,11	1	5,11	CHI
202002184748	BURITI ALEGRE	BG12000130	ITUMBIARA VELHA S2	28/02/2020 18:36	29/02/2020 12:44	28/02/2020 18:36	29/02/2020 12:44	18,13	1	18,13	CHI
202002184752	FORMOSA	FA12085494	ITUIQUIRA	28/02/2020 18:16	28/02/2020 20:11	28/02/2020 18:16	28/02/2020 20:11	1,91	4	7,64	CHI
202002184753	PORTEIROAO	10003128944	RIO DOS BOIS	28/02/2020 18:36	29/02/2020 00:50	28/02/2020 18:36	29/02/2020 00:50	6,23	1	6,23	CHI
202002184756	CAMPO ALEGRE DE GOIAS	CM21333412	CAMPO ALEGRE DE GOIAS	28/02/2020 18:37	29/02/2020 08:33	28/02/2020 18:37	29/02/2020 08:33	13,92	2	27,84	CHI
202002184758	CACHOEIRA ALTA	CA21190372	CACHOEIRA ALTA	28/02/2020 18:37	29/02/2020 14:00	28/02/2020 18:37	29/02/2020 14:00	19,37	2	38,74	CHI
202002184762	CALDAS NOVAS	CN12082136RE	SERRA DE CALDAS	28/02/2020 17:47	28/02/2020 20:49	28/02/2020 17:47	28/02/2020 20:49	3,03	29	87,83	CHI
202002184763	CACU	CC12293980	CACHOEIRA ALTA	28/02/2020 18:38	29/02/2020 12:00	28/02/2020 18:38	29/02/2020 12:00	17,35	5	86,76	CHI
202002184765	JUSSARA	JR21137156	JUSSARA	28/02/2020 18:39	29/02/2020 12:38	28/02/2020 18:39	29/02/2020 12:38	17,98	4	71,93	CHI
202002184770	CORUMBA DE GOIAS	CB21215248	CORUMBA	28/02/2020 18:39	28/02/2020 20:33	28/02/2020 18:39	28/02/2020 20:33	1,88	1	1,88	CHI
202002184776	CATALAO	CT12231540RE	CATALAO S1	28/02/2020 18:41	28/02/2020 22:31	28/02/2020 18:41	28/02/2020 22:31	3,83	11	42,08	CHI
202002184783	BOM JESUS DE GOIAS	DM12153969	RIO DOS BOIS	28/02/2020 18:39	29/02/2020 01:15	28/02/2020 18:39	29/02/2020 01:15	6,59	1	6,59	CHI
202002184783	CASTELANDIA	DM12153969	RIO DOS BOIS	28/02/2020 18:39	29/02/2020 01:15	28/02/2020 18:39	29/02/2020 01:15	6,59	5	32,96	CHI
202002184783	QUIRINOPOLIS	DM12153969	RIO DOS BOIS	28/02/2020 18:39	29/02/2020 01:15	28/02/2020 18:39	29/02/2020 01:15	6,59	9	59,33	CHI
202002184785	FAZENDA NOVA	NB12250852	JUSSARA	28/02/2020 19:49	29/02/2020 10:40	28/02/2020 19:49	29/02/2020 10:40	14,84	4	59,37	CHI
202002184785	NOVO BRASIL	NB12250852	JUSSARA	28/02/2020 19:49	29/02/2020 10:40	28/02/2020 19:49	29/02/2020 10:40	14,84	2	29,68	CHI

202002184789	RIO VERDE	630043991	RIO VERDE S2	28/02/2020 18:44	29/02/2020 10:21	28/02/2020 18:44	29/02/2020 10:21	15,60	1	15,60	CHI
202002184791	MORRINHOS	MR12000105	MORRINHOS	28/02/2020 18:44	29/02/2020 00:29	28/02/2020 18:44	29/02/2020 00:29	5,74	6	34,43	CHI
202002184795	RIO QUENTE	RQ12050875	VILA CORUMBA	28/02/2020 18:45	28/02/2020 19:27	28/02/2020 18:45	28/02/2020 19:27	0,69	13	9,02	CHI
202002184800	NIQUELANDIA	NQ12239432	URUACU	28/02/2020 16:47	28/02/2020 21:00	28/02/2020 16:47	28/02/2020 21:00	4,21	19	80,04	CHI
202002184801	BOM JARDIM DE GOIAS	BM12064260	BOM JARDIM	28/02/2020 18:46	29/02/2020 08:37	28/02/2020 18:46	29/02/2020 08:37	13,84	17	235,28	CHI
202002184803	TRINDADE	TR11053494	TRINDADE	28/02/2020 18:43	28/02/2020 21:25	28/02/2020 18:43	28/02/2020 21:25	2,69	185	497,14	CHI
202002184805	CAIAPONIA	CP12372013	IPORA	28/02/2020 18:47	29/02/2020 17:48	28/02/2020 18:47	29/02/2020 17:48	23,01	2	46,02	CHI
202002184814	GOIANIA	12930180	GOYA S1	28/02/2020 18:50	28/02/2020 20:15	28/02/2020 18:50	28/02/2020 20:15	1,41	1	1,41	CHI
202002184816	GOIANIA	14599089	FERROVIARIO S2	28/02/2020 18:50	28/02/2020 21:00	28/02/2020 18:50	28/02/2020 21:00	2,16	1	2,16	CHI
202002184820	AGUAS LINDAS DE GOIAS	10000220009	AGUAS LINDAS DE GOIAS S1	28/02/2020 18:51	28/02/2020 22:20	28/02/2020 18:51	28/02/2020 22:20	3,47	1	3,47	CHI
202002184821	PIRENOPOLIS	PV21082681	SAO FRANCISCO DE GOIAS	28/02/2020 18:51	28/02/2020 22:47	28/02/2020 18:51	28/02/2020 22:47	3,92	3	11,76	CHI
202002184822	ANAPOLIS	20308840	JUNDIAI S1	28/02/2020 18:51	29/02/2020 13:24	28/02/2020 18:51	29/02/2020 13:24	18,54	1	18,54	CHI
202002184826	GOIANIA	10011842022	MEIA PONTE	28/02/2020 18:53	28/02/2020 21:14	28/02/2020 18:53	28/02/2020 21:14	2,34	1	2,34	CHI
202002184828	PIRACANJUBA	PJ21011467	MORRINHOS	28/02/2020 18:54	29/02/2020 09:29	28/02/2020 18:54	29/02/2020 09:29	14,58	1	14,58	CHI
202002184835	CATALAO	CT12266179	CATALAO S1	28/02/2020 16:43	28/02/2020 22:37	28/02/2020 16:43	28/02/2020 22:37	5,89	26	153,09	CHI
202002184844	FORMOSA	610176122	ITUIQUIRA	28/02/2020 18:58	28/02/2020 20:50	28/02/2020 18:58	28/02/2020 20:50	1,86	1	1,86	CHI
202002184845	ACREUNA	EU12085776	ACREUNA	28/02/2020 18:58	01/03/2020 07:13	28/02/2020 18:58	01/03/2020 07:13	36,25	7	253,74	CHI
202002184851	CORUMBAIBA	CI21405700	VILA CORUMBA	28/02/2020 18:59	29/02/2020 22:10	28/02/2020 18:59	29/02/2020 22:10	27,19	1	27,19	CHI
202002184854	PROFESSOR JAMIL SAFADY	JS12000115	ROCHEDO	28/02/2020 19:00	29/02/2020 13:32	28/02/2020 19:00	29/02/2020 13:32	18,52	7	129,62	CHI
202002184855	MOZARLANDIA	MZ12220222	MOZARLANDIA	28/02/2020 15:07	29/02/2020 08:39	28/02/2020 15:07	29/02/2020 08:39	17,52	10	175,23	CHI
202002184856	CACHOEIRA ALTA	CA12200638	CACHOEIRA ALTA	28/02/2020 19:01	29/02/2020 10:40	28/02/2020 19:01	29/02/2020 10:40	15,64	9	140,79	CHI
202002184856	CACU	CA12200638	CACHOEIRA ALTA	28/02/2020 19:01	29/02/2020 10:40	28/02/2020 19:01	29/02/2020 10:40	15,64	5	78,22	CHI
202002184866	FORMOSA	FA21364954	ITUIQUIRA	28/02/2020 19:03	28/02/2020 21:11	28/02/2020 19:03	28/02/2020 21:11	2,12	1	2,12	CHI
202002184886	OUVIDOR	OU21250411	CATALAO S1	28/02/2020 19:08	29/02/2020 12:20	28/02/2020 19:08	29/02/2020 12:20	17,18	9	154,66	CHI
202002184887	APARECIDA DE GOIANIA	10008294672	INDEPENDENCIA S2	28/02/2020 19:08	28/02/2020 20:45	28/02/2020 19:08	28/02/2020 20:45	1,60	1	1,60	CHI
202002184892	MIMOSO DE GOIAS	MJ12304747	PADRE BERNARDO	28/02/2020 19:10	28/02/2020 21:00	28/02/2020 19:10	28/02/2020 21:00	1,82	8	14,60	CHI
202002184893	DISTRITO FEDERAL	05410226	MARAJOARA	28/02/2020 17:34	28/02/2020 20:51	28/02/2020 17:34	28/02/2020 20:51	3,28	50	164,03	CHI
202002184893	NOVO GAMA	05410226	MARAJOARA	28/02/2020 17:34	28/02/2020 20:51	28/02/2020 17:34	28/02/2020 20:51	3,28	9	29,52	CHI
202002184893	SANTO ANTONIO DO DESCOBERTO	05410226	MARAJOARA	28/02/2020 17:34	28/02/2020 20:51	28/02/2020 17:34	28/02/2020 20:51	3,28	774	2539,15	CHI
202002184894	GOUVELANDIA	GB21361055	QUIRINOPOLIS	28/02/2020 19:10	29/02/2020 10:00	28/02/2020 19:10	29/02/2020 10:00	14,82	1	14,82	CHI
202002184895	LUZIANIA	LZ12209616	MARAJOARA	28/02/2020 17:38	28/02/2020 20:17	28/02/2020 17:38	28/02/2020 20:17	2,63	121	318,80	CHI
202002184897	FORMOSO	FO21145394	PORANGATU	28/02/2020 19:11	29/02/2020 10:07	28/02/2020 19:11	29/02/2020 10:07	14,93	1	14,93	CHI
202002184898	INACIOLANDIA	ID21128155	QUIRINOPOLIS	28/02/2020 19:11	29/02/2020 08:40	28/02/2020 19:11	29/02/2020 08:40	13,48	1	13,48	CHI
202002184907	BELA VISTA DE GOIAS	240035355	BELA VISTA S1	28/02/2020 19:15	29/02/2020 10:33	28/02/2020 19:15	29/02/2020 10:33	15,29	1	15,29	CHI
202002184910	GOIANESIA	NP12312796	GOIANESIA S2	28/02/2020 19:16	29/02/2020 01:00	28/02/2020 19:16	29/02/2020 01:00	5,74	2	11,47	CHI
202002184910	VILA PROPICIO	NP12312796	GOIANESIA S2	28/02/2020 19:16	29/02/2020 01:00	28/02/2020 19:16	29/02/2020 01:00	5,74	1	5,74	CHI
202002184914	CIDADE OCIDENTAL	2680164447	MARAJOARA	28/02/2020 19:17	28/02/2020 21:24	28/02/2020 19:17	28/02/2020 21:24	2,12	1	2,12	CHI
202002184915	CALDAS NOVAS	760037188	CALDAS NOVAS S1	28/02/2020 19:17	29/02/2020 00:21	28/02/2020 19:17	29/02/2020 00:21	5,06	1	5,06	CHI
202002184919	PIRENOPOLIS	PV21121851	CORUMBA	28/02/2020 19:18	29/02/2020 13:29	28/02/2020 19:18	29/02/2020 13:29	18,17	1	18,17	CHI
202002184920	ITUMBIARA	IT12305608	ITUMBIARA NOVA	28/02/2020 19:18	01/03/2020 15:28	28/02/2020 19:18	01/03/2020 15:28	44,16	1	44,16	CHI
202002184921	PARANAIGUARA	QI12306101	QUIRINOPOLIS	28/02/2020 19:18	29/02/2020 09:55	28/02/2020 19:18	29/02/2020 09:55	14,61	6	87,64	CHI
202002184921	QUIRINOPOLIS	QI12306101	QUIRINOPOLIS	28/02/2020 19:18	29/02/2020 09:55	28/02/2020 19:18	29/02/2020 09:55	14,61	2	29,21	CHI
202002184923	HIDROLINA	3070000561	URUACU	28/02/2020 19:19	29/02/2020 01:40	28/02/2020 19:19	29/02/2020 01:40	6,35	1	6,35	CHI
202002184924	MONTIVIDIU	MV12076156	MONTIVIDIU T	28/02/2020 19:19	29/02/2020 16:28	28/02/2020 19:19	29/02/2020 16:28	21,15	5	105,74	CHI

202002185006	JUSSARA	JR12250544	BRITANIA	28/02/2020 19:22	29/02/2020 10:17	28/02/2020 19:22	29/02/2020 10:17	14,90	30	447,10	CHI
202002185007	EDEIA	EA21312259	VICENTINOPOLIS	28/02/2020 19:23	29/02/2020 11:28	28/02/2020 19:23	29/02/2020 11:28	16,08	1	16,08	CHI
202002185010	QUIRINOPOLIS	80098265	QUIRINOPOLIS	28/02/2020 19:24	29/02/2020 07:14	28/02/2020 19:24	29/02/2020 07:14	11,82	1	11,82	CHI
202002185011	VALPARAISO DE GOIAS	VA11330500	PACAEMBU S1	28/02/2020 19:24	28/02/2020 21:15	28/02/2020 19:24	28/02/2020 21:15	1,84	45	82,70	CHI
202002185012	BALIZA	BH12210020	BOM JARDIM	28/02/2020 19:23	29/02/2020 02:18	28/02/2020 19:23	29/02/2020 02:18	6,91	93	642,29	CHI
202002185027	MONTIVIDIU	MV12010585	MONTIVIDIU T	28/02/2020 19:08	29/02/2020 07:40	28/02/2020 19:08	29/02/2020 07:40	12,53	19	238,00	CHI
202002185027	RIO VERDE	MV12010585	MONTIVIDIU T	28/02/2020 19:08	29/02/2020 07:40	28/02/2020 19:08	29/02/2020 07:40	12,53	11	137,79	CHI
202002185030	CALDAS NOVAS	760078919	SERRA DE CALDAS	28/02/2020 19:30	28/02/2020 23:20	28/02/2020 19:30	28/02/2020 23:20	3,82	1	3,82	CHI
202002185033	PORANGATU	PO12141124	NOVO PLANALTO	28/02/2020 17:04	28/02/2020 22:28	28/02/2020 17:04	28/02/2020 22:28	5,39	20	107,77	CHI
202002185034	MINEIROS	MY12390605	PARQUE DAS EMAS	28/02/2020 19:32	29/02/2020 11:00	28/02/2020 19:32	29/02/2020 11:00	15,47	15	231,98	CHI
202002185035	APARECIDA DE GOIANIA	10001757693	ATLANTICO S3	28/02/2020 19:32	28/02/2020 21:04	28/02/2020 19:32	28/02/2020 21:04	1,53	1	1,53	CHI
202002185042	SANTO ANTONIO DO DESCOBERTO	10012048680	ALEXANIA	28/02/2020 19:33	28/02/2020 23:53	28/02/2020 19:33	28/02/2020 23:53	4,32	1	4,32	CHI
202002185043	NOVO BRASIL	NB21116394	JUSSARA	28/02/2020 19:33	29/02/2020 20:38	28/02/2020 19:33	29/02/2020 20:38	25,07	1	25,07	CHI
202002185049	CAMPOS VERDES	VD21252854	SANTA TEREZINHA	28/02/2020 19:36	29/02/2020 06:22	28/02/2020 19:36	29/02/2020 06:22	10,76	1	10,76	CHI
202002185050	PARANAIGUARA	PC12035750	CACHOEIRA ALTA	28/02/2020 19:32	28/02/2020 23:38	28/02/2020 19:32	28/02/2020 23:38	4,09	34	139,09	CHI
202002185057	JATAI	290223453	JATAI S2	28/02/2020 19:39	28/02/2020 21:52	28/02/2020 19:39	28/02/2020 21:52	2,21	1	2,21	CHI
202002185060	RIO VERDE	RV12273766	MONTIVIDIU T	28/02/2020 17:42	29/02/2020 18:28	28/02/2020 17:42	29/02/2020 18:28	24,76	3	74,28	CHI
202002185064	SAO JOAO D ALIANCA	JL12106845	SAO JOAO D ALIANCA	28/02/2020 19:40	29/02/2020 11:53	28/02/2020 19:40	29/02/2020 11:53	16,20	15	243,03	CHI
202002185066	GOIANIA	13516498	GOYA S1	28/02/2020 19:42	28/02/2020 21:26	28/02/2020 19:42	28/02/2020 21:26	1,72	1	1,72	CHI
202002185067	GAMELEIRA DE GOIAS	AN11273412	DAIA S1	28/02/2020 19:42	29/02/2020 07:01	28/02/2020 19:42	29/02/2020 07:01	11,30	31	350,36	CHI
202002185073	MONTIVIDIU	MV12085665	MONTIVIDIU T	28/02/2020 17:50	28/02/2020 21:14	28/02/2020 17:50	28/02/2020 21:14	3,40	2	6,80	CHI
202002185074	ARAGOIANIA	HD21199320	GUAPO S2	28/02/2020 19:44	28/02/2020 22:25	28/02/2020 19:44	28/02/2020 22:25	2,68	1	2,68	CHI
202002185076	ARAGOIANIA	AO21249528	GUAPO S2	28/02/2020 19:45	28/02/2020 22:17	28/02/2020 19:45	28/02/2020 22:17	2,53	2	5,06	CHI
202002185078	CRIXAS	2490004627	SERRA DO OURO	28/02/2020 19:45	28/02/2020 23:57	28/02/2020 19:45	28/02/2020 23:57	4,19	1	4,19	CHI
202002185081	MINEIROS	PW12301784	PARQUE DAS EMAS	28/02/2020 17:59	29/02/2020 10:58	28/02/2020 17:59	29/02/2020 10:58	16,97	9	152,72	CHI
202002185082	ORIZONA	OZ21137517	VIANOPOLIS	28/02/2020 19:46	29/02/2020 12:10	28/02/2020 19:46	29/02/2020 12:10	16,39	3	49,16	CHI
202002185084	GOIANIA	GN11247767	CARAJAS S1	28/02/2020 19:46	28/02/2020 20:58	28/02/2020 19:46	28/02/2020 20:58	1,19	131	155,45	CHI
202002185085	ITAPIRAPUA	IU12067919	MATRINCHA	28/02/2020 12:08	29/02/2020 01:03	28/02/2020 12:08	29/02/2020 01:03	12,91	8	103,28	CHI
202002185095	ORIZONA	OZ12306688	PIRES DO RIO S2	28/02/2020 19:49	29/02/2020 19:50	28/02/2020 19:49	29/02/2020 19:50	24,00	5	120,02	CHI
202002185101	CALDAS NOVAS	CN21119144	SERRA DE CALDAS	28/02/2020 19:51	29/02/2020 12:26	28/02/2020 19:51	29/02/2020 12:26	16,57	1	16,57	CHI
202002185103	HIDROLINA	SZ12262918	ITAPACI	28/02/2020 19:33	28/02/2020 21:34	28/02/2020 19:33	28/02/2020 21:34	2,01	11	22,13	CHI
202002185105	BOM JARDIM DE GOIAS	BM12334785	BOM JARDIM	28/02/2020 19:52	29/02/2020 08:13	28/02/2020 19:52	29/02/2020 08:13	12,34	58	715,54	CHI
202002185114	CALDAS NOVAS	CN21100152	VILA CORUMBA	28/02/2020 19:54	29/02/2020 11:08	28/02/2020 19:54	29/02/2020 11:08	15,22	1	15,22	CHI
202002185122	URUACU	UR21000029	CAMPINORTE	28/02/2020 19:57	28/02/2020 21:05	28/02/2020 19:57	28/02/2020 21:05	1,13	1	1,13	CHI
202002185123	ANAPOLIS	AN11000499	JUNDIAI S2	28/02/2020 19:47	28/02/2020 22:46	28/02/2020 19:47	28/02/2020 22:46	2,98	149	443,52	CHI
202002185126	GOIANIA	GN11171199	XAVANTES	28/02/2020 19:58	29/02/2020 03:13	28/02/2020 19:58	29/02/2020 03:13	7,24	41	296,69	CHI
202002185128	IPAMERI	580109136	IPAMERI	28/02/2020 20:00	29/02/2020 13:37	28/02/2020 20:00	29/02/2020 13:37	17,61	1	17,61	CHI
202002185131	GOIANIA	10245145	CAMPINAS S3	28/02/2020 20:01	28/02/2020 21:22	28/02/2020 20:01	28/02/2020 21:22	1,34	1	1,34	CHI
202002185132	PLANALTINA	PI12216405	PLANALTINA	28/02/2020 19:53	28/02/2020 20:48	28/02/2020 19:53	28/02/2020 20:48	0,91	258	235,14	CHI
202002185138	PIRACANJUBA	PJ12082652	PIRACANJUBA	28/02/2020 20:03	29/02/2020 20:57	28/02/2020 20:03	29/02/2020 20:57	24,89	2	49,79	CHI
202002185139	TROMBAS	MX12328051	PORANGATU	28/02/2020 16:49	28/02/2020 22:34	28/02/2020 16:49	28/02/2020 22:34	5,74	3	17,23	CHI
202002185140	FORMOSA	FA21062287	ITUIQUIRA	28/02/2020 20:04	28/02/2020 21:58	28/02/2020 20:04	28/02/2020 21:58	1,90	2	3,79	CHI
202002185142	CAIAPONIA	CP21303504	MONTIVIDIU T	28/02/2020 20:05	29/02/2020 09:30	28/02/2020 20:05	29/02/2020 09:30	13,42	1	13,42	CHI
202002185143	GOUVELANDIA	GB12303229	QUIRINOPOLIS	28/02/2020 20:03	28/02/2020 22:45	28/02/2020 20:03	28/02/2020 22:45	2,69	6	16,16	CHI

202002185144	GOIATUBA	GT12390091	GOIATUBA S2	28/02/2020 20:05	28/02/2020 20:48	28/02/2020 20:05	28/02/2020 20:48	0,71	9	6,43	CHI
202002185153	GOIANIA	10017136	CARAJAS S1	28/02/2020 20:08	29/02/2020 00:02	28/02/2020 20:08	29/02/2020 00:02	3,90	1	3,90	CHI
202002185154	GOIANDIRA	GD21323416	CATALAO S1	28/02/2020 20:08	29/02/2020 11:02	28/02/2020 20:08	29/02/2020 11:02	14,89	1	14,89	CHI
202002185158	GOIANIA	11050937	ATLANTICO S1	28/02/2020 20:09	28/02/2020 21:42	28/02/2020 20:09	28/02/2020 21:42	1,54	1	1,54	CHI
202002185159	CAIAPONIA	CP21244443	CAIAPONIA	28/02/2020 20:09	29/02/2020 11:49	28/02/2020 20:09	29/02/2020 11:49	15,65	1	15,65	CHI
202002185161	AGUAS LINDAS DE GOIAS	LA11146691	AGUAS LINDAS DE GOIAS S2	28/02/2020 19:09	28/02/2020 21:22	28/02/2020 19:09	28/02/2020 21:22	2,20	89	196,10	CHI
202002185163	JATAI	290044121	JATAI S3	28/02/2020 20:11	28/02/2020 22:38	28/02/2020 20:11	28/02/2020 22:38	2,44	1	2,44	CHI
202002185164	ITUMBIARA	BG12000073	ITUMBIARA VELHA S2	28/02/2020 20:08	29/02/2020 08:39	28/02/2020 20:08	29/02/2020 08:39	12,51	15	187,61	CHI
202002185165	COLINAS DO SUL	TI21236630	MINACU	28/02/2020 20:12	29/02/2020 09:40	28/02/2020 20:12	29/02/2020 09:40	13,46	1	13,46	CHI
202002185167	AGUAS LINDAS DE GOIAS	4830311199	AGUAS LINDAS DE GOIAS S1	28/02/2020 20:12	28/02/2020 22:48	28/02/2020 20:12	28/02/2020 22:48	2,59	1	2,59	CHI
202002185169	MONTIVIDIU	MV21075459	MONTIVIDIU T	28/02/2020 20:13	28/02/2020 22:50	28/02/2020 20:13	28/02/2020 22:50	2,60	2	5,21	CHI
202002185171	HIDROLANDIA	AO21298342	INDEPENDENCIA S1	28/02/2020 20:14	29/02/2020 04:32	28/02/2020 20:14	29/02/2020 04:32	8,30	3	24,89	CHI
202002185187	COCALZINHO DE GOIAS	ZN12351596	COCALZINHO	28/02/2020 20:20	28/02/2020 21:55	28/02/2020 20:20	28/02/2020 21:55	1,58	2	3,16	CHI
202002185190	CRIXAS	CX21213053	SERRA DO OURO	28/02/2020 20:21	29/02/2020 10:54	28/02/2020 20:21	29/02/2020 10:54	14,55	1	14,55	CHI
202002185191	GOIANESIA	GE21357126	GOIANESIA S1	28/02/2020 20:22	28/02/2020 22:22	28/02/2020 20:22	28/02/2020 22:22	1,99	1	1,99	CHI
202002185193	GAMELEIRA DE GOIAS	SV31068087	DAIA S2	28/02/2020 20:22	28/02/2020 23:40	28/02/2020 20:22	28/02/2020 23:40	3,29	1	3,29	CHI
202002185198	ABADIA DE GOIAS	TR31053671	GUAPO S1	28/02/2020 20:24	29/02/2020 04:06	28/02/2020 20:24	29/02/2020 04:06	7,69	1	7,69	CHI
202002185204	ARUANA	AK12396237	BRITANIA	28/02/2020 20:27	29/02/2020 17:28	28/02/2020 20:27	29/02/2020 17:28	21,01	4	84,03	CHI
202002185205	MARA ROSA	MQ12031345	MARA ROSA	28/02/2020 20:27	29/02/2020 11:50	28/02/2020 20:27	29/02/2020 11:50	15,37	5	76,87	CHI
202002185210	SAO MIGUEL DO ARAGUAIA	SM21128388	SAO MIGUEL DO ARAGUAIA	28/02/2020 20:29	28/02/2020 23:28	28/02/2020 20:29	28/02/2020 23:28	2,97	1	2,97	CHI
202002185211	AGUAS LINDAS DE GOIAS	LA11261061	AGUAS LINDAS DE GOIAS S1	28/02/2020 20:30	28/02/2020 21:22	28/02/2020 20:30	28/02/2020 21:22	0,86	128	110,40	CHI
202002185214	NOVA AURORA	NE12149259	CATALAO S1	28/02/2020 18:18	28/02/2020 23:04	28/02/2020 18:18	28/02/2020 23:04	4,75	6	28,52	CHI
202002185215	SANTA FE DE GOIAS	IU12018758	MATRINCHA	28/02/2020 19:51	29/02/2020 02:54	28/02/2020 19:51	29/02/2020 02:54	7,04	12	84,52	CHI
202002185217	IVOLANDIA	IV12206098	IPORA	28/02/2020 20:31	29/02/2020 08:10	28/02/2020 20:31	29/02/2020 08:10	11,65	2	23,30	CHI
202002185222	ORIZONA	OZ21398586	PIRES DO RIO S1	28/02/2020 20:32	29/02/2020 08:42	28/02/2020 20:32	29/02/2020 08:42	12,16	1	12,16	CHI
202002185224	PARAUNA	EU21000134	ACREUNA	28/02/2020 20:16	29/02/2020 07:52	28/02/2020 20:16	29/02/2020 07:52	11,59	1	11,59	CHI
202002185226	ACREUNA	EU12044291	ACREUNA	28/02/2020 20:16	29/02/2020 00:57	28/02/2020 20:16	29/02/2020 00:57	4,68	50	233,85	CHI
202002185226	JANDAIA	EU12044291	ACREUNA	28/02/2020 20:16	29/02/2020 00:57	28/02/2020 20:16	29/02/2020 00:57	4,68	7	32,74	CHI
202002185226	PARAUNA	EU12044291	ACREUNA	28/02/2020 20:16	29/02/2020 00:57	28/02/2020 20:16	29/02/2020 00:57	4,68	62	289,97	CHI
202002185234	ANAPOLIS	AN11155292	ANAPOLIS UNIVERSITARIO S2	28/02/2020 20:32	29/02/2020 02:08	28/02/2020 20:32	29/02/2020 02:08	5,59	149	833,57	CHI
202002185240	SAO LUIZ DO NORTE	SZ12348617	ITAPACI	28/02/2020 19:45	29/02/2020 18:13	28/02/2020 19:45	29/02/2020 05:10	9,41	32	301,21	CHI
202002185240	SAO LUIZ DO NORTE	SZ12348617	ITAPACI	28/02/2020 19:45	29/02/2020 18:13	29/02/2020 05:13	29/02/2020 10:37	5,39	30	161,79	CHI
202002185240	SAO LUIZ DO NORTE	SZ13245949	ITAPACI	28/02/2020 19:45	29/02/2020 18:13	29/02/2020 05:13	29/02/2020 18:13	12,99	2	25,98	CHI
202002185247	LUZIANIA	LZ12261767	CRISTALINA S2	28/02/2020 20:41	29/02/2020 01:12	28/02/2020 20:41	29/02/2020 01:12	4,51	12	54,13	CHI
202002185257	BURITINOPOLIS	BQ12168775	IACIARA S2	28/02/2020 20:45	28/02/2020 22:15	28/02/2020 20:45	28/02/2020 22:15	1,49	38	56,57	CHI
202002185259	PARAUNA	PU12081329	PARAUNA	28/02/2020 20:46	28/02/2020 23:16	28/02/2020 20:46	28/02/2020 23:16	2,49	64	159,40	CHI
202002185260	SAO LUIZ DO NORTE	3090018479	BARRO ALTO	28/02/2020 20:46	28/02/2020 21:27	28/02/2020 20:46	28/02/2020 21:27	0,68	1	0,68	CHI
202002185261	PIRES DO RIO	PR21407522	PIRES DO RIO S2	28/02/2020 20:47	29/02/2020 09:42	28/02/2020 20:47	29/02/2020 09:42	12,91	1	12,91	CHI
202002185272	JANDAIA	JD12005405	PALMEIRAS	28/02/2020 20:52	29/02/2020 12:44	28/02/2020 20:52	29/02/2020 08:57	12,08	7	84,54	CHI
202002185272	JANDAIA	JD12005405	PALMEIRAS	28/02/2020 20:52	29/02/2020 12:44	29/02/2020 07:00	29/02/2020 08:57	1,95	4	7,82	CHI
202002185272	PALMEIRAS DE GOIAS	JD12005405	PALMEIRAS	28/02/2020 20:52	29/02/2020 12:44	28/02/2020 20:52	29/02/2020 11:03	14,18	52	737,11	CHI
202002185272	PALMEIRAS DE GOIAS	JD12005405	PALMEIRAS	28/02/2020 20:52	29/02/2020 12:44	28/02/2020 20:52	29/02/2020 12:44	15,86	1	15,86	CHI
202002185281	SAO SIMAO	SO12129690	CACHOEIRA ALTA	28/02/2020 20:03	29/02/2020 02:04	28/02/2020 20:03	29/02/2020 02:04	6,01	154	926,01	CHI
202002185284	ALEXANIA	480019745	ALEXANIA	28/02/2020 20:59	29/02/2020 11:32	28/02/2020 20:59	29/02/2020 11:32	14,55	1	14,55	CHI

202002185294	APARECIDA DE GOIANIA	12619450	ATLANTICO S2	28/02/2020 21:06	28/02/2020 22:28	28/02/2020 21:06	28/02/2020 22:28	1,36	1	1,36	CHI
202002185298	COCALZINHO DE GOIAS	10026822529	AGUAS LINDAS DE GOIAS S1	28/02/2020 21:08	29/02/2020 06:54	28/02/2020 21:08	29/02/2020 06:54	9,75	1	9,75	CHI
202002185302	LEOPOLDO DE BULHOES	LB21313046	DAIA S2	28/02/2020 21:11	29/02/2020 05:18	28/02/2020 21:11	29/02/2020 05:18	8,12	2	16,23	CHI
202002185303	OUVIDOR	OU11161393	CATALAO S1	28/02/2020 21:11	29/02/2020 10:49	28/02/2020 21:11	29/02/2020 10:49	13,63	6	81,78	CHI
202002185304	ARAGARCAS	AG12138460	ARAGARCAS	28/02/2020 21:11	29/02/2020 07:24	28/02/2020 21:11	29/02/2020 07:24	10,21	13	132,68	CHI
202002185308	SAO SIMAO	SO21196229	CACHOEIRA ALTA	28/02/2020 21:14	29/02/2020 15:47	28/02/2020 21:14	29/02/2020 15:47	18,54	1	18,54	CHI
202002185309	COCALZINHO DE GOIAS	ZN12320107	AGUAS LINDAS DE GOIAS S1	28/02/2020 21:15	29/02/2020 07:50	28/02/2020 21:15	29/02/2020 07:50	10,58	13	137,51	CHI
202002185310	CAMPOS BELOS	MA12209854	SAO DOMINGOS	28/02/2020 21:15	28/02/2020 22:35	28/02/2020 21:15	28/02/2020 22:35	1,32	4	5,29	CHI
202002185310	MONTE ALEGRE DE GOIAS	MA12209854	SAO DOMINGOS	28/02/2020 21:15	28/02/2020 22:35	28/02/2020 21:15	28/02/2020 22:35	1,32	18	23,81	CHI
202002185313	PIRENOPOLIS	PV21232833	CORUMBA	28/02/2020 21:18	29/02/2020 00:20	28/02/2020 21:18	29/02/2020 00:20	3,02	2	6,04	CHI
202002185315	SAO LUIZ DO NORTE	GE12382134	BARRO ALTO	28/02/2020 20:13	29/02/2020 03:44	28/02/2020 20:13	29/02/2020 03:44	7,50	2	15,00	CHI
202002185320	GUARAITA	IK12250511	ITAPURANGA	28/02/2020 21:22	28/02/2020 22:27	28/02/2020 21:22	28/02/2020 22:27	1,07	7	7,49	CHI
202002185320	ITAPURANGA	IK12250511	ITAPURANGA	28/02/2020 21:22	28/02/2020 22:27	28/02/2020 21:22	28/02/2020 22:27	1,07	38	40,66	CHI
202002185324	NIQUELANDIA	NQ12090406	NIQUELANDIA SUBTRANSMISSAO	28/02/2020 21:25	29/02/2020 00:19	28/02/2020 21:25	29/02/2020 00:19	2,89	3	8,66	CHI
202002185325	HIDROLANDIA	HD21000252	CEPAIGO S2	28/02/2020 21:28	28/02/2020 22:52	28/02/2020 21:28	28/02/2020 22:52	1,40	1	1,40	CHI
202002185327	CRIXAS	CX12140958	SANTA TEREZINHA	28/02/2020 21:28	29/02/2020 16:57	28/02/2020 21:28	29/02/2020 16:57	19,48	9	175,36	CHI
202002185329	JATAI	290090180	JATAI S3	28/02/2020 21:29	29/02/2020 00:20	28/02/2020 21:29	29/02/2020 00:20	2,84	1	2,84	CHI
202002185330	IACIARA	IA12262059	IACIARA S1	28/02/2020 21:30	29/02/2020 08:54	28/02/2020 21:30	29/02/2020 08:54	11,40	8	91,20	CHI
202002185331	JUSSARA	JR13198430	BRITANIA	28/02/2020 21:05	29/02/2020 11:55	28/02/2020 21:05	29/02/2020 10:06	13,01	192	2498,83	CHI
202002185331	MONTES CLAROS DE GOIAS	JR13198430	BRITANIA	28/02/2020 21:05	29/02/2020 11:55	28/02/2020 21:05	29/02/2020 10:06	13,01	424	5518,24	CHI
202002185331	JUSSARA	JR13198430	BRITANIA	28/02/2020 21:05	29/02/2020 11:55	29/02/2020 11:25	29/02/2020 11:55	0,51	192	98,67	CHI
202002185331	MONTES CLAROS DE GOIAS	JR13198430	BRITANIA	28/02/2020 21:05	29/02/2020 11:55	29/02/2020 11:25	29/02/2020 11:55	0,51	424	217,89	CHI
202002185333	NOVO GAMA	NJ11084529	PACAEMBU S1	28/02/2020 20:41	28/02/2020 22:13	28/02/2020 20:41	28/02/2020 22:13	1,52	244	371,35	CHI
202002185334	APARECIDA DE GOIANIA	11921122	ATLANTICO S1	28/02/2020 21:33	28/02/2020 23:13	28/02/2020 21:33	28/02/2020 23:13	1,66	1	1,66	CHI
202002185337	MINEIROS	MY12303820	PARQUE DAS EMAS	28/02/2020 21:34	29/02/2020 11:27	28/02/2020 21:34	29/02/2020 11:27	13,88	28	388,60	CHI
202002185337	SANTA RITA DO ARAGUAIA	MY12303820	PARQUE DAS EMAS	28/02/2020 21:34	29/02/2020 11:27	28/02/2020 21:34	29/02/2020 11:27	13,88	2	27,76	CHI
202002185341	BURITI ALEGRE	420046938	ALTO BURITI	28/02/2020 21:35	29/02/2020 17:08	28/02/2020 21:35	29/02/2020 17:08	19,54	1	19,54	CHI
202002185346	GOIANIA	12038131	REAL S1	28/02/2020 21:38	28/02/2020 22:36	28/02/2020 21:38	28/02/2020 22:36	0,96	1	0,96	CHI
202002185350	QUIRINOPOLIS	QI32058080	QUIRINOPOLIS	28/02/2020 21:41	29/02/2020 07:35	28/02/2020 21:41	29/02/2020 07:35	9,89	10	98,94	CHI
202002185367	GOIAS	GS12217745	MATRINCHA	29/02/2020 06:33	29/02/2020 12:05	29/02/2020 06:33	29/02/2020 12:05	5,53	3	16,58	CHI
202002185372	SANTA HELENA DE GOIAS	TD12246741	RIO DOS BOIS	28/02/2020 21:58	29/02/2020 10:20	28/02/2020 21:58	29/02/2020 10:20	12,36	13	160,63	CHI
202002185372	TURVELANDIA	TD12246741	RIO DOS BOIS	28/02/2020 21:58	29/02/2020 10:20	28/02/2020 21:58	29/02/2020 10:20	12,36	4	49,42	CHI
202002185376	GOIANIRA	390069243	GOIANIRA	28/02/2020 21:59	29/02/2020 00:11	28/02/2020 21:59	29/02/2020 00:11	2,19	1	2,19	CHI
202002185380	ARENOPOLIS	AY13204816	IPORA	28/02/2020 21:42	29/02/2020 11:53	28/02/2020 21:42	29/02/2020 11:53	14,19	106	1504,64	CHI
202002185380	MONTES CLAROS DE GOIAS	AY13204816	IPORA	28/02/2020 21:42	29/02/2020 11:53	28/02/2020 21:42	29/02/2020 11:53	14,19	83	1178,16	CHI
202002185380	PIRANHAS	AY13204816	IPORA	28/02/2020 21:42	29/02/2020 11:53	28/02/2020 21:42	29/02/2020 11:53	14,19	2	28,39	CHI
202002185382	GOIANIA	14884185	ATLANTICO S3	28/02/2020 22:02	29/02/2020 00:52	28/02/2020 22:02	29/02/2020 00:52	2,83	1	2,83	CHI
202002185383	ITUMBIARA	IT12000221	ITUMBIARA NOVA	28/02/2020 22:02	29/02/2020 00:17	28/02/2020 22:02	29/02/2020 00:17	2,24	7	15,71	CHI
202002185391	TRINDADE	TR11053494	TRINDADE	28/02/2020 21:53	29/02/2020 00:11	28/02/2020 21:53	29/02/2020 00:11	2,30	185	425,04	CHI
202002185392	PORANGATU	PO12239639	MARA ROSA	28/02/2020 22:07	29/02/2020 03:33	28/02/2020 22:07	29/02/2020 03:33	5,42	31	168,05	CHI
202002185410	ANAPOLIS	AN11130801	JUNDIAI S2	28/02/2020 23:58	29/02/2020 04:00	28/02/2020 23:58	29/02/2020 04:00	4,03	125	503,54	CHI
202002185503	APARECIDA DE GOIANIA	200564432	INDEPENDENCIA S1	28/02/2020 22:10	28/02/2020 23:28	28/02/2020 22:10	28/02/2020 23:28	1,30	0	0,00	CHI
202002185506	DAMIANOPOLIS	DA21399591	IACIARA S2	28/02/2020 22:10	29/02/2020 09:25	28/02/2020 22:10	29/02/2020 09:25	11,23	1	11,23	CHI
202002185513	ANAPOLIS	AN11003272	JUNDIAI S1	28/02/2020 22:08	29/02/2020 01:11	28/02/2020 22:08	29/02/2020 01:11	3,04	140	425,17	CHI

202002185536	NIQUELANDIA	NQ12366185	SAO JOAO D ALIANCA	28/02/2020 14:08	29/02/2020 08:40	28/02/2020 14:08	29/02/2020 08:40	18,53	6	111,20	CHI
202002185562	LUZIANIA	LZ12245978	CRISTALINA S2	28/02/2020 22:30	29/02/2020 02:20	28/02/2020 22:30	29/02/2020 02:20	3,83	8	30,66	CHI
202002185563	JATAI	10012999855	JATAI S3	28/02/2020 22:30	29/02/2020 08:27	28/02/2020 22:30	29/02/2020 08:27	9,94	1	9,94	CHI
202002185565	PLANALTINA	PI12216405	PLANALTINA	28/02/2020 22:30	28/02/2020 23:03	28/02/2020 22:30	28/02/2020 23:03	0,54	258	140,04	CHI
202002185574	IPORA	IR12223066	IPORA	28/02/2020 22:33	29/02/2020 07:28	28/02/2020 22:33	29/02/2020 07:28	8,91	19	169,31	CHI
202002185576	GOIANIA	BW12151470	NEROPOLIS S1	28/02/2020 22:33	29/02/2020 01:43	28/02/2020 22:33	29/02/2020 01:43	3,16	130	410,87	CHI
202002185576	SANTO ANTONIO DE GOIAS	BW12151470	NEROPOLIS S1	28/02/2020 22:33	29/02/2020 01:43	28/02/2020 22:33	29/02/2020 01:43	3,16	2	6,32	CHI
202002185586	AGUA LIMPA	AL21171511	VILA CORUMBA	28/02/2020 22:35	29/02/2020 17:50	28/02/2020 22:35	29/02/2020 17:50	19,23	1	19,23	CHI
202002185590	GOIANIA	GN16404316	CAMPINAS S2	28/02/2020 22:36	29/02/2020 18:36	28/02/2020 22:36	29/02/2020 01:59	3,39	1	3,39	CHI
202002185590	GOIANIA	GN10383691	CAMPINAS S2	28/02/2020 22:35	29/02/2020 18:36	29/02/2020 02:35	29/02/2020 02:57	0,36	3279	1190,46	CHI
202002185590	GOIANIA	GN16409427	CAMPINAS S2	28/02/2020 22:36	29/02/2020 18:36	28/02/2020 22:36	29/02/2020 02:58	4,37	1106	4830,15	CHI
202002185590	GOIANIA	8468816	CAMPINAS S2	28/02/2020 22:36	29/02/2020 18:36	28/02/2020 22:36	29/02/2020 15:29	16,89	27	456,09	CHI
202002185590	GOIANIA	GN11040727	CAMPINAS S2	28/02/2020 22:35	29/02/2020 18:36	29/02/2020 09:10	29/02/2020 15:36	6,44	111	715,03	CHI
202002185590	GOIANIA	GN11197075	CAMPINAS S2	28/02/2020 22:36	29/02/2020 18:36	28/02/2020 22:36	29/02/2020 15:59	17,39	31	539,13	CHI
202002185590	GOIANIA	GN21329199	CAMPINAS S2	28/02/2020 22:35	29/02/2020 18:36	29/02/2020 16:25	29/02/2020 18:35	2,16	1	2,16	CHI
202002185590	GOIANIA	GN12001798	CAMPINAS S2	28/02/2020 22:35	29/02/2020 18:36	29/02/2020 16:11	29/02/2020 18:36	2,43	110	267,36	CHI
202002185592	PIRACANJUBA	PJ12082241	PIRACANJUBA	28/02/2020 22:38	29/02/2020 09:28	28/02/2020 22:38	29/02/2020 09:28	10,82	7	75,77	CHI
202002185594	ANAPOLIS	AN21075819	DAIA S1	28/02/2020 22:39	29/02/2020 02:50	28/02/2020 22:39	29/02/2020 02:50	4,17	1	4,17	CHI
202002185611	GOIANIA	10840655	GOIANIA LESTE S2	28/02/2020 22:54	29/02/2020 01:52	28/02/2020 22:54	29/02/2020 01:52	2,96	1	2,96	CHI
202002185612	CEZARINA	CZ21287736	CEZARINA	28/02/2020 22:55	29/02/2020 09:20	28/02/2020 22:55	29/02/2020 09:20	10,41	1	10,41	CHI
202002185613	ITABERAI	IB12220379	ITABERAI S1	28/02/2020 22:21	29/02/2020 02:48	28/02/2020 22:21	29/02/2020 02:48	4,44	102	453,22	CHI
202002185616	PETROLINA DE GOIAS	PG12025388	SAO FRANCISCO DE GOIAS	29/02/2020 05:59	29/02/2020 07:53	29/02/2020 05:59	29/02/2020 07:53	1,89	10	18,91	CHI
202002185616	PIRENOPOLIS	PG12025388	SAO FRANCISCO DE GOIAS	29/02/2020 05:59	29/02/2020 07:53	29/02/2020 05:59	29/02/2020 07:53	1,89	38	71,85	CHI
202002185617	JUSSARA	JR12204144	BRITANIA	28/02/2020 22:57	29/02/2020 14:36	28/02/2020 22:57	29/02/2020 14:36	15,64	2	31,29	CHI
202002185620	JATAI	290118049	JATAI S3	28/02/2020 22:58	28/02/2020 23:52	28/02/2020 22:58	28/02/2020 23:52	0,89	1	0,89	CHI
202002185621	GOIANIA	12953246	ATLANTICO S2	28/02/2020 22:59	29/02/2020 00:20	28/02/2020 22:59	29/02/2020 00:20	1,35	1	1,35	CHI
202002185622	SENADOR CANEDO	SW11092646	SENADOR CANEDO	28/02/2020 22:08	29/02/2020 00:48	28/02/2020 22:08	29/02/2020 00:48	2,66	115	306,47	CHI
202002185624	MONTES CLAROS DE GOIAS	ME12334949	IPORA	28/02/2020 23:03	29/02/2020 11:40	28/02/2020 23:03	29/02/2020 11:40	12,62	7	88,32	CHI
202002185631	GOIANIA	10847080	GOIANIA LESTE S3	28/02/2020 23:07	29/02/2020 00:49	28/02/2020 23:07	29/02/2020 00:49	1,70	1	1,70	CHI
202002185632	ITAUCU	IX12000021	INHUMAS S1	28/02/2020 23:07	29/02/2020 04:00	28/02/2020 23:07	29/02/2020 04:00	4,87	14	68,23	CHI
202002185632	TAQUARAL DE GOIAS	IX12000021	INHUMAS S1	28/02/2020 23:07	29/02/2020 04:00	28/02/2020 23:07	29/02/2020 04:00	4,87	7	34,12	CHI
202002185639	CROMINIA	MI12249916RE	PONTALINA	28/02/2020 15:08	29/02/2020 09:43	28/02/2020 15:08	29/02/2020 09:43	18,57	13	241,39	CHI
202002185639	MAIRIPOTABA	MI12249916RE	PONTALINA	28/02/2020 15:08	29/02/2020 09:43	28/02/2020 15:08	29/02/2020 09:43	18,57	57	1058,39	CHI
202002185640	ANAPOLIS	20582225	ANAPOLIS UNIVERSITARIO S2	28/02/2020 23:15	29/02/2020 10:13	28/02/2020 23:15	29/02/2020 10:13	10,96	1	10,96	CHI
202002185644	SAO DOMINGOS	SD12218642	SAO DOMINGOS	28/02/2020 23:21	29/02/2020 08:45	28/02/2020 23:21	29/02/2020 08:45	9,40	82	770,62	CHI
202002185650	SITIO D ABADIA	SI12302925	IACIARA S2	28/02/2020 23:25	29/02/2020 10:03	28/02/2020 23:25	29/02/2020 10:03	10,63	4	42,51	CHI
202002185655	GUARAITA	IK12364707	ITAPURANGA	28/02/2020 23:34	29/02/2020 00:52	28/02/2020 23:34	29/02/2020 00:52	1,30	6	7,80	CHI
202002185655	ITAPURANGA	IK12364707	ITAPURANGA	28/02/2020 23:34	29/02/2020 00:52	28/02/2020 23:34	29/02/2020 00:52	1,30	11	14,29	CHI
202002185657	JARAGUA	JA12040435	SAO FRANCISCO DE GOIAS	28/02/2020 23:30	29/02/2020 11:05	28/02/2020 23:30	29/02/2020 11:05	11,57	3	34,71	CHI
202002185657	JESUPOLIS	JA12040435	SAO FRANCISCO DE GOIAS	28/02/2020 23:30	29/02/2020 11:05	28/02/2020 23:30	29/02/2020 11:05	11,57	19	219,84	CHI
202002185663	BONOPOLIS	BX12079321	SAO MIGUEL DO ARAGUAIA	28/02/2020 23:49	29/02/2020 01:57	28/02/2020 23:49	29/02/2020 01:57	2,13	58	123,67	CHI
202002185666	GUAPO	GA12008530	GUAPO S2	28/02/2020 23:51	29/02/2020 07:58	28/02/2020 23:51	29/02/2020 07:58	8,12	2	16,23	CHI
202002185702	CACHOEIRA ALTA	10009418618	CACHOEIRA ALTA	29/02/2020 00:11	29/02/2020 17:02	29/02/2020 00:11	29/02/2020 17:02	16,85	1	16,85	CHI
202002185711	ANAPOLIS	AN21071891	ANAPOLIS UNIVERSITARIO S2	29/02/2020 00:31	29/02/2020 03:02	29/02/2020 00:31	29/02/2020 03:02	2,51	1	2,51	CHI

202002185713	PLANALTINA	10006402176	PLANALTINA	29/02/2020 00:35	29/02/2020 05:29	29/02/2020 00:35	29/02/2020 05:29	4,89	1	4,89	CHI
202002185714	LUZIANIA	LZ12000276RE	MARAJOARA	29/02/2020 00:36	29/02/2020 05:12	29/02/2020 00:36	29/02/2020 05:12	4,59	8	36,73	CHI
202002185716	SERRANOPOLIS	SX12216725	JATAI S1	29/02/2020 00:45	29/02/2020 07:16	29/02/2020 00:45	29/02/2020 07:16	6,51	25	162,77	CHI
202002185719	EDEIA	EA12394173	EDEIA	28/02/2020 23:21	01/03/2020 11:13	28/02/2020 23:21	01/03/2020 11:13	35,86	2	71,71	CHI
202002185802	MONTIVIDIU DO NORTE	MX11228906	PORANGATU	28/02/2020 17:33	29/02/2020 02:10	28/02/2020 17:33	29/02/2020 02:10	8,61	1	8,61	CHI
202002185803	MONTIVIDIU DO NORTE	MX11226396	PORANGATU	28/02/2020 22:19	29/02/2020 14:54	28/02/2020 22:19	29/02/2020 14:00	15,68	1	15,68	CHI
202002185803	MONTIVIDIU DO NORTE	MX12226413	PORANGATU	28/02/2020 22:19	29/02/2020 14:54	29/02/2020 13:00	29/02/2020 14:54	1,90	36	68,41	CHI
202002185807	EDEALINA	EA10394609	EDEIA	29/02/2020 02:52	01/03/2020 10:35	29/02/2020 02:52	29/02/2020 07:20	4,48	1	4,48	CHI
202002185807	EDEIA	EA10394609	EDEIA	29/02/2020 02:52	01/03/2020 10:35	29/02/2020 02:52	29/02/2020 07:20	4,48	160	716,04	CHI
202002185807	EDEIA	EA10394609	EDEIA	29/02/2020 02:52	01/03/2020 10:35	29/02/2020 02:52	01/03/2020 10:35	31,71	31	983,12	CHI
202002185807	EDEALINA	EA10394609	EDEIA	29/02/2020 02:52	01/03/2020 10:35	29/02/2020 07:22	01/03/2020 10:35	27,21	1	27,21	CHI
202002185807	EDEIA	EA10394609	EDEIA	29/02/2020 02:52	01/03/2020 10:35	29/02/2020 07:22	01/03/2020 10:35	27,21	160	4354,36	CHI
202002185808	JATAI	JT10394711	JATAI S3	29/02/2020 04:20	01/03/2020 22:20	29/02/2020 04:20	29/02/2020 05:43	1,38	24	33,12	CHI
202002185808	JATAI	JT10394711	JATAI S3	29/02/2020 04:20	01/03/2020 22:20	29/02/2020 07:57	29/02/2020 08:13	0,27	24	6,57	CHI
202002185808	JATAI	JT13013384	JATAI S3	29/02/2020 04:20	01/03/2020 22:20	29/02/2020 04:20	29/02/2020 08:52	4,53	11	49,85	CHI
202002185808	JATAI	JT10394711	JATAI S3	29/02/2020 04:20	01/03/2020 22:20	29/02/2020 09:59	29/02/2020 10:16	0,28	35	9,93	CHI
202002185808	JATAI	JT10394711	JATAI S3	29/02/2020 04:20	01/03/2020 22:20	29/02/2020 18:51	29/02/2020 19:02	0,18	35	6,46	CHI
202002185808	JATAI	JT13264337	JATAI S3	29/02/2020 04:20	01/03/2020 22:20	29/02/2020 04:20	01/03/2020 07:52	27,52	49	1348,33	CHI
202002185808	JATAI	JT13324664	JATAI S3	29/02/2020 04:20	01/03/2020 22:20	29/02/2020 04:20	01/03/2020 09:41	29,35	5	146,74	CHI
202002185808	JATAI	JT13234317	JATAI S3	29/02/2020 04:20	01/03/2020 22:20	29/02/2020 04:20	01/03/2020 10:54	30,55	9	274,95	CHI
202002185808	JATAI	JT13234317	JATAI S3	29/02/2020 04:20	01/03/2020 22:20	01/03/2020 10:54	01/03/2020 12:38	1,74	6	10,41	CHI
202002185808	JATAI	JT12214362	JATAI S3	29/02/2020 04:20	01/03/2020 22:20	29/02/2020 04:20	01/03/2020 13:32	33,19	3	99,58	CHI
202002185808	JATAI	JT13234317	JATAI S3	29/02/2020 04:20	01/03/2020 22:20	01/03/2020 15:36	01/03/2020 16:26	0,83	6	5,00	CHI
202002185808	JATAI	JT10394711	JATAI S3	29/02/2020 04:20	01/03/2020 22:20	01/03/2020 16:47	01/03/2020 17:09	0,36	35	12,70	CHI
202002185808	JATAI	JT13234317	JATAI S3	29/02/2020 04:20	01/03/2020 22:20	01/03/2020 13:55	01/03/2020 18:26	4,52	3	13,56	CHI
202002185808	JATAI	JT13234317	JATAI S3	29/02/2020 04:20	01/03/2020 22:20	01/03/2020 16:47	01/03/2020 18:26	1,66	6	9,94	CHI
202002185808	JATAI	JT13234317	JATAI S3	29/02/2020 04:20	01/03/2020 22:20	29/02/2020 04:20	01/03/2020 19:02	38,70	111	4295,67	CHI
202002185808	RIO VERDE	JT13234317	JATAI S3	29/02/2020 04:20	01/03/2020 22:20	29/02/2020 04:20	01/03/2020 19:02	38,70	8	309,60	CHI
202002185808	JATAI	JT12061509	JATAI S3	29/02/2020 04:20	01/03/2020 22:20	29/02/2020 04:20	01/03/2020 19:56	39,60	8	316,77	CHI
202002185808	JATAI	JT13234317	JATAI S3	29/02/2020 04:20	01/03/2020 22:20	01/03/2020 10:54	01/03/2020 20:11	9,30	1	9,30	CHI
202002185808	JATAI	JT12241758	JATAI S3	29/02/2020 04:20	01/03/2020 22:20	01/03/2020 10:54	01/03/2020 20:50	9,95	2	19,90	CHI
202002185808	JATAI	JT12324668	JATAI S3	29/02/2020 04:20	01/03/2020 22:20	01/03/2020 22:07	01/03/2020 22:20	0,22	5	1,11	CHI
202002185809	GAMELEIRA DE GOIAS	SV10394762	VIANOPOLIS	29/02/2020 05:41	29/02/2020 19:28	29/02/2020 05:41	29/02/2020 19:28	13,79	20	275,85	CHI
202002185809	LUZIANIA	SV10394762	VIANOPOLIS	29/02/2020 05:41	29/02/2020 19:28	29/02/2020 05:41	29/02/2020 19:28	13,79	359	4951,51	CHI
202002185809	LUZIANIA	SV10394762	VIANOPOLIS	29/02/2020 05:41	29/02/2020 19:28	29/02/2020 05:41	29/02/2020 19:28	13,79	23	317,23	CHI
202002185809	SILVANIA	SV10394762	VIANOPOLIS	29/02/2020 05:41	29/02/2020 19:28	29/02/2020 05:41	29/02/2020 19:28	13,79	257	3544,67	CHI
202002185809	SILVANIA	SV10394762	VIANOPOLIS	29/02/2020 05:41	29/02/2020 19:28	29/02/2020 05:41	29/02/2020 19:28	13,79	109	1503,38	CHI
202002185809	SILVANIA	SV10394762	VIANOPOLIS	29/02/2020 05:41	29/02/2020 19:28	29/02/2020 05:41	29/02/2020 19:28	13,79	20	275,85	CHI
202002185810	BOM JESUS DE GOIAS	00230424	BOM JESUS DE GOIAS	29/02/2020 05:43	29/02/2020 13:25	29/02/2020 05:43	29/02/2020 07:09	1,44	10	14,42	CHI
202002185810	ITUMBIARA	00230424	BOM JESUS DE GOIAS	29/02/2020 05:43	29/02/2020 13:25	29/02/2020 05:43	29/02/2020 07:09	1,44	3	4,33	CHI
202002185810	BOM JESUS DE GOIAS	BJ13208037	BOM JESUS DE GOIAS	29/02/2020 05:43	29/02/2020 13:25	29/02/2020 05:43	29/02/2020 09:53	4,16	11	45,81	CHI
202002185810	GOIATUBA	BJ13208037	BOM JESUS DE GOIAS	29/02/2020 05:43	29/02/2020 13:25	29/02/2020 05:43	29/02/2020 09:53	4,16	8	33,31	CHI
202002185810	GOIATUBA	GT13330334	BOM JESUS DE GOIAS	29/02/2020 05:43	29/02/2020 13:25	29/02/2020 05:43	29/02/2020 09:56	4,22	130	548,49	CHI
202002185810	GOIATUBA	GT13134949	BOM JESUS DE GOIAS	29/02/2020 05:43	29/02/2020 13:25	29/02/2020 05:43	29/02/2020 11:14	5,52	9	49,64	CHI

202002185810	GOIATUBA	GT13000320	BOM JESUS DE GOIAS	29/02/2020 05:43	29/02/2020 13:25	29/02/2020 05:43	29/02/2020 12:06	6,39	2	12,78	CHI
202002185810	GOIATUBA	GT13254721	BOM JESUS DE GOIAS	29/02/2020 05:43	29/02/2020 13:25	29/02/2020 05:43	29/02/2020 12:18	6,58	3	19,75	CHI
202002185810	GOIATUBA	GT13254736	BOM JESUS DE GOIAS	29/02/2020 05:43	29/02/2020 13:25	29/02/2020 13:06	29/02/2020 13:19	0,23	129	29,06	CHI
202002185810	GOIATUBA	GT13254738	BOM JESUS DE GOIAS	29/02/2020 05:43	29/02/2020 13:25	29/02/2020 05:43	29/02/2020 13:25	7,71	103	794,30	CHI
202002185811	PARAUNA	PU12205936	PARAUNA	29/02/2020 05:57	29/02/2020 10:13	29/02/2020 05:57	29/02/2020 10:13	4,26	5	21,28	CHI
202002185826	ITUMBIARA	IT16408164	ITUMBIARA VELHA S1	29/02/2020 07:30	29/02/2020 11:56	29/02/2020 07:30	29/02/2020 07:35	0,08	1402	111,38	CHI
202002185826	ITUMBIARA	IT16408201	ITUMBIARA VELHA S1	29/02/2020 07:30	29/02/2020 11:56	29/02/2020 07:30	29/02/2020 07:36	0,10	1514	145,51	CHI
202002185826	ITUMBIARA	IT16408148	ITUMBIARA VELHA S1	29/02/2020 07:30	29/02/2020 11:56	29/02/2020 07:30	29/02/2020 08:28	0,96	975	940,06	CHI
202002185826	ITUMBIARA	00990234	ITUMBIARA VELHA S1	29/02/2020 07:30	29/02/2020 11:56	29/02/2020 07:30	29/02/2020 11:56	4,42	1585	7009,66	CHI
202002185827	MINEIROS	MY10396884	PARQUE DAS EMAS	29/02/2020 07:39	29/02/2020 18:34	29/02/2020 07:39	29/02/2020 07:45	0,10	1536	154,03	CHI
202002185827	MINEIROS	MY10396884	PARQUE DAS EMAS	29/02/2020 07:39	29/02/2020 18:34	29/02/2020 07:39	29/02/2020 08:46	1,11	228	252,45	CHI
202002185827	MINEIROS	MY10396884	PARQUE DAS EMAS	29/02/2020 07:39	29/02/2020 18:34	29/02/2020 07:39	29/02/2020 10:31	2,86	68	194,67	CHI
202002185827	MINEIROS	MY10396884	PARQUE DAS EMAS	29/02/2020 07:39	29/02/2020 18:34	29/02/2020 07:39	29/02/2020 11:03	3,38	18	60,93	CHI
202002185827	MINEIROS	MY12217013	PARQUE DAS EMAS	29/02/2020 07:39	29/02/2020 18:34	29/02/2020 07:39	29/02/2020 18:34	10,90	73	795,74	CHI
202002185840	GOIANIA	00580264	GOIANIA LESTE S1	29/02/2020 08:09	29/02/2020 15:25	29/02/2020 08:09	29/02/2020 08:14	0,07	7123	504,55	CHI
202002185840	GOIANIA	00580264	GOIANIA LESTE S1	29/02/2020 08:09	29/02/2020 15:25	29/02/2020 08:09	29/02/2020 08:14	0,08	463	36,65	CHI
202002185840	SENADOR CANEDO	00580264	GOIANIA LESTE S1	29/02/2020 08:09	29/02/2020 15:25	29/02/2020 08:09	29/02/2020 08:14	0,08	3877	306,93	CHI
202002185840	SENADOR CANEDO	00580264	GOIANIA LESTE S1	29/02/2020 08:09	29/02/2020 15:25	29/02/2020 08:11	29/02/2020 08:14	0,05	1	0,05	CHI
202002185840	GOIANIA	GN13000142	GOIANIA LESTE S1	29/02/2020 08:09	29/02/2020 15:25	29/02/2020 08:23	29/02/2020 09:24	1,03	4266	4376,21	CHI
202002185840	GOIANIA	GN10380003	GOIANIA LESTE S1	29/02/2020 08:09	29/02/2020 15:25	29/02/2020 09:01	29/02/2020 10:14	1,23	294	360,72	CHI
202002185840	GOIANIA	GN13000479	GOIANIA LESTE S1	29/02/2020 08:09	29/02/2020 15:25	29/02/2020 09:01	29/02/2020 10:27	1,45	394	570,75	CHI
202002185840	GOIANIA	GN16407397	GOIANIA LESTE S1	29/02/2020 08:09	29/02/2020 15:25	29/02/2020 09:01	29/02/2020 11:32	2,52	1271	3200,45	CHI
202002185840	GOIANIA	GN16407397	GOIANIA LESTE S1	29/02/2020 08:09	29/02/2020 15:25	29/02/2020 09:01	29/02/2020 11:40	2,66	663	1766,16	CHI
202002185840	GOIANIA	GN16407397	GOIANIA LESTE S1	29/02/2020 08:09	29/02/2020 15:25	29/02/2020 09:01	29/02/2020 12:11	3,17	1	3,17	CHI
202002185840	GOIANIA	GN16407397	GOIANIA LESTE S1	29/02/2020 08:09	29/02/2020 15:25	29/02/2020 09:01	29/02/2020 15:25	6,41	234	1500,79	CHI
202002185842	PARANAIGUARA	PC12370096	QUIRINOPOLIS	28/02/2020 19:43	29/02/2020 10:50	28/02/2020 19:43	29/02/2020 10:50	15,11	3	45,32	CHI
202002185848	CATALAO	00830404	IPAMERI	29/02/2020 08:32	29/02/2020 13:28	29/02/2020 08:32	29/02/2020 11:52	3,32	2	6,63	CHI
202002185848	IPAMERI	00830404	IPAMERI	29/02/2020 08:32	29/02/2020 13:28	29/02/2020 08:32	29/02/2020 11:52	3,32	39	129,37	CHI
202002185848	IPAMERI	00830404	IPAMERI	29/02/2020 08:32	29/02/2020 13:28	29/02/2020 08:32	29/02/2020 11:52	3,32	99	328,40	CHI
202002185848	IPAMERI	00830404	IPAMERI	29/02/2020 08:32	29/02/2020 13:28	29/02/2020 08:32	29/02/2020 13:28	4,93	147	725,12	CHI
202002185848	IPAMERI	IP12275809	IPAMERI	29/02/2020 08:32	29/02/2020 13:28	29/02/2020 10:35	29/02/2020 13:28	2,90	1	2,90	CHI
202002185858	SANTA TEREZA DE GOIAS	SE21187888	MARA ROSA	29/02/2020 09:08	29/02/2020 11:29	29/02/2020 10:30	29/02/2020 11:29	0,98	1	0,98	CHI
202002185867	ARUANA	O3200434	ARUANA	29/02/2020 09:16	29/02/2020 13:01	29/02/2020 09:16	29/02/2020 12:30	3,23	8	25,84	CHI
202002185867	ARUANA	O3200434	ARUANA	29/02/2020 09:16	29/02/2020 13:01	29/02/2020 12:43	29/02/2020 13:01	0,31	8	2,47	CHI
202002185877	CAMPESTRE DE GOIAS	GC21026237	TRINDADE	29/02/2020 07:50	29/02/2020 10:57	29/02/2020 07:50	29/02/2020 10:57	3,10	1	3,10	CHI
202002185878	CAMPESTRE DE GOIAS	CP21357087	TRINDADE	29/02/2020 08:12	29/02/2020 12:51	29/02/2020 08:12	29/02/2020 12:51	4,64	3	13,93	CHI
202002185901	IPAMERI	IP12027098	URUTAI	29/02/2020 00:59	29/02/2020 13:48	29/02/2020 00:59	29/02/2020 13:48	12,82	8	102,53	CHI
202002185903	GOIANESIA	GE21080396	GOIANESIA S1	29/02/2020 01:04	29/02/2020 14:10	29/02/2020 01:04	29/02/2020 14:10	13,10	1	13,10	CHI
202002185904	RIO VERDE	RV11326759	RIO VERDE S1	29/02/2020 01:04	29/02/2020 23:39	29/02/2020 09:30	29/02/2020 23:39	14,16	86	1217,86	CHI
202002186101	DOVERLANDIA	DV12123974	CAIAPONIA	29/02/2020 07:18	29/02/2020 08:43	29/02/2020 07:18	29/02/2020 08:43	1,41	12	16,87	CHI
202002186103	PIRANHAS	PH12024566	ARENOPOLIS	29/02/2020 01:31	29/02/2020 07:58	29/02/2020 01:31	29/02/2020 07:58	6,44	23	148,18	CHI
202002186105	MOSSAMEDES	SC12323577	FIRMINOPOLIS S2	29/02/2020 01:40	29/02/2020 10:57	29/02/2020 01:40	29/02/2020 10:57	9,28	1	9,28	CHI
202002186105	SANCLERLANDIA	SC12323577	FIRMINOPOLIS S2	29/02/2020 01:40	29/02/2020 10:57	29/02/2020 01:40	29/02/2020 10:57	9,28	63	584,75	CHI
202002186107	BURITI DE GOIAS	BS12304459	FIRMINOPOLIS S2	29/02/2020 01:48	29/02/2020 07:50	29/02/2020 01:48	29/02/2020 07:50	6,03	10	60,29	CHI

202002186107	MOSSAMEDES	BS12304459	FIRMINOPOLIS S2	29/02/2020 01:48	29/02/2020 07:50	29/02/2020 01:48	29/02/2020 07:50	6,03	5	30,14	CHI
202002186107	SANCLERLANDIA	BS12304459	FIRMINOPOLIS S2	29/02/2020 01:48	29/02/2020 07:50	29/02/2020 01:48	29/02/2020 07:50	6,03	1	6,03	CHI
202002186111	MARA ROSA	MQ21134086	MARA ROSA	29/02/2020 02:09	29/02/2020 11:46	29/02/2020 02:09	29/02/2020 11:46	9,61	1	9,61	CHI
202002186113	PALMEIRAS DE GOIAS	PL12277480	PALMEIRAS	29/02/2020 02:13	29/02/2020 08:15	29/02/2020 02:13	29/02/2020 08:15	6,03	19	114,52	CHI
202002186114	AURILANDIA	CG12391526	FIRMINOPOLIS S2	29/02/2020 02:20	29/02/2020 11:24	29/02/2020 02:20	29/02/2020 11:24	9,05	2	18,11	CHI
202002186114	CACHOEIRA DE GOIAS	CG12391526	FIRMINOPOLIS S2	29/02/2020 02:20	29/02/2020 11:24	29/02/2020 02:20	29/02/2020 11:24	9,05	11	99,60	CHI
202002186114	PARAUNA	CG12391526	FIRMINOPOLIS S2	29/02/2020 02:20	29/02/2020 11:24	29/02/2020 02:20	29/02/2020 11:24	9,05	32	289,76	CHI
202002186115	ANAPOLIS	AN11215207	ANAPOLIS UNIVERSITARIO S2	29/02/2020 02:20	29/02/2020 04:18	29/02/2020 02:20	29/02/2020 04:18	1,95	28	54,62	CHI
202002186116	GOIANIA	10786820	CARAJAS S1	29/02/2020 02:23	29/02/2020 03:33	29/02/2020 02:23	29/02/2020 03:33	1,16	1	1,16	CHI
202002186118	HIDROLANDIA	HD31234712	CEPAIGO S2	29/02/2020 02:34	29/02/2020 13:45	29/02/2020 02:34	29/02/2020 13:45	11,18	1	11,18	CHI
202002186119	MINEIROS	SU12184127	SANTA RITA DO ARAGUAIA	29/02/2020 02:34	29/02/2020 15:25	29/02/2020 02:34	29/02/2020 15:25	12,85	14	179,87	CHI
202002186120	TRINDADE	TR11365570	TRINDADE	29/02/2020 02:41	29/02/2020 05:40	29/02/2020 02:41	29/02/2020 05:40	2,98	129	384,81	CHI
202002186126	SANTA RITA DO ARAGUAIA	SU12188579	PARQUE DAS EMAS	29/02/2020 03:03	29/02/2020 19:28	29/02/2020 03:03	29/02/2020 19:28	16,41	5	82,03	CHI
202002186129	AMORINOPOLIS	AM12133498	IPORA	29/02/2020 03:06	29/02/2020 09:24	29/02/2020 03:06	29/02/2020 07:45	4,64	112	519,68	CHI
202002186129	AMORINOPOLIS	AM11231074	IPORA	29/02/2020 03:06	29/02/2020 09:24	29/02/2020 03:06	29/02/2020 09:24	6,31	65	409,84	CHI
202002186133	PALMEIRAS DE GOIAS	PL21000136	PALMEIRAS	29/02/2020 03:29	29/02/2020 08:54	29/02/2020 03:29	29/02/2020 08:54	5,41	1	5,41	CHI
202002186136	MOSSAMEDES	MD12024152	FIRMINOPOLIS S2	29/02/2020 01:02	29/02/2020 07:15	29/02/2020 01:02	29/02/2020 07:15	6,21	109	677,28	CHI
202002186136	SANCLERLANDIA	MD12024152	FIRMINOPOLIS S2	29/02/2020 01:02	29/02/2020 07:15	29/02/2020 01:02	29/02/2020 07:15	6,21	9	55,92	CHI
202002186138	GOIANIA	GN11249509	GOIANIA LESTE S3	29/02/2020 03:46	29/02/2020 13:25	29/02/2020 03:46	29/02/2020 13:25	9,64	128	1233,81	CHI
202002186142	FORMOSO	FO12145370	PORANGATU	29/02/2020 00:58	29/02/2020 09:06	29/02/2020 00:58	29/02/2020 09:06	8,13	57	463,47	CHI
202002186145	MOZARLANDIA	MZ12055650	MOZARLANDIA	29/02/2020 04:19	01/03/2020 20:59	29/02/2020 04:19	29/02/2020 20:21	16,04	2	32,09	CHI
202002186145	NOVA CRIXAS	MZ12055650	MOZARLANDIA	29/02/2020 04:19	01/03/2020 20:59	29/02/2020 04:19	29/02/2020 20:21	16,04	23	368,98	CHI
202002186145	CRIXAS	MZ12055650	MOZARLANDIA	29/02/2020 04:19	01/03/2020 20:59	29/02/2020 04:19	01/03/2020 13:43	33,40	4	133,60	CHI
202002186145	NOVA CRIXAS	MZ12055650	MOZARLANDIA	29/02/2020 04:19	01/03/2020 20:59	29/02/2020 04:19	01/03/2020 13:43	33,40	4	133,60	CHI
202002186145	CRIXAS	MZ12055650	MOZARLANDIA	29/02/2020 04:19	01/03/2020 20:59	29/02/2020 04:19	01/03/2020 19:35	39,28	2	78,56	CHI
202002186145	MOZARLANDIA	MZ12055650	MOZARLANDIA	29/02/2020 04:19	01/03/2020 20:59	29/02/2020 04:19	01/03/2020 19:35	39,28	2	78,56	CHI
202002186145	CRIXAS	MZ12055650	MOZARLANDIA	29/02/2020 04:19	01/03/2020 20:59	29/02/2020 04:19	01/03/2020 20:05	39,77	50	1988,28	CHI
202002186145	CRIXAS	MZ12055650	MOZARLANDIA	29/02/2020 04:19	01/03/2020 20:59	29/02/2020 04:19	01/03/2020 20:59	40,68	19	772,84	CHI
202002186145	MOZARLANDIA	MZ12055650	MOZARLANDIA	29/02/2020 04:19	01/03/2020 20:59	29/02/2020 04:19	01/03/2020 20:59	40,68	1	40,68	CHI
202002186148	ITABERAI	IB12016899	INHUMAS S1	29/02/2020 04:30	29/02/2020 12:06	29/02/2020 04:30	29/02/2020 12:06	7,59	30	227,64	CHI
202002186153	SAO DOMINGOS	SD21090136	SAO DOMINGOS	29/02/2020 04:57	29/02/2020 07:51	29/02/2020 04:57	29/02/2020 07:51	2,90	1	2,90	CHI
202002186154	ITAPURANGA	GK12300357	ITAPURANGA	29/02/2020 04:59	29/02/2020 07:39	29/02/2020 04:59	29/02/2020 07:39	2,66	14	37,17	CHI
202002186160	CALDAS NOVAS	IX12000065	INHUMAS S1	29/02/2020 05:14	29/02/2020 12:06	29/02/2020 05:14	29/02/2020 12:06	6,86	1	6,86	CHI
202002186160	ITABERAI	IX12000065	INHUMAS S1	29/02/2020 05:14	29/02/2020 12:06	29/02/2020 05:14	29/02/2020 12:06	6,86	12	82,33	CHI
202002186160	ITAUCU	IX12000065	INHUMAS S1	29/02/2020 05:14	29/02/2020 12:06	29/02/2020 05:14	29/02/2020 12:06	6,86	38	260,72	CHI
202002186169	AMARALINA	MU12391672	MARA ROSA	29/02/2020 05:12	29/02/2020 08:01	29/02/2020 05:12	29/02/2020 08:01	2,81	101	284,20	CHI
202002186169	MUTUNOPOLIS	MU12391672	MARA ROSA	29/02/2020 05:12	29/02/2020 08:01	29/02/2020 05:12	29/02/2020 08:01	2,81	7	19,70	CHI
202002186172	SAO MIGUEL DO ARAGUAIA	SM12013036	SAO MIGUEL DO ARAGUAIA	29/02/2020 05:38	29/02/2020 10:42	29/02/2020 05:38	29/02/2020 10:42	5,07	22	111,47	CHI
202002186173	ORIZONA	OZ21022984	PIRES DO RIO S2	29/02/2020 05:39	29/02/2020 08:46	29/02/2020 05:39	29/02/2020 08:46	3,11	1	3,11	CHI
202002186174	CATALAO	CT12190396	CATALAO S2	29/02/2020 05:39	29/02/2020 08:10	29/02/2020 05:39	29/02/2020 08:10	2,51	371	930,80	CHI
202002186177	GOIANESIA	GE12376540	GOIANESIA S1	29/02/2020 05:41	29/02/2020 09:53	29/02/2020 05:41	29/02/2020 09:53	4,20	214	897,97	CHI
202002186180	GOIAS	GS12087523	GOIAS	29/02/2020 05:45	29/02/2020 16:54	29/02/2020 05:45	29/02/2020 16:54	11,14	68	757,35	CHI
202002186189	GOIATUBA	GT12000264	GOIATUBA S1	29/02/2020 05:58	29/02/2020 10:50	29/02/2020 05:58	29/02/2020 10:50	4,85	16	77,61	CHI
202002186189	PANAMA	GT12000264	GOIATUBA S1	29/02/2020 05:58	29/02/2020 10:50	29/02/2020 05:58	29/02/2020 10:50	4,85	1	4,85	CHI

202002186189	RUBIATABA	GT12000264	GOIATUBA S1	29/02/2020 05:58	29/02/2020 10:50	29/02/2020 05:58	29/02/2020 10:50	4,85	1	4,85	CHI
202002186191	FORMOSA	FA12404372	ITUIQUIRA	29/02/2020 06:00	29/02/2020 08:15	29/02/2020 06:00	29/02/2020 08:15	2,24	169	378,47	CHI
202002186192	NOVA CRIXAS	NA11357664	NOVA CRIXAS	29/02/2020 06:01	29/02/2020 16:38	29/02/2020 06:01	29/02/2020 16:38	10,61	1	10,61	CHI
202002186194	PORANGATU	PO12141124	NOVO PLANALTO	29/02/2020 02:53	29/02/2020 08:02	29/02/2020 02:53	29/02/2020 08:02	5,14	20	102,74	CHI
202002186196	ORIZONA	3450000285	PIRES DO RIO S2	29/02/2020 06:03	29/02/2020 08:10	29/02/2020 06:03	29/02/2020 08:10	2,11	1	2,11	CHI
202002186200	MONTES CLAROS DE GOIAS	ME12088929	IPORA	29/02/2020 06:08	29/02/2020 09:25	29/02/2020 06:08	29/02/2020 09:25	3,28	4	13,12	CHI
202002186207	ARENOPOLIS	AY12380961	ARENOPOLIS	29/02/2020 06:11	29/02/2020 09:37	29/02/2020 06:11	29/02/2020 09:37	3,43	2	6,86	CHI
202002186207	PALESTINA DE GOIAS	AY12380961	ARENOPOLIS	29/02/2020 06:11	29/02/2020 09:37	29/02/2020 06:11	29/02/2020 09:37	3,43	3	10,28	CHI
202002186212	GOIAS	GS12319371	GOIAS	29/02/2020 06:12	29/02/2020 11:30	29/02/2020 06:12	29/02/2020 11:30	5,28	1	5,28	CHI
202002186218	ITAUUCU	PV17246847	CORUMBA	29/02/2020 04:42	29/02/2020 09:59	29/02/2020 04:42	29/02/2020 09:59	5,27	1	5,27	CHI
202002186218	PIRENOPOLIS	PV17246847	CORUMBA	29/02/2020 04:42	29/02/2020 09:59	29/02/2020 04:42	29/02/2020 09:59	5,27	70	368,90	CHI
202002186220	ITABERAI	IB21183013	ITABERAI S1	28/02/2020 20:20	29/02/2020 07:21	28/02/2020 20:20	29/02/2020 07:21	11,01	1	11,01	CHI
202002186221	RIO VERDE	RV12260579	RIO VERDE S1	29/02/2020 05:28	29/02/2020 14:25	29/02/2020 05:28	29/02/2020 14:25	8,95	16	143,14	CHI
202002186225	QUIRINOPOLIS	QI32052820	QUIRINOPOLIS	28/02/2020 22:04	29/02/2020 07:40	28/02/2020 22:04	29/02/2020 07:40	9,59	36	345,33	CHI
202002186226	CRIXAS	CX12318400	MOZARLANDIA	29/02/2020 06:20	01/03/2020 13:33	29/02/2020 06:20	29/02/2020 14:12	7,86	4	31,44	CHI
202002186226	CRIXAS	CX12318400	MOZARLANDIA	29/02/2020 06:20	01/03/2020 13:33	29/02/2020 06:20	29/02/2020 20:55	14,58	6	87,47	CHI
202002186226	CRIXAS	CX12318400	MOZARLANDIA	29/02/2020 06:20	01/03/2020 13:33	29/02/2020 06:20	01/03/2020 13:33	31,22	1	31,22	CHI
202002186230	PORTEIRAO	CL12230806	RIO DOS BOIS	29/02/2020 06:21	29/02/2020 09:22	29/02/2020 06:21	29/02/2020 09:22	3,01	4	12,04	CHI
202002186230	VICENTINOPOLIS	CL12230806	RIO DOS BOIS	29/02/2020 06:21	29/02/2020 09:22	29/02/2020 06:21	29/02/2020 09:22	3,01	4	12,04	CHI
202002186232	MINACU	IH12171869	MINACU	29/02/2020 06:22	29/02/2020 08:22	29/02/2020 06:22	29/02/2020 08:22	1,99	74	147,53	CHI
202002186235	CARMO DO RIO VERDE	IK12311305	ITAPURANGA	29/02/2020 04:43	29/02/2020 08:34	29/02/2020 04:43	29/02/2020 08:34	3,85	28	107,68	CHI
202002186235	ITAPURANGA	IK12311305	ITAPURANGA	29/02/2020 04:43	29/02/2020 08:34	29/02/2020 04:43	29/02/2020 08:34	3,85	120	461,50	CHI
202002186246	SAO PATRICIO	RB21053429	RUBIATABA	29/02/2020 06:31	29/02/2020 10:00	29/02/2020 06:31	29/02/2020 10:00	3,48	1	3,48	CHI
202002186250	GOIAS	GS12076721	GOIAS	29/02/2020 06:32	29/02/2020 14:45	29/02/2020 06:32	29/02/2020 14:45	8,21	23	188,78	CHI
202002186257	BURITINOPOLIS	SU12248425	SANTA RITA DO ARAGUAIA	29/02/2020 06:32	29/02/2020 14:00	29/02/2020 06:32	29/02/2020 14:00	7,46	1	7,46	CHI
202002186257	MINEIROS	SU12248425	SANTA RITA DO ARAGUAIA	29/02/2020 06:32	29/02/2020 14:00	29/02/2020 06:32	29/02/2020 14:00	7,46	11	82,09	CHI
202002186257	SANTA RITA DO ARAGUAIA	SU12248425	SANTA RITA DO ARAGUAIA	29/02/2020 06:32	29/02/2020 14:00	29/02/2020 06:32	29/02/2020 14:00	7,46	131	977,66	CHI
202002186259	CORUMBAIBA	CI12298710	VILA CORUMBA	29/02/2020 06:24	29/02/2020 09:54	29/02/2020 06:24	29/02/2020 09:54	3,50	15	52,45	CHI
202002186264	ACREUNA	2440071013	ACREUNA	29/02/2020 06:34	29/02/2020 19:56	29/02/2020 06:34	29/02/2020 19:56	13,35	1	13,35	CHI
202002186265	APORE	AE12324797	ITAJA S1	29/02/2020 06:34	29/02/2020 09:21	29/02/2020 06:34	29/02/2020 09:21	2,77	11	30,49	CHI
202002186265	SERRANOPOLIS	AE12324797	ITAJA S1	29/02/2020 06:34	29/02/2020 09:21	29/02/2020 06:34	29/02/2020 09:21	2,77	8	22,18	CHI
202002186266	AMARALINA	MU12391981	MARA ROSA	29/02/2020 06:35	29/02/2020 09:20	29/02/2020 06:35	29/02/2020 09:20	2,75	5	13,74	CHI
202002186266	MUTUNOPOLIS	MU12391981	MARA ROSA	29/02/2020 06:35	29/02/2020 09:20	29/02/2020 06:35	29/02/2020 09:20	2,75	5	13,74	CHI
202002186268	ITAPIRAPUA	IU12142823	MATRINCHA	29/02/2020 06:35	29/02/2020 08:20	29/02/2020 06:35	29/02/2020 08:20	1,75	3	5,24	CHI
202002186269	SILVANIA	LZ12009166	VIANOPOLIS	29/02/2020 06:35	29/02/2020 10:15	29/02/2020 06:35	29/02/2020 10:15	3,65	5	18,27	CHI
202002186270	IPAMERI	IP12248620	CRISTALINA S2	29/02/2020 06:27	29/02/2020 11:12	29/02/2020 06:27	29/02/2020 11:12	4,74	9	42,68	CHI
202002186272	JATAI	JT12211164	JATAI S2	29/02/2020 06:37	29/02/2020 10:47	29/02/2020 06:37	29/02/2020 10:47	4,16	9	37,47	CHI
202002186280	IPAMERI	GD12075517	IPAMERI	28/02/2020 20:47	29/02/2020 16:38	28/02/2020 20:47	29/02/2020 16:38	19,84	12	238,02	CHI
202002186283	QUIRINOPOLIS	QI31007606	SANTA HELENA S1	29/02/2020 06:42	29/02/2020 09:32	29/02/2020 06:42	29/02/2020 09:32	2,83	2	5,67	CHI
202002186284	PARAUNA	PU21028675	PARAUNA	29/02/2020 06:41	29/02/2020 15:00	29/02/2020 06:41	29/02/2020 15:00	8,30	1	8,30	CHI
202002186290	CRISTALINA	KR12290718	CRISTALINA S1	29/02/2020 06:43	29/02/2020 09:38	29/02/2020 06:43	29/02/2020 09:38	2,91	35	101,74	CHI
202002186293	CIDADE OCIDENTAL	LZ12261690	MARAJOARA	29/02/2020 06:43	29/02/2020 08:59	29/02/2020 06:43	29/02/2020 08:59	2,25	70	157,66	CHI
202002186293	CRISTALINA	LZ12261690	MARAJOARA	29/02/2020 06:43	29/02/2020 08:59	29/02/2020 06:43	29/02/2020 08:59	2,25	1	2,25	CHI
202002186297	DIVINOPOLIS DE GOIAS	GH12151237	SAO DOMINGOS	29/02/2020 06:45	29/02/2020 09:50	29/02/2020 06:45	29/02/2020 09:50	3,08	29	89,38	CHI

202002186297	SAO DOMINGOS	GH12151237	SAO DOMINGOS	29/02/2020 06:45	29/02/2020 09:50	29/02/2020 06:45	29/02/2020 09:50	3,08	21	64,72	CHI
202002186299	GOIANIA	GN11213539	MEIA PONTE	29/02/2020 06:45	29/02/2020 11:26	29/02/2020 06:45	29/02/2020 11:26	4,68	73	341,40	CHI
202002186301	SAO LUIS DE MONTES BELOS	SL12019499	SAO LUIZ DOS MONTES BELOS	29/02/2020 06:46	29/02/2020 10:03	29/02/2020 06:46	29/02/2020 10:03	3,28	24	78,71	CHI
202002186304	PIRACANJUBA	PJ12105715	MORRINHOS	29/02/2020 06:46	29/02/2020 11:47	29/02/2020 06:46	29/02/2020 11:47	5,01	4	20,03	CHI
202002186313	MARA ROSA	MQ12146955	MARA ROSA	29/02/2020 06:50	29/02/2020 11:50	29/02/2020 06:50	29/02/2020 11:50	5,00	12	59,94	CHI
202002186318	PIRENOPOLIS	PV12123145	SAO FRANCISCO DE GOIAS	29/02/2020 06:52	29/02/2020 11:02	29/02/2020 06:52	29/02/2020 11:02	4,17	11	45,82	CHI
202002186324	SITIO D ABADIA	SI12236825	IACIARA S2	29/02/2020 06:53	29/02/2020 09:43	29/02/2020 06:53	29/02/2020 09:43	2,83	4	11,31	CHI
202002186330	ALTO PARAISO DE GOIAS	BF12206279	NIQUELANDIA SUBTRANSMISSAO	29/02/2020 06:54	29/02/2020 12:13	29/02/2020 06:54	29/02/2020 12:13	5,31	7	37,15	CHI
202002186330	SAO JOAO D ALIANCA	BF12206279	NIQUELANDIA SUBTRANSMISSAO	29/02/2020 06:54	29/02/2020 12:13	29/02/2020 06:54	29/02/2020 12:13	5,31	1	5,31	CHI
202002186332	ITAPURANGA	IK11220449	ITAPURANGA	29/02/2020 06:55	29/02/2020 09:39	29/02/2020 06:55	29/02/2020 09:39	2,73	111	302,57	CHI
202002186339	MINEIROS	MY12156850	PARQUE DAS EMAS	29/02/2020 06:40	29/02/2020 13:48	29/02/2020 06:40	29/02/2020 13:48	7,12	30	213,60	CHI
202002186343	SANTA TEREZINHA DE GOIAS	SG12202092	SANTA TEREZINHA	29/02/2020 06:58	29/02/2020 10:40	29/02/2020 06:58	29/02/2020 10:40	3,70	6	22,17	CHI
202002186347	CATALAO	CT12093871	CATALAO S1	29/02/2020 07:00	29/02/2020 11:06	29/02/2020 07:00	29/02/2020 11:06	4,09	40	163,61	CHI
202002186348	COCALZINHO DE GOIAS	ZN12382928	AGUAS LINDAS DE GOIAS S2	29/02/2020 07:01	29/02/2020 10:44	29/02/2020 07:01	29/02/2020 10:44	3,71	1	3,71	CHI
202002186353	COCALZINHO DE GOIAS	ZN12216781	PADRE BERNARDO	29/02/2020 07:02	29/02/2020 11:31	29/02/2020 07:02	29/02/2020 11:31	4,48	2	8,96	CHI
202002186356	CRISTALINA	KR12171519	CRISTALINA S1	29/02/2020 07:03	29/02/2020 12:01	29/02/2020 07:03	29/02/2020 12:01	4,96	12	59,54	CHI
202002186357	ANICUNS	AC12024032	ANICUNS	29/02/2020 06:42	29/02/2020 10:39	29/02/2020 06:42	29/02/2020 10:39	3,94	24	94,51	CHI
202002186357	TURVANIA	AC12024032	ANICUNS	29/02/2020 06:42	29/02/2020 10:39	29/02/2020 06:42	29/02/2020 10:39	3,94	4	15,75	CHI
202002186358	LUZIANIA	LZ21370705	VIANOPOLIS	29/02/2020 07:03	29/02/2020 14:49	29/02/2020 07:03	29/02/2020 14:49	7,77	1	7,77	CHI
202002186360	SILVANIA	SV11157613	VIANOPOLIS	28/02/2020 21:50	29/02/2020 08:45	28/02/2020 21:50	29/02/2020 08:45	10,90	97	1057,49	CHI
202002186361	MATRINCHA	MP12237240	MATRINCHA	29/02/2020 06:58	29/02/2020 12:01	29/02/2020 06:58	29/02/2020 12:01	5,05	5	25,25	CHI
202002186365	FAINA	FC12147794	GOIAS	29/02/2020 07:06	29/02/2020 12:41	29/02/2020 07:06	29/02/2020 12:41	5,57	51	284,08	CHI
202002186366	MINEIROS	MY21303703	PARQUE DAS EMAS	29/02/2020 07:06	29/02/2020 13:53	29/02/2020 07:06	29/02/2020 13:53	6,77	1	6,77	CHI
202002186367	CORUMBAIBA	CI12107484	VILA CORUMBA	28/02/2020 19:56	29/02/2020 11:49	28/02/2020 19:56	29/02/2020 11:49	15,87	3	47,61	CHI
202002186370	JARAGUA	JA12298041	JARAGUA	29/02/2020 06:32	29/02/2020 10:22	29/02/2020 06:32	29/02/2020 10:22	3,83	62	237,46	CHI
202002186374	SIMOLANDIA	SA21366209	IACIARA S2	29/02/2020 07:09	29/02/2020 09:21	29/02/2020 07:09	29/02/2020 09:21	2,19	1	2,19	CHI
202002186375	CRISTALINA	KR12199519	PAMPLONA	29/02/2020 07:09	29/02/2020 10:14	29/02/2020 07:09	29/02/2020 10:14	3,07	4	12,27	CHI
202002186376	ANAPOLIS	AN12000193RE	ANAPOLIS UNIVERSITARIO S2	29/02/2020 05:39	29/02/2020 10:54	29/02/2020 05:39	29/02/2020 10:54	5,24	48	251,63	CHI
202002186376	PIRENOPOLIS	AN12000193RE	ANAPOLIS UNIVERSITARIO S2	29/02/2020 05:39	29/02/2020 10:54	29/02/2020 05:39	29/02/2020 10:54	5,24	16	83,88	CHI
202002186377	AMERICANO DO BRASIL	IB12000062	ITABERAI S2	29/02/2020 07:10	29/02/2020 09:35	29/02/2020 07:10	29/02/2020 09:35	2,41	11	26,56	CHI
202002186377	ITABERAI	IB12000062	ITABERAI S2	29/02/2020 07:10	29/02/2020 09:35	29/02/2020 07:10	29/02/2020 09:35	2,41	18	43,46	CHI
202002186380	SANTA FE DE GOIAS	RN12362428	BRITANIA	29/02/2020 07:10	29/02/2020 10:49	29/02/2020 07:10	29/02/2020 10:49	3,64	3	10,93	CHI
202002186384	GOIAS	GS12070348	GOIAS	29/02/2020 07:10	29/02/2020 16:00	29/02/2020 07:10	29/02/2020 16:00	8,84	6	53,01	CHI
202002186388	IACIARA	IA12218798LD	IACIARA S2	29/02/2020 07:13	29/02/2020 10:25	29/02/2020 07:13	29/02/2020 10:25	3,20	1	3,20	CHI
202002186388	SAO DOMINGOS	IA12218798LD	IACIARA S2	29/02/2020 07:13	29/02/2020 10:25	29/02/2020 07:13	29/02/2020 10:25	3,20	3	9,59	CHI
202002186389	AMORINOPOLIS	AM12035305	IPORA	29/02/2020 05:54	29/02/2020 12:58	29/02/2020 05:54	29/02/2020 12:58	7,07	12	84,78	CHI
202002186393	ARENOPOLIS	AY12103482	ARENOPOLIS	29/02/2020 07:12	29/02/2020 19:50	29/02/2020 07:12	29/02/2020 19:50	12,63	11	138,96	CHI
202002186393	DIORAMA	AY12103482	ARENOPOLIS	29/02/2020 07:12	29/02/2020 19:50	29/02/2020 07:12	29/02/2020 19:50	12,63	9	113,69	CHI
202002186396	PIRACANJUBA	PJ21282980	PIRACANJUBA	29/02/2020 07:16	29/02/2020 19:00	29/02/2020 07:16	29/02/2020 19:00	11,73	1	11,73	CHI
202002186401	AMORINOPOLIS	AM12039409	IPORA	29/02/2020 06:44	29/02/2020 10:05	29/02/2020 06:44	29/02/2020 10:05	3,35	5	16,73	CHI
202002186401	IPORA	AM12039409	IPORA	29/02/2020 06:44	29/02/2020 10:05	29/02/2020 06:44	29/02/2020 10:05	3,35	1	3,35	CHI
202002186407	CAMPOS BELOS	CH12338303	SAO DOMINGOS	29/02/2020 07:19	29/02/2020 11:43	29/02/2020 07:19	29/02/2020 11:43	4,40	7	30,77	CHI
202002186408	HIDROLANDIA	HD21000202	CEPAIGO S2	29/02/2020 07:19	29/02/2020 15:38	29/02/2020 07:19	29/02/2020 15:38	8,31	1	8,31	CHI
202002186416	CAMPOS VERDES	VD12257347	SANTA TEREZINHA	29/02/2020 07:21	29/02/2020 12:59	29/02/2020 07:21	29/02/2020 12:59	5,63	3	16,89	CHI

202002186422	POSSE	PS12255419	IACIARA S2	29/02/2020 07:22	29/02/2020 10:56	29/02/2020 07:22	29/02/2020 10:56	3,56	12	42,67	CHI
202002186424	PIRENOPOLIS	PV12196919	SAO FRANCISCO DE GOIAS	29/02/2020 07:07	29/02/2020 09:03	29/02/2020 07:07	29/02/2020 09:03	1,92	9	17,32	CHI
202002186426	IVOLANDIA	MO12336568	IPORA	29/02/2020 07:19	29/02/2020 11:55	29/02/2020 07:19	29/02/2020 11:55	4,60	6	27,58	CHI
202002186426	MOIPORA	MO12336568	IPORA	29/02/2020 07:19	29/02/2020 11:55	29/02/2020 07:19	29/02/2020 11:55	4,60	5	22,98	CHI
202002186429	JATAI	JT12062162	JATAI S1	29/02/2020 07:24	29/02/2020 12:41	29/02/2020 07:24	29/02/2020 12:41	5,29	20	105,83	CHI
202002186434	ARUANA	AK12310720	ARUANA	29/02/2020 07:25	29/02/2020 16:25	29/02/2020 07:25	29/02/2020 16:25	8,99	3	26,98	CHI
202002186435	ITAPIRAPUA	IU12250533	MATRINCHA	29/02/2020 07:25	29/02/2020 17:57	29/02/2020 07:25	29/02/2020 17:57	10,52	1	10,52	CHI
202002186438	NIQUELANDIA	NQ21268973	URUACU	29/02/2020 07:26	29/02/2020 12:53	29/02/2020 07:26	29/02/2020 12:53	5,44	1	5,44	CHI
202002186441	CALDAZINHA	LB12270648	DAIA S2	29/02/2020 07:27	29/02/2020 09:58	29/02/2020 07:27	29/02/2020 09:58	2,53	1	2,53	CHI
202002186441	LEOPOLDO DE BULHOES	LB12270648	DAIA S2	29/02/2020 07:27	29/02/2020 09:58	29/02/2020 07:27	29/02/2020 09:58	2,53	18	45,47	CHI
202002186446	PARAUNA	EU12279651	ACREUNA	29/02/2020 07:28	29/02/2020 18:55	29/02/2020 07:28	29/02/2020 18:55	11,45	2	22,90	CHI
202002186449	MINACU	IH12134994	MINACU	29/02/2020 07:28	29/02/2020 10:16	29/02/2020 07:28	29/02/2020 10:16	2,79	11	30,71	CHI
202002186450	POSSE	1480034839	IACIARA S2	29/02/2020 07:28	29/02/2020 08:59	29/02/2020 07:28	29/02/2020 08:59	1,50	1	1,50	CHI
202002186455	MONTE ALEGRE DE GOIAS	ND12164550	IACIARA S2	29/02/2020 06:58	29/02/2020 10:08	29/02/2020 06:58	29/02/2020 10:08	3,16	1	3,16	CHI
202002186455	NOVA ROMA	ND12164550	IACIARA S2	29/02/2020 06:58	29/02/2020 10:08	29/02/2020 06:58	29/02/2020 10:08	3,16	219	692,71	CHI
202002186460	CAMPOS VERDES	VD12145521	SANTA TEREZINHA	29/02/2020 04:24	29/02/2020 12:11	29/02/2020 04:24	29/02/2020 12:11	7,78	2	15,55	CHI
202002186460	SANTA TEREZINHA DE GOIAS	VD12145521	SANTA TEREZINHA	29/02/2020 04:24	29/02/2020 12:11	29/02/2020 04:24	29/02/2020 12:11	7,78	29	225,50	CHI
202002186462	CABECEIRAS	CW12181818	ITIQUEIRA	29/02/2020 07:31	29/02/2020 10:10	29/02/2020 07:31	29/02/2020 10:10	2,64	3	7,92	CHI
202002186466	ARAGUAPAZ	AZ12404563	GOIAS	29/02/2020 07:32	29/02/2020 09:22	29/02/2020 07:32	29/02/2020 09:22	1,83	20	36,63	CHI
202002186466	FAINA	AZ12404563	GOIAS	29/02/2020 07:32	29/02/2020 09:22	29/02/2020 07:32	29/02/2020 09:22	1,83	1	1,83	CHI
202002186468	ANAPOLIS	AN11157960	ANAPOLIS UNIVERSITARIO S2	29/02/2020 06:41	29/02/2020 09:12	29/02/2020 06:41	29/02/2020 09:12	2,51	98	245,73	CHI
202002186477	CAMPO LIMPO	10029100206	NEROPOLIS S1	29/02/2020 07:34	29/02/2020 10:13	29/02/2020 07:34	29/02/2020 10:13	2,64	1	2,64	CHI
202002186478	PIRENOPOLIS	PV12008488	CORUMBA	29/02/2020 07:00	29/02/2020 11:02	29/02/2020 07:00	29/02/2020 11:02	4,02	8	32,19	CHI
202002186482	PETROLINA DE GOIAS	PG21028353	PETROLINA	29/02/2020 07:35	29/02/2020 13:31	29/02/2020 07:35	29/02/2020 13:31	5,92	2	11,84	CHI
202002186484	PIRENOPOLIS	PV12000461	SAO FRANCISCO DE GOIAS	29/02/2020 07:35	29/02/2020 10:11	29/02/2020 07:35	29/02/2020 10:11	2,59	65	168,15	CHI
202002186485	ARAGARCAS	AG12341726	IPORA	29/02/2020 07:36	29/02/2020 10:56	29/02/2020 07:36	29/02/2020 10:56	3,33	28	93,29	CHI
202002186487	SAO SIMAO	SO13226524	CACHOEIRA ALTA	29/02/2020 06:44	29/02/2020 11:15	29/02/2020 06:44	29/02/2020 11:15	4,51	197	889,24	CHI
202002186487	SAO SIMAO	SO13226524	CACHOEIRA ALTA	29/02/2020 06:44	29/02/2020 11:15	29/02/2020 10:40	29/02/2020 11:15	0,57	17	9,73	CHI
202002186488	BOM JESUS DE GOIAS	BJ21205362	RIO DOS BOIS	29/02/2020 07:36	29/02/2020 14:00	29/02/2020 07:36	29/02/2020 14:00	6,39	2	12,77	CHI
202002186498	ACREUNA	EU12097073	ACREUNA	29/02/2020 07:38	29/02/2020 12:24	29/02/2020 07:38	29/02/2020 12:24	4,76	3	14,28	CHI
202002186503	LUZIANIA	LZ21304776	VIANOPOLIS	29/02/2020 07:39	29/02/2020 17:35	29/02/2020 07:39	29/02/2020 17:35	9,92	1	9,92	CHI
202002186508	CAIAPONIA	CP12207986	CAIAPONIA	29/02/2020 07:41	29/02/2020 16:54	29/02/2020 07:41	29/02/2020 16:54	9,21	12	110,57	CHI
202002186510	LUZIANIA	LZ12206739	VIANOPOLIS	29/02/2020 07:41	29/02/2020 12:36	29/02/2020 07:41	29/02/2020 12:36	4,92	1	4,92	CHI
202002186511	GOIANIA	10911595	GOIANIA LESTE S2	29/02/2020 07:41	29/02/2020 09:15	29/02/2020 07:41	29/02/2020 09:15	1,56	1	1,56	CHI
202002186512	CRIXAS	NA21281782	SERRA DO OURO	29/02/2020 07:41	29/02/2020 15:41	29/02/2020 07:41	29/02/2020 15:41	7,99	2	15,98	CHI
202002186513	CEZARINA	ED12108537	PONTALINA	29/02/2020 05:34	29/02/2020 12:20	29/02/2020 05:34	29/02/2020 12:20	6,75	4	27,01	CHI
202002186513	EDEALINA	ED12108537	PONTALINA	29/02/2020 05:34	29/02/2020 12:20	29/02/2020 05:34	29/02/2020 12:20	6,75	53	357,84	CHI
202002186513	INDIARA	ED12108537	PONTALINA	29/02/2020 05:34	29/02/2020 12:20	29/02/2020 05:34	29/02/2020 12:20	6,75	2	13,50	CHI
202002186514	QUIRINOPOLIS	QI32058080	QUIRINOPOLIS	29/02/2020 07:42	29/02/2020 09:38	29/02/2020 07:42	29/02/2020 09:38	1,92	10	19,18	CHI
202002186516	MORRINHOS	MR21000089	GOIATUBA S1	29/02/2020 07:43	29/02/2020 12:53	29/02/2020 07:43	29/02/2020 12:53	5,17	1	5,17	CHI
202002186517	ARAGOIANIA	AO12291291	GUAPO S2	29/02/2020 06:32	29/02/2020 13:23	29/02/2020 06:32	29/02/2020 13:23	6,86	44	301,82	CHI
202002186517	HIDROLANDIA	AO12291291	GUAPO S2	29/02/2020 06:32	29/02/2020 13:23	29/02/2020 06:32	29/02/2020 13:23	6,86	2	13,72	CHI
202002186518	FLORES DE GOIAS	FB12204157	FLORES DE GOIAS	29/02/2020 07:43	29/02/2020 09:27	29/02/2020 07:43	29/02/2020 09:27	1,72	13	22,36	CHI
202002186521	FORMOSA	FA21233604	ITIQUEIRA	29/02/2020 07:44	29/02/2020 09:19	29/02/2020 07:44	29/02/2020 09:19	1,58	1	1,58	CHI

202002186523	GOIANIA	GN11001897	AEROPORTO S1	29/02/2020 07:44	29/02/2020 09:46	29/02/2020 08:19	29/02/2020 09:46	1,45	15	21,75	CHI
202002186524	GOIANESIA	GE21115124	GOIANESIA S2	29/02/2020 07:44	29/02/2020 10:15	29/02/2020 07:44	29/02/2020 10:15	2,52	1	2,52	CHI
202002186527	AGUA LIMPA	AL12000251	VILA CORUMBA	29/02/2020 06:13	29/02/2020 09:31	29/02/2020 06:13	29/02/2020 09:31	3,28	52	170,78	CHI
202002186527	BURITI ALEGRE	AL12000251	VILA CORUMBA	29/02/2020 06:13	29/02/2020 09:31	29/02/2020 06:13	29/02/2020 09:31	3,28	3	9,85	CHI
202002186527	MORRINHOS	AL12000251	VILA CORUMBA	29/02/2020 06:13	29/02/2020 09:31	29/02/2020 06:13	29/02/2020 09:31	3,28	2	6,57	CHI
202002186529	HIDROLINA	HL21133372	ITAPACI	29/02/2020 07:46	29/02/2020 09:49	29/02/2020 07:46	29/02/2020 09:49	2,04	1	2,04	CHI
202002186530	GOIANDIRA	GD21215720	CATALAO S1	29/02/2020 07:46	01/03/2020 08:28	29/02/2020 07:46	01/03/2020 08:28	24,69	2	49,39	CHI
202002186534	FORMOSA	610309160	ITUIQUIRA	29/02/2020 07:46	29/02/2020 08:58	29/02/2020 07:46	29/02/2020 08:58	1,19	1	1,19	CHI
202002186539	TURVELANDIA	TD12303622	RIO DOS BOIS	29/02/2020 07:47	29/02/2020 14:56	29/02/2020 07:47	29/02/2020 14:56	7,14	26	185,60	CHI
202002186540	CACHOEIRA ALTA	PC12209796	CACHOEIRA ALTA	29/02/2020 07:47	29/02/2020 16:39	29/02/2020 07:47	29/02/2020 16:39	8,85	3	26,56	CHI
202002186541	PIRACANJUBA	PJ21340081	PIRACANJUBA	29/02/2020 07:48	29/02/2020 12:45	29/02/2020 07:48	29/02/2020 12:45	4,95	2	9,89	CHI
202002186542	BOM JARDIM DE GOIAS	BM12286263	BOM JARDIM	29/02/2020 07:48	29/02/2020 11:46	29/02/2020 07:48	29/02/2020 11:46	3,96	4	15,82	CHI
202002186543	INDIARA	IY21312481	CEZARINA	29/02/2020 07:48	29/02/2020 12:53	29/02/2020 07:48	29/02/2020 12:53	5,07	1	5,07	CHI
202002186549	SITIO D ABADIA	AQ21302896	IACIARA S2	29/02/2020 07:49	29/02/2020 10:47	29/02/2020 07:49	29/02/2020 10:47	2,95	1	2,95	CHI
202002186601	ORIZONA	OZ212152754	PIRES DO RIO S2	29/02/2020 05:08	29/02/2020 10:46	29/02/2020 05:08	29/02/2020 10:46	5,63	18	101,37	CHI
202002186704	NOVA ROMA	ND12392238	IACIARA S2	29/02/2020 07:12	29/02/2020 11:40	29/02/2020 07:12	29/02/2020 11:40	4,46	232	1034,59	CHI
202002186705	PARANAIGUARA	PC21295753	CACHOEIRA ALTA	29/02/2020 07:50	29/02/2020 20:46	29/02/2020 07:50	29/02/2020 20:46	12,92	1	12,92	CHI
202002186712	SAO JOAO D ALIANCA	JL12325730	SAO JOAO D ALIANCA	29/02/2020 07:51	29/02/2020 18:50	29/02/2020 07:51	29/02/2020 18:50	10,98	13	142,74	CHI
202002186721	RIO VERDE	RV21123301	SANTA HELENA S1	29/02/2020 07:53	29/02/2020 13:22	29/02/2020 07:53	29/02/2020 13:22	5,50	1	5,50	CHI
202002186724	NOVO PLANALTO	TA12391932	NOVO PLANALTO	29/02/2020 07:46	29/02/2020 10:00	29/02/2020 07:46	29/02/2020 10:00	2,22	6	13,32	CHI
202002186726	GOIANIA	14688062	SENADOR CANEDO	29/02/2020 07:54	29/02/2020 09:34	29/02/2020 07:54	29/02/2020 09:34	1,66	1	1,66	CHI
202002186728	GOIANIA	GN11169638	REAL S1	29/02/2020 07:54	29/02/2020 12:40	29/02/2020 09:55	29/02/2020 12:40	2,75	46	126,50	CHI
202002186729	GUAPO	GA21011345	GUAPO S2	29/02/2020 07:54	29/02/2020 10:44	29/02/2020 07:54	29/02/2020 10:44	2,82	1	2,82	CHI
202002186732	PARANAIGUARA	PC21093840	QUIRINOPOLIS	29/02/2020 07:55	29/02/2020 18:55	29/02/2020 07:55	29/02/2020 18:55	11,00	1	11,00	CHI
202002186741	CRISTALINA	KR21305007	PAMPLONA	29/02/2020 07:55	29/02/2020 11:28	29/02/2020 07:55	29/02/2020 11:28	3,55	1	3,55	CHI
202002186801	DOVERLANDIA	DV21342674	CAIAPONIA	29/02/2020 07:55	29/02/2020 10:16	29/02/2020 07:55	29/02/2020 10:16	2,33	1	2,33	CHI
202002186901	EDEALINA	ED12007679	PONTALINA	29/02/2020 06:38	29/02/2020 11:19	29/02/2020 06:38	29/02/2020 11:19	4,67	16	74,77	CHI
202002187004	PIRANHAS	PH12201916	BOM JARDIM	29/02/2020 07:47	01/03/2020 08:36	29/02/2020 07:47	01/03/2020 08:36	24,81	9	223,26	CHI
202002187007	MORRINHOS	MR21137789	MORRINHOS	29/02/2020 07:56	29/02/2020 11:46	29/02/2020 07:56	29/02/2020 11:46	3,82	1	3,82	CHI
202002187008	DIORAMA	JP12074459	IPORA	29/02/2020 06:33	29/02/2020 09:33	29/02/2020 06:33	29/02/2020 09:33	2,99	3	8,96	CHI
202002187008	JAUPACI	JP12074459	IPORA	29/02/2020 06:33	29/02/2020 09:33	29/02/2020 06:33	29/02/2020 09:33	2,99	5	14,93	CHI
202002187009	PLANALTINA	PI12375541	PLANALTINA	29/02/2020 07:57	29/02/2020 09:38	29/02/2020 07:57	29/02/2020 09:38	1,68	183	307,69	CHI
202002187010	JARAGUA	JA12000117	JARAGUA	29/02/2020 07:38	29/02/2020 13:46	29/02/2020 07:38	29/02/2020 13:46	6,13	2	12,25	CHI
202002187013	IPAMERI	IP12266894	IPAMERI	29/02/2020 07:57	29/02/2020 19:52	29/02/2020 07:57	29/02/2020 19:52	11,91	14	166,69	CHI
202002187020	COCALZINHO DE GOIAS	ZN12000125	COCALZINHO	29/02/2020 07:03	29/02/2020 10:09	29/02/2020 07:03	29/02/2020 10:09	3,09	41	126,84	CHI
202002187020	CORUMBA DE GOIAS	ZN12000125	COCALZINHO	29/02/2020 07:03	29/02/2020 10:09	29/02/2020 07:03	29/02/2020 10:09	3,09	19	58,78	CHI
202002187021	CATALAO	CT21195433	CATALAO S1	29/02/2020 07:58	29/02/2020 13:50	29/02/2020 07:58	29/02/2020 13:50	5,86	1	5,86	CHI
202002187022	CAMPINACU	UC11269803	MARA ROSA	29/02/2020 07:58	29/02/2020 10:47	29/02/2020 07:58	29/02/2020 10:47	2,81	1	2,81	CHI
202002187023	SANTO ANTONIO DO DESCOBERTO	SN11290585	AGUAS LINDAS DE GOIAS S2	29/02/2020 03:32	29/02/2020 09:59	29/02/2020 03:32	29/02/2020 09:59	6,44	136	876,22	CHI
202002187025	BOM JARDIM DE GOIAS	ME12251375	IPORA	29/02/2020 07:28	29/02/2020 14:13	29/02/2020 07:28	29/02/2020 14:13	6,74	17	114,66	CHI
202002187025	MONTES CLAROS DE GOIAS	ME12251375	IPORA	29/02/2020 07:28	29/02/2020 14:13	29/02/2020 07:28	29/02/2020 14:13	6,74	7	47,21	CHI
202002187026	CHAPADAO DO CEU	DJ12248365	CHAPADAO DO CEU	29/02/2020 07:59	29/02/2020 11:13	29/02/2020 07:59	29/02/2020 11:13	3,23	3	9,69	CHI
202002187027	PIRACANJUBA	PJ12106576	CALDAS NOVAS S1	29/02/2020 07:50	29/02/2020 10:47	29/02/2020 07:50	29/02/2020 10:47	2,94	24	70,65	CHI
202002187033	GOIANIA	10011100743	ATLANTICO S2	29/02/2020 08:00	29/02/2020 11:11	29/02/2020 08:00	29/02/2020 11:11	3,18	1	3,18	CHI

202002187034	PARAUNA	PU12301182LD	ACREUNA	29/02/2020 07:37	29/02/2020 12:05	29/02/2020 07:37	29/02/2020 12:05	4,46	24	107,13	CHI
202002187038	SAO DOMINGOS	SD12254497	SAO DOMINGOS	29/02/2020 08:01	01/03/2020 09:55	29/02/2020 08:01	29/02/2020 22:28	14,45	4	57,82	CHI
202002187038	SAO DOMINGOS	6882741	SAO DOMINGOS	29/02/2020 08:01	01/03/2020 09:55	29/02/2020 08:01	01/03/2020 09:55	25,91	4	103,62	CHI
202002187042	SAO FRANCISCO DE GOIAS	SF12039351	SAO FRANCISCO DE GOIAS	29/02/2020 08:02	29/02/2020 11:20	29/02/2020 08:02	29/02/2020 11:20	3,29	20	65,78	CHI
202002187043	GOIANESIA	GE16407078	GOIANESIA S2	29/02/2020 07:57	29/02/2020 13:05	29/02/2020 07:57	29/02/2020 13:05	5,13	1520	7802,67	CHI
202002187043	VILA PROPICIO	GE16407078	GOIANESIA S2	29/02/2020 07:57	29/02/2020 13:05	29/02/2020 07:57	29/02/2020 13:05	5,13	49	251,53	CHI
202002187052	JUSSARA	JR12157820	BRITANIA	29/02/2020 08:03	29/02/2020 12:48	29/02/2020 08:03	29/02/2020 12:48	4,74	2	9,48	CHI
202002187055	GOIATUBA	GT12041937	GOIATUBA S2	29/02/2020 08:03	29/02/2020 12:50	29/02/2020 08:03	29/02/2020 12:50	4,77	2	9,55	CHI
202002187058	URUTAI	600001933	URUTAI	29/02/2020 08:04	29/02/2020 11:10	29/02/2020 08:04	29/02/2020 11:10	3,09	1	3,09	CHI
202002187060	ORIZONA	OZ21207568	VIANOPOLIS	29/02/2020 08:05	29/02/2020 11:21	29/02/2020 08:05	29/02/2020 11:21	3,25	1	3,25	CHI
202002187063	ACREUNA	EU12045007	ACREUNA	29/02/2020 08:01	29/02/2020 09:41	29/02/2020 08:01	29/02/2020 09:41	1,66	4	6,65	CHI
202002187072	APARECIDA DE GOIANIA	AP11095065	ANHANGUERA	29/02/2020 07:55	29/02/2020 12:18	29/02/2020 07:55	29/02/2020 12:18	4,40	154	677,09	CHI
202002187078	CORUMBAIBA	CI12127541	CATALAO S1	29/02/2020 06:20	29/02/2020 18:15	29/02/2020 06:20	29/02/2020 18:15	11,90	24	285,63	CHI
202002187078	NOVA AURORA	CI12127541	CATALAO S1	29/02/2020 06:20	29/02/2020 18:15	29/02/2020 06:20	29/02/2020 18:15	11,90	8	95,21	CHI
202002187079	NOVA CRIXAS	NA12334349	NOVA CRIXAS	29/02/2020 08:09	29/02/2020 17:33	29/02/2020 08:09	29/02/2020 17:33	9,40	86	808,11	CHI
202002187081	GOIANIA	GN12049397	ATLANTICO S3	29/02/2020 08:54	29/02/2020 11:54	29/02/2020 08:54	29/02/2020 11:54	2,99	279	834,13	CHI
202002187084	LUZIANIA	120208556	RIO VERMELHO	29/02/2020 08:09	29/02/2020 09:46	29/02/2020 08:09	29/02/2020 09:46	1,61	1	1,61	CHI
202002187085	PARAUNA	EU21000184	ACREUNA	29/02/2020 08:10	29/02/2020 21:33	29/02/2020 08:10	29/02/2020 21:33	13,38	1	13,38	CHI
202002187087	IVOLANDIA	IV12129886	IPORA	29/02/2020 07:25	29/02/2020 10:17	29/02/2020 07:25	29/02/2020 10:17	2,85	44	125,47	CHI
202002187087	PALESTINA DE GOIAS	IV12129886	IPORA	29/02/2020 07:25	29/02/2020 10:17	29/02/2020 07:25	29/02/2020 10:17	2,85	12	34,22	CHI
202002187095	BURITI ALEGRE	BG12263593	ITUMBIARA VELHA S2	29/02/2020 08:11	01/03/2020 10:50	29/02/2020 08:11	01/03/2020 10:50	26,63	4	106,54	CHI
202002187096	MINEIROS	MY12043894	PARQUE DAS EMAS	29/02/2020 03:32	29/02/2020 13:39	29/02/2020 03:32	29/02/2020 13:39	10,10	102	1030,34	CHI
202002187097	CAMPESTRE DE GOIAS	GC21281543	TRINDADE	29/02/2020 09:31	29/02/2020 10:00	29/02/2020 09:31	29/02/2020 10:00	0,48	1	0,48	CHI
202002187101	FLORES DE GOIAS	FB12164628	IACIARA S2	29/02/2020 08:12	29/02/2020 11:23	29/02/2020 08:12	29/02/2020 11:23	3,18	41	130,21	CHI
202002187107	GOIANDIRA	GD21156353	CATALAO S1	29/02/2020 08:13	29/02/2020 10:54	29/02/2020 08:13	29/02/2020 10:54	2,68	1	2,68	CHI
202002187111	GOIANIA	GN11313037	ATLANTICO S2	29/02/2020 08:13	29/02/2020 10:31	29/02/2020 08:13	29/02/2020 10:31	2,30	52	119,44	CHI
202002187115	FORMOSO	2410017429	PORANGATU	29/02/2020 08:14	29/02/2020 09:45	29/02/2020 08:14	29/02/2020 09:45	1,50	1	1,50	CHI
202002187117	JUSSARA	10026323220	JUSSARA	29/02/2020 08:15	29/02/2020 13:20	29/02/2020 08:15	29/02/2020 13:20	5,08	1	5,08	CHI
202002187118	COCALZINHO DE GOIAS	ZN12302401	COCALZINHO	29/02/2020 07:38	29/02/2020 12:27	29/02/2020 07:38	29/02/2020 12:27	4,82	4	19,26	CHI
202002187118	CORUMBA DE GOIAS	ZN12302401	COCALZINHO	29/02/2020 07:38	29/02/2020 12:27	29/02/2020 07:38	29/02/2020 12:27	4,82	22	105,94	CHI
202002187120	RIO VERDE	RV12340873	MONTIVIDIU T	29/02/2020 08:17	29/02/2020 12:26	29/02/2020 08:17	29/02/2020 12:26	4,15	1	4,15	CHI
202002187129	GOIANIRA	GR12036509LD	GOIANIRA	29/02/2020 08:18	29/02/2020 10:35	29/02/2020 08:18	29/02/2020 10:35	2,27	4	9,09	CHI
202002187130	COCALZINHO DE GOIAS	ZN12381218	COCALZINHO	29/02/2020 07:34	29/02/2020 11:21	29/02/2020 07:34	29/02/2020 11:21	3,79	13	49,22	CHI
202002187132	MORRINHOS	10028589520	MORRINHOS	29/02/2020 08:19	29/02/2020 11:45	29/02/2020 08:19	29/02/2020 11:45	3,45	1	3,45	CHI
202002187137	CAMPO ALEGRE DE GOIAS	CM12352814	CAMPO ALEGRE DE GOIAS	29/02/2020 08:19	29/02/2020 13:36	29/02/2020 08:19	29/02/2020 13:36	5,27	2	10,55	CHI
202002187144	MAIRIPOTABA	PK21247824	PONTALINA	29/02/2020 08:21	29/02/2020 19:07	29/02/2020 08:21	29/02/2020 19:07	10,75	1	10,75	CHI
202002187145	MONTIVIDIU	MV12160710	MONTIVIDIU T	28/02/2020 20:35	29/02/2020 11:29	28/02/2020 20:35	29/02/2020 11:29	14,90	21	312,89	CHI
202002187146	CALDAS NOVAS	760347591	CALDAS NOVAS S2	29/02/2020 08:22	29/02/2020 11:43	29/02/2020 08:22	29/02/2020 11:43	3,37	1	3,37	CHI
202002187149	ANAPOLIS	20078365	ANAPOLIS UNIVERSITARIO S2	29/02/2020 08:22	29/02/2020 11:26	29/02/2020 08:22	29/02/2020 11:26	3,06	1	3,06	CHI
202002187153	ITAUCU	IX12015031	INHUMAS S1	29/02/2020 08:22	29/02/2020 17:37	29/02/2020 08:22	29/02/2020 17:37	9,24	16	147,79	CHI
202002187156	TURVANIA	TV21111586	FIRMINOPOLIS S1	29/02/2020 08:22	29/02/2020 10:36	29/02/2020 08:22	29/02/2020 10:36	2,22	2	4,43	CHI
202002187157	BOM JARDIM DE GOIAS	BM12354692	BOM JARDIM	29/02/2020 08:23	29/02/2020 09:15	29/02/2020 08:23	29/02/2020 09:15	0,86	4	3,45	CHI
202002187161	TURVANIA	TV12215375	FIRMINOPOLIS S1	29/02/2020 08:24	29/02/2020 11:48	29/02/2020 08:24	29/02/2020 11:48	3,39	4	13,58	CHI
202002187162	GOIAS	GS12234107	GOIAS	29/02/2020 08:24	29/02/2020 17:23	29/02/2020 08:24	29/02/2020 17:23	8,98	1	8,98	CHI

202002187165	JARAGUA	JA12035312	JARAGUA	29/02/2020 08:24	29/02/2020 14:12	29/02/2020 08:24	29/02/2020 14:12	5,79	6	34,75	CHI
202002187168	SAO LUIS DE MONTES BELOS	SL12000019	SAO LUIZ DOS MONTES BELOS	29/02/2020 06:21	29/02/2020 10:24	29/02/2020 06:21	29/02/2020 10:24	4,04	188	760,36	CHI
202002187170	PIRENOPOLIS	PV12381260	CORUMBA	29/02/2020 08:25	29/02/2020 13:50	29/02/2020 08:25	29/02/2020 13:50	5,40	73	394,28	CHI
202002187175	CAMPESTRE DE GOIAS	GC21005200	TRINDADE	29/02/2020 08:26	29/02/2020 16:13	29/02/2020 08:26	29/02/2020 16:13	7,78	1	7,78	CHI
202002187177	ESTRELA DO NORTE	ET12012488	MARA ROSA	29/02/2020 08:26	29/02/2020 10:26	29/02/2020 08:26	29/02/2020 10:26	1,99	17	33,83	CHI
202002187178	APARECIDA DO RIO DOCE	JT12081473	JATAI S1	29/02/2020 08:26	29/02/2020 14:28	29/02/2020 08:26	29/02/2020 14:28	6,02	9	54,18	CHI
202002187183	APARECIDA DE GOIANIA	13901059	INDEPENDENCIA S2	29/02/2020 08:26	29/02/2020 10:33	29/02/2020 08:26	29/02/2020 10:33	2,10	0	0,00	CHI
202002187189	CORUMBAIBA	CI12110154	VILA CORUMBA	29/02/2020 06:13	01/03/2020 10:00	29/02/2020 06:13	01/03/2020 10:00	27,78	67	1861,45	CHI
202002187191	SAO LUIS DE MONTES BELOS	500059354	SAO LUIZ DOS MONTES BELOS	29/02/2020 08:29	29/02/2020 12:55	29/02/2020 08:29	29/02/2020 12:55	4,43	1	4,43	CHI
202002187196	MORRINHOS	MR11182561	MORRINHOS	29/02/2020 08:30	29/02/2020 12:25	29/02/2020 08:30	29/02/2020 12:25	3,91	2	7,81	CHI
202002187199	PIRENOPOLIS	PV21273400	SAO FRANCISCO DE GOIAS	29/02/2020 08:31	29/02/2020 19:12	29/02/2020 08:31	29/02/2020 19:12	10,68	2	21,37	CHI
202002187204	GOIANIA	AP12200145	CEPAIGO S1	29/02/2020 08:32	29/02/2020 12:53	29/02/2020 08:32	29/02/2020 12:53	4,35	9	39,13	CHI
202002187205	APARECIDA DE GOIANIA	AP21000308	CEPAIGO S1	29/02/2020 08:32	29/02/2020 10:47	29/02/2020 08:32	29/02/2020 10:47	2,25	1	2,25	CHI
202002187206	MINEIROS	MY21324424	PARQUE DAS EMAS	29/02/2020 08:32	29/02/2020 22:58	29/02/2020 08:32	29/02/2020 22:58	14,43	1	14,43	CHI
202002187208	PALMEIRAS DE GOIAS	PL21377161	PALMEIRAS	29/02/2020 08:32	29/02/2020 09:41	29/02/2020 08:32	29/02/2020 09:41	1,14	1	1,14	CHI
202002187210	GOIANIA	GN11001760	AEROPORTO S3	29/02/2020 08:32	29/02/2020 10:02	29/02/2020 08:32	29/02/2020 10:02	1,49	15	22,35	CHI
202002187212	ANAPOLIS	AN12319783	ANAPOLIS UNIVERSITARIO S2	29/02/2020 08:11	29/02/2020 11:30	29/02/2020 08:11	29/02/2020 11:30	3,31	1	3,31	CHI
202002187212	PIRENOPOLIS	AN12319783	ANAPOLIS UNIVERSITARIO S2	29/02/2020 08:11	29/02/2020 11:30	29/02/2020 08:11	29/02/2020 11:30	3,31	17	56,28	CHI
202002187218	BELA VISTA DE GOIAS	LB12270662	DAIA S2	29/02/2020 07:56	29/02/2020 09:46	29/02/2020 07:56	29/02/2020 09:46	1,83	1	1,83	CHI
202002187218	CALDAZINHA	LB12270662	DAIA S2	29/02/2020 07:56	29/02/2020 09:46	29/02/2020 07:56	29/02/2020 09:46	1,83	60	109,88	CHI
202002187218	LEOPOLDO DE BULHOES	LB12270662	DAIA S2	29/02/2020 07:56	29/02/2020 09:46	29/02/2020 07:56	29/02/2020 09:46	1,83	5	9,16	CHI
202002187218	SILVANIA	LB12270662	DAIA S2	29/02/2020 07:56	29/02/2020 09:46	29/02/2020 07:56	29/02/2020 09:46	1,83	57	104,39	CHI
202002187227	NAZARIO	NZ21144250	ANICUNS	29/02/2020 08:36	29/02/2020 11:12	29/02/2020 08:36	29/02/2020 11:12	2,60	1	2,60	CHI
202002187230	SAO DOMINGOS	8680010184	SAO DOMINGOS	29/02/2020 08:37	29/02/2020 11:36	29/02/2020 08:37	29/02/2020 11:36	2,98	1	2,98	CHI
202002187244	ACREUNA	EU12045029LD	ACREUNA	29/02/2020 07:23	29/02/2020 13:22	29/02/2020 07:23	29/02/2020 13:22	5,98	8	47,83	CHI
202002187246	ACREUNA	EU12301173	ACREUNA	29/02/2020 07:28	29/02/2020 10:53	29/02/2020 07:28	29/02/2020 10:53	3,42	11	37,58	CHI
202002187248	JARAGUA	JA21059951	JARAGUA	29/02/2020 08:39	29/02/2020 10:11	29/02/2020 08:39	29/02/2020 10:11	1,52	1	1,52	CHI
202002187249	GOIANIA	10021087073	CAMPINAS S3	29/02/2020 08:39	29/02/2020 09:47	29/02/2020 08:39	29/02/2020 09:47	1,12	1	1,12	CHI
202002187250	VALPARAISO DE GOIAS	3350114505	PACAEMBU S1	29/02/2020 08:39	29/02/2020 10:43	29/02/2020 08:39	29/02/2020 10:43	2,05	1	2,05	CHI
202002187252	INHUMAS	10004448438	INHUMAS S2	29/02/2020 08:40	29/02/2020 10:49	29/02/2020 08:40	29/02/2020 10:49	2,15	1	2,15	CHI
202002187256	AGUA FRIA DE GOIAS	TL21211516	SAO JOAO D ALIANCA	29/02/2020 08:41	29/02/2020 10:14	29/02/2020 08:41	29/02/2020 10:14	1,54	1	1,54	CHI
202002187257	MAIRIPOTABA	PK21364559	PONTALINA	29/02/2020 08:41	01/03/2020 21:39	29/02/2020 08:41	01/03/2020 21:39	36,95	1	36,95	CHI
202002187261	CATALAO	CT11216098	CATALAO S2	29/02/2020 08:42	29/02/2020 10:27	29/02/2020 08:42	29/02/2020 10:27	1,73	31	53,78	CHI
202002187265	MONTIVIDIU DO NORTE	MX12192266	PORANGATU	29/02/2020 08:43	29/02/2020 10:41	29/02/2020 08:43	29/02/2020 10:41	1,97	60	117,92	CHI
202002187265	TROMBAS	MX12192266	PORANGATU	29/02/2020 08:43	29/02/2020 10:41	29/02/2020 08:43	29/02/2020 10:41	1,97	23	45,20	CHI
202002187277	JATAI	JT11083494	JATAI S2	29/02/2020 08:44	29/02/2020 10:50	29/02/2020 08:44	29/02/2020 10:50	2,08	1	2,08	CHI
202002187281	TRINDADE	TR31190548	TRINDADE	29/02/2020 08:45	29/02/2020 15:17	29/02/2020 08:45	29/02/2020 15:17	6,52	1	6,52	CHI
202002187285	CACU	CC12072092	CACHOEIRA ALTA	29/02/2020 08:46	01/03/2020 09:59	29/02/2020 08:46	01/03/2020 09:59	25,21	2	50,42	CHI
202002187288	MINEIROS	1390024146	PARQUE DAS EMAS	29/02/2020 08:47	29/02/2020 10:05	29/02/2020 08:47	29/02/2020 10:05	1,30	1	1,30	CHI
202002187289	ITAUCU	110033000	INHUMAS S1	29/02/2020 08:47	29/02/2020 15:05	29/02/2020 08:47	29/02/2020 15:05	6,30	1	6,30	CHI
202002187291	AGUA LIMPA	AL21251314	VILA CORUMBA	29/02/2020 08:47	01/03/2020 01:07	29/02/2020 08:47	01/03/2020 01:07	16,33	1	16,33	CHI
202002187292	DIVINOPOLIS DE GOIAS	GH12228817	SAO DOMINGOS	29/02/2020 07:20	29/02/2020 11:21	29/02/2020 07:20	29/02/2020 11:21	4,00	13	52,03	CHI
202002187293	EDEALINA	ED12063150	PONTALINA	29/02/2020 06:58	29/02/2020 13:15	29/02/2020 06:58	29/02/2020 13:15	6,28	10	62,76	CHI
202002187299	PONTALINA	PK12046026	GOIATUBA S1	29/02/2020 08:48	29/02/2020 14:30	29/02/2020 08:48	29/02/2020 14:30	5,69	23	130,95	CHI

202002187308	CHAPADAO DO CEU	DJ21131313	CHAPADAO DO CEU	29/02/2020 07:59	29/02/2020 11:56	29/02/2020 07:59	29/02/2020 11:56	3,95	1	3,95	CHI
202002187310	SAO LUIS DE MONTES BELOS	SL31145868	SAO LUIZ DOS MONTES BELOS	29/02/2020 08:50	29/02/2020 11:19	29/02/2020 08:50	29/02/2020 11:19	2,48	1	2,48	CHI
202002187316	CRIXAS	2490008979	SERRA DO OURO	29/02/2020 08:51	29/02/2020 10:52	29/02/2020 08:51	29/02/2020 10:52	2,01	1	2,01	CHI
202002187317	GOIANIRA	390036456	GOIANIRA	29/02/2020 08:51	29/02/2020 13:16	29/02/2020 08:51	29/02/2020 13:16	4,41	1	4,41	CHI
202002187319	ANAPOLIS	21237580	ANAPOLIS UNIVERSITARIO S2	29/02/2020 08:51	29/02/2020 13:13	29/02/2020 08:51	29/02/2020 13:13	4,35	1	4,35	CHI
202002187321	ITARUMA	IM21122630	CACHOEIRA ALTA	29/02/2020 08:51	29/02/2020 20:52	29/02/2020 08:51	29/02/2020 20:52	12,01	1	12,01	CHI
202002187322	SILVANIA	SV12194949	VIANOPOLIS	29/02/2020 08:51	01/03/2020 11:12	29/02/2020 08:51	01/03/2020 11:12	26,34	13	342,39	CHI
202002187323	ITABERAI	IB12021978	ITABERAI S2	29/02/2020 08:51	29/02/2020 10:05	29/02/2020 08:51	29/02/2020 10:05	1,22	11	13,40	CHI
202002187328	CATALAO	CT11192512	CATALAO S2	29/02/2020 08:53	29/02/2020 11:57	29/02/2020 08:53	29/02/2020 11:57	3,07	68	208,53	CHI
202002187330	FLORES DE GOIAS	FB12239102	IACIARA S2	29/02/2020 08:53	29/02/2020 12:44	29/02/2020 08:53	29/02/2020 12:44	3,85	19	73,12	CHI
202002187335	SAO LUIS DE MONTES BELOS	SL21222084	SAO LUIZ DOS MONTES BELOS	29/02/2020 08:54	29/02/2020 16:22	29/02/2020 08:54	29/02/2020 16:22	7,46	1	7,46	CHI
202002187338	CACHOEIRA ALTA	CA21150602	CACHOEIRA ALTA	29/02/2020 08:54	29/02/2020 16:10	29/02/2020 08:54	29/02/2020 16:10	7,26	1	7,26	CHI
202002187349	PADRE BERNARDO	PB12339694	PADRE BERNARDO	29/02/2020 08:57	29/02/2020 12:20	29/02/2020 08:57	29/02/2020 12:20	3,37	3	10,10	CHI
202002187351	PALESTINA DE GOIAS	PY12079592	PALESTINA	29/02/2020 08:38	29/02/2020 10:46	29/02/2020 08:38	29/02/2020 10:46	2,13	18	38,38	CHI
202002187352	AGUA FRIA DE GOIAS	TL21194754	SAO JOAO D ALIANCA	29/02/2020 08:58	29/02/2020 11:23	29/02/2020 08:58	29/02/2020 11:23	2,41	1	2,41	CHI
202002187353	POSSE	PS12133567	IACIARA S2	29/02/2020 08:58	29/02/2020 11:03	29/02/2020 08:58	29/02/2020 11:03	2,07	22	45,60	CHI
202002187355	PONTALINA	PK12308745	PONTALINA	29/02/2020 08:58	29/02/2020 14:18	29/02/2020 08:58	29/02/2020 14:18	5,32	1	5,32	CHI
202002187356	PETROLINA DE GOIAS	PG12071661	PETROLINA	29/02/2020 08:59	29/02/2020 12:26	29/02/2020 08:59	29/02/2020 12:26	3,45	3	10,35	CHI
202002187363	RIO VERDE	RV12098521	CABRIUVA S2	29/02/2020 07:05	29/02/2020 20:33	29/02/2020 07:05	29/02/2020 20:33	13,45	15	201,80	CHI
202002187371	PIRACANJUBA	PJ21017501	MORRINHOS	29/02/2020 09:01	29/02/2020 12:31	29/02/2020 09:01	29/02/2020 12:31	3,49	1	3,49	CHI
202002187374	CATALAO	CT12338751	CATALAO S1	29/02/2020 09:01	29/02/2020 18:34	29/02/2020 09:01	29/02/2020 18:34	9,53	4	38,14	CHI
202002187375	DISTRITO FEDERAL	05410226	MARAJOARA	29/02/2020 08:59	29/02/2020 11:35	29/02/2020 08:59	29/02/2020 11:35	2,60	50	129,78	CHI
202002187375	NOVO GAMA	05410226	MARAJOARA	29/02/2020 08:59	29/02/2020 11:35	29/02/2020 08:59	29/02/2020 11:35	2,60	9	23,36	CHI
202002187375	SANTO ANTONIO DO DESCOBERTO	05410226	MARAJOARA	29/02/2020 08:59	29/02/2020 11:35	29/02/2020 08:59	29/02/2020 11:35	2,60	831	2156,91	CHI
202002187377	OUVIDOR	OU21195340	CATALAO S1	29/02/2020 09:02	29/02/2020 21:26	29/02/2020 09:02	29/02/2020 21:26	12,39	2	24,78	CHI
202002187379	GOIANIA	11226870	GOIANIA LESTE S3	29/02/2020 09:03	29/02/2020 15:08	29/02/2020 09:03	29/02/2020 15:08	6,09	1	6,09	CHI
202002187381	PETROLINA DE GOIAS	SR21019000	INHUMAS S1	29/02/2020 09:03	29/02/2020 13:30	29/02/2020 09:03	29/02/2020 13:30	4,44	1	4,44	CHI
202002187382	APARECIDA DE GOIANIA	10012595339	REAL S1	29/02/2020 09:03	29/02/2020 10:07	29/02/2020 09:03	29/02/2020 10:07	1,05	1	1,05	CHI
202002187387	PIRACANJUBA	PJ21092778	CRISTIANOPOLIS	29/02/2020 09:04	29/02/2020 11:24	29/02/2020 09:04	29/02/2020 11:24	2,32	1	2,32	CHI
202002187389	GOIANIA	GN12059699	AEROPORTO S3	29/02/2020 09:05	29/02/2020 11:00	29/02/2020 10:24	29/02/2020 11:00	0,59	28	16,59	CHI
202002187389	GOIANIA	GN11001901	AEROPORTO S3	29/02/2020 09:05	29/02/2020 11:00	29/02/2020 09:34	29/02/2020 11:00	1,44	45	64,64	CHI
202002187392	PALMEIRAS DE GOIAS	PL12391392	PALMEIRAS	29/02/2020 09:06	29/02/2020 11:23	29/02/2020 09:06	29/02/2020 11:23	2,28	4	9,12	CHI
202002187396	CAMPO ALEGRE DE GOIAS	CM21215490	CAMPO ALEGRE DE GOIAS	29/02/2020 09:06	29/02/2020 18:47	29/02/2020 09:06	29/02/2020 18:47	9,67	1	9,67	CHI
202002187402	ALVORADA DO NORTE	PI12146189	PLANALTINA	29/02/2020 09:08	29/02/2020 10:53	29/02/2020 09:08	29/02/2020 10:53	1,74	60	104,20	CHI
202002187402	PLANALTINA	PI12146189	PLANALTINA	29/02/2020 09:08	29/02/2020 10:53	29/02/2020 09:08	29/02/2020 10:53	1,74	919	1596,00	CHI
202002187404	CAIAPONIA	CP12269004	CAIAPONIA	29/02/2020 09:09	29/02/2020 18:23	29/02/2020 09:09	29/02/2020 18:23	9,23	4	36,90	CHI
202002187408	IPORA	IR12065120	IPORA	29/02/2020 08:56	29/02/2020 12:20	29/02/2020 08:56	29/02/2020 12:20	3,39	6	20,35	CHI
202002187413	RIO VERDE	630281622	RIO VERDE S1	29/02/2020 09:10	29/02/2020 16:00	29/02/2020 09:10	29/02/2020 16:00	6,83	1	6,83	CHI
202002187419	JATAI	290229431	JATAI S2	29/02/2020 09:11	29/02/2020 11:41	29/02/2020 09:11	29/02/2020 11:41	2,50	1	2,50	CHI
202002187430	ANAPOLIS	AN12000150	JUNDIAI S2	29/02/2020 09:12	29/02/2020 10:01	29/02/2020 09:12	29/02/2020 10:01	0,81	20	16,27	CHI
202002187431	ABADIANIA	AN21258790	ANAPOLIS UNIVERSITARIO S2	29/02/2020 09:15	29/02/2020 10:58	29/02/2020 09:15	29/02/2020 10:58	1,71	2	3,42	CHI
202002187455	CAMPOS BELOS	820025008	SAO DOMINGOS	29/02/2020 09:18	29/02/2020 13:54	29/02/2020 09:18	29/02/2020 13:54	4,60	1	4,60	CHI
202002187457	PADRE BERNARDO	PB12376763	PADRE BERNARDO	29/02/2020 09:18	29/02/2020 17:42	29/02/2020 09:18	29/02/2020 17:42	8,39	12	100,65	CHI
202002187464	APARECIDA DE GOIANIA	10015694842	INDEPENDENCIA S1	29/02/2020 09:20	29/02/2020 11:07	29/02/2020 09:20	29/02/2020 11:07	1,78	1	1,78	CHI

202002187467	PIRACANJUBA	10020116215	PIRACANJUBA	29/02/2020 09:20	01/03/2020 08:40	29/02/2020 09:20	01/03/2020 08:40	23,32	1	23,32	CHI
202002187468	CROMINIA	CQ21291864	PONTALINA	29/02/2020 09:20	29/02/2020 11:22	29/02/2020 09:20	29/02/2020 11:22	2,02	1	2,02	CHI
202002187470	BOM JARDIM DE GOIAS	BM12245130	BOM JARDIM	29/02/2020 08:09	29/02/2020 22:01	29/02/2020 08:09	29/02/2020 22:01	13,86	6	83,17	CHI
202002187470	PIRANHAS	BM12245130	BOM JARDIM	29/02/2020 08:09	29/02/2020 22:01	29/02/2020 08:09	29/02/2020 22:01	13,86	4	55,44	CHI
202002187490	GOIANIRA	390097883	GOIANIRA	29/02/2020 09:24	29/02/2020 11:48	29/02/2020 09:24	29/02/2020 11:48	2,38	1	2,38	CHI
202002187491	GOIANIA	10000422558	ATLANTICO S3	29/02/2020 09:25	29/02/2020 12:20	29/02/2020 09:25	29/02/2020 12:20	2,92	1	2,92	CHI
202002187498	JARAGUA	JA21336699	JARAGUA	29/02/2020 09:26	29/02/2020 13:12	29/02/2020 09:26	29/02/2020 13:12	3,76	1	3,76	CHI
202002187499	PALMEIRAS DE GOIAS	PL21386431	PALMEIRAS	29/02/2020 09:26	29/02/2020 13:12	29/02/2020 09:26	29/02/2020 13:12	3,76	4	15,04	CHI
202002187500	AGUAS LINDAS DE GOIAS	10008635399	AGUAS LINDAS DE GOIAS S2	29/02/2020 09:26	29/02/2020 11:12	29/02/2020 09:26	29/02/2020 11:12	1,75	1	1,75	CHI
202002187505	CAMPOS VERDES	VD21065503	SANTA TEREZINHA	29/02/2020 09:27	29/02/2020 16:46	29/02/2020 09:27	29/02/2020 16:46	7,31	1	7,31	CHI
202002187518	NOVA AMERICA	NM21187161	RUBIATABA	29/02/2020 09:29	29/02/2020 13:55	29/02/2020 09:29	29/02/2020 13:55	4,42	1	4,42	CHI
202002187531	QUIRINOPOLIS	QI32094325	QUIRINOPOLIS	29/02/2020 09:31	29/02/2020 13:20	29/02/2020 09:31	29/02/2020 13:20	3,81	7	26,68	CHI
202002187536	CIDADE OCIDENTAL	10010791378	MARAJOARA	29/02/2020 09:31	29/02/2020 10:58	29/02/2020 09:31	29/02/2020 10:58	1,44	1	1,44	CHI
202002187541	FAZENDA NOVA	NB12116397	JUSSARA	29/02/2020 09:32	29/02/2020 11:39	29/02/2020 09:32	29/02/2020 11:39	2,11	2	4,23	CHI
202002187546	VIANOPOLIS	VN21221256	VIANOPOLIS	29/02/2020 09:32	29/02/2020 17:14	29/02/2020 09:32	29/02/2020 17:14	7,69	1	7,69	CHI
202002187550	ADELANDIA	DN11160989	FIRMINOPOLIS S2	29/02/2020 08:27	29/02/2020 13:50	29/02/2020 08:27	29/02/2020 13:50	5,38	45	242,11	CHI
202002187552	GOIANIA	10002370091	REAL S1	29/02/2020 09:33	29/02/2020 11:53	29/02/2020 09:33	29/02/2020 11:53	2,33	1	2,33	CHI
202002187561	ARUANA	AK11183267	ARUANA	29/02/2020 09:33	29/02/2020 22:17	29/02/2020 09:33	29/02/2020 22:17	12,72	18	228,91	CHI
202002187566	TRINDADE	40106731	TRINDADE	29/02/2020 09:34	29/02/2020 11:34	29/02/2020 09:34	29/02/2020 11:34	1,99	1	1,99	CHI
202002187573	ITAPURANGA	IK21307318	ITAPURANGA	29/02/2020 09:35	01/03/2020 08:22	29/02/2020 09:35	01/03/2020 08:22	22,78	1	22,78	CHI
202002187576	ABADIANIA	350009960	ANAPOLIS UNIVERSITARIO S1	29/02/2020 09:35	29/02/2020 11:29	29/02/2020 09:35	29/02/2020 11:29	1,89	1	1,89	CHI
202002187589	PIRENOPOLIS	PV21286406	SAO FRANCISCO DE GOIAS	29/02/2020 09:37	29/02/2020 15:10	29/02/2020 09:37	29/02/2020 15:10	5,55	1	5,55	CHI
202002187594	NOVA CRIXAS	NA12057214	MOZARLANDIA	29/02/2020 09:37	29/02/2020 17:41	29/02/2020 09:37	29/02/2020 17:41	8,05	5	40,27	CHI
202002187615	GOIANIA	10028324470	INDEPENDENCIA S1	29/02/2020 09:39	29/02/2020 11:49	29/02/2020 09:39	29/02/2020 11:49	2,16	1	2,16	CHI
202002187624	RIO QUENTE	RQ12316156	VILA CORUMBA	29/02/2020 09:40	29/02/2020 12:55	29/02/2020 09:40	29/02/2020 12:55	3,25	2	6,49	CHI
202002187625	PIRENOPOLIS	02040234	CORUMBA	29/02/2020 09:18	29/02/2020 09:34	29/02/2020 09:18	29/02/2020 09:34	0,26	4117	1065,85	CHI
202002187627	GOIANIRA	GR21148395	INHUMAS S1	29/02/2020 09:40	29/02/2020 16:22	29/02/2020 09:40	29/02/2020 16:22	6,69	2	13,38	CHI
202002187628	AGUAS LINDAS DE GOIAS	LA11149750	AGUAS LINDAS DE GOIAS S2	29/02/2020 09:40	29/02/2020 16:09	29/02/2020 09:40	29/02/2020 16:09	6,47	17	110,00	CHI
202002187711	HIDROLANDIA	HD11251854	CEPAIGO S2	29/02/2020 09:42	29/02/2020 12:41	29/02/2020 09:42	29/02/2020 12:41	2,98	76	226,65	CHI
202002187720	MORRINHOS	150156133	MORRINHOS	29/02/2020 09:43	29/02/2020 11:00	29/02/2020 09:43	29/02/2020 11:00	1,29	1	1,29	CHI
202002187727	MOSSAMEDES	MD12089244	ITABERAI S2	29/02/2020 09:36	29/02/2020 11:42	29/02/2020 09:36	29/02/2020 11:42	2,09	13	27,15	CHI
202002187732	SAO LUIZ DO NORTE	SZ11201722	ITAPACI	29/02/2020 09:44	29/02/2020 14:07	29/02/2020 09:44	29/02/2020 14:07	4,37	58	253,48	CHI
202002187757	GUARANI DE GOIAS	GY21267296	IACIARA S2	29/02/2020 09:48	29/02/2020 15:18	29/02/2020 09:48	29/02/2020 15:18	5,49	2	10,99	CHI
202002187760	GOIANIA	16244606	CARAJAS S1	29/02/2020 09:48	29/02/2020 15:20	29/02/2020 09:48	29/02/2020 15:20	5,52	1	5,52	CHI
202002187761	GOIANIA	14097126	ATLANTICO S1	29/02/2020 09:48	29/02/2020 12:54	29/02/2020 09:48	29/02/2020 12:54	3,08	1	3,08	CHI
202002187762	ANAPOLIS	10013881025	ANAPOLIS UNIVERSITARIO S2	29/02/2020 09:49	29/02/2020 12:55	29/02/2020 09:49	29/02/2020 12:55	3,10	1	3,10	CHI
202002187763	LUZIANIA	LZ11183964	RIO VERMELHO	29/02/2020 09:49	29/02/2020 11:40	29/02/2020 09:49	29/02/2020 11:40	1,86	19	35,27	CHI
202002187764	GOIANIA	GN13028114	GOIANIA LESTE S2	29/02/2020 08:48	29/02/2020 12:41	29/02/2020 09:48	29/02/2020 12:41	2,87	614	1764,74	CHI
202002187764	GOIANIA	GN13028114	GOIANIA LESTE S2	29/02/2020 08:48	29/02/2020 12:41	29/02/2020 12:10	29/02/2020 12:41	0,51	114	57,67	CHI
202002187767	GUAPO	10024851696	GUAPO S2	29/02/2020 09:49	29/02/2020 12:42	29/02/2020 09:49	29/02/2020 12:42	2,87	1	2,87	CHI
202002187774	AVELINOPOLIS	AV12020301	ANICUNS	29/02/2020 09:50	29/02/2020 12:43	29/02/2020 09:50	29/02/2020 12:43	2,87	1	2,87	CHI
202002187781	SAO DOMINGOS	SD12398379	SAO DOMINGOS	29/02/2020 09:52	29/02/2020 13:08	29/02/2020 09:52	29/02/2020 13:08	3,26	5	16,30	CHI
202002187789	JUSSARA	JR12074365	BRITANIA	29/02/2020 09:54	29/02/2020 15:45	29/02/2020 09:54	29/02/2020 15:45	5,85	37	216,37	CHI
202002187789	SANTA FE DE GOIAS	JR12074365	BRITANIA	29/02/2020 09:54	29/02/2020 15:45	29/02/2020 09:54	29/02/2020 15:45	5,85	21	122,80	CHI

202002187793	BOM JARDIM DE GOIAS	BM12253665	BOM JARDIM	29/02/2020 09:54	01/03/2020 03:01	29/02/2020 09:54	01/03/2020 03:01	17,11	3	51,33	CHI
202002187793	PIRANHAS	BM12253665	BOM JARDIM	29/02/2020 09:54	01/03/2020 03:01	29/02/2020 09:54	01/03/2020 03:01	17,11	3	51,33	CHI
202002187794	MONTE ALEGRE DE GOIAS	SD21195789	SAO DOMINGOS	29/02/2020 09:55	29/02/2020 17:06	29/02/2020 09:55	29/02/2020 17:06	7,18	2	14,37	CHI
202002187799	PLANALTINA	PI21243161	PLANALTINA	29/02/2020 09:56	29/02/2020 12:08	29/02/2020 09:56	29/02/2020 12:08	2,19	1	2,19	CHI
202002187801	GOIANIA	14942112	FERROVIARIO S1	29/02/2020 09:58	29/02/2020 11:00	29/02/2020 09:58	29/02/2020 11:00	1,03	1	1,03	CHI
202002187808	GOIANIA	GN12378757	ATLANTICO S2	29/02/2020 09:58	29/02/2020 16:08	29/02/2020 09:58	29/02/2020 16:08	6,15	53	325,98	CHI
202002187812	IVOLANDIA	MO12165608	IPORA	29/02/2020 10:00	29/02/2020 12:46	29/02/2020 10:00	29/02/2020 12:46	2,77	17	47,03	CHI
202002187812	MOIPORA	MO12165608	IPORA	29/02/2020 10:00	29/02/2020 12:46	29/02/2020 10:00	29/02/2020 12:46	2,77	1	2,77	CHI
202002187816	NOVA VENEZA	NV11200121	INHUMAS S1	29/02/2020 10:00	29/02/2020 12:17	29/02/2020 10:00	29/02/2020 12:17	2,28	97	220,86	CHI
202002187823	MORRINHOS	150010369	MORRINHOS	29/02/2020 10:02	29/02/2020 14:20	29/02/2020 10:02	29/02/2020 14:20	4,30	1	4,30	CHI
202002187826	JANDAIA	JD21034533	PALMEIRAS	29/02/2020 10:03	29/02/2020 18:33	29/02/2020 10:03	29/02/2020 18:33	8,50	1	8,50	CHI
202002187827	PALMEIRAS DE GOIAS	10015309574	PALMEIRAS	29/02/2020 10:03	29/02/2020 12:42	29/02/2020 10:03	29/02/2020 12:42	2,65	1	2,65	CHI
202002187833	BELA VISTA DE GOIAS	BV21092444	BELA VISTA S1	29/02/2020 10:04	29/02/2020 12:36	29/02/2020 10:04	29/02/2020 12:36	2,52	1	2,52	CHI
202002187845	JARAGUA	7490000013	JARAGUA	29/02/2020 10:08	29/02/2020 14:16	29/02/2020 10:08	29/02/2020 14:16	4,12	1	4,12	CHI
202002187850	NOVA CRIXAS	NA12035650	NOVA CRIXAS	29/02/2020 09:58	01/03/2020 16:28	29/02/2020 09:58	29/02/2020 16:26	6,47	11	71,21	CHI
202002187850	NOVA CRIXAS	NA12035650	NOVA CRIXAS	29/02/2020 09:58	01/03/2020 16:28	29/02/2020 21:48	01/03/2020 11:10	13,37	11	147,03	CHI
202002187850	MUNDO NOVO DE GOIAS	NA12035650	NOVA CRIXAS	29/02/2020 09:58	01/03/2020 16:28	29/02/2020 09:58	01/03/2020 13:41	27,71	7	193,98	CHI
202002187850	NOVA CRIXAS	NA12035650	NOVA CRIXAS	29/02/2020 09:58	01/03/2020 16:28	29/02/2020 09:58	01/03/2020 13:41	27,71	4	110,85	CHI
202002187850	MUNDO NOVO DE GOIAS	NA12050943LD	NOVA CRIXAS	29/02/2020 09:58	01/03/2020 16:28	29/02/2020 12:39	01/03/2020 13:41	25,04	1	25,04	CHI
202002187850	NOVA CRIXAS	NA12035650	NOVA CRIXAS	29/02/2020 09:58	01/03/2020 16:28	29/02/2020 09:58	01/03/2020 15:20	29,36	4	117,43	CHI
202002187850	NOVA CRIXAS	NA12035650	NOVA CRIXAS	29/02/2020 09:58	01/03/2020 16:28	29/02/2020 09:58	01/03/2020 16:28	30,51	5	152,53	CHI
202002187851	SAO FRANCISCO DE GOIAS	SF21285011	SAO FRANCISCO DE GOIAS	29/02/2020 10:09	29/02/2020 11:58	29/02/2020 10:09	29/02/2020 11:58	1,80	2	3,61	CHI
202002187857	ALEXANIA	480098347	ALEXANIA	29/02/2020 10:10	29/02/2020 12:54	29/02/2020 10:10	29/02/2020 12:54	2,72	1	2,72	CHI
202002187858	DOVERLANDIA	DV12381090	CAIAPONIA	29/02/2020 10:10	29/02/2020 11:21	29/02/2020 10:10	29/02/2020 11:21	1,17	7	8,19	CHI
202002187860	GOIANIRA	GR12011976	NEROPOLIS S1	29/02/2020 09:39	29/02/2020 11:30	29/02/2020 09:39	29/02/2020 11:30	1,84	5	9,18	CHI
202002187864	SILVANIA	SV21236996	DAIA S2	29/02/2020 10:12	01/03/2020 09:41	29/02/2020 10:12	01/03/2020 09:41	23,48	1	23,48	CHI
202002187871	CRISTALINA	KR21028911	CRISTALINA S1	29/02/2020 10:13	29/02/2020 12:49	29/02/2020 10:13	29/02/2020 12:49	2,59	1	2,59	CHI
202002187878	RIO VERDE	RV12279692	RIO VERDE S1	29/02/2020 10:14	29/02/2020 12:10	29/02/2020 10:14	29/02/2020 12:10	1,93	1	1,93	CHI
202002187879	GOIANIA	GN11126836	AEROPORTO S2	29/02/2020 10:14	29/02/2020 12:12	29/02/2020 10:14	29/02/2020 12:12	1,96	19	37,25	CHI
202002187880	PARAUNA	980008049	PARAUNA	29/02/2020 10:14	29/02/2020 22:21	29/02/2020 10:14	29/02/2020 22:21	12,11	1	12,11	CHI
202002187882	LUZIANIA	LZ12041439	RIO VERMELHO	29/02/2020 09:26	29/02/2020 12:47	29/02/2020 09:26	29/02/2020 12:47	3,34	55	183,52	CHI
202002187884	RIO QUENTE	RQ12050875	VILA CORUMBA	29/02/2020 10:10	29/02/2020 11:55	29/02/2020 10:10	29/02/2020 11:55	1,74	13	22,68	CHI
202002187888	APARECIDA DE GOIANIA	10011032446	INDEPENDENCIA S2	29/02/2020 10:16	29/02/2020 11:54	29/02/2020 10:16	29/02/2020 11:54	1,62	1	1,62	CHI
202002187891	GOIANIA	15333530	XAVANTES	29/02/2020 10:17	29/02/2020 11:11	29/02/2020 10:17	29/02/2020 11:11	0,89	1	0,89	CHI
202002187900	NIQUELANDIA	NQ21355508	NIQUELANDIA SUBTRANSMISSAO	29/02/2020 10:18	29/02/2020 21:01	29/02/2020 10:18	29/02/2020 21:01	10,71	1	10,71	CHI
202002187901	NIQUELANDIA	NQ12284693	NIQUELANDIA SUBTRANSMISSAO	29/02/2020 10:19	29/02/2020 11:39	29/02/2020 10:19	29/02/2020 11:39	1,33	1	1,33	CHI
202002187903	COCALZINHO DE GOIAS	PB21142281	AGUAS LINDAS DE GOIAS S2	29/02/2020 07:38	29/02/2020 12:51	29/02/2020 07:38	29/02/2020 12:51	5,21	1	5,21	CHI
202002187904	PIRENOPOLIS	PV21080600	CORUMBA	29/02/2020 10:19	29/02/2020 12:56	29/02/2020 10:19	29/02/2020 12:56	2,61	3	7,82	CHI
202002187905	ITUMBIARA	690174238	PARANAIBA	29/02/2020 10:19	29/02/2020 16:46	29/02/2020 10:19	29/02/2020 16:46	6,45	1	6,45	CHI
202002187908	GOIANESIA	GE21000040	GOIANESIA S1	29/02/2020 10:21	29/02/2020 15:38	29/02/2020 10:21	29/02/2020 15:38	5,28	1	5,28	CHI
202002187915	ALTO PARAISO DE GOIAS	JL12257606	SAO JOAO D ALIANCA	29/02/2020 10:22	29/02/2020 16:49	29/02/2020 10:22	29/02/2020 16:49	6,44	2	12,88	CHI
202002187915	SAO JOAO D ALIANCA	JL12257606	SAO JOAO D ALIANCA	29/02/2020 10:22	29/02/2020 16:49	29/02/2020 10:22	29/02/2020 16:49	6,44	81	521,75	CHI
202002187921	QUIRINOPOLIS	6968177	RIO DOS BOIS	29/02/2020 10:22	29/02/2020 20:21	29/02/2020 10:22	29/02/2020 20:21	9,97	1	9,97	CHI
202002187922	MORRINHOS	MR12251748RE	MORRINHOS	29/02/2020 10:23	29/02/2020 19:36	29/02/2020 10:23	29/02/2020 19:36	9,21	7	64,47	CHI

202002187924	ITABERAÍ	IB21105409	ITABERAÍ S1	29/02/2020 10:25	29/02/2020 11:02	29/02/2020 10:25	29/02/2020 11:02	0,61	1	0,61	CHI
202002187925	CALDAZINHA	BV12032340	CEPAIGO S2	29/02/2020 10:17	29/02/2020 11:34	29/02/2020 10:17	29/02/2020 11:34	1,27	19	24,15	CHI
202002187925	SENADOR CANEDO	BV12032340	CEPAIGO S2	29/02/2020 10:17	29/02/2020 11:34	29/02/2020 10:17	29/02/2020 11:34	1,27	1	1,27	CHI
202002187932	GUARINOS	GG12237782	URUACU	29/02/2020 10:26	29/02/2020 14:55	29/02/2020 10:26	29/02/2020 14:55	4,47	3	13,42	CHI
202002187932	SANTA TEREZINHA DE GOIAS	GG12237782	URUACU	29/02/2020 10:26	29/02/2020 14:55	29/02/2020 10:26	29/02/2020 14:55	4,47	1	4,47	CHI
202002187933	MAURILANDIA	10004323341	RIO DOS BOIS	29/02/2020 10:27	29/02/2020 15:42	29/02/2020 10:27	29/02/2020 15:42	5,25	1	5,25	CHI
202002187942	INDIARA	IY21142872	EDEIA	29/02/2020 10:29	01/03/2020 11:37	29/02/2020 10:29	01/03/2020 11:37	25,13	1	25,13	CHI
202002187944	GOIANIA	11315684	GOIANIA LESTE S1	29/02/2020 10:29	29/02/2020 13:57	29/02/2020 10:29	29/02/2020 13:57	3,45	1	3,45	CHI
202002187950	ARUANA	AK12077033	ARUANA	29/02/2020 10:30	01/03/2020 09:58	29/02/2020 10:30	01/03/2020 09:58	23,46	3	70,38	CHI
202002187954	GOIANIA	GN11001678	CAMPINAS S1	29/02/2020 10:32	29/02/2020 14:59	29/02/2020 10:32	29/02/2020 14:59	4,45	54	240,10	CHI
202002187961	MINEIROS	MY11346597	PARQUE DAS EMAS	29/02/2020 10:22	29/02/2020 11:05	29/02/2020 10:22	29/02/2020 11:05	0,71	101	71,40	CHI
202002187964	PONTALINA	PK21181908	PONTALINA	29/02/2020 10:34	29/02/2020 15:55	29/02/2020 10:34	29/02/2020 15:55	5,35	1	5,35	CHI
202002187968	CAMPESTRE DE GOIAS	GC21006381	TRINDADE	29/02/2020 10:35	29/02/2020 11:49	29/02/2020 10:35	29/02/2020 11:49	1,22	1	1,22	CHI
202002187972	COCALZINHO DE GOIAS	ZN21344981	COCALZINHO	29/02/2020 10:36	29/02/2020 15:19	29/02/2020 10:36	29/02/2020 15:19	4,71	1	4,71	CHI
202002187977	INDIARA	IY12056541	EDEIA	29/02/2020 10:37	29/02/2020 20:03	29/02/2020 10:37	29/02/2020 20:03	9,44	6	56,66	CHI
202002187978	JATAI	JT12390597	JATAI S1	29/02/2020 10:37	29/02/2020 14:19	29/02/2020 10:37	29/02/2020 14:19	3,70	13	48,04	CHI
202002187978	PEROLANDIA	JT12390597	JATAI S1	29/02/2020 10:37	29/02/2020 14:19	29/02/2020 10:37	29/02/2020 14:19	3,70	6	22,17	CHI
202002187982	CACU	CC11041640	CACHOEIRA ALTA	29/02/2020 10:38	29/02/2020 13:45	29/02/2020 10:38	29/02/2020 13:45	3,11	34	105,75	CHI
202002187985	GOIANIA	GN12071845	GOIANIA LESTE S3	29/02/2020 10:39	01/03/2020 01:34	29/02/2020 14:37	01/03/2020 01:34	10,95	4	43,80	CHI
202002187986	PALMEIRAS DE GOIAS	10002382707	PALMEIRAS	29/02/2020 10:39	29/02/2020 20:35	29/02/2020 10:39	29/02/2020 20:35	9,92	1	9,92	CHI
202002187993	PETROLINA DE GOIAS	PG21072954	PETROLINA	29/02/2020 10:41	29/02/2020 14:23	29/02/2020 10:41	29/02/2020 14:23	3,69	2	7,38	CHI
202002187994	ANAPOLIS	10023694180	JUNDIAI S2	29/02/2020 10:41	29/02/2020 17:30	29/02/2020 10:41	29/02/2020 17:30	6,81	1	6,81	CHI
202002188024	IPAMERI	IP21195048	IPAMERI	29/02/2020 10:35	01/03/2020 12:41	29/02/2020 10:35	01/03/2020 12:41	26,10	1	26,10	CHI
202002188029	MORRINHOS	150147314	MORRINHOS	29/02/2020 11:24	29/02/2020 15:07	29/02/2020 11:24	29/02/2020 15:07	3,71	1	3,71	CHI
202002188030	SAO SIMAO	SO21323872	CACHOEIRA ALTA	29/02/2020 11:31	29/02/2020 13:28	29/02/2020 11:31	29/02/2020 13:28	1,94	1	1,94	CHI
202002188038	MAURILANDIA	ML12000173	RIO DOS BOIS	29/02/2020 12:06	01/03/2020 10:17	29/02/2020 12:06	01/03/2020 10:17	22,18	1	22,18	CHI
202002188039	CATALAO	CT12408622	CATALAO S2	29/02/2020 12:17	29/02/2020 14:07	29/02/2020 12:17	29/02/2020 14:07	1,83	58	106,14	CHI
202002188049	GOIANIA	GN10400634	AEROPORTO S2	29/02/2020 13:02	29/02/2020 20:24	29/02/2020 13:02	29/02/2020 13:07	0,08	1335	111,25	CHI
202002188049	GOIANIA	GN10383781	AEROPORTO S2	29/02/2020 13:02	29/02/2020 20:24	29/02/2020 13:02	29/02/2020 13:07	0,09	187	16,62	CHI
202002188049	GOIANIA	GN10383781	AEROPORTO S2	29/02/2020 13:02	29/02/2020 20:24	29/02/2020 13:02	29/02/2020 14:04	1,04	647	670,36	CHI
202002188049	GOIANIA	GN10383781	AEROPORTO S2	29/02/2020 13:02	29/02/2020 20:24	29/02/2020 14:10	29/02/2020 14:28	0,30	834	249,27	CHI
202002188049	GOIANIA	GN16413692	AEROPORTO S2	29/02/2020 13:02	29/02/2020 20:24	29/02/2020 14:37	29/02/2020 15:24	0,78	183	142,33	CHI
202002188049	GOIANIA	GN16413885	AEROPORTO S1	29/02/2020 13:02	29/02/2020 20:24	29/02/2020 15:42	29/02/2020 15:47	0,08	3800	300,83	CHI
202002188049	GOIANIA	GN16413885	CAMPINAS S3	29/02/2020 13:02	29/02/2020 20:24	29/02/2020 15:42	29/02/2020 15:47	0,08	2257	178,68	CHI
202002188049	GOIANIA	GN16413692	AEROPORTO S2	29/02/2020 13:02	29/02/2020 20:24	29/02/2020 14:37	29/02/2020 16:55	2,30	648	1489,68	CHI
202002188049	GOIANIA	GN16413885	CAMPINAS S3	29/02/2020 13:02	29/02/2020 20:24	29/02/2020 15:42	29/02/2020 17:02	1,33	275	365,67	CHI
202002188049	GOIANIA	GN16413885	CAMPINAS S3	29/02/2020 13:02	29/02/2020 20:24	29/02/2020 15:42	29/02/2020 17:04	1,36	452	616,10	CHI
202002188049	GOIANIA	00612244	CAMPINAS S3	29/02/2020 13:02	29/02/2020 20:24	29/02/2020 17:03	29/02/2020 18:13	1,17	1	1,17	CHI
202002188049	GOIANIA	GN16413692	AEROPORTO S2	29/02/2020 13:02	29/02/2020 20:24	29/02/2020 14:37	29/02/2020 18:52	4,24	3	12,72	CHI
202002188049	GOIANIA	GN13377942	CAMPINAS S3	29/02/2020 13:02	29/02/2020 20:24	29/02/2020 17:03	29/02/2020 19:28	2,42	274	662,01	CHI
202002188049	GOIANIA	GN13000081	AEROPORTO S2	29/02/2020 13:02	29/02/2020 20:24	29/02/2020 20:19	29/02/2020 20:24	0,09	2166	190,13	CHI
202002188051	ITABERAÍ	IB12108135LD	ITABERAÍ S2	29/02/2020 13:15	29/02/2020 19:22	29/02/2020 14:47	29/02/2020 18:37	3,83	2	7,67	CHI
202002188051	ITABERAÍ	IB12253438	ITABERAÍ S1	29/02/2020 13:15	29/02/2020 19:22	29/02/2020 14:13	29/02/2020 19:22	5,15	5	25,73	CHI
202002188056	ANAPOLIS	10017066431	ANAPOLIS UNIVERSITARIO S2	28/02/2020 14:02	28/02/2020 17:00	28/02/2020 14:02	28/02/2020 17:00	2,97	1	2,97	CHI

202002188058	APARECIDA DE GOIANIA	10028653759	INDEPENDENCIA S1	28/02/2020 16:04	28/02/2020 19:14	28/02/2020 16:04	28/02/2020 19:14	3,16	1	3,16	CHI
202002188063	AMARALINA	MH12391970LD	NOVA CRIXAS	29/02/2020 08:39	29/02/2020 17:48	29/02/2020 08:39	29/02/2020 17:48	9,15	1	9,15	CHI
202002188063	MUNDO NOVO DE GOIAS	MH12391970LD	NOVA CRIXAS	29/02/2020 08:39	29/02/2020 17:48	29/02/2020 08:39	29/02/2020 17:48	9,15	2	18,29	CHI
202002188109	CAMPINORTE	MQ12028706	MARA ROSA	29/02/2020 08:28	29/02/2020 14:08	29/02/2020 08:28	29/02/2020 14:08	5,66	7	39,61	CHI
202002188113	CORUMBAIBA	CI12377064	CATALAO S1	29/02/2020 06:08	29/02/2020 14:14	29/02/2020 06:08	29/02/2020 14:14	8,09	12	97,09	CHI
202002188119	TURVANIA	TV21332342	FIRMINOPOLIS S2	29/02/2020 10:47	29/02/2020 16:23	29/02/2020 10:47	29/02/2020 16:23	5,59	1	5,59	CHI
202002188124	SENADOR CANEDO	15846519	GOIANIA LESTE S1	29/02/2020 10:48	29/02/2020 13:13	29/02/2020 10:48	29/02/2020 13:13	2,41	1	2,41	CHI
202002188133	GOIANIA	13506560	XAVANTES	29/02/2020 10:49	29/02/2020 11:57	29/02/2020 10:49	29/02/2020 11:57	1,12	1	1,12	CHI
202002188136	PORANGATU	PO12141124	NOVO PLANALTO	29/02/2020 10:13	29/02/2020 16:39	29/02/2020 10:13	29/02/2020 16:39	6,43	20	128,54	CHI
202002188137	CRISTALINA	KR21028909	CRISTALINA S1	29/02/2020 10:51	29/02/2020 13:13	29/02/2020 10:51	29/02/2020 13:13	2,36	1	2,36	CHI
202002188141	GOIANESIA	GE21000029	GOIANESIA S2	29/02/2020 10:52	29/02/2020 17:15	29/02/2020 10:52	29/02/2020 17:15	6,38	1	6,38	CHI
202002188142	PIRACANJUBA	PJ12035476	PIRACANJUBA	28/02/2020 22:35	29/02/2020 15:52	28/02/2020 22:35	29/02/2020 15:52	17,28	17	293,78	CHI
202002188150	ANAPOLIS	AN12000150	JUNDIAI S2	29/02/2020 10:22	29/02/2020 11:39	29/02/2020 10:22	29/02/2020 11:39	1,27	21	26,65	CHI
202002188157	MINACU	IH12220694	MINACU	29/02/2020 10:55	29/02/2020 12:46	29/02/2020 10:55	29/02/2020 12:46	1,84	5	9,22	CHI
202002188161	PLANALTINA	2960096788	PLANALTINA	29/02/2020 10:56	29/02/2020 11:48	29/02/2020 10:56	29/02/2020 11:48	0,87	1	0,87	CHI
202002188163	SAO DOMINGOS	SD12262420	SAO DOMINGOS	29/02/2020 10:56	29/02/2020 18:09	29/02/2020 10:56	29/02/2020 18:09	7,21	1	7,21	CHI
202002188164	AGUA LIMPA	AL21113202	VILA CORUMBA	29/02/2020 10:56	01/03/2020 00:04	29/02/2020 10:56	01/03/2020 00:04	13,13	1	13,13	CHI
202002188165	PLANALTINA	PI12375541	PLANALTINA	29/02/2020 10:54	29/02/2020 11:50	29/02/2020 10:54	29/02/2020 11:50	0,92	178	164,40	CHI
202002188167	MONTIVIDIU	MV21154016	MONTIVIDIU T	29/02/2020 10:57	01/03/2020 15:01	29/02/2020 10:57	01/03/2020 15:01	28,06	1	28,06	CHI
202002188172	IVOLANDIA	IV21193825	IPORA	29/02/2020 07:36	29/02/2020 14:52	29/02/2020 07:36	29/02/2020 14:52	7,25	1	7,25	CHI
202002188173	ANAPOLIS	AN21341981	JUNDIAI S1	29/02/2020 11:00	29/02/2020 13:18	29/02/2020 11:00	29/02/2020 13:18	2,30	2	4,60	CHI
202002188175	ARENOPOLIS	AY12156761	ARENOPOLIS	29/02/2020 05:26	29/02/2020 18:11	29/02/2020 05:26	29/02/2020 18:11	12,75	5	63,74	CHI
202002188179	FAZENDA NOVA	1080014874	JUSSARA	29/02/2020 11:00	29/02/2020 16:33	29/02/2020 11:00	29/02/2020 16:33	5,54	1	5,54	CHI
202002188181	ITAUCU	IX21172644	INHUMAS S1	29/02/2020 11:01	29/02/2020 18:20	29/02/2020 11:01	29/02/2020 18:20	7,30	1	7,30	CHI
202002188189	PIRACANJUBA	60005488	PIRACANJUBA	29/02/2020 11:04	29/02/2020 18:59	29/02/2020 11:04	29/02/2020 18:59	7,92	1	7,92	CHI
202002188197	BELA VISTA DE GOIAS	240088347	BELA VISTA S1	29/02/2020 11:06	29/02/2020 12:47	29/02/2020 11:06	29/02/2020 12:47	1,67	1	1,67	CHI
202002188200	ANAPOLIS	AN21340034	DAIA S1	29/02/2020 11:07	29/02/2020 12:50	29/02/2020 11:07	29/02/2020 12:50	1,71	8	13,69	CHI
202002188204	CACU	10019209949	CACHOEIRA ALTA	29/02/2020 11:07	29/02/2020 15:40	29/02/2020 11:07	29/02/2020 15:40	4,54	1	4,54	CHI
202002188206	BALIZA	BM12390150	BOM JARDIM	29/02/2020 10:30	29/02/2020 17:38	29/02/2020 10:30	29/02/2020 17:38	7,14	48	342,52	CHI
202002188206	BOM JARDIM DE GOIAS	BM12390150	BOM JARDIM	29/02/2020 10:30	29/02/2020 17:38	29/02/2020 10:30	29/02/2020 17:38	7,14	9	64,22	CHI
202002188207	COCALZINHO DE GOIAS	ZN21062133	COCALZINHO	29/02/2020 11:08	29/02/2020 13:34	29/02/2020 11:08	29/02/2020 13:34	2,43	1	2,43	CHI
202002188209	CALDAZINHA	DE21168755	SENADOR CANEDO	29/02/2020 11:08	29/02/2020 13:20	29/02/2020 11:08	29/02/2020 13:20	2,19	2	4,38	CHI
202002188211	BURITI DE GOIAS	SC12052751	FIRMINOPOLIS S2	29/02/2020 11:09	29/02/2020 13:55	29/02/2020 11:09	29/02/2020 13:55	2,76	3	8,27	CHI
202002188211	SANCLERLANDIA	SC12052751	FIRMINOPOLIS S2	29/02/2020 11:09	29/02/2020 13:55	29/02/2020 11:09	29/02/2020 13:55	2,76	19	52,36	CHI
202002188218	GAMELEIRA DE GOIAS	SV12077017	DAIA S2	29/02/2020 10:18	01/03/2020 05:12	29/02/2020 10:18	01/03/2020 05:12	18,90	2	37,80	CHI
202002188218	SILVANIA	SV12077017	DAIA S2	29/02/2020 10:18	01/03/2020 05:12	29/02/2020 10:18	01/03/2020 05:12	18,90	3	56,69	CHI
202002188219	CEZARINA	CZ21344876	CEZARINA	29/02/2020 11:11	29/02/2020 13:42	29/02/2020 11:11	29/02/2020 13:42	2,51	1	2,51	CHI
202002188222	NEROPOLIS	NR21009835	NEROPOLIS S2	29/02/2020 11:12	29/02/2020 11:50	29/02/2020 11:12	29/02/2020 11:50	0,63	2	1,25	CHI
202002188223	ITUMBIARA	10011790421	PARANAIBA	29/02/2020 11:12	29/02/2020 17:27	29/02/2020 11:12	29/02/2020 17:27	6,25	1	6,25	CHI
202002188231	AMARALINA	MH12037774	NOVA CRIXAS	29/02/2020 07:14	29/02/2020 16:38	29/02/2020 07:14	29/02/2020 16:38	9,39	45	422,44	CHI
202002188231	MARA ROSA	MH12037774	NOVA CRIXAS	29/02/2020 07:14	29/02/2020 16:38	29/02/2020 07:14	29/02/2020 16:38	9,39	38	356,72	CHI
202002188231	MUNDO NOVO DE GOIAS	MH12037774	NOVA CRIXAS	29/02/2020 07:14	29/02/2020 16:38	29/02/2020 07:14	29/02/2020 16:38	9,39	5	46,94	CHI
202002188231	SANTA TEREZINHA DE GOIAS	MH12037774	NOVA CRIXAS	29/02/2020 07:14	29/02/2020 16:38	29/02/2020 07:14	29/02/2020 16:38	9,39	1	9,39	CHI
202002188231	UIRAPURU	MH12037774	NOVA CRIXAS	29/02/2020 07:14	29/02/2020 16:38	29/02/2020 07:14	29/02/2020 16:38	9,39	73	685,29	CHI

202002188233	VIANOPOLIS	VN12014680	VIANOPOLIS	29/02/2020 09:45	29/02/2020 14:30	29/02/2020 09:45	29/02/2020 14:30	4,75	10	47,48	CHI
202002188236	GOIANESIA	GE21115124	GOIANESIA S2	29/02/2020 11:16	29/02/2020 22:55	29/02/2020 11:16	29/02/2020 22:55	11,65	1	11,65	CHI
202002188238	GOIANIA	16705312	GOIANIA LESTE S3	29/02/2020 11:16	29/02/2020 13:52	29/02/2020 11:16	29/02/2020 13:52	2,59	1	2,59	CHI
202002188240	MORRINHOS	150048543	MORRINHOS	29/02/2020 11:17	29/02/2020 14:44	29/02/2020 11:17	29/02/2020 14:44	3,45	1	3,45	CHI
202002188243	JARAGUA	JA12000236	JARAGUA	29/02/2020 11:17	29/02/2020 18:43	29/02/2020 11:17	29/02/2020 18:43	7,43	27	200,48	CHI
202002188246	GOIATUBA	GT21050594	BOM JESUS DE GOIAS	29/02/2020 11:17	29/02/2020 23:10	29/02/2020 11:17	29/02/2020 23:10	11,88	1	11,88	CHI
202002188255	APARECIDA DE GOIANIA	12372808	INDEPENDENCIA S2	29/02/2020 11:21	29/02/2020 13:09	29/02/2020 11:21	29/02/2020 13:09	1,80	1	1,80	CHI
202002188260	ITAJA	IJ12162692	ITAJA S2	29/02/2020 09:30	29/02/2020 12:56	29/02/2020 09:30	29/02/2020 12:56	3,43	6	20,58	CHI
202002188262	URUACU	UR12353573	URUACU	29/02/2020 11:23	29/02/2020 12:53	29/02/2020 11:23	29/02/2020 12:53	1,49	10	14,94	CHI
202002188263	CAMPESTRE DE GOIAS	GC21281543	TRINDADE	29/02/2020 11:24	29/02/2020 13:20	29/02/2020 11:24	29/02/2020 13:20	1,93	1	1,93	CHI
202002188269	CACHOEIRA ALTA	QI12126503	QUIRINOPOLIS	29/02/2020 11:25	29/02/2020 23:19	29/02/2020 11:25	29/02/2020 23:19	11,89	5	59,46	CHI
202002188269	RIO VERDE	QI12126503	QUIRINOPOLIS	29/02/2020 11:25	29/02/2020 23:19	29/02/2020 11:25	29/02/2020 23:19	11,89	5	59,46	CHI
202002188280	PIRES DO RIO	PR21000072	PIRES DO RIO S1	29/02/2020 11:28	29/02/2020 16:25	29/02/2020 11:28	29/02/2020 16:25	4,94	1	4,94	CHI
202002188285	ALTO HORIZONTE	AJ11300507	SANTA TEREZINHA	29/02/2020 11:17	29/02/2020 22:57	29/02/2020 11:17	29/02/2020 22:57	11,66	79	921,34	CHI
202002188286	COCALZINHO DE GOIAS	ZN12148908	AGUAS LINDAS DE GOIAS S2	29/02/2020 11:29	29/02/2020 13:27	29/02/2020 11:29	29/02/2020 13:27	1,97	2	3,93	CHI
202002188287	ALTO PARAISO DE GOIAS	BF21365280	SAO JOAO D ALIANCA	29/02/2020 11:30	29/02/2020 15:53	29/02/2020 11:30	29/02/2020 15:53	4,38	1	4,38	CHI
202002188289	GOIANIA	12038131	REAL S1	29/02/2020 11:31	29/02/2020 20:19	29/02/2020 11:31	29/02/2020 20:19	8,79	1	8,79	CHI
202002188292	MAIRIPOTABA	MR12000060RE	MORRINHOS	29/02/2020 11:32	29/02/2020 19:35	29/02/2020 11:32	29/02/2020 19:35	8,04	15	120,61	CHI
202002188292	MORRINHOS	MR12000060RE	MORRINHOS	29/02/2020 11:32	29/02/2020 19:35	29/02/2020 11:32	29/02/2020 19:35	8,04	32	257,30	CHI
202002188292	PIRACANJUBA	MR12000060RE	MORRINHOS	29/02/2020 11:32	29/02/2020 19:35	29/02/2020 11:32	29/02/2020 19:35	8,04	7	56,28	CHI
202002188292	PONTALINA	MR12000060RE	MORRINHOS	29/02/2020 11:32	29/02/2020 19:35	29/02/2020 11:32	29/02/2020 19:35	8,04	10	80,41	CHI
202002188293	BELA VISTA DE GOIAS	BV32097920	BELA VISTA S2	29/02/2020 11:33	29/02/2020 13:50	29/02/2020 11:33	29/02/2020 13:50	2,28	18	41,07	CHI
202002188302	GOIANESIA	GE12373995	GOIANESIA S2	29/02/2020 07:51	29/02/2020 15:25	29/02/2020 07:51	29/02/2020 15:25	7,56	18	136,11	CHI
202002188310	FAZENDA NOVA	NB12250852	JUSSARA	29/02/2020 11:27	29/02/2020 15:42	29/02/2020 11:27	29/02/2020 15:42	4,25	4	17,00	CHI
202002188310	NOVO BRASIL	NB12250852	JUSSARA	29/02/2020 11:27	29/02/2020 15:42	29/02/2020 11:27	29/02/2020 15:42	4,25	2	8,50	CHI
202002188314	RIO VERDE	630002502	RIO VERDE S1	29/02/2020 11:38	29/02/2020 16:38	29/02/2020 11:38	29/02/2020 16:38	4,99	1	4,99	CHI
202002188316	ANAPOLIS	OV12384197	NEROPOLIS S1	29/02/2020 11:39	29/02/2020 14:14	29/02/2020 11:39	29/02/2020 14:14	2,58	5	12,89	CHI
202002188316	OURO VERDE DE GOIAS	OV12384197	NEROPOLIS S1	29/02/2020 11:39	29/02/2020 14:14	29/02/2020 11:39	29/02/2020 14:14	2,58	2	5,16	CHI
202002188317	GUARANI DE GOIAS	SD10401447	SAO DOMINGOS	29/02/2020 11:32	29/02/2020 15:49	29/02/2020 11:33	29/02/2020 11:36	0,05	147	7,76	CHI
202002188317	SAO DOMINGOS	SD10401447	SAO DOMINGOS	29/02/2020 11:32	29/02/2020 15:49	29/02/2020 11:33	29/02/2020 11:36	0,05	483	25,49	CHI
202002188317	GUARANI DE GOIAS	02090424	SAO DOMINGOS	29/02/2020 11:32	29/02/2020 15:49	29/02/2020 11:41	29/02/2020 13:59	2,31	2	4,61	CHI
202002188317	SAO DOMINGOS	02090424	SAO DOMINGOS	29/02/2020 11:32	29/02/2020 15:49	29/02/2020 11:41	29/02/2020 13:59	2,31	299	689,28	CHI
202002188317	SAO DOMINGOS	02090424	SAO DOMINGOS	29/02/2020 11:32	29/02/2020 15:49	29/02/2020 11:41	29/02/2020 14:57	3,27	52	169,91	CHI
202002188317	NOVA ROMA	SD10401447	SAO DOMINGOS	29/02/2020 11:32	29/02/2020 15:49	29/02/2020 11:33	29/02/2020 15:49	4,27	3	12,80	CHI
202002188317	SAO DOMINGOS	SD10401447	SAO DOMINGOS	29/02/2020 11:32	29/02/2020 15:49	29/02/2020 11:33	29/02/2020 15:49	4,27	177	755,45	CHI
202002188317	GUARANI DE GOIAS	SD13103880	SAO DOMINGOS	29/02/2020 11:32	29/02/2020 15:49	29/02/2020 11:41	29/02/2020 15:49	4,14	147	608,83	CHI
202002188317	SAO DOMINGOS	02090424	SAO DOMINGOS	29/02/2020 11:32	29/02/2020 15:49	29/02/2020 11:41	29/02/2020 15:49	4,14	139	575,69	CHI
202002188317	SAO DOMINGOS	SD13103880	SAO DOMINGOS	29/02/2020 11:32	29/02/2020 15:49	29/02/2020 11:41	29/02/2020 15:49	4,14	483	2000,43	CHI
202002188319	PIRACANJUBA	60057452	PIRACANJUBA	29/02/2020 11:39	29/02/2020 20:26	29/02/2020 11:39	29/02/2020 20:26	8,77	1	8,77	CHI
202002188320	GOIANIA	AP12265059	INDEPENDENCIA S2	29/02/2020 11:39	29/02/2020 15:11	29/02/2020 11:39	29/02/2020 15:11	3,52	550	1934,93	CHI
202002188321	ANICUNS	10019427822	ANICUNS	29/02/2020 11:40	29/02/2020 16:30	29/02/2020 11:40	29/02/2020 16:30	4,83	1	4,83	CHI
202002188325	ESTRELA DO NORTE	ET12256551	MARA ROSA	29/02/2020 11:41	29/02/2020 14:01	29/02/2020 11:41	29/02/2020 14:01	2,33	9	20,98	CHI
202002188327	BONOPOLIS	BX12079321	SAO MIGUEL DO ARAGUAIA	29/02/2020 11:41	29/02/2020 13:47	29/02/2020 11:41	29/02/2020 13:47	2,10	58	121,54	CHI
202002188331	NOVA CRIXAS	NA12262740	NOVA CRIXAS	01/03/2020 09:57	01/03/2020 11:33	01/03/2020 09:57	01/03/2020 11:33	1,59	102	162,35	CHI

202002188341	MINEIROS	1390089876	PARQUE DAS EMAS	29/02/2020 11:44	01/03/2020 07:52	29/02/2020 11:44	01/03/2020 07:52	20,12	1	20,12	CHI
202002188348	AMARALINA	MU12391672	MARA ROSA	29/02/2020 11:46	29/02/2020 15:18	29/02/2020 11:46	29/02/2020 15:18	3,53	101	356,59	CHI
202002188348	MUTUNOPOLIS	MU12391672	MARA ROSA	29/02/2020 11:46	29/02/2020 15:18	29/02/2020 11:46	29/02/2020 15:18	3,53	7	24,71	CHI
202002188350	ANAPOLIS	LB12078506	DAIA S2	29/02/2020 11:46	29/02/2020 15:16	29/02/2020 11:46	29/02/2020 15:16	3,49	8	27,96	CHI
202002188350	LEOPOLDO DE BULHOES	LB12078506	DAIA S2	29/02/2020 11:46	29/02/2020 15:16	29/02/2020 11:46	29/02/2020 15:16	3,49	6	20,97	CHI
202002188351	GOIANIA	GN11001901	AEROPORTO S3	29/02/2020 11:45	29/02/2020 19:57	29/02/2020 11:45	29/02/2020 19:57	8,19	45	368,60	CHI
202002188352	DOVERLANDIA	DV12380977	CAIAPONIA	29/02/2020 11:20	29/02/2020 17:01	29/02/2020 11:20	29/02/2020 17:01	5,68	89	505,37	CHI
202002188353	RIO VERDE	RV21033133	CABRIUVA S2	29/02/2020 11:46	01/03/2020 09:41	29/02/2020 11:46	01/03/2020 09:41	21,90	1	21,90	CHI
202002188358	ITAGUARU	230002640	ITABERAI S1	29/02/2020 11:47	29/02/2020 12:51	29/02/2020 11:47	29/02/2020 12:51	1,05	1	1,05	CHI
202002188359	GOIANESIA	10029194634	GOIANESIA S2	29/02/2020 11:48	29/02/2020 14:59	29/02/2020 11:48	29/02/2020 14:59	3,19	1	3,19	CHI
202002188361	SERRANOPOLIS	SX11147543	JATAI S1	29/02/2020 11:48	29/02/2020 18:48	29/02/2020 11:48	29/02/2020 18:48	6,99	91	635,79	CHI
202002188362	IVOLANDIA	IV21011806	IPORA	29/02/2020 11:48	29/02/2020 19:15	29/02/2020 11:48	29/02/2020 19:15	7,44	1	7,44	CHI
202002188363	CALDAS NOVAS	CN21110343	SERRA DE CALDAS	29/02/2020 11:49	29/02/2020 17:13	29/02/2020 11:49	29/02/2020 17:13	5,40	2	10,80	CHI
202002188364	SENADOR CANEDO	190139146	SENADOR CANEDO	29/02/2020 11:49	29/02/2020 15:44	29/02/2020 11:49	29/02/2020 15:44	3,91	0	0,00	CHI
202002188378	SAO MIGUEL DO ARAGUAIA	SM12390369	SAO MIGUEL DO ARAGUAIA	29/02/2020 11:51	29/02/2020 14:53	29/02/2020 11:51	29/02/2020 14:53	3,03	1	3,03	CHI
202002188382	CAMPOS VERDES	VD12049799	SANTA TEREZINHA	29/02/2020 11:51	29/02/2020 18:41	29/02/2020 11:51	29/02/2020 18:41	6,82	21	143,27	CHI
202002188382	PILAR DE GOIAS	VD12049799	SANTA TEREZINHA	29/02/2020 11:51	29/02/2020 18:41	29/02/2020 11:51	29/02/2020 18:41	6,82	5	34,11	CHI
202002188382	SANTA TEREZINHA DE GOIAS	VD12049799	SANTA TEREZINHA	29/02/2020 11:51	29/02/2020 18:41	29/02/2020 11:51	29/02/2020 18:41	6,82	3	20,47	CHI
202002188386	RIO VERDE	630102612	RIO VERDE S1	29/02/2020 11:52	29/02/2020 15:10	29/02/2020 11:52	29/02/2020 15:10	3,30	1	3,30	CHI
202002188388	MONTE ALEGRE DE GOIAS	MA21269359	SAO DOMINGOS	29/02/2020 11:52	29/02/2020 18:40	29/02/2020 11:52	29/02/2020 18:40	6,79	1	6,79	CHI
202002188392	ANAPOLIS	AN12000150	JUNDIAI S2	29/02/2020 11:53	29/02/2020 14:06	29/02/2020 11:53	29/02/2020 14:06	2,21	7	15,45	CHI
202002188400	GOIANIA	12265639	ATLANTICO S1	29/02/2020 11:53	29/02/2020 13:45	29/02/2020 11:53	29/02/2020 13:45	1,85	1	1,85	CHI
202002188407	ARAGARCAS	AG12000006	ARAGARCAS	29/02/2020 11:16	29/02/2020 18:46	29/02/2020 11:16	29/02/2020 14:31	3,25	20	65,06	CHI
202002188407	ARAGARCAS	AG12087132LD	ARAGARCAS	29/02/2020 11:16	29/02/2020 18:46	29/02/2020 11:16	29/02/2020 17:01	5,76	3	17,27	CHI
202002188407	ARAGARCAS	AG12380911	ARAGARCAS	29/02/2020 11:16	29/02/2020 18:46	29/02/2020 11:16	29/02/2020 17:28	6,20	1	6,20	CHI
202002188407	ARAGARCAS	AG12334803	ARAGARCAS	29/02/2020 11:16	29/02/2020 18:46	29/02/2020 11:16	29/02/2020 18:04	6,81	9	61,25	CHI
202002188407	ARAGARCAS	AG12355341	ARAGARCAS	29/02/2020 11:16	29/02/2020 18:46	29/02/2020 11:16	29/02/2020 18:46	7,51	9	67,56	CHI
202002188418	INDIARA	10023306384	EDEIA	29/02/2020 11:57	29/02/2020 18:17	29/02/2020 11:57	29/02/2020 18:17	6,32	1	6,32	CHI
202002188436	ITUMBIARA	IT21249851	ITUMBIARA NOVA	29/02/2020 12:03	29/02/2020 17:52	29/02/2020 12:03	29/02/2020 17:52	5,81	1	5,81	CHI
202002188438	GOIANIA	GN12000977	GOYA S1	29/02/2020 12:03	29/02/2020 15:09	29/02/2020 12:03	29/02/2020 15:09	3,08	2	6,17	CHI
202002188441	PARAUNA	PU12301178	ACREUNA	29/02/2020 12:04	29/02/2020 13:14	29/02/2020 12:04	29/02/2020 13:14	1,16	9	10,44	CHI
202002188460	QUIRINOPOLIS	QI21306065	QUIRINOPOLIS	29/02/2020 12:10	29/02/2020 19:46	29/02/2020 12:10	29/02/2020 19:46	7,59	1	7,59	CHI
202002188462	ARAGARCAS	AG21093571	IPORA	29/02/2020 12:10	29/02/2020 22:53	29/02/2020 12:10	29/02/2020 22:53	10,71	1	10,71	CHI
202002188471	RIO VERDE	630297230	RIO VERDE S2	29/02/2020 12:13	29/02/2020 17:28	29/02/2020 12:13	29/02/2020 17:28	5,25	1	5,25	CHI
202002188476	CACHOEIRA ALTA	RV12101165	CACHOEIRA ALTA	29/02/2020 11:51	29/02/2020 18:55	29/02/2020 11:51	29/02/2020 18:55	7,06	1	7,06	CHI
202002188476	RIO VERDE	RV12101165	CACHOEIRA ALTA	29/02/2020 11:51	29/02/2020 18:55	29/02/2020 11:51	29/02/2020 18:55	7,06	37	261,19	CHI
202002188485	MONTES CLAROS DE GOIAS	ME12204886	IPORA	29/02/2020 12:03	29/02/2020 16:34	29/02/2020 12:03	29/02/2020 16:34	4,50	77	346,59	CHI
202002188486	JUSSARA	JR21018562	BRITANIA	29/02/2020 11:20	29/02/2020 15:07	29/02/2020 11:20	29/02/2020 15:07	3,78	1	3,78	CHI
202002188495	ARAGUAPAZ	AZ12404563	GOIAS	29/02/2020 11:07	29/02/2020 15:00	29/02/2020 11:07	29/02/2020 15:00	3,88	20	77,68	CHI
202002188495	FAINA	AZ12404563	GOIAS	29/02/2020 11:07	29/02/2020 15:00	29/02/2020 11:07	29/02/2020 15:00	3,88	1	3,88	CHI
202002188497	MONTES CLAROS DE GOIAS	ME21183237	BRITANIA	29/02/2020 12:17	01/03/2020 01:54	29/02/2020 12:17	01/03/2020 01:54	13,60	1	13,60	CHI
202002188504	CAMPOS VERDES	SG12181588	SANTA TEREZINHA	29/02/2020 12:19	29/02/2020 15:29	29/02/2020 12:19	29/02/2020 15:29	3,16	8	25,26	CHI
202002188504	SANTA TEREZINHA DE GOIAS	SG12181588	SANTA TEREZINHA	29/02/2020 12:19	29/02/2020 15:29	29/02/2020 12:19	29/02/2020 15:29	3,16	6	18,94	CHI
202002188505	BARRO ALTO	BA12210734	BARRO ALTO	29/02/2020 09:14	29/02/2020 14:14	29/02/2020 09:14	29/02/2020 14:14	5,00	4	20,00	CHI

202002188506	EDEIA	EA12086939	EDEIA	29/02/2020 11:56	29/02/2020 21:45	29/02/2020 11:56	29/02/2020 21:45	9,80	9	88,21	CHI
202002188510	PALESTINA DE GOIAS	CP12395428	PALESTINA	29/02/2020 04:23	29/02/2020 14:18	29/02/2020 04:23	29/02/2020 14:18	9,90	5	49,52	CHI
202002188511	CATURAI	CK21035357	INHUMAS S1	29/02/2020 12:21	29/02/2020 14:08	29/02/2020 12:21	29/02/2020 14:08	1,78	1	1,78	CHI
202002188513	CAIAPONIA	PH21187417	CAIAPONIA	29/02/2020 12:22	29/02/2020 21:12	29/02/2020 12:22	29/02/2020 21:12	8,82	1	8,82	CHI
202002188514	PORANGATU	PO12391933	MARA ROSA	29/02/2020 12:23	29/02/2020 20:48	29/02/2020 12:23	29/02/2020 20:48	8,41	5	42,05	CHI
202002188521	BURITINOPOLIS	BQ21234594	IACIARA S2	29/02/2020 12:23	29/02/2020 14:25	29/02/2020 12:23	29/02/2020 14:25	2,02	1	2,02	CHI
202002188525	ANAPOLIS	10001328229	ANAPOLIS UNIVERSITARIO S2	29/02/2020 12:25	29/02/2020 14:22	29/02/2020 12:25	29/02/2020 14:22	1,95	1	1,95	CHI
202002188528	PLANALTINA	2960084907	PLANALTINA	29/02/2020 12:25	29/02/2020 14:30	29/02/2020 12:25	29/02/2020 14:30	2,08	1	2,08	CHI
202002188529	SAO MIGUEL DO PASSA QUATRO	SQ21252444	CRISTIANOPOLIS	29/02/2020 12:25	29/02/2020 18:41	29/02/2020 12:25	29/02/2020 18:41	6,26	1	6,26	CHI
202002188530	QUIRINOPOLIS	QI32058080	QUIRINOPOLIS	29/02/2020 12:25	29/02/2020 14:31	29/02/2020 12:25	29/02/2020 14:31	2,09	10	20,92	CHI
202002188531	GOIANIA	17355539	GOYA S1	29/02/2020 12:25	29/02/2020 16:15	29/02/2020 12:25	29/02/2020 16:15	3,82	1	3,82	CHI
202002188534	AGUAS LINDAS DE GOIAS	4830425144	AGUAS LINDAS DE GOIAS S2	29/02/2020 12:25	29/02/2020 14:16	29/02/2020 12:25	29/02/2020 14:16	1,84	1	1,84	CHI
202002188536	ARUANA	2380018383	ARUANA	29/02/2020 12:26	29/02/2020 22:53	29/02/2020 12:26	29/02/2020 22:53	10,45	1	10,45	CHI
202002188537	APARECIDA DE GOIANIA	10024641241	ANHANGUERA	29/02/2020 12:26	29/02/2020 13:39	29/02/2020 12:26	29/02/2020 13:39	1,21	1	1,21	CHI
202002188539	MORRINHOS	10000008840	MORRINHOS	29/02/2020 12:26	29/02/2020 16:27	29/02/2020 12:26	29/02/2020 16:27	4,01	1	4,01	CHI
202002188543	MONTIVIDIU DO NORTE	TB12156640	PORANGATU	29/02/2020 12:27	29/02/2020 16:31	29/02/2020 16:02	29/02/2020 16:30	0,46	1	0,46	CHI
202002188543	TROMBAS	TB12156640	PORANGATU	29/02/2020 12:27	29/02/2020 16:31	29/02/2020 16:02	29/02/2020 16:30	0,46	29	13,27	CHI
202002188543	TROMBAS	TB11337384	PORANGATU	29/02/2020 12:27	29/02/2020 16:31	29/02/2020 12:27	29/02/2020 16:31	4,07	1	4,07	CHI
202002188544	SILVANIA	SV12087254	DAIA S2	29/02/2020 12:27	01/03/2020 16:29	29/02/2020 12:27	29/02/2020 22:20	9,89	7	69,24	CHI
202002188544	SILVANIA	SV12087254	DAIA S2	29/02/2020 12:27	01/03/2020 16:29	29/02/2020 12:27	01/03/2020 16:29	28,04	5	140,19	CHI
202002188547	NOVA CRIXAS	NA21121161	NOVA CRIXAS	29/02/2020 12:27	29/02/2020 19:38	29/02/2020 12:27	29/02/2020 19:38	7,17	1	7,17	CHI
202002188557	GOIANIA	GN11049376	ATLANTICO S3	29/02/2020 08:54	29/02/2020 14:51	29/02/2020 08:54	29/02/2020 14:51	5,94	128	760,28	CHI
202002188558	BONFINOPOLIS	BO21157057	GOIANIA LESTE S2	29/02/2020 12:29	29/02/2020 17:41	29/02/2020 12:29	29/02/2020 17:41	5,19	2	10,37	CHI
202002188567	APARECIDA DE GOIANIA	200411627	ANHANGUERA	29/02/2020 12:31	29/02/2020 16:40	29/02/2020 12:31	29/02/2020 16:40	4,14	1	4,14	CHI
202002188579	IPORA	730114594	IPORA	29/02/2020 12:35	29/02/2020 16:08	29/02/2020 12:35	29/02/2020 16:08	3,54	1	3,54	CHI
202002188581	AGUA FRIA DE GOIAS	TL12381390	SAO JOAO D ALIANCA	29/02/2020 12:35	01/03/2020 15:13	29/02/2020 12:35	29/02/2020 23:26	10,83	3	32,50	CHI
202002188581	PLANALTINA	TL12381390	SAO JOAO D ALIANCA	29/02/2020 12:35	01/03/2020 15:13	29/02/2020 12:35	29/02/2020 23:26	10,83	16	173,35	CHI
202002188581	PLANALTINA	TL12381390	SAO JOAO D ALIANCA	29/02/2020 12:35	01/03/2020 15:13	29/02/2020 12:35	01/03/2020 15:13	26,62	4	106,47	CHI
202002188586	GOIANIA	GN11238221	GOIANIA LESTE S3	29/02/2020 11:26	29/02/2020 17:25	29/02/2020 11:26	29/02/2020 17:25	5,97	167	997,59	CHI
202002188587	NEROPOLIS	10009603113	NEROPOLIS S2	29/02/2020 12:37	29/02/2020 14:06	29/02/2020 12:37	29/02/2020 14:06	1,47	1	1,47	CHI
202002188596	APARECIDA DE GOIANIA	AP11095065	ANHANGUERA	29/02/2020 12:39	29/02/2020 15:44	29/02/2020 12:39	29/02/2020 15:44	3,07	154	473,04	CHI
202002188602	TURVANIA	TV12215366LD	FIRMINOPOLIS S2	29/02/2020 12:42	29/02/2020 15:32	29/02/2020 12:42	29/02/2020 15:16	2,56	230	588,74	CHI
202002188602	TURVANIA	TV12215366LD	FIRMINOPOLIS S2	29/02/2020 12:42	29/02/2020 15:32	29/02/2020 12:42	29/02/2020 15:25	2,71	2	5,42	CHI
202002188602	TURVANIA	TV12215366LD	FIRMINOPOLIS S2	29/02/2020 12:42	29/02/2020 15:32	29/02/2020 12:42	29/02/2020 15:32	2,83	8	22,67	CHI
202002188603	PONTALINA	PK12328982	PONTALINA	29/02/2020 11:00	29/02/2020 14:50	29/02/2020 11:00	29/02/2020 14:50	3,82	7	26,76	CHI
202002188605	GOIANIRA	390085121	MEIA PONTE	29/02/2020 12:43	29/02/2020 14:44	29/02/2020 12:43	29/02/2020 14:44	2,02	1	2,02	CHI
202002188607	GOIANIA	12622084	MEIA PONTE	29/02/2020 12:44	29/02/2020 14:47	29/02/2020 12:44	29/02/2020 14:47	2,05	1	2,05	CHI
202002188609	AGUAS LINDAS DE GOIAS	LA12412179	AGUAS LINDAS DE GOIAS S1	29/02/2020 12:45	29/02/2020 15:03	29/02/2020 12:45	29/02/2020 15:03	2,30	1	2,30	CHI
202002188611	GOIATUBA	GT21150869	GOIATUBA S2	29/02/2020 12:45	01/03/2020 07:04	29/02/2020 12:45	01/03/2020 07:04	18,30	1	18,30	CHI
202002188612	CAMPESTRE DE GOIAS	GC21281544	TRINDADE	29/02/2020 12:45	29/02/2020 18:47	29/02/2020 12:45	29/02/2020 18:47	6,02	1	6,02	CHI
202002188614	AGUAS LINDAS DE GOIAS	4830065875	AGUAS LINDAS DE GOIAS S1	29/02/2020 12:46	29/02/2020 14:12	29/02/2020 12:46	29/02/2020 14:12	1,43	1	1,43	CHI
202002188617	ISRAELANDIA	1270010466	IPORA	29/02/2020 12:46	29/02/2020 18:39	29/02/2020 12:46	29/02/2020 18:39	5,87	1	5,87	CHI
202002188627	BONOPOLIS	BX12394407	SAO MIGUEL DO ARAGUAIA	29/02/2020 12:48	29/02/2020 14:41	29/02/2020 12:48	29/02/2020 14:41	1,88	6	11,29	CHI
202002188631	GOIANIA	10003123616	GOIANIA LESTE S2	29/02/2020 12:50	29/02/2020 18:39	29/02/2020 12:50	29/02/2020 18:39	5,81	1	5,81	CHI

202002188632	IVOLANDIA	IV12231092	IPORA	29/02/2020 12:50	29/02/2020 15:10	29/02/2020 12:50	29/02/2020 15:10	2,33	2	4,66	CHI
202002188633	AGUA FRIA DE GOIAS	TL12067446	SAO JOAO D ALIANCA	29/02/2020 12:50	29/02/2020 19:10	29/02/2020 12:50	29/02/2020 19:10	6,33	2	12,66	CHI
202002188633	MIMOSO DE GOIAS	TL12067446	SAO JOAO D ALIANCA	29/02/2020 12:50	29/02/2020 19:10	29/02/2020 12:50	29/02/2020 19:10	6,33	3	18,99	CHI
202002188636	VILA PROPICIO	NP12382314	GOIANESIA S1	29/02/2020 08:54	29/02/2020 20:23	29/02/2020 08:54	29/02/2020 20:23	11,49	12	137,85	CHI
202002188641	SAO LUIS DE MONTES BELOS	SL21080639	SAO LUIZ DOS MONTES BELOS	29/02/2020 12:53	29/02/2020 15:58	29/02/2020 12:53	29/02/2020 15:58	3,08	1	3,08	CHI
202002188642	CAIAPONIA	930006756	CAIAPONIA	29/02/2020 12:54	29/02/2020 18:00	29/02/2020 12:54	29/02/2020 18:00	5,10	1	5,10	CHI
202002188644	CEZARINA	1650021036	CEZARINA	29/02/2020 12:54	29/02/2020 18:36	29/02/2020 12:54	29/02/2020 18:36	5,69	1	5,69	CHI
202002188645	CATALAO	CT11379397	CATALAO S2	29/02/2020 12:54	29/02/2020 13:30	29/02/2020 12:54	29/02/2020 13:30	0,58	12	7,01	CHI
202002188653	SAO MIGUEL DO ARAGUAIA	SM12013036	SAO MIGUEL DO ARAGUAIA	29/02/2020 12:56	29/02/2020 17:43	29/02/2020 12:56	29/02/2020 17:43	4,78	22	105,07	CHI
202002188656	CAMPESTRE DE GOIAS	GC12000123	TRINDADE	29/02/2020 12:56	29/02/2020 14:53	29/02/2020 12:56	29/02/2020 14:53	1,94	1	1,94	CHI
202002188658	GOIANIA	16787948	FERROVIARIO S2	29/02/2020 12:57	29/02/2020 15:34	29/02/2020 12:57	29/02/2020 15:34	2,61	1	2,61	CHI
202002188665	IPAMERI	IP12215594	PIRES DO RIO S2	29/02/2020 12:58	01/03/2020 11:58	29/02/2020 12:58	01/03/2020 11:58	23,00	7	161,03	CHI
202002188672	ORIZONA	OZ21026602	PIRES DO RIO S2	29/02/2020 12:59	29/02/2020 17:02	29/02/2020 12:59	29/02/2020 17:02	4,05	1	4,05	CHI
202002188673	CATALAO	CT12318869	CATALAO S1	29/02/2020 12:59	01/03/2020 08:39	29/02/2020 12:59	01/03/2020 08:39	19,66	5	98,32	CHI
202002188681	NAZARIO	440001547	ANICUNS	29/02/2020 13:00	29/02/2020 17:18	29/02/2020 13:00	29/02/2020 17:18	4,29	1	4,29	CHI
202002188682	GOIANIA	10752857	CAMPINAS S1	29/02/2020 13:00	29/02/2020 16:05	29/02/2020 13:00	29/02/2020 16:05	3,07	1	3,07	CHI
202002188684	POSSE	PS21160036	IACIARA S2	29/02/2020 13:01	29/02/2020 14:55	29/02/2020 13:01	29/02/2020 14:55	1,90	1	1,90	CHI
202002188685	MINACU	IH11182443	MINACU	29/02/2020 12:47	29/02/2020 16:28	29/02/2020 12:47	29/02/2020 16:28	3,68	136	500,14	CHI
202002188688	GOIANIA	10008545152	INDEPENDENCIA S2	29/02/2020 13:02	29/02/2020 16:38	29/02/2020 13:02	29/02/2020 16:38	3,60	1	3,60	CHI
202002188692	BONOPOLIS	BX10403944	SAO MIGUEL DO ARAGUAIA	29/02/2020 12:40	29/02/2020 15:54	29/02/2020 12:40	29/02/2020 15:54	3,23	270	873,07	CHI
202002188697	CEZARINA	CZ12000034	CEZARINA	29/02/2020 12:59	29/02/2020 20:03	29/02/2020 12:59	29/02/2020 20:03	7,06	21	148,21	CHI
202002188697	INDIARA	CZ12000034	CEZARINA	29/02/2020 12:59	29/02/2020 20:03	29/02/2020 12:59	29/02/2020 20:03	7,06	9	63,52	CHI
202002188699	FORMOSA	10013387292	ITUIQUIRA	29/02/2020 13:04	29/02/2020 15:32	29/02/2020 13:04	29/02/2020 15:32	2,47	1	2,47	CHI
202002188710	NOVA CRIXAS	NA12375098	NOVA CRIXAS	29/02/2020 13:06	29/02/2020 23:40	29/02/2020 13:06	29/02/2020 23:40	10,55	2	21,11	CHI
202002188712	CACU	CC21076564	CACHOEIRA ALTA	29/02/2020 13:07	29/02/2020 14:59	29/02/2020 13:07	29/02/2020 14:59	1,87	1	1,87	CHI
202002188713	ANAPOLIS	21108250	JUNDIAI S1	29/02/2020 13:07	29/02/2020 15:32	29/02/2020 13:07	29/02/2020 15:32	2,42	1	2,42	CHI
202002188719	NOVA CRIXAS	NA12375099	NOVA CRIXAS	29/02/2020 13:10	01/03/2020 01:07	29/02/2020 13:10	01/03/2020 01:07	11,95	5	59,75	CHI
202002188726	RIO VERDE	630099662	RIO VERDE S1	29/02/2020 13:13	01/03/2020 10:16	29/02/2020 13:13	01/03/2020 10:16	21,05	1	21,05	CHI
202002188730	CALDAS NOVAS	CN12213917	CALDAS NOVAS S1	29/02/2020 13:07	29/02/2020 16:46	29/02/2020 13:07	29/02/2020 16:46	3,65	37	135,06	CHI
202002188731	MINEIROS	MY12194498	PARQUE DAS EMAS	29/02/2020 13:15	01/03/2020 11:52	29/02/2020 13:15	01/03/2020 11:52	22,62	1	22,62	CHI
202002188741	ITAPIRAPUA	1420005355	MATRINCHA	29/02/2020 13:20	29/02/2020 20:45	29/02/2020 13:20	29/02/2020 20:45	7,41	1	7,41	CHI
202002188742	PALESTINA DE GOIAS	PY12187367	PALESTINA	29/02/2020 13:20	29/02/2020 21:58	29/02/2020 13:20	29/02/2020 21:58	8,62	3	25,86	CHI
202002188747	APARECIDA DE GOIANIA	15079168	INDEPENDENCIA S2	29/02/2020 13:21	29/02/2020 14:40	29/02/2020 13:21	29/02/2020 14:40	1,31	1	1,31	CHI
202002188751	VILA PROPICIO	NP12228399	GOIANESIA S1	29/02/2020 13:19	29/02/2020 19:28	29/02/2020 13:19	29/02/2020 19:28	6,14	9	55,28	CHI
202002188755	JUSSARA	JR12027532	BRITANIA	29/02/2020 13:23	29/02/2020 21:24	29/02/2020 13:23	29/02/2020 21:24	8,01	39	312,52	CHI
202002188758	GOIANIA	GN11282010	AEROPORTO S1	29/02/2020 13:13	29/02/2020 14:12	29/02/2020 13:13	29/02/2020 14:12	0,97	79	76,52	CHI
202002188760	AMORINOPOLIS	AM12362188	IPORA	29/02/2020 13:23	29/02/2020 16:07	29/02/2020 13:23	29/02/2020 16:07	2,72	4	10,88	CHI
202002188762	SANTO ANTONIO DO DESCOBERTO	SN12345926	MARAJOARA	29/02/2020 13:24	29/02/2020 18:44	29/02/2020 13:24	29/02/2020 18:44	5,33	2	10,66	CHI
202002188763	JATAI	JT12072680	JATAI S1	29/02/2020 13:13	29/02/2020 17:39	29/02/2020 13:13	29/02/2020 17:39	4,43	15	66,43	CHI
202002188764	FORMOSA	610289597	ITUIQUIRA	29/02/2020 13:24	29/02/2020 15:15	29/02/2020 13:24	29/02/2020 15:15	1,84	1	1,84	CHI
202002188768	VILA PROPICIO	PV21141644	GOIANESIA S1	29/02/2020 13:26	29/02/2020 20:50	29/02/2020 13:26	29/02/2020 20:50	7,41	1	7,41	CHI
202002188769	PORANGATU	PO12208396	PORANGATU	29/02/2020 13:26	29/02/2020 16:34	29/02/2020 13:26	29/02/2020 16:34	3,13	1	3,13	CHI
202002188771	INACIOLANDIA	2810007750	QUIRINOPOLIS	29/02/2020 13:27	29/02/2020 15:00	29/02/2020 13:27	29/02/2020 15:00	1,55	1	1,55	CHI
202002188773	MAIRIPOTABA	MI12000420	PONTALINA	29/02/2020 11:28	29/02/2020 16:22	29/02/2020 11:28	29/02/2020 16:22	4,90	4	19,60	CHI

202002188774	URUACU	UR12317135	URUACU	29/02/2020 13:27	01/03/2020 08:32	29/02/2020 13:27	01/03/2020 08:32	19,08	11	209,84	CHI
202002188778	NOVA CRIXAS	NA12234569	MOZARLANDIA	29/02/2020 13:29	01/03/2020 16:20	29/02/2020 13:29	01/03/2020 16:20	26,84	1	26,84	CHI
202002188782	SAO LUIS DE MONTES BELOS	500059354	SAO LUIZ DOS MONTES BELOS	29/02/2020 13:29	29/02/2020 17:42	29/02/2020 13:29	29/02/2020 17:42	4,21	1	4,21	CHI
202002188787	MUTUNOPOLIS	MU21086713	MARA ROSA	29/02/2020 13:31	29/02/2020 19:05	29/02/2020 13:31	29/02/2020 19:05	5,56	1	5,56	CHI
202002188788	NOVO PLANALTO	TA12192346	SAO MIGUEL DO ARAGUAIA	29/02/2020 13:31	29/02/2020 20:03	29/02/2020 13:31	29/02/2020 20:03	6,52	101	658,52	CHI
202002188792	JARAGUA	JA12298079	JARAGUA	29/02/2020 13:32	29/02/2020 15:19	29/02/2020 13:32	29/02/2020 15:19	1,78	10	17,77	CHI
202002188796	INDIARA	IY12010845	EDEIA	29/02/2020 11:19	29/02/2020 14:37	29/02/2020 11:19	29/02/2020 14:37	3,30	9	29,69	CHI
202002188801	NEROPOLIS	NR12317362	NEROPOLIS S2	29/02/2020 13:33	29/02/2020 16:45	29/02/2020 13:33	29/02/2020 16:45	3,19	11	35,10	CHI
202002188806	VALPARAISO DE GOIAS	3350045994	PACAEMBU S1	29/02/2020 13:34	29/02/2020 18:29	29/02/2020 13:34	29/02/2020 18:29	4,90	1	4,90	CHI
202002188807	EDEALINA	1130004044	PONTALINA	29/02/2020 13:35	29/02/2020 15:53	29/02/2020 13:35	29/02/2020 15:53	2,30	1	2,30	CHI
202002188808	PARAUNA	PU12301178	ACREUNA	29/02/2020 13:35	01/03/2020 10:35	29/02/2020 13:35	01/03/2020 10:35	21,00	9	188,96	CHI
202002188812	JATAI	JT21360670	CABRIUVA S2	29/02/2020 13:36	29/02/2020 19:32	29/02/2020 13:36	29/02/2020 19:32	5,93	1	5,93	CHI
202002188818	GOIANIA	GN12000110	GOIANIA LESTE S1	29/02/2020 12:39	29/02/2020 14:21	29/02/2020 12:39	29/02/2020 14:21	1,69	434	733,94	CHI
202002188827	BARRO ALTO	00180434	BARRO ALTO	29/02/2020 13:32	01/03/2020 15:14	29/02/2020 13:32	29/02/2020 13:37	0,07	2	0,14	CHI
202002188827	SANTA RITA DO NOVO DESTINO	00180434	BARRO ALTO	29/02/2020 13:32	01/03/2020 15:14	29/02/2020 13:32	29/02/2020 13:37	0,07	7	0,49	CHI
202002188827	SAO LUIZ DO NORTE	00180434	BARRO ALTO	29/02/2020 13:32	01/03/2020 15:14	29/02/2020 13:32	29/02/2020 13:37	0,07	2	0,14	CHI
202002188827	MIMOSO DE GOIAS	BA10400443	BARRO ALTO	29/02/2020 13:32	01/03/2020 15:14	29/02/2020 13:34	01/03/2020 02:39	13,08	4	52,34	CHI
202002188827	NIQUELANDIA	BA10400443	BARRO ALTO	29/02/2020 13:32	01/03/2020 15:14	29/02/2020 13:34	01/03/2020 02:39	13,08	986	12901,26	CHI
202002188827	VILA PROPICIO	BA10400443	BARRO ALTO	29/02/2020 13:32	01/03/2020 15:14	29/02/2020 13:34	01/03/2020 02:39	13,08	32	418,70	CHI
202002188827	BARRO ALTO	BA10400443	BARRO ALTO	29/02/2020 13:32	01/03/2020 15:14	01/03/2020 02:31	01/03/2020 02:48	0,29	59	17,00	CHI
202002188827	NIQUELANDIA	BA10400443	BARRO ALTO	29/02/2020 13:32	01/03/2020 15:14	01/03/2020 02:31	01/03/2020 02:48	0,29	4	1,15	CHI
202002188827	VILA PROPICIO	BA10400443	BARRO ALTO	29/02/2020 13:32	01/03/2020 15:14	01/03/2020 02:31	01/03/2020 02:48	0,29	24	6,91	CHI
202002188827	MIMOSO DE GOIAS	NQ13405305B	BARRO ALTO	29/02/2020 13:32	01/03/2020 15:14	01/03/2020 02:39	01/03/2020 03:40	1,01	4	4,05	CHI
202002188827	NIQUELANDIA	NQ13405305B	BARRO ALTO	29/02/2020 13:32	01/03/2020 15:14	01/03/2020 02:39	01/03/2020 03:40	1,01	327	331,36	CHI
202002188827	VILA PROPICIO	NQ13405305B	BARRO ALTO	29/02/2020 13:32	01/03/2020 15:14	01/03/2020 02:39	01/03/2020 03:40	1,01	32	32,43	CHI
202002188827	NIQUELANDIA	NQ13035665	BARRO ALTO	29/02/2020 13:32	01/03/2020 15:14	01/03/2020 02:39	01/03/2020 09:20	6,67	106	707,37	CHI
202002188827	NIQUELANDIA	NQ12292484	BARRO ALTO	29/02/2020 13:32	01/03/2020 15:14	01/03/2020 02:39	01/03/2020 10:55	8,26	587	4846,66	CHI
202002188827	VILA PROPICIO	00180434	BARRO ALTO	29/02/2020 13:32	01/03/2020 15:14	29/02/2020 13:32	01/03/2020 12:44	23,19	1	23,19	CHI
202002188827	MIMOSO DE GOIAS	BA10400442	BARRO ALTO	29/02/2020 13:32	01/03/2020 15:14	29/02/2020 13:34	01/03/2020 13:44	24,17	7	169,22	CHI
202002188827	NIQUELANDIA	BA10400442	BARRO ALTO	29/02/2020 13:32	01/03/2020 15:14	29/02/2020 13:34	01/03/2020 13:44	24,17	173	4182,03	CHI
202002188827	VILA PROPICIO	BA10400442	BARRO ALTO	29/02/2020 13:32	01/03/2020 15:14	29/02/2020 13:34	01/03/2020 13:44	24,17	48	1160,33	CHI
202002188827	MIMOSO DE GOIAS	NQ13269863	BARRO ALTO	29/02/2020 13:32	01/03/2020 15:14	01/03/2020 15:00	01/03/2020 15:14	0,22	4	0,89	CHI
202002188827	NIQUELANDIA	NQ13269863	BARRO ALTO	29/02/2020 13:32	01/03/2020 15:14	01/03/2020 15:00	01/03/2020 15:14	0,22	1018	226,51	CHI
202002188827	VILA PROPICIO	NQ13269863	BARRO ALTO	29/02/2020 13:32	01/03/2020 15:14	01/03/2020 15:00	01/03/2020 15:14	0,22	32	7,12	CHI
202002188832	MINEIROS	PW12000116	PARQUE DAS EMAS	29/02/2020 08:57	29/02/2020 18:53	29/02/2020 08:57	29/02/2020 18:53	9,92	4	39,67	CHI
202002188832	PORTELANDIA	PW12000116	PARQUE DAS EMAS	29/02/2020 08:57	29/02/2020 18:53	29/02/2020 08:57	29/02/2020 18:53	9,92	4	39,67	CHI
202002188834	BOM JESUS DE GOIAS	BJ11134665	BOM JESUS DE GOIAS	29/02/2020 13:27	29/02/2020 20:49	29/02/2020 13:27	29/02/2020 20:49	7,35	162	1191,42	CHI
202002188836	CAMPINACU	5700013737	PORANGATU	29/02/2020 13:42	29/02/2020 17:42	29/02/2020 13:42	29/02/2020 17:42	3,99	1	3,99	CHI
202002188843	ALTO HORIZONTE	10002652100	SANTA TEREZINHA	29/02/2020 13:43	01/03/2020 00:59	29/02/2020 13:43	01/03/2020 00:59	11,26	1	11,26	CHI
202002188848	BARRO ALTO	BA21169570	GOIANESIA S1	29/02/2020 13:43	01/03/2020 02:37	29/02/2020 13:43	01/03/2020 02:37	12,89	1	12,89	CHI
202002188850	MONTIVIDIU	RV12384572B	MONTIVIDIU T	29/02/2020 13:03	02/03/2020 14:04	29/02/2020 13:03	29/02/2020 22:28	9,42	11	103,64	CHI
202002188850	MONTIVIDIU	05700434	MONTIVIDIU T	29/02/2020 13:03	02/03/2020 14:04	29/02/2020 23:07	01/03/2020 01:03	1,94	23	44,56	CHI
202002188850	RIO VERDE	05700434	MONTIVIDIU T	29/02/2020 13:03	02/03/2020 14:04	29/02/2020 23:07	01/03/2020 01:03	1,94	1	1,94	CHI
202002188850	CAIAPONIA	05700434	MONTIVIDIU T	29/02/2020 13:03	02/03/2020 14:04	29/02/2020 23:07	01/03/2020 02:38	3,52	4	14,08	CHI

202002188850	MONTIVIDIU	05700434	MONTIVIDIU T	29/02/2020 13:03	02/03/2020 14:04	29/02/2020 23:07	01/03/2020 02:38	3,52	101	355,41	CHI
202002188850	CAIAPONIA	MV13054390	MONTIVIDIU T	29/02/2020 13:03	02/03/2020 14:04	29/02/2020 23:11	01/03/2020 02:38	3,45	12	41,43	CHI
202002188850	MONTIVIDIU	MV13054390	MONTIVIDIU T	29/02/2020 13:03	02/03/2020 14:04	29/02/2020 23:11	01/03/2020 02:38	3,45	18	62,14	CHI
202002188850	MONTIVIDIU	RV12384572B	MONTIVIDIU T	29/02/2020 13:03	02/03/2020 14:04	29/02/2020 23:07	01/03/2020 08:05	8,98	11	98,80	CHI
202002188850	MONTIVIDIU	RV12384572B	MONTIVIDIU T	29/02/2020 13:03	02/03/2020 14:04	29/02/2020 13:03	01/03/2020 08:44	19,68	4	78,74	CHI
202002188850	CAIAPONIA	05700434	MONTIVIDIU T	29/02/2020 13:03	02/03/2020 14:04	01/03/2020 09:02	01/03/2020 09:15	0,21	16	3,36	CHI
202002188850	MONTIVIDIU	05700434	MONTIVIDIU T	29/02/2020 13:03	02/03/2020 14:04	01/03/2020 09:02	01/03/2020 09:15	0,21	137	28,77	CHI
202002188850	RIO VERDE	05700434	MONTIVIDIU T	29/02/2020 13:03	02/03/2020 14:04	01/03/2020 09:02	01/03/2020 09:15	0,21	1	0,21	CHI
202002188850	MONTIVIDIU	RV12384572B	MONTIVIDIU T	29/02/2020 13:03	02/03/2020 14:04	29/02/2020 13:03	01/03/2020 09:37	20,57	3	61,71	CHI
202002188850	CAIAPONIA	05700434	MONTIVIDIU T	29/02/2020 13:03	02/03/2020 14:04	29/02/2020 23:07	01/03/2020 11:11	12,07	2	24,13	CHI
202002188850	MONTIVIDIU	05700434	MONTIVIDIU T	29/02/2020 13:03	02/03/2020 14:04	29/02/2020 23:07	01/03/2020 11:11	12,07	1	12,07	CHI
202002188850	CAIAPONIA	MV13123330	MONTIVIDIU T	29/02/2020 13:03	02/03/2020 14:04	29/02/2020 23:11	01/03/2020 11:11	12,00	16	192,00	CHI
202002188850	MONTIVIDIU	MV13123330	MONTIVIDIU T	29/02/2020 13:03	02/03/2020 14:04	29/02/2020 23:11	01/03/2020 11:11	12,00	22	264,01	CHI
202002188850	CAIAPONIA	MV13080903	MONTIVIDIU T	29/02/2020 13:03	02/03/2020 14:04	01/03/2020 12:32	01/03/2020 13:00	0,47	15	7,00	CHI
202002188850	MONTIVIDIU	MV13080903	MONTIVIDIU T	29/02/2020 13:03	02/03/2020 14:04	01/03/2020 12:32	01/03/2020 13:00	0,47	5	2,33	CHI
202002188850	MONTIVIDIU	05700434	MONTIVIDIU T	29/02/2020 13:03	02/03/2020 14:04	01/03/2020 13:00	01/03/2020 13:19	0,31	106	33,04	CHI
202002188850	RIO VERDE	05700434	MONTIVIDIU T	29/02/2020 13:03	02/03/2020 14:04	01/03/2020 13:00	01/03/2020 13:19	0,31	1	0,31	CHI
202002188850	CAIAPONIA	05700434	MONTIVIDIU T	29/02/2020 13:03	02/03/2020 14:04	29/02/2020 23:07	01/03/2020 17:04	17,95	0	0,00	CHI
202002188850	MONTIVIDIU	05700434	MONTIVIDIU T	29/02/2020 13:03	02/03/2020 14:04	29/02/2020 23:07	01/03/2020 17:04	17,95	2	35,90	CHI
202002188850	RIO VERDE	05700434	MONTIVIDIU T	29/02/2020 13:03	02/03/2020 14:04	29/02/2020 23:07	01/03/2020 17:04	17,95	1	17,95	CHI
202002188850	CAIAPONIA	MV13080903	MONTIVIDIU T	29/02/2020 13:03	02/03/2020 14:04	29/02/2020 23:11	01/03/2020 17:04	17,88	3	53,65	CHI
202002188850	MONTIVIDIU	MV13080903	MONTIVIDIU T	29/02/2020 13:03	02/03/2020 14:04	29/02/2020 23:11	01/03/2020 17:04	17,88	12	214,60	CHI
202002188850	RIO VERDE	MV13080903	MONTIVIDIU T	29/02/2020 13:03	02/03/2020 14:04	29/02/2020 23:11	01/03/2020 17:04	17,88	1	17,88	CHI
202002188850	CAIAPONIA	MV13080903	MONTIVIDIU T	29/02/2020 13:03	02/03/2020 14:04	01/03/2020 11:53	01/03/2020 17:04	5,18	17	88,12	CHI
202002188850	MONTIVIDIU	MV13080903	MONTIVIDIU T	29/02/2020 13:03	02/03/2020 14:04	01/03/2020 11:53	01/03/2020 17:04	5,18	22	114,03	CHI
202002188850	MONTIVIDIU	MV13080903	MONTIVIDIU T	29/02/2020 13:03	02/03/2020 14:04	01/03/2020 12:32	02/03/2020 12:47	24,26	8	194,11	CHI
202002188850	MONTIVIDIU	MV13123330	MONTIVIDIU T	29/02/2020 13:03	02/03/2020 14:04	01/03/2020 17:04	02/03/2020 12:47	19,73	1	19,73	CHI
202002188850	MONTIVIDIU	MV12030666	MONTIVIDIU T	29/02/2020 13:03	02/03/2020 14:04	01/03/2020 12:32	02/03/2020 13:27	24,92	15	373,79	CHI
202002188850	MONTIVIDIU	RV12030642	MONTIVIDIU T	29/02/2020 13:03	02/03/2020 14:04	01/03/2020 12:32	02/03/2020 14:04	25,55	1	25,55	CHI
202002188856	SAO MIGUEL DO ARAGUAIA	SM12262623	SAO MIGUEL DO ARAGUAIA	29/02/2020 13:45	29/02/2020 19:45	29/02/2020 13:45	29/02/2020 19:45	6,00	2	12,00	CHI
202002188903	MONTES CLAROS DE GOIAS	ME11243786	BRITANIA	29/02/2020 13:45	01/03/2020 00:38	29/02/2020 13:45	01/03/2020 00:38	10,87	12	130,49	CHI
202002188905	BARRO ALTO	BA21344550	GOIANESIA S1	29/02/2020 13:45	01/03/2020 01:21	29/02/2020 13:45	01/03/2020 01:21	11,58	1	11,58	CHI
202002188910	ITAUCU	IB21317394	INHUMAS S1	29/02/2020 13:47	29/02/2020 19:50	29/02/2020 13:47	29/02/2020 19:50	6,04	3	18,13	CHI
202002188911	PIRENOPOLIS	PV21111250	CORUMBA	29/02/2020 13:47	29/02/2020 15:50	29/02/2020 13:47	29/02/2020 15:50	2,04	1	2,04	CHI
202002188912	NIQUELANDIA	NQ21366187	SAO JOAO D ALIANCA	29/02/2020 13:47	01/03/2020 10:40	29/02/2020 13:47	01/03/2020 10:40	20,88	1	20,88	CHI
202002188916	ITAPACI	IW11282293	ITAPACI	29/02/2020 13:48	29/02/2020 15:42	29/02/2020 13:48	29/02/2020 15:42	1,89	102	193,09	CHI
202002188921	GOIANIA	GN12170731	GOIANIA LESTE S3	29/02/2020 11:26	29/02/2020 14:44	29/02/2020 11:26	29/02/2020 14:44	3,28	258	847,17	CHI
202002188927	SENADOR CANEDO	SW12349603	SENADOR CANEDO	29/02/2020 12:47	29/02/2020 15:16	29/02/2020 12:47	29/02/2020 15:16	2,47	207	511,87	CHI
202002188928	TRINDADE	TR11202316	TRINDADE	29/02/2020 13:51	29/02/2020 16:44	29/02/2020 13:51	29/02/2020 16:44	2,88	157	452,38	CHI
202002188936	APARECIDA DE GOIANIA	12140181	REAL S1	29/02/2020 13:54	29/02/2020 16:41	29/02/2020 13:54	29/02/2020 16:41	2,78	1	2,78	CHI
202002188944	ITAUCU	IX21285561	INHUMAS S1	29/02/2020 13:56	29/02/2020 16:07	29/02/2020 13:56	29/02/2020 16:07	2,17	1	2,17	CHI
202002188947	ABADIANIA	AA12390623	ANAPOLIS UNIVERSITARIO S1	29/02/2020 13:29	29/02/2020 16:06	29/02/2020 13:29	29/02/2020 16:06	2,61	32	83,50	CHI
202002188947	GAMELEIRA DE GOIAS	AA12390623	ANAPOLIS UNIVERSITARIO S1	29/02/2020 13:29	29/02/2020 16:06	29/02/2020 13:29	29/02/2020 16:06	2,61	2	5,22	CHI
202002188951	MORRINHOS	PJ21199430	MORRINHOS	29/02/2020 13:58	29/02/2020 16:42	29/02/2020 13:58	29/02/2020 16:42	2,72	2	5,44	CHI

202002188955	BOM JARDIM DE GOIAS	BM21356608	BOM JARDIM	29/02/2020 14:00	01/03/2020 07:47	29/02/2020 14:00	01/03/2020 07:47	17,77	1	17,77	CHI
202002188956	GOIANIA	SW10395400	CEPAIGO S1	29/02/2020 14:00	29/02/2020 22:28	29/02/2020 16:19	29/02/2020 16:40	0,35	45	15,84	CHI
202002188956	SENADOR CANEDO	SW10395400	CEPAIGO S1	29/02/2020 14:00	29/02/2020 22:28	29/02/2020 16:19	29/02/2020 16:40	0,35	387	136,20	CHI
202002188956	SENADOR CANEDO	SW10395400	SENADOR CANEDO	29/02/2020 14:00	29/02/2020 22:28	29/02/2020 16:19	29/02/2020 16:40	0,35	410	144,30	CHI
202002188956	SENADOR CANEDO	SW10395400	SENADOR CANEDO	29/02/2020 14:00	29/02/2020 22:28	29/02/2020 16:19	29/02/2020 16:40	0,35	264	92,91	CHI
202002188956	SENADOR CANEDO	SW21079083	SENADOR CANEDO	29/02/2020 14:00	29/02/2020 22:28	29/02/2020 16:19	29/02/2020 22:28	6,14	1	6,14	CHI
202002188958	IPORA	IR12334815	IPORA	29/02/2020 12:58	29/02/2020 15:44	29/02/2020 12:58	29/02/2020 15:44	2,76	10	27,56	CHI
202002188962	CIDADE OCIDENTAL	10010321304	MARAJOARA	29/02/2020 14:02	29/02/2020 16:57	29/02/2020 14:02	29/02/2020 16:57	2,90	1	2,90	CHI
202002188963	SANTA RITA DO NOVO DESTINO	BA21208881	BARRO ALTO	29/02/2020 14:03	01/03/2020 00:20	29/02/2020 14:03	01/03/2020 00:20	10,29	1	10,29	CHI
202002188964	GOIANIA	11296975	GOIANIA LESTE S1	29/02/2020 14:03	29/02/2020 16:08	29/02/2020 14:03	29/02/2020 16:08	2,08	1	2,08	CHI
202002188965	CAMPOS VERDES	VD21252854	SANTA TEREZINHA	29/02/2020 14:03	29/02/2020 19:52	29/02/2020 14:03	29/02/2020 19:52	5,81	1	5,81	CHI
202002188966	ARAGOIANA	7531081	GUAPO S2	29/02/2020 13:54	29/02/2020 18:32	29/02/2020 13:54	29/02/2020 18:32	4,63	6	27,78	CHI
202002188968	SAO DOMINGOS	SD21344041	SAO DOMINGOS	29/02/2020 14:04	29/02/2020 16:57	29/02/2020 14:04	29/02/2020 16:57	2,88	1	2,88	CHI
202002188969	PIRES DO RIO	PR21051683	PIRES DO RIO S2	29/02/2020 14:04	29/02/2020 15:38	29/02/2020 14:04	29/02/2020 15:38	1,58	1	1,58	CHI
202002188976	ITUMBIARA	IT12273841	PARANAIBA	29/02/2020 13:47	29/02/2020 16:53	29/02/2020 13:47	29/02/2020 16:53	3,10	3	9,30	CHI
202002188978	MORRINHOS	150168408	MORRINHOS	29/02/2020 14:07	29/02/2020 16:10	29/02/2020 14:07	29/02/2020 16:10	2,05	1	2,05	CHI
202002188983	IPAMERI	6940002827	CRISTALINA S1	29/02/2020 14:09	01/03/2020 01:06	29/02/2020 14:09	01/03/2020 01:06	10,94	1	10,94	CHI
202002188985	DAMIANOPOLIS	SI12295432	IACIARA S2	29/02/2020 14:10	29/02/2020 16:13	29/02/2020 14:10	29/02/2020 16:13	2,04	9	18,35	CHI
202002188986	IPORA	730141494	IPORA	29/02/2020 14:11	29/02/2020 15:44	29/02/2020 14:11	29/02/2020 15:44	1,54	1	1,54	CHI
202002188989	NOVA IGUACU DE GOIAS	NH12317131	CAMPINORTE	29/02/2020 12:46	01/03/2020 00:04	29/02/2020 12:46	01/03/2020 00:04	11,30	42	474,42	CHI
202002188992	GOIANIA	15670843	GOIANIA LESTE S1	29/02/2020 14:12	29/02/2020 16:37	29/02/2020 14:12	29/02/2020 16:37	2,42	1	2,42	CHI
202002188996	GOIANESIA	GE21384174	GOIANESIA S2	29/02/2020 14:12	01/03/2020 00:05	29/02/2020 14:12	01/03/2020 00:05	9,88	1	9,88	CHI
202002188998	CEZARINA	ED12108520LD	PONTALINA	29/02/2020 12:46	29/02/2020 19:53	29/02/2020 12:46	29/02/2020 19:53	7,11	4	28,44	CHI
202002188998	EDEALINA	ED12108520LD	PONTALINA	29/02/2020 12:46	29/02/2020 19:53	29/02/2020 12:46	29/02/2020 19:53	7,11	47	334,18	CHI
202002188998	INDIARA	ED12108520LD	PONTALINA	29/02/2020 12:46	29/02/2020 19:53	29/02/2020 12:46	29/02/2020 19:53	7,11	2	14,22	CHI
202002188998	EDEALINA	ED12108520LD	PONTALINA	29/02/2020 12:46	29/02/2020 19:53	29/02/2020 18:08	29/02/2020 19:53	1,74	1	1,74	CHI
202002189002	GOIANESIA	550094830	GOIANESIA S2	29/02/2020 14:14	29/02/2020 20:30	29/02/2020 14:14	29/02/2020 20:30	6,27	1	6,27	CHI
202002189003	AMARALINA	MU12394938	MARA ROSA	29/02/2020 13:16	29/02/2020 17:44	29/02/2020 13:16	29/02/2020 17:44	4,45	7	31,18	CHI
202002189003	BONOPOLIS	MU12394938	MARA ROSA	29/02/2020 13:16	29/02/2020 17:44	29/02/2020 13:16	29/02/2020 17:44	4,45	2	8,91	CHI
202002189003	MUTUNOPOLIS	MU12394938	MARA ROSA	29/02/2020 13:16	29/02/2020 17:44	29/02/2020 13:16	29/02/2020 17:44	4,45	14	62,35	CHI
202002189003	PORANGATU	MU12394938	MARA ROSA	29/02/2020 13:16	29/02/2020 17:44	29/02/2020 13:16	29/02/2020 17:44	4,45	75	334,04	CHI
202002189012	CRISTALINA	03470464	CRISTALINA S2	29/02/2020 14:00	29/02/2020 22:01	29/02/2020 14:00	29/02/2020 15:18	1,31	436	570,07	CHI
202002189012	CRISTALINA	KR10400735	CRISTALINA S2	29/02/2020 14:00	29/02/2020 22:01	29/02/2020 14:00	29/02/2020 15:18	1,31	27	35,30	CHI
202002189012	LUZIANIA	03470464	CRISTALINA S2	29/02/2020 14:00	29/02/2020 22:01	29/02/2020 14:00	29/02/2020 15:18	1,31	253	330,80	CHI
202002189012	LUZIANIA	KR10400735	CRISTALINA S2	29/02/2020 14:00	29/02/2020 22:01	29/02/2020 14:00	29/02/2020 15:18	1,31	212	277,19	CHI
202002189012	CRISTALINA	03470464	CRISTALINA S2	29/02/2020 14:00	29/02/2020 22:01	29/02/2020 14:00	29/02/2020 16:25	2,42	129	312,25	CHI
202002189012	CRISTALINA	03470464	CRISTALINA S2	29/02/2020 14:00	29/02/2020 22:01	29/02/2020 15:15	29/02/2020 16:25	1,18	2	2,36	CHI
202002189012	CRISTALINA	03470464	CRISTALINA S2	29/02/2020 14:00	29/02/2020 22:01	29/02/2020 14:00	29/02/2020 21:27	7,44	15	111,62	CHI
202002189012	CRISTALINA	03470464	CRISTALINA S2	29/02/2020 14:00	29/02/2020 22:01	29/02/2020 21:31	29/02/2020 21:36	0,07	144	10,04	CHI
202002189012	CRISTALINA	03470464	CRISTALINA S2	29/02/2020 14:00	29/02/2020 22:01	29/02/2020 14:00	29/02/2020 22:01	8,01	86	688,79	CHI
202002189015	URUACU	UR11221613	URUACU	29/02/2020 14:17	29/02/2020 18:01	29/02/2020 14:17	29/02/2020 18:01	3,72	33	122,79	CHI
202002189016	ADELANDIA	DN12160971	FIRMINOPOLIS S2	29/02/2020 14:18	29/02/2020 17:45	29/02/2020 14:18	29/02/2020 17:45	3,44	45	154,74	CHI
202002189017	AGUAS LINDAS DE GOIAS	LA11261543	AGUAS LINDAS DE GOIAS S1	29/02/2020 14:19	01/03/2020 09:39	29/02/2020 18:43	01/03/2020 09:39	14,92	196	2924,37	CHI
202002189021	HIDROLANDIA	HD21000201	CEPAIGO S2	29/02/2020 14:21	29/02/2020 19:10	29/02/2020 14:21	29/02/2020 19:10	4,81	1	4,81	CHI

202002189023	NOVA CRIXAS	NA12322837	MOZARLANDIA	29/02/2020 14:21	01/03/2020 09:45	29/02/2020 14:21	01/03/2020 09:45	19,39	1	19,39	CHI
202002189037	PIRES DO RIO	460138431	PIRES DO RIO S1	29/02/2020 14:25	29/02/2020 18:01	29/02/2020 14:25	29/02/2020 18:01	3,60	1	3,60	CHI
202002189039	ALVORADA DO NORTE	AQ12232934	IACIARA S2	29/02/2020 14:25	29/02/2020 16:33	29/02/2020 14:25	29/02/2020 16:33	2,12	10	21,20	CHI
202002189043	COCALZINHO DE GOIAS	ZN12302401	COCALZINHO	29/02/2020 13:10	29/02/2020 17:15	29/02/2020 13:10	29/02/2020 17:15	4,08	4	16,30	CHI
202002189043	CORUMBA DE GOIAS	ZN12302401	COCALZINHO	29/02/2020 13:10	29/02/2020 17:15	29/02/2020 13:10	29/02/2020 17:15	4,08	22	89,66	CHI
202002189044	JARAGUA	JA21114633	JARAGUA	29/02/2020 14:27	29/02/2020 17:35	29/02/2020 14:27	29/02/2020 17:35	3,13	1	3,13	CHI
202002189046	IPAMERI	IP12000086	IPAMERI	29/02/2020 09:29	29/02/2020 19:02	29/02/2020 09:29	29/02/2020 19:02	9,55	4	38,19	CHI
202002189049	SAO LUIS DE MONTES BELOS	SL21237708	SAO LUIZ DOS MONTES BELOS	29/02/2020 14:28	29/02/2020 16:55	29/02/2020 14:28	29/02/2020 16:55	2,45	3	7,34	CHI
202002189050	APARECIDA DE GOIANIA	10009031152	INDEPENDENCIA S1	29/02/2020 14:28	29/02/2020 19:39	29/02/2020 14:28	29/02/2020 19:39	5,17	1	5,17	CHI
202002189054	ARAGOIANIA	HD32064193	GUAPO S2	29/02/2020 13:32	29/02/2020 20:01	29/02/2020 13:32	29/02/2020 20:01	6,48	1	6,48	CHI
202002189054	HIDROLANDIA	HD32064193	GUAPO S2	29/02/2020 13:32	29/02/2020 20:01	29/02/2020 13:32	29/02/2020 20:01	6,48	3	19,45	CHI
202002189058	PARANAIGUARA	QI12276207	QUIRINOPOLIS	29/02/2020 14:33	29/02/2020 17:36	29/02/2020 14:33	29/02/2020 17:36	3,05	5	15,25	CHI
202002189058	QUIRINOPOLIS	QI12276207	QUIRINOPOLIS	29/02/2020 14:33	29/02/2020 17:36	29/02/2020 14:33	29/02/2020 17:36	3,05	50	152,50	CHI
202002189063	SAO JOAO D ALIANCA	JL11131832	SAO JOAO D ALIANCA	29/02/2020 14:34	29/02/2020 22:00	29/02/2020 14:34	29/02/2020 22:00	7,42	25	185,62	CHI
202002189064	IPORA	IR12390098	IPORA	29/02/2020 06:48	29/02/2020 16:57	29/02/2020 06:48	29/02/2020 16:57	10,15	10	101,48	CHI
202002189072	ANAPOLIS	AN31028679	JUNDIAI S2	29/02/2020 14:35	29/02/2020 16:35	29/02/2020 14:35	29/02/2020 16:35	2,00	2	4,00	CHI
202002189073	GOIANIA	GN11036039	GOYA S1	29/02/2020 14:04	29/02/2020 15:28	29/02/2020 14:04	29/02/2020 15:28	1,39	97	134,48	CHI
202002189074	AGUAS LINDAS DE GOIAS	10011359526	AGUAS LINDAS DE GOIAS S1	29/02/2020 14:36	29/02/2020 15:23	29/02/2020 14:36	29/02/2020 15:23	0,78	1	0,78	CHI
202002189076	BARRO ALTO	BA12064539	BARRO ALTO	29/02/2020 13:49	29/02/2020 15:29	29/02/2020 13:49	29/02/2020 15:29	1,67	10	16,67	CHI
202002189078	PADRE BERNARDO	PB12335637	PADRE BERNARDO	29/02/2020 14:36	29/02/2020 21:17	29/02/2020 14:36	29/02/2020 21:17	6,67	22	146,72	CHI
202002189086	IPAMERI	IP21133616	CRISTALINA S2	29/02/2020 14:39	01/03/2020 08:56	29/02/2020 14:39	01/03/2020 08:56	18,27	1	18,27	CHI
202002189087	BRITANIA	BT12101446	BRITANIA	29/02/2020 14:39	01/03/2020 08:04	29/02/2020 14:39	01/03/2020 08:04	17,41	47	818,10	CHI
202002189089	CIDADE OCIDENTAL	DH11199631	MARAJOARA	29/02/2020 14:40	29/02/2020 17:57	29/02/2020 14:40	29/02/2020 17:57	3,28	111	363,77	CHI
202002189090	GOIAS	GS12380081	GOIAS	29/02/2020 14:40	29/02/2020 18:15	29/02/2020 14:40	29/02/2020 18:15	3,57	1	3,57	CHI
202002189093	CRISTALINA	1060054684	CRISTALINA S1	29/02/2020 14:42	29/02/2020 18:49	29/02/2020 14:42	29/02/2020 18:49	4,11	0	0,00	CHI
202002189094	POSSE	PS21255354	IACIARA S2	29/02/2020 14:42	29/02/2020 16:33	29/02/2020 14:42	29/02/2020 16:33	1,84	2	3,68	CHI
202002189096	GOIANIA	10094374	CAMPINAS S3	29/02/2020 14:42	29/02/2020 18:43	29/02/2020 14:42	29/02/2020 18:43	4,00	1	4,00	CHI
202002189099	JATAI	10017612371	JATAI S3	29/02/2020 14:43	01/03/2020 00:42	29/02/2020 14:43	01/03/2020 00:42	9,98	1	9,98	CHI
202002189110	LUZIANIA	LZ11136571	MARAJOARA	29/02/2020 14:44	29/02/2020 18:26	29/02/2020 14:44	29/02/2020 18:26	3,69	42	155,00	CHI
202002189111	MATRINCHA	MP12212598	MATRINCHA	29/02/2020 14:28	01/03/2020 01:28	29/02/2020 14:28	01/03/2020 01:28	11,00	11	120,95	CHI
202002189114	ITUMBIARA	IT21273956	CACHOEIRA DOURADA	29/02/2020 14:44	01/03/2020 01:08	29/02/2020 14:44	01/03/2020 01:08	10,39	1	10,39	CHI
202002189119	BURITI DE GOIAS	SC12052751	FIRMINOPOLIS S2	29/02/2020 14:45	29/02/2020 16:38	29/02/2020 14:45	29/02/2020 16:38	1,88	3	5,64	CHI
202002189119	SANCLERLANDIA	SC12052751	FIRMINOPOLIS S2	29/02/2020 14:45	29/02/2020 16:38	29/02/2020 14:45	29/02/2020 16:38	1,88	19	35,70	CHI
202002189124	URUACU	UR12353573	URUACU	29/02/2020 13:27	29/02/2020 17:37	29/02/2020 13:27	29/02/2020 17:37	4,16	10	41,64	CHI
202002189135	EDEIA	EA12007673	RIO DOS BOIS	29/02/2020 12:16	01/03/2020 18:39	29/02/2020 12:16	01/03/2020 18:39	30,38	2	60,76	CHI
202002189136	GAMELEIRA DE GOIAS	SV21160631	DAIA S2	29/02/2020 14:49	01/03/2020 11:47	29/02/2020 14:49	01/03/2020 11:47	20,96	1	20,96	CHI
202002189152	INDIARA	IY21038811	EDEIA	29/02/2020 14:52	01/03/2020 08:21	29/02/2020 14:52	01/03/2020 08:21	17,49	1	17,49	CHI
202002189153	CAMPOS BELOS	CH11256111	SAO DOMINGOS	29/02/2020 14:52	29/02/2020 19:19	29/02/2020 14:52	29/02/2020 19:19	4,44	140	621,44	CHI
202002189154	CAVALCANTE	TI12156216RE	MINACU	29/02/2020 14:53	29/02/2020 19:46	29/02/2020 14:53	29/02/2020 19:46	4,88	65	317,36	CHI
202002189154	COLINAS DO SUL	TI12156216RE	MINACU	29/02/2020 14:53	29/02/2020 19:46	29/02/2020 14:53	29/02/2020 19:46	4,88	40	195,30	CHI
202002189159	ALEXANIA	AX10403901	ALEXANIA	29/02/2020 14:51	29/02/2020 16:33	29/02/2020 14:51	29/02/2020 16:33	1,70	317	540,13	CHI
202002189161	GOIANESIA	GE12000167	GOIANESIA S1	29/02/2020 10:36	29/02/2020 16:45	29/02/2020 10:36	29/02/2020 16:45	6,15	5	30,77	CHI
202002189162	BOM JESUS DE GOIAS	BJ12134669	BOM JESUS DE GOIAS	29/02/2020 13:39	29/02/2020 19:53	29/02/2020 13:39	29/02/2020 19:53	6,22	135	840,04	CHI
202002189164	BARRO ALTO	DF12382135	BARRO ALTO	29/02/2020 13:58	29/02/2020 21:04	29/02/2020 13:58	29/02/2020 21:04	7,10	34	241,32	CHI

202002189164	SANTA RITA DO NOVO DESTINO	DF12382135	BARRO ALTO	29/02/2020 13:58	29/02/2020 21:04	29/02/2020 13:58	29/02/2020 21:04	7,10	2	14,20	CHI
202002189167	URUACU	UR10410223	URUACU	29/02/2020 14:51	29/02/2020 23:35	29/02/2020 14:51	29/02/2020 16:56	2,09	31	64,81	CHI
202002189167	URUACU	UR10410223	URUACU	29/02/2020 14:51	29/02/2020 23:35	29/02/2020 17:11	29/02/2020 17:23	0,20	31	6,21	CHI
202002189167	URUACU	UR12374761LD	URUACU	29/02/2020 14:51	29/02/2020 23:35	29/02/2020 14:51	29/02/2020 17:44	2,88	11	31,68	CHI
202002189167	URUACU	UR10410223	URUACU	29/02/2020 14:51	29/02/2020 23:35	29/02/2020 14:51	29/02/2020 23:29	8,63	2	17,25	CHI
202002189167	URUACU	UR12038758	URUACU	29/02/2020 14:51	29/02/2020 23:35	29/02/2020 14:51	29/02/2020 23:35	8,73	2	17,47	CHI
202002189168	VILA PROPICIO	NP11327880	GOIANESIA S1	29/02/2020 14:56	29/02/2020 21:50	29/02/2020 14:56	29/02/2020 21:50	6,91	1	6,91	CHI
202002189172	PARAUNA	RV12306606	MONTIVIDIU T	28/02/2020 20:46	29/02/2020 18:11	28/02/2020 20:46	29/02/2020 18:11	21,41	5	107,07	CHI
202002189177	ARAGARCAS	AG12234256	ARAGARCAS	29/02/2020 08:50	29/02/2020 20:06	29/02/2020 08:50	29/02/2020 20:06	11,25	17	191,27	CHI
202002189184	MINACU	IH12063607	MINACU	29/02/2020 15:00	29/02/2020 18:12	29/02/2020 15:00	29/02/2020 18:12	3,20	245	783,25	CHI
202002189188	CAMPOS BELOS	CH11046869	SAO DOMINGOS	29/02/2020 15:00	29/02/2020 17:11	29/02/2020 15:00	29/02/2020 17:11	2,17	256	555,09	CHI
202002189194	GOIANIA	10046896	XAVANTES	29/02/2020 15:02	29/02/2020 18:29	29/02/2020 15:02	29/02/2020 18:29	3,44	1	3,44	CHI
202002189197	TRINDADE	TR11161116	TRINDADE	29/02/2020 14:34	29/02/2020 16:59	29/02/2020 14:34	29/02/2020 16:59	2,41	106	255,81	CHI
202002189198	MINEIROS	MY12324344	PARQUE DAS EMAS	29/02/2020 15:03	01/03/2020 11:14	29/02/2020 15:03	01/03/2020 11:14	20,17	7	141,20	CHI
202002189201	MINACU	IH11255677	MINACU	29/02/2020 15:04	29/02/2020 17:32	29/02/2020 15:04	29/02/2020 17:32	2,46	79	194,65	CHI
202002189204	PADRE BERNARDO	PB12290544	PADRE BERNARDO	29/02/2020 15:04	29/02/2020 22:51	29/02/2020 15:04	29/02/2020 22:51	7,77	2	15,54	CHI
202002189205	AGUAS LINDAS DE GOIAS	LA11347930	AGUAS LINDAS DE GOIAS S1	29/02/2020 15:04	29/02/2020 16:22	29/02/2020 15:04	29/02/2020 16:22	1,29	84	107,99	CHI
202002189208	NIQUELANDIA	NQ12095753	NIQUELANDIA SUBTRANSMISSAO	29/02/2020 14:01	29/02/2020 19:03	29/02/2020 14:01	29/02/2020 19:03	5,03	341	1715,04	CHI
202002189208	URUACU	NQ12095753	NIQUELANDIA SUBTRANSMISSAO	29/02/2020 14:01	29/02/2020 19:03	29/02/2020 14:01	29/02/2020 19:03	5,03	3	15,09	CHI
202002189209	MONTES CLAROS DE GOIAS	ME12187647	IPORA	29/02/2020 15:06	01/03/2020 16:49	29/02/2020 15:06	01/03/2020 16:49	25,72	12	308,68	CHI
202002189211	FORMOSA	VB12164674	ITIQUEIRA	29/02/2020 15:07	29/02/2020 19:45	29/02/2020 15:07	29/02/2020 19:45	4,63	44	203,77	CHI
202002189211	VILA BOA	VB12164674	ITIQUEIRA	29/02/2020 15:07	29/02/2020 19:45	29/02/2020 15:07	29/02/2020 19:45	4,63	6	27,79	CHI
202002189215	CATALAO	CT12190396	CATALAO S2	29/02/2020 14:44	29/02/2020 16:55	29/02/2020 14:44	29/02/2020 16:55	2,17	371	805,48	CHI
202002189220	AGUAS LINDAS DE GOIAS	4830307767	AGUAS LINDAS DE GOIAS S1	29/02/2020 15:11	29/02/2020 16:40	29/02/2020 15:11	29/02/2020 16:40	1,47	1	1,47	CHI
202002189225	GOIANIA	12549150	ATLANTICO S3	29/02/2020 15:13	29/02/2020 16:29	29/02/2020 15:13	29/02/2020 16:29	1,26	1	1,26	CHI
202002189230	ABADIA DE GOIAS	LG11373005	INDEPENDENCIA S2	29/02/2020 15:14	29/02/2020 16:25	29/02/2020 15:14	29/02/2020 16:25	1,17	27	31,57	CHI
202002189238	CAIAPONIA	CP12151179	CAIAPONIA	29/02/2020 15:18	01/03/2020 13:01	29/02/2020 20:40	29/02/2020 23:18	2,63	74	194,83	CHI
202002189238	CAIAPONIA	CP12252503	CAIAPONIA	29/02/2020 15:18	01/03/2020 13:01	29/02/2020 15:18	01/03/2020 10:49	19,51	4	78,03	CHI
202002189238	CAIAPONIA	CP12252503	CAIAPONIA	29/02/2020 15:18	01/03/2020 13:01	29/02/2020 15:18	01/03/2020 11:36	20,29	1	20,29	CHI
202002189238	CAIAPONIA	CP12252503	CAIAPONIA	29/02/2020 15:18	01/03/2020 13:01	29/02/2020 15:18	01/03/2020 13:01	21,72	1	21,72	CHI
202002189240	JATAI	290293686	JATAI S2	29/02/2020 15:18	29/02/2020 22:41	29/02/2020 15:18	29/02/2020 22:41	7,37	1	7,37	CHI
202002189245	MIMOSO DE GOIAS	MJ12377231	PADRE BERNARDO	29/02/2020 15:20	01/03/2020 09:08	29/02/2020 15:20	01/03/2020 09:08	17,79	45	800,34	CHI
202002189247	JARAGUA	JA21306908	JARAGUA	29/02/2020 15:21	29/02/2020 17:45	29/02/2020 15:21	29/02/2020 17:45	2,39	1	2,39	CHI
202002189253	EDEALINA	ED21160342	PONTALINA	29/02/2020 15:22	01/03/2020 10:09	29/02/2020 15:22	01/03/2020 10:09	18,77	2	37,54	CHI
202002189254	ITAPURANGA	IK12364720	ITAPURANGA	29/02/2020 15:22	01/03/2020 06:35	29/02/2020 15:22	01/03/2020 06:35	15,21	4	60,85	CHI
202002189256	FORMOSA	FA12207282	ITIQUEIRA	29/02/2020 14:41	29/02/2020 17:58	29/02/2020 14:41	29/02/2020 17:58	3,28	15	49,16	CHI
202002189260	LUZIANIA	LZ21051367	CRISTALINA S2	29/02/2020 15:24	29/02/2020 17:33	29/02/2020 15:24	29/02/2020 17:33	2,14	1	2,14	CHI
202002189262	IPIRANGA DE GOIAS	RB21114318	RUBIATABA	29/02/2020 15:24	29/02/2020 17:39	29/02/2020 15:24	29/02/2020 17:39	2,24	1	2,24	CHI
202002189263	GAMELEIRA DE GOIAS	AN11273412	DAIA S1	29/02/2020 15:24	29/02/2020 17:40	29/02/2020 15:24	29/02/2020 17:40	2,25	31	69,90	CHI
202002189266	INDIARA	IY21312481	CEZARINA	29/02/2020 15:25	01/03/2020 09:20	29/02/2020 15:25	01/03/2020 09:20	17,92	1	17,92	CHI
202002189268	QUIRINOPOLIS	QI21091036	QUIRINOPOLIS	29/02/2020 15:26	01/03/2020 02:03	29/02/2020 15:26	01/03/2020 02:03	10,61	1	10,61	CHI
202002189274	LUZIANIA	LZ21153868	CRISTALINA S2	29/02/2020 15:27	29/02/2020 18:11	29/02/2020 15:27	29/02/2020 18:11	2,73	1	2,73	CHI
202002189280	GOIANIA	10771621	ATLANTICO S1	29/02/2020 15:28	29/02/2020 17:07	29/02/2020 15:28	29/02/2020 17:07	1,64	1	1,64	CHI
202002189283	GOIANAPOLIS	GP12273038	DAIA S2	29/02/2020 15:28	01/03/2020 15:24	29/02/2020 15:28	01/03/2020 15:24	23,93	7	167,49	CHI

202002189289	NIQUELANDIA	NQ12332844	NIQUELANDIA SUBTRANSMISSAO	29/02/2020 15:30	01/03/2020 10:29	29/02/2020 15:30	01/03/2020 10:29	18,98	1	18,98	CHI
202002189295	URUACU	UR21066501	URUACU	29/02/2020 15:32	01/03/2020 08:08	29/02/2020 15:32	01/03/2020 08:08	16,60	2	33,20	CHI
202002189298	CAMPESTRE DE GOIAS	GC12004762	TRINDADE	29/02/2020 15:32	29/02/2020 20:26	29/02/2020 15:32	29/02/2020 20:26	4,89	4	19,58	CHI
202002189301	GOIANDIRA	GD12127552	CATALAO S1	29/02/2020 14:57	29/02/2020 21:24	29/02/2020 14:57	29/02/2020 21:24	6,45	4	25,78	CHI
202002189306	ITAPURANGA	170026139	ITAPURANGA	29/02/2020 15:34	29/02/2020 20:24	29/02/2020 15:34	29/02/2020 20:24	4,82	1	4,82	CHI
202002189308	SENADOR CANEDO	10005816708	SENADOR CANEDO	29/02/2020 15:35	29/02/2020 17:59	29/02/2020 15:35	29/02/2020 17:59	2,40	1	2,40	CHI
202002189309	CACHOEIRA DOURADA	CD21242534	CACHOEIRA DOURADA	29/02/2020 15:36	01/03/2020 13:00	29/02/2020 15:36	01/03/2020 13:00	21,39	2	42,79	CHI
202002189310	ALEXANIA	AX21099849	ALEXANIA	29/02/2020 15:36	29/02/2020 19:11	29/02/2020 15:36	29/02/2020 19:11	3,58	2	7,16	CHI
202002189311	PORANGATU	TB12262770	PORANGATU	29/02/2020 13:50	29/02/2020 17:51	29/02/2020 13:50	29/02/2020 17:51	4,00	1	4,00	CHI
202002189311	SANTA TEREZA DE GOIAS	TB12262770	PORANGATU	29/02/2020 13:50	29/02/2020 17:51	29/02/2020 13:50	29/02/2020 17:51	4,00	5	20,02	CHI
202002189311	TROMBAS	TB12262770	PORANGATU	29/02/2020 13:50	29/02/2020 17:51	29/02/2020 13:50	29/02/2020 17:51	4,00	13	52,06	CHI
202002189314	PADRE BERNARDO	PB12375233	PADRE BERNARDO	29/02/2020 15:38	01/03/2020 07:23	29/02/2020 15:38	01/03/2020 07:23	15,75	1	15,75	CHI
202002189323	FORMOSA	610136306	ITUIQUIRA	29/02/2020 15:39	29/02/2020 19:43	29/02/2020 15:39	29/02/2020 19:43	4,06	1	4,06	CHI
202002189325	TRES RANCHOS	TH12131002	CATALAO S1	29/02/2020 13:17	29/02/2020 16:41	29/02/2020 13:17	29/02/2020 16:41	3,40	34	115,57	CHI
202002189334	LUZIANIA	LZ21149079	CRISTALINA S2	29/02/2020 15:42	29/02/2020 23:35	29/02/2020 15:42	29/02/2020 23:35	7,87	2	15,75	CHI
202002189340	BARRO ALTO	NQ12243457	URUACU	29/02/2020 15:43	29/02/2020 23:40	29/02/2020 15:43	29/02/2020 23:40	7,93	1	7,93	CHI
202002189340	NIQUELANDIA	NQ12243457	URUACU	29/02/2020 15:43	29/02/2020 23:40	29/02/2020 15:43	29/02/2020 23:40	7,93	2	15,87	CHI
202002189341	GOIAS	GS12020848	MATRINCHA	29/02/2020 15:44	29/02/2020 21:08	29/02/2020 15:44	29/02/2020 21:08	5,40	1	5,40	CHI
202002189344	PLANALTINA	PI12248182	PLANALTINA	29/02/2020 15:32	29/02/2020 18:44	29/02/2020 15:32	29/02/2020 18:44	3,20	26	83,14	CHI
202002189347	MOZARLANDIA	410010182	MOZARLANDIA	29/02/2020 15:45	01/03/2020 02:02	29/02/2020 15:45	01/03/2020 02:02	10,27	1	10,27	CHI
202002189349	CIDADE OCIDENTAL	LZ21082933	MARAJOARA	29/02/2020 15:46	29/02/2020 17:15	29/02/2020 15:46	29/02/2020 17:15	1,48	2	2,97	CHI
202002189351	TRINDADE	TR11000038	TRINDADE	29/02/2020 15:46	29/02/2020 16:56	29/02/2020 15:46	29/02/2020 16:56	1,15	84	96,81	CHI
202002189356	CUMARI	CT21287037	CATALAO S1	29/02/2020 15:47	01/03/2020 09:40	29/02/2020 15:47	01/03/2020 09:40	17,87	1	17,87	CHI
202002189357	ALTO HORIZONTE	AJ12086081	SANTA TEREZINHA	29/02/2020 13:47	29/02/2020 17:24	29/02/2020 13:47	29/02/2020 17:24	3,61	46	166,11	CHI
202002189357	CAMPOS VERDES	AJ12086081	SANTA TEREZINHA	29/02/2020 13:47	29/02/2020 17:24	29/02/2020 13:47	29/02/2020 17:24	3,61	8	28,89	CHI
202002189357	PILAR DE GOIAS	AJ12086081	SANTA TEREZINHA	29/02/2020 13:47	29/02/2020 17:24	29/02/2020 13:47	29/02/2020 17:24	3,61	1	3,61	CHI
202002189358	CALDAS NOVAS	CN11257959	SERRA DE CALDAS	29/02/2020 15:48	29/02/2020 18:05	29/02/2020 15:48	29/02/2020 18:05	2,28	13	29,63	CHI
202002189363	CAMPINORTE	CR12405383	MARA ROSA	29/02/2020 14:17	01/03/2020 00:05	29/02/2020 14:17	01/03/2020 00:05	9,79	8	78,34	CHI
202002189363	MARA ROSA	CR12405383	MARA ROSA	29/02/2020 14:17	01/03/2020 00:05	29/02/2020 14:17	01/03/2020 00:05	9,79	5	48,96	CHI
202002189367	ARENOPOLIS	AY12223147	IPORA	29/02/2020 14:16	29/02/2020 20:50	29/02/2020 14:16	29/02/2020 20:50	6,56	57	374,09	CHI
202002189367	MONTES CLAROS DE GOIAS	AY12223147	IPORA	29/02/2020 14:16	29/02/2020 20:50	29/02/2020 14:16	29/02/2020 20:50	6,56	1	6,56	CHI
202002189367	PIRANHAS	AY12223147	IPORA	29/02/2020 14:16	29/02/2020 20:50	29/02/2020 14:16	29/02/2020 20:50	6,56	1	6,56	CHI
202002189369	COLINAS DO SUL	TI12357757	NIQUELANDIA SUBTRANSMISSAO	29/02/2020 15:50	29/02/2020 21:01	29/02/2020 15:50	29/02/2020 21:01	5,17	7	36,18	CHI
202002189372	PETROLINA DE GOIAS	PG10390335	PETROLINA	29/02/2020 14:45	29/02/2020 19:20	29/02/2020 19:12	29/02/2020 19:19	0,11	207	23,57	CHI
202002189372	PETROLINA DE GOIAS	PG12070562	PETROLINA	29/02/2020 14:45	29/02/2020 19:20	29/02/2020 14:45	29/02/2020 19:20	4,57	11	50,31	CHI
202002189375	MAMBAI	1570002438	IACIARA S2	29/02/2020 15:51	29/02/2020 16:47	29/02/2020 15:51	29/02/2020 16:47	0,92	1	0,92	CHI
202002189376	ITUMBUIARA	IT12030720	BOM JESUS DE GOIAS	29/02/2020 15:51	01/03/2020 10:29	29/02/2020 15:51	01/03/2020 10:29	18,62	10	186,17	CHI
202002189387	JUSSARA	JR12341198	JUSSARA	29/02/2020 15:54	29/02/2020 17:27	29/02/2020 15:54	29/02/2020 17:27	1,54	7	10,80	CHI
202002189393	BONOPOLIS	BX12079321	SAO MIGUEL DO ARAGUAIA	29/02/2020 15:44	29/02/2020 17:33	29/02/2020 15:44	29/02/2020 17:33	1,81	58	104,72	CHI
202002189394	PADRE BERNARDO	PB12382210	PADRE BERNARDO	29/02/2020 14:51	01/03/2020 00:12	29/02/2020 14:51	01/03/2020 00:12	9,34	37	345,56	CHI
202002189400	APARECIDA DE GOIANIA	200463147	INDEPENDENCIA S2	29/02/2020 15:56	29/02/2020 17:13	29/02/2020 15:56	29/02/2020 17:13	1,27	1	1,27	CHI
202002189411	MINEIROS	MY12193782	PARQUE DAS EMAS	28/02/2020 08:03	29/02/2020 20:47	28/02/2020 08:03	29/02/2020 20:47	36,72	5	183,62	CHI
202002189444	AMORINOPOLIS	AM12097732	IPORA	29/02/2020 15:14	01/03/2020 09:38	29/02/2020 15:14	01/03/2020 09:38	18,40	1	18,40	CHI
202002189451	CACHOEIRA ALTA	PC21000061	CACHOEIRA ALTA	29/02/2020 18:44	29/02/2020 20:34	29/02/2020 18:44	29/02/2020 20:34	1,83	1	1,83	CHI

202002189452	GOIANIA	GN11271021	XAVANTES	29/02/2020 19:44	29/02/2020 22:22	29/02/2020 19:44	29/02/2020 22:22	2,63	88	231,10	CHI
202002189453	CACHOEIRA ALTA	PC12209796	CACHOEIRA ALTA	29/02/2020 17:55	01/03/2020 00:26	29/02/2020 17:55	01/03/2020 00:26	6,51	3	19,53	CHI
202002189471	CAIAPONIA	PY10406617	PALESTINA	29/02/2020 22:42	01/03/2020 08:52	29/02/2020 22:42	01/03/2020 08:52	10,17	216	2196,72	CHI
202002189471	PALESTINA DE GOIAS	PY10406617	PALESTINA	29/02/2020 22:42	01/03/2020 08:52	29/02/2020 22:42	01/03/2020 08:52	10,17	84	854,28	CHI
202002189501	AGUA LIMPA	AL21000260	VILA CORUMBA	29/02/2020 15:56	29/02/2020 18:30	29/02/2020 15:56	29/02/2020 18:30	2,55	1	2,55	CHI
202002189504	MINACU	IH12282167	MINACU	29/02/2020 15:57	29/02/2020 18:13	29/02/2020 15:57	29/02/2020 18:13	2,26	626	1415,80	CHI
202002189507	ARAGOIANIA	GA12007521	GUAPO S1	29/02/2020 11:58	29/02/2020 18:46	29/02/2020 11:58	29/02/2020 18:46	6,80	9	61,23	CHI
202002189507	GUAPO	GA12007521	GUAPO S1	29/02/2020 11:58	29/02/2020 18:46	29/02/2020 11:58	29/02/2020 18:46	6,80	3	20,41	CHI
202002189507	VARJAO	GA12007521	GUAPO S1	29/02/2020 11:58	29/02/2020 18:46	29/02/2020 11:58	29/02/2020 18:46	6,80	7	47,62	CHI
202002189509	AGUA LIMPA	AL12392069	VILA CORUMBA	29/02/2020 15:58	01/03/2020 16:58	29/02/2020 15:58	01/03/2020 16:58	25,00	2	49,99	CHI
202002189509	CORUMBAIBA	AL12392069	VILA CORUMBA	29/02/2020 15:58	01/03/2020 16:58	29/02/2020 15:58	01/03/2020 16:58	25,00	1	25,00	CHI
202002189511	MUTUNOPOLIS	MU12246496	MARA ROSA	29/02/2020 15:58	01/03/2020 08:44	29/02/2020 15:58	01/03/2020 08:44	16,76	2	33,51	CHI
202002189522	GOIANIA	GN12032726	GOYA S2	29/02/2020 14:55	29/02/2020 16:43	29/02/2020 14:55	29/02/2020 16:43	1,80	478	858,14	CHI
202002189524	SANTA CRUZ DE GOIAS	PJ21120706	PIRACANJUBA	29/02/2020 16:00	29/02/2020 18:09	29/02/2020 16:00	29/02/2020 18:09	2,14	1	2,14	CHI
202002189528	PLANALTINA	PI11043447	PLANALTINA	29/02/2020 16:01	29/02/2020 18:43	29/02/2020 16:01	29/02/2020 18:43	2,68	124	332,91	CHI
202002189533	PADRE BERNARDO	PB12382921	PADRE BERNARDO	29/02/2020 15:01	29/02/2020 19:31	29/02/2020 15:01	29/02/2020 19:31	4,49	52	233,35	CHI
202002189541	SANTA FE DE GOIAS	2070009355	BRITANIA	29/02/2020 16:06	01/03/2020 15:32	29/02/2020 16:06	01/03/2020 15:32	23,44	1	23,44	CHI
202002189544	BARRO ALTO	BA12357169	BARRO ALTO	29/02/2020 16:06	29/02/2020 18:49	29/02/2020 16:06	29/02/2020 18:49	2,70	3	8,11	CHI
202002189546	IPAMERI	580111465	IPAMERI	29/02/2020 16:07	29/02/2020 17:53	29/02/2020 16:07	29/02/2020 17:53	1,76	1	1,76	CHI
202002189548	JATAI	290320630	JATAI S2	29/02/2020 16:07	29/02/2020 18:05	29/02/2020 16:07	29/02/2020 18:05	1,96	1	1,96	CHI
202002189549	BELA VISTA DE GOIAS	BV12012781	BELA VISTA S2	29/02/2020 15:41	01/03/2020 00:53	29/02/2020 15:41	01/03/2020 00:53	9,20	84	772,59	CHI
202002189552	PADRE BERNARDO	PB12376762	PADRE BERNARDO	29/02/2020 16:08	29/02/2020 22:47	29/02/2020 16:08	29/02/2020 22:47	6,63	3	19,90	CHI
202002189553	CAIAPONIA	CP21358786	CAIAPONIA	29/02/2020 16:09	01/03/2020 09:44	29/02/2020 16:09	01/03/2020 09:44	17,58	1	17,58	CHI
202002189555	DISTRITO FEDERAL	2900055850	MARAJOARA	29/02/2020 16:09	29/02/2020 18:41	29/02/2020 16:09	29/02/2020 18:41	2,52	1	2,52	CHI
202002189556	RIO VERDE	10002944748	RIO VERDE S1	29/02/2020 16:10	01/03/2020 14:30	29/02/2020 16:10	01/03/2020 14:30	22,34	1	22,34	CHI
202002189559	LUZIANIA	LZ12330594	CRISTALINA S2	29/02/2020 16:11	29/02/2020 19:26	29/02/2020 16:11	29/02/2020 19:26	3,25	15	48,71	CHI
202002189563	ORIZONA	OZ21114456	PIRES DO RIO S2	29/02/2020 16:11	29/02/2020 18:26	29/02/2020 16:11	29/02/2020 18:26	2,23	1	2,23	CHI
202002189565	PLANALTINA	PI11257579	PLANALTINA	29/02/2020 16:12	29/02/2020 22:48	29/02/2020 16:12	29/02/2020 22:48	6,60	40	263,89	CHI
202002189566	CORUMBA DE GOIAS	CB21111203	CORUMBA	29/02/2020 16:12	29/02/2020 19:00	29/02/2020 16:12	29/02/2020 19:00	2,80	1	2,80	CHI
202002189571	ORIZONA	PR21100471	PIRES DO RIO S2	29/02/2020 16:15	01/03/2020 11:29	29/02/2020 16:15	01/03/2020 11:29	19,23	1	19,23	CHI
202002189572	CATALAO	CT21286348	CATALAO S1	29/02/2020 16:15	01/03/2020 09:49	29/02/2020 16:15	01/03/2020 09:49	17,56	1	17,56	CHI
202002189574	EDEIA	EA11000003	EDEIA	29/02/2020 16:07	29/02/2020 18:03	29/02/2020 16:07	29/02/2020 18:03	1,93	85	164,19	CHI
202002189576	RIO VERDE	RV12205429	MONTIVIDIU T	29/02/2020 15:48	29/02/2020 20:50	29/02/2020 15:48	29/02/2020 20:50	5,02	40	200,78	CHI
202002189582	GOIAS	GS21311234	ITABERAI S1	29/02/2020 16:18	29/02/2020 18:09	29/02/2020 16:18	29/02/2020 18:09	1,85	1	1,85	CHI
202002189584	EDEIA	1120028027	EDEIA	29/02/2020 16:18	29/02/2020 22:13	29/02/2020 16:18	29/02/2020 22:13	5,91	1	5,91	CHI
202002189585	APARECIDA DE GOIANIA	AP12051730	REAL S1	29/02/2020 16:18	29/02/2020 18:51	29/02/2020 16:18	29/02/2020 18:51	2,54	998	2535,75	CHI
202002189587	NIQUELANDIA	NQ12035673	NIQUELANDIA SUBTRANSMISSAO	29/02/2020 14:57	29/02/2020 19:49	29/02/2020 14:57	29/02/2020 19:49	4,86	408	1982,31	CHI
202002189591	QUIRINOPOLIS	QI12000241	QUIRINOPOLIS	29/02/2020 16:19	29/02/2020 17:40	29/02/2020 16:19	29/02/2020 17:40	1,35	9	12,11	CHI
202002189592	PLANALTINA	PI12062190	PLANALTINA	29/02/2020 15:46	29/02/2020 19:43	29/02/2020 15:46	29/02/2020 19:43	3,95	21	82,89	CHI
202002189594	PADRE BERNARDO	PB11192995	PADRE BERNARDO	29/02/2020 15:22	29/02/2020 18:56	29/02/2020 15:22	29/02/2020 18:56	3,57	163	581,37	CHI
202002189596	FORMOSA	FA11397060	ITUIQUIRA	29/02/2020 16:19	29/02/2020 18:58	29/02/2020 16:19	29/02/2020 18:58	2,63	1	2,63	CHI
202002189597	MINACU	IH11135615	MINACU	29/02/2020 16:19	29/02/2020 19:06	29/02/2020 16:19	29/02/2020 19:06	2,77	91	251,79	CHI
202002189600	GOIANIA	16988139	CARAJAS S1	29/02/2020 16:20	29/02/2020 17:34	29/02/2020 16:20	29/02/2020 17:34	1,23	1	1,23	CHI
202002189602	ITAGUARI	10007219278	ITABERAI S1	29/02/2020 16:20	29/02/2020 17:11	29/02/2020 16:20	29/02/2020 17:11	0,84	1	0,84	CHI

202002189603	PIRES DO RIO	PR21191532	PIRES DO RIO S2	29/02/2020 16:21	29/02/2020 17:52	29/02/2020 16:21	29/02/2020 17:52	1,53	1	1,53	CHI
202002189604	GOIANIA	10026106610	CARAJAS S1	29/02/2020 16:21	29/02/2020 17:55	29/02/2020 16:21	29/02/2020 17:55	1,57	1	1,57	CHI
202002189606	ITUMBIARA	690023315	ITUMBIARA VELHA S1	29/02/2020 16:21	29/02/2020 20:26	29/02/2020 16:21	29/02/2020 20:26	4,08	1	4,08	CHI
202002189612	CATALAO	CT11216098	CATALAO S2	29/02/2020 16:22	29/02/2020 18:40	29/02/2020 16:22	29/02/2020 18:40	2,30	31	71,19	CHI
202002189616	GOIANIA	10802629	GOIANIA LESTE S1	29/02/2020 16:23	29/02/2020 20:04	29/02/2020 16:23	29/02/2020 20:04	3,67	1	3,67	CHI
202002189619	PARAUNA	PU12163951	PARAUNA	29/02/2020 16:24	29/02/2020 20:28	29/02/2020 16:24	29/02/2020 20:28	4,07	3	12,21	CHI
202002189621	BRAZABRANTES	IN12321577	INHUMAS S1	29/02/2020 16:25	29/02/2020 18:42	29/02/2020 16:25	29/02/2020 18:42	2,28	2	4,57	CHI
202002189621	DAMOLANDIA	IN12321577	INHUMAS S1	29/02/2020 16:25	29/02/2020 18:42	29/02/2020 16:25	29/02/2020 18:42	2,28	3	6,85	CHI
202002189623	ALTO PARAISO DE GOIAS	BF10400692	FLORES DE GOIAS	29/02/2020 16:16	29/02/2020 17:55	29/02/2020 16:16	29/02/2020 17:55	1,65	215	354,63	CHI
202002189623	SAO JOAO D ALIANCA	BF10400692	FLORES DE GOIAS	29/02/2020 16:16	29/02/2020 17:55	29/02/2020 16:16	29/02/2020 17:55	1,65	2	3,30	CHI
202002189625	CAMPO ALEGRE DE GOIAS	CM12042424	CAMPO ALEGRE DE GOIAS	29/02/2020 14:51	29/02/2020 17:43	29/02/2020 14:51	29/02/2020 17:43	2,85	25	71,35	CHI
202002189628	SILVANIA	660050882	VIANOPOLIS	29/02/2020 16:27	29/02/2020 22:22	29/02/2020 16:27	29/02/2020 22:22	5,92	1	5,92	CHI
202002189630	APARECIDA DE GOIANIA	10018610003	INDEPENDENCIA S1	29/02/2020 16:27	29/02/2020 17:51	29/02/2020 16:27	29/02/2020 17:51	1,39	1	1,39	CHI
202002189632	POSSE	PS12257684	IACIARA S2	29/02/2020 16:28	29/02/2020 18:45	29/02/2020 16:28	29/02/2020 18:45	2,27	5	11,37	CHI
202002189635	GOIANESIA	10007786296	GOIANESIA S2	29/02/2020 16:29	29/02/2020 22:07	29/02/2020 16:29	29/02/2020 22:07	5,62	1	5,62	CHI
202002189639	GAMELEIRA DE GOIAS	3830003971	DAIA S2	29/02/2020 16:30	01/03/2020 02:13	29/02/2020 16:30	01/03/2020 02:13	9,71	1	9,71	CHI
202002189640	GOIANIA	GN11161522	CAMPINAS S1	29/02/2020 16:30	29/02/2020 18:28	29/02/2020 16:30	29/02/2020 18:28	1,95	14	27,36	CHI
202002189648	ARUANA	AK21294097	MOZARLANDIA	29/02/2020 16:32	29/02/2020 18:14	29/02/2020 16:32	29/02/2020 18:14	1,69	1	1,69	CHI
202002189654	ACREUNA	EU12045542	ACREUNA	29/02/2020 15:24	29/02/2020 18:42	29/02/2020 15:24	29/02/2020 18:42	3,29	5	16,47	CHI
202002189655	FORMOSA	610324858	ITUIQUIRA	29/02/2020 16:34	29/02/2020 17:54	29/02/2020 16:34	29/02/2020 17:54	1,32	1	1,32	CHI
202002189656	SAO JOAO D ALIANCA	JL11280297	SAO JOAO D ALIANCA	29/02/2020 16:35	29/02/2020 23:05	29/02/2020 16:35	29/02/2020 23:05	6,50	9	58,49	CHI
202002189660	APARECIDA DE GOIANIA	200571424	INDEPENDENCIA S2	29/02/2020 16:36	29/02/2020 18:22	29/02/2020 16:36	29/02/2020 18:22	1,76	1	1,76	CHI
202002189662	HIDROLANDIA	HD21000252	CEPAIGO S2	29/02/2020 16:36	29/02/2020 20:42	29/02/2020 16:36	29/02/2020 20:42	4,09	1	4,09	CHI
202002189664	RIO VERDE	RV11038421	RIO VERDE S1	29/02/2020 16:37	01/03/2020 13:30	29/02/2020 16:37	01/03/2020 13:30	20,88	137	2860,26	CHI
202002189674	MUTUNOPOLIS	MU12265809	MARA ROSA	29/02/2020 16:39	29/02/2020 20:19	29/02/2020 16:39	29/02/2020 20:19	3,66	1	3,66	CHI
202002189675	AGUA FRIA DE GOIAS	MJ12183873	PADRE BERNARDO	29/02/2020 15:26	29/02/2020 21:12	29/02/2020 15:26	29/02/2020 21:12	5,75	2	11,50	CHI
202002189675	MIMOSO DE GOIAS	MJ12183873	PADRE BERNARDO	29/02/2020 15:26	29/02/2020 21:12	29/02/2020 15:26	29/02/2020 21:12	5,75	9	51,77	CHI
202002189676	CATALAO	10015210616	CATALAO S2	29/02/2020 13:22	29/02/2020 18:27	29/02/2020 13:22	29/02/2020 18:27	5,08	1	5,08	CHI
202002189687	PADRE BERNARDO	PB12284769	PADRE BERNARDO	29/02/2020 16:18	29/02/2020 21:01	29/02/2020 16:18	29/02/2020 21:01	4,70	67	315,07	CHI
202002189693	FLORES DE GOIAS	FB12390645	IACIARA S2	29/02/2020 16:44	29/02/2020 19:32	29/02/2020 16:44	29/02/2020 19:32	2,80	167	467,37	CHI
202002189693	FORMOSA	FB12390645	IACIARA S2	29/02/2020 16:44	29/02/2020 19:32	29/02/2020 16:44	29/02/2020 19:32	2,80	1	2,80	CHI
202002189693	VILA BOA	FB12390645	IACIARA S2	29/02/2020 16:44	29/02/2020 19:32	29/02/2020 16:44	29/02/2020 19:32	2,80	4	11,19	CHI
202002189694	CACHOEIRA DOURADA	CD21305506	CACHOEIRA DOURADA	29/02/2020 11:44	01/03/2020 11:20	29/02/2020 11:44	01/03/2020 11:20	23,59	2	47,18	CHI
202002189696	AMORINOPOLIS	AM211039410	IPORA	29/02/2020 14:34	29/02/2020 19:52	29/02/2020 14:34	29/02/2020 19:52	5,30	1	5,30	CHI
202002189699	APARECIDA DE GOIANIA	200567482	INDEPENDENCIA S2	29/02/2020 16:45	29/02/2020 18:34	29/02/2020 16:45	29/02/2020 18:34	1,81	1	1,81	CHI
202002189700	ALEXANIA	AX12095958	CORUMBA	29/02/2020 16:45	29/02/2020 19:06	29/02/2020 16:45	29/02/2020 19:06	2,34	6	14,07	CHI
202002189700	CORUMBA DE GOIAS	AX12095958	CORUMBA	29/02/2020 16:45	29/02/2020 19:06	29/02/2020 16:45	29/02/2020 19:06	2,34	3	7,03	CHI
202002189701	MUTUNOPOLIS	MU12086730	MARA ROSA	29/02/2020 16:45	29/02/2020 18:28	29/02/2020 16:45	29/02/2020 18:28	1,71	31	52,98	CHI
202002189702	FORMOSA	FA21106826	ITUIQUIRA	29/02/2020 16:45	29/02/2020 18:17	29/02/2020 16:45	29/02/2020 18:17	1,52	1	1,52	CHI
202002189704	CALDAS NOVAS	CN12223439	VILA CORUMBA	29/02/2020 16:45	29/02/2020 18:56	29/02/2020 16:45	29/02/2020 18:56	2,17	1	2,17	CHI
202002189709	PLANALTINA	10027346577	PLANALTINA	29/02/2020 16:46	01/03/2020 00:18	29/02/2020 16:46	01/03/2020 00:18	7,54	1	7,54	CHI
202002189715	GOIANDIRA	GD12131063	CATALAO S1	29/02/2020 16:47	01/03/2020 11:38	29/02/2020 16:47	01/03/2020 11:38	18,84	4	75,36	CHI
202002189716	BARRO ALTO	BA12000049	BARRO ALTO	29/02/2020 15:07	29/02/2020 23:45	29/02/2020 15:07	29/02/2020 23:45	8,63	7	60,40	CHI
202002189721	ITUMBIARA	BJ12039450	BOM JESUS DE GOIAS	29/02/2020 16:49	29/02/2020 23:35	29/02/2020 16:49	29/02/2020 23:35	6,76	4	27,06	CHI

202002189724	LEOPOLDO DE BULHOES	LB21270621	DAIA S2	29/02/2020 16:49	01/03/2020 04:19	29/02/2020 16:49	01/03/2020 04:19	11,49	1	11,49	CHI
202002189725	GOUVELANDIA	GB12303158	QUIRINOPOLIS	29/02/2020 16:49	29/02/2020 18:26	29/02/2020 16:49	29/02/2020 18:26	1,60	6	9,62	CHI
202002189801	PADRE BERNARDO	PB12277183	PADRE BERNARDO	29/02/2020 15:43	29/02/2020 20:22	29/02/2020 15:43	29/02/2020 20:22	4,63	55	254,89	CHI
202002189802	ALTO PARAISO DE GOIAS	BF12375516	FLORES DE GOIAS	29/02/2020 16:46	29/02/2020 18:52	29/02/2020 16:46	29/02/2020 18:52	2,09	8	16,70	CHI
202002189907	CATALAO	10003845883	CATALAO S2	29/02/2020 16:50	29/02/2020 20:55	29/02/2020 16:50	29/02/2020 20:55	4,07	1	4,07	CHI
202002189923	APARECIDA DE GOIANIA	200066810	ANHANGUERA	29/02/2020 16:54	29/02/2020 18:10	29/02/2020 16:54	29/02/2020 18:10	1,26	0	0,00	CHI
202002189925	LUZIANIA	LZ21247958	CRISTALINA S2	29/02/2020 16:54	29/02/2020 20:30	29/02/2020 16:54	29/02/2020 20:30	3,59	1	3,59	CHI
202002189926	JANDAIA	JD21008589	PALMEIRAS	29/02/2020 16:55	29/02/2020 19:50	29/02/2020 16:55	29/02/2020 19:50	2,92	1	2,92	CHI
202002189929	ITUMBIARA	IT21352641	PARANAIBA	29/02/2020 16:55	29/02/2020 20:16	29/02/2020 16:55	29/02/2020 20:16	3,34	1	3,34	CHI
202002189933	MONTES CLAROS DE GOIAS	ME12380990	IPORA	29/02/2020 16:58	01/03/2020 04:08	29/02/2020 16:58	01/03/2020 04:08	11,16	5	55,81	CHI
202002189939	AURILANDIA	AI11000008	FIRMINOPOLIS S2	29/02/2020 16:59	29/02/2020 20:14	29/02/2020 16:59	29/02/2020 20:14	3,24	29	94,10	CHI
202002189940	ITARUMA	2310007943	CACHOEIRA ALTA	29/02/2020 16:59	01/03/2020 10:14	29/02/2020 16:59	01/03/2020 10:14	17,24	1	17,24	CHI
202002189949	PORANGATU	10006663301	PORANGATU	29/02/2020 17:03	29/02/2020 18:41	29/02/2020 17:03	29/02/2020 18:41	1,63	1	1,63	CHI
202002189950	NOVO BRASIL	NB21111471	JUSSARA	29/02/2020 17:03	29/02/2020 22:23	29/02/2020 17:03	29/02/2020 22:23	5,33	2	10,66	CHI
202002189959	FORMOSA	FA12042025	ITIQUEIRA	29/02/2020 17:05	29/02/2020 21:00	29/02/2020 17:05	29/02/2020 21:00	3,90	3	11,70	CHI
202002189960	PIRACANJUBA	PJ21032903	CALDAS NOVAS S1	29/02/2020 17:06	01/03/2020 09:03	29/02/2020 17:06	01/03/2020 09:03	15,95	1	15,95	CHI
202002189965	CRISTALINA	KR21171559	CRISTALINA S2	29/02/2020 17:07	01/03/2020 08:03	29/02/2020 17:07	01/03/2020 08:03	14,93	1	14,93	CHI
202002189966	MUNDO NOVO DE GOIAS	MH12291037	NOVA CRIXAS	29/02/2020 17:07	01/03/2020 13:25	29/02/2020 17:07	01/03/2020 13:25	20,30	4	81,18	CHI
202002189974	PEROLANDIA	DP12182220	JATAI S1	29/02/2020 16:28	29/02/2020 18:14	29/02/2020 16:28	29/02/2020 18:14	1,76	7	12,29	CHI
202002189975	PADRE BERNARDO	PB12163212	PADRE BERNARDO	29/02/2020 15:27	29/02/2020 19:56	29/02/2020 15:27	29/02/2020 19:56	4,48	31	138,97	CHI
202002189982	JATAI	JT12234311	JATAI S2	29/02/2020 16:25	29/02/2020 18:32	29/02/2020 16:25	29/02/2020 18:32	2,12	36	76,19	CHI
202002189986	BURITI DE GOIAS	SC12052751	FIRMINOPOLIS S2	29/02/2020 17:10	29/02/2020 19:40	29/02/2020 17:10	29/02/2020 19:40	2,49	3	7,46	CHI
202002189986	SANCLERLANDIA	SC12052751	FIRMINOPOLIS S2	29/02/2020 17:10	29/02/2020 19:40	29/02/2020 17:10	29/02/2020 19:40	2,49	19	47,24	CHI
202002189988	FORMOSA	FA12241609	ITIQUEIRA	29/02/2020 17:11	29/02/2020 19:24	29/02/2020 17:11	29/02/2020 19:24	2,22	16	35,47	CHI
202002189997	SANTA HELENA DE GOIAS	SH12000021	IPEGUARI	29/02/2020 17:13	01/03/2020 19:48	01/03/2020 17:50	01/03/2020 19:48	1,98	25	49,44	CHI
202002190001	INDIARA	IY12205923	EDEIA	29/02/2020 16:04	29/02/2020 19:54	29/02/2020 16:04	29/02/2020 19:54	3,82	33	126,20	CHI
202002190001	PALMEIRAS DE GOIAS	IY12205923	EDEIA	29/02/2020 16:04	29/02/2020 19:54	29/02/2020 16:04	29/02/2020 19:54	3,82	5	19,12	CHI
202002190013	NIQUELANDIA	NQ12262804	URUACU	29/02/2020 17:18	29/02/2020 22:18	29/02/2020 17:18	29/02/2020 22:18	4,99	2	9,98	CHI
202002190014	PIRANHAS	PH12399648	BOM JARDIM	29/02/2020 11:53	01/03/2020 10:29	29/02/2020 11:53	01/03/2020 10:29	22,59	4	90,37	CHI
202002190018	GOIAS	GS12063196	GOIAS	29/02/2020 17:19	29/02/2020 18:29	29/02/2020 17:19	29/02/2020 18:29	1,15	18	20,79	CHI
202002190019	SAO LUIS DE MONTES BELOS	SL12000024	SAO LUIZ DOS MONTES BELOS	29/02/2020 17:20	29/02/2020 18:34	29/02/2020 17:20	29/02/2020 18:34	1,23	225	276,62	CHI
202002190022	PEROLANDIA	DP11000002	JATAI S1	29/02/2020 15:12	29/02/2020 21:35	29/02/2020 15:12	29/02/2020 21:35	6,37	139	885,35	CHI
202002190024	GOUVELANDIA	GB12144239	QUIRINOPOLIS	29/02/2020 17:21	29/02/2020 19:52	29/02/2020 17:21	29/02/2020 19:52	2,51	6	15,06	CHI
202002190025	GOIANIA	GN11210898	AEROPORTO S3	29/02/2020 17:21	29/02/2020 19:39	29/02/2020 18:49	29/02/2020 19:39	0,83	11	9,17	CHI
202002190027	SAO JOAO D ALIANCA	JL11049189	SAO JOAO D ALIANCA	29/02/2020 17:06	29/02/2020 21:02	29/02/2020 17:06	29/02/2020 21:02	3,93	89	349,55	CHI
202002190044	LUZIANIA	3200030870	MARAJOARA	29/02/2020 17:28	29/02/2020 19:08	29/02/2020 17:28	29/02/2020 19:08	1,67	1	1,67	CHI
202002190046	BOM JARDIM DE GOIAS	ME12251375	IPORA	29/02/2020 15:18	29/02/2020 21:59	29/02/2020 15:18	29/02/2020 21:59	6,67	17	113,43	CHI
202002190046	MONTES CLAROS DE GOIAS	ME12251375	IPORA	29/02/2020 15:18	29/02/2020 21:59	29/02/2020 15:18	29/02/2020 21:59	6,67	7	46,71	CHI
202002190048	CATALAO	CT21280942	CATALAO S1	29/02/2020 17:29	29/02/2020 20:47	29/02/2020 17:29	29/02/2020 20:47	3,30	1	3,30	CHI
202002190049	MONTES CLAROS DE GOIAS	ME21038973	IPORA	29/02/2020 17:29	29/02/2020 17:54	29/02/2020 17:29	29/02/2020 17:54	0,41	1	0,41	CHI
202002190051	CHAPADAO DO CEU	DJ12148315	CHAPADAO DO CEU	29/02/2020 17:30	29/02/2020 19:37	29/02/2020 17:30	29/02/2020 19:37	2,11	5	10,55	CHI
202002190057	BELA VISTA DE GOIAS	BV11211149	BELA VISTA S1	29/02/2020 17:33	29/02/2020 22:47	29/02/2020 17:33	29/02/2020 22:47	5,23	21	109,84	CHI
202002190059	GOIANIA	14228828	FERROVIARIO S1	29/02/2020 17:34	29/02/2020 19:26	29/02/2020 17:34	29/02/2020 19:26	1,87	1	1,87	CHI
202002190060	ALVORADA DO NORTE	AQ12257608	FLORES DE GOIAS	29/02/2020 17:34	29/02/2020 19:58	29/02/2020 17:34	29/02/2020 19:58	2,40	10	23,96	CHI

202002190060	IACIARA	AQ12257608	FLORES DE GOIAS	29/02/2020 17:34	29/02/2020 19:58	29/02/2020 17:34	29/02/2020 19:58	2,40	4	9,58	CHI
202002190060	POSSE	AQ12257608	FLORES DE GOIAS	29/02/2020 17:34	29/02/2020 19:58	29/02/2020 17:34	29/02/2020 19:58	2,40	2	4,79	CHI
202002190061	URUACU	UR21290134	URUACU	29/02/2020 17:34	01/03/2020 09:31	29/02/2020 17:34	01/03/2020 09:31	15,94	1	15,94	CHI
202002190062	CRISTALINA	KR21094565	PAMPLONA	29/02/2020 17:34	29/02/2020 19:10	29/02/2020 17:34	29/02/2020 19:10	1,60	1	1,60	CHI
202002190072	MORRINHOS	10016243526	MORRINHOS	29/02/2020 17:36	01/03/2020 03:52	29/02/2020 17:36	01/03/2020 03:52	10,26	1	10,26	CHI
202002190073	RUBIATABA	780072455	RUBIATABA	29/02/2020 17:36	29/02/2020 23:45	29/02/2020 17:36	29/02/2020 23:45	6,14	1	6,14	CHI
202002190080	ANAPOLIS	20375580	ANAPOLIS UNIVERSITARIO S1	29/02/2020 17:37	29/02/2020 19:32	29/02/2020 17:37	29/02/2020 19:32	1,91	1	1,91	CHI
202002190084	CUMARI	CY12000314	CATALAO S1	29/02/2020 17:38	01/03/2020 11:49	29/02/2020 17:38	01/03/2020 11:49	18,18	1	18,18	CHI
202002190096	TRES RANCHOS	TH12131002	CATALAO S1	29/02/2020 17:15	29/02/2020 19:46	29/02/2020 17:15	29/02/2020 19:46	2,51	34	85,39	CHI
202002190121	SANTA RITA DO ARAGUAIA	SU21301973	SANTA RITA DO ARAGUAIA	29/02/2020 17:44	01/03/2020 01:22	29/02/2020 17:44	01/03/2020 01:22	7,62	1	7,62	CHI
202002190123	GOIANIA	10005817070	CAMPINAS S2	29/02/2020 17:45	29/02/2020 19:35	29/02/2020 17:45	29/02/2020 19:35	1,83	1	1,83	CHI
202002190132	QUIRINOPOLIS	QI21058197	QUIRINOPOLIS	29/02/2020 17:46	01/03/2020 08:59	29/02/2020 17:46	01/03/2020 08:59	15,20	1	15,20	CHI
202002190135	JANDAIA	JD12008614	PALMEIRAS	29/02/2020 17:47	29/02/2020 20:58	29/02/2020 17:47	29/02/2020 20:58	3,19	22	70,24	CHI
202002190135	PARAUNA	JD12008614	PALMEIRAS	29/02/2020 17:47	29/02/2020 20:58	29/02/2020 17:47	29/02/2020 20:58	3,19	6	19,16	CHI
202002190136	ANAPOLIS	AN11157960	ANAPOLIS UNIVERSITARIO S2	29/02/2020 17:48	29/02/2020 18:46	29/02/2020 17:48	29/02/2020 18:46	0,96	98	94,43	CHI
202002190137	QUIRINOPOLIS	QI21064751	QUIRINOPOLIS	29/02/2020 17:48	29/02/2020 21:07	29/02/2020 17:48	29/02/2020 21:07	3,31	1	3,31	CHI
202002190138	JANDAIA	JD12008673	PALMEIRAS	29/02/2020 17:49	29/02/2020 23:41	29/02/2020 17:49	29/02/2020 23:41	5,87	13	76,26	CHI
202002190139	ITAGUARU	IB12310440	ITABERAI S1	29/02/2020 17:49	29/02/2020 21:00	29/02/2020 17:49	29/02/2020 21:00	3,18	1	3,18	CHI
202002190144	MINACU	IH11052538	MINACU	29/02/2020 17:39	01/03/2020 12:02	29/02/2020 17:39	01/03/2020 12:02	18,37	76	1395,99	CHI
202002190145	CATALAO	CT11379400	CATALAO S2	29/02/2020 17:51	29/02/2020 19:11	29/02/2020 17:51	29/02/2020 19:11	1,32	54	71,35	CHI
202002190154	GOIANIA	GN11271021	XAVANTES	29/02/2020 17:47	29/02/2020 19:36	29/02/2020 17:47	29/02/2020 19:36	1,81	88	159,62	CHI
202002190159	FLORES DE GOIAS	FB12211537	IACIARA S2	29/02/2020 17:55	29/02/2020 20:55	29/02/2020 17:55	29/02/2020 20:55	2,99	14	41,81	CHI
202002190160	QUIRINOPOLIS	QI21306072	QUIRINOPOLIS	29/02/2020 17:55	29/02/2020 22:09	29/02/2020 17:55	29/02/2020 22:09	4,22	1	4,22	CHI
202002190162	MONTES CLAROS DE GOIAS	ME12023293	IPORA	29/02/2020 11:18	29/02/2020 19:24	29/02/2020 11:18	29/02/2020 19:24	8,09	11	89,04	CHI
202002190170	NEROPOLIS	NR12356429	NEROPOLIS S2	29/02/2020 17:57	29/02/2020 19:41	29/02/2020 17:57	29/02/2020 19:41	1,72	2	3,45	CHI
202002190171	SAO LUIS DE MONTES BELOS	500113087	SAO LUIZ DOS MONTES BELOS	29/02/2020 17:57	01/03/2020 07:43	29/02/2020 17:57	01/03/2020 07:43	13,76	1	13,76	CHI
202002190172	DAMOLANDIA	IN12014342	INHUMAS S1	29/02/2020 17:58	29/02/2020 20:43	29/02/2020 17:58	29/02/2020 20:43	2,75	27	74,24	CHI
202002190172	INHUMAS	IN12014342	INHUMAS S1	29/02/2020 17:58	29/02/2020 20:43	29/02/2020 17:58	29/02/2020 20:43	2,75	18	49,49	CHI
202002190172	PETROLINA DE GOIAS	IN12014342	INHUMAS S1	29/02/2020 17:58	29/02/2020 20:43	29/02/2020 17:58	29/02/2020 20:43	2,75	5	13,75	CHI
202002190182	ARAGARCAS	AG12334918	ARAGARCAS	29/02/2020 17:59	29/02/2020 22:27	29/02/2020 17:59	29/02/2020 22:27	4,46	3	13,38	CHI
202002190184	FORMOSA	FA21322758	ITUIQUIRA	29/02/2020 17:59	29/02/2020 20:53	29/02/2020 17:59	29/02/2020 20:53	2,89	1	2,89	CHI
202002190189	MOZARLANDIA	410036390	MOZARLANDIA	29/02/2020 18:01	01/03/2020 02:58	29/02/2020 18:01	01/03/2020 02:58	8,94	1	8,94	CHI
202002190200	URUACU	UR21066509	URUACU	29/02/2020 18:04	01/03/2020 09:42	29/02/2020 18:04	01/03/2020 09:42	15,63	1	15,63	CHI
202002190201	PORANGATU	PO12145187	PORANGATU	29/02/2020 18:04	01/03/2020 10:46	29/02/2020 18:04	01/03/2020 08:40	14,60	8	116,77	CHI
202002190201	PORANGATU	PO12145187	PORANGATU	29/02/2020 18:04	01/03/2020 10:46	01/03/2020 08:40	01/03/2020 10:46	2,10	8	16,80	CHI
202002190208	CRISTALINA	LZ12076063	CRISTALINA S2	29/02/2020 10:11	29/02/2020 21:45	29/02/2020 10:11	29/02/2020 21:45	11,56	3	34,68	CHI
202002190208	LUZIANIA	LZ12076063	CRISTALINA S2	29/02/2020 10:11	29/02/2020 21:45	29/02/2020 10:11	29/02/2020 21:45	11,56	1	11,56	CHI
202002190209	PIRACANJUBA	PJ21182745	PIRACANJUBA	29/02/2020 18:06	01/03/2020 08:50	29/02/2020 18:06	01/03/2020 08:50	14,73	1	14,73	CHI
202002190211	JARAGUA	JA21029526	JARAGUA	29/02/2020 18:06	29/02/2020 18:54	29/02/2020 18:06	29/02/2020 18:54	0,79	3	2,37	CHI
202002190212	GOIANIA	16763014	XAVANTES	29/02/2020 18:06	29/02/2020 20:03	29/02/2020 18:06	29/02/2020 20:03	1,93	1	1,93	CHI
202002190214	LEOPOLDO DE BULHOES	LB21302185	DAIA S1	29/02/2020 18:07	01/03/2020 00:01	29/02/2020 18:07	01/03/2020 00:01	5,89	3	17,67	CHI
202002190217	MINEIROS	MY12248454	PARQUE DAS EMAS	29/02/2020 15:44	29/02/2020 23:39	29/02/2020 15:44	29/02/2020 23:39	7,90	4	31,60	CHI
202002190224	HIDROLANDIA	HD12007513	PONTALINA	29/02/2020 18:10	01/03/2020 08:22	29/02/2020 18:10	01/03/2020 08:22	14,20	52	738,15	CHI
202002190225	SAO JOAO D ALIANCA	JL12048019	SAO JOAO D ALIANCA	29/02/2020 16:05	29/02/2020 22:22	29/02/2020 16:05	29/02/2020 22:22	6,27	15	94,04	CHI

202002190232	NOVA CRIXAS	NA12250950	NOVA CRIXAS	29/02/2020 18:12	01/03/2020 10:44	29/02/2020 18:12	01/03/2020 10:44	16,52	2	33,05	CHI
202002190233	VIANOPOLIS	VN21060535	PIRES DO RIO S2	29/02/2020 18:12	01/03/2020 10:25	29/02/2020 18:12	01/03/2020 10:25	16,21	1	16,21	CHI
202002190234	CRISTALINA	KR21171580	CRISTALINA S2	29/02/2020 18:12	01/03/2020 10:10	29/02/2020 18:12	01/03/2020 10:10	15,96	2	31,91	CHI
202002190235	ANAPOLIS	10000509548	JUNDIAI S1	29/02/2020 18:12	29/02/2020 20:27	29/02/2020 18:12	29/02/2020 20:27	2,24	1	2,24	CHI
202002190236	GOIANIA	10841593	GOIANIA LESTE S2	29/02/2020 18:13	29/02/2020 20:10	29/02/2020 18:13	29/02/2020 20:10	1,95	1	1,95	CHI
202002190239	SANTA HELENA DE GOIAS	SH21219436	SANTA HELENA S1	29/02/2020 18:14	01/03/2020 00:05	29/02/2020 18:14	01/03/2020 00:05	5,84	1	5,84	CHI
202002190245	MONTES CLAROS DE GOIAS	ME12088929	IPORA	29/02/2020 17:10	01/03/2020 08:54	29/02/2020 17:10	01/03/2020 08:54	15,72	4	62,87	CHI
202002190247	HIDROLANDIA	HD21034367	CEPAIGO S2	29/02/2020 18:16	01/03/2020 03:15	29/02/2020 18:16	01/03/2020 03:15	8,99	1	8,99	CHI
202002190253	LUZIANIA	120308125	RIO VERMELHO	29/02/2020 18:17	29/02/2020 20:29	29/02/2020 18:17	29/02/2020 20:29	2,19	1	2,19	CHI
202002190256	GOIANESIA	10014064705	GOIANESIA S2	29/02/2020 18:18	01/03/2020 01:38	29/02/2020 18:18	01/03/2020 01:38	7,33	1	7,33	CHI
202002190261	SAO DOMINGOS	SD12262418	SAO DOMINGOS	29/02/2020 18:19	29/02/2020 18:59	29/02/2020 18:19	29/02/2020 18:59	0,66	2	1,32	CHI
202002190262	GOIANIA	13030231	GOYA S2	29/02/2020 18:20	29/02/2020 19:24	29/02/2020 18:20	29/02/2020 19:24	1,07	1	1,07	CHI
202002190263	URUTAI	UT12115680	PIRES DO RIO S2	29/02/2020 18:18	29/02/2020 21:37	29/02/2020 18:18	29/02/2020 21:37	3,31	33	109,24	CHI
202002190265	POSSE	1480043907	IACIARA S2	29/02/2020 18:20	29/02/2020 19:10	29/02/2020 18:20	29/02/2020 19:10	0,82	1	0,82	CHI
202002190270	SAO JOAO D ALIANCA	JL10400661	SAO JOAO D ALIANCA	29/02/2020 17:49	01/03/2020 20:08	29/02/2020 17:49	01/03/2020 01:23	7,56	18	136,04	CHI
202002190270	SAO JOAO D ALIANCA	JL10400661	SAO JOAO D ALIANCA	29/02/2020 17:49	01/03/2020 20:08	01/03/2020 01:23	01/03/2020 08:59	7,59	8	60,76	CHI
202002190270	SAO JOAO D ALIANCA	JL12131828LD	SAO JOAO D ALIANCA	29/02/2020 17:49	01/03/2020 20:08	01/03/2020 01:23	01/03/2020 18:46	17,38	1	17,38	CHI
202002190270	SAO JOAO D ALIANCA	JL12218396	SAO JOAO D ALIANCA	29/02/2020 17:49	01/03/2020 20:08	01/03/2020 01:23	01/03/2020 18:46	17,38	7	121,69	CHI
202002190270	SAO JOAO D ALIANCA	JL12218486	SAO JOAO D ALIANCA	29/02/2020 17:49	01/03/2020 20:08	01/03/2020 01:23	01/03/2020 20:08	18,76	2	37,52	CHI
202002190274	PIRES DO RIO	PR12051695	PIRES DO RIO S2	29/02/2020 17:02	29/02/2020 18:38	29/02/2020 17:02	29/02/2020 18:38	1,60	8	12,82	CHI
202002190278	URUACU	640078205	URUACU	29/02/2020 18:23	01/03/2020 04:18	29/02/2020 18:23	01/03/2020 04:18	9,90	1	9,90	CHI
202002190279	ABADIA DE GOIAS	LG31190616	TRINDADE	29/02/2020 18:24	29/02/2020 20:19	29/02/2020 18:24	29/02/2020 20:19	1,91	4	7,66	CHI
202002190282	MORRINHOS	BG21263829	GOIATUBA S2	29/02/2020 18:24	01/03/2020 16:48	29/02/2020 18:24	01/03/2020 16:48	22,39	1	22,39	CHI
202002190283	ALVORADA DO NORTE	AQ12240883LD	IACIARA S2	29/02/2020 18:24	01/03/2020 11:07	29/02/2020 18:24	01/03/2020 11:07	16,71	7	116,94	CHI
202002190289	AGUA LIMPA	RQ12063059RE	VILA CORUMBA	29/02/2020 18:18	29/02/2020 21:47	29/02/2020 18:18	29/02/2020 21:47	3,48	16	55,63	CHI
202002190289	CALDAS NOVAS	RQ12063059RE	VILA CORUMBA	29/02/2020 18:18	29/02/2020 21:47	29/02/2020 18:18	29/02/2020 21:47	3,48	20	69,53	CHI
202002190289	MORRINHOS	RQ12063059RE	VILA CORUMBA	29/02/2020 18:18	29/02/2020 21:47	29/02/2020 18:18	29/02/2020 21:47	3,48	5	17,38	CHI
202002190289	RIO QUENTE	RQ12063059RE	VILA CORUMBA	29/02/2020 18:18	29/02/2020 21:47	29/02/2020 18:18	29/02/2020 21:47	3,48	111	385,91	CHI
202002190290	JANDIAIA	1180011718	PALMEIRAS	29/02/2020 18:27	29/02/2020 21:55	29/02/2020 18:27	29/02/2020 21:55	3,47	1	3,47	CHI
202002190293	CATURAI	GR31004765	TRINDADE	29/02/2020 18:27	01/03/2020 03:53	29/02/2020 18:27	01/03/2020 03:53	9,43	1	9,43	CHI
202002190297	EDEIA	EA21086963	EDEIA	29/02/2020 18:28	01/03/2020 19:00	29/02/2020 18:28	01/03/2020 19:00	24,52	1	24,52	CHI
202002190299	INDIARA	2710031031	EDEIA	29/02/2020 18:29	29/02/2020 23:35	29/02/2020 18:29	29/02/2020 23:35	5,10	1	5,10	CHI
202002190301	ARENOPOLIS	AY12381016	IPORA	29/02/2020 18:03	29/02/2020 21:18	29/02/2020 18:03	29/02/2020 21:18	3,24	45	145,63	CHI
202002190301	PIRANHAS	AY12381016	IPORA	29/02/2020 18:03	29/02/2020 21:18	29/02/2020 18:03	29/02/2020 21:18	3,24	1	3,24	CHI
202002190302	GOIANESIA	GE21026066	GOIANESIA S1	29/02/2020 18:29	01/03/2020 00:40	29/02/2020 18:29	01/03/2020 00:40	6,17	2	12,34	CHI
202002190305	PARAUNA	980027342	PARAUNA	29/02/2020 18:31	01/03/2020 16:40	29/02/2020 18:31	01/03/2020 16:40	22,15	1	22,15	CHI
202002190307	SILVANIA	660005669	VIANOPOLIS	29/02/2020 18:33	29/02/2020 23:29	29/02/2020 18:33	29/02/2020 23:29	4,93	1	4,93	CHI
202002190312	LUZIANIA	120255078	RIO VERMELHO	29/02/2020 18:34	29/02/2020 20:51	29/02/2020 18:34	29/02/2020 20:51	2,27	1	2,27	CHI
202002190315	PORTELANDIA	PW21303806	PARQUE DAS EMAS	29/02/2020 18:34	01/03/2020 09:17	29/02/2020 18:34	01/03/2020 09:17	14,70	1	14,70	CHI
202002190321	AGUAS LINDAS DE GOIAS	LA11382905	AGUAS LINDAS DE GOIAS S2	29/02/2020 18:37	29/02/2020 20:02	29/02/2020 18:37	29/02/2020 20:02	1,42	266	376,76	CHI
202002190322	GOIANIA	10634502	AEROPORTO S3	29/02/2020 18:37	29/02/2020 21:12	29/02/2020 18:37	29/02/2020 21:12	2,58	1	2,58	CHI
202002190323	RIO VERDE	10002751974	RIO VERDE S2	29/02/2020 18:37	01/03/2020 10:00	29/02/2020 18:37	01/03/2020 10:00	15,39	1	15,39	CHI
202002190329	MINACU	IH11187761	MINACU	29/02/2020 18:39	29/02/2020 20:39	29/02/2020 18:39	29/02/2020 20:39	2,00	102	203,52	CHI
202002190334	EDEALINA	1130004378	EDEIA	29/02/2020 18:40	01/03/2020 07:16	29/02/2020 18:40	01/03/2020 07:16	12,59	1	12,59	CHI

202002190337	ITUMBIARA	10029465085	ITUMBIARA VELHA S1	29/02/2020 18:41	29/02/2020 21:47	29/02/2020 18:41	29/02/2020 21:47	3,09	1	3,09	CHI
202002190339	GOIANIA	11720839	CARAJAS S1	29/02/2020 18:41	29/02/2020 20:24	29/02/2020 18:41	29/02/2020 20:24	1,70	1	1,70	CHI
202002190340	MINEIROS	MY21070322	PARQUE DAS EMAS	29/02/2020 18:42	29/02/2020 22:42	29/02/2020 18:42	29/02/2020 22:42	4,00	1	4,00	CHI
202002190343	QUIRINOPOLIS	QI21075285	QUIRINOPOLIS	29/02/2020 18:42	29/02/2020 23:38	29/02/2020 18:42	29/02/2020 23:38	4,92	1	4,92	CHI
202002190349	APARECIDA DE GOIANIA	200063558	INDEPENDENCIA S1	29/02/2020 18:43	29/02/2020 20:50	29/02/2020 18:43	29/02/2020 20:50	2,10	1	2,10	CHI
202002190350	URUTAI	UT21337187	URUTAI	29/02/2020 18:43	29/02/2020 22:29	29/02/2020 18:43	29/02/2020 22:29	3,75	1	3,75	CHI
202002190351	JARAGUA	JA12297944	JARAGUA	29/02/2020 18:43	01/03/2020 00:02	29/02/2020 18:43	01/03/2020 00:02	5,30	11	58,32	CHI
202002190352	CAIAPONIA	CP12260986	MONTIVIDIU T	29/02/2020 15:49	01/03/2020 09:10	29/02/2020 15:49	01/03/2020 09:10	17,36	34	590,38	CHI
202002190356	PONTALINA	PK12000100	PONTALINA	29/02/2020 18:09	29/02/2020 21:34	29/02/2020 18:09	29/02/2020 21:34	3,41	11	37,48	CHI
202002190358	ANAPOLIS	20015628	ANAPOLIS UNIVERSITARIO S2	29/02/2020 18:46	29/02/2020 19:58	29/02/2020 18:46	29/02/2020 19:58	1,20	1	1,20	CHI
202002190365	CRIXAS	CX21181338	SERRA DO OURO	29/02/2020 18:47	29/02/2020 21:04	29/02/2020 18:47	29/02/2020 21:04	2,27	1	2,27	CHI
202002190367	SAO FRANCISCO DE GOIAS	490019810	SAO FRANCISCO DE GOIAS	29/02/2020 18:48	29/02/2020 20:56	29/02/2020 18:48	29/02/2020 20:56	2,13	1	2,13	CHI
202002190368	GOIANESIA	550053359	GOIANESIA S2	29/02/2020 18:48	29/02/2020 20:41	29/02/2020 18:48	29/02/2020 20:41	1,88	1	1,88	CHI
202002190378	MONTES CLAROS DE GOIAS	ME11358458	IPORA	29/02/2020 18:52	29/02/2020 20:35	29/02/2020 18:52	29/02/2020 20:35	1,71	42	71,93	CHI
202002190380	MONTIVIDIU	MV12160710	MONTIVIDIU T	29/02/2020 17:49	02/03/2020 00:42	29/02/2020 17:49	02/03/2020 00:42	30,88	21	648,54	CHI
202002190394	ALTO HORIZONTE	9640008211	SANTA TEREZINHA	29/02/2020 18:54	01/03/2020 10:27	29/02/2020 18:54	01/03/2020 10:27	15,55	1	15,55	CHI
202002190400	SENADOR CANEDO	SW11092646	SENADOR CANEDO	29/02/2020 17:47	29/02/2020 20:56	29/02/2020 17:47	29/02/2020 20:56	3,15	115	361,96	CHI
202002190407	SAO LUIS DE MONTES BELOS	SL11000036	SAO LUIZ DOS MONTES BELOS	29/02/2020 18:58	29/02/2020 22:24	29/02/2020 18:58	29/02/2020 22:24	3,43	146	501,27	CHI
202002190410	SENADOR CANEDO	SW11384961	SENADOR CANEDO	29/02/2020 18:58	29/02/2020 21:39	29/02/2020 18:58	29/02/2020 21:39	2,67	169	451,42	CHI
202002190415	PADRE BERNARDO	PB12376777	PADRE BERNARDO	29/02/2020 19:00	29/02/2020 23:40	29/02/2020 19:00	29/02/2020 23:40	4,66	16	74,59	CHI
202002190418	AGUAS LINDAS DE GOIAS	4830209678	AGUAS LINDAS DE GOIAS S1	29/02/2020 19:01	29/02/2020 21:01	29/02/2020 19:01	29/02/2020 21:01	1,99	1	1,99	CHI
202002190419	FORMOSA	610005558	ITUIQUIRA	29/02/2020 19:02	29/02/2020 20:15	29/02/2020 19:02	29/02/2020 20:15	1,22	1	1,22	CHI
202002190427	CATALAO	CT12250357RE	CATALAO S1	29/02/2020 16:44	01/03/2020 02:05	29/02/2020 16:44	01/03/2020 02:05	9,34	14	130,74	CHI
202002190427	TRES RANCHOS	CT12250357RE	CATALAO S1	29/02/2020 16:44	01/03/2020 02:05	29/02/2020 16:44	01/03/2020 02:05	9,34	1	9,34	CHI
202002190431	GOIANIA	16604374	CARAJAS S1	29/02/2020 19:04	29/02/2020 19:42	29/02/2020 19:04	29/02/2020 19:42	0,62	1	0,62	CHI
202002190439	TRINDADE	TR11053494	TRINDADE	29/02/2020 19:05	29/02/2020 19:53	29/02/2020 19:05	29/02/2020 19:53	0,79	185	146,97	CHI
202002190443	EDEALINA	ED31022485	PONTALINA	29/02/2020 19:07	29/02/2020 23:42	29/02/2020 19:07	29/02/2020 23:42	4,58	1	4,58	CHI
202002190444	APARECIDA DE GOIANIA	16495366	INDEPENDENCIA S1	29/02/2020 19:07	29/02/2020 20:07	29/02/2020 19:07	29/02/2020 20:07	0,99	1	0,99	CHI
202002190452	AGUA LIMPA	AL21113296	VILA CORUMBA	29/02/2020 19:09	01/03/2020 16:02	29/02/2020 19:09	01/03/2020 16:02	20,88	1	20,88	CHI
202002190454	AGUA FRIA DE GOIAS	JL21264711	SAO JOAO D ALIANCA	29/02/2020 19:09	29/02/2020 21:27	29/02/2020 19:09	29/02/2020 21:27	2,29	1	2,29	CHI
202002190456	JATAI	290315270	JATAI S2	29/02/2020 19:09	29/02/2020 22:53	29/02/2020 19:09	29/02/2020 22:53	3,72	1	3,72	CHI
202002190462	GOIANIA	10008783649	MEIA PONTE	29/02/2020 19:11	29/02/2020 20:38	29/02/2020 19:11	29/02/2020 20:38	1,44	1	1,44	CHI
202002190464	MONTE ALEGRE DE GOIAS	MA12233170	SAO DOMINGOS	29/02/2020 19:11	29/02/2020 20:37	29/02/2020 19:11	29/02/2020 20:37	1,42	2	2,85	CHI
202002190471	APARECIDA DE GOIANIA	AP11095065	ANHANGUERA	29/02/2020 19:12	29/02/2020 20:09	29/02/2020 19:12	29/02/2020 20:09	0,94	154	145,10	CHI
202002190476	ALTO PARAISO DE GOIAS	BF21361703	FLORES DE GOIAS	29/02/2020 19:13	01/03/2020 08:07	29/02/2020 19:13	01/03/2020 08:07	12,89	2	25,79	CHI
202002190480	SANTA HELENA DE GOIAS	SH11033711	IPEGUARI	29/02/2020 19:12	29/02/2020 23:49	29/02/2020 19:12	29/02/2020 23:49	4,62	137	632,33	CHI
202002190482	ITAPURANGA	IK12124739	ITAPURANGA	29/02/2020 18:52	29/02/2020 20:54	29/02/2020 18:52	29/02/2020 20:54	2,02	188	380,02	CHI
202002190487	GOIANIA	GN11162459	GOIANIA LESTE S3	29/02/2020 19:16	01/03/2020 00:53	29/02/2020 19:16	01/03/2020 00:53	5,61	22	123,43	CHI
202002190488	NOVO GAMA	NJ11183662	PACAEMBU S1	29/02/2020 19:13	29/02/2020 22:41	29/02/2020 19:13	29/02/2020 22:41	3,47	191	661,82	CHI
202002190490	JUSSARA	1290069843	JUSSARA	29/02/2020 19:17	29/02/2020 22:39	29/02/2020 19:17	29/02/2020 22:39	3,36	1	3,36	CHI
202002190492	PORANGATU	PO12072275	MARA ROSA	29/02/2020 19:17	01/03/2020 00:07	29/02/2020 19:17	01/03/2020 00:07	4,82	1	4,82	CHI
202002190500	BONOPOLIS	BX12165447	SAO MIGUEL DO ARAGUAIA	29/02/2020 19:20	29/02/2020 23:43	29/02/2020 19:20	29/02/2020 23:43	4,38	3	13,14	CHI
202002190516	RIO VERDE	630138576	RIO VERDE S1	29/02/2020 19:24	01/03/2020 11:50	29/02/2020 19:24	01/03/2020 11:50	16,45	1	16,45	CHI
202002190518	NIQUELANDIA	NQ12237500	URUACU	29/02/2020 16:53	29/02/2020 21:38	29/02/2020 16:53	29/02/2020 21:38	4,75	3	14,24	CHI

202002190520	CATALAO	CT12104168	CATALAO S1	29/02/2020 19:25	29/02/2020 22:24	29/02/2020 19:25	29/02/2020 22:24	2,98	4	11,91	CHI
202002190525	ARAGOIANIA	GA21000328	GUAPO S1	29/02/2020 19:26	01/03/2020 09:24	29/02/2020 19:26	01/03/2020 09:24	13,96	1	13,96	CHI
202002190527	CATALAO	1990023256	CATALAO S2	29/02/2020 19:27	29/02/2020 23:51	29/02/2020 19:27	29/02/2020 23:51	4,40	1	4,40	CHI
202002190530	ALTO PARAISO DE GOIAS	BF21231947	FLORES DE GOIAS	29/02/2020 19:27	29/02/2020 21:26	29/02/2020 19:27	29/02/2020 21:26	1,97	1	1,97	CHI
202002190533	PADRE BERNARDO	PB11261452	PADRE BERNARDO	29/02/2020 19:21	29/02/2020 21:39	29/02/2020 19:21	29/02/2020 21:39	2,29	42	95,98	CHI
202002190534	PORANGATU	PO12285222	PORANGATU	29/02/2020 19:29	01/03/2020 17:53	29/02/2020 19:29	01/03/2020 17:53	22,40	14	313,56	CHI
202002190540	VALPARAISO DE GOIAS	2860215081	MARAJOARA	29/02/2020 19:29	29/02/2020 20:21	29/02/2020 19:29	29/02/2020 20:21	0,86	1	0,86	CHI
202002190542	ANICUNS	AC11000013	ANICUNS	29/02/2020 19:29	01/03/2020 13:07	29/02/2020 19:29	01/03/2020 13:07	17,63	146	2574,02	CHI
202002190548	BELA VISTA DE GOIAS	BV21311463	BELA VISTA S1	29/02/2020 19:30	01/03/2020 00:02	29/02/2020 19:30	01/03/2020 00:02	4,52	1	4,52	CHI
202002190551	PIRENOPOLIS	PV12034069	CORUMBA	29/02/2020 19:30	29/02/2020 22:04	29/02/2020 19:30	29/02/2020 22:04	2,55	78	198,99	CHI
202002190554	NEROPOLIS	NR12060061	NEROPOLIS S2	29/02/2020 19:29	29/02/2020 20:35	29/02/2020 19:29	29/02/2020 20:35	1,09	107	116,51	CHI
202002190561	AGUAS LINDAS DE GOIAS	4830039323	AGUAS LINDAS DE GOIAS S1	29/02/2020 19:35	29/02/2020 20:51	29/02/2020 19:35	29/02/2020 20:51	1,26	1	1,26	CHI
202002190565	BONFINOPOLIS	BO21205527	CEPAIGO S2	29/02/2020 19:36	01/03/2020 02:19	29/02/2020 19:36	01/03/2020 02:19	6,72	1	6,72	CHI
202002190569	GOIANIA	11033370	AEROPORTO S1	29/02/2020 19:37	29/02/2020 21:53	29/02/2020 19:37	29/02/2020 21:53	2,27	1	2,27	CHI
202002190571	JATAI	290058843	JATAI S3	29/02/2020 19:37	29/02/2020 22:41	29/02/2020 19:37	29/02/2020 22:41	3,05	1	3,05	CHI
202002190577	GOIANIA	GN11320653	CARAJAS S1	29/02/2020 19:22	29/02/2020 21:11	29/02/2020 19:22	29/02/2020 21:11	1,82	77	139,86	CHI
202002190580	APARECIDA DE GOIANIA	10005028424	INDEPENDENCIA S2	29/02/2020 19:41	29/02/2020 21:10	29/02/2020 19:41	29/02/2020 21:10	1,48	1	1,48	CHI
202002190582	AGUAS LINDAS DE GOIAS	4830054592	AGUAS LINDAS DE GOIAS S1	29/02/2020 19:42	29/02/2020 21:40	29/02/2020 19:42	29/02/2020 21:40	1,96	1	1,96	CHI
202002190583	MATRINCHA	MP11073657	MATRINCHA	29/02/2020 19:24	29/02/2020 22:56	29/02/2020 19:24	29/02/2020 22:56	3,53	71	250,73	CHI
202002190585	GUARINOS	9210000139	SANTA TEREZINHA	29/02/2020 19:42	29/02/2020 23:51	29/02/2020 19:42	29/02/2020 23:51	4,14	1	4,14	CHI
202002190589	CALDAS NOVAS	CN11163531	CALDAS NOVAS S2	29/02/2020 19:33	29/02/2020 21:09	29/02/2020 19:33	29/02/2020 21:09	1,60	201	320,71	CHI
202002190590	APARECIDA DE GOIANIA	200412553	ANHANGUERA	29/02/2020 19:44	29/02/2020 21:03	29/02/2020 19:44	29/02/2020 21:03	1,31	1	1,31	CHI
202002190591	MINACU	IH11063604	MINACU	29/02/2020 18:54	01/03/2020 01:21	29/02/2020 18:54	01/03/2020 01:21	6,44	82	528,08	CHI
202002190596	TRINDADE	40017060	TRINDADE	29/02/2020 19:48	29/02/2020 23:19	29/02/2020 19:48	29/02/2020 23:19	3,52	1	3,52	CHI
202002190597	CACU	CC21214267	CACHOEIRA ALTA	29/02/2020 19:48	01/03/2020 08:19	29/02/2020 19:48	01/03/2020 08:19	12,51	1	12,51	CHI
202002190599	PIRANHAS	1930020652	PIRANHAS	29/02/2020 19:48	01/03/2020 09:45	29/02/2020 19:48	01/03/2020 09:45	13,94	1	13,94	CHI
202002190601	CORUMBAIBA	CI12127541	CATALAO S1	29/02/2020 18:34	01/03/2020 13:25	29/02/2020 18:34	01/03/2020 13:25	18,84	24	452,06	CHI
202002190601	NOVA AURORA	CI12127541	CATALAO S1	29/02/2020 18:34	01/03/2020 13:25	29/02/2020 18:34	01/03/2020 13:25	18,84	8	150,69	CHI
202002190604	GOIANESIA	GE21134027	GOIANESIA S2	29/02/2020 19:49	29/02/2020 21:39	29/02/2020 19:49	29/02/2020 21:39	1,82	3	5,47	CHI
202002190608	COCALZINHO DE GOIAS	CB12028344	COCALZINHO	29/02/2020 19:52	29/02/2020 22:09	29/02/2020 19:52	29/02/2020 22:09	2,28	4	9,13	CHI
202002190614	MINACU	IH12375476	MINACU	29/02/2020 19:54	29/02/2020 21:33	29/02/2020 19:54	29/02/2020 21:33	1,64	48	78,69	CHI
202002190617	NOVA CRIXAS	NA12091692	NOVA CRIXAS	29/02/2020 19:56	01/03/2020 10:42	29/02/2020 19:56	01/03/2020 10:42	14,77	22	324,83	CHI
202002190623	GOIANIA	10963510	CAMPINAS S3	29/02/2020 19:57	29/02/2020 20:26	29/02/2020 19:57	29/02/2020 20:26	0,48	1	0,48	CHI
202002190626	ARENOPOLIS	AY12156761	ARENOPOLIS	29/02/2020 19:58	02/03/2020 18:55	29/02/2020 19:58	01/03/2020 17:37	21,64	5	108,19	CHI
202002190626	ARENOPOLIS	AY12156761	ARENOPOLIS	29/02/2020 19:58	02/03/2020 18:55	01/03/2020 17:37	01/03/2020 21:03	3,43	5	17,17	CHI
202002190626	ARENOPOLIS	AY12156761	ARENOPOLIS	29/02/2020 19:58	02/03/2020 18:55	01/03/2020 21:10	02/03/2020 18:21	21,18	4	84,72	CHI
202002190626	ARENOPOLIS	AY12156761	ARENOPOLIS	29/02/2020 19:58	02/03/2020 18:55	01/03/2020 21:10	02/03/2020 18:55	21,75	1	21,75	CHI
202002190630	ORIZONA	PR12100238	PIRES DO RIO S1	29/02/2020 19:58	29/02/2020 22:01	29/02/2020 19:58	29/02/2020 22:01	2,05	3	6,14	CHI
202002190630	PIRES DO RIO	PR12100238	PIRES DO RIO S1	29/02/2020 19:58	29/02/2020 22:01	29/02/2020 19:58	29/02/2020 22:01	2,05	13	26,61	CHI
202002190633	HEITORAI	HE12099418	ITAPURANGA	29/02/2020 20:03	01/03/2020 08:19	29/02/2020 20:03	01/03/2020 08:19	12,25	38	465,53	CHI
202002190634	SAO LUIS DE MONTES BELOS	500100524	SAO LUIZ DOS MONTES BELOS	29/02/2020 20:04	01/03/2020 10:07	29/02/2020 20:04	01/03/2020 10:07	14,05	1	14,05	CHI
202002190638	BURITINOPOLIS	3610005280	IACIARA S2	29/02/2020 20:04	29/02/2020 22:18	29/02/2020 20:04	29/02/2020 22:18	2,22	1	2,22	CHI
202002190647	PARAUNA	PU21309551	ACREUNA	29/02/2020 20:07	01/03/2020 18:01	29/02/2020 20:07	01/03/2020 18:01	21,88	1	21,88	CHI
202002190648	MORRINHOS	PJ21031711	MORRINHOS	29/02/2020 20:08	29/02/2020 22:45	29/02/2020 20:08	29/02/2020 22:45	2,62	1	2,62	CHI

202002190651	SANTA CRUZ DE GOIAS	BC11012514	PIRES DO RIO S2	29/02/2020 19:53	29/02/2020 21:27	29/02/2020 19:53	29/02/2020 21:27	1,55	64	99,34	CHI
202002190657	EDEIA	1120042681	EDEIA	29/02/2020 20:10	01/03/2020 11:12	29/02/2020 20:10	01/03/2020 11:12	15,03	1	15,03	CHI
202002190658	ITAPACI	SZ12190053LD	ITAPACI	29/02/2020 20:10	01/03/2020 11:54	01/03/2020 08:43	01/03/2020 11:54	3,18	3	9,53	CHI
202002190658	NOVA GLORIA	SZ12190053LD	ITAPACI	29/02/2020 20:10	01/03/2020 11:54	01/03/2020 08:43	01/03/2020 11:54	3,18	1	3,18	CHI
202002190658	SAO LUIZ DO NORTE	SZ12190053LD	ITAPACI	29/02/2020 20:10	01/03/2020 11:54	01/03/2020 08:43	01/03/2020 11:54	3,18	57	181,13	CHI
202002190664	INHUMAS	IN21138806	INHUMAS S2	29/02/2020 20:12	01/03/2020 00:01	29/02/2020 20:12	01/03/2020 00:01	3,80	2	7,60	CHI
202002190673	FIRMINOPOLIS	FR12058252	FIRMINOPOLIS S1	29/02/2020 22:24	01/03/2020 11:26	29/02/2020 22:24	01/03/2020 11:26	13,03	2	26,06	CHI
202002190677	GOIAS	GS12063196	GOIAS	29/02/2020 19:27	01/03/2020 15:50	29/02/2020 19:27	01/03/2020 15:50	20,38	18	366,75	CHI
202002190678	SILVANIA	SV21249290	VIANOPOLIS	29/02/2020 20:17	01/03/2020 14:16	29/02/2020 20:17	01/03/2020 14:16	17,98	1	17,98	CHI
202002190682	PLANALTINA	PI12099511	PLANALTINA	29/02/2020 20:18	01/03/2020 00:27	29/02/2020 20:18	01/03/2020 00:27	4,15	17	70,55	CHI
202002190683	ANAPOLIS	20516988	JUNDIAI S1	29/02/2020 20:18	29/02/2020 22:06	29/02/2020 20:18	29/02/2020 22:06	1,79	1	1,79	CHI
202002190684	JATAI	JT12260451	JATAI S1	29/02/2020 20:18	29/02/2020 22:37	29/02/2020 20:18	29/02/2020 22:37	2,30	3	6,91	CHI
202002190684	SERRANOPOLIS	JT12260451	JATAI S1	29/02/2020 20:18	29/02/2020 22:37	29/02/2020 20:18	29/02/2020 22:37	2,30	1	2,30	CHI
202002190686	JATAI	10018333247	JATAI S2	29/02/2020 20:20	01/03/2020 02:22	29/02/2020 20:20	01/03/2020 02:22	6,03	1	6,03	CHI
202002190688	ANAPOLIS	AN11000008	ANAPOLIS UNIVERSITARIO S2	29/02/2020 20:20	29/02/2020 22:09	29/02/2020 20:20	29/02/2020 22:09	1,81	77	139,09	CHI
202002190689	GOIANIA	12179206	CAMPINAS S2	29/02/2020 20:21	29/02/2020 21:59	29/02/2020 20:21	29/02/2020 21:59	1,62	1	1,62	CHI
202002190690	FAINA	IK12299351	ITAPURANGA	29/02/2020 19:02	29/02/2020 22:39	29/02/2020 19:02	29/02/2020 22:39	3,60	17	61,26	CHI
202002190711	SITIO D ABADIA	SI12302726	IACIARA S2	29/02/2020 20:27	29/02/2020 22:25	29/02/2020 20:27	29/02/2020 22:25	1,97	74	145,49	CHI
202002190713	DOVERLANDIA	DV12259474	CAIAPONIA	29/02/2020 20:29	01/03/2020 02:13	29/02/2020 20:29	01/03/2020 02:13	5,72	38	217,32	CHI
202002190718	MONTE ALEGRE DE GOIAS	MA12071358	SAO DOMINGOS	29/02/2020 20:32	01/03/2020 04:06	29/02/2020 20:32	01/03/2020 04:06	7,56	533	4031,11	CHI
202002190729	PADRE BERNARDO	PB11277156	PADRE BERNARDO	29/02/2020 20:38	29/02/2020 22:43	29/02/2020 20:38	29/02/2020 22:43	2,08	65	134,93	CHI
202002190737	MONTE ALEGRE DE GOIAS	MA12211597	SAO DOMINGOS	29/02/2020 20:42	01/03/2020 07:55	29/02/2020 20:42	01/03/2020 07:55	11,21	10	112,14	CHI
202002190738	ADELANDIA	DN11160989	FIRMINOPOLIS S2	29/02/2020 20:32	01/03/2020 00:48	29/02/2020 20:32	01/03/2020 00:48	4,26	45	191,49	CHI
202002190740	PIRENOPOLIS	OV12115767	NEROPOLIS S1	29/02/2020 20:44	01/03/2020 03:08	29/02/2020 20:44	01/03/2020 03:08	6,40	22	140,75	CHI
202002190742	JATAI	JT12353687	JATAI S1	29/02/2020 20:45	01/03/2020 10:20	29/02/2020 20:45	01/03/2020 10:20	13,58	1	13,58	CHI
202002190748	GOIANIA	10001831079	REAL S1	29/02/2020 20:48	29/02/2020 22:18	29/02/2020 20:48	29/02/2020 22:18	1,49	1	1,49	CHI
202002190752	PIRENOPOLIS	PV31114223	SAO FRANCISCO DE GOIAS	29/02/2020 20:49	29/02/2020 23:46	29/02/2020 20:49	29/02/2020 23:46	2,94	1	2,94	CHI
202002190755	GOIANIA	16870724	FERROVIARIO S3	29/02/2020 20:51	29/02/2020 23:26	29/02/2020 20:51	29/02/2020 23:26	2,57	1	2,57	CHI
202002190759	JATAI	JT12209819	JATAI S1	29/02/2020 20:53	01/03/2020 02:00	29/02/2020 20:53	01/03/2020 02:00	5,11	10	51,10	CHI
202002190760	JOVIANIA	VI12208231RE	VICENTINOPOLIS	29/02/2020 14:51	01/03/2020 11:01	29/02/2020 14:51	01/03/2020 00:58	10,11	13	131,44	CHI
202002190760	PONTALINA	VI12208231RE	VICENTINOPOLIS	29/02/2020 14:51	01/03/2020 11:01	29/02/2020 14:51	01/03/2020 00:58	10,11	25	252,76	CHI
202002190760	VICENTINOPOLIS	VI12208231RE	VICENTINOPOLIS	29/02/2020 14:51	01/03/2020 11:01	29/02/2020 14:51	01/03/2020 00:58	10,11	29	293,21	CHI
202002190760	JOVIANIA	VI12208231LD	VICENTINOPOLIS	29/02/2020 14:51	01/03/2020 11:01	01/03/2020 00:58	01/03/2020 11:01	10,04	22	220,98	CHI
202002190760	PONTALINA	VI12208231LD	VICENTINOPOLIS	29/02/2020 14:51	01/03/2020 11:01	01/03/2020 00:58	01/03/2020 11:01	10,04	24	241,07	CHI
202002190760	VICENTINOPOLIS	VI12208231LD	VICENTINOPOLIS	29/02/2020 14:51	01/03/2020 11:01	01/03/2020 00:58	01/03/2020 11:01	10,04	31	311,39	CHI
202002190762	ANAPOLIS	21297060	JUNDIAI S1	29/02/2020 20:55	29/02/2020 22:48	29/02/2020 20:55	29/02/2020 22:48	1,87	1	1,87	CHI
202002190766	DIORAMA	ME12023292	IPORA	29/02/2020 20:56	29/02/2020 22:43	29/02/2020 20:56	29/02/2020 22:43	1,78	6	10,66	CHI
202002190766	MONTES CLAROS DE GOIAS	ME12023292	IPORA	29/02/2020 20:56	29/02/2020 22:43	29/02/2020 20:56	29/02/2020 22:43	1,78	3	5,33	CHI
202002190767	CACU	1140031858	CACHOEIRA ALTA	29/02/2020 20:57	01/03/2020 09:07	29/02/2020 20:57	01/03/2020 09:07	12,18	1	12,18	CHI
202002190771	GOIAS	GS12014796	MATRINCHA	29/02/2020 20:46	01/03/2020 02:06	29/02/2020 20:46	01/03/2020 02:06	5,32	94	500,39	CHI
202002190773	PIRENOPOLIS	PV21230710	SAO FRANCISCO DE GOIAS	29/02/2020 20:59	29/02/2020 23:14	29/02/2020 20:59	29/02/2020 23:14	2,24	2	4,47	CHI
202002190775	FLORES DE GOIAS	FB11130075	IACIARA S2	29/02/2020 21:00	29/02/2020 23:21	29/02/2020 21:00	29/02/2020 23:21	2,33	219	511,06	CHI
202002190776	SAO DOMINGOS	SD12161809	SAO DOMINGOS	29/02/2020 11:32	01/03/2020 15:35	29/02/2020 11:41	01/03/2020 15:35	27,90	12	334,85	CHI
202002190778	FIRMINOPOLIS	TV21098072	FIRMINOPOLIS S1	29/02/2020 21:03	29/02/2020 23:19	29/02/2020 21:03	29/02/2020 23:19	2,27	1	2,27	CHI

202002190783	FORMOSA	FA11180623	ITUIQUIRA	29/02/2020 21:04	29/02/2020 21:40	29/02/2020 21:04	29/02/2020 21:40	0,59	208	122,72	CHI
202002190801	ARUANA	AK21201046	MOZARLANDIA	29/02/2020 21:17	01/03/2020 13:35	29/02/2020 21:17	01/03/2020 13:35	16,28	1	16,28	CHI
202002190802	JOVIANIA	570002321	GOIATUBA S1	29/02/2020 21:18	01/03/2020 12:58	29/02/2020 21:18	01/03/2020 12:58	15,68	1	15,68	CHI
202002190820	HIDROLANDIA	HD12389419	CEPAIGO S2	29/02/2020 21:27	01/03/2020 11:14	29/02/2020 21:27	01/03/2020 11:14	13,77	3	41,32	CHI
202002190828	ANAPOLIS	AN11130707	JUNDIAI S1	29/02/2020 21:33	29/02/2020 22:36	29/02/2020 21:33	29/02/2020 22:36	1,04	180	187,10	CHI
202002190831	ALEXANIA	AX21144174	ALEXANIA	29/02/2020 21:34	29/02/2020 23:02	29/02/2020 21:34	29/02/2020 23:02	1,45	1	1,45	CHI
202002190834	SANTO ANTONIO DO DESCOBERTO	2210137166	ALEXANIA	29/02/2020 21:40	29/02/2020 22:39	29/02/2020 21:40	29/02/2020 22:39	0,97	1	0,97	CHI
202002190837	ITUMBIARA	IT21381126	BOM JESUS DE GOIAS	29/02/2020 21:41	01/03/2020 08:46	29/02/2020 21:41	01/03/2020 08:46	11,08	1	11,08	CHI
202002190839	NOVO BRASIL	3080000831	JUSSARA	29/02/2020 21:41	01/03/2020 14:50	29/02/2020 21:41	01/03/2020 14:50	17,14	1	17,14	CHI
202002190841	SILVANIA	SV21197185	VIANOPOLIS	29/02/2020 21:42	01/03/2020 14:48	29/02/2020 21:42	01/03/2020 14:48	17,10	1	17,10	CHI
202002190847	GOIANIA	GN11131188	FERROVIARIO S1	29/02/2020 21:46	01/03/2020 00:45	29/02/2020 21:46	01/03/2020 00:45	2,97	101	299,83	CHI
202002190848	SAO JOAO DA PARAUNA	RP21349327	FIRMINOPOLIS S1	29/02/2020 21:47	01/03/2020 07:33	29/02/2020 21:47	01/03/2020 07:33	9,76	2	19,52	CHI
202002190852	NOVA CRIXAS	NA12334349	NOVA CRIXAS	01/03/2020 05:08	01/03/2020 11:12	01/03/2020 05:08	01/03/2020 11:12	6,07	86	521,66	CHI
202002190860	FORMOSA	FA11211482	ITUIQUIRA	29/02/2020 21:58	01/03/2020 00:03	29/02/2020 21:58	01/03/2020 00:03	2,07	44	90,96	CHI
202002190861	PALMEIRAS DE GOIAS	PL12034684	PALMEIRAS	29/02/2020 21:56	01/03/2020 01:32	29/02/2020 21:56	01/03/2020 01:32	3,59	13	46,69	CHI
202002190863	MORRINHOS	MR12402501	GOIATUBA S1	29/02/2020 22:00	01/03/2020 09:43	29/02/2020 22:00	01/03/2020 09:43	11,72	46	539,09	CHI
202002190873	FORMOSA	10004078304	ITUIQUIRA	29/02/2020 22:07	01/03/2020 01:33	29/02/2020 22:07	01/03/2020 01:33	3,42	1	3,42	CHI
202002190875	PADRE BERNARDO	10021204118	PADRE BERNARDO	29/02/2020 22:11	29/02/2020 22:43	29/02/2020 22:11	29/02/2020 22:43	0,53	1	0,53	CHI
202002190876	SANCLERLANDIA	SC12005463	SAO LUIZ DOS MONTES BELOS	29/02/2020 22:12	01/03/2020 10:22	29/02/2020 22:12	01/03/2020 10:22	12,16	13	158,11	CHI
202002190876	SAO LUIS DE MONTES BELOS	SC12005463	SAO LUIZ DOS MONTES BELOS	29/02/2020 22:12	01/03/2020 10:22	29/02/2020 22:12	01/03/2020 10:22	12,16	19	231,08	CHI
202002190878	AMORINOPOLIS	AM21193757	IPORA	29/02/2020 22:13	01/03/2020 01:32	29/02/2020 22:13	01/03/2020 01:32	3,31	1	3,31	CHI
202002190881	INHUMAS	IN12253101	INHUMAS S2	29/02/2020 22:15	01/03/2020 00:11	29/02/2020 22:15	01/03/2020 00:11	1,93	49	94,46	CHI
202002190882	BONOPOLIS	BX12233111	SAO MIGUEL DO ARAGUAIA	29/02/2020 22:15	01/03/2020 15:22	29/02/2020 22:15	01/03/2020 15:22	17,11	3	51,32	CHI
202002190882	NOVO PLANALTO	BX12233111	SAO MIGUEL DO ARAGUAIA	29/02/2020 22:15	01/03/2020 15:22	29/02/2020 22:15	01/03/2020 15:22	17,11	1	17,11	CHI
202002190883	AURILANDIA	AI21306954	FIRMINOPOLIS S2	29/02/2020 22:17	01/03/2020 07:35	29/02/2020 22:17	01/03/2020 07:35	9,29	1	9,29	CHI
202002190885	CAMPO ALEGRE DE GOIAS	6944720	CAMPO ALEGRE DE GOIAS	01/03/2020 06:40	01/03/2020 11:05	01/03/2020 06:40	01/03/2020 11:05	4,41	23	101,35	CHI
202002190894	AURILANDIA	SL12003813	SAO LUIZ DOS MONTES BELOS	29/02/2020 22:30	01/03/2020 12:22	29/02/2020 22:30	01/03/2020 12:22	13,86	6	83,18	CHI
202002190894	FIRMINOPOLIS	SL12003813	SAO LUIZ DOS MONTES BELOS	29/02/2020 22:30	01/03/2020 12:22	29/02/2020 22:30	01/03/2020 12:22	13,86	2	27,73	CHI
202002190894	SANCLERLANDIA	SL12003813	SAO LUIZ DOS MONTES BELOS	29/02/2020 22:30	01/03/2020 12:22	29/02/2020 22:30	01/03/2020 12:22	13,86	1	13,86	CHI
202002190894	SAO LUIS DE MONTES BELOS	SL12003813	SAO LUIZ DOS MONTES BELOS	29/02/2020 22:30	01/03/2020 12:22	29/02/2020 22:30	01/03/2020 12:22	13,86	20	277,27	CHI
202002190895	PANAMA	PX12171365	GOIATUBA S1	29/02/2020 22:30	01/03/2020 08:28	29/02/2020 22:30	01/03/2020 08:28	9,95	6	59,71	CHI
202002190900	SERRANOPOLIS	SX11147543	JATAI S1	29/02/2020 22:40	01/03/2020 07:51	29/02/2020 22:40	01/03/2020 07:51	9,17	91	834,92	CHI
202002190904	CALDAS NOVAS	CN21204423	SERRA DE CALDAS	29/02/2020 22:41	01/03/2020 13:10	29/02/2020 22:41	01/03/2020 12:30	13,82	1	13,82	CHI
202002190904	CALDAS NOVAS	8060479	SERRA DE CALDAS	29/02/2020 22:41	01/03/2020 13:10	29/02/2020 22:41	01/03/2020 13:10	14,48	1	14,48	CHI
202002190907	PALESTINA DE GOIAS	PY21221783	ARENOPOLIS	29/02/2020 22:42	01/03/2020 10:51	29/02/2020 22:42	01/03/2020 10:51	12,15	1	12,15	CHI
202002190910	GOIANIA	10006605174	REAL S1	29/02/2020 22:45	29/02/2020 23:34	29/02/2020 22:45	29/02/2020 23:34	0,82	1	0,82	CHI
202002190912	ANICUNS	AC12090273	ANICUNS	29/02/2020 22:45	01/03/2020 03:11	29/02/2020 22:45	01/03/2020 03:11	4,43	22	97,36	CHI
202002190916	SAO MIGUEL DO PASSA QUATRO	VN12117212	PIRES DO RIO S2	29/02/2020 18:10	01/03/2020 08:25	29/02/2020 18:10	01/03/2020 08:25	14,24	2	28,48	CHI
202002190916	VIANOPOLIS	VN12117212	PIRES DO RIO S2	29/02/2020 18:10	01/03/2020 08:25	29/02/2020 18:10	01/03/2020 08:25	14,24	37	526,85	CHI
202002190919	PIRACANJUBA	PJ21010505	ROCHEDO	29/02/2020 22:55	01/03/2020 02:35	29/02/2020 22:55	01/03/2020 02:35	3,67	1	3,67	CHI
202002190920	PONTALINA	210019487	PONTALINA	29/02/2020 22:58	01/03/2020 15:04	29/02/2020 22:58	01/03/2020 15:04	16,09	1	16,09	CHI
202002190922	FAZENDA NOVA	FN21277939	JUSSARA	29/02/2020 23:01	01/03/2020 07:46	29/02/2020 23:01	01/03/2020 07:46	8,74	1	8,74	CHI
202002190925	PETROLINA DE GOIAS	PV12302405	SAO FRANCISCO DE GOIAS	29/02/2020 22:46	29/02/2020 23:55	29/02/2020 22:46	29/02/2020 23:55	1,15	5	5,76	CHI
202002190925	PIRENOPOLIS	PV12302405	SAO FRANCISCO DE GOIAS	29/02/2020 22:46	29/02/2020 23:55	29/02/2020 22:46	29/02/2020 23:55	1,15	57	65,64	CHI

202002190925	SAO FRANCISCO DE GOIAS	PV12302405	SAO FRANCISCO DE GOIAS	29/02/2020 22:46	29/02/2020 23:55	29/02/2020 22:46	29/02/2020 23:55	1,15	20	23,03	CHI
202002190927	CRIXAS	CX12380748	SERRA DO OURO	29/02/2020 23:10	02/03/2020 20:13	02/03/2020 12:51	02/03/2020 17:55	5,06	15	75,93	CHI
202002190927	CRIXAS	CX12181532	SERRA DO OURO	29/02/2020 23:10	02/03/2020 20:13	29/02/2020 23:10	02/03/2020 20:13	45,05	10	450,46	CHI
202002190930	SAO MIGUEL DO ARAGUAIA	SM12031421	SAO MIGUEL DO ARAGUAIA	29/02/2020 23:13	01/03/2020 03:07	29/02/2020 23:13	01/03/2020 03:07	3,89	18	70,06	CHI
202002190935	ARAGARCAS	AG21000014	ARAGARCAS	29/02/2020 23:17	01/03/2020 20:55	29/02/2020 23:17	01/03/2020 20:55	21,62	1	21,62	CHI
202002190937	FORMOSA	FA12254223	ITUIQUIRA	29/02/2020 23:19	01/03/2020 00:48	29/02/2020 23:19	01/03/2020 00:48	1,47	23	33,78	CHI
202002190939	GOIANIA	12461581	CAMPINAS S1	29/02/2020 23:26	01/03/2020 00:59	29/02/2020 23:26	01/03/2020 00:59	1,55	1	1,55	CHI
202002190941	GOIANDIRA	2010013573	CATALAO S1	29/02/2020 23:27	01/03/2020 02:24	29/02/2020 23:27	01/03/2020 02:24	2,94	1	2,94	CHI
202002190942	NOVO GAMA	NJ11183662	PACAEMBU S1	29/02/2020 23:28	01/03/2020 01:56	29/02/2020 23:28	01/03/2020 01:56	2,47	191	470,87	CHI
202002190943	CARMO DO RIO VERDE	IK12311305	ITAPURANGA	29/02/2020 22:05	01/03/2020 01:17	29/02/2020 22:05	01/03/2020 01:17	3,20	4	12,79	CHI
202002190943	ITAPURANGA	IK12311305	ITAPURANGA	29/02/2020 22:05	01/03/2020 01:17	29/02/2020 22:05	01/03/2020 01:17	3,20	30	95,90	CHI
202002190944	GOIANIA	12449635	CAMPINAS S2	29/02/2020 23:29	01/03/2020 00:35	29/02/2020 23:29	01/03/2020 00:35	1,09	1	1,09	CHI
202002190948	TRINDADE	10016416994	TRINDADE	29/02/2020 23:33	01/03/2020 01:42	29/02/2020 23:33	01/03/2020 01:42	2,13	1	2,13	CHI
202002190953	RIO VERDE	RV12207146	MONTIVIDIU T	29/02/2020 23:34	01/03/2020 08:32	29/02/2020 23:34	01/03/2020 08:32	8,96	22	197,12	CHI
202002190955	CRIXAS	RB12114265	RUBIATABA	29/02/2020 22:40	01/03/2020 05:02	29/02/2020 22:40	01/03/2020 05:02	6,35	1	6,35	CHI
202002190955	NOVA AMERICA	RB12114265	RUBIATABA	29/02/2020 22:40	01/03/2020 05:02	29/02/2020 22:40	01/03/2020 05:02	6,35	18	114,38	CHI
202002190955	RUBIATABA	RB12114265	RUBIATABA	29/02/2020 22:40	01/03/2020 05:02	29/02/2020 22:40	01/03/2020 05:02	6,35	82	521,09	CHI
202002190957	FORMOSA	FA11218307	SAO JOAO D ALIANCA	29/02/2020 23:44	01/03/2020 16:05	29/02/2020 23:44	01/03/2020 16:05	16,35	1	16,35	CHI
202002190960	ANAPOLIS	AN11166251	JUNDIAI S1	29/02/2020 23:50	01/03/2020 02:29	29/02/2020 23:50	01/03/2020 02:29	2,64	96	253,15	CHI
202002190963	BELA VISTA DE GOIAS	BV12011067	BELA VISTA S1	29/02/2020 23:58	01/03/2020 07:59	29/02/2020 23:58	01/03/2020 07:59	8,01	29	232,22	CHI
202002190964	APARECIDA DE GOIANIA	AP12004870	ATLANTICO S1	29/02/2020 23:59	01/03/2020 04:06	29/02/2020 23:59	01/03/2020 01:50	1,85	458	846,15	CHI
202002190964	APARECIDA DE GOIANIA	AP11004867	ATLANTICO S1	29/02/2020 23:59	01/03/2020 04:06	01/03/2020 02:10	01/03/2020 03:53	1,72	74	127,10	CHI
202002190964	APARECIDA DE GOIANIA	AP12004870	ATLANTICO S1	29/02/2020 23:59	01/03/2020 04:06	01/03/2020 02:53	01/03/2020 04:06	1,23	383	469,92	CHI
202002191142	DAVINOPOLIS	IO12000007	CATALAO S1	28/02/2020 09:54	28/02/2020 18:03	28/02/2020 09:54	28/02/2020 18:03	8,14	3	24,43	CHI
202002191147	CALDAS NOVAS	01240414	MORRINHOS	29/02/2020 19:03	01/03/2020 00:55	29/02/2020 19:03	29/02/2020 20:24	1,34	2	2,68	CHI
202002191147	MORRINHOS	01240414	MORRINHOS	29/02/2020 19:03	01/03/2020 00:55	29/02/2020 19:03	29/02/2020 20:24	1,34	237	318,17	CHI
202002191147	MORRINHOS	01240414	MORRINHOS	29/02/2020 19:03	01/03/2020 00:55	29/02/2020 19:03	29/02/2020 20:24	1,34	364	488,67	CHI
202002191147	MORRINHOS	01240414	MORRINHOS	29/02/2020 19:03	01/03/2020 00:55	29/02/2020 19:03	29/02/2020 20:24	1,34	75	100,69	CHI
202002191147	RIO QUENTE	01240414	MORRINHOS	29/02/2020 19:03	01/03/2020 00:55	29/02/2020 19:03	29/02/2020 20:24	1,34	20	26,85	CHI
202002191147	MORRINHOS	01240414	MORRINHOS	29/02/2020 19:03	01/03/2020 00:55	29/02/2020 19:03	01/03/2020 00:55	5,86	13	76,17	CHI
202002191147	CALDAS NOVAS	01240414	MORRINHOS	29/02/2020 19:03	01/03/2020 00:55	29/02/2020 20:25	01/03/2020 00:55	4,49	2	8,98	CHI
202002191147	MORRINHOS	01240414	MORRINHOS	29/02/2020 19:03	01/03/2020 00:55	29/02/2020 20:25	01/03/2020 00:55	4,49	237	1064,00	CHI
202002191147	MORRINHOS	01240414	MORRINHOS	29/02/2020 19:03	01/03/2020 00:55	29/02/2020 20:25	01/03/2020 00:55	4,49	364	1634,16	CHI
202002191147	MORRINHOS	01240414	MORRINHOS	29/02/2020 19:03	01/03/2020 00:55	29/02/2020 20:25	01/03/2020 00:55	4,49	75	336,71	CHI
202002191147	RIO QUENTE	01240414	MORRINHOS	29/02/2020 19:03	01/03/2020 00:55	29/02/2020 20:25	01/03/2020 00:55	4,49	20	89,79	CHI
202002191179	NIQUELANDIA	NQ10400422	URUACU	28/02/2020 17:49	01/03/2020 01:37	28/02/2020 17:49	28/02/2020 18:21	0,53	1160	611,58	CHI
202002191179	NIQUELANDIA	NQ10400422	URUACU	28/02/2020 17:49	01/03/2020 01:37	28/02/2020 18:23	28/02/2020 18:34	0,18	1160	211,38	CHI
202002191179	NIQUELANDIA	NQ10400422	URUACU	28/02/2020 17:49	01/03/2020 01:37	28/02/2020 17:49	29/02/2020 16:57	23,13	19	439,53	CHI
202002191179	NIQUELANDIA	NQ10400422	URUACU	28/02/2020 17:49	01/03/2020 01:37	29/02/2020 13:18	29/02/2020 17:36	4,30	10	42,96	CHI
202002191179	NIQUELANDIA	NQ12221654LD	URUACU	28/02/2020 17:49	01/03/2020 01:37	29/02/2020 13:18	29/02/2020 18:34	5,28	20	105,51	CHI
202002191179	NIQUELANDIA	NQ10400422	URUACU	28/02/2020 17:49	01/03/2020 01:37	29/02/2020 20:02	29/02/2020 20:22	0,34	30	10,06	CHI
202002191179	NIQUELANDIA	NQ10400422	URUACU	28/02/2020 17:49	01/03/2020 01:37	29/02/2020 13:18	01/03/2020 01:37	12,31	374	4605,81	CHI
202002191179	NIQUELANDIA	NQ13235629	URUACU	28/02/2020 17:49	01/03/2020 01:37	29/02/2020 13:18	01/03/2020 01:37	12,31	756	9310,14	CHI
202002191198	SANTO ANTONIO DO DESCOBERTO	SN12059822LD	MARAJOARA	29/02/2020 14:05	01/03/2020 01:15	29/02/2020 14:05	01/03/2020 00:42	10,63	5	53,13	CHI

202002191198	ALEXANIA	SN13286432	MARAJOARA	29/02/2020 14:05	01/03/2020 01:15	01/03/2020 00:42	01/03/2020 01:15	0,55	5	2,73	CHI
202002191198	DISTRITO FEDERAL	SN13286432	MARAJOARA	29/02/2020 14:05	01/03/2020 01:15	01/03/2020 00:42	01/03/2020 01:15	0,55	3	1,64	CHI
202002191198	SANTO ANTONIO DO DESCOBERTO	SN13286432	MARAJOARA	29/02/2020 14:05	01/03/2020 01:15	01/03/2020 00:42	01/03/2020 01:15	0,55	512	279,18	CHI
202002191199	EDEALINA	EA21034060	VICENTINOPOLIS	27/02/2020 21:14	28/02/2020 20:36	27/02/2020 21:14	28/02/2020 20:36	23,36	1	23,36	CHI
202002191261	ANAPOLIS	AN12205789	ANAPOLIS UNIVERSITARIO S2	28/02/2020 09:22	29/02/2020 03:15	28/02/2020 09:22	28/02/2020 11:59	2,61	269	703,14	CHI
202002191261	ANAPOLIS	AN12205789	ANAPOLIS UNIVERSITARIO S2	28/02/2020 09:22	29/02/2020 03:15	28/02/2020 12:30	28/02/2020 13:05	0,60	269	160,88	CHI
202002191261	ANAPOLIS	AN12205789	ANAPOLIS UNIVERSITARIO S2	28/02/2020 09:22	29/02/2020 03:15	28/02/2020 20:20	28/02/2020 21:13	0,89	269	240,68	CHI
202002191261	ANAPOLIS	AN11043967	ANAPOLIS UNIVERSITARIO S2	28/02/2020 09:22	29/02/2020 03:15	29/02/2020 00:15	29/02/2020 03:10	2,92	126	367,99	CHI
202002191261	ANAPOLIS	AN11393140	ANAPOLIS UNIVERSITARIO S2	28/02/2020 09:22	29/02/2020 03:15	28/02/2020 09:22	29/02/2020 03:15	17,89	1	17,89	CHI
202002191277	URUTAI	UT12016932RE	URUTAI	28/02/2020 11:41	03/03/2020 15:11	28/02/2020 11:41	01/03/2020 17:17	53,59	5	267,97	CHI
202002191277	URUTAI	UT12000608	URUTAI	28/02/2020 11:41	03/03/2020 15:11	01/03/2020 17:17	02/03/2020 09:03	15,76	26	409,80	CHI
202002191277	URUTAI	UT12000608	URUTAI	28/02/2020 11:41	03/03/2020 15:11	02/03/2020 12:15	02/03/2020 12:19	0,06	6	0,38	CHI
202002191277	URUTAI	UT12000608	URUTAI	28/02/2020 11:41	03/03/2020 15:11	02/03/2020 12:15	02/03/2020 16:10	3,91	20	78,14	CHI
202002191277	URUTAI	UT12016932RE	URUTAI	28/02/2020 11:41	03/03/2020 15:11	02/03/2020 16:49	03/03/2020 01:59	9,17	1	9,17	CHI
202002191277	URUTAI	UT12016932RE	URUTAI	28/02/2020 11:41	03/03/2020 15:11	02/03/2020 16:49	03/03/2020 12:13	19,41	1	19,41	CHI
202002191277	URUTAI	UT12016932RE	URUTAI	28/02/2020 11:41	03/03/2020 15:11	03/03/2020 10:05	03/03/2020 12:13	2,14	1	2,14	CHI
202002191277	IPAMERI	UT12016932RE	URUTAI	28/02/2020 11:41	03/03/2020 15:11	28/02/2020 11:41	03/03/2020 13:41	97,99	3	293,98	CHI
202002191277	URUTAI	UT12016932RE	URUTAI	28/02/2020 11:41	03/03/2020 15:11	02/03/2020 16:49	03/03/2020 15:11	22,37	3	67,10	CHI
202002191277	IPAMERI	UT12016932RE	URUTAI	28/02/2020 11:41	03/03/2020 15:11	03/03/2020 14:07	03/03/2020 15:11	1,06	3	3,19	CHI
202002191277	URUTAI	UT12016932RE	URUTAI	28/02/2020 11:41	03/03/2020 15:11	03/03/2020 14:07	03/03/2020 15:11	1,06	2	2,13	CHI
202002191289	PORANGATU	4590001112	PORANGATU	29/02/2020 19:29	01/03/2020 17:53	29/02/2020 19:29	01/03/2020 17:53	22,40	1	22,40	CHI
202002191299	IPAMERI	IP12068500	CRISTALINA S2	28/02/2020 06:48	29/02/2020 02:18	28/02/2020 06:48	28/02/2020 10:14	3,43	54	185,47	CHI
202002191299	IPAMERI	IP12068500	CRISTALINA S2	28/02/2020 06:48	29/02/2020 02:18	28/02/2020 06:48	29/02/2020 02:18	19,49	3	58,48	CHI
202002191308	CORUMBAIBA	CN10400582	VILA CORUMBA	28/02/2020 16:17	02/03/2020 16:38	28/02/2020 16:17	28/02/2020 18:51	2,57	3452	8873,56	CHI
202002191308	CORUMBAIBA	CN10400582	VILA CORUMBA	28/02/2020 16:17	02/03/2020 16:38	28/02/2020 16:17	28/02/2020 18:51	2,57	1010	2596,26	CHI
202002191308	CORUMBAIBA	CN10400582	VILA CORUMBA	28/02/2020 16:17	02/03/2020 16:38	28/02/2020 16:17	28/02/2020 18:51	2,57	60	154,23	CHI
202002191308	NOVA AURORA	CN10400582	VILA CORUMBA	28/02/2020 16:17	02/03/2020 16:38	28/02/2020 16:17	28/02/2020 18:51	2,57	7	17,99	CHI
202002191308	CALDAS NOVAS	MG10406644	VILA CORUMBA	28/02/2020 16:17	02/03/2020 16:38	28/02/2020 19:00	28/02/2020 19:41	0,69	6	4,16	CHI
202002191308	MARZAGAO	MG10406644	VILA CORUMBA	28/02/2020 16:17	02/03/2020 16:38	28/02/2020 19:00	28/02/2020 19:41	0,69	7	4,85	CHI
202002191308	CORUMBAIBA	MG10406644	VILA CORUMBA	28/02/2020 16:17	02/03/2020 16:38	28/02/2020 19:00	28/02/2020 19:42	0,71	3453	2449,71	CHI
202002191308	CORUMBAIBA	MG10406644	VILA CORUMBA	28/02/2020 16:17	02/03/2020 16:38	28/02/2020 19:00	28/02/2020 19:42	0,71	1010	716,54	CHI
202002191308	CORUMBAIBA	CN10404201	VILA CORUMBA	28/02/2020 16:17	02/03/2020 16:38	28/02/2020 19:00	28/02/2020 19:42	0,71	59	41,86	CHI
202002191308	NOVA AURORA	MG10406644	VILA CORUMBA	28/02/2020 16:17	02/03/2020 16:38	28/02/2020 19:00	28/02/2020 19:42	0,71	7	4,97	CHI
202002191308	CORUMBAIBA	CI12381139LD	VILA CORUMBA	28/02/2020 16:17	02/03/2020 16:38	28/02/2020 19:00	28/02/2020 21:10	2,16	1	2,16	CHI
202002191308	AGUA LIMPA	CN10396194	VILA CORUMBA	28/02/2020 16:17	02/03/2020 16:38	29/02/2020 18:38	29/02/2020 18:43	0,10	16	1,58	CHI
202002191308	AGUA LIMPA	CN10396194	VILA CORUMBA	28/02/2020 16:17	02/03/2020 16:38	29/02/2020 18:38	29/02/2020 18:43	0,10	8	0,79	CHI
202002191308	CALDAS NOVAS	CN10396194	VILA CORUMBA	28/02/2020 16:17	02/03/2020 16:38	29/02/2020 18:38	29/02/2020 18:43	0,10	20	1,98	CHI
202002191308	CALDAS NOVAS	CN10396194	VILA CORUMBA	28/02/2020 16:17	02/03/2020 16:38	29/02/2020 18:38	29/02/2020 18:43	0,10	59	5,83	CHI
202002191308	CORUMBAIBA	CN10396194	VILA CORUMBA	28/02/2020 16:17	02/03/2020 16:38	29/02/2020 18:38	29/02/2020 18:43	0,10	39	3,86	CHI
202002191308	CORUMBAIBA	CN10396194	VILA CORUMBA	28/02/2020 16:17	02/03/2020 16:38	29/02/2020 18:38	29/02/2020 18:43	0,10	60	5,93	CHI
202002191308	MARZAGAO	CN10396194	VILA CORUMBA	28/02/2020 16:17	02/03/2020 16:38	29/02/2020 18:38	29/02/2020 18:43	0,10	1094	108,18	CHI
202002191308	MARZAGAO	CN10396194	VILA CORUMBA	28/02/2020 16:17	02/03/2020 16:38	29/02/2020 18:38	29/02/2020 18:43	0,10	36	3,56	CHI
202002191308	MARZAGAO	CN10396194	VILA CORUMBA	28/02/2020 16:17	02/03/2020 16:38	29/02/2020 18:38	29/02/2020 18:43	0,10	47	4,65	CHI
202002191308	RIO QUENTE	CN10396194	VILA CORUMBA	28/02/2020 16:17	02/03/2020 16:38	29/02/2020 18:38	29/02/2020 18:43	0,10	4	0,40	CHI

202002191308	RIO QUENTE	CN10396194	VILA CORUMBA	28/02/2020 16:17	02/03/2020 16:38	29/02/2020 18:38	29/02/2020 18:43	0,10	1	0,10	CHI
202002191308	AGUA LIMPA	CN10396194	VILA CORUMBA	28/02/2020 16:17	02/03/2020 16:38	29/02/2020 18:49	29/02/2020 19:06	0,29	16	4,65	CHI
202002191308	AGUA LIMPA	CN10396194	VILA CORUMBA	28/02/2020 16:17	02/03/2020 16:38	29/02/2020 18:49	29/02/2020 19:06	0,29	869	252,49	CHI
202002191308	AGUA LIMPA	CN10396194	VILA CORUMBA	28/02/2020 16:17	02/03/2020 16:38	29/02/2020 18:49	29/02/2020 19:06	0,29	136	39,52	CHI
202002191308	AGUA LIMPA	CN10396194	VILA CORUMBA	28/02/2020 16:17	02/03/2020 16:38	29/02/2020 18:49	29/02/2020 19:06	0,29	8	2,32	CHI
202002191308	BURITI ALEGRE	CN10396194	VILA CORUMBA	28/02/2020 16:17	02/03/2020 16:38	29/02/2020 18:49	29/02/2020 19:06	0,29	3	0,87	CHI
202002191308	CALDAS NOVAS	CN10396194	VILA CORUMBA	28/02/2020 16:17	02/03/2020 16:38	29/02/2020 18:49	29/02/2020 19:06	0,29	20	5,81	CHI
202002191308	CALDAS NOVAS	CN10396194	VILA CORUMBA	28/02/2020 16:17	02/03/2020 16:38	29/02/2020 18:49	29/02/2020 19:06	0,29	59	17,14	CHI
202002191308	CORUMBAIBA	CN10396194	VILA CORUMBA	28/02/2020 16:17	02/03/2020 16:38	29/02/2020 18:49	29/02/2020 19:06	0,29	39	11,33	CHI
202002191308	MARZAGAO	CN10396194	VILA CORUMBA	28/02/2020 16:17	02/03/2020 16:38	29/02/2020 18:49	29/02/2020 19:06	0,29	1094	317,87	CHI
202002191308	MARZAGAO	CN10396194	VILA CORUMBA	28/02/2020 16:17	02/03/2020 16:38	29/02/2020 18:49	29/02/2020 19:06	0,29	3	0,87	CHI
202002191308	MARZAGAO	CN10396194	VILA CORUMBA	28/02/2020 16:17	02/03/2020 16:38	29/02/2020 18:49	29/02/2020 19:06	0,29	36	10,46	CHI
202002191308	MARZAGAO	CN10396194	VILA CORUMBA	28/02/2020 16:17	02/03/2020 16:38	29/02/2020 18:49	29/02/2020 19:06	0,29	47	13,66	CHI
202002191308	MORRINHOS	CN10396194	VILA CORUMBA	28/02/2020 16:17	02/03/2020 16:38	29/02/2020 18:49	29/02/2020 19:06	0,29	2	0,58	CHI
202002191308	MORRINHOS	CN10396194	VILA CORUMBA	28/02/2020 16:17	02/03/2020 16:38	29/02/2020 18:49	29/02/2020 19:06	0,29	54	15,69	CHI
202002191308	RIO QUENTE	CN10396194	VILA CORUMBA	28/02/2020 16:17	02/03/2020 16:38	29/02/2020 18:49	29/02/2020 19:06	0,29	4	1,16	CHI
202002191308	RIO QUENTE	CN10396194	VILA CORUMBA	28/02/2020 16:17	02/03/2020 16:38	29/02/2020 18:49	29/02/2020 19:06	0,29	1	0,29	CHI
202002191308	CORUMBAIBA	CN10404201	VILA CORUMBA	28/02/2020 16:17	02/03/2020 16:38	29/02/2020 18:49	29/02/2020 19:07	0,30	60	18,05	CHI
202002191308	CORUMBAIBA	CI10407944	VILA CORUMBA	28/02/2020 16:17	02/03/2020 16:38	29/02/2020 15:59	29/02/2020 21:45	5,77	216	1245,60	CHI
202002191308	CORUMBAIBA	CI16411328	VILA CORUMBA	28/02/2020 16:17	02/03/2020 16:38	29/02/2020 15:59	29/02/2020 21:45	5,77	79	455,57	CHI
202002191308	CALDAS NOVAS	03850424	VILA CORUMBA	28/02/2020 16:17	02/03/2020 16:38	29/02/2020 15:59	29/02/2020 21:45	5,78	54	312,12	CHI
202002191308	AGUA LIMPA	MG10400583	VILA CORUMBA	28/02/2020 16:17	02/03/2020 16:38	02/03/2020 14:01	02/03/2020 14:39	0,64	9	5,80	CHI
202002191308	AGUA LIMPA	MG10400583	VILA CORUMBA	28/02/2020 16:17	02/03/2020 16:38	02/03/2020 14:01	02/03/2020 14:39	0,64	876	564,29	CHI
202002191308	AGUA LIMPA	MG10400583	VILA CORUMBA	28/02/2020 16:17	02/03/2020 16:38	02/03/2020 14:01	02/03/2020 14:39	0,64	135	86,96	CHI
202002191308	AGUA LIMPA	MG10400583	VILA CORUMBA	28/02/2020 16:17	02/03/2020 16:38	02/03/2020 14:01	02/03/2020 14:39	0,64	8	5,15	CHI
202002191308	BURITI ALEGRE	MG10400583	VILA CORUMBA	28/02/2020 16:17	02/03/2020 16:38	02/03/2020 14:01	02/03/2020 14:39	0,64	3	1,93	CHI
202002191308	CALDAS NOVAS	MG10400583	VILA CORUMBA	28/02/2020 16:17	02/03/2020 16:38	02/03/2020 14:01	02/03/2020 14:39	0,64	20	12,88	CHI
202002191308	CALDAS NOVAS	MG10400583	VILA CORUMBA	28/02/2020 16:17	02/03/2020 16:38	02/03/2020 14:01	02/03/2020 14:39	0,64	6	3,86	CHI
202002191308	CORUMBAIBA	MG10400583	VILA CORUMBA	28/02/2020 16:17	02/03/2020 16:38	02/03/2020 14:01	02/03/2020 14:39	0,64	39	25,12	CHI
202002191308	CORUMBAIBA	MG10400583	VILA CORUMBA	28/02/2020 16:17	02/03/2020 16:38	02/03/2020 14:01	02/03/2020 14:39	0,64	1	0,64	CHI
202002191308	MARZAGAO	MG10400583	VILA CORUMBA	28/02/2020 16:17	02/03/2020 16:38	02/03/2020 14:01	02/03/2020 14:39	0,64	1101	709,23	CHI
202002191308	MARZAGAO	MG10400583	VILA CORUMBA	28/02/2020 16:17	02/03/2020 16:38	02/03/2020 14:01	02/03/2020 14:39	0,64	4	2,58	CHI
202002191308	MARZAGAO	MG10400583	VILA CORUMBA	28/02/2020 16:17	02/03/2020 16:38	02/03/2020 14:01	02/03/2020 14:39	0,64	36	23,19	CHI
202002191308	MARZAGAO	MG10400583	VILA CORUMBA	28/02/2020 16:17	02/03/2020 16:38	02/03/2020 14:01	02/03/2020 14:39	0,64	7	4,51	CHI
202002191308	MORRINHOS	MG10400583	VILA CORUMBA	28/02/2020 16:17	02/03/2020 16:38	02/03/2020 14:01	02/03/2020 14:39	0,64	2	1,29	CHI
202002191308	MORRINHOS	MG10400583	VILA CORUMBA	28/02/2020 16:17	02/03/2020 16:38	02/03/2020 14:01	02/03/2020 14:39	0,64	50	32,21	CHI
202002191308	RIO QUENTE	MG10400583	VILA CORUMBA	28/02/2020 16:17	02/03/2020 16:38	02/03/2020 14:01	02/03/2020 14:39	0,64	4	2,58	CHI
202002191308	CORUMBAIBA	MG10400583	VILA CORUMBA	28/02/2020 16:17	02/03/2020 16:38	02/03/2020 14:01	02/03/2020 15:22	1,35	3310	4471,26	CHI
202002191308	CORUMBAIBA	MG10400583	VILA CORUMBA	28/02/2020 16:17	02/03/2020 16:38	02/03/2020 14:01	02/03/2020 15:22	1,35	1007	1360,29	CHI
202002191308	CORUMBAIBA	CN10400582	VILA CORUMBA	28/02/2020 16:17	02/03/2020 16:38	02/03/2020 14:01	02/03/2020 15:22	1,35	60	81,05	CHI
202002191308	NOVA AURORA	MG10400583	VILA CORUMBA	28/02/2020 16:17	02/03/2020 16:38	02/03/2020 14:01	02/03/2020 15:22	1,35	7	9,46	CHI
202002191308	CALDAS NOVAS	CN12216502	VILA CORUMBA	28/02/2020 16:17	02/03/2020 16:38	01/03/2020 11:10	02/03/2020 16:38	29,47	43	1267,05	CHI
202003166908	CAMPOS BELOS	CH12243118	SAO DOMINGOS	01/03/2020 16:10	01/03/2020 18:06	01/03/2020 16:10	01/03/2020 18:06	1,92	6	11,51	CHI
202003166908	MONTE ALEGRE DE GOIAS	CH12243118	SAO DOMINGOS	01/03/2020 16:10	01/03/2020 18:06	01/03/2020 16:10	01/03/2020 18:06	1,92	3	5,75	CHI

202003166934	GOIANIA	GN12140168	AEROPORTO S1	01/03/2020 15:48	01/03/2020 17:37	01/03/2020 15:48	01/03/2020 17:37	1,81	110	199,16	CHI
202003166967	GUAPO	VJ32066141	GUAPO S2	01/03/2020 16:41	01/03/2020 18:56	01/03/2020 16:41	01/03/2020 18:56	2,24	3	6,73	CHI
202003166967	VARJAO	VJ32066141	GUAPO S2	01/03/2020 16:41	01/03/2020 18:56	01/03/2020 16:41	01/03/2020 18:56	2,24	5	11,22	CHI
202003167015	RIO VERDE	RV12085763	MONTIVIDIU T	02/03/2020 07:14	02/03/2020 10:19	02/03/2020 07:14	02/03/2020 10:19	3,07	5	15,36	CHI
202003167068	PIRACANJUBA	PJ12039108	PIRACANJUBA	02/03/2020 07:57	02/03/2020 10:10	02/03/2020 07:57	02/03/2020 10:10	2,21	6	13,28	CHI
202003167142	AURILANDIA	AI12206461	FIRMINOPOLIS S2	02/03/2020 09:36	02/03/2020 12:55	02/03/2020 09:36	02/03/2020 12:55	3,32	13	43,11	CHI
202003167142	FIRMINOPOLIS	AI12206461	FIRMINOPOLIS S2	02/03/2020 09:36	02/03/2020 12:55	02/03/2020 09:36	02/03/2020 12:55	3,32	16	53,05	CHI
202003167339	ANAPOLIS	AN11385776	ANAPOLIS UNIVERSITARIO S2	05/03/2020 12:28	05/03/2020 15:12	05/03/2020 12:28	05/03/2020 15:12	2,72	140	380,49	CHI
202003167522	FORMOSA	FA12381543	ITIQUEIRA	02/03/2020 15:53	02/03/2020 23:18	02/03/2020 15:53	02/03/2020 23:18	7,42	4	29,67	CHI
202003167577	LUZIANIA	LZ12051365	CRISTALINA S2	02/03/2020 17:13	02/03/2020 22:32	02/03/2020 17:13	02/03/2020 22:32	5,31	7	37,20	CHI
202003167659	CRISTALINA	KR12304816	CRISTALINA S2	03/03/2020 06:58	03/03/2020 11:10	03/03/2020 06:58	03/03/2020 11:10	4,19	15	62,89	CHI
202003167681	URUTAI	UT12337239	PIRES DO RIO S2	01/03/2020 06:49	01/03/2020 09:56	01/03/2020 06:49	01/03/2020 09:56	3,11	9	27,99	CHI
202003167729	LUZIANIA	LZ12245978	CRISTALINA S2	03/03/2020 09:41	03/03/2020 13:29	03/03/2020 09:41	03/03/2020 13:29	3,79	8	30,33	CHI
202003167884	ARAGUAPAZ	MP12355886	MATRINCHA	03/03/2020 13:30	03/03/2020 17:47	03/03/2020 13:30	03/03/2020 17:47	4,28	1	4,28	CHI
202003167884	FAINA	MP12355886	MATRINCHA	03/03/2020 13:30	03/03/2020 17:47	03/03/2020 13:30	03/03/2020 17:47	4,28	2	8,56	CHI
202003168002	BONOPOLIS	BX12266016	SAO MIGUEL DO ARAGUAIA	03/03/2020 19:51	04/03/2020 01:37	03/03/2020 19:51	04/03/2020 01:37	5,76	9	51,84	CHI
202003168536	ORIZONA	PR12270804RE	PIRES DO RIO S1	02/03/2020 05:55	02/03/2020 13:57	02/03/2020 05:55	02/03/2020 13:57	8,02	25	200,51	CHI
202003168536	PIRES DO RIO	PR12270804RE	PIRES DO RIO S1	02/03/2020 05:55	02/03/2020 13:57	02/03/2020 05:55	02/03/2020 13:57	8,02	1	8,02	CHI
202003169603	CATALAO	CT12344449	CATALAO S2	05/03/2020 10:59	05/03/2020 12:48	05/03/2020 10:59	05/03/2020 12:48	1,81	1	1,81	CHI
202003174027	BOM JESUS DE GOIAS	BJ11163877	BOM JESUS DE GOIAS	01/03/2020 19:24	02/03/2020 21:06	01/03/2020 19:24	02/03/2020 21:06	25,71	86	2211,18	CHI
202003174027	BOM JESUS DE GOIAS	BJ10394629	BOM JESUS DE GOIAS	01/03/2020 19:24	02/03/2020 21:06	02/03/2020 19:32	02/03/2020 21:06	1,57	110	172,98	CHI
202003179512	NIQUELÂNDIA	NQ12398048	URUACU	05/03/2020 07:02	05/03/2020 17:49	05/03/2020 07:02	05/03/2020 17:49	10,79	103	1111,23	CHI
202003180003	MIMOSO DE GOIAS	3170005908	PADRE BERNARDO	05/03/2020 08:16	05/03/2020 15:01	05/03/2020 08:16	05/03/2020 15:01	6,74	1	6,74	CHI
202003180005	MIMOSO DE GOIAS	3170005910	PADRE BERNARDO	05/03/2020 11:57	05/03/2020 15:01	05/03/2020 11:57	05/03/2020 15:01	3,06	1	3,06	CHI
202003193422	MONTES CLAROS DE GOIAS	1440010812	IPORA	02/03/2020 17:45	03/03/2020 07:40	02/03/2020 17:45	03/03/2020 07:40	13,91	1	13,91	CHI
202003199155	VIANOPOLIS	OZ21185982	VIANOPOLIS	04/03/2020 17:23	04/03/2020 22:22	04/03/2020 17:23	04/03/2020 22:22	4,98	1	4,98	CHI
202003199156	FAINA	GS10400720	GOIAS	03/03/2020 04:00	03/03/2020 08:53	03/03/2020 04:00	03/03/2020 05:31	1,53	73	111,59	CHI
202003199156	GOIAS	GS10400720	GOIAS	03/03/2020 04:00	03/03/2020 08:53	03/03/2020 04:00	03/03/2020 05:31	1,53	83	126,87	CHI
202003199156	FAINA	GS10400720	GOIAS	03/03/2020 04:00	03/03/2020 08:53	03/03/2020 04:00	03/03/2020 07:59	3,99	186	741,78	CHI
202003199156	FAINA	FC12147804	GOIAS	03/03/2020 04:00	03/03/2020 08:53	03/03/2020 04:00	03/03/2020 08:36	4,61	43	198,04	CHI
202003199156	GOIAS	FC12147804	GOIAS	03/03/2020 04:00	03/03/2020 08:53	03/03/2020 04:00	03/03/2020 08:36	4,61	2	9,21	CHI
202003199156	FAINA	FC12147800	GOIAS	03/03/2020 04:00	03/03/2020 08:53	03/03/2020 04:00	03/03/2020 08:53	4,89	92	449,91	CHI
202003199157	ARAGUAPAZ	O1000416	GOIAS	03/03/2020 04:00	03/03/2020 07:59	03/03/2020 04:00	03/03/2020 07:59	3,99	161	642,08	CHI
202003199157	ARAGUAPAZ	O1000416	GOIAS	03/03/2020 04:00	03/03/2020 07:59	03/03/2020 04:00	03/03/2020 07:59	3,99	220	877,37	CHI
202003199157	FAINA	O1000416	GOIAS	03/03/2020 04:00	03/03/2020 07:59	03/03/2020 04:00	03/03/2020 07:59	3,99	532	2121,65	CHI
202003199157	FAINA	O1000416	GOIAS	03/03/2020 04:00	03/03/2020 07:59	03/03/2020 04:00	03/03/2020 07:59	3,99	1983	7908,31	CHI
202003199157	GOIAS	O1000416	GOIAS	03/03/2020 04:00	03/03/2020 07:59	03/03/2020 04:00	03/03/2020 07:59	3,99	8	31,90	CHI
202003199157	ITABERAÍ	O1000416	GOIAS	03/03/2020 04:00	03/03/2020 07:59	03/03/2020 04:00	03/03/2020 07:59	3,99	1	3,99	CHI
202003199157	ITAPURANGA	O1000416	GOIAS	03/03/2020 04:00	03/03/2020 07:59	03/03/2020 04:00	03/03/2020 07:59	3,99	2	7,98	CHI
202003199157	MORRO AGUDO DE GOIAS	O1000416	GOIAS	03/03/2020 04:00	03/03/2020 07:59	03/03/2020 04:00	03/03/2020 07:59	3,99	2	7,98	CHI
202003199157	MOZARLÂNDIA	O1000416	GOIAS	03/03/2020 04:00	03/03/2020 07:59	03/03/2020 04:00	03/03/2020 07:59	3,99	3	11,96	CHI
202003199183	LUZIANIA	SV10394762	VIANOPOLIS	05/03/2020 09:36	05/03/2020 22:52	05/03/2020 09:39	05/03/2020 11:38	1,98	19	37,67	CHI
202003199183	SILVANIA	SV10394762	VIANOPOLIS	05/03/2020 09:36	05/03/2020 22:52	05/03/2020 09:39	05/03/2020 11:38	1,98	1	1,98	CHI
202003199183	LUZIANIA	SV12376114LD	VIANOPOLIS	05/03/2020 09:36	05/03/2020 22:52	05/03/2020 09:39	05/03/2020 13:53	4,23	4	16,93	CHI

202003199183	SILVANIA	SV12376114LD	VIANOPOLIS	05/03/2020 09:36	05/03/2020 22:52	05/03/2020 09:39	05/03/2020 13:53	4,23	7	29,63	CHI
202003199183	SILVANIA	SV10394762	VIANOPOLIS	05/03/2020 09:36	05/03/2020 22:52	05/03/2020 09:39	05/03/2020 17:15	7,60	4	30,38	CHI
202003199183	GAMELEIRA DE GOIAS	SV10394762	VIANOPOLIS	05/03/2020 09:36	05/03/2020 22:52	05/03/2020 09:39	05/03/2020 18:55	9,27	20	185,43	CHI
202003199183	LUZIANIA	SV10394762	VIANOPOLIS	05/03/2020 09:36	05/03/2020 22:52	05/03/2020 09:39	05/03/2020 18:55	9,27	363	3365,62	CHI
202003199183	SILVANIA	SV10394762	VIANOPOLIS	05/03/2020 09:36	05/03/2020 22:52	05/03/2020 09:39	05/03/2020 18:55	9,27	62	574,84	CHI
202003199183	SILVANIA	SV10394762	VIANOPOLIS	05/03/2020 09:36	05/03/2020 22:52	05/03/2020 09:39	05/03/2020 18:55	9,27	109	1010,61	CHI
202003199183	SILVANIA	SV10394762	VIANOPOLIS	05/03/2020 09:36	05/03/2020 22:52	05/03/2020 09:39	05/03/2020 18:55	9,27	1	9,27	CHI
202003199183	SILVANIA	SV10394762	VIANOPOLIS	05/03/2020 09:36	05/03/2020 22:52	05/03/2020 09:39	05/03/2020 19:15	9,60	3	28,81	CHI
202003199183	SILVANIA	SV10394762	VIANOPOLIS	05/03/2020 09:36	05/03/2020 22:52	05/03/2020 09:39	05/03/2020 22:28	12,81	197	2524,28	CHI
202003199183	SILVANIA	SV12205353	VIANOPOLIS	05/03/2020 09:36	05/03/2020 22:52	05/03/2020 09:39	05/03/2020 22:52	13,22	7	92,53	CHI
202003199238	SAO JOAO D ALIANCA	JL12383340	SAO JOAO D ALIANCA	02/03/2020 19:55	02/03/2020 22:19	02/03/2020 19:55	02/03/2020 21:36	1,67	69	115,31	CHI
202003199238	SAO JOAO D ALIANCA	JL12268121	SAO JOAO D ALIANCA	02/03/2020 19:55	02/03/2020 22:19	02/03/2020 19:55	02/03/2020 22:19	2,40	7	16,80	CHI
202003199239	INDIARA	2710043902	EDEIA	04/03/2020 23:15	05/03/2020 05:58	04/03/2020 23:15	05/03/2020 05:58	6,72	1	6,72	CHI
202003199243	GOUVELANDIA	GB12394808	QUIRINOPOLIS	03/03/2020 09:30	03/03/2020 10:31	03/03/2020 09:30	03/03/2020 10:31	1,01	2	2,01	CHI
202003199243	QUIRINOPOLIS	GB12394808	QUIRINOPOLIS	03/03/2020 09:30	03/03/2020 10:31	03/03/2020 09:30	03/03/2020 10:31	1,01	77	77,49	CHI
202003199253	CACHOEIRA ALTA	01560404	QUIRINOPOLIS	04/03/2020 17:10	05/03/2020 15:28	04/03/2020 17:10	04/03/2020 17:52	0,70	37	25,76	CHI
202003199253	CACHOEIRA ALTA	01560404	QUIRINOPOLIS	04/03/2020 17:10	05/03/2020 15:28	04/03/2020 17:10	04/03/2020 17:52	0,70	3	2,09	CHI
202003199253	QUIRINOPOLIS	01560404	QUIRINOPOLIS	04/03/2020 17:10	05/03/2020 15:28	04/03/2020 17:10	04/03/2020 17:52	0,70	85	59,17	CHI
202003199253	QUIRINOPOLIS	01560404	QUIRINOPOLIS	04/03/2020 17:10	05/03/2020 15:28	04/03/2020 17:10	04/03/2020 17:52	0,70	285	198,39	CHI
202003199253	QUIRINOPOLIS	01560404	QUIRINOPOLIS	04/03/2020 17:10	05/03/2020 15:28	04/03/2020 17:10	04/03/2020 17:52	0,70	276	192,13	CHI
202003199253	RIO VERDE	01560404	QUIRINOPOLIS	04/03/2020 17:10	05/03/2020 15:28	04/03/2020 17:10	04/03/2020 17:52	0,70	113	78,66	CHI
202003199253	RIO VERDE	01560404	QUIRINOPOLIS	04/03/2020 17:10	05/03/2020 15:28	04/03/2020 17:10	04/03/2020 17:52	0,70	42	29,24	CHI
202003199253	PARANAIGUARA	01560404	QUIRINOPOLIS	04/03/2020 17:10	05/03/2020 15:28	04/03/2020 17:10	04/03/2020 18:36	1,44	215	309,24	CHI
202003199253	QUIRINOPOLIS	01560404	QUIRINOPOLIS	04/03/2020 17:10	05/03/2020 15:28	04/03/2020 17:10	04/03/2020 18:36	1,44	60	86,30	CHI
202003199253	QUIRINOPOLIS	01560404	QUIRINOPOLIS	04/03/2020 17:10	05/03/2020 15:28	04/03/2020 17:10	04/03/2020 18:36	1,44	243	349,52	CHI
202003199253	QUIRINOPOLIS	01560404	QUIRINOPOLIS	04/03/2020 17:10	05/03/2020 15:28	04/03/2020 17:10	05/03/2020 15:28	22,29	13	289,83	CHI
202003199277	BONOPOLIS	BX10403944	SAO MIGUEL DO ARAGUAIA	03/03/2020 15:58	04/03/2020 10:21	03/03/2020 15:58	03/03/2020 16:50	0,88	269	236,72	CHI
202003199277	BONOPOLIS	SM10400363	SAO MIGUEL DO ARAGUAIA	03/03/2020 15:58	04/03/2020 10:21	03/03/2020 15:58	03/03/2020 18:35	2,62	3	7,85	CHI
202003199277	NOVO PLANALTO	SM10400363	SAO MIGUEL DO ARAGUAIA	03/03/2020 15:58	04/03/2020 10:21	03/03/2020 15:58	03/03/2020 18:35	2,62	324	847,62	CHI
202003199277	SAO MIGUEL DO ARAGUAIA	SM10400363	SAO MIGUEL DO ARAGUAIA	03/03/2020 15:58	04/03/2020 10:21	03/03/2020 15:58	03/03/2020 18:35	2,62	168	439,51	CHI
202003199277	BONOPOLIS	01710424	SAO MIGUEL DO ARAGUAIA	03/03/2020 15:58	04/03/2020 10:21	03/03/2020 15:58	03/03/2020 19:25	3,45	731	2521,95	CHI
202003199277	BONOPOLIS	01710424	SAO MIGUEL DO ARAGUAIA	03/03/2020 15:58	04/03/2020 10:21	03/03/2020 15:58	03/03/2020 19:25	3,45	282	972,90	CHI
202003199277	CACU	01710424	SAO MIGUEL DO ARAGUAIA	03/03/2020 15:58	04/03/2020 10:21	03/03/2020 15:58	03/03/2020 19:25	3,45	1	3,45	CHI
202003199277	PORANGATU	01710424	SAO MIGUEL DO ARAGUAIA	03/03/2020 15:58	04/03/2020 10:21	03/03/2020 15:58	03/03/2020 19:25	3,45	1	3,45	CHI
202003199277	AMARALINA	01710424	SAO MIGUEL DO ARAGUAIA	03/03/2020 15:58	04/03/2020 10:21	03/03/2020 15:58	03/03/2020 20:10	4,21	221	929,86	CHI
202003199277	BONOPOLIS	01710424	SAO MIGUEL DO ARAGUAIA	03/03/2020 15:58	04/03/2020 10:21	03/03/2020 15:58	03/03/2020 20:10	4,21	12	50,49	CHI
202003199277	NOVO PLANALTO	SM10400363	SAO MIGUEL DO ARAGUAIA	03/03/2020 15:58	04/03/2020 10:21	03/03/2020 15:58	03/03/2020 23:31	7,56	1	7,56	CHI
202003199277	SAO MIGUEL DO ARAGUAIA	SM10400363	SAO MIGUEL DO ARAGUAIA	03/03/2020 15:58	04/03/2020 10:21	03/03/2020 15:58	03/03/2020 23:31	7,56	6	45,35	CHI
202003199277	BONOPOLIS	SM10400363	SAO MIGUEL DO ARAGUAIA	03/03/2020 15:58	04/03/2020 10:21	03/03/2020 15:58	04/03/2020 09:54	17,94	20	358,88	CHI
202003199277	NOVO PLANALTO	SM10400363	SAO MIGUEL DO ARAGUAIA	03/03/2020 15:58	04/03/2020 10:21	03/03/2020 15:58	04/03/2020 09:54	17,94	14	251,22	CHI
202003199277	SAO MIGUEL DO ARAGUAIA	SM10400363	SAO MIGUEL DO ARAGUAIA	03/03/2020 15:58	04/03/2020 10:21	03/03/2020 15:58	04/03/2020 09:54	17,94	20	358,88	CHI
202003199277	AMARALINA	BX13262653	SAO MIGUEL DO ARAGUAIA	03/03/2020 15:58	04/03/2020 10:21	04/03/2020 10:06	04/03/2020 10:17	0,17	221	37,94	CHI
202003199277	BONOPOLIS	BX13262653	SAO MIGUEL DO ARAGUAIA	03/03/2020 15:58	04/03/2020 10:21	04/03/2020 10:06	04/03/2020 10:17	0,17	743	127,55	CHI
202003199277	CACU	BX13262653	SAO MIGUEL DO ARAGUAIA	03/03/2020 15:58	04/03/2020 10:21	04/03/2020 10:06	04/03/2020 10:17	0,17	1	0,17	CHI

202003199277	BONOPOLIS	BX13262671	SAO MIGUEL DO ARAGUAIA	03/03/2020 15:58	04/03/2020 10:21	04/03/2020 10:06	04/03/2020 10:21	0,25	550	135,21	CHI
202003199277	PORANGATU	BX13262671	SAO MIGUEL DO ARAGUAIA	03/03/2020 15:58	04/03/2020 10:21	04/03/2020 10:06	04/03/2020 10:21	0,25	1	0,25	CHI
202003199278	PALMINOPOLIS	JD21328252	PALMEIRAS	01/03/2020 06:08	01/03/2020 08:23	01/03/2020 06:08	01/03/2020 08:23	2,24	1	2,24	CHI
202003199289	CAMPINACU	04690224	MARA ROSA	02/03/2020 19:35	04/03/2020 01:44	02/03/2020 19:35	02/03/2020 21:24	1,81	281	508,53	CHI
202003199289	CAMPINORTE	04690224	MARA ROSA	02/03/2020 19:35	04/03/2020 01:44	02/03/2020 19:35	02/03/2020 21:24	1,81	114	206,31	CHI
202003199289	URUACU	04690224	MARA ROSA	02/03/2020 19:35	04/03/2020 01:44	02/03/2020 19:35	02/03/2020 21:24	1,81	254	459,67	CHI
202003199289	CAMPINORTE	04690224	MARA ROSA	02/03/2020 19:35	04/03/2020 01:44	02/03/2020 19:35	02/03/2020 22:53	3,29	12	39,49	CHI
202003199289	URUACU	04690224	MARA ROSA	02/03/2020 19:35	04/03/2020 01:44	02/03/2020 19:35	02/03/2020 22:53	3,29	15	49,36	CHI
202003199289	CAMPINORTE	CR10404187	MARA ROSA	02/03/2020 19:35	04/03/2020 01:44	02/03/2020 19:35	03/03/2020 04:21	8,77	17	149,02	CHI
202003199289	CAMPINORTE	CR13025409	MARA ROSA	02/03/2020 19:35	04/03/2020 01:44	02/03/2020 19:35	04/03/2020 01:44	30,15	58	1748,43	CHI
202003199289	URUACU	CR13025409	MARA ROSA	02/03/2020 19:35	04/03/2020 01:44	02/03/2020 19:35	04/03/2020 01:44	30,15	105	3165,25	CHI
202003199289	CAMPINORTE	CR13025409	MARA ROSA	02/03/2020 19:35	04/03/2020 01:44	03/03/2020 12:46	04/03/2020 01:44	12,96	2	25,92	CHI
202003199295	BURITI ALEGRE	IT10408204	PARANAIBA	01/03/2020 19:22	02/03/2020 10:36	01/03/2020 19:30	01/03/2020 22:32	3,04	8	24,30	CHI
202003199295	ITUMBIARA	IT10408204	PARANAIBA	01/03/2020 19:22	02/03/2020 10:36	01/03/2020 19:30	01/03/2020 22:32	3,04	88	267,32	CHI
202003199295	PANAMA	IT10408204	PARANAIBA	01/03/2020 19:22	02/03/2020 10:36	01/03/2020 19:30	01/03/2020 22:32	3,04	2	6,08	CHI
202003199295	GOIATUBA	IT10408204	GOIATUBA S1	01/03/2020 19:22	02/03/2020 10:36	01/03/2020 19:30	01/03/2020 23:11	3,68	19	69,83	CHI
202003199295	PANAMA	IT10408204	GOIATUBA S1	01/03/2020 19:22	02/03/2020 10:36	01/03/2020 19:30	01/03/2020 23:11	3,68	10	36,75	CHI
202003199295	RUBIATABA	IT10408204	GOIATUBA S1	01/03/2020 19:22	02/03/2020 10:36	01/03/2020 19:30	01/03/2020 23:11	3,68	1	3,68	CHI
202003199295	GOIATUBA	IT10408204	PARANAIBA	01/03/2020 19:22	02/03/2020 10:36	01/03/2020 19:30	01/03/2020 23:11	3,68	6	22,05	CHI
202003199295	ITUMBIARA	IT10408204	PARANAIBA	01/03/2020 19:22	02/03/2020 10:36	01/03/2020 19:30	01/03/2020 23:11	3,68	3	11,03	CHI
202003199295	PANAMA	IT10408204	PARANAIBA	01/03/2020 19:22	02/03/2020 10:36	01/03/2020 19:30	01/03/2020 23:11	3,68	15	55,13	CHI
202003199295	BURITI ALEGRE	IT10408204	PARANAIBA	01/03/2020 19:22	02/03/2020 10:36	01/03/2020 22:38	01/03/2020 23:11	0,54	8	4,30	CHI
202003199295	ITUMBIARA	IT10408204	PARANAIBA	01/03/2020 19:22	02/03/2020 10:36	01/03/2020 22:38	01/03/2020 23:11	0,54	88	47,25	CHI
202003199295	PANAMA	IT10408204	PARANAIBA	01/03/2020 19:22	02/03/2020 10:36	01/03/2020 22:38	01/03/2020 23:11	0,54	2	1,07	CHI
202003199295	ITUMBIARA	IT12208088LD	PARANAIBA	01/03/2020 19:22	02/03/2020 10:36	01/03/2020 19:30	01/03/2020 23:28	3,96	22	87,05	CHI
202003199295	PANAMA	IT12208088LD	PARANAIBA	01/03/2020 19:22	02/03/2020 10:36	01/03/2020 19:30	01/03/2020 23:28	3,96	24	94,96	CHI
202003199295	ITUMBIARA	IT10408204	PARANAIBA	01/03/2020 19:22	02/03/2020 10:36	02/03/2020 00:23	02/03/2020 08:21	7,96	79	629,04	CHI
202003199295	GOIATUBA	IT10408204	GOIATUBA S1	01/03/2020 19:22	02/03/2020 10:36	02/03/2020 00:23	02/03/2020 09:16	8,88	19	168,66	CHI
202003199295	PANAMA	IT10408204	GOIATUBA S1	01/03/2020 19:22	02/03/2020 10:36	02/03/2020 00:23	02/03/2020 09:16	8,88	10	88,77	CHI
202003199295	RUBIATABA	IT10408204	GOIATUBA S1	01/03/2020 19:22	02/03/2020 10:36	02/03/2020 00:23	02/03/2020 09:16	8,88	1	8,88	CHI
202003199295	GOIATUBA	IT10408204	PARANAIBA	01/03/2020 19:22	02/03/2020 10:36	02/03/2020 00:23	02/03/2020 09:16	8,88	6	53,26	CHI
202003199295	ITUMBIARA	IT10408204	PARANAIBA	01/03/2020 19:22	02/03/2020 10:36	02/03/2020 00:23	02/03/2020 09:16	8,88	26	230,79	CHI
202003199295	PANAMA	IT10408204	PARANAIBA	01/03/2020 19:22	02/03/2020 10:36	02/03/2020 00:23	02/03/2020 09:16	8,88	39	346,19	CHI
202003199295	BURITI ALEGRE	IT12000114RE	PARANAIBA	01/03/2020 19:22	02/03/2020 10:36	02/03/2020 00:23	02/03/2020 10:08	9,75	8	77,98	CHI
202003199295	ITUMBIARA	IT12000114RE	PARANAIBA	01/03/2020 19:22	02/03/2020 10:36	02/03/2020 00:23	02/03/2020 10:08	9,75	8	77,98	CHI
202003199295	PANAMA	IT12000114RE	PARANAIBA	01/03/2020 19:22	02/03/2020 10:36	02/03/2020 00:23	02/03/2020 10:08	9,75	2	19,50	CHI
202003199295	GOIATUBA	GT13025324	GOIATUBA S1	01/03/2020 19:22	02/03/2020 10:36	02/03/2020 10:04	02/03/2020 10:36	0,54	19	10,18	CHI
202003199295	PANAMA	GT13025324	GOIATUBA S1	01/03/2020 19:22	02/03/2020 10:36	02/03/2020 10:04	02/03/2020 10:36	0,54	10	5,36	CHI
202003199295	RUBIATABA	GT13025324	GOIATUBA S1	01/03/2020 19:22	02/03/2020 10:36	02/03/2020 10:04	02/03/2020 10:36	0,54	1	0,54	CHI
2020022800072	MOZARLANDIA	MZ10400739	MOZARLANDIA	28/02/2020 05:34	28/02/2020 09:50	28/02/2020 05:34	28/02/2020 05:43	0,15	77	11,49	CHI
2020022800072	CRIXAS	03374118	MOZARLANDIA	28/02/2020 05:34	28/02/2020 09:50	28/02/2020 05:34	28/02/2020 07:27	1,88	104	195,58	CHI
2020022800072	MOZARLANDIA	03374118	MOZARLANDIA	28/02/2020 05:34	28/02/2020 09:50	28/02/2020 05:34	28/02/2020 07:27	1,88	4898	9210,96	CHI
2020022800072	MOZARLANDIA	03374118	MOZARLANDIA	28/02/2020 05:34	28/02/2020 09:50	28/02/2020 05:34	28/02/2020 07:27	1,88	816	1534,53	CHI
2020022800072	MOZARLANDIA	MZ10406643	MOZARLANDIA	28/02/2020 05:34	28/02/2020 09:50	28/02/2020 05:34	28/02/2020 07:27	1,88	149	280,20	CHI

2020022800072	NOVA CRIXAS	03374118	MOZARLANDIA	28/02/2020 05:34	28/02/2020 09:50	28/02/2020 05:34	28/02/2020 07:27	1,88	171	321,58	CHI
2020022800072	CRIXAS	MZ10400707	MOZARLANDIA	28/02/2020 05:34	28/02/2020 09:50	28/02/2020 07:40	28/02/2020 08:09	0,49	3	1,46	CHI
2020022800072	MOZARLANDIA	MZ10400707	MOZARLANDIA	28/02/2020 05:34	28/02/2020 09:50	28/02/2020 07:40	28/02/2020 08:09	0,49	35	17,04	CHI
2020022800072	NOVA CRIXAS	MZ10400707	MOZARLANDIA	28/02/2020 05:34	28/02/2020 09:50	28/02/2020 07:40	28/02/2020 08:09	0,49	144	70,12	CHI
2020022800072	ARUANA	03374118	MOZARLANDIA	28/02/2020 05:34	28/02/2020 09:50	28/02/2020 05:34	28/02/2020 09:22	3,81	8	30,50	CHI
2020022800072	ARUANA	03374118	MOZARLANDIA	28/02/2020 05:34	28/02/2020 09:50	28/02/2020 05:34	28/02/2020 09:22	3,81	43	163,95	CHI
2020022800072	MOZARLANDIA	03374118	MOZARLANDIA	28/02/2020 05:34	28/02/2020 09:50	28/02/2020 05:34	28/02/2020 09:22	3,81	95	362,21	CHI
2020022800072	MOZARLANDIA	03374118	MOZARLANDIA	28/02/2020 05:34	28/02/2020 09:50	28/02/2020 05:34	28/02/2020 09:22	3,81	13	49,57	CHI
2020022800072	MOZARLANDIA	03374118	MOZARLANDIA	28/02/2020 05:34	28/02/2020 09:50	28/02/2020 05:34	28/02/2020 09:22	3,81	4	15,25	CHI
2020022800072	NOVA CRIXAS	03374118	MOZARLANDIA	28/02/2020 05:34	28/02/2020 09:50	28/02/2020 05:34	28/02/2020 09:22	3,81	35	133,45	CHI
2020022800072	NOVA CRIXAS	03374118	MOZARLANDIA	28/02/2020 05:34	28/02/2020 09:50	28/02/2020 05:34	28/02/2020 09:22	3,81	31	118,20	CHI
2020022800072	ARAGUAPAZ	03374118	MOZARLANDIA	28/02/2020 05:34	28/02/2020 09:50	28/02/2020 05:34	28/02/2020 09:22	3,81	2836	10815,40	CHI
2020022800072	ARAGUAPAZ	MZ10291679	MOZARLANDIA	28/02/2020 05:34	28/02/2020 09:50	28/02/2020 05:34	28/02/2020 09:22	3,81	35	133,48	CHI
2020022800072	ARUANA	03374118	MOZARLANDIA	28/02/2020 05:34	28/02/2020 09:50	28/02/2020 05:34	28/02/2020 09:22	3,81	73	278,39	CHI
2020022800072	MATRINCHA	03374118	MOZARLANDIA	28/02/2020 05:34	28/02/2020 09:50	28/02/2020 05:34	28/02/2020 09:22	3,81	39	148,73	CHI
2020022800072	MOZARLANDIA	03374118	MOZARLANDIA	28/02/2020 05:34	28/02/2020 09:50	28/02/2020 05:34	28/02/2020 09:22	3,81	10	38,14	CHI
2020022800072	MOZARLANDIA	MZ10291679	MOZARLANDIA	28/02/2020 05:34	28/02/2020 09:50	28/02/2020 05:34	28/02/2020 09:22	3,81	109	415,68	CHI
2020022800072	CRIXAS	MZ10404285	MOZARLANDIA	28/02/2020 05:34	28/02/2020 09:50	28/02/2020 07:40	28/02/2020 09:50	2,17	99	214,44	CHI
2020022800072	MOZARLANDIA	MZ10404285	MOZARLANDIA	28/02/2020 05:34	28/02/2020 09:50	28/02/2020 07:40	28/02/2020 09:50	2,17	75	162,46	CHI
2020022800072	NOVA CRIXAS	MZ10404285	MOZARLANDIA	28/02/2020 05:34	28/02/2020 09:50	28/02/2020 07:40	28/02/2020 09:50	2,17	27	58,48	CHI
2020022800073	ARUANA	43002	MOZARLANDIA	28/02/2020 05:34	28/02/2020 09:21	28/02/2020 05:34	28/02/2020 09:21	3,78	1	3,78	CHI
2020022800073	NOVA CRIXAS	43002	MOZARLANDIA	28/02/2020 05:34	28/02/2020 09:21	28/02/2020 05:34	28/02/2020 09:21	3,78	1	3,78	CHI
2020022800089	GUARANI DE GOIAS	01230214	IACIARA S1	28/02/2020 02:10	28/02/2020 02:13	28/02/2020 02:10	28/02/2020 02:13	0,05	1292	64,60	CHI
2020022800089	IACIARA	01230214	IACIARA S1	28/02/2020 02:10	28/02/2020 02:13	28/02/2020 02:10	28/02/2020 02:13	0,05	4282	214,10	CHI
2020022800089	POSSE	01230214	IACIARA S1	28/02/2020 02:10	28/02/2020 02:13	28/02/2020 02:10	28/02/2020 02:13	0,05	171	8,55	CHI
2020022800089	SAO DOMINGOS	01230214	IACIARA S1	28/02/2020 02:10	28/02/2020 02:13	28/02/2020 02:10	28/02/2020 02:13	0,05	1	0,05	CHI
2020022800089	ALTO PARAISO DE GOIAS	01230414	IACIARA S2	28/02/2020 02:10	28/02/2020 02:13	28/02/2020 02:10	28/02/2020 02:13	0,05	18	0,90	CHI
2020022800089	BURITINOPOLIS	47202	IACIARA S2	28/02/2020 02:10	28/02/2020 02:13	28/02/2020 02:10	28/02/2020 02:13	0,05	2	0,10	CHI
2020022800089	FLORES DE GOIAS	01230414	IACIARA S2	28/02/2020 02:10	28/02/2020 02:13	28/02/2020 02:10	28/02/2020 02:13	0,05	1	0,05	CHI
2020022800089	GUARANI DE GOIAS	01230434	IACIARA S2	28/02/2020 02:10	28/02/2020 02:13	28/02/2020 02:10	28/02/2020 02:13	0,05	99	4,95	CHI
2020022800089	IACIARA	26202	IACIARA S2	28/02/2020 02:10	28/02/2020 02:13	28/02/2020 02:10	28/02/2020 02:13	0,05	1	0,05	CHI
2020022800089	IACIARA	01230414	IACIARA S2	28/02/2020 02:10	28/02/2020 02:13	28/02/2020 02:10	28/02/2020 02:13	0,05	154	7,70	CHI
2020022800089	IACIARA	01230424	IACIARA S2	28/02/2020 02:10	28/02/2020 02:13	28/02/2020 02:10	28/02/2020 02:13	0,05	12	0,60	CHI
2020022800089	IACIARA	01230434	IACIARA S2	28/02/2020 02:10	28/02/2020 02:13	28/02/2020 02:10	28/02/2020 02:13	0,05	103	5,15	CHI
2020022800089	MAMBAI	47202	IACIARA S2	28/02/2020 02:10	28/02/2020 02:13	28/02/2020 02:10	28/02/2020 02:13	0,05	27	1,35	CHI
2020022800089	MONTE ALEGRE DE GOIAS	01230414	IACIARA S2	28/02/2020 02:10	28/02/2020 02:13	28/02/2020 02:10	28/02/2020 02:13	0,05	1	0,05	CHI
2020022800089	NOVA ROMA	01230414	IACIARA S2	28/02/2020 02:10	28/02/2020 02:13	28/02/2020 02:10	28/02/2020 02:13	0,05	1546	77,30	CHI
2020022800089	POSSE	26201	IACIARA S2	28/02/2020 02:10	28/02/2020 02:13	28/02/2020 02:10	28/02/2020 02:13	0,05	6860	343,00	CHI
2020022800089	POSSE	47201	IACIARA S2	28/02/2020 02:10	28/02/2020 02:13	28/02/2020 02:10	28/02/2020 02:13	0,05	969	48,45	CHI
2020022800089	POSSE	26202	IACIARA S2	28/02/2020 02:10	28/02/2020 02:13	28/02/2020 02:10	28/02/2020 02:13	0,05	3397	169,85	CHI
2020022800089	POSSE	47202	IACIARA S2	28/02/2020 02:10	28/02/2020 02:13	28/02/2020 02:10	28/02/2020 02:13	0,05	50	2,50	CHI
2020022800089	POSSE	01230414	IACIARA S2	28/02/2020 02:10	28/02/2020 02:13	28/02/2020 02:10	28/02/2020 02:13	0,05	1	0,05	CHI
2020022800089	POSSE	01230424	IACIARA S2	28/02/2020 02:10	28/02/2020 02:13	28/02/2020 02:10	28/02/2020 02:13	0,05	280	14,00	CHI
2020022800089	POSSE	01230434	IACIARA S2	28/02/2020 02:10	28/02/2020 02:13	28/02/2020 02:10	28/02/2020 02:13	0,05	1603	80,15	CHI

2020022800089	SAO DOMINGOS	01230414	IACIARA S2	28/02/2020 02:10	28/02/2020 02:13	28/02/2020 02:10	28/02/2020 02:13	0,05	7	0,35	CHI
2020022800089	SAO JOAO D ALIANCA	01230414	IACIARA S2	28/02/2020 02:10	28/02/2020 02:13	28/02/2020 02:10	28/02/2020 02:13	0,05	27	1,35	CHI
2020022800117	CAMPOS BELOS	07601	SAO DOMINGOS	28/02/2020 22:14	28/02/2020 22:25	28/02/2020 22:14	28/02/2020 22:25	0,18	4286	785,77	CHI
2020022800117	CAMPOS BELOS	07602	SAO DOMINGOS	28/02/2020 22:14	28/02/2020 22:25	28/02/2020 22:14	28/02/2020 22:25	0,18	2776	508,93	CHI
2020022800117	CAMPOS BELOS	02090504	SAO DOMINGOS	28/02/2020 22:14	28/02/2020 22:25	28/02/2020 22:14	28/02/2020 22:25	0,18	99	18,15	CHI
2020022800117	CAMPOS BELOS	07632	SAO DOMINGOS	28/02/2020 22:14	28/02/2020 22:25	28/02/2020 22:14	28/02/2020 22:25	0,18	153	28,05	CHI
2020022800117	CAMPOS BELOS	07633	SAO DOMINGOS	28/02/2020 22:14	28/02/2020 22:25	28/02/2020 22:14	28/02/2020 22:25	0,18	362	66,37	CHI
2020022800117	CAVALCANTE	34301	SAO DOMINGOS	28/02/2020 22:14	28/02/2020 22:25	28/02/2020 22:14	28/02/2020 22:25	0,18	170	31,17	CHI
2020022800117	DIVINOPOLIS DE GOIAS	02090504	SAO DOMINGOS	28/02/2020 22:14	28/02/2020 22:25	28/02/2020 22:14	28/02/2020 22:25	0,18	2238	410,30	CHI
2020022800117	DIVINOPOLIS DE GOIAS	07633	SAO DOMINGOS	28/02/2020 22:14	28/02/2020 22:25	28/02/2020 22:14	28/02/2020 22:25	0,18	3	0,55	CHI
2020022800117	GUARANI DE GOIAS	02090504	SAO DOMINGOS	28/02/2020 22:14	28/02/2020 22:25	28/02/2020 22:14	28/02/2020 22:25	0,18	149	27,32	CHI
2020022800117	MONTE ALEGRE DE GOIAS	07601	SAO DOMINGOS	28/02/2020 22:14	28/02/2020 22:25	28/02/2020 22:14	28/02/2020 22:25	0,18	57	10,45	CHI
2020022800117	MONTE ALEGRE DE GOIAS	34301	SAO DOMINGOS	28/02/2020 22:14	28/02/2020 22:25	28/02/2020 22:14	28/02/2020 22:25	0,18	1902	348,70	CHI
2020022800117	MONTE ALEGRE DE GOIAS	02090504	SAO DOMINGOS	28/02/2020 22:14	28/02/2020 22:25	28/02/2020 22:14	28/02/2020 22:25	0,18	138	25,30	CHI
2020022800117	MONTE ALEGRE DE GOIAS	02090504	SAO DOMINGOS	28/02/2020 22:14	28/02/2020 22:25	28/02/2020 22:14	28/02/2020 22:25	0,18	2	0,37	CHI
2020022800117	MONTE ALEGRE DE GOIAS	07633	SAO DOMINGOS	28/02/2020 22:14	28/02/2020 22:25	28/02/2020 22:14	28/02/2020 22:25	0,18	735	134,75	CHI
2020022800117	NOVA ROMA	34301	SAO DOMINGOS	28/02/2020 22:14	28/02/2020 22:25	28/02/2020 22:14	28/02/2020 22:25	0,18	57	10,45	CHI
2020022800117	NOVA ROMA	02090504	SAO DOMINGOS	28/02/2020 22:14	28/02/2020 22:25	28/02/2020 22:14	28/02/2020 22:25	0,18	3	0,55	CHI
2020022800117	SAO DOMINGOS	02090504	SAO DOMINGOS	28/02/2020 22:14	28/02/2020 22:25	28/02/2020 22:14	28/02/2020 22:25	0,18	2381	436,52	CHI
2020022800117	SAO DOMINGOS	02090504	SAO DOMINGOS	28/02/2020 22:14	28/02/2020 22:25	28/02/2020 22:14	28/02/2020 22:25	0,18	395	72,42	CHI
2020022800117	SAO DOMINGOS	02090504	SAO DOMINGOS	28/02/2020 22:14	28/02/2020 22:25	28/02/2020 22:14	28/02/2020 22:25	0,18	1164	213,40	CHI
2020022800117	SAO DOMINGOS	07633	SAO DOMINGOS	28/02/2020 22:14	28/02/2020 22:25	28/02/2020 22:14	28/02/2020 22:25	0,18	287	52,62	CHI
2020022900006	GOIATUBA	45801	BOM JESUS DE GOIAS	29/02/2020 05:15	29/02/2020 05:30	29/02/2020 05:15	29/02/2020 05:30	0,25	130	32,50	CHI
2020022900006	GOIATUBA	45802	BOM JESUS DE GOIAS	29/02/2020 05:15	29/02/2020 05:30	29/02/2020 05:15	29/02/2020 05:30	0,25	103	25,75	CHI
2020022900006	ITUMBIARA	00230444	BOM JESUS DE GOIAS	29/02/2020 05:15	29/02/2020 05:30	29/02/2020 05:15	29/02/2020 05:30	0,25	4	1,00	CHI
2020022900015	BOM JESUS DE GOIAS	00230424	BOM JESUS DE GOIAS	29/02/2020 15:49	29/02/2020 15:53	29/02/2020 15:49	29/02/2020 15:53	0,07	21	1,40	CHI
2020022900015	GOIATUBA	45801	BOM JESUS DE GOIAS	29/02/2020 15:49	29/02/2020 15:53	29/02/2020 15:49	29/02/2020 15:53	0,07	89	5,93	CHI
2020022900015	GOIATUBA	45802	BOM JESUS DE GOIAS	29/02/2020 15:49	29/02/2020 15:53	29/02/2020 15:49	29/02/2020 15:53	0,07	63	4,20	CHI
2020022900015	GOIATUBA	00230424	BOM JESUS DE GOIAS	29/02/2020 15:49	29/02/2020 15:53	29/02/2020 15:49	29/02/2020 15:53	0,07	22	1,47	CHI
2020022900015	ITUMBIARA	00230424	BOM JESUS DE GOIAS	29/02/2020 15:49	29/02/2020 15:53	29/02/2020 15:49	29/02/2020 15:53	0,07	3	0,20	CHI
2020022900016	GOIATUBA	45801	BOM JESUS DE GOIAS	29/02/2020 15:49	29/02/2020 15:53	29/02/2020 15:49	29/02/2020 15:53	0,07	40	2,67	CHI
2020022900016	GOIATUBA	45802	BOM JESUS DE GOIAS	29/02/2020 15:49	29/02/2020 15:53	29/02/2020 15:49	29/02/2020 15:53	0,07	40	2,67	CHI
2020022900041	CORUMBAIBA	08401	VILA CORUMBA	29/02/2020 15:59	29/02/2020 21:45	29/02/2020 15:59	29/02/2020 21:45	5,77	3091	17824,77	CHI
2020022900041	CORUMBAIBA	08402	VILA CORUMBA	29/02/2020 15:59	29/02/2020 21:45	29/02/2020 15:59	29/02/2020 21:45	5,77	1010	5824,33	CHI
2020022900041	NOVA AURORA	08401	VILA CORUMBA	29/02/2020 15:59	29/02/2020 21:45	29/02/2020 15:59	29/02/2020 21:45	5,77	7	40,37	CHI
2020022900085	GOIANIA	00582004	GOIANIA LESTE S3	29/02/2020 12:25	29/02/2020 12:28	29/02/2020 12:25	29/02/2020 12:28	0,05	15417	770,85	CHI
2020030100034	AMARALINA	35201	MARA ROSA	01/03/2020 13:14	01/03/2020 14:00	01/03/2020 13:14	01/03/2020 14:00	0,77	6	4,60	CHI
2020030100034	AMARALINA	35202	MARA ROSA	01/03/2020 13:14	01/03/2020 14:00	01/03/2020 13:14	01/03/2020 14:00	0,77	142	108,87	CHI
2020030100034	AMARALINA	04732	MARA ROSA	01/03/2020 13:14	01/03/2020 14:00	01/03/2020 13:14	01/03/2020 14:00	0,77	47	36,03	CHI
2020030100034	BONOPOLIS	35201	MARA ROSA	01/03/2020 13:14	01/03/2020 14:00	01/03/2020 13:14	01/03/2020 14:00	0,77	2	1,53	CHI
2020030100034	CAMPINORTE	46902	MARA ROSA	01/03/2020 13:14	01/03/2020 14:00	01/03/2020 13:14	01/03/2020 14:00	0,77	1	0,77	CHI
2020030100034	ESTRELA DO NORTE	04701	MARA ROSA	01/03/2020 13:14	01/03/2020 14:00	01/03/2020 13:14	01/03/2020 14:00	0,77	1421	1089,43	CHI
2020030100034	ESTRELA DO NORTE	20701	MARA ROSA	01/03/2020 13:14	01/03/2020 14:00	01/03/2020 13:14	01/03/2020 14:00	0,77	3	2,30	CHI
2020030100034	ESTRELA DO NORTE	35202	MARA ROSA	01/03/2020 13:14	01/03/2020 14:00	01/03/2020 13:14	01/03/2020 14:00	0,77	1	0,77	CHI

2020030100034	ESTRELA DO NORTE	04731	MARA ROSA	01/03/2020 13:14	01/03/2020 14:00	01/03/2020 13:14	01/03/2020 14:00	0,77	51	39,10	CHI
2020030100034	ESTRELA DO NORTE	04732	MARA ROSA	01/03/2020 13:14	01/03/2020 14:00	01/03/2020 13:14	01/03/2020 14:00	0,77	43	32,97	CHI
2020030100034	FORMOSO	04701	MARA ROSA	01/03/2020 13:14	01/03/2020 14:00	01/03/2020 13:14	01/03/2020 14:00	0,77	74	56,73	CHI
2020030100034	FORMOSO	20701	MARA ROSA	01/03/2020 13:14	01/03/2020 14:00	01/03/2020 13:14	01/03/2020 14:00	0,77	104	79,73	CHI
2020030100034	FORMOSO	04731	MARA ROSA	01/03/2020 13:14	01/03/2020 14:00	01/03/2020 13:14	01/03/2020 14:00	0,77	84	64,40	CHI
2020030100034	MARA ROSA	04701	MARA ROSA	01/03/2020 13:14	01/03/2020 14:00	01/03/2020 13:14	01/03/2020 14:00	0,77	103	78,97	CHI
2020030100034	MARA ROSA	04732	MARA ROSA	01/03/2020 13:14	01/03/2020 14:00	01/03/2020 13:14	01/03/2020 14:00	0,77	30	23,00	CHI
2020030100034	MUTUNOPOLIS	20701	MARA ROSA	01/03/2020 13:14	01/03/2020 14:00	01/03/2020 13:14	01/03/2020 14:00	0,77	6	4,60	CHI
2020030100034	MUTUNOPOLIS	35201	MARA ROSA	01/03/2020 13:14	01/03/2020 14:00	01/03/2020 13:14	01/03/2020 14:00	0,77	230	176,33	CHI
2020030100034	MUTUNOPOLIS	35202	MARA ROSA	01/03/2020 13:14	01/03/2020 14:00	01/03/2020 13:14	01/03/2020 14:00	0,77	1431	1097,10	CHI
2020030100034	MUTUNOPOLIS	04732	MARA ROSA	01/03/2020 13:14	01/03/2020 14:00	01/03/2020 13:14	01/03/2020 14:00	0,77	97	74,37	CHI
2020030100034	PORANGATU	20701	MARA ROSA	01/03/2020 13:14	01/03/2020 14:00	01/03/2020 13:14	01/03/2020 14:00	0,77	3	2,30	CHI
2020030100034	PORANGATU	35201	MARA ROSA	01/03/2020 13:14	01/03/2020 14:00	01/03/2020 13:14	01/03/2020 14:00	0,77	235	180,17	CHI
2020030100034	SANTA TEREZA DE GOIAS	20701	MARA ROSA	01/03/2020 13:14	01/03/2020 14:00	01/03/2020 13:14	01/03/2020 14:00	0,77	1661	1273,43	CHI
2020030100034	SANTA TEREZA DE GOIAS	04731	MARA ROSA	01/03/2020 13:14	01/03/2020 14:00	01/03/2020 13:14	01/03/2020 14:00	0,77	61	46,77	CHI
2020030100034	URUACU	46902	MARA ROSA	01/03/2020 13:14	01/03/2020 14:00	01/03/2020 13:14	01/03/2020 14:00	0,77	1	0,77	CHI
2020030100035	AMARALINA	35201	MARA ROSA	01/03/2020 15:49	01/03/2020 15:55	01/03/2020 15:49	01/03/2020 15:55	0,10	6	0,60	CHI
2020030100035	AMARALINA	35202	MARA ROSA	01/03/2020 15:49	01/03/2020 15:55	01/03/2020 15:49	01/03/2020 15:55	0,10	142	14,20	CHI
2020030100035	AMARALINA	04732	MARA ROSA	01/03/2020 15:49	01/03/2020 15:55	01/03/2020 15:49	01/03/2020 15:55	0,10	47	4,70	CHI
2020030100035	BONOPOLIS	35201	MARA ROSA	01/03/2020 15:49	01/03/2020 15:55	01/03/2020 15:49	01/03/2020 15:55	0,10	2	0,20	CHI
2020030100035	CAMPINACU	46901	MARA ROSA	01/03/2020 15:49	01/03/2020 15:55	01/03/2020 15:49	01/03/2020 15:55	0,10	11	1,10	CHI
2020030100035	CAMPINACU	46902	MARA ROSA	01/03/2020 15:49	01/03/2020 15:55	01/03/2020 15:49	01/03/2020 15:55	0,10	281	28,10	CHI
2020030100035	CAMPINORTE	46901	MARA ROSA	01/03/2020 15:49	01/03/2020 15:55	01/03/2020 15:49	01/03/2020 15:55	0,10	283	28,30	CHI
2020030100035	CAMPINORTE	46902	MARA ROSA	01/03/2020 15:49	01/03/2020 15:55	01/03/2020 15:49	01/03/2020 15:55	0,10	201	20,10	CHI
2020030100035	CAMPINORTE	01120424	MARA ROSA	01/03/2020 15:49	01/03/2020 15:55	01/03/2020 15:49	01/03/2020 15:55	0,10	2	0,20	CHI
2020030100035	ESTRELA DO NORTE	04701	MARA ROSA	01/03/2020 15:49	01/03/2020 15:55	01/03/2020 15:49	01/03/2020 15:55	0,10	1421	142,10	CHI
2020030100035	ESTRELA DO NORTE	20701	MARA ROSA	01/03/2020 15:49	01/03/2020 15:55	01/03/2020 15:49	01/03/2020 15:55	0,10	3	0,30	CHI
2020030100035	ESTRELA DO NORTE	35202	MARA ROSA	01/03/2020 15:49	01/03/2020 15:55	01/03/2020 15:49	01/03/2020 15:55	0,10	1	0,10	CHI
2020030100035	ESTRELA DO NORTE	04731	MARA ROSA	01/03/2020 15:49	01/03/2020 15:55	01/03/2020 15:49	01/03/2020 15:55	0,10	51	5,10	CHI
2020030100035	ESTRELA DO NORTE	01120414	MARA ROSA	01/03/2020 15:49	01/03/2020 15:55	01/03/2020 15:49	01/03/2020 15:55	0,10	17	1,70	CHI
2020030100035	ESTRELA DO NORTE	04732	MARA ROSA	01/03/2020 15:49	01/03/2020 15:55	01/03/2020 15:49	01/03/2020 15:55	0,10	43	4,30	CHI
2020030100035	FORMOSO	04701	MARA ROSA	01/03/2020 15:49	01/03/2020 15:55	01/03/2020 15:49	01/03/2020 15:55	0,10	74	7,40	CHI
2020030100035	FORMOSO	20701	MARA ROSA	01/03/2020 15:49	01/03/2020 15:55	01/03/2020 15:49	01/03/2020 15:55	0,10	104	10,40	CHI
2020030100035	FORMOSO	46901	MARA ROSA	01/03/2020 15:49	01/03/2020 15:55	01/03/2020 15:49	01/03/2020 15:55	0,10	3	0,30	CHI
2020030100035	FORMOSO	04731	MARA ROSA	01/03/2020 15:49	01/03/2020 15:55	01/03/2020 15:49	01/03/2020 15:55	0,10	84	8,40	CHI
2020030100035	MARA ROSA	04701	MARA ROSA	01/03/2020 15:49	01/03/2020 15:55	01/03/2020 15:49	01/03/2020 15:55	0,10	103	10,30	CHI
2020030100035	MARA ROSA	46901	MARA ROSA	01/03/2020 15:49	01/03/2020 15:55	01/03/2020 15:49	01/03/2020 15:55	0,10	10	1,00	CHI
2020030100035	MARA ROSA	01120414	MARA ROSA	01/03/2020 15:49	01/03/2020 15:55	01/03/2020 15:49	01/03/2020 15:55	0,10	73	7,30	CHI
2020030100035	MARA ROSA	04732	MARA ROSA	01/03/2020 15:49	01/03/2020 15:55	01/03/2020 15:49	01/03/2020 15:55	0,10	30	3,00	CHI
2020030100035	MARA ROSA	01120424	MARA ROSA	01/03/2020 15:49	01/03/2020 15:55	01/03/2020 15:49	01/03/2020 15:55	0,10	2	0,20	CHI
2020030100035	MUTUNOPOLIS	20701	MARA ROSA	01/03/2020 15:49	01/03/2020 15:55	01/03/2020 15:49	01/03/2020 15:55	0,10	6	0,60	CHI
2020030100035	MUTUNOPOLIS	35201	MARA ROSA	01/03/2020 15:49	01/03/2020 15:55	01/03/2020 15:49	01/03/2020 15:55	0,10	230	23,00	CHI
2020030100035	MUTUNOPOLIS	35202	MARA ROSA	01/03/2020 15:49	01/03/2020 15:55	01/03/2020 15:49	01/03/2020 15:55	0,10	1431	143,10	CHI
2020030100035	MUTUNOPOLIS	04732	MARA ROSA	01/03/2020 15:49	01/03/2020 15:55	01/03/2020 15:49	01/03/2020 15:55	0,10	94	9,40	CHI

2020030100035	PORANGATU	20701	MARA ROSA	01/03/2020 15:49	01/03/2020 15:55	01/03/2020 15:49	01/03/2020 15:55	0,10	3	0,30	CHI
2020030100035	PORANGATU	35201	MARA ROSA	01/03/2020 15:49	01/03/2020 15:55	01/03/2020 15:49	01/03/2020 15:55	0,10	235	23,50	CHI
2020030100035	SANTA TEREZA DE GOIAS	20701	MARA ROSA	01/03/2020 15:49	01/03/2020 15:55	01/03/2020 15:49	01/03/2020 15:55	0,10	1661	166,10	CHI
2020030100035	SANTA TEREZA DE GOIAS	04731	MARA ROSA	01/03/2020 15:49	01/03/2020 15:55	01/03/2020 15:49	01/03/2020 15:55	0,10	61	6,10	CHI
2020030100035	URUACU	46901	MARA ROSA	01/03/2020 15:49	01/03/2020 15:55	01/03/2020 15:49	01/03/2020 15:55	0,10	1	0,10	CHI
2020030100035	URUACU	46902	MARA ROSA	01/03/2020 15:49	01/03/2020 15:55	01/03/2020 15:49	01/03/2020 15:55	0,10	374	37,40	CHI
2020030100035	URUACU	01120424	MARA ROSA	01/03/2020 15:49	01/03/2020 15:55	01/03/2020 15:49	01/03/2020 15:55	0,10	5	0,50	CHI
2020030200044	CABECEIRAS	03740454	ITIQUEIRA	02/03/2020 14:28	02/03/2020 14:31	02/03/2020 14:28	02/03/2020 14:31	0,05	40	2,00	CHI
2020030200044	DISTRITO FEDERAL	03740454	ITIQUEIRA	02/03/2020 14:28	02/03/2020 14:31	02/03/2020 14:28	02/03/2020 14:31	0,05	1	0,05	CHI
2020030200044	FLORES DE GOIAS	25901	ITIQUEIRA	02/03/2020 14:28	02/03/2020 14:31	02/03/2020 14:28	02/03/2020 14:31	0,05	3	0,15	CHI
2020030200044	FORMOSA	25901	ITIQUEIRA	02/03/2020 14:28	02/03/2020 14:31	02/03/2020 14:28	02/03/2020 14:31	0,05	577	28,85	CHI
2020030200044	FORMOSA	28201	ITIQUEIRA	02/03/2020 14:28	02/03/2020 14:31	02/03/2020 14:28	02/03/2020 14:31	0,05	795	39,75	CHI
2020030200044	FORMOSA	03740454	ITIQUEIRA	02/03/2020 14:28	02/03/2020 14:31	02/03/2020 14:28	02/03/2020 14:31	0,05	2434	121,70	CHI
2020030200044	SAO JOAO D ALIANCA	25901	ITIQUEIRA	02/03/2020 14:28	02/03/2020 14:31	02/03/2020 14:28	02/03/2020 14:31	0,05	228	11,40	CHI
2020030200044	VILA BOA	25901	ITIQUEIRA	02/03/2020 14:28	02/03/2020 14:31	02/03/2020 14:28	02/03/2020 14:31	0,05	6	0,30	CHI
2020030200044	VILA BOA	28201	ITIQUEIRA	02/03/2020 14:28	02/03/2020 14:31	02/03/2020 14:28	02/03/2020 14:31	0,05	4	0,20	CHI
2020030200044	VILA BOA	03740454	ITIQUEIRA	02/03/2020 14:28	02/03/2020 14:31	02/03/2020 14:28	02/03/2020 14:31	0,05	202	10,10	CHI
2020030400023	CALDAS NOVAS	34101	MORRINHOS	04/03/2020 19:06	04/03/2020 19:17	04/03/2020 19:06	04/03/2020 19:16	0,17	2	0,33	CHI
2020030400023	MORRINHOS	34101	MORRINHOS	04/03/2020 19:06	04/03/2020 19:17	04/03/2020 19:06	04/03/2020 19:16	0,17	238	39,67	CHI
2020030400023	MORRINHOS	34102	MORRINHOS	04/03/2020 19:06	04/03/2020 19:17	04/03/2020 19:06	04/03/2020 19:16	0,17	362	60,33	CHI
2020030400023	MORRINHOS	01240414	MORRINHOS	04/03/2020 19:06	04/03/2020 19:17	04/03/2020 19:06	04/03/2020 19:16	0,17	88	14,67	CHI
2020030400023	RIO QUENTE	34101	MORRINHOS	04/03/2020 19:06	04/03/2020 19:17	04/03/2020 19:06	04/03/2020 19:16	0,17	20	3,33	CHI
2020030400023	CALDAS NOVAS	42602	MORRINHOS	04/03/2020 19:06	04/03/2020 19:17	04/03/2020 19:06	04/03/2020 19:17	0,18	7	1,28	CHI
2020030400023	MAIRIPOTABA	42601	MORRINHOS	04/03/2020 19:06	04/03/2020 19:17	04/03/2020 19:06	04/03/2020 19:17	0,18	15	2,75	CHI
2020030400023	MORRINHOS	42601	MORRINHOS	04/03/2020 19:06	04/03/2020 19:17	04/03/2020 19:06	04/03/2020 19:17	0,18	193	35,38	CHI
2020030400023	MORRINHOS	42602	MORRINHOS	04/03/2020 19:06	04/03/2020 19:17	04/03/2020 19:06	04/03/2020 19:17	0,18	24	4,40	CHI
2020030400023	MORRINHOS	01240424	MORRINHOS	04/03/2020 19:06	04/03/2020 19:17	04/03/2020 19:06	04/03/2020 19:17	0,18	20	3,67	CHI
2020030400023	PIRACANJUBA	42601	MORRINHOS	04/03/2020 19:06	04/03/2020 19:17	04/03/2020 19:06	04/03/2020 19:17	0,18	79	14,48	CHI
2020030400023	PIRACANJUBA	42602	MORRINHOS	04/03/2020 19:06	04/03/2020 19:17	04/03/2020 19:06	04/03/2020 19:17	0,18	162	29,70	CHI
2020030400023	PIRACANJUBA	01240424	MORRINHOS	04/03/2020 19:06	04/03/2020 19:17	04/03/2020 19:06	04/03/2020 19:17	0,18	3	0,55	CHI
2020030400023	PONTALINA	42601	MORRINHOS	04/03/2020 19:06	04/03/2020 19:17	04/03/2020 19:06	04/03/2020 19:17	0,18	15	2,75	CHI
2020030400052	ALVORADA DO NORTE	00010214	IACIARA S2	04/03/2020 01:54	04/03/2020 01:57	04/03/2020 01:54	04/03/2020 01:57	0,05	2006	100,30	CHI
2020030400052	ALVORADA DO NORTE	00010224	IACIARA S2	04/03/2020 01:54	04/03/2020 01:57	04/03/2020 01:54	04/03/2020 01:57	0,05	1154	57,70	CHI
2020030400052	ALVORADA DO NORTE	00010414	IACIARA S2	04/03/2020 01:54	04/03/2020 01:57	04/03/2020 01:54	04/03/2020 01:57	0,05	290	14,50	CHI
2020030400052	ALVORADA DO NORTE	00010424	IACIARA S2	04/03/2020 01:54	04/03/2020 01:57	04/03/2020 01:54	04/03/2020 01:57	0,05	3	0,15	CHI
2020030400052	ALVORADA DO NORTE	00010434	IACIARA S2	04/03/2020 01:54	04/03/2020 01:57	04/03/2020 01:54	04/03/2020 01:57	0,05	178	8,90	CHI
2020030400052	BURITINOPOLIS	00010214	IACIARA S2	04/03/2020 01:54	04/03/2020 01:57	04/03/2020 01:54	04/03/2020 01:57	0,05	1036	51,80	CHI
2020030400052	BURITINOPOLIS	49901	IACIARA S2	04/03/2020 01:54	04/03/2020 01:57	04/03/2020 01:54	04/03/2020 01:57	0,05	443	22,15	CHI
2020030400052	BURITINOPOLIS	00010434	IACIARA S2	04/03/2020 01:54	04/03/2020 01:57	04/03/2020 01:54	04/03/2020 01:57	0,05	7	0,35	CHI
2020030400052	DAMIANOPOLIS	11101	IACIARA S2	04/03/2020 01:54	04/03/2020 01:57	04/03/2020 01:54	04/03/2020 01:57	0,05	133	6,65	CHI
2020030400052	DAMIANOPOLIS	49902	IACIARA S2	04/03/2020 01:54	04/03/2020 01:57	04/03/2020 01:54	04/03/2020 01:57	0,05	1528	76,40	CHI
2020030400052	DAMIANOPOLIS	00010434	IACIARA S2	04/03/2020 01:54	04/03/2020 01:57	04/03/2020 01:54	04/03/2020 01:57	0,05	3	0,15	CHI
2020030400052	FLORES DE GOIAS	00010414	IACIARA S2	04/03/2020 01:54	04/03/2020 01:57	04/03/2020 01:54	04/03/2020 01:57	0,05	968	48,40	CHI
2020030400052	FORMOSA	00010414	IACIARA S2	04/03/2020 01:54	04/03/2020 01:57	04/03/2020 01:54	04/03/2020 01:57	0,05	1	0,05	CHI

2020030400052	IACIARA	00010414	IACIARA S2	04/03/2020 01:54	04/03/2020 01:57	04/03/2020 01:54	04/03/2020 01:57	0,05	1	0,05	CHI
2020030400052	MAMBAI	49901	IACIARA S2	04/03/2020 01:54	04/03/2020 01:57	04/03/2020 01:54	04/03/2020 01:57	0,05	2892	144,60	CHI
2020030400052	MAMBAI	49902	IACIARA S2	04/03/2020 01:54	04/03/2020 01:57	04/03/2020 01:54	04/03/2020 01:57	0,05	84	4,20	CHI
2020030400052	MAMBAI	00010434	IACIARA S2	04/03/2020 01:54	04/03/2020 01:57	04/03/2020 01:54	04/03/2020 01:57	0,05	17	0,85	CHI
2020030400052	POSSE	00010214	IACIARA S2	04/03/2020 01:54	04/03/2020 01:57	04/03/2020 01:54	04/03/2020 01:57	0,05	105	5,25	CHI
2020030400052	POSSE	00010424	IACIARA S2	04/03/2020 01:54	04/03/2020 01:57	04/03/2020 01:54	04/03/2020 01:57	0,05	82	4,10	CHI
2020030400052	SIMOLANDIA	00010214	IACIARA S2	04/03/2020 01:54	04/03/2020 01:57	04/03/2020 01:54	04/03/2020 01:57	0,05	2114	105,70	CHI
2020030400052	SIMOLANDIA	00010224	IACIARA S2	04/03/2020 01:54	04/03/2020 01:57	04/03/2020 01:54	04/03/2020 01:57	0,05	3	0,15	CHI
2020030400052	SIMOLANDIA	00010414	IACIARA S2	04/03/2020 01:54	04/03/2020 01:57	04/03/2020 01:54	04/03/2020 01:57	0,05	1	0,05	CHI
2020030400052	SIMOLANDIA	00010424	IACIARA S2	04/03/2020 01:54	04/03/2020 01:57	04/03/2020 01:54	04/03/2020 01:57	0,05	249	12,45	CHI
2020030400052	SITIO D ABADIA	11101	IACIARA S2	04/03/2020 01:54	04/03/2020 01:57	04/03/2020 01:54	04/03/2020 01:57	0,05	383	19,15	CHI
2020030400052	SITIO D ABADIA	42901	IACIARA S2	04/03/2020 01:54	04/03/2020 01:57	04/03/2020 01:54	04/03/2020 01:57	0,05	91	4,55	CHI
2020030400052	SITIO D ABADIA	49901	IACIARA S2	04/03/2020 01:54	04/03/2020 01:57	04/03/2020 01:54	04/03/2020 01:57	0,05	1	0,05	CHI
2020030400052	SITIO D ABADIA	42902	IACIARA S2	04/03/2020 01:54	04/03/2020 01:57	04/03/2020 01:54	04/03/2020 01:57	0,05	481	24,05	CHI
2020030400052	SITIO D ABADIA	00010414	IACIARA S2	04/03/2020 01:54	04/03/2020 01:57	04/03/2020 01:54	04/03/2020 01:57	0,05	144	7,20	CHI
2020030400052	SITIO D ABADIA	00010434	IACIARA S2	04/03/2020 01:54	04/03/2020 01:57	04/03/2020 01:54	04/03/2020 01:57	0,05	36	1,80	CHI
2020030400052	VILA BOA	18901	IACIARA S2	04/03/2020 01:54	04/03/2020 01:57	04/03/2020 01:54	04/03/2020 01:57	0,05	1351	67,55	CHI
2020030400052	VILA BOA	00010414	IACIARA S2	04/03/2020 01:54	04/03/2020 01:57	04/03/2020 01:54	04/03/2020 01:57	0,05	66	3,30	CHI
2020030400053	CAMPOS BELOS	07601	SAO DOMINGOS	04/03/2020 01:54	04/03/2020 01:59	04/03/2020 01:54	04/03/2020 01:59	0,08	4583	381,92	CHI
2020030400053	CAMPOS BELOS	07602	SAO DOMINGOS	04/03/2020 01:54	04/03/2020 01:59	04/03/2020 01:54	04/03/2020 01:59	0,08	2772	231,00	CHI
2020030400053	CAMPOS BELOS	02090504	SAO DOMINGOS	04/03/2020 01:54	04/03/2020 01:59	04/03/2020 01:54	04/03/2020 01:59	0,08	102	8,50	CHI
2020030400053	CAMPOS BELOS	07632	SAO DOMINGOS	04/03/2020 01:54	04/03/2020 01:59	04/03/2020 01:54	04/03/2020 01:59	0,08	152	12,67	CHI
2020030400053	CAMPOS BELOS	07633	SAO DOMINGOS	04/03/2020 01:54	04/03/2020 01:59	04/03/2020 01:54	04/03/2020 01:59	0,08	362	30,17	CHI
2020030400053	CAVALCANTE	34301	SAO DOMINGOS	04/03/2020 01:54	04/03/2020 01:59	04/03/2020 01:54	04/03/2020 01:59	0,08	169	14,08	CHI
2020030400053	DIVINOPOLIS DE GOIAS	02090504	SAO DOMINGOS	04/03/2020 01:54	04/03/2020 01:59	04/03/2020 01:54	04/03/2020 01:59	0,08	2216	184,67	CHI
2020030400053	DIVINOPOLIS DE GOIAS	07633	SAO DOMINGOS	04/03/2020 01:54	04/03/2020 01:59	04/03/2020 01:54	04/03/2020 01:59	0,08	3	0,25	CHI
2020030400053	GUARANI DE GOIAS	02090504	SAO DOMINGOS	04/03/2020 01:54	04/03/2020 01:59	04/03/2020 01:54	04/03/2020 01:59	0,08	151	12,58	CHI
2020030400053	MONTE ALEGRE DE GOIAS	07601	SAO DOMINGOS	04/03/2020 01:54	04/03/2020 01:59	04/03/2020 01:54	04/03/2020 01:59	0,08	57	4,75	CHI
2020030400053	MONTE ALEGRE DE GOIAS	34301	SAO DOMINGOS	04/03/2020 01:54	04/03/2020 01:59	04/03/2020 01:54	04/03/2020 01:59	0,08	1960	163,33	CHI
2020030400053	MONTE ALEGRE DE GOIAS	02090504	SAO DOMINGOS	04/03/2020 01:54	04/03/2020 01:59	04/03/2020 01:54	04/03/2020 01:59	0,08	154	12,83	CHI
2020030400053	MONTE ALEGRE DE GOIAS	02090504	SAO DOMINGOS	04/03/2020 01:54	04/03/2020 01:59	04/03/2020 01:54	04/03/2020 01:59	0,08	2	0,17	CHI
2020030400053	MONTE ALEGRE DE GOIAS	07633	SAO DOMINGOS	04/03/2020 01:54	04/03/2020 01:59	04/03/2020 01:54	04/03/2020 01:59	0,08	733	61,08	CHI
2020030400053	NOVA ROMA	34301	SAO DOMINGOS	04/03/2020 01:54	04/03/2020 01:59	04/03/2020 01:54	04/03/2020 01:59	0,08	54	4,50	CHI
2020030400053	NOVA ROMA	02090504	SAO DOMINGOS	04/03/2020 01:54	04/03/2020 01:59	04/03/2020 01:54	04/03/2020 01:59	0,08	3	0,25	CHI
2020030400053	SAO DOMINGOS	02090504	SAO DOMINGOS	04/03/2020 01:54	04/03/2020 01:59	04/03/2020 01:54	04/03/2020 01:59	0,08	2378	198,17	CHI
2020030400053	SAO DOMINGOS	02090504	SAO DOMINGOS	04/03/2020 01:54	04/03/2020 01:59	04/03/2020 01:54	04/03/2020 01:59	0,08	396	33,00	CHI
2020030400053	SAO DOMINGOS	02090504	SAO DOMINGOS	04/03/2020 01:54	04/03/2020 01:59	04/03/2020 01:54	04/03/2020 01:59	0,08	1150	95,83	CHI
2020030400053	SAO DOMINGOS	07633	SAO DOMINGOS	04/03/2020 01:54	04/03/2020 01:59	04/03/2020 01:54	04/03/2020 01:59	0,08	284	23,67	CHI
2020030500076	ALVORADA DO NORTE	00010214	IACIARA S2	05/03/2020 16:13	05/03/2020 16:16	05/03/2020 16:13	05/03/2020 16:16	0,05	2006	100,30	CHI
2020030500076	ALVORADA DO NORTE	00010224	IACIARA S2	05/03/2020 16:13	05/03/2020 16:16	05/03/2020 16:13	05/03/2020 16:16	0,05	1154	57,70	CHI
2020030500076	ALVORADA DO NORTE	00010414	IACIARA S2	05/03/2020 16:13	05/03/2020 16:16	05/03/2020 16:13	05/03/2020 16:16	0,05	290	14,50	CHI
2020030500076	ALVORADA DO NORTE	00010424	IACIARA S2	05/03/2020 16:13	05/03/2020 16:16	05/03/2020 16:13	05/03/2020 16:16	0,05	3	0,15	CHI
2020030500076	ALVORADA DO NORTE	00010434	IACIARA S2	05/03/2020 16:13	05/03/2020 16:16	05/03/2020 16:13	05/03/2020 16:16	0,05	178	8,90	CHI
2020030500076	BURITINOPOLIS	00010214	IACIARA S2	05/03/2020 16:13	05/03/2020 16:16	05/03/2020 16:13	05/03/2020 16:16	0,05	1036	51,80	CHI

2020030500076	BURITINOPOLIS	49901	IACIARA S2	05/03/2020 16:13	05/03/2020 16:16	05/03/2020 16:13	05/03/2020 16:16	0,05	443	22,15	CHI
2020030500076	BURITINOPOLIS	00010434	IACIARA S2	05/03/2020 16:13	05/03/2020 16:16	05/03/2020 16:13	05/03/2020 16:16	0,05	7	0,35	CHI
2020030500076	DAMIANOPOLIS	11101	IACIARA S2	05/03/2020 16:13	05/03/2020 16:16	05/03/2020 16:13	05/03/2020 16:16	0,05	133	6,65	CHI
2020030500076	DAMIANOPOLIS	49902	IACIARA S2	05/03/2020 16:13	05/03/2020 16:16	05/03/2020 16:13	05/03/2020 16:16	0,05	1528	76,40	CHI
2020030500076	DAMIANOPOLIS	00010434	IACIARA S2	05/03/2020 16:13	05/03/2020 16:16	05/03/2020 16:13	05/03/2020 16:16	0,05	3	0,15	CHI
2020030500076	FLORES DE GOIAS	00010414	IACIARA S2	05/03/2020 16:13	05/03/2020 16:16	05/03/2020 16:13	05/03/2020 16:16	0,05	964	48,20	CHI
2020030500076	FORMOSA	00010414	IACIARA S2	05/03/2020 16:13	05/03/2020 16:16	05/03/2020 16:13	05/03/2020 16:16	0,05	1	0,05	CHI
2020030500076	IACIARA	00010414	IACIARA S2	05/03/2020 16:13	05/03/2020 16:16	05/03/2020 16:13	05/03/2020 16:16	0,05	1	0,05	CHI
2020030500076	MAMBAL	49901	IACIARA S2	05/03/2020 16:13	05/03/2020 16:16	05/03/2020 16:13	05/03/2020 16:16	0,05	2892	144,60	CHI
2020030500076	MAMBAL	49902	IACIARA S2	05/03/2020 16:13	05/03/2020 16:16	05/03/2020 16:13	05/03/2020 16:16	0,05	84	4,20	CHI
2020030500076	MAMBAL	00010434	IACIARA S2	05/03/2020 16:13	05/03/2020 16:16	05/03/2020 16:13	05/03/2020 16:16	0,05	17	0,85	CHI
2020030500076	POSSE	00010214	IACIARA S2	05/03/2020 16:13	05/03/2020 16:16	05/03/2020 16:13	05/03/2020 16:16	0,05	105	5,25	CHI
2020030500076	POSSE	00010424	IACIARA S2	05/03/2020 16:13	05/03/2020 16:16	05/03/2020 16:13	05/03/2020 16:16	0,05	82	4,10	CHI
2020030500076	SIMOLANDIA	00010214	IACIARA S2	05/03/2020 16:13	05/03/2020 16:16	05/03/2020 16:13	05/03/2020 16:16	0,05	2114	105,70	CHI
2020030500076	SIMOLANDIA	00010224	IACIARA S2	05/03/2020 16:13	05/03/2020 16:16	05/03/2020 16:13	05/03/2020 16:16	0,05	3	0,15	CHI
2020030500076	SIMOLANDIA	00010414	IACIARA S2	05/03/2020 16:13	05/03/2020 16:16	05/03/2020 16:13	05/03/2020 16:16	0,05	1	0,05	CHI
2020030500076	SIMOLANDIA	00010424	IACIARA S2	05/03/2020 16:13	05/03/2020 16:16	05/03/2020 16:13	05/03/2020 16:16	0,05	249	12,45	CHI
2020030500076	SITIO D ABADIA	11101	IACIARA S2	05/03/2020 16:13	05/03/2020 16:16	05/03/2020 16:13	05/03/2020 16:16	0,05	383	19,15	CHI
2020030500076	SITIO D ABADIA	42901	IACIARA S2	05/03/2020 16:13	05/03/2020 16:16	05/03/2020 16:13	05/03/2020 16:16	0,05	91	4,55	CHI
2020030500076	SITIO D ABADIA	49901	IACIARA S2	05/03/2020 16:13	05/03/2020 16:16	05/03/2020 16:13	05/03/2020 16:16	0,05	1	0,05	CHI
2020030500076	SITIO D ABADIA	42902	IACIARA S2	05/03/2020 16:13	05/03/2020 16:16	05/03/2020 16:13	05/03/2020 16:16	0,05	481	24,05	CHI
2020030500076	SITIO D ABADIA	00010414	IACIARA S2	05/03/2020 16:13	05/03/2020 16:16	05/03/2020 16:13	05/03/2020 16:16	0,05	144	7,20	CHI
2020030500076	SITIO D ABADIA	00010434	IACIARA S2	05/03/2020 16:13	05/03/2020 16:16	05/03/2020 16:13	05/03/2020 16:16	0,05	36	1,80	CHI
2020030500076	VILA BOA	18901	IACIARA S2	05/03/2020 16:13	05/03/2020 16:16	05/03/2020 16:13	05/03/2020 16:16	0,05	1351	67,55	CHI
2020030500076	VILA BOA	00010414	IACIARA S2	05/03/2020 16:13	05/03/2020 16:16	05/03/2020 16:13	05/03/2020 16:16	0,05	66	3,30	CHI
2020030500077	CABECEIRAS	22101	ITIQUEIRA	05/03/2020 16:13	05/03/2020 16:17	05/03/2020 16:13	05/03/2020 16:17	0,07	2880	192,00	CHI
2020030500077	CABECEIRAS	03740424	ITIQUEIRA	05/03/2020 16:13	05/03/2020 16:17	05/03/2020 16:13	05/03/2020 16:17	0,07	48	3,20	CHI
2020030500077	CABECEIRAS	03740434	ITIQUEIRA	05/03/2020 16:13	05/03/2020 16:17	05/03/2020 16:13	05/03/2020 16:17	0,07	199	13,27	CHI
2020030500077	CABECEIRAS	22134	ITIQUEIRA	05/03/2020 16:13	05/03/2020 16:17	05/03/2020 16:13	05/03/2020 16:17	0,07	24	1,60	CHI
2020030500077	CABECEIRAS	03740444	ITIQUEIRA	05/03/2020 16:13	05/03/2020 16:17	05/03/2020 16:13	05/03/2020 16:17	0,07	141	9,40	CHI
2020030500077	CABECEIRAS	03740454	ITIQUEIRA	05/03/2020 16:13	05/03/2020 16:17	05/03/2020 16:13	05/03/2020 16:17	0,07	40	2,67	CHI
2020030500077	DISTRITO FEDERAL	22101	ITIQUEIRA	05/03/2020 16:13	05/03/2020 16:17	05/03/2020 16:13	05/03/2020 16:17	0,07	1	0,07	CHI
2020030500077	DISTRITO FEDERAL	03740414	ITIQUEIRA	05/03/2020 16:13	05/03/2020 16:17	05/03/2020 16:13	05/03/2020 16:17	0,07	2	0,13	CHI
2020030500077	DISTRITO FEDERAL	22134	ITIQUEIRA	05/03/2020 16:13	05/03/2020 16:17	05/03/2020 16:13	05/03/2020 16:17	0,07	1	0,07	CHI
2020030500077	DISTRITO FEDERAL	03740454	ITIQUEIRA	05/03/2020 16:13	05/03/2020 16:17	05/03/2020 16:13	05/03/2020 16:17	0,07	1	0,07	CHI
2020030500077	FLORES DE GOIAS	25901	ITIQUEIRA	05/03/2020 16:13	05/03/2020 16:17	05/03/2020 16:13	05/03/2020 16:17	0,07	3	0,20	CHI
2020030500077	FORMOSA	25901	ITIQUEIRA	05/03/2020 16:13	05/03/2020 16:17	05/03/2020 16:13	05/03/2020 16:17	0,07	577	38,47	CHI
2020030500077	FORMOSA	28201	ITIQUEIRA	05/03/2020 16:13	05/03/2020 16:17	05/03/2020 16:13	05/03/2020 16:17	0,07	795	53,00	CHI
2020030500077	FORMOSA	03740214	ITIQUEIRA	05/03/2020 16:13	05/03/2020 16:17	05/03/2020 16:13	05/03/2020 16:17	0,07	10747	716,47	CHI
2020030500077	FORMOSA	03740224	ITIQUEIRA	05/03/2020 16:13	05/03/2020 16:17	05/03/2020 16:13	05/03/2020 16:17	0,07	15417	1027,80	CHI
2020030500077	FORMOSA	03742134	ITIQUEIRA	05/03/2020 16:13	05/03/2020 16:17	05/03/2020 16:13	05/03/2020 16:17	0,07	14614	974,27	CHI
2020030500077	FORMOSA	03740414	ITIQUEIRA	05/03/2020 16:13	05/03/2020 16:17	05/03/2020 16:13	05/03/2020 16:17	0,07	27	1,80	CHI
2020030500077	FORMOSA	03740214	ITIQUEIRA	05/03/2020 16:13	05/03/2020 16:17	05/03/2020 16:13	05/03/2020 16:17	0,07	1540	102,67	CHI
2020030500077	FORMOSA	03740424	ITIQUEIRA	05/03/2020 16:13	05/03/2020 16:17	05/03/2020 16:13	05/03/2020 16:17	0,07	6	0,40	CHI

2020030500077	FORMOSA	03740434	ITIQUEIRA	05/03/2020 16:13	05/03/2020 16:17	05/03/2020 16:13	05/03/2020 16:17	0,07	2	0,13	CHI
2020030500077	FORMOSA	03740444	ITIQUEIRA	05/03/2020 16:13	05/03/2020 16:17	05/03/2020 16:13	05/03/2020 16:17	0,07	29	1,93	CHI
2020030500077	FORMOSA	03740454	ITIQUEIRA	05/03/2020 16:13	05/03/2020 16:17	05/03/2020 16:13	05/03/2020 16:17	0,07	2444	162,93	CHI
2020030500077	ITARUMA	03742134	ITIQUEIRA	05/03/2020 16:13	05/03/2020 16:17	05/03/2020 16:13	05/03/2020 16:17	0,07	3	0,20	CHI
2020030500077	SAO JOAO D ALIANCA	25901	ITIQUEIRA	05/03/2020 16:13	05/03/2020 16:17	05/03/2020 16:13	05/03/2020 16:17	0,07	228	15,20	CHI
2020030500077	VILA BOA	25901	ITIQUEIRA	05/03/2020 16:13	05/03/2020 16:17	05/03/2020 16:13	05/03/2020 16:17	0,07	6	0,40	CHI
2020030500077	VILA BOA	28201	ITIQUEIRA	05/03/2020 16:13	05/03/2020 16:17	05/03/2020 16:13	05/03/2020 16:17	0,07	4	0,27	CHI
2020030500077	VILA BOA	03740454	ITIQUEIRA	05/03/2020 16:13	05/03/2020 16:17	05/03/2020 16:13	05/03/2020 16:17	0,07	202	13,47	CHI
2020030500089	ALVORADA DO NORTE	00015124	IACIARA S2	05/03/2020 23:17	05/03/2020 23:20	05/03/2020 23:17	05/03/2020 23:20	0,05	2006	100,30	CHI
2020030500089	ALVORADA DO NORTE	00015124	IACIARA S2	05/03/2020 23:17	05/03/2020 23:20	05/03/2020 23:17	05/03/2020 23:20	0,05	1154	57,70	CHI
2020030500089	ALVORADA DO NORTE	00015124	IACIARA S2	05/03/2020 23:17	05/03/2020 23:20	05/03/2020 23:17	05/03/2020 23:20	0,05	290	14,50	CHI
2020030500089	ALVORADA DO NORTE	00015124	IACIARA S2	05/03/2020 23:17	05/03/2020 23:20	05/03/2020 23:17	05/03/2020 23:20	0,05	3	0,15	CHI
2020030500089	ALVORADA DO NORTE	00015124	IACIARA S2	05/03/2020 23:17	05/03/2020 23:20	05/03/2020 23:17	05/03/2020 23:20	0,05	178	8,90	CHI
2020030500089	BURITINOPOLIS	00015124	IACIARA S2	05/03/2020 23:17	05/03/2020 23:20	05/03/2020 23:17	05/03/2020 23:20	0,05	1036	51,80	CHI
2020030500089	BURITINOPOLIS	49901	IACIARA S2	05/03/2020 23:17	05/03/2020 23:20	05/03/2020 23:17	05/03/2020 23:20	0,05	443	22,15	CHI
2020030500089	BURITINOPOLIS	00015124	IACIARA S2	05/03/2020 23:17	05/03/2020 23:20	05/03/2020 23:17	05/03/2020 23:20	0,05	7	0,35	CHI
2020030500089	DAMIANOPOLIS	11101	IACIARA S2	05/03/2020 23:17	05/03/2020 23:20	05/03/2020 23:17	05/03/2020 23:20	0,05	133	6,65	CHI
2020030500089	DAMIANOPOLIS	49902	IACIARA S2	05/03/2020 23:17	05/03/2020 23:20	05/03/2020 23:17	05/03/2020 23:20	0,05	1528	76,40	CHI
2020030500089	DAMIANOPOLIS	00015124	IACIARA S2	05/03/2020 23:17	05/03/2020 23:20	05/03/2020 23:17	05/03/2020 23:20	0,05	3	0,15	CHI
2020030500089	FLORES DE GOIAS	00015124	IACIARA S2	05/03/2020 23:17	05/03/2020 23:20	05/03/2020 23:17	05/03/2020 23:20	0,05	968	48,40	CHI
2020030500089	FORMOSA	00015124	IACIARA S2	05/03/2020 23:17	05/03/2020 23:20	05/03/2020 23:17	05/03/2020 23:20	0,05	1	0,05	CHI
2020030500089	IACIARA	00015124	IACIARA S2	05/03/2020 23:17	05/03/2020 23:20	05/03/2020 23:17	05/03/2020 23:20	0,05	1	0,05	CHI
2020030500089	MAMBAI	49901	IACIARA S2	05/03/2020 23:17	05/03/2020 23:20	05/03/2020 23:17	05/03/2020 23:20	0,05	2892	144,60	CHI
2020030500089	MAMBAI	49902	IACIARA S2	05/03/2020 23:17	05/03/2020 23:20	05/03/2020 23:17	05/03/2020 23:20	0,05	84	4,20	CHI
2020030500089	MAMBAI	00015124	IACIARA S2	05/03/2020 23:17	05/03/2020 23:20	05/03/2020 23:17	05/03/2020 23:20	0,05	17	0,85	CHI
2020030500089	POSSE	00015124	IACIARA S2	05/03/2020 23:17	05/03/2020 23:20	05/03/2020 23:17	05/03/2020 23:20	0,05	105	5,25	CHI
2020030500089	POSSE	00015124	IACIARA S2	05/03/2020 23:17	05/03/2020 23:20	05/03/2020 23:17	05/03/2020 23:20	0,05	82	4,10	CHI
2020030500089	SIMOLANDIA	00015124	IACIARA S2	05/03/2020 23:17	05/03/2020 23:20	05/03/2020 23:17	05/03/2020 23:20	0,05	2114	105,70	CHI
2020030500089	SIMOLANDIA	00015124	IACIARA S2	05/03/2020 23:17	05/03/2020 23:20	05/03/2020 23:17	05/03/2020 23:20	0,05	3	0,15	CHI
2020030500089	SIMOLANDIA	00015124	IACIARA S2	05/03/2020 23:17	05/03/2020 23:20	05/03/2020 23:17	05/03/2020 23:20	0,05	1	0,05	CHI
2020030500089	SIMOLANDIA	00015124	IACIARA S2	05/03/2020 23:17	05/03/2020 23:20	05/03/2020 23:17	05/03/2020 23:20	0,05	249	12,45	CHI
2020030500089	SITIO D ABADIA	11101	IACIARA S2	05/03/2020 23:17	05/03/2020 23:20	05/03/2020 23:17	05/03/2020 23:20	0,05	383	19,15	CHI
2020030500089	SITIO D ABADIA	42901	IACIARA S2	05/03/2020 23:17	05/03/2020 23:20	05/03/2020 23:17	05/03/2020 23:20	0,05	91	4,55	CHI
2020030500089	SITIO D ABADIA	49901	IACIARA S2	05/03/2020 23:17	05/03/2020 23:20	05/03/2020 23:17	05/03/2020 23:20	0,05	1	0,05	CHI
2020030500089	SITIO D ABADIA	42902	IACIARA S2	05/03/2020 23:17	05/03/2020 23:20	05/03/2020 23:17	05/03/2020 23:20	0,05	481	24,05	CHI
2020030500089	SITIO D ABADIA	00015124	IACIARA S2	05/03/2020 23:17	05/03/2020 23:20	05/03/2020 23:17	05/03/2020 23:20	0,05	144	7,20	CHI
2020030500089	SITIO D ABADIA	00015124	IACIARA S2	05/03/2020 23:17	05/03/2020 23:20	05/03/2020 23:17	05/03/2020 23:20	0,05	36	1,80	CHI
2020030500089	VILA BOA	18901	IACIARA S2	05/03/2020 23:17	05/03/2020 23:20	05/03/2020 23:17	05/03/2020 23:20	0,05	1351	67,55	CHI
2020030500089	VILA BOA	00015124	IACIARA S2	05/03/2020 23:17	05/03/2020 23:20	05/03/2020 23:17	05/03/2020 23:20	0,05	66	3,30	CHI
2020030500095	CAMPOS BELOS	07601	SAO DOMINGOS	05/03/2020 23:20	05/03/2020 23:24	05/03/2020 23:20	05/03/2020 23:24	0,07	4583	305,53	CHI
2020030500095	CAMPOS BELOS	07602	SAO DOMINGOS	05/03/2020 23:20	05/03/2020 23:24	05/03/2020 23:20	05/03/2020 23:24	0,07	2772	184,80	CHI
2020030500095	CAMPOS BELOS	02090504	SAO DOMINGOS	05/03/2020 23:20	05/03/2020 23:24	05/03/2020 23:20	05/03/2020 23:24	0,07	102	6,80	CHI
2020030500095	CAMPOS BELOS	07632	SAO DOMINGOS	05/03/2020 23:20	05/03/2020 23:24	05/03/2020 23:20	05/03/2020 23:24	0,07	152	10,13	CHI
2020030500095	CAMPOS BELOS	07633	SAO DOMINGOS	05/03/2020 23:20	05/03/2020 23:24	05/03/2020 23:20	05/03/2020 23:24	0,07	362	24,13	CHI

2020030500095	CAVALCANTE	34301	SAO DOMINGOS	05/03/2020 23:20	05/03/2020 23:24	05/03/2020 23:20	05/03/2020 23:24	0,07	169	11,27	CHI
2020030500095	DIVINOPOLIS DE GOIAS	02090504	SAO DOMINGOS	05/03/2020 23:20	05/03/2020 23:24	05/03/2020 23:20	05/03/2020 23:24	0,07	2216	147,73	CHI
2020030500095	DIVINOPOLIS DE GOIAS	07633	SAO DOMINGOS	05/03/2020 23:20	05/03/2020 23:24	05/03/2020 23:20	05/03/2020 23:24	0,07	3	0,20	CHI
2020030500095	GUARANI DE GOIAS	02090504	SAO DOMINGOS	05/03/2020 23:20	05/03/2020 23:24	05/03/2020 23:20	05/03/2020 23:24	0,07	148	9,87	CHI
2020030500095	MONTE ALEGRE DE GOIAS	07601	SAO DOMINGOS	05/03/2020 23:20	05/03/2020 23:24	05/03/2020 23:20	05/03/2020 23:24	0,07	57	3,80	CHI
2020030500095	MONTE ALEGRE DE GOIAS	34301	SAO DOMINGOS	05/03/2020 23:20	05/03/2020 23:24	05/03/2020 23:20	05/03/2020 23:24	0,07	1960	130,67	CHI
2020030500095	MONTE ALEGRE DE GOIAS	02090504	SAO DOMINGOS	05/03/2020 23:20	05/03/2020 23:24	05/03/2020 23:20	05/03/2020 23:24	0,07	154	10,27	CHI
2020030500095	MONTE ALEGRE DE GOIAS	02090504	SAO DOMINGOS	05/03/2020 23:20	05/03/2020 23:24	05/03/2020 23:20	05/03/2020 23:24	0,07	2	0,13	CHI
2020030500095	MONTE ALEGRE DE GOIAS	07633	SAO DOMINGOS	05/03/2020 23:20	05/03/2020 23:24	05/03/2020 23:20	05/03/2020 23:24	0,07	733	48,87	CHI
2020030500095	NOVA ROMA	34301	SAO DOMINGOS	05/03/2020 23:20	05/03/2020 23:24	05/03/2020 23:20	05/03/2020 23:24	0,07	54	3,60	CHI
2020030500095	NOVA ROMA	02090504	SAO DOMINGOS	05/03/2020 23:20	05/03/2020 23:24	05/03/2020 23:20	05/03/2020 23:24	0,07	3	0,20	CHI
2020030500095	SAO DOMINGOS	02090504	SAO DOMINGOS	05/03/2020 23:20	05/03/2020 23:24	05/03/2020 23:20	05/03/2020 23:24	0,07	2378	158,53	CHI
2020030500095	SAO DOMINGOS	02090504	SAO DOMINGOS	05/03/2020 23:20	05/03/2020 23:24	05/03/2020 23:20	05/03/2020 23:24	0,07	395	26,33	CHI
2020030500095	SAO DOMINGOS	02090504	SAO DOMINGOS	05/03/2020 23:20	05/03/2020 23:24	05/03/2020 23:20	05/03/2020 23:24	0,07	1086	72,40	CHI
2020030500095	SAO DOMINGOS	07633	SAO DOMINGOS	05/03/2020 23:20	05/03/2020 23:24	05/03/2020 23:20	05/03/2020 23:24	0,07	284	18,93	CHI
2020030600022	PARAUNA	05760224	PARAUNA	06/03/2020 09:36	06/03/2020 15:01	06/03/2020 09:36	06/03/2020 12:28	2,86	839	2396,28	CHI
2020030600022	FIRMINOPOLIS	05760234	FIRMINOPOLIS S1	06/03/2020 09:36	06/03/2020 15:01	06/03/2020 09:36	06/03/2020 12:29	2,87	10	28,72	CHI
2020030600022	PALMINOPOLIS	05760234	FIRMINOPOLIS S1	06/03/2020 09:36	06/03/2020 15:01	06/03/2020 09:36	06/03/2020 12:29	2,87	1	2,87	CHI
2020030600022	SAO JOAO DA PARAUNA	05760234	FIRMINOPOLIS S1	06/03/2020 09:36	06/03/2020 15:01	06/03/2020 09:36	06/03/2020 12:29	2,87	20	57,44	CHI
2020030600022	PARAUNA	05760234	PARAUNA	06/03/2020 09:36	06/03/2020 15:01	06/03/2020 09:36	06/03/2020 12:29	2,87	405	1163,14	CHI
2020030600022	PARAUNA	05760234	PARAUNA	06/03/2020 09:36	06/03/2020 15:01	06/03/2020 09:36	06/03/2020 12:29	2,87	2483	7131,04	CHI
2020030600022	SAO JOAO DA PARAUNA	05760234	PARAUNA	06/03/2020 09:36	06/03/2020 15:01	06/03/2020 09:36	06/03/2020 12:29	2,87	49	140,73	CHI
2020030600022	PARAUNA	05760214	PARAUNA	06/03/2020 09:36	06/03/2020 15:01	06/03/2020 09:36	06/03/2020 12:55	3,32	616	2046,32	CHI
2020030600022	PARAUNA	05760214	PARAUNA	06/03/2020 09:36	06/03/2020 15:01	06/03/2020 09:36	06/03/2020 13:22	3,76	94	353,26	CHI
2020030600022	PARAUNA	05760214	PARAUNA	06/03/2020 09:36	06/03/2020 15:01	06/03/2020 09:36	06/03/2020 14:25	4,82	24	115,63	CHI
2020030600022	PARAUNA	05760214	PARAUNA	06/03/2020 09:36	06/03/2020 15:01	06/03/2020 09:36	06/03/2020 15:01	5,42	30	162,66	CHI

Plotagem das Ocorrências conforme a Espacialização das Chuvas

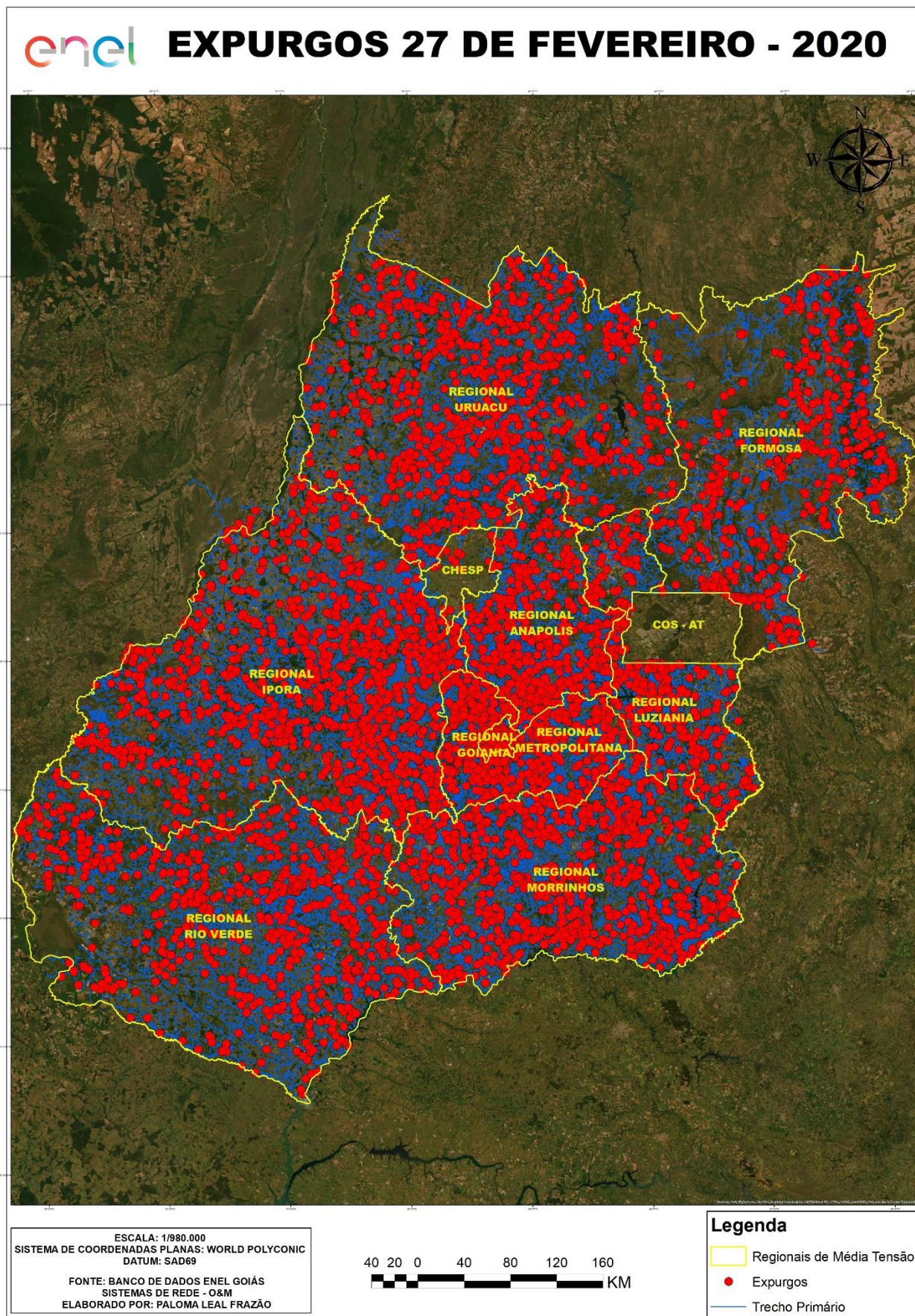

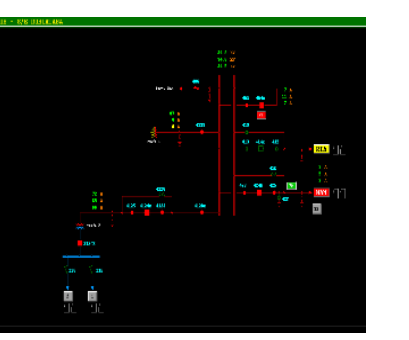
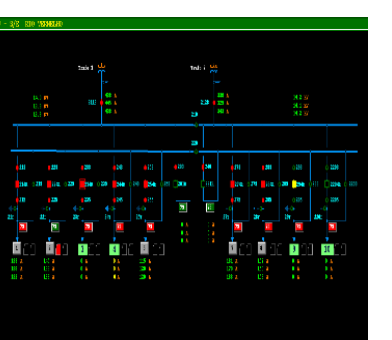
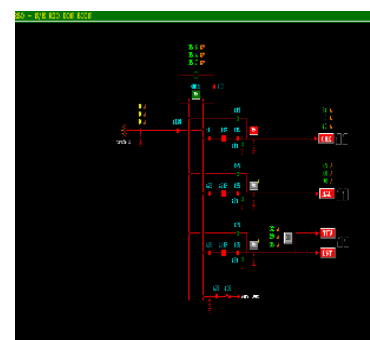
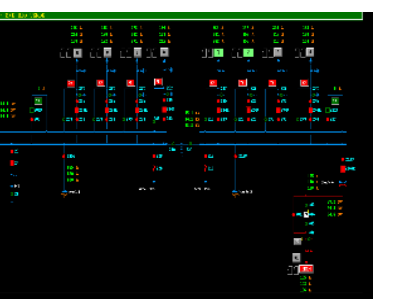
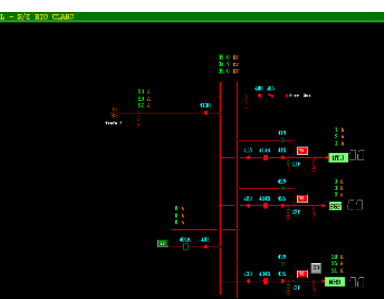
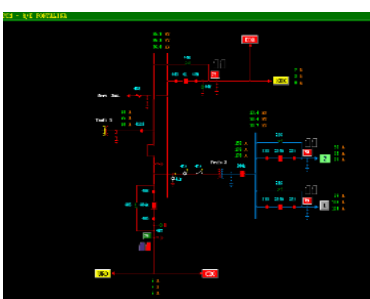
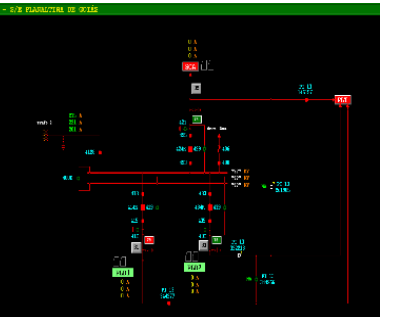
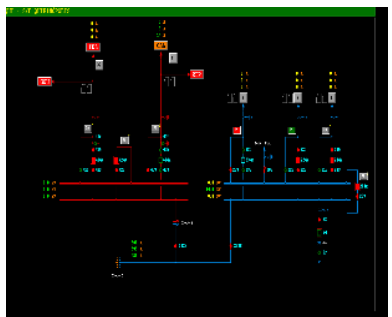
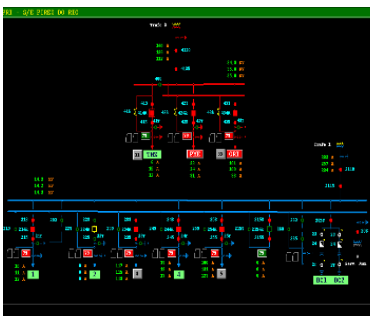
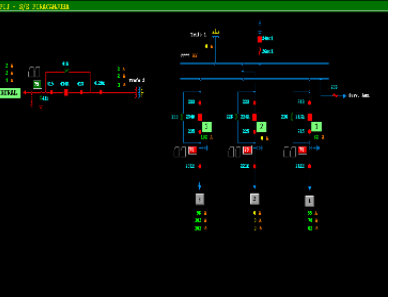
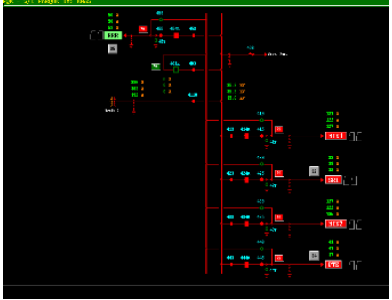
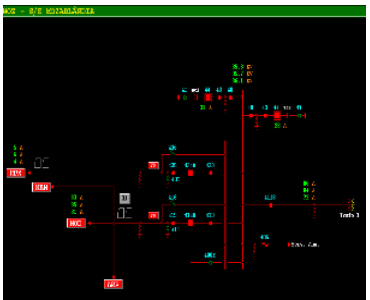
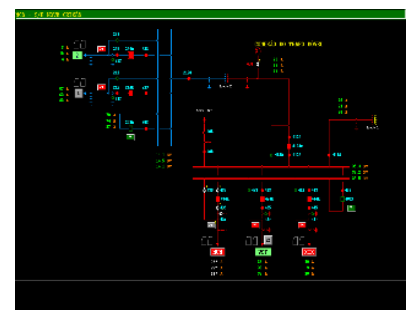
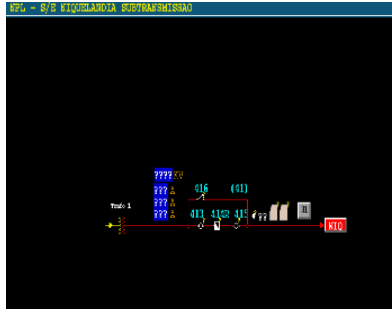

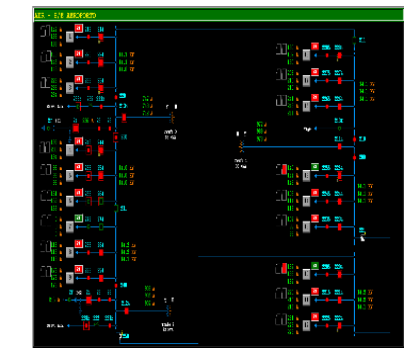
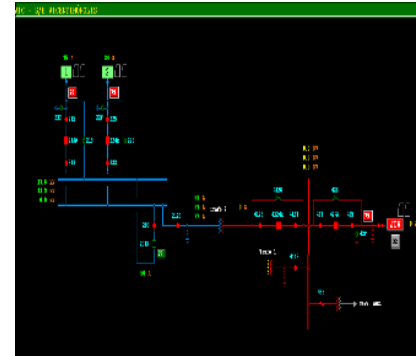
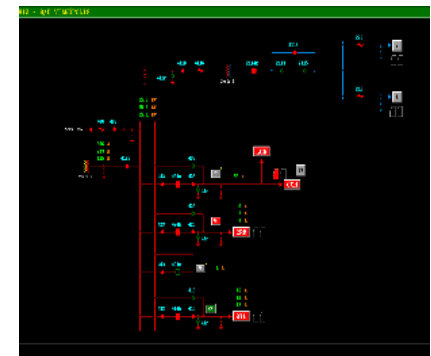
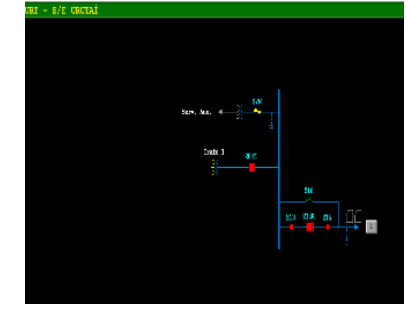
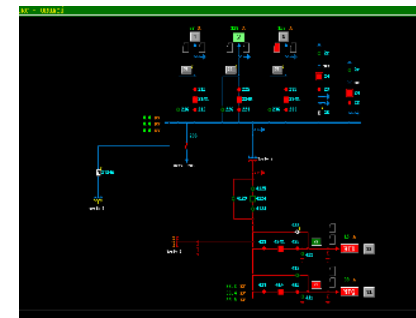
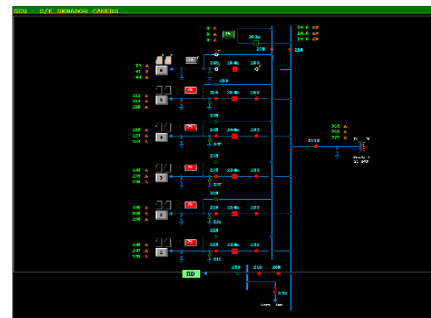
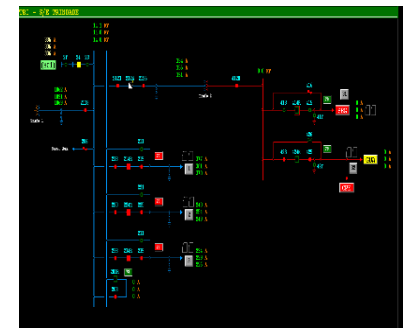
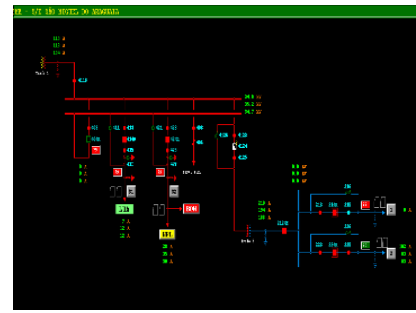
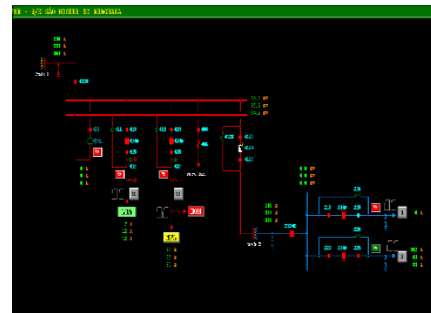
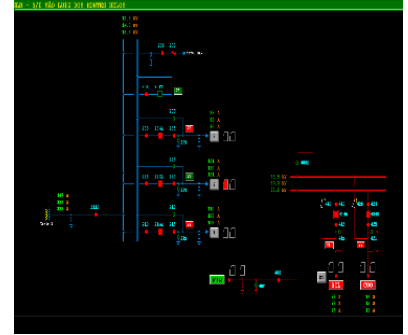
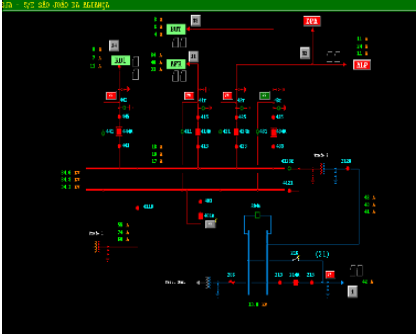
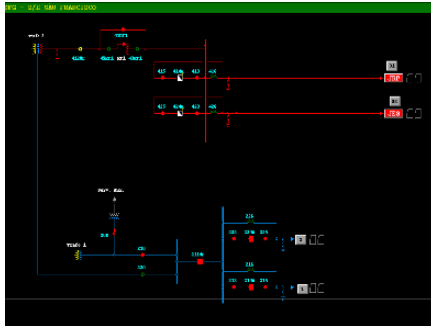
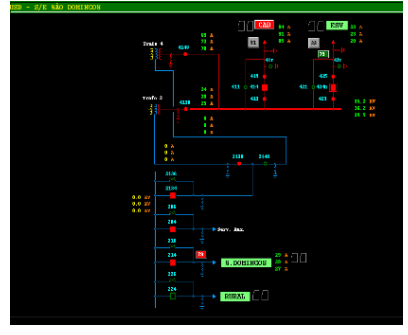
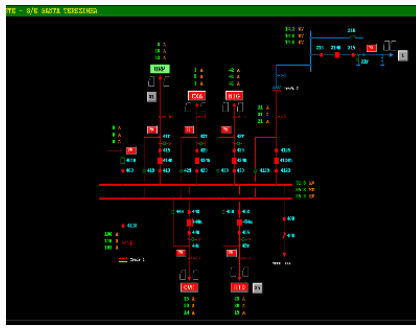
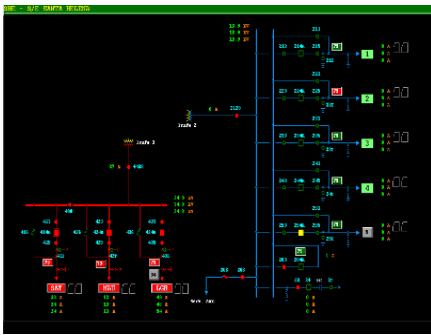

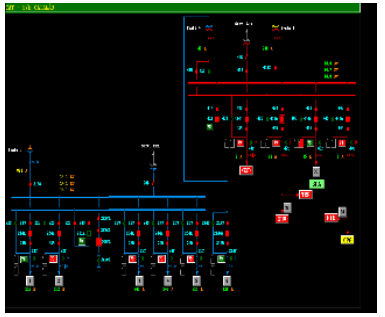
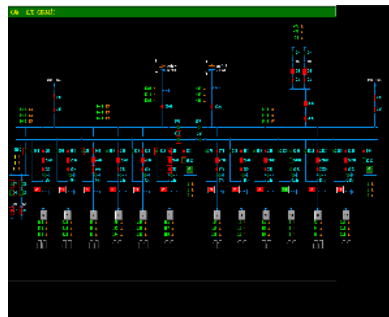
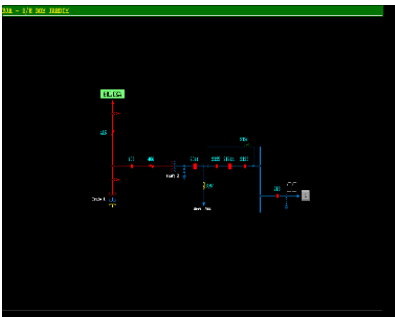
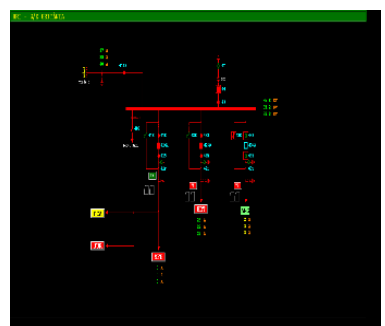
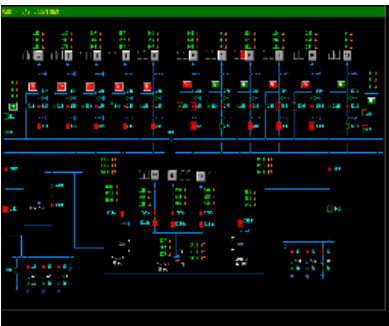
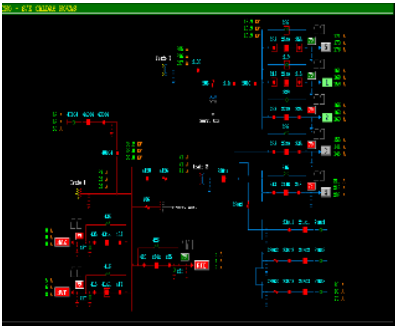
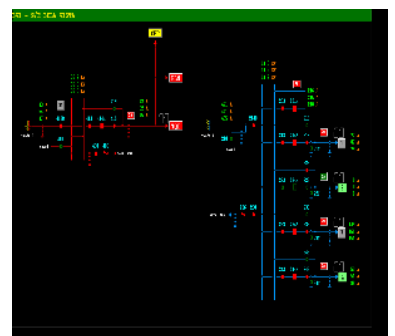
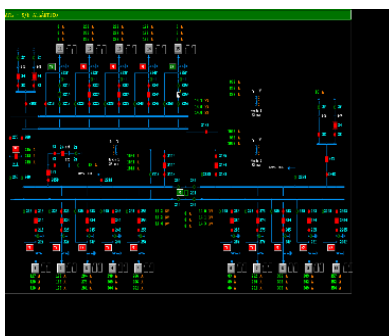
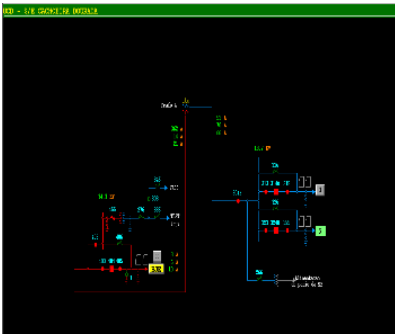
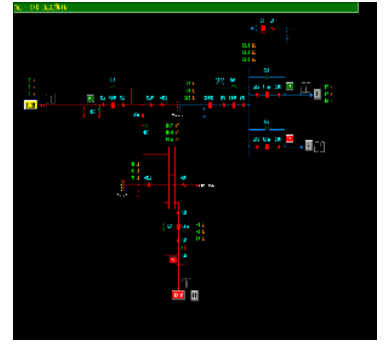
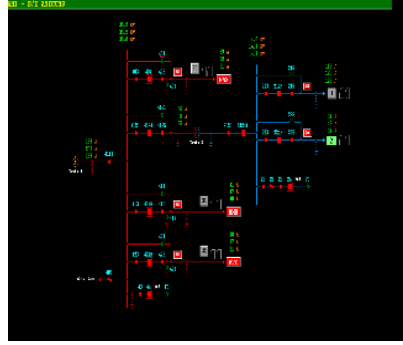
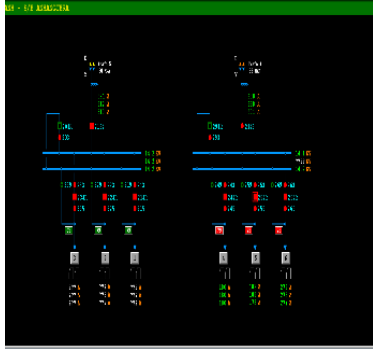
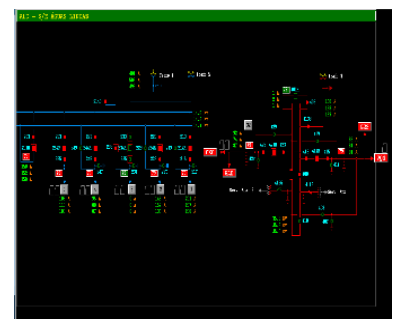
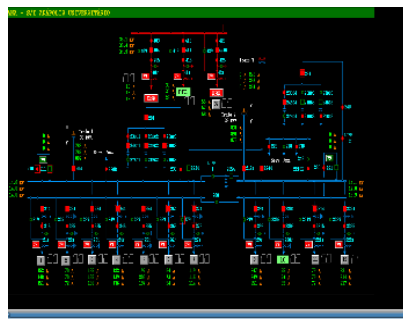
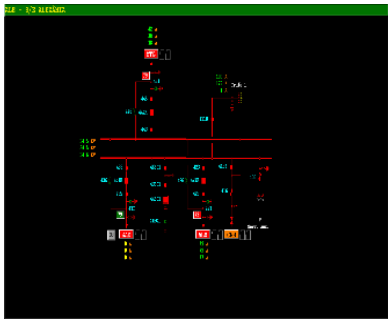

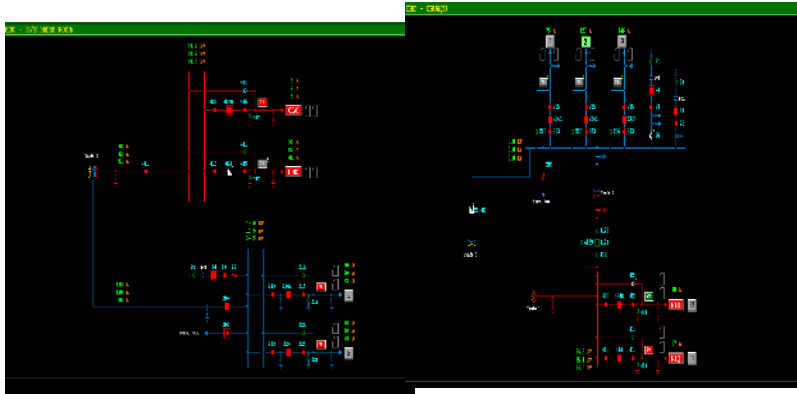
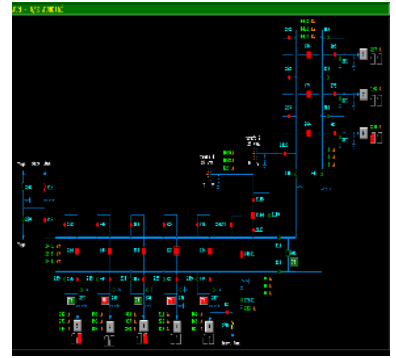
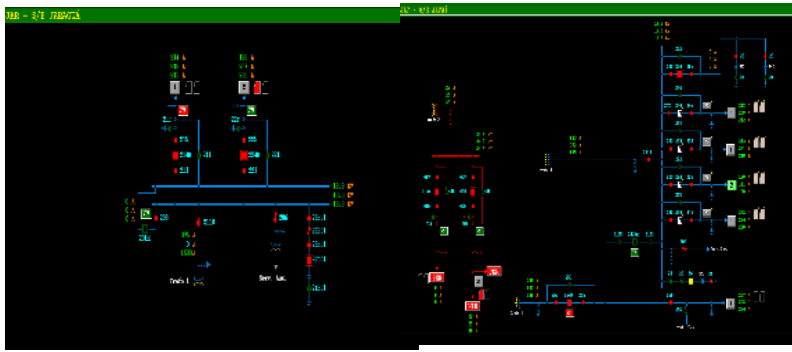

DEMAIS EVIDÊNCIAS

DADOS TÉCNICO - OPERACIONAIS ENEL GO

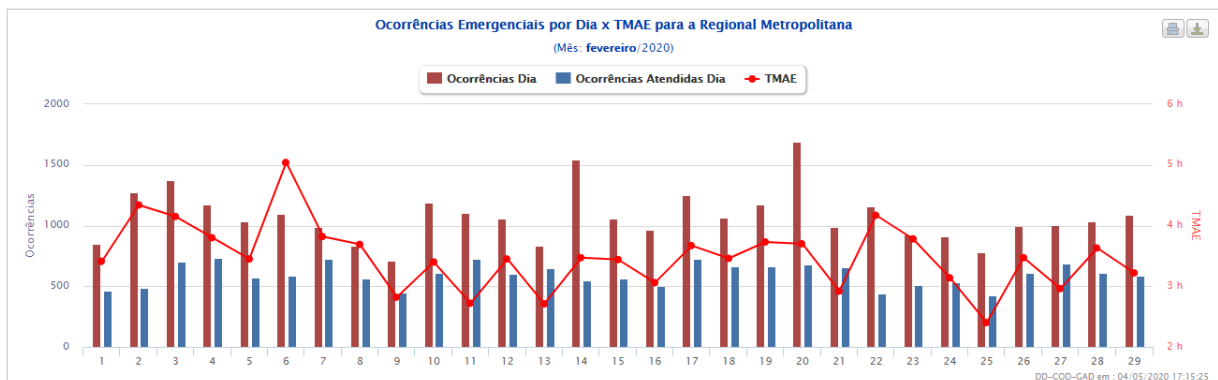
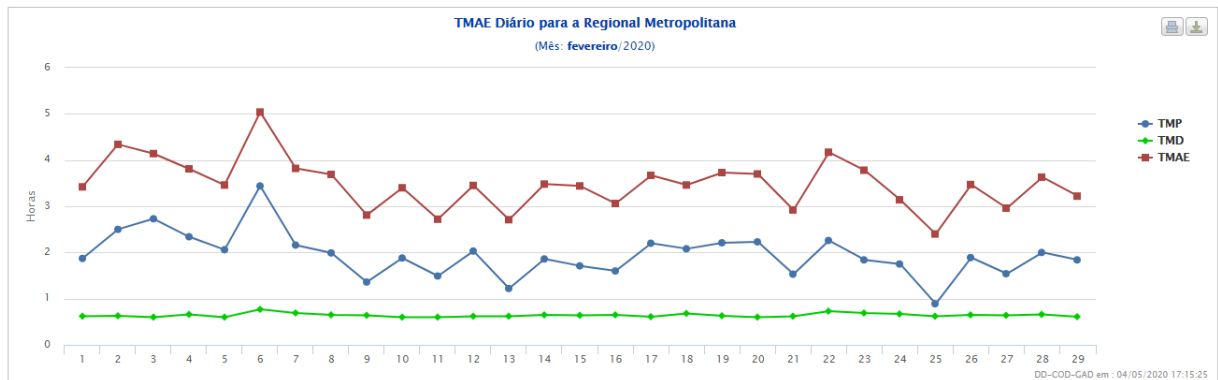
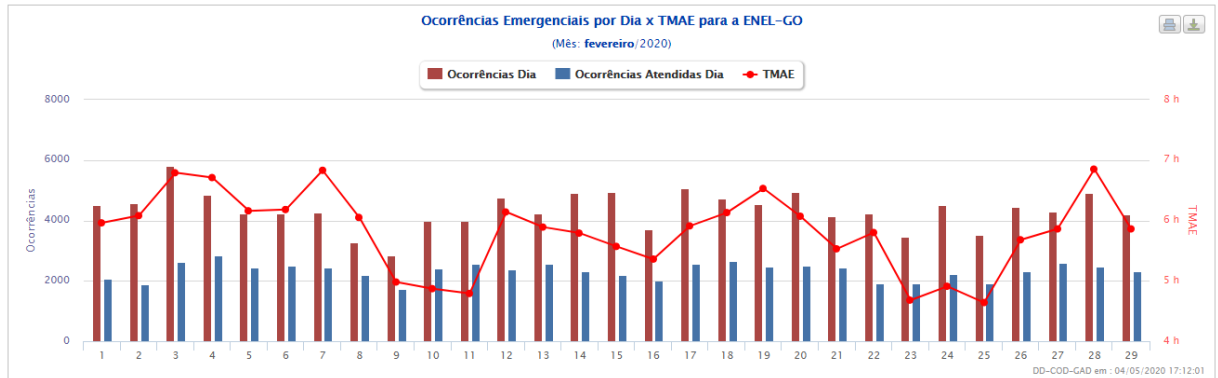
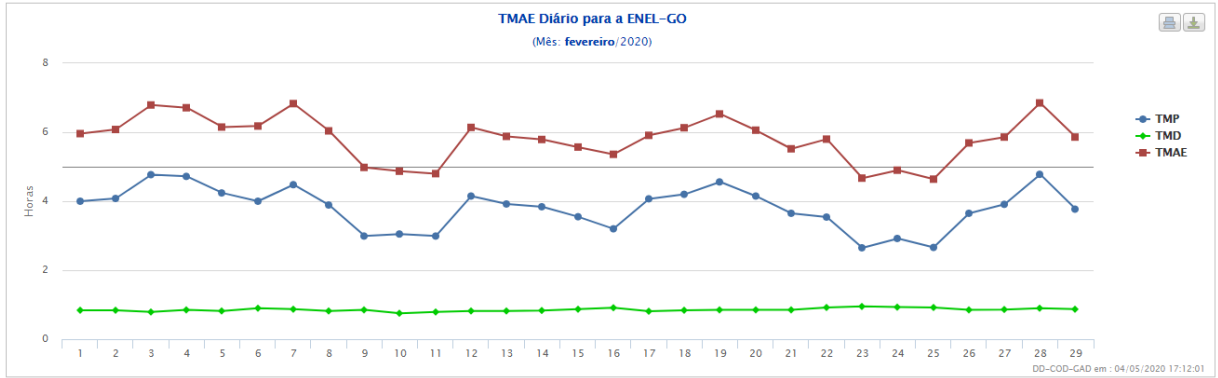

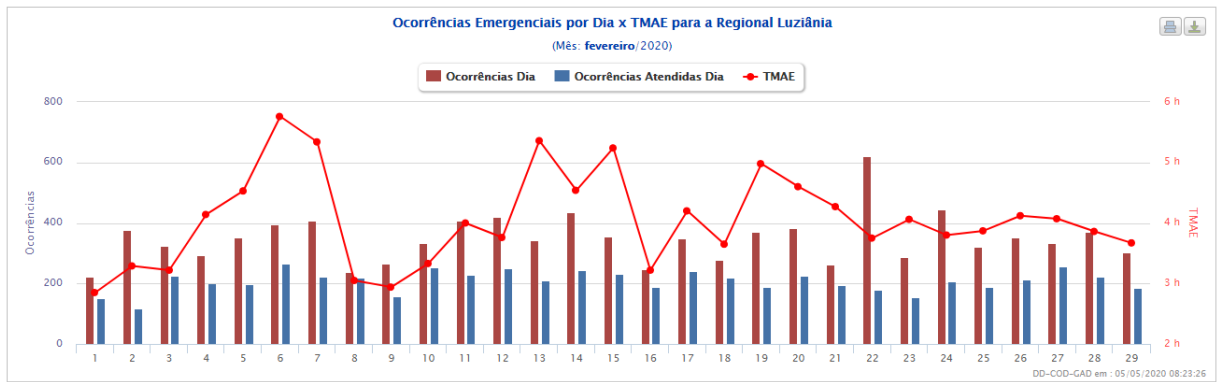
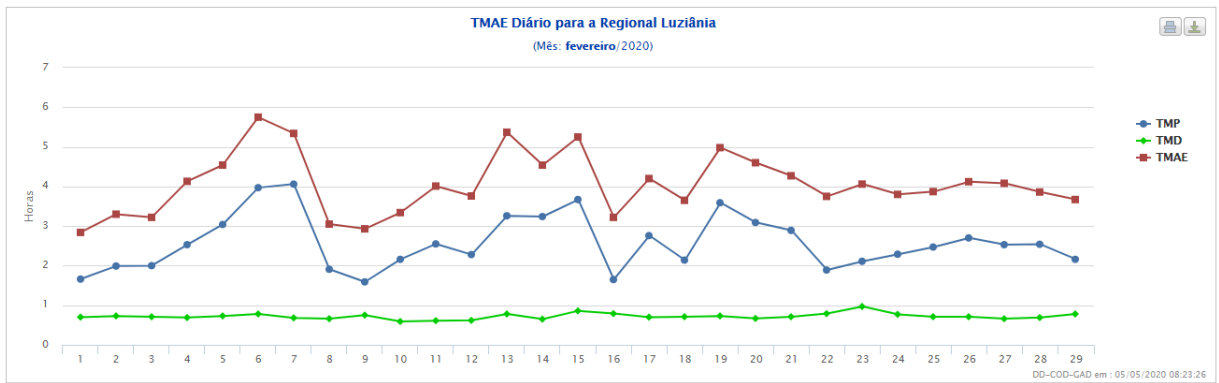
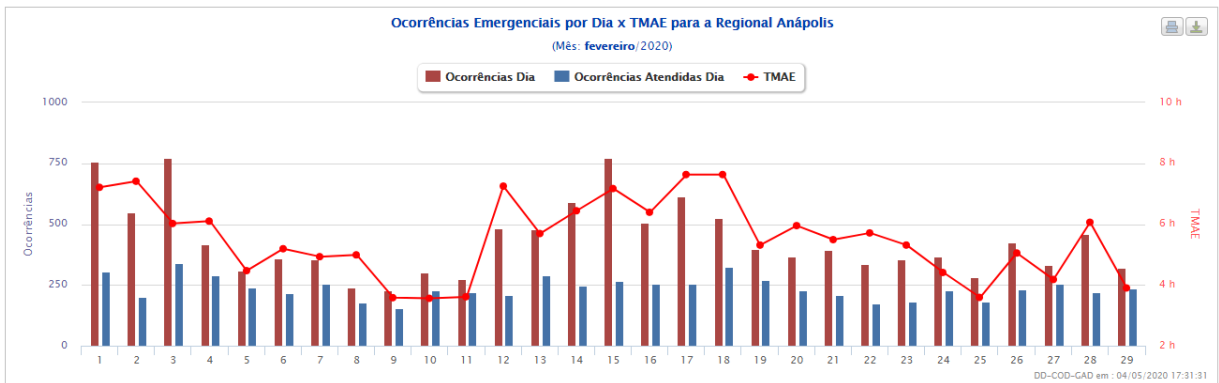
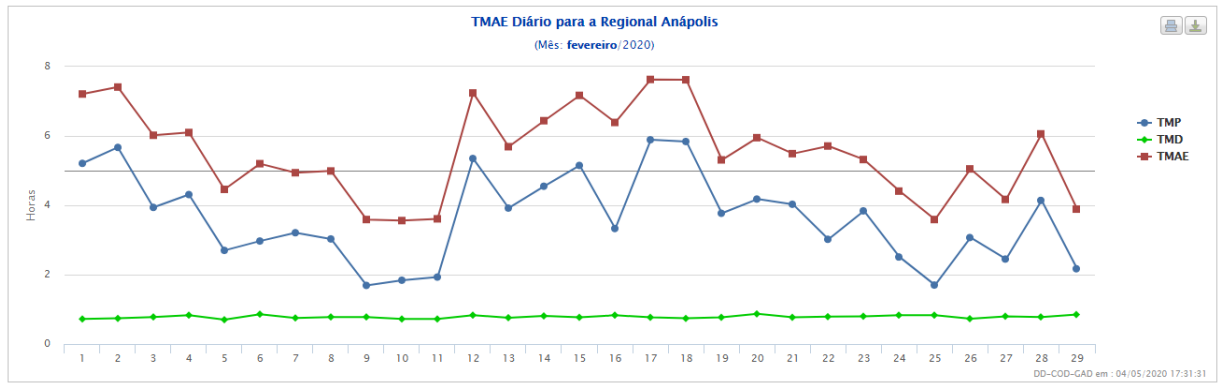

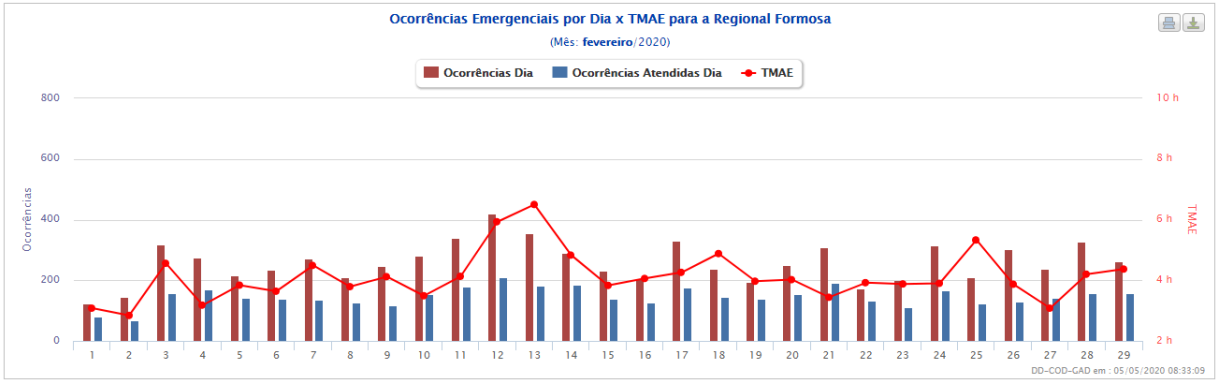
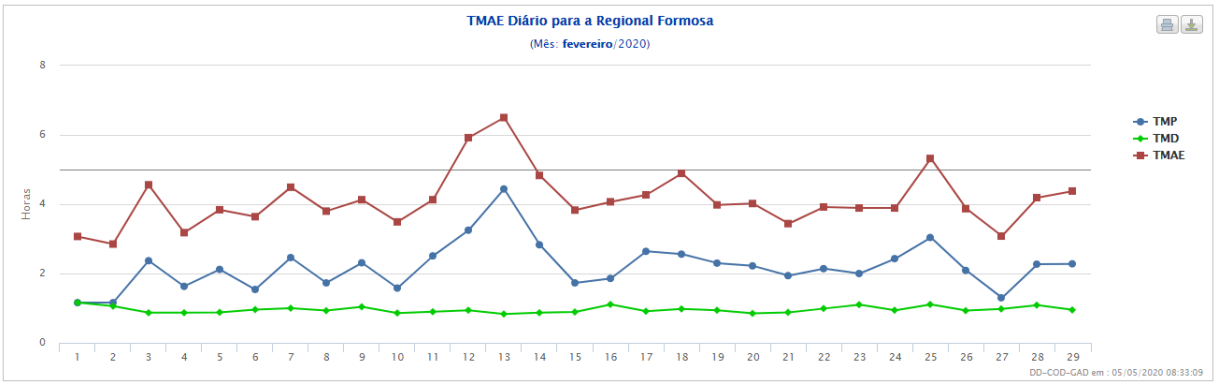
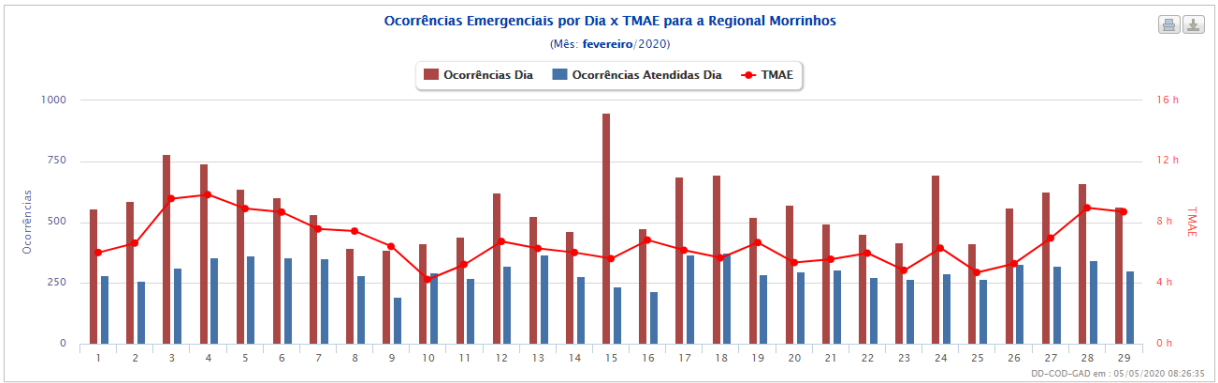
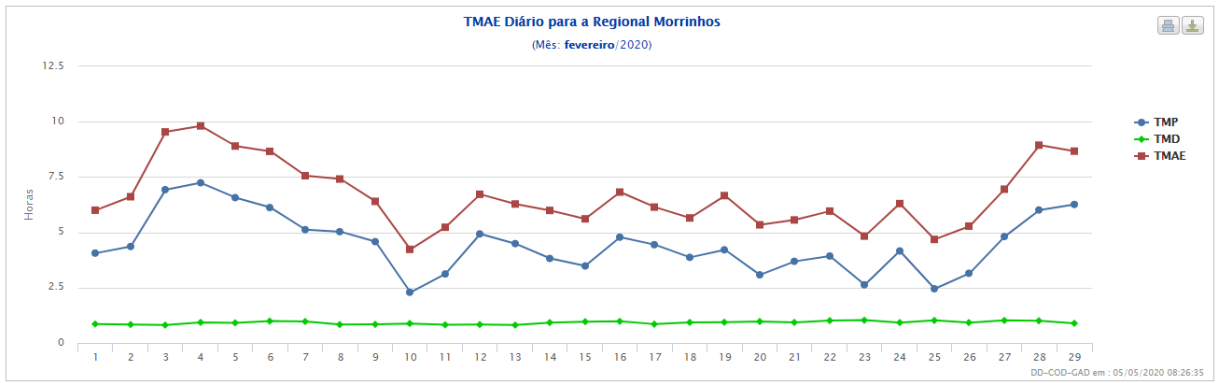

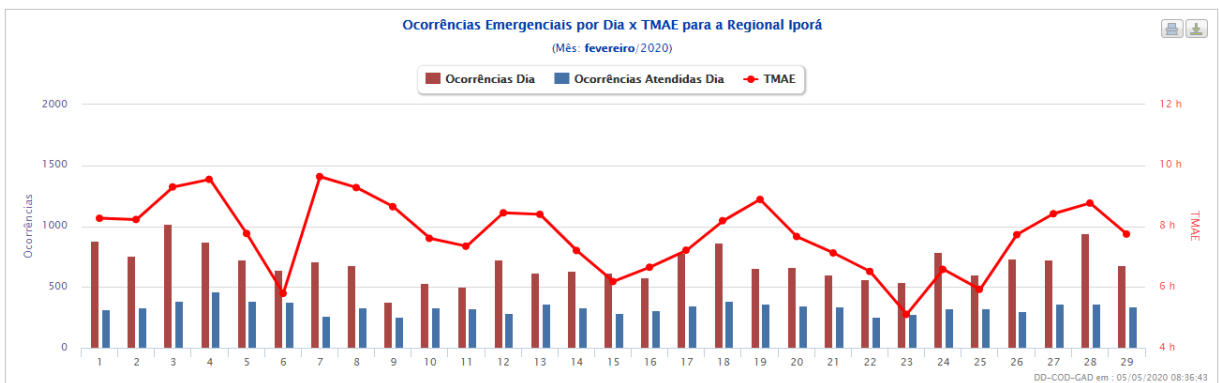
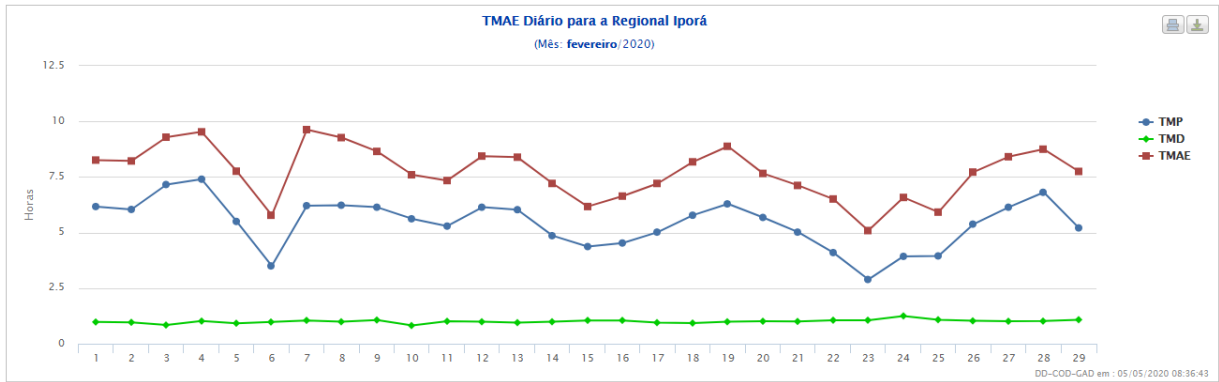
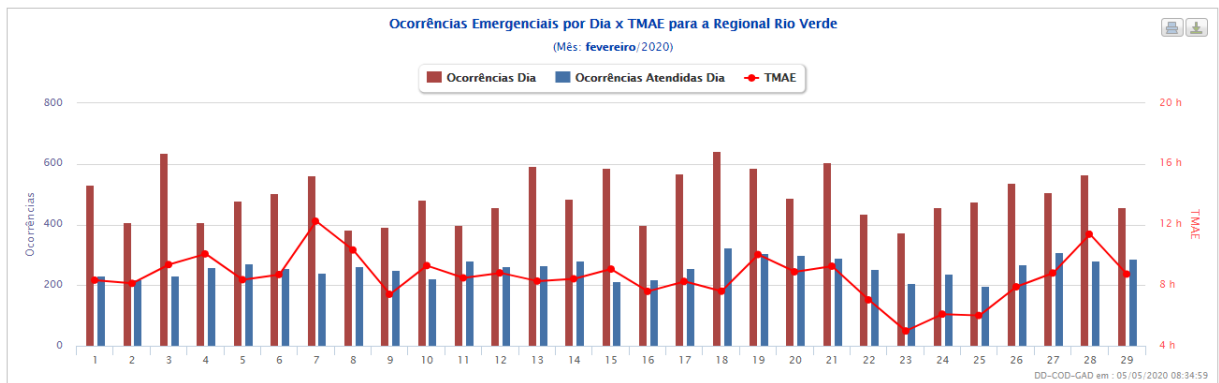
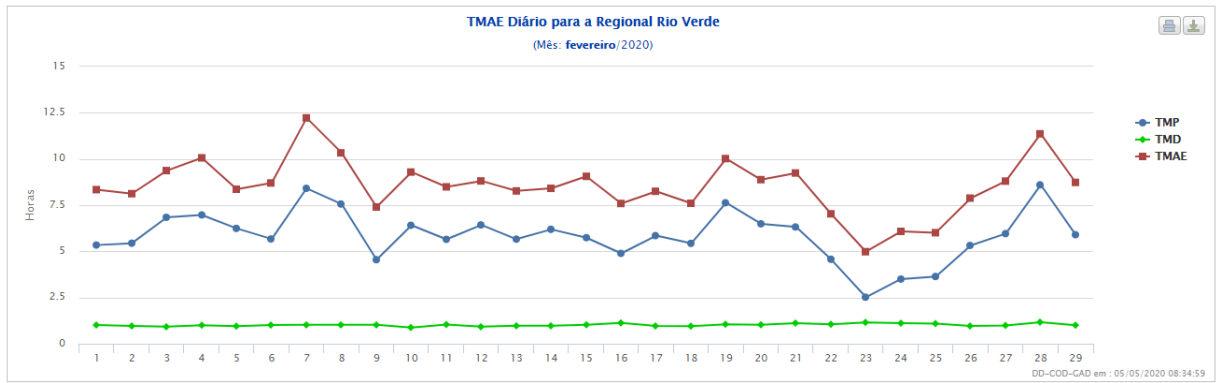

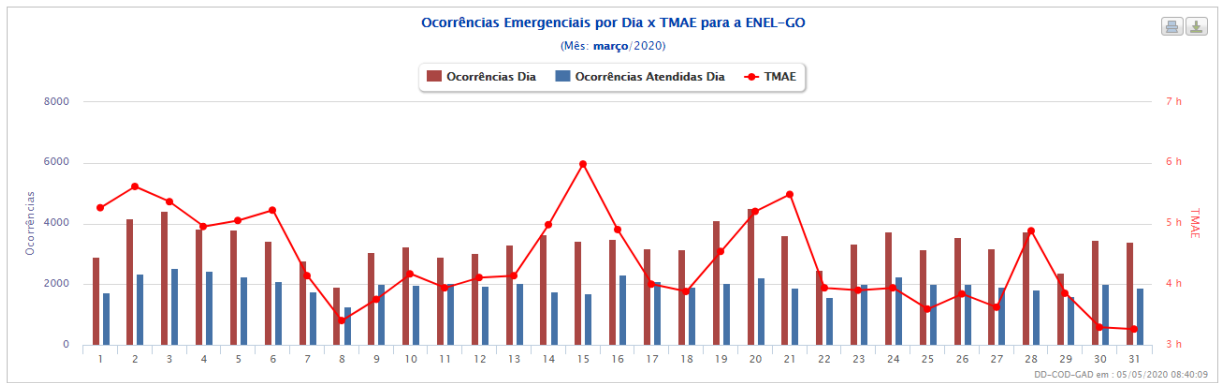
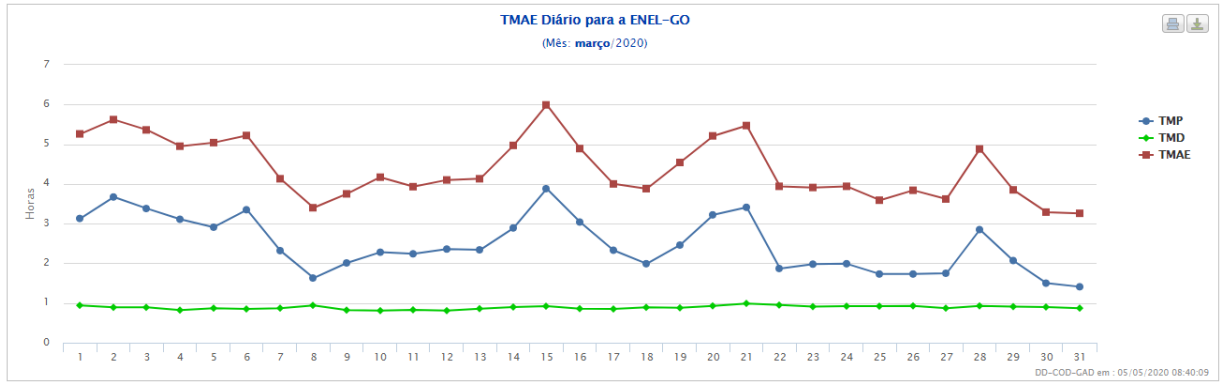
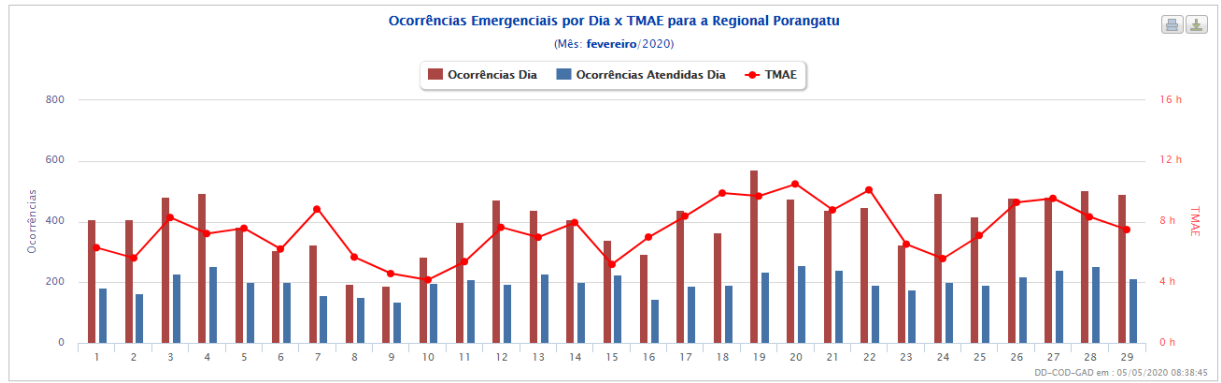
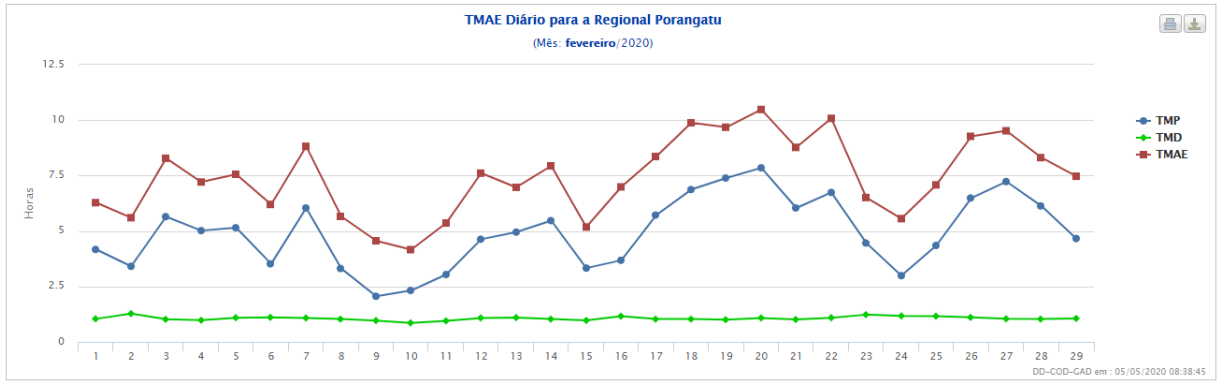

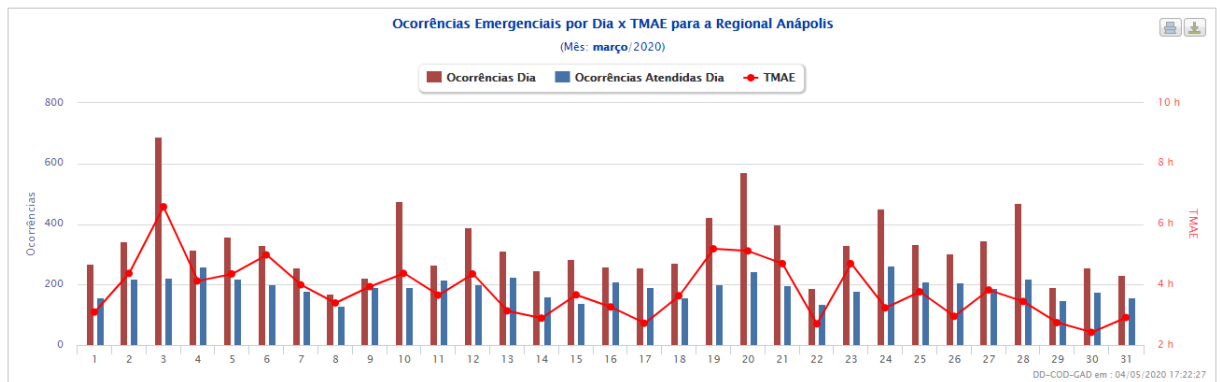
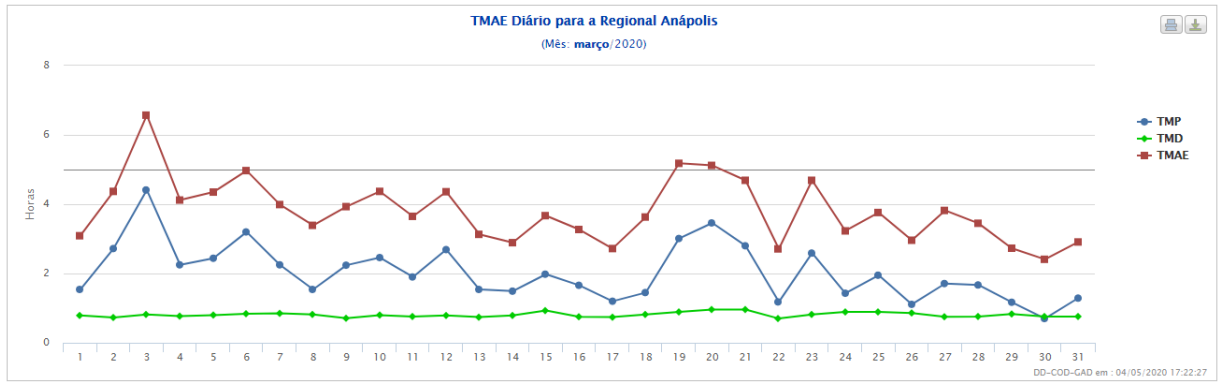
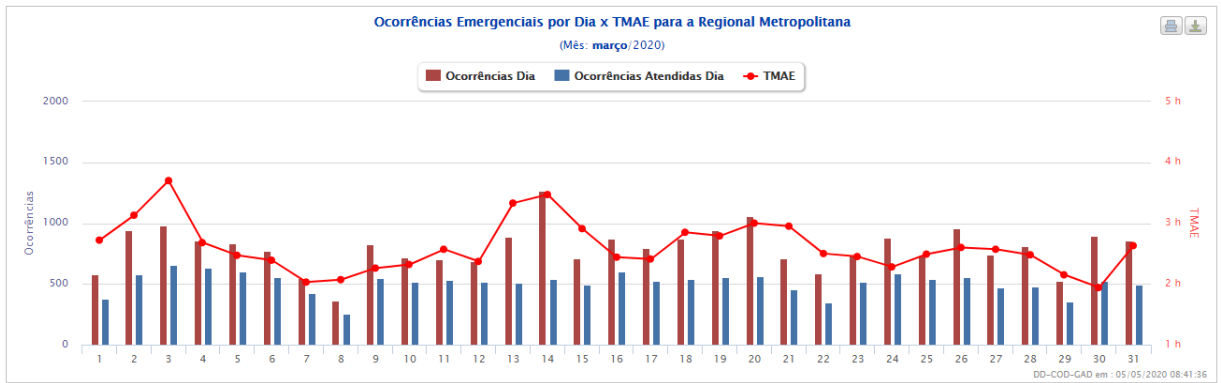
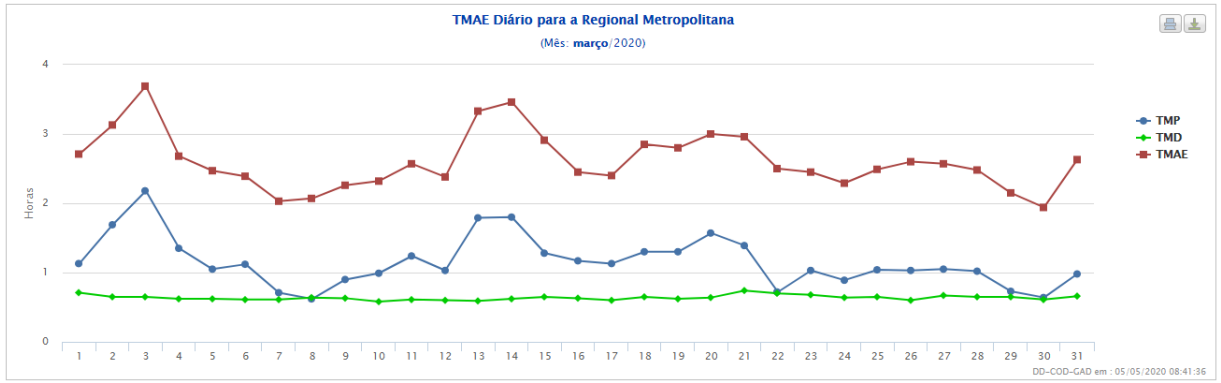

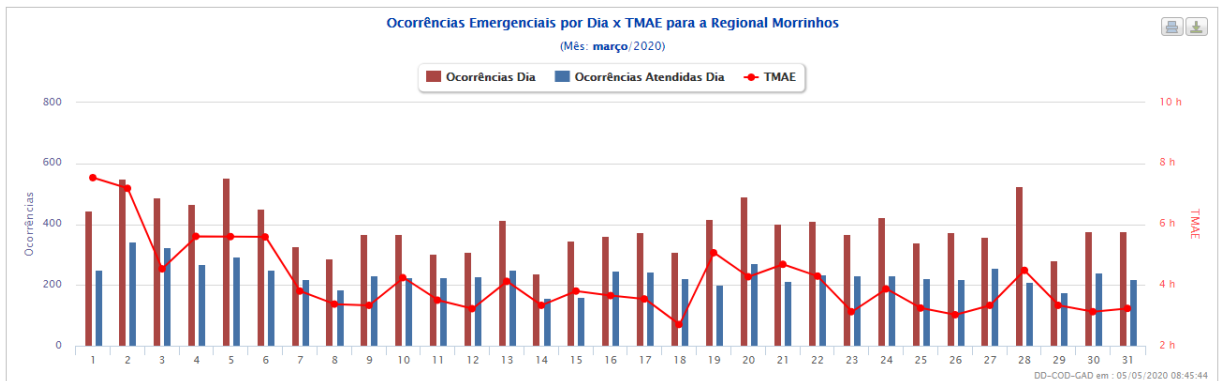
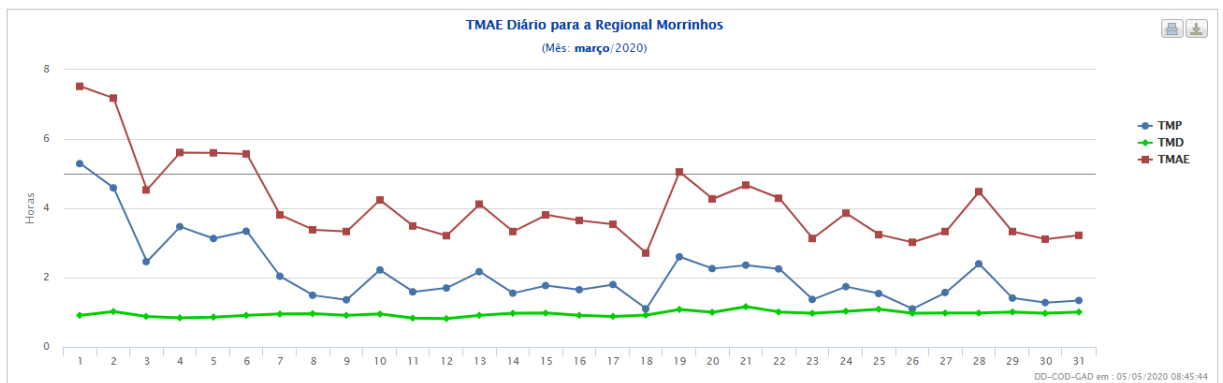
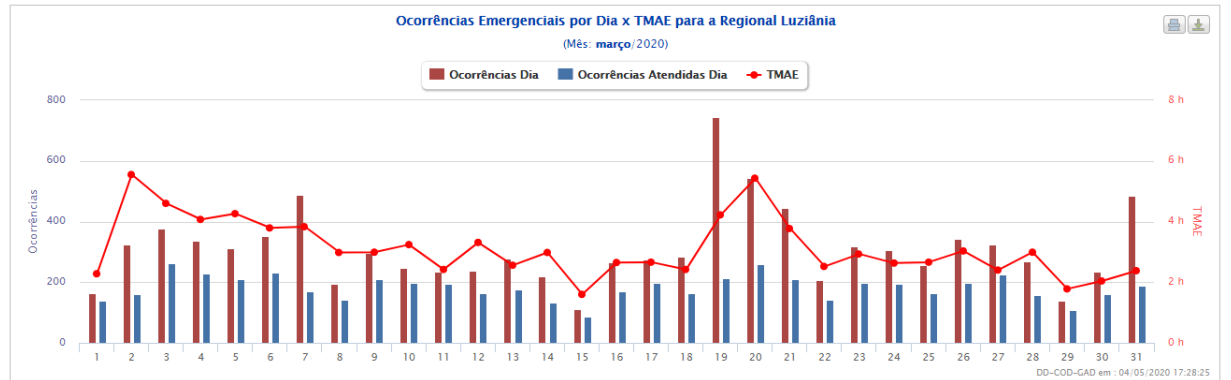
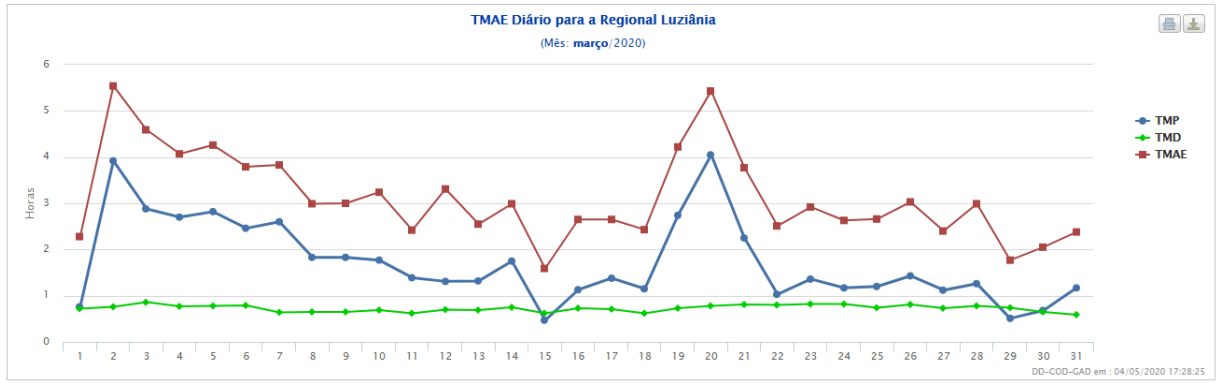

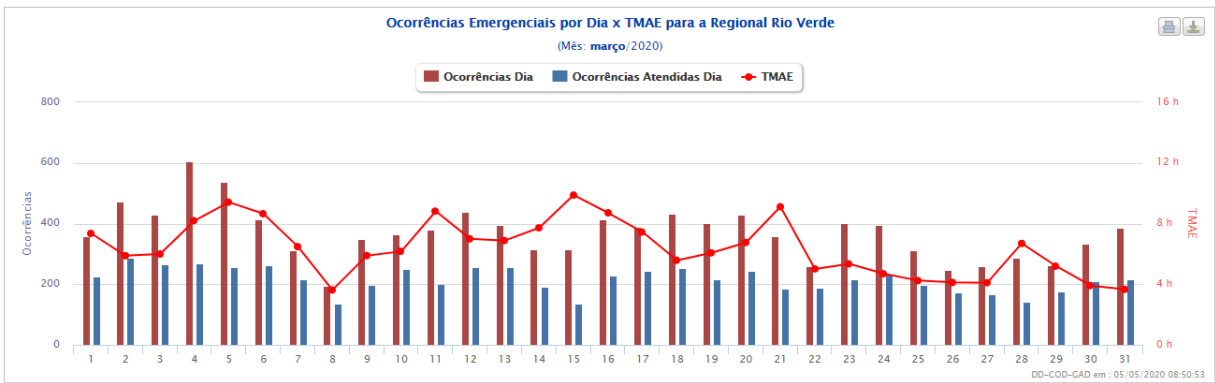
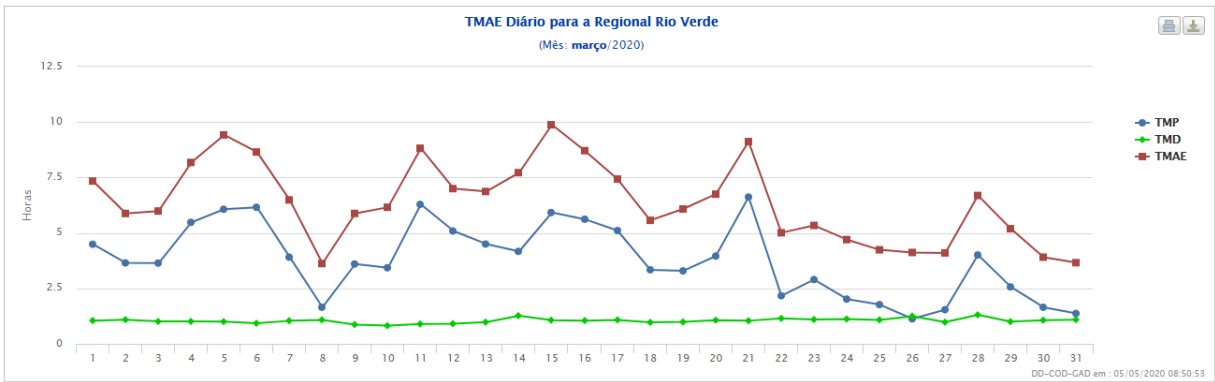
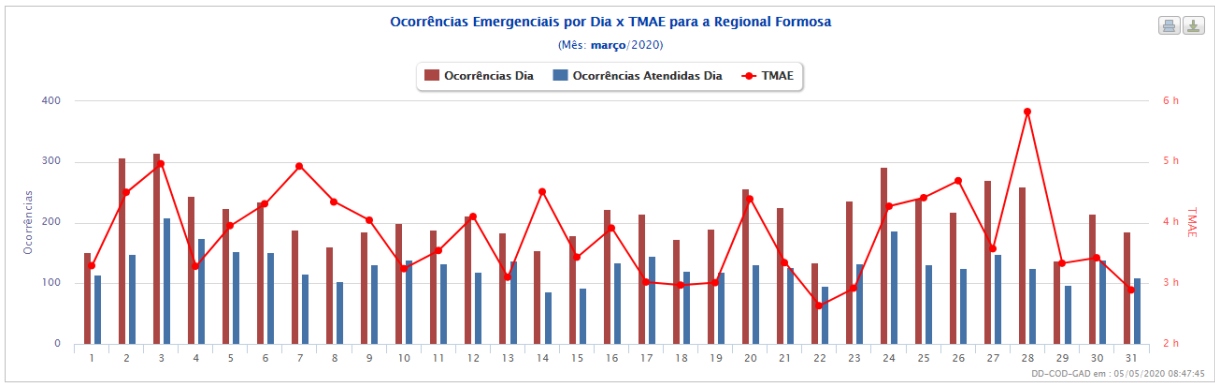
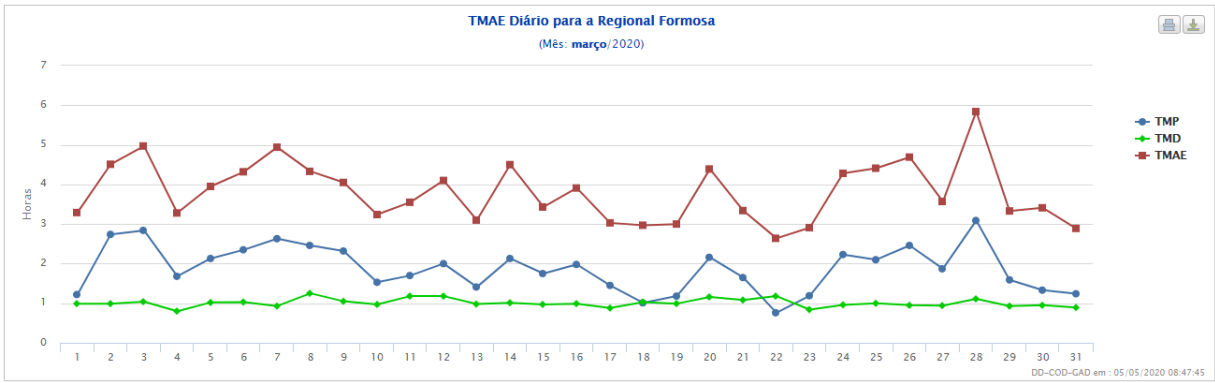

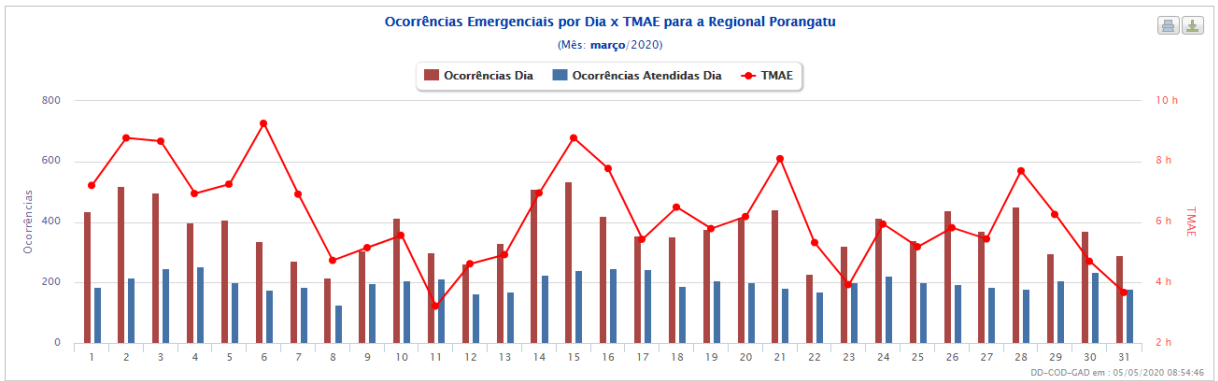
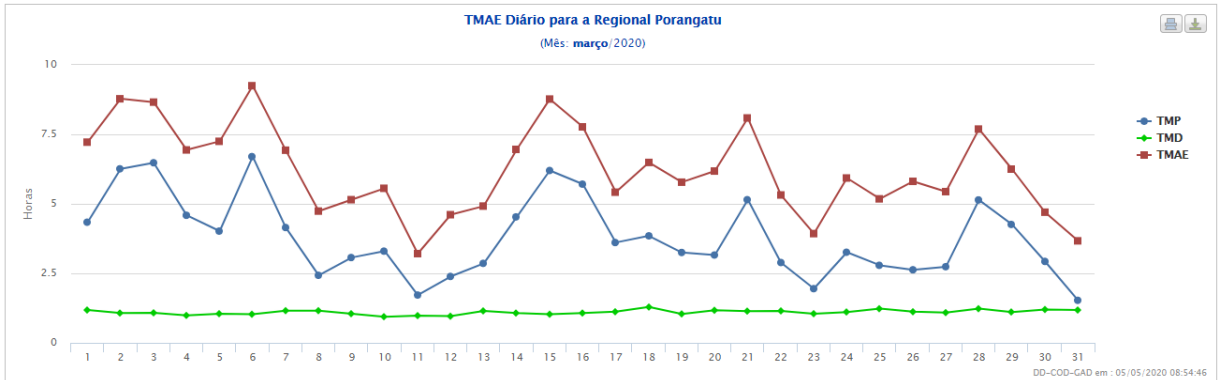
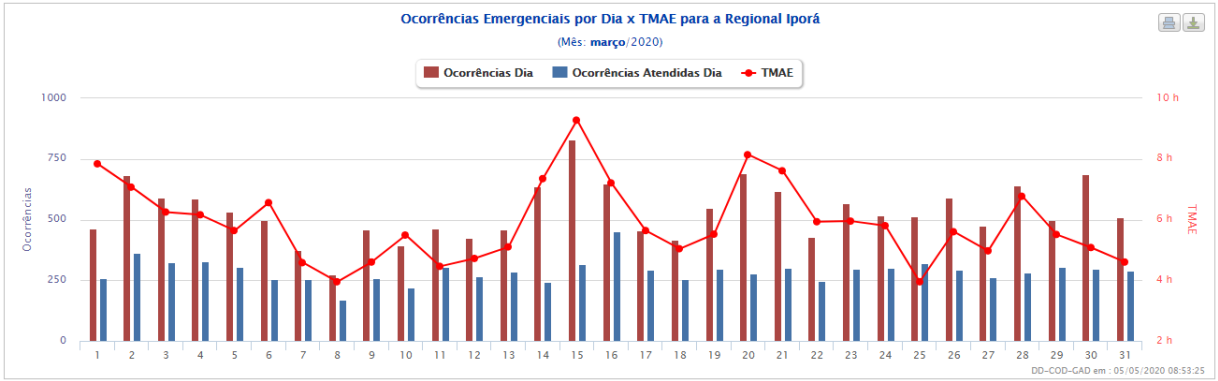
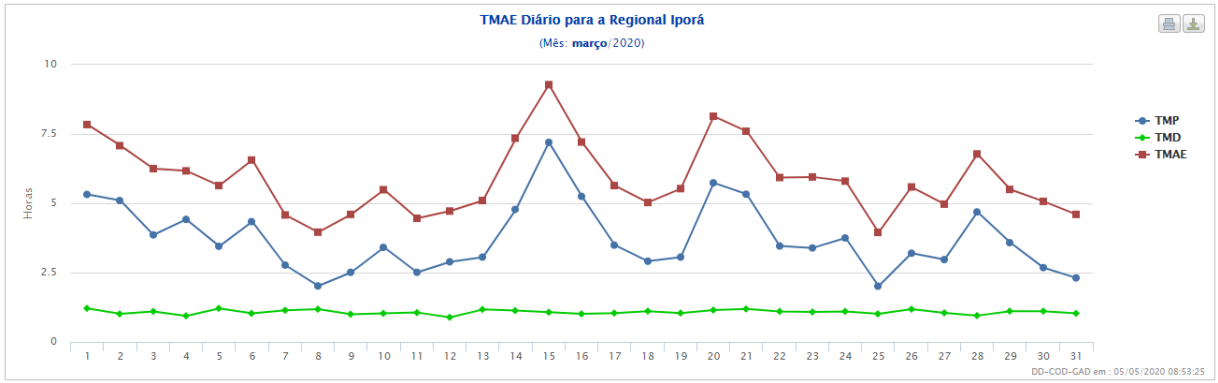

CLIMATEMPO

**Laudo Meteorológico de Evento Climático -
ENEL Goiás - 27 de Fevereiro de 2020**

São Paulo, SP, Brasil

Março de 2020

Sumário

1	ANÁLISE DE EVENTO METEOROLÓGICO	2
1.1	Descrição do Evento.....	2
1.2	Abrangência do Evento	11
2	CLASSIFICAÇÃO COBRADE	32
3	RESUMO DO EVENTO	33
4	REFERÊNCIAS.....	37

1 Análise de Evento Meteorológico

1.1 Descrição do Evento

Na figura a seguir é apresentada a área de concessão da ENEL DISTRIBUIÇÃO GOIÁS, dividida em regiões, a serem analisadas neste relatório.



Figura 1 – Regiões atendidas pela ENEL Goiás.

A atuação de uma Zona de Convergência do Atlântico Sul (ZCAS) favoreceu a organização de áreas de instabilidade sobre o estado de Goiás entre os dias 27 de fevereiro e 09 de março de 2020.

Nas Figuras 2 e 3 são apresentadas as descargas atmosféricas nuvem-solo (raios) e nuvem-nuvem detectadas pelo sistema Earth Networks. Entre as 11h30 do dia 27 de fevereiro e 21h00 do dia 09 de março de 2020 foram registrados 26228 raios nuvem-solo e 21979 descargas nuvem-nuvem sobre a área da ENEL DISTRIBUIÇÃO GOIÁS.

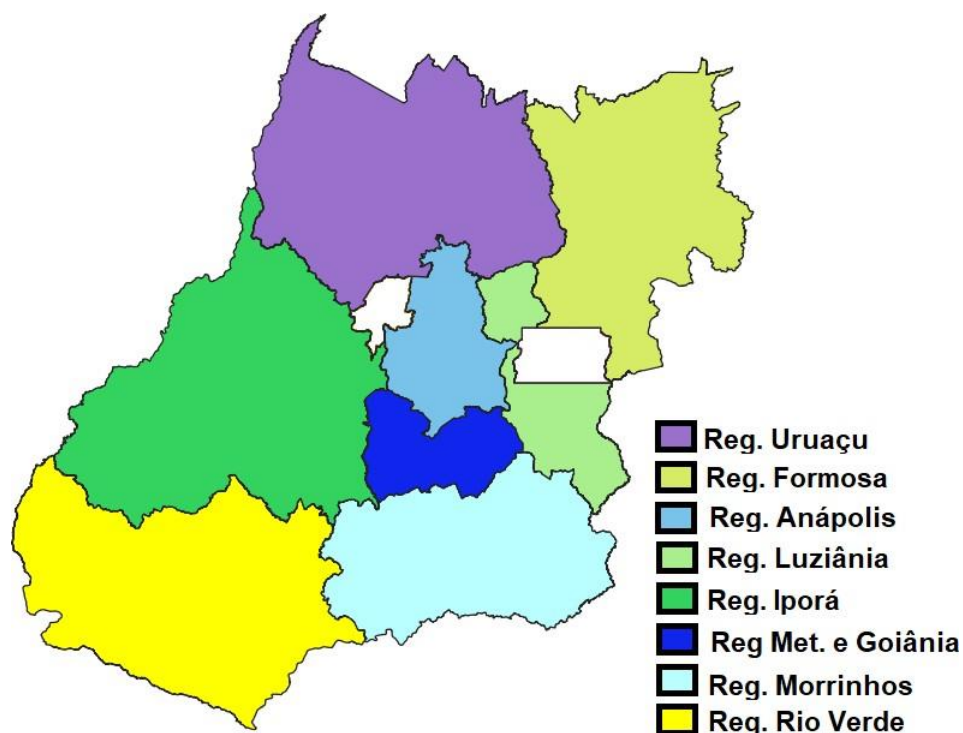

Figura 2 – Descargas atmosféricas nuvem-solo (em preto) detectadas pelo sistema Earth Networks entre 11h30 do dia 27 de fevereiro e 21h00 do dia 09 de março de 2020 sobre a área de concessão da CELG Distribuição.



Figura 3 – Descargas atmosféricas nuvem-nuvem (em vermelho) detectadas pelo sistema Earth Networks entre 11h30 do dia 27 de fevereiro e 21h00 do dia 09 de março de 2020 sobre a área de concessão da CELG Distribuição.

Estações do Instituto Nacional de Meteorologia (INMET), representativas da área de concessão da CELG Distribuição Goiás, registraram chuva forte (segundo a American Meteorological Society - Sociedade Meteorológica Americana -, chuvas com taxa entre 2,5mm a 7,6 mm por hora são consideradas moderadas e aquelas com taxa superior a 7,6 mm por hora são consideradas chuva forte). Na tabela 1 são apresentados os registros de acumulados horários superiores a 7,6 mm entre os dias 27 de fevereiro e 09 de março de 2020.

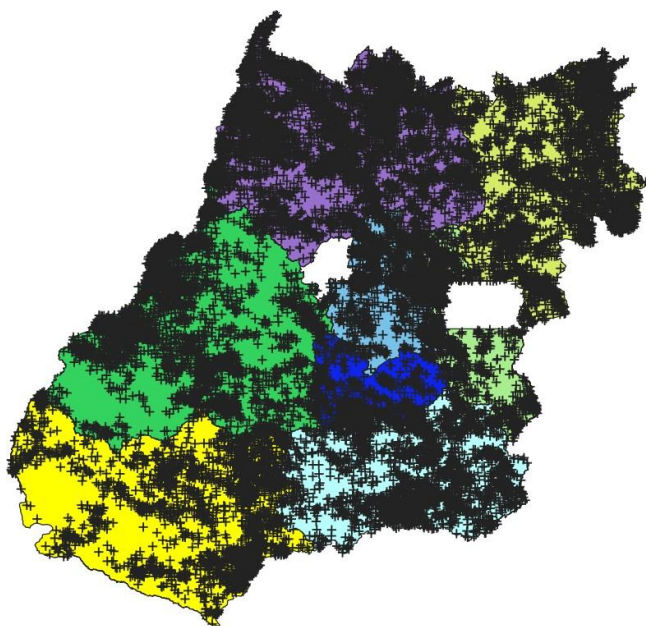
Nas tabelas 2 a 13 são apresentados os acumulados registrados em períodos de 24 horas, entre os dias 27 de fevereiro e 09 de março de 2020. Na figura 4 é apresentado o acumulado de chuva entre os dias 09h do dia 25 de fevereiro e 09h do dia 10 de março de 2020. Como é possível observar, grande parte do estado registrou acumulados acima de 150 mm e em algumas áreas o acumulado passou de 200 mm.

Na tabela 14 são apresentadas as rajadas de vento iguais ou superiores a 50 km/h registradas por estações do Instituto Nacional de Meteorologia (INMET) representativas da área de concessão da ENEL Distribuição Goiás. Como é possível observar, o maior valor registrado foi de 98,6 km/h na estação de Catalão entre as 16h e 17h do dia 05 de março, vento classificado como tempestade pela escala Beaufort.

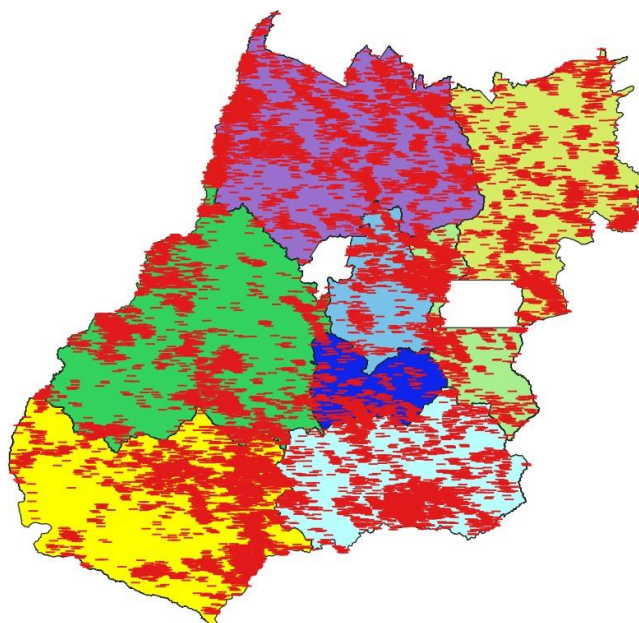
Tabela 1 – Acumulado horário de chuva registrada pelo INMET.

Estação	Horário	Precipitação (mm)
Alto Araguaia	Entre 13h e 14h do dia 28/2/2020	23.2
Alto Paraíso de Goiás	Entre 0h e 1h do dia 6/3/2020	27.6
Alto Paraíso de Goiás	Entre 16h e 17h do dia 8/3/2020	11.4
Alto Paraíso de Goiás	Entre 17h e 18h do dia 8/3/2020	11
Aragarças	Entre 18h e 19h do dia 27/2/2020	35
Aragarças	Entre 2h e 3h do dia 1/3/2020	24.8
Aragarças	Entre 1h e 2h do dia 2/3/2020	22.6
Catalão	Entre 15h e 16h do dia 27/2/2020	13.8
Catalão	Entre 16h e 17h do dia 27/2/2020	28.2
Catalão	Entre 16h e 17h do dia 28/2/2020	17
Catalão	Entre 17h e 18h do dia 28/2/2020	23.6
Catalão	Entre 7h e 8h do dia 29/2/2020	10.6
Catalão	Entre 3h e 4h do dia 1/3/2020	10.4
Catalão	Entre 22h e 23h do dia 1/3/2020	22.4
Catalão	Entre 16h e 17h do dia 5/3/2020	26
Catalão	Entre 12h e 13h do dia 9/3/2020	28.2
Cristalina	Entre 13h e 14h do dia 29/2/2020	25.8
Cristalina	Entre 17h e 18h do dia 2/3/2020	15.6

Cristalina	Entre 20h e 21h do dia 2/3/2020	30.8
Cristalina	Entre 22h e 23h do dia 5/3/2020	22.8
Goianésia	Entre 10h e 11h do dia 28/2/2020	12
Goianésia	Entre 11h e 12h do dia 28/2/2020	26.4
Goianésia	Entre 2h e 3h do dia 29/2/2020	8.4
Goianésia	Entre 12h e 13h do dia 2/3/2020	9.4
Goianésia	Entre 10h e 11h do dia 5/3/2020	8.6
Goianésia	Entre 12h e 13h do dia 5/3/2020	15.6
Goianésia	Entre 7h e 8h do dia 6/3/2020	9.6
Goianésia	Entre 8h e 9h do dia 6/3/2020	21.4
Goianésia	Entre 9h e 10h do dia 6/3/2020	12
Goianésia	Entre 19h e 20h do dia 6/3/2020	11.4
Goianésia	Entre 20h e 21h do dia 6/3/2020	11.4
Goiânia	Entre 12h e 13h do dia 27/2/2020	14.8
Goiânia	Entre 20h e 21h do dia 27/2/2020	14.2
Goiânia	Entre 7h e 8h do dia 29/2/2020	12.4
Goiânia	Entre 10h e 11h do dia 2/3/2020	8.8
Goiânia	Entre 21h e 22h do dia 5/3/2020	12.2
Goiás	Entre 11h e 12h do dia 28/2/2020	13
Goiás	Entre 4h e 5h do dia 29/2/2020	9
Goiás	Entre 15h e 16h do dia 2/3/2020	18.4
Goiás	Entre 11h e 12h do dia 6/3/2020	21.6
Goiás	Entre 12h e 13h do dia 6/3/2020	9.2
Goiás	Entre 13h e 14h do dia 6/3/2020	8.8
Iporá	Entre 16h e 17h do dia 5/3/2020	7.8
Iporá	Entre 17h e 18h do dia 5/3/2020	20
Itapaci	Entre 9h e 10h do dia 2/3/2020	8
Itapaci	Entre 19h e 20h do dia 2/3/2020	8.8
Itapaci	Entre 7h e 8h do dia 6/3/2020	22
Itapaci	Entre 17h e 18h do dia 6/3/2020	21.2
Itapaci	Entre 19h e 20h do dia 6/3/2020	31
Luziânia	Entre 13h e 14h do dia 29/2/2020	11.4
Luziânia	Entre 22h e 23h do dia 1/3/2020	9.6
Luziânia	Entre 11h e 12h do dia 2/3/2020	9.8
Luziânia	Entre 16h e 17h do dia 6/3/2020	9.4
Mineiros	Entre 4h e 5h do dia 28/2/2020	8.8
Mineiros	Entre 5h e 6h do dia 28/2/2020	13.6
Mineiros	Entre 23h e 0h do dia 6/3/2020	15.6
Monte Alegre de Goiás	Entre 12h e 13h do dia 4/3/2020	17.4

Monte Alegre de Goiás	Entre 13h e 14h do dia 4/3/2020	13.8
Monte Alegre de Goiás	Entre 11h e 12h do dia 8/3/2020	39.2
Morrinhos	Entre 15h e 16h do dia 28/2/2020	20.8
Morrinhos	Entre 5h e 6h do dia 29/2/2020	8.2
Morrinhos	Entre 6h e 7h do dia 29/2/2020	19.8
Morrinhos	Entre 4h e 5h do dia 2/3/2020	9.2
Morrinhos	Entre 6h e 7h do dia 2/3/2020	11.8
Morrinhos	Entre 1h e 2h do dia 5/3/2020	8
Morrinhos	Entre 15h e 16h do dia 6/3/2020	16.2
Paraúna	Entre 12h e 13h do dia 28/2/2020	11.2
Paraúna	Entre 13h e 14h do dia 28/2/2020	16.4
Paraúna	Entre 14h e 15h do dia 28/2/2020	11.2
Paraúna	Entre 1h e 2h do dia 29/2/2020	11.6
Paraúna	Entre 18h e 19h do dia 1/3/2020	16.6
Paraúna	Entre 19h e 20h do dia 1/3/2020	17.4
Silvânia	Entre 14h e 15h do dia 27/2/2020	11.6
Silvânia	Entre 15h e 16h do dia 27/2/2020	13.2
Silvânia	Entre 16h e 17h do dia 27/2/2020	11.4
Silvânia	Entre 17h e 18h do dia 27/2/2020	9.8
Silvânia	Entre 0h e 1h do dia 6/3/2020	14

Tabela 2 – Precipitação acumulada entre 09h do dia 27 e 09h do dia 28 de fevereiro de 2020. FONTE: INMET

Estação	Precipitação Acumulada(mm)
ARAGARCAS	52,0
SILVANIA	51,4
ARAGARÇAS	50,4
CATALÃO	46,6
IPAMERI	39,3
PIRES DO RIO	38,6
MINEIROS	36,2
RIO VERDE	31,0

Tabela 3 – Precipitação acumulada entre 09h do dia 28 e 09h do dia 29 de fevereiro de 2020. FONTE: INMET

Estação	Precipitação Acumulada(mm)
CATALÃO	77,0
MORRINHOS	70,6
EDEIA	68,0
PARAUNA	64,2
GOIANESIA	51,2

Tabela 4 – Precipitação acumulada entre 09h do dia 29 de fevereiro e 09h do dia 01 de março de 2020. FONTE: INMET

Estação	Precipitação Acumulada(mm)
ARAGARÇAS	45,8
CRISTALINA (FAZENDA SANTA MÔNICA)	39,6
CRISTALINA	39,2

Tabela 5 – Precipitação acumulada entre 09h do dia 01 e 09h do dia 02 de março de 2020. FONTE: INMET

Estação	Precipitação Acumulada(mm)
PARAUNA	55,8
EDEIA	47,0
CATALÃO	41,4
IPAMERI	34,7
MORRINHOS	33,4
ARAGARÇAS	32,2
CATALÃO	31,9
ARAGARCAS	30,8

Tabela 6 – Precipitação acumulada entre 09h do dia 02 e 09h do dia 03 de março de 2020. FONTE: INMET

Estação	Precipitação Acumulada(mm)
FORMOSA	68,6
CRISTALINA	58,6
ITUMBIARA	47,8

Tabela 7 – Precipitação acumulada entre 09h do dia 03 e 09h do dia 04 de março de 2020. FONTE: INMET

Estação	Precipitação Acumulada(mm)
PORANGATU	18,0

Tabela 8 – Precipitação acumulada entre 09h do dia 04 e 09h do dia 05 de março de 2020. FONTE: INMET

Estação	Precipitação Acumulada(mm)
MONTE ALEGRE DE GOIAS	35,8
RIO VERDE	30,3

Tabela 9 – Precipitação acumulada entre 09h do dia 05 e 09h do dia 06 de março de 2020. FONTE: INMET

Estação	Precipitação Acumulada(mm)
GOIANESIA	72,6
ITAPACI	59,8
ALTO PARAISO DE GOIAS	51,0
CATALÃO	38,6
CATALAO	36,8
POSSE	30,8

Tabela 10 – Precipitação acumulada entre 09h do dia 06 e 09h do dia 07 de março de 2020. FONTE: INMET

Estação	Precipitação Acumulada(mm)
ITAPACI	60,0
GOIANESIA	48,8
GOIÁS	48,2

Tabela 11 – Precipitação acumulada entre 09h do dia 07 e 09h do dia 08 de março de 2020. FONTE: INMET

Estação	Precipitação Acumulada(mm)
CRISTALINA	15,0

Tabela 12 – Precipitação acumulada entre 09h do dia 08 e 09h do dia 09 de março de 2020. FONTE: INMET

Estação	Precipitação Acumulada(mm)
MONTE ALEGRE DE GOIAS	48,0

Tabela 13 – Precipitação acumulada entre 09h do dia 09 e 09h do dia 10 de março de 2020. FONTE: INMET

Estação	Precipitação Acumulada(mm)
CATALÃO	30,2



Figura 4 – Mapa de precipitação acumulada entre as 09h do dia 25 de fevereiro e 09h do dia 10 de março de 2020. FONTE: Cptec/INPE.

Tabela 14 – Rajadas de vento maiores ou iguais a 50 km/h registradas pelo INMET. Segundo a escala Beaufort, ventos entre 50 e 61 km/h são classificados como vento forte, entre 62 e 74 km/h como ventania, entre 75 e 88 km/h como ventania forte e entre 89 e 102 km/h como tempestade..

Estação	Horário	Rajada (km/h)
Alto Paraíso de Goiás	Entre 16h e 17h do dia 29/2/2020	67.7
Alto Araguaia	Entre 15h e 16h do dia 5/3/2020	58.0
Alto Araguaia	Entre 16h e 17h do dia 5/3/2020	58.0
Catalão	Entre 16h e 17h do dia 5/3/2020	98.6
Luziânia	Entre 18h e 19h do dia 3/3/2020	52.9
Luziânia	Entre 17h e 18h do dia 4/3/2020	50.8
Luziânia	Entre 18h e 19h do dia 4/3/2020	50.8
Mineiros	Entre 13h e 14h do dia 5/3/2020	65.9

1.2 Abrangência do Evento

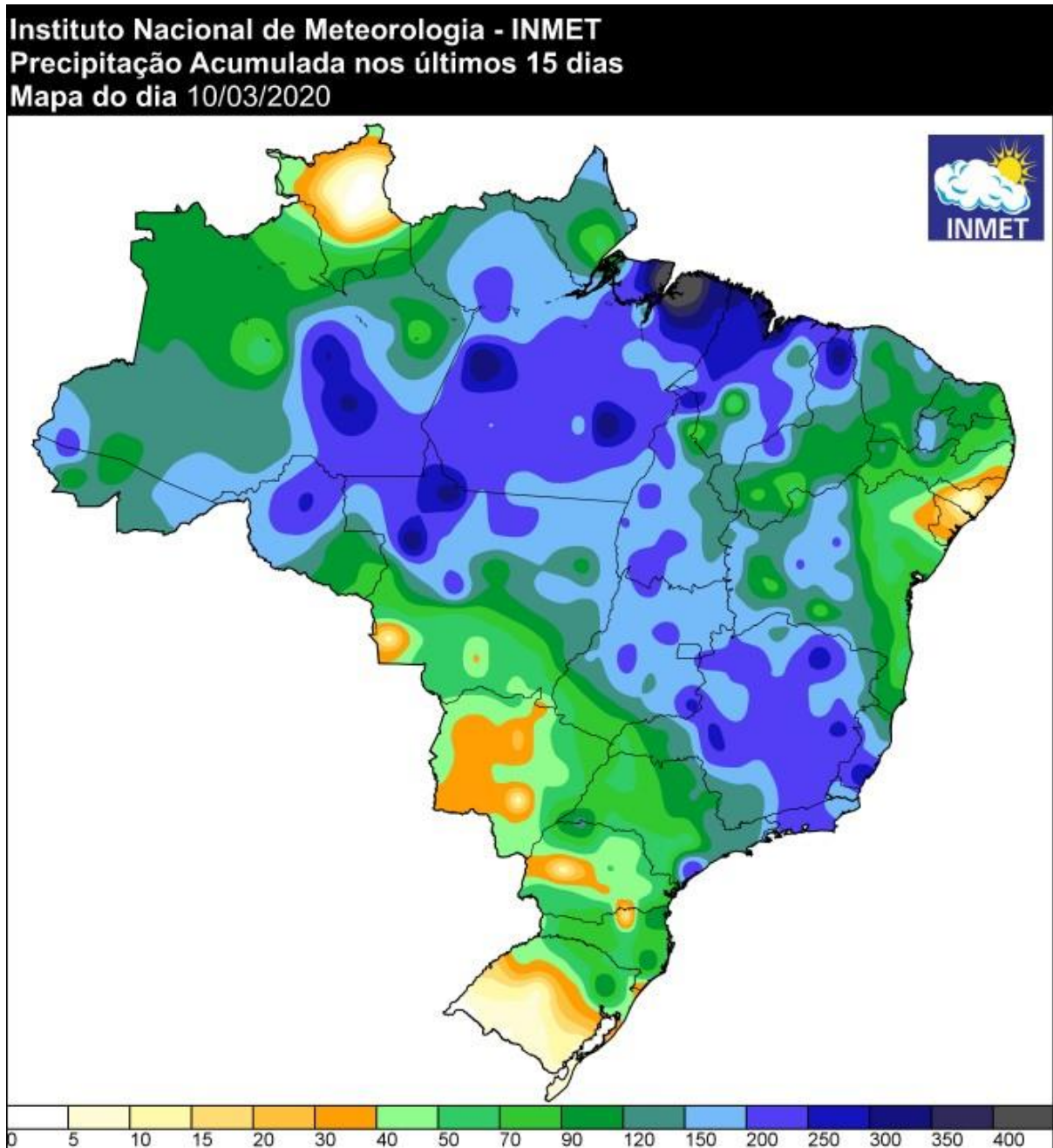
A seguir são apresentadas as imagens realçadas do satélite GOES-16 entre as 15h00 do dia 27 de fevereiro e 15h00 do dia 09 de março de 2020. Os tons em vermelho e preto indicam a presença de nuvens de grande desenvolvimento vertical, geralmente associadas à ocorrência de tempo severo.



Figura 5 – Imagens realçadas do satélite GOES-16 das 15h00 do dia 27 de Fevereiro de 2020. FONTE: Cptec/INPE.



Figura 6 – Imagens realçadas do satélite GOES-16 das 21h00 do dia 27 de Fevereiro de 2020. FONTE: Cptec/INPE.

3h00 - 28 de Fevereiro de 2020

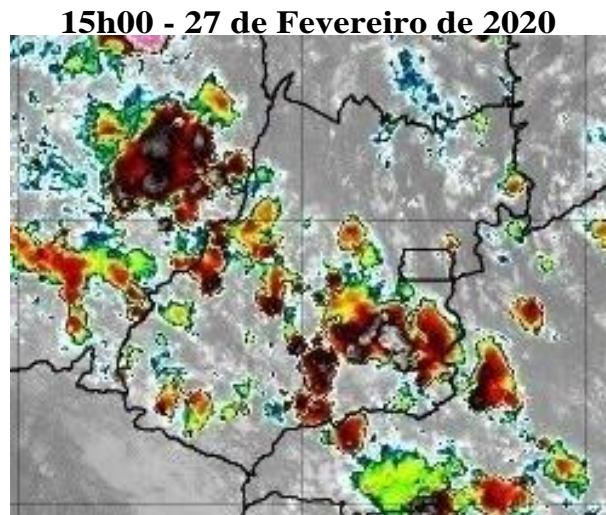
Figura 7 – Imagens realçadas do satélite GOES-16 das 3h00 do dia 28 de Fevereiro de 2020. FONTE: Cptec/INPE.

9h00 - 28 de Fevereiro de 2020

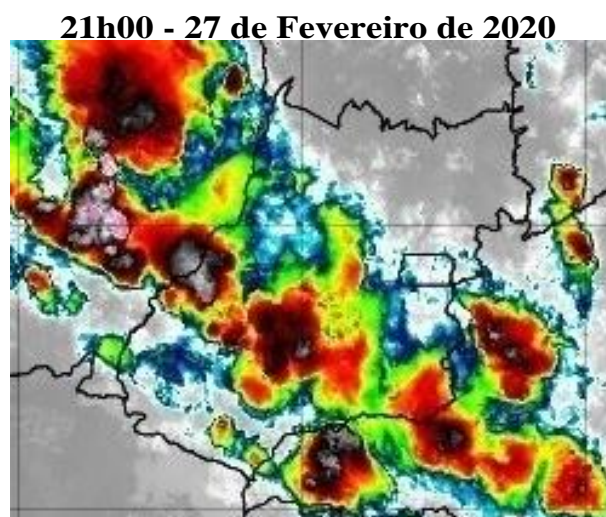
Figura 8 – Imagens realçadas do satélite GOES-16 das 9h00 do dia 28 de Fevereiro de 2020. FONTE: Cptec/INPE.

15h00 - 28 de Fevereiro de 2020

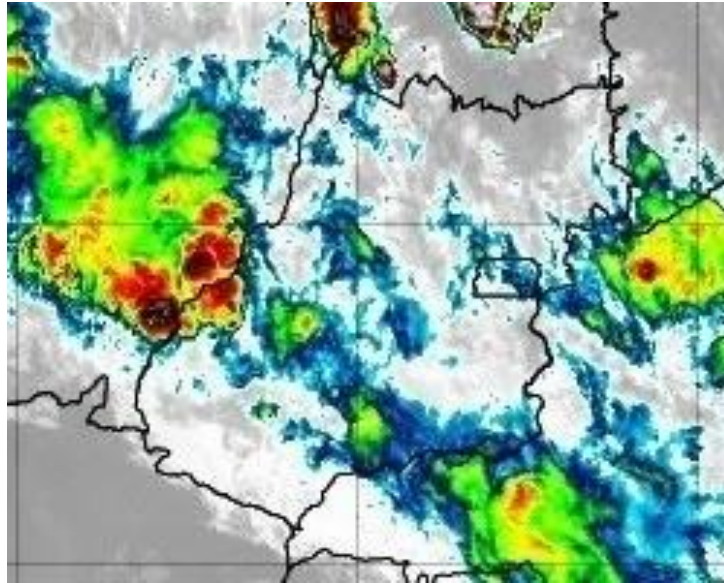
Figura 9 – Imagens realçadas do satélite GOES-16 das 15h00 do dia 28 de Fevereiro de 2020. FONTE: Cptec/INPE.

21h00 - 28 de Fevereiro de 2020

Figura 10 – Imagens realçadas do satélite GOES-16 das 21h00 do dia 28 de Fevereiro de 2020. FONTE: Cptec/INPE.

9h00 - 29 de Fevereiro de 2020

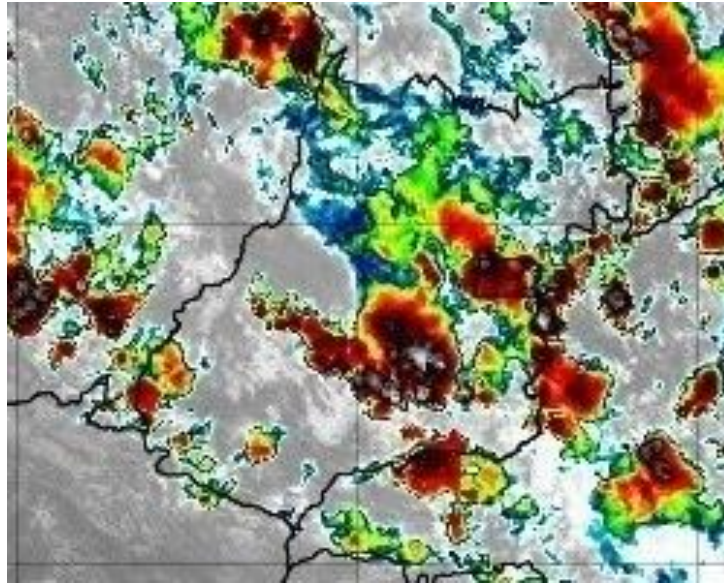
Figura 11 – Imagens realçadas do satélite GOES-16 das 9h00 do dia 29 de Fevereiro de 2020. FONTE: Cptec/INPE.

15h00 - 29 de Fevereiro de 2020

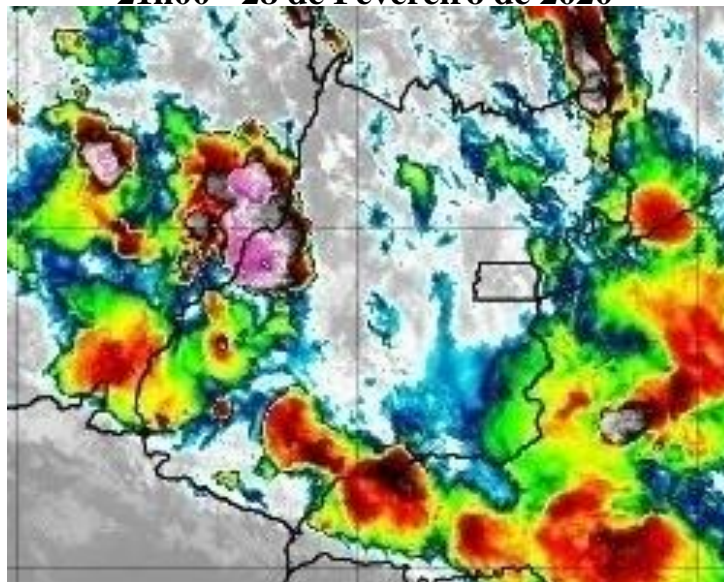
Figura 12 – Imagens realçadas do satélite GOES-16 das 15h00 do dia 29 de Fevereiro de 2020. FONTE: Cptec/INPE.

21h00 - 00 de Março de 2020

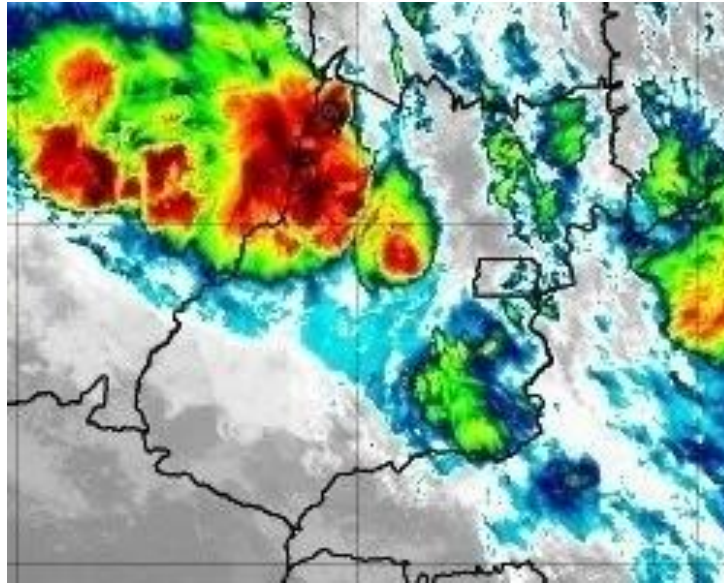

Figura 13 – Imagens realçadas do satélite GOES-16 das 21h00 do dia 00 de Março de 2020. FONTE: Cptec/INPE.

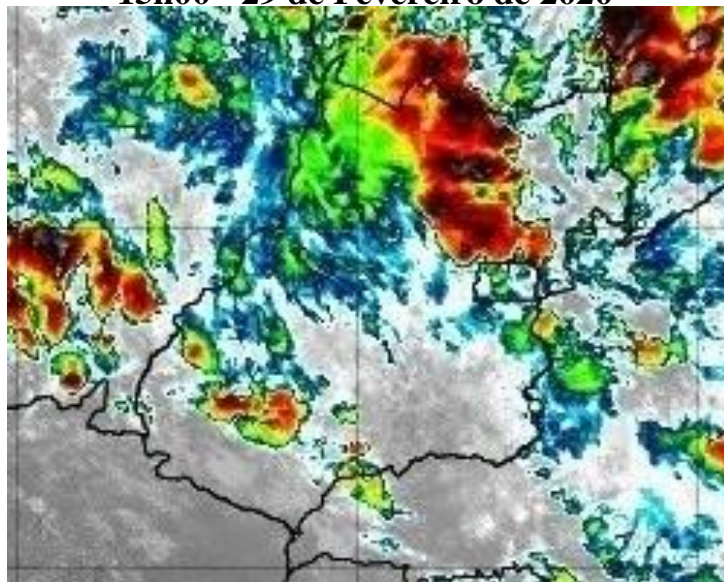
3h00 - 01 de Março de 2020

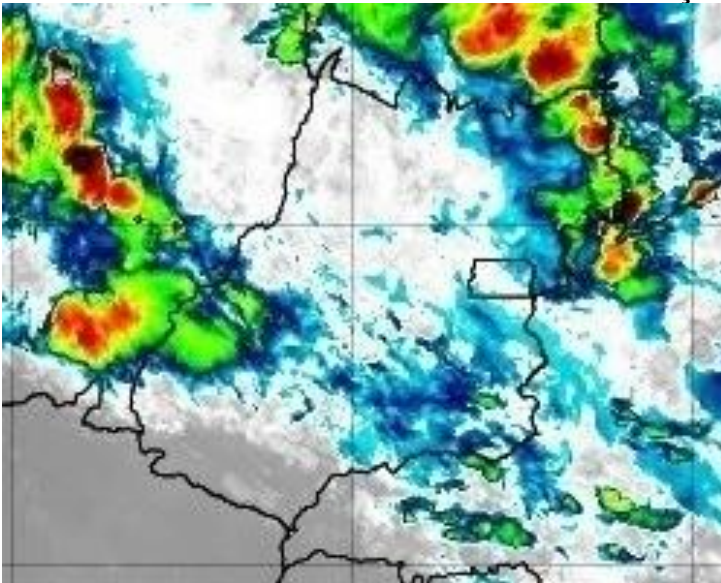

Figura 14 – Imagens realçadas do satélite GOES-16 das 3h00 do dia 01 de Março de 2020. FONTE: Cptec/INPE.

9h00 - 01 de Março de 2020

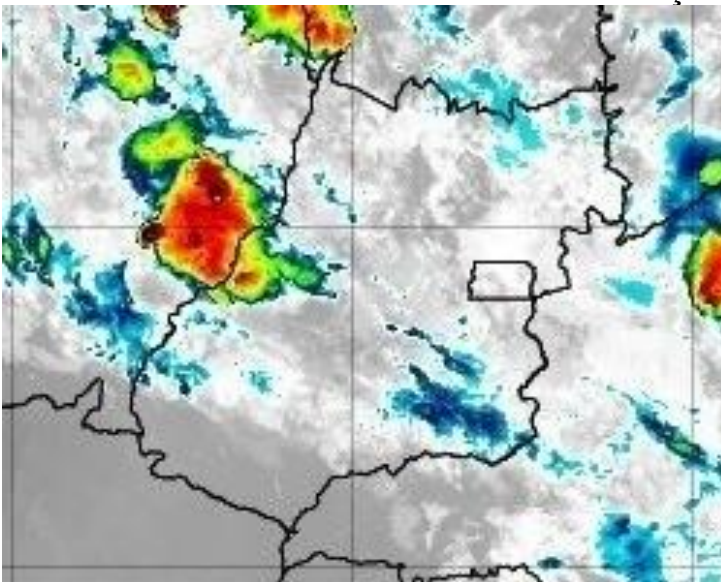

Figura 15 – Imagens realçadas do satélite GOES-16 das 9h00 do dia 01 de Março de 2020. FONTE: Cptec/INPE.

15h00 - 01 de Março de 2020

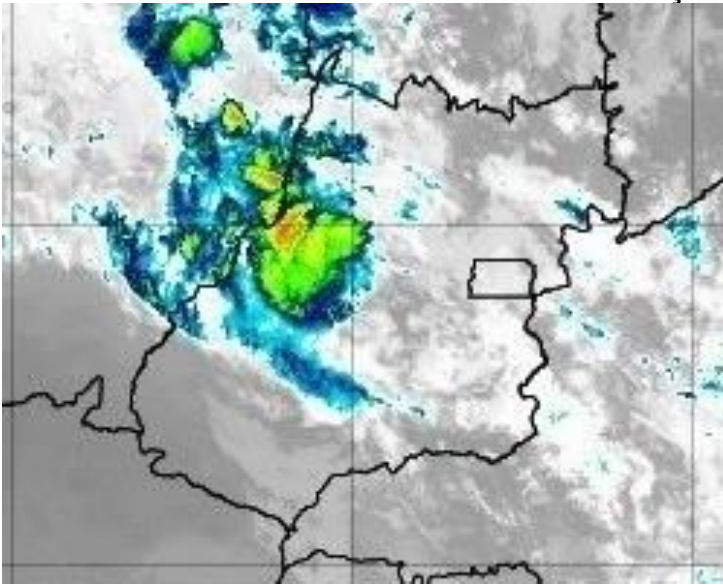

Figura 16 – Imagens realçadas do satélite GOES-16 das 15h00 do dia 01 de Março de 2020. FONTE: Cptec/INPE.

21h00 - 01 de Março de 2020

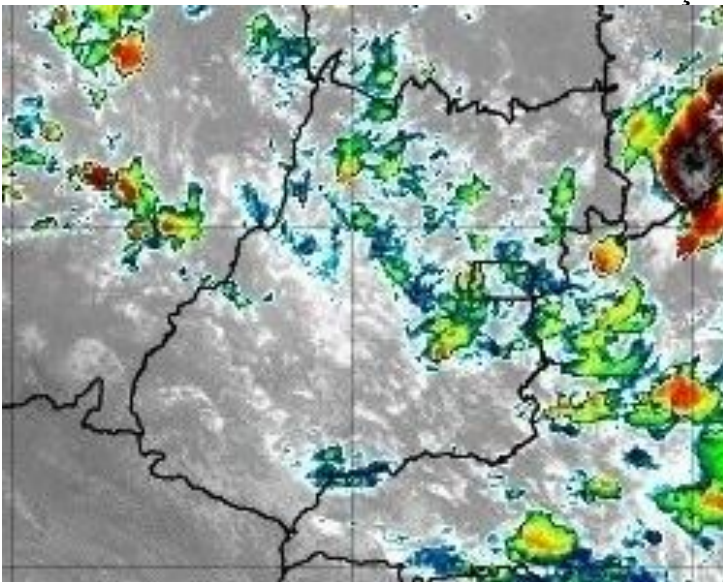

Figura 17 – Imagens realçadas do satélite GOES-16 das 21h00 do dia 01 de Março de 2020. FONTE: Cptec/INPE.

3h00 - 02 de Março de 2020



Figura 18 – Imagens realçadas do satélite GOES-16 das 3h00 do dia 02 de Março de 2020. FONTE: Cptec/INPE.

9h00 - 02 de Março de 2020

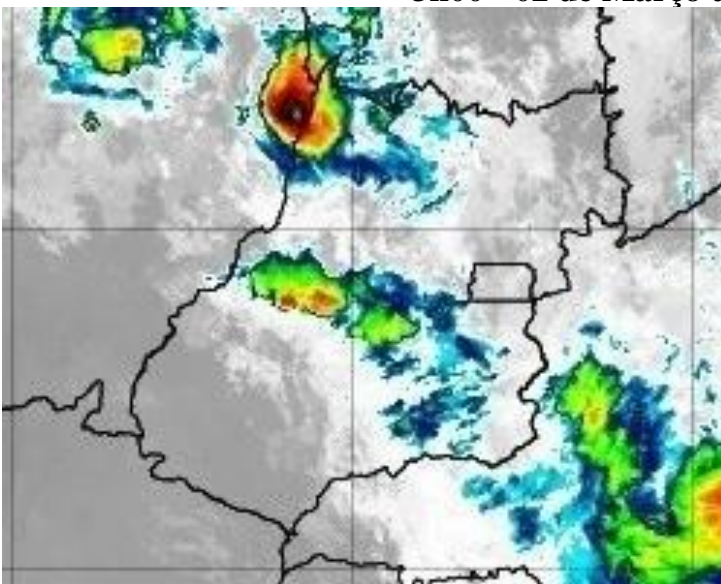

Figura 19 – Imagens realçadas do satélite GOES-16 das 9h00 do dia 02 de Março de 2020. FONTE: Cptec/INPE.

15h00 - 02 de Março de 2020



Figura 20 – Imagens realçadas do satélite GOES-16 das 15h00 do dia 02 de Março de 2020. FONTE: Cptec/INPE.

21h00 - 02 de Março de 2020

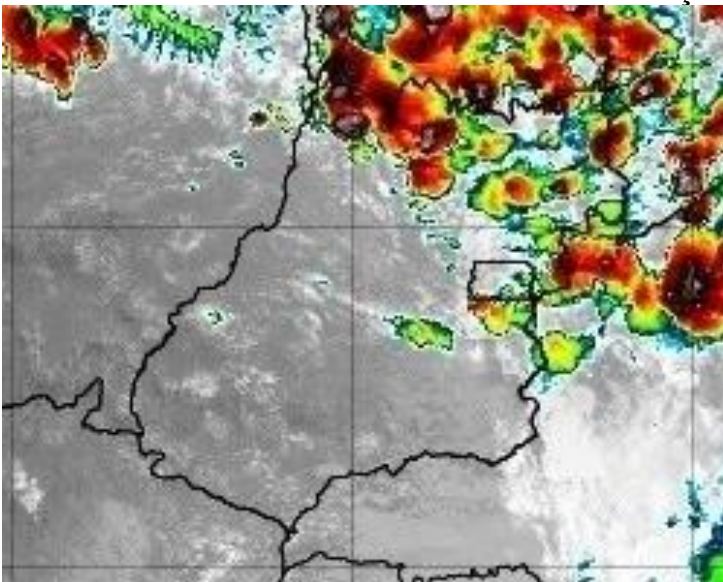

Figura 21 – Imagens realçadas do satélite GOES-16 das 21h00 do dia 02 de Março de 2020. FONTE: Cptec/INPE.

3h00 - 03 de Março de 2020



Figura 22 – Imagens realçadas do satélite GOES-16 das 3h00 do dia 03 de Março de 2020. FONTE: Cptec/INPE.

9h00 - 03 de Março de 2020



Figura 23 – Imagens realçadas do satélite GOES-16 das 9h00 do dia 03 de Março de 2020. FONTE: Cptec/INPE.

15h00 - 03 de Março de 2020



Figura 24 – Imagens realçadas do satélite GOES-16 das 15h00 do dia 03 de Março de 2020. FONTE: Cptec/INPE.

21h00 - 03 de Março de 2020

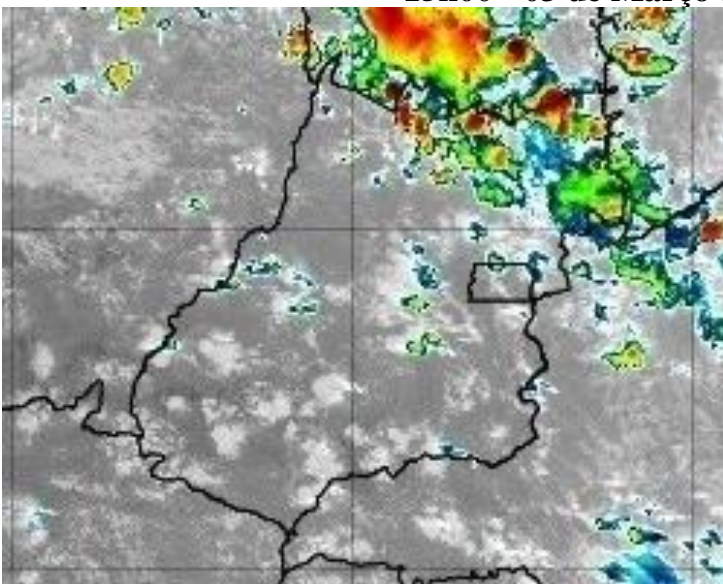

Figura 25 – Imagens realçadas do satélite GOES-16 das 21h00 do dia 03 de Março de 2020. FONTE: Cptec/INPE.

3h00 - 04 de Março de 2020

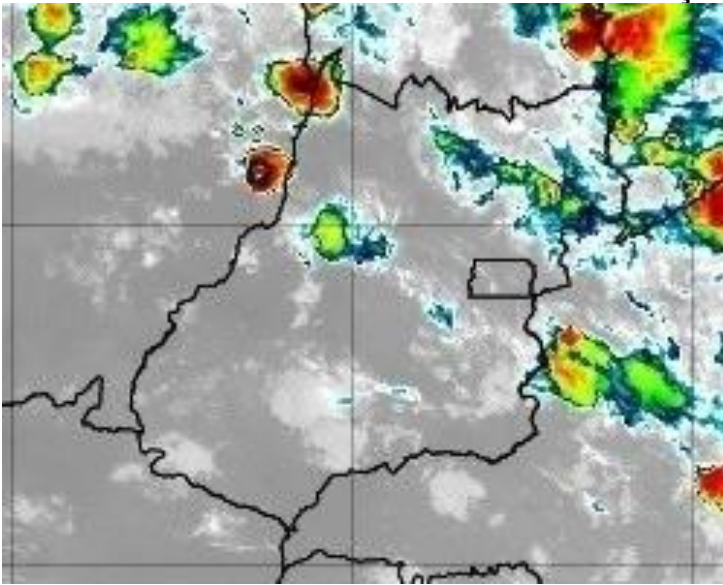

Figura 26 – Imagens realçadas do satélite GOES-16 das 3h00 do dia 04 de Março de 2020. FONTE: Cptec/INPE.

9h00 - 04 de Março de 2020



Figura 27 – Imagens realçadas do satélite GOES-16 das 9h00 do dia 04 de Março de 2020. FONTE: Cptec/INPE.

15h00 - 04 de Março de 2020

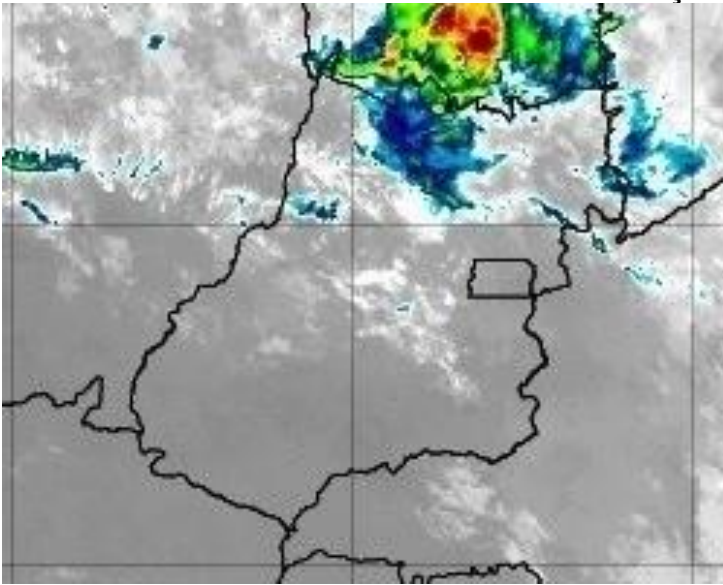

Figura 28 – Imagens realçadas do satélite GOES-16 das 15h00 do dia 04 de Março de 2020. FONTE: Cptec/INPE.

21h00 - 04 de Março de 2020



Figura 29 – Imagens realçadas do satélite GOES-16 das 21h00 do dia 04 de Março de 2020. FONTE: Cptec/INPE.

3h00 - 05 de Março de 2020

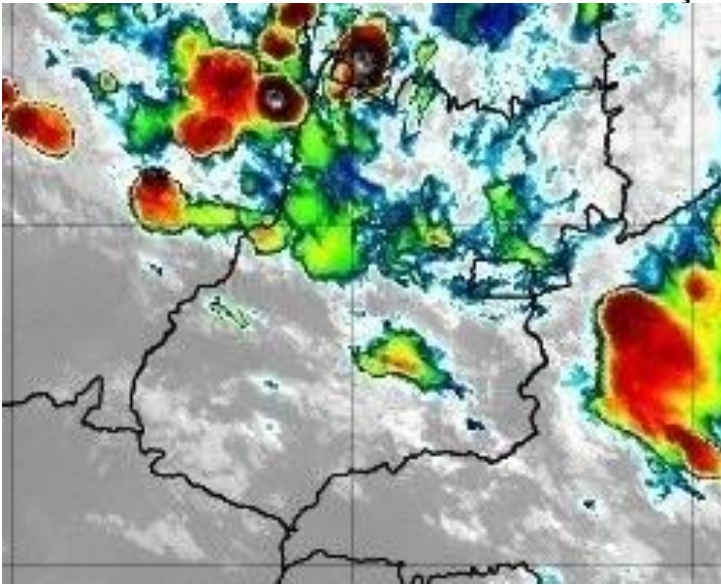

Figura 30 – Imagens realçadas do satélite GOES-16 das 3h00 do dia 05 de Março de 2020. FONTE: Cptec/INPE.

15h00 - 05 de Março de 2020



Figura 31 – Imagens realçadas do satélite GOES-16 das 15h00 do dia 05 de Março de 2020. FONTE: Cptec/INPE.

21h00 - 05 de Março de 2020

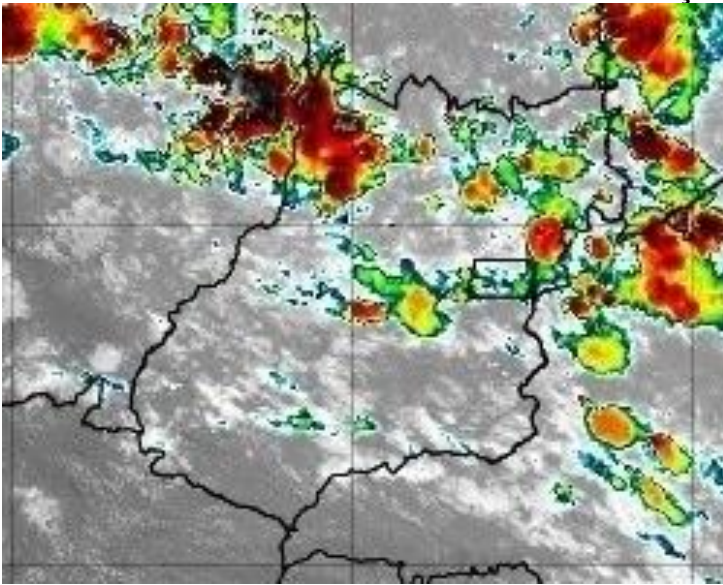

Figura 32 – Imagens realçadas do satélite GOES-16 das 21h00 do dia 05 de Março de 2020. FONTE: Cptec/INPE.

3h00 - 06 de Março de 2020

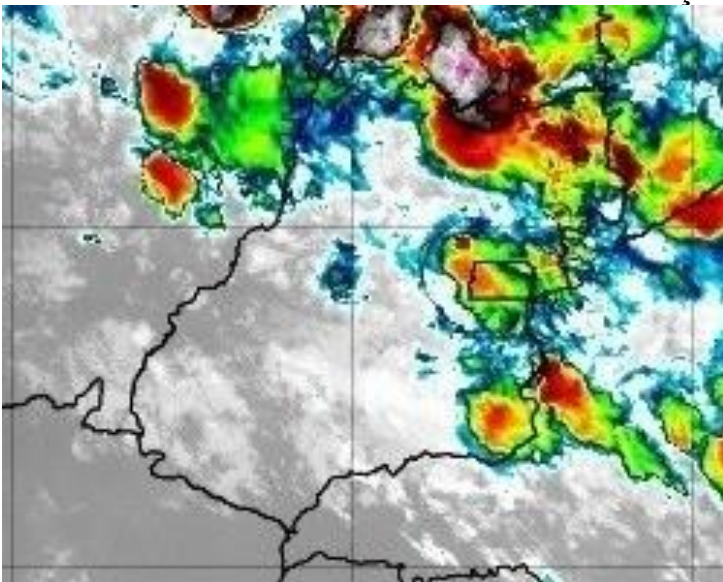

Figura 33 – Imagens realçadas do satélite GOES-16 das 3h00 do dia 06 de Março de 2020.
FONTE: Cptec/INPE.

9h00 - 06 de Março de 2020

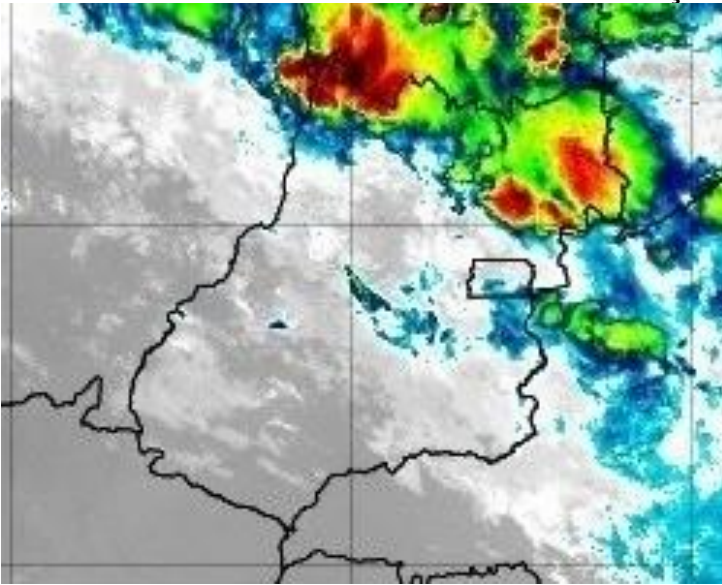

Figura 34 – Imagens realçadas do satélite GOES-16 das 9h00 do dia 06 de Março de 2020.
FONTE: Cptec/INPE.

15h00 - 06 de Março de 2020

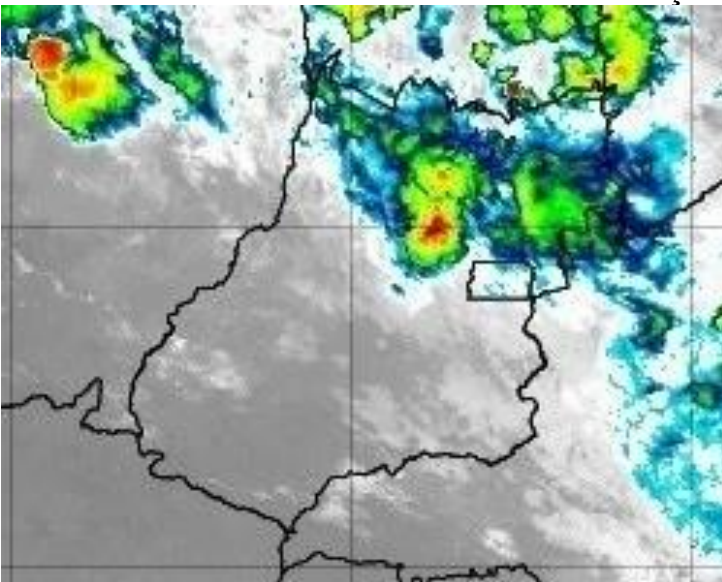

Figura 35 – Imagens realçadas do satélite GOES-16 das 15h00 do dia 06 de Março de 2020. FONTE: Cptec/INPE.

21h00 - 06 de Março de 2020



Figura 36 – Imagens realçadas do satélite GOES-16 das 21h00 do dia 06 de Março de 2020. FONTE: Cptec/INPE.

3h00 - 07 de Março de 2020

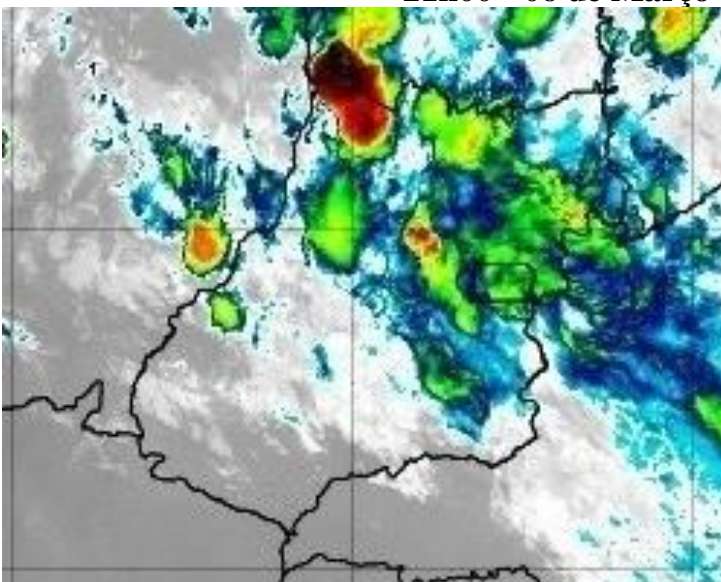

Figura 37 – Imagens realçadas do satélite GOES-16 das 3h00 do dia 07 de Março de 2020.
FONTE: Cptec/INPE.

9h00 - 07 de Março de 2020

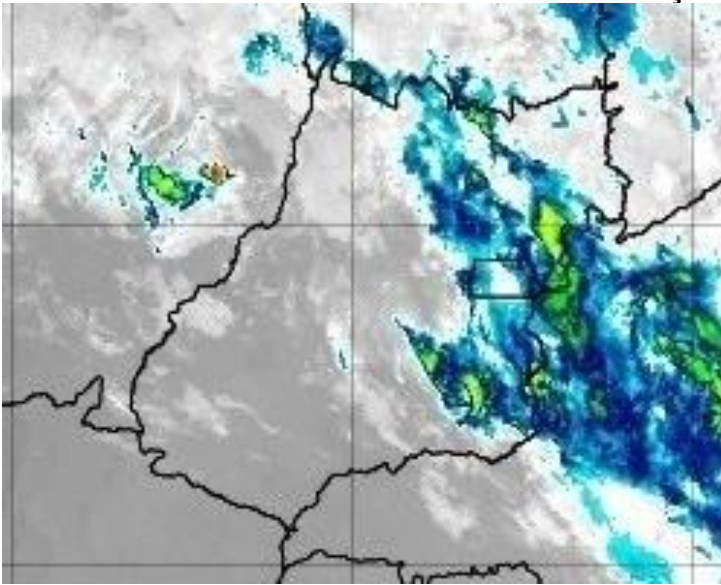

Figura 38 – Imagens realçadas do satélite GOES-16 das 9h00 do dia 07 de Março de 2020.
FONTE: Cptec/INPE.

15h00 - 07 de Março de 2020

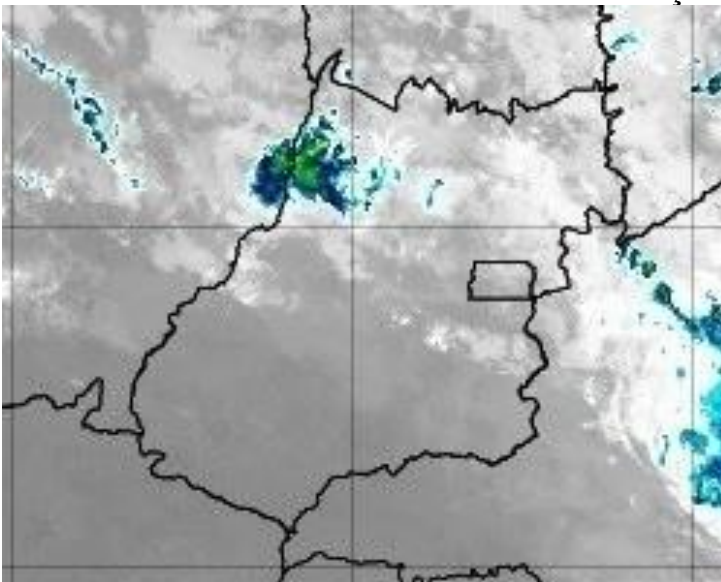

Figura 39 – Imagens realçadas do satélite GOES-16 das 15h00 do dia 07 de Março de 2020. FONTE: Cptec/INPE.

21h00 - 07 de Março de 2020

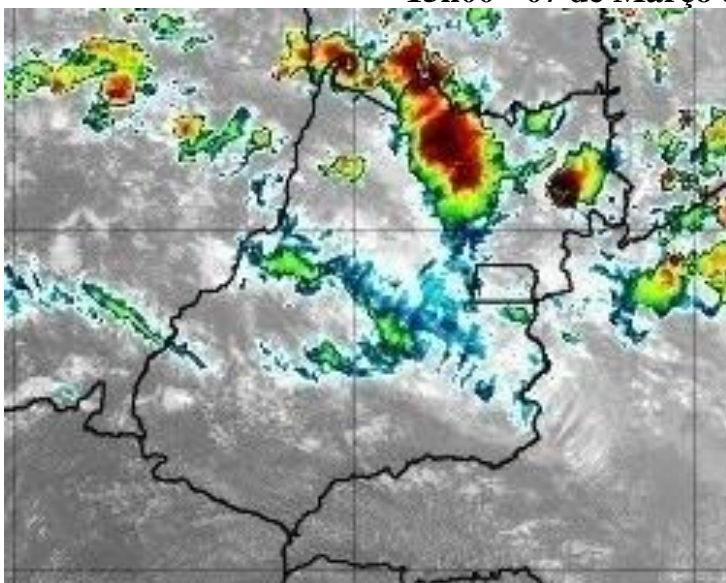

Figura 40 – Imagens realçadas do satélite GOES-16 das 21h00 do dia 07 de Março de 2020. FONTE: Cptec/INPE.

9h00 - 08 de Março de 2020

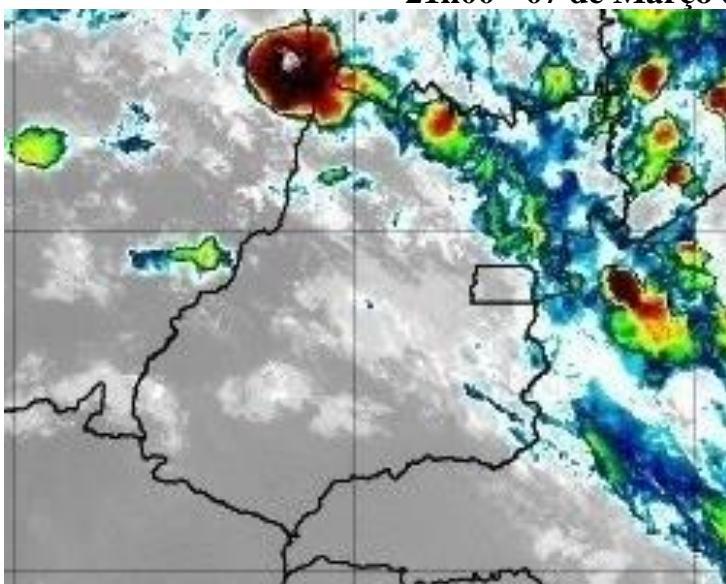

Figura 41 – Imagens realçadas do satélite GOES-16 das 9h00 do dia 08 de Março de 2020. FONTE: Cptec/INPE.

15h00 - 08 de Março de 2020



Figura 42 – Imagens realçadas do satélite GOES-16 das 15h00 do dia 08 de Março de 2020. FONTE: Cptec/INPE.

21h00 - 08 de Março de 2020

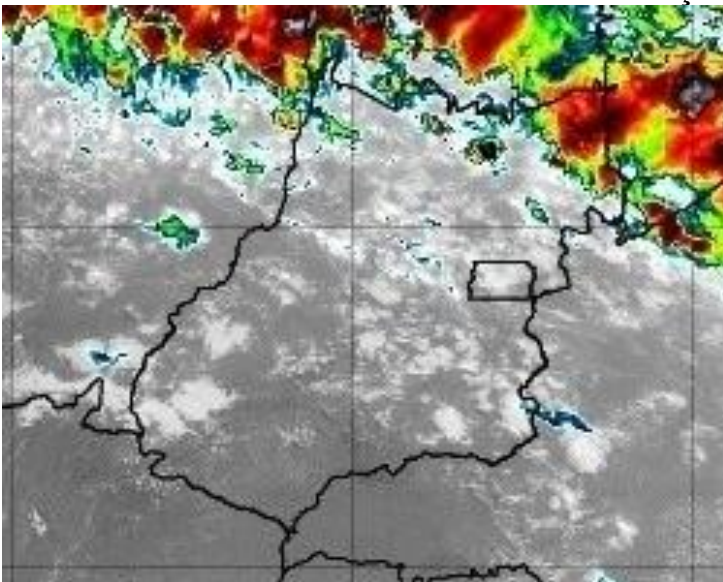

Figura 43 – Imagens realçadas do satélite GOES-16 das 21h00 do dia 08 de Março de 2020. FONTE: Cptec/INPE.

3h00 - 09 de Março de 2020

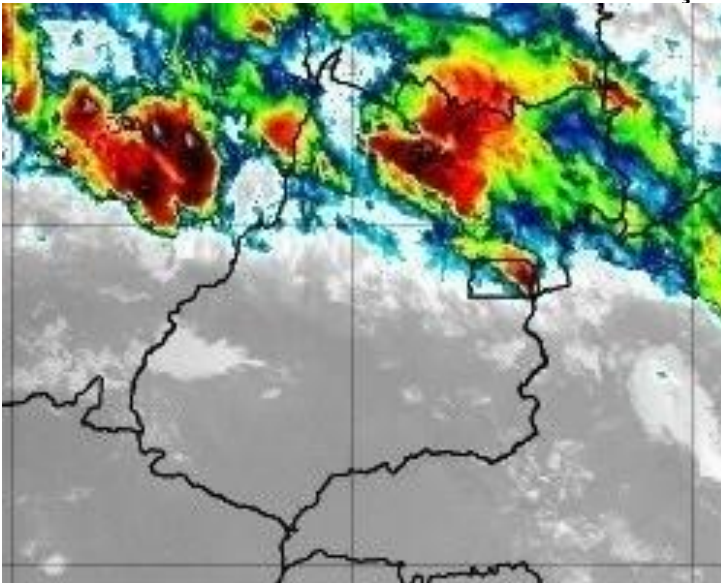

Figura 44 – Imagens realçadas do satélite GOES-16 das 3h00 do dia 09 de Março de 2020. FONTE: Cptec/INPE.

9h00 - 09 de Março de 2020

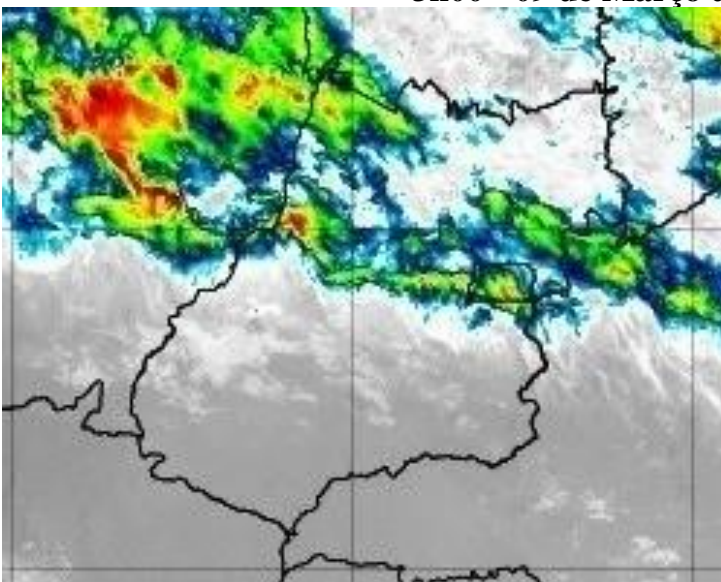

Figura 45 – Imagens realçadas do satélite GOES-16 das 9h00 do dia 09 de Março de 2020. FONTE: Cptec/INPE.

15h00 - 09 de Março de 2020



Figura 46 – Imagens realçadas do satélite GOES-16 das 15h00 do dia 09 de Março de 2020. FONTE: Cptec/INPE.

2 Classificação COBRADE

O COBRADE (Classificação e Codificação Brasileira de Desastres) foi criado com o intuito de adequar a classificação brasileira à classificação utilizada pela ONU na classificação de desastres e nivelar o país aos demais organismos de gestão de desastres do mundo.

Baseados nos dados analisados nos itens anteriores, podemos classificar o evento ocorrido sobre a área de concessão da ENEL Distribuição Goiás como Zona de Convergência (Código 1.3.1.2.0).

3 Resumo do Evento

Áreas de instabilidade associadas à ZCAS favoreceram a ocorrência de chuva forte, raios e rajadas de vento sobre o estado de Goiás entre a manhã do dia 27 de fevereiro e a noite do dia 09 de março de 2020.

O sistema de detecção da EarthNetworks registrou 48207 descargas atmosféricas sobre a área de concessão da ENEL em Goiás entre as 11h00 do dia 27 de fevereiro e 21h00 do dia 09 de março de 2020.

Rajadas de vento forte a temporal foram registrados pelo INMET. Na cidade de Catalão ocorreram ventos de até 98,6 km/h entre as 16h e 17h do dia 05 de março de 2020, vento classificado como temporal pela escala Beaufort.

Estações do INMET também registraram chuva forte entre os dias 27 de fevereiro e 09 de março de 2020. O acumulado de chuva entre os dias 25 de fevereiro e 10 de março de 2020 corresponde às médias históricas tanto do mês de fevereiro, como do mês de março.

Tabela 15 – Resumo do evento Regional Rio Verde

Número/Código do Evento	
Número/Código do Relatório	
Descrição	Região ligada à tempestade causada por uma zona de baixa pressão atmosférica, provocando forte deslocamento de massas de ar, vendavais, chuvas intensa e possível queda de granizo.
Código COBRADE	1.3.1.2.0 – Zona de Convergência
Hora início do evento	12h00 do dia 27 de fevereiro de 2020
Hora de fim do evento	22h30 do dia 07 de março
Abrangência	Regional Rio Verde

Tabela 16 – Resumo do evento Regional Morrinhos

Número/Código do Evento	
Número/Código do Relatório	
Descrição	Região ligada à tempestade causada por uma zona de baixa pressão atmosférica, provocando forte deslocamento de massas de ar, vendavais, chuvas intensa e possível queda de granizo.
Código COBRADE	1.3.1.2.0 – Zona de Convergência
Hora início do evento	12h30 do dia 27 de fevereiro de 2020
Hora de fim do evento	16h30 do dia 08 de março
Abrangência	Regional Morrinhos

Tabela 17 – Resumo do evento Regional Metropolitana e Goiânia

Número/Código do Evento	
Número/Código do Relatório	
Descrição	Região ligada à tempestade causada por uma zona de baixa pressão atmosférica, provocando forte deslocamento de massas de ar, vendavais, chuvas intensa e possível queda de granizo.
Código COBRADE	1.3.1.2.0 – Zona de Convergência
Hora início do evento	11h30 do dia 27 de fevereiro de 2020
Hora de fim do evento	13h30 do dia 08 de março
Abrangência	Regional Metropolitana e Goiânia

Tabela 18 – Resumo do evento Regional Iporá

Número/Código do Evento	
Número/Código do Relatório	
Descrição	Região ligada à tempestade causada por uma zona de baixa pressão atmosférica, provocando forte deslocamento de massas de ar, vendavais, chuvas intensa e possível queda de granizo.
Código COBRADE	1.3.1.2.0 – Zona de Convergência
Hora início do evento	11h30 do dia 27 de fevereiro de 2020
Hora de fim do evento	14h40 do dia 08 de março
Abrangência	Regional Iporá

Tabela 19 – Resumo do evento Regional Luziânia

Número/Código do Evento	
Número/Código do Relatório	
Descrição	Região ligada à tempestade causada por uma zona de baixa pressão atmosférica, provocando forte deslocamento de massas de ar, vendavais, chuvas intensa e possível queda de granizo.
Código COBRADE	1.3.1.2.0 – Zona de Convergência
Hora início do evento	11h30 do dia 27 de fevereiro de 2020
Hora de fim do evento	22h30 do dia 08 de março
Abrangência	Regional Luziânia

Tabela 20 – Resumo do evento Regional Anápolis

Número/Código do Evento	
Número/Código do Relatório	
Descrição	Região ligada à tempestade causada por uma zona de baixa pressão atmosférica, provocando forte deslocamento de massas de ar, vendavais, chuvas intensa e possível queda de granizo.
Código COBRADE	1.3.1.2.0 – Zona de Convergência
Hora início do evento	12h30 do dia 27 de fevereiro de 2020
Hora de fim do evento	22h30 do dia 08 de março
Abrangência	Regional Anápolis

Tabela 21 – Resumo do evento Regional Uruaçu

Número/Código do Evento	
Número/Código do Relatório	
Descrição	Região ligada à tempestade causada por uma zona de baixa pressão atmosférica, provocando forte deslocamento de massas de ar, vendavais, chuvas intensa e possível queda de granizo.
Código COBRADE	1.3.1.2.0 – Zona de Convergência
Hora início do evento	12h40 do dia 27 de fevereiro de 2020
Hora de fim do evento	18h30 do dia 09 de março
Abrangência	Regional Uruaçu

Tabela 22 – Resumo do evento Regional Formosa

Número/Código do Evento	
Número/Código do Relatório	
Descrição	Região ligada à tempestade causada por uma zona de baixa pressão atmosférica, provocando forte deslocamento de massas de ar, vendavais, chuvas intensa e possível queda de granizo.
Código COBRADE	1.3.1.2.0 – Zona de Convergência
Hora início do evento	13h30 do dia 27 de fevereiro de 2020
Hora de fim do evento	19h30 do dia 09 de março
Abrangência	Regional Formosa

4 Referências

- RMets Royal Meteorological Society – Beaufort Scale - <https://www.rmets.org/weather-and-climate/observing/beaufort-scale>
- Instituto Nacional de Meteorologia (INMET) - <http://www.inmet.gov.br>
- Cptec/INPE- <https://www.cptec.inpe.br/>
- Centro de Hidrografia da Marinha do Brasil - <https://www.marinha.mil.br/chm/>
- Meteorology Glossary - American Meteorological Society - <http://glossary.ametsoc.org/>

Anexos

A.1 Carta Sinótica



Figura A1 - Carta sinótica para as 1200Z do dia 27 de fevereiro de 2020 (0900 do dia 27 de fevereiro de 2020 hora local. FONTE: Marinha do Brasil).



Figura A2 - Carta sinótica para as 1200Z do dia 28 de fevereiro de 2020 (09h00 do dia 28 de fevereiro de 2020 hora local. FONTE: Marinha do Brasil).

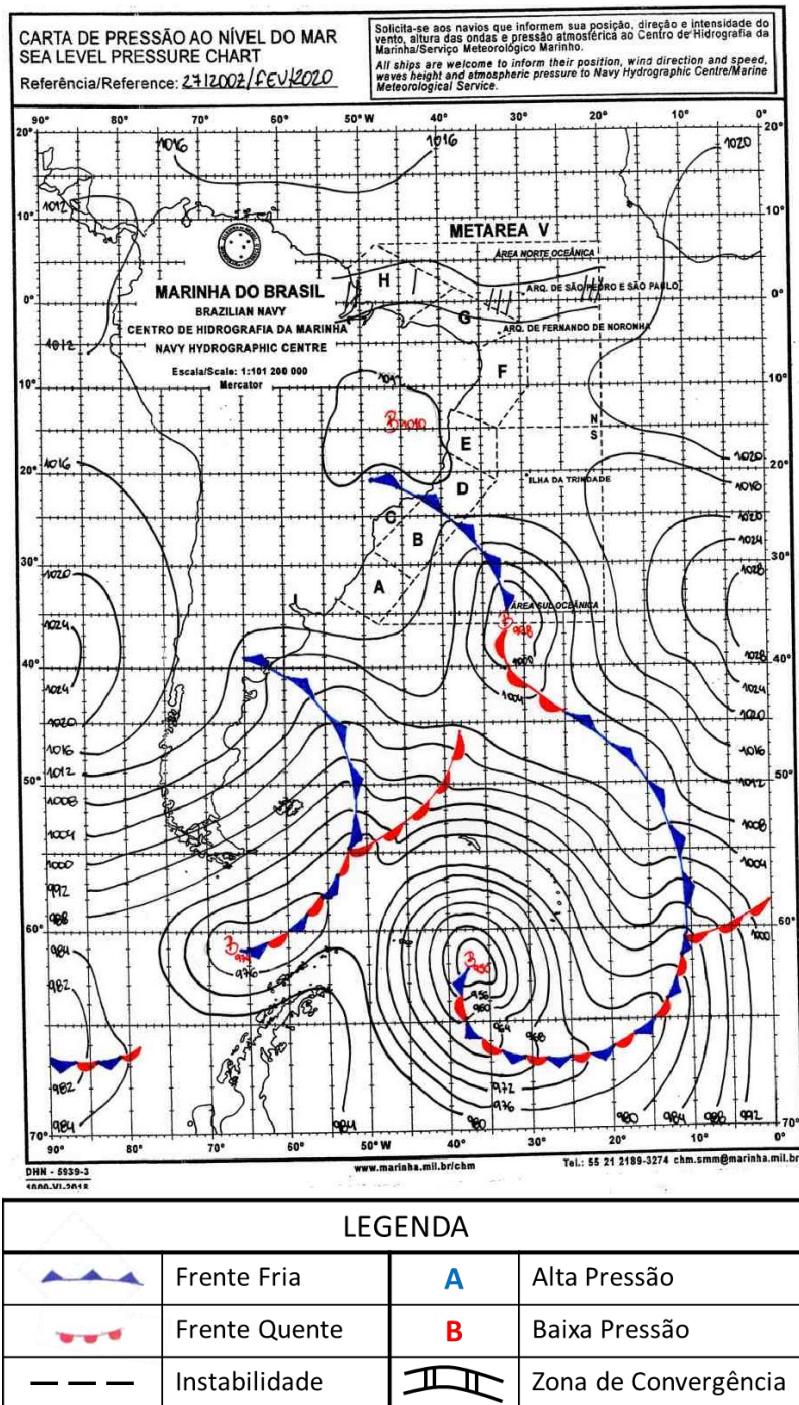

LEGENDA			
	Frente Fria	A	Alta Pressão
	Frente Quente	B	Baixa Pressão
	Instabilidade		Zona de Convergência

Figura A3 - Carta sinótica para as 1200Z do dia 29 de fevereiro de 2020 (09h00 do dia 29 de fevereiro de 2020 hora local). FONTE: Marinha do Brasil.

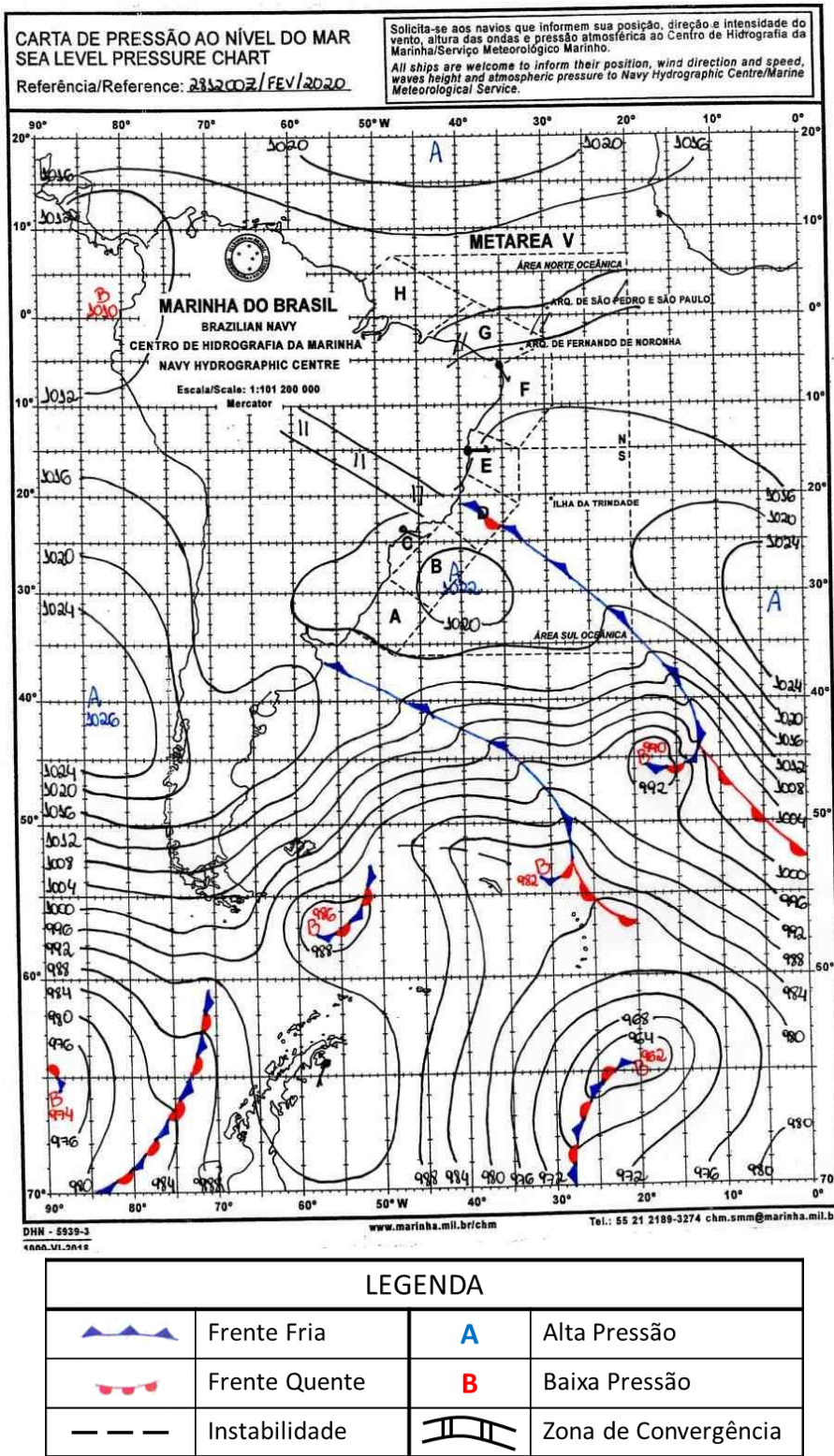
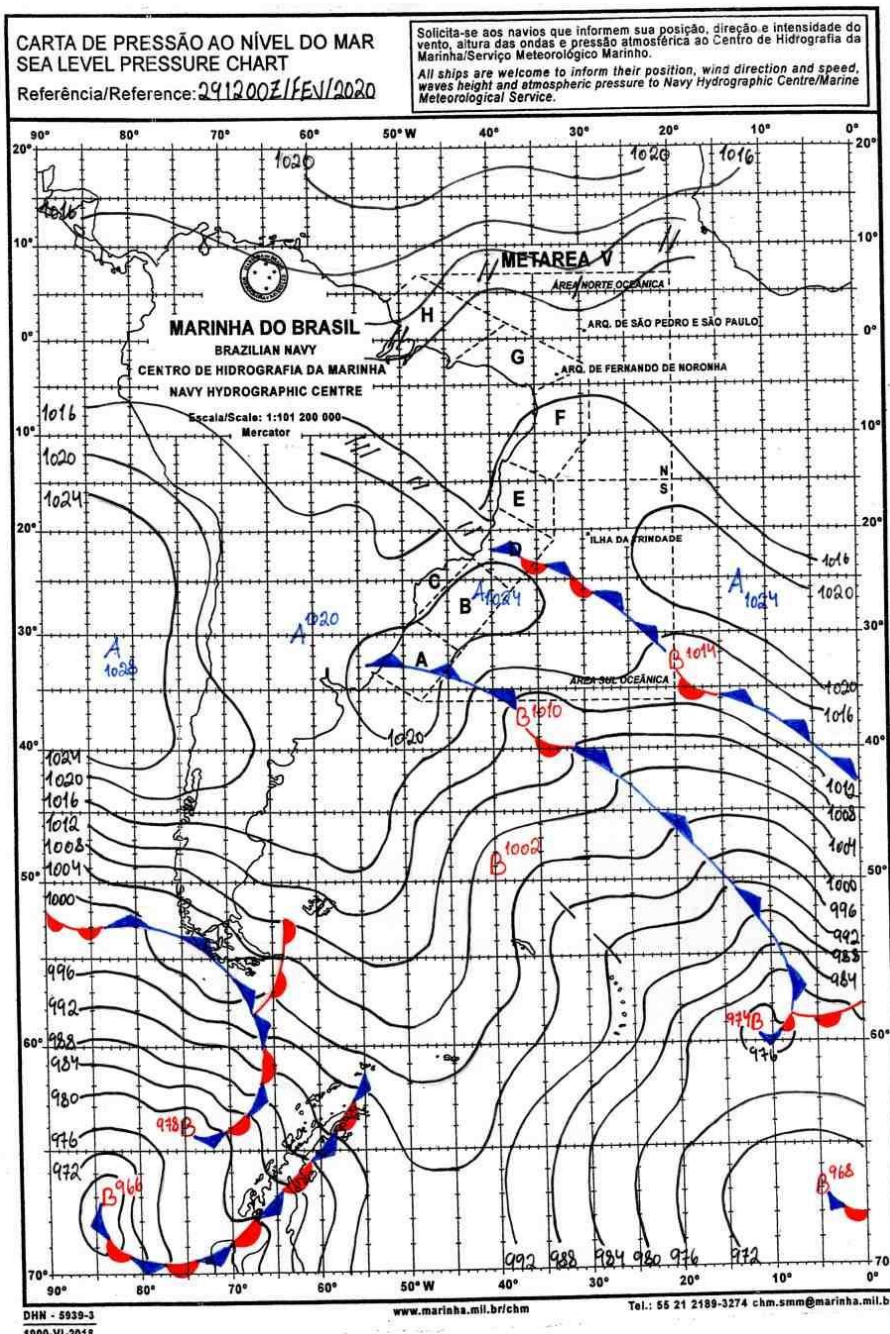
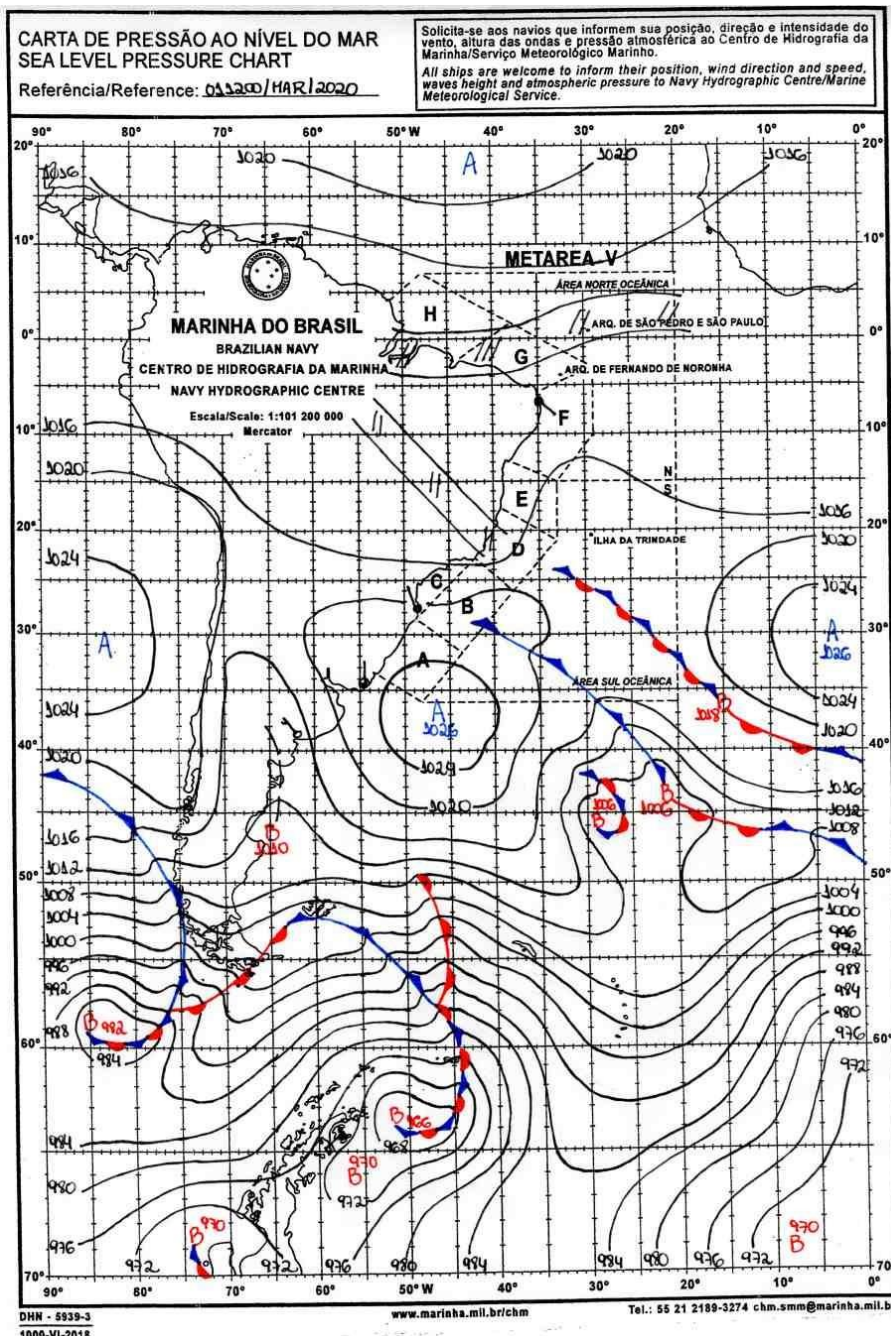

LEGENDA			
	Frente Fria	A	Alta Pressão
	Frente Quente	B	Baixa Pressão
	Instabilidade		Zona de Convergência

Figura A4 - Carta sinótica para as 1200Z do dia 01 de março de 2020 (09h00 do dia 01 de março de 2020 hora local. FONTE: Marinha do Brasil).

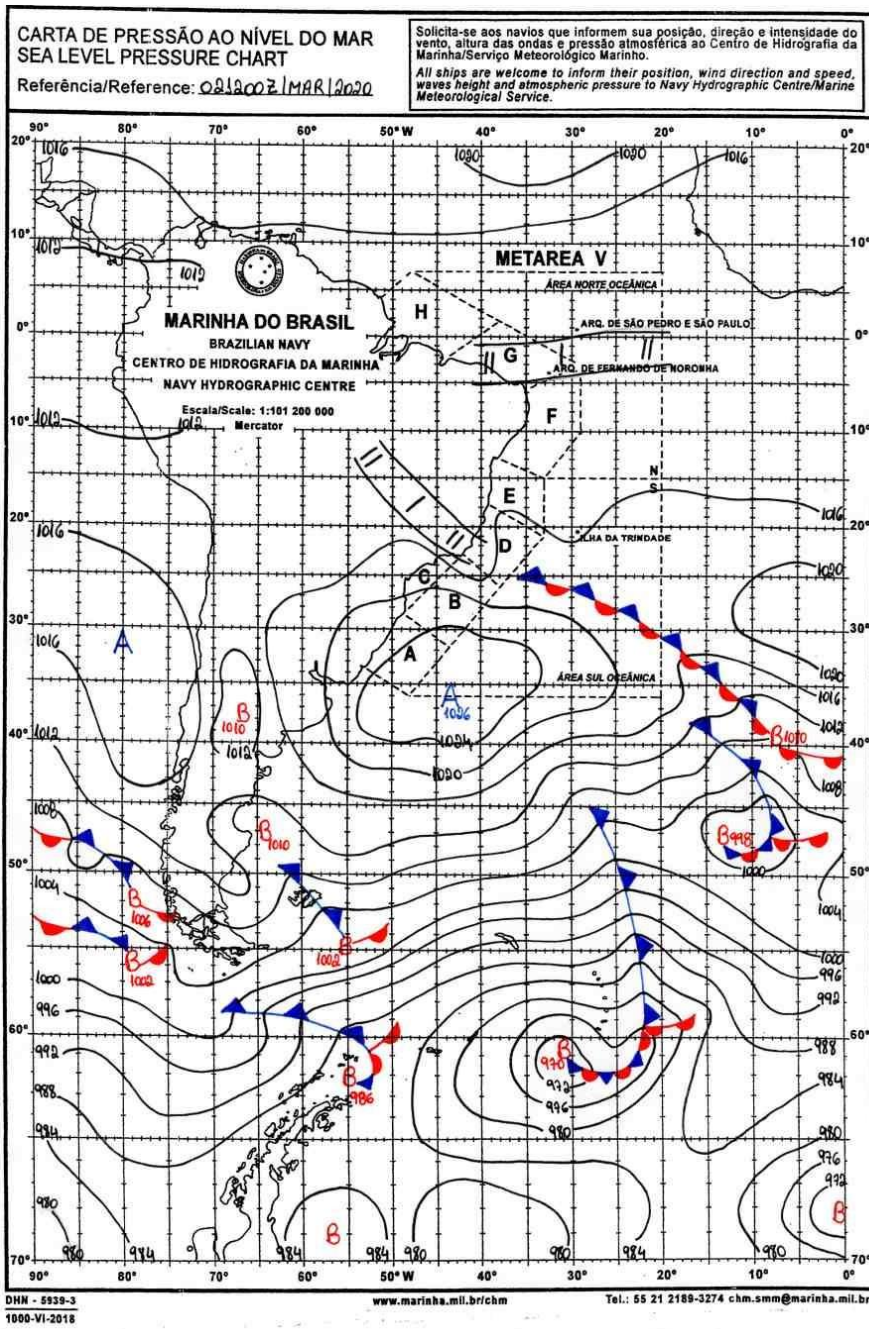

LEGENDA			
	Frente Fria	A	Alta Pressão
	Frente Quente	B	Baixa Pressão
	Instabilidade		Zona de Convergência

Figura A5 - Carta sinótica para as 1200Z do dia 02 de março de 2020 (09h00 do dia 02 de março de 2020 hora local). FONTE: Marinha do Brasil).

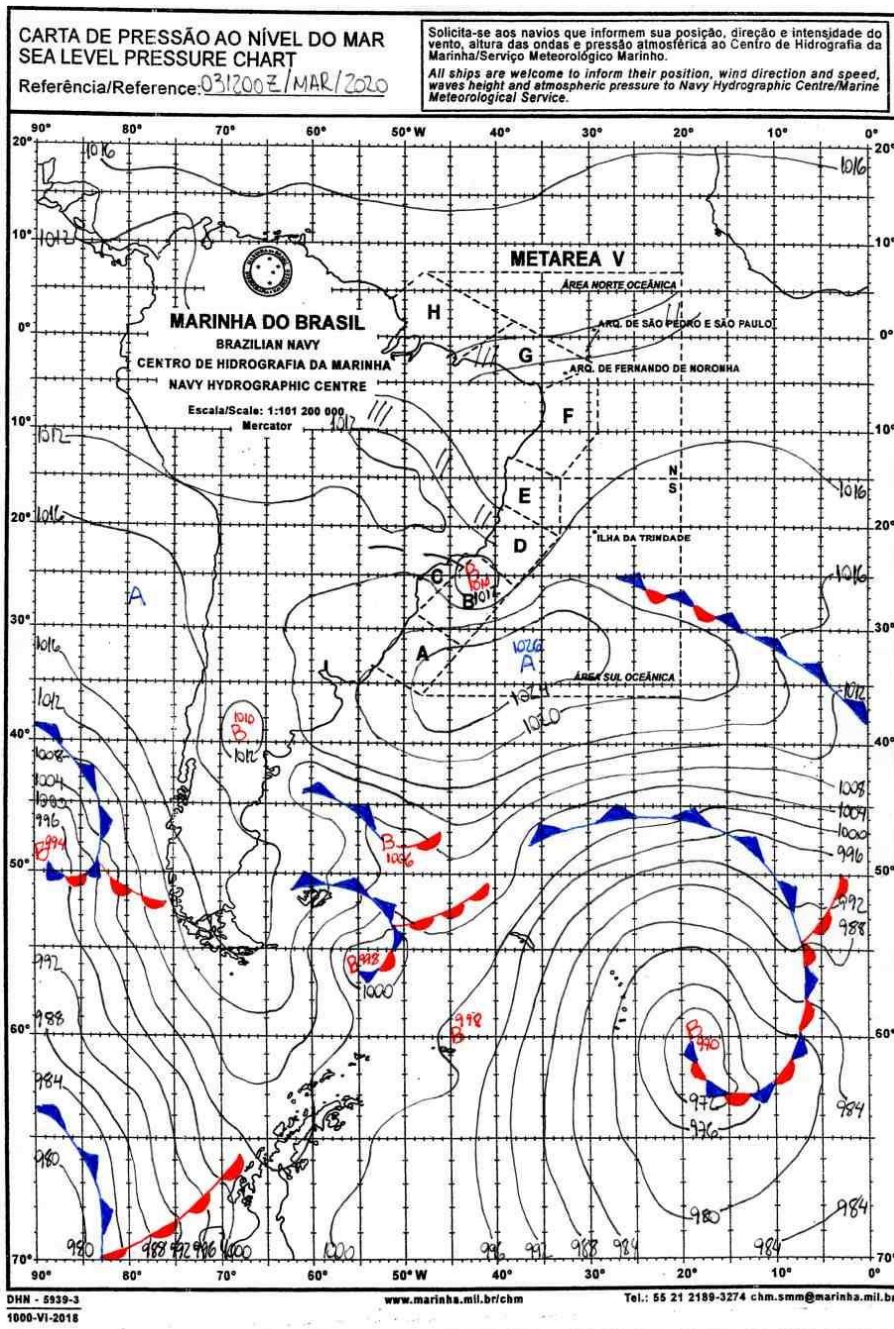

LEGENDA			
	Frente Fria	A	Alta Pressão
	Frente Quente	B	Baixa Pressão
	Instabilidade		Zona de Convergência

Figura A6 - Carta sinótica para as 1200Z do dia 03 de março de 2020 (09h00 do dia 03 de março de 2020 hora local). FONTE: Marinha do Brasil).

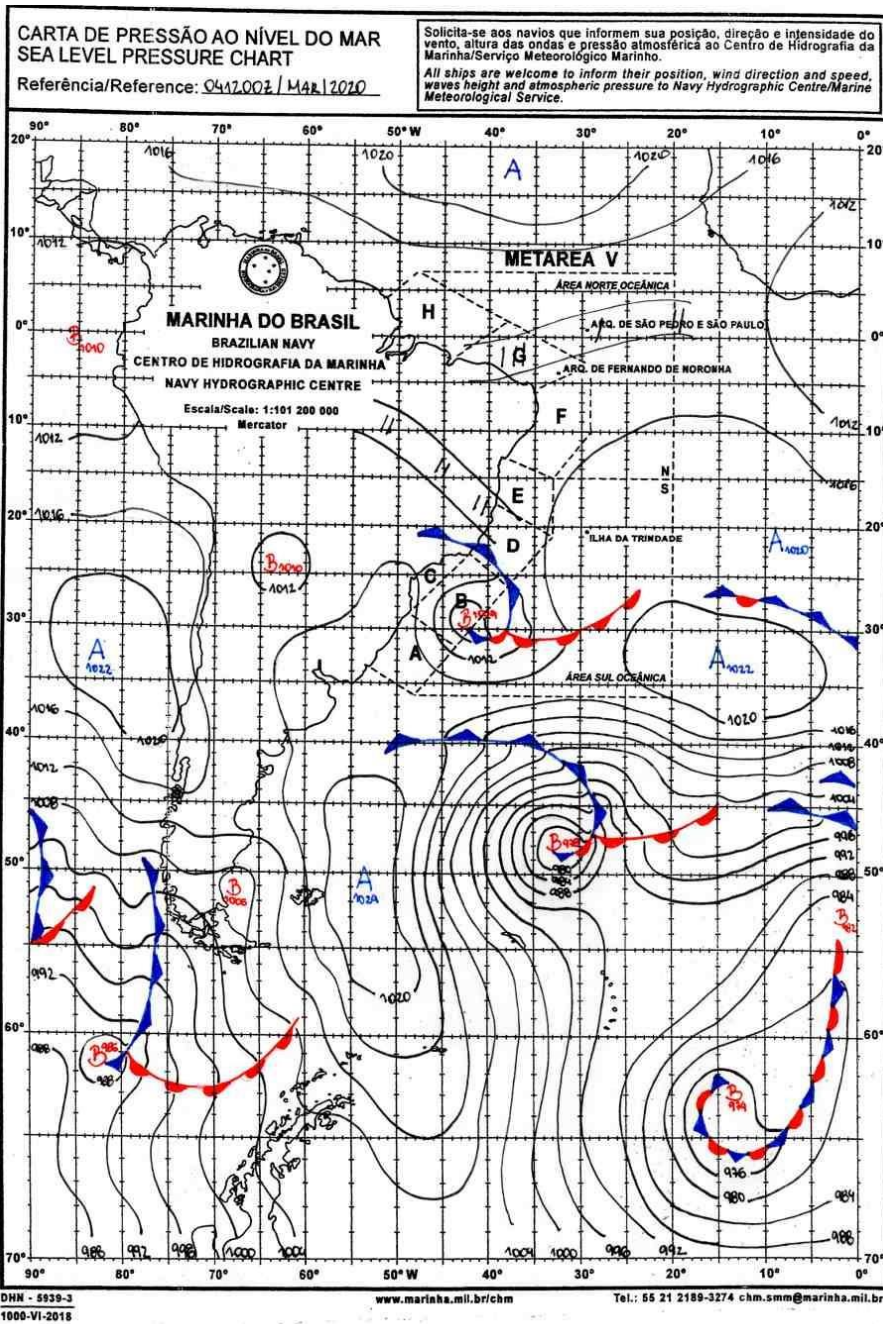

LEGENDA			
	Frente Fria	A	Alta Pressão
	Frente Quente	B	Baixa Pressão
	Instabilidade		Zona de Convergência

Figura A7 - Carta sinótica para as 1200Z do dia 04 de março de 2020 (09h00 do dia 04 de março de 2020 hora local). FONTE: Marinha do Brasil).

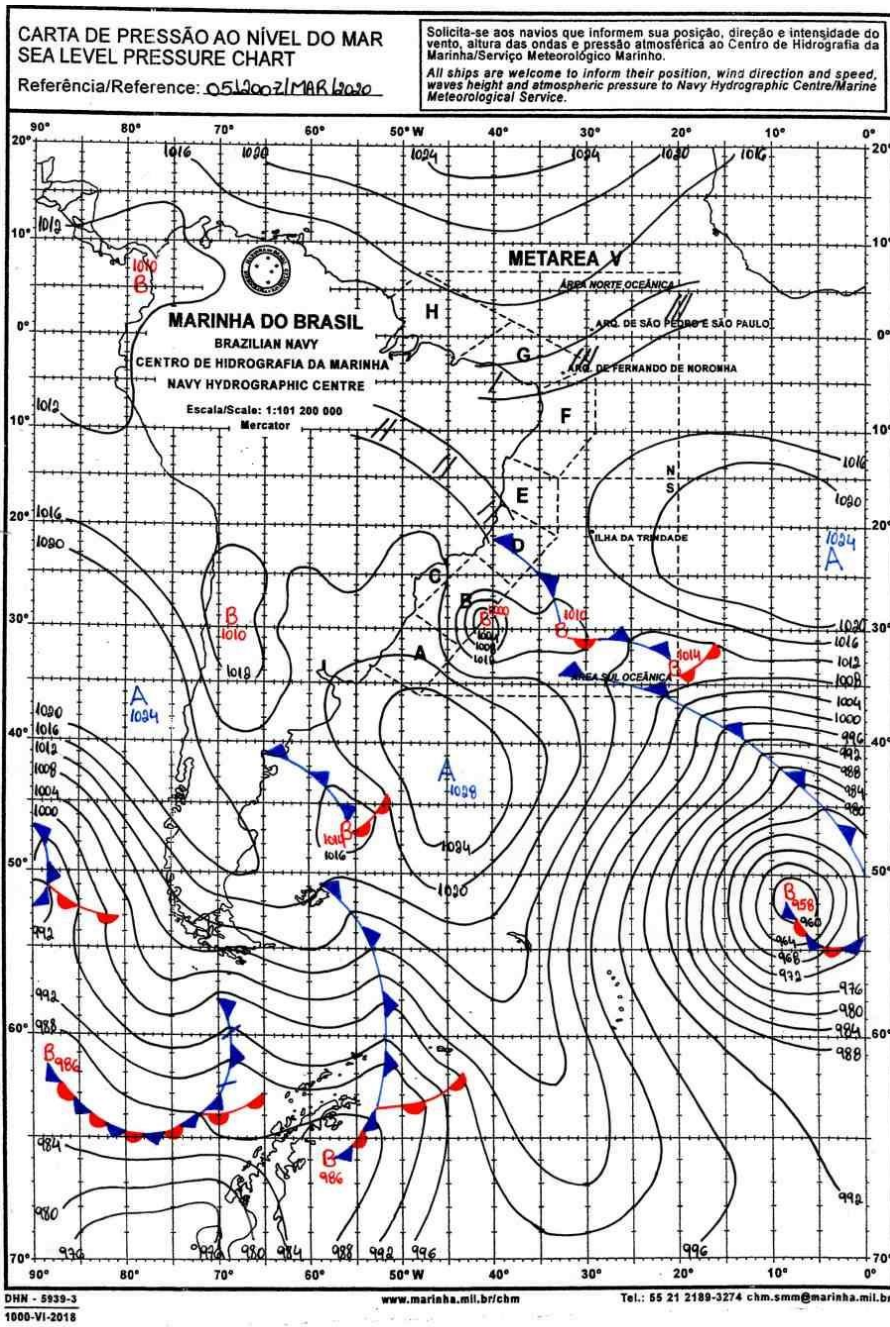

LEGENDA			
	Frente Fria	A	Alta Pressão
	Frente Quente	B	Baixa Pressão
	Instabilidade		Zona de Convergência

Figura A8 - Carta sinótica para as 1200Z do dia 05 de março de 2020 (09h00 do dia 05 de março de 2020 hora local). FONTE: Marinha do Brasil).

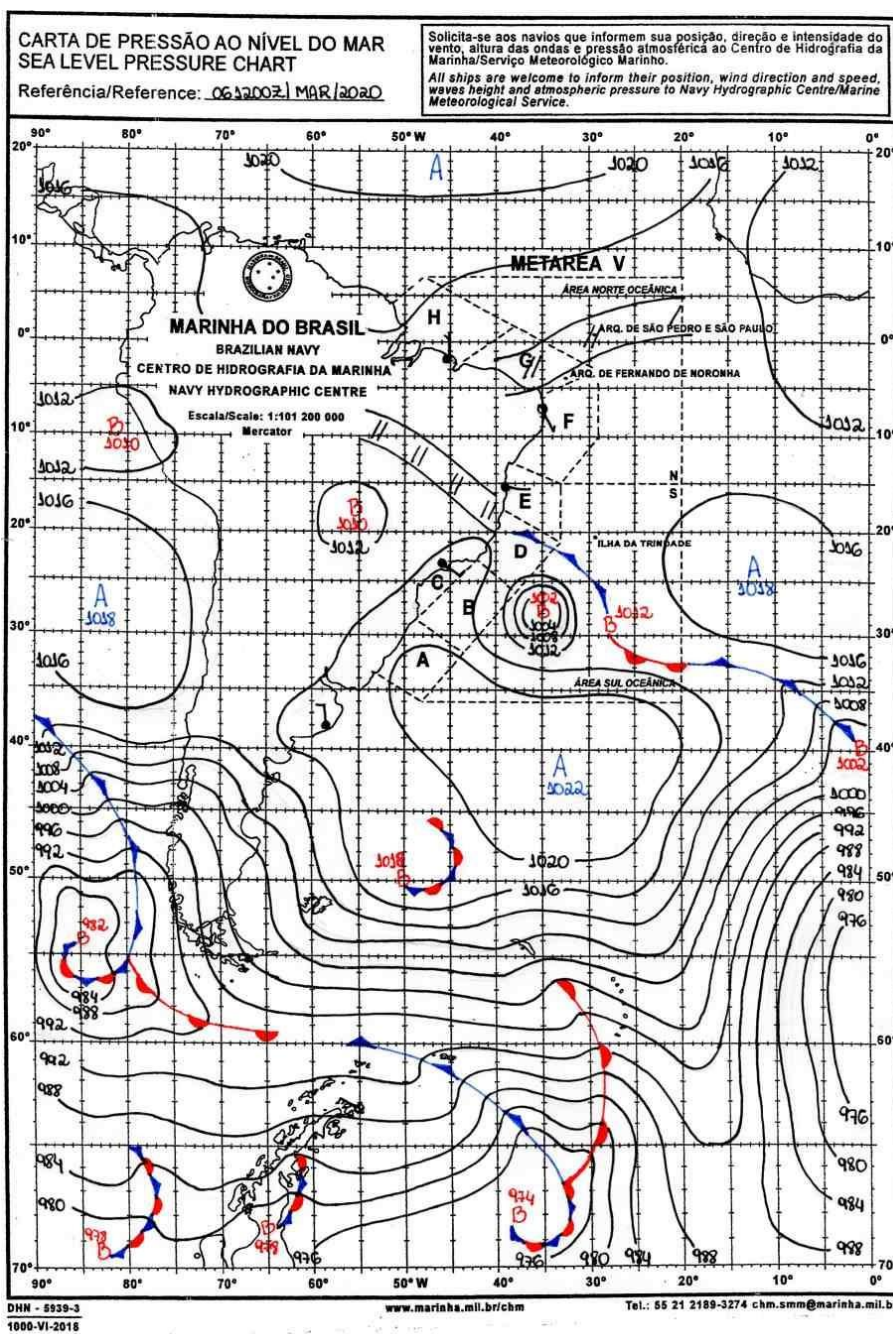

LEGENDA			
	Frente Fria	A	Alta Pressão
	Frente Quente	B	Baixa Pressão
	Instabilidade		Zona de Convergência

Figura A9 - Carta sinótica para as 1200Z do dia 06 de março de 2020 (09h00 do dia 06 de março de 2020 hora local). FONTE: Marinha do Brasil).

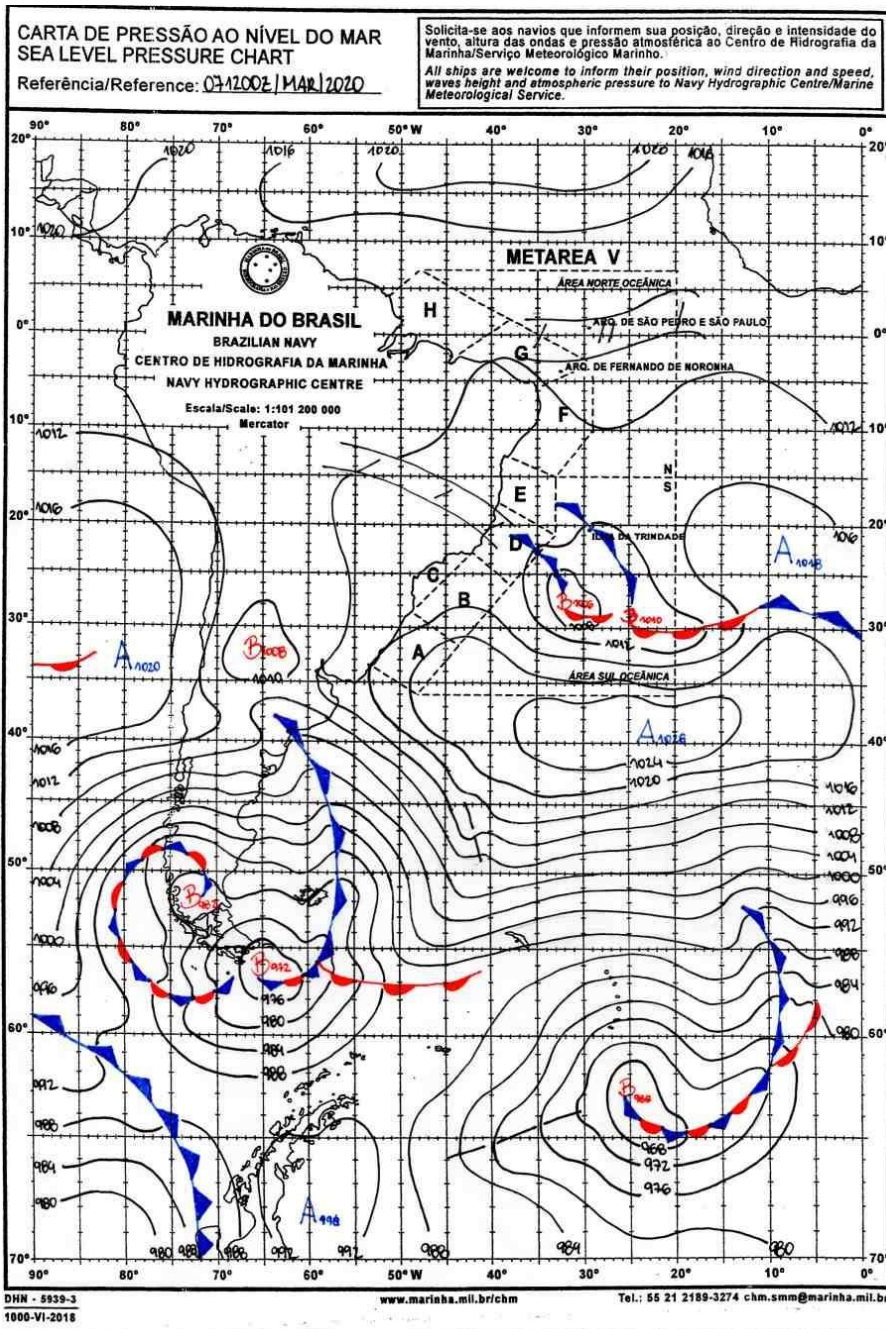

LEGENDA			
	Frente Fria	A	Alta Pressão
	Frente Quente	B	Baixa Pressão
	Instabilidade		Zona de Convergência

Figura A10 - Carta sinótica para as 1200Z do dia 07 de março de 2020 (09h00 do dia 07 de março de 2020 hora local). FONTE: Marinha do Brasil).

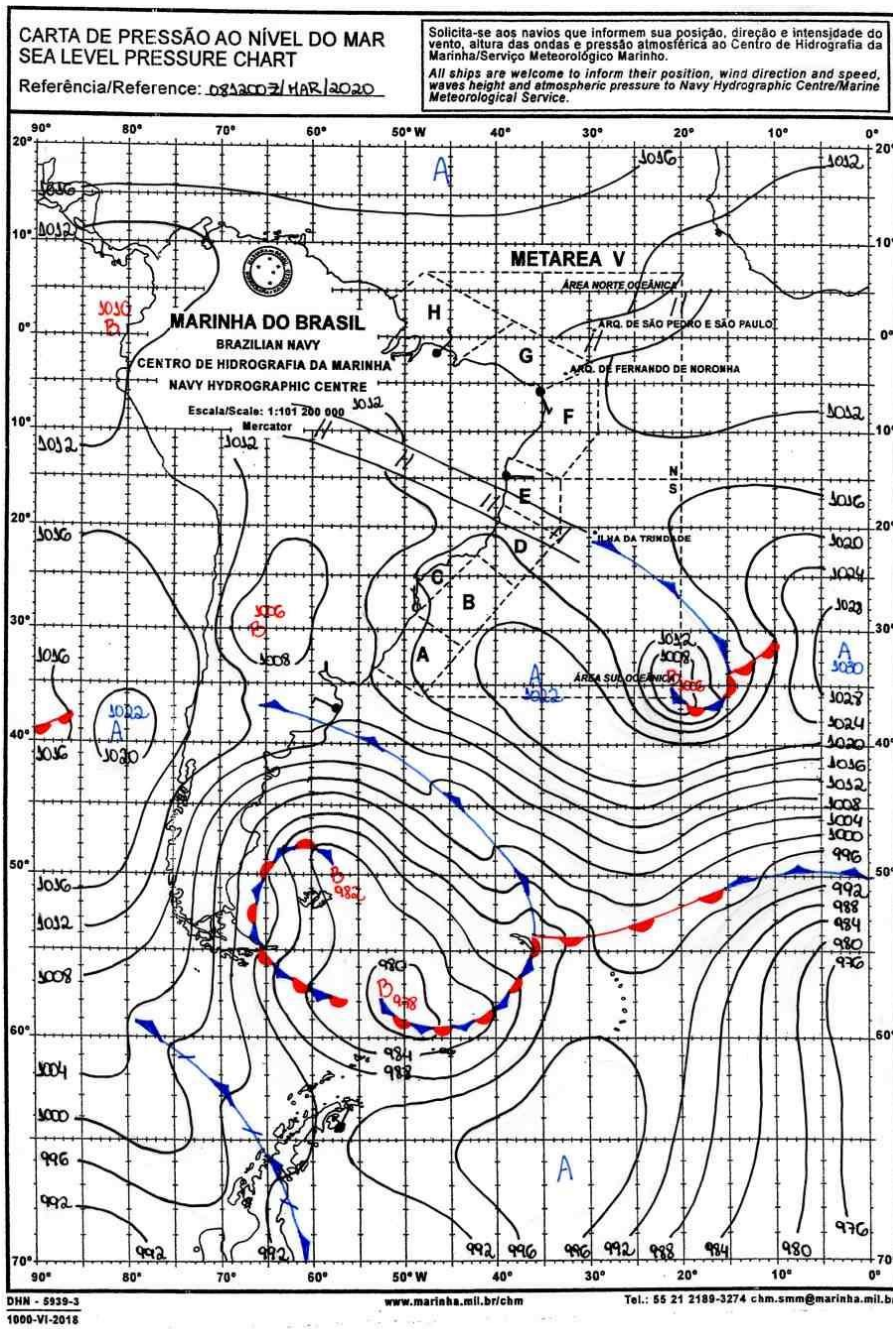

LEGENDA			
	Frente Fria	A	Alta Pressão
	Frente Quente	B	Baixa Pressão
	Instabilidade		Zona de Convergência

Figura A11 - Carta sinótica para as 1200Z do dia 08 de março de 2020 (09h00 do dia 08 de março de 2020 hora local). FONTE: Marinha do Brasil).

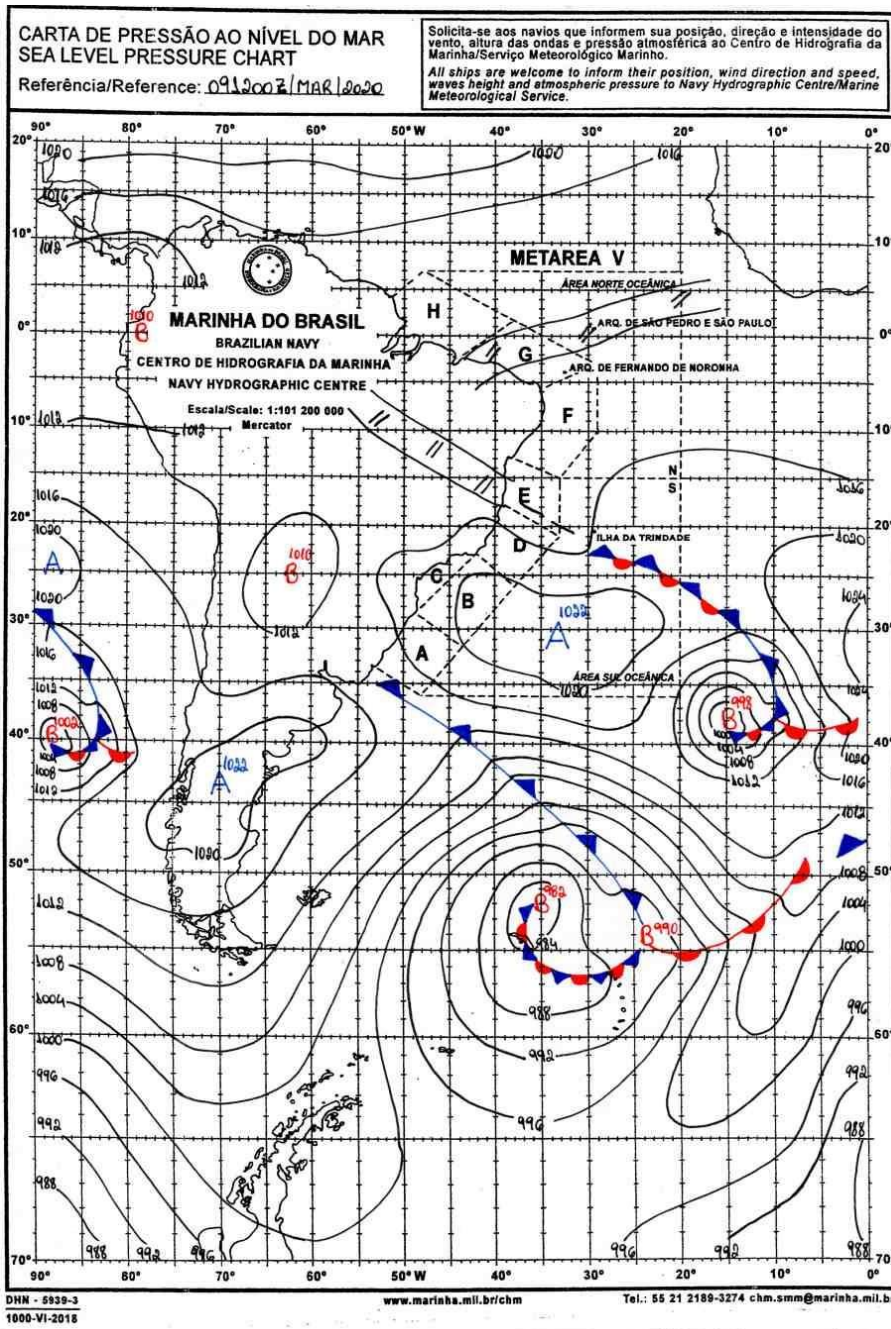

LEGENDA			
	Frente Fria	A	Alta Pressão
	Frente Quente	B	Baixa Pressão
	Instabilidade		Zona de Convergência

Figura A12 - Carta sinótica para as 1200Z do dia 09 de março de 2020 (09h00 do dia 09 de março de 2020 hora local). FONTE: Marinha do Brasil).

A.2 Notícias associadas

- Bombeiros resgatam famílias que ficaram ilhadas após forte chuva em Planaltina de Goiás

<https://g1.globo.com/go/goias/noticia/2020/03/01/bombeiros-resgatam-familias-que-ficaram-ilhadas-apos-forte-chuva-em-planaltina-de-goias.ghtml>

- Tarde de chuva forte no Sul de Goiás

<https://corumbaibanoticias.com.br/noticia/1879/tarde-de-chuva-forte-no-sul-de-goias>

Bianca Lobo Silva

Meteorologista

CREA 5063840461

Instituto Nacional de Meteorologia - INMET

Chuva Acumulada 24h

Estação: ARAGARCAS - 02/2020



Instituto Nacional de Meteorologia - INMET

Chuva Acumulada 24h

Estação: CATALAO - 02/2020

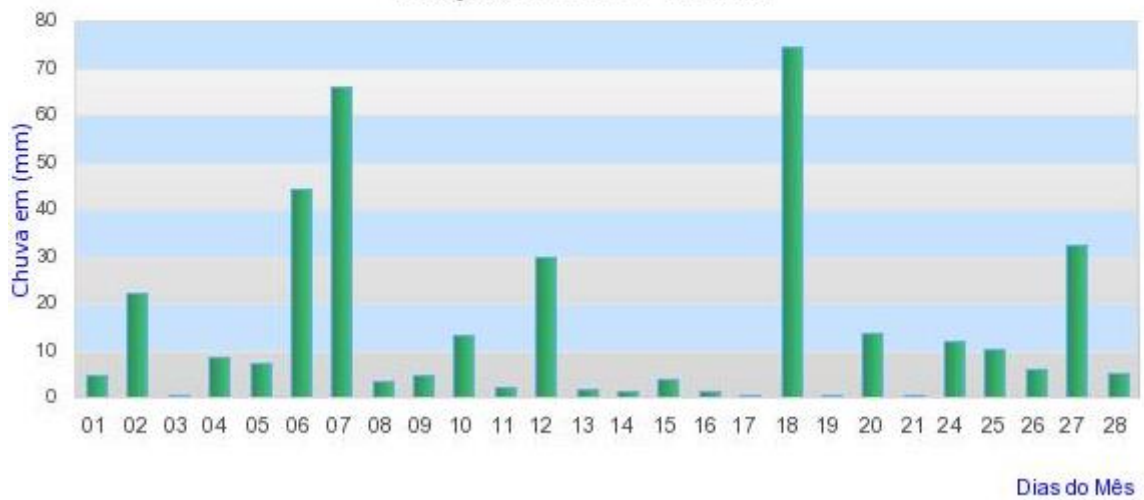

Instituto Nacional de Meteorologia - INMET

Chuva Acumulada 24h
Estação: FORMOSA - 02/2020

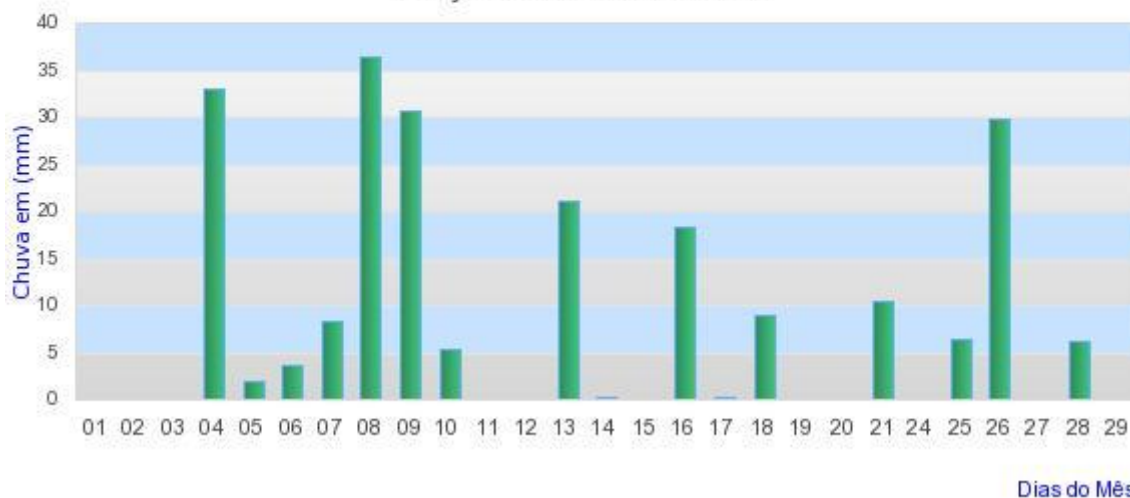

Instituto Nacional de Meteorologia - INMET

Chuva Acumulada 24h
Estação: GOIANIA - 02/2020

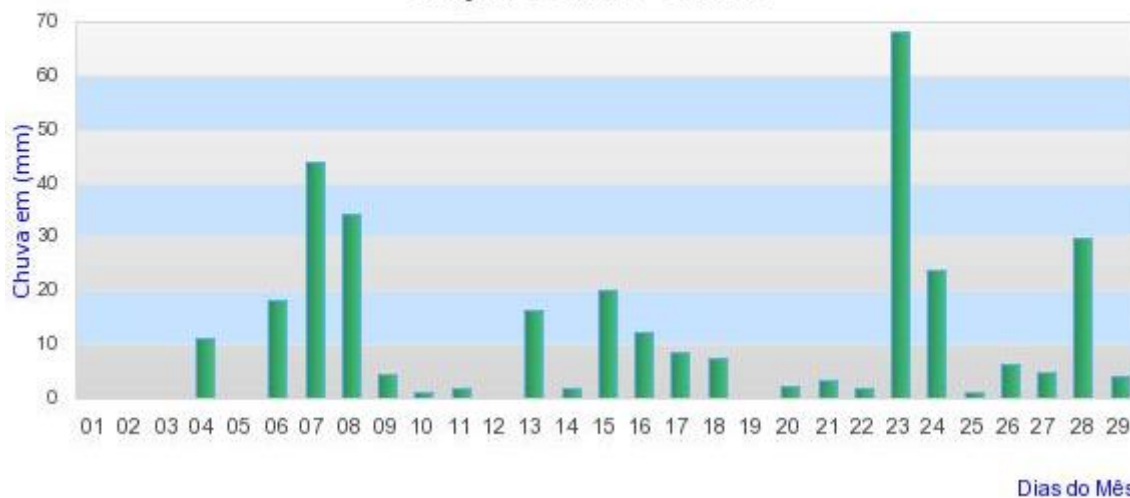

Instituto Nacional de Meteorologia - INMET

Chuva Acumulada 24h
Estação: IPAMERI - 02/2020



Instituto Nacional de Meteorologia - INMET

Chuva Acumulada 24h
Estação: JATAI - 02/2020

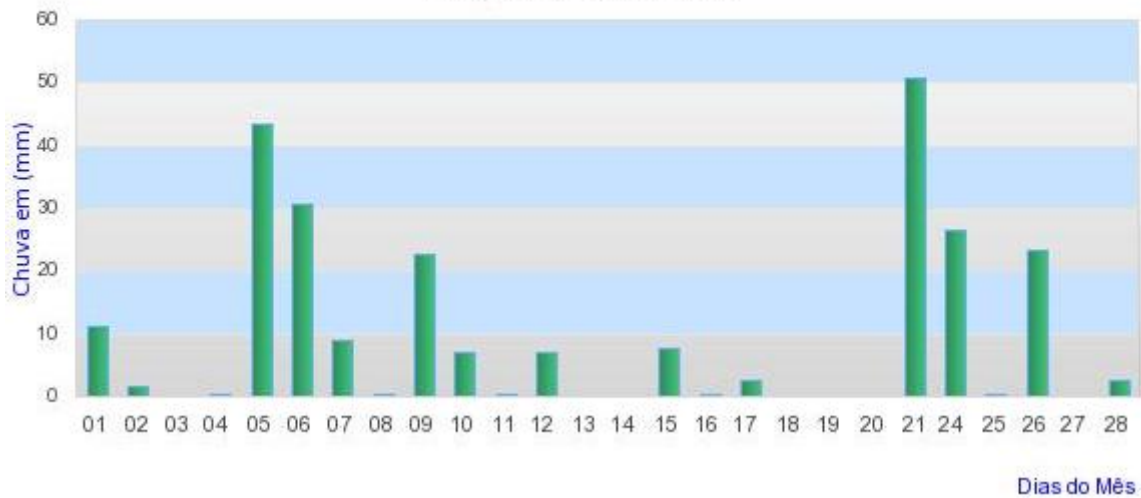

Instituto Nacional de Meteorologia - INMET

Chuva Acumulada 24h

Estação: PIRENOPOLIS - 02/2020

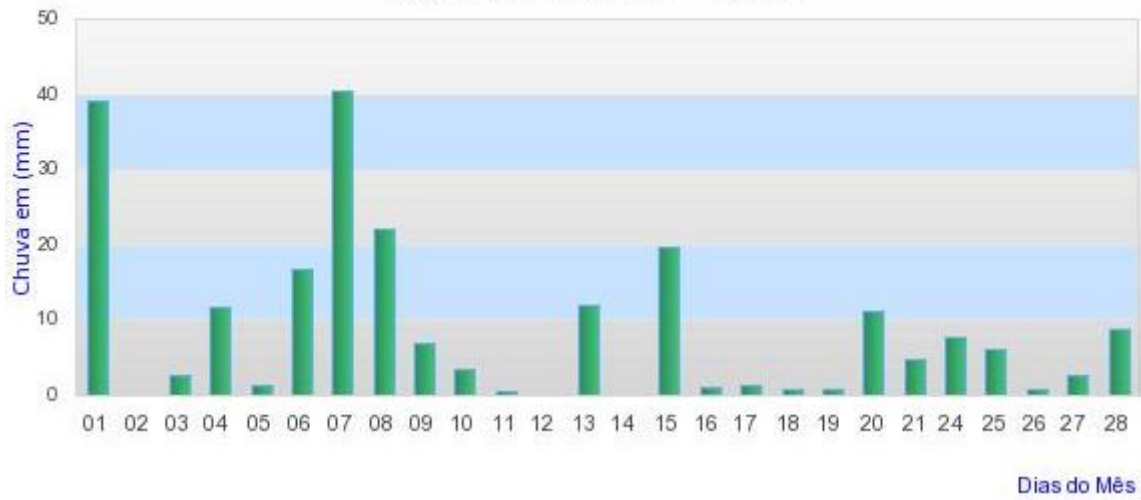

Instituto Nacional de Meteorologia - INMET

Chuva Acumulada 24h

Estação: POSSE - 02/2020



Instituto Nacional de Meteorologia - INMET

Chuva Acumulada 24h
Estação: RIO VERDE - 02/2020



Instituto Nacional de Meteorologia - INMET

Chuva Acumulada 24h
Estação: ARAGARCAS - 03/2020



Instituto Nacional de Meteorologia - INMET

Chuva Acumulada 24h
Estação: CATALAO - 03/2020

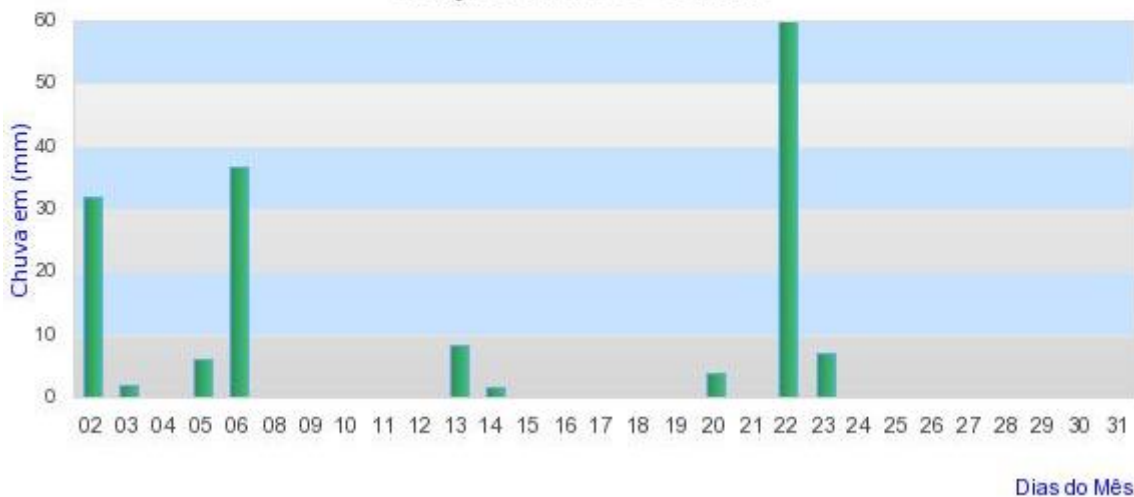

Instituto Nacional de Meteorologia - INMET

Chuva Acumulada 24h
Estação: FORMOSA - 03/2020

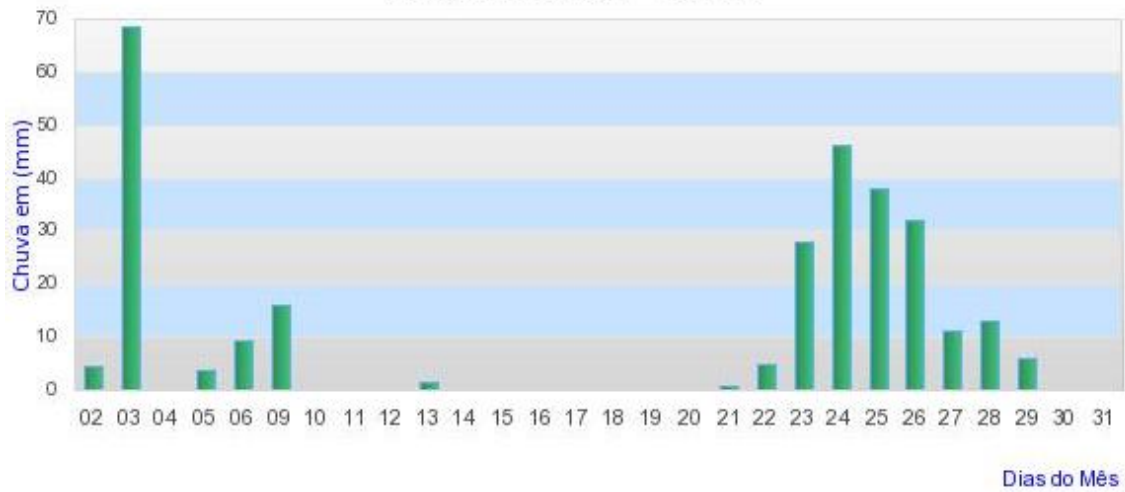

Dias do Mês

Instituto Nacional de Meteorologia - INMET

Chuva Acumulada 24h
Estação: GOIANIA - 03/2020



Dias do Mês

Instituto Nacional de Meteorologia - INMET

Chuva Acumulada 24h
Estação: IPAMERI - 03/2020



Dias do Mês



Instituto Nacional de Meteorologia - INMET

Chuva Acumulada 24h
Estação: JATAI - 03/2020

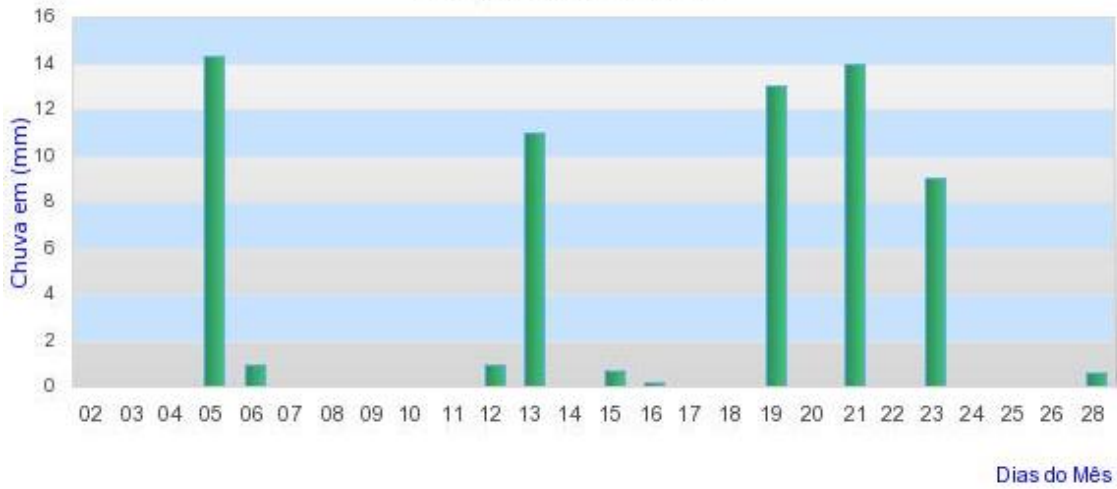

Instituto Nacional de Meteorologia - INMET

Chuva Acumulada 24h
Estação: PIRENÓPOLIS - 03/2020

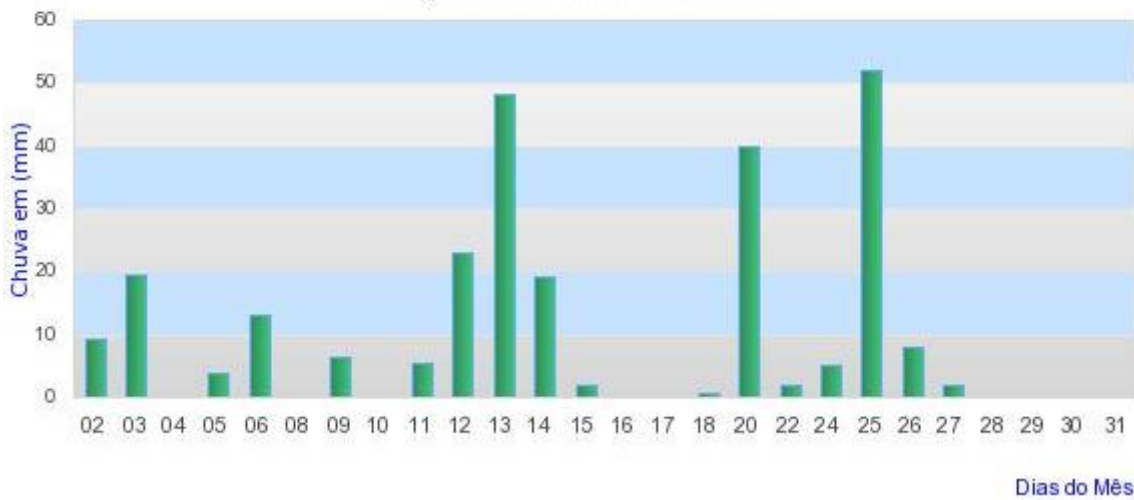

Instituto Nacional de Meteorologia - INMET

Chuva Acumulada 24h
Estação: POSSE - 03/2020

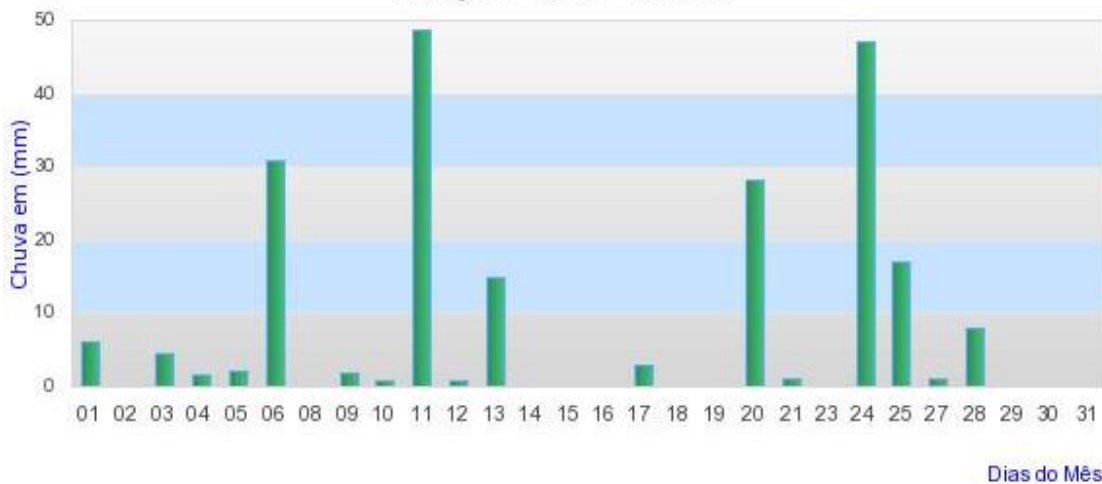

Instituto Nacional de Meteorologia - INMET

Chuva Acumulada 24h
Estação: RIO VERDE - 03/2020

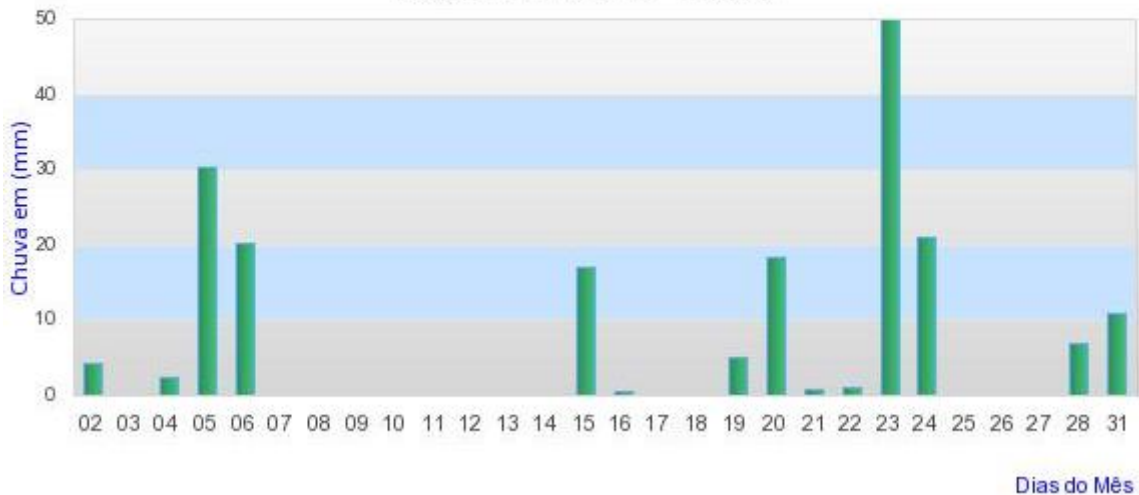

Goiania - Estação CELG Estação Aerodromo Goiania - Março de 2020
Para ver os dados horários clique no dia desejado

Dia	Precip.	Prec Acum.	Vel. Vent. (m/s)	Dir. Vent.	Umid. Relat. AR (Max) %	Umid. Relat. AR (Min) %	Umid. Relat. AR (Média)%	Temp. Max. °C Dia	Temp. Min. °C Dia	Temp. Med. °C do Ar	Temp. 09:00h	Temp. 21:00h	Ponto orvalho	Razao Mistura
1	7.60	7.60	1.8	N	100.0	75.0	87.2	25.8	20.1	22.68	23.3	22.1	20.69167	-
2	6.80	14.40	1.6	N	100.0	74.0	86.7	26.8	20.0	22.56	21.6	22.2	21.00417	-
3	11.40	25.80	1.7	N	100.0	65.0	91.7	27.9	20.2	22.68	22.1	21.6	20.24167	-
4	17.80	43.60	1.9	N	100.0	62.0	85.2	28.0	19.2	22.72	22.2	22.1	20.32917	-
5	6.80	50.40	1.6	NO	100.0	67.0	86	28.4	19.8	23.18	22.9	22.4	20.70833	-
6	0.40	50.80	1.6	N	100.0	76.0	83.5	24.5	19.7	22.68	24	22.6	20.13333	-
7	0.00	50.80	1.6	N	100.0	63.0	79.7	27.1	19.3	22.88	21.4	23.3	19.89583	-
8	0.00	50.80	1.2	SO	96.0	51.0	70.2	28.9	19.7	24.86	25.5	25.1	19.44583	-
9	0.00	50.80	1.2	SO	93.0	50.0	62	29.5	20.4	24.7	23.4	25.1	18.72917	-
10	0.00	50.80	1.7	SE	83.0	47.0	65	30.7	21.1	25.98	25.5	26.3	18.91667	-
11	0.00	50.80	1.9	SE	84.0	48.0	69.7	30.6	22.3	25.66	24.8	25.3	19.40000	-
12	0.00	50.80	1.8	L	92.0	54.0	73.5	30.3	21.7	24.72	25.8	22.9	20.14167	-
13	0.20	51.00	1.9	S	96.0	53.0	73	29.9	20.5	24.48	25	23.5	20.03333	-
14	0.00	51.00	2.1	SE	91.0	51.0	68.7	30.3	21.4	25.24	25.3	24.6	19.98333	-
15	0.80	51.80	1.7	S	93.0	51.0	74.7	30.1	21.3	24.7	25.9	23.1	19.70833	-
16	0.40	52.20	1.4	NO	96.0	49.0	68.2	30.1	20.6	24.98	24.4	24.9	19.11250	-
17	0.00	52.20	1.3	NO	94.0	43.0	62	30.8	20.0	25.7	25.3	26.2	18.78333	-
18	1.60	53.80	1.7	N	88.0	51.0	71.7	31.3	21.7	25.48	25.8	24.3	19.86667	-
19	0.40	54.20	1.9	NO	97.0	58.0	73	29.9	21.6	25.12	24.3	24.9	20.70417	-
20	46.40	100.60	2.4	N	100.0	80.0	91.2	24.1	20.6	21.8	20.9	21.7	20.76667	-
21	0.00	100.60	2.7	N	99.0	64.0	83	28.5	20.6	23.36	23.5	22.1	20.95833	-
22	3.60	104.20	1.6	N	100.0	76.0	86	26.1	20.7	23.3	23.5	23.1	20.85000	-
23	5.60	109.80	1.5	SE	100.0	55.0	82	29.6	20.7	23.66	24.2	21.9	20.49583	-
24	27.20	137.00	2.3	SE	100.0	55.0	85	29.1	20.8	23.3	22.4	22.1	20.66667	-
25	1.60	138.60	1.8	L	100.0	76.0	90.5	25.3	20.5	21.98	22.1	21	20.30417	-
26	0.00	138.60	2.1	SE	100.0	61.0	77.2	28.0	19.1	23.58	23.4	23.7	19.90833	-
27	8.20	146.80	2.1	SE	100.0	72.0	88.7	26.4	20.7	22.62	24.2	20.9	20.53750	-
28	7.20	154.00	1.6	L	100.0	65.0	92.5	28.2	20.8	23.12	23.4	21.6	20.96250	-
29	0.20	154.20	2.0	SO	100.0	52.0	69.7	29.9	20.3	24.88	22.6	25.8	20.20833	-
30	0.00	154.20	1.9	S	95.0	42.0	57	30.8	20.7	25.84	24.5	26.6	18.80000	-
31	0.00	154.20	1.7	S	95.0	39.0	52.7	31.0	20.5	26	25.1	26.7	17.78333	-

Anapolis - Estação CELG Estação Anapolis - Março de 2020
 Para ver os dados horários clique no dia desejado

Dia	Precip.	Prec. Acum.	Vel. Vent. (m/s)	Dir. Vent.	Umid. Relat. AR (Max) %	Umid. Relat. AR (Min) %	Umid. Relat. AR (Média)%	Temp. Max. °C Dia	Temp. Min. °C Dia	Temp. Med. °C do Ar	Temp. 09:00h	Temp. 21:00h	Ponto orvalho	Razao Mistura
1	7.00	7.00	1.5	N	98.0	69.0	88.5	25.6	18.8	21.88	23.4	20.8	19.51250	16.1597
2	8.80	15.80	1.2	N	99.0	74.0	92.2	25.6	19.4	21.44	21.6	20.3	19.82083	16.3403
3	13.20	29.00	1.4	O	100.0	62.0	79	26.5	18.3	21.52	20.4	21.2	18.91667	15.4722
4	4.60	33.60	1.3	N	100.0	61.0	80.2	27.5	19.5	22.6	23	21.5	19.38750	16.1042
5	28.80	62.40	1.2	N	100.0	74.0	84	25.5	18.3	22.06	23.3	21.6	19.74167	16.3889
6	6.40	68.80	1.4	N	100.0	84.0	91.7	21.7	18.4	20.4	19.9	21	19.15417	15.7014
7	9.20	78.00	1.0	N	100.0	69.0	93	25.6	18.1	21.2	22.5	19.9	19.22083	15.8333
8	0.00	78.00	1.1	L	100.0	54.0	71.2	28.5	18.3	23.52	23.6	23.6	18.66667	15.2986
9	0.00	78.00	1.0	L	96.0	53.0	70.7	27.6	18.9	23.38	23	23.7	18.35000	14.9167
10	0.60	78.60	1.8	L	95.0	59.0	73.5	27.6	19.3	23.02	23.4	22.4	18.80417	15.4931
11	0.00	78.60	1.7	L	95.0	58.0	76	27.9	19.7	23.46	22.3	23.7	19.37500	16.1250
12	0.00	78.60	1.8	L	98.0	59.0	82.2	28.4	19.7	22.84	23.5	21.3	19.77083	16.3750
13	0.00	78.60	1.7	L	100.0	56.0	76.5	28.9	18.3	23.38	22.1	23.8	19.41667	16.0833
14	0.00	78.60	1.8	L	96.0	58.0	74	28.2	18.7	23.38	24	23	19.05000	15.6667
15	0.00	78.60	2.0	L	97.0	56.0	69.5	28.2	19.3	23.74	24.2	23.5	18.92083	15.5139
16	0.00	78.60	1.1	L	95.0	45.0	64.7	27.6	17.7	23.32	23.5	23.9	17.10833	13.8750
17	0.00	78.60	1.2	L	95.0	47.0	67.2	28.4	18.0	23.48	24.8	23.1	18.06667	14.7431
18	4.40	83.00	1.0	O	87.0	56.0	75	28.6	21.2	24.12	25.4	22.7	18.62500	15.2569
19	18.40	101.40	1.2	O	100.0	66.0	79.7	28.5	19.5	23.5	24.9	22.3	19.65000	16.2778
20	15.40	116.80	1.7	N	100.0	82.0	92.5	23.0	18.8	20.62	20.3	20.5	19.55000	16.1250
21	1.60	118.40	1.7	N	99.0	68.0	85	27.2	19.5	22.48	21.7	22	19.92083	16.6250
22	5.20	123.60	1.2	NO	98.0	77.0	90.5	24.1	20.1	21.86	22.1	21.5	19.96667	16.5000
23	20.20	143.80	0.9	SE	100.0	65.0	93.7	27.1	19.5	21.76	22.6	19.8	19.99583	16.4236
24	41.80	185.60	1.9	L	100.0	68.0	92	28.0	18.8	20.78	19.9	19.6	19.52500	16.1181
25	13.00	198.60	1.6	L	100.0	85.0	98.5	21.8	18.7	20.1	19.8	20.1	19.46667	16.0833
26	0.00	198.60	2.2	L	100.0	76.0	92.5	24.6	18.3	20.68	20.3	20.1	19.45417	16.0833
27	27.40	226.00	2.1	L	100.0	65.0	89.2	26.7	19.1	21.56	21.8	20.1	19.69167	16.3264
28	6.20	232.20	1.8	L	100.0	71.0	88.7	25.4	19.1	21.08	22.1	19.4	19.69167	16.1875
29	0.00	232.20	1.4	L	100.0	61.0	77.7	27.8	18.4	22.5	20.9	22.7	18.97500	15.6597
30	0.00	232.20	1.5	L	96.0	49.0	64.5	28.3	18.1	23.48	23.4	23.8	17.62083	14.0903
31	0.00	232.20	1.1	L	91.0	44.0	61.2	28.9	18.8	23.5	23.4	23.2	16.62083	13.3472

REDE DE OBSERVAÇÕES

Goiania - Estação CELG Estação Autodromo - Março de 2020
 Para ver os dados horários clique no dia desejado

Dia	Precip.	Prec. Acum.	Vel. Vent. (m/s)	Dir. Vent.	Umid. Relat. AR (Max) %	Umid. Relat. AR (Min) %	Umid. Relat. AR (Média)%	Temp. Max. °C Dia	Temp. Min. °C Dia	Temp. Med. °C do Ar	Temp. 09:00h	Temp. 21:00h	Ponto orvalho	Razao Mistura
1	2.80	2.80	1.5	N	100.0	67.0	86.5	27.8	20.2	23.36	23	22.9	20.80833	16.9167
2	13.80	16.60	1.7	SE	100.0	72.0	91	27.7	20.0	22.02	20	21.2	20.83750	16.9583
3	6.60	23.20	1.7	N	100.0	60.0	83	28.3	19.3	22.94	22.3	22.4	20.30833	16.3819
4	1.60	24.80	2.0	N	99.0	61.0	85.2	28.8	19.4	22.86	22.1	22	20.41667	16.4514
5	23.20	48.00	1.5	S	100.0	64.0	91.7	28.2	19.6	22.24	23.2	20.1	20.41667	16.8181
6	0.00	48.00	1.6	N	100.0	74.0	82.5	25.3	19.6	22.5	23.4	22.1	19.99167	16.1667
7	0.00	48.00	1.3	S	98.0	58.0	82.7	27.8	20.0	22.96	21.4	22.8	19.79167	15.9514
8	0.00	48.00	1.2	SO	98.0	48.0	74.5	29.5	19.5	24.42	24.7	24.2	19.66667	15.7986
9	0.00	48.00	1.1	SE	98.0	39.0	67.5	30.4	19.3	24.26	24	23.8	18.71667	14.8819
10	0.00	48.00	1.6	S	94.0	47.0	68.2	30.6	19.3	24.96	25.3	24.8	19.15833	15.2847
11	0.00	48.00	1.6	L	88.0	50.0	68.5	30.5	22.0	25.68	24.3	25.8	19.81667	16.0278
12	0.00	48.00	1.8	SE	93.0	52.0	74.7	29.9	21.2	24.92	25.7	23.9	20.20000	16.2500
13	4.80	52.80	1.6	SE	98.0	55.0	84	30.9	19.6	23.94	24.6	22.3	20.45833	16.5417
14	5.60	58.40	1.9	L	96.0	46.0	76.5	31.4	20.8	24.92	25.6	23.4	20.17917	16.3403
15	0.20	58.60	1.8	N	95.0	50.0	72.5	30.7	20.7	24.7	25.5	23.3	19.75417	15.7917
16	0.00	58.60	1.3	N	100.0	43.0	66.2	30.0	18.5	24.54	24.2	25	18.68333	14.7153
17	0.00	58.60	1.1	N	96.0	43.0	62.7	31.3	19.1	25.48	24.8	26.1	18.70417	14.9931
18	0.00	58.60	1.6	N	91.0	45.0	68	31.9	20.8	25.72	25.9	25	19.60833	15.6667
19	4.60	63.20	1.9	NO	94.0	50.0	73.7	31.4	21.7	25.1	25.6	23.4	20.47917	16.5764
20	3.20	66.40	2.6	N	97.0	75.0	87	25.5	21.4	22.62	21.6	22.3	20.71667	16.8403
21	0.40	66.80	3.1	N	93.0	60.0	82.7	28.7	21.6	24.3	24.2	23.5	20.75000	16.9514
22	5.00	71.80	1.8	N	95.0	71.0	89	26.5	20.0	23.02	23.8	22.4	20.55417	16.5833
23	14.00	85.80	1.4	S	100.0	66.0	85.7	29.3	20.3	23.16	23	21.6	20.72083	16.8333
24	25.80	111.60	2.0	S	100.0	60.0	77.2	28.7	20.8	23.98	22.8	23.8	20.52500	16.6736
25	5.80	117.40	1.4	L	98.0	72.0	91.5	26.0	19.9	21.54	21.8	20	19.99583	16.0417
26	0.20	117.60	1.8	SE	97.0	61.0	78.2	28.1	19.1	23.22	22.7	23.1	19.72500	15.7500
27	4.00	121.60	1.7	L	97.0	69.0	86.5	26.9	20.2	22.7	23.2	21.6	20.40417	16.6250
28	5.20	126.80	1.2	S	100.0	71.0	93	27.3	20.9	22.94	23.7	21.4	20.97083	17.0764
29	0.00	126.80	1.6	S	100.0	50.0	71.2	30.0	19.9	24.48	22.5	25	20.30833	16.2986
30	0.00	126.80	1.5	S	97.0	41.0	66.2	31.1	20.0	24.96	23.1	25.3	19.11667	15.2917
31	0.00	126.80	1.4	S	97.0	40.0	64.2	30.6	19.5	24.84	24.3	24.9	18.15417	14.4236

Bela Vista - Estação CELG Estação Bela Vista - Março de 2020

Para ver os dados horários clique no dia desejado

Dia	Precip.	Prec.Acum.	Vel. Vent. (m/s)	Dir. Vent.	Umid. Relat. AR (Max) %	Umid. Relat. AR (Min) %	Umid. Relat. AR (Média)%	Temp. Max. °C Dia	Temp. Min. °C Dia	Temp. Med. °C do Ar	Temp. 09:00h	Temp. 21:00h	Ponto orvalho	Razao Mistura
1	3.00	3.00	1.1	NO	100.0	85.0	93.5	27.8	19.6	22.42	22.9	20.9	20.70000	16.9583
2	32.80	35.60	1.8	SE	100.0	71.0	90.7	27.2	18.8	21.72	18.8	21.9	20.37917	16.7153
3	0.00	35.60	1.8	L	100.0	56.0	82.5	29.4	18.2	22.56	22	21.6	19.78750	16.0000
4	0.00	35.60	1.7	N	100.0	59.0	82.2	28.5	18.8	22.88	23.3	21.9	20.14583	16.3750
5	29.20	64.80	1.7	N	100.0	61.0	86.2	29.3	19.3	22.36	23.6	19.8	20.16687	16.3681
6	0.00	64.80	1.4	L	100.0	73.0	84	25.6	19.3	21.78	23.2	20.4	19.65833	15.8819
7	0.00	64.80	1.0	L	99.0	61.0	77	27.9	18.2	22.8	22.1	22.9	19.22500	15.5764
8	0.00	64.80	1.2	L	100.0	50.0	68.2	29.6	18.4	24.1	24.9	23.8	19.20833	15.3403
9	0.00	64.80	1.1	S	99.0	46.0	71.5	30.3	18.6	23.62	24	22.6	18.67917	14.9653
10	0.00	64.80	1.5	L	93.0	52.0	72	29.4	19.2	24.3	24.9	24	19.11687	15.2431
11	0.00	64.80	1.9	L	90.0	49.0	72.2	30.3	20.7	24.84	25.4	23.9	19.63750	15.7361
12	0.00	64.80	2.1	L	92.0	51.0	69.5	29.9	20.3	25.02	25.9	24.5	19.90417	16.1319
13	11.20	76.00	1.8	L	96.0	56.0	85.2	30.1	19.9	23.56	25.8	24.1	20.13750	16.2500
14	0.00	76.00	2.5	L	96.0	52.0	71.2	30.5	20.4	25	25.5	24.3	19.87917	16.1687
15	0.20	76.20	1.8	L	93.0	54.0	72.5	29.8	20.4	24.48	25.4	23.4	19.51250	15.6319
16	0.00	76.20	1.1	L	96.0	45.0	63.7	30.3	17.8	24	24.1	23.9	17.55000	13.8819
17	0.00	76.20	0.9	N	85.0	50.0	64.7	29.8	19.2	24.64	25.2	24.5	18.17083	14.4931
18	2.20	78.40	1.3	L	91.0	47.0	69.5	31.9	19.9	25.28	26	24.3	19.50417	15.7847
19	2.80	81.20	1.4	L	97.0	56.0	81.2	30.7	20.7	24.5	25.1	23	20.84167	17.0347
20	8.40	89.60	2.2	N	100.0	78.0	90.2	26.5	20.2	22.1	21.6	21.6	20.74167	16.9653
21	27.20	116.80	2.1	N	100.0	69.0	90.7	27.4	20.1	22.26	22.6	20.6	20.82083	17.1181
22	11.80	128.60	1.4	N	100.0	66.0	87	26.9	19.4	22.92	22.3	23	20.70000	16.9236
23	10.40	139.00	1.2	L	100.0	57.0	81	29.2	19.5	23.76	24.5	22.8	20.40000	16.8181
24	7.80	146.80	2.7	L	100.0	65.0	79.7	27.8	19.7	22.96	22.5	22.4	20.33333	16.5139
25	9.20	156.00	1.9	L	100.0	72.0	93.5	26.0	19.7	21.66	22.4	20.1	19.88333	16.0347
26	0.00	156.00	2.4	L	100.0	62.0	79.5	27.9	18.5	22.62	22.7	22	19.58750	15.7917
27	10.40	166.40	2.3	L	98.0	64.0	84.7	28.1	19.5	23.04	23.6	22	20.22083	16.5764
28	4.40	170.80	1.9	L	100.0	68.0	94	27.5	20.4	22.52	23.3	20.7	20.53750	16.6736
29	0.00	170.80	1.5	SE	100.0	57.0	75	29.6	19.4	24.26	24.9	23.7	20.45833	16.6250
30	0.00	170.80	1.6	L	95.0	42.0	69	30.9	19.8	24.42	25.2	23.1	18.99583	15.1687
31	0.00	170.80	1.2	L	96.0	42.0	64.7	30.9	19.0	24.64	25.5	23.9	18.47500	14.6389

Araçá - Estação CELG Estação Emater Araçá - Março de 2020

Para ver os dados horários clique no dia desejado

Dia	Precip.	Prec.Acum.	Vel. Vent. (m/s)	Dir. Vent.	Umid. Relat. AR (Max) %	Umid. Relat. AR (Min) %	Umid. Relat. AR (Média)%	Temp. Max. °C Dia	Temp. Min. °C Dia	Temp. Med. °C do Ar	Temp. 09:00h	Temp. 21:00h	Ponto orvalho	Razao Mistura
1	0.00	0.00	1.4	N	98.0	69.0	84.7	26.8	20.4	22.88	23.2	22	20.78750	16.7569
2	21.20	21.20	1.4	N	97.0	83.0	93.2	27.3	19.6	21.98	22.8	20.1	21.30417	17.4306
3	8.20	29.40	0.9	N	100.0	85.0	93.5	26.6	19.3	22.22	23	21.1	21.07273	17.1894
4	2.20	31.60	1.1	N	100.0	78.0	91.2	27.7	17.8	22.34	22.6	21.8	20.77391	16.9058
5	11.80	43.40	0.6	N	100.0	81.0	93.7	26.7	18.5	22.38	23.1	21.8	21.07500	17.1875
6	0.80	44.20	1.2	N	100.0	97.0	99.5	23.8	20.4	21.74	21.9	21.3	21.82500	17.9653
7	0.00	44.20	1.2	N	100.0	70.0	87.2	27.6	19.5	22.74	20.6	23	21.11250	17.2083
8	0.00	44.20	0.8	N	99.0	59.0	81.5	29.5	19.4	23.26	23.2	22.1	20.53750	16.6319
9	0.00	44.20	0.8	SO	98.0	51.0	77.5	30.4	19.0	23.12	23.6	21.3	19.63333	15.6736
10	2.60	46.80	0.8	N	96.0	57.0	77.7	30.4	17.6	23.82	24.1	23.5	19.70000	16.2681
11	4.00	50.80	0.7	N	96.0	63.0	83.7	29.6	21.0	24.08	23.4	23.2	21.48261	17.7464
12	2.00	52.80	0.7	N	95.0	59.0	86.5	30.3	19.9	23.28	24.4	20.9	20.96818	16.8884
13	6.00	58.80	0.8	N	97.0	68.0	87	29.0	17.7	23.26	23.2	23.2	20.56667	16.7083
14	15.80	74.60	0.9	N	96.0	60.0	84	29.8	19.1	23.86	25	22.7	20.70000	16.7986
15	1.40	76.00	1.0	N	97.0	65.0	84.7	28.4	19.1	22.58	23.6	20.9	20.09583	16.0625
16	0.00	76.00	0.7	N	96.0	51.0	78.5	29.9	18.1	23.08	23.4	22	19.58696	15.7826
17	0.00	76.00	0.8	N	97.0	48.0	77.7	31.1	18.5	23.56	24	22.1	19.63333	15.6667
18	4.80	80.80	0.7	N	96.0	65.0	79.5	30.2	19.7	24.08	24.9	22.8	20.61667	16.7500
19	5.80	86.60	1.0	SO	98.0	64.0	84	30.0	20.8	24.22	22.7	23.8	21.67917	17.8611
20	15.20	101.80	1.1	N	98.0	91.0	97.5	22.3	20.5	21.14	21.7	20.6	20.75417	16.8333
21	4.40	106.20	1.8	N	99.0	79.0	90.7	26.9	21.1	22.84	23.2	21.5	21.60417	17.6319
22	3.20	109.40	0.9	N	98.0	90.0	94	25.9	20.9	22.58	22.3	21.9	21.76667	17.9167
23	0.00	109.40	0.9	N	99.0	77.0	89.2	27.3	20.4	23.12	23.1	22.4	21.66667	17.7847
24	44.40	153.80	1.0	N	100.0	83.0	93.7	27.8	20.6	23.22	22.3	22.7	22.14167	18.3819
25	20.20	174.00	0.9	N	100.0	92.0	96.7	23.9	20.1	21.78	21.9	21.5	21.15417	17.2847
26	4.40	178.40	0.8	SO	100.0	66.0	87	28.6	18.5	22.5	22	21.7	20.80417	16.7986
27	0.60	179.00	1.0	N	97.0	72.0	88	28.3	21.1	23.56	23.4	22.5	21.56667	17.7778
28	15.20	194.20	1.1	N	98.0	70.0	87	27.9	20.3	22.7	23.3	22.1	21.18696	17.1377
29	0.40	194.60	0.7	N	100.0	63.0	84.7	29.6	20.0	23.38	22.1	22.6	21.02500	16.9167
30	0.00	194.60	0.6	N	98.0	46.0	76.2	31.8	18.5	23.24	23.1	21.4	19.47917	15.5417
31	0.00	194.60	0.6	N	95.0	46.0	-	31.1	17.8	-	22.9	-	19.51250	16.1648

Goiania - Estação CELG Estação Goiania 2 - Março de 2020
 Para ver os dados horários clique no dia desejado

Dia	Precip.	Prec.Acum.	Vel. Vent. (m/s)	Dir. Vent.	Umid. Relat. AR (Max) %	Umid. Relat. AR (Min) %	Umid. Relat. AR (Média)%	Temp. Max. °C Dia	Temp. Min. °C Dia	Temp. Med. °C do Ar	Temp. 09:00h	Temp. 21:00h	Ponto orvalho	Razao Mistura
1	4.20	4.20	0.6	NO	100.0	66.0	91.2	28.5	20.0	23.34	24.2	22	21.25000	17.3264
2	17.00	21.20	0.5	SE	100.0	75.0	93.7	27.7	20.4	22.28	20.9	21.2	21.57083	17.5488
3	4.40	25.60	0.5	NO	100.0	63.0	97.5	29.1	20.0	22.48	21.5	20.9	20.73333	16.7153
4	3.40	29.00	0.7	NO	100.0	59.0	88.7	29.4	18.7	22.92	22.9	21.8	20.74583	16.7847
5	17.40	46.40	0.4	N	100.0	61.0	89.7	29.9	19.7	23.16	22.2	22	21.02083	17.0069
6	0.00	46.40	0.6	N	100.0	75.0	88	25.4	19.8	22.48	22.9	22.1	20.85833	17.0278
7	0.00	46.40	0.4	NO	100.0	50.0	82.2	29.2	19.4	23.38	22.4	22.9	20.38333	16.2569
8	0.60	47.00	0.2	SE	100.0	52.0	88.7	30.4	19.1	23.78	25.4	22	20.47500	16.3819
9	0.00	47.00	0.3	NO	100.0	40.0	73	31.1	19.0	24.16	23.9	23.4	19.45417	15.4167
10	0.00	47.00	0.3	L	100.0	48.0	68.7	30.8	18.8	25.12	27	24.5	19.92500	15.9583
11	0.00	47.00	0.4	NO	98.0	49.0	72.7	31.3	21.4	25.5	25.6	24.6	20.77083	16.8194
12	0.00	47.00	0.4	NO	100.0	54.0	79.2	31.3	20.6	24.56	26.7	22.1	21.27917	17.2988
13	3.00	50.00	0.4	SE	100.0	55.0	76.7	31.1	19.3	24.74	26.7	23.3	21.13333	17.1250
14	0.40	50.40	0.6	NO	100.0	53.0	76.2	31.6	19.4	24.92	26.4	23.6	20.83333	16.8819
15	0.00	50.40	0.6	NO	100.0	49.0	76.5	31.3	20.5	24.46	26.7	21.9	20.33750	16.3264
16	0.00	50.40	0.4	O	100.0	45.0	74.2	31.6	19.1	24.26	25.6	22.5	19.54583	15.4653
17	0.00	50.40	0.4	N	100.0	41.0	72.7	32.0	18.5	24.42	25.2	23.2	19.42500	15.3750
18	0.00	50.40	0.4	NO	100.0	51.0	77	32.0	19.9	24.8	26.7	22.7	20.75000	16.7847
19	0.20	50.60	0.5	O	98.0	51.0	78.7	31.9	21.3	25.18	25.1	23.8	21.35417	17.4167
20	8.60	59.20	0.6	NO	100.0	79.0	92.7	25.6	20.8	22.04	21.2	21.3	21.35833	17.5000
21	0.00	59.20	0.7	NO	100.0	63.0	83	29.2	20.7	24.02	25.2	22.5	21.40833	17.4931
22	8.00	67.20	0.3	N	100.0	71.0	91.7	27.5	20.8	23.52	24.3	22.5	21.39583	17.4583
23	8.00	75.20	0.3	SE	100.0	53.0	86	31.2	20.5	23.92	25.1	21.4	21.26250	17.1736
24	20.80	96.00	0.6	SE	100.0	61.0	82.7	29.7	20.7	24.04	21.6	24.1	21.13750	17.0488
25	10.80	106.80	0.4	SE	100.0	77.0	95.7	25.8	20.1	21.68	21.7	20.4	21.04167	17.0417
26	0.60	107.20	0.3	SE	100.0	60.0	83.2	29.6	18.5	23.02	22	22.5	20.59583	16.5833
27	8.80	116.00	0.5	SE	100.0	57.0	86.7	30.0	20.7	23.68	24.7	21.5	20.97500	17.0764
28	0.80	116.80	0.5	N	100.0	64.0	89	28.5	20.9	23.08	22.6	21.7	21.40000	17.4583
29	0.20	117.00	0.3	L	100.0	52.0	84.2	31.2	20.1	24.08	22.3	23.4	21.18750	17.1250
30	0.00	117.00	0.3	SE	100.0	44.0	76.5	31.5	20.1	24.38	24.7	22.8	20.33750	16.2988
31	0.00	117.00	0.3	SE	100.0	42.0	76.2	32.2	19.5	24.08	25.7	21.5	19.50833	15.4167

Senador Canedo - Estação CELG Estação Senador Canedo - Março de 2020
 Para ver os dados horários clique no dia desejado

Dia	Precip.	Prec.Acum.	Vel. Vent. (m/s)	Dir. Vent.	Umid. Relat. AR (Max) %	Umid. Relat. AR (Min) %	Umid. Relat. AR (Média)%	Temp. Max. °C Dia	Temp. Min. °C Dia	Temp. Med. °C do Ar	Temp. 09:00h	Temp. 21:00h	Ponto orvalho	Razao Mistura
1	4.80	4.80	0.9	N	100.0	72.0	90	26.9	19.5	22.56	23.4	21.5	20.59167	17.0000
2	17.00	21.80	1.1	N	100.0	79.0	94.2	25.6	19.5	21.24	19.5	20.8	20.57500	16.7988
3	2.80	24.60	1.3	N	100.0	62.0	88.2	28.2	19.0	22.28	21.6	21.3	19.96667	16.0903
4	1.20	25.80	1.5	N	99.0	63.0	82	28.0	19.3	23.14	22.4	23	19.99583	16.3194
5	24.00	49.80	1.0	SO	100.0	66.0	90.5	27.6	19.2	21.92	22.8	20	20.21667	16.4236
6	1.40	51.20	1.1	L	100.0	78.0	83.7	24.2	19.1	21.88	23.1	21.5	19.77917	16.1250
7	0.00	51.20	0.9	SO	100.0	62.0	82.5	27.2	19.0	22.74	21.1	23.2	19.58333	15.7569
8	0.00	51.20	0.8	SO	99.0	52.0	72.5	28.8	19.4	24.1	24.1	24.1	19.32083	15.5069
9	0.00	51.20	0.8	SO	91.0	43.0	66.5	30.0	20.3	24.4	23.9	23.9	18.32083	14.6250
10	0.20	51.40	1.4	L	86.0	49.0	69	30.2	21.1	25.08	25.3	24.4	18.98750	15.2083
11	0.00	51.40	1.3	L	89.0	53.0	68	29.4	21.3	25.52	24.1	26.4	19.53750	15.9097
12	0.00	51.40	1.7	L	90.0	51.0	70.2	29.5	21.4	25.1	25.4	24.6	19.64167	15.9167
13	0.40	51.80	1.2	SO	92.0	56.0	79.2	30.3	20.3	24.34	25.5	22.8	19.99167	16.2083
14	1.40	53.20	1.6	L	91.0	49.0	71.2	30.6	20.5	25.04	25.7	24.2	19.75000	15.9931
15	0.80	54.00	1.7	L	95.0	49.0	72.2	30.4	21.1	24.38	25.8	22.3	19.68750	15.8472
16	0.00	54.00	0.7	NO	93.0	43.0	64.5	29.7	19.7	24.38	24.5	24	18.04583	14.2569
17	0.00	54.00	0.8	N	84.0	46.0	66.5	30.4	20.9	25.12	24.9	24.7	18.61667	14.8750
18	0.00	54.00	1.1	N	88.0	44.0	67	31.4	21.3	25.78	25.8	25.2	19.55000	15.7778
19	3.00	57.00	1.1	N	92.0	56.0	74.5	30.0	21.4	24.96	24.8	24.3	20.13750	16.3750
20	3.80	60.80	2.0	N	99.0	79.0	91.2	24.9	20.6	21.78	21	21.2	20.53333	16.8333
21	0.80	61.60	1.9	N	98.0	66.0	84.5	28.4	20.7	23.58	24.2	22.3	20.87917	17.3681
22	4.00	65.60	1.1	N	99.0	74.0	87.5	26.0	20.0	22.88	23.2	22.6	20.52500	16.8333
23	6.60	72.20	1.0	N	98.0	56.0	84.2	29.1	20.5	23.16	23.6	21.3	20.48333	16.7153
24	20.80	92.80	1.7	L	100.0	60.0	80	28.2	20.2	23.24	21.8	23	20.24583	16.5903
25	7.60	100.40	1.5	L	100.0	75.0	96.2	24.5	19.2	20.76	21.7	19.2	19.87917	16.1667
26	0.20	100.60	1.9	L	98.0	64.0	83	27.6	19.0	22.52	22	22	19.79583	16.0417
27	2.40	103.00	1.7	L	98.0	73.0	91	25.8	20.1	22.12	22.9	20.9	20.35000	16.7014
28	8.80	111.80	1.3	L	100.0	69.0	89	26.9	20.6	22.76	23.3	21.5	20.52500	16.9236
29	0.00	111.80	1.0	L	100.0	56.0	72.7	29.3	19.0	24.2	23.1	24.8	19.96667	16.1250
30	0.00	111.80	1.2	SO	95.0	39.0	60.5	30.4	19.9	25.06	23.6	25.7	18.34583	14.7083
31	0.00	111.80	1.1	L	97.0	38.0	58	30.4	19.3	25.04	25.1	25.2	17.45000	13.8958

Goiânia - Estação Heliporto Goiânia - Março de 2020

Para ver os dados horários clique no dia desejado

Dia	Precip.	Prec.Acum.	Vel. Vent. (m/s)	Dir. Vent.	Umid. Relat. AR (Max) %	Umid. Relat. AR (Min) %	Umid. Relat. AR (Média)%	Temp. Max. °C Dia	Temp. Min. °C Dia	Temp. Med. °C do Ar	Temp. 09:00h	Temp. 21:00h	Ponto orvalho	Razao Mistura	Radiação Solar Diária MJ/m²
1	1.20	1.20	1.4	NO	99.0	68.0	83.7	26.8	20.7	23.46	23.6	23.1	-	-	12
2	15.40	16.60	1.3	SE	100.0	67.0	91.2	27.4	19.8	22.24	19.8	22.1	-	-	11.9
3	15.60	32.20	1.3	SE	100.0	58.0	94.2	28.0	20.0	22.58	21.9	21.5	-	-	11.2
4	0.00	32.20	1.1	N	100.0	56.0	85.2	28.6	19.4	23	22	22.5	-	-	12.5
5	27.60	59.80	1.4	NO	100.0	59.0	89.7	28.1	20.1	22.72	23.4	21	-	-	11.4
6	2.00	61.80	1.0	SE	100.0	74.0	83.2	25.1	19.8	22.5	23.6	22	-	-	8.3
7	0.00	61.80	0.9	N	100.0	50.0	81.7	27.6	19.8	23.34	22.1	23.6	-	-	14.2
8	0.00	61.80	1.0	SO	97.0	48.0	65.2	29.4	20.7	25.44	25.1	26	-	-	14
9	0.00	61.80	1.3	SE	99.0	33.0	54	30.0	20.9	25.6	24.1	26.5	-	-	13.8
10	0.00	61.80	1.3	SE	83.0	40.0	64.5	30.0	21.8	25.76	26	25.5	-	-	13.7
11	0.00	61.80	1.4	SE	84.0	43.0	64.5	30.6	22.9	26.36	26.3	26.5	-	-	15.2
12	0.00	61.80	1.2	SE	89.0	47.0	70.7	30.6	22.6	25.52	26.4	24	-	-	12.1
13	7.20	69.00	1.2	SE	97.0	52.0	76.7	30.3	21.7	24.74	25.5	23.1	-	-	12.9
14	2.00	71.00	1.8	SE	90.0	40.0	72.5	32.1	21.7	25.58	26.9	24.1	-	-	14
15	0.00	71.00	1.3	SE	93.0	47.0	69.2	30.4	21.8	25.14	25.5	24	-	-	13.3
16	0.00	71.00	0.8	SE	100.0	41.0	62	29.6	20.9	25.38	25.4	25.5	-	-	13.8
17	0.00	71.00	0.9	NO	94.0	37.0	56	31.6	20.8	26.42	25.5	27.1	-	-	16.8
18	0.00	71.00	1.0	NO	89.0	42.0	66.5	31.8	22.1	26.34	26.6	25.6	-	-	14.3
19	0.40	71.40	1.4	NO	94.0	48.0	71.7	30.6	22.1	25.8	24.5	25.9	-	-	17.4
20	5.00	76.40	1.4	N	100.0	79.0	91.2	24.6	20.8	22.16	21.4	22	-	-	6.2
21	0.00	76.40	1.5	N	100.0	59.0	80	28.5	21.1	23.72	23.4	22.8	-	-	11.5
22	0.00	76.40	1.2	N	100.0	70.0	83	26.3	21.1	23.52	23	23.6	-	-	7.6
23	0.00	76.40	1.0	SE	100.0	51.0	79	29.6	21.6	24.32	24.6	22.9	-	-	12.4
24	15.40	91.80	1.9	SE	100.0	54.0	78.5	29.5	20.6	23.98	22	23.9	-	-	12.2
25	23.00	114.80	1.3	SE	100.0	75.0	96	25.5	20.0	21.42	21.6	20	-	-	5.8
26	0.20	115.00	1.9	SE	100.0	56.0	79	29.0	19.4	23.6	22.8	23.4	-	-	15.3
27	5.40	120.40	1.9	SE	100.0	68.0	89.7	26.6	20.8	22.62	23.1	21.3	-	-	7.7
28	0.80	121.20	1.1	SE	100.0	65.0	91.7	27.1	21.3	23.16	23.4	22	-	-	9.7
29	0.40	121.60	1.4	SE	100.0	44.0	66.7	30.8	20.0	25.16	22.8	26.1	-	-	14.1
30	0.00	121.60	1.7	SE	93.0	30.0	53.2	31.8	21.3	26.28	24.1	27.1	-	-	16.7
31	0.00	121.60	1.3	SE	92.0	34.0	49.5	31.3	21.4	26.58	26	27.1	-	-	17.9

Palmeiras de Goiás - Estação Palmeiras de Goiás - Março de 2020

Para ver os dados horários clique no dia desejado

Dia	Precip.	Prec.Acum.	Vel. Vent. (m/s)	Dir. Vent.	Umid. Relat. AR (Max) %	Umid. Relat. AR (Min) %	Umid. Relat. AR (Média)%	Temp. Max. °C Dia	Temp. Min. °C Dia	Temp. Med. °C do Ar	Temp. 09:00h	Temp. 21:00h	Ponto orvalho	Razao Mistura	Radiação Solar Diária MJ/m²
1	0.60	0.60	1.8	S	100.0	72.0	89.7	27.3	20.3	23.96	24	24.1	-	-	-
2	24.80	25.20	2.3	S	100.0	64.0	88.5	29.2	20.8	24.36	22.8	24.5	-	-	-
3	0.80	26.00	2.1	S	100.0	50.0	84.2	30.9	20.6	24.36	22.5	23.9	-	-	-
4	26.60	52.60	3.9	O	100.0	49.0	86.2	32.0	19.9	24.1	25	21.8	-	-	-
5	13.40	66.00	3.8	O	100.0	57.0	93.7	29.8	20.1	23.5	24.2	21.7	-	-	-
6	0.40	66.40	3.7	L	100.0	60.0	91.7	28.8	20.9	24.38	25.4	23.4	-	-	-
7	0.20	66.60	2.9	SO	100.0	57.0	81.2	30.0	20.0	24.74	22.1	25.8	-	-	-
8	0.00	66.60	2.7	SO	100.0	45.0	66.5	31.3	20.7	25.52	26.2	24.7	-	-	-
9	0.00	66.60	1.7	S	100.0	42.0	64	31.9	21.1	25.62	25.5	25.3	-	-	-
10	0.00	66.60	2.7	S	100.0	45.0	66.7	32.1	19.4	25.8	24.9	26.3	-	-	-
11	0.00	66.60	2.1	SE	100.0	49.0	73.5	31.3	22.1	26.44	26	26.4	-	-	-
12	0.00	66.60	3.4	SE	100.0	51.0	78.2	31.8	22.2	25.7	26.3	24.1	-	-	-
13	5.60	72.20	3.2	L	100.0	49.0	77.7	32.2	21.4	25.86	26.7	24.5	-	-	-
14	15.00	87.20	4.0	L	100.0	53.0	83	31.1	21.2	24.84	26.9	22.5	-	-	-
15	0.20	87.40	3.4	S	100.0	59.0	85.5	30.4	19.7	24.94	25.2	24.7	-	-	-
16	0.00	87.40	3.4	S	100.0	48.0	77.2	32.1	20.9	25.6	25.2	24.9	-	-	-
17	0.00	87.40	0.8	O	100.0	40.0	67.7	32.7	20.7	26.5	26.5	26.3	-	-	-
18	0.00	87.40	0.9	O	100.0	45.0	70.2	33.5	21.8	27.18	27.8	26.4	-	-	-
19	5.80	93.20	2.4	SE	100.0	52.0	79.5	31.3	21.2	25.58	22	26.7	-	-	-
20	32.80	125.80	3.7	S	100.0	80.0	94.5	25.1	20.8	22.74	22.4	22.7	-	-	-
21	0.00	125.80	3.3	L	100.0	66.0	93.2	29.7	21.2	24.38	23.6	23.7	-	-	-
22	4.60	130.40	1.9	L	100.0	80.0	95.5	27.7	21.7	24.36	24	23.9	-	-	-
23	27.80	158.20	1.1	SO	100.0	63.0	91.5	30.1	21.2	24.9	24	24.6	-	-	-
24	52.00	210.20	3.6	L	100.0	65.0	90.7	29.5	21.1	24.54	24.9	23.6	-	-	-
25	1.00	211.20	1.8	S	100.0	75.0	93.7	28.8	21.3	22.9	22.2	22.1	-	-	-
26	0.00	211.20	2.2	SO	100.0	62.0	79	29.7	19.8	24.8	22.9	25.8	-	-	-
27	21.40	232.60	2.3	L	100.0	77.0	92	27.7	21.3	23.78	25.1	22.4	-	-	-
28	7.20	239.80	0.9	SO	100.0	65.0	91.2	29.6	21.0	23.68	23.4	22.2	-	-	-
29	1.60	241.40	1.8	SO	100.0	62.0	90	30.3	21.1	25.12	23.4	25.4	-	-	-
30	0.40	241.80	1.6	L	100.0	44.0	82	31.6	21.7	25.24	25.3	23.8	-	-	-
31	0.00	241.80	3.4	SO	100.0	43.0	74.7	31.9	20.3	25.52	26.2	24.6	-	-	-

Santo Antônio de Goiás - Estação Sto Antônio de Goiás - Embrapa - Março de 2020

Para ver os dados horários clique no dia desejado

Dia	Precip.	Prec.Acum.	Vel. Vent. (m/s)	Dir. Vent.	Umid. Relat. AR (Max) %	Umid. Relat. AR (Min) %	Umid. Relat. AR (Média)%	Temp. Max. °C Dia	Temp. Min. °C Dia	Temp. Med. °C do Ar	Temp. 09:00h	Temp. 21:00h	Ponto orvalho	Razao Mistura	Radiação Solar Diana MJ/m²
1	301.60	301.60	-	-	100.0	70.0	94.5	26.9	18.9	22.56	23.6	21.7	-	-	13.8
2	20.00	321.60	-	-	100.0	83.0	98.7	25.2	19.8	21.36	22.2	19.8	-	-	9.5
3	11.20	332.80	-	-	100.0	68.0	92	28.5	19.1	21.86	22.5	19.6	-	-	16
4	6.60	339.40	-	-	100.0	62.0	92.2	27.9	18.5	22.26	22.7	21.1	-	-	15.1
5	11.80	351.20	-	-	100.0	69.0	96	27.9	19.5	22.88	22.4	22.3	-	-	12.5
6	0.40	351.60	-	-	100.0	78.0	93.2	24.6	19.5	21.88	22.5	21.4	-	-	8.8
7	0.00	351.60	-	-	100.0	62.0	91	27.8	18.8	22.26	20.9	21.9	-	-	15.6
8	0.00	351.60	-	-	100.0	53.0	71	29.3	18.9	24.14	24.5	24	-	-	19.2
9	0.00	351.60	-	-	100.0	44.0	68.7	29.9	19.4	24.16	23.3	24.1	-	-	19.5
10	0.00	351.60	-	-	100.0	50.0	72.5	30.5	19.4	24.32	25.3	23.2	-	-	17.7
11	0.00	351.60	-	-	100.0	48.0	74	30.6	20.5	24.7	24.8	23.8	-	-	17.2
12	0.00	351.60	-	-	100.0	53.0	78	30.3	20.5	24.12	26.2	21.8	-	-	14.9
13	1.60	353.20	-	-	100.0	53.0	83.5	29.4	19.1	23.46	25.6	21.6	-	-	15.3
14	0.40	353.60	-	-	100.0	49.0	88.7	30.7	19.2	23.98	25.8	22.1	-	-	15.8
15	4.80	358.40	-	-	100.0	49.0	80.7	30.4	19.7	23.56	25.7	21	-	-	16.9
16	0.20	358.60	-	-	100.0	50.0	72.2	29.6	18.9	23.86	24.8	23	-	-	19.2
17	-358.60	0.00	-	-	100.0	45.0	70.7	30.4	18.7	24.42	24.8	24.1	-	-	17.9
18	0.00	0.00	-	-	100.0	48.0	72.7	31.4	20.5	24.62	25.6	22.8	-	-	17.3
19	0.00	0.00	-	-	100.0	57.0	79.7	30.2	20.8	24.46	24.5	23.4	-	-	20.2
20	12.20	12.20	-	-	100.0	85.0	96.5	24.1	20.4	21.34	21	20.6	-	-	7
21	7.60	19.80	-	-	100.0	67.0	88.5	27.3	20.4	22.76	23.7	21.2	-	-	12.8
22	1.40	21.20	-	-	100.0	78.0	93.7	24.9	20.3	22.48	22.8	22.2	-	-	10.6
23	47.20	68.40	-	-	100.0	62.0	73.5	29.2	20.2	23	23.6	21	-	-	14.1
24	95.60	164.00	-	-	100.0	62.0	92.2	29.0	20.1	22.52	22.3	20.6	-	-	16
25	50.00	214.00	-	-	100.0	78.0	98	25.2	19.6	20.98	20.9	19.6	-	-	9.3
26	0.20	214.20	-	-	100.0	65.0	86.7	27.7	18.3	22.38	22.9	21.5	-	-	16.6
27	5.40	219.60	-	-	100.0	67.0	92	27.1	20.2	22.48	24.1	20.5	-	-	11.9
28	1.20	220.80	-	-	100.0	61.0	90.7	28.2	20.1	22.78	23.8	20.9	-	-	12.6
29	0.40	221.20	-	-	100.0	57.0	80	30.1	19.7	23.98	23.9	23.1	-	-	16.8
30	0.00	221.20	-	-	100.0	37.0	63.7	30.8	19.2	24.52	24.6	24	-	-	18
31	0.00	221.20	-	-	100.0	36.0	60.2	31.3	19.0	24.74	25.6	23.9	-	-	19.4



Clique para ativar o plug-in Adobe Flash Player

REDE DE OBSERVAÇÕES

Morrinhos - Estação Usina CEM - Morrinhos - Março de 2020

Para ver os dados horários clique no dia desejado

Dia	Precip.	Prec.Acum.	Vel. Vent. (m/s)	Dir. Vent.	Umid. Relat. AR (Max) %	Umid. Relat. AR (Min) %	Umid. Relat. AR (Média)%	Temp. Max. °C Dia	Temp. Min. °C Dia	Temp. Med. °C do Ar	Temp. 09:00h	Temp. 21:00h	Ponto orvalho	Razao Mistura	Radiação Solar Diana MJ/m²
1	40.20	40.20	2.7	N	100.0	92.0	100	27.9	19.4	22.06	22.6	20.2	-	-	17
2	36.40	76.60	2.8	SE	100.0	73.0	94	27.3	18.4	21.7	19.4	21.7	-	-	16.9
3	0.00	76.60	2.7	L	100.0	69.0	92.5	29.0	19.2	23.1	22.1	22.6	-	-	19.3
4	0.00	76.60	2.1	NO	100.0	69.0	100	28.9	19.1	23.28	26.4	21	-	-	19.6
5	40.60	117.20	2.0	S	100.0	69.0	85	28.8	19.9	23.42	24.6	21.9	-	-	13.3
6	26.20	143.40	2.2	L	100.0	69.0	84.5	26.1	18.9	22.2	23.8	21.1	-	-	13.2
7	0.20	143.60	1.7	S	100.0	69.0	-	28.8	18.6	-	23.3	-	-	-	20.7

Santa Isabel - Estação Usina Codora - Santa Isabel - Março de 2020

Para ver os dados horários clique no dia desejado

Dia	Precip.	Prec.Acum.	Vel. Vent. (m/s)	Dir. Vent.	Umid. Relat. AR (Max) %	Umid. Relat. AR (Min) %	Umid. Relat. AR (Média)%	Temp. Max. °C Dia	Temp. Min. °C Dia	Temp. Med. °C do Ar	Temp. 09:00h	Temp. 21:00h	Ponto orvalho	Razao Mistura	Radiação Solar Diária MJ/m²
1	2.20	2.20	1.4	NO	100.0	71.0	86.7	27.6	20.6	23.96	24	23.8	-	-	11.5
2	11.00	13.20	1.6	NO	100.0	62.0	87.2	29.6	22.1	24.28	25.1	22.3	-	-	13.3
3	8.40	21.60	1.8	L	100.0	63.0	91.5	29.9	21.9	23.92	23.6	22.1	-	-	16.8
4	11.20	32.80	2.0	L	100.0	63.0	88	28.9	21.9	24.66	24.5	24	-	-	13.3
5	34.20	67.00	1.5	N	100.0	66.0	92.2	28.1	21.6	23.36	23.1	22	-	-	11.5
6	60.60	127.60	1.4	L	100.0	74.0	93.7	26.4	20.3	21.84	20.3	21.1	-	-	9.1
7	1.00	128.60	1.4	L	100.0	74.0	95	26.6	20.4	22.96	22.6	22.6	-	-	9.2
8	0.00	128.60	1.8	L	100.0	63.0	88.7	29.5	21.4	24.28	23.3	23.6	-	-	14.4
9	16.00	144.60	1.5	L	100.0	63.0	88.7	28.8	20.4	24.1	23.1	24.1	-	-	14.1
10	8.80	153.40	1.5	SO	100.0	54.0	78	31.1	21.3	24.76	26.6	22.4	-	-	16.2
11	1.40	154.80	1.7	N	100.0	59.0	82.7	30.6	21.1	24.56	24.4	23.4	-	-	16.1
12	3.00	157.80	2.1	L	100.0	67.0	84	28.0	21.5	23.96	23.1	23.6	-	-	13.2
13	0.00	157.80	1.6	S	100.0	58.0	84.7	30.4	21.5	24.86	26.6	22.9	-	-	15
14	5.00	162.80	2.2	L	100.0	48.0	74.2	31.1	21.0	25.18	26.8	23.5	-	-	18
15	2.80	165.60	1.7	SO	100.0	57.0	85.7	30.5	21.1	25.04	26.6	23.5	-	-	14.5
16	1.60	167.20	1.4	SO	100.0	52.0	82.7	30.5	20.1	23.94	23.9	22.6	-	-	16.8
17	2.60	169.80	1.5	N	100.0	51.0	77	31.8	20.4	24.4	24.8	22.5	-	-	17.6
18	0.00	169.80	1.3	S	97.0	50.0	75.7	32.5	20.7	25.54	26.3	24.1	-	-	15.4
19	0.60	170.40	2.0	L	96.0	43.0	71.7	33.3	21.3	25.98	27.1	24.1	-	-	20.7
20	17.60	188.00	2.0	L	100.0	91.0	96.7	24.6	21.4	22.26	22.5	21.4	-	-	3.5
21	2.20	190.20	2.0	L	100.0	69.0	92.2	28.6	21.2	23.5	23.5	22.1	-	-	11.3
22	0.20	190.40	1.7	L	100.0	67.0	90.7	28.6	21.6	23.8	22.8	23	-	-	12.9
23	0.00	190.40	1.5	N	100.0	53.0	83.5	30.8	21.3	25.34	26	24.3	-	-	17.1
24	10.60	201.00	1.8	L	100.0	69.0	95.5	27.5	21.8	23.1	22	22.1	-	-	9.7
25	51.20	252.20	1.8	L	100.0	64.0	87.7	28.3	21.4	23.74	23	23	-	-	13.9
26	46.20	298.40	1.6	L	100.0	64.0	91	28.8	20.4	23.26	22.3	22.4	-	-	9.2
27	3.40	301.80	2.1	SE	100.0	66.0	90.7	29.1	20.9	24.14	24.1	23.3	-	-	14.8
28	18.00	319.80	2.1	SO	100.0	63.0	94.5	30.1	20.4	22.96	23.1	20.6	-	-	5.2
29	0.20	320.00	2.3	SE	100.0	54.0	-	30.9	20.7	25.18	23.1	25.6	-	-	16.8
30	0.00	320.00	2.1	SE	84.0	44.0	65.2	31.1	21.1	25.26	26.9	23.6	-	-	19.6
31	0.00	320.00	1.6	S	92.0	42.0	59	31.5	20.4	25.86	27.6	24.9	-	-	18.7

Bom Jesus de Goiás - Estação Usina Goiasa - Bom Jesus de Goiás - Março de 2020

Para ver os dados horários clique no dia desejado

Dia	Precip.	Prec.Acum.	Vel. Vent. (m/s)	Dir. Vent.	Umid. Relat. AR (Max) %	Umid. Relat. AR (Min) %	Umid. Relat. AR (Média)%	Temp. Max. °C Dia	Temp. Min. °C Dia	Temp. Med. °C do Ar	Temp. 09:00h	Temp. 21:00h	Ponto orvalho	Razao Mistura	Radiação Solar Diária MJ/m²
1	37.20	37.20	1.9	NO	100.0	61.0	87.5	28.3	19.6	23.18	23.8	22.1	-	-	13.7
2	4.00	41.20	2.8	L	100.0	60.0	86	28.8	19.6	22.64	21.8	21.5	-	-	15.4
3	0.00	41.20	2.3	L	100.0	54.0	76.7	29.0	19.9	23.5	23.6	22.5	-	-	16.6
4	0.00	41.20	1.7	NO	96.0	50.0	78	30.3	20.8	23.8	24.1	21.9	-	-	16
5	5.40	46.60	1.2	L	100.0	57.0	92.7	29.1	20.1	23.72	24.6	22.4	-	-	12.2
6	0.60	47.20	1.9	L	100.0	62.0	82.7	27.6	19.6	22.88	23	22.1	-	-	14.4
7	0.00	47.20	2.0	S	98.0	47.0	69.5	29.6	18.4	22.96	24.6	21.1	-	-	18
8	0.00	47.20	2.7	S	77.0	35.0	54	30.4	19.0	23.58	25.9	21.3	-	-	17.3
9	0.00	47.20	2.6	S	73.0	31.0	53.2	30.6	18.9	23.86	26.4	21.7	-	-	19.5
10	0.00	47.20	2.6	SE	80.0	39.0	61.2	31.8	19.3	24.68	26.1	23.1	-	-	14.6
11	0.00	47.20	3.2	L	85.0	46.0	64.5	31.1	20.1	25.32	25.4	25	-	-	18.4
12	0.00	47.20	3.3	L	89.0	46.0	64.2	30.9	21.8	26	26.3	25.5	-	-	17.4
13	0.00	47.20	2.9	SE	92.0	36.0	64.5	31.6	20.5	25.04	25.9	23.6	-	-	18.5
14	0.00	47.20	3.2	L	89.0	48.0	68.7	31.3	21.0	25.76	26.3	25.1	-	-	15.7
15	0.00	47.20	2.7	L	95.0	44.0	67.2	31.1	20.6	25.06	25.6	24	-	-	16.2
16	0.00	47.20	2.1	L	99.0	39.0	62.5	30.4	19.4	24.32	25	23.4	-	-	18.5
17	0.00	47.20	2.1	L	83.0	37.0	59	31.6	19.5	25.18	26.6	24.1	-	-	17.8
18	2.00	49.20	1.8	L	85.0	43.0	66.7	32.2	21.2	25.8	27	24.3	-	-	15.1
19	3.80	53.00	2.6	L	89.0	48.0	74	31.1	22.0	25.7	26.6	24.4	-	-	15.9
20	1.40	54.40	2.8	N	100.0	64.0	83	28.9	21.0	23.42	22.6	22.3	-	-	12.8
21	0.00	54.40	2.0	N	98.0	61.0	81.5	28.3	21.2	24.1	22.8	24.1	-	-	9.5
22	7.20	61.60	2.1	SE	100.0	61.0	81.2	27.9	20.4	23	20.5	23.1	-	-	11.3
23	0.00	61.60	1.9	S	99.0	58.0	77	28.4	20.7	24.06	24.6	23.3	-	-	12.2
24	0.00	61.60	3.4	SE	95.0	57.0	72	28.9	20.8	24	24.1	23.1	-	-	14.9
25	0.00	61.60	3.3	L	91.0	59.0	74.2	27.9	20.4	23.18	23	22.3	-	-	14.1
26	0.00	61.60	3.1	L	100.0	51.0	66.5	28.6	19.2	23.74	22.9	24	-	-	14.5
27	0.00	61.60	3.6	L	97.0	58.0	74.5	29.1	19.4	23.88	23.1	23.9	-	-	15.7
28	7.80	69.40	2.7	L	100.0	83.0	94.7	24.6	21.3	22.12	21.3	21.7	-	-	4.5
29	0.00	69.40	2.5	L	100.0	59.0	79.7	29.1	20.8	23.72	23.5	22.6	-	-	10.8
30	5.60	75.00	2.7	S	94.0	54.0	85.2	29.6	20.3	23.08	24.3	20.6	-	-	11.2
31	0.00	75.00	2.5	S	93.0	43.0	70.2	31.0	20.5	24.62	24.6	23.5	-	-	16.7

Maurilândia - Estação Usina Vale do Verdão - Maurilândia - Março de 2020

Para ver os dados horários clique no dia desejado

Dia	Precip.	Prec.Acum.	Vel. Vent. (m/s)	Dir. Vent.	Umid. Relat. AR (Max) %	Umid. Relat. AR (Min) %	Umid. Relat. AR (Média)%	Temp. Max. °C Dia	Temp. Min. °C Dia	Temp. Med. °C do Ar	Temp. 09:00h	Temp. 21:00h	Ponto orvalho	Razao Mistura	Radiação Solar Diária MJ/m²
1	11.00	11.00	1.6	N	3.0	0.0	1	-10.0	-10.0	-10	-10	-10	-	-	13.4
2	0.40	11.40	1.8	S	4.0	0.0	1.2	-10.0	-10.0	-10	-10	-10	-	-	12.3
3	0.00	11.40	1.8	S	6.0	0.0	2	-10.0	-10.0	-10	-10	-10	-	-	15
4	2.40	13.80	1.5	NO	6.0	0.0	2.2	-10.0	-10.0	-10	-10	-10	-	-	14.6
5	0.40	14.20	1.3	NO	7.0	0.0	3	-10.0	-10.0	-10	-10	-10	-	-	14
6	0.20	14.40	1.5	O	7.0	0.0	2.5	-10.0	-10.0	-10	-10	-10	-	-	15.4
7	0.00	14.40	1.4	S	6.0	0.0	1.7	-10.0	-10.0	-10	-10	-10	-	-	16.1
8	0.00	14.40	1.5	L	4.0	0.0	1	-10.0	-10.0	-10	-10	-10	-	-	17.5
9	0.00	14.40	1.6	S	3.0	0.0	0.7	-10.0	-10.0	-10	-10	-10	-	-	17.5
10	0.00	14.40	1.2	O	3.0	0.0	0.5	-10.0	-10.0	-10	-10	-10	-	-	16.8
11	0.00	14.40	1.3	NO	4.0	0.0	0.5	-10.0	-10.0	-10	-10	-10	-	-	16.9
12	0.00	14.40	1.4	SO	4.0	0.0	0.5	-10.0	-10.0	-10	-10	-10	-	-	15.4
13	0.00	14.40	1.4	S	3.0	0.0	0.2	-10.0	-10.0	-10	-10	-10	-	-	15.9
14	0.00	14.40	1.5	N	3.0	0.0	0.2	-10.0	-10.0	-10	-10	-10	-	-	15.1
15	0.00	14.40	1.6	N	2.0	0.0	0	-10.0	-10.0	-10	-10	-10	-	-	16.1
16	0.00	14.40	1.0	SE	2.0	0.0	0	-10.0	-10.0	-10	-10	-10	-	-	13.5
17	0.00	14.40	1.0	N	1.0	0.0	0	-10.0	-10.0	-10	-10	-10	-	-	15.9
18	0.00	14.40	1.2	NO	1.0	0.0	0	-10.0	-10.0	-10	-10	-10	-	-	15.5
19	0.00	14.40	1.6	NO	1.0	0.0	0	-10.0	-10.0	-10	-10	-10	-	-	14.5
20	32.40	46.80	2.0	N	0.0	0.0	0	-10.0	-10.0	-10	-10	-10	-	-	9.7
21	0.40	47.20	1.3	NO	0.0	0.0	0	-10.0	-10.0	-10	-10	-10	-	-	11.2
22	0.00	47.20	1.6	SE	0.0	0.0	0	-10.0	-10.0	-10	-10	-10	-	-	7
23	0.00	47.20	1.7	SE	0.0	0.0	0	-10.0	-10.0	-10	-10	-10	-	-	12.2
24	0.00	47.20	1.8	SE	0.0	0.0	0	-10.0	-10.0	-10	-10	-10	-	-	10.2
25	1.40	48.60	1.7	L	0.0	0.0	0	-10.0	-10.0	-10	-10	-10	-	-	12.3
26	0.00	48.60	1.6	N	0.0	0.0	0	-10.0	-10.0	-10	-10	-10	-	-	13.7
27	0.40	49.00	1.6	L	0.0	0.0	0	-10.0	-10.0	-10	-10	-10	-	-	12.7
28	0.20	49.20	1.4	NO	0.0	0.0	0	-10.0	-10.0	-10	-10	-10	-	-	5.5
29	0.40	49.60	1.2	SE	0.0	0.0	0	-10.0	-10.0	-10	-10	-10	-	-	8.9
30	3.20	52.80	2.0	SE	0.0	0.0	0	-10.0	-10.0	-10	-10	-10	-	-	9.3
31	0.20	53.00	0.9	S	0.0	0.0	0	-10.0	-10.0	-10	-10	-10	-	-	10.3

NOTÍCIAS RELACIONADAS

<https://g1.globo.com/go/goias/noticia/2020/03/01/bombeiros-resgatam-familias-que-ficaram-ilhadas-apos-forte-chuva-em-planaltina-de-goias.ghtml>

<https://g1.globo.com/go/goias/noticia/2020/03/01/bombeiros-resgatam-familias-que-ficaram-ilhadas-apos-forte-chuva-em-planaltina-de-goias.ghtml>

Bombeiros resgatam famílias que ficaram ilhadas após forte chuva em Planaltina de Goiás

Cerca de 20 pessoas precisaram ser resgatadas pela corporação. Segundo bombeiro, água atingiu 2 metros de altura em seu ponto mais alto.

Por Danielle Oliveira, G1 GO
01/03/2020 18h14 - Atualizado há 2 meses







CSCs Anápolis/ Jaraguá
Adaniil, Adriano Cesar, Andre, Augusto Cesar, Carlos, Christian, C...
posso passar para essa ocorrência de Corumbá? 09:49

CSC Dinamo - Mesa Norte
Encaminhada

0:18 09:56

ocorrências 138392 e 139277 sem acesso rio muito cheio, lá segundo equipe sempre que reclamam à a 12 operada 09:57

CSC Dinamo - Mesa Norte

CSC Dinamo - Mesa Norte
ocorrências 138392 e 139277 sem acesso rio muito cheio, lá segundo equipe sempre que reclamam à a 12 operada

Rogério lá rio esta cheio, é possível acionar o helicóptero? 10:13

Dia: 23/01/2020
Cidade: Cocalzinho

Relato: Ocorrências 138392 e 139277 sem acesso rio muito cheio devido chuvas, impedindo acesso por ponte



<https://corumbaibanoticias.com.br/noticia/1879/tarde-de-chuva-forte-no-sul-de-goias>

<https://corumbaibanoticias.com.br/noticia/1879/tarde-de-chuva-forte-no-sul-de-goias>

Home



28/02/2020 às 21h40min - Atualizada em 28/02/2020 às 21h40min

Tarde de chuva forte no Sul de Goiás

Estragos e prejuízos em várias partes do estado

Comentar



Redação



Reprodução



Fortes chuvas entre Marzagão e a ponte do Rio Corumbá, na GO-139.

As chuvas fortes nesta tarde atingiram toda região inclusive com rompimento de represa entre Água Limpa e Buriti Alegre.

E falta no fornecimento de energia elétrica.

Veja o vídeo da chuva na GO - 139 imagens redes sociais. No link abaixo.

<https://www.facebook.com/corumbaibanoticias/videos/653202458780477/>

<https://corumbaibanoticias.com.br/noticia/1878/chuva-causa-rompimento-de-represa-entre-agua-limpa-e-buriti-alegre>

<https://corumbaibanoticias.com.br/noticia/1878/chuva-causa-rompimento-de-represa-entre-agua-limpa-e-buriti-alegre>

Home



ANUNCIE AQUI
0800 8811401

Início » Editoria » Notícias

CHUVAS

29/02/2020 às 21h38min - Atualizada em 29/02/2020 às 21h38min

CHUVA CAUSA ROMPIMENTO DE REPRESA ENTRE ÁGUA LIMPA E BURITI ALEGRE

Quantidade de chuva do mês em um dia

Comentar



radialista Fábio Alves/Buriti Alegre



Reprodução

As fortes chuvas que atingiram a região nesta sexta-feira (28), causaram o rompimento de uma represa situada entre as cidades de Buriti Alegre e Água Limpa. As imagens foram gravadas agora à pouco na propriedade do senhor Sebastião Protásio.

Apesar do estrago, ninguém se feriu.



<https://www.instagram.com/p/B9FDmr6lRoW/>



maisgoiás

Moradores de Portelândia reclamam da falta de asfalto em trecho da GO-194

maisgoias • Seguir

maisgoias Moradores de Portelândia e municípios da região reclamam do fato de a GO-194 ter um trecho de 33 quilômetros sem pavimentação. Eles afirmam que a ausência de capa asfáltica – combinada com as chuvas desta época do ano – resulta em atoleiros e buracos. Em época de seca, o cenário é de poeira no ar.

A funcionária pública Gleiciane Magalhães, que mora em Portelândia, diz que a má qualidade da rodovia dificulta o trânsito de pessoas que residem na cidade de Ribeirãozinho, no Mato Grosso, e fazem tratamento de saúde em Barretos (São Paulo). Gleiciane explica que os pacientes

Curtido por **albeert_cp** e outras 1.506 pessoas

27 DE FEVEREIRO

<https://www.instagram.com/p/B9FTs6yI9pV/>



maisgoiás • Seguir

ameliaizaac @studiocarinesilva
9 sem Responder

karla_smeves @brunacruzsoares
famosa sua cidade 😊
9 sem Responder

Ver respostas (1)

vaniapinchemel Vixe.
9 sem Responder

dalvamariamirandabarro TENHO PRIMO E TIA Q.MORAM NA PRES D VARGAS
9 sem Responder

48.687 visualizações

27 DE FEVEREIRO

Adicione um comentário... **Publicar**

<https://www.instagram.com/p/B9HptGDI4PC/>

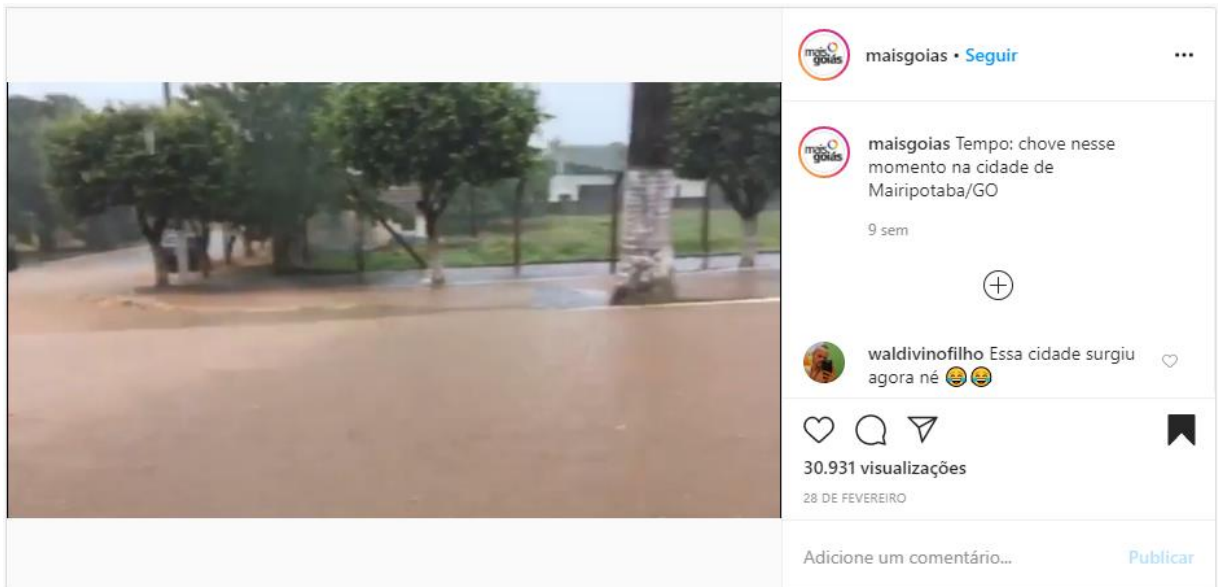

<https://www.instagram.com/p/B9ICjUIKuD/>



<https://www.instagram.com/p/B9INuAFdoV/>



maisgoiás • Seguir



maisgoiás Confira o vídeo: represa rompe por causa da chuva na região sul do estado

Uma represa se rompeu, na tarde desta sexta-feira (28), na divisa entre os municípios de Água Limpa e Buriti Alegre, na região sul do Estado. De acordo com informações preliminares, a estrutura cedeu por causa das fortes chuvas que atingem a região. Não há informações de vítimas.

Segundo o jornalista da região, Fábio Alves, a barragem cedeu entre às 14h30 e 15h30. As imagens abaixo foram gravadas por um morador da zona rural da região.



31.067 visualizações

28 DE FEVEREIRO

<https://www.instagram.com/p/B9JlvOilP5W/>



maisgoiás • Seguir



maisgoiás Bom dia, Goiânia! Vídeo @patricialeiterocha

9 sem



jas.gatos Nossa cidade maravilhosa!



9 sem Responder



iamalansantoss @lutravassos27



9 sem Responder



celiabernardes21 Que vídeo lindo



41.569 visualizações

29 DE FEVEREIRO

<https://www.instagram.com/p/B9JekrIFC3/>



<https://www.instagram.com/p/B9MZtWVlPIQ/>



<https://www.instagram.com/p/B9Ms1bYIGQx/>



maisgoias • Seguir



maisgoias Tempo: chove forte nesse momento em vários bairros de Goiânia!

9 sem



fidelescastro @carlos_diego_2019



9 sem 1 curtida Responder



goianofominha ja fez sol



9 sem Responder



katybertolucci Alguém sabe se está chovendo em Campinas?



51.678 visualizações

1 DE MARÇO

<https://www.instagram.com/p/B9MtngFhNM/>



maisgoias • Seguir



maisgoias Tempo: imagem registrada há pouco na Avenida T-7.

9 sem



drbaianu Não entendo, parece que tem horas q estamos em outra cidade



9 sem 1 curtida Responder



mary_magayver misericórdia



9 sem Responder



marcia_10 Meu Deus kd



131.509 visualizações

1 DE MARÇO

<https://www.instagram.com/p/B9OpqnylRdv/>



maisgoias • Seguir



maisgoias Trânsito: motoristas enfrentam lentidão na Marginal Botafogo, sentido Centro/Pedro Ludovico

9 sem



danieljfilho Todo dia né, quando chove é pior!



9 sem 3 curtidas Responder



denise.montalvao Rs rs rs rs "Goiânia véia" não vejo lentidão nenhuma. Tudo normal. Lentidão são as rodovias de São Paulo.



Curtido por tayara_cristina e outras 5.113 pessoas

2 DE MARÇO

Adicione um comentário...

Publicar

<https://www.instagram.com/p/B9XkmHwF2zz/>



maisgoias • Seguir



naranubia13 A chuva aqui só chegou agora, saída de Anápolis.



8 sem 1 curtida Responder



carlosguiasoosa 😊



8 sem Responder



mendesjunqueirasarah 😊



8 sem Responder



ilana.siilvaa Passei por lá tbm nesse momento, fiquei impressionada com o tanto de água, alagou geral a BR



8 sem Responder



22.097 visualizações

5 DE MARÇO

Adicione um comentário...

Publicar

<https://www.instagram.com/p/B9Y4IDRIR3G/>



maisgoias • Seguir



ver respostas (1)



elianealves37 Viu isso
@neanderlv



8 sem 1 curtida Responder

Ver respostas (1)



antoniofernandesfernando 🤔



8 sem Responder



referreira9 🤔🤔🤔🤔🤔
a coisa ta feia 🤔🤔🤔



8 sem Responder



enggilsonpablo @elineysouto



8 sem 1 curtida Responder



42.734 visualizações

6 DE MARÇO

Adicione um comentário...

Publicar

Dia: 27/02/2020
Cidade: Ipameri

Relato: Forte chuva na cidade inundou boa tarde do município.



Dia: 28/02/2020
Cidade: Buriti Alegre

Relato: Forte chuva fez uma represa se romper entre os municípios de Buriti Alegre



Dia: 27/02/2020
Cidade: Goiânia

Relato: Grandes chuvas na região Noroeste de Goiânia causaram diversos curto circuitos em cabos de Média tensão

Dia: 27/02/2020
Cidade: Anápolis

Relato: Chuva causou estragos em Anápolis nesta quinta feira (27/02) foram mais de 45 milímetros em menos de duas horas, provocando enxurrada e deixando bairros sem energia.
<https://globoplay.globo.com/v/7160107/>

Chuva causa estragos em Anápolis e provoca enxurrada em Goiânia

MAIS INFORMAÇÕES | [Tweetar](#) [Curtir 0](#)



Chuva com alagamento Planaltina-GO 29/02/2020

Planaltina-GO



Chuva com alagamento Planaltina-GO 29/02/2020

Planaltina-GO



Ocorrência Emergencial 2020-02-189528 29/02/2020

Vídeo da Equipe no local de alagamento provocado pelas chuvas Planaltina – GO



Chuva com alagamento Formosa-GO 29/02/2020

Formosa-GO



Chuva com alagamento Formosa-GO 29/02/2020

Formosa-GO

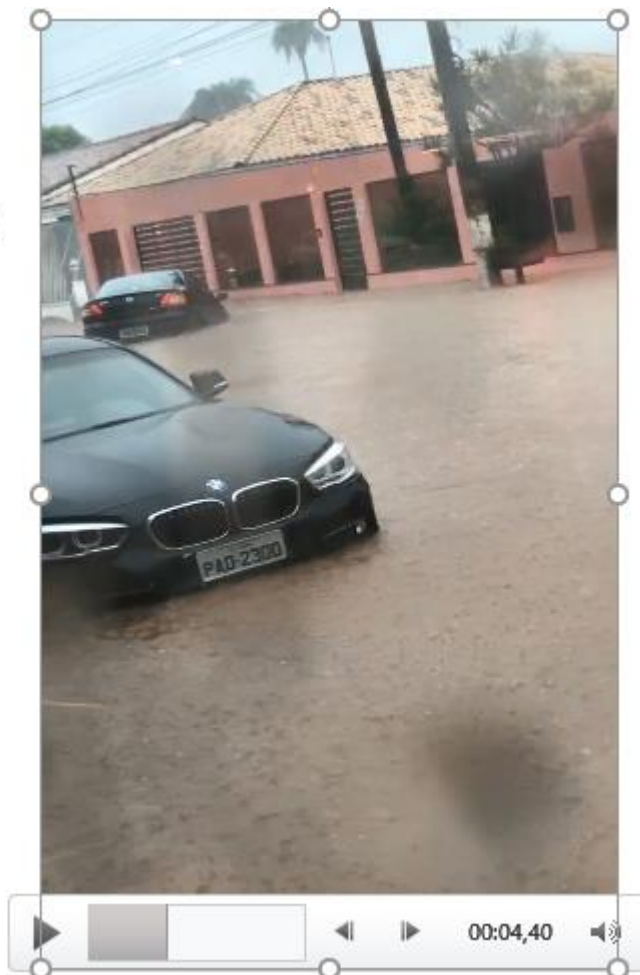

CIDADE: MOIPORÁ - GO

DIA: 27-02-2020

RELATO: ESTRADA NA ZONA RURAL DE MOIPORA TEVE UM DESLIZAMENTO DE TERRA DECORRENTE AO NUMERO GRANDE DE CHUVA, E GRANDES ATOLEIRO ATRAPALHANDO O FLUXO DE EQUIPES DE EMERGÊNCIA.

enel
REGIONAL DE IPORA



CIDADE: HEITORAI - GO

DIA: 28-02-2020

RELATO: RIO E REPRESA NA ZONA RURAL DE HEITORAÍ TRANSBORDARAM POR CAUSA DO GRANDE VOLUME DE CHUVAS NO MUNICÍPIO, EQUIPES TEVE UM RETARDAMENTO NO ATENDIMENTO POR NÃO TER ACESSO AOS PONTO DE DEFEITO.

enel
REGIONAL DE IPORA



enel
REGIONAL DE IPORA

**CIDADE: DIORAMA –GO
MONTES CLARO - GO**

DIA: 29-02-2020

RELATO: GO – 174 ENTRE OS MUNICÍPIOS DE DIORAMA E MONTES CLARO, RODOVIA FICOU INTERDITADA DEVIDO OS ATOLEIROS CAUSADOS PELA FORTE CHUVA NA REGIÃO.



**Dia: 04/03/2020
Cidade: Quirinópolis**

Relato: Temporal com grande precipitação de água e ventos fortes. Destruiu asfalto, derrubou árvores e houve danos a terceiros. Neste dia houveram incidências de condutores partidos, objetos estranhos na rede, vegetação na rede.



Dia: 04/03/2020
Cidade: Quirinópolis

Relato: Temporal com grande precipitação de água e ventos fortes. Destruiu asfalto, derrubou árvores e houve danos a terceiros.



Dia: 04/03/2020
Cidade: Quirinópolis

Relato:
Temporal com grande precipitação de água e ventos fortes. Destruiu asfalto, derrubou árvores e houve danos a terceiros.



Dia: 04/03/2020
Cidade: Quirinópolis

Relato: Temporal com grande precipitação de água e ventos fortes. Destruiu asfalto, derrubou árvores e houve danos a terceiros.



Dia: 06/03/2020
Cidade: Jaraguá

Relato: Equipe em atendimento a Ocorrência informando que a chuva estava atrapalhando para realizar a atividade.



Dia: 08/03/2020
Cidade: Cocalzinho

Relato: Equipes em a atendimento as região rurais de Cocalzinho nos informando e enviando vídeos que devido a quantidade de chuvas na região atrapalhou e muito nos atendimentos principalmente nas zonas rurais .



Dia: 03/03/2020
Cidade: Goiânia

Relato: Ocorrência 03/10504 na Saída da SE Goiânia Leste circuito 06, cabo rompido logo após chuvas com trovoadas.



Dia:04/03/2020
Cidade: Padre Bernardo

Relato: Provoca atoleiros e danifica pontes atrasando a chegada das equipes chegue ate o local do serviços



Dia:07/03/2020
Cidade: Padre Bernardo

Relato: chuvas causou interdição de estradas região rural de Padre Bernardo



Dia:07/03/2020
Cidade: Novo Gama

Relato: Abaloamento de poste na linha de transmissão Brasília Sul afetando as SE Marajoara, SE Pacaembu, SE Pamplona e SE Cristalina

Ocorrência Emergencial 2020-03-22060

- Vídeo da Equipe 939065 Alagamento – Flores



Ocorrência Emergencial 2020-03-23252

- Vídeo da Equipe 939046 Alagamento – Flores





CIDADE: SANCLERLÂNDIA - GO

DIA: 01-03-2020

RELATO: RODOVIA GO – 164 ENTRE OS MUNICÍPIOS DE SANCLERLÂNDIA E SÃO LUIZ DE MONTES BELOS, DEVIDO CONSTANTES CHUVAS NA REGIÃO CÓRREGO TRANSBORDOU E INTERDITOU TODA A RODOVIA.



CIDADE: ARAGUAPAZ - GO

DIA: 02-03-2020

RELATO: ESTRADAS RURAIS EM ARAGUAPAZ INTERDITADAS, FORTES E CONSTANTES CHUVAS CAUSARAM TRANSBORDAMENTOS DE RIO E CÓRREGO, IMPEDINDO EQUIPES SE DESLOCAR PARA ATENDIMENTO DE OCORRÊNCIAS.



CIDADE: ARUANA - GO

DIA: 03-03-2020

RELATO: ESTRADA ALAGADA NO MUNICÍPIO DE ARUANA, DEVIDO A CONSTANTE CHUVAS NA REGIÃO IMPEDINDO EQUIPES SE DESLOCAR PARA ATENDIMENTO DE EMERGÊNCIA.



CIDADE: ITAPURANGA – GO

DIA: 04-05-2020

RELATO: CONSTANTES CHUVAS EM ITAPURANGA CAUSA TRANSBORDAMENTO DE CÓRREGOS CAUSANDO RETARDAMENTO NO ATENDIMENTO DE EMERGÊNCIA.



CIDADE: CIDADE DE GOIÁS

DIA: 05-03-2020

RELATO: RIO TRANSBORDA E LEVA ESTRADA NO MUNICÍPIO DA CIDADE DE GOIÁS, EQUIPE DE EMERGÊNCIA NÃO TEVE CONDIÇÃO DE PASSAR PARA ATENDER OCORRÊNCIA.



CIDADE: CÓRREGO DO OURO - GO

DIA: 06-03-2020

RELATO: EQUIPES EM ATENDIMENTO EMERGENCIAL NO MUNICÍPIO DE CÓRREGO DO OURO, RIO TRANSBORDOU E ALAGOU O PONTO DE DEFEITO, E EQUIPE TEVE GRANDE RETARDAMENTO PARA CONSEGUIR RECUPERAR O DEFEITO.



CIDADE: ITAPIRAPUÃ - GO

DIA: 07-03-2020

RELATO: EQUIPE TEVE RETARDAMENTO NO ATENDIMENTO DE EMERGÊNCIA DEVIDO BURACO FEITO PELA CONSTANTE CHUVA NA REGIÃO DE ITAPIRAPUÃ.



CIDADE: PIRANHAS - GO

DIA: 08-03-2020

RELATO: CÔRREGO NO MUNICÍPIO DE PIRANHAS TRANSBORDOU DEVIDO FORTES CHUVAS, CAUSANDO INTERDIÇÃO DE ESTRADAS RURAIS.



CIDADE: NOVO BRASIL - GO

DIA: 09-03-2020

RELATO: PONTE EM ESTRADA VICINAL NO MUNICÍPIO DE NOVO BRASIL CAI DEVIDO CONSTANTES CHUVAS, CAUSANDO A INTERDIÇÃO DA ESTRADA, ATRAPALHANDO O DESLOCAMENTO DE EQUIPES DE EMERGÊNCIA NO ATENDIMENTO DE OCORRÊNCIAS .

<https://globoplay.globo.com/v/8377535/>

→ ↻ 🔒 <https://globoplay.globo.com/v/8377535/>

globoplay Agora na Globo Novelas Séries Cinema Infantil Mais ▾

#BomDiaGoias



GO 6:45 **ESTRAGOS EM QUIRINÓPOLIS**
Depois da chuva, o dia foi de limpeza

Bom Dia GO >

Lagos transbordam após forte chuva em Quirinópolis

3 min Exibição em 6 Mar 2020

Árvores caíram e uma casa ficou praticamente destruída.

<https://globoplay.globo.com/v/8374731/>

→ ↻ 🔒 <https://globoplay.globo.com/v/8374731/>

globoplay Agora na Globo Novelas Séries Cinema Infantil Mais ▾

#BomDiaGoias



GO 7:31 **CHUVA EM QUIRINÓPOLIS**
Estragos durante uma chuva rápida

AO VIVO

Bom Dia GO >

Forte chuva provoca estragos em Quirinópolis

2 min Exibição em 5 Mar 2020

Temporal provocou queda de árvores e destelhamento de casas na cidade.

DIÁRIO OFICIAL DA UNIÃO

Publicado em: 09/03/2020 | Edição: 46 | Seção: 1 | Página: 12

Órgão: Ministério do Desenvolvimento Regional/Secretaria Nacional de Proteção e Defesa Civil

PORTARIA Nº 477, DE 6 DE MARÇO DE 2020

O SECRETÁRIO NACIONAL DE PROTEÇÃO E DEFESA CIVIL, no uso da competência que lhe foi delegada pela Portaria Ministerial nº 1763-A, de 07 de novembro de 2008, publicada no Diário Oficial da União, Seção II, de 23 de dezembro de 2008, resolve:

Art. 1º Reconhecer a situação de emergência na área descrita no Formulário de Informações do Desastre - FIDE, conforme informações relacionadas abaixo.

UF	Município	Desastre	Decreto	Data	Processo
CE	Jaguaribe	Seca - COBRADE14.12.0	1081	03/01/2020	59051.007978/2020-00
CE	Jucás	Seca - COBRADE14.12.0	006	27/01/2020	59051.008041/2020-43
ES	São Mateus	Chuvas Intensas - COBRADE 13.2.14	11.208	29/01/2020	59051.007957/2020-86
GO	Pontalina	Alagamento - COBRADE 12.3.0.0	076	28/02/2020	59051.007835/2020-90
MG	Tabuleiro	Chuvas Intensas - COBRADE 13.2.14	008	03/01/2020	59051.007956/2020-31
PE	Salgadinho	Estiagem - COBRADE 14.11.0	01	02/01/2020	59051.007774/2020-61
RS	Camaquã	Estiagem - COBRADE 14.11.0	22.950	02/01/2020	59051.008063/2020-1
RS	Jari	Estiagem - COBRADE 14.11.0	4.040	17/01/2020	59051.008058/2020-09
RS	Paraíso do Sul	Estiagem - COBRADE 14.11.0	013	20/01/2020	59051.007879/2020-10
RS	Piratini	Estiagem - COBRADE 14.11.0	027	22/01/2020	59051.007980/2020-71
RS	Manoel Viana	Estiagem - COBRADE 14.11.0	11	11/02/2020	59051.008038/2020-20
RJ	Queimados	Chuvas Intensas - COBRADE 13.2.14	2471	10/02/2020	59051.007973/2020-79
SP	Taboão da Serra	Chuvas Intensas - COBRADE 13.2.14	2.471	10/02/2020	59051.008031/2020-16
SP	Itaquaquecetuba	Chuvas Intensas - COBRADE 13.2.14	7.794	17/02/2020	59051.008075/2020-38
SP	Itápolis	Alagamento - COBRADE 12.3.0.0	5.530	15/01/2020	59051.007947/2020-41
SE	Ribeirópolis	Estiagem - COBRADE 14.11.0	37	17/02/2020	59051.008033/2020-05
SC	Brusque	Deslizamentos - COBRADE -13.2.14	8.527	14/01/2020	59051.007958/2020-21

Art. 2º Esta portaria entra em vigor na data de sua publicação.

ALEXANDRE LUCAS ALVES

Este conteúdo não substitui o publicado na versão certificada.

Voltar

GOVERNO DO ESTADO DE GOIÁS
Secretaria de Estado da Casa Civil

DECRETO Nº 9.413, DE 13 DE MARÇO DE 2019

Declara SITUAÇÃO ANORMAL, CARACTERIZADA COMO SITUAÇÃO DE EMERGÊNCIA, nos municípios que especifica, afetados por Chuvas Intensas – 1.3.2.1.4 – COBRADE, conforme IN/MI 02/2016, e dá outras providências.

O GOVERNADOR DO ESTADO DE GOIÁS, no uso de suas atribuições constitucionais, com fundamento na Lei Federal nº 12.340, de 1º de dezembro de 2010, no inciso VII do artigo 7º da Lei Federal nº 12.608, de 10 de abril de 2012, no Decreto Federal nº 7.257, de 4 de agosto de 2010, e na Instrução Normativa nº 2, de 20 de dezembro de 2016, que trata dos procedimentos e critérios para a decretação de situação de emergência ou estado de calamidade pública, e

CONSIDERANDO que as fortes chuvas que assolaram diversos municípios goianos nos últimos dias estão causando sérios danos e prejuízos a toda a população;

CONSIDERANDO que o forte incremento de precipitações hídricas no município de Israelândia provocou o desmoronamento do aterro sobre o bueiro no Km 171 da rodovia estadual GO-060, provocando o colapso da estrutura e impedindo o trânsito de qualquer espécie de veículos no local;

CONSIDERANDO que a referida situação compromete a segurança de pessoas, obras, serviços, equipamentos e outros bens, públicos e particulares e, portanto, requer atuação emergencial;

CONSIDERANDO que o trecho atingido se encontra interditado e está afetando diretamente a população dos municípios de Amarinópolis, Arenópolis, Baliza, Bom Jardim de Goiás, Caiapônia, Diorama, Doverlândia, Iporá, Israelândia, Jaupaci, Palestina de Goiás e Piranhas;

CONSIDERANDO que a população afetada nos municípios é superior a 99.517 pessoas, uma vez que o trecho interditado é a principal via de entrada de mantimentos, medicamentos, implementos, insumos e utensílios que abastecem o comércio de todas as cidades;

CONSIDERANDO que o sistema de saúde da região é deficitário, exigindo que a população dos municípios afetados procure atendimento especializado na capital, e a situação narrada dificulta o transporte de pacientes graves dos centros de saúde dos municípios afetados até Goiânia;

CONSIDERANDO que as fortes chuvas também agravaram as más condições de trafegabilidade das estradas, ensejando inclusive colapso de estruturas, o que eleva os riscos de acidentes e impossibilita a locomoção dos habitantes de diversos municípios;

CONSIDERANDO que a má conservação das estradas inibe o desenvolvimento de atividades econômicas, enseja o acréscimo no consumo de combustíveis, no tempo de viagem, custos dos fretes e redução da vida útil do pavimento;

CONSIDERANDO que a Agência Goiana de Infraestrutura e Transportes – GOINFRA – deve adotar medidas urgentes para reparação dos trechos rodoviários prejudicados;

CONSIDERANDO a necessidade de observância da ordem cronológica de pagamentos das obrigações relativas ao fornecimento de bens, serviços, obras e serviços de engenharia;

CONSIDERANDO que a referida ordem cronológica, nos termos do artigo 5º da Lei Federal nº 8.666/93, somente pode ser excepcionada quando presentes relevantes razões de interesse público e mediante prévia justificativa da autoridade competente, devidamente publicada.

D E C R E T A:

Art. 1º Fica declarada a existência de situação anormal - provocada por desastre súbito, Chuvas Intensas - caracterizada como SITUAÇÃO DE EMERGÊNCIA, nos municípios de Amorinópolis, Arenópolis, Baliza, Bom Jardim de Goiás, Caiapônia, Diorama, Doverlândia, Iporá, Israelândia, Jaupaci, Palestina de Goiás e Piranhas, afetados pelo forte incremento de precipitações hídricas que assolaram e causaram sérios danos e prejuízos aos citados municípios e região.

Parágrafo Único. Esta declaração de situação de anormalidade é eficaz apenas quanto aos municípios goianos comprovadamente afetados pelo desastre, conforme Parecer GCG-09879 nº 2/2019 da Coordenadoria Estadual de Defesa Civil do Corpo de Bombeiros Militar do Estado de Goiás.

Art. 2º O pagamento das despesas referentes às obras de reparos, intervenções emergenciais e manutenção das rodovias relacionadas no artigo 1º deste decreto poderá ser excepcionado da ordem cronológica das obrigações relativas ao fornecimento de bens, serviços, obras e serviços de engenharia.

Art. 3º Em decorrência das disposições do art. 1º, os órgãos do Sistema Nacional de Proteção e Defesa Civil – SINPDEC, sediados neste Estado, ficam autorizados a prestar apoio suplementar aos Municípios afetados pelo desastre.

Art. 4º Confirma-se a mobilização do Sistema Nacional de Proteção e Defesa Civil no âmbito do Estado, para prestar apoio complementar aos municípios atingidos, mediante articulação com todos os setores do Governo Estadual e a Coordenadoria Estadual de Defesa Civil – CEDEC do Corpo de Bombeiros Militar do Estado de Goiás.

Art. 5º Com base no Inciso IV do artigo 24 da Lei nº 8.666 de 21.06.1993, sem prejuízo das restrições da Lei de Responsabilidade Fiscal (LC 101/2000), ficam dispensados de licitação os contratos de aquisição de bens necessários às atividades de resposta ao desastre, de prestação de serviços e de obras relacionadas com a reabilitação dos cenários dos desastres, desde que possam ser concluídas no prazo máximo de cento e oitenta dias consecutivos e ininterruptos, contados a partir da caracterização do desastre, vedada a prorrogação dos contratos.

Art. 6º Este decreto entrará em vigor na data de sua publicação, devendo vigorar por um prazo máximo de 180 (cento e oitenta) dias.

PALÁCIO DO GOVERNO DO ESTADO DE GOIÁS, em Goiânia, 13 de março de 2019, 131ª da República.

RONALDO RAMOS CAIADO



DECRETO Nº 020/PMI

ISRAELÂNDIA, 11 DE MARÇO DE 2019

"Declara situação de emergência no âmbito do município de Israelândia – GO, e autoriza o Poder Executivo a adotar medidas administrativas para o enfrentamento das consequências resultantes da falta de energia e dá outras providências"

A PREFEITA DO MUNICÍPIO DE ISRAELÂNDIA, Estado de Goiás, no uso de suas atribuições constitucionais e legais, especificamente o inciso VI do art. 79 da Lei Orgânica Municipal

CONSIDERANDO as fortes e contínuas chuvas que culminaram com o intenso temporal que produziu graves transtornos na cidade, como falta de energia com início às 17:20h do dia 10/03/2019, estendendo-se até às 13:56 h do dia 11/03/2019;

CONSIDERANDO os transtornos decorrentes da falta de energia, nas escolas, Hospital, Posto de Saúde, praças, lojas, comércio, nas fazendas, chácaras;

CONSIDERANDO que em virtudes desses fortes chuvas foram rompidos cabos de energia que fazem a distribuição de energia elétrica para a cidade de Israelândia – GO.

CONSIDERANDO que é dever do Município de amenizar esta situação, procurar a empresa competente, para o pronto reestabelecimento da situações, a fim sanar os transtornos causado pela falta de energia a população local;

DECRETA:

Art. 1º Fica declarada situação de emergência no âmbito do Município de Israelândia – GO, em decorrência das fortes e contínuas chuvas que culminaram com o intenso temporal que produziu graves transtornos na cidade, como falta de energia com início às 17:20h do dia 10/03/2019, estendendo-se até às 13:56 h do dia 11/03/2019.

Art. 2º A situação de emergência ora declarada autoriza a adoção de todas as medidas administrativas necessárias a assegurar a imediata resposta por parte do Poder Público Municipal à situação ora vigente e assegurar o retorno à normalidade:

Art. 3º - Cessada a situação de emergência, será revogado este Decreto específico, determinando-se as medidas necessárias ao retorno da normalidade, com apuração das responsabilidades pelos eventuais atos que tenham causado prejuízo ao patrimônio público municipal, bens e valores do Município de Israelândia – GO.

Art. 4º - Este Decreto entra em vigor na data de sua publicação.

Publique-se, Registre-se e Cumpra-se.

GABINETE DA PREFEITA DO MUNICÍPIO DE ISRAELÂNDIA, Estado de Goiás, aos 11 (onze) dias do mês de março de 2019

Miriã Pires Barbosa Souza Dantas
Prefeita Municipal

Prefeitura Mun. de Israelândia - GO CERTIFI
que publiquei o presente Instrumento no placar
Prefeitura, mediante afixação de seu inteiro teor
forma da Lei Orgânica do Município e Lei nº 8
de 21/06/1993

Rua Rio Claro, Nº 186 - Centro - Tel.: (064) 3678-1305

CEP: 76.205-000 - Israelândia/GO

Email: prefisraelandiagabinete@gmail.com

Site: www.israelandia.go.br

11 / 03 / 2019



trecho interditado entre
Israelandia e trevo de
Fazenda Nova 04 e
05/03/19



Alimentador -33 S/E 320(ARUANÃ TRANSMISSÃO) alagamento de rede em 06/03/2019



Alimentador -33 S/E 320(ARUANÃ TRANSMISSÃO) alagamento de rede em 06/03/2019



Alimentador -33 S/E 320(ARUANÃ TRANSMISSÃO) alagamento de rede em 06/03/2019



Alimentador -33 S/E 320(ARUANÃ TRANSMISSÃO) alagamento de rede em 06/03/2019



Alimentador 71-31 Goiás /Faina.05 e 06/03/2019



Alimentador 71-31 Goiás /Faina.05 e 06/03/2019

Algumas fotos de arvores caída na beira do asfalto que os bombeiros já haviam retirado devido aos fortes ventos na região.



Alimentador 71-31 Goiás /Faina.05 e 06/03/2019



Alimentador 71-31 Goiás /Faina.05 e 06/03/2019



Alimentador 71-31 Goiás /Faina.05 e 06/03/2019



Alimentador 71-31 Goiás /Faina.05 e 06/03/2019



Alimentador 71-31 Goiás /Faina.05 e 06/03/2019



CIRCUITO 02-ANICUNS (09)- OE-210962 EM 06 e 07/03/2019 – FORTE VENTOS E DIFICULDADE DE CAMINHÃO ACESSAR O LOCAL DEVIDO ATOLEIRO.