

## **Resumo Executivo**

O Presente Relatório tem como objetivo a incorporação de informações que sejam relevantes para que se possa fazer a devida associação aos dados contidos no corpo do documento objeto da classificação de Situação de Emergência caracterizada pelo Módulo 8 do Prodist, que tem como foco o impacto do evento sobre determinada rede geelétrica e cuja denominação é definida como CHI (Consumidor hora interrompido). O parâmetro para enquadramento nesta classificação de expurgo tem como premissa inicial o limite de Consumidor hora interrompido definido pela fórmula descrita no Módulo 01 do Prodist (Revisão - 9), acrescido de todos os outros informes e dados listados no Módulo 08 (Revisão 10) do Prodist. Este enquadramento se apresenta na maioria das vezes em condições climáticas adversas com severidade dos fatores inerentes a situação, caracterizado na maioria dos casos por fortes ventos e chuvas de grande intensidade e continuidade.

Entre a madrugada do dia 14/04/2020 – terça-feira – e a manhã do dia 15/04/2020 – quarta-feira – Áreas de instabilidade associadas ao deslocamento de uma frente fria pelo país favoreceram a ocorrência de chuva forte, rajadas de vento e raios sobre o estado de Goiás.

Conforme informações do Climatempo Meteorologia, o Instituto Nacional de Meteorologia (INMET) detectou rajadas de vento acima de 50km/h na manhã do dia 14 de abril de 2020. Na estação de Alto Araguaia ocorreram ventos de até 90,4 km/h entre as 07h e 08h do dia 14 de abril de 2020, classificada como tempestade, segundo a escala Beaufort.

O sistema de detecção da EarthNetworks registrou 26.391 descargas atmosféricas (7.325 nuvem-solo e 19.066 nuvem-nuvem) sobre a área de concessão da ENEL em Goiás entre as 03h20 e 23h00 do dia 14 de abril de 2020, o que causou grande instabilidade na rede.

## **Relatório de Ocorrências do período**

Em todo o Estado de Goiás verificou-se também que a intensidade da chuva e dos ventos danificaram a rede de distribuição de energia elétrica em diversos pontos, registrando aproximadamente 141 mil clientes com interrupção no fornecimento de energia elétrica devido a eventos relacionados ao temporal.

Para otimizar o volume de atendimentos e reduzir os tempos de interrupção foram mobilizados os recursos extras da empresa que aumentou o contingente em relação a situação normal de operação. O acompanhamento da quantidade de equipes e o Tempo Médio de Atendimento podem ser consultados na Pág.02 do Relatório em anexo.

O impacto e severidade do evento estão relatados em artigos de mídia, como fotos e reportagens que demonstram os danos na Rede de Distribuição, oriundos dos eventos climáticos no período. Eventos estes que afetaram 141.287 consumidores com CHI de 524.215,40 superior ao de 482.597,74 estabelecido como limite para definição de Situação de Emergência, conforme resumo das informações obrigatórias.

<b>Empresa</b>	ENEL DISTRIBUIÇÃO GOIÁS		
<b>Código do Relatório</b>	CHI-047 - ENEL DISTRIBUIÇÃO GOIÁS		
<b>Evento:</b>	TEMPORAL NA AREA DE CONCESSÃO DA ENEL DISTRIBUIÇÃO GOIAS		
<b>Código COBRADE:</b>	1.3.1.2.0	<b>Data Inicio</b>	14/04/2020
		<b>Hora início</b>	03h20
<b>Código do Evento:</b>	CHI-047-ENEL GO	<b>Data Término</b>	15/04/2020
		<b>Hora Término</b>	08h59
<b>Valor CHI (Limite e Real)</b>	482.597,74	524.215,40	
<b>Código do Decreto (Se Houver):</b>			
<b>Quantidade de Interrupções (Evento)</b>	1.510		
<b>Início 1ª Incidência (Data e Hora)</b>	14/04/2020 04:02	<b>Subestações Atingidas</b>	ABADIANIA / ACREUNA / ADELANDIA / AEROPORTO / AGUA LIMPA (MARZAGAO) / AGUAS LINDAS / ALEXANIA / ALMERINDONOPOLIS / ALOANDIA / ALTO BURITI / ALVORADA DO NORTE / AMERICANO ( RIO VERDE ) / AMERICANO DO BRASIL / AMORINOPOLIS / ANAPOLIS UNIVERSITARIA / ANHANGUERA / ANICUNS / APARECIDA DO RIO DOCE / APORE / ARACU / ARAGARCAS / ARAGOIANIA / ARAGUAPAZ / ARARAS / AREIAS / ARENOPOLIS / ARUANA / ATLANTICO / AURILANDIA / AVELINOPOLIS / BACURI (RIO VERDE) / BARCELONA / BARREIRO (PORANGATU) / BARRO ALTO / BELA VISTA (TRANSMISSAO) / BOM JARDIM / BOM JESUS DE GOIAS / BONFINOPOLIS / BONITO / BONOPOLIS / BRITANIA / BURITI ALEGRE / BURITI DE GOIAS / BURITIZINHO / CABRIUVA (RIO VERDE) / CACHOEIRA ALTA / CACHOEIRA DOURADA / CACHOEIRINHA (ITARUMA) / CACU / CAIAPONIA / CALDAS NOVAS / CALDAZINHA / CAMPESTRE / CAMPINAS / CAMPINORTE / CAMPO ALEGRE DE GOIAS / CAMPO NOVO / CAMPOS BELOS / CAMPOS VERDES / CARAJAS / CASTELANDIA / CATALAO / CATURAI / CEBRASA FABRICA DA AMBEV / CEPAGO / CEZARINA / CHAPADAO DO CEU / CIDADE OCIDENTAL / COCALZINHO / COLINACU / CORREGO DO OURO / CORUMBAIBA / CRISTALINA TRANSMISSAO / CRISTIANOPOLIS / CRIXAS / CROMINIA / CUMARI / DAIA - ANAPOLIS / DAVINOPOLIS / DESTILARIA BRASIL CENTRAL / DIMIC / DIORAMA / DOVERLANDIA / EDEALINA / EDEIA / ENERSUL / FAINA / FAZENDA CANADA / FAZENDA NOVA / FERROVIARIO / FIRMINOPOLIS / FLORES DE GOIAS / FORMIGA / FRONTEIRA / GAMELEIRA / GOIANAPOLIS / GOIANDIRA / GOIANESIA / GOIANIA LESTE / GOIANIRA / GOIAS / GOIATUBA / GOYA / GUAPO / HIDROLANDIA / HIDROLINA / IACIARA / INDEPENDENCIA / INDIARA / INHUMAS / IPAMERI / IPEGUARI / IPORA / ISRAELANDIA / ITABERAI / ITAGUARI / ITAGUARU / ITAJA / ITAPACI / ITAPACI (TRANSMISSAO) / ITAPIRAPUA / ITAPURANGA / ITAPURANGA (TRANSMISSAO) / ITARUMA / ITAUCU / ITIQUIRA (FORMOSA) / ITUMBIARA NOVA / ITUMBIARA VELHA / JACILANDIA / JANDAIA / JARAGUA / JARANAPOLIS / JATAI / JAUPACI / JESUPOLIS / JOVIANIA / JUNDIAI / JURUMIRIM / JUSSARA / LAGES / LAGOA DO BAUZINHO (RIO VERDE) / LEOPOLDO DE BULHOES / MAIRIPOTABA / MARA ROSA / MARAJOARA / MARCIANOPOLIS / MARZAGAO / MATO GRANDE / MATRINCHA / MAURILANDIA / MEIA PONTE / MINACU / MINEIROS / MINEIROS TRANSMISSAO / MOIPORA / MONTES CLAROS DE GOIAS / MONTIVIDIU T / MORRINHOS / MORRO AGUDO / MOSSAMEDES / MOZARLANDIA / MOZARLANDIA (TRANSMISSAO) / MUTUNOPOLIS / NAVESLANDIA ( JATAI ) / NAZARIO / NEROPOLIS / NIQUELANDIA / NOVA AMERICA / NOVA CRIXAS (TRANSMISSAO) / NOVA IGUACU / NOVO BRASIL / NOVO PLANALTO / OLHOS DAGUA / ORIZONA / OURO VERDE DE GOIAS / OUIDOR / PACAEMBU (NOVO GAMA) / PALESTINA / PALMEIRAS / PALMEIRAS DE GOIAS / PALMELO / PALMINOPOLIS / PAMPLONA / PANAMA / PARANA / PARANAIBA / PARANAIGUARA / PARAUNA SE ALTA TENSAO / PARQUE DAS EMAS (MINEIROS) / PEROLANDIA / PILOANDIA / PIRACANJUBA / PIRANHAS T / PIRENOPOLIS / PIRES BELO / PIRES DO RIO / PLANALTINA / PLANALTINA (TRANSMISSAO) / PLANALTO / PONTALINA / PORANGATU / PORTEIRAO / PORTELANDIA / PROFESSOR JAMIL / QUEBRA LINHA / QUIRINOPOLIS / REAL / RETIRO / GOIAS / RIO CLARO JATAI MONTIVIDIU / RIO DO PEIXE / RIO DOS BOIS (MAURILANDIA) / RIO PRETO / RIO QUENTE / RIO VERDE / RIO VERMELHO / RIVERLANDIA (RIO VERDE) / ROCHEDO (UEH) / RUBIATABA / SANCLERLANDIA / SANTA HELENA / SANTA RITA DO ARAGUAIA / SANTA ROSA / SANTA ROSA DE GOIAS / SANTA ROSA DO MEIA PONTE / SANTA TEREZINHA / SANTO ANTONIO DA BARRA / SAO BARTOLOMEU / SAO DOMINGOS / SAO FRANCISCO DE GOIAS / SAO JOAO D ALIANCA / SAO JOAO DA PARAUNA / SAO LUIZ DOS MONTES BELOS / SAO MIGUEL DO ARAGUAIA / SAO MIGUEL DO PASSA QUATRO / SENADOR CANEDO TRANSMISSAO / SERRA AZUL (JATAI) / SERRA DE CALDAS / SOUZALANDIA / SUCURI / TAIOBA / TAQUARAL / TAQUARI / TRES RANCHOS / TRINDADE / TURVANIA / TURVELANDIA / URUACU / URUTAI / VENDA SECA / VIANOPOLIS / VICENTINOPOLIS / VILA CORUMBA / VILA PROPICIO / XAVANTES / XIXA / ZELANDIA / VILA BOA
<b>Início Ultima Incidência (Data e Hora)</b>	15/04/2020 08:49		
<b>Média de Duração das Incidências (h)</b>	8,18		
<b>Duração da Incidência mais longa (h)</b>	68,92		
<b>Total de Clientes afetados</b>	141.287	<b>Municípios Atingidos</b>	ABADIA DE GOIAS / ABADIANIA / ACREUNA / ADELANDIA / AGUA FRIA DE GOIAS / AGUA LIMPA / AGUAS LINDAS DE GOIAS / ALEXANIA / ALTO HORIZONTE / ALTO PARAISO DE GOIAS / ALVORADA DO NORTE / AMARALINA / AMERICANO DO BRASIL / AMORINOPOLIS / ANAPOLIS / ANHANGUERA / ANICUNS / APARECIDA DE GOIANIA / APARECIDA DO RIO DOCE / APORE / ARAGARCAS / ARAGOIANIA / ARAGUAPAZ / ARENOPOLIS / ARUANA / AURILANDIA / AVELINOPOLIS / BALIZA / BARRO ALTO / BELA VISTA DE GOIAS / BOM JARDIM DE GOIAS / BOM JESUS DE GOIAS / BONFINOPOLIS / BONOPOLIS / BRITANIA / BURITI ALEGRE / BURITI DE GOIAS / BURITINOPOLIS / CABECEIRAS / CACHOEIRA ALTA / CACHOEIRA DE GOIAS / CACHOEIRA DOURADA / CACU / CAIAPONIA / CALDAS NOVAS / CAMPESTRE DE GOIAS / CAMPINORTE / CAMPO ALEGRE DE GOIAS / CAMPO LIMPO / CAMPOS BELOS / CAMPOS VERDES / CASTELANDIA / CATALAO / CATURAI / CEZARINA / CHAPADAO DO CEU / CIDADE OCIDENTAL / COCALZINHO DE GOIAS / COLINAS DO SUL / CORREGO DO OURO / CORUMBA DE GOIAS / CORUMBAIBA / CRISTALINA / CRISTIANOPOLIS / CRIXAS / CROMINIA / CUMARI / DAVINOPOLIS / DIORAMA / DISTRITO FEDERAL / DIVINOPOLIS DE GOIAS / DOVERLANDIA / EDEALINA / EDEIA / FAINA / FAZENDA NOVA / FIRMINOPOLIS / FLORES DE GOIAS / FORMOSA / GOIANAPOLIS / GOIANDIRA / GOIANESIA / GOIANIA / GOIANIRA / GOIAS / GOIATUBA / GOUVELANDIA / GUAPO / GUARAITA / GUARANI DE GOIAS / GUARINOS / HEITORAI / HIDROLANDIA / HIDROLINA / IACIARA / INACIOLANDIA / INDIARA / INHUMAS / IPAMERI / IPORA / ISRAELANDIA / ITABERAI / ITAGUARI / ITAGUARU / ITAJA / ITAPACI / ITAPIRAPUA / ITAPURANGA / ITARUMA / ITAUCU /

			ITUMBIARA / IVOLANDIA / JANDAIA / JARAGUA / JATAI / JAUPACI / JESUPOLIS / JOVIANIA / JUSSARA / LAGOA SANTA / LEOPOLDO DE BULHOES / LUZIANIA / MAIRIPOTABA / MARA ROSA / MARZAGAO / MATRINCHA / MAURILANDIA / MINACU / MINEIROS / MOIPORA / MONTE ALEGRE DE GOIAS / MONTES CLAROS DE GOIAS / MONTIVIDIU / MORRINHOS / MORRO AGUDO DE GOIAS / MOSSAMEDES / MOZARLANDIA / MUNDO NOVO DE GOIAS / MUTUNOPOLIS / NAZARIO / NEROPOLIS / NIQUELANDIA / NOVA AMERICA / NOVA CRIXAS / NOVA IGUACU DE GOIAS / NOVA ROMA / NOVO BRASIL / NOVO GAMA / ORIZONA / OUVIDOR / PADRE BERNARDO / PALESTINA DE GOIAS / PALMEIRAS DE GOIAS / PALMELO / PALMINOPOLIS / PANAMA / PARANAIGUARA / PARAUNA / PEROLANDIA / PETROLINA DE GOIAS / PILAR DE GOIAS / PIRACANJUBA / PIRANHAS / PIRENOPOLIS / PIRES DO RIO / PLANALTINA / PONTALINA / PORANGATU / PORTEIRAO / PORTELANDIA / POSSE / PROFESSOR JAMIL SAFADY / QUIRINOPOLIS / RIO QUENTE / RIO VERDE / RUBIATABA / SANCLERLANDIA / SANTA BARBARA DE GOIAS / SANTA CRUZ DE GOIAS / SANTA FE DE GOIAS / SANTA HELENA DE GOIAS / SANTA RITA DO ARAGUAIA / SANTA ROSA DE GOIAS / SANTO ANTONIO DA BARRA / SANTO ANTONIO DE GOIAS / SANTO ANTONIO DO DESCOBERTO / SAO DOMINGOS / SAO FRANCISCO DE GOIAS / SAO JOAO D ALIANCA / SAO JOAO DA PARAUNA / SAO LUIS DE MONTES BELOS / SAO LUIZ DO NORTE / SAO MIGUEL DO ARAGUAIA / SAO MIGUEL DO PASSA QUATRO / SAO SIMAO / SENADOR CANEDO / SERRANOPOLIS / SILVANIA / SIMOLANDIA / TAQUARAL DE GOIAS / TERESINA DE GOIAS / TRES RANCHOS / TRINDADE / TURVANIA / TURVELANDIA / UIRAPURU / URUACU / URUTAI / VARIAO / VIANOPOLIS / VICENTINOPOLIS / VILA BOA / VILA PROPICIO
--	--	--	---

DANOS CAUSADOS			
Equipamentos Danificado	Importância para o Sistema	Local	Quantidade
Disjuntor/Religador Operado	Proteção do Alimentador	Área de Concessão	62
Chaves Fusíveis Operada	Proteção de Ramais de Alimentadores	Área de Concessão	484
Transformador Operado	Proteção do Transformador	Área de Concessão	324

Relato técnico sobre a Intervenção realizada em Goiânia e Região Metropolitana			
Informações sobre Equipes	14/04	15/04	
Quantidade Usual	717	717	turmas
Quantidade Adicional	49	52	turmas
Quantidade Total	766	769	turmas
Tempos Médios			
Preparação	5,08	2,39	Horas
Deslocamento	0,89	0,88	Horas
Execução	1,40	1,21	Horas
TMAE	7,33	4,48	Horas

### Principais Dificuldades Encontradas:

Chuvas com ventos fortes provocaram muitos pontos de alagamento e enxurrada, trânsito impedido por vários semáforos desligados dificultando a chegada ao atendimento das ocorrências emergenciais. Em determinadas regiões, decorrente dos fortes ventos, houve o tombamento de árvores nas estruturas de alimentação de média tensão, danos em ramais de ligação dos clientes, impedimentos de acesso e atolamentos em estradas rurais.

<b>Empresa</b>	ENEL DISTRIBUIÇÃO GOIAS		
<b>Valor CHI (Limite e Real)</b>	<b>482.597,74</b>		<b>524.215,40</b>

DOC ORIGEM	MIUNICIPIO	EQP_ORIGEM	CONJUNTO	INI_OCORRENC	FIM_OCORRENC	DT_INI_EVENTO	DT_FIM_EVENTO	DURAÇ	UC INT	CHI	EXPURGO
20200442747	MONTIVIDIU	MV12260781	MONTIVIDIU T	14/04/2020 04:02	14/04/2020 13:16	14/04/2020 04:02	14/04/2020 13:16	9,23	3	27,70	CHI
20200442747	RIO VERDE	MV12260781	MONTIVIDIU T	14/04/2020 04:02	14/04/2020 13:16	14/04/2020 04:02	14/04/2020 13:16	9,23	4	36,93	CHI
20200442747	RIO VERDE	MV12260781	MONTIVIDIU T	14/04/2020 04:02	14/04/2020 13:16	14/04/2020 07:25	14/04/2020 13:16	5,86	3	17,59	CHI
20200442755	GOIAS	IK12299970	GOIAS	14/04/2020 04:33	14/04/2020 08:00	14/04/2020 04:33	14/04/2020 08:00	3,44	25	85,90	CHI
20200442755	HEITORAI	IK12299970	GOIAS	14/04/2020 04:33	14/04/2020 08:00	14/04/2020 04:33	14/04/2020 08:00	3,44	33	113,38	CHI
20200442755	ITABERAI	IK12299970	GOIAS	14/04/2020 04:33	14/04/2020 08:00	14/04/2020 04:33	14/04/2020 08:00	3,44	3	10,31	CHI
20200442755	ITAPURANGA	IK12299970	GOIAS	14/04/2020 04:33	14/04/2020 08:00	14/04/2020 04:33	14/04/2020 08:00	3,44	3	10,31	CHI
20200442767	FAZENDA NOVA	FN12250851	JUSSARA	14/04/2020 05:19	14/04/2020 08:06	14/04/2020 05:19	14/04/2020 08:06	2,78	9	25,00	CHI
20200442770	ITABERAI	IB12078567	ITABERAI S1	14/04/2020 05:26	14/04/2020 08:54	14/04/2020 05:26	14/04/2020 08:54	3,46	17	58,84	CHI
20200442770	ITAUCU	IB12078567	ITABERAI S1	14/04/2020 05:26	14/04/2020 08:54	14/04/2020 05:26	14/04/2020 08:54	3,46	2	6,92	CHI
20200442774	QUIRINOPOLIS	QI32058080	QUIRINOPOLIS	14/04/2020 05:33	14/04/2020 07:24	14/04/2020 05:33	14/04/2020 07:24	1,85	10	18,48	CHI
20200442379	CRISTIANOPOLIS	CF12337210	CRISTIANOPOLIS	14/04/2020 05:44	14/04/2020 10:38	14/04/2020 05:44	14/04/2020 09:23	3,65	4	14,59	CHI
20200442379	SANTA CRUZ DE GOIAS	CF12337210	CRISTIANOPOLIS	14/04/2020 05:44	14/04/2020 10:38	14/04/2020 05:44	14/04/2020 09:23	3,65	4	14,59	CHI
20200442379	CRISTIANOPOLIS	CF12337210	CRISTIANOPOLIS	14/04/2020 05:44	14/04/2020 10:38	14/04/2020 05:44	14/04/2020 10:38	4,90	3	14,69	CHI
20200442780	FIRMINOPOLIS	FR12000070	FIRMINOPOLIS S1	14/04/2020 05:50	14/04/2020 07:30	14/04/2020 05:50	14/04/2020 07:30	1,66	6	9,93	CHI
20200442787	ITUMBIARA	IT12273930	CACHOEIRA DOURADA	14/04/2020 06:00	14/04/2020 08:11	14/04/2020 06:00	14/04/2020 08:11	2,17	15	32,61	CHI
20200443070	IPAMERI	IP12216237	IPAMERI	14/04/2020 06:06	14/04/2020 09:31	14/04/2020 06:06	14/04/2020 09:31	3,41	25	85,28	CHI
20200442800	JANDAIA	PP12126013	PALMEIRAS	14/04/2020 06:15	14/04/2020 10:08	14/04/2020 06:15	14/04/2020 10:08	3,88	29	112,60	CHI
20200442800	PALMINOPOLIS	PP12126013	PALMEIRAS	14/04/2020 06:15	14/04/2020 10:08	14/04/2020 06:15	14/04/2020 10:08	3,88	15	58,24	CHI
20200442803	FAINA	FC12378894	MATRINCHA	14/04/2020 06:15	14/04/2020 07:35	14/04/2020 06:15	14/04/2020 07:35	1,32	13	17,16	CHI
20200442803	MATRINCHA	FC12378894	MATRINCHA	14/04/2020 06:15	14/04/2020 07:35	14/04/2020 06:15	14/04/2020 07:35	1,32	7	9,24	CHI
20200442817	GUARAITA	IK12064427	ITAPURANGA	14/04/2020 06:22	14/04/2020 07:56	14/04/2020 06:22	14/04/2020 07:56	1,55	1	1,55	CHI
20200442817	ITAPURANGA	IK12064427	ITAPURANGA	14/04/2020 06:22	14/04/2020 07:56	14/04/2020 06:22	14/04/2020 07:56	1,55	15	23,27	CHI
20200442822	MINEIROS	MY12043893	PARQUE DAS EMAS	14/04/2020 06:25	14/04/2020 08:22	14/04/2020 06:25	14/04/2020 08:22	1,94	3	5,83	CHI
20200443089	MINEIROS	MY21253762	PARQUE DAS EMAS	14/04/2020 06:25	14/04/2020 09:30	14/04/2020 06:25	14/04/2020 09:30	3,08	1	3,08	CHI
20200442827	CROMINIA	CQ12060616	ROCHEDO	14/04/2020 06:27	14/04/2020 09:35	14/04/2020 06:27	14/04/2020 09:35	3,12	21	65,52	CHI
20200442829	EDEIA	EA12160385	VICENTINOPOLIS	14/04/2020 06:28	14/04/2020 10:35	14/04/2020 06:28	14/04/2020 10:35	4,13	10	41,28	CHI
20200442830	SANTA HELENA DE GOIAS	400020713	IPEGUARI	14/04/2020 06:28	14/04/2020 09:28	14/04/2020 06:28	14/04/2020 09:28	2,99	1	2,99	CHI
20200442831	PARAUNA	PU21347244	PARAUNA	14/04/2020 06:28	14/04/2020 10:17	14/04/2020 06:28	14/04/2020 10:17	3,80	1	3,80	CHI

20200442833	OUVIDOR	OU12077428	CATALAO S1	14/04/2020 06:29	14/04/2020 09:39	14/04/2020 06:29	14/04/2020 09:39	3,15	189	595,93	CHI
20200442833	TRES RANCHOS	OU12077428	CATALAO S1	14/04/2020 06:29	14/04/2020 09:39	14/04/2020 06:29	14/04/2020 09:39	3,15	26	81,98	CHI
20200442834	BALIZA	BH12331250	CAIAPONIA	14/04/2020 06:30	14/04/2020 20:14	14/04/2020 06:30	14/04/2020 20:14	13,73	97	1331,59	CHI
20200442848	PARAUNA	PU12000012	PARAUNA	14/04/2020 06:34	14/04/2020 07:32	14/04/2020 07:13	14/04/2020 07:30	0,28	104	29,47	CHI
20200442848	PARAUNA	PU13000004	PARAUNA	14/04/2020 06:34	14/04/2020 07:32	14/04/2020 07:13	14/04/2020 07:32	0,32	180	57,00	CHI
20200442868	JUSSARA	JR13250622	BRITANIA	14/04/2020 06:39	14/04/2020 17:29	14/04/2020 06:39	14/04/2020 17:29	10,84	119	1289,56	CHI
20200442868	JUSSARA	JR10401446	BRITANIA	14/04/2020 06:39	14/04/2020 17:29	14/04/2020 06:39	14/04/2020 17:29	10,84	23	249,24	CHI
20200442868	MONTES CLAROS DE GOIAS	JR13250622	BRITANIA	14/04/2020 06:39	14/04/2020 17:29	14/04/2020 06:39	14/04/2020 17:29	10,84	140	1517,13	CHI
20200442868	JUSSARA	JR10401446	BRITANIA	14/04/2020 06:39	14/04/2020 17:29	14/04/2020 11:41	14/04/2020 17:29	5,81	2	11,61	CHI
20200442869	IPAMERI	IP12300933	IPAMERI	14/04/2020 06:39	14/04/2020 10:05	14/04/2020 06:39	14/04/2020 10:05	3,42	52	177,80	CHI
20200448908	JUSSARA	JR12027532	BRITANIA	14/04/2020 06:39	15/04/2020 10:43	14/04/2020 06:39	15/04/2020 10:43	28,07	39	1094,68	CHI
20200442873	GOIATUBA	JV12208104	GOIATUBA S1	14/04/2020 06:40	14/04/2020 13:19	14/04/2020 06:40	14/04/2020 13:19	6,64	14	93,00	CHI
20200442873	JOVIANIA	JV12208104	GOIATUBA S1	14/04/2020 06:40	14/04/2020 13:19	14/04/2020 06:40	14/04/2020 13:19	6,64	5	33,21	CHI
20200440787	CACHOEIRA ALTA	00270434	CACHOEIRA ALTA	14/04/2020 06:42	15/04/2020 04:25	14/04/2020 06:42	14/04/2020 19:47	13,08	6	78,48	CHI
20200440787	CACU	00270434	CACHOEIRA ALTA	14/04/2020 06:42	15/04/2020 04:25	14/04/2020 06:42	14/04/2020 23:22	16,66	42	699,60	CHI
20200440787	ITAJA	00270434	CACHOEIRA ALTA	14/04/2020 06:42	15/04/2020 04:25	14/04/2020 06:42	14/04/2020 23:22	16,66	7	116,60	CHI
20200440787	ITARUMA	00270434	CACHOEIRA ALTA	14/04/2020 06:42	15/04/2020 04:25	14/04/2020 06:42	14/04/2020 23:22	16,66	79	1315,92	CHI
20200440787	CACHOEIRA ALTA	00270434	CACHOEIRA ALTA	14/04/2020 06:42	15/04/2020 04:25	14/04/2020 06:42	15/04/2020 04:06	21,39	1	21,39	CHI
20200440787	CACU	00270434	CACHOEIRA ALTA	14/04/2020 06:42	15/04/2020 04:25	14/04/2020 06:42	15/04/2020 04:06	21,39	1	21,39	CHI
20200440787	CACU	00270434	CACHOEIRA ALTA	14/04/2020 06:42	15/04/2020 04:25	14/04/2020 06:42	15/04/2020 04:10	21,46	4	85,86	CHI
20200440787	CACU	00270434	CACHOEIRA ALTA	14/04/2020 06:42	15/04/2020 04:25	14/04/2020 06:42	15/04/2020 04:10	21,46	1	21,46	CHI
20200440787	ITAJA	00270434	CACHOEIRA ALTA	14/04/2020 06:42	15/04/2020 04:25	14/04/2020 06:42	15/04/2020 04:10	21,46	31	665,41	CHI
20200440787	ITAJA	00270434	CACHOEIRA ALTA	14/04/2020 06:42	15/04/2020 04:25	14/04/2020 06:42	15/04/2020 04:10	21,46	40	858,59	CHI
20200440787	ITAJA	00270434	CACHOEIRA ALTA	14/04/2020 06:42	15/04/2020 04:25	14/04/2020 06:42	15/04/2020 04:10	21,46	78	1674,25	CHI
20200440787	ITAJA	00270434	CACHOEIRA ALTA	14/04/2020 06:42	15/04/2020 04:25	14/04/2020 06:42	15/04/2020 04:10	21,46	2	42,93	CHI
20200440787	ITARUMA	00270434	CACHOEIRA ALTA	14/04/2020 06:42	15/04/2020 04:25	14/04/2020 06:42	15/04/2020 04:10	21,46	43	922,98	CHI
20200440787	ITARUMA	00270434	CACHOEIRA ALTA	14/04/2020 06:42	15/04/2020 04:25	14/04/2020 06:42	15/04/2020 04:10	21,46	132	2833,34	CHI
20200440787	ITARUMA	00270434	CACHOEIRA ALTA	14/04/2020 06:42	15/04/2020 04:25	14/04/2020 06:42	15/04/2020 04:10	21,46	6	128,79	CHI
20200440787	LAGOA SANTA	00270434	CACHOEIRA ALTA	14/04/2020 06:42	15/04/2020 04:25	14/04/2020 06:42	15/04/2020 04:10	21,46	16	343,44	CHI
20200440787	LAGOA SANTA	00270434	CACHOEIRA ALTA	14/04/2020 06:42	15/04/2020 04:25	14/04/2020 06:42	15/04/2020 04:10	21,46	10	214,65	CHI
20200440787	CACU	00270434	CACHOEIRA ALTA	14/04/2020 06:42	15/04/2020 04:25	14/04/2020 06:42	15/04/2020 04:21	21,64	1	21,64	CHI
20200440787	CACHOEIRA ALTA	CA13241774	CACHOEIRA ALTA	14/04/2020 06:42	15/04/2020 04:25	14/04/2020 19:02	15/04/2020 04:25	9,39	3	28,16	CHI
20200440787	CACU	CA13241774	CACHOEIRA ALTA	14/04/2020 06:42	15/04/2020 04:25	14/04/2020 19:02	15/04/2020 04:25	9,39	4	37,54	CHI

20200442880	ITAJA	IM12202616	ITAJA S2	14/04/2020 06:44	14/04/2020 12:57	14/04/2020 06:44	14/04/2020 09:15	2,51	11	27,56	CHI
20200442880	ITARUMA	IM12202616	ITAJA S2	14/04/2020 06:44	14/04/2020 12:57	14/04/2020 06:44	14/04/2020 09:15	2,51	30	75,16	CHI
20200442880	ITAJA	IM12202616	ITAJA S2	14/04/2020 06:44	14/04/2020 12:57	14/04/2020 09:45	14/04/2020 12:57	3,21	11	35,28	CHI
20200442880	ITARUMA	IM12202616	ITAJA S2	14/04/2020 06:44	14/04/2020 12:57	14/04/2020 09:45	14/04/2020 12:57	3,21	31	99,42	CHI
20200442904	CRISTIANOPOLIS	CF12344684	CRISTIANOPOLIS	14/04/2020 06:45	14/04/2020 08:05	14/04/2020 06:45	14/04/2020 08:05	1,33	21	27,84	CHI
20200442962	BELA VISTA DE GOIAS	00440414	CRISTIANOPOLIS	14/04/2020 06:47	14/04/2020 09:45	14/04/2020 06:47	14/04/2020 08:43	1,92	1	1,92	CHI
20200442962	BELA VISTA DE GOIAS	05240414	CRISTIANOPOLIS	14/04/2020 06:47	14/04/2020 09:45	14/04/2020 06:47	14/04/2020 08:43	1,92	84	161,63	CHI
20200442962	CRISTIANOPOLIS	05240414	CRISTIANOPOLIS	14/04/2020 06:47	14/04/2020 09:45	14/04/2020 06:47	14/04/2020 08:43	1,92	22	42,33	CHI
20200442962	SAO MIGUEL DO ARAGUAIA	05240414	CRISTIANOPOLIS	14/04/2020 06:47	14/04/2020 09:45	14/04/2020 06:47	14/04/2020 08:43	1,92	0	0,00	CHI
20200442962	SAO MIGUEL DO PASSA QUATRO	05240414	CRISTIANOPOLIS	14/04/2020 06:47	14/04/2020 09:45	14/04/2020 06:47	14/04/2020 08:43	1,92	279	536,84	CHI
20200442962	SAO MIGUEL DO PASSA QUATRO	05240414	CRISTIANOPOLIS	14/04/2020 06:47	14/04/2020 09:45	14/04/2020 06:47	14/04/2020 08:43	1,92	1610	3097,91	CHI
20200442962	VIANOPOLIS	05240414	CRISTIANOPOLIS	14/04/2020 06:47	14/04/2020 09:45	14/04/2020 06:47	14/04/2020 08:43	1,92	3	5,77	CHI
20200442962	VIANOPOLIS	05240414	CRISTIANOPOLIS	14/04/2020 06:47	14/04/2020 09:45	14/04/2020 06:47	14/04/2020 08:43	1,92	38	73,12	CHI
20200442962	SAO MIGUEL DO PASSA QUATRO	SQ16413294	CRISTIANOPOLIS	14/04/2020 06:47	14/04/2020 09:45	14/04/2020 08:52	14/04/2020 08:55	0,05	314	17,01	CHI
20200442962	BELA VISTA DE GOIAS	05240214	CRISTIANOPOLIS	14/04/2020 06:47	14/04/2020 09:45	14/04/2020 08:56	14/04/2020 09:45	0,83	84	69,98	CHI
20200442962	CRISTIANOPOLIS	05240214	CRISTIANOPOLIS	14/04/2020 06:47	14/04/2020 09:45	14/04/2020 08:56	14/04/2020 09:45	0,83	22	18,33	CHI
20200442962	SAO MIGUEL DO PASSA QUATRO	05240214	CRISTIANOPOLIS	14/04/2020 06:47	14/04/2020 09:45	14/04/2020 08:56	14/04/2020 09:45	0,83	279	232,42	CHI
20200442962	VIANOPOLIS	05240214	CRISTIANOPOLIS	14/04/2020 06:47	14/04/2020 09:45	14/04/2020 08:56	14/04/2020 09:45	0,83	3	2,50	CHI
20200442899	NOVO BRASIL	NB12378883	JUSSARA	14/04/2020 06:49	14/04/2020 12:32	14/04/2020 06:49	14/04/2020 12:32	5,71	5	28,55	CHI
20200442902	MINEIROS	MY12362701	PARQUE DAS EMAS	14/04/2020 06:49	14/04/2020 13:26	14/04/2020 06:49	14/04/2020 13:26	6,61	4	26,43	CHI
20200442924	RIO VERDE	10020574264	RIO VERDE S1	14/04/2020 06:56	14/04/2020 09:20	14/04/2020 06:56	14/04/2020 09:20	2,38	1	2,38	CHI
20200442928	SANTA CRUZ DE GOIAS	BC21080767	CRISTIANOPOLIS	14/04/2020 06:57	14/04/2020 10:32	14/04/2020 06:57	14/04/2020 10:32	3,58	1	3,58	CHI
20200442810	IPAMERI	IP16407459	IPAMERI	14/04/2020 06:58	14/04/2020 08:22	14/04/2020 06:58	14/04/2020 08:22	1,40	579	807,87	CHI
20200442942	CALDAS NOVAS	CN12409029	CALDAS NOVAS S1	14/04/2020 07:01	14/04/2020 08:47	14/04/2020 07:01	14/04/2020 08:47	1,75	7	12,25	CHI
20200442949	CAIAPONIA	930010565	CAIAPONIA	14/04/2020 07:02	14/04/2020 10:29	14/04/2020 07:02	14/04/2020 10:29	3,44	1	3,44	CHI
20200442951	APORE	AE10352438	ITAJA S1	14/04/2020 07:03	14/04/2020 12:11	14/04/2020 07:03	14/04/2020 10:32	3,48	39	135,63	CHI
20200442951	APORE	AE10352438	ITAJA S1	14/04/2020 07:03	14/04/2020 12:11	14/04/2020 07:03	14/04/2020 10:32	3,48	49	170,41	CHI
20200442951	APORE	AE10352438	ITAJA S1	14/04/2020 07:03	14/04/2020 12:11	14/04/2020 07:03	14/04/2020 10:32	3,48	5	17,39	CHI
20200442951	SERRANOPOLIS	AE10352438	ITAJA S1	14/04/2020 07:03	14/04/2020 12:11	14/04/2020 07:03	14/04/2020 10:32	3,48	43	149,54	CHI
20200442951	APORE	AE10352438	ITAJA S2	14/04/2020 07:03	14/04/2020 12:11	14/04/2020 07:03	14/04/2020 10:32	3,48	104	361,69	CHI
20200442951	DISTRITO FEDERAL	AE10352438	ITAJA S2	14/04/2020 07:03	14/04/2020 12:11	14/04/2020 07:03	14/04/2020 10:32	3,48	3	10,43	CHI
20200442951	APORE	AE10352438	ITAJA S1	14/04/2020 07:03	14/04/2020 12:11	14/04/2020 10:40	14/04/2020 12:11	1,52	94	142,57	CHI
20200442951	APORE	AE10352438	ITAJA S1	14/04/2020 07:03	14/04/2020 12:11	14/04/2020 10:40	14/04/2020 12:11	1,52	56	84,93	CHI

20200442951	APORE	AE10352438	ITAJA S1	14/04/2020 07:03	14/04/2020 12:11	14/04/2020 10:40	14/04/2020 12:11	1,52	7	10,62	CHI
20200442951	SERRANOPOLIS	AE10352438	ITAJA S1	14/04/2020 07:03	14/04/2020 12:11	14/04/2020 10:40	14/04/2020 12:11	1,52	46	69,77	CHI
20200442951	APORE	AE10352438	ITAJA S2	14/04/2020 07:03	14/04/2020 12:11	14/04/2020 10:40	14/04/2020 12:11	1,52	114	172,90	CHI
20200442951	DISTRITO FEDERAL	AE10352438	ITAJA S2	14/04/2020 07:03	14/04/2020 12:11	14/04/2020 10:40	14/04/2020 12:11	1,52	3	4,55	CHI
20200442975	ARAGUAPAZ	AZ12404546	MOZARLANDIA	14/04/2020 07:08	14/04/2020 09:13	14/04/2020 07:08	14/04/2020 09:13	2,08	7	14,56	CHI
20200442976	BURITI DE GOIAS	BS12099754	FIRMINOPOLIS S2	14/04/2020 07:08	14/04/2020 11:24	14/04/2020 07:08	14/04/2020 11:24	4,26	14	59,68	CHI
20200442979	BALIZA	BH12243875	CAIAPONIA	14/04/2020 07:09	14/04/2020 11:20	14/04/2020 07:09	14/04/2020 11:20	4,18	3	12,54	CHI
20200442991	JANDAIA	JD21147526	PALMEIRAS	14/04/2020 07:11	14/04/2020 10:10	14/04/2020 07:11	14/04/2020 10:10	2,98	1	2,98	CHI
20200442992	ADELANDIA	DN12304596	FIRMINOPOLIS S2	14/04/2020 07:11	14/04/2020 17:50	14/04/2020 07:11	14/04/2020 17:50	10,66	10	106,58	CHI
20200443366	AMERICANO DO BRASIL	KB12107298	ANICUNS	14/04/2020 07:13	14/04/2020 11:19	14/04/2020 07:13	14/04/2020 11:19	4,10	5	20,49	CHI
20200443011	ORIZONA	OZ21062410	PIRES DO RIO S2	14/04/2020 07:14	14/04/2020 08:42	14/04/2020 07:14	14/04/2020 08:42	1,46	1	1,46	CHI
20200443012	MORRINHOS	MR12075101	MORRINHOS	14/04/2020 07:14	14/04/2020 08:16	14/04/2020 07:14	14/04/2020 08:16	1,02	43	44,05	CHI
20200443015	GOIANDIRA	CT21166871	CATALAO S1	14/04/2020 07:14	14/04/2020 08:25	14/04/2020 07:14	14/04/2020 08:25	1,17	1	1,17	CHI
20200443038	ORIZONA	OZ12114508	PIRES DO RIO S2	14/04/2020 07:19	14/04/2020 09:05	14/04/2020 07:19	14/04/2020 09:05	1,76	12	21,09	CHI
20200443039	VIANOPOLIS	VN12159849	PIRES DO RIO S2	14/04/2020 07:19	14/04/2020 14:54	14/04/2020 07:19	14/04/2020 14:54	7,57	8	60,59	CHI
20200449233	VIANOPOLIS	VN21159799	PIRES DO RIO S2	14/04/2020 07:19	15/04/2020 02:42	14/04/2020 07:19	15/04/2020 02:42	19,37	1	19,37	CHI
20200443064	PIRACANJUBA	PJ21000150	PIRACANJUBA	14/04/2020 07:23	14/04/2020 08:34	14/04/2020 07:23	14/04/2020 08:34	1,17	1	1,17	CHI
20200443077	SERRANOPOLIS	SX12205266	JATAI S1	14/04/2020 07:26	14/04/2020 11:09	14/04/2020 07:26	14/04/2020 11:09	3,70	7	25,93	CHI
20200443104	BURITINOPOLIS	O2610424	SANTA RITA DO ARAGUAIA	14/04/2020 07:27	14/04/2020 15:53	14/04/2020 07:27	14/04/2020 09:50	2,38	1	2,38	CHI
20200443104	MINEIROS	O2610424	SANTA RITA DO ARAGUAIA	14/04/2020 07:27	14/04/2020 15:53	14/04/2020 07:27	14/04/2020 09:50	2,38	11	26,13	CHI
20200443104	SANTA RITA DO ARAGUAIA	O2610424	SANTA RITA DO ARAGUAIA	14/04/2020 07:27	14/04/2020 15:53	14/04/2020 07:27	14/04/2020 09:50	2,38	1171	2781,78	CHI
20200443104	MINEIROS	O2610424	SANTA RITA DO ARAGUAIA	14/04/2020 07:27	14/04/2020 15:53	14/04/2020 07:27	14/04/2020 09:52	2,41	33	79,49	CHI
20200443104	SANTA RITA DO ARAGUAIA	O2610424	SANTA RITA DO ARAGUAIA	14/04/2020 07:27	14/04/2020 15:53	14/04/2020 07:27	14/04/2020 09:52	2,41	2003	4825,00	CHI
20200443104	MINEIROS	O2610424	PARQUE DAS EMAS	14/04/2020 07:27	14/04/2020 15:53	14/04/2020 07:27	14/04/2020 09:53	2,43	13	31,58	CHI
20200443104	PORTELANDIA	O2610424	PARQUE DAS EMAS	14/04/2020 07:27	14/04/2020 15:53	14/04/2020 07:27	14/04/2020 09:53	2,43	1	2,43	CHI
20200443104	MINEIROS	O2610424	PARQUE DAS EMAS	14/04/2020 07:27	14/04/2020 15:53	14/04/2020 07:27	14/04/2020 11:05	3,63	2	7,26	CHI
20200443104	PORTELANDIA	O2610424	PARQUE DAS EMAS	14/04/2020 07:27	14/04/2020 15:53	14/04/2020 07:27	14/04/2020 11:05	3,63	5	18,15	CHI
20200443104	MINEIROS	O2610424	PARQUE DAS EMAS	14/04/2020 07:27	14/04/2020 15:53	14/04/2020 07:27	14/04/2020 14:29	7,03	44	309,12	CHI
20200443104	MONTIVIDIU	O2610424	PARQUE DAS EMAS	14/04/2020 07:27	14/04/2020 15:53	14/04/2020 07:27	14/04/2020 14:29	7,03	1	7,03	CHI
20200443104	PORTELANDIA	O2610424	PARQUE DAS EMAS	14/04/2020 07:27	14/04/2020 15:53	14/04/2020 07:27	14/04/2020 14:29	7,03	6	42,15	CHI
20200443104	MINEIROS	O2610424	PARQUE DAS EMAS	14/04/2020 07:27	14/04/2020 15:53	14/04/2020 07:27	14/04/2020 15:44	8,28	5	41,40	CHI
20200443104	MINEIROS	O2610424	PARQUE DAS EMAS	14/04/2020 07:27	14/04/2020 15:53	14/04/2020 07:27	14/04/2020 15:53	8,43	5	42,14	CHI
20200443216	MAIRIPOTABA	MI12166303	PONTALINA	14/04/2020 07:27	14/04/2020 09:31	14/04/2020 07:27	14/04/2020 09:31	2,06	1	2,06	CHI

20200443216	PONTALINA	MI12166303	PONTALINA	14/04/2020 07:27	14/04/2020 09:31	14/04/2020 07:27	14/04/2020 09:31	2,06	3	6,18	CHI
20200443204	GOIAS	GS12222226	GOIAS	14/04/2020 07:31	14/04/2020 14:12	14/04/2020 07:31	14/04/2020 14:12	6,69	3	20,06	CHI
20200443219	CATALAO	CT12288394	CAMPO ALEGRE DE GOIAS	14/04/2020 07:34	14/04/2020 09:50	14/04/2020 07:34	14/04/2020 09:50	2,26	3	6,79	CHI
20200442789	PORTEIRAO	GT12052140	RIO DOS BOIS	14/04/2020 07:35	15/04/2020 13:31	14/04/2020 07:35	15/04/2020 13:31	29,93	4	119,73	CHI
20200443232	NOVA CRIXAS	NA12092868	MOZARLANDIA	14/04/2020 07:36	14/04/2020 14:07	14/04/2020 07:36	14/04/2020 14:07	6,51	4	26,04	CHI
20200443235	GOIATUBA	GT12044823	GOIATUBA S2	14/04/2020 07:36	14/04/2020 14:00	14/04/2020 07:36	14/04/2020 14:00	6,39	9	57,53	CHI
20200443235	MORRINHOS	GT12044823	GOIATUBA S2	14/04/2020 07:36	14/04/2020 14:00	14/04/2020 07:36	14/04/2020 14:00	6,39	7	44,74	CHI
20200443247	GOIAS	GS21183079	GOIAS	14/04/2020 07:38	14/04/2020 09:41	14/04/2020 07:38	14/04/2020 09:41	2,05	1	2,05	CHI
20200443250	FAZENDA NOVA	FN12119562	IPORA	14/04/2020 07:38	14/04/2020 13:55	14/04/2020 07:38	14/04/2020 13:55	6,27	11	69,00	CHI
20200443260	ITABERAI	IB21221128	ITABERAI S1	14/04/2020 07:39	14/04/2020 09:43	14/04/2020 07:39	14/04/2020 09:43	2,05	1	2,05	CHI
20200443263	TURVELANDIA	TD12025880	RIO DOS BOIS	14/04/2020 07:40	14/04/2020 11:04	14/04/2020 07:40	14/04/2020 11:04	3,40	3	10,19	CHI
20200443274	MONTES CLAROS DE GOIAS	1440013795	IPORA	14/04/2020 07:42	14/04/2020 10:23	14/04/2020 07:42	14/04/2020 10:23	2,68	1	2,68	CHI
20200449541	CACHOEIRA DOURADA	CD12000067LD	CACHOEIRA DOURADA	14/04/2020 07:44	15/04/2020 18:08	14/04/2020 13:37	15/04/2020 00:00	10,38	16	166,13	CHI
20200449541	CACHOEIRA DOURADA	CD13000008	CACHOEIRA DOURADA	14/04/2020 07:44	15/04/2020 18:08	14/04/2020 13:37	15/04/2020 00:30	10,88	31	337,38	CHI
20200449541	INACIOLANDIA	CD13000008	CACHOEIRA DOURADA	14/04/2020 07:44	15/04/2020 18:08	14/04/2020 13:37	15/04/2020 00:30	10,88	103	1120,98	CHI
20200449541	ITUMBIARA	CD13000008	CACHOEIRA DOURADA	14/04/2020 07:44	15/04/2020 18:08	14/04/2020 13:37	15/04/2020 00:30	10,88	13	141,48	CHI
20200449541	CACHOEIRA DOURADA	CD12000067LD	CACHOEIRA DOURADA	14/04/2020 07:44	15/04/2020 18:08	14/04/2020 13:37	15/04/2020 18:08	28,52	1	28,52	CHI
202004105700	INACIOLANDIA	2810012290	CACHOEIRA DOURADA	14/04/2020 07:44	14/04/2020 13:37	14/04/2020 07:44	14/04/2020 13:37	5,87	1	5,87	CHI
20200443292	ITABERAI	IB12300330	ITABERAI S2	14/04/2020 07:46	14/04/2020 13:05	14/04/2020 07:46	14/04/2020 13:05	5,30	14	74,26	CHI
20200443310	PARANAIGUARA	00270414	QUIRINOPOLIS	14/04/2020 07:51	14/04/2020 11:28	14/04/2020 10:45	14/04/2020 11:28	0,72	204	146,82	CHI
20200443310	QUIRINOPOLIS	00270414	QUIRINOPOLIS	14/04/2020 07:51	14/04/2020 11:28	14/04/2020 10:45	14/04/2020 11:28	0,72	108	77,73	CHI
20200443325	SANTA HELENA DE GOIAS	SH12301331	IPEGUARI	14/04/2020 07:53	14/04/2020 13:20	14/04/2020 07:53	14/04/2020 13:20	5,44	5	27,22	CHI
20200443336	PIRACANJUBA	PJ12040425	MORRINHOS	14/04/2020 07:55	14/04/2020 11:11	14/04/2020 07:55	14/04/2020 11:11	3,26	15	48,84	CHI
20200443375	ACREUNA	BZ12240318	ACREUNA	14/04/2020 07:55	14/04/2020 14:20	14/04/2020 07:55	14/04/2020 14:20	6,42	2	12,84	CHI
20200443375	RIO VERDE	BZ12240318	ACREUNA	14/04/2020 07:55	14/04/2020 14:20	14/04/2020 07:55	14/04/2020 14:20	6,42	1	6,42	CHI
20200443375	SANTO ANTONIO DA BARRA	BZ12240318	ACREUNA	14/04/2020 07:55	14/04/2020 14:20	14/04/2020 07:55	14/04/2020 14:20	6,42	21	134,83	CHI
20200443341	BOM JARDIM DE GOIAS	BM12333265	ARAGARCAS	14/04/2020 07:58	14/04/2020 10:21	14/04/2020 07:58	14/04/2020 10:21	2,38	4	9,53	CHI
20200443343	CAIAPONIA	DP10394739	JATAI S1	14/04/2020 07:58	14/04/2020 13:20	14/04/2020 07:58	14/04/2020 13:20	5,36	20	107,18	CHI
20200443343	JATAI	DP10394739	JATAI S1	14/04/2020 07:58	14/04/2020 13:20	14/04/2020 07:58	14/04/2020 13:20	5,36	228	1221,83	CHI
20200443343	PEROLANDIA	DP10394739	JATAI S1	14/04/2020 07:58	14/04/2020 13:20	14/04/2020 07:58	14/04/2020 13:20	5,36	11	58,95	CHI
20200443371	GOIATUBA	GT21134951	BOM JESUS DE GOIAS	14/04/2020 08:03	14/04/2020 11:48	14/04/2020 08:03	14/04/2020 11:48	3,74	1	3,74	CHI
20200443381	ORIZONA	OZ12114502	PIRES DO RIO S2	14/04/2020 08:04	14/04/2020 09:12	14/04/2020 08:04	14/04/2020 09:12	1,13	16	18,03	CHI
20200443382	MINEIROS	MY11359695	PARQUE DAS EMAS	14/04/2020 08:04	14/04/2020 21:25	14/04/2020 08:04	14/04/2020 21:25	13,34	29	386,93	CHI



20200443388	MORRINHOS	MR12380550	PONTALINA	14/04/2020 08:05	14/04/2020 09:30	14/04/2020 08:05	14/04/2020 09:30	1,42	1	1,42	CHI
20200443453	ARENOPOLIS	AY12188398	ARENOPOLIS	14/04/2020 08:05	14/04/2020 10:16	14/04/2020 08:05	14/04/2020 10:16	2,17	10	21,69	CHI
20200443453	DIORAMA	AY12188398	ARENOPOLIS	14/04/2020 08:05	14/04/2020 10:16	14/04/2020 08:05	14/04/2020 10:16	2,17	7	15,18	CHI
202004105670	MINEIROS	MY12390605	PARQUE DAS EMAS	14/04/2020 08:08	14/04/2020 11:44	14/04/2020 08:08	14/04/2020 11:44	3,59	11	39,46	CHI
20200443153	MINEIROS	MY10401436	PARQUE DAS EMAS	14/04/2020 08:10	14/04/2020 20:24	14/04/2020 08:10	14/04/2020 12:31	4,35	29	126,13	CHI
20200443153	MINEIROS	MY10401436	PARQUE DAS EMAS	14/04/2020 08:10	14/04/2020 20:24	14/04/2020 08:10	14/04/2020 19:19	11,15	2	22,29	CHI
20200443153	MINEIROS	MY10401436	PARQUE DAS EMAS	14/04/2020 08:10	14/04/2020 20:24	14/04/2020 08:10	14/04/2020 20:24	12,24	5	61,21	CHI
20200443423	RIO VERDE	RV11054045	RIO VERDE S1	14/04/2020 08:11	14/04/2020 13:13	14/04/2020 08:11	14/04/2020 13:13	5,03	95	477,80	CHI
20200443424	EDEALINA	ED12108424	PONTALINA	14/04/2020 08:11	14/04/2020 09:32	14/04/2020 08:11	14/04/2020 09:32	1,34	1	1,34	CHI
20200443437	EDEIA	EA21305963	RIO DOS BOIS	14/04/2020 08:13	14/04/2020 12:42	14/04/2020 08:13	14/04/2020 12:42	4,48	1	4,48	CHI
20200443445	PIRACANJUBA	PJ12249878	PIRACANJUBA	14/04/2020 08:14	14/04/2020 10:13	14/04/2020 08:14	14/04/2020 10:13	1,98	6	11,86	CHI
20200443579	CORUMBAIBA	CI12110154	VILA CORUMBA	14/04/2020 08:14	14/04/2020 16:06	14/04/2020 08:14	14/04/2020 16:06	7,86	67	526,34	CHI
20200443455	CALDAS NOVAS	CN21075124	RIO QUENTE	14/04/2020 08:16	14/04/2020 10:32	14/04/2020 08:16	14/04/2020 10:32	2,26	1	2,26	CHI
20200443460	BALIZA	BH21253651	BOM JARDIM	14/04/2020 08:16	14/04/2020 10:31	14/04/2020 08:16	14/04/2020 10:31	2,23	1	2,23	CHI
20200443475	ITABERAI	50028807	ITABERAI S2	14/04/2020 08:18	14/04/2020 09:59	14/04/2020 08:18	14/04/2020 09:59	1,67	1	1,67	CHI
20200443171	CACHOEIRA ALTA	01410234	CACHOEIRA ALTA	14/04/2020 08:20	14/04/2020 15:18	14/04/2020 08:20	14/04/2020 11:26	3,10	8	24,81	CHI
20200443171	PARANAIGUARA	01410234	CACHOEIRA ALTA	14/04/2020 08:20	14/04/2020 15:18	14/04/2020 08:20	14/04/2020 11:26	3,10	68	210,91	CHI
20200443171	SAO SIMAO	01410234	CACHOEIRA ALTA	14/04/2020 08:20	14/04/2020 15:18	14/04/2020 08:20	14/04/2020 11:26	3,10	11	34,12	CHI
20200443171	CACHOEIRA ALTA	01410234	CACHOEIRA ALTA	14/04/2020 08:20	14/04/2020 15:18	14/04/2020 08:20	14/04/2020 15:18	6,97	6	41,82	CHI
20200443171	CACU	01410234	CACHOEIRA ALTA	14/04/2020 08:20	14/04/2020 15:18	14/04/2020 08:20	14/04/2020 15:18	6,97	98	683,11	CHI
20200443171	PARANAIGUARA	01410234	CACHOEIRA ALTA	14/04/2020 08:20	14/04/2020 15:18	14/04/2020 08:20	14/04/2020 15:18	6,97	61	425,20	CHI
20200443171	SAO SIMAO	01410234	CACHOEIRA ALTA	14/04/2020 08:20	14/04/2020 15:18	14/04/2020 08:20	14/04/2020 15:18	6,97	625	4356,60	CHI
20200443499	MORRINHOS	MR21308022	MORRINHOS	14/04/2020 08:23	14/04/2020 09:08	14/04/2020 08:23	14/04/2020 09:08	0,75	1	0,75	CHI
20200443587	ITARUMA	IM12296697	CACHOEIRA ALTA	14/04/2020 08:25	14/04/2020 11:19	14/04/2020 08:25	14/04/2020 11:19	2,89	13	37,56	CHI
20200443529	CORUMBAIBA	CI12298710	VILA CORUMBA	14/04/2020 08:27	14/04/2020 10:00	14/04/2020 08:27	14/04/2020 10:00	1,54	14	21,59	CHI
20200443532	GOIAS	GS12188132	GOIAS	14/04/2020 08:27	14/04/2020 13:30	14/04/2020 08:27	14/04/2020 13:30	5,04	26	131,02	CHI
20200444212	FAZENDA NOVA	FN12119554	IPORA	14/04/2020 08:28	15/04/2020 09:01	14/04/2020 08:28	15/04/2020 09:01	24,54	3	73,63	CHI
20200443847	CATALAO	CT12316068	CATALAO S2	14/04/2020 08:29	14/04/2020 11:24	14/04/2020 08:29	14/04/2020 11:24	2,90	11	31,91	CHI
20200443847	CUMARI	CT12316068	CATALAO S2	14/04/2020 08:29	14/04/2020 11:24	14/04/2020 08:29	14/04/2020 11:24	2,90	1	2,90	CHI
20200443586	VICENTINOPOLIS	VI12047297	VICENTINOPOLIS	14/04/2020 08:31	14/04/2020 20:08	14/04/2020 08:31	14/04/2020 20:08	11,61	5	58,07	CHI
20200445160	CHAPADAO DO CEU	DJ12152817	CHAPADAO DO CEU	14/04/2020 08:31	14/04/2020 21:21	14/04/2020 08:31	14/04/2020 18:33	10,02	14	140,28	CHI
20200445160	CHAPADAO DO CEU	DJ12152817	CHAPADAO DO CEU	14/04/2020 08:31	14/04/2020 21:21	14/04/2020 08:31	14/04/2020 21:21	12,82	4	51,28	CHI
20200443563	FAINA	FC12272620	GOIAS	14/04/2020 08:33	14/04/2020 10:19	14/04/2020 08:33	14/04/2020 10:19	1,76	4	7,05	CHI

20200443806	JATAI	7801160	JATAI S1	14/04/2020 08:33	14/04/2020 14:15	14/04/2020 08:33	14/04/2020 13:05	4,52	6	27,13	CHI
20200443806	JATAI	7801160	JATAI S1	14/04/2020 08:33	14/04/2020 14:15	14/04/2020 08:33	14/04/2020 14:15	5,69	420	2389,22	CHI
20200443806	SERRANOPOLIS	7801160	JATAI S1	14/04/2020 08:33	14/04/2020 14:15	14/04/2020 08:33	14/04/2020 14:15	5,69	66	375,45	CHI
20200443572	GOIAS	GS12087533	ITABERAI S2	14/04/2020 08:34	14/04/2020 12:16	14/04/2020 08:34	14/04/2020 12:16	3,70	7	25,87	CHI
20200443578	QUIRINOPOLIS	QI11000018	QUIRINOPOLIS	14/04/2020 08:35	14/04/2020 10:30	14/04/2020 08:35	14/04/2020 10:30	1,92	119	228,05	CHI
20200443188	RIO VERDE	RV10400562	CABRIUVA S2	14/04/2020 08:36	15/04/2020 07:51	14/04/2020 08:36	14/04/2020 08:39	0,05	62	3,29	CHI
20200443188	RIO VERDE	RV10408114	CABRIUVA S2	14/04/2020 08:36	15/04/2020 07:51	14/04/2020 08:55	14/04/2020 11:47	2,86	62	177,39	CHI
20200443188	RIO VERDE	RV10400562	CABRIUVA S2	14/04/2020 08:36	15/04/2020 07:51	14/04/2020 08:36	14/04/2020 15:10	6,57	9	59,09	CHI
20200443188	RIO VERDE	RV10400562	CABRIUVA S2	14/04/2020 08:36	15/04/2020 07:51	14/04/2020 08:36	14/04/2020 15:41	7,08	39	276,08	CHI
20200443188	APARECIDA DO RIO DOCE	RV12402229LD	CABRIUVA S2	14/04/2020 08:36	15/04/2020 07:51	14/04/2020 08:36	15/04/2020 07:51	23,24	6	139,44	CHI
20200443188	RIO VERDE	RV12402229LD	CABRIUVA S2	14/04/2020 08:36	15/04/2020 07:51	14/04/2020 08:36	15/04/2020 07:51	23,24	7	162,68	CHI
20200443583	IPAMERI	IP21233844	IPAMERI	14/04/2020 08:36	14/04/2020 11:21	14/04/2020 08:36	14/04/2020 11:21	2,74	1	2,74	CHI
20200443585	CALDAS NOVAS	CN21110329	CALDAS NOVAS S1	14/04/2020 08:36	14/04/2020 10:25	14/04/2020 08:36	14/04/2020 10:25	1,80	1	1,80	CHI
20200443591	MORRINHOS	MR12352575	MORRINHOS	14/04/2020 08:37	14/04/2020 10:11	14/04/2020 08:37	14/04/2020 10:11	1,55	52	80,70	CHI
20200443601	MORRINHOS	MR21092109	MORRINHOS	14/04/2020 08:39	14/04/2020 09:55	14/04/2020 08:39	14/04/2020 09:55	1,26	2	2,52	CHI
20200443623	ACREUNA	IY12205934	EDEIA	14/04/2020 08:42	14/04/2020 11:07	14/04/2020 08:42	14/04/2020 11:07	2,40	6	14,40	CHI
20200443623	INDIARA	IY12205934	EDEIA	14/04/2020 08:42	14/04/2020 11:07	14/04/2020 08:42	14/04/2020 11:07	2,40	6	14,40	CHI
20200443636	FIRMINOPOLIS	FR11024014	FIRMINOPOLIS S1	14/04/2020 08:45	14/04/2020 13:45	14/04/2020 08:45	14/04/2020 13:45	5,00	120	600,00	CHI
20200443643	PALMEIRAS DE GOIAS	PL31167191	PALMEIRAS	14/04/2020 08:45	14/04/2020 11:08	14/04/2020 08:45	14/04/2020 11:08	2,37	1	2,37	CHI
20200443649	QUIRINOPOLIS	QI12207068	QUIRINOPOLIS	14/04/2020 08:46	14/04/2020 09:54	14/04/2020 08:46	14/04/2020 09:54	1,12	2	2,24	CHI
20200443662	MONTIVIDIU	MV12241233	MONTIVIDIU T	14/04/2020 08:48	14/04/2020 11:59	14/04/2020 08:48	14/04/2020 11:59	3,17	4	12,67	CHI
20200443199	QUIRINOPOLIS	QI10400627	QUIRINOPOLIS	14/04/2020 08:51	14/04/2020 17:40	14/04/2020 08:51	14/04/2020 12:06	3,24	63	203,93	CHI
20200443199	QUIRINOPOLIS	QI10400627	QUIRINOPOLIS	14/04/2020 08:51	14/04/2020 17:40	14/04/2020 08:51	14/04/2020 15:43	6,87	4	27,46	CHI
20200443199	QUIRINOPOLIS	QI12133409LD	QUIRINOPOLIS	14/04/2020 08:51	14/04/2020 17:40	14/04/2020 08:51	14/04/2020 16:44	7,88	10	78,83	CHI
20200443199	QUIRINOPOLIS	RV32073779	QUIRINOPOLIS	14/04/2020 08:51	14/04/2020 17:40	14/04/2020 08:51	14/04/2020 17:40	8,81	1	8,81	CHI
20200443199	RIO VERDE	RV32073779	QUIRINOPOLIS	14/04/2020 08:51	14/04/2020 17:40	14/04/2020 08:51	14/04/2020 17:40	8,81	43	378,84	CHI
20200443673	APARECIDA DO RIO DOCE	AW11000003	CACHOEIRA ALTA	14/04/2020 08:51	14/04/2020 23:12	14/04/2020 08:51	14/04/2020 23:12	14,34	110	1577,92	CHI
20200443678	MINEIROS	MY12209668	PARQUE DAS EMAS	14/04/2020 08:52	14/04/2020 13:12	14/04/2020 08:52	14/04/2020 13:12	4,32	90	389,03	CHI
20200443692	RIO VERDE	RV12205429	MONTIVIDIU T	14/04/2020 08:54	15/04/2020 09:12	14/04/2020 08:54	14/04/2020 16:30	7,59	19	144,17	CHI
20200443692	RIO VERDE	RV12205429	MONTIVIDIU T	14/04/2020 08:54	15/04/2020 09:12	14/04/2020 08:54	15/04/2020 09:12	24,29	22	534,32	CHI
20200443699	ITABERAI	IB21220143	ITABERAI S2	14/04/2020 08:56	14/04/2020 10:16	14/04/2020 08:56	14/04/2020 10:16	1,32	1	1,32	CHI
20200443817	JATAI	JT21213516	JATAI S1	14/04/2020 08:59	14/04/2020 14:30	14/04/2020 08:59	14/04/2020 14:30	5,50	1	5,50	CHI
20200443857	JATAI	JT12182074	JATAI S1	14/04/2020 09:04	14/04/2020 13:42	14/04/2020 09:04	14/04/2020 13:42	4,62	8	36,94	CHI

20200443858	PARAUNA	10010736032	PARAUNA	14/04/2020 09:05	14/04/2020 11:14	14/04/2020 09:05	14/04/2020 11:14	2,15	1	2,15	CHI
20200443870	CRISTIANOPOLIS	CF21300736	CRISTIANOPOLIS	14/04/2020 09:07	14/04/2020 11:15	14/04/2020 09:07	14/04/2020 11:15	2,13	1	2,13	CHI
20200443740	RIO VERDE	RV13190628	CABRIUVA S2	14/04/2020 09:08	14/04/2020 14:56	14/04/2020 09:10	14/04/2020 11:15	2,07	52	107,52	CHI
20200443740	JATAI	02450424	CABRIUVA S2	14/04/2020 09:08	14/04/2020 14:56	14/04/2020 09:10	14/04/2020 13:41	4,50	14	63,05	CHI
20200443740	RIO VERDE	02450424	CABRIUVA S2	14/04/2020 09:08	14/04/2020 14:56	14/04/2020 09:10	14/04/2020 13:41	4,50	43	193,66	CHI
20200443740	JATAI	RV10402217	CABRIUVA S2	14/04/2020 09:08	14/04/2020 14:56	14/04/2020 09:10	14/04/2020 13:41	4,51	12	54,11	CHI
20200443740	RIO VERDE	RV10402217	CABRIUVA S2	14/04/2020 09:08	14/04/2020 14:56	14/04/2020 09:10	14/04/2020 13:41	4,51	46	207,43	CHI
20200443740	RIO VERDE	02450424	CABRIUVA S2	14/04/2020 09:08	14/04/2020 14:56	14/04/2020 09:10	14/04/2020 14:56	5,76	7	40,32	CHI
20200443892	PARANAIGUARA	PC12249183	QUIRINOPOLIS	14/04/2020 09:11	14/04/2020 21:56	14/04/2020 09:11	14/04/2020 21:56	12,75	3	38,24	CHI
20200443902	MINEIROS	MY12193782	PARQUE DAS EMAS	14/04/2020 09:13	14/04/2020 20:47	14/04/2020 09:13	14/04/2020 20:47	11,56	5	57,79	CHI
20200443915	CACHOEIRA ALTA	QI12279622	QUIRINOPOLIS	14/04/2020 09:13	14/04/2020 12:20	14/04/2020 09:13	14/04/2020 12:20	3,11	14	43,52	CHI
20200444304	MINEIROS	MY12274100	PARQUE DAS EMAS	14/04/2020 09:14	15/04/2020 17:37	14/04/2020 09:14	14/04/2020 23:21	14,12	8	112,93	CHI
20200444304	MINEIROS	MY12350926LD	PARQUE DAS EMAS	14/04/2020 09:14	15/04/2020 17:37	14/04/2020 09:14	15/04/2020 00:00	14,77	7	103,38	CHI
20200444304	MINEIROS	MY12274100	PARQUE DAS EMAS	14/04/2020 09:14	15/04/2020 17:37	14/04/2020 09:14	15/04/2020 17:37	32,39	1	32,39	CHI
20200443916	RIO VERDE	RV12030734	CABRIUVA S1	14/04/2020 09:16	14/04/2020 14:45	14/04/2020 09:16	14/04/2020 14:45	5,48	12	65,75	CHI
20200444008	RIO VERDE	01600244	RIO VERDE S2	14/04/2020 09:16	14/04/2020 13:15	14/04/2020 09:18	14/04/2020 09:23	0,08	315	24,59	CHI
20200444008	RIO VERDE	RV16407145	RIO VERDE S2	14/04/2020 09:16	14/04/2020 13:15	14/04/2020 09:18	14/04/2020 09:25	0,11	47	5,35	CHI
20200444008	RIO VERDE	RV16406924	RIO VERDE S2	14/04/2020 09:16	14/04/2020 13:15	14/04/2020 09:18	14/04/2020 09:29	0,18	124	21,91	CHI
20200444008	RIO VERDE	RV10408206	RIO VERDE S2	14/04/2020 09:16	14/04/2020 13:15	14/04/2020 09:18	14/04/2020 09:34	0,26	520	136,79	CHI
20200444008	SANTA HELENA DE GOIAS	RV10408206	RIO VERDE S2	14/04/2020 09:16	14/04/2020 13:15	14/04/2020 09:18	14/04/2020 09:34	0,26	70	18,41	CHI
20200444008	RIO VERDE	RV16407145	RIO VERDE S2	14/04/2020 09:16	14/04/2020 13:15	14/04/2020 10:09	14/04/2020 13:15	3,10	644	1998,37	CHI
20200444008	SANTA HELENA DE GOIAS	RV16407145	RIO VERDE S2	14/04/2020 09:16	14/04/2020 13:15	14/04/2020 10:09	14/04/2020 13:15	3,10	70	217,21	CHI
20200444675	RIO VERDE	RV12106375	CABRIUVA S2	14/04/2020 09:17	14/04/2020 17:57	14/04/2020 09:17	14/04/2020 17:57	8,66	16	138,54	CHI
20200443932	MINEIROS	MY12244170	PARQUE DAS EMAS	14/04/2020 09:20	14/04/2020 18:10	14/04/2020 09:20	14/04/2020 18:10	8,82	5	44,11	CHI
20200443976	CRISTIANOPOLIS	CF12337210	CRISTIANOPOLIS	14/04/2020 09:20	14/04/2020 10:38	14/04/2020 09:20	14/04/2020 10:38	1,29	5	6,45	CHI
20200443976	SANTA CRUZ DE GOIAS	CF12337210	CRISTIANOPOLIS	14/04/2020 09:20	14/04/2020 10:38	14/04/2020 09:20	14/04/2020 10:38	1,29	1	1,29	CHI
20200444391	RIO VERDE	RV16402247	CABRIUVA S1	14/04/2020 09:21	14/04/2020 14:03	14/04/2020 09:21	14/04/2020 14:03	4,70	1422	6682,22	CHI
20200443946	MINEIROS	MY21324501	PARQUE DAS EMAS	14/04/2020 09:22	14/04/2020 11:51	14/04/2020 09:22	14/04/2020 11:51	2,48	1	2,48	CHI
20200443947	SAO LUIS DE MONTES BELOS	SL12259164	FIRMINOPOLIS S2	14/04/2020 09:22	15/04/2020 08:15	14/04/2020 09:22	15/04/2020 08:15	22,88	1	22,88	CHI
20200443950	MONTES CLAROS DE GOIAS	ME12050933	IPORA	14/04/2020 09:22	15/04/2020 19:15	14/04/2020 09:22	15/04/2020 19:15	33,88	7	237,15	CHI
20200444331	RIO VERDE	RV11226318	RIO VERDE S1	14/04/2020 09:23	14/04/2020 18:52	14/04/2020 09:23	14/04/2020 18:52	9,48	175	1659,24	CHI
20200444003	RIO VERDE	630430391	RIO VERDE S2	14/04/2020 09:24	14/04/2020 13:44	14/04/2020 09:24	14/04/2020 13:44	4,34	1	4,34	CHI
20200450658	MINEIROS	MY11150298	PARQUE DAS EMAS	14/04/2020 09:25	15/04/2020 00:54	14/04/2020 09:25	15/04/2020 00:54	15,48	257	3978,22	CHI

20200443969	JATAI	JT12244770	JATAI S1	14/04/2020 09:27	14/04/2020 14:14	14/04/2020 09:27	14/04/2020 14:14	4,77	12	57,24	CHI
20200443971	CACHOEIRA ALTA	CA12078930	CACHOEIRA ALTA	14/04/2020 09:27	15/04/2020 12:50	14/04/2020 09:27	15/04/2020 12:50	27,38	4	109,50	CHI
20200444228	CACHOEIRA ALTA	CA12338666	CACHOEIRA ALTA	14/04/2020 09:27	14/04/2020 12:39	14/04/2020 09:27	14/04/2020 12:39	3,20	14	44,79	CHI
20200444006	RIO VERDE	RV11000028	RIO VERDE S2	14/04/2020 09:29	14/04/2020 11:41	14/04/2020 09:29	14/04/2020 11:41	2,19	142	310,98	CHI
20200444014	RIO VERDE	RV11092199	RIO VERDE S1	14/04/2020 09:32	14/04/2020 15:05	14/04/2020 09:32	14/04/2020 15:05	5,54	28	155,10	CHI
20200444015	ANICUNS	TV12304696	FIRMINOPOLIS S2	14/04/2020 09:32	14/04/2020 11:40	14/04/2020 09:32	14/04/2020 11:40	2,12	3	6,36	CHI
20200444015	TURVANIA	TV12304696	FIRMINOPOLIS S2	14/04/2020 09:32	14/04/2020 11:40	14/04/2020 09:32	14/04/2020 11:40	2,12	14	29,66	CHI
20200444033	AMERICANO DO BRASIL	AC12308555	ANICUNS	14/04/2020 09:34	14/04/2020 13:48	14/04/2020 09:34	14/04/2020 13:48	4,22	18	75,95	CHI
20200444033	ANICUNS	AC12308555	ANICUNS	14/04/2020 09:34	14/04/2020 13:48	14/04/2020 09:34	14/04/2020 13:48	4,22	4	16,88	CHI
20200444033	MOSSAMEDES	AC12308555	ANICUNS	14/04/2020 09:34	14/04/2020 13:48	14/04/2020 09:34	14/04/2020 13:48	4,22	18	75,95	CHI
20200444335	APARECIDA DO RIO DOCE	04070214	JATAI S1	14/04/2020 09:34	14/04/2020 14:15	14/04/2020 14:08	14/04/2020 14:15	0,12	68	7,93	CHI
20200444335	JATAI	04070214	JATAI S1	14/04/2020 09:34	14/04/2020 14:15	14/04/2020 14:08	14/04/2020 14:15	0,12	296	34,53	CHI
20200444335	JATAI	04070406	JATAI S1	14/04/2020 09:34	14/04/2020 14:15	14/04/2020 09:34	14/04/2020 14:15	4,67	82	382,94	CHI
20200444168	MONTIVIDIU	MV10398076	MONTIVIDIU T	14/04/2020 09:36	15/04/2020 08:15	14/04/2020 09:36	14/04/2020 09:40	0,06	29	1,77	CHI
20200444168	RIO VERDE	MV10398076	MONTIVIDIU T	14/04/2020 09:36	15/04/2020 08:15	14/04/2020 09:36	14/04/2020 09:40	0,06	28	1,71	CHI
20200444168	RIO VERDE	MV10398076	MONTIVIDIU T	14/04/2020 09:36	15/04/2020 08:15	14/04/2020 09:36	14/04/2020 09:40	0,06	88	5,38	CHI
20200444168	RIO VERDE	MV10398076	MONTIVIDIU T	14/04/2020 09:36	15/04/2020 08:15	14/04/2020 09:36	14/04/2020 09:40	0,06	41	2,51	CHI
20200444168	MONTIVIDIU	RV10401437	MONTIVIDIU T	14/04/2020 09:36	15/04/2020 08:15	14/04/2020 09:37	14/04/2020 09:40	0,06	1	0,06	CHI
20200444168	RIO VERDE	MV10398076	MONTIVIDIU T	14/04/2020 09:36	15/04/2020 08:15	14/04/2020 09:37	14/04/2020 09:40	0,06	6	0,34	CHI
20200444168	MONTIVIDIU	MV10398076	MONTIVIDIU T	14/04/2020 09:36	15/04/2020 08:15	14/04/2020 09:41	14/04/2020 14:51	5,16	18	92,95	CHI
20200444168	RIO VERDE	RV10401437	MONTIVIDIU T	14/04/2020 09:36	15/04/2020 08:15	14/04/2020 09:41	14/04/2020 17:52	8,18	28	229,16	CHI
20200444168	RIO VERDE	RV10401437	MONTIVIDIU T	14/04/2020 09:36	15/04/2020 08:15	14/04/2020 09:41	14/04/2020 17:52	8,18	94	769,34	CHI
20200444168	RIO VERDE	RV10401437	MONTIVIDIU T	14/04/2020 09:36	15/04/2020 08:15	14/04/2020 09:41	14/04/2020 17:52	8,18	5	40,92	CHI
20200444168	RIO VERDE	RV13322229	MONTIVIDIU T	14/04/2020 09:36	15/04/2020 08:15	14/04/2020 09:41	14/04/2020 18:53	9,19	6	55,14	CHI
20200444168	MONTIVIDIU	MV13213455	MONTIVIDIU T	14/04/2020 09:36	15/04/2020 08:15	14/04/2020 09:41	14/04/2020 23:21	13,66	1	13,66	CHI
20200444168	RIO VERDE	MV13213455	MONTIVIDIU T	14/04/2020 09:36	15/04/2020 08:15	14/04/2020 09:41	14/04/2020 23:21	13,66	26	355,17	CHI
20200444168	MONTIVIDIU	MV12054362	MONTIVIDIU T	14/04/2020 09:36	15/04/2020 08:15	14/04/2020 09:41	14/04/2020 23:55	14,22	6	85,34	CHI
20200444168	MONTIVIDIU	MV12267717	MONTIVIDIU T	14/04/2020 09:36	15/04/2020 08:15	14/04/2020 09:41	15/04/2020 07:31	21,83	3	65,48	CHI
20200444168	RIO VERDE	MV12267717	MONTIVIDIU T	14/04/2020 09:36	15/04/2020 08:15	14/04/2020 09:41	15/04/2020 07:31	21,83	2	43,65	CHI
20200444168	MONTIVIDIU	MV12260796	MONTIVIDIU T	14/04/2020 09:36	15/04/2020 08:15	14/04/2020 09:41	15/04/2020 08:15	22,57	2	45,13	CHI
20200444168	RIO VERDE	MV12260796	MONTIVIDIU T	14/04/2020 09:36	15/04/2020 08:15	14/04/2020 09:41	15/04/2020 08:15	22,57	2	45,13	CHI
20200444076	RIO VERDE	RV21230932	RIO VERDE S1	14/04/2020 09:41	14/04/2020 21:12	14/04/2020 09:41	14/04/2020 21:12	11,51	1	11,51	CHI
20200444077	RIO VERDE	RV12279565	CABRIUVA S1	14/04/2020 09:41	15/04/2020 20:35	14/04/2020 09:41	14/04/2020 22:40	12,98	11	142,73	CHI

20200444077	JATAI	RV12279565	CABRIUVA S1	14/04/2020 09:41	15/04/2020 20:35	14/04/2020 09:41	15/04/2020 20:35	34,89	1	34,89	CHI
20200444077	RIO VERDE	RV12279565	CABRIUVA S1	14/04/2020 09:41	15/04/2020 20:35	14/04/2020 09:41	15/04/2020 20:35	34,89	21	732,67	CHI
20200444079	SANTA HELENA DE GOIAS	01660434	SANTA HELENA S1	14/04/2020 09:41	14/04/2020 14:09	14/04/2020 09:41	14/04/2020 12:19	2,64	14	36,91	CHI
20200444079	MAURILANDIA	SH13189248	SANTA HELENA S1	14/04/2020 09:41	14/04/2020 14:09	14/04/2020 09:41	14/04/2020 12:39	2,98	4	11,92	CHI
20200444079	SANTA HELENA DE GOIAS	SH13189248	SANTA HELENA S1	14/04/2020 09:41	14/04/2020 14:09	14/04/2020 09:41	14/04/2020 12:39	2,98	2	5,96	CHI
20200444079	TURVELANDIA	SH13189248	SANTA HELENA S1	14/04/2020 09:41	14/04/2020 14:09	14/04/2020 09:41	14/04/2020 12:39	2,98	5	14,90	CHI
20200444079	MAURILANDIA	01660434	SANTA HELENA S1	14/04/2020 09:41	14/04/2020 14:09	14/04/2020 09:41	14/04/2020 14:09	4,48	28	125,40	CHI
20200444079	MAURILANDIA	01660434	SANTA HELENA S1	14/04/2020 09:41	14/04/2020 14:09	14/04/2020 09:41	14/04/2020 14:09	4,48	6	26,87	CHI
20200444079	QUIRINOPOLIS	01660434	SANTA HELENA S1	14/04/2020 09:41	14/04/2020 14:09	14/04/2020 09:41	14/04/2020 14:09	4,48	43	192,58	CHI
20200444079	QUIRINOPOLIS	01660434	SANTA HELENA S1	14/04/2020 09:41	14/04/2020 14:09	14/04/2020 09:41	14/04/2020 14:09	4,48	10	44,79	CHI
20200444079	RIO VERDE	01660434	SANTA HELENA S1	14/04/2020 09:41	14/04/2020 14:09	14/04/2020 09:41	14/04/2020 14:09	4,48	625	2799,13	CHI
20200444079	RIO VERDE	01660434	SANTA HELENA S1	14/04/2020 09:41	14/04/2020 14:09	14/04/2020 09:41	14/04/2020 14:09	4,48	382	1710,83	CHI
20200444079	RIO VERDE	01660434	SANTA HELENA S1	14/04/2020 09:41	14/04/2020 14:09	14/04/2020 09:41	14/04/2020 14:09	4,48	655	2933,49	CHI
20200444079	RIO VERDE	01660434	SANTA HELENA S1	14/04/2020 09:41	14/04/2020 14:09	14/04/2020 09:41	14/04/2020 14:09	4,48	26	116,44	CHI
20200444079	RIO VERDE	SH13240306	SANTA HELENA S1	14/04/2020 09:41	14/04/2020 14:09	14/04/2020 09:41	14/04/2020 14:09	4,48	1	4,48	CHI
20200444079	SANTA HELENA DE GOIAS	01660434	SANTA HELENA S1	14/04/2020 09:41	14/04/2020 14:09	14/04/2020 09:41	14/04/2020 14:09	4,48	53	237,37	CHI
20200444079	SANTA HELENA DE GOIAS	01660434	SANTA HELENA S1	14/04/2020 09:41	14/04/2020 14:09	14/04/2020 09:41	14/04/2020 14:09	4,48	1	4,48	CHI
20200444079	SANTA HELENA DE GOIAS	SH13240306	SANTA HELENA S1	14/04/2020 09:41	14/04/2020 14:09	14/04/2020 09:41	14/04/2020 14:09	4,48	2	8,96	CHI
20200444286	RIO VERDE	RV12214126	RIO VERDE S1	14/04/2020 09:42	16/04/2020 01:39	14/04/2020 09:42	15/04/2020 07:39	21,94	42	921,43	CHI
20200444286	SANTA HELENA DE GOIAS	RV12214126	RIO VERDE S1	14/04/2020 09:42	16/04/2020 01:39	14/04/2020 09:42	15/04/2020 07:39	21,94	25	548,47	CHI
20200444286	RIO VERDE	RV12214126	RIO VERDE S1	14/04/2020 09:42	16/04/2020 01:39	14/04/2020 09:42	16/04/2020 01:39	39,95	29	1158,65	CHI
20200444286	SANTA HELENA DE GOIAS	RV12214126	RIO VERDE S1	14/04/2020 09:42	16/04/2020 01:39	14/04/2020 09:42	16/04/2020 01:39	39,95	20	799,07	CHI
20200444286	RIO VERDE	RV12214126	RIO VERDE S1	14/04/2020 09:42	16/04/2020 01:39	15/04/2020 09:09	16/04/2020 01:39	16,51	41	677,07	CHI
20200444286	SANTA HELENA DE GOIAS	RV12214126	RIO VERDE S1	14/04/2020 09:42	16/04/2020 01:39	15/04/2020 09:09	16/04/2020 01:39	16,51	25	412,85	CHI
20200444697	QUIRINOPOLIS	QI12271537	QUIRINOPOLIS	14/04/2020 09:42	14/04/2020 12:20	14/04/2020 09:42	14/04/2020 12:20	2,62	93	243,76	CHI
20200444088	CUMARI	CT21267101	CATALAO S2	14/04/2020 09:43	14/04/2020 10:44	14/04/2020 09:43	14/04/2020 10:44	1,01	1	1,01	CHI
20200444202	MONTIVIDIU	RV12384572B	MONTIVIDIU T	14/04/2020 09:44	14/04/2020 13:12	14/04/2020 09:44	14/04/2020 13:12	3,45	18	62,19	CHI
20200444295	BOM JESUS DE GOIAS	03270414	RIO DOS BOIS	14/04/2020 09:44	14/04/2020 18:26	14/04/2020 09:44	14/04/2020 12:42	2,97	22	65,30	CHI
20200444295	BOM JESUS DE GOIAS	03270414	RIO DOS BOIS	14/04/2020 09:44	14/04/2020 18:26	14/04/2020 09:44	14/04/2020 12:42	2,97	5	14,84	CHI
20200444295	CASTELANDIA	03270414	RIO DOS BOIS	14/04/2020 09:44	14/04/2020 18:26	14/04/2020 09:44	14/04/2020 12:42	2,97	1551	4603,88	CHI
20200444295	CASTELANDIA	03270414	RIO DOS BOIS	14/04/2020 09:44	14/04/2020 18:26	14/04/2020 09:44	14/04/2020 12:42	2,97	1	2,97	CHI
20200444295	CASTELANDIA	03270414	RIO DOS BOIS	14/04/2020 09:44	14/04/2020 18:26	14/04/2020 09:44	14/04/2020 12:42	2,97	2	5,94	CHI
20200444295	GOIAS	03270414	RIO DOS BOIS	14/04/2020 09:44	14/04/2020 18:26	14/04/2020 09:44	14/04/2020 12:42	2,97	1	2,97	CHI

20200444295	GOIATUBA	03270414	RIO DOS BOIS	14/04/2020 09:44	14/04/2020 18:26	14/04/2020 09:44	14/04/2020 12:42	2,97	20	59,37	CHI
20200444295	GOIATUBA	03270414	RIO DOS BOIS	14/04/2020 09:44	14/04/2020 18:26	14/04/2020 09:44	14/04/2020 12:42	2,97	393	1166,55	CHI
20200444295	GOIATUBA	03270414	RIO DOS BOIS	14/04/2020 09:44	14/04/2020 18:26	14/04/2020 09:44	14/04/2020 12:42	2,97	19	56,40	CHI
20200444295	GOIATUBA	03270414	RIO DOS BOIS	14/04/2020 09:44	14/04/2020 18:26	14/04/2020 09:44	14/04/2020 12:42	2,97	4	11,87	CHI
20200444295	MAURILANDIA	03270414	RIO DOS BOIS	14/04/2020 09:44	14/04/2020 18:26	14/04/2020 09:44	14/04/2020 12:42	2,97	1	2,97	CHI
20200444295	MAURILANDIA	03270414	RIO DOS BOIS	14/04/2020 09:44	14/04/2020 18:26	14/04/2020 09:44	14/04/2020 12:42	2,97	4	11,87	CHI
20200444295	MAURILANDIA	03270414	RIO DOS BOIS	14/04/2020 09:44	14/04/2020 18:26	14/04/2020 09:44	14/04/2020 12:42	2,97	11	32,65	CHI
20200444295	PORTEIRAO	03270414	RIO DOS BOIS	14/04/2020 09:44	14/04/2020 18:26	14/04/2020 09:44	14/04/2020 12:42	2,97	7	20,78	CHI
20200444295	PORTEIRAO	03270414	RIO DOS BOIS	14/04/2020 09:44	14/04/2020 18:26	14/04/2020 09:44	14/04/2020 12:42	2,97	2	5,94	CHI
20200444295	PORTEIRAO	03270414	RIO DOS BOIS	14/04/2020 09:44	14/04/2020 18:26	14/04/2020 09:44	14/04/2020 12:42	2,97	6	17,81	CHI
20200444295	PORTEIRAO	03270414	RIO DOS BOIS	14/04/2020 09:44	14/04/2020 18:26	14/04/2020 09:44	14/04/2020 12:42	2,97	4	11,87	CHI
20200444295	QUIRINOPOLIS	03270414	RIO DOS BOIS	14/04/2020 09:44	14/04/2020 18:26	14/04/2020 09:44	14/04/2020 12:42	2,97	44	130,61	CHI
20200444295	MAURILANDIA	ML13214209	RIO DOS BOIS	14/04/2020 09:44	14/04/2020 18:26	14/04/2020 09:44	14/04/2020 18:26	8,70	2	17,40	CHI
20200444211	QUIRINOPOLIS	80079222	QUIRINOPOLIS	14/04/2020 09:45	14/04/2020 17:52	14/04/2020 09:45	14/04/2020 17:52	8,11	1	8,11	CHI
20200444222	PALMEIRAS DE GOIAS	PL21118584	PALMEIRAS	14/04/2020 09:45	14/04/2020 10:54	14/04/2020 09:45	14/04/2020 10:54	1,15	1	1,15	CHI
20200444221	QUIRINOPOLIS	QI12239488	QUIRINOPOLIS	14/04/2020 09:46	14/04/2020 11:32	14/04/2020 09:46	14/04/2020 11:32	1,75	4	7,01	CHI
20200444246	RIO VERDE	RV11025888	RIO VERDE S1	14/04/2020 09:47	14/04/2020 17:50	14/04/2020 09:47	14/04/2020 17:50	8,05	19	152,91	CHI
20200444249	ITUMBIARA	3910000731	ITUMBIARA NOVA	14/04/2020 09:50	14/04/2020 18:54	14/04/2020 09:50	14/04/2020 18:54	9,07	1	9,07	CHI
20200444254	RIO VERDE	RV21255787	RIO VERDE S1	14/04/2020 09:51	14/04/2020 15:00	14/04/2020 09:51	14/04/2020 15:00	5,14	3	15,43	CHI
20200444263	ACREUNA	EU21189129	ACREUNA	14/04/2020 09:52	14/04/2020 20:41	14/04/2020 09:52	14/04/2020 20:41	10,81	1	10,81	CHI
20200445447	PORTELANDIA	PW12303429	PARQUE DAS EMAS	14/04/2020 09:52	14/04/2020 17:43	14/04/2020 09:52	14/04/2020 17:43	7,84	10	78,36	CHI
202004105662	CROMINIA	03110214	PONTALINA	14/04/2020 09:55	14/04/2020 22:01	14/04/2020 09:55	14/04/2020 22:01	12,10	1782	21569,13	CHI
202004105662	MAIRIPOTABA	03110214	PONTALINA	14/04/2020 09:55	14/04/2020 22:01	14/04/2020 09:55	14/04/2020 22:01	12,10	69	835,17	CHI
202004105662	PONTALINA	03110214	PONTALINA	14/04/2020 09:55	14/04/2020 22:01	14/04/2020 09:55	14/04/2020 22:01	12,10	34	411,53	CHI
202004105662	PROFESSOR JAMIL SAFADY	03110214	PONTALINA	14/04/2020 09:55	14/04/2020 22:01	14/04/2020 09:55	14/04/2020 22:01	12,10	14	169,45	CHI
20200444296	IPAMERI	580067397	IPAMERI	14/04/2020 09:59	14/04/2020 11:39	14/04/2020 09:59	14/04/2020 11:39	1,66	1	1,66	CHI
20200444320	QUIRINOPOLIS	QI32052820	QUIRINOPOLIS	14/04/2020 10:02	15/04/2020 12:12	14/04/2020 10:02	14/04/2020 18:00	7,96	10	79,55	CHI
20200444320	QUIRINOPOLIS	QI32052820	QUIRINOPOLIS	14/04/2020 10:02	15/04/2020 12:12	14/04/2020 22:18	14/04/2020 22:45	0,44	9	3,98	CHI
20200444320	QUIRINOPOLIS	QI32052820	QUIRINOPOLIS	14/04/2020 10:02	15/04/2020 12:12	14/04/2020 10:02	14/04/2020 23:23	13,35	10	133,52	CHI
20200444320	QUIRINOPOLIS	QI32052820	QUIRINOPOLIS	14/04/2020 10:02	15/04/2020 12:12	14/04/2020 10:02	15/04/2020 12:12	26,16	18	470,87	CHI
20200444327	MATRINCHA	MP21183173	MATRINCHA	14/04/2020 10:03	14/04/2020 15:27	14/04/2020 10:03	14/04/2020 15:27	5,39	6	32,32	CHI
20200444558	RIO VERDE	RV12200741	CABRIUVA S2	14/04/2020 10:04	15/04/2020 09:42	14/04/2020 10:04	15/04/2020 09:42	23,62	8	188,96	CHI
20200444341	JATAI	290148807	JATAI S2	14/04/2020 10:05	15/04/2020 11:07	14/04/2020 10:05	15/04/2020 11:07	25,02	1	25,02	CHI

2020044353	DIORAMA	DI12390154	IPORA	14/04/2020 10:07	14/04/2020 11:31	14/04/2020 10:07	14/04/2020 11:31	1,39	6	8,36	CHI
2020044353	IPORA	DI12390154	IPORA	14/04/2020 10:07	14/04/2020 11:31	14/04/2020 10:07	14/04/2020 11:31	1,39	10	13,93	CHI
2020044357	RIO VERDE	RV12327004	RIO VERDE S2	14/04/2020 10:07	14/04/2020 17:35	14/04/2020 10:07	14/04/2020 17:35	7,45	3	22,35	CHI
2020044358	QUIRINOPOLIS	80086822	QUIRINOPOLIS	14/04/2020 10:07	14/04/2020 11:23	14/04/2020 10:07	14/04/2020 11:23	1,26	1	1,26	CHI
20200444707	RIO VERDE	BZ12211442	SANTA HELENA S1	14/04/2020 10:08	14/04/2020 18:03	14/04/2020 10:08	14/04/2020 18:03	7,90	4	31,62	CHI
20200444707	SANTO ANTONIO DA BARRA	BZ12211442	SANTA HELENA S1	14/04/2020 10:08	14/04/2020 18:03	14/04/2020 10:08	14/04/2020 18:03	7,90	20	158,08	CHI
20200444374	INDIARA	PL12349352	PALMEIRAS	14/04/2020 10:10	14/04/2020 12:49	14/04/2020 10:10	14/04/2020 12:49	2,65	3	7,94	CHI
20200444374	PALMEIRAS DE GOIAS	PL12349352	PALMEIRAS	14/04/2020 10:10	14/04/2020 12:49	14/04/2020 10:10	14/04/2020 12:49	2,65	66	174,59	CHI
20200444382	RIO VERDE	RV21049122	MONTIVIDIU T	14/04/2020 10:11	15/04/2020 13:20	14/04/2020 10:11	15/04/2020 13:20	27,15	1	27,15	CHI
20200444446	SANTA HELENA DE GOIAS	SH12279869	IPEGUARI	14/04/2020 10:11	14/04/2020 18:30	14/04/2020 10:11	14/04/2020 18:30	8,31	166	1379,60	CHI
20200444949	MINEIROS	MY11037696	PARQUE DAS EMAS	14/04/2020 10:11	14/04/2020 15:12	14/04/2020 10:11	14/04/2020 15:12	5,02	97	486,89	CHI
20200444404	BOM JESUS DE GOIAS	BJ12000149RE	BOM JESUS DE GOIAS	14/04/2020 10:13	14/04/2020 12:59	14/04/2020 10:13	14/04/2020 12:59	2,75	18	49,55	CHI
20200444411	SANCLERLANDIA	SC12068212	FIRMINOPOLIS S2	14/04/2020 10:14	14/04/2020 13:46	14/04/2020 10:14	14/04/2020 13:46	3,52	12	42,27	CHI
20200450450	MONTIVIDIU	RV12205424	MONTIVIDIU T	14/04/2020 10:14	15/04/2020 09:34	14/04/2020 10:14	15/04/2020 09:34	23,33	1	23,33	CHI
20200450450	RIO VERDE	RV12205424	MONTIVIDIU T	14/04/2020 10:14	15/04/2020 09:34	14/04/2020 10:14	15/04/2020 09:34	23,33	39	909,80	CHI
20200444416	SANTA RITA DO ARAGUAIA	SU11271643	SANTA RITA DO ARAGUAIA	14/04/2020 10:15	14/04/2020 15:58	14/04/2020 10:15	14/04/2020 15:58	5,71	33	188,42	CHI
20200444427	RIO VERDE	RV12098593	RIO VERDE S1	14/04/2020 10:17	14/04/2020 15:45	14/04/2020 10:17	14/04/2020 15:45	5,46	9	49,17	CHI
20200444520	OUVIDOR	OU12337537	CATALAO S1	14/04/2020 10:20	14/04/2020 13:10	14/04/2020 10:20	14/04/2020 13:10	2,82	34	96,05	CHI
20200444474	MORRINHOS	MR11075097	MORRINHOS	14/04/2020 10:21	14/04/2020 12:11	14/04/2020 10:21	14/04/2020 12:11	1,82	2	3,64	CHI
20200444476	ITUMBIARA	IT11128200	ITUMBIARA VELHA S1	14/04/2020 10:21	14/04/2020 12:10	14/04/2020 10:21	14/04/2020 12:10	1,80	129	232,81	CHI
20200444491	APORE	IJ12161267	ITAJA S2	14/04/2020 10:23	14/04/2020 13:27	14/04/2020 10:23	14/04/2020 13:27	3,05	1	3,05	CHI
20200444491	ITAJA	IJ12161267	ITAJA S2	14/04/2020 10:23	14/04/2020 13:27	14/04/2020 10:23	14/04/2020 13:27	3,05	3	9,16	CHI
20200444500	CACHOEIRA ALTA	CA12071521	CACHOEIRA ALTA	14/04/2020 10:24	15/04/2020 08:37	14/04/2020 10:24	15/04/2020 08:37	22,20	1	22,20	CHI
20200444513	SANTA HELENA DE GOIAS	SH21000120	ACREUNA	14/04/2020 10:25	14/04/2020 17:54	14/04/2020 10:25	14/04/2020 17:54	7,47	1	7,47	CHI
20200444162	ACREUNA	00080234	ACREUNA	14/04/2020 10:27	14/04/2020 13:54	14/04/2020 10:27	14/04/2020 11:03	0,59	2660	1557,58	CHI
20200444162	ACREUNA	EU13048992	ACREUNA	14/04/2020 10:27	14/04/2020 13:54	14/04/2020 10:27	14/04/2020 12:00	1,53	1149	1763,08	CHI
20200444162	ACREUNA	EU12271443LD	ACREUNA	14/04/2020 10:27	14/04/2020 13:54	14/04/2020 10:27	14/04/2020 12:53	2,42	1768	4276,60	CHI
20200444162	ACREUNA	EU12207090LD	ACREUNA	14/04/2020 10:27	14/04/2020 13:54	14/04/2020 10:27	14/04/2020 13:54	3,43	1051	3609,60	CHI
20200444538	PALMEIRAS DE GOIAS	PL12046351	PALMEIRAS	14/04/2020 10:29	14/04/2020 19:56	14/04/2020 10:29	14/04/2020 19:56	9,45	4	37,78	CHI
20200444560	RIO VERDE	RV12190361	CABRIUVA S2	14/04/2020 10:32	15/04/2020 11:42	14/04/2020 10:32	15/04/2020 11:42	25,17	11	276,91	CHI
20200444570	CACHOEIRA DOURADA	3280007407	CACHOEIRA DOURADA	14/04/2020 10:33	14/04/2020 12:54	14/04/2020 10:33	14/04/2020 12:54	2,34	1	2,34	CHI
20200445771	CACHOEIRA ALTA	CA12402274	CACHOEIRA ALTA	14/04/2020 10:33	15/04/2020 16:42	14/04/2020 10:33	14/04/2020 21:27	10,89	51	555,38	CHI
20200445771	CACHOEIRA ALTA	CA12402274	CACHOEIRA ALTA	14/04/2020 10:33	15/04/2020 16:42	14/04/2020 22:12	14/04/2020 22:37	0,43	51	22,07	CHI

20200445771	CACHOEIRA ALTA	CA13279744	CACHOEIRA ALTA	14/04/2020 10:33	15/04/2020 16:42	14/04/2020 10:33	15/04/2020 16:11	29,63	32	948,20	CHI
20200445771	CACHOEIRA ALTA	CA13279744	CACHOEIRA ALTA	14/04/2020 10:33	15/04/2020 16:42	14/04/2020 22:11	15/04/2020 16:11	17,99	1	17,99	CHI
20200445771	CACHOEIRA ALTA	CA13161862	CACHOEIRA ALTA	14/04/2020 10:33	15/04/2020 16:42	14/04/2020 10:33	15/04/2020 16:42	30,15	15	452,31	CHI
20200445771	CACU	CA13161862	CACHOEIRA ALTA	14/04/2020 10:33	15/04/2020 16:42	14/04/2020 10:33	15/04/2020 16:42	30,15	11	331,70	CHI
20200445771	ITARUMA	CA13161862	CACHOEIRA ALTA	14/04/2020 10:33	15/04/2020 16:42	14/04/2020 10:33	15/04/2020 16:42	30,15	3	90,46	CHI
20200444579	MAURILANDIA	ML21147890	SANTA HELENA S1	14/04/2020 10:34	14/04/2020 20:00	14/04/2020 10:34	14/04/2020 20:00	9,42	1	9,42	CHI
20200444584	PARAUNA	PU12314958	PARAUNA	14/04/2020 10:34	14/04/2020 13:48	14/04/2020 10:34	14/04/2020 13:48	3,22	8	25,74	CHI
20200444584	RIO VERDE	PU12314958	PARAUNA	14/04/2020 10:34	14/04/2020 13:48	14/04/2020 10:34	14/04/2020 13:48	3,22	2	6,44	CHI
20200444585	BOM JESUS DE GOIAS	BJ11000015	BOM JESUS DE GOIAS	14/04/2020 10:35	14/04/2020 12:00	14/04/2020 10:35	14/04/2020 12:00	1,41	109	154,20	CHI
20200444634	VARJAO	VJ21126405	CEZARINA	14/04/2020 10:36	14/04/2020 18:57	14/04/2020 10:36	14/04/2020 18:57	8,34	1	8,34	CHI
2020041400095	INDIARA	IY10400609	CEZARINA	14/04/2020 10:36	14/04/2020 13:55	14/04/2020 10:36	14/04/2020 10:58	0,36	41	14,70	CHI
2020041400095	CEZARINA	CZ10406616	CEZARINA	14/04/2020 10:36	14/04/2020 13:55	14/04/2020 10:36	14/04/2020 11:50	1,23	363	448,10	CHI
2020041400095	INDIARA	CZ10406616	CEZARINA	14/04/2020 10:36	14/04/2020 13:55	14/04/2020 10:36	14/04/2020 11:50	1,23	53	65,43	CHI
2020041400095	CEZARINA	00375114	CEZARINA	14/04/2020 10:36	14/04/2020 13:55	14/04/2020 10:36	14/04/2020 11:52	1,26	2978	3740,70	CHI
2020041400095	INDIARA	00375114	CEZARINA	14/04/2020 10:36	14/04/2020 13:55	14/04/2020 10:36	14/04/2020 11:52	1,26	9	11,30	CHI
2020041400095	PALMEIRAS DE GOIAS	00375114	CEZARINA	14/04/2020 10:36	14/04/2020 13:55	14/04/2020 10:36	14/04/2020 11:52	1,26	21	26,38	CHI
2020041400095	VARJAO	00375114	CEZARINA	14/04/2020 10:36	14/04/2020 13:55	14/04/2020 10:36	14/04/2020 11:52	1,26	11	13,82	CHI
2020041400095	CEZARINA	CZ13215265	CEZARINA	14/04/2020 10:36	14/04/2020 13:55	14/04/2020 10:36	14/04/2020 13:47	3,17	256	812,30	CHI
2020041400095	INDIARA	CZ13215265	CEZARINA	14/04/2020 10:36	14/04/2020 13:55	14/04/2020 10:36	14/04/2020 13:47	3,17	7	22,21	CHI
2020041400095	CEZARINA	CZ12308530LD	CEZARINA	14/04/2020 10:36	14/04/2020 13:55	14/04/2020 10:36	14/04/2020 13:55	3,31	1	3,31	CHI
20200444604	ITARUMA	IM21239519	ITAJA S2	14/04/2020 10:37	14/04/2020 15:22	14/04/2020 10:37	14/04/2020 15:22	4,74	1	4,74	CHI
20200444606	ACREUNA	EU12045542	ACREUNA	14/04/2020 10:37	14/04/2020 17:37	14/04/2020 10:37	14/04/2020 17:37	7,00	5	34,98	CHI
20200444631	CAIAPONIA	CP12036958	CAIAPONIA	14/04/2020 10:40	14/04/2020 12:23	14/04/2020 10:40	14/04/2020 12:23	1,71	57	97,45	CHI
20200445144	PEROLANDIA	DP12133585	JATAI S1	14/04/2020 10:40	14/04/2020 18:00	14/04/2020 10:40	14/04/2020 18:00	7,32	6	43,90	CHI
20200446038	JATAI	JT12378137	JATAI S2	14/04/2020 10:42	14/04/2020 19:15	14/04/2020 10:42	14/04/2020 17:41	6,98	6	41,85	CHI
20200446038	JATAI	JT12063144LD	JATAI S2	14/04/2020 10:42	14/04/2020 19:15	14/04/2020 10:42	14/04/2020 19:15	8,54	1	8,54	CHI
20200444654	ANICUNS	AC12000068	ANICUNS	14/04/2020 10:43	14/04/2020 12:16	14/04/2020 10:43	14/04/2020 12:16	1,54	35	53,85	CHI
20200444662	MINEIROS	MY12324396	PARQUE DAS EMAS	14/04/2020 10:44	14/04/2020 20:35	14/04/2020 10:44	14/04/2020 20:35	9,84	9	88,56	CHI
20200444679	SANTA RITA DO ARAGUAIA	SU11324697	SANTA RITA DO ARAGUAIA	14/04/2020 10:46	15/04/2020 01:16	14/04/2020 10:46	15/04/2020 01:16	14,49	190	2753,52	CHI
20200444852	EDEALINA	VI10400586	VICENTINOPOLIS	14/04/2020 10:47	14/04/2020 22:33	14/04/2020 10:51	14/04/2020 16:30	5,64	34	191,88	CHI
20200444852	EDEIA	VI10400586	VICENTINOPOLIS	14/04/2020 10:47	14/04/2020 22:33	14/04/2020 10:51	14/04/2020 16:30	5,64	1	5,64	CHI
20200444852	GOIATUBA	VI10400586	VICENTINOPOLIS	14/04/2020 10:47	14/04/2020 22:33	14/04/2020 10:51	14/04/2020 16:30	5,64	13	73,37	CHI
20200444852	VICENTINOPOLIS	VI10400586	VICENTINOPOLIS	14/04/2020 10:47	14/04/2020 22:33	14/04/2020 10:51	14/04/2020 16:30	5,64	53	299,11	CHI



20200444852	EDEALINA	VI10400586	VICENTINOPOLIS	14/04/2020 10:47	14/04/2020 22:33	14/04/2020 10:51	14/04/2020 18:30	7,65	15	114,68	CHI
20200444852	EDEIA	VI10400586	VICENTINOPOLIS	14/04/2020 10:47	14/04/2020 22:33	14/04/2020 10:51	14/04/2020 18:30	7,65	11	84,10	CHI
20200444852	EDEIA	VI10400586	VICENTINOPOLIS	14/04/2020 10:47	14/04/2020 22:33	14/04/2020 10:51	14/04/2020 18:30	7,65	22	168,20	CHI
20200444852	EDEIA	VI13166480	VICENTINOPOLIS	14/04/2020 10:47	14/04/2020 22:33	14/04/2020 10:51	14/04/2020 18:30	7,65	1	7,65	CHI
20200444852	PONTALINA	VI10400586	VICENTINOPOLIS	14/04/2020 10:47	14/04/2020 22:33	14/04/2020 10:51	14/04/2020 18:30	7,65	1	7,65	CHI
20200444852	VICENTINOPOLIS	VI10400586	VICENTINOPOLIS	14/04/2020 10:47	14/04/2020 22:33	14/04/2020 10:51	14/04/2020 18:30	7,65	1	7,65	CHI
20200444852	VICENTINOPOLIS	VI10400586	VICENTINOPOLIS	14/04/2020 10:47	14/04/2020 22:33	14/04/2020 10:51	14/04/2020 18:30	7,65	3	22,94	CHI
20200444852	VICENTINOPOLIS	VI13166480	VICENTINOPOLIS	14/04/2020 10:47	14/04/2020 22:33	14/04/2020 10:51	14/04/2020 18:30	7,65	33	252,29	CHI
20200444852	VICENTINOPOLIS	VI12328992LD	VICENTINOPOLIS	14/04/2020 10:47	14/04/2020 22:33	14/04/2020 10:51	14/04/2020 20:40	9,81	10	98,06	CHI
20200444852	EDEIA	VI13124464	VICENTINOPOLIS	14/04/2020 10:47	14/04/2020 22:33	14/04/2020 10:51	14/04/2020 21:58	11,12	3	33,35	CHI
20200444852	VICENTINOPOLIS	VI13124464	VICENTINOPOLIS	14/04/2020 10:47	14/04/2020 22:33	14/04/2020 10:51	14/04/2020 21:58	11,12	13	144,52	CHI
20200444852	EDEIA	VI12257165LD	VICENTINOPOLIS	14/04/2020 10:47	14/04/2020 22:33	14/04/2020 10:51	14/04/2020 22:33	11,69	5	58,46	CHI
20200445000	CACHOEIRA ALTA	CA11029084	CACHOEIRA ALTA	14/04/2020 10:47	14/04/2020 23:20	14/04/2020 10:47	14/04/2020 23:20	12,54	181	2269,64	CHI
20200448702	EDEIA	EA21329066	VICENTINOPOLIS	14/04/2020 10:47	15/04/2020 10:58	14/04/2020 10:51	15/04/2020 10:58	24,10	1	24,10	CHI
20200444715	INDIARA	IY21093806	EDEIA	14/04/2020 10:50	14/04/2020 12:47	14/04/2020 10:50	14/04/2020 12:47	1,94	1	1,94	CHI
20200444985	PORTEIRAO	CL16402441	RIO DOS BOIS	14/04/2020 10:50	14/04/2020 18:43	14/04/2020 10:50	14/04/2020 18:43	7,88	63	496,42	CHI
20200444720	EDEALINA	ED21073068	PONTALINA	14/04/2020 10:51	14/04/2020 13:01	14/04/2020 10:51	14/04/2020 13:01	2,17	1	2,17	CHI
202004105716	GOIATUBA	04580214	BOM JESUS DE GOIAS	14/04/2020 10:54	16/04/2020 20:15	14/04/2020 10:54	14/04/2020 17:50	6,93	116	803,62	CHI
202004105716	GOIATUBA	04580214	BOM JESUS DE GOIAS	14/04/2020 10:54	16/04/2020 20:15	14/04/2020 10:54	14/04/2020 19:08	8,23	14	115,23	CHI
202004105716	GOIATUBA	04580214	BOM JESUS DE GOIAS	14/04/2020 10:54	16/04/2020 20:15	14/04/2020 19:10	14/04/2020 19:15	0,10	116	11,12	CHI
202004105716	GOIATUBA	GT13309834	BOM JESUS DE GOIAS	14/04/2020 10:54	16/04/2020 20:15	14/04/2020 19:10	15/04/2020 09:52	14,70	5	73,50	CHI
202004105716	GOIATUBA	04580214	BOM JESUS DE GOIAS	14/04/2020 10:54	16/04/2020 20:15	15/04/2020 15:19	15/04/2020 15:44	0,41	121	49,04	CHI
202004105716	GOIATUBA	04580214	BOM JESUS DE GOIAS	14/04/2020 10:54	16/04/2020 20:15	15/04/2020 20:24	15/04/2020 21:12	0,80	121	96,80	CHI
202004105716	GOIATUBA	GT13332549	BOM JESUS DE GOIAS	14/04/2020 10:54	16/04/2020 20:15	14/04/2020 19:10	16/04/2020 18:30	47,34	4	189,36	CHI
202004105716	GOIATUBA	GT13332549	BOM JESUS DE GOIAS	14/04/2020 10:54	16/04/2020 20:15	14/04/2020 19:10	16/04/2020 20:15	49,09	5	245,43	CHI
20200444775	ITUMBIARA	CD12097345RE	CACHOEIRA DOURADA	14/04/2020 10:55	14/04/2020 14:22	14/04/2020 10:55	14/04/2020 14:22	3,44	9	30,99	CHI
20200444776	CAIAPONIA	PY13316484	PALESTINA	14/04/2020 10:55	14/04/2020 15:56	14/04/2020 10:55	14/04/2020 15:56	5,01	348	1742,22	CHI
20200444776	PALESTINA DE GOIAS	PY13316484	PALESTINA	14/04/2020 10:55	14/04/2020 15:56	14/04/2020 10:55	14/04/2020 15:56	5,01	248	1241,58	CHI
20200444776	CAIAPONIA	PY13316484	PALESTINA	14/04/2020 10:55	14/04/2020 15:56	14/04/2020 14:55	14/04/2020 15:56	1,01	115	115,99	CHI
20200444776	PALESTINA DE GOIAS	PY13316484	PALESTINA	14/04/2020 10:55	14/04/2020 15:56	14/04/2020 14:55	14/04/2020 15:56	1,01	103	103,89	CHI
20200444789	DOVERLANDIA	DV12207831	CAIAPONIA	14/04/2020 10:57	14/04/2020 12:29	14/04/2020 10:57	14/04/2020 12:29	1,53	3	4,58	CHI
20200444792	BOM JESUS DE GOIAS	10023818040	BOM JESUS DE GOIAS	14/04/2020 10:57	14/04/2020 14:34	14/04/2020 10:57	14/04/2020 14:34	3,61	1	3,61	CHI
20200444807	MOSSAMEDES	1310037830	FIRMINOPOLIS S2	14/04/2020 10:58	14/04/2020 11:39	14/04/2020 10:58	14/04/2020 11:39	0,67	1	0,67	CHI

20200444812	CALDAS NOVAS	CN11246639	SERRA DE CALDAS	14/04/2020 10:59	14/04/2020 15:49	14/04/2020 10:59	14/04/2020 15:49	4,82	154	742,49	CHI
20200445002	SANTA HELENA DE GOIAS	SH12301071	RIO DOS BOIS	14/04/2020 11:00	14/04/2020 17:05	14/04/2020 11:00	14/04/2020 17:05	6,07	8	48,55	CHI
20200445002	TURVELANDIA	SH12301071	RIO DOS BOIS	14/04/2020 11:00	14/04/2020 17:05	14/04/2020 11:00	14/04/2020 17:05	6,07	2	12,14	CHI
20200445022	GOUVELANDIA	GB12303256	QUIRINOPOLIS	14/04/2020 11:00	15/04/2020 11:50	14/04/2020 11:00	15/04/2020 10:06	23,10	8	184,76	CHI
20200445022	GOUVELANDIA	GB12303263	QUIRINOPOLIS	14/04/2020 11:00	15/04/2020 11:50	14/04/2020 11:00	15/04/2020 10:46	23,76	69	1639,54	CHI
20200445022	GOUVELANDIA	GB12303256	QUIRINOPOLIS	14/04/2020 11:00	15/04/2020 11:50	14/04/2020 11:00	15/04/2020 11:50	24,83	1	24,83	CHI
20200452739	GOUVELANDIA	GB21303264	QUIRINOPOLIS	14/04/2020 11:00	15/04/2020 15:42	14/04/2020 11:00	15/04/2020 15:42	28,69	1	28,69	CHI
20200444872	PARAUNA	PU12288631LD	MONTVIDIU T	14/04/2020 11:02	14/04/2020 19:54	14/04/2020 11:02	14/04/2020 19:54	8,87	23	203,91	CHI
20200444175	IPORA	730100753	IPORA	14/04/2020 11:03	14/04/2020 17:38	14/04/2020 11:03	14/04/2020 17:38	6,58	1	6,58	CHI
20200446514	SANTA HELENA DE GOIAS	TD12226264	RIO DOS BOIS	14/04/2020 11:03	14/04/2020 18:25	14/04/2020 11:03	14/04/2020 18:25	7,36	2	14,73	CHI
20200446514	TURVELANDIA	TD12226264	RIO DOS BOIS	14/04/2020 11:03	14/04/2020 18:25	14/04/2020 11:03	14/04/2020 18:25	7,36	2	14,73	CHI
20200444846	ACREUNA	SH12271266	SANTA HELENA S1	14/04/2020 11:04	14/04/2020 17:17	14/04/2020 11:04	14/04/2020 17:17	6,22	1	6,22	CHI
20200444846	SANTA HELENA DE GOIAS	SH12271266	SANTA HELENA S1	14/04/2020 11:04	14/04/2020 17:17	14/04/2020 11:04	14/04/2020 17:17	6,22	2	12,43	CHI
20200445044	INDIARA	IY12205923	EDEIA	14/04/2020 11:05	14/04/2020 14:30	14/04/2020 11:05	14/04/2020 14:30	3,40	33	112,30	CHI
20200445044	PALMEIRAS DE GOIAS	IY12205923	EDEIA	14/04/2020 11:05	14/04/2020 14:30	14/04/2020 11:05	14/04/2020 14:30	3,40	5	17,02	CHI
20200444177	IPORA	730060494	IPORA	14/04/2020 11:07	14/04/2020 17:18	14/04/2020 11:07	14/04/2020 17:18	6,18	1	6,18	CHI
20200444884	JUSSARA	JR12090187	JUSSARA	14/04/2020 11:07	15/04/2020 07:28	14/04/2020 11:07	15/04/2020 07:28	20,34	3	61,01	CHI
20200445218	ITUMBIARA	03840234	PARANAIBA	14/04/2020 11:07	15/04/2020 00:28	14/04/2020 11:07	14/04/2020 11:13	0,10	10	0,99	CHI
20200445218	ITUMBIARA	03840234	PARANAIBA	14/04/2020 11:07	15/04/2020 00:28	14/04/2020 11:07	14/04/2020 11:13	0,10	618	61,28	CHI
20200445218	BURITI ALEGRE	03840234	PARANAIBA	14/04/2020 11:07	15/04/2020 00:28	14/04/2020 11:07	14/04/2020 11:21	0,24	8	1,92	CHI
20200445218	GOIATUBA	03840234	PARANAIBA	14/04/2020 11:07	15/04/2020 00:28	14/04/2020 11:07	14/04/2020 11:21	0,24	6	1,44	CHI
20200445218	ITUMBIARA	03840234	PARANAIBA	14/04/2020 11:07	15/04/2020 00:28	14/04/2020 11:07	14/04/2020 11:21	0,24	111	26,58	CHI
20200445218	PANAMA	03840234	PARANAIBA	14/04/2020 11:07	15/04/2020 00:28	14/04/2020 11:07	14/04/2020 11:21	0,24	41	9,82	CHI
20200445218	ITUMBIARA	IT10408204	PARANAIBA	14/04/2020 11:07	15/04/2020 00:28	14/04/2020 11:09	14/04/2020 11:21	0,20	1	0,20	CHI
20200445218	GOIATUBA	03840234	PARANAIBA	14/04/2020 11:07	15/04/2020 00:28	14/04/2020 16:15	14/04/2020 16:31	0,27	6	1,63	CHI
20200445218	ITUMBIARA	03840234	PARANAIBA	14/04/2020 11:07	15/04/2020 00:28	14/04/2020 16:15	14/04/2020 16:31	0,27	114	30,94	CHI
20200445218	ITUMBIARA	03840234	PARANAIBA	14/04/2020 11:07	15/04/2020 00:28	14/04/2020 16:15	14/04/2020 16:31	0,27	618	167,72	CHI
20200445218	PANAMA	03840234	PARANAIBA	14/04/2020 11:07	15/04/2020 00:28	14/04/2020 16:15	14/04/2020 16:31	0,27	39	10,58	CHI
20200445218	ITUMBIARA	03840234	PARANAIBA	14/04/2020 11:07	15/04/2020 00:28	14/04/2020 11:07	15/04/2020 00:28	13,36	59	788,09	CHI
20200444888	QUIRINOPOLIS	QI12207068	QUIRINOPOLIS	14/04/2020 11:08	14/04/2020 13:29	14/04/2020 11:08	14/04/2020 13:29	2,34	2	4,69	CHI
20200444907	ITABERAI	10001613284	ITABERAI S2	14/04/2020 11:11	14/04/2020 13:39	14/04/2020 11:11	14/04/2020 13:39	2,46	1	2,46	CHI
20200444995	ITUMBIARA	00980224	ITUMBIARA NOVA	14/04/2020 11:11	14/04/2020 20:04	14/04/2020 11:11	14/04/2020 11:54	0,72	192	137,87	CHI
20200444995	ITUMBIARA	00980224	ITUMBIARA NOVA	14/04/2020 11:11	14/04/2020 20:04	14/04/2020 11:11	14/04/2020 12:01	0,83	4853	4045,51	CHI

2020044995	ITUMBIARA	00980224	ITUMBIARA NOVA	14/04/2020 11:11	14/04/2020 20:04	14/04/2020 11:11	14/04/2020 12:07	0,94	1923	1815,10	CHI
2020044995	ITUMBIARA	00980224	ITUMBIARA NOVA	14/04/2020 11:11	14/04/2020 20:04	14/04/2020 11:11	14/04/2020 20:04	8,88	119	1057,25	CHI
20200445991	ITUMBIARA	IT13000014	ITUMBIARA VELHA S1	14/04/2020 11:11	14/04/2020 14:52	14/04/2020 11:11	14/04/2020 14:52	3,68	1735	6393,47	CHI
20200447103	ITUMBIARA	IT11000022	ITUMBIARA VELHA S1	14/04/2020 11:11	14/04/2020 17:12	14/04/2020 11:11	14/04/2020 17:12	6,02	178	1071,02	CHI
20200444931	CACHOEIRA DOURADA	CD11000012	CACHOEIRA DOURADA	14/04/2020 11:13	15/04/2020 12:12	14/04/2020 11:13	15/04/2020 12:12	24,98	87	2173,57	CHI
20200444935	RIO QUENTE	RQ21153402	VILA CORUMBA	14/04/2020 11:13	14/04/2020 17:00	14/04/2020 11:13	14/04/2020 17:00	5,77	1	5,77	CHI
20200445778	ITUMBIARA	IT16411349	PARANAIBA	14/04/2020 11:13	14/04/2020 11:20	14/04/2020 11:13	14/04/2020 11:17	0,06	690	43,13	CHI
20200445778	ITUMBIARA	IT16411350	PARANAIBA	14/04/2020 11:13	14/04/2020 11:20	14/04/2020 11:13	14/04/2020 11:18	0,08	1045	81,28	CHI
20200445778	ITUMBIARA	IT16408161	PARANAIBA	14/04/2020 11:13	14/04/2020 11:20	14/04/2020 11:13	14/04/2020 11:19	0,09	720	68,00	CHI
20200445778	ITUMBIARA	IT16411372	PARANAIBA	14/04/2020 11:13	14/04/2020 11:20	14/04/2020 11:13	14/04/2020 11:20	0,11	1954	222,54	CHI
20200444957	MOSSAMEDES	MD12057741	FIRMINOPOLIS S2	14/04/2020 11:14	14/04/2020 23:20	14/04/2020 11:14	14/04/2020 23:20	12,10	17	205,64	CHI
20200444957	SANCLERLANDIA	MD12057741	FIRMINOPOLIS S2	14/04/2020 11:14	14/04/2020 23:20	14/04/2020 11:14	14/04/2020 23:20	12,10	1	12,10	CHI
20200446860	ARENOPOLIS	PH10400399	PIRANHAS	14/04/2020 11:16	16/04/2020 09:39	14/04/2020 11:16	15/04/2020 20:50	33,57	10	335,68	CHI
20200446860	PIRANHAS	PH10400399	PIRANHAS	14/04/2020 11:16	16/04/2020 09:39	14/04/2020 11:16	15/04/2020 20:50	33,57	71	2383,35	CHI
20200446860	ARENOPOLIS	PH10400399	PIRANHAS	14/04/2020 11:16	16/04/2020 09:39	15/04/2020 21:01	15/04/2020 21:05	0,06	10	0,60	CHI
20200446860	PIRANHAS	PH10400399	PIRANHAS	14/04/2020 11:16	16/04/2020 09:39	15/04/2020 21:01	15/04/2020 21:05	0,06	71	4,26	CHI
20200446860	PIRANHAS	PH13193440	PIRANHAS	14/04/2020 11:16	16/04/2020 09:39	15/04/2020 21:11	15/04/2020 23:09	1,96	39	76,62	CHI
20200446860	PIRANHAS	PH13023519	PIRANHAS	14/04/2020 11:16	16/04/2020 09:39	15/04/2020 21:11	16/04/2020 07:49	10,64	5	53,19	CHI
20200446860	ARENOPOLIS	PH12023602	PIRANHAS	14/04/2020 11:16	16/04/2020 09:39	15/04/2020 21:11	16/04/2020 08:35	11,41	6	68,45	CHI
20200446860	PIRANHAS	PH12023602	PIRANHAS	14/04/2020 11:16	16/04/2020 09:39	15/04/2020 21:11	16/04/2020 08:35	11,41	9	102,67	CHI
20200446860	ARENOPOLIS	PH12104024	PIRANHAS	14/04/2020 11:16	16/04/2020 09:39	15/04/2020 21:11	16/04/2020 09:39	12,46	4	49,85	CHI
20200446860	PIRANHAS	PH12104024	PIRANHAS	14/04/2020 11:16	16/04/2020 09:39	15/04/2020 21:11	16/04/2020 09:39	12,46	18	224,34	CHI
20200445224	ITUMBIARA	CD12000284	CACHOEIRA DOURADA	14/04/2020 11:17	14/04/2020 15:33	14/04/2020 11:17	14/04/2020 15:33	4,26	21	89,36	CHI
20200444979	PARAUNA	PU21007967	PARAUNA	14/04/2020 11:19	14/04/2020 16:40	14/04/2020 11:19	14/04/2020 16:40	5,34	1	5,34	CHI
20200444982	OUVIDOR	CT12053650	CATALAO S1	14/04/2020 11:19	14/04/2020 14:16	14/04/2020 11:19	14/04/2020 14:16	2,93	5	14,67	CHI
20200445286	BELA VISTA DE GOIAS	BV12211127	CRISTIANOPOLIS	14/04/2020 11:19	14/04/2020 14:27	14/04/2020 11:19	14/04/2020 14:27	3,12	1	3,12	CHI
20200445286	SAO MIGUEL DO PASSA QUATRO	BV12211127	CRISTIANOPOLIS	14/04/2020 11:19	14/04/2020 14:27	14/04/2020 11:19	14/04/2020 14:27	3,12	13	40,53	CHI
20200444992	IVOLANDIA	IV21158487	IPORA	14/04/2020 11:22	14/04/2020 18:45	14/04/2020 11:22	14/04/2020 18:45	7,38	1	7,38	CHI
20200443003	SANTA CRUZ DE GOIAS	BC12012502	PIRES DO RIO S2	14/04/2020 11:24	14/04/2020 16:03	14/04/2020 11:24	14/04/2020 16:03	4,65	10	46,48	CHI
20200443003	SANTA CRUZ DE GOIAS	BC12012502	PIRES DO RIO S2	14/04/2020 11:24	14/04/2020 16:03	14/04/2020 13:53	14/04/2020 16:03	2,16	31	67,01	CHI
20200445009	SAO LUIS DE MONTES BELOS	10030936665	SAO LUIZ DOS MONTES BELOS	14/04/2020 11:24	14/04/2020 22:26	14/04/2020 11:24	14/04/2020 22:26	11,03	1	11,03	CHI
20200448084	SANTA CRUZ DE GOIAS	BC21068926	PIRES DO RIO S2	14/04/2020 11:24	15/04/2020 02:40	14/04/2020 11:24	15/04/2020 02:40	15,26	1	15,26	CHI
20200445019	IPORA	IR11354674	IPORA	14/04/2020 11:25	14/04/2020 13:12	14/04/2020 11:25	14/04/2020 13:12	1,78	103	182,88	CHI

20200445024	AURILANDIA	RP12076381	FIRMINOPOLIS S2	14/04/2020 11:25	14/04/2020 14:17	14/04/2020 11:25	14/04/2020 14:17	2,85	4	11,41	CHI
20200445024	SAO JOAO DA PARAUNA	RP12076381	FIRMINOPOLIS S2	14/04/2020 11:25	14/04/2020 14:17	14/04/2020 11:25	14/04/2020 14:17	2,85	26	74,15	CHI
20200445077	PALMEIRAS DE GOIAS	PL12323493	PALMEIRAS	14/04/2020 11:32	14/04/2020 14:53	14/04/2020 11:32	14/04/2020 14:53	3,35	255	855,24	CHI
20200445292	ITUMBIARA	IT11309849	ITUMBIARA NOVA	14/04/2020 11:35	14/04/2020 16:59	14/04/2020 11:35	14/04/2020 16:59	5,38	58	312,30	CHI
20200445109	BOM JESUS DE GOIAS	BJ12392116	BOM JESUS DE GOIAS	14/04/2020 11:36	14/04/2020 18:30	14/04/2020 11:36	14/04/2020 18:30	6,91	14	96,73	CHI
20200448704	BOM JESUS DE GOIAS	BJ21316670	BOM JESUS DE GOIAS	14/04/2020 11:36	14/04/2020 22:10	14/04/2020 11:36	14/04/2020 22:10	10,56	1	10,56	CHI
20200446374	ITUMBIARA	IT12000302	ITUMBIARA NOVA	14/04/2020 11:37	14/04/2020 15:34	14/04/2020 11:37	14/04/2020 15:34	3,95	320	1263,47	CHI
20200447217	VICENTINOPOLIS	VI12208230	VICENTINOPOLIS	14/04/2020 11:39	14/04/2020 23:47	14/04/2020 11:39	14/04/2020 23:47	12,13	260	3154,16	CHI
20200445159	PARAUNA	PU21213504	PARAUNA	14/04/2020 11:43	15/04/2020 13:38	14/04/2020 11:43	15/04/2020 13:38	25,90	1	25,90	CHI
20200445161	IPORA	IR12074019	IPORA	14/04/2020 11:43	14/04/2020 14:07	14/04/2020 11:43	14/04/2020 14:07	2,38	15	35,77	CHI
20200445243	ITUMBIARA	IT11097310	ITUMBIARA VELHA S1	14/04/2020 11:43	15/04/2020 11:12	14/04/2020 11:43	15/04/2020 11:12	23,47	156	3661,97	CHI
20200445563	GUARAITA	IK12064427	ITAPURANGA	14/04/2020 11:45	14/04/2020 14:29	14/04/2020 11:45	14/04/2020 14:29	2,72	1	2,72	CHI
20200445563	ITAPURANGA	IK12064427	ITAPURANGA	14/04/2020 11:45	14/04/2020 14:29	14/04/2020 11:45	14/04/2020 14:29	2,72	15	40,87	CHI
20200446200	ITUMBIARA	IT11000105	ITUMBIARA NOVA	14/04/2020 11:45	14/04/2020 17:32	14/04/2020 11:45	14/04/2020 17:32	5,77	94	542,77	CHI
20200445178	PONTALINA	PK21111929	PONTALINA	14/04/2020 11:46	14/04/2020 16:45	14/04/2020 11:46	14/04/2020 16:45	4,98	1	4,98	CHI
20200445463	DIORAMA	IR10403921	ARENOPOLIS	14/04/2020 11:46	14/04/2020 21:01	14/04/2020 12:19	14/04/2020 21:01	8,70	115	1000,98	CHI
20200445463	IPORA	IR10403921	ARENOPOLIS	14/04/2020 11:46	14/04/2020 21:01	14/04/2020 12:19	14/04/2020 21:01	8,70	10	87,04	CHI
20200445463	MONTES CLAROS DE GOIAS	IR10403921	ARENOPOLIS	14/04/2020 11:46	14/04/2020 21:01	14/04/2020 12:19	14/04/2020 21:01	8,70	41	356,87	CHI
20200445587	ITUMBIARA	IT11143878	ITUMBIARA VELHA S1	14/04/2020 11:46	15/04/2020 10:56	14/04/2020 11:46	15/04/2020 10:56	23,15	93	2153,41	CHI
20200445188	ITABERAI	IB12000026	ITABERAI S2	14/04/2020 11:47	14/04/2020 15:14	14/04/2020 11:47	14/04/2020 15:14	3,44	51	175,64	CHI
20200445188	ITAPURANGA	IB12000026	ITABERAI S2	14/04/2020 11:47	14/04/2020 15:14	14/04/2020 11:47	14/04/2020 15:14	3,44	1	3,44	CHI
20200446650	ITUMBIARA	IT11000037	ITUMBIARA VELHA S1	14/04/2020 11:47	14/04/2020 21:25	14/04/2020 11:47	14/04/2020 21:25	9,63	118	1136,63	CHI
20200447219	ITABERAI	IB21147129	ITABERAI S2	14/04/2020 11:47	14/04/2020 17:05	14/04/2020 11:47	14/04/2020 17:05	5,29	1	5,29	CHI
20200445201	CATALAO	10022025373	CAMPO ALEGRE DE GOIAS	14/04/2020 11:48	14/04/2020 15:10	14/04/2020 11:48	14/04/2020 15:10	3,36	1	3,36	CHI
20200446134	ITUMBIARA	IT12033049	BOM JESUS DE GOIAS	14/04/2020 11:48	16/04/2020 05:45	14/04/2020 11:48	15/04/2020 23:46	35,97	1	35,97	CHI
20200446134	ITUMBIARA	IT12305380LD	BOM JESUS DE GOIAS	14/04/2020 11:48	16/04/2020 05:45	14/04/2020 11:48	16/04/2020 05:45	41,95	6	251,70	CHI
20200445211	FAINA	FC11169232	GOIAS	14/04/2020 11:49	14/04/2020 13:59	14/04/2020 11:49	14/04/2020 13:59	2,16	172	371,47	CHI
20200445280	AURILANDIA	SL10400789	SAO LUIZ DOS MONTES BELOS	14/04/2020 11:49	15/04/2020 09:50	14/04/2020 11:49	14/04/2020 13:54	2,08	27	56,18	CHI
20200445280	MOIPORA	SL10400789	SAO LUIZ DOS MONTES BELOS	14/04/2020 11:49	15/04/2020 09:50	14/04/2020 11:49	14/04/2020 13:54	2,08	13	27,05	CHI
20200445280	SAO LUIS DE MONTES BELOS	SL10400789	SAO LUIZ DOS MONTES BELOS	14/04/2020 11:49	15/04/2020 09:50	14/04/2020 11:49	14/04/2020 13:54	2,08	16	33,29	CHI
20200445280	MOIPORA	MO12003717LD	SAO LUIZ DOS MONTES BELOS	14/04/2020 11:49	15/04/2020 09:50	14/04/2020 11:49	14/04/2020 17:52	6,06	7	42,39	CHI
20200445280	CORREGO DO OURO	SL12206016LD	SAO LUIZ DOS MONTES BELOS	14/04/2020 11:49	15/04/2020 09:50	14/04/2020 11:49	14/04/2020 22:18	10,48	15	157,24	CHI
20200445280	MOIPORA	SL12206016LD	SAO LUIZ DOS MONTES BELOS	14/04/2020 11:49	15/04/2020 09:50	14/04/2020 11:49	14/04/2020 22:18	10,48	5	52,41	CHI

20200445280	CORREGO DO OURO	CO12028902	SAO LUIZ DOS MONTES BELOS	14/04/2020 11:49	15/04/2020 09:50	14/04/2020 11:49	15/04/2020 09:50	22,01	55	1210,76	CHI
20200445323	JANDAIA	JD12003211	PALMEIRAS	14/04/2020 11:49	14/04/2020 15:36	14/04/2020 11:49	14/04/2020 15:36	3,78	10	37,77	CHI
20200445323	PALMEIRAS DE GOIAS	JD12003211	PALMEIRAS	14/04/2020 11:49	14/04/2020 15:36	14/04/2020 11:49	14/04/2020 15:36	3,78	4	15,11	CHI
20200445323	PALMINOPOLIS	JD12003211	PALMEIRAS	14/04/2020 11:49	14/04/2020 15:36	14/04/2020 11:49	14/04/2020 15:36	3,78	15	56,65	CHI
20200447728	VICENTINOPOLIS	VI12203267RE	VICENTINOPOLIS	14/04/2020 11:49	14/04/2020 21:24	14/04/2020 11:49	14/04/2020 21:24	9,58	97	929,45	CHI
20200445452	ITUMBIARA	IT11000091	ITUMBIARA VELHA S1	14/04/2020 11:50	14/04/2020 18:35	14/04/2020 11:50	14/04/2020 18:35	6,75	55	371,25	CHI
20200445714	PALMEIRAS DE GOIAS	PL12143287	PALMEIRAS	14/04/2020 11:50	14/04/2020 17:42	14/04/2020 11:50	14/04/2020 17:42	5,86	37	216,78	CHI
20200446186	ITUMBIARA	IT11000018	ITUMBIARA VELHA S1	14/04/2020 11:51	14/04/2020 15:39	14/04/2020 11:51	14/04/2020 15:39	3,80	249	945,44	CHI
20200446579	ITUMBIARA	IT12000128	PARANAIBA	14/04/2020 11:51	14/04/2020 20:53	14/04/2020 11:51	14/04/2020 20:53	9,02	281	2535,01	CHI
20200445312	BOM JARDIM DE GOIAS	BM12245130	BOM JARDIM	14/04/2020 11:52	14/04/2020 15:44	14/04/2020 11:52	14/04/2020 15:44	3,86	6	23,17	CHI
20200445312	PIRANHAS	BM12245130	BOM JARDIM	14/04/2020 11:52	14/04/2020 15:44	14/04/2020 11:52	14/04/2020 15:44	3,86	4	15,45	CHI
202004105663	ITUMBIARA	IT11034271	ITUMBIARA VELHA S1	14/04/2020 11:52	15/04/2020 10:55	14/04/2020 11:52	15/04/2020 01:00	13,13	58	761,60	CHI
202004105663	ITUMBIARA	IT12222577	ITUMBIARA VELHA S1	14/04/2020 11:52	15/04/2020 10:55	15/04/2020 08:16	15/04/2020 10:26	2,17	60	130,27	CHI
202004105663	ITUMBIARA	IT12284928	ITUMBIARA VELHA S1	14/04/2020 11:52	15/04/2020 10:55	15/04/2020 08:16	15/04/2020 10:55	2,65	1	2,65	CHI
20200445258	BALIZA	BH12356956	BOM JARDIM	14/04/2020 11:56	14/04/2020 15:44	14/04/2020 11:56	14/04/2020 15:44	3,81	2	7,62	CHI
20200445264	GOIATUBA	GT11218099	GOIATUBA S2	14/04/2020 11:56	15/04/2020 21:41	14/04/2020 11:56	15/04/2020 21:41	33,74	29	978,44	CHI
2020041400104	IPORA	00850224	IPORA	14/04/2020 11:58	14/04/2020 12:01	14/04/2020 11:58	14/04/2020 12:01	0,05	7266	363,30	CHI
20200446204	ITUMBIARA	IT11208180	ITUMBIARA VELHA S1	14/04/2020 12:01	14/04/2020 17:20	14/04/2020 12:01	14/04/2020 17:20	5,31	109	579,15	CHI
20200445303	PALMEIRAS DE GOIAS	10030239190	PALMEIRAS	14/04/2020 12:02	14/04/2020 14:28	14/04/2020 12:02	14/04/2020 14:28	2,42	1	2,42	CHI
20200445661	FIRMINOPOLIS	SL12004026	SAO LUIZ DOS MONTES BELOS	14/04/2020 12:05	14/04/2020 23:15	14/04/2020 12:05	14/04/2020 23:15	11,16	18	200,89	CHI
20200445661	SAO LUIS DE MONTES BELOS	SL12004026	SAO LUIZ DOS MONTES BELOS	14/04/2020 12:05	14/04/2020 23:15	14/04/2020 12:05	14/04/2020 23:15	11,16	33	368,30	CHI
20200448875	SAO LUIS DE MONTES BELOS	SL11006854	SAO LUIZ DOS MONTES BELOS	14/04/2020 12:08	14/04/2020 23:25	14/04/2020 12:08	14/04/2020 23:25	11,28	222	2504,28	CHI
20200446164	DIORAMA	DI12390154	IPORA	14/04/2020 12:09	14/04/2020 20:02	14/04/2020 12:09	14/04/2020 20:02	7,88	6	47,30	CHI
20200446164	IPORA	DI12390154	IPORA	14/04/2020 12:09	14/04/2020 20:02	14/04/2020 12:09	14/04/2020 20:02	7,88	10	78,83	CHI
20200445378	FIRMINOPOLIS	8080908	FIRMINOPOLIS S1	14/04/2020 12:10	14/04/2020 20:55	14/04/2020 12:10	14/04/2020 20:55	8,74	35	305,88	CHI
20200445378	TURVANIA	8080908	FIRMINOPOLIS S1	14/04/2020 12:10	14/04/2020 20:55	14/04/2020 12:10	14/04/2020 20:55	8,74	1	8,74	CHI
20200445472	SAO LUIS DE MONTES BELOS	SL11233479	SAO LUIZ DOS MONTES BELOS	14/04/2020 12:10	14/04/2020 17:55	14/04/2020 12:10	14/04/2020 17:55	5,74	199	1141,87	CHI
20200445566	PIRACANJUBA	PJ12040425	MORRINHOS	14/04/2020 12:10	14/04/2020 21:13	14/04/2020 12:10	14/04/2020 16:53	4,70	7	32,93	CHI
20200445566	PIRACANJUBA	PJ12040425	MORRINHOS	14/04/2020 12:10	14/04/2020 21:13	14/04/2020 12:10	14/04/2020 21:13	9,04	8	72,30	CHI
20200445926	SAO LUIS DE MONTES BELOS	SL12000043	SAO LUIZ DOS MONTES BELOS	14/04/2020 12:11	14/04/2020 21:49	14/04/2020 12:11	14/04/2020 21:49	9,63	431	4148,38	CHI
20200445403	COLINAS DO SUL	TI12295072	MINACU	14/04/2020 12:12	14/04/2020 14:50	14/04/2020 12:12	14/04/2020 14:50	2,62	6	15,71	CHI
20200445905	GOIAS	IB12210550	ITABERAI S1	14/04/2020 12:12	14/04/2020 16:01	14/04/2020 12:12	14/04/2020 16:01	3,81	2	7,61	CHI
20200445905	ITABERAI	IB12210550	ITABERAI S1	14/04/2020 12:12	14/04/2020 16:01	14/04/2020 12:12	14/04/2020 16:01	3,81	35	133,26	CHI

20200446478	INDIARA	IY11215330	EDEIA	14/04/2020 12:12	14/04/2020 19:19	14/04/2020 12:12	14/04/2020 19:19	7,12	199	1416,33	CHI
20200499261	ITABERAI	IB12336527	ITABERAI S2	14/04/2020 12:12	14/04/2020 16:28	14/04/2020 12:12	14/04/2020 16:28	4,27	230	981,01	CHI
20200445407	JARAGUA	JA21238168	JARAGUA	14/04/2020 12:13	14/04/2020 16:21	14/04/2020 12:13	14/04/2020 16:21	4,13	1	4,13	CHI
20200445412	CAMPOS VERDES	SG12171809	SANTA TEREZINHA	14/04/2020 12:13	14/04/2020 22:18	14/04/2020 12:13	14/04/2020 22:18	10,07	13	130,96	CHI
20200445426	CALDAS NOVAS	10016274782	SERRA DE CALDAS	14/04/2020 12:16	14/04/2020 15:17	14/04/2020 12:16	14/04/2020 15:17	3,02	1	3,02	CHI
20200445435	PIRANHAS	PH11052932	PIRANHAS	14/04/2020 12:17	14/04/2020 19:34	14/04/2020 12:17	14/04/2020 19:34	7,28	174	1267,25	CHI
20200445451	GOIATUBA	140104495	GOIATUBA S2	14/04/2020 12:18	15/04/2020 07:37	14/04/2020 12:18	15/04/2020 07:37	19,31	1	19,31	CHI
20200445461	ARENOPOLIS	AY12381016	IPORA	14/04/2020 12:19	15/04/2020 00:13	14/04/2020 12:19	15/04/2020 00:13	11,90	45	535,48	CHI
20200445461	PIRANHAS	AY12381016	IPORA	14/04/2020 12:19	15/04/2020 00:13	14/04/2020 12:19	15/04/2020 00:13	11,90	1	11,90	CHI
20200445475	FAINA	FC12220907	GOIAS	14/04/2020 12:19	14/04/2020 16:30	14/04/2020 12:19	14/04/2020 16:30	4,19	11	46,05	CHI
20200445482	IPORA	IR12014505	IPORA	14/04/2020 12:20	14/04/2020 15:23	14/04/2020 12:20	14/04/2020 15:23	3,05	3	9,14	CHI
20200445487	FAZENDA NOVA	JP12316446	IPORA	14/04/2020 12:20	14/04/2020 17:35	14/04/2020 12:20	14/04/2020 17:35	5,25	3	15,74	CHI
20200445487	JAUPACI	JP12316446	IPORA	14/04/2020 12:20	14/04/2020 17:35	14/04/2020 12:20	14/04/2020 17:35	5,25	4	20,99	CHI
20200445494	MORRINHOS	MR21231868	MORRINHOS	14/04/2020 12:21	15/04/2020 15:49	14/04/2020 12:21	15/04/2020 15:49	27,48	1	27,48	CHI
20200445522	PALMEIRAS DE GOIAS	PL12169788	PALMEIRAS	14/04/2020 12:24	14/04/2020 16:13	14/04/2020 12:24	14/04/2020 16:13	3,80	9	34,24	CHI
20200499515	SAO LUIS DE MONTES BELOS	SL12349287LD	SAO LUIZ DOS MONTES BELOS	14/04/2020 12:25	15/04/2020 00:48	14/04/2020 12:25	15/04/2020 00:48	12,38	112	1386,96	CHI
20200445542	MAIRIPOTABA	MI11204476	PONTALINA	14/04/2020 12:27	14/04/2020 15:57	14/04/2020 12:27	14/04/2020 15:57	3,50	16	55,94	CHI
20200446099	ITUMBIARA	IT11143915	ITUMBIARA VELHA S1	14/04/2020 12:27	14/04/2020 17:21	14/04/2020 12:27	14/04/2020 17:21	4,89	134	655,93	CHI
20200444190	CEZARINA	PL12349283	PALMEIRAS	14/04/2020 12:28	14/04/2020 15:57	14/04/2020 12:28	14/04/2020 15:15	2,79	1	2,79	CHI
20200444190	PALMEIRAS DE GOIAS	PL12361565	PALMEIRAS	14/04/2020 12:28	14/04/2020 15:57	14/04/2020 12:28	14/04/2020 15:36	3,14	4	12,55	CHI
20200444190	PALMEIRAS DE GOIAS	PL12312515	PALMEIRAS	14/04/2020 12:28	14/04/2020 15:57	14/04/2020 12:28	14/04/2020 15:57	3,49	3	10,47	CHI
20200445545	ARAGARCAS	AG12000021	ARAGARCAS	14/04/2020 12:28	14/04/2020 22:13	14/04/2020 12:28	14/04/2020 22:13	9,75	63	613,97	CHI
20200445553	PONTALINA	VI12335578	VICENTINOPOLIS	14/04/2020 12:29	14/04/2020 19:24	14/04/2020 12:29	14/04/2020 19:24	6,91	3	20,72	CHI
20200445553	VICENTINOPOLIS	VI12335578	VICENTINOPOLIS	14/04/2020 12:29	14/04/2020 19:24	14/04/2020 12:29	14/04/2020 19:24	6,91	10	69,07	CHI
20200445556	CRISTIANOPOLIS	CF21000002	CRISTIANOPOLIS	14/04/2020 12:29	14/04/2020 13:49	14/04/2020 12:29	14/04/2020 13:49	1,32	2	2,64	CHI
20200446440	FIRMINOPOLIS	FR11076437	FIRMINOPOLIS S1	14/04/2020 12:29	14/04/2020 17:50	14/04/2020 12:29	14/04/2020 17:50	5,34	122	651,21	CHI
20200445570	CALDAS NOVAS	CN12404748	CALDAS NOVAS S1	14/04/2020 12:32	14/04/2020 16:33	14/04/2020 12:32	14/04/2020 16:33	4,02	6	24,10	CHI
20200445570	RIO QUENTE	CN12404748	CALDAS NOVAS S1	14/04/2020 12:32	14/04/2020 16:33	14/04/2020 12:32	14/04/2020 16:33	4,02	40	160,64	CHI
20200445571	ARAGARCAS	AG12000003	ARAGARCAS	14/04/2020 12:32	14/04/2020 16:59	14/04/2020 12:32	14/04/2020 16:59	4,45	20	88,96	CHI
20200447051	ARAGARCAS	AG11401207	ARAGARCAS	14/04/2020 12:32	14/04/2020 22:41	14/04/2020 12:32	14/04/2020 22:41	10,15	46	466,81	CHI
20200448814	ARAGARCAS	AG11000003	ARAGARCAS	14/04/2020 12:32	14/04/2020 21:21	14/04/2020 12:32	14/04/2020 21:21	8,82	30	264,45	CHI
20200445583	AMERICANO DO BRASIL	KB12391521	ANICUNS	14/04/2020 12:33	14/04/2020 18:01	14/04/2020 12:33	14/04/2020 18:01	5,46	11	60,10	CHI
20200445583	MOSSAMEDES	KB12391521	ANICUNS	14/04/2020 12:33	14/04/2020 18:01	14/04/2020 12:33	14/04/2020 18:01	5,46	11	60,10	CHI

20200446199	ADELANDIA	DN12047420	FIRMINOPOLIS S2	14/04/2020 12:33	14/04/2020 15:39	14/04/2020 12:33	14/04/2020 15:39	3,09	3	9,27	CHI
20200446199	ANICUNS	DN12047420	FIRMINOPOLIS S2	14/04/2020 12:33	14/04/2020 15:39	14/04/2020 12:33	14/04/2020 15:39	3,09	76	234,86	CHI
20200446563	FAZENDA NOVA	FN12220464	JUSSARA	14/04/2020 12:34	15/04/2020 10:27	14/04/2020 12:34	15/04/2020 10:27	21,88	29	634,60	CHI
20200445621	INDIARA	IY12010924	PALMEIRAS	14/04/2020 12:36	15/04/2020 10:02	14/04/2020 12:36	15/04/2020 10:02	21,42	14	299,84	CHI
20200445621	JANDAIA	IY12010924	PALMEIRAS	14/04/2020 12:36	15/04/2020 10:02	14/04/2020 12:36	15/04/2020 10:02	21,42	1	21,42	CHI
20200445646	BRITANIA	BT12030159	BRITANIA	14/04/2020 12:39	14/04/2020 15:19	14/04/2020 12:39	14/04/2020 15:19	2,65	2	5,30	CHI
20200445646	JUSSARA	BT12030159	BRITANIA	14/04/2020 12:39	14/04/2020 15:19	14/04/2020 12:39	14/04/2020 15:19	2,65	1	2,65	CHI
20200446898	FIRMINOPOLIS	FR11076439	FIRMINOPOLIS S1	14/04/2020 12:39	14/04/2020 19:20	14/04/2020 12:39	14/04/2020 19:20	6,67	87	580,56	CHI
20200445653	ANAPOLIS	Z1160405	JUNDIAI S1	14/04/2020 12:40	14/04/2020 18:24	14/04/2020 12:40	14/04/2020 18:24	5,73	1	5,73	CHI
20200448667	CORUMBAIBA	CI12000093RE	VILA CORUMBA	14/04/2020 12:40	15/04/2020 08:42	14/04/2020 12:40	15/04/2020 08:42	20,03	108	2163,27	CHI
20200445662	SANTA CRUZ DE GOIAS	PZ12311653	PIRES DO RIO S2	14/04/2020 12:41	14/04/2020 16:14	14/04/2020 12:41	14/04/2020 16:14	3,54	7	24,81	CHI
20200445670	MOIPORA	MO12374844	IPORA	14/04/2020 12:42	14/04/2020 15:49	14/04/2020 12:42	14/04/2020 15:49	3,11	9	28,02	CHI
20200448563	ARAGARCAS	AG11053350	ARAGARCAS	14/04/2020 12:44	14/04/2020 19:36	14/04/2020 12:44	14/04/2020 19:36	6,86	145	995,22	CHI
20200447201	CORREGO DO OURO	CO12056203	FIRMINOPOLIS S2	14/04/2020 12:45	14/04/2020 17:15	14/04/2020 12:45	14/04/2020 17:15	4,49	230	1033,15	CHI
20200445702	AGUA LIMPA	AL12263211	VILA CORUMBA	14/04/2020 12:46	14/04/2020 15:36	14/04/2020 12:46	14/04/2020 15:36	2,83	1	2,83	CHI
20200445709	ITUMBIARA	IT11000051	ITUMBIARA VELHA S1	14/04/2020 12:46	15/04/2020 12:03	14/04/2020 12:46	15/04/2020 12:03	23,27	91	2117,70	CHI
20200446180	SAO LUIS DE MONTES BELOS	SL11259146	SAO LUIZ DOS MONTES BELOS	14/04/2020 12:46	15/04/2020 04:28	14/04/2020 12:46	15/04/2020 04:28	15,69	28	439,27	CHI
20200446884	ITABERAI	IB12020728	ITABERAI S2	14/04/2020 12:46	14/04/2020 21:45	14/04/2020 12:46	14/04/2020 16:54	4,13	1	4,13	CHI
20200446884	ITABERAI	IB12020728	ITABERAI S2	14/04/2020 12:46	14/04/2020 21:45	14/04/2020 12:46	14/04/2020 21:45	8,98	5	44,91	CHI
20200445717	NOVA CRIXAS	NA21059979	MOZARLANDIA	14/04/2020 12:47	14/04/2020 21:31	14/04/2020 12:47	14/04/2020 21:31	8,73	1	8,73	CHI
20200445723	SAO LUIS DE MONTES BELOS	500035600	SAO LUIZ DOS MONTES BELOS	14/04/2020 12:47	14/04/2020 14:38	14/04/2020 12:47	14/04/2020 14:38	1,84	1	1,84	CHI
20200446615	NAZARIO	NZ12259134	ANICUNS	14/04/2020 12:47	14/04/2020 15:12	14/04/2020 12:47	14/04/2020 15:12	2,40	3	7,21	CHI
20200446615	PALMEIRAS DE GOIAS	NZ12259134	ANICUNS	14/04/2020 12:47	14/04/2020 15:12	14/04/2020 12:47	14/04/2020 15:12	2,40	3	7,21	CHI
20200445732	ARAGUAPAZ	AZ12210559	GOIAS	14/04/2020 12:49	14/04/2020 18:40	14/04/2020 12:49	14/04/2020 18:40	5,85	3	17,54	CHI
20200445739	PORANGATU	PO12192281	PORANGATU	14/04/2020 12:50	14/04/2020 14:46	14/04/2020 12:50	14/04/2020 14:46	1,93	2	3,86	CHI
20200445948	MONTES CLAROS DE GOIAS	ME11076598	IPORA	14/04/2020 12:51	15/04/2020 00:17	14/04/2020 12:51	15/04/2020 00:17	11,43	123	1405,65	CHI
20200445762	URUACU	UR21237317	URUACU	14/04/2020 12:53	14/04/2020 15:12	14/04/2020 12:53	14/04/2020 15:12	2,31	1	2,31	CHI
20200447795	FIRMINOPOLIS	SL12111561	FIRMINOPOLIS S1	14/04/2020 12:54	14/04/2020 22:05	14/04/2020 12:54	14/04/2020 22:05	9,17	6	55,04	CHI
20200447795	SAO LUIS DE MONTES BELOS	SL12111561	FIRMINOPOLIS S1	14/04/2020 12:54	14/04/2020 22:05	14/04/2020 12:54	14/04/2020 22:05	9,17	3	27,52	CHI
20200445792	ARAGARCAS	BM12155745	BOM JARDIM	14/04/2020 12:55	14/04/2020 17:48	14/04/2020 12:55	14/04/2020 17:48	4,87	86	419,11	CHI
20200445792	BOM JARDIM DE GOIAS	BM12155745	BOM JARDIM	14/04/2020 12:55	14/04/2020 17:48	14/04/2020 12:55	14/04/2020 17:48	4,87	51	248,54	CHI
20200448096	BOM JARDIM DE GOIAS	BM21335407	BOM JARDIM	14/04/2020 12:55	15/04/2020 03:51	14/04/2020 12:55	15/04/2020 03:51	14,92	2	29,85	CHI
20200450924	ARAGARCAS	BM11372325	BOM JARDIM	14/04/2020 12:55	15/04/2020 09:36	14/04/2020 12:55	15/04/2020 09:36	20,67	1	20,67	CHI

20200445785	PORANGATU	PO12012430	PORANGATU	14/04/2020 12:56	14/04/2020 16:06	14/04/2020 12:56	14/04/2020 16:06	3,16	3	9,49	CHI
20200445797	GOIAS	GS12071258	GOIAS	14/04/2020 12:57	14/04/2020 17:30	14/04/2020 12:57	14/04/2020 17:30	4,54	91	413,19	CHI
20200446509	NOVO BRASIL	NB12087607	JUSSARA	14/04/2020 12:57	16/04/2020 12:05	14/04/2020 12:57	16/04/2020 10:30	45,54	5	227,72	CHI
20200446509	NOVO BRASIL	NB12087607	JUSSARA	14/04/2020 12:57	16/04/2020 12:05	14/04/2020 12:57	16/04/2020 11:04	46,12	2	92,24	CHI
20200446509	NOVO BRASIL	NB12091821LD	JUSSARA	14/04/2020 12:57	16/04/2020 12:05	16/04/2020 11:26	16/04/2020 11:30	0,07	2	0,13	CHI
20200446509	NOVO BRASIL	NB12087607	JUSSARA	14/04/2020 12:57	16/04/2020 12:05	14/04/2020 12:57	16/04/2020 12:05	47,13	3	141,39	CHI
20200446085	ITUMBIARA	IT12088613	PARANAIBA	14/04/2020 12:58	14/04/2020 19:04	14/04/2020 12:58	14/04/2020 19:04	6,09	7	42,66	CHI
20200445815	ITUMBIARA	00990234	ITUMBIARA VELHA S1	14/04/2020 12:59	14/04/2020 17:05	14/04/2020 12:59	14/04/2020 14:30	1,53	3319	5074,38	CHI
20200445815	ITUMBIARA	00990234	ITUMBIARA VELHA S1	14/04/2020 12:59	14/04/2020 17:05	14/04/2020 14:03	14/04/2020 14:30	0,46	255	117,80	CHI
20200445815	ITUMBIARA	00990234	ITUMBIARA VELHA S1	14/04/2020 12:59	14/04/2020 17:05	14/04/2020 12:59	14/04/2020 16:54	3,92	913	3578,20	CHI
20200445815	ITUMBIARA	00990234	ITUMBIARA VELHA S1	14/04/2020 12:59	14/04/2020 17:05	14/04/2020 12:59	14/04/2020 17:05	4,10	394	1615,40	CHI
20200445909	MOSSAMEDES	SC12395118	FIRMINOPOLIS S2	14/04/2020 12:59	14/04/2020 15:10	14/04/2020 12:59	14/04/2020 15:10	2,18	28	61,00	CHI
20200445909	SANCLERLANDIA	SC12395118	FIRMINOPOLIS S2	14/04/2020 12:59	14/04/2020 15:10	14/04/2020 12:59	14/04/2020 15:10	2,18	3	6,54	CHI
20200445917	PONTALINA	PK12249759RE	VICENTINOPOLIS	14/04/2020 12:59	14/04/2020 16:15	14/04/2020 12:59	14/04/2020 16:15	3,26	4	13,05	CHI
20200446266	MONTES CLAROS DE GOIAS	ME11091486	IPORA	14/04/2020 12:59	14/04/2020 21:02	14/04/2020 12:59	14/04/2020 21:02	8,04	75	602,92	CHI
20200445923	ITAGUARI	II12030291	ITABERAI S1	14/04/2020 13:00	14/04/2020 23:02	14/04/2020 13:00	14/04/2020 23:02	10,02	73	731,56	CHI
20200446013	MORRINHOS	MR12000148	MORRINHOS	14/04/2020 13:00	15/04/2020 13:20	14/04/2020 13:00	14/04/2020 20:22	7,37	21	154,83	CHI
20200446013	MORRINHOS	MR12028278LD	MORRINHOS	14/04/2020 13:00	15/04/2020 13:20	14/04/2020 13:00	15/04/2020 13:20	24,34	1	24,34	CHI
20200445930	PANAMA	PX12309830	GOIATUBA S1	14/04/2020 13:02	15/04/2020 07:10	14/04/2020 13:02	15/04/2020 07:10	18,13	2	36,26	CHI
20200445804	PIRACANJUBA	PJ13329054	ROCHEDO	14/04/2020 13:03	14/04/2020 19:28	14/04/2020 13:03	14/04/2020 18:36	5,54	49	271,42	CHI
20200445804	PROFESSOR JAMIL SAFADY	PJ13329054	ROCHEDO	14/04/2020 13:03	14/04/2020 19:28	14/04/2020 13:03	14/04/2020 18:36	5,54	25	138,48	CHI
20200445804	PIRACANJUBA	PJ13023193	ROCHEDO	14/04/2020 13:03	14/04/2020 19:28	14/04/2020 14:54	14/04/2020 19:28	4,58	314	1438,99	CHI
20200445938	MORRO AGUDO DE GOIAS	MS12331540	ITAPURANGA	14/04/2020 13:03	14/04/2020 15:53	14/04/2020 13:03	14/04/2020 15:53	2,83	1	2,83	CHI
20200445939	EDEIA	EA21000046	EDEIA	14/04/2020 13:03	14/04/2020 14:26	14/04/2020 13:03	14/04/2020 14:26	1,38	1	1,38	CHI
20200445944	ITUMBIARA	IT12273935	ITUMBIARA NOVA	14/04/2020 13:03	15/04/2020 02:42	14/04/2020 13:03	15/04/2020 02:42	13,64	106	1445,52	CHI
20200445944	ITUMBIARA	IT12273935	ITUMBIARA NOVA	14/04/2020 13:03	15/04/2020 02:42	15/04/2020 00:53	15/04/2020 02:42	1,81	394	711,94	CHI
20200446373	APARECIDA DE GOIANIA	AP11079021	INDEPENDENCIA S1	14/04/2020 13:03	14/04/2020 15:18	14/04/2020 13:03	14/04/2020 15:18	2,24	83	185,90	CHI
20200445950	SAO LUIS DE MONTES BELOS	SL11006847	SAO LUIZ DOS MONTES BELOS	14/04/2020 13:04	14/04/2020 16:35	14/04/2020 13:04	14/04/2020 16:35	3,51	268	941,50	CHI
20200445972	JUSSARA	JR12220051	JUSSARA	14/04/2020 13:04	14/04/2020 22:37	14/04/2020 13:04	14/04/2020 22:37	9,54	70	667,98	CHI
20200446250	JUSSARA	JR11183443	JUSSARA	14/04/2020 13:05	14/04/2020 19:56	14/04/2020 13:05	14/04/2020 19:56	6,84	73	499,18	CHI
20200446640	ARAGOIANIA	AO11000024	GUAPO S2	14/04/2020 13:05	14/04/2020 17:37	14/04/2020 13:05	14/04/2020 17:37	4,52	114	515,25	CHI
20200445964	NIQUELANDIA	2750129303	URUACU	14/04/2020 13:06	14/04/2020 19:56	14/04/2020 13:06	14/04/2020 19:56	6,85	1	6,85	CHI
20200445970	IPORA	IR21097781	IPORA	14/04/2020 13:06	15/04/2020 03:38	14/04/2020 13:06	15/04/2020 03:38	14,52	1	14,52	CHI



20200445971	PORANGATU	840060350	PORANGATU	14/04/2020 13:06	14/04/2020 16:03	14/04/2020 13:06	14/04/2020 16:03	2,94	1	2,94	CHI
20200445973	APARECIDA DE GOIANIA	AP11157226	INDEPENDENCIA S2	14/04/2020 13:06	14/04/2020 15:47	14/04/2020 13:06	14/04/2020 15:47	2,67	118	314,99	CHI
20200445975	MONTES CLAROS DE GOIAS	ME12380972	IPORA	14/04/2020 13:07	15/04/2020 13:40	14/04/2020 13:07	15/04/2020 13:40	24,55	8	196,40	CHI
20200445980	ABADIA DE GOIAS	AO12032892	INDEPENDENCIA S2	14/04/2020 13:07	15/04/2020 02:06	14/04/2020 13:07	15/04/2020 02:06	12,98	21	272,56	CHI
20200445982	JUSSARA	JR11012055	JUSSARA	14/04/2020 13:07	14/04/2020 18:29	14/04/2020 13:07	14/04/2020 18:29	5,36	111	594,81	CHI
20200445813	GOIAS	GS12087533	ITABERAI S2	14/04/2020 13:08	14/04/2020 18:52	14/04/2020 13:08	14/04/2020 18:52	5,72	7	40,07	CHI
20200445986	VILA PROPICIO	NP21318172	GOIANESIA S2	14/04/2020 13:08	14/04/2020 23:37	14/04/2020 13:08	14/04/2020 23:37	10,48	1	10,48	CHI
20200446064	APARECIDA DE GOIANIA	AP11004682	INDEPENDENCIA S2	14/04/2020 13:08	14/04/2020 17:29	14/04/2020 13:08	14/04/2020 17:29	4,34	108	468,96	CHI
20200446040	APARECIDA DE GOIANIA	AP11162102	ATLANTICO S2	14/04/2020 13:09	14/04/2020 14:48	14/04/2020 13:09	14/04/2020 14:48	1,64	106	174,02	CHI
20200446016	SILVANIA	SV12329394	VIANOPOLIS	14/04/2020 13:10	14/04/2020 15:19	14/04/2020 13:10	14/04/2020 15:19	2,14	1	2,14	CHI
20200446022	SENADOR CANEDO	SW12323510	CEPAIGO S2	14/04/2020 13:11	14/04/2020 17:56	14/04/2020 13:11	14/04/2020 17:56	4,75	2	9,49	CHI
20200446023	ANICUNS	AC11382518	ANICUNS	14/04/2020 13:11	14/04/2020 16:02	14/04/2020 13:11	14/04/2020 16:02	2,85	62	176,51	CHI
20200446027	PIRACANJUBA	PJ21182743	PIRACANJUBA	14/04/2020 13:11	14/04/2020 14:48	14/04/2020 13:11	14/04/2020 14:48	1,61	1	1,61	CHI
20200446033	INHUMAS	10020767356	INHUMAS S2	14/04/2020 13:11	14/04/2020 15:42	14/04/2020 13:11	14/04/2020 15:42	2,50	1	2,50	CHI
20200446034	AMORINOPOLIS	IV12165613	IPORA	14/04/2020 13:11	14/04/2020 20:41	14/04/2020 13:11	14/04/2020 20:41	7,48	6	44,90	CHI
20200446034	IVOLANDIA	IV12165613	IPORA	14/04/2020 13:11	14/04/2020 20:41	14/04/2020 13:11	14/04/2020 20:41	7,48	6	44,90	CHI
20200446132	ITAPIRAPUA	IU12264118	MATRINCHA	14/04/2020 13:11	14/04/2020 23:24	14/04/2020 13:11	14/04/2020 23:24	10,21	8	81,70	CHI
20200446183	TRINDADE	TR12000098	TRINDADE	14/04/2020 13:11	14/04/2020 17:05	14/04/2020 13:11	14/04/2020 17:05	3,91	1843	7199,47	CHI
20200446452	APARECIDA DE GOIANIA	AP11095069	ATLANTICO S2	14/04/2020 13:12	14/04/2020 15:18	14/04/2020 13:12	14/04/2020 15:18	2,10	114	239,11	CHI
20200446493	JUSSARA	JR11026991	JUSSARA	14/04/2020 13:12	14/04/2020 21:12	14/04/2020 13:12	14/04/2020 21:12	7,99	71	567,63	CHI
20200446376	FAZENDA NOVA	FN12223049	IPORA	14/04/2020 13:13	15/04/2020 12:32	14/04/2020 13:13	15/04/2020 12:32	23,30	8	186,42	CHI
20200446376	ISRAELANDIA	FN12223049	IPORA	14/04/2020 13:13	15/04/2020 12:32	14/04/2020 13:13	15/04/2020 12:32	23,30	2	46,61	CHI
20200446182	GOIANIA	GN11040700	ATLANTICO S2	14/04/2020 13:14	14/04/2020 19:07	14/04/2020 13:14	14/04/2020 19:07	5,88	122	717,09	CHI
20200446224	PIRACANJUBA	PJ12212173	PIRACANJUBA	14/04/2020 13:15	14/04/2020 16:21	14/04/2020 13:15	14/04/2020 16:21	3,10	19	58,92	CHI
20200445817	GOIANIA	02400254	AEROPORTO S1	14/04/2020 13:16	14/04/2020 13:31	14/04/2020 13:19	14/04/2020 13:23	0,06	2225	126,70	CHI
20200445817	GOIANIA	GN10400634	AEROPORTO S2	14/04/2020 13:16	14/04/2020 13:31	14/04/2020 13:16	14/04/2020 13:24	0,13	447	60,34	CHI
20200445817	GOIANIA	GN10383781	AEROPORTO S2	14/04/2020 13:16	14/04/2020 13:31	14/04/2020 13:16	14/04/2020 13:25	0,16	833	134,44	CHI
20200445817	GOIANIA	GN16413692	AEROPORTO S1	14/04/2020 13:16	14/04/2020 13:31	14/04/2020 13:16	14/04/2020 13:31	0,25	95	23,80	CHI
20200445817	GOIANIA	GN16413692	AEROPORTO S2	14/04/2020 13:16	14/04/2020 13:31	14/04/2020 13:16	14/04/2020 13:31	0,25	770	192,93	CHI
20200445817	GOIANIA	GN10383797	AEROPORTO S1	14/04/2020 13:16	14/04/2020 13:31	14/04/2020 13:19	14/04/2020 13:31	0,20	1586	318,52	CHI
20200446073	PIRANHAS	PH12184374	PIRANHAS	14/04/2020 13:16	14/04/2020 19:29	14/04/2020 13:16	14/04/2020 19:29	6,21	8	49,71	CHI
20200446774	APARECIDA DE GOIANIA	AP11137108	INDEPENDENCIA S1	14/04/2020 13:16	14/04/2020 19:17	14/04/2020 13:16	14/04/2020 19:17	6,01	267	1605,04	CHI
20200446152	APARECIDA DE GOIANIA	AP11051637	ATLANTICO S1	14/04/2020 13:17	14/04/2020 15:47	14/04/2020 13:17	14/04/2020 15:47	2,50	64	159,72	CHI

20200446093	COLINAS DO SUL	TI21364449	MINACU	14/04/2020 13:18	14/04/2020 16:04	14/04/2020 13:18	14/04/2020 16:04	2,76	1	2,76	CHI
20200446102	SAO MIGUEL DO PASSA QUATRO	SQ21186645	CRISTIANOPOLIS	14/04/2020 13:19	14/04/2020 17:41	14/04/2020 13:19	14/04/2020 17:41	4,36	1	4,36	CHI
20200446103	PORANGATU	PO21136914	NOVO PLANALTO	14/04/2020 13:19	14/04/2020 19:53	14/04/2020 13:19	14/04/2020 19:53	6,56	1	6,56	CHI
20200446109	ARAGOIANIA	AO21362871	GUAPO S2	14/04/2020 13:19	15/04/2020 10:54	14/04/2020 13:19	15/04/2020 10:54	21,57	2	43,14	CHI
20200446245	FAZENDA NOVA	NB12061633	JUSSARA	14/04/2020 13:19	14/04/2020 22:15	14/04/2020 13:19	14/04/2020 22:15	8,92	1	8,92	CHI
20200446245	JUSSARA	NB12061633	JUSSARA	14/04/2020 13:19	14/04/2020 22:15	14/04/2020 13:19	14/04/2020 22:15	8,92	11	98,11	CHI
20200446245	NOVO BRASIL	NB12061633	JUSSARA	14/04/2020 13:19	14/04/2020 22:15	14/04/2020 13:19	14/04/2020 22:15	8,92	12	107,03	CHI
20200446375	GOIANIA	GN11001649	GOIANIA LESTE S2	14/04/2020 13:19	14/04/2020 17:23	14/04/2020 13:19	14/04/2020 17:23	4,05	45	182,40	CHI
20200446238	CALDAS NOVAS	CN21333022	CALDAS NOVAS S1	14/04/2020 13:19	14/04/2020 23:31	14/04/2020 13:19	14/04/2020 23:31	10,19	2	20,39	CHI
20200446258	SANTA CRUZ DE GOIAS	CN21180292	CALDAS NOVAS S1	14/04/2020 13:19	14/04/2020 20:37	14/04/2020 13:19	14/04/2020 20:37	7,29	1	7,29	CHI
20200447499	ITUMBIARA	IT12304170	ITUMBIARA NOVA	14/04/2020 13:20	15/04/2020 09:23	14/04/2020 13:20	15/04/2020 09:23	20,05	7	140,32	CHI
20200446130	GOIANIA	GN12001010	GOYA S2	14/04/2020 13:21	14/04/2020 17:29	14/04/2020 13:21	14/04/2020 17:29	4,13	21	86,80	CHI
20200446141	ARENOPOLIS	PH12204850RE	ARENOPOLIS	14/04/2020 13:21	14/04/2020 20:45	14/04/2020 13:21	14/04/2020 20:45	7,39	1	7,39	CHI
20200446141	PIRANHAS	PH12204850RE	ARENOPOLIS	14/04/2020 13:21	14/04/2020 20:45	14/04/2020 13:21	14/04/2020 20:45	7,39	4	29,56	CHI
20200446226	GOIANIA	GN11000654	CAMPINAS S3	14/04/2020 13:21	15/04/2020 02:30	14/04/2020 13:21	15/04/2020 02:30	13,14	100	1314,47	CHI
20200446359	GOIANIA	GN16416199	GOIANIA LESTE S2	14/04/2020 13:21	14/04/2020 13:25	14/04/2020 13:21	14/04/2020 13:25	0,07	1457	99,16	CHI
20200445824	BELA VISTA DE GOIAS	BV10400759	BELA VISTA S1	14/04/2020 13:22	15/04/2020 12:25	14/04/2020 13:22	14/04/2020 20:17	6,92	17	117,58	CHI
20200445824	PIRACANJUBA	BV10400759	BELA VISTA S1	14/04/2020 13:22	15/04/2020 12:25	14/04/2020 13:22	14/04/2020 20:17	6,92	16	110,66	CHI
20200445824	BELA VISTA DE GOIAS	BV10400759	BELA VISTA S1	14/04/2020 13:22	15/04/2020 12:25	14/04/2020 20:44	14/04/2020 20:57	0,22	17	3,66	CHI
20200445824	PIRACANJUBA	BV10400759	BELA VISTA S1	14/04/2020 13:22	15/04/2020 12:25	14/04/2020 20:44	14/04/2020 20:57	0,22	16	3,45	CHI
20200445824	BELA VISTA DE GOIAS	BV10400759	BELA VISTA S1	14/04/2020 13:22	15/04/2020 12:25	14/04/2020 13:22	15/04/2020 12:25	23,05	217	5001,13	CHI
20200445824	PIRACANJUBA	BV10400759	BELA VISTA S1	14/04/2020 13:22	15/04/2020 12:25	14/04/2020 13:22	15/04/2020 12:25	23,05	133	3065,21	CHI
20200445824	PIRACANJUBA	BV10400759	BELA VISTA S1	14/04/2020 13:22	15/04/2020 12:25	14/04/2020 13:41	15/04/2020 12:25	22,73	1	22,73	CHI
20200446149	CRIXAS	GF12243493	SANTA TEREZINHA	14/04/2020 13:22	14/04/2020 18:57	14/04/2020 13:22	14/04/2020 18:57	5,58	3	16,75	CHI
20200446149	GUARINOS	GF12243493	SANTA TEREZINHA	14/04/2020 13:22	14/04/2020 18:57	14/04/2020 13:22	14/04/2020 18:57	5,58	13	72,58	CHI
20200446431	URUACU	UR12318742	MARA ROSA	14/04/2020 13:22	14/04/2020 22:28	14/04/2020 13:22	14/04/2020 22:28	9,10	7	63,67	CHI
20200446181	APARECIDA DE GOIANIA	12966289	INDEPENDENCIA S1	14/04/2020 13:23	14/04/2020 18:15	14/04/2020 13:23	14/04/2020 18:15	4,85	1	4,85	CHI
20200446188	GOIANIA	GN12064341	CARAJAS S1	14/04/2020 13:23	14/04/2020 16:19	14/04/2020 13:23	14/04/2020 16:19	2,92	1	2,92	CHI
20200446873	ITAPURANGA	IK12220549	ITAPURANGA	14/04/2020 13:23	14/04/2020 16:42	14/04/2020 13:23	14/04/2020 16:42	3,30	4	13,21	CHI
20200450447	ITAPURANGA	IK21298527	ITAPURANGA	14/04/2020 13:23	15/04/2020 12:52	14/04/2020 13:23	15/04/2020 12:52	23,47	1	23,47	CHI
20200446193	ANICUNS	AC12266584	ANICUNS	14/04/2020 13:24	16/04/2020 09:13	14/04/2020 13:24	15/04/2020 17:48	28,41	1	28,41	CHI
20200446193	TURVANIA	AC12266584	ANICUNS	14/04/2020 13:24	16/04/2020 09:13	14/04/2020 13:24	15/04/2020 23:20	33,94	6	203,65	CHI
20200446193	ANICUNS	AC12266584	ANICUNS	14/04/2020 13:24	16/04/2020 09:13	15/04/2020 23:21	16/04/2020 09:13	9,86	1	9,86	CHI

20200446193	TURVANIA	AC12266584	ANICUNS	14/04/2020 13:24	16/04/2020 09:13	15/04/2020 23:21	16/04/2020 09:13	9,86	5	49,32	CHI
20200446196	TAQUARAL DE GOIAS	TQ12000107	ITABERAI S1	14/04/2020 13:24	14/04/2020 15:58	14/04/2020 13:24	14/04/2020 15:58	2,56	27	69,08	CHI
20200446415	GOIANIA	GN11203354	GOYA S2	14/04/2020 13:24	14/04/2020 16:12	14/04/2020 13:24	14/04/2020 16:12	2,78	244	679,27	CHI
20200446830	GOIANIA	GN12026287	GOIANIA LESTE S3	14/04/2020 13:24	14/04/2020 17:50	14/04/2020 13:24	14/04/2020 17:50	4,43	235	1040,01	CHI
20200446854	MONTES CLAROS DE GOIAS	ME12088922	IPORA	14/04/2020 13:24	15/04/2020 15:36	14/04/2020 13:24	15/04/2020 15:36	26,19	17	445,18	CHI
20200446212	GOIANIA	GN11275002	CARAJAS S1	14/04/2020 13:25	14/04/2020 18:20	14/04/2020 13:25	14/04/2020 18:20	4,92	72	353,96	CHI
20200446628	GOIANIA	GN12164391	MEIA PONTE	14/04/2020 13:25	14/04/2020 19:17	14/04/2020 13:25	14/04/2020 19:17	5,86	192	1125,39	CHI
20200447175	ITAPIRAPUA	IU11172040	MATRINCHA	14/04/2020 13:25	14/04/2020 20:04	14/04/2020 13:25	14/04/2020 20:04	6,64	82	544,34	CHI
20200449758	GOIANIA	GN11166217	MEIA PONTE	14/04/2020 13:25	14/04/2020 22:56	14/04/2020 13:25	14/04/2020 22:56	9,51	53	504,12	CHI
20200446216	CUMARI	CT21267101	CATALAO S2	14/04/2020 13:26	14/04/2020 14:36	14/04/2020 13:26	14/04/2020 14:36	1,17	1	1,17	CHI
20200446221	BELA VISTA DE GOIAS	BV12324973	BELA VISTA S2	14/04/2020 13:26	15/04/2020 11:18	14/04/2020 13:26	15/04/2020 11:18	21,86	2	43,72	CHI
20200446221	SAO MIGUEL DO PASSA QUATRO	BV12324973	BELA VISTA S2	14/04/2020 13:26	15/04/2020 11:18	14/04/2020 13:26	15/04/2020 11:18	21,86	1	21,86	CHI
20200448657	PIRENOPOLIS	PV12000464	SAO FRANCISCO DE GOIAS	14/04/2020 13:26	14/04/2020 20:30	14/04/2020 13:26	14/04/2020 20:30	7,07	41	289,68	CHI
2020041400116	JARAGUA	03165126	SAO FRANCISCO DE GOIAS	14/04/2020 13:26	14/04/2020 16:35	14/04/2020 13:26	14/04/2020 16:26	3,00	22	65,97	CHI
2020041400116	JESUPOLIS	03165126	SAO FRANCISCO DE GOIAS	14/04/2020 13:26	14/04/2020 16:35	14/04/2020 13:26	14/04/2020 16:26	3,00	966	2896,66	CHI
2020041400116	PETROLINA DE GOIAS	03165126	SAO FRANCISCO DE GOIAS	14/04/2020 13:26	14/04/2020 16:35	14/04/2020 13:26	14/04/2020 16:26	3,00	1	3,00	CHI
2020041400116	PETROLINA DE GOIAS	03165126	SAO FRANCISCO DE GOIAS	14/04/2020 13:26	14/04/2020 16:35	14/04/2020 13:26	14/04/2020 16:26	3,00	13	38,98	CHI
2020041400116	PETROLINA DE GOIAS	03165126	SAO FRANCISCO DE GOIAS	14/04/2020 13:26	14/04/2020 16:35	14/04/2020 13:26	14/04/2020 16:26	3,00	3	9,00	CHI
2020041400116	PETROLINA DE GOIAS	03165126	SAO FRANCISCO DE GOIAS	14/04/2020 13:26	14/04/2020 16:35	14/04/2020 13:26	14/04/2020 16:26	3,00	3	9,00	CHI
2020041400116	PIRENOPOLIS	03165126	SAO FRANCISCO DE GOIAS	14/04/2020 13:26	14/04/2020 16:35	14/04/2020 13:26	14/04/2020 16:26	3,00	1148	3442,41	CHI
2020041400116	PIRENOPOLIS	03165126	SAO FRANCISCO DE GOIAS	14/04/2020 13:26	14/04/2020 16:35	14/04/2020 13:26	14/04/2020 16:26	3,00	330	989,54	CHI
2020041400116	PIRENOPOLIS	03165126	SAO FRANCISCO DE GOIAS	14/04/2020 13:26	14/04/2020 16:35	14/04/2020 13:26	14/04/2020 16:26	3,00	1	3,00	CHI
2020041400116	SAO FRANCISCO DE GOIAS	03165126	SAO FRANCISCO DE GOIAS	14/04/2020 13:26	14/04/2020 16:35	14/04/2020 13:26	14/04/2020 16:26	3,00	21	62,97	CHI
2020041400116	SAO FRANCISCO DE GOIAS	03165126	SAO FRANCISCO DE GOIAS	14/04/2020 13:26	14/04/2020 16:35	14/04/2020 13:26	14/04/2020 16:26	3,00	25	74,97	CHI
2020041400116	SAO FRANCISCO DE GOIAS	03165126	SAO FRANCISCO DE GOIAS	14/04/2020 13:26	14/04/2020 16:35	14/04/2020 13:26	14/04/2020 16:26	3,00	1	3,00	CHI
2020041400116	JESUPOLIS	JE13021068	SAO FRANCISCO DE GOIAS	14/04/2020 13:26	14/04/2020 16:35	14/04/2020 13:26	14/04/2020 16:35	3,15	153	481,69	CHI
2020041400116	SAO FRANCISCO DE GOIAS	JE13021068	SAO FRANCISCO DE GOIAS	14/04/2020 13:26	14/04/2020 16:35	14/04/2020 13:26	14/04/2020 16:35	3,15	85	267,61	CHI
20200446240	ALTO HORIZONTE	MQ13074152	MARA ROSA	14/04/2020 13:27	14/04/2020 17:36	14/04/2020 13:27	14/04/2020 17:34	4,12	3	12,36	CHI
20200446240	AMARALINA	MQ13074152	MARA ROSA	14/04/2020 13:27	14/04/2020 17:36	14/04/2020 13:27	14/04/2020 17:34	4,12	1057	4356,31	CHI
20200446240	MARA ROSA	MQ13074152	MARA ROSA	14/04/2020 13:27	14/04/2020 17:36	14/04/2020 13:27	14/04/2020 17:34	4,12	369	1520,79	CHI
20200446240	MUTUNOPOLIS	MQ13074152	MARA ROSA	14/04/2020 13:27	14/04/2020 17:36	14/04/2020 13:27	14/04/2020 17:34	4,12	2	8,24	CHI
20200446240	CAMPINORTE	01120224	MARA ROSA	14/04/2020 13:27	14/04/2020 17:36	14/04/2020 17:25	14/04/2020 17:34	0,16	148	23,47	CHI
20200446240	MARA ROSA	01120224	MARA ROSA	14/04/2020 13:27	14/04/2020 17:36	14/04/2020 17:25	14/04/2020 17:34	0,16	6	0,95	CHI

20200446240	NOVA IGUACU DE GOIAS	O1120224	MARA ROSA	14/04/2020 13:27	14/04/2020 17:36	14/04/2020 17:25	14/04/2020 17:34	0,16	14	2,22	CHI
20200446240	ALTO HORIZONTE	MQ10403947	MARA ROSA	14/04/2020 13:27	14/04/2020 17:36	14/04/2020 17:17	14/04/2020 17:36	0,31	4	1,25	CHI
20200446240	MARA ROSA	MQ10403947	MARA ROSA	14/04/2020 13:27	14/04/2020 17:36	14/04/2020 17:17	14/04/2020 17:36	0,31	65	20,35	CHI
20200446240	NOVA IGUACU DE GOIAS	MQ10403947	MARA ROSA	14/04/2020 13:27	14/04/2020 17:36	14/04/2020 17:17	14/04/2020 17:36	0,31	12	3,76	CHI
20200449204	NOVA IGUACU DE GOIAS	NH21086279	MARA ROSA	14/04/2020 13:27	15/04/2020 00:04	14/04/2020 17:25	15/04/2020 00:04	6,65	1	6,65	CHI
20200448671	TRINDADE	TR11002501	TRINDADE	14/04/2020 13:27	14/04/2020 21:49	14/04/2020 13:27	14/04/2020 21:49	8,36	52	434,63	CHI
20200446241	ARAGOIANIA	10024872332	GUAPO S2	14/04/2020 13:28	15/04/2020 05:19	14/04/2020 13:28	15/04/2020 05:19	15,85	1	15,85	CHI
20200446242	GOIANIA	15627123	AEROPORTO S1	14/04/2020 13:28	14/04/2020 18:21	14/04/2020 13:28	14/04/2020 18:21	4,88	1	4,88	CHI
20200446243	APARECIDA DE GOIANIA	AP12251634	INDEPENDENCIA S2	14/04/2020 13:28	14/04/2020 20:21	14/04/2020 13:28	14/04/2020 20:21	6,88	1	6,88	CHI
20200446244	GOIANIA	GN11273548	GOYA S1	14/04/2020 13:28	14/04/2020 16:37	14/04/2020 13:28	14/04/2020 16:37	3,14	67	210,47	CHI
20200447019	JARAGUA	JA12027414	SAO FRANCISCO DE GOIAS	14/04/2020 13:28	14/04/2020 18:45	14/04/2020 13:28	14/04/2020 18:45	5,27	4	21,08	CHI
20200446251	APARECIDA DE GOIANIA	AP12212348	ANHANGUERA	14/04/2020 13:29	14/04/2020 18:23	14/04/2020 13:29	14/04/2020 18:22	4,90	18	88,14	CHI
20200446251	APARECIDA DE GOIANIA	AP16407252	ANHANGUERA	14/04/2020 13:29	14/04/2020 18:23	14/04/2020 18:18	14/04/2020 18:23	0,08	81	6,64	CHI
20200446263	GOIANIA	GN12001781	GOYA S1	14/04/2020 13:29	14/04/2020 15:39	14/04/2020 13:29	14/04/2020 15:39	2,15	90	193,65	CHI
20200447760	GOIANIA	GN11002145	GOYA S1	14/04/2020 13:29	14/04/2020 19:27	14/04/2020 13:29	14/04/2020 19:27	5,95	87	517,80	CHI
20200446277	ARAGUAPAZ	RB12372516	RUBIATABA	14/04/2020 13:31	14/04/2020 18:17	14/04/2020 13:31	14/04/2020 18:17	4,76	1	4,76	CHI
20200446277	MORRO AGUDO DE GOIAS	RB12372516	RUBIATABA	14/04/2020 13:31	14/04/2020 18:17	14/04/2020 13:31	14/04/2020 18:17	4,76	14	66,61	CHI
20200446277	RUBIATABA	RB12372516	RUBIATABA	14/04/2020 13:31	14/04/2020 18:17	14/04/2020 13:31	14/04/2020 18:17	4,76	156	742,17	CHI
20200446676	GOIANIA	GN11189624	GOIANIA LESTE S1	14/04/2020 13:31	14/04/2020 18:26	14/04/2020 13:31	14/04/2020 18:26	4,91	100	490,83	CHI
20200446290	TURVANIA	TV21105319	FIRMINOPOLIS S1	14/04/2020 13:32	15/04/2020 10:30	14/04/2020 13:32	15/04/2020 10:30	20,95	1	20,95	CHI
20200446405	CALDAS NOVAS	CN12213749	CALDAS NOVAS S1	14/04/2020 13:32	15/04/2020 08:41	14/04/2020 13:32	15/04/2020 08:41	19,14	110	2105,46	CHI
20200446296	GOIANIA	GN21366080	GOYA S1	14/04/2020 13:33	14/04/2020 16:14	14/04/2020 13:33	14/04/2020 16:14	2,68	1	2,68	CHI
20200446549	GOIANIA	GN11089169	FERROVIARIO S1	14/04/2020 13:33	14/04/2020 15:58	14/04/2020 13:33	14/04/2020 15:58	2,41	125	301,35	CHI
20200446388	GOIANIA	GN11169153	FERROVIARIO S2	14/04/2020 13:34	14/04/2020 16:51	14/04/2020 13:34	14/04/2020 16:51	3,27	103	336,95	CHI
20200446603	GOIANIA	GN11000261	AEROPORTO S2	14/04/2020 13:34	14/04/2020 16:17	14/04/2020 13:34	14/04/2020 16:17	2,71	73	197,47	CHI
20200449127	FIRMINOPOLIS	TV12098088	FIRMINOPOLIS S1	14/04/2020 13:34	15/04/2020 11:27	14/04/2020 13:34	15/04/2020 11:27	21,87	1	21,87	CHI
20200449127	TURVANIA	TV12098088	FIRMINOPOLIS S1	14/04/2020 13:34	15/04/2020 11:27	14/04/2020 13:34	15/04/2020 11:27	21,87	5	109,37	CHI
20200446321	GOIANIRA	GR32018478	MEIA PONTE	14/04/2020 13:35	14/04/2020 17:13	14/04/2020 13:35	14/04/2020 17:13	3,63	27	97,93	CHI
20200446328	GOIANIA	GN11138866	GOIANIA LESTE S1	14/04/2020 13:35	14/04/2020 23:03	14/04/2020 13:35	14/04/2020 23:03	9,45	150	1418,04	CHI
20200446358	GOIANIA	GN11167695	ATLANTICO S3	14/04/2020 13:35	14/04/2020 19:18	14/04/2020 13:35	14/04/2020 19:18	5,70	111	632,79	CHI
20200448097	GOIANIRA	GR21138919	MEIA PONTE	14/04/2020 13:35	15/04/2020 04:36	14/04/2020 13:35	15/04/2020 04:36	15,01	1	15,01	CHI
20200447984	GOIANIA	GN11214766	CAMPINAS S2	14/04/2020 13:35	14/04/2020 19:21	14/04/2020 13:35	14/04/2020 19:21	5,76	84	483,56	CHI
20200446334	BOM JARDIM DE GOIAS	BM21155677	BOM JARDIM	14/04/2020 13:36	14/04/2020 16:30	14/04/2020 13:36	14/04/2020 16:30	2,90	1	2,90	CHI

20200446348	GOIANIA	GN11000476	AEROPORTO S2	14/04/2020 13:37	14/04/2020 21:08	14/04/2020 13:37	14/04/2020 21:08	7,52	59	443,78	CHI
20200446348	GOIANIA	GN13000300	AEROPORTO S2	14/04/2020 13:37	14/04/2020 21:08	14/04/2020 17:38	14/04/2020 21:08	3,50	87	304,57	CHI
20200446349	ANHANGUERA	AH12082016RE	CATALAO S1	14/04/2020 13:37	14/04/2020 20:06	14/04/2020 13:37	14/04/2020 20:06	6,48	11	71,27	CHI
20200446349	CUMARI	AH12082016RE	CATALAO S1	14/04/2020 13:37	14/04/2020 20:06	14/04/2020 13:37	14/04/2020 20:06	6,48	21	136,06	CHI
20200446356	ITAPACI	10023522605	ITAPACI	14/04/2020 13:37	14/04/2020 20:06	14/04/2020 13:37	14/04/2020 20:06	6,47	1	6,47	CHI
20200446369	JANDAIA	JD21028293	PALMEIRAS	14/04/2020 13:38	14/04/2020 22:28	14/04/2020 13:38	14/04/2020 22:28	8,82	1	8,82	CHI
20200446371	SAO LUIS DE MONTES BELOS	SL21186363	SAO LUIZ DOS MONTES BELOS	14/04/2020 13:38	14/04/2020 18:53	14/04/2020 13:38	14/04/2020 18:53	5,23	1	5,23	CHI
20200446846	AURILANDIA	AI12206461	FIRMINOPOLIS S2	14/04/2020 13:38	14/04/2020 18:36	14/04/2020 13:38	14/04/2020 18:36	4,96	14	69,42	CHI
20200446846	FIRMINOPOLIS	AI12206461	FIRMINOPOLIS S2	14/04/2020 13:38	14/04/2020 18:36	14/04/2020 13:38	14/04/2020 18:36	4,96	16	79,34	CHI
20200446381	PIRANHAS	PH12374859	PIRANHAS	14/04/2020 13:39	14/04/2020 23:18	14/04/2020 22:44	14/04/2020 23:16	0,53	14	7,41	CHI
20200446381	PIRANHAS	PH11354653	PIRANHAS	14/04/2020 13:39	14/04/2020 23:18	14/04/2020 13:39	14/04/2020 23:18	9,64	40	385,71	CHI
20200446384	GOIANIA	10008167174	XAVANTES	14/04/2020 13:40	14/04/2020 19:27	14/04/2020 13:40	14/04/2020 19:27	5,78	1	5,78	CHI
20200446729	BURITI ALEGRE	IT12000114RE	PARANAIBA	14/04/2020 13:40	14/04/2020 20:31	14/04/2020 13:40	14/04/2020 20:31	6,84	8	54,70	CHI
20200446729	ITUMBIARA	IT12000114RE	PARANAIBA	14/04/2020 13:40	14/04/2020 20:31	14/04/2020 13:40	14/04/2020 20:31	6,84	8	54,70	CHI
20200446729	PANAMA	IT12000114RE	PARANAIBA	14/04/2020 13:40	14/04/2020 20:31	14/04/2020 13:40	14/04/2020 20:31	6,84	2	13,68	CHI
20200447742	TRINDADE	TR11162119	TRINDADE	14/04/2020 13:41	14/04/2020 20:11	14/04/2020 13:41	14/04/2020 20:11	6,49	174	1129,84	CHI
20200449084	APARECIDA DE GOIANIA	AP11137017	INDEPENDENCIA S2	14/04/2020 13:41	14/04/2020 20:41	14/04/2020 13:41	14/04/2020 20:41	6,99	137	957,82	CHI
20200446414	DAVINOPOLIS	IO12000011RE	CATALAO S1	14/04/2020 13:42	14/04/2020 17:20	14/04/2020 13:42	14/04/2020 17:20	3,62	33	119,42	CHI
20200446414	DISTRITO FEDERAL	IO12000011RE	CATALAO S1	14/04/2020 13:42	14/04/2020 17:20	14/04/2020 13:42	14/04/2020 17:20	3,62	3	10,86	CHI
20200446414	OUVIDOR	IO12000011RE	CATALAO S1	14/04/2020 13:42	14/04/2020 17:20	14/04/2020 13:42	14/04/2020 17:20	3,62	12	43,43	CHI
20200446414	TRES RANCHOS	IO12000011RE	CATALAO S1	14/04/2020 13:42	14/04/2020 17:20	14/04/2020 13:42	14/04/2020 17:20	3,62	4	14,48	CHI
20200446418	ITAPIRAPUA	IU21137834	MATRINCHA	14/04/2020 13:43	15/04/2020 12:26	14/04/2020 13:43	15/04/2020 12:26	22,71	1	22,71	CHI
20200446421	GOIANIA	GN11166598	CAMPINAS S2	14/04/2020 13:43	14/04/2020 23:27	14/04/2020 13:43	14/04/2020 23:27	9,72	22	213,88	CHI
20200446526	SAO LUIS DE MONTES BELOS	SL12004163	SAO LUIZ DOS MONTES BELOS	14/04/2020 13:43	14/04/2020 17:23	14/04/2020 13:43	14/04/2020 17:23	3,67	283	1037,20	CHI
20200446426	HIDROLANDIA	HD11251854	CEPAIGO S2	14/04/2020 13:44	14/04/2020 15:50	14/04/2020 13:44	14/04/2020 15:50	2,09	77	161,04	CHI
20200446429	SANCLERLANDIA	SC12005460	FIRMINOPOLIS S2	14/04/2020 13:44	14/04/2020 21:56	14/04/2020 13:44	14/04/2020 21:56	8,18	4	32,74	CHI
20200446878	GOIANIA	GN11002051	FERROVIARIO S3	14/04/2020 13:44	14/04/2020 18:57	14/04/2020 13:44	14/04/2020 18:57	5,20	71	369,44	CHI
20200446432	URUACU	UR12398055	URUACU	14/04/2020 13:45	14/04/2020 15:57	14/04/2020 13:45	14/04/2020 15:57	2,20	13	28,55	CHI
20200446445	AVELINOPOLIS	AV12071782	ANICUNS	14/04/2020 13:46	15/04/2020 11:45	14/04/2020 13:46	15/04/2020 11:45	21,99	10	219,87	CHI
20200446445	SANTA BARBARA DE GOIAS	AV12071782	ANICUNS	14/04/2020 13:46	15/04/2020 11:45	14/04/2020 13:46	15/04/2020 11:45	21,99	8	175,89	CHI
20200446446	MARA ROSA	MQ12249544	MARA ROSA	14/04/2020 13:46	14/04/2020 17:34	14/04/2020 13:46	14/04/2020 17:34	3,80	2	7,61	CHI
20200446454	ITABERAI	IB12124895	ITABERAI S2	14/04/2020 13:46	14/04/2020 16:52	14/04/2020 13:46	14/04/2020 16:52	3,09	43	132,70	CHI
20200446495	GOIANIA	GN11209291	MEIA PONTE	14/04/2020 13:46	14/04/2020 16:43	14/04/2020 13:46	14/04/2020 16:43	2,95	128	376,96	CHI

20200446461	SENADOR CANEDO	SW12133927	SENADOR CANEDO	14/04/2020 13:47	14/04/2020 15:33	14/04/2020 13:47	14/04/2020 15:33	1,75	433	758,47	CHI
20200446462	APARECIDA DE GOIANIA	AP11234814	ATLANTICO S2	14/04/2020 13:48	14/04/2020 18:02	14/04/2020 13:48	14/04/2020 18:02	4,23	63	266,72	CHI
20200446725	GOIANIA	GN12098425	CEPAIGO S1	14/04/2020 13:48	14/04/2020 16:37	14/04/2020 13:48	14/04/2020 16:37	2,81	114	320,82	CHI
20200446770	GOIAS	03290414	MATRINCHA	14/04/2020 13:48	14/04/2020 13:54	14/04/2020 13:48	14/04/2020 13:53	0,09	569	51,53	CHI
20200446770	ITAPIRAPUA	03290414	MATRINCHA	14/04/2020 13:48	14/04/2020 13:54	14/04/2020 13:48	14/04/2020 13:53	0,09	1689	152,95	CHI
20200446770	ITAPIRAPUA	03290414	MATRINCHA	14/04/2020 13:48	14/04/2020 13:54	14/04/2020 13:48	14/04/2020 13:53	0,09	1319	119,44	CHI
20200446770	NOVO BRASIL	03290414	MATRINCHA	14/04/2020 13:48	14/04/2020 13:54	14/04/2020 13:48	14/04/2020 13:53	0,09	32	2,90	CHI
20200446770	ARAGUAPAZ	03290414	MATRINCHA	14/04/2020 13:48	14/04/2020 13:54	14/04/2020 13:48	14/04/2020 13:54	0,10	1	0,10	CHI
20200446770	ARUANA	03290414	MATRINCHA	14/04/2020 13:48	14/04/2020 13:54	14/04/2020 13:48	14/04/2020 13:54	0,10	5	0,50	CHI
20200446770	FAINA	03290414	MATRINCHA	14/04/2020 13:48	14/04/2020 13:54	14/04/2020 13:48	14/04/2020 13:54	0,10	121	12,13	CHI
20200446770	GOIAS	03290414	MATRINCHA	14/04/2020 13:48	14/04/2020 13:54	14/04/2020 13:48	14/04/2020 13:54	0,10	396	39,71	CHI
20200446770	ITAPIRAPUA	03290414	MATRINCHA	14/04/2020 13:48	14/04/2020 13:54	14/04/2020 13:48	14/04/2020 13:54	0,10	124	12,43	CHI
20200446770	MATRINCHA	03290414	MATRINCHA	14/04/2020 13:48	14/04/2020 13:54	14/04/2020 13:48	14/04/2020 13:54	0,10	2228	223,42	CHI
2020041400119	GOIAS	03290414	MATRINCHA	14/04/2020 13:48	14/04/2020 13:52	14/04/2020 13:48	14/04/2020 13:52	0,07	38	2,53	CHI
2020041400119	ITAPIRAPUA	09201	MATRINCHA	14/04/2020 13:48	14/04/2020 13:52	14/04/2020 13:48	14/04/2020 13:52	0,07	1	0,07	CHI
2020041400119	ITAPIRAPUA	03290414	MATRINCHA	14/04/2020 13:48	14/04/2020 13:52	14/04/2020 13:48	14/04/2020 13:52	0,07	16	1,07	CHI
2020041400119	NOVO BRASIL	09201	MATRINCHA	14/04/2020 13:48	14/04/2020 13:52	14/04/2020 13:48	14/04/2020 13:52	0,07	4	0,27	CHI
2020041400120	BRITANIA	47502	MATRINCHA	14/04/2020 13:48	14/04/2020 13:52	14/04/2020 13:48	14/04/2020 13:52	0,07	6	0,40	CHI
2020041400120	ITAPIRAPUA	47501	MATRINCHA	14/04/2020 13:48	14/04/2020 13:52	14/04/2020 13:48	14/04/2020 13:52	0,07	420	28,00	CHI
2020041400120	ITAPIRAPUA	47502	MATRINCHA	14/04/2020 13:48	14/04/2020 13:52	14/04/2020 13:48	14/04/2020 13:52	0,07	92	6,13	CHI
2020041400120	ITAPIRAPUA	03290424	MATRINCHA	14/04/2020 13:48	14/04/2020 13:52	14/04/2020 13:48	14/04/2020 13:52	0,07	1	0,07	CHI
2020041400120	JUSSARA	47501	MATRINCHA	14/04/2020 13:48	14/04/2020 13:52	14/04/2020 13:48	14/04/2020 13:52	0,07	4	0,27	CHI
2020041400120	MATRINCHA	03290424	MATRINCHA	14/04/2020 13:48	14/04/2020 13:52	14/04/2020 13:48	14/04/2020 13:52	0,07	21	1,40	CHI
2020041400120	SANTA FE DE GOIAS	47501	MATRINCHA	14/04/2020 13:48	14/04/2020 13:52	14/04/2020 13:48	14/04/2020 13:52	0,07	12	0,80	CHI
20200446474	ANAPOLIS	21271446	ANAPOLIS UNIVERSITARIO S1	14/04/2020 13:49	14/04/2020 17:16	14/04/2020 13:49	14/04/2020 17:16	3,45	1	3,45	CHI
20200446475	AMORINOPOLIS	AM11231074	IPORA	14/04/2020 13:49	14/04/2020 17:51	14/04/2020 13:49	14/04/2020 17:51	4,03	65	262,13	CHI
20200446477	SENADOR CANEDO	SW11060134	GOIANIA LESTE S1	14/04/2020 13:49	14/04/2020 16:27	14/04/2020 13:49	14/04/2020 16:27	2,63	221	581,48	CHI
20200446480	JANDAIA	JD12289836	PALMEIRAS	14/04/2020 13:49	14/04/2020 22:57	14/04/2020 13:49	14/04/2020 22:57	9,13	7	63,91	CHI
20200446485	BOM JARDIM DE GOIAS	BM21155704	BOM JARDIM	14/04/2020 13:49	15/04/2020 07:36	14/04/2020 13:49	15/04/2020 07:36	17,77	1	17,77	CHI
20200446487	GOIANIA	13944230	MEIA PONTE	14/04/2020 13:49	14/04/2020 19:16	14/04/2020 13:49	14/04/2020 19:16	5,43	1	5,43	CHI
20200446555	CALDAS NOVAS	CN16404326	CALDAS NOVAS S2	14/04/2020 13:49	14/04/2020 19:43	14/04/2020 15:35	14/04/2020 16:42	1,13	3060	3446,75	CHI
20200446555	CALDAS NOVAS	CN12139717LD	CALDAS NOVAS S2	14/04/2020 13:49	14/04/2020 19:43	14/04/2020 15:35	14/04/2020 19:43	4,13	1596	6599,02	CHI
20200446555	PIRACANJUBA	CN12139717LD	CALDAS NOVAS S2	14/04/2020 13:49	14/04/2020 19:43	14/04/2020 15:35	14/04/2020 19:43	4,13	2	8,27	CHI

20200450251	SANCLERLANDIA	SL12145801	FIRMINOPOLIS S2	14/04/2020 13:49	15/04/2020 11:27	14/04/2020 13:49	15/04/2020 11:27	21,63	3	64,89	CHI
20200446490	GOIANIA	15434424	FERROVIARIO S3	14/04/2020 13:50	14/04/2020 18:29	14/04/2020 13:50	14/04/2020 18:29	4,65	1	4,65	CHI
20200446504	AURILANDIA	AI21033489	FIRMINOPOLIS S2	14/04/2020 13:51	14/04/2020 23:27	14/04/2020 13:51	14/04/2020 23:27	9,59	2	19,18	CHI
20200446757	GOIANIA	GN12002240	GOIANIA LESTE S1	14/04/2020 13:51	14/04/2020 15:56	14/04/2020 13:51	14/04/2020 15:56	2,08	142	295,52	CHI
20200446796	BURITI ALEGRE	BG12203252	ITUMBIARA VELHA S2	14/04/2020 13:51	15/04/2020 15:58	14/04/2020 13:51	15/04/2020 15:58	26,11	192	5013,07	CHI
20200446510	SENADOR CANEDO	SW11209176	CEPAIGO S2	14/04/2020 13:52	14/04/2020 16:05	14/04/2020 13:52	14/04/2020 16:05	2,22	15	33,23	CHI
20200446517	DOVERLANDIA	DV21138094	CAIAPONIA	14/04/2020 13:52	14/04/2020 18:00	14/04/2020 13:52	14/04/2020 18:00	4,12	1	4,12	CHI
20200446834	RIO QUENTE	RQ12392082	VILA CORUMBA	14/04/2020 13:52	16/04/2020 18:52	14/04/2020 13:52	16/04/2020 18:52	53,01	17	901,09	CHI
20200449722	CATURAI	CK12030017	ARACU	14/04/2020 13:52	15/04/2020 09:50	14/04/2020 13:52	15/04/2020 09:50	19,96	2	39,92	CHI
20200449722	GOIANIRA	CK12030017	ARACU	14/04/2020 13:52	15/04/2020 09:50	14/04/2020 13:52	15/04/2020 09:50	19,96	1	19,96	CHI
20200446525	SAO LUIS DE MONTES BELOS	10008433389	SAO LUIZ DOS MONTES BELOS	14/04/2020 13:53	15/04/2020 09:11	14/04/2020 13:53	15/04/2020 09:11	19,29	1	19,29	CHI
20200446529	SANTA ROSA DE GOIAS	SR21079762	INHUMAS S1	14/04/2020 13:53	14/04/2020 19:59	14/04/2020 13:53	14/04/2020 19:59	6,09	1	6,09	CHI
20200446732	SENADOR CANEDO	SW12392773	SENADOR CANEDO	14/04/2020 13:53	14/04/2020 15:57	14/04/2020 13:53	14/04/2020 15:57	2,06	346	711,99	CHI
20200446533	ITUMBIARA	IT11208052	PARANAIBA	14/04/2020 13:54	14/04/2020 17:41	14/04/2020 13:54	14/04/2020 17:41	3,80	57	216,50	CHI
20200446537	ORIZONA	OZ21409098	PIRES DO RIO S2	14/04/2020 13:54	14/04/2020 16:50	14/04/2020 13:54	14/04/2020 16:50	2,92	1	2,92	CHI
20200446539	FAINA	FC12299850	GOIAS	14/04/2020 13:54	14/04/2020 17:05	14/04/2020 13:54	14/04/2020 17:05	3,17	1	3,17	CHI
20200446539	GOIAS	FC12299850	GOIAS	14/04/2020 13:54	14/04/2020 17:05	14/04/2020 13:54	14/04/2020 17:05	3,17	4	12,69	CHI
20200446540	ITABERAI	IB12336526	ITABERAI S1	14/04/2020 13:54	14/04/2020 18:00	14/04/2020 13:54	14/04/2020 18:00	4,09	3	12,26	CHI
20200446561	RUBIATABA	RB12255942	RUBIATABA	14/04/2020 13:55	14/04/2020 16:19	14/04/2020 13:55	14/04/2020 16:19	2,39	47	112,15	CHI
20200446572	ITAGUARI	JA12300396	ITABERAI S1	14/04/2020 13:56	14/04/2020 19:31	14/04/2020 13:56	14/04/2020 19:31	5,57	11	61,25	CHI
20200446572	JARAGUA	JA12300396	ITABERAI S1	14/04/2020 13:56	14/04/2020 19:31	14/04/2020 13:56	14/04/2020 19:31	5,57	21	116,94	CHI
20200447115	TRINDADE	TR11180169	TRINDADE	14/04/2020 13:57	14/04/2020 17:17	14/04/2020 13:57	14/04/2020 17:17	3,32	101	335,12	CHI
20200446815	GOIANIA	GN11162201	FERROVIARIO S1	14/04/2020 13:58	14/04/2020 16:54	14/04/2020 13:58	14/04/2020 16:54	2,92	103	300,56	CHI
20200446608	GOIANIA	GN11169542	CAMPINAS S1	14/04/2020 13:59	14/04/2020 16:21	14/04/2020 13:59	14/04/2020 16:21	2,36	65	153,27	CHI
20200446616	IPAMERI	UT12000608	URUTAI	14/04/2020 13:59	14/04/2020 15:27	14/04/2020 13:59	14/04/2020 15:27	1,45	3	4,35	CHI
20200446616	URUTAI	UT12000608	URUTAI	14/04/2020 13:59	14/04/2020 15:27	14/04/2020 13:59	14/04/2020 15:27	1,45	26	37,72	CHI
20200446782	PIRENOPOLIS	1200024087	COCALZINHO	14/04/2020 13:59	14/04/2020 19:44	14/04/2020 13:59	14/04/2020 19:44	5,75	1	5,75	CHI
20200446626	CAMPOS BELOS	MA12352870	SAO DOMINGOS	14/04/2020 14:00	14/04/2020 19:01	14/04/2020 14:00	14/04/2020 19:01	5,01	1	5,01	CHI
20200446626	MONTE ALEGRE DE GOIAS	MA12352870	SAO DOMINGOS	14/04/2020 14:00	14/04/2020 19:01	14/04/2020 14:00	14/04/2020 19:01	5,01	1	5,01	CHI
20200446630	GUAPO	GA12310250	GUAPO S1	14/04/2020 14:00	15/04/2020 04:15	14/04/2020 14:00	15/04/2020 04:15	14,24	3	42,71	CHI
20200447435	ALVORADA DO NORTE	AQ12204159	IACIARA S2	14/04/2020 14:00	15/04/2020 10:11	14/04/2020 14:00	15/04/2020 10:11	20,17	24	484,19	CHI
20200446634	ITABERAI	GS12379734	ITABERAI S1	14/04/2020 14:01	15/04/2020 12:59	14/04/2020 14:01	15/04/2020 12:59	22,96	4	91,85	CHI
20200447101	GOIANIA	GN11001362	AEROPORTO S3	14/04/2020 14:01	15/04/2020 01:09	14/04/2020 14:01	15/04/2020 01:09	11,12	84	934,01	CHI

20200447273	BELA VISTA DE GOIAS	BV12120914	BELA VISTA S1	14/04/2020 14:01	14/04/2020 22:22	14/04/2020 14:01	14/04/2020 19:42	5,69	267	1519,90	CHI
20200447273	BELA VISTA DE GOIAS	BV12120914	BELA VISTA S1	14/04/2020 14:01	14/04/2020 22:22	14/04/2020 17:05	14/04/2020 19:42	2,63	2	5,25	CHI
20200447273	BELA VISTA DE GOIAS	BV12120914	BELA VISTA S1	14/04/2020 14:01	14/04/2020 22:22	14/04/2020 14:01	14/04/2020 22:22	8,36	155	1295,24	CHI
20200447273	BELA VISTA DE GOIAS	BV12067601	BELA VISTA S1	14/04/2020 14:01	14/04/2020 22:22	14/04/2020 17:05	14/04/2020 22:22	5,29	5	26,45	CHI
20200448598	CAMPESTRE DE GOIAS	GC12322913	TRINDADE	14/04/2020 14:01	15/04/2020 12:56	14/04/2020 14:01	15/04/2020 12:56	22,91	3	68,72	CHI
20200446646	NEROPOLIS	10013867987	NEROPOLIS S1	14/04/2020 14:02	14/04/2020 15:47	14/04/2020 14:02	14/04/2020 15:47	1,75	1	1,75	CHI
20200446662	GOIAS	GS12310466	ITABERAI S1	14/04/2020 14:03	14/04/2020 18:30	14/04/2020 14:03	14/04/2020 18:30	4,43	3	13,30	CHI
20200446666	TRINDADE	12915737	GOYA S2	14/04/2020 14:04	15/04/2020 10:43	14/04/2020 14:04	15/04/2020 10:43	20,65	1	20,65	CHI
20200446674	GOIANIA	10003576866	CARAJAS S2	14/04/2020 14:05	14/04/2020 16:52	14/04/2020 14:05	14/04/2020 16:52	2,78	1	2,78	CHI
20200448510	INHUMAS	IN11012065	INHUMAS S2	14/04/2020 14:06	15/04/2020 01:16	14/04/2020 14:06	15/04/2020 01:16	11,15	115	1282,60	CHI
20200446701	SANCLERLANDIA	SC12391511	FIRMINOPOLIS S2	14/04/2020 14:07	15/04/2020 09:15	14/04/2020 14:07	15/04/2020 09:15	19,14	10	191,38	CHI
20200446827	TRINDADE	TR11000034	TRINDADE	14/04/2020 14:07	14/04/2020 17:42	14/04/2020 14:07	14/04/2020 17:42	3,58	122	437,00	CHI
20200447034	APARECIDA DE GOIANIA	AP11075384	REAL S2	14/04/2020 14:07	14/04/2020 17:37	14/04/2020 14:07	14/04/2020 17:37	3,49	131	456,79	CHI
20200446710	JARAGUA	JA12382495RE	JARAGUA	14/04/2020 14:08	15/04/2020 00:08	14/04/2020 14:08	14/04/2020 16:29	2,35	13	30,55	CHI
20200446710	JARAGUA	JA12382495RE	JARAGUA	14/04/2020 14:08	15/04/2020 00:08	14/04/2020 14:08	14/04/2020 21:10	7,03	112	787,67	CHI
20200446710	PIRENOPOLIS	JA12382495RE	JARAGUA	14/04/2020 14:08	15/04/2020 00:08	14/04/2020 14:08	14/04/2020 21:10	7,03	96	675,15	CHI
20200446710	JARAGUA	JA12382495RE	JARAGUA	14/04/2020 14:08	15/04/2020 00:08	14/04/2020 14:08	15/04/2020 00:08	10,00	8	80,00	CHI
20200446711	GOIAS	GS12206884	GOIAS	14/04/2020 14:08	14/04/2020 16:36	14/04/2020 14:08	14/04/2020 16:36	2,46	16	39,43	CHI
20200446715	PIRES DO RIO	PR12000045	PIRES DO RIO S1	14/04/2020 14:08	14/04/2020 20:59	14/04/2020 14:08	14/04/2020 17:40	3,53	342	1205,74	CHI
20200446715	PIRES DO RIO	PR12058863LD	PIRES DO RIO S1	14/04/2020 14:08	14/04/2020 20:59	14/04/2020 14:08	14/04/2020 20:59	6,85	8	54,76	CHI
20200447552	JARAGUA	JA21024490	JARAGUA	14/04/2020 14:08	14/04/2020 21:10	14/04/2020 14:08	14/04/2020 21:10	7,03	1	7,03	CHI
20200446723	PIRES DO RIO	PZ12000510	PIRES DO RIO S2	14/04/2020 14:09	15/04/2020 08:23	14/04/2020 14:09	15/04/2020 08:23	18,23	1	18,23	CHI
20200446723	SANTA CRUZ DE GOIAS	PZ12000510	PIRES DO RIO S2	14/04/2020 14:09	15/04/2020 08:23	14/04/2020 14:09	15/04/2020 08:23	18,23	16	291,69	CHI
20200446746	GOIATUBA	10029423129	GOIATUBA S2	14/04/2020 14:11	14/04/2020 16:40	14/04/2020 14:11	14/04/2020 16:40	2,48	1	2,48	CHI
20200446749	GOIANIA	GN12059752	GOYA S1	14/04/2020 14:11	14/04/2020 17:07	14/04/2020 14:11	14/04/2020 17:07	2,93	2	5,86	CHI
20200446751	FAINA	FC11309257	GOIAS	14/04/2020 14:11	14/04/2020 21:03	14/04/2020 14:11	14/04/2020 21:03	6,86	58	397,91	CHI
20200447412	GOIANESIA	GE12000180	GOIANESIA S2	14/04/2020 14:11	14/04/2020 22:16	14/04/2020 14:11	14/04/2020 22:16	8,07	20	161,37	CHI
20200448779	CORREGO DO OURO	CO11004039	FIRMINOPOLIS S2	14/04/2020 14:11	14/04/2020 19:36	14/04/2020 14:11	14/04/2020 19:36	5,41	173	936,46	CHI
20200446759	PIRACANJUBA	PJ12025290	PIRACANJUBA	14/04/2020 14:12	14/04/2020 18:52	14/04/2020 14:12	14/04/2020 18:52	4,66	20	93,27	CHI
20200446766	CALDAS NOVAS	10029059788	SERRA DE CALDAS	14/04/2020 14:12	14/04/2020 20:14	14/04/2020 14:12	14/04/2020 20:14	6,02	1	6,02	CHI
20200446758	CAMPESTRE DE GOIAS	03310214	TRINDADE	14/04/2020 14:13	15/04/2020 15:43	14/04/2020 14:13	14/04/2020 16:02	1,81	1331	2410,59	CHI
20200446758	PALMEIRAS DE GOIAS	03310214	TRINDADE	14/04/2020 14:13	15/04/2020 15:43	14/04/2020 14:13	14/04/2020 16:02	1,81	13	23,54	CHI
20200446758	TRINDADE	03310214	TRINDADE	14/04/2020 14:13	15/04/2020 15:43	14/04/2020 14:13	14/04/2020 16:02	1,81	403	729,88	CHI



20200446758	CAMPESTRE DE GOIAS	GC10395378	TRINDADE	14/04/2020 14:13	15/04/2020 15:43	14/04/2020 14:13	14/04/2020 16:07	1,89	50	94,74	CHI
20200446758	SANTA BARBARA DE GOIAS	GC10395378	TRINDADE	14/04/2020 14:13	15/04/2020 15:43	14/04/2020 14:13	14/04/2020 16:07	1,89	10	18,95	CHI
20200446758	TRINDADE	GC10395378	TRINDADE	14/04/2020 14:13	15/04/2020 15:43	14/04/2020 14:13	14/04/2020 16:07	1,89	68	128,84	CHI
20200446758	CAMPESTRE DE GOIAS	GC10395378	TRINDADE	14/04/2020 14:13	15/04/2020 15:43	14/04/2020 16:08	14/04/2020 17:06	0,96	33	31,70	CHI
20200446758	SANTA BARBARA DE GOIAS	GC10395378	TRINDADE	14/04/2020 14:13	15/04/2020 15:43	14/04/2020 16:08	14/04/2020 17:06	0,96	10	9,61	CHI
20200446758	TRINDADE	GC10395378	TRINDADE	14/04/2020 14:13	15/04/2020 15:43	14/04/2020 16:08	14/04/2020 17:06	0,96	63	60,51	CHI
20200446758	CAMPESTRE DE GOIAS	GC13395378B	TRINDADE	14/04/2020 14:13	15/04/2020 15:43	14/04/2020 16:08	14/04/2020 21:33	5,42	17	92,13	CHI
20200446758	TRINDADE	GC13395378B	TRINDADE	14/04/2020 14:13	15/04/2020 15:43	14/04/2020 16:08	14/04/2020 21:33	5,42	5	27,10	CHI
20200446758	CAMPESTRE DE GOIAS	GC13395378B	TRINDADE	14/04/2020 14:13	15/04/2020 15:43	14/04/2020 17:07	14/04/2020 21:33	4,44	28	124,20	CHI
20200446758	TRINDADE	GC13395378B	TRINDADE	14/04/2020 14:13	15/04/2020 15:43	14/04/2020 17:07	14/04/2020 21:33	4,44	13	57,67	CHI
20200446758	CAMPESTRE DE GOIAS	TR13043038	TRINDADE	14/04/2020 14:13	15/04/2020 15:43	14/04/2020 17:07	15/04/2020 15:43	22,59	5	112,94	CHI
20200446758	SANTA BARBARA DE GOIAS	TR13043038	TRINDADE	14/04/2020 14:13	15/04/2020 15:43	14/04/2020 17:07	15/04/2020 15:43	22,59	10	225,88	CHI
20200446758	TRINDADE	TR13043038	TRINDADE	14/04/2020 14:13	15/04/2020 15:43	14/04/2020 17:07	15/04/2020 15:43	22,59	50	1129,42	CHI
20200447523	MONTES CLAROS DE GOIAS	ME12062838	IPORA	14/04/2020 14:13	15/04/2020 02:40	14/04/2020 14:13	15/04/2020 02:40	12,44	15	186,60	CHI
20200446778	GOIANIA	GN12001158	AEROPORTO S1	14/04/2020 14:14	14/04/2020 21:19	14/04/2020 14:14	14/04/2020 21:19	7,08	3	21,25	CHI
20200446784	IPAMERI	IP12056133	IPAMERI	14/04/2020 14:14	14/04/2020 17:40	14/04/2020 14:14	14/04/2020 17:40	3,43	508	1740,18	CHI
20200446801	APARECIDA DE GOIANIA	200650294	INDEPENDENCIA S2	14/04/2020 14:15	14/04/2020 22:40	14/04/2020 14:15	14/04/2020 22:40	8,40	1	8,40	CHI
20200450830	INHUMAS	IN12098387	INHUMAS S2	14/04/2020 14:15	15/04/2020 01:44	14/04/2020 14:15	15/04/2020 01:44	11,48	16	183,64	CHI
20200446810	BURITI DE GOIAS	BS12332910	FIRMINOPOLIS S2	14/04/2020 14:16	15/04/2020 10:23	14/04/2020 14:16	15/04/2020 10:23	20,11	4	80,43	CHI
20200446813	GOIANIA	GN12000977	GOYA S1	14/04/2020 14:16	14/04/2020 18:54	14/04/2020 14:16	14/04/2020 18:54	4,62	2	9,24	CHI
20200449933	JUSSARA	BT12274297	BRITANIA	14/04/2020 14:16	16/04/2020 15:53	15/04/2020 15:11	15/04/2020 22:07	6,94	18	124,91	CHI
20200449933	JUSSARA	JR12016151	BRITANIA	14/04/2020 14:16	16/04/2020 15:53	14/04/2020 14:16	16/04/2020 10:40	44,39	3	133,17	CHI
20200449933	JUSSARA	JR12016151	BRITANIA	14/04/2020 14:16	16/04/2020 15:53	15/04/2020 15:10	16/04/2020 10:40	19,48	6	116,91	CHI
20200449933	JUSSARA	JR12016151	BRITANIA	14/04/2020 14:16	16/04/2020 15:53	14/04/2020 14:16	16/04/2020 15:53	49,62	5	248,09	CHI
20200449933	JUSSARA	JR12292766LD	BRITANIA	14/04/2020 14:16	16/04/2020 15:53	15/04/2020 15:10	16/04/2020 15:53	24,71	5	123,56	CHI
20200446824	EDEALINA	ED11359988	PONTALINA	14/04/2020 14:17	14/04/2020 17:41	14/04/2020 14:17	14/04/2020 17:41	3,39	5	16,96	CHI
20200446836	TRINDADE	TR12200181	TRINDADE	14/04/2020 14:18	14/04/2020 18:07	14/04/2020 14:18	14/04/2020 18:07	3,81	3	11,44	CHI
20200446838	GOIAS	GS12299706	GOIAS	14/04/2020 14:18	14/04/2020 18:15	14/04/2020 14:18	14/04/2020 18:15	3,94	3	11,83	CHI
20200446843	GUAPO	TR12040839	GUAPO S1	14/04/2020 14:18	15/04/2020 00:27	14/04/2020 14:18	15/04/2020 00:27	10,14	4	40,56	CHI
20200446844	NIQUELANDIA	NQ21095777	NIQUELANDIA SUBTRANSMISSAO	14/04/2020 14:18	14/04/2020 20:28	14/04/2020 14:18	14/04/2020 20:28	6,16	1	6,16	CHI
20200446858	CRISTIANOPOLIS	CF12300696	CRISTIANOPOLIS	14/04/2020 14:20	14/04/2020 16:24	14/04/2020 14:20	14/04/2020 16:24	2,06	6	12,38	CHI
20200446872	BELA VISTA DE GOIAS	BV21119274	CEPAIGO S2	14/04/2020 14:20	15/04/2020 09:19	14/04/2020 14:20	15/04/2020 09:19	18,97	1	18,97	CHI
20200446883	PALMEIRAS DE GOIAS	10001413919	PALMEIRAS	14/04/2020 14:21	14/04/2020 16:54	14/04/2020 14:21	14/04/2020 16:54	2,54	1	2,54	CHI

20200446890	GOIANIA	15785506	MEIA PONTE	14/04/2020 14:22	14/04/2020 20:26	14/04/2020 14:22	14/04/2020 20:26	6,06	1	6,06	CHI
20200446891	JUSSARA	JR21020148	JUSSARA	14/04/2020 14:22	14/04/2020 19:58	14/04/2020 14:22	14/04/2020 19:58	5,59	2	11,19	CHI
20200446895	CATURAI	CK21167906	ARACU	14/04/2020 14:22	15/04/2020 10:59	14/04/2020 14:22	15/04/2020 10:59	20,61	1	20,61	CHI
20200446906	CALDAS NOVAS	CN21186893	CALDAS NOVAS S1	14/04/2020 14:23	14/04/2020 21:14	14/04/2020 14:23	14/04/2020 21:14	6,84	2	13,67	CHI
20200446932	ARUANA	AK12016493	ARUANA	14/04/2020 14:26	14/04/2020 19:22	14/04/2020 14:26	14/04/2020 16:36	2,16	170	367,77	CHI
20200446932	ARUANA	AK12310815	ARUANA	14/04/2020 14:26	14/04/2020 19:22	14/04/2020 14:26	14/04/2020 19:22	4,93	5	24,64	CHI
20200446933	MORRINHOS	MR21236338	MORRINHOS	14/04/2020 14:26	14/04/2020 16:37	14/04/2020 14:26	14/04/2020 16:37	2,17	1	2,17	CHI
20200446942	MORRINHOS	MR12100140	MORRINHOS	14/04/2020 14:27	14/04/2020 17:54	14/04/2020 14:27	14/04/2020 17:54	3,44	4	13,77	CHI
20200446945	CATALAO	CT12077697	CATALAO S1	14/04/2020 14:27	14/04/2020 17:36	14/04/2020 14:27	14/04/2020 17:36	3,14	2	6,28	CHI
20200447814	MORRINHOS	MR31100141	MORRINHOS	14/04/2020 14:27	14/04/2020 18:23	14/04/2020 14:27	14/04/2020 18:23	3,93	1	3,93	CHI
20200445827	SAO LUIS DE MONTES BELOS	SL12125618	FIRMINOPOLIS S1	14/04/2020 14:28	15/04/2020 10:00	14/04/2020 14:28	15/04/2020 10:00	19,53	2	39,05	CHI
20200446949	ISRAELANDIA	FN21119480	IPORA	14/04/2020 14:28	15/04/2020 12:35	14/04/2020 14:28	15/04/2020 12:35	22,11	1	22,11	CHI
20200446951	BONFINOPOLIS	BO11212637	CEPAIGO S2	14/04/2020 14:28	14/04/2020 18:00	14/04/2020 14:28	14/04/2020 18:00	3,53	136	479,74	CHI
20200447938	BOM JARDIM DE GOIAS	BM12064234	BOM JARDIM	14/04/2020 14:28	14/04/2020 19:47	14/04/2020 14:28	14/04/2020 19:47	5,31	4	21,25	CHI
20200446964	MARZAGAO	MG12000366	VILA CORUMBA	14/04/2020 14:29	14/04/2020 18:25	14/04/2020 14:29	14/04/2020 18:25	3,93	9	35,40	CHI
20200446989	GOIANIA	12043825	CAMPINAS S1	14/04/2020 14:30	14/04/2020 17:12	14/04/2020 14:30	14/04/2020 17:12	2,69	1	2,69	CHI
20200447350	PIRENOPOLIS	PV12285301	CORUMBA	14/04/2020 14:30	14/04/2020 19:41	14/04/2020 14:30	14/04/2020 19:41	5,18	56	290,27	CHI
20200447007	COCALZINHO DE GOIAS	ZN12144220	COCALZINHO	14/04/2020 14:32	14/04/2020 18:05	14/04/2020 14:32	14/04/2020 18:05	3,54	1	3,54	CHI
20200447014	GOIANIA	10027831530	CARAJAS S1	14/04/2020 14:32	14/04/2020 21:56	14/04/2020 14:32	14/04/2020 21:56	7,39	1	7,39	CHI
20200447058	GOIANIA	GN11034283	ATLANTICO S2	14/04/2020 14:32	14/04/2020 17:31	14/04/2020 14:32	14/04/2020 17:31	2,98	100	298,33	CHI
20200448688	ITAGUARI	IC12219941	ITABERAI S1	14/04/2020 14:32	14/04/2020 21:33	14/04/2020 14:32	14/04/2020 21:33	7,01	31	217,45	CHI
20200448688	ITAGUARU	IC12219941	ITABERAI S1	14/04/2020 14:32	14/04/2020 21:33	14/04/2020 14:32	14/04/2020 21:33	7,01	21	147,30	CHI
20200447025	EDEIA	EA12044006	EDEIA	14/04/2020 14:34	17/04/2020 11:49	14/04/2020 14:34	15/04/2020 11:10	20,61	3	61,84	CHI
20200447025	EDEIA	EA12044006	EDEIA	14/04/2020 14:34	17/04/2020 11:49	14/04/2020 14:34	15/04/2020 16:21	25,78	1	25,78	CHI
20200447025	EDEIA	EA12044006	EDEIA	14/04/2020 14:34	17/04/2020 11:49	14/04/2020 14:34	15/04/2020 19:44	29,17	3	87,52	CHI
20200447025	EDEIA	EA12044006	EDEIA	14/04/2020 14:34	17/04/2020 11:49	15/04/2020 18:24	15/04/2020 19:44	1,34	3	4,01	CHI
20200447025	EDEIA	EA12044006	EDEIA	14/04/2020 14:34	17/04/2020 11:49	15/04/2020 19:46	15/04/2020 20:33	0,78	4	3,11	CHI
20200447025	EDEIA	EA12044006	EDEIA	14/04/2020 14:34	17/04/2020 11:49	16/04/2020 18:51	16/04/2020 23:00	4,14	4	16,58	CHI
20200447025	EDEIA	EA12044006	EDEIA	14/04/2020 14:34	17/04/2020 11:49	15/04/2020 19:46	17/04/2020 09:14	37,46	3	112,38	CHI
20200447025	EDEIA	EA12044006	EDEIA	14/04/2020 14:34	17/04/2020 11:49	17/04/2020 08:55	17/04/2020 09:14	0,31	4	1,25	CHI
20200447025	EDEIA	EA12044006	EDEIA	14/04/2020 14:34	17/04/2020 11:49	17/04/2020 10:51	17/04/2020 11:10	0,31	6	1,87	CHI
20200447025	EDEIA	EA12161207LD	EDEIA	14/04/2020 14:34	17/04/2020 11:49	14/04/2020 14:34	17/04/2020 11:29	68,92	5	344,62	CHI
20200447025	EDEIA	8172382	EDEIA	14/04/2020 14:34	17/04/2020 11:49	17/04/2020 10:51	17/04/2020 11:49	0,97	1	0,97	CHI

20200447033	GOIANIA	GN11162183	REAL S1	14/04/2020 14:34	14/04/2020 17:36	14/04/2020 17:21	14/04/2020 17:36	0,25	126	31,50	CHI
20200447037	PALMELO	PR12000096RE	PIRES DO RIO S1	14/04/2020 14:35	14/04/2020 17:53	14/04/2020 14:35	14/04/2020 17:53	3,29	6	19,75	CHI
20200447037	PIRES DO RIO	PR12000096RE	PIRES DO RIO S1	14/04/2020 14:35	14/04/2020 17:53	14/04/2020 14:35	14/04/2020 17:53	3,29	22	72,40	CHI
20200447044	CALDAS NOVAS	CN21298654	CALDAS NOVAS S2	14/04/2020 14:35	14/04/2020 18:10	14/04/2020 14:35	14/04/2020 18:10	3,57	1	3,57	CHI
20200447046	ALEXANIA	AX21072788	ALEXANIA	14/04/2020 14:36	14/04/2020 19:16	14/04/2020 14:36	14/04/2020 19:16	4,66	1	4,66	CHI
20200447047	GOIANIA	16711488	CAMPINAS S2	14/04/2020 14:36	14/04/2020 23:40	14/04/2020 14:36	14/04/2020 23:40	9,06	1	9,06	CHI
20200447054	PIRACANJUBA	PJ21131956	CRISTIANOPOLIS	14/04/2020 14:37	14/04/2020 17:53	14/04/2020 14:37	14/04/2020 17:53	3,26	1	3,26	CHI
20200447055	GOIAS	GS11162387	MATRINCHA	14/04/2020 14:37	14/04/2020 18:50	14/04/2020 14:37	14/04/2020 18:50	4,21	2	8,43	CHI
20200447066	ITABERAI	IB12066172	ITABERAI S1	14/04/2020 14:38	14/04/2020 18:11	14/04/2020 14:38	14/04/2020 18:11	3,54	11	38,99	CHI
20200447070	SANTA ROSA DE GOIAS	SR11054607	INHUMAS S1	14/04/2020 14:38	14/04/2020 18:11	14/04/2020 14:38	14/04/2020 18:11	3,54	131	464,18	CHI
20200447106	APARECIDA DE GOIANIA	AP11160116	ANHANGUERA	14/04/2020 14:38	14/04/2020 21:52	14/04/2020 14:38	14/04/2020 21:52	7,22	30	216,66	CHI
20200447248	ANAPOLIS	AN12267912	NEROPOLIS S1	14/04/2020 14:38	14/04/2020 21:14	14/04/2020 14:38	14/04/2020 21:14	6,59	22	144,94	CHI
20200447248	CAMPO LIMPO	AN12267912	NEROPOLIS S1	14/04/2020 14:38	14/04/2020 21:14	14/04/2020 14:38	14/04/2020 21:14	6,59	1	6,59	CHI
20200448473	TRINDADE	TR32045221	TRINDADE	14/04/2020 14:38	14/04/2020 23:52	14/04/2020 14:38	14/04/2020 23:52	9,22	10	92,21	CHI
20200447080	JARAGUA	JA21157780	JARAGUA	14/04/2020 14:39	14/04/2020 18:35	14/04/2020 14:39	14/04/2020 18:35	3,93	1	3,93	CHI
20200447090	BONOPOLIS	BX21158479	SAO MIGUEL DO ARAGUAIA	14/04/2020 14:39	14/04/2020 16:35	14/04/2020 14:39	14/04/2020 16:35	1,92	1	1,92	CHI
20200447277	ITAUCU	IX12384482	INHUMAS S1	14/04/2020 14:39	15/04/2020 07:44	14/04/2020 14:39	15/04/2020 07:44	17,08	3	51,24	CHI
20200447109	GOIANIRA	10021951746	GOIANIRA	14/04/2020 14:41	14/04/2020 18:20	14/04/2020 14:41	14/04/2020 18:20	3,66	1	3,66	CHI
20200447111	GUARAITA	19635540	ITAPURANGA	14/04/2020 14:41	14/04/2020 23:51	14/04/2020 14:41	14/04/2020 23:51	9,16	19	174,09	CHI
20200447112	ANAPOLIS	21109540	DAIA S1	14/04/2020 14:41	14/04/2020 19:00	14/04/2020 14:41	14/04/2020 19:00	4,31	1	4,31	CHI
20200447122	ITABERAI	IB21106166	ITABERAI S2	14/04/2020 14:42	14/04/2020 19:17	14/04/2020 14:42	14/04/2020 19:17	4,58	1	4,58	CHI
20200447123	NEROPOLIS	NR12324560	NEROPOLIS S2	14/04/2020 14:42	14/04/2020 17:31	14/04/2020 14:42	14/04/2020 17:31	2,81	4	11,24	CHI
20200447123	SANTO ANTONIO DE GOIAS	NR12324560	NEROPOLIS S2	14/04/2020 14:42	14/04/2020 17:31	14/04/2020 14:42	14/04/2020 17:31	2,81	4	11,24	CHI
20200447126	GOIANDIRA	GD12127529	CATALAO S1	14/04/2020 14:42	14/04/2020 16:28	14/04/2020 14:42	14/04/2020 16:28	1,76	9	15,83	CHI
20200447320	ITAPIRAPUA	NB12020254	JUSSARA	14/04/2020 14:42	15/04/2020 00:19	14/04/2020 14:42	15/04/2020 00:19	9,61	4	38,43	CHI
20200447320	NOVO BRASIL	NB12020254	JUSSARA	14/04/2020 14:42	15/04/2020 00:19	14/04/2020 14:42	15/04/2020 00:19	9,61	24	230,57	CHI
20200447882	ANAPOLIS	AN11000262	ANAPOLIS UNIVERSITARIO S2	14/04/2020 14:43	14/04/2020 21:08	14/04/2020 14:43	14/04/2020 21:08	6,40	141	902,52	CHI
20200448458	CALDAS NOVAS	CN11392103	CALDAS NOVAS S1	14/04/2020 14:43	14/04/2020 20:54	14/04/2020 14:43	14/04/2020 20:54	6,17	51	314,85	CHI
20200447143	LUZIANIA	LZ21219761	PAMPLONA	14/04/2020 14:44	14/04/2020 18:57	14/04/2020 14:44	14/04/2020 18:57	4,22	1	4,22	CHI
20200447145	GOIANIA	10082384	AEROPORTO S1	14/04/2020 14:44	14/04/2020 17:27	14/04/2020 14:44	14/04/2020 17:27	2,71	1	2,71	CHI
20200449507	ITAGUARI	IC12036612	ITABERAI S1	14/04/2020 14:44	14/04/2020 22:14	14/04/2020 14:44	14/04/2020 22:14	7,49	15	112,37	CHI
20200449507	ITAGUARU	IC12036612	ITABERAI S1	14/04/2020 14:44	14/04/2020 22:14	14/04/2020 14:44	14/04/2020 22:14	7,49	21	157,31	CHI
20200449507	JARAGUA	IC12036612	ITABERAI S1	14/04/2020 14:44	14/04/2020 22:14	14/04/2020 14:44	14/04/2020 22:14	7,49	94	704,16	CHI

20200447155	JARAGUA	JA21124469	JARAGUA	14/04/2020 14:45	14/04/2020 20:30	14/04/2020 14:45	14/04/2020 20:30	5,75	1	5,75	CHI
20200448045	INHUMAS	IN11265238	INHUMAS S2	14/04/2020 14:45	14/04/2020 21:09	14/04/2020 14:45	14/04/2020 21:09	6,39	140	894,79	CHI
20200447173	BELA VISTA DE GOIAS	BV21020388	CRISTIANOPOLIS	14/04/2020 14:46	15/04/2020 00:36	14/04/2020 14:46	15/04/2020 00:36	9,82	1	9,82	CHI
20200447180	AURILANDIA	CG12391407	FIRMINOPOLIS S2	14/04/2020 14:47	15/04/2020 16:21	15/04/2020 13:13	15/04/2020 16:21	3,13	2	6,26	CHI
20200447180	CACHOEIRA DE GOIAS	CG12391407	FIRMINOPOLIS S2	14/04/2020 14:47	15/04/2020 16:21	15/04/2020 13:13	15/04/2020 16:21	3,13	67	209,78	CHI
20200447180	PARAUNA	CG12391407	FIRMINOPOLIS S2	14/04/2020 14:47	15/04/2020 16:21	15/04/2020 13:13	15/04/2020 16:21	3,13	32	100,20	CHI
20200447190	ANAPOLIS	AN21325276	ANAPOLIS UNIVERSITARIO S1	14/04/2020 14:47	15/04/2020 02:26	14/04/2020 14:47	15/04/2020 02:26	11,64	1	11,64	CHI
20200447194	CALDAS NOVAS	760037589	SERRA DE CALDAS	14/04/2020 14:47	14/04/2020 18:27	14/04/2020 14:47	14/04/2020 18:27	3,65	1	3,65	CHI
20200447490	GOIAS	IK12250721	GOIAS	14/04/2020 14:47	15/04/2020 11:09	14/04/2020 14:47	15/04/2020 11:09	20,36	15	305,44	CHI
20200447490	ITABERAÍ	IK12250721	GOIAS	14/04/2020 14:47	15/04/2020 11:09	14/04/2020 14:47	15/04/2020 11:09	20,36	3	61,09	CHI
20200447490	ITAPURANGA	IK12250721	GOIAS	14/04/2020 14:47	15/04/2020 11:09	14/04/2020 14:47	15/04/2020 11:09	20,36	3	61,09	CHI
20200447680	APARECIDA DE GOIANIA	AP11383821	INDEPENDENCIA S1	14/04/2020 14:47	14/04/2020 18:41	14/04/2020 14:47	14/04/2020 18:41	3,90	76	296,32	CHI
20200447834	OUVIDOR	OU12077663RE	CATALAO S1	14/04/2020 14:47	14/04/2020 22:55	14/04/2020 14:47	14/04/2020 22:55	8,13	98	796,33	CHI
20200447834	TRES RANCHOS	OU12077663RE	CATALAO S1	14/04/2020 14:47	14/04/2020 22:55	14/04/2020 14:47	14/04/2020 22:55	8,13	26	211,27	CHI
20200449506	JUSSARA	JR12025870	JUSSARA	14/04/2020 14:47	15/04/2020 00:13	14/04/2020 14:47	15/04/2020 00:13	9,42	29	273,27	CHI
202004105711	PARAUNA	980031000	FIRMINOPOLIS S2	14/04/2020 14:47	15/04/2020 13:13	14/04/2020 14:47	15/04/2020 13:13	22,43	1	22,43	CHI
20200447199	GOIANIA	10004785795	GOYA S1	14/04/2020 14:48	14/04/2020 20:42	14/04/2020 14:48	14/04/2020 20:42	5,89	1	5,89	CHI
20200447204	BELA VISTA DE GOIAS	SV12389455	DAIA S2	14/04/2020 14:48	14/04/2020 17:57	14/04/2020 14:48	14/04/2020 17:57	3,14	7	21,98	CHI
20200447204	SILVANIA	SV12389455	DAIA S2	14/04/2020 14:48	14/04/2020 17:57	14/04/2020 14:48	14/04/2020 17:57	3,14	124	389,29	CHI
20200447206	PIRENOPOLIS	PV31101842	SAO FRANCISCO DE GOIAS	14/04/2020 14:49	14/04/2020 23:24	14/04/2020 14:49	14/04/2020 23:24	8,58	1	8,58	CHI
20200447209	GOIANIA	GN11002048	CAMPINAS S1	14/04/2020 14:49	14/04/2020 18:18	14/04/2020 14:49	14/04/2020 18:18	3,48	75	260,94	CHI
20200447211	PIRES DO RIO	PR11195108	PIRES DO RIO S1	14/04/2020 14:49	14/04/2020 20:29	14/04/2020 14:49	14/04/2020 20:29	5,66	79	446,90	CHI
20200447215	GOIANESIA	10029710403	GOIANESIA S2	14/04/2020 14:49	14/04/2020 19:12	14/04/2020 14:49	14/04/2020 19:12	4,37	1	4,37	CHI
20200448845	INHUMAS	IN12247254	INHUMAS S1	14/04/2020 14:49	14/04/2020 22:58	14/04/2020 14:49	14/04/2020 22:58	8,14	10	81,45	CHI
20200447221	CUMARI	CY11161450	CATALAO S1	14/04/2020 14:50	14/04/2020 19:14	14/04/2020 14:50	14/04/2020 19:14	4,39	71	311,97	CHI
20200447222	RIO QUENTE	10029466472	RIO QUENTE	14/04/2020 14:50	14/04/2020 18:40	14/04/2020 14:50	14/04/2020 18:40	3,83	1	3,83	CHI
20200447223	ARAGUAPAZ	AZ11236746	MOZARLANDIA	14/04/2020 14:50	14/04/2020 17:53	14/04/2020 14:50	14/04/2020 17:53	3,05	1	3,05	CHI
20200447236	BOM JESUS DE GOIAS	1250020107	BOM JESUS DE GOIAS	14/04/2020 14:51	14/04/2020 19:18	14/04/2020 14:51	14/04/2020 19:18	4,45	1	4,45	CHI
20200447242	ORIZONA	OZ12113702	PIRES DO RIO S2	14/04/2020 14:52	14/04/2020 19:41	14/04/2020 14:52	14/04/2020 19:41	4,82	11	53,05	CHI
20200447247	SANTA ROSA DE GOIAS	SR12079786	INHUMAS S1	14/04/2020 14:52	14/04/2020 19:42	14/04/2020 14:52	14/04/2020 19:42	4,82	7	33,76	CHI
20200448309	BOM JARDIM DE GOIAS	BM12325755	BOM JARDIM	14/04/2020 14:52	14/04/2020 20:55	14/04/2020 14:52	14/04/2020 20:55	6,04	6	36,25	CHI
20200447258	ARAGUAPAZ	AZ21094676	MOZARLANDIA	14/04/2020 14:53	15/04/2020 05:00	14/04/2020 14:53	15/04/2020 05:00	14,12	1	14,12	CHI
20200447265	PILAR DE GOIAS	GG21243186	SANTA TEREZINHA	14/04/2020 14:53	15/04/2020 08:57	14/04/2020 14:53	15/04/2020 08:57	18,05	2	36,10	CHI

20200449070	BURITI ALEGRE	BG12040290	ALTO BURITI	14/04/2020 14:53	15/04/2020 03:42	14/04/2020 14:53	15/04/2020 03:42	12,81	122	1563,06	CHI
20200447281	ANAPOLIS	AN13388834	ANAPOLIS UNIVERSITARIO S1	14/04/2020 14:54	14/04/2020 23:30	14/04/2020 14:54	14/04/2020 23:30	8,59	718	6165,23	CHI
20200447281	ANAPOLIS	AN13388834	ANAPOLIS UNIVERSITARIO S1	14/04/2020 14:54	14/04/2020 23:30	14/04/2020 21:50	14/04/2020 23:30	1,66	2324	3861,07	CHI
20200447287	SAO FRANCISCO DE GOIAS	SF12211814	SAO FRANCISCO DE GOIAS	14/04/2020 14:55	14/04/2020 18:14	14/04/2020 14:55	14/04/2020 18:14	3,31	14	46,40	CHI
20200447675	ANAPOLIS	AN12082525	ANAPOLIS UNIVERSITARIO S2	14/04/2020 14:55	14/04/2020 19:58	14/04/2020 14:55	14/04/2020 19:58	5,05	32	161,47	CHI
20200448895	CAIAPONIA	CP11091224	CAIAPONIA	14/04/2020 14:55	14/04/2020 19:53	14/04/2020 14:55	14/04/2020 19:53	4,96	123	610,49	CHI
20200447301	EDEALINA	ED21160342	PONTALINA	14/04/2020 14:56	14/04/2020 18:57	14/04/2020 14:56	14/04/2020 18:57	4,01	2	8,02	CHI
20200447307	GOIANIA	GN12405637LD	GOIANIA LESTE S2	14/04/2020 14:56	14/04/2020 20:01	14/04/2020 14:56	14/04/2020 20:01	5,08	2	10,15	CHI
20200447308	BELA VISTA DE GOIAS	BV31071699	BELA VISTA S1	14/04/2020 14:56	15/04/2020 10:10	14/04/2020 14:56	15/04/2020 10:10	19,23	2	38,46	CHI
20200447312	TRINDADE	TR32027908	TRINDADE	14/04/2020 14:56	14/04/2020 18:34	14/04/2020 14:56	14/04/2020 18:34	3,62	1	3,62	CHI
20200447314	PIRES DO RIO	460085311	PIRES DO RIO S1	14/04/2020 14:56	14/04/2020 16:57	14/04/2020 14:56	14/04/2020 16:57	2,00	1	2,00	CHI
20200447325	ANAPOLIS	10003448973	JUNDAI S1	14/04/2020 14:57	14/04/2020 17:51	14/04/2020 14:57	14/04/2020 17:51	2,89	1	2,89	CHI
20200448844	GOIATUBA	GT11000055	GOIATUBA S2	14/04/2020 14:57	15/04/2020 03:06	14/04/2020 14:57	15/04/2020 03:06	12,14	68	825,67	CHI
20200447349	PIRACANJUBA	PJ21134764	PIRACANJUBA	14/04/2020 14:58	14/04/2020 17:37	14/04/2020 14:58	14/04/2020 17:37	2,64	1	2,64	CHI
20200445848	CAMPO ALEGRE DE GOIAS	CM10397305	CAMPO ALEGRE DE GOIAS	14/04/2020 14:59	15/04/2020 11:15	14/04/2020 14:59	14/04/2020 17:43	2,73	29	79,25	CHI
20200445848	CAMPO ALEGRE DE GOIAS	CM10397305	CAMPO ALEGRE DE GOIAS	14/04/2020 14:59	15/04/2020 11:15	14/04/2020 14:59	14/04/2020 19:06	4,10	24	98,47	CHI
20200445848	CATALAO	CM10397305	CAMPO ALEGRE DE GOIAS	14/04/2020 14:59	15/04/2020 11:15	14/04/2020 14:59	14/04/2020 19:06	4,10	1	4,10	CHI
20200445848	CAMPO ALEGRE DE GOIAS	CM10397305	CAMPO ALEGRE DE GOIAS	14/04/2020 14:59	15/04/2020 11:15	14/04/2020 14:59	14/04/2020 20:24	5,41	32	173,23	CHI
20200445848	CATALAO	CM10397305	CAMPO ALEGRE DE GOIAS	14/04/2020 14:59	15/04/2020 11:15	14/04/2020 14:59	14/04/2020 20:24	5,41	17	92,03	CHI
20200445848	DISTRITO FEDERAL	CM10397305	CAMPO ALEGRE DE GOIAS	14/04/2020 14:59	15/04/2020 11:15	14/04/2020 14:59	14/04/2020 20:24	5,41	1	5,41	CHI
20200445848	CAMPO ALEGRE DE GOIAS	CM10397305	CAMPO ALEGRE DE GOIAS	14/04/2020 14:59	15/04/2020 11:15	14/04/2020 14:59	15/04/2020 10:17	19,30	34	656,20	CHI
20200445848	CATALAO	CM10397305	CAMPO ALEGRE DE GOIAS	14/04/2020 14:59	15/04/2020 11:15	14/04/2020 14:59	15/04/2020 10:17	19,30	3	57,90	CHI
20200445848	IPAMERI	CM10397305	CAMPO ALEGRE DE GOIAS	14/04/2020 14:59	15/04/2020 11:15	14/04/2020 14:59	15/04/2020 10:17	19,30	10	193,00	CHI
20200445848	CAMPO ALEGRE DE GOIAS	CM12281443	CAMPO ALEGRE DE GOIAS	14/04/2020 14:59	15/04/2020 11:15	14/04/2020 14:59	15/04/2020 11:15	20,25	14	283,53	CHI
20200445848	IPAMERI	CM12281443	CAMPO ALEGRE DE GOIAS	14/04/2020 14:59	15/04/2020 11:15	14/04/2020 14:59	15/04/2020 11:15	20,25	1	20,25	CHI
20200447380	PIRES DO RIO	PR11195083	PIRES DO RIO S1	14/04/2020 15:00	14/04/2020 17:41	14/04/2020 15:00	14/04/2020 17:41	2,67	60	160,48	CHI
20200448317	ABADIA DE GOIAS	LG12337876	TRINDADE	14/04/2020 15:01	15/04/2020 00:40	14/04/2020 15:01	15/04/2020 00:40	9,64	138	1330,93	CHI
20200447425	CALDAS NOVAS	CN11000058	SERRA DE CALDAS	14/04/2020 15:02	14/04/2020 19:54	14/04/2020 15:02	14/04/2020 19:54	4,86	186	904,01	CHI
20200447429	INDIARA	IY21289794	EDEIA	14/04/2020 15:02	15/04/2020 03:29	14/04/2020 15:02	15/04/2020 03:29	12,44	2	24,88	CHI
20200447858	CUMARI	CY12000302	CATALAO S1	14/04/2020 15:02	14/04/2020 21:16	14/04/2020 15:02	14/04/2020 20:24	5,35	233	1247,00	CHI
20200447858	CUMARI	CY12270715	CATALAO S1	14/04/2020 15:02	14/04/2020 21:16	14/04/2020 15:02	14/04/2020 20:53	5,84	307	1793,48	CHI
20200447858	CUMARI	CY12376060	CATALAO S1	14/04/2020 15:02	14/04/2020 21:16	14/04/2020 15:02	14/04/2020 21:16	6,23	10	62,28	CHI
20200447446	BOM JESUS DE GOIAS	1250042814	BOM JESUS DE GOIAS	14/04/2020 15:03	14/04/2020 19:20	14/04/2020 15:03	14/04/2020 19:20	4,28	1	4,28	CHI

20200448858	ITAPIRAPUA	IU12060539	MATRINCHA	14/04/2020 15:03	15/04/2020 11:28	14/04/2020 15:03	15/04/2020 11:28	20,41	4	81,62	CHI
20200449468	CORUMBAIBA	CI12263342	VILA CORUMBA	14/04/2020 15:03	15/04/2020 21:02	14/04/2020 15:03	15/04/2020 03:35	12,52	69	864,09	CHI
20200449468	CORUMBAIBA	CI12263342	VILA CORUMBA	14/04/2020 15:03	15/04/2020 21:02	14/04/2020 15:03	15/04/2020 10:18	19,25	108	2079,48	CHI
20200449468	CORUMBAIBA	CI11381147	VILA CORUMBA	14/04/2020 15:03	15/04/2020 21:02	14/04/2020 15:03	15/04/2020 13:20	22,27	18	400,92	CHI
20200449468	CORUMBAIBA	CI12263342	VILA CORUMBA	14/04/2020 15:03	15/04/2020 21:02	14/04/2020 15:03	15/04/2020 13:26	22,39	200	4477,33	CHI
20200449468	CORUMBAIBA	CI12263342	VILA CORUMBA	14/04/2020 15:03	15/04/2020 21:02	15/04/2020 13:33	15/04/2020 20:03	6,50	106	689,24	CHI
20200449468	CORUMBAIBA	CI12391595	VILA CORUMBA	14/04/2020 15:03	15/04/2020 21:02	15/04/2020 13:35	15/04/2020 20:03	6,46	2	12,92	CHI
20200449468	CORUMBAIBA	CI12263342	VILA CORUMBA	14/04/2020 15:03	15/04/2020 21:02	15/04/2020 13:33	15/04/2020 21:02	7,49	218	1633,30	CHI
20200447467	ITAUCU	IX32180430	INHUMAS S1	14/04/2020 15:04	15/04/2020 15:46	14/04/2020 15:04	15/04/2020 15:46	24,69	2	49,38	CHI
20200447472	GOIANIA	10005986859	INDEPENDENCIA S2	14/04/2020 15:05	14/04/2020 18:37	14/04/2020 15:05	14/04/2020 18:37	3,53	1	3,53	CHI
20200447482	HIDROLANDIA	180032999	CEPAIGO S2	14/04/2020 15:05	14/04/2020 17:17	14/04/2020 15:05	14/04/2020 17:17	2,19	1	2,19	CHI
20200447496	PIRES DO RIO	PR21154622	PIRES DO RIO S1	14/04/2020 15:06	14/04/2020 19:54	14/04/2020 15:06	14/04/2020 19:54	4,79	1	4,79	CHI
20200447498	ANAPOLIS	20635606	ANAPOLIS UNIVERSITARIO S2	14/04/2020 15:06	15/04/2020 00:30	14/04/2020 15:06	15/04/2020 00:30	9,39	1	9,39	CHI
20200447502	ARENOPOLIS	AY21040879	ARENOPOLIS	14/04/2020 15:06	15/04/2020 16:41	14/04/2020 15:06	15/04/2020 16:41	25,57	1	25,57	CHI
20200447508	CRISTALINA	KR21237873	CRISTALINA S2	14/04/2020 15:07	14/04/2020 17:58	14/04/2020 15:07	14/04/2020 17:58	2,84	1	2,84	CHI
20200447035	MONTE ALEGRE DE GOIAS	MA21285595	SAO DOMINGOS	14/04/2020 15:08	14/04/2020 21:12	14/04/2020 15:08	14/04/2020 21:12	6,05	2	12,11	CHI
20200448261	ARAGUAPAZ	MS12113246	ITAPURANGA	14/04/2020 15:08	15/04/2020 01:38	14/04/2020 15:08	15/04/2020 01:38	10,49	2	20,98	CHI
20200448261	FAINA	MS12113246	ITAPURANGA	14/04/2020 15:08	15/04/2020 01:38	14/04/2020 15:08	15/04/2020 01:38	10,49	7	73,41	CHI
20200448261	MORRO AGUDO DE GOIAS	MS12113246	ITAPURANGA	14/04/2020 15:08	15/04/2020 01:38	14/04/2020 15:08	15/04/2020 01:38	10,49	7	73,41	CHI
20200447531	TRINDADE	GR21015751	INHUMAS S1	14/04/2020 15:09	15/04/2020 10:30	14/04/2020 15:09	15/04/2020 10:30	19,35	1	19,35	CHI
20200447532	LEOPOLDO DE BULHOES	LB21068300	DAIA S2	14/04/2020 15:09	15/04/2020 09:08	14/04/2020 15:09	15/04/2020 09:08	17,98	1	17,98	CHI
20200447543	GOIANAPOLIS	GP11029289	JUNDIAI S1	14/04/2020 15:09	15/04/2020 02:02	14/04/2020 15:09	15/04/2020 02:02	10,87	11	119,62	CHI
20200447545	ABADIANIA	AA12271855	ANAPOLIS UNIVERSITARIO S1	14/04/2020 15:09	14/04/2020 19:38	14/04/2020 15:09	14/04/2020 19:38	4,48	8	35,83	CHI
20200447554	ORIZONA	OZ12115152	PIRES DO RIO S2	14/04/2020 15:10	14/04/2020 21:11	14/04/2020 15:10	14/04/2020 21:11	6,01	9	54,11	CHI
20200447569	GUARANI DE GOIAS	GY12160070	IACIARA S1	14/04/2020 15:11	14/04/2020 22:18	14/04/2020 15:11	14/04/2020 22:18	7,11	3	21,34	CHI
20200447569	IACIARA	GY12160070	IACIARA S1	14/04/2020 15:11	14/04/2020 22:18	14/04/2020 15:11	14/04/2020 22:18	7,11	2	14,23	CHI
20200447569	SAO DOMINGOS	GY12160070	IACIARA S1	14/04/2020 15:11	14/04/2020 22:18	14/04/2020 15:11	14/04/2020 22:18	7,11	1	7,11	CHI
20200447571	SAO LUIS DE MONTES BELOS	500028539	SAO LUIZ DOS MONTES BELOS	14/04/2020 15:11	14/04/2020 18:43	14/04/2020 15:11	14/04/2020 18:43	3,53	1	3,53	CHI
20200447574	ANAPOLIS	20436130	ANAPOLIS UNIVERSITARIO S1	14/04/2020 15:11	14/04/2020 18:28	14/04/2020 15:11	14/04/2020 18:28	3,27	1	3,27	CHI
20200449044	CATALAO	CT12265212	CATALAO S1	14/04/2020 15:11	15/04/2020 09:16	14/04/2020 15:11	15/04/2020 09:16	18,07	17	307,16	CHI
20200445850	BARRO ALTO	03620214	GOIANESIA S1	14/04/2020 15:12	15/04/2020 05:57	14/04/2020 15:12	14/04/2020 21:48	6,60	91	600,93	CHI
20200445850	GOIANESIA	03620214	GOIANESIA S1	14/04/2020 15:12	15/04/2020 05:57	14/04/2020 15:12	14/04/2020 21:48	6,60	113	746,21	CHI
20200445850	VILA PROPICIO	03620214	GOIANESIA S1	14/04/2020 15:12	15/04/2020 05:57	14/04/2020 15:12	14/04/2020 21:48	6,60	12	79,24	CHI

20200445850	BARRO ALTO	03620214	GOIANESIA S1	14/04/2020 15:12	15/04/2020 05:57	14/04/2020 15:12	15/04/2020 05:57	14,74	1	14,74	CHI
20200445850	COCALZINHO DE GOIAS	03620214	GOIANESIA S1	14/04/2020 15:12	15/04/2020 05:57	14/04/2020 15:12	15/04/2020 05:57	14,74	1	14,74	CHI
20200445850	PADRE BERNARDO	03620214	GOIANESIA S1	14/04/2020 15:12	15/04/2020 05:57	14/04/2020 15:12	15/04/2020 05:57	14,74	10	147,43	CHI
20200445850	VILA PROPICIO	03620214	GOIANESIA S1	14/04/2020 15:12	15/04/2020 05:57	14/04/2020 15:12	15/04/2020 05:57	14,74	895	13195,03	CHI
20200445850	BARRO ALTO	BA13210804	GOIANESIA S1	14/04/2020 15:12	15/04/2020 05:57	15/04/2020 04:24	15/04/2020 05:57	1,55	91	141,05	CHI
20200445850	GOIANESIA	BA13210804	GOIANESIA S1	14/04/2020 15:12	15/04/2020 05:57	15/04/2020 04:24	15/04/2020 05:57	1,55	113	175,15	CHI
20200445850	VILA PROPICIO	BA13210804	GOIANESIA S1	14/04/2020 15:12	15/04/2020 05:57	15/04/2020 04:24	15/04/2020 05:57	1,55	12	18,60	CHI
20200447639	ORIZONA	OZ11047554	PIRES DO RIO S2	14/04/2020 15:15	14/04/2020 20:40	14/04/2020 15:15	14/04/2020 20:40	5,41	91	492,18	CHI
20200447641	CATALAO	TH21192609	CATALAO S1	14/04/2020 15:15	15/04/2020 08:42	14/04/2020 15:15	15/04/2020 08:42	17,44	2	34,88	CHI
20200447651	ORIZONA	OZ12011583	PIRES DO RIO S2	14/04/2020 15:16	14/04/2020 18:20	14/04/2020 15:16	14/04/2020 18:20	3,06	5	15,32	CHI
20200449000	ORIZONA	OZ21200137	PIRES DO RIO S2	14/04/2020 15:16	14/04/2020 22:50	14/04/2020 15:16	14/04/2020 22:50	7,56	2	15,13	CHI
20200447671	LEOPOLDO DE BULHOES	LB11000002	DAIA S2	14/04/2020 15:17	14/04/2020 20:58	14/04/2020 15:17	14/04/2020 20:58	5,68	54	306,73	CHI
20200447977	CEZARINA	CZ11186432	CEZARINA	14/04/2020 15:18	15/04/2020 11:52	14/04/2020 15:18	15/04/2020 11:52	20,57	154	3167,99	CHI
20200448950	ABADIANIA	AA12349438	ANAPOLIS UNIVERSITARIO S1	14/04/2020 15:19	14/04/2020 20:33	14/04/2020 15:19	14/04/2020 20:33	5,22	25	130,56	CHI
20200449429	ITUMBIARA	IT12249852	PARANAIBA	14/04/2020 15:19	14/04/2020 20:53	14/04/2020 15:19	14/04/2020 20:53	5,56	272	1513,30	CHI
20200447731	ARAGUAPAZ	AZ12307224	GOIAS	14/04/2020 15:21	15/04/2020 08:50	14/04/2020 15:21	15/04/2020 08:50	17,48	1	17,48	CHI
20200447843	GOIATUBA	GT12052880	GOIATUBA S1	14/04/2020 15:21	14/04/2020 19:51	14/04/2020 15:21	14/04/2020 19:51	4,49	12	53,90	CHI
20200445852	PIRENOPOLIS	01840214	GOIANESIA S1	14/04/2020 15:22	15/04/2020 13:38	14/04/2020 15:22	14/04/2020 16:43	1,36	34	46,32	CHI
20200445852	VILA PROPICIO	01840214	GOIANESIA S1	14/04/2020 15:22	15/04/2020 13:38	14/04/2020 15:22	14/04/2020 16:43	1,36	760	1035,29	CHI
20200445852	VILA PROPICIO	01840214	GOIANESIA S1	14/04/2020 15:22	15/04/2020 13:38	14/04/2020 15:22	14/04/2020 19:13	3,86	2	7,72	CHI
20200445852	VILA PROPICIO	01840214	GOIANESIA S1	14/04/2020 15:22	15/04/2020 13:38	14/04/2020 15:22	15/04/2020 13:07	21,75	28	609,00	CHI
20200445852	VILA PROPICIO	01840214	GOIANESIA S1	14/04/2020 15:22	15/04/2020 13:38	14/04/2020 15:22	15/04/2020 13:38	22,27	38	846,24	CHI
20200447750	BONOPOLIS	BX12193536	SAO MIGUEL DO ARAGUAIA	14/04/2020 15:22	14/04/2020 18:43	14/04/2020 15:22	14/04/2020 18:43	3,34	9	30,09	CHI
20200449329	BONOPOLIS	BX21123196	SAO MIGUEL DO ARAGUAIA	14/04/2020 15:22	14/04/2020 20:25	14/04/2020 15:22	14/04/2020 20:25	5,04	1	5,04	CHI
20200449729	VILA PROPICIO	PV21146825	GOIANESIA S1	14/04/2020 15:22	15/04/2020 03:14	14/04/2020 15:22	15/04/2020 03:14	11,87	1	11,87	CHI
20200447776	IPAMERI	IP12404729	IPAMERI	14/04/2020 15:24	15/04/2020 00:37	14/04/2020 15:24	15/04/2020 00:37	9,21	15	138,21	CHI
20200447803	FAZENDA NOVA	FN11242304	IPORA	14/04/2020 15:25	15/04/2020 11:50	14/04/2020 15:25	15/04/2020 11:50	20,41	1	20,41	CHI
20200447812	CUMARI	CY21317588	CATALAO S1	14/04/2020 15:25	15/04/2020 08:19	14/04/2020 15:25	15/04/2020 08:19	16,89	1	16,89	CHI
20200447817	CAMPO ALEGRE DE GOIAS	CM21122441	CAMPO ALEGRE DE GOIAS	14/04/2020 15:25	15/04/2020 11:49	14/04/2020 15:25	15/04/2020 11:49	20,38	1	20,38	CHI
20200447819	NIQUELANDIA	NQ12055114	NIQUELANDIA SUBTRANSMISSAO	14/04/2020 15:25	14/04/2020 19:45	14/04/2020 15:25	14/04/2020 19:45	4,32	1	4,32	CHI
20200448607	ITUMBIARA	IT12273840RE	ITUMBIARA NOVA	14/04/2020 15:25	14/04/2020 20:35	14/04/2020 15:25	14/04/2020 20:35	5,16	48	247,81	CHI
20200447844	ORIZONA	5070000656	PIRES DO RIO S2	14/04/2020 15:27	14/04/2020 19:36	14/04/2020 15:27	14/04/2020 19:36	4,14	1	4,14	CHI
20200448153	ITAPURANGA	IK12299461	ITAPURANGA	14/04/2020 15:28	15/04/2020 08:46	14/04/2020 15:28	15/04/2020 08:46	17,31	8	138,50	CHI

20200445853	AGUAS LINDAS DE GOIAS	LA11149040	AGUAS LINDAS DE GOIAS S1	14/04/2020 15:29	14/04/2020 17:03	14/04/2020 15:29	14/04/2020 17:03	1,56	218	339,17	CHI
20200449248	FAINA	FC12299779	MATRINCHA	14/04/2020 15:30	15/04/2020 08:46	14/04/2020 15:30	15/04/2020 08:46	17,26	15	258,97	CHI
20200449248	MATRINCHA	FC12299779	MATRINCHA	14/04/2020 15:30	15/04/2020 08:46	14/04/2020 15:30	15/04/2020 08:46	17,26	38	656,05	CHI
20200449644	MOSSAMEDES	MD12057741	FIRMINOPOLIS S2	14/04/2020 15:30	14/04/2020 23:20	14/04/2020 15:30	14/04/2020 23:20	7,83	1	7,83	CHI
20200447943	GOIAS	GS12220578	GOIAS	14/04/2020 15:31	14/04/2020 21:07	14/04/2020 15:31	14/04/2020 21:07	5,60	11	61,55	CHI
20200447898	CIDADE OCIDENTAL	10012440963	MARAJOARA	14/04/2020 15:32	14/04/2020 19:50	14/04/2020 15:32	14/04/2020 19:50	4,29	1	4,29	CHI
20200447992	ORIZONA	OZ11000132	PIRES DO RIO S2	14/04/2020 15:32	15/04/2020 00:25	14/04/2020 15:32	15/04/2020 00:25	8,87	131	1161,79	CHI
20200447906	SANTA CRUZ DE GOIAS	BC12027036	PIRES DO RIO S2	14/04/2020 15:33	14/04/2020 20:33	14/04/2020 15:33	14/04/2020 20:33	5,00	6	29,98	CHI
20200447908	ANAPOLIS	AN12273056	ANAPOLIS UNIVERSITARIO S2	14/04/2020 15:33	14/04/2020 21:59	14/04/2020 15:33	14/04/2020 21:59	6,43	16	102,85	CHI
20200447911	CUMARI	CT21078774	CATALAO S2	14/04/2020 15:33	15/04/2020 05:30	14/04/2020 15:33	15/04/2020 05:30	13,94	1	13,94	CHI
20200447927	ARAGUAPAZ	AZ12404519	MOZARLANDIA	14/04/2020 15:35	14/04/2020 23:10	14/04/2020 15:35	14/04/2020 23:10	7,60	10	75,97	CHI
20200447935	GOIATUBA	10027615110	GOIATUBA S2	14/04/2020 15:35	15/04/2020 06:21	14/04/2020 15:35	15/04/2020 06:21	14,76	1	14,76	CHI
20200449424	PADRE BERNARDO	PI12105583LD	PLANALTINA	14/04/2020 15:35	14/04/2020 22:27	14/04/2020 15:35	14/04/2020 22:27	6,85	14	95,94	CHI
20200449424	PLANALTINA	PI12105583LD	PLANALTINA	14/04/2020 15:35	14/04/2020 22:27	14/04/2020 15:35	14/04/2020 22:27	6,85	23	157,61	CHI
20200447959	URUTAI	UT21311707	URUTAI	14/04/2020 15:37	14/04/2020 20:56	14/04/2020 15:37	14/04/2020 20:56	5,31	1	5,31	CHI
20200447962	ORIZONA	2060028742	PIRES DO RIO S2	14/04/2020 15:37	14/04/2020 20:30	14/04/2020 15:37	14/04/2020 20:30	4,87	1	4,87	CHI
20200448872	ABADIANIA	AA12199755	ANAPOLIS UNIVERSITARIO S1	14/04/2020 15:37	14/04/2020 21:59	14/04/2020 15:37	14/04/2020 21:59	6,36	12	76,26	CHI
20200448003	EDEALINA	1130014440	PONTALINA	14/04/2020 15:41	14/04/2020 18:59	14/04/2020 15:41	14/04/2020 18:59	3,30	1	3,30	CHI
20200448011	ITABERAI	IB12300082	ITABERAI S2	14/04/2020 15:41	14/04/2020 23:09	14/04/2020 15:41	14/04/2020 23:09	7,46	15	111,84	CHI
20200448011	ITAPURANGA	IB12300082	ITABERAI S2	14/04/2020 15:41	14/04/2020 23:09	14/04/2020 15:41	14/04/2020 23:09	7,46	1	7,46	CHI
20200448929	CALDAS NOVAS	CN11162997	SERRA DE CALDAS	14/04/2020 15:41	14/04/2020 21:35	14/04/2020 15:41	14/04/2020 21:35	5,90	152	896,50	CHI
20200449285	MOZARLANDIA	MZ12181320	MOZARLANDIA	14/04/2020 15:41	16/04/2020 21:41	14/04/2020 15:41	15/04/2020 17:36	25,93	7	181,48	CHI
20200449285	MOZARLANDIA	MZ12064155	MOZARLANDIA	14/04/2020 15:41	16/04/2020 21:41	14/04/2020 15:41	15/04/2020 19:30	27,82	2	55,65	CHI
20200449285	MOZARLANDIA	7939362	MOZARLANDIA	14/04/2020 15:41	16/04/2020 21:41	14/04/2020 15:41	16/04/2020 21:41	54,01	11	594,15	CHI
20200448029	MORRINHOS	MR12252186	GOIATUBA S1	14/04/2020 15:42	15/04/2020 11:49	14/04/2020 15:42	15/04/2020 11:49	20,10	3	60,31	CHI
20200448031	NOVO BRASIL	FN21019391	JUSSARA	14/04/2020 15:42	15/04/2020 12:56	14/04/2020 15:42	15/04/2020 12:56	21,22	1	21,22	CHI
20200447187	URUACU	UR21346781	CAMPINORTE	14/04/2020 15:43	14/04/2020 17:13	14/04/2020 15:43	14/04/2020 17:13	1,48	2	2,97	CHI
20200448041	SAO LUIS DE MONTES BELOS	500065810	SAO LUIZ DOS MONTES BELOS	14/04/2020 15:43	15/04/2020 07:40	14/04/2020 15:43	15/04/2020 07:40	15,94	1	15,94	CHI
20200448043	JARAGUA	JA21006445	JARAGUA	14/04/2020 15:44	14/04/2020 21:40	14/04/2020 15:44	14/04/2020 21:40	5,93	1	5,93	CHI
20200448048	ALTO HORIZONTE	AJ12375644	SANTA TEREZINHA	14/04/2020 15:44	14/04/2020 21:19	14/04/2020 15:44	14/04/2020 21:19	5,58	9	50,18	CHI
20200448048	PILAR DE GOIAS	AJ12375644	SANTA TEREZINHA	14/04/2020 15:44	14/04/2020 21:19	14/04/2020 15:44	14/04/2020 21:19	5,58	1	5,58	CHI
20200448059	MORRINHOS	MR21153544	MORRINHOS	14/04/2020 15:45	14/04/2020 22:30	14/04/2020 15:45	14/04/2020 22:30	6,74	1	6,74	CHI
20200445858	RUBIATABA	01630424	RUBIATABA	14/04/2020 15:46	15/04/2020 12:29	14/04/2020 15:46	14/04/2020 15:53	0,12	2	0,25	CHI



20200445858	ARAGUAPAZ	01630424	RUBIATABA	14/04/2020 15:46	15/04/2020 12:29	14/04/2020 15:46	14/04/2020 15:54	0,13	97	12,69	CHI
20200445858	CRIXAS	01630424	RUBIATABA	14/04/2020 15:46	15/04/2020 12:29	14/04/2020 15:46	14/04/2020 15:54	0,13	496	64,89	CHI
20200445858	MOZARLANDIA	01630424	RUBIATABA	14/04/2020 15:46	15/04/2020 12:29	14/04/2020 15:46	14/04/2020 15:54	0,13	4	0,52	CHI
20200445858	NOVA AMERICA	01630424	RUBIATABA	14/04/2020 15:46	15/04/2020 12:29	14/04/2020 15:46	14/04/2020 15:54	0,13	194	25,38	CHI
20200445858	NOVA CRIXAS	01630424	RUBIATABA	14/04/2020 15:46	15/04/2020 12:29	14/04/2020 15:46	14/04/2020 15:54	0,13	1	0,13	CHI
20200445858	NOVA IGUACU DE GOIAS	01630424	RUBIATABA	14/04/2020 15:46	15/04/2020 12:29	14/04/2020 15:46	14/04/2020 15:54	0,13	1	0,13	CHI
20200445858	RUBIATABA	01630424	RUBIATABA	14/04/2020 15:46	15/04/2020 12:29	14/04/2020 15:46	14/04/2020 15:54	0,13	8	1,05	CHI
20200445858	ARAGUAPAZ	MZ10400739	RUBIATABA	14/04/2020 15:46	15/04/2020 12:29	14/04/2020 15:47	14/04/2020 15:54	0,11	4	0,42	CHI
20200445858	CRIXAS	MZ10400739	RUBIATABA	14/04/2020 15:46	15/04/2020 12:29	14/04/2020 15:47	14/04/2020 15:54	0,11	85	8,97	CHI
20200445858	NOVA AMERICA	MZ10400739	RUBIATABA	14/04/2020 15:46	15/04/2020 12:29	14/04/2020 15:47	14/04/2020 15:54	0,11	13	1,37	CHI
20200445858	RUBIATABA	01630424	RUBIATABA	14/04/2020 15:46	15/04/2020 12:29	14/04/2020 15:46	14/04/2020 19:30	3,74	86	321,76	CHI
20200445858	RUBIATABA	01630424	RUBIATABA	14/04/2020 15:46	15/04/2020 12:29	14/04/2020 15:47	14/04/2020 19:30	3,72	5	18,58	CHI
20200445858	RUBIATABA	01630424	RUBIATABA	14/04/2020 15:46	15/04/2020 12:29	14/04/2020 15:46	14/04/2020 20:25	4,64	1	4,64	CHI
20200445858	RUBIATABA	01630424	RUBIATABA	14/04/2020 15:46	15/04/2020 12:29	14/04/2020 19:58	14/04/2020 20:25	0,45	91	40,50	CHI
20200445858	NOVA AMERICA	01630424	RUBIATABA	14/04/2020 15:46	15/04/2020 12:29	14/04/2020 15:46	15/04/2020 11:36	19,84	19	376,99	CHI
20200445858	RUBIATABA	01630424	RUBIATABA	14/04/2020 15:46	15/04/2020 12:29	14/04/2020 15:46	15/04/2020 11:36	19,84	14	277,78	CHI
20200445858	NOVA AMERICA	01630424	RUBIATABA	14/04/2020 15:46	15/04/2020 12:29	14/04/2020 15:47	15/04/2020 11:36	19,82	3	59,45	CHI
20200445858	RUBIATABA	01630424	RUBIATABA	14/04/2020 15:46	15/04/2020 12:29	14/04/2020 15:47	15/04/2020 11:36	19,82	1	19,82	CHI
20200445858	ARAGUAPAZ	MZ10400739	RUBIATABA	14/04/2020 15:46	15/04/2020 12:29	14/04/2020 17:53	15/04/2020 12:29	18,60	101	1878,49	CHI
20200445858	CRIXAS	MZ10400739	RUBIATABA	14/04/2020 15:46	15/04/2020 12:29	14/04/2020 17:53	15/04/2020 12:29	18,60	565	10508,37	CHI
20200445858	MOZARLANDIA	MZ10400739	RUBIATABA	14/04/2020 15:46	15/04/2020 12:29	14/04/2020 17:53	15/04/2020 12:29	18,60	4	74,40	CHI
20200445858	NOVA AMERICA	MZ10400739	RUBIATABA	14/04/2020 15:46	15/04/2020 12:29	14/04/2020 17:53	15/04/2020 12:29	18,60	205	3812,77	CHI
20200445858	NOVA CRIXAS	MZ10400739	RUBIATABA	14/04/2020 15:46	15/04/2020 12:29	14/04/2020 17:53	15/04/2020 12:29	18,60	1	18,60	CHI
20200445858	NOVA IGUACU DE GOIAS	MZ10400739	RUBIATABA	14/04/2020 15:46	15/04/2020 12:29	14/04/2020 17:53	15/04/2020 12:29	18,60	1	18,60	CHI
20200445858	RUBIATABA	MZ10400739	RUBIATABA	14/04/2020 15:46	15/04/2020 12:29	14/04/2020 17:53	15/04/2020 12:29	18,60	8	148,79	CHI
20200445858	NOVA AMERICA	01630424	RUBIATABA	14/04/2020 15:46	15/04/2020 12:29	14/04/2020 15:46	15/04/2020 12:29	20,72	19	393,65	CHI
20200452165	NOVA AMERICA	NM21273701	RUBIATABA	14/04/2020 15:46	15/04/2020 17:33	14/04/2020 17:53	15/04/2020 17:33	23,66	2	47,33	CHI
20200448076	PIRES DO RIO	PR12344664	PIRES DO RIO S2	14/04/2020 15:47	14/04/2020 20:06	14/04/2020 15:47	14/04/2020 20:06	4,30	2	8,61	CHI
20200448079	MAIRIPOTABA	MI12394189	PONTALINA	14/04/2020 15:47	14/04/2020 23:25	14/04/2020 15:47	14/04/2020 23:25	7,62	1	7,62	CHI
20200448079	PONTALINA	MI12394189	PONTALINA	14/04/2020 15:47	14/04/2020 23:25	14/04/2020 15:47	14/04/2020 23:25	7,62	3	22,86	CHI
20200448180	MOZARLANDIA	MZ12217251	MOZARLANDIA	14/04/2020 15:47	15/04/2020 06:56	14/04/2020 15:47	15/04/2020 06:56	15,14	103	1559,68	CHI
20200448976	SILVANIA	SV12087628	DAIA S2	14/04/2020 15:48	15/04/2020 00:05	14/04/2020 15:48	15/04/2020 00:05	8,28	61	504,89	CHI
20200451205	BELA VISTA DE GOIAS	BV12080831	CRISTIANOPOLIS	14/04/2020 15:48	15/04/2020 10:27	14/04/2020 15:48	15/04/2020 10:27	18,65	1	18,65	CHI

20200451205	SAO MIGUEL DO PASSA QUATRO	BV12080831	CRISTIANOPOLIS	14/04/2020 15:48	15/04/2020 10:27	14/04/2020 15:48	15/04/2020 10:27	18,65	14	261,10	CHI
20200448103	GOIANESIA	10005300191	GOIANESIA S2	14/04/2020 15:50	14/04/2020 22:24	14/04/2020 15:50	14/04/2020 22:24	6,57	1	6,57	CHI
20200448108	ORIZONA	OZ12022991	PIRES DO RIO S2	14/04/2020 15:51	15/04/2020 00:35	14/04/2020 15:51	15/04/2020 00:35	8,73	1	8,73	CHI
20200448466	MOZARLANDIA	MZ11278264	MOZARLANDIA	14/04/2020 15:51	15/04/2020 00:36	14/04/2020 15:51	15/04/2020 00:36	8,75	56	489,80	CHI
20200448137	ANAPOLIS	AN11000896	ANAPOLIS UNIVERSITARIO S2	14/04/2020 15:54	14/04/2020 19:19	14/04/2020 15:54	14/04/2020 19:19	3,41	55	187,82	CHI
20200448146	LEOPOLDO DE BULHOES	LB21042220	DAIA S2	14/04/2020 15:55	14/04/2020 21:06	14/04/2020 15:55	14/04/2020 21:06	5,18	1	5,18	CHI
20200448185	AURILANDIA	AI12383536	FIRMINOPOLIS S2	14/04/2020 15:56	15/04/2020 14:53	14/04/2020 15:56	15/04/2020 14:53	22,93	3	68,80	CHI
20200448203	PORANGATU	PO12350109	PORANGATU	14/04/2020 15:57	14/04/2020 22:14	14/04/2020 15:57	14/04/2020 22:14	6,27	11	68,94	CHI
20200448214	CEZARINA	CZ11377173	CEZARINA	14/04/2020 15:58	15/04/2020 09:02	14/04/2020 15:58	15/04/2020 09:02	17,05	62	1057,29	CHI
20200448355	BONOPOLIS	BX12079317	SAO MIGUEL DO ARAGUAIA	14/04/2020 15:58	14/04/2020 19:45	14/04/2020 15:58	14/04/2020 19:45	3,78	37	139,85	CHI
20200449433	PALMEIRAS DE GOIAS	PL12323493	PALMEIRAS	14/04/2020 15:58	15/04/2020 00:35	14/04/2020 15:58	15/04/2020 00:35	8,62	255	2197,46	CHI
20200449582	MOZARLANDIA	MZ12220223	MOZARLANDIA	14/04/2020 16:00	15/04/2020 19:10	14/04/2020 16:00	15/04/2020 19:10	27,16	8	217,31	CHI
20200448251	AMORINOPOLIS	1540001146	IPORA	14/04/2020 16:01	14/04/2020 23:17	14/04/2020 16:01	14/04/2020 23:17	7,27	1	7,27	CHI
20200448255	ARAGUAPAZ	MP12355886	MATRINCHA	14/04/2020 16:01	15/04/2020 08:01	14/04/2020 16:01	15/04/2020 08:01	15,99	1	15,99	CHI
20200448255	FAINA	MP12355886	MATRINCHA	14/04/2020 16:01	15/04/2020 08:01	14/04/2020 16:01	15/04/2020 08:01	15,99	2	31,97	CHI
20200448461	MORRINHOS	MR11090578	MORRINHOS	14/04/2020 16:01	15/04/2020 03:56	14/04/2020 16:01	15/04/2020 03:56	11,91	103	1226,87	CHI
20200445861	ALEXANIA	AX10404067	CORUMBA	14/04/2020 16:02	14/04/2020 22:07	14/04/2020 16:02	14/04/2020 17:40	1,64	79	129,23	CHI
20200445861	CORUMBA DE GOIAS	AX10404067	CORUMBA	14/04/2020 16:02	14/04/2020 22:07	14/04/2020 16:02	14/04/2020 17:40	1,64	57	93,24	CHI
20200445861	ALEXANIA	AX10404067	CORUMBA	14/04/2020 16:02	14/04/2020 22:07	14/04/2020 16:02	14/04/2020 19:28	3,44	6	20,65	CHI
20200445861	CORUMBA DE GOIAS	AX10404067	CORUMBA	14/04/2020 16:02	14/04/2020 22:07	14/04/2020 16:02	14/04/2020 19:28	3,44	98	337,26	CHI
20200445861	CORUMBA DE GOIAS	AX10404067	CORUMBA	14/04/2020 16:02	14/04/2020 22:07	14/04/2020 16:02	14/04/2020 21:21	5,33	158	842,32	CHI
20200445861	CORUMBA DE GOIAS	CB12297694	CORUMBA	14/04/2020 16:02	14/04/2020 22:07	14/04/2020 16:02	14/04/2020 22:07	6,09	36	219,14	CHI
20200448278	VILA BOA	2880002741	IACIARA S2	14/04/2020 16:03	14/04/2020 19:13	14/04/2020 16:03	14/04/2020 19:13	3,16	1	3,16	CHI
20200448410	ALEXANIA	AX11284985	ALEXANIA	14/04/2020 16:04	14/04/2020 20:38	14/04/2020 16:04	14/04/2020 20:38	4,56	118	537,69	CHI
20200448315	MATRINCHA	MP12171758	MATRINCHA	14/04/2020 16:06	15/04/2020 12:42	14/04/2020 16:06	15/04/2020 12:42	20,60	1	20,60	CHI
20200448320	ARUANA	AK21220213	ARUANA	14/04/2020 16:06	15/04/2020 07:43	14/04/2020 16:06	15/04/2020 07:43	15,61	1	15,61	CHI
20200448745	CEZARINA	CZ11349340	CEZARINA	14/04/2020 16:06	15/04/2020 08:20	14/04/2020 16:06	15/04/2020 08:20	16,22	52	843,43	CHI
20200448332	ABADIANIA	AA12057569	ANAPOLIS UNIVERSITARIO S1	14/04/2020 16:07	14/04/2020 23:19	14/04/2020 16:07	14/04/2020 23:19	7,19	9	64,73	CHI
20200448496	OUVIDOR	OU12308656	CATALAO S1	14/04/2020 16:07	15/04/2020 12:23	14/04/2020 16:07	14/04/2020 22:36	6,47	69	446,37	CHI
20200448496	OUVIDOR	OU12308656	CATALAO S1	14/04/2020 16:07	15/04/2020 12:23	14/04/2020 22:40	15/04/2020 11:23	12,71	69	876,91	CHI
20200448496	OUVIDOR	OU12308657LD	CATALAO S1	14/04/2020 16:07	15/04/2020 12:23	14/04/2020 16:07	15/04/2020 12:23	20,26	3	60,79	CHI
20200448342	ITUMBIARA	IT21097280	ITUMBIARA VELHA S2	14/04/2020 16:08	15/04/2020 12:07	14/04/2020 16:08	15/04/2020 12:07	19,98	16	319,71	CHI
20200448346	ITABERAI	IB21336380	ITABERAI S2	14/04/2020 16:08	15/04/2020 02:15	14/04/2020 16:08	15/04/2020 02:15	10,11	1	10,11	CHI

20200448348	SANTA CRUZ DE GOIAS	BC11012006	PIRES DO RIO S2	14/04/2020 16:08	15/04/2020 13:52	14/04/2020 16:08	15/04/2020 13:52	21,72	60	1303,20	CHI
20200448370	SAO LUIZ DO NORTE	SZ21143509	ITAPACI	14/04/2020 16:10	15/04/2020 05:31	14/04/2020 16:10	15/04/2020 05:31	13,34	2	26,68	CHI
20200450334	ITAPURANGA	IK12299283	ITAPURANGA	14/04/2020 16:10	15/04/2020 12:23	14/04/2020 16:10	15/04/2020 12:23	20,21	1	20,21	CHI
20200448375	ITUMBIARA	IT12404221	PARANAIBA	14/04/2020 16:11	14/04/2020 19:46	14/04/2020 16:11	14/04/2020 19:46	3,58	25	89,46	CHI
20200448382	SAO LUIS DE MONTES BELOS	500059184	SAO LUIZ DOS MONTES BELOS	14/04/2020 16:11	15/04/2020 08:51	14/04/2020 16:11	15/04/2020 08:51	16,65	1	16,65	CHI
20200448384	GOIATUBA	GT12000094	GOIATUBA S2	14/04/2020 16:11	15/04/2020 00:50	14/04/2020 16:11	15/04/2020 00:50	8,63	6	51,81	CHI
20200448386	AURILANDIA	CG21311368	FIRMINOPOLIS S2	14/04/2020 16:12	15/04/2020 15:38	14/04/2020 16:12	15/04/2020 15:38	23,43	1	23,43	CHI
20200448407	LUZIANIA	LZ12290755	RIO VERMELHO	14/04/2020 16:14	14/04/2020 21:38	14/04/2020 16:14	14/04/2020 21:38	5,39	13	70,13	CHI
20200448421	SANTO ANTONIO DO DESCOBERTO	SN12345965	AGUAS LINDAS DE GOIAS S2	14/04/2020 16:15	14/04/2020 19:45	14/04/2020 16:15	14/04/2020 19:45	3,49	2	6,99	CHI
20200448436	LEOPOLDO DE BULHOES	LB21155871	DAIA S2	14/04/2020 16:16	15/04/2020 09:35	14/04/2020 16:16	15/04/2020 09:35	17,30	1	17,30	CHI
20200448447	CRISTALINA	KR12217277	CRISTALINA S1	14/04/2020 16:17	15/04/2020 13:34	14/04/2020 16:17	15/04/2020 13:34	21,28	12	255,36	CHI
20200448447	CRISTALINA	KR12217277	CRISTALINA S1	14/04/2020 16:17	15/04/2020 13:34	15/04/2020 10:00	15/04/2020 13:34	3,56	1	3,56	CHI
20200449034	PIRENOPOLIS	PV12311868	CORUMBA	14/04/2020 16:18	14/04/2020 19:55	14/04/2020 16:18	14/04/2020 19:55	3,60	35	126,05	CHI
20200449066	HIDROLINA	HL11253146	URUACU	14/04/2020 16:18	14/04/2020 21:54	14/04/2020 16:18	14/04/2020 21:54	5,59	37	206,79	CHI
20200449940	CAIAPONIA	CP12308692	PALESTINA	14/04/2020 16:18	14/04/2020 21:46	14/04/2020 16:18	14/04/2020 21:46	5,46	9	49,11	CHI
20200448465	GUARANI DE GOIAS	SD12165583	SAO DOMINGOS	14/04/2020 16:19	14/04/2020 23:37	14/04/2020 16:19	14/04/2020 23:37	7,29	2	14,58	CHI
20200448465	SAO DOMINGOS	SD12165583	SAO DOMINGOS	14/04/2020 16:19	14/04/2020 23:37	14/04/2020 16:19	14/04/2020 23:37	7,29	74	539,52	CHI
20200448469	VILA PROPICIO	NP21294001	GOIANESIA S1	14/04/2020 16:19	15/04/2020 02:14	14/04/2020 16:19	15/04/2020 02:14	9,90	2	19,80	CHI
20200448484	ITABERAI	IB21281182	ITABERAI S1	14/04/2020 16:21	15/04/2020 04:08	14/04/2020 16:21	15/04/2020 04:08	11,78	1	11,78	CHI
20200449596	ITABERAI	IB12105489	ITABERAI S2	14/04/2020 16:21	14/04/2020 21:37	14/04/2020 16:21	14/04/2020 21:37	5,26	18	94,72	CHI
20200448505	LEOPOLDO DE BULHOES	LB21155221	DAIA S2	14/04/2020 16:23	15/04/2020 01:40	14/04/2020 16:23	15/04/2020 01:40	9,28	1	9,28	CHI
20200448511	IPAMERI	IP21373679	PIRES DO RIO S2	14/04/2020 16:23	15/04/2020 10:33	14/04/2020 16:23	15/04/2020 10:33	18,15	1	18,15	CHI
20200449110	ORIZONA	OZ11231356	PIRES DO RIO S2	14/04/2020 16:25	14/04/2020 20:46	14/04/2020 16:25	14/04/2020 20:46	4,34	88	381,92	CHI
20200449674	CRIXAS	CX12201610	SANTA TEREZINHA	14/04/2020 16:25	14/04/2020 22:40	14/04/2020 16:25	14/04/2020 22:40	6,24	160	997,82	CHI
20200448741	NAZARIO	NZ12100859	ANICUNS	14/04/2020 16:26	14/04/2020 21:29	14/04/2020 16:26	14/04/2020 21:29	5,05	1	5,05	CHI
20200448741	PALMEIRAS DE GOIAS	NZ12100859	ANICUNS	14/04/2020 16:26	14/04/2020 21:29	14/04/2020 16:26	14/04/2020 21:29	5,05	3	15,15	CHI
20200448556	PALESTINA DE GOIAS	PY21374975	ARENOPOLIS	14/04/2020 16:27	15/04/2020 11:21	14/04/2020 16:27	15/04/2020 11:21	18,89	1	18,89	CHI
20200449053	GUARINOS	GF11099026	SANTA TEREZINHA	14/04/2020 16:27	14/04/2020 21:20	14/04/2020 16:27	14/04/2020 21:20	4,87	133	648,01	CHI
20200448570	LUZIANIA	LZ12290803	MARAJOARA	14/04/2020 16:28	14/04/2020 20:01	14/04/2020 16:28	14/04/2020 20:01	3,54	2	7,08	CHI
20200448588	MONTES CLAROS DE GOIAS	ME12203472	IPORA	14/04/2020 16:28	15/04/2020 12:25	14/04/2020 16:28	15/04/2020 12:25	19,94	5	99,69	CHI
20200448575	ORIZONA	OZ21189415	PIRES DO RIO S2	14/04/2020 16:29	14/04/2020 23:53	14/04/2020 16:29	14/04/2020 23:53	7,40	1	7,40	CHI
20200448601	LUZIANIA	120140950	RIO VERMELHO	14/04/2020 16:31	14/04/2020 21:40	14/04/2020 16:31	14/04/2020 21:40	5,14	1	5,14	CHI
20200448616	BALIZA	BH11331015	CAIAPONIA	14/04/2020 16:32	14/04/2020 20:56	14/04/2020 16:32	14/04/2020 20:56	4,39	1	4,39	CHI

20200448621	NOVO GAMA	NJ11290459	PACAEMBU S1	14/04/2020 16:32	14/04/2020 19:38	14/04/2020 16:32	14/04/2020 19:38	3,08	21	64,76	CHI
20200449990	CAIAPONIA	CP12245298	CAIAPONIA	14/04/2020 16:33	14/04/2020 23:35	14/04/2020 16:33	14/04/2020 23:35	7,02	6	42,13	CHI
20200448637	CALDAS NOVAS	10007733117	CALDAS NOVAS S2	14/04/2020 16:34	14/04/2020 19:25	14/04/2020 16:34	14/04/2020 19:25	2,84	1	2,84	CHI
20200448644	CALDAS NOVAS	760379749	CALDAS NOVAS S2	14/04/2020 16:34	14/04/2020 19:35	14/04/2020 16:34	14/04/2020 19:35	3,00	1	3,00	CHI
20200448664	HIDROLINA	HL12269821	URUACU	14/04/2020 16:34	14/04/2020 20:44	14/04/2020 16:34	14/04/2020 20:44	4,16	82	340,89	CHI
20200448709	GOIANESIA	GE12000230	GOIANESIA S2	14/04/2020 16:34	15/04/2020 08:49	14/04/2020 16:34	15/04/2020 08:49	16,25	13	211,23	CHI
20200449581	ITAPURANGA	IK12310858	ITAPURANGA	14/04/2020 16:34	15/04/2020 00:40	14/04/2020 16:34	15/04/2020 00:40	8,10	6	48,58	CHI
20200450518	FAINA	FC11299832	GOIAS	14/04/2020 16:34	15/04/2020 10:15	14/04/2020 16:34	15/04/2020 10:15	17,67	68	1201,41	CHI
20200448649	CRISTIANOPOLIS	CF12045580	CRISTIANOPOLIS	14/04/2020 16:35	15/04/2020 00:31	14/04/2020 16:35	15/04/2020 00:31	7,93	3	23,79	CHI
20200448738	GOIANESIA	GE12384154	GOIANESIA S2	14/04/2020 16:35	14/04/2020 20:58	14/04/2020 16:35	14/04/2020 20:58	4,38	3	13,14	CHI
20200448740	ITAPURANGA	IK11220251	ITAPURANGA	14/04/2020 16:35	15/04/2020 11:08	14/04/2020 16:35	15/04/2020 11:08	18,53	97	1797,79	CHI
20200448677	INDIARA	IY12205923	EDEIA	14/04/2020 16:37	16/04/2020 21:30	14/04/2020 16:37	16/04/2020 21:02	52,42	2	104,85	CHI
20200448677	INDIARA	IY12205923	EDEIA	14/04/2020 16:37	16/04/2020 21:30	14/04/2020 16:37	16/04/2020 21:30	52,88	31	1639,38	CHI
20200448677	PALMEIRAS DE GOIAS	IY12205923	EDEIA	14/04/2020 16:37	16/04/2020 21:30	14/04/2020 16:37	16/04/2020 21:30	52,88	5	264,42	CHI
20200449431	ORIZONA	OZ11288384	PIRES DO RIO S2	14/04/2020 16:37	14/04/2020 19:44	14/04/2020 16:37	14/04/2020 19:44	3,11	44	136,71	CHI
20200448711	CALDAS NOVAS	760090099	SERRA DE CALDAS	14/04/2020 16:40	14/04/2020 21:38	14/04/2020 16:40	14/04/2020 21:38	4,96	1	4,96	CHI
20200448827	ARAGUAPAZ	AZ12290380	MOZARLANDIA	14/04/2020 16:40	15/04/2020 17:15	14/04/2020 16:40	15/04/2020 10:55	18,24	5	91,19	CHI
20200448827	MOZARLANDIA	AZ12290380	MOZARLANDIA	14/04/2020 16:40	15/04/2020 17:15	14/04/2020 16:40	15/04/2020 10:55	18,24	1	18,24	CHI
20200448827	ARAGUAPAZ	AZ12290380	MOZARLANDIA	14/04/2020 16:40	15/04/2020 17:15	14/04/2020 16:40	15/04/2020 12:25	19,74	2	39,47	CHI
20200448827	MOZARLANDIA	AZ12290380	MOZARLANDIA	14/04/2020 16:40	15/04/2020 17:15	14/04/2020 16:40	15/04/2020 12:25	19,74	1	19,74	CHI
20200448827	ARAGUAPAZ	AZ12290380	MOZARLANDIA	14/04/2020 16:40	15/04/2020 17:15	15/04/2020 11:30	15/04/2020 12:25	0,92	4	3,67	CHI
20200448827	MOZARLANDIA	AZ12290380	MOZARLANDIA	14/04/2020 16:40	15/04/2020 17:15	15/04/2020 11:30	15/04/2020 12:25	0,92	1	0,92	CHI
20200448827	ARAGUAPAZ	AZ12290380	MOZARLANDIA	14/04/2020 16:40	15/04/2020 17:15	15/04/2020 11:16	15/04/2020 17:15	6,00	1	6,00	CHI
20200448827	ARAGUAPAZ	AZ12290380	MOZARLANDIA	14/04/2020 16:40	15/04/2020 17:15	15/04/2020 16:40	15/04/2020 17:15	0,60	6	3,59	CHI
20200448827	MOZARLANDIA	AZ12290380	MOZARLANDIA	14/04/2020 16:40	15/04/2020 17:15	15/04/2020 16:40	15/04/2020 17:15	0,60	2	1,20	CHI
20200448716	CRISTALINA	KR12247906	CRISTALINA S1	14/04/2020 16:41	15/04/2020 18:29	14/04/2020 16:41	15/04/2020 18:29	25,81	7	180,69	CHI
20200448722	SAO LUIS DE MONTES BELOS	10028130675	SAO LUIZ DOS MONTES BELOS	14/04/2020 16:41	15/04/2020 09:15	14/04/2020 16:41	15/04/2020 09:15	16,56	1	16,56	CHI
20200447627	CIDADE OCIDENTAL	LZ13198372	MARAJOARA	14/04/2020 16:42	14/04/2020 20:08	14/04/2020 16:42	14/04/2020 20:08	3,42	50	170,87	CHI
20200447627	CRISTALINA	LZ13198372	MARAJOARA	14/04/2020 16:42	14/04/2020 20:08	14/04/2020 16:42	14/04/2020 20:08	3,42	33	112,78	CHI
20200447627	LUZIANIA	LZ13198372	MARAJOARA	14/04/2020 16:42	14/04/2020 20:08	14/04/2020 16:42	14/04/2020 20:08	3,42	165	563,89	CHI
20200449190	ANICUNS	AC12304650	ANICUNS	14/04/2020 16:42	14/04/2020 21:54	14/04/2020 16:42	14/04/2020 21:54	5,19	4	20,74	CHI
20200448786	PILAR DE GOIAS	GG21135633	SANTA TEREZINHA	14/04/2020 16:44	15/04/2020 10:40	14/04/2020 16:44	15/04/2020 10:40	17,93	1	17,93	CHI
20200448758	ANAPOLIS	AN11068625	JUNDIAI S1	14/04/2020 16:45	14/04/2020 19:18	14/04/2020 16:45	14/04/2020 19:18	2,54	278	705,97	CHI

20200448762	SANTA CRUZ DE GOIAS	BC21075305	PIRES DO RIO S2	14/04/2020 16:45	15/04/2020 07:41	14/04/2020 16:45	15/04/2020 07:41	14,92	1	14,92	CHI
20200449793	CAIAPONIA	PY18040163TS	PALESTINA	14/04/2020 16:47	15/04/2020 01:59	14/04/2020 16:47	15/04/2020 01:59	9,19	44	404,45	CHI
20200449793	PALESTINA DE GOIAS	PY18040163TS	PALESTINA	14/04/2020 16:47	15/04/2020 01:59	14/04/2020 16:47	15/04/2020 01:59	9,19	103	946,77	CHI
20200450139	MOZARLANDIA	MZ12058584	MOZARLANDIA	14/04/2020 16:48	15/04/2020 15:22	14/04/2020 16:48	15/04/2020 15:22	22,56	13	293,31	CHI
20200448806	SANCLERLANDIA	SC11377197	FIRMINOPOLIS S2	14/04/2020 16:50	15/04/2020 00:12	14/04/2020 16:50	15/04/2020 00:12	7,37	9	66,29	CHI
20200448828	ANICUNS	AC21304590	FIRMINOPOLIS S2	14/04/2020 16:51	15/04/2020 00:10	14/04/2020 16:51	15/04/2020 00:10	7,31	2	14,61	CHI
20200448846	MORRINHOS	MR21122176	MORRINHOS	14/04/2020 16:53	15/04/2020 10:20	14/04/2020 16:53	15/04/2020 10:20	17,44	1	17,44	CHI
20200448861	EDEALINA	1130013471	PONTALINA	14/04/2020 16:55	14/04/2020 20:47	14/04/2020 16:55	14/04/2020 20:47	3,87	1	3,87	CHI
20200448871	LUZIANIA	LZ12261750	CRISTALINA S2	14/04/2020 16:55	15/04/2020 09:22	14/04/2020 16:55	15/04/2020 09:22	16,44	6	98,62	CHI
20200449254	CATALAO	CT12267054	CATALAO S1	14/04/2020 16:56	15/04/2020 17:13	14/04/2020 16:56	15/04/2020 12:18	19,37	6	116,24	CHI
20200449254	CATALAO	CT12267054	CATALAO S1	14/04/2020 16:56	15/04/2020 17:13	14/04/2020 16:56	15/04/2020 17:13	24,28	12	291,33	CHI
20200448884	CRISTALINA	KR12210364	CRISTALINA S2	14/04/2020 16:57	14/04/2020 21:36	14/04/2020 16:57	14/04/2020 21:36	4,64	2	9,29	CHI
20200449194	LUZIANIA	LZ12313691	CRISTALINA S2	14/04/2020 16:58	15/04/2020 10:32	14/04/2020 16:58	15/04/2020 10:32	17,55	20	351,03	CHI
20200448909	NOVO GAMA	2460021945	PACAEMBU S1	14/04/2020 16:59	14/04/2020 22:08	14/04/2020 16:59	14/04/2020 22:08	5,14	1	5,14	CHI
20200448911	BURITI ALEGRE	BG21280887	ITUMBIARA VELHA S2	14/04/2020 16:59	15/04/2020 07:47	14/04/2020 16:59	15/04/2020 07:47	14,80	1	14,80	CHI
20200451214	GOIAS	GS12217234	MATRINCHA	14/04/2020 16:59	15/04/2020 10:12	14/04/2020 16:59	15/04/2020 10:12	17,21	83	1428,45	CHI
20200451214	ITAPIRAPUA	GS12217234	MATRINCHA	14/04/2020 16:59	15/04/2020 10:12	14/04/2020 16:59	15/04/2020 10:12	17,21	1	17,21	CHI
20200451214	NOVO BRASIL	GS12217234	MATRINCHA	14/04/2020 16:59	15/04/2020 10:12	14/04/2020 16:59	15/04/2020 10:12	17,21	36	619,57	CHI
20200448935	FIRMINOPOLIS	AI21342962	FIRMINOPOLIS S2	14/04/2020 17:01	15/04/2020 00:35	14/04/2020 17:01	15/04/2020 00:35	7,55	1	7,55	CHI
20200448942	MORRINHOS	GT21190832	GOIATUBA S2	14/04/2020 17:02	14/04/2020 22:01	14/04/2020 17:02	14/04/2020 22:01	4,98	2	9,96	CHI
20200448951	ANAPOLIS	20645910	ANAPOLIS UNIVERSITARIO S2	14/04/2020 17:03	14/04/2020 21:53	14/04/2020 17:03	14/04/2020 21:53	4,83	1	4,83	CHI
20200448957	VILA BOA	VB21235781	IACIARA S2	14/04/2020 17:03	14/04/2020 20:07	14/04/2020 17:03	14/04/2020 20:07	3,06	1	3,06	CHI
20200449776	MUTUNOPOLIS	MU12391986	MARA ROSA	14/04/2020 17:03	14/04/2020 21:02	14/04/2020 17:03	14/04/2020 21:02	3,97	68	270,28	CHI
20200449341	ORIZONA	OZ12026601	PIRES DO RIO S2	14/04/2020 17:04	14/04/2020 23:07	14/04/2020 17:04	14/04/2020 23:07	6,05	12	72,57	CHI
20200449384	LUZIANIA	LZ11149778	MARAJOARA	14/04/2020 17:05	14/04/2020 23:20	14/04/2020 22:55	14/04/2020 23:20	0,42	171	71,01	CHI
20200448998	CAIAPONIA	930038903	CAIAPONIA	14/04/2020 17:07	14/04/2020 21:21	14/04/2020 17:07	14/04/2020 21:21	4,22	1	4,22	CHI
20200449008	GOIANESIA	10003104255	GOIANESIA S2	14/04/2020 17:09	15/04/2020 00:10	14/04/2020 17:09	15/04/2020 00:10	7,01	1	7,01	CHI
20200449025	AVELINOPOLIS	AV21054497	ANICUNS	14/04/2020 17:10	15/04/2020 10:25	14/04/2020 17:10	15/04/2020 10:25	17,25	1	17,25	CHI
20200449029	BARRO ALTO	BA12066363	BARRO ALTO	14/04/2020 17:10	15/04/2020 07:44	14/04/2020 17:10	15/04/2020 07:44	14,56	7	101,91	CHI
20200449274	PIRENOPOLIS	PV12185528	CORUMBA	14/04/2020 17:10	14/04/2020 22:00	14/04/2020 17:10	14/04/2020 22:00	4,82	42	202,60	CHI
20200449039	RUBIATABA	RB21110470	RUBIATABA	14/04/2020 17:11	15/04/2020 04:45	14/04/2020 17:11	15/04/2020 04:45	11,56	1	11,56	CHI
20200449056	ANAPOLIS	21095103	ANAPOLIS UNIVERSITARIO S2	14/04/2020 17:12	15/04/2020 00:58	14/04/2020 17:12	15/04/2020 00:58	7,76	1	7,76	CHI
20200449063	CRIXAS	CX12319088	SERRA DO OURO	14/04/2020 17:13	15/04/2020 00:44	14/04/2020 17:13	15/04/2020 00:44	7,51	8	60,06	CHI

20200449088	NOVO BRASIL	NB21112724	JUSSARA	14/04/2020 17:15	15/04/2020 13:53	14/04/2020 17:15	15/04/2020 13:53	20,62	1	20,62	CHI
20200449089	SANTO ANTONIO DO DESCOBERTO	SN21248685	MARAJOARA	14/04/2020 17:15	14/04/2020 21:41	14/04/2020 17:15	14/04/2020 21:41	4,43	1	4,43	CHI
20200449828	LUZIANIA	LZ12041471	RIO VERMELHO	14/04/2020 17:16	14/04/2020 21:25	14/04/2020 17:16	14/04/2020 21:25	4,14	9	37,27	CHI
20200449103	ITAPURANGA	IK21300178	ITAPURANGA	14/04/2020 17:17	15/04/2020 15:43	14/04/2020 17:17	15/04/2020 15:43	22,43	1	22,43	CHI
20200449462	JUSSARA	JR12074365	BRITANIA	14/04/2020 17:19	15/04/2020 12:03	14/04/2020 17:19	15/04/2020 12:03	18,73	37	692,98	CHI
20200449462	SANTA FE DE GOIAS	JR12074365	BRITANIA	14/04/2020 17:19	15/04/2020 12:03	14/04/2020 17:19	15/04/2020 12:03	18,73	21	393,31	CHI
20200449123	CEZARINA	CZ13215265	CEZARINA	14/04/2020 17:20	15/04/2020 01:06	14/04/2020 17:20	15/04/2020 00:47	7,45	256	1906,56	CHI
20200449123	INDIARA	CZ13215265	CEZARINA	14/04/2020 17:20	15/04/2020 01:06	14/04/2020 17:20	15/04/2020 00:47	7,45	7	52,13	CHI
20200449123	CEZARINA	CZ12308530LD	CEZARINA	14/04/2020 17:20	15/04/2020 01:06	14/04/2020 17:20	15/04/2020 01:06	7,76	1	7,76	CHI
20200449385	PIRES DO RIO	PR11043805	PIRES DO RIO S1	14/04/2020 17:20	14/04/2020 22:45	14/04/2020 17:20	14/04/2020 22:45	5,42	103	557,80	CHI
20200449133	VILA PROPICIO	NP21216971	GOIANESIA S1	14/04/2020 17:21	15/04/2020 12:25	14/04/2020 17:21	15/04/2020 12:25	19,07	1	19,07	CHI
20200450044	CORUMBAIBA	CI12392072	VILA CORUMBA	14/04/2020 17:22	15/04/2020 11:56	14/04/2020 17:22	15/04/2020 11:56	18,56	6	111,38	CHI
20200449158	BURITI ALEGRE	BG12000160	ITUMBIARA VELHA S2	14/04/2020 17:24	15/04/2020 08:40	14/04/2020 17:24	15/04/2020 08:40	15,26	245	3739,11	CHI
20200449163	ARUANA	AK21259737	MOZARLANDIA	14/04/2020 17:24	14/04/2020 22:58	14/04/2020 17:24	14/04/2020 22:58	5,55	1	5,55	CHI
20200449184	CRIXAS	NA12171143	NOVA CRIXAS	14/04/2020 17:24	15/04/2020 09:24	14/04/2020 17:24	15/04/2020 09:24	16,00	4	63,98	CHI
20200449165	IPORA	IR12374853	IPORA	14/04/2020 17:25	15/04/2020 08:07	14/04/2020 17:25	15/04/2020 08:07	14,70	2	29,39	CHI
20200449166	PIRACANJUBA	PJ21087663	PIRACANJUBA	14/04/2020 17:25	14/04/2020 19:56	14/04/2020 17:25	14/04/2020 19:56	2,51	3	7,53	CHI
20200449432	LUZIANIA	LZ12209643	PACAEMBU S1	14/04/2020 17:25	15/04/2020 08:10	14/04/2020 17:25	15/04/2020 08:10	14,74	10	147,44	CHI
20200449179	IVOLANDIA	IV21014468	IPORA	14/04/2020 17:27	15/04/2020 16:53	14/04/2020 17:27	15/04/2020 16:53	23,42	1	23,42	CHI
20200449182	MINACU	IH21236078	MINACU	14/04/2020 17:27	14/04/2020 21:21	14/04/2020 17:27	14/04/2020 21:21	3,88	1	3,88	CHI
20200449185	PIRANHAS	PH12307515	PIRANHAS	14/04/2020 17:28	15/04/2020 09:49	14/04/2020 17:28	15/04/2020 09:49	16,35	3	49,04	CHI
20200449188	GOIANESIA	GE11406312	GOIANESIA S2	14/04/2020 17:28	15/04/2020 01:09	14/04/2020 17:28	15/04/2020 01:09	7,68	2	15,36	CHI
20200449335	CATALAO	CT11358412	CATALAO S2	14/04/2020 17:29	15/04/2020 10:59	14/04/2020 17:29	15/04/2020 10:59	17,48	84	1468,62	CHI
20200449218	GOIANESIA	GE12135234	GOIANESIA S1	14/04/2020 17:31	15/04/2020 13:46	14/04/2020 17:31	15/04/2020 13:46	20,25	2	40,49	CHI
20200449218	VILA PROPICIO	GE12135234	GOIANESIA S1	14/04/2020 17:31	15/04/2020 13:46	14/04/2020 17:31	15/04/2020 13:46	20,25	3	60,74	CHI
20200449222	SANTA CRUZ DE GOIAS	BC21095397	PIRES DO RIO S2	14/04/2020 17:31	15/04/2020 09:32	14/04/2020 17:31	15/04/2020 09:32	16,00	1	16,00	CHI
20200449330	ANAPOLIS	AN12000072	ANAPOLIS UNIVERSITARIO S2	14/04/2020 17:34	14/04/2020 21:08	14/04/2020 17:34	14/04/2020 21:08	3,56	994	3540,85	CHI
20200449253	VILA PROPICIO	PV12115143	GOIANESIA S1	14/04/2020 17:35	15/04/2020 13:05	14/04/2020 17:35	15/04/2020 13:05	19,49	4	77,98	CHI
20200449267	BARRO ALTO	BA21239011	BARRO ALTO	14/04/2020 17:36	15/04/2020 02:28	14/04/2020 17:36	15/04/2020 02:28	8,86	1	8,86	CHI
20200449280	SAO FRANCISCO DE GOIAS	PV21021304	SAO FRANCISCO DE GOIAS	14/04/2020 17:38	14/04/2020 22:38	14/04/2020 17:38	14/04/2020 22:38	5,00	1	5,00	CHI
20200450158	GUARINOS	GF12099271	SANTA TEREZINHA	14/04/2020 17:38	14/04/2020 22:07	14/04/2020 17:38	14/04/2020 22:07	4,47	5	22,37	CHI
20200450158	PILAR DE GOIAS	GF12099271	SANTA TEREZINHA	14/04/2020 17:38	14/04/2020 22:07	14/04/2020 17:38	14/04/2020 22:07	4,47	1	4,47	CHI
20200449299	NIQUELANDIA	4640000274	BARRO ALTO	14/04/2020 17:40	15/04/2020 11:18	14/04/2020 17:40	15/04/2020 11:18	17,62	1	17,62	CHI

20200449349	MUNDO NOVO DE GOIAS	MH12269269	NOVA CRIXAS	14/04/2020 17:46	14/04/2020 23:54	14/04/2020 17:46	14/04/2020 23:54	6,13	7	42,93	CHI
20200449537	IPAMERI	IP12000013	IPAMERI	14/04/2020 17:47	14/04/2020 21:19	14/04/2020 17:47	14/04/2020 21:19	3,52	326	1148,24	CHI
20200449374	CUMARI	CT12042313	CATALAO S2	14/04/2020 17:50	15/04/2020 08:52	14/04/2020 17:50	15/04/2020 08:52	15,02	8	120,19	CHI
20200449374	GOIANDIRA	CT12042313	CATALAO S2	14/04/2020 17:50	15/04/2020 08:52	14/04/2020 17:50	15/04/2020 08:52	15,02	3	45,07	CHI
20200449401	MORRINHOS	MR21401427	MORRINHOS	14/04/2020 17:55	15/04/2020 09:25	14/04/2020 17:55	15/04/2020 09:25	15,50	1	15,50	CHI
20200449406	GOIATUBA	GT21052726	GOIATUBA S2	14/04/2020 17:55	14/04/2020 23:30	14/04/2020 17:55	14/04/2020 23:30	5,58	1	5,58	CHI
20200449455	BELA VISTA DE GOIAS	CF12363931	CRISTIANOPOLIS	14/04/2020 18:03	15/04/2020 11:04	14/04/2020 18:03	15/04/2020 11:04	17,01	6	102,04	CHI
20200449455	CRISTIANOPOLIS	CF12363931	CRISTIANOPOLIS	14/04/2020 18:03	15/04/2020 11:04	14/04/2020 18:03	15/04/2020 11:04	17,01	6	102,04	CHI
20200449647	URUACU	UR12055924	URUACU	14/04/2020 18:04	14/04/2020 21:11	14/04/2020 18:04	14/04/2020 21:11	3,11	188	584,16	CHI
20200449498	ORIZONA	OZ21149983	PIRES DO RIO S2	14/04/2020 18:09	15/04/2020 10:26	14/04/2020 18:09	15/04/2020 10:26	16,28	1	16,28	CHI
20200449518	CAMPO ALEGRE DE GOIAS	1160002864	CAMPO ALEGRE DE GOIAS	14/04/2020 18:11	15/04/2020 14:35	14/04/2020 18:11	15/04/2020 14:35	20,39	1	20,39	CHI
20200449521	MARA ROSA	VD12201669	SANTA TEREZINHA	14/04/2020 18:12	15/04/2020 08:29	14/04/2020 18:12	15/04/2020 08:29	14,28	2	28,55	CHI
202004105705	CATALAO	CT13353532	CATALAO S2	14/04/2020 18:16	14/04/2020 21:23	14/04/2020 18:16	14/04/2020 21:23	3,11	7333	22809,70	CHI
202004105705	CATALAO	CT13333700	CATALAO S2	14/04/2020 18:16	14/04/2020 21:23	14/04/2020 21:15	14/04/2020 21:23	0,13	3	0,40	CHI
20200449561	UIRAPURU	UP12391846	SANTA TEREZINHA	14/04/2020 18:17	15/04/2020 04:39	14/04/2020 18:17	15/04/2020 04:39	10,36	8	82,85	CHI
20200449590	CATALAO	CT11379392	CATALAO S2	14/04/2020 18:20	15/04/2020 01:16	14/04/2020 18:20	15/04/2020 01:16	6,93	16	110,83	CHI
20200449597	NOVA CRIXAS	NA12391973	NOVA CRIXAS	14/04/2020 18:21	15/04/2020 11:53	14/04/2020 18:21	15/04/2020 11:53	17,53	15	262,96	CHI
20200449632	CACHOEIRA DOURADA	CD12222457	CACHOEIRA DOURADA	14/04/2020 18:24	15/04/2020 12:18	14/04/2020 18:24	15/04/2020 12:18	17,90	3	53,69	CHI
20200449635	NIQUELANDIA	NQ12254469	URUACU	14/04/2020 18:24	15/04/2020 04:55	14/04/2020 18:24	15/04/2020 04:55	10,50	8	84,02	CHI
20200450024	UIRAPURU	UP11094091	NOVA CRIXAS	14/04/2020 18:27	14/04/2020 22:51	14/04/2020 18:27	14/04/2020 22:51	4,39	104	456,42	CHI
20200449696	PIRES DO RIO	PZ12300691	PIRES DO RIO S2	14/04/2020 18:30	15/04/2020 09:59	14/04/2020 18:30	15/04/2020 09:59	15,47	7	108,29	CHI
20200449736	ITUMBIARA	IT21352787	ITUMBIARA NOVA	14/04/2020 18:35	15/04/2020 09:03	14/04/2020 18:35	15/04/2020 09:03	14,45	1	14,45	CHI
20200449738	SANTA CRUZ DE GOIAS	BC12110028RE	PIRES DO RIO S2	14/04/2020 18:36	15/04/2020 10:46	14/04/2020 18:36	15/04/2020 10:46	16,17	19	307,16	CHI
20200449752	ORIZONA	OZ21151507	PIRES DO RIO S2	14/04/2020 18:37	15/04/2020 07:57	14/04/2020 18:37	15/04/2020 07:57	13,32	1	13,32	CHI
20200449795	MORRINHOS	MR21284226	MORRINHOS	14/04/2020 18:42	15/04/2020 08:34	14/04/2020 18:42	15/04/2020 08:34	13,87	1	13,87	CHI
20200449814	URUACU	UR12325140	URUACU	14/04/2020 18:43	14/04/2020 22:52	14/04/2020 18:43	14/04/2020 22:52	4,13	7	28,94	CHI
20200449847	FORMOSA	FA11180623	ITUIQUIRA	14/04/2020 18:43	14/04/2020 20:11	14/04/2020 18:43	14/04/2020 20:11	1,47	205	300,55	CHI
20200449844	URUTAI	600014710	URUTAI	14/04/2020 18:47	15/04/2020 08:41	14/04/2020 18:47	15/04/2020 08:41	13,89	1	13,89	CHI
20200450043	NOVA CRIXAS	03960214	NOVA CRIXAS	14/04/2020 18:48	15/04/2020 12:28	14/04/2020 18:48	15/04/2020 01:57	7,13	91	649,16	CHI
20200450043	ARUANA	NA12213185LD	NOVA CRIXAS	14/04/2020 18:48	15/04/2020 12:28	14/04/2020 18:48	15/04/2020 12:28	17,66	25	441,59	CHI
20200450127	ITUMBIARA	IT12000076	PARANAIBA	14/04/2020 18:48	14/04/2020 20:09	14/04/2020 18:48	14/04/2020 20:09	1,35	283	381,11	CHI
20200450006	PLANALTINA	PI11000032	PLANALTINA	14/04/2020 18:50	14/04/2020 20:36	14/04/2020 18:50	14/04/2020 20:36	1,75	327	573,25	CHI
20200450573	GUARINOS	IW12201636	ITAPACI	14/04/2020 18:52	14/04/2020 21:36	14/04/2020 18:52	14/04/2020 21:36	2,72	7	19,06	CHI

20200450573	ITAPACI	IW12201636	ITAPACI	14/04/2020 18:52	14/04/2020 21:36	14/04/2020 18:52	14/04/2020 21:36	2,72	245	667,01	CHI
20200450573	PILAR DE GOIAS	IW12201636	ITAPACI	14/04/2020 18:52	14/04/2020 21:36	14/04/2020 18:52	14/04/2020 21:36	2,72	1	2,72	CHI
20200449923	SAO MIGUEL DO ARAGUAIA	SM12000053	SAO MIGUEL DO ARAGUAIA	14/04/2020 18:54	14/04/2020 21:28	14/04/2020 18:54	14/04/2020 21:28	2,56	4	10,25	CHI
20200449970	PONTALINA	PK12060875	PONTALINA	14/04/2020 18:59	14/04/2020 21:53	14/04/2020 18:59	14/04/2020 21:53	2,89	7	20,22	CHI
20200449975	FORMOSA	FA12130051	ITIQUIRA	14/04/2020 19:00	14/04/2020 20:27	14/04/2020 19:00	14/04/2020 20:27	1,44	83	119,64	CHI
20200449993	PLANALTINA	PI11146248	PLANALTINA	14/04/2020 19:01	14/04/2020 20:21	14/04/2020 19:01	14/04/2020 20:21	1,32	403	531,62	CHI
20200450065	PORANGATU	840094802	PORANGATU	14/04/2020 19:11	14/04/2020 22:30	14/04/2020 19:11	14/04/2020 22:30	3,31	1	3,31	CHI
20200450104	PLANALTINA	PI21332780	SAO JOAO D ALIANCA	14/04/2020 19:17	15/04/2020 09:47	14/04/2020 19:17	15/04/2020 09:47	14,50	1	14,50	CHI
20200450165	PLANALTINA	PI21362469	SAO JOAO D ALIANCA	14/04/2020 19:26	15/04/2020 08:48	14/04/2020 19:26	15/04/2020 08:48	13,35	1	13,35	CHI
20200450191	SAO JOAO D ALIANCA	JL12255794LD	ITIQUIRA	14/04/2020 19:31	15/04/2020 09:54	14/04/2020 19:31	15/04/2020 09:54	14,37	3	43,12	CHI
20200449876	CAMPOS BELOS	820009295	SAO DOMINGOS	14/04/2020 19:35	15/04/2020 13:20	14/04/2020 19:35	15/04/2020 13:20	17,74	1	17,74	CHI
20200450253	FORMOSA	FA11237894	ITIQUIRA	14/04/2020 19:42	14/04/2020 21:48	14/04/2020 19:42	14/04/2020 21:48	2,10	62	129,99	CHI
20200450257	SAO MIGUEL DO ARAGUAIA	SM12074411	SAO MIGUEL DO ARAGUAIA	14/04/2020 19:42	15/04/2020 18:20	14/04/2020 19:42	15/04/2020 08:13	12,51	1	12,51	CHI
20200450257	SAO MIGUEL DO ARAGUAIA	SM13342074	SAO MIGUEL DO ARAGUAIA	14/04/2020 19:42	15/04/2020 18:20	14/04/2020 19:42	15/04/2020 18:20	22,62	5	113,10	CHI
20200450271	NIQUELANDIA	NQ12392028	URUACU	14/04/2020 19:44	14/04/2020 22:17	14/04/2020 19:44	14/04/2020 22:17	2,53	9	22,81	CHI
20200450409	PORANGATU	PO12020611	NOVO PLANALTO	14/04/2020 19:52	14/04/2020 20:52	14/04/2020 19:52	14/04/2020 20:52	0,99	8	7,95	CHI
20200450449	NIQUELANDIA	NQ12218323	URUACU	14/04/2020 20:02	15/04/2020 10:10	14/04/2020 20:02	15/04/2020 10:10	14,12	5	70,58	CHI
20200450461	CAMPOS BELOS	MA12261978	SAO DOMINGOS	14/04/2020 20:06	14/04/2020 23:59	14/04/2020 20:06	14/04/2020 23:59	3,88	21	81,38	CHI
20200450461	MONTE ALEGRE DE GOIAS	MA12261978	SAO DOMINGOS	14/04/2020 20:06	14/04/2020 23:59	14/04/2020 20:06	14/04/2020 23:59	3,88	36	139,51	CHI
20200451386	MONTE ALEGRE DE GOIAS	SD12322677	SAO DOMINGOS	14/04/2020 20:12	15/04/2020 10:47	14/04/2020 20:12	15/04/2020 10:47	14,58	2	29,15	CHI
20200451386	NOVA ROMA	SD12322677	SAO DOMINGOS	14/04/2020 20:12	15/04/2020 10:47	14/04/2020 20:12	15/04/2020 10:47	14,58	3	43,73	CHI
20200451386	SAO DOMINGOS	SD12322677	SAO DOMINGOS	14/04/2020 20:12	15/04/2020 10:47	14/04/2020 20:12	15/04/2020 10:47	14,58	35	510,13	CHI
20200450545	SAO MIGUEL DO ARAGUAIA	SM12236306	SAO MIGUEL DO ARAGUAIA	14/04/2020 20:30	14/04/2020 23:21	14/04/2020 20:30	14/04/2020 23:21	2,85	2	5,69	CHI
20200450548	AMARALINA	LC12276051	SAO MIGUEL DO ARAGUAIA	14/04/2020 20:32	15/04/2020 00:33	14/04/2020 20:32	15/04/2020 00:33	4,01	10	40,14	CHI
20200450618	FORMOSA	FA11180623	ITIQUIRA	14/04/2020 20:35	14/04/2020 21:20	14/04/2020 20:35	14/04/2020 21:20	0,75	205	153,35	CHI
20200450596	IACIARA	IA12262204	IACIARA S2	14/04/2020 20:51	14/04/2020 21:48	14/04/2020 20:51	14/04/2020 21:48	0,95	10	9,50	CHI
20200450611	SAO MIGUEL DO ARAGUAIA	SM12192355	SAO MIGUEL DO ARAGUAIA	14/04/2020 20:58	15/04/2020 00:31	14/04/2020 20:58	15/04/2020 00:31	3,55	3	10,65	CHI
20200450702	RUBIATABA	RB12066220	RUBIATABA	14/04/2020 21:29	15/04/2020 10:02	14/04/2020 21:29	15/04/2020 10:02	12,54	5	62,70	CHI
20200450718	AGUA FRIA DE GOIAS	TL11284048	SAO JOAO D ALIANCA	14/04/2020 21:36	14/04/2020 23:29	14/04/2020 21:36	14/04/2020 23:29	1,88	1	1,88	CHI
20200450788	IACIARA	IA11195766	IACIARA S1	14/04/2020 22:10	14/04/2020 23:56	14/04/2020 22:10	14/04/2020 23:56	1,76	52	91,40	CHI
20200450836	FORMOSA	FA12325476	ITIQUIRA	14/04/2020 22:57	15/04/2020 12:06	14/04/2020 22:57	15/04/2020 12:06	13,15	1	13,15	CHI
20200450956	PADRE BERNARDO	10008207761	PLANALTINA	15/04/2020 05:03	15/04/2020 14:51	15/04/2020 05:03	15/04/2020 14:51	9,80	1	9,80	CHI
20200450350	CAMPOS BELOS	00760444	SAO DOMINGOS	15/04/2020 05:45	15/04/2020 22:41	15/04/2020 05:45	15/04/2020 08:20	2,58	136	351,14	CHI



20200450350	CAMPOS BELOS	00760444	SAO DOMINGOS	15/04/2020 05:45	15/04/2020 22:41	15/04/2020 05:45	15/04/2020 22:41	16,93	18	304,82	CHI
20200451012	PLANALTINA	2960213458	PLANALTINA	15/04/2020 06:17	15/04/2020 18:18	15/04/2020 06:17	15/04/2020 18:18	12,02	1	12,02	CHI
20200451160	ALTO PARAISO DE GOIAS	ND12302636	IACIARA S2	15/04/2020 06:26	15/04/2020 11:00	15/04/2020 06:26	15/04/2020 11:00	4,57	19	86,76	CHI
20200451160	NOVA ROMA	ND12302636	IACIARA S2	15/04/2020 06:26	15/04/2020 11:00	15/04/2020 06:26	15/04/2020 11:00	4,57	98	447,48	CHI
20200451160	SAO JOAO D ALIANCA	ND12302636	IACIARA S2	15/04/2020 06:26	15/04/2020 11:00	15/04/2020 06:26	15/04/2020 11:00	4,57	13	59,36	CHI
20200451376	NOVA ROMA	FB12314721	FLORES DE GOIAS	15/04/2020 06:47	15/04/2020 12:30	15/04/2020 06:47	15/04/2020 12:30	5,72	2	11,43	CHI
20200451376	SAO JOAO D ALIANCA	FB12314721	FLORES DE GOIAS	15/04/2020 06:47	15/04/2020 12:30	15/04/2020 06:47	15/04/2020 12:30	5,72	16	91,45	CHI
20200451372	DIVINOPOLIS DE GOIAS	GH12256132	SAO DOMINGOS	15/04/2020 06:54	15/04/2020 13:41	15/04/2020 06:54	15/04/2020 13:41	6,77	19	128,69	CHI
20200451178	POSSE	10010118975	IACIARA S2	15/04/2020 07:13	15/04/2020 09:02	15/04/2020 07:13	15/04/2020 09:02	1,81	1	1,81	CHI
20200451186	FORMOSA	FA12058455	SAO JOAO D ALIANCA	15/04/2020 07:16	15/04/2020 10:25	15/04/2020 07:16	15/04/2020 10:25	3,14	8	25,09	CHI
20200451245	PLANALTINA	PI12067828	PLANALTINA	15/04/2020 07:23	15/04/2020 12:50	15/04/2020 07:23	15/04/2020 12:50	5,44	5	27,21	CHI
20200451248	FORMOSA	FA12404371	ITIQUEIRA	15/04/2020 07:24	15/04/2020 17:11	15/04/2020 15:46	15/04/2020 17:11	1,41	6	8,46	CHI
202004105739	FORMOSA	10027010986	ITIQUEIRA	15/04/2020 07:24	15/04/2020 15:46	15/04/2020 07:24	15/04/2020 15:46	8,37	1	8,37	CHI
20200451316	FORMOSA	FA21282346	ITIQUEIRA	15/04/2020 07:37	15/04/2020 13:39	15/04/2020 07:37	15/04/2020 13:39	6,03	1	6,03	CHI
20200451347	CABECEIRAS	CW12194580	ITIQUEIRA	15/04/2020 07:42	15/04/2020 10:44	15/04/2020 07:42	15/04/2020 10:44	3,03	2	6,06	CHI
20200451756	NOVA ROMA	ND12392238	IACIARA S2	15/04/2020 07:44	15/04/2020 11:55	15/04/2020 07:44	15/04/2020 11:55	4,17	232	968,41	CHI
20200451362	FORMOSA	FA21316946	ITIQUEIRA	15/04/2020 07:45	15/04/2020 12:18	15/04/2020 07:45	15/04/2020 12:18	4,55	2	9,10	CHI
20200452471	SAO JOAO D ALIANCA	FB11295085	IACIARA S2	15/04/2020 07:47	15/04/2020 14:24	15/04/2020 07:47	15/04/2020 14:24	6,60	6	39,61	CHI
20200451395	MONTE ALEGRE DE GOIAS	MA12261959	SAO DOMINGOS	15/04/2020 07:50	16/04/2020 20:20	15/04/2020 07:50	15/04/2020 20:27	12,61	11	138,70	CHI
20200451395	MONTE ALEGRE DE GOIAS	MA12195729LD	SAO DOMINGOS	15/04/2020 07:50	16/04/2020 20:20	15/04/2020 07:50	15/04/2020 22:15	14,42	2	28,83	CHI
20200451395	MONTE ALEGRE DE GOIAS	MA12240206LD	SAO DOMINGOS	15/04/2020 07:50	16/04/2020 20:20	15/04/2020 07:50	16/04/2020 20:20	36,51	15	547,59	CHI
20200451703	FLORES DE GOIAS	FB12204157	FLORES DE GOIAS	15/04/2020 07:53	15/04/2020 12:13	15/04/2020 07:53	15/04/2020 12:13	4,33	13	56,26	CHI
20200451441	GUARANI DE GOIAS	GY11383310	IACIARA S1	15/04/2020 08:00	15/04/2020 11:42	15/04/2020 08:00	15/04/2020 11:42	3,69	1	3,69	CHI
20200451592	SAO JOAO D ALIANCA	3480026495	IACIARA S2	15/04/2020 08:01	15/04/2020 15:35	15/04/2020 08:01	15/04/2020 15:35	7,56	1	7,56	CHI
20200451640	FORMOSA	610035642	ITIQUEIRA	15/04/2020 08:25	15/04/2020 10:13	15/04/2020 08:25	15/04/2020 10:13	1,79	1	1,79	CHI
20200451716	POSSE	PS12344418	IACIARA S1	15/04/2020 08:39	15/04/2020 12:02	15/04/2020 08:39	15/04/2020 12:02	3,37	41	138,17	CHI
20200451734	SIMOLANDIA	SA12246943	IACIARA S2	15/04/2020 08:41	15/04/2020 15:37	15/04/2020 08:41	15/04/2020 15:37	6,92	6	41,54	CHI
20200451769	NOVA ROMA	TE12284926	FLORES DE GOIAS	15/04/2020 08:49	15/04/2020 11:53	15/04/2020 08:49	15/04/2020 11:53	3,06	23	70,42	CHI
20200451769	TERESINA DE GOIAS	TE12284926	FLORES DE GOIAS	15/04/2020 08:49	15/04/2020 11:53	15/04/2020 08:49	15/04/2020 11:53	3,06	11	33,68	CHI

# Plotagem das Ocorrências conforme a Espacialização das Chuvas

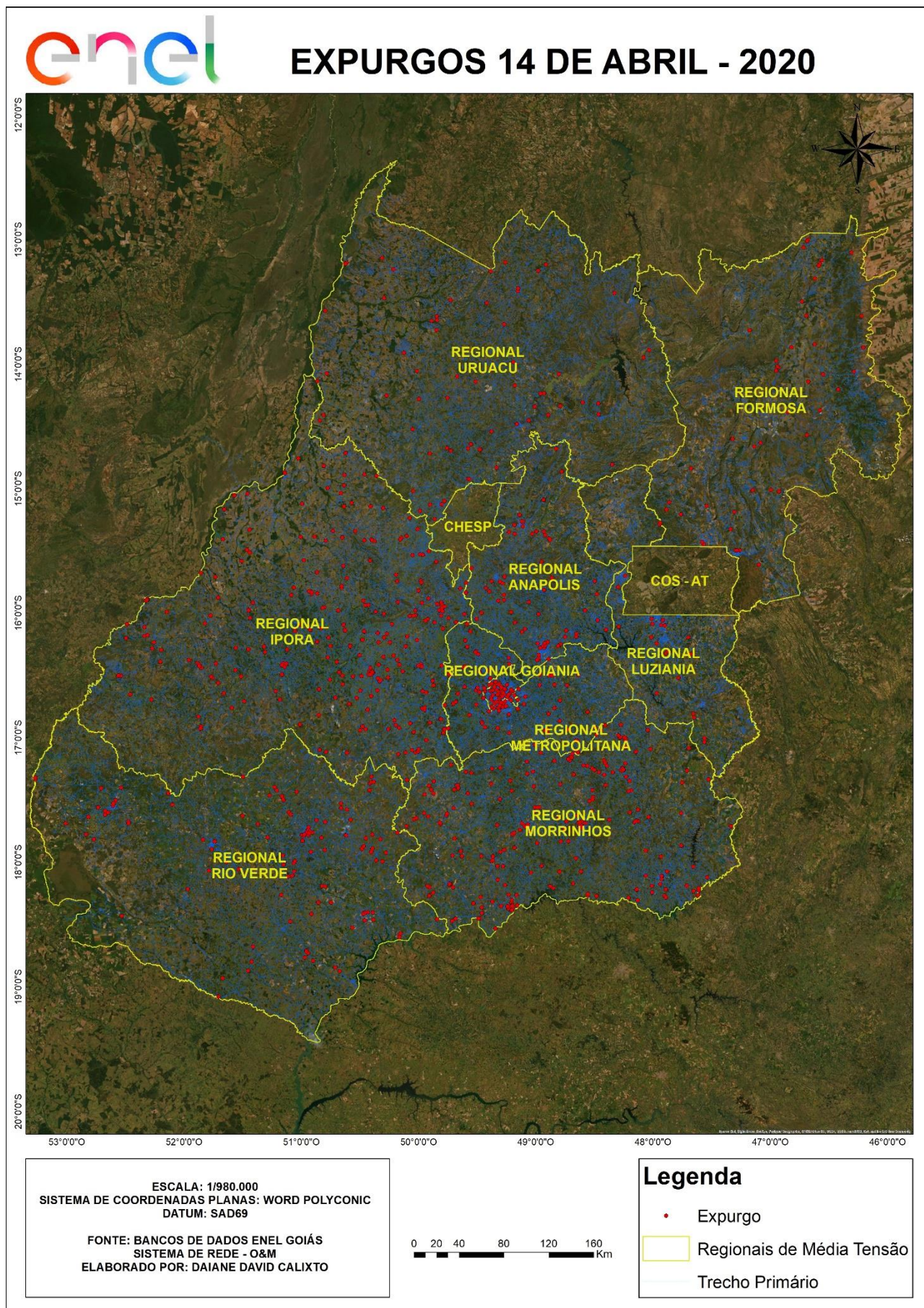

# Diagramas Unifilares

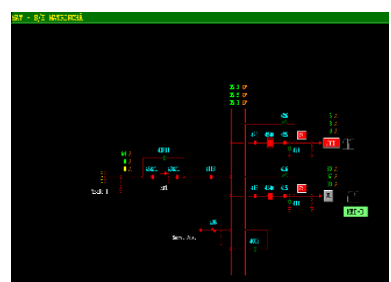
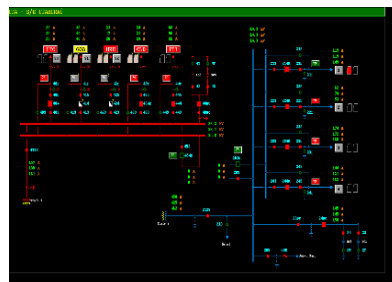
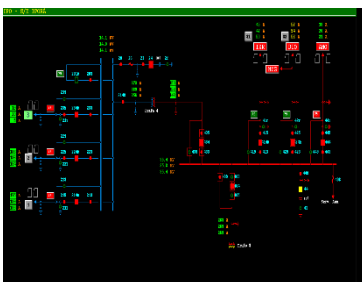
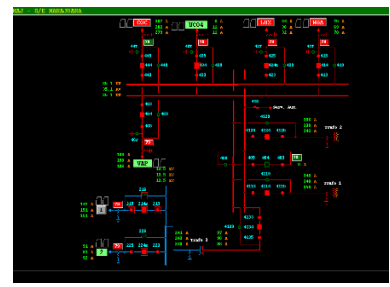
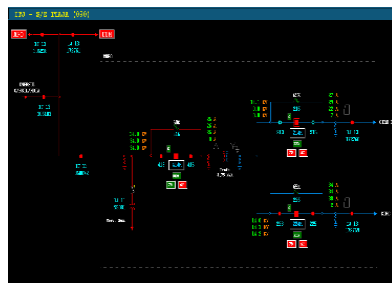
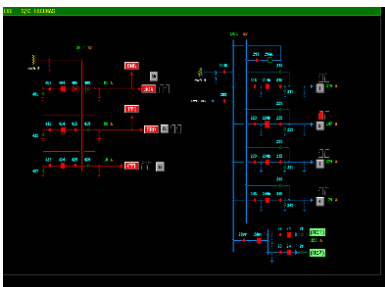
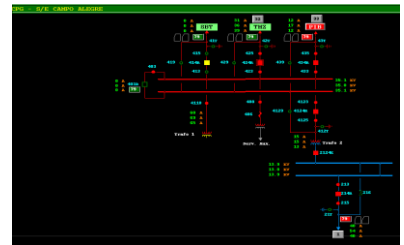
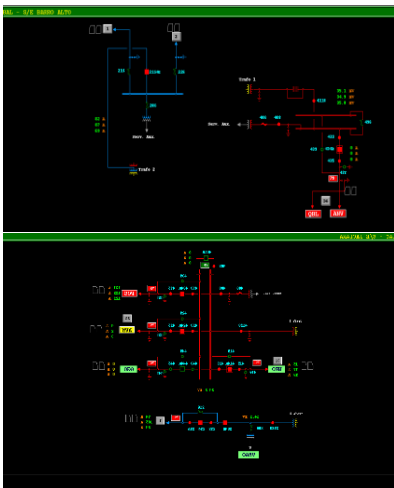
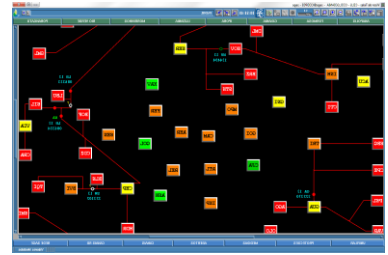
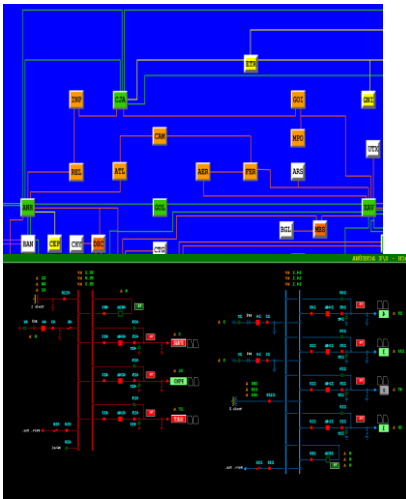



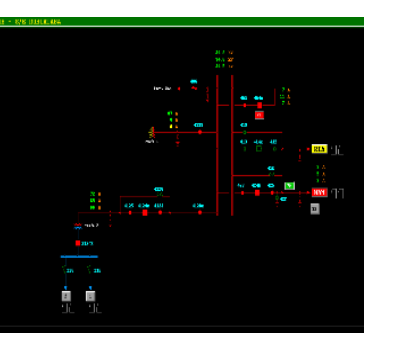
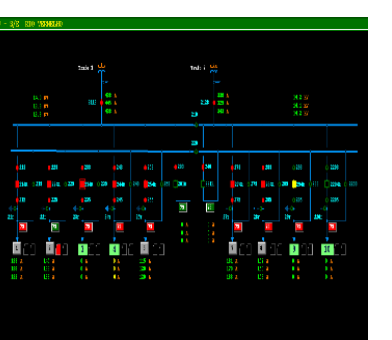
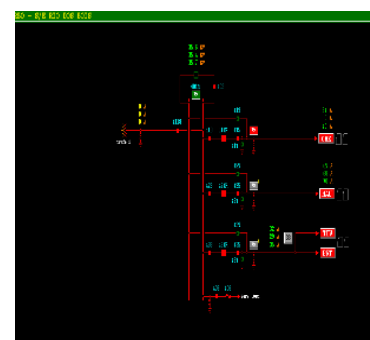
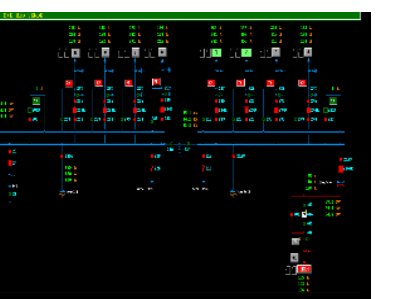
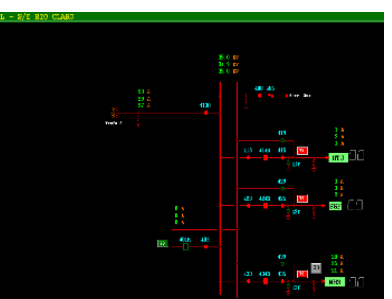
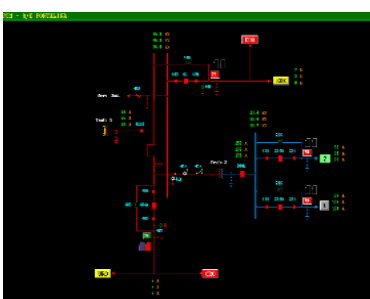
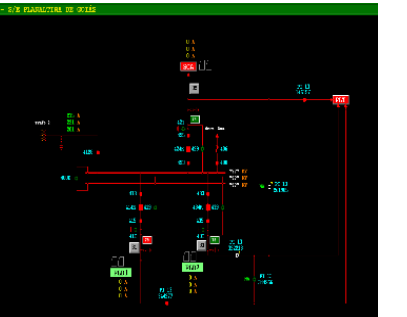
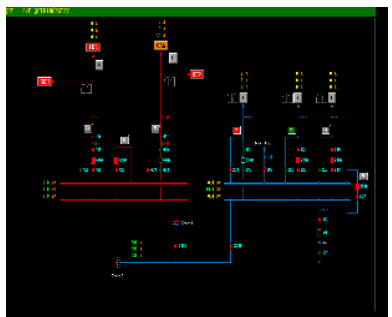
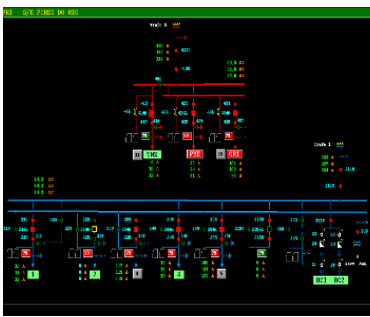
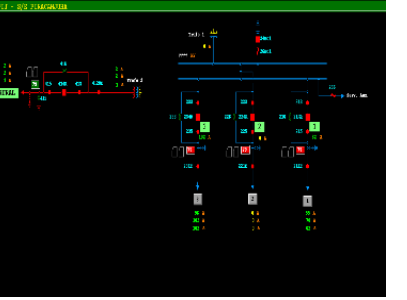
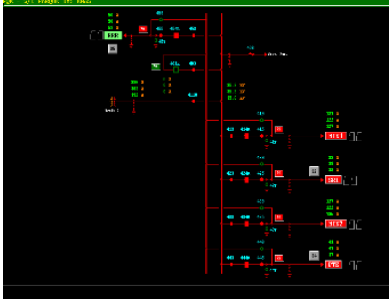
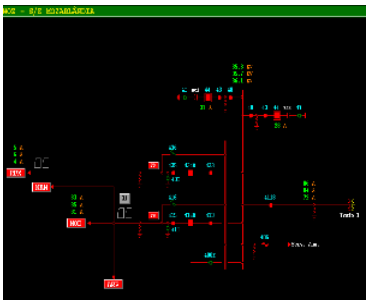
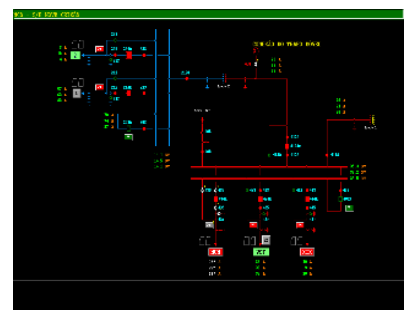
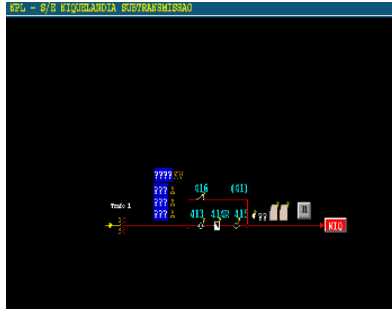

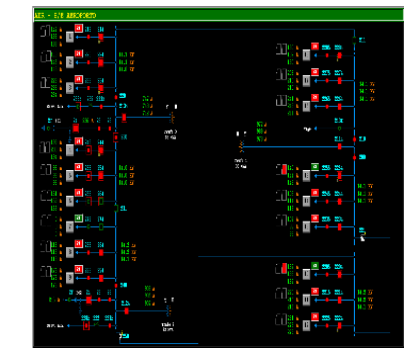
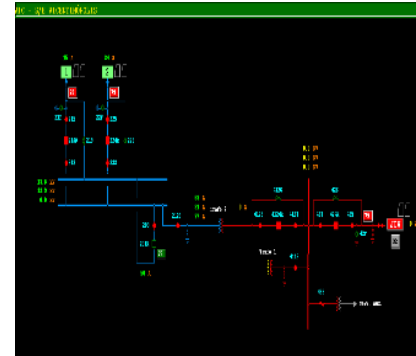
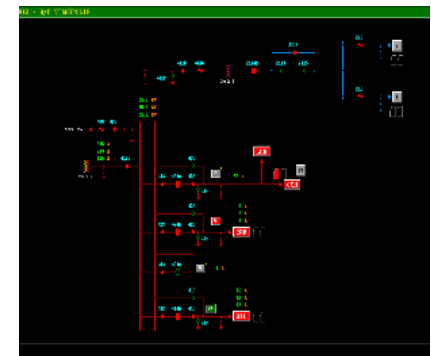
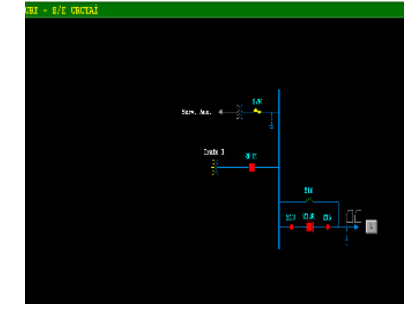
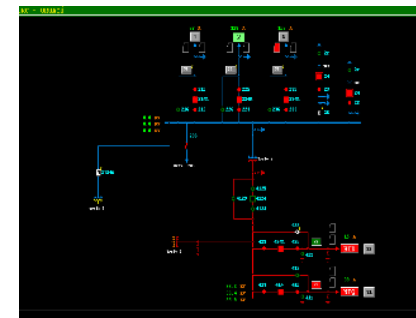
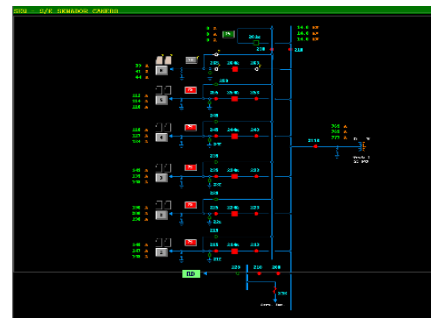
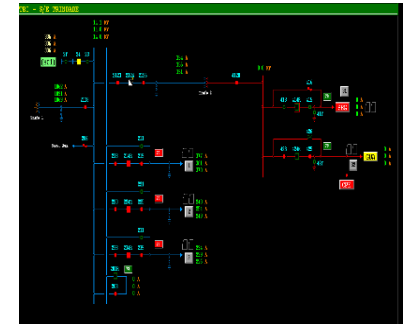
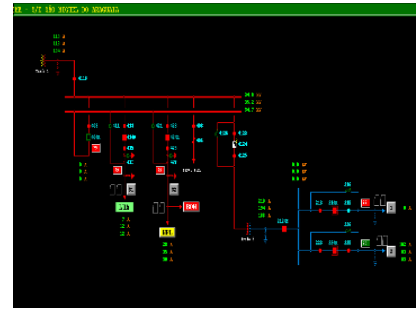
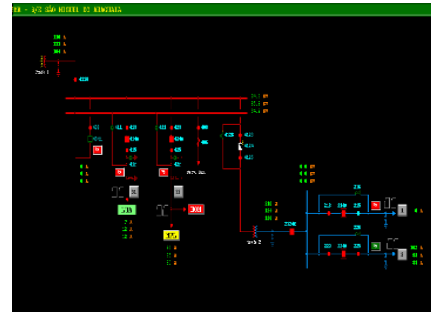
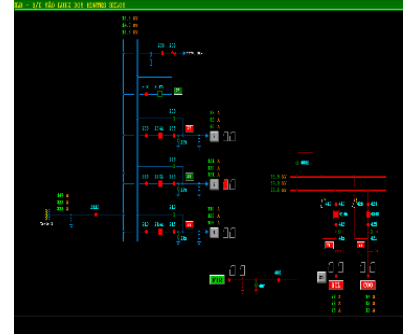
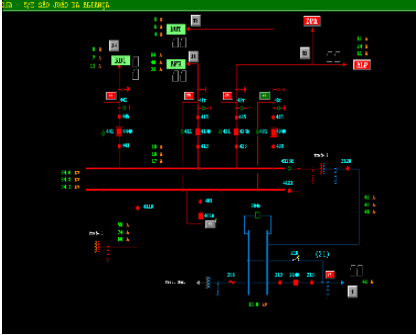
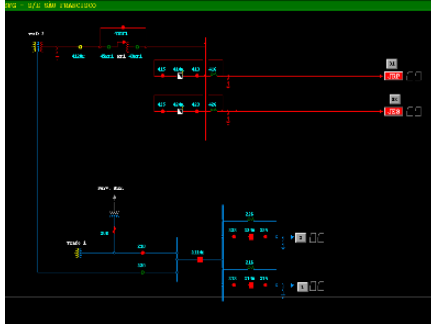
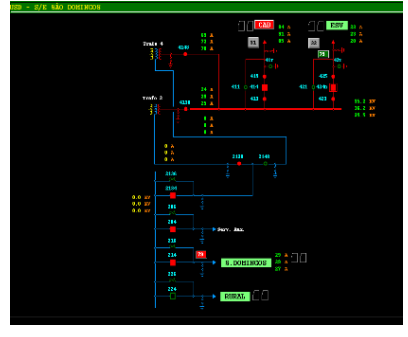
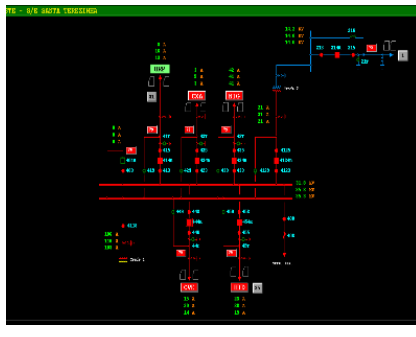
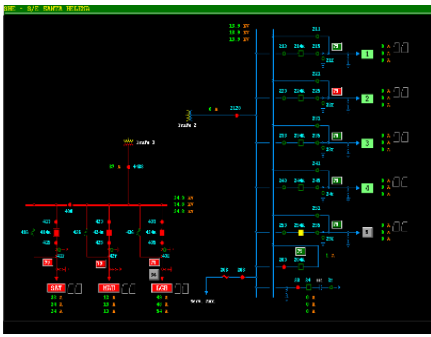



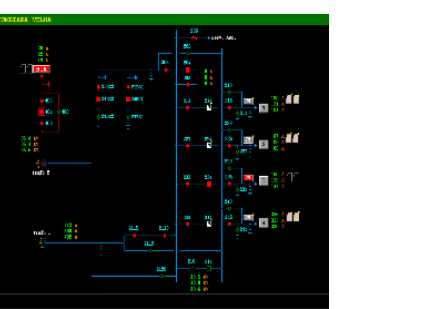
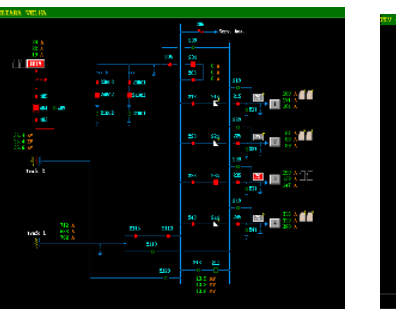
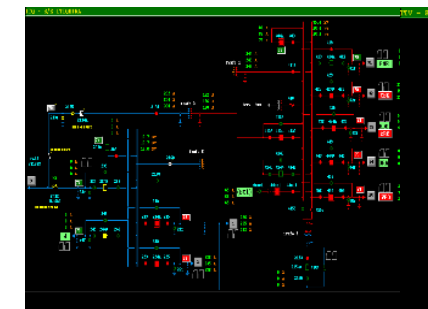
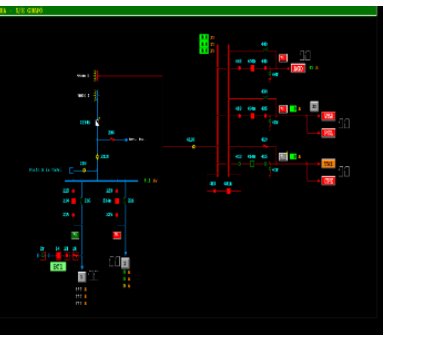
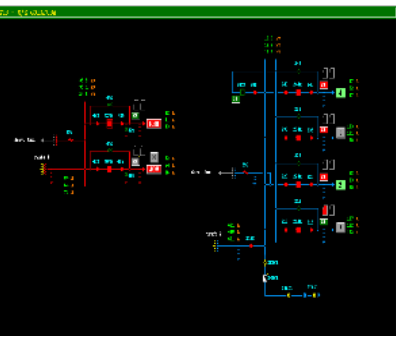
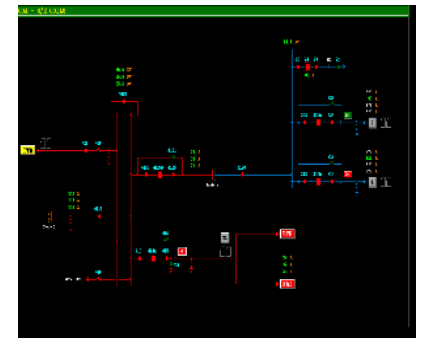
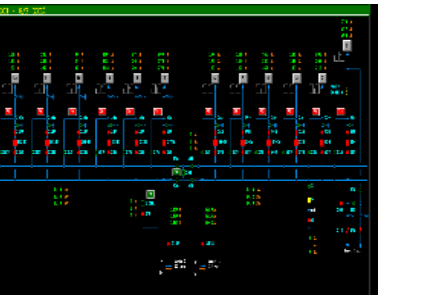
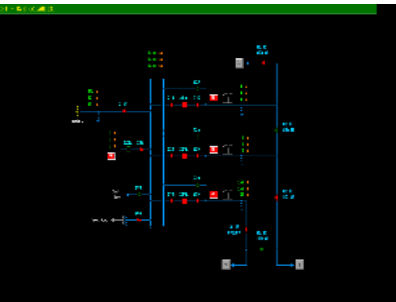
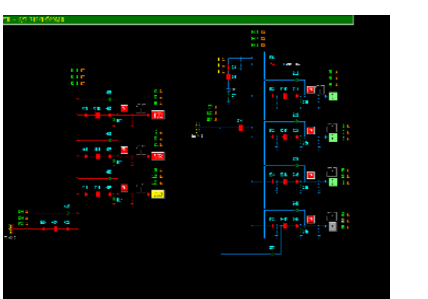
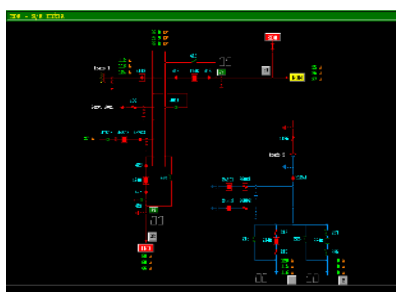
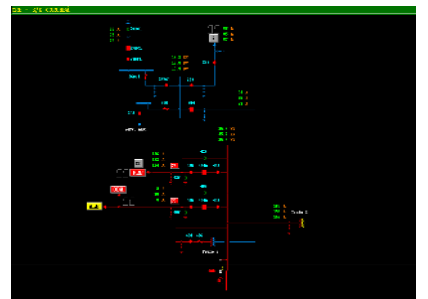
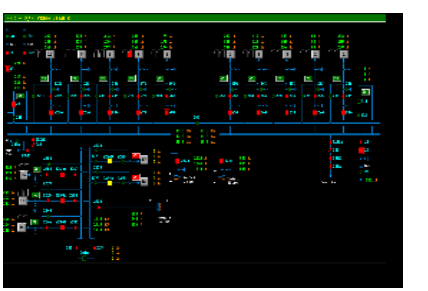
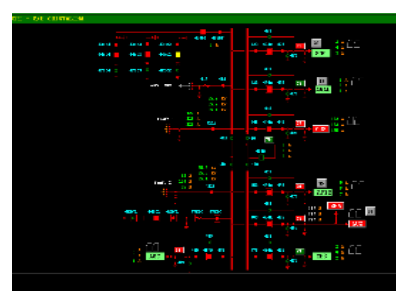
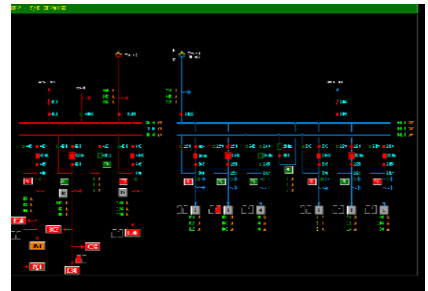
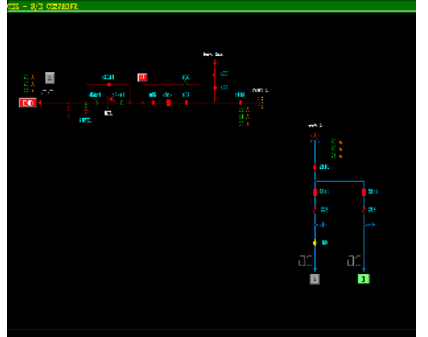
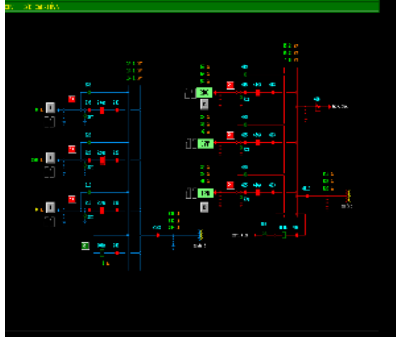
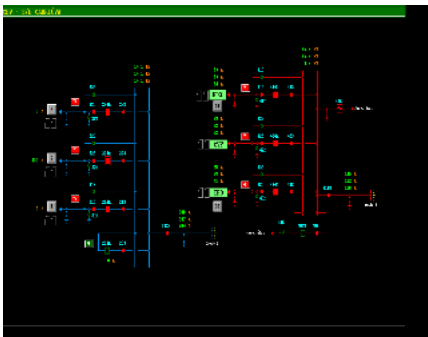

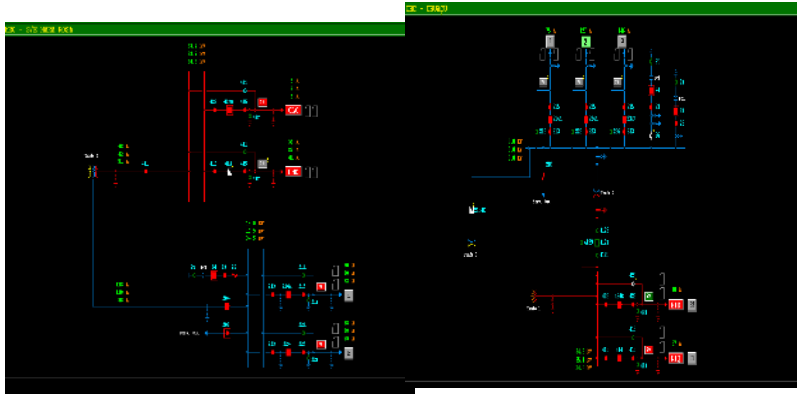
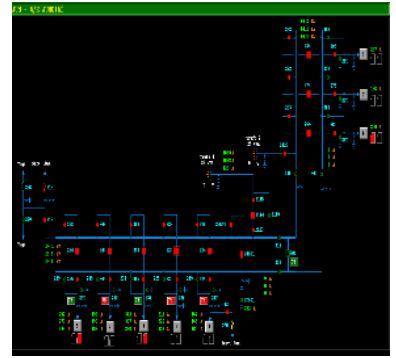
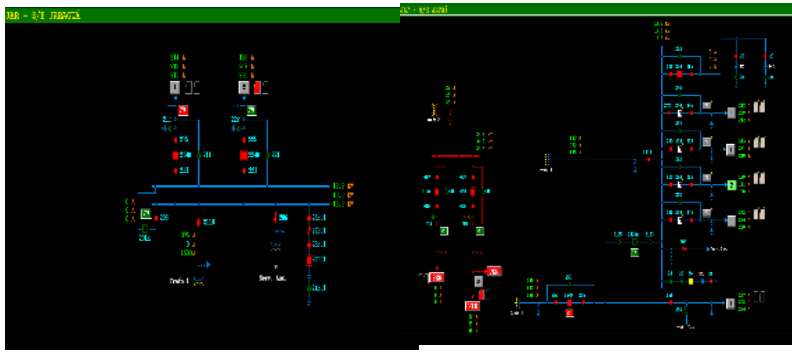



# DEMAIS EVIDÊNCIAS

## DADOS TÉCNICO - OPERACIONAIS ENEL GO

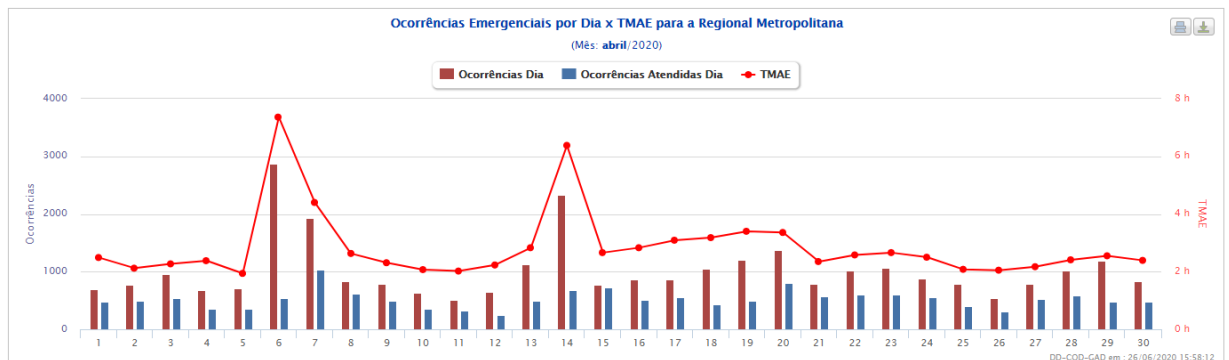
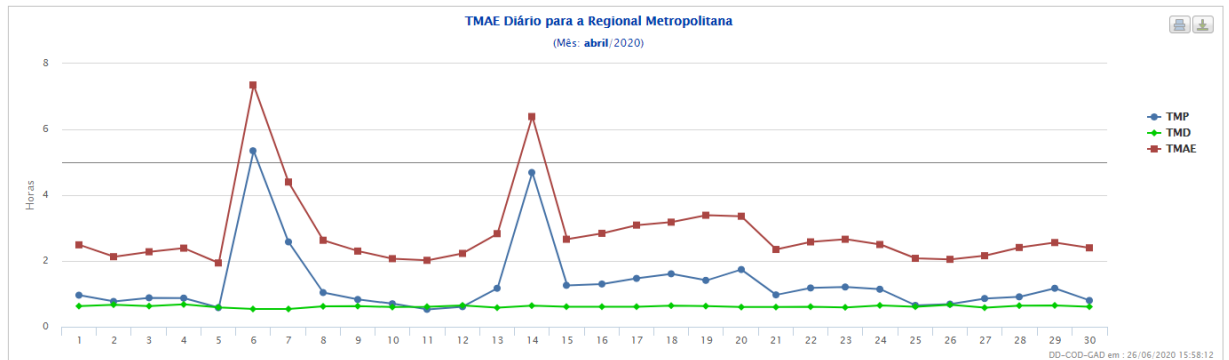
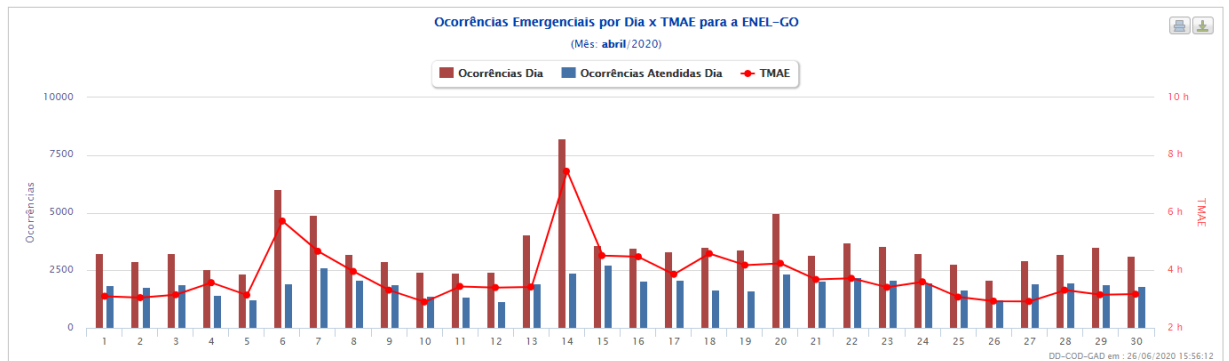
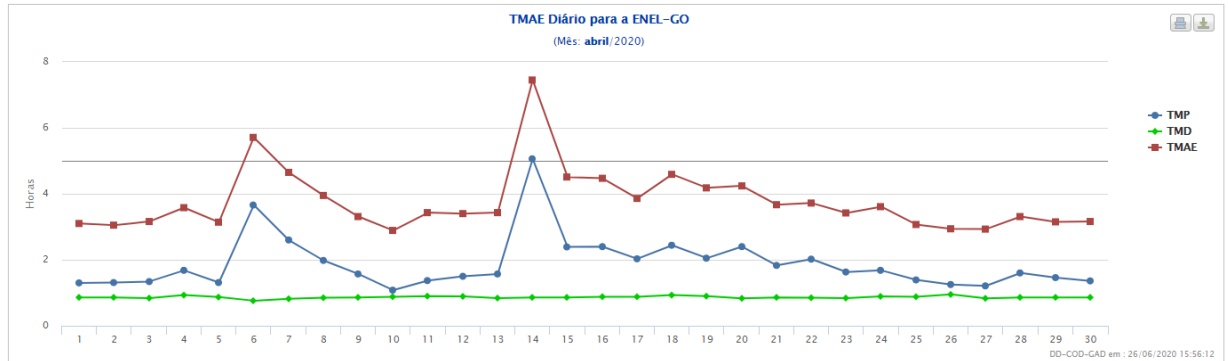

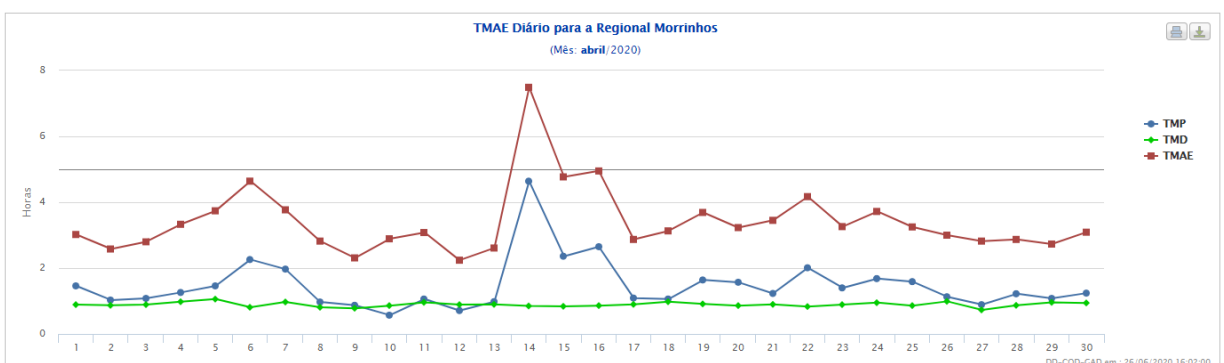
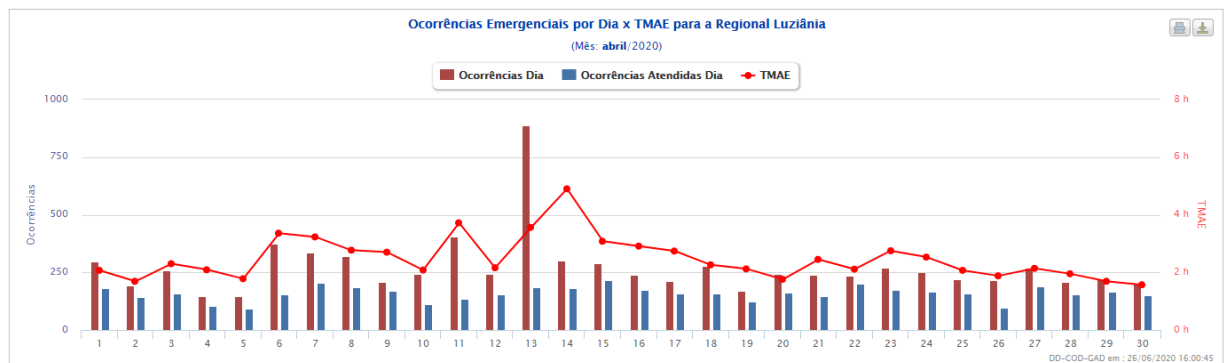
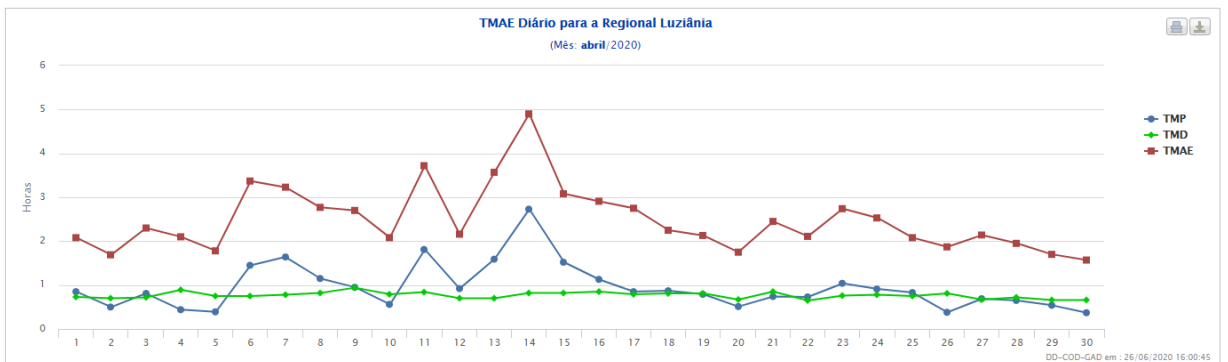
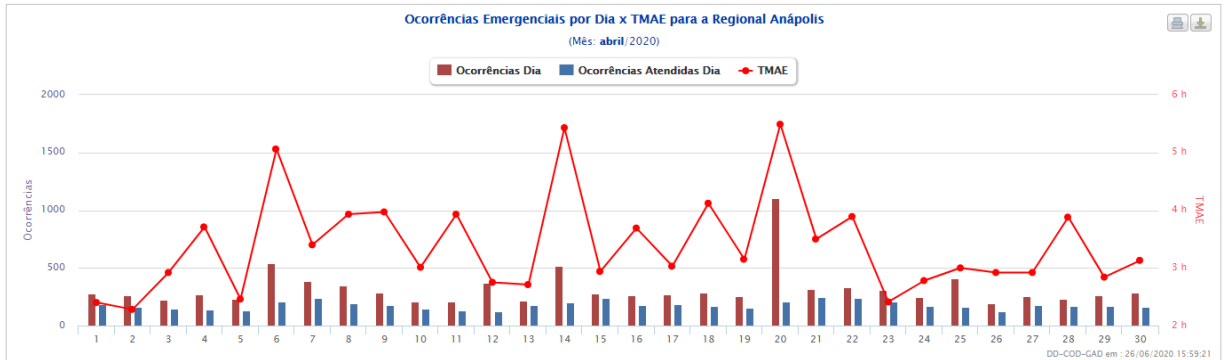
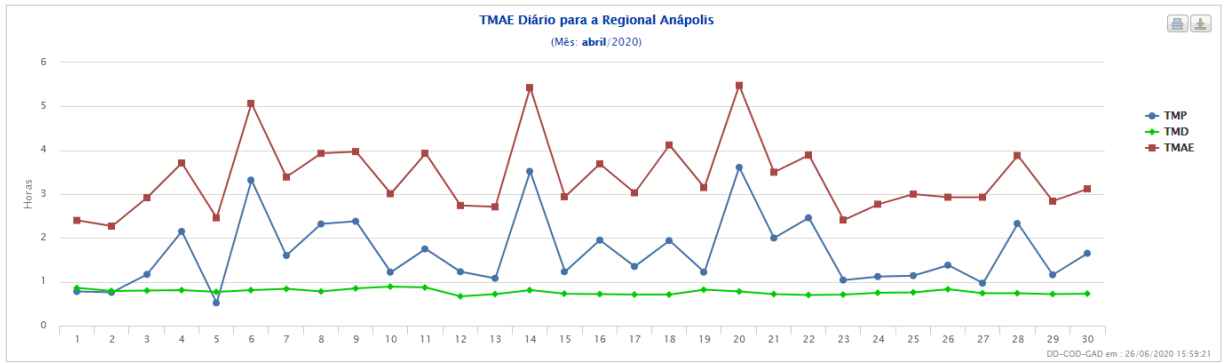

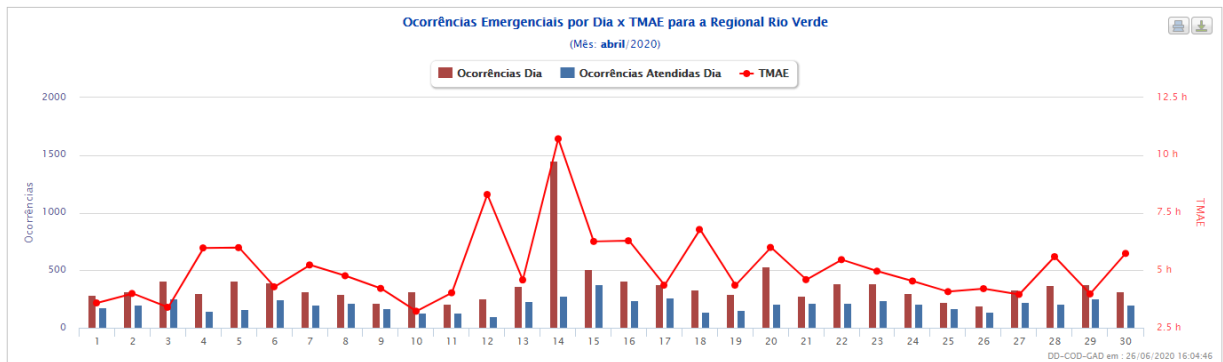
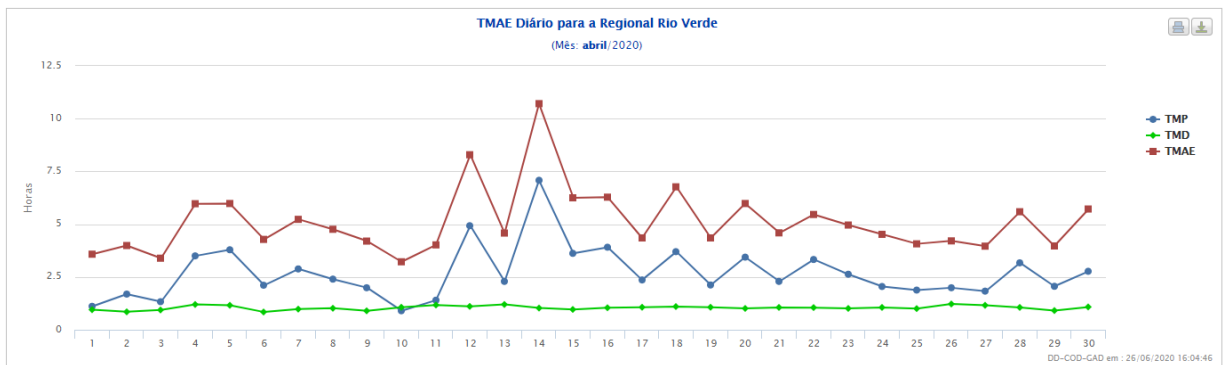
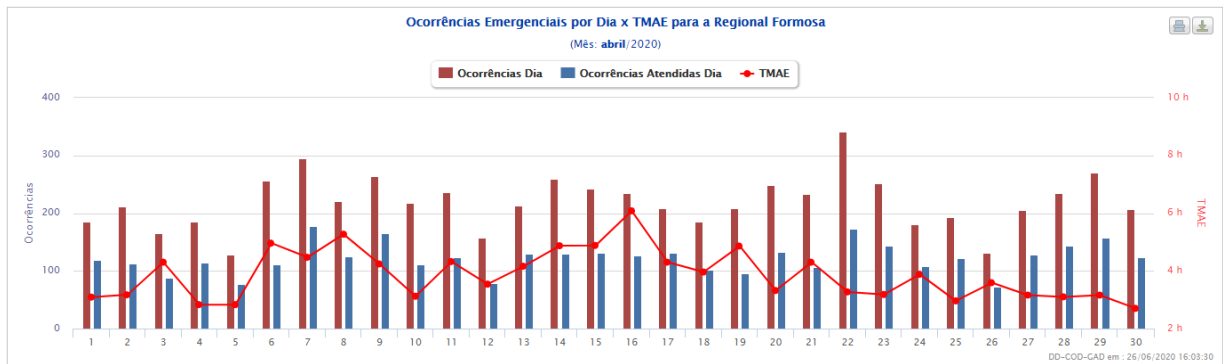
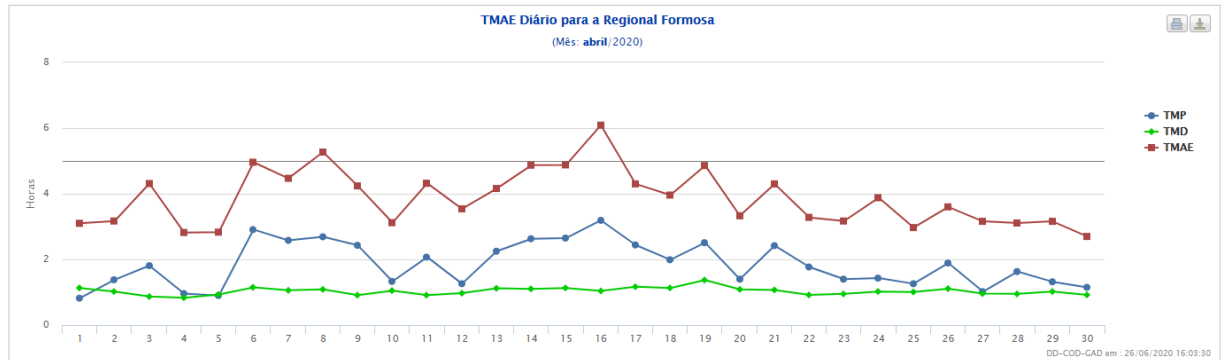
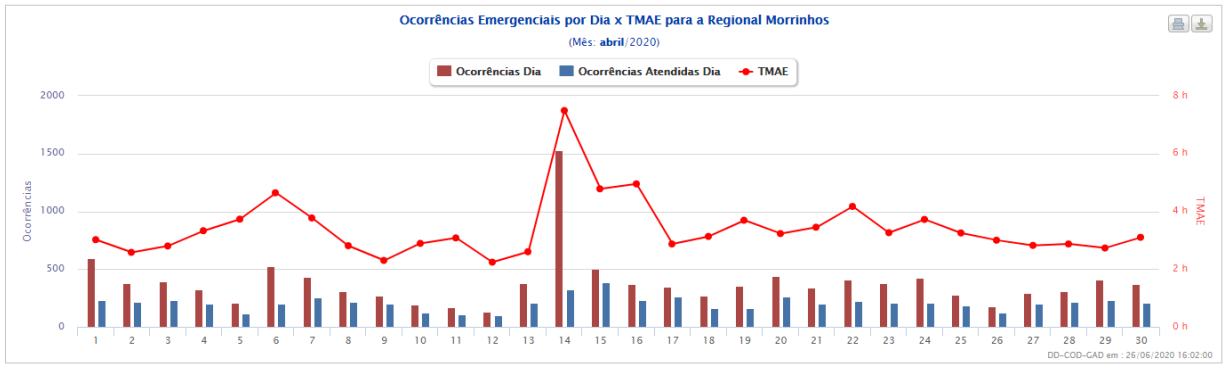

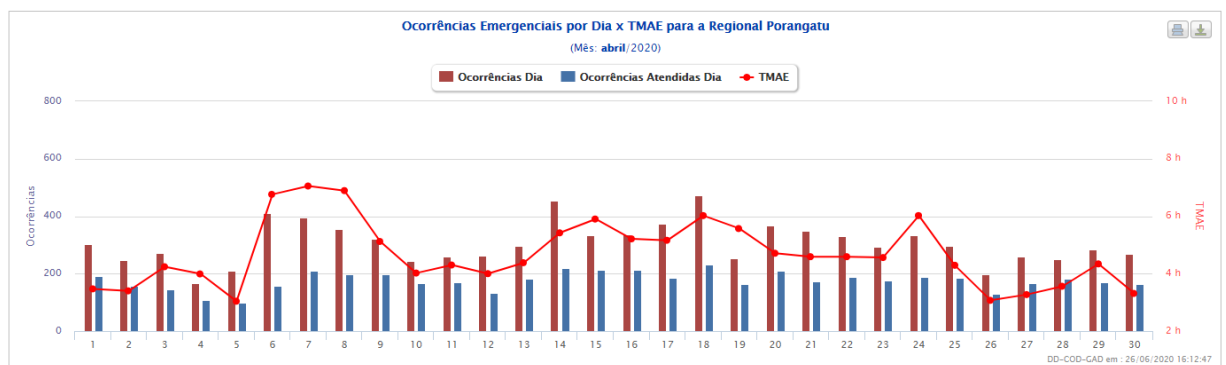
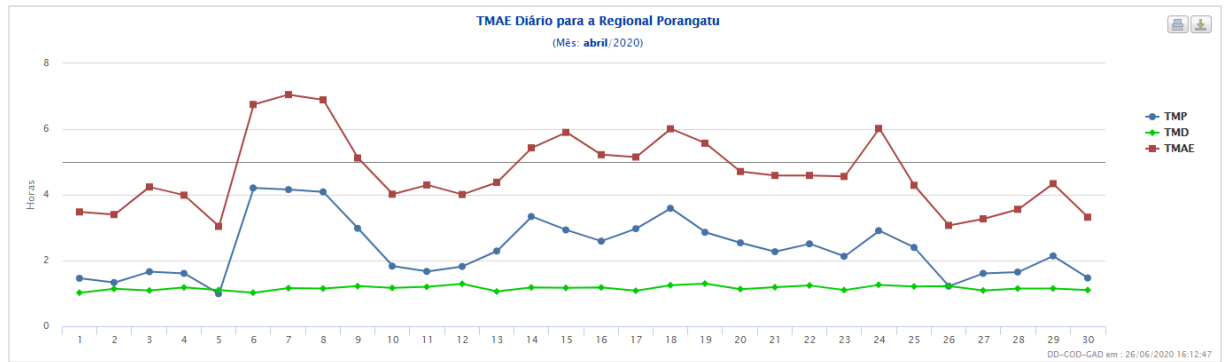
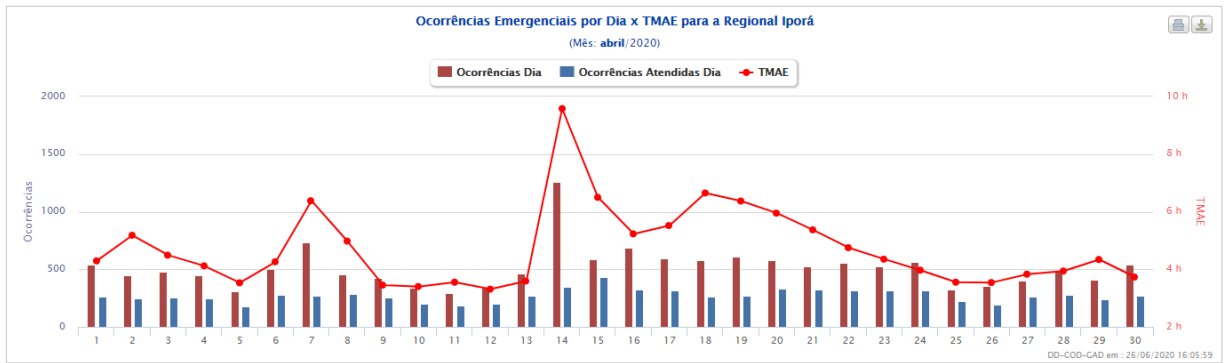
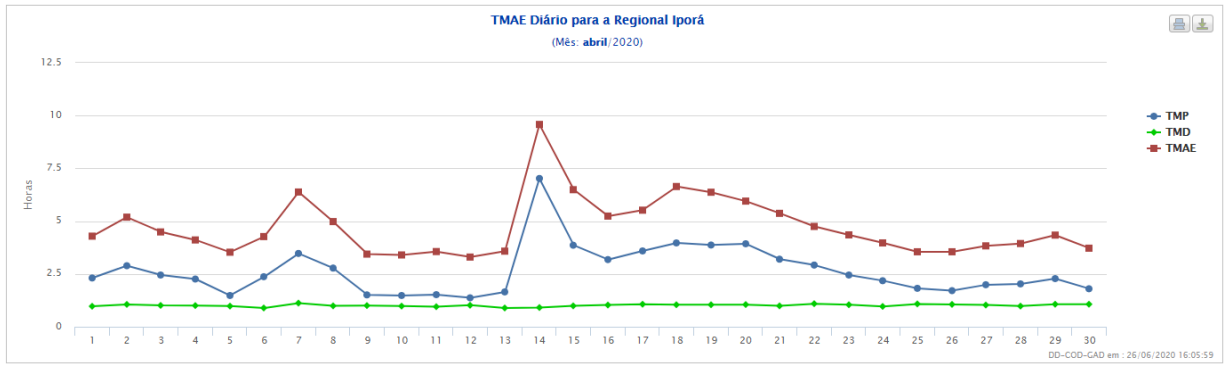

CLIMATEMPO

**Laudo Meteorológico de Evento Climático -  
ENEL Goiás - 14 de abril de 2020**

São Paulo, SP, Brasil

Abril de 2020

## Sumário

<b>1</b>	<b>ANÁLISE DE EVENTO METEOROLÓGICO .....</b>	<b>2</b>
<b>1.1</b>	<b>Descrição do Evento.....</b>	<b>2</b>
<b>1.2</b>	<b>Abrangência do Evento .....</b>	<b>5</b>
<b>2</b>	<b>CLASSIFICAÇÃO COBRADE .....</b>	<b>10</b>
<b>3</b>	<b>RESUMO DO EVENTO .....</b>	<b>11</b>
<b>4</b>	<b>REFERÊNCIAS.....</b>	<b>14</b>

# 1 Análise de Evento Meteorológico

## 1.1 Descrição do Evento

Na figura a seguir é apresentada a área de concessão da ENEL DISTRIBUIÇÃO GOIÁS, dividida em regiões, a serem analisadas neste relatório.



Figura 1 – Regiões atendidas pela ENEL Goiás.

O deslocamento de uma frente fria favoreceu a formação de áreas de instabilidade que avançaram sobre o estado de Goiás a partir da madrugada do dia 14 de abril de 2020.

Nas Figuras 2 e 3 são apresentadas as descargas atmosféricas nuvem-solo (raios) e nuvem-nuvem detectadas pelo sistema Earth Networks. Entre as 03h20 e 23h00 do dia 14 de abril de 2020 foram registrados 7325 raios nuvem-solo e 19066 descargas nuvem-nuvem sobre a área da ENEL DISTRIBUIÇÃO GOIÁS.

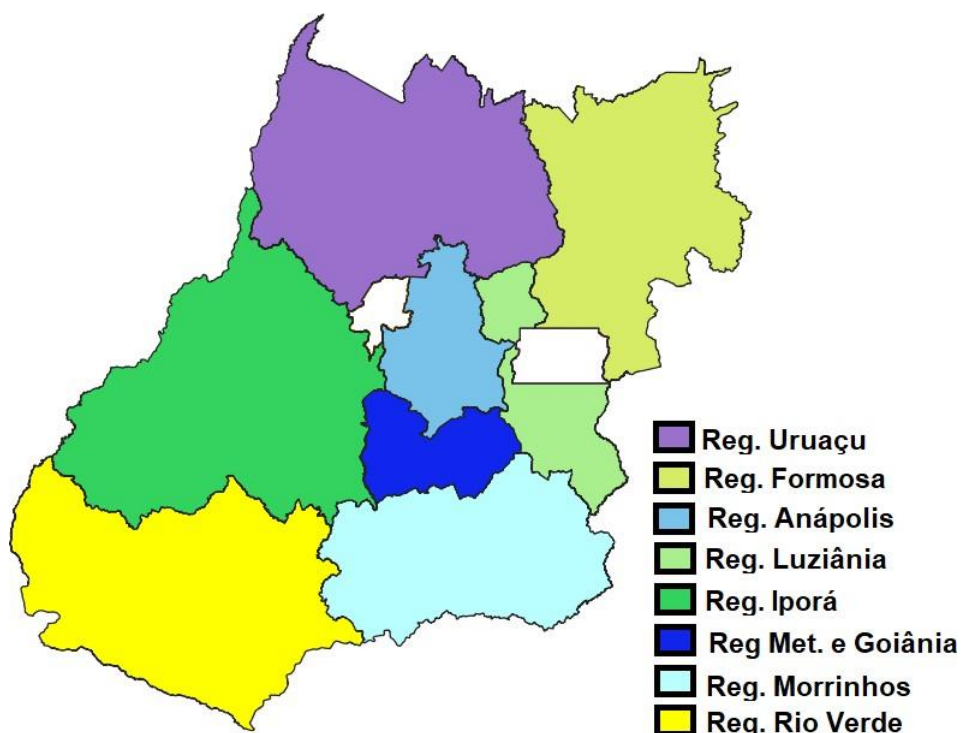

Figura 2 – Descargas atmosféricas nuvem-solo (em preto) detectadas pelo sistema Earth Networks entre 03h20 e 23h00 do dia 14 de abril de 2020 sobre a área de concessão da CELG Distribuição.



Figura 3 – Descargas atmosféricas nuvem-nuvem (em vermelho) detectadas pelo sistema Earth Networks entre 03h20 e 23h00 do dia 14 de abril de 2020 sobre a área de concessão da CELG Distribuição.

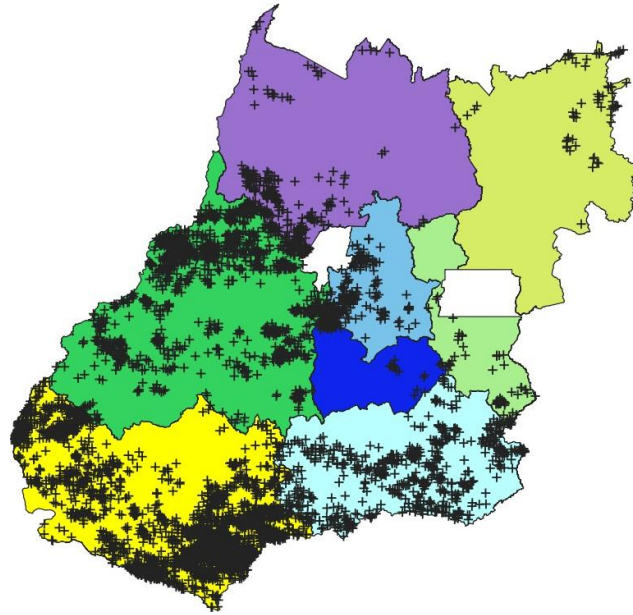

Estações do Instituto Nacional de Meteorologia (INMET), representativas da área de concessão da CELG Distribuição Goiás, registraram chuva forte (segundo a American Meteorological Society - Sociedade Meteorológica Americana -, chuvas com taxa entre 2,5mm a 7,6 mm por hora são consideradas moderadas e aquelas com taxa superior a 7,6 mm por hora são consideradas chuva forte). Na tabela 1 são apresentados os registros de acumulados horários superiores a 7,6 mm.

Tabela 1 – Acumulado horário de chuva registrada pelo INMET.

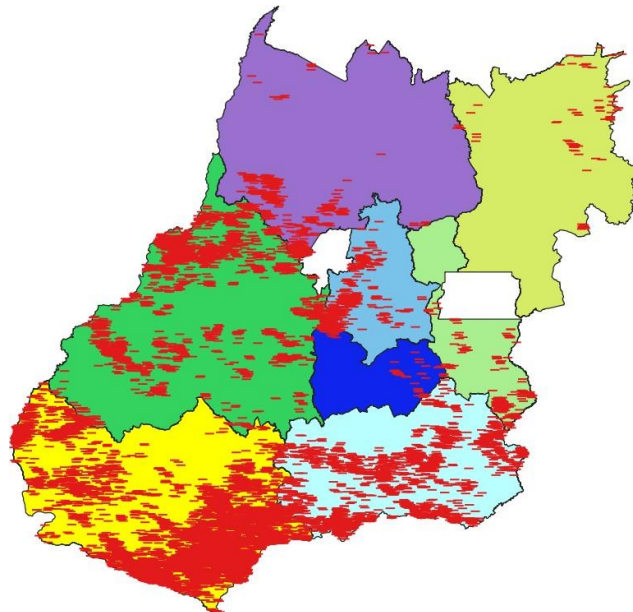
Estação	Horário	Precipitação (mm)
Alto Araguaia	Entre 7h e 8h do dia 14/4/2020	34.6
Goiás	Entre 6h e 7h do dia 14/4/2020	8.0
Goiás	Entre 7h e 8h do dia 14/4/2020	8.8
Goiás	Entre 13h e 14h do dia 14/4/2020	8.4
Iporá	Entre 12h e 13h do dia 14/4/2020	11.4
Mineiros	Entre 9h e 10h do dia 14/4/2020	8.2
Monte Alegre de Goiás	Entre 23h e 0h do dia 15/4/2020	9.4
Monte Alegre de Goiás	Entre 6h e 7h do dia 15/4/2020	19.8

Na tabela 2 são apresentadas as rajadas de vento iguais ou superiores a 50 km/h registradas por estações do Instituto Nacional de Meteorologia (INMET) representativas da área de concessão da ENEL Distribuição Goiás. Como é possível observar, o maior valor registrado foi de 90,4 km/h na estação de Alto Araguaia entre as 7h e 8h do dia 14 de abril, vento classificado como tempestade pela escala Beaufort.

Tabela 2 – Rajadas de vento maiores ou iguais a 50 km/h registradas pelo INMET. Segundo a escala Beaufort, ventos entre 50 e 61 km/h são classificados como vento forte, entre 62 e 74 km/h como ventania, entre 75 e 88 km/h como ventania forte e entre 89 e 102 km/h como tempestade.

Estação	Horário	Rajada (km/h)
Alto Araguaia	Entre 7h e 8h do dia 14/4/2020	90.4
Aragarças	Entre 12h e 13h do dia 14/4/2020	56.5
Caiapônia	Entre 10h e 11h do dia 14/4/2020	61.2
Caiapônia	Entre 11h e 12h do dia 14/4/2020	50.8
Goianésia	Entre 16h e 17h do dia 14/4/2020	50.8
Goiânia	Entre 13h e 14h do dia 14/4/2020	51.1
Goiás	Entre 13h e 14h do dia 14/4/2020	54.0
Iporá	Entre 11h e 12h do dia 14/4/2020	50.8
Itumbiara	Entre 11h e 12h do dia 14/4/2020	63.0
Mineiros	Entre 8h e 9h do dia 14/4/2020	53.6
Mineiros	Entre 9h e 10h do dia 14/4/2020	54.4
Pires do Rio	Entre 13h e 14h do dia 14/4/2020	52.6
Pires do Rio	Entre 14h e 15h do dia 14/4/2020	52.6

## 1.2 Abrangência do Evento

A seguir são apresentadas as imagens realçadas do satélite GOES-16 entre as 06h00 do dia 14 e 06h00 do dia 15 de abril de 2020. Os tons em vermelho e preto indicam a presença de nuvens de grande desenvolvimento vertical, geralmente associadas à ocorrência de tempo severo.

06h00 - 14 de Abril de 2020



Figura 4 – Imagens realçadas do satélite GOES-16 das 06h00 do dia 14 de Abril de 2020.  
FONTE: Cptec/INPE.

09h00 - 14 de Abril de 2020

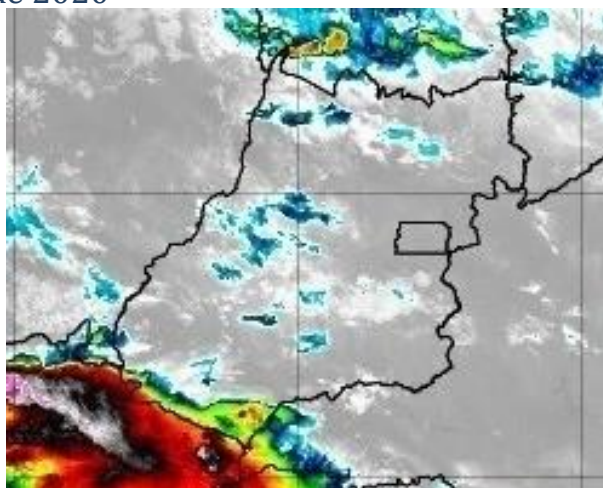

Figura 5 – Imagens realçadas do satélite GOES-16 das 09h00 do dia 14 de Abril de 2020.  
FONTE: Cptec/INPE.

12h00 - 14 de Abril de 2020

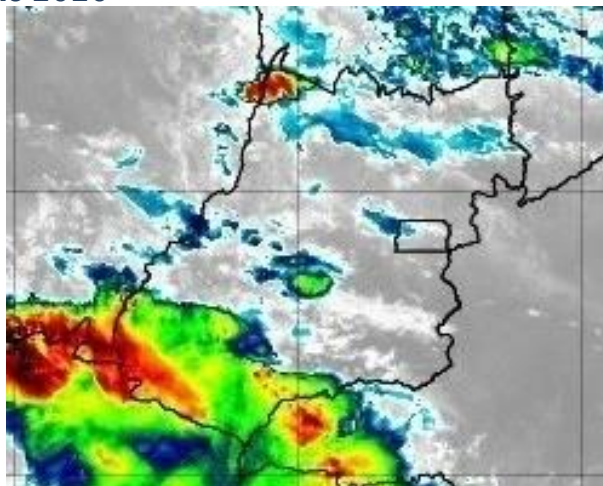

Figura 6 – Imagens realçadas do satélite GOES-16 das 12h00 do dia 14 de Abril de 2020.  
FONTE: Cptec/INPE.

15h00 - 14 de Abril de 2020



Figura 7 – Imagens realçadas do satélite GOES-16 das 15h00 do dia 14 de Abril de 2020.  
FONTE: Cptec/INPE.

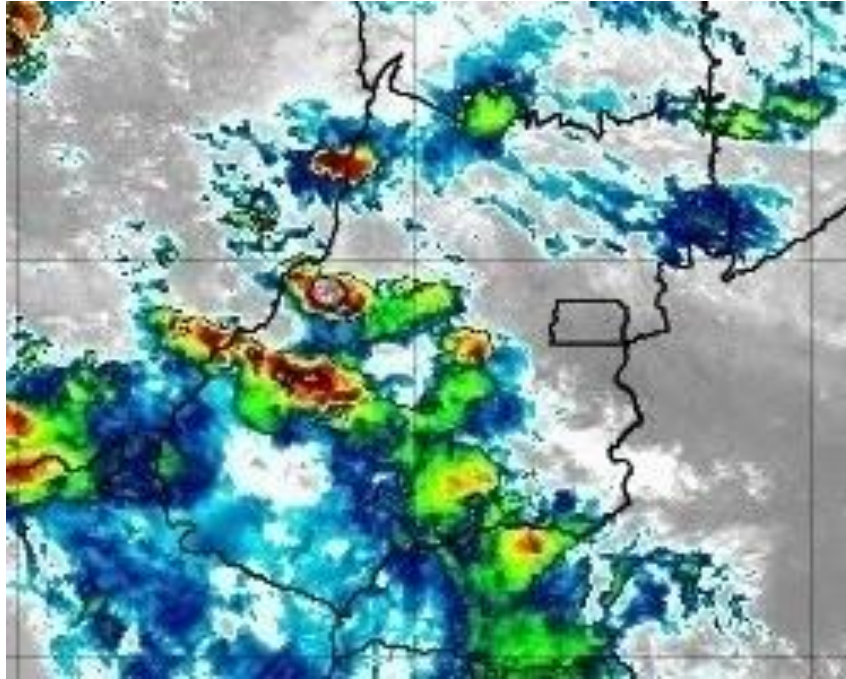

18h10 - 14 de Abril de 2020

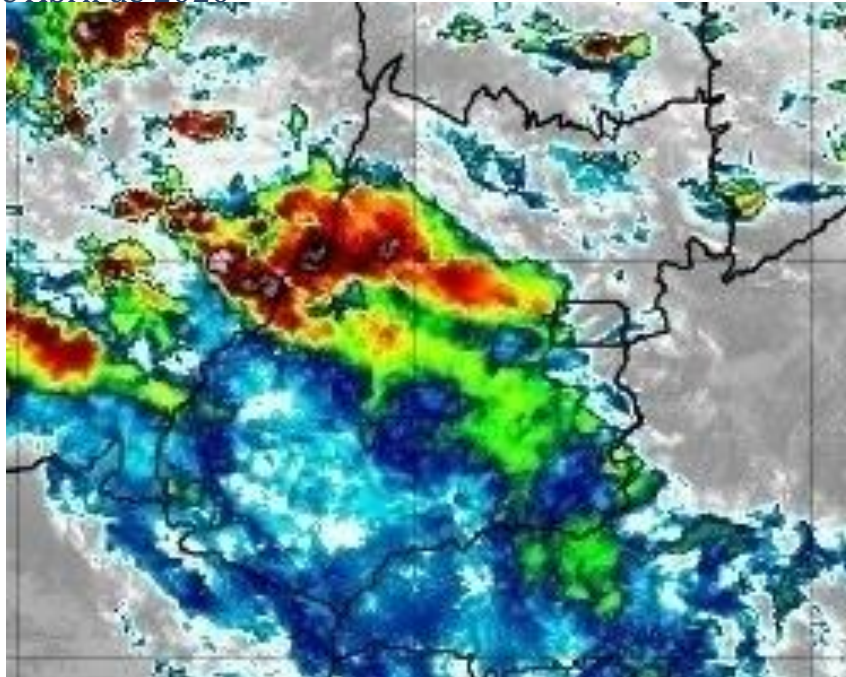

Figura 8 – Imagens realçadas do satélite GOES-16 das 18h00 do dia 14 de Abril de 2020.  
FONTE: Cptec/INPE.

21h00 - 14 de Abril de 2020

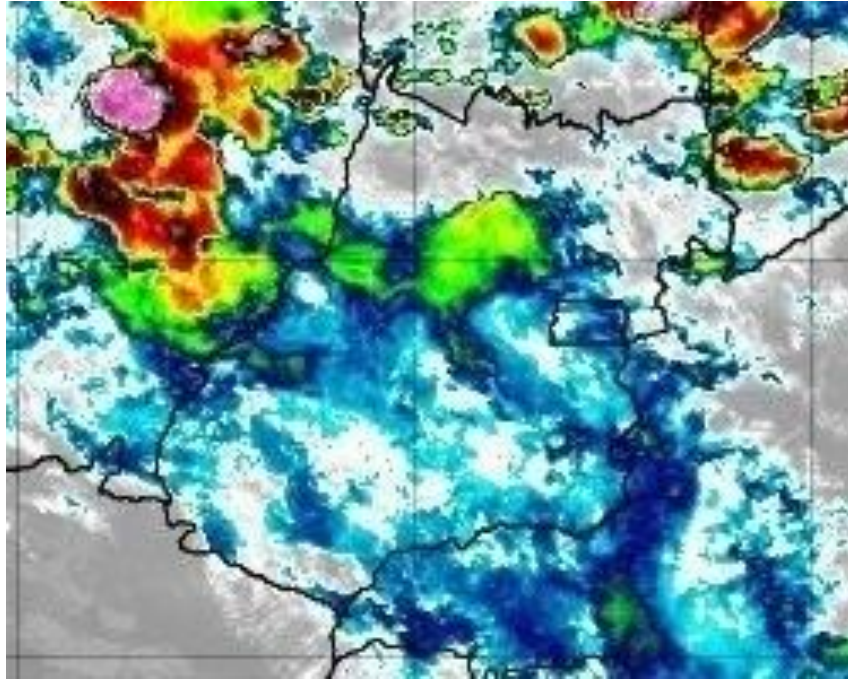

Figura 9 – Imagens realçadas do satélite GOES-16 das 21h00 do dia 14 de Abril de 2020.  
FONTE: Cptec/INPE.

0h00 - 15 de Abril de 2020

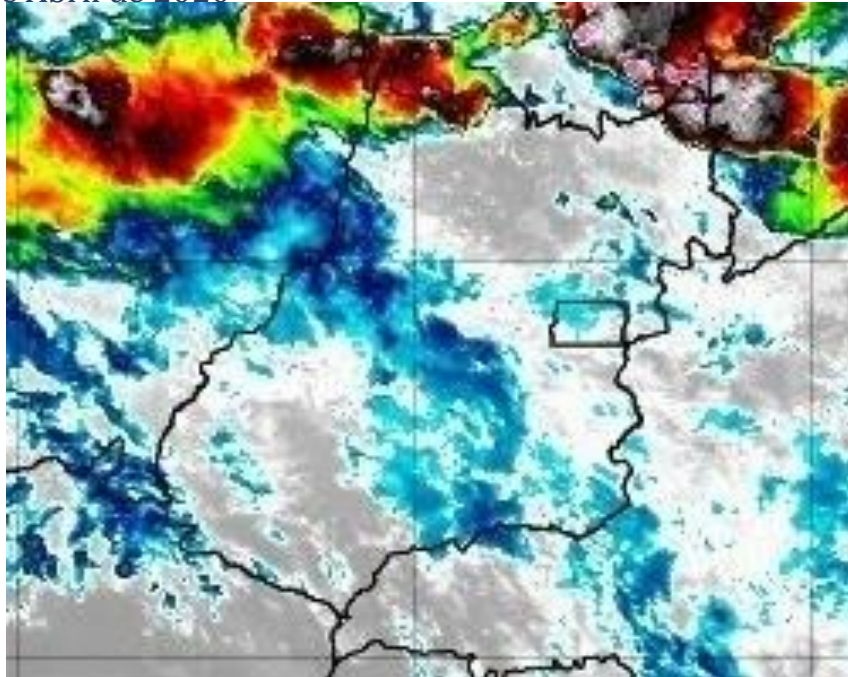

Figura 10 – Imagens realçadas do satélite GOES-16 das 0h00 do dia 15 de Abril de 2020.  
FONTE: Cptec/INPE.

3h00 - 15 de Abril de 2020



Figura 11 – Imagens realçadas do satélite GOES-16 das 3h00 do dia 15 de Abril de 2020.  
FONTE: Cptec/INPE.

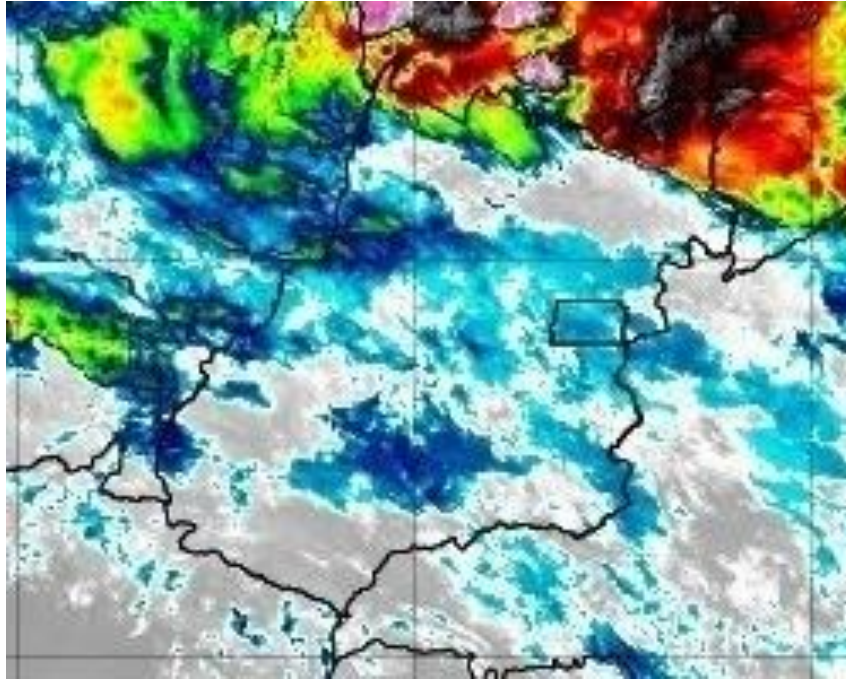

6h00 - 15 de Abril de 2020

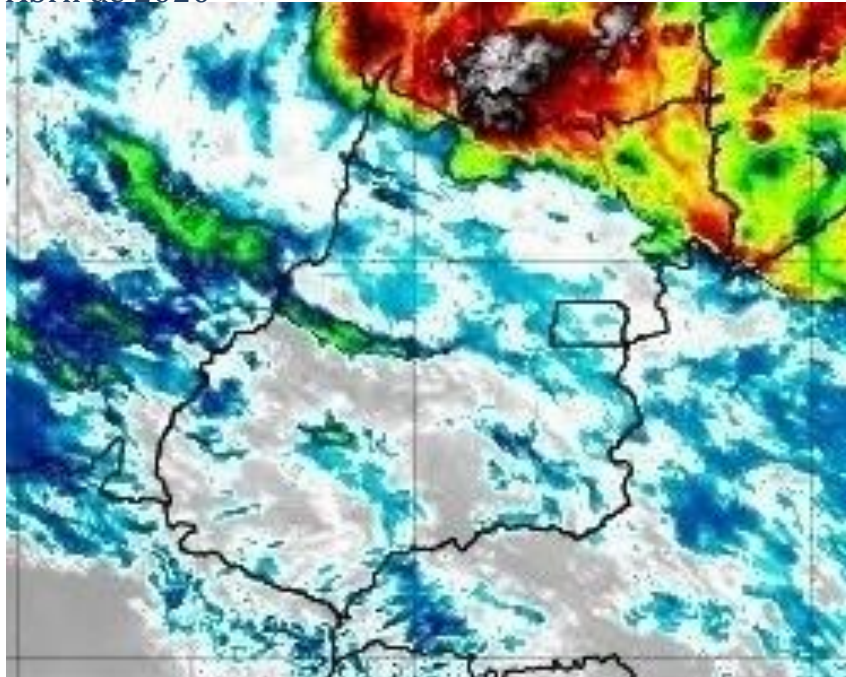

Figura 12 – Imagens realçadas do satélite GOES-16 das 6h00 do dia 15 de Abril de 2020.  
FONTE: Cptec/INPE.

## 2 Classificação COBRADE

O COBRADE (Classificação e Codificação Brasileira de Desastres) foi criado com o intuito de adequar a classificação brasileira à classificação utilizada pela ONU na classificação de desastres e nivelar o país aos demais organismos de gestão de desastres do mundo.

Baseados nos dados analisados nos itens anteriores, podemos classificar o evento ocorrido sobre a área de concessão da ENEL Distribuição Goiás como Zona de Convergência (Código 1.3.1.2.0).

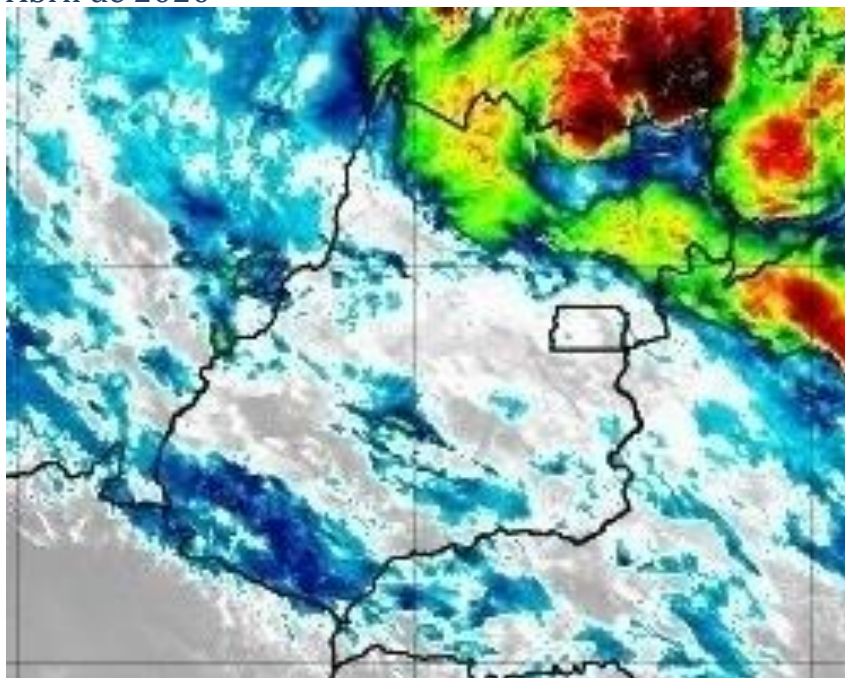
### 3 Resumo do Evento

Áreas de instabilidades associadas ao deslocamento de uma frente fria pelo país favoreceram a ocorrência de chuva forte, rajadas de vento e raios sobre o estado de Goiás a partir da madrugada do dia 14 de abril de 2020.

O sistema de detecção da EarthNetworks registrou 26391 descargas atmosféricas sobre a área de concessão da ENEL em Goiás entre as 03h20 e 23h00 do dia 14 de abril de 2020. Rajadas de vento classificadas como tempestade pela escala Beaufort foram registrados pelo INMET na estação de Alto Araguaia na manhã do dia 14 de abril. Outras estações também registraram vento forte ou ventania e chuva forte durante a atuação das áreas de instabilidade.

Tabela 3 – Resumo do evento Regional Rio Verde

Número/Código do Evento	
Número/Código do Relatório	
Descrição	Zona de convergência é uma região que está ligada à tempestade causada por uma zona de baixa pressão atmosférica, provocando forte deslocamento de massas de ar, vendavais, chuvas intensas e até queda de granizo.
Código COBRADE	1.3.1.2.0 - Zona de Convergência
Hora início do evento	03h20 do dia 14 de abril de 2020
Hora de fim do evento	11h10 do dia 14 de abril de 2020
Abrangência	Regional Rio Verde

Tabela 4 – Resumo do evento Regional Morrinhos

Número/Código do Evento	
Número/Código do Relatório	
Descrição	Zona de convergência é uma região que está ligada à tempestade causada por uma zona de baixa pressão atmosférica, provocando forte deslocamento de massas de ar, vendavais, chuvas intensas e até queda de granizo.
Código COBRADE	1.3.1.2.0 - Zona de Convergência
Hora início do evento	03h30 do dia 14 de abril de 2020
Hora de fim do evento	19h00 do dia 14 de abril de 2020
Abrangência	Regional Morrinhos



Tabela 5 – Resumo do evento Regional Metropolitana e Goiânia

Número/Código do Evento	
Número/Código do Relatório	
Descrição	Zona de convergência é uma região que está ligada à tempestade causada por uma zona de baixa pressão atmosférica, provocando forte deslocamento de massas de ar, vendavais, chuvas intensas e até queda de granizo.
Código COBRADE	1.3.1.2.0 - Zona de Convergência
Hora início do evento	13h00 do dia 14 de abril de 2020
Hora de fim do evento	15h10 do dia 14 de abril de 2020
Abrangência	Regional Metropolitana e Goiânia

Tabela 6 – Resumo do evento Regional Iporá

Número/Código do Evento	
Número/Código do Relatório	
Descrição	Zona de convergência é uma região que está ligada à tempestade causada por uma zona de baixa pressão atmosférica, provocando forte deslocamento de massas de ar, vendavais, chuvas intensas e até queda de granizo.
Código COBRADE	1.3.1.2.0 - Zona de Convergência
Hora início do evento	03h45 do dia 14 de abril de 2020
Hora de fim do evento	17h30 do dia 14 de abril de 2020
Abrangência	Regional Iporá

Tabela 7 – Resumo do evento Regional Luziânia

Número/Código do Evento	
Número/Código do Relatório	
Descrição	Zona de convergência é uma região que está ligada à tempestade causada por uma zona de baixa pressão atmosférica, provocando forte deslocamento de massas de ar, vendavais, chuvas intensas e até queda de granizo.
Código COBRADE	1.3.1.2.0 - Zona de Convergência
Hora início do evento	14h30 do dia 14 de abril de 2020
Hora de fim do evento	17h30 do dia 14 de abril de 2020
Abrangência	Regional Luziânia

Tabela 8 – Resumo do evento Regional Anápolis

Número/Código do Evento	
Número/Código do Relatório	
Descrição	Zona de convergência é uma região que está ligada à tempestade causada por uma zona de baixa pressão atmosférica, provocando forte deslocamento de massas de ar, vendavais, chuvas intensas e até queda de granizo.
Código COBRADE	1.3.1.2.0 - Zona de Convergência
Hora início do evento	11h30 do dia 14 de abril de 2020
Hora de fim do evento	17h50 do dia 14 de abril de 2020
Abrangência	Regional Anápolis

Tabela 9 – Resumo do evento Regional Uruaçu

Número/Código do Evento	
Número/Código do Relatório	
Descrição	Zona de convergência é uma região que está ligada à tempestade causada por uma zona de baixa pressão atmosférica, provocando forte deslocamento de massas de ar, vendavais, chuvas intensas e até queda de granizo.
Código COBRADE	1.3.1.2.0 - Zona de Convergência
Hora início do evento	12h00 do dia 14 de abril de 2020
Hora de fim do evento	21h30 do dia 14 de abril de 2020
Abrangência	Regional Uruaçu

Tabela 10 – Resumo do evento Regional Formosa

Número/Código do Evento	
Número/Código do Relatório	
Descrição	Zona de convergência é uma região que está ligada à tempestade causada por uma zona de baixa pressão atmosférica, provocando forte deslocamento de massas de ar, vendavais, chuvas intensas e até queda de granizo.
Código COBRADE	1.3.1.2.0 - Zona de Convergência
Hora início do evento	14h00 do dia 14 de abril de 2020
Hora de fim do evento	07h00 do dia 15 de abril de 2020
Abrangência	Regional Formosa

#### 4 Referências

- RMetS Royal Meteorological Society – Beaufort Scale - <https://www.rmets.org/weather-and-climate/observing/beaufort-scale>
- Cptec/INPE- <https://www.cptec.inpe.br/>
- Centro de Hidrografia da Marinha do Brasil - <https://www.marinha.mil.br/chm/>

Anexos

A.1 Carta Sinótica



Figura A1 - Carta sinótica para as 1200Z do dia 14 de abril de 2020 (09h00 do dia 14 de abril de 2020 hora local. FONTE: Marinha do Brasil).

## A.2 Notícias associadas

- Temporais causam estragos no interior de Goiás

<http://g1.globo.com/goias/videos/t/todos-os-videos/v/temporais-causam-estragos-no-interior-de-goias/8483223/>

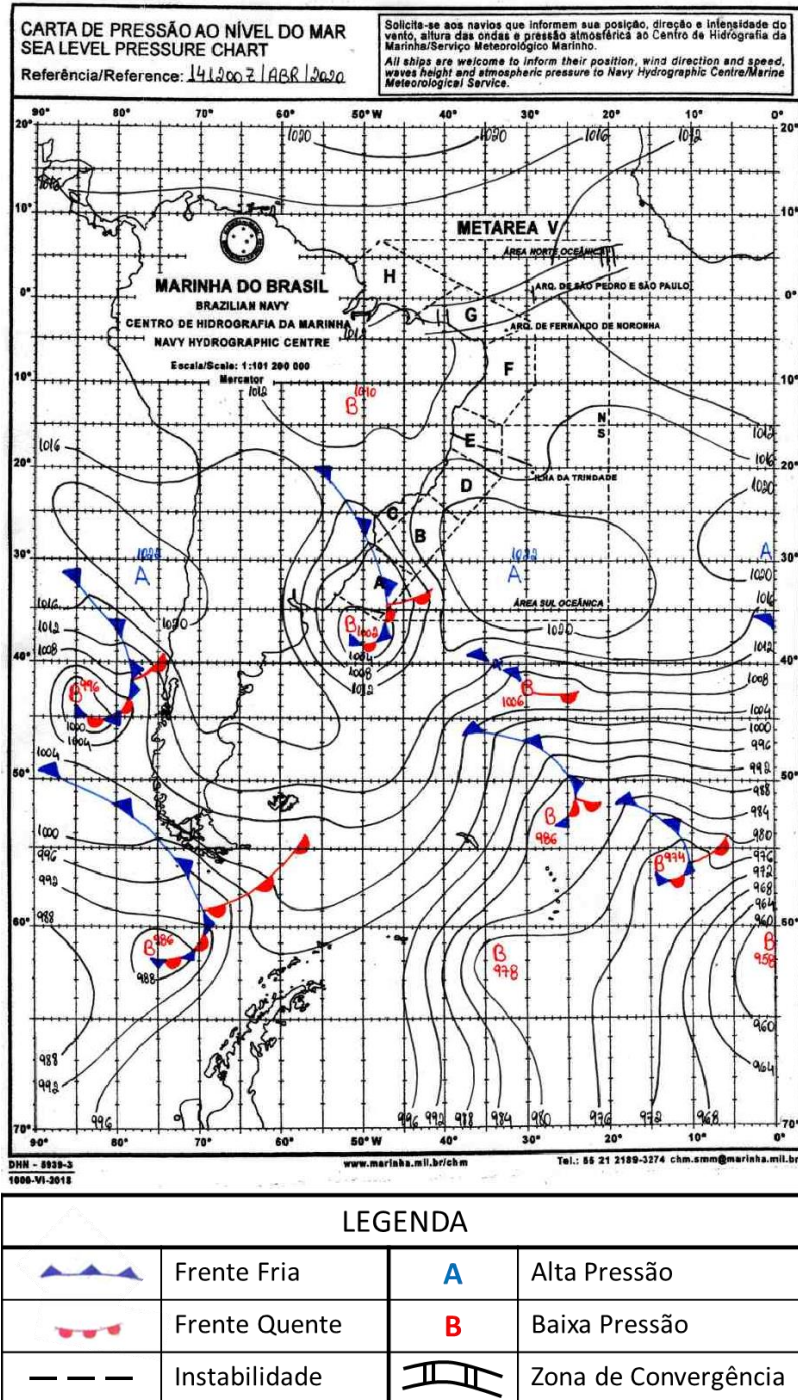
Bianca Lobo

Silva

Meteorologista

CREA

5063840461

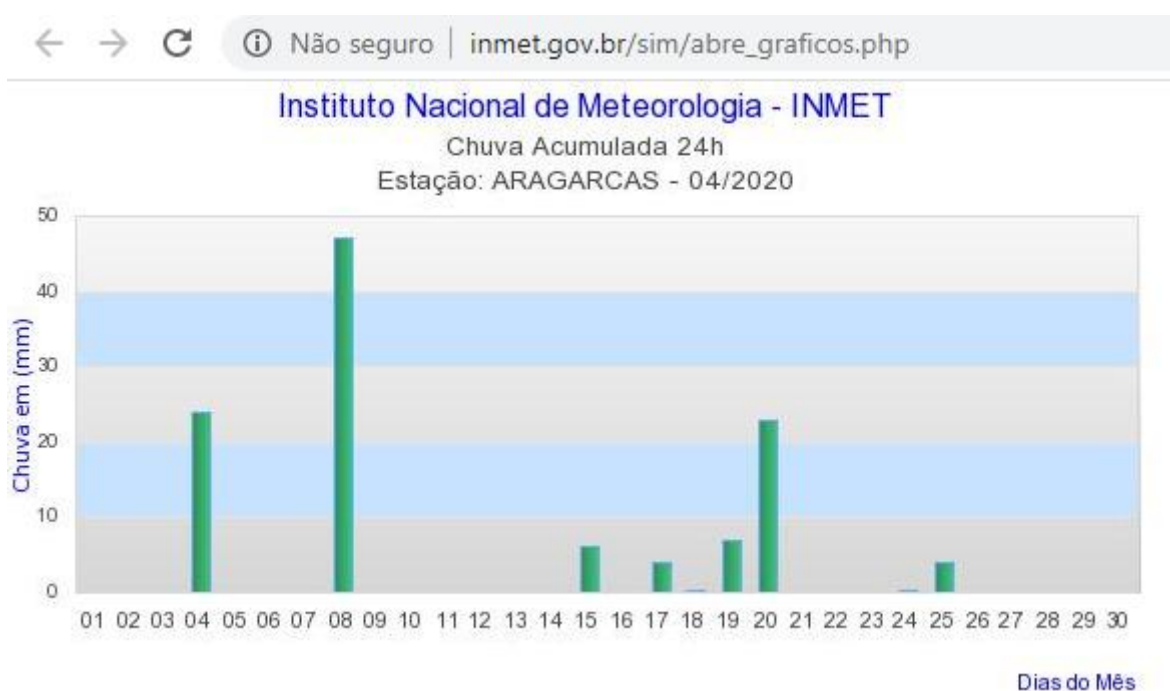

### Instituto Nacional de Meteorologia - INMET

Chuva Acumulada 24h  
Estação: CATALAO - 04/2020

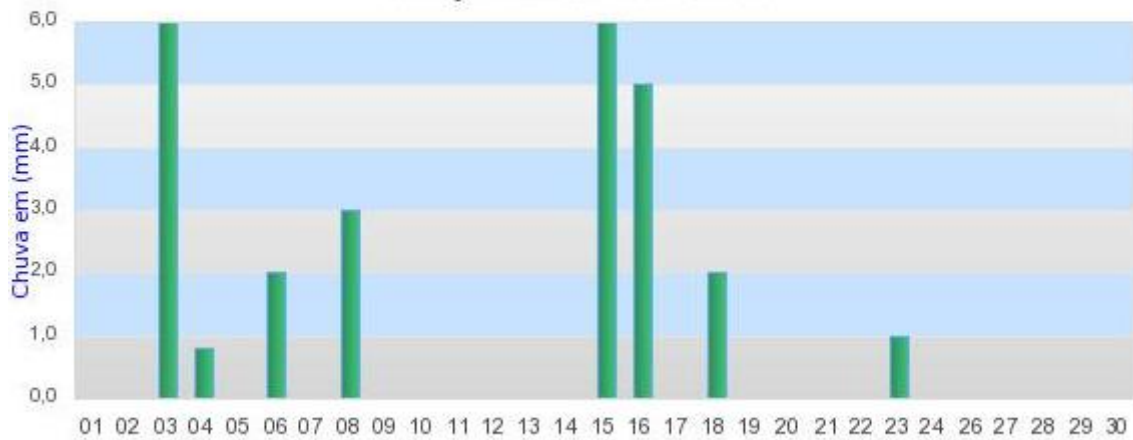

Dias do Mês

### Instituto Nacional de Meteorologia - INMET

Chuva Acumulada 24h  
Estação: FORMOSA - 04/2020

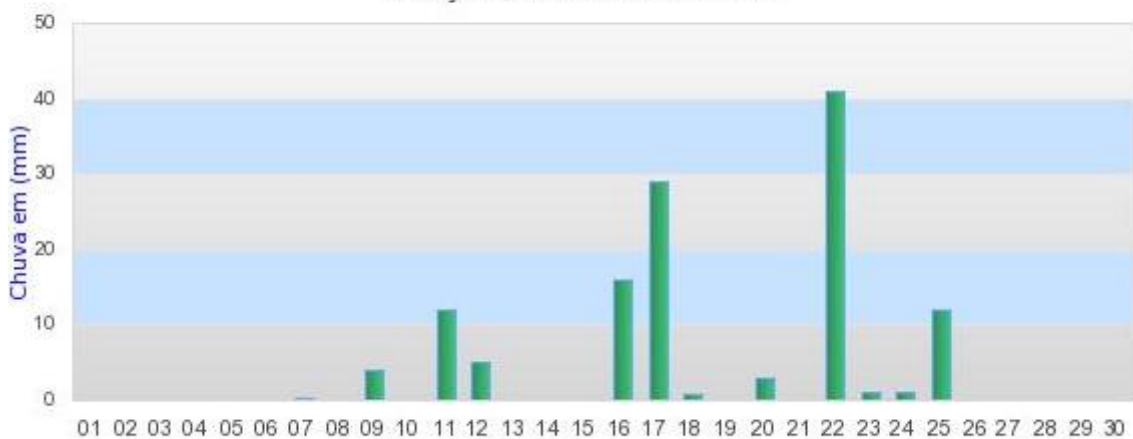

Dias do Mês

### Instituto Nacional de Meteorologia - INMET

Chuva Acumulada 24h  
Estação: GOIANIA - 04/2020

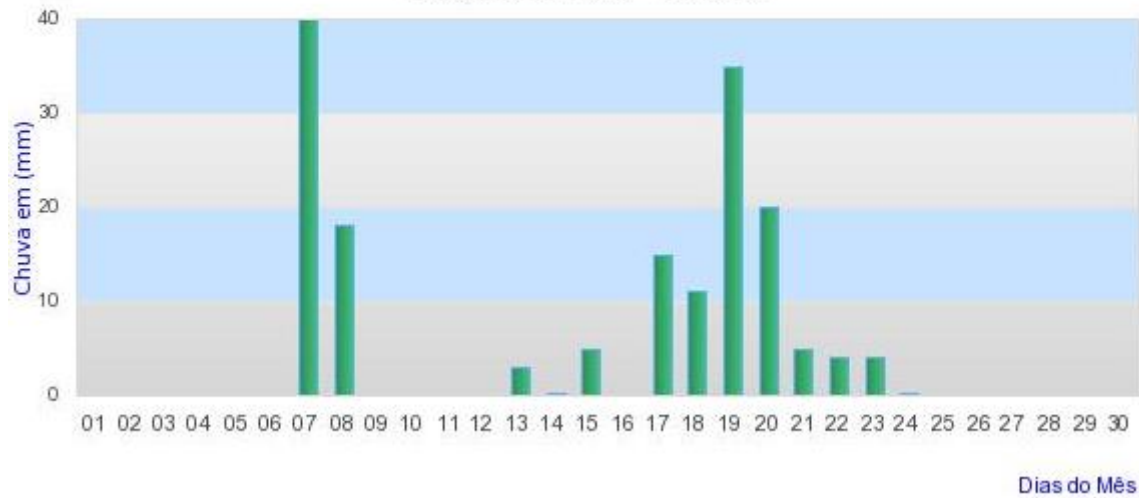

### Instituto Nacional de Meteorologia - INMET

Chuva Acumulada 24h  
Estação: IPAMERI - 04/2020

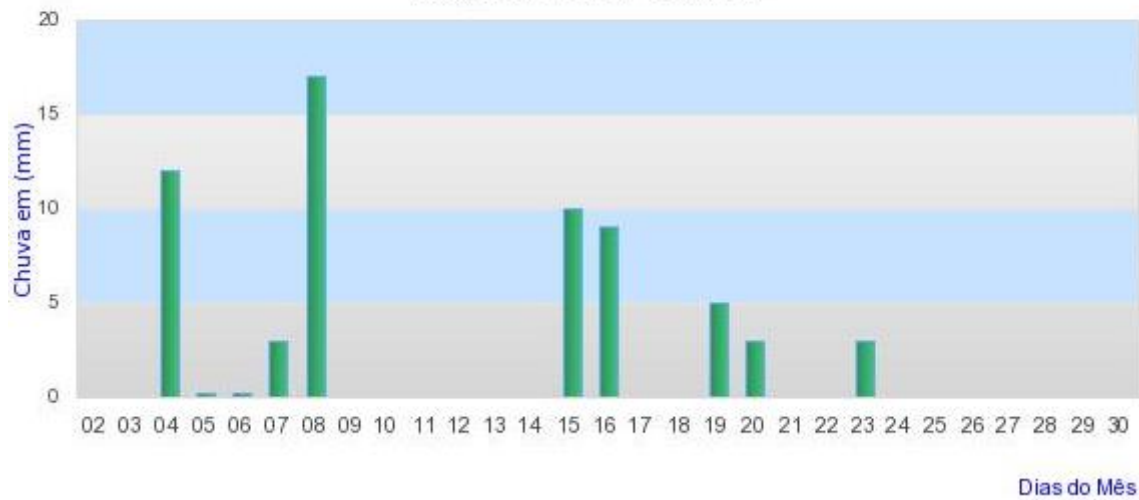



### Instituto Nacional de Meteorologia - INMET

Chuva Acumulada 24h  
Estação: JATAI - 04/2020

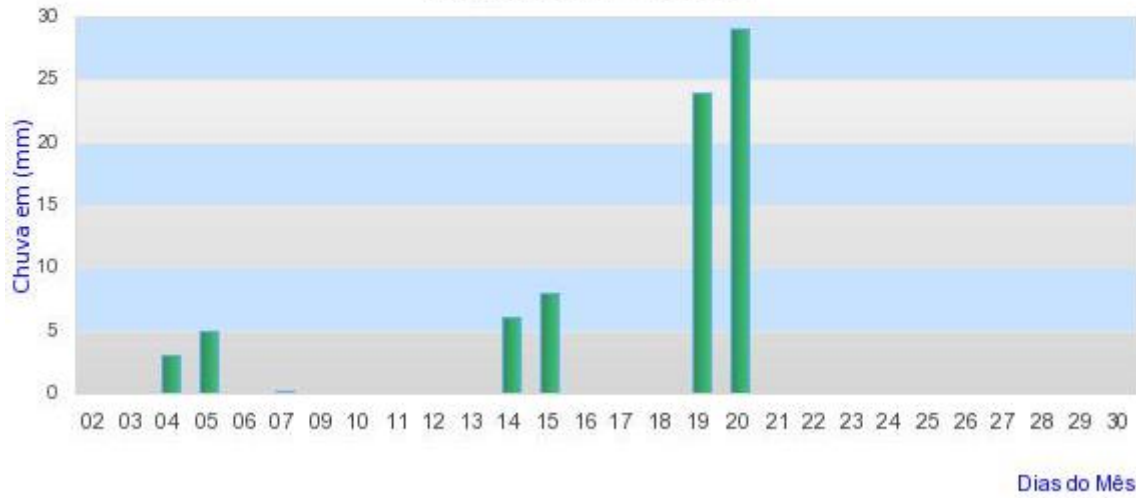

Dias do Mês

### Instituto Nacional de Meteorologia - INMET

Chuva Acumulada 24h  
Estação: PIRENOPOLIS - 04/2020

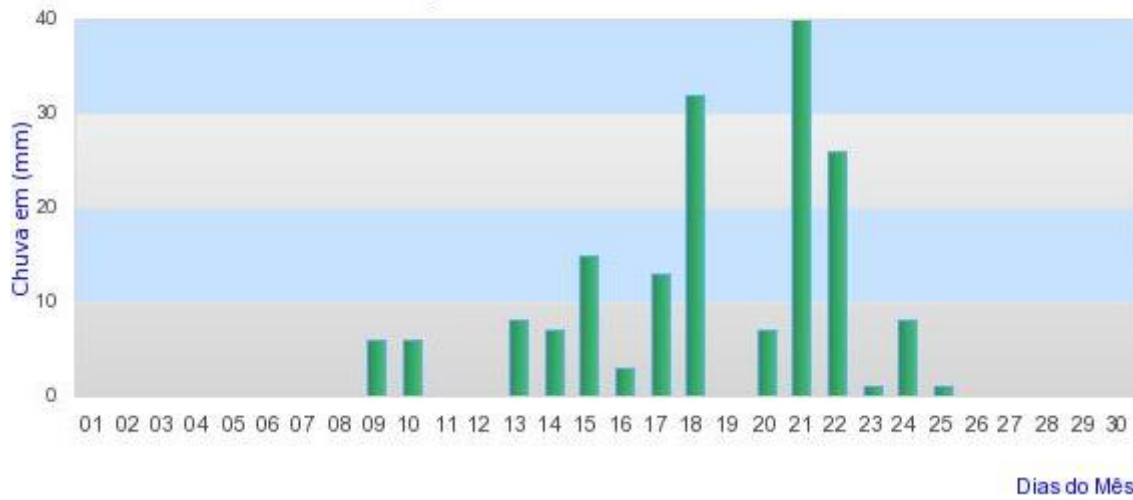

Dias do Mês



### Instituto Nacional de Meteorologia - INMET

Chuva Acumulada 24h  
Estação: POSSE - 04/2020

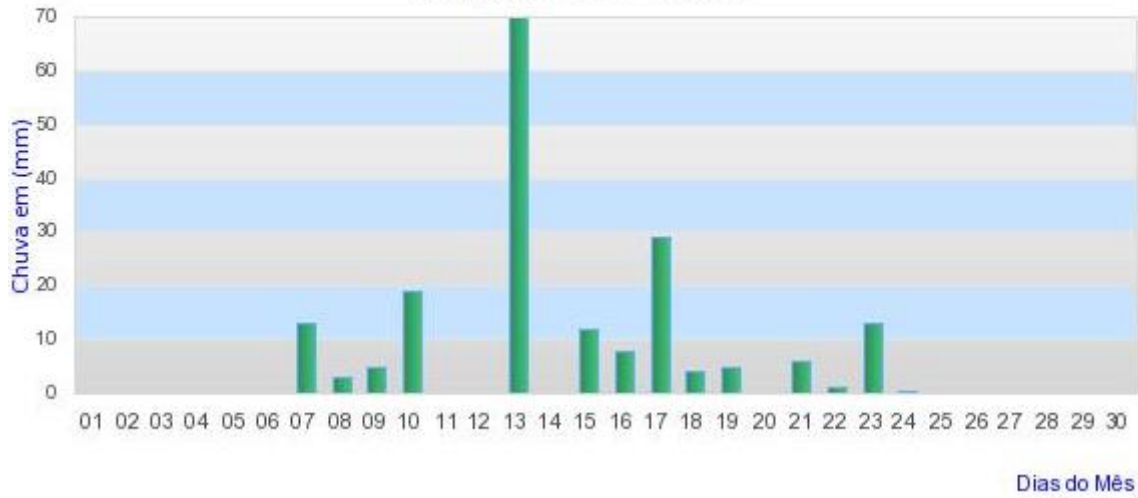

### Instituto Nacional de Meteorologia - INMET

Chuva Acumulada 24h  
Estação: RIO VERDE - 04/2020

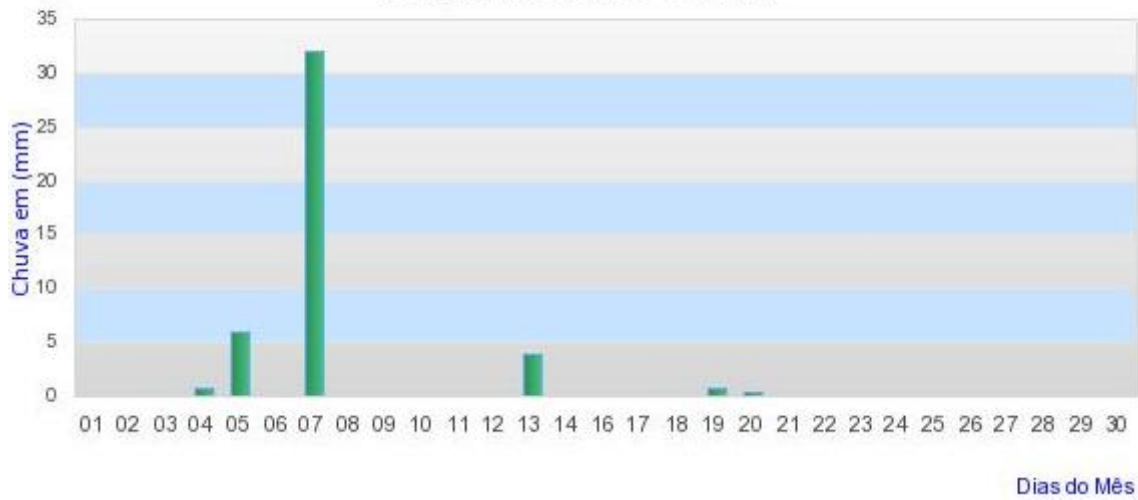

## NOTÍCIAS RELACIONADAS

<http://g1.globo.com/goias/videos/t/todos-os-videos/v/temporais-causam-estragos-%20no-interior-de-goias/8483223/>

### Temporais causam estragos no interior de Goiás

Temporais

15/04/2020 | 03:28

MAIS INFORMAÇÕES

Frente fria no estado alterou as temperaturas nos últimos dias.

Goias



maisgoias • Seguindo



maisgoias Tempo: chove forte nesse momento na cidade de Itaberaí. Vídeo @anjufilho

10 sem



andreaborges02 😊



10 sem Responder



marinalva.marques.5 😊



10 sem Responder



\_eluciana O triste desse vídeo é o povo achando graça.



160.080 visualizações

14 DE ABRIL

Adicione um comentário...

Publicar

<https://www.instagram.com/p/B-98hHgFDk/?igshid=1pwy2ehnj3xl0>



maisgoias • Seguindo



**maisgoias** Tempo: chove forte nesse momento em vários bairros de Goiânia. Vídeo registrado no Jardim América pela leitora @kandiceveigajardim

10 sem



**souzafilho27** É Goiânia véia.. 🤔



10 sem 2 curtidas Responder



**ivan\_ribeiro\_2017** É tempinho bom viu graças a Deus



10 sem 3 curtidas Responder



**sarah.costa.94** Jardim Europa também chove assim.



40.618 visualizações

16 DE ABRIL

Adicione um comentário...

Publicar

[https://www.instagram.com/p/B\\_Da1VVFLkQ/](https://www.instagram.com/p/B_Da1VVFLkQ/)