

EDEL DISTRIBUIÇÃO GOIÁS



Relatório de Evento em Situação de Emergência
Nº CHI-048

Introdução

As concessionárias do serviço público de distribuição de energia elétrica devem prover o serviço de forma adequada, buscando sempre a eficiência, conforme disposto na legislação e nos respectivos contratos de concessão.

Dentre a legislação vigente, destacam-se os Procedimentos de Distribuição de Energia Elétrica no Sistema Elétrico Nacional – PRODIST, que consistem em documentos elaborados pela Agência Nacional de Energia Elétrica – ANEEL, com a participação dos agentes de distribuição e de outras entidades e associações do setor elétrico nacional, que normatizam e padronizam as atividades técnicas relacionadas ao funcionamento e desempenho dos sistemas de distribuição de energia elétrica.

O Módulo 8 do PRODIST – Revisão 11, mais especificamente em sua Seção 8.2, regulamenta a qualidade do serviço prestado pelas distribuidoras de energia elétrica, estabelecendo a metodologia para apuração dos indicadores de continuidade e dos tempos de atendimento a ocorrências emergenciais.

O referido regulamento prevê que, na apuração dos indicadores coletivos e individuais deverão ser consideradas todas as interrupções de longa duração que atingirem as unidades consumidoras, admitidas algumas exceções (denominadas expurgos), que podem ser encontradas no Item 5.6.2.2 da seção 8.2 do Módulo 8 do PRODIST, transcrito abaixo:

5.6.2.2 Na apuração dos indicadores DEC e FEC devem ser consideradas todas as interrupções, admitidas apenas as seguintes exceções:

i. falha nas instalações da unidade consumidora que não provoque interrupção em instalações de terceiros;

ii. interrupção decorrente de obras de interesse exclusivo do consumidor e que afete somente a unidade consumidora do mesmo;

iii. Interrupção em Situação de Emergência;

iv. suspensão por inadimplemento do consumidor ou por deficiência técnica e/ou de segurança das instalações da unidade consumidora que não provoque interrupção em instalações de terceiros, previstas em regulamentação;

v. vinculadas a programas de racionamento instituídos pela União;

vi. ocorridas em Dia Crítico;

vii. oriundas de atuação de Esquema Regional de Alívio de Carga estabelecido pelo ONS. [grifos nossos]

Para os casos de expurgo por Interrupção em Situação de Emergência (ISE), a alínea “h” do Item 5.12.1 da seção 8.2 do Módulo 8 do PRODIST estabelece a obrigatoriedade das distribuidoras em disponibilizar, em seu sítio eletrônico, relatórios digitais com as evidências do evento que tenha gerado tais interrupções enquadradas no inciso iii do Item 5.6.2.2 do mesmo.

Nesta seara, o presente documento, visa apresentar as evidências de um evento ocorrido na área de concessão da Eletropaulo, bem como informações relevantes a respeito das interrupções em Situação de Emergência decorrentes do mesmo.

Destaca-se que, para o entendimento completo das regras de apuração dos indicadores de continuidade e expurgos, faz-se necessário também a observação das regras contidas nos Módulos 1 e 6 do PRODIST. Todos os módulos destes procedimentos encontram-se disponíveis para consulta no site da ANEEL (www.aneel.gov.br) e as principais definições relacionadas ao tema estão contidas no item 2 deste documento.

Definição

Seção 1.2 do Módulo 1 do PRODIST – Revisão 10

2.198 Evento

Acontecimento que afete as condições normais de funcionamento de uma rede elétrica, podendo gerar uma ou mais interrupções no fornecimento de energia.

2.131 e 2.158 DIC

Duração de interrupção individual por unidade consumidora, ou seja, intervalo de tempo que, no

período de apuração, em cada unidade consumidora ou ponto de conexão ocorreu descontinuidade da distribuição de energia elétrica.

2.216 e 2.220 FIC

Frequência de interrupção individual por unidade consumidora, ou seja, Número de interrupções ocorridas, no período de apuração, em cada unidade consumidora ou ponto de conexão.

2.87 Consumidor Hora Interrompido (CHI):

Somatório dos DICs dos consumidores atingidos por interrupção no fornecimento de energia, expresso em horas e centésimos de horas.

2.251 Interrupção em Situação de Emergência:

Interrupção originada no sistema de distribuição, resultante de Evento que comprovadamente impossibilite a atuação imediata da distribuidora e que não tenha sido provocada ou agravada por esta e que seja:

- Decorrentes de evento associado a Decreto de Declaração de Situação de Emergência ou Estado de Calamidade Pública emitido por órgão competente; ou
- Decorrentes de Evento cuja soma do CHI das interrupções ocorridas no sistema de distribuição seja superior ao calculado conforme equação a seguir:

$$2.612 \times N^{0,35}$$

N – número de unidades consumidoras faturadas e atendidas em BT ou MT, com 2 (duas) casas decimais, do mês de outubro do ano anterior ao período de apuração

Resumo Executivo

O Presente Relatório tem como objetivo a incorporação de informações que sejam relevantes para que se possa fazer a devida associação aos dados contidos no documento objeto da classificação de Situação de Emergência caracterizada pelo Módulo 8 do Prodist. Este enquadramento se apresenta na maioria das vezes em condições climáticas adversas com severidade dos fatores inerentes a situação, caracterizado na maioria dos casos por fortes ventos e chuvas de grande intensidade e continuidade.

A partir do fim da manhã do dia 21/09/2020 – segunda-feira – Áreas de instabilidade organizadas pela passagem de uma frente fria pela costa brasileira favoreceram a formação de nuvens de tempestade que atuaram sobre o estado de Goiás.

Conforme informações do Climatempo Meteorologia, o Instituto Nacional de Meteorologia (INMET) detectou rajadas de vento acima de 50km/h na noite do dia 21 de setembro de 2020. Na estação de Goiás ocorreram ventos de até 55,8 km/h entre as 20h e 21h do dia 21 de setembro de 2020, classificada como vento forte, segundo a escala Beaufort.

O sistema de detecção da EarthNetworks registrou 41.248 descargas atmosféricas (11.310 nuvem-solo e 29.938 nuvem-nuvem) sobre a área de concessão da ENEL em Goiás entre as 09h00 do dia 21 de setembro de 2020 e 21h30 do dia 23 de setembro de 2020, causando grande instabilidade na rede.

Chuva forte foi registrada pelo INMET em estações representativas da área de concessão da ENEL Distribuição Goiás. Na estação de Caiapônia foram acumulados 59,0 mm de chuva entre as 09h do dia 21 e 09h do dia 23 de setembro. Em apenas 48h choveu a média histórica do mês na região.

Relatório de Ocorrências do período

Em todo o Estado de Goiás verificou-se também que a intensidade da chuva e dos ventos danificaram a rede de distribuição de energia elétrica em diversos pontos, registrando aproximadamente 410 mil clientes com interrupção no fornecimento de energia elétrica devido a eventos relacionados ao temporal, afetando 182 municípios e 213 Subestações.

Para otimizar o volume de atendimentos e reduzir os tempos de interrupção foram mobilizados os recursos extras da empresa que aumentou o contingente em relação a situação normal de operação. O acompanhamento da quantidade de equipes e o Tempo Médio de Atendimento podem ser consultados na Pág.05 do Relatório em anexo.

O impacto e severidade do evento estão relatados em artigos de mídia, como fotos e reportagens que demonstram os danos na Rede de Distribuição, oriundos dos eventos climáticos no período. Eventos estes que afetaram 410.049 consumidores com CHI de 1.218.595,59 superior ao de 482.597,74 estabelecido como limite para definição de Situação de Emergência, conforme resumo das informações obrigatórias.

Empresa	ENEL DISTRIBUIÇÃO GOIÁS					
Código do Relatório	CHI-048 - ENEL DISTRIBUIÇÃO GOIÁS					
Evento:	TEMPORAL NA AREA DE CONCESSÃO DA ENEL DISTRIBUIÇÃO GOIAS					
Código COBRADE:	1.3.1.2.0	Data Início	21/09/2020	Hora início	08h00	
Código do Evento:	CHI-048-ENEL GO	Data Término	23/09/2020	Hora Término	21h45	
Valor CHI (Limite e Real)	482.597,74	1.218.595,59				
Código do Decreto (Se Houver):						
Quantidade de Interrupções (Evento)	4.561					
Início 1ª Incidência (Data e Hora)	21/09/2020 09:02		Subestações Atingidas	ABADIANA / ABC / ACREUNA / ADELANDIA / AGUAS LINDAS / ALEXANIA / ALEXANIA TRANSMISSAO / ALPHAVILLE / ALTO HORIZONTE / ALTO PARAISO DE GOIAS / ALVORADA DO NORTE / AMERICANO DO BRASIL / AMORINOPOLIS / ANAPOLIS UNIVERSITARIA / ANICUNS / ANTONIO DO VITTO / APARECIDA DO RIO DOCE / APORE / ARAGARCAS / ARAGUAPAZ / ARENOPOLIS / ARUANA / ARUANA (TRANSMISSAO) / ASA BRANCA / AURILANDIA / AVELINOPOLIS / BACURI (RIO VERDE) / BARBOSELANDIA / BARREIRO (PORANGATU) / BARRO ALTO / BOM JARDIM / BONOPOLIS / BONSUCESSO (RIO VERDE) / BRITANIA / BURITI DE GOIAS / CABECEIRAS / CABRIUVA (RIO VERDE) / CACHOEIRA ALTA / CACHOEIRINHA (ITARUMA) / CACU / CAIAPONIA / CAMPINORTE / CAMPO NOVO / CAMPOS BELOS / CAMPOS VERDES / CASTELANDIA / CEBRASA FABRICA DA AMBEV / CEMAT/BALIZA / CEZARINA / CHAPADAO DO CEU / CIDADE OCIDENTAL / COCALZINHO / COLINACU / CORUMBA / CRISTALINA / CRISTALINA TRANSMISSAO / CRIXAS / DAIA - ANAPOLIS / DESFECHO / DESTILARIA BRASIL CENTRAL / DIORAMA / DORCELINO PEIXOTO DE MORAES / DOVERLANDIA / ENERSUL / ESTRELA DO NORTE / FAINA / FAZENDA CANADA / FAZENDA NOVA / FIRMINOPOLIS / FLORES DE GOIAS / FORMOSO / FRONTEIRA / GAMELEIRA / GOIANAPOLIS / GOIANESIA / GOIAS / GOUVERLANDIA / HEITORAI / HIDROLINA / IACIARA / INACIOLANDIA / INDIARA / IPEGUARI / IPORA / ISRAELANDIA / ITABERAI / ITAGUARI / ITAGUARU / ITAJA / ITAPACI / ITAPACI (TRANSMISSAO) / ITAPIRAPUA / ITAPURANGA / ITARUMA / ITIQUIRA (FORMOSA) / JACILANDIA / JANDAIA / JARAGUA / JARANAPOLIS / JATAI / JAUPACI / JESUPOLIS / JUNDIAI / JURUMIRIM / JUSCELANDIA / JUSSARA / LAGES / LAGOA DO BAUZINHO (RIO VERDE) / LEOPOLDO DE BULHOES / LUZIANIA / LUZIANIA INDUSTRIAL / MAMBAI / MARA ROSA / MARAJOARA / MARIAPOLIS (PADRE BERNARDO) / MATO GRANDE / MATRINCHA / MAURILANDIA / MINACU / MINEIROS / MINEIROS TRANSMISSAO / MOIPORA / MONTE ALEGRE / MONTES CLAROS DE GOIAS / MONTIVIDIU T / MORRO AGUDO / MOZARLANDIA / MOZARLANDIA (TRANSMISSAO) / MUNDO NOVO DE GOIAS / MUTUNOPOLIS / NAVESLANDIA (JATAI) / NAZARIO / NIQUELANDIA / NOVA AMERICA / NOVA CRIXAS (TRANSMISSAO) / NOVA IGUACU / NOVA PONTE / NOVO GAMA / NOVO PLANALTO / OLHOS DAGUA / PACAEMBU (NOVO GAMA) / PADRE BERNARDO / PALESTINA / PALMEIRAS / PALMEIRAS DE GOIAS / PALMINOPOLIS / PAMPLONA / PARANA / PARANAIGUARA / PARAUNA SE ALTA TENSÃO / PARQUE DAS EMAS (MINEIROS) / PARQUE DAS NACOES / PEROLANDIA / PETROLINA / PILAR / PIRANHAS T / PIRENOPOLIS / PLANALTINA / PLANALTINA (TRANSMISSAO) / PORANGATU / PORTEIRAO / PORTELANDIA / PORTO SAO SIMAO / POSSE / QUEBRA LINHA / QUIRINOPOLIS / RETIRO / GOIAS / RIO CLARO JATAI MONTIVIDIU / RIO DO PEIXE / RIO DOS BOIS (MAURILANDIA) / RIO PRETO / RIO VERDE / RIO VERMELHO / RIVERLANDIA (RIO VERDE) / RUBIATABA / SANCLERLANDIA / SANTA FE DE GOIAS / SANTA HELENA / SANTA RITA DO ARAGUAIA / SANTA ROSA / SANTA TEREZA DE GOIAS / SANTA TEREZINHA / SANTANA / SANTO ANTONIO DA BARRA / SANTO ANTONIO DO DESCOBERTO / SAO BARTOLOMEU / SAO DOMINGOS / SAO FRANCISCO DE GOIAS / SAO GABRIEL DE GOIAS / SAO JOAO D ALIANCA / SAO JOAO DA PARAUNA / SAO LUIZ DOS MONTES BELOS / SAO MIGUEL DO ARAGUAIA / SAO SIMAO / SERRA AZUL (JATAI) / SERRANOPOLIS / SOUZALANDIA / SUCURI / TAQUARAL / TEREZOPOLIS / TRAJANOPOLIS (PADRE BERNARDO) / TRES BARRAS / TURVANIA / TURVELANDIA / URU / URUACU / USINA DE ACUCAR DE GOIANESIA / USINA MAMBAI / VALPARAISO / VILA PROPICIO / XIXA / ZELANDIA / VILA BOA		
Início Ultima Incidência (Data e Hora)	23/09/2020 21:13			Municípios Atingidos	ABADIA DE GOIAS / ABADIANA / ACREUNA / ADELANDIA / AGUA FRIA DE GOIAS / AGUAS LINDAS DE GOIAS / ALEXANIA / ALTO HORIZONTE / ALTO PARAISO DE GOIAS / ALVORADA DO NORTE / AMARALINA / AMERICANO DO BRASIL / AMORINOPOLIS / ANAPOLIS / ANICUNS / APARECIDA DO RIO DOCE / APORE / ARAGARCAS / ARAGUAPAZ / ARENOPOLIS / ARUANA / AURILANDIA / AVELINOPOLIS / BALIZA / BARRO ALTO / BOM JARDIM DE GOIAS / BOM JESUS DE GOIAS / BONOPOLIS / BRITANIA / BURITI DE GOIAS / BURITINOPOLIS / CABECEIRAS / CACHOEIRA ALTA / CACHOEIRA DE GOIAS / CACU / CAIAPONIA / CAMPINACU / CAMPINORTE / CAMPOS BELOS / CAMPOS VERDES / CARMO DO RIO VERDE / CASTELANDIA / CAVALCANTE / CERES / CEZARINA / CHAPADAO DO CEU / CIDADE OCIDENTAL / COCALZINHO DE GOIAS / COLINAS DO SUL / CORREGO DO OURO / CORUMBA DE GOIAS / CRISTALINA / CRIXAS / DAMIANOPOLIS / DIORAMA / DISTRITO FEDERAL / DIVINOPOLIS DE GOIAS / DOVERLANDIA / EDEIA / ESTRELA DO NORTE / FAINA / FAZENDA NOVA / FIRMINOPOLIS / FLORES DE GOIAS / FORMOSA / FORMOSO /	
Média de Duração das Incidências (h)	8,92					
Duração da Incidência mais longa (h)	78,85					
Total de Clientes afetados	410.049					

			GAMELEIRA DE GOIAS / GOIANAPOLIS / GOIANESIA / GOIAS / GOUVELANDIA / GUARAITA / GUARANI DE GOIAS / GUARINOS / HEITORAI / HIDROLINA / IACIARA / INACIOLANDIA / INDIARA / IPAMERI / IPIRANGA DE GOIAS / IPORA / ISRAELANDIA / ITABERAI / ITAGUARI / ITAGUARU / ITAJA / ITAPACI / ITAPIRAPUA / ITAPURANGA / ITARUMA / ITAUCU / ITUMBIARA / IVOLANDIA / JANDAIA / JARAGUA / JATAI / JAUPACI / JESUPOLIS / JUSSARA / LAGOA SANTA / LEOPOLDO DE BULHOES / LUZIANIA / MAMBAI / MARA ROSA / MATRINCHA / MAURILANDIA / MIMOSO DE GOIAS / MINACU / MINEIROS / MOIPORA / MONTE ALEGRE DE GOIAS / MONTES CLAROS DE GOIAS / MONTIVIDIU / MONTIVIDIU DO NORTE / MORRO AGUDO DE GOIAS / MOSSAMEDES / MOZARLANDIA / MUNDO NOVO DE GOIAS / MUTUNOPOLIS / NAZARIO / NIQUELANDIA / NOVA AMERICA / NOVA CRIXAS / NOVA GLORIA / NOVA IGUACU DE GOIAS / NOVA ROMA / NOVO BRASIL / NOVO GAMA / NOVO PLANALTO / PADRE BERNARDO / PALESTINA DE GOIAS / PALMEIRAS DE GOIAS / PALMINOPOLIS / PARANAIGUARA / PARAUNA / PEROLANDIA / PETROLINA DE GOIAS / PILAR DE GOIAS / PIRANHAS / PIRENOPOLIS / PLANALTINA / PORANGATU / PORTEIRAO / PORTELANDIA / POSSE / QUIRINOPOLIS / RIO VERDE / RUBIATABA / SANCLERLANDIA / SANTA FE DE GOIAS / SANTA HELENA DE GOIAS / SANTA ISABEL / SANTA RITA DO ARAGUAIA / SANTA RITA DO NOVO DESTINO / SANTA TEREZA DE GOIAS / SANTA TEREZINHA DE GOIAS / SANTO ANTONIO DA BARRA / SANTO ANTONIO DO DESCOBERTO / SAO DOMINGOS / SAO FRANCISCO DE GOIAS / SAO JOAO D ALIANCA / SAO JOAO DA PARAUNA / SAO LUIS DE MONTES BELOS / SAO LUIZ DO NORTE / SAO MIGUEL DO ARAGUAIA / SAO SIMAO / SERRANOPOLIS / SILVANIA / SIMOLANDIA / SITIO D ABADIA / TAQUARAL DE GOIAS / TERESINA DE GOIAS / TEREZOPOLIS DE GOIAS / TROMBAS / TURVANIA / TURVELANDIA / UIRAPURU / URUACU / VALPARAISO DE GOIAS / VILA BOA / VILA PROPICIO
--	--	--	-------------------------------------------------------------------------------------------------------------------------------------------------------------------------------------------------------------------------------------------------------------------------------------------------------------------------------------------------------------------------------------------------------------------------------------------------------------------------------------------------------------------------------------------------------------------------------------------------------------------------------------------------------------------------------------------------------------------------------------------------------------------------------------------------------------------------------------------------------------------------------------------------------------------------------------------------------------------------------------------------------------------------------------------------------------------------------------------------------------------------------------------------------------------------------------------------------------------------------------------------------------------------------------------------------------------------------------------------------------------------------------------------------------------------------------------------------------------------------------------------------------------------------------------------------------------------------------------------------------------------------------------------------------------------------------------------------------------------------------------------------------------------------------------------------------------------

DANOS CAUSADOS			
Equipamentos Danificado	Importância para o Sistema	Local	Quantidade
Disjuntor/Religador Operado	Proteção do Alimentador	Área de Concessão	143
Chaves Fusíveis Operada	Proteção de Ramais de Alimentadores	Área de Concessão	1.032
Transformador Operado	Proteção do Transformador	Área de Concessão	958

Relato técnico sobre a Intervenção realizada em Goiânia e Região Metropolitana				
Informações sobre Equipes	21/09	22/09	23/09	
Quantidade Usual	916	916	916	turmas
Quantidade Adicional	7	107	144	turmas
Quantidade Total	923	1023	1060	turmas
Tempos Médios				
Preparação	4,05	6,25	3,88	Horas
Deslocamento	0,73	0,58	0,63	Horas
Execução	0,93	0,9	0,75	Horas
TMAE	5,70	7,73	5,27	Horas

Principais Dificuldades Encontradas:

Chuvas com ventos fortes provocaram muitos pontos de alagamento e enxurrada, trânsito impedido por vários semáforos desligados dificultando a chegada ao atendimento das ocorrências emergenciais. Em determinadas regiões, decorrente dos fortes ventos, houve o tombamento de árvores nas estruturas de alimentação de média tensão, danos em ramais de ligação dos clientes, impedimentos de acesso e atolamentos em estradas rurais.

Empresa	ENEL DISTRIBUIÇÃO GOIAS		
Valor CHI (Limite e Real)	482.597,74		1.218.595,59

DOC ORIGEM	MIUNICIPIO	EQP_ORIGEM	CONJUNTO	INI_OCORRENC	FIM_OCORRENC	DT_INI_EVENTO	DT_FIM_EVENTO	DURAÇ	UC INT	CHI	EXPURGO
20200954967	RIO VERDE	RV12384641	RIO VERDE S2	21/09/2020 09:02	21/09/2020 10:53	21/09/2020 09:02	21/09/2020 10:53	1,84	548	1010,15	CHI
20200954688	QUIRINOPOLIS	10017211628	QUIRINOPOLIS	21/09/2020 09:04	21/09/2020 10:56	21/09/2020 09:04	21/09/2020 10:56	1,87	1	1,87	CHI
20200954776	RIO VERDE	RV10402239	CABRIUVA S2	21/09/2020 09:06	21/09/2020 16:17	21/09/2020 09:06	21/09/2020 11:11	2,08	12	24,92	CHI
20200954776	RIO VERDE	RV10402239	CABRIUVA S2	21/09/2020 09:06	21/09/2020 16:17	21/09/2020 09:06	21/09/2020 12:09	3,04	7	21,25	CHI
20200954776	RIO VERDE	RV10402239	CABRIUVA S2	21/09/2020 09:06	21/09/2020 16:17	21/09/2020 09:06	21/09/2020 14:04	4,95	6	29,72	CHI
20200954776	RIO VERDE	RV12332189LD	CABRIUVA S2	21/09/2020 09:06	21/09/2020 16:17	21/09/2020 09:06	21/09/2020 16:17	7,18	5	35,88	CHI
20200954710	QUIRINOPOLIS	80076671	QUIRINOPOLIS	21/09/2020 09:09	21/09/2020 10:18	21/09/2020 09:09	21/09/2020 10:18	1,15	1	1,15	CHI
20200954739	RIO VERDE	RV21301034	CABRIUVA S2	21/09/2020 09:12	21/09/2020 15:24	21/09/2020 09:12	21/09/2020 15:24	6,18	1	6,18	CHI
20200954741	RIO VERDE	RV12260596	CABRIUVA S2	21/09/2020 09:13	21/09/2020 16:15	21/09/2020 09:13	21/09/2020 16:15	7,03	2	14,05	CHI
20200954754	MINEIROS	1390107106	PARQUE DAS EMAS	21/09/2020 09:15	21/09/2020 11:04	21/09/2020 09:15	21/09/2020 11:04	1,81	1	1,81	CHI
20200954793	RIO VERDE	RV12327049	CABRIUVA S2	21/09/2020 09:17	21/09/2020 20:34	21/09/2020 09:17	21/09/2020 20:34	11,27	3	33,81	CHI
20200954792	SANTA HELENA DE GOIAS	SH12207104	IPEGUARI	21/09/2020 09:18	21/09/2020 11:34	21/09/2020 09:18	21/09/2020 11:34	2,25	18	40,56	CHI
20200954787	CASTELANDIA	1890015626	RIO DOS BOIS	21/09/2020 09:19	21/09/2020 17:01	21/09/2020 09:19	21/09/2020 17:01	7,69	1	7,69	CHI
20200955321	RIO VERDE	RV12279609	RIO VERDE S1	21/09/2020 09:20	21/09/2020 15:08	21/09/2020 09:20	21/09/2020 15:08	5,79	31	179,34	CHI
20200954817	ACREUNA	EU21045191	ACREUNA	21/09/2020 09:23	21/09/2020 10:53	21/09/2020 09:23	21/09/2020 10:53	1,49	1	1,49	CHI
20200954837	MINEIROS	SU21157165	SANTA RITA DO ARAGUAIA	21/09/2020 09:26	21/09/2020 11:23	21/09/2020 09:26	21/09/2020 11:23	1,94	1	1,94	CHI
202009107091	RIO VERDE	RV21383946	CABRIUVA S2	21/09/2020 09:28	21/09/2020 10:11	21/09/2020 09:28	21/09/2020 10:11	0,72	1	0,72	CHI
20200954894	SAO SIMAO	SO12226538LD	CACHOEIRA ALTA	21/09/2020 09:37	21/09/2020 18:16	21/09/2020 09:37	21/09/2020 18:16	8,64	26	224,65	CHI
20200954901	PARANAIGUARA	2230008487	CACHOEIRA ALTA	21/09/2020 09:38	21/09/2020 13:12	21/09/2020 09:38	21/09/2020 13:12	3,56	1	3,56	CHI
20200954936	RIO VERDE	RV12222010	MONTIVIDIU T	21/09/2020 09:43	21/09/2020 13:49	21/09/2020 09:43	21/09/2020 13:49	4,10	9	36,89	CHI

INTERNAL

20200954942	RIO VERDE	MV12214147	MONTIVIDIU T	21/09/2020 09:43	21/09/2020 11:18	21/09/2020 09:43	21/09/2020 11:18	1,57	2	3,13	CHI
20200954942	MONTIVIDIU	MV12214147	MONTIVIDIU T	21/09/2020 09:43	21/09/2020 11:18	21/09/2020 09:43	21/09/2020 11:18	1,57	3	4,70	CHI
20200954957	RIO VERDE	630296935	RIO VERDE S1	21/09/2020 09:47	22/09/2020 11:56	21/09/2020 09:47	22/09/2020 11:56	26,15	1	26,15	CHI
20200954983	JATAI	290296493	JATAI S3	21/09/2020 09:52	21/09/2020 16:41	21/09/2020 09:52	21/09/2020 16:41	6,83	1	6,83	CHI
20200956105	RIO VERDE	RV12303758	RIO VERDE S1	21/09/2020 09:54	21/09/2020 15:56	21/09/2020 09:54	21/09/2020 15:56	6,03	180	1085,95	CHI
20200955036	CACU	CC21075797	CACHOEIRA ALTA	21/09/2020 10:04	21/09/2020 13:53	21/09/2020 10:04	21/09/2020 13:53	3,81	1	3,81	CHI
20200955042	CACHOEIRA ALTA	CA12079000	CACHOEIRA ALTA	21/09/2020 10:04	21/09/2020 11:58	21/09/2020 10:04	21/09/2020 11:58	1,89	9	16,98	CHI
20200955051	FORMOSA	FA31042659	ITUIQUIRA	21/09/2020 10:06	21/09/2020 13:23	21/09/2020 10:06	21/09/2020 13:23	3,27	1	3,27	CHI
202009107089	RIO VERDE	RV10406663	CABRIUVA S2	21/09/2020 10:07	21/09/2020 16:07	21/09/2020 10:07	21/09/2020 10:11	0,06	37	2,23	CHI
202009107089	RIO VERDE	RV10406663	CABRIUVA S2	21/09/2020 10:07	21/09/2020 16:07	21/09/2020 10:07	21/09/2020 10:11	0,06	41	2,59	CHI
202009107089	RIO VERDE	RV10406663	CABRIUVA S2	21/09/2020 10:07	21/09/2020 16:07	21/09/2020 10:07	21/09/2020 14:23	4,26	36	153,28	CHI
202009107089	RIO VERDE	RV10406663	CABRIUVA S2	21/09/2020 10:07	21/09/2020 16:07	21/09/2020 10:07	21/09/2020 16:07	5,99	10	59,89	CHI
20200955068	JATAI	290219139	JATAI S2	21/09/2020 10:08	22/09/2020 09:13	21/09/2020 10:08	22/09/2020 09:13	23,07	1	23,07	CHI
20200955088	ACREUNA	EU21000141	ACREUNA	21/09/2020 10:10	21/09/2020 12:08	21/09/2020 10:10	21/09/2020 12:08	1,95	2	3,90	CHI
20200955297	RIO VERDE	RV12237206	CABRIUVA S2	21/09/2020 10:14	21/09/2020 13:15	21/09/2020 10:14	21/09/2020 13:15	3,01	4	12,04	CHI
20200955185	QUIRINOPOLIS	QI11018006	QUIRINOPOLIS	21/09/2020 10:14	21/09/2020 11:02	21/09/2020 10:14	21/09/2020 11:02	0,79	114	89,74	CHI
20200955494	RIO VERDE	RV11000020	RIO VERDE S2	21/09/2020 10:18	21/09/2020 14:42	21/09/2020 10:18	21/09/2020 14:42	4,40	92	404,42	CHI
20200955126	SANTA HELENA DE GOIAS	400111457	IPEGUARI	21/09/2020 10:20	21/09/2020 18:40	21/09/2020 10:20	21/09/2020 18:40	8,33	1	8,33	CHI
20200955165	FLORES DE GOIAS	FB21233550	FLORES DE GOIAS	21/09/2020 10:26	21/09/2020 13:49	21/09/2020 10:26	21/09/2020 13:49	3,38	1	3,38	CHI
20200955173	FORMOSA	FA12042035	ITUIQUIRA	21/09/2020 10:27	21/09/2020 11:37	21/09/2020 10:27	21/09/2020 11:37	1,16	4	4,63	CHI
20200955219	RIO VERDE	RV21260771	CABRIUVA S1	21/09/2020 10:32	21/09/2020 17:41	21/09/2020 10:32	21/09/2020 17:41	7,14	1	7,14	CHI
20200955244	FORMOSA	FA11363500	SAO JOAO D ALIANCA	21/09/2020 10:38	21/09/2020 15:39	21/09/2020 10:38	21/09/2020 15:39	5,01	1	5,01	CHI
20200955295	CACU	10001667066	CACHOEIRA ALTA	21/09/2020 10:47	21/09/2020 17:07	21/09/2020 10:47	21/09/2020 17:07	6,32	1	6,32	CHI
20200955303	IACIARA	1550019548	IACIARA S1	21/09/2020 10:50	21/09/2020 14:42	21/09/2020 10:50	21/09/2020 14:42	3,86	1	3,86	CHI
20200955313	IACIARA	IA12046295	IACIARA S2	21/09/2020 10:51	21/09/2020 13:30	21/09/2020 10:51	21/09/2020 13:30	2,64	62	163,40	CHI
20200955313	FLORES DE GOIAS	IA12046295	IACIARA S2	21/09/2020 10:51	21/09/2020 13:30	21/09/2020 10:51	21/09/2020 13:30	2,64	1	2,64	CHI
20200955333	POSSE	1480008786	IACIARA S2	21/09/2020 10:55	21/09/2020 14:24	21/09/2020 10:55	21/09/2020 14:24	3,48	1	3,48	CHI
20200955335	MINEIROS	MY21370554	PARQUE DAS EMAS	21/09/2020 10:55	21/09/2020 15:27	21/09/2020 10:55	21/09/2020 15:27	4,52	2	9,04	CHI
20200955397	SAO SIMAO	SO11380617	CACHOEIRA ALTA	21/09/2020 10:56	21/09/2020 14:12	21/09/2020 10:56	21/09/2020 14:12	3,25	44	143,18	CHI
20200955345	JATAI	JT12191107	JATAI S1	21/09/2020 10:58	21/09/2020 14:05	21/09/2020 10:58	21/09/2020 14:05	3,11	6	18,67	CHI
20200955361	FORMOSA	FA12243086	ITUIQUIRA	21/09/2020 11:01	21/09/2020 12:35	21/09/2020 11:01	21/09/2020 12:35	1,56	1	1,56	CHI
20200955364	JATAI	290167553	JATAI S3	21/09/2020 11:02	22/09/2020 12:04	21/09/2020 11:02	22/09/2020 12:04	25,02	1	25,02	CHI
20200956069	RIO VERDE	RV12296245	CABRIUVA S1	21/09/2020 11:06	22/09/2020 06:38	21/09/2020 11:06	21/09/2020 20:35	9,48	5	47,39	CHI

INTERNAL

20200956069	RIO VERDE	RV12296022LD	CABRIUVA S1	21/09/2020 11:06	22/09/2020 06:38	21/09/2020 11:06	22/09/2020 06:38	19,53	5	97,65	CHI
20200955380	ITARUMA	IM21239544	CACHOEIRA ALTA	21/09/2020 11:07	21/09/2020 16:56	21/09/2020 11:07	21/09/2020 16:56	5,81	4	23,25	CHI
20200955395	ITARUMA	2310002570	CACHOEIRA ALTA	21/09/2020 11:10	21/09/2020 14:58	21/09/2020 11:10	21/09/2020 14:58	3,79	1	3,79	CHI
20200955406	ITARUMA	IM21041684	CACHOEIRA ALTA	21/09/2020 11:12	21/09/2020 19:18	21/09/2020 11:12	21/09/2020 19:18	8,09	2	16,19	CHI
20200955409	DAMIANOPOLIS	DA12060858	IACIARA S2	21/09/2020 11:13	21/09/2020 12:18	21/09/2020 11:13	21/09/2020 12:18	1,08	2	2,16	CHI
20200955423	FORMOSA	FA21325408	ITIQUEIRA	21/09/2020 11:18	21/09/2020 15:01	21/09/2020 11:18	21/09/2020 15:01	3,71	1	3,71	CHI
20200955442	RIO VERDE	630014863	RIO VERDE S2	21/09/2020 11:26	22/09/2020 12:45	21/09/2020 11:26	22/09/2020 12:45	25,30	1	25,30	CHI
20200955454	FORMOSA	2970001981	ITIQUEIRA	21/09/2020 11:30	21/09/2020 13:27	21/09/2020 11:30	21/09/2020 13:27	1,94	1	1,94	CHI
20200955457	ABADIANIA	AA21021505	ANAPOLIS UNIVERSITARIO S1	21/09/2020 11:31	21/09/2020 13:17	21/09/2020 11:31	21/09/2020 13:17	1,77	1	1,77	CHI
20200955465	MAURILANDIA	ML11338605	RIO DOS BOIS	21/09/2020 11:33	21/09/2020 12:38	21/09/2020 11:33	21/09/2020 12:38	1,08	142	153,48	CHI
20200955907	JATAI	JT12072427	JATAI S1	21/09/2020 11:35	21/09/2020 15:32	21/09/2020 11:35	21/09/2020 15:32	3,95	4	15,79	CHI
20200956403	JATAI	290157614	JATAI S3	21/09/2020 11:44	22/09/2020 10:14	21/09/2020 11:44	22/09/2020 10:14	22,50	1	22,50	CHI
20200955513	CACHOEIRA ALTA	1090020421	CACHOEIRA ALTA	21/09/2020 11:46	21/09/2020 12:52	21/09/2020 11:46	21/09/2020 12:52	1,09	1	1,09	CHI
20200955514	SANTA RITA DO ARAGUAIA	SU12374325RE	SANTA RITA DO ARAGUAIA	21/09/2020 11:46	21/09/2020 15:47	21/09/2020 11:46	21/09/2020 15:47	4,00	29	116,10	CHI
20200955525	RIO VERDE	630043309	RIO VERDE S1	21/09/2020 11:50	21/09/2020 12:26	21/09/2020 11:50	21/09/2020 12:26	0,59	1	0,59	CHI
20200955530	NIQUELANDIA	2750026216	NIQUELANDIA SUBTRANSMISSAO	21/09/2020 11:51	21/09/2020 14:13	21/09/2020 11:51	21/09/2020 14:13	2,36	1	2,36	CHI
20200955538	GOUVELANDIA	GB11303200	QUIRINOPOLIS	21/09/2020 11:53	21/09/2020 21:07	21/09/2020 11:53	21/09/2020 21:00	9,12	52	474,10	CHI
20200955538	GOUVELANDIA	GB12029096	QUIRINOPOLIS	21/09/2020 11:53	21/09/2020 21:07	21/09/2020 20:42	21/09/2020 21:07	0,41	338	139,05	CHI
20200955551	ALTO PARAISO DE GOIAS	BF12384770	FLORES DE GOIAS	21/09/2020 11:56	22/09/2020 14:40	21/09/2020 11:56	22/09/2020 14:40	26,73	43	1149,27	CHI
20200955551	SAO JOAO D ALIANCA	BF12384770	FLORES DE GOIAS	21/09/2020 11:56	22/09/2020 14:40	21/09/2020 11:56	22/09/2020 14:40	26,73	2	53,45	CHI
20200955559	RIO VERDE	630349836	RIO VERDE S1	21/09/2020 11:58	21/09/2020 17:40	21/09/2020 11:58	21/09/2020 17:40	5,69	1	5,69	CHI
20200955563	MONTE ALEGRE DE GOIAS	MA21285575	SAO DOMINGOS	21/09/2020 11:59	21/09/2020 16:12	21/09/2020 11:59	21/09/2020 16:12	4,21	1	4,21	CHI
20200955564	INACIOLANDIA	ID31128249	QUIRINOPOLIS	21/09/2020 11:59	21/09/2020 15:03	21/09/2020 11:59	21/09/2020 15:03	3,06	2	6,12	CHI
20200955573	COCALZINHO DE GOIAS	ZN12297509	COCALZINHO	21/09/2020 12:01	21/09/2020 15:06	21/09/2020 12:01	21/09/2020 15:06	3,08	21	64,73	CHI
20200955579	JARAGUA	JA21121657	JARAGUA	21/09/2020 12:02	21/09/2020 13:56	21/09/2020 12:02	21/09/2020 13:56	1,90	2	3,79	CHI
20200955583	SANTA RITA DO ARAGUAIA	2130009330	SANTA RITA DO ARAGUAIA	21/09/2020 12:03	21/09/2020 17:21	21/09/2020 12:03	21/09/2020 17:21	5,29	1	5,29	CHI
20200955593	QUIRINOPOLIS	QI21000253	QUIRINOPOLIS	21/09/2020 12:06	21/09/2020 21:31	21/09/2020 12:06	21/09/2020 21:31	9,41	1	9,41	CHI
20200955837	SANTA HELENA DE GOIAS	SH11000025	IPEGUARI	21/09/2020 12:06	21/09/2020 13:43	21/09/2020 12:06	21/09/2020 13:43	1,60	56	89,74	CHI
20200955633	SILVANIA	SV21321126	DAIA S2	21/09/2020 12:16	21/09/2020 13:37	21/09/2020 12:16	21/09/2020 13:37	1,35	1	1,35	CHI
20200955647	FORMOSA	610044114	ITIQUEIRA	21/09/2020 12:18	21/09/2020 13:53	21/09/2020 12:18	21/09/2020 13:53	1,57	1	1,57	CHI
20200955653	PARANAIGUARA	PC21295753	CACHOEIRA ALTA	21/09/2020 12:21	21/09/2020 19:35	21/09/2020 12:21	21/09/2020 19:35	7,23	1	7,23	CHI
20200955665	SANTA HELENA DE GOIAS	SH21000226	IPEGUARI	21/09/2020 12:24	21/09/2020 22:16	21/09/2020 12:24	21/09/2020 22:16	9,85	2	19,70	CHI
20200955669	ANAPOLIS	AN11096685	ANAPOLIS UNIVERSITARIO S2	21/09/2020 12:25	21/09/2020 16:19	21/09/2020 12:25	21/09/2020 16:19	3,88	195	757,36	CHI

INTERNAL

20200955672	IACIARA	IA21062100	IACIARA S1	21/09/2020 12:26	21/09/2020 15:26	21/09/2020 12:26	21/09/2020 15:26	2,99	1	2,99	CHI
20200955757	JATAI	JT12182189	JATAI S3	21/09/2020 12:27	21/09/2020 13:22	21/09/2020 12:27	21/09/2020 13:22	0,91	528	483,12	CHI
20200955675	TURVELANDIA	TD12306313	RIO DOS BOIS	21/09/2020 12:27	21/09/2020 15:28	21/09/2020 12:27	21/09/2020 15:28	3,01	10	30,14	CHI
20200957076	CRIXAS	CX12151609RE	SANTA TEREZINHA	21/09/2020 12:29	21/09/2020 19:13	21/09/2020 12:29	21/09/2020 19:13	6,73	36	242,32	CHI
20200955693	PORANGATU	840059152	PORANGATU	21/09/2020 12:32	21/09/2020 14:37	21/09/2020 12:32	21/09/2020 14:37	2,07	1	2,07	CHI
20200955701	VALPARAISO DE GOIAS	10031333620	MARAJOARA	21/09/2020 12:34	21/09/2020 14:44	21/09/2020 12:34	21/09/2020 14:44	2,16	1	2,16	CHI
20200955714	RIO VERDE	630069487	RIO VERDE S2	21/09/2020 12:37	22/09/2020 11:13	21/09/2020 12:37	22/09/2020 11:13	22,60	1	22,60	CHI
20200955717	URUACU	UR11243481	URUACU	21/09/2020 12:38	21/09/2020 15:07	21/09/2020 12:38	21/09/2020 15:07	2,47	101	249,64	CHI
20200956319	ITAPACI	IW11044775	ITAPACI	21/09/2020 12:40	21/09/2020 17:03	21/09/2020 12:40	21/09/2020 17:03	4,37	183	799,20	CHI
20200955734	RIO VERDE	10006975923	RIO VERDE S2	21/09/2020 12:41	22/09/2020 10:02	21/09/2020 12:41	22/09/2020 10:02	21,35	1	21,35	CHI
20200955961	CORUMBA DE GOIAS	CB12382199	CORUMBA	21/09/2020 12:45	21/09/2020 14:34	21/09/2020 12:45	21/09/2020 14:34	1,80	7	12,63	CHI
20200955775	ANAPOLIS	AN12339396	JUNDIAI S2	21/09/2020 12:46	21/09/2020 13:50	21/09/2020 12:46	21/09/2020 13:50	1,06	921	971,66	CHI
20200955768	JATAI	290213484	JATAI S3	21/09/2020 12:49	22/09/2020 09:03	21/09/2020 12:49	22/09/2020 09:03	20,22	1	20,22	CHI
20200955770	GUARINOS	IW12201636	ITAPACI	21/09/2020 12:50	21/09/2020 14:26	21/09/2020 12:50	21/09/2020 14:26	1,60	7	11,20	CHI
20200955770	PILAR DE GOIAS	IW12201636	ITAPACI	21/09/2020 12:50	21/09/2020 14:26	21/09/2020 12:50	21/09/2020 14:26	1,60	1	1,60	CHI
20200955770	ITAPACI	IW12201636	ITAPACI	21/09/2020 12:50	21/09/2020 14:26	21/09/2020 12:50	21/09/2020 14:26	1,60	247	395,27	CHI
20200955972	ALEXANIA	AX12362305	ALEXANIA	21/09/2020 12:53	21/09/2020 15:12	21/09/2020 12:53	21/09/2020 15:12	2,31	33	76,15	CHI
20200955782	RIO VERDE	630003518	RIO VERDE S1	21/09/2020 12:54	22/09/2020 13:50	21/09/2020 12:54	22/09/2020 13:50	24,93	1	24,93	CHI
20200955788	AGUA FRIA DE GOIAS	TL12320501	SAO JOAO D ALIANCA	21/09/2020 12:55	21/09/2020 14:15	21/09/2020 12:55	21/09/2020 14:15	1,33	37	49,13	CHI
20200955818	CIDADE OCIDENTAL	DH11199642	MARAJOARA	21/09/2020 12:56	21/09/2020 18:22	21/09/2020 12:56	21/09/2020 18:22	5,42	112	607,54	CHI
20200955802	JATAI	290126885	JATAI S3	21/09/2020 12:56	21/09/2020 19:25	21/09/2020 12:56	21/09/2020 19:25	6,47	1	6,47	CHI
20200955812	VALPARAISO DE GOIAS	2860298867	PACAEMBU S1	21/09/2020 12:58	21/09/2020 15:36	21/09/2020 12:58	21/09/2020 15:36	2,63	1	2,63	CHI
20200955816	MARA ROSA	FO21115554	MARA ROSA	21/09/2020 12:59	22/09/2020 13:30	21/09/2020 12:59	22/09/2020 13:30	24,52	1	24,52	CHI
20200955824	NOVA CRIXAS	MH12125309	NOVA CRIXAS	21/09/2020 13:00	21/09/2020 16:22	21/09/2020 13:00	21/09/2020 16:22	3,35	3	10,06	CHI
20200955824	MUNDO NOVO DE GOIAS	MH12125309	NOVA CRIXAS	21/09/2020 13:00	21/09/2020 16:22	21/09/2020 13:00	21/09/2020 16:22	3,35	2	6,71	CHI
20200956213	CIDADE OCIDENTAL	DH11128792	MARAJOARA	21/09/2020 13:01	22/09/2020 02:08	21/09/2020 13:01	22/09/2020 02:08	13,10	122	1598,67	CHI
20200956575	SAO LUIS DE MONTES BELOS	SL12125616	FIRMINOPOLIS S1	21/09/2020 13:05	21/09/2020 17:25	21/09/2020 13:05	21/09/2020 17:25	4,33	10	43,27	CHI
20200956005	ITAPACI	IW12123102	ITAPACI	21/09/2020 13:06	21/09/2020 16:37	21/09/2020 13:06	21/09/2020 16:37	3,51	10	35,10	CHI
20200955871	VALPARAISO DE GOIAS	VA11247721	MARAJOARA	21/09/2020 13:07	21/09/2020 16:37	21/09/2020 13:07	21/09/2020 16:37	3,49	191	666,80	CHI
20200955875	GOIAS	GS21145693	MATRINCHA	21/09/2020 13:09	21/09/2020 16:34	21/09/2020 13:09	21/09/2020 16:34	3,41	1	3,41	CHI
20200956230	PADRE BERNARDO	02280214	PADRE BERNARDO	21/09/2020 13:09	21/09/2020 13:13	21/09/2020 13:09	21/09/2020 13:12	0,05	965	52,81	CHI
20200956230	PADRE BERNARDO	02280214	PADRE BERNARDO	21/09/2020 13:09	21/09/2020 13:13	21/09/2020 13:09	21/09/2020 13:13	0,06	633	39,21	CHI
20200956230	PADRE BERNARDO	02280214	PADRE BERNARDO	21/09/2020 13:09	21/09/2020 13:13	21/09/2020 13:09	21/09/2020 13:13	0,07	738	52,07	CHI

INTERNAL

20200956060	CIDADE OCIDENTAL	DH11389549	MARAJOARA	21/09/2020 13:12	21/09/2020 20:37	21/09/2020 13:12	21/09/2020 20:37	7,41	36	266,73	CHI
20200955967	PORTEIRAO	CL12230803	RIO DOS BOIS	21/09/2020 13:12	21/09/2020 18:11	21/09/2020 13:12	21/09/2020 18:11	4,97	6	29,80	CHI
20200955912	PALMEIRAS DE GOIAS	PL11349337	PALMEIRAS	21/09/2020 13:15	21/09/2020 23:20	21/09/2020 13:15	21/09/2020 23:20	10,09	9	90,80	CHI
20200955915	ANAPOLIS	AN12311962	DAIA S2	21/09/2020 13:15	21/09/2020 15:50	21/09/2020 13:15	21/09/2020 15:50	2,57	4	10,30	CHI
20200955930	ITAPACI	IW12333893	ITAPACI	21/09/2020 13:18	21/09/2020 17:44	21/09/2020 13:18	21/09/2020 17:44	4,43	26	115,25	CHI
20200955930	PILAR DE GOIAS	IW12333893	ITAPACI	21/09/2020 13:18	21/09/2020 17:44	21/09/2020 13:18	21/09/2020 17:44	4,43	38	168,45	CHI
20200955931	CIDADE OCIDENTAL	DH12370801	MARAJOARA	21/09/2020 13:18	21/09/2020 18:01	21/09/2020 13:18	21/09/2020 18:01	4,71	63	296,87	CHI
20200955933	RIO VERDE	RV12207197	MONTIVIDIU T	21/09/2020 13:18	21/09/2020 17:53	21/09/2020 13:18	21/09/2020 17:53	4,58	6	27,46	CHI
20200955937	CAVALCANTE	CJ12346073	MINACU	21/09/2020 13:19	22/09/2020 10:09	21/09/2020 13:19	22/09/2020 10:09	20,82	194	4039,83	CHI
20200955946	GOIAS	50029526	ITABERAI S1	21/09/2020 13:21	21/09/2020 16:18	21/09/2020 13:21	21/09/2020 16:18	2,96	1	2,96	CHI
20200955950	ITABERAI	HE12310804	ITABERAI S1	21/09/2020 13:21	21/09/2020 16:14	21/09/2020 13:21	21/09/2020 16:14	2,87	1	2,87	CHI
20200955950	HEITORAI	HE12310804	ITABERAI S1	21/09/2020 13:21	21/09/2020 16:14	21/09/2020 13:21	21/09/2020 16:14	2,87	21	60,35	CHI
202009103034	RIO VERDE	RV12207146	MONTIVIDIU T	21/09/2020 13:22	21/09/2020 18:45	21/09/2020 13:22	21/09/2020 18:45	5,38	22	118,33	CHI
20200955955	CRIXAS	10006356034	SERRA DO OURO	21/09/2020 13:23	21/09/2020 15:16	21/09/2020 13:23	21/09/2020 15:16	1,88	1	1,88	CHI
20200955965	SAO SIMAO	10016863338	CACHOEIRA ALTA	21/09/2020 13:25	21/09/2020 21:36	21/09/2020 13:25	21/09/2020 21:36	8,18	1	8,18	CHI
20200955971	SANTA RITA DO ARAGUAIA	2130012833	SANTA RITA DO ARAGUAIA	21/09/2020 13:26	21/09/2020 17:49	21/09/2020 13:26	21/09/2020 17:49	4,38	1	4,38	CHI
20200955977	SANTO ANTONIO DO DESCOBERTO	SN21290586	AGUAS LINDAS DE GOIAS S2	21/09/2020 13:27	21/09/2020 16:23	21/09/2020 13:27	21/09/2020 16:23	2,93	1	2,93	CHI
20200955981	CIDADE OCIDENTAL	DH11128727	MARAJOARA	21/09/2020 13:27	21/09/2020 15:51	21/09/2020 13:27	21/09/2020 15:51	2,39	126	300,58	CHI
20200956000	VALPARAISO DE GOIAS	VA11136564	PACAEMBU S1	21/09/2020 13:31	21/09/2020 17:50	21/09/2020 13:31	21/09/2020 17:50	4,31	159	685,86	CHI
20200956860	ITAPACI	IW12405289	ITAPACI	21/09/2020 13:33	21/09/2020 19:41	21/09/2020 13:33	21/09/2020 19:41	6,12	17	104,04	CHI
20200956017	SANTA HELENA DE GOIAS	400132667	IPEGUARI	21/09/2020 13:34	21/09/2020 19:54	21/09/2020 13:34	21/09/2020 19:54	6,33	1	6,33	CHI
20200956594	LUZIANIA	LZ12000232	RIO VERMELHO	21/09/2020 13:36	21/09/2020 17:20	21/09/2020 13:36	21/09/2020 17:20	3,72	74	275,34	CHI
20200956031	CACHOEIRA ALTA	CA21000055	CACHOEIRA ALTA	21/09/2020 13:36	21/09/2020 15:32	21/09/2020 13:36	21/09/2020 15:32	1,92	1	1,92	CHI
20200956039	JATAI	JT12165965	JATAI S2	21/09/2020 13:38	22/09/2020 13:27	21/09/2020 13:38	22/09/2020 13:27	23,81	8	190,49	CHI
20200956046	NIQUELANDIA	NQ12094112	NIQUELANDIA SUBTRANSMISSAO	21/09/2020 13:39	21/09/2020 15:39	21/09/2020 13:39	21/09/2020 15:39	1,99	254	505,95	CHI
20200956052	AMORINOPOLIS	AM21212861	IPORA	21/09/2020 13:41	21/09/2020 15:16	21/09/2020 13:41	21/09/2020 15:16	1,58	1	1,58	CHI
20200956900	VALPARAISO DE GOIAS	VA11192964	MARAJOARA	21/09/2020 13:42	21/09/2020 18:46	21/09/2020 13:42	21/09/2020 18:46	5,06	115	582,12	CHI
20200956057	ARUANA	10008437040	ARUANA	21/09/2020 13:42	21/09/2020 15:50	21/09/2020 13:42	21/09/2020 15:50	2,13	0	0,00	CHI
20200956251	LUZIANIA	LZ11136514	RIO VERMELHO	21/09/2020 13:42	21/09/2020 21:15	21/09/2020 13:42	21/09/2020 21:15	7,54	245	1846,28	CHI
20200956117	VALPARAISO DE GOIAS	VA11169041	MARAJOARA	21/09/2020 13:44	21/09/2020 17:15	21/09/2020 13:44	21/09/2020 17:15	3,52	222	780,33	CHI
20200956281	CIDADE OCIDENTAL	DH11199626	MARAJOARA	21/09/2020 13:45	21/09/2020 18:02	21/09/2020 13:45	21/09/2020 18:02	4,27	100	427,36	CHI
20200956082	RIO VERDE	RV21260054	RIO VERDE S2	21/09/2020 13:45	21/09/2020 19:27	21/09/2020 13:45	21/09/2020 19:27	5,69	1	5,69	CHI
20200956078	MUNDO NOVO DE GOIAS	4240003478	NOVA CRIXAS	21/09/2020 13:45	21/09/2020 16:39	21/09/2020 13:45	21/09/2020 16:39	2,89	1	2,89	CHI

INTERNAL

20200958145	NIQUELANDIA	NQ12275490	NIQUELANDIA SUBTRANSMISSAO	21/09/2020 13:46	21/09/2020 20:12	21/09/2020 13:46	21/09/2020 20:12	6,43	200	1285,61	CHI
20200956085	MOZARLANDIA	MZ21055717	MOZARLANDIA	21/09/2020 13:46	21/09/2020 22:23	21/09/2020 13:46	21/09/2020 22:23	8,60	1	8,60	CHI
20200956089	ANAPOLIS	AN12261185	ANAPOLIS UNIVERSITARIO S2	21/09/2020 13:47	21/09/2020 15:38	21/09/2020 13:47	21/09/2020 15:38	1,84	12	22,13	CHI
20200956145	LUZIANIA	LZ11128809	RIO VERMELHO	21/09/2020 13:48	22/09/2020 04:45	21/09/2020 13:48	22/09/2020 04:45	14,95	39	583,05	CHI
20200956145	LUZIANIA	LZ10404160	RIO VERMELHO	21/09/2020 13:48	22/09/2020 04:45	21/09/2020 13:48	22/09/2020 04:45	14,95	219	3274,35	CHI
20200956095	URUACU	640010337	URUACU	21/09/2020 13:48	21/09/2020 19:01	21/09/2020 13:48	21/09/2020 19:01	5,21	1	5,21	CHI
20200956514	ALEXANIA	AX11101793	ALEXANIA	21/09/2020 13:48	21/09/2020 23:15	21/09/2020 13:48	21/09/2020 23:15	9,44	48	453,21	CHI
20200956099	CACHOEIRA ALTA	CA12193846	CACHOEIRA ALTA	21/09/2020 13:48	21/09/2020 20:13	21/09/2020 13:48	21/09/2020 20:13	6,41	1	6,41	CHI
20200956102	ARAGARCAS	AG12223122	ARAGARCAS	21/09/2020 13:48	21/09/2020 17:34	21/09/2020 13:48	21/09/2020 15:38	1,84	91	167,01	CHI
20200956102	ARAGARCAS	AG11000010	ARAGARCAS	21/09/2020 13:48	21/09/2020 17:34	21/09/2020 13:48	21/09/2020 17:34	3,77	84	316,26	CHI
20200956116	GOIANESIA	GE12000064	GOIANESIA S2	21/09/2020 13:50	21/09/2020 15:24	21/09/2020 13:50	21/09/2020 15:24	1,56	665	1037,95	CHI
20200957185	GOIANESIA	00560224	GOIANESIA S2	21/09/2020 13:50	21/09/2020 14:03	21/09/2020 13:50	21/09/2020 13:53	0,05	1641	82,51	CHI
20200957185	GOIANESIA	00560224	GOIANESIA S2	21/09/2020 13:50	21/09/2020 14:03	21/09/2020 13:50	21/09/2020 14:01	0,19	1007	187,13	CHI
20200957185	GOIANESIA	00560224	GOIANESIA S2	21/09/2020 13:50	21/09/2020 14:03	21/09/2020 13:50	21/09/2020 14:03	0,22	7805	1686,75	CHI
20200957185	SANTA ISABEL	00560224	GOIANESIA S2	21/09/2020 13:50	21/09/2020 14:03	21/09/2020 13:50	21/09/2020 14:03	0,22	1	0,22	CHI
20200957185	GOIANESIA	00560224	GOIANESIA S2	21/09/2020 13:50	21/09/2020 14:03	21/09/2020 13:50	21/09/2020 14:03	0,21	296	62,41	CHI
20200957185	GOIANESIA	00560224	GOIANESIA S2	21/09/2020 13:50	21/09/2020 14:03	21/09/2020 13:52	21/09/2020 14:03	0,19	54	10,14	CHI
20200956157	GOIANESIA	GE12291463	GOIANESIA S2	21/09/2020 13:50	21/09/2020 15:10	21/09/2020 13:52	21/09/2020 15:10	1,29	382	494,37	CHI
20200957185	GOIANESIA	00560214	GOIANESIA S2	21/09/2020 13:50	21/09/2020 14:03	21/09/2020 13:52	21/09/2020 13:57	0,09	6275	587,41	CHI
20200957185	PIRENOPOLIS	00560214	GOIANESIA S2	21/09/2020 13:50	21/09/2020 14:03	21/09/2020 13:52	21/09/2020 13:57	0,09	1	0,09	CHI
20200957185	VILA PROPICIO	00560214	GOIANESIA S2	21/09/2020 13:50	21/09/2020 14:03	21/09/2020 13:52	21/09/2020 13:57	0,09	18	1,69	CHI
20200957185	JARAGUA	00560214	GOIANESIA S2	21/09/2020 13:50	21/09/2020 14:03	21/09/2020 13:52	21/09/2020 13:57	0,09	492	46,06	CHI
20200956222	JATAI	JT12182189	JATAI S3	21/09/2020 13:52	21/09/2020 15:52	21/09/2020 13:52	21/09/2020 15:52	2,00	528	1055,12	CHI
20200956118	CAIAPONIA	CP21060790	CAIAPONIA	21/09/2020 13:53	21/09/2020 23:49	21/09/2020 13:53	21/09/2020 23:49	9,93	2	19,86	CHI
20200956128	ARAGUAPAZ	AZ11245236	RUBIATABA	21/09/2020 13:55	21/09/2020 17:09	21/09/2020 13:55	21/09/2020 17:09	3,23	1	3,23	CHI
202009107098	INACIOLANDIA	01560414	QUIRINOPOLIS	21/09/2020 13:55	21/09/2020 14:33	21/09/2020 13:55	21/09/2020 14:33	0,64	14	8,94	CHI
202009107098	ITUMBIARA	01560414	QUIRINOPOLIS	21/09/2020 13:55	21/09/2020 14:33	21/09/2020 13:55	21/09/2020 14:33	0,64	9	5,75	CHI
202009107098	QUIRINOPOLIS	01560414	QUIRINOPOLIS	21/09/2020 13:55	21/09/2020 14:33	21/09/2020 13:55	21/09/2020 14:33	0,64	88	56,20	CHI
202009107098	BOM JESUS DE GOIAS	01560414	QUIRINOPOLIS	21/09/2020 13:55	21/09/2020 14:33	21/09/2020 13:55	21/09/2020 14:33	0,64	70	44,70	CHI
202009107098	GOUVELANDIA	01560414	QUIRINOPOLIS	21/09/2020 13:55	21/09/2020 14:33	21/09/2020 13:55	21/09/2020 14:33	0,64	1982	1265,73	CHI
202009107098	GOUVELANDIA	01560414	QUIRINOPOLIS	21/09/2020 13:55	21/09/2020 14:33	21/09/2020 13:55	21/09/2020 14:33	0,64	15	9,58	CHI
202009107098	INACIOLANDIA	01560414	QUIRINOPOLIS	21/09/2020 13:55	21/09/2020 14:33	21/09/2020 13:55	21/09/2020 14:33	0,64	2692	1719,14	CHI
202009107098	QUIRINOPOLIS	01560414	QUIRINOPOLIS	21/09/2020 13:55	21/09/2020 14:33	21/09/2020 13:55	21/09/2020 14:33	0,64	23	14,69	CHI

INTERNAL

20200956830	ALEXANIA	AX12114206	ALEXANIA	21/09/2020 13:55	21/09/2020 17:28	21/09/2020 13:55	21/09/2020 17:28	3,54	110	389,71	CHI
20200956938	GOIANESIA	GE10400378	GOIANESIA S1	21/09/2020 13:56	22/09/2020 11:59	21/09/2020 13:56	21/09/2020 17:19	3,39	5	16,95	CHI
20200956938	GOIANESIA	GE13327916	GOIANESIA S1	21/09/2020 13:56	22/09/2020 11:59	21/09/2020 13:56	22/09/2020 11:59	22,05	1	22,05	CHI
2020092100090	VILA PROPICIO	18431	GOIANESIA S1	21/09/2020 13:56	21/09/2020 14:00	21/09/2020 13:56	21/09/2020 14:00	0,07	179	11,93	CHI
2020092100090	GOIANESIA	46401	GOIANESIA S1	21/09/2020 13:56	21/09/2020 14:00	21/09/2020 13:56	21/09/2020 14:00	0,07	392	26,13	CHI
2020092100090	PIRENOPOLIS	18402	GOIANESIA S1	21/09/2020 13:56	21/09/2020 14:00	21/09/2020 13:56	21/09/2020 14:00	0,07	1	0,07	CHI
2020092100090	VILA PROPICIO	18401	GOIANESIA S1	21/09/2020 13:56	21/09/2020 14:00	21/09/2020 13:56	21/09/2020 14:00	0,07	840	56,00	CHI
2020092100090	COCALZINHO DE GOIAS	18431	GOIANESIA S1	21/09/2020 13:56	21/09/2020 14:00	21/09/2020 13:56	21/09/2020 14:00	0,07	265	17,67	CHI
2020092100090	VILA PROPICIO	00560434	GOIANESIA S1	21/09/2020 13:56	21/09/2020 14:00	21/09/2020 13:56	21/09/2020 14:00	0,07	140	9,33	CHI
2020092100090	VILA PROPICIO	18402	GOIANESIA S1	21/09/2020 13:56	21/09/2020 14:00	21/09/2020 13:56	21/09/2020 14:00	0,07	142	9,47	CHI
2020092100090	SANTA ISABEL	46401	GOIANESIA S1	21/09/2020 13:56	21/09/2020 14:00	21/09/2020 13:56	21/09/2020 14:00	0,07	2	0,13	CHI
2020092100090	GOIANESIA	00560434	GOIANESIA S1	21/09/2020 13:56	21/09/2020 14:00	21/09/2020 13:56	21/09/2020 14:00	0,07	14	0,93	CHI
2020092100090	SANTA ISABEL	46402	GOIANESIA S1	21/09/2020 13:56	21/09/2020 14:00	21/09/2020 13:56	21/09/2020 14:00	0,07	22	1,47	CHI
2020092100090	SAO LUIZ DO NORTE	46401	GOIANESIA S1	21/09/2020 13:56	21/09/2020 14:00	21/09/2020 13:56	21/09/2020 14:00	0,07	21	1,40	CHI
2020092100090	NOVA GLORIA	46401	GOIANESIA S1	21/09/2020 13:56	21/09/2020 14:00	21/09/2020 13:56	21/09/2020 14:00	0,07	2	0,13	CHI
2020092100090	GOIANESIA	46402	GOIANESIA S1	21/09/2020 13:56	21/09/2020 14:00	21/09/2020 13:56	21/09/2020 14:00	0,07	608	40,53	CHI
2020092100090	PIRENOPOLIS	18401	GOIANESIA S1	21/09/2020 13:56	21/09/2020 14:00	21/09/2020 13:56	21/09/2020 14:00	0,07	33	2,20	CHI
20200956133	SANTA HELENA DE GOIAS	10000818338	IPEGUARI	21/09/2020 13:56	21/09/2020 18:34	21/09/2020 13:56	21/09/2020 18:34	4,63	1	4,63	CHI
20200959885	JATAI	JT12378171	MONTIVIDIU T	21/09/2020 13:56	22/09/2020 09:00	21/09/2020 13:56	22/09/2020 09:00	19,06	5	95,29	CHI
20200956137	DOVERLANDIA	DV11228254	CAIAPONIA	21/09/2020 13:56	21/09/2020 18:59	21/09/2020 13:56	21/09/2020 18:59	5,04	1	5,04	CHI
20200956139	VILA BOA	FA12146215	ITUIQUIRA	21/09/2020 13:56	21/09/2020 16:13	21/09/2020 13:56	21/09/2020 16:13	2,27	2	4,54	CHI
20200956758	ITAPACI	IW12405295	ITAPACI	21/09/2020 13:56	21/09/2020 22:43	21/09/2020 13:56	21/09/2020 22:43	8,77	42	368,22	CHI
20200956758	NOVA GLORIA	IW12405295	ITAPACI	21/09/2020 13:56	21/09/2020 22:43	21/09/2020 13:56	21/09/2020 22:43	8,77	1	8,77	CHI
20200956938	GOIANESIA	GE10400378	GOIANESIA S1	21/09/2020 13:56	22/09/2020 11:59	21/09/2020 19:03	22/09/2020 03:58	8,92	5	44,58	CHI
20200956155	FORMOSA	10023779401	ITUIQUIRA	21/09/2020 13:57	21/09/2020 14:38	21/09/2020 13:57	21/09/2020 14:38	0,67	1	0,67	CHI
20200956193	VALPARAISO DE GOIAS	XX29354705	PACAEMBU S2	21/09/2020 13:59	22/09/2020 12:40	21/09/2020 13:59	21/09/2020 22:55	8,93	145	1294,89	CHI
20200956193	VALPARAISO DE GOIAS	VA11169024	PACAEMBU S2	21/09/2020 13:59	22/09/2020 12:40	21/09/2020 13:59	22/09/2020 12:40	22,68	74	1678,63	CHI
20200956163	FORMOSA	610159045	ITUIQUIRA	21/09/2020 13:59	21/09/2020 16:24	21/09/2020 13:59	21/09/2020 16:24	2,40	1	2,40	CHI
20200956193	VALPARAISO DE GOIAS	XX2932337X	PACAEMBU S2	21/09/2020 13:59	22/09/2020 12:40	21/09/2020 20:27	21/09/2020 22:55	2,46	1222	3009,51	CHI
20200956193	VALPARAISO DE GOIAS	03862224	PACAEMBU S2	21/09/2020 13:59	22/09/2020 12:40	21/09/2020 21:53	21/09/2020 21:58	0,08	4758	363,46	CHI
20200956193	VALPARAISO DE GOIAS	03862224	PACAEMBU S2	21/09/2020 13:59	22/09/2020 12:40	21/09/2020 21:53	21/09/2020 21:58	0,08	409	31,24	CHI
20200956165	URUACU	UR12398055	URUACU	21/09/2020 14:00	22/09/2020 11:27	21/09/2020 14:00	22/09/2020 11:27	21,45	13	278,85	CHI
20200956168	GOIAS	GS12220122	ITABERAI S2	21/09/2020 14:00	21/09/2020 15:39	21/09/2020 14:00	21/09/2020 15:39	1,64	9	14,78	CHI

INTERNAL

20200956168	ITABERAÍ	GS12220122	ITABERAÍ S2	21/09/2020 14:00	21/09/2020 15:39	21/09/2020 14:00	21/09/2020 15:39	1,64	4	6,57	CHI
20200956174	SAO MIGUEL DO ARAGUAIA	SM11358670	SAO MIGUEL DO ARAGUAIA	21/09/2020 14:00	21/09/2020 17:17	21/09/2020 14:00	21/09/2020 17:17	3,27	1	3,27	CHI
20200956269	LUZIANIA	LZ11000004	RIO VERMELHO	21/09/2020 14:02	21/09/2020 17:20	21/09/2020 14:02	21/09/2020 17:20	3,29	95	312,58	CHI
20200956189	ITAPACI	100038232	ITAPACI	21/09/2020 14:03	21/09/2020 16:20	21/09/2020 14:03	21/09/2020 16:20	2,28	1	2,28	CHI
20200956201	ARAGARCAS	AG11212895	ARAGARCAS	21/09/2020 14:05	21/09/2020 18:15	21/09/2020 14:05	21/09/2020 18:15	4,16	113	469,61	CHI
20200956545	JATAI	JT12104476RE	JATAI S3	21/09/2020 14:06	21/09/2020 15:59	21/09/2020 14:06	21/09/2020 15:59	1,88	12	22,55	CHI
20200956545	RIO VERDE	JT12104476RE	JATAI S3	21/09/2020 14:06	21/09/2020 15:59	21/09/2020 14:06	21/09/2020 15:59	1,88	3	5,64	CHI
20200956658	CIDADE OCIDENTAL	DH11128796	MARAJOARA	21/09/2020 14:06	22/09/2020 01:43	21/09/2020 14:06	22/09/2020 01:43	11,60	94	1090,82	CHI
20200956218	CAMPOS BELOS	820042286	SAO DOMINGOS	21/09/2020 14:07	21/09/2020 17:31	21/09/2020 14:07	21/09/2020 17:31	3,39	1	3,39	CHI
20200956225	RIO VERDE	RV12326829	RIO VERDE S2	21/09/2020 14:09	21/09/2020 17:09	21/09/2020 14:09	21/09/2020 17:09	3,00	59	176,72	CHI
20200956234	MINEIROS	MY12296347	PARQUE DAS EMAS	21/09/2020 14:10	21/09/2020 19:44	21/09/2020 14:10	21/09/2020 19:44	5,56	1	5,56	CHI
20200956237	NIQUELANDIA	2750077650	NIQUELANDIA SUBTRANSMISSAO	21/09/2020 14:10	22/09/2020 17:08	21/09/2020 14:10	22/09/2020 17:08	26,95	1	26,95	CHI
20200956548	RUBIATABA	RB12246312	RUBIATABA	21/09/2020 14:11	21/09/2020 18:32	21/09/2020 14:11	21/09/2020 18:32	4,34	326	1413,66	CHI
20200956253	LUZIANIA	LZ11168743	RIO VERMELHO	21/09/2020 14:11	21/09/2020 14:56	21/09/2020 14:11	21/09/2020 14:56	0,73	151	110,86	CHI
20200956620	CIDADE OCIDENTAL	DH11199643	MARAJOARA	21/09/2020 14:13	22/09/2020 01:24	21/09/2020 14:13	22/09/2020 01:24	11,17	178	1988,26	CHI
20200956689	CIDADE OCIDENTAL	DH11376127	MARAJOARA	21/09/2020 14:13	21/09/2020 16:30	21/09/2020 14:13	21/09/2020 16:30	2,27	94	213,20	CHI
20200958773	NOVO GAMA	NJ11059740	PACAEMBU S1	21/09/2020 14:14	21/09/2020 21:43	21/09/2020 14:14	21/09/2020 21:43	7,48	135	1009,24	CHI
20200956309	NIQUELANDIA	NQ10400419	URUACU	21/09/2020 14:14	22/09/2020 17:19	21/09/2020 14:14	21/09/2020 14:18	0,06	2	0,11	CHI
20200956309	NIQUELANDIA	NQ10400419	URUACU	21/09/2020 14:14	22/09/2020 17:19	21/09/2020 14:14	22/09/2020 09:55	19,68	422	8304,02	CHI
20200956309	NIQUELANDIA	NQ10400419	URUACU	21/09/2020 14:14	22/09/2020 17:19	21/09/2020 14:14	22/09/2020 13:03	22,82	10	228,16	CHI
20200956309	NIQUELANDIA	NQ10400419	URUACU	21/09/2020 14:14	22/09/2020 17:19	21/09/2020 14:14	22/09/2020 17:19	27,07	328	8879,05	CHI
20200956309	NIQUELANDIA	NQ10400419	URUACU	21/09/2020 14:14	22/09/2020 17:19	21/09/2020 14:18	22/09/2020 09:55	19,62	3	58,86	CHI
20200956309	NIQUELANDIA	NQ10400422	URUACU	21/09/2020 14:14	22/09/2020 17:19	21/09/2020 17:51	21/09/2020 18:25	0,56	435	242,39	CHI
20200956309	NIQUELANDIA	NQ10400422	URUACU	21/09/2020 14:14	22/09/2020 17:19	21/09/2020 18:27	21/09/2020 21:24	2,94	52	152,88	CHI
20200956309	NIQUELANDIA	NQ13235629	URUACU	21/09/2020 14:14	22/09/2020 17:19	21/09/2020 18:27	22/09/2020 03:30	9,04	383	3461,89	CHI
20200956420	MOZARLANDIA	MZ12060054	MOZARLANDIA	21/09/2020 14:15	21/09/2020 16:10	21/09/2020 14:15	21/09/2020 16:10	1,92	778	1490,30	CHI
20200956695	GOIANESIA	GE11098869	GOIANESIA S2	21/09/2020 14:15	21/09/2020 16:08	21/09/2020 14:15	21/09/2020 16:08	1,87	130	243,14	CHI
20200956302	VALPARAISO DE GOIAS	2860003958	MARAJOARA	21/09/2020 14:17	21/09/2020 16:34	21/09/2020 14:17	21/09/2020 16:34	2,27	1	2,27	CHI
20200956306	RIO VERDE	630230493	RIO VERDE S1	21/09/2020 14:18	21/09/2020 17:45	21/09/2020 14:18	21/09/2020 17:45	3,44	1	3,44	CHI
20200956308	MONTE ALEGRE DE GOIAS	7970000756	SAO DOMINGOS	21/09/2020 14:18	21/09/2020 17:55	21/09/2020 14:18	21/09/2020 17:55	3,60	1	3,60	CHI
20200956311	SERRANOPOLIS	DJ12135998	CHAPADAO DO CEU	21/09/2020 14:19	22/09/2020 12:56	21/09/2020 14:19	22/09/2020 12:56	22,61	2	45,22	CHI
20200956359	ALEXANIA	AX12211855	ALEXANIA	21/09/2020 14:20	21/09/2020 15:55	21/09/2020 14:20	21/09/2020 15:55	1,58	877	1383,71	CHI
20200956440	NOVO GAMA	NJ12261815	MARAJOARA	21/09/2020 14:20	21/09/2020 22:59	21/09/2020 14:20	21/09/2020 22:59	8,65	412	3564,03	CHI

INTERNAL

20200956328	MINEIROS	MY12325793	PARQUE DAS EMAS	21/09/2020 14:20	21/09/2020 15:34	21/09/2020 14:20	21/09/2020 15:34	1,22	1	1,22	CHI
20200956330	JATAI	290172767	JATAI S3	21/09/2020 14:21	22/09/2020 12:14	21/09/2020 14:21	22/09/2020 12:14	21,88	1	21,88	CHI
20200956334	GOIANESIA	GE11273132	GOIANESIA S2	21/09/2020 14:21	21/09/2020 15:41	21/09/2020 14:21	21/09/2020 15:41	1,32	88	116,23	CHI
20200956618	VALPARAISO DE GOIAS	VA11381904	PACAEMBU S1	21/09/2020 14:22	21/09/2020 20:15	21/09/2020 14:22	21/09/2020 20:15	5,87	26	152,58	CHI
20200956595	AGUAS LINDAS DE GOIAS	03730414	AGUAS LINDAS DE GOIAS S2	21/09/2020 14:22	21/09/2020 19:15	21/09/2020 14:23	21/09/2020 19:15	4,86	1	4,86	CHI
20200956595	AGUAS LINDAS DE GOIAS	LA16413244	AGUAS LINDAS DE GOIAS S2	21/09/2020 14:22	21/09/2020 19:15	21/09/2020 14:23	21/09/2020 14:27	0,06	2285	143,45	CHI
20200956595	COCALZINHO DE GOIAS	LA16408775	AGUAS LINDAS DE GOIAS S2	21/09/2020 14:22	21/09/2020 19:15	21/09/2020 14:23	21/09/2020 16:34	2,18	67	145,73	CHI
20200956595	AGUAS LINDAS DE GOIAS	LA16408775	AGUAS LINDAS DE GOIAS S2	21/09/2020 14:22	21/09/2020 19:15	21/09/2020 14:23	21/09/2020 16:34	2,18	557	1211,48	CHI
20200956595	PADRE BERNARDO	LA16408775	AGUAS LINDAS DE GOIAS S2	21/09/2020 14:22	21/09/2020 19:15	21/09/2020 14:23	21/09/2020 16:34	2,18	2	4,35	CHI
20200956351	ALEXANIA	AX12216776	ALEXANIA	21/09/2020 14:23	21/09/2020 20:33	21/09/2020 14:23	21/09/2020 20:33	6,17	205	1264,22	CHI
20200956354	GOUVELANDIA	GB21296588	QUIRINOPOLIS	21/09/2020 14:24	21/09/2020 18:57	21/09/2020 14:24	21/09/2020 18:57	4,55	1	4,55	CHI
20200956361	CRISTALINA	KR12170191	CRISTALINA S1	21/09/2020 14:25	21/09/2020 15:12	21/09/2020 14:25	21/09/2020 15:12	0,78	59	45,99	CHI
20200956365	CRISTALINA	10025418341	CRISTALINA S2	21/09/2020 14:25	21/09/2020 17:03	21/09/2020 14:25	21/09/2020 17:03	2,62	1	2,62	CHI
20200956378	FORMOSA	10010554120	ITUIQUIRA	21/09/2020 14:27	21/09/2020 15:59	21/09/2020 14:27	21/09/2020 15:59	1,53	1	1,53	CHI
20200956383	PETROLINA DE GOIAS	PG21287924	PETROLINA	21/09/2020 14:28	21/09/2020 15:41	21/09/2020 14:28	21/09/2020 15:41	1,22	2	2,43	CHI
20200956551	RUBIATABA	RB21228753	RUBIATABA	21/09/2020 14:28	23/09/2020 03:26	21/09/2020 14:28	23/09/2020 03:26	36,96	1	36,96	CHI
20200956402	CRISTALINA	KR21320132	PAMPLONA	21/09/2020 14:30	21/09/2020 19:49	21/09/2020 14:30	21/09/2020 19:49	5,33	1	5,33	CHI
20200956406	RIO VERDE	630282134	RIO VERDE S2	21/09/2020 14:30	21/09/2020 20:40	21/09/2020 14:30	21/09/2020 20:40	6,16	1	6,16	CHI
20200956414	AGUAS LINDAS DE GOIAS	LA11164932	AGUAS LINDAS DE GOIAS S1	21/09/2020 14:31	22/09/2020 02:24	21/09/2020 14:31	22/09/2020 02:05	11,57	119	1377,06	CHI
20200956414	COCALZINHO DE GOIAS	LA12349043LD	AGUAS LINDAS DE GOIAS S1	21/09/2020 14:31	22/09/2020 02:24	22/09/2020 00:42	22/09/2020 02:24	1,71	1	1,71	CHI
20200956414	SANTO ANTONIO DO DESCOBERTO	LA12349043LD	AGUAS LINDAS DE GOIAS S1	21/09/2020 14:31	22/09/2020 02:24	22/09/2020 00:42	22/09/2020 02:24	1,71	18	30,82	CHI
20200956414	AGUAS LINDAS DE GOIAS	LA12349043LD	AGUAS LINDAS DE GOIAS S1	21/09/2020 14:31	22/09/2020 02:24	22/09/2020 00:42	22/09/2020 02:24	1,71	1163	1991,31	CHI
20200956432	URUACU	10011539486	URUACU	21/09/2020 14:34	21/09/2020 15:48	21/09/2020 14:34	21/09/2020 15:48	1,23	1	1,23	CHI
20200957808	LUZIANIA	LZ12370861	MARAJOARA	21/09/2020 14:34	21/09/2020 23:00	21/09/2020 14:34	21/09/2020 23:00	8,43	23	193,87	CHI
20200956453	SANTA TEREZINHA DE GOIAS	SG10394720	SANTA TEREZINHA	21/09/2020 14:34	22/09/2020 14:59	21/09/2020 14:34	21/09/2020 16:34	2,01	205	411,42	CHI
20200956453	PILAR DE GOIAS	SG10394720	SANTA TEREZINHA	21/09/2020 14:34	22/09/2020 14:59	21/09/2020 14:34	21/09/2020 16:34	2,01	13	26,09	CHI
20200956453	ITAPACI	SG10394720	SANTA TEREZINHA	21/09/2020 14:34	22/09/2020 14:59	21/09/2020 14:34	21/09/2020 18:29	3,91	6	23,45	CHI
20200956453	CRIXAS	SG10394720	SANTA TEREZINHA	21/09/2020 14:34	22/09/2020 14:59	21/09/2020 14:34	21/09/2020 18:29	3,91	304	1188,05	CHI
20200956453	GUARINOS	SG10394720	SANTA TEREZINHA	21/09/2020 14:34	22/09/2020 14:59	21/09/2020 14:34	21/09/2020 18:29	3,91	919	3591,50	CHI
20200956453	PILAR DE GOIAS	SG10394720	SANTA TEREZINHA	21/09/2020 14:34	22/09/2020 14:59	21/09/2020 14:34	21/09/2020 18:29	3,91	28	109,43	CHI
20200956453	GUARINOS	GF12213049	SANTA TEREZINHA	21/09/2020 14:34	22/09/2020 14:59	21/09/2020 14:34	21/09/2020 21:01	6,44	2	12,88	CHI
20200956453	PILAR DE GOIAS	GF12213049	SANTA TEREZINHA	21/09/2020 14:34	22/09/2020 14:59	21/09/2020 14:34	21/09/2020 21:01	6,44	1	6,44	CHI
20200956453	PILAR DE GOIAS	GF12235854LD	SANTA TEREZINHA	21/09/2020 14:34	22/09/2020 14:59	21/09/2020 14:34	22/09/2020 12:38	22,07	3	66,20	CHI

INTERNAL

20200956453	GUARINOS	GF12323411LD	SANTA TEREZINHA	21/09/2020 14:34	22/09/2020 14:59	21/09/2020 14:34	22/09/2020 14:59	24,42	2	48,85	CHI
20200956453	PILAR DE GOIAS	GF12323411LD	SANTA TEREZINHA	21/09/2020 14:34	22/09/2020 14:59	21/09/2020 14:34	22/09/2020 14:59	24,42	1	24,42	CHI
20200956453	GUARINOS	GF12321203LD	SANTA TEREZINHA	21/09/2020 14:34	22/09/2020 14:59	21/09/2020 14:34	22/09/2020 14:59	24,42	3	73,27	CHI
20200956956	VALPARAISO DE GOIAS	LZ12388659	MARAJOARA	21/09/2020 14:36	21/09/2020 19:21	21/09/2020 14:36	21/09/2020 19:21	4,74	26	123,16	CHI
20200956956	LUZIANIA	LZ12388659	MARAJOARA	21/09/2020 14:36	21/09/2020 19:21	21/09/2020 14:36	21/09/2020 19:21	4,74	8	37,90	CHI
20200956456	CAMPINACU	UC12239754	PORANGATU	21/09/2020 14:37	21/09/2020 16:22	21/09/2020 14:37	21/09/2020 16:22	1,74	11	19,18	CHI
20200956458	NIQUELANDIA	2750056026	NIQUELANDIA SUBTRANSMISSAO	21/09/2020 14:37	22/09/2020 00:30	21/09/2020 14:37	22/09/2020 00:30	9,87	1	9,87	CHI
20200956460	SANTA HELENA DE GOIAS	SH12000250	IPEGUARI	21/09/2020 14:37	21/09/2020 19:17	21/09/2020 14:37	21/09/2020 19:17	4,65	2	9,30	CHI
20200956522	PARAUNA	PU12205947	PARAUNA	21/09/2020 14:38	21/09/2020 16:44	21/09/2020 14:38	21/09/2020 16:44	2,08	3	6,25	CHI
20200956475	ALEXANIA	AX12297688	ALEXANIA	21/09/2020 14:39	22/09/2020 10:39	21/09/2020 14:39	22/09/2020 10:39	19,99	7	139,95	CHI
20200956477	AGUA FRIA DE GOIAS	PI12048037	SAO JOAO D ALIANCA	21/09/2020 14:39	21/09/2020 17:15	21/09/2020 14:39	21/09/2020 17:15	2,59	7	18,10	CHI
202009106989	ALTO PARAISO DE GOIAS	00520214	FLORES DE GOIAS	21/09/2020 14:40	21/09/2020 22:57	21/09/2020 14:40	21/09/2020 15:42	1,03	1485	1530,37	CHI
202009106989	ALTO PARAISO DE GOIAS	00520214	FLORES DE GOIAS	21/09/2020 14:40	21/09/2020 22:57	21/09/2020 14:40	21/09/2020 15:43	1,05	358	374,91	CHI
202009106989	ALTO PARAISO DE GOIAS	00520214	FLORES DE GOIAS	21/09/2020 14:40	21/09/2020 22:57	21/09/2020 14:40	21/09/2020 17:48	3,14	583	1831,11	CHI
202009106989	ALTO PARAISO DE GOIAS	00520214	FLORES DE GOIAS	21/09/2020 14:40	21/09/2020 22:57	21/09/2020 14:40	21/09/2020 18:07	3,45	839	2896,41	CHI
202009106989	ALTO PARAISO DE GOIAS	00520214	FLORES DE GOIAS	21/09/2020 14:40	21/09/2020 22:57	21/09/2020 14:40	21/09/2020 22:57	8,29	151	1251,75	CHI
20200956598	VILA PROPICIO	GE12004544	GOIANESIA S2	21/09/2020 14:40	21/09/2020 17:09	21/09/2020 14:40	21/09/2020 17:09	2,48	28	69,38	CHI
20200956598	GOIANESIA	GE12004544	GOIANESIA S2	21/09/2020 14:40	21/09/2020 17:09	21/09/2020 14:40	21/09/2020 17:09	2,48	10	24,78	CHI
20200958043	GOIANESIA	GE11040928	GOIANESIA S2	21/09/2020 14:40	22/09/2020 01:15	21/09/2020 14:40	22/09/2020 01:15	10,57	108	1141,35	CHI
202009106989	ALTO PARAISO DE GOIAS	00520214	FLORES DE GOIAS	21/09/2020 14:40	21/09/2020 22:57	21/09/2020 15:44	21/09/2020 15:48	0,07	1843	136,18	CHI
202009106989	ALTO PARAISO DE GOIAS	BF10410982	FLORES DE GOIAS	21/09/2020 14:40	21/09/2020 22:57	21/09/2020 16:48	21/09/2020 19:50	3,03	992	3009,07	CHI
202009106989	ALTO PARAISO DE GOIAS	BF11047999	FLORES DE GOIAS	21/09/2020 14:40	21/09/2020 22:57	21/09/2020 16:48	21/09/2020 19:58	3,17	133	421,61	CHI
202009106989	ALTO PARAISO DE GOIAS	BF11320603	FLORES DE GOIAS	21/09/2020 14:40	21/09/2020 22:57	21/09/2020 16:48	21/09/2020 21:52	5,08	68	345,36	CHI
202009106989	ALTO PARAISO DE GOIAS	00520214	FLORES DE GOIAS	21/09/2020 14:40	21/09/2020 22:57	21/09/2020 17:00	21/09/2020 17:17	0,27	650	174,96	CHI
202009106989	ALTO PARAISO DE GOIAS	BF16409771	FLORES DE GOIAS	21/09/2020 14:40	21/09/2020 22:57	21/09/2020 18:03	21/09/2020 18:07	0,06	583	32,71	CHI
20200957772	CAMPINACU	UC12285921	PORANGATU	21/09/2020 14:41	22/09/2020 00:24	21/09/2020 14:41	22/09/2020 00:24	9,71	41	398,18	CHI
20200956499	BURITI DE GOIAS	BS11103262	FIRMINOPOLIS S2	21/09/2020 14:42	21/09/2020 17:38	21/09/2020 14:42	21/09/2020 17:38	2,93	126	369,50	CHI
20200956521	VALPARAISO DE GOIAS	10010812430	PACAEMBU S2	21/09/2020 14:44	22/09/2020 11:40	21/09/2020 14:44	22/09/2020 11:40	20,93	1	20,93	CHI
20200956523	NIQUELANDIA	NQ21204149	NIQUELANDIA SUBTRANSMISSAO	21/09/2020 14:44	21/09/2020 22:07	21/09/2020 14:44	21/09/2020 22:07	7,37	1	7,37	CHI
2020092100100	NOVA GLORIA	01630414	ITAPACI	21/09/2020 14:47	21/09/2020 14:50	21/09/2020 14:47	21/09/2020 14:50	0,05	15	0,75	CHI
2020092100100	ITAPACI	01630414	ITAPACI	21/09/2020 14:47	21/09/2020 14:50	21/09/2020 14:47	21/09/2020 14:50	0,05	8	0,40	CHI
2020092100100	IPIRANGA DE GOIAS	01630414	RUBIATABA	21/09/2020 14:47	21/09/2020 14:50	21/09/2020 14:47	21/09/2020 14:50	0,05	47	2,35	CHI
2020092100100	CERES	01630414	RUBIATABA	21/09/2020 14:47	21/09/2020 14:50	21/09/2020 14:47	21/09/2020 14:50	0,05	21	1,05	CHI

INTERNAL

2020092100100	ITAPACI	01630414	RUBIATABA	21/09/2020 14:47	21/09/2020 14:50	21/09/2020 14:47	21/09/2020 14:50	0,05	10	0,50	CHI
2020092100100	NOVA GLORIA	01630414	RUBIATABA	21/09/2020 14:47	21/09/2020 14:50	21/09/2020 14:47	21/09/2020 14:50	0,05	76	3,80	CHI
2020092100100	RUBIATABA	01630414	RUBIATABA	21/09/2020 14:47	21/09/2020 14:50	21/09/2020 14:47	21/09/2020 14:50	0,05	152	7,60	CHI
20200956543	CRISTALINA	KR21338008	PAMPLONA	21/09/2020 14:47	21/09/2020 18:33	21/09/2020 14:47	21/09/2020 18:33	3,76	1	3,76	CHI
20200957314	MONTIVIDIU DO NORTE	MX12187845RE	PORANGATU	21/09/2020 14:49	23/09/2020 15:20	21/09/2020 14:49	23/09/2020 15:20	48,52	13	630,71	CHI
20200955548	SITIO D ABADIA	AQ12344369	IACIARA S2	21/09/2020 14:51	21/09/2020 18:34	21/09/2020 14:51	21/09/2020 18:34	3,71	3	11,14	CHI
20200956570	SAO JOAO D ALIANCA	JL21332961	SAO JOAO D ALIANCA	21/09/2020 14:51	21/09/2020 15:40	21/09/2020 14:51	21/09/2020 15:40	0,80	2	1,61	CHI
20200956805	GOIANESIA	GE11000050	GOIANESIA S2	21/09/2020 14:52	21/09/2020 17:21	21/09/2020 14:52	21/09/2020 17:21	2,48	104	258,30	CHI
20200956623	ITAPACI	IW11000007	ITAPACI	21/09/2020 14:52	22/09/2020 00:34	21/09/2020 14:52	22/09/2020 00:34	9,69	80	775,22	CHI
20200957444	ALEXANIA	AX10397586	ALEXANIA	21/09/2020 14:55	22/09/2020 07:48	21/09/2020 14:55	21/09/2020 18:35	3,66	162	592,88	CHI
20200957444	ABADIANIA	AX10397586	ALEXANIA	21/09/2020 14:55	22/09/2020 07:48	21/09/2020 14:55	22/09/2020 07:48	16,88	13	219,42	CHI
20200957444	ALEXANIA	AX10397586	ALEXANIA	21/09/2020 14:55	22/09/2020 07:48	21/09/2020 14:55	22/09/2020 07:48	16,88	217	3662,66	CHI
20200957444	ALEXANIA	AX16407536	ALEXANIA	21/09/2020 14:55	22/09/2020 07:48	21/09/2020 14:55	22/09/2020 07:48	16,88	2	33,76	CHI
20200957444	CORUMBA DE GOIAS	AX16407536	ALEXANIA	21/09/2020 14:55	22/09/2020 07:48	21/09/2020 14:55	22/09/2020 07:48	16,88	124	2092,95	CHI
20200957444	ABADIANIA	AX16407536	ALEXANIA	21/09/2020 14:55	22/09/2020 07:48	21/09/2020 14:55	22/09/2020 07:48	16,88	4	67,51	CHI
20200957064	VALPARAISO DE GOIAS	2860034270	MARAJOARA	21/09/2020 14:55	21/09/2020 17:17	21/09/2020 14:55	21/09/2020 17:17	2,36	1	2,36	CHI
20200956608	CIDADE OCIDENTAL	DH11248733	MARAJOARA	21/09/2020 14:57	21/09/2020 17:20	21/09/2020 14:57	21/09/2020 17:20	2,38	86	204,87	CHI
20200956630	PLANALTINA	PI12355771	PLANALTINA	21/09/2020 14:57	21/09/2020 16:23	21/09/2020 14:57	21/09/2020 16:23	1,43	7	10,00	CHI
20200956907	AGUA FRIA DE GOIAS	TL10402672	SAO JOAO D ALIANCA	21/09/2020 14:57	22/09/2020 15:01	21/09/2020 14:57	21/09/2020 18:36	3,65	20	73,07	CHI
20200956907	AGUA FRIA DE GOIAS	TL12105362LD	SAO JOAO D ALIANCA	21/09/2020 14:57	22/09/2020 15:01	21/09/2020 14:57	21/09/2020 19:29	4,53	5	22,66	CHI
20200956907	AGUA FRIA DE GOIAS	TL10402672	SAO JOAO D ALIANCA	21/09/2020 14:57	22/09/2020 15:01	21/09/2020 14:57	22/09/2020 15:01	24,07	13	312,90	CHI
20200956907	AGUA FRIA DE GOIAS	TL10402672	SAO JOAO D ALIANCA	21/09/2020 14:57	22/09/2020 15:01	21/09/2020 19:12	21/09/2020 19:29	0,29	20	5,74	CHI
20200956907	AGUA FRIA DE GOIAS	TL13233773	SAO JOAO D ALIANCA	21/09/2020 14:57	22/09/2020 15:01	22/09/2020 10:07	22/09/2020 15:01	4,91	25	122,65	CHI
20200956621	SANTA HELENA DE GOIAS	SH21301724	ACREUNA	21/09/2020 14:58	21/09/2020 21:01	21/09/2020 14:58	21/09/2020 21:01	6,04	3	18,13	CHI
20200956629	JATAI	10012276101	JATAI S2	21/09/2020 14:59	22/09/2020 18:04	21/09/2020 14:59	22/09/2020 18:04	27,08	1	27,08	CHI
20200956642	ANAPOLIS	10029152036	ANAPOLIS UNIVERSITARIO S2	21/09/2020 15:00	21/09/2020 17:30	21/09/2020 15:00	21/09/2020 17:30	2,51	1	2,51	CHI
20200956883	ITAPIRAPUA	IU12089757	MATRINCHA	21/09/2020 15:00	21/09/2020 17:43	21/09/2020 15:00	21/09/2020 17:43	2,71	9	24,35	CHI
20200957068	CORUMBA DE GOIAS	CB12221423	CORUMBA	21/09/2020 15:01	21/09/2020 19:47	21/09/2020 15:01	21/09/2020 19:47	4,77	80	381,33	CHI
20200956954	RUBIATABA	RB12201812	RUBIATABA	21/09/2020 15:01	22/09/2020 08:17	21/09/2020 15:01	22/09/2020 08:17	17,27	13	224,46	CHI
20200956655	NIQUELANDIA	NQ21197544	NIQUELANDIA SUBTRANSMISSAO	21/09/2020 15:01	21/09/2020 15:40	21/09/2020 15:01	21/09/2020 15:40	0,64	2	1,28	CHI
20200957073	ITAPACI	IW12262868	ITAPACI	21/09/2020 15:02	21/09/2020 19:02	21/09/2020 15:02	21/09/2020 19:02	3,99	62	247,55	CHI
20200956665	ITABERAI	TQ12009067	ITABERAI S1	21/09/2020 15:02	21/09/2020 16:06	21/09/2020 15:02	21/09/2020 16:06	1,05	3	3,16	CHI
20200956665	TAQUARAL DE GOIAS	TQ12009067	ITABERAI S1	21/09/2020 15:02	21/09/2020 16:06	21/09/2020 15:02	21/09/2020 16:06	1,05	20	21,05	CHI

INTERNAL

20200956666	FORMOSA	FA12194791	ITUIQUIRA	21/09/2020 15:03	21/09/2020 19:18	21/09/2020 15:03	21/09/2020 19:18	4,25	3	12,75	CHI
20200956667	ANAPOLIS	21108638	DAIA S1	21/09/2020 15:03	21/09/2020 15:51	21/09/2020 15:03	21/09/2020 15:51	0,80	1	0,80	CHI
20200956675	JATAI	JT12155864	JATAI S3	21/09/2020 15:04	21/09/2020 17:57	21/09/2020 15:04	21/09/2020 17:57	2,88	8	23,02	CHI
20200957023	CIDADE OCIDENTAL	DH11128884	MARAJOARA	21/09/2020 15:05	22/09/2020 01:18	21/09/2020 15:05	22/09/2020 01:18	10,20	136	1387,69	CHI
20200956694	AGUAS LINDAS DE GOIAS	LA11090609	AGUAS LINDAS DE GOIAS S1	21/09/2020 15:06	21/09/2020 20:52	21/09/2020 15:06	21/09/2020 20:52	5,75	49	281,80	CHI
20200958282	ITAPACI	IW12081353	ITAPACI	21/09/2020 15:09	22/09/2020 17:15	21/09/2020 15:09	22/09/2020 17:15	26,10	23	600,27	CHI
20200956765	ANAPOLIS	AN11059829	JUNDIAI S1	21/09/2020 15:09	21/09/2020 16:47	21/09/2020 15:09	21/09/2020 16:47	1,63	81	131,81	CHI
20200956987	GOIANESIA	GE12379075	GOIANESIA S2	21/09/2020 15:10	21/09/2020 17:34	21/09/2020 15:10	21/09/2020 17:34	2,40	350	838,44	CHI
20200956721	GOIANESIA	GE12256024	GOIANESIA S2	21/09/2020 15:11	21/09/2020 18:09	21/09/2020 15:11	21/09/2020 18:09	2,96	18	53,36	CHI
202009107043	CAMPINORTE	CR21374796	MARA ROSA	21/09/2020 15:12	24/09/2020 15:05	21/09/2020 15:12	24/09/2020 15:05	71,87	1	71,87	CHI
20200956730	URUACU	UR12231321	MARA ROSA	21/09/2020 15:12	24/09/2020 15:05	22/09/2020 06:03	24/09/2020 15:05	57,03	32	1824,89	CHI
20200956732	LUZIANIA	LZ11351337	RIO VERMELHO	21/09/2020 15:13	21/09/2020 18:31	21/09/2020 15:13	21/09/2020 18:31	3,30	17	56,10	CHI
20200956733	CRISTALINA	KR12351414	PAMPLONA	21/09/2020 15:13	21/09/2020 17:54	21/09/2020 15:13	21/09/2020 17:54	2,68	6	16,09	CHI
20200957113	VALPARAISO DE GOIAS	10012293162	MARAJOARA	21/09/2020 15:16	21/09/2020 18:16	21/09/2020 15:16	21/09/2020 18:16	3,00	1	3,00	CHI
20200957357	CORUMBA DE GOIAS	ZN12382309	COCALZINHO	21/09/2020 15:16	21/09/2020 18:00	21/09/2020 15:16	21/09/2020 18:00	2,73	64	174,47	CHI
20200957116	ANAPOLIS	AN12059830	JUNDIAI S1	21/09/2020 15:19	21/09/2020 17:09	21/09/2020 15:19	21/09/2020 17:09	1,83	468	855,40	CHI
20200956770	SANTO ANTONIO DO DESCOBERTO	SN11131982	MARAJOARA	21/09/2020 15:21	21/09/2020 17:23	21/09/2020 15:21	21/09/2020 17:23	2,02	53	106,91	CHI
20200956772	AGUAS LINDAS DE GOIAS	LA11261139	AGUAS LINDAS DE GOIAS S1	21/09/2020 15:22	21/09/2020 16:51	21/09/2020 15:22	21/09/2020 16:51	1,48	168	248,69	CHI
20200956951	NOVO GAMA	NJ11163871	MARAJOARA	21/09/2020 15:22	21/09/2020 22:00	21/09/2020 15:22	21/09/2020 22:00	6,63	118	781,88	CHI
20200957469	CIDADE OCIDENTAL	DH12261352	MARAJOARA	21/09/2020 15:22	21/09/2020 18:36	21/09/2020 15:22	21/09/2020 18:36	3,23	17	54,84	CHI
20200956782	ANICUNS	KB21031455	ANICUNS	21/09/2020 15:24	21/09/2020 18:53	21/09/2020 15:24	21/09/2020 18:53	3,48	1	3,48	CHI
20200956785	CRISTALINA	KR12276500	CRISTALINA S2	21/09/2020 15:24	21/09/2020 18:29	21/09/2020 15:24	21/09/2020 18:29	3,07	17	52,23	CHI
20200956786	ITAPACI	10010607569	ITAPACI	21/09/2020 15:24	23/09/2020 14:03	21/09/2020 15:24	23/09/2020 14:03	46,64	1	46,64	CHI
20200956788	RIO VERDE	630445606	RIO VERDE S2	21/09/2020 15:24	21/09/2020 18:10	21/09/2020 15:24	21/09/2020 18:10	2,75	1	2,75	CHI
20200956789	FORMOSA	610002296	ITUIQUIRA	21/09/2020 15:24	21/09/2020 18:06	21/09/2020 15:24	21/09/2020 18:06	2,68	1	2,68	CHI
20200956792	ITAPACI	IW12379430	ITAPACI	21/09/2020 15:25	23/09/2020 17:00	21/09/2020 15:25	23/09/2020 17:00	49,57	2	99,15	CHI
20200956792	ITAPACI	IW12275237	ITAPACI	21/09/2020 15:25	23/09/2020 17:00	23/09/2020 13:30	23/09/2020 13:49	0,33	1	0,33	CHI
20200956796	CACU	1140010478	CACHOEIRA ALTA	21/09/2020 15:27	21/09/2020 18:50	21/09/2020 15:27	21/09/2020 18:50	3,37	1	3,37	CHI
20200956800	MOZARLANDIA	MZ12300442	MOZARLANDIA	21/09/2020 15:28	21/09/2020 21:22	21/09/2020 15:28	21/09/2020 21:22	5,91	5	29,55	CHI
20200956802	FLORES DE GOIAS	FB21044986	IACIARA S2	21/09/2020 15:28	21/09/2020 19:22	21/09/2020 15:28	21/09/2020 19:22	3,89	1	3,89	CHI
202009107028	PORANGATU	840136810	PORANGATU	21/09/2020 15:28	21/09/2020 18:43	21/09/2020 15:28	21/09/2020 18:43	3,26	1	3,26	CHI
20200960353	MUTUNOPOLIS	PO12391912	PORANGATU	21/09/2020 15:28	22/09/2020 16:58	21/09/2020 18:43	22/09/2020 16:58	22,23	37	822,66	CHI
20200960353	PORANGATU	PO12391912	PORANGATU	21/09/2020 15:28	22/09/2020 16:58	21/09/2020 18:43	22/09/2020 16:58	22,23	98	2178,95	CHI

INTERNAL

20200959384	NIQUELANDIA	NQ13317144	BARRO ALTO	21/09/2020 15:29	23/09/2020 11:31	21/09/2020 15:29	23/09/2020 11:31	44,02	52	2289,03	CHI
20200959384	NIQUELANDIA	NQ13317144	BARRO ALTO	21/09/2020 15:29	23/09/2020 11:31	23/09/2020 09:12	23/09/2020 11:31	2,32	1	2,32	CHI
20200956814	RIO VERDE	630182292	CABRIUVA S1	21/09/2020 15:30	22/09/2020 10:25	21/09/2020 15:30	22/09/2020 10:25	18,91	1	18,91	CHI
20200956815	NIQUELANDIA	2750020299	NIQUELANDIA SUBTRANSMISSAO	21/09/2020 15:30	22/09/2020 13:47	21/09/2020 15:30	22/09/2020 13:47	22,27	1	22,27	CHI
20200956838	URUACU	UR11221613	URUACU	21/09/2020 15:32	21/09/2020 18:15	21/09/2020 15:32	21/09/2020 18:15	2,71	34	92,03	CHI
20200958363	LUZIANIA	LZ11383062	MARAJOARA	21/09/2020 15:33	21/09/2020 20:39	21/09/2020 15:33	21/09/2020 20:39	5,10	147	749,58	CHI
20200956843	CIDADE OCIDENTAL	DH11261695	MARAJOARA	21/09/2020 15:33	21/09/2020 17:41	21/09/2020 15:33	21/09/2020 17:41	2,13	104	221,46	CHI
20200956843	CIDADE OCIDENTAL	DH12261759	MARAJOARA	21/09/2020 15:33	21/09/2020 17:41	21/09/2020 15:34	21/09/2020 17:41	2,11	228	481,33	CHI
20200956847	LUZIANIA	10012722314	MARAJOARA	21/09/2020 15:34	22/09/2020 01:24	21/09/2020 15:34	22/09/2020 01:24	9,83	1	9,83	CHI
20200957037	CIDADE OCIDENTAL	DH11347308	MARAJOARA	21/09/2020 15:35	21/09/2020 17:39	21/09/2020 15:35	21/09/2020 17:39	2,06	50	102,85	CHI
20200956879	LUZIANIA	LZ11168719	RIO VERMELHO	21/09/2020 15:36	21/09/2020 16:42	21/09/2020 15:36	21/09/2020 16:42	1,09	158	172,88	CHI
20200956880	RUBIATABA	780052298	RUBIATABA	21/09/2020 15:36	23/09/2020 16:16	21/09/2020 15:36	23/09/2020 16:16	48,65	1	48,65	CHI
20200956994	CIDADE OCIDENTAL	DH12192976	MARAJOARA	21/09/2020 15:37	22/09/2020 01:15	21/09/2020 15:37	22/09/2020 01:15	9,62	125	1203,06	CHI
20200958093	SAO SIMAO	SO11153942	CACHOEIRA ALTA	21/09/2020 15:37	21/09/2020 19:07	21/09/2020 15:37	21/09/2020 19:07	3,49	41	142,93	CHI
20200956920	SANTA TEREZA DE GOIAS	FO12060936RE	MARA ROSA	21/09/2020 15:38	22/09/2020 21:24	21/09/2020 15:38	22/09/2020 20:34	28,94	18	520,86	CHI
20200956920	FORMOSO	FO12060936RE	MARA ROSA	21/09/2020 15:38	22/09/2020 21:24	21/09/2020 15:38	22/09/2020 20:34	28,94	1	28,94	CHI
20200956920	SANTA TEREZA DE GOIAS	FO12060936RE	MARA ROSA	21/09/2020 15:38	22/09/2020 21:24	21/09/2020 15:38	22/09/2020 21:24	29,78	3	89,34	CHI
20200956891	GOIANESIA	GE11215140	GOIANESIA S2	21/09/2020 15:38	21/09/2020 18:18	21/09/2020 15:38	21/09/2020 18:18	2,66	112	298,04	CHI
20200956920	FORMOSO	FO12060936RE	MARA ROSA	21/09/2020 15:38	22/09/2020 21:24	21/09/2020 20:31	22/09/2020 20:34	24,05	4	96,18	CHI
20200956920	SANTA TEREZA DE GOIAS	FO12060936RE	MARA ROSA	21/09/2020 15:38	22/09/2020 21:24	21/09/2020 20:31	22/09/2020 20:34	24,05	1	24,05	CHI
20200956920	SANTA TEREZA DE GOIAS	SE13066559	MARA ROSA	21/09/2020 15:38	22/09/2020 21:24	21/09/2020 20:31	22/09/2020 21:24	24,89	14	348,46	CHI
20200956990	VILA PROPICIO	NP12327893	GOIANESIA S1	21/09/2020 15:39	21/09/2020 17:38	21/09/2020 15:39	21/09/2020 17:38	1,97	98	193,52	CHI
20200956913	QUIRINOPOLIS	80075678	QUIRINOPOLIS	21/09/2020 15:40	21/09/2020 17:42	21/09/2020 15:40	21/09/2020 17:42	2,03	1	2,03	CHI
20200956914	LUZIANIA	LZ11405491	RIO VERMELHO	21/09/2020 15:40	21/09/2020 21:19	21/09/2020 15:40	21/09/2020 21:19	5,64	3	16,93	CHI
20200957323	MOZARLANDIA	MZ12064157	MOZARLANDIA	21/09/2020 15:42	21/09/2020 18:54	21/09/2020 15:42	21/09/2020 18:54	3,18	15	47,76	CHI
20200957039	RUBIATABA	RB12255942	RUBIATABA	21/09/2020 15:43	22/09/2020 14:08	21/09/2020 15:43	22/09/2020 14:08	22,41	48	1075,69	CHI
20200956941	MIMOSO DE GOIAS	MJ12313857	PADRE BERNARDO	21/09/2020 15:43	21/09/2020 19:07	21/09/2020 15:43	21/09/2020 19:07	3,39	13	44,08	CHI
20200956945	MONTIVIDIU DO NORTE	9670004335	PORANGATU	21/09/2020 15:43	22/09/2020 00:07	21/09/2020 15:43	22/09/2020 00:07	8,38	1	8,38	CHI
20200956959	AGUAS LINDAS DE GOIAS	LA12389384	AGUAS LINDAS DE GOIAS S2	21/09/2020 15:45	21/09/2020 18:05	21/09/2020 15:45	21/09/2020 18:05	2,32	3	6,97	CHI
20200956961	CAIAPONIA	CP21188434	CAIAPONIA	21/09/2020 15:45	21/09/2020 17:32	21/09/2020 15:45	21/09/2020 17:32	1,77	1	1,77	CHI
20200956973	RUBIATABA	RB12022135	RUBIATABA	21/09/2020 15:47	22/09/2020 17:44	21/09/2020 15:47	22/09/2020 17:44	25,94	2	51,89	CHI
20200957133	CAMPINACU	UC12055175	PORANGATU	21/09/2020 15:47	21/09/2020 21:08	21/09/2020 15:47	21/09/2020 21:08	5,34	17	90,74	CHI
20200957082	GOIANESIA	GE11273406	GOIANESIA S2	21/09/2020 15:48	21/09/2020 18:14	21/09/2020 15:48	21/09/2020 18:14	2,43	101	245,71	CHI

INTERNAL

20200956980	TROMBAS	TB12143685	PORANGATU	21/09/2020 15:48	21/09/2020 18:12	21/09/2020 15:48	21/09/2020 18:12	2,40	18	43,12	CHI
20200956980	MONTIVIDIU DO NORTE	TB12143685	PORANGATU	21/09/2020 15:48	21/09/2020 18:12	21/09/2020 15:48	21/09/2020 18:12	2,40	10	23,95	CHI
20200957030	AGUAS LINDAS DE GOIAS	LA12165006	AGUAS LINDAS DE GOIAS S2	21/09/2020 15:48	21/09/2020 17:18	21/09/2020 15:48	21/09/2020 17:18	1,49	1547	2306,75	CHI
20200956997	RIO VERDE	RV12249048	MONTIVIDIU T	21/09/2020 15:50	21/09/2020 18:49	21/09/2020 15:50	21/09/2020 18:49	2,98	4	11,93	CHI
20200956998	CIDADE OCIDENTAL	LZ12030237LD	MARAJOARA	21/09/2020 15:50	22/09/2020 17:44	21/09/2020 15:50	22/09/2020 17:44	25,91	26	673,60	CHI
20200957677	RUBIATABA	RB12262942	RUBIATABA	21/09/2020 15:53	22/09/2020 09:26	21/09/2020 15:53	22/09/2020 09:26	17,55	15	263,20	CHI
20200957710	CIDADE OCIDENTAL	LZ12072636	MARAJOARA	21/09/2020 15:53	21/09/2020 21:46	21/09/2020 15:53	21/09/2020 21:46	5,88	19	111,67	CHI
202009106988	PLANALTINA	PI12149019	PLANALTINA	21/09/2020 15:54	22/09/2020 13:24	21/09/2020 15:54	22/09/2020 09:04	17,17	66	1132,96	CHI
202009106988	PLANALTINA	PI12149019	PLANALTINA	21/09/2020 15:54	22/09/2020 13:24	21/09/2020 15:54	22/09/2020 12:30	20,60	14	288,34	CHI
202009106988	PLANALTINA	PI12149019	PLANALTINA	21/09/2020 15:54	22/09/2020 13:24	21/09/2020 15:54	22/09/2020 12:30	20,61	79	1628,21	CHI
202009106988	PLANALTINA	PI12149019	PLANALTINA	21/09/2020 15:54	22/09/2020 13:24	21/09/2020 15:54	22/09/2020 12:31	20,62	72	1484,44	CHI
202009106988	PLANALTINA	PI12149019	PLANALTINA	21/09/2020 15:54	22/09/2020 13:24	21/09/2020 15:54	22/09/2020 12:31	20,62	38	783,70	CHI
202009106988	PLANALTINA	PI12149019	PLANALTINA	21/09/2020 15:54	22/09/2020 13:24	21/09/2020 15:54	22/09/2020 13:19	21,42	56	1199,54	CHI
202009106988	PLANALTINA	PI12149019	PLANALTINA	21/09/2020 15:54	22/09/2020 13:24	21/09/2020 15:54	22/09/2020 13:19	21,43	36	771,36	CHI
202009106988	PLANALTINA	PI12149019	PLANALTINA	21/09/2020 15:54	22/09/2020 13:24	21/09/2020 15:54	22/09/2020 13:20	21,43	42	900,24	CHI
202009106988	PLANALTINA	PI12149019	PLANALTINA	21/09/2020 15:54	22/09/2020 13:24	21/09/2020 15:54	22/09/2020 13:20	21,44	18	385,92	CHI
202009106988	PLANALTINA	PI12149019	PLANALTINA	21/09/2020 15:54	22/09/2020 13:24	21/09/2020 15:54	22/09/2020 13:21	21,46	1	21,46	CHI
202009106988	PLANALTINA	PI12149019	PLANALTINA	21/09/2020 15:54	22/09/2020 13:24	21/09/2020 15:54	22/09/2020 13:22	21,46	75	1609,79	CHI
202009106988	PLANALTINA	PI12149019	PLANALTINA	21/09/2020 15:54	22/09/2020 13:24	21/09/2020 15:54	22/09/2020 13:22	21,47	46	987,76	CHI
202009106988	PLANALTINA	PI12149019	PLANALTINA	21/09/2020 15:54	22/09/2020 13:24	21/09/2020 15:54	22/09/2020 13:23	21,48	49	1052,56	CHI
202009106988	PLANALTINA	PI12149019	PLANALTINA	21/09/2020 15:54	22/09/2020 13:24	21/09/2020 15:54	22/09/2020 13:23	21,49	49	1053,08	CHI
202009106988	PLANALTINA	PI12149019	PLANALTINA	21/09/2020 15:54	22/09/2020 13:24	21/09/2020 15:54	22/09/2020 13:24	21,50	35	752,42	CHI
202009106988	PLANALTINA	PI12149019	PLANALTINA	21/09/2020 15:54	22/09/2020 13:24	21/09/2020 15:54	22/09/2020 13:24	21,50	26	559,09	CHI
202009106988	PLANALTINA	PI12149019	PLANALTINA	21/09/2020 15:54	22/09/2020 13:24	21/09/2020 15:54	22/09/2020 13:24	21,51	18	387,19	CHI
20200957058	RIO VERDE	630045318	RIO VERDE S2	21/09/2020 15:56	22/09/2020 05:15	21/09/2020 15:56	22/09/2020 05:15	13,33	1	13,33	CHI
20200957169	TROMBAS	TB12240756	PORANGATU	21/09/2020 15:56	21/09/2020 19:29	21/09/2020 15:56	21/09/2020 19:29	3,54	47	166,43	CHI
20200957048	NIQUELANDIA	NQ11088751	NIQUELANDIA SUBTRANSMISSAO	21/09/2020 15:56	21/09/2020 20:48	21/09/2020 15:56	21/09/2020 20:48	4,86	111	539,15	CHI
20200957559	TROMBAS	TB11143648	PORANGATU	21/09/2020 15:57	21/09/2020 21:21	21/09/2020 15:57	21/09/2020 21:21	5,39	191	1029,86	CHI
20200957057	PLANALTINA	PI12149019	PLANALTINA	21/09/2020 15:58	22/09/2020 12:59	22/09/2020 11:28	22/09/2020 11:54	0,43	66	28,49	CHI
20200957057	PLANALTINA	PI11386350	PLANALTINA	21/09/2020 15:58	22/09/2020 12:59	22/09/2020 12:36	22/09/2020 12:59	0,38	79	29,98	CHI
20200958889	CIDADE OCIDENTAL	DH11199641	MARAJOARA	21/09/2020 15:59	22/09/2020 02:31	21/09/2020 15:59	22/09/2020 02:31	10,53	110	1158,51	CHI
20200957100	CIDADE OCIDENTAL	DH11133215	MARAJOARA	21/09/2020 15:59	21/09/2020 21:16	21/09/2020 15:59	21/09/2020 21:16	5,28	110	581,04	CHI
20200957668	CIDADE OCIDENTAL	DH12248721	MARAJOARA	21/09/2020 16:00	21/09/2020 19:14	21/09/2020 16:00	21/09/2020 19:14	3,23	72	232,80	CHI

INTERNAL

20200957067	COCALZINHO DE GOIAS	ZN11252289	COCALZINHO	21/09/2020 16:00	21/09/2020 18:49	21/09/2020 16:00	21/09/2020 18:49	2,82	61	171,77	CHI
20200957301	NIQUELANDIA	NQ12056788	URUACU	21/09/2020 16:01	21/09/2020 19:15	21/09/2020 16:01	21/09/2020 19:15	3,22	94	302,63	CHI
20200957086	QUIRINOPOLIS	QI21100930	QUIRINOPOLIS	21/09/2020 16:02	21/09/2020 18:30	21/09/2020 16:02	21/09/2020 18:30	2,46	1	2,46	CHI
20200957089	VALPARAISO DE GOIAS	2860057839	MARAJOARA	21/09/2020 16:02	22/09/2020 11:19	21/09/2020 16:02	22/09/2020 11:19	19,27	1	19,27	CHI
20200957094	AGUAS LINDAS DE GOIAS	LA12096115	AGUAS LINDAS DE GOIAS S1	21/09/2020 16:02	21/09/2020 18:02	21/09/2020 16:02	21/09/2020 18:02	1,98	115	228,27	CHI
20200957096	RIO VERDE	630035039	RIO VERDE S2	21/09/2020 16:03	22/09/2020 16:01	21/09/2020 16:03	22/09/2020 16:01	23,98	1	23,98	CHI
20200957111	LUZIANIA	KR12261706	PAMPLONA	21/09/2020 16:04	22/09/2020 11:33	21/09/2020 16:04	22/09/2020 11:33	19,47	4	77,89	CHI
20200957136	PLANALTINA	2960001236	PLANALTINA	21/09/2020 16:07	22/09/2020 11:31	21/09/2020 16:07	22/09/2020 11:31	19,39	1	19,39	CHI
20200957138	RIO VERDE	RV21271348	CABRIUVA S2	21/09/2020 16:07	22/09/2020 09:31	21/09/2020 16:07	22/09/2020 09:31	17,39	2	34,78	CHI
20200957154	NOVO GAMA	4990032550	PACAEMBU S1	21/09/2020 16:09	22/09/2020 09:47	21/09/2020 16:09	22/09/2020 09:47	17,62	1	17,62	CHI
20200960137	NIQUELANDIA	NQ11090411	BARRO ALTO	21/09/2020 16:10	22/09/2020 19:22	21/09/2020 16:10	22/09/2020 19:22	27,20	24	652,72	CHI
20200960030	JATAI	290035934	JATAI S3	21/09/2020 16:10	22/09/2020 14:20	21/09/2020 16:10	22/09/2020 14:20	22,16	1	22,16	CHI
20200957197	MONTIVIDIU DO NORTE	MX12203423	PORANGATU	21/09/2020 16:10	22/09/2020 14:22	21/09/2020 16:10	22/09/2020 14:22	22,19	17	377,20	CHI
20200957605	ESTRELA DO NORTE	ET11171881	MARA ROSA	21/09/2020 16:10	22/09/2020 12:47	21/09/2020 16:10	22/09/2020 12:47	20,60	62	1277,42	CHI
20200957390	NOVO GAMA	00060414	MARAJOARA	21/09/2020 16:10	21/09/2020 20:30	21/09/2020 16:15	21/09/2020 20:23	4,13	1	4,13	CHI
20200957390	DISTRITO FEDERAL	NJ16410040	MARAJOARA	21/09/2020 16:10	21/09/2020 20:30	21/09/2020 18:26	21/09/2020 18:29	0,06	743	41,69	CHI
20200957390	NOVO GAMA	NJ16410040	MARAJOARA	21/09/2020 16:10	21/09/2020 20:30	21/09/2020 18:26	21/09/2020 18:29	0,06	637	35,74	CHI
20200957390	DISTRITO FEDERAL	NJ16410972	MARAJOARA	21/09/2020 16:10	21/09/2020 20:30	21/09/2020 20:26	21/09/2020 20:30	0,07	52	3,52	CHI
20200957390	NOVO GAMA	NJ16410972	MARAJOARA	21/09/2020 16:10	21/09/2020 20:30	21/09/2020 20:26	21/09/2020 20:30	0,07	3028	205,23	CHI
20200957547	NOVO GAMA	NJ11209636	PACAEMBU S2	21/09/2020 16:11	21/09/2020 23:12	21/09/2020 16:11	21/09/2020 23:12	7,02	150	1052,54	CHI
20200957182	RUBIATABA	RB12039395	RUBIATABA	21/09/2020 16:11	22/09/2020 10:08	21/09/2020 16:11	22/09/2020 10:08	17,94	13	233,21	CHI
20200957186	PADRE BERNARDO	PB11192959	PADRE BERNARDO	21/09/2020 16:11	21/09/2020 21:06	21/09/2020 16:11	21/09/2020 21:06	4,90	146	715,81	CHI
20200957954	SANTA TEREZA DE GOIAS	SE11098952	MARA ROSA	21/09/2020 16:11	21/09/2020 21:31	21/09/2020 16:11	21/09/2020 21:31	5,32	105	558,54	CHI
20200957199	PIRENOPOLIS	PV11122923	CORUMBA	21/09/2020 16:12	21/09/2020 19:45	21/09/2020 16:12	21/09/2020 19:45	3,55	113	400,84	CHI
20200957477	DISTRITO FEDERAL	PI11085605	PLANALTINA	21/09/2020 16:12	22/09/2020 00:43	21/09/2020 16:12	22/09/2020 00:43	8,51	125	1063,68	CHI
20200957244	ITAPURANGA	MS10400600	ITAPURANGA	21/09/2020 16:13	21/09/2020 16:27	21/09/2020 16:13	21/09/2020 16:27	0,24	38	8,94	CHI
20200957244	MORRO AGUDO DE GOIAS	MS10400600	ITAPURANGA	21/09/2020 16:13	21/09/2020 16:27	21/09/2020 16:13	21/09/2020 16:27	0,24	62	14,59	CHI
20200958524	NIQUELANDIA	NQ12243514	BARRO ALTO	21/09/2020 16:15	21/09/2020 21:10	21/09/2020 16:15	21/09/2020 21:10	4,91	25	122,72	CHI
20200957213	SANTA TEREZINHA DE GOIAS	01490224	URUACU	21/09/2020 16:15	21/09/2020 23:43	21/09/2020 16:15	21/09/2020 21:36	5,35	5	26,75	CHI
20200957213	GUARINOS	01490224	URUACU	21/09/2020 16:15	21/09/2020 23:43	21/09/2020 16:15	21/09/2020 21:36	5,35	11	58,86	CHI
20200957213	PILAR DE GOIAS	01490224	URUACU	21/09/2020 16:15	21/09/2020 23:43	21/09/2020 16:15	21/09/2020 21:36	5,35	626	3349,62	CHI
20200957213	ITAPACI	01490224	URUACU	21/09/2020 16:15	21/09/2020 23:43	21/09/2020 16:15	21/09/2020 21:36	5,35	2	10,70	CHI
20200957213	PILAR DE GOIAS	GG21340130	URUACU	21/09/2020 16:15	21/09/2020 23:43	21/09/2020 16:15	21/09/2020 21:37	5,36	1	5,36	CHI

INTERNAL

20200957213	PILAR DE GOIAS	GG11135574	URUACU	21/09/2020 16:15	21/09/2020 23:43	21/09/2020 16:15	21/09/2020 23:43	7,46	86	641,85	CHI
20200957236	MARA ROSA	MQ10396038	MARA ROSA	21/09/2020 16:16	23/09/2020 22:00	21/09/2020 16:16	21/09/2020 19:48	3,54	95	336,12	CHI
20200957236	ALTO HORIZONTE	MQ13220761	MARA ROSA	21/09/2020 16:16	23/09/2020 22:00	21/09/2020 16:16	22/09/2020 14:38	22,36	2	44,73	CHI
20200957236	MARA ROSA	MQ13220761	MARA ROSA	21/09/2020 16:16	23/09/2020 22:00	21/09/2020 16:16	22/09/2020 14:38	22,36	64	1431,29	CHI
20200957236	MARA ROSA	MQ13220761	MARA ROSA	21/09/2020 16:16	23/09/2020 22:00	21/09/2020 16:16	22/09/2020 20:44	28,46	5	142,31	CHI
20200957236	MARA ROSA	MQ13220761	MARA ROSA	21/09/2020 16:16	23/09/2020 22:00	21/09/2020 16:16	23/09/2020 19:11	50,91	1	50,91	CHI
20200957236	AMARALINA	MQ13252086	MARA ROSA	21/09/2020 16:16	23/09/2020 22:00	21/09/2020 16:16	23/09/2020 20:01	51,75	205	10609,21	CHI
20200957236	MARA ROSA	MQ13252086	MARA ROSA	21/09/2020 16:16	23/09/2020 22:00	21/09/2020 16:16	23/09/2020 20:01	51,75	6	310,51	CHI
20200957236	MARA ROSA	MQ12241457	MARA ROSA	21/09/2020 16:16	23/09/2020 22:00	21/09/2020 16:16	23/09/2020 21:16	53,00	1	53,00	CHI
20200957236	MARA ROSA	MQ12288582	MARA ROSA	21/09/2020 16:16	23/09/2020 22:00	21/09/2020 16:16	23/09/2020 22:00	53,73	5	268,67	CHI
20200957219	NIQUELANDIA	2750081628	NIQUELANDIA SUBTRANSMISSAO	21/09/2020 16:16	22/09/2020 19:09	21/09/2020 16:16	22/09/2020 19:09	26,87	1	26,87	CHI
20200957236	MARA ROSA	MQ10396038	MARA ROSA	21/09/2020 16:16	23/09/2020 22:00	22/09/2020 10:20	22/09/2020 10:34	0,23	105	24,56	CHI
20200957236	MARA ROSA	MQ13220761	MARA ROSA	21/09/2020 16:16	23/09/2020 22:00	22/09/2020 10:20	22/09/2020 14:38	4,29	11	47,24	CHI
20200957236	ALTO HORIZONTE	MQ13220761	MARA ROSA	21/09/2020 16:16	23/09/2020 22:00	22/09/2020 10:20	22/09/2020 14:38	4,29	1	4,29	CHI
20200957236	MARA ROSA	MQ13246523	MARA ROSA	21/09/2020 16:16	23/09/2020 22:00	22/09/2020 10:20	22/09/2020 20:44	10,39	4	41,57	CHI
20200957236	MARA ROSA	MQ12241457	MARA ROSA	21/09/2020 16:16	23/09/2020 22:00	22/09/2020 10:20	23/09/2020 21:16	34,93	1	34,93	CHI
20200957236	MARA ROSA	MQ10396038	MARA ROSA	21/09/2020 16:16	23/09/2020 22:00	22/09/2020 20:44	22/09/2020 21:41	0,94	180	169,35	CHI
20200957236	ALTO HORIZONTE	MQ10396038	MARA ROSA	21/09/2020 16:16	23/09/2020 22:00	22/09/2020 20:44	22/09/2020 21:41	0,94	3	2,82	CHI
20200957236	ALTO HORIZONTE	6195928	MARA ROSA	21/09/2020 16:16	23/09/2020 22:00	23/09/2020 09:55	23/09/2020 17:04	7,14	3	21,43	CHI
20200957236	MARA ROSA	6195928	MARA ROSA	21/09/2020 16:16	23/09/2020 22:00	23/09/2020 09:55	23/09/2020 17:04	7,14	182	1300,39	CHI
20200959211	CAMPINACU	UC11058960	PORANGATU	21/09/2020 16:17	22/09/2020 00:14	21/09/2020 16:17	22/09/2020 00:14	7,95	101	802,56	CHI
20200957223	LUZIANIA	120235936	RIO VERMELHO	21/09/2020 16:17	22/09/2020 00:29	21/09/2020 16:17	22/09/2020 00:29	8,19	1	8,19	CHI
20200957227	FORMOSA	610082772	ITIQUEIRA	21/09/2020 16:17	21/09/2020 16:59	21/09/2020 16:17	21/09/2020 16:59	0,69	1	0,69	CHI
20200957366	MARA ROSA	ET18050738FS	MARA ROSA	21/09/2020 16:17	22/09/2020 13:30	21/09/2020 16:17	22/09/2020 13:30	21,20	63	1335,90	CHI
20200957366	FORMOSO	ET18050738FS	MARA ROSA	21/09/2020 16:17	22/09/2020 13:30	21/09/2020 16:17	22/09/2020 13:30	21,20	74	1569,15	CHI
20200957366	ESTRELA DO NORTE	ET18050738FS	MARA ROSA	21/09/2020 16:17	22/09/2020 13:30	21/09/2020 16:17	22/09/2020 13:30	21,20	11	233,25	CHI
20200957487	COCALZINHO DE GOIAS	CB12043123	COCALZINHO	21/09/2020 16:18	21/09/2020 21:09	21/09/2020 16:18	21/09/2020 21:09	4,85	7	33,95	CHI
20200957264	URUACU	UR12201647	URUACU	21/09/2020 16:18	23/09/2020 13:57	21/09/2020 16:18	23/09/2020 13:57	45,64	6	273,87	CHI
20200957246	SAO JOAO D ALIANCA	JL11130015	SAO JOAO D ALIANCA	21/09/2020 16:19	21/09/2020 18:49	21/09/2020 16:19	21/09/2020 18:49	2,50	7	17,49	CHI
20200957248	PILAR DE GOIAS	HL12293455	URUACU	21/09/2020 16:19	22/09/2020 22:36	21/09/2020 16:19	22/09/2020 22:36	30,27	1	30,27	CHI
20200957248	HIDROLINA	HL12293455	URUACU	21/09/2020 16:19	22/09/2020 22:36	21/09/2020 16:19	22/09/2020 22:36	30,27	2	60,54	CHI
20200957253	SAO SIMAO	10018351407	CACHOEIRA ALTA	21/09/2020 16:20	21/09/2020 17:30	21/09/2020 16:20	21/09/2020 17:30	1,16	1	1,16	CHI
20200958032	CAMPINACU	UC12265729	PORANGATU	21/09/2020 16:20	21/09/2020 23:23	21/09/2020 16:20	21/09/2020 23:23	7,04	26	183,16	CHI

INTERNAL

20200957624	VALPARAISO DE GOIAS	VA11330723	PACAEMBU S2	21/09/2020 16:20	21/09/2020 19:02	21/09/2020 16:20	21/09/2020 19:02	2,69	57	153,11	CHI
20200960138	NIQUELANDIA	NQ12268729	BARRO ALTO	21/09/2020 16:21	22/09/2020 08:59	21/09/2020 16:21	22/09/2020 08:59	16,63	63	1047,69	CHI
20200957280	PADRE BERNARDO	PB12305105	PADRE BERNARDO	21/09/2020 16:22	21/09/2020 18:11	21/09/2020 16:22	21/09/2020 18:11	1,80	18	32,46	CHI
20200957282	PLANALTINA	2960153577	PLANALTINA	21/09/2020 16:23	21/09/2020 17:27	21/09/2020 16:23	21/09/2020 17:27	1,06	1	1,06	CHI
20200957283	PORANGATU	PO11328821	PORANGATU	21/09/2020 16:23	22/09/2020 12:09	21/09/2020 16:23	22/09/2020 12:09	19,76	1	19,76	CHI
20200957284	SANTA HELENA DE GOIAS	400017398	IPEGUARI	21/09/2020 16:23	21/09/2020 21:06	21/09/2020 16:23	21/09/2020 21:06	4,71	1	4,71	CHI
20200957290	AVELINOPOLIS	AV21193585	ANICUNS	21/09/2020 16:24	21/09/2020 20:27	21/09/2020 16:24	21/09/2020 20:27	4,05	2	8,10	CHI
20200957292	LUZIANIA	LZ21054572	MARAJOARA	21/09/2020 16:24	22/09/2020 00:26	21/09/2020 16:24	22/09/2020 00:26	8,03	1	8,03	CHI
20200957368	MOZARLANDIA	MZ12181384	MOZARLANDIA	21/09/2020 16:24	21/09/2020 19:56	21/09/2020 16:24	21/09/2020 19:56	3,52	5	17,60	CHI
20200957312	CRISTALINA	KR12163713	CRISTALINA S2	21/09/2020 16:26	22/09/2020 14:05	21/09/2020 16:26	22/09/2020 14:05	21,65	4	86,58	CHI
20200958941	PLANALTINA	PI16397565	PLANALTINA	21/09/2020 16:27	22/09/2020 05:04	21/09/2020 16:27	22/09/2020 05:04	12,61	850	10722,04	CHI
20200958100	SANTA TEREZINHA DE GOIAS	SG12181363	SANTA TEREZINHA	21/09/2020 16:27	21/09/2020 22:34	21/09/2020 16:27	21/09/2020 22:34	6,10	144	878,68	CHI
20200957534	PORANGATU	PO12048411	PORANGATU	21/09/2020 16:27	21/09/2020 19:22	21/09/2020 16:27	21/09/2020 19:22	2,90	17	49,33	CHI
20200957329	SAO JOAO D ALIANCA	JL21332961	SAO JOAO D ALIANCA	21/09/2020 16:27	21/09/2020 17:06	21/09/2020 16:27	21/09/2020 17:06	0,63	2	1,27	CHI
20200958941	DISTRITO FEDERAL	PI16397565	PLANALTINA	21/09/2020 16:27	22/09/2020 05:04	22/09/2020 03:32	22/09/2020 05:04	1,53	5	7,66	CHI
20200958941	PLANALTINA	PI16397565	PLANALTINA	21/09/2020 16:27	22/09/2020 05:04	22/09/2020 03:32	22/09/2020 05:04	1,53	3438	5267,78	CHI
20200957331	TURVANIA	FR12105326	FIRMINOPOLIS S1	21/09/2020 16:28	22/09/2020 17:24	21/09/2020 16:28	22/09/2020 17:24	24,94	3	74,81	CHI
20200957345	MINEIROS	MY21036643	PARQUE DAS EMAS	21/09/2020 16:30	21/09/2020 17:18	21/09/2020 16:30	21/09/2020 17:18	0,79	1	0,79	CHI
20200957370	PORANGATU	PO10400350	PORANGATU	21/09/2020 16:30	22/09/2020 11:40	21/09/2020 16:30	22/09/2020 10:37	18,11	5	90,56	CHI
20200957370	PORANGATU	PO10400350	PORANGATU	21/09/2020 16:30	22/09/2020 11:40	21/09/2020 16:30	22/09/2020 11:00	18,50	75	1387,19	CHI
20200957370	PORANGATU	PO10400350	PORANGATU	21/09/2020 16:30	22/09/2020 11:40	21/09/2020 16:30	22/09/2020 11:40	19,16	164	3141,83	CHI
20200957353	TROMBAS	TB12202556	PORANGATU	21/09/2020 16:32	21/09/2020 20:00	21/09/2020 16:32	21/09/2020 20:00	3,47	1	3,47	CHI
20200957391	ITAJA	IJ21154264	CACHOEIRA ALTA	21/09/2020 16:34	22/09/2020 00:00	21/09/2020 16:34	22/09/2020 00:00	7,42	1	7,42	CHI
20200957397	COCALZINHO DE GOIAS	ZN12284334	COCALZINHO	21/09/2020 16:35	22/09/2020 16:38	21/09/2020 16:35	22/09/2020 16:38	24,04	1	24,04	CHI
20200957402	ANAPOLIS	AN11214729	ANAPOLIS UNIVERSITARIO S2	21/09/2020 16:36	21/09/2020 17:57	21/09/2020 16:36	21/09/2020 17:57	1,34	115	154,32	CHI
20200957409	NOVO GAMA	4990010323	PACAEMBU S1	21/09/2020 16:37	22/09/2020 08:32	21/09/2020 16:37	22/09/2020 08:32	15,92	1	15,92	CHI
20200957689	BARRO ALTO	BA12194375	BARRO ALTO	21/09/2020 16:37	21/09/2020 23:13	21/09/2020 16:37	21/09/2020 23:13	6,59	7	46,14	CHI
20200957418	LUZIANIA	LZ21000395	PACAEMBU S2	21/09/2020 16:38	22/09/2020 13:37	21/09/2020 16:38	22/09/2020 13:37	20,98	1	20,98	CHI
20200957510	CAMPINACU	UC12239716	PORANGATU	21/09/2020 16:38	21/09/2020 20:15	21/09/2020 16:38	21/09/2020 20:15	3,61	36	130,03	CHI
20200959059	LUZIANIA	LZ11095625	MARAJOARA	21/09/2020 16:39	21/09/2020 20:21	21/09/2020 16:39	21/09/2020 20:21	3,69	79	291,49	CHI
202009102984	GOIANESIA	GE12372672	GOIANESIA S1	21/09/2020 16:39	21/09/2020 20:54	21/09/2020 16:39	21/09/2020 20:54	4,26	22	93,61	CHI
20200957685	COCALZINHO DE GOIAS	ZN12302398	COCALZINHO	21/09/2020 16:40	21/09/2020 20:03	21/09/2020 16:40	21/09/2020 20:03	3,37	11	37,11	CHI
20200957437	CABECEIRAS	CW12108823	ITIQUEIRA	21/09/2020 16:40	21/09/2020 20:41	21/09/2020 16:40	21/09/2020 20:41	4,00	8	32,04	CHI

INTERNAL

20200957801	PORANGATU	PO12192252	PORANGATU	21/09/2020 16:41	21/09/2020 18:48	21/09/2020 16:41	21/09/2020 18:48	2,11	25	52,86	CHI
20200957485	CABECEIRAS	FA10401453	ITIQUEIRA	21/09/2020 16:42	22/09/2020 06:01	21/09/2020 16:42	21/09/2020 21:57	5,26	71	373,38	CHI
20200957485	FORMOSA	FA10401453	ITIQUEIRA	21/09/2020 16:42	22/09/2020 06:01	21/09/2020 16:42	21/09/2020 21:57	5,26	16	84,14	CHI
20200957485	FORMOSA	FA10401453	ITIQUEIRA	21/09/2020 16:42	22/09/2020 06:01	21/09/2020 16:42	21/09/2020 23:52	7,17	4	28,69	CHI
20200957485	CABECEIRAS	FA10401453	ITIQUEIRA	21/09/2020 16:42	22/09/2020 06:01	21/09/2020 16:42	21/09/2020 23:52	7,17	47	337,16	CHI
20200957485	CABECEIRAS	FA10401453	ITIQUEIRA	21/09/2020 16:42	22/09/2020 06:01	21/09/2020 16:42	22/09/2020 00:09	7,46	27	201,44	CHI
20200957623	NIQUELANDIA	NQ12257262	URUACU	21/09/2020 16:42	21/09/2020 23:44	21/09/2020 16:42	21/09/2020 23:44	7,02	8	56,15	CHI
20200957485	CABECEIRAS	CW13342409	ITIQUEIRA	21/09/2020 16:42	22/09/2020 06:01	22/09/2020 05:50	22/09/2020 06:01	0,17	27	4,60	CHI
20200957455	CIDADE OCIDENTAL	LZ21072623	MARAJOARA	21/09/2020 16:43	21/09/2020 23:05	21/09/2020 16:43	21/09/2020 23:05	6,36	1	6,36	CHI
20200959267	LUZIANIA	LZ11169001	MARAJOARA	21/09/2020 16:44	21/09/2020 22:04	21/09/2020 16:44	21/09/2020 22:04	5,33	15	79,94	CHI
20200957473	AGUAS LINDAS DE GOIAS	4830432161	AGUAS LINDAS DE GOIAS S1	21/09/2020 16:45	21/09/2020 17:51	21/09/2020 16:45	21/09/2020 17:51	1,09	1	1,09	CHI
20200957476	CAIAPONIA	CP12358785	CAIAPONIA	21/09/2020 16:46	22/09/2020 10:38	21/09/2020 16:46	22/09/2020 10:38	17,87	2	35,73	CHI
20200957483	GOIANAPOLIS	GP12000144	DAIA S2	21/09/2020 16:46	21/09/2020 18:27	21/09/2020 16:46	21/09/2020 18:27	1,67	21	35,15	CHI
20200957484	SANTA HELENA DE GOIAS	400118907	IPEGUARI	21/09/2020 16:47	22/09/2020 00:22	21/09/2020 16:47	22/09/2020 00:22	7,58	1	7,58	CHI
20200958018	COCALZINHO DE GOIAS	CB12075828	COCALZINHO	21/09/2020 16:47	22/09/2020 00:25	21/09/2020 16:47	22/09/2020 00:25	7,62	11	83,80	CHI
20200957556	CAMPINORTE	CR10398028	CAMPINORTE	21/09/2020 16:48	22/09/2020 02:16	21/09/2020 16:48	21/09/2020 19:13	2,43	26	63,16	CHI
20200957556	URUACU	CR10398028	CAMPINORTE	21/09/2020 16:48	22/09/2020 02:16	21/09/2020 16:48	22/09/2020 02:16	9,47	431	4083,13	CHI
20200957556	CAMPINORTE	CR10398028	CAMPINORTE	21/09/2020 16:48	22/09/2020 02:16	21/09/2020 16:48	22/09/2020 02:16	9,47	13	123,16	CHI
20200958119	COCALZINHO DE GOIAS	CB12043411	COCALZINHO	21/09/2020 16:48	22/09/2020 09:57	21/09/2020 16:48	22/09/2020 09:57	17,14	5	85,69	CHI
20200957556	CAMPINORTE	CR10398028	CAMPINORTE	21/09/2020 16:48	22/09/2020 02:16	21/09/2020 16:48	21/09/2020 19:13	2,42	1	2,42	CHI
20200957556	URUACU	CR13285342	CAMPINORTE	21/09/2020 16:48	22/09/2020 02:16	21/09/2020 16:48	22/09/2020 02:16	9,46	3	28,38	CHI
20200958754	LUZIANIA	LZ12070127RE	MARAJOARA	21/09/2020 16:48	21/09/2020 22:53	21/09/2020 16:48	21/09/2020 22:53	6,07	17	103,15	CHI
20200957506	GOIAS	GS12064392	MATRINCHA	21/09/2020 16:50	21/09/2020 20:50	21/09/2020 16:50	21/09/2020 20:50	3,99	4	15,95	CHI
20200957519	PARAUNA	PU12336678	PARAUNA	21/09/2020 16:52	21/09/2020 18:34	21/09/2020 16:52	21/09/2020 18:34	1,69	2	3,38	CHI
20200957678	VILA PROPICIO	PV12102018	GOIANESIA S1	21/09/2020 16:53	21/09/2020 20:05	21/09/2020 16:53	21/09/2020 20:05	3,19	4	12,77	CHI
20200958116	PIRENOPOLIS	PV12311923	CORUMBA	21/09/2020 16:55	21/09/2020 23:45	21/09/2020 16:55	21/09/2020 23:45	6,82	289	1970,74	CHI
20200957923	URUACU	UR12310343	URUACU	21/09/2020 16:56	22/09/2020 04:11	21/09/2020 16:56	22/09/2020 04:11	11,24	103	1157,83	CHI
20200957557	PLANALTINA	2960147085	PLANALTINA	21/09/2020 16:57	22/09/2020 12:30	21/09/2020 16:57	22/09/2020 12:30	19,53	1	19,53	CHI
20200957569	ALTO PARAISO DE GOIAS	10030234253	FLORES DE GOIAS	21/09/2020 17:00	22/09/2020 00:28	21/09/2020 17:00	22/09/2020 00:28	7,47	1	7,47	CHI
20200957571	ANAPOLIS	10017026871	ANAPOLIS UNIVERSITARIO S2	21/09/2020 17:00	21/09/2020 20:59	21/09/2020 17:00	21/09/2020 20:59	3,98	1	3,98	CHI
20200957573	GOIANESIA	GE12219198	GOIANESIA S2	21/09/2020 17:00	22/09/2020 12:40	21/09/2020 17:00	22/09/2020 12:40	19,67	2	39,33	CHI
20200957575	CORUMBA DE GOIAS	260021763	CORUMBA	21/09/2020 17:00	21/09/2020 20:21	21/09/2020 17:00	21/09/2020 20:21	3,34	1	3,34	CHI
20200957584	LUZIANIA	LZ11209467	RIO VERMELHO	21/09/2020 17:01	21/09/2020 19:42	21/09/2020 17:01	21/09/2020 19:42	2,67	35	93,48	CHI

INTERNAL

20200957608	CRISTALINA	KR10413322	PAMPLONA	21/09/2020 17:02	22/09/2020 16:19	21/09/2020 17:02	22/09/2020 16:19	23,28	2	46,57	CHI
20200957596	PLANALTINA	PI12085617RE	PLANALTINA	21/09/2020 17:02	21/09/2020 20:06	21/09/2020 17:02	21/09/2020 20:06	3,06	410	1252,66	CHI
20200957598	FORMOSA	10022686884	ITUIQUIRA	21/09/2020 17:02	21/09/2020 22:35	21/09/2020 17:02	21/09/2020 22:35	5,54	1	5,54	CHI
20200957610	BOM JARDIM DE GOIAS	BM21123531	BOM JARDIM	21/09/2020 17:03	21/09/2020 19:00	21/09/2020 17:03	21/09/2020 19:00	1,94	1	1,94	CHI
20200958785	NOVO GAMA	NJ12344854	PACAEMBU S1	21/09/2020 17:06	21/09/2020 23:17	21/09/2020 17:06	21/09/2020 23:17	6,18	232	1434,34	CHI
20200957915	VALPARAISO DE GOIAS	VA11183701	PACAEMBU S1	21/09/2020 17:07	21/09/2020 20:32	21/09/2020 17:07	21/09/2020 20:32	3,42	46	157,15	CHI
20200957638	LUZIANIA	LZ12261750	CRISTALINA S2	21/09/2020 17:07	21/09/2020 21:41	21/09/2020 17:07	21/09/2020 21:41	4,55	6	27,32	CHI
20200957642	ITABERAI	50060946	ITABERAI S2	21/09/2020 17:08	21/09/2020 21:40	21/09/2020 17:08	21/09/2020 21:40	4,53	1	4,53	CHI
20200957657	SANTO ANTONIO DO DESCOBERTO	2210001827	AGUAS LINDAS DE GOIAS S2	21/09/2020 17:09	21/09/2020 18:38	21/09/2020 17:09	21/09/2020 18:38	1,47	1	1,47	CHI
20200957659	ANAPOLIS	AN21222250	ANAPOLIS UNIVERSITARIO S2	21/09/2020 17:10	21/09/2020 18:26	21/09/2020 17:10	21/09/2020 18:26	1,26	1	1,26	CHI
20200957667	ITAPURANGA	IK12311030	ITAPURANGA	21/09/2020 17:11	21/09/2020 20:13	21/09/2020 17:11	21/09/2020 20:13	3,02	3	9,06	CHI
20200957671	PARAUNA	980029521	PARAUNA	21/09/2020 17:12	21/09/2020 17:57	21/09/2020 17:12	21/09/2020 17:57	0,74	1	0,74	CHI
20200958848	LUZIANIA	LZ12136513	RIO VERMELHO	21/09/2020 17:14	21/09/2020 21:15	21/09/2020 17:14	21/09/2020 21:15	4,02	308	1236,96	CHI
20200957682	ANAPOLIS	21353153	ANAPOLIS UNIVERSITARIO S2	21/09/2020 17:14	21/09/2020 19:37	21/09/2020 17:14	21/09/2020 19:37	2,38	1	2,38	CHI
20200957684	URUACU	UR11356493	URUACU	21/09/2020 17:14	21/09/2020 19:48	21/09/2020 17:14	21/09/2020 19:48	2,56	4	10,25	CHI
20200957691	JATAI	JT21164228	JATAI S3	21/09/2020 17:14	22/09/2020 10:03	21/09/2020 17:14	22/09/2020 10:03	16,80	2	33,60	CHI
20200957699	RUBIATABA	780025386	RUBIATABA	21/09/2020 17:16	23/09/2020 13:45	21/09/2020 17:16	23/09/2020 13:45	44,48	1	44,48	CHI
20200957711	PLANALTINA	2960219710	PLANALTINA	21/09/2020 17:18	21/09/2020 18:18	21/09/2020 17:18	21/09/2020 18:18	0,99	1	0,99	CHI
20200957714	BARRO ALTO	BA21302407	BARRO ALTO	21/09/2020 17:18	22/09/2020 10:22	21/09/2020 17:18	22/09/2020 10:22	17,07	1	17,07	CHI
20200957721	PADRE BERNARDO	PB12290579	PADRE BERNARDO	21/09/2020 17:19	22/09/2020 09:04	21/09/2020 17:19	22/09/2020 09:04	15,74	6	94,43	CHI
20200957722	FORMOSA	610177485	ITUIQUIRA	21/09/2020 17:20	21/09/2020 18:53	21/09/2020 17:20	21/09/2020 18:53	1,55	1	1,55	CHI
20200957728	LUZIANIA	3200267470	MARAJOARA	21/09/2020 17:20	22/09/2020 09:28	21/09/2020 17:20	22/09/2020 09:28	16,12	1	16,12	CHI
20200957756	JATAI	290220798	JATAI S3	21/09/2020 17:21	22/09/2020 11:01	21/09/2020 17:21	22/09/2020 11:01	17,67	1	17,67	CHI
20200957761	SANTO ANTONIO DO DESCOBERTO	2210061575	ALEXANIA	21/09/2020 17:22	21/09/2020 21:08	21/09/2020 17:22	21/09/2020 21:08	3,78	1	3,78	CHI
20200957764	ABADIANIA	AA21121522	ANAPOLIS UNIVERSITARIO S1	21/09/2020 17:22	21/09/2020 20:40	21/09/2020 17:22	21/09/2020 20:40	3,30	1	3,30	CHI
202009106995	URUACU	UR11094190	URUACU	21/09/2020 17:23	22/09/2020 10:31	21/09/2020 17:23	22/09/2020 10:31	17,13	133	2278,55	CHI
20200957768	AGUAS LINDAS DE GOIAS	LA11188622	AGUAS LINDAS DE GOIAS S1	21/09/2020 17:23	21/09/2020 19:51	21/09/2020 17:23	21/09/2020 19:51	2,46	11	27,11	CHI
20200957773	MINEIROS	MY21324478	PARQUE DAS EMAS	21/09/2020 17:23	21/09/2020 23:18	21/09/2020 17:23	21/09/2020 23:18	5,90	1	5,90	CHI
20200957788	ANAPOLIS	20678939	ANAPOLIS UNIVERSITARIO S1	21/09/2020 17:25	21/09/2020 19:45	21/09/2020 17:25	21/09/2020 19:45	2,33	1	2,33	CHI
20200957816	LUZIANIA	LZ10404166	MARAJOARA	21/09/2020 17:27	21/09/2020 23:21	21/09/2020 17:27	21/09/2020 19:51	2,41	1688	4063,86	CHI
20200957816	LUZIANIA	LZ12000174LD	MARAJOARA	21/09/2020 17:27	21/09/2020 23:21	21/09/2020 17:27	21/09/2020 23:21	5,90	442	2609,15	CHI
20200957798	CORUMBA DE GOIAS	260012464	CORUMBA	21/09/2020 17:27	21/09/2020 22:32	21/09/2020 17:27	21/09/2020 22:32	5,07	1	5,07	CHI
20200957911	SANTA TEREZINHA DE GOIAS	SG11034165	SANTA TEREZINHA	21/09/2020 17:31	21/09/2020 21:02	21/09/2020 17:31	21/09/2020 21:02	3,51	201	706,29	CHI

INTERNAL

20200957825	FORMOSA	FA31057073	ITIQUEIRA	21/09/2020 17:31	21/09/2020 20:41	21/09/2020 17:31	21/09/2020 20:41	3,16	1	3,16	CHI
20200957836	NIQUELANDIA	NQ21238450	URUACU	21/09/2020 17:31	22/09/2020 15:51	21/09/2020 17:31	22/09/2020 15:51	22,32	1	22,32	CHI
20200957935	SANTA RITA DO NOVO DESTINO	DF12382140	BARRO ALTO	21/09/2020 17:32	21/09/2020 21:53	21/09/2020 17:32	21/09/2020 21:53	4,34	15	65,16	CHI
20200959232	CIDADE OCIDENTAL	DH11133224	MARAJOARA	21/09/2020 17:32	21/09/2020 22:44	21/09/2020 17:32	21/09/2020 22:44	5,19	79	409,70	CHI
20200957845	CACU	CC21305851	CACHOEIRA ALTA	21/09/2020 17:32	21/09/2020 19:53	21/09/2020 17:32	21/09/2020 19:53	2,33	1	2,33	CHI
20200957858	PIRENOPOLIS	PV21294276	CORUMBA	21/09/2020 17:34	21/09/2020 21:08	21/09/2020 17:34	21/09/2020 21:08	3,55	1	3,55	CHI
20200958474	CIDADE OCIDENTAL	2680127761	MARAJOARA	21/09/2020 17:35	21/09/2020 20:24	21/09/2020 17:35	21/09/2020 20:24	2,81	1	2,81	CHI
20200957939	URUACU	UR11038732	URUACU	21/09/2020 17:36	21/09/2020 21:57	21/09/2020 17:36	21/09/2020 21:57	4,35	243	1055,97	CHI
20200957872	BALIZA	BH12331310	CAIAPONIA	21/09/2020 17:36	21/09/2020 21:25	21/09/2020 17:36	21/09/2020 21:25	3,81	3	11,43	CHI
20200958475	CIDADE OCIDENTAL	DH12041545	MARAJOARA	21/09/2020 17:36	21/09/2020 23:00	21/09/2020 17:36	21/09/2020 23:00	5,39	607	3271,90	CHI
202009107046	AMARALINA	MU11335284	MARA ROSA	21/09/2020 17:37	23/09/2020 23:31	21/09/2020 17:37	23/09/2020 23:31	53,89	1	53,89	CHI
202009107046	AMARALINA	MU11335280	MARA ROSA	21/09/2020 17:37	23/09/2020 23:31	21/09/2020 18:13	23/09/2020 23:31	53,28	1	53,28	CHI
20200973194	AMARALINA	MU12335286	MARA ROSA	21/09/2020 17:37	23/09/2020 23:31	23/09/2020 12:48	23/09/2020 23:31	10,71	4	42,84	CHI
20200959090	URUACU	CR12202139RE	MARA ROSA	21/09/2020 17:38	22/09/2020 09:09	21/09/2020 17:38	22/09/2020 09:09	15,51	106	1643,79	CHI
20200959090	CAMPINORTE	CR12202139RE	MARA ROSA	21/09/2020 17:38	22/09/2020 09:09	21/09/2020 17:38	22/09/2020 09:09	15,51	32	496,24	CHI
20200957888	NOVO GAMA	4990041769	PACAEMBU S1	21/09/2020 17:38	22/09/2020 02:28	21/09/2020 17:38	22/09/2020 02:28	8,83	1	8,83	CHI
20200957893	MONTIVIDIU	MV21271676	MONTIVIDIU T	21/09/2020 17:39	21/09/2020 19:41	21/09/2020 17:39	21/09/2020 19:41	2,03	1	2,03	CHI
20200957913	JATAI	290191543	JATAI S2	21/09/2020 17:42	22/09/2020 09:26	21/09/2020 17:42	22/09/2020 09:26	15,73	1	15,73	CHI
20200958302	MINEIROS	02610434	PARQUE DAS EMAS	21/09/2020 17:42	22/09/2020 05:18	21/09/2020 18:01	21/09/2020 21:16	3,26	11	35,86	CHI
20200958302	MINEIROS	02610434	PARQUE DAS EMAS	21/09/2020 17:42	22/09/2020 05:18	21/09/2020 18:01	22/09/2020 04:18	10,28	9	92,55	CHI
20200958302	MINEIROS	02610434	PARQUE DAS EMAS	21/09/2020 17:42	22/09/2020 05:18	21/09/2020 18:02	21/09/2020 21:16	3,24	1	3,24	CHI
20200958302	MINEIROS	MY13164252	PARQUE DAS EMAS	21/09/2020 17:42	22/09/2020 05:18	21/09/2020 18:02	22/09/2020 04:18	10,27	1	10,27	CHI
20200958302	MINEIROS	MY13209820	PARQUE DAS EMAS	21/09/2020 17:42	22/09/2020 05:18	22/09/2020 00:21	22/09/2020 05:18	4,95	1	4,95	CHI
20200958302	MINEIROS	MY13209820	PARQUE DAS EMAS	21/09/2020 17:42	22/09/2020 05:18	22/09/2020 00:21	22/09/2020 05:18	4,95	91	450,07	CHI
20200957933	URUACU	UR12331932	URUACU	21/09/2020 17:44	22/09/2020 13:00	21/09/2020 17:44	22/09/2020 13:00	19,26	2	38,51	CHI
20200958051	CIDADE OCIDENTAL	DH11325532	MARAJOARA	21/09/2020 17:44	21/09/2020 21:56	21/09/2020 17:44	21/09/2020 21:56	4,19	81	339,05	CHI
20200957978	RIO VERDE	630030224	RIO VERDE S1	21/09/2020 17:45	22/09/2020 17:11	21/09/2020 17:45	22/09/2020 17:11	23,44	1	23,44	CHI
20200957945	BONOPOLIS	BX12291268	SAO MIGUEL DO ARAGUAIA	21/09/2020 17:45	22/09/2020 08:12	21/09/2020 17:45	22/09/2020 08:12	14,44	1	14,44	CHI
20200957947	LEOPOLDO DE BULHOES	LB21351252	DAIA S2	21/09/2020 17:46	21/09/2020 19:03	21/09/2020 17:46	21/09/2020 19:03	1,28	2	2,56	CHI
20200957948	NIQUELANDIA	2750073930	NIQUELANDIA SUBTRANSMISSAO	21/09/2020 17:46	22/09/2020 21:10	21/09/2020 17:46	22/09/2020 21:10	27,40	1	27,40	CHI
20200957959	FORMOSA	610075482	ITIQUEIRA	21/09/2020 17:47	21/09/2020 19:14	21/09/2020 17:47	21/09/2020 19:14	1,43	1	1,43	CHI
20200958406	NOVA IGUACU DE GOIAS	NH12190114	SANTA TEREZINHA	21/09/2020 17:48	22/09/2020 14:41	21/09/2020 17:48	22/09/2020 14:41	20,88	121	2526,11	CHI
20200957971	PADRE BERNARDO	9980010106	PADRE BERNARDO	21/09/2020 17:49	21/09/2020 20:24	21/09/2020 17:49	21/09/2020 20:24	2,58	1	2,58	CHI

INTERNAL

20200958395	MIMOSO DE GOIAS	MJ18071960FS	PADRE BERNARDO	21/09/2020 17:49	21/09/2020 21:17	21/09/2020 17:49	21/09/2020 21:17	3,45	161	555,63	CHI
20200958395	NIQUELANDIA	MJ18071960FS	PADRE BERNARDO	21/09/2020 17:49	21/09/2020 21:17	21/09/2020 17:49	21/09/2020 21:17	3,45	1	3,45	CHI
20200957979	RIO VERDE	10007641700	RIO VERDE S1	21/09/2020 17:50	21/09/2020 18:47	21/09/2020 17:50	21/09/2020 18:47	0,95	1	0,95	CHI
20200957986	LUZIANIA	3200002199	MARAJOARA	21/09/2020 17:51	22/09/2020 15:15	21/09/2020 17:51	22/09/2020 15:15	21,40	1	21,40	CHI
20200959131	PADRE BERNARDO	PB12330439	PADRE BERNARDO	21/09/2020 17:52	22/09/2020 08:03	21/09/2020 17:52	22/09/2020 08:03	14,18	35	496,33	CHI
20200958005	PLANALTINA	2960184938	PLANALTINA	21/09/2020 17:53	22/09/2020 10:53	21/09/2020 17:53	22/09/2020 10:53	17,00	1	17,00	CHI
20200958011	MIMOSO DE GOIAS	NQ12371855RE	BARRO ALTO	21/09/2020 17:53	22/09/2020 10:31	21/09/2020 17:53	22/09/2020 10:31	16,63	4	66,51	CHI
20200958011	NIQUELANDIA	NQ12371855RE	BARRO ALTO	21/09/2020 17:53	22/09/2020 10:31	21/09/2020 17:53	22/09/2020 10:31	16,63	245	4073,81	CHI
20200959155	TROMBAS	TB12345570	PORANGATU	21/09/2020 17:53	22/09/2020 07:53	21/09/2020 17:53	22/09/2020 07:53	13,99	16	223,83	CHI
20200958017	GOIAS	GS12310533	GOIAS	21/09/2020 17:53	21/09/2020 20:03	21/09/2020 17:53	21/09/2020 20:03	2,15	4	8,60	CHI
20200958436	ITAPURANGA	IK12298425	ITAPURANGA	21/09/2020 17:54	22/09/2020 15:58	21/09/2020 17:54	22/09/2020 15:58	22,06	4	88,23	CHI
20200958436	ITAPURANGA	IK12298425	ITAPURANGA	21/09/2020 17:54	22/09/2020 15:58	21/09/2020 17:54	22/09/2020 15:58	22,06	10	220,59	CHI
202009104562	SANTA RITA DO ARAGUAIA	02610424	SANTA RITA DO ARAGUAIA	21/09/2020 17:55	22/09/2020 23:39	21/09/2020 17:55	21/09/2020 18:35	0,67	2030	1365,18	CHI
202009104562	MINEIROS	02610424	SANTA RITA DO ARAGUAIA	21/09/2020 17:55	22/09/2020 23:39	21/09/2020 17:55	21/09/2020 18:35	0,67	33	22,19	CHI
202009104562	SANTA RITA DO ARAGUAIA	02610424	SANTA RITA DO ARAGUAIA	21/09/2020 17:55	22/09/2020 23:39	21/09/2020 17:55	21/09/2020 18:51	0,93	1204	1124,07	CHI
202009104562	BURITINOPOLIS	02610424	SANTA RITA DO ARAGUAIA	21/09/2020 17:55	22/09/2020 23:39	21/09/2020 17:55	21/09/2020 18:51	0,93	1	0,93	CHI
202009104562	MINEIROS	02610424	SANTA RITA DO ARAGUAIA	21/09/2020 17:55	22/09/2020 23:39	21/09/2020 17:55	21/09/2020 18:51	0,93	11	10,27	CHI
202009104562	MINEIROS	02610424	PARQUE DAS EMAS	21/09/2020 17:55	22/09/2020 23:39	21/09/2020 17:55	21/09/2020 20:56	3,02	59	178,10	CHI
202009104562	PORTELANDIA	02610424	PARQUE DAS EMAS	21/09/2020 17:55	22/09/2020 23:39	21/09/2020 17:55	21/09/2020 20:56	3,02	12	36,22	CHI
202009104562	MONTIVIDIU	02610424	PARQUE DAS EMAS	21/09/2020 17:55	22/09/2020 23:39	21/09/2020 17:55	21/09/2020 20:56	3,02	1	3,02	CHI
202009104562	MINEIROS	02610424	PARQUE DAS EMAS	21/09/2020 17:55	22/09/2020 23:39	21/09/2020 17:55	21/09/2020 23:33	5,64	5	28,21	CHI
202009104562	MINEIROS	02610424	PARQUE DAS EMAS	21/09/2020 17:55	22/09/2020 23:39	21/09/2020 17:55	22/09/2020 01:34	7,65	5	38,23	CHI
202009107029	ESTRELA DO NORTE	2420009790	MARA ROSA	21/09/2020 17:55	22/09/2020 06:46	21/09/2020 17:55	22/09/2020 06:46	12,84	1	12,84	CHI
202009104562	MONTIVIDIU	02610424	PARQUE DAS EMAS	21/09/2020 17:55	22/09/2020 23:39	22/09/2020 00:19	22/09/2020 00:38	0,31	1	0,31	CHI
202009104562	MINEIROS	02610424	PARQUE DAS EMAS	21/09/2020 17:55	22/09/2020 23:39	22/09/2020 00:19	22/09/2020 00:38	0,31	64	19,64	CHI
202009104562	PORTELANDIA	02610424	PARQUE DAS EMAS	21/09/2020 17:55	22/09/2020 23:39	22/09/2020 00:19	22/09/2020 00:38	0,31	12	3,68	CHI
20200959960	ESTRELA DO NORTE	ET11053273	MARA ROSA	21/09/2020 17:55	22/09/2020 09:50	22/09/2020 06:46	22/09/2020 09:50	3,06	201	615,34	CHI
202009104562	SANTA RITA DO ARAGUAIA	SU13273995	SANTA RITA DO ARAGUAIA	21/09/2020 17:55	22/09/2020 23:39	22/09/2020 16:32	22/09/2020 18:07	1,58	1204	1904,33	CHI
202009104562	BURITINOPOLIS	SU13273995	SANTA RITA DO ARAGUAIA	21/09/2020 17:55	22/09/2020 23:39	22/09/2020 16:32	22/09/2020 18:07	1,58	1	1,58	CHI
202009104562	MINEIROS	SU13273995	SANTA RITA DO ARAGUAIA	21/09/2020 17:55	22/09/2020 23:39	22/09/2020 16:32	22/09/2020 18:07	1,58	11	17,40	CHI
202009104562	SANTA RITA DO ARAGUAIA	SU21184144	SANTA RITA DO ARAGUAIA	21/09/2020 17:55	22/09/2020 23:39	22/09/2020 18:08	22/09/2020 23:39	5,53	1	5,53	CHI
20200958134	ARAGARCAS	AG11000007	ARAGARCAS	21/09/2020 17:56	21/09/2020 20:04	21/09/2020 17:56	21/09/2020 20:04	2,13	52	110,53	CHI
20200958036	FORMOSA	610182213	ITUIQUIRA	21/09/2020 17:56	22/09/2020 11:23	21/09/2020 17:56	22/09/2020 11:23	17,44	1	17,44	CHI

INTERNAL

20200960523	SANTA TEREZINHA DE GOIAS	SG11181030	SANTA TEREZINHA	21/09/2020 17:56	22/09/2020 02:35	21/09/2020 17:56	22/09/2020 02:35	8,64	158	1365,21	CHI
20200958040	JATAI	JT12303855	JATAI S1	21/09/2020 17:56	22/09/2020 14:57	21/09/2020 17:56	22/09/2020 14:57	21,00	7	147,03	CHI
20200958045	PORANGATU	PO11170059	PORANGATU	21/09/2020 17:57	23/09/2020 17:45	21/09/2020 17:57	23/09/2020 17:45	47,80	69	3298,01	CHI
20200958704	JATAI	JT12234396	JATAI S1	21/09/2020 17:57	21/09/2020 21:35	21/09/2020 17:57	21/09/2020 21:35	3,63	9	32,68	CHI
20200958047	NOVA CRIXAS	8570001176	NOVA CRIXAS	21/09/2020 17:57	21/09/2020 20:45	21/09/2020 17:57	21/09/2020 20:45	2,80	1	2,80	CHI
20200958060	URUACU	UR11000001	URUACU	21/09/2020 17:58	21/09/2020 21:13	21/09/2020 17:58	21/09/2020 21:13	3,24	83	268,69	CHI
20200958057	RIO VERDE	630460516	RIO VERDE S1	21/09/2020 17:59	22/09/2020 15:54	21/09/2020 17:59	22/09/2020 15:54	21,91	1	21,91	CHI
20200958059	PLANALTINA	10025197850	PLANALTINA	21/09/2020 17:59	22/09/2020 07:18	21/09/2020 17:59	22/09/2020 07:18	13,31	1	13,31	CHI
20200958061	BURITINOPOLIS	BQ11190592	IACIARA S2	21/09/2020 17:59	21/09/2020 18:51	21/09/2020 17:59	21/09/2020 18:51	0,85	8	6,84	CHI
20200959834	NIQUELANDIA	PV12152505	BARRO ALTO	21/09/2020 17:59	22/09/2020 11:52	21/09/2020 17:59	22/09/2020 11:52	17,87	15	268,04	CHI
20200959834	MIMOSO DE GOIAS	PV12152505	BARRO ALTO	21/09/2020 17:59	22/09/2020 11:52	21/09/2020 17:59	22/09/2020 11:52	17,87	9	160,83	CHI
20200959834	VILA PROPICIO	PV12152505	BARRO ALTO	21/09/2020 17:59	22/09/2020 11:52	21/09/2020 17:59	22/09/2020 11:52	17,87	20	357,39	CHI
20200958423	PIRENOPOLIS	PV12000004	CORUMBA	21/09/2020 18:00	21/09/2020 21:52	21/09/2020 18:00	21/09/2020 21:52	3,87	15	58,00	CHI
20200958069	PADRE BERNARDO	PB21092845	PADRE BERNARDO	21/09/2020 18:00	23/09/2020 02:57	21/09/2020 18:00	22/09/2020 02:46	8,77	1	8,77	CHI
20200958069	PADRE BERNARDO	PB12092844	PADRE BERNARDO	21/09/2020 18:00	23/09/2020 02:57	21/09/2020 18:00	22/09/2020 05:17	11,28	3	33,83	CHI
20200958069	PADRE BERNARDO	PB12092844	PADRE BERNARDO	21/09/2020 18:00	23/09/2020 02:57	21/09/2020 18:00	23/09/2020 02:57	32,95	1	32,95	CHI
20200958069	PADRE BERNARDO	PB21092845	PADRE BERNARDO	21/09/2020 18:00	23/09/2020 02:57	22/09/2020 03:54	22/09/2020 20:30	16,60	1	16,60	CHI
20200958069	PADRE BERNARDO	PB12092844	PADRE BERNARDO	21/09/2020 18:00	23/09/2020 02:57	22/09/2020 21:07	23/09/2020 02:57	5,84	3	17,52	CHI
20200958078	GOIANESIA	GE16413707	GOIANESIA S2	21/09/2020 18:01	21/09/2020 23:09	21/09/2020 18:01	21/09/2020 23:09	5,13	5456	27989,28	CHI
20200958078	SANTA ISABEL	GE16413707	GOIANESIA S2	21/09/2020 18:01	21/09/2020 23:09	21/09/2020 18:01	21/09/2020 23:09	5,13	1	5,13	CHI
20200958082	NOVO GAMA	4990008018	PACAEMBU S1	21/09/2020 18:01	22/09/2020 01:09	21/09/2020 18:01	22/09/2020 01:09	7,12	1	7,12	CHI
20200958078	GOIANESIA	GE16413707	GOIANESIA S2	21/09/2020 18:01	21/09/2020 23:09	21/09/2020 19:22	21/09/2020 23:09	3,78	1094	4130,46	CHI
20200958086	BARRO ALTO	BA21342222	GOIANESIA S1	21/09/2020 18:02	22/09/2020 00:09	21/09/2020 18:02	22/09/2020 00:09	6,11	1	6,11	CHI
20200958087	CIDADE OCIDENTAL	DH11199615	MARAJOARA	21/09/2020 18:02	21/09/2020 21:58	21/09/2020 18:02	21/09/2020 21:58	3,93	143	561,87	CHI
20200958089	ISRAELANDIA	IS12027946	IPORA	21/09/2020 18:02	22/09/2020 15:10	21/09/2020 18:02	21/09/2020 23:10	5,14	97	498,26	CHI
20200958089	ISRAELANDIA	IS12027946	IPORA	21/09/2020 18:02	22/09/2020 15:10	21/09/2020 18:02	22/09/2020 15:10	21,13	1	21,13	CHI
20200958098	FORMOSA	FA21085592	SAO JOAO D ALIANCA	21/09/2020 18:02	22/09/2020 16:54	21/09/2020 18:02	22/09/2020 16:54	22,85	1	22,85	CHI
20200958089	ISRAELANDIA	IS12027946	IPORA	21/09/2020 18:02	22/09/2020 15:10	22/09/2020 11:24	22/09/2020 15:10	3,76	97	364,56	CHI
20200959289	ITAPURANGA	IK12311024	ITAPURANGA	21/09/2020 18:03	21/09/2020 21:46	21/09/2020 18:03	21/09/2020 21:46	3,71	7	25,98	CHI
20200958102	PLANALTINA	PI21202203	PLANALTINA	21/09/2020 18:03	21/09/2020 19:30	21/09/2020 18:03	21/09/2020 19:30	1,44	1	1,44	CHI
20200958108	MINACU	IH21244533	MINACU	21/09/2020 18:03	21/09/2020 21:38	21/09/2020 18:03	21/09/2020 21:38	3,57	1	3,57	CHI
20200958117	NIQUELANDIA	NQ12117625	BARRO ALTO	21/09/2020 18:04	22/09/2020 14:14	21/09/2020 18:04	22/09/2020 14:14	20,16	6	120,97	CHI
20200958135	MOZARLANDIA	MZ21063711	MOZARLANDIA	21/09/2020 18:05	21/09/2020 21:50	21/09/2020 18:05	21/09/2020 21:50	3,74	1	3,74	CHI

INTERNAL

20200958162	NIQUELANDIA	NQ12398048	URUACU	21/09/2020 18:07	22/09/2020 16:30	21/09/2020 18:07	22/09/2020 16:30	22,38	103	2305,08	CHI
20200958157	PORANGATU	PO21021175	PORANGATU	21/09/2020 18:07	23/09/2020 10:32	21/09/2020 18:07	23/09/2020 10:32	40,40	1	40,40	CHI
20200959633	FORMOSA	FA32042639	ITIQUEIRA	21/09/2020 18:09	22/09/2020 11:57	21/09/2020 18:09	22/09/2020 11:57	17,80	10	178,00	CHI
20200958171	VILA BOA	VB11131746	IACIARA S2	21/09/2020 18:09	21/09/2020 21:16	21/09/2020 18:09	21/09/2020 21:16	3,12	308	959,76	CHI
20200958181	CAMPINORTE	CR21320944	MARA ROSA	21/09/2020 18:10	22/09/2020 10:36	21/09/2020 18:10	22/09/2020 10:36	16,43	2	32,86	CHI
20200958730	PEROLANDIA	02610454	JATAI S1	21/09/2020 18:10	23/09/2020 13:56	21/09/2020 18:10	21/09/2020 18:14	0,06	1032	62,21	CHI
20200958730	JATAI	JT10400565	JATAI S1	21/09/2020 18:10	23/09/2020 13:56	21/09/2020 18:10	21/09/2020 18:14	0,06	12	0,72	CHI
20200958730	PEROLANDIA	02610454	JATAI S1	21/09/2020 18:10	23/09/2020 13:56	21/09/2020 18:10	21/09/2020 18:14	0,06	41	2,47	CHI
20200958730	JATAI	02610454	JATAI S1	21/09/2020 18:10	23/09/2020 13:56	21/09/2020 18:10	21/09/2020 18:14	0,06	302	18,20	CHI
20200958730	PEROLANDIA	02610454	JATAI S1	21/09/2020 18:10	23/09/2020 13:56	21/09/2020 18:10	21/09/2020 18:14	0,06	136	8,20	CHI
20200958730	CAIAPONIA	02610454	JATAI S1	21/09/2020 18:10	23/09/2020 13:56	21/09/2020 18:10	21/09/2020 18:14	0,06	20	1,21	CHI
20200958730	CAIAPONIA	02610454	JATAI S1	21/09/2020 18:10	23/09/2020 13:56	21/09/2020 18:10	21/09/2020 18:14	0,06	38	2,29	CHI
20200958730	MINEIROS	02610454	JATAI S1	21/09/2020 18:10	23/09/2020 13:56	21/09/2020 18:10	21/09/2020 18:14	0,06	2	0,12	CHI
20200958730	MINEIROS	02610454	JATAI S1	21/09/2020 18:10	23/09/2020 13:56	21/09/2020 18:10	21/09/2020 18:14	0,06	3	0,18	CHI
20200958730	PEROLANDIA	JT10400565	JATAI S1	21/09/2020 18:10	23/09/2020 13:56	21/09/2020 18:10	21/09/2020 18:14	0,06	37	2,23	CHI
20200958730	MINEIROS	JT10400565	PARQUE DAS EMAS	21/09/2020 18:10	23/09/2020 13:56	21/09/2020 18:10	21/09/2020 18:14	0,06	174	10,49	CHI
20200958730	JATAI	JT10400565	PARQUE DAS EMAS	21/09/2020 18:10	23/09/2020 13:56	21/09/2020 18:10	21/09/2020 18:14	0,06	29	1,75	CHI
20200958730	SERRANOPOLIS	JT10400565	PARQUE DAS EMAS	21/09/2020 18:10	23/09/2020 13:56	21/09/2020 18:10	21/09/2020 18:14	0,06	7	0,42	CHI
20200958730	PEROLANDIA	JT10400565	PARQUE DAS EMAS	21/09/2020 18:10	23/09/2020 13:56	21/09/2020 18:10	21/09/2020 18:14	0,06	19	1,15	CHI
20200958730	MINEIROS	02610454	PARQUE DAS EMAS	21/09/2020 18:10	23/09/2020 13:56	21/09/2020 18:10	21/09/2020 22:34	4,41	49	215,86	CHI
20200958730	MINEIROS	02610454	PARQUE DAS EMAS	21/09/2020 18:10	23/09/2020 13:56	21/09/2020 18:10	22/09/2020 01:09	6,98	2	13,97	CHI
20200958730	MINEIROS	02610454	PARQUE DAS EMAS	21/09/2020 18:10	23/09/2020 13:56	21/09/2020 18:10	22/09/2020 10:45	16,59	289	4794,27	CHI
20200958730	MINEIROS	02610454	PARQUE DAS EMAS	21/09/2020 18:10	23/09/2020 13:56	21/09/2020 18:10	22/09/2020 19:39	25,49	3	76,47	CHI
20200958730	MINEIROS	02610454	PARQUE DAS EMAS	21/09/2020 18:10	23/09/2020 13:56	21/09/2020 18:10	23/09/2020 13:13	43,05	2	86,11	CHI
20200958730	MINEIROS	02610454	PARQUE DAS EMAS	21/09/2020 18:10	23/09/2020 13:56	21/09/2020 18:10	23/09/2020 13:39	43,48	3	130,43	CHI
20200958730	MINEIROS	02610454	PARQUE DAS EMAS	21/09/2020 18:10	23/09/2020 13:56	21/09/2020 18:10	23/09/2020 13:48	43,63	4	174,54	CHI
20200958730	MINEIROS	02610454	PARQUE DAS EMAS	21/09/2020 18:10	23/09/2020 13:56	21/09/2020 18:10	23/09/2020 13:56	43,77	2	87,54	CHI
20200958730	MINEIROS	02610454	PARQUE DAS EMAS	21/09/2020 18:10	23/09/2020 13:56	21/09/2020 18:13	21/09/2020 22:34	4,36	3	13,09	CHI
20200958730	MINEIROS	02610454	PARQUE DAS EMAS	21/09/2020 18:10	23/09/2020 13:56	21/09/2020 18:13	22/09/2020 10:45	16,55	429	7098,76	CHI
20200958730	MINEIROS	01140434	PARQUE DAS EMAS	21/09/2020 18:10	23/09/2020 13:56	22/09/2020 10:16	22/09/2020 11:04	0,81	116	94,06	CHI
20200958730	MINEIROS	01140404	PARQUE DAS EMAS	21/09/2020 18:10	23/09/2020 13:56	22/09/2020 11:02	22/09/2020 11:26	0,40	818	325,38	CHI
20200958730	MINEIROS	02610454	PARQUE DAS EMAS	21/09/2020 18:10	23/09/2020 13:56	22/09/2020 19:07	22/09/2020 19:39	0,54	54	29,18	CHI
20200958196	DOVERLANDIA	DV12221021	CAIAPONIA	21/09/2020 18:11	21/09/2020 20:15	21/09/2020 18:11	21/09/2020 20:15	2,06	22	45,23	CHI

INTERNAL

20200959094	URUACU	CR12164041	MARA ROSA	21/09/2020 18:11	23/09/2020 16:20	21/09/2020 18:11	23/09/2020 16:20	46,14	5	230,69	CHI
20200959094	CAMPINORTE	CR12164041	MARA ROSA	21/09/2020 18:11	23/09/2020 16:20	21/09/2020 18:11	23/09/2020 16:20	46,14	15	692,08	CHI
20200959180	VALPARAISO DE GOIAS	VA11183521	PACAEMBU S1	21/09/2020 18:13	21/09/2020 21:10	21/09/2020 18:13	21/09/2020 21:10	2,94	36	105,98	CHI
20200958239	ITAPACI	IW12360508	ITAPACI	21/09/2020 18:14	23/09/2020 17:08	21/09/2020 18:14	23/09/2020 17:08	46,90	3	140,70	CHI
20200958243	PARAUNA	PU21158491	PARAUNA	21/09/2020 18:14	21/09/2020 20:05	21/09/2020 18:14	21/09/2020 20:05	1,84	1	1,84	CHI
20200958257	CORUMBA DE GOIAS	260009568	CORUMBA	21/09/2020 18:15	21/09/2020 23:08	21/09/2020 18:15	21/09/2020 23:08	4,87	1	4,87	CHI
20200958259	VILA PROPICIO	PB12095000	PADRE BERNARDO	21/09/2020 18:16	23/09/2020 00:38	21/09/2020 18:16	23/09/2020 00:38	30,37	8	242,96	CHI
20200958259	MIMOSO DE GOIAS	PB12095000	PADRE BERNARDO	21/09/2020 18:16	23/09/2020 00:38	21/09/2020 18:16	23/09/2020 00:38	30,37	48	1457,76	CHI
20200958259	PADRE BERNARDO	PB12095000	PADRE BERNARDO	21/09/2020 18:16	23/09/2020 00:38	21/09/2020 18:16	23/09/2020 00:38	30,37	37	1123,69	CHI
20200958279	URUACU	640062714	URUACU	21/09/2020 18:16	22/09/2020 02:25	21/09/2020 18:16	22/09/2020 02:25	8,15	1	8,15	CHI
20200958337	ALTO PARAISO DE GOIAS	BF11256443	FLORES DE GOIAS	21/09/2020 18:16	21/09/2020 21:00	21/09/2020 18:16	21/09/2020 21:00	2,72	101	274,52	CHI
20200958293	URUACU	UR12317135	URUACU	21/09/2020 18:17	22/09/2020 01:35	21/09/2020 18:17	22/09/2020 01:35	7,29	11	80,17	CHI
20200958289	AGUAS LINDAS DE GOIAS	LA11377264	AGUAS LINDAS DE GOIAS S1	21/09/2020 18:17	21/09/2020 18:49	21/09/2020 18:17	21/09/2020 18:49	0,52	51	26,61	CHI
20200958388	URUACU	UR10409505	URUACU	21/09/2020 18:18	22/09/2020 00:00	21/09/2020 18:18	22/09/2020 00:00	5,71	1716	9804,56	CHI
20200959045	CIDADE OCIDENTAL	DH11347308	MARAJOARA	21/09/2020 18:18	21/09/2020 22:56	21/09/2020 18:18	21/09/2020 22:56	4,62	50	231,24	CHI
20200958315	PLANALTINA	2960116052	PLANALTINA	21/09/2020 18:19	21/09/2020 21:16	21/09/2020 18:19	21/09/2020 21:16	2,93	1	2,93	CHI
20200958331	ANICUNS	AC21196708	ANICUNS	21/09/2020 18:20	21/09/2020 20:49	21/09/2020 18:20	21/09/2020 20:49	2,47	1	2,47	CHI
20200958356	PARAUNA	PU21118478	FIRMINOPOLIS S2	21/09/2020 18:22	21/09/2020 20:04	21/09/2020 18:22	21/09/2020 20:04	1,69	1	1,69	CHI
20200959070	CAMPOS VERDES	VD11055153	SANTA TEREZINHA	21/09/2020 18:23	22/09/2020 04:17	21/09/2020 18:23	22/09/2020 04:17	9,89	39	385,65	CHI
20200959077	MINEIROS	MY12036176	PARQUE DAS EMAS	21/09/2020 18:24	21/09/2020 22:46	21/09/2020 18:24	21/09/2020 22:46	4,36	198	863,67	CHI
20200958392	MAMBAI	1570004186	IACIARA S2	21/09/2020 18:25	21/09/2020 20:02	21/09/2020 18:25	21/09/2020 20:02	1,61	1	1,61	CHI
20200958396	SERRANOPOLIS	SX12165995	CHAPADAO DO CEU	21/09/2020 18:25	22/09/2020 13:34	21/09/2020 18:25	22/09/2020 13:34	19,14	4	76,55	CHI
20200958744	AGUA FRIA DE GOIAS	02160434	SAO JOAO D ALIANCA	21/09/2020 18:25	22/09/2020 20:50	21/09/2020 18:30	21/09/2020 18:34	0,06	16	1,01	CHI
20200958744	SAO JOAO D ALIANCA	02160434	SAO JOAO D ALIANCA	21/09/2020 18:25	22/09/2020 20:50	21/09/2020 18:30	21/09/2020 18:34	0,06	123	7,79	CHI
20200958744	NIQUELANDIA	02160434	SAO JOAO D ALIANCA	21/09/2020 18:25	22/09/2020 20:50	21/09/2020 18:30	21/09/2020 18:34	0,06	2	0,13	CHI
20200958744	AGUA FRIA DE GOIAS	TL13270104	SAO JOAO D ALIANCA	21/09/2020 18:25	22/09/2020 20:50	21/09/2020 18:30	21/09/2020 22:38	4,13	2	8,25	CHI
20200958744	NIQUELANDIA	TL13270104	SAO JOAO D ALIANCA	21/09/2020 18:25	22/09/2020 20:50	21/09/2020 18:30	21/09/2020 22:38	4,13	2	8,25	CHI
20200958744	NIQUELANDIA	02160434	SAO JOAO D ALIANCA	21/09/2020 18:25	22/09/2020 20:50	21/09/2020 18:30	21/09/2020 23:42	5,19	212	1100,81	CHI
20200958744	AGUA FRIA DE GOIAS	02160434	SAO JOAO D ALIANCA	21/09/2020 18:25	22/09/2020 20:50	21/09/2020 18:30	21/09/2020 23:42	5,19	72	373,86	CHI
20200958744	AGUA FRIA DE GOIAS	02160434	SAO JOAO D ALIANCA	21/09/2020 18:25	22/09/2020 20:50	21/09/2020 18:35	21/09/2020 21:21	2,77	2	5,53	CHI
20200958744	SAO JOAO D ALIANCA	02160434	SAO JOAO D ALIANCA	21/09/2020 18:25	22/09/2020 20:50	21/09/2020 18:35	21/09/2020 21:21	2,77	11	30,44	CHI
20200958744	AGUA FRIA DE GOIAS	TL13270104	SAO JOAO D ALIANCA	21/09/2020 18:25	22/09/2020 20:50	21/09/2020 18:35	21/09/2020 22:38	4,04	8	32,29	CHI
20200958744	SAO JOAO D ALIANCA	TL13270104	SAO JOAO D ALIANCA	21/09/2020 18:25	22/09/2020 20:50	21/09/2020 18:35	21/09/2020 22:38	4,04	3	12,11	CHI

INTERNAL

20200958744	NIQUELANDIA	TL13270104	SAO JOAO D ALIANCA	21/09/2020 18:25	22/09/2020 20:50	21/09/2020 18:35	21/09/2020 22:38	4,04	2	8,07	CHI
20200958744	SAO JOAO D ALIANCA	JL12262352	SAO JOAO D ALIANCA	21/09/2020 18:25	22/09/2020 20:50	21/09/2020 18:35	21/09/2020 23:18	4,70	109	512,66	CHI
20200958744	AGUA FRIA DE GOIAS	JL12262352	SAO JOAO D ALIANCA	21/09/2020 18:25	22/09/2020 20:50	21/09/2020 18:35	21/09/2020 23:18	4,70	6	28,22	CHI
20200958744	AGUA FRIA DE GOIAS	02160434	SAO JOAO D ALIANCA	21/09/2020 18:25	22/09/2020 20:50	21/09/2020 23:19	21/09/2020 23:42	0,38	18	6,79	CHI
20200958744	NIQUELANDIA	02160434	SAO JOAO D ALIANCA	21/09/2020 18:25	22/09/2020 20:50	21/09/2020 23:19	21/09/2020 23:42	0,38	4	1,51	CHI
20200958744	SAO JOAO D ALIANCA	02160434	SAO JOAO D ALIANCA	21/09/2020 18:25	22/09/2020 20:50	21/09/2020 23:19	21/09/2020 23:42	0,38	123	46,40	CHI
20200958744	AGUA FRIA DE GOIAS	JL12262352	SAO JOAO D ALIANCA	21/09/2020 18:25	22/09/2020 20:50	22/09/2020 00:04	22/09/2020 10:01	9,94	3	29,82	CHI
20200958744	SAO JOAO D ALIANCA	JL12262352	SAO JOAO D ALIANCA	21/09/2020 18:25	22/09/2020 20:50	22/09/2020 00:04	22/09/2020 10:01	9,94	1	9,94	CHI
20200958744	AGUA FRIA DE GOIAS	JL12262352	SAO JOAO D ALIANCA	21/09/2020 18:25	22/09/2020 20:50	22/09/2020 00:04	22/09/2020 20:50	20,77	3	62,30	CHI
20200958744	SAO JOAO D ALIANCA	JL12262352	SAO JOAO D ALIANCA	21/09/2020 18:25	22/09/2020 20:50	22/09/2020 00:04	22/09/2020 20:50	20,77	108	2242,89	CHI
20200958744	AGUA FRIA DE GOIAS	JL12262352	SAO JOAO D ALIANCA	21/09/2020 18:25	22/09/2020 20:50	22/09/2020 16:46	22/09/2020 20:50	4,08	3	12,23	CHI
20200958744	SAO JOAO D ALIANCA	JL12262352	SAO JOAO D ALIANCA	21/09/2020 18:25	22/09/2020 20:50	22/09/2020 16:46	22/09/2020 20:50	4,08	1	4,08	CHI
20200958416	FORMOSA	FA21130080	ITIQUEIRA	21/09/2020 18:27	21/09/2020 21:32	21/09/2020 18:27	21/09/2020 21:32	3,07	2	6,14	CHI
20200958421	PORANGATU	TA12139159LD	NOVO PLANALTO	21/09/2020 18:27	22/09/2020 19:55	21/09/2020 18:27	22/09/2020 19:55	25,46	23	585,59	CHI
20200958421	NOVO PLANALTO	TA12139159LD	NOVO PLANALTO	21/09/2020 18:27	22/09/2020 19:55	21/09/2020 18:27	22/09/2020 19:55	25,46	11	280,06	CHI
20200958460	GOIANESIA	GE12126780	GOIANESIA S2	21/09/2020 18:28	21/09/2020 21:47	21/09/2020 18:28	21/09/2020 21:47	3,31	359	1189,29	CHI
20200958426	PORANGATU	840131264	PORANGATU	21/09/2020 18:28	22/09/2020 10:52	21/09/2020 18:28	22/09/2020 10:52	16,40	1	16,40	CHI
20200958432	PADRE BERNARDO	2760030472	PADRE BERNARDO	21/09/2020 18:29	22/09/2020 09:56	21/09/2020 18:29	22/09/2020 09:56	15,45	1	15,45	CHI
20200958858	GOIANAPOLIS	GP12351049	DAIA S2	21/09/2020 18:29	22/09/2020 10:04	21/09/2020 18:29	22/09/2020 10:04	15,58	5	77,88	CHI
20200958858	TEREZOPOLIS DE GOIAS	GP12351049	DAIA S2	21/09/2020 18:29	22/09/2020 10:04	21/09/2020 18:29	22/09/2020 10:04	15,58	47	732,06	CHI
20200958477	ALEXANIA	AX11273229	ALEXANIA	21/09/2020 18:32	21/09/2020 20:25	21/09/2020 18:32	21/09/2020 20:25	1,87	15	28,06	CHI
20200958516	CIDADE OCIDENTAL	DH11030503	MARAJOARA	21/09/2020 18:33	21/09/2020 19:48	21/09/2020 18:33	21/09/2020 19:48	1,25	208	259,19	CHI
20200958485	JAUPACI	10020589270	IPORA	21/09/2020 18:33	21/09/2020 22:56	21/09/2020 18:33	21/09/2020 22:56	4,38	1	4,38	CHI
20200961546	JATAI	JT12260447LD	JATAI S1	21/09/2020 18:34	22/09/2020 23:02	21/09/2020 18:34	22/09/2020 14:00	19,43	4	77,71	CHI
20200961546	JATAI	JT12260447LD	JATAI S1	21/09/2020 18:34	22/09/2020 23:02	21/09/2020 18:34	22/09/2020 14:00	19,43	52	1010,23	CHI
20200961546	SERRANOPOLIS	JT12260447LD	JATAI S1	21/09/2020 18:34	22/09/2020 23:02	21/09/2020 18:34	22/09/2020 23:02	28,47	33	939,53	CHI
20200961546	JATAI	JT12260447LD	JATAI S1	21/09/2020 18:34	22/09/2020 23:02	21/09/2020 18:34	22/09/2020 23:02	28,47	49	1395,06	CHI
20200958502	CACHOEIRA ALTA	PC21000061	CACHOEIRA ALTA	21/09/2020 18:34	21/09/2020 22:42	21/09/2020 18:34	21/09/2020 22:42	4,12	1	4,12	CHI
20200958519	MINEIROS	1390166925	PARQUE DAS EMAS	21/09/2020 18:36	22/09/2020 19:13	21/09/2020 18:36	22/09/2020 19:13	24,60	1	24,60	CHI
20200958551	CAIAPONIA	CP12242698	CAIAPONIA	21/09/2020 18:39	21/09/2020 22:57	21/09/2020 18:39	21/09/2020 22:57	4,30	9	38,70	CHI
20200958564	AGUAS LINDAS DE GOIAS	LA11154859	AGUAS LINDAS DE GOIAS S1	21/09/2020 18:40	21/09/2020 21:10	21/09/2020 18:40	21/09/2020 21:10	2,49	15	37,34	CHI
20200958678	SANTO ANTONIO DO DESCOBERTO	SN12082883	MARAJOARA	21/09/2020 18:40	21/09/2020 20:56	21/09/2020 18:40	21/09/2020 20:56	2,26	23	51,91	CHI
20200958678	ALEXANIA	SN12082883	MARAJOARA	21/09/2020 18:40	21/09/2020 20:56	21/09/2020 18:40	21/09/2020 20:56	2,26	4	9,03	CHI

INTERNAL

20200958578	FORMOSA	FA12383392	ITIQUIRA	21/09/2020 18:42	22/09/2020 13:14	21/09/2020 18:42	22/09/2020 13:14	18,53	1	18,53	CHI
20200958578	DISTRITO FEDERAL	FA12383392	ITIQUIRA	21/09/2020 18:42	22/09/2020 13:14	21/09/2020 18:42	22/09/2020 13:14	18,53	2	37,05	CHI
20200958597	FORMOSA	FA12325370	ITIQUIRA	21/09/2020 18:43	23/09/2020 00:05	21/09/2020 18:43	22/09/2020 16:10	21,44	3	64,33	CHI
20200958597	FORMOSA	7194593	ITIQUIRA	21/09/2020 18:43	23/09/2020 00:05	22/09/2020 12:01	22/09/2020 23:22	11,36	15	170,44	CHI
20200958597	FORMOSA	FA12269989	ITIQUIRA	21/09/2020 18:43	23/09/2020 00:05	22/09/2020 12:01	22/09/2020 23:38	11,62	1	11,62	CHI
20200958597	FORMOSA	FA12278186	ITIQUIRA	21/09/2020 18:43	23/09/2020 00:05	22/09/2020 12:01	23/09/2020 00:05	12,07	14	168,99	CHI
20200958597	FORMOSA	FA12325370	ITIQUIRA	21/09/2020 18:43	23/09/2020 00:05	22/09/2020 16:16	22/09/2020 23:21	7,07	3	21,22	CHI
20200958607	ALTO PARAISO DE GOIAS	BF11125289	FLORES DE GOIAS	21/09/2020 18:44	21/09/2020 21:49	21/09/2020 18:44	21/09/2020 21:49	3,08	124	381,64	CHI
20200958737	ALTO PARAISO DE GOIAS	BF12125000LD	FLORES DE GOIAS	21/09/2020 18:44	22/09/2020 01:05	21/09/2020 18:44	22/09/2020 01:05	6,34	652	4134,22	CHI
20200958737	ALTO PARAISO DE GOIAS	BF12384793	FLORES DE GOIAS	21/09/2020 18:44	22/09/2020 01:05	21/09/2020 23:34	22/09/2020 00:57	1,39	124	172,05	CHI
20200958628	LUZIANIA	10017521171	RIO VERMELHO	21/09/2020 18:46	22/09/2020 00:27	21/09/2020 18:46	22/09/2020 00:27	5,68	1	5,68	CHI
20200958634	SANTA HELENA DE GOIAS	400078855	IPEGUARI	21/09/2020 18:46	22/09/2020 21:15	21/09/2020 18:46	22/09/2020 21:15	26,48	1	26,48	CHI
20200958637	RUBIATABA	RB21144521	RUBIATABA	21/09/2020 18:46	22/09/2020 17:07	21/09/2020 18:46	22/09/2020 17:07	22,34	1	22,34	CHI
20200959487	AMARALINA	LC12270112	SAO MIGUEL DO ARAGUAIA	21/09/2020 18:46	23/09/2020 17:34	21/09/2020 18:46	22/09/2020 20:07	25,35	13	329,49	CHI
20200959487	AMARALINA	LC12270112	SAO MIGUEL DO ARAGUAIA	21/09/2020 18:46	23/09/2020 17:34	21/09/2020 18:46	23/09/2020 17:34	46,79	5	233,93	CHI
20200959487	AMARALINA	LC12270112	SAO MIGUEL DO ARAGUAIA	21/09/2020 18:46	23/09/2020 17:34	22/09/2020 19:05	22/09/2020 20:07	1,04	32	33,25	CHI
20200959487	AMARALINA	LC13268915	SAO MIGUEL DO ARAGUAIA	21/09/2020 18:46	23/09/2020 17:34	22/09/2020 19:05	23/09/2020 17:34	22,48	12	269,77	CHI
20200959783	SANTA TEREZINHA DE GOIAS	SG12049774	SANTA TEREZINHA	21/09/2020 18:47	22/09/2020 04:19	21/09/2020 18:47	22/09/2020 04:19	9,53	140	1334,36	CHI
20200958685	ARAGARCAS	AG12000012	ARAGARCAS	21/09/2020 18:50	21/09/2020 21:19	21/09/2020 18:50	21/09/2020 21:19	2,48	42	104,21	CHI
20200958830	MINEIROS	MY11150298	PARQUE DAS EMAS	21/09/2020 18:50	22/09/2020 00:24	21/09/2020 18:50	22/09/2020 00:24	5,55	263	1460,02	CHI
20200958685	ARAGARCAS	AG12140067	ARAGARCAS	21/09/2020 18:50	21/09/2020 21:19	21/09/2020 20:22	21/09/2020 21:03	0,69	14	9,62	CHI
20200958715	MINEIROS	MY21036640	PARQUE DAS EMAS	21/09/2020 18:52	23/09/2020 10:17	21/09/2020 18:52	23/09/2020 10:17	39,41	2	78,83	CHI
20200959428	FORMOSA	FA11085601	ITIQUIRA	21/09/2020 18:53	22/09/2020 00:24	21/09/2020 18:53	22/09/2020 00:24	5,51	115	633,23	CHI
20200958743	FORMOSA	FA11098457	ITIQUIRA	21/09/2020 18:56	21/09/2020 23:24	21/09/2020 18:56	21/09/2020 23:24	4,46	222	989,93	CHI
20200958747	MARA ROSA	2260021287	MARA ROSA	21/09/2020 18:56	23/09/2020 11:30	21/09/2020 18:56	23/09/2020 11:30	40,55	1	40,55	CHI
20200958749	FORMOSA	610161428	ITIQUIRA	21/09/2020 18:56	22/09/2020 00:44	21/09/2020 18:56	22/09/2020 00:44	5,78	1	5,78	CHI
20200958750	APORE	AE12059186	ITAJA S1	21/09/2020 18:56	22/09/2020 08:30	21/09/2020 18:56	22/09/2020 08:30	13,55	4	54,20	CHI
20200958752	ANAPOLIS	20664667	DAIA S1	21/09/2020 18:57	21/09/2020 19:37	21/09/2020 18:57	21/09/2020 19:37	0,67	1	0,67	CHI
20200958756	SANTO ANTONIO DO DESCOBERTO	2210037100	ALEXANIA	21/09/2020 18:57	21/09/2020 22:10	21/09/2020 18:57	21/09/2020 22:10	3,21	1	3,21	CHI
20200959154	DOVERLANDIA	DV11193287	CAIAPONIA	21/09/2020 18:57	22/09/2020 10:05	21/09/2020 18:57	22/09/2020 10:05	15,12	56	846,86	CHI
20200958766	URUACU	10014563540	URUACU	21/09/2020 18:58	22/09/2020 02:14	21/09/2020 18:58	22/09/2020 02:14	7,26	1	7,26	CHI
20200959416	PADRE BERNARDO	PB12382215	PADRE BERNARDO	21/09/2020 18:59	22/09/2020 08:22	21/09/2020 18:59	22/09/2020 08:22	13,37	15	200,62	CHI
20200958912	PORANGATU	PO11252080	PORANGATU	21/09/2020 19:01	21/09/2020 20:48	21/09/2020 19:01	21/09/2020 20:48	1,78	104	185,38	CHI

INTERNAL

20200958793	IPORA	730013534	IPORA	21/09/2020 19:01	21/09/2020 19:45	21/09/2020 19:01	21/09/2020 19:45	0,73	1	0,73	CHI
20200958796	CAIAPONIA	CP21188434	CAIAPONIA	21/09/2020 19:01	22/09/2020 02:31	21/09/2020 19:01	22/09/2020 02:31	7,50	1	7,50	CHI
20200958806	URUACU	UR21243495	URUACU	21/09/2020 19:02	22/09/2020 00:49	21/09/2020 19:02	22/09/2020 00:49	5,78	1	5,78	CHI
20200958813	FAZENDA NOVA	FN11183126	JUSSARA	21/09/2020 19:02	22/09/2020 01:06	21/09/2020 19:02	22/09/2020 01:06	6,06	77	466,58	CHI
20200958816	LUZIANIA	LZ11169005	MARAJOARA	21/09/2020 19:02	22/09/2020 14:52	21/09/2020 19:02	22/09/2020 14:52	19,82	21	416,24	CHI
2020092100118	GOIANESIA	46401	GOIANESIA S1	21/09/2020 19:03	21/09/2020 19:10	21/09/2020 19:03	21/09/2020 19:10	0,12	392	45,73	CHI
2020092100118	SAO LUIZ DO NORTE	46401	GOIANESIA S1	21/09/2020 19:03	21/09/2020 19:10	21/09/2020 19:03	21/09/2020 19:10	0,12	21	2,45	CHI
2020092100118	VILA PROPICIO	18431	GOIANESIA S1	21/09/2020 19:03	21/09/2020 19:10	21/09/2020 19:03	21/09/2020 19:10	0,12	179	20,88	CHI
2020092100118	GOIANESIA	00560434	GOIANESIA S1	21/09/2020 19:03	21/09/2020 19:10	21/09/2020 19:03	21/09/2020 19:10	0,12	14	1,63	CHI
2020092100118	SANTA ISABEL	46402	GOIANESIA S1	21/09/2020 19:03	21/09/2020 19:10	21/09/2020 19:03	21/09/2020 19:10	0,12	22	2,57	CHI
2020092100118	PIRENOPOLIS	18402	GOIANESIA S1	21/09/2020 19:03	21/09/2020 19:10	21/09/2020 19:03	21/09/2020 19:10	0,12	1	0,12	CHI
2020092100118	VILA PROPICIO	18402	GOIANESIA S1	21/09/2020 19:03	21/09/2020 19:10	21/09/2020 19:03	21/09/2020 19:10	0,12	142	16,57	CHI
2020092100118	NOVA GLORIA	46401	GOIANESIA S1	21/09/2020 19:03	21/09/2020 19:10	21/09/2020 19:03	21/09/2020 19:10	0,12	2	0,23	CHI
2020092100118	SANTA ISABEL	46401	GOIANESIA S1	21/09/2020 19:03	21/09/2020 19:10	21/09/2020 19:03	21/09/2020 19:10	0,12	2	0,23	CHI
2020092100118	GOIANESIA	46402	GOIANESIA S1	21/09/2020 19:03	21/09/2020 19:10	21/09/2020 19:03	21/09/2020 19:10	0,12	586	68,37	CHI
2020092100118	COCALZINHO DE GOIAS	18431	GOIANESIA S1	21/09/2020 19:03	21/09/2020 19:10	21/09/2020 19:03	21/09/2020 19:10	0,12	265	30,92	CHI
2020092100118	PIRENOPOLIS	18401	GOIANESIA S1	21/09/2020 19:03	21/09/2020 19:10	21/09/2020 19:03	21/09/2020 19:10	0,12	33	3,85	CHI
2020092100118	VILA PROPICIO	18401	GOIANESIA S1	21/09/2020 19:03	21/09/2020 19:10	21/09/2020 19:03	21/09/2020 19:10	0,12	836	97,53	CHI
2020092100118	VILA PROPICIO	00560434	GOIANESIA S1	21/09/2020 19:03	21/09/2020 19:10	21/09/2020 19:03	21/09/2020 19:10	0,12	140	16,33	CHI
20200958824	CHAPADAO DO CEU	AE21107453	CHAPADAO DO CEU	21/09/2020 19:03	21/09/2020 23:14	21/09/2020 19:03	21/09/2020 23:14	4,18	1	4,18	CHI
20200958825	AGUAS LINDAS DE GOIAS	LA12412178	AGUAS LINDAS DE GOIAS S1	21/09/2020 19:03	22/09/2020 12:07	21/09/2020 19:03	22/09/2020 12:07	17,06	11	187,65	CHI
20200959114	PORANGATU	PO12320949	PORANGATU	21/09/2020 19:03	22/09/2020 11:47	21/09/2020 19:03	22/09/2020 11:47	16,72	49	819,50	CHI
20200958433	AGUAS LINDAS DE GOIAS	LA11347924	AGUAS LINDAS DE GOIAS S1	21/09/2020 19:03	21/09/2020 20:22	21/09/2020 20:05	21/09/2020 20:22	0,28	83	23,17	CHI
20200959233	MINEIROS	MY11101091	PARQUE DAS EMAS	21/09/2020 19:04	21/09/2020 23:37	21/09/2020 19:04	21/09/2020 23:37	4,55	173	787,15	CHI
20200958837	ITAPACI	IW21079707	ITAPACI	21/09/2020 19:04	22/09/2020 14:07	21/09/2020 19:04	22/09/2020 14:07	19,05	1	19,05	CHI
20200958840	SITIO D ABADIA	SI12375586	IACIARA S2	21/09/2020 19:04	21/09/2020 22:13	21/09/2020 19:04	21/09/2020 22:13	3,14	4	12,56	CHI
20200958840	FLORES DE GOIAS	SI12375586	IACIARA S2	21/09/2020 19:04	21/09/2020 22:13	21/09/2020 19:04	21/09/2020 22:13	3,14	4	12,56	CHI
20200958854	URUACU	UR11221613	URUACU	21/09/2020 19:06	23/09/2020 00:13	21/09/2020 19:06	23/09/2020 00:13	29,11	34	989,89	CHI
20200959102	NOVA IGUACU DE GOIAS	NH12202113	SANTA TEREZINHA	21/09/2020 19:06	25/09/2020 01:57	21/09/2020 19:06	23/09/2020 10:35	39,49	2	78,98	CHI
20200959102	NOVA IGUACU DE GOIAS	NH12202113	SANTA TEREZINHA	21/09/2020 19:06	25/09/2020 01:57	21/09/2020 19:06	23/09/2020 16:58	45,86	21	963,11	CHI
20200959102	NOVA IGUACU DE GOIAS	NH12202113	SANTA TEREZINHA	21/09/2020 19:06	25/09/2020 01:57	21/09/2020 19:06	23/09/2020 21:17	50,18	1	50,18	CHI
20200959102	NOVA IGUACU DE GOIAS	NH12202113	SANTA TEREZINHA	21/09/2020 19:06	25/09/2020 01:57	21/09/2020 19:06	23/09/2020 22:41	51,59	4	206,35	CHI
20200959102	NOVA IGUACU DE GOIAS	NH12202113	SANTA TEREZINHA	21/09/2020 19:06	25/09/2020 01:57	21/09/2020 19:06	25/09/2020 01:37	78,52	3	235,55	CHI

INTERNAL

20200959102	NOVA IGUACU DE GOIAS	NH12202113	SANTA TEREZINHA	21/09/2020 19:06	25/09/2020 01:57	21/09/2020 19:06	25/09/2020 01:57	78,85	33	2602,16	CHI
20200958972	MINEIROS	PW10406624	PARQUE DAS EMAS	21/09/2020 19:06	22/09/2020 19:26	21/09/2020 19:06	22/09/2020 19:26	24,32	61	1483,77	CHI
20200958972	PORTELANDIA	PW10406624	PARQUE DAS EMAS	21/09/2020 19:06	22/09/2020 19:26	21/09/2020 19:06	22/09/2020 19:26	24,32	3	72,97	CHI
20200959102	NOVA IGUACU DE GOIAS	NH12202113	SANTA TEREZINHA	21/09/2020 19:06	25/09/2020 01:57	24/09/2020 23:41	25/09/2020 01:37	1,92	28	53,89	CHI
20200958878	LUZIANIA	LZ11219653	RIO VERMELHO	21/09/2020 19:07	22/09/2020 02:20	21/09/2020 19:07	22/09/2020 02:20	7,20	72	518,68	CHI
20200958885	CRISTALINA	KR21206514	PAMPLONA	21/09/2020 19:08	21/09/2020 20:58	21/09/2020 19:08	21/09/2020 20:47	1,65	1	1,65	CHI
20200958887	MINEIROS	MY11248474	PARQUE DAS EMAS	21/09/2020 19:08	22/09/2020 14:20	21/09/2020 19:08	22/09/2020 14:20	19,19	19	364,68	CHI
20200958888	MINEIROS	MY21070320	PARQUE DAS EMAS	21/09/2020 19:08	21/09/2020 23:24	21/09/2020 19:08	21/09/2020 23:24	4,26	1	4,26	CHI
20200958885	CRISTALINA	KR21206514	PAMPLONA	21/09/2020 19:08	21/09/2020 20:58	21/09/2020 20:53	21/09/2020 20:58	0,09	1	0,09	CHI
20200958911	JANDAIA	1180001452	PALMEIRAS	21/09/2020 19:10	21/09/2020 20:53	21/09/2020 19:10	21/09/2020 20:53	1,71	1	1,71	CHI
20200958913	CAIAPONIA	CP21346551	CAIAPONIA	21/09/2020 19:10	22/09/2020 03:55	21/09/2020 19:10	22/09/2020 03:55	8,74	1	8,74	CHI
20200959833	VILA PROPICIO	GE12000035	GOIANESIA S2	21/09/2020 19:10	22/09/2020 07:49	21/09/2020 19:10	22/09/2020 07:49	12,64	8	101,10	CHI
20200959833	GOIANESIA	GE12000035	GOIANESIA S2	21/09/2020 19:10	22/09/2020 07:49	21/09/2020 19:10	22/09/2020 07:49	12,64	3	37,91	CHI
202009106987	FLORES DE GOIAS	FB11286812	FLORES DE GOIAS	21/09/2020 19:11	21/09/2020 22:41	21/09/2020 19:11	21/09/2020 22:41	3,51	1	3,51	CHI
20200958940	CAMPINORTE	MQ12082973	MARA ROSA	21/09/2020 19:12	23/09/2020 15:01	21/09/2020 19:12	23/09/2020 15:01	43,81	1	43,81	CHI
20200958940	MARA ROSA	MQ12082973	MARA ROSA	21/09/2020 19:12	23/09/2020 15:01	21/09/2020 19:12	23/09/2020 15:01	43,81	2	87,62	CHI
20200958942	MOZARLANDIA	410024934	MOZARLANDIA	21/09/2020 19:12	22/09/2020 10:45	21/09/2020 19:12	22/09/2020 10:45	15,53	1	15,53	CHI
20200958944	CACHOEIRA DE GOIAS	CG21165615	FIRMINOPOLIS S2	21/09/2020 19:13	21/09/2020 21:48	21/09/2020 19:13	21/09/2020 21:48	2,58	1	2,58	CHI
20200958946	FORMOSA	610039763	ITIQUEIRA	21/09/2020 19:13	22/09/2020 01:09	21/09/2020 19:13	22/09/2020 01:09	5,93	1	5,93	CHI
20200958958	CIDADE OCIDENTAL	2680143330	MARAJOARA	21/09/2020 19:14	21/09/2020 22:19	21/09/2020 19:14	21/09/2020 22:19	3,08	1	3,08	CHI
20200959190	CAIAPONIA	CP11259376	CAIAPONIA	21/09/2020 19:15	21/09/2020 22:30	21/09/2020 19:15	21/09/2020 22:30	3,24	91	295,27	CHI
202009107051	FORMOSA	FA21322769	ITIQUEIRA	21/09/2020 19:16	22/09/2020 16:33	21/09/2020 19:16	22/09/2020 16:33	21,29	1	21,29	CHI
20200958986	FORMOSA	610287734	ITIQUEIRA	21/09/2020 19:16	21/09/2020 23:02	21/09/2020 19:16	21/09/2020 23:02	3,76	1	3,76	CHI
20200958995	MINEIROS	MY12303356	PARQUE DAS EMAS	21/09/2020 19:16	21/09/2020 22:00	21/09/2020 19:16	21/09/2020 22:00	2,73	3	8,18	CHI
202009107051	FORMOSA	FA21130074	ITIQUEIRA	21/09/2020 19:16	22/09/2020 16:33	21/09/2020 20:28	22/09/2020 04:05	7,62	1	7,62	CHI
202009106999	RIO VERDE	RV21076339	RIO VERDE S1	21/09/2020 19:17	21/09/2020 22:16	21/09/2020 19:17	21/09/2020 22:16	2,98	1	2,98	CHI
20200959003	LUZIANIA	120080825	RIO VERMELHO	21/09/2020 19:17	22/09/2020 10:54	21/09/2020 19:17	22/09/2020 10:54	15,60	1	15,60	CHI
20200959010	NOVO GAMA	4990071762	PACAEMBU S1	21/09/2020 19:18	22/09/2020 04:44	21/09/2020 19:18	22/09/2020 04:44	9,43	1	9,43	CHI
202009107053	PORANGATU	PO11301017	MARA ROSA	21/09/2020 19:18	24/09/2020 13:57	21/09/2020 19:18	22/09/2020 12:18	16,99	1	16,99	CHI
202009107053	PORANGATU	PO11300988	MARA ROSA	21/09/2020 19:18	24/09/2020 13:57	22/09/2020 05:52	24/09/2020 13:57	56,09	1	56,09	CHI
202009107053	PORANGATU	PO11289320	MARA ROSA	21/09/2020 19:18	24/09/2020 13:57	22/09/2020 08:03	24/09/2020 13:57	53,91	1	53,91	CHI
202009107053	PORANGATU	PO11297070	MARA ROSA	21/09/2020 19:18	24/09/2020 13:57	22/09/2020 08:54	22/09/2020 12:18	3,38	1	3,38	CHI
20200959152	CAIAPONIA	CP12200875	CAIAPONIA	21/09/2020 19:19	21/09/2020 22:31	21/09/2020 19:19	21/09/2020 22:31	3,19	9	28,75	CHI

INTERNAL

20200959721	MINEIROS	MY11219530	PARQUE DAS EMAS	21/09/2020 19:19	22/09/2020 10:56	21/09/2020 19:19	22/09/2020 10:56	15,60	90	1404,20	CHI
20200959031	FORMOSA	FA11363505	SAO JOAO D ALIANCA	21/09/2020 19:19	22/09/2020 13:31	21/09/2020 19:19	22/09/2020 13:31	18,19	2	36,37	CHI
20200959142	ANAPOLIS	AN11000261	JUNDIAI S1	21/09/2020 19:20	21/09/2020 20:29	21/09/2020 19:20	21/09/2020 20:29	1,15	117	134,55	CHI
20200959042	MUNDO NOVO DE GOIAS	MH12318486	NOVA CRIXAS	21/09/2020 19:21	22/09/2020 02:26	21/09/2020 19:21	22/09/2020 02:26	7,08	45	318,67	CHI
20200959055	PIRENOPOLIS	220007858	CORUMBA	21/09/2020 19:22	22/09/2020 00:02	21/09/2020 19:22	22/09/2020 00:02	4,66	1	4,66	CHI
20200959058	SAO MIGUEL DO ARAGUAIA	SM21000040	SAO MIGUEL DO ARAGUAIA	21/09/2020 19:23	22/09/2020 07:00	21/09/2020 19:23	22/09/2020 07:00	11,62	1	11,62	CHI
20200961583	ITAPACI	IW12167983	ITAPACI	21/09/2020 19:23	22/09/2020 10:20	21/09/2020 19:23	22/09/2020 10:20	14,94	29	433,20	CHI
20200959065	FLORES DE GOIAS	FB12245566	IACIARA S2	21/09/2020 19:24	21/09/2020 23:25	21/09/2020 19:24	21/09/2020 23:25	4,01	73	293,07	CHI
20200959065	SITIO D ABADIA	FB12245566	IACIARA S2	21/09/2020 19:24	21/09/2020 23:25	21/09/2020 19:24	21/09/2020 23:25	4,01	39	156,57	CHI
20200959654	FORMOSO	FO12000025	PORANGATU	21/09/2020 19:25	21/09/2020 23:37	21/09/2020 19:25	21/09/2020 23:37	4,21	447	1881,87	CHI
20200959073	FORMOSA	610049653	ITUIQUIRA	21/09/2020 19:25	22/09/2020 00:10	21/09/2020 19:25	22/09/2020 00:10	4,74	1	4,74	CHI
20200959078	JARAGUA	10004713271	JARAGUA	21/09/2020 19:25	21/09/2020 21:19	21/09/2020 19:25	21/09/2020 21:19	1,89	1	1,89	CHI
20200959088	DOVERLANDIA	DV12207831	CAIAPONIA	21/09/2020 19:26	21/09/2020 23:34	21/09/2020 19:26	21/09/2020 23:34	4,13	3	12,40	CHI
20200959091	ANAPOLIS	AN12319689	ANAPOLIS UNIVERSITARIO S2	21/09/2020 19:27	21/09/2020 20:37	21/09/2020 19:27	21/09/2020 20:37	1,16	295	343,27	CHI
20200959098	SANTA HELENA DE GOIAS	400099690	IPEGUARI	21/09/2020 19:27	21/09/2020 21:10	21/09/2020 19:27	21/09/2020 21:10	1,71	1	1,71	CHI
20200959099	IACIARA	1550003371	IACIARA S1	21/09/2020 19:27	21/09/2020 21:01	21/09/2020 19:27	21/09/2020 21:01	1,56	1	1,56	CHI
20200959106	PILAR DE GOIAS	GG12171805RE	SANTA TEREZINHA	21/09/2020 19:28	22/09/2020 12:47	21/09/2020 19:28	22/09/2020 12:47	17,31	60	1038,37	CHI
20200959106	SANTA TEREZINHA DE GOIAS	GG12171805RE	SANTA TEREZINHA	21/09/2020 19:28	22/09/2020 12:47	21/09/2020 19:28	22/09/2020 12:47	17,31	45	778,78	CHI
20200959113	CIDADE OCIDENTAL	DH11355903	MARAJOARA	21/09/2020 19:29	21/09/2020 22:49	21/09/2020 19:29	21/09/2020 22:49	3,33	21	69,91	CHI
20200959116	MONTIVIDIU	MV21147897	MONTIVIDIU T	21/09/2020 19:29	22/09/2020 15:45	21/09/2020 19:29	22/09/2020 15:45	20,25	1	20,25	CHI
20200993478	JATAI	JT12182140	JATAI S1	21/09/2020 19:31	22/09/2020 12:27	21/09/2020 19:31	22/09/2020 00:03	4,54	9	40,85	CHI
20200993478	SERRANOPOLIS	JT12182140	JATAI S1	21/09/2020 19:31	22/09/2020 12:27	21/09/2020 19:31	22/09/2020 00:03	4,54	2	9,08	CHI
20200959134	SAO LUIS DE MONTES BELOS	SL21125654	FIRMINOPOLIS S1	21/09/2020 19:31	21/09/2020 21:54	21/09/2020 19:31	21/09/2020 21:54	2,37	1	2,37	CHI
20200993478	SERRANOPOLIS	JT12182140	JATAI S1	21/09/2020 19:31	22/09/2020 12:27	22/09/2020 00:33	22/09/2020 12:27	11,88	2	23,77	CHI
20200993478	JATAI	JT12182140	JATAI S1	21/09/2020 19:31	22/09/2020 12:27	22/09/2020 00:33	22/09/2020 12:27	11,88	9	106,96	CHI
20200959143	AGUAS LINDAS DE GOIAS	LA11192770	AGUAS LINDAS DE GOIAS S1	21/09/2020 19:32	22/09/2020 01:53	21/09/2020 19:32	22/09/2020 01:53	6,34	186	1179,55	CHI
20200959168	NIQUELANDIA	2750000677	NIQUELANDIA SUBTRANSMISSAO	21/09/2020 19:34	23/09/2020 00:01	21/09/2020 19:34	23/09/2020 00:01	28,43	1	28,43	CHI
20200959173	RIO VERDE	630480096	CABRIUVA S1	21/09/2020 19:35	21/09/2020 20:28	21/09/2020 19:35	21/09/2020 20:28	0,88	1	0,88	CHI
20200959178	FORMOSA	610019120	ITUIQUIRA	21/09/2020 19:35	21/09/2020 23:53	21/09/2020 19:35	21/09/2020 23:53	4,28	1	4,28	CHI
20200959182	SAO LUIZ DO NORTE	3090010183	ITAPACI	21/09/2020 19:36	22/09/2020 14:12	21/09/2020 19:36	22/09/2020 14:12	18,60	1	18,60	CHI
20200959196	LEOPOLDO DE BULHOES	LB11000004	DAIA S2	21/09/2020 19:37	21/09/2020 21:14	21/09/2020 19:37	21/09/2020 21:14	1,61	109	175,52	CHI
20200959551	AGUAS LINDAS DE GOIAS	LA12165006	AGUAS LINDAS DE GOIAS S2	21/09/2020 19:37	21/09/2020 23:01	21/09/2020 19:37	21/09/2020 23:01	3,39	1547	5248,63	CHI
20200959207	MONTIVIDIU DO NORTE	MX12364028	PORANGATU	21/09/2020 19:38	24/09/2020 11:26	21/09/2020 19:38	24/09/2020 11:26	63,80	8	510,38	CHI

INTERNAL

20200959209	MINEIROS	MY21034242	PARQUE DAS EMAS	21/09/2020 19:38	22/09/2020 17:19	21/09/2020 19:38	22/09/2020 17:19	21,68	1	21,68	CHI
20200959217	FORMOSA	610057376	ITUIQUIRA	21/09/2020 19:40	22/09/2020 09:32	21/09/2020 19:40	22/09/2020 09:32	13,86	1	13,86	CHI
20200959373	VALPARAISO DE GOIAS	VA11192940	MARAJOARA	21/09/2020 19:41	21/09/2020 23:02	21/09/2020 19:41	21/09/2020 23:02	3,34	96	320,88	CHI
20200959237	GOIANESIA	550036118	GOIANESIA S2	21/09/2020 19:43	21/09/2020 22:49	21/09/2020 19:43	21/09/2020 22:49	3,10	1	3,10	CHI
20200961541	PORANGATU	MU12094084	MARA ROSA	21/09/2020 19:43	22/09/2020 09:29	21/09/2020 19:43	22/09/2020 09:29	13,75	84	1155,07	CHI
20200959256	FORMOSA	610015849	ITUIQUIRA	21/09/2020 19:45	22/09/2020 11:40	21/09/2020 19:45	22/09/2020 11:40	15,91	1	15,91	CHI
202009107044	BONOPOLIS	BX12202590	SAO MIGUEL DO ARAGUAIA	21/09/2020 19:45	23/09/2020 01:27	21/09/2020 19:45	23/09/2020 01:27	29,69	11	326,61	CHI
20200959260	CHAPADAO DO CEU	9880013596	CHAPADAO DO CEU	21/09/2020 19:45	21/09/2020 22:36	21/09/2020 19:45	21/09/2020 22:36	2,84	1	2,84	CHI
20200959270	FORMOSA	610177278	ITUIQUIRA	21/09/2020 19:48	22/09/2020 06:55	21/09/2020 19:48	22/09/2020 06:55	11,12	1	11,12	CHI
20200959278	MORRO AGUDO DE GOIAS	3690006970	ITAPURANGA	21/09/2020 19:49	22/09/2020 12:17	21/09/2020 19:49	22/09/2020 12:17	16,46	1	16,46	CHI
20200959283	CAIAPONIA	930030710	CAIAPONIA	21/09/2020 19:49	22/09/2020 08:24	21/09/2020 19:49	22/09/2020 08:24	12,57	1	12,57	CHI
20200959295	NOVO GAMA	4990031107	PACAEMBU S1	21/09/2020 19:51	21/09/2020 21:20	21/09/2020 19:51	21/09/2020 21:20	1,48	1	1,48	CHI
20200959299	RIO VERDE	RV21205437	MONTIVIDIU T	21/09/2020 19:52	22/09/2020 19:04	21/09/2020 19:52	22/09/2020 17:37	21,76	13	282,87	CHI
20200959301	ALEXANIA	AX12370321	ALEXANIA	21/09/2020 19:52	21/09/2020 23:15	21/09/2020 19:52	21/09/2020 23:15	3,38	2	6,75	CHI
20200959417	MUNDO NOVO DE GOIAS	MH12216327	NOVA CRIXAS	21/09/2020 19:52	22/09/2020 14:50	21/09/2020 19:52	22/09/2020 14:50	18,95	279	5288,13	CHI
20200959299	RIO VERDE	RV12260927	MONTIVIDIU T	21/09/2020 19:52	22/09/2020 19:04	22/09/2020 18:31	22/09/2020 19:04	0,55	13	7,13	CHI
20200959307	MONTIVIDIU DO NORTE	MX11362077	PORANGATU	21/09/2020 19:53	24/09/2020 14:53	21/09/2020 19:53	24/09/2020 14:53	67,00	1	67,00	CHI
20200959310	GOIANESIA	GE21000334	GOIANESIA S2	21/09/2020 19:53	21/09/2020 21:58	21/09/2020 19:53	21/09/2020 21:58	2,08	1	2,08	CHI
20200959321	RUBIATABA	780005582	RUBIATABA	21/09/2020 19:54	23/09/2020 11:40	21/09/2020 19:54	23/09/2020 11:40	39,77	1	39,77	CHI
20200993443	SERRANOPOLIS	JT12092386RE	JATAI S1	21/09/2020 19:55	22/09/2020 12:00	21/09/2020 19:55	22/09/2020 00:03	4,14	4	16,57	CHI
20200993443	JATAI	JT12092386RE	JATAI S1	21/09/2020 19:55	22/09/2020 12:00	21/09/2020 19:55	22/09/2020 00:03	4,14	45	186,45	CHI
20200959526	MUNDO NOVO DE GOIAS	MH12220605	NOVA CRIXAS	21/09/2020 19:55	21/09/2020 23:35	21/09/2020 19:55	21/09/2020 23:35	3,66	130	476,12	CHI
20200993443	SERRANOPOLIS	JT12092386RE	JATAI S1	21/09/2020 19:55	22/09/2020 12:00	22/09/2020 00:33	22/09/2020 12:00	11,43	4	45,74	CHI
20200993443	JATAI	JT12092386RE	JATAI S1	21/09/2020 19:55	22/09/2020 12:00	22/09/2020 00:33	22/09/2020 12:00	11,43	45	514,57	CHI
20200959338	FORMOSA	610188343	ITUIQUIRA	21/09/2020 19:56	22/09/2020 09:50	21/09/2020 19:56	22/09/2020 09:50	13,90	1	13,90	CHI
20200959340	CACU	CC12080196	CACHOEIRA ALTA	21/09/2020 19:57	21/09/2020 22:58	21/09/2020 19:57	21/09/2020 22:58	3,02	5	15,08	CHI
20200959345	RIO VERDE	10001187404	RIO VERDE S2	21/09/2020 19:58	21/09/2020 21:42	21/09/2020 19:58	21/09/2020 21:42	1,72	1	1,72	CHI
20200959360	FLORES DE GOIAS	FB10407036	FLORES DE GOIAS	21/09/2020 19:59	22/09/2020 13:28	21/09/2020 19:59	21/09/2020 22:41	2,71	109	295,60	CHI
20200959360	SAO JOAO D ALIANCA	FB10407036	FLORES DE GOIAS	21/09/2020 19:59	22/09/2020 13:28	21/09/2020 19:59	21/09/2020 22:41	2,71	33	89,49	CHI
20200959360	FLORES DE GOIAS	FB10407036	FLORES DE GOIAS	21/09/2020 19:59	22/09/2020 13:28	21/09/2020 19:59	22/09/2020 01:45	5,78	295	1703,79	CHI
20200959360	SAO JOAO D ALIANCA	FB10407036	FLORES DE GOIAS	21/09/2020 19:59	22/09/2020 13:28	21/09/2020 19:59	22/09/2020 03:33	7,58	6	45,46	CHI
20200959360	FLORES DE GOIAS	FB10407036	FLORES DE GOIAS	21/09/2020 19:59	22/09/2020 13:28	21/09/2020 19:59	22/09/2020 11:56	15,96	561	8954,34	CHI
20200959360	NOVA ROMA	FB10407036	FLORES DE GOIAS	21/09/2020 19:59	22/09/2020 13:28	21/09/2020 19:59	22/09/2020 11:56	15,96	2	31,92	CHI

INTERNAL

20200959360	SAO JOAO D ALIANCA	FB10407036	FLORES DE GOIAS	21/09/2020 19:59	22/09/2020 13:28	21/09/2020 19:59	22/09/2020 11:56	15,96	66	1053,45	CHI
20200959360	SAO JOAO D ALIANCA	FB10407036	FLORES DE GOIAS	21/09/2020 19:59	22/09/2020 13:28	22/09/2020 02:44	22/09/2020 03:33	0,83	33	27,27	CHI
20200959360	FLORES DE GOIAS	FB10407036	FLORES DE GOIAS	21/09/2020 19:59	22/09/2020 13:28	22/09/2020 02:44	22/09/2020 03:33	0,83	110	90,90	CHI
20200959360	FLORES DE GOIAS	FB13329787	FLORES DE GOIAS	21/09/2020 19:59	22/09/2020 13:28	22/09/2020 02:44	22/09/2020 10:37	7,89	155	1223,42	CHI
20200959360	FLORES DE GOIAS	FB12071376	FLORES DE GOIAS	21/09/2020 19:59	22/09/2020 13:28	22/09/2020 02:44	22/09/2020 13:01	10,29	51	525,00	CHI
20200959360	FLORES DE GOIAS	FB12211631LD	FLORES DE GOIAS	21/09/2020 19:59	22/09/2020 13:28	22/09/2020 02:44	22/09/2020 13:28	10,74	89	956,03	CHI
20200959402	RIO VERDE	630241790	RIO VERDE S2	21/09/2020 20:00	21/09/2020 21:00	21/09/2020 20:00	21/09/2020 21:00	1,01	1	1,01	CHI
20200959352	PEROLANDIA	DP12260367	JATAI S1	21/09/2020 20:00	22/09/2020 09:10	21/09/2020 20:00	22/09/2020 09:10	13,16	6	78,96	CHI
20200959361	MONTIVIDIU	MV12214147	MONTIVIDIU T	21/09/2020 20:01	21/09/2020 22:44	21/09/2020 20:01	21/09/2020 22:44	2,71	2	5,42	CHI
20200959361	RIO VERDE	MV12214147	MONTIVIDIU T	21/09/2020 20:01	21/09/2020 22:44	21/09/2020 20:01	21/09/2020 22:44	2,71	2	5,42	CHI
20200959471	ITAPACI	IW11162608	ITAPACI	21/09/2020 20:02	22/09/2020 00:02	21/09/2020 20:02	22/09/2020 00:02	3,99	137	546,40	CHI
20200959379	ESTRELA DO NORTE	ET12231930	MARA ROSA	21/09/2020 20:03	22/09/2020 15:17	21/09/2020 20:03	22/09/2020 15:17	19,22	4	76,88	CHI
20200959398	MINEIROS	MY12219457RE	PARQUE DAS EMAS	21/09/2020 20:04	21/09/2020 22:01	21/09/2020 20:04	21/09/2020 22:01	1,94	22	42,69	CHI
20200959403	FORMOSA	FA11062213	ITUIQUIRA	21/09/2020 20:04	22/09/2020 00:59	21/09/2020 20:04	22/09/2020 00:59	4,91	4	19,62	CHI
20200959490	PORANGATU	04140224	PORANGATU	21/09/2020 20:04	21/09/2020 22:10	21/09/2020 20:04	21/09/2020 22:10	2,09	1034	2164,79	CHI
20200959490	TROMBAS	04140224	PORANGATU	21/09/2020 20:04	21/09/2020 22:10	21/09/2020 20:04	21/09/2020 22:10	2,09	152	318,23	CHI
20200959490	MONTIVIDIU DO NORTE	04140224	PORANGATU	21/09/2020 20:04	21/09/2020 22:10	21/09/2020 20:04	21/09/2020 22:10	2,09	6	12,56	CHI
20200959490	SANTA TEREZA DE GOIAS	04140224	PORANGATU	21/09/2020 20:04	21/09/2020 22:10	21/09/2020 20:04	21/09/2020 22:10	2,09	6	12,56	CHI
20200959406	ANAPOLIS	AN12273271	DAIA S1	21/09/2020 20:04	21/09/2020 21:25	21/09/2020 20:04	21/09/2020 21:25	1,34	3	4,03	CHI
20200959409	FORMOSO	2410020052	PORANGATU	21/09/2020 20:05	21/09/2020 23:41	21/09/2020 20:05	21/09/2020 23:41	3,60	1	3,60	CHI
20200959414	FORMOSA	610158740	ITUIQUIRA	21/09/2020 20:05	22/09/2020 08:43	21/09/2020 20:05	22/09/2020 08:43	12,62	1	12,62	CHI
20200959421	ALEXANIA	AX21364386	ALEXANIA	21/09/2020 20:06	22/09/2020 08:29	21/09/2020 20:06	22/09/2020 08:29	12,38	1	12,38	CHI
20200959426	JARAGUA	JA11254206	JARAGUA	21/09/2020 20:07	22/09/2020 00:35	21/09/2020 20:07	22/09/2020 00:35	4,45	100	445,47	CHI
20200959501	PEROLANDIA	DP13234299	JATAI S1	21/09/2020 20:07	22/09/2020 15:25	21/09/2020 20:07	22/09/2020 00:11	4,06	57	231,36	CHI
20200959501	MINEIROS	DP12254560LD	JATAI S1	21/09/2020 20:07	22/09/2020 15:25	21/09/2020 20:07	22/09/2020 15:25	19,30	3	57,91	CHI
20200959501	PEROLANDIA	DP12254560LD	JATAI S1	21/09/2020 20:07	22/09/2020 15:25	21/09/2020 20:07	22/09/2020 15:25	19,30	79	1524,83	CHI
20200959501	PEROLANDIA	DP13234299	JATAI S1	21/09/2020 20:07	22/09/2020 15:25	22/09/2020 00:13	22/09/2020 12:59	12,76	6	76,57	CHI
20200959501	PEROLANDIA	DP13402497	JATAI S1	21/09/2020 20:07	22/09/2020 15:25	22/09/2020 00:13	22/09/2020 13:49	13,60	51	693,76	CHI
20200959450	PLANALTINA	2960166912	PLANALTINA	21/09/2020 20:12	22/09/2020 21:16	21/09/2020 20:12	22/09/2020 21:16	25,08	1	25,08	CHI
202009106982	VALPARAISO DE GOIAS	3350051039	PACAEMBU S2	21/09/2020 20:12	22/09/2020 21:39	21/09/2020 20:12	22/09/2020 21:39	25,45	1	25,45	CHI
20200959452	VALPARAISO DE GOIAS	VA11136515	PACAEMBU S2	21/09/2020 20:12	22/09/2020 23:16	22/09/2020 21:39	22/09/2020 23:16	1,61	198	318,78	CHI
20200959469	SAO MIGUEL DO ARAGUAIA	SM11276122	SAO MIGUEL DO ARAGUAIA	21/09/2020 20:14	22/09/2020 22:18	21/09/2020 20:14	22/09/2020 22:18	26,05	1	26,05	CHI
20200959470	NOVA CRIXAS	NA11282178	NOVA CRIXAS	21/09/2020 20:15	21/09/2020 21:43	21/09/2020 20:15	21/09/2020 21:43	1,47	73	106,95	CHI

INTERNAL

20200959626	ITABERAI	IB12310505	ITABERAI S2	21/09/2020 20:15	22/09/2020 23:25	21/09/2020 20:15	22/09/2020 19:56	23,67	13	307,75	CHI
20200959626	ITABERAI	IB12310505	ITABERAI S2	21/09/2020 20:15	22/09/2020 23:25	21/09/2020 20:15	22/09/2020 23:25	27,15	1	27,15	CHI
20200959481	JATAI	290216680	JATAI S3	21/09/2020 20:16	22/09/2020 16:31	21/09/2020 20:16	22/09/2020 16:31	20,24	1	20,24	CHI
20200959491	PLANALTINA	2960090117	PLANALTINA	21/09/2020 20:17	22/09/2020 16:20	21/09/2020 20:17	22/09/2020 16:20	20,05	1	20,05	CHI
20200959628	BONOPOLIS	BX11391652	SAO MIGUEL DO ARAGUAIA	21/09/2020 20:18	24/09/2020 02:55	21/09/2020 20:18	24/09/2020 02:55	54,61	37	2020,43	CHI
20200959511	ALTO PARAISO DE GOIAS	BF12129915	FLORES DE GOIAS	21/09/2020 20:20	21/09/2020 22:52	21/09/2020 20:20	21/09/2020 22:52	2,53	24	60,73	CHI
20200959515	TURVANIA	TV12058371	FIRMINOPOLIS S2	21/09/2020 20:20	21/09/2020 23:42	21/09/2020 20:20	21/09/2020 23:42	3,36	6	20,14	CHI
20200959541	PEROLANDIA	DP12260360	JATAI S1	21/09/2020 20:25	22/09/2020 09:33	21/09/2020 20:25	22/09/2020 09:33	13,13	3	39,39	CHI
20200959544	FORMOSA	610005339	ITUIQUIRA	21/09/2020 20:25	22/09/2020 12:02	21/09/2020 20:25	22/09/2020 12:02	15,61	1	15,61	CHI
20200959649	LUZIANIA	120122443	MARAJOARA	21/09/2020 20:25	22/09/2020 11:59	21/09/2020 20:25	22/09/2020 11:59	15,56	1	15,56	CHI
20200959550	FORMOSO	2410000843	PORANGATU	21/09/2020 20:26	22/09/2020 15:13	21/09/2020 20:26	22/09/2020 15:13	18,77	1	18,77	CHI
20200959552	GAMELEIRA DE GOIAS	LB12011659	DAIA S2	21/09/2020 20:27	22/09/2020 00:31	21/09/2020 20:27	22/09/2020 00:31	4,06	15	60,91	CHI
20200959552	SILVANIA	LB12011659	DAIA S2	21/09/2020 20:27	22/09/2020 00:31	21/09/2020 20:27	22/09/2020 00:31	4,06	28	113,70	CHI
20200959552	LEOPOLDO DE BULHOES	LB12011659	DAIA S2	21/09/2020 20:27	22/09/2020 00:31	21/09/2020 20:27	22/09/2020 00:31	4,06	5	20,30	CHI
20200959560	JATAI	JT12296503	JATAI S1	21/09/2020 20:27	22/09/2020 00:25	21/09/2020 20:27	22/09/2020 00:25	3,96	16	63,41	CHI
20200959560	PEROLANDIA	JT12296503	JATAI S1	21/09/2020 20:27	22/09/2020 00:25	21/09/2020 20:27	22/09/2020 00:25	3,96	3	11,89	CHI
20200959792	MUNDO NOVO DE GOIAS	MH11170096	NOVA CRIXAS	21/09/2020 20:29	22/09/2020 07:45	21/09/2020 20:29	22/09/2020 07:45	11,26	75	844,48	CHI
20200959577	ITAGUARI	770015979	ITABERAI S1	21/09/2020 20:30	22/09/2020 09:40	21/09/2020 20:30	22/09/2020 09:40	13,16	1	13,16	CHI
20200959951	ITAPACI	100081873	ITAPACI	21/09/2020 20:35	22/09/2020 08:35	21/09/2020 20:35	22/09/2020 08:35	12,00	1	12,00	CHI
20200959847	PLANALTINA	PI12375541	PLANALTINA	21/09/2020 20:36	22/09/2020 07:17	21/09/2020 20:36	22/09/2020 07:17	10,67	180	1920,25	CHI
20200962226	PEROLANDIA	DP12103843LD	JATAI S1	21/09/2020 20:37	22/09/2020 11:12	21/09/2020 20:37	22/09/2020 11:12	14,58	13	189,52	CHI
20200959869	PORTELANDIA	PW12219564	PARQUE DAS EMAS	21/09/2020 20:38	22/09/2020 23:44	21/09/2020 20:38	22/09/2020 23:44	27,10	12	325,15	CHI
20200959869	MINEIROS	PW12219564	PARQUE DAS EMAS	21/09/2020 20:38	22/09/2020 23:44	21/09/2020 20:38	22/09/2020 23:44	27,10	7	189,67	CHI
20200959629	FORMOSA	10015532281	ITUIQUIRA	21/09/2020 20:40	22/09/2020 10:45	21/09/2020 20:40	22/09/2020 10:45	14,08	1	14,08	CHI
20200959655	JATAI	JT11274030	JATAI S2	21/09/2020 20:41	22/09/2020 01:30	21/09/2020 20:41	22/09/2020 01:30	4,81	104	500,12	CHI
20200959650	PORANGATU	840065942	PORANGATU	21/09/2020 20:46	22/09/2020 15:49	21/09/2020 20:46	22/09/2020 15:49	19,04	1	19,04	CHI
20200959691	MINEIROS	MY12149301RE	PARQUE DAS EMAS	21/09/2020 20:48	22/09/2020 09:11	21/09/2020 20:48	22/09/2020 09:11	12,37	17	210,29	CHI
20200959691	PEROLANDIA	MY12149301RE	PARQUE DAS EMAS	21/09/2020 20:48	22/09/2020 09:11	21/09/2020 20:48	22/09/2020 09:11	12,37	1	12,37	CHI
20200959663	ALEXANIA	AX21384861	ALEXANIA	21/09/2020 20:48	22/09/2020 10:41	21/09/2020 20:48	22/09/2020 10:41	13,87	1	13,87	CHI
20200961755	PEROLANDIA	JT12182223	JATAI S1	21/09/2020 20:49	22/09/2020 10:30	21/09/2020 20:49	22/09/2020 10:30	13,68	12	164,19	CHI
20200959676	PETROLINA DE GOIAS	320000450	PETROLINA	21/09/2020 20:50	21/09/2020 22:18	21/09/2020 20:50	21/09/2020 22:18	1,45	1	1,45	CHI
20200959677	ARAGUAPAZ	1780013532	MOZARLANDIA	21/09/2020 20:51	22/09/2020 00:03	21/09/2020 20:51	22/09/2020 00:03	3,21	1	3,21	CHI
20200959680	FORMOSA	610056610	ITUIQUIRA	21/09/2020 20:51	22/09/2020 16:47	21/09/2020 20:51	22/09/2020 16:47	19,93	1	19,93	CHI

INTERNAL

20200959684	ACREUNA	10016930132	ACREUNA	21/09/2020 20:51	21/09/2020 22:30	21/09/2020 20:51	21/09/2020 22:30	1,64	1	1,64	CHI
20200959701	JATAI	290037761	JATAI S2	21/09/2020 20:54	23/09/2020 07:35	21/09/2020 20:54	23/09/2020 07:35	34,67	1	34,67	CHI
20200959703	ANAPOLIS	21018704	ANAPOLIS UNIVERSITARIO S2	21/09/2020 20:55	21/09/2020 22:58	21/09/2020 20:55	21/09/2020 22:58	2,05	1	2,05	CHI
20200959716	CORUMBA DE GOIAS	CB12144031	CORUMBA	21/09/2020 20:56	22/09/2020 10:07	21/09/2020 20:56	22/09/2020 10:07	13,17	8	105,35	CHI
20200959717	FAINA	2580008245	GOIAS	21/09/2020 20:57	21/09/2020 22:18	21/09/2020 20:57	21/09/2020 22:18	1,35	1	1,35	CHI
20200961190	PORTELANDIA	PW12303420	PARQUE DAS EMAS	21/09/2020 20:57	22/09/2020 23:48	21/09/2020 20:57	22/09/2020 23:48	26,85	14	375,85	CHI
20200959727	CAMPOS VERDES	VD11029481	SANTA TEREZINHA	21/09/2020 20:58	23/09/2020 11:33	21/09/2020 20:58	23/09/2020 11:33	38,57	2	77,15	CHI
20200959732	CABECEIRAS	CW21157388	ITUIQUIRA	21/09/2020 20:59	22/09/2020 09:17	21/09/2020 20:59	22/09/2020 09:17	12,29	1	12,29	CHI
20200959738	ALVORADA DO NORTE	AQ12000012	IACIARA S2	21/09/2020 21:00	22/09/2020 00:55	21/09/2020 21:00	21/09/2020 21:55	0,91	84	76,72	CHI
20200959738	ALVORADA DO NORTE	AQ11180501	IACIARA S2	21/09/2020 21:00	22/09/2020 00:55	21/09/2020 21:00	22/09/2020 00:55	3,92	85	333,22	CHI
20200959743	VALPARAISO DE GOIAS	VA11372278	MARAJOARA	21/09/2020 21:01	22/09/2020 04:52	21/09/2020 21:01	22/09/2020 04:52	7,85	101	792,74	CHI
20200959745	ARAGUAPAZ	AZ11328973	MOZARLANDIA	21/09/2020 21:02	22/09/2020 01:10	21/09/2020 21:02	22/09/2020 01:10	4,13	1	4,13	CHI
20200960467	JATAI	JT11390598	JATAI S3	21/09/2020 21:02	22/09/2020 12:39	21/09/2020 21:02	22/09/2020 12:39	15,61	60	936,83	CHI
20200959750	LUZIANIA	LZ11000107	RIO VERMELHO	21/09/2020 21:02	22/09/2020 01:07	21/09/2020 21:02	22/09/2020 01:07	4,08	161	656,16	CHI
20200959762	POSSE	PS11071364	IACIARA S2	21/09/2020 21:02	21/09/2020 22:41	21/09/2020 21:02	21/09/2020 22:41	1,64	85	139,14	CHI
202009107058	MUTUNOPOLIS	MU21147221	MARA ROSA	21/09/2020 21:03	23/09/2020 14:27	21/09/2020 21:03	23/09/2020 14:27	41,40	1	41,40	CHI
202009107058	MUTUNOPOLIS	MU21127940	MARA ROSA	21/09/2020 21:03	23/09/2020 14:27	21/09/2020 21:33	23/09/2020 14:27	40,90	1	40,90	CHI
20200959764	CRISTALINA	LZ21041608	PAMPLONA	21/09/2020 21:04	21/09/2020 23:12	21/09/2020 21:04	21/09/2020 23:12	2,13	1	2,13	CHI
20200959765	JARAGUA	JA21000092	JARAGUA	21/09/2020 21:04	22/09/2020 15:25	21/09/2020 21:04	22/09/2020 15:25	18,34	1	18,34	CHI
20200959777	JARAGUA	JA10411463	JARAGUA	21/09/2020 21:04	23/09/2020 07:47	21/09/2020 21:04	21/09/2020 21:54	0,83	1232	1025,30	CHI
20200959777	JARAGUA	JA12374473LD	JARAGUA	21/09/2020 21:04	23/09/2020 07:47	21/09/2020 21:04	21/09/2020 23:29	2,42	76	183,94	CHI
20200959777	JARAGUA	JA10411463	JARAGUA	21/09/2020 21:04	23/09/2020 07:47	21/09/2020 21:04	22/09/2020 09:25	12,35	53	654,48	CHI
20200959777	JARAGUA	JA12374667LD	JARAGUA	21/09/2020 21:04	23/09/2020 07:47	21/09/2020 21:04	22/09/2020 12:46	15,70	25	392,40	CHI
20200959777	JARAGUA	JA10411463	JARAGUA	21/09/2020 21:04	23/09/2020 07:47	21/09/2020 21:04	22/09/2020 15:30	18,42	116	2137,27	CHI
20200959777	JARAGUA	JA12374667LD	JARAGUA	21/09/2020 21:04	23/09/2020 07:47	21/09/2020 21:04	23/09/2020 07:47	34,72	30	1041,67	CHI
20200959766	FORMOSO	FO21181075	MARA ROSA	21/09/2020 21:04	22/09/2020 19:36	21/09/2020 21:04	22/09/2020 19:36	22,52	2	45,05	CHI
20200959767	ALTO PARAISO DE GOIAS	BF12244573	SAO JOAO D ALIANCA	21/09/2020 21:04	22/09/2020 11:52	21/09/2020 21:04	22/09/2020 11:52	14,79	1	14,79	CHI
20200959777	JARAGUA	JA12374473LD	JARAGUA	21/09/2020 21:04	23/09/2020 07:47	21/09/2020 21:05	21/09/2020 23:29	2,41	1	2,41	CHI
20200959777	JARAGUA	JA10411463	JARAGUA	21/09/2020 21:04	23/09/2020 07:47	22/09/2020 11:12	22/09/2020 11:34	0,37	1361	497,90	CHI
20200959776	JATAI	290063383	JATAI S2	21/09/2020 21:06	22/09/2020 16:54	21/09/2020 21:06	22/09/2020 16:54	19,81	1	19,81	CHI
20200960238	CAMPOS VERDES	VD12055155	SANTA TEREZINHA	21/09/2020 21:07	22/09/2020 03:30	21/09/2020 21:07	22/09/2020 03:30	6,37	129	822,09	CHI
20200959828	HEITORAI	HE11243991	ITAPURANGA	21/09/2020 21:19	22/09/2020 16:53	21/09/2020 21:19	22/09/2020 16:53	19,56	1	19,56	CHI
20200959830	JATAI	290098294	JATAI S2	21/09/2020 21:19	22/09/2020 12:58	21/09/2020 21:19	22/09/2020 12:58	15,64	1	15,64	CHI

INTERNAL

20200962981	PLANALTINA	PI12100880	PLANALTINA	21/09/2020 21:20	22/09/2020 17:52	21/09/2020 21:20	22/09/2020 11:30	14,17	80	1133,80	CHI
20200962981	PLANALTINA	PI12100880	PLANALTINA	21/09/2020 21:20	22/09/2020 17:52	21/09/2020 21:20	22/09/2020 17:52	20,55	23	472,55	CHI
20200959837	PIRENOPOLIS	PV12382357	CORUMBA	21/09/2020 21:20	21/09/2020 23:28	21/09/2020 21:20	21/09/2020 23:28	2,12	3	6,35	CHI
20200962981	PLANALTINA	PI12100880	PLANALTINA	21/09/2020 21:20	22/09/2020 17:52	22/09/2020 15:19	22/09/2020 17:52	2,56	80	205,00	CHI
20200959850	FAZENDA NOVA	FN16410228	JUSSARA	21/09/2020 21:22	21/09/2020 22:37	21/09/2020 21:22	21/09/2020 22:01	0,66	356	234,07	CHI
20200959850	FAZENDA NOVA	FN16410228	JUSSARA	21/09/2020 21:22	21/09/2020 22:37	21/09/2020 21:22	21/09/2020 22:37	1,25	205	255,28	CHI
20200959845	GOIANESIA	10005546450	GOIANESIA S2	21/09/2020 21:23	22/09/2020 01:59	21/09/2020 21:23	22/09/2020 01:59	4,59	1	4,59	CHI
20200959854	JATAI	JT11194918	JATAI S3	21/09/2020 21:25	22/09/2020 11:01	21/09/2020 21:25	22/09/2020 11:01	13,60	105	1427,85	CHI
20200959855	ITABERAI	IB12108144	ITABERAI S2	21/09/2020 21:25	22/09/2020 08:54	21/09/2020 21:25	22/09/2020 08:54	11,48	20	229,63	CHI
20200959862	APORE	AE12216751	ITAJA S2	21/09/2020 21:26	22/09/2020 06:30	21/09/2020 21:26	22/09/2020 06:30	9,05	4	36,21	CHI
20200959867	VILA PROPICIO	NP11228733	GOIANESIA S1	21/09/2020 21:27	22/09/2020 08:36	21/09/2020 21:27	22/09/2020 08:36	11,14	1	11,14	CHI
20200959871	AMERICANO DO BRASIL	KB11377158	ANICUNS	21/09/2020 21:28	21/09/2020 23:34	21/09/2020 21:28	21/09/2020 23:34	2,09	5	10,46	CHI
20200959872	ACREUNA	EU21301165	ACREUNA	21/09/2020 21:28	21/09/2020 23:26	21/09/2020 21:28	21/09/2020 23:26	1,95	2	3,90	CHI
20200960035	DOVERLANDIA	DV12396128	CAIAPONIA	21/09/2020 21:31	22/09/2020 04:09	21/09/2020 21:31	22/09/2020 01:22	3,85	87	335,26	CHI
20200960035	DOVERLANDIA	DV11193281	CAIAPONIA	21/09/2020 21:31	22/09/2020 04:09	21/09/2020 21:31	22/09/2020 04:09	6,62	61	404,04	CHI
20200960456	MATRINCHA	GS12362364	MATRINCHA	21/09/2020 21:32	22/09/2020 13:39	21/09/2020 21:32	22/09/2020 13:39	16,11	1	16,11	CHI
20200960456	FAINA	GS12362364	MATRINCHA	21/09/2020 21:32	22/09/2020 13:39	21/09/2020 21:32	22/09/2020 13:39	16,11	11	177,19	CHI
20200960456	GOIAS	GS12362364	MATRINCHA	21/09/2020 21:32	22/09/2020 13:39	21/09/2020 21:32	22/09/2020 13:39	16,11	8	128,86	CHI
20200959888	PARAUNA	PU12205943	PARAUNA	21/09/2020 21:32	22/09/2020 15:19	21/09/2020 21:32	22/09/2020 15:19	17,78	22	391,20	CHI
20200959888	JANDAIA	PU12205943	PARAUNA	21/09/2020 21:32	22/09/2020 15:19	21/09/2020 21:32	22/09/2020 15:19	17,78	2	35,56	CHI
20200959893	ANAPOLIS	20888338	JUNDIAI S2	21/09/2020 21:33	21/09/2020 23:18	21/09/2020 21:33	21/09/2020 23:18	1,74	1	1,74	CHI
20200959902	URUACU	640007119	URUACU	21/09/2020 21:36	22/09/2020 09:44	21/09/2020 21:36	22/09/2020 09:44	12,12	1	12,12	CHI
20200959904	SANTA HELENA DE GOIAS	SH21350873	SANTA HELENA S1	21/09/2020 21:36	21/09/2020 23:09	21/09/2020 21:36	21/09/2020 23:09	1,53	1	1,53	CHI
20200959920	RIO VERDE	RV10212406	CABRIUVA S2	21/09/2020 21:37	22/09/2020 08:50	21/09/2020 21:37	22/09/2020 01:11	3,57	34	121,40	CHI
20200959920	RIO VERDE	RV12207053LD	CABRIUVA S2	21/09/2020 21:37	22/09/2020 08:50	21/09/2020 21:37	22/09/2020 05:13	7,61	26	197,76	CHI
20200959920	RIO VERDE	RV12349540LD	CABRIUVA S2	21/09/2020 21:37	22/09/2020 08:50	21/09/2020 21:37	22/09/2020 08:50	11,22	1	11,22	CHI
20200959912	ITAPURANGA	170088078	ITAPURANGA	21/09/2020 21:38	22/09/2020 22:10	21/09/2020 21:38	22/09/2020 22:10	24,53	1	24,53	CHI
20200961957	NIQUELANDIA	NQ12095753RE	NIQUELANDIA SUBTRANSMISSAO	21/09/2020 21:40	22/09/2020 08:09	21/09/2020 21:40	22/09/2020 08:09	10,47	203	2125,02	CHI
20200960029	TEREZOPOLIS DE GOIAS	TJ11078526	DAIA S2	21/09/2020 21:41	22/09/2020 00:50	21/09/2020 21:41	22/09/2020 00:50	3,14	60	188,12	CHI
20200959925	JESUPOLIS	SF21000117	SAO FRANCISCO DE GOIAS	21/09/2020 21:42	22/09/2020 00:24	21/09/2020 21:42	22/09/2020 00:24	2,70	1	2,70	CHI
20200960517	RIO VERDE	RV11136195	RIO VERDE S2	21/09/2020 21:43	22/09/2020 01:08	21/09/2020 21:43	22/09/2020 01:08	3,41	120	408,67	CHI
20200959954	JATAI	JT10394741	JATAI S1	21/09/2020 21:45	22/09/2020 06:09	21/09/2020 21:45	22/09/2020 00:03	2,30	25	57,50	CHI
20200959954	SERRANOPOLIS	JT10394741	JATAI S1	21/09/2020 21:45	22/09/2020 06:09	21/09/2020 21:45	22/09/2020 00:03	2,30	29	66,70	CHI

INTERNAL

20200959954	JATAI	JT13092336	JATAI S1	21/09/2020 21:45	22/09/2020 06:09	21/09/2020 21:45	22/09/2020 00:21	2,60	3	7,80	CHI
20200959954	SERRANOPOLIS	JT13092336	JATAI S1	21/09/2020 21:45	22/09/2020 06:09	21/09/2020 21:45	22/09/2020 00:21	2,60	62	161,22	CHI
20200959954	APORE	JT10394741	JATAI S1	21/09/2020 21:45	22/09/2020 06:09	21/09/2020 21:45	22/09/2020 06:09	8,40	7	58,78	CHI
20200959954	SERRANOPOLIS	JT10394741	JATAI S1	21/09/2020 21:45	22/09/2020 06:09	21/09/2020 21:45	22/09/2020 06:09	8,40	3272	27473,89	CHI
20200959954	JATAI	JT10394741	JATAI S1	21/09/2020 21:45	22/09/2020 06:09	21/09/2020 21:45	22/09/2020 06:09	8,40	13	109,16	CHI
20200959954	ITARUMA	JT10394741	JATAI S1	21/09/2020 21:45	22/09/2020 06:09	21/09/2020 21:45	22/09/2020 06:09	8,40	1	8,40	CHI
20200959954	SERRANOPOLIS	SX13394788	JATAI S1	21/09/2020 21:45	22/09/2020 06:09	21/09/2020 21:45	22/09/2020 06:09	8,40	19	159,54	CHI
20200959954	SERRANOPOLIS	JT10394741	JATAI S1	21/09/2020 21:45	22/09/2020 06:09	21/09/2020 21:45	22/09/2020 06:09	8,40	85	713,72	CHI
20200959954	JATAI	JT10394741	JATAI S1	21/09/2020 21:45	22/09/2020 06:09	22/09/2020 00:33	22/09/2020 01:01	0,47	28	13,07	CHI
20200959954	SERRANOPOLIS	JT10394741	JATAI S1	21/09/2020 21:45	22/09/2020 06:09	22/09/2020 00:33	22/09/2020 01:01	0,47	91	42,47	CHI
20200959944	ACREUNA	JD12323641RE	ACREUNA	21/09/2020 21:46	22/09/2020 14:56	21/09/2020 21:46	22/09/2020 11:15	13,48	7	94,33	CHI
20200959944	INDIARA	JD12323641RE	ACREUNA	21/09/2020 21:46	22/09/2020 14:56	21/09/2020 21:46	22/09/2020 11:15	13,48	21	283,00	CHI
20200959944	JANDAIA	00080424	ACREUNA	21/09/2020 21:46	22/09/2020 14:56	22/09/2020 08:23	22/09/2020 08:43	0,34	31	10,52	CHI
20200959944	INDIARA	00080424	ACREUNA	21/09/2020 21:46	22/09/2020 14:56	22/09/2020 08:23	22/09/2020 08:43	0,34	3	1,02	CHI
20200959944	PARAUNA	00080424	ACREUNA	21/09/2020 21:46	22/09/2020 14:56	22/09/2020 08:23	22/09/2020 08:43	0,34	1	0,34	CHI
20200959944	ACREUNA	00080424	ACREUNA	21/09/2020 21:46	22/09/2020 14:56	22/09/2020 08:23	22/09/2020 08:43	0,34	29	9,84	CHI
20200959944	JANDAIA	00080424	ACREUNA	21/09/2020 21:46	22/09/2020 14:56	22/09/2020 08:23	22/09/2020 08:43	0,33	2	0,65	CHI
20200959944	JANDAIA	00080424	ACREUNA	21/09/2020 21:46	22/09/2020 14:56	22/09/2020 10:35	22/09/2020 11:15	0,67	33	22,06	CHI
20200959944	PARAUNA	00080424	ACREUNA	21/09/2020 21:46	22/09/2020 14:56	22/09/2020 10:35	22/09/2020 11:15	0,67	1	0,67	CHI
20200959944	INDIARA	00080424	ACREUNA	21/09/2020 21:46	22/09/2020 14:56	22/09/2020 10:35	22/09/2020 11:15	0,67	3	2,01	CHI
20200959944	ACREUNA	00080424	ACREUNA	21/09/2020 21:46	22/09/2020 14:56	22/09/2020 10:35	22/09/2020 11:15	0,67	29	19,38	CHI
20200959944	INDIARA	JD12323641RE	ACREUNA	21/09/2020 21:46	22/09/2020 14:56	22/09/2020 11:16	22/09/2020 11:42	0,43	6	2,60	CHI
20200959944	ACREUNA	IY13207111	ACREUNA	21/09/2020 21:46	22/09/2020 14:56	22/09/2020 11:16	22/09/2020 14:25	3,14	7	22,01	CHI
20200959944	INDIARA	IY13207111	ACREUNA	21/09/2020 21:46	22/09/2020 14:56	22/09/2020 11:16	22/09/2020 14:25	3,14	13	40,88	CHI
20200959944	INDIARA	IY12385120	ACREUNA	21/09/2020 21:46	22/09/2020 14:56	22/09/2020 11:16	22/09/2020 14:56	3,67	3	11,01	CHI
20200959962	SAO DOMINGOS	SD10408312	SAO DOMINGOS	21/09/2020 21:47	22/09/2020 21:28	21/09/2020 21:47	22/09/2020 01:26	3,65	109	397,46	CHI
20200959962	SAO DOMINGOS	SD12144375LD	SAO DOMINGOS	21/09/2020 21:47	22/09/2020 21:28	21/09/2020 21:47	22/09/2020 15:03	17,26	4	69,02	CHI
20200959962	MONTE ALEGRE DE GOIAS	SD12218815LD	SAO DOMINGOS	21/09/2020 21:47	22/09/2020 21:28	21/09/2020 21:47	22/09/2020 20:51	23,06	1	23,06	CHI
20200959962	SAO DOMINGOS	SD12218815LD	SAO DOMINGOS	21/09/2020 21:47	22/09/2020 21:28	21/09/2020 21:47	22/09/2020 20:51	23,06	40	922,40	CHI
20200959962	NOVA ROMA	SD12218815LD	SAO DOMINGOS	21/09/2020 21:47	22/09/2020 21:28	21/09/2020 21:47	22/09/2020 20:51	23,06	3	69,18	CHI
20200959962	SAO DOMINGOS	SD12144375LD	SAO DOMINGOS	21/09/2020 21:47	22/09/2020 21:28	21/09/2020 21:47	22/09/2020 21:08	23,35	7	163,42	CHI
20200959962	SAO DOMINGOS	SD12144375LD	SAO DOMINGOS	21/09/2020 21:47	22/09/2020 21:28	21/09/2020 21:47	22/09/2020 21:28	23,68	20	473,64	CHI
20200959962	SAO DOMINGOS	SD10408312	SAO DOMINGOS	21/09/2020 21:47	22/09/2020 21:28	22/09/2020 11:02	22/09/2020 11:17	0,25	109	26,74	CHI

INTERNAL

20200959962	SAO DOMINGOS	SD10408312	SAO DOMINGOS	21/09/2020 21:47	22/09/2020 21:28	22/09/2020 13:09	22/09/2020 13:15	0,09	109	9,84	CHI
20200959962	SAO DOMINGOS	SD12144375LD	SAO DOMINGOS	21/09/2020 21:47	22/09/2020 21:28	22/09/2020 15:06	22/09/2020 20:20	5,24	4	20,96	CHI
20200959959	APORE	AE12205140	ITAJA S2	21/09/2020 21:48	22/09/2020 07:00	21/09/2020 21:48	22/09/2020 07:00	9,18	18	165,33	CHI
202009107030	ESTRELA DO NORTE	2420010092	MARA ROSA	21/09/2020 21:48	22/09/2020 06:46	21/09/2020 21:48	22/09/2020 06:46	8,96	1	8,96	CHI
20200960504	RIO VERDE	RV12384641	RIO VERDE S2	21/09/2020 21:50	22/09/2020 07:47	21/09/2020 21:50	22/09/2020 07:47	9,94	548	5445,75	CHI
20200959969	MATRINCHA	4380007055	MATRINCHA	21/09/2020 21:51	22/09/2020 06:50	21/09/2020 21:51	22/09/2020 06:50	8,98	1	8,98	CHI
20200960242	AGUA FRIA DE GOIAS	TL12264732	SAO JOAO D ALIANCA	21/09/2020 21:52	23/09/2020 01:04	21/09/2020 21:52	23/09/2020 01:04	27,20	7	190,40	CHI
20200961626	ITAPURANGA	FC12160891	GOIAS	21/09/2020 21:52	22/09/2020 09:20	21/09/2020 21:52	22/09/2020 09:20	11,45	2	22,91	CHI
20200961626	FAINA	FC12160891	GOIAS	21/09/2020 21:52	22/09/2020 09:20	21/09/2020 21:52	22/09/2020 09:20	11,45	15	171,81	CHI
20200961626	MORRO AGUDO DE GOIAS	FC12160891	GOIAS	21/09/2020 21:52	22/09/2020 09:20	21/09/2020 21:52	22/09/2020 09:20	11,45	2	22,91	CHI
20200959978	FIRMINOPOLIS	FR12096845	FIRMINOPOLIS S1	21/09/2020 21:52	22/09/2020 00:41	21/09/2020 21:52	22/09/2020 00:41	2,80	17	47,64	CHI
20200959995	ANAPOLIS	20587776	JUNDIAI S1	21/09/2020 21:56	22/09/2020 12:04	21/09/2020 21:56	22/09/2020 12:04	14,12	1	14,12	CHI
20200960013	HIDROLINA	HL12003223RE	SANTA TEREZINHA	21/09/2020 21:59	22/09/2020 15:26	21/09/2020 21:59	22/09/2020 15:26	17,44	1	17,44	CHI
20200960013	PILAR DE GOIAS	HL12003223RE	SANTA TEREZINHA	21/09/2020 21:59	22/09/2020 15:26	21/09/2020 21:59	22/09/2020 15:26	17,44	49	854,42	CHI
20200960013	URUACU	HL12003223RE	SANTA TEREZINHA	21/09/2020 21:59	22/09/2020 15:26	21/09/2020 21:59	22/09/2020 15:26	17,44	4	69,75	CHI
20200960016	PALMEIRAS DE GOIAS	PL21000100	PALMEIRAS	21/09/2020 22:00	22/09/2020 07:04	21/09/2020 22:00	22/09/2020 07:04	9,06	1	9,06	CHI
20200962718	SAO JOAO D ALIANCA	JL12383338	SAO JOAO D ALIANCA	21/09/2020 22:01	22/09/2020 10:35	21/09/2020 22:01	22/09/2020 10:35	12,56	39	490,01	CHI
20200960025	RIO VERDE	630273960	RIO VERDE S1	21/09/2020 22:01	22/09/2020 07:56	21/09/2020 22:01	22/09/2020 07:56	9,91	1	9,91	CHI
20200960041	JUSSARA	JR10395391	BRITANIA	21/09/2020 22:02	22/09/2020 06:02	21/09/2020 22:02	22/09/2020 05:45	7,71	2	15,42	CHI
20200960041	JUSSARA	JR10395391	BRITANIA	21/09/2020 22:02	22/09/2020 06:02	21/09/2020 22:02	22/09/2020 06:02	8,01	1	8,01	CHI
20200960394	FAINA	FC12250737	GOIAS	21/09/2020 22:03	22/09/2020 07:27	21/09/2020 22:03	22/09/2020 07:27	9,40	3	28,20	CHI
20200960037	RIO VERDE	RV21123232	CABRIUVA S2	21/09/2020 22:03	22/09/2020 11:50	21/09/2020 22:03	22/09/2020 11:50	13,78	1	13,78	CHI
20200960044	COCALZINHO DE GOIAS	CB12043123	COCALZINHO	21/09/2020 22:05	22/09/2020 13:16	21/09/2020 22:05	22/09/2020 13:15	15,16	2	30,32	CHI
20200960044	COCALZINHO DE GOIAS	ZN21321419	COCALZINHO	21/09/2020 22:05	22/09/2020 13:16	21/09/2020 22:05	22/09/2020 13:16	15,18	1	15,18	CHI
20200960063	JUSSARA	JR12022269RE	BRITANIA	21/09/2020 22:06	22/09/2020 13:27	21/09/2020 22:06	22/09/2020 13:27	15,34	30	460,27	CHI
20200960063	MONTES CLAROS DE GOIAS	JR12022269RE	BRITANIA	21/09/2020 22:06	22/09/2020 13:27	21/09/2020 22:06	22/09/2020 13:27	15,34	264	4050,35	CHI
20200960051	ITAJA	IJ10352433	ITAJA S2	21/09/2020 22:06	22/09/2020 09:44	21/09/2020 22:06	22/09/2020 02:06	3,99	5	19,95	CHI
20200960051	ITAJA	IJ10352433	ITAJA S2	21/09/2020 22:06	22/09/2020 09:44	21/09/2020 22:06	22/09/2020 06:33	8,44	10	84,36	CHI
20200960051	ITAJA	IJ12214312	ITAJA S2	21/09/2020 22:06	22/09/2020 09:44	22/09/2020 03:00	22/09/2020 09:44	6,75	5	33,74	CHI
20200960060	SAO LUIS DE MONTES BELOS	500018261	SAO LUIZ DOS MONTES BELOS	21/09/2020 22:08	22/09/2020 00:19	21/09/2020 22:08	22/09/2020 00:19	2,18	1	2,18	CHI
20200960074	PIRANHAS	PH12380983	PIRANHAS	21/09/2020 22:08	22/09/2020 00:02	21/09/2020 22:08	22/09/2020 00:02	1,89	6	11,34	CHI
20200960065	RIO VERDE	630266300	RIO VERDE S1	21/09/2020 22:09	22/09/2020 08:57	21/09/2020 22:09	22/09/2020 08:57	10,79	1	10,79	CHI
20200960112	SANTA HELENA DE GOIAS	RV10371479	RIO VERDE S1	21/09/2020 22:09	23/09/2020 12:52	21/09/2020 22:09	21/09/2020 22:16	0,11	58	6,15	CHI

INTERNAL

20200960112	RIO VERDE	RV10371479	RIO VERDE S1	21/09/2020 22:09	23/09/2020 12:52	21/09/2020 22:09	21/09/2020 22:16	0,11	283	30,03	CHI
20200960112	RIO VERDE	RV10400679	RIO VERDE S1	21/09/2020 22:09	23/09/2020 12:52	21/09/2020 22:09	22/09/2020 19:47	21,63	93	2011,20	CHI
20200960112	RIO VERDE	RV10400679	RIO VERDE S1	21/09/2020 22:09	23/09/2020 12:52	21/09/2020 22:09	23/09/2020 02:12	28,04	4	112,17	CHI
20200960112	RIO VERDE	RV10400679	RIO VERDE S1	21/09/2020 22:09	23/09/2020 12:52	21/09/2020 22:09	23/09/2020 10:32	36,37	1	36,37	CHI
20200960112	SANTA HELENA DE GOIAS	RV12000203LD	RIO VERDE S1	21/09/2020 22:09	23/09/2020 12:52	22/09/2020 00:37	23/09/2020 02:07	25,51	47	1198,97	CHI
20200960112	RIO VERDE	RV12000203LD	RIO VERDE S1	21/09/2020 22:09	23/09/2020 12:52	22/09/2020 00:37	23/09/2020 02:07	25,51	161	4107,11	CHI
20200960112	RIO VERDE	RV10371479	RIO VERDE S1	21/09/2020 22:09	23/09/2020 12:52	22/09/2020 01:11	22/09/2020 05:37	4,44	51	226,68	CHI
20200960112	RIO VERDE	RV13305835	RIO VERDE S1	21/09/2020 22:09	23/09/2020 12:52	22/09/2020 01:11	22/09/2020 14:38	13,45	28	376,59	CHI
20200960112	SANTA HELENA DE GOIAS	RV12000199	RIO VERDE S1	21/09/2020 22:09	23/09/2020 12:52	22/09/2020 01:11	22/09/2020 14:49	13,65	11	150,13	CHI
20200960112	RIO VERDE	RV12000199	RIO VERDE S1	21/09/2020 22:09	23/09/2020 12:52	22/09/2020 01:11	22/09/2020 14:49	13,65	31	423,11	CHI
20200960112	RIO VERDE	RV12338598	RIO VERDE S1	21/09/2020 22:09	23/09/2020 12:52	22/09/2020 01:11	22/09/2020 15:21	14,17	7	99,22	CHI
20200960112	RIO VERDE	RV13305835	RIO VERDE S1	21/09/2020 22:09	23/09/2020 12:52	22/09/2020 01:11	22/09/2020 19:38	18,45	6	110,72	CHI
20200960112	RIO VERDE	RV10371479	RIO VERDE S1	21/09/2020 22:09	23/09/2020 12:52	22/09/2020 08:05	22/09/2020 08:12	0,12	51	6,08	CHI
20200960112	RIO VERDE	RV10371479	RIO VERDE S1	21/09/2020 22:09	23/09/2020 12:52	22/09/2020 09:50	22/09/2020 09:59	0,15	51	7,61	CHI
20200960112	RIO VERDE	RV10371479	RIO VERDE S1	21/09/2020 22:09	23/09/2020 12:52	22/09/2020 10:50	22/09/2020 10:55	0,09	51	4,70	CHI
20200960112	RIO VERDE	RV10371479	RIO VERDE S1	21/09/2020 22:09	23/09/2020 12:52	22/09/2020 20:54	22/09/2020 21:06	0,21	123	25,97	CHI
20200960112	SANTA HELENA DE GOIAS	RV10371479	RIO VERDE S1	21/09/2020 22:09	23/09/2020 12:52	22/09/2020 20:54	22/09/2020 21:06	0,21	11	2,32	CHI
20200960112	RIO VERDE	RV10400679	RIO VERDE S1	21/09/2020 22:09	23/09/2020 12:52	22/09/2020 20:54	23/09/2020 02:12	5,31	42	222,84	CHI
20200960112	RIO VERDE	RV10400679	RIO VERDE S1	21/09/2020 22:09	23/09/2020 12:52	22/09/2020 20:54	23/09/2020 09:10	12,28	47	577,13	CHI
20200960112	RIO VERDE	RV12214125	RIO VERDE S1	21/09/2020 22:09	23/09/2020 12:52	22/09/2020 20:54	23/09/2020 10:08	13,23	3	39,70	CHI
20200960112	RIO VERDE	RV12136248	RIO VERDE S1	21/09/2020 22:09	23/09/2020 12:52	22/09/2020 20:54	23/09/2020 12:52	15,97	1	15,97	CHI
20200960112	RIO VERDE	RV10400679	RIO VERDE S1	21/09/2020 22:09	23/09/2020 12:52	23/09/2020 07:27	23/09/2020 09:10	1,73	24	41,52	CHI
20200960112	RIO VERDE	RV12136248	RIO VERDE S1	21/09/2020 22:09	23/09/2020 12:52	23/09/2020 07:27	23/09/2020 12:52	5,42	8	43,33	CHI
20200960072	ANAPOLIS	20637378	JUNDIAI S2	21/09/2020 22:10	22/09/2020 15:07	21/09/2020 22:10	22/09/2020 15:07	16,94	1	16,94	CHI
20200960076	LUZIANIA	LZ11405491	RIO VERMELHO	21/09/2020 22:11	22/09/2020 00:53	21/09/2020 22:11	22/09/2020 00:53	2,70	3	8,09	CHI
20200960078	ANAPOLIS	20444795	JUNDIAI S2	21/09/2020 22:11	22/09/2020 11:33	21/09/2020 22:11	22/09/2020 11:33	13,36	1	13,36	CHI
20200960187	ABADIANIA	AN10415886	ANAPOLIS UNIVERSITARIO S1	21/09/2020 22:12	22/09/2020 11:32	21/09/2020 22:12	21/09/2020 22:23	0,18	1	0,18	CHI
20200960187	CORUMBA DE GOIAS	AN10415886	ANAPOLIS UNIVERSITARIO S1	21/09/2020 22:12	22/09/2020 11:32	21/09/2020 22:12	21/09/2020 22:33	0,36	4	1,44	CHI
20200960187	ABADIANIA	AN10415886	ANAPOLIS UNIVERSITARIO S1	21/09/2020 22:12	22/09/2020 11:32	21/09/2020 22:12	21/09/2020 22:33	0,36	3550	1278,00	CHI
20200960187	GAMELEIRA DE GOIAS	AN10415886	ANAPOLIS UNIVERSITARIO S1	21/09/2020 22:12	22/09/2020 11:32	21/09/2020 22:12	21/09/2020 22:33	0,36	11	3,96	CHI
20200960187	CORUMBA DE GOIAS	AN10415886	ANAPOLIS UNIVERSITARIO S1	21/09/2020 22:12	22/09/2020 11:32	21/09/2020 22:12	21/09/2020 22:33	0,36	62	22,32	CHI
20200960187	ABADIANIA	AN10415886	ANAPOLIS UNIVERSITARIO S1	21/09/2020 22:12	22/09/2020 11:32	21/09/2020 22:12	21/09/2020 22:33	0,36	1504	541,44	CHI
20200960187	ABADIA DE GOIAS	AN10415886	ANAPOLIS UNIVERSITARIO S1	21/09/2020 22:12	22/09/2020 11:32	21/09/2020 22:12	21/09/2020 22:33	0,36	1	0,36	CHI

INTERNAL

20200960187	ANAPOLIS	AN10415886	ANAPOLIS UNIVERSITARIO S1	21/09/2020 22:12	22/09/2020 11:32	21/09/2020 22:12	22/09/2020 09:00	10,80	101	1090,94	CHI
20200960187	ANAPOLIS	AN10415886	ANAPOLIS UNIVERSITARIO S1	21/09/2020 22:12	22/09/2020 11:32	21/09/2020 22:12	22/09/2020 10:40	12,47	11	137,16	CHI
20200960187	ABADIANIA	AN10415886	ANAPOLIS UNIVERSITARIO S1	21/09/2020 22:12	22/09/2020 11:32	21/09/2020 22:12	22/09/2020 10:40	12,47	6	74,82	CHI
20200960187	ABADIANIA	AN10415886	ANAPOLIS UNIVERSITARIO S1	21/09/2020 22:12	22/09/2020 11:32	21/09/2020 22:12	22/09/2020 11:32	13,34	10	133,36	CHI
2020092100056	ABADIANIA	02002	ANAPOLIS UNIVERSITARIO S1	21/09/2020 22:12	21/09/2020 22:18	21/09/2020 22:12	21/09/2020 22:18	0,10	63	6,30	CHI
2020092100056	ABADIANIA	02001	ANAPOLIS UNIVERSITARIO S1	21/09/2020 22:12	21/09/2020 22:18	21/09/2020 22:12	21/09/2020 22:18	0,10	1	0,10	CHI
20200960081	NOVA CRIXAS	NA11323846	NOVA CRIXAS	21/09/2020 22:12	22/09/2020 00:06	21/09/2020 22:12	22/09/2020 00:06	1,89	74	139,92	CHI
20200960187	ABADIANIA	AN10415886	ANAPOLIS UNIVERSITARIO S1	21/09/2020 22:12	22/09/2020 11:32	21/09/2020 22:18	21/09/2020 22:33	0,26	1	0,26	CHI
20200960187	ANAPOLIS	AN10415886	ANAPOLIS UNIVERSITARIO S1	21/09/2020 22:12	22/09/2020 11:32	22/09/2020 10:26	22/09/2020 10:40	0,23	101	22,92	CHI
20200960187	ABADIANIA	00050424	ANAPOLIS UNIVERSITARIO S1	21/09/2020 22:12	22/09/2020 11:32	22/09/2020 11:10	22/09/2020 11:32	0,37	6	2,21	CHI
20200960187	ANAPOLIS	00050424	ANAPOLIS UNIVERSITARIO S1	21/09/2020 22:12	22/09/2020 11:32	22/09/2020 11:10	22/09/2020 11:32	0,37	112	41,35	CHI
20200960093	ANAPOLIS	AN11107997	ANAPOLIS UNIVERSITARIO S2	21/09/2020 22:14	22/09/2020 07:49	21/09/2020 22:14	22/09/2020 07:49	9,57	113	1081,97	CHI
20200960098	ANAPOLIS	AN21096787	JUNDIAI S1	21/09/2020 22:15	22/09/2020 01:12	21/09/2020 22:15	22/09/2020 01:12	2,94	1	2,94	CHI
20200960104	ANAPOLIS	20795154	ANAPOLIS UNIVERSITARIO S2	21/09/2020 22:16	22/09/2020 09:44	21/09/2020 22:16	22/09/2020 09:44	11,46	1	11,46	CHI
20200960111	ITABERAI	IB12307280	ITABERAI S2	21/09/2020 22:17	22/09/2020 02:17	21/09/2020 22:17	22/09/2020 02:17	3,99	129	514,78	CHI
20200960113	MUNDO NOVO DE GOIAS	MH11037811	NOVA CRIXAS	21/09/2020 22:18	22/09/2020 16:59	22/09/2020 14:00	22/09/2020 16:59	2,98	78	232,72	CHI
20200960287	ANAPOLIS	AN11135787	ANAPOLIS UNIVERSITARIO S2	21/09/2020 22:19	22/09/2020 01:55	21/09/2020 22:19	22/09/2020 01:55	3,59	95	340,94	CHI
20200960136	SAO MIGUEL DO ARAGUAIA	SM12059999	SAO MIGUEL DO ARAGUAIA	21/09/2020 22:21	22/09/2020 10:31	21/09/2020 22:21	22/09/2020 10:31	12,16	10	121,65	CHI
20200960147	GOIANESIA	GE11221386	GOIANESIA S2	21/09/2020 22:22	21/09/2020 23:15	21/09/2020 22:22	21/09/2020 23:15	0,88	54	47,70	CHI
20200961623	ANAPOLIS	AN12096740	JUNDIAI S2	21/09/2020 22:22	22/09/2020 08:39	21/09/2020 22:22	22/09/2020 08:39	10,28	21	215,94	CHI
20200960165	IVOLANDIA	IV10404257	IPORA	21/09/2020 22:23	22/09/2020 21:00	21/09/2020 22:23	22/09/2020 21:00	22,61	134	3029,93	CHI
20200960165	MOIPORA	IV10404257	IPORA	21/09/2020 22:23	22/09/2020 21:00	21/09/2020 22:23	22/09/2020 21:00	22,61	21	474,84	CHI
20200960165	ISRAELANDIA	IV10404257	IPORA	21/09/2020 22:23	22/09/2020 21:00	21/09/2020 22:23	22/09/2020 21:00	22,61	4	90,45	CHI
20200960212	ANAPOLIS	AN12003540	JUNDIAI S1	21/09/2020 22:26	22/09/2020 01:20	21/09/2020 22:26	22/09/2020 01:20	2,89	354	1024,04	CHI
20200960175	MATRINCHA	4380000164	MATRINCHA	21/09/2020 22:27	22/09/2020 08:09	21/09/2020 22:27	22/09/2020 08:09	9,70	1	9,70	CHI
20200960182	GOIAS	90075602	GOIAS	21/09/2020 22:29	22/09/2020 10:06	21/09/2020 22:29	22/09/2020 10:06	11,61	1	11,61	CHI
20200960616	ITABERAI	IB13144320	ITABERAI S1	21/09/2020 22:29	22/09/2020 11:11	21/09/2020 22:29	22/09/2020 11:08	12,65	146	1846,78	CHI
20200960616	ITABERAI	IB13144319	ITABERAI S1	21/09/2020 22:29	22/09/2020 11:11	21/09/2020 22:29	22/09/2020 11:09	12,66	73	924,46	CHI
20200960616	GOIAS	IB13144319	ITABERAI S1	21/09/2020 22:29	22/09/2020 11:11	21/09/2020 22:29	22/09/2020 11:09	12,66	39	493,89	CHI
20200960616	HEITORAI	IB13144319	ITABERAI S1	21/09/2020 22:29	22/09/2020 11:11	21/09/2020 22:29	22/09/2020 11:09	12,66	23	291,27	CHI
20200960616	HEITORAI	IB13250651	ITABERAI S1	21/09/2020 22:29	22/09/2020 11:11	21/09/2020 22:29	22/09/2020 11:11	12,70	2	25,40	CHI
20200960616	ITABERAI	IB13250651	ITABERAI S1	21/09/2020 22:29	22/09/2020 11:11	21/09/2020 22:29	22/09/2020 11:11	12,70	5	63,50	CHI
20200960204	ANAPOLIS	20259402	ANAPOLIS UNIVERSITARIO S2	21/09/2020 22:34	22/09/2020 06:33	21/09/2020 22:34	22/09/2020 06:33	7,98	1	7,98	CHI

INTERNAL

20200960205	BRITANIA	2110011756	BRITANIA	21/09/2020 22:34	21/09/2020 23:44	21/09/2020 22:34	21/09/2020 23:44	1,16	1	1,16	CHI
20200960211	ANAPOLIS	AN11043575	ANAPOLIS UNIVERSITARIO S2	21/09/2020 22:35	22/09/2020 09:06	21/09/2020 22:35	22/09/2020 09:06	10,51	131	1376,81	CHI
20200960220	ANAPOLIS	20584970	ANAPOLIS UNIVERSITARIO S2	21/09/2020 22:36	22/09/2020 13:26	21/09/2020 22:36	22/09/2020 13:26	14,82	1	14,82	CHI
20200960223	RIO VERDE	630282134	RIO VERDE S2	21/09/2020 22:37	22/09/2020 12:31	21/09/2020 22:37	22/09/2020 12:31	13,90	1	13,90	CHI
20200961914	RIO VERDE	RV12245473	CABRIUVA S2	21/09/2020 22:38	22/09/2020 08:32	21/09/2020 22:38	22/09/2020 08:32	9,89	6	59,36	CHI
20200960381	NIQUELANDIA	NQ13407763	NIQUELANDIA SUBTRANSMISSAO	21/09/2020 22:40	22/09/2020 02:53	21/09/2020 22:40	22/09/2020 02:15	3,60	2463	8855,17	CHI
20200960381	NIQUELANDIA	NQ13407763	NIQUELANDIA SUBTRANSMISSAO	21/09/2020 22:40	22/09/2020 02:53	21/09/2020 22:40	22/09/2020 02:15	3,60	421	1513,61	CHI
20200960246	ACREUNA	2440016920	ACREUNA	21/09/2020 22:40	21/09/2020 23:48	21/09/2020 22:40	21/09/2020 23:48	1,13	1	1,13	CHI
20200960381	NIQUELANDIA	NQ16405221	NIQUELANDIA SUBTRANSMISSAO	21/09/2020 22:40	22/09/2020 02:53	22/09/2020 01:02	22/09/2020 02:15	1,22	125	151,88	CHI
20200960381	NIQUELANDIA	NQ12058944	NIQUELANDIA SUBTRANSMISSAO	21/09/2020 22:40	22/09/2020 02:53	22/09/2020 01:02	22/09/2020 02:53	1,84	1	1,84	CHI
20200960255	ITAPURANGA	IK11272637	ITAPURANGA	21/09/2020 22:41	22/09/2020 04:35	21/09/2020 22:41	22/09/2020 04:35	5,89	89	524,63	CHI
20200960256	BURITI DE GOIAS	BS21126054	FIRMINOPOLIS S2	21/09/2020 22:41	22/09/2020 01:26	21/09/2020 22:41	22/09/2020 01:26	2,74	1	2,74	CHI
20200960257	RIO VERDE	630127359	RIO VERDE S2	21/09/2020 22:42	22/09/2020 15:54	21/09/2020 22:42	22/09/2020 15:54	17,21	1	17,21	CHI
20200960327	FORMOSA	FA10396080	ITIQUEIRA	21/09/2020 22:42	22/09/2020 23:19	21/09/2020 22:42	21/09/2020 22:49	0,11	1	0,11	CHI
20200960327	CABECEIRAS	FA10396080	ITIQUEIRA	21/09/2020 22:42	22/09/2020 23:19	21/09/2020 22:42	22/09/2020 04:05	5,37	40	214,89	CHI
20200960327	FORMOSA	FA10396080	ITIQUEIRA	21/09/2020 22:42	22/09/2020 23:19	21/09/2020 22:42	22/09/2020 04:05	5,37	133	714,51	CHI
20200960327	FORMOSA	FA10396080	ITIQUEIRA	21/09/2020 22:42	22/09/2020 23:19	21/09/2020 22:42	22/09/2020 16:33	17,84	24	428,26	CHI
20200960327	FORMOSA	FA10396080	ITIQUEIRA	21/09/2020 22:42	22/09/2020 23:19	21/09/2020 22:42	22/09/2020 19:26	20,73	1	20,73	CHI
20200960327	FORMOSA	FA10396080	ITIQUEIRA	21/09/2020 22:42	22/09/2020 23:19	21/09/2020 22:42	22/09/2020 21:25	22,70	27	612,97	CHI
20200960327	DISTRITO FEDERAL	FA10396080	ITIQUEIRA	21/09/2020 22:42	22/09/2020 23:19	21/09/2020 22:42	22/09/2020 21:25	22,70	1	22,70	CHI
20200960327	FORMOSA	FA12262114LD	ITIQUEIRA	21/09/2020 22:42	22/09/2020 23:19	21/09/2020 22:42	22/09/2020 22:25	23,72	5	118,58	CHI
20200960327	FORMOSA	FA12361293	ITIQUEIRA	21/09/2020 22:42	22/09/2020 23:19	21/09/2020 22:42	22/09/2020 23:08	24,42	1	24,42	CHI
20200960327	FORMOSA	FA12206255	ITIQUEIRA	21/09/2020 22:42	22/09/2020 23:19	22/09/2020 22:47	22/09/2020 23:19	0,53	2	1,06	CHI
20200960278	LEOPOLDO DE BULHOES	LB12241053	DAIA S2	21/09/2020 22:44	22/09/2020 00:31	21/09/2020 22:44	22/09/2020 00:31	1,77	21	37,23	CHI
20200960278	SILVANIA	LB12241053	DAIA S2	21/09/2020 22:44	22/09/2020 00:31	21/09/2020 22:44	22/09/2020 00:31	1,77	65	115,23	CHI
20200960285	RIO VERDE	RV12237206	CABRIUVA S2	21/09/2020 22:45	22/09/2020 14:45	21/09/2020 22:45	22/09/2020 09:27	10,71	5	53,53	CHI
20200960285	RIO VERDE	RV12237206	CABRIUVA S2	21/09/2020 22:45	22/09/2020 14:45	21/09/2020 22:45	22/09/2020 13:53	15,13	1	15,13	CHI
20200960285	RIO VERDE	RV12237206	CABRIUVA S2	21/09/2020 22:45	22/09/2020 14:45	22/09/2020 11:48	22/09/2020 14:45	2,94	5	14,72	CHI
20200960290	BOM JARDIM DE GOIAS	BM12374961	BOM JARDIM	21/09/2020 22:47	22/09/2020 20:16	21/09/2020 22:47	22/09/2020 20:16	21,48	6	128,88	CHI
20200960293	NOVA CRIXAS	8570017007	NOVA CRIXAS	21/09/2020 22:48	22/09/2020 03:21	21/09/2020 22:48	22/09/2020 03:21	4,55	1	4,55	CHI
20200960425	ANAPOLIS	AN11000452	ANAPOLIS UNIVERSITARIO S2	21/09/2020 22:48	22/09/2020 01:16	21/09/2020 22:48	22/09/2020 01:16	2,45	99	242,80	CHI
20200960310	ANAPOLIS	20283659	JUNDIAI S2	21/09/2020 22:50	22/09/2020 10:00	21/09/2020 22:50	22/09/2020 10:00	11,16	1	11,16	CHI
20200960314	ANAPOLIS	20930471	ANAPOLIS UNIVERSITARIO S2	21/09/2020 22:51	22/09/2020 13:31	21/09/2020 22:51	22/09/2020 13:31	14,66	1	14,66	CHI

INTERNAL

20200960352	ANAPOLIS	AN12100278	JUNDIAI S1	21/09/2020 22:51	22/09/2020 00:17	21/09/2020 22:51	22/09/2020 00:17	1,43	565	806,85	CHI
20200960325	MOIPIORA	MO11015704	IPORA	21/09/2020 22:52	22/09/2020 14:00	21/09/2020 22:52	22/09/2020 14:00	15,14	95	1438,27	CHI
20200960416	PALMEIRAS DE GOIAS	PL12233352	PALMEIRAS	21/09/2020 22:53	22/09/2020 02:15	21/09/2020 22:53	22/09/2020 02:15	3,36	248	832,25	CHI
20200960333	RIO VERDE	630529991	CABRIUVA S1	21/09/2020 22:53	22/09/2020 12:52	21/09/2020 22:53	22/09/2020 12:52	13,97	1	13,97	CHI
202009106944	ANAPOLIS	AN12000105	ANAPOLIS UNIVERSITARIO S2	21/09/2020 22:53	22/09/2020 03:08	21/09/2020 22:53	22/09/2020 03:08	4,23	51	215,94	CHI
20200960349	IACIARA	1550017680	IACIARA S1	21/09/2020 22:57	22/09/2020 08:58	21/09/2020 22:57	22/09/2020 08:58	10,01	1	10,01	CHI
20200960364	ITARUMA	IM10394710	CACHOEIRA ALTA	21/09/2020 22:57	22/09/2020 15:15	21/09/2020 22:57	22/09/2020 02:21	3,41	93	316,77	CHI
20200960364	ITAJA	IM10394710	CACHOEIRA ALTA	21/09/2020 22:57	22/09/2020 15:15	21/09/2020 22:57	22/09/2020 02:21	3,41	1	3,41	CHI
20200960364	JATAI	IM10394710	CACHOEIRA ALTA	21/09/2020 22:57	22/09/2020 15:15	21/09/2020 22:57	22/09/2020 02:21	3,41	12	40,87	CHI
20200960364	SERRANOPOLIS	IM10394710	CACHOEIRA ALTA	21/09/2020 22:57	22/09/2020 15:15	21/09/2020 22:57	22/09/2020 15:06	16,15	41	662,02	CHI
20200960364	ITARUMA	IM10394710	CACHOEIRA ALTA	21/09/2020 22:57	22/09/2020 15:15	21/09/2020 22:57	22/09/2020 15:06	16,15	21	339,09	CHI
20200960364	SERRANOPOLIS	IM12107433	CACHOEIRA ALTA	21/09/2020 22:57	22/09/2020 15:15	21/09/2020 22:57	22/09/2020 15:15	16,29	8	130,32	CHI
20200960364	ITARUMA	IM12107433	CACHOEIRA ALTA	21/09/2020 22:57	22/09/2020 15:15	21/09/2020 22:57	22/09/2020 15:15	16,29	7	114,03	CHI
20200960364	JATAI	IM10394710	CACHOEIRA ALTA	21/09/2020 22:57	22/09/2020 15:15	22/09/2020 04:10	22/09/2020 04:49	0,65	12	7,85	CHI
20200960364	ITARUMA	IM10394710	CACHOEIRA ALTA	21/09/2020 22:57	22/09/2020 15:15	22/09/2020 04:10	22/09/2020 04:49	0,65	94	61,47	CHI
20200960364	ITAJA	IM10394710	CACHOEIRA ALTA	21/09/2020 22:57	22/09/2020 15:15	22/09/2020 04:10	22/09/2020 04:49	0,65	1	0,65	CHI
20200962047	PLANALTINA	PI12302898	PLANALTINA	21/09/2020 22:58	22/09/2020 12:36	21/09/2020 22:58	22/09/2020 12:36	13,63	69	940,22	CHI
20200960375	ANAPOLIS	AN12256051	DAIA S1	21/09/2020 23:03	22/09/2020 03:08	21/09/2020 23:03	22/09/2020 03:08	4,08	4	16,32	CHI
20200960384	VALPARAISO DE GOIAS	2860039461	MARAJOARA	21/09/2020 23:05	22/09/2020 01:43	21/09/2020 23:05	22/09/2020 01:43	2,63	1	2,63	CHI
20200960401	ANAPOLIS	20431764	ANAPOLIS UNIVERSITARIO S2	21/09/2020 23:06	22/09/2020 11:55	21/09/2020 23:06	22/09/2020 11:55	12,80	1	12,80	CHI
20200960409	GOIAS	MD12062634RE	ITABERAI S1	21/09/2020 23:08	22/09/2020 11:50	21/09/2020 23:08	22/09/2020 11:50	12,69	5	63,47	CHI
20200960409	ITABERAI	MD12062634RE	ITABERAI S1	21/09/2020 23:08	22/09/2020 11:50	21/09/2020 23:08	22/09/2020 11:50	12,69	4	50,78	CHI
20200960409	MOSSAMEDES	MD12062634RE	ITABERAI S1	21/09/2020 23:08	22/09/2020 11:50	21/09/2020 23:08	22/09/2020 11:50	12,69	201	2551,58	CHI
20200960411	JATAI	10018964590	JATAI S3	21/09/2020 23:09	22/09/2020 11:32	21/09/2020 23:09	22/09/2020 11:32	12,37	1	12,37	CHI
20200960421	JARAGUA	70019848	JARAGUA	21/09/2020 23:12	22/09/2020 07:32	21/09/2020 23:12	22/09/2020 07:32	8,32	1	8,32	CHI
20200960423	MATRINCHA	MP12299732	MATRINCHA	21/09/2020 23:13	22/09/2020 12:46	21/09/2020 23:13	22/09/2020 12:46	13,54	62	839,22	CHI
20200960423	ARAGUAPAZ	MP12299732	MATRINCHA	21/09/2020 23:13	22/09/2020 12:46	21/09/2020 23:13	22/09/2020 12:46	13,54	1	13,54	CHI
20200960423	FAINA	MP12299732	MATRINCHA	21/09/2020 23:13	22/09/2020 12:46	21/09/2020 23:13	22/09/2020 12:46	13,54	66	893,36	CHI
20200960429	ANAPOLIS	20814379	ANAPOLIS UNIVERSITARIO S2	21/09/2020 23:14	22/09/2020 14:56	21/09/2020 23:14	22/09/2020 14:56	15,69	1	15,69	CHI
20200960432	TAQUARAL DE GOIAS	340009603	ITABERAI S1	21/09/2020 23:16	22/09/2020 11:22	21/09/2020 23:16	22/09/2020 11:22	12,10	1	12,10	CHI
20200960433	CAIAPONIA	CP11259376	CAIAPONIA	21/09/2020 23:16	22/09/2020 06:04	21/09/2020 23:16	22/09/2020 06:04	6,80	91	618,57	CHI
20200960438	ANAPOLIS	20868960	ANAPOLIS UNIVERSITARIO S2	21/09/2020 23:17	22/09/2020 17:07	21/09/2020 23:17	22/09/2020 17:07	17,82	1	17,82	CHI
20200962172	MONTIVIDIU	MV12214244	MONTIVIDIU T	21/09/2020 23:19	23/09/2020 14:24	21/09/2020 23:19	22/09/2020 15:08	15,82	13	205,69	CHI

INTERNAL

20200962172	MONTIVIDIU	MV12214244	MONTIVIDIU T	21/09/2020 23:19	23/09/2020 14:24	21/09/2020 23:19	23/09/2020 14:24	39,10	3	117,29	CHI
20200962172	RIO VERDE	MV12214244	MONTIVIDIU T	21/09/2020 23:19	23/09/2020 14:24	21/09/2020 23:19	23/09/2020 14:24	39,10	2	78,19	CHI
20200962172	MONTIVIDIU	MV12214244	MONTIVIDIU T	21/09/2020 23:19	23/09/2020 14:24	22/09/2020 19:17	22/09/2020 20:54	1,60	13	20,81	CHI
20200960457	CAIAPONIA	PY10406617	PALESTINA	21/09/2020 23:20	23/09/2020 14:19	21/09/2020 23:20	21/09/2020 23:30	0,17	4	0,66	CHI
20200960457	CAIAPONIA	PY10406617	PALESTINA	21/09/2020 23:20	23/09/2020 14:19	21/09/2020 23:20	22/09/2020 08:39	9,31	2	18,63	CHI
20200960457	PALESTINA DE GOIAS	PY10406617	PALESTINA	21/09/2020 23:20	23/09/2020 14:19	21/09/2020 23:20	22/09/2020 08:39	9,31	7	65,19	CHI
20200960457	CAIAPONIA	PY10406617	PALESTINA	21/09/2020 23:20	23/09/2020 14:19	21/09/2020 23:20	22/09/2020 10:05	10,75	88	946,27	CHI
20200960457	PALESTINA DE GOIAS	PY10406617	PALESTINA	21/09/2020 23:20	23/09/2020 14:19	21/09/2020 23:20	22/09/2020 10:05	10,75	58	623,68	CHI
20200960457	PALESTINA DE GOIAS	PY12020908LD	PALESTINA	21/09/2020 23:20	23/09/2020 14:19	21/09/2020 23:20	22/09/2020 14:19	14,98	12	179,77	CHI
20200960457	PALESTINA DE GOIAS	PY10406617	PALESTINA	21/09/2020 23:20	23/09/2020 14:19	21/09/2020 23:20	22/09/2020 16:08	16,79	10	167,93	CHI
20200960457	CAIAPONIA	PY10406617	PALESTINA	21/09/2020 23:20	23/09/2020 14:19	21/09/2020 23:20	22/09/2020 16:08	16,79	74	1242,67	CHI
20200960457	CAIAPONIA	PY10406617	PALESTINA	21/09/2020 23:20	23/09/2020 14:19	21/09/2020 23:20	23/09/2020 14:19	38,98	17	662,67	CHI
20200960457	CAIAPONIA	PY13091230	PALESTINA	21/09/2020 23:20	23/09/2020 14:19	21/09/2020 23:30	22/09/2020 10:05	10,58	1	10,58	CHI
20200960457	CAIAPONIA	CP13253709	PALESTINA	21/09/2020 23:20	23/09/2020 14:19	21/09/2020 23:30	23/09/2020 14:19	38,81	2	77,62	CHI
20200960457	CAIAPONIA	PY10406617	PALESTINA	21/09/2020 23:20	23/09/2020 14:19	22/09/2020 21:31	22/09/2020 21:40	0,14	163	22,68	CHI
20200960457	PALESTINA DE GOIAS	PY10406617	PALESTINA	21/09/2020 23:20	23/09/2020 14:19	22/09/2020 21:31	22/09/2020 21:40	0,14	87	12,11	CHI
20200960457	PALESTINA DE GOIAS	PY10406617	PALESTINA	21/09/2020 23:20	23/09/2020 14:19	22/09/2020 21:41	22/09/2020 23:25	1,75	87	151,86	CHI
20200960457	CAIAPONIA	PY10406617	PALESTINA	21/09/2020 23:20	23/09/2020 14:19	22/09/2020 21:41	22/09/2020 23:25	1,75	163	284,53	CHI
20200960457	PALESTINA DE GOIAS	PY10406617	PALESTINA	21/09/2020 23:20	23/09/2020 14:19	22/09/2020 23:30	23/09/2020 13:44	14,23	87	1238,28	CHI
20200960457	CAIAPONIA	PY10406617	PALESTINA	21/09/2020 23:20	23/09/2020 14:19	22/09/2020 23:30	23/09/2020 13:44	14,23	163	2319,99	CHI
20200960450	ITAPURANGA	IK21298480	ITAPURANGA	21/09/2020 23:22	22/09/2020 11:54	21/09/2020 23:22	22/09/2020 11:54	12,52	1	12,52	CHI
20200960453	VILA BOA	2880008664	IACIARA S2	21/09/2020 23:24	22/09/2020 07:52	21/09/2020 23:24	22/09/2020 07:52	8,46	1	8,46	CHI
202009107101	ANAPOLIS	20378488	ANAPOLIS UNIVERSITARIO S1	21/09/2020 23:24	22/09/2020 04:02	21/09/2020 23:24	22/09/2020 04:02	4,64	1	4,64	CHI
20200960459	ANAPOLIS	20972817	ANAPOLIS UNIVERSITARIO S2	21/09/2020 23:25	22/09/2020 09:53	21/09/2020 23:25	22/09/2020 09:53	10,46	1	10,46	CHI
202009106879	ARAGARCAS	1820056391	ARAGARCAS	21/09/2020 23:28	22/09/2020 00:58	21/09/2020 23:28	22/09/2020 00:58	1,50	1	1,50	CHI
20200963028	JATAI	JT12184065	JATAI S2	21/09/2020 23:32	22/09/2020 16:54	21/09/2020 23:32	22/09/2020 16:54	17,36	13	225,68	CHI
20200960489	SANTA HELENA DE GOIAS	SH10394747	IPEGUARI	21/09/2020 23:32	22/09/2020 16:02	21/09/2020 23:32	22/09/2020 01:32	1,99	553	1101,08	CHI
20200960489	SANTA HELENA DE GOIAS	SH12271530RE	IPEGUARI	21/09/2020 23:32	22/09/2020 16:02	21/09/2020 23:32	22/09/2020 14:53	15,35	9	138,15	CHI
20200960489	SANTA HELENA DE GOIAS	SH12271530RE	IPEGUARI	21/09/2020 23:32	22/09/2020 16:02	21/09/2020 23:32	22/09/2020 15:20	15,80	15	236,96	CHI
20200960489	RIO VERDE	SH12271530RE	IPEGUARI	21/09/2020 23:32	22/09/2020 16:02	21/09/2020 23:32	22/09/2020 15:36	16,06	1	16,06	CHI
20200960489	SANTA HELENA DE GOIAS	SH12271530RE	IPEGUARI	21/09/2020 23:32	22/09/2020 16:02	21/09/2020 23:32	22/09/2020 15:36	16,06	23	369,27	CHI
20200960489	SANTA HELENA DE GOIAS	SH12271530RE	IPEGUARI	21/09/2020 23:32	22/09/2020 16:02	21/09/2020 23:32	22/09/2020 16:02	16,49	5	82,47	CHI
20200960489	RIO VERDE	SH12271530RE	IPEGUARI	21/09/2020 23:32	22/09/2020 16:02	21/09/2020 23:32	22/09/2020 16:02	16,49	1	16,49	CHI

INTERNAL

20200960489	SANTA HELENA DE GOIAS	SH12271530RE	IPEGUARI	21/09/2020 23:32	22/09/2020 16:02	21/09/2020 23:33	22/09/2020 14:53	15,35	1	15,35	CHI
20200993825	TURVELANDIA	ML12023693LD	RIO DOS BOIS	21/09/2020 23:33	22/09/2020 21:12	21/09/2020 23:33	22/09/2020 06:20	6,78	7	47,45	CHI
20200993825	SANTA HELENA DE GOIAS	ML12023693LD	RIO DOS BOIS	21/09/2020 23:33	22/09/2020 21:12	21/09/2020 23:33	22/09/2020 09:27	9,90	52	514,55	CHI
20200993825	TURVELANDIA	ML12023693LD	RIO DOS BOIS	21/09/2020 23:33	22/09/2020 21:12	21/09/2020 23:33	22/09/2020 09:27	9,90	17	168,22	CHI
20200993825	MAURILANDIA	ML12023693LD	RIO DOS BOIS	21/09/2020 23:33	22/09/2020 21:12	21/09/2020 23:33	22/09/2020 09:27	9,90	11	108,85	CHI
20200993825	TURVELANDIA	ML12023693LD	RIO DOS BOIS	21/09/2020 23:33	22/09/2020 21:12	21/09/2020 23:33	22/09/2020 21:12	21,65	20	432,99	CHI
20200960618	PETROLINA DE GOIAS	SFG-TR2	SAO FRANCISCO DE GOIAS	21/09/2020 23:35	22/09/2020 22:06	22/09/2020 00:15	22/09/2020 00:24	0,15	1	0,15	CHI
20200960618	SAO FRANCISCO DE GOIAS	SFG-TR2	SAO FRANCISCO DE GOIAS	21/09/2020 23:35	22/09/2020 22:06	22/09/2020 00:15	22/09/2020 00:24	0,15	1	0,15	CHI
20200960618	JESUPOLIS	SFG-TR2	SAO FRANCISCO DE GOIAS	21/09/2020 23:35	22/09/2020 22:06	22/09/2020 00:15	22/09/2020 00:24	0,15	154	23,19	CHI
20200960618	JESUPOLIS	SFG-TR2	SAO FRANCISCO DE GOIAS	21/09/2020 23:35	22/09/2020 22:06	22/09/2020 00:15	22/09/2020 00:24	0,15	979	147,39	CHI
20200960618	SAO FRANCISCO DE GOIAS	SFG-TR2	SAO FRANCISCO DE GOIAS	21/09/2020 23:35	22/09/2020 22:06	22/09/2020 00:15	22/09/2020 00:24	0,15	82	12,35	CHI
20200960618	JARAGUA	SFG-TR2	SAO FRANCISCO DE GOIAS	21/09/2020 23:35	22/09/2020 22:06	22/09/2020 00:15	22/09/2020 00:24	0,15	22	3,31	CHI
20200960618	PIRENOPOLIS	SFG-TR2	SAO FRANCISCO DE GOIAS	21/09/2020 23:35	22/09/2020 22:06	22/09/2020 00:15	22/09/2020 00:24	0,15	332	51,28	CHI
20200960618	PETROLINA DE GOIAS	SFG-TR2	SAO FRANCISCO DE GOIAS	21/09/2020 23:35	22/09/2020 22:06	22/09/2020 00:15	22/09/2020 00:24	0,15	14	2,16	CHI
20200960618	SAO FRANCISCO DE GOIAS	SFG-TR2	SAO FRANCISCO DE GOIAS	21/09/2020 23:35	22/09/2020 22:06	22/09/2020 00:15	22/09/2020 00:24	0,15	25	3,86	CHI
20200960618	PETROLINA DE GOIAS	SFG-TR2	SAO FRANCISCO DE GOIAS	21/09/2020 23:35	22/09/2020 22:06	22/09/2020 00:15	22/09/2020 00:24	0,15	3	0,46	CHI
20200960618	PIRENOPOLIS	SFG-TR2	SAO FRANCISCO DE GOIAS	21/09/2020 23:35	22/09/2020 22:06	22/09/2020 00:15	22/09/2020 00:24	0,15	1195	184,56	CHI
20200960618	PIRENOPOLIS	SFG-TR2	SAO FRANCISCO DE GOIAS	21/09/2020 23:35	22/09/2020 22:06	22/09/2020 00:15	22/09/2020 00:24	0,15	1	0,15	CHI
20200960618	PETROLINA DE GOIAS	SFG-TR2	SAO FRANCISCO DE GOIAS	21/09/2020 23:35	22/09/2020 22:06	22/09/2020 00:15	22/09/2020 00:24	0,15	3	0,46	CHI
20200960618	SAO FRANCISCO DE GOIAS	SFG-TR2	SAO FRANCISCO DE GOIAS	21/09/2020 23:35	22/09/2020 22:06	22/09/2020 00:15	22/09/2020 00:24	0,15	21	3,24	CHI
20200960618	JARAGUA	SFG-TR2	SAO FRANCISCO DE GOIAS	21/09/2020 23:35	22/09/2020 22:06	22/09/2020 00:41	22/09/2020 01:57	1,26	22	27,81	CHI
20200960618	SAO FRANCISCO DE GOIAS	SFG-TR2	SAO FRANCISCO DE GOIAS	21/09/2020 23:35	22/09/2020 22:06	22/09/2020 00:41	22/09/2020 01:57	1,26	1	1,26	CHI
20200960618	JESUPOLIS	SFG-TR2	SAO FRANCISCO DE GOIAS	21/09/2020 23:35	22/09/2020 22:06	22/09/2020 00:41	22/09/2020 01:57	1,26	979	1237,62	CHI
20200960618	PETROLINA DE GOIAS	SFG-TR2	SAO FRANCISCO DE GOIAS	21/09/2020 23:35	22/09/2020 22:06	22/09/2020 00:41	22/09/2020 01:57	1,26	1	1,26	CHI
20200960618	JESUPOLIS	SFG-TR2	SAO FRANCISCO DE GOIAS	21/09/2020 23:35	22/09/2020 22:06	22/09/2020 00:41	22/09/2020 01:57	1,26	155	195,95	CHI
20200960618	SAO FRANCISCO DE GOIAS	SFG-TR2	SAO FRANCISCO DE GOIAS	21/09/2020 23:35	22/09/2020 22:06	22/09/2020 00:41	22/09/2020 01:57	1,26	85	107,45	CHI
20200960618	PIRENOPOLIS	SFG-TR2	SAO FRANCISCO DE GOIAS	21/09/2020 23:35	22/09/2020 22:06	22/09/2020 00:41	22/09/2020 12:55	12,23	334	4086,12	CHI
20200960618	PETROLINA DE GOIAS	SFG-TR2	SAO FRANCISCO DE GOIAS	21/09/2020 23:35	22/09/2020 22:06	22/09/2020 00:41	22/09/2020 12:55	12,23	3	36,70	CHI
20200960618	PETROLINA DE GOIAS	SFG-TR2	SAO FRANCISCO DE GOIAS	21/09/2020 23:35	22/09/2020 22:06	22/09/2020 00:41	22/09/2020 12:55	12,24	14	171,39	CHI
20200960618	PIRENOPOLIS	SFG-TR2	SAO FRANCISCO DE GOIAS	21/09/2020 23:35	22/09/2020 22:06	22/09/2020 00:41	22/09/2020 12:55	12,24	1201	14702,58	CHI
20200960618	SAO FRANCISCO DE GOIAS	SFG-TR2	SAO FRANCISCO DE GOIAS	21/09/2020 23:35	22/09/2020 22:06	22/09/2020 00:41	22/09/2020 12:55	12,24	21	257,08	CHI
20200960618	PIRENOPOLIS	SFG-TR2	SAO FRANCISCO DE GOIAS	21/09/2020 23:35	22/09/2020 22:06	22/09/2020 00:41	22/09/2020 18:10	17,48	1	17,48	CHI
20200960618	PETROLINA DE GOIAS	SFG-TR2	SAO FRANCISCO DE GOIAS	21/09/2020 23:35	22/09/2020 22:06	22/09/2020 00:41	22/09/2020 18:10	17,48	3	52,43	CHI

INTERNAL

20200960618	SAO FRANCISCO DE GOIAS	SFG-TR2	SAO FRANCISCO DE GOIAS	21/09/2020 23:35	22/09/2020 22:06	22/09/2020 00:41	22/09/2020 18:10	17,48	25	436,90	CHI
20200960618	JARAGUA	03165126	SAO FRANCISCO DE GOIAS	21/09/2020 23:35	22/09/2020 22:06	22/09/2020 06:05	22/09/2020 06:15	0,18	22	3,95	CHI
20200960618	SAO FRANCISCO DE GOIAS	03165126	SAO FRANCISCO DE GOIAS	21/09/2020 23:35	22/09/2020 22:06	22/09/2020 06:05	22/09/2020 06:15	0,18	1	0,18	CHI
20200960618	JESUPOLIS	03165126	SAO FRANCISCO DE GOIAS	21/09/2020 23:35	22/09/2020 22:06	22/09/2020 06:05	22/09/2020 06:15	0,18	155	27,86	CHI
20200960618	PETROLINA DE GOIAS	03165126	SAO FRANCISCO DE GOIAS	21/09/2020 23:35	22/09/2020 22:06	22/09/2020 06:05	22/09/2020 06:15	0,18	1	0,18	CHI
20200960618	JESUPOLIS	03165126	SAO FRANCISCO DE GOIAS	21/09/2020 23:35	22/09/2020 22:06	22/09/2020 06:05	22/09/2020 06:15	0,18	978	175,77	CHI
20200960618	SAO FRANCISCO DE GOIAS	03165126	SAO FRANCISCO DE GOIAS	21/09/2020 23:35	22/09/2020 22:06	22/09/2020 06:05	22/09/2020 06:15	0,18	85	15,28	CHI
20200960618	PIRENOPOLIS	AN16401592	ANAPOLIS UNIVERSITARIO S2	21/09/2020 23:35	22/09/2020 22:06	22/09/2020 12:38	22/09/2020 12:55	0,29	55	15,83	CHI
20200960618	ANAPOLIS	AN16401592	ANAPOLIS UNIVERSITARIO S2	21/09/2020 23:35	22/09/2020 22:06	22/09/2020 12:38	22/09/2020 12:55	0,29	410	117,99	CHI
20200960618	SAO FRANCISCO DE GOIAS	PV13353511	SAO FRANCISCO DE GOIAS	21/09/2020 23:35	22/09/2020 22:06	22/09/2020 21:18	22/09/2020 21:22	0,06	21	1,29	CHI
20200960618	PETROLINA DE GOIAS	PV13353511	SAO FRANCISCO DE GOIAS	21/09/2020 23:35	22/09/2020 22:06	22/09/2020 21:18	22/09/2020 21:22	0,06	14	0,86	CHI
20200960618	PIRENOPOLIS	PV13353511	SAO FRANCISCO DE GOIAS	21/09/2020 23:35	22/09/2020 22:06	22/09/2020 21:18	22/09/2020 21:22	0,06	1200	73,67	CHI
20200960618	PETROLINA DE GOIAS	PV13370486	SAO FRANCISCO DE GOIAS	21/09/2020 23:35	22/09/2020 22:06	22/09/2020 21:56	22/09/2020 22:06	0,16	3	0,49	CHI
20200960618	PIRENOPOLIS	PV13370486	SAO FRANCISCO DE GOIAS	21/09/2020 23:35	22/09/2020 22:06	22/09/2020 21:56	22/09/2020 22:06	0,16	334	54,92	CHI
20200965121	RIO VERDE	RV12240290	MONTIVIDIU T	21/09/2020 23:36	22/09/2020 13:20	21/09/2020 23:36	22/09/2020 13:20	13,72	14	192,04	CHI
20200960499	CACHOEIRA ALTA	00270214	CACHOEIRA ALTA	21/09/2020 23:40	22/09/2020 10:48	21/09/2020 23:40	22/09/2020 01:52	2,19	26	57,01	CHI
20200960499	CACU	00270214	CACHOEIRA ALTA	21/09/2020 23:40	22/09/2020 10:48	21/09/2020 23:40	22/09/2020 01:52	2,19	6	13,16	CHI
20200960499	CACHOEIRA ALTA	00270214	CACHOEIRA ALTA	21/09/2020 23:40	22/09/2020 10:48	21/09/2020 23:40	22/09/2020 07:26	7,76	14	108,67	CHI
20200960499	CACHOEIRA ALTA	00270214	CACHOEIRA ALTA	21/09/2020 23:40	22/09/2020 10:48	21/09/2020 23:40	22/09/2020 08:51	9,19	34	312,52	CHI
20200960499	CACHOEIRA ALTA	00270214	CACHOEIRA ALTA	21/09/2020 23:40	22/09/2020 10:48	21/09/2020 23:40	22/09/2020 09:52	10,21	8	81,66	CHI
20200960499	CACHOEIRA ALTA	00270214	CACHOEIRA ALTA	21/09/2020 23:40	22/09/2020 10:48	21/09/2020 23:40	22/09/2020 10:48	11,14	4	44,57	CHI
20200960498	SANTO ANTONIO DA BARRA	2270002587	ACREUNA	21/09/2020 23:42	22/09/2020 09:46	21/09/2020 23:42	22/09/2020 09:46	10,07	1	10,07	CHI
20200960501	ANAPOLIS	20099903	JUNDIAI S2	21/09/2020 23:43	22/09/2020 10:52	21/09/2020 23:43	22/09/2020 10:52	11,15	1	11,15	CHI
20200960511	SAO DOMINGOS	ND10416743	IACIARA S2	21/09/2020 23:44	22/09/2020 14:20	21/09/2020 23:44	22/09/2020 14:20	14,59	3	43,76	CHI
20200960511	NOVA ROMA	ND10416743	IACIARA S2	21/09/2020 23:44	22/09/2020 14:20	21/09/2020 23:44	22/09/2020 14:20	14,59	8	116,69	CHI
20200960511	SAO DOMINGOS	ND10401466	IACIARA S2	21/09/2020 23:44	22/09/2020 14:20	21/09/2020 23:52	22/09/2020 06:32	6,67	1	6,67	CHI
20200960511	NOVA ROMA	ND10401466	IACIARA S2	21/09/2020 23:44	22/09/2020 14:20	21/09/2020 23:52	22/09/2020 06:32	6,67	307	2048,20	CHI
20200960511	NOVA ROMA	ND10401466	IACIARA S2	21/09/2020 23:44	22/09/2020 14:20	21/09/2020 23:52	22/09/2020 07:51	8,00	1099	8790,78	CHI
20200960511	MONTE ALEGRE DE GOIAS	ND10401466	IACIARA S2	21/09/2020 23:44	22/09/2020 14:20	21/09/2020 23:52	22/09/2020 07:51	8,00	1	8,00	CHI
20200960508	ITABERAI	10004455680	ITABERAI S1	21/09/2020 23:46	22/09/2020 15:33	21/09/2020 23:46	22/09/2020 15:33	15,78	1	15,78	CHI
20200960509	MONTIVIDIU	10005295716	MONTIVIDIU T	21/09/2020 23:46	22/09/2020 08:32	21/09/2020 23:46	22/09/2020 08:32	8,75	1	8,75	CHI
20200960512	GOIAS	90025090	GOIAS	21/09/2020 23:47	22/09/2020 16:44	21/09/2020 23:47	22/09/2020 16:44	16,95	1	16,95	CHI
20200960521	ALTO PARAISO DE GOIAS	10018867551	FLORES DE GOIAS	21/09/2020 23:50	22/09/2020 00:51	21/09/2020 23:50	22/09/2020 00:51	1,01	1	1,01	CHI

INTERNAL

2020092100159	NOVA ROMA	01230414	IACIARA S2	21/09/2020 23:52	21/09/2020 23:57	21/09/2020 23:52	21/09/2020 23:57	0,08	152	12,67	CHI
2020092100159	FLORES DE GOIAS	01230414	IACIARA S2	21/09/2020 23:52	21/09/2020 23:57	21/09/2020 23:52	21/09/2020 23:57	0,08	1	0,08	CHI
2020092100159	SAO JOAO D ALIANCA	01230414	IACIARA S2	21/09/2020 23:52	21/09/2020 23:57	21/09/2020 23:52	21/09/2020 23:57	0,08	28	2,33	CHI
2020092100159	IACIARA	01230414	IACIARA S2	21/09/2020 23:52	21/09/2020 23:57	21/09/2020 23:52	21/09/2020 23:57	0,08	154	12,83	CHI
2020092100159	ALTO PARAISO DE GOIAS	01230414	IACIARA S2	21/09/2020 23:52	21/09/2020 23:57	21/09/2020 23:52	21/09/2020 23:57	0,08	19	1,58	CHI
2020092100159	SAO DOMINGOS	01230414	IACIARA S2	21/09/2020 23:52	21/09/2020 23:57	21/09/2020 23:52	21/09/2020 23:57	0,08	3	0,25	CHI
2020092100159	POSSE	01230414	IACIARA S2	21/09/2020 23:52	21/09/2020 23:57	21/09/2020 23:52	21/09/2020 23:57	0,08	1	0,08	CHI
20200960590	RIO VERDE	01600274	RIO VERDE S1	21/09/2020 23:53	21/09/2020 23:58	21/09/2020 23:53	21/09/2020 23:57	0,08	2560	199,82	CHI
20200960590	RIO VERDE	RV16407143	RIO VERDE S1	21/09/2020 23:53	21/09/2020 23:58	21/09/2020 23:53	21/09/2020 23:58	0,09	3000	261,67	CHI
20200960590	RIO VERDE	RV16404648	RIO VERDE S1	21/09/2020 23:53	21/09/2020 23:58	21/09/2020 23:53	21/09/2020 23:58	0,09	6397	604,16	CHI
20200960547	CRISTALINA	KR10409765	PAMPLONA	21/09/2020 23:53	22/09/2020 12:34	21/09/2020 23:53	21/09/2020 23:57	0,05	1	0,05	CHI
20200960547	CRISTALINA	KR10409765	PAMPLONA	21/09/2020 23:53	22/09/2020 12:34	21/09/2020 23:53	22/09/2020 11:45	11,87	6	71,22	CHI
20200960547	CRISTALINA	KR12168098LD	PAMPLONA	21/09/2020 23:53	22/09/2020 12:34	21/09/2020 23:53	22/09/2020 12:34	12,67	3	38,01	CHI
20200960528	MONTE ALEGRE DE GOIAS	1620005041	SAO DOMINGOS	21/09/2020 23:53	22/09/2020 05:56	21/09/2020 23:53	22/09/2020 05:56	6,03	1	6,03	CHI
20200960547	CRISTALINA	KR10409765	PAMPLONA	21/09/2020 23:53	22/09/2020 12:34	21/09/2020 23:55	22/09/2020 11:45	11,84	5	59,19	CHI
20200960547	CRISTALINA	KR12168098LD	PAMPLONA	21/09/2020 23:53	22/09/2020 12:34	21/09/2020 23:55	22/09/2020 12:34	12,64	7	88,47	CHI
20200960529	ITABERAI	1810000560	ITABERAI S1	21/09/2020 23:54	22/09/2020 18:29	21/09/2020 23:54	22/09/2020 18:29	18,58	1	18,58	CHI
20200960539	ANAPOLIS	20869113	ANAPOLIS UNIVERSITARIO S1	21/09/2020 23:55	22/09/2020 14:10	21/09/2020 23:55	22/09/2020 14:10	14,24	1	14,24	CHI
202009106880	ARAGARCAS	1820056937	ARAGARCAS	21/09/2020 23:55	22/09/2020 00:58	21/09/2020 23:55	22/09/2020 00:58	1,04	1	1,04	CHI
20200960541	TERESINA DE GOIAS	TE12257469	FLORES DE GOIAS	21/09/2020 23:56	22/09/2020 08:34	21/09/2020 23:56	22/09/2020 08:34	8,63	133	1147,90	CHI
20200960578	RUBIATABA	01330434	RUBIATABA	21/09/2020 23:57	22/09/2020 12:40	21/09/2020 23:57	22/09/2020 09:19	9,36	8	74,86	CHI
20200960578	NOVA AMERICA	01330434	RUBIATABA	21/09/2020 23:57	22/09/2020 12:40	21/09/2020 23:57	22/09/2020 09:19	9,36	208	1946,24	CHI
20200960578	NOVA IGUACU DE GOIAS	01330434	RUBIATABA	21/09/2020 23:57	22/09/2020 12:40	21/09/2020 23:57	22/09/2020 09:19	9,36	1	9,36	CHI
20200960578	CRIXAS	01330434	RUBIATABA	21/09/2020 23:57	22/09/2020 12:40	21/09/2020 23:57	22/09/2020 09:19	9,36	357	3340,43	CHI
20200960578	ARAGUAPAZ	01330434	RUBIATABA	21/09/2020 23:57	22/09/2020 12:40	21/09/2020 23:57	22/09/2020 12:04	12,11	6	72,66	CHI
20200960578	CRIXAS	01330434	RUBIATABA	21/09/2020 23:57	22/09/2020 12:40	21/09/2020 23:57	22/09/2020 12:04	12,11	95	1150,37	CHI
20200960578	CRIXAS	01330434	RUBIATABA	21/09/2020 23:57	22/09/2020 12:40	21/09/2020 23:57	22/09/2020 12:15	12,30	136	1673,29	CHI
20200960578	NOVA CRIXAS	01330434	RUBIATABA	21/09/2020 23:57	22/09/2020 12:40	21/09/2020 23:57	22/09/2020 12:15	12,30	1	12,30	CHI
20200960578	MOZARLANDIA	01330434	RUBIATABA	21/09/2020 23:57	22/09/2020 12:40	21/09/2020 23:57	22/09/2020 12:15	12,30	4	49,21	CHI
20200960578	ARAGUAPAZ	01330434	RUBIATABA	21/09/2020 23:57	22/09/2020 12:40	21/09/2020 23:57	22/09/2020 12:15	12,30	97	1193,45	CHI
20200960578	ARAGUAPAZ	NM13095556	RUBIATABA	21/09/2020 23:57	22/09/2020 12:40	22/09/2020 12:30	22/09/2020 12:40	0,16	97	15,63	CHI
20200960578	MOZARLANDIA	NM13095556	RUBIATABA	21/09/2020 23:57	22/09/2020 12:40	22/09/2020 12:30	22/09/2020 12:40	0,16	4	0,64	CHI
20200960578	NOVA CRIXAS	NM13095556	RUBIATABA	21/09/2020 23:57	22/09/2020 12:40	22/09/2020 12:30	22/09/2020 12:40	0,16	1	0,16	CHI

INTERNAL

20200960578	CRIXAS	NM13095556	RUBIATABA	21/09/2020 23:57	22/09/2020 12:40	22/09/2020 12:30	22/09/2020 12:40	0,16	136	21,91	CHI
20200960553	PORTEIRAO	DM12191983	RIO DOS BOIS	22/09/2020 00:00	22/09/2020 18:34	22/09/2020 00:00	22/09/2020 18:34	18,57	3	55,70	CHI
20200960563	RIO VERDE	10000837871	RIO VERDE S1	22/09/2020 00:02	22/09/2020 09:51	22/09/2020 00:02	22/09/2020 09:51	9,81	1	9,81	CHI
20200960568	SAO LUIZ DO NORTE	SZ21351557	ITAPACI	22/09/2020 00:03	22/09/2020 09:11	22/09/2020 00:03	22/09/2020 09:11	9,12	1	9,12	CHI
20200960569	ESTRELA DO NORTE	ET12143705	MARA ROSA	22/09/2020 00:04	22/09/2020 11:25	22/09/2020 00:04	22/09/2020 11:25	11,35	9	102,13	CHI
20200960569	FORMOSO	ET12143705	MARA ROSA	22/09/2020 00:04	22/09/2020 11:25	22/09/2020 00:04	22/09/2020 11:25	11,35	7	79,44	CHI
20200960572	TURVELANDIA	TD12226264	RIO DOS BOIS	22/09/2020 00:06	22/09/2020 05:50	22/09/2020 00:06	22/09/2020 05:50	5,73	81	464,38	CHI
20200960572	SANTA HELENA DE GOIAS	TD12226264	RIO DOS BOIS	22/09/2020 00:06	22/09/2020 05:50	22/09/2020 00:06	22/09/2020 05:50	5,73	2	11,47	CHI
20200960573	HEITORAI	HE21274487	ITAPURANGA	22/09/2020 00:06	22/09/2020 13:04	22/09/2020 00:06	22/09/2020 13:04	12,96	1	12,96	CHI
20200960580	RIO VERDE	RV21326777	CABRIUVA S2	22/09/2020 00:10	22/09/2020 13:11	22/09/2020 00:10	22/09/2020 13:11	13,00	1	13,00	CHI
20200960583	ITAUCU	110030989	ITABERAI S1	22/09/2020 00:12	22/09/2020 02:37	22/09/2020 00:12	22/09/2020 02:37	2,40	1	2,40	CHI
20200960593	CACHOEIRA ALTA	00270434	CACHOEIRA ALTA	22/09/2020 00:17	22/09/2020 17:30	22/09/2020 00:17	22/09/2020 04:26	4,14	8	33,12	CHI
20200960593	CACU	00270434	CACHOEIRA ALTA	22/09/2020 00:17	22/09/2020 17:30	22/09/2020 00:17	22/09/2020 04:26	4,14	3	12,42	CHI
20200960593	LAGOA SANTA	00270434	CACHOEIRA ALTA	22/09/2020 00:17	22/09/2020 17:30	22/09/2020 00:17	22/09/2020 09:45	9,46	16	151,28	CHI
20200960593	ITAJA	00270434	CACHOEIRA ALTA	22/09/2020 00:17	22/09/2020 17:30	22/09/2020 00:17	22/09/2020 09:45	9,46	7	66,19	CHI
20200960593	ITARUMA	00270434	CACHOEIRA ALTA	22/09/2020 00:17	22/09/2020 17:30	22/09/2020 00:17	22/09/2020 09:45	9,46	45	425,49	CHI
20200960593	ITARUMA	00270434	CACHOEIRA ALTA	22/09/2020 00:17	22/09/2020 17:30	22/09/2020 00:17	22/09/2020 09:45	9,46	6	56,73	CHI
20200960593	ITARUMA	00270434	CACHOEIRA ALTA	22/09/2020 00:17	22/09/2020 17:30	22/09/2020 00:17	22/09/2020 09:45	9,46	81	765,88	CHI
20200960593	ITAJA	00270434	CACHOEIRA ALTA	22/09/2020 00:17	22/09/2020 17:30	22/09/2020 00:17	22/09/2020 09:45	9,46	41	387,67	CHI
20200960593	ITAJA	00270434	CACHOEIRA ALTA	22/09/2020 00:17	22/09/2020 17:30	22/09/2020 00:17	22/09/2020 16:10	15,88	2	31,75	CHI
20200960593	CACU	00270434	CACHOEIRA ALTA	22/09/2020 00:17	22/09/2020 17:30	22/09/2020 00:17	22/09/2020 17:10	16,87	4	67,47	CHI
20200960593	ITARUMA	00270434	CACHOEIRA ALTA	22/09/2020 00:17	22/09/2020 17:30	22/09/2020 00:17	22/09/2020 17:10	16,87	132	2226,62	CHI
20200960593	ITAJA	00270434	CACHOEIRA ALTA	22/09/2020 00:17	22/09/2020 17:30	22/09/2020 00:17	22/09/2020 17:10	16,87	1	16,87	CHI
20200960593	ITAJA	00270434	CACHOEIRA ALTA	22/09/2020 00:17	22/09/2020 17:30	22/09/2020 00:17	22/09/2020 17:10	16,87	31	522,92	CHI
20200960593	ITAJA	00270434	CACHOEIRA ALTA	22/09/2020 00:17	22/09/2020 17:30	22/09/2020 00:17	22/09/2020 17:30	17,20	73	1255,72	CHI
20200960593	LAGOA SANTA	00270434	CACHOEIRA ALTA	22/09/2020 00:17	22/09/2020 17:30	22/09/2020 00:17	22/09/2020 17:30	17,20	86	1479,34	CHI
20200960591	POSSE	PS12218770	IACIARA S1	22/09/2020 00:20	23/09/2020 00:43	22/09/2020 00:20	22/09/2020 09:49	9,49	20	189,74	CHI
20200960591	POSSE	PS12218770	IACIARA S1	22/09/2020 00:20	23/09/2020 00:43	22/09/2020 00:20	23/09/2020 00:43	24,39	151	3682,72	CHI
20200960596	RIO VERDE	630293351	RIO VERDE S2	22/09/2020 00:23	22/09/2020 11:05	22/09/2020 00:23	22/09/2020 11:05	10,70	1	10,70	CHI
20200960605	PILAR DE GOIAS	GG21340130	URUACU	22/09/2020 00:24	24/09/2020 12:49	22/09/2020 00:24	24/09/2020 12:49	60,41	1	60,41	CHI
2020092200008	SERRANOPOLIS	01670214	JATAI S1	22/09/2020 00:33	22/09/2020 02:13	22/09/2020 00:33	22/09/2020 02:13	1,67	1	1,67	CHI
20200960621	CAMPOS BELOS	820006210	SAO DOMINGOS	22/09/2020 00:34	22/09/2020 06:54	22/09/2020 00:34	22/09/2020 06:54	6,32	1	6,32	CHI
20200960624	ANICUNS	AC11126093	ANICUNS	22/09/2020 00:36	22/09/2020 08:50	22/09/2020 00:36	22/09/2020 08:50	8,22	6	49,31	CHI

INTERNAL

20200960649	RIO VERDE	RV11113529	RIO VERDE S1	22/09/2020 00:42	22/09/2020 01:59	22/09/2020 00:42	22/09/2020 01:59	1,27	142	180,14	CHI
20200962050	ALVORADA DO NORTE	AQ12160975	IACIARA S2	22/09/2020 00:45	22/09/2020 08:06	22/09/2020 00:45	22/09/2020 08:06	7,34	17	124,76	CHI
20200960641	CIDADE OCIDENTAL	10024896673	MARAJOARA	22/09/2020 00:47	22/09/2020 11:07	22/09/2020 00:47	22/09/2020 11:07	10,32	1	10,32	CHI
20200960646	BARRO ALTO	BA21342222	GOIANESIA S1	22/09/2020 00:51	22/09/2020 12:31	22/09/2020 00:51	22/09/2020 12:31	11,66	1	11,66	CHI
20200960667	ANAPOLIS	20535673	ANAPOLIS UNIVERSITARIO S2	22/09/2020 01:01	22/09/2020 10:59	22/09/2020 01:01	22/09/2020 10:59	9,96	1	9,96	CHI
20200960678	NOVA ROMA	ND12117611	IACIARA S2	22/09/2020 01:06	22/09/2020 10:00	22/09/2020 01:06	22/09/2020 10:00	8,90	8	71,17	CHI
20200960756	JARAGUA	70097562	JARAGUA	22/09/2020 01:06	22/09/2020 07:11	22/09/2020 01:06	22/09/2020 07:11	6,08	1	6,08	CHI
20200961834	ABADIANIA	AA12033506	CORUMBA	22/09/2020 01:06	22/09/2020 13:06	22/09/2020 01:06	22/09/2020 13:06	11,99	8	95,92	CHI
20200961834	CORUMBA DE GOIAS	AA12033506	CORUMBA	22/09/2020 01:06	22/09/2020 13:06	22/09/2020 01:06	22/09/2020 13:06	11,99	2	23,98	CHI
2020092200142	COCALZINHO DE GOIAS	03730284	AGUAS LINDAS DE GOIAS S1	22/09/2020 01:11	22/09/2020 01:16	22/09/2020 01:11	22/09/2020 01:16	0,08	3	0,25	CHI
2020092200142	AGUAS LINDAS DE GOIAS	03730284	AGUAS LINDAS DE GOIAS S1	22/09/2020 01:11	22/09/2020 01:16	22/09/2020 01:11	22/09/2020 01:16	0,08	13218	1101,50	CHI
20200960766	CRISTALINA	KR10410940	PAMPLONA	22/09/2020 01:28	22/09/2020 11:59	22/09/2020 01:28	22/09/2020 04:32	3,08	17	52,28	CHI
20200960766	CRISTALINA	7499676	PAMPLONA	22/09/2020 01:28	22/09/2020 11:59	22/09/2020 01:28	22/09/2020 09:02	7,56	12	90,74	CHI
20200960766	CRISTALINA	KR12171525LD	PAMPLONA	22/09/2020 01:28	22/09/2020 11:59	22/09/2020 01:28	22/09/2020 11:59	10,51	17	178,67	CHI
20200960744	PIRANHAS	1930026320	PIRANHAS	22/09/2020 01:29	22/09/2020 07:55	22/09/2020 01:29	22/09/2020 07:55	6,42	1	6,42	CHI
20200960747	BOM JARDIM DE GOIAS	BM11380933	BOM JARDIM	22/09/2020 01:32	22/09/2020 05:14	22/09/2020 01:32	22/09/2020 05:14	3,69	79	291,64	CHI
20200960752	ANAPOLIS	AN12319196	DAIA S1	22/09/2020 01:34	22/09/2020 10:37	22/09/2020 01:34	22/09/2020 10:37	9,05	10	90,53	CHI
20200961476	ANAPOLIS	AN11334273	JUNDIAI S1	22/09/2020 01:41	22/09/2020 08:07	22/09/2020 01:41	22/09/2020 08:07	6,43	115	739,00	CHI
20200960799	PIRANHAS	PH11041156	PIRANHAS	22/09/2020 01:50	22/09/2020 10:18	22/09/2020 01:50	22/09/2020 10:18	8,45	145	1225,33	CHI
20200960789	ANAPOLIS	AN11315977	ANAPOLIS UNIVERSITARIO S2	22/09/2020 01:53	22/09/2020 14:20	22/09/2020 01:53	22/09/2020 02:25	0,53	101	53,50	CHI
20200960789	ANAPOLIS	05800234	ANAPOLIS UNIVERSITARIO S2	22/09/2020 01:53	22/09/2020 14:20	22/09/2020 02:00	22/09/2020 02:32	0,53	4183	2222,80	CHI
20200960789	ANAPOLIS	AN13408382	ANAPOLIS UNIVERSITARIO S2	22/09/2020 01:53	22/09/2020 14:20	22/09/2020 02:00	22/09/2020 03:43	1,71	223	381,70	CHI
20200960789	ANAPOLIS	AN13388850	ANAPOLIS UNIVERSITARIO S2	22/09/2020 01:53	22/09/2020 14:20	22/09/2020 02:00	22/09/2020 05:01	3,03	843	2550,54	CHI
20200960789	ANAPOLIS	AN12407497LD	ANAPOLIS UNIVERSITARIO S2	22/09/2020 01:53	22/09/2020 14:20	22/09/2020 02:00	22/09/2020 14:20	12,33	109	1343,55	CHI
20200960803	PETROLINA DE GOIAS	320007583	PETROLINA	22/09/2020 01:58	22/09/2020 08:51	22/09/2020 01:58	22/09/2020 08:51	6,88	1	6,88	CHI
20200960816	ITABERAI	IB11274344	ITABERAI S2	22/09/2020 02:08	22/09/2020 10:55	22/09/2020 02:08	22/09/2020 10:55	8,78	123	1079,80	CHI
20200960845	ANAPOLIS	20518067	JUNDIAI S2	22/09/2020 02:21	22/09/2020 19:31	22/09/2020 02:21	22/09/2020 19:31	17,17	1	17,17	CHI
20200960855	JARAGUA	70067636	JARAGUA	22/09/2020 02:25	22/09/2020 09:21	22/09/2020 02:25	22/09/2020 09:21	6,93	1	6,93	CHI
20200960871	IACIARA	1550013674	IACIARA S1	22/09/2020 02:32	22/09/2020 10:35	22/09/2020 02:32	22/09/2020 10:35	8,03	1	8,03	CHI
202009107102	ANAPOLIS	20249100	ANAPOLIS UNIVERSITARIO S1	22/09/2020 02:34	22/09/2020 04:02	22/09/2020 02:34	22/09/2020 04:02	1,48	1	1,48	CHI
20200960885	ITAGUARI	II21183094	ITABERAI S1	22/09/2020 02:38	22/09/2020 07:48	22/09/2020 02:38	22/09/2020 07:48	5,16	2	10,32	CHI
20200960886	IPORA	730101538	IPORA	22/09/2020 02:39	22/09/2020 14:15	22/09/2020 02:39	22/09/2020 14:15	11,59	1	11,59	CHI
20200960919	GOIANAPOLIS	950019318	DAIA S2	22/09/2020 02:51	22/09/2020 10:11	22/09/2020 02:51	22/09/2020 10:11	7,33	1	7,33	CHI

INTERNAL

20200960920	PLANALTINA	PI12131808	PLANALTINA	22/09/2020 02:51	22/09/2020 10:11	22/09/2020 02:51	22/09/2020 10:11	7,33	1	7,33	CHI
20200960927	IPORA	730048834	IPORA	22/09/2020 02:54	22/09/2020 10:17	22/09/2020 02:54	22/09/2020 10:17	7,38	1	7,38	CHI
20200962327	FORMOSO	FO12000025	PORANGATU	22/09/2020 02:54	22/09/2020 08:27	22/09/2020 02:54	22/09/2020 08:27	5,54	447	2477,75	CHI
20200960934	INDIARA	IY12395106	EDEIA	22/09/2020 02:55	22/09/2020 09:50	22/09/2020 02:55	22/09/2020 09:50	6,91	283	1954,90	CHI
20200960934	JANDAIA	IY12395106	PALMEIRAS	22/09/2020 02:55	22/09/2020 09:50	22/09/2020 02:55	22/09/2020 09:50	6,91	16	110,52	CHI
20200960934	INDIARA	IY12395106	PALMEIRAS	22/09/2020 02:55	22/09/2020 09:50	22/09/2020 02:55	22/09/2020 09:50	6,91	49	338,48	CHI
20200960937	IPORA	730017114	IPORA	22/09/2020 02:56	22/09/2020 06:58	22/09/2020 02:56	22/09/2020 06:58	4,03	1	4,03	CHI
20200960952	SAO LUIS DE MONTES BELOS	SL12233451	SAO LUIZ DOS MONTES BELOS	22/09/2020 03:03	22/09/2020 11:01	22/09/2020 03:03	22/09/2020 11:01	7,96	211	1678,97	CHI
202009107103	ANAPOLIS	20656993	ANAPOLIS UNIVERSITARIO S1	22/09/2020 03:13	22/09/2020 04:02	22/09/2020 03:13	22/09/2020 04:02	0,83	1	0,83	CHI
20200962462	JARAGUA	JA11370455	JARAGUA	22/09/2020 03:13	22/09/2020 08:45	22/09/2020 03:13	22/09/2020 08:45	5,53	88	486,44	CHI
2020092200145	NOVA GLORIA	09102	ITAPACI	22/09/2020 03:14	22/09/2020 03:17	22/09/2020 03:14	22/09/2020 03:17	0,05	4	0,20	CHI
2020092200145	ITAPACI	02600414	ITAPACI	22/09/2020 03:14	22/09/2020 03:17	22/09/2020 03:14	22/09/2020 03:17	0,05	3	0,15	CHI
2020092200145	ITAPACI	19501	ITAPACI	22/09/2020 03:14	22/09/2020 03:17	22/09/2020 03:14	22/09/2020 03:17	0,05	174	8,70	CHI
2020092200145	GUARINOS	09102	ITAPACI	22/09/2020 03:14	22/09/2020 03:17	22/09/2020 03:14	22/09/2020 03:17	0,05	7	0,35	CHI
2020092200145	ITAPACI	09101	ITAPACI	22/09/2020 03:14	22/09/2020 03:17	22/09/2020 03:14	22/09/2020 03:17	0,05	5396	269,80	CHI
2020092200145	ITAPACI	09102	ITAPACI	22/09/2020 03:14	22/09/2020 03:17	22/09/2020 03:14	22/09/2020 03:17	0,05	3410	170,50	CHI
2020092200145	PILAR DE GOIAS	09102	ITAPACI	22/09/2020 03:14	22/09/2020 03:17	22/09/2020 03:14	22/09/2020 03:17	0,05	1	0,05	CHI
2020092200145	GUARINOS	19501	ITAPACI	22/09/2020 03:14	22/09/2020 03:17	22/09/2020 03:14	22/09/2020 03:17	0,05	20	1,00	CHI
2020092200145	NOVA GLORIA	19501	ITAPACI	22/09/2020 03:14	22/09/2020 03:17	22/09/2020 03:14	22/09/2020 03:17	0,05	2	0,10	CHI
2020092200145	NOVA GLORIA	09101	ITAPACI	22/09/2020 03:14	22/09/2020 03:17	22/09/2020 03:14	22/09/2020 03:17	0,05	27	1,35	CHI
2020092200145	PILAR DE GOIAS	09101	ITAPACI	22/09/2020 03:14	22/09/2020 03:17	22/09/2020 03:14	22/09/2020 03:17	0,05	38	1,90	CHI
20200960975	RIO VERDE	630229200	RIO VERDE S1	22/09/2020 03:15	22/09/2020 12:23	22/09/2020 03:15	22/09/2020 12:23	9,12	1	9,12	CHI
20200961000	PARAUNA	PU13233446	FIRMINOPOLIS S2	22/09/2020 03:21	22/09/2020 22:31	22/09/2020 03:21	22/09/2020 09:08	5,78	7	40,48	CHI
20200961000	SAO JOAO DA PARAUNA	PU13233446	FIRMINOPOLIS S2	22/09/2020 03:21	22/09/2020 22:31	22/09/2020 03:21	22/09/2020 09:08	5,78	55	318,07	CHI
20200961000	FIRMINOPOLIS	PU13233446	FIRMINOPOLIS S2	22/09/2020 03:21	22/09/2020 22:31	22/09/2020 03:21	22/09/2020 09:08	5,78	3	17,35	CHI
20200961000	PALMINOPOLIS	PU13233446	FIRMINOPOLIS S2	22/09/2020 03:21	22/09/2020 22:31	22/09/2020 03:21	22/09/2020 09:08	5,78	1	5,78	CHI
20200961000	AURILANDIA	PU13233446	FIRMINOPOLIS S2	22/09/2020 03:21	22/09/2020 22:31	22/09/2020 03:21	22/09/2020 09:08	5,78	17	98,31	CHI
20200961000	AURILANDIA	00490404	FIRMINOPOLIS S2	22/09/2020 03:21	22/09/2020 22:31	22/09/2020 03:21	22/09/2020 12:44	9,38	1	9,38	CHI
20200961000	FIRMINOPOLIS	00490404	FIRMINOPOLIS S2	22/09/2020 03:21	22/09/2020 22:31	22/09/2020 03:21	22/09/2020 12:44	9,38	19	178,16	CHI
20200961000	AURILANDIA	00490404	FIRMINOPOLIS S2	22/09/2020 03:21	22/09/2020 22:31	22/09/2020 03:21	22/09/2020 13:38	10,27	42	431,55	CHI
20200961000	FIRMINOPOLIS	00490404	FIRMINOPOLIS S2	22/09/2020 03:21	22/09/2020 22:31	22/09/2020 03:21	22/09/2020 13:38	10,27	16	164,40	CHI
20200961000	SAO JOAO DA PARAUNA	00490404	FIRMINOPOLIS S2	22/09/2020 03:21	22/09/2020 22:31	22/09/2020 03:21	22/09/2020 14:26	11,07	70	774,88	CHI
20200961000	AURILANDIA	00490404	FIRMINOPOLIS S2	22/09/2020 03:21	22/09/2020 22:31	22/09/2020 03:21	22/09/2020 14:26	11,07	1554	17202,35	CHI

INTERNAL

20200961000	FIRMINOPOLIS	00490404	FIRMINOPOLIS S2	22/09/2020 03:21	22/09/2020 22:31	22/09/2020 03:21	22/09/2020 14:26	11,07	112	1239,81	CHI
20200961000	CACHOEIRA DE GOIAS	00490404	FIRMINOPOLIS S2	22/09/2020 03:21	22/09/2020 22:31	22/09/2020 03:21	22/09/2020 14:26	11,07	768	8501,55	CHI
20200961000	PARAUNA	00490404	FIRMINOPOLIS S2	22/09/2020 03:21	22/09/2020 22:31	22/09/2020 03:21	22/09/2020 14:26	11,07	30	332,09	CHI
20200961000	MOIPORA	00490404	FIRMINOPOLIS S2	22/09/2020 03:21	22/09/2020 22:31	22/09/2020 03:21	22/09/2020 14:26	11,07	1	11,07	CHI
20200961000	AURILANDIA	00490404	FIRMINOPOLIS S2	22/09/2020 03:21	22/09/2020 22:31	22/09/2020 05:28	22/09/2020 12:44	7,27	1	7,27	CHI
20200961000	AURILANDIA	FR13126024	FIRMINOPOLIS S2	22/09/2020 03:21	22/09/2020 22:31	22/09/2020 05:28	22/09/2020 13:38	8,17	1	8,17	CHI
20200961000	PALMINOPOLIS	RP10403066	FIRMINOPOLIS S2	22/09/2020 03:21	22/09/2020 22:31	22/09/2020 09:12	22/09/2020 10:22	1,18	2	2,36	CHI
20200961000	FIRMINOPOLIS	RP10403066	FIRMINOPOLIS S2	22/09/2020 03:21	22/09/2020 22:31	22/09/2020 09:12	22/09/2020 10:22	1,18	3	3,54	CHI
20200961000	SAO JOAO DA PARAUNA	RP10403066	FIRMINOPOLIS S2	22/09/2020 03:21	22/09/2020 22:31	22/09/2020 09:12	22/09/2020 10:22	1,18	50	58,93	CHI
20200961000	AURILANDIA	RP10403066	FIRMINOPOLIS S2	22/09/2020 03:21	22/09/2020 22:31	22/09/2020 09:12	22/09/2020 10:22	1,18	18	21,22	CHI
20200961000	PARAUNA	PU13233446	FIRMINOPOLIS S2	22/09/2020 03:21	22/09/2020 22:31	22/09/2020 17:20	22/09/2020 20:57	3,62	3	10,86	CHI
20200961000	PARAUNA	PU13363283	FIRMINOPOLIS S2	22/09/2020 03:21	22/09/2020 22:31	22/09/2020 21:47	22/09/2020 22:31	0,73	10	7,29	CHI
20200961000	SAO JOAO DA PARAUNA	PU13363283	FIRMINOPOLIS S2	22/09/2020 03:21	22/09/2020 22:31	22/09/2020 21:47	22/09/2020 22:31	0,73	2	1,46	CHI
20200961036	SAO LUIZ DO NORTE	SZ12348617	ITAPACI	22/09/2020 03:40	22/09/2020 10:43	22/09/2020 03:40	22/09/2020 10:43	7,04	7	49,30	CHI
20200961062	MAURILANDIA	ML16406930	RIO DOS BOIS	22/09/2020 03:43	23/09/2020 01:46	22/09/2020 03:43	22/09/2020 03:47	0,08	652	49,99	CHI
20200961062	MAURILANDIA	ML16406950	RIO DOS BOIS	22/09/2020 03:43	23/09/2020 01:46	22/09/2020 03:43	22/09/2020 03:47	0,08	399	30,59	CHI
20200961062	MAURILANDIA	ML16418462	RIO DOS BOIS	22/09/2020 03:43	23/09/2020 01:46	22/09/2020 03:43	22/09/2020 03:48	0,09	1353	125,15	CHI
20200961062	TURVELANDIA	TD10400677	RIO DOS BOIS	22/09/2020 03:43	23/09/2020 01:46	22/09/2020 03:43	22/09/2020 11:24	7,69	1	7,69	CHI
20200961062	PORTEIRAO	TD10400677	RIO DOS BOIS	22/09/2020 03:43	23/09/2020 01:46	22/09/2020 03:43	22/09/2020 11:24	7,69	13	99,96	CHI
20200961062	MAURILANDIA	CL13030865	RIO DOS BOIS	22/09/2020 03:43	23/09/2020 01:46	22/09/2020 03:43	22/09/2020 14:18	10,58	5	52,92	CHI
20200961062	PORTEIRAO	CL13030865	RIO DOS BOIS	22/09/2020 03:43	23/09/2020 01:46	22/09/2020 03:43	22/09/2020 14:18	10,58	7	74,09	CHI
20200961062	PORTEIRAO	CL13030904	RIO DOS BOIS	22/09/2020 03:43	23/09/2020 01:46	22/09/2020 03:43	23/09/2020 01:46	22,05	8	176,38	CHI
20200961063	BURITI DE GOIAS	SC12052751	FIRMINOPOLIS S2	22/09/2020 03:49	22/09/2020 05:01	22/09/2020 03:49	22/09/2020 05:01	1,18	3	3,55	CHI
20200961063	SANCLERLANDIA	SC12052751	FIRMINOPOLIS S2	22/09/2020 03:49	22/09/2020 05:01	22/09/2020 03:49	22/09/2020 05:01	1,18	19	22,51	CHI
20200961066	ANAPOLIS	20989738	ANAPOLIS UNIVERSITARIO S1	22/09/2020 03:52	22/09/2020 15:55	22/09/2020 03:52	22/09/2020 15:55	12,04	1	12,04	CHI
20200961087	SAO LUIS DE MONTES BELOS	500031113	SAO LUIZ DOS MONTES BELOS	22/09/2020 03:59	22/09/2020 09:48	22/09/2020 03:59	22/09/2020 09:48	5,80	1	5,80	CHI
20200961129	ANAPOLIS	AN10383660	ANAPOLIS UNIVERSITARIO S1	22/09/2020 04:02	22/09/2020 11:25	22/09/2020 04:02	22/09/2020 04:06	0,07	1145	76,33	CHI
20200961129	ANAPOLIS	AN10383660	ANAPOLIS UNIVERSITARIO S1	22/09/2020 04:02	22/09/2020 11:25	22/09/2020 04:02	22/09/2020 04:07	0,08	2084	162,67	CHI
20200961129	ANAPOLIS	AN10383660	ANAPOLIS UNIVERSITARIO S1	22/09/2020 04:02	22/09/2020 11:25	22/09/2020 04:02	22/09/2020 04:09	0,11	1048	110,62	CHI
20200961129	ANAPOLIS	AN10383660	ANAPOLIS UNIVERSITARIO S1	22/09/2020 04:02	22/09/2020 11:25	22/09/2020 04:02	22/09/2020 04:09	0,12	1057	126,84	CHI
20200961129	ANAPOLIS	AN10383660	ANAPOLIS UNIVERSITARIO S1	22/09/2020 04:02	22/09/2020 11:25	22/09/2020 04:02	22/09/2020 11:23	7,34	855	6278,79	CHI
20200961129	ANAPOLIS	AN10383660	ANAPOLIS UNIVERSITARIO S1	22/09/2020 04:02	22/09/2020 11:25	22/09/2020 04:02	22/09/2020 11:25	7,39	3010	22233,87	CHI
20200961113	ANAPOLIS	AN10411436	ANAPOLIS UNIVERSITARIO S2	22/09/2020 04:06	22/09/2020 10:04	22/09/2020 04:06	22/09/2020 10:04	5,97	1097	6548,79	CHI

INTERNAL

20200961110	ITABERAÍ	IB12078567	ITABERAÍ S1	22/09/2020 04:08	22/09/2020 11:07	22/09/2020 04:08	22/09/2020 11:07	6,98	7	48,84	CHI
20200961110	ITAUCU	IB12078567	ITABERAÍ S1	22/09/2020 04:08	22/09/2020 11:07	22/09/2020 04:08	22/09/2020 11:07	6,98	1	6,98	CHI
20200961117	POSSE	PS21160025	IACIARA S2	22/09/2020 04:12	22/09/2020 18:50	22/09/2020 04:12	22/09/2020 18:50	14,63	1	14,63	CHI
20200961127	ANAPOLIS	AN11141059	JUNDIAÍ S1	22/09/2020 04:15	22/09/2020 16:36	22/09/2020 04:15	22/09/2020 16:36	12,34	89	1098,31	CHI
20200961141	FORMOSA	FA11302888	ITUIQUIRA	22/09/2020 04:22	22/09/2020 09:35	22/09/2020 04:22	22/09/2020 09:35	5,22	64	333,78	CHI
20200961156	ANAPOLIS	20150945	JUNDIAÍ S2	22/09/2020 04:27	23/09/2020 00:48	22/09/2020 04:27	23/09/2020 00:48	20,35	1	20,35	CHI
20200961163	JARAGUA	JA12273177	JARAGUA	22/09/2020 04:28	22/09/2020 07:50	22/09/2020 04:28	22/09/2020 07:50	3,35	6	20,13	CHI
20200963672	CIDADE OCIDENTAL	DH11355907	MARAJÓARA	22/09/2020 04:35	22/09/2020 12:54	22/09/2020 04:35	22/09/2020 12:54	8,31	41	340,84	CHI
20200961188	GOIAS	GS12099152	GOIAS	22/09/2020 04:36	22/09/2020 05:39	22/09/2020 04:36	22/09/2020 05:39	1,05	7	7,33	CHI
20200961200	GOIANESIA	GE11000026	GOIANESIA S2	22/09/2020 04:41	22/09/2020 09:35	22/09/2020 04:41	22/09/2020 09:35	4,89	108	527,67	CHI
20200961220	SAO JOAO DA PARAUNA	PU10377154	PARAUNA	22/09/2020 04:44	22/09/2020 11:35	22/09/2020 04:44	22/09/2020 04:47	0,06	51	2,95	CHI
20200961220	PARAUNA	PU10377154	PARAUNA	22/09/2020 04:44	22/09/2020 11:35	22/09/2020 04:44	22/09/2020 04:47	0,06	37	2,14	CHI
20200961220	PARAUNA	PU10377154	PARAUNA	22/09/2020 04:44	22/09/2020 11:35	22/09/2020 04:44	22/09/2020 06:50	2,10	40	84,20	CHI
20200961220	JANDAIA	PU10377154	PARAUNA	22/09/2020 04:44	22/09/2020 11:35	22/09/2020 04:44	22/09/2020 09:45	5,03	3	15,08	CHI
20200961220	PARAUNA	PU10377154	PARAUNA	22/09/2020 04:44	22/09/2020 11:35	22/09/2020 04:44	22/09/2020 09:45	5,03	17	85,48	CHI
20200961220	PARAUNA	PU12103374	PARAUNA	22/09/2020 04:44	22/09/2020 11:35	22/09/2020 04:44	22/09/2020 11:08	6,40	5	32,00	CHI
20200961220	PARAUNA	PU12103379LD	PARAUNA	22/09/2020 04:44	22/09/2020 11:35	22/09/2020 04:44	22/09/2020 11:35	6,85	7	47,98	CHI
20200961930	QUIRINOPOLIS	QI12271537	QUIRINOPOLIS	22/09/2020 04:45	22/09/2020 16:48	22/09/2020 04:45	22/09/2020 16:48	12,05	93	1120,83	CHI
20200961215	ANAPOLIS	20466286	JUNDIAÍ S2	22/09/2020 04:48	22/09/2020 12:53	22/09/2020 04:48	22/09/2020 12:53	8,07	1	8,07	CHI
20200961217	BURITI DE GOIAS	BS12008822	FIRMINOPOLIS S2	22/09/2020 04:48	22/09/2020 11:23	22/09/2020 04:48	22/09/2020 11:23	6,58	33	217,09	CHI
20200963399	LUZIANIA	LZ12000383	MARAJÓARA	22/09/2020 04:51	22/09/2020 09:48	22/09/2020 04:51	22/09/2020 09:48	4,94	1044	5160,84	CHI
20200967307	GUARANI DE GOIAS	GY12393812	IACIARA S1	22/09/2020 04:52	22/09/2020 15:49	22/09/2020 04:52	22/09/2020 15:49	10,95	22	240,90	CHI
20200962612	SAO LUIS DE MONTES BELOS	SL12388874	SAO LUIZ DOS MONTES BELOS	22/09/2020 04:53	22/09/2020 15:31	22/09/2020 04:53	22/09/2020 15:31	10,63	27	286,93	CHI
20200967188	MUTUNOPOLIS	LC12182362	MARA ROSA	22/09/2020 04:55	23/09/2020 01:19	22/09/2020 04:55	23/09/2020 01:19	20,39	2	40,79	CHI
20200967188	AMARALINA	LC12182362	MARA ROSA	22/09/2020 04:55	23/09/2020 01:19	22/09/2020 04:55	23/09/2020 01:19	20,39	105	2141,24	CHI
20200967188	MARA ROSA	LC12182362	MARA ROSA	22/09/2020 04:55	23/09/2020 01:19	22/09/2020 04:55	23/09/2020 01:19	20,39	8	163,14	CHI
20200963247	ANAPOLIS	AN12382308	ANAPOLIS UNIVERSITARIO S2	22/09/2020 05:01	22/09/2020 12:18	22/09/2020 05:01	22/09/2020 12:18	7,28	267	1943,91	CHI
20200961251	PIRENOPOLIS	PV21332856	SAO FRANCISCO DE GOIAS	22/09/2020 05:04	22/09/2020 09:14	22/09/2020 05:04	22/09/2020 09:14	4,15	2	8,31	CHI
20200962054	ANAPOLIS	AN12000049	ANAPOLIS UNIVERSITARIO S2	22/09/2020 05:12	22/09/2020 08:29	22/09/2020 05:12	22/09/2020 08:29	3,27	684	2238,96	CHI
20200962841	ANAPOLIS	AN11077943	ANAPOLIS UNIVERSITARIO S2	22/09/2020 05:15	22/09/2020 08:48	22/09/2020 05:15	22/09/2020 08:48	3,54	73	258,48	CHI
20200961938	FIRMINOPOLIS	SL12004026RE	SAO LUIZ DOS MONTES BELOS	22/09/2020 05:16	22/09/2020 15:14	22/09/2020 05:16	22/09/2020 15:14	9,96	92	916,19	CHI
20200961938	SAO LUIS DE MONTES BELOS	SL12004026RE	SAO LUIZ DOS MONTES BELOS	22/09/2020 05:16	22/09/2020 15:14	22/09/2020 05:16	22/09/2020 15:14	9,96	99	985,90	CHI
20200964647	CAMPOS VERDES	VD11055150	SANTA TEREZINHA	22/09/2020 05:16	22/09/2020 15:43	22/09/2020 14:40	22/09/2020 15:43	1,05	129	135,13	CHI

INTERNAL

20200959751	JATAI	JT12219384RE	JATAI S3	22/09/2020 05:17	22/09/2020 08:44	22/09/2020 05:17	22/09/2020 08:44	3,45	80	275,64	CHI
20200964033	SAO LUIZ DO NORTE	SZ12090338	ITAPACI	22/09/2020 05:17	22/09/2020 11:50	22/09/2020 05:17	22/09/2020 11:50	6,54	294	1923,33	CHI
20200961314	RIO VERDE	RV12360999	CABRIUVA S1	22/09/2020 05:23	22/09/2020 08:25	22/09/2020 05:23	22/09/2020 08:25	3,03	144	436,28	CHI
20200965310	RUBIATABA	RB12062073	RUBIATABA	22/09/2020 05:32	22/09/2020 16:01	22/09/2020 05:32	22/09/2020 16:01	10,48	2	20,95	CHI
20200961350	ANAPOLIS	AN11215206	ANAPOLIS UNIVERSITARIO S2	22/09/2020 05:32	22/09/2020 09:53	22/09/2020 05:32	22/09/2020 09:53	4,34	57	247,10	CHI
20200961357	JARAGUA	70020395	JARAGUA	22/09/2020 05:34	22/09/2020 09:20	22/09/2020 05:34	22/09/2020 09:20	3,76	1	3,76	CHI
20200965981	DIORAMA	ME12062803	ARENOPOLIS	22/09/2020 05:36	22/09/2020 19:36	22/09/2020 05:36	22/09/2020 19:36	13,99	2	27,98	CHI
20200965981	MONTES CLAROS DE GOIAS	ME12062803	ARENOPOLIS	22/09/2020 05:36	22/09/2020 19:36	22/09/2020 05:36	22/09/2020 19:36	13,99	6	83,94	CHI
20200960118	ITABERAI	19619413	ITABERAI S2	22/09/2020 05:37	22/09/2020 09:20	22/09/2020 05:37	22/09/2020 09:20	3,72	83	308,37	CHI
20200962864	SAO DOMINGOS	GH12088002	SAO DOMINGOS	22/09/2020 05:38	22/09/2020 11:12	22/09/2020 05:38	22/09/2020 11:12	5,56	128	711,43	CHI
20200962864	DIVINOPOLIS DE GOIAS	GH12088002	SAO DOMINGOS	22/09/2020 05:38	22/09/2020 11:12	22/09/2020 05:38	22/09/2020 11:12	5,56	48	266,79	CHI
20200964341	MUTUNOPOLIS	MU12257886	MARA ROSA	22/09/2020 05:40	24/09/2020 18:16	22/09/2020 05:40	24/09/2020 18:16	60,61	1	60,61	CHI
20200964341	AMARALINA	MU12257886	MARA ROSA	22/09/2020 05:40	24/09/2020 18:16	22/09/2020 05:40	24/09/2020 18:16	60,61	36	2181,91	CHI
20200961422	SAO LUIS DE MONTES BELOS	SL16414970	SAO LUIZ DOS MONTES BELOS	22/09/2020 05:42	22/09/2020 14:35	22/09/2020 05:42	22/09/2020 08:33	2,84	1556	4423,79	CHI
20200961422	SAO LUIS DE MONTES BELOS	SL16414970	SAO LUIZ DOS MONTES BELOS	22/09/2020 05:42	22/09/2020 14:35	22/09/2020 05:42	22/09/2020 08:33	2,84	289	821,64	CHI
20200961422	SAO LUIS DE MONTES BELOS	SL13126009	SAO LUIZ DOS MONTES BELOS	22/09/2020 05:42	22/09/2020 14:35	22/09/2020 05:42	22/09/2020 10:53	5,17	139	718,75	CHI
20200961422	SAO LUIS DE MONTES BELOS	SL16418791	SAO LUIZ DOS MONTES BELOS	22/09/2020 05:42	22/09/2020 14:35	22/09/2020 05:42	22/09/2020 10:58	5,26	120	631,30	CHI
20200961422	SAO LUIS DE MONTES BELOS	SL16418791	SAO LUIZ DOS MONTES BELOS	22/09/2020 05:42	22/09/2020 14:35	22/09/2020 05:42	22/09/2020 10:58	5,26	1693	8906,59	CHI
20200961422	SAO LUIS DE MONTES BELOS	SL12000041LD	SAO LUIZ DOS MONTES BELOS	22/09/2020 05:42	22/09/2020 14:35	22/09/2020 05:42	22/09/2020 14:10	8,45	62	524,12	CHI
20200961422	SAO LUIS DE MONTES BELOS	SL11000058	SAO LUIZ DOS MONTES BELOS	22/09/2020 05:42	22/09/2020 14:35	22/09/2020 05:42	22/09/2020 14:35	8,87	227	2013,55	CHI
20200961400	ANAPOLIS	10001968031	JUNDIAI S2	22/09/2020 05:42	23/09/2020 03:35	22/09/2020 05:42	23/09/2020 03:35	21,87	1	21,87	CHI
20200966518	PALMINOPOLIS	PP12031600	PALMEIRAS	22/09/2020 05:43	22/09/2020 16:21	22/09/2020 05:43	22/09/2020 16:21	10,63	26	276,37	CHI
20200961428	URUACU	UR21181452	URUACU	22/09/2020 05:47	22/09/2020 08:17	22/09/2020 05:47	22/09/2020 08:17	2,50	2	4,99	CHI
20200962435	MUTUNOPOLIS	MU12076698	MARA ROSA	22/09/2020 05:48	23/09/2020 14:27	22/09/2020 05:48	23/09/2020 14:27	32,64	29	946,43	CHI
20200962435	ESTRELA DO NORTE	MU12076698	MARA ROSA	22/09/2020 05:48	23/09/2020 14:27	22/09/2020 05:48	23/09/2020 14:27	32,64	1	32,64	CHI
20200961449	MOZARLANDIA	AZ12290380	MOZARLANDIA	22/09/2020 05:50	22/09/2020 07:55	22/09/2020 05:50	22/09/2020 07:55	2,08	2	4,15	CHI
20200961449	ARAGUAPAZ	AZ12290380	MOZARLANDIA	22/09/2020 05:50	22/09/2020 07:55	22/09/2020 05:50	22/09/2020 07:55	2,08	7	14,53	CHI
20200961452	ITAPURANGA	IK12316147	ITAPURANGA	22/09/2020 05:51	23/09/2020 08:36	22/09/2020 05:51	23/09/2020 08:36	26,75	2	53,50	CHI
20200963029	FORMOSA	FA12098456	ITUIQUIRA	22/09/2020 05:51	22/09/2020 13:58	22/09/2020 05:51	22/09/2020 10:13	4,36	101	440,00	CHI
20200963029	FORMOSA	FA12098456	ITUIQUIRA	22/09/2020 05:51	22/09/2020 13:58	22/09/2020 05:51	22/09/2020 13:58	8,10	222	1798,45	CHI
20200963599	BARRO ALTO	BA12035658	BARRO ALTO	22/09/2020 05:54	22/09/2020 13:02	22/09/2020 05:54	22/09/2020 13:02	7,13	3	21,39	CHI
20200963599	NIQUELANDIA	BA12035658	BARRO ALTO	22/09/2020 05:54	22/09/2020 13:02	22/09/2020 05:54	22/09/2020 13:02	7,13	1	7,13	CHI
20200961477	ANAPOLIS	20342809	JUNDIAI S2	22/09/2020 05:54	22/09/2020 14:23	22/09/2020 05:54	22/09/2020 14:23	8,48	1	8,48	CHI

INTERNAL

20200961487	IACIARA	ND21381621	IACIARA S2	22/09/2020 05:57	22/09/2020 10:56	22/09/2020 05:57	22/09/2020 10:56	4,98	1	4,98	CHI
20200961488	SAO LUIS DE MONTES BELOS	SL21006935	SAO LUIZ DOS MONTES BELOS	22/09/2020 05:57	22/09/2020 06:37	22/09/2020 05:57	22/09/2020 06:37	0,66	3	1,98	CHI
20200961493	ANAPOLIS	AN12258960	ANAPOLIS UNIVERSITARIO S1	22/09/2020 05:58	22/09/2020 17:28	22/09/2020 05:58	22/09/2020 17:28	11,49	7	80,45	CHI
20200961511	LUZIANIA	10021460220	RIO VERMELHO	22/09/2020 06:01	22/09/2020 13:21	22/09/2020 06:01	22/09/2020 13:21	7,33	1	7,33	CHI
20200961518	AVELINOPOLIS	AV21011826	ANICUNS	22/09/2020 06:01	22/09/2020 07:20	22/09/2020 06:01	22/09/2020 07:20	1,30	1	1,30	CHI
20200961526	LUZIANIA	LZ12000232	RIO VERMELHO	22/09/2020 06:03	22/09/2020 08:46	22/09/2020 06:03	22/09/2020 08:46	2,72	41	111,38	CHI
20200961531	PLANALTINA	10004561471	PLANALTINA	22/09/2020 06:03	22/09/2020 19:57	22/09/2020 06:03	22/09/2020 19:57	13,89	1	13,89	CHI
20200961533	CAIAPONIA	CP12238236	CAIAPONIA	22/09/2020 06:03	22/09/2020 17:20	22/09/2020 06:03	22/09/2020 17:20	11,27	3	33,82	CHI
20200961537	ANAPOLIS	20301054	JUNDIAI S2	22/09/2020 06:04	22/09/2020 10:43	22/09/2020 06:04	22/09/2020 10:43	4,64	1	4,64	CHI
20200961539	SANTA HELENA DE GOIAS	SH21295820	IPEGUARI	22/09/2020 06:05	22/09/2020 07:33	22/09/2020 06:05	22/09/2020 07:33	1,46	2	2,93	CHI
20200961563	ANAPOLIS	AN21096787	JUNDIAI S1	22/09/2020 06:09	22/09/2020 07:45	22/09/2020 06:09	22/09/2020 07:45	1,60	1	1,60	CHI
20200964216	DOVERLANDIA	MY12217015RE	PARQUE DAS EMAS	22/09/2020 06:09	22/09/2020 22:25	22/09/2020 06:09	22/09/2020 22:25	16,26	31	504,20	CHI
20200964216	MINEIROS	MY12217015RE	PARQUE DAS EMAS	22/09/2020 06:09	22/09/2020 22:25	22/09/2020 06:09	22/09/2020 22:25	16,26	9	146,38	CHI
20200961805	PORANGATU	PO12104347	PORANGATU	22/09/2020 06:10	23/09/2020 09:44	22/09/2020 06:10	23/09/2020 09:44	27,57	8	220,52	CHI
20200962184	DOVERLANDIA	DV12023480	CAIAPONIA	22/09/2020 06:10	24/09/2020 01:40	22/09/2020 06:10	22/09/2020 15:14	9,05	3	27,16	CHI
20200962184	CAIAPONIA	DV12023480	CAIAPONIA	22/09/2020 06:10	24/09/2020 01:40	22/09/2020 06:10	22/09/2020 15:14	9,05	3	27,16	CHI
20200962184	CAIAPONIA	DV12023480	CAIAPONIA	22/09/2020 06:10	24/09/2020 01:40	22/09/2020 06:10	24/09/2020 00:06	41,92	4	167,69	CHI
20200962184	PIRANHAS	DV12023480	CAIAPONIA	22/09/2020 06:10	24/09/2020 01:40	22/09/2020 06:10	24/09/2020 01:40	43,49	6	260,95	CHI
20200961582	CIDADE OCIDENTAL	DH11325532	MARAJOARA	22/09/2020 06:10	22/09/2020 12:15	22/09/2020 06:10	22/09/2020 12:15	6,07	81	491,65	CHI
20200962184	CAIAPONIA	DV12023480	CAIAPONIA	22/09/2020 06:10	24/09/2020 01:40	22/09/2020 09:55	22/09/2020 15:14	5,32	100	531,67	CHI
20200962184	DOVERLANDIA	DV12023480	CAIAPONIA	22/09/2020 06:10	24/09/2020 01:40	22/09/2020 09:55	22/09/2020 15:14	5,32	8	42,53	CHI
20200962184	CAIAPONIA	CP12204323LD	CAIAPONIA	22/09/2020 06:10	24/09/2020 01:40	22/09/2020 09:55	22/09/2020 20:10	10,25	9	92,29	CHI
20200962184	CAIAPONIA	CP12054805LD	CAIAPONIA	22/09/2020 06:10	24/09/2020 01:40	22/09/2020 09:55	24/09/2020 00:06	38,18	20	763,69	CHI
20200962184	PIRANHAS	PH12187316LD	CAIAPONIA	22/09/2020 06:10	24/09/2020 01:40	22/09/2020 09:55	24/09/2020 01:40	39,75	71	2822,53	CHI
20200962184	CAIAPONIA	PH12187316LD	CAIAPONIA	22/09/2020 06:10	24/09/2020 01:40	22/09/2020 09:55	24/09/2020 01:40	39,75	10	397,54	CHI
20200961584	TEREZOPOLIS DE GOIAS	TJ11273378	DAIA S2	22/09/2020 06:11	22/09/2020 13:32	22/09/2020 06:11	22/09/2020 13:32	7,35	11	80,85	CHI
20200966127	PORANGATU	MU12391982	MARA ROSA	22/09/2020 06:11	22/09/2020 14:02	22/09/2020 06:11	22/09/2020 14:02	7,85	17	133,42	CHI
20200961588	BOM JARDIM DE GOIAS	BM11369875	ARAGARCAS	22/09/2020 06:11	22/09/2020 08:25	22/09/2020 06:11	22/09/2020 08:25	2,23	1	2,23	CHI
20200961589	ITAPIRAPUA	IU12072164	MATRINCHA	22/09/2020 06:11	22/09/2020 08:03	22/09/2020 06:11	22/09/2020 08:03	1,86	4	7,44	CHI
20200962460	JATAI	JT12184194	JATAI S1	22/09/2020 06:11	22/09/2020 12:33	22/09/2020 06:11	22/09/2020 12:33	6,35	12	76,24	CHI
20200963027	ALEXANIA	AX11101793	ALEXANIA	22/09/2020 06:12	22/09/2020 08:49	22/09/2020 06:12	22/09/2020 08:49	2,60	48	124,85	CHI
20200968972	ITABERAI	IB11018283	ITABERAI S2	22/09/2020 06:12	22/09/2020 16:55	22/09/2020 06:12	22/09/2020 16:55	10,70	182	1947,55	CHI
20200961607	PALMEIRAS DE GOIAS	PL21000023	PALMEIRAS	22/09/2020 06:13	22/09/2020 07:17	22/09/2020 06:13	22/09/2020 07:17	1,06	2	2,12	CHI

INTERNAL

20200961608	SIMOLANDIA	SA12221147	IACIARA S2	22/09/2020 06:13	22/09/2020 09:36	22/09/2020 06:13	22/09/2020 09:36	3,37	16	53,96	CHI
20200961613	JANDAIA	10022697517	PALMEIRAS	22/09/2020 06:14	22/09/2020 09:29	22/09/2020 06:14	22/09/2020 09:29	3,26	1	3,26	CHI
20200962377	PORANGATU	PO12027986	PORANGATU	22/09/2020 06:14	22/09/2020 15:34	22/09/2020 06:14	22/09/2020 15:34	9,33	9	83,98	CHI
20200961615	IPORA	IR12207784	IPORA	22/09/2020 06:14	22/09/2020 08:18	22/09/2020 06:14	22/09/2020 08:18	2,06	105	216,74	CHI
20200961616	FLORES DE GOIAS	FB12204157	FLORES DE GOIAS	22/09/2020 06:14	22/09/2020 21:31	22/09/2020 06:14	22/09/2020 21:31	15,28	13	198,64	CHI
20200961625	GUARANI DE GOIAS	GY21256739	SAO DOMINGOS	22/09/2020 06:15	22/09/2020 11:00	22/09/2020 06:15	22/09/2020 11:00	4,75	1	4,75	CHI
20200961632	ANAPOLIS	20158427	JUNDIAI S1	22/09/2020 06:15	23/09/2020 01:46	22/09/2020 06:15	23/09/2020 01:46	19,51	1	19,51	CHI
20200961641	ABADIANIA	AA21254180	ANAPOLIS UNIVERSITARIO S1	22/09/2020 06:16	22/09/2020 08:56	22/09/2020 06:16	22/09/2020 08:56	2,65	1	2,65	CHI
20200961849	PIRENOPOLIS	PV12381260	CORUMBA	22/09/2020 06:16	22/09/2020 09:58	22/09/2020 06:16	22/09/2020 09:58	3,68	76	279,95	CHI
20200962202	CEZARINA	CZ12314871	CEZARINA	22/09/2020 06:17	22/09/2020 15:07	22/09/2020 06:17	22/09/2020 15:07	8,83	20	176,68	CHI
20200961653	JATAI	JT12286459	CABRIUVA S2	22/09/2020 06:17	22/09/2020 11:38	22/09/2020 06:17	22/09/2020 11:38	5,34	9	48,09	CHI
20200961654	JATAI	JT12196081RE	JATAI S3	22/09/2020 06:17	22/09/2020 09:32	22/09/2020 06:17	22/09/2020 09:32	3,24	6	19,44	CHI
20200961659	GOIANESIA	GE12302590	GOIANESIA S2	22/09/2020 06:18	22/09/2020 09:00	22/09/2020 06:18	22/09/2020 09:00	2,70	2	5,40	CHI
20200961660	ARUANA	AK12328949	MOZARLANDIA	22/09/2020 06:18	22/09/2020 08:52	22/09/2020 06:18	22/09/2020 08:52	2,56	17	43,59	CHI
20200961836	SERRANOPOLIS	SX12361089	JATAI S1	22/09/2020 06:18	22/09/2020 07:27	22/09/2020 06:18	22/09/2020 07:27	1,14	5	5,70	CHI
20200961672	JARAGUA	JA12059799	ITABERAI S1	22/09/2020 06:18	22/09/2020 13:34	22/09/2020 06:18	22/09/2020 13:34	7,25	5	36,27	CHI
20200964731	TURVANIA	TV11005730	FIRMINOPOLIS S2	22/09/2020 06:18	22/09/2020 18:24	22/09/2020 08:09	22/09/2020 18:24	10,24	99	1013,65	CHI
20200963519	ITABERAI	IB12040389	ITABERAI S2	22/09/2020 06:19	22/09/2020 11:16	22/09/2020 06:19	22/09/2020 10:04	3,75	33	123,62	CHI
20200961681	ANAPOLIS	20629047	JUNDIAI S1	22/09/2020 06:19	23/09/2020 03:32	22/09/2020 06:19	23/09/2020 03:32	21,21	1	21,21	CHI
20200961686	SANTA HELENA DE GOIAS	SH21325774	SANTA HELENA S1	22/09/2020 06:19	22/09/2020 18:46	22/09/2020 06:19	22/09/2020 18:46	12,44	1	12,44	CHI
20200963519	ITABERAI	IB12108138	ITABERAI S2	22/09/2020 06:19	22/09/2020 11:16	22/09/2020 11:02	22/09/2020 11:16	0,22	28	6,25	CHI
20200961706	ARUANA	AK12404527	MOZARLANDIA	22/09/2020 06:21	22/09/2020 09:34	22/09/2020 06:21	22/09/2020 09:34	3,20	34	108,89	CHI
20200962013	SANTA TEREZINHA DE GOIAS	SG11181030	SANTA TEREZINHA	22/09/2020 06:22	22/09/2020 11:40	22/09/2020 06:22	22/09/2020 11:40	5,29	158	836,57	CHI
20200961747	FLORES DE GOIAS	FB12106993	FLORES DE GOIAS	22/09/2020 06:23	22/09/2020 18:05	22/09/2020 06:23	22/09/2020 18:05	11,69	14	163,65	CHI
20200961747	FORMOSA	FB12106993	FLORES DE GOIAS	22/09/2020 06:23	22/09/2020 18:05	22/09/2020 06:23	22/09/2020 18:05	11,69	138	1613,10	CHI
20200961747	SAO JOAO D ALIANCA	FB12106993	FLORES DE GOIAS	22/09/2020 06:23	22/09/2020 18:05	22/09/2020 06:23	22/09/2020 18:05	11,69	5	58,45	CHI
20200961747	FORMOSO	FB12106993	FLORES DE GOIAS	22/09/2020 06:23	22/09/2020 18:05	22/09/2020 06:23	22/09/2020 18:05	11,69	1	11,69	CHI
20200961732	CACHOEIRA ALTA	CA12094391	CACHOEIRA ALTA	22/09/2020 06:23	22/09/2020 13:04	22/09/2020 06:23	22/09/2020 13:04	6,67	7	46,69	CHI
20200969158	CAMPINORTE	CR12053035	MARA ROSA	22/09/2020 06:25	22/09/2020 18:43	22/09/2020 06:25	22/09/2020 18:43	12,30	4	49,20	CHI
20200961741	ANAPOLIS	20796171	ANAPOLIS UNIVERSITARIO S2	22/09/2020 06:25	22/09/2020 12:57	22/09/2020 06:25	22/09/2020 12:57	6,53	1	6,53	CHI
20200961750	ANAPOLIS	20268063	ANAPOLIS UNIVERSITARIO S2	22/09/2020 06:26	23/09/2020 04:24	22/09/2020 06:26	23/09/2020 04:24	21,96	1	21,96	CHI
20200966780	PLANALTINA	PI12103612	PLANALTINA	22/09/2020 06:27	22/09/2020 15:30	22/09/2020 06:27	22/09/2020 15:30	9,05	2	18,09	CHI
20200961760	PLANALTINA	PI12361252	PLANALTINA	22/09/2020 06:27	22/09/2020 19:41	22/09/2020 06:27	22/09/2020 19:41	13,23	35	462,88	CHI

INTERNAL

20200961763	ITAGUARI	II21401116	ITABERAÍ S1	22/09/2020 06:27	22/09/2020 10:32	22/09/2020 06:27	22/09/2020 10:32	4,07	1	4,07	CHI
20200962082	FORMOSA	FA12322646	ITIQUEIRA	22/09/2020 06:28	22/09/2020 09:43	22/09/2020 06:28	22/09/2020 09:43	3,24	126	408,35	CHI
20200961775	SANCLERLANDIA	SC21005478	FIRMINOPOLIS S2	22/09/2020 06:28	22/09/2020 11:18	22/09/2020 06:28	22/09/2020 11:18	4,82	1	4,82	CHI
20200961788	PARANAIGUARA	PC21000118	QUIRINOPOLIS	22/09/2020 06:29	22/09/2020 10:45	22/09/2020 06:29	22/09/2020 10:45	4,25	1	4,25	CHI
20200961693	FIRMINOPOLIS	8081405	FIRMINOPOLIS S1	22/09/2020 06:30	22/09/2020 13:53	22/09/2020 06:30	22/09/2020 13:41	7,17	5	35,87	CHI
20200961693	FIRMINOPOLIS	FR12096977LD	FIRMINOPOLIS S1	22/09/2020 06:30	22/09/2020 13:53	22/09/2020 06:30	22/09/2020 13:53	7,38	81	597,83	CHI
20200961799	ITAPURANGA	IK12299453	ITAPURANGA	22/09/2020 06:31	22/09/2020 09:02	22/09/2020 06:31	22/09/2020 09:02	2,52	8	20,12	CHI
20200961814	SANTO ANTONIO DO DESCOBERTO	SN12330527	MARAJOARA	22/09/2020 06:32	23/09/2020 13:05	22/09/2020 06:32	23/09/2020 10:56	28,40	12	340,81	CHI
20200961814	SANTO ANTONIO DO DESCOBERTO	SN12330527	MARAJOARA	22/09/2020 06:32	23/09/2020 13:05	22/09/2020 06:32	23/09/2020 13:05	30,55	2	61,10	CHI
20200962502	GOIAS	GS12188036	GOIAS	22/09/2020 06:32	22/09/2020 11:40	22/09/2020 06:32	22/09/2020 11:40	5,12	36	184,38	CHI
20200961814	SANTO ANTONIO DO DESCOBERTO	SN12330527	MARAJOARA	22/09/2020 06:32	23/09/2020 13:05	22/09/2020 12:14	23/09/2020 10:56	22,71	2	45,42	CHI
20200961830	CAVALCANTE	TE21379628	FLORES DE GOIAS	22/09/2020 06:34	22/09/2020 09:39	22/09/2020 06:34	22/09/2020 09:39	3,08	1	3,08	CHI
20200961833	NOVA CRIXAS	NA11229694	NOVA CRIXAS	22/09/2020 06:34	22/09/2020 09:42	22/09/2020 06:34	22/09/2020 09:42	3,12	1	3,12	CHI
20200961839	GOIAS	GS12233054	MATRINCHA	22/09/2020 06:35	22/09/2020 10:58	22/09/2020 06:35	22/09/2020 10:58	4,38	2	8,76	CHI
20200961840	IVOLANDIA	PU12306629	MONTIVIDIU T	22/09/2020 06:35	24/09/2020 18:08	22/09/2020 06:35	22/09/2020 20:02	13,45	3	40,34	CHI
20200961840	PARAUNA	PU12306629	MONTIVIDIU T	22/09/2020 06:35	24/09/2020 18:08	22/09/2020 06:35	22/09/2020 20:02	13,45	15	201,68	CHI
20200961840	IVOLANDIA	PU12306629	MONTIVIDIU T	22/09/2020 06:35	24/09/2020 18:08	22/09/2020 06:35	24/09/2020 18:08	59,56	19	1131,57	CHI
20200961846	PLANALTINA	PI12262322	PLANALTINA	22/09/2020 06:36	22/09/2020 12:29	22/09/2020 06:36	22/09/2020 12:29	5,88	13	76,48	CHI
20200964516	MONTIVIDIU DO NORTE	MX12168971	PORANGATU	22/09/2020 06:37	22/09/2020 11:43	22/09/2020 06:37	22/09/2020 11:43	5,08	238	1210,16	CHI
20200964076	MAMBAI	PS12189370	IACIARA S2	22/09/2020 06:38	22/09/2020 19:25	22/09/2020 06:38	22/09/2020 19:25	12,78	28	357,71	CHI
20200964076	BURITINOPOLIS	PS12189370	IACIARA S2	22/09/2020 06:38	22/09/2020 19:25	22/09/2020 06:38	22/09/2020 19:25	12,78	2	25,55	CHI
20200964076	POSSE	PS12189370	IACIARA S2	22/09/2020 06:38	22/09/2020 19:25	22/09/2020 06:38	22/09/2020 19:25	12,78	4	51,10	CHI
20200961882	PIRANHAS	1930013301	PIRANHAS	22/09/2020 06:40	22/09/2020 18:08	22/09/2020 06:40	22/09/2020 18:08	11,48	1	11,48	CHI
20200962767	IVOLANDIA	IR10409815	IPORA	22/09/2020 06:41	22/09/2020 14:27	22/09/2020 06:41	22/09/2020 14:27	7,76	57	442,19	CHI
20200962767	AMORINOPOLIS	IR10409815	IPORA	22/09/2020 06:41	22/09/2020 14:27	22/09/2020 06:41	22/09/2020 14:27	7,76	8	62,06	CHI
20200962767	MOIPORA	IR10409815	IPORA	22/09/2020 06:41	22/09/2020 14:27	22/09/2020 06:41	22/09/2020 14:27	7,76	14	108,61	CHI
20200962767	IPORA	IR10409815	IPORA	22/09/2020 06:41	22/09/2020 14:27	22/09/2020 06:41	22/09/2020 14:27	7,76	149	1155,91	CHI
20200962767	MOIPORA	IR16411417	IPORA	22/09/2020 06:41	22/09/2020 14:27	22/09/2020 12:51	22/09/2020 14:27	1,59	80	126,89	CHI
20200962767	IVOLANDIA	IR16411417	IPORA	22/09/2020 06:41	22/09/2020 14:27	22/09/2020 12:51	22/09/2020 14:27	1,59	6	9,52	CHI
20200962767	IPORA	IR16411417	IPORA	22/09/2020 06:41	22/09/2020 14:27	22/09/2020 12:51	22/09/2020 14:27	1,59	168	266,47	CHI
20200962767	ISRAELANDIA	IR16411417	IPORA	22/09/2020 06:41	22/09/2020 14:27	22/09/2020 12:51	22/09/2020 14:27	1,59	25	39,65	CHI
20200961908	JUSSARA	JR11034613	IPORA	22/09/2020 06:42	22/09/2020 09:45	22/09/2020 06:42	22/09/2020 09:45	3,04	36	109,45	CHI
20200961910	FORMOSA	FA11270018	ITIQUEIRA	22/09/2020 06:42	22/09/2020 09:54	22/09/2020 06:42	22/09/2020 09:54	3,19	1	3,19	CHI

INTERNAL

20200963369	PARAUNA	PU11000011	PARAUNA	22/09/2020 06:47	22/09/2020 08:43	22/09/2020 06:47	22/09/2020 08:43	1,93	92	177,25	CHI
20200961971	FORMOSA	610258370	ITUIQUIRA	22/09/2020 06:47	22/09/2020 11:19	22/09/2020 06:47	22/09/2020 11:19	4,53	1	4,53	CHI
20200961972	JARAGUA	JA21362327	JARAGUA	22/09/2020 06:47	22/09/2020 15:20	22/09/2020 06:47	22/09/2020 15:20	8,54	4	34,17	CHI
20200965109	CAIAPONIA	CP12237190	CAIAPONIA	22/09/2020 06:48	22/09/2020 11:37	22/09/2020 06:48	22/09/2020 11:37	4,81	2	9,61	CHI
20200961991	SANTA HELENA DE GOIAS	SH12387441	SANTA HELENA S1	22/09/2020 06:49	22/09/2020 09:46	22/09/2020 06:49	22/09/2020 09:46	2,95	3	8,84	CHI
20200961998	CAIAPONIA	CP21188422	PIRANHAS	22/09/2020 06:50	22/09/2020 10:30	22/09/2020 06:50	22/09/2020 10:30	3,66	1	3,66	CHI
20200963043	RIO VERDE	RV12303286	CABRIUVA S2	22/09/2020 06:52	22/09/2020 13:34	22/09/2020 06:52	22/09/2020 13:34	6,69	9	60,24	CHI
20200958814	CIDADE OCIDENTAL	DH12376123	MARAJOARA	22/09/2020 06:53	22/09/2020 14:41	22/09/2020 06:53	22/09/2020 14:41	7,80	6	46,79	CHI
20200966039	SANTA HELENA DE GOIAS	SH12271563LD	IPEGUARI	22/09/2020 06:54	23/09/2020 13:32	22/09/2020 06:54	23/09/2020 12:15	29,35	8	234,76	CHI
20200966039	SANTA HELENA DE GOIAS	SH12271563LD	IPEGUARI	22/09/2020 06:54	23/09/2020 13:32	22/09/2020 06:54	23/09/2020 12:47	29,87	2	59,75	CHI
20200966039	TURVELANDIA	SH12271563LD	IPEGUARI	22/09/2020 06:54	23/09/2020 13:32	22/09/2020 06:54	23/09/2020 12:47	29,87	9	268,87	CHI
20200966039	TURVELANDIA	SH12271563LD	IPEGUARI	22/09/2020 06:54	23/09/2020 13:32	22/09/2020 06:54	23/09/2020 13:32	30,64	3	91,91	CHI
20200966039	SANTA HELENA DE GOIAS	SH12271563LD	IPEGUARI	22/09/2020 06:54	23/09/2020 13:32	22/09/2020 06:54	23/09/2020 13:32	30,64	19	582,12	CHI
20200962052	SANTA FE DE GOIAS	RN21298935	BRITANIA	22/09/2020 06:55	22/09/2020 11:13	22/09/2020 06:55	22/09/2020 11:13	4,29	1	4,29	CHI
20200963880	SITIO D ABADIA	SI12236825	IACIARA S2	22/09/2020 06:56	22/09/2020 15:44	22/09/2020 06:56	22/09/2020 15:44	8,80	4	35,18	CHI
20200962066	PADRE BERNARDO	PB21172141	PADRE BERNARDO	22/09/2020 06:56	22/09/2020 11:13	22/09/2020 06:56	22/09/2020 11:13	4,28	1	4,28	CHI
20200962093	CAMPOS BELOS	CH12041155LD	SAO DOMINGOS	22/09/2020 06:56	22/09/2020 16:40	22/09/2020 08:48	22/09/2020 16:40	7,87	32	251,81	CHI
20200962077	SAO DOMINGOS	SD12132214	SAO DOMINGOS	22/09/2020 06:57	22/09/2020 13:50	22/09/2020 06:57	22/09/2020 13:50	6,88	3	20,63	CHI
20200964706	ANAPOLIS	AN11000063	ANAPOLIS UNIVERSITARIO S2	22/09/2020 06:58	22/09/2020 12:10	22/09/2020 06:58	22/09/2020 12:10	5,19	83	430,68	CHI
20200963100	URUACU	UR12003398	URUACU	22/09/2020 06:59	22/09/2020 12:03	22/09/2020 06:59	22/09/2020 12:03	5,06	69	349,27	CHI
20200962111	PADRE BERNARDO	10032135546	PADRE BERNARDO	22/09/2020 06:59	22/09/2020 11:47	22/09/2020 06:59	22/09/2020 11:47	4,80	1	4,80	CHI
20200962115	ITABERAI	50049227	ITABERAI S2	22/09/2020 07:00	22/09/2020 16:50	22/09/2020 07:00	22/09/2020 16:50	9,83	1	9,83	CHI
20200962116	ITABERAI	IB12230573	ITABERAI S2	22/09/2020 07:00	22/09/2020 20:05	22/09/2020 07:00	22/09/2020 20:05	13,08	3	39,23	CHI
20200962122	PALMEIRAS DE GOIAS	PL12000059	PALMEIRAS	22/09/2020 07:01	22/09/2020 08:35	22/09/2020 07:01	22/09/2020 08:35	1,56	5	7,80	CHI
20200963574	ANAPOLIS	AN11000452	ANAPOLIS UNIVERSITARIO S2	22/09/2020 07:02	22/09/2020 13:08	22/09/2020 07:02	22/09/2020 13:08	6,10	99	603,82	CHI
20200962144	ALTO PARAISO DE GOIAS	BF12128334	SAO JOAO D ALIANCA	22/09/2020 07:02	22/09/2020 16:27	22/09/2020 07:02	22/09/2020 16:27	9,40	3	28,20	CHI
20200962163	JESUPOLIS	JE12055331	SAO FRANCISCO DE GOIAS	22/09/2020 07:04	22/09/2020 13:54	22/09/2020 07:04	22/09/2020 13:54	6,84	184	1258,41	CHI
20200963740	PLANALTINA	PI11146240	SAO JOAO D ALIANCA	22/09/2020 07:05	22/09/2020 14:29	22/09/2020 07:05	22/09/2020 14:29	7,39	77	569,33	CHI
20200962181	ITAPURANGA	GK21339126	ITAPURANGA	22/09/2020 07:05	22/09/2020 08:31	22/09/2020 07:05	22/09/2020 08:31	1,42	1	1,42	CHI
20200962185	JATAI	JT21296421	JATAI S1	22/09/2020 07:06	22/09/2020 10:08	22/09/2020 07:06	22/09/2020 10:08	3,03	1	3,03	CHI
20200965065	PETROLINA DE GOIAS	PG12015839	PETROLINA	22/09/2020 07:06	22/09/2020 14:12	22/09/2020 07:06	22/09/2020 14:12	7,09	5	35,47	CHI
20200962195	JUSSARA	JR12220059	JUSSARA	22/09/2020 07:06	22/09/2020 09:53	22/09/2020 07:06	22/09/2020 09:53	2,77	12	33,25	CHI
20200962659	SAO SIMAO	SO12000023RE	CACHOEIRA ALTA	22/09/2020 07:06	22/09/2020 09:36	22/09/2020 07:06	22/09/2020 09:36	2,49	32	79,55	CHI

INTERNAL

20200962659	PARANAIGUARA	SO1200023RE	CACHOEIRA ALTA	22/09/2020 07:06	22/09/2020 09:36	22/09/2020 07:06	22/09/2020 09:36	2,49	62	154,12	CHI
20200960038	BALIZA	BH11334950	BOM JARDIM	22/09/2020 07:06	22/09/2020 09:30	22/09/2020 07:06	22/09/2020 09:30	2,39	84	200,41	CHI
20200962210	ANAPOLIS	20782706	ANAPOLIS UNIVERSITARIO S2	22/09/2020 07:07	22/09/2020 12:19	22/09/2020 07:07	22/09/2020 12:19	5,19	1	5,19	CHI
20200962209	MONTE ALEGRE DE GOIAS	MA21236762	SAO DOMINGOS	22/09/2020 07:07	22/09/2020 11:57	22/09/2020 07:07	22/09/2020 11:57	4,82	1	4,82	CHI
20200968451	MONTES CLAROS DE GOIAS	ME12210017	IPORA	22/09/2020 07:07	22/09/2020 18:48	22/09/2020 07:07	22/09/2020 18:48	11,67	12	140,06	CHI
20200962009	MUTUNOPOLIS	MU12068529	MARA ROSA	22/09/2020 07:07	24/09/2020 15:00	22/09/2020 07:07	22/09/2020 11:50	4,70	14	65,81	CHI
20200962009	MUTUNOPOLIS	MU12068529	MARA ROSA	22/09/2020 07:07	24/09/2020 15:00	22/09/2020 07:07	22/09/2020 15:48	8,67	7	60,70	CHI
20200962009	MUTUNOPOLIS	MU12068529	MARA ROSA	22/09/2020 07:07	24/09/2020 15:00	22/09/2020 07:07	22/09/2020 18:58	11,85	10	118,48	CHI
20200962009	MUTUNOPOLIS	MU12068529	MARA ROSA	22/09/2020 07:07	24/09/2020 15:00	22/09/2020 07:07	23/09/2020 09:33	26,43	10	264,29	CHI
20200962009	PORANGATU	MU12068529	MARA ROSA	22/09/2020 07:07	24/09/2020 15:00	22/09/2020 07:07	23/09/2020 16:05	32,95	6	197,72	CHI
20200962009	MUTUNOPOLIS	MU12068529	MARA ROSA	22/09/2020 07:07	24/09/2020 15:00	22/09/2020 07:07	23/09/2020 16:05	32,95	2	65,91	CHI
20200962009	PORANGATU	MU12068529	MARA ROSA	22/09/2020 07:07	24/09/2020 15:00	22/09/2020 07:07	24/09/2020 15:00	55,88	6	335,27	CHI
20200962009	MUTUNOPOLIS	MU12068529	MARA ROSA	22/09/2020 07:07	24/09/2020 15:00	23/09/2020 11:42	23/09/2020 14:31	2,83	41	115,86	CHI
20200962224	CIDADE OCIDENTAL	DH12170619	MARAJOARA	22/09/2020 07:08	22/09/2020 11:50	22/09/2020 07:08	22/09/2020 11:50	4,69	4	18,76	CHI
20200964730	PILAR DE GOIAS	GG12313404	URUACU	22/09/2020 07:08	22/09/2020 18:23	22/09/2020 07:08	22/09/2020 18:23	11,24	4	44,95	CHI
20200962231	SANTO ANTONIO DA BARRA	RV21106351	ACREUNA	22/09/2020 07:08	22/09/2020 14:17	22/09/2020 07:08	22/09/2020 14:17	7,14	1	7,14	CHI
20200962539	RUBIATABA	RB12003320	RUBIATABA	22/09/2020 07:08	22/09/2020 11:24	22/09/2020 07:08	22/09/2020 11:24	4,25	89	378,32	CHI
20200963381	ALTO HORIZONTE	AJ12320992RE	SANTA TEREZINHA	22/09/2020 07:09	22/09/2020 18:22	22/09/2020 07:09	22/09/2020 18:22	11,22	47	527,17	CHI
20200962243	JESUPOLIS	SF12000163	SAO FRANCISCO DE GOIAS	22/09/2020 07:09	22/09/2020 17:18	22/09/2020 07:09	22/09/2020 17:18	10,15	25	253,71	CHI
20200963573	RIO VERDE	RV11000106	RIO VERDE S1	22/09/2020 07:09	22/09/2020 10:23	22/09/2020 07:09	22/09/2020 10:23	3,23	81	261,59	CHI
20200962275	GOIANESIA	GE11139640	GOIANESIA S2	22/09/2020 07:10	22/09/2020 08:44	22/09/2020 07:10	22/09/2020 08:44	1,56	187	291,98	CHI
20200962268	PIRENOPOLIS	PV21028719	CORUMBA	22/09/2020 07:10	22/09/2020 10:14	22/09/2020 07:10	22/09/2020 10:14	3,05	1	3,05	CHI
202009107057	FLORES DE GOIAS	9620004649	IACIARA S2	22/09/2020 07:11	22/09/2020 07:28	22/09/2020 07:11	22/09/2020 07:28	0,29	1	0,29	CHI
20200962284	PORTEIRAO	CL12230803	RIO DOS BOIS	22/09/2020 07:12	22/09/2020 17:55	22/09/2020 07:12	22/09/2020 17:55	10,71	6	64,29	CHI
20200964456	CACU	CC12028172	CACHOEIRA ALTA	22/09/2020 07:12	22/09/2020 11:45	22/09/2020 07:12	22/09/2020 11:45	4,53	3	13,60	CHI
20200962304	ANAPOLIS	20038951	ANAPOLIS UNIVERSITARIO S2	22/09/2020 07:13	23/09/2020 02:23	22/09/2020 07:13	23/09/2020 02:23	19,16	1	19,16	CHI
20200962305	AGUAS LINDAS DE GOIAS	LA11095441	AGUAS LINDAS DE GOIAS S1	22/09/2020 07:13	22/09/2020 12:02	22/09/2020 07:13	22/09/2020 12:02	4,81	155	745,42	CHI
20200963420	PLANALTINA	PI12375598	PLANALTINA	22/09/2020 07:13	23/09/2020 09:56	22/09/2020 07:13	23/09/2020 09:56	26,70	2	53,41	CHI
20200962314	AURILANDIA	AI21323816	SAO LUIZ DOS MONTES BELOS	22/09/2020 07:14	22/09/2020 21:45	22/09/2020 07:14	22/09/2020 21:45	14,51	1	14,51	CHI
20200965889	FLORES DE GOIAS	FB12211536	IACIARA S2	22/09/2020 07:14	22/09/2020 18:27	22/09/2020 07:14	22/09/2020 18:27	11,20	119	1332,97	CHI
20200962334	CAMPINACU	UC12239723	PORANGATU	22/09/2020 07:15	22/09/2020 10:05	22/09/2020 07:15	22/09/2020 10:05	2,82	4	11,29	CHI
20200962343	BALIZA	BH11331061	CAIAPONIA	22/09/2020 07:16	22/09/2020 09:07	22/09/2020 07:16	22/09/2020 09:07	1,85	1	1,85	CHI
20200962345	PADRE BERNARDO	PB21320214	PADRE BERNARDO	22/09/2020 07:16	22/09/2020 15:15	22/09/2020 07:16	22/09/2020 15:15	7,98	1	7,98	CHI

INTERNAL

20200962351	RIO VERDE	MV12303378	MONTIVIDIU T	22/09/2020 07:16	22/09/2020 10:32	22/09/2020 07:16	22/09/2020 10:32	3,25	5	16,26	CHI
20200962351	MONTIVIDIU	MV12303378	MONTIVIDIU T	22/09/2020 07:16	22/09/2020 10:32	22/09/2020 07:16	22/09/2020 10:32	3,25	15	48,79	CHI
20200962937	LEOPOLDO DE BULHOES	LB12011659	DAIA S2	22/09/2020 07:16	24/09/2020 00:44	22/09/2020 07:50	22/09/2020 22:05	14,25	5	71,26	CHI
20200962937	SILVANIA	LB12011659	DAIA S2	22/09/2020 07:16	24/09/2020 00:44	22/09/2020 07:50	22/09/2020 22:05	14,25	11	156,76	CHI
20200962937	SILVANIA	LB12011659	DAIA S2	22/09/2020 07:16	24/09/2020 00:44	22/09/2020 07:50	24/09/2020 00:44	40,90	12	490,76	CHI
20200962937	LEOPOLDO DE BULHOES	LB12011659	DAIA S2	22/09/2020 07:16	24/09/2020 00:44	22/09/2020 22:07	23/09/2020 08:54	10,78	5	53,90	CHI
20200962937	SILVANIA	LB12011659	DAIA S2	22/09/2020 07:16	24/09/2020 00:44	22/09/2020 22:07	23/09/2020 08:54	10,78	8	86,24	CHI
20200962937	SILVANIA	LB12011659	DAIA S2	22/09/2020 07:16	24/09/2020 00:44	22/09/2020 22:07	24/09/2020 00:44	26,61	3	79,84	CHI
20200962937	LEOPOLDO DE BULHOES	LB21322363	DAIA S2	22/09/2020 07:16	24/09/2020 00:44	23/09/2020 08:57	24/09/2020 00:25	15,46	1	15,46	CHI
20200962937	SILVANIA	LB12011659	DAIA S2	22/09/2020 07:16	24/09/2020 00:44	23/09/2020 08:57	24/09/2020 00:44	15,79	8	126,30	CHI
20200962937	LEOPOLDO DE BULHOES	LB12011659	DAIA S2	22/09/2020 07:16	24/09/2020 00:44	23/09/2020 08:57	24/09/2020 00:44	15,79	4	63,15	CHI
20200963263	ANAPOLIS	AN11381280	JUNDIAI S1	22/09/2020 07:17	22/09/2020 10:04	22/09/2020 07:17	22/09/2020 10:04	2,78	51	141,60	CHI
20200965613	JATAI	JT12211164	JATAI S2	22/09/2020 07:17	22/09/2020 11:22	22/09/2020 07:17	22/09/2020 11:22	4,08	10	40,75	CHI
20200965190	ITABERAI	IB12220541	ITABERAI S1	22/09/2020 07:17	22/09/2020 16:47	22/09/2020 07:17	22/09/2020 16:47	9,50	4	37,98	CHI
20200966203	PILAR DE GOIAS	NH12202110RE	SANTA TEREZINHA	22/09/2020 07:18	22/09/2020 17:23	22/09/2020 07:18	22/09/2020 17:23	10,08	16	161,30	CHI
20200966203	ALTO HORIZONTE	NH12202110RE	SANTA TEREZINHA	22/09/2020 07:18	22/09/2020 17:23	22/09/2020 07:18	22/09/2020 17:23	10,08	12	120,97	CHI
20200966203	NOVA IGUACU DE GOIAS	NH12202110RE	SANTA TEREZINHA	22/09/2020 07:18	22/09/2020 17:23	22/09/2020 07:18	22/09/2020 17:23	10,08	1	10,08	CHI
20200966203	SANTA TEREZINHA DE GOIAS	NH12202110RE	SANTA TEREZINHA	22/09/2020 07:18	22/09/2020 17:23	22/09/2020 07:18	22/09/2020 17:23	10,08	23	231,87	CHI
20200962376	FAINA	GS12220409RE	GOIAS	22/09/2020 07:18	22/09/2020 10:22	22/09/2020 07:18	22/09/2020 10:22	3,06	1	3,06	CHI
20200962376	GOIAS	GS12220409RE	GOIAS	22/09/2020 07:18	22/09/2020 10:22	22/09/2020 07:18	22/09/2020 10:22	3,06	83	253,89	CHI
20200962382	ITABERAI	50002650	ITABERAI S2	22/09/2020 07:18	22/09/2020 15:35	22/09/2020 07:18	22/09/2020 15:35	8,27	1	8,27	CHI
20200962383	ITABERAI	IB12220127	ITABERAI S1	22/09/2020 07:18	22/09/2020 10:15	22/09/2020 07:18	22/09/2020 10:15	2,94	294	863,46	CHI
20200962398	FORMOSA	FA12392207	ITIQUEIRA	22/09/2020 07:19	22/09/2020 12:26	22/09/2020 07:19	22/09/2020 12:26	5,10	2	10,20	CHI
20200962402	PALMEIRAS DE GOIAS	PL21207921	PALMEIRAS	22/09/2020 07:20	22/09/2020 08:20	22/09/2020 07:20	22/09/2020 08:20	1,00	1	1,00	CHI
20200966150	PORANGATU	PO12320999	PORANGATU	22/09/2020 07:20	22/09/2020 14:39	22/09/2020 07:20	22/09/2020 14:39	7,31	6	43,88	CHI
20200962413	ANAPOLIS	20559318	JUNDIAI S1	22/09/2020 07:20	22/09/2020 11:25	22/09/2020 07:20	22/09/2020 11:25	4,07	1	4,07	CHI
20200962422	PETROLINA DE GOIAS	320025214	PETROLINA	22/09/2020 07:20	22/09/2020 19:23	22/09/2020 07:20	22/09/2020 19:23	12,03	1	12,03	CHI
20200962431	ARUANA	10008720019	ARUANA	22/09/2020 07:21	22/09/2020 10:38	22/09/2020 07:21	22/09/2020 10:38	3,27	1	3,27	CHI
20200962974	SAO JOAO D ALIANCA	JL12106845	SAO JOAO D ALIANCA	22/09/2020 07:22	22/09/2020 15:06	22/09/2020 07:22	22/09/2020 15:06	7,73	15	115,88	CHI
20200965131	NIQUELANDIA	NQ12056787RE	URUACU	22/09/2020 07:22	22/09/2020 13:38	22/09/2020 07:22	22/09/2020 13:38	6,25	73	456,35	CHI
20200962451	ITAJA	IJ12370148	ITAJA S2	22/09/2020 07:22	23/09/2020 12:40	22/09/2020 07:22	23/09/2020 12:40	29,28	2	58,57	CHI
20200962465	PADRE BERNARDO	PB21330791	PADRE BERNARDO	22/09/2020 07:23	22/09/2020 17:42	22/09/2020 07:23	22/09/2020 17:42	10,30	1	10,30	CHI
20200962469	PORANGATU	PO21020563	PORANGATU	22/09/2020 07:24	23/09/2020 15:58	22/09/2020 07:24	23/09/2020 15:58	32,57	1	32,57	CHI

INTERNAL

20200962494	SAO JOAO D ALIANCA	ND12394116	IACIARA S2	22/09/2020 07:24	22/09/2020 08:56	22/09/2020 07:24	22/09/2020 08:56	1,52	15	22,85	CHI
20200962494	NOVA ROMA	ND12394116	IACIARA S2	22/09/2020 07:24	22/09/2020 08:56	22/09/2020 07:24	22/09/2020 08:56	1,52	5	7,62	CHI
20200962477	CRISTALINA	KR21163053	PAMPLONA	22/09/2020 07:24	22/09/2020 11:42	22/09/2020 07:24	22/09/2020 11:42	4,30	3	12,89	CHI
20200962806	GOIAS	IU12060536	MATRINCHA	22/09/2020 07:25	22/09/2020 11:30	22/09/2020 07:25	22/09/2020 11:30	4,08	2	8,16	CHI
20200962806	ITAPIRAPUA	IU12060536	MATRINCHA	22/09/2020 07:25	22/09/2020 11:30	22/09/2020 07:25	22/09/2020 11:30	4,08	16	65,28	CHI
20200962484	FAINA	FC12159226	ITAPURANGA	22/09/2020 07:25	22/09/2020 10:53	22/09/2020 07:25	22/09/2020 10:53	3,46	7	24,24	CHI
20200967612	CAIAPONIA	RV12030683	MONTIVIDIU T	22/09/2020 07:25	22/09/2020 16:20	22/09/2020 07:25	22/09/2020 16:20	8,91	210	1871,62	CHI
20200967612	RIO VERDE	RV12030683	MONTIVIDIU T	22/09/2020 07:25	22/09/2020 16:20	22/09/2020 07:25	22/09/2020 16:20	8,91	6	53,47	CHI
20200964678	RIO VERDE	RV12106546	CABRIUVA S2	22/09/2020 07:25	22/09/2020 13:31	22/09/2020 07:25	22/09/2020 13:31	6,09	10	60,90	CHI
20200962492	GOIANESIA	GE21181786	GOIANESIA S1	22/09/2020 07:25	22/09/2020 08:35	22/09/2020 07:25	22/09/2020 08:35	1,15	1	1,15	CHI
20200962495	AGUAS LINDAS DE GOIAS	LA12044220	AGUAS LINDAS DE GOIAS S2	22/09/2020 07:26	22/09/2020 10:03	22/09/2020 07:26	22/09/2020 10:03	2,61	2	5,23	CHI
20200966961	AGUA FRIA DE GOIAS	NQ12140182	SAO JOAO D ALIANCA	22/09/2020 07:26	22/09/2020 17:37	22/09/2020 07:26	22/09/2020 17:37	10,18	10	101,77	CHI
20200966961	NIQUELANDIA	NQ12140182	SAO JOAO D ALIANCA	22/09/2020 07:26	22/09/2020 17:37	22/09/2020 07:26	22/09/2020 17:37	10,18	1	10,18	CHI
20200964158	ANAPOLIS	AN12258854	ANAPOLIS UNIVERSITARIO S2	22/09/2020 07:26	22/09/2020 11:05	22/09/2020 07:26	22/09/2020 11:05	3,64	22	80,02	CHI
20200964870	AGUA FRIA DE GOIAS	TL12048061	SAO JOAO D ALIANCA	22/09/2020 07:26	22/09/2020 18:03	22/09/2020 07:26	22/09/2020 18:03	10,60	53	561,90	CHI
20200962524	PALMEIRAS DE GOIAS	590026010	PALMEIRAS	22/09/2020 07:27	22/09/2020 09:48	22/09/2020 07:27	22/09/2020 09:48	2,34	1	2,34	CHI
20200965080	SITIO D ABADIA	FB12245566	IACIARA S2	22/09/2020 07:28	22/09/2020 17:58	22/09/2020 07:28	22/09/2020 17:58	10,49	39	409,13	CHI
20200965080	FLORES DE GOIAS	FB12245566	IACIARA S2	22/09/2020 07:28	22/09/2020 17:58	22/09/2020 07:28	22/09/2020 17:58	10,49	73	765,81	CHI
20200962541	LUZIANIA	120211671	RIO VERMELHO	22/09/2020 07:28	22/09/2020 12:25	22/09/2020 07:28	22/09/2020 12:25	4,94	1	4,94	CHI
20200962542	MONTE ALEGRE DE GOIAS	MA12302753	SAO DOMINGOS	22/09/2020 07:29	22/09/2020 09:01	22/09/2020 07:29	22/09/2020 09:01	1,53	36	55,19	CHI
20200962545	JATAI	JT11083831	JATAI S2	22/09/2020 07:29	22/09/2020 16:57	22/09/2020 07:29	22/09/2020 16:57	9,46	1	9,46	CHI
20200966836	ACREUNA	EU12301574	ACREUNA	22/09/2020 07:29	22/09/2020 17:57	22/09/2020 07:29	22/09/2020 17:57	10,46	8	83,69	CHI
20200962551	RIO VERDE	RV21383946	CABRIUVA S2	22/09/2020 07:29	22/09/2020 15:00	22/09/2020 07:29	22/09/2020 15:00	7,52	1	7,52	CHI
20200962554	JATAI	RV12248973	CABRIUVA S2	22/09/2020 07:29	22/09/2020 11:07	22/09/2020 07:29	22/09/2020 11:07	3,62	11	39,84	CHI
20200962554	RIO VERDE	RV12248973	CABRIUVA S2	22/09/2020 07:29	22/09/2020 11:07	22/09/2020 07:29	22/09/2020 11:07	3,62	33	119,52	CHI
20200962562	LUZIANIA	LZ11136507	RIO VERMELHO	22/09/2020 07:30	22/09/2020 13:59	22/09/2020 07:30	22/09/2020 13:59	6,47	13	84,14	CHI
20200962570	JANDAIA	JD21234532	PALMEIRAS	22/09/2020 07:31	22/09/2020 13:54	22/09/2020 07:31	22/09/2020 13:54	6,38	1	6,38	CHI
20200962577	BONOPOLIS	BX12369999	NOVO PLANALTO	22/09/2020 07:31	22/09/2020 12:06	22/09/2020 07:31	22/09/2020 12:06	4,57	1	4,57	CHI
20200962591	VILA PROPICIO	NP21248155	GOIANESIA S1	22/09/2020 07:32	22/09/2020 09:47	22/09/2020 07:32	22/09/2020 09:47	2,24	1	2,24	CHI
20200963523	ANAPOLIS	02370244	JUNDIAI S1	22/09/2020 07:33	22/09/2020 11:22	22/09/2020 07:33	22/09/2020 07:36	0,07	2405	156,33	CHI
20200963523	ANAPOLIS	02370244	JUNDIAI S1	22/09/2020 07:33	22/09/2020 11:22	22/09/2020 07:33	22/09/2020 07:37	0,08	3340	268,13	CHI
20200963523	ANAPOLIS	02370244	JUNDIAI S1	22/09/2020 07:33	22/09/2020 11:22	22/09/2020 07:33	22/09/2020 11:22	3,82	168	641,15	CHI
20200962925	DISTRITO FEDERAL	NJ11219669	MARAJOARA	22/09/2020 07:33	22/09/2020 11:06	22/09/2020 07:33	22/09/2020 11:06	3,55	56	198,89	CHI

INTERNAL

20200962616	FAINA	FC12268680	GOIAS	22/09/2020 07:33	22/09/2020 10:08	22/09/2020 07:33	22/09/2020 10:08	2,57	15	38,55	CHI
20200962623	RIO VERDE	8325859	MONTIVIDIU T	22/09/2020 07:34	22/09/2020 12:00	22/09/2020 07:34	22/09/2020 12:00	4,43	5	22,14	CHI
20200962622	ARAGARCAS	AG11000012	ARAGARCAS	22/09/2020 07:34	22/09/2020 11:16	22/09/2020 07:34	22/09/2020 11:16	3,70	123	454,49	CHI
20200963076	VALPARAISO DE GOIAS	VA11192787	PACAEMBU S2	22/09/2020 07:34	22/09/2020 09:35	22/09/2020 07:34	22/09/2020 09:35	2,01	67	134,78	CHI
20200962629	VALPARAISO DE GOIAS	2860027823	PACAEMBU S2	22/09/2020 07:34	22/09/2020 11:09	22/09/2020 07:34	22/09/2020 11:09	3,57	1	3,57	CHI
20200962631	QUIRINOPOLIS	80047439	QUIRINOPOLIS	22/09/2020 07:34	22/09/2020 10:50	22/09/2020 07:34	22/09/2020 10:50	3,26	1	3,26	CHI
20200963437	URUACU	UR12405303	MARA ROSA	22/09/2020 07:35	22/09/2020 12:58	22/09/2020 07:35	22/09/2020 12:58	5,37	52	279,23	CHI
20200962650	SANTA RITA DO ARAGUAIA	SU13191740	SANTA RITA DO ARAGUAIA	22/09/2020 07:35	22/09/2020 07:47	22/09/2020 07:35	22/09/2020 07:47	0,19	2030	382,32	CHI
20200962650	MINEIROS	SU13191740	SANTA RITA DO ARAGUAIA	22/09/2020 07:35	22/09/2020 07:47	22/09/2020 07:35	22/09/2020 07:47	0,19	33	6,22	CHI
20200962649	JATAI	JT21166035	JATAI S3	22/09/2020 07:35	22/09/2020 11:49	22/09/2020 07:35	22/09/2020 11:49	4,22	11	46,39	CHI
20200962651	ITARUMA	6368157	PADRE BERNARDO	22/09/2020 07:36	22/09/2020 14:51	22/09/2020 07:36	22/09/2020 14:51	7,25	1	7,25	CHI
20200962651	DISTRITO FEDERAL	6368157	PADRE BERNARDO	22/09/2020 07:36	22/09/2020 14:51	22/09/2020 07:36	22/09/2020 14:51	7,25	6	43,50	CHI
20200962651	PADRE BERNARDO	6368157	PADRE BERNARDO	22/09/2020 07:36	22/09/2020 14:51	22/09/2020 07:36	22/09/2020 14:51	7,25	7	50,75	CHI
20200962651	PLANALTINA	6368157	PADRE BERNARDO	22/09/2020 07:36	22/09/2020 14:51	22/09/2020 07:36	22/09/2020 14:51	7,25	15	108,75	CHI
20200966308	ITAPURANGA	IK21298354	ITAPURANGA	22/09/2020 07:36	22/09/2020 12:04	22/09/2020 07:36	22/09/2020 12:04	4,46	1	4,46	CHI
20200962666	ITABERAI	IB21377482	ANICUNS	22/09/2020 07:36	22/09/2020 14:47	22/09/2020 07:36	22/09/2020 14:47	7,17	1	7,17	CHI
20200962679	JARAGUA	70042240	JARAGUA	22/09/2020 07:37	22/09/2020 16:45	22/09/2020 07:37	22/09/2020 16:45	9,13	1	9,13	CHI
20200962687	PALMEIRAS DE GOIAS	PL21304483	PALMEIRAS	22/09/2020 07:37	22/09/2020 09:09	22/09/2020 07:37	22/09/2020 09:09	1,52	1	1,52	CHI
20200966361	TURVELANDIA	TD12306313	RIO DOS BOIS	22/09/2020 07:38	22/09/2020 18:00	22/09/2020 07:38	22/09/2020 18:00	10,36	10	103,58	CHI
20200962715	CEZARINA	1650000987	CEZARINA	22/09/2020 07:39	22/09/2020 09:23	22/09/2020 07:39	22/09/2020 09:23	1,74	1	1,74	CHI
20200969443	FLORES DE GOIAS	FB12239102	IACIARA S2	22/09/2020 07:39	22/09/2020 17:40	22/09/2020 07:39	22/09/2020 17:40	10,01	19	190,11	CHI
20200962838	PIRANHAS	PH12244913	PIRANHAS	22/09/2020 07:39	22/09/2020 10:30	22/09/2020 07:39	22/09/2020 10:30	2,83	4	11,34	CHI
20200962731	CAVALCANTE	CJ21147590	FLORES DE GOIAS	22/09/2020 07:40	22/09/2020 12:04	22/09/2020 07:40	22/09/2020 12:04	4,40	1	4,40	CHI
20200962745	AGUAS LINDAS DE GOIAS	4830043661	AGUAS LINDAS DE GOIAS S1	22/09/2020 07:40	22/09/2020 09:34	22/09/2020 07:40	22/09/2020 09:34	1,88	1	1,88	CHI
20200962763	ANAPOLIS	20083816	ANAPOLIS UNIVERSITARIO S2	22/09/2020 07:42	23/09/2020 04:53	22/09/2020 07:42	23/09/2020 04:53	21,18	1	21,18	CHI
20200962766	URUACU	UR12291075RE	URUACU	22/09/2020 07:42	22/09/2020 19:52	22/09/2020 07:42	22/09/2020 15:33	7,85	49	384,73	CHI
20200962766	URUACU	UR11352087	URUACU	22/09/2020 07:42	22/09/2020 19:52	22/09/2020 07:42	22/09/2020 19:52	12,16	6	72,97	CHI
20200962770	BOM JARDIM DE GOIAS	BM11380935	BOM JARDIM	22/09/2020 07:42	22/09/2020 14:01	22/09/2020 07:42	22/09/2020 14:01	6,31	64	403,73	CHI
20200962771	JATAI	JT21211177	JATAI S3	22/09/2020 07:42	22/09/2020 12:52	22/09/2020 07:42	22/09/2020 12:52	5,16	1	5,16	CHI
20200962789	ADELANDIA	DN21228759	FIRMINOPOLIS S2	22/09/2020 07:43	22/09/2020 09:57	22/09/2020 07:43	22/09/2020 09:57	2,22	1	2,22	CHI
20200962808	RIO VERDE	RV21260097	CABRIUVA S1	22/09/2020 07:44	22/09/2020 09:06	22/09/2020 07:44	22/09/2020 09:06	1,36	2	2,72	CHI
20200963031	ITAGUARU	IC12219967	ITABERAI S1	22/09/2020 07:45	22/09/2020 14:40	22/09/2020 07:45	22/09/2020 14:40	6,91	16	110,56	CHI
20200963292	PORANGATU	PO11000012	PORANGATU	22/09/2020 07:46	22/09/2020 11:15	22/09/2020 07:46	22/09/2020 11:15	3,48	49	170,56	CHI

INTERNAL

20200962861	PADRE BERNARDO	PB21148885	PADRE BERNARDO	22/09/2020 07:46	22/09/2020 20:00	22/09/2020 07:46	22/09/2020 20:00	12,22	2	24,44	CHI
20200962870	CRISTALINA	KR21228574	PAMPLONA	22/09/2020 07:47	22/09/2020 19:17	22/09/2020 07:47	22/09/2020 19:17	11,49	1	11,49	CHI
20200964748	NOVO GAMA	NJ11209636	PACAEMBU S2	22/09/2020 07:47	22/09/2020 13:19	22/09/2020 07:47	22/09/2020 13:19	5,52	150	827,71	CHI
20200962878	MINACU	IH12182288	MINACU	22/09/2020 07:48	22/09/2020 13:16	22/09/2020 07:48	22/09/2020 13:16	5,46	2	10,93	CHI
20200962882	ITABERAÍ	IB12000029	ITABERAÍ S2	22/09/2020 07:48	22/09/2020 10:20	22/09/2020 07:48	22/09/2020 10:20	2,53	5	12,64	CHI
20200962895	IPORA	730054378	IPORA	22/09/2020 07:48	22/09/2020 17:16	22/09/2020 07:48	22/09/2020 17:16	9,45	1	9,45	CHI
20200965958	MINEIROS	MY12209687	PARQUE DAS EMAS	22/09/2020 07:48	22/09/2020 14:45	22/09/2020 07:48	22/09/2020 14:45	6,94	9	62,42	CHI
20200962911	ANAPOLIS	AN21089172	ANAPOLIS UNIVERSITARIO S1	22/09/2020 07:49	23/09/2020 14:32	22/09/2020 07:49	23/09/2020 14:32	30,71	2	61,42	CHI
20200962919	CEZARINA	2150000411	CEZARINA	22/09/2020 07:49	22/09/2020 11:12	22/09/2020 07:49	22/09/2020 11:12	3,38	1	3,38	CHI
20200962922	PIRANHAS	PH21092242	BOM JARDIM	22/09/2020 07:49	22/09/2020 13:28	22/09/2020 07:49	22/09/2020 13:28	5,63	1	5,63	CHI
20200962928	ANAPOLIS	AN11288615	JUNDIAI S2	22/09/2020 07:50	22/09/2020 15:40	22/09/2020 07:50	22/09/2020 15:40	7,83	39	305,21	CHI
20200962929	CORREGO DO OURO	SC21005409	SAO LUIZ DOS MONTES BELOS	22/09/2020 07:50	23/09/2020 17:25	22/09/2020 07:50	23/09/2020 17:25	33,57	1	33,57	CHI
20200962940	TAQUARAL DE GOIAS	TQ21299887	ITABERAÍ S1	22/09/2020 07:50	22/09/2020 14:43	22/09/2020 07:50	22/09/2020 14:43	6,87	1	6,87	CHI
20200962956	ANICUNS	AC12061366	ANICUNS	22/09/2020 07:52	22/09/2020 08:43	22/09/2020 07:52	22/09/2020 08:43	0,86	14	12,07	CHI
20200962961	PLANALTINA	PI21125110	SAO JOAO D ALIANCA	22/09/2020 07:52	22/09/2020 17:29	22/09/2020 07:52	22/09/2020 17:29	9,61	1	9,61	CHI
20200962968	FORMOSA	2970005676	ITUIQUIRA	22/09/2020 07:53	22/09/2020 11:07	22/09/2020 07:53	22/09/2020 11:07	3,22	1	3,22	CHI
20200962970	PARAUNA	PU21301681	ACREUNA	22/09/2020 07:53	22/09/2020 11:29	22/09/2020 07:53	22/09/2020 11:29	3,59	1	3,59	CHI
20200962991	MONTES CLAROS DE GOIAS	ME11253723	IPORA	22/09/2020 07:55	22/09/2020 12:29	22/09/2020 07:55	22/09/2020 12:29	4,57	73	333,31	CHI
20200963414	SANTO ANTONIO DO DESCOBERTO	SN12426653	MARAJOARA	22/09/2020 07:55	22/09/2020 10:45	22/09/2020 07:55	22/09/2020 10:45	2,82	30	84,67	CHI
20200963012	PLANALTINA	2960167783	PLANALTINA	22/09/2020 07:55	22/09/2020 18:22	22/09/2020 07:55	22/09/2020 18:22	10,45	1	10,45	CHI
20200963015	PALMEIRAS DE GOIAS	PL11000039	PALMEIRAS	22/09/2020 07:56	22/09/2020 09:49	22/09/2020 07:56	22/09/2020 09:49	1,88	142	266,92	CHI
20200963016	RIO VERDE	RV21000076	RIO VERDE S2	22/09/2020 07:56	22/09/2020 14:44	22/09/2020 07:56	22/09/2020 14:44	6,80	1	6,80	CHI
20200963026	RIO VERDE	RV21028146	SANTA HELENA S1	22/09/2020 07:56	22/09/2020 23:48	22/09/2020 07:56	22/09/2020 23:48	15,85	3	47,56	CHI
20200963034	IPORA	730086495	IPORA	22/09/2020 07:57	22/09/2020 17:27	22/09/2020 07:57	22/09/2020 17:27	9,49	1	9,49	CHI
20200963044	LUZIANIA	LZ11128809	RIO VERMELHO	22/09/2020 07:57	22/09/2020 14:15	22/09/2020 07:57	22/09/2020 14:15	6,30	39	245,61	CHI
20200963046	SAO MIGUEL DO ARAGUAIA	SM12238245RE	SAO MIGUEL DO ARAGUAIA	22/09/2020 07:57	22/09/2020 21:29	22/09/2020 07:57	22/09/2020 21:29	13,52	18	243,33	CHI
20200965366	PIRENOPOLIS	PV12362263	CORUMBA	22/09/2020 07:58	22/09/2020 11:23	22/09/2020 07:58	22/09/2020 11:23	3,41	13	44,38	CHI
20200963053	PADRE BERNARDO	PB12104239	PADRE BERNARDO	22/09/2020 07:58	22/09/2020 12:29	22/09/2020 07:58	22/09/2020 12:29	4,51	19	85,65	CHI
20200963060	RIO VERDE	630358515	RIO VERDE S1	22/09/2020 07:58	22/09/2020 15:39	22/09/2020 07:58	22/09/2020 15:39	7,67	1	7,67	CHI
20200963062	JATAI	JT21159424	JATAI S1	22/09/2020 07:59	22/09/2020 19:50	22/09/2020 07:59	22/09/2020 19:50	11,85	1	11,85	CHI
20200963066	SANTA RITA DO NOVO DESTINO	BA21000051	BARRO ALTO	22/09/2020 07:59	22/09/2020 17:02	22/09/2020 07:59	22/09/2020 17:02	9,05	1	9,05	CHI
20200963081	GOIANESIA	550128440	GOIANESIA S2	22/09/2020 08:00	22/09/2020 11:45	22/09/2020 08:00	22/09/2020 11:45	3,75	1	3,75	CHI
20200963089	MONTES CLAROS DE GOIAS	ME12355657	IPORA	22/09/2020 08:00	22/09/2020 10:20	22/09/2020 08:00	22/09/2020 10:20	2,33	7	16,29	CHI

INTERNAL

20200963092	RIO VERDE	QI12163448RE	SANTA HELENA S1	22/09/2020 08:00	23/09/2020 01:05	22/09/2020 08:00	22/09/2020 18:47	10,79	1	10,79	CHI
20200963092	QUIRINOPOLIS	QI12163448RE	SANTA HELENA S1	22/09/2020 08:00	23/09/2020 01:05	22/09/2020 08:00	23/09/2020 01:05	17,07	10	170,74	CHI
20200963092	RIO VERDE	QI12163448RE	SANTA HELENA S1	22/09/2020 08:00	23/09/2020 01:05	22/09/2020 19:19	23/09/2020 01:05	5,76	1	5,76	CHI
20200963104	NOVA CRIXAS	8570022027	NOVA CRIXAS	22/09/2020 08:01	22/09/2020 10:31	22/09/2020 08:01	22/09/2020 10:31	2,50	1	2,50	CHI
20200963116	CORUMBA DE GOIAS	AX12061965	CORUMBA	22/09/2020 08:01	22/09/2020 12:17	22/09/2020 08:01	22/09/2020 12:17	4,25	2	8,51	CHI
20200963124	URUACU	UR12147094	CAMPINORTE	22/09/2020 08:02	22/09/2020 10:20	22/09/2020 08:02	22/09/2020 10:20	2,30	2	4,59	CHI
20200963128	MUNDO NOVO DE GOIAS	4240003752	NOVA CRIXAS	22/09/2020 08:02	22/09/2020 13:15	22/09/2020 08:02	22/09/2020 13:15	5,21	1	5,21	CHI
20200963136	RIO VERDE	630076996	RIO VERDE S1	22/09/2020 08:03	22/09/2020 12:21	22/09/2020 08:03	22/09/2020 12:21	4,30	1	4,30	CHI
20200963141	ITAPURANGA	170030854	ITAPURANGA	22/09/2020 08:03	22/09/2020 15:22	22/09/2020 08:03	22/09/2020 15:22	7,31	1	7,31	CHI
20200963163	SANTA RITA DO NOVO DESTINO	BA21208881	BARRO ALTO	22/09/2020 08:04	22/09/2020 15:38	22/09/2020 08:04	22/09/2020 15:38	7,57	1	7,57	CHI
20200963177	GAMELEIRA DE GOIAS	SV12221314	DAIA S2	22/09/2020 08:04	22/09/2020 16:48	22/09/2020 08:04	22/09/2020 16:48	8,72	1	8,72	CHI
20200963183	ESTRELA DO NORTE	10023545974	MARA ROSA	22/09/2020 08:05	22/09/2020 20:42	22/09/2020 08:05	22/09/2020 20:42	12,61	1	12,61	CHI
20200963190	TURVANIA	TV21299166	FIRMINOPOLIS S2	22/09/2020 08:05	22/09/2020 21:47	22/09/2020 08:05	22/09/2020 21:47	13,69	1	13,69	CHI
20200963208	RIO VERDE	630310361	CABRIUVA S1	22/09/2020 08:06	22/09/2020 14:16	22/09/2020 08:06	22/09/2020 14:16	6,16	1	6,16	CHI
20200963212	JARAGUA	70070738	JARAGUA	22/09/2020 08:06	22/09/2020 11:18	22/09/2020 08:06	22/09/2020 11:18	3,19	1	3,19	CHI
20200963939	CEZARINA	CZ12102109	CEZARINA	22/09/2020 08:07	22/09/2020 11:19	22/09/2020 08:07	22/09/2020 11:19	3,20	11	35,17	CHI
20200963233	GOIAS	90036580	GOIAS	22/09/2020 08:07	22/09/2020 11:45	22/09/2020 08:07	22/09/2020 11:45	3,63	1	3,63	CHI
20200963237	ITAPACI	IW12405204	ITAPACI	22/09/2020 08:07	22/09/2020 10:38	22/09/2020 08:07	22/09/2020 10:38	2,50	16	40,07	CHI
20200963238	JATAI	JT21248405	JATAI S2	22/09/2020 08:07	22/09/2020 13:06	22/09/2020 08:07	22/09/2020 13:06	4,97	1	4,97	CHI
20200963246	ITABERAI	10015169110	ITABERAI S2	22/09/2020 08:08	22/09/2020 12:23	22/09/2020 08:08	22/09/2020 12:23	4,25	1	4,25	CHI
20200963253	GOIANAPOLIS	GP12234972	DAIA S2	22/09/2020 08:08	22/09/2020 12:08	22/09/2020 08:08	22/09/2020 12:08	3,99	1	3,99	CHI
20200963272	ARAGARCAS	1820014130	ARAGARCAS	22/09/2020 08:09	22/09/2020 13:41	22/09/2020 08:09	22/09/2020 13:41	5,52	1	5,52	CHI
20200964274	ANAPOLIS	AN12000026	ANAPOLIS UNIVERSITARIO S2	22/09/2020 08:09	22/09/2020 09:45	22/09/2020 08:09	22/09/2020 09:45	1,58	234	370,69	CHI
20200963294	MINEIROS	MY12195578	PARQUE DAS EMAS	22/09/2020 08:10	23/09/2020 00:58	22/09/2020 08:10	23/09/2020 00:58	16,79	9	151,13	CHI
20200963279	ARUANA	AK21140338	MOZARLANDIA	22/09/2020 08:10	22/09/2020 18:51	22/09/2020 13:23	22/09/2020 18:51	5,47	1	5,47	CHI
20200963326	ALEXANIA	480048691	ALEXANIA	22/09/2020 08:11	22/09/2020 14:16	22/09/2020 08:11	22/09/2020 14:16	6,08	1	6,08	CHI
20200963327	ITAPURANGA	170039365	ITAPURANGA	22/09/2020 08:11	22/09/2020 19:48	22/09/2020 08:11	22/09/2020 19:48	11,61	0	0,00	CHI
20200963337	GOIANESIA	GE12000280	GOIANESIA S2	22/09/2020 08:12	22/09/2020 13:13	22/09/2020 08:12	22/09/2020 13:13	5,01	9	45,12	CHI
20200963337	SANTA ISABEL	GE12000280	GOIANESIA S2	22/09/2020 08:12	22/09/2020 13:13	22/09/2020 08:12	22/09/2020 13:13	5,01	1	5,01	CHI
20200963349	ANAPOLIS	20065863	ANAPOLIS UNIVERSITARIO S2	22/09/2020 08:12	23/09/2020 07:47	22/09/2020 08:12	23/09/2020 07:47	23,57	1	23,57	CHI
202009103153	SANTO ANTONIO DA BARRA	BZ12213478	SANTA HELENA S1	22/09/2020 08:13	22/09/2020 20:01	22/09/2020 08:13	22/09/2020 20:01	11,80	5	59,00	CHI
20200963380	JARAGUA	70095164	JARAGUA	22/09/2020 08:13	22/09/2020 13:16	22/09/2020 08:13	22/09/2020 13:16	5,04	1	5,04	CHI
20200963386	GAMELEIRA DE GOIAS	GL12319531	DAIA S2	22/09/2020 08:13	22/09/2020 10:01	22/09/2020 08:13	22/09/2020 10:01	1,79	5	8,94	CHI

INTERNAL

20200965160	PORANGATU	PO12104342	PORANGATU	22/09/2020 08:14	22/09/2020 13:10	22/09/2020 08:14	22/09/2020 13:10	4,92	2	9,84	CHI
20200963405	JATAI	JT21267566	JATAI S3	22/09/2020 08:14	22/09/2020 09:29	22/09/2020 08:14	22/09/2020 09:29	1,24	1	1,24	CHI
20200963407	GOIAS	GS12220505	GOIAS	22/09/2020 08:14	22/09/2020 12:50	22/09/2020 08:14	22/09/2020 10:08	1,89	16	30,18	CHI
20200963407	GOIAS	GS11220506	GOIAS	22/09/2020 08:14	22/09/2020 12:50	22/09/2020 08:14	22/09/2020 12:50	4,60	186	856,07	CHI
20200963559	AGUA FRIA DE GOIAS	TL12233976	SAO JOAO D ALIANCA	22/09/2020 08:14	23/09/2020 03:57	22/09/2020 08:14	23/09/2020 03:57	19,70	23	453,14	CHI
20200964966	ANAPOLIS	20794678	ANAPOLIS UNIVERSITARIO S2	22/09/2020 08:15	22/09/2020 11:45	22/09/2020 08:15	22/09/2020 11:45	3,51	1	3,51	CHI
20200963811	ABADIANIA	AN12261177	ANAPOLIS UNIVERSITARIO S2	22/09/2020 08:15	22/09/2020 12:02	22/09/2020 08:15	22/09/2020 12:02	3,77	21	79,25	CHI
20200963429	MARA ROSA	2260029973	MARA ROSA	22/09/2020 08:16	24/09/2020 03:18	22/09/2020 08:16	24/09/2020 03:18	43,03	1	43,03	CHI
20200965025	MARA ROSA	MQ12255180	MARA ROSA	22/09/2020 08:16	22/09/2020 19:53	22/09/2020 08:16	22/09/2020 19:53	11,61	7	81,28	CHI
20200963436	CAIAPONIA	CP21020916	CAIAPONIA	22/09/2020 08:16	22/09/2020 15:53	22/09/2020 08:16	22/09/2020 15:53	7,62	1	7,62	CHI
20200963435	FAINA	FC12084191	GOIAS	22/09/2020 08:16	22/09/2020 11:51	22/09/2020 08:16	22/09/2020 11:51	3,58	3	10,73	CHI
20200964374	COCALZINHO DE GOIAS	CB12075828	COCALZINHO	22/09/2020 08:16	22/09/2020 17:05	22/09/2020 08:16	22/09/2020 17:05	8,80	11	96,84	CHI
20200963448	CRISTALINA	KR21349075	PAMPLONA	22/09/2020 08:17	22/09/2020 13:59	22/09/2020 08:17	22/09/2020 13:59	5,70	1	5,70	CHI
20200963452	SANTA HELENA DE GOIAS	SH21023943	RIO VERDE S2	22/09/2020 08:17	22/09/2020 12:27	22/09/2020 08:17	22/09/2020 12:27	4,16	1	4,16	CHI
20200963460	ITABERAI	IB12018321	ITABERAI S2	22/09/2020 08:17	22/09/2020 12:56	22/09/2020 08:17	22/09/2020 12:56	4,63	7	32,44	CHI
20200963462	PIRENOPOLIS	PV21072529	CORUMBA	22/09/2020 08:18	23/09/2020 09:43	22/09/2020 08:18	23/09/2020 09:43	25,42	1	25,42	CHI
20200963486	LUZIANIA	LZ21192781	MARAJOARA	22/09/2020 08:18	22/09/2020 09:50	22/09/2020 08:18	22/09/2020 09:50	1,52	3	4,56	CHI
20200963488	PARAUNA	IV12165764	IPORA	22/09/2020 08:18	22/09/2020 15:44	22/09/2020 08:18	22/09/2020 15:44	7,42	1	7,42	CHI
20200963488	IVOLANDIA	IV12165764	IPORA	22/09/2020 08:18	22/09/2020 15:44	22/09/2020 08:18	22/09/2020 15:44	7,42	5	37,09	CHI
20200964443	JAUPACI	JP12028023	IPORA	22/09/2020 08:19	22/09/2020 16:18	22/09/2020 08:19	22/09/2020 16:18	7,98	7	55,86	CHI
20200970214	SANTA TEREZA DE GOIAS	SE11098952	MARA ROSA	22/09/2020 08:20	23/09/2020 00:05	22/09/2020 08:20	23/09/2020 00:05	15,75	105	1653,37	CHI
20200963863	TURVANIA	TV11005732	FIRMINOPOLIS S2	22/09/2020 08:20	22/09/2020 14:20	22/09/2020 08:20	22/09/2020 14:20	5,99	162	970,74	CHI
20200963532	VALPARAISO DE GOIAS	2860039199	MARAJOARA	22/09/2020 08:21	22/09/2020 15:28	22/09/2020 08:21	22/09/2020 15:28	7,11	1	7,11	CHI
20200963545	SANTO ANTONIO DO DESCOBERTO	SN21214800	ALEXANIA	22/09/2020 08:22	22/09/2020 11:49	22/09/2020 08:22	22/09/2020 11:49	3,44	2	6,89	CHI
20200971040	RIO VERDE	JT12200070	JATAI S3	22/09/2020 08:22	23/09/2020 12:20	22/09/2020 08:22	23/09/2020 12:20	27,96	3	83,87	CHI
20200963567	ITAJA	IJ12062602	ITAJA S2	22/09/2020 08:23	23/09/2020 12:05	22/09/2020 08:23	23/09/2020 12:05	27,69	2	55,38	CHI
20200963569	ITAPACI	IW12079629	ITAPACI	22/09/2020 08:23	23/09/2020 11:49	22/09/2020 08:23	23/09/2020 11:49	27,42	3	82,26	CHI
20200963570	ITAPURANGA	170045997	ITAPURANGA	22/09/2020 08:23	23/09/2020 04:29	22/09/2020 08:23	23/09/2020 04:29	20,09	1	20,09	CHI
20200963569	ITAPACI	IW12333893	ITAPACI	22/09/2020 08:23	23/09/2020 11:49	23/09/2020 10:16	23/09/2020 11:48	1,52	23	34,93	CHI
20200963569	PILAR DE GOIAS	IW12333893	ITAPACI	22/09/2020 08:23	23/09/2020 11:49	23/09/2020 10:16	23/09/2020 11:48	1,52	38	57,72	CHI
20200963600	INDIARA	IY21134825	CEZARINA	22/09/2020 08:25	22/09/2020 17:18	22/09/2020 08:25	22/09/2020 17:18	8,89	1	8,89	CHI
20200963610	CAMPINACU	UC12346900	PORANGATU	22/09/2020 08:25	22/09/2020 12:17	22/09/2020 08:25	22/09/2020 12:17	3,85	5	19,26	CHI
20200963625	ANAPOLIS	20997127	ANAPOLIS UNIVERSITARIO S2	22/09/2020 08:26	22/09/2020 13:45	22/09/2020 08:26	22/09/2020 13:45	5,31	1	5,31	CHI

INTERNAL

20200963628	ITAPURANGA	IK12311324	ITAPURANGA	22/09/2020 08:26	22/09/2020 12:38	22/09/2020 08:26	22/09/2020 12:38	4,19	6	25,13	CHI
20200963637	GOIANESIA	GE21211151	GOIANESIA S1	22/09/2020 08:26	22/09/2020 10:00	22/09/2020 08:26	22/09/2020 10:00	1,55	1	1,55	CHI
20200963638	ITABERAI	50013798	ITABERAI S2	22/09/2020 08:27	22/09/2020 15:09	22/09/2020 08:27	22/09/2020 15:09	6,70	1	6,70	CHI
20200963679	CIDADE OCIDENTAL	2680157352	MARAJOARA	22/09/2020 08:29	22/09/2020 18:40	22/09/2020 08:29	22/09/2020 18:40	10,17	1	10,17	CHI
20200963690	JATAI	JT21196073	JATAI S1	22/09/2020 08:30	22/09/2020 12:43	22/09/2020 08:30	22/09/2020 12:43	4,21	1	4,21	CHI
20200963693	MINACU	IH21386705	MINACU	22/09/2020 08:30	22/09/2020 10:18	22/09/2020 08:30	22/09/2020 10:18	1,79	1	1,79	CHI
20200963700	CABECEIRAS	CW12052029	ITIQUEIRA	22/09/2020 08:30	22/09/2020 15:17	22/09/2020 08:30	22/09/2020 12:38	4,14	6	24,81	CHI
20200963700	CABECEIRAS	CW12052029	ITIQUEIRA	22/09/2020 08:30	22/09/2020 15:17	22/09/2020 08:30	22/09/2020 15:17	6,77	1	6,77	CHI
20200963700	CABECEIRAS	CW12052029	ITIQUEIRA	22/09/2020 08:30	22/09/2020 15:17	22/09/2020 11:36	22/09/2020 12:38	1,05	1	1,05	CHI
20200963710	BALIZA	BH11227615	BOM JARDIM	22/09/2020 08:31	22/09/2020 10:36	22/09/2020 08:31	22/09/2020 10:36	2,08	1	2,08	CHI
20200963711	AVELINOPOLIS	AV21020498	ANICUNS	22/09/2020 08:31	22/09/2020 11:45	22/09/2020 08:31	22/09/2020 11:45	3,22	1	3,22	CHI
20200963728	PADRE BERNARDO	PB21142294	PADRE BERNARDO	22/09/2020 08:32	22/09/2020 14:04	22/09/2020 08:32	22/09/2020 14:04	5,53	1	5,53	CHI
20200963729	MINEIROS	MY11360784	PARQUE DAS EMAS	22/09/2020 08:32	22/09/2020 10:02	22/09/2020 08:32	22/09/2020 10:02	1,49	78	116,20	CHI
20200963744	ALTO PARAISO DE GOIAS	BF21194788	SAO JOAO D ALIANCA	22/09/2020 08:33	22/09/2020 13:06	22/09/2020 08:33	22/09/2020 13:06	4,54	1	4,54	CHI
20200963745	MAMBAI	4580001036	IACIARA S2	22/09/2020 08:33	22/09/2020 22:51	22/09/2020 08:33	22/09/2020 22:51	14,29	1	14,29	CHI
20200963752	GOIANESIA	550173857	GOIANESIA S2	22/09/2020 08:33	22/09/2020 14:04	22/09/2020 08:33	22/09/2020 14:04	5,50	1	5,50	CHI
20200963757	ANAPOLIS	AN21000104	ANAPOLIS UNIVERSITARIO S2	22/09/2020 08:34	23/09/2020 15:16	22/09/2020 08:34	23/09/2020 15:09	30,59	1	30,59	CHI
20200963766	NIQUELANDIA	NQ21377401	NIQUELANDIA SUBTRANSMISSAO	22/09/2020 08:34	22/09/2020 16:37	22/09/2020 08:34	22/09/2020 16:37	8,04	1	8,04	CHI
20200964134	JESUPOLIS	SF12000165	SAO FRANCISCO DE GOIAS	22/09/2020 08:34	22/09/2020 11:32	22/09/2020 08:34	22/09/2020 11:32	2,95	12	35,40	CHI
20200963757	ANAPOLIS	AN12000065	ANAPOLIS UNIVERSITARIO S2	22/09/2020 08:34	23/09/2020 15:16	23/09/2020 13:48	23/09/2020 15:16	1,46	37	53,86	CHI
20200964589	GOIAS	GS12188167	MATRINCHA	22/09/2020 08:35	22/09/2020 13:52	22/09/2020 08:35	22/09/2020 13:52	5,28	10	52,79	CHI
20200963785	RIO VERDE	RV12075420	RIO VERDE S1	22/09/2020 08:35	22/09/2020 10:26	22/09/2020 08:35	22/09/2020 10:26	1,84	16	29,37	CHI
20200963799	ANAPOLIS	21280423	JUNDIAI S2	22/09/2020 08:37	23/09/2020 11:37	22/09/2020 08:37	23/09/2020 11:37	27,00	1	27,00	CHI
20200963804	ANAPOLIS	20396892	ANAPOLIS UNIVERSITARIO S2	22/09/2020 08:37	22/09/2020 09:59	22/09/2020 08:37	22/09/2020 09:59	1,36	1	1,36	CHI
20200963805	ANAPOLIS	20688167	ANAPOLIS UNIVERSITARIO S2	22/09/2020 08:37	22/09/2020 15:27	22/09/2020 08:37	22/09/2020 15:27	6,83	1	6,83	CHI
20200964924	ABADIANIA	AA12349438	ANAPOLIS UNIVERSITARIO S1	22/09/2020 08:37	22/09/2020 11:08	22/09/2020 08:37	22/09/2020 11:08	2,51	27	67,66	CHI
20200963820	ITABERAI	50028870	ITABERAI S2	22/09/2020 08:38	22/09/2020 18:00	22/09/2020 08:38	22/09/2020 18:00	9,37	1	9,37	CHI
20200963837	ANAPOLIS	20652033	JUNDIAI S2	22/09/2020 08:38	22/09/2020 15:42	22/09/2020 08:38	22/09/2020 15:42	7,05	1	7,05	CHI
20200963840	PARAUNA	PU21167141	PARAUNA	22/09/2020 08:39	22/09/2020 09:29	22/09/2020 08:39	22/09/2020 09:29	0,83	1	0,83	CHI
20200963842	MINEIROS	MY11348939	PARQUE DAS EMAS	22/09/2020 08:39	22/09/2020 11:34	22/09/2020 08:39	22/09/2020 11:34	2,91	32	93,21	CHI
20200963843	PALMEIRAS DE GOIAS	590047188	PALMEIRAS	22/09/2020 08:39	22/09/2020 11:19	22/09/2020 08:39	22/09/2020 11:19	2,67	1	2,67	CHI
20200963845	GOIANAPOLIS	950017814	DAIA S2	22/09/2020 08:39	23/09/2020 10:14	22/09/2020 08:39	23/09/2020 10:14	25,58	1	25,58	CHI
20200963847	URUACU	640039078	URUACU	22/09/2020 08:39	22/09/2020 12:07	22/09/2020 08:39	22/09/2020 12:07	3,46	1	3,46	CHI

INTERNAL

20200964793	PADRE BERNARDO	PB12255470	PADRE BERNARDO	22/09/2020 08:39	22/09/2020 15:12	22/09/2020 08:39	22/09/2020 15:12	6,54	6	39,22	CHI
20200963854	GOIAS	90113809	GOIAS	22/09/2020 08:40	22/09/2020 10:49	22/09/2020 08:40	22/09/2020 10:49	2,15	1	2,15	CHI
20200963859	ANAPOLIS	AN21270348	JUNDIAI S1	22/09/2020 08:40	22/09/2020 16:00	22/09/2020 08:40	22/09/2020 16:00	7,33	1	7,33	CHI
20200963864	LUZIANIA	120187942	RIO VERMELHO	22/09/2020 08:40	22/09/2020 11:35	22/09/2020 08:40	22/09/2020 11:35	2,91	1	2,91	CHI
20200963867	JATAI	290291665	JATAI S2	22/09/2020 08:40	22/09/2020 16:07	22/09/2020 08:40	22/09/2020 16:07	7,44	1	7,44	CHI
20200963869	ITAPIRAPUA	IU12089742	MATRINCHA	22/09/2020 08:40	22/09/2020 13:12	22/09/2020 08:40	22/09/2020 13:12	4,52	6	27,14	CHI
20200963874	TERESINA DE GOIAS	TE21218389	FLORES DE GOIAS	22/09/2020 08:40	22/09/2020 11:03	22/09/2020 08:40	22/09/2020 11:03	2,37	1	2,37	CHI
20200963894	LEOPOLDO DE BULHOES	LB12281923	DAIA S2	22/09/2020 08:41	22/09/2020 11:11	22/09/2020 08:41	22/09/2020 11:11	2,49	95	236,10	CHI
20200967393	ANAPOLIS	AN12000327	JUNDIAI S1	22/09/2020 08:42	22/09/2020 16:47	22/09/2020 08:42	22/09/2020 16:47	8,07	6	48,41	CHI
20200963920	SILVANIA	LB21011662	DAIA S2	22/09/2020 08:43	22/09/2020 16:13	22/09/2020 08:43	22/09/2020 16:13	7,49	1	7,49	CHI
20200963935	ANAPOLIS	21130190	JUNDIAI S2	22/09/2020 08:44	22/09/2020 14:46	22/09/2020 08:44	22/09/2020 14:46	6,02	1	6,02	CHI
20200967227	ANAPOLIS	AN11209268	ANAPOLIS UNIVERSITARIO S2	22/09/2020 08:45	22/09/2020 15:19	22/09/2020 08:45	22/09/2020 15:19	6,57	14	91,93	CHI
20200963951	BALIZA	BH12331383	CAIAPONIA	22/09/2020 08:45	22/09/2020 10:16	22/09/2020 08:45	22/09/2020 10:16	1,51	1	1,51	CHI
20200963958	ANAPOLIS	20650103	JUNDIAI S2	22/09/2020 08:46	23/09/2020 12:20	22/09/2020 08:46	23/09/2020 12:20	27,56	1	27,56	CHI
20200962138	PADRE BERNARDO	PB12363227	PADRE BERNARDO	22/09/2020 08:47	22/09/2020 13:59	22/09/2020 08:47	22/09/2020 12:06	3,33	8	26,60	CHI
20200962138	PADRE BERNARDO	PB12363227	PADRE BERNARDO	22/09/2020 08:47	22/09/2020 13:59	22/09/2020 08:47	22/09/2020 13:59	5,20	1	5,20	CHI
20200963983	LEOPOLDO DE BULHOES	LB12011166	DAIA S2	22/09/2020 08:47	22/09/2020 12:31	22/09/2020 08:47	22/09/2020 12:31	3,72	1	3,72	CHI
20200963983	SILVANIA	LB12011166	DAIA S2	22/09/2020 08:47	22/09/2020 12:31	22/09/2020 08:47	22/09/2020 12:31	3,72	2	7,44	CHI
20200964000	TURVANIA	TV12215375	FIRMINOPOLIS S1	22/09/2020 08:48	23/09/2020 10:12	22/09/2020 08:48	23/09/2020 10:12	25,39	4	101,57	CHI
20200964003	PIRENOPOLIS	PV21000004	CORUMBA	22/09/2020 08:48	22/09/2020 17:20	22/09/2020 08:48	22/09/2020 17:20	8,52	2	17,05	CHI
20200964015	ANAPOLIS	20983669	JUNDIAI S2	22/09/2020 08:48	22/09/2020 12:12	22/09/2020 08:48	22/09/2020 12:12	3,39	1	3,39	CHI
20200964037	CAMPINACU	UC12034240	MARA ROSA	22/09/2020 08:49	22/09/2020 11:25	22/09/2020 08:49	22/09/2020 11:25	2,59	2	5,18	CHI
20200964038	MONTIVIDIU	MV12260779	MONTIVIDIU T	22/09/2020 08:49	22/09/2020 21:40	22/09/2020 08:49	22/09/2020 21:40	12,84	1	12,84	CHI
20200964038	MONTIVIDIU	MV12260779	MONTIVIDIU T	22/09/2020 08:49	22/09/2020 21:40	22/09/2020 11:44	22/09/2020 21:40	9,93	2	19,87	CHI
20200964049	SANCLERLANDIA	SC12036215	FIRMINOPOLIS S2	22/09/2020 08:50	22/09/2020 18:35	22/09/2020 08:50	22/09/2020 18:35	9,74	1	9,74	CHI
20200964054	FAZENDA NOVA	2290001606	IPORA	22/09/2020 08:50	22/09/2020 21:24	22/09/2020 08:50	22/09/2020 21:24	12,56	1	12,56	CHI
20200964059	GOIANAPOLIS	950032918	DAIA S2	22/09/2020 08:50	22/09/2020 20:37	22/09/2020 08:50	22/09/2020 20:37	11,77	1	11,77	CHI
20200964061	MARA ROSA	2260001951	MARA ROSA	22/09/2020 08:50	23/09/2020 16:25	22/09/2020 08:50	23/09/2020 16:25	31,57	1	31,57	CHI
20200964063	ITABERAI	IB21217060	ITABERAI S2	22/09/2020 08:50	22/09/2020 14:42	22/09/2020 08:50	22/09/2020 14:42	5,85	1	5,85	CHI
20200964422	ITAPURANGA	IK11000007	ITAPURANGA	22/09/2020 08:51	22/09/2020 12:30	22/09/2020 08:51	22/09/2020 12:30	3,64	141	513,63	CHI
20200964087	PIRENOPOLIS	PV21370307	CORUMBA	22/09/2020 08:51	22/09/2020 17:55	22/09/2020 08:51	22/09/2020 17:55	9,05	1	9,05	CHI
20200964090	LEOPOLDO DE BULHOES	LB21387913	DAIA S2	22/09/2020 08:52	23/09/2020 10:41	22/09/2020 08:52	23/09/2020 10:41	25,81	1	25,81	CHI
20200964095	ANAPOLIS	AN12084749	JUNDIAI S1	22/09/2020 08:52	23/09/2020 09:45	22/09/2020 08:52	23/09/2020 09:45	24,87	3	74,62	CHI

INTERNAL

20200964106	VILA BOA	2880012734	IACIARA S2	22/09/2020 08:53	22/09/2020 13:41	22/09/2020 08:53	22/09/2020 13:41	4,80	1	4,80	CHI
20200964107	NIQUELANDIA	NQ12270115	SAO JOAO D ALIANCA	22/09/2020 08:53	24/09/2020 04:11	22/09/2020 08:53	24/09/2020 04:11	43,31	1	43,31	CHI
20200967780	VALPARAISO DE GOIAS	VA12183504	PACAEMBU S1	22/09/2020 08:53	22/09/2020 14:50	22/09/2020 08:53	22/09/2020 14:50	5,94	82	486,83	CHI
20200964119	SANTA FE DE GOIAS	2070004680	BRITANIA	22/09/2020 08:53	22/09/2020 14:49	22/09/2020 08:53	22/09/2020 14:49	5,92	1	5,92	CHI
20200964121	ITARUMA	IM21340962	CACHOEIRA ALTA	22/09/2020 08:53	22/09/2020 17:25	22/09/2020 08:53	22/09/2020 17:25	8,52	1	8,52	CHI
20200964126	GOUVELANDIA	GB12402356	QUIRINOPOLIS	22/09/2020 08:53	22/09/2020 11:01	22/09/2020 08:53	22/09/2020 11:01	2,12	4	8,47	CHI
20200964136	ACREUNA	2440040521	ACREUNA	22/09/2020 08:54	22/09/2020 12:40	22/09/2020 08:54	22/09/2020 12:40	3,76	1	3,76	CHI
20200964144	PEROLANDIA	DP12182220	JATAI S1	22/09/2020 08:54	22/09/2020 10:59	22/09/2020 08:54	22/09/2020 10:59	2,07	6	12,40	CHI
20200964269	CRISTALINA	KR12025841	PAMPLONA	22/09/2020 08:55	22/09/2020 11:40	22/09/2020 08:55	22/09/2020 11:40	2,74	3	8,23	CHI
20200964159	ARENOPOLIS	1920007213	ARENOPOLIS	22/09/2020 08:56	22/09/2020 14:45	22/09/2020 08:56	22/09/2020 14:45	5,82	1	5,82	CHI
20200964171	VILA PROPICIO	NP12382314	GOIANESIA S1	22/09/2020 08:56	22/09/2020 10:33	22/09/2020 08:56	22/09/2020 10:33	1,61	12	19,28	CHI
20200964174	GOIAS	90048891	GOIAS	22/09/2020 08:56	22/09/2020 18:07	22/09/2020 08:56	22/09/2020 18:07	9,17	1	9,17	CHI
20200964177	NIQUELANDIA	4360003238	URUACU	22/09/2020 08:56	22/09/2020 12:32	22/09/2020 08:56	22/09/2020 12:32	3,59	1	3,59	CHI
20200968334	PADRE BERNARDO	PB12375256	PADRE BERNARDO	22/09/2020 08:57	22/09/2020 15:30	22/09/2020 08:57	22/09/2020 15:30	6,54	10	65,40	CHI
20200968560	CORUMBA DE GOIAS	CB12121725	CORUMBA	22/09/2020 08:58	23/09/2020 18:08	22/09/2020 08:58	23/09/2020 18:08	33,16	6	198,99	CHI
20200967109	FORMOSA	FA12071400	SAO JOAO D ALIANCA	22/09/2020 08:58	23/09/2020 10:49	22/09/2020 08:58	23/09/2020 10:49	25,85	8	206,78	CHI
20200964208	MOZARLANDIA	MZ12300442	MOZARLANDIA	22/09/2020 08:58	22/09/2020 14:27	22/09/2020 08:58	22/09/2020 14:27	5,48	5	27,38	CHI
20200964209	RIO VERDE	630152196	RIO VERDE S1	22/09/2020 08:58	22/09/2020 19:33	22/09/2020 08:58	22/09/2020 19:33	10,58	1	10,58	CHI
20200964213	PIRENOPOLIS	PV21000026	CORUMBA	22/09/2020 08:58	22/09/2020 16:55	22/09/2020 08:58	22/09/2020 16:55	7,94	1	7,94	CHI
20200964218	ARAGUAPAZ	1780025650	GOIAS	22/09/2020 08:58	22/09/2020 16:35	22/09/2020 08:58	22/09/2020 16:35	7,61	1	7,61	CHI
20200964220	NIQUELANDIA	NQ12237500	URUACU	22/09/2020 08:58	22/09/2020 10:54	22/09/2020 08:58	22/09/2020 10:54	1,92	2	3,84	CHI
20200964234	ACREUNA	EU21301165	ACREUNA	22/09/2020 08:59	22/09/2020 18:29	22/09/2020 08:59	22/09/2020 18:29	9,49	2	18,98	CHI
20200964237	NOVO GAMA	2460100985	PACAEMBU S1	22/09/2020 09:00	22/09/2020 11:52	22/09/2020 09:00	22/09/2020 11:52	2,87	1	2,87	CHI
20200965578	JARAGUA	JA11370455	JARAGUA	22/09/2020 09:00	22/09/2020 11:37	22/09/2020 09:00	22/09/2020 11:37	2,61	88	229,53	CHI
20200964248	LUZIANIA	120115268	RIO VERMELHO	22/09/2020 09:00	22/09/2020 11:33	22/09/2020 09:00	22/09/2020 11:33	2,55	1	2,55	CHI
20200964259	GOIAS	GS12299706	GOIAS	22/09/2020 09:01	22/09/2020 19:50	22/09/2020 09:01	22/09/2020 19:50	10,82	3	32,45	CHI
20200964268	SAO FRANCISCO DE GOIAS	SF21211910	SAO FRANCISCO DE GOIAS	22/09/2020 09:01	23/09/2020 07:28	22/09/2020 09:01	23/09/2020 07:28	22,44	1	22,44	CHI
20200964271	GOIAS	90030485	GOIAS	22/09/2020 09:02	22/09/2020 15:43	22/09/2020 09:02	22/09/2020 15:43	6,68	1	6,68	CHI
20200964272	RIO VERDE	RV21340871	MONTIVIDIU T	22/09/2020 09:02	23/09/2020 08:17	22/09/2020 09:02	23/09/2020 08:17	23,25	1	23,25	CHI
20200964281	SAO LUIS DE MONTES BELOS	SL12111553	FIRMINOPOLIS S1	22/09/2020 09:02	22/09/2020 11:58	22/09/2020 09:02	22/09/2020 11:58	2,92	7	20,45	CHI
20200964296	IACIARA	1550009178	IACIARA S1	22/09/2020 09:03	22/09/2020 10:04	22/09/2020 09:03	22/09/2020 10:04	1,02	1	1,02	CHI
20200964920	ALEXANIA	AX11185413	ALEXANIA	22/09/2020 09:04	22/09/2020 11:47	22/09/2020 09:04	22/09/2020 11:47	2,72	113	306,80	CHI
20200964317	ANAPOLIS	20891258	JUNDIAI S1	22/09/2020 09:04	22/09/2020 13:26	22/09/2020 09:04	22/09/2020 13:26	4,36	1	4,36	CHI

INTERNAL

20200964320	FIRMINOPOLIS	900026080	FIRMINOPOLIS S1	22/09/2020 09:04	22/09/2020 15:00	22/09/2020 09:04	22/09/2020 15:00	5,93	1	5,93	CHI
20200967954	SAO DOMINGOS	SD12208672	SAO DOMINGOS	22/09/2020 09:04	22/09/2020 18:28	22/09/2020 09:04	22/09/2020 18:28	9,39	27	253,46	CHI
20200964328	MARA ROSA	2260031943	MARA ROSA	22/09/2020 09:04	23/09/2020 14:45	22/09/2020 09:04	23/09/2020 14:45	29,67	1	29,67	CHI
20200966591	SANCLERLANDIA	SC12000023	FIRMINOPOLIS S2	22/09/2020 09:05	22/09/2020 17:36	22/09/2020 09:05	22/09/2020 17:36	8,51	6	51,06	CHI
20200964340	TEREZOPOLIS DE GOIAS	TJ21186931	JUNDIAI S1	22/09/2020 09:05	22/09/2020 15:49	22/09/2020 09:05	22/09/2020 15:49	6,72	1	6,72	CHI
20200964347	NIQUELANDIA	NQ21092989	URUACU	22/09/2020 09:06	22/09/2020 12:26	22/09/2020 09:06	22/09/2020 12:26	3,33	1	3,33	CHI
202009107067	SANTO ANTONIO DO DESCOBERTO	2210039934	ALEXANIA	22/09/2020 09:07	22/09/2020 13:19	22/09/2020 09:07	22/09/2020 13:19	4,20	1	4,20	CHI
20200964390	RIO VERDE	630188816	CABRIUVA S1	22/09/2020 09:07	22/09/2020 15:47	22/09/2020 09:07	22/09/2020 15:47	6,66	1	6,66	CHI
20200964395	VILA PROPICIO	PV12073537	GOIANESIA S1	22/09/2020 09:07	22/09/2020 14:24	22/09/2020 09:07	22/09/2020 14:24	5,27	8	42,16	CHI
20200964396	VILA PROPICIO	GE21358981	GOIANESIA S2	22/09/2020 09:07	23/09/2020 09:31	22/09/2020 09:07	23/09/2020 09:31	24,39	1	24,39	CHI
20200964407	AMERICANO DO BRASIL	KB21323562	ANICUNS	22/09/2020 09:08	22/09/2020 09:52	22/09/2020 09:08	22/09/2020 09:52	0,73	1	0,73	CHI
20200964411	IPORA	730058694	IPORA	22/09/2020 09:08	23/09/2020 09:27	22/09/2020 09:08	23/09/2020 09:27	24,31	1	24,31	CHI
20200966580	PIRENOPOLIS	PV11057885	CORUMBA	22/09/2020 09:08	22/09/2020 12:47	22/09/2020 09:08	22/09/2020 12:47	3,64	111	404,01	CHI
20200964432	GOIANESIA	550136745	GOIANESIA S2	22/09/2020 09:09	22/09/2020 11:09	22/09/2020 09:09	22/09/2020 11:09	1,99	1	1,99	CHI
20200964448	SIMOLANDIA	1940005969	IACIARA S2	22/09/2020 09:10	22/09/2020 13:59	22/09/2020 09:10	22/09/2020 13:59	4,81	1	4,81	CHI
20200964474	JARAGUA	JA21035544	GOIANESIA S2	22/09/2020 09:11	22/09/2020 16:02	22/09/2020 09:11	22/09/2020 16:02	6,83	1	6,83	CHI
20200964699	SAO FRANCISCO DE GOIAS	SF12026053	SAO FRANCISCO DE GOIAS	22/09/2020 09:12	22/09/2020 19:32	22/09/2020 09:12	22/09/2020 19:32	10,32	10	103,25	CHI
20200964956	HIDROLINA	HL12000009	URUACU	22/09/2020 09:15	22/09/2020 16:00	22/09/2020 09:15	22/09/2020 16:00	6,73	4	26,94	CHI
20200964548	SAO JOAO D ALIANCA	JL12383335	SAO JOAO D ALIANCA	22/09/2020 09:16	22/09/2020 11:14	22/09/2020 09:16	22/09/2020 11:14	1,96	12	23,47	CHI
20200964553	PADRE BERNARDO	PB12089582	PADRE BERNARDO	22/09/2020 09:16	22/09/2020 14:04	22/09/2020 09:16	22/09/2020 14:04	4,79	3	14,36	CHI
20200964554	IPORA	730124952	IPORA	22/09/2020 09:16	22/09/2020 12:04	22/09/2020 09:16	22/09/2020 12:04	2,79	1	2,79	CHI
20200964557	FORMOSA	FA12000078	ITIQUEIRA	22/09/2020 09:16	22/09/2020 12:01	22/09/2020 09:16	22/09/2020 12:01	2,73	1	2,73	CHI
20200964564	IPORA	730095393	IPORA	22/09/2020 09:17	22/09/2020 16:40	22/09/2020 09:17	22/09/2020 16:40	7,38	1	7,38	CHI
20200965917	PLANALTINA	TL12206256	SAO JOAO D ALIANCA	22/09/2020 09:17	23/09/2020 08:53	22/09/2020 09:17	23/09/2020 08:53	23,59	4	94,35	CHI
20200964581	TAQUARAL DE GOIAS	TQ11352484	ITABERAÍ S1	22/09/2020 09:17	22/09/2020 16:33	22/09/2020 09:17	22/09/2020 16:33	7,25	71	514,81	CHI
20200964584	PADRE BERNARDO	PB12382941	PADRE BERNARDO	22/09/2020 09:17	22/09/2020 14:29	22/09/2020 09:17	22/09/2020 14:29	5,18	3	15,55	CHI
20200964600	JARAGUA	70140789	JARAGUA	22/09/2020 09:19	23/09/2020 00:59	22/09/2020 09:19	23/09/2020 00:59	15,67	1	15,67	CHI
20200964607	ANAPOLIS	20725085	ANAPOLIS UNIVERSITARIO S2	22/09/2020 09:19	23/09/2020 08:06	22/09/2020 09:19	23/09/2020 08:06	22,78	1	22,78	CHI
20200964608	RIO VERDE	RV21135954	RIO VERDE S1	22/09/2020 09:19	22/09/2020 10:48	22/09/2020 09:19	22/09/2020 10:48	1,48	1	1,48	CHI
20200964612	JATAI	JT21387369	MONTIVIDIU T	22/09/2020 09:19	22/09/2020 11:29	22/09/2020 09:19	22/09/2020 11:29	2,16	1	2,16	CHI
20200964618	VALPARAISO DE GOIAS	VA11041608	MARAJOARA	22/09/2020 09:20	22/09/2020 14:55	22/09/2020 09:20	22/09/2020 14:55	5,58	9	50,25	CHI
20200964643	JATAI	SX21100843	JATAI S1	22/09/2020 09:21	22/09/2020 10:38	22/09/2020 09:21	22/09/2020 10:38	1,28	1	1,28	CHI
20200964658	PIRENOPOLIS	220032749	CORUMBA	22/09/2020 09:22	23/09/2020 13:46	22/09/2020 09:22	23/09/2020 13:46	28,40	1	28,40	CHI

INTERNAL

20200964679	SANTA TEREZA DE GOIAS	2430014549	MARA ROSA	22/09/2020 09:23	23/09/2020 02:00	22/09/2020 09:23	23/09/2020 02:00	16,61	1	16,61	CHI
20200964712	RIO VERDE	RV12200056LD	MONTIVIDIU T	22/09/2020 09:25	22/09/2020 11:19	22/09/2020 09:25	22/09/2020 11:19	1,90	1	1,90	CHI
20200967990	PORANGATU	PO12328829	PORANGATU	22/09/2020 09:26	22/09/2020 15:50	22/09/2020 09:26	22/09/2020 15:50	6,39	4	25,57	CHI
20200964738	ANAPOLIS	21332551	JUNDIAI S1	22/09/2020 09:26	22/09/2020 19:15	22/09/2020 09:26	22/09/2020 19:15	9,81	1	9,81	CHI
20200964743	JATAI	3920000727	JATAI S1	22/09/2020 09:26	23/09/2020 09:41	22/09/2020 09:26	23/09/2020 09:41	24,24	1	24,24	CHI
20200964749	APORE	AE12219493	ITAJA S1	22/09/2020 09:27	22/09/2020 10:10	22/09/2020 09:27	22/09/2020 10:10	0,71	3	2,14	CHI
20200964761	PIRENOPOLIS	PV21215247	CORUMBA	22/09/2020 09:27	22/09/2020 15:50	22/09/2020 14:25	22/09/2020 15:50	1,42	1	1,42	CHI
20200964780	ANAPOLIS	10016896074	JUNDIAI S1	22/09/2020 09:28	22/09/2020 16:57	22/09/2020 09:28	22/09/2020 16:57	7,47	1	7,47	CHI
20200964781	VALPARAISO DE GOIAS	3350051982	PACAEMBU S1	22/09/2020 09:28	22/09/2020 14:29	22/09/2020 09:28	22/09/2020 14:29	5,00	1	5,00	CHI
20200964788	BURITI DE GOIAS	BS11375304	FIRMINOPOLIS S2	22/09/2020 09:29	22/09/2020 13:20	22/09/2020 09:29	22/09/2020 13:20	3,86	19	73,37	CHI
20200964794	POSSE	1480011402	IACIARA S2	22/09/2020 09:29	22/09/2020 16:37	22/09/2020 09:29	22/09/2020 16:37	7,12	1	7,12	CHI
20200964795	ARAGARCAS	1820031175	ARAGARCAS	22/09/2020 09:29	22/09/2020 13:07	22/09/2020 09:29	22/09/2020 13:07	3,62	1	3,62	CHI
20200964799	BURITINOPOLIS	BQ12262077	IACIARA S2	22/09/2020 09:30	22/09/2020 11:20	22/09/2020 09:30	22/09/2020 11:20	1,83	53	97,09	CHI
20200966683	RUBIATABA	RB12126565	RUBIATABA	22/09/2020 09:30	23/09/2020 16:51	22/09/2020 09:30	23/09/2020 16:51	31,34	59	1849,11	CHI
20200966683	MORRO AGUDO DE GOIAS	RB12126565	RUBIATABA	22/09/2020 09:30	23/09/2020 16:51	22/09/2020 09:30	23/09/2020 16:51	31,34	4	125,36	CHI
20200964807	JARAGUA	70033523	GOIANESIA S2	22/09/2020 09:30	23/09/2020 09:43	22/09/2020 09:30	23/09/2020 09:43	24,22	1	24,22	CHI
20200964815	CAIAPONIA	CP21137082	CAIAPONIA	22/09/2020 09:31	22/09/2020 11:46	22/09/2020 09:31	22/09/2020 11:46	2,25	1	2,25	CHI
20200964841	SAO LUIS DE MONTES BELOS	500026208	SAO LUIZ DOS MONTES BELOS	22/09/2020 09:31	22/09/2020 14:38	22/09/2020 09:31	22/09/2020 14:38	5,11	1	5,11	CHI
20200964831	ARAGUAPAZ	1780017914	MOZARLANDIA	22/09/2020 09:31	22/09/2020 10:48	22/09/2020 09:31	22/09/2020 10:48	1,27	1	1,27	CHI
20200964843	VALPARAISO DE GOIAS	2860216644	PACAEMBU S1	22/09/2020 09:32	22/09/2020 13:06	22/09/2020 09:32	22/09/2020 13:06	3,55	1	3,55	CHI
20200965347	IACIARA	IA12243184RE	IACIARA S1	22/09/2020 09:32	22/09/2020 15:28	22/09/2020 09:32	22/09/2020 15:28	5,92	11	65,09	CHI
20200965327	ANAPOLIS	20335271	ANAPOLIS UNIVERSITARIO S2	22/09/2020 09:33	22/09/2020 17:28	22/09/2020 09:33	22/09/2020 17:28	7,92	1	7,92	CHI
20200964865	ITAGUARU	230011664	ITABERAI S1	22/09/2020 09:33	22/09/2020 14:02	22/09/2020 09:33	22/09/2020 14:02	4,48	1	4,48	CHI
20200964871	CACHOEIRA ALTA	CA21103647	CACHOEIRA ALTA	22/09/2020 09:34	22/09/2020 15:01	22/09/2020 09:34	22/09/2020 15:01	5,44	1	5,44	CHI
20200965633	ANAPOLIS	20794617	ANAPOLIS UNIVERSITARIO S2	22/09/2020 09:34	22/09/2020 16:29	22/09/2020 09:34	22/09/2020 16:29	6,90	1	6,90	CHI
20200964884	ANAPOLIS	10022217370	ANAPOLIS UNIVERSITARIO S2	22/09/2020 09:35	22/09/2020 14:41	22/09/2020 09:35	22/09/2020 14:41	5,10	1	5,10	CHI
20200965312	ARAGARCAS	AG11207479	ARAGARCAS	22/09/2020 09:35	22/09/2020 16:24	22/09/2020 09:35	22/09/2020 16:24	6,81	79	538,36	CHI
20200964907	ITAPURANGA	IK21308346	ITAPURANGA	22/09/2020 09:36	22/09/2020 12:41	22/09/2020 09:36	22/09/2020 12:41	3,08	1	3,08	CHI
20200964937	VILA PROPICIO	PV21122856	GOIANESIA S1	22/09/2020 09:38	22/09/2020 11:36	22/09/2020 09:38	22/09/2020 11:36	1,96	1	1,96	CHI
20200964947	PIRANHAS	10012869765	PIRANHAS	22/09/2020 09:39	22/09/2020 17:01	22/09/2020 09:39	22/09/2020 17:01	7,36	1	7,36	CHI
20200964951	ANAPOLIS	20777097	ANAPOLIS UNIVERSITARIO S2	22/09/2020 09:39	22/09/2020 17:16	22/09/2020 09:39	22/09/2020 17:16	7,61	1	7,61	CHI
20200964962	APORE	AE12188958	ITAJA S2	22/09/2020 09:40	22/09/2020 15:57	22/09/2020 09:40	22/09/2020 11:13	1,55	8	12,37	CHI
20200964968	ANAPOLIS	20777103	ANAPOLIS UNIVERSITARIO S2	22/09/2020 09:40	22/09/2020 17:53	22/09/2020 09:40	22/09/2020 17:53	8,21	1	8,21	CHI

INTERNAL

20200964975	AGUAS LINDAS DE GOIAS	4830043065	AGUAS LINDAS DE GOIAS S2	22/09/2020 09:40	22/09/2020 11:08	22/09/2020 09:40	22/09/2020 11:08	1,45	1	1,45	CHI
20200964962	APORE	AE12188958	ITAJA S2	22/09/2020 09:40	22/09/2020 15:57	22/09/2020 11:14	22/09/2020 15:57	4,73	8	37,85	CHI
20200964983	SAO LUIS DE MONTES BELOS	500079493	SAO LUIZ DOS MONTES BELOS	22/09/2020 09:41	22/09/2020 16:03	22/09/2020 09:41	22/09/2020 16:03	6,36	1	6,36	CHI
20200964986	PARAUNA	PU21316248	PARAUNA	22/09/2020 09:41	22/09/2020 11:14	22/09/2020 09:41	22/09/2020 11:14	1,54	1	1,54	CHI
20200964990	ANAPOLIS	20776410	ANAPOLIS UNIVERSITARIO S2	22/09/2020 09:41	22/09/2020 16:04	22/09/2020 09:41	22/09/2020 16:04	6,37	1	6,37	CHI
20200964992	ACREUNA	EU21000091	ACREUNA	22/09/2020 09:41	23/09/2020 11:08	22/09/2020 09:41	23/09/2020 11:08	25,43	1	25,43	CHI
20200964998	GOIAS	GS12206917	ITABERAI S1	22/09/2020 09:42	22/09/2020 13:32	22/09/2020 09:42	22/09/2020 13:32	3,83	9	34,46	CHI
20200965003	RIO VERDE	RV12271276	CABRIUVA S2	22/09/2020 09:42	23/09/2020 13:47	22/09/2020 09:42	23/09/2020 13:47	28,08	1	28,08	CHI
20200965008	MARA ROSA	ET12136395	MARA ROSA	22/09/2020 09:42	22/09/2020 11:59	22/09/2020 09:42	22/09/2020 11:59	2,27	9	20,44	CHI
20200965008	ESTRELA DO NORTE	ET12136395	MARA ROSA	22/09/2020 09:42	22/09/2020 11:59	22/09/2020 09:42	22/09/2020 11:59	2,27	10	22,71	CHI
20200965049	RIO VERDE	630250637	RIO VERDE S1	22/09/2020 09:45	22/09/2020 21:47	22/09/2020 09:45	22/09/2020 21:47	12,03	1	12,03	CHI
20200965085	RIO VERDE	RV11231004	RIO VERDE S2	22/09/2020 09:47	22/09/2020 15:10	22/09/2020 09:47	22/09/2020 15:10	5,38	96	516,83	CHI
20200965097	URUACU	640062714	URUACU	22/09/2020 09:47	22/09/2020 12:20	22/09/2020 09:47	22/09/2020 12:20	2,54	1	2,54	CHI
20200965098	GUARAITA	GK21299441	ITAPURANGA	22/09/2020 09:47	23/09/2020 10:45	22/09/2020 09:47	23/09/2020 10:45	24,95	1	24,95	CHI
20200965116	SAO JOAO D ALIANCA	JL21144676	SAO JOAO D ALIANCA	22/09/2020 09:48	22/09/2020 14:04	22/09/2020 09:48	22/09/2020 14:04	4,25	1	4,25	CHI
20200965118	BONOPOLIS	BX12391937	SAO MIGUEL DO ARAGUAIA	22/09/2020 09:48	22/09/2020 16:06	22/09/2020 09:48	22/09/2020 16:06	6,28	2	12,57	CHI
20200965116	SAO JOAO D ALIANCA	JL21144678	SAO JOAO D ALIANCA	22/09/2020 09:48	22/09/2020 14:04	22/09/2020 12:18	22/09/2020 14:04	1,77	1	1,77	CHI
20200965116	SAO JOAO D ALIANCA	JL12144641	SAO JOAO D ALIANCA	22/09/2020 09:48	22/09/2020 14:04	22/09/2020 12:43	22/09/2020 13:32	0,83	4	3,33	CHI
20200965144	FORMOSA	FA21278177	ITIQUEIRA	22/09/2020 09:50	23/09/2020 22:00	22/09/2020 09:50	23/09/2020 22:00	36,17	1	36,17	CHI
20200965289	ITAPIRAPUA	MP12299736	MATRINCHA	22/09/2020 09:50	22/09/2020 12:25	22/09/2020 09:50	22/09/2020 12:25	2,58	3	7,74	CHI
20200965289	MATRINCHA	MP12299736	MATRINCHA	22/09/2020 09:50	22/09/2020 12:25	22/09/2020 09:50	22/09/2020 12:25	2,58	187	482,46	CHI
20200965675	RIO VERDE	RV11349529	RIO VERDE S2	22/09/2020 09:50	22/09/2020 13:32	22/09/2020 09:50	22/09/2020 13:32	3,69	50	184,68	CHI
20200965154	SANTO ANTONIO DA BARRA	5450001762	ACREUNA	22/09/2020 09:50	22/09/2020 11:30	22/09/2020 09:50	22/09/2020 11:30	1,66	1	1,66	CHI
20200965155	IPORA	730082933	IPORA	22/09/2020 09:50	22/09/2020 19:37	22/09/2020 09:50	22/09/2020 19:37	9,78	1	9,78	CHI
20200965183	TERESINA DE GOIAS	TE12328409	FLORES DE GOIAS	22/09/2020 09:51	22/09/2020 10:33	22/09/2020 09:51	22/09/2020 10:33	0,69	16	10,99	CHI
20200965191	MAURILANDIA	1040029349	RIO DOS BOIS	22/09/2020 09:52	22/09/2020 20:21	22/09/2020 09:52	22/09/2020 20:21	10,48	1	10,48	CHI
20200965197	NOVO BRASIL	NB21152601	MATRINCHA	22/09/2020 09:52	23/09/2020 00:43	22/09/2020 09:52	23/09/2020 00:43	14,84	1	14,84	CHI
20200965212	ANICUNS	910046736	ANICUNS	22/09/2020 09:53	22/09/2020 14:17	22/09/2020 09:53	22/09/2020 14:17	4,39	1	4,39	CHI
20200965879	MONTES CLAROS DE GOIAS	ME12088929	IPORA	22/09/2020 09:53	22/09/2020 15:51	22/09/2020 09:53	22/09/2020 15:51	5,96	4	23,85	CHI
20200965232	HIDROLINA	1020001292	URUACU	22/09/2020 09:54	23/09/2020 18:08	22/09/2020 09:54	23/09/2020 18:08	32,23	1	32,23	CHI
20200965234	SAO LUIS DE MONTES BELOS	500011990	SAO LUIZ DOS MONTES BELOS	22/09/2020 09:54	22/09/2020 12:11	22/09/2020 09:54	22/09/2020 12:11	2,28	1	2,28	CHI
20200965251	IPORA	IR12259455	IPORA	22/09/2020 09:54	22/09/2020 16:34	22/09/2020 09:54	22/09/2020 16:34	6,65	3	19,96	CHI
20200965280	TURVELANDIA	TD21000254	RIO DOS BOIS	22/09/2020 09:55	22/09/2020 23:49	22/09/2020 09:55	22/09/2020 23:49	13,89	1	13,89	CHI

INTERNAL

2020092200182	SAO JOAO D ALIANCA	02160434	SAO JOAO D ALIANCA	22/09/2020 09:56	22/09/2020 10:01	22/09/2020 09:56	22/09/2020 10:01	0,08	14	1,17	CHI
2020092200182	AGUA FRIA DE GOIAS	02160434	SAO JOAO D ALIANCA	22/09/2020 09:56	22/09/2020 10:01	22/09/2020 09:56	22/09/2020 10:01	0,08	74	6,17	CHI
2020092200182	NIQUELANDIA	02160434	SAO JOAO D ALIANCA	22/09/2020 09:56	22/09/2020 10:01	22/09/2020 09:56	22/09/2020 10:01	0,08	213	17,75	CHI
20200965283	AGUA FRIA DE GOIAS	PI21049176	SAO JOAO D ALIANCA	22/09/2020 09:56	23/09/2020 12:05	22/09/2020 09:56	23/09/2020 12:05	26,15	1	26,15	CHI
20200965287	CAMPINACU	5700001231	PORANGATU	22/09/2020 09:56	24/09/2020 09:01	22/09/2020 09:56	24/09/2020 09:01	47,08	1	47,08	CHI
20200965290	PARANAIGUARA	PC21333327	CACHOEIRA ALTA	22/09/2020 09:56	22/09/2020 12:08	22/09/2020 09:56	22/09/2020 12:08	2,20	8	17,57	CHI
20200965301	MONTE ALEGRE DE GOIAS	MA11129994	SAO DOMINGOS	22/09/2020 09:56	22/09/2020 11:14	22/09/2020 09:56	22/09/2020 11:14	1,28	114	146,33	CHI
20200965311	SAO LUIS DE MONTES BELOS	500079948	SAO LUIZ DOS MONTES BELOS	22/09/2020 09:57	22/09/2020 11:41	22/09/2020 09:57	22/09/2020 11:41	1,73	1	1,73	CHI
20200965325	ALTO PARAISO DE GOIAS	3870021261	FLORES DE GOIAS	22/09/2020 09:58	22/09/2020 11:59	22/09/2020 09:58	22/09/2020 11:59	2,01	1	2,01	CHI
20200965331	ANAPOLIS	20067240	JUNDIAI S2	22/09/2020 09:58	22/09/2020 19:40	22/09/2020 09:58	22/09/2020 19:40	9,68	1	9,68	CHI
202009107068	SANTO ANTONIO DO DESCOBERTO	10015376212	ALEXANIA	22/09/2020 10:00	22/09/2020 13:19	22/09/2020 10:00	22/09/2020 13:19	3,32	1	3,32	CHI
20200965363	PIRANHAS	1930003745	PIRANHAS	22/09/2020 10:00	22/09/2020 15:38	22/09/2020 10:00	22/09/2020 15:38	5,62	1	5,62	CHI
20200965369	VILA BOA	2880002560	IACIARA S2	22/09/2020 10:01	22/09/2020 14:03	22/09/2020 10:01	22/09/2020 14:03	4,03	1	4,03	CHI
20200965852	NOVA ROMA	MA12236748	SAO DOMINGOS	22/09/2020 10:01	22/09/2020 17:07	22/09/2020 10:01	22/09/2020 17:07	7,09	57	404,26	CHI
20200965852	MONTE ALEGRE DE GOIAS	MA12236748	SAO DOMINGOS	22/09/2020 10:01	22/09/2020 17:07	22/09/2020 10:01	22/09/2020 17:07	7,09	2	14,18	CHI
20200965379	RIO VERDE	RV21273697	CABRIUVA S2	22/09/2020 10:02	22/09/2020 22:28	22/09/2020 10:02	22/09/2020 22:28	12,43	1	12,43	CHI
20200965388	ALTO HORIZONTE	9640004771	SANTA TEREZINHA	22/09/2020 10:02	23/09/2020 19:32	22/09/2020 10:02	23/09/2020 19:32	33,49	1	33,49	CHI
20200965400	JUSSARA	JR11341242	IPORA	22/09/2020 10:03	22/09/2020 11:35	22/09/2020 10:03	22/09/2020 11:35	1,54	52	80,18	CHI
20200965402	DOVERLANDIA	DV11259467	CAIAPONIA	22/09/2020 10:03	23/09/2020 07:23	22/09/2020 10:03	23/09/2020 07:23	21,32	1	21,32	CHI
20200965404	ANAPOLIS	20627713	JUNDIAI S1	22/09/2020 10:04	22/09/2020 15:33	22/09/2020 10:04	22/09/2020 15:33	5,48	1	5,48	CHI
20200965416	CAIAPONIA	930008753	CAIAPONIA	22/09/2020 10:04	23/09/2020 08:50	22/09/2020 10:04	23/09/2020 08:50	22,75	1	22,75	CHI
20200965418	MATRINCHA	4380008928	MATRINCHA	22/09/2020 10:04	22/09/2020 17:36	22/09/2020 10:04	22/09/2020 17:36	7,52	1	7,52	CHI
20200965437	ITAPACI	100005962	ITAPACI	22/09/2020 10:05	22/09/2020 15:12	22/09/2020 10:05	22/09/2020 15:12	5,10	1	5,10	CHI
20200965439	PARAUNA	PU21212820	PARAUNA	22/09/2020 10:06	22/09/2020 12:34	22/09/2020 10:06	22/09/2020 12:34	2,47	1	2,47	CHI
20200971273	SANTA ISABEL	GE12191489	ITAPACI	22/09/2020 10:08	22/09/2020 20:24	22/09/2020 10:08	22/09/2020 20:24	10,27	3	30,80	CHI
20200965466	NAZARIO	NZ21285452	ANICUNS	22/09/2020 10:08	22/09/2020 11:59	22/09/2020 10:08	22/09/2020 11:59	1,84	1	1,84	CHI
20200965512	JATAI	JT12191695	MONTIVIDIU T	22/09/2020 10:10	22/09/2020 10:41	22/09/2020 10:10	22/09/2020 10:41	0,50	1	0,50	CHI
20200965510	FORMOSA	610066511	ITUIQUIRA	22/09/2020 10:11	22/09/2020 17:15	22/09/2020 10:11	22/09/2020 17:15	7,07	1	7,07	CHI
20200966573	JATAI	290178850	JATAI S1	22/09/2020 10:11	22/09/2020 14:54	22/09/2020 10:11	22/09/2020 14:54	4,72	1	4,72	CHI
20200965514	CAMPINORTE	CR21101015	CAMPINORTE	22/09/2020 10:11	22/09/2020 11:30	22/09/2020 10:11	22/09/2020 11:30	1,31	1	1,31	CHI
20200965519	JATAI	JT21134475	JATAI S1	22/09/2020 10:11	22/09/2020 17:15	22/09/2020 10:11	22/09/2020 17:15	7,07	1	7,07	CHI
20200965524	LUZIANIA	120129243	RIO VERMELHO	22/09/2020 10:11	22/09/2020 15:15	22/09/2020 10:11	22/09/2020 15:15	5,06	1	5,06	CHI
20200965528	AMORINOPOLIS	AM21000074	IPORA	22/09/2020 10:11	22/09/2020 16:00	22/09/2020 10:11	22/09/2020 16:00	5,81	1	5,81	CHI

INTERNAL

20200965532	NOVA ROMA	ND12264858	IACIARA S2	22/09/2020 10:11	22/09/2020 12:19	22/09/2020 10:11	22/09/2020 12:19	2,12	85	180,03	CHI
20200965541	QUIRINOPOLIS	RV18301218TS	SANTA HELENA S1	22/09/2020 10:13	22/09/2020 12:59	22/09/2020 10:13	22/09/2020 12:59	2,77	38	105,12	CHI
20200965541	RIO VERDE	RV18301218TS	SANTA HELENA S1	22/09/2020 10:13	22/09/2020 12:59	22/09/2020 10:13	22/09/2020 12:59	2,77	17	47,03	CHI
20200965550	QUIRINOPOLIS	QI21101234	QUIRINOPOLIS	22/09/2020 10:13	22/09/2020 11:55	22/09/2020 10:13	22/09/2020 11:55	1,69	1	1,69	CHI
20200965554	BURITI DE GOIAS	1660003160	FIRMINOPOLIS S2	22/09/2020 10:13	22/09/2020 14:15	22/09/2020 10:13	22/09/2020 14:15	4,02	1	4,02	CHI
20200965555	IPORA	730115847	IPORA	22/09/2020 10:13	22/09/2020 14:48	22/09/2020 10:13	22/09/2020 14:48	4,57	1	4,57	CHI
20200965557	PIRENOPOLIS	PV21297615	CORUMBA	22/09/2020 10:13	22/09/2020 16:37	22/09/2020 10:13	22/09/2020 16:37	6,38	1	6,38	CHI
20200965562	JATAI	10023845706	JATAI S2	22/09/2020 10:14	22/09/2020 17:46	22/09/2020 10:14	22/09/2020 17:46	7,53	1	7,53	CHI
20200965583	MINEIROS	1390042847	PARQUE DAS EMAS	22/09/2020 10:15	23/09/2020 08:04	22/09/2020 10:15	23/09/2020 08:04	21,80	1	21,80	CHI
20200965584	NOVO GAMA	LZ21000107	PACAEMBU S1	22/09/2020 10:16	22/09/2020 17:36	22/09/2020 10:16	22/09/2020 17:36	7,33	1	7,33	CHI
20200965587	JATAI	JT21326424	JATAI S3	22/09/2020 10:16	22/09/2020 16:01	22/09/2020 10:16	22/09/2020 16:01	5,75	1	5,75	CHI
20200965591	URUACU	CR12282384	MARA ROSA	22/09/2020 10:16	22/09/2020 20:03	22/09/2020 10:16	22/09/2020 20:03	9,77	3	29,32	CHI
20200965591	CAMPINORTE	CR12282384	MARA ROSA	22/09/2020 10:16	22/09/2020 20:03	22/09/2020 10:16	22/09/2020 20:03	9,77	1	9,77	CHI
20200965593	DIORAMA	DI21135463	IPORA	22/09/2020 10:16	22/09/2020 18:10	22/09/2020 10:16	22/09/2020 18:10	7,90	1	7,90	CHI
20200965598	CIDADE OCIDENTAL	LZ21039298	MARAJOARA	22/09/2020 10:17	22/09/2020 16:45	22/09/2020 10:17	22/09/2020 16:45	6,47	1	6,47	CHI
20200965611	QUIRINOPOLIS	80000289	QUIRINOPOLIS	22/09/2020 10:18	22/09/2020 12:24	22/09/2020 10:18	22/09/2020 12:24	2,10	1	2,10	CHI
20200967524	ALTO PARAISO DE GOIAS	BF11056214	FLORES DE GOIAS	22/09/2020 10:19	22/09/2020 15:00	22/09/2020 10:19	22/09/2020 15:00	4,68	88	411,96	CHI
20200965621	PIRANHAS	1930018566	PIRANHAS	22/09/2020 10:19	22/09/2020 20:58	22/09/2020 10:19	22/09/2020 20:58	10,65	1	10,65	CHI
20200965627	SAO MIGUEL DO ARAGUAIA	SM21106743	SAO MIGUEL DO ARAGUAIA	22/09/2020 10:19	22/09/2020 12:19	22/09/2020 10:19	22/09/2020 12:19	1,99	1	1,99	CHI
20200965629	LUZIANIA	10021153890	MARAJOARA	22/09/2020 10:19	22/09/2020 16:51	22/09/2020 10:19	22/09/2020 16:51	6,52	1	6,52	CHI
20200965638	CIDADE OCIDENTAL	10028023160	MARAJOARA	22/09/2020 10:20	22/09/2020 12:28	22/09/2020 10:20	22/09/2020 12:28	2,13	1	2,13	CHI
20200965646	PARANAIGUARA	PC12360645	CACHOEIRA ALTA	22/09/2020 10:21	22/09/2020 14:50	22/09/2020 10:21	22/09/2020 14:50	4,48	58	259,98	CHI
20200965646	SAO SIMAO	PC12360645	CACHOEIRA ALTA	22/09/2020 10:21	22/09/2020 14:50	22/09/2020 10:21	22/09/2020 14:50	4,48	7	31,38	CHI
20200965648	ARUANA	AK13307491	MOZARLANDIA	22/09/2020 10:21	22/09/2020 20:28	22/09/2020 10:21	22/09/2020 20:28	10,12	20	202,31	CHI
20200965649	URUACU	640083304	URUACU	22/09/2020 10:21	22/09/2020 14:58	22/09/2020 10:21	22/09/2020 14:58	4,61	1	4,61	CHI
20200965697	MONTE ALEGRE DE GOIAS	MA12235989	SAO DOMINGOS	22/09/2020 10:21	22/09/2020 11:41	22/09/2020 10:21	22/09/2020 11:41	1,32	22	28,99	CHI
20200965659	MONTIVIDIU	MV12226309	MONTIVIDIU T	22/09/2020 10:22	22/09/2020 19:51	22/09/2020 10:22	22/09/2020 19:51	9,48	1	9,48	CHI
20200965658	MINEIROS	MY12240339	PARQUE DAS EMAS	22/09/2020 10:22	22/09/2020 19:19	22/09/2020 10:22	22/09/2020 19:19	8,95	2	17,90	CHI
20200965660	VALPARAISO DE GOIAS	2860064595	MARAJOARA	22/09/2020 10:22	22/09/2020 16:45	22/09/2020 10:22	22/09/2020 16:45	6,38	1	6,38	CHI
20200965661	BALIZA	BH12193416	BOM JARDIM	22/09/2020 10:22	22/09/2020 15:29	22/09/2020 10:22	22/09/2020 15:29	5,11	3	15,34	CHI
20200965661	BOM JARDIM DE GOIAS	BH12193416	BOM JARDIM	22/09/2020 10:22	22/09/2020 15:29	22/09/2020 10:22	22/09/2020 15:29	5,11	4	20,46	CHI
20200966353	LUZIANIA	LZ11000292	MARAJOARA	22/09/2020 10:22	22/09/2020 13:27	22/09/2020 10:22	22/09/2020 13:27	3,08	136	419,14	CHI
20200965668	ITAPURANGA	170017576	ITAPURANGA	22/09/2020 10:22	23/09/2020 02:01	22/09/2020 10:22	23/09/2020 02:01	15,64	1	15,64	CHI

INTERNAL

20200965682	PIRANHAS	1930042787	PIRANHAS	22/09/2020 10:24	22/09/2020 18:08	22/09/2020 10:24	22/09/2020 18:08	7,73	1	7,73	CHI
20200965691	CIDADE OCIDENTAL	2680016495	MARAJOARA	22/09/2020 10:24	22/09/2020 12:35	22/09/2020 10:24	22/09/2020 12:35	2,17	1	2,17	CHI
20200965693	AMERICANO DO BRASIL	1410010809	ANICUNS	22/09/2020 10:24	22/09/2020 14:41	22/09/2020 10:24	22/09/2020 14:41	4,27	1	4,27	CHI
20200967667	CAIAPONIA	CP12260792	MONTIVIDIU T	22/09/2020 10:25	22/09/2020 17:52	22/09/2020 10:25	22/09/2020 17:00	6,57	1	6,57	CHI
20200967667	MONTIVIDIU	CP12267739	MONTIVIDIU T	22/09/2020 10:25	22/09/2020 17:52	22/09/2020 10:25	22/09/2020 17:52	7,45	3	22,36	CHI
20200967667	CAIAPONIA	CP12267739	MONTIVIDIU T	22/09/2020 10:25	22/09/2020 17:52	22/09/2020 10:25	22/09/2020 17:52	7,45	2	14,90	CHI
20200965717	ANICUNS	AC12012920	ANICUNS	22/09/2020 10:26	22/09/2020 17:15	22/09/2020 10:26	22/09/2020 17:15	6,81	4	27,25	CHI
20200965733	ANAPOLIS	20164270	ANAPOLIS UNIVERSITARIO S2	22/09/2020 10:27	23/09/2020 12:13	22/09/2020 10:27	23/09/2020 12:13	25,76	1	25,76	CHI
20200965740	IACIARA	IA21390886	IACIARA S2	22/09/2020 10:27	22/09/2020 15:05	22/09/2020 10:27	22/09/2020 15:05	4,62	1	4,62	CHI
20200965741	INDIARA	IY21304671	PALMEIRAS	22/09/2020 10:27	22/09/2020 14:55	22/09/2020 10:27	22/09/2020 14:55	4,46	2	8,91	CHI
20200965749	GOIAS	90083453	GOIAS	22/09/2020 10:28	22/09/2020 14:17	22/09/2020 10:28	22/09/2020 14:17	3,82	1	3,82	CHI
20200965760	ANAPOLIS	20184876	JUNDIAI S2	22/09/2020 10:28	22/09/2020 13:12	22/09/2020 10:28	22/09/2020 13:12	2,72	1	2,72	CHI
20200965766	GOIANESIA	550148280	GOIANESIA S2	22/09/2020 10:29	22/09/2020 13:56	22/09/2020 10:29	22/09/2020 13:56	3,45	1	3,45	CHI
20200965772	ITAPURANGA	170109793	ITAPURANGA	22/09/2020 10:29	22/09/2020 11:48	22/09/2020 10:29	22/09/2020 11:48	1,31	1	1,31	CHI
20200965774	ANAPOLIS	20843835	ANAPOLIS UNIVERSITARIO S2	22/09/2020 10:29	22/09/2020 16:45	22/09/2020 10:29	22/09/2020 16:45	6,25	1	6,25	CHI
20200965777	PADRE BERNARDO	10032221612	PADRE BERNARDO	22/09/2020 10:30	22/09/2020 16:09	22/09/2020 10:30	22/09/2020 16:09	5,65	1	5,65	CHI
20200965786	VILA BOA	2880007593	IACIARA S2	22/09/2020 10:30	23/09/2020 14:33	22/09/2020 10:30	23/09/2020 14:33	28,04	1	28,04	CHI
20200965789	SANTA FE DE GOIAS	RN12167348	BRITANIA	22/09/2020 10:30	22/09/2020 11:55	22/09/2020 10:30	22/09/2020 11:55	1,40	1	1,40	CHI
20200965791	RIO VERDE	630173230	RIO VERDE S1	22/09/2020 10:30	22/09/2020 15:46	22/09/2020 10:30	22/09/2020 15:46	5,25	1	5,25	CHI
20200965807	QUIRINOPOLIS	QI31052461	QUIRINOPOLIS	22/09/2020 10:32	22/09/2020 23:49	22/09/2020 10:32	22/09/2020 23:49	13,28	1	13,28	CHI
20200965812	ANAPOLIS	AN21017632	ANAPOLIS UNIVERSITARIO S2	22/09/2020 10:32	22/09/2020 16:18	22/09/2020 10:32	22/09/2020 16:18	5,76	1	5,76	CHI
20200965830	PALMEIRAS DE GOIAS	590024012	PALMEIRAS	22/09/2020 10:34	22/09/2020 15:53	22/09/2020 10:34	22/09/2020 15:53	5,31	1	5,31	CHI
20200965835	CACU	1140001945	CACHOEIRA ALTA	22/09/2020 10:35	22/09/2020 13:56	22/09/2020 10:35	22/09/2020 13:56	3,35	1	3,35	CHI
20200968054	DOVERLANDIA	DV11193289	CAIAPONIA	22/09/2020 10:35	22/09/2020 16:19	22/09/2020 10:35	22/09/2020 16:19	5,73	27	154,77	CHI
20200968980	ANAPOLIS	20037510	ANAPOLIS UNIVERSITARIO S2	22/09/2020 10:35	22/09/2020 17:09	22/09/2020 10:35	22/09/2020 17:09	6,58	1	6,58	CHI
20200965838	FIRMINOPOLIS	FR11072543	FIRMINOPOLIS S1	22/09/2020 10:35	22/09/2020 14:16	22/09/2020 10:35	22/09/2020 14:16	3,68	118	433,94	CHI
20200965871	GOIANESIA	550002807	GOIANESIA S2	22/09/2020 10:38	22/09/2020 13:32	22/09/2020 10:38	22/09/2020 13:32	2,90	1	2,90	CHI
20200965876	ANAPOLIS	20497945	JUNDIAI S1	22/09/2020 10:38	22/09/2020 11:44	22/09/2020 10:38	22/09/2020 11:44	1,08	1	1,08	CHI
20200965883	MINEIROS	MY12303356	PARQUE DAS EMAS	22/09/2020 10:39	22/09/2020 21:51	22/09/2020 10:39	22/09/2020 21:51	11,19	3	33,56	CHI
20200965887	CACHOEIRA ALTA	QI12279622	QUIRINOPOLIS	22/09/2020 10:39	22/09/2020 14:02	22/09/2020 10:39	22/09/2020 14:02	3,37	14	47,14	CHI
20200966036	JARAGUA	JA12273177	JARAGUA	22/09/2020 10:40	22/09/2020 19:05	22/09/2020 10:40	22/09/2020 19:05	8,42	6	50,49	CHI
20200965905	DOVERLANDIA	4220007132	CAIAPONIA	22/09/2020 10:41	23/09/2020 09:34	22/09/2020 10:41	23/09/2020 09:34	22,88	1	22,88	CHI
20200965926	LUZIANIA	10030783109	RIO VERMELHO	22/09/2020 10:43	22/09/2020 12:31	22/09/2020 10:43	22/09/2020 12:31	1,80	1	1,80	CHI

INTERNAL

20200965936	AGUA FRIA DE GOIAS	TL21204671	SAO JOAO D ALIANCA	22/09/2020 10:43	22/09/2020 15:50	22/09/2020 10:43	22/09/2020 15:50	5,10	1	5,10	CHI
20200965940	ANAPOLIS	20573546	JUNDIAI S2	22/09/2020 10:44	23/09/2020 03:54	22/09/2020 10:44	23/09/2020 03:54	17,16	1	17,16	CHI
20200965941	RIO VERDE	630084063	RIO VERDE S2	22/09/2020 10:44	23/09/2020 20:06	22/09/2020 10:44	23/09/2020 20:06	33,36	1	33,36	CHI
20200965943	APORE	AE12041637	ITAJA S1	22/09/2020 10:44	23/09/2020 07:17	22/09/2020 10:44	23/09/2020 07:17	20,54	1	20,54	CHI
20200966795	GOIANAPOLIS	GP12351049	DAIA S2	22/09/2020 10:44	23/09/2020 15:12	22/09/2020 10:44	22/09/2020 14:05	3,33	5	16,67	CHI
20200966795	TEREZOPOLIS DE GOIAS	TJ12379432LD	DAIA S2	22/09/2020 10:44	23/09/2020 15:12	22/09/2020 10:44	23/09/2020 13:53	27,13	36	976,86	CHI
20200966795	TEREZOPOLIS DE GOIAS	TJ12197112	DAIA S2	22/09/2020 10:44	23/09/2020 15:12	22/09/2020 10:44	23/09/2020 15:12	28,46	11	313,10	CHI
20200965960	ANAPOLIS	10012168007	ANAPOLIS UNIVERSITARIO S2	22/09/2020 10:45	23/09/2020 02:17	22/09/2020 10:45	23/09/2020 02:17	15,54	1	15,54	CHI
20200965963	PORANGATU	PO21187978	PORANGATU	22/09/2020 10:45	22/09/2020 12:58	22/09/2020 10:45	22/09/2020 12:58	2,21	1	2,21	CHI
20200966349	PALESTINA DE GOIAS	PY12132875	PALESTINA	22/09/2020 10:45	23/09/2020 03:03	22/09/2020 10:45	23/09/2020 03:03	16,28	18	293,12	CHI
20200965977	GAMELEIRA DE GOIAS	21134108	DAIA S1	22/09/2020 10:47	22/09/2020 12:55	22/09/2020 10:47	22/09/2020 12:55	2,14	1	2,14	CHI
20200966673	MARA ROSA	MQ12249312	SANTA TEREZINHA	22/09/2020 10:47	22/09/2020 21:40	22/09/2020 10:47	22/09/2020 21:40	10,87	11	119,54	CHI
20200966002	ALVORADA DO NORTE	SA12221147	IACIARA S2	22/09/2020 10:49	22/09/2020 13:04	22/09/2020 10:49	22/09/2020 13:04	2,25	3	6,74	CHI
20200966002	SIMOLANDIA	SA12221147	IACIARA S2	22/09/2020 10:49	22/09/2020 13:04	22/09/2020 10:49	22/09/2020 13:04	2,25	61	137,01	CHI
20200966012	ANAPOLIS	20485840	JUNDIAI S1	22/09/2020 10:50	23/09/2020 09:21	22/09/2020 10:50	23/09/2020 09:21	22,52	1	22,52	CHI
20200966022	JATAI	JT21324824	JATAI S1	22/09/2020 10:50	22/09/2020 12:10	22/09/2020 10:50	22/09/2020 12:10	1,32	1	1,32	CHI
20200966028	INDIARA	IY21206440	CEZARINA	22/09/2020 10:51	22/09/2020 17:57	22/09/2020 10:51	22/09/2020 17:57	7,10	1	7,10	CHI
20200966037	CIDADE OCIDENTAL	2680115000	MARAJOARA	22/09/2020 10:52	22/09/2020 15:27	22/09/2020 10:52	22/09/2020 15:27	4,58	1	4,58	CHI
20200966099	ANAPOLIS	21295645	JUNDIAI S1	22/09/2020 10:52	23/09/2020 19:02	22/09/2020 10:52	23/09/2020 19:02	32,15	1	32,15	CHI
20200966050	SAO FRANCISCO DE GOIAS	490012723	SAO FRANCISCO DE GOIAS	22/09/2020 10:53	22/09/2020 22:13	22/09/2020 10:53	22/09/2020 22:13	11,33	1	11,33	CHI
20200966052	ANAPOLIS	20588239	ANAPOLIS UNIVERSITARIO S2	22/09/2020 10:53	23/09/2020 10:17	22/09/2020 10:53	23/09/2020 10:17	23,40	1	23,40	CHI
20200966067	ALEXANIA	AX21421349	ALEXANIA	22/09/2020 10:54	22/09/2020 13:23	22/09/2020 10:54	22/09/2020 13:23	2,48	1	2,48	CHI
20200966070	ANAPOLIS	20196350	JUNDIAI S2	22/09/2020 10:54	22/09/2020 14:00	22/09/2020 10:54	22/09/2020 14:00	3,09	1	3,09	CHI
20200966087	PLANALTINA	2960075724	PLANALTINA	22/09/2020 10:55	22/09/2020 18:11	22/09/2020 10:55	22/09/2020 18:11	7,25	1	7,25	CHI
20200966090	BALIZA	BH21148522	BOM JARDIM	22/09/2020 10:56	22/09/2020 12:34	22/09/2020 10:56	22/09/2020 12:34	1,63	1	1,63	CHI
20200966098	RIO VERDE	630167990	CABRIUVA S1	22/09/2020 10:56	23/09/2020 08:27	22/09/2020 10:56	23/09/2020 08:27	21,50	1	21,50	CHI
20200966102	RIO VERDE	RV12160803	MONTIVIDIU T	22/09/2020 10:57	22/09/2020 14:29	22/09/2020 10:57	22/09/2020 14:29	3,53	5	17,63	CHI
20200966105	JARAGUA	JA21314078	SAO FRANCISCO DE GOIAS	22/09/2020 10:57	22/09/2020 12:41	22/09/2020 10:57	22/09/2020 12:41	1,72	2	3,44	CHI
20200966107	QUIRINOPOLIS	QI21302541	QUIRINOPOLIS	22/09/2020 10:57	22/09/2020 13:17	22/09/2020 10:57	22/09/2020 13:17	2,32	1	2,32	CHI
20200966116	ARUANA	AK12016451	BRITANIA	22/09/2020 10:58	22/09/2020 17:22	22/09/2020 10:58	22/09/2020 17:22	6,39	2	12,78	CHI
20200966128	LUZIANIA	120294916	RIO VERMELHO	22/09/2020 10:59	22/09/2020 12:52	22/09/2020 10:59	22/09/2020 12:52	1,88	1	1,88	CHI
20200964750	FLORES DE GOIAS	FB12248173	IACIARA S2	22/09/2020 10:59	22/09/2020 17:08	22/09/2020 10:59	22/09/2020 17:08	6,14	20	122,89	CHI
20200966148	INDIARA	IY21016771	PALMEIRAS	22/09/2020 11:00	22/09/2020 20:22	22/09/2020 11:00	22/09/2020 20:22	9,36	1	9,36	CHI

INTERNAL

20200966159	ACREUNA	2440049834	ACREUNA	22/09/2020 11:01	22/09/2020 16:37	22/09/2020 11:01	22/09/2020 16:37	5,59	1	5,59	CHI
20200966173	ANAPOLIS	20393295	JUNDIAI S1	22/09/2020 11:02	23/09/2020 11:23	22/09/2020 11:02	23/09/2020 11:23	24,34	1	24,34	CHI
20200966182	ITABERAI	IB12307280	ITABERAI S2	22/09/2020 11:02	22/09/2020 16:09	22/09/2020 11:02	22/09/2020 16:09	5,10	126	642,67	CHI
20200966179	ANAPOLIS	20700430	ANAPOLIS UNIVERSITARIO S2	22/09/2020 11:03	23/09/2020 11:50	22/09/2020 11:03	23/09/2020 11:50	24,78	1	24,78	CHI
20200966185	ANAPOLIS	20421369	ANAPOLIS UNIVERSITARIO S2	22/09/2020 11:03	23/09/2020 11:00	22/09/2020 11:03	23/09/2020 11:00	23,94	1	23,94	CHI
20200966186	ITABERAI	10000751454	ITABERAI S2	22/09/2020 11:03	22/09/2020 13:56	22/09/2020 11:03	22/09/2020 13:56	2,89	1	2,89	CHI
20200966198	MONTES CLAROS DE GOIAS	1440007941	IPORA	22/09/2020 11:04	22/09/2020 15:35	22/09/2020 11:04	22/09/2020 15:35	4,51	1	4,51	CHI
20200966208	CAMPOS BELOS	820015933	SAO DOMINGOS	22/09/2020 11:05	22/09/2020 13:44	22/09/2020 11:05	22/09/2020 13:44	2,64	1	2,64	CHI
20200966209	URUACU	UR12374770	URUACU	22/09/2020 11:05	23/09/2020 00:50	22/09/2020 11:05	23/09/2020 00:50	13,74	13	178,57	CHI
20200966210	FAINA	2580019991	GOIAS	22/09/2020 11:06	22/09/2020 13:41	22/09/2020 11:06	22/09/2020 13:41	2,58	1	2,58	CHI
20200966221	ANAPOLIS	10030984678	JUNDIAI S1	22/09/2020 11:07	23/09/2020 12:07	22/09/2020 11:07	23/09/2020 12:07	24,99	1	24,99	CHI
20200966226	ITAPURANGA	170100790	ITAPURANGA	22/09/2020 11:07	22/09/2020 14:46	22/09/2020 11:07	22/09/2020 14:46	3,64	1	3,64	CHI
20200966227	COCALZINHO DE GOIAS	ZN12285303	COCALZINHO	22/09/2020 11:07	22/09/2020 18:27	22/09/2020 11:07	22/09/2020 18:27	7,32	11	80,55	CHI
20200966234	LUZIANIA	120157767	RIO VERMELHO	22/09/2020 11:08	22/09/2020 11:33	22/09/2020 11:08	22/09/2020 11:33	0,41	1	0,41	CHI
20200966243	PALMEIRAS DE GOIAS	590063250	PALMEIRAS	22/09/2020 11:09	22/09/2020 13:07	22/09/2020 11:09	22/09/2020 13:07	1,96	1	1,96	CHI
20200966252	ANAPOLIS	20069704	JUNDIAI S1	22/09/2020 11:10	22/09/2020 14:55	22/09/2020 11:10	22/09/2020 14:55	3,75	1	3,75	CHI
20200966260	JARAGUA	JA12000117	JARAGUA	22/09/2020 11:11	22/09/2020 12:46	22/09/2020 11:11	22/09/2020 12:46	1,58	1	1,58	CHI
20200968411	FAINA	GS12274473LD	MATRINCHA	22/09/2020 11:11	22/09/2020 16:06	22/09/2020 11:11	22/09/2020 16:06	4,90	4	19,62	CHI
20200968411	MATRINCHA	GS12274473LD	MATRINCHA	22/09/2020 11:11	22/09/2020 16:06	22/09/2020 11:11	22/09/2020 16:06	4,90	282	1383,21	CHI
20200968411	GOIAS	GS12274473LD	MATRINCHA	22/09/2020 11:11	22/09/2020 16:06	22/09/2020 11:11	22/09/2020 16:06	4,90	32	156,96	CHI
20200966279	VALPARAISO DE GOIAS	2860020350	PACAEMBU S1	22/09/2020 11:12	23/09/2020 00:03	22/09/2020 11:12	23/09/2020 00:03	12,84	1	12,84	CHI
20200966294	TERESINA DE GOIAS	TE11257468	FLORES DE GOIAS	22/09/2020 11:14	22/09/2020 19:12	22/09/2020 11:14	22/09/2020 19:12	7,96	133	1059,31	CHI
20200966298	PLANALTINA	2960038661	PLANALTINA	22/09/2020 11:14	22/09/2020 22:42	22/09/2020 11:14	22/09/2020 22:42	11,46	1	11,46	CHI
20200966299	ANAPOLIS	20325691	ANAPOLIS UNIVERSITARIO S2	22/09/2020 11:14	23/09/2020 16:19	22/09/2020 11:14	23/09/2020 16:19	29,07	1	29,07	CHI
20200966296	GOIANAPOLIS	GP11000004	DAIA S2	22/09/2020 11:14	22/09/2020 19:36	22/09/2020 19:30	22/09/2020 19:36	0,10	147	14,13	CHI
20200966309	VALPARAISO DE GOIAS	2860004136	MARAJOARA	22/09/2020 11:15	22/09/2020 16:20	22/09/2020 11:15	22/09/2020 16:20	5,08	1	5,08	CHI
20200966322	SAO SIMAO	SO21216658	CACHOEIRA ALTA	22/09/2020 11:16	22/09/2020 17:56	22/09/2020 11:16	22/09/2020 17:56	6,66	1	6,66	CHI
20200966323	JATAI	JT21191694	MONTIVIDIU T	22/09/2020 11:16	22/09/2020 15:08	22/09/2020 11:16	22/09/2020 15:08	3,86	1	3,86	CHI
20200966324	ALEXANIA	AX21091388	ALEXANIA	22/09/2020 11:16	23/09/2020 13:51	22/09/2020 11:16	23/09/2020 13:51	26,57	1	26,57	CHI
20200966337	FORMOSA	FA11085453	ITUIQUIRA	22/09/2020 11:17	22/09/2020 15:40	22/09/2020 11:17	22/09/2020 15:40	4,37	3	13,12	CHI
20200968985	MONTES CLAROS DE GOIAS	ME12184448	IPORA	22/09/2020 11:18	22/09/2020 23:46	22/09/2020 11:18	22/09/2020 23:46	12,46	7	87,19	CHI
20200966346	PETROLINA DE GOIAS	320007870	PETROLINA	22/09/2020 11:18	22/09/2020 14:31	22/09/2020 11:18	22/09/2020 14:31	3,21	1	3,21	CHI
20200966385	ITABERAI	IB12220126	ITABERAI S1	22/09/2020 11:19	22/09/2020 16:18	22/09/2020 11:19	22/09/2020 16:18	4,98	5	24,90	CHI

INTERNAL

20200969073	ITABERAÍ	II12217217	ITABERAÍ S1	22/09/2020 11:19	22/09/2020 18:25	22/09/2020 11:19	22/09/2020 18:25	7,09	22	156,01	CHI
20200969073	TAQUARAL DE GOÍAS	II12217217	ITABERAÍ S1	22/09/2020 11:19	22/09/2020 18:25	22/09/2020 11:19	22/09/2020 18:25	7,09	46	326,20	CHI
20200969073	ITAGUARI	II12217217	ITABERAÍ S1	22/09/2020 11:19	22/09/2020 18:25	22/09/2020 11:19	22/09/2020 18:25	7,09	43	304,93	CHI
20200966378	JATAÍ	290317435	JATAÍ S2	22/09/2020 11:20	22/09/2020 18:22	22/09/2020 11:20	22/09/2020 18:22	7,02	1	7,02	CHI
20200966397	ALVORADA DO NORTE	1510014138	IACIARA S2	22/09/2020 11:22	22/09/2020 12:37	22/09/2020 11:22	22/09/2020 12:37	1,24	1	1,24	CHI
20200966399	SAO LUIS DE MONTES BELOS	500083216	SAO LUIZ DOS MONTES BELOS	22/09/2020 11:22	22/09/2020 12:42	22/09/2020 11:22	22/09/2020 12:42	1,32	1	1,32	CHI
20200966403	SAO JOAO D ALIANCA	JL21146210	SAO JOAO D ALIANCA	22/09/2020 11:23	23/09/2020 00:09	22/09/2020 11:23	23/09/2020 00:09	12,76	1	12,76	CHI
20200966416	GOUVELANDIA	GB11209430	QUIRINOPOLIS	22/09/2020 11:24	22/09/2020 13:18	22/09/2020 11:24	22/09/2020 13:18	1,89	54	102,17	CHI
20200966431	ITAPIRAPUA	1420027338	MATRINCHA	22/09/2020 11:25	22/09/2020 13:45	22/09/2020 11:25	22/09/2020 13:45	2,32	1	2,32	CHI
20200966438	PALMEIRAS DE GOÍAS	590041666	PALMEIRAS	22/09/2020 11:26	22/09/2020 14:40	22/09/2020 11:26	22/09/2020 14:40	3,23	1	3,23	CHI
20200966443	LEOPOLDO DE BULHOES	870025089	DAIA S2	22/09/2020 11:26	22/09/2020 15:32	22/09/2020 11:26	22/09/2020 15:32	4,09	1	4,09	CHI
20200966453	ITAPURANGA	10003711500	ITAPURANGA	22/09/2020 11:27	22/09/2020 18:31	22/09/2020 11:27	22/09/2020 18:31	7,06	1	7,06	CHI
20200966450	GOIANESIA	550106200	GOIANESIA S2	22/09/2020 11:27	22/09/2020 17:45	22/09/2020 11:27	22/09/2020 17:45	6,29	1	6,29	CHI
20200966452	IPORA	730102245	IPORA	22/09/2020 11:27	22/09/2020 20:02	22/09/2020 11:27	22/09/2020 20:02	8,58	1	8,58	CHI
20200966460	PADRE BERNARDO	PB21230224	PADRE BERNARDO	22/09/2020 11:28	22/09/2020 15:42	22/09/2020 11:28	22/09/2020 15:42	4,23	1	4,23	CHI
20200966479	CAVALCANTE	CJ12163386	FLORES DE GOÍAS	22/09/2020 11:29	22/09/2020 15:02	22/09/2020 11:29	22/09/2020 15:02	3,54	9	31,83	CHI
20200966480	SANTA RITA DO ARAGUAIA	SU21090643	SANTA RITA DO ARAGUAIA	22/09/2020 11:30	22/09/2020 12:47	22/09/2020 11:30	22/09/2020 12:47	1,28	1	1,28	CHI
20200966490	RIO VERDE	630062020	RIO VERDE S2	22/09/2020 11:30	22/09/2020 22:13	22/09/2020 11:30	22/09/2020 22:13	10,72	1	10,72	CHI
20200966495	QUIRINOPOLIS	QI21091046	QUIRINOPOLIS	22/09/2020 11:31	22/09/2020 12:38	22/09/2020 11:31	22/09/2020 12:38	1,12	1	1,12	CHI
20200966513	FORMOSA	610321699	ITUIQUIRA	22/09/2020 11:33	22/09/2020 15:10	22/09/2020 11:33	22/09/2020 15:10	3,62	1	3,62	CHI
20200966524	ITAPIRAPUA	1420025081	MATRINCHA	22/09/2020 11:34	22/09/2020 18:07	22/09/2020 11:34	22/09/2020 18:07	6,55	1	6,55	CHI
20200966547	RIO VERDE	RV21198333	MONTIVIDIU T	22/09/2020 11:36	22/09/2020 16:40	22/09/2020 11:36	22/09/2020 16:40	5,06	1	5,06	CHI
20200966548	QUIRINOPOLIS	80037800	QUIRINOPOLIS	22/09/2020 11:36	22/09/2020 16:00	22/09/2020 11:36	22/09/2020 16:00	4,39	1	4,39	CHI
20200966562	ACREUNA	2440036645	ACREUNA	22/09/2020 11:37	22/09/2020 22:46	22/09/2020 11:37	22/09/2020 22:46	11,13	1	11,13	CHI
20200966571	ITABERAÍ	IB21040785	ITABERAÍ S2	22/09/2020 11:39	22/09/2020 16:15	22/09/2020 11:39	22/09/2020 16:15	4,59	1	4,59	CHI
20200966572	ITAPACI	IW12405289	ITAPACI	22/09/2020 11:39	22/09/2020 13:45	22/09/2020 11:39	22/09/2020 13:45	2,09	3	6,28	CHI
20200966574	RIO VERDE	10010193500	RIO VERDE S1	22/09/2020 11:39	23/09/2020 08:37	22/09/2020 11:39	23/09/2020 08:37	20,96	1	20,96	CHI
20200966575	AMARALINA	3590002680	MARA ROSA	22/09/2020 11:39	24/09/2020 00:33	22/09/2020 11:39	24/09/2020 00:33	36,89	1	36,89	CHI
20200966581	RIO VERDE	630126021	RIO VERDE S2	22/09/2020 11:39	22/09/2020 15:49	22/09/2020 11:39	22/09/2020 15:49	4,15	1	4,15	CHI
20200966587	MINEIROS	MY21303815	PARQUE DAS EMAS	22/09/2020 11:40	22/09/2020 19:40	22/09/2020 11:40	22/09/2020 19:40	8,00	1	8,00	CHI
20200966590	SAO LUIS DE MONTES BELOS	SL21125622	FIRMINOPOLIS S1	22/09/2020 11:40	22/09/2020 16:01	22/09/2020 11:40	22/09/2020 16:01	4,34	1	4,34	CHI
20200966593	ANAPOLIS	330001371	ANAPOLIS UNIVERSITARIO S2	22/09/2020 11:40	23/09/2020 12:20	22/09/2020 11:40	23/09/2020 12:20	24,65	1	24,65	CHI
20200966596	ITABERAÍ	IB12300330	ITABERAÍ S2	22/09/2020 11:40	22/09/2020 18:26	22/09/2020 11:40	22/09/2020 18:26	6,75	14	94,52	CHI

INTERNAL

20200966601	JUSSARA	JR12093790	JUSSARA	22/09/2020 11:41	22/09/2020 17:13	22/09/2020 11:41	22/09/2020 17:13	5,53	2	11,06	CHI
20200966605	LUZIANIA	LZ31059756	MARAJOARA	22/09/2020 11:41	22/09/2020 15:25	22/09/2020 11:41	22/09/2020 15:25	3,73	1	3,73	CHI
20200968295	ANAPOLIS	AN12288618	JUNDIAI S2	22/09/2020 11:42	22/09/2020 15:40	22/09/2020 11:42	22/09/2020 15:40	3,95	60	237,23	CHI
20200966624	VILA PROPICIO	NP21312770	CORUMBA	22/09/2020 11:42	23/09/2020 08:21	22/09/2020 11:42	23/09/2020 08:21	20,63	1	20,63	CHI
20200966628	ANAPOLIS	AN21302304	JUNDIAI S2	22/09/2020 11:43	22/09/2020 15:59	22/09/2020 11:43	22/09/2020 15:59	4,27	1	4,27	CHI
20200966635	TURVELANDIA	TD21118506	SANTA HELENA S1	22/09/2020 11:43	23/09/2020 01:48	22/09/2020 11:43	23/09/2020 01:48	14,07	1	14,07	CHI
20200969636	PILAR DE GOIAS	GG12245205	SANTA TEREZINHA	22/09/2020 11:44	22/09/2020 22:24	22/09/2020 11:44	22/09/2020 22:24	10,66	13	138,58	CHI
20200966906	ANAPOLIS	AN11382385	ANAPOLIS UNIVERSITARIO S2	22/09/2020 11:45	22/09/2020 13:59	22/09/2020 11:45	22/09/2020 13:59	2,23	121	270,20	CHI
20200966674	RIO VERDE	630270107	RIO VERDE S2	22/09/2020 11:46	23/09/2020 00:10	22/09/2020 11:46	23/09/2020 00:10	12,39	1	12,39	CHI
20200957882	AMARALINA	MU12391653	MARA ROSA	22/09/2020 11:47	23/09/2020 11:49	22/09/2020 11:47	23/09/2020 11:49	24,03	18	432,60	CHI
20200966682	FORMOSA	FA11218290	SAO JOAO D ALIANCA	22/09/2020 11:48	22/09/2020 19:36	22/09/2020 11:48	22/09/2020 19:36	7,80	1	7,80	CHI
20200966703	JATAI	JT21324859	JATAI S1	22/09/2020 11:49	22/09/2020 14:20	22/09/2020 11:49	22/09/2020 14:18	2,47	2	4,94	CHI
20200966703	JATAI	JT12324858	JATAI S1	22/09/2020 11:49	22/09/2020 14:20	22/09/2020 13:35	22/09/2020 14:20	0,75	1	0,75	CHI
20200966706	VALPARAISO DE GOIAS	VA11373781	PACAEMBU S2	22/09/2020 11:50	22/09/2020 18:08	22/09/2020 11:50	22/09/2020 18:08	6,29	55	346,21	CHI
20200966708	RIO VERDE	630052414	RIO VERDE S1	22/09/2020 11:50	23/09/2020 13:00	22/09/2020 11:50	23/09/2020 13:00	25,16	1	25,16	CHI
20200966723	VALPARAISO DE GOIAS	2860033963	MARAJOARA	22/09/2020 11:51	22/09/2020 16:17	22/09/2020 11:51	22/09/2020 16:17	4,42	1	4,42	CHI
20200966736	PARAUNA	PU12109626	PARAUNA	22/09/2020 11:53	22/09/2020 13:53	22/09/2020 11:53	22/09/2020 13:53	2,00	8	16,00	CHI
20200966739	RIO VERDE	RV21322316	CABRIUVA S2	22/09/2020 11:53	22/09/2020 16:03	22/09/2020 11:53	22/09/2020 16:03	4,16	1	4,16	CHI
20200966850	FAZENDA NOVA	NB12396253	JUSSARA	22/09/2020 11:54	23/09/2020 16:11	22/09/2020 11:54	23/09/2020 13:22	25,46	5	127,32	CHI
20200966850	FAZENDA NOVA	NB12396253	JUSSARA	22/09/2020 11:54	23/09/2020 16:11	22/09/2020 11:54	23/09/2020 16:11	28,30	8	226,36	CHI
20200966850	JUSSARA	NB12396253	JUSSARA	22/09/2020 11:54	23/09/2020 16:11	22/09/2020 11:54	23/09/2020 16:11	28,30	1	28,30	CHI
20200966752	FAINA	FC12399465	GOIAS	22/09/2020 11:54	22/09/2020 13:11	22/09/2020 11:54	22/09/2020 13:11	1,28	1	1,28	CHI
20200969752	ITAUCU	IB12078567	ITABERAI S1	22/09/2020 11:54	22/09/2020 21:23	22/09/2020 11:54	22/09/2020 21:23	9,47	2	18,94	CHI
20200969752	ITABERAI	IB12078567	ITABERAI S1	22/09/2020 11:54	22/09/2020 21:23	22/09/2020 11:54	22/09/2020 21:23	9,47	17	160,99	CHI
20200966760	SAO FRANCISCO DE GOIAS	490019663	SAO FRANCISCO DE GOIAS	22/09/2020 11:54	23/09/2020 23:16	22/09/2020 11:54	23/09/2020 23:16	35,35	1	35,35	CHI
20200966770	LUZIANIA	120094198	RIO VERMELHO	22/09/2020 11:55	22/09/2020 14:31	22/09/2020 11:55	22/09/2020 14:31	2,58	1	2,58	CHI
20200966772	SAO DOMINGOS	SD12384774	SAO DOMINGOS	22/09/2020 11:55	22/09/2020 16:18	22/09/2020 11:55	22/09/2020 16:18	4,37	41	179,06	CHI
20200966823	AGUAS LINDAS DE GOIAS	4830303968	AGUAS LINDAS DE GOIAS S1	22/09/2020 12:00	22/09/2020 12:56	22/09/2020 12:00	22/09/2020 12:56	0,92	1	0,92	CHI
20200966845	NIQUELANDIA	NQ11171104	BARRO ALTO	22/09/2020 12:02	23/09/2020 16:19	22/09/2020 12:02	23/09/2020 16:19	28,27	2	56,55	CHI
20200966848	SAO LUIS DE MONTES BELOS	500020589	SAO LUIZ DOS MONTES BELOS	22/09/2020 12:02	22/09/2020 16:55	22/09/2020 12:02	22/09/2020 16:55	4,87	1	4,87	CHI
20200967535	FORMOSA	FA12204758	ITUIQUIRA	22/09/2020 12:04	22/09/2020 18:49	22/09/2020 12:04	22/09/2020 18:49	6,74	19	128,14	CHI
20200961658	CIDADE OCIDENTAL	DH21128821	MARAJOARA	22/09/2020 12:04	22/09/2020 21:38	22/09/2020 12:04	22/09/2020 21:38	9,55	7	66,86	CHI
20200966885	URUACU	10014744145	URUACU	22/09/2020 12:05	23/09/2020 08:39	22/09/2020 12:05	23/09/2020 08:39	20,57	1	20,57	CHI

INTERNAL

20200966888	NIQUELANDIA	10014289693	NIQUELANDIA SUBTRANSMISSAO	22/09/2020 12:05	23/09/2020 16:03	22/09/2020 12:05	23/09/2020 16:03	27,96	1	27,96	CHI
20200966899	NAZARIO	NZ11054735	ANICUNS	22/09/2020 12:06	22/09/2020 15:26	22/09/2020 12:06	22/09/2020 15:26	3,33	155	516,37	CHI
20200966903	MINEIROS	MY21349164	PARQUE DAS EMAS	22/09/2020 12:06	22/09/2020 16:10	22/09/2020 12:06	22/09/2020 16:10	4,06	1	4,06	CHI
20200966905	MONTES CLAROS DE GOIAS	2700001017	IPORA	22/09/2020 12:06	22/09/2020 20:58	22/09/2020 12:06	22/09/2020 20:58	8,86	1	8,86	CHI
20200966924	FORMOSA	610046111	ITUIQUIRA	22/09/2020 12:07	22/09/2020 15:46	22/09/2020 12:07	22/09/2020 15:46	3,64	1	3,64	CHI
20200966930	TAQUARAL DE GOIAS	TQ21000091	ITABERAÍ S2	22/09/2020 12:08	23/09/2020 08:57	22/09/2020 12:08	23/09/2020 08:57	20,81	1	20,81	CHI
202009107069	SANTO ANTONIO DO DESCOBERTO	1850002517	ALEXANIA	22/09/2020 12:08	22/09/2020 13:19	22/09/2020 12:08	22/09/2020 13:19	1,18	1	1,18	CHI
20200966945	POSSE	1480048681	IACIARA S2	22/09/2020 12:09	22/09/2020 17:52	22/09/2020 12:09	22/09/2020 17:52	5,71	1	5,71	CHI
20200966948	ANAPOLIS	20015987	ANAPOLIS UNIVERSITARIO S2	22/09/2020 12:09	23/09/2020 08:34	22/09/2020 12:09	23/09/2020 08:34	20,40	1	20,40	CHI
20200966955	ANAPOLIS	20044525	JUNDIAI S2	22/09/2020 12:10	23/09/2020 18:51	22/09/2020 12:10	23/09/2020 18:51	30,67	1	30,67	CHI
20200966974	GOIANESIA	10019213342	GOIANESIA S2	22/09/2020 12:12	22/09/2020 16:18	22/09/2020 12:12	22/09/2020 16:18	4,08	1	4,08	CHI
20200967758	SANTA HELENA DE GOIAS	SH12280603	IPEGUARI	22/09/2020 12:15	22/09/2020 15:28	22/09/2020 12:15	22/09/2020 15:28	3,21	548	1760,15	CHI
20200967003	SAO JOAO D ALIANCA	JL12268121	SAO JOAO D ALIANCA	22/09/2020 12:15	22/09/2020 18:12	22/09/2020 12:15	22/09/2020 18:12	5,94	6	35,65	CHI
20200967015	JATAI	JT21105471	JATAI S1	22/09/2020 12:16	22/09/2020 14:52	22/09/2020 12:16	22/09/2020 14:52	2,59	1	2,59	CHI
20200967017	GOIANESIA	550035783	GOIANESIA S2	22/09/2020 12:17	22/09/2020 15:24	22/09/2020 12:17	22/09/2020 15:24	3,12	1	3,12	CHI
20200967019	ACREUNA	EU12350868	ACREUNA	22/09/2020 12:17	23/09/2020 11:05	22/09/2020 12:17	23/09/2020 11:05	22,79	5	113,97	CHI
20200967231	PARANAIGUARA	PC12060518	QUIRINOPOLIS	22/09/2020 12:17	22/09/2020 14:56	22/09/2020 12:17	22/09/2020 14:56	2,64	5	13,20	CHI
20200967026	MAURILANDIA	DM21160801	RIO DOS BOIS	22/09/2020 12:17	23/09/2020 05:18	22/09/2020 12:17	23/09/2020 05:18	17,00	1	17,00	CHI
20200965143	PORANGATU	PO13380736	MARA ROSA	22/09/2020 12:18	24/09/2020 13:57	22/09/2020 12:18	24/09/2020 13:57	49,67	35	1738,29	CHI
20200967043	ANAPOLIS	20256127	ANAPOLIS UNIVERSITARIO S1	22/09/2020 12:19	23/09/2020 18:00	22/09/2020 12:19	23/09/2020 18:00	29,67	1	29,67	CHI
20200969434	ITAGUARU	230016182	ITABERAÍ S1	22/09/2020 12:20	22/09/2020 19:08	22/09/2020 12:20	22/09/2020 19:08	6,80	1	6,80	CHI
20200967181	SANTA FE DE GOIAS	RN12079527	BRITANIA	22/09/2020 12:21	22/09/2020 16:12	22/09/2020 12:21	22/09/2020 16:12	3,84	11	42,29	CHI
20200967181	JUSSARA	RN12079527	BRITANIA	22/09/2020 12:21	22/09/2020 16:12	22/09/2020 12:21	22/09/2020 16:12	3,84	2	7,69	CHI
20200967071	CEZARINA	1650023215	CEZARINA	22/09/2020 12:22	22/09/2020 19:51	22/09/2020 12:22	22/09/2020 19:51	7,48	1	7,48	CHI
20200967082	JATAI	10000923158	JATAI S2	22/09/2020 12:23	22/09/2020 17:11	22/09/2020 12:23	22/09/2020 17:11	4,80	1	4,80	CHI
20200967088	JATAI	290101463	JATAI S2	22/09/2020 12:23	22/09/2020 19:56	22/09/2020 12:23	22/09/2020 19:56	7,54	1	7,54	CHI
20200967527	ARENOPOLIS	AY12193296	ARENOPOLIS	22/09/2020 12:23	22/09/2020 16:05	22/09/2020 12:23	22/09/2020 16:05	3,69	89	328,36	CHI
20200967092	ANAPOLIS	20745760	JUNDIAI S1	22/09/2020 12:23	22/09/2020 16:18	22/09/2020 12:23	22/09/2020 16:18	3,90	1	3,90	CHI
20200969269	PIRENOPOLIS	PV12381260	CORUMBA	22/09/2020 12:24	23/09/2020 07:41	22/09/2020 12:24	23/09/2020 07:41	19,27	76	1464,79	CHI
20200967104	ANAPOLIS	20949728	ANAPOLIS UNIVERSITARIO S2	22/09/2020 12:25	23/09/2020 09:58	22/09/2020 12:25	23/09/2020 09:58	21,55	1	21,55	CHI
20200970448	ABADIANIA	AA11156848	ANAPOLIS UNIVERSITARIO S1	22/09/2020 12:25	22/09/2020 19:25	22/09/2020 12:25	22/09/2020 19:25	6,99	162	1131,89	CHI
20200967119	ANAPOLIS	20621267	JUNDIAI S1	22/09/2020 12:25	22/09/2020 18:41	22/09/2020 12:25	22/09/2020 18:41	6,25	1	6,25	CHI
20200967130	ANAPOLIS	20864670	ANAPOLIS UNIVERSITARIO S1	22/09/2020 12:26	23/09/2020 17:13	22/09/2020 12:26	23/09/2020 17:13	28,77	1	28,77	CHI

INTERNAL

20200967136	PIRENOPOLIS	PV21278794	CORUMBA	22/09/2020 12:28	23/09/2020 09:44	22/09/2020 12:28	23/09/2020 09:44	21,27	1	21,27	CHI
20200969405	SAO DOMINGOS	GH12398369	SAO DOMINGOS	22/09/2020 12:29	22/09/2020 21:27	22/09/2020 12:29	22/09/2020 21:27	8,96	19	170,32	CHI
20200969405	DIVINOPOLIS DE GOIAS	GH12398369	SAO DOMINGOS	22/09/2020 12:29	22/09/2020 21:27	22/09/2020 12:29	22/09/2020 21:27	8,96	21	188,25	CHI
20200967151	JATAI	290049714	JATAI S3	22/09/2020 12:30	23/09/2020 02:52	22/09/2020 12:30	23/09/2020 02:52	14,37	1	14,37	CHI
20200967158	CEZARINA	CZ21067958	CEZARINA	22/09/2020 12:31	22/09/2020 17:44	22/09/2020 12:31	22/09/2020 17:44	5,22	1	5,22	CHI
20200967163	ANAPOLIS	20319836	ANAPOLIS UNIVERSITARIO S1	22/09/2020 12:31	23/09/2020 15:48	22/09/2020 12:31	23/09/2020 15:48	27,27	1	27,27	CHI
20200967174	ANAPOLIS	20249100	ANAPOLIS UNIVERSITARIO S1	22/09/2020 12:32	22/09/2020 23:04	22/09/2020 12:32	22/09/2020 23:04	10,52	1	10,52	CHI
20200967180	RIO VERDE	RV12271609	CABRIUVA S2	22/09/2020 12:33	22/09/2020 15:59	22/09/2020 12:33	22/09/2020 15:59	3,43	1	3,43	CHI
20200967185	CAMPINACU	UC12285919	PORANGATU	22/09/2020 12:33	22/09/2020 15:55	22/09/2020 12:33	22/09/2020 15:55	3,36	2	6,72	CHI
20200967259	CRIXAS	CX10394727	SERRA DO OURO	22/09/2020 12:34	24/09/2020 18:50	22/09/2020 12:34	22/09/2020 14:16	1,70	96	162,85	CHI
20200967259	CRIXAS	CX10394727	SERRA DO OURO	22/09/2020 12:34	24/09/2020 18:50	22/09/2020 12:34	22/09/2020 16:35	4,02	74	297,25	CHI
20200967259	CRIXAS	CX12285878LD	SERRA DO OURO	22/09/2020 12:34	24/09/2020 18:50	22/09/2020 12:34	22/09/2020 21:03	8,48	26	220,41	CHI
20200967259	CRIXAS	CX10394727	SERRA DO OURO	22/09/2020 12:34	24/09/2020 18:50	22/09/2020 12:34	22/09/2020 21:51	9,28	15	139,14	CHI
20200967259	CRIXAS	CX10394727	SERRA DO OURO	22/09/2020 12:34	24/09/2020 18:50	22/09/2020 12:34	23/09/2020 00:44	12,16	2	24,32	CHI
20200967259	CRIXAS	CX10394727	SERRA DO OURO	22/09/2020 12:34	24/09/2020 18:50	22/09/2020 12:34	23/09/2020 12:21	23,79	9	214,13	CHI
20200967259	NOVA ROMA	CX10394727	SERRA DO OURO	22/09/2020 12:34	24/09/2020 18:50	22/09/2020 12:34	24/09/2020 17:11	52,61	1	52,61	CHI
20200967259	CRIXAS	CX10394727	SERRA DO OURO	22/09/2020 12:34	24/09/2020 18:50	22/09/2020 12:34	24/09/2020 17:11	52,61	76	3998,49	CHI
20200967259	PORANGATU	CX10394727	SERRA DO OURO	22/09/2020 12:34	24/09/2020 18:50	22/09/2020 12:34	24/09/2020 17:11	52,61	1	52,61	CHI
20200967259	CRIXAS	CX12181251	SERRA DO OURO	22/09/2020 12:34	24/09/2020 18:50	22/09/2020 12:34	24/09/2020 17:42	53,13	1	53,13	CHI
20200967259	CRIXAS	CX12235697	SERRA DO OURO	22/09/2020 12:34	24/09/2020 18:50	22/09/2020 12:34	24/09/2020 18:03	53,48	3	160,45	CHI
20200967259	CRIXAS	CX12394449	SERRA DO OURO	22/09/2020 12:34	24/09/2020 18:50	22/09/2020 12:34	24/09/2020 18:50	54,27	22	1193,85	CHI
20200967195	QUIRINOPOLIS	80138184	QUIRINOPOLIS	22/09/2020 12:34	22/09/2020 16:54	22/09/2020 12:34	22/09/2020 16:54	4,32	1	4,32	CHI
20200967259	CRIXAS	CX10394727	SERRA DO OURO	22/09/2020 12:34	24/09/2020 18:50	22/09/2020 12:37	22/09/2020 14:16	1,65	1	1,65	CHI
20200967259	CRIXAS	CX13145558	SERRA DO OURO	22/09/2020 12:34	24/09/2020 18:50	22/09/2020 12:37	22/09/2020 16:35	3,97	1	3,97	CHI
20200967259	CRIXAS	CX12285878LD	SERRA DO OURO	22/09/2020 12:34	24/09/2020 18:50	22/09/2020 12:37	22/09/2020 21:03	8,43	1	8,43	CHI
20200967259	CRIXAS	CX13350038	SERRA DO OURO	22/09/2020 12:34	24/09/2020 18:50	22/09/2020 12:37	22/09/2020 21:51	9,23	26	239,91	CHI
20200967259	CRIXAS	CX13350038	SERRA DO OURO	22/09/2020 12:34	24/09/2020 18:50	22/09/2020 12:37	23/09/2020 12:21	23,74	1	23,74	CHI
20200967259	CRIXAS	CX13350038	SERRA DO OURO	22/09/2020 12:34	24/09/2020 18:50	22/09/2020 12:37	24/09/2020 17:11	52,56	7	367,94	CHI
20200967259	CRIXAS	CX12235697	SERRA DO OURO	22/09/2020 12:34	24/09/2020 18:50	22/09/2020 12:37	24/09/2020 18:03	53,44	7	374,05	CHI
20200967259	CRIXAS	CX10394727	SERRA DO OURO	22/09/2020 12:34	24/09/2020 18:50	22/09/2020 21:51	22/09/2020 22:27	0,61	199	121,00	CHI
20200967259	CRIXAS	CX10394727	SERRA DO OURO	22/09/2020 12:34	24/09/2020 18:50	23/09/2020 00:44	23/09/2020 01:07	0,39	199	77,11	CHI
20200967259	CRIXAS	CX10394727	SERRA DO OURO	22/09/2020 12:34	24/09/2020 18:50	23/09/2020 05:51	23/09/2020 06:13	0,37	199	73,24	CHI
20200967259	CRIXAS	CX13350038	SERRA DO OURO	22/09/2020 12:34	24/09/2020 18:50	24/09/2020 16:53	24/09/2020 17:11	0,29	10	2,91	CHI

INTERNAL

20200967208	ANAPOLIS	20388445	ANAPOLIS UNIVERSITARIO S2	22/09/2020 12:37	22/09/2020 19:21	22/09/2020 12:37	22/09/2020 19:21	6,73	1	6,73	CHI
20200967222	GOIANESIA	GE21000288	GOIANESIA S1	22/09/2020 12:37	22/09/2020 19:00	22/09/2020 12:37	22/09/2020 19:00	6,37	1	6,37	CHI
20200967241	DIORAMA	1530006494	IPORA	22/09/2020 12:40	23/09/2020 03:23	22/09/2020 12:40	23/09/2020 03:23	14,71	1	14,71	CHI
20200967242	ANAPOLIS	20542082	ANAPOLIS UNIVERSITARIO S2	22/09/2020 12:40	23/09/2020 17:36	22/09/2020 12:40	23/09/2020 17:36	28,92	1	28,92	CHI
20200967250	NOVA AMERICA	NM21184698	RUBIATABA	22/09/2020 12:41	23/09/2020 00:47	22/09/2020 12:41	23/09/2020 00:47	12,09	1	12,09	CHI
20200967280	LUZIANIA	120197030	RIO VERMELHO	22/09/2020 12:43	22/09/2020 16:40	22/09/2020 12:43	22/09/2020 16:40	3,94	1	3,94	CHI
20200967282	NOVO GAMA	4990090148	PACAEMBU S1	22/09/2020 12:44	22/09/2020 21:15	22/09/2020 12:44	22/09/2020 21:15	8,52	1	8,52	CHI
20200967286	RIO VERDE	RV12355032	CABRIUVA S2	22/09/2020 12:44	22/09/2020 18:39	22/09/2020 12:44	22/09/2020 18:39	5,91	1	5,91	CHI
20200967291	JARAGUA	JA21201529	JARAGUA	22/09/2020 12:44	22/09/2020 19:15	22/09/2020 12:44	22/09/2020 19:15	6,50	1	6,50	CHI
20200967306	ANAPOLIS	20632745	ANAPOLIS UNIVERSITARIO S1	22/09/2020 12:46	23/09/2020 09:39	22/09/2020 12:46	23/09/2020 09:39	20,87	1	20,87	CHI
20200967323	JATAI	JT21274168	JATAI S1	22/09/2020 12:48	22/09/2020 14:28	22/09/2020 12:48	22/09/2020 14:28	1,65	2	3,31	CHI
20200967338	GOIANESIA	550049551	GOIANESIA S2	22/09/2020 12:49	23/09/2020 08:28	22/09/2020 12:49	23/09/2020 08:28	19,64	1	19,64	CHI
20200967332	VILA BOA	2880009097	IACIARA S2	22/09/2020 12:49	23/09/2020 11:56	22/09/2020 12:49	23/09/2020 11:56	23,11	1	23,11	CHI
20200967789	CORUMBA DE GOIAS	CB12089823	ALEXANIA	22/09/2020 12:50	22/09/2020 20:38	22/09/2020 12:50	22/09/2020 20:38	7,81	11	85,90	CHI
20200967789	ABADIANIA	CB12089823	ALEXANIA	22/09/2020 12:50	22/09/2020 20:38	22/09/2020 12:50	22/09/2020 20:38	7,81	4	31,24	CHI
20200967354	ANAPOLIS	20896890	JUNDIAI S1	22/09/2020 12:51	22/09/2020 17:48	22/09/2020 12:51	22/09/2020 17:48	4,95	1	4,95	CHI
20200967361	JATAI	JT21240295	JATAI S1	22/09/2020 12:52	22/09/2020 13:55	22/09/2020 12:52	22/09/2020 13:55	1,04	1	1,04	CHI
20200967375	ITAPIRAPUA	MP12299736	MATRINCHA	22/09/2020 12:53	22/09/2020 17:39	22/09/2020 12:53	22/09/2020 17:39	4,75	2	9,50	CHI
20200967375	MATRINCHA	MP12299736	MATRINCHA	22/09/2020 12:53	22/09/2020 17:39	22/09/2020 12:53	22/09/2020 17:39	4,75	61	289,87	CHI
20200967388	LUZIANIA	120243507	RIO VERMELHO	22/09/2020 12:54	22/09/2020 14:54	22/09/2020 12:54	22/09/2020 14:54	1,98	1	1,98	CHI
20200967871	IACIARA	IA11287897	IACIARA S1	22/09/2020 12:55	22/09/2020 21:24	22/09/2020 12:55	22/09/2020 21:24	8,48	40	339,12	CHI
20200967395	JARAGUA	70034540	JARAGUA	22/09/2020 12:55	23/09/2020 11:36	22/09/2020 12:55	23/09/2020 11:36	22,67	1	22,67	CHI
20200967403	MAURILANDIA	ML21303572	RIO DOS BOIS	22/09/2020 12:56	22/09/2020 19:26	22/09/2020 12:56	22/09/2020 19:26	6,51	1	6,51	CHI
20200967409	MINEIROS	MY11348499	PARQUE DAS EMAS	22/09/2020 12:57	22/09/2020 15:35	22/09/2020 12:57	22/09/2020 15:35	2,63	74	194,60	CHI
20200957372	COCALZINHO DE GOIAS	CB12042883	COCALZINHO	22/09/2020 12:57	22/09/2020 15:01	22/09/2020 12:57	22/09/2020 15:01	2,06	9	18,53	CHI
20200967569	RIO VERDE	RV11000053	RIO VERDE S1	22/09/2020 12:58	22/09/2020 15:36	22/09/2020 12:58	22/09/2020 15:36	2,63	161	422,63	CHI
20200967436	VALPARAISO DE GOIAS	10010867595	PACAEMBU S2	22/09/2020 12:59	22/09/2020 16:14	22/09/2020 12:59	22/09/2020 16:14	3,24	1	3,24	CHI
20200967461	ESTRELA DO NORTE	2420008838	MARA ROSA	22/09/2020 13:02	22/09/2020 21:54	22/09/2020 13:02	22/09/2020 21:54	8,86	1	8,86	CHI
20200967468	MINEIROS	MY21301826	PARQUE DAS EMAS	22/09/2020 13:02	23/09/2020 10:21	22/09/2020 13:02	23/09/2020 10:21	21,31	1	21,31	CHI
20200967467	CIDADE OCIDENTAL	DH11248739	MARAJOARA	22/09/2020 13:02	22/09/2020 15:52	22/09/2020 15:21	22/09/2020 15:52	0,52	48	24,76	CHI
20200967474	SANTA HELENA DE GOIAS	SH31074185	ACREUNA	22/09/2020 13:03	22/09/2020 17:37	22/09/2020 13:03	22/09/2020 17:37	4,56	1	4,56	CHI
20200967479	CAIAPONIA	930012331	CAIAPONIA	22/09/2020 13:03	22/09/2020 15:40	22/09/2020 13:03	22/09/2020 15:40	2,60	1	2,60	CHI
20200967480	ANAPOLIS	20797205	ANAPOLIS UNIVERSITARIO S2	22/09/2020 13:04	22/09/2020 15:46	22/09/2020 13:04	22/09/2020 15:46	2,70	1	2,70	CHI

INTERNAL

20200967493	MATRINCHA	MP12299716	MATRINCHA	22/09/2020 13:05	22/09/2020 16:16	22/09/2020 13:05	22/09/2020 16:16	3,18	20	63,62	CHI
20200967495	VILA PROPICIO	PV21115146	GOIANESIA S1	22/09/2020 13:05	22/09/2020 22:32	22/09/2020 13:05	22/09/2020 22:32	9,44	1	9,44	CHI
20200967497	CIDADE OCIDENTAL	2680008383	MARAJOARA	22/09/2020 13:05	22/09/2020 17:06	22/09/2020 13:05	22/09/2020 17:06	4,01	1	4,01	CHI
20200967499	PIRANHAS	1930027956	PIRANHAS	22/09/2020 13:05	23/09/2020 00:13	22/09/2020 13:05	23/09/2020 00:13	11,12	1	11,12	CHI
20200967513	SANTA HELENA DE GOIAS	SH12033693	IPEGUARI	22/09/2020 13:06	22/09/2020 20:24	22/09/2020 13:06	22/09/2020 20:24	7,29	318	2317,07	CHI
20200967520	NIQUELANDIA	NQ21197572	URUACU	22/09/2020 13:07	22/09/2020 17:52	22/09/2020 13:07	22/09/2020 17:52	4,74	1	4,74	CHI
20200967536	MONTE ALEGRE DE GOIAS	MA12236672	SAO DOMINGOS	22/09/2020 13:09	22/09/2020 21:20	22/09/2020 13:09	22/09/2020 17:22	4,22	1	4,22	CHI
20200967536	MONTE ALEGRE DE GOIAS	MA12236672	SAO DOMINGOS	22/09/2020 13:09	22/09/2020 21:20	22/09/2020 13:09	22/09/2020 21:20	8,18	1	8,18	CHI
20200967539	RIO VERDE	RV21048982	ACREUNA	22/09/2020 13:09	22/09/2020 15:20	22/09/2020 13:09	22/09/2020 15:20	2,18	1	2,18	CHI
20200967540	CARMO DO RIO VERDE	IK21298367	ITAPURANGA	22/09/2020 13:09	22/09/2020 19:36	22/09/2020 13:09	22/09/2020 19:36	6,44	1	6,44	CHI
20200967549	ANAPOLIS	20262190	JUNDIAI S2	22/09/2020 13:10	22/09/2020 22:27	22/09/2020 13:10	22/09/2020 22:27	9,28	1	9,28	CHI
20200967555	ANAPOLIS	20183033	ANAPOLIS UNIVERSITARIO S2	22/09/2020 13:10	22/09/2020 20:23	22/09/2020 13:10	22/09/2020 20:23	7,20	1	7,20	CHI
20200967801	ANAPOLIS	AN11135851	ANAPOLIS UNIVERSITARIO S1	22/09/2020 13:12	22/09/2020 14:45	22/09/2020 13:12	22/09/2020 14:45	1,55	125	193,40	CHI
20200967571	FORMOSA	610116915	ITUIQUIRA	22/09/2020 13:12	22/09/2020 17:06	22/09/2020 13:12	22/09/2020 17:06	3,89	1	3,89	CHI
20200967577	ANAPOLIS	20565240	JUNDIAI S1	22/09/2020 13:13	22/09/2020 15:39	22/09/2020 13:13	22/09/2020 15:39	2,43	1	2,43	CHI
20200967579	LUZIANIA	LZ21128880	MARAJOARA	22/09/2020 13:13	22/09/2020 15:49	22/09/2020 13:13	22/09/2020 15:49	2,60	1	2,60	CHI
20200967595	SANTA RITA DO NOVO DESTINO	BA21286925	BARRO ALTO	22/09/2020 13:15	22/09/2020 16:20	22/09/2020 13:15	22/09/2020 16:20	3,08	1	3,08	CHI
20200967605	GOIAS	90081640	GOIAS	22/09/2020 13:15	22/09/2020 18:12	22/09/2020 13:15	22/09/2020 18:12	4,94	1	4,94	CHI
20200967616	POSSE	1480014270	IACIARA S2	22/09/2020 13:17	22/09/2020 20:13	22/09/2020 13:17	22/09/2020 20:13	6,93	1	6,93	CHI
20200967617	RUBIATABA	RB11051015	RUBIATABA	22/09/2020 13:17	24/09/2020 03:30	22/09/2020 13:17	24/09/2020 03:30	38,21	7	267,46	CHI
20200967623	FORMOSA	10018113077	ITUIQUIRA	22/09/2020 13:17	22/09/2020 18:11	22/09/2020 13:17	22/09/2020 18:11	4,89	1	4,89	CHI
20200967625	ALTO PARAISO DE GOIAS	10023438493	FLORES DE GOIAS	22/09/2020 13:17	22/09/2020 17:01	22/09/2020 13:17	22/09/2020 17:01	3,72	1	3,72	CHI
20200968726	ITABERAI	IB12310505	ITABERAI S2	22/09/2020 13:18	22/09/2020 23:25	22/09/2020 13:18	22/09/2020 19:56	6,64	55	364,97	CHI
20200968726	ITABERAI	IB12310505	ITABERAI S2	22/09/2020 13:18	22/09/2020 23:25	22/09/2020 13:18	22/09/2020 23:14	9,94	2	19,89	CHI
20200968726	ITABERAI	IB12310505	ITABERAI S2	22/09/2020 13:18	22/09/2020 23:25	22/09/2020 13:18	22/09/2020 23:25	10,12	8	80,94	CHI
20200967626	GOUVELANDIA	QI21096900	QUIRINOPOLIS	22/09/2020 13:18	22/09/2020 18:36	22/09/2020 13:18	22/09/2020 18:36	5,30	1	5,30	CHI
20200967628	JATAI	JT12413145	CABRIUVA S2	22/09/2020 13:18	22/09/2020 19:53	22/09/2020 13:18	22/09/2020 19:53	6,58	3	19,74	CHI
20200967639	ITABERAI	50121522	ITABERAI S2	22/09/2020 13:19	22/09/2020 16:37	22/09/2020 13:19	22/09/2020 16:37	3,31	1	3,31	CHI
20200967666	SANTO ANTONIO DO DESCOBERTO	SN16413336	ALEXANIA	22/09/2020 13:19	22/09/2020 20:23	22/09/2020 13:19	22/09/2020 13:27	0,14	2553	352,46	CHI
20200967666	SANTO ANTONIO DO DESCOBERTO	SN10404168	ALEXANIA	22/09/2020 13:19	22/09/2020 20:23	22/09/2020 13:19	22/09/2020 13:28	0,15	1832	266,15	CHI
20200967666	SANTO ANTONIO DO DESCOBERTO	SN16410092	ALEXANIA	22/09/2020 13:19	22/09/2020 20:23	22/09/2020 13:19	22/09/2020 13:28	0,15	7109	1094,00	CHI
20200967666	CORUMBA DE GOIAS	SN16410092	ALEXANIA	22/09/2020 13:19	22/09/2020 20:23	22/09/2020 13:19	22/09/2020 13:28	0,15	13	2,00	CHI
20200967666	SANTO ANTONIO DO DESCOBERTO	AX10400726	ALEXANIA	22/09/2020 13:19	22/09/2020 20:23	22/09/2020 13:19	22/09/2020 16:08	2,82	3	8,47	CHI

INTERNAL

20200967666	SANTO ANTONIO DO DESCOBERTO	SN13079669	ALEXANIA	22/09/2020 13:19	22/09/2020 20:23	22/09/2020 13:19	22/09/2020 19:40	6,34	33	209,36	CHI
20200967642	NOVA ROMA	8720006885	IACIARA S2	22/09/2020 13:19	22/09/2020 20:17	22/09/2020 13:19	22/09/2020 20:17	6,96	1	6,96	CHI
20200967666	SANTO ANTONIO DO DESCOBERTO	SN10408273	ALEXANIA	22/09/2020 13:19	22/09/2020 20:23	22/09/2020 13:29	22/09/2020 15:03	1,56	1834	2862,06	CHI
20200967666	SANTO ANTONIO DO DESCOBERTO	SN10408273	ALEXANIA	22/09/2020 13:19	22/09/2020 20:23	22/09/2020 13:29	22/09/2020 16:53	3,39	379	1284,92	CHI
20200967666	SANTO ANTONIO DO DESCOBERTO	SN12151226LD	ALEXANIA	22/09/2020 13:19	22/09/2020 20:23	22/09/2020 13:29	22/09/2020 20:23	6,89	1327	9143,40	CHI
20200967666	SANTO ANTONIO DO DESCOBERTO	01680414	AGUAS LINDAS DE GOIAS S2	22/09/2020 13:19	22/09/2020 20:23	22/09/2020 13:29	22/09/2020 14:39	1,16	9797	11372,68	CHI
20200967666	DISTRITO FEDERAL	01680414	AGUAS LINDAS DE GOIAS S2	22/09/2020 13:19	22/09/2020 20:23	22/09/2020 13:29	22/09/2020 14:39	1,16	1	1,16	CHI
20200967666	SANTO ANTONIO DO DESCOBERTO	01680414	ALEXANIA	22/09/2020 13:19	22/09/2020 20:23	22/09/2020 13:29	22/09/2020 14:40	1,17	7954	9292,92	CHI
20200967666	CORUMBA DE GOIAS	01680414	ALEXANIA	22/09/2020 13:19	22/09/2020 20:23	22/09/2020 13:29	22/09/2020 14:40	1,17	13	15,19	CHI
20200967666	SANTO ANTONIO DO DESCOBERTO	AX10400726	ALEXANIA	22/09/2020 13:19	22/09/2020 20:23	22/09/2020 17:16	22/09/2020 17:36	0,32	3	0,97	CHI
20200967646	AGUAS LINDAS DE GOIAS	LA12412176	AGUAS LINDAS DE GOIAS S1	22/09/2020 13:20	22/09/2020 16:49	22/09/2020 13:20	22/09/2020 16:49	3,48	1	3,48	CHI
20200967650	CAMPOS VERDES	3790026760	SANTA TEREZINHA	22/09/2020 13:20	23/09/2020 21:18	22/09/2020 13:20	23/09/2020 21:18	31,96	1	31,96	CHI
20200967655	GAMELEIRA DE GOIAS	SV21232897	DAIA S1	22/09/2020 13:21	23/09/2020 00:06	22/09/2020 13:21	23/09/2020 00:06	10,75	2	21,50	CHI
20200967664	FAINA	FC21199787	GOIAS	22/09/2020 13:22	22/09/2020 17:18	22/09/2020 13:22	22/09/2020 17:18	3,93	1	3,93	CHI
20200967678	ARUANA	AK21274223	BRITANIA	22/09/2020 13:23	22/09/2020 17:38	22/09/2020 13:23	22/09/2020 17:38	4,24	1	4,24	CHI
20200967701	URUACU	UR21135509	URUACU	22/09/2020 13:24	23/09/2020 07:13	22/09/2020 13:24	23/09/2020 07:13	17,81	1	17,81	CHI
20200967713	BOM JARDIM DE GOIAS	BM12238904	BOM JARDIM	22/09/2020 13:25	22/09/2020 17:15	22/09/2020 13:25	22/09/2020 17:15	3,83	1	3,83	CHI
20200967717	JATAI	JT12260426RE	JATAI S1	22/09/2020 13:25	24/09/2020 11:13	22/09/2020 13:25	22/09/2020 17:15	3,83	65	249,06	CHI
20200967717	JATAI	JT12260426RE	JATAI S1	22/09/2020 13:25	24/09/2020 11:13	22/09/2020 13:25	22/09/2020 18:54	5,47	33	180,67	CHI
20200967717	JATAI	JT12260426RE	JATAI S1	22/09/2020 13:25	24/09/2020 11:13	22/09/2020 13:25	23/09/2020 09:56	20,51	8	164,11	CHI
20200967717	JATAI	JT12260426RE	JATAI S1	22/09/2020 13:25	24/09/2020 11:13	22/09/2020 13:25	24/09/2020 11:13	45,80	5	229,02	CHI
20200967719	JESUPOLIS	SF21000125	SAO FRANCISCO DE GOIAS	22/09/2020 13:25	22/09/2020 17:55	22/09/2020 13:25	22/09/2020 17:55	4,49	1	4,49	CHI
20200967771	JANDAIA	JD12199849	ACREUNA	22/09/2020 13:25	22/09/2020 17:06	22/09/2020 13:25	22/09/2020 17:06	3,68	5	18,38	CHI
20200967720	CRISTALINA	KR21199526	PAMPLONA	22/09/2020 13:25	22/09/2020 15:11	22/09/2020 13:25	22/09/2020 15:11	1,75	1	1,75	CHI
20200967717	JATAI	JT12260426RE	JATAI S1	22/09/2020 13:25	24/09/2020 11:13	22/09/2020 15:50	22/09/2020 17:15	1,42	2	2,84	CHI
20200967717	JATAI	JT13337001	JATAI S1	22/09/2020 13:25	24/09/2020 11:13	22/09/2020 15:50	22/09/2020 18:54	3,07	1	3,07	CHI
20200967717	JATAI	JT13374281	JATAI S1	22/09/2020 13:25	24/09/2020 11:13	22/09/2020 15:50	23/09/2020 09:56	18,10	5	90,52	CHI
20200967717	JATAI	JT12260426RE	JATAI S1	22/09/2020 13:25	24/09/2020 11:13	23/09/2020 10:00	23/09/2020 11:09	1,15	102	117,24	CHI
20200967717	JATAI	JT13374281	JATAI S1	22/09/2020 13:25	24/09/2020 11:13	23/09/2020 10:00	23/09/2020 16:49	6,81	13	88,58	CHI
20200967717	JATAI	JT12260426RE	JATAI S1	22/09/2020 13:25	24/09/2020 11:13	23/09/2020 17:30	23/09/2020 18:16	0,77	102	78,26	CHI
20200967717	JATAI	JT13374281	JATAI S1	22/09/2020 13:25	24/09/2020 11:13	23/09/2020 17:30	23/09/2020 23:04	5,55	4	22,22	CHI
20200967717	JATAI	JT13374281	JATAI S1	22/09/2020 13:25	24/09/2020 11:13	23/09/2020 17:30	24/09/2020 10:30	16,99	6	101,92	CHI
20200967717	JATAI	JT12260426RE	JATAI S1	22/09/2020 13:25	24/09/2020 11:13	23/09/2020 23:05	23/09/2020 23:28	0,40	102	40,74	CHI

INTERNAL

20200967730	MONTIVIDIU	2840018063	MONTIVIDIU T	22/09/2020 13:26	22/09/2020 15:58	22/09/2020 13:26	22/09/2020 15:58	2,52	1	2,52	CHI
20200967734	GOIAS	90026809	GOIAS	22/09/2020 13:27	22/09/2020 16:48	22/09/2020 13:27	22/09/2020 16:48	3,34	1	3,34	CHI
20200967735	ABADIANIA	AN12001083	ANAPOLIS UNIVERSITARIO S2	22/09/2020 13:27	23/09/2020 13:23	22/09/2020 13:27	22/09/2020 19:31	6,06	1	6,06	CHI
20200967735	ABADIANIA	AN12001083	ANAPOLIS UNIVERSITARIO S2	22/09/2020 13:27	23/09/2020 13:23	22/09/2020 13:27	23/09/2020 13:23	23,93	13	311,15	CHI
20200963083	ALEXANIA	AX10402663	ALEXANIA	22/09/2020 13:27	22/09/2020 20:38	22/09/2020 13:27	22/09/2020 20:38	7,18	747	5365,54	CHI
20200963083	ABADIANIA	AX10402663	ALEXANIA	22/09/2020 13:27	22/09/2020 20:38	22/09/2020 13:27	22/09/2020 20:38	7,18	13	93,38	CHI
20200963083	CORUMBA DE GOIAS	AX10402663	ALEXANIA	22/09/2020 13:27	22/09/2020 20:38	22/09/2020 13:27	22/09/2020 20:38	7,18	113	811,65	CHI
20200963083	JARAGUA	AX10402663	ALEXANIA	22/09/2020 13:27	22/09/2020 20:38	22/09/2020 18:15	22/09/2020 20:38	2,38	73	173,74	CHI
20200963083	ALEXANIA	AX10402663	ALEXANIA	22/09/2020 13:27	22/09/2020 20:38	22/09/2020 18:15	22/09/2020 20:38	2,38	1307	3110,66	CHI
20200967735	ABADIANIA	AN12001083	ANAPOLIS UNIVERSITARIO S2	22/09/2020 13:27	23/09/2020 13:23	22/09/2020 19:31	23/09/2020 13:23	17,87	4	71,48	CHI
20200967745	ITAPURANGA	IK12311030	ITAPURANGA	22/09/2020 13:28	23/09/2020 20:24	22/09/2020 13:28	23/09/2020 20:24	30,93	3	92,78	CHI
20200967761	FAINA	FC12274318	GOIAS	22/09/2020 13:29	22/09/2020 16:30	22/09/2020 13:29	22/09/2020 16:30	3,00	16	48,07	CHI
20200967762	IPORA	730083081	IPORA	22/09/2020 13:30	22/09/2020 19:06	22/09/2020 13:30	22/09/2020 19:06	5,61	1	5,61	CHI
20200969623	MONTIVIDIU DO NORTE	MX12168971	PORANGATU	22/09/2020 13:33	25/09/2020 15:38	22/09/2020 13:33	23/09/2020 16:56	27,37	40	1094,87	CHI
20200967794	FLORES DE GOIAS	FB12286863	FLORES DE GOIAS	22/09/2020 13:33	22/09/2020 17:18	22/09/2020 13:33	22/09/2020 17:18	3,74	82	306,48	CHI
20200967807	SITIO D ABADIA	SI12329755	IACIARA S2	22/09/2020 13:33	22/09/2020 20:33	22/09/2020 13:33	22/09/2020 20:33	6,98	5	34,92	CHI
20200969623	MONTIVIDIU DO NORTE	MX12168971	PORANGATU	22/09/2020 13:33	25/09/2020 15:38	22/09/2020 21:33	23/09/2020 16:56	19,38	57	1104,82	CHI
20200969623	MONTIVIDIU DO NORTE	MX12168971	PORANGATU	22/09/2020 13:33	25/09/2020 15:38	22/09/2020 21:33	24/09/2020 12:35	39,05	187	7302,19	CHI
20200969623	TROMBAS	MX10400351	PORANGATU	22/09/2020 13:33	25/09/2020 15:38	22/09/2020 23:07	22/09/2020 23:31	0,41	3	1,22	CHI
20200969623	MONTIVIDIU DO NORTE	MX10400351	PORANGATU	22/09/2020 13:33	25/09/2020 15:38	22/09/2020 23:07	22/09/2020 23:31	0,41	317	128,56	CHI
20200969623	TROMBAS	MX10400351	PORANGATU	22/09/2020 13:33	25/09/2020 15:38	22/09/2020 23:07	23/09/2020 23:35	24,47	21	513,88	CHI
20200969623	MONTIVIDIU DO NORTE	MX10400351	PORANGATU	22/09/2020 13:33	25/09/2020 15:38	22/09/2020 23:07	23/09/2020 23:35	24,47	33	807,53	CHI
20200969623	MONTIVIDIU DO NORTE	MX12168971	PORANGATU	22/09/2020 13:33	25/09/2020 15:38	23/09/2020 16:57	23/09/2020 18:43	1,78	97	172,34	CHI
20200969623	MONTIVIDIU DO NORTE	MX12168971	PORANGATU	22/09/2020 13:33	25/09/2020 15:38	23/09/2020 19:08	24/09/2020 11:31	16,38	39	638,87	CHI
20200969623	MONTIVIDIU DO NORTE	MX12226413RE	PORANGATU	22/09/2020 13:33	25/09/2020 15:38	23/09/2020 19:08	24/09/2020 20:44	25,60	5	127,99	CHI
20200969623	MONTIVIDIU DO NORTE	MX12226413RE	PORANGATU	22/09/2020 13:33	25/09/2020 15:38	23/09/2020 19:08	24/09/2020 22:36	27,47	1	27,47	CHI
20200969623	MONTIVIDIU DO NORTE	MX12226413RE	PORANGATU	22/09/2020 13:33	25/09/2020 15:38	23/09/2020 19:08	24/09/2020 23:56	28,80	2	57,60	CHI
20200969623	MONTIVIDIU DO NORTE	MX10400351	PORANGATU	22/09/2020 13:33	25/09/2020 15:38	23/09/2020 23:06	23/09/2020 23:35	0,47	317	150,31	CHI
20200969623	TROMBAS	MX10400351	PORANGATU	22/09/2020 13:33	25/09/2020 15:38	23/09/2020 23:06	23/09/2020 23:35	0,47	3	1,42	CHI
20200969623	MONTIVIDIU DO NORTE	MX12168971	PORANGATU	22/09/2020 13:33	25/09/2020 15:38	23/09/2020 23:06	24/09/2020 11:31	12,40	18	223,28	CHI
20200969623	MONTIVIDIU DO NORTE	MX12226413RE	PORANGATU	22/09/2020 13:33	25/09/2020 15:38	24/09/2020 12:50	24/09/2020 20:44	7,90	15	118,54	CHI
20200969623	MONTIVIDIU DO NORTE	MX12228960LD	PORANGATU	22/09/2020 13:33	25/09/2020 15:38	24/09/2020 12:50	24/09/2020 21:55	9,08	4	36,34	CHI
20200969623	MONTIVIDIU DO NORTE	MX12226413RE	PORANGATU	22/09/2020 13:33	25/09/2020 15:38	24/09/2020 12:50	24/09/2020 22:36	9,77	5	48,87	CHI

INTERNAL

20200969623	MONTIVIDIU DO NORTE	MX12226412LD	PORANGATU	22/09/2020 13:33	25/09/2020 15:38	24/09/2020 12:50	24/09/2020 23:56	11,10	7	77,73	CHI
20200969623	MONTIVIDIU DO NORTE	MX12226413RE	PORANGATU	22/09/2020 13:33	25/09/2020 15:38	24/09/2020 12:50	25/09/2020 15:38	26,80	1	26,80	CHI
20200967950	MONTE ALEGRE DE GOIAS	MA12240201	SAO DOMINGOS	22/09/2020 13:35	23/09/2020 01:11	22/09/2020 13:35	23/09/2020 01:11	11,59	14	162,31	CHI
20200967822	RIO VERDE	RV21214197	CABRIUVA S2	22/09/2020 13:36	22/09/2020 16:49	22/09/2020 13:36	22/09/2020 16:49	3,21	1	3,21	CHI
20200967829	IACIARA	IA12117792	IACIARA S1	22/09/2020 13:36	22/09/2020 18:44	22/09/2020 13:36	22/09/2020 18:44	5,12	24	122,92	CHI
20200967829	GUARANI DE GOIAS	IA12117792	IACIARA S1	22/09/2020 13:36	22/09/2020 18:44	22/09/2020 13:36	22/09/2020 18:44	5,12	18	92,19	CHI
20200967829	SAO DOMINGOS	IA12117792	IACIARA S1	22/09/2020 13:36	22/09/2020 18:44	22/09/2020 13:36	22/09/2020 18:44	5,12	1	5,12	CHI
20200967830	ITABERAÍ	IB21031260	ITABERAÍ S2	22/09/2020 13:36	22/09/2020 17:20	22/09/2020 13:36	22/09/2020 17:20	3,72	1	3,72	CHI
20200967834	BURITINOPOLIS	3610005929	IACIARA S2	22/09/2020 13:37	22/09/2020 15:06	22/09/2020 13:37	22/09/2020 15:06	1,48	1	1,48	CHI
20200967840	ITABERAÍ	IB21322815	ANICUNS	22/09/2020 13:37	22/09/2020 16:38	22/09/2020 13:37	22/09/2020 16:38	3,00	1	3,00	CHI
20200967855	URUACU	640054079	URUACU	22/09/2020 13:38	24/09/2020 12:32	22/09/2020 13:38	24/09/2020 12:32	46,88	1	46,88	CHI
20200967916	SAO FRANCISCO DE GOIAS	SF12034822	SAO FRANCISCO DE GOIAS	22/09/2020 13:38	22/09/2020 20:35	22/09/2020 13:38	22/09/2020 20:35	6,93	8	55,48	CHI
20200967863	JATAÍ	290259137	JATAÍ S2	22/09/2020 13:39	22/09/2020 15:51	22/09/2020 13:39	22/09/2020 15:51	2,20	1	2,20	CHI
20200967870	PARAUNA	PU21136889	PARAUNA	22/09/2020 13:40	22/09/2020 15:27	22/09/2020 13:40	22/09/2020 15:27	1,78	2	3,55	CHI
20200967887	MONTE ALEGRE DE GOIAS	MA12235989	SAO DOMINGOS	22/09/2020 13:42	22/09/2020 20:55	22/09/2020 13:42	22/09/2020 20:55	7,21	22	158,63	CHI
20200968265	SAO LUIS DE MONTES BELOS	SL12019284	SAO LUIZ DOS MONTES BELOS	22/09/2020 13:44	22/09/2020 16:22	22/09/2020 13:44	22/09/2020 16:22	2,63	59	155,15	CHI
20200968265	SANCLERLANDIA	SL12019284	SAO LUIZ DOS MONTES BELOS	22/09/2020 13:44	22/09/2020 16:22	22/09/2020 13:44	22/09/2020 16:22	2,63	28	73,63	CHI
20200967912	CRISTALINA	1060088712	PAMPLONA	22/09/2020 13:45	22/09/2020 22:38	22/09/2020 13:45	22/09/2020 22:38	8,88	1	8,88	CHI
20200967911	PORANGATU	PO21265746	PORANGATU	22/09/2020 13:45	22/09/2020 16:28	22/09/2020 13:45	22/09/2020 16:28	2,72	1	2,72	CHI
20200967915	CAMPINORTE	CR21000041	CAMPINORTE	22/09/2020 13:45	24/09/2020 16:14	22/09/2020 13:45	24/09/2020 16:14	50,48	1	50,48	CHI
20200967925	GAMELEIRA DE GOIAS	SV12089081	DAIA S1	22/09/2020 13:46	22/09/2020 23:29	22/09/2020 13:46	22/09/2020 23:29	9,71	8	77,68	CHI
20200967928	ITAPIRAPUA	1420021075	MATRINCHA	22/09/2020 13:46	22/09/2020 19:39	22/09/2020 13:46	22/09/2020 19:39	5,87	1	5,87	CHI
20200967932	ANAPOLIS	20755934	JUNDIAI S1	22/09/2020 13:46	22/09/2020 20:49	22/09/2020 13:46	22/09/2020 20:49	7,04	1	7,04	CHI
20200967943	SANCLERLANDIA	10001930875	FIRMINOPOLIS S2	22/09/2020 13:47	22/09/2020 21:26	22/09/2020 13:47	22/09/2020 21:26	7,64	1	7,64	CHI
20200967959	CAVALCANTE	CJ11264840	FLORES DE GOIAS	22/09/2020 13:48	22/09/2020 22:08	22/09/2020 13:48	22/09/2020 22:08	8,32	4	33,28	CHI
20200967962	PETROLINA DE GOIAS	PG21060609	PETROLINA	22/09/2020 13:49	23/09/2020 01:04	22/09/2020 13:49	23/09/2020 01:04	11,25	1	11,25	CHI
20200967980	URUACU	UR12398055	URUACU	22/09/2020 13:50	23/09/2020 12:29	22/09/2020 13:50	23/09/2020 12:29	22,64	13	294,33	CHI
20200967984	SANTA TEREZINHA DE GOIAS	10024837910	SANTA TEREZINHA	22/09/2020 13:51	23/09/2020 00:42	22/09/2020 13:51	23/09/2020 00:42	10,84	1	10,84	CHI
20200967985	MINEIROS	MY21325792	PARQUE DAS EMAS	22/09/2020 13:51	23/09/2020 09:10	22/09/2020 13:51	23/09/2020 09:10	19,31	1	19,31	CHI
20200967988	GOIANESIA	550047554	GOIANESIA S2	22/09/2020 13:51	23/09/2020 00:27	22/09/2020 13:51	23/09/2020 00:27	10,59	1	10,59	CHI
20200967987	ANAPOLIS	20096148	JUNDIAI S1	22/09/2020 13:51	22/09/2020 17:48	22/09/2020 13:51	22/09/2020 17:48	3,94	1	3,94	CHI
20200970774	COLINAS DO SUL	TI12155538	MINACU	22/09/2020 13:52	23/09/2020 15:14	22/09/2020 13:52	23/09/2020 15:14	25,35	130	3295,97	CHI
20200968010	SANTO ANTONIO DA BARRA	BZ21295800	ACREUNA	22/09/2020 13:54	22/09/2020 16:45	22/09/2020 13:54	22/09/2020 16:45	2,85	1	2,85	CHI

INTERNAL

20200968037	RIO VERDE	630045318	RIO VERDE S2	22/09/2020 13:56	23/09/2020 10:53	22/09/2020 13:56	23/09/2020 10:53	20,94	1	20,94	CHI
20200968041	SAO LUIS DE MONTES BELOS	500048836	SAO LUIZ DOS MONTES BELOS	22/09/2020 13:56	23/09/2020 12:02	22/09/2020 13:56	23/09/2020 12:02	22,09	1	22,09	CHI
20200968061	GOIAS	GS21183464	GOIAS	22/09/2020 13:58	22/09/2020 17:02	22/09/2020 13:58	22/09/2020 17:02	3,06	1	3,06	CHI
20200968072	JUSSARA	1290057002	JUSSARA	22/09/2020 13:59	22/09/2020 15:46	22/09/2020 13:59	22/09/2020 15:46	1,78	1	1,78	CHI
20200968079	PLANALTINA	PI21382874	SAO JOAO D ALIANCA	22/09/2020 13:59	23/09/2020 09:20	22/09/2020 13:59	23/09/2020 09:20	19,33	1	19,33	CHI
20200968091	MINACU	IH11063606	MINACU	22/09/2020 14:00	22/09/2020 19:06	22/09/2020 14:00	22/09/2020 19:06	5,09	54	274,68	CHI
20200968095	ANAPOLIS	20100309	JUNDIAI S2	22/09/2020 14:00	23/09/2020 11:51	22/09/2020 14:00	23/09/2020 11:51	21,83	1	21,83	CHI
20200968097	FORMOSA	FA21000079	ITUIQUIRA	22/09/2020 14:01	22/09/2020 20:18	22/09/2020 14:01	22/09/2020 20:18	6,28	2	12,55	CHI
20200968108	SANTA HELENA DE GOIAS	SH21249424	RIO VERDE S2	22/09/2020 14:02	22/09/2020 19:25	22/09/2020 14:02	22/09/2020 19:25	5,38	2	10,76	CHI
202009107048	MARA ROSA	2260040956	SANTA TEREZINHA	22/09/2020 14:03	24/09/2020 19:39	22/09/2020 14:03	24/09/2020 19:39	53,61	1	53,61	CHI
20200968115	LUZIANIA	120225207	RIO VERMELHO	22/09/2020 14:03	22/09/2020 21:05	22/09/2020 14:03	22/09/2020 21:05	7,03	1	7,03	CHI
20200981217	MARA ROSA	MQ12285145	SANTA TEREZINHA	22/09/2020 14:03	24/09/2020 22:33	24/09/2020 19:39	24/09/2020 22:33	2,89	5	14,45	CHI
20200968128	SILVANIA	LB21118247	DAIA S2	22/09/2020 14:04	22/09/2020 22:07	22/09/2020 14:04	22/09/2020 22:07	8,04	1	8,04	CHI
20200968131	JANDAIA	JD12391446	PALMEIRAS	22/09/2020 14:05	22/09/2020 21:43	22/09/2020 14:05	22/09/2020 21:43	7,63	4	30,52	CHI
20200968133	MINEIROS	MY21302947	PARQUE DAS EMAS	22/09/2020 14:05	22/09/2020 20:43	22/09/2020 14:05	22/09/2020 20:43	6,62	1	6,62	CHI
20200968148	TAQUARAL DE GOIAS	TQ21220149	ITABERAI S1	22/09/2020 14:07	22/09/2020 19:22	22/09/2020 14:07	22/09/2020 19:22	5,25	1	5,25	CHI
20200968162	SAO LUIS DE MONTES BELOS	500038077	SAO LUIZ DOS MONTES BELOS	22/09/2020 14:08	23/09/2020 10:17	22/09/2020 14:08	23/09/2020 10:17	20,15	1	20,15	CHI
20200968360	CIDADE OCIDENTAL	DH11199617	MARAJOARA	22/09/2020 14:08	22/09/2020 15:58	22/09/2020 14:08	22/09/2020 15:58	1,83	107	195,72	CHI
20200968169	ANAPOLIS	AN11003281	ANAPOLIS UNIVERSITARIO S1	22/09/2020 14:08	22/09/2020 16:31	22/09/2020 14:08	22/09/2020 16:31	2,38	82	195,02	CHI
20200968168	FLORES DE GOIAS	FB21161681	FLORES DE GOIAS	22/09/2020 14:08	23/09/2020 08:06	22/09/2020 14:08	23/09/2020 08:06	17,95	1	17,95	CHI
20200968186	SANTA RITA DO NOVO DESTINO	DF12382137	BARRO ALTO	22/09/2020 14:11	22/09/2020 16:49	22/09/2020 14:11	22/09/2020 16:49	2,63	12	31,52	CHI
20200969114	MONTES CLAROS DE GOIAS	ME12380868	IPORA	22/09/2020 14:11	22/09/2020 22:58	22/09/2020 14:11	22/09/2020 22:58	8,77	6	52,61	CHI
20200968194	PALMEIRAS DE GOIAS	590035265	PALMEIRAS	22/09/2020 14:11	22/09/2020 17:59	22/09/2020 14:11	22/09/2020 17:59	3,79	1	3,79	CHI
20200968217	MONTIVIDIU	2840010386	MONTIVIDIU T	22/09/2020 14:15	22/09/2020 18:15	22/09/2020 14:15	22/09/2020 18:15	4,00	1	4,00	CHI
20200968219	SANTA RITA DO NOVO DESTINO	DF21240142	BARRO ALTO	22/09/2020 14:15	23/09/2020 10:04	22/09/2020 14:15	23/09/2020 10:04	19,81	1	19,81	CHI
20200968240	LUZIANIA	120356545	MARAJOARA	22/09/2020 14:17	22/09/2020 16:02	22/09/2020 14:17	22/09/2020 16:02	1,75	1	1,75	CHI
20200968242	VILA PROPICIO	NP21240127	GOIANESIA S1	22/09/2020 14:17	22/09/2020 18:52	22/09/2020 14:17	22/09/2020 18:52	4,58	1	4,58	CHI
20200968247	JANDAIA	1180011524	PALMEIRAS	22/09/2020 14:17	22/09/2020 16:44	22/09/2020 14:17	22/09/2020 16:44	2,44	1	2,44	CHI
20200968258	SANCLERLANDIA	1210019386	FIRMINOPOLIS S2	22/09/2020 14:19	22/09/2020 16:39	22/09/2020 14:19	22/09/2020 16:39	2,33	1	2,33	CHI
20200968260	NIQUELANDIA	NQ21294227	URUACU	22/09/2020 14:19	22/09/2020 15:46	22/09/2020 14:19	22/09/2020 15:46	1,45	1	1,45	CHI
20200968262	SANCLERLANDIA	1210028831	FIRMINOPOLIS S2	22/09/2020 14:19	22/09/2020 18:35	22/09/2020 14:19	22/09/2020 18:35	4,25	1	4,25	CHI
20200968263	ITABERAI	IB21107123	ITABERAI S2	22/09/2020 14:20	22/09/2020 21:27	22/09/2020 14:20	22/09/2020 18:34	4,23	1	4,23	CHI
20200968266	NIQUELANDIA	NQ21274782	BARRO ALTO	22/09/2020 14:20	23/09/2020 20:35	22/09/2020 14:20	23/09/2020 20:35	30,25	1	30,25	CHI

INTERNAL

20200968263	ITABERAÍ	IB12105489	ITABERAÍ S2	22/09/2020 14:20	22/09/2020 21:27	22/09/2020 18:33	22/09/2020 21:27	2,89	17	49,14	CHI
20200968966	LUZIANIA	04210224	RIO VERMELHO	22/09/2020 14:22	22/09/2020 15:08	22/09/2020 14:22	22/09/2020 15:08	0,77	6959	5327,50	CHI
20200968308	TURVANIA	TV11413067	FIRMINOPOLIS S2	22/09/2020 14:23	23/09/2020 13:28	22/09/2020 14:23	23/09/2020 13:28	23,08	1	23,08	CHI
20200968321	COCALZINHO DE GOIAS	ZN21185716	COCALZINHO	22/09/2020 14:24	22/09/2020 23:43	22/09/2020 14:24	22/09/2020 23:43	9,31	1	9,31	CHI
20200968332	AGUAS LINDAS DE GOIAS	SN21203230	AGUAS LINDAS DE GOIAS S1	22/09/2020 14:25	22/09/2020 20:14	22/09/2020 14:25	22/09/2020 20:14	5,82	1	5,82	CHI
20200968335	PLANALTINA	3890001061	PLANALTINA	22/09/2020 14:25	22/09/2020 20:45	22/09/2020 14:25	22/09/2020 20:45	6,33	1	6,33	CHI
20200968344	ABADIANIA	PV12359357	CORUMBA	22/09/2020 14:26	23/09/2020 16:58	22/09/2020 14:26	23/09/2020 16:58	26,54	2	53,08	CHI
20200968353	COCALZINHO DE GOIAS	ZN21302341	COCALZINHO	22/09/2020 14:27	22/09/2020 17:27	22/09/2020 14:27	22/09/2020 17:27	2,99	1	2,99	CHI
20200968381	GOIANESIA	10010034640	GOIANESIA S2	22/09/2020 14:30	22/09/2020 20:49	22/09/2020 14:30	22/09/2020 20:49	6,31	1	6,31	CHI
20200968785	CACHOEIRA ALTA	QI12279622	QUIRINOPOLIS	22/09/2020 14:30	22/09/2020 20:43	22/09/2020 14:30	22/09/2020 20:43	6,21	14	86,97	CHI
20200970793	TURVELANDIA	TD12226264	RIO DOS BOIS	22/09/2020 14:32	22/09/2020 21:43	22/09/2020 14:32	22/09/2020 21:43	7,18	73	523,92	CHI
20200968435	ITAPACI	IW12123121	ITAPACI	22/09/2020 14:32	23/09/2020 20:55	22/09/2020 14:32	23/09/2020 20:55	30,37	1	30,37	CHI
20200968458	ITAPIRAPUA	IU12073732	MATRINCHA	22/09/2020 14:33	23/09/2020 21:58	22/09/2020 14:33	23/09/2020 21:58	31,40	28	879,27	CHI
20200968485	TURVANIA	1220014830	FIRMINOPOLIS S2	22/09/2020 14:35	23/09/2020 14:11	22/09/2020 14:35	23/09/2020 14:11	23,59	1	23,59	CHI
20200970321	CRISTALINA	KR12287399	CRISTALINA S1	22/09/2020 14:35	22/09/2020 23:31	22/09/2020 14:35	22/09/2020 23:31	8,92	10	89,18	CHI
20200968500	JARAGUA	JA21298039	JARAGUA	22/09/2020 14:36	23/09/2020 14:35	22/09/2020 14:36	23/09/2020 14:35	23,97	1	23,97	CHI
20200968503	ARUANA	10019364421	ARUANA	22/09/2020 14:37	22/09/2020 15:54	22/09/2020 14:37	22/09/2020 15:54	1,28	1	1,28	CHI
20200968505	CACU	CC12202627	CACHOEIRA ALTA	22/09/2020 14:37	22/09/2020 16:26	22/09/2020 14:37	22/09/2020 16:26	1,81	2	3,62	CHI
20200968516	ANAPOLIS	21368820	ANAPOLIS UNIVERSITARIO S2	22/09/2020 14:38	23/09/2020 11:24	22/09/2020 14:38	23/09/2020 11:24	20,77	1	20,77	CHI
20200968536	ITAGUARI	770014860	ITABERAÍ S1	22/09/2020 14:39	23/09/2020 07:44	22/09/2020 14:39	23/09/2020 07:44	17,08	1	17,08	CHI
20200968559	PALMEIRAS DE GOIAS	590054892	PALMEIRAS	22/09/2020 14:41	22/09/2020 16:04	22/09/2020 14:41	22/09/2020 16:04	1,38	1	1,38	CHI
20200968563	CIDADE OCIDENTAL	2680161343	MARAJOARA	22/09/2020 14:41	22/09/2020 17:01	22/09/2020 14:41	22/09/2020 17:01	2,32	1	2,32	CHI
20200968570	PALMEIRAS DE GOIAS	590054880	PALMEIRAS	22/09/2020 14:42	22/09/2020 16:18	22/09/2020 14:42	22/09/2020 16:18	1,60	1	1,60	CHI
20200968573	LUZIANIA	LZ11000292	MARAJOARA	22/09/2020 14:42	22/09/2020 16:45	22/09/2020 14:42	22/09/2020 16:45	2,04	136	277,78	CHI
20200968907	SAO LUIS DE MONTES BELOS	500010675	SAO LUIZ DOS MONTES BELOS	22/09/2020 14:44	23/09/2020 10:36	22/09/2020 14:44	23/09/2020 10:36	19,86	1	19,86	CHI
20200968603	VALPARAISO DE GOIAS	3350035253	PACAEMBU S2	22/09/2020 14:44	23/09/2020 00:04	22/09/2020 14:44	23/09/2020 00:04	9,33	1	9,33	CHI
20200968610	SERRANOPOLIS	SX12165995	CHAPADAO DO CEU	22/09/2020 14:44	23/09/2020 17:06	22/09/2020 14:44	23/09/2020 13:37	22,87	3	68,61	CHI
20200968610	SERRANOPOLIS	SX12308125LD	CHAPADAO DO CEU	22/09/2020 14:44	23/09/2020 17:06	22/09/2020 22:58	23/09/2020 17:06	18,14	1	18,14	CHI
20200972627	SANTA HELENA DE GOIAS	SH12029905	IPEGUARI	22/09/2020 14:47	23/09/2020 09:11	22/09/2020 14:47	23/09/2020 09:11	18,40	10	184,00	CHI
20200970891	LUZIANIA	LZ11041556	MARAJOARA	22/09/2020 14:47	22/09/2020 19:56	22/09/2020 14:47	22/09/2020 19:56	5,14	154	791,22	CHI
20200968648	AGUA FRIA DE GOIAS	TL21302716	SAO JOAO D ALIANCA	22/09/2020 14:48	23/09/2020 06:55	22/09/2020 14:48	23/09/2020 06:55	16,11	1	16,11	CHI
20200968652	SAO LUIS DE MONTES BELOS	SL11314962	SAO LUIZ DOS MONTES BELOS	22/09/2020 14:48	22/09/2020 21:40	22/09/2020 14:48	22/09/2020 21:40	6,87	34	233,71	CHI
20200968657	FLORES DE GOIAS	FB12344120	FLORES DE GOIAS	22/09/2020 14:48	22/09/2020 19:27	22/09/2020 14:48	22/09/2020 19:27	4,64	1	4,64	CHI

INTERNAL

20200968661	SANTA TEREZINHA DE GOIAS	SG12156648	SANTA TEREZINHA	22/09/2020 14:49	22/09/2020 17:03	22/09/2020 14:49	22/09/2020 17:03	2,23	1	2,23	CHI
20200969398	PIRENOPOLIS	PV11057885	CORUMBA	22/09/2020 14:49	22/09/2020 19:45	22/09/2020 14:49	22/09/2020 19:45	4,93	111	546,80	CHI
20200968674	GOUVELANDIA	GB21000197	QUIRINOPOLIS	22/09/2020 14:50	22/09/2020 17:44	22/09/2020 14:50	22/09/2020 17:44	2,90	1	2,90	CHI
20200968675	ANAPOLIS	20797369	ANAPOLIS UNIVERSITARIO S2	22/09/2020 14:50	22/09/2020 18:11	22/09/2020 14:50	22/09/2020 18:11	3,35	0	0,00	CHI
20200968795	RIO VERDE	RV16408210	RIO VERDE S2	22/09/2020 14:51	22/09/2020 17:05	22/09/2020 14:51	22/09/2020 14:56	0,08	3359	271,52	CHI
20200968795	RIO VERDE	RV16406925	RIO VERDE S2	22/09/2020 14:51	22/09/2020 17:05	22/09/2020 14:51	22/09/2020 16:42	1,86	1466	2726,76	CHI
20200968795	RIO VERDE	RV13402399	RIO VERDE S2	22/09/2020 14:51	22/09/2020 17:05	22/09/2020 14:51	22/09/2020 17:05	2,23	1248	2781,65	CHI
20200969511	GUARANI DE GOIAS	SD12262409	SAO DOMINGOS	22/09/2020 14:51	22/09/2020 22:27	22/09/2020 14:51	22/09/2020 22:27	7,59	3	22,77	CHI
20200969511	SAO DOMINGOS	SD12262409	SAO DOMINGOS	22/09/2020 14:51	22/09/2020 22:27	22/09/2020 14:51	22/09/2020 22:27	7,59	70	531,22	CHI
20200968706	MINACU	IH11257878	MINACU	22/09/2020 14:53	23/09/2020 10:48	22/09/2020 14:53	23/09/2020 10:48	19,90	77	1532,56	CHI
20200969781	CIDADE OCIDENTAL	DH11325532	MARAJOARA	22/09/2020 14:54	22/09/2020 20:03	22/09/2020 14:54	22/09/2020 20:03	5,15	81	417,15	CHI
20200968725	PADRE BERNARDO	PB21149775	PADRE BERNARDO	22/09/2020 14:55	22/09/2020 15:52	22/09/2020 14:55	22/09/2020 15:52	0,95	1	0,95	CHI
20200968751	RIO VERDE	RV21359387	CABRIUVA S1	22/09/2020 14:57	23/09/2020 13:00	22/09/2020 14:57	23/09/2020 13:00	22,05	1	22,05	CHI
20200970895	ALVORADA DO NORTE	FB12143258	IACIARA S2	22/09/2020 14:58	22/09/2020 20:23	22/09/2020 14:58	22/09/2020 20:23	5,41	30	162,27	CHI
20200970895	FLORES DE GOIAS	FB12143258	IACIARA S2	22/09/2020 14:58	22/09/2020 20:23	22/09/2020 14:58	22/09/2020 20:23	5,41	27	146,04	CHI
20200968768	PADRE BERNARDO	PB11275351	PADRE BERNARDO	22/09/2020 14:58	22/09/2020 16:37	22/09/2020 14:58	22/09/2020 16:37	1,64	3	4,92	CHI
20200968776	ITABERAI	1810002579	ITABERAI S1	22/09/2020 14:59	22/09/2020 17:47	22/09/2020 14:59	22/09/2020 17:47	2,80	1	2,80	CHI
20200968798	ARAGUAPAZ	CX12058576RE	RUBIATABA	22/09/2020 14:59	23/09/2020 10:14	22/09/2020 14:59	23/09/2020 10:14	19,24	6	115,42	CHI
20200968798	CRIXAS	CX12058576RE	RUBIATABA	22/09/2020 14:59	23/09/2020 10:14	22/09/2020 14:59	23/09/2020 10:14	19,24	1	19,24	CHI
20200968800	ANAPOLIS	20603162	ANAPOLIS UNIVERSITARIO S2	22/09/2020 15:00	22/09/2020 19:22	22/09/2020 15:00	22/09/2020 19:22	4,35	1	4,35	CHI
20200968833	NOVA ROMA	ND21117506	IACIARA S2	22/09/2020 15:03	22/09/2020 16:27	22/09/2020 15:03	22/09/2020 16:27	1,39	1	1,39	CHI
20200968836	ANAPOLIS	20383630	ANAPOLIS UNIVERSITARIO S1	22/09/2020 15:03	23/09/2020 20:24	22/09/2020 15:03	23/09/2020 20:24	29,34	1	29,34	CHI
20200968855	SANTA TEREZINHA DE GOIAS	SG21172084	SANTA TEREZINHA	22/09/2020 15:05	23/09/2020 08:46	22/09/2020 15:05	23/09/2020 08:46	17,68	1	17,68	CHI
20200968931	ANAPOLIS	AN11077943	ANAPOLIS UNIVERSITARIO S2	22/09/2020 15:06	22/09/2020 16:05	22/09/2020 15:06	22/09/2020 16:05	0,98	73	71,76	CHI
20200968865	ANAPOLIS	20382364	JUNDIAI S1	22/09/2020 15:06	22/09/2020 21:19	22/09/2020 15:06	22/09/2020 21:19	6,21	1	6,21	CHI
20200968872	LUZIANIA	LZ21133915	MARAJOARA	22/09/2020 15:06	22/09/2020 23:36	22/09/2020 15:06	22/09/2020 23:36	8,49	1	8,49	CHI
20200968868	FORMOSA	FA21262442	ITUIQUIRA	22/09/2020 15:06	22/09/2020 15:49	22/09/2020 15:06	22/09/2020 15:49	0,70	1	0,70	CHI
20200968878	AGUA FRIA DE GOIAS	TL12337462	SAO JOAO D ALIANCA	22/09/2020 15:07	22/09/2020 17:20	22/09/2020 15:07	22/09/2020 17:20	2,21	3	6,63	CHI
20200969347	CIDADE OCIDENTAL	DH11347308	MARAJOARA	22/09/2020 15:11	22/09/2020 18:00	22/09/2020 17:45	22/09/2020 18:00	0,25	50	12,43	CHI
20200972476	PEROLANDIA	DP12346700	JATAI S1	22/09/2020 15:12	23/09/2020 14:11	22/09/2020 15:12	23/09/2020 14:11	22,97	1	22,97	CHI
20200968946	PARAUNA	PU21243886	PARAUNA	22/09/2020 15:13	22/09/2020 16:44	22/09/2020 15:13	22/09/2020 16:44	1,50	1	1,50	CHI
20200968947	RIO VERDE	630228670	RIO VERDE S1	22/09/2020 15:13	22/09/2020 20:00	22/09/2020 15:13	22/09/2020 20:00	4,77	1	4,77	CHI
20200968958	ANAPOLIS	20754012	ANAPOLIS UNIVERSITARIO S2	22/09/2020 15:15	23/09/2020 11:28	22/09/2020 15:15	23/09/2020 11:28	20,21	1	20,21	CHI

INTERNAL

20200968962	ANAPOLIS	10002380461	JUNDIAI S1	22/09/2020 15:15	22/09/2020 18:41	22/09/2020 15:15	22/09/2020 18:41	3,42	1	3,42	CHI
20200968968	NOVA ROMA	ND21286025	IACIARA S2	22/09/2020 15:16	22/09/2020 19:42	22/09/2020 15:16	22/09/2020 19:42	4,43	1	4,43	CHI
20200968975	VALPARAISO DE GOIAS	10006764981	MARAJOARA	22/09/2020 15:17	22/09/2020 17:59	22/09/2020 15:17	22/09/2020 17:59	2,69	1	2,69	CHI
20200968978	MINEIROS	1390132265	PARQUE DAS EMAS	22/09/2020 15:17	23/09/2020 08:04	22/09/2020 15:17	23/09/2020 08:04	16,77	1	16,77	CHI
20200968986	PLANALTINA	10009833968	PLANALTINA	22/09/2020 15:18	22/09/2020 22:12	22/09/2020 15:18	22/09/2020 22:12	6,89	1	6,89	CHI
20200968989	RIO VERDE	630007238	RIO VERDE S2	22/09/2020 15:19	23/09/2020 16:20	22/09/2020 15:19	23/09/2020 16:20	25,02	1	25,02	CHI
20200968992	ARAGARCAS	1820029247	ARAGARCAS	22/09/2020 15:19	22/09/2020 16:30	22/09/2020 15:19	22/09/2020 16:30	1,19	1	1,19	CHI
20200968999	PILAR DE GOIAS	HL21000010	URUACU	22/09/2020 15:20	23/09/2020 22:40	22/09/2020 15:20	23/09/2020 22:40	31,33	1	31,33	CHI
20200969002	AURILANDIA	AI21000028	FIRMINOPOLIS S2	22/09/2020 15:20	22/09/2020 17:18	22/09/2020 15:20	22/09/2020 17:18	1,96	2	3,92	CHI
20200969004	RIO VERDE	630062675	RIO VERDE S2	22/09/2020 15:20	23/09/2020 08:03	22/09/2020 15:20	23/09/2020 08:03	16,71	1	16,71	CHI
20200969031	ANAPOLIS	20295250	JUNDIAI S1	22/09/2020 15:23	22/09/2020 18:52	22/09/2020 15:23	22/09/2020 18:52	3,47	1	3,47	CHI
20200969034	CACHOEIRA ALTA	1090009413	CACHOEIRA ALTA	22/09/2020 15:23	22/09/2020 18:33	22/09/2020 15:23	22/09/2020 18:33	3,15	1	3,15	CHI
20200969035	ITABERAI	50046081	ITABERAI S2	22/09/2020 15:23	22/09/2020 18:03	22/09/2020 15:23	22/09/2020 18:03	2,65	1	2,65	CHI
20200969036	JATAI	JT21063270	JATAI S3	22/09/2020 15:24	22/09/2020 16:47	22/09/2020 15:24	22/09/2020 16:47	1,38	1	1,38	CHI
20200969204	HIDROLINA	HL12245283	URUACU	22/09/2020 15:25	22/09/2020 19:21	22/09/2020 15:25	22/09/2020 19:21	3,92	7	27,45	CHI
20200969053	CAIAPONIA	CP12259511	CAIAPONIA	22/09/2020 15:26	22/09/2020 19:27	22/09/2020 15:26	22/09/2020 19:27	4,01	1	4,01	CHI
20200969056	LUZIANIA	LZ12351426LD	RIO VERMELHO	22/09/2020 15:26	22/09/2020 19:46	22/09/2020 15:26	22/09/2020 19:46	4,33	1208	5230,64	CHI
20200969056	LUZIANIA	LZ12351426LD	RIO VERMELHO	22/09/2020 15:26	22/09/2020 19:46	22/09/2020 19:11	22/09/2020 19:46	0,58	1696	976,14	CHI
202009107065	ANAPOLIS	20555088	JUNDIAI S2	22/09/2020 15:30	23/09/2020 07:09	22/09/2020 15:30	23/09/2020 07:09	15,65	1	15,65	CHI
20200969096	CRISTALINA	10020332619	CRISTALINA S2	22/09/2020 15:31	22/09/2020 17:29	22/09/2020 15:31	22/09/2020 17:29	1,96	1	1,96	CHI
20200969105	VALPARAISO DE GOIAS	10026484747	MARAJOARA	22/09/2020 15:32	23/09/2020 01:15	22/09/2020 15:32	23/09/2020 01:15	9,72	1	9,72	CHI
20200969111	ANAPOLIS	20318716	ANAPOLIS UNIVERSITARIO S1	22/09/2020 15:32	23/09/2020 16:41	22/09/2020 15:32	23/09/2020 16:41	25,14	1	25,14	CHI
20200969115	HIDROLINA	HL21000048	URUACU	22/09/2020 15:32	23/09/2020 19:19	22/09/2020 15:32	23/09/2020 19:19	27,77	1	27,77	CHI
20200969127	AMERICANO DO BRASIL	1410007987	ANICUNS	22/09/2020 15:34	22/09/2020 17:41	22/09/2020 15:34	22/09/2020 17:41	2,10	1	2,10	CHI
20200969134	LUZIANIA	LZ21206515	PACAEMBU S2	22/09/2020 15:35	22/09/2020 17:48	22/09/2020 15:35	22/09/2020 17:48	2,20	1	2,20	CHI
20200969137	MORRO AGUDO DE GOIAS	3690000991	ITAPURANGA	22/09/2020 15:36	22/09/2020 19:53	22/09/2020 15:36	22/09/2020 19:53	4,28	1	4,28	CHI
20200969142	ITABERAI	50058058	ITABERAI S2	22/09/2020 15:36	23/09/2020 08:20	22/09/2020 15:36	23/09/2020 08:20	16,72	1	16,72	CHI
20200969153	NOVA ROMA	ND12392238	IACIARA S2	22/09/2020 15:38	22/09/2020 17:32	22/09/2020 15:38	22/09/2020 17:32	1,90	232	440,67	CHI
202009107081	ACREUNA	2440040480	ACREUNA	22/09/2020 15:39	22/09/2020 22:14	22/09/2020 15:39	22/09/2020 22:14	6,59	1	6,59	CHI
20200969160	MONTIVIDIU	2840012838	MONTIVIDIU T	22/09/2020 15:39	22/09/2020 19:49	22/09/2020 15:39	22/09/2020 19:49	4,17	1	4,17	CHI
20200969165	LUZIANIA	LZ21206569	PACAEMBU S2	22/09/2020 15:39	22/09/2020 23:11	22/09/2020 15:39	22/09/2020 23:11	7,53	1	7,53	CHI
20200969170	JATAI	JT21156142	JATAI S3	22/09/2020 15:39	22/09/2020 19:24	22/09/2020 15:39	22/09/2020 19:24	3,74	1	3,74	CHI
20200972373	INDIARA	JD12323641RE	ACREUNA	22/09/2020 15:39	24/09/2020 15:53	22/09/2020 22:14	23/09/2020 19:25	21,17	15	317,59	CHI

INTERNAL

20200972373	INDIARA	JD12323641RE	ACREUNA	22/09/2020 15:39	24/09/2020 15:53	22/09/2020 22:14	23/09/2020 21:41	23,45	1	23,45	CHI
20200972373	INDIARA	JD12323641RE	ACREUNA	22/09/2020 15:39	24/09/2020 15:53	22/09/2020 22:14	23/09/2020 22:29	24,24	4	96,97	CHI
20200972373	ACREUNA	JD12323641RE	ACREUNA	22/09/2020 15:39	24/09/2020 15:53	22/09/2020 22:14	23/09/2020 22:29	24,24	1	24,24	CHI
20200972373	INDIARA	JD12323641RE	ACREUNA	22/09/2020 15:39	24/09/2020 15:53	22/09/2020 22:14	24/09/2020 13:05	38,85	1	38,85	CHI
20200972373	INDIARA	JD12323641RE	ACREUNA	22/09/2020 15:39	24/09/2020 15:53	22/09/2020 22:14	24/09/2020 15:53	41,65	1	41,65	CHI
20200972373	ACREUNA	JD12323641RE	ACREUNA	22/09/2020 15:39	24/09/2020 15:53	22/09/2020 22:14	24/09/2020 15:53	41,65	6	249,92	CHI
20200972373	INDIARA	JD12323641RE	ACREUNA	22/09/2020 15:39	24/09/2020 15:53	23/09/2020 21:41	23/09/2020 22:29	0,79	15	11,85	CHI
20200972373	INDIARA	IY13097068	ACREUNA	22/09/2020 15:39	24/09/2020 15:53	24/09/2020 14:31	24/09/2020 15:53	1,37	3	4,10	CHI
20200972373	ACREUNA	IY13097068	ACREUNA	22/09/2020 15:39	24/09/2020 15:53	24/09/2020 14:31	24/09/2020 15:53	1,37	1	1,37	CHI
20200969184	LUZIANIA	120047524	RIO VERMELHO	22/09/2020 15:42	22/09/2020 20:02	22/09/2020 15:42	22/09/2020 20:02	4,33	1	4,33	CHI
20200969189	ANAPOLIS	20335969	ANAPOLIS UNIVERSITARIO S1	22/09/2020 15:42	23/09/2020 17:31	22/09/2020 15:42	23/09/2020 17:31	25,80	1	25,80	CHI
20200969235	PEROLANDIA	DP11272277	JATAI S1	22/09/2020 15:48	23/09/2020 12:13	22/09/2020 15:48	23/09/2020 12:13	20,40	1	20,40	CHI
20200969244	PARANAIGUARA	PC11361063	CACHOEIRA ALTA	22/09/2020 15:49	22/09/2020 17:10	22/09/2020 15:49	22/09/2020 17:10	1,34	1	1,34	CHI
20200969501	ANAPOLIS	AN11377552	ANAPOLIS UNIVERSITARIO S2	22/09/2020 15:50	22/09/2020 18:31	22/09/2020 15:50	22/09/2020 18:31	2,68	91	243,70	CHI
20200969246	MINEIROS	1390006508	PARQUE DAS EMAS	22/09/2020 15:50	23/09/2020 10:23	22/09/2020 15:50	23/09/2020 10:23	18,54	1	18,54	CHI
20200969250	RIO VERDE	630300367	CABRIUVA S1	22/09/2020 15:50	23/09/2020 10:42	22/09/2020 15:50	23/09/2020 10:42	18,86	1	18,86	CHI
20200969253	ANAPOLIS	20508049	ANAPOLIS UNIVERSITARIO S1	22/09/2020 15:50	23/09/2020 09:49	22/09/2020 15:50	23/09/2020 09:49	17,97	1	17,97	CHI
20200962282	DISTRITO FEDERAL	PI11085605	PLANALTINA	22/09/2020 15:50	22/09/2020 17:39	22/09/2020 15:50	22/09/2020 17:39	1,80	125	225,45	CHI
20200969263	RIO VERDE	RV12349540LD	CABRIUVA S2	22/09/2020 15:51	22/09/2020 20:37	22/09/2020 15:51	22/09/2020 20:37	4,76	1	4,76	CHI
20200969290	CRISTALINA	KR21152357	PAMPLONA	22/09/2020 15:53	22/09/2020 23:25	22/09/2020 15:53	22/09/2020 23:25	7,52	1	7,52	CHI
20200969294	ANICUNS	TV12005709	FIRMINOPOLIS S2	22/09/2020 15:54	22/09/2020 18:52	22/09/2020 15:54	22/09/2020 18:52	2,96	19	56,30	CHI
20200969418	SAO LUIS DE MONTES BELOS	SL11015455	SAO LUIZ DOS MONTES BELOS	22/09/2020 15:54	23/09/2020 01:06	22/09/2020 15:54	23/09/2020 01:06	9,20	164	1508,21	CHI
20200969456	ABADIANIA	AA12072462	CORUMBA	22/09/2020 15:54	22/09/2020 18:09	22/09/2020 15:54	22/09/2020 18:09	2,24	29	64,98	CHI
20200969308	PALMEIRAS DE GOIAS	PL21171536	PALMEIRAS	22/09/2020 15:56	22/09/2020 21:45	22/09/2020 15:56	22/09/2020 21:45	5,81	1	5,81	CHI
20200969340	ANAPOLIS	AN10383659	ANAPOLIS UNIVERSITARIO S2	22/09/2020 15:59	23/09/2020 00:25	22/09/2020 15:59	23/09/2020 00:25	8,43	96	809,44	CHI
20200969340	ANAPOLIS	AN10383659	ANAPOLIS UNIVERSITARIO S2	22/09/2020 15:59	23/09/2020 00:25	22/09/2020 22:11	23/09/2020 00:25	2,23	131	292,42	CHI
20200969351	PILAR DE GOIAS	GG12238584	SANTA TEREZINHA	22/09/2020 16:01	23/09/2020 11:20	22/09/2020 16:01	23/09/2020 11:20	19,33	8	154,64	CHI
20200969354	NIQUELANDIA	2750067188	NIQUELANDIA SUBTRANSMISSAO	22/09/2020 16:02	23/09/2020 11:45	22/09/2020 16:02	23/09/2020 11:45	19,71	1	19,71	CHI
20200969362	MINACU	IH12346526	MINACU	22/09/2020 16:03	22/09/2020 19:46	22/09/2020 16:03	22/09/2020 19:46	3,71	67	248,76	CHI
20200969363	SAO LUIZ DO NORTE	SZ21352325	GOIANESIA S1	22/09/2020 16:03	24/09/2020 08:56	22/09/2020 16:03	24/09/2020 08:56	40,88	1	40,88	CHI
20200969675	CORUMBA DE GOIAS	CB12056813	CORUMBA	22/09/2020 16:05	22/09/2020 17:39	22/09/2020 16:05	22/09/2020 17:39	1,57	24	37,57	CHI
20200969381	SAO LUIS DE MONTES BELOS	500079950	SAO LUIZ DOS MONTES BELOS	22/09/2020 16:05	23/09/2020 10:33	22/09/2020 16:05	23/09/2020 10:33	18,46	1	18,46	CHI
20200969383	ANAPOLIS	10013227287	ANAPOLIS UNIVERSITARIO S2	22/09/2020 16:05	23/09/2020 13:41	22/09/2020 16:05	23/09/2020 13:41	21,59	1	21,59	CHI

INTERNAL

20200969406	PLANALTINA	PI12262322	PLANALTINA	22/09/2020 16:07	23/09/2020 17:30	22/09/2020 16:07	23/09/2020 10:25	18,29	1	18,29	CHI
20200969406	PLANALTINA	PI12262322	PLANALTINA	22/09/2020 16:07	23/09/2020 17:30	22/09/2020 16:07	23/09/2020 17:30	25,38	12	304,54	CHI
20200969406	PLANALTINA	PI12262322	PLANALTINA	22/09/2020 16:07	23/09/2020 17:30	23/09/2020 09:08	23/09/2020 17:30	8,37	1	8,37	CHI
20200969406	PLANALTINA	PI12262322	PLANALTINA	22/09/2020 16:07	23/09/2020 17:30	23/09/2020 16:37	23/09/2020 17:30	0,89	1	0,89	CHI
20200969408	SAO LUIS DE MONTES BELOS	SL21000008	SAO LUIZ DOS MONTES BELOS	22/09/2020 16:08	23/09/2020 09:04	22/09/2020 16:08	23/09/2020 09:04	16,93	6	101,60	CHI
20200969428	HIDROLINA	1020008286	URUACU	22/09/2020 16:10	23/09/2020 16:34	22/09/2020 16:10	23/09/2020 16:34	24,39	1	24,39	CHI
20200969429	ANAPOLIS	20777139	ANAPOLIS UNIVERSITARIO S2	22/09/2020 16:10	23/09/2020 10:10	22/09/2020 16:10	23/09/2020 10:10	17,99	1	17,99	CHI
20200969506	FORMOSA	FA12364302	SAO JOAO D ALIANCA	22/09/2020 16:11	23/09/2020 03:47	22/09/2020 16:11	23/09/2020 03:47	11,59	4	46,35	CHI
20200969436	PARAUNA	980021273	PARAUNA	22/09/2020 16:11	22/09/2020 17:26	22/09/2020 16:11	22/09/2020 17:26	1,24	1	1,24	CHI
20200969454	RIO VERDE	630202266	RIO VERDE S1	22/09/2020 16:13	23/09/2020 02:08	22/09/2020 16:13	23/09/2020 02:08	9,91	1	9,91	CHI
20200969466	PLANALTINA	PI12359115	SAO JOAO D ALIANCA	22/09/2020 16:14	22/09/2020 18:07	22/09/2020 16:14	22/09/2020 18:07	1,88	6	11,29	CHI
20200969469	JATAI	290253512	JATAI S3	22/09/2020 16:14	23/09/2020 11:00	22/09/2020 16:14	23/09/2020 11:00	18,78	1	18,78	CHI
20200969476	JATAI	JT12214347	JATAI S2	22/09/2020 16:15	23/09/2020 00:52	22/09/2020 16:15	23/09/2020 00:52	8,62	13	112,08	CHI
20200969482	SERRANOPOLIS	DJ12164061	CHAPADAO DO CEU	22/09/2020 16:16	23/09/2020 16:40	22/09/2020 16:16	23/09/2020 16:40	24,40	2	48,80	CHI
20200969491	PLANALTINA	2960211309	PLANALTINA	22/09/2020 16:16	23/09/2020 10:24	22/09/2020 16:16	23/09/2020 10:24	18,13	1	18,13	CHI
20200969492	GOIANESIA	550013027	GOIANESIA S2	22/09/2020 16:17	23/09/2020 01:35	22/09/2020 16:17	23/09/2020 01:35	9,30	1	9,30	CHI
20200969496	ITARUMA	IM21205246	CACHOEIRA ALTA	22/09/2020 16:17	23/09/2020 10:18	22/09/2020 16:17	23/09/2020 10:18	18,01	1	18,01	CHI
20200969635	IPAMERI	KR10370643	CRISTALINA S1	22/09/2020 16:19	22/09/2020 18:47	22/09/2020 16:19	22/09/2020 16:27	0,13	1293	161,63	CHI
20200969635	CRISTALINA	KR10370643	CRISTALINA S1	22/09/2020 16:19	22/09/2020 18:47	22/09/2020 16:19	22/09/2020 16:27	0,13	30	3,75	CHI
20200969635	LUZIANIA	KR10400684	CRISTALINA S1	22/09/2020 16:19	22/09/2020 18:47	22/09/2020 16:19	22/09/2020 18:47	2,45	38	93,24	CHI
20200969635	CRISTALINA	KR10400684	CRISTALINA S1	22/09/2020 16:19	22/09/2020 18:47	22/09/2020 16:19	22/09/2020 18:47	2,45	204	500,54	CHI
20200969635	IPAMERI	KR10400684	CRISTALINA S1	22/09/2020 16:19	22/09/2020 18:47	22/09/2020 16:19	22/09/2020 18:47	2,45	1	2,45	CHI
20200969514	NIQUELANDIA	NQ21413987	URUACU	22/09/2020 16:19	22/09/2020 17:32	22/09/2020 16:19	22/09/2020 17:32	1,20	1	1,20	CHI
20200969515	JATAI	290149125	JATAI S2	22/09/2020 16:19	22/09/2020 22:10	22/09/2020 16:19	22/09/2020 22:10	5,83	1	5,83	CHI
20200969635	IPAMERI	KR10370643	CRISTALINA S1	22/09/2020 16:19	22/09/2020 18:47	22/09/2020 16:38	22/09/2020 17:25	0,79	1293	1019,67	CHI
20200969635	CRISTALINA	KR10370643	CRISTALINA S1	22/09/2020 16:19	22/09/2020 18:47	22/09/2020 16:38	22/09/2020 17:25	0,79	30	23,66	CHI
20200970424	NOVA ROMA	ND12256420	IACIARA S2	22/09/2020 16:21	22/09/2020 18:47	22/09/2020 16:21	22/09/2020 18:47	2,42	30	72,52	CHI
20200969533	ITAGUARU	230021920	ITABERAI S1	22/09/2020 16:22	22/09/2020 19:58	22/09/2020 16:22	22/09/2020 19:58	3,61	1	3,61	CHI
20200970552	VALPARAISO DE GOIAS	VA11164930	PACAEMBU S2	22/09/2020 16:22	22/09/2020 20:16	22/09/2020 16:22	22/09/2020 20:16	3,89	184	715,96	CHI
20200969544	MINEIROS	MY21274160	PARQUE DAS EMAS	22/09/2020 16:23	23/09/2020 00:49	22/09/2020 16:23	23/09/2020 00:49	8,42	1	8,42	CHI
20200969554	VALPARAISO DE GOIAS	3350067357	PACAEMBU S1	22/09/2020 16:24	22/09/2020 22:52	22/09/2020 16:24	22/09/2020 22:52	6,46	1	6,46	CHI
20200969558	BONOPOLIS	BX21254003	NOVO PLANALTO	22/09/2020 16:25	23/09/2020 00:02	22/09/2020 16:25	23/09/2020 00:02	7,62	1	7,62	CHI
20200969655	TROMBAS	TB12256991	PORANGATU	22/09/2020 16:26	23/09/2020 22:30	22/09/2020 16:26	23/09/2020 22:30	30,05	22	661,14	CHI

INTERNAL

20200969655	MINACU	TB12256991	PORANGATU	22/09/2020 16:26	23/09/2020 22:30	22/09/2020 16:26	23/09/2020 22:30	30,05	12	360,62	CHI
20200969574	ACREUNA	2440053618	ACREUNA	22/09/2020 16:27	23/09/2020 10:40	22/09/2020 16:27	23/09/2020 10:40	18,21	1	18,21	CHI
20200969580	VALPARAISO DE GOIAS	VA12112989	MARAJOARA	22/09/2020 16:28	23/09/2020 05:03	22/09/2020 16:28	23/09/2020 04:51	12,37	93	1150,67	CHI
20200969580	VALPARAISO DE GOIAS	VA12112989	MARAJOARA	22/09/2020 16:28	23/09/2020 05:03	22/09/2020 16:28	23/09/2020 04:58	12,49	33	412,14	CHI
20200969580	VALPARAISO DE GOIAS	VA12112989	MARAJOARA	22/09/2020 16:28	23/09/2020 05:03	22/09/2020 16:28	23/09/2020 05:03	12,57	81	1018,55	CHI
20200969925	URUACU	UR11003386	URUACU	22/09/2020 16:28	22/09/2020 21:10	22/09/2020 16:28	22/09/2020 21:10	4,69	132	618,82	CHI
20200969594	ARAGARCAS	1820025448	ARAGARCAS	22/09/2020 16:30	22/09/2020 18:02	22/09/2020 16:30	22/09/2020 18:02	1,52	1	1,52	CHI
20200969601	MONTE ALEGRE DE GOIAS	MA12236750	SAO DOMINGOS	22/09/2020 16:31	22/09/2020 17:48	22/09/2020 16:31	22/09/2020 17:48	1,28	2	2,57	CHI
20200969610	IACIARA	IA12195746	IACIARA S2	22/09/2020 16:32	22/09/2020 20:41	22/09/2020 16:32	22/09/2020 20:41	4,14	1	4,14	CHI
20200970670	UIRAPURU	UP12391845	SANTA TEREZINHA	22/09/2020 16:33	23/09/2020 12:17	22/09/2020 16:33	23/09/2020 12:17	19,73	24	473,57	CHI
20200970308	TROMBAS	TB12156807	PORANGATU	22/09/2020 16:33	23/09/2020 23:38	22/09/2020 16:33	23/09/2020 23:38	31,07	72	2237,12	CHI
20200969621	AGUAS LINDAS DE GOIAS	LA11377264	AGUAS LINDAS DE GOIAS S1	22/09/2020 16:34	22/09/2020 18:12	22/09/2020 16:34	22/09/2020 18:12	1,63	51	83,03	CHI
20200969622	NIQUELANDIA	NQ21274760	BARRO ALTO	22/09/2020 16:34	23/09/2020 19:08	22/09/2020 16:34	23/09/2020 19:08	26,56	2	53,12	CHI
20200969644	LUZIANIA	120031188	RIO VERMELHO	22/09/2020 16:35	22/09/2020 22:53	22/09/2020 16:35	22/09/2020 22:53	6,29	1	6,29	CHI
20200969645	SANTA TEREZINHA DE GOIAS	2480033461	SANTA TEREZINHA	22/09/2020 16:35	23/09/2020 01:53	22/09/2020 16:35	23/09/2020 01:53	9,29	1	9,29	CHI
20200971556	PORANGATU	PO11208632	PORANGATU	22/09/2020 16:36	23/09/2020 11:49	22/09/2020 16:36	23/09/2020 11:49	19,23	74	1422,67	CHI
20200969648	ITABERAI	10001360351	ITABERAI S2	22/09/2020 16:36	22/09/2020 18:48	22/09/2020 16:36	22/09/2020 18:48	2,21	1	2,21	CHI
20200969650	FORMOSA	610197710	ITUIQUIRA	22/09/2020 16:36	22/09/2020 17:32	22/09/2020 16:36	22/09/2020 17:32	0,93	1	0,93	CHI
20200969653	JARAGUA	70014711	JARAGUA	22/09/2020 16:36	23/09/2020 07:55	22/09/2020 16:36	23/09/2020 07:55	15,31	1	15,31	CHI
20200969654	MONTE ALEGRE DE GOIAS	1620003081	SAO DOMINGOS	22/09/2020 16:36	22/09/2020 20:18	22/09/2020 16:36	22/09/2020 20:18	3,69	1	3,69	CHI
2020092200190	CRISTALINA	03470444	CRISTALINA S1	22/09/2020 16:37	22/09/2020 16:58	22/09/2020 16:37	22/09/2020 16:58	0,35	3	1,05	CHI
20200969660	MINACU	IH12313441	MINACU	22/09/2020 16:37	22/09/2020 23:54	22/09/2020 16:37	22/09/2020 23:54	7,28	4	29,13	CHI
20200969665	LUZIANIA	LZ21192781	MARAJOARA	22/09/2020 16:37	22/09/2020 20:16	22/09/2020 16:37	22/09/2020 20:16	3,64	3	10,93	CHI
20200969671	PILAR DE GOIAS	GG13213130	SANTA TEREZINHA	22/09/2020 16:38	22/09/2020 20:59	22/09/2020 16:38	22/09/2020 20:59	4,36	1	4,36	CHI
20200969671	GUARINOS	GG13213130	SANTA TEREZINHA	22/09/2020 16:38	22/09/2020 20:59	22/09/2020 16:38	22/09/2020 20:59	4,36	2	8,72	CHI
20200969671	PILAR DE GOIAS	SG10394720	SANTA TEREZINHA	22/09/2020 16:38	22/09/2020 20:59	22/09/2020 17:21	22/09/2020 19:30	2,15	13	27,99	CHI
20200969671	SANTA TEREZINHA DE GOIAS	SG10394720	SANTA TEREZINHA	22/09/2020 16:38	22/09/2020 20:59	22/09/2020 17:21	22/09/2020 19:30	2,15	205	441,32	CHI
20200969671	GUARINOS	SG10394720	SANTA TEREZINHA	22/09/2020 16:38	22/09/2020 20:59	22/09/2020 17:21	22/09/2020 20:59	3,64	912	3315,12	CHI
20200969671	ITAPACI	SG10394720	SANTA TEREZINHA	22/09/2020 16:38	22/09/2020 20:59	22/09/2020 17:21	22/09/2020 20:59	3,64	6	21,81	CHI
20200969671	CRIXAS	SG10394720	SANTA TEREZINHA	22/09/2020 16:38	22/09/2020 20:59	22/09/2020 17:21	22/09/2020 20:59	3,64	304	1105,04	CHI
20200969671	PILAR DE GOIAS	SG10394720	SANTA TEREZINHA	22/09/2020 16:38	22/09/2020 20:59	22/09/2020 17:21	22/09/2020 20:59	3,64	32	116,32	CHI
20200969677	ALEXANIA	AX12295524	ALEXANIA	22/09/2020 16:39	23/09/2020 16:15	22/09/2020 16:39	23/09/2020 16:15	23,60	2	47,19	CHI
20200969686	RUBIATABA	RB21283565	RUBIATABA	22/09/2020 16:40	23/09/2020 10:21	22/09/2020 16:40	23/09/2020 10:21	17,68	1	17,68	CHI

INTERNAL

20200969687	TERESINA DE GOIAS	TE12328391	FLORES DE GOIAS	22/09/2020 16:40	22/09/2020 20:01	22/09/2020 16:40	22/09/2020 20:01	3,35	2	6,69	CHI
20200969714	ANAPOLIS	20642325	ANAPOLIS UNIVERSITARIO S2	22/09/2020 16:43	23/09/2020 14:57	22/09/2020 16:43	23/09/2020 14:57	22,23	1	22,23	CHI
20200969716	ANAPOLIS	20613866	ANAPOLIS UNIVERSITARIO S2	22/09/2020 16:43	23/09/2020 12:06	22/09/2020 16:43	23/09/2020 12:06	19,38	1	19,38	CHI
20200969717	LUZIANIA	LZ11230128	RIO VERMELHO	22/09/2020 16:43	22/09/2020 18:08	22/09/2020 16:43	22/09/2020 18:08	1,41	19	26,74	CHI
20200969728	PILAR DE GOIAS	HL21238595	SANTA TEREZINHA	22/09/2020 16:43	22/09/2020 20:47	22/09/2020 16:43	22/09/2020 20:47	4,05	1	4,05	CHI
20200969746	RIO VERDE	630072863	RIO VERDE S1	22/09/2020 16:45	23/09/2020 03:52	22/09/2020 16:45	23/09/2020 03:52	11,12	1	11,12	CHI
20200969959	ITARUMA	IM10401499	ITAJA S2	22/09/2020 16:46	23/09/2020 17:36	22/09/2020 16:46	22/09/2020 16:55	0,16	99	15,48	CHI
20200969959	APORE	IM10401499	ITAJA S2	22/09/2020 16:46	23/09/2020 17:36	22/09/2020 16:46	22/09/2020 16:55	0,16	4	0,63	CHI
20200969959	ITAJA	IM10401499	ITAJA S2	22/09/2020 16:46	23/09/2020 17:36	22/09/2020 16:46	22/09/2020 16:55	0,16	97	15,17	CHI
20200969959	ITAJA	09929511	ITAJA S2	22/09/2020 16:46	23/09/2020 17:36	22/09/2020 16:46	22/09/2020 20:32	3,77	2	7,53	CHI
20200969959	ITAJA	IJ10400580	ITAJA S2	22/09/2020 16:46	23/09/2020 17:36	22/09/2020 16:46	22/09/2020 20:44	3,98	15	59,69	CHI
20200969959	APORE	IJ10400580	ITAJA S2	22/09/2020 16:46	23/09/2020 17:36	22/09/2020 16:46	22/09/2020 20:44	3,98	110	437,74	CHI
20200969959	DISTRITO FEDERAL	IJ10400580	ITAJA S2	22/09/2020 16:46	23/09/2020 17:36	22/09/2020 16:46	22/09/2020 20:44	3,98	3	11,94	CHI
20200969959	ITAJA	09929511	ITAJA S2	22/09/2020 16:46	23/09/2020 17:36	22/09/2020 16:46	22/09/2020 23:58	7,20	4	28,81	CHI
20200969959	ITAJA	09929511	ITAJA S2	22/09/2020 16:46	23/09/2020 17:36	22/09/2020 16:46	23/09/2020 17:36	24,83	5	124,17	CHI
2020092200192	AGUA FRIA DE GOIAS	02160434	SAO JOAO D ALIANCA	22/09/2020 16:46	22/09/2020 16:51	22/09/2020 16:46	22/09/2020 16:51	0,08	74	6,17	CHI
2020092200192	NIQUELANDIA	02160434	SAO JOAO D ALIANCA	22/09/2020 16:46	22/09/2020 16:51	22/09/2020 16:46	22/09/2020 16:51	0,08	212	17,67	CHI
2020092200192	SAO JOAO D ALIANCA	02160434	SAO JOAO D ALIANCA	22/09/2020 16:46	22/09/2020 16:51	22/09/2020 16:46	22/09/2020 16:51	0,08	14	1,17	CHI
20200969762	JARAGUA	70034989	JARAGUA	22/09/2020 16:46	23/09/2020 10:24	22/09/2020 16:46	23/09/2020 10:24	17,62	1	17,62	CHI
20200969766	ARAGARCAS	1820039370	ARAGARCAS	22/09/2020 16:46	22/09/2020 20:19	22/09/2020 16:46	22/09/2020 20:19	3,54	1	3,54	CHI
20200969959	ITAJA	IM10401499	ITAJA S2	22/09/2020 16:46	23/09/2020 17:36	22/09/2020 18:53	22/09/2020 18:57	0,07	1761	129,14	CHI
20200969959	DISTRITO FEDERAL	IM10401499	ITAJA S2	22/09/2020 16:46	23/09/2020 17:36	22/09/2020 18:53	22/09/2020 18:57	0,07	5	0,37	CHI
20200969959	LAGOA SANTA	IM10401499	ITAJA S2	22/09/2020 16:46	23/09/2020 17:36	22/09/2020 18:53	22/09/2020 18:57	0,07	795	58,30	CHI
20200969959	ITARUMA	IM10401499	ITAJA S2	22/09/2020 16:46	23/09/2020 17:36	22/09/2020 18:53	22/09/2020 18:57	0,07	100	7,33	CHI
20200969959	ITAJA	IM10401499	ITAJA S2	22/09/2020 16:46	23/09/2020 17:36	22/09/2020 18:53	22/09/2020 18:57	0,07	99	7,26	CHI
20200969959	APORE	IM10401499	ITAJA S2	22/09/2020 16:46	23/09/2020 17:36	22/09/2020 18:53	22/09/2020 18:57	0,07	4	0,29	CHI
20200969959	ITAJA	IM10401499	ITAJA S2	22/09/2020 16:46	23/09/2020 17:36	22/09/2020 18:53	22/09/2020 18:57	0,07	46	3,37	CHI
20200969959	APORE	IM10401499	ITAJA S1	22/09/2020 16:46	23/09/2020 17:36	22/09/2020 18:53	22/09/2020 20:44	1,86	5	9,29	CHI
20200969959	ITAJA	IJ10400580	ITAJA S2	22/09/2020 16:46	23/09/2020 17:36	22/09/2020 18:53	22/09/2020 20:44	1,86	2	3,72	CHI
20200969959	APORE	IM10401499	ITAJA S1	22/09/2020 16:46	23/09/2020 17:36	22/09/2020 19:20	22/09/2020 20:44	1,40	55	77,26	CHI
20200969959	SERRANOPOLIS	IM10401499	ITAJA S1	22/09/2020 16:46	23/09/2020 17:36	22/09/2020 19:20	22/09/2020 20:44	1,40	46	64,62	CHI
20200969959	APORE	IM10401499	ITAJA S1	22/09/2020 16:46	23/09/2020 17:36	22/09/2020 19:20	22/09/2020 20:44	1,40	46	64,62	CHI
20200969959	APORE	IM10401499	ITAJA S1	22/09/2020 16:46	23/09/2020 17:36	22/09/2020 19:20	22/09/2020 20:44	1,40	53	74,45	CHI

INTERNAL

20200969959	APORE	IM10401499	ITAJA S1	22/09/2020 16:46	23/09/2020 17:36	22/09/2020 19:20	22/09/2020 20:44	1,40	1	1,40	CHI
20200969959	APORE	IJ10400580	ITAJA S2	22/09/2020 16:46	23/09/2020 17:36	22/09/2020 19:20	22/09/2020 20:44	1,40	5	7,02	CHI
20200969959	ITAJA	09929511	ITAJA S2	22/09/2020 16:46	23/09/2020 17:36	22/09/2020 21:23	23/09/2020 00:00	2,61	2	5,22	CHI
20200969771	GOIAS	90000031	GOIAS	22/09/2020 16:47	22/09/2020 18:43	22/09/2020 16:47	22/09/2020 18:43	1,93	1	1,93	CHI
20200969803	CRIXAS	CX10401472	RUBIATABA	22/09/2020 16:48	22/09/2020 22:06	22/09/2020 16:48	22/09/2020 19:45	2,96	51	150,79	CHI
20200969803	CRIXAS	CX12201729LD	RUBIATABA	22/09/2020 16:48	22/09/2020 22:06	22/09/2020 16:48	22/09/2020 21:00	4,21	209	879,08	CHI
20200969803	NOVA IGUACU DE GOIAS	CX12201729LD	RUBIATABA	22/09/2020 16:48	22/09/2020 22:06	22/09/2020 16:48	22/09/2020 21:00	4,21	1	4,21	CHI
20200969803	CRIXAS	CX12190022	RUBIATABA	22/09/2020 16:48	22/09/2020 22:06	22/09/2020 16:48	22/09/2020 21:46	4,96	18	89,34	CHI
20200969803	CRIXAS	CX12181454LD	RUBIATABA	22/09/2020 16:48	22/09/2020 22:06	22/09/2020 16:48	22/09/2020 22:06	5,30	17	90,18	CHI
20200969802	INDIARA	IY21162588	CEZARINA	22/09/2020 16:49	22/09/2020 19:34	22/09/2020 16:49	22/09/2020 19:34	2,73	1	2,73	CHI
20200969814	JATAI	10006573221	JATAI S3	22/09/2020 16:50	23/09/2020 08:56	22/09/2020 16:50	23/09/2020 08:56	16,09	1	16,09	CHI
20200969823	LUZIANIA	LZ12400838	MARAJOARA	22/09/2020 16:51	22/09/2020 19:30	22/09/2020 16:51	22/09/2020 19:30	2,64	9	23,79	CHI
20200969839	CASTELANDIA	1890000684	RIO DOS BOIS	22/09/2020 16:53	23/09/2020 13:18	22/09/2020 16:53	23/09/2020 13:18	20,42	1	20,42	CHI
20200970314	MONTIVIDIU DO NORTE	9670004098	PORANGATU	22/09/2020 16:53	23/09/2020 23:27	22/09/2020 16:53	23/09/2020 23:27	30,56	1	30,56	CHI
20200969849	FORMOSA	FA12022177	ITUIQUIRA	22/09/2020 16:53	22/09/2020 20:49	22/09/2020 16:53	22/09/2020 20:49	3,92	1	3,92	CHI
20200969862	MINACU	IH11151069	MINACU	22/09/2020 16:55	22/09/2020 21:33	22/09/2020 16:55	22/09/2020 21:33	4,62	39	180,18	CHI
20200969875	LUZIANIA	120197832	RIO VERMELHO	22/09/2020 16:56	22/09/2020 19:46	22/09/2020 16:56	22/09/2020 19:46	2,82	1	2,82	CHI
20200969880	CRIXAS	3880000138	RUBIATABA	22/09/2020 16:57	23/09/2020 13:10	22/09/2020 16:57	23/09/2020 13:10	20,21	1	20,21	CHI
20200969897	SAO LUIS DE MONTES BELOS	500054540	SAO LUIZ DOS MONTES BELOS	22/09/2020 16:58	23/09/2020 10:31	22/09/2020 16:58	23/09/2020 10:31	17,54	1	17,54	CHI
20200969908	ANAPOLIS	AN12270460	ANAPOLIS UNIVERSITARIO S2	22/09/2020 16:59	22/09/2020 17:26	22/09/2020 16:59	22/09/2020 17:26	0,44	73	32,08	CHI
20200969937	CRISTALINA	KR21000012	CRISTALINA S2	22/09/2020 17:01	22/09/2020 21:32	22/09/2020 17:01	22/09/2020 21:32	4,51	3	13,52	CHI
20200969940	PLANALTINA	2960125533	PLANALTINA	22/09/2020 17:01	22/09/2020 23:41	22/09/2020 17:01	22/09/2020 23:41	6,66	1	6,66	CHI
20200969951	RIO VERDE	630036469	RIO VERDE S2	22/09/2020 17:02	23/09/2020 00:25	22/09/2020 17:02	23/09/2020 00:25	7,39	1	7,39	CHI
20200969956	JATAI	JT12267428	JATAI S1	22/09/2020 17:02	23/09/2020 10:11	22/09/2020 17:02	23/09/2020 10:11	17,13	3	51,40	CHI
20200969958	LUZIANIA	120118178	RIO VERMELHO	22/09/2020 17:03	22/09/2020 23:02	22/09/2020 17:03	22/09/2020 23:02	5,99	1	5,99	CHI
20200969961	RIO VERDE	RV12338619	CABRIUVA S2	22/09/2020 17:03	23/09/2020 07:24	22/09/2020 17:03	23/09/2020 07:24	14,35	1	14,35	CHI
20200969964	IACIARA	1550026036	IACIARA S1	22/09/2020 17:03	22/09/2020 19:49	22/09/2020 17:03	22/09/2020 19:49	2,76	1	2,76	CHI
20200969966	ANAPOLIS	20895483	ANAPOLIS UNIVERSITARIO S2	22/09/2020 17:03	23/09/2020 13:25	22/09/2020 17:03	23/09/2020 13:25	20,35	1	20,35	CHI
20200969967	ANAPOLIS	10004287604	ANAPOLIS UNIVERSITARIO S2	22/09/2020 17:03	23/09/2020 10:33	22/09/2020 17:03	23/09/2020 10:33	17,48	1	17,48	CHI
20200969968	LUZIANIA	LZ12000717	PACAEMBU S2	22/09/2020 17:03	23/09/2020 13:29	22/09/2020 17:03	23/09/2020 13:29	20,43	3	61,28	CHI
20200971336	MINACU	IH12032066	MINACU	22/09/2020 17:04	23/09/2020 01:51	22/09/2020 17:04	23/09/2020 01:51	8,77	122	1070,24	CHI
20200969994	CRISTALINA	KR12163713	CRISTALINA S2	22/09/2020 17:06	22/09/2020 22:27	22/09/2020 17:06	22/09/2020 22:27	5,34	4	21,36	CHI
20200969997	LUZIANIA	LZ21244585	CRISTALINA S2	22/09/2020 17:06	23/09/2020 21:12	22/09/2020 17:06	23/09/2020 21:12	28,10	1	28,10	CHI

INTERNAL

20200970036	PLANALTINA	PI12344175	SAO JOAO D ALIANCA	22/09/2020 17:07	23/09/2020 10:47	22/09/2020 17:07	23/09/2020 10:47	17,66	23	406,14	CHI
20200970008	MONTIVIDIU DO NORTE	MX12187847	PORANGATU	22/09/2020 17:07	24/09/2020 00:30	22/09/2020 17:07	24/09/2020 00:30	31,37	29	909,67	CHI
20200971632	MONTIVIDIU DO NORTE	MX11139248	PORANGATU	22/09/2020 17:10	24/09/2020 12:14	22/09/2020 17:10	24/09/2020 12:14	43,05	156	6715,93	CHI
20200970045	RIO VERDE	630030224	RIO VERDE S1	22/09/2020 17:11	23/09/2020 10:51	22/09/2020 17:11	23/09/2020 10:51	17,66	1	17,66	CHI
20200970062	ANAPOLIS	20476449	ANAPOLIS UNIVERSITARIO S2	22/09/2020 17:14	23/09/2020 12:58	22/09/2020 17:14	23/09/2020 12:58	19,73	1	19,73	CHI
20200970065	PLANALTINA	PI11248811	PLANALTINA	22/09/2020 17:14	23/09/2020 11:06	22/09/2020 17:14	23/09/2020 11:06	17,85	1	17,85	CHI
20200970066	PADRE BERNARDO	2760049559	PADRE BERNARDO	22/09/2020 17:15	22/09/2020 19:36	22/09/2020 17:15	22/09/2020 19:36	2,36	1	2,36	CHI
20200970074	GAMELEIRA DE GOIAS	GL21346279	ANAPOLIS UNIVERSITARIO S2	22/09/2020 17:15	23/09/2020 01:01	22/09/2020 17:15	23/09/2020 01:01	7,75	1	7,75	CHI
20200970617	MATRINCHA	MP12122364	MATRINCHA	22/09/2020 17:16	23/09/2020 12:45	22/09/2020 17:16	23/09/2020 12:45	19,47	11	214,16	CHI
20200970140	MINACU	IH11182441	MINACU	22/09/2020 17:17	22/09/2020 21:37	22/09/2020 17:17	22/09/2020 21:37	4,32	132	570,68	CHI
20200970084	FAINA	FC12274318	GOIAS	22/09/2020 17:17	23/09/2020 20:24	22/09/2020 17:17	22/09/2020 21:10	3,87	2	7,74	CHI
20200970084	FAINA	FC12274318	GOIAS	22/09/2020 17:17	23/09/2020 20:24	22/09/2020 17:17	23/09/2020 20:24	27,11	15	406,65	CHI
20200970098	RIO VERDE	RV12249048	MONTIVIDIU T	22/09/2020 17:18	22/09/2020 18:48	22/09/2020 17:18	22/09/2020 18:48	1,49	4	5,96	CHI
20200970098	MONTIVIDIU	RV12249048	MONTIVIDIU T	22/09/2020 17:18	22/09/2020 18:48	22/09/2020 17:18	22/09/2020 18:48	1,49	1	1,49	CHI
20200970788	MOSSAMEDES	MD12170893	ITABERA S1	22/09/2020 17:18	23/09/2020 08:17	22/09/2020 17:18	23/09/2020 08:17	14,97	182	2724,49	CHI
20200970136	RIO VERDE	630053650	RIO VERDE S2	22/09/2020 17:23	23/09/2020 06:27	22/09/2020 17:23	23/09/2020 06:27	13,07	1	13,07	CHI
20200970150	ANAPOLIS	20545381	ANAPOLIS UNIVERSITARIO S2	22/09/2020 17:24	23/09/2020 15:13	22/09/2020 17:24	23/09/2020 15:13	21,80	1	21,80	CHI
20200970152	ANAPOLIS	20786062	ANAPOLIS UNIVERSITARIO S2	22/09/2020 17:25	22/09/2020 23:48	22/09/2020 17:25	22/09/2020 23:48	6,38	1	6,38	CHI
20200970196	TURVANIA	TV12005581	FIRMINOPOLIS S2	22/09/2020 17:26	23/09/2020 14:55	22/09/2020 17:26	23/09/2020 14:55	21,48	11	236,23	CHI
20200970210	ACREUNA	EU11000015	ACREUNA	22/09/2020 17:27	22/09/2020 20:57	22/09/2020 17:27	22/09/2020 20:57	3,49	189	659,61	CHI
20200970211	SANTA FE DE GOIAS	RN12055147	BRITANIA	22/09/2020 17:31	23/09/2020 22:01	22/09/2020 17:31	23/09/2020 15:04	21,55	1	21,55	CHI
20200970211	SANTA FE DE GOIAS	RN12217612LD	BRITANIA	22/09/2020 17:31	23/09/2020 22:01	22/09/2020 17:31	23/09/2020 22:01	28,50	1	28,50	CHI
20200970223	ANAPOLIS	20601657	ANAPOLIS UNIVERSITARIO S2	22/09/2020 17:32	23/09/2020 18:27	22/09/2020 17:32	23/09/2020 18:27	24,91	1	24,91	CHI
20200970230	JATAI	JT21115872	JATAI S1	22/09/2020 17:32	23/09/2020 10:03	22/09/2020 17:32	23/09/2020 10:03	16,51	2	33,01	CHI
20200970315	PARAUNA	PU12332611	PARAUNA	22/09/2020 17:33	22/09/2020 18:37	22/09/2020 17:33	22/09/2020 18:37	1,07	6	6,40	CHI
20200971162	CRIXAS	NA12057181	MOZARLANDIA	22/09/2020 17:34	22/09/2020 20:15	22/09/2020 17:34	22/09/2020 20:15	2,67	2	5,34	CHI
20200971162	NOVA CRIXAS	NA12057181	MOZARLANDIA	22/09/2020 17:34	22/09/2020 20:15	22/09/2020 17:34	22/09/2020 20:15	2,67	53	141,52	CHI
20200970480	ANAPOLIS	AN16401600	ANAPOLIS UNIVERSITARIO S2	22/09/2020 17:35	22/09/2020 18:06	22/09/2020 17:39	22/09/2020 17:42	0,05	2239	115,06	CHI
20200970480	ANAPOLIS	AN16416192	ANAPOLIS UNIVERSITARIO S2	22/09/2020 17:35	22/09/2020 18:06	22/09/2020 17:39	22/09/2020 17:45	0,09	772	69,69	CHI
20200970480	ANAPOLIS	AN16413934	ANAPOLIS UNIVERSITARIO S2	22/09/2020 17:35	22/09/2020 18:06	22/09/2020 17:39	22/09/2020 17:45	0,10	555	54,11	CHI
20200970480	ANAPOLIS	AN10384930	ANAPOLIS UNIVERSITARIO S2	22/09/2020 17:35	22/09/2020 18:06	22/09/2020 17:39	22/09/2020 17:46	0,10	2	0,20	CHI
20200970480	ANAPOLIS	AN10400594	ANAPOLIS UNIVERSITARIO S2	22/09/2020 17:35	22/09/2020 18:06	22/09/2020 17:39	22/09/2020 17:46	0,11	181	19,21	CHI
20200970480	ANAPOLIS	AN10400616	ANAPOLIS UNIVERSITARIO S2	22/09/2020 17:35	22/09/2020 18:06	22/09/2020 17:39	22/09/2020 17:47	0,13	492	65,05	CHI

INTERNAL

20200970480	ANAPOLIS	AN10383661	JUNDIAI S2	22/09/2020 17:35	22/09/2020 18:06	22/09/2020 17:39	22/09/2020 17:49	0,15	274	41,79	CHI
20200970480	ANAPOLIS	AN16416193	ANAPOLIS UNIVERSITARIO S2	22/09/2020 17:35	22/09/2020 18:06	22/09/2020 17:39	22/09/2020 17:49	0,16	595	95,03	CHI
20200970480	ANAPOLIS	AN10384955	JUNDIAI S2	22/09/2020 17:35	22/09/2020 18:06	22/09/2020 17:39	22/09/2020 17:49	0,16	1460	237,25	CHI
20200970480	ANAPOLIS	AN10383652	ANAPOLIS UNIVERSITARIO S2	22/09/2020 17:35	22/09/2020 18:06	22/09/2020 17:39	22/09/2020 17:50	0,17	385	67,05	CHI
20200970480	ANAPOLIS	AN16401600	ANAPOLIS UNIVERSITARIO S2	22/09/2020 17:35	22/09/2020 18:06	22/09/2020 17:39	22/09/2020 17:51	0,19	3155	596,82	CHI
20200970480	ANAPOLIS	AN16411664	ANAPOLIS UNIVERSITARIO S2	22/09/2020 17:35	22/09/2020 18:06	22/09/2020 17:39	22/09/2020 17:51	0,20	2579	507,92	CHI
20200970480	ANAPOLIS	AN16406958	ANAPOLIS UNIVERSITARIO S2	22/09/2020 17:35	22/09/2020 18:06	22/09/2020 18:01	22/09/2020 18:06	0,08	1036	82,88	CHI
20200970263	LUZIANIA	8407670	MARAJOARA	22/09/2020 17:36	22/09/2020 23:18	22/09/2020 17:36	22/09/2020 23:18	5,69	25	142,37	CHI
20200970266	CABECEIRAS	CW21157340	ITIQUEIRA	22/09/2020 17:36	23/09/2020 07:27	22/09/2020 17:36	23/09/2020 07:27	13,83	1	13,83	CHI
20200970267	SANTA TEREZA DE GOIAS	01520404	PORANGATU	22/09/2020 17:36	23/09/2020 01:15	22/09/2020 17:36	22/09/2020 17:41	0,07	1	0,07	CHI
20200970267	PORANGATU	01520404	PORANGATU	22/09/2020 17:36	23/09/2020 01:15	22/09/2020 17:36	22/09/2020 17:41	0,07	45	3,26	CHI
20200970267	PORANGATU	01520404	PORANGATU	22/09/2020 17:36	23/09/2020 01:15	22/09/2020 17:36	22/09/2020 17:41	0,07	6	0,44	CHI
20200970267	PORANGATU	01520404	PORANGATU	22/09/2020 17:36	23/09/2020 01:15	22/09/2020 17:36	22/09/2020 19:24	1,79	170	304,06	CHI
20200970267	PORANGATU	01520404	PORANGATU	22/09/2020 17:36	23/09/2020 01:15	22/09/2020 17:36	22/09/2020 20:41	3,07	2	6,14	CHI
20200970267	PORANGATU	01520404	PORANGATU	22/09/2020 17:36	23/09/2020 01:15	22/09/2020 17:36	23/09/2020 01:12	7,60	2	15,19	CHI
20200970267	PORANGATU	PO10400350	PORANGATU	22/09/2020 17:36	23/09/2020 01:15	22/09/2020 17:37	22/09/2020 19:24	1,78	108	192,42	CHI
20200970267	PORANGATU	PO13208978	PORANGATU	22/09/2020 17:36	23/09/2020 01:15	22/09/2020 17:41	22/09/2020 20:41	3,00	3	8,99	CHI
20200970267	PORANGATU	PO13208987	PORANGATU	22/09/2020 17:36	23/09/2020 01:15	22/09/2020 17:41	23/09/2020 01:12	7,52	3	22,57	CHI
20200970267	PORANGATU	PO13209445	PORANGATU	22/09/2020 17:36	23/09/2020 01:15	22/09/2020 17:41	23/09/2020 01:15	7,58	2	15,15	CHI
20200970267	PORANGATU	01520404	PORANGATU	22/09/2020 17:36	23/09/2020 01:15	22/09/2020 21:32	22/09/2020 21:36	0,07	302	20,55	CHI
20200970278	ITAPACI	100021451	ITAPACI	22/09/2020 17:38	22/09/2020 20:46	22/09/2020 17:38	22/09/2020 20:46	3,13	1	3,13	CHI
20200970281	BALIZA	BH21148520	BOM JARDIM	22/09/2020 17:38	22/09/2020 19:40	22/09/2020 17:38	22/09/2020 19:40	2,02	1	2,02	CHI
20200970480	ANAPOLIS	ANA-TR2	ANAPOLIS UNIVERSITARIO S1	22/09/2020 17:39	22/09/2020 18:06	22/09/2020 17:39	22/09/2020 17:51	0,20	112	22,96	CHI
20200970480	ANAPOLIS	ANA-TR2	ANAPOLIS UNIVERSITARIO S1	22/09/2020 17:39	22/09/2020 18:06	22/09/2020 17:39	22/09/2020 17:51	0,20	372	76,26	CHI
20200970480	ABADIANIA	ANA-TR2	ANAPOLIS UNIVERSITARIO S1	22/09/2020 17:39	22/09/2020 18:06	22/09/2020 17:39	22/09/2020 17:51	0,20	1505	308,52	CHI
20200970480	CORUMBA DE GOIAS	ANA-TR2	ANAPOLIS UNIVERSITARIO S1	22/09/2020 17:39	22/09/2020 18:06	22/09/2020 17:39	22/09/2020 17:51	0,20	4	0,82	CHI
20200970480	ABADIANIA	ANA-TR2	ANAPOLIS UNIVERSITARIO S1	22/09/2020 17:39	22/09/2020 18:06	22/09/2020 17:39	22/09/2020 17:51	0,20	21	4,30	CHI
20200970480	ABADIANIA	ANA-TR2	ANAPOLIS UNIVERSITARIO S1	22/09/2020 17:39	22/09/2020 18:06	22/09/2020 17:39	22/09/2020 17:51	0,20	67	13,73	CHI
20200970480	GAMELEIRA DE GOIAS	ANA-TR2	ANAPOLIS UNIVERSITARIO S1	22/09/2020 17:39	22/09/2020 18:06	22/09/2020 17:39	22/09/2020 17:51	0,20	34	6,97	CHI
20200970480	ANAPOLIS	ANA-TR2	ANAPOLIS UNIVERSITARIO S1	22/09/2020 17:39	22/09/2020 18:06	22/09/2020 17:39	22/09/2020 17:51	0,20	61	12,50	CHI
20200970480	ABADIANIA	ANA-TR2	ANAPOLIS UNIVERSITARIO S1	22/09/2020 17:39	22/09/2020 18:06	22/09/2020 17:39	22/09/2020 17:51	0,20	16	3,28	CHI
20200970480	ABADIANIA	ANA-TR2	ANAPOLIS UNIVERSITARIO S1	22/09/2020 17:39	22/09/2020 18:06	22/09/2020 17:39	22/09/2020 17:51	0,20	3449	707,04	CHI
20200970480	ANAPOLIS	ANA-TR2	ANAPOLIS UNIVERSITARIO S1	22/09/2020 17:39	22/09/2020 18:06	22/09/2020 17:39	22/09/2020 17:51	0,20	1	0,20	CHI

INTERNAL

20200970480	ANAPOLIS	ANA-TR2	ANAPOLIS UNIVERSITARIO S1	22/09/2020 17:39	22/09/2020 18:06	22/09/2020 17:39	22/09/2020 17:51	0,20	428	87,74	CHI
20200970480	CORUMBA DE GOIAS	ANA-TR2	ANAPOLIS UNIVERSITARIO S1	22/09/2020 17:39	22/09/2020 18:06	22/09/2020 17:39	22/09/2020 17:51	0,20	60	12,30	CHI
20200970480	ABADIANIA	ANA-TR2	ANAPOLIS UNIVERSITARIO S1	22/09/2020 17:39	22/09/2020 18:06	22/09/2020 17:39	22/09/2020 17:51	0,20	136	27,88	CHI
20200970480	ABADIA DE GOIAS	ANA-TR2	ANAPOLIS UNIVERSITARIO S1	22/09/2020 17:39	22/09/2020 18:06	22/09/2020 17:39	22/09/2020 17:51	0,20	1	0,20	CHI
20200970480	GAMELEIRA DE GOIAS	ANA-TR2	ANAPOLIS UNIVERSITARIO S1	22/09/2020 17:39	22/09/2020 18:06	22/09/2020 17:39	22/09/2020 17:51	0,20	11	2,25	CHI
20200970480	ABADIANIA	ANA-TR2	ANAPOLIS UNIVERSITARIO S1	22/09/2020 17:39	22/09/2020 18:06	22/09/2020 17:39	22/09/2020 17:51	0,20	20	4,10	CHI
2020092200130	ANAPOLIS	00052204	ANAPOLIS UNIVERSITARIO S2	22/09/2020 17:39	22/09/2020 17:52	22/09/2020 17:39	22/09/2020 17:52	0,22	5699	1234,78	CHI
2020092200129	ABADIANIA	00050424	ANAPOLIS UNIVERSITARIO S1	22/09/2020 17:39	22/09/2020 17:50	22/09/2020 17:39	22/09/2020 17:50	0,18	1	0,18	CHI
2020092200129	ABADIANIA	02002	ANAPOLIS UNIVERSITARIO S1	22/09/2020 17:39	22/09/2020 17:50	22/09/2020 17:39	22/09/2020 17:50	0,18	3	0,55	CHI
2020092200129	ANAPOLIS	00201	ANAPOLIS UNIVERSITARIO S1	22/09/2020 17:39	22/09/2020 17:50	22/09/2020 17:39	22/09/2020 17:50	0,18	3	0,55	CHI
2020092200129	CORUMBA DE GOIAS	02001	ANAPOLIS UNIVERSITARIO S1	22/09/2020 17:39	22/09/2020 17:50	22/09/2020 17:39	22/09/2020 17:50	0,18	2	0,37	CHI
2020092200129	ANAPOLIS	00202	ANAPOLIS UNIVERSITARIO S1	22/09/2020 17:39	22/09/2020 17:50	22/09/2020 17:39	22/09/2020 17:50	0,18	2	0,37	CHI
2020092200129	ABADIANIA	00232	ANAPOLIS UNIVERSITARIO S1	22/09/2020 17:39	22/09/2020 17:50	22/09/2020 17:39	22/09/2020 17:50	0,18	9	1,65	CHI
20200971552	GAMELEIRA DE GOIAS	GL12319531	DAIA S2	22/09/2020 17:39	23/09/2020 02:10	22/09/2020 17:39	23/09/2020 02:10	8,50	5	42,50	CHI
202009107100	ANAPOLIS	AN21167602	ANAPOLIS UNIVERSITARIO S2	22/09/2020 17:41	22/09/2020 17:54	22/09/2020 17:41	22/09/2020 17:54	0,22	2	0,44	CHI
202009107100	ANAPOLIS	AN16411022	ANAPOLIS UNIVERSITARIO S2	22/09/2020 17:41	22/09/2020 17:54	22/09/2020 17:41	22/09/2020 17:54	0,22	946	210,48	CHI
20200971633	MONTIVIDIU DO NORTE	MX11215820	PORANGATU	22/09/2020 17:41	24/09/2020 01:53	24/09/2020 01:10	24/09/2020 01:53	0,71	60	42,63	CHI
20200970324	CIDADE OCIDENTAL	2680034266	MARAJOARA	22/09/2020 17:42	22/09/2020 20:30	22/09/2020 17:42	22/09/2020 20:30	2,80	1	2,80	CHI
20200970338	ALTO PARAISO DE GOIAS	BF12128334	SAO JOAO D ALIANCA	22/09/2020 17:42	22/09/2020 19:14	22/09/2020 17:42	22/09/2020 19:14	1,53	3	4,58	CHI
20200970995	CRISTALINA	KR12383045	CRISTALINA S2	22/09/2020 17:42	22/09/2020 20:37	22/09/2020 17:42	22/09/2020 20:37	2,91	12	34,90	CHI
20200970337	ANAPOLIS	20656993	ANAPOLIS UNIVERSITARIO S1	22/09/2020 17:43	23/09/2020 21:22	22/09/2020 17:43	23/09/2020 21:22	27,66	1	27,66	CHI
20200970341	LUZIANIA	LZ21219758	PAMPLONA	22/09/2020 17:43	23/09/2020 00:17	22/09/2020 17:43	23/09/2020 00:17	6,56	1	6,56	CHI
20200970346	CHAPADAO DO CEU	DJ21241808	CHAPADAO DO CEU	22/09/2020 17:44	23/09/2020 08:23	22/09/2020 17:44	23/09/2020 08:23	14,66	1	14,66	CHI
20200967105	SAO JOAO D ALIANCA	JL12218373	SAO JOAO D ALIANCA	22/09/2020 17:45	22/09/2020 23:23	22/09/2020 17:45	22/09/2020 23:23	5,62	137	769,71	CHI
20200970383	IPORA	IR11398782	IPORA	22/09/2020 17:46	22/09/2020 23:49	22/09/2020 17:46	22/09/2020 23:49	6,05	22	133,02	CHI
20200970397	JANDAIA	JD21323461	ACREUNA	22/09/2020 17:47	22/09/2020 19:18	22/09/2020 17:47	22/09/2020 19:18	1,52	1	1,52	CHI
202009106924	PORANGATU	PO10391979	PORANGATU	22/09/2020 17:48	23/09/2020 14:02	22/09/2020 17:48	22/09/2020 19:45	1,95	15	29,30	CHI
202009106924	PORANGATU	PO12004088LD	PORANGATU	22/09/2020 17:48	23/09/2020 14:02	22/09/2020 17:48	23/09/2020 14:02	20,24	30	607,25	CHI
20200970415	CIDADE OCIDENTAL	2680034278	MARAJOARA	22/09/2020 17:48	22/09/2020 20:27	22/09/2020 17:48	22/09/2020 20:27	2,64	1	2,64	CHI
20200970418	ITAPIRAPUA	GS12003616	MATRINCHA	22/09/2020 17:48	23/09/2020 14:49	22/09/2020 17:48	23/09/2020 14:49	21,01	1	21,01	CHI
202009106924	PORANGATU	PO16404038	PORANGATU	22/09/2020 17:48	23/09/2020 14:02	22/09/2020 20:20	22/09/2020 20:24	0,06	183	10,57	CHI
202009106924	SANTA TEREZA DE GOIAS	PO13220891	PORANGATU	22/09/2020 17:48	23/09/2020 14:02	22/09/2020 20:43	22/09/2020 21:27	0,73	11	8,06	CHI
202009106924	PORANGATU	PO13220891	PORANGATU	22/09/2020 17:48	23/09/2020 14:02	22/09/2020 20:43	22/09/2020 21:27	0,73	625	458,16	CHI

INTERNAL

202009106924	TROMBAS	PO13220891	PORANGATU	22/09/2020 17:48	23/09/2020 14:02	22/09/2020 20:43	22/09/2020 21:27	0,73	171	125,35	CHI
202009106924	PORANGATU	PO10396207	PORANGATU	22/09/2020 17:48	23/09/2020 14:02	22/09/2020 20:43	22/09/2020 22:01	1,29	441	569,26	CHI
202009106924	MONTIVIDIU DO NORTE	PO10396207	PORANGATU	22/09/2020 17:48	23/09/2020 14:02	22/09/2020 20:43	22/09/2020 22:01	1,29	6	7,74	CHI
20200970436	FAINA	2580018263	GOIAS	22/09/2020 17:49	23/09/2020 10:17	22/09/2020 17:49	23/09/2020 10:17	16,46	1	16,46	CHI
20200970456	HIDROLINA	1020007427	URUACU	22/09/2020 17:50	23/09/2020 11:28	22/09/2020 17:50	23/09/2020 11:28	17,62	1	17,62	CHI
20200970466	GOIANESIA	10006128783	GOIANESIA S2	22/09/2020 17:51	23/09/2020 00:04	22/09/2020 17:51	23/09/2020 00:04	6,21	1	6,21	CHI
202009107066	ANAPOLIS	20578337	JUNDIAI S2	22/09/2020 17:53	23/09/2020 07:09	22/09/2020 17:53	23/09/2020 07:09	13,27	1	13,27	CHI
20200970491	ARAGARCAS	AG11341746	ARAGARCAS	22/09/2020 17:53	23/09/2020 00:08	22/09/2020 17:53	23/09/2020 00:08	6,24	72	449,36	CHI
20200970507	LUZIANIA	120132862	RIO VERMELHO	22/09/2020 17:55	22/09/2020 20:35	22/09/2020 17:55	22/09/2020 20:35	2,66	1	2,66	CHI
20200970517	EDEIA	EA21033670	RIO DOS BOIS	22/09/2020 17:56	23/09/2020 11:16	22/09/2020 17:56	23/09/2020 11:16	17,33	1	17,33	CHI
20200970536	FAZENDA NOVA	FN12390139	IPORA	22/09/2020 17:59	23/09/2020 19:54	22/09/2020 17:59	23/09/2020 19:54	25,91	8	207,32	CHI
20200970584	SAO DOMINGOS	SD12067690	IACIARA S2	22/09/2020 17:59	22/09/2020 23:39	22/09/2020 17:59	22/09/2020 23:39	5,66	2	11,33	CHI
20200970584	NOVA ROMA	SD12067690	IACIARA S2	22/09/2020 17:59	22/09/2020 23:39	22/09/2020 17:59	22/09/2020 23:39	5,66	1	5,66	CHI
20200970540	PIRANHAS	1930017732	PIRANHAS	22/09/2020 17:59	23/09/2020 09:52	22/09/2020 17:59	23/09/2020 09:52	15,87	1	15,87	CHI
20200970548	DIVINOPOLIS DE GOIAS	2570007128	SAO DOMINGOS	22/09/2020 18:00	23/09/2020 10:17	22/09/2020 18:00	23/09/2020 10:17	16,28	1	16,28	CHI
20200970591	RIO VERDE	RV21260617	MONTIVIDIU T	22/09/2020 18:06	23/09/2020 10:05	22/09/2020 18:06	23/09/2020 10:05	15,97	1	15,97	CHI
20200970595	NIQUELANDIA	NQ12358185	URUACU	22/09/2020 18:07	23/09/2020 10:34	22/09/2020 18:07	23/09/2020 10:34	16,44	4	65,77	CHI
20200971816	CRIXAS	CX12169995	SERRA DO OURO	22/09/2020 18:08	23/09/2020 14:34	22/09/2020 18:08	23/09/2020 14:34	20,42	3	61,27	CHI
20200970610	QUIRINOPOLIS	QI21014254	QUIRINOPOLIS	22/09/2020 18:09	22/09/2020 20:44	22/09/2020 18:09	22/09/2020 20:44	2,57	2	5,14	CHI
20200971558	PORANGATU	PO12208367	PORANGATU	22/09/2020 18:12	23/09/2020 11:16	22/09/2020 18:12	23/09/2020 11:16	17,06	107	1825,54	CHI
20200970632	JATAI	JT11354920	JATAI S1	22/09/2020 18:13	22/09/2020 21:41	22/09/2020 18:13	22/09/2020 21:41	3,46	1	3,46	CHI
20200970635	GOIANESIA	1320000694	GOIANESIA S1	22/09/2020 18:14	22/09/2020 22:24	22/09/2020 18:14	22/09/2020 22:24	4,17	1	4,17	CHI
20200970639	LUZIANIA	10028750053	RIO VERMELHO	22/09/2020 18:14	22/09/2020 21:13	22/09/2020 18:14	22/09/2020 21:13	2,97	1	2,97	CHI
20200970664	RIO VERDE	10020284010	RIO VERDE S2	22/09/2020 18:16	23/09/2020 08:46	22/09/2020 18:16	23/09/2020 08:46	14,49	1	14,49	CHI
20200970666	ARUANA	AK11183268	ARUANA	22/09/2020 18:16	22/09/2020 19:21	22/09/2020 18:16	22/09/2020 19:21	1,07	42	44,84	CHI
20200970676	NIQUELANDIA	8470000540	BARRO ALTO	22/09/2020 18:17	23/09/2020 13:01	22/09/2020 18:17	23/09/2020 13:01	18,73	1	18,73	CHI
20200970690	APORE	IJ12194905LD	ITAJA S2	22/09/2020 18:19	23/09/2020 11:23	22/09/2020 18:19	23/09/2020 11:23	17,06	1	17,06	CHI
20200970690	ITAJA	IJ12194905LD	ITAJA S2	22/09/2020 18:19	23/09/2020 11:23	22/09/2020 18:19	23/09/2020 11:23	17,06	31	528,96	CHI
20200970693	ANAPOLIS	20044422	JUNDIAI S2	22/09/2020 18:19	23/09/2020 13:39	22/09/2020 18:19	23/09/2020 13:39	19,33	1	19,33	CHI
20200970810	ANAPOLIS	AN12386259	ANAPOLIS UNIVERSITARIO S2	22/09/2020 18:22	22/09/2020 22:28	22/09/2020 18:22	22/09/2020 22:28	4,08	11	44,93	CHI
20200970725	TURVANIA	TV21105319	FIRMINOPOLIS S1	22/09/2020 18:23	23/09/2020 14:40	22/09/2020 18:23	23/09/2020 14:40	20,29	1	20,29	CHI
20200970728	ITAPIRAPUA	1420024817	MATRINCHA	22/09/2020 18:23	23/09/2020 11:49	22/09/2020 18:23	23/09/2020 11:49	17,43	1	17,43	CHI
20200970729	NOVO GAMA	10006185086	PACAEMBU S1	22/09/2020 18:23	22/09/2020 20:42	22/09/2020 18:23	22/09/2020 20:42	2,31	1	2,31	CHI

INTERNAL

20200972261	PORANGATU	PO11064856	PORANGATU	22/09/2020 18:24	23/09/2020 17:22	22/09/2020 18:24	23/09/2020 17:22	22,97	124	2847,80	CHI
20200970757	ALEXANIA	AX11288674	ALEXANIA	22/09/2020 18:25	23/09/2020 01:43	22/09/2020 18:25	23/09/2020 01:43	7,29	16	116,62	CHI
20200970759	CAIAPONIA	930015733	CAIAPONIA	22/09/2020 18:25	22/09/2020 20:40	22/09/2020 18:25	22/09/2020 20:40	2,23	1	2,23	CHI
20200970762	AGUAS LINDAS DE GOIAS	LA10413233	AGUAS LINDAS DE GOIAS S2	22/09/2020 18:26	22/09/2020 22:48	22/09/2020 18:26	22/09/2020 22:48	4,37	1547	6758,67	CHI
20200970765	VILA PROPICIO	NP12188681	GOIANESIA S1	22/09/2020 18:26	22/09/2020 19:55	22/09/2020 18:26	22/09/2020 19:55	1,47	93	137,15	CHI
20200970766	UIRAPURU	4200004629	SANTA TEREZINHA	22/09/2020 18:26	23/09/2020 02:21	22/09/2020 18:26	23/09/2020 02:21	7,92	1	7,92	CHI
20200970773	FAZENDA NOVA	FN21141452	JUSSARA	22/09/2020 18:27	23/09/2020 16:58	22/09/2020 18:27	23/09/2020 16:58	22,52	1	22,52	CHI
20200970786	RIO VERDE	630120316	RIO VERDE S2	22/09/2020 18:28	23/09/2020 13:50	22/09/2020 18:28	23/09/2020 13:50	19,36	1	19,36	CHI
20200971211	MARA ROSA	MQ12162718	MARA ROSA	22/09/2020 18:29	23/09/2020 01:37	22/09/2020 18:29	23/09/2020 01:37	7,13	5	35,64	CHI
20200970806	ANAPOLIS	20735406	ANAPOLIS UNIVERSITARIO S2	22/09/2020 18:30	23/09/2020 09:50	22/09/2020 18:30	23/09/2020 09:50	15,34	1	15,34	CHI
20200971369	FORMOSA	FA11375599	ITUIQUIRA	22/09/2020 18:30	22/09/2020 22:08	22/09/2020 18:30	22/09/2020 22:08	3,63	119	431,57	CHI
20200971170	CIDADE OCIDENTAL	DH12376124	MARAJOARA	22/09/2020 18:31	22/09/2020 22:23	22/09/2020 18:31	22/09/2020 22:23	3,86	5	19,29	CHI
20200972186	MUNDO NOVO DE GOIAS	NA21128439	NOVA CRIXAS	22/09/2020 18:31	23/09/2020 09:40	22/09/2020 21:05	23/09/2020 09:40	12,57	1	12,57	CHI
20200972130	MUNDO NOVO DE GOIAS	MH11254826	NOVA CRIXAS	22/09/2020 18:31	23/09/2020 01:19	22/09/2020 21:05	23/09/2020 01:19	4,22	181	764,47	CHI
20200972347	MUNDO NOVO DE GOIAS	MH11255526	NOVA CRIXAS	22/09/2020 18:31	23/09/2020 00:30	22/09/2020 21:05	23/09/2020 00:30	3,41	56	190,80	CHI
20200970823	MAMBAI	MB11243114	IACIARA S2	22/09/2020 18:32	22/09/2020 20:50	22/09/2020 18:32	22/09/2020 20:50	2,30	67	153,80	CHI
20200970838	FLORES DE GOIAS	FB12262035	IACIARA S2	22/09/2020 18:33	23/09/2020 20:01	22/09/2020 18:33	23/09/2020 20:01	25,46	3	76,38	CHI
20200971068	CRISTALINA	KR11408856	PAMPLONA	22/09/2020 18:33	22/09/2020 22:20	22/09/2020 18:33	22/09/2020 22:20	3,78	57	215,22	CHI
20200971848	COCALZINHO DE GOIAS	ZN11090240	AGUAS LINDAS DE GOIAS S1	22/09/2020 18:33	22/09/2020 22:06	22/09/2020 18:33	22/09/2020 22:06	3,54	11	38,91	CHI
20200970844	IACIARA	1550017977	IACIARA S1	22/09/2020 18:34	23/09/2020 03:04	22/09/2020 18:34	23/09/2020 03:04	8,50	1	8,50	CHI
20200970852	LUZIANIA	120015766	RIO VERMELHO	22/09/2020 18:34	22/09/2020 22:18	22/09/2020 18:34	22/09/2020 22:18	3,72	1	3,72	CHI
20200970854	SAO FRANCISCO DE GOIAS	SF21197405	SAO FRANCISCO DE GOIAS	22/09/2020 18:34	23/09/2020 16:20	22/09/2020 18:34	23/09/2020 16:20	21,75	2	43,51	CHI
20200970855	ANAPOLIS	20923764	ANAPOLIS UNIVERSITARIO S2	22/09/2020 18:34	23/09/2020 10:42	22/09/2020 18:34	23/09/2020 10:42	16,12	1	16,12	CHI
20200970878	RIO VERDE	630082339	RIO VERDE S2	22/09/2020 18:36	23/09/2020 08:54	22/09/2020 18:36	23/09/2020 08:54	14,30	1	14,30	CHI
20200970919	ANAPOLIS	21068069	ANAPOLIS UNIVERSITARIO S1	22/09/2020 18:40	23/09/2020 09:16	22/09/2020 18:40	23/09/2020 09:16	14,59	1	14,59	CHI
20200971016	PORANGATU	PO11020558	PORANGATU	22/09/2020 18:41	23/09/2020 11:49	22/09/2020 18:41	23/09/2020 11:49	17,13	120	2055,50	CHI
20200970933	PALMEIRAS DE GOIAS	590040753	PALMEIRAS	22/09/2020 18:41	23/09/2020 10:00	22/09/2020 18:41	23/09/2020 10:00	15,31	1	15,31	CHI
20200970944	MINACU	IH12246544	MINACU	22/09/2020 18:42	22/09/2020 22:42	22/09/2020 18:42	22/09/2020 22:42	3,99	1	3,99	CHI
20200970953	GOIANESIA	550101457	GOIANESIA S2	22/09/2020 18:43	22/09/2020 22:03	22/09/2020 18:43	22/09/2020 22:03	3,33	1	3,33	CHI
20200971443	MATRINCHA	GS12362364	MATRINCHA	22/09/2020 18:43	24/09/2020 17:05	22/09/2020 18:43	23/09/2020 19:59	25,27	1	25,27	CHI
20200971443	FAINA	GS12362364	MATRINCHA	22/09/2020 18:43	24/09/2020 17:05	22/09/2020 18:43	23/09/2020 19:59	25,27	6	151,61	CHI
20200971443	GOIAS	GS12362364	MATRINCHA	22/09/2020 18:43	24/09/2020 17:05	22/09/2020 18:43	23/09/2020 19:59	25,27	7	176,88	CHI
20200971443	FAINA	FC12311200	MATRINCHA	22/09/2020 18:43	24/09/2020 17:05	22/09/2020 18:43	23/09/2020 20:35	25,87	4	103,46	CHI

INTERNAL

20200971443	FAINA	GS12198593	MATRINCHA	22/09/2020 18:43	24/09/2020 17:05	22/09/2020 18:43	24/09/2020 17:04	46,35	1	46,35	CHI
20200971443	GOIAS	GS12198593	MATRINCHA	22/09/2020 18:43	24/09/2020 17:05	22/09/2020 18:43	24/09/2020 17:04	46,35	1	46,35	CHI
20200970957	FIRMINOPOLIS	900029110	FIRMINOPOLIS S1	22/09/2020 18:43	23/09/2020 10:45	22/09/2020 18:43	23/09/2020 10:45	16,02	1	16,02	CHI
20200971212	CAMPINORTE	CR12202139RE	MARA ROSA	22/09/2020 18:43	22/09/2020 21:00	22/09/2020 18:43	22/09/2020 21:00	2,27	32	72,64	CHI
20200971212	URUACU	CR12202139RE	MARA ROSA	22/09/2020 18:43	22/09/2020 21:00	22/09/2020 18:43	22/09/2020 21:00	2,27	106	240,62	CHI
20200971443	GOIAS	GS10400430	MATRINCHA	22/09/2020 18:43	24/09/2020 17:05	24/09/2020 09:20	24/09/2020 13:16	3,93	65	255,68	CHI
20200971443	FAINA	GS10400430	MATRINCHA	22/09/2020 18:43	24/09/2020 17:05	24/09/2020 09:20	24/09/2020 13:16	3,93	15	59,00	CHI
20200971443	MATRINCHA	GS10400430	MATRINCHA	22/09/2020 18:43	24/09/2020 17:05	24/09/2020 09:20	24/09/2020 13:16	3,93	306	1203,68	CHI
20200971443	MATRINCHA	GS13055009	MATRINCHA	22/09/2020 18:43	24/09/2020 17:05	24/09/2020 09:20	24/09/2020 15:43	6,39	1	6,39	CHI
20200971443	FAINA	GS13055009	MATRINCHA	22/09/2020 18:43	24/09/2020 17:05	24/09/2020 09:20	24/09/2020 15:43	6,39	10	63,86	CHI
20200971443	GOIAS	GS13055009	MATRINCHA	22/09/2020 18:43	24/09/2020 17:05	24/09/2020 09:20	24/09/2020 15:43	6,39	10	63,86	CHI
20200971443	FAINA	GS12362362	MATRINCHA	22/09/2020 18:43	24/09/2020 17:05	24/09/2020 09:20	24/09/2020 17:05	7,75	4	30,99	CHI
20200971443	GOIAS	GS10400430	MATRINCHA	22/09/2020 18:43	24/09/2020 17:05	24/09/2020 14:37	24/09/2020 14:56	0,31	60	18,50	CHI
20200971443	FAINA	GS10400430	MATRINCHA	22/09/2020 18:43	24/09/2020 17:05	24/09/2020 14:37	24/09/2020 14:56	0,31	15	4,62	CHI
20200971443	MATRINCHA	GS10400430	MATRINCHA	22/09/2020 18:43	24/09/2020 17:05	24/09/2020 14:37	24/09/2020 14:56	0,31	306	94,35	CHI
20200970967	MOIPORA	MO12004152	SAO LUIZ DOS MONTES BELOS	22/09/2020 18:44	23/09/2020 15:06	22/09/2020 18:44	23/09/2020 15:06	20,36	5	101,78	CHI
20200970970	RIO VERDE	630353839	RIO VERDE S2	22/09/2020 18:45	23/09/2020 22:41	22/09/2020 18:45	23/09/2020 22:41	27,93	1	27,93	CHI
20200970971	ITABERAI	IB12353033	ITABERAI S1	22/09/2020 18:45	23/09/2020 07:04	22/09/2020 18:45	23/09/2020 07:04	12,31	5	61,57	CHI
20200971505	ALEXANIA	480095206	ALEXANIA	22/09/2020 18:45	23/09/2020 03:06	22/09/2020 18:45	23/09/2020 03:06	8,34	1	8,34	CHI
2020092200027	MONTIVIDIU	02610424	PARQUE DAS EMAS	22/09/2020 18:47	22/09/2020 19:26	22/09/2020 18:47	22/09/2020 19:26	0,65	1	0,65	CHI
2020092200027	MINEIROS	02610424	PARQUE DAS EMAS	22/09/2020 18:47	22/09/2020 19:26	22/09/2020 18:47	22/09/2020 19:26	0,65	69	44,85	CHI
2020092200027	PORTELANDIA	02610424	PARQUE DAS EMAS	22/09/2020 18:47	22/09/2020 19:26	22/09/2020 18:47	22/09/2020 19:26	0,65	12	7,80	CHI
20200971020	RIO VERDE	630224547	RIO VERDE S2	22/09/2020 18:48	23/09/2020 10:34	22/09/2020 18:48	23/09/2020 10:34	15,76	1	15,76	CHI
20200971026	AGUAS LINDAS DE GOIAS	4830232895	AGUAS LINDAS DE GOIAS S1	22/09/2020 18:49	22/09/2020 22:13	22/09/2020 18:49	22/09/2020 22:13	3,39	1	3,39	CHI
20200971030	FIRMINOPOLIS	900018434	FIRMINOPOLIS S1	22/09/2020 18:50	23/09/2020 13:01	22/09/2020 18:50	23/09/2020 13:01	18,18	1	18,18	CHI
20200971031	PLANALTINA	2960024157	PLANALTINA	22/09/2020 18:50	23/09/2020 12:32	22/09/2020 18:50	23/09/2020 12:32	17,69	1	17,69	CHI
20200971609	TEREZOPOLIS DE GOIAS	GP12011844	JUNDIAI S1	22/09/2020 18:51	23/09/2020 02:25	22/09/2020 18:51	23/09/2020 02:25	7,58	18	136,40	CHI
20200971041	NOVO GAMA	2460097457	PACAEMBU S1	22/09/2020 18:51	22/09/2020 21:42	22/09/2020 18:51	22/09/2020 21:42	2,84	1	2,84	CHI
20200971059	ANAPOLIS	AN10384930	ANAPOLIS UNIVERSITARIO S2	22/09/2020 18:52	23/09/2020 14:01	23/09/2020 13:55	23/09/2020 14:01	0,10	445	45,49	CHI
20200971063	SANTO ANTONIO DO DESCOBERTO	SN12345962	AGUAS LINDAS DE GOIAS S2	22/09/2020 18:53	23/09/2020 08:08	22/09/2020 18:53	23/09/2020 08:08	13,25	5	66,25	CHI
20200971077	QUIRINOPOLIS	80137313	QUIRINOPOLIS	22/09/2020 18:53	22/09/2020 20:06	22/09/2020 18:53	22/09/2020 20:06	1,20	1	1,20	CHI
20200971323	ANAPOLIS	AN11380258	ANAPOLIS UNIVERSITARIO S2	22/09/2020 18:53	22/09/2020 20:22	22/09/2020 18:53	22/09/2020 20:22	1,47	45	66,14	CHI
20200971778	ANAPOLIS	AN12000131	JUNDIAI S1	22/09/2020 18:55	22/09/2020 20:37	22/09/2020 18:55	22/09/2020 20:37	1,70	236	400,22	CHI

INTERNAL

20200971096	ITABERAÍ	GS12206906	ITABERAÍ S1	22/09/2020 18:55	22/09/2020 21:21	22/09/2020 18:55	22/09/2020 21:21	2,43	12	29,11	CHI
20200971149	PALMEIRAS DE GOIAS	PL11323548	PALMEIRAS	22/09/2020 18:55	22/09/2020 20:35	22/09/2020 18:55	22/09/2020 20:35	1,65	89	147,10	CHI
20200971109	CACU	CC12080197	CACHOEIRA ALTA	22/09/2020 18:56	23/09/2020 00:06	22/09/2020 18:56	23/09/2020 00:06	5,16	1	5,16	CHI
20200971121	ANAPOLIS	20053150	ANAPOLIS UNIVERSITARIO S2	22/09/2020 18:57	23/09/2020 13:24	22/09/2020 18:57	23/09/2020 13:24	18,44	1	18,44	CHI
20200971135	CRISTALINA	KR21206514	PAMPLONA	22/09/2020 18:58	23/09/2020 11:40	22/09/2020 18:58	23/09/2020 11:40	16,69	1	16,69	CHI
20200971137	MONTE ALEGRE DE GOIAS	MA21290200	SAO DOMINGOS	22/09/2020 18:58	23/09/2020 09:55	22/09/2020 18:58	23/09/2020 09:55	14,93	1	14,93	CHI
20200971142	CIDADE OCIDENTAL	LZ21030238	MARAJÓARA	22/09/2020 18:59	23/09/2020 13:38	22/09/2020 18:59	23/09/2020 13:38	18,65	1	18,65	CHI
20200971145	TAQUARAL DE GOIAS	II21217078	ITABERAÍ S1	22/09/2020 18:59	23/09/2020 10:44	22/09/2020 18:59	23/09/2020 10:44	15,74	2	31,47	CHI
20200971142	CIDADE OCIDENTAL	LZ12030237LD	MARAJÓARA	22/09/2020 18:59	23/09/2020 13:38	22/09/2020 21:14	23/09/2020 13:30	16,26	25	406,60	CHI
20200971182	ANAPOLIS	21197222	ANAPOLIS UNIVERSITARIO S2	22/09/2020 19:03	22/09/2020 23:34	22/09/2020 19:03	22/09/2020 23:34	4,51	1	4,51	CHI
20200971183	SAO LUIS DE MONTES BELOS	SL21154572	SAO LUIZ DOS MONTES BELOS	22/09/2020 19:03	22/09/2020 23:53	22/09/2020 19:03	22/09/2020 23:53	4,82	1	4,82	CHI
20200971261	JATAÍ	JT11037070	JATAÍ S2	22/09/2020 19:04	22/09/2020 20:03	22/09/2020 19:04	22/09/2020 20:03	0,97	184	178,63	CHI
20200971232	MUNDO NOVO DE GOIAS	NA10396027	NOVA CRIXAS	22/09/2020 19:04	22/09/2020 23:09	22/09/2020 19:04	22/09/2020 20:32	1,45	8	11,63	CHI
20200971232	NOVA CRIXAS	NA10396027	NOVA CRIXAS	22/09/2020 19:04	22/09/2020 23:09	22/09/2020 19:04	22/09/2020 20:32	1,45	69	100,32	CHI
20200971232	MUNDO NOVO DE GOIAS	NA13351137	NOVA CRIXAS	22/09/2020 19:04	22/09/2020 23:09	22/09/2020 19:04	22/09/2020 22:20	3,25	37	120,41	CHI
20200971232	NOVA CRIXAS	NA13351137	NOVA CRIXAS	22/09/2020 19:04	22/09/2020 23:09	22/09/2020 19:04	22/09/2020 22:20	3,25	40	130,18	CHI
20200971232	NOVA CRIXAS	NA12263044LD	NOVA CRIXAS	22/09/2020 19:04	22/09/2020 23:09	22/09/2020 19:04	22/09/2020 23:09	4,09	87	355,54	CHI
20200971308	NIQUELANDIA	NQ12293886	URUACU	22/09/2020 19:04	23/09/2020 10:30	22/09/2020 19:04	23/09/2020 10:30	15,42	14	215,84	CHI
20200971206	PLANALTINA	2960075438	PLANALTINA	22/09/2020 19:06	22/09/2020 22:50	22/09/2020 19:06	22/09/2020 22:50	3,73	1	3,73	CHI
20200971296	COCALZINHO DE GOIAS	ZN12068045	AGUAS LINDAS DE GOIAS S1	22/09/2020 19:09	22/09/2020 22:07	22/09/2020 19:09	22/09/2020 22:07	2,97	13	38,55	CHI
20200971840	PORANGATU	PO12000056	PORANGATU	22/09/2020 19:09	22/09/2020 22:59	22/09/2020 19:09	22/09/2020 22:59	3,82	207	791,72	CHI
20200972214	ESTRELA DO NORTE	ET11171881	MARA ROSA	22/09/2020 19:09	23/09/2020 01:10	22/09/2020 19:09	23/09/2020 01:10	6,00	62	372,24	CHI
20200971269	DOVERLANDIA	MY12219553	PARQUE DAS EMAS	22/09/2020 19:10	23/09/2020 01:16	22/09/2020 19:10	23/09/2020 01:16	6,09	47	286,15	CHI
20200971277	MINEIROS	10022620573	PARQUE DAS EMAS	22/09/2020 19:11	23/09/2020 03:22	22/09/2020 19:11	23/09/2020 03:22	8,18	1	8,18	CHI
20200971288	MONTIVIDIU	2840020460	MONTIVIDIU T	22/09/2020 19:12	22/09/2020 21:32	22/09/2020 19:12	22/09/2020 21:32	2,33	1	2,33	CHI
20200971290	ARAGARCAS	1820033639	ARAGARCAS	22/09/2020 19:12	22/09/2020 21:31	22/09/2020 19:12	22/09/2020 21:31	2,32	1	2,32	CHI
20200970733	PORANGATU	PO11345568	PORANGATU	22/09/2020 19:12	23/09/2020 08:54	22/09/2020 19:12	23/09/2020 08:54	13,69	77	1053,83	CHI
20200968722	ITAPIRAPUA	IU12072448	MATRINCHA	22/09/2020 19:13	23/09/2020 10:59	22/09/2020 19:13	23/09/2020 10:59	15,76	1	15,76	CHI
20200971312	ARENOPOLIS	1920001820	ARENOPOLIS	22/09/2020 19:13	23/09/2020 17:19	22/09/2020 19:13	23/09/2020 17:19	22,09	1	22,09	CHI
20200971590	PORANGATU	PO11262730	PORANGATU	22/09/2020 19:15	23/09/2020 15:35	22/09/2020 19:15	23/09/2020 15:35	20,33	117	2378,15	CHI
20200971648	GUARINOS	02600414	ITAPACI	22/09/2020 19:15	22/09/2020 19:19	22/09/2020 19:15	22/09/2020 19:19	0,05	20	1,09	CHI
20200971648	ITAPACI	02600414	ITAPACI	22/09/2020 19:15	22/09/2020 19:19	22/09/2020 19:15	22/09/2020 19:19	0,05	6	0,33	CHI
20200971648	ITAPACI	02600414	ITAPACI	22/09/2020 19:15	22/09/2020 19:19	22/09/2020 19:15	22/09/2020 19:19	0,05	170	9,30	CHI

INTERNAL

20200971648	NOVA GLORIA	02600414	ITAPACI	22/09/2020 19:15	22/09/2020 19:19	22/09/2020 19:15	22/09/2020 19:19	0,05	15	0,82	CHI
20200971648	NOVA GLORIA	02600414	ITAPACI	22/09/2020 19:15	22/09/2020 19:19	22/09/2020 19:15	22/09/2020 19:19	0,05	2	0,11	CHI
20200971648	NOVA GLORIA	02600414	RUBIATABA	22/09/2020 19:15	22/09/2020 19:19	22/09/2020 19:15	22/09/2020 19:19	0,05	75	4,10	CHI
20200971648	IPIRANGA DE GOIAS	02600414	RUBIATABA	22/09/2020 19:15	22/09/2020 19:19	22/09/2020 19:15	22/09/2020 19:19	0,05	15	0,82	CHI
20200971648	RUBIATABA	02600414	RUBIATABA	22/09/2020 19:15	22/09/2020 19:19	22/09/2020 19:15	22/09/2020 19:19	0,05	2	0,11	CHI
20200971648	CERES	02600414	RUBIATABA	22/09/2020 19:15	22/09/2020 19:19	22/09/2020 19:15	22/09/2020 19:19	0,05	21	1,15	CHI
20200971341	PILAR DE GOIAS	GG21012463	SANTA TEREZINHA	22/09/2020 19:16	23/09/2020 14:49	22/09/2020 19:16	23/09/2020 14:49	19,55	1	19,55	CHI
20200971350	ANAPOLIS	AN21313067	ANAPOLIS UNIVERSITARIO S1	22/09/2020 19:17	22/09/2020 22:43	22/09/2020 19:17	22/09/2020 22:43	3,42	1	3,42	CHI
20200971351	ITAPURANGA	IK12157850	ITAPURANGA	22/09/2020 19:17	23/09/2020 14:20	22/09/2020 19:17	23/09/2020 14:20	19,05	7	133,35	CHI
20200971356	SANTA TEREZA DE GOIAS	SE12094686	MARA ROSA	22/09/2020 19:18	23/09/2020 00:35	22/09/2020 19:18	23/09/2020 00:35	5,28	7	36,97	CHI
20200971494	CACHOEIRA ALTA	CA11306224	CACHOEIRA ALTA	22/09/2020 19:18	22/09/2020 21:24	22/09/2020 19:18	22/09/2020 21:24	2,09	74	155,03	CHI
20200971365	MINEIROS	MY12043094	PARQUE DAS EMAS	22/09/2020 19:18	23/09/2020 06:50	22/09/2020 19:18	23/09/2020 06:50	11,52	3	34,55	CHI
20200971365	PEROLANDIA	MY12043094	PARQUE DAS EMAS	22/09/2020 19:18	23/09/2020 06:50	22/09/2020 19:18	23/09/2020 06:50	11,52	2	23,03	CHI
20200971377	BONOPOLIS	10025971237	SAO MIGUEL DO ARAGUAIA	22/09/2020 19:19	23/09/2020 22:41	22/09/2020 19:19	23/09/2020 22:41	27,36	1	27,36	CHI
20200971429	ANAPOLIS	AN11068142	ANAPOLIS UNIVERSITARIO S2	22/09/2020 19:19	22/09/2020 23:18	22/09/2020 19:19	22/09/2020 23:18	3,97	205	813,68	CHI
20200971389	JATAI	290044315	JATAI S3	22/09/2020 19:20	23/09/2020 08:25	22/09/2020 19:20	23/09/2020 08:25	13,07	1	13,07	CHI
20200971116	PORANGATU	10015054886	PORANGATU	22/09/2020 19:20	23/09/2020 08:26	22/09/2020 19:20	23/09/2020 08:26	13,10	1	13,10	CHI
20200971405	PORANGATU	PO12371807	PORANGATU	22/09/2020 19:22	23/09/2020 17:48	22/09/2020 19:22	23/09/2020 17:48	22,43	12	269,18	CHI
20200971412	PORANGATU	10009788890	PORANGATU	22/09/2020 19:22	23/09/2020 01:09	22/09/2020 19:22	23/09/2020 01:09	5,77	1	5,77	CHI
20200971421	CRISTALINA	1060086119	CRISTALINA S1	22/09/2020 19:23	22/09/2020 22:46	22/09/2020 19:23	22/09/2020 22:46	3,37	1	3,37	CHI
20200971425	MINEIROS	MY11349096	PARQUE DAS EMAS	22/09/2020 19:23	23/09/2020 09:52	22/09/2020 19:23	23/09/2020 09:52	14,47	1	14,47	CHI
202009107074	AGUA FRIA DE GOIAS	4440004028	SAO JOAO D ALIANCA	22/09/2020 19:24	23/09/2020 07:00	22/09/2020 19:24	23/09/2020 07:00	11,60	1	11,60	CHI
20200971433	SANTO ANTONIO DO DESCOBERTO	2210113253	AGUAS LINDAS DE GOIAS S2	22/09/2020 19:24	23/09/2020 00:38	22/09/2020 19:24	23/09/2020 00:38	5,22	1	5,22	CHI
20200971428	NIQUELANDIA	NQ12270128RE	SAO JOAO D ALIANCA	22/09/2020 19:24	23/09/2020 13:01	23/09/2020 07:00	23/09/2020 13:01	6,01	17	102,22	CHI
20200971428	AGUA FRIA DE GOIAS	NQ12270128RE	SAO JOAO D ALIANCA	22/09/2020 19:24	23/09/2020 13:01	23/09/2020 07:00	23/09/2020 13:01	6,01	71	426,93	CHI
20200971462	SIMOLANDIA	SA11262379	IACIARA S2	22/09/2020 19:27	23/09/2020 01:06	22/09/2020 19:27	23/09/2020 01:06	5,64	10	56,36	CHI
20200971468	CACHOEIRA ALTA	CA21193936	CACHOEIRA ALTA	22/09/2020 19:28	22/09/2020 22:42	22/09/2020 19:28	22/09/2020 22:42	3,23	1	3,23	CHI
20200971473	FORMOSA	FA12395906	FLORES DE GOIAS	22/09/2020 19:28	23/09/2020 10:00	22/09/2020 19:28	23/09/2020 10:00	14,52	27	392,02	CHI
20200971500	ALTO PARAISO DE GOIAS	BF21140119	SAO JOAO D ALIANCA	22/09/2020 19:32	23/09/2020 19:30	22/09/2020 19:32	23/09/2020 19:30	23,96	1	23,96	CHI
20200971625	FAZENDA NOVA	FN12113964	IPORA	22/09/2020 19:33	22/09/2020 22:45	22/09/2020 19:33	22/09/2020 22:45	3,18	18	57,32	CHI
20200971516	CACHOEIRA ALTA	CA11370060	CACHOEIRA ALTA	22/09/2020 19:34	22/09/2020 21:53	22/09/2020 19:34	22/09/2020 21:53	2,30	84	193,43	CHI
20200973308	FORMOSO	ET12143681	MARA ROSA	22/09/2020 19:36	23/09/2020 10:37	22/09/2020 19:36	23/09/2020 10:37	15,02	13	195,20	CHI
20200971534	MONTIVIDIU	2840028100	MONTIVIDIU T	22/09/2020 19:36	22/09/2020 22:48	22/09/2020 19:36	22/09/2020 22:48	3,19	1	3,19	CHI

INTERNAL

20200971535	ITABERAÍ	50028870	ITABERAÍ S2	22/09/2020 19:36	23/09/2020 06:56	22/09/2020 19:36	23/09/2020 06:56	11,32	1	11,32	CHI
20200971545	GOIÁS	GS12220106	ITABERAÍ S1	22/09/2020 19:37	23/09/2020 09:15	22/09/2020 19:37	23/09/2020 09:15	13,62	9	122,56	CHI
20200971557	MINEIROS	MY12034240	PARQUE DAS EMAS	22/09/2020 19:39	23/09/2020 10:17	22/09/2020 19:39	23/09/2020 10:17	14,62	2	29,24	CHI
20200971564	CRIXAS	CX21309185	RUBIATABA	22/09/2020 19:40	24/09/2020 11:31	22/09/2020 19:40	24/09/2020 11:31	39,84	1	39,84	CHI
20200971594	URUACU	UR21262787	URUACU	22/09/2020 19:43	24/09/2020 14:59	22/09/2020 19:43	24/09/2020 14:59	43,26	2	86,51	CHI
20200971755	RIO VERDE	RV11049075	RIO VERDE S1	22/09/2020 19:44	22/09/2020 21:31	22/09/2020 19:44	22/09/2020 21:31	1,78	218	386,95	CHI
20200971606	RIO VERDE	10031683477	RIO VERDE S2	22/09/2020 19:45	23/09/2020 11:43	22/09/2020 19:45	23/09/2020 11:43	15,96	1	15,96	CHI
20200971622	ANAPOLIS	10030416041	JUNDIAÍ S2	22/09/2020 19:49	23/09/2020 15:46	22/09/2020 19:49	23/09/2020 15:46	19,95	1	19,95	CHI
20200974256	MARA ROSA	2260022206	MARA ROSA	22/09/2020 19:49	23/09/2020 15:14	22/09/2020 19:49	23/09/2020 15:14	19,41	1	19,41	CHI
20200971631	ANAPOLIS	20078778	ANAPOLIS UNIVERSITÁRIO S2	22/09/2020 19:50	23/09/2020 22:33	22/09/2020 19:50	23/09/2020 22:33	26,70	1	26,70	CHI
20200971652	ANAPOLIS	20347376	ANAPOLIS UNIVERSITÁRIO S2	22/09/2020 19:52	23/09/2020 16:47	22/09/2020 19:52	23/09/2020 16:47	20,90	1	20,90	CHI
20200971661	PORANGATU	840102690	PORANGATU	22/09/2020 19:53	24/09/2020 09:46	22/09/2020 19:53	24/09/2020 09:46	37,87	1	37,87	CHI
20200971663	AGUAS LINDAS DE GOIÁS	LA11377264	AGUAS LINDAS DE GOIÁS S1	22/09/2020 19:53	22/09/2020 21:23	22/09/2020 19:53	22/09/2020 21:23	1,48	51	75,73	CHI
20200971672	FORMOSA	610162366	ITUIQUIRA	22/09/2020 19:55	23/09/2020 04:43	22/09/2020 19:55	23/09/2020 04:43	8,80	1	8,80	CHI
20200971677	SAO SIMAO	SO16408215	CACHOEIRA ALTA	22/09/2020 19:55	23/09/2020 01:05	22/09/2020 19:55	22/09/2020 22:08	2,22	47	104,50	CHI
20200971677	SAO SIMAO	7316347	CACHOEIRA ALTA	22/09/2020 19:55	23/09/2020 01:05	22/09/2020 19:55	23/09/2020 01:05	5,16	5	25,80	CHI
20200971677	SAO SIMAO	03170214	CACHOEIRA ALTA	22/09/2020 19:55	23/09/2020 01:05	22/09/2020 21:10	23/09/2020 01:05	3,90	1	3,90	CHI
20200971696	ANAPOLIS	20860560	JUNDIAÍ S1	22/09/2020 19:58	22/09/2020 22:05	22/09/2020 19:58	22/09/2020 22:05	2,12	1	2,12	CHI
20200971704	DIVINOPOLIS DE GOIÁS	2570016075	SAO DOMINGOS	22/09/2020 19:59	23/09/2020 11:41	22/09/2020 19:59	23/09/2020 11:41	15,69	1	15,69	CHI
20200971706	GOIÁS	90070422	GOIÁS	22/09/2020 19:59	23/09/2020 06:24	22/09/2020 19:59	23/09/2020 06:24	10,41	1	10,41	CHI
20200971707	AMARALINA	MU12390127	MARA ROSA	22/09/2020 19:59	24/09/2020 15:36	22/09/2020 19:59	24/09/2020 15:36	43,61	6	261,64	CHI
20200971724	TURVANIA	1220016862	FIRMINOPOLIS S2	22/09/2020 20:01	23/09/2020 08:00	22/09/2020 20:01	23/09/2020 08:00	11,98	1	11,98	CHI
20200971740	MINACU	4020005097	MINACU	22/09/2020 20:02	23/09/2020 15:14	22/09/2020 20:02	23/09/2020 15:14	19,19	1	19,19	CHI
20200971744	LEOPOLDO DE BULHOES	LB11212308	DAIA S2	22/09/2020 20:03	22/09/2020 23:57	22/09/2020 20:03	22/09/2020 23:57	3,89	49	190,73	CHI
20200971759	SANTO ANTONIO DO DESCOBERTO	2210115535	AGUAS LINDAS DE GOIÁS S2	22/09/2020 20:04	23/09/2020 02:18	22/09/2020 20:04	23/09/2020 02:18	6,22	1	6,22	CHI
20200971784	LUZIANIA	LZ12000232	RIO VERMELHO	22/09/2020 20:07	22/09/2020 22:25	22/09/2020 20:07	22/09/2020 22:25	2,29	74	169,09	CHI
20200973382	MARA ROSA	MQ12051834	MARA ROSA	22/09/2020 20:09	23/09/2020 12:39	22/09/2020 20:09	23/09/2020 10:28	14,32	12	171,79	CHI
20200973382	MARA ROSA	MQ12051834	MARA ROSA	22/09/2020 20:09	23/09/2020 12:39	22/09/2020 20:09	23/09/2020 12:39	16,51	1	16,51	CHI
20200971790	PADRE BERNARDO	ZN21146723	PADRE BERNARDO	22/09/2020 20:09	23/09/2020 11:26	22/09/2020 20:09	23/09/2020 11:26	15,28	3	45,83	CHI
20200972042	ITAPACI	IW12318412	ITAPACI	22/09/2020 20:09	23/09/2020 04:12	22/09/2020 20:09	23/09/2020 04:12	8,04	544	4373,91	CHI
20200971795	NIQUELANDIA	NQ11202062	URUACU	22/09/2020 20:10	23/09/2020 04:28	22/09/2020 20:10	23/09/2020 04:28	8,29	72	596,96	CHI
20200971798	FORMOSA	FA21243117	SAO JOAO D ALIANCA	22/09/2020 20:10	23/09/2020 11:57	22/09/2020 20:10	23/09/2020 11:57	15,77	1	15,77	CHI
20200971802	GOIANAPOLIS	GP11329438	DAIA S2	22/09/2020 20:12	23/09/2020 11:38	22/09/2020 20:12	23/09/2020 11:38	15,43	28	432,06	CHI

INTERNAL

20200971824	PALMEIRAS DE GOIAS	PL21027207	PALMEIRAS	22/09/2020 20:14	23/09/2020 12:08	22/09/2020 20:14	23/09/2020 12:08	15,89	1	15,89	CHI
20200971833	SANTO ANTONIO DO DESCOBERTO	SN11133135	AGUAS LINDAS DE GOIAS S2	22/09/2020 20:15	23/09/2020 05:01	22/09/2020 20:15	23/09/2020 05:01	8,76	146	1278,96	CHI
20200971844	RIO VERDE	RV12271644	RIO VERDE S1	22/09/2020 20:17	22/09/2020 23:51	22/09/2020 20:17	22/09/2020 23:51	3,55	175	621,69	CHI
20200971852	JATAI	290106138	JATAI S3	22/09/2020 20:19	22/09/2020 21:46	22/09/2020 20:19	22/09/2020 21:46	1,44	1	1,44	CHI
20200971853	FORMOSA	10003710872	ITUIQUIRA	22/09/2020 20:20	23/09/2020 02:56	22/09/2020 20:20	23/09/2020 02:56	6,60	1	6,60	CHI
20200972011	ANAPOLIS	AN11129394	ANAPOLIS UNIVERSITARIO S2	22/09/2020 20:20	23/09/2020 11:20	22/09/2020 20:20	23/09/2020 00:15	3,93	86	337,79	CHI
20200972011	ANAPOLIS	AN12321991	ANAPOLIS UNIVERSITARIO S2	22/09/2020 20:20	23/09/2020 11:20	23/09/2020 02:30	23/09/2020 02:35	0,08	343	27,54	CHI
20200972011	ANAPOLIS	AN12321991	ANAPOLIS UNIVERSITARIO S2	22/09/2020 20:20	23/09/2020 11:20	23/09/2020 02:37	23/09/2020 03:33	0,92	257	237,65	CHI
20200972011	ANAPOLIS	AN11129394	ANAPOLIS UNIVERSITARIO S2	22/09/2020 20:20	23/09/2020 11:20	23/09/2020 02:37	23/09/2020 04:16	1,65	86	142,16	CHI
20200972011	ANAPOLIS	AN11129394	ANAPOLIS UNIVERSITARIO S2	22/09/2020 20:20	23/09/2020 11:20	23/09/2020 04:22	23/09/2020 11:20	6,96	86	598,15	CHI
20200971886	ITAJA	IJ21000077	CACHOEIRA ALTA	22/09/2020 20:26	23/09/2020 11:51	22/09/2020 20:26	23/09/2020 11:51	15,41	1	15,41	CHI
20200971894	SAO LUIS DE MONTES BELOS	SL21145985	FIRMINOPOLIS S2	22/09/2020 20:27	22/09/2020 23:59	22/09/2020 20:27	22/09/2020 23:59	3,52	1	3,52	CHI
20200971897	LUZIANIA	LZ11029351	RIO VERMELHO	22/09/2020 20:28	23/09/2020 01:16	22/09/2020 20:28	23/09/2020 01:16	4,80	113	542,09	CHI
20200971899	PEROLANDIA	JT21152141	JATAI S1	22/09/2020 20:28	23/09/2020 15:48	22/09/2020 20:28	23/09/2020 15:48	19,32	1	19,32	CHI
20200977093	HIDROLINA	HL21237758	URUACU	22/09/2020 20:29	23/09/2020 16:39	22/09/2020 20:29	23/09/2020 16:39	20,16	2	40,33	CHI
20200971909	PORANGATU	PO12020611	NOVO PLANALTO	22/09/2020 20:29	23/09/2020 09:51	22/09/2020 20:29	23/09/2020 09:51	13,37	8	106,92	CHI
20200972441	NIQUELANDIA	NQ12358188	URUACU	22/09/2020 20:30	23/09/2020 08:49	22/09/2020 20:30	23/09/2020 08:49	12,32	87	1071,55	CHI
20200971914	PLANALTINA	2960091833	PLANALTINA	22/09/2020 20:30	22/09/2020 23:51	22/09/2020 20:30	22/09/2020 23:51	3,34	1	3,34	CHI
20200972060	LUZIANIA	LZ11169066	RIO VERMELHO	22/09/2020 20:31	22/09/2020 21:52	22/09/2020 20:31	22/09/2020 21:52	1,34	146	195,84	CHI
20200971935	ITABERAI	IB12299550LD	ITABERAI S2	22/09/2020 20:33	23/09/2020 01:04	22/09/2020 20:33	23/09/2020 01:04	4,51	52	234,40	CHI
20200972117	NIQUELANDIA	NQ12095766	NIQUELANDIA SUBTRANSMISSAO	22/09/2020 20:34	23/09/2020 10:14	22/09/2020 20:34	23/09/2020 10:14	13,66	73	996,98	CHI
20200972117	URUACU	NQ12095766	NIQUELANDIA SUBTRANSMISSAO	22/09/2020 20:34	23/09/2020 10:14	22/09/2020 20:34	23/09/2020 10:14	13,66	3	40,97	CHI
20200971961	COCALZINHO DE GOIAS	ZN21302258	COCALZINHO	22/09/2020 20:38	23/09/2020 11:04	22/09/2020 20:38	23/09/2020 11:04	14,43	1	14,43	CHI
202009106980	DOVERLANDIA	4220023563	CAIAPONIA	22/09/2020 20:40	22/09/2020 21:14	22/09/2020 20:40	22/09/2020 21:14	0,58	1	0,58	CHI
20200971971	MARA ROSA	MQ21208392	MARA ROSA	22/09/2020 20:40	23/09/2020 11:54	22/09/2020 20:40	23/09/2020 11:54	15,23	1	15,23	CHI
20200971973	PARANAIGUARA	PC21035759	CACHOEIRA ALTA	22/09/2020 20:40	23/09/2020 07:51	22/09/2020 20:40	23/09/2020 07:51	11,17	1	11,17	CHI
20200971994	LUZIANIA	LZ12390041	CRISTALINA S2	22/09/2020 20:46	23/09/2020 21:12	22/09/2020 20:46	23/09/2020 10:54	14,14	1	14,14	CHI
20200971994	LUZIANIA	LZ12390041	CRISTALINA S2	22/09/2020 20:46	23/09/2020 21:12	22/09/2020 20:46	23/09/2020 14:19	17,55	1	17,55	CHI
20200971994	LUZIANIA	LZ12390041	CRISTALINA S2	22/09/2020 20:46	23/09/2020 21:12	22/09/2020 20:46	23/09/2020 21:12	24,44	7	171,07	CHI
20200971994	LUZIANIA	7518428	CRISTALINA S2	22/09/2020 20:46	23/09/2020 21:12	23/09/2020 19:56	23/09/2020 21:12	1,27	1	1,27	CHI
20200971997	BONOPOLIS	BX12198524	SAO MIGUEL DO ARAGUAIA	22/09/2020 20:47	23/09/2020 10:45	22/09/2020 20:47	23/09/2020 10:45	13,96	6	83,74	CHI
20200971999	FLORES DE GOIAS	FB21334129	FLORES DE GOIAS	22/09/2020 20:47	23/09/2020 01:09	22/09/2020 20:47	23/09/2020 01:09	4,35	1	4,35	CHI
20200972002	MARA ROSA	MQ21255181	MARA ROSA	22/09/2020 20:49	24/09/2020 10:32	22/09/2020 20:49	24/09/2020 10:32	37,71	1	37,71	CHI

INTERNAL

20200972067	CAMPOS BELOS	CH12208686	SAO DOMINGOS	22/09/2020 20:52	22/09/2020 22:44	22/09/2020 20:52	22/09/2020 22:44	1,86	242	450,52	CHI
20200972419	PORANGATU	PO11208439	PORANGATU	22/09/2020 20:54	23/09/2020 01:03	22/09/2020 20:54	23/09/2020 01:03	4,15	112	464,64	CHI
20200972026	RIO VERDE	630374302	RIO VERDE S1	22/09/2020 20:54	23/09/2020 03:00	22/09/2020 20:54	23/09/2020 03:00	6,10	1	6,10	CHI
20200972032	ITAPACI	100013090	ITAPACI	22/09/2020 20:55	23/09/2020 17:31	22/09/2020 20:55	23/09/2020 17:31	20,59	1	20,59	CHI
20200972073	FAINA	FC11250739	GOIAS	22/09/2020 20:56	22/09/2020 22:22	22/09/2020 20:56	22/09/2020 22:22	1,42	130	184,27	CHI
20200972044	SANTA TEREZINHA DE GOIAS	2480022116	SANTA TEREZINHA	22/09/2020 20:57	23/09/2020 04:31	22/09/2020 20:57	23/09/2020 04:31	7,56	1	7,56	CHI
20200972055	VILA PROPICIO	NP11327871	GOIANESIA S1	22/09/2020 20:59	22/09/2020 23:21	22/09/2020 20:59	22/09/2020 23:21	2,36	1	2,36	CHI
20200972066	FORMOSA	FA12254298	ITUIQUIRA	22/09/2020 21:01	23/09/2020 07:51	22/09/2020 21:01	23/09/2020 07:51	10,82	6	64,91	CHI
20200972127	POSSE	PS10400659	IACIARA S2	22/09/2020 21:06	23/09/2020 01:19	22/09/2020 21:13	22/09/2020 22:36	1,39	17	23,63	CHI
20200972127	POSSE	PS13104979	IACIARA S2	22/09/2020 21:06	23/09/2020 01:19	22/09/2020 21:13	22/09/2020 23:19	2,10	66	138,60	CHI
20200972127	POSSE	PS12132045	IACIARA S2	22/09/2020 21:06	23/09/2020 01:19	22/09/2020 21:13	23/09/2020 00:45	3,53	116	409,61	CHI
20200972127	POSSE	PS12181886	IACIARA S2	22/09/2020 21:06	23/09/2020 01:19	22/09/2020 21:13	23/09/2020 01:01	3,80	55	209,03	CHI
20200972127	POSSE	PS12257701	IACIARA S2	22/09/2020 21:06	23/09/2020 01:19	22/09/2020 21:13	23/09/2020 01:19	4,11	31	127,52	CHI
20200972088	PARANAIGUARA	PC12060518	QUIRINOPOLIS	22/09/2020 21:07	23/09/2020 00:36	22/09/2020 21:07	23/09/2020 00:36	3,47	5	17,37	CHI
20200972103	JATAI	JT12083645	JATAI S2	22/09/2020 21:10	23/09/2020 09:50	22/09/2020 21:10	23/09/2020 09:50	12,67	2	25,33	CHI
202009106979	CAIAPONIA	CP10400723	CAIAPONIA	22/09/2020 21:11	23/09/2020 04:23	22/09/2020 21:14	22/09/2020 22:44	1,50	7	10,48	CHI
202009106979	CAIAPONIA	CP10400723	CAIAPONIA	22/09/2020 21:11	23/09/2020 04:23	22/09/2020 21:14	23/09/2020 04:23	7,14	157	1121,20	CHI
202009106979	DOVERLANDIA	CP10400723	CAIAPONIA	22/09/2020 21:11	23/09/2020 04:23	22/09/2020 21:14	23/09/2020 04:23	7,14	10	71,41	CHI
202009106979	BALIZA	CP10400723	CAIAPONIA	22/09/2020 21:11	23/09/2020 04:23	22/09/2020 21:14	23/09/2020 04:23	7,15	632	4517,04	CHI
202009106979	CAIAPONIA	CP10400723	CAIAPONIA	22/09/2020 21:11	23/09/2020 04:23	22/09/2020 21:14	23/09/2020 04:23	7,15	23	164,39	CHI
202009106979	CAIAPONIA	CP10400723	CAIAPONIA	22/09/2020 21:11	23/09/2020 04:23	22/09/2020 21:14	23/09/2020 04:23	7,15	112	800,49	CHI
202009106979	DOVERLANDIA	CP10400723	CAIAPONIA	22/09/2020 21:11	23/09/2020 04:23	22/09/2020 21:14	23/09/2020 04:23	7,15	512	3659,38	CHI
202009106979	DOVERLANDIA	CP10400723	CAIAPONIA	22/09/2020 21:11	23/09/2020 04:23	22/09/2020 21:14	23/09/2020 04:23	7,15	3134	22399,39	CHI
202009106979	CAIAPONIA	CP10400723	CAIAPONIA	22/09/2020 21:11	23/09/2020 04:23	22/09/2020 23:50	23/09/2020 00:17	0,44	7	3,11	CHI
202009106979	CAIAPONIA	CP10400723	CAIAPONIA	22/09/2020 21:11	23/09/2020 04:23	23/09/2020 03:33	23/09/2020 03:58	0,42	7	2,95	CHI
202009106979	CAIAPONIA	CP10400723	CAIAPONIA	22/09/2020 21:11	23/09/2020 04:23	23/09/2020 04:01	23/09/2020 04:23	0,37	7	2,61	CHI
20200972108	BURITINOPOLIS	MB12314303	IACIARA S2	22/09/2020 21:12	23/09/2020 08:34	22/09/2020 21:12	23/09/2020 08:34	11,36	2	22,72	CHI
20200972108	MAMBAI	MB12314303	IACIARA S2	22/09/2020 21:12	23/09/2020 08:34	22/09/2020 21:12	23/09/2020 08:34	11,36	4	45,44	CHI
20200972110	AGUAS LINDAS DE GOIAS	10001736300	AGUAS LINDAS DE GOIAS S1	22/09/2020 21:12	22/09/2020 23:33	22/09/2020 21:12	22/09/2020 23:33	2,34	1	2,34	CHI
20200972116	JARAGUA	JA12298111	JARAGUA	22/09/2020 21:13	22/09/2020 22:21	22/09/2020 21:13	22/09/2020 22:21	1,12	399	446,66	CHI
20200972124	SAO JOAO D ALIANCA	JL21325743	SAO JOAO D ALIANCA	22/09/2020 21:16	23/09/2020 15:13	22/09/2020 21:16	23/09/2020 15:13	17,95	1	17,95	CHI
20200972283	PIRANHAS	PH12244913	PIRANHAS	22/09/2020 21:20	23/09/2020 10:41	22/09/2020 21:20	23/09/2020 10:41	13,35	4	53,39	CHI
202009107076	RUBIATABA	RB12070849	RUBIATABA	22/09/2020 21:21	23/09/2020 14:51	22/09/2020 21:21	23/09/2020 14:51	17,50	69	1207,27	CHI

INTERNAL

20200972156	MINACU	IH12208345	MINACU	22/09/2020 21:21	23/09/2020 02:35	22/09/2020 21:21	23/09/2020 02:35	5,22	97	506,31	CHI
20200972158	BOM JARDIM DE GOIAS	BM11380935	BOM JARDIM	22/09/2020 21:22	23/09/2020 03:42	22/09/2020 21:22	23/09/2020 03:42	6,33	64	405,23	CHI
20200972699	PARAUNA	PU12081329	PARAUNA	22/09/2020 21:22	23/09/2020 08:41	22/09/2020 21:22	23/09/2020 08:41	11,30	69	779,99	CHI
20200972269	ANAPOLIS	AN12039265	ANAPOLIS UNIVERSITARIO S2	22/09/2020 21:24	22/09/2020 22:37	22/09/2020 21:24	22/09/2020 22:37	1,21	344	415,48	CHI
20200972192	JARAGUA	70018479	JARAGUA	22/09/2020 21:28	23/09/2020 10:31	22/09/2020 21:28	23/09/2020 10:31	13,04	1	13,04	CHI
20200972194	VALPARAISO DE GOIAS	2860232108	PACAEMBU S2	22/09/2020 21:29	23/09/2020 03:13	22/09/2020 21:29	23/09/2020 03:13	5,73	1	5,73	CHI
20200972201	PLANALTINA	PI12394160	SAO JOAO D ALIANCA	22/09/2020 21:30	23/09/2020 12:32	22/09/2020 21:30	23/09/2020 12:32	15,03	7	105,19	CHI
20200972270	VALPARAISO DE GOIAS	VA11164930	PACAEMBU S2	22/09/2020 21:32	22/09/2020 23:08	22/09/2020 21:32	22/09/2020 23:08	1,59	184	292,46	CHI
20200972209	SAO LUIS DE MONTES BELOS	500039513	SAO LUIZ DOS MONTES BELOS	22/09/2020 21:32	23/09/2020 13:41	22/09/2020 21:32	23/09/2020 13:41	16,14	1	16,14	CHI
20200972211	NOVO GAMA	2900006643	MARAJOARA	22/09/2020 21:32	23/09/2020 02:36	22/09/2020 21:32	23/09/2020 02:36	5,05	1	5,05	CHI
20200972427	CAMPINORTE	CR12202139RE	MARA ROSA	22/09/2020 21:33	23/09/2020 13:48	22/09/2020 21:33	23/09/2020 13:48	16,24	32	519,72	CHI
20200972427	URUACU	CR12202139RE	MARA ROSA	22/09/2020 21:33	23/09/2020 13:48	22/09/2020 21:33	23/09/2020 13:48	16,24	106	1721,56	CHI
20200972224	MINEIROS	MY12126392	PARQUE DAS EMAS	22/09/2020 21:35	23/09/2020 03:53	22/09/2020 21:35	23/09/2020 03:53	6,29	14	88,12	CHI
20200972230	MUNDO NOVO DE GOIAS	10020649507	NOVA CRIXAS	22/09/2020 21:36	23/09/2020 03:25	22/09/2020 21:36	23/09/2020 03:25	5,82	1	5,82	CHI
20200972239	MUNDO NOVO DE GOIAS	4240022140	NOVA CRIXAS	22/09/2020 21:39	23/09/2020 02:17	22/09/2020 21:39	23/09/2020 02:17	4,63	1	4,63	CHI
20200972242	CAIAPONIA	DP21182186	JATAI S1	22/09/2020 21:39	23/09/2020 12:17	22/09/2020 21:39	23/09/2020 12:17	14,62	1	14,62	CHI
20200972245	SANTA HELENA DE GOIAS	400151455	IPEGUARI	22/09/2020 21:40	22/09/2020 22:39	22/09/2020 21:40	22/09/2020 22:39	0,97	1	0,97	CHI
20200972266	SANTA TEREZA DE GOIAS	SE12061012	MARA ROSA	22/09/2020 21:46	23/09/2020 16:14	22/09/2020 21:46	23/09/2020 16:14	18,45	1	18,45	CHI
20200972267	FAINA	FC12072196	GOIAS	22/09/2020 21:47	23/09/2020 11:21	22/09/2020 21:47	23/09/2020 11:21	13,56	6	81,36	CHI
20200972353	SAO LUIZ DO NORTE	SZ12090338	ITAPACI	22/09/2020 21:58	23/09/2020 01:27	22/09/2020 21:58	23/09/2020 01:27	3,47	292	1014,62	CHI
20200972305	NOVO GAMA	2460213482	PACAEMBU S1	22/09/2020 22:01	23/09/2020 03:22	22/09/2020 22:01	23/09/2020 03:22	5,34	1	5,34	CHI
20200972306	QUIRINOPOLIS	80077754	QUIRINOPOLIS	22/09/2020 22:01	22/09/2020 23:39	22/09/2020 22:01	22/09/2020 23:39	1,62	1	1,62	CHI
20200972310	MUNDO NOVO DE GOIAS	4240014415	NOVA CRIXAS	22/09/2020 22:03	23/09/2020 11:19	22/09/2020 22:03	23/09/2020 11:19	13,26	1	13,26	CHI
20200972313	SANTO ANTONIO DO DESCOBERTO	2210061575	ALEXANIA	22/09/2020 22:05	23/09/2020 09:33	22/09/2020 22:05	23/09/2020 09:33	11,46	1	11,46	CHI
20200972324	INDIARA	CZ12323632	CEZARINA	22/09/2020 22:10	23/09/2020 01:01	22/09/2020 22:10	23/09/2020 01:01	2,84	3	8,52	CHI
20200972324	CEZARINA	CZ12323632	CEZARINA	22/09/2020 22:10	23/09/2020 01:01	22/09/2020 22:10	23/09/2020 01:01	2,84	4	11,35	CHI
20200972331	JUSSARA	1290034257	JUSSARA	22/09/2020 22:15	23/09/2020 07:52	22/09/2020 22:15	23/09/2020 07:52	9,60	1	9,60	CHI
20200972340	SANTA FE DE GOIAS	2070006652	BRITANIA	22/09/2020 22:18	23/09/2020 12:40	22/09/2020 22:18	23/09/2020 12:40	14,36	1	14,36	CHI
20200972341	COCALZINHO DE GOIAS	CB21075829	COCALZINHO	22/09/2020 22:19	23/09/2020 10:22	22/09/2020 22:19	23/09/2020 10:22	12,04	1	12,04	CHI
20200972349	FORMOSA	FA11046851	ITUIQUIRA	22/09/2020 22:23	23/09/2020 00:50	22/09/2020 22:23	23/09/2020 00:50	2,44	108	263,37	CHI
20200972365	CIDADE OCIDENTAL	2680002447	MARAJOARA	22/09/2020 22:30	23/09/2020 00:02	22/09/2020 22:30	23/09/2020 00:02	1,52	1	1,52	CHI
20200972372	CIDADE OCIDENTAL	2680104724	MARAJOARA	22/09/2020 22:33	23/09/2020 08:21	22/09/2020 22:33	23/09/2020 08:21	9,79	1	9,79	CHI
20200972375	CACU	CC12080196	CACHOEIRA ALTA	22/09/2020 22:34	23/09/2020 02:47	22/09/2020 22:34	23/09/2020 02:47	4,21	5	21,06	CHI

INTERNAL

20200972377	JATAI	JT12196090	JATAI S2	22/09/2020 22:35	23/09/2020 07:08	22/09/2020 22:35	23/09/2020 07:08	8,54	12	102,45	CHI
20200972386	SAO LUIZ DO NORTE	SZ12348585	ITAPACI	22/09/2020 22:42	24/09/2020 12:17	22/09/2020 22:42	24/09/2020 12:17	37,57	3	112,71	CHI
20200972390	JATAI	290097629	JATAI S3	22/09/2020 22:45	23/09/2020 09:31	22/09/2020 22:45	23/09/2020 09:31	10,76	1	10,76	CHI
20200973008	FIRMINOPOLIS	FR12096845	FIRMINOPOLIS S1	22/09/2020 22:52	23/09/2020 14:47	22/09/2020 22:52	23/09/2020 14:47	15,92	17	270,57	CHI
20200972782	ANICUNS	TV12005585	FIRMINOPOLIS S2	22/09/2020 22:53	23/09/2020 09:31	22/09/2020 22:53	23/09/2020 09:31	10,63	22	233,83	CHI
20200972782	TURVANIA	TV12005585	FIRMINOPOLIS S2	22/09/2020 22:53	23/09/2020 09:31	22/09/2020 22:53	23/09/2020 09:31	10,63	16	170,06	CHI
20200973605	PORANGATU	PO12282160	PORANGATU	22/09/2020 22:53	23/09/2020 10:59	22/09/2020 22:53	23/09/2020 10:59	12,09	10	120,91	CHI
20200972431	MOZARLANDIA	410018077	MOZARLANDIA	22/09/2020 23:06	23/09/2020 11:04	22/09/2020 23:06	23/09/2020 11:04	11,96	1	11,96	CHI
20200972501	SAO LUIS DE MONTES BELOS	SL12233451	SAO LUIZ DOS MONTES BELOS	22/09/2020 23:08	23/09/2020 03:49	22/09/2020 23:08	23/09/2020 03:49	4,67	211	986,31	CHI
20200972459	RIO VERDE	RV11380684	CABRIUVA S1	22/09/2020 23:12	23/09/2020 01:00	22/09/2020 23:12	23/09/2020 01:00	1,80	98	176,37	CHI
20200972481	ITABERAI	IB12000047	ITABERAI S2	22/09/2020 23:31	23/09/2020 17:35	22/09/2020 23:31	23/09/2020 17:18	17,78	9	160,06	CHI
20200972481	ITABERAI	IB12051436	ITABERAI S1	22/09/2020 23:31	23/09/2020 17:35	23/09/2020 14:47	23/09/2020 17:35	2,80	6	16,80	CHI
20200972493	SAO LUIS DE MONTES BELOS	500112885	SAO LUIZ DOS MONTES BELOS	22/09/2020 23:42	23/09/2020 15:41	22/09/2020 23:42	23/09/2020 15:41	15,98	1	15,98	CHI
20200972507	ARAGARCAS	1820042276	ARAGARCAS	22/09/2020 23:58	23/09/2020 01:28	22/09/2020 23:58	23/09/2020 01:28	1,49	1	1,49	CHI
20200972514	LUZIANIA	LZ11000523	RIO VERMELHO	23/09/2020 00:08	23/09/2020 03:31	23/09/2020 00:08	23/09/2020 03:31	3,37	139	468,62	CHI
20200972525	PIRANHAS	AY21000016	ARENOPOLIS	23/09/2020 00:22	23/09/2020 12:31	23/09/2020 00:22	23/09/2020 12:31	12,14	1	12,14	CHI
20200973288	CAIAPONIA	CP12135376	CAIAPONIA	23/09/2020 00:36	24/09/2020 16:47	23/09/2020 00:36	24/09/2020 03:17	26,68	8	213,41	CHI
20200973288	CAIAPONIA	CP12135376	CAIAPONIA	23/09/2020 00:36	24/09/2020 16:47	24/09/2020 03:18	24/09/2020 16:47	13,48	8	107,85	CHI
20200972586	INDIARA	IY10395372	CEZARINA	23/09/2020 00:50	23/09/2020 11:05	23/09/2020 00:56	23/09/2020 07:38	6,70	21	140,63	CHI
20200972586	INDIARA	IY13312584	CEZARINA	23/09/2020 00:50	23/09/2020 11:05	23/09/2020 00:56	23/09/2020 09:18	8,37	15	125,53	CHI
20200972586	INDIARA	IY13417725	CEZARINA	23/09/2020 00:50	23/09/2020 11:05	23/09/2020 00:56	23/09/2020 11:05	10,15	6	60,88	CHI
20200972559	ARAGARCAS	1820031722	ARAGARCAS	23/09/2020 00:51	23/09/2020 11:35	23/09/2020 00:51	23/09/2020 11:35	10,72	1	10,72	CHI
20200972564	CAIAPONIA	CP12151179	CAIAPONIA	23/09/2020 00:55	23/09/2020 07:57	23/09/2020 00:55	23/09/2020 07:57	7,02	88	618,03	CHI
20200972565	NAZARIO	440006910	ANICUNS	23/09/2020 00:57	23/09/2020 09:06	23/09/2020 00:57	23/09/2020 09:06	8,16	1	8,16	CHI
20200972566	AMORINOPOLIS	1240006539	IPORA	23/09/2020 00:57	23/09/2020 17:20	23/09/2020 00:57	23/09/2020 17:20	16,37	1	16,37	CHI
20200972571	MONTIVIDIU	MV11106466	MONTIVIDIU T	23/09/2020 01:04	23/09/2020 04:46	23/09/2020 01:04	23/09/2020 04:46	3,69	61	224,87	CHI
20200972580	ITABERAI	IB16408584	ITABERAI S2	23/09/2020 01:21	23/09/2020 10:01	23/09/2020 01:21	23/09/2020 02:03	0,71	388	276,56	CHI
20200972580	GOIAS	IB13418584	ITABERAI S2	23/09/2020 01:21	23/09/2020 10:01	23/09/2020 01:21	23/09/2020 10:01	8,68	108	937,20	CHI
20200972580	ITABERAI	IB16408584	ITABERAI S2	23/09/2020 01:21	23/09/2020 10:01	23/09/2020 01:21	23/09/2020 10:01	8,68	26	225,62	CHI
20200972580	MOSSAMEDES	IB13418584	ITABERAI S2	23/09/2020 01:21	23/09/2020 10:01	23/09/2020 01:21	23/09/2020 10:01	8,68	260	2256,22	CHI
20200972580	ITABERAI	IB13418584	ITABERAI S2	23/09/2020 01:21	23/09/2020 10:01	23/09/2020 01:21	23/09/2020 10:01	8,68	238	2065,31	CHI
20200972580	ITABERAI	IB16408584	ITABERAI S2	23/09/2020 01:21	23/09/2020 10:01	23/09/2020 05:12	23/09/2020 06:14	1,04	371	384,91	CHI
20200972580	ITABERAI	IB13274427	ITABERAI S2	23/09/2020 01:21	23/09/2020 10:01	23/09/2020 05:12	23/09/2020 10:01	4,83	17	82,03	CHI

INTERNAL

2020092300002	APORE	43202	ITAJA S1	23/09/2020 01:37	23/09/2020 01:59	23/09/2020 01:37	23/09/2020 01:59	0,37	56	20,53	CHI
2020092300002	SERRANOPOLIS	43201	ITAJA S1	23/09/2020 01:37	23/09/2020 01:59	23/09/2020 01:37	23/09/2020 01:59	0,37	46	16,87	CHI
2020092300002	ITARUMA	01001	ITAJA S1	23/09/2020 01:37	23/09/2020 01:59	23/09/2020 01:37	23/09/2020 01:59	0,37	1	0,37	CHI
2020092300002	APORE	43202	ITAJA S1	23/09/2020 01:37	23/09/2020 01:59	23/09/2020 01:37	23/09/2020 01:59	0,37	50	18,33	CHI
2020092300002	APORE	43201	ITAJA S1	23/09/2020 01:37	23/09/2020 01:59	23/09/2020 01:37	23/09/2020 01:59	0,37	96	35,20	CHI
2020092300002	DISTRITO FEDERAL	01001	ITAJA S1	23/09/2020 01:37	23/09/2020 01:59	23/09/2020 01:37	23/09/2020 01:59	0,37	2	0,73	CHI
2020092300002	APORE	01031	ITAJA S1	23/09/2020 01:37	23/09/2020 01:59	23/09/2020 01:37	23/09/2020 01:59	0,37	8	2,93	CHI
2020092300002	JATAI	01001	ITAJA S1	23/09/2020 01:37	23/09/2020 01:59	23/09/2020 01:37	23/09/2020 01:59	0,37	1	0,37	CHI
2020092300002	ITAJA	01001	ITAJA S1	23/09/2020 01:37	23/09/2020 01:59	23/09/2020 01:37	23/09/2020 01:59	0,37	1	0,37	CHI
2020092300002	APORE	01001	ITAJA S1	23/09/2020 01:37	23/09/2020 01:59	23/09/2020 01:37	23/09/2020 01:59	0,37	1563	573,10	CHI
2020092300002	ITAJA	09929511	ITAJA S2	23/09/2020 01:37	23/09/2020 01:59	23/09/2020 01:37	23/09/2020 01:59	0,37	118	43,27	CHI
2020092300002	DISTRITO FEDERAL	09001	ITAJA S2	23/09/2020 01:37	23/09/2020 01:59	23/09/2020 01:37	23/09/2020 01:59	0,37	5	1,83	CHI
2020092300002	APORE	09929511	ITAJA S2	23/09/2020 01:37	23/09/2020 01:59	23/09/2020 01:37	23/09/2020 01:59	0,37	119	43,63	CHI
2020092300002	ITAJA	09002	ITAJA S2	23/09/2020 01:37	23/09/2020 01:59	23/09/2020 01:37	23/09/2020 01:59	0,37	1761	645,70	CHI
2020092300002	ITARUMA	09929511	ITAJA S2	23/09/2020 01:37	23/09/2020 01:59	23/09/2020 01:37	23/09/2020 01:59	0,37	100	36,67	CHI
2020092300002	LAGOA SANTA	09001	ITAJA S2	23/09/2020 01:37	23/09/2020 01:59	23/09/2020 01:37	23/09/2020 01:59	0,37	795	291,50	CHI
2020092300002	DISTRITO FEDERAL	09929511	ITAJA S2	23/09/2020 01:37	23/09/2020 01:59	23/09/2020 01:37	23/09/2020 01:59	0,37	3	1,10	CHI
2020092300002	ITAJA	09001	ITAJA S2	23/09/2020 01:37	23/09/2020 01:59	23/09/2020 01:37	23/09/2020 01:59	0,37	50	18,33	CHI
20200972587	RIO VERDE	RV12230629	CABRIUVA S2	23/09/2020 01:37	23/09/2020 08:35	23/09/2020 01:37	23/09/2020 08:35	6,96	8	55,68	CHI
20200972598	ADELANDIA	00090414	ANICUNS	23/09/2020 01:45	23/09/2020 11:48	23/09/2020 01:45	23/09/2020 01:55	0,18	31	5,55	CHI
20200972598	AMERICANO DO BRASIL	00090414	ANICUNS	23/09/2020 01:45	23/09/2020 11:48	23/09/2020 01:45	23/09/2020 01:55	0,18	86	15,41	CHI
20200972598	ANICUNS	00090414	ANICUNS	23/09/2020 01:45	23/09/2020 11:48	23/09/2020 01:45	23/09/2020 01:55	0,18	39	6,99	CHI
20200972598	MOSSAMEDES	00090414	ANICUNS	23/09/2020 01:45	23/09/2020 11:48	23/09/2020 01:45	23/09/2020 01:55	0,18	46	8,24	CHI
20200972598	ANICUNS	00090414	ANICUNS	23/09/2020 01:45	23/09/2020 11:48	23/09/2020 01:45	23/09/2020 03:49	2,07	26	53,79	CHI
20200972598	AMERICANO DO BRASIL	00090414	ANICUNS	23/09/2020 01:45	23/09/2020 11:48	23/09/2020 01:45	23/09/2020 03:49	2,07	2	4,14	CHI
20200972598	ANICUNS	00090414	ANICUNS	23/09/2020 01:45	23/09/2020 11:48	23/09/2020 01:45	23/09/2020 03:49	2,07	190	394,20	CHI
20200972598	ITABERAI	00090414	ANICUNS	23/09/2020 01:45	23/09/2020 11:48	23/09/2020 01:45	23/09/2020 03:49	2,07	105	217,85	CHI
20200972598	ITABERAI	00090414	ANICUNS	23/09/2020 01:45	23/09/2020 11:48	23/09/2020 01:45	23/09/2020 03:49	2,07	2	4,15	CHI
20200972598	MOSSAMEDES	00090414	ANICUNS	23/09/2020 01:45	23/09/2020 11:48	23/09/2020 01:45	23/09/2020 03:49	2,07	37	76,76	CHI
20200972598	ANICUNS	00090414	ANICUNS	23/09/2020 01:45	23/09/2020 11:48	23/09/2020 01:45	23/09/2020 03:49	2,07	22	45,64	CHI
20200972598	AMERICANO DO BRASIL	00090414	ANICUNS	23/09/2020 01:45	23/09/2020 11:48	23/09/2020 01:45	23/09/2020 03:49	2,07	335	695,03	CHI
20200972598	AMERICANO DO BRASIL	00090414	ANICUNS	23/09/2020 01:45	23/09/2020 11:48	23/09/2020 01:45	23/09/2020 03:49	2,07	2202	4568,54	CHI
20200972598	MOSSAMEDES	00090414	ANICUNS	23/09/2020 01:45	23/09/2020 11:48	23/09/2020 01:45	23/09/2020 09:58	8,21	2	16,43	CHI

INTERNAL

20200972598	AMERICANO DO BRASIL	00090414	ANICUNS	23/09/2020 01:45	23/09/2020 11:48	23/09/2020 01:45	23/09/2020 09:58	8,21	7	57,49	CHI
20200972598	ANICUNS	00090414	ANICUNS	23/09/2020 01:45	23/09/2020 11:48	23/09/2020 01:45	23/09/2020 09:58	8,21	3	24,64	CHI
20200972598	ANICUNS	00090414	ANICUNS	23/09/2020 01:45	23/09/2020 11:48	23/09/2020 01:45	23/09/2020 11:05	9,33	8	74,64	CHI
20200972598	AMERICANO DO BRASIL	00090414	ANICUNS	23/09/2020 01:45	23/09/2020 11:48	23/09/2020 01:45	23/09/2020 11:48	10,05	5	50,24	CHI
20200972598	MOSSAMEDES	00090414	ANICUNS	23/09/2020 01:45	23/09/2020 11:48	23/09/2020 01:45	23/09/2020 11:48	10,05	1	10,05	CHI
20200972598	ANICUNS	00090414	ANICUNS	23/09/2020 01:45	23/09/2020 11:48	23/09/2020 01:45	23/09/2020 11:48	10,05	1	10,05	CHI
20200972598	MOSSAMEDES	00090414	ANICUNS	23/09/2020 01:45	23/09/2020 11:48	23/09/2020 01:45	23/09/2020 03:49	2,07	1	2,07	CHI
20200972598	ANICUNS	00090414	ANICUNS	23/09/2020 01:45	23/09/2020 11:48	23/09/2020 05:20	23/09/2020 05:26	0,10	22	2,30	CHI
20200972598	ANICUNS	00090414	ANICUNS	23/09/2020 01:45	23/09/2020 11:48	23/09/2020 05:20	23/09/2020 05:26	0,10	229	23,98	CHI
20200972598	ANICUNS	00090414	ANICUNS	23/09/2020 01:45	23/09/2020 11:48	23/09/2020 05:20	23/09/2020 05:26	0,10	26	2,72	CHI
20200972598	MOSSAMEDES	00090414	ANICUNS	23/09/2020 01:45	23/09/2020 11:48	23/09/2020 05:20	23/09/2020 05:26	0,10	46	4,82	CHI
20200972598	ADELANDIA	00090414	ANICUNS	23/09/2020 01:45	23/09/2020 11:48	23/09/2020 05:20	23/09/2020 05:26	0,10	31	3,25	CHI
20200972598	AMERICANO DO BRASIL	00090414	ANICUNS	23/09/2020 01:45	23/09/2020 11:48	23/09/2020 05:20	23/09/2020 05:26	0,10	2202	230,60	CHI
20200972598	MOSSAMEDES	00090414	ANICUNS	23/09/2020 01:45	23/09/2020 11:48	23/09/2020 05:20	23/09/2020 05:26	0,10	38	3,98	CHI
20200972598	ITABERAI	00090414	ANICUNS	23/09/2020 01:45	23/09/2020 11:48	23/09/2020 05:20	23/09/2020 05:26	0,10	2	0,21	CHI
20200972598	AMERICANO DO BRASIL	00090414	ANICUNS	23/09/2020 01:45	23/09/2020 11:48	23/09/2020 05:20	23/09/2020 05:26	0,10	421	44,09	CHI
20200972598	AMERICANO DO BRASIL	00090414	ANICUNS	23/09/2020 01:45	23/09/2020 11:48	23/09/2020 05:20	23/09/2020 05:26	0,10	2	0,21	CHI
20200972598	ITABERAI	00090414	ANICUNS	23/09/2020 01:45	23/09/2020 11:48	23/09/2020 05:20	23/09/2020 05:26	0,10	104	10,89	CHI
20200972598	MOSSAMEDES	AC13308494	ANICUNS	23/09/2020 01:45	23/09/2020 11:48	23/09/2020 11:38	23/09/2020 11:48	0,16	2	0,32	CHI
20200972598	ANICUNS	AC13308494	ANICUNS	23/09/2020 01:45	23/09/2020 11:48	23/09/2020 11:38	23/09/2020 11:48	0,16	3	0,49	CHI
20200972598	AMERICANO DO BRASIL	AC13308494	ANICUNS	23/09/2020 01:45	23/09/2020 11:48	23/09/2020 11:38	23/09/2020 11:48	0,16	7	1,14	CHI
20200972601	PORANGATU	PO10404107	PORANGATU	23/09/2020 01:55	23/09/2020 05:22	23/09/2020 01:55	23/09/2020 02:34	0,64	1496	960,76	CHI
20200972601	PORANGATU	PO10404107	PORANGATU	23/09/2020 01:55	23/09/2020 05:22	23/09/2020 01:55	23/09/2020 03:55	2,00	310	619,31	CHI
20200972601	PORANGATU	PO12000035LD	PORANGATU	23/09/2020 01:55	23/09/2020 05:22	23/09/2020 01:55	23/09/2020 05:05	3,16	231	729,19	CHI
20200972601	PORANGATU	PO12000037LD	PORANGATU	23/09/2020 01:55	23/09/2020 05:22	23/09/2020 01:55	23/09/2020 05:22	3,45	111	382,52	CHI
20200972600	JUSSARA	JR12074365	BRITANIA	23/09/2020 01:57	23/09/2020 09:30	23/09/2020 01:57	23/09/2020 09:30	7,55	4	30,19	CHI
20200972600	SANTA FE DE GOIAS	JR12074365	BRITANIA	23/09/2020 01:57	23/09/2020 09:30	23/09/2020 01:57	23/09/2020 09:30	7,55	4	30,19	CHI
20200972604	LUZIANIA	120329013	RIO VERMELHO	23/09/2020 01:58	23/09/2020 05:04	23/09/2020 01:58	23/09/2020 05:04	3,08	1	3,08	CHI
20200972608	MONTE ALEGRE DE GOIAS	MA11129994	SAO DOMINGOS	23/09/2020 02:06	23/09/2020 05:07	23/09/2020 02:06	23/09/2020 05:07	3,02	114	344,31	CHI
20200972613	MINACU	4020073080	MINACU	23/09/2020 02:15	23/09/2020 12:18	23/09/2020 02:15	23/09/2020 12:18	10,03	1	10,03	CHI
20200972615	PORTEIRAO	CL12230803	RIO DOS BOIS	23/09/2020 02:17	23/09/2020 15:04	23/09/2020 02:17	23/09/2020 15:04	12,77	6	76,62	CHI
20200972616	CAIAPONIA	CP12200875	CAIAPONIA	23/09/2020 02:18	23/09/2020 08:50	23/09/2020 02:18	23/09/2020 08:50	6,53	9	58,75	CHI
20200972617	AURILANDIA	1010014447	FIRMINOPOLIS S2	23/09/2020 02:19	23/09/2020 10:18	23/09/2020 02:19	23/09/2020 10:18	7,97	1	7,97	CHI

INTERNAL

20200972635	AGUA FRIA DE GOIAS	TL10402672	SAO JOAO D ALIANCA	23/09/2020 02:28	23/09/2020 12:44	23/09/2020 02:28	23/09/2020 07:47	5,32	25	132,92	CHI
20200972635	AGUA FRIA DE GOIAS	TL12220968LD	SAO JOAO D ALIANCA	23/09/2020 02:28	23/09/2020 12:44	23/09/2020 02:28	23/09/2020 12:44	10,26	13	133,34	CHI
20200972878	AURILANDIA	CG12391526	FIRMINOPOLIS S2	23/09/2020 02:32	23/09/2020 10:50	23/09/2020 02:32	23/09/2020 10:50	8,30	2	16,59	CHI
20200972878	PARAUNA	CG12391526	FIRMINOPOLIS S2	23/09/2020 02:32	23/09/2020 10:50	23/09/2020 02:32	23/09/2020 10:50	8,30	32	265,48	CHI
20200972878	CACHOEIRA DE GOIAS	CG12391526	FIRMINOPOLIS S2	23/09/2020 02:32	23/09/2020 10:50	23/09/2020 02:32	23/09/2020 10:50	8,30	11	91,26	CHI
20200972657	PALMEIRAS DE GOIAS	03300414	PALMEIRAS	23/09/2020 02:53	23/09/2020 10:06	23/09/2020 02:53	23/09/2020 03:00	0,12	1	0,12	CHI
20200972657	PALMEIRAS DE GOIAS	03300414	PALMEIRAS	23/09/2020 02:53	23/09/2020 10:06	23/09/2020 02:53	23/09/2020 03:01	0,13	148	18,71	CHI
20200972657	PALMEIRAS DE GOIAS	03300414	PALMEIRAS	23/09/2020 02:53	23/09/2020 10:06	23/09/2020 02:53	23/09/2020 10:06	7,22	11	79,41	CHI
20200972657	NAZARIO	03300414	PALMEIRAS	23/09/2020 02:53	23/09/2020 10:06	23/09/2020 02:53	23/09/2020 10:06	7,22	2	14,44	CHI
20200972657	PALMEIRAS DE GOIAS	PL16404284	PALMEIRAS	23/09/2020 02:53	23/09/2020 10:06	23/09/2020 02:54	23/09/2020 03:00	0,10	16	1,58	CHI
20200972657	JANDAIA	PL16409820	PALMEIRAS	23/09/2020 02:53	23/09/2020 10:06	23/09/2020 02:54	23/09/2020 03:01	0,10	1	0,10	CHI
20200972657	PALMEIRAS DE GOIAS	PL16409820	PALMEIRAS	23/09/2020 02:53	23/09/2020 10:06	23/09/2020 02:54	23/09/2020 03:01	0,10	2430	251,10	CHI
20200972657	PALMEIRAS DE GOIAS	PL10406687	PALMEIRAS	23/09/2020 02:53	23/09/2020 10:06	23/09/2020 02:54	23/09/2020 03:01	0,11	989	110,71	CHI
20200972657	PALMEIRAS DE GOIAS	PL16407966	PALMEIRAS	23/09/2020 02:53	23/09/2020 10:06	23/09/2020 02:54	23/09/2020 03:04	0,16	989	157,69	CHI
20200972657	PALMEIRAS DE GOIAS	PL10400708	PALMEIRAS	23/09/2020 02:53	23/09/2020 10:06	23/09/2020 02:54	23/09/2020 03:05	0,18	221	40,03	CHI
20200972657	PALMEIRAS DE GOIAS	03300414	PALMEIRAS	23/09/2020 02:53	23/09/2020 10:06	23/09/2020 02:54	23/09/2020 07:34	4,66	6	27,95	CHI
20200972657	NAZARIO	NZ13401418B	PALMEIRAS	23/09/2020 02:53	23/09/2020 10:06	23/09/2020 02:54	23/09/2020 10:06	7,20	1	7,20	CHI
20200972657	PALMEIRAS DE GOIAS	NZ13401418B	PALMEIRAS	23/09/2020 02:53	23/09/2020 10:06	23/09/2020 02:54	23/09/2020 10:06	7,20	13	93,55	CHI
20200972648	MINACU	IH21248581	MINACU	23/09/2020 02:57	23/09/2020 08:37	23/09/2020 02:57	23/09/2020 08:37	5,66	1	5,66	CHI
20200972660	SANTO ANTONIO DA BARRA	EU12000181	ACREUNA	23/09/2020 03:09	23/09/2020 07:49	23/09/2020 03:09	23/09/2020 07:49	4,65	1	4,65	CHI
20200972660	ACREUNA	EU12000181	ACREUNA	23/09/2020 03:09	23/09/2020 07:49	23/09/2020 03:09	23/09/2020 07:49	4,65	25	116,36	CHI
20200972661	LUZIANIA	LZ21336028	PAMPLONA	23/09/2020 03:10	23/09/2020 17:14	23/09/2020 03:10	23/09/2020 17:14	14,06	1	14,06	CHI
20200968318	SANTA ISABEL	10010290301	ITAPACI	23/09/2020 03:16	23/09/2020 11:15	23/09/2020 03:16	23/09/2020 11:15	8,00	1	8,00	CHI
20200972676	RIO VERDE	630131983	RIO VERDE S1	23/09/2020 03:33	23/09/2020 10:26	23/09/2020 03:33	23/09/2020 10:26	6,88	1	6,88	CHI
20200972677	CRISTALINA	1060057892	CRISTALINA S1	23/09/2020 03:37	23/09/2020 07:55	23/09/2020 03:37	23/09/2020 07:55	4,30	1	4,30	CHI
20200972679	GOIAS	GS12099152	GOIAS	23/09/2020 03:41	23/09/2020 09:01	23/09/2020 03:41	23/09/2020 09:01	5,34	7	37,35	CHI
20200972681	ESTRELA DO NORTE	MQ12150566	MARA ROSA	23/09/2020 03:43	23/09/2020 12:37	23/09/2020 03:43	23/09/2020 12:37	8,90	7	62,29	CHI
20200972681	MARA ROSA	MQ12150566	MARA ROSA	23/09/2020 03:43	23/09/2020 12:37	23/09/2020 03:43	23/09/2020 12:37	8,90	7	62,29	CHI
20200972683	FORMOSA	610068817	ITIQUIRA	23/09/2020 03:45	23/09/2020 07:40	23/09/2020 03:45	23/09/2020 07:40	3,90	1	3,90	CHI
20200972688	ARAGARCAS	AG12334803	ARAGARCAS	23/09/2020 03:53	23/09/2020 08:13	23/09/2020 03:53	23/09/2020 08:13	4,33	9	38,94	CHI
20200972697	FORMOSA	610200306	ITIQUIRA	23/09/2020 03:56	23/09/2020 16:29	23/09/2020 03:56	23/09/2020 16:29	12,54	1	12,54	CHI
20200972698	FORMOSA	610248546	ITIQUIRA	23/09/2020 03:58	23/09/2020 11:35	23/09/2020 03:58	23/09/2020 11:35	7,62	1	7,62	CHI
20200972704	FORMOSA	610049653	ITIQUIRA	23/09/2020 04:03	23/09/2020 08:11	23/09/2020 04:03	23/09/2020 08:11	4,12	1	4,12	CHI

INTERNAL

20200972708	SANCLERLANDIA	SC21019486	FIRMINOPOLIS S2	23/09/2020 04:05	23/09/2020 07:57	23/09/2020 04:05	23/09/2020 07:57	3,85	1	3,85	CHI
20200972716	FORMOSA	FA12164673	ITUIQUIRA	23/09/2020 04:13	23/09/2020 09:21	23/09/2020 04:13	23/09/2020 09:21	5,12	682	3492,03	CHI
20200973994	SAO LUIS DE MONTES BELOS	SL12233451	SAO LUIZ DOS MONTES BELOS	23/09/2020 04:25	23/09/2020 09:32	23/09/2020 04:25	23/09/2020 09:32	5,10	211	1077,04	CHI
20200972730	ALTO PARAISO DE GOIAS	BF10409732	SAO JOAO D ALIANCA	23/09/2020 04:25	23/09/2020 15:30	23/09/2020 04:25	23/09/2020 07:40	3,24	61	197,93	CHI
20200972730	ALTO PARAISO DE GOIAS	BF12155974LD	SAO JOAO D ALIANCA	23/09/2020 04:25	23/09/2020 15:30	23/09/2020 04:25	23/09/2020 11:03	6,62	102	675,47	CHI
20200972730	ALTO PARAISO DE GOIAS	BF12244628LD	SAO JOAO D ALIANCA	23/09/2020 04:25	23/09/2020 15:30	23/09/2020 04:25	23/09/2020 12:29	8,06	33	266,06	CHI
20200972730	ALTO PARAISO DE GOIAS	BF12365360LD	SAO JOAO D ALIANCA	23/09/2020 04:25	23/09/2020 15:30	23/09/2020 04:25	23/09/2020 14:31	10,09	16	161,49	CHI
20200972730	ALTO PARAISO DE GOIAS	BF12365234	SAO JOAO D ALIANCA	23/09/2020 04:25	23/09/2020 15:30	23/09/2020 04:25	23/09/2020 15:00	10,58	10	105,84	CHI
20200972730	ALTO PARAISO DE GOIAS	BF12365259	SAO JOAO D ALIANCA	23/09/2020 04:25	23/09/2020 15:30	23/09/2020 04:25	23/09/2020 15:30	11,07	6	66,43	CHI
20200973080	SAO LUIS DE MONTES BELOS	SL12019284	SAO LUIZ DOS MONTES BELOS	23/09/2020 04:30	23/09/2020 09:41	23/09/2020 04:30	23/09/2020 09:41	5,18	59	305,54	CHI
20200973080	SANCLERLANDIA	SL12019284	SAO LUIZ DOS MONTES BELOS	23/09/2020 04:30	23/09/2020 09:41	23/09/2020 04:30	23/09/2020 09:41	5,18	28	145,00	CHI
20200972733	LUZIANIA	120260256	RIO VERMELHO	23/09/2020 04:33	23/09/2020 09:12	23/09/2020 04:33	23/09/2020 09:12	4,64	1	4,64	CHI
20200972778	CRISTALINA	03470474	CRISTALINA S2	23/09/2020 04:35	23/09/2020 16:09	23/09/2020 04:46	23/09/2020 11:04	6,30	1	6,30	CHI
20200972778	LUZIANIA	KR13313623	CRISTALINA S2	23/09/2020 04:35	23/09/2020 16:09	23/09/2020 04:46	23/09/2020 16:09	11,38	4	45,51	CHI
20200972778	CRISTALINA	KR13313623	CRISTALINA S2	23/09/2020 04:35	23/09/2020 16:09	23/09/2020 04:46	23/09/2020 16:09	11,38	4	45,51	CHI
20200972778	CRISTALINA	KR12248700	CRISTALINA S2	23/09/2020 04:35	23/09/2020 16:09	23/09/2020 11:54	23/09/2020 15:39	3,76	22	82,76	CHI
20200972743	BONOPOLIS	BX12369999	NOVO PLANALTO	23/09/2020 04:39	24/09/2020 12:04	23/09/2020 04:39	24/09/2020 12:04	31,41	1	31,41	CHI
202009107095	PADRE BERNARDO	PB21376776	PADRE BERNARDO	23/09/2020 04:40	23/09/2020 19:48	23/09/2020 04:40	23/09/2020 19:48	15,13	1	15,13	CHI
202009107095	PADRE BERNARDO	PB21227298	PADRE BERNARDO	23/09/2020 04:40	23/09/2020 19:48	23/09/2020 06:12	23/09/2020 19:48	13,59	1	13,59	CHI
20200972748	NAZARIO	440012752	ANICUNS	23/09/2020 04:41	23/09/2020 10:30	23/09/2020 04:41	23/09/2020 10:30	5,82	1	5,82	CHI
20200973068	BONOPOLIS	BX12168214	SAO MIGUEL DO ARAGUAIA	23/09/2020 04:46	23/09/2020 09:49	23/09/2020 04:46	23/09/2020 09:49	5,04	7	35,29	CHI
20200973436	DOVERLANDIA	MY12219258	PARQUE DAS EMAS	23/09/2020 04:50	23/09/2020 12:23	23/09/2020 04:50	23/09/2020 12:23	7,54	18	135,79	CHI
20200972794	SAO JOAO DA PARAUNA	RP12156223RE	FIRMINOPOLIS S2	23/09/2020 05:05	23/09/2020 10:20	23/09/2020 05:05	23/09/2020 10:20	5,25	28	146,88	CHI
20200972794	PALMINOPOLIS	RP12156223RE	FIRMINOPOLIS S2	23/09/2020 05:05	23/09/2020 10:20	23/09/2020 05:05	23/09/2020 10:20	5,25	2	10,49	CHI
20200972776	JATAI	JT12021080	JATAI S3	23/09/2020 05:06	23/09/2020 09:49	23/09/2020 05:06	23/09/2020 09:49	4,72	3	14,15	CHI
20200972779	SANCLERLANDIA	SC21357317	FIRMINOPOLIS S2	23/09/2020 05:07	23/09/2020 11:50	23/09/2020 05:07	23/09/2020 11:30	6,38	1	6,38	CHI
20200972779	SANCLERLANDIA	SC21154596	FIRMINOPOLIS S2	23/09/2020 05:07	23/09/2020 11:50	23/09/2020 05:07	23/09/2020 11:45	6,64	1	6,64	CHI
20200972779	SANCLERLANDIA	SC21235853	FIRMINOPOLIS S2	23/09/2020 05:07	23/09/2020 11:50	23/09/2020 05:07	23/09/2020 11:50	6,71	1	6,71	CHI
20200972783	ANAPOLIS	AN12000193RE	ANAPOLIS UNIVERSITARIO S2	23/09/2020 05:11	23/09/2020 08:53	23/09/2020 05:11	23/09/2020 08:53	3,69	14	51,65	CHI
20200972783	PIRENOPOLIS	AN12000193RE	ANAPOLIS UNIVERSITARIO S2	23/09/2020 05:11	23/09/2020 08:53	23/09/2020 05:11	23/09/2020 08:53	3,69	3	11,07	CHI
20200974662	DOVERLANDIA	MY12219553	PARQUE DAS EMAS	23/09/2020 05:16	23/09/2020 11:57	23/09/2020 05:16	23/09/2020 11:57	6,68	47	314,04	CHI
20200973580	SANTA TEREZINHA DE GOIAS	GG12181600	SANTA TEREZINHA	23/09/2020 05:21	23/09/2020 17:06	23/09/2020 05:21	23/09/2020 17:06	11,74	7	82,17	CHI
20200972803	TURVANIA	TV12259072	FIRMINOPOLIS S2	23/09/2020 05:26	23/09/2020 09:16	23/09/2020 05:26	23/09/2020 09:16	3,83	3	11,48	CHI

INTERNAL

20200972804	CAIAPONIA	MV11301393	MONTIVIDIU T	23/09/2020 05:26	23/09/2020 08:34	23/09/2020 05:26	23/09/2020 08:34	3,12	91	284,25	CHI
20200972805	LUZIANIA	120075118	RIO VERMELHO	23/09/2020 05:26	23/09/2020 07:39	23/09/2020 05:26	23/09/2020 07:39	2,21	1	2,21	CHI
20200973024	CORREGO DO OURO	CO12028902	SAO LUIZ DOS MONTES BELOS	23/09/2020 05:28	23/09/2020 09:20	23/09/2020 05:28	23/09/2020 09:20	3,86	55	212,22	CHI
20200972809	NIQUELANDIA	NQ21086273	URUACU	23/09/2020 05:28	23/09/2020 08:44	23/09/2020 05:28	23/09/2020 08:44	3,25	1	3,25	CHI
20200972810	CIDADE OCIDENTAL	2680102909	MARAJOARA	23/09/2020 05:29	23/09/2020 09:23	23/09/2020 05:29	23/09/2020 09:23	3,90	1	3,90	CHI
20200972861	BONOPOLIS	BX12192399	SAO MIGUEL DO ARAGUAIA	23/09/2020 05:32	23/09/2020 08:45	23/09/2020 05:32	23/09/2020 08:45	3,21	5	16,07	CHI
20200972816	FORMOSA	10010054594	ITIQUEIRA	23/09/2020 05:33	23/09/2020 07:01	23/09/2020 05:33	23/09/2020 07:01	1,46	1	1,46	CHI
20200973484	VILA PROPICIO	NP12307145	BARRO ALTO	23/09/2020 05:35	23/09/2020 12:56	23/09/2020 05:35	23/09/2020 12:56	7,34	15	110,05	CHI
20200972820	ACREUNA	EU12214067	ACREUNA	23/09/2020 05:35	23/09/2020 10:38	23/09/2020 05:35	23/09/2020 10:38	5,03	52	261,79	CHI
20200975443	NOVA CRIXAS	NA12057216	MOZARLANDIA	23/09/2020 05:37	23/09/2020 15:47	23/09/2020 05:37	23/09/2020 15:47	10,16	4	40,66	CHI
20200972831	QUIRINOPOLIS	10023508092	QUIRINOPOLIS	23/09/2020 05:42	23/09/2020 07:27	23/09/2020 05:42	23/09/2020 07:27	1,75	1	1,75	CHI
20200974942	FORMOSO	ET12349192	MARA ROSA	23/09/2020 05:45	23/09/2020 11:33	23/09/2020 05:45	23/09/2020 11:33	5,79	7	40,53	CHI
20200974942	ESTRELA DO NORTE	ET12349192	MARA ROSA	23/09/2020 05:45	23/09/2020 11:33	23/09/2020 05:45	23/09/2020 11:33	5,79	1	5,79	CHI
20200972845	FAINA	FC12336280	GOIAS	23/09/2020 05:47	23/09/2020 09:08	23/09/2020 05:47	23/09/2020 09:08	3,35	3	10,04	CHI
20200972847	SANTA RITA DO ARAGUAIA	SU21027484	SANTA RITA DO ARAGUAIA	23/09/2020 05:47	23/09/2020 13:15	23/09/2020 05:47	23/09/2020 13:15	7,46	1	7,46	CHI
20200972848	LUZIANIA	LZ11414435	MARAJOARA	23/09/2020 05:47	23/09/2020 18:22	23/09/2020 05:47	23/09/2020 18:22	12,57	25	314,25	CHI
20200973143	RIO VERDE	QI12370150	QUIRINOPOLIS	23/09/2020 05:48	23/09/2020 09:39	23/09/2020 05:48	23/09/2020 09:39	3,85	1	3,85	CHI
20200973143	QUIRINOPOLIS	QI12370150	QUIRINOPOLIS	23/09/2020 05:48	23/09/2020 09:39	23/09/2020 05:48	23/09/2020 09:39	3,85	49	188,65	CHI
20200973143	CASTELANDIA	QI12370150	QUIRINOPOLIS	23/09/2020 05:48	23/09/2020 09:39	23/09/2020 05:48	23/09/2020 09:39	3,85	2	7,70	CHI
20200972850	GUARINOS	GF12164881	SANTA TEREZINHA	23/09/2020 05:48	23/09/2020 11:01	23/09/2020 05:48	23/09/2020 11:01	5,22	36	187,78	CHI
20200972851	FORMOSA	610292742	ITIQUEIRA	23/09/2020 05:48	23/09/2020 13:48	23/09/2020 05:48	23/09/2020 13:48	7,99	1	7,99	CHI
20200972852	SANCLERLANDIA	SC12006150	FIRMINOPOLIS S2	23/09/2020 05:49	23/09/2020 11:25	23/09/2020 05:49	23/09/2020 11:25	5,59	32	178,78	CHI
20200973762	IPORA	IR12223074	IPORA	23/09/2020 05:49	23/09/2020 12:10	23/09/2020 05:49	23/09/2020 12:10	6,34	177	1121,59	CHI
20200973776	MUTUNOPOLIS	LC12182362	MARA ROSA	23/09/2020 05:51	23/09/2020 12:34	23/09/2020 05:51	23/09/2020 11:26	5,58	2	11,16	CHI
20200973776	AMARALINA	LC12182362	MARA ROSA	23/09/2020 05:51	23/09/2020 12:34	23/09/2020 05:51	23/09/2020 11:26	5,58	70	390,77	CHI
20200973776	MARA ROSA	LC12168855	MARA ROSA	23/09/2020 05:51	23/09/2020 12:34	23/09/2020 05:51	23/09/2020 12:34	6,73	8	53,80	CHI
20200973776	AMARALINA	LC12168855	MARA ROSA	23/09/2020 05:51	23/09/2020 12:34	23/09/2020 05:51	23/09/2020 12:34	6,73	35	235,38	CHI
20200972855	VILA BOA	FA12218264	ITIQUEIRA	23/09/2020 05:51	23/09/2020 08:55	23/09/2020 05:51	23/09/2020 08:55	3,06	4	12,23	CHI
20200972855	FORMOSA	FA12218264	ITIQUEIRA	23/09/2020 05:51	23/09/2020 08:55	23/09/2020 05:51	23/09/2020 08:55	3,06	96	293,63	CHI
20200972856	PLANALTINA	PI12361252	PLANALTINA	23/09/2020 05:51	23/09/2020 09:44	23/09/2020 05:51	23/09/2020 09:44	3,87	35	135,39	CHI
20200973179	VALPARAISO DE GOIAS	VA11164930	PACAEMBU S2	23/09/2020 05:52	23/09/2020 08:44	23/09/2020 08:10	23/09/2020 08:44	0,57	184	104,83	CHI
20200972860	BOM JARDIM DE GOIAS	BM12358510	BOM JARDIM	23/09/2020 05:54	23/09/2020 08:44	23/09/2020 05:54	23/09/2020 08:44	2,83	1	2,83	CHI
20200972863	PIRANHAS	1930006217	PIRANHAS	23/09/2020 05:55	23/09/2020 12:12	23/09/2020 05:55	23/09/2020 12:12	6,28	1	6,28	CHI

INTERNAL

20200972952	AMARALINA	MU12390477	MARA ROSA	23/09/2020 05:55	24/09/2020 11:50	23/09/2020 05:55	24/09/2020 11:50	29,90	94	2810,86	CHI
20200972935	ITAPACI	IW12081353	ITAPACI	23/09/2020 05:56	23/09/2020 12:47	23/09/2020 05:56	23/09/2020 12:47	6,85	23	157,44	CHI
20200972874	SANTA RITA DO NOVO DESTINO	GE12322006	GOIANESIA S1	23/09/2020 05:57	23/09/2020 09:20	23/09/2020 05:57	23/09/2020 09:20	3,38	8	27,01	CHI
20200972874	GOIANESIA	GE12322006	GOIANESIA S1	23/09/2020 05:57	23/09/2020 09:20	23/09/2020 05:57	23/09/2020 09:20	3,38	7	23,63	CHI
20200974061	DOVERLANDIA	DV12324390RE	PARQUE DAS EMAS	23/09/2020 05:58	24/09/2020 09:26	23/09/2020 05:58	24/09/2020 09:26	27,47	11	302,16	CHI
20200972880	JANDAIA	JD12304492	PALMEIRAS	23/09/2020 06:00	24/09/2020 13:13	23/09/2020 06:00	24/09/2020 12:19	30,31	16	485,03	CHI
20200972880	PALMEIRAS DE GOIAS	JD12304492	PALMEIRAS	23/09/2020 06:00	24/09/2020 13:13	23/09/2020 06:00	24/09/2020 12:19	30,31	13	394,08	CHI
20200972880	INDIARA	JD12304492	PALMEIRAS	23/09/2020 06:00	24/09/2020 13:13	23/09/2020 06:00	24/09/2020 13:13	31,21	5	156,06	CHI
20200972880	JANDAIA	JD12304492	PALMEIRAS	23/09/2020 06:00	24/09/2020 13:13	23/09/2020 06:00	24/09/2020 13:13	31,21	4	124,85	CHI
20200972880	PALMEIRAS DE GOIAS	JD12304492	PALMEIRAS	23/09/2020 06:00	24/09/2020 13:13	23/09/2020 06:00	24/09/2020 13:13	31,21	25	780,31	CHI
20200972881	FORMOSA	FA12404505	ITUIQUIRA	23/09/2020 06:00	23/09/2020 12:17	23/09/2020 06:00	23/09/2020 12:17	6,28	3	18,83	CHI
20200972882	ITABERAI	IB21373127	ITABERAI S1	23/09/2020 06:01	23/09/2020 09:51	23/09/2020 06:01	23/09/2020 09:51	3,83	1	3,83	CHI
20200973301	CRIXAS	CX12391661	SANTA TEREZINHA	23/09/2020 06:01	23/09/2020 15:18	23/09/2020 06:01	23/09/2020 15:18	9,28	32	297,00	CHI
20200972887	CACU	CC21357956	CACHOEIRA ALTA	23/09/2020 06:02	23/09/2020 07:22	23/09/2020 06:02	23/09/2020 07:22	1,32	1	1,32	CHI
20200972890	BARRO ALTO	GE12006481	BARRO ALTO	23/09/2020 06:03	23/09/2020 10:58	23/09/2020 06:03	23/09/2020 10:58	4,91	21	103,02	CHI
20200972890	SANTA RITA DO NOVO DESTINO	GE12006481	BARRO ALTO	23/09/2020 06:03	23/09/2020 10:58	23/09/2020 06:03	23/09/2020 10:58	4,91	10	49,06	CHI
20200972895	SANTA TEREZA DE GOIAS	SE21094118	MARA ROSA	23/09/2020 06:05	24/09/2020 14:23	23/09/2020 06:05	24/09/2020 14:23	32,30	1	32,30	CHI
20200972898	MATRINCHA	MP12070343	MATRINCHA	23/09/2020 06:05	23/09/2020 14:33	23/09/2020 06:05	23/09/2020 14:33	8,46	2	16,92	CHI
20200972898	ITAPIRAPUA	MP12070343	MATRINCHA	23/09/2020 06:05	23/09/2020 14:33	23/09/2020 06:05	23/09/2020 14:33	8,46	5	42,29	CHI
20200973295	SAO JOAO DA PARAUNA	RP12076381RE	FIRMINOPOLIS S2	23/09/2020 06:05	23/09/2020 13:13	23/09/2020 06:05	23/09/2020 13:13	7,12	33	235,03	CHI
20200973295	AURILANDIA	RP12076381RE	FIRMINOPOLIS S2	23/09/2020 06:05	23/09/2020 13:13	23/09/2020 06:05	23/09/2020 13:13	7,12	4	28,49	CHI
20200972903	CRISTALINA	KR21320148	PAMPLONA	23/09/2020 06:06	23/09/2020 17:47	23/09/2020 06:06	23/09/2020 17:47	11,68	1	11,68	CHI
20200974314	ARENOPOLIS	AY12139436	ARENOPOLIS	23/09/2020 06:06	24/09/2020 00:27	23/09/2020 06:06	24/09/2020 00:27	18,35	16	293,57	CHI
20200974314	IPORA	AY12139436	ARENOPOLIS	23/09/2020 06:06	24/09/2020 00:27	23/09/2020 06:06	24/09/2020 00:27	18,35	11	201,83	CHI
20200972905	URUACU	UR21247222	MARA ROSA	23/09/2020 06:06	25/09/2020 10:15	23/09/2020 06:06	25/09/2020 10:15	52,16	1	52,16	CHI
20200972906	SANTA TEREZINHA DE GOIAS	SG12202092	SANTA TEREZINHA	23/09/2020 06:06	23/09/2020 09:29	23/09/2020 06:06	23/09/2020 09:29	3,38	6	20,27	CHI
20200973759	ADELANDIA	DN12021716	ANICUNS	23/09/2020 06:06	23/09/2020 14:30	23/09/2020 06:06	23/09/2020 14:30	8,39	10	83,88	CHI
20200975716	MARA ROSA	MQ12099868	MARA ROSA	23/09/2020 06:07	23/09/2020 16:20	23/09/2020 06:07	23/09/2020 16:20	10,21	22	224,53	CHI
20200975716	CAMPINORTE	MQ12099868	MARA ROSA	23/09/2020 06:07	23/09/2020 16:20	23/09/2020 06:07	23/09/2020 16:20	10,21	4	40,82	CHI
20200973417	IACIARA	IA12211563	IACIARA S1	23/09/2020 06:08	23/09/2020 11:05	23/09/2020 06:08	23/09/2020 11:05	4,95	8	39,56	CHI
202009107096	PADRE BERNARDO	2800008540	PADRE BERNARDO	23/09/2020 06:08	23/09/2020 07:34	23/09/2020 06:08	23/09/2020 07:34	1,43	1	1,43	CHI
20200972916	PORANGATU	PO12049340	PORANGATU	23/09/2020 06:08	23/09/2020 10:22	23/09/2020 06:08	23/09/2020 10:22	4,22	7	29,56	CHI
20200972920	NOVA CRIXAS	NA21057264	MOZARLANDIA	23/09/2020 06:09	23/09/2020 17:21	23/09/2020 06:09	23/09/2020 17:21	11,20	1	11,20	CHI

INTERNAL

20200973064	MARA ROSA	MQ12072578	MARA ROSA	23/09/2020 06:09	23/09/2020 11:26	23/09/2020 06:09	23/09/2020 11:26	5,28	6	31,68	CHI
20200972924	PARANAIGUARA	QJ21100544	QUIRINOPOLIS	23/09/2020 06:09	23/09/2020 08:24	23/09/2020 06:09	23/09/2020 08:24	2,24	1	2,24	CHI
20200961524	PIRENOPOLIS	PV12295641	SAO FRANCISCO DE GOIAS	23/09/2020 06:10	23/09/2020 08:37	23/09/2020 06:10	23/09/2020 08:37	2,44	182	443,52	CHI
20200973276	BALIZA	BH12331383	CAIAPONIA	23/09/2020 06:11	24/09/2020 13:17	23/09/2020 06:11	24/09/2020 13:17	31,10	10	311,00	CHI
20200973122	NAZARIO	NZ12003964	ANICUNS	23/09/2020 06:12	23/09/2020 08:28	23/09/2020 06:12	23/09/2020 08:28	2,26	12	27,15	CHI
20200972949	SAO LUIS DE MONTES BELOS	SL21003730	SAO LUIZ DOS MONTES BELOS	23/09/2020 06:14	23/09/2020 12:25	23/09/2020 06:14	23/09/2020 12:25	6,18	1	6,18	CHI
20200972951	LUZIANIA	120118178	RIO VERMELHO	23/09/2020 06:15	23/09/2020 10:51	23/09/2020 06:15	23/09/2020 10:51	4,60	1	4,60	CHI
20200973450	ANICUNS	AC12299011	FIRMINOPOLIS S2	23/09/2020 06:16	23/09/2020 13:52	23/09/2020 06:16	23/09/2020 13:52	7,60	10	75,98	CHI
20200972960	CIDADE OCIDENTAL	2680040618	MARAJOARA	23/09/2020 06:16	23/09/2020 10:30	23/09/2020 06:16	23/09/2020 10:30	4,22	1	4,22	CHI
20200974041	COLINAS DO SUL	TI12355503	MINACU	23/09/2020 06:16	23/09/2020 12:03	23/09/2020 06:16	23/09/2020 12:03	5,77	9	51,95	CHI
20200972965	CRISTALINA	KR12212020	PAMPLONA	23/09/2020 06:17	23/09/2020 13:56	23/09/2020 06:17	23/09/2020 13:56	7,65	2	15,29	CHI
20200972967	CRISTALINA	1060026536	CRISTALINA S1	23/09/2020 06:18	23/09/2020 07:53	23/09/2020 06:18	23/09/2020 07:53	1,57	1	1,57	CHI
20200972969	CRIXAS	NA12319060	SERRA DO OURO	23/09/2020 06:18	23/09/2020 13:20	23/09/2020 06:18	23/09/2020 13:20	7,02	1	7,02	CHI
20200973485	CAMPINACU	UC12236229	PORANGATU	23/09/2020 06:19	23/09/2020 09:08	23/09/2020 06:19	23/09/2020 09:08	2,82	29	81,65	CHI
20200973012	MARA ROSA	MQ12086247	MARA ROSA	23/09/2020 06:19	24/09/2020 00:46	23/09/2020 06:19	24/09/2020 00:46	18,44	7	129,10	CHI
20200972974	JATAI	JT12411985	CABRIUVA S2	23/09/2020 06:19	23/09/2020 10:44	23/09/2020 06:19	23/09/2020 10:44	4,40	2	8,81	CHI
20200972982	APORE	AE21405877	ITAJA S2	23/09/2020 06:21	23/09/2020 09:30	23/09/2020 06:21	23/09/2020 09:30	3,13	1	3,13	CHI
20200972987	LAGOA SANTA	IJ21155328	ITAJA S2	23/09/2020 06:22	23/09/2020 13:49	23/09/2020 06:22	23/09/2020 13:49	7,43	1	7,43	CHI
20200972989	ITAGUARU	IC21068821	ITABERAÍ S1	23/09/2020 06:23	23/09/2020 10:51	23/09/2020 06:23	23/09/2020 10:51	4,46	1	4,46	CHI
20200972992	CABECEIRAS	CW12204613	ITUIQUIRA	23/09/2020 06:24	23/09/2020 12:07	23/09/2020 06:24	23/09/2020 12:07	5,71	1	5,71	CHI
20200973708	CABECEIRAS	CW12383348LD	ITUIQUIRA	23/09/2020 06:24	23/09/2020 08:39	23/09/2020 06:24	23/09/2020 08:39	2,24	123	276,07	CHI
20200973026	ANAPOLIS	AN12285273	ANAPOLIS UNIVERSITARIO S2	23/09/2020 06:25	23/09/2020 12:12	23/09/2020 06:25	23/09/2020 12:12	5,78	96	555,09	CHI
20200975338	MUTUNOPOLIS	MU12086704	MARA ROSA	23/09/2020 06:25	24/09/2020 15:54	23/09/2020 06:25	24/09/2020 15:54	33,48	7	234,36	CHI
20200973155	ITAPACI	IW12210177	ITAPACI	23/09/2020 06:26	23/09/2020 08:59	23/09/2020 06:26	23/09/2020 08:59	2,55	7	17,82	CHI
20200973155	PILAR DE GOIAS	IW12210177	ITAPACI	23/09/2020 06:26	23/09/2020 08:59	23/09/2020 06:26	23/09/2020 08:59	2,55	3	7,64	CHI
20200972654	SAO LUIZ DO NORTE	SZ10410838	ITAPACI	23/09/2020 06:31	23/09/2020 10:35	23/09/2020 06:31	23/09/2020 10:35	4,07	153	622,54	CHI
20200972654	SANTA ISABEL	SZ10410838	ITAPACI	23/09/2020 06:31	23/09/2020 10:35	23/09/2020 06:31	23/09/2020 10:35	4,07	4	16,28	CHI
20200972654	GOIANESIA	SZ10410838	ITAPACI	23/09/2020 06:31	23/09/2020 10:35	23/09/2020 06:31	23/09/2020 10:35	4,07	12	48,83	CHI
20200973539	ARAGARCAS	AG11341746	ARAGARCAS	23/09/2020 06:36	23/09/2020 12:07	23/09/2020 06:36	23/09/2020 12:07	5,50	72	396,16	CHI
20200973617	RIO VERDE	CP12075058	CAIAPONIA	23/09/2020 06:36	24/09/2020 08:13	23/09/2020 06:36	24/09/2020 08:13	25,60	4	102,40	CHI
20200973617	JATAI	CP12075058	CAIAPONIA	23/09/2020 06:36	24/09/2020 08:13	23/09/2020 06:36	24/09/2020 08:13	25,60	3	76,80	CHI
20200973617	CAIAPONIA	CP12075058	CAIAPONIA	23/09/2020 06:36	24/09/2020 08:13	23/09/2020 06:36	24/09/2020 08:13	25,60	21	537,62	CHI
20200973631	BALIZA	BH12331445	CAIAPONIA	23/09/2020 06:39	23/09/2020 10:18	23/09/2020 06:39	23/09/2020 10:18	3,65	17	61,98	CHI

INTERNAL

20200973076	PARANAIGUARA	PC21100295	CACHOEIRA ALTA	23/09/2020 06:41	23/09/2020 10:34	23/09/2020 06:41	23/09/2020 10:34	3,88	1	3,88	CHI
20200973078	CAVALCANTE	CJ12239935	FLORES DE GOIAS	23/09/2020 06:43	23/09/2020 09:05	23/09/2020 06:43	23/09/2020 09:05	2,36	126	297,92	CHI
20200973082	PORANGATU	PO12359260	PORANGATU	23/09/2020 06:43	23/09/2020 14:38	23/09/2020 06:43	23/09/2020 14:38	7,90	2	15,81	CHI
20200973087	MINACU	IH12360453	MINACU	23/09/2020 06:47	23/09/2020 10:47	23/09/2020 06:47	23/09/2020 10:47	4,00	72	287,76	CHI
20200973087	CAMPINACU	IH12360453	MINACU	23/09/2020 06:47	23/09/2020 10:47	23/09/2020 06:47	23/09/2020 10:47	4,00	5	19,98	CHI
20200973426	RIO VERDE	RV12030683	MONTIVIDIU T	23/09/2020 06:48	23/09/2020 08:58	23/09/2020 06:48	23/09/2020 08:58	2,17	3	6,50	CHI
20200973426	CAIAPONIA	RV12030683	MONTIVIDIU T	23/09/2020 06:48	23/09/2020 08:58	23/09/2020 06:48	23/09/2020 08:58	2,17	119	257,83	CHI
20200974466	URUACU	UR12247225	MARA ROSA	23/09/2020 06:48	23/09/2020 23:00	23/09/2020 06:48	23/09/2020 23:00	16,20	7	113,40	CHI
20200973091	RIO VERDE	RV12371494	SANTA HELENA S1	23/09/2020 06:48	23/09/2020 09:33	23/09/2020 06:48	23/09/2020 09:33	2,75	4	10,99	CHI
20200973091	QUIRINOPOLIS	RV12371494	SANTA HELENA S1	23/09/2020 06:48	23/09/2020 09:33	23/09/2020 06:48	23/09/2020 09:33	2,75	38	104,39	CHI
20200973268	MARA ROSA	MQ12390121	MARA ROSA	23/09/2020 06:50	23/09/2020 14:55	23/09/2020 06:50	23/09/2020 14:55	8,08	12	96,90	CHI
20200973098	JATAI	JT12260447LD	JATAI S1	23/09/2020 06:51	23/09/2020 17:40	23/09/2020 06:51	23/09/2020 13:25	6,57	11	72,22	CHI
20200973098	JATAI	JT13264279	JATAI S1	23/09/2020 06:51	23/09/2020 17:40	23/09/2020 06:51	23/09/2020 17:20	10,49	3	31,48	CHI
20200973098	SERRANOPOLIS	JT13264279	JATAI S1	23/09/2020 06:51	23/09/2020 17:40	23/09/2020 06:51	23/09/2020 17:20	10,49	1	10,49	CHI
20200973098	JATAI	JT13248376	JATAI S1	23/09/2020 06:51	23/09/2020 17:40	23/09/2020 06:51	23/09/2020 17:40	10,83	41	443,89	CHI
20200977649	RUBIATABA	10003636281	RUBIATABA	23/09/2020 06:51	23/09/2020 17:44	23/09/2020 06:51	23/09/2020 17:44	10,87	1	10,87	CHI
20200973098	SERRANOPOLIS	JT13264279	JATAI S1	23/09/2020 06:51	23/09/2020 17:40	23/09/2020 14:37	23/09/2020 17:20	2,72	10	27,22	CHI
20200973098	JATAI	JT13264279	JATAI S1	23/09/2020 06:51	23/09/2020 17:40	23/09/2020 14:37	23/09/2020 17:20	2,72	12	32,66	CHI
20200973106	ALTO HORIZONTE	AJ21265873	SANTA TEREZINHA	23/09/2020 06:52	24/09/2020 15:36	23/09/2020 06:52	24/09/2020 15:36	32,73	1	32,73	CHI
20200975392	MUTUNOPOLIS	MU12170091	MARA ROSA	23/09/2020 06:52	24/09/2020 22:21	23/09/2020 06:52	24/09/2020 22:21	39,48	19	750,04	CHI
20200973116	RIO VERDE	RV12260256	RIO VERDE S1	23/09/2020 06:53	23/09/2020 12:40	23/09/2020 06:53	23/09/2020 12:40	5,77	19	109,59	CHI
20200973120	JARAGUA	JA21360286	GOIANESIA S2	23/09/2020 06:54	23/09/2020 11:00	23/09/2020 06:54	23/09/2020 11:00	4,09	1	4,09	CHI
20200973151	FORMOSA	FA12071048	ITIQUEIRA	23/09/2020 06:55	23/09/2020 08:08	23/09/2020 06:55	23/09/2020 08:08	1,20	14	16,83	CHI
20200973469	PARAUNA	PU12110555	PARAUNA	23/09/2020 06:55	23/09/2020 11:34	23/09/2020 06:55	23/09/2020 11:34	4,63	16	74,16	CHI
20200978181	SAO JOAO D ALIANCA	JL12321184	SAO JOAO D ALIANCA	23/09/2020 06:56	23/09/2020 20:56	23/09/2020 06:56	23/09/2020 20:56	14,00	6	84,00	CHI
20200973463	PORANGATU	PO12265802	PORANGATU	23/09/2020 06:57	25/09/2020 08:49	23/09/2020 06:57	23/09/2020 09:47	2,84	11	31,21	CHI
20200973463	PORANGATU	PO12265802	PORANGATU	23/09/2020 06:57	25/09/2020 08:49	23/09/2020 06:57	25/09/2020 01:17	42,33	42	1777,94	CHI
20200973146	JANDAIA	PU12172481	PARAUNA	23/09/2020 06:57	23/09/2020 10:04	23/09/2020 06:57	23/09/2020 10:04	3,11	1	3,11	CHI
20200973146	PARAUNA	PU12172481	PARAUNA	23/09/2020 06:57	23/09/2020 10:04	23/09/2020 06:57	23/09/2020 10:04	3,11	7	21,78	CHI
20200973147	FORMOSA	FA13361342	ITIQUEIRA	23/09/2020 06:57	24/09/2020 00:58	23/09/2020 06:57	23/09/2020 10:09	3,21	1	3,21	CHI
20200973147	FLORES DE GOIAS	FA13361342	ITIQUEIRA	23/09/2020 06:57	24/09/2020 00:58	23/09/2020 06:57	23/09/2020 10:56	3,98	2	7,95	CHI
20200973147	FORMOSA	FA13361342	ITIQUEIRA	23/09/2020 06:57	24/09/2020 00:58	23/09/2020 06:57	23/09/2020 10:56	3,98	51	202,80	CHI
20200973147	SAO JOAO D ALIANCA	FA13361342	ITIQUEIRA	23/09/2020 06:57	24/09/2020 00:58	23/09/2020 06:57	23/09/2020 10:56	3,98	1	3,98	CHI

INTERNAL

20200973147	VILA BOA	FA13361342	ITIQUEIRA	23/09/2020 06:57	24/09/2020 00:58	23/09/2020 06:57	23/09/2020 10:56	3,98	4	15,91	CHI
20200973147	FORMOSA	FA13361342	ITIQUEIRA	23/09/2020 06:57	24/09/2020 00:58	23/09/2020 06:57	23/09/2020 12:20	5,38	5	26,91	CHI
20200973147	FORMOSA	FA13361342	ITIQUEIRA	23/09/2020 06:57	24/09/2020 00:58	23/09/2020 06:57	23/09/2020 13:16	6,31	46	290,18	CHI
20200973147	VILA BOA	FA13361342	ITIQUEIRA	23/09/2020 06:57	24/09/2020 00:58	23/09/2020 06:57	23/09/2020 14:34	7,62	2	15,23	CHI
20200973147	FORMOSA	FA13361342	ITIQUEIRA	23/09/2020 06:57	24/09/2020 00:58	23/09/2020 06:57	23/09/2020 14:34	7,62	18	137,09	CHI
20200973147	FORMOSA	FA13361342	ITIQUEIRA	23/09/2020 06:57	24/09/2020 00:58	23/09/2020 06:57	23/09/2020 15:38	8,68	111	963,29	CHI
20200973147	FORMOSA	FA13361342	ITIQUEIRA	23/09/2020 06:57	24/09/2020 00:58	23/09/2020 06:57	23/09/2020 18:45	11,80	135	1592,40	CHI
20200973147	FLORES DE GOIAS	FA13361342	ITIQUEIRA	23/09/2020 06:57	24/09/2020 00:58	23/09/2020 06:57	23/09/2020 21:35	14,62	1	14,62	CHI
20200973147	SAO JOAO D ALIANCA	FA13361342	ITIQUEIRA	23/09/2020 06:57	24/09/2020 00:58	23/09/2020 06:57	23/09/2020 21:35	14,62	228	3334,06	CHI
20200973147	FORMOSA	FA13361342	ITIQUEIRA	23/09/2020 06:57	24/09/2020 00:58	23/09/2020 06:57	23/09/2020 21:35	14,62	211	3085,46	CHI
20200973463	PORANGATU	PO12265802	PORANGATU	23/09/2020 06:57	25/09/2020 08:49	23/09/2020 09:47	25/09/2020 01:17	39,49	5	197,47	CHI
20200973463	PORANGATU	PO13291225	PORANGATU	23/09/2020 06:57	25/09/2020 08:49	23/09/2020 09:47	25/09/2020 08:49	47,03	8	376,22	CHI
20200973147	FORMOSA	FA12204762LD	ITIQUEIRA	23/09/2020 06:57	24/09/2020 00:58	23/09/2020 10:09	23/09/2020 13:16	3,10	1	3,10	CHI
20200973147	FORMOSA	02590206	ITIQUEIRA	23/09/2020 06:57	24/09/2020 00:58	23/09/2020 10:09	23/09/2020 21:35	11,42	1	11,42	CHI
20200973463	PORANGATU	PO12265802	PORANGATU	23/09/2020 06:57	25/09/2020 08:49	23/09/2020 12:41	25/09/2020 01:17	36,60	22	805,14	CHI
20200973147	FORMOSA	FA12204759	ITIQUEIRA	23/09/2020 06:57	24/09/2020 00:58	23/09/2020 15:40	23/09/2020 17:15	1,59	18	28,69	CHI
20200973147	VILA BOA	FA12204759	ITIQUEIRA	23/09/2020 06:57	24/09/2020 00:58	23/09/2020 15:40	23/09/2020 17:15	1,59	2	3,19	CHI
20200973147	FORMOSA	FA13329653	ITIQUEIRA	23/09/2020 06:57	24/09/2020 00:58	23/09/2020 15:40	23/09/2020 18:45	3,09	49	151,37	CHI
20200973147	FORMOSA	FA13233611	ITIQUEIRA	23/09/2020 06:57	24/09/2020 00:58	23/09/2020 15:40	24/09/2020 00:13	8,55	62	530,12	CHI
20200973147	VILA BOA	FA12204759	ITIQUEIRA	23/09/2020 06:57	24/09/2020 00:58	23/09/2020 19:10	23/09/2020 20:08	0,98	2	1,96	CHI
20200973147	FORMOSA	FA12204759	ITIQUEIRA	23/09/2020 06:57	24/09/2020 00:58	23/09/2020 19:10	23/09/2020 20:08	0,98	18	17,63	CHI
20200973147	FORMOSA	FA13329653	ITIQUEIRA	23/09/2020 06:57	24/09/2020 00:58	23/09/2020 19:10	23/09/2020 23:47	4,63	165	763,40	CHI
20200973147	FORMOSA	FA12404512	ITIQUEIRA	23/09/2020 06:57	24/09/2020 00:58	23/09/2020 19:10	24/09/2020 00:31	5,37	4	21,46	CHI
20200973147	FORMOSA	FA12270998	ITIQUEIRA	23/09/2020 06:57	24/09/2020 00:58	23/09/2020 19:10	24/09/2020 00:58	5,81	16	93,02	CHI
20200973147	FLORES DE GOIAS	02590206	ITIQUEIRA	23/09/2020 06:57	24/09/2020 00:58	23/09/2020 20:10	23/09/2020 21:35	1,42	2	2,83	CHI
20200973147	VILA BOA	02590206	ITIQUEIRA	23/09/2020 06:57	24/09/2020 00:58	23/09/2020 20:10	23/09/2020 21:35	1,42	6	8,50	CHI
20200973147	FORMOSA	02590206	ITIQUEIRA	23/09/2020 06:57	24/09/2020 00:58	23/09/2020 20:10	23/09/2020 21:35	1,42	116	164,30	CHI
20200973147	SAO JOAO D ALIANCA	02590206	ITIQUEIRA	23/09/2020 06:57	24/09/2020 00:58	23/09/2020 20:10	23/09/2020 21:35	1,42	2	2,83	CHI
20200973158	CRISTALINA	KR12330533	CRISTALINA S1	23/09/2020 06:58	23/09/2020 09:21	23/09/2020 06:58	23/09/2020 09:21	2,37	34	80,74	CHI
20200973158	IPAMERI	KR12330533	CRISTALINA S1	23/09/2020 06:58	23/09/2020 09:21	23/09/2020 06:58	23/09/2020 09:21	2,37	1	2,37	CHI
20200973158	LUZIANIA	KR12330533	CRISTALINA S1	23/09/2020 06:58	23/09/2020 09:21	23/09/2020 06:58	23/09/2020 09:21	2,37	8	19,00	CHI
20200961609	PADRE BERNARDO	01370414	PADRE BERNARDO	23/09/2020 06:58	23/09/2020 14:22	23/09/2020 09:32	23/09/2020 09:47	0,26	1230	313,99	CHI
20200961609	ITARUMA	01370414	PADRE BERNARDO	23/09/2020 06:58	23/09/2020 14:22	23/09/2020 09:32	23/09/2020 09:47	0,26	2	0,51	CHI

INTERNAL

20200961609	PADRE BERNARDO	01370414	PADRE BERNARDO	23/09/2020 06:58	23/09/2020 14:22	23/09/2020 09:32	23/09/2020 09:47	0,26	910	232,30	CHI
20200961609	PADRE BERNARDO	01370414	PADRE BERNARDO	23/09/2020 06:58	23/09/2020 14:22	23/09/2020 09:32	23/09/2020 09:47	0,26	11	2,81	CHI
20200961609	COCALZINHO DE GOIAS	01370414	PADRE BERNARDO	23/09/2020 06:58	23/09/2020 14:22	23/09/2020 09:32	23/09/2020 09:47	0,26	92	23,49	CHI
20200961609	PLANALTINA	01370414	PADRE BERNARDO	23/09/2020 06:58	23/09/2020 14:22	23/09/2020 09:32	23/09/2020 09:47	0,26	15	3,83	CHI
20200961609	PADRE BERNARDO	01370414	PADRE BERNARDO	23/09/2020 06:58	23/09/2020 14:22	23/09/2020 09:32	23/09/2020 09:47	0,26	3734	953,21	CHI
20200961609	DISTRITO FEDERAL	01370414	PADRE BERNARDO	23/09/2020 06:58	23/09/2020 14:22	23/09/2020 09:32	23/09/2020 09:47	0,26	10	2,55	CHI
20200961609	PADRE BERNARDO	PB13314030	PADRE BERNARDO	23/09/2020 06:58	23/09/2020 14:22	23/09/2020 10:00	23/09/2020 14:22	4,36	11	47,97	CHI
20200973168	BOM JARDIM DE GOIAS	1880017432	BOM JARDIM	23/09/2020 07:00	23/09/2020 09:51	23/09/2020 07:00	23/09/2020 09:51	2,85	1	2,85	CHI
20200973170	FORMOSA	FA12146199	ITIQUEIRA	23/09/2020 07:00	23/09/2020 10:08	23/09/2020 07:00	23/09/2020 10:08	3,13	9	28,17	CHI
20200973180	MINACU	IH21230434	MINACU	23/09/2020 07:01	23/09/2020 15:28	23/09/2020 07:01	23/09/2020 15:28	8,44	1	8,44	CHI
20200973182	LUZIANIA	10004356517	CRISTALINA S2	23/09/2020 07:01	23/09/2020 09:06	23/09/2020 07:01	23/09/2020 09:06	2,08	1	2,08	CHI
20200973186	IPORA	IR21014083	IPORA	23/09/2020 07:02	23/09/2020 09:25	23/09/2020 07:02	23/09/2020 09:25	2,38	1	2,38	CHI
20200974408	ALTO PARAISO DE GOIAS	BF12105395	SAO JOAO D ALIANCA	23/09/2020 07:02	23/09/2020 17:05	23/09/2020 07:02	23/09/2020 17:05	10,04	14	140,55	CHI
20200974237	JARAGUA	JA11255159	JARAGUA	23/09/2020 07:02	23/09/2020 10:00	23/09/2020 07:02	23/09/2020 10:00	2,96	83	245,36	CHI
20200973368	PORANGATU	PO13181689	PORANGATU	23/09/2020 07:03	23/09/2020 11:47	23/09/2020 07:03	23/09/2020 11:47	4,73	29	137,28	CHI
20200973368	MUTUNOPOLIS	PO13181689	PORANGATU	23/09/2020 07:03	23/09/2020 11:47	23/09/2020 07:03	23/09/2020 11:47	4,73	5	23,67	CHI
20200973204	SANTA HELENA DE GOIAS	ML12000158	RIO DOS BOIS	23/09/2020 07:03	23/09/2020 17:07	23/09/2020 07:03	23/09/2020 17:07	10,06	4	40,22	CHI
20200973210	SANTO ANTONIO DO DESCOBERTO	LZ21046988	ALEXANIA	23/09/2020 07:04	23/09/2020 12:00	23/09/2020 07:04	23/09/2020 12:00	4,93	1	4,93	CHI
20200973899	MINACU	IH12262532	MINACU	23/09/2020 07:04	23/09/2020 12:47	23/09/2020 07:04	23/09/2020 12:47	5,70	67	382,16	CHI
20200973220	RUBIATABA	RB21228850	RUBIATABA	23/09/2020 07:05	23/09/2020 12:37	23/09/2020 07:05	23/09/2020 12:37	5,53	1	5,53	CHI
20200973224	CRISTALINA	1060079127	CRISTALINA S1	23/09/2020 07:06	23/09/2020 09:11	23/09/2020 07:06	23/09/2020 09:11	2,08	1	2,08	CHI
20200973236	GOIAS	GS21308090	GOIAS	23/09/2020 07:07	23/09/2020 09:36	23/09/2020 07:07	23/09/2020 09:36	2,47	1	2,47	CHI
20200974087	PIRENOPOLIS	PV12093270	SAO FRANCISCO DE GOIAS	23/09/2020 07:07	23/09/2020 09:38	23/09/2020 07:07	23/09/2020 09:38	2,50	8	20,02	CHI
20200973240	PETROLINA DE GOIAS	PG21237654	PETROLINA	23/09/2020 07:08	23/09/2020 16:04	23/09/2020 07:08	23/09/2020 16:04	8,93	1	8,93	CHI
20200973429	ANAPOLIS	AN11096679	JUNDIAI S2	23/09/2020 07:09	23/09/2020 15:45	23/09/2020 07:09	23/09/2020 15:45	8,60	101	868,26	CHI
20200973257	CACU	CA12384078	CACHOEIRA ALTA	23/09/2020 07:09	23/09/2020 10:43	23/09/2020 07:09	23/09/2020 10:43	3,56	1	3,56	CHI
20200973257	CACHOEIRA ALTA	CA12384078	CACHOEIRA ALTA	23/09/2020 07:09	23/09/2020 10:43	23/09/2020 07:09	23/09/2020 10:43	3,56	7	24,89	CHI
20200973259	ANAPOLIS	20896890	JUNDIAI S1	23/09/2020 07:10	23/09/2020 09:57	23/09/2020 07:10	23/09/2020 09:57	2,78	1	2,78	CHI
20200973278	TURVELANDIA	TD21322161	RIO DOS BOIS	23/09/2020 07:11	23/09/2020 18:42	23/09/2020 07:11	23/09/2020 18:42	11,52	1	11,52	CHI
20200973265	LUZIANIA	LZ12330887	RIO VERMELHO	23/09/2020 07:11	23/09/2020 11:50	23/09/2020 07:11	23/09/2020 11:50	4,66	131	610,57	CHI
20200973269	LUZIANIA	120112814	RIO VERMELHO	23/09/2020 07:11	23/09/2020 12:01	23/09/2020 07:11	23/09/2020 12:01	4,82	1	4,82	CHI
20200973271	MARA ROSA	MQ12325668	SANTA TEREZINHA	23/09/2020 07:11	24/09/2020 17:38	23/09/2020 07:11	24/09/2020 17:38	34,44	49	1687,48	CHI
20200973274	NOVA ROMA	ND12216998	IACIARA S2	23/09/2020 07:12	23/09/2020 08:47	23/09/2020 07:12	23/09/2020 08:47	1,58	23	36,23	CHI

INTERNAL

20200973292	VILA PROPICIO	GE21213555	GOIANESIA S1	23/09/2020 07:16	23/09/2020 11:24	23/09/2020 07:16	23/09/2020 11:24	4,13	1	4,13	CHI
20200974595	CAIAPONIA	CP12119387RE	CAIAPONIA	23/09/2020 07:16	23/09/2020 21:39	23/09/2020 07:16	23/09/2020 21:39	14,37	30	431,03	CHI
20200973296	SANTO ANTONIO DO DESCOBERTO	2210140803	AGUAS LINDAS DE GOIAS S2	23/09/2020 07:17	23/09/2020 11:20	23/09/2020 07:17	23/09/2020 11:20	4,05	1	4,05	CHI
20200973304	PORANGATU	PO12020608	NOVO PLANALTO	23/09/2020 07:19	23/09/2020 14:33	23/09/2020 07:19	23/09/2020 14:33	7,22	3	21,67	CHI
20200973305	VILA PROPICIO	NP12382314	GOIANESIA S1	23/09/2020 07:19	23/09/2020 13:22	23/09/2020 07:19	23/09/2020 13:22	6,04	12	72,44	CHI
20200973306	IPAMERI	IP12100702	CRISTALINA S2	23/09/2020 07:20	23/09/2020 08:24	23/09/2020 07:20	23/09/2020 08:24	1,07	2	2,13	CHI
20200973306	CRISTALINA	IP12100702	CRISTALINA S2	23/09/2020 07:20	23/09/2020 08:24	23/09/2020 07:20	23/09/2020 08:24	1,07	1	1,07	CHI
20200973309	GOIANESIA	GE21246307	GOIANESIA S1	23/09/2020 07:20	23/09/2020 11:08	23/09/2020 07:20	23/09/2020 11:08	3,79	1	3,79	CHI
20200973316	RIO VERDE	630169433	RIO VERDE S1	23/09/2020 07:22	23/09/2020 09:23	23/09/2020 07:22	23/09/2020 09:23	2,01	1	2,01	CHI
20200973320	CORUMBA DE GOIAS	ZN21302361	COCALZINHO	23/09/2020 07:22	23/09/2020 13:01	23/09/2020 07:22	23/09/2020 13:01	5,64	1	5,64	CHI
20200973325	PADRE BERNARDO	PB12330893	PADRE BERNARDO	23/09/2020 07:23	23/09/2020 14:36	23/09/2020 07:23	23/09/2020 14:36	7,20	4	28,81	CHI
20200976775	HIDROLINA	HL12000009	URUACU	23/09/2020 07:23	23/09/2020 19:04	23/09/2020 07:23	23/09/2020 19:04	11,67	4	46,67	CHI
20200973342	ARAGARCAS	1820057401	ARAGARCAS	23/09/2020 07:27	23/09/2020 17:31	23/09/2020 07:27	23/09/2020 17:31	10,06	1	10,06	CHI
20200973345	ACREUNA	EU12000067	ACREUNA	23/09/2020 07:27	23/09/2020 09:36	23/09/2020 07:27	23/09/2020 09:36	2,14	494	1055,79	CHI
20200973352	ESTRELA DO NORTE	ET21187899	MARA ROSA	23/09/2020 07:28	24/09/2020 17:04	23/09/2020 07:28	24/09/2020 17:04	33,60	1	33,60	CHI
20200973360	UIRAPURU	UP21257292	SANTA TEREZINHA	23/09/2020 07:28	23/09/2020 21:30	23/09/2020 07:28	23/09/2020 21:30	14,02	2	28,04	CHI
20200973370	TROMBAS	MX12240734	PORANGATU	23/09/2020 07:30	24/09/2020 16:02	23/09/2020 07:30	24/09/2020 16:02	32,53	1	32,53	CHI
20200973370	MONTIVIDIU DO NORTE	MX12240734	PORANGATU	23/09/2020 07:30	24/09/2020 16:02	23/09/2020 07:30	24/09/2020 16:02	32,53	7	227,70	CHI
20200973376	CRIXAS	NA13245196	NOVA CRIXAS	23/09/2020 07:30	23/09/2020 09:04	23/09/2020 08:57	23/09/2020 09:04	0,12	1	0,12	CHI
20200973376	NOVA CRIXAS	NA13245196	NOVA CRIXAS	23/09/2020 07:30	23/09/2020 09:04	23/09/2020 08:57	23/09/2020 09:04	0,12	1	0,12	CHI
20200973376	UIRAPURU	NA13245196	NOVA CRIXAS	23/09/2020 07:30	23/09/2020 09:04	23/09/2020 08:57	23/09/2020 09:04	0,12	59	6,87	CHI
20200973843	SANTA FE DE GOIAS	RN12009764	BRITANIA	23/09/2020 07:32	23/09/2020 10:01	23/09/2020 07:32	23/09/2020 10:01	2,48	6	14,89	CHI
20200973392	SANTA TEREZINHA DE GOIAS	2480026146	SANTA TEREZINHA	23/09/2020 07:32	23/09/2020 20:51	23/09/2020 07:32	23/09/2020 20:51	13,31	1	13,31	CHI
20200973402	UIRAPURU	UP12391844	SANTA TEREZINHA	23/09/2020 07:32	23/09/2020 11:37	23/09/2020 07:32	23/09/2020 11:37	4,07	6	24,41	CHI
20200973407	MINEIROS	MY12360720RE	PARQUE DAS EMAS	23/09/2020 07:33	23/09/2020 09:36	23/09/2020 07:33	23/09/2020 09:36	2,05	4	8,18	CHI
20200973412	MINEIROS	MY12209687	PARQUE DAS EMAS	23/09/2020 07:33	23/09/2020 13:36	23/09/2020 07:33	23/09/2020 13:36	6,03	9	54,31	CHI
20200973413	ANAPOLIS	AN21241546	ANAPOLIS UNIVERSITARIO S2	23/09/2020 07:33	23/09/2020 14:32	23/09/2020 07:33	23/09/2020 14:32	6,97	4	27,89	CHI
20200973414	RIO VERDE	RV21231000	MONTIVIDIU T	23/09/2020 07:33	23/09/2020 11:48	23/09/2020 07:33	23/09/2020 11:48	4,23	1	4,23	CHI
202009107094	PADRE BERNARDO	PB13033195	PADRE BERNARDO	23/09/2020 07:34	23/09/2020 19:48	23/09/2020 07:34	23/09/2020 15:26	7,86	1103	8673,87	CHI
202009107094	PLANALTINA	PB13033195	PADRE BERNARDO	23/09/2020 07:34	23/09/2020 19:48	23/09/2020 07:34	23/09/2020 19:48	12,23	69	843,85	CHI
202009107094	PADRE BERNARDO	PB13033195	PADRE BERNARDO	23/09/2020 07:34	23/09/2020 19:48	23/09/2020 07:34	23/09/2020 19:48	12,23	324	3962,43	CHI
20200973421	VALPARAISO DE GOIAS	10002555393	PACAEMBU S2	23/09/2020 07:34	23/09/2020 11:09	23/09/2020 07:34	23/09/2020 11:09	3,58	1	3,58	CHI
20200973432	PALMEIRAS DE GOIAS	PP21007102	PALMEIRAS	23/09/2020 07:35	23/09/2020 14:13	23/09/2020 07:35	23/09/2020 14:13	6,63	1	6,63	CHI

INTERNAL

20200973445	PIRENOPOLIS	PV21266571	CORUMBA	23/09/2020 07:36	23/09/2020 09:59	23/09/2020 07:36	23/09/2020 09:59	2,38	1	2,38	CHI
20200974591	JATAI	JT12286459	CABRIUVA S2	23/09/2020 07:36	23/09/2020 13:11	23/09/2020 07:36	23/09/2020 13:11	5,58	9	50,19	CHI
20200973457	GAMELEIRA DE GOIAS	GL21313072	DAIA S2	23/09/2020 07:37	23/09/2020 09:23	23/09/2020 07:37	23/09/2020 09:23	1,76	1	1,76	CHI
20200973464	ACREUNA	EU12045007	ACREUNA	23/09/2020 07:38	23/09/2020 17:30	23/09/2020 07:38	23/09/2020 17:30	9,86	4	39,46	CHI
20200973467	FAINA	FC21123754	GOIAS	23/09/2020 07:38	23/09/2020 09:42	23/09/2020 07:38	23/09/2020 09:42	2,06	1	2,06	CHI
20200973473	CRIXAS	2490022927	SERRA DO OURO	23/09/2020 07:38	24/09/2020 18:26	23/09/2020 07:38	24/09/2020 18:26	34,78	1	34,78	CHI
20200973478	JARAGUA	70015636	JARAGUA	23/09/2020 07:39	23/09/2020 11:22	23/09/2020 07:39	23/09/2020 11:22	3,71	1	3,71	CHI
20200973597	FLORES DE GOIAS	FB12245566	IACIARA S2	23/09/2020 07:39	23/09/2020 10:14	23/09/2020 07:39	23/09/2020 10:14	2,57	73	187,77	CHI
20200973597	SITIO D ABADIA	FB12245566	IACIARA S2	23/09/2020 07:39	23/09/2020 10:14	23/09/2020 07:39	23/09/2020 10:14	2,57	38	97,74	CHI
20200973486	GOIANAPOLIS	GP12234972	DAIA S2	23/09/2020 07:40	23/09/2020 12:56	23/09/2020 07:40	23/09/2020 12:56	5,26	1	5,26	CHI
20200973496	CRISTALINA	KR12118520	PAMPLONA	23/09/2020 07:41	23/09/2020 15:30	23/09/2020 07:41	23/09/2020 15:30	7,81	2	15,63	CHI
20200973506	ESTRELA DO NORTE	2420007470	MARA ROSA	23/09/2020 07:41	23/09/2020 13:56	23/09/2020 07:41	23/09/2020 13:56	6,24	1	6,24	CHI
20200973510	NOVO GAMA	2460041221	PACAEMBU S1	23/09/2020 07:42	23/09/2020 09:40	23/09/2020 07:42	23/09/2020 09:40	1,96	1	1,96	CHI
20200973521	CABECEIRAS	CW21381539	ITIQUEIRA	23/09/2020 07:43	23/09/2020 14:22	23/09/2020 07:43	23/09/2020 14:22	6,64	2	13,28	CHI
20200973541	CABECEIRAS	CW21151429	ITIQUEIRA	23/09/2020 07:45	23/09/2020 16:58	23/09/2020 07:45	23/09/2020 16:58	9,21	1	9,21	CHI
20200973549	TURVANIA	1220001913	FIRMINOPOLIS S2	23/09/2020 07:45	23/09/2020 12:23	23/09/2020 07:45	23/09/2020 12:23	4,62	1	4,62	CHI
20200974330	ACREUNA	EU11135963	ACREUNA	23/09/2020 07:45	23/09/2020 11:28	23/09/2020 07:45	23/09/2020 11:28	3,70	82	303,49	CHI
202009106888	PALMEIRAS DE GOIAS	PL21304483	PALMEIRAS	23/09/2020 07:46	24/09/2020 02:39	23/09/2020 07:46	24/09/2020 02:39	18,88	1	18,88	CHI
20200973576	TURVELANDIA	SH12301310	SANTA HELENA S1	23/09/2020 07:47	23/09/2020 13:03	23/09/2020 07:47	23/09/2020 13:03	5,25	5	26,26	CHI
20200973577	SANTA HELENA DE GOIAS	SH12271332	IPEGUARI	23/09/2020 07:48	23/09/2020 10:36	23/09/2020 07:48	23/09/2020 10:36	2,80	4	11,19	CHI
20200973578	MINEIROS	MY21374011	PARQUE DAS EMAS	23/09/2020 07:48	23/09/2020 18:30	23/09/2020 07:48	23/09/2020 18:30	10,70	2	21,39	CHI
20200973579	ACREUNA	2440060404	ACREUNA	23/09/2020 07:48	23/09/2020 13:13	23/09/2020 07:48	23/09/2020 13:13	5,41	1	5,41	CHI
20200973982	ALEXANIA	480028047	ALEXANIA	23/09/2020 07:48	23/09/2020 13:45	23/09/2020 07:48	23/09/2020 13:45	5,95	1	5,95	CHI
20200973589	CIDADE OCIDENTAL	2680137766	MARAJOARA	23/09/2020 07:48	23/09/2020 10:49	23/09/2020 07:48	23/09/2020 10:49	3,00	1	3,00	CHI
20200973593	NOVA GLORIA	NG21181410	RUBIATABA	23/09/2020 07:49	23/09/2020 16:07	23/09/2020 07:49	23/09/2020 16:07	8,29	1	8,29	CHI
20200973594	AGUA FRIA DE GOIAS	TL21321474	SAO JOAO D ALIANCA	23/09/2020 07:49	23/09/2020 15:23	23/09/2020 07:49	23/09/2020 15:23	7,56	1	7,56	CHI
20200973595	CABECEIRAS	CW21181828	ITIQUEIRA	23/09/2020 07:49	23/09/2020 18:31	23/09/2020 07:49	23/09/2020 18:31	10,69	1	10,69	CHI
20200973726	NOVA GLORIA	NG12181395	RUBIATABA	23/09/2020 07:50	23/09/2020 14:47	23/09/2020 07:50	23/09/2020 14:47	6,95	5	34,74	CHI
20200973609	PEROLANDIA	DP12254641	JATAI S1	23/09/2020 07:50	23/09/2020 09:08	23/09/2020 07:50	23/09/2020 09:08	1,29	28	35,98	CHI
20200973616	NOVA CRIXAS	NA21158720	NOVA CRIXAS	23/09/2020 07:51	23/09/2020 09:20	23/09/2020 07:51	23/09/2020 09:20	1,47	1	1,47	CHI
20200973627	CRISTALINA	KR21336015	CRISTALINA S2	23/09/2020 07:52	23/09/2020 10:21	23/09/2020 07:52	23/09/2020 10:21	2,48	1	2,48	CHI
20200976891	FORMOSA	FA12204758	ITIQUEIRA	23/09/2020 07:52	23/09/2020 18:19	23/09/2020 07:52	23/09/2020 18:19	10,44	19	198,40	CHI
20200973930	ANAPOLIS	AN12096740	JUNDIAI S2	23/09/2020 07:52	23/09/2020 12:16	23/09/2020 07:52	23/09/2020 12:16	4,39	21	92,13	CHI

INTERNAL

20200974794	MONTES CLAROS DE GOIAS	ME12334772	ARENOPOLIS	23/09/2020 07:53	23/09/2020 14:51	23/09/2020 07:53	23/09/2020 14:51	6,95	11	76,50	CHI
20200973660	RIO VERDE	RV12000192	RIO VERDE S1	23/09/2020 07:55	23/09/2020 15:16	23/09/2020 07:55	23/09/2020 15:16	7,34	20	146,77	CHI
20200973664	FLORES DE GOIAS	FB11286858	FLORES DE GOIAS	23/09/2020 07:55	23/09/2020 11:50	23/09/2020 07:55	23/09/2020 11:50	3,90	1	3,90	CHI
20200973671	FORMOSO	FO21137204	MARA ROSA	23/09/2020 07:56	25/09/2020 09:30	23/09/2020 07:56	25/09/2020 09:30	49,55	1	49,55	CHI
20200973684	CRISTALINA	10013146970	CRISTALINA S1	23/09/2020 07:57	23/09/2020 12:13	23/09/2020 07:57	23/09/2020 12:13	4,25	1	4,25	CHI
20200973694	RIO VERDE	630311390	RIO VERDE S2	23/09/2020 07:58	23/09/2020 15:17	23/09/2020 07:58	23/09/2020 15:17	7,31	1	7,31	CHI
20200973700	ITABERAI	10000725550	ITABERAI S2	23/09/2020 07:59	23/09/2020 09:07	23/09/2020 07:59	23/09/2020 09:07	1,13	1	1,13	CHI
20200973923	CRISTALINA	KR12383045	CRISTALINA S2	23/09/2020 07:59	23/09/2020 16:15	23/09/2020 07:59	23/09/2020 16:15	8,26	12	99,16	CHI
20200973706	MARA ROSA	MQ21192449	MARA ROSA	23/09/2020 07:59	24/09/2020 15:04	23/09/2020 07:59	24/09/2020 15:04	31,07	1	31,07	CHI
20200973712	PEROLANDIA	MY21172849	PARQUE DAS EMAS	23/09/2020 08:00	24/09/2020 04:17	23/09/2020 08:00	24/09/2020 04:17	20,28	1	20,28	CHI
20200973714	GOIAS	GS21259597	ITABERAI S1	23/09/2020 08:00	23/09/2020 09:35	23/09/2020 08:00	23/09/2020 09:35	1,57	1	1,57	CHI
20200973718	SAO LUIS DE MONTES BELOS	SL12111553	FIRMINOPOLIS S1	23/09/2020 08:00	23/09/2020 11:26	23/09/2020 08:00	23/09/2020 11:26	3,42	7	23,94	CHI
20200973729	PORTELANDIA	PW12374317RE	PARQUE DAS EMAS	23/09/2020 08:01	23/09/2020 16:32	23/09/2020 08:01	23/09/2020 16:32	8,51	4	34,02	CHI
20200973729	PEROLANDIA	PW12374317RE	PARQUE DAS EMAS	23/09/2020 08:01	23/09/2020 16:32	23/09/2020 08:01	23/09/2020 16:32	8,51	3	25,52	CHI
20200973729	MINEIROS	PW12374317RE	PARQUE DAS EMAS	23/09/2020 08:01	23/09/2020 16:32	23/09/2020 08:01	23/09/2020 16:32	8,51	9	76,55	CHI
20200973739	PIRENOPOLIS	PV12093297	SAO FRANCISCO DE GOIAS	23/09/2020 08:01	23/09/2020 09:02	23/09/2020 08:01	23/09/2020 09:02	1,00	6	6,00	CHI
20200974054	DOVERLANDIA	DV12155481	CAIAPONIA	23/09/2020 08:02	23/09/2020 13:52	23/09/2020 08:02	23/09/2020 13:52	5,83	5	29,17	CHI
20200973737	FORMOSA	610243342	ITUIQUIRA	23/09/2020 08:02	23/09/2020 09:44	23/09/2020 08:02	23/09/2020 09:44	1,69	1	1,69	CHI
20200973741	LUZIANIA	3200116156	RIO VERMELHO	23/09/2020 08:02	23/09/2020 09:42	23/09/2020 08:02	23/09/2020 09:42	1,65	1	1,65	CHI
20200973744	ITAJA	IJ21017219	ITAJA S2	23/09/2020 08:03	23/09/2020 13:47	23/09/2020 08:03	23/09/2020 13:47	5,73	1	5,73	CHI
20200970465	RIO VERDE	RV12021124	SANTA HELENA S1	23/09/2020 08:03	23/09/2020 15:16	23/09/2020 08:03	23/09/2020 15:16	7,22	8	57,76	CHI
20200973749	VILA PROPICIO	NP11228029	GOIANESIA S1	23/09/2020 08:03	23/09/2020 16:33	23/09/2020 08:03	23/09/2020 16:33	8,50	1	8,50	CHI
20200973760	PORANGATU	PO21115473	PORANGATU	23/09/2020 08:04	23/09/2020 17:52	23/09/2020 08:04	23/09/2020 17:52	9,80	1	9,80	CHI
20200973763	PIRENOPOLIS	PV21297987	SAO FRANCISCO DE GOIAS	23/09/2020 08:04	23/09/2020 11:46	23/09/2020 08:04	23/09/2020 11:46	3,69	2	7,39	CHI
20200973766	PLANALTINA	2960144655	PLANALTINA	23/09/2020 08:04	23/09/2020 11:25	23/09/2020 08:04	23/09/2020 11:25	3,34	1	3,34	CHI
20200974033	ARENOPOLIS	AY12380961	ARENOPOLIS	23/09/2020 08:04	23/09/2020 19:49	23/09/2020 08:04	23/09/2020 19:49	11,74	2	23,48	CHI
20200974033	PALESTINA DE GOIAS	AY12380961	ARENOPOLIS	23/09/2020 08:04	23/09/2020 19:49	23/09/2020 08:04	23/09/2020 19:49	11,74	3	35,22	CHI
20200973777	NAZARIO	440010123	ANICUNS	23/09/2020 08:05	23/09/2020 09:26	23/09/2020 08:05	23/09/2020 09:26	1,35	1	1,35	CHI
20200975163	SANTA TEREZA DE GOIAS	ET12143710	MARA ROSA	23/09/2020 08:05	24/09/2020 10:59	23/09/2020 08:05	24/09/2020 10:59	26,89	4	107,57	CHI
20200975163	ESTRELA DO NORTE	ET12143710	MARA ROSA	23/09/2020 08:05	24/09/2020 10:59	23/09/2020 08:05	24/09/2020 10:59	26,89	4	107,57	CHI
20200973789	URUACU	UR21279148	URUACU	23/09/2020 08:05	24/09/2020 12:37	23/09/2020 08:05	24/09/2020 12:37	28,52	5	142,61	CHI
20200973791	ARAGARCAS	1820034747	ARAGARCAS	23/09/2020 08:06	23/09/2020 17:35	23/09/2020 08:06	23/09/2020 17:35	9,48	1	9,48	CHI
20200973815	CIDADE OCIDENTAL	2680031095	MARAJOARA	23/09/2020 08:07	23/09/2020 13:45	23/09/2020 08:07	23/09/2020 13:45	5,63	1	5,63	CHI

INTERNAL

20200973825	IPORA	730071765	IPORA	23/09/2020 08:08	23/09/2020 10:26	23/09/2020 08:08	23/09/2020 10:26	2,30	1	2,30	CHI
20200973829	RIO VERDE	630053650	RIO VERDE S2	23/09/2020 08:08	23/09/2020 17:23	23/09/2020 08:08	23/09/2020 17:23	9,24	1	9,24	CHI
20200973835	GOIANESIA	GE21000102	GOIANESIA S1	23/09/2020 08:09	23/09/2020 10:46	23/09/2020 08:09	23/09/2020 10:46	2,62	1	2,62	CHI
20200973837	GOIAS	GS11162322	GOIAS	23/09/2020 08:09	23/09/2020 13:19	23/09/2020 08:09	23/09/2020 13:19	5,17	1	5,17	CHI
20200973838	LUZIANIA	LZ11149879	RIO VERMELHO	23/09/2020 08:09	23/09/2020 14:21	23/09/2020 08:09	23/09/2020 14:21	6,21	13	80,73	CHI
20200973841	IPORA	730082933	IPORA	23/09/2020 08:09	23/09/2020 17:04	23/09/2020 08:09	23/09/2020 17:04	8,91	1	8,91	CHI
20200973845	VALPARAISO DE GOIAS	10007928864	PACAEMBU S2	23/09/2020 08:10	23/09/2020 09:50	23/09/2020 08:10	23/09/2020 09:50	1,67	1	1,67	CHI
20200973861	PETROLINA DE GOIAS	320017552	PETROLINA	23/09/2020 08:11	23/09/2020 19:17	23/09/2020 08:11	23/09/2020 19:17	11,09	1	11,09	CHI
20200973864	ITABERAI	IB21337298	ITABERAI S2	23/09/2020 08:11	23/09/2020 11:09	23/09/2020 08:11	23/09/2020 11:09	2,95	1	2,95	CHI
20200973866	FORMOSA	10020414690	ITUIQUIRA	23/09/2020 08:12	23/09/2020 12:09	23/09/2020 08:12	23/09/2020 12:09	3,95	1	3,95	CHI
20200973896	SANTA RITA DO ARAGUAIA	SU12306507RE	SANTA RITA DO ARAGUAIA	23/09/2020 08:12	23/09/2020 11:10	23/09/2020 08:12	23/09/2020 11:10	2,96	15	44,47	CHI
20200973872	VALPARAISO DE GOIAS	2860046659	MARAJOARA	23/09/2020 08:12	23/09/2020 10:11	23/09/2020 08:12	23/09/2020 10:11	1,97	1	1,97	CHI
20200973877	ITAGUARI	IC21250670	ITABERAI S1	23/09/2020 08:13	23/09/2020 11:37	23/09/2020 08:13	23/09/2020 11:37	3,40	3	10,19	CHI
20200973888	MOZARLANDIA	410017243	MOZARLANDIA	23/09/2020 08:13	23/09/2020 15:01	23/09/2020 08:13	23/09/2020 15:01	6,78	1	6,78	CHI
20200973889	UIRAPURU	4210001595	NOVA CRIXAS	23/09/2020 08:14	23/09/2020 11:31	23/09/2020 08:14	23/09/2020 11:31	3,28	1	3,28	CHI
20200973898	FORMOSA	610188100	ITUIQUIRA	23/09/2020 08:14	23/09/2020 15:13	23/09/2020 08:14	23/09/2020 15:13	6,97	1	6,97	CHI
20200973897	MONTIVIDIU	MV11301687	MONTIVIDIU T	23/09/2020 08:14	23/09/2020 09:51	23/09/2020 08:14	23/09/2020 09:51	1,61	62	99,63	CHI
20200973903	ESTRELA DO NORTE	ET12182462	MARA ROSA	23/09/2020 08:15	24/09/2020 15:01	23/09/2020 08:15	24/09/2020 15:01	30,76	3	92,29	CHI
20200973912	LUZIANIA	120142041	RIO VERMELHO	23/09/2020 08:15	23/09/2020 09:38	23/09/2020 08:15	23/09/2020 09:38	1,37	1	1,37	CHI
20200973992	MONTIVIDIU	MV12267740	MONTIVIDIU T	23/09/2020 08:15	23/09/2020 11:31	23/09/2020 08:15	23/09/2020 11:31	3,25	1	3,25	CHI
20200973992	CAIAPONIA	MV12267740	MONTIVIDIU T	23/09/2020 08:15	23/09/2020 11:31	23/09/2020 08:15	23/09/2020 11:31	3,25	11	35,78	CHI
20200973920	LUZIANIA	3200086139	MARAJOARA	23/09/2020 08:15	23/09/2020 10:48	23/09/2020 08:15	23/09/2020 10:48	2,53	1	2,53	CHI
20200973924	PLANALTINA	PI21359586	SAO JOAO D ALIANCA	23/09/2020 08:16	23/09/2020 11:20	23/09/2020 08:16	23/09/2020 11:20	3,06	1	3,06	CHI
20200976362	ABADIANIA	AA12327809	DAIA S2	23/09/2020 08:16	23/09/2020 20:45	23/09/2020 08:16	23/09/2020 20:45	12,47	14	174,63	CHI
20200973933	SANTO ANTONIO DO DESCOBERTO	SN21214800	ALEXANIA	23/09/2020 08:16	23/09/2020 13:14	23/09/2020 08:16	23/09/2020 13:14	4,95	2	9,90	CHI
20200973936	RIO VERDE	630230936	RIO VERDE S1	23/09/2020 08:17	23/09/2020 10:33	23/09/2020 08:17	23/09/2020 10:33	2,27	1	2,27	CHI
20200973939	ACREUNA	3330004792	ACREUNA	23/09/2020 08:17	23/09/2020 12:56	23/09/2020 08:17	23/09/2020 12:56	4,65	1	4,65	CHI
20200977095	HIDROLINA	HL21284754	URUACU	23/09/2020 08:17	23/09/2020 16:14	23/09/2020 08:17	23/09/2020 16:14	7,94	1	7,94	CHI
20200973956	AMERICANO DO BRASIL	KB21107299	ANICUNS	23/09/2020 08:18	23/09/2020 18:00	23/09/2020 08:18	23/09/2020 18:00	9,71	2	19,41	CHI
20200973969	MINACU	4020060758	MINACU	23/09/2020 08:19	23/09/2020 19:34	23/09/2020 08:19	23/09/2020 19:34	11,25	1	11,25	CHI
20200974941	PORANGATU	PO12328896	PORANGATU	23/09/2020 08:19	23/09/2020 12:39	23/09/2020 08:19	23/09/2020 12:39	4,32	7	30,27	CHI
20200973985	ANAPOLIS	20466286	JUNDIAI S2	23/09/2020 08:19	23/09/2020 16:43	23/09/2020 08:19	23/09/2020 16:43	8,39	1	8,39	CHI
20200973991	LUZIANIA	LZ12351273	MARAJOARA	23/09/2020 08:20	23/09/2020 19:48	23/09/2020 08:20	23/09/2020 19:48	11,47	6	68,82	CHI

INTERNAL

20200974002	CIDADE OCIDENTAL	2680039495	MARAJOARA	23/09/2020 08:21	23/09/2020 10:57	23/09/2020 08:21	23/09/2020 10:57	2,60	1	2,60	CHI
20200974004	JANDAIA	JD12199849	ACREUNA	23/09/2020 08:21	24/09/2020 16:49	23/09/2020 08:21	24/09/2020 16:49	32,47	5	162,33	CHI
20200974007	GOIANESIA	GE11334985	GOIANESIA S1	23/09/2020 08:21	23/09/2020 10:47	23/09/2020 08:21	23/09/2020 10:47	2,42	105	254,57	CHI
20200974009	FIRMINOPOLIS	900027216	FIRMINOPOLIS S1	23/09/2020 08:21	23/09/2020 11:31	23/09/2020 08:21	23/09/2020 11:31	3,15	1	3,15	CHI
20200974011	SAO JOAO DA PARAUNA	FR12040685	FIRMINOPOLIS S2	23/09/2020 08:21	23/09/2020 17:40	23/09/2020 08:21	23/09/2020 17:40	9,30	6	55,81	CHI
20200974031	LUZIANIA	3200143548	MARAJOARA	23/09/2020 08:23	23/09/2020 11:19	23/09/2020 08:23	23/09/2020 11:19	2,92	1	2,92	CHI
20200974038	SANTA TEREZINHA DE GOIAS	SG21190162	SANTA TEREZINHA	23/09/2020 08:23	24/09/2020 11:16	23/09/2020 08:23	24/09/2020 11:16	26,87	1	26,87	CHI
20200974037	CORUMBA DE GOIAS	AX12061965	CORUMBA	23/09/2020 08:23	23/09/2020 10:49	23/09/2020 08:23	23/09/2020 10:49	2,42	2	4,84	CHI
20200974036	VALPARAISO DE GOIAS	2860213205	MARAJOARA	23/09/2020 08:23	23/09/2020 09:52	23/09/2020 08:23	23/09/2020 09:52	1,47	1	1,47	CHI
20200974043	MONTE ALEGRE DE GOIAS	MA12358005	SAO DOMINGOS	23/09/2020 08:23	23/09/2020 11:19	23/09/2020 08:23	23/09/2020 11:19	2,92	2	5,84	CHI
20200974046	CACU	CC21322238	CACHOEIRA ALTA	23/09/2020 08:23	23/09/2020 11:07	23/09/2020 08:23	23/09/2020 11:07	2,72	1	2,72	CHI
20200974109	MARA ROSA	ET12000003	MARA ROSA	23/09/2020 08:23	24/09/2020 12:19	23/09/2020 08:23	24/09/2020 12:19	27,92	2	55,83	CHI
20200974109	ESTRELA DO NORTE	ET12000003	MARA ROSA	23/09/2020 08:23	24/09/2020 12:19	23/09/2020 08:23	24/09/2020 12:19	27,92	1	27,92	CHI
20200974056	FORMOSA	610285816	ITUIQUIRA	23/09/2020 08:24	23/09/2020 14:34	23/09/2020 08:24	23/09/2020 14:34	6,16	1	6,16	CHI
20200974956	PORANGATU	PO11374534	PORANGATU	23/09/2020 08:24	23/09/2020 20:53	23/09/2020 08:24	23/09/2020 20:53	12,47	47	585,96	CHI
20200974100	FIRMINOPOLIS	AI12039582LD	FIRMINOPOLIS S2	23/09/2020 08:25	23/09/2020 17:36	23/09/2020 08:25	23/09/2020 17:36	9,18	4	36,73	CHI
20200974100	AURILANDIA	AI12039582LD	FIRMINOPOLIS S2	23/09/2020 08:25	23/09/2020 17:36	23/09/2020 08:25	23/09/2020 17:36	9,18	11	101,01	CHI
20200974064	UIRAPURU	UP21252554	SANTA TEREZINHA	23/09/2020 08:25	24/09/2020 12:17	23/09/2020 08:25	24/09/2020 12:17	27,86	1	27,86	CHI
20200974996	ACREUNA	EU12214065	ACREUNA	23/09/2020 08:25	23/09/2020 16:04	23/09/2020 08:25	23/09/2020 16:04	7,65	5	38,24	CHI
20200974074	URUACU	640122401	URUACU	23/09/2020 08:25	23/09/2020 12:05	23/09/2020 08:25	23/09/2020 12:05	3,67	1	3,67	CHI
20200974675	JARAGUA	JA11345534	JARAGUA	23/09/2020 08:25	23/09/2020 11:03	23/09/2020 08:25	23/09/2020 11:03	2,62	45	118,09	CHI
20200974221	MUTUNOPOLIS	MU12129781	MARA ROSA	23/09/2020 08:26	25/09/2020 02:11	23/09/2020 08:26	25/09/2020 02:11	41,75	7	292,25	CHI
20200974092	LEOPOLDO DE BULHOES	950033625	DAIA S2	23/09/2020 08:26	23/09/2020 15:36	23/09/2020 08:26	23/09/2020 15:36	7,15	1	7,15	CHI
20200974094	SAO LUIS DE MONTES BELOS	500079122	SAO LUIZ DOS MONTES BELOS	23/09/2020 08:26	23/09/2020 15:13	23/09/2020 08:26	23/09/2020 15:13	6,77	1	6,77	CHI
20200974095	RIO VERDE	630101772	RIO VERDE S2	23/09/2020 08:27	23/09/2020 12:04	23/09/2020 08:27	23/09/2020 12:04	3,62	1	3,62	CHI
20200974102	TEREZOPOLIS DE GOIAS	GP12011844	JUNDIAI S1	23/09/2020 08:27	24/09/2020 09:32	23/09/2020 08:27	24/09/2020 09:32	25,08	3	75,23	CHI
20200974102	TEREZOPOLIS DE GOIAS	GP12011844	JUNDIAI S1	23/09/2020 08:27	24/09/2020 09:32	24/09/2020 09:14	24/09/2020 09:32	0,29	15	4,41	CHI
20200974111	CACU	CC21161598	CACHOEIRA ALTA	23/09/2020 08:28	23/09/2020 11:49	23/09/2020 08:28	23/09/2020 11:49	3,35	1	3,35	CHI
20200974152	MARA ROSA	LC12308828	MARA ROSA	23/09/2020 08:28	23/09/2020 23:32	23/09/2020 08:28	23/09/2020 23:32	15,06	1	15,06	CHI
20200974152	AMARALINA	LC12308828	MARA ROSA	23/09/2020 08:28	23/09/2020 23:32	23/09/2020 08:28	23/09/2020 23:32	15,06	2	30,11	CHI
20200974135	CACHOEIRA ALTA	CA12200649	CACHOEIRA ALTA	23/09/2020 08:29	23/09/2020 12:41	23/09/2020 08:29	23/09/2020 12:41	4,19	2	8,38	CHI
20200974137	PORANGATU	840077750	PORANGATU	23/09/2020 08:29	24/09/2020 09:11	23/09/2020 08:29	24/09/2020 09:11	24,69	1	24,69	CHI
20200974154	MINEIROS	MY12324458	PARQUE DAS EMAS	23/09/2020 08:30	23/09/2020 18:18	23/09/2020 08:30	23/09/2020 18:18	9,78	1	9,78	CHI

INTERNAL

20200974156	DIORAMA	DI12245747	IPORA	23/09/2020 08:31	23/09/2020 17:41	23/09/2020 08:31	23/09/2020 17:41	9,16	1	9,16	CHI
20200974164	PETROLINA DE GOIAS	320014423	PETROLINA	23/09/2020 08:31	23/09/2020 19:59	23/09/2020 08:31	23/09/2020 19:59	11,46	1	11,46	CHI
20200974168	CRISTALINA	1060032561	CRISTALINA S1	23/09/2020 08:31	23/09/2020 10:39	23/09/2020 08:31	23/09/2020 10:39	2,12	1	2,12	CHI
20200974169	SAO JOAO D ALIANCA	JL21144678	SAO JOAO D ALIANCA	23/09/2020 08:32	23/09/2020 21:28	23/09/2020 08:32	23/09/2020 21:28	12,93	1	12,93	CHI
20200974474	PORANGATU	PO11208439	PORANGATU	23/09/2020 08:32	23/09/2020 12:17	23/09/2020 08:32	23/09/2020 12:17	3,75	112	419,84	CHI
20200973940	HIDROLINA	HL21272690	URUACU	23/09/2020 08:32	23/09/2020 15:44	23/09/2020 08:32	23/09/2020 15:44	7,19	1	7,19	CHI
20200974176	JARAGUA	70034047	JARAGUA	23/09/2020 08:32	23/09/2020 12:28	23/09/2020 08:32	23/09/2020 12:28	3,92	1	3,92	CHI
20200974181	ITAGUARU	IC21065764	ITABERAI S1	23/09/2020 08:33	23/09/2020 11:52	23/09/2020 08:33	23/09/2020 11:52	3,31	2	6,62	CHI
20200974351	ITARUMA	CA12296034LD	CACHOEIRA ALTA	23/09/2020 08:33	23/09/2020 10:33	23/09/2020 08:33	23/09/2020 10:33	1,99	7	13,96	CHI
20200974351	CACU	CA12296034LD	CACHOEIRA ALTA	23/09/2020 08:33	23/09/2020 10:33	23/09/2020 08:33	23/09/2020 10:33	1,99	54	107,65	CHI
20200974351	CACHOEIRA ALTA	CA12296034LD	CACHOEIRA ALTA	23/09/2020 08:33	23/09/2020 10:33	23/09/2020 08:33	23/09/2020 10:33	1,99	117	233,25	CHI
20200974191	ANAPOLIS	20239105	JUNDIAI S2	23/09/2020 08:33	23/09/2020 17:45	23/09/2020 08:33	23/09/2020 17:45	9,19	1	9,19	CHI
20200974194	MONTIVIDIU	MV21267736	MONTIVIDIU T	23/09/2020 08:33	23/09/2020 12:04	23/09/2020 08:33	23/09/2020 12:04	3,50	1	3,50	CHI
20200974196	TURVANIA	1220013680	FIRMINOPOLIS S2	23/09/2020 08:34	23/09/2020 16:47	23/09/2020 08:34	23/09/2020 16:47	8,21	1	8,21	CHI
20200974198	IPORA	730043964	IPORA	23/09/2020 08:34	23/09/2020 09:49	23/09/2020 08:34	23/09/2020 09:49	1,24	1	1,24	CHI
20200975118	SAO LUIS DE MONTES BELOS	SL12388880	SAO LUIZ DOS MONTES BELOS	23/09/2020 08:34	23/09/2020 11:21	23/09/2020 08:34	23/09/2020 11:21	2,77	679	1883,28	CHI
20200974215	CARMO DO RIO VERDE	IK12170874	ITAPURANGA	23/09/2020 08:35	23/09/2020 14:42	23/09/2020 08:35	23/09/2020 14:42	6,10	12	73,23	CHI
20200974211	FIRMINOPOLIS	900008325	FIRMINOPOLIS S1	23/09/2020 08:35	23/09/2020 14:03	23/09/2020 08:35	23/09/2020 14:03	5,45	1	5,45	CHI
20200974226	SAO LUIS DE MONTES BELOS	500029489	SAO LUIZ DOS MONTES BELOS	23/09/2020 08:37	23/09/2020 16:06	23/09/2020 08:37	23/09/2020 16:06	7,48	1	7,48	CHI
20200974232	ITAPACI	100041978	ITAPACI	23/09/2020 08:37	24/09/2020 10:28	23/09/2020 08:37	24/09/2020 10:28	25,84	1	25,84	CHI
20200974235	MONTES CLAROS DE GOIAS	ME21184432	IPORA	23/09/2020 08:37	23/09/2020 10:45	23/09/2020 08:37	23/09/2020 10:45	2,12	1	2,12	CHI
20200974244	FORMOSA	610006873	ITUIQUIRA	23/09/2020 08:38	23/09/2020 14:45	23/09/2020 08:38	23/09/2020 14:45	6,11	1	6,11	CHI
20200974249	SAO LUIS DE MONTES BELOS	500084830	SAO LUIZ DOS MONTES BELOS	23/09/2020 08:39	23/09/2020 12:00	23/09/2020 08:39	23/09/2020 12:00	3,36	1	3,36	CHI
20200974251	RIO VERDE	630150151	RIO VERDE S2	23/09/2020 08:39	23/09/2020 19:16	23/09/2020 08:39	23/09/2020 19:16	10,61	1	10,61	CHI
20200974272	NAZARIO	NZ21279052	ANICUNS	23/09/2020 08:41	23/09/2020 11:12	23/09/2020 08:41	23/09/2020 11:12	2,51	2	5,02	CHI
20200974277	RIO VERDE	RV12093109	MONTIVIDIU T	23/09/2020 08:41	23/09/2020 13:58	23/09/2020 08:41	23/09/2020 13:58	5,27	4	21,08	CHI
20200974284	JARAGUA	JA21294759	SAO FRANCISCO DE GOIAS	23/09/2020 08:42	23/09/2020 12:48	23/09/2020 08:42	23/09/2020 12:48	4,10	1	4,10	CHI
20200974285	SANTO ANTONIO DO DESCOBERTO	2210060315	AGUAS LINDAS DE GOIAS S2	23/09/2020 08:42	23/09/2020 14:38	23/09/2020 08:42	23/09/2020 14:38	5,93	1	5,93	CHI
20200974287	LUZIANIA	120132515	RIO VERMELHO	23/09/2020 08:42	23/09/2020 09:56	23/09/2020 08:42	23/09/2020 09:56	1,23	1	1,23	CHI
20200974290	JATAI	JT12184205	JATAI S1	23/09/2020 08:42	23/09/2020 13:05	23/09/2020 08:42	23/09/2020 13:05	4,38	2	8,75	CHI
20200974291	CRISTALINA	KR21338008	PAMPLONA	23/09/2020 08:42	23/09/2020 15:45	23/09/2020 08:42	23/09/2020 15:45	7,05	1	7,05	CHI
20200974296	RIO VERDE	630001480	RIO VERDE S1	23/09/2020 08:42	23/09/2020 11:43	23/09/2020 08:42	23/09/2020 11:43	3,01	1	3,01	CHI
20200976207	BURITI DE GOIAS	BS11375304	FIRMINOPOLIS S2	23/09/2020 08:42	23/09/2020 14:49	23/09/2020 08:42	23/09/2020 14:49	6,10	19	115,97	CHI

INTERNAL

20200974309	SAO FRANCISCO DE GOIAS	490000289	SAO FRANCISCO DE GOIAS	23/09/2020 08:43	23/09/2020 12:22	23/09/2020 08:43	23/09/2020 12:22	3,64	1	3,64	CHI
20200974310	JAUPACI	JP21028024	IPORA	23/09/2020 08:43	23/09/2020 17:50	23/09/2020 08:43	23/09/2020 17:50	9,11	1	9,11	CHI
20200974319	RUBIATABA	RB12213119	RUBIATABA	23/09/2020 08:44	24/09/2020 16:41	23/09/2020 08:44	24/09/2020 16:41	31,95	2	63,89	CHI
20200974323	SANCLERLANDIA	1210022129	FIRMINOPOLIS S2	23/09/2020 08:44	23/09/2020 17:37	23/09/2020 08:44	23/09/2020 17:37	8,88	1	8,88	CHI
20200974324	IPORA	730027120	IPORA	23/09/2020 08:44	23/09/2020 12:54	23/09/2020 08:44	23/09/2020 12:54	4,16	1	4,16	CHI
20200975178	JATAI	JT21412985	CABRIUVA S2	23/09/2020 08:45	23/09/2020 11:13	23/09/2020 08:45	23/09/2020 11:13	2,46	1	2,46	CHI
20200974346	FORMOSA	610114372	ITIQUEIRA	23/09/2020 08:45	23/09/2020 14:10	23/09/2020 08:45	23/09/2020 14:10	5,41	1	5,41	CHI
20200974361	CORUMBA DE GOIAS	CB21155928	ALEXANIA	23/09/2020 08:47	23/09/2020 12:04	23/09/2020 08:47	23/09/2020 12:04	3,28	2	6,56	CHI
20200974363	SANCLERLANDIA	SC12068220	FIRMINOPOLIS S2	23/09/2020 08:47	23/09/2020 16:02	23/09/2020 08:47	23/09/2020 16:02	7,25	2	14,49	CHI
20200974364	FORMOSA	FA11098457	ITIQUEIRA	23/09/2020 08:47	23/09/2020 10:35	23/09/2020 08:47	23/09/2020 10:35	1,80	222	400,34	CHI
20200974365	JUSSARA	JR21121204	IPORA	23/09/2020 08:47	23/09/2020 11:40	23/09/2020 08:47	23/09/2020 11:40	2,88	1	2,88	CHI
20200974369	CABECEIRAS	CW21218518	ITIQUEIRA	23/09/2020 08:47	23/09/2020 23:06	23/09/2020 08:47	23/09/2020 23:06	14,30	1	14,30	CHI
20200975288	PALESTINA DE GOIAS	PY12023466	PALESTINA	23/09/2020 08:48	24/09/2020 02:07	23/09/2020 08:48	24/09/2020 02:07	17,32	4	69,27	CHI
20200974378	RIO VERDE	RV21333071	CABRIUVA S2	23/09/2020 08:48	23/09/2020 11:00	23/09/2020 08:48	23/09/2020 11:00	2,20	2	4,39	CHI
20200974392	PIRENOPOLIS	PV12098126	SAO FRANCISCO DE GOIAS	23/09/2020 08:48	23/09/2020 10:48	23/09/2020 08:48	23/09/2020 10:48	1,99	12	23,90	CHI
20200974393	LUZIANIA	3200092176	MARAJOARA	23/09/2020 08:49	23/09/2020 10:48	23/09/2020 08:49	23/09/2020 10:48	1,98	1	1,98	CHI
20200974395	AGUAS LINDAS DE GOIAS	4830196118	AGUAS LINDAS DE GOIAS S1	23/09/2020 08:49	23/09/2020 10:03	23/09/2020 08:49	23/09/2020 10:03	1,23	1	1,23	CHI
20200974397	JATAI	JT12260378	JATAI S2	23/09/2020 08:49	23/09/2020 10:39	23/09/2020 08:49	23/09/2020 10:39	1,83	1	1,83	CHI
20200974403	BOM JARDIM DE GOIAS	1880016026	BOM JARDIM	23/09/2020 08:49	23/09/2020 13:19	23/09/2020 08:49	23/09/2020 13:19	4,49	1	4,49	CHI
20200974404	ANAPOLIS	20510123	JUNDIAI S1	23/09/2020 08:49	23/09/2020 23:21	23/09/2020 08:49	23/09/2020 23:21	14,52	1	14,52	CHI
20200974411	FIRMINOPOLIS	900034750	FIRMINOPOLIS S1	23/09/2020 08:50	23/09/2020 13:10	23/09/2020 08:50	23/09/2020 13:10	4,32	1	4,32	CHI
20200974412	IPORA	730049267	IPORA	23/09/2020 08:50	23/09/2020 11:10	23/09/2020 08:50	23/09/2020 11:10	2,33	1	2,33	CHI
20200975862	ARAGARCAS	ME12095835	IPORA	23/09/2020 08:50	25/09/2020 13:50	23/09/2020 08:50	23/09/2020 14:20	5,49	1	5,49	CHI
20200975862	MONTES CLAROS DE GOIAS	ME12095835	IPORA	23/09/2020 08:50	25/09/2020 13:50	23/09/2020 08:50	24/09/2020 09:38	24,79	3	74,37	CHI
20200975862	ARAGARCAS	ME12095835	IPORA	23/09/2020 08:50	25/09/2020 13:50	23/09/2020 08:50	24/09/2020 09:38	24,79	2	49,58	CHI
20200975862	MONTES CLAROS DE GOIAS	ME12095835	IPORA	23/09/2020 08:50	25/09/2020 13:50	23/09/2020 08:50	24/09/2020 10:34	25,72	3	77,17	CHI
20200975862	ARAGARCAS	ME12095835	IPORA	23/09/2020 08:50	25/09/2020 13:50	23/09/2020 08:50	24/09/2020 10:34	25,72	1	25,72	CHI
20200975862	ARAGARCAS	ME12095835	IPORA	23/09/2020 08:50	25/09/2020 13:50	23/09/2020 08:50	24/09/2020 20:07	35,27	47	1657,91	CHI
20200975862	BOM JARDIM DE GOIAS	ME12095835	IPORA	23/09/2020 08:50	25/09/2020 13:50	23/09/2020 08:50	24/09/2020 20:07	35,27	2	70,55	CHI
20200975862	MONTES CLAROS DE GOIAS	ME12095835	IPORA	23/09/2020 08:50	25/09/2020 13:50	23/09/2020 08:50	24/09/2020 20:07	35,27	2	70,55	CHI
20200974416	IPORA	730054159	IPORA	23/09/2020 08:50	23/09/2020 13:02	23/09/2020 08:50	23/09/2020 13:02	4,20	1	4,20	CHI
20200974418	CRISTALINA	KR21249263	CRISTALINA S2	23/09/2020 08:50	23/09/2020 10:15	23/09/2020 08:50	23/09/2020 10:15	1,40	1	1,40	CHI
20200975862	ARAGARCAS	ME12095835	IPORA	23/09/2020 08:50	25/09/2020 13:50	24/09/2020 20:15	24/09/2020 21:36	1,35	3	4,04	CHI

INTERNAL

20200975862	MONTES CLAROS DE GOIAS	ME12095835	IPORA	23/09/2020 08:50	25/09/2020 13:50	24/09/2020 20:15	24/09/2020 21:36	1,35	6	8,07	CHI
20200975862	MONTES CLAROS DE GOIAS	AG12060894LD	IPORA	23/09/2020 08:50	25/09/2020 13:50	24/09/2020 20:15	25/09/2020 12:20	16,08	2	32,15	CHI
20200975862	ARAGARCAS	AG12060894LD	IPORA	23/09/2020 08:50	25/09/2020 13:50	24/09/2020 20:15	25/09/2020 13:12	16,95	44	745,71	CHI
20200975862	ARAGARCAS	AG12060894LD	IPORA	23/09/2020 08:50	25/09/2020 13:50	24/09/2020 20:15	25/09/2020 13:50	17,58	4	70,32	CHI
20200975862	BOM JARDIM DE GOIAS	AG12060894LD	IPORA	23/09/2020 08:50	25/09/2020 13:50	24/09/2020 20:15	25/09/2020 13:50	17,58	2	35,16	CHI
20200975862	MONTES CLAROS DE GOIAS	ME12095835	IPORA	23/09/2020 08:50	25/09/2020 13:50	25/09/2020 11:04	25/09/2020 12:20	1,27	6	7,60	CHI
20200975862	ARAGARCAS	ME12095835	IPORA	23/09/2020 08:50	25/09/2020 13:50	25/09/2020 11:04	25/09/2020 12:20	1,27	3	3,80	CHI
20200974433	LUZIANIA	10013901956	RIO VERMELHO	23/09/2020 08:51	23/09/2020 09:41	23/09/2020 08:51	23/09/2020 09:41	0,82	1	0,82	CHI
20200974440	BOM JARDIM DE GOIAS	BM21065742	BOM JARDIM	23/09/2020 08:52	23/09/2020 11:10	23/09/2020 08:52	23/09/2020 11:10	2,30	1	2,30	CHI
20200976397	DOVERLANDIA	DV12138316	CAIAPONIA	23/09/2020 08:52	24/09/2020 01:27	23/09/2020 08:52	24/09/2020 01:27	16,58	2	33,15	CHI
20200974718	ANAPOLIS	AN12353433	JUNDIAI S1	23/09/2020 08:52	23/09/2020 12:20	23/09/2020 08:52	23/09/2020 12:20	3,45	5	17,27	CHI
20200974445	MONTIVIDIU	MV21200733	MONTIVIDIU T	23/09/2020 08:52	23/09/2020 13:54	23/09/2020 08:52	23/09/2020 13:54	5,02	1	5,02	CHI
20200976131	UIRAPURU	UP12294696	NOVA CRIXAS	23/09/2020 08:52	25/09/2020 06:46	23/09/2020 14:00	23/09/2020 21:19	7,32	4	29,30	CHI
20200976131	MARA ROSA	UP12294696	NOVA CRIXAS	23/09/2020 08:52	25/09/2020 06:46	23/09/2020 14:00	23/09/2020 21:19	7,32	43	314,94	CHI
20200976131	AMARALINA	UP12294696	NOVA CRIXAS	23/09/2020 08:52	25/09/2020 06:46	23/09/2020 14:00	23/09/2020 21:19	7,32	54	395,50	CHI
20200976131	SANTA TEREZINHA DE GOIAS	UP12294696	NOVA CRIXAS	23/09/2020 08:52	25/09/2020 06:46	23/09/2020 14:00	23/09/2020 21:19	7,32	1	7,32	CHI
20200976131	UIRAPURU	UP12294696	NOVA CRIXAS	23/09/2020 08:52	25/09/2020 06:46	23/09/2020 21:23	24/09/2020 14:56	17,54	4	70,18	CHI
20200976131	SANTA TEREZINHA DE GOIAS	UP12294696	NOVA CRIXAS	23/09/2020 08:52	25/09/2020 06:46	23/09/2020 21:23	24/09/2020 14:56	17,54	1	17,54	CHI
20200976131	MARA ROSA	UP12294696	NOVA CRIXAS	23/09/2020 08:52	25/09/2020 06:46	23/09/2020 21:23	24/09/2020 14:56	17,54	37	649,12	CHI
20200976131	AMARALINA	UP12294696	NOVA CRIXAS	23/09/2020 08:52	25/09/2020 06:46	23/09/2020 21:23	24/09/2020 14:56	17,54	21	368,42	CHI
20200976131	MARA ROSA	UP12294696	NOVA CRIXAS	23/09/2020 08:52	25/09/2020 06:46	23/09/2020 21:23	25/09/2020 06:46	33,38	6	200,29	CHI
20200976131	AMARALINA	UP12294696	NOVA CRIXAS	23/09/2020 08:52	25/09/2020 06:46	23/09/2020 21:23	25/09/2020 06:46	33,38	33	1101,59	CHI
20200976131	UIRAPURU	UP12294696	NOVA CRIXAS	23/09/2020 08:52	25/09/2020 06:46	24/09/2020 15:00	24/09/2020 17:08	2,13	4	8,51	CHI
20200976131	AMARALINA	UP12294696	NOVA CRIXAS	23/09/2020 08:52	25/09/2020 06:46	24/09/2020 15:00	25/09/2020 06:46	15,77	21	331,21	CHI
20200976131	MARA ROSA	UP12294696	NOVA CRIXAS	23/09/2020 08:52	25/09/2020 06:46	24/09/2020 15:00	25/09/2020 06:46	15,77	37	583,56	CHI
20200976131	SANTA TEREZINHA DE GOIAS	UP12294696	NOVA CRIXAS	23/09/2020 08:52	25/09/2020 06:46	24/09/2020 15:00	25/09/2020 06:46	15,77	1	15,77	CHI
20200976131	UIRAPURU	UP12294696	NOVA CRIXAS	23/09/2020 08:52	25/09/2020 06:46	25/09/2020 04:55	25/09/2020 06:46	1,85	4	7,42	CHI
20200974448	ALEXANIA	AX21302431	ALEXANIA	23/09/2020 08:53	23/09/2020 18:54	23/09/2020 08:53	23/09/2020 18:54	10,02	1	10,02	CHI
20200976807	PORANGATU	PO12384305	PORANGATU	23/09/2020 08:53	23/09/2020 17:52	23/09/2020 08:53	23/09/2020 17:52	8,98	4	35,93	CHI
20200974459	SAO FRANCISCO DE GOIAS	490013820	SAO FRANCISCO DE GOIAS	23/09/2020 08:53	23/09/2020 16:57	23/09/2020 08:53	23/09/2020 16:57	8,05	1	8,05	CHI
20200974461	ARAGARCAS	1820053195	ARAGARCAS	23/09/2020 08:54	23/09/2020 20:05	23/09/2020 08:54	23/09/2020 20:05	11,18	1	11,18	CHI
20200980228	CEZARINA	1650015905	CEZARINA	23/09/2020 08:55	24/09/2020 12:03	23/09/2020 08:55	24/09/2020 12:03	27,13	1	27,13	CHI
20200974556	AURILANDIA	AI12215407	FIRMINOPOLIS S2	23/09/2020 08:55	24/09/2020 08:03	23/09/2020 08:55	24/09/2020 08:03	23,12	10	231,17	CHI

INTERNAL

20200975121	NIQUELANDIA	NQ12398048	URUACU	23/09/2020 08:56	23/09/2020 19:09	23/09/2020 08:56	23/09/2020 16:25	7,50	48	359,96	CHI
20200975121	NIQUELANDIA	NQ12146059LD	URUACU	23/09/2020 08:56	23/09/2020 19:09	23/09/2020 08:56	23/09/2020 19:09	10,23	54	552,31	CHI
20200974796	PARAUNA	PU12336680	PARAUNA	23/09/2020 08:56	23/09/2020 13:56	23/09/2020 08:56	23/09/2020 13:56	4,99	41	204,70	CHI
20200974492	LUZIANIA	120264924	RIO VERMELHO	23/09/2020 08:56	23/09/2020 14:53	23/09/2020 08:56	23/09/2020 14:53	5,94	1	5,94	CHI
20200974495	AGUAS LINDAS DE GOIAS	4830426276	AGUAS LINDAS DE GOIAS S1	23/09/2020 08:56	23/09/2020 11:34	23/09/2020 08:56	23/09/2020 11:34	2,62	1	2,62	CHI
20200974496	ANAPOLIS	20358910	JUNDIAI S1	23/09/2020 08:56	23/09/2020 17:44	23/09/2020 08:56	23/09/2020 17:44	8,78	1	8,78	CHI
20200974509	IVOLANDIA	IV12245744	IPORA	23/09/2020 08:58	23/09/2020 19:33	23/09/2020 08:58	23/09/2020 19:33	10,57	3	31,72	CHI
20200974512	IACIARA	10002482884	IACIARA S1	23/09/2020 08:58	23/09/2020 12:42	23/09/2020 08:58	23/09/2020 12:42	3,72	1	3,72	CHI
20200974514	VALPARAISO DE GOIAS	2860013228	PACAEMBU S2	23/09/2020 08:58	23/09/2020 14:15	23/09/2020 08:58	23/09/2020 14:15	5,27	1	5,27	CHI
20200974540	SAO LUIS DE MONTES BELOS	SL31125660	FIRMINOPOLIS S1	23/09/2020 09:00	23/09/2020 18:27	23/09/2020 09:00	23/09/2020 18:27	9,45	1	9,45	CHI
20200974555	SAO LUIS DE MONTES BELOS	500025770	SAO LUIZ DOS MONTES BELOS	23/09/2020 09:01	23/09/2020 14:44	23/09/2020 09:01	23/09/2020 14:44	5,72	1	5,72	CHI
20200974571	QUIRINOPOLIS	QI21000212	QUIRINOPOLIS	23/09/2020 09:02	23/09/2020 13:44	23/09/2020 09:02	23/09/2020 13:44	4,70	1	4,70	CHI
20200974582	JATAI	JT21327044	CABRIUVA S2	23/09/2020 09:02	23/09/2020 13:38	23/09/2020 09:02	23/09/2020 13:38	4,59	1	4,59	CHI
20200974603	MUNDO NOVO DE GOIAS	MH11269142	NOVA CRIXAS	23/09/2020 09:04	23/09/2020 11:22	23/09/2020 09:04	23/09/2020 11:22	2,30	1	2,30	CHI
20200974610	MINEIROS	MY21277188	PARQUE DAS EMAS	23/09/2020 09:04	23/09/2020 12:21	23/09/2020 09:04	23/09/2020 12:21	3,28	1	3,28	CHI
20200974626	CEZARINA	10024636337	CEZARINA	23/09/2020 09:04	23/09/2020 11:34	23/09/2020 09:04	23/09/2020 11:34	2,49	1	2,49	CHI
20200974644	IPORA	730123133	IPORA	23/09/2020 09:06	23/09/2020 14:36	23/09/2020 09:06	23/09/2020 14:36	5,49	1	5,49	CHI
20200974650	ITAPACI	IW21167987	ITAPACI	23/09/2020 09:06	24/09/2020 01:12	23/09/2020 09:06	24/09/2020 01:12	16,09	1	16,09	CHI
20200974652	SAO LUIZ DO NORTE	3090006349	ITAPACI	23/09/2020 09:06	23/09/2020 19:14	23/09/2020 09:06	23/09/2020 19:14	10,12	1	10,12	CHI
20200974690	FORMOSA	610091773	ITUIQUIRA	23/09/2020 09:10	23/09/2020 17:50	23/09/2020 09:10	23/09/2020 17:50	8,67	1	8,67	CHI
20200974698	FORMOSA	610018267	ITUIQUIRA	23/09/2020 09:10	23/09/2020 12:50	23/09/2020 09:10	23/09/2020 12:50	3,65	1	3,65	CHI
20200974732	AGUA FRIA DE GOIAS	TL21264731	SAO JOAO D ALIANCA	23/09/2020 09:12	23/09/2020 17:28	23/09/2020 09:12	23/09/2020 17:28	8,26	1	8,26	CHI
20200974735	MARA ROSA	2260030355	MARA ROSA	23/09/2020 09:12	23/09/2020 13:52	23/09/2020 09:12	23/09/2020 13:52	4,65	1	4,65	CHI
20200974736	ITARUMA	IJ12107422LD	ITAJA S2	23/09/2020 09:12	23/09/2020 14:42	23/09/2020 09:12	23/09/2020 14:42	5,49	25	137,13	CHI
20200974751	ITAJA	IJ12202625RE	ITAJA S2	23/09/2020 09:13	23/09/2020 12:05	23/09/2020 09:13	23/09/2020 12:05	2,85	14	39,96	CHI
20200974751	APORE	IJ12202625RE	ITAJA S2	23/09/2020 09:13	23/09/2020 12:05	23/09/2020 09:13	23/09/2020 12:05	2,85	4	11,42	CHI
20200977653	JANDAIA	JD12391446	PALMEIRAS	23/09/2020 09:14	24/09/2020 04:42	23/09/2020 09:14	24/09/2020 04:42	19,47	4	77,87	CHI
20200974757	TURVELANDIA	1760000738	RIO DOS BOIS	23/09/2020 09:14	24/09/2020 10:14	23/09/2020 09:14	24/09/2020 10:14	25,00	1	25,00	CHI
20200976019	JANDAIA	JD12008652	PALMEIRAS	23/09/2020 09:14	24/09/2020 11:27	23/09/2020 09:14	24/09/2020 10:48	25,56	8	204,50	CHI
20200976019	JANDAIA	JD12008652	PALMEIRAS	23/09/2020 09:14	24/09/2020 11:27	23/09/2020 09:14	24/09/2020 11:02	25,79	2	51,58	CHI
20200976019	JANDAIA	JD12008652	PALMEIRAS	23/09/2020 09:14	24/09/2020 11:27	23/09/2020 09:14	24/09/2020 11:27	26,21	4	104,84	CHI
20200968228	CAIAPONIA	CP11020859	CAIAPONIA	23/09/2020 09:14	23/09/2020 16:35	23/09/2020 15:52	23/09/2020 16:35	0,71	109	77,03	CHI
20200974782	RIO VERDE	630036469	RIO VERDE S2	23/09/2020 09:15	23/09/2020 17:04	23/09/2020 09:15	23/09/2020 17:04	7,81	1	7,81	CHI

INTERNAL

20200974774	GOIAS	GS21055012	MATRINCHA	23/09/2020 09:15	24/09/2020 02:42	23/09/2020 21:48	24/09/2020 02:15	4,46	1	4,46	CHI
20200974774	FAINA	GS13055009	MATRINCHA	23/09/2020 09:15	24/09/2020 02:42	23/09/2020 23:08	24/09/2020 02:42	3,57	14	49,98	CHI
20200974774	GOIAS	GS13055009	MATRINCHA	23/09/2020 09:15	24/09/2020 02:42	23/09/2020 23:08	24/09/2020 02:42	3,57	9	32,13	CHI
20200974774	MATRINCHA	GS13055009	MATRINCHA	23/09/2020 09:15	24/09/2020 02:42	23/09/2020 23:08	24/09/2020 02:42	3,57	1	3,57	CHI
20200974791	FORMOSA	610073450	ITUIQUIRA	23/09/2020 09:16	23/09/2020 12:40	23/09/2020 09:16	23/09/2020 12:40	3,39	1	3,39	CHI
20200974801	BONOPOLIS	BX21198520	NOVO PLANALTO	23/09/2020 09:16	23/09/2020 11:18	23/09/2020 09:16	23/09/2020 11:18	2,02	2	4,04	CHI
20200974806	SANTA TEREZINHA DE GOIAS	2480030204	SANTA TEREZINHA	23/09/2020 09:17	23/09/2020 22:31	23/09/2020 09:17	23/09/2020 22:31	13,22	1	13,22	CHI
20200978728	PORANGATU	PO12230401	MARA ROSA	23/09/2020 09:18	24/09/2020 15:02	23/09/2020 09:18	24/09/2020 15:02	29,72	5	148,62	CHI
20200974814	IPORA	IR21014421	IPORA	23/09/2020 09:18	23/09/2020 13:30	23/09/2020 09:18	23/09/2020 13:30	4,19	1	4,19	CHI
20200974827	SAO LUIZ DO NORTE	3090011242	ITAPACI	23/09/2020 09:19	24/09/2020 11:16	23/09/2020 09:19	24/09/2020 11:16	25,95	1	25,95	CHI
20200974832	ITABERAI	IB21322815	ANICUNS	23/09/2020 09:19	23/09/2020 11:28	23/09/2020 09:19	23/09/2020 11:28	2,14	1	2,14	CHI
20200974838	ITABERAI	IB11228580	ITABERAI S2	23/09/2020 09:20	23/09/2020 18:50	23/09/2020 09:20	23/09/2020 18:50	9,49	80	759,56	CHI
20200974848	ARAGARCAS	1820003090	ARAGARCAS	23/09/2020 09:20	23/09/2020 15:40	23/09/2020 09:20	23/09/2020 15:40	6,32	1	6,32	CHI
20200974852	RIO VERDE	RV12303491	MONTIVIDIU T	23/09/2020 09:21	23/09/2020 11:09	23/09/2020 09:21	23/09/2020 11:09	1,79	2	3,59	CHI
20200975581	JANDAIA	PP12233311RE	PALMEIRAS	23/09/2020 09:22	24/09/2020 15:17	23/09/2020 09:22	23/09/2020 22:30	13,13	19	249,46	CHI
20200975581	PALMINOPOLIS	PP12233311RE	PALMEIRAS	23/09/2020 09:22	24/09/2020 15:17	23/09/2020 09:22	23/09/2020 22:30	13,13	39	512,06	CHI
20200974859	ITAPACI	IW21190003	ITAPACI	23/09/2020 09:22	23/09/2020 18:43	23/09/2020 09:22	23/09/2020 18:43	9,35	2	18,69	CHI
20200975581	PALMINOPOLIS	PP12233311RE	PALMEIRAS	23/09/2020 09:22	24/09/2020 15:17	23/09/2020 22:31	24/09/2020 14:08	15,63	16	250,04	CHI
20200975581	PALMINOPOLIS	PP12008241	PALMEIRAS	23/09/2020 09:22	24/09/2020 15:17	23/09/2020 22:31	24/09/2020 15:01	16,51	23	379,71	CHI
20200975581	JANDAIA	PP12233311RE	PALMEIRAS	23/09/2020 09:22	24/09/2020 15:17	23/09/2020 22:31	24/09/2020 15:17	16,77	19	318,70	CHI
20200974867	FORMOSA	610137980	ITUIQUIRA	23/09/2020 09:23	23/09/2020 14:23	23/09/2020 09:23	23/09/2020 14:23	5,00	1	5,00	CHI
20200974869	FORMOSA	FA21320493	ITUIQUIRA	23/09/2020 09:23	23/09/2020 12:38	23/09/2020 09:23	23/09/2020 12:38	3,24	1	3,24	CHI
20200974872	BONOPOLIS	PO12103385	NOVO PLANALTO	23/09/2020 09:23	24/09/2020 16:17	23/09/2020 09:23	24/09/2020 16:17	30,90	1	30,90	CHI
20200974882	SANTA TEREZA DE GOIAS	2430014859	MARA ROSA	23/09/2020 09:24	24/09/2020 14:18	23/09/2020 09:24	24/09/2020 14:18	28,90	1	28,90	CHI
20200974889	PEROLANDIA	DP12272507	JATAI S1	23/09/2020 09:24	23/09/2020 11:10	23/09/2020 09:24	23/09/2020 11:10	1,75	4	7,01	CHI
20200974897	AGUA FRIA DE GOIAS	TL21152788	SAO JOAO D ALIANCA	23/09/2020 09:25	23/09/2020 13:36	23/09/2020 09:25	23/09/2020 13:36	4,17	1	4,17	CHI
20200974943	FORMOSA	610057522	ITUIQUIRA	23/09/2020 09:29	23/09/2020 12:07	23/09/2020 09:29	23/09/2020 12:07	2,64	1	2,64	CHI
20200974946	GOIAS	GS21231938	ITABERAI S1	23/09/2020 09:29	23/09/2020 11:15	23/09/2020 09:29	23/09/2020 11:15	1,76	1	1,76	CHI
20200974948	FORMOSA	610151198	ITUIQUIRA	23/09/2020 09:29	23/09/2020 16:10	23/09/2020 09:29	23/09/2020 16:10	6,67	1	6,67	CHI
20200974958	CACHOEIRA ALTA	CA12089803	CACHOEIRA ALTA	23/09/2020 09:31	23/09/2020 12:36	23/09/2020 09:31	23/09/2020 12:36	3,08	2	6,17	CHI
20200974959	RUBIATABA	RB12070014	RUBIATABA	23/09/2020 09:31	24/09/2020 02:35	23/09/2020 09:31	24/09/2020 02:35	17,07	3	51,20	CHI
20200974974	ALTO PARAISO DE GOIAS	BF12224061	SAO JOAO D ALIANCA	23/09/2020 09:32	23/09/2020 20:50	23/09/2020 09:32	23/09/2020 20:50	11,29	1	11,29	CHI
20200974995	SAO JOAO D ALIANCA	JL21146210	SAO JOAO D ALIANCA	23/09/2020 09:34	23/09/2020 13:59	23/09/2020 09:34	23/09/2020 13:59	4,41	1	4,41	CHI

INTERNAL

20200974998	MINEIROS	MY21195515	PARQUE DAS EMAS	23/09/2020 09:34	23/09/2020 15:40	23/09/2020 09:34	23/09/2020 15:40	6,09	1	6,09	CHI
20200975001	NOVO PLANALTO	TA21141121	SAO MIGUEL DO ARAGUAIA	23/09/2020 09:35	23/09/2020 15:19	23/09/2020 09:35	23/09/2020 15:19	5,73	1	5,73	CHI
20200975176	SAO LUIS DE MONTES BELOS	19855074	SAO LUIZ DOS MONTES BELOS	23/09/2020 09:35	23/09/2020 15:54	23/09/2020 09:35	23/09/2020 15:54	6,32	113	713,69	CHI
20200975011	TURVELANDIA	TD21000211	ACREUNA	23/09/2020 09:35	24/09/2020 09:55	23/09/2020 09:35	24/09/2020 09:55	24,32	1	24,32	CHI
20200975025	ACREUNA	EU21085752	ACREUNA	23/09/2020 09:37	24/09/2020 09:53	23/09/2020 09:37	24/09/2020 09:53	24,26	1	24,26	CHI
20200975031	QUIRINOPOLIS	80125360	QUIRINOPOLIS	23/09/2020 09:37	23/09/2020 15:35	23/09/2020 09:37	23/09/2020 15:35	5,95	1	5,95	CHI
20200975043	RIO VERDE	630031952	RIO VERDE S1	23/09/2020 09:39	23/09/2020 12:22	23/09/2020 09:39	23/09/2020 12:22	2,70	1	2,70	CHI
20200975061	IPORA	730084607	IPORA	23/09/2020 09:42	23/09/2020 11:15	23/09/2020 09:42	23/09/2020 11:15	1,55	1	1,55	CHI
20200978535	MONTIVIDIU DO NORTE	9660001039	PORANGATU	23/09/2020 09:42	24/09/2020 17:00	23/09/2020 09:42	24/09/2020 17:00	31,29	1	31,29	CHI
20200975075	RIO VERDE	RV21033133	CABRIUVA S2	23/09/2020 09:43	23/09/2020 12:27	23/09/2020 09:43	23/09/2020 12:27	2,72	1	2,72	CHI
20200975076	TURVANIA	1220000775	FIRMINOPOLIS S2	23/09/2020 09:43	23/09/2020 18:07	23/09/2020 09:43	23/09/2020 18:07	8,39	1	8,39	CHI
20200975119	PALMEIRAS DE GOIAS	590012629	PALMEIRAS	23/09/2020 09:45	23/09/2020 12:17	23/09/2020 09:45	23/09/2020 12:17	2,54	1	2,54	CHI
20200975130	JATAI	JT10400238	JATAI S1	23/09/2020 09:45	23/09/2020 09:51	23/09/2020 09:45	23/09/2020 09:51	0,10	38	3,93	CHI
20200975130	SERRANOPOLIS	JT10400238	JATAI S1	23/09/2020 09:45	23/09/2020 09:51	23/09/2020 09:45	23/09/2020 09:51	0,10	6	0,62	CHI
20200975106	URUACU	640067359	URUACU	23/09/2020 09:46	24/09/2020 13:50	23/09/2020 09:46	24/09/2020 13:50	28,07	1	28,07	CHI
20200975108	RIO VERDE	RV21191788	MONTIVIDIU T	23/09/2020 09:47	23/09/2020 14:06	23/09/2020 09:47	23/09/2020 14:06	4,32	1	4,32	CHI
20200975115	JATAI	290245229	JATAI S2	23/09/2020 09:48	23/09/2020 12:34	23/09/2020 09:48	23/09/2020 12:34	2,76	1	2,76	CHI
20200975120	RIO VERDE	RV21427254	RIO VERDE S2	23/09/2020 09:48	23/09/2020 10:58	23/09/2020 09:48	23/09/2020 10:58	1,15	1	1,15	CHI
20200977281	SANCLERLANDIA	SC11055347	FIRMINOPOLIS S2	23/09/2020 09:49	23/09/2020 16:50	23/09/2020 09:49	23/09/2020 16:50	7,01	69	484,03	CHI
20200975146	GUARAITA	GK21299352	ITAPURANGA	23/09/2020 09:50	23/09/2020 11:30	23/09/2020 09:50	23/09/2020 11:30	1,66	1	1,66	CHI
20200975165	TURVANIA	1220017313	FIRMINOPOLIS S2	23/09/2020 09:52	23/09/2020 17:41	23/09/2020 09:52	23/09/2020 17:41	7,82	1	7,82	CHI
20200975168	PORANGATU	PO12391664	PORANGATU	23/09/2020 09:52	24/09/2020 10:58	23/09/2020 09:52	24/09/2020 10:58	25,09	1	25,09	CHI
20200975170	MAMBAI	MB11189300	IACIARA S2	23/09/2020 09:52	23/09/2020 13:28	23/09/2020 09:52	23/09/2020 13:28	3,59	3	10,76	CHI
20200975172	ACREUNA	2440037303	ACREUNA	23/09/2020 09:52	24/09/2020 10:11	23/09/2020 09:52	24/09/2020 10:11	24,30	1	24,30	CHI
20200975189	PARANAIGUARA	SO12000023RE	CACHOEIRA ALTA	23/09/2020 09:54	23/09/2020 12:18	23/09/2020 09:54	23/09/2020 12:18	2,39	62	148,13	CHI
20200975189	SAO SIMAO	SO12000023RE	CACHOEIRA ALTA	23/09/2020 09:54	23/09/2020 12:18	23/09/2020 09:54	23/09/2020 12:18	2,39	32	76,45	CHI
20200975192	CAIAPONIA	CP21188386	PIRANHAS	23/09/2020 09:54	23/09/2020 18:20	23/09/2020 09:54	23/09/2020 18:20	8,42	2	16,84	CHI
20200975208	FORMOSA	610000044	ITUIQUIRA	23/09/2020 09:56	23/09/2020 14:49	23/09/2020 09:56	23/09/2020 14:49	4,87	1	4,87	CHI
20200976083	AMARALINA	MU12269538	MARA ROSA	23/09/2020 09:57	23/09/2020 16:02	23/09/2020 09:57	23/09/2020 16:02	6,08	4	24,32	CHI
20200976083	MUTUNOPOLIS	MU12269538	MARA ROSA	23/09/2020 09:57	23/09/2020 16:02	23/09/2020 09:57	23/09/2020 16:02	6,08	52	316,16	CHI
20200975215	RIO VERDE	630201316	RIO VERDE S2	23/09/2020 09:57	23/09/2020 18:21	23/09/2020 09:57	23/09/2020 18:21	8,39	1	8,39	CHI
20200975245	NOVA CRIXAS	NA21229207	NOVA CRIXAS	23/09/2020 09:59	23/09/2020 14:01	23/09/2020 09:59	23/09/2020 14:01	4,02	1	4,02	CHI
20200975664	BURITINOPOLIS	SU12301950RE	SANTA RITA DO ARAGUAIA	23/09/2020 10:00	23/09/2020 11:50	23/09/2020 10:00	23/09/2020 11:50	1,83	1	1,83	CHI

INTERNAL

20200975664	SANTA RITA DO ARAGUAIA	SU12301950RE	SANTA RITA DO ARAGUAIA	23/09/2020 10:00	23/09/2020 11:50	23/09/2020 10:00	23/09/2020 11:50	1,83	21	38,38	CHI
20200975268	IPORA	IR21014069	IPORA	23/09/2020 10:01	23/09/2020 12:00	23/09/2020 10:01	23/09/2020 12:00	1,98	1	1,98	CHI
20200975279	RIO VERDE	RV12260596	CABRIUVA S2	23/09/2020 10:02	23/09/2020 12:05	23/09/2020 10:02	23/09/2020 12:05	2,04	2	4,07	CHI
20200975282	NAZARIO	NZ21279045	ANICUNS	23/09/2020 10:03	23/09/2020 21:38	23/09/2020 10:03	23/09/2020 21:38	11,58	1	11,58	CHI
20200975285	PORANGATU	PO21139133	NOVO PLANALTO	23/09/2020 10:03	23/09/2020 19:40	23/09/2020 10:03	23/09/2020 19:40	9,61	1	9,61	CHI
20200975290	MINACU	10021216469	MINACU	23/09/2020 10:04	23/09/2020 16:41	23/09/2020 10:04	23/09/2020 16:41	6,60	1	6,60	CHI
20200975293	SAO LUIS DE MONTES BELOS	SC21019468	SAO LUIZ DOS MONTES BELOS	23/09/2020 10:05	23/09/2020 18:16	23/09/2020 10:05	23/09/2020 18:16	8,18	1	8,18	CHI
20200977586	FORMOSA	10018277819	ITUIQUIRA	23/09/2020 10:05	23/09/2020 16:51	23/09/2020 10:05	23/09/2020 16:51	6,76	1	6,76	CHI
202009107055	CRIXAS	CX21342234	SANTA TEREZINHA	23/09/2020 10:06	24/09/2020 08:07	23/09/2020 10:06	24/09/2020 08:07	22,02	1	22,02	CHI
202009107055	CRIXAS	CX21146913	SANTA TEREZINHA	23/09/2020 10:06	24/09/2020 08:07	23/09/2020 13:54	24/09/2020 08:07	18,23	1	18,23	CHI
20200978245	TROMBAS	TB12185402	PORANGATU	23/09/2020 10:07	24/09/2020 14:00	23/09/2020 10:07	24/09/2020 14:00	27,87	3	83,61	CHI
20200975557	RIO VERDE	RV12402229	CABRIUVA S2	23/09/2020 10:07	23/09/2020 12:30	23/09/2020 10:07	23/09/2020 12:30	2,37	6	14,22	CHI
20200975557	APARECIDA DO RIO DOCE	RV12402229	CABRIUVA S2	23/09/2020 10:07	23/09/2020 12:30	23/09/2020 10:07	23/09/2020 12:30	2,37	6	14,22	CHI
20200975329	GOIAS	GS12217235	MATRINCHA	23/09/2020 10:07	23/09/2020 21:50	23/09/2020 10:07	23/09/2020 21:50	11,71	3	35,12	CHI
20200975336	ANICUNS	910037905	ANICUNS	23/09/2020 10:08	23/09/2020 14:20	23/09/2020 10:08	23/09/2020 14:20	4,19	1	4,19	CHI
20200975346	PLANALTINA	2960218195	PLANALTINA	23/09/2020 10:09	23/09/2020 12:07	23/09/2020 10:09	23/09/2020 12:07	1,97	1	1,97	CHI
20200975348	SANTA TEREZA DE GOIAS	2430001520	MARA ROSA	23/09/2020 10:09	24/09/2020 15:33	23/09/2020 10:09	24/09/2020 15:33	29,41	1	29,41	CHI
20200975350	RIO VERDE	RV12271289	CABRIUVA S2	23/09/2020 10:09	23/09/2020 11:52	23/09/2020 10:09	23/09/2020 11:52	1,70	39	66,40	CHI
20200975367	ITABERAI	50028870	ITABERAI S2	23/09/2020 10:11	23/09/2020 16:01	23/09/2020 10:11	23/09/2020 16:01	5,82	1	5,82	CHI
20200975370	RIO VERDE	630056882	RIO VERDE S2	23/09/2020 10:12	23/09/2020 15:08	23/09/2020 10:12	23/09/2020 15:08	4,93	1	4,93	CHI
20200975391	PEROLANDIA	MY21172752	PARQUE DAS EMAS	23/09/2020 10:14	24/09/2020 08:34	23/09/2020 10:14	24/09/2020 08:34	22,33	1	22,33	CHI
20200975398	SAO MIGUEL DO ARAGUAIA	SM21081440	SAO MIGUEL DO ARAGUAIA	23/09/2020 10:14	23/09/2020 12:30	23/09/2020 10:14	23/09/2020 12:30	2,26	1	2,26	CHI
20200975400	ANICUNS	910014206	ANICUNS	23/09/2020 10:14	23/09/2020 18:36	23/09/2020 10:14	23/09/2020 18:36	8,35	1	8,35	CHI
20200975413	CRIXAS	2490013926	SERRA DO OURO	23/09/2020 10:16	24/09/2020 20:08	23/09/2020 10:16	24/09/2020 20:08	33,86	1	33,86	CHI
20200975419	RIO VERDE	10021498421	CABRIUVA S1	23/09/2020 10:17	23/09/2020 11:46	23/09/2020 10:17	23/09/2020 11:46	1,48	1	1,48	CHI
20200975424	PARAUNA	PU21382099	MONTIVIDIU T	23/09/2020 10:17	23/09/2020 19:46	23/09/2020 10:17	23/09/2020 19:46	9,48	1	9,48	CHI
20200975424	MONTIVIDIU	MV13290841	MONTIVIDIU T	23/09/2020 10:17	23/09/2020 19:46	23/09/2020 14:50	23/09/2020 19:46	4,94	36	177,80	CHI
20200975424	RIO VERDE	MV13290841	MONTIVIDIU T	23/09/2020 10:17	23/09/2020 19:46	23/09/2020 14:50	23/09/2020 19:46	4,94	1	4,94	CHI
20200975424	PARAUNA	MV13290841	MONTIVIDIU T	23/09/2020 10:17	23/09/2020 19:46	23/09/2020 14:50	23/09/2020 19:46	4,94	87	429,68	CHI
20200975424	IVOLANDIA	MV13290841	MONTIVIDIU T	23/09/2020 10:17	23/09/2020 19:46	23/09/2020 14:50	23/09/2020 19:46	4,94	11	54,33	CHI
20200975424	CAIAPONIA	MV13290841	MONTIVIDIU T	23/09/2020 10:17	23/09/2020 19:46	23/09/2020 14:50	23/09/2020 19:46	4,94	38	187,68	CHI
20200975462	CACU	CC11306355	CACHOEIRA ALTA	23/09/2020 10:17	23/09/2020 19:43	23/09/2020 17:25	23/09/2020 19:43	2,30	58	133,11	CHI
20200975440	ITABERAI	IB12021852	ITABERAI S2	23/09/2020 10:18	23/09/2020 15:15	23/09/2020 10:18	23/09/2020 15:15	4,93	80	394,71	CHI

INTERNAL

20200975452	ITABERAÍ	IB12000033	ITABERAÍ S2	23/09/2020 10:20	23/09/2020 20:56	23/09/2020 10:20	23/09/2020 20:56	10,60	1	10,60	CHI
20200975456	NIQUELANDIA	NQ21237376	URUACU	23/09/2020 10:20	24/09/2020 11:40	23/09/2020 10:20	24/09/2020 11:40	25,33	1	25,33	CHI
20200975885	BONOPOLIS	BX12193536	SAO MIGUEL DO ARAGUAIA	23/09/2020 10:20	23/09/2020 18:59	23/09/2020 10:20	23/09/2020 18:59	8,64	10	86,39	CHI
20200975461	PORTELANDIA	10025707912	PARQUE DAS EMAS	23/09/2020 10:21	23/09/2020 19:31	23/09/2020 10:21	23/09/2020 19:31	9,17	1	9,17	CHI
20200975469	RIO VERDE	630043620	RIO VERDE S2	23/09/2020 10:21	23/09/2020 11:42	23/09/2020 10:21	23/09/2020 11:42	1,35	1	1,35	CHI
20200975476	FORMOSA	610171410	ITIQUEIRA	23/09/2020 10:21	23/09/2020 13:54	23/09/2020 10:21	23/09/2020 13:54	3,54	1	3,54	CHI
20200975482	CAIAPONIA	CP21099837	MONTIVIDIU T	23/09/2020 10:22	23/09/2020 19:40	23/09/2020 10:22	23/09/2020 19:40	9,29	1	9,29	CHI
20200975487	ITAPURANGA	IK21310909	ITAPURANGA	23/09/2020 10:23	23/09/2020 14:54	23/09/2020 10:23	23/09/2020 14:54	4,51	1	4,51	CHI
20200975486	CAIAPONIA	930010358	CAIAPONIA	23/09/2020 10:23	23/09/2020 12:15	23/09/2020 10:23	23/09/2020 12:15	1,88	1	1,88	CHI
20200975488	FORMOSA	610112181	ITIQUEIRA	23/09/2020 10:23	23/09/2020 17:13	23/09/2020 10:23	23/09/2020 17:13	6,83	1	6,83	CHI
20200975491	MONTIVIDIU DO NORTE	MX12202551	PORANGATU	23/09/2020 10:23	24/09/2020 17:00	23/09/2020 10:23	24/09/2020 17:00	30,61	2	61,22	CHI
20200975495	NAZARIO	440006910	ANICUNS	23/09/2020 10:24	23/09/2020 17:22	23/09/2020 10:24	23/09/2020 17:22	6,96	1	6,96	CHI
20200975533	FORMOSA	610009760	ITIQUEIRA	23/09/2020 10:28	23/09/2020 15:50	23/09/2020 10:28	23/09/2020 15:50	5,36	1	5,36	CHI
20200975535	SERRANOPOLIS	3000008728	JATAI S1	23/09/2020 10:28	23/09/2020 15:39	23/09/2020 10:28	23/09/2020 15:39	5,17	1	5,17	CHI
20200975536	NIQUELANDIA	NQ21086225	URUACU	23/09/2020 10:28	23/09/2020 12:02	23/09/2020 10:28	23/09/2020 12:02	1,56	1	1,56	CHI
20200975537	FORMOSA	610057996	ITIQUEIRA	23/09/2020 10:28	23/09/2020 14:56	23/09/2020 10:28	23/09/2020 14:56	4,45	1	4,45	CHI
20200975543	FORMOSA	FA21204772	ITIQUEIRA	23/09/2020 10:29	23/09/2020 12:15	23/09/2020 10:29	23/09/2020 12:15	1,76	1	1,76	CHI
20200975567	CABECEIRAS	CW21184957	ITIQUEIRA	23/09/2020 10:32	23/09/2020 17:40	23/09/2020 10:32	23/09/2020 17:40	7,12	1	7,12	CHI
20200975601	RIO VERDE	630012430	RIO VERDE S2	23/09/2020 10:36	23/09/2020 14:49	23/09/2020 10:36	23/09/2020 14:49	4,21	1	4,21	CHI
20200975609	MINEIROS	1390095682	PARQUE DAS EMAS	23/09/2020 10:37	23/09/2020 13:12	23/09/2020 10:37	23/09/2020 13:12	2,58	1	2,58	CHI
20200975624	URUACU	UR21221694	URUACU	23/09/2020 10:39	24/09/2020 10:06	23/09/2020 10:39	24/09/2020 10:06	23,44	1	23,44	CHI
20200975632	ACREUNA	2440053977	ACREUNA	23/09/2020 10:40	24/09/2020 10:01	23/09/2020 10:40	24/09/2020 10:01	23,35	1	23,35	CHI
20200975636	PARAUNA	EU21296103	ACREUNA	23/09/2020 10:40	24/09/2020 13:17	23/09/2020 10:40	24/09/2020 13:17	26,60	1	26,60	CHI
20200976984	SAO LUIS DE MONTES BELOS	500002277	SAO LUIZ DOS MONTES BELOS	23/09/2020 10:40	23/09/2020 16:06	23/09/2020 10:40	23/09/2020 16:06	5,42	1	5,42	CHI
20200975672	RIO VERDE	630390265	RIO VERDE S1	23/09/2020 10:44	23/09/2020 12:23	23/09/2020 10:44	23/09/2020 12:23	1,63	1	1,63	CHI
20200975676	GUARINOS	3720004427	SANTA TEREZINHA	23/09/2020 10:45	24/09/2020 16:50	23/09/2020 10:45	24/09/2020 16:50	30,08	1	30,08	CHI
20200975678	PLANALTINA	2960070337	PLANALTINA	23/09/2020 10:45	23/09/2020 12:08	23/09/2020 10:45	23/09/2020 12:08	1,37	1	1,37	CHI
20200975681	CAMPINACU	UC21265725	PORANGATU	23/09/2020 10:46	23/09/2020 15:44	23/09/2020 10:46	23/09/2020 15:44	4,96	1	4,96	CHI
20200975797	MUNDO NOVO DE GOIAS	MH11170096	NOVA CRIXAS	23/09/2020 10:46	23/09/2020 13:54	23/09/2020 10:46	23/09/2020 13:54	3,13	75	234,60	CHI
20200975685	ANICUNS	910004535	ANICUNS	23/09/2020 10:46	23/09/2020 20:17	23/09/2020 10:46	23/09/2020 20:17	9,51	1	9,51	CHI
20200975687	CORREGO DO OURO	1070010859	SAO LUIZ DOS MONTES BELOS	23/09/2020 10:46	23/09/2020 19:47	23/09/2020 10:46	23/09/2020 19:47	9,01	1	9,01	CHI
20200975693	ITAPACI	IW21150537	ITAPACI	23/09/2020 10:46	24/09/2020 04:50	23/09/2020 10:46	24/09/2020 04:50	18,05	1	18,05	CHI
20200975696	NAZARIO	440019989	ANICUNS	23/09/2020 10:46	23/09/2020 15:33	23/09/2020 10:46	23/09/2020 15:33	4,77	1	4,77	CHI

INTERNAL

20200975705	ARENOPOLIS	1920000711	ARENOPOLIS	23/09/2020 10:47	24/09/2020 10:57	23/09/2020 10:47	24/09/2020 10:57	24,15	1	24,15	CHI
20200975727	ALTO HORIZONTE	AJ12213246	SANTA TEREZINHA	23/09/2020 10:50	25/09/2020 10:39	23/09/2020 10:50	25/09/2020 10:39	47,81	1	47,81	CHI
20200975728	PIRANHAS	PH21243838	PIRANHAS	23/09/2020 10:50	23/09/2020 16:04	23/09/2020 10:50	23/09/2020 16:04	5,23	1	5,23	CHI
20200975737	TROMBAS	2560007788	PORANGATU	23/09/2020 10:51	25/09/2020 07:03	23/09/2020 10:51	25/09/2020 07:03	44,20	1	44,20	CHI
20200975740	CRIXAS	CX21172917	RUBIATABA	23/09/2020 10:51	23/09/2020 16:47	23/09/2020 10:51	23/09/2020 16:47	5,93	1	5,93	CHI
20200975743	ACREUNA	2440019714	ACREUNA	23/09/2020 10:51	23/09/2020 16:45	23/09/2020 10:51	23/09/2020 16:45	5,90	1	5,90	CHI
20200975752	SANCLERLANDIA	1210020352	FIRMINOPOLIS S2	23/09/2020 10:52	23/09/2020 16:45	23/09/2020 10:52	23/09/2020 16:45	5,88	1	5,88	CHI
20200975762	NIQUELANDIA	NQ21413987	URUACU	23/09/2020 10:53	23/09/2020 16:30	23/09/2020 10:53	23/09/2020 16:30	5,60	1	5,60	CHI
20200975764	JANDAIA	JD21214056	ACREUNA	23/09/2020 10:53	23/09/2020 22:00	23/09/2020 10:53	23/09/2020 22:00	11,10	1	11,10	CHI
20200975773	CAIAPONIA	CP21357593	CAIAPONIA	23/09/2020 10:55	24/09/2020 12:17	23/09/2020 10:55	24/09/2020 12:17	25,36	1	25,36	CHI
20200975774	AGUA FRIA DE GOIAS	TL21337447	SAO JOAO D ALIANCA	23/09/2020 10:55	23/09/2020 17:21	23/09/2020 10:55	23/09/2020 17:21	6,43	1	6,43	CHI
20200975777	FLORES DE GOIAS	FB11277916	IACIARA S2	23/09/2020 10:55	23/09/2020 11:45	23/09/2020 10:55	23/09/2020 11:45	0,82	2	1,64	CHI
20200975782	PORANGATU	PO12020611	NOVO PLANALTO	23/09/2020 10:56	23/09/2020 15:19	23/09/2020 10:56	23/09/2020 15:19	4,38	8	35,00	CHI
20200975786	BALIZA	BH12360382	BOM JARDIM	23/09/2020 10:56	23/09/2020 16:32	23/09/2020 10:56	23/09/2020 16:32	5,59	3	16,76	CHI
20200976110	JAUPACI	JP12349721	IPORA	23/09/2020 10:57	23/09/2020 16:43	23/09/2020 10:57	23/09/2020 16:43	5,76	7	40,32	CHI
20200975804	MINACU	IH12346526	MINACU	23/09/2020 10:58	23/09/2020 14:55	23/09/2020 10:58	23/09/2020 14:55	3,95	65	256,73	CHI
20200975806	TURVELANDIA	TD21193724	RIO DOS BOIS	23/09/2020 10:58	23/09/2020 19:15	23/09/2020 10:58	23/09/2020 19:15	8,28	1	8,28	CHI
20200975822	CRIXAS	2490028413	SERRA DO OURO	23/09/2020 11:00	24/09/2020 10:50	23/09/2020 11:00	24/09/2020 10:50	23,83	1	23,83	CHI
20200975834	PARAUNA	PU21303606	PARAUNA	23/09/2020 11:01	23/09/2020 20:46	23/09/2020 11:01	23/09/2020 20:46	9,75	2	19,49	CHI
20200975835	SAO MIGUEL DO ARAGUAIA	SM21000026	SAO MIGUEL DO ARAGUAIA	23/09/2020 11:01	23/09/2020 15:36	23/09/2020 11:01	23/09/2020 15:36	4,57	1	4,57	CHI
20200975855	SAO MIGUEL DO ARAGUAIA	SM11240698	SAO MIGUEL DO ARAGUAIA	23/09/2020 11:04	23/09/2020 16:39	23/09/2020 11:04	23/09/2020 16:39	5,57	1	5,57	CHI
20200975863	IPORA	730076878	IPORA	23/09/2020 11:05	23/09/2020 15:28	23/09/2020 11:05	23/09/2020 15:28	4,38	1	4,38	CHI
20200975866	FORMOSA	610271295	ITIQUEIRA	23/09/2020 11:05	23/09/2020 14:14	23/09/2020 11:05	23/09/2020 14:14	3,14	1	3,14	CHI
20200975884	NIQUELANDIA	NQ21256594	NIQUELANDIA SUBTRANSMISSAO	23/09/2020 11:05	23/09/2020 14:52	23/09/2020 11:05	23/09/2020 14:52	3,77	1	3,77	CHI
20200975981	PORANGATU	PO12139105	PORANGATU	23/09/2020 11:06	23/09/2020 16:44	23/09/2020 11:06	23/09/2020 16:44	5,62	3	16,86	CHI
20200975876	RIO VERDE	630296777	RIO VERDE S2	23/09/2020 11:07	23/09/2020 15:09	23/09/2020 11:07	23/09/2020 15:09	4,03	1	4,03	CHI
20200975881	FIRMINOPOLIS	900026339	FIRMINOPOLIS S1	23/09/2020 11:07	23/09/2020 15:28	23/09/2020 11:07	23/09/2020 15:28	4,34	1	4,34	CHI
20200975888	PLANALTINA	PI12324322	SAO JOAO D ALIANCA	23/09/2020 11:08	23/09/2020 11:29	23/09/2020 11:08	23/09/2020 11:29	0,35	7	2,42	CHI
20200975886	FORMOSA	10017580828	ITIQUEIRA	23/09/2020 11:08	23/09/2020 12:50	23/09/2020 11:08	23/09/2020 12:50	1,69	1	1,69	CHI
20200975892	FORMOSA	610112624	ITIQUEIRA	23/09/2020 11:09	23/09/2020 16:15	23/09/2020 11:09	23/09/2020 16:15	5,11	1	5,11	CHI
20200975895	FORMOSA	610209437	ITIQUEIRA	23/09/2020 11:09	23/09/2020 12:30	23/09/2020 11:09	23/09/2020 12:30	1,34	1	1,34	CHI
20200976649	PALMEIRAS DE GOIAS	CZ12000022LD	CEZARINA	23/09/2020 11:11	23/09/2020 17:21	23/09/2020 11:11	23/09/2020 17:21	6,16	21	129,34	CHI
20200976649	INDIARA	CZ12000022LD	CEZARINA	23/09/2020 11:11	23/09/2020 17:21	23/09/2020 11:11	23/09/2020 17:21	6,16	9	55,43	CHI

INTERNAL

20200976649	CEZARINA	CZ12000022LD	CEZARINA	23/09/2020 11:11	23/09/2020 17:21	23/09/2020 11:11	23/09/2020 17:21	6,16	103	634,37	CHI
20200975918	ITAPACI	100025705	ITAPACI	23/09/2020 11:13	24/09/2020 08:30	23/09/2020 11:13	24/09/2020 08:30	21,28	1	21,28	CHI
20200975943	FIRMINOPOLIS	900010125	FIRMINOPOLIS S1	23/09/2020 11:15	23/09/2020 16:24	23/09/2020 11:15	23/09/2020 16:24	5,15	1	5,15	CHI
20200975946	PLANALTINA	PI21180800	PLANALTINA	23/09/2020 11:16	23/09/2020 14:57	23/09/2020 11:16	23/09/2020 14:57	3,67	1	3,67	CHI
20200977359	FORMOSO	ET12143681	MARA ROSA	23/09/2020 11:17	23/09/2020 19:43	23/09/2020 11:17	23/09/2020 19:43	8,43	13	109,55	CHI
20200975957	MINACU	IH21246536	MINACU	23/09/2020 11:18	24/09/2020 09:21	23/09/2020 11:18	24/09/2020 09:21	22,04	1	22,04	CHI
20200975976	ACREUNA	2440028934	ACREUNA	23/09/2020 11:20	23/09/2020 22:48	23/09/2020 11:20	23/09/2020 22:48	11,46	1	11,46	CHI
20200975986	CARMO DO RIO VERDE	IK12298412	ITAPURANGA	23/09/2020 11:21	23/09/2020 16:06	23/09/2020 11:21	23/09/2020 16:06	4,74	4	18,96	CHI
20200975993	PORANGATU	PO13320936	PORANGATU	23/09/2020 11:22	23/09/2020 13:56	23/09/2020 11:22	23/09/2020 13:56	2,56	6	15,36	CHI
20200976002	ITARUMA	IM21041697	CACHOEIRA ALTA	23/09/2020 11:23	23/09/2020 16:06	23/09/2020 11:23	23/09/2020 16:06	4,71	1	4,71	CHI
20200976007	POSSE	PS11389693	IACIARA S2	23/09/2020 11:23	23/09/2020 12:48	23/09/2020 11:23	23/09/2020 12:48	1,40	9	12,63	CHI
20200976022	JATAI	290189731	JATAI S1	23/09/2020 11:25	23/09/2020 16:00	23/09/2020 11:25	23/09/2020 16:00	4,58	1	4,58	CHI
20200976025	AMORINOPOLIS	AM21138488	IPORA	23/09/2020 11:25	23/09/2020 19:44	23/09/2020 11:25	23/09/2020 19:44	8,30	1	8,30	CHI
20200976030	JARAGUA	JA21068863	ITABERAI S1	23/09/2020 11:26	24/09/2020 00:35	23/09/2020 11:26	24/09/2020 00:35	13,14	3	39,43	CHI
20200976038	ALTO HORIZONTE	10029964235	SANTA TEREZINHA	23/09/2020 11:28	24/09/2020 15:51	23/09/2020 11:28	24/09/2020 15:51	28,38	1	28,38	CHI
20200976053	RIO VERDE	630305274	RIO VERDE S2	23/09/2020 11:29	24/09/2020 08:59	23/09/2020 11:29	24/09/2020 08:59	21,49	1	21,49	CHI
20200976063	ACREUNA	2440002702	ACREUNA	23/09/2020 11:31	23/09/2020 18:55	23/09/2020 11:31	23/09/2020 18:55	7,40	1	7,40	CHI
20200976073	PLANALTINA	10031250279	PLANALTINA	23/09/2020 11:33	23/09/2020 12:09	23/09/2020 11:33	23/09/2020 12:09	0,60	1	0,60	CHI
20200976079	MINACU	4020055441	MINACU	23/09/2020 11:33	24/09/2020 10:29	23/09/2020 11:33	24/09/2020 10:29	22,93	1	22,93	CHI
20200976084	FORMOSO	FO21313419	MARA ROSA	23/09/2020 11:34	25/09/2020 08:56	23/09/2020 11:34	25/09/2020 08:56	45,37	1	45,37	CHI
20200976100	FORMOSA	10019536974	ITUIQUIRA	23/09/2020 11:35	23/09/2020 15:36	23/09/2020 11:35	23/09/2020 15:36	4,01	1	4,01	CHI
20200976102	CAMPINORTE	2040010756	CAMPINORTE	23/09/2020 11:36	23/09/2020 17:56	23/09/2020 11:36	23/09/2020 17:56	6,33	1	6,33	CHI
20200976127	FAINA	GS12362362	MATRINCHA	23/09/2020 11:39	23/09/2020 16:23	23/09/2020 11:39	23/09/2020 16:23	4,72	1	4,72	CHI
20200976132	SANTA TEREZINHA DE GOIAS	SG12201778	SANTA TEREZINHA	23/09/2020 11:40	23/09/2020 19:09	23/09/2020 11:40	23/09/2020 19:09	7,47	1	7,47	CHI
20200976151	IPORA	730035414	IPORA	23/09/2020 11:43	23/09/2020 15:53	23/09/2020 11:43	23/09/2020 15:53	4,16	1	4,16	CHI
20200976158	ITAJA	IJ21000009	ITAJA S2	23/09/2020 11:44	23/09/2020 14:19	23/09/2020 11:44	23/09/2020 14:19	2,57	1	2,57	CHI
20200976164	QUIRINOPOLIS	QI12000241	QUIRINOPOLIS	23/09/2020 11:45	23/09/2020 13:52	23/09/2020 11:45	23/09/2020 13:52	2,11	9	18,98	CHI
20200976166	ITABERAI	IB21000056	ITABERAI S2	23/09/2020 11:45	23/09/2020 18:33	23/09/2020 11:45	23/09/2020 18:33	6,78	2	13,57	CHI
20200976171	SANTA HELENA DE GOIAS	400044535	IPEGUARI	23/09/2020 11:46	23/09/2020 17:59	23/09/2020 11:46	23/09/2020 17:59	6,21	1	6,21	CHI
20200976172	MINACU	4020088276	MINACU	23/09/2020 11:46	23/09/2020 16:55	23/09/2020 11:46	23/09/2020 16:55	5,14	1	5,14	CHI
20200976178	JATAI	290097265	JATAI S3	23/09/2020 11:47	23/09/2020 12:37	23/09/2020 11:47	23/09/2020 12:37	0,84	1	0,84	CHI
20200976183	SERRANOPOLIS	SX21080878	JATAI S1	23/09/2020 11:47	24/09/2020 08:49	23/09/2020 11:47	24/09/2020 08:49	21,02	1	21,02	CHI
20200976609	SANTA TEREZINHA DE GOIAS	SG12049774	SANTA TEREZINHA	23/09/2020 11:48	23/09/2020 15:30	23/09/2020 11:48	23/09/2020 15:30	3,69	140	516,37	CHI

INTERNAL

20200976216	MINACU	IH21244543	MINACU	23/09/2020 11:54	23/09/2020 17:03	23/09/2020 11:54	23/09/2020 17:03	5,14	1	5,14	CHI
20200976221	BONOPOLIS	BX12369990	NOVO PLANALTO	23/09/2020 11:55	23/09/2020 21:56	23/09/2020 11:55	23/09/2020 21:56	10,02	1	10,02	CHI
20200976224	GOIANESIA	SZ21094175	ITAPACI	23/09/2020 11:55	23/09/2020 16:35	23/09/2020 11:55	23/09/2020 16:35	4,66	1	4,66	CHI
20200976227	APARECIDA DO RIO DOCE	3650008930	CACHOEIRA ALTA	23/09/2020 11:55	23/09/2020 14:04	23/09/2020 11:55	23/09/2020 14:04	2,14	1	2,14	CHI
20200976342	FORMOSA	FA12376671	ITUIQUIRA	23/09/2020 11:55	23/09/2020 22:55	23/09/2020 11:55	23/09/2020 22:55	10,99	25	274,65	CHI
20200976241	PILAR DE GOIAS	GG21141551	ITAPACI	23/09/2020 11:57	24/09/2020 15:51	23/09/2020 11:57	24/09/2020 15:51	27,90	1	27,90	CHI
20200976264	ARAGARCAS	BM11362543	BOM JARDIM	23/09/2020 11:59	23/09/2020 15:21	23/09/2020 11:59	23/09/2020 15:21	3,35	1	3,35	CHI
20200976274	MARA ROSA	2260024616	MARA ROSA	23/09/2020 12:00	23/09/2020 16:52	23/09/2020 12:00	23/09/2020 16:52	4,85	1	4,85	CHI
20200976278	CABECEIRAS	CW21322756	ITUIQUIRA	23/09/2020 12:01	23/09/2020 21:35	23/09/2020 12:01	23/09/2020 21:35	9,56	1	9,56	CHI
20200976283	JATAI	JT21324824	JATAI S1	23/09/2020 12:02	23/09/2020 14:28	23/09/2020 12:02	23/09/2020 14:28	2,43	1	2,43	CHI
20200976302	FLORES DE GOIAS	FB11255061	FLORES DE GOIAS	23/09/2020 12:04	23/09/2020 18:44	23/09/2020 12:04	23/09/2020 18:44	6,65	13	86,46	CHI
20200976336	PARAUNA	PU12336678	PARAUNA	23/09/2020 12:09	24/09/2020 02:35	23/09/2020 12:09	24/09/2020 02:35	14,42	2	28,85	CHI
20200976338	ITARUMA	IM12058060	CACHOEIRA ALTA	23/09/2020 12:09	23/09/2020 18:06	23/09/2020 12:09	23/09/2020 18:06	5,94	16	94,98	CHI
20200976347	ADELANDIA	2330004480	FIRMINOPOLIS S2	23/09/2020 12:10	23/09/2020 18:38	23/09/2020 12:10	23/09/2020 18:38	6,45	1	6,45	CHI
20200976349	PALMEIRAS DE GOIAS	590005832	PALMEIRAS	23/09/2020 12:11	23/09/2020 17:21	23/09/2020 12:11	23/09/2020 17:21	5,17	1	5,17	CHI
20200976368	FORMOSA	10030119667	ITUIQUIRA	23/09/2020 12:14	23/09/2020 14:27	23/09/2020 12:14	23/09/2020 14:27	2,21	1	2,21	CHI
20200976382	FIRMINOPOLIS	FR12206071	FIRMINOPOLIS S2	23/09/2020 12:16	23/09/2020 20:15	23/09/2020 12:16	23/09/2020 20:15	7,98	4	31,91	CHI
20200976383	PALMEIRAS DE GOIAS	10018945714	PALMEIRAS	23/09/2020 12:16	23/09/2020 18:56	23/09/2020 12:16	23/09/2020 18:56	6,66	1	6,66	CHI
20200976384	RIO VERDE	630340341	RIO VERDE S2	23/09/2020 12:16	23/09/2020 14:55	23/09/2020 12:16	23/09/2020 14:55	2,64	1	2,64	CHI
20200976395	EDEIA	EA21033670	RIO DOS BOIS	23/09/2020 12:18	23/09/2020 13:21	23/09/2020 12:18	23/09/2020 13:21	1,04	1	1,04	CHI
20200976396	GUARANI DE GOIAS	GY12271756	SAO DOMINGOS	23/09/2020 12:18	23/09/2020 15:32	23/09/2020 12:18	23/09/2020 15:32	3,22	1	3,22	CHI
20200977981	FORMOSO	ET12143705	MARA ROSA	23/09/2020 12:20	24/09/2020 10:03	23/09/2020 12:20	24/09/2020 10:03	21,71	7	151,97	CHI
20200977981	ESTRELA DO NORTE	ET12143705	MARA ROSA	23/09/2020 12:20	24/09/2020 10:03	23/09/2020 12:20	24/09/2020 10:03	21,71	9	195,39	CHI
20200976405	RIO VERDE	630131983	RIO VERDE S1	23/09/2020 12:20	23/09/2020 18:43	23/09/2020 12:20	23/09/2020 18:43	6,39	1	6,39	CHI
20200976416	PLANALTINA	2960133451	PLANALTINA	23/09/2020 12:22	23/09/2020 13:39	23/09/2020 12:22	23/09/2020 13:39	1,28	1	1,28	CHI
20200976417	RIO VERDE	630292358	RIO VERDE S1	23/09/2020 12:22	23/09/2020 15:00	23/09/2020 12:22	23/09/2020 15:00	2,63	1	2,63	CHI
20200976455	PORANGATU	PO11020558	PORANGATU	23/09/2020 12:22	23/09/2020 17:03	23/09/2020 12:22	23/09/2020 17:03	4,67	120	560,17	CHI
20200976460	GOIAS	GS12220106	ITABERAI S1	23/09/2020 12:28	23/09/2020 17:05	23/09/2020 12:28	23/09/2020 17:05	4,61	9	41,50	CHI
20200976464	JATAI	290157195	JATAI S3	23/09/2020 12:28	23/09/2020 15:43	23/09/2020 12:28	23/09/2020 15:43	3,24	1	3,24	CHI
20200976467	RIO VERDE	630333403	RIO VERDE S2	23/09/2020 12:28	23/09/2020 18:19	23/09/2020 12:28	23/09/2020 18:19	5,84	1	5,84	CHI
20200976473	QUIRINOPOLIS	80075794	QUIRINOPOLIS	23/09/2020 12:29	23/09/2020 15:48	23/09/2020 12:29	23/09/2020 15:48	3,31	1	3,31	CHI
20200976494	MARA ROSA	MQ12333916	MARA ROSA	23/09/2020 12:32	24/09/2020 12:11	23/09/2020 12:32	24/09/2020 12:11	23,64	2	47,28	CHI
20200976499	UIRAPURU	UP21147334	SANTA TEREZINHA	23/09/2020 12:33	24/09/2020 14:56	23/09/2020 12:33	24/09/2020 14:56	26,38	1	26,38	CHI

INTERNAL

20200976510	UIRAPURU	UP21257310	SANTA TEREZINHA	23/09/2020 12:35	24/09/2020 15:47	23/09/2020 12:35	24/09/2020 15:47	27,20	2	54,39	CHI
20200976526	RIO VERDE	630141757	RIO VERDE S1	23/09/2020 12:36	24/09/2020 01:05	23/09/2020 12:36	24/09/2020 01:05	12,47	1	12,47	CHI
20200976544	IPORA	730060664	IPORA	23/09/2020 12:38	23/09/2020 16:12	23/09/2020 12:38	23/09/2020 16:12	3,57	1	3,57	CHI
20200976546	CACU	CC12080196	CACHOEIRA ALTA	23/09/2020 12:38	23/09/2020 17:37	23/09/2020 12:38	23/09/2020 17:37	4,98	5	24,90	CHI
20200976548	PARAUNA	PU11233914	MONTIVIDIU T	23/09/2020 12:38	23/09/2020 19:11	23/09/2020 12:38	23/09/2020 19:11	6,54	2	13,07	CHI
20200976554	GOIAS	GS12061617	ITABERAI S1	23/09/2020 12:39	23/09/2020 14:45	23/09/2020 12:39	23/09/2020 14:45	2,09	10	20,91	CHI
20200976561	FORMOSA	610156111	ITUIQUIRA	23/09/2020 12:40	23/09/2020 15:00	23/09/2020 12:40	23/09/2020 15:00	2,33	1	2,33	CHI
20200976573	SAO DOMINGOS	SD21242373	SAO DOMINGOS	23/09/2020 12:43	23/09/2020 15:42	23/09/2020 12:43	23/09/2020 15:42	2,98	1	2,98	CHI
20200976582	ITABERAI	50123361	ITABERAI S2	23/09/2020 12:44	23/09/2020 14:27	23/09/2020 12:44	23/09/2020 14:27	1,71	1	1,71	CHI
20200976597	FLORES DE GOIAS	FB21261870	FLORES DE GOIAS	23/09/2020 12:46	23/09/2020 14:22	23/09/2020 12:46	23/09/2020 14:22	1,59	3	4,78	CHI
20200976612	PORANGATU	10017797290	PORANGATU	23/09/2020 12:49	23/09/2020 19:45	23/09/2020 12:49	23/09/2020 19:45	6,92	1	6,92	CHI
20200976614	MONTIVIDIU	2840020460	MONTIVIDIU T	23/09/2020 12:50	23/09/2020 18:01	23/09/2020 12:50	23/09/2020 18:01	5,18	1	5,18	CHI
20200976618	ANICUNS	910064090	ANICUNS	23/09/2020 12:51	23/09/2020 23:35	23/09/2020 12:51	23/09/2020 23:35	10,73	1	10,73	CHI
20200976624	SANCLERLANDIA	1210039300	FIRMINOPOLIS S2	23/09/2020 12:52	23/09/2020 18:35	23/09/2020 12:52	23/09/2020 18:35	5,72	1	5,72	CHI
20200976627	PALMEIRAS DE GOIAS	590060442	PALMEIRAS	23/09/2020 12:52	23/09/2020 17:58	23/09/2020 12:52	23/09/2020 17:58	5,09	1	5,09	CHI
20200977632	RUBIATABA	RB12003201	RUBIATABA	23/09/2020 12:54	24/09/2020 00:01	23/09/2020 12:54	24/09/2020 00:01	11,10	17	188,74	CHI
20200976639	IPORA	IR21091425	IPORA	23/09/2020 12:57	23/09/2020 17:00	23/09/2020 12:57	23/09/2020 17:00	4,04	2	8,09	CHI
20200976640	CACHOEIRA ALTA	CA21078886	CACHOEIRA ALTA	23/09/2020 12:57	23/09/2020 15:39	23/09/2020 12:57	23/09/2020 15:39	2,69	1	2,69	CHI
20200976680	IACIARA	IA21184991	IACIARA S2	23/09/2020 13:02	23/09/2020 15:25	23/09/2020 13:02	23/09/2020 15:25	2,37	1	2,37	CHI
20200976690	PIRANHAS	1930040031	PIRANHAS	23/09/2020 13:03	24/09/2020 11:25	23/09/2020 13:03	24/09/2020 11:25	22,35	1	22,35	CHI
20200976714	PILAR DE GOIAS	HL21000009	URUACU	23/09/2020 13:08	23/09/2020 23:55	23/09/2020 13:08	23/09/2020 23:55	10,78	1	10,78	CHI
20200976716	SAO DOMINGOS	SD12345873	SAO DOMINGOS	23/09/2020 13:08	23/09/2020 17:25	23/09/2020 13:08	23/09/2020 17:25	4,27	2	8,55	CHI
20200976721	JAUPACI	JP21139351	IPORA	23/09/2020 13:09	23/09/2020 15:24	23/09/2020 13:09	23/09/2020 15:24	2,25	1	2,25	CHI
20200977167	FAINA	FC12321457	GOIAS	23/09/2020 13:13	23/09/2020 22:19	23/09/2020 13:13	23/09/2020 22:19	9,09	20	181,82	CHI
20200977232	MUNDO NOVO DE GOIAS	SM10401470	NOVA CRIXAS	23/09/2020 13:15	24/09/2020 15:31	23/09/2020 13:15	23/09/2020 17:19	4,07	103	419,61	CHI
20200977232	SAO MIGUEL DO ARAGUAIA	SM10401470	NOVA CRIXAS	23/09/2020 13:15	24/09/2020 15:31	23/09/2020 13:15	23/09/2020 18:55	5,68	12	68,18	CHI
20200977232	SAO MIGUEL DO ARAGUAIA	SM10401470	NOVA CRIXAS	23/09/2020 13:15	24/09/2020 15:31	23/09/2020 13:15	24/09/2020 15:31	26,28	10	262,79	CHI
20200976783	SANTA TEREZA DE GOIAS	2430010210	MARA ROSA	23/09/2020 13:18	24/09/2020 20:59	23/09/2020 13:18	24/09/2020 20:59	31,68	1	31,68	CHI
20200976786	NAZARIO	440012752	ANICUNS	23/09/2020 13:18	23/09/2020 20:28	23/09/2020 13:18	23/09/2020 20:28	7,15	1	7,15	CHI
20200976802	IPORA	730053994	IPORA	23/09/2020 13:22	23/09/2020 16:50	23/09/2020 13:22	23/09/2020 16:50	3,46	1	3,46	CHI
20200977019	SANTA TEREZINHA DE GOIAS	SG12181588	SANTA TEREZINHA	23/09/2020 13:23	23/09/2020 20:25	23/09/2020 13:23	23/09/2020 20:25	7,02	6	42,15	CHI
20200977019	CAMPOS VERDES	SG12181588	SANTA TEREZINHA	23/09/2020 13:23	23/09/2020 20:25	23/09/2020 13:23	23/09/2020 20:25	7,02	8	56,20	CHI
20200976836	NOVA CRIXAS	8570039921	NOVA CRIXAS	23/09/2020 13:25	23/09/2020 17:32	23/09/2020 13:25	23/09/2020 17:32	4,12	1	4,12	CHI

INTERNAL

20200976844	MINEIROS	MY12296380	PARQUE DAS EMAS	23/09/2020 13:26	23/09/2020 15:34	23/09/2020 13:26	23/09/2020 15:34	2,13	3	6,40	CHI
20200976857	PLANALTINA	PI12324338	SAO JOAO D ALIANCA	23/09/2020 13:28	23/09/2020 17:20	23/09/2020 13:28	23/09/2020 17:20	3,86	6	23,15	CHI
20200976874	CACHOEIRA ALTA	CA21374279	CACHOEIRA ALTA	23/09/2020 13:31	23/09/2020 15:54	23/09/2020 13:31	23/09/2020 15:54	2,38	1	2,38	CHI
20200976879	PALMEIRAS DE GOIAS	590046093	PALMEIRAS	23/09/2020 13:32	23/09/2020 15:17	23/09/2020 13:32	23/09/2020 15:17	1,74	1	1,74	CHI
20200976894	PALMEIRAS DE GOIAS	PL11277560	PALMEIRAS	23/09/2020 13:34	24/09/2020 09:13	23/09/2020 13:34	24/09/2020 09:13	19,65	1	19,65	CHI
20200976898	PORANGATU	PO21286167	PORANGATU	23/09/2020 13:34	23/09/2020 16:25	23/09/2020 13:34	23/09/2020 16:25	2,84	1	2,84	CHI
20200976940	MINEIROS	MY21324513	PARQUE DAS EMAS	23/09/2020 13:40	23/09/2020 22:24	23/09/2020 13:40	23/09/2020 22:24	8,72	1	8,72	CHI
20200976946	BALIZA	BH11331431	CAIAPONIA	23/09/2020 13:42	24/09/2020 03:19	23/09/2020 13:42	24/09/2020 03:19	13,61	1	13,61	CHI
20200976947	ITAUCU	IX21380018	ITABERAI S1	23/09/2020 13:42	23/09/2020 17:31	23/09/2020 13:42	23/09/2020 17:31	3,81	1	3,81	CHI
20200976955	ITABERAI	50079967	ITABERAI S2	23/09/2020 13:43	23/09/2020 17:49	23/09/2020 13:43	23/09/2020 17:49	4,10	1	4,10	CHI
20200977272	SAO LUIS DE MONTES BELOS	SL11000055	SAO LUIZ DOS MONTES BELOS	23/09/2020 13:44	23/09/2020 16:10	23/09/2020 13:44	23/09/2020 16:10	2,43	77	187,05	CHI
20200976966	MAURILANDIA	1040011126	RIO DOS BOIS	23/09/2020 13:45	24/09/2020 12:11	23/09/2020 13:45	24/09/2020 12:11	22,43	1	22,43	CHI
20200976994	GOIAS	IU12000012LD	MATRINCHA	23/09/2020 13:45	23/09/2020 23:28	23/09/2020 13:45	23/09/2020 23:28	9,72	118	1147,03	CHI
20200976994	ITAPIRAPUA	IU12000012LD	MATRINCHA	23/09/2020 13:45	23/09/2020 23:28	23/09/2020 13:45	23/09/2020 23:28	9,72	48	466,59	CHI
20200976969	AMARALINA	LC21244195	MARA ROSA	23/09/2020 13:45	24/09/2020 15:11	23/09/2020 13:45	24/09/2020 15:11	25,42	1	25,42	CHI
20200976988	SANCLERLANDIA	1210020613	FIRMINOPOLIS S2	23/09/2020 13:47	23/09/2020 17:07	23/09/2020 13:47	23/09/2020 17:07	3,33	1	3,33	CHI
20200977030	ACREUNA	2440081602	ACREUNA	23/09/2020 13:54	23/09/2020 19:32	23/09/2020 13:54	23/09/2020 19:32	5,63	1	5,63	CHI
20200977032	PORANGATU	PO12028736	PORANGATU	23/09/2020 13:55	23/09/2020 18:37	23/09/2020 13:55	23/09/2020 18:37	4,69	4	18,78	CHI
20200977058	MONTES CLAROS DE GOIAS	1440000752	IPORA	23/09/2020 13:58	23/09/2020 17:56	23/09/2020 13:58	23/09/2020 17:56	3,95	1	3,95	CHI
20200977059	MONTES CLAROS DE GOIAS	1440011970	IPORA	23/09/2020 13:59	23/09/2020 18:05	23/09/2020 13:59	23/09/2020 18:05	4,10	1	4,10	CHI
20200978578	DIVINOPOLIS DE GOIAS	GH11222712	SAO DOMINGOS	23/09/2020 14:00	23/09/2020 20:09	23/09/2020 14:00	23/09/2020 20:09	6,14	131	804,27	CHI
20200977074	GOIAS	IB21198988	ITABERAI S2	23/09/2020 14:01	23/09/2020 17:20	23/09/2020 14:01	23/09/2020 17:20	3,31	1	3,31	CHI
20200977082	MAMBAI	8123075	IACIARA S2	23/09/2020 14:02	23/09/2020 23:39	23/09/2020 14:02	23/09/2020 23:39	9,62	2	19,23	CHI
20200978099	MARA ROSA	MQ12208528	MARA ROSA	23/09/2020 14:02	24/09/2020 01:57	23/09/2020 14:02	24/09/2020 01:57	11,91	1	11,91	CHI
20200977108	FORMOSA	FA21096304	SAO JOAO D ALIANCA	23/09/2020 14:06	23/09/2020 17:40	23/09/2020 14:06	23/09/2020 17:40	3,55	2	7,11	CHI
20200977135	PEROLANDIA	DP11254561	JATAI S1	23/09/2020 14:13	23/09/2020 16:41	23/09/2020 14:13	23/09/2020 16:41	2,46	1	2,46	CHI
20200977137	SAO LUIS DE MONTES BELOS	500009168	SAO LUIZ DOS MONTES BELOS	23/09/2020 14:14	23/09/2020 16:33	23/09/2020 14:14	23/09/2020 16:33	2,32	1	2,32	CHI
20200977141	SANTA ISABEL	SZ21316169	ITAPACI	23/09/2020 14:17	23/09/2020 17:04	23/09/2020 14:17	23/09/2020 17:04	2,78	1	2,78	CHI
20200977147	ARENOPOLIS	AY21156788	ARENOPOLIS	23/09/2020 14:18	24/09/2020 07:58	23/09/2020 14:18	24/09/2020 07:58	17,67	1	17,67	CHI
20200977151	IPORA	730089502	IPORA	23/09/2020 14:18	24/09/2020 07:40	23/09/2020 14:18	24/09/2020 07:40	17,35	1	17,35	CHI
20200977156	FORMOSA	FA21062250	ITUIQUIRA	23/09/2020 14:19	23/09/2020 19:16	23/09/2020 14:19	23/09/2020 19:16	4,94	2	9,88	CHI
20200977275	CAMPINORTE	CR12202139RE	MARA ROSA	23/09/2020 14:21	23/09/2020 16:57	23/09/2020 14:21	23/09/2020 16:57	2,59	32	82,90	CHI
20200977275	URUACU	CR12202139RE	MARA ROSA	23/09/2020 14:21	23/09/2020 16:57	23/09/2020 14:21	23/09/2020 16:57	2,59	106	274,60	CHI

INTERNAL

20200977207	ITAPACI	IW12081353	ITAPACI	23/09/2020 14:22	23/09/2020 15:58	23/09/2020 14:22	23/09/2020 15:58	1,58	23	36,44	CHI
20200977206	ITAPIRAPUA	1420000084	MATRINCHA	23/09/2020 14:24	23/09/2020 17:57	23/09/2020 14:24	23/09/2020 17:57	3,53	1	3,53	CHI
20200977215	AGUA FRIA DE GOIAS	TL12337440	SAO JOAO D ALIANCA	23/09/2020 14:25	23/09/2020 18:41	23/09/2020 14:25	23/09/2020 18:41	4,25	5	21,27	CHI
20200978040	PALMEIRAS DE GOIAS	PL12000032	PALMEIRAS	23/09/2020 14:26	24/09/2020 08:10	23/09/2020 14:26	24/09/2020 08:10	17,73	6	106,38	CHI
20200977229	INACIOLANDIA	2810018383	QUIRINOPOLIS	23/09/2020 14:27	23/09/2020 17:24	23/09/2020 14:27	23/09/2020 17:24	2,94	1	2,94	CHI
20200977230	RIO VERDE	630134029	RIO VERDE S2	23/09/2020 14:27	23/09/2020 17:05	23/09/2020 14:27	23/09/2020 17:05	2,62	1	2,62	CHI
20200977225	QUIRINOPOLIS	QI11047648	QUIRINOPOLIS	23/09/2020 14:27	23/09/2020 16:19	23/09/2020 15:50	23/09/2020 16:19	0,48	179	86,52	CHI
20200977238	MINACU	10015540586	MINACU	23/09/2020 14:29	24/09/2020 03:22	23/09/2020 14:29	24/09/2020 03:22	12,88	1	12,88	CHI
20200977242	PORTELANDIA	1470008194	PARQUE DAS EMAS	23/09/2020 14:29	23/09/2020 18:42	23/09/2020 14:29	23/09/2020 18:42	4,21	1	4,21	CHI
20200977243	JATAI	290133245	JATAI S3	23/09/2020 14:29	23/09/2020 19:44	23/09/2020 14:29	23/09/2020 19:44	5,25	1	5,25	CHI
20200977250	ITAPIRAPUA	1420006670	MATRINCHA	23/09/2020 14:30	23/09/2020 16:21	23/09/2020 14:30	23/09/2020 16:21	1,84	1	1,84	CHI
20200977293	ARAGUAPAZ	AZ21132890	MOZARLANDIA	23/09/2020 14:34	23/09/2020 17:09	23/09/2020 14:34	23/09/2020 17:09	2,57	1	2,57	CHI
20200977299	ITABERAI	50073461	ITABERAI S2	23/09/2020 14:35	23/09/2020 22:36	23/09/2020 14:35	23/09/2020 22:36	8,01	1	8,01	CHI
20200977306	URUACU	640107977	URUACU	23/09/2020 14:37	24/09/2020 10:58	23/09/2020 14:37	24/09/2020 10:58	20,35	1	20,35	CHI
20200977312	CAIAPONIA	CP21020916	CAIAPONIA	23/09/2020 14:37	23/09/2020 19:40	23/09/2020 14:37	23/09/2020 19:40	5,03	1	5,03	CHI
20200977313	PLANALTINA	PI21154256	PLANALTINA	23/09/2020 14:38	23/09/2020 15:50	23/09/2020 14:38	23/09/2020 15:50	1,21	2	2,42	CHI
20200977327	PALMEIRAS DE GOIAS	590063510	PALMEIRAS	23/09/2020 14:39	23/09/2020 19:39	23/09/2020 14:39	23/09/2020 19:39	5,00	1	5,00	CHI
20200977339	JATAI	JT11036825	JATAI S2	23/09/2020 14:40	23/09/2020 17:06	23/09/2020 14:40	23/09/2020 17:06	2,43	142	344,82	CHI
20200977355	PALESTINA DE GOIAS	CP21020923	PALESTINA	23/09/2020 14:42	23/09/2020 16:26	23/09/2020 14:42	23/09/2020 16:26	1,72	1	1,72	CHI
20200977373	MARA ROSA	MQ21287618	MARA ROSA	23/09/2020 14:44	24/09/2020 19:29	23/09/2020 14:44	24/09/2020 19:29	28,73	1	28,73	CHI
20200977383	ITABERAI	IB12379749	ITABERAI S2	23/09/2020 14:45	23/09/2020 18:46	23/09/2020 14:45	23/09/2020 18:46	4,01	6	24,05	CHI
20200977386	MUNDO NOVO DE GOIAS	MH12418306	NOVA CRIXAS	23/09/2020 14:46	23/09/2020 20:52	23/09/2020 14:46	23/09/2020 20:52	6,10	4	24,40	CHI
20200977385	RIO VERDE	RV21018253	MONTIVIDIU T	23/09/2020 14:46	23/09/2020 18:19	23/09/2020 14:46	23/09/2020 18:19	3,55	1	3,55	CHI
20200977390	ITABERAI	IB12274501	ITABERAI S1	23/09/2020 14:46	23/09/2020 17:50	23/09/2020 14:46	23/09/2020 17:50	3,05	3	9,16	CHI
20200977960	PORANGATU	PO11208646	PORANGATU	23/09/2020 14:52	23/09/2020 22:14	23/09/2020 14:52	23/09/2020 22:14	7,36	155	1140,84	CHI
20200977418	CAIAPONIA	CP21243854	CAIAPONIA	23/09/2020 14:52	23/09/2020 16:35	23/09/2020 14:52	23/09/2020 16:35	1,71	1	1,71	CHI
20200977424	JANDAIA	JD12152771	PALMEIRAS	23/09/2020 14:55	24/09/2020 15:35	23/09/2020 14:55	24/09/2020 15:35	24,66	1	24,66	CHI
20200977431	FORMOSA	FA21120086	ITUIQUIRA	23/09/2020 14:55	23/09/2020 23:49	23/09/2020 14:55	23/09/2020 23:13	8,29	1	8,29	CHI
20200977431	FORMOSA	FA12262114LD	ITUIQUIRA	23/09/2020 14:55	23/09/2020 23:49	23/09/2020 14:55	23/09/2020 23:49	8,89	5	44,44	CHI
20200976960	SANTA HELENA DE GOIAS	SH12207104	IPEGUARI	23/09/2020 14:56	23/09/2020 15:34	23/09/2020 14:56	23/09/2020 15:34	0,65	18	11,69	CHI
20200977437	FORMOSA	610228018	ITUIQUIRA	23/09/2020 14:57	23/09/2020 16:24	23/09/2020 14:57	23/09/2020 16:24	1,45	1	1,45	CHI
20200977443	ESTRELA DO NORTE	ET11374539	MARA ROSA	23/09/2020 14:57	23/09/2020 17:20	23/09/2020 14:57	23/09/2020 17:20	2,37	8	18,94	CHI
20200977475	SAO LUIS DE MONTES BELOS	6859671	SAO LUIZ DOS MONTES BELOS	23/09/2020 15:01	23/09/2020 19:49	23/09/2020 15:01	23/09/2020 19:49	4,80	3	14,40	CHI

INTERNAL

20200977477	PEROLANDIA	2370010491	JATAI S1	23/09/2020 15:01	23/09/2020 18:42	23/09/2020 15:01	23/09/2020 18:42	3,69	1	3,69	CHI
20200977479	SAO DOMINGOS	4950001293	SAO DOMINGOS	23/09/2020 15:01	23/09/2020 16:27	23/09/2020 15:01	23/09/2020 16:27	1,42	1	1,42	CHI
20200977494	PALMEIRAS DE GOIAS	PL21062640	PALMEIRAS	23/09/2020 15:05	23/09/2020 20:55	23/09/2020 15:05	23/09/2020 20:55	5,82	1	5,82	CHI
20200977506	CAIAPONIA	PY12096414	PALESTINA	23/09/2020 15:08	24/09/2020 00:29	23/09/2020 15:08	24/09/2020 00:29	9,34	34	317,61	CHI
20200977506	PALESTINA DE GOIAS	PY12096414	PALESTINA	23/09/2020 15:08	24/09/2020 00:29	23/09/2020 15:08	24/09/2020 00:29	9,34	1	9,34	CHI
20200977522	SAO LUIZ DO NORTE	SZ21346782	ITAPACI	23/09/2020 15:10	24/09/2020 10:33	23/09/2020 15:10	24/09/2020 10:33	19,37	1	19,37	CHI
20200977602	SAO JOAO D ALIANCA	FB12250123	FLORES DE GOIAS	23/09/2020 15:11	23/09/2020 17:13	23/09/2020 15:11	23/09/2020 17:13	2,03	20	40,51	CHI
20200977602	FLORES DE GOIAS	FB12250123	FLORES DE GOIAS	23/09/2020 15:11	23/09/2020 17:13	23/09/2020 15:11	23/09/2020 17:13	2,03	119	241,04	CHI
20200977535	BOM JARDIM DE GOIAS	10019501577	BOM JARDIM	23/09/2020 15:13	23/09/2020 16:46	23/09/2020 15:13	23/09/2020 16:46	1,55	1	1,55	CHI
20200977541	PALMEIRAS DE GOIAS	590009618	PALMEIRAS	23/09/2020 15:13	24/09/2020 10:47	23/09/2020 15:13	24/09/2020 10:47	19,55	1	19,55	CHI
20200977545	RIO VERDE	630182620	RIO VERDE S1	23/09/2020 15:14	24/09/2020 10:25	23/09/2020 15:14	24/09/2020 10:25	19,18	1	19,18	CHI
20200977557	DIVINOPOLIS DE GOIAS	2570009629	SAO DOMINGOS	23/09/2020 15:16	24/09/2020 10:13	23/09/2020 15:16	24/09/2020 10:13	18,95	1	18,95	CHI
20200977579	PLANALTINA	2960199220	PLANALTINA	23/09/2020 15:19	23/09/2020 17:06	23/09/2020 15:19	23/09/2020 17:06	1,78	1	1,78	CHI
20200977593	RIO VERDE	RV21311797	CABRIUVA S2	23/09/2020 15:22	23/09/2020 16:23	23/09/2020 15:22	23/09/2020 16:23	1,01	1	1,01	CHI
20200977608	SANTA TEREZINHA DE GOIAS	SG11365879	SANTA TEREZINHA	23/09/2020 15:24	24/09/2020 22:58	23/09/2020 15:24	24/09/2020 22:58	31,55	12	378,60	CHI
20200977609	PALMEIRAS DE GOIAS	590026951	PALMEIRAS	23/09/2020 15:25	23/09/2020 18:38	23/09/2020 15:25	23/09/2020 18:38	3,21	1	3,21	CHI
20200977612	RIO VERDE	RV21322288	CABRIUVA S2	23/09/2020 15:25	23/09/2020 17:26	23/09/2020 15:25	23/09/2020 17:26	2,01	1	2,01	CHI
20200977615	PLANALTINA	PI12375598	PLANALTINA	23/09/2020 15:25	23/09/2020 20:33	23/09/2020 15:25	23/09/2020 20:33	5,12	3	15,35	CHI
20200977622	ARAGARCAS	BM11372337	BOM JARDIM	23/09/2020 15:26	24/09/2020 09:51	23/09/2020 15:26	24/09/2020 09:51	18,41	1	18,41	CHI
20200977623	TURVANIA	TV21005594	FIRMINOPOLIS S1	23/09/2020 15:26	23/09/2020 18:12	23/09/2020 15:26	23/09/2020 18:12	2,75	1	2,75	CHI
20200978074	NOVA CRIXAS	NA12391973	NOVA CRIXAS	23/09/2020 15:27	24/09/2020 18:15	23/09/2020 15:27	24/09/2020 18:13	26,77	11	294,49	CHI
20200978074	NOVA CRIXAS	NA12391973	NOVA CRIXAS	23/09/2020 15:27	24/09/2020 18:15	23/09/2020 15:27	24/09/2020 18:15	26,79	3	80,37	CHI
20200978074	NOVA CRIXAS	NA12328070	NOVA CRIXAS	23/09/2020 15:27	24/09/2020 18:15	24/09/2020 05:11	24/09/2020 05:20	0,15	96	14,19	CHI
20200978074	NOVA CRIXAS	NA12391973	NOVA CRIXAS	23/09/2020 15:27	24/09/2020 18:15	24/09/2020 05:11	24/09/2020 18:13	13,04	1	13,04	CHI
20200978075	INDIARA	JD12340064	ACREUNA	23/09/2020 15:28	24/09/2020 09:46	23/09/2020 15:28	24/09/2020 09:46	18,30	3	54,90	CHI
20200978075	JANDAIA	JD12340064	ACREUNA	23/09/2020 15:28	24/09/2020 09:46	23/09/2020 15:28	24/09/2020 09:46	18,30	13	237,90	CHI
20200977655	JATAI	JT21104000	JATAI S3	23/09/2020 15:31	23/09/2020 16:40	23/09/2020 15:31	23/09/2020 16:40	1,15	1	1,15	CHI
20200977671	PALMINOPOLIS	0314214R	PALMEIRAS	23/09/2020 15:32	24/09/2020 18:47	23/09/2020 15:32	23/09/2020 19:12	3,67	20	73,31	CHI
20200977671	PALMEIRAS DE GOIAS	PL13006762	PALMEIRAS	23/09/2020 15:32	24/09/2020 18:47	23/09/2020 15:32	23/09/2020 20:24	4,86	49	238,25	CHI
20200977671	PALMINOPOLIS	PL13006762	PALMEIRAS	23/09/2020 15:32	24/09/2020 18:47	23/09/2020 15:32	23/09/2020 20:24	4,86	5	24,31	CHI
20200977671	PALMINOPOLIS	PP12007014LD	PALMEIRAS	23/09/2020 15:32	24/09/2020 18:47	23/09/2020 15:32	23/09/2020 22:42	7,15	4	28,61	CHI
20200977671	PALMEIRAS DE GOIAS	PP12007014LD	PALMEIRAS	23/09/2020 15:32	24/09/2020 18:47	23/09/2020 15:32	23/09/2020 22:42	7,15	18	128,77	CHI
20200977671	PALMINOPOLIS	PP12312564	PALMEIRAS	23/09/2020 15:32	24/09/2020 18:47	23/09/2020 15:32	24/09/2020 00:23	8,85	15	132,70	CHI

INTERNAL

20200977671	PALMINOPOLIS	PP12312565	PALMEIRAS	23/09/2020 15:32	24/09/2020 18:47	23/09/2020 15:32	24/09/2020 08:02	16,50	4	66,00	CHI
20200977671	PALMINOPOLIS	PP12314793	PALMEIRAS	23/09/2020 15:32	24/09/2020 18:47	23/09/2020 15:32	24/09/2020 08:36	17,06	39	665,51	CHI
20200977671	PALMEIRAS DE GOIAS	PP12314793	PALMEIRAS	23/09/2020 15:32	24/09/2020 18:47	23/09/2020 15:32	24/09/2020 08:36	17,06	2	34,13	CHI
20200977671	PALMINOPOLIS	PP12233536	PALMEIRAS	23/09/2020 15:32	24/09/2020 18:47	23/09/2020 15:32	24/09/2020 08:41	17,14	1	17,14	CHI
20200977671	PALMEIRAS DE GOIAS	PP12233536	PALMEIRAS	23/09/2020 15:32	24/09/2020 18:47	23/09/2020 15:32	24/09/2020 08:41	17,14	11	188,53	CHI
20200977671	PALMINOPOLIS	PP12014747	PALMEIRAS	23/09/2020 15:32	24/09/2020 18:47	23/09/2020 15:32	24/09/2020 08:55	17,38	1	17,38	CHI
20200977671	PALMEIRAS DE GOIAS	PP12233536	PALMEIRAS	23/09/2020 15:32	24/09/2020 18:47	24/09/2020 08:45	24/09/2020 18:47	10,04	11	110,45	CHI
20200977671	PALMINOPOLIS	PP12233536	PALMEIRAS	23/09/2020 15:32	24/09/2020 18:47	24/09/2020 08:45	24/09/2020 18:47	10,04	1	10,04	CHI
20200977670	SANCLERLANDIA	MD21295020	FIRMINOPOLIS S2	23/09/2020 15:34	23/09/2020 17:51	23/09/2020 15:34	23/09/2020 17:51	2,28	1	2,28	CHI
20200977684	TURVANIA	1220017430	FIRMINOPOLIS S2	23/09/2020 15:37	23/09/2020 20:13	23/09/2020 15:37	23/09/2020 20:13	4,59	1	4,59	CHI
20200977685	NOVA CRIXAS	NA21057215	MOZARLANDIA	23/09/2020 15:37	23/09/2020 18:47	23/09/2020 15:37	23/09/2020 18:47	3,15	1	3,15	CHI
20200977915	AMARALINA	LC12325787	NOVA CRIXAS	23/09/2020 15:39	24/09/2020 20:57	24/09/2020 19:50	24/09/2020 20:57	1,12	3	3,35	CHI
20200977721	CAIAPONIA	CP12344723	MONTIVIDIU T	23/09/2020 15:46	23/09/2020 19:05	23/09/2020 15:46	23/09/2020 19:05	3,30	8	26,43	CHI
20200977995	GOIAS	IU12089755	MATRINCHA	23/09/2020 15:48	24/09/2020 04:45	23/09/2020 15:48	24/09/2020 04:45	12,93	1	12,93	CHI
20200977995	ITAPIRAPUA	IU12089755	MATRINCHA	23/09/2020 15:48	24/09/2020 04:45	23/09/2020 15:48	24/09/2020 04:45	12,93	56	724,31	CHI
20200977764	MINEIROS	MY12296380	PARQUE DAS EMAS	23/09/2020 15:54	23/09/2020 21:47	23/09/2020 15:54	23/09/2020 21:47	5,89	3	17,67	CHI
20200977815	JARAGUA	II12250783	ITABERAI S1	23/09/2020 15:54	23/09/2020 17:04	23/09/2020 15:54	23/09/2020 17:04	1,16	9	10,41	CHI
20200977815	ITAGUARI	II12250783	ITABERAI S1	23/09/2020 15:54	23/09/2020 17:04	23/09/2020 15:54	23/09/2020 17:04	1,16	11	12,73	CHI
20200977763	FORMOSA	610103696	ITUIQUIRA	23/09/2020 15:55	23/09/2020 17:06	23/09/2020 15:55	23/09/2020 17:06	1,18	1	1,18	CHI
20200977771	RIO VERDE	RV21230875	CABRIUVA S2	23/09/2020 15:57	23/09/2020 17:29	23/09/2020 15:57	23/09/2020 17:29	1,53	1	1,53	CHI
20200977772	ITABERAI	50059166	ITABERAI S2	23/09/2020 15:57	23/09/2020 17:27	23/09/2020 15:57	23/09/2020 17:27	1,50	1	1,50	CHI
20200977776	BONOPOLIS	BX21198509	NOVO PLANALTO	23/09/2020 15:57	23/09/2020 21:00	23/09/2020 15:57	23/09/2020 21:00	5,03	1	5,03	CHI
20200977778	ITAPURANGA	170004727	ITAPURANGA	23/09/2020 15:58	23/09/2020 21:00	23/09/2020 15:58	23/09/2020 21:00	5,03	1	5,03	CHI
20200977781	SAO JOAO D ALIANCA	3840003608	SAO JOAO D ALIANCA	23/09/2020 15:58	23/09/2020 17:04	23/09/2020 15:58	23/09/2020 17:04	1,09	1	1,09	CHI
20200977792	RIO VERDE	630040035	RIO VERDE S1	23/09/2020 16:01	23/09/2020 17:56	23/09/2020 16:01	23/09/2020 17:56	1,91	1	1,91	CHI
20200977793	AGUA FRIA DE GOIAS	TL21095904	SAO JOAO D ALIANCA	23/09/2020 16:01	23/09/2020 20:32	23/09/2020 16:01	23/09/2020 20:32	4,51	1	4,51	CHI
20200977812	NIQUELANDIA	NQ12140182	SAO JOAO D ALIANCA	23/09/2020 16:04	23/09/2020 23:05	23/09/2020 16:04	23/09/2020 23:05	7,01	6	42,09	CHI
20200977812	AGUA FRIA DE GOIAS	NQ12140182	SAO JOAO D ALIANCA	23/09/2020 16:04	23/09/2020 23:05	23/09/2020 16:04	23/09/2020 23:05	7,01	71	498,06	CHI
20200977801	DOVERLANDIA	4220001294	CAIAPONIA	23/09/2020 16:04	24/09/2020 00:35	23/09/2020 16:04	24/09/2020 00:35	8,52	1	8,52	CHI
20200977805	ESTRELA DO NORTE	2420010584	MARA ROSA	23/09/2020 16:04	24/09/2020 15:26	23/09/2020 16:04	24/09/2020 15:26	23,36	1	23,36	CHI
20200977810	CEZARINA	CZ21076716	CEZARINA	23/09/2020 16:05	23/09/2020 22:15	23/09/2020 16:05	23/09/2020 22:15	6,16	5	30,82	CHI
20200977813	CAMPINORTE	MQ21000006	MARA ROSA	23/09/2020 16:05	24/09/2020 15:37	23/09/2020 16:05	24/09/2020 15:37	23,53	1	23,53	CHI
20200977819	RIO VERDE	RV21338620	CABRIUVA S2	23/09/2020 16:05	23/09/2020 16:41	23/09/2020 16:05	23/09/2020 16:41	0,59	1	0,59	CHI

INTERNAL

20200977829	FORMOSA	610051258	ITAIQUIRA	23/09/2020 16:07	23/09/2020 17:48	23/09/2020 16:07	23/09/2020 17:48	1,67	1	1,67	CHI
20200977831	ITABERAI	50058058	ITABERAI S2	23/09/2020 16:07	24/09/2020 08:49	23/09/2020 16:07	24/09/2020 08:49	16,68	1	16,68	CHI
20200978494	SANTA TEREZINHA DE GOIAS	SG12202092	SANTA TEREZINHA	23/09/2020 16:08	24/09/2020 03:30	23/09/2020 16:08	24/09/2020 03:30	11,37	6	68,20	CHI
20200977836	PALMEIRAS DE GOIAS	PL12041808	PALMEIRAS	23/09/2020 16:09	23/09/2020 18:01	23/09/2020 16:09	23/09/2020 18:01	1,87	8	14,92	CHI
20200977850	HIDROLINA	HL21272690	URUACU	23/09/2020 16:11	23/09/2020 18:12	23/09/2020 16:11	23/09/2020 18:12	2,01	1	2,01	CHI
20200977855	MONTIVIDIU	RV12311791	MONTIVIDIU T	23/09/2020 16:13	23/09/2020 17:46	23/09/2020 16:13	23/09/2020 17:46	1,54	2	3,09	CHI
20200977855	RIO VERDE	RV12311791	MONTIVIDIU T	23/09/2020 16:13	23/09/2020 17:46	23/09/2020 16:13	23/09/2020 17:46	1,54	7	10,80	CHI
20200977871	PORANGATU	PO11262730	PORANGATU	23/09/2020 16:14	23/09/2020 16:53	23/09/2020 16:14	23/09/2020 16:53	0,64	117	74,88	CHI
20200977867	NOVA CRIXAS	8570000512	NOVA CRIXAS	23/09/2020 16:17	24/09/2020 11:08	23/09/2020 16:17	24/09/2020 11:08	18,84	1	18,84	CHI
20200977869	CHAPADAO DO CEU	AE21107453	CHAPADAO DO CEU	23/09/2020 16:17	23/09/2020 21:18	23/09/2020 16:17	23/09/2020 21:18	5,00	1	5,00	CHI
20200977884	JATAI	JT12219503	JATAI S3	23/09/2020 16:21	23/09/2020 19:21	23/09/2020 16:21	23/09/2020 19:21	2,99	3	8,97	CHI
20200977893	PLANALTINA	2960169690	PLANALTINA	23/09/2020 16:22	23/09/2020 19:10	23/09/2020 16:22	23/09/2020 19:10	2,79	1	2,79	CHI
20200977897	ITAPACI	IW21285056	ITAPACI	23/09/2020 16:23	23/09/2020 20:51	23/09/2020 16:23	23/09/2020 20:51	4,46	1	4,46	CHI
20200977919	CAIAPONIA	CP21354665	CAIAPONIA	23/09/2020 16:26	24/09/2020 16:00	23/09/2020 16:26	24/09/2020 16:00	23,55	0	0,00	CHI
20200977921	ACREUNA	2440040156	ACREUNA	23/09/2020 16:27	23/09/2020 20:29	23/09/2020 16:27	23/09/2020 20:29	4,03	1	4,03	CHI
20200977937	MINEIROS	MY21374297	PARQUE DAS EMAS	23/09/2020 16:30	24/09/2020 08:52	23/09/2020 16:30	24/09/2020 08:52	16,36	1	16,36	CHI
20200977947	SANTA HELENA DE GOIAS	10019710753	IPEGUARI	23/09/2020 16:32	23/09/2020 21:59	23/09/2020 16:32	23/09/2020 21:59	5,45	1	5,45	CHI
20200977961	FIRMINOPOLIS	900032595	FIRMINOPOLIS S1	23/09/2020 16:34	23/09/2020 18:16	23/09/2020 16:34	23/09/2020 18:16	1,70	1	1,70	CHI
20200977962	SAO LUIS DE MONTES BELOS	500127542	SAO LUIZ DOS MONTES BELOS	23/09/2020 16:35	23/09/2020 19:22	23/09/2020 16:35	23/09/2020 19:22	2,79	1	2,79	CHI
20200978619	CAMPINACU	IH12320899	MINACU	23/09/2020 16:35	24/09/2020 01:36	23/09/2020 16:35	24/09/2020 01:36	9,01	13	117,13	CHI
20200978619	MINACU	IH12320899	MINACU	23/09/2020 16:35	24/09/2020 01:36	23/09/2020 16:35	24/09/2020 01:36	9,01	9	81,09	CHI
20200977971	ITABERAI	IB12124892	ITABERAI S2	23/09/2020 16:36	23/09/2020 18:40	23/09/2020 16:36	23/09/2020 18:40	2,06	11	22,68	CHI
20200978039	SANTA TEREZINHA DE GOIAS	SG12049774	SANTA TEREZINHA	23/09/2020 16:37	24/09/2020 00:56	23/09/2020 16:37	24/09/2020 00:56	8,30	140	1162,43	CHI
20200977988	MINACU	4020053808	MINACU	23/09/2020 16:38	23/09/2020 18:43	23/09/2020 16:38	23/09/2020 18:43	2,08	1	2,08	CHI
20200977996	DOVERLANDIA	DV21139981	CAIAPONIA	23/09/2020 16:39	24/09/2020 02:58	23/09/2020 16:39	24/09/2020 02:58	10,30	1	10,30	CHI
20200978051	SANTA TEREZA DE GOIAS	PO10391979	PORANGATU	23/09/2020 16:40	24/09/2020 18:25	23/09/2020 16:40	23/09/2020 16:46	0,10	11	1,15	CHI
20200978051	TROMBAS	PO10391979	PORANGATU	23/09/2020 16:40	24/09/2020 18:25	23/09/2020 16:40	23/09/2020 16:46	0,10	171	17,91	CHI
20200978051	PORANGATU	PO10391979	PORANGATU	23/09/2020 16:40	24/09/2020 18:25	23/09/2020 16:40	23/09/2020 16:46	0,10	45	4,71	CHI
20200978051	PORANGATU	PO10391979	PORANGATU	23/09/2020 16:40	24/09/2020 18:25	23/09/2020 16:40	23/09/2020 16:46	0,10	183	19,16	CHI
20200978051	PORANGATU	PO10391979	PORANGATU	23/09/2020 16:40	24/09/2020 18:25	23/09/2020 16:40	23/09/2020 16:46	0,10	622	65,14	CHI
20200978051	PORANGATU	PO10391979	PORANGATU	23/09/2020 16:40	24/09/2020 18:25	23/09/2020 16:40	23/09/2020 19:20	2,67	157	419,80	CHI
20200978051	PORANGATU	PO10391979	PORANGATU	23/09/2020 16:40	24/09/2020 18:25	23/09/2020 16:40	24/09/2020 10:35	17,93	8	143,44	CHI
20200978051	PORANGATU	PO10391979	PORANGATU	23/09/2020 16:40	24/09/2020 18:25	23/09/2020 16:40	24/09/2020 15:53	23,23	49	1138,24	CHI

INTERNAL

20200978051	PORANGATU	PO12052522	PORANGATU	23/09/2020 16:40	24/09/2020 18:25	23/09/2020 16:40	24/09/2020 16:40	24,01	62	1488,62	CHI
20200978051	PORANGATU	PO12094115RE	PORANGATU	23/09/2020 16:40	24/09/2020 18:25	23/09/2020 16:40	24/09/2020 17:01	24,35	72	1753,48	CHI
20200978051	MONTIVIDIU DO NORTE	PO12094115RE	PORANGATU	23/09/2020 16:40	24/09/2020 18:25	23/09/2020 16:40	24/09/2020 17:01	24,35	6	146,12	CHI
20200978051	PORANGATU	PO12115502	PORANGATU	23/09/2020 16:40	24/09/2020 18:25	23/09/2020 16:40	24/09/2020 18:25	25,75	93	2395,03	CHI
20200978051	PORANGATU	PO10396207	PORANGATU	23/09/2020 16:40	24/09/2020 18:25	23/09/2020 22:10	23/09/2020 22:33	0,37	157	58,26	CHI
20200978019	BOM JARDIM DE GOIAS	1880010164	BOM JARDIM	23/09/2020 16:47	23/09/2020 19:42	23/09/2020 16:47	23/09/2020 19:42	2,91	1	2,91	CHI
20200978056	ITABERAI	19624013	ITABERAI S1	23/09/2020 16:53	23/09/2020 20:50	23/09/2020 16:53	23/09/2020 20:50	3,93	3	11,80	CHI
20200978057	SAO JOAO D ALIANCA	JL21146210	SAO JOAO D ALIANCA	23/09/2020 16:54	23/09/2020 18:18	23/09/2020 16:54	23/09/2020 18:18	1,40	1	1,40	CHI
20200978061	ARAGARCAS	AG11072871	ARAGARCAS	23/09/2020 16:54	24/09/2020 02:47	23/09/2020 16:54	24/09/2020 02:47	9,87	2	19,73	CHI
20200978062	URUACU	UR21117949	URUACU	23/09/2020 16:55	23/09/2020 19:13	23/09/2020 16:55	23/09/2020 19:13	2,30	1	2,30	CHI
20200978070	FORMOSA	610235448	ITUIQUIRA	23/09/2020 16:57	23/09/2020 17:45	23/09/2020 16:57	23/09/2020 17:45	0,79	1	0,79	CHI
20200978076	ITAPACI	IW21070626	ITAPACI	23/09/2020 16:58	24/09/2020 17:30	23/09/2020 16:58	24/09/2020 17:30	24,53	1	24,53	CHI
20200978081	JATAI	290277784	JATAI S3	23/09/2020 16:58	23/09/2020 18:39	23/09/2020 16:58	23/09/2020 18:39	1,67	1	1,67	CHI
20200978083	JATAI	JT12336925	MONTIVIDIU T	23/09/2020 16:59	24/09/2020 08:25	23/09/2020 16:59	24/09/2020 08:25	15,43	1	15,43	CHI
20200978109	ITAJA	IJ12200688	ITAJA S2	23/09/2020 17:02	23/09/2020 19:03	23/09/2020 17:02	23/09/2020 19:03	2,00	2	4,00	CHI
20200978625	CAMPOS VERDES	SG12171809	SANTA TEREZINHA	23/09/2020 17:05	23/09/2020 21:21	23/09/2020 17:05	23/09/2020 21:21	4,25	13	55,31	CHI
20200978144	FORMOSA	610074581	ITUIQUIRA	23/09/2020 17:08	23/09/2020 21:55	23/09/2020 17:08	23/09/2020 21:55	4,77	1	4,77	CHI
20200978309	MINACU	IH12262532	MINACU	23/09/2020 17:11	23/09/2020 22:27	23/09/2020 17:11	23/09/2020 22:27	5,27	67	352,87	CHI
20200978155	DIVINOPOLIS DE GOIAS	2570004462	SAO DOMINGOS	23/09/2020 17:11	24/09/2020 06:49	23/09/2020 17:11	24/09/2020 06:49	13,64	1	13,64	CHI
20200977706	JUSSARA	JR12198907	BRITANIA	23/09/2020 17:12	23/09/2020 21:22	23/09/2020 17:12	23/09/2020 21:22	4,17	27	112,46	CHI
20200977706	JUSSARA	JR12198907	BRITANIA	23/09/2020 17:12	23/09/2020 21:22	23/09/2020 19:38	23/09/2020 21:22	1,73	7	12,08	CHI
20200978697	ITABERAI	IB12021852	ITABERAI S2	23/09/2020 17:13	23/09/2020 21:06	23/09/2020 17:13	23/09/2020 21:06	3,87	80	309,82	CHI
202009107033	CAVALCANTE	10031376469	MINACU	23/09/2020 17:15	23/09/2020 17:56	23/09/2020 17:15	23/09/2020 17:56	0,68	1	0,68	CHI
20200978174	JATAI	290097265	JATAI S3	23/09/2020 17:15	23/09/2020 21:47	23/09/2020 17:15	23/09/2020 21:47	4,52	1	4,52	CHI
20200978298	SAO DOMINGOS	SD12208672	SAO DOMINGOS	23/09/2020 17:19	23/09/2020 21:23	23/09/2020 17:19	23/09/2020 21:23	4,06	27	109,54	CHI
20200978205	HIDROLINA	1020007427	URUACU	23/09/2020 17:22	24/09/2020 10:37	23/09/2020 17:22	24/09/2020 10:37	17,25	1	17,25	CHI
20200978215	JANDAIA	JD12008662	PALMEIRAS	23/09/2020 17:25	24/09/2020 10:55	23/09/2020 17:25	24/09/2020 10:55	17,49	30	524,82	CHI
20200978237	PORTELANDIA	PW12374317RE	PARQUE DAS EMAS	23/09/2020 17:25	23/09/2020 19:25	23/09/2020 17:25	23/09/2020 19:25	1,98	4	7,94	CHI
20200978237	MINEIROS	PW12374317RE	PARQUE DAS EMAS	23/09/2020 17:25	23/09/2020 19:25	23/09/2020 17:25	23/09/2020 19:25	1,98	1	1,98	CHI
20200978477	CAMPINORTE	MQ12390470	MARA ROSA	23/09/2020 17:26	24/09/2020 11:44	23/09/2020 17:26	24/09/2020 11:44	18,29	1	18,29	CHI
20200978477	MARA ROSA	MQ12390470	MARA ROSA	23/09/2020 17:26	24/09/2020 11:44	23/09/2020 17:26	24/09/2020 11:44	18,29	3	54,87	CHI
20200978231	AGUA FRIA DE GOIAS	TL21322494	SAO JOAO D ALIANCA	23/09/2020 17:28	23/09/2020 23:18	23/09/2020 17:28	23/09/2020 23:18	5,83	3	17,49	CHI
202009107037	COLINAS DO SUL	5300004344	MINACU	23/09/2020 17:28	23/09/2020 17:56	23/09/2020 17:28	23/09/2020 17:56	0,46	1	0,46	CHI

INTERNAL

20200978244	CACHOEIRA ALTA	CA12327414	CACHOEIRA ALTA	23/09/2020 17:30	23/09/2020 19:19	23/09/2020 17:30	23/09/2020 19:19	1,81	5	9,05	CHI
20200978252	CAIAPONIA	930029586	CAIAPONIA	23/09/2020 17:32	24/09/2020 14:42	23/09/2020 17:32	24/09/2020 14:42	21,16	1	21,16	CHI
20200978286	MINACU	IH11063611	MINACU	23/09/2020 17:32	24/09/2020 01:52	23/09/2020 17:32	24/09/2020 01:52	8,32	129	1073,35	CHI
20200978574	ITAPIRAPUA	IU12121437	MATRINCHA	23/09/2020 17:34	24/09/2020 00:22	23/09/2020 17:34	24/09/2020 00:22	6,80	16	108,77	CHI
20200978265	PORTEIRAO	CL12326945	RIO DOS BOIS	23/09/2020 17:34	24/09/2020 14:15	23/09/2020 17:34	24/09/2020 14:15	20,68	1	20,68	CHI
20200978275	PALMINOPOLIS	PP21007081	PALMEIRAS	23/09/2020 17:36	24/09/2020 15:47	23/09/2020 17:36	24/09/2020 15:47	22,18	1	22,18	CHI
20200978278	FORMOSO	2410014453	PORANGATU	23/09/2020 17:36	24/09/2020 17:50	23/09/2020 17:36	24/09/2020 17:50	24,22	1	24,22	CHI
20200978280	SANCLERLANDIA	SC21307085	FIRMINOPOLIS S2	23/09/2020 17:37	23/09/2020 18:23	23/09/2020 17:37	23/09/2020 18:23	0,77	2	1,53	CHI
20200978304	FORMOSA	610110305	ITUIQUIRA	23/09/2020 17:42	23/09/2020 19:23	23/09/2020 17:42	23/09/2020 19:23	1,68	1	1,68	CHI
20200978316	PORANGATU	PO12038770	PORANGATU	23/09/2020 17:45	24/09/2020 11:30	23/09/2020 17:45	24/09/2020 11:30	17,74	8	141,96	CHI
20200978316	MUTUNOPOLIS	PO12038770	PORANGATU	23/09/2020 17:45	24/09/2020 11:30	23/09/2020 17:45	24/09/2020 11:30	17,74	1	17,74	CHI
20200978331	RUBIATABA	RB21297318	RUBIATABA	23/09/2020 17:48	24/09/2020 15:04	23/09/2020 17:48	24/09/2020 15:04	21,25	2	42,51	CHI
20200978336	JATAI	JT21037064	JATAI S2	23/09/2020 17:49	23/09/2020 22:34	23/09/2020 17:49	23/09/2020 22:34	4,74	1	4,74	CHI
20200978569	CHAPADAO DO CEU	DJ11260347	CHAPADAO DO CEU	23/09/2020 17:49	23/09/2020 20:25	23/09/2020 17:49	23/09/2020 20:25	2,59	70	181,28	CHI
20200978346	NIQUELANDIA	2750083182	NIQUELANDIA SUBTRANSMISSAO	23/09/2020 17:51	24/09/2020 04:55	23/09/2020 17:51	24/09/2020 04:55	11,06	1	11,06	CHI
20200978353	RIO VERDE	630137900	RIO VERDE S2	23/09/2020 17:52	23/09/2020 20:48	23/09/2020 17:52	23/09/2020 20:48	2,92	1	2,92	CHI
20200978390	CAVALCANTE	TI10401551	MINACU	23/09/2020 17:56	24/09/2020 22:09	23/09/2020 17:56	23/09/2020 18:39	0,72	66	47,37	CHI
20200978390	COLINAS DO SUL	TI10401551	MINACU	23/09/2020 17:56	24/09/2020 22:09	23/09/2020 17:56	23/09/2020 18:39	0,72	390	279,93	CHI
20200978390	URUACU	TI10401551	MINACU	23/09/2020 17:56	24/09/2020 22:09	23/09/2020 17:56	23/09/2020 18:39	0,72	1	0,72	CHI
20200978390	NIQUELANDIA	TI10401551	MINACU	23/09/2020 17:56	24/09/2020 22:09	23/09/2020 17:56	23/09/2020 18:39	0,72	1	0,72	CHI
20200978390	COLINAS DO SUL	TI12265458LD	MINACU	23/09/2020 17:56	24/09/2020 22:09	23/09/2020 17:56	23/09/2020 21:50	3,91	14	54,67	CHI
20200978390	CAVALCANTE	TI10401551	MINACU	23/09/2020 17:56	24/09/2020 22:09	23/09/2020 17:56	23/09/2020 22:08	4,20	288	1209,92	CHI
20200978390	COLINAS DO SUL	TI10401551	MINACU	23/09/2020 17:56	24/09/2020 22:09	23/09/2020 17:56	23/09/2020 22:08	4,20	24	100,83	CHI
20200978390	COLINAS DO SUL	TI10401551	MINACU	23/09/2020 17:56	24/09/2020 22:09	23/09/2020 17:56	24/09/2020 18:36	24,66	4	98,64	CHI
20200978390	CAVALCANTE	TI10401551	MINACU	23/09/2020 17:56	24/09/2020 22:09	23/09/2020 17:56	24/09/2020 18:36	24,66	3	73,98	CHI
20200978390	CAVALCANTE	TI10401551	MINACU	23/09/2020 17:56	24/09/2020 22:09	23/09/2020 17:56	24/09/2020 18:50	24,90	12	298,81	CHI
20200978373	CAIAPONIA	930017894	CAIAPONIA	23/09/2020 17:56	24/09/2020 18:01	23/09/2020 17:56	24/09/2020 18:01	24,08	1	24,08	CHI
20200978390	CAVALCANTE	TI10401551	MINACU	23/09/2020 17:56	24/09/2020 22:09	23/09/2020 18:38	23/09/2020 20:43	2,08	7	14,58	CHI
20200978390	NIQUELANDIA	TI13265471	MINACU	23/09/2020 17:56	24/09/2020 22:09	24/09/2020 21:54	24/09/2020 22:09	0,24	1	0,24	CHI
20200978390	URUACU	TI13265471	MINACU	23/09/2020 17:56	24/09/2020 22:09	24/09/2020 21:54	24/09/2020 22:09	0,24	1	0,24	CHI
20200978390	COLINAS DO SUL	TI13265471	MINACU	23/09/2020 17:56	24/09/2020 22:09	24/09/2020 21:54	24/09/2020 22:09	0,24	356	86,23	CHI
20200978390	CAVALCANTE	TI13265471	MINACU	23/09/2020 17:56	24/09/2020 22:09	24/09/2020 21:54	24/09/2020 22:09	0,24	68	16,47	CHI
20200978761	AMARALINA	MU12269538	MARA ROSA	23/09/2020 17:57	24/09/2020 14:50	23/09/2020 17:57	24/09/2020 14:50	20,89	4	83,57	CHI

INTERNAL

20200978761	MUTUNOPOLIS	MU12269538	MARA ROSA	23/09/2020 17:57	24/09/2020 14:50	23/09/2020 17:57	24/09/2020 14:50	20,89	43	898,33	CHI
20200978761	MUTUNOPOLIS	MU12269538	MARA ROSA	23/09/2020 17:57	24/09/2020 14:50	24/09/2020 09:00	24/09/2020 14:50	5,85	9	52,62	CHI
20200978386	RIO VERDE	MV12338540	MONTIVIDIU T	23/09/2020 17:58	23/09/2020 23:18	23/09/2020 17:58	23/09/2020 23:18	5,32	17	90,49	CHI
20200978389	SAO LUIS DE MONTES BELOS	500085973	SAO LUIZ DOS MONTES BELOS	23/09/2020 17:59	24/09/2020 17:08	23/09/2020 17:59	24/09/2020 17:08	23,15	1	23,15	CHI
20200978397	RIO VERDE	630266104	RIO VERDE S1	23/09/2020 17:59	23/09/2020 23:24	23/09/2020 17:59	23/09/2020 23:24	5,40	1	5,40	CHI
20200978402	PALMEIRAS DE GOIAS	PL21207921	PALMEIRAS	23/09/2020 18:00	23/09/2020 20:34	23/09/2020 18:00	23/09/2020 20:34	2,56	1	2,56	CHI
20200978416	SERRANOPOLIS	SX12264387RE	JATAI S1	23/09/2020 18:03	24/09/2020 10:57	23/09/2020 18:03	24/09/2020 10:57	16,90	5	84,49	CHI
20200978416	JATAI	SX12264387RE	JATAI S1	23/09/2020 18:03	24/09/2020 10:57	23/09/2020 18:03	24/09/2020 10:57	16,90	4	67,59	CHI
20200978423	JATAI	JT21260483	JATAI S1	23/09/2020 18:04	24/09/2020 11:59	23/09/2020 18:04	24/09/2020 11:59	17,91	1	17,91	CHI
20200978433	FORMOSA	610142859	ITUIQUIRA	23/09/2020 18:06	23/09/2020 21:59	23/09/2020 18:06	23/09/2020 21:59	3,87	1	3,87	CHI
20200978448	PEROLANDIA	MY12402481RE	PARQUE DAS EMAS	23/09/2020 18:09	23/09/2020 23:03	23/09/2020 18:09	23/09/2020 23:03	4,89	7	34,25	CHI
20200978448	CAIAPONIA	MY12402481RE	PARQUE DAS EMAS	23/09/2020 18:09	23/09/2020 23:03	23/09/2020 18:09	23/09/2020 23:03	4,89	5	24,47	CHI
20200978448	MINEIROS	MY12402481RE	PARQUE DAS EMAS	23/09/2020 18:09	23/09/2020 23:03	23/09/2020 18:09	23/09/2020 23:03	4,89	11	53,82	CHI
20200978443	CACU	10015627428	CACHOEIRA ALTA	23/09/2020 18:09	23/09/2020 20:19	23/09/2020 18:09	23/09/2020 20:19	2,17	1	2,17	CHI
20200978462	FORMOSA	FA11254261	ITUIQUIRA	23/09/2020 18:12	24/09/2020 01:12	23/09/2020 18:12	24/09/2020 01:12	6,99	1	6,99	CHI
20200978662	RIO VERDE	RV11230855	RIO VERDE S2	23/09/2020 18:19	23/09/2020 23:12	23/09/2020 18:19	23/09/2020 23:12	4,88	99	483,40	CHI
20200978493	HIDROLINA	HL21237758	URUACU	23/09/2020 18:19	24/09/2020 01:24	23/09/2020 18:19	24/09/2020 01:24	7,07	2	14,13	CHI
20200978961	NIQUELANDIA	NQ12265691	URUACU	23/09/2020 18:21	24/09/2020 00:03	23/09/2020 18:21	24/09/2020 00:03	5,69	18	102,40	CHI
20200978506	JATAI	JT21374248	JATAI S1	23/09/2020 18:22	24/09/2020 10:21	23/09/2020 18:22	24/09/2020 10:21	15,97	1	15,97	CHI
20200978525	URUACU	10025646379	URUACU	23/09/2020 18:25	24/09/2020 02:49	23/09/2020 18:25	24/09/2020 02:49	8,39	1	8,39	CHI
20200978541	MINACU	IH12230473	MINACU	23/09/2020 18:29	24/09/2020 05:50	23/09/2020 18:29	24/09/2020 05:50	11,35	7	79,43	CHI
20200978653	FORMOSA	FA12195774	ITUIQUIRA	23/09/2020 18:31	23/09/2020 20:13	23/09/2020 18:31	23/09/2020 20:13	1,69	681	1152,40	CHI
20200978557	COLINAS DO SUL	TI21181231	MINACU	23/09/2020 18:31	24/09/2020 08:18	23/09/2020 18:31	24/09/2020 08:18	13,77	2	27,55	CHI
20200978565	IACIARA	IA12195746	IACIARA S2	23/09/2020 18:32	23/09/2020 19:34	23/09/2020 18:32	23/09/2020 19:34	1,02	1	1,02	CHI
20200972357	BONOPOLIS	10004358170	SAO MIGUEL DO ARAGUAIA	23/09/2020 18:33	23/09/2020 20:17	23/09/2020 18:33	23/09/2020 20:17	1,72	1	1,72	CHI
20200978591	PORANGATU	PO21038749	PORANGATU	23/09/2020 18:35	23/09/2020 20:52	23/09/2020 18:35	23/09/2020 20:52	2,27	1	2,27	CHI
20200978623	MARA ROSA	MQ12338175	MARA ROSA	23/09/2020 18:40	25/09/2020 05:42	23/09/2020 18:40	25/09/2020 05:42	35,02	1	35,02	CHI
20200978953	COLINAS DO SUL	TI11116081	MINACU	23/09/2020 18:43	25/09/2020 10:51	23/09/2020 18:43	25/09/2020 10:51	40,13	61	2448,03	CHI
20200978639	DIVINOPOLIS DE GOIAS	GH12241928	SAO DOMINGOS	23/09/2020 18:43	23/09/2020 20:11	23/09/2020 18:43	23/09/2020 20:11	1,46	40	58,29	CHI
20200978639	MONTE ALEGRE DE GOIAS	GH12241928	SAO DOMINGOS	23/09/2020 18:43	23/09/2020 20:11	23/09/2020 18:43	23/09/2020 20:11	1,46	2	2,91	CHI
20200978639	SAO DOMINGOS	GH12241928	SAO DOMINGOS	23/09/2020 18:43	23/09/2020 20:11	23/09/2020 18:43	23/09/2020 20:11	1,46	12	17,49	CHI
20200978647	URUACU	UR21147040	URUACU	23/09/2020 18:44	24/09/2020 01:23	23/09/2020 18:44	24/09/2020 01:23	6,65	1	6,65	CHI
20200978651	MARA ROSA	MQ21333889	MARA ROSA	23/09/2020 18:45	24/09/2020 08:08	23/09/2020 18:45	24/09/2020 08:08	13,37	1	13,37	CHI

INTERNAL

20200978677	PLANALTINA	2960120237	PLANALTINA	23/09/2020 18:49	23/09/2020 19:17	23/09/2020 18:49	23/09/2020 19:17	0,46	1	0,46	CHI
20200978686	NOVA CRIXAS	8570013427	NOVA CRIXAS	23/09/2020 18:50	24/09/2020 23:42	23/09/2020 18:50	24/09/2020 23:42	28,86	1	28,86	CHI
20200978764	GUARANI DE GOIAS	SD12153745	SAO DOMINGOS	23/09/2020 18:53	23/09/2020 22:56	23/09/2020 18:53	23/09/2020 22:56	4,04	2	8,07	CHI
20200978764	SAO DOMINGOS	SD12153745	SAO DOMINGOS	23/09/2020 18:53	23/09/2020 22:56	23/09/2020 18:53	23/09/2020 22:56	4,04	215	868,00	CHI
20200978786	NOVA CRIXAS	NA21121151	NOVA CRIXAS	23/09/2020 19:04	23/09/2020 22:39	23/09/2020 19:04	23/09/2020 22:39	3,57	1	3,57	CHI
20200978812	NOVA CRIXAS	NA21057381	NOVA CRIXAS	23/09/2020 19:09	24/09/2020 01:48	23/09/2020 19:09	24/09/2020 01:48	6,64	1	6,64	CHI
20200978854	URUACU	CR12202139RE	MARA ROSA	23/09/2020 19:14	24/09/2020 07:34	23/09/2020 19:14	24/09/2020 07:34	12,33	106	1306,80	CHI
20200978854	CAMPINORTE	CR12202139RE	MARA ROSA	23/09/2020 19:14	24/09/2020 07:34	23/09/2020 19:14	24/09/2020 07:34	12,33	32	394,51	CHI
20200978979	FORMOSA	FA12254298	ITIQUEIRA	23/09/2020 19:15	24/09/2020 01:49	23/09/2020 19:15	24/09/2020 01:49	6,56	6	39,36	CHI
20200978876	URUACU	640064085	URUACU	23/09/2020 19:18	24/09/2020 15:56	23/09/2020 19:18	24/09/2020 15:56	20,63	1	20,63	CHI
20200978919	SAO MIGUEL DO ARAGUAIA	SM11030537	SAO MIGUEL DO ARAGUAIA	23/09/2020 19:20	24/09/2020 01:27	23/09/2020 19:20	24/09/2020 01:27	6,11	201	1229,11	CHI
20200978957	RUBIATABA	RB21200977	RUBIATABA	23/09/2020 19:28	24/09/2020 09:19	23/09/2020 19:28	24/09/2020 09:19	13,84	1	13,84	CHI
20200978988	DIVINOPOLIS DE GOIAS	GH11096272	SAO DOMINGOS	23/09/2020 19:36	24/09/2020 04:39	23/09/2020 19:36	24/09/2020 04:39	9,04	133	1201,88	CHI
20200979015	PLANALTINA	PI12326688	SAO JOAO D ALIANCA	23/09/2020 19:41	24/09/2020 10:53	23/09/2020 19:41	24/09/2020 10:53	15,19	4	60,78	CHI
20200979068	PLANALTINA	2960211309	PLANALTINA	23/09/2020 19:48	23/09/2020 21:05	23/09/2020 19:48	23/09/2020 21:05	1,28	1	1,28	CHI
20200979193	DIVINOPOLIS DE GOIAS	GH21209861	SAO DOMINGOS	23/09/2020 20:10	23/09/2020 22:30	23/09/2020 20:10	23/09/2020 22:30	2,32	1	2,32	CHI
20200979324	ALTO PARAISO DE GOIAS	BF21224073	SAO JOAO D ALIANCA	23/09/2020 20:53	23/09/2020 22:05	23/09/2020 20:53	23/09/2020 22:05	1,19	1	1,19	CHI
20200979347	PLANALTINA	2960007585	PLANALTINA	23/09/2020 21:04	23/09/2020 23:15	23/09/2020 21:04	23/09/2020 23:15	2,17	1	2,17	CHI
20200979359	SAO DOMINGOS	8680005103	SAO DOMINGOS	23/09/2020 21:10	23/09/2020 22:56	23/09/2020 21:10	23/09/2020 22:56	1,76	1	1,76	CHI
20200979366	SAO DOMINGOS	8680005851	SAO DOMINGOS	23/09/2020 21:13	24/09/2020 11:03	23/09/2020 21:13	24/09/2020 11:03	13,83	1	13,83	CHI

Plotagem das Ocorrências conforme a Espacialização das Chuvas

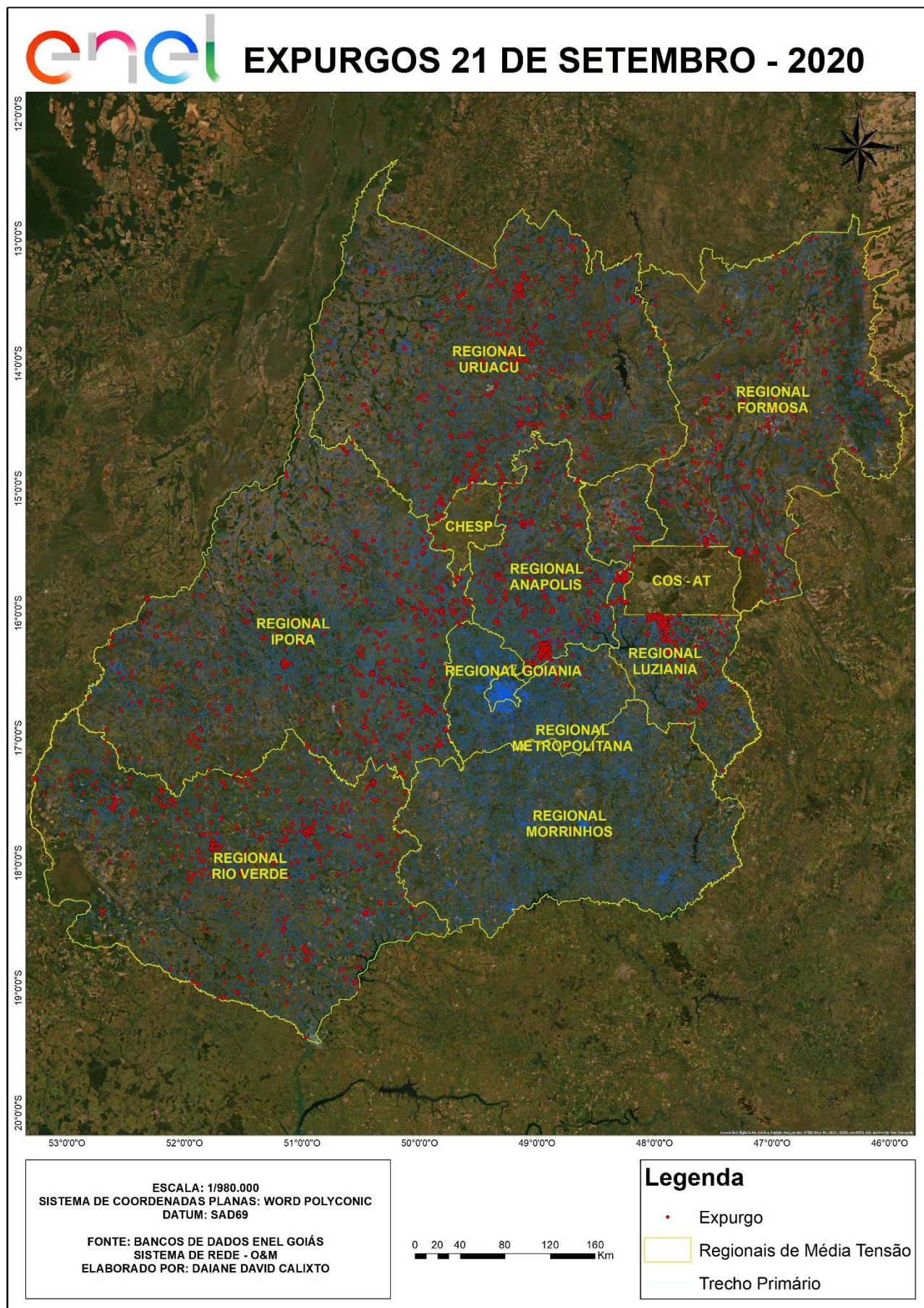

Diagramas Unifilares

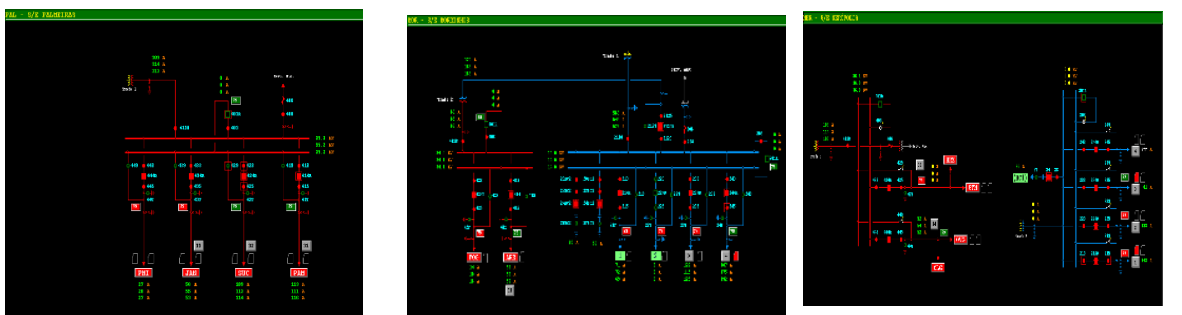
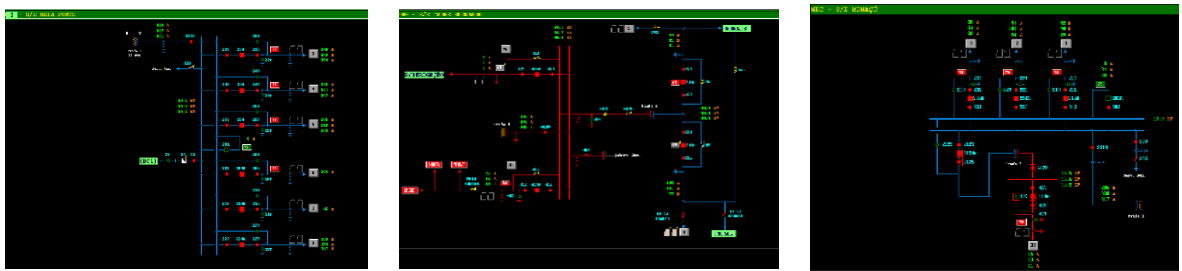
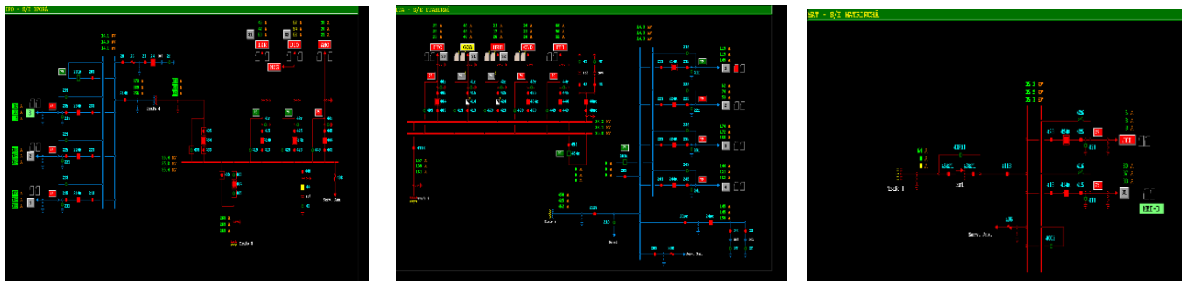
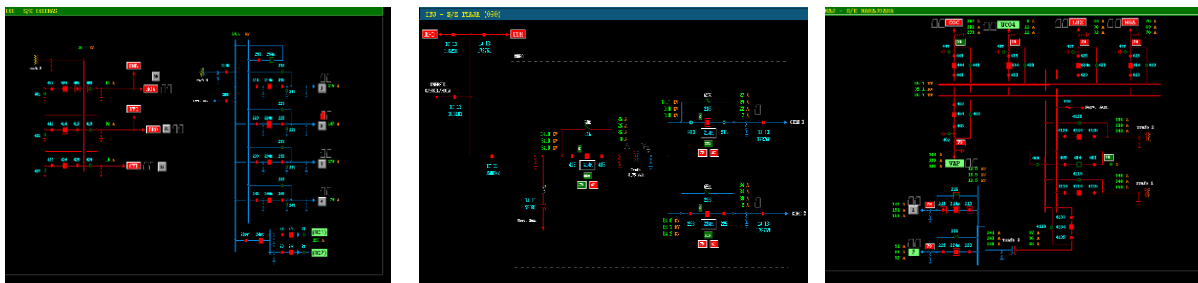
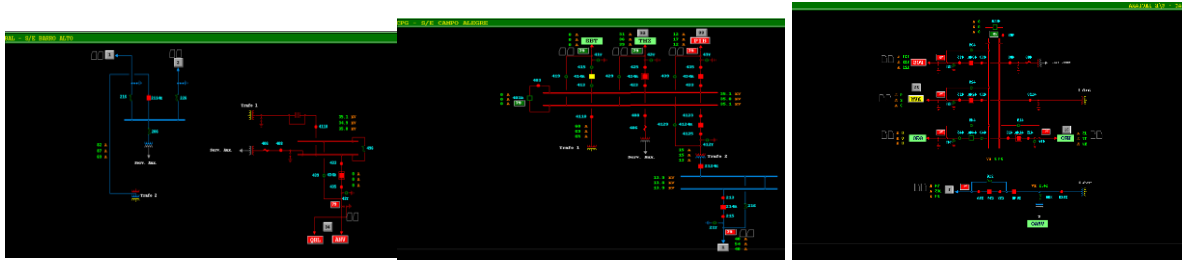
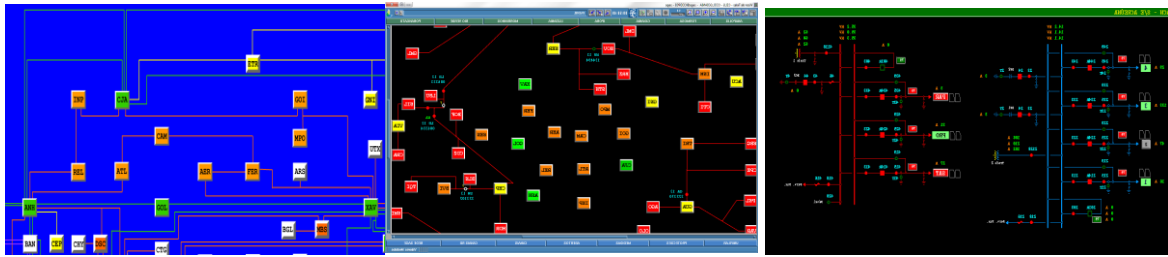

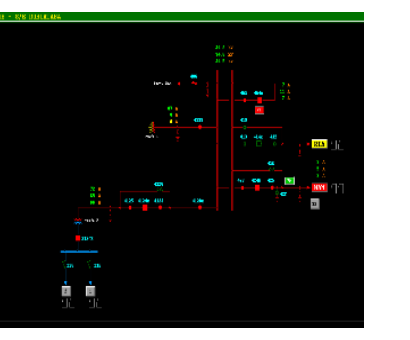
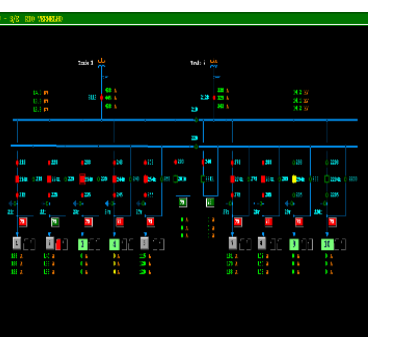
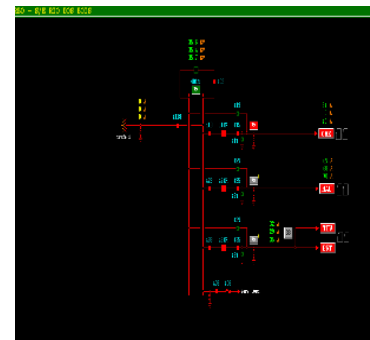
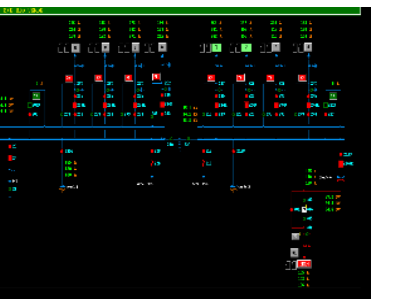
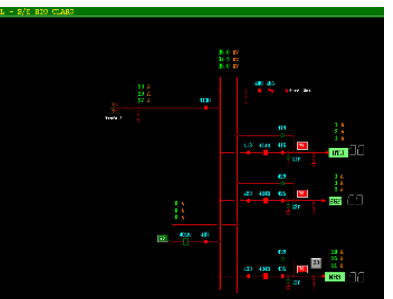
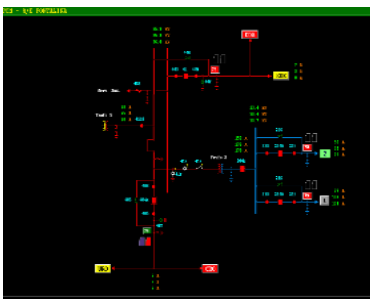
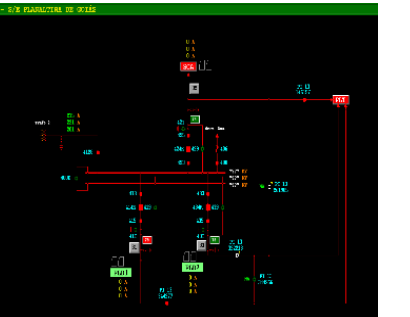
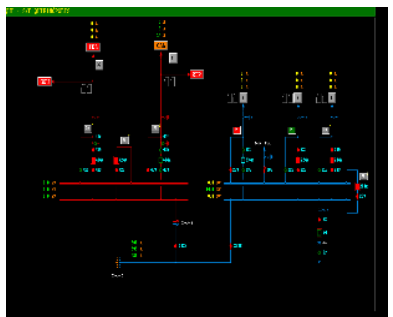
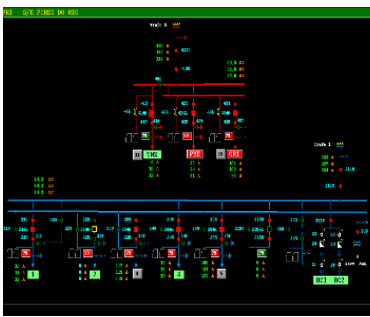
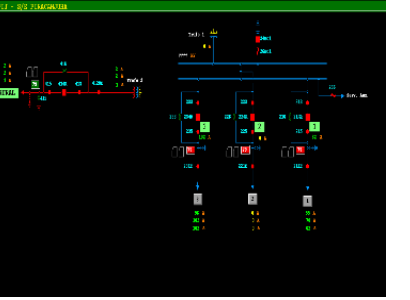
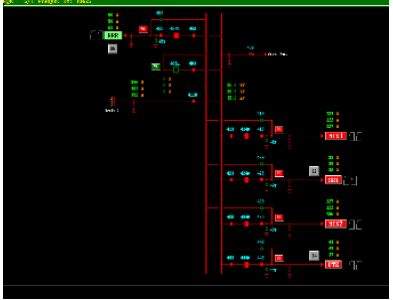
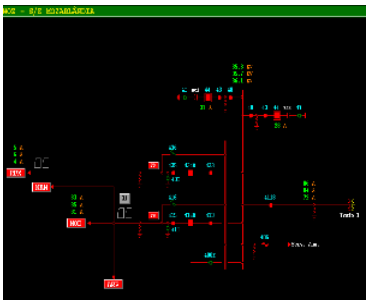
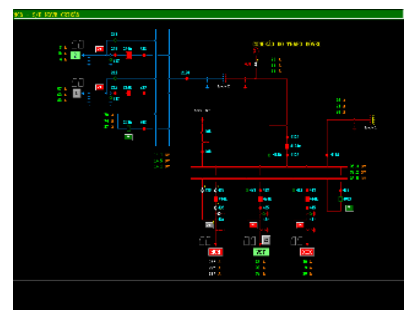
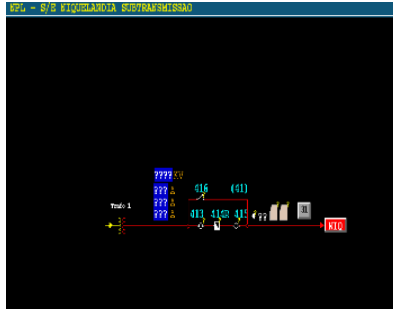

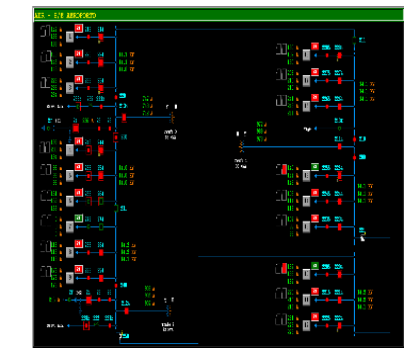
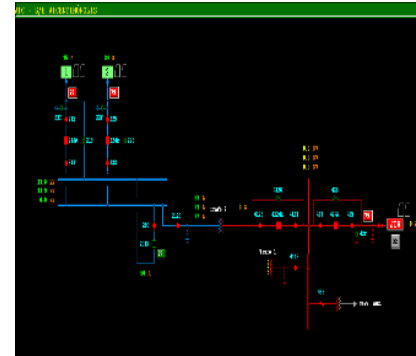
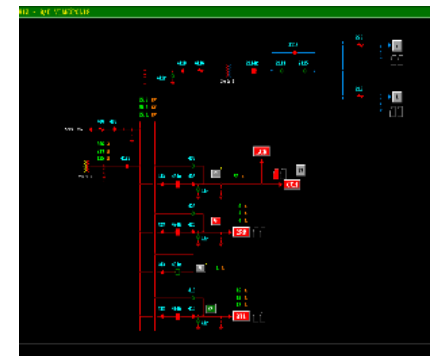
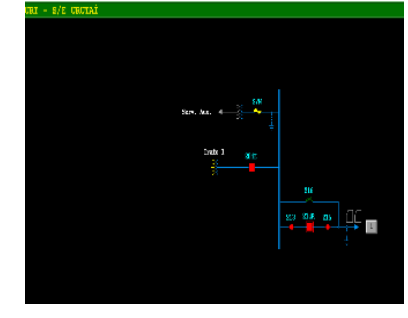
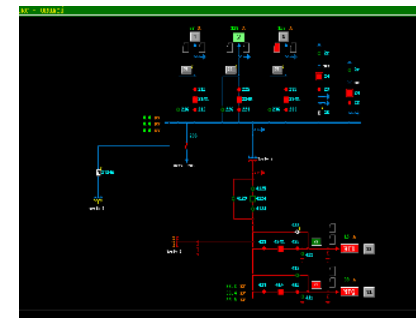
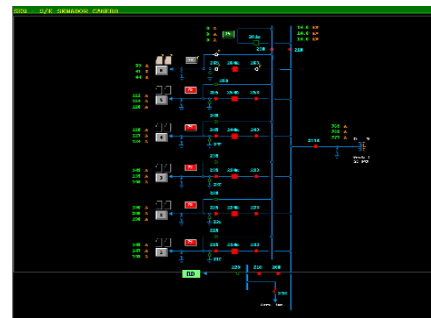
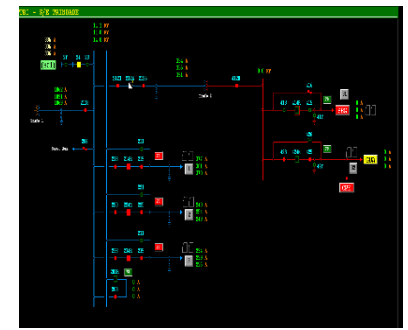
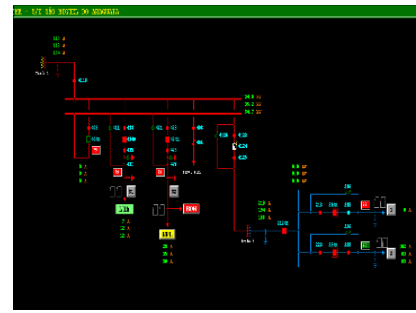
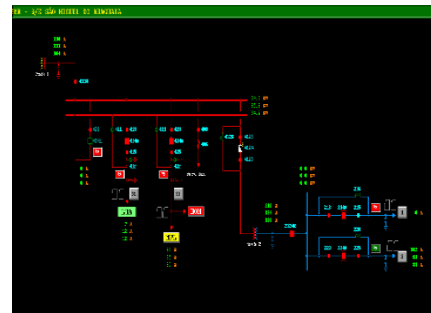
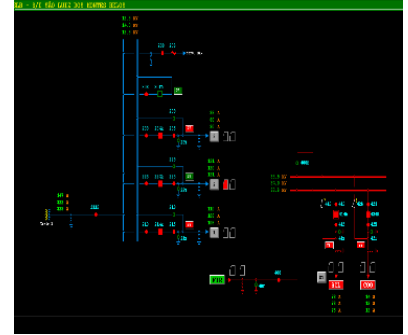
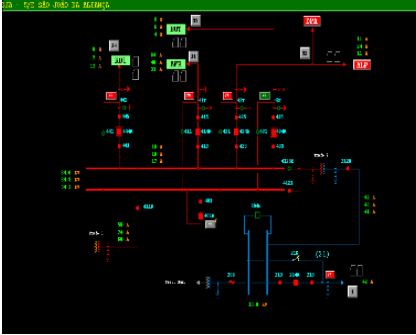
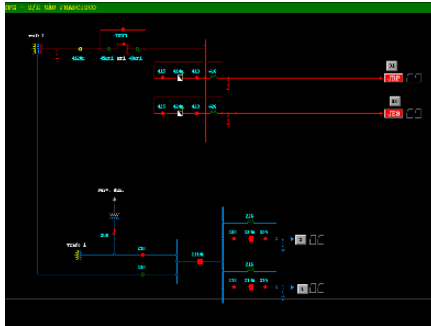
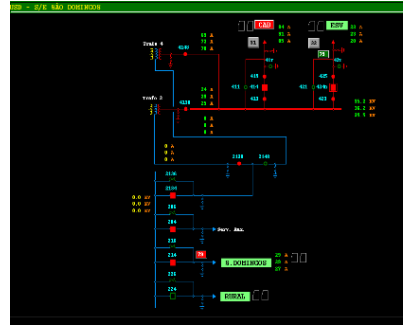
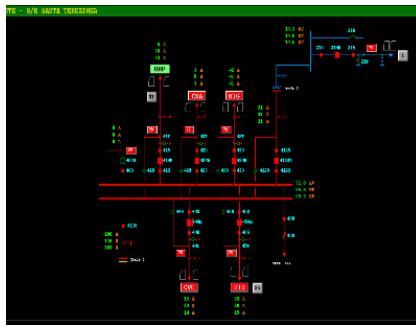
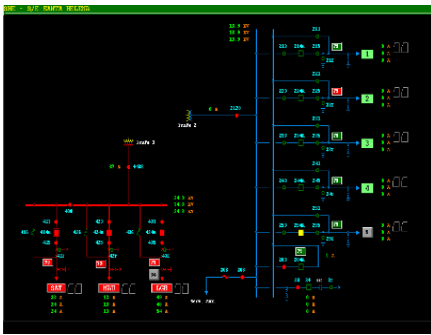

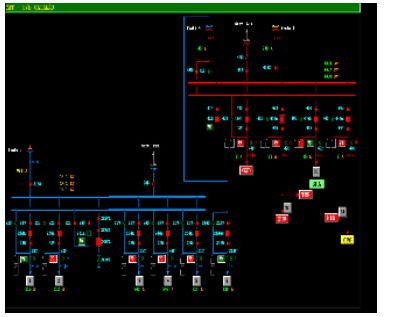
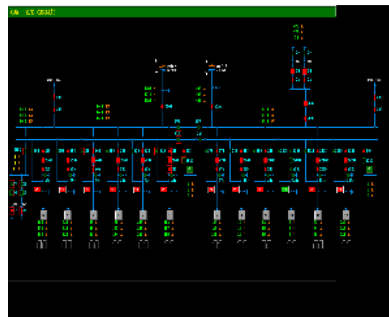
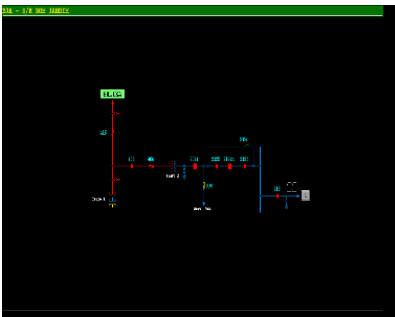
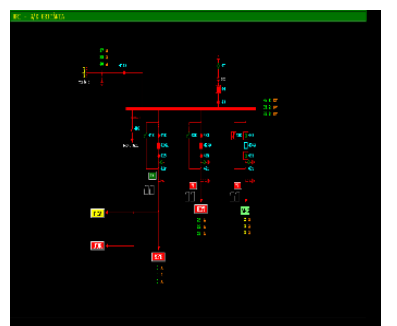
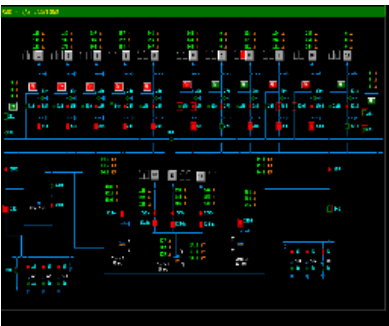
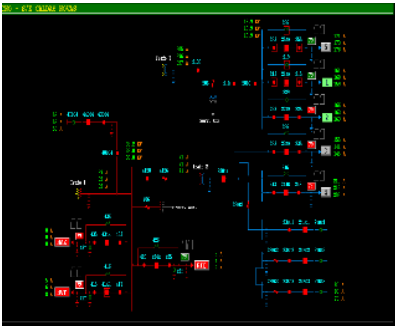
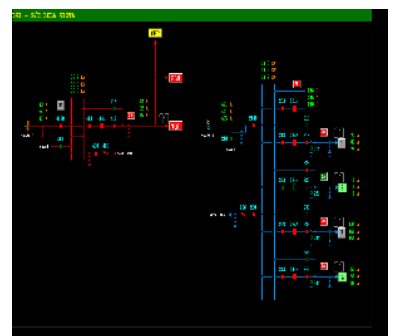
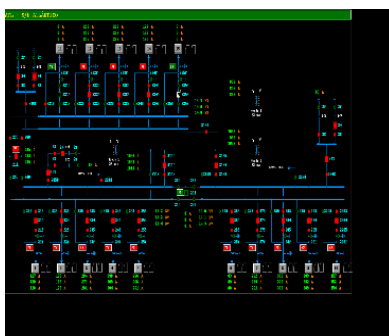
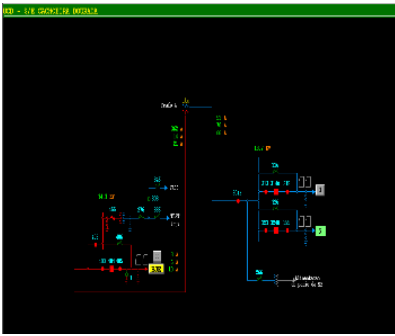
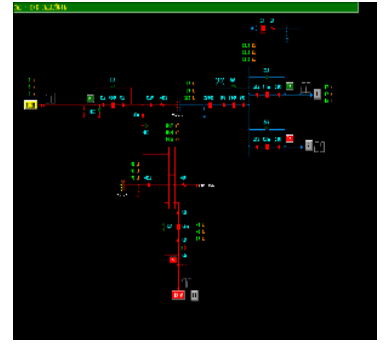
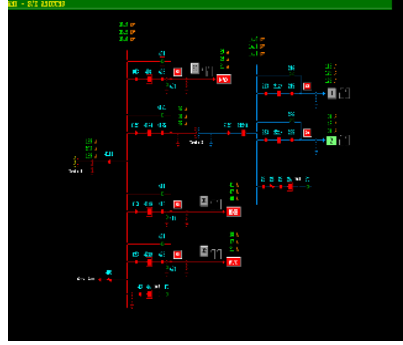
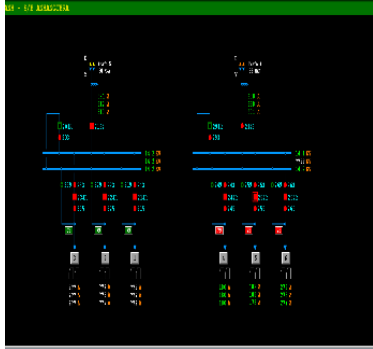
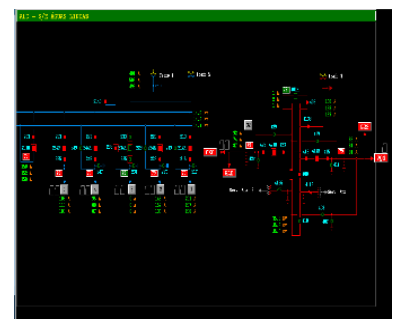
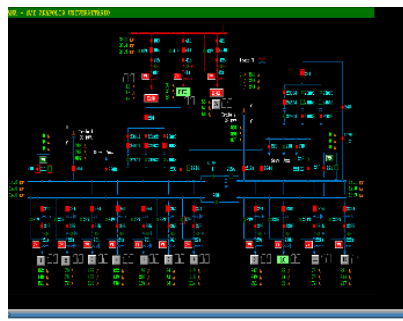
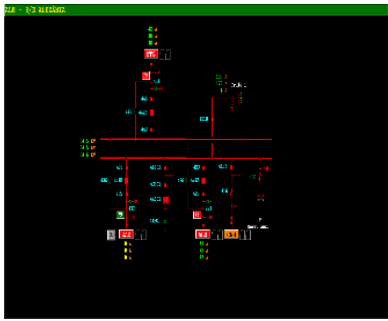

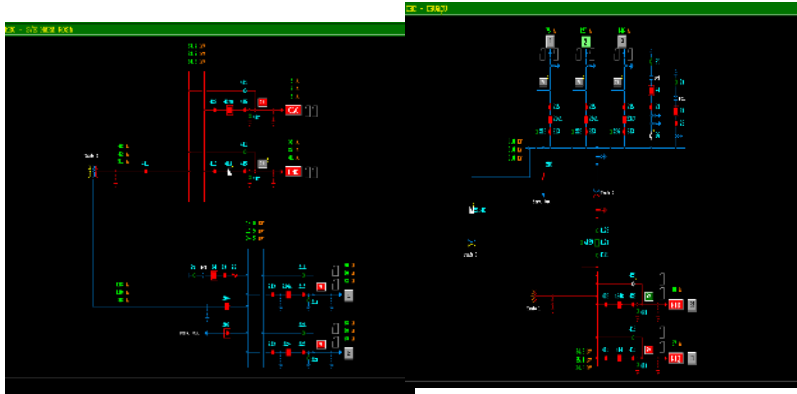
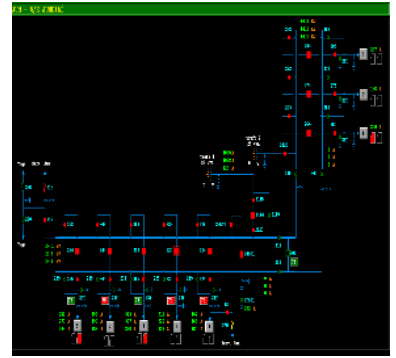
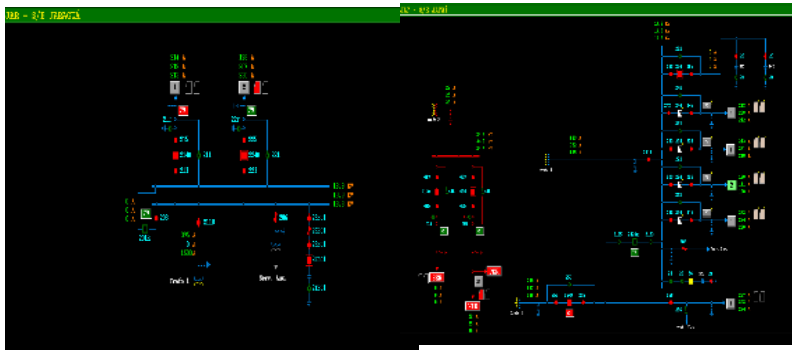

CLIMATEMPO

**Laudo Meteorológico de Evento Climático
- ENEL Goiás - 21 de setembro de 2020**

São Paulo, SP, Brasil

Outubro de 2020

Sumário

1	ANÁLISE DE EVENTO METEOROLÓGICO	2
1.1	Descrição do Evento.....	2
1.2	Abrangência do Evento	5
2	CLASSIFICAÇÃO COBRADE	19
3	RESUMO DO EVENTO	20
4	REFERÊNCIAS.....	23

1 Análise de Evento Meteorológico

1.1 Descrição do Evento

Na figura a seguir é apresentada a área de concessão da ENEL DISTRIBUIÇÃO GOIÁS, dividida em regiões, a serem analisadas neste relatório.



Figura 1 – Regiões atendidas pela ENEL Goiás.

Entre os dias 21 e 23 de setembro de 2020 o avanço de uma frente fria pela costa do Brasil favoreceu a organização de áreas de instabilidade sobre o estado de Goiás.

Nas Figuras 2 e 3 são apresentadas as descargas atmosféricas nuvem-solo (raios) e nuvem-nuvem detectadas pelo sistema Earth Networks. Entre as 09h00 do dia 21 e 21h30 do dia 23 de setembro de 2020 foram registrados 11310 raios nuvem-solo e 29938 descargas nuvem-nuvem sobre a área da ENEL DISTRIBUIÇÃO GOIÁS.

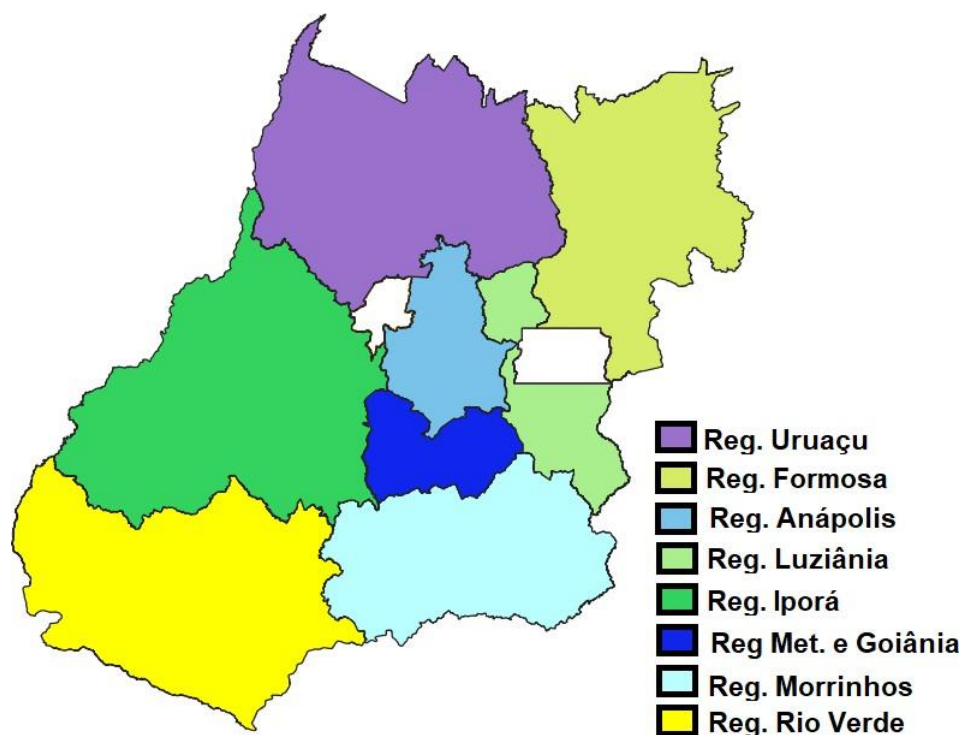

Figura 2 – Descargas atmosféricas nuvem-solo (em preto) detectadas pelo sistema Earth Networks entre 09h00 do dia 21 e 21h30 do dia 23 de setembro de 2020 sobre a área de concessão da ENEL DISTRIBUIÇÃO GOIÁS.



Figura 3 – Descargas atmosféricas nuvem-nuvem (em vermelho) detectadas pelo sistema Earth Networks entre 09h00 do dia 21 e 21h30 do dia 23 de setembro de 2020 sobre a área de concessão da ENEL DISTRIBUIÇÃO GOIÁS.

Estações do Instituto Nacional de Meteorologia (INMET), representativas da área de concessão da ENEL DISTRIBUIÇÃO GOIÁS, registraram chuva forte (segundo a American Meteorological Society - Sociedade Meteorológica Americana -, chuvas com taxa entre 2,5mm a 7,6 mm por hora são consideradas moderadas e aquelas com taxa superior a 7,6 mm por hora são consideradas chuva forte). Na tabela 1 são apresentados os registros de acumulados horários superiores a 7,6 mm.

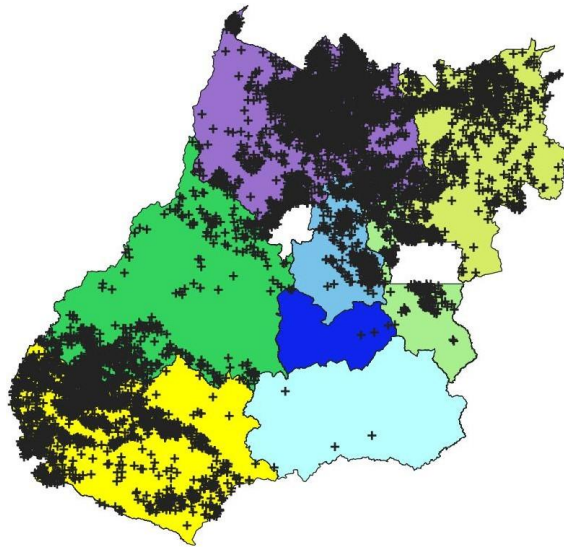
A estação de Caiapônia do INMET acumulou 59,0 mm entre as 09h do dia 21 e 09h do dia 23 de setembro de 2020, valor que corresponde à média climatológica de precipitação mensal para setembro na região. Ou seja, em apenas 48 horas choveu a média histórica do mês na região.

Tabela 1 – Acumulado horário de chuva registrada pelo INMET.

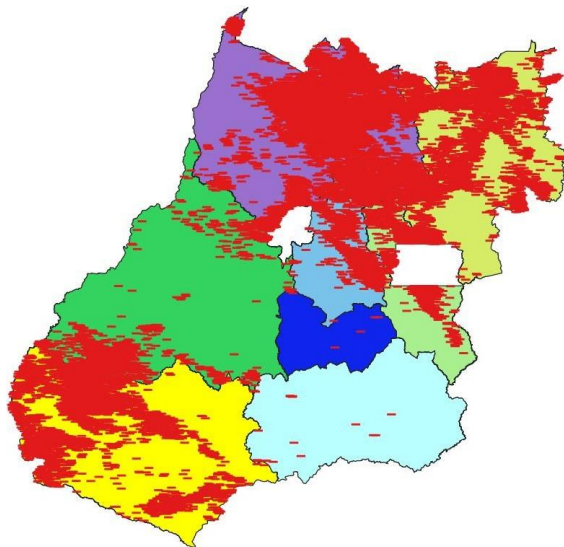
Estação	Horário	Precipitação (mm)
Caiapônia	Entre 22h e 23h do dia 22/9/2020	8.6
Caiapônia	Entre 23h e 0h do dia 23/9/2020	8.4
Itapaci	Entre 13h e 14h do dia 21/9/2020	11
Jataí	Entre 21h e 22h do dia 21/9/2020	11.2
Mineiros	Entre 17h e 18h do dia 21/9/2020	16.8
Paraúna	Entre 3h e 4h do dia 22/9/2020	7.8

Na tabela 2 são apresentadas as rajadas de vento iguais ou superiores a 50 km/h registradas por estações do Instituto Nacional de Meteorologia (INMET) representativas da área de concessão da ENEL Distribuição Goiás. Como é possível observar, o maior valor registrado foi de 55,8 km/h na estação de Goiás entre as 20h e 21h do dia 21 de setembro, vento classificado como vento forte pela escala Beaufort.

Tabela 2 – Rajadas de vento maiores ou iguais a 50 km/h registradas pelo INMET. Segundo a escala Beaufort, ventos entre 50 e 61 km/h são classificados como vento forte.

Estação	Horário	Rajada (km/h)
Goiás	Entre 19h e 20h do dia 21/9/2020	51.1
Goiás	Entre 20h e 21h do dia 21/9/2020	55.8
Mineiros	Entre 17h e 18h do dia 21/9/2020	50.0
Mineiros	Entre 18h e 19h do dia 21/9/2020	50.0

1.2 Abrangência do Evento

A seguir são apresentadas as imagens realçadas do satélite GOES-16 o fim da manhã do dia 21 e a madrugada do dia 24 de setembro de 2020. Os tons em vermelho e preto indicam a presença de nuvens de grande desenvolvimento vertical, geralmente associadas à ocorrência de tempo severo.

11h00 - 21 de Setembro de 2020



Figura 4 – Imagens realçadas do satélite GOES-16 das 11h00 do dia 21 de Setembro de 2020.
FONTE: Cptec/INPE.

13h00 - 21 de Setembro de 2020

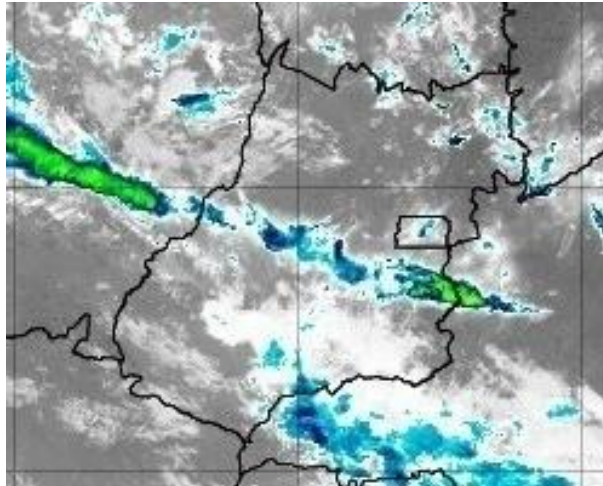

Figura 5 – Imagens realçadas do satélite GOES-16 das 13h00 do dia 21 de Setembro de 2020.
FONTE: Cptec/INPE.

15h00 - 21 de Setembro de 2020

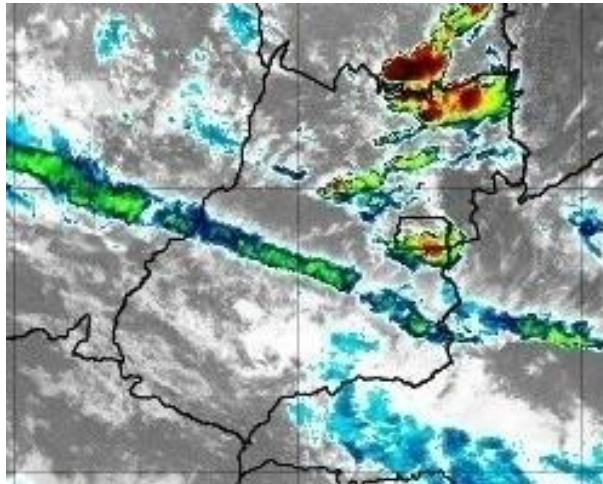

Figura 6 – Imagens realçadas do satélite GOES-16 das 15h00 do dia 21 de Setembro de 2020.
FONTE: Cptec/INPE.

17h00 - 21 de Setembro de 2020

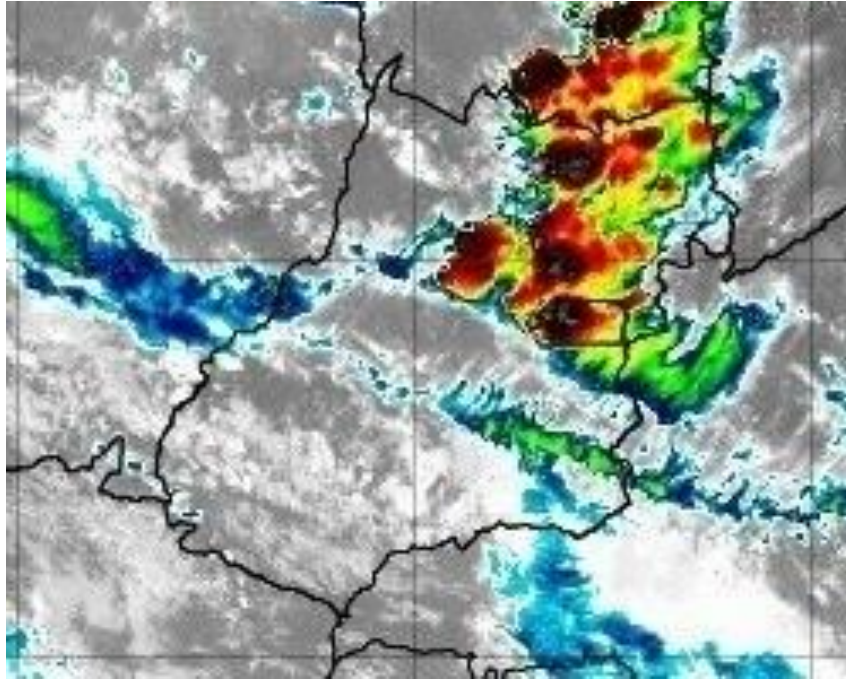

Figura 7 – Imagens realçadas do satélite GOES-16 das 17h00 do dia 21 de Setembro de 2020.
FONTE: Cptec/INPE.

19h00 - 21 de Setembro de 2020

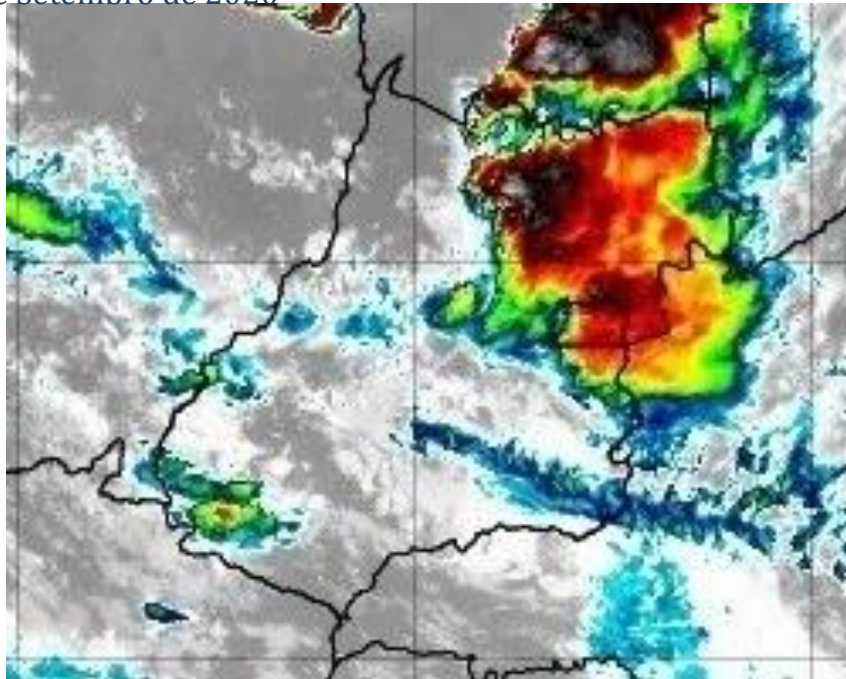

Figura 8 – Imagens realçadas do satélite GOES-16 das 19h00 do dia 21 de Setembro de 2020.
FONTE: Cptec/INPE.

21h00 - 21 de Setembro de 2020

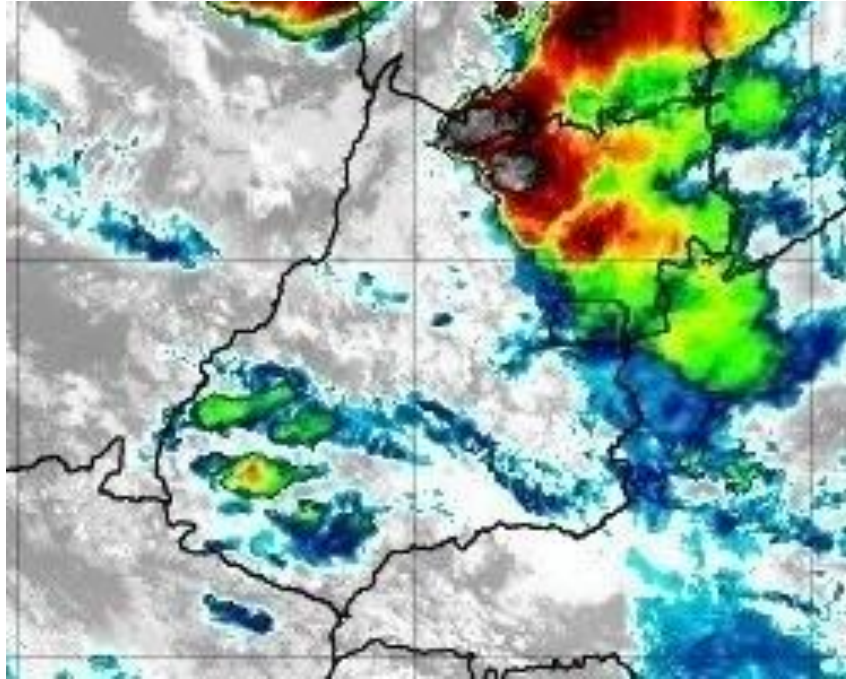

Figura 9 – Imagens realçadas do satélite GOES-16 das 21h00 do dia 21 de Setembro de 2020.
FONTE: Cptec/INPE.

23h00 - 21 de Setembro de 2020

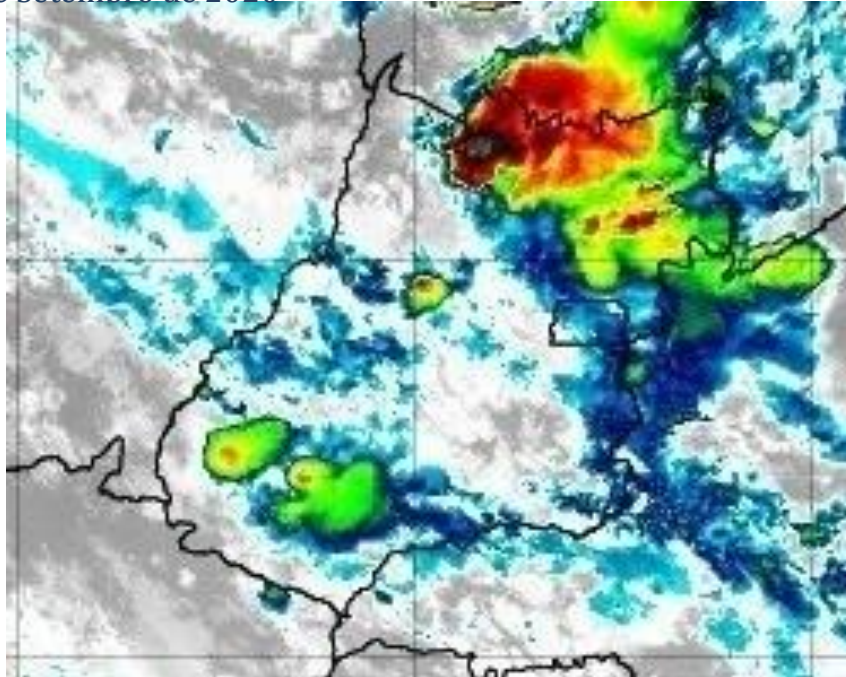

Figura 10 – Imagens realçadas do satélite GOES-16 das 23h00 do dia 21 de Setembro de 2020.
FONTE: Cptec/INPE.

1h00 - 22 de Setembro de 2020

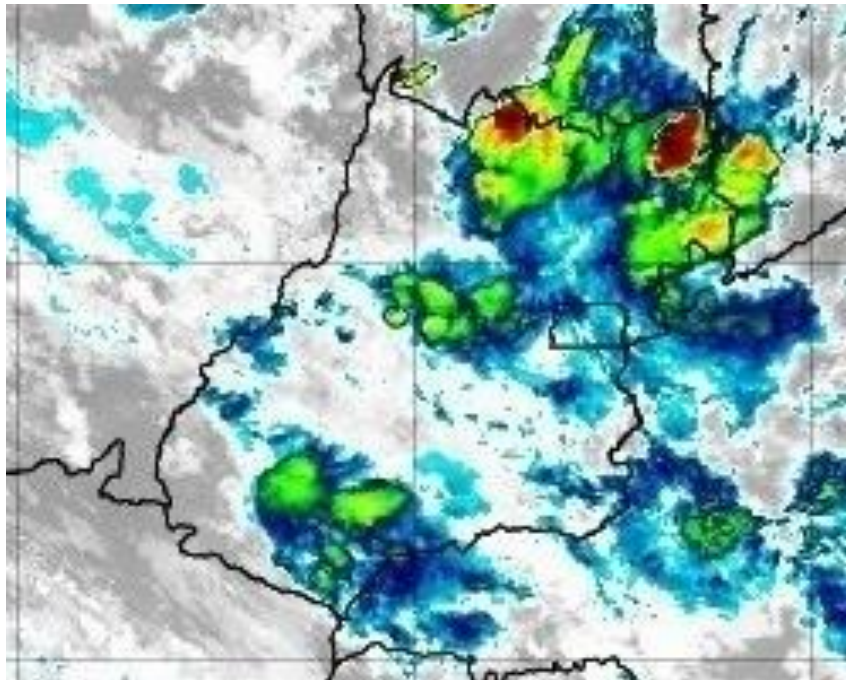

Figura 11 – Imagens realçadas do satélite GOES-16 das 1h00 do dia 22 de Setembro de 2020.
FONTE: Cptec/INPE.

3h00 - 22 de Setembro de 2020

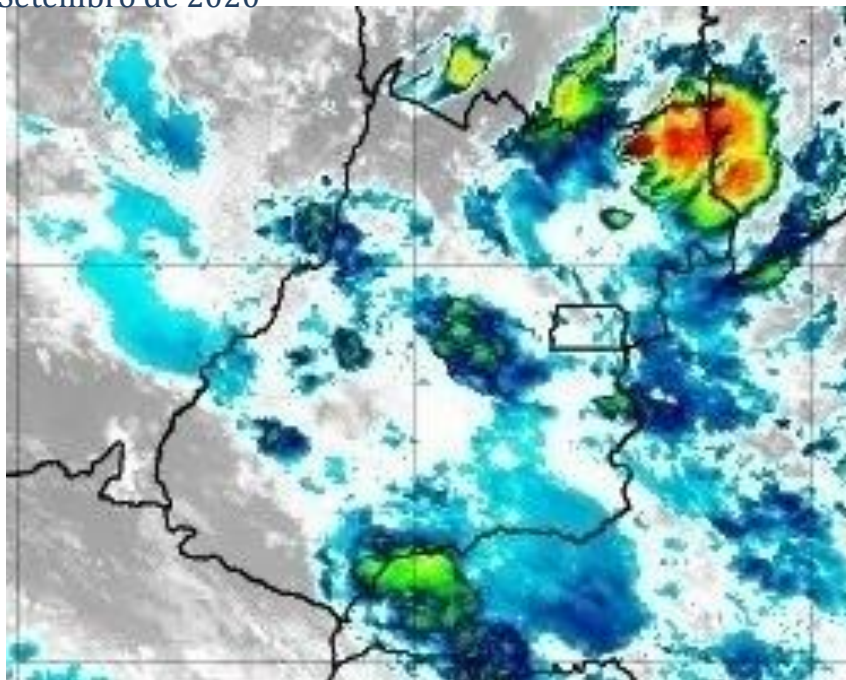

Figura 12 – Imagens realçadas do satélite GOES-16 das 3h00 do dia 22 de Setembro de 2020.
FONTE: Cptec/INPE.

11h00 - 22 de Setembro de 2020

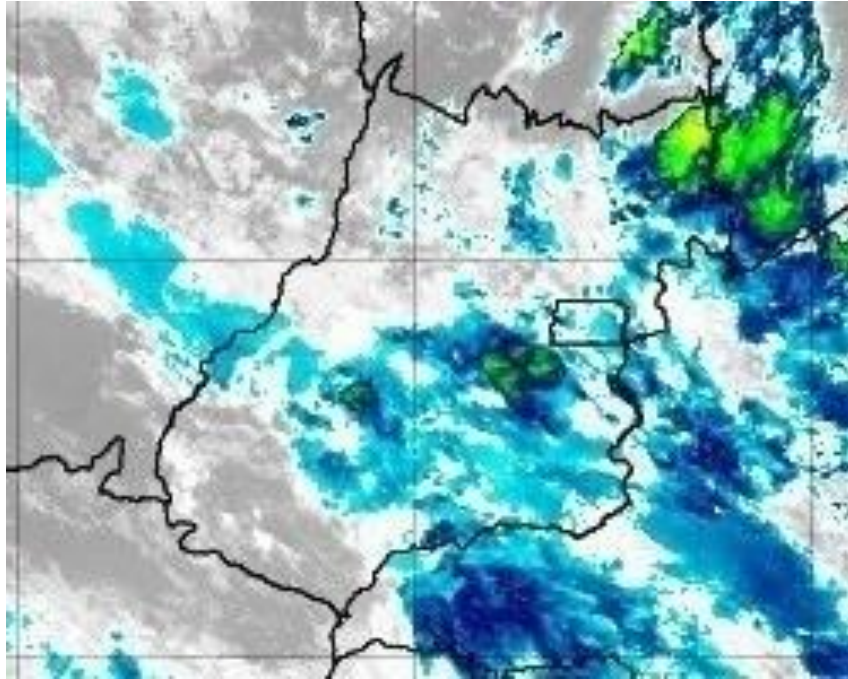

Figura 13 – Imagens realçadas do satélite GOES-16 das 11h00 do dia 22 de Setembro de 2020.
FONTE: Cptec/INPE.

13h00 - 22 de Setembro de 2020



Figura 14 – Imagens realçadas do satélite GOES-16 das 13h00 do dia 22 de Setembro de 2020.
FONTE: Cptec/INPE.

15h00 - 22 de Setembro de 2020



Figura 15 – Imagens realçadas do satélite GOES-16 das 15h00 do dia 22 de Setembro de 2020.
FONTE: Cptec/INPE.

17h00 - 22 de Setembro de 2020

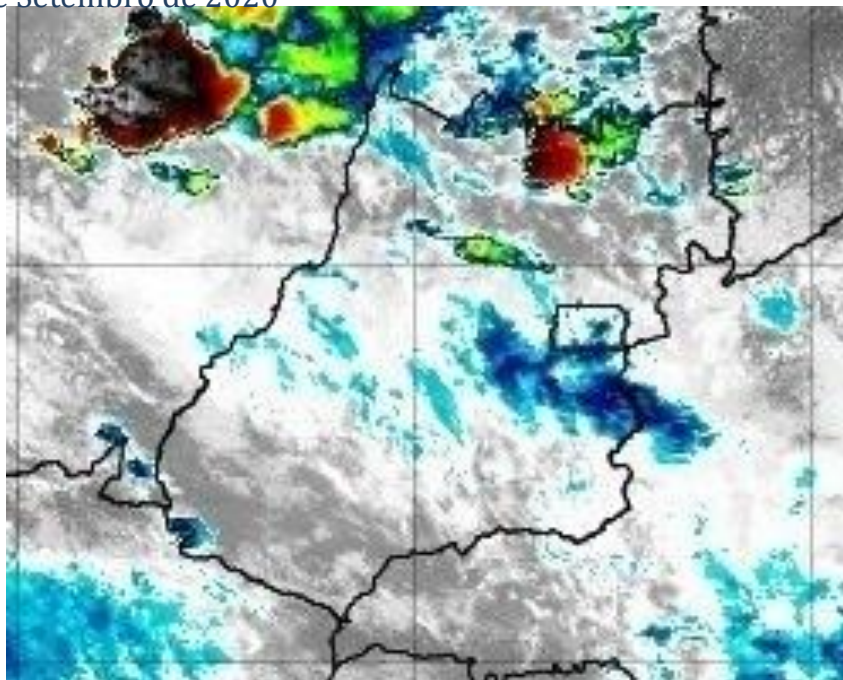

Figura 16 – Imagens realçadas do satélite GOES-16 das 17h00 do dia 22 de Setembro de 2020.
FONTE: Cptec/INPE.

19h00 - 22 de Setembro de 2020

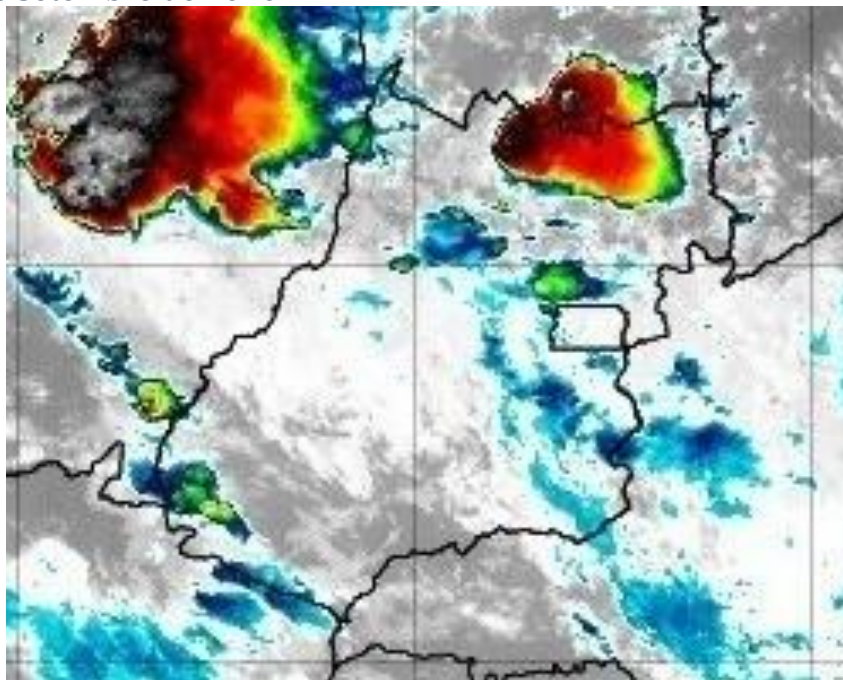

Figura 17 – Imagens realçadas do satélite GOES-16 das 19h00 do dia 22 de Setembro de 2020.
FONTE: Cptec/INPE.

21h00 - 22 de Setembro de 2020

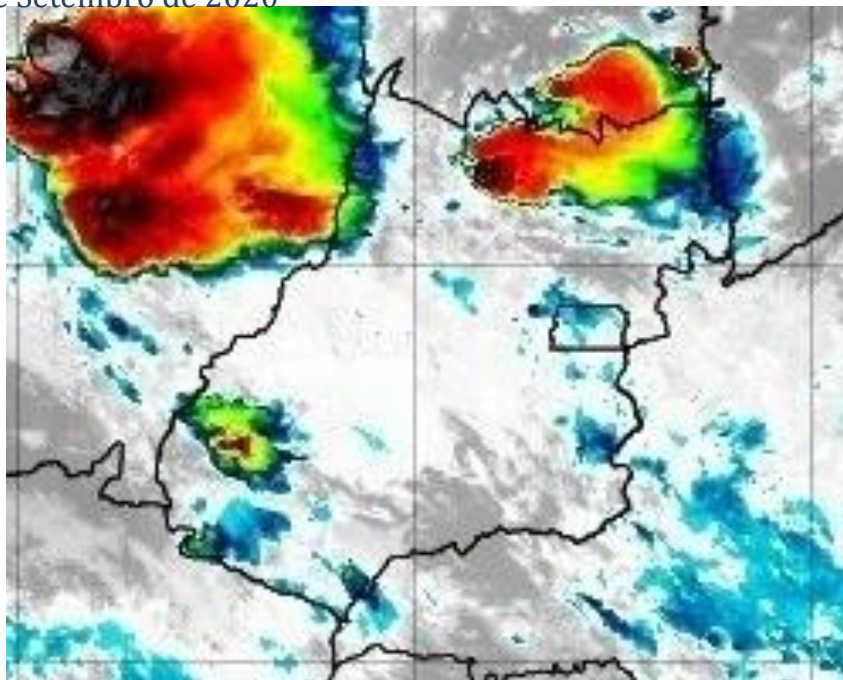

Figura 18 – Imagens realçadas do satélite GOES-16 das 21h00 do dia 22 de Setembro de 2020. FONTE: Cptec/INPE.

23h00 - 22 de Setembro de 2020

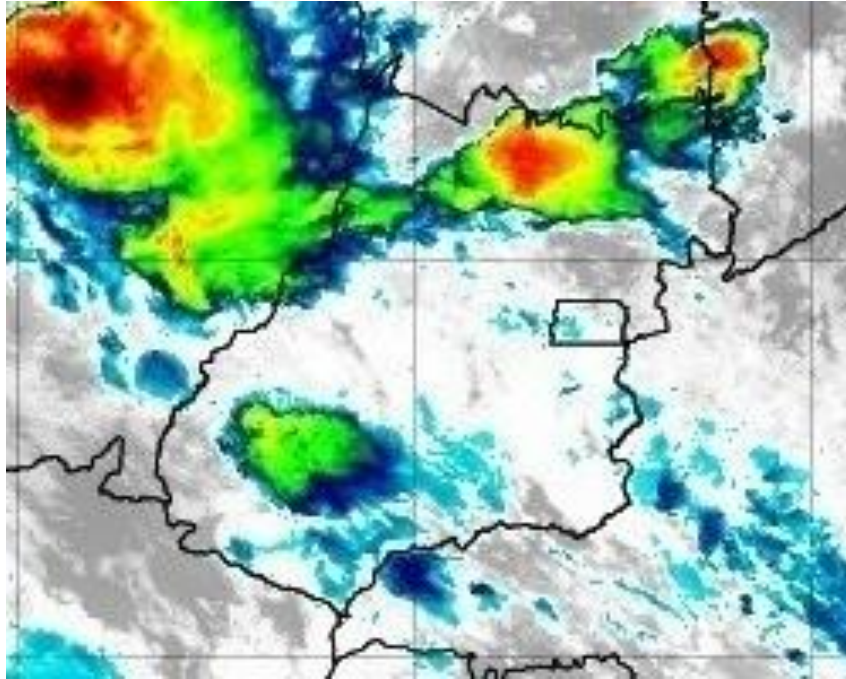

Figura 19 – Imagens realçadas do satélite GOES-16 das 23h00 do dia 22 de Setembro de 2020. FONTE: Cptec/INPE.

1h00 - 23 de Setembro de 2020

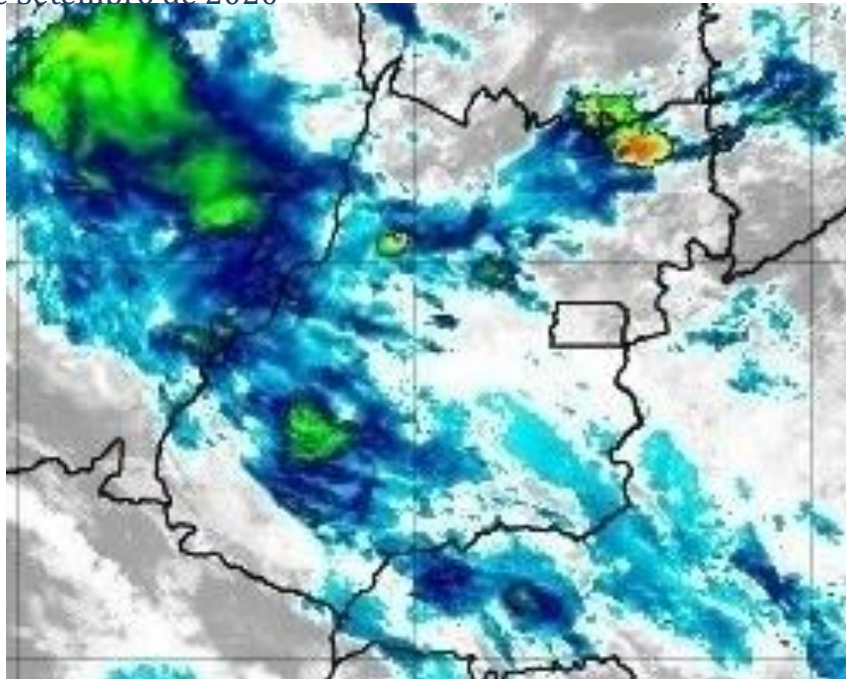

Figura 20 – Imagens realçadas do satélite GOES-16 das 1h00 do dia 23 de Setembro de 2020.
FONTE: Cptec/INPE.

3h00 - 23 de Setembro de 2020

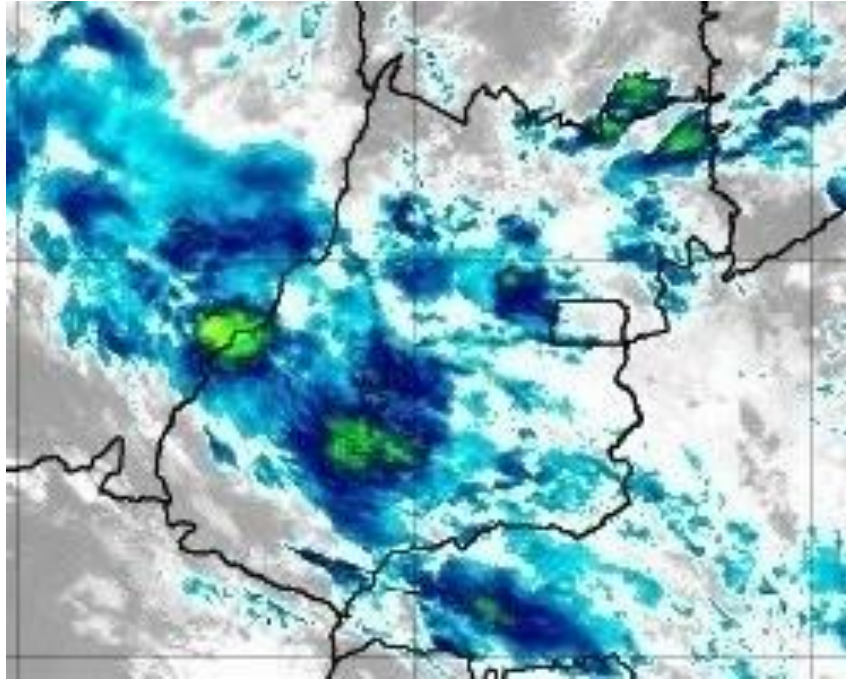

Figura 21 – Imagens realçadas do satélite GOES-16 das 3h00 do dia 23 de Setembro de 2020.
FONTE: Cptec/INPE.

11h00 - 23 de Setembro de 2020

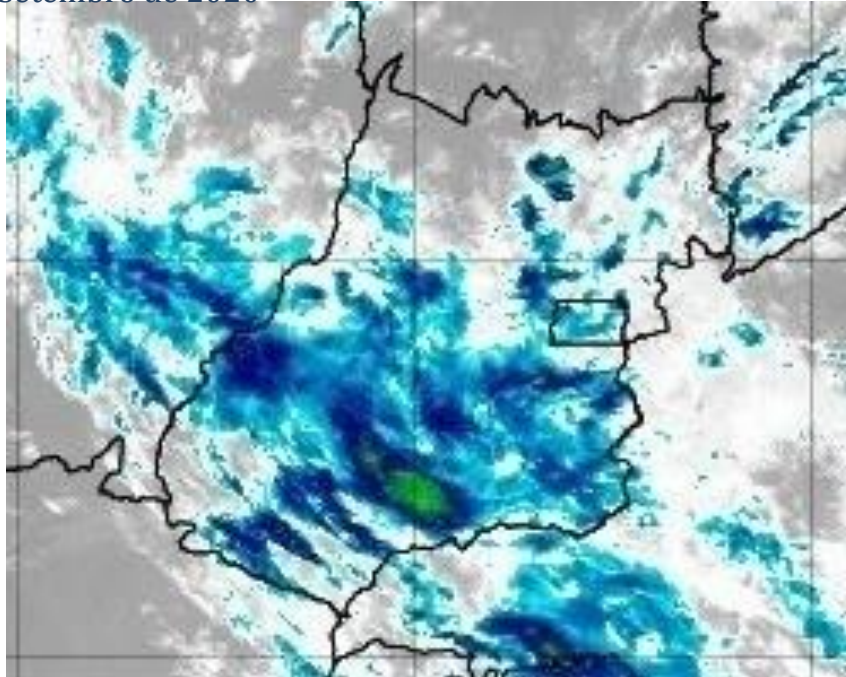

Figura 22 – Imagens realçadas do satélite GOES-16 das 11h00 do dia 23 de Setembro de 2020.
FONTE: Cptec/INPE.

13h00 - 23 de Setembro de 2020



Figura 23 – Imagens realçadas do satélite GOES-16 das 13h00 do dia 23 de Setembro de 2020.
FONTE: Cptec/INPE.

15h00 - 23 de Setembro de 2020

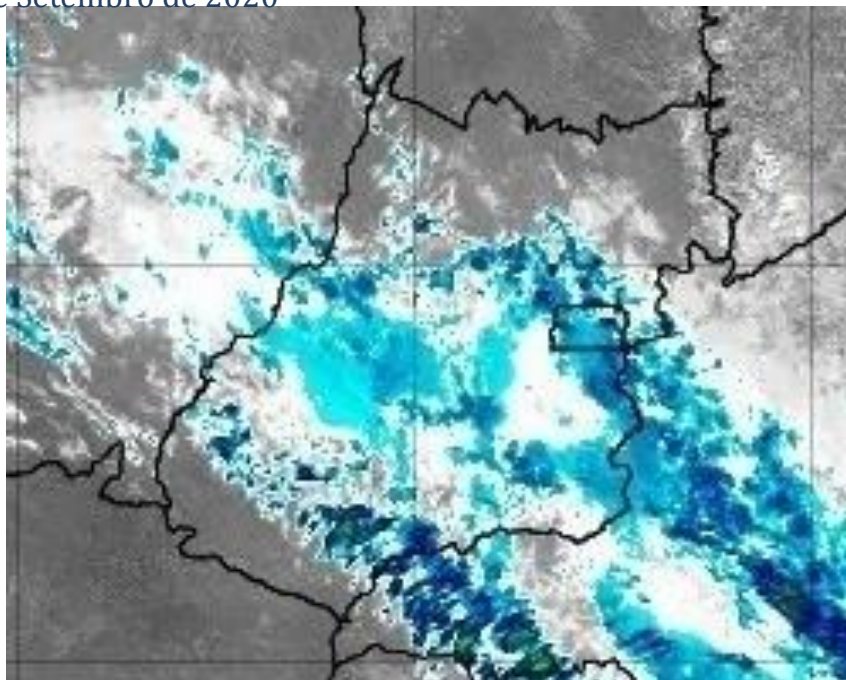

Figura 24 – Imagens realçadas do satélite GOES-16 das 15h00 do dia 23 de Setembro de 2020.
FONTE: Cptec/INPE.

17h00 - 23 de Setembro de 2020

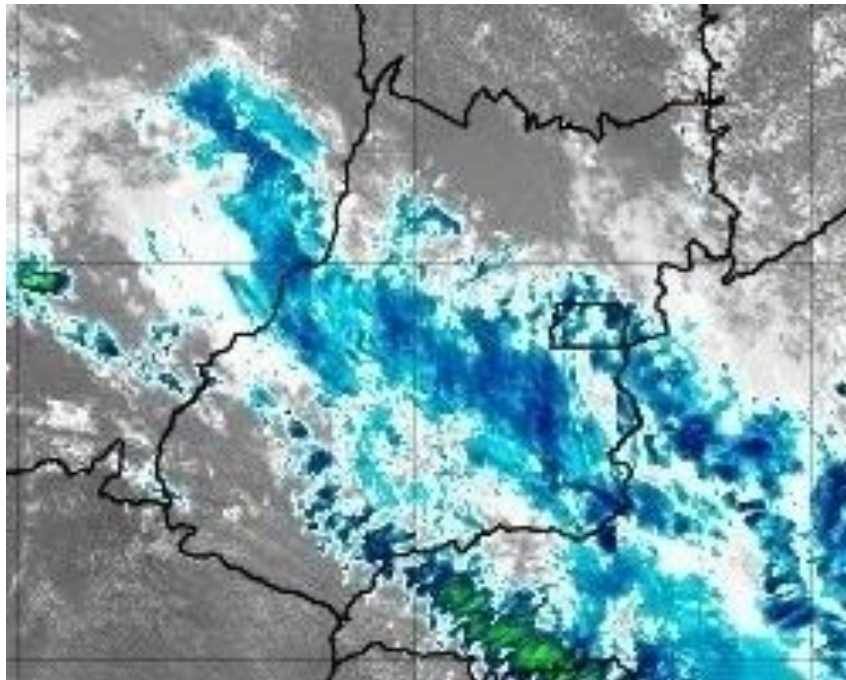

Figura 25 – Imagens realçadas do satélite GOES-16 das 17h00 do dia 23 de Setembro de 2020.
FONTE: Cptec/INPE.

19h00 - 23 de Setembro de 2020

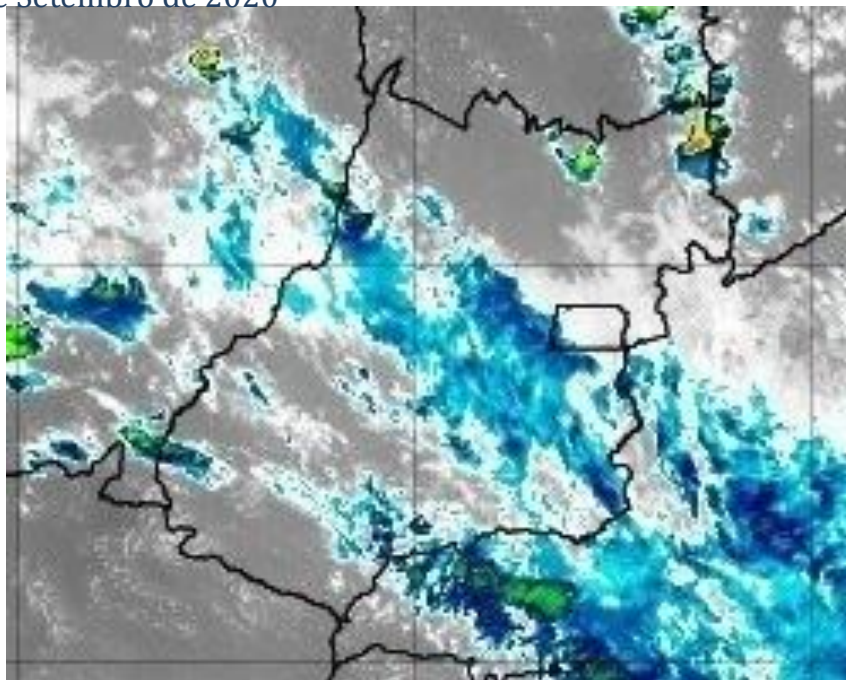

Figura 26 – Imagens realçadas do satélite GOES-16 das 19h00 do dia 23 de Setembro de 2020. FONTE: Cptec/INPE.

21h00 - 23 de Setembro de 2020

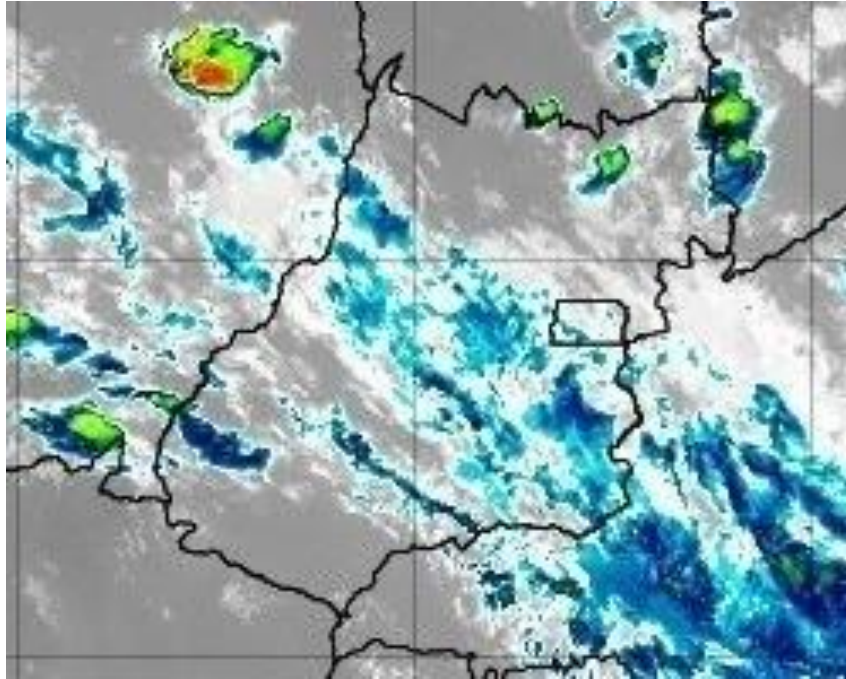

Figura 27 – Imagens realçadas do satélite GOES-16 das 21h00 do dia 23 de Setembro de 2020. FONTE: Cptec/INPE.

23h00 - 23 de Setembro de 2020

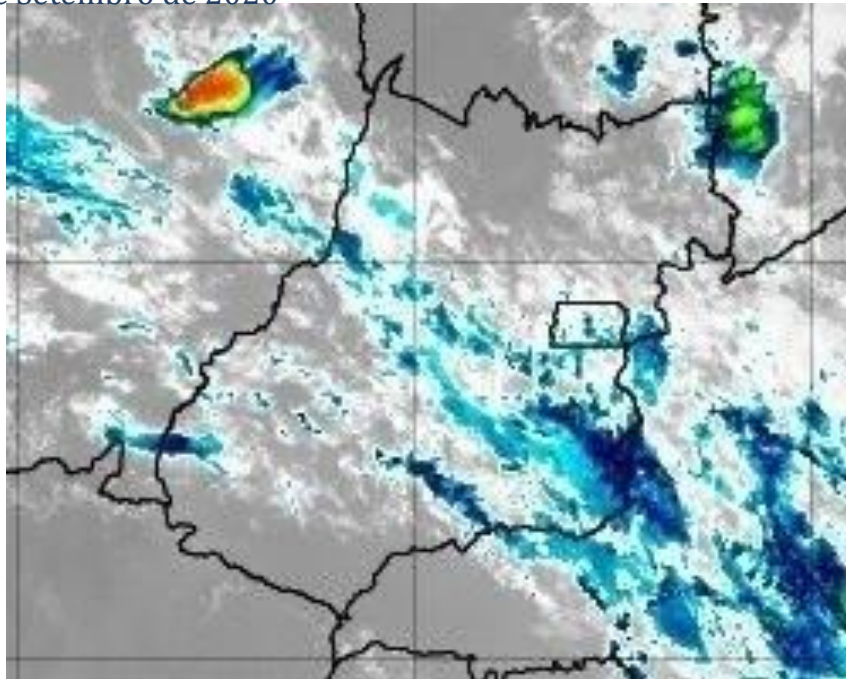

Figura 28 – Imagens realçadas do satélite GOES-16 das 23h00 do dia 23 de Setembro de 2020. FONTE: Cptec/INPE.

01h00 - 24 de Setembro de 2020

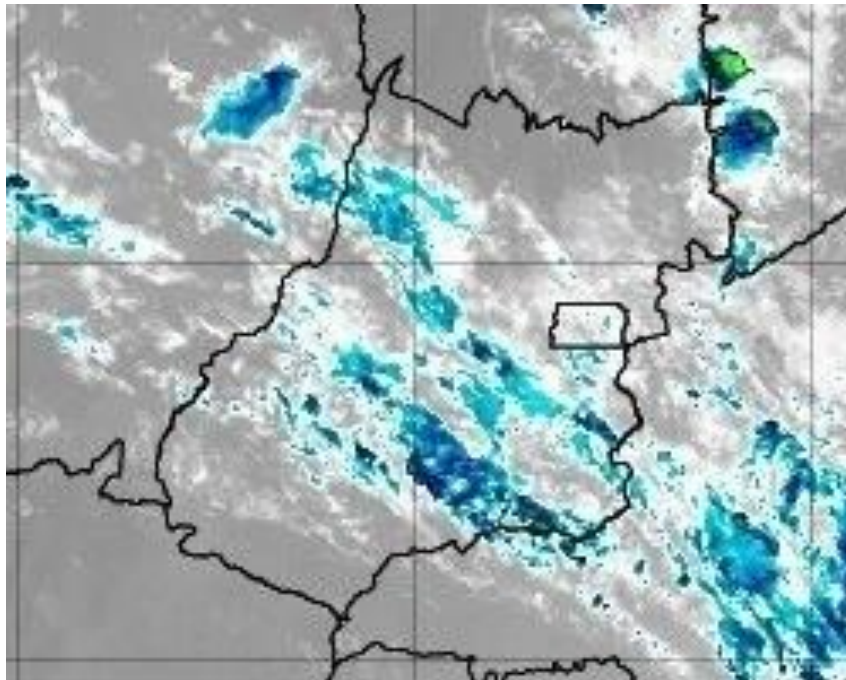

Figura 29 – Imagens realçadas do satélite GOES-16 das 01h00 do dia 24 de Setembro de 2020. FONTE: Cptec/INPE.

03h00 - 24 de Setembro de 2020



Figura 30 – Imagens realçadas do satélite GOES-16 das 03h00 do dia 24 de Setembro de 2020. FONTE: Cptec/INPE.

2 Classificação COBRADE

O COBRADE (Classificação e Codificação Brasileira de Desastres) foi criado com o intuito de adequar a classificação brasileira à classificação utilizada pela ONU na classificação de desastres e nivelar o país aos demais organismos de gestão de desastres do mundo.

Baseados nos dados analisados nos itens anteriores, podemos classificar o evento ocorrido sobre a área de concessão da ENEL DISTRIBUIÇÃO GOIÁS como Zona de Convergência (Código 1.3.1.2.0).

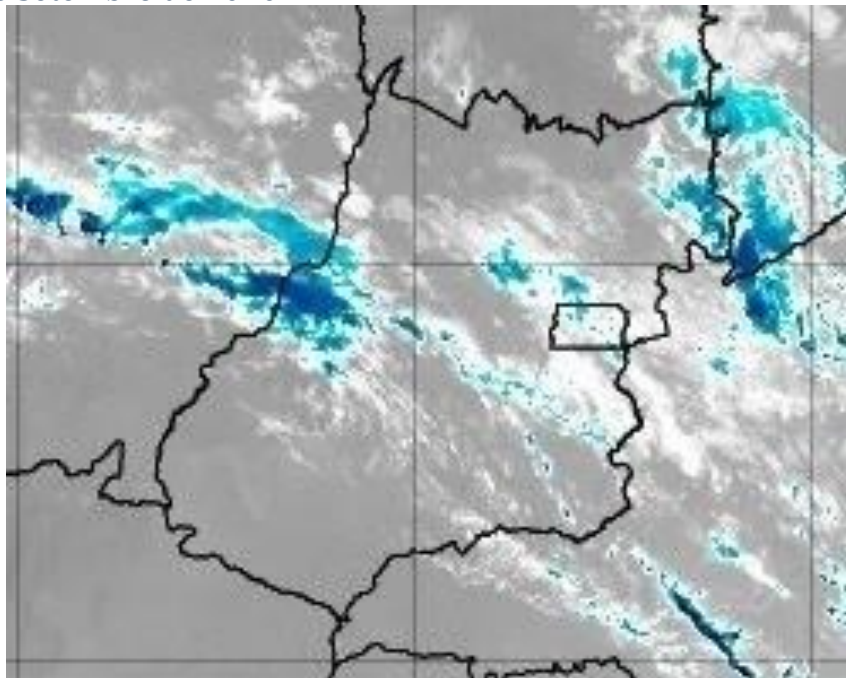
3 Resumo do Evento

Áreas de instabilidade organizadas pela passagem de uma frente fria pela costa brasileira favoreceram a formação de nuvens de tempestade que atuaram sobre o estado de Goiás a partir do fim da manhã do dia 21 de setembro de 2020.

O sistema de detecção da Earth Networks registrou 41248 descargas atmosféricas sobre a área de concessão da ENEL em Goiás entre as 09h00 do dia 21 e 21h30 do dia 23 de setembro de 2020.

Rajadas de vento classificadas como vento forte pela escala Beaufort foram registradas em estações do INMET representativas da região durante o período. Em Caiapônia foram acumulados em 48 horas a média de precipitação total mensal para setembro na região. Além do vento forte, estações do INMET também registraram chuva forte durante o evento.

Tabela 3 – Resumo do evento Regional Rio Verde

Número/Código do Evento	
Número/Código do Relatório	
Descrição	Zona de convergência é uma região que está ligada à tempestade causada por uma zona de baixa pressão atmosférica, provocando forte deslocamento de massas de ar, vendavais, chuvas intensas e até queda de granizo.
Código COBRADE	1.3.1.2.0 - Zona de Convergência
Hora início do evento	09h00 do dia 21 de setembro de 2020
Hora de fim do evento	18h30 do dia 23 de setembro de 2020
Abrangência	Regional Rio Verde

Tabela 4 – Resumo do evento Regional Iporá

Número/Código do Evento	
Número/Código do Relatório	
Descrição	Zona de convergência é uma região que está ligada à tempestade causada por uma zona de baixa pressão atmosférica, provocando forte deslocamento de massas de ar, vendavais, chuvas intensas e até queda de granizo.
Código COBRADE	1.3.1.2.0 - Zona de Convergência
Hora início do evento	13h00 do dia 21 de setembro de 2020
Hora de fim do evento	18h00 do dia 23 de setembro de 2020
Abrangência	Regional Iporá

Tabela 5 – Resumo do evento Regional Luziânia

Número/Código do Evento	
Número/Código do Relatório	
Descrição	Zona de convergência é uma região que está ligada à tempestade causada por uma zona de baixa pressão atmosférica, provocando forte deslocamento de massas de ar, vendavais, chuvas intensas e até queda de granizo.
Código COBRADE	1.3.1.2.0 - Zona de Convergência
Hora início do evento	12h00 do dia 21 de setembro de 2020
Hora de fim do evento	04h30 do dia 23 de setembro de 2020
Abrangência	Regional Luziânia

Tabela 6 – Resumo do evento Regional Anápolis

Número/Código do Evento	
Número/Código do Relatório	
Descrição	Zona de convergência é uma região que está ligada à tempestade causada por uma zona de baixa pressão atmosférica, provocando forte deslocamento de massas de ar, vendavais, chuvas intensas e até queda de granizo.
Código COBRADE	1.3.1.2.0 - Zona de Convergência
Hora início do evento	11h30 do dia 21 de setembro de 2020
Hora de fim do evento	00h30 do dia 23 de setembro de 2020
Abrangência	Regional Anápolis

Tabela 7 – Resumo do evento Regional Uruaçu

Número/Código do Evento	
Número/Código do Relatório	
Descrição	Zona de convergência é uma região que está ligada à tempestade causada por uma zona de baixa pressão atmosférica, provocando forte deslocamento de massas de ar, vendavais, chuvas intensas e até queda de granizo.
Código COBRADE	1.3.1.2.0 - Zona de Convergência
Hora início do evento	11h30 do dia 21 de setembro de 2020
Hora de fim do evento	19h30 do dia 23 de setembro de 2020
Abrangência	Regional Uruaçu

Tabela 8 – Resumo do evento Regional Formosa

Número/Código do Evento	
Número/Código do Relatório	
Descrição	Zona de convergência é uma região que está ligada à tempestade causada por uma zona de baixa pressão atmosférica, provocando forte deslocamento de massas de ar, vendavais, chuvas intensas e até queda de granizo.
Código COBRADE	1.3.1.2.0 - Zona de Convergência
Hora início do evento	10h00 do dia 21 de setembro de 2020
Hora de fim do evento	21h45 do dia 23 de setembro de 2020
Abrangência	Regional Formosa

4 Referências

- RMetS Royal Meteorological Society – Beaufort Scale - <https://www.rmets.org/weather-and-climate/observing/beaufort-scale>
- Cptec/INPE- <https://www.cptec.inpe.br/>
- Centro de Hidrografia da Marinha do Brasil - <https://www.marinha.mil.br/chm/>

Anexos

A.1 Carta Sinótica



Figura A1 - Carta sinótica da Marinha do Brasil para as 1200Z do dia 21 de setembro de 2020 (09h00 do dia 21 de setembro de 2020, hora local).



Figura A2 - Carta sinótica da Marinha do Brasil para as 1200Z do dia 22 de setembro de 2020 (09h00 do dia 22 de setembro de 2020, hora local).

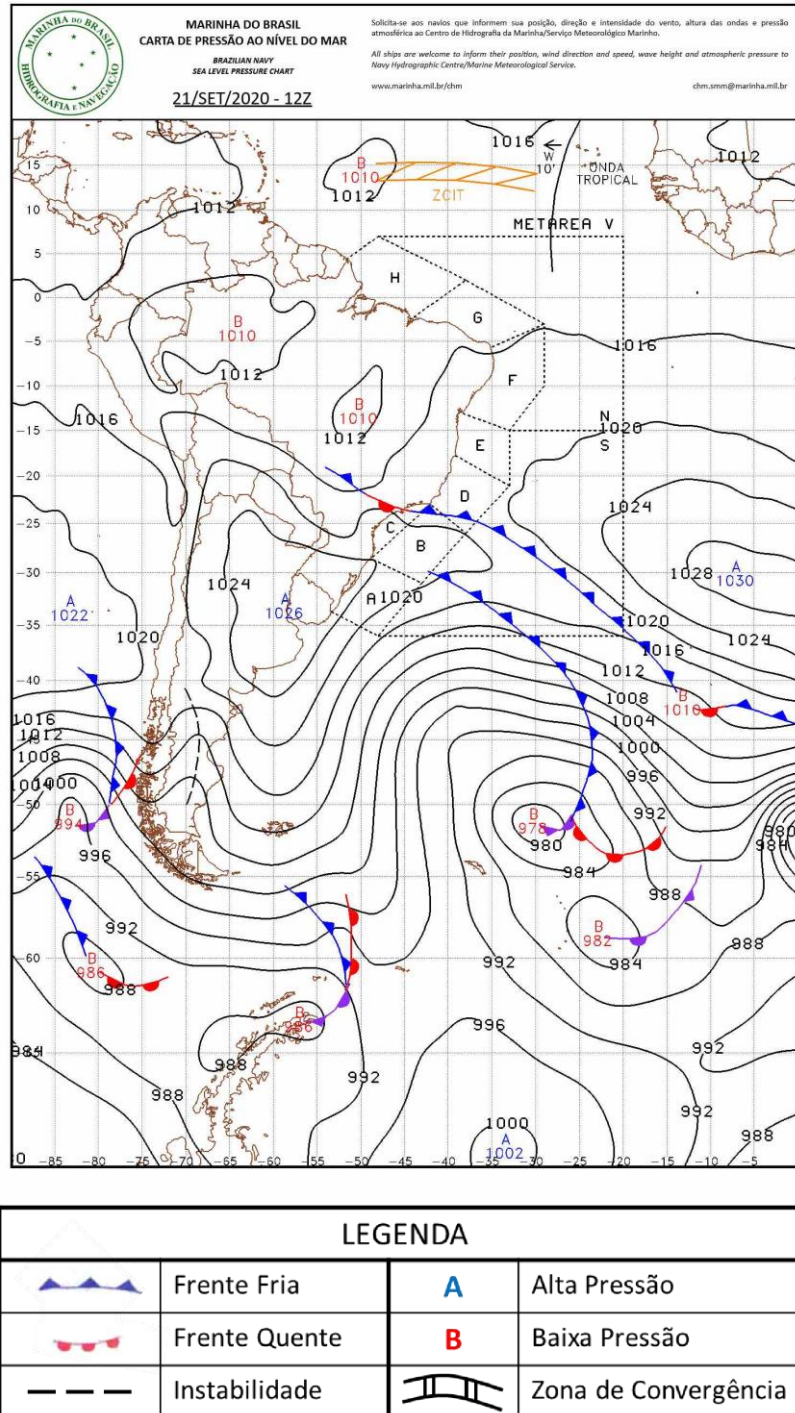

Figura A3 - Carta sinótica da Marinha do Brasil para as 1200Z do dia 23 de setembro de 2020 (09h00 do dia 23 de setembro de 2020, hora local).

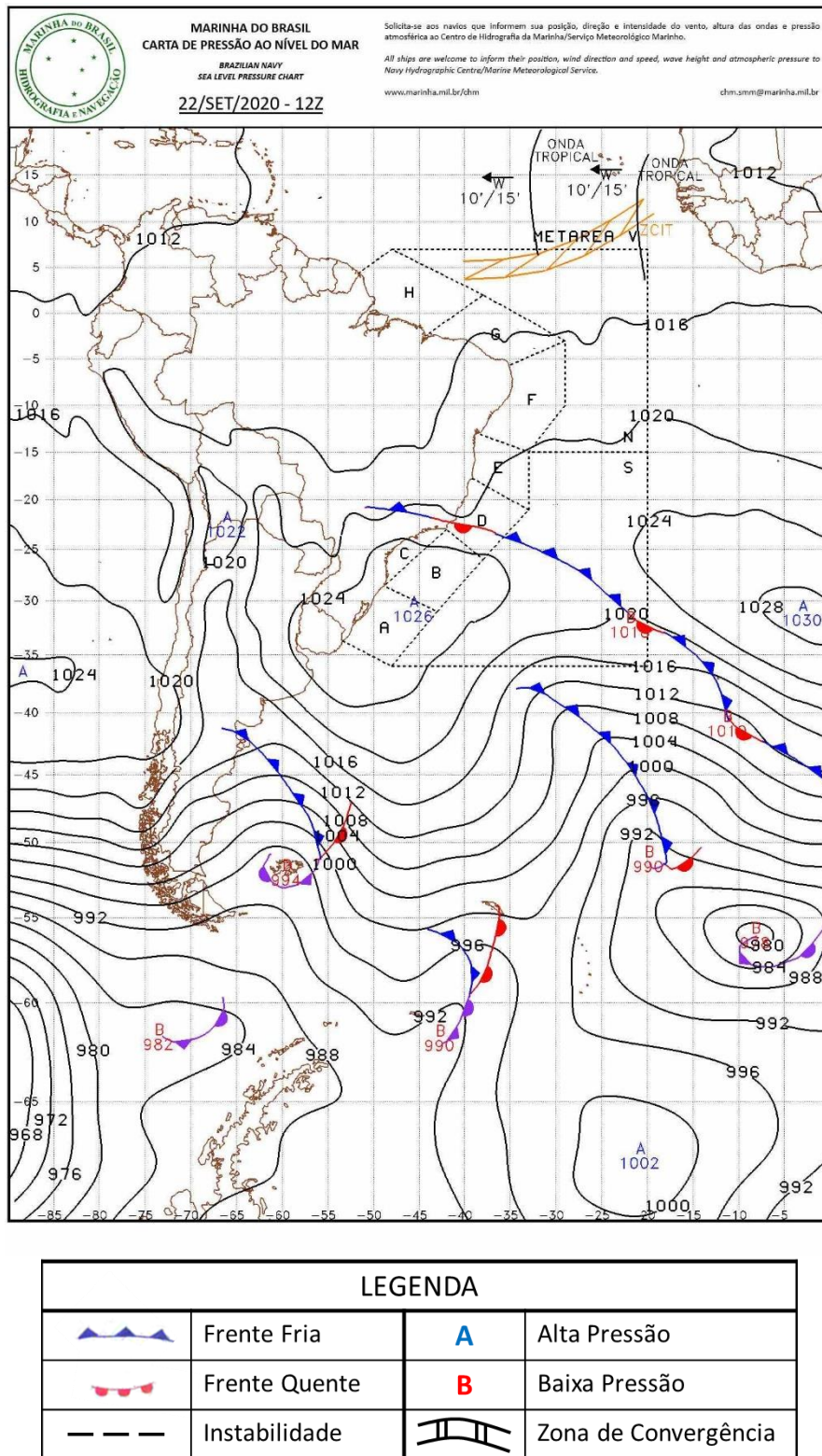

Figura A4 - Carta sinótica da Marinha do Brasil para as 1200Z do dia 23 de setembro de 2020 (09h00 do dia 23 de setembro de 2020, hora local).

A.2 Notícias associadas

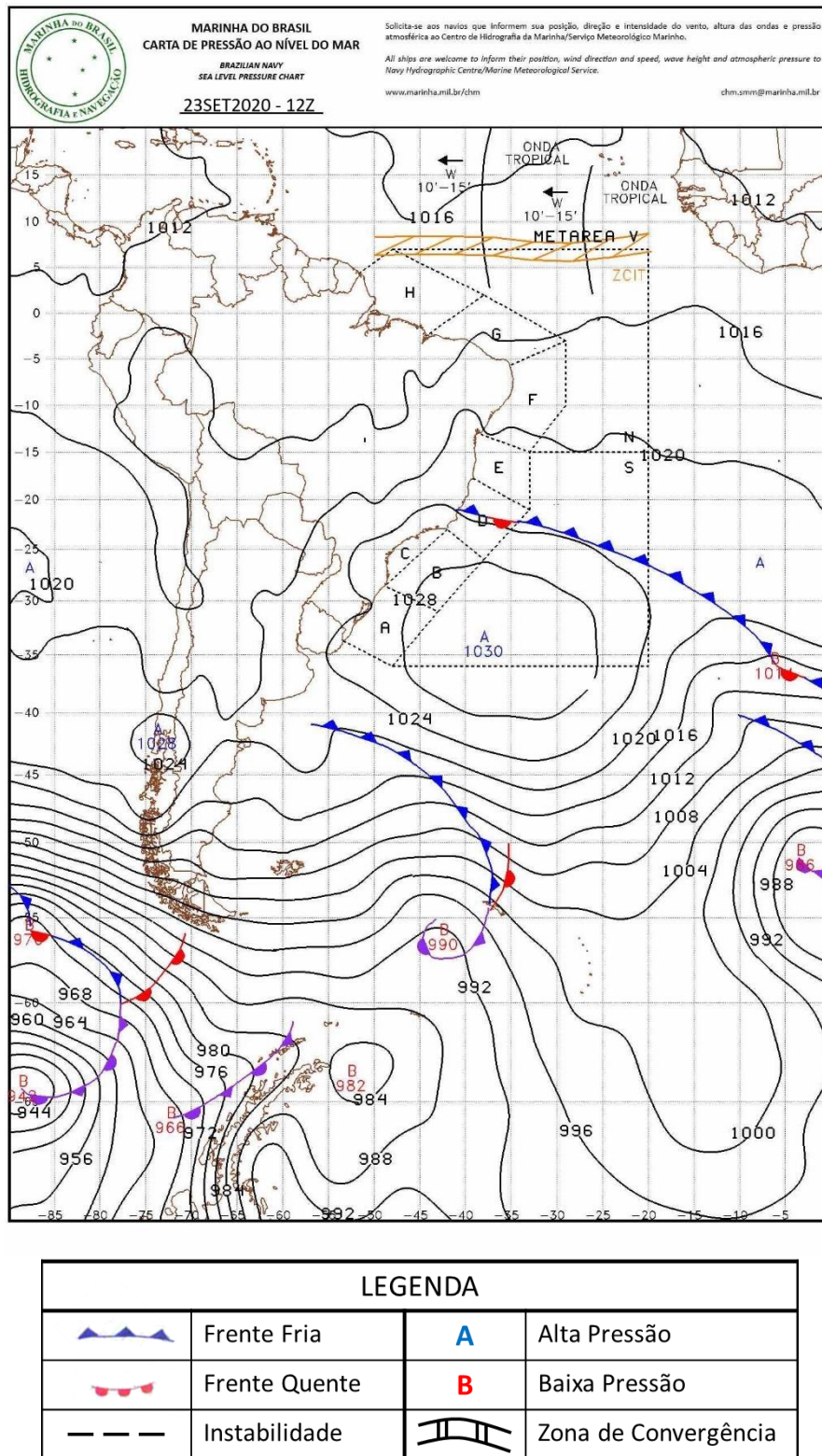
- Após 119 dias de seca, moradores registram chuva em cidades do interior de Goiás

<https://www.onortedegoias.com.br/post/ap>

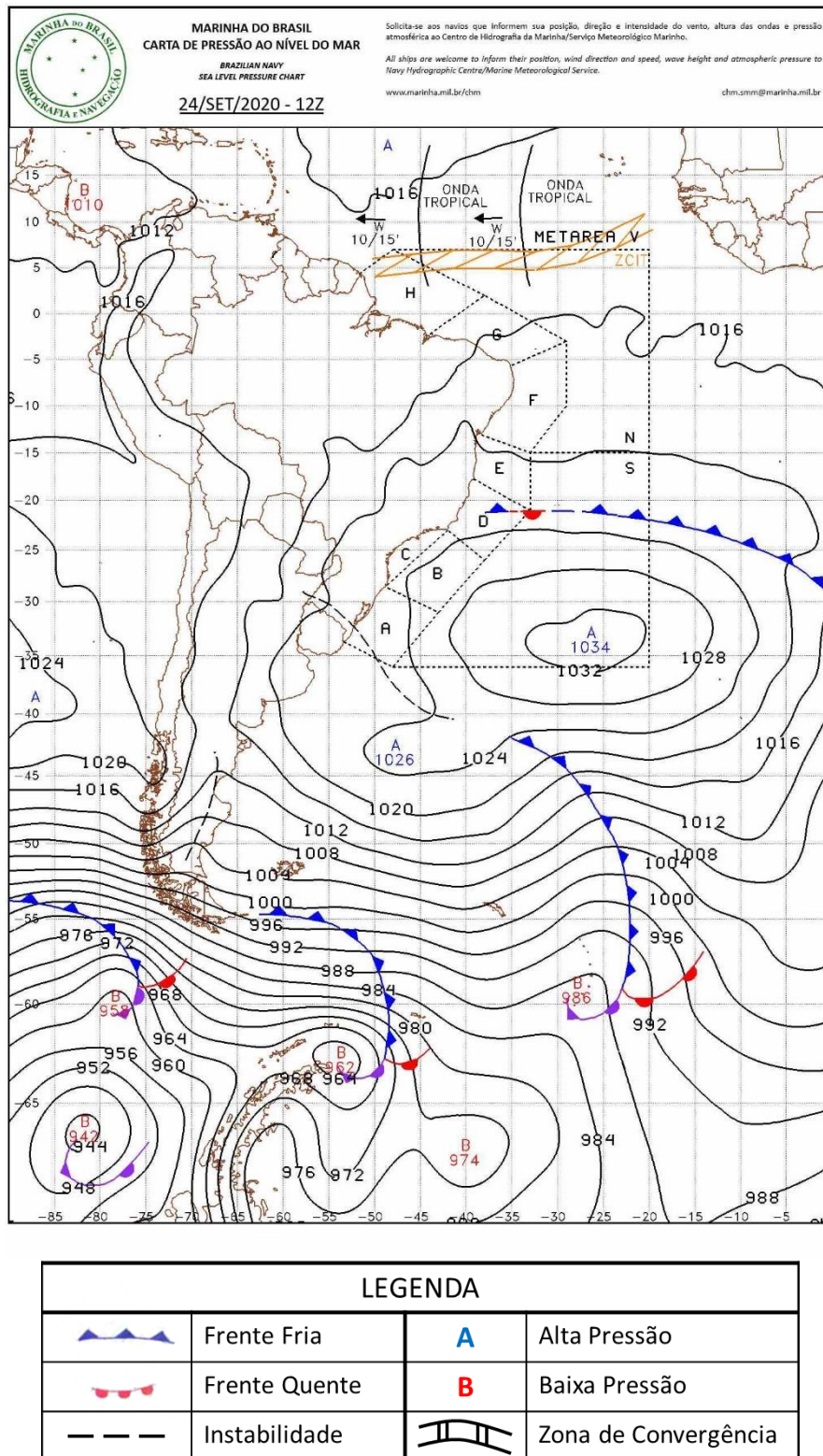
- Rio Verde e região ainda podem ter chuvas isoladas hoje e amanhã (23)

[http://jornalsomos.com.br/rio-verde/detalhe/rio-verde-e-regiao-ainda-podem-ter- chuvas-isoladas- hoje-e-amanha-23](http://jornalsomos.com.br/rio-verde/detalhe/rio-verde-e-regiao-ainda-podem-ter-chuvas-isoladas- hoje-e-amanha-23)

Bianca Lobo Silva
Meteorologista
CREA 5063840461

Dados climatológicos pelo INMET

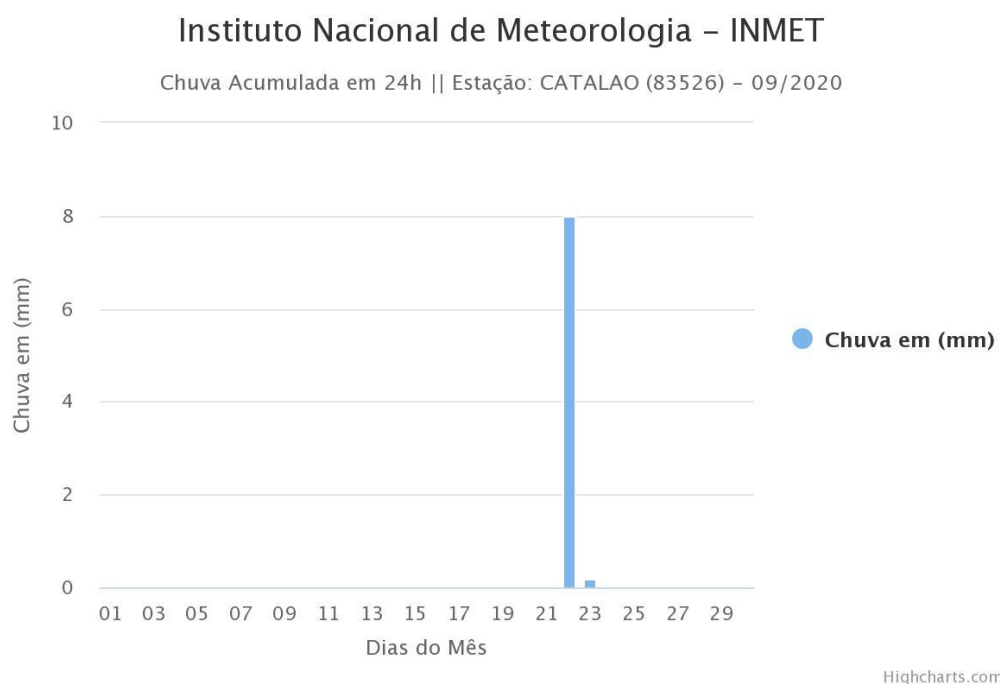
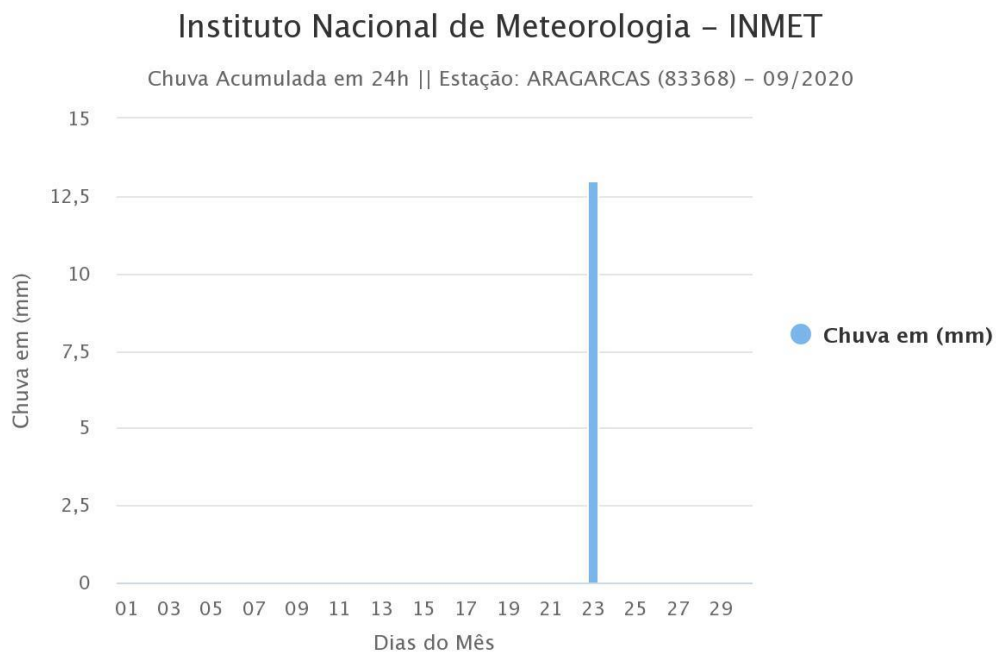

Instituto Nacional de Meteorologia – INMET

Chuva Acumulada em 24h || Estação: FORMOSA (83379) – 09/2020

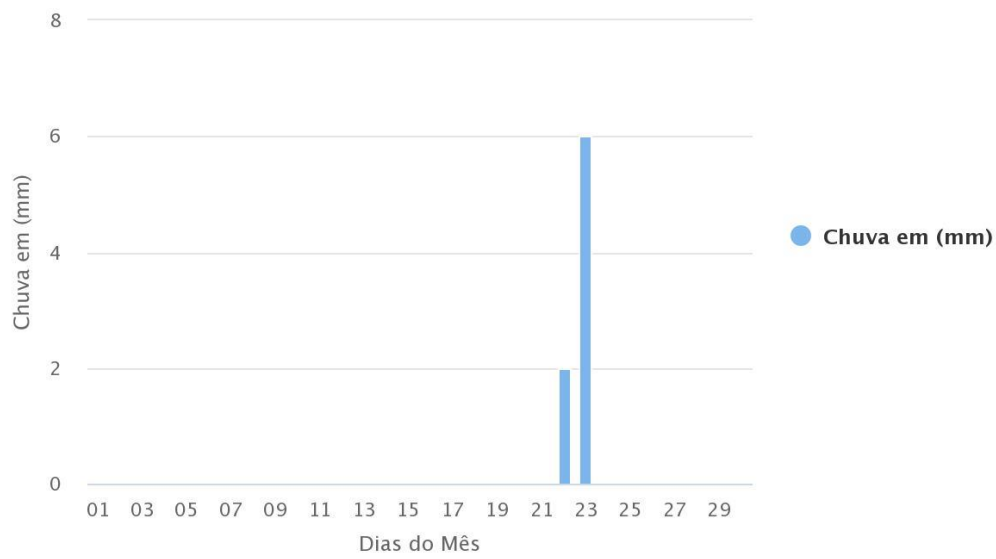

Instituto Nacional de Meteorologia – INMET

Chuva Acumulada em 24h || Estação: GOIANIA (83423) – 09/2020

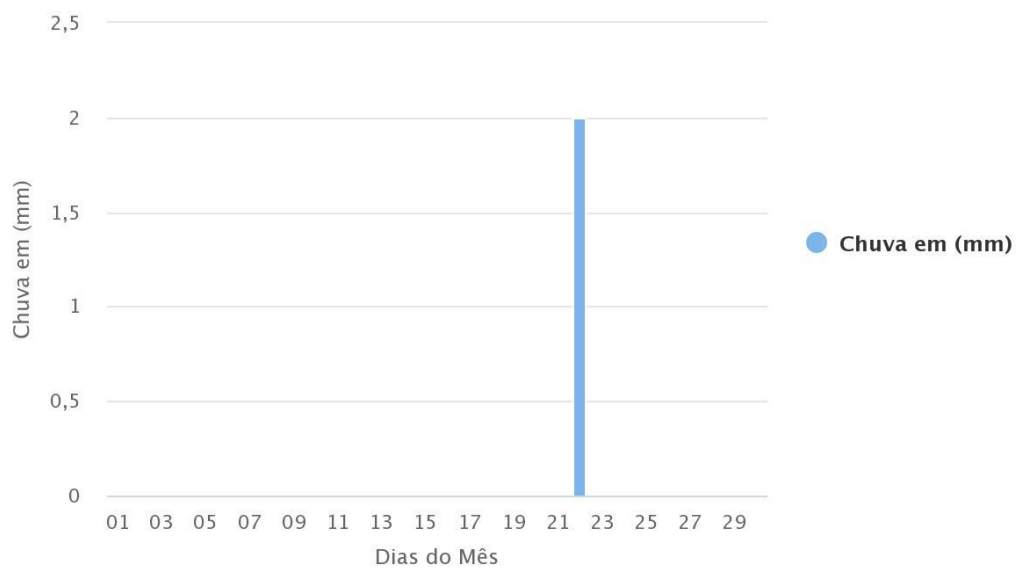

Instituto Nacional de Meteorologia – INMET

Chuva Acumulada em 24h || Estação: IPAMERI (83522) – 09/2020

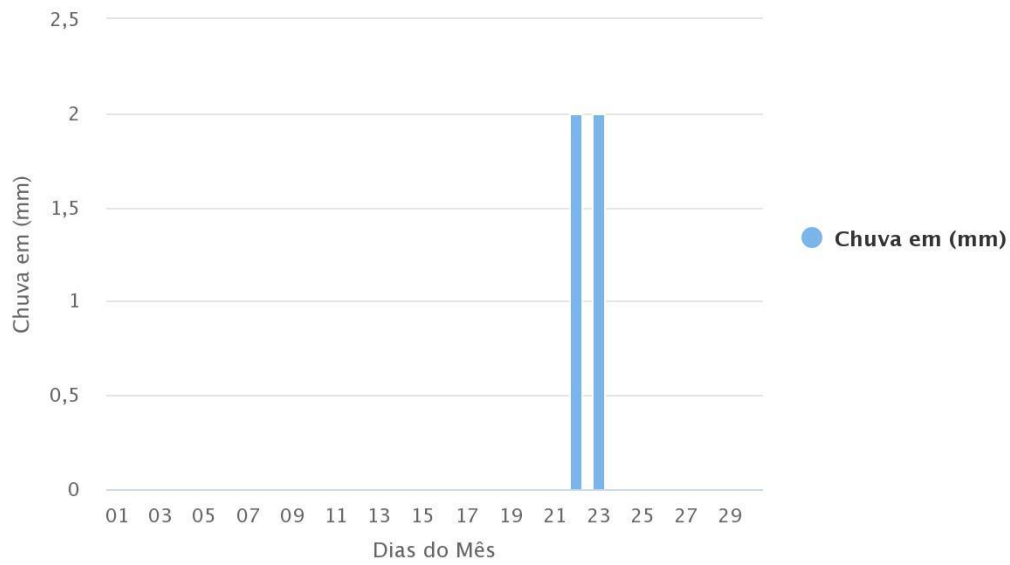

Highcharts.com

Instituto Nacional de Meteorologia – INMET

Chuva Acumulada em 24h || Estação: JATAI (83464) – 09/2020

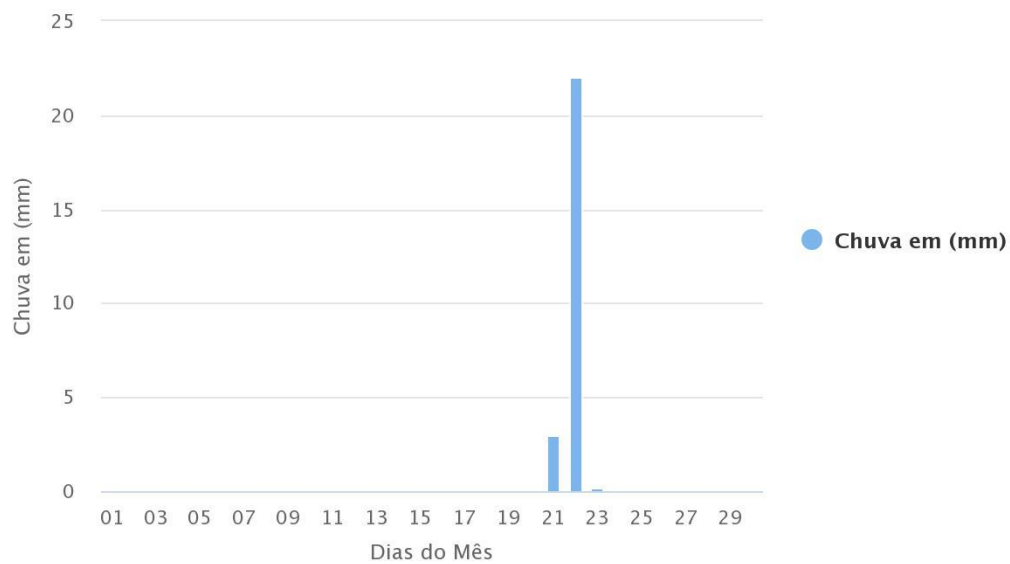

Highcharts.com

Instituto Nacional de Meteorologia – INMET

Chuva Acumulada em 24h || Estação: PIRENOPOLIS (83376) – 09/2020

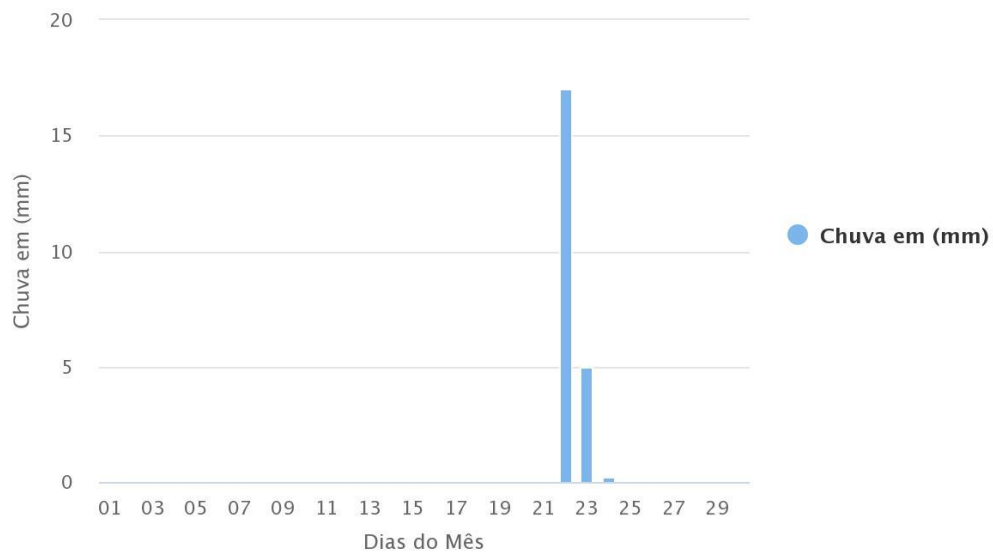

Highcharts.com

Instituto Nacional de Meteorologia – INMET

Chuva Acumulada em 24h || Estação: RIO VERDE (83470) – 09/2020

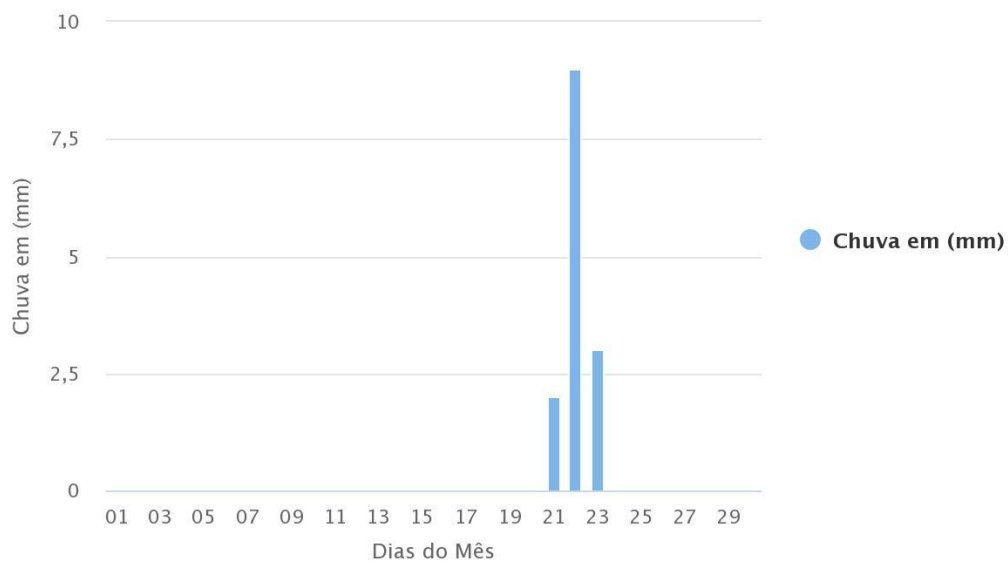

Highcharts.com

NOTÍCIAS RELACIONADAS

[http://jornalsomos.com.br/rio-verde/detalhe/rio-verde-e-regiao-ainda-podem-ter-chuvas-isoladas-
hoje-e-amanha-23](http://jornalsomos.com.br/rio-verde/detalhe/rio-verde-e-regiao-ainda-podem-ter-chuvas-isoladas-hoje-e-amanha-23)

Rio Verde e região ainda podem ter chuvas isoladas hoje e amanhã (23)

POR CAMILLA PAES LEME | 22/09/2020



Segundo informações do Centro de Informações Meteorológicas e Hidrológicas de Goiás (Cimehgo), a previsão é que tenha pancadas de chuva isoladas em Goiás ainda hoje, terça-feira (22/09), e amanhã (quarta-feira, 23). Isso, principalmente, para as regiões Sul e Sudoeste do estado que ainda está sob influência da frente fria que entrou no Brasil desde o final da semana passada.

Segundo o gerente do Cimehgo, André Amorim, a chuva inesperada se deve a massa de ar frio e a fumaça do Amazonas para Goiás. E também, de acordo com ele, em Jataí e Rio Verde, no sudoeste do estado, a população presenciou pancadas de chuvas isoladas desde sábado, 29. Da média de temperatura da semana passada para o início dessa semana a queda chega a 10°C de diferença, já que as máximas da semana passada foram de aproximadamente 36°C, e hoje, terça-feira (22), a previsão do tempo tem marca máxima de 26°C.

Entretanto, Amorim explica que apesar das pancadas isoladas nesta segunda metade do mês de setembro, o período de chuva no estado começa efetivamente apenas na segunda quinzena de outubro.