

EDEL DISTRIBUIÇÃO GOIÁS



Relatório de Evento em Situação de Emergência
Nº CHI-049

1. INTRODUÇÃO.....	3
2. DEFINIÇÃO	3
3. RESUMO EXECUTIVO.....	5
3.1. RELATÓRIO DE OCORRÊNCIAS DO PERÍODO	5
4. LISTA DE OCORRÊNCIAS	9
5. PLOTAGEM DAS OCORRÊNCIAS CONFORME A ESPACIALIZAÇÃO DAS CHUVAS	188
6. CLIENTES AFETADOS E IMPACTOS GLOBAIS	189
7. DIAGRAMAS UNIFILARES	190
8. DEMAIS EVIDÊNCIAS	196
8.1. DADOS TÉCNICO - OPERACIONAIS ENEL GO.....	196
8.2. DADOS CLIMATOLÓGICOS PELO INMET	198
9. NOTÍCIAS RELACIONADAS.....	202
10. LAUDO TÉCNICO.....	208
SUMÁRIO	209

1. Introdução

As concessionárias do serviço público de distribuição de energia elétrica devem prover o serviço de forma adequada, buscando sempre a eficiência, conforme disposto na legislação e nos respectivos contratos de concessão.

Dentre a legislação vigente, destacam-se os Procedimentos de Distribuição de Energia Elétrica no Sistema Elétrico Nacional – PRODIST, que consistem em documentos elaborados pela Agência Nacional de Energia Elétrica – ANEEL, com a participação dos agentes de distribuição e de outras entidades e associações do setor elétrico nacional, que normatizam e padronizam as atividades técnicas relacionadas ao funcionamento e desempenho dos sistemas de distribuição de energia elétrica.

O Módulo 8 do PRODIST – Revisão 11, mais especificamente em sua Seção 8.2, regulamenta a qualidade do serviço prestado pelas distribuidoras de energia elétrica, estabelecendo a metodologia para apuração dos indicadores de continuidade e dos tempos de atendimento a ocorrências emergenciais.

O referido regulamento prevê que, na apuração dos indicadores coletivos e individuais deverão ser consideradas todas as interrupções de longa duração que atingirem as unidades consumidoras, admitidas algumas exceções (denominadas expurgos), que podem ser encontradas no Item 5.6.2.2 da seção 8.2 do Módulo 8 do PRODIST, transcrito abaixo:

5.6.2.2 Na apuração dos indicadores DEC e FEC devem ser consideradas todas as interrupções, admitidas apenas as seguintes exceções:

i. falha nas instalações da unidade consumidora que não provoque interrupção em instalações de terceiros;

ii. interrupção decorrente de obras de interesse exclusivo do consumidor e que afete somente a unidade consumidora do mesmo;

iii. Interrupção em Situação de Emergência;

iv. suspensão por inadimplemento do consumidor ou por deficiência técnica e/ou de segurança das instalações da unidade consumidora que não provoque interrupção em instalações de terceiros, previstas em regulamentação;

v. vinculadas a programas de racionamento instituídos pela União;

vi. ocorridas em Dia Crítico;

vii. oriundas de atuação de Esquema Regional de Alívio de Carga estabelecido pelo ONS. [grifos nossos]

Para os casos de expurgo por Interrupção em Situação de Emergência (ISE), a alínea “h” do Item 5.12.1 da seção 8.2 do Módulo 8 do PRODIST estabelece a obrigatoriedade das distribuidoras em disponibilizar, em seu sítio eletrônico, relatórios digitais com as evidências do evento que tenha gerado tais interrupções enquadradas no inciso iii do Item 5.6.2.2 do mesmo.

Nesta seara, o presente documento, visa apresentar as evidências de um evento ocorrido na área de concessão da Eletropaulo, bem como informações relevantes a respeito das interrupções em Situação de Emergência decorrentes do mesmo.

Destaca-se que, para o entendimento completo das regras de apuração dos indicadores de continuidade e expurgos, faz-se necessário também a observação das regras contidas nos Módulos 1 e 6 do PRODIST. Todos os módulos destes procedimentos encontram-se disponíveis para consulta no site da ANEEL (www.aneel.gov.br) e as principais definições relacionadas ao tema estão contidas no item 2 deste documento.

2. Definição

Seção 1.2 do Módulo 1 do PRODIST – Revisão 10

2.198 Evento

Acontecimento que afete as condições normais de funcionamento de uma rede elétrica, podendo gerar uma ou mais interrupções no fornecimento de energia.

2.131 e 2.158 DIC

Duração de interrupção individual por unidade consumidora, ou seja, intervalo de tempo que, no período de apuração, em cada unidade consumidora ou ponto de conexão ocorreu descontinuidade da distribuição de energia elétrica.

2.216 e 2.220 FIC

Frequência de interrupção individual por unidade consumidora, ou seja, Número de interrupções ocorridas, no período de apuração, em cada unidade consumidora ou ponto de conexão.

2.87 Consumidor Hora Interrompido (CHI):

Somatório dos DICs dos consumidores atingidos por interrupção no fornecimento de energia, expresso em horas e centésimos de horas.

2.251 Interrupção em Situação de Emergência:

Interrupção originada no sistema de distribuição, resultante de Evento que comprovadamente impossibilite a atuação imediata da distribuidora e que não tenha sido provocada ou agravada por esta e que seja:

- Decorrentes de evento associado a Decreto de Declaração de Situação de Emergência ou Estado de Calamidade Pública emitido por órgão competente; ou
- Decorrentes de Evento cuja soma do CHI das interrupções ocorridas no sistema de distribuição seja superior ao calculado conforme equação a seguir:

$$2.612 \times N^{0,35}$$

N – número de unidades consumidoras faturadas e atendidas em BT ou MT, com 2 (duas) casas decimais, do mês de outubro do ano anterior ao período de apuração

3. Resumo Executivo

O Presente Relatório tem como objetivo a incorporação de informações que sejam relevantes para que se possa fazer a devida associação aos dados contidos no documento objeto da classificação de Situação de Emergência caracterizada pelo Módulo 8 do Prodist. Este enquadramento se apresenta na maioria das vezes em condições climáticas adversas com severidade dos fatores inerentes a situação, caracterizado na maioria dos casos por fortes ventos e chuvas de grande intensidade e continuidade.

A partir do início da tarde do dia 09/10/2020 – sexta-feira – Áreas de instabilidade organizadas pela presença de uma frente fria pela costa brasileira favoreceram a formação de um canal de umidade que atuaram sobre o estado de Goiás.

Conforme informações do Climatempo Meteorologia, o Instituto Nacional de Meteorologia (INMET) detectou rajadas de vento acima de 50km/h registradas por estações representativas da área de concessão da ENEL Distribuição Goiás. Na estação de Goiás ocorreram ventos de até 79,9 km/h entre as 18h e 19h do dia 12 de outubro de 2020, classificada como ventania forte, segundo a escala Beaufort.

O sistema de detecção da EarthNetworks registrou 124.054 descargas atmosféricas (34.105 nuvem-solo e 89.949 nuvem-nuvem) sobre a área de concessão da ENEL em Goiás entre as 12h30 do dia 09 de outubro de 2020 e 11h40 do dia 14 de outubro de 2020, causando grande instabilidade na rede.

Chuva forte foi registrada pelo INMET em estações representativas da área de concessão da ENEL Distribuição Goiás. Na estação de Alto Araguaia foram acumulados 73,0 mm de chuva entre as 17h e 18h do dia 11 de outubro de 2020, valor que corresponde 58,0% da média de chuva para o mês na região.

3.1. Relatório de Ocorrências do período

Em todo o Estado de Goiás verificou-se também que a intensidade da chuva e dos ventos danificaram a rede de distribuição de energia elétrica em diversos pontos, registrando aproximadamente 1 milhão e 95 mil clientes com interrupção no fornecimento de energia elétrica devido a eventos relacionados ao temporal, afetando 243 municípios e 326 Subestações.

Para otimizar o volume de atendimentos e reduzir os tempos de interrupção foram mobilizados os recursos extras da empresa que aumentou o contingente em relação a situação normal de operação. O acompanhamento da quantidade de equipes e o Tempo Médio de Atendimento podem ser consultados na Pág.05 do Relatório em anexo.

O impacto e severidade do evento estão relatados em artigos de mídia, como fotos e reportagens que demonstram os danos na Rede de Distribuição, oriundos dos eventos climáticos no período. Eventos estes que afetaram 1.094.881 consumidores com CHI de 3.545.660,78 superior ao de 482.597,74 estabelecido como limite para definição de Situação de Emergência, conforme resumo das informações obrigatórias.

Empresa		ENEL DISTRIBUIÇÃO GOIÁS			
Código do Relatório		CHI-049 - ENEL DISTRIBUIÇÃO GOIÁS			
Evento:		TEMPORAL NA AREA DE CONCESSÃO DA ENEL DISTRIBUIÇÃO GOIAS			
Código COBRADE:	1.3.1.2.0	Data Início	09/10/2020	Hora início	12h00
Código do Evento:	CHI-049-ENEL GO	Data Término	14/10/2020	Hora Término	12h00
Valor CHI (Limite e Real)	482.597,74	3.545.660,78			
Código do Decreto (Se Houver):					
Quantidade de Interrupções (Evento)		4.561			
Início 1ª Incidência (Data e Hora)	09/10/2020 12:03		Subestações Atingidas	ABADIANIA / ABC / ACREUNA / ADELANDIA / AEROPORTO / AGUAS LINDAS / ALEXANIA / ALEXANIA TRANSMISSAO / ALMERINDONOPOLIS / ALOANDIA / ALPHAVILLE / ALTO BURITI / ALTO HORIZONTE / ALTO PARAISO DE GOIAS / ALVORADA DO NORTE / AMERICANO (RIO VERDE) / AMERICANO DO BRASIL / AMORINOPOLIS / ANAPOLIS UNIVERSITARIA / ANHANGUERA / ANICUNS / ANTONIO DO VITTO / APARECIDA DO RIO DOCE / APORE / ARACU / ARAGARCAS / ARAGOIANIA / ARAGUAPAZ / ARARAS / AREIAS / ARENOPSIS / ARUANA / ARUANA (TRANSMISSAO) / ASA BRANCA / ATLANTICO / AURILANDIA / AVELINOPOLIS / BACURI (RIO VERDE) / BARBOSELANDIA / BARCELONA / BARREIRO (PORANGATU) / BARRO ALTO / BELA VISTA (TRANSMISSAO) / BOA VISTA / BOM JARDIM / BOM JESUS DE GOIAS / BONFINOPOLIS / BONITO / BONOPOLIS / BONSUCESSO (RIO VERDE) / BRAZABRANTES / BRITANIA / BRITANIA (TRANSMISSAO) / BURITI ALEGRE / BURITI DE GOIAS / BURITIZINHO / CABECEIRAS / CABRIUVA (RIO VERDE) / CACHOEIRA ALTA / CACHOEIRA DOURADA / CACHOEIRA NOVA / CACHOEIRINHA (ITARUMA) / CACU / CAIAPONIA / CALCILANDIA / CALDAS NOVAS / CALDAZINHA / CAMPESTRE / CAMPINAS / CAMPINORTE / CAMPO ALEGRE DE GOIAS / CAMPO LIMPO DE GOIAS / CAMPO NOVO / CAMPOS BELOS / CAMPOS VERDES / CARAIBAS / CARAJAS / CASTELANDIA / CATALAO / CATURAI / CEBRASA FABRICA DA AMBEV / CEMAT/BALIZA / CEPAIGO / CEZARINA / CHAPADAO DO CEU / CIDADE ECLETICA / CIDADE OCIDENTAL / COCALZINHO / COLINACU / CORREGO DO OURO / CORUMBA / CORUMBAIBA / CRISTALINA / CRISTALINA TRANSMISSAO / CRISTIANOPOLIS / CRIXAS / CROMINIA / CUMARI / DAIA - ANAPOLIS / DAMOLANDIA / DAVINOPOLIS / DESFECHO / DESTILARIA ALTO PARAISO / DESTILARIA BRASIL CENTRAL / DIMIC / DIORAMA / DORCELINO PEIXOTO DE MORAES / DOVERLANDIA / EDEALINA / EDEIA / ENERSUL / ESTANIFERA / ESTRELA DO NORTE / FAINA / FAZENDA CANADA / FAZENDA NOVA / FERROVIARIO / FIRMINOPOLIS / FLORES DE GOIAS / FORMIGA / FORMOSO / FRONTEIRA / GAMELEIRA / GIRASSOL / GOIANAPOLIS / GOIANDIRA / GOIANESIA / GOIANIA LESTE / GOIANIRA / GOIAS / GOIATUBA / GOUVERLANDIA / GOYA / GUAPO / HEITORAI / HIDROLANDIA / HIDROLINA / IACIARA / INACIOLANDIA / INDEPENDENCIA / INDIARA / INHUMAS / IPAMERI / IPEGUARI / IPORA / ISRAELANDIA / ITABERAI / ITAGUARI / ITAGUARU / ITAJA / ITAPACI / ITAPACI (TRANSMISSAO) / ITAPIRAPUA / ITAPURANGA / ITAPURANGA (TRANSMISSAO) / ITARUMA / ITAUCU / ITIQUIRA (FORMOSA) / ITUMBIARA NOVA / ITUMBIARA VELHA / JACILANDIA / JANDAIA / JARAGUA / JARANAPOLIS / JATAI / JAUPACI / JESUPOLIS / JOVIANIA / JUNDIAI / JURUMIRIM / JUSCELANDIA / JUSSARA / LAGES / LAGOA DA SERRA / LAGOA DO BAUZINHO (RIO VERDE) / LEOPOLDO DE BULHOES / LUZIANIA / MAIRIPOTABA / MAMBAI / MARA ROSA / MARAJOARA / MARCIANOPOLIS / MARIAPOLIS (PADRE BERNARDO) / MATO GRANDE / MATRINCHA / MAURILANDIA / MEIA PONTE / MINACU / MINEIROS / MINEIROS TRANSMISSAO / MOIPORA / MONTE ALEGRE / MONTES CLAROS DE GOIAS / MONTIVIDIU T / MORRINHOS / MORRO AGUDO / MOSSAMEDES / MOZARLANDIA / MOZARLANDIA (TRANSMISSAO) / MUNDO NOVO DE GOIAS / MUTUNOPOLIS / NAVESLANDIA (JATAI) / NAZARIO / NEROPOLIS / NIQUELANDIA / NOVA AMERICA / NOVA AURORA / NOVA CRIXAS (TRANSMISSAO) / NOVA IGUACU / NOVA PONTE / NOVA VENEZA / NOVO BRASIL / NOVO GAMA / NOVO PLANALTO / OLHOS DAGUA / OLOANA / ORIZONA / OURO VERDE DE GOIAS / OUVIDOR / PACAEMBU (NOVO GAMA) / PADRE BERNARDO / PALESTINA / PALMEIRAS / PALMEIRAS DE GOIAS / PALMELO / PALMINOPOLIS / PAMPLONA / PARANA / PARANAIBA / PARANAIGUARA / PARAUNA SE ALTA TENSAO / PARQUE DAS EMAS (MINEIROS) / PARQUE DAS NACOES / PEROLANDIA / PETROLINA / PILAR / PIRACANJUBA / PIRANHAS T / PIRENOPOLIS / PIRES BELO / PIRES DO RIO / PLANALTINA / PLANALTINA (TRANSMISSAO) / PLANALTO / PONTALINA / PORANGATU / PORTEIRO / PORTEIRO / PORTELANDIA / POSSE / POSSELANDIA / PROFESSOR JAMIL / QUEBRA LINHA / QUIRINOPOLIS / REAL / RETIRO / GOIAS / RIO CLARO JATAI MONTIVIDIU / RIO DO PEIXE / RIO DOS BOIS (MAURILANDIA) / RIO PRETO / RIO QUENTE / RIO VERDE / RIO VERMELHO / RIVERLANDIA (RIO VERDE) / RUBIATABA / SANCLERLANDIA / SANTA BARBARA / SANTA FE DE GOIAS / SANTA HELENA / SANTA RITA DO ARAGUAIA / SANTA ROSA / SANTA ROSA DE GOIAS / SANTA ROSA DO MEIA PONTE / SANTA TEREZA DE GOIAS / SANTA TEREZINHA / SANTANA / SANTO ANTONIO DA BARRA / SANTO ANTONIO DE GOIAS / SANTO ANTONIO DO DESCOBERTO / SAO BARTOLOMEU / SAO DOMINGOS / SAO FRANCISCO DE GOIAS / SAO GABRIEL DE GOIAS / SAO JOAO D ALIANCA / SAO JOAO DA PARAUNA / SAO JUDAS	

			TADEU / SAO LUIZ DOS MONTES BELOS / SAO MIGUEL DO ARAGUAIA / SAO MIGUEL DO PASSA QUATRO / SAO SIMAO / SENADOR CANEDO TRANSMISSAO / SERRA AZUL (JATAI) / SERRA DE CALDAS / SERRANOPOLIS / SILVANIA / SITIO DABADIA / SOUZALANDIA / SUCURI / TAIOBA / TAQUARAL / TAQUARI / TEREZOPOLIS / TERRA VERMELHA / TRAJANOPOLIS (PADRE BERNARDO) / TRES BARRAS / TRES RANCHOS / TRINDADE / TUCUNARE / TURVANIA / TURVELANDIA / URU / URUACU / URUTAI / USINA DE ACUCAR DE GOIANESIA / USINA MAMBAI / VALPARAISO / VARJAO / VENDA SECA / VIANOPOLIS / VICENTINOPOLIS / VILA CORUMBA / VILA PROPICIO / XAVANTES / XIXA / ZELANDIA / NIQUELANDIA 69KV / VILA BOA
Início Última Incidência (Data e Hora)	14/10/2020 11:52		
Média de Duração das Incidências (h)	7,87		
Duração da Incidência mais longa (h)	102,82		
Total de Clientes afetados	1.094.881	Municípios Atingidos	ABADIA DE GOIAS / ABADIANIA / ACREUNA / ADELANDIA / AGUA FRIA DE GOIAS / AGUAS LINDAS DE GOIAS / ALEXANIA / ALOANDIA / ALTO HORIZONTE / ALTO PARAISO DE GOIAS / ALVORADA DO NORTE / AMARALINA / AMERICANO DO BRASIL / AMORINOPOLIS / ANAPOLIS / ANICUNS / APARECIDA DE GOIANIA / APARECIDA DO RIO DOCE / APORE / ARACU / ARAGARCAS / ARAGOIANIA / ARAGUAPAZ / ARENOPOLIS / ARUANA / AURILANDIA / AVELINOPOLIS / BALIZA / BARRO ALTO / BELA VISTA DE GOIAS / BOM JARDIM DE GOIAS / BOM JESUS DE GOIAS / BONFINOPOLIS / BONOPOLIS / BRAZABRANTES / BRITANIA / BURITI ALEGRE / BURITI DE GOIAS / BURITINOPOLIS / CABECEIRAS / CACHOEIRA ALTA / CACHOEIRA DE GOIAS / CACHOEIRA DOURADA / CACU / CAIAPONIA / CALDAS NOVAS / CALDAZINHA / CAMPESTRE DE GOIAS / CAMPINACU / CAMPINORTE / CAMPO ALEGRE DE GOIAS / CAMPO LIMPO / CAMPOS BELOS / CAMPOS VERDES / CARMO DO RIO VERDE / CASTELANDIA / CATALAO / CATURAI / CAVALCANTE / CERES / CEZARINA / CHAPADAO DO CEU / CIDADE OCIDENTAL / COCALZINHO DE GOIAS / COLINAS DO SUL / CORREGO DO OURO / CORUMBA DE GOIAS / CORUMBAIBA / CRISTALINA / CRISTIANOPOLIS / CRIXAS / CROMINIA / CUMARI / DAMIANOPOLIS / DAMOLANDIA / DAVINOPOLIS / DIORAMA / DISTRITO FEDERAL / DIVINOPOLIS DE GOIAS / DOVERLANDIA / EDEALINA / EDEIA / ESTRELA DO NORTE / FAINA / FAZENDA NOVA / FIRMINOPOLIS / FLORES DE GOIAS / FORMOSA / FORMOSO / GAMELEIRA DE GOIAS / GOIANAPOLIS / GOIANDIRA / GOIANESIA / GOIANIA / GOIANIRA / GOIAS / GOIATUBA / GOUVELANDIA / GUAPO / GUARAITA / GUARANI DE GOIAS / GUARINOS / HEITORAI / HIDROLANDIA / HIDROLINA / IACIARA / INACIOLANDIA / INDIARA / INHUMAS / IPAMERI / IPIRANGA DE GOIAS / IPORA / ISRAELANDIA / ITABERAÍ / ITAGUARI / ITAGUARU / ITAJA / ITAPACI / ITAPIRAPUA / ITAPURANGA / ITARUMA / ITAUCU / ITUMBIARA / IVOLANDIA / JANDAIA / JARAGUA / JATAI / JAUPACI / JESUPOLIS / JOVIANIA / JUSSARA / LAGOA SANTA / LEOPOLDO DE BULHOES / LUZIANIA / MAIRIPOTABA / MAMBAI / MARA ROSA / MARZAGAO / MATRINCHA / MAURILANDIA / MIMOSO DE GOIAS / MINACU / MINEIROS / MOIPORA / MONTE ALEGRE DE GOIAS / MONTES CLAROS DE GOIAS / MONTIVIDIU / MONTIVIDIU DO NORTE / MORRINHOS / MORRO AGUDO DE GOIAS / MOSSAMEDES / MOZARLANDIA / MUNDO NOVO DE GOIAS / MUTUNOPOLIS / NAZARIO / NEROPOLIS / NIQUELANDIA / NOVA AMERICA / NOVA AURORA / NOVA CRIXAS / NOVA GLORIA / NOVA IGUACU DE GOIAS / NOVA ROMA / NOVA VENEZA / NOVO BRASIL / NOVO GAMA / NOVO PLANALTO / ORIZONA / OURO VERDE DE GOIAS / OUVIDOR / PADRE BERNARDO / PALESTINA DE GOIAS / PALMEIRAS DE GOIAS / PALMELO / PALMINOPOLIS / PANAMA / PARANAIGUARA / PARAUNA / PEROLANDIA / PETROLINA DE GOIAS / PILAR DE GOIAS / PIRACANJUBA / PIRANHAS / PIRENOPOLIS / PIRES DO RIO / PLANALTINA / PONTALINA / PORANGATU / PORTEIRAO / PORTELANDIA / POSSE / PROFESSOR JAMIL SAFADY / QUIRINOPOLIS / RIO QUENTE / RIO VERDE / RUBIATABA / SANCLERLANDIA / SANTA BARBARA DE GOIAS / SANTA CRUZ DE GOIAS / SANTA FE DE GOIAS / SANTA HELENA DE GOIAS / SANTA ISABEL / SANTA RITA DO ARAGUAIA / SANTA RITA DO NOVO DESTINO / SANTA ROSA DE GOIAS / SANTA TEREZA DE GOIAS / SANTA TEREZINHA DE GOIAS / SANTO ANTONIO DA BARRA / SANTO ANTONIO DE GOIAS / SANTO ANTONIO DO DESCOBERTO / SAO DOMINGOS / SAO FRANCISCO DE GOIAS / SAO JOAO D ALIANCA / SAO JOAO DA PARAUNA / SAO LUIS DE MONTES BELOS / SAO LUIZ DO NORTE / SAO MIGUEL DO ARAGUAIA / SAO MIGUEL DO PASSA QUATRO / SAO PATRICIO / SAO SIMAO / SENADOR CANEDO / SERRANOPOLIS / SILVANIA / SIMOLANDIA / SITIO D ABADIA / TAQUARAL DE GOIAS / TERESINA DE GOIAS / TEREZOPOLIS DE GOIAS / TRES RANCHOS / TRINDADE / TROMBAS / TURVANIA / TURVELANDIA / UIRAPURU / URUACU / URUANA / URUTAI / VALPARAISO DE GOIAS / VARJAO / VIANOPOLIS / VICENTINOPOLIS / VILA BOA / VILA PROPICIO

DANOS CAUSADOS			
Equipamentos Danificado	Importância para o Sistema	Local	Quantidade
Disjuntor/Religador Operado	Proteção do Alimentador	Área de Concessão	325
Chaves Fusíveis Operada	Proteção de Ramais de Alimentadores	Área de Concessão	2.526
Transformador Operado	Proteção do Transformador	Área de Concessão	2.351

Relato técnico sobre a Intervenção realizada em Goiânia e Região Metropolitana							
Informações sobre Equipas	09/10	10/10	11/10	12/10	13/10	14/10	
Quantidade Usual	927	795	719	908	1.046	1.046	turmas
Quantidade Adicional	0	0	15	0	24	0	turmas
Quantidade Total	927	795	734	908	1.070	1.046	turmas
Tempos Médios							
Preparação	2,25	4,33	8,03	4,24	4,80	3,94	Horas
Deslocamento	0,78	0,78	0,59	0,77	0,63	0,95	Horas
Execução	0,81	1,07	0,78	0,94	0,74	1,13	Horas
TMAE	3,83	6,18	9,40	5,94	6,17	6,02	Horas

Principais Dificuldades Encontradas:

Chuvas com ventos fortes provocaram muitos pontos de alagamento e enxurrada, trânsito impedido por vários semáforos desligados dificultando a chegada ao atendimento das ocorrências emergenciais. Em determinadas regiões, decorrente dos fortes ventos, houve o tombamento de árvores nas estruturas de alimentação de média tensão. danos em ramais de ligação dos clientes. impedimentos

Empresa	ENEL DISTRIBUIÇÃO GOIAS		
Valor CHI (Limite e Real)	482.597,74		3.545.660,78

4. Lista de Ocorrências

DOC ORIGEM	MUNICIPIO	EQP_ORIGEM	CONJUNTO	INI_OCORRENC	FIM_OCORRENC	DT_INI_EVENTO	DT_FIM_EVENTO	DURAÇ	UC INT	CHI	EXPURGO
20201037264	JATAI	Z90220531	JATAI S3	09/10/2020 12:03	10/10/2020 10:09	09/10/2020 12:03	10/10/2020 10:09	22,09	1	22,09	CHI
20201037943	ITARUMA	IM12205220LD	ITAJA S2	09/10/2020 12:08	09/10/2020 18:12	09/10/2020 12:08	09/10/2020 18:12	6,05	9	54,47	CHI
20201037476	MINEIROS	MY12024312RE	PARQUE DAS EMAS	09/10/2020 12:12	09/10/2020 16:27	09/10/2020 12:12	09/10/2020 16:27	4,24	69	292,62	CHI
20201037476	SANTA RITA DO ARAGUAIA	MY12024312RE	PARQUE DAS EMAS	09/10/2020 12:12	09/10/2020 16:27	09/10/2020 12:12	09/10/2020 16:27	4,24	19	80,58	CHI
20201037396	DOVERLANDIA	MY12219553	PARQUE DAS EMAS	09/10/2020 12:19	09/10/2020 18:25	09/10/2020 12:19	09/10/2020 18:25	6,09	47	286,22	CHI
20201037322	RIO VERDE	RV21219427	ACREUNA	09/10/2020 12:20	09/10/2020 16:35	09/10/2020 12:20	09/10/2020 16:35	4,24	1	4,24	CHI
20201037356	SANTO ANTONIO DA BARRA	BZ21302020	ACREUNA	09/10/2020 12:27	09/10/2020 13:05	09/10/2020 12:27	09/10/2020 13:05	0,62	1	0,62	CHI
20201037423	CACU	CA12013274	CACHOEIRA ALTA	09/10/2020 12:42	09/10/2020 14:29	09/10/2020 12:42	09/10/2020 14:29	1,78	6	10,69	CHI
20201037478	JATAI	JT10400676	JATAI S2	09/10/2020 12:48	09/10/2020 16:42	09/10/2020 12:48	09/10/2020 14:19	1,52	1808	2754,19	CHI
20201037478	JATAI	JT10400676	JATAI S2	09/10/2020 12:48	09/10/2020 16:42	09/10/2020 12:48	09/10/2020 15:16	2,48	1636	4056,83	CHI
20201037478	JATAI	JT12104535	JATAI S2	09/10/2020 12:48	09/10/2020 16:42	09/10/2020 16:27	09/10/2020 16:32	0,09	1808	155,69	CHI
20201037478	JATAI	JT12165942	JATAI S2	09/10/2020 12:48	09/10/2020 16:42	09/10/2020 16:30	09/10/2020 16:42	0,20	457	93,18	CHI
20201037478	JATAI	6137545	JATAI S2	09/10/2020 12:48	09/10/2020 16:42	09/10/2020 15:18	09/10/2020 16:42	1,39	1	1,39	CHI
20201037926	APORE	IJ12202625RE	ITAJA S2	09/10/2020 12:49	09/10/2020 22:09	09/10/2020 12:49	09/10/2020 22:09	9,32	4	37,29	CHI
20201037926	ITAJA	IJ12202625RE	ITAJA S2	09/10/2020 12:49	09/10/2020 22:09	09/10/2020 12:49	09/10/2020 22:09	9,32	19	177,12	CHI
20201037497	FLORES DE GOIAS	FB12211535	IACIARA S2	09/10/2020 13:01	09/10/2020 19:36	09/10/2020 13:01	09/10/2020 17:43	4,69	46	215,73	CHI
20201037497	FLORES DE GOIAS	FB12211535	IACIARA S2	09/10/2020 13:01	09/10/2020 19:36	09/10/2020 13:01	09/10/2020 19:36	6,57	262	1721,34	CHI
20201037636	RIO VERDE	04160224	MONTIVIDIU T	09/10/2020 13:04	09/10/2020 14:50	09/10/2020 13:04	09/10/2020 14:50	1,76	98	172,83	CHI
20201037512	MAMBAI	MB11302678	IACIARA S2	09/10/2020 13:04	09/10/2020 14:33	09/10/2020 13:04	09/10/2020 14:33	1,47	112	165,20	CHI
20201037540	RIO VERDE	630250777	CABRIUVA S1	09/10/2020 13:09	09/10/2020 19:59	09/10/2020 13:09	09/10/2020 19:59	6,82	1	6,82	CHI
20201037566	GOUVELANDIA	GB21152563	QUIRINOPOLIS	09/10/2020 13:13	09/10/2020 14:48	09/10/2020 13:13	09/10/2020 14:48	1,57	4	6,27	CHI
20201037625	CACHOEIRA ALTA	CA12041724	CACHOEIRA ALTA	09/10/2020 13:13	09/10/2020 16:24	09/10/2020 13:13	09/10/2020 16:24	3,17	8	25,34	CHI
20201037625	RIO VERDE	CA12041724	CACHOEIRA ALTA	09/10/2020 13:13	09/10/2020 16:24	09/10/2020 13:13	09/10/2020 16:24	3,17	6	19,00	CHI
20201037592	RIO VERDE	RV12200741	CABRIUVA S2	09/10/2020 13:14	11/10/2020 18:00	09/10/2020 13:14	10/10/2020 14:38	25,40	13	330,15	CHI
20201037592	RIO VERDE	RV12260118	CABRIUVA S1	09/10/2020 13:14	11/10/2020 18:00	09/10/2020 22:10	11/10/2020 18:00	43,84	13	569,93	CHI
20201037593	RIO VERDE	RV11402379	CABRIUVA S1	09/10/2020 13:20	09/10/2020 18:31	09/10/2020 13:20	09/10/2020 18:31	5,18	26	134,59	CHI
20201037781	MINEIROS	MY12197173	PARQUE DAS EMAS	09/10/2020 13:21	09/10/2020 15:34	09/10/2020 13:21	09/10/2020 15:34	2,21	21	46,50	CHI
20201037615	RIO VERDE	RV11360678	RIO VERDE S2	09/10/2020 13:22	09/10/2020 17:20	09/10/2020 13:22	09/10/2020 17:20	3,96	10	39,57	CHI
20201037933	ALVORADA DO NORTE	AQ12204159	IACIARA S2	09/10/2020 13:23	09/10/2020 21:10	09/10/2020 13:23	09/10/2020 21:10	7,78	24	186,60	CHI
20201037633	JATAI	JT12182083	JATAI S1	09/10/2020 13:23	09/10/2020 18:42	09/10/2020 13:23	09/10/2020 18:42	5,30	3	15,91	CHI
20201037645	RIO VERDE	RV21271366	CABRIUVA S2	09/10/2020 13:26	10/10/2020 08:19	09/10/2020 13:26	10/10/2020 08:19	18,88	1	18,88	CHI
20201037658	APORE	AE21107343	ITAJA S1	09/10/2020 13:29	09/10/2020 17:09	09/10/2020 13:29	09/10/2020 17:09	3,66	1	3,66	CHI
20201037660	SANTA HELENA DE GOIAS	SH12365460	RIO VERDE S1	09/10/2020 13:30	09/10/2020 19:13	09/10/2020 13:30	09/10/2020 19:13	5,72	19	108,59	CHI
20201037660	RIO VERDE	SH12365460	RIO VERDE S1	09/10/2020 13:30	09/10/2020 19:13	09/10/2020 13:30	09/10/2020 19:13	5,72	14	80,01	CHI
20201037725	SANTA HELENA DE GOIAS	SH10394752	IPEGUARI	09/10/2020 13:31	09/10/2020 16:38	09/10/2020 13:31	09/10/2020 14:21	0,83	78	64,98	CHI
20201037725	SANTA HELENA DE GOIAS	SH12279533LD	IPEGUARI	09/10/2020 13:31	09/10/2020 16:38	09/10/2020 13:31	09/10/2020 16:12	2,69	21	56,47	CHI
20201037725	SANTA HELENA DE GOIAS	SH12296132LD	IPEGUARI	09/10/2020 13:31	09/10/2020 16:38	09/10/2020 13:31	09/10/2020 16:38	3,12	14	43,63	CHI
20201037736	CACU	CC11000017	CACHOEIRA ALTA	09/10/2020 13:40	09/10/2020 17:36	09/10/2020 13:40	09/10/2020 17:36	3,93	116	455,78	CHI
20201037811	JATAI	JT21103643	JATAI S1	09/10/2020 13:53	09/10/2020 18:33	09/10/2020 13:53	09/10/2020 18:33	4,66	1	4,66	CHI
20201037823	FORMOSA	610189098	ITUIQUIRA	09/10/2020 13:56	09/10/2020 19:18	09/10/2020 13:56	09/10/2020 19:18	5,36	1	5,36	CHI
20201037902	POSSE	PS11199471	IACIARA S2	09/10/2020 14:05	09/10/2020 16:35	09/10/2020 14:05	09/10/2020 16:35	2,49	33	82,22	CHI
20201038993	SANTA HELENA DE GOIAS	19934944	IPEGUARI	09/10/2020 14:07	09/10/2020 22:52	09/10/2020 14:07	09/10/2020 22:52	8,75	8	70,00	CHI
20201038981	TURVELANDIA	ML12023693LD	RIO DOS BOIS	09/10/2020 14:19	09/10/2020 20:06	09/10/2020 14:19	09/10/2020 20:06	5,77	44	253,93	CHI
20201038981	MAURILANDIA	ML12023693LD	RIO DOS BOIS	09/10/2020 14:19	09/10/2020 20:06	09/10/2020 14:19	09/10/2020 20:06	5,77	11	63,48	CHI
20201038981	SANTA HELENA DE GOIAS	ML12023693LD	RIO DOS BOIS	09/10/2020 14:19	09/10/2020 20:06	09/10/2020 14:19	09/10/2020 20:06	5,77	51	294,33	CHI
20201038007	RIO VERDE	RV10407541	SANTA HELENA S1	09/10/2020 14:22	09/10/2020 16:39	09/10/2020 14:22	09/10/2020 14:53	0,51	416	213,66	CHI
20201038007	MAURILANDIA	01420204	SANTA HELENA S1	09/10/2020 14:22	09/10/2020 16:39	09/10/2020 14:22	09/10/2020 16:39	2,28	27	61,55	CHI
20201038007	SANTA HELENA DE GOIAS	01420204	SANTA HELENA S1	09/10/2020 14:22	09/10/2020 16:39	09/10/2020 14:22	09/10/2020 16:39	2,28	51	116,27	CHI
20201038007	RIO VERDE	01420204	SANTA HELENA S1	09/10/2020 14:22	09/10/2020 16:39	09/10/2020 14:22	09/10/2020 16:39	2,28	131	298,64	CHI
20201038603	ALTO PARAISO DE GOIAS	BF16407210	FLORES DE GOIAS	09/10/2020 14:23	09/10/2020 20:31	09/10/2020 14:23	09/10/2020 20:31	6,14	660	4053,50	CHI
20201038603	ALTO PARAISO DE GOIAS	BF16407210	FLORES DE GOIAS	09/10/2020 14:23	09/10/2020 20:31	09/10/2020 19:01	09/10/2020 20:31	1,51	240	362,27	CHI
20201038019	RIO VERDE	RV12279877	CABRIUVA S1	09/10/2020 14:23	09/10/2020 17:35	09/10/2020 14:23	09/10/2020 17:35	3,18	119	379,01	CHI
20201039045	RIO VERDE	RV12371440	MONTIVIDIU T	09/10/2020 14:26	09/10/2020 19:40	09/10/2020 14:26	09/10/2020 19:40	5,22	16	83,56	CHI
20201038123	MAURILANDIA	01130214	RIO DOS BOIS	09/10/2020 14:27	09/10/2020 14:35	09/10/2020 14:27	09/10/2020 14:31	0,06	4	0,25	CHI
20201038123	PORTEIRAO	01130214	RIO DOS BOIS	09/10/2020 14:27	09/10/2020 14:35	09/10/2020 14:27	09/10/2020 14:31	0,06	28	1,73	CHI

20201038123	TURVELANDIA	01130214	RIO DOS BOIS	09/10/2020 14:27	09/10/2020 14:35	09/10/2020 14:27	09/10/2020 14:31	0,06	1	0,06	CHI
20201038123	MAURILANDIA	01130214	RIO DOS BOIS	09/10/2020 14:27	09/10/2020 14:35	09/10/2020 14:27	09/10/2020 14:32	0,08	400	33,89	CHI
20201038123	MAURILANDIA	01130214	RIO DOS BOIS	09/10/2020 14:27	09/10/2020 14:35	09/10/2020 14:27	09/10/2020 14:34	0,11	661	76,01	CHI
20201038123	MAURILANDIA	01130214	RIO DOS BOIS	09/10/2020 14:27	09/10/2020 14:35	09/10/2020 14:27	09/10/2020 14:35	0,14	685	97,42	CHI
20201038043	SAO JOAO D ALIANCA	JL12257606	SAO JOAO D ALIANCA	09/10/2020 14:27	09/10/2020 16:06	09/10/2020 14:27	09/10/2020 16:06	1,64	83	136,51	CHI
20201038043	ALTO PARAISO DE GOIAS	JL12257606	SAO JOAO D ALIANCA	09/10/2020 14:27	09/10/2020 16:06	09/10/2020 14:27	09/10/2020 16:06	1,64	2	3,29	CHI
20201039150	RIO VERDE	RV12271289	CABRIUVA S2	09/10/2020 14:27	09/10/2020 19:47	09/10/2020 14:27	09/10/2020 19:47	5,32	39	207,49	CHI
20201038762	TURVELANDIA	TD11170323	RIO DOS BOIS	09/10/2020 14:29	10/10/2020 18:01	09/10/2020 14:29	09/10/2020 22:38	8,14	84	683,39	CHI
20201038762	TURVELANDIA	TD11170323	RIO DOS BOIS	09/10/2020 14:29	10/10/2020 18:01	10/10/2020 13:00	10/10/2020 18:00	5,00	84	420,00	CHI
20201038762	TURVELANDIA	TD11170324	RIO DOS BOIS	09/10/2020 14:29	10/10/2020 18:01	10/10/2020 13:38	10/10/2020 18:01	4,38	108	473,07	CHI
20201038090	CATALAO	CM21215695	CAMPO ALEGRE DE GOIAS	09/10/2020 14:33	09/10/2020 18:00	09/10/2020 14:33	09/10/2020 18:00	3,43	1	3,43	CHI
20201038102	MINEIROS	MY12296303	PARQUE DAS EMAS	09/10/2020 14:35	09/10/2020 18:41	09/10/2020 14:35	09/10/2020 18:41	4,09	4	16,36	CHI
20201039058	SANTA HELENA DE GOIAS	SH12387441	SANTA HELENA S1	09/10/2020 14:37	09/10/2020 20:28	09/10/2020 14:37	09/10/2020 20:28	5,84	3	17,52	CHI
20201038124	AGUA FRIA DE GOIAS	TL12152808	SAO JOAO D ALIANCA	09/10/2020 14:38	09/10/2020 18:53	09/10/2020 14:38	09/10/2020 18:53	4,23	1	4,23	CHI
20201038182	ACREUNA	JD12323641LD	ACREUNA	09/10/2020 14:39	09/10/2020 16:54	09/10/2020 14:39	09/10/2020 16:54	2,24	7	15,69	CHI
20201038182	INDIARA	JD12323641LD	ACREUNA	09/10/2020 14:39	09/10/2020 16:54	09/10/2020 14:39	09/10/2020 16:54	2,24	21	47,08	CHI
20201038199	IPAMERI	IP12099279	PIRES DO RIO S2	09/10/2020 14:39	09/10/2020 18:24	09/10/2020 14:39	09/10/2020 18:24	3,74	2	7,47	CHI
20201038143	GOIANAPOLIS	GP11029286	JUNDAI S1	09/10/2020 14:42	09/10/2020 15:56	09/10/2020 14:42	09/10/2020 15:56	1,23	46	56,71	CHI
20201038292	FORMOSA	FA11322765	ITUIQUIRA	09/10/2020 14:45	09/10/2020 16:31	09/10/2020 14:45	09/10/2020 16:31	1,76	88	154,81	CHI
20201038190	PLANALTINA	PI12375541	PLANALTINA	09/10/2020 14:48	09/10/2020 16:01	09/10/2020 14:48	09/10/2020 16:01	1,21	188	227,48	CHI
20201038193	NOVA AMERICA	NM21295388	RUBIATABA	09/10/2020 14:48	09/10/2020 16:23	09/10/2020 14:48	09/10/2020 16:23	1,58	1	1,58	CHI
20201038201	MARA ROSA	MQ21181677	MARA ROSA	09/10/2020 14:49	09/10/2020 15:47	09/10/2020 14:49	09/10/2020 15:47	0,96	1	0,96	CHI
20201038476	MORRINHOS	MR32060369	MORRINHOS	09/10/2020 14:50	09/10/2020 20:46	09/10/2020 14:50	09/10/2020 20:46	5,92	23	136,17	CHI
20201038215	POSSE	10028308920	IACIARA S2	09/10/2020 14:51	09/10/2020 18:39	09/10/2020 14:51	09/10/2020 18:39	3,79	1	3,79	CHI
20201038216	CRIXAS	2490005723	SERRA DO OURO	09/10/2020 14:51	09/10/2020 23:07	09/10/2020 14:51	09/10/2020 23:07	8,26	1	8,26	CHI
20201038220	SAO MIGUEL DO ARAGUAIA	SM21280316	SAO MIGUEL DO ARAGUAIA	09/10/2020 14:52	09/10/2020 17:42	09/10/2020 14:52	09/10/2020 17:42	2,83	1	2,83	CHI
20201038392	SANTA HELENA DE GOIAS	SH12271338	ACREUNA	09/10/2020 14:55	09/10/2020 19:30	09/10/2020 14:55	09/10/2020 19:30	4,57	7	32,02	CHI
20201038245	CACU	CA12013274	CACHOEIRA ALTA	09/10/2020 14:55	10/10/2020 08:47	09/10/2020 14:55	10/10/2020 08:47	17,86	6	107,14	CHI
20201039414	ITAJA	IM12016195	CACHOEIRA ALTA	09/10/2020 15:00	10/10/2020 00:19	09/10/2020 15:00	10/10/2020 00:19	9,31	5	46,55	CHI
20201039414	ITARUMA	IM12016195	CACHOEIRA ALTA	09/10/2020 15:00	10/10/2020 00:19	09/10/2020 15:00	10/10/2020 00:19	9,31	9	83,79	CHI
20201038281	MAURILANDIA	ML11054042	RIO DOS BOIS	09/10/2020 15:00	09/10/2020 22:47	09/10/2020 15:00	09/10/2020 22:47	7,77	73	567,11	CHI
20201039262	MAURILANDIA	ML11072174	RIO DOS BOIS	09/10/2020 15:00	10/10/2020 01:33	09/10/2020 15:00	10/10/2020 01:33	10,54	127	1338,16	CHI
20201038299	VICENTINOPOLIS	VI12218198RE	VICENTINOPOLIS	09/10/2020 15:03	09/10/2020 16:59	09/10/2020 15:03	09/10/2020 16:59	1,93	13	25,07	CHI
20201038299	JOVIANIA	VI12218198RE	VICENTINOPOLIS	09/10/2020 15:03	09/10/2020 16:59	09/10/2020 15:03	09/10/2020 16:59	1,93	28	53,99	CHI
20201038310	CATALAO	1990086631	CATALAO S2	09/10/2020 15:05	09/10/2020 15:58	09/10/2020 15:05	09/10/2020 15:58	0,88	1	0,88	CHI
20201038311	IPAMERI	MR12093241	MORRINHOS	09/10/2020 15:05	09/10/2020 17:39	09/10/2020 15:05	09/10/2020 17:39	2,56	1	2,56	CHI
20201038311	MORRINHOS	MR12093241	MORRINHOS	09/10/2020 15:05	09/10/2020 17:39	09/10/2020 15:05	09/10/2020 17:39	2,56	6	15,35	CHI
20201038664	MORRINHOS	MR21122129	MORRINHOS	09/10/2020 15:05	09/10/2020 19:06	09/10/2020 15:05	09/10/2020 19:06	4,01	1	4,01	CHI
20201038317	ITUMBIARA	CD21000139	CACHOEIRA DOURADA	09/10/2020 15:06	09/10/2020 17:34	09/10/2020 15:06	09/10/2020 17:34	2,45	1	2,45	CHI
20201038339	FORMOSA	610002480	ITUIQUIRA	09/10/2020 15:11	09/10/2020 18:38	09/10/2020 15:11	09/10/2020 18:38	3,45	1	3,45	CHI
20201038343	CABECEIRAS	9590000088	ITUIQUIRA	09/10/2020 15:11	09/10/2020 17:06	09/10/2020 15:11	09/10/2020 17:06	1,90	1	1,90	CHI
20201038353	MINACU	IH11202482	MINACU	09/10/2020 15:13	09/10/2020 19:31	09/10/2020 15:13	09/10/2020 19:31	4,29	11	47,23	CHI
20201038369	ANAPOLIS	AN12000310	ANAPOLIS UNIVERSITARIO S2	09/10/2020 15:15	09/10/2020 16:17	09/10/2020 15:15	09/10/2020 16:17	1,02	169	171,96	CHI
20201038372	GOIANESIA	GE21000184	GOIANESIA S2	09/10/2020 15:16	09/10/2020 18:15	09/10/2020 15:16	09/10/2020 18:15	2,97	1	2,97	CHI
20201039238	BOM JESUS DE GOIAS	BJ12392128	BOM JESUS DE GOIAS	09/10/2020 15:23	09/10/2020 20:30	09/10/2020 15:23	09/10/2020 20:30	5,11	3	15,33	CHI
20201039238	GOIATUBA	BJ12392128	BOM JESUS DE GOIAS	09/10/2020 15:23	09/10/2020 20:30	09/10/2020 15:23	09/10/2020 20:30	5,11	1	5,11	CHI
20201038490	TROMBAS	TB12240756	PORANGATU	09/10/2020 15:24	09/10/2020 18:14	09/10/2020 15:24	09/10/2020 18:14	2,82	47	132,77	CHI
20201038590	MAURILANDIA	ML11000006	RIO DOS BOIS	09/10/2020 15:26	09/10/2020 16:48	09/10/2020 15:26	09/10/2020 16:48	1,35	132	178,82	CHI
20201038462	PEROLANDIA	DP11254587	JATAI S1	09/10/2020 15:30	09/10/2020 16:28	09/10/2020 15:30	09/10/2020 16:28	0,95	1	0,95	CHI
20201038495	MORRINHOS	150181917	MORRINHOS	09/10/2020 15:34	09/10/2020 17:42	09/10/2020 15:34	09/10/2020 17:42	2,12	1	2,12	CHI
20201039239	PONTALINA	PK12293231	PONTALINA	09/10/2020 15:35	09/10/2020 19:24	09/10/2020 15:35	09/10/2020 19:24	3,81	19	72,35	CHI
20201039239	MORRINHOS	PK12293231	PONTALINA	09/10/2020 15:35	09/10/2020 19:24	09/10/2020 15:35	09/10/2020 19:24	3,81	1	3,81	CHI
20201038607	TURVELANDIA	TD12226264	RIO DOS BOIS	09/10/2020 15:36	11/10/2020 08:52	09/10/2020 15:36	10/10/2020 11:32	19,93	7	139,53	CHI
20201038607	TURVELANDIA	TD12226264	RIO DOS BOIS	09/10/2020 15:36	11/10/2020 08:52	09/10/2020 15:36	11/10/2020 08:52	41,26	78	3218,58	CHI
20201038607	SANTA HELENA DE GOIAS	TD12226264	RIO DOS BOIS	09/10/2020 15:36	11/10/2020 08:52	09/10/2020 15:36	11/10/2020 08:52	41,26	3	123,79	CHI
20201038764	MONTE ALEGRE DE GOIAS	GH10401448	SAO DOMINGOS	09/10/2020 15:37	09/10/2020 15:48	09/10/2020 15:37	09/10/2020 15:45	0,13	605	76,47	CHI
20201038764	MONTE ALEGRE DE GOIAS	GH10401448	SAO DOMINGOS	09/10/2020 15:37	09/10/2020 15:48	09/10/2020 15:37	09/10/2020 15:45	0,13	127	16,05	CHI
20201038764	SAO DOMINGOS	GH10401448	SAO DOMINGOS	09/10/2020 15:37	09/10/2020 15:48	09/10/2020 15:37	09/10/2020 15:45	0,13	283	35,77	CHI

20201038764	CAMPOS BELOS	GH10401448	SAO DOMINGOS	09/10/2020 15:37	09/10/2020 15:48	09/10/2020 15:37	09/10/2020 15:45	0,13	99	12,51	CHI
20201038764	DIVINOPOLIS DE GOIAS	GH10401448	SAO DOMINGOS	09/10/2020 15:37	09/10/2020 15:48	09/10/2020 15:37	09/10/2020 15:45	0,13	3	0,38	CHI
20201038764	CAMPOS BELOS	GH10401448	SAO DOMINGOS	09/10/2020 15:37	09/10/2020 15:48	09/10/2020 15:37	09/10/2020 15:45	0,13	374	47,27	CHI
20201038764	CAMPOS BELOS	GH10401448	SAO DOMINGOS	09/10/2020 15:37	09/10/2020 15:48	09/10/2020 15:38	09/10/2020 15:45	0,11	3	0,34	CHI
20201038764	MONTE ALEGRE DE GOIAS	GH10401448	SAO DOMINGOS	09/10/2020 15:37	09/10/2020 15:48	09/10/2020 15:38	09/10/2020 15:45	0,11	149	17,01	CHI
20201038764	SAO DOMINGOS	GH10401448	SAO DOMINGOS	09/10/2020 15:37	09/10/2020 15:48	09/10/2020 15:38	09/10/2020 15:45	0,11	4	0,46	CHI
20201038764	CAMPOS BELOS	MA10401422	SAO DOMINGOS	09/10/2020 15:37	09/10/2020 15:48	09/10/2020 15:38	09/10/2020 15:45	0,11	3	0,34	CHI
20201038764	MONTE ALEGRE DE GOIAS	MA10401422	SAO DOMINGOS	09/10/2020 15:37	09/10/2020 15:48	09/10/2020 15:38	09/10/2020 15:45	0,11	7	0,80	CHI
20201038764	CAMPOS BELOS	GH10401448	SAO DOMINGOS	09/10/2020 15:37	09/10/2020 15:48	09/10/2020 15:37	09/10/2020 15:47	0,16	2642	424,92	CHI
20201038764	MONTE ALEGRE DE GOIAS	GH10401448	SAO DOMINGOS	09/10/2020 15:37	09/10/2020 15:48	09/10/2020 15:37	09/10/2020 15:47	0,16	51	8,20	CHI
20201038764	CAMPOS BELOS	GH10401448	SAO DOMINGOS	09/10/2020 15:37	09/10/2020 15:48	09/10/2020 15:37	09/10/2020 15:47	0,16	4715	758,33	CHI
20201038764	CAMPOS BELOS	GH10401448	SAO DOMINGOS	09/10/2020 15:37	09/10/2020 15:48	09/10/2020 15:38	09/10/2020 15:47	0,15	185	27,49	CHI
20201038764	MONTE ALEGRE DE GOIAS	GH10401448	SAO DOMINGOS	09/10/2020 15:37	09/10/2020 15:48	09/10/2020 15:38	09/10/2020 15:47	0,15	7	1,04	CHI
20201038764	CAMPOS BELOS	GH10401448	SAO DOMINGOS	09/10/2020 15:37	09/10/2020 15:48	09/10/2020 15:38	09/10/2020 15:47	0,15	24	3,57	CHI
20201038764	CAMPOS BELOS	GH10401448	SAO DOMINGOS	09/10/2020 15:37	09/10/2020 15:48	09/10/2020 15:37	09/10/2020 15:48	0,18	156	27,60	CHI
20201038516	LAGOA SANTA	LS21214288	ITAJA S2	09/10/2020 15:39	09/10/2020 17:05	09/10/2020 15:39	09/10/2020 17:05	1,42	1	1,42	CHI
20201038535	BOM JESUS DE GOIAS	BJ12000139	BOM JESUS DE GOIAS	09/10/2020 15:41	10/10/2020 00:06	09/10/2020 15:41	10/10/2020 00:06	8,41	4	33,63	CHI
202010179862	RIO QUENTE	O1240414	MORRINHOS	09/10/2020 15:42	09/10/2020 16:29	09/10/2020 15:42	09/10/2020 16:29	0,79	20	15,71	CHI
202010179862	MORRINHOS	O1240414	MORRINHOS	09/10/2020 15:42	09/10/2020 16:29	09/10/2020 15:42	09/10/2020 16:29	0,79	362	284,27	CHI
202010179862	CALDAS NOVAS	O1240414	MORRINHOS	09/10/2020 15:42	09/10/2020 16:29	09/10/2020 15:42	09/10/2020 16:29	0,79	2	1,57	CHI
202010179862	MORRINHOS	O1240414	MORRINHOS	09/10/2020 15:42	09/10/2020 16:29	09/10/2020 15:42	09/10/2020 16:29	0,79	241	189,25	CHI
202010179862	MORRINHOS	O1240414	MORRINHOS	09/10/2020 15:42	09/10/2020 16:29	09/10/2020 15:42	09/10/2020 16:29	0,79	90	70,67	CHI
20201038547	FORMOSA	610031340	ITQUIRA	09/10/2020 15:43	09/10/2020 17:34	09/10/2020 15:43	09/10/2020 17:34	1,84	1	1,84	CHI
20201038591	COCALZINHO DE GOIAS	ZN21201296	COCALZINHO	09/10/2020 15:50	10/10/2020 01:23	09/10/2020 15:50	10/10/2020 01:23	9,55	1	9,55	CHI
20201038594	COCALZINHO DE GOIAS	ZN21345246	COCALZINHO	09/10/2020 15:50	10/10/2020 03:39	09/10/2020 15:50	10/10/2020 03:39	11,81	1	11,81	CHI
20201038597	NIQUELANDIA	10006876585	BARRO ALTO	09/10/2020 15:50	10/10/2020 16:44	09/10/2020 15:50	10/10/2020 16:44	24,89	1	24,89	CHI
20201038601	FORMOSA	FA21146166	ITQUIRA	09/10/2020 15:51	09/10/2020 18:38	09/10/2020 15:51	09/10/2020 18:38	2,78	1	2,78	CHI
20201039189	FLORES DE GOIAS	FB12243096	FLORES DE GOIAS	09/10/2020 15:53	09/10/2020 18:23	09/10/2020 15:53	09/10/2020 18:23	2,50	6	14,99	CHI
20201039649	RIO VERDE	RV12205429RE	MONTIVIDIU T	09/10/2020 15:54	09/10/2020 23:25	09/10/2020 15:54	09/10/2020 23:25	7,50	41	307,57	CHI
20201038645	PANAMA	BJ10407481	CACHOEIRA DOURADA	09/10/2020 15:55	10/10/2020 06:03	09/10/2020 15:55	10/10/2020 06:03	14,14	8	113,14	CHI
20201038645	GOIATUBA	BJ10407481	CACHOEIRA DOURADA	09/10/2020 15:55	10/10/2020 06:03	09/10/2020 15:55	10/10/2020 06:03	14,14	7	99,00	CHI
20201038645	BOM JESUS DE GOIAS	BJ10407481	CACHOEIRA DOURADA	09/10/2020 15:55	10/10/2020 06:03	09/10/2020 15:55	10/10/2020 06:03	14,14	30	424,27	CHI
20201038645	ITUMBIARA	BJ10407481	CACHOEIRA DOURADA	09/10/2020 15:55	10/10/2020 06:03	09/10/2020 15:55	10/10/2020 06:03	14,14	85	1202,09	CHI
20201038630	PIRENOPOLIS	PV21287781	SAO FRANCISCO DE GOIAS	09/10/2020 15:55	09/10/2020 20:17	09/10/2020 15:55	09/10/2020 20:17	4,36	2	8,73	CHI
20201038659	SANTA HELENA DE GOIAS	SH12301062	RIO DOS BOIS	09/10/2020 15:59	12/10/2020 12:27	11/10/2020 19:21	11/10/2020 23:37	4,25	3	12,76	CHI
20201038659	TURVELANDIA	SH12301062	RIO DOS BOIS	09/10/2020 15:59	12/10/2020 12:27	11/10/2020 19:21	11/10/2020 23:37	4,25	3	12,76	CHI
20201038659	TURVELANDIA	SH12301310	SANTA HELENA S1	09/10/2020 15:59	12/10/2020 12:27	09/10/2020 15:59	12/10/2020 12:27	68,46	5	342,32	CHI
20201038659	SANTA HELENA DE GOIAS	SH12301310	SANTA HELENA S1	09/10/2020 15:59	12/10/2020 12:27	09/10/2020 15:59	12/10/2020 12:27	68,46	2	136,93	CHI
20201038668	CHAPADAO DO CEU	9880001090	CHAPADAO DO CEU	09/10/2020 16:00	09/10/2020 23:43	09/10/2020 16:00	09/10/2020 23:43	7,71	1	7,71	CHI
20201038680	ANAPOLIS	AN11171479	JUNDIAI S1	09/10/2020 16:02	09/10/2020 18:33	09/10/2020 16:02	09/10/2020 18:33	2,51	73	183,37	CHI
20201039106	MINEROS	MY12209756	PARQUE DAS EMAS	09/10/2020 16:03	09/10/2020 23:04	09/10/2020 16:03	09/10/2020 23:04	7,01	4	28,03	CHI
20201038701	PEROLANDIA	DP12194926	PARQUE DAS EMAS	09/10/2020 16:04	09/10/2020 20:17	09/10/2020 16:04	09/10/2020 20:17	4,21	2	8,43	CHI
20201039752	ITARUMA	IM12234538	CACHOEIRA ALTA	09/10/2020 16:04	11/10/2020 01:03	09/10/2020 16:04	09/10/2020 23:18	7,23	6	43,38	CHI
20201039752	CACU	IM12234538	CACHOEIRA ALTA	09/10/2020 16:04	11/10/2020 01:03	09/10/2020 22:41	09/10/2020 23:18	0,62	30	18,51	CHI
20201039752	JATAI	IM12234538	CACHOEIRA ALTA	09/10/2020 16:04	11/10/2020 01:03	09/10/2020 22:41	09/10/2020 23:18	0,62	20	12,34	CHI
20201039752	ITARUMA	IM12234538	CACHOEIRA ALTA	09/10/2020 16:04	11/10/2020 01:03	09/10/2020 22:41	09/10/2020 23:18	0,62	22	13,57	CHI
20201039752	ITARUMA	IM12234538	CACHOEIRA ALTA	09/10/2020 16:04	11/10/2020 01:03	10/10/2020 11:49	10/10/2020 12:52	1,05	28	29,39	CHI
20201039752	JATAI	IM12234538	CACHOEIRA ALTA	09/10/2020 16:04	11/10/2020 01:03	10/10/2020 11:49	10/10/2020 12:52	1,05	20	20,99	CHI
20201039752	CACU	IM12234538	CACHOEIRA ALTA	09/10/2020 16:04	11/10/2020 01:03	10/10/2020 11:49	10/10/2020 12:52	1,05	30	31,49	CHI
20201039752	CACU	IM12234538	CACHOEIRA ALTA	09/10/2020 16:04	11/10/2020 01:03	09/10/2020 16:04	10/10/2020 14:49	22,75	8	182,03	CHI
20201039752	ITARUMA	IM12234538	CACHOEIRA ALTA	09/10/2020 16:04	11/10/2020 01:03	09/10/2020 16:04	10/10/2020 14:49	22,75	2	45,51	CHI
20201039752	CACU	IM12234538	CACHOEIRA ALTA	09/10/2020 16:04	11/10/2020 01:03	09/10/2020 16:04	10/10/2020 15:35	23,52	1	23,52	CHI
20201039752	ITARUMA	IM12234538	CACHOEIRA ALTA	09/10/2020 16:04	11/10/2020 01:03	09/10/2020 16:04	10/10/2020 15:35	23,52	6	141,09	CHI
20201039752	CACU	IM12234538	CACHOEIRA ALTA	09/10/2020 16:04	11/10/2020 01:03	09/10/2020 16:04	10/10/2020 18:59	26,91	3	80,73	CHI
20201039752	CACU	IM12234538	CACHOEIRA ALTA	09/10/2020 16:04	11/10/2020 01:03	09/10/2020 16:04	11/10/2020 01:03	32,97	20	659,42	CHI
20201038717	TEREZOPOLIS DE GOIAS	TJ11258065	DAIA S2	09/10/2020 16:05	09/10/2020 18:26	09/10/2020 16:05	09/10/2020 18:26	2,34	57	133,57	CHI
20201038727	PLANALTINA	PI12131790	PLANALTINA	09/10/2020 16:06	09/10/2020 17:54	09/10/2020 16:06	09/10/2020 17:54	1,80	19	34,18	CHI
20201039029	CASTELANDIA	DM11000010	RIO DOS BOIS	09/10/2020 16:06	09/10/2020 18:41	09/10/2020 16:06	09/10/2020 18:41	2,57	85	218,19	CHI

20201038910	JATAI	JT11000094	JATAI S3	09/10/2020 16:07	09/10/2020 17:34	09/10/2020 16:07	09/10/2020 17:34	1,45	120	174,00	CHI
20201039194	NIQUELANDIA	NQ12285213	NIQUELANDIA SUBTRANSMISSAO	09/10/2020 16:07	09/10/2020 22:21	09/10/2020 16:07	09/10/2020 22:21	6,22	7	43,54	CHI
20201039884	GOIATUBA	GT12052882	GOIATUBA S1	09/10/2020 16:09	10/10/2020 23:11	09/10/2020 16:09	10/10/2020 01:56	9,79	26	254,46	CHI
20201039884	GOIATUBA	GT12052882	GOIATUBA S1	09/10/2020 16:09	10/10/2020 23:11	10/10/2020 11:14	10/10/2020 12:42	1,47	26	38,21	CHI
20201039884	GOIATUBA	GT12052882	GOIATUBA S1	09/10/2020 16:09	10/10/2020 23:11	09/10/2020 16:09	10/10/2020 23:11	31,03	3	93,09	CHI
20201038759	INACIOLANDIA	ID31128287	QUIRINOPOLIS	09/10/2020 16:09	09/10/2020 17:51	09/10/2020 16:09	09/10/2020 17:51	1,69	1	1,69	CHI
20201038761	MINACU	4020060114	MINACU	09/10/2020 16:10	09/10/2020 20:21	09/10/2020 16:10	09/10/2020 20:21	4,18	1	4,18	CHI
20201038766	CABECEIRAS	CW21184541	ITUIQUIRA	09/10/2020 16:10	09/10/2020 17:38	09/10/2020 16:10	09/10/2020 17:38	1,46	2	2,91	CHI
20201038770	AGUA FRIA DE GOIAS	TL12394165	SAO JOAO D ALIANCA	09/10/2020 16:12	09/10/2020 17:25	09/10/2020 16:12	09/10/2020 17:25	1,21	20	24,15	CHI
20201038774	ABADIANIA	AA21295627	ANAPOLIS UNIVERSITARIO S1	09/10/2020 16:13	09/10/2020 18:18	09/10/2020 16:13	09/10/2020 18:18	2,08	3	6,23	CHI
20201038784	PIRENOPOLIS	10004187073	CORUMBA	09/10/2020 16:15	09/10/2020 22:49	09/10/2020 16:15	09/10/2020 22:49	6,55	1	6,55	CHI
20201038788	ANAPOLIS	10030737263	JUNDIAI S1	09/10/2020 16:16	09/10/2020 22:27	09/10/2020 16:16	09/10/2020 22:27	6,18	1	6,18	CHI
20201038796	QUIRINOPOLIS	QI21065222	CACHOEIRA ALTA	09/10/2020 16:17	09/10/2020 18:16	09/10/2020 16:17	09/10/2020 18:16	1,97	1	1,97	CHI
20201038813	VILA PROPICIO	PV12089909	GOIANESIA S1	09/10/2020 16:19	09/10/2020 17:33	09/10/2020 16:19	09/10/2020 17:33	1,22	3	3,66	CHI
20201038856	BARRO ALTO	BA13210804	GOIANESIA S1	09/10/2020 16:27	09/10/2020 23:25	09/10/2020 16:27	09/10/2020 23:25	6,96	15	104,42	CHI
20201038856	VILA PROPICIO	BA13210804	GOIANESIA S1	09/10/2020 16:27	09/10/2020 23:25	09/10/2020 16:27	09/10/2020 23:25	6,96	12	83,54	CHI
20201038856	GOIANESIA	BA13210804	GOIANESIA S1	09/10/2020 16:27	09/10/2020 23:25	09/10/2020 16:27	09/10/2020 23:25	6,96	113	786,67	CHI
20201038856	COCALZINHO DE GOIAS	BA13210804	GOIANESIA S1	09/10/2020 16:27	09/10/2020 23:25	09/10/2020 21:00	09/10/2020 23:25	2,41	1	2,41	CHI
20201038856	BARRO ALTO	BA13210804	GOIANESIA S1	09/10/2020 16:27	09/10/2020 23:25	09/10/2020 21:00	09/10/2020 23:25	2,41	114	274,42	CHI
20201038856	PADRE BERNARDO	BA13210804	GOIANESIA S1	09/10/2020 16:27	09/10/2020 23:25	09/10/2020 21:00	09/10/2020 23:25	2,41	11	26,48	CHI
20201038856	VILA PROPICIO	BA13210804	GOIANESIA S1	09/10/2020 16:27	09/10/2020 23:25	09/10/2020 21:00	09/10/2020 23:25	2,41	910	2190,57	CHI
20201038860	CAMPO ALEGRE DE GOIAS	CM12073560	CAMPO ALEGRE DE GOIAS	09/10/2020 16:28	10/10/2020 08:26	09/10/2020 16:28	10/10/2020 08:26	15,96	4	63,84	CHI
20201038870	HIDROLINA	3540000110	URUACU	09/10/2020 16:29	09/10/2020 18:38	09/10/2020 16:29	09/10/2020 18:38	2,14	1	2,14	CHI
20201038879	AGUAS LINDAS DE GOIAS	10024472857	AGUAS LINDAS DE GOIAS S1	09/10/2020 16:31	09/10/2020 18:11	09/10/2020 16:31	09/10/2020 18:11	1,66	1	1,66	CHI
20201038882	RIO VERDE	630030510	RIO VERDE S1	09/10/2020 16:32	10/10/2020 00:42	09/10/2020 16:32	10/10/2020 00:42	8,16	1	8,16	CHI
20201038884	UIRAPURU	UP21082364	NOVA CRIXAS	09/10/2020 16:32	10/10/2020 09:03	09/10/2020 16:32	10/10/2020 09:03	16,51	2	33,01	CHI
20201038896	LUZIANIA	LZ21149915	RIO VERMELHO	09/10/2020 16:34	09/10/2020 18:27	09/10/2020 16:34	09/10/2020 18:27	1,87	1	1,87	CHI
20201038905	GOIANESIA	GE11135759	GOIANESIA S2	09/10/2020 16:36	09/10/2020 19:59	09/10/2020 16:36	09/10/2020 19:59	3,37	133	448,36	CHI
20201038912	CATALAO	CT12266179	CATALAO S1	09/10/2020 16:37	09/10/2020 18:28	09/10/2020 16:37	09/10/2020 18:28	1,84	26	47,93	CHI
20201038965	BOM JESUS DE GOIAS	BJ21000054	BOM JESUS DE GOIAS	09/10/2020 16:42	09/10/2020 22:11	09/10/2020 16:42	09/10/2020 21:46	5,08	1	5,08	CHI
20201038965	BOM JESUS DE GOIAS	BJ21000040	BOM JESUS DE GOIAS	09/10/2020 16:42	09/10/2020 22:11	09/10/2020 19:51	09/10/2020 22:11	2,34	3	7,01	CHI
20201038970	PIRENOPOLIS	PV21201243	CORUMBA	09/10/2020 16:42	09/10/2020 23:19	09/10/2020 16:42	09/10/2020 23:19	6,61	1	6,61	CHI
20201039023	CATALAO	CT11266349	CATALAO S2	09/10/2020 16:49	09/10/2020 18:31	09/10/2020 16:49	09/10/2020 18:31	1,70	117	198,67	CHI
20201039114	CRISTALINA	KR12320036	CRISTALINA S2	09/10/2020 16:49	09/10/2020 21:31	09/10/2020 16:49	09/10/2020 21:31	4,69	11	51,56	CHI
20201039079	JATAI	JT12355226	JATAI S1	09/10/2020 16:51	09/10/2020 19:45	09/10/2020 16:51	09/10/2020 19:45	2,89	5	14,47	CHI
20201039013	SANTA HELENA DE GOIAS	SH21314162	IPEGUARI	09/10/2020 16:52	09/10/2020 22:11	09/10/2020 16:52	09/10/2020 22:11	5,31	1	5,31	CHI
20201039348	ITUMBIARA	CD12000007RE	CACHOEIRA DOURADA	09/10/2020 16:52	09/10/2020 18:38	09/10/2020 16:52	09/10/2020 18:38	1,76	27	47,56	CHI
20201039348	CACHOEIRA DOURADA	CD12000007RE	CACHOEIRA DOURADA	09/10/2020 16:52	09/10/2020 18:38	09/10/2020 16:52	09/10/2020 18:38	1,76	27	47,56	CHI
20201039025	UIRAPURU	UP21131263	NOVA CRIXAS	09/10/2020 16:55	10/10/2020 10:12	09/10/2020 16:55	10/10/2020 10:12	17,28	1	17,28	CHI
20201039035	JATAI	290046865	JATAI S2	09/10/2020 16:56	09/10/2020 17:35	09/10/2020 16:56	09/10/2020 17:35	0,64	1	0,64	CHI
20201039039	ANAPOLIS	AN12000076	JUNDIAI S2	09/10/2020 16:57	09/10/2020 19:04	09/10/2020 16:57	09/10/2020 19:04	2,11	1	2,11	CHI
20201039047	CIDADE OCIDENTAL	10022237567	MARAJOARA	09/10/2020 16:59	09/10/2020 19:22	09/10/2020 16:59	09/10/2020 19:22	2,38	1	2,38	CHI
20201039051	GOIANESIA	GE12000299	GOIANESIA S2	09/10/2020 16:59	09/10/2020 21:02	09/10/2020 16:59	09/10/2020 21:02	4,04	17	68,62	CHI
20201039051	VILA PROPICIO	GE12000299	GOIANESIA S2	09/10/2020 16:59	09/10/2020 21:02	09/10/2020 16:59	09/10/2020 21:02	4,04	6	24,22	CHI
20201039433	TURVELANDIA	TD11249125	RIO DOS BOIS	09/10/2020 17:00	09/10/2020 23:29	09/10/2020 17:00	09/10/2020 23:29	6,47	131	847,21	CHI
20201039220	ANAPOLIS	AN11135744	ANAPOLIS UNIVERSITARIO S2	09/10/2020 17:01	09/10/2020 20:59	09/10/2020 17:01	09/10/2020 20:59	3,96	46	182,33	CHI
20201039070	ITAJA	IJ12226574	ITAJA S2	09/10/2020 17:04	09/10/2020 22:42	09/10/2020 17:04	09/10/2020 22:42	5,63	5	28,14	CHI
20201039281	LUZIANIA	LZ12085956	CRISTALINA S2	09/10/2020 17:05	09/10/2020 19:36	09/10/2020 17:05	09/10/2020 19:36	2,52	16	40,25	CHI
20201039081	ANAPOLIS	20536010	JUNDIAI S1	09/10/2020 17:05	09/10/2020 19:00	09/10/2020 17:05	09/10/2020 19:00	1,91	1	1,91	CHI
20201039385	ITAPACI	IW12318412	ITAPACI	09/10/2020 17:07	09/10/2020 19:04	09/10/2020 17:07	09/10/2020 19:04	1,95	550	1071,28	CHI
20201039089	CRISTIANOPOLIS	CF31114885	CRISTIANOPOLIS	09/10/2020 17:07	09/10/2020 19:31	09/10/2020 17:07	09/10/2020 19:31	2,40	1	2,40	CHI
20201039094	GAMELEIRA DE GOIAS	SV12009191	DAIA S2	09/10/2020 17:07	09/10/2020 21:11	09/10/2020 17:07	09/10/2020 21:11	4,06	10	40,62	CHI
20201039097	CATALAO	1990126264	CATALAO S1	09/10/2020 17:08	09/10/2020 19:10	09/10/2020 17:08	09/10/2020 19:10	2,02	1	2,02	CHI
20201039100	CALDAS NOVAS	CN12111408	SERRA DE CALDAS	09/10/2020 17:09	09/10/2020 18:47	09/10/2020 17:09	09/10/2020 18:47	1,63	124	202,09	CHI
20201039101	AGUAS LINDAS DE GOIAS	4830172655	AGUAS LINDAS DE GOIAS S1	09/10/2020 17:09	09/10/2020 19:09	09/10/2020 17:09	09/10/2020 19:09	1,99	1	1,99	CHI
20201039127	ITUMBIARA	IT11208181	ITUMBIARA VELHA S1	09/10/2020 17:13	09/10/2020 17:48	09/10/2020 17:13	09/10/2020 17:48	0,58	150	87,42	CHI
20201039142	JATAI	290037591	JATAI S3	09/10/2020 17:16	10/10/2020 09:39	09/10/2020 17:16	10/10/2020 09:39	16,38	1	16,38	CHI
20201039144	ITUMBIARA	IT21309841	PARANAIBA	09/10/2020 17:16	09/10/2020 18:18	09/10/2020 17:16	09/10/2020 18:18	1,03	1	1,03	CHI

20201039210	ITUMBIARA	IT12000100RE	PARANAIBA	09/10/2020 17:17	09/10/2020 20:27	09/10/2020 17:17	09/10/2020 20:27	3,16	6	18,98	CHI
20201039153	FORMOSA	610315444	ITUIQUIRA	09/10/2020 17:17	09/10/2020 20:04	09/10/2020 17:17	09/10/2020 20:04	2,77	1	2,77	CHI
20201039175	ITUMBIARA	IT10406885	PARANAIBA	09/10/2020 17:18	09/10/2020 17:22	09/10/2020 17:18	09/10/2020 17:22	0,06	63	3,88	CHI
20201039166	JATAI	JT12413145	CABRIUVA S2	09/10/2020 17:19	09/10/2020 22:17	09/10/2020 17:19	09/10/2020 22:17	4,96	3	14,89	CHI
20201039576	SANTA TEREZINHA DE GOIAS	SG12049774	SANTA TEREZINHA	09/10/2020 17:19	09/10/2020 19:58	09/10/2020 17:19	09/10/2020 19:58	2,64	93	245,70	CHI
20201039169	MINEROS	MY21209654	PARQUE DAS EMAS	09/10/2020 17:19	09/10/2020 21:48	09/10/2020 17:19	09/10/2020 21:48	4,47	1	4,47	CHI
20201039177	GOIATUBA	140044504	GOIATUBA S2	09/10/2020 17:20	09/10/2020 18:57	09/10/2020 17:20	09/10/2020 18:57	1,60	1	1,60	CHI
20201039631	SANTA HELENA DE GOIAS	SH32230816	IPEGUARI	09/10/2020 17:21	11/10/2020 17:08	09/10/2020 17:21	11/10/2020 17:08	47,79	4	191,16	CHI
20201039400	COLINAS DO SUL	TI12162624	NIQUELANDIA SUBTRANSMISSAO	09/10/2020 17:22	10/10/2020 00:39	09/10/2020 17:22	10/10/2020 00:39	7,28	6	43,65	CHI
20201039400	CAVALCANTE	TI12162624	NIQUELANDIA SUBTRANSMISSAO	09/10/2020 17:22	10/10/2020 00:39	09/10/2020 17:22	10/10/2020 00:39	7,28	51	371,05	CHI
20201039191	GOIANESIA	GE21290368	GOIANESIA S2	09/10/2020 17:23	09/10/2020 20:23	09/10/2020 17:23	09/10/2020 20:23	2,99	2	5,99	CHI
20201039193	ITUMBIARA	IT11282406	ITUMBIARA VELHA S1	09/10/2020 17:23	09/10/2020 18:02	09/10/2020 17:23	09/10/2020 18:02	0,64	75	47,85	CHI
20201039313	ITUMBIARA	IT11222369	PARANAIBA	09/10/2020 17:25	09/10/2020 22:52	09/10/2020 17:25	09/10/2020 22:52	5,45	76	413,97	CHI
20201039207	GOIANESIA	GE21285433	GOIANESIA S2	09/10/2020 17:26	09/10/2020 21:32	09/10/2020 17:26	09/10/2020 21:32	4,10	2	8,20	CHI
20201039287	TROMBAS	MX12240692	PORANGATU	09/10/2020 17:31	09/10/2020 19:51	09/10/2020 17:31	09/10/2020 19:51	2,32	1	2,32	CHI
20201039287	MONTIVIDIU DO NORTE	MX12240692	PORANGATU	09/10/2020 17:31	09/10/2020 19:51	09/10/2020 17:31	09/10/2020 19:51	2,32	2	4,64	CHI
20201039233	QUIRINOPOLIS	80088910	QUIRINOPOLIS	09/10/2020 17:32	09/10/2020 19:37	09/10/2020 17:32	09/10/2020 19:37	2,08	1	2,08	CHI
20201039257	MAURILANDIA	ML21214174	RIO DOS BOIS	09/10/2020 17:36	10/10/2020 12:50	09/10/2020 17:36	10/10/2020 12:50	19,22	1	19,22	CHI
20201039259	LEOPOLDO DE BULHOES	LB21402694	DAIA S2	09/10/2020 17:37	10/10/2020 00:12	09/10/2020 17:37	10/10/2020 00:12	6,58	2	13,17	CHI
20201039926	TURVELANDIA	TD11170324	RIO DOS BOIS	09/10/2020 17:37	10/10/2020 00:00	09/10/2020 17:37	10/10/2020 00:00	6,37	108	687,66	CHI
20201039282	ITUMBIARA	IT121373955	PARANAIBA	09/10/2020 17:38	09/10/2020 18:42	09/10/2020 17:38	09/10/2020 18:42	1,06	1	1,06	CHI
20201039283	EDEALINA	ED21158593	PONTALINA	09/10/2020 17:38	09/10/2020 18:28	09/10/2020 17:38	09/10/2020 18:28	0,83	2	1,65	CHI
20201039288	CACHOEIRA DOURADA	CD21296958	CACHOEIRA DOURADA	09/10/2020 17:39	09/10/2020 20:20	09/10/2020 17:39	09/10/2020 20:20	2,68	1	2,68	CHI
20201039291	ANAPOLIS	21356658	ANAPOLIS UNIVERSITARIO S2	09/10/2020 17:40	09/10/2020 20:13	09/10/2020 17:40	09/10/2020 20:13	2,54	1	2,54	CHI
20201039293	BARRO ALTO	BA21346778	GOIANESIA S1	09/10/2020 17:41	10/10/2020 00:13	09/10/2020 17:41	10/10/2020 00:13	6,53	1	6,53	CHI
20201039303	CAMPINORTE	10020079425	CAMPINORTE	09/10/2020 17:42	09/10/2020 21:37	09/10/2020 17:42	09/10/2020 21:37	3,92	1	3,92	CHI
20201039309	PEROLANDIA	DP11272271	JATAI S1	09/10/2020 17:42	09/10/2020 22:03	09/10/2020 17:42	09/10/2020 22:03	4,34	1	4,34	CHI
20201039314	CHAPADAO DO CEU	DJ12324690	CHAPADAO DO CEU	09/10/2020 17:43	09/10/2020 21:06	09/10/2020 19:18	09/10/2020 19:36	0,30	33	9,81	CHI
20201039314	CHAPADAO DO CEU	DJ11324689	CHAPADAO DO CEU	09/10/2020 17:43	09/10/2020 21:06	09/10/2020 17:43	09/10/2020 21:06	3,37	73	246,29	CHI
20201039319	CABECEIRAS	CW21257624	ITUIQUIRA	09/10/2020 17:44	09/10/2020 18:34	09/10/2020 17:44	09/10/2020 18:34	0,82	1	0,82	CHI
20201039327	ITUMBIARA	IT11000117	ITUMBIARA VELHA S1	09/10/2020 17:46	09/10/2020 18:48	09/10/2020 17:46	09/10/2020 18:48	1,03	123	126,48	CHI
20201039336	CACHOEIRA ALTA	RV21112429	CACHOEIRA ALTA	09/10/2020 17:48	10/10/2020 09:32	09/10/2020 17:48	10/10/2020 09:32	15,72	1	15,72	CHI
20201039339	RIO VERDE	ML21301200	SANTA HELENA S1	09/10/2020 17:49	09/10/2020 21:53	09/10/2020 17:49	09/10/2020 21:53	4,06	1	4,06	CHI
20201039345	JATAI	6137545	JATAI S2	09/10/2020 17:49	09/10/2020 21:28	09/10/2020 17:49	09/10/2020 21:28	1,06	1	1,06	CHI
20201039345	JATAI	6137545	JATAI S2	09/10/2020 17:49	09/10/2020 21:28	09/10/2020 17:49	09/10/2020 21:28	2,56	1	2,56	CHI
20201039343	MARA ROSA	MQ21250986	MARA ROSA	09/10/2020 17:50	09/10/2020 19:58	09/10/2020 17:50	09/10/2020 19:58	2,13	1	2,13	CHI
20201039358	CORUMBAIBA	IP12337197	IPAMERI	09/10/2020 17:52	09/10/2020 22:03	09/10/2020 17:52	09/10/2020 22:03	4,17	3	12,50	CHI
20201039358	IPAMERI	IP12337197	IPAMERI	09/10/2020 17:52	09/10/2020 22:03	09/10/2020 17:52	09/10/2020 22:03	4,17	9	37,51	CHI
20201039370	MARZAGAO	MG211392151	VILA CORUMBA	09/10/2020 17:55	09/10/2020 19:09	09/10/2020 17:55	09/10/2020 19:09	1,22	1	1,22	CHI
20201039407	MORRINHOS	MR12239042	MORRINHOS	09/10/2020 18:03	09/10/2020 21:04	09/10/2020 18:03	09/10/2020 21:04	3,02	3	9,06	CHI
20201039408	ITUMBIARA	IT11000015	ITUMBIARA VELHA S1	09/10/2020 18:05	09/10/2020 18:56	09/10/2020 18:05	09/10/2020 18:56	0,84	138	116,19	CHI
20201039420	JATAI	290120056	JATAI S3	09/10/2020 18:09	10/10/2020 07:46	09/10/2020 18:09	10/10/2020 07:46	13,61	1	13,61	CHI
20201039501	ITARUMA	IJ12107422LD	ITAJA S2	09/10/2020 18:09	09/10/2020 23:07	09/10/2020 18:09	09/10/2020 23:07	4,95	35	173,30	CHI
20201039435	ITARUMA	IM10394710	CACHOEIRA ALTA	09/10/2020 18:10	10/10/2020 01:57	09/10/2020 18:10	10/10/2020 01:40	7,51	106	796,56	CHI
20201039435	ITAJA	IM10394710	CACHOEIRA ALTA	09/10/2020 18:10	10/10/2020 01:57	09/10/2020 18:10	10/10/2020 01:40	7,51	1	7,51	CHI
20201039435	SERRANOPOLIS	IM10394710	CACHOEIRA ALTA	09/10/2020 18:10	10/10/2020 01:57	09/10/2020 18:10	10/10/2020 01:40	7,51	51	383,25	CHI
20201039435	JATAI	IM10394710	CACHOEIRA ALTA	09/10/2020 18:10	10/10/2020 01:57	09/10/2020 18:10	10/10/2020 01:40	7,51	12	90,18	CHI
20201039435	ITARUMA	IM12107406	CACHOEIRA ALTA	09/10/2020 18:10	10/10/2020 01:57	09/10/2020 18:10	10/10/2020 01:57	7,78	17	132,34	CHI
20201039426	ANAPOLIS	20286892	JUNDIAI S1	09/10/2020 18:10	09/10/2020 20:05	09/10/2020 18:10	09/10/2020 20:05	1,91	1	1,91	CHI
20201039472	JATAI	JT10274087	JATAI S1	09/10/2020 18:14	10/10/2020 12:39	09/10/2020 18:14	09/10/2020 20:29	2,25	24	54,03	CHI
20201039472	JATAI	JT12260447LD	JATAI S1	09/10/2020 18:14	10/10/2020 12:39	09/10/2020 18:14	09/10/2020 21:26	3,20	52	166,20	CHI
20201039472	JATAI	JT10274087	JATAI S1	09/10/2020 18:14	10/10/2020 12:39	09/10/2020 18:14	10/10/2020 02:24	8,16	93	758,85	CHI
20201039472	ITARUMA	JT10274087	JATAI S1	09/10/2020 18:14	10/10/2020 12:39	09/10/2020 18:14	10/10/2020 02:24	8,16	1	8,16	CHI
20201039472	SERRANOPOLIS	JT10274087	JATAI S1	09/10/2020 18:14	10/10/2020 12:39	09/10/2020 18:14	10/10/2020 02:24	8,16	3298	26910,76	CHI
20201039472	JATAI	JT10274087	JATAI S1	09/10/2020 18:14	10/10/2020 12:39	09/10/2020 18:14	10/10/2020 02:24	8,16	13	106,08	CHI
20201039472	APORE	JT10274087	JATAI S1	09/10/2020 18:14	10/10/2020 12:39	09/10/2020 18:14	10/10/2020 02:24	8,16	7	57,12	CHI
20201039472	SERRANOPOLIS	JT10274087	JATAI S1	09/10/2020 18:14	10/10/2020 12:39	09/10/2020 18:14	10/10/2020 02:24	8,16	87	709,90	CHI
20201039472	SERRANOPOLIS	JT10274087	JATAI S1	09/10/2020 18:14	10/10/2020 12:39	09/10/2020 18:14	10/10/2020 02:24	8,16	115	938,37	CHI

20201039472	JATAI	JT12260426RE	JATAI S1	09/10/2020 18:14	10/10/2020 12:39	09/10/2020 18:14	10/10/2020 02:25	8,17	18	147,09	CHI
20201039472	JATAI	JT12260426RE	JATAI S1	09/10/2020 18:14	10/10/2020 12:39	09/10/2020 18:14	10/10/2020 10:50	16,59	101	1675,45	CHI
20201039472	JATAI	JT12260426RE	JATAI S1	09/10/2020 18:14	10/10/2020 12:39	09/10/2020 18:14	10/10/2020 12:39	18,41	1	18,41	CHI
20201039451	ITUMBIARA	IT13392098	PARANAIBA	09/10/2020 18:15	10/10/2020 01:55	09/10/2020 22:06	10/10/2020 01:52	3,75	35	131,41	CHI
20201039451	ITUMBIARA	IT10406885	PARANAIBA	09/10/2020 18:15	10/10/2020 01:55	09/10/2020 18:15	10/10/2020 01:55	7,67	63	483,51	CHI
20201039457	CALDAS NOVAS	760302390	SERRA DE CALDAS	09/10/2020 18:15	09/10/2020 19:39	09/10/2020 18:15	09/10/2020 19:39	1,39	1	1,39	CHI
20201039537	ORIZONA	OZ12000353LD	PIRES DO RIO S1	09/10/2020 18:16	09/10/2020 20:44	09/10/2020 18:16	09/10/2020 20:44	2,46	35	86,17	CHI
20201039542	ANAPOLIS	AN10394595	JUNDIAI S2	09/10/2020 18:19	09/10/2020 18:22	09/10/2020 18:19	09/10/2020 18:22	0,06	1473	82,65	CHI
20201039478	GOIANESIA	GE21185212	GOIANESIA S1	09/10/2020 18:19	09/10/2020 19:54	09/10/2020 18:19	09/10/2020 19:54	1,57	1	1,57	CHI
20201039483	ANAPOLIS	21070040	ANAPOLIS UNIVERSITARIO S2	09/10/2020 18:21	09/10/2020 20:25	09/10/2020 18:21	09/10/2020 20:25	2,06	1	2,06	CHI
20201039485	QUIRINOPOLIS	QI21191856	QUIRINOPOLIS	09/10/2020 18:22	10/10/2020 19:36	09/10/2020 18:22	10/10/2020 19:36	25,23	1	25,23	CHI
20201039487	AGUAS LINDAS DE GOIAS	10014453345	AGUAS LINDAS DE GOIAS S2	09/10/2020 18:22	09/10/2020 20:03	09/10/2020 18:22	09/10/2020 20:03	1,68	1	1,68	CHI
20201039489	CATALAO	10001804462	CATALAO S2	09/10/2020 18:22	10/10/2020 01:41	09/10/2020 18:22	10/10/2020 01:41	7,30	1	7,30	CHI
20201039807	NOVA AURORA	NE12143243	CATALAO S1	09/10/2020 18:25	10/10/2020 00:58	09/10/2020 18:25	10/10/2020 00:58	6,54	5	32,72	CHI
20201039519	ANAPOLIS	10008453959	ANAPOLIS UNIVERSITARIO S2	09/10/2020 18:28	09/10/2020 20:49	09/10/2020 18:28	09/10/2020 20:49	2,35	1	2,35	CHI
20201039524	COCALZINHO DE GOIAS	ZN21290375	COCALZINHO	09/10/2020 18:29	10/10/2020 01:56	09/10/2020 18:29	10/10/2020 01:56	7,45	2	14,90	CHI
20201039528	CATALAO	CT11384535	CATALAO S1	09/10/2020 18:30	09/10/2020 23:38	09/10/2020 18:30	09/10/2020 23:38	5,13	28	143,53	CHI
20201039538	NIQUELANDIA	NQ12317146	NIQUELANDIA SUBTRANSMISSAO	09/10/2020 18:32	10/10/2020 01:20	09/10/2020 18:32	10/10/2020 01:20	6,79	228	1547,36	CHI
20201039739	ITARUMA	IM12058351	CACHOEIRA ALTA	09/10/2020 18:34	09/10/2020 21:46	09/10/2020 18:34	09/10/2020 21:46	3,20	18	57,59	CHI
20201039552	SANTA HELENA DE GOIAS	SH10394752	IPEGUARI	09/10/2020 18:34	11/10/2020 17:08	10/10/2020 05:07	10/10/2020 14:25	9,30	43	399,71	CHI
20201039552	SANTA HELENA DE GOIAS	SH10394752	IPEGUARI	09/10/2020 18:34	11/10/2020 17:08	09/10/2020 18:34	11/10/2020 17:08	46,57	11	512,28	CHI
20201039552	SANTA HELENA DE GOIAS	SH10394752	IPEGUARI	09/10/2020 18:34	11/10/2020 17:08	10/10/2020 05:07	11/10/2020 17:08	36,02	54	1944,99	CHI
20201039552	SANTA HELENA DE GOIAS	SH10394752	IPEGUARI	09/10/2020 18:34	11/10/2020 17:08	11/10/2020 15:28	11/10/2020 17:08	1,67	43	71,80	CHI
20201039554	JATAI	JT21234391	JATAI S3	09/10/2020 18:34	10/10/2020 07:54	09/10/2020 18:34	10/10/2020 07:54	13,32	1	13,32	CHI
20201039560	PLANALTINA	10018216011	PLANALTINA	09/10/2020 18:36	09/10/2020 20:01	09/10/2020 18:36	09/10/2020 20:01	1,41	1	1,41	CHI
20201039569	ESTRELA DO NORTE	ET21145242	MARA ROSA	09/10/2020 18:39	09/10/2020 20:14	09/10/2020 18:39	09/10/2020 20:14	1,58	1	1,58	CHI
20201039585	VICENTINOPOLIS	VI12218196	VICENTINOPOLIS	09/10/2020 18:41	09/10/2020 23:33	09/10/2020 18:41	09/10/2020 23:33	4,85	5	24,27	CHI
20201039592	RUBIATABA	RB21358937	RUBIATABA	09/10/2020 18:44	09/10/2020 20:20	09/10/2020 18:44	09/10/2020 20:20	1,60	1	1,60	CHI
20201039600	NIQUELANDIA	10006766399	NIQUELANDIA SUBTRANSMISSAO	09/10/2020 18:47	10/10/2020 11:36	09/10/2020 18:47	10/10/2020 11:36	16,81	1	16,81	CHI
20201039640	MINEIROS	05810224	PARQUE DAS EMAS	09/10/2020 18:47	09/10/2020 20:40	09/10/2020 18:47	09/10/2020 18:50	0,05	11205	563,36	CHI
20201039640	MINEIROS	MY10416714	PARQUE DAS EMAS	09/10/2020 18:47	09/10/2020 20:40	09/10/2020 18:47	09/10/2020 19:13	0,42	534	225,02	CHI
20201039640	MINEIROS	MY10416714	PARQUE DAS EMAS	09/10/2020 18:47	09/10/2020 20:40	09/10/2020 18:59	09/10/2020 19:13	0,23	842	197,87	CHI
20201039640	MINEIROS	MY12035970	PARQUE DAS EMAS	09/10/2020 18:47	09/10/2020 20:40	09/10/2020 19:33	09/10/2020 20:40	1,12	166	185,78	CHI
20201039610	SANTA HELENA DE GOIAS	400102237	IPEGUARI	09/10/2020 18:48	09/10/2020 22:46	09/10/2020 18:48	09/10/2020 22:46	3,96	1	3,96	CHI
20201039612	ALEXANIA	AX21070945	ALEXANIA	09/10/2020 18:48	09/10/2020 23:01	09/10/2020 18:48	09/10/2020 23:01	4,20	1	4,20	CHI
20201039630	MINEIROS	MY21347895	PARQUE DAS EMAS	09/10/2020 18:51	09/10/2020 23:17	09/10/2020 18:51	09/10/2020 23:17	4,42	1	4,42	CHI
20201041008	PARANAIGUARA	QI12054841	QUIRINOPOLIS	09/10/2020 18:53	10/10/2020 12:04	09/10/2020 18:53	10/10/2020 12:04	17,19	1	17,19	CHI
20201041008	QUIRINOPOLIS	QI12054841	QUIRINOPOLIS	09/10/2020 18:53	10/10/2020 12:04	09/10/2020 18:53	10/10/2020 12:04	17,19	17	292,15	CHI
20201039652	NIQUELANDIA	NQ12262921	BARRO ALTO	09/10/2020 18:53	10/10/2020 09:52	09/10/2020 18:53	10/10/2020 09:52	14,98	6	89,89	CHI
20201039744	POSSE	PS12237064	IACIARA S2	09/10/2020 19:00	09/10/2020 20:44	09/10/2020 19:00	09/10/2020 20:44	1,73	4	6,90	CHI
20201039695	RIO VERDE	RV12104444	RIO VERDE S1	09/10/2020 19:04	10/10/2020 15:53	09/10/2020 19:04	10/10/2020 15:53	20,82	77	1603,05	CHI
20201039699	CACU	CC12191711	CACHOEIRA ALTA	09/10/2020 19:04	10/10/2020 10:15	09/10/2020 19:04	10/10/2020 10:15	15,17	4	60,69	CHI
20201039702	MONTIVIDIU	RV12311791	MONTIVIDIU T	09/10/2020 19:05	10/10/2020 13:45	09/10/2020 19:05	10/10/2020 10:14	15,16	2	30,32	CHI
20201039702	RIO VERDE	RV12311791	MONTIVIDIU T	09/10/2020 19:05	10/10/2020 13:45	09/10/2020 19:05	10/10/2020 10:14	15,16	6	90,95	CHI
20201039702	RIO VERDE	RV21361044	MONTIVIDIU T	09/10/2020 19:05	10/10/2020 13:45	09/10/2020 19:05	10/10/2020 13:45	18,68	1	18,68	CHI
20201041122	NIQUELANDIA	NQ12392028	URUACU	09/10/2020 19:06	10/10/2020 11:09	09/10/2020 19:06	10/10/2020 11:09	16,05	9	144,41	CHI
20201039732	PIRENOPOLIS	PV10395367	SAO FRANCISCO DE GOIAS	09/10/2020 19:07	09/10/2020 22:04	09/10/2020 19:07	09/10/2020 20:08	1,02	3	3,05	CHI
20201039732	SAO FRANCISCO DE GOIAS	PV10395367	CORUMBA	09/10/2020 19:07	09/10/2020 22:04	09/10/2020 19:07	09/10/2020 20:08	1,02	2	2,03	CHI
20201039732	PIRENOPOLIS	PV10395367	CORUMBA	09/10/2020 19:07	09/10/2020 22:04	09/10/2020 19:07	09/10/2020 20:08	1,02	352	357,38	CHI
20201039732	PIRENOPOLIS	PV10395367	CORUMBA	09/10/2020 19:07	09/10/2020 22:04	09/10/2020 19:07	09/10/2020 21:07	2,01	320	642,49	CHI
20201039732	JARAGUA	PV10395367	CORUMBA	09/10/2020 19:07	09/10/2020 22:04	09/10/2020 19:07	09/10/2020 21:07	2,01	13	26,10	CHI
20201039732	PIRENOPOLIS	PV10395367	CORUMBA	09/10/2020 19:07	09/10/2020 22:04	09/10/2020 20:12	09/10/2020 21:07	0,91	49	44,78	CHI
20201039732	PIRENOPOLIS	PV13382375	CORUMBA	09/10/2020 19:07	09/10/2020 22:04	09/10/2020 20:12	09/10/2020 21:57	1,74	150	261,08	CHI
20201039732	PIRENOPOLIS	PV13362318	CORUMBA	09/10/2020 19:07	09/10/2020 22:04	09/10/2020 20:12	09/10/2020 22:04	1,87	153	285,47	CHI
20201039732	SAO FRANCISCO DE GOIAS	PV13362318	CORUMBA	09/10/2020 19:07	09/10/2020 22:04	09/10/2020 20:12	09/10/2020 22:04	1,87	2	3,73	CHI
20201039732	PIRENOPOLIS	PV13362318	SAO FRANCISCO DE GOIAS	09/10/2020 19:07	09/10/2020 22:04	09/10/2020 20:12	09/10/2020 22:04	1,87	3	5,60	CHI
20201039715	PLANALTINA	PI11149011	PLANALTINA	09/10/2020 19:07	09/10/2020 19:31	09/10/2020 19:07	09/10/2020 19:31	0,39	59	22,94	CHI
20201039730	RUBIATABA	780022701	RUBIATABA	09/10/2020 19:09	09/10/2020 22:21	09/10/2020 19:09	09/10/2020 22:21	3,20	1	3,20	CHI

20201039764	LAGOA SANTA	00270434	CACHOEIRA ALTA	09/10/2020 19:10	09/10/2020 21:01	09/10/2020 19:10	09/10/2020 21:01	1,86	86	159,74	CHI
20201039764	ITAJA	00270434	CACHOEIRA ALTA	09/10/2020 19:10	09/10/2020 21:01	09/10/2020 19:10	09/10/2020 21:01	1,86	73	135,60	CHI
20201039764	ITAJA	00270434	CACHOEIRA ALTA	09/10/2020 19:10	09/10/2020 21:01	09/10/2020 19:10	09/10/2020 21:01	1,86	30	55,72	CHI
20201039764	ITARUMA	00270434	CACHOEIRA ALTA	09/10/2020 19:10	09/10/2020 21:01	09/10/2020 19:10	09/10/2020 21:01	1,86	71	131,88	CHI
20201039764	ITARUMA	00270434	CACHOEIRA ALTA	09/10/2020 19:10	09/10/2020 21:01	09/10/2020 19:10	09/10/2020 21:01	1,86	3	5,57	CHI
20201039764	ITAJA	00270434	CACHOEIRA ALTA	09/10/2020 19:10	09/10/2020 21:01	09/10/2020 19:10	09/10/2020 21:01	1,86	41	76,16	CHI
20201039764	ITARUMA	00270434	CACHOEIRA ALTA	09/10/2020 19:10	09/10/2020 21:01	09/10/2020 19:10	09/10/2020 21:01	1,86	44	81,73	CHI
20201039764	ITARUMA	00270434	CACHOEIRA ALTA	09/10/2020 19:10	09/10/2020 21:01	09/10/2020 19:10	09/10/2020 21:01	1,86	129	239,62	CHI
20201039764	CACHOEIRA ALTA	00270434	CACHOEIRA ALTA	09/10/2020 19:10	09/10/2020 21:01	09/10/2020 19:10	09/10/2020 21:01	1,86	8	14,86	CHI
20201039764	ITAJA	00270434	CACHOEIRA ALTA	09/10/2020 19:10	09/10/2020 21:01	09/10/2020 19:10	09/10/2020 21:01	1,86	3	5,57	CHI
20201039764	LAGOA SANTA	00270434	CACHOEIRA ALTA	09/10/2020 19:10	09/10/2020 21:01	09/10/2020 19:10	09/10/2020 21:01	1,86	17	31,58	CHI
20201039764	CACU	00270434	CACHOEIRA ALTA	09/10/2020 19:10	09/10/2020 21:01	09/10/2020 19:10	09/10/2020 21:01	1,86	3	5,57	CHI
20201039764	CACU	00270434	CACHOEIRA ALTA	09/10/2020 19:10	09/10/2020 21:01	09/10/2020 19:10	09/10/2020 21:01	1,86	4	7,43	CHI
20201039747	CATALAO	CT12077317	CATALAO S2	09/10/2020 19:12	09/10/2020 21:58	09/10/2020 19:12	09/10/2020 21:58	2,75	192	528,91	CHI
20201039765	GOIANESIA	GE21326340	GOIANESIA S2	09/10/2020 19:16	09/10/2020 22:37	09/10/2020 19:16	09/10/2020 22:37	3,34	2	6,68	CHI
20201039767	RUBIATABA	780081699	RUBIATABA	09/10/2020 19:16	10/10/2020 01:13	09/10/2020 19:16	10/10/2020 01:13	5,93	1	5,93	CHI
20201039770	SAO LUIZ DO NORTE	SZ12348617	ITAPACI	09/10/2020 19:17	10/10/2020 00:46	09/10/2020 19:17	10/10/2020 00:46	5,48	31	169,92	CHI
20201039774	ORIZONA	OZ12114492	PIRES DO RIO S2	09/10/2020 19:19	09/10/2020 22:00	09/10/2020 19:19	09/10/2020 22:00	2,69	8	21,55	CHI
202010189018	SERRANOPOLIS	SX12080854RE	JATAI S1	09/10/2020 19:20	10/10/2020 20:45	09/10/2020 19:20	10/10/2020 20:45	25,42	24	610,13	CHI
202010189018	JATAI	SX12080854RE	JATAI S1	09/10/2020 19:20	10/10/2020 20:45	09/10/2020 19:20	10/10/2020 20:45	25,42	50	1271,11	CHI
20201039786	CACU	CC12322236LD	CACHOEIRA ALTA	09/10/2020 19:20	10/10/2020 12:58	09/10/2020 19:20	10/10/2020 12:58	17,62	1	17,62	CHI
20201039806	CABECEIRAS	CW21108840	ITIQUEIRA	09/10/2020 19:24	09/10/2020 20:13	09/10/2020 19:24	09/10/2020 20:13	0,81	1	0,81	CHI
20201039810	FORMOSA	FA11397685	ITIQUEIRA	09/10/2020 19:24	09/10/2020 21:27	09/10/2020 19:24	09/10/2020 21:27	2,04	1	2,04	CHI
20201039266	MAURILANDIA	ML11000004	RIO DOS BOIS	09/10/2020 19:26	10/10/2020 11:45	09/10/2020 19:26	10/10/2020 01:29	6,06	84	509,04	CHI
20201039266	MAURILANDIA	ML12000005	RIO DOS BOIS	09/10/2020 19:26	10/10/2020 11:45	09/10/2020 19:26	10/10/2020 11:45	16,32	61	995,32	CHI
20201039836	MONTE ALEGRE DE GOIAS	MA12233165	SAO DOMINGOS	09/10/2020 19:30	09/10/2020 21:08	09/10/2020 19:30	09/10/2020 21:08	1,63	6	9,80	CHI
20201039843	GOIANESIA	GE11090257	GOIANESIA S1	09/10/2020 19:30	09/10/2020 22:06	09/10/2020 19:30	09/10/2020 22:06	2,60	84	218,31	CHI
20201039421	MAURILANDIA	CL16404243	RIO DOS BOIS	09/10/2020 19:30	10/10/2020 14:55	10/10/2020 13:16	10/10/2020 13:22	0,09	1	0,09	CHI
20201039421	PORTEIRAO	CL16404243	RIO DOS BOIS	09/10/2020 19:30	10/10/2020 14:55	10/10/2020 13:16	10/10/2020 13:22	0,09	28	2,49	CHI
20201039421	TURVELANDIA	CL16404243	RIO DOS BOIS	09/10/2020 19:30	10/10/2020 14:55	10/10/2020 13:16	10/10/2020 13:22	0,09	1	0,09	CHI
20201039421	MAURILANDIA	O1130214	RIO DOS BOIS	09/10/2020 19:30	10/10/2020 14:55	10/10/2020 13:16	10/10/2020 13:26	0,16	1207	189,10	CHI
20201039421	TURVELANDIA	O1130214	RIO DOS BOIS	09/10/2020 19:30	10/10/2020 14:55	10/10/2020 13:16	10/10/2020 13:26	0,16	2	0,31	CHI
20201039421	MAURILANDIA	O1130214	RIO DOS BOIS	09/10/2020 19:30	10/10/2020 14:55	10/10/2020 13:16	10/10/2020 14:01	0,73	685	503,47	CHI
20201039421	MAURILANDIA	O1130214	RIO DOS BOIS	09/10/2020 19:30	10/10/2020 14:55	10/10/2020 13:16	10/10/2020 14:38	1,36	616	839,30	CHI
20201039421	MAURILANDIA	ML12286261	RIO DOS BOIS	09/10/2020 19:30	10/10/2020 14:55	09/10/2020 19:30	10/10/2020 14:55	19,42	45	873,74	CHI
20201039870	MORRINHOS	PK12293231	PONTALINA	09/10/2020 19:30	09/10/2020 21:09	09/10/2020 19:30	09/10/2020 21:09	1,64	1	1,64	CHI
20201039870	PONTALINA	PK12293231	PONTALINA	09/10/2020 19:30	09/10/2020 21:09	09/10/2020 19:30	09/10/2020 21:09	1,64	19	31,18	CHI
20201039905	CACHOEIRA DOURADA	CD12000188	CACHOEIRA DOURADA	09/10/2020 19:31	10/10/2020 11:15	09/10/2020 19:31	10/10/2020 11:15	15,74	8	125,92	CHI
20201039905	ITUMBIARA	CD12000188	CACHOEIRA DOURADA	09/10/2020 19:31	10/10/2020 11:15	09/10/2020 19:31	10/10/2020 11:15	15,74	2	31,48	CHI
20201039848	FORMOSA	610303818	ITIQUEIRA	09/10/2020 19:31	09/10/2020 20:29	09/10/2020 19:31	09/10/2020 20:29	0,96	1	0,96	CHI
20201039858	MINEIROS	MY21149344	PARQUE DAS EMAS	09/10/2020 19:33	10/10/2020 05:21	09/10/2020 19:33	10/10/2020 05:21	9,80	2	19,60	CHI
20201039861	JATAI	10012017807	JATAI S1	09/10/2020 19:33	10/10/2020 01:38	09/10/2020 19:33	10/10/2020 01:38	6,08	1	6,08	CHI
20201039873	MINEIROS	MY21348934	PARQUE DAS EMAS	09/10/2020 19:37	10/10/2020 04:39	09/10/2020 19:37	10/10/2020 04:39	9,03	1	9,03	CHI
20201039886	CAMPO ALEGRE DE GOIAS	1160013576	CAMPO ALEGRE DE GOIAS	09/10/2020 19:40	09/10/2020 23:02	09/10/2020 19:40	09/10/2020 23:02	3,36	1	3,36	CHI
20201040195	QUIRINOPOLIS	PC12000120	QUIRINOPOLIS	09/10/2020 19:40	10/10/2020 02:00	09/10/2020 19:40	10/10/2020 02:00	6,32	5	31,61	CHI
20201040195	PARANAIGUARA	PC12000120	QUIRINOPOLIS	09/10/2020 19:40	10/10/2020 02:00	09/10/2020 19:40	10/10/2020 02:00	6,32	79	499,39	CHI
20201039894	ANAPOLIS	20821281	JUNDIAI S1	09/10/2020 19:43	09/10/2020 20:35	09/10/2020 19:43	09/10/2020 20:35	0,88	1	0,88	CHI
20201039913	ITARUMA	CC12202746	CACHOEIRA ALTA	09/10/2020 19:48	10/10/2020 16:12	09/10/2020 19:48	10/10/2020 16:12	20,40	2	40,79	CHI
20201039914	MINACU	4020066785	MINACU	09/10/2020 19:48	09/10/2020 21:35	09/10/2020 19:48	09/10/2020 21:35	1,78	1	1,78	CHI
20201039951	ALEXANIA	AX12353458	ALEXANIA	09/10/2020 19:53	09/10/2020 21:51	09/10/2020 19:53	09/10/2020 21:51	1,96	17	33,40	CHI
20201039952	ANAPOLIS	21317239	ANAPOLIS UNIVERSITARIO S2	09/10/2020 20:01	09/10/2020 22:27	09/10/2020 20:01	09/10/2020 22:27	2,42	1	2,42	CHI
20201039959	INDIARA	EA12056544	EDEIA	09/10/2020 20:02	09/10/2020 21:22	09/10/2020 20:02	09/10/2020 21:22	1,33	10	13,26	CHI
20201039967	FORMOSA	610078641	ITIQUEIRA	09/10/2020 20:06	09/10/2020 21:32	09/10/2020 20:06	09/10/2020 21:32	1,43	1	1,43	CHI
20201039970	MARA ROSA	MQ21170943	NOVA CRIXAS	09/10/2020 20:07	09/10/2020 23:54	09/10/2020 20:07	09/10/2020 23:54	3,78	1	3,78	CHI
20201039972	CACHOEIRA ALTA	CA12196169	CACHOEIRA ALTA	09/10/2020 20:08	10/10/2020 09:23	09/10/2020 20:08	10/10/2020 09:23	13,25	5	66,25	CHI
20201039997	PORTELANDIA	DP12210131RE	PARQUE DAS EMAS	09/10/2020 20:09	09/10/2020 23:38	09/10/2020 20:09	09/10/2020 23:38	3,47	1	3,47	CHI
20201039997	MINEIROS	DP12210131RE	PARQUE DAS EMAS	09/10/2020 20:09	09/10/2020 23:38	09/10/2020 20:09	09/10/2020 23:38	3,47	13	45,16	CHI
20201039997	PEROLANDIA	DP12210131RE	PARQUE DAS EMAS	09/10/2020 20:09	09/10/2020 23:38	09/10/2020 20:09	09/10/2020 23:38	3,47	5	17,37	CHI

20201040042	CARMO DO RIO VERDE	IK12298505	ITAPURANGA	09/10/2020 20:12	09/10/2020 22:39	09/10/2020 20:12	09/10/2020 22:39	2,45	35	85,59	CHI
20201040042	ITAPURANGA	IK12298505	ITAPURANGA	09/10/2020 20:12	09/10/2020 22:39	09/10/2020 20:12	09/10/2020 22:39	2,45	9	22,01	CHI
20201040005	MINEIROS	MY21244163	PARQUE DAS EMAS	09/10/2020 20:16	09/10/2020 22:20	09/10/2020 20:16	09/10/2020 22:20	2,06	1	2,06	CHI
20201040023	INACIOLANDIA	CD10407487	CACHOEIRA DOURADA	09/10/2020 20:16	09/10/2020 22:15	09/10/2020 20:16	09/10/2020 21:55	1,65	2	3,30	CHI
20201040023	CACHOEIRA DOURADA	CD10407487	CACHOEIRA DOURADA	09/10/2020 20:16	09/10/2020 22:15	09/10/2020 20:16	09/10/2020 21:55	1,65	45	74,33	CHI
20201040023	CACHOEIRA DOURADA	CD10407487	CACHOEIRA DOURADA	09/10/2020 20:16	09/10/2020 22:15	09/10/2020 20:16	09/10/2020 22:15	1,99	1	1,99	CHI
20201040023	INACIOLANDIA	CD10407487	CACHOEIRA DOURADA	09/10/2020 20:16	09/10/2020 22:15	09/10/2020 20:16	09/10/2020 22:15	1,99	97	192,90	CHI
20201040023	ITUMBIARA	CD10407487	CACHOEIRA DOURADA	09/10/2020 20:16	09/10/2020 22:15	09/10/2020 20:16	09/10/2020 22:15	1,99	13	25,85	CHI
20201040016	LUZIANIA	LZ11169003	MARAJOARA	09/10/2020 20:18	09/10/2020 23:01	09/10/2020 20:18	09/10/2020 23:01	2,72	42	114,09	CHI
20201040031	PALMEIRAS DE GOIAS	PL12349324	PALMEIRAS	09/10/2020 20:18	10/10/2020 09:31	09/10/2020 20:18	10/10/2020 09:31	13,21	187	2470,95	CHI
20201040093	IPAMERI	IP12095243	IPAMERI	09/10/2020 20:19	09/10/2020 22:34	09/10/2020 20:19	09/10/2020 22:34	2,24	7	15,70	CHI
20201040027	ITARUMA	IM21327054	ITAJA S2	09/10/2020 20:21	10/10/2020 17:20	09/10/2020 20:21	10/10/2020 17:20	20,97	1	20,97	CHI
20201040043	CIDADE OCIDENTAL	2680008292	MARAJOARA	09/10/2020 20:22	09/10/2020 21:46	09/10/2020 20:22	09/10/2020 21:46	1,39	1	1,39	CHI
20201040070	ANAPOLIS	AN11000333	JUNDIAI S2	09/10/2020 20:25	10/10/2020 05:00	09/10/2020 20:25	10/10/2020 01:41	5,27	72	379,18	CHI
20201040070	ANAPOLIS	AN11000333	JUNDIAI S2	09/10/2020 20:25	10/10/2020 05:00	10/10/2020 01:42	10/10/2020 05:00	3,31	72	238,52	CHI
20201040100	JATAI	JT12036247	JATAI S3	09/10/2020 20:27	09/10/2020 21:50	09/10/2020 20:27	09/10/2020 21:50	1,37	776	1064,63	CHI
20201040074	SANTA HELENA DE GOIAS	SH12301071	RIO DOS BOIS	09/10/2020 20:32	10/10/2020 16:50	09/10/2020 20:32	10/10/2020 14:48	18,27	3	54,81	CHI
20201040074	TURVELANDIA	SH12301071	RIO DOS BOIS	09/10/2020 20:32	10/10/2020 16:50	10/10/2020 20:32	10/10/2020 16:50	20,31	2	40,61	CHI
20201040074	SANTA HELENA DE GOIAS	SH12301072LD	RIO DOS BOIS	09/10/2020 20:32	10/10/2020 16:50	09/10/2020 20:32	10/10/2020 16:50	20,31	6	121,83	CHI
20201040074	SANTA HELENA DE GOIAS	SH12301071	RIO DOS BOIS	09/10/2020 20:32	10/10/2020 16:50	10/10/2020 15:32	10/10/2020 16:50	1,30	3	3,90	CHI
20201040078	RIO VERDE	RV21048976	ACREUNA	09/10/2020 20:32	10/10/2020 08:36	09/10/2020 20:32	10/10/2020 08:36	12,05	1	12,05	CHI
20201040079	BARRO ALTO	10001560172	BARRO ALTO	09/10/2020 20:32	10/10/2020 12:57	09/10/2020 20:32	10/10/2020 12:57	16,40	1	16,40	CHI
20201040409	JATAI	JT12000167RE	JATAI S1	09/10/2020 20:33	10/10/2020 11:02	09/10/2020 20:33	10/10/2020 11:02	14,48	25	361,94	CHI
20201040083	QUIRINOPOLIS	80077080	QUIRINOPOLIS	09/10/2020 20:33	10/10/2020 20:09	09/10/2020 20:33	10/10/2020 20:09	23,59	1	23,59	CHI
20201040091	SAO LUIS DE MONTES BELOS	SL12391408	FIRMINOPOLIS S2	09/10/2020 20:34	10/10/2020 00:58	09/10/2020 20:34	10/10/2020 00:58	4,38	2	8,77	CHI
20201040092	PADRE BERNARDO	PB12261643	PADRE BERNARDO	09/10/2020 20:35	09/10/2020 22:04	09/10/2020 20:35	09/10/2020 22:04	1,48	205	302,66	CHI
20201040107	MORRINHOS	MR11263653	MORRINHOS	09/10/2020 20:38	09/10/2020 23:54	09/10/2020 20:38	09/10/2020 23:54	3,26	1	3,26	CHI
20201040113	CALDAS NOVAS	760203246	SERRA DE CALDAS	09/10/2020 20:38	09/10/2020 22:26	09/10/2020 20:38	09/10/2020 22:26	1,79	1	1,79	CHI
20201040118	QUIRINOPOLIS	80039583	QUIRINOPOLIS	09/10/2020 20:40	09/10/2020 23:12	09/10/2020 20:40	09/10/2020 23:12	2,52	1	2,52	CHI
20201040123	CABECEIRAS	CW21151429	ITUIQUIRA	09/10/2020 20:41	09/10/2020 21:23	09/10/2020 20:41	09/10/2020 21:23	0,69	1	0,69	CHI
20201040136	MUTUNOPOLIS	MU12257886	MARA ROSA	09/10/2020 20:46	10/10/2020 00:21	09/10/2020 20:46	10/10/2020 00:21	3,57	1	3,57	CHI
20201040136	AMARALINA	MU12257886	MARA ROSA	09/10/2020 20:46	10/10/2020 00:21	09/10/2020 20:46	10/10/2020 00:21	3,57	35	124,91	CHI
20201040139	LUZIANIA	LZ12383044	CRISTALINA S2	09/10/2020 20:46	10/10/2020 00:21	09/10/2020 20:46	10/10/2020 00:21	3,57	96	342,45	CHI
20201040139	CRISTALINA	LZ12383044	CRISTALINA S2	09/10/2020 20:46	10/10/2020 00:21	09/10/2020 20:46	10/10/2020 00:21	3,57	21	74,91	CHI
20201040140	CALDAS NOVAS	CN21298655	CALDAS NOVAS S2	09/10/2020 20:47	09/10/2020 21:40	09/10/2020 20:47	09/10/2020 21:40	0,88	1	0,88	CHI
20201040146	NIQUELANDIA	NQ21146904	URUACU	09/10/2020 20:48	10/10/2020 20:55	09/10/2020 20:48	10/10/2020 20:55	24,11	1	24,11	CHI
20201040149	ITUMBIARA	IT12000242	ITUMBIARA NOVA	09/10/2020 20:49	10/10/2020 06:01	09/10/2020 20:49	10/10/2020 06:01	9,20	3	27,59	CHI
20201040156	SAO LUIS DE MONTES BELOS	SL21145819	FIRMINOPOLIS S2	09/10/2020 20:50	10/10/2020 07:39	09/10/2020 20:50	10/10/2020 07:39	10,81	1	10,81	CHI
20201040186	CAIAPONIA	03280434	MONTIVIDIU T	09/10/2020 20:52	10/10/2020 14:38	09/10/2020 20:52	09/10/2020 22:52	2,02	292	588,46	CHI
20201040186	CAIAPONIA	03280434	MONTIVIDIU T	09/10/2020 20:52	10/10/2020 14:38	09/10/2020 20:52	09/10/2020 22:52	2,02	23	46,35	CHI
20201040186	MONTIVIDIU	03280434	MONTIVIDIU T	09/10/2020 20:52	10/10/2020 14:38	09/10/2020 20:52	09/10/2020 22:52	2,02	6	12,09	CHI
20201040186	RIO VERDE	03280434	MONTIVIDIU T	09/10/2020 20:52	10/10/2020 14:38	09/10/2020 20:52	09/10/2020 22:52	2,02	2	4,03	CHI
20201040186	RIO VERDE	03280434	MONTIVIDIU T	09/10/2020 20:52	10/10/2020 14:38	09/10/2020 20:52	09/10/2020 22:52	2,02	75	151,15	CHI
20201040186	JATAI	03280434	MONTIVIDIU T	09/10/2020 20:52	10/10/2020 14:38	09/10/2020 20:52	09/10/2020 22:52	2,02	6	12,09	CHI
20201040186	MONTIVIDIU	03280434	MONTIVIDIU T	09/10/2020 20:52	10/10/2020 14:38	09/10/2020 20:52	09/10/2020 22:52	2,02	58	116,89	CHI
20201040186	JATAI	MV13123330	MONTIVIDIU T	09/10/2020 20:52	10/10/2020 14:38	09/10/2020 20:52	09/10/2020 22:52	2,01	1	2,01	CHI
20201040186	MONTIVIDIU	MV13123330	MONTIVIDIU T	09/10/2020 20:52	10/10/2020 14:38	09/10/2020 20:52	09/10/2020 22:52	2,01	1	2,01	CHI
20201040186	RIO VERDE	MV13123330	MONTIVIDIU T	09/10/2020 20:52	10/10/2020 14:38	09/10/2020 20:52	09/10/2020 21:15	1,63	7	11,41	CHI
20201040186	JATAI	03280434	MONTIVIDIU T	09/10/2020 20:52	10/10/2020 14:38	09/10/2020 20:52	09/10/2020 23:55	3,06	4	12,25	CHI
20201040186	RIO VERDE	03280434	MONTIVIDIU T	09/10/2020 20:52	10/10/2020 14:38	09/10/2020 20:52	09/10/2020 23:55	3,06	3	9,19	CHI
20201040186	JATAI	03280434	MONTIVIDIU T	09/10/2020 20:52	10/10/2020 14:38	09/10/2020 20:52	09/10/2020 23:55	3,06	1	3,06	CHI
20201040186	RIO VERDE	03280434	MONTIVIDIU T	09/10/2020 20:52	10/10/2020 14:38	09/10/2020 20:52	10/10/2020 14:25	17,56	9	158,01	CHI
20201040186	MONTIVIDIU	03280434	MONTIVIDIU T	09/10/2020 20:52	10/10/2020 14:38	09/10/2020 20:52	10/10/2020 14:38	17,77	31	550,77	CHI
20201040186	RIO VERDE	03280434	MONTIVIDIU T	09/10/2020 20:52	10/10/2020 14:38	09/10/2020 20:52	10/10/2020 14:38	17,77	16	284,27	CHI
20201040181	CALDAS NOVAS	CN12054006	SERRA DE CALDAS	09/10/2020 20:57	10/10/2020 03:53	10/10/2020 02:51	10/10/2020 03:53	1,04	226	234,47	CHI
20201040181	CALDAS NOVAS	CN11054003	SERRA DE CALDAS	09/10/2020 20:57	10/10/2020 03:53	10/10/2020 20:57	10/10/2020 03:53	6,94	216	1498,32	CHI
20201040211	MORRINHOS	MR12000039	MORRINHOS	09/10/2020 21:02	09/10/2020 21:46	09/10/2020 21:02	09/10/2020 21:46	0,72	245	175,92	CHI
20201040287	QUIRINOPOLIS	QI12276207RE	QUIRINOPOLIS	09/10/2020 21:06	10/10/2020 05:00	09/10/2020 21:06	10/10/2020 05:00	7,89	51	402,26	CHI

20201040287	PARANAIGUARA	QI12276207RE	QUIRINOPOLIS	09/10/2020 21:06	10/10/2020 05:00	09/10/2020 21:06	10/10/2020 05:00	7,89	5	39,44	CHI
20201040983	CACHOEIRA ALTA	CA12014743RE	CACHOEIRA ALTA	09/10/2020 21:07	10/10/2020 08:26	09/10/2020 21:07	10/10/2020 08:26	11,31	69	780,66	CHI
20201040230	BELA VISTA DE GOIAS	SQ12318950RE	CRISTIANOPOLIS	09/10/2020 21:08	10/10/2020 01:14	09/10/2020 21:08	10/10/2020 01:14	4,10	18	73,78	CHI
20201040230	VIANOPOLIS	SQ12318950RE	CRISTIANOPOLIS	09/10/2020 21:08	10/10/2020 01:14	09/10/2020 21:08	10/10/2020 01:14	4,10	3	12,30	CHI
20201040230	SAO MIGUEL DO PASSA QUATRO	SQ12318950RE	CRISTIANOPOLIS	09/10/2020 21:08	10/10/2020 01:14	09/10/2020 21:08	10/10/2020 01:14	4,10	81	332,01	CHI
20201040230	CRISTIANOPOLIS	SQ12318950RE	CRISTIANOPOLIS	09/10/2020 21:08	10/10/2020 01:14	09/10/2020 21:08	10/10/2020 01:14	4,10	22	90,18	CHI
20201040225	LEOPOLDO DE BULHOES	LB21334842	DAIA S2	09/10/2020 21:09	10/10/2020 00:42	09/10/2020 21:09	10/10/2020 00:42	3,54	1	3,54	CHI
20201040226	PIRENOPOLIS	PV12382344	CORUMBA	09/10/2020 21:09	10/10/2020 01:00	09/10/2020 21:09	10/10/2020 01:00	3,84	4	15,36	CHI
20201040234	ITUMBIARA	IT11143878	ITUMBIARA VELHA S1	09/10/2020 21:10	10/10/2020 09:26	09/10/2020 21:10	10/10/2020 09:26	12,26	95	1165,10	CHI
20201040476	ITUMBIARA	IT12203288	ITUMBIARA NOVA	09/10/2020 21:12	10/10/2020 00:38	09/10/2020 21:12	10/10/2020 00:38	3,42	174	595,85	CHI
20201040672	CACHOEIRA ALTA	CA12078918	CACHOEIRA ALTA	09/10/2020 21:15	10/10/2020 03:54	09/10/2020 21:15	10/10/2020 03:54	6,64	5	33,22	CHI
20201040672	PARANAIGUARA	CA12078918	CACHOEIRA ALTA	09/10/2020 21:15	10/10/2020 03:54	09/10/2020 21:15	10/10/2020 03:54	6,64	25	166,09	CHI
20201040256	GOIATUBA	GT12190915	GOIATUBA S2	09/10/2020 21:17	10/10/2020 05:27	09/10/2020 21:17	10/10/2020 05:27	8,15	29	236,38	CHI
20201040261	RIO VERDE	04860416	QUIRINOPOLIS	09/10/2020 21:19	09/10/2020 21:23	09/10/2020 21:19	09/10/2020 21:23	0,06	93	5,73	CHI
20201040261	RIO VERDE	04860416	QUIRINOPOLIS	09/10/2020 21:19	09/10/2020 21:23	09/10/2020 21:19	09/10/2020 21:23	0,06	43	2,65	CHI
20201040261	QUIRINOPOLIS	04860416	QUIRINOPOLIS	09/10/2020 21:19	09/10/2020 21:23	09/10/2020 21:19	09/10/2020 21:23	0,06	288	17,76	CHI
20201040261	CACHOEIRA ALTA	04860416	QUIRINOPOLIS	09/10/2020 21:19	09/10/2020 21:23	09/10/2020 21:19	09/10/2020 21:23	0,06	34	2,10	CHI
20201040261	QUIRINOPOLIS	04860416	QUIRINOPOLIS	09/10/2020 21:19	09/10/2020 21:23	09/10/2020 21:19	09/10/2020 21:23	0,06	73	4,50	CHI
20201040277	CALDAZINHA	LB21010542	DAIA S2	09/10/2020 21:26	09/10/2020 22:07	09/10/2020 21:26	09/10/2020 22:07	0,68	1	0,68	CHI
20201040280	BOM JESUS DE GOIAS	BJ12352647LD	BOM JESUS DE GOIAS	09/10/2020 21:26	09/10/2020 23:48	09/10/2020 21:26	09/10/2020 23:48	2,35	3	7,06	CHI
20201040293	COLINAS DO SUL	9700002980	NIQUELANDIA SUBTRANSMISSAO	09/10/2020 21:32	10/10/2020 09:48	09/10/2020 21:32	10/10/2020 09:48	12,26	1	12,26	CHI
20201040305	MINACU	4020066670	MINACU	09/10/2020 21:34	09/10/2020 22:54	09/10/2020 21:34	09/10/2020 22:54	1,32	1	1,32	CHI
20201040307	FAINA	MS12113246	ITAPURANGA	09/10/2020 21:36	10/10/2020 00:22	09/10/2020 21:36	10/10/2020 00:22	2,76	7	19,34	CHI
20201040307	MORRO AGUDO DE GOIAS	MS12113246	ITAPURANGA	09/10/2020 21:36	10/10/2020 00:22	09/10/2020 21:36	10/10/2020 00:22	2,76	7	19,34	CHI
20201040307	ARAGUAPAZ	MS12113246	ITAPURANGA	09/10/2020 21:36	10/10/2020 00:22	09/10/2020 21:36	10/10/2020 00:22	2,76	2	5,53	CHI
20201040326	POSSE	02620424	IACIARA S2	09/10/2020 21:36	09/10/2020 22:20	09/10/2020 21:36	09/10/2020 22:20	0,72	3501	2511,97	CHI
20201040326	POSSE	02620424	IACIARA S2	09/10/2020 21:36	09/10/2020 22:20	09/10/2020 21:36	09/10/2020 22:20	0,72	6926	4969,40	CHI
20201040326	IACIARA	02620424	IACIARA S2	09/10/2020 21:36	09/10/2020 22:20	09/10/2020 21:36	09/10/2020 22:20	0,72	1	0,72	CHI
20201040311	CALDAS NOVAS	760371970	SERRA DE CALDAS	09/10/2020 21:38	09/10/2020 22:51	09/10/2020 21:38	09/10/2020 22:51	1,21	1	1,21	CHI
20201040312	TURVELANDIA	SH12301080RE	RIO DOS BOIS	09/10/2020 21:38	09/10/2020 23:56	09/10/2020 21:38	09/10/2020 23:56	2,29	6	13,74	CHI
20201040312	SANTA HELENA DE GOIAS	SH12301080RE	RIO DOS BOIS	09/10/2020 21:38	09/10/2020 23:56	09/10/2020 21:38	09/10/2020 23:56	2,29	19	43,50	CHI
20201040316	LUZIANIA	LZ11314033	MARAJOARA	09/10/2020 21:39	09/10/2020 23:03	09/10/2020 21:39	09/10/2020 23:03	1,39	9	12,54	CHI
20201040328	MORRINHOS	MR12093241	MORRINHOS	09/10/2020 21:41	10/10/2020 00:35	09/10/2020 21:41	10/10/2020 00:35	2,89	7	20,20	CHI
20201040328	IPAMERI	MR12093241	MORRINHOS	09/10/2020 21:41	10/10/2020 00:35	09/10/2020 21:41	10/10/2020 00:35	2,89	1	2,89	CHI
20201040335	QUIRINOPOLIS	80117375	QUIRINOPOLIS	09/10/2020 21:44	10/10/2020 08:20	09/10/2020 21:44	10/10/2020 08:20	10,60	1	10,60	CHI
20201040349	BRITANIA	BT21362344	BRITANIA	09/10/2020 21:49	10/10/2020 08:30	09/10/2020 21:49	10/10/2020 08:30	10,68	1	10,68	CHI
2020100900019	CHAPADAO DO CEU	02430524	CHAPADAO DO CEU	09/10/2020 21:56	09/10/2020 21:59	09/10/2020 21:56	09/10/2020 21:59	0,06	2402	136,78	CHI
2020100900019	CHAPADAO DO CEU	02430524	CHAPADAO DO CEU	09/10/2020 21:56	09/10/2020 21:59	09/10/2020 21:56	09/10/2020 21:59	0,06	2106	119,92	CHI
2020100900019	MINEIROS	02430524	CHAPADAO DO CEU	09/10/2020 21:56	09/10/2020 21:59	09/10/2020 21:56	09/10/2020 21:59	0,06	9	0,51	CHI
20201040584	JATAI	JT12063437	JATAI S3	09/10/2020 21:57	10/10/2020 00:39	09/10/2020 21:57	10/10/2020 00:39	2,69	434	1169,63	CHI
20201040642	JATAI	JT12264371	JATAI S3	09/10/2020 22:00	10/10/2020 00:07	09/10/2020 22:00	10/10/2020 00:07	2,12	329	696,02	CHI
20201040406	CATALAO	CT11144776	CATALAO S2	09/10/2020 22:00	09/10/2020 23:53	09/10/2020 22:00	09/10/2020 23:53	1,87	83	155,56	CHI
20201040489	JATAI	JT12000085	JATAI S3	09/10/2020 22:01	09/10/2020 23:00	09/10/2020 22:01	09/10/2020 23:00	0,98	1443	1413,74	CHI
20201040425	URUACU	UR12074232RE	URUACU	09/10/2020 22:03	10/10/2020 00:26	09/10/2020 22:03	10/10/2020 00:26	2,38	51	121,13	CHI
20201040425	CAMPINORTE	UR12074232RE	URUACU	09/10/2020 22:03	10/10/2020 00:26	09/10/2020 22:03	10/10/2020 00:26	2,38	14	33,25	CHI
20201040426	GUARINOS	GF12380720	SANTA TEREZINHA	09/10/2020 22:03	10/10/2020 03:39	09/10/2020 22:03	10/10/2020 03:39	5,59	17	95,01	CHI
20201040525	JATAI	JT12165942	JATAI S2	09/10/2020 22:06	09/10/2020 23:28	09/10/2020 22:06	09/10/2020 23:28	1,35	456	616,49	CHI
20201040463	RIO VERDE	RV21226254	CABRIUVA S1	09/10/2020 22:10	10/10/2020 01:15	09/10/2020 22:10	10/10/2020 01:15	3,08	1	3,08	CHI
20201040480	FAZENDA NOVA	FN12073183	BRITANIA	09/10/2020 22:11	10/10/2020 02:27	09/10/2020 22:11	10/10/2020 02:27	4,26	69	293,61	CHI
20201040493	FORMOSA	FA21325719	ITUIQUIRA	09/10/2020 22:17	09/10/2020 23:48	09/10/2020 22:17	09/10/2020 23:48	1,51	1	1,51	CHI
20201040607	ALTO HORIZONTE	AJ11162622	SANTA TEREZINHA	09/10/2020 22:17	10/10/2020 02:40	09/10/2020 22:17	10/10/2020 02:40	4,37	91	398,00	CHI
20201040625	MAURILANDIA	ML12036530	RIO DOS BOIS	09/10/2020 22:18	10/10/2020 10:37	09/10/2020 22:18	10/10/2020 10:37	12,31	102	1255,42	CHI
20201040506	ANAPOLIS	21381756	ANAPOLIS UNIVERSITARIO S2	09/10/2020 22:21	09/10/2020 23:47	09/10/2020 22:21	09/10/2020 23:47	1,42	1	1,42	CHI
20201040517	PONTALINA	PK11000012	PONTALINA	09/10/2020 22:27	09/10/2020 23:14	09/10/2020 22:27	09/10/2020 23:14	0,77	61	46,89	CHI
20201040631	PORANGATU	PO12262621	PORANGATU	09/10/2020 22:29	09/10/2020 23:49	09/10/2020 22:29	09/10/2020 23:49	1,33	362	480,96	CHI
20201040526	SAO MIGUEL DO ARAGUAIA	SM11217904	SAO MIGUEL DO ARAGUAIA	09/10/2020 22:29	10/10/2020 10:40	09/10/2020 22:29	10/10/2020 10:40	12,17	163	1984,07	CHI
20201041192	RIO VERDE	RV12123367	RIO VERDE S1	09/10/2020 22:30	12/10/2020 14:55	09/10/2020 22:30	10/10/2020 14:53	16,38	34	556,95	CHI
20201041192	RIO VERDE	RV12260690LD	RIO VERDE S1	09/10/2020 22:30	12/10/2020 14:55	09/10/2020 22:30	12/10/2020 14:55	64,43	11	708,69	CHI

20201040543	MAURILANDIA	01130214	RIO DOS BOIS	09/10/2020 22:30	10/10/2020 10:48	10/10/2020 02:42	10/10/2020 02:47	0,09	2363	219,89	CHI
20201040543	TURVELANDIA	01130214	RIO DOS BOIS	09/10/2020 22:30	10/10/2020 10:48	10/10/2020 02:42	10/10/2020 02:47	0,09	2	0,19	CHI
20201040543	TURVELANDIA	TD10400677	RIO DOS BOIS	09/10/2020 22:30	10/10/2020 10:48	09/10/2020 22:30	10/10/2020 04:36	6,10	1	6,10	CHI
20201040543	PORTEIRAO	TD10400677	RIO DOS BOIS	09/10/2020 22:30	10/10/2020 10:48	09/10/2020 22:30	10/10/2020 04:36	6,10	13	79,31	CHI
20201040543	PORTEIRAO	CL13030865	RIO DOS BOIS	09/10/2020 22:30	10/10/2020 10:48	09/10/2020 22:30	10/10/2020 08:46	10,26	7	71,79	CHI
20201040543	MAURILANDIA	CL13030865	RIO DOS BOIS	09/10/2020 22:30	10/10/2020 10:48	09/10/2020 22:30	10/10/2020 08:46	10,26	4	41,02	CHI
20201040543	PORTEIRAO	CL13030904	RIO DOS BOIS	09/10/2020 22:30	10/10/2020 10:48	09/10/2020 22:30	10/10/2020 09:42	11,19	2	22,38	CHI
20201040543	PORTEIRAO	CL12301092	RIO DOS BOIS	09/10/2020 22:30	10/10/2020 10:48	09/10/2020 22:30	10/10/2020 10:48	12,30	6	73,78	CHI
20201040537	NOVA CRIXAS	NA31058237	MOZARLANDIA	09/10/2020 22:31	10/10/2020 10:00	09/10/2020 22:31	10/10/2020 10:00	11,47	1	11,47	CHI
20201040538	PIRENOPOLIS	10017126124	CORUMBA	09/10/2020 22:32	10/10/2020 00:37	09/10/2020 22:32	10/10/2020 00:37	2,08	1	2,08	CHI
20201040539	ANAPOLIS	AN21351172	DAIA S1	09/10/2020 22:32	10/10/2020 00:18	09/10/2020 22:32	10/10/2020 00:18	1,76	1	1,76	CHI
20201040576	SANTA TEREZINHA DE GOIAS	SG11350042	SANTA TEREZINHA	09/10/2020 22:33	10/10/2020 01:28	09/10/2020 22:33	10/10/2020 01:28	2,91	97	282,40	CHI
20201040554	ITARUMA	IM12086918	CACHOEIRA ALTA	09/10/2020 22:38	10/10/2020 03:09	09/10/2020 22:38	10/10/2020 03:09	4,50	6	27,01	CHI
20201040562	RIO VERDE	RV12355049LD	MONTIVIDIU T	09/10/2020 22:42	10/10/2020 22:11	09/10/2020 22:42	10/10/2020 22:11	23,48	13	305,23	CHI
20201040566	CALDAS NOVAS	760417430	CALDAS NOVAS S1	09/10/2020 22:45	09/10/2020 23:54	09/10/2020 22:45	09/10/2020 23:54	1,15	1	1,15	CHI
20201040660	JUSSARA	JR11071485	JUSSARA	09/10/2020 22:46	10/10/2020 04:13	09/10/2020 22:46	10/10/2020 04:13	5,44	203	1105,05	CHI
20201040579	ITUMBIARA	IT21373955	PARANAIBA	09/10/2020 22:51	10/10/2020 09:44	09/10/2020 22:51	10/10/2020 09:44	10,87	1	10,87	CHI
20201040590	BOM JARDIM DE GOIAS	BM21380889	IPORA	09/10/2020 23:00	10/10/2020 10:37	09/10/2020 23:00	10/10/2020 10:37	11,60	1	11,60	CHI
20201040602	VILA BOA	2880001682	IACIARA S2	09/10/2020 23:02	09/10/2020 23:42	09/10/2020 23:02	09/10/2020 23:42	0,66	1	0,66	CHI
20201040603	CALDAS NOVAS	CN11249873	SERRA DE CALDAS	09/10/2020 23:03	10/10/2020 01:05	09/10/2020 23:03	10/10/2020 01:05	2,03	69	140,05	CHI
20201040812	CRIXAS	CX12074656	RUBIATABA	09/10/2020 23:11	10/10/2020 08:40	09/10/2020 23:11	10/10/2020 08:40	9,48	15	142,22	CHI
20201041111	BOM JESUS DE GOIAS	BJ12305405	BOM JESUS DE GOIAS	09/10/2020 23:25	10/10/2020 14:51	09/10/2020 23:25	10/10/2020 14:51	15,42	9	138,81	CHI
20201040907	RIO VERDE	RV12303286	CABRIUVA S2	09/10/2020 23:26	10/10/2020 11:52	09/10/2020 23:26	10/10/2020 11:39	12,22	8	97,74	CHI
20201040907	RIO VERDE	RV21306405	CABRIUVA S2	09/10/2020 23:26	10/10/2020 11:52	09/10/2020 23:26	10/10/2020 11:52	12,42	1	12,42	CHI
20201040688	MINERIOS	1390025734	PARQUE DAS EMAS	09/10/2020 23:34	10/10/2020 01:18	09/10/2020 23:34	10/10/2020 01:18	1,72	1	1,72	CHI
20201040710	RIO VERDE	05700414	CABRIUVA S2	09/10/2020 23:46	10/10/2020 16:20	09/10/2020 23:46	09/10/2020 23:53	0,12	2	0,24	CHI
20201040710	RIO VERDE	05700414	CABRIUVA S2	09/10/2020 23:46	10/10/2020 16:20	09/10/2020 23:46	10/10/2020 04:17	4,53	58	262,53	CHI
20201040710	MONTIVIDIU	05700414	MONTIVIDIU T	09/10/2020 23:46	10/10/2020 16:20	09/10/2020 23:46	10/10/2020 08:24	8,64	4	34,57	CHI
20201040710	RIO VERDE	05700414	MONTIVIDIU T	09/10/2020 23:46	10/10/2020 16:20	09/10/2020 23:46	10/10/2020 08:24	8,64	21	181,51	CHI
20201040710	RIO VERDE	05700414	MONTIVIDIU T	09/10/2020 23:46	10/10/2020 16:20	09/10/2020 23:46	10/10/2020 10:20	10,57	9	95,14	CHI
20201040710	RIO VERDE	05700414	CABRIUVA S2	09/10/2020 23:46	10/10/2020 16:20	09/10/2020 23:46	10/10/2020 10:20	10,56	76	802,39	CHI
20201040710	RIO VERDE	RV10409400	MONTIVIDIU T	09/10/2020 23:46	10/10/2020 16:20	09/10/2020 23:46	10/10/2020 10:20	10,56	1	10,56	CHI
20201040710	RIO VERDE	RV10212406	CABRIUVA S2	09/10/2020 23:46	10/10/2020 16:20	10/10/2020 04:17	10/10/2020 10:20	6,06	1	6,06	CHI
20201040710	RIO VERDE	05700414	MONTIVIDIU T	09/10/2020 23:46	10/10/2020 16:20	09/10/2020 23:46	10/10/2020 10:25	10,65	26	276,94	CHI
20201040710	RIO VERDE	RV13383488	MONTIVIDIU T	09/10/2020 23:46	10/10/2020 16:20	09/10/2020 23:46	10/10/2020 10:25	10,64	2	21,27	CHI
20201040710	RIO VERDE	05700414	MONTIVIDIU T	09/10/2020 23:46	10/10/2020 16:20	10/10/2020 13:19	10/10/2020 13:33	0,23	13	3,02	CHI
20201040710	RIO VERDE	05700414	MONTIVIDIU T	09/10/2020 23:46	10/10/2020 16:20	10/10/2020 13:19	10/10/2020 13:33	0,23	36	8,35	CHI
20201040710	MONTIVIDIU	05700414	MONTIVIDIU T	09/10/2020 23:46	10/10/2020 16:20	10/10/2020 13:19	10/10/2020 13:33	0,23	4	0,93	CHI
20201040710	RIO VERDE	RV13074474	MONTIVIDIU T	09/10/2020 23:46	10/10/2020 16:20	10/10/2020 13:19	10/10/2020 16:20	3,02	5	15,11	CHI
20201038804	TURVELANDIA	TD11289539	RIO DOS BOIS	09/10/2020 23:50	11/10/2020 03:33	09/10/2020 23:50	11/10/2020 03:33	27,72	71	1967,88	CHI
20201040724	ALEXANIA	AX21315426	ALEXANIA	09/10/2020 23:56	10/10/2020 08:48	09/10/2020 23:56	10/10/2020 08:48	8,85	1	8,85	CHI
20201040729	VILA BOA	VB11131746	IACIARA S2	10/10/2020 00:00	10/10/2020 00:54	10/10/2020 00:00	10/10/2020 00:54	0,90	309	277,41	CHI
20201040735	ITAPIRAPUA	IU10407188	MATRINCHA	10/10/2020 00:00	10/10/2020 10:52	10/10/2020 00:00	10/10/2020 03:17	3,28	105	344,49	CHI
20201040735	ITAPIRAPUA	IU10407188	MATRINCHA	10/10/2020 00:00	10/10/2020 10:52	10/10/2020 04:50	10/10/2020 05:02	0,20	105	20,59	CHI
20201040735	ITAPIRAPUA	IU12165453LD	MATRINCHA	10/10/2020 00:00	10/10/2020 10:52	10/10/2020 00:00	10/10/2020 10:23	10,39	105	1090,45	CHI
20201040735	ITAPIRAPUA	IU12165453LD	MATRINCHA	10/10/2020 00:00	10/10/2020 10:52	10/10/2020 00:00	10/10/2020 10:27	10,45	159	1660,98	CHI
20201040735	ITAPIRAPUA	IU12165453LD	MATRINCHA	10/10/2020 00:00	10/10/2020 10:52	10/10/2020 00:00	10/10/2020 10:52	10,86	67	727,51	CHI
20201040734	ACREUNA	00080424	ACREUNA	10/10/2020 00:00	10/10/2020 13:57	10/10/2020 00:00	10/10/2020 01:52	1,87	28	52,26	CHI
20201040734	ACREUNA	EU13074470	ACREUNA	10/10/2020 00:00	10/10/2020 13:57	10/10/2020 00:00	10/10/2020 03:15	3,25	1	3,25	CHI
20201040734	JANDAIA	EU13074470	ACREUNA	10/10/2020 00:00	10/10/2020 13:57	10/10/2020 00:00	10/10/2020 03:15	3,25	2	6,49	CHI
20201040734	PARAUNA	EU13074470	ACREUNA	10/10/2020 00:00	10/10/2020 13:57	10/10/2020 00:00	10/10/2020 03:15	3,25	1	3,25	CHI
20201040734	JANDAIA	EU13074471	ACREUNA	10/10/2020 00:00	10/10/2020 13:57	10/10/2020 00:00	10/10/2020 04:56	4,93	14	68,96	CHI
20201040734	INDIARA	EU13074469	ACREUNA	10/10/2020 00:00	10/10/2020 13:57	10/10/2020 00:00	10/10/2020 13:06	13,10	3	39,29	CHI
20201040734	JANDAIA	EU13074469	ACREUNA	10/10/2020 00:00	10/10/2020 13:57	10/10/2020 00:00	10/10/2020 13:06	13,10	17	222,64	CHI
20201040734	ACREUNA	IY13209766	ACREUNA	10/10/2020 00:00	10/10/2020 13:57	10/10/2020 00:00	10/10/2020 13:34	13,56	7	94,95	CHI
20201040734	INDIARA	IY13209766	ACREUNA	10/10/2020 00:00	10/10/2020 13:57	10/10/2020 00:00	10/10/2020 13:34	13,56	22	298,41	CHI
20201040734	JANDAIA	JD12301620	ACREUNA	10/10/2020 00:00	10/10/2020 13:57	10/10/2020 13:34	10/10/2020 13:57	0,37	14	5,18	CHI
20201040734	INDIARA	JD12301620	ACREUNA	10/10/2020 00:00	10/10/2020 13:57	10/10/2020 13:34	10/10/2020 13:57	0,37	3	1,11	CHI

20201040744	URUACU	640084692	URUACU	10/10/2020 00:13	10/10/2020 10:38	10/10/2020 00:13	10/10/2020 10:38	10,40	1	10,40	CHI
20201040747	RIO VERDE	630059196	RIO VERDE S2	10/10/2020 00:18	10/10/2020 13:23	10/10/2020 00:18	10/10/2020 13:23	13,08	1	13,08	CHI
20201040766	RIO VERDE	RV11213409	RIO VERDE S2	10/10/2020 00:18	10/10/2020 08:14	10/10/2020 00:18	10/10/2020 08:14	7,92	179	1417,83	CHI
20201038991	TURVELANDIA	TD11230954	RIO DOS BOIS	10/10/2020 00:20	11/10/2020 08:15	10/10/2020 00:20	11/10/2020 08:15	31,92	69	2202,25	CHI
20201040751	MINEIROS	1390080927	PARQUE DAS EMAS	10/10/2020 00:20	10/10/2020 08:16	10/10/2020 00:20	10/10/2020 08:16	7,92	1	7,92	CHI
20201040755	EDEIA	EA12160409	VICENTINOPOLIS	10/10/2020 00:24	10/10/2020 08:17	10/10/2020 00:24	10/10/2020 08:17	7,87	21	165,23	CHI
20201040756	SAO LUIZ DO NORTE	SZ12347240	BARRO ALTO	10/10/2020 00:25	10/10/2020 14:45	10/10/2020 00:25	10/10/2020 14:45	14,33	1	14,33	CHI
20201040768	RIO VERDE	RV11045938	CABRIUVA S1	10/10/2020 00:40	10/10/2020 00:44	10/10/2020 00:40	10/10/2020 00:44	0,07	107	7,16	CHI
20201040777	LUZIANIA	LZ11313579	MARAJOARA	10/10/2020 00:55	10/10/2020 02:53	10/10/2020 00:55	10/10/2020 02:53	1,96	8	15,69	CHI
20201040913	MONTES CLAROS DE GOIAS	JR12022269RE	BRITANIA	10/10/2020 00:59	11/10/2020 17:36	10/10/2020 00:59	10/10/2020 11:05	10,08	1	10,08	CHI
20201040913	JUSSARA	JR12022269RE	BRITANIA	10/10/2020 00:59	11/10/2020 17:36	10/10/2020 00:59	10/10/2020 11:05	10,08	5	50,42	CHI
20201040913	JUSSARA	JR12022269RE	BRITANIA	10/10/2020 00:59	11/10/2020 17:36	10/10/2020 00:59	10/10/2020 14:24	13,41	13	174,38	CHI
20201040913	JUSSARA	JR12022269RE	BRITANIA	10/10/2020 00:59	11/10/2020 17:36	10/10/2020 00:59	10/10/2020 15:22	14,37	1	14,37	CHI
20201040913	JUSSARA	JR12022269RE	BRITANIA	10/10/2020 00:59	11/10/2020 17:36	10/10/2020 00:59	10/10/2020 18:00	17,00	11	187,05	CHI
20201040913	MONTES CLAROS DE GOIAS	JR12022269RE	BRITANIA	10/10/2020 00:59	11/10/2020 17:36	10/10/2020 00:59	10/10/2020 19:15	18,25	1	18,25	CHI
20201040913	MONTES CLAROS DE GOIAS	JR12022269RE	BRITANIA	10/10/2020 00:59	11/10/2020 17:36	10/10/2020 00:59	10/10/2020 21:31	20,53	13	266,83	CHI
20201040913	MONTES CLAROS DE GOIAS	JR12022269RE	BRITANIA	10/10/2020 00:59	11/10/2020 17:36	10/10/2020 22:37	11/10/2020 00:56	2,33	14	32,65	CHI
20201040913	JUSSARA	JR12022269RE	BRITANIA	10/10/2020 00:59	11/10/2020 17:36	10/10/2020 22:37	11/10/2020 00:56	2,33	25	58,30	CHI
20201040913	MONTES CLAROS DE GOIAS	JR12022269RE	BRITANIA	10/10/2020 00:59	11/10/2020 17:36	10/10/2020 00:59	11/10/2020 16:55	39,92	5	199,60	CHI
20201040913	MONTES CLAROS DE GOIAS	JR12022269RE	BRITANIA	10/10/2020 00:59	11/10/2020 17:36	10/10/2020 00:59	11/10/2020 17:36	40,62	247	10032,18	CHI
20201040803	SANTA TEREZINHA DE GOIAS	SG11034165	SANTA TEREZINHA	10/10/2020 01:02	10/10/2020 02:47	10/10/2020 01:02	10/10/2020 02:47	1,74	200	348,78	CHI
20201040786	BARRO ALTO	BA21342222	GOIANESIA S1	10/10/2020 01:05	10/10/2020 07:51	10/10/2020 01:05	10/10/2020 07:51	6,75	1	6,75	CHI
20201040816	ANAPOLIS	AN16416865	ANAPOLIS UNIVERSITARIO S2	10/10/2020 01:16	10/10/2020 01:36	10/10/2020 01:17	10/10/2020 01:21	0,07	960	68,00	CHI
20201040816	ANAPOLIS	AN10383720	ANAPOLIS UNIVERSITARIO S2	10/10/2020 01:16	10/10/2020 01:36	10/10/2020 01:16	10/10/2020 01:24	0,15	892	129,84	CHI
20201040816	ANAPOLIS	AN10383720	ANAPOLIS UNIVERSITARIO S2	10/10/2020 01:16	10/10/2020 01:36	10/10/2020 01:16	10/10/2020 01:30	0,24	1525	361,76	CHI
20201040816	ANAPOLIS	AN10383720	ANAPOLIS UNIVERSITARIO S2	10/10/2020 01:16	10/10/2020 01:36	10/10/2020 01:16	10/10/2020 01:36	0,33	1235	412,35	CHI
20201040793	INDIARA	IY11393274	EDEIA	10/10/2020 01:16	10/10/2020 02:31	10/10/2020 01:16	10/10/2020 02:31	1,24	54	66,86	CHI
20201040807	RIO VERDE	RV16407799	RIO VERDE S1	10/10/2020 01:19	10/10/2020 10:35	10/10/2020 01:19	10/10/2020 10:07	8,79	107	940,77	CHI
20201040807	RIO VERDE	RV16407799	RIO VERDE S1	10/10/2020 01:19	10/10/2020 10:35	10/10/2020 01:19	10/10/2020 10:28	9,15	132	1208,20	CHI
20201040807	RIO VERDE	RV16407799	RIO VERDE S1	10/10/2020 01:19	10/10/2020 10:35	10/10/2020 01:19	10/10/2020 10:35	9,26	677	6269,58	CHI
20201040807	RIO VERDE	RT00560213	RIO VERDE S1	10/10/2020 01:19	10/10/2020 10:35	10/10/2020 02:38	10/10/2020 10:35	7,95	1	7,95	CHI
20201040800	ALEXANIA	AX21138024	ALEXANIA	10/10/2020 01:20	10/10/2020 09:20	10/10/2020 01:20	10/10/2020 09:20	7,98	1	7,98	CHI
20201040834	GOIAS	HE12250701	ITAPURANGA	10/10/2020 01:27	10/10/2020 09:02	10/10/2020 01:27	10/10/2020 09:02	7,58	15	113,63	CHI
20201040834	HEITORAI	HE12250701	ITAPURANGA	10/10/2020 01:27	10/10/2020 09:02	10/10/2020 01:27	10/10/2020 09:02	7,58	6	45,45	CHI
20201040813	SANTA HELENA DE GOIAS	SH21301302	SANTA HELENA S1	10/10/2020 01:30	10/10/2020 08:03	10/10/2020 01:30	10/10/2020 08:03	6,54	1	6,54	CHI
20201040814	RIO VERDE	630026737	RIO VERDE S2	10/10/2020 01:31	11/10/2020 18:24	10/10/2020 01:31	11/10/2020 18:24	40,87	1	40,87	CHI
20201040108	BOM JESUS DE GOIAS	BJ12000024LD	BOM JESUS DE GOIAS	10/10/2020 01:38	10/10/2020 11:39	10/10/2020 01:38	10/10/2020 11:39	10,03	2	20,05	CHI
20201040108	ITUMBIARA	BJ12000024LD	BOM JESUS DE GOIAS	10/10/2020 01:38	10/10/2020 11:39	10/10/2020 01:38	10/10/2020 11:39	10,03	67	671,84	CHI
202010401052	CASTELANDIA	DM12000064	RIO DOS BOIS	10/10/2020 01:45	11/10/2020 08:37	10/10/2020 01:45	11/10/2020 08:37	30,86	10	308,60	CHI
202010401052	MAURILANDIA	DM12000064	RIO DOS BOIS	10/10/2020 01:45	11/10/2020 08:37	10/10/2020 01:45	11/10/2020 08:37	30,86	1	30,86	CHI
20201041137	RIO VERDE	RV32191805	SANTA HELENA S1	10/10/2020 01:50	10/10/2020 18:12	10/10/2020 01:50	10/10/2020 18:12	16,37	16	262,00	CHI
20201041137	MAURILANDIA	RV32191805	SANTA HELENA S1	10/10/2020 01:50	10/10/2020 18:12	10/10/2020 01:50	10/10/2020 18:12	16,37	28	458,49	CHI
20201041137	SANTA HELENA DE GOIAS	RV32191805	SANTA HELENA S1	10/10/2020 01:50	10/10/2020 18:12	10/10/2020 01:50	10/10/2020 18:12	16,37	4	65,50	CHI
20201040829	RIO VERDE	630061830	RIO VERDE S2	10/10/2020 01:55	11/10/2020 08:09	10/10/2020 01:55	11/10/2020 08:09	30,22	1	30,22	CHI
20201040832	ANAPOLIS	AN11297757	JUNDIAI S1	10/10/2020 02:08	10/10/2020 04:57	10/10/2020 02:08	10/10/2020 04:57	2,81	50	140,58	CHI
20201041486	JATAI	JT12260304	JATAI S2	10/10/2020 02:25	10/10/2020 09:56	10/10/2020 02:25	10/10/2020 09:56	7,51	37	277,95	CHI
20201040843	CIDADE OCIDENTAL	DH11199633	MARAJOARA	10/10/2020 02:35	10/10/2020 03:42	10/10/2020 02:35	10/10/2020 03:42	1,11	97	107,56	CHI
20201041083	RIO VERDE	RV12000199	RIO VERDE S1	10/10/2020 02:39	12/10/2020 04:20	10/10/2020 02:39	10/10/2020 13:51	11,21	3	33,62	CHI
20201041083	RIO VERDE	RV12000199	RIO VERDE S1	10/10/2020 02:39	12/10/2020 04:20	11/10/2020 17:39	11/10/2020 22:19	4,68	3	14,04	CHI
20201041083	RIO VERDE	RV12000199	RIO VERDE S1	10/10/2020 02:39	12/10/2020 04:20	10/10/2020 02:39	12/10/2020 04:20	49,70	28	1391,55	CHI
20201041083	SANTA HELENA DE GOIAS	RV12000199	RIO VERDE S1	10/10/2020 02:39	12/10/2020 04:20	10/10/2020 02:39	12/10/2020 04:20	49,70	11	546,68	CHI
20201040855	FORMOSA	TL12131760	SAO JOAO D ALIANCA	10/10/2020 02:52	10/10/2020 08:05	10/10/2020 02:52	10/10/2020 08:05	5,21	1	5,21	CHI
20201040855	AGUA FRIA DE GOIAS	TL12131760	SAO JOAO D ALIANCA	10/10/2020 02:52	10/10/2020 08:05	10/10/2020 02:52	10/10/2020 08:05	5,21	7	36,44	CHI
20201040856	MOZARLANDIA	MZ21300437	MOZARLANDIA	10/10/2020 02:54	10/10/2020 10:21	10/10/2020 02:54	10/10/2020 10:21	7,44	2	14,87	CHI
20201040971	ALTO HORIZONTE	AJ11162622	SANTA TEREZINHA	10/10/2020 02:57	10/10/2020 15:27	10/10/2020 02:57	10/10/2020 15:27	12,49	91	1136,34	CHI
20201040860	CAIAPONIA	CP12238236	CAIAPONIA	10/10/2020 03:01	10/10/2020 04:36	10/10/2020 03:01	10/10/2020 04:36	1,58	3	4,73	CHI
20201040861	NOVO GAMA	NJ11169011	PACAEMBU S1	10/10/2020 03:01	10/10/2020 09:07	10/10/2020 03:01	10/10/2020 09:07	6,09	144	877,04	CHI
20201040863	LUZIANIA	LZ11061777	MARAJOARA	10/10/2020 03:03	10/10/2020 04:09	10/10/2020 03:03	10/10/2020 04:09	1,08	26	28,17	CHI

20201040867	SANTA TEREZINHA DE GOIAS	SG11034165	SANTA TEREZINHA	10/10/2020 03:17	10/10/2020 04:13	10/10/2020 03:17	10/10/2020 04:13	0,92	200	184,17	CHI
20201042264	RIO VERDE	RV12109994	CABRIUVA S2	10/10/2020 03:23	11/10/2020 23:38	10/10/2020 03:23	11/10/2020 23:38	44,24	4	176,94	CHI
202010189493	SANTO ANTONIO DA BARRA	BZ12295804	ACREUNA	10/10/2020 03:36	11/10/2020 11:37	10/10/2020 03:36	10/10/2020 05:19	1,71	1	1,71	CHI
202010189493	SANTO ANTONIO DA BARRA	BZ12295804	ACREUNA	10/10/2020 03:36	11/10/2020 11:37	10/10/2020 03:36	10/10/2020 12:37	9,01	6	54,08	CHI
202010189493	SANTA HELENA DE GOIAS	BZ12295804	ACREUNA	10/10/2020 03:36	11/10/2020 11:37	10/10/2020 03:36	10/10/2020 14:44	11,14	5	55,68	CHI
202010189493	RIO VERDE	BZ12295804	ACREUNA	10/10/2020 03:36	11/10/2020 11:37	10/10/2020 03:36	10/10/2020 14:44	11,14	10	111,36	CHI
202010189493	SANTO ANTONIO DA BARRA	BZ12295804	ACREUNA	10/10/2020 03:36	11/10/2020 11:37	10/10/2020 03:36	10/10/2020 14:44	11,14	7	77,95	CHI
202010189493	SANTO ANTONIO DA BARRA	BZ12295804	ACREUNA	10/10/2020 03:36	11/10/2020 11:37	10/10/2020 03:36	11/10/2020 09:48	30,20	30	905,96	CHI
202010189493	RIO VERDE	BZ12295804	ACREUNA	10/10/2020 03:36	11/10/2020 11:37	10/10/2020 03:36	11/10/2020 09:48	30,20	8	241,59	CHI
202010189493	SANTO ANTONIO DA BARRA	BZ12295804	ACREUNA	10/10/2020 03:36	11/10/2020 11:37	10/10/2020 03:36	11/10/2020 11:37	32,03	1	32,03	CHI
202010189493	RIO VERDE	BZ12295804	ACREUNA	10/10/2020 03:36	11/10/2020 11:37	10/10/2020 03:36	11/10/2020 11:37	32,03	7	224,20	CHI
20201040877	MORRINHOS	MR12049675	MORRINHOS	10/10/2020 03:41	10/10/2020 08:22	10/10/2020 03:41	10/10/2020 08:22	4,68	258	1206,44	CHI
20201041842	MORRINHOS	MR11212237	MORRINHOS	10/10/2020 03:41	10/10/2020 10:20	10/10/2020 03:41	10/10/2020 10:20	6,65	83	551,54	CHI
20201040878	QUIRINOPOLIS	QI21301487	QUIRINOPOLIS	10/10/2020 03:41	10/10/2020 13:16	10/10/2020 03:41	10/10/2020 13:16	9,57	4	38,27	CHI
20201040919	ITAJA	IM12148585	CACHOEIRA ALTA	10/10/2020 04:38	10/10/2020 08:11	10/10/2020 04:38	10/10/2020 08:11	3,54	11	38,89	CHI
20201041028	PARAUNA	PU12336680	PARAUNA	10/10/2020 04:43	10/10/2020 08:55	10/10/2020 04:43	10/10/2020 08:55	4,19	41	171,62	CHI
20201041301	VILA PROPICIO	PV12089909	GOIANESIA S1	10/10/2020 04:44	10/10/2020 08:55	10/10/2020 04:44	10/10/2020 08:55	4,17	3	12,51	CHI
20201040897	GOIATUBA	O4580214	BOM JESUS DE GOIAS	10/10/2020 04:49	10/10/2020 09:35	10/10/2020 04:49	10/10/2020 09:35	4,77	132	629,20	CHI
20201040906	ITUMBIARA	CD10407487	CACHOEIRA DOURADA	10/10/2020 04:54	10/10/2020 16:04	10/10/2020 07:05	10/10/2020 07:19	0,24	2	0,47	CHI
20201040906	INACIOLANDIA	CD10407487	CACHOEIRA DOURADA	10/10/2020 04:54	10/10/2020 16:04	10/10/2020 07:05	10/10/2020 07:19	0,24	30	7,08	CHI
20201040906	CACHOEIRA DOURADA	CD10407487	CACHOEIRA DOURADA	10/10/2020 04:54	10/10/2020 16:04	10/10/2020 07:05	10/10/2020 07:19	0,24	5	1,18	CHI
20201040906	INACIOLANDIA	CD12000137	CACHOEIRA DOURADA	10/10/2020 04:54	10/10/2020 16:04	10/10/2020 04:54	10/10/2020 16:04	11,18	18	201,20	CHI
20201040911	MUNDO NOVO DE GOIAS	4240006972	NOVA CRIXAS	10/10/2020 05:18	10/10/2020 08:47	10/10/2020 05:18	10/10/2020 08:47	3,47	1	3,47	CHI
20201040915	CALDAS NOVAS	PJ12263230	CALDAS NOVAS S1	10/10/2020 05:23	10/10/2020 09:04	10/10/2020 05:23	10/10/2020 09:04	3,68	1	3,68	CHI
20201040915	PIRACANJUBA	PJ12263230	CALDAS NOVAS S1	10/10/2020 05:23	10/10/2020 09:04	10/10/2020 05:23	10/10/2020 09:04	3,68	17	62,61	CHI
20201040917	CORUMBAIBA	CI21000531	VILA CORUMBA	10/10/2020 05:24	10/10/2020 08:02	10/10/2020 05:24	10/10/2020 08:02	2,63	1	2,63	CHI
20201040920	ARUANA	AK11183286	ARUANA	10/10/2020 05:27	10/10/2020 07:57	10/10/2020 05:27	10/10/2020 07:57	2,49	80	199,47	CHI
20201040922	CACHOEIRA ALTA	CA21190372	CACHOEIRA ALTA	10/10/2020 05:28	10/10/2020 09:33	10/10/2020 05:28	10/10/2020 09:33	4,08	2	8,16	CHI
20201041006	GOIATUBA	O4580224	BOM JESUS DE GOIAS	10/10/2020 05:29	10/10/2020 09:35	10/10/2020 05:29	10/10/2020 09:35	4,10	28	114,82	CHI
20201040925	SANTA HELENA DE GOIAS	SH12000204	SANTA HELENA S1	10/10/2020 05:29	10/10/2020 12:23	10/10/2020 05:29	10/10/2020 12:23	6,89	2	13,79	CHI
20201040941	CAIAPONIA	CP21346551	CAIAPONIA	10/10/2020 05:41	10/10/2020 07:51	10/10/2020 05:41	10/10/2020 07:51	2,16	1	2,16	CHI
20201040944	CACU	CC12227992	CACHOEIRA ALTA	10/10/2020 05:44	10/10/2020 13:02	10/10/2020 05:44	10/10/2020 13:02	7,30	6	43,78	CHI
20201040947	IVOLANDIA	MO12336568	IPORA	10/10/2020 05:47	10/10/2020 08:10	10/10/2020 05:47	10/10/2020 08:10	2,37	6	14,25	CHI
20201040947	MOIPIORA	MO12336568	IPORA	10/10/2020 05:47	10/10/2020 08:10	10/10/2020 05:47	10/10/2020 08:10	2,37	6	14,25	CHI
20201041463	BOM JESUS DE GOIAS	00230424	BOM JESUS DE GOIAS	10/10/2020 05:50	10/10/2020 09:35	10/10/2020 05:50	10/10/2020 09:35	3,74	22	82,36	CHI
20201041463	ITUMBIARA	00230424	BOM JESUS DE GOIAS	10/10/2020 05:50	10/10/2020 09:35	10/10/2020 05:50	10/10/2020 09:35	3,74	3	11,23	CHI
20201041463	GOIATUBA	00230424	BOM JESUS DE GOIAS	10/10/2020 05:50	10/10/2020 09:35	10/10/2020 05:50	10/10/2020 09:35	3,74	26	97,33	CHI
20201040952	VILA PROPICIO	NP12307145	BARRO ALTO	10/10/2020 05:53	10/10/2020 11:39	10/10/2020 05:53	10/10/2020 11:39	5,76	15	86,40	CHI
20201041557	ITAJA	CC12000104	CACHOEIRA ALTA	10/10/2020 05:55	10/10/2020 14:47	10/10/2020 05:55	10/10/2020 14:47	8,87	4	35,46	CHI
20201041557	ITARUMA	CC12000104	CACHOEIRA ALTA	10/10/2020 05:55	10/10/2020 14:47	10/10/2020 05:55	10/10/2020 14:47	8,87	8	70,92	CHI
20201040999	ITAGUARI	II12300400	ITABERAI S1	10/10/2020 05:55	10/10/2020 08:04	10/10/2020 05:55	10/10/2020 08:04	2,14	24	51,26	CHI
20201040999	ITABERAI	II12300400	ITABERAI S1	10/10/2020 05:55	10/10/2020 08:04	10/10/2020 05:55	10/10/2020 08:04	2,14	20	42,72	CHI
20201040962	ITUMBIARA	CD12097345RE	BOM JESUS DE GOIAS	10/10/2020 05:59	10/10/2020 08:22	10/10/2020 05:59	10/10/2020 08:22	2,38	9	21,44	CHI
20201041793	JATAI	JT12264347	JATAI S1	10/10/2020 06:00	10/10/2020 15:29	10/10/2020 06:00	10/10/2020 15:29	9,48	3	28,45	CHI
20201040969	ITARUMA	IM12303220	CACHOEIRA ALTA	10/10/2020 06:03	10/10/2020 10:37	10/10/2020 06:03	10/10/2020 10:37	4,56	2	9,11	CHI
20201040972	FLORES DE GOIAS	FB12286863	FLORES DE GOIAS	10/10/2020 06:04	10/10/2020 07:46	10/10/2020 06:04	10/10/2020 07:46	1,70	85	144,48	CHI
20201042016	GOUVELANDIA	GB12119878	QUIRINOPOLIS	10/10/2020 06:05	10/10/2020 17:06	10/10/2020 06:05	10/10/2020 17:06	11,00	7	77,02	CHI
20201042016	QUIRINOPOLIS	GB12119878	QUIRINOPOLIS	10/10/2020 06:05	10/10/2020 17:06	10/10/2020 06:05	10/10/2020 17:06	11,00	13	143,04	CHI
20201040874	BALIZA	BH12187387LD	BOM JARDIM	10/10/2020 06:07	10/10/2020 10:20	10/10/2020 06:07	10/10/2020 10:20	4,20	721	3029,00	CHI
20201041456	RIO VERDE	RV12260256	RIO VERDE S1	10/10/2020 06:12	11/10/2020 12:59	10/10/2020 06:12	11/10/2020 12:59	30,78	19	584,86	CHI
20201042135	PARANAIGUARA	QI12306077	QUIRINOPOLIS	10/10/2020 06:14	10/10/2020 15:40	10/10/2020 06:14	10/10/2020 15:40	9,43	3	28,28	CHI
20201042135	QUIRINOPOLIS	QI12306077	QUIRINOPOLIS	10/10/2020 06:14	10/10/2020 15:40	10/10/2020 06:14	10/10/2020 15:40	9,43	20	188,55	CHI
20201041003	GOIANESIA	10007597108	GOIANESIA S2	10/10/2020 06:15	10/10/2020 08:48	10/10/2020 06:15	10/10/2020 08:48	2,54	1	2,54	CHI
20201041004	FORMOSA	VB12262281	ITQUIRA	10/10/2020 06:15	10/10/2020 07:35	10/10/2020 06:15	10/10/2020 07:35	1,32	16	21,13	CHI
202010189442	COLINAS DO SUL	TI12295044RE	MINACU	10/10/2020 06:16	10/10/2020 12:01	10/10/2020 06:16	10/10/2020 12:01	5,76	6	34,54	CHI
202010189442	CAVALCANTE	TI12295044RE	MINACU	10/10/2020 06:16	10/10/2020 12:01	10/10/2020 06:16	10/10/2020 12:01	5,76	22	126,64	CHI
20201042185	QUIRINOPOLIS	QI12000060	QUIRINOPOLIS	10/10/2020 06:19	10/10/2020 14:29	10/10/2020 06:19	10/10/2020 14:29	8,15	7	57,08	CHI
20201041790	RIO VERDE	RV12159300	CABRIUVA S2	10/10/2020 06:20	10/10/2020 15:51	10/10/2020 06:20	10/10/2020 15:51	9,51	11	104,65	CHI

20201041019	DAMIANOPOLIS	DA12060858	IACIARA S2	10/10/2020 06:20	10/10/2020 09:01	10/10/2020 06:20	10/10/2020 09:01	2,68	2	5,35	CHI
20201041022	CATALAO	CT21274688	CATALAO S1	10/10/2020 06:22	10/10/2020 07:45	10/10/2020 06:22	10/10/2020 07:45	1,38	1	1,38	CHI
20201041024	PORTEIRAO	GT12140377	RIO DOS BOIS	10/10/2020 06:22	11/10/2020 18:58	10/10/2020 06:22	11/10/2020 18:58	36,60	3	109,79	CHI
20201041029	SITIO D ABADIA	SI12131972	IACIARA S2	10/10/2020 06:23	10/10/2020 08:21	10/10/2020 06:23	10/10/2020 08:21	1,97	45	88,50	CHI
20201041030	ARAGARCAS	1820014165	ARAGARCAS	10/10/2020 06:23	10/10/2020 11:18	10/10/2020 06:23	10/10/2020 11:18	4,93	1	4,93	CHI
20201041375	RIO VERDE	RV12260699	CABRIUVA S1	10/10/2020 06:25	11/10/2020 21:01	10/10/2020 06:25	10/10/2020 12:18	5,88	2	11,75	CHI
20201041375	RIO VERDE	RV12260699	CABRIUVA S1	10/10/2020 06:25	11/10/2020 21:01	10/10/2020 14:26	10/10/2020 15:20	0,90	2	1,81	CHI
20201041375	RIO VERDE	RV12260699	CABRIUVA S1	10/10/2020 06:25	11/10/2020 21:01	10/10/2020 18:46	10/10/2020 19:49	1,04	2	2,07	CHI
20201041375	RIO VERDE	RV12260699	CABRIUVA S1	10/10/2020 06:25	11/10/2020 21:01	10/10/2020 06:25	11/10/2020 00:36	18,18	14	254,47	CHI
20201041375	RIO VERDE	RV12260699	CABRIUVA S1	10/10/2020 06:25	11/10/2020 21:01	10/10/2020 06:25	11/10/2020 21:01	38,59	3	115,78	CHI
20201041040	CORREGO DO OURO	CO21079912	SAO LUIZ DOS MONTES BELOS	10/10/2020 06:27	10/10/2020 08:49	10/10/2020 06:27	10/10/2020 08:49	2,36	1	2,36	CHI
20201041050	RIO VERDE	RV21048988	ACREUNA	10/10/2020 06:32	10/10/2020 10:33	10/10/2020 06:32	10/10/2020 10:33	4,00	1	4,00	CHI
20201041058	ORIZONA	OZ12000353LD	PIRES DO RIO S1	10/10/2020 06:35	10/10/2020 10:50	10/10/2020 06:35	10/10/2020 10:50	4,25	35	148,75	CHI
20201041060	TURVANIA	1220015109	FIRMINOPOLIS S2	10/10/2020 06:35	10/10/2020 08:34	10/10/2020 06:35	10/10/2020 08:34	1,97	1	1,97	CHI
20201041063	PORTELANDIA	MY12393226	PARQUE DAS EMAS	10/10/2020 06:37	10/10/2020 09:16	10/10/2020 06:37	10/10/2020 09:16	2,65	2	5,29	CHI
20201041063	MINEIROS	MY12393226	PARQUE DAS EMAS	10/10/2020 06:37	10/10/2020 09:16	10/10/2020 06:37	10/10/2020 09:16	2,65	4	10,58	CHI
20201041136	RIO VERDE	RV12260185	CABRIUVA S1	10/10/2020 06:38	13/10/2020 00:47	10/10/2020 06:38	11/10/2020 00:38	18,01	3	54,04	CHI
20201041136	RIO VERDE	RV12260185	CABRIUVA S1	10/10/2020 06:38	13/10/2020 00:47	10/10/2020 06:38	11/10/2020 10:07	27,49	21	577,34	CHI
20201041136	RIO VERDE	RV12260185	CABRIUVA S1	10/10/2020 06:38	13/10/2020 00:47	11/10/2020 10:09	11/10/2020 16:11	6,05	13	78,61	CHI
20201041136	RIO VERDE	RV13219429	CABRIUVA S1	10/10/2020 06:38	13/10/2020 00:47	11/10/2020 10:09	13/10/2020 00:47	38,65	11	425,10	CHI
20201041072	ORIZONA	OZ11231356	PIRES DO RIO S2	10/10/2020 06:39	10/10/2020 07:52	10/10/2020 06:39	10/10/2020 07:52	1,21	91	110,56	CHI
20201041088	CRISTALINA	KR21137501	CRISTALINA S2	10/10/2020 06:44	10/10/2020 08:48	10/10/2020 06:44	10/10/2020 08:48	2,06	1	2,06	CHI
20201041997	JATAI	SX12205192RE	JATAI S1	10/10/2020 06:44	10/10/2020 10:58	10/10/2020 06:44	10/10/2020 10:58	4,22	3	12,65	CHI
20201041997	SERRANOPOLIS	SX12205192RE	JATAI S1	10/10/2020 06:44	10/10/2020 10:58	10/10/2020 06:44	10/10/2020 10:58	4,22	18	75,92	CHI
20201041094	NOVO BRASIL	NB12088246	JUSSARA	10/10/2020 06:47	10/10/2020 11:02	10/10/2020 06:47	10/10/2020 11:02	4,24	3	12,71	CHI
20201041097	RIO VERDE	RV12172877	CABRIUVA S2	10/10/2020 06:48	10/10/2020 15:30	10/10/2020 06:48	10/10/2020 15:30	8,70	12	104,35	CHI
20201041104	RIO VERDE	630102077	RIO VERDE S1	10/10/2020 06:51	11/10/2020 20:55	10/10/2020 06:51	11/10/2020 20:55	38,06	1	38,06	CHI
20201041114	CAMPINORTE	CR12325222	PORANGATU	10/10/2020 06:54	10/10/2020 11:27	10/10/2020 06:54	10/10/2020 11:27	4,55	3	13,64	CHI
20201041117	LEOPOLDO DE BULHOES	LB21273354	DAIA S2	10/10/2020 06:54	10/10/2020 12:42	10/10/2020 06:54	10/10/2020 12:42	5,79	6	34,73	CHI
20201041291	GOUVELANDIA	QI12301482	QUIRINOPOLIS	10/10/2020 06:55	10/10/2020 15:58	10/10/2020 06:55	10/10/2020 15:58	9,05	2	18,11	CHI
20201041124	RIO VERDE	10018864870	RIO VERDE S2	10/10/2020 06:56	11/10/2020 09:48	10/10/2020 06:56	11/10/2020 09:48	26,86	1	26,86	CHI
20201041435	TURVELANDIA	TD12246842	RIO DOS BOIS	10/10/2020 06:56	10/10/2020 21:15	10/10/2020 06:56	10/10/2020 16:21	9,41	4	37,66	CHI
20201041435	TURVELANDIA	TD12023715	RIO DOS BOIS	10/10/2020 06:56	10/10/2020 21:15	10/10/2020 06:56	10/10/2020 21:15	14,31	3	42,92	CHI
20201041127	QUIRINOPOLIS	QI12360849	QUIRINOPOLIS	10/10/2020 06:56	10/10/2020 13:24	10/10/2020 06:56	10/10/2020 13:24	6,45	2	12,91	CHI
20201041131	ANAPOLIS	AN21325308	JUNDIAI S1	10/10/2020 06:58	10/10/2020 08:08	10/10/2020 06:58	10/10/2020 08:08	1,16	1	1,16	CHI
20201041133	CATALAO	CT12078234	CATALAO S2	10/10/2020 06:59	10/10/2020 08:18	10/10/2020 06:59	10/10/2020 08:18	1,31	98	128,82	CHI
20201041472	CACHOEIRA ALTA	QI12189166	CACHOEIRA ALTA	10/10/2020 06:59	10/10/2020 12:36	10/10/2020 06:59	10/10/2020 12:36	5,61	3	16,84	CHI
20201041472	QUIRINOPOLIS	QI12189166	CACHOEIRA ALTA	10/10/2020 06:59	10/10/2020 12:36	10/10/2020 06:59	10/10/2020 12:36	5,61	2	11,23	CHI
20201041142	DISTRITO FEDERAL	FA12322759	ITUIQUIRA	10/10/2020 07:01	10/10/2020 09:26	10/10/2020 07:01	10/10/2020 09:26	2,41	1	2,41	CHI
20201041142	FORMOSA	FA12322759	ITUIQUIRA	10/10/2020 07:01	10/10/2020 09:26	10/10/2020 07:01	10/10/2020 09:26	2,41	12	28,90	CHI
20201041150	SAO DOMINGOS	SD12161805	SAO DOMINGOS	10/10/2020 07:03	10/10/2020 09:09	10/10/2020 07:03	10/10/2020 09:09	2,09	49	102,48	CHI
20201041160	MONTIVIDIU	MV21207097	MONTIVIDIU T	10/10/2020 07:06	11/10/2020 15:44	10/10/2020 07:06	11/10/2020 15:44	32,63	1	32,63	CHI
20201041163	IPORA	730010478	IPORA	10/10/2020 07:07	10/10/2020 12:53	10/10/2020 07:07	10/10/2020 12:53	5,76	1	5,76	CHI
20201041165	NOVA GLORIA	NG12181391	RUBIATABA	10/10/2020 07:08	10/10/2020 08:58	10/10/2020 07:08	10/10/2020 08:58	1,82	21	38,23	CHI
20201041166	MINEIROS	MY11171859	PARQUE DAS EMAS	10/10/2020 07:09	10/10/2020 08:54	10/10/2020 07:09	10/10/2020 08:54	1,74	125	217,64	CHI
20201041171	NOVA CRIXAS	NA21288806	NOVA CRIXAS	10/10/2020 07:10	10/10/2020 16:16	10/10/2020 07:10	10/10/2020 16:16	9,09	1	9,09	CHI
20201041205	SANTA HELENA DE GOIAS	SH12301407	SANTA HELENA S1	10/10/2020 07:11	11/10/2020 17:06	10/10/2020 07:11	10/10/2020 15:57	8,76	7	61,29	CHI
20201041205	RIO VERDE	SH12301407	SANTA HELENA S1	10/10/2020 07:11	11/10/2020 17:06	10/10/2020 07:11	10/10/2020 15:57	8,76	3	26,27	CHI
20201041205	SANTA HELENA DE GOIAS	SH12029299LD	SANTA HELENA S1	10/10/2020 07:11	11/10/2020 17:06	10/10/2020 07:11	11/10/2020 17:06	33,92	3	101,75	CHI
20201041205	SANTA HELENA DE GOIAS	SH12301407	SANTA HELENA S1	10/10/2020 07:11	11/10/2020 17:06	11/10/2020 16:25	11/10/2020 17:06	0,68	7	4,79	CHI
20201041205	RIO VERDE	SH12301407	SANTA HELENA S1	10/10/2020 07:11	11/10/2020 17:06	11/10/2020 16:25	11/10/2020 17:06	0,68	3	2,05	CHI
20201041177	GOIATUBA	GT12190915	GOIATUBA S2	10/10/2020 07:11	10/10/2020 10:49	10/10/2020 07:11	10/10/2020 10:49	3,62	29	104,89	CHI
20201041182	TEREZOPOLIS DE GOIAS	AN21258081	JUNDIAI S1	10/10/2020 07:12	10/10/2020 09:00	10/10/2020 07:12	10/10/2020 09:00	1,79	2	3,58	CHI
20201041185	CACU	1140042820	CACHOEIRA ALTA	10/10/2020 07:12	10/10/2020 11:21	10/10/2020 07:12	10/10/2020 11:21	4,14	1	4,14	CHI
20201041201	ANAPOLIS	AN21007269	DAIA S1	10/10/2020 07:15	10/10/2020 08:16	10/10/2020 07:15	10/10/2020 08:16	1,00	32	32,14	CHI
20201041207	NOVA CRIXAS	NA21065016	NOVA CRIXAS	10/10/2020 07:16	10/10/2020 10:45	10/10/2020 07:16	10/10/2020 10:45	3,48	1	3,48	CHI
20201042076	CACU	CC12235896	CACHOEIRA ALTA	10/10/2020 07:17	10/10/2020 14:53	10/10/2020 07:17	10/10/2020 14:53	7,58	16	121,36	CHI
20201042076	JATAI	CC12235896	CACHOEIRA ALTA	10/10/2020 07:17	10/10/2020 14:53	10/10/2020 07:17	10/10/2020 14:53	7,58	9	68,26	CHI

20201041213	CACHOEIRA DOURADA	CD21028777	CACHOEIRA DOURADA	10/10/2020 07:18	10/10/2020 12:18	10/10/2020 07:18	10/10/2020 12:18	4,99	1	4,99	CHI
20201041215	ITUMBIARA	690250812	PARANAIBA	10/10/2020 07:19	10/10/2020 09:38	10/10/2020 07:19	10/10/2020 09:38	2,31	1	2,31	CHI
20201041216	IVOLANDIA	IV21332048	IPORA	10/10/2020 07:19	10/10/2020 13:39	10/10/2020 07:19	10/10/2020 13:39	6,33	1	6,33	CHI
20201041220	ITAPURANGA	IK12064427	ITAPURANGA	10/10/2020 07:20	10/10/2020 09:41	10/10/2020 07:20	10/10/2020 09:41	2,35	15	35,19	CHI
20201041220	GUARAITA	IK12064427	ITAPURANGA	10/10/2020 07:20	10/10/2020 09:41	10/10/2020 07:20	10/10/2020 09:41	2,35	1	2,35	CHI
20201041230	RIO VERDE	RV12338619	CABRIUVA S2	10/10/2020 07:24	11/10/2020 09:50	10/10/2020 07:24	11/10/2020 09:50	26,43	1	26,43	CHI
20201041237	MUTUNOPOLIS	MU21143701	MARA ROSA	10/10/2020 07:26	10/10/2020 09:53	10/10/2020 07:26	10/10/2020 09:53	2,45	1	2,45	CHI
20201041238	ESTRELA DO NORTE	ET21022152	MARA ROSA	10/10/2020 07:26	10/10/2020 08:37	10/10/2020 07:26	10/10/2020 08:37	1,18	1	1,18	CHI
20201041239	FAZENDA NOVA	NB21238937	JUSSARA	10/10/2020 07:26	10/10/2020 15:56	10/10/2020 07:26	10/10/2020 15:56	8,49	2	16,99	CHI
20201041240	FORMOSA	FA12149075	ITUIQUIRA	10/10/2020 07:26	10/10/2020 09:49	10/10/2020 07:26	10/10/2020 09:49	2,37	5	11,87	CHI
20201041241	RIO VERDE	7114827	CABRIUVA S2	10/10/2020 07:26	10/10/2020 18:23	10/10/2020 07:26	10/10/2020 18:23	10,94	2	21,88	CHI
20201041243	RIO VERDE	RV12260693	CABRIUVA S1	10/10/2020 07:26	10/10/2020 19:21	10/10/2020 07:26	10/10/2020 19:21	11,90	1	11,90	CHI
20201041245	CORUMBAIBA	CI21311808	VILA CORUMBA	10/10/2020 07:27	10/10/2020 11:56	10/10/2020 07:27	10/10/2020 11:56	4,48	2	8,96	CHI
20201041246	ALEXANIA	AX11114210	ALEXANIA	10/10/2020 07:27	10/10/2020 10:09	10/10/2020 07:27	10/10/2020 10:09	2,70	66	177,87	CHI
20201041250	ITUMBIARA	IT21134600	PARANAIBA	10/10/2020 07:28	10/10/2020 11:45	10/10/2020 07:28	10/10/2020 11:41	4,21	1	4,21	CHI
20201041250	ITUMBIARA	IT21304285	PARANAIBA	10/10/2020 07:28	10/10/2020 11:45	10/10/2020 07:28	10/10/2020 11:45	4,28	1	4,28	CHI
20201041263	ARUANA	AK12157845	MOZARLANDIA	10/10/2020 07:30	10/10/2020 10:46	10/10/2020 07:30	10/10/2020 10:46	3,27	62	202,43	CHI
20201044450	ITAJA	IJ12066512	CACHOEIRA ALTA	10/10/2020 07:31	11/10/2020 16:39	10/10/2020 07:31	11/10/2020 16:39	33,13	2	66,25	CHI
20201041262	DIVINOPOLIS DE GOIAS	GH12256132	SAO DOMINGOS	10/10/2020 07:31	10/10/2020 10:43	10/10/2020 07:31	10/10/2020 10:43	3,19	19	60,63	CHI
20201041264	LEOPOLDO DE BULHOES	LB21011655	DAIA S2	10/10/2020 07:31	10/10/2020 09:25	10/10/2020 07:31	10/10/2020 09:25	1,89	1	1,89	CHI
20201041265	ANAPOLIS	AN12000598	ANAPOLIS UNIVERSITARIO S2	10/10/2020 07:31	10/10/2020 10:01	10/10/2020 07:31	10/10/2020 10:01	2,49	10	24,89	CHI
20201041270	BONOPOLIS	BX21146570	SAO MIGUEL DO ARAGUAIA	10/10/2020 07:31	10/10/2020 08:39	10/10/2020 07:31	10/10/2020 08:39	1,12	1	1,12	CHI
20201041275	SAO JOAO D ALIANCA	JL12268121	SAO JOAO D ALIANCA	10/10/2020 07:32	10/10/2020 09:57	10/10/2020 07:32	10/10/2020 09:57	2,41	7	16,84	CHI
20201041246	MONTES CLAROS DE GOIAS	ME12050933	IPORA	10/10/2020 07:33	10/10/2020 11:15	10/10/2020 07:33	10/10/2020 11:15	3,69	7	25,80	CHI
20201041283	AMARALINA	LC12286013	NOVA CRIXAS	10/10/2020 07:35	10/10/2020 11:52	10/10/2020 07:35	10/10/2020 11:52	4,27	9	38,47	CHI
20201041283	MARA ROSA	LC12286013	NOVA CRIXAS	10/10/2020 07:35	10/10/2020 11:52	10/10/2020 07:35	10/10/2020 11:52	4,27	1	4,27	CHI
20201041284	VILA PROPICIO	NP21235921	GOIANESIA S1	10/10/2020 07:35	10/10/2020 12:08	10/10/2020 07:35	10/10/2020 12:08	4,54	1	4,54	CHI
20201041292	SANTA FE DE GOIAS	RN12324624	BRITANIA	10/10/2020 07:37	10/10/2020 18:35	10/10/2020 07:37	10/10/2020 18:35	10,96	4	43,85	CHI
20201041735	ITARUMA	IM12018052	CACHOEIRA ALTA	10/10/2020 07:37	10/10/2020 16:51	10/10/2020 07:37	10/10/2020 16:51	9,22	7	64,53	CHI
2020101000044	ARUANA	03200434	ARUANA	10/10/2020 07:38	10/10/2020 07:45	10/10/2020 07:38	10/10/2020 07:45	0,12	8	0,93	CHI
20201041300	CAMPO ALEGRE DE GOIAS	IP132291335	PIRES DO RIO S2	10/10/2020 07:38	10/10/2020 11:48	10/10/2020 07:38	10/10/2020 11:48	4,18	19	79,34	CHI
20201041300	IPAMERI	IP132291335	PIRES DO RIO S2	10/10/2020 07:38	10/10/2020 11:48	10/10/2020 07:38	10/10/2020 11:48	4,18	115	480,19	CHI
20201041307	FORMOSA	FA21115745	ITUIQUIRA	10/10/2020 07:39	10/10/2020 09:20	10/10/2020 07:39	10/10/2020 09:20	1,67	1	1,67	CHI
202010189421	NIQUELANDIA	10009796124	NIQUELANDIA SUBTRANSMISSAO	10/10/2020 07:40	10/10/2020 09:49	10/10/2020 07:40	10/10/2020 09:49	2,15	1	2,15	CHI
20201041309	JATAI	290328469	JATAI S2	10/10/2020 07:40	10/10/2020 11:29	10/10/2020 07:40	10/10/2020 11:29	3,80	1	3,80	CHI
20201041312	ITUMBIARA	IT11352615	ITUMBIARA NOVA	10/10/2020 07:41	10/10/2020 20:48	10/10/2020 07:41	10/10/2020 20:48	13,11	119	1560,42	CHI
20201041317	NOVA AURORA	NE12143243	CATALAO S1	10/10/2020 07:42	10/10/2020 10:36	10/10/2020 07:42	10/10/2020 10:36	2,90	5	14,50	CHI
202010189420	NIQUELANDIA	10010222519	NIQUELANDIA SUBTRANSMISSAO	10/10/2020 07:43	10/10/2020 09:49	10/10/2020 07:43	10/10/2020 09:49	2,10	1	2,10	CHI
20201041324	VILA PROPICIO	NP21235925	GOIANESIA S2	10/10/2020 07:43	10/10/2020 10:48	10/10/2020 07:43	10/10/2020 10:48	3,08	1	3,08	CHI
20201041328	CORUMBAIBA	IP21167958	IPAMERI	10/10/2020 07:44	10/10/2020 12:42	10/10/2020 07:44	10/10/2020 12:42	4,96	1	4,96	CHI
20201041334	CRISTALINA	KR12307562	CRISTALINA S1	10/10/2020 07:45	10/10/2020 10:25	10/10/2020 07:45	10/10/2020 10:25	2,66	13	34,58	CHI
20201041338	PARAUNA	PU21152649	PARAUNA	10/10/2020 07:46	10/10/2020 11:10	10/10/2020 07:46	10/10/2020 11:10	3,40	1	3,40	CHI
20201041345	RIO VERDE	RV12111052	CABRIUVA S2	10/10/2020 07:46	10/10/2020 17:20	10/10/2020 07:46	10/10/2020 17:20	9,55	5	47,77	CHI
20201041341	RIO VERDE	RV21074488	CABRIUVA S1	10/10/2020 07:46	11/10/2020 11:15	10/10/2020 07:46	11/10/2020 11:15	27,48	1	27,48	CHI
20201041342	PARAUNA	CG12391526	FIRMINOPOLIS S2	10/10/2020 07:47	10/10/2020 16:05	10/10/2020 07:47	10/10/2020 13:07	5,33	3	16,00	CHI
20201041342	AURILANDIA	CG12391526	FIRMINOPOLIS S2	10/10/2020 07:47	10/10/2020 16:05	10/10/2020 07:47	10/10/2020 13:07	5,33	2	10,66	CHI
20201041342	CACHOEIRA DE GOIAS	CG12391526	FIRMINOPOLIS S2	10/10/2020 07:47	10/10/2020 16:05	10/10/2020 07:47	10/10/2020 13:07	5,33	5	26,66	CHI
20201041342	PARAUNA	CG12391526	FIRMINOPOLIS S2	10/10/2020 07:47	10/10/2020 16:05	10/10/2020 07:47	10/10/2020 13:58	6,18	17	105,14	CHI
20201041342	CACHOEIRA DE GOIAS	CG12391526	FIRMINOPOLIS S2	10/10/2020 07:47	10/10/2020 16:05	10/10/2020 07:47	10/10/2020 13:58	6,18	6	37,11	CHI
20201041342	PARAUNA	CG12391526	FIRMINOPOLIS S2	10/10/2020 07:47	10/10/2020 16:05	10/10/2020 07:47	10/10/2020 16:05	8,30	12	99,57	CHI
20201041351	NOVO PLANALTO	TA12020765	NOVO PLANALTO	10/10/2020 07:49	10/10/2020 09:44	10/10/2020 07:49	10/10/2020 09:44	1,91	1	1,91	CHI
20201041356	PONTALINA	PK21098700	PONTALINA	10/10/2020 07:50	10/10/2020 08:47	10/10/2020 07:50	10/10/2020 08:47	0,94	1	0,94	CHI
20201041359	MINEIROS	MY21324478	PARQUE DAS EMAS	10/10/2020 07:50	10/10/2020 09:37	10/10/2020 07:50	10/10/2020 09:37	1,77	1	1,77	CHI
20201041360	MARA ROSA	MQ21285994	SANTA TEREZINHA	10/10/2020 07:50	10/10/2020 14:12	10/10/2020 07:50	10/10/2020 14:12	6,35	1	6,35	CHI
20201043693	INDIARA	IY21114114	EDEIA	10/10/2020 07:51	10/10/2020 16:18	10/10/2020 07:51	10/10/2020 16:18	8,45	2	16,90	CHI
20201041365	AGUA FRIA DE GOIAS	TL21211516	SAO JOAO D ALIANCA	10/10/2020 07:51	10/10/2020 10:15	10/10/2020 07:51	10/10/2020 10:15	2,38	1	2,38	CHI
20201041371	ITARUMA	IM21345988	CACHOEIRA ALTA	10/10/2020 07:53	11/10/2020 08:49	10/10/2020 07:53	11/10/2020 08:49	24,93	1	24,93	CHI
20201041378	ITUMBIARA	CD21222294	BOM JESUS DE GOIAS	10/10/2020 07:54	10/10/2020 17:16	10/10/2020 07:54	10/10/2020 17:16	9,36	1	9,36	CHI

20201041383	ITARUMA	IJ12321778RE	CACHOEIRA ALTA	10/10/2020 07:55	10/10/2020 17:50	10/10/2020 07:55	10/10/2020 17:50	9,91	27	267,51	CHI
20201041383	ITAJA	IJ12321778RE	CACHOEIRA ALTA	10/10/2020 07:55	10/10/2020 17:50	10/10/2020 07:55	10/10/2020 17:50	9,91	8	79,26	CHI
20201041384	ANAPOLIS	AN11000449	ANAPOLIS UNIVERSITARIO S2	10/10/2020 07:55	10/10/2020 09:02	10/10/2020 07:55	10/10/2020 09:02	1,11	39	43,12	CHI
20201042425	RIO VERDE	RV12355126	RIO VERDE S1	10/10/2020 07:56	11/10/2020 14:29	10/10/2020 07:56	11/10/2020 14:29	30,54	3	91,62	CHI
20201041393	PADRE BERNARDO	PB11277796	PADRE BERNARDO	10/10/2020 07:57	10/10/2020 10:03	10/10/2020 07:57	10/10/2020 10:03	2,10	52	108,97	CHI
20201041395	ANICUNS	AC21278616	FIRMINOPOLIS S2	10/10/2020 07:57	10/10/2020 09:53	10/10/2020 07:57	10/10/2020 09:53	1,93	1	1,93	CHI
20201041402	DOVERLANDIA	DV11227886	CAIAPONIA	10/10/2020 07:59	10/10/2020 10:07	10/10/2020 07:59	10/10/2020 10:07	2,12	1	2,12	CHI
20201041404	INDIARA	IY21000001	EDEIA	10/10/2020 07:59	10/10/2020 16:01	10/10/2020 07:59	10/10/2020 16:01	8,02	1	8,02	CHI
20201041409	ITUMBIARA	IT12310019	PARANAIBA	10/10/2020 08:00	10/10/2020 08:59	10/10/2020 08:00	10/10/2020 08:59	0,97	3	2,90	CHI
20201041411	ADELANDIA	DN11018614	FIRMINOPOLIS S2	10/10/2020 08:01	10/10/2020 08:45	10/10/2020 08:01	10/10/2020 08:45	0,72	125	90,00	CHI
20201041413	ARAGUAPAZ	AZ12017422	MOZARLANDIA	10/10/2020 08:01	10/10/2020 13:30	10/10/2020 08:01	10/10/2020 13:30	5,47	4	21,87	CHI
20201041424	PONTALINA	PK12063358	PONTALINA	10/10/2020 08:03	10/10/2020 09:44	10/10/2020 08:03	10/10/2020 09:44	1,68	6	10,06	CHI
20201041428	JATAI	JT12384009	JATAI S1	10/10/2020 08:04	10/10/2020 14:00	10/10/2020 08:04	10/10/2020 14:00	5,93	1	5,93	CHI
20201041428	JATAI	JT12384009	JATAI S1	10/10/2020 08:04	10/10/2020 14:00	10/10/2020 13:14	10/10/2020 14:00	0,77	1	0,77	CHI
20201041430	CALDAS NOVAS	CN11213984	SERRA DE CALDAS	10/10/2020 08:05	10/10/2020 08:51	10/10/2020 08:05	10/10/2020 08:51	0,76	101	76,93	CHI
20201041433	COCALZINHO DE GOIAS	CN12290411	COCALZINHO	10/10/2020 08:05	10/10/2020 12:30	10/10/2020 08:05	10/10/2020 12:30	4,41	5	22,04	CHI
20201041440	AMORINOPOLIS	AM21284841	IPORA	10/10/2020 08:07	10/10/2020 10:20	10/10/2020 08:07	10/10/2020 10:20	2,22	2	4,43	CHI
20201041441	SANTA HELENA DE GOIAS	SH21000196	IPEGUARI	10/10/2020 08:07	10/10/2020 10:48	10/10/2020 08:07	10/10/2020 10:48	2,68	1	2,68	CHI
20201041443	IVOLANDIA	AM21244918	IPORA	10/10/2020 08:08	10/10/2020 12:54	10/10/2020 08:08	10/10/2020 12:54	4,77	1	4,77	CHI
20201041455	SANTA HELENA DE GOIAS	SH21350873	SANTA HELENA S1	10/10/2020 08:10	10/10/2020 09:38	10/10/2020 08:10	10/10/2020 09:38	1,45	1	1,45	CHI
20201041460	ITUMBIARA	IY21305525	BOM JESUS DE GOIAS	10/10/2020 08:11	10/10/2020 12:09	10/10/2020 08:11	10/10/2020 12:09	3,96	1	3,96	CHI
20201041942	MAURILANDIA	ML11054039	RIO DOS BOIS	10/10/2020 08:12	10/10/2020 10:59	10/10/2020 08:12	10/10/2020 10:59	2,77	67	185,85	CHI
20201041467	SAO JOAO D ALIANCA	JL11238303	ITUQUIRA	10/10/2020 08:12	10/10/2020 11:34	10/10/2020 08:12	10/10/2020 11:34	3,35	1	3,35	CHI
20201041642	RIO VERDE	RV12296245	CABRIUVA S1	10/10/2020 08:13	11/10/2020 16:31	10/10/2020 08:13	11/10/2020 16:31	32,30	10	323,00	CHI
20201041523	ITUMBIARA	IT12309906	CACHOEIRA DOURADA	10/10/2020 08:13	10/10/2020 12:04	10/10/2020 08:13	10/10/2020 12:04	3,84	4	15,38	CHI
20201041479	JATAI	JT21105247	JATAI S1	10/10/2020 08:16	10/10/2020 12:05	10/10/2020 08:16	10/10/2020 12:05	3,81	1	3,81	CHI
20201041497	JATAI	JT12338599	JATAI S1	10/10/2020 08:17	10/10/2020 10:12	10/10/2020 08:17	10/10/2020 10:12	1,91	2	3,82	CHI
20201041484	GOIATUBA	GT32052921	GOIATUBA S2	10/10/2020 08:17	10/10/2020 13:06	10/10/2020 08:17	10/10/2020 13:06	4,80	2	9,61	CHI
20201041492	NAZARIO	NZ12003900	ANICUNS	10/10/2020 08:18	10/10/2020 11:58	10/10/2020 08:18	10/10/2020 11:25	3,12	12	37,46	CHI
20201041492	NAZARIO	NZ12003900	ANICUNS	10/10/2020 08:18	10/10/2020 11:58	10/10/2020 11:27	10/10/2020 11:58	0,51	12	6,11	CHI
20201041495	JATAI	JT12260447LD	JATAI S1	10/10/2020 08:18	12/10/2020 16:39	10/10/2020 08:18	11/10/2020 02:05	17,79	3	53,36	CHI
20201041495	JATAI	JT12260447LD	JATAI S1	10/10/2020 08:18	12/10/2020 16:39	10/10/2020 12:40	11/10/2020 02:05	13,43	49	658,06	CHI
20201041495	JATAI	JT13401132B	JATAI S1	10/10/2020 08:18	12/10/2020 16:39	11/10/2020 01:34	11/10/2020 04:47	3,22	18	57,91	CHI
20201041495	SERRANOPOLIS	JT13264279	JATAI S1	10/10/2020 08:18	12/10/2020 16:39	11/10/2020 01:34	11/10/2020 13:04	11,51	1	11,51	CHI
20201041495	JATAI	JT13264279	JATAI S1	10/10/2020 08:18	12/10/2020 16:39	11/10/2020 01:34	11/10/2020 13:04	11,51	19	218,66	CHI
20201041495	SERRANOPOLIS	JT13274084	JATAI S1	10/10/2020 08:18	12/10/2020 16:39	11/10/2020 01:34	11/10/2020 14:39	13,09	18	235,67	CHI
20201041495	JATAI	JT13274084	JATAI S1	10/10/2020 08:18	12/10/2020 16:39	11/10/2020 01:34	11/10/2020 14:39	13,09	14	183,30	CHI
20201041495	JATAI	JT12260447LD	JATAI S1	10/10/2020 08:18	12/10/2020 16:39	12/10/2020 06:01	12/10/2020 13:22	7,36	27	198,68	CHI
20201041495	JATAI	JT12260447LD	JATAI S1	10/10/2020 08:18	12/10/2020 16:39	12/10/2020 06:01	12/10/2020 13:22	7,36	52	382,65	CHI
20201041495	JATAI	JT13241743	JATAI S1	10/10/2020 08:18	12/10/2020 16:39	12/10/2020 12:20	12/10/2020 15:43	3,39	27	91,62	CHI
20201041495	SERRANOPOLIS	JT13241743	JATAI S1	10/10/2020 08:18	12/10/2020 16:39	12/10/2020 12:20	12/10/2020 15:43	3,39	20	67,87	CHI
20201041495	JATAI	JT12324906	JATAI S1	10/10/2020 08:18	12/10/2020 16:39	12/10/2020 16:23	12/10/2020 16:31	0,14	7	0,99	CHI
20201041495	SERRANOPOLIS	SX13337015	JATAI S1	10/10/2020 08:18	12/10/2020 16:39	11/10/2020 01:34	12/10/2020 16:39	39,08	13	508,07	CHI
20201041496	BURITI ALEGRE	BG21102573	ITUMBIARA VELHA S2	10/10/2020 08:18	10/10/2020 16:10	10/10/2020 08:18	10/10/2020 16:10	7,86	1	7,86	CHI
20201041583	ANAPOLIS	O2370249	JUNDIAI S1	10/10/2020 08:20	10/10/2020 08:27	10/10/2020 08:20	10/10/2020 08:23	0,06	2573	162,96	CHI
20201041583	ANAPOLIS	AN10383757	JUNDIAI S1	10/10/2020 08:20	10/10/2020 08:27	10/10/2020 08:20	10/10/2020 08:27	0,13	3360	429,33	CHI
20201041614	MONTIVIDIU	MV12305995	MONTIVIDIU T	10/10/2020 08:20	10/10/2020 23:46	10/10/2020 08:20	10/10/2020 23:46	15,43	28	432,16	CHI
20201041614	IVOLANDIA	MV12305995	MONTIVIDIU T	10/10/2020 08:20	10/10/2020 23:46	10/10/2020 08:20	10/10/2020 23:46	15,43	29	447,59	CHI
20201041614	PARAUNA	MV12305995	MONTIVIDIU T	10/10/2020 08:20	10/10/2020 23:46	10/10/2020 08:20	10/10/2020 23:46	15,43	61	941,48	CHI
20201041614	CAIAPONIA	MV12305995	MONTIVIDIU T	10/10/2020 08:20	10/10/2020 23:46	10/10/2020 08:20	10/10/2020 23:46	15,43	38	586,50	CHI
20201041510	AGUA FRIA DE GOIAS	TL21242866	SAO JOAO D ALIANCA	10/10/2020 08:20	10/10/2020 09:42	10/10/2020 08:20	10/10/2020 09:42	1,36	2	2,71	CHI
20201041516	CATALAO	10012307546	CATALAO S2	10/10/2020 08:21	10/10/2020 09:32	10/10/2020 08:21	10/10/2020 09:32	1,18	1	1,18	CHI
20201041634	CALDAS NOVAS	CN12391593RE	SERRA DE CALDAS	10/10/2020 08:22	10/10/2020 09:59	10/10/2020 08:22	10/10/2020 09:59	1,61	170	274,27	CHI
20201041530	CATALAO	10030046368	CATALAO S2	10/10/2020 08:24	10/10/2020 10:26	10/10/2020 08:24	10/10/2020 10:26	2,02	1	2,02	CHI
20201041535	CRISTALINA	1060036128	CRISTALINA S1	10/10/2020 08:25	10/10/2020 11:37	10/10/2020 08:25	10/10/2020 11:37	3,19	1	3,19	CHI
20201041538	ALEXANIA	AX21000005	ALEXANIA	10/10/2020 08:26	10/10/2020 11:19	10/10/2020 08:26	10/10/2020 11:19	2,88	1	2,88	CHI
20201041540	AGUA FRIA DE GOIAS	TL21169881	SAO JOAO D ALIANCA	10/10/2020 08:26	10/10/2020 10:05	10/10/2020 08:26	10/10/2020 10:05	1,65	2	3,29	CHI
20201041542	ITARUMA	IM12296701	CACHOEIRA ALTA	10/10/2020 08:26	10/10/2020 14:24	10/10/2020 08:26	10/10/2020 14:24	5,96	3	17,88	CHI

20201042318	BOM JARDIM DE GOIAS	BM12208862	BOM JARDIM	10/10/2020 08:26	10/10/2020 14:48	10/10/2020 08:26	10/10/2020 14:48	6,35	33	209,66	CHI
20201041552	CAMPINACU	UC21310266	PORANGATU	10/10/2020 08:27	10/10/2020 09:47	10/10/2020 08:27	10/10/2020 09:47	1,32	1	1,32	CHI
20201041558	RIO VERDE	RV12000004	RIO VERDE S2	10/10/2020 08:28	10/10/2020 16:10	10/10/2020 08:28	10/10/2020 16:10	7,69	4	30,75	CHI
20201041562	CRISTALINA	KR12290773	CRISTALINA S2	10/10/2020 08:29	10/10/2020 10:13	10/10/2020 08:29	10/10/2020 10:13	1,73	5	8,65	CHI
20201041562	LUZIANIA	KR12290773	CRISTALINA S2	10/10/2020 08:29	10/10/2020 10:13	10/10/2020 08:29	10/10/2020 10:13	1,73	3	5,19	CHI
20201041566	VILA BOA	FA12065577	ITUIQUIRA	10/10/2020 08:29	10/10/2020 10:48	10/10/2020 08:29	10/10/2020 10:48	2,31	2	4,61	CHI
20201041567	ESTRELA DO NORTE	ET21181733	MARA ROSA	10/10/2020 08:29	10/10/2020 10:46	10/10/2020 08:29	10/10/2020 10:46	2,27	1	2,27	CHI
20201041610	IPORA	IR11014381	IPORA	10/10/2020 08:30	10/10/2020 10:05	10/10/2020 08:30	10/10/2020 10:05	1,58	113	178,45	CHI
20201042342	RIO VERDE	RV11000162	RIO VERDE S2	10/10/2020 08:31	10/10/2020 14:39	10/10/2020 08:31	10/10/2020 14:39	6,12	133	814,33	CHI
20201041592	BALIZA	BH11331046	CAIAPONIA	10/10/2020 08:31	10/10/2020 11:48	10/10/2020 08:31	10/10/2020 11:48	3,27	1	3,27	CHI
20201041595	QUIRINOPOLIS	80020239	QUIRINOPOLIS	10/10/2020 08:33	10/10/2020 09:10	10/10/2020 08:33	10/10/2020 09:10	0,62	1	0,62	CHI
20201041598	COCALZINHO DE GOIAS	ZN12295667	COCALZINHO	10/10/2020 08:33	11/10/2020 20:50	10/10/2020 08:33	11/10/2020 20:50	36,28	4	145,13	CHI
20201041598	COCALZINHO DE GOIAS	ZN12295667	COCALZINHO	10/10/2020 08:33	11/10/2020 20:50	11/10/2020 18:31	11/10/2020 20:50	2,30	9	20,73	CHI
20201041618	JATAI	290230159	JATAI S3	10/10/2020 08:38	10/10/2020 11:11	10/10/2020 08:38	10/10/2020 11:11	2,55	1	2,55	CHI
20201041620	LUZIANIA	120052702	RIO VERMELHO	10/10/2020 08:38	10/10/2020 09:40	10/10/2020 08:38	10/10/2020 09:40	1,03	1	1,03	CHI
20201041621	RIO VERDE	10004046658	RIO VERDE S1	10/10/2020 08:38	11/10/2020 10:11	10/10/2020 08:38	11/10/2020 10:11	25,54	1	25,54	CHI
20201041649	QUIRINOPOLIS	QI21370296	QUIRINOPOLIS	10/10/2020 08:42	10/10/2020 11:23	10/10/2020 08:42	10/10/2020 11:23	2,69	1	2,69	CHI
20201041651	SANTA HELENA DE GOIAS	SH12038288	RIO DOS BOIS	10/10/2020 08:42	10/10/2020 11:48	10/10/2020 08:42	10/10/2020 11:48	3,09	1	3,09	CHI
20201041280	AMERICANO DO BRASIL	7285665	ANICUNS	10/10/2020 08:42	10/10/2020 10:34	10/10/2020 08:42	10/10/2020 10:34	1,86	2	3,72	CHI
20201041280	ANICUNS	7285665	ANICUNS	10/10/2020 08:42	10/10/2020 10:34	10/10/2020 08:42	10/10/2020 10:34	1,86	1	1,86	CHI
20201041764	LEOPOLDO DE BULHOES	LB12032455	DAIA S2	10/10/2020 08:43	10/10/2020 14:13	10/10/2020 08:43	10/10/2020 10:27	1,73	41	70,91	CHI
20201041764	LEOPOLDO DE BULHOES	LB12032455	DAIA S2	10/10/2020 08:43	10/10/2020 14:13	10/10/2020 10:30	10/10/2020 11:43	1,22	41	50,09	CHI
20201041764	LEOPOLDO DE BULHOES	LB12032455	DAIA S2	10/10/2020 08:43	10/10/2020 14:13	10/10/2020 11:53	10/10/2020 12:17	0,39	41	15,79	CHI
20201041764	LEOPOLDO DE BULHOES	LB12032455	DAIA S2	10/10/2020 08:43	10/10/2020 14:13	10/10/2020 12:45	10/10/2020 14:13	1,47	41	60,13	CHI
20201042449	PARANAIGUARA	PC12193841	QUIRINOPOLIS	10/10/2020 08:44	10/10/2020 23:23	10/10/2020 08:44	10/10/2020 23:23	14,64	7	102,48	CHI
20201041888	MONTIVIDIU DO NORTE	MX12248220	PORANGATU	10/10/2020 08:45	10/10/2020 12:40	10/10/2020 08:45	10/10/2020 12:40	3,92	10	39,17	CHI
20201041676	ARAGARCAS	AG11212886	ARAGARCAS	10/10/2020 08:46	10/10/2020 12:16	10/10/2020 08:46	10/10/2020 12:16	3,49	75	261,52	CHI
20201041678	GOIANESIA	GE12255877	GOIANESIA S2	10/10/2020 08:47	10/10/2020 11:08	10/10/2020 08:47	10/10/2020 11:08	2,34	1	2,34	CHI
20201041692	NOVO GAMA	NJ11165078	MARAJOARA	10/10/2020 08:50	10/10/2020 11:13	10/10/2020 08:50	10/10/2020 11:13	2,37	18	42,61	CHI
20201041695	CIDADE OCIDENTAL	2680043243	MARAJOARA	10/10/2020 08:51	10/10/2020 10:02	10/10/2020 08:51	10/10/2020 10:02	1,18	1	1,18	CHI
20201041704	COLINAS DO SUL	TI10401551	MINACU	10/10/2020 08:51	11/10/2020 19:46	10/10/2020 08:51	10/10/2020 11:06	2,25	42	94,49	CHI
20201041704	CAVALCANTE	TI10401551	MINACU	10/10/2020 08:51	11/10/2020 19:46	10/10/2020 08:51	10/10/2020 11:06	2,25	303	681,67	CHI
20201041704	CAVALCANTE	TI10401551	MINACU	10/10/2020 08:51	11/10/2020 19:46	10/10/2020 08:51	10/10/2020 12:01	3,17	46	145,63	CHI
20201041704	URUACU	TI10401551	MINACU	10/10/2020 08:51	11/10/2020 19:46	10/10/2020 08:51	10/10/2020 12:01	3,17	1	3,17	CHI
20201041704	NIQUELANDIA	TI10401551	MINACU	10/10/2020 08:51	11/10/2020 19:46	10/10/2020 08:51	10/10/2020 12:01	3,17	1	3,17	CHI
20201041704	COLINAS DO SUL	TI10401551	MINACU	10/10/2020 08:51	11/10/2020 19:46	10/10/2020 08:51	10/10/2020 12:01	3,17	236	747,14	CHI
20201041704	COLINAS DO SUL	TI13340351	MINACU	10/10/2020 08:51	11/10/2020 19:46	10/10/2020 08:53	10/10/2020 12:01	3,13	1	3,13	CHI
20201041704	COLINAS DO SUL	TI12295044RE	MINACU	10/10/2020 08:51	11/10/2020 19:46	10/10/2020 12:19	10/10/2020 12:35	0,27	6	1,64	CHI
20201041704	CAVALCANTE	TI12295044RE	MINACU	10/10/2020 08:51	11/10/2020 19:46	10/10/2020 12:19	10/10/2020 12:35	0,27	21	5,75	CHI
20201041704	CAVALCANTE	TI10401551	MINACU	10/10/2020 08:51	11/10/2020 19:46	10/10/2020 08:51	10/10/2020 12:51	4,00	8	31,98	CHI
20201041704	CAVALCANTE	TI10401551	MINACU	10/10/2020 08:51	11/10/2020 19:46	10/10/2020 12:53	10/10/2020 13:57	1,07	303	323,20	CHI
20201041704	COLINAS DO SUL	TI10401551	MINACU	10/10/2020 08:51	11/10/2020 19:46	10/10/2020 12:53	10/10/2020 13:57	1,07	42	44,80	CHI
20201041704	URUACU	TI13340351	MINACU	10/10/2020 08:51	11/10/2020 19:46	10/10/2020 12:53	11/10/2020 08:43	19,83	1	19,83	CHI
20201041704	COLINAS DO SUL	TI13340351	MINACU	10/10/2020 08:51	11/10/2020 19:46	10/10/2020 12:53	11/10/2020 08:43	19,83	179	3549,87	CHI
20201041704	NIQUELANDIA	TI13340351	MINACU	10/10/2020 08:51	11/10/2020 19:46	10/10/2020 12:53	11/10/2020 08:43	19,83	1	19,83	CHI
20201041704	CAVALCANTE	20104017	MINACU	10/10/2020 08:51	11/10/2020 19:46	10/10/2020 12:53	11/10/2020 10:36	21,71	66	1433,17	CHI
20201041704	COLINAS DO SUL	20104017	MINACU	10/10/2020 08:51	11/10/2020 19:46	10/10/2020 12:53	11/10/2020 10:36	21,71	53	1150,88	CHI
20201041704	URUACU	TI10401551	MINACU	10/10/2020 08:51	11/10/2020 19:46	11/10/2020 13:34	11/10/2020 13:38	0,07	1	0,07	CHI
20201041704	COLINAS DO SUL	TI10401551	MINACU	10/10/2020 08:51	11/10/2020 19:46	11/10/2020 13:34	11/10/2020 13:38	0,07	242	17,01	CHI
20201041704	NIQUELANDIA	TI10401551	MINACU	10/10/2020 08:51	11/10/2020 19:46	11/10/2020 13:34	11/10/2020 13:38	0,07	1	0,07	CHI
20201041704	CAVALCANTE	TI10401551	MINACU	10/10/2020 08:51	11/10/2020 19:46	11/10/2020 13:34	11/10/2020 13:38	0,07	350	24,60	CHI
20201041704	COLINAS DO SUL	TI10401551	MINACU	10/10/2020 08:51	11/10/2020 19:46	10/10/2020 08:51	11/10/2020 16:12	31,35	65	2037,68	CHI
20201041704	COLINAS DO SUL	TI13221610	MINACU	10/10/2020 08:51	11/10/2020 19:46	10/10/2020 08:53	11/10/2020 16:12	31,31	2	62,62	CHI
20201041704	CAVALCANTE	TI10401551	MINACU	10/10/2020 08:51	11/10/2020 19:46	11/10/2020 13:34	11/10/2020 19:39	6,09	8	48,75	CHI
20201041704	CAVALCANTE	TI10401551	MINACU	10/10/2020 08:51	11/10/2020 19:46	11/10/2020 19:31	11/10/2020 19:39	0,14	303	42,59	CHI
20201041704	COLINAS DO SUL	TI10401551	MINACU	10/10/2020 08:51	11/10/2020 19:46	11/10/2020 19:31	11/10/2020 19:39	0,14	34	4,78	CHI
20201041704	COLINAS DO SUL	TI10401551	MINACU	10/10/2020 08:51	11/10/2020 19:46	10/10/2020 08:51	11/10/2020 19:46	34,91	90	3142,33	CHI
20201041704	CAVALCANTE	TI10401551	MINACU	10/10/2020 08:51	11/10/2020 19:46	11/10/2020 13:34	11/10/2020 19:46	6,21	21	130,38	CHI

20201041704	COLINAS DO SUL	TI10401551	MINACU	10/10/2020 08:51	11/10/2020 19:46	11/10/2020 13:34	11/10/2020 19:46	6,21	43	266,97	CHI
20201041704	NIQUELANDIA	TI10401551	MINACU	10/10/2020 08:51	11/10/2020 19:46	11/10/2020 19:31	11/10/2020 19:46	0,26	1	0,26	CHI
20201041704	CAVALCANTE	TI10401551	MINACU	10/10/2020 08:51	11/10/2020 19:46	11/10/2020 19:31	11/10/2020 19:46	0,26	47	11,99	CHI
20201041704	COLINAS DO SUL	TI10401551	MINACU	10/10/2020 08:51	11/10/2020 19:46	11/10/2020 19:31	11/10/2020 19:46	0,26	275	70,13	CHI
20201041704	URUACU	TI10401551	MINACU	10/10/2020 08:51	11/10/2020 19:46	11/10/2020 19:31	11/10/2020 19:46	0,26	1	0,26	CHI
20201041698	NIQUELANDIA	NQ11048783	NIQUELANDIA SUBTRANSMISSAO	10/10/2020 08:52	10/10/2020 21:30	10/10/2020 08:52	10/10/2020 21:30	12,63	128	1617,03	CHI
20201041699	CATALAO	IP12234083	IPAMERI	10/10/2020 08:52	10/10/2020 11:00	10/10/2020 08:52	10/10/2020 11:00	2,13	2	4,26	CHI
20201041700	IPAMERI	IP21080274	CAMPO ALEGRE DE GOIAS	10/10/2020 08:52	10/10/2020 15:01	10/10/2020 08:52	10/10/2020 15:01	6,14	1	6,14	CHI
20201041705	CRISTALINA	1750001837	CRISTALINA S2	10/10/2020 08:53	10/10/2020 13:22	10/10/2020 08:53	10/10/2020 13:22	4,50	1	4,50	CHI
20201041499	ARUANA	2380019715	ARUANA	10/10/2020 08:53	10/10/2020 17:19	10/10/2020 08:53	10/10/2020 17:19	8,43	1	8,43	CHI
20201041712	MARA ROSA	MQ21220764	SANTA TEREZINHA	10/10/2020 08:54	10/10/2020 11:52	10/10/2020 08:54	10/10/2020 11:52	2,96	1	2,96	CHI
20201041720	PIRENOPOLIS	PV21171449	CORUMBA	10/10/2020 08:56	10/10/2020 11:50	10/10/2020 08:56	10/10/2020 11:50	2,89	3	8,68	CHI
20201041724	QUIRINOPOLIS	80040500	QUIRINOPOLIS	10/10/2020 08:57	10/10/2020 11:47	10/10/2020 08:57	10/10/2020 11:47	2,84	1	2,84	CHI
20201041728	DOVERLANDIA	DV12171957	CAIAPONIA	10/10/2020 08:57	10/10/2020 10:43	10/10/2020 08:57	10/10/2020 10:43	1,75	24	42,05	CHI
20201041729	QUIRINOPOLIS	QI12053191LD	QUIRINOPOLIS	10/10/2020 08:58	10/10/2020 14:55	10/10/2020 08:58	10/10/2020 14:55	5,95	2	11,89	CHI
20201041732	RIO VERDE	630289323	RIO VERDE S1	10/10/2020 08:59	11/10/2020 17:20	10/10/2020 08:59	11/10/2020 17:20	32,34	1	32,34	CHI
20201041746	SANTA HELENA DE GOIAS	400073663	IPEGUARI	10/10/2020 09:02	12/10/2020 00:07	10/10/2020 09:02	12/10/2020 00:07	39,08	1	39,08	CHI
20201041749	ANAPOLIS	20502552	JUNDIAI S1	10/10/2020 09:02	10/10/2020 10:04	10/10/2020 09:02	10/10/2020 10:04	1,02	1	1,02	CHI
20201041759	URUACU	640049758	URUACU	10/10/2020 09:04	10/10/2020 11:44	10/10/2020 09:04	10/10/2020 11:44	2,66	1	2,66	CHI
20201041766	DAMIANOPOLIS	1520000616	IACIARA S2	10/10/2020 09:05	10/10/2020 10:42	10/10/2020 09:05	10/10/2020 10:42	1,61	1	1,61	CHI
20201041768	CATALAO	CT21266243	CATALAO S1	10/10/2020 09:05	10/10/2020 11:31	10/10/2020 09:05	10/10/2020 11:31	2,42	1	2,42	CHI
20201042214	PARAUNA	PU12273594	PARAUNA	10/10/2020 09:05	10/10/2020 19:26	10/10/2020 09:05	10/10/2020 19:26	10,34	9	93,03	CHI
20201041770	ANAPOLIS	20259037	ANAPOLIS UNIVERSITARIO S2	10/10/2020 09:06	10/10/2020 11:32	10/10/2020 09:06	10/10/2020 11:32	2,43	1	2,43	CHI
20201043029	CACU	CC12191736	CACHOEIRA ALTA	10/10/2020 09:06	10/10/2020 21:37	10/10/2020 09:06	10/10/2020 21:37	12,50	6	75,02	CHI
20201041774	SANTO ANTONIO DA BARRA	2270005151	ACREUNA	10/10/2020 09:06	10/10/2020 14:01	10/10/2020 09:06	10/10/2020 14:01	4,90	1	4,90	CHI
20201041779	ITABERAI	50018905	ITABERAI S2	10/10/2020 09:08	10/10/2020 12:49	10/10/2020 09:08	10/10/2020 12:49	3,68	1	3,68	CHI
20201041960	RIO VERDE	RV11402234	RIO VERDE S2	10/10/2020 09:08	10/10/2020 16:49	10/10/2020 09:08	10/10/2020 16:49	7,67	85	651,95	CHI
20201041788	JUSSARA	JR12114079	BRITANIA	10/10/2020 09:10	10/10/2020 21:44	10/10/2020 09:10	10/10/2020 21:44	12,55	4	50,21	CHI
20201041791	ANAPOLIS	AN12054439	ANAPOLIS UNIVERSITARIO S2	10/10/2020 09:11	10/10/2020 10:39	10/10/2020 09:11	10/10/2020 10:39	1,46	1	1,46	CHI
20201041801	QUIRINOPOLIS	QI12226698	SANTA HELENA S1	10/10/2020 09:11	10/10/2020 11:30	10/10/2020 09:11	10/10/2020 11:30	2,30	6	13,83	CHI
20201041797	PORTEIRAO	CL12213422	RIO DOS BOIS	10/10/2020 09:12	11/10/2020 11:29	10/10/2020 09:12	11/10/2020 11:29	26,27	1	26,27	CHI
20201041804	JATAI	JT21202647	JATAI S1	10/10/2020 09:14	10/10/2020 10:24	10/10/2020 09:14	10/10/2020 10:24	1,16	1	1,16	CHI
20201041806	CACHOEIRA ALTA	PC12389640	CACHOEIRA ALTA	10/10/2020 09:15	10/10/2020 13:29	10/10/2020 09:15	10/10/2020 13:29	4,23	3	12,70	CHI
20201041806	PARANAIGUARA	PC12389640	CACHOEIRA ALTA	10/10/2020 09:15	10/10/2020 13:29	10/10/2020 09:15	10/10/2020 13:29	4,23	22	93,10	CHI
20201041808	MONTE ALEGRE DE GOIAS	MA21235997	SAO DOMINGOS	10/10/2020 09:15	10/10/2020 12:48	10/10/2020 09:15	10/10/2020 12:48	3,55	1	3,55	CHI
20201041826	MINACU	IH10403949	MINACU	10/10/2020 09:15	10/10/2020 09:23	10/10/2020 09:15	10/10/2020 09:23	0,13	3383	436,03	CHI
20201041818	URUACU	UR21291074	URUACU	10/10/2020 09:17	10/10/2020 10:35	10/10/2020 09:17	10/10/2020 10:35	1,29	6	7,76	CHI
20201041825	GOIAS	GS21124376	ITAPURANGA	10/10/2020 09:20	10/10/2020 12:04	10/10/2020 09:20	10/10/2020 12:04	2,74	1	2,74	CHI
20201044281	QUIRINOPOLIS	QI12203939	CACHOEIRA ALTA	10/10/2020 09:21	11/10/2020 00:48	10/10/2020 09:21	11/10/2020 00:48	15,45	5	77,24	CHI
20201041831	RIO VERDE	RV12327004	RIO VERDE S2	10/10/2020 09:21	11/10/2020 18:26	10/10/2020 09:21	11/10/2020 18:26	33,08	3	99,24	CHI
20201041847	BOM JARDIM DE GOIAS	BM21333256	BOM JARDIM	10/10/2020 09:24	10/10/2020 14:48	10/10/2020 09:24	10/10/2020 14:48	5,39	1	5,39	CHI
20201041849	NOVA AURORA	NE21157514	CATALAO S1	10/10/2020 09:25	10/10/2020 14:22	10/10/2020 09:25	10/10/2020 14:22	4,95	1	4,95	CHI
20201041858	RIO VERDE	RV21370293	MONTIVIDIU T	10/10/2020 09:27	10/10/2020 23:43	10/10/2020 09:27	10/10/2020 23:43	14,26	1	14,26	CHI
20201041870	CRIXAS	CX21252252	RUBIATABA	10/10/2020 09:31	10/10/2020 13:00	10/10/2020 09:31	10/10/2020 13:00	3,48	1	3,48	CHI
20201041875	PALMEIRAS DE GOIAS	CZ21011078	CEZARINA	10/10/2020 09:31	10/10/2020 16:26	10/10/2020 09:31	10/10/2020 16:26	6,90	1	6,90	CHI
20201041881	ANAPOLIS	20268737	ANAPOLIS UNIVERSITARIO S1	10/10/2020 09:33	10/10/2020 10:35	10/10/2020 09:33	10/10/2020 10:35	1,02	1	1,02	CHI
20201041886	PORANGATU	PO12262596	PORANGATU	10/10/2020 09:34	10/10/2020 11:09	10/10/2020 09:34	10/10/2020 11:09	1,57	38	59,81	CHI
20201041890	CAVALCANTE	CJ11384707	SAO DOMINGOS	10/10/2020 09:35	10/10/2020 13:04	10/10/2020 09:35	10/10/2020 13:04	3,48	1	3,48	CHI
20201041899	EDEIA	EA12160385	VICENTINOPOLIS	10/10/2020 09:36	10/10/2020 11:27	10/10/2020 09:36	10/10/2020 11:27	1,85	11	20,30	CHI
20201041900	ANAPOLIS	21376311	ANAPOLIS UNIVERSITARIO S2	10/10/2020 09:36	10/10/2020 13:19	10/10/2020 09:36	10/10/2020 13:19	3,71	1	3,71	CHI
20201041904	JUSSARA	JR12011813	BRITANIA	10/10/2020 09:38	10/10/2020 23:03	10/10/2020 09:38	10/10/2020 23:03	13,42	12	160,99	CHI
20201040977	RIO VERDE	04860416	QUIRINOPOLIS	10/10/2020 09:40	10/10/2020 16:51	10/10/2020 09:40	10/10/2020 16:51	7,19	94	675,76	CHI
20201040977	RIO VERDE	04860416	QUIRINOPOLIS	10/10/2020 09:40	10/10/2020 16:51	10/10/2020 09:40	10/10/2020 16:51	7,19	43	309,12	CHI
20201040977	QUIRINOPOLIS	04860416	QUIRINOPOLIS	10/10/2020 09:40	10/10/2020 16:51	10/10/2020 09:40	10/10/2020 16:51	7,19	83	596,68	CHI
20201040977	QUIRINOPOLIS	04860416	QUIRINOPOLIS	10/10/2020 09:40	10/10/2020 16:51	10/10/2020 09:40	10/10/2020 16:51	7,19	283	2034,46	CHI
20201040977	CACHOEIRA ALTA	04860416	QUIRINOPOLIS	10/10/2020 09:40	10/10/2020 16:51	10/10/2020 09:40	10/10/2020 16:51	7,19	34	244,42	CHI
20201041914	PLANALTINA	10026587805	PLANALTINA	10/10/2020 09:40	10/10/2020 11:22	10/10/2020 09:40	10/10/2020 11:22	1,69	1	1,69	CHI
20201041917	ITUMBIARA	IT21304209	ITUMBIARA NOVA	10/10/2020 09:41	10/10/2020 12:50	10/10/2020 09:41	10/10/2020 12:50	3,14	1	3,14	CHI

20201041927	MORRINHOS	MR21363998	MORRINHOS	10/10/2020 09:44	10/10/2020 12:37	10/10/2020 09:44	10/10/2020 12:37	2,88	1	2,88	CHI
20201042018	ANICUNS	AC18000072TS	ANICUNS	10/10/2020 09:44	10/10/2020 11:52	10/10/2020 09:44	10/10/2020 11:52	2,13	63	134,08	CHI
20201041933	FORMOSA	10015044465	ITUIQUIRA	10/10/2020 09:44	10/10/2020 09:57	10/10/2020 09:44	10/10/2020 09:57	0,20	1	0,20	CHI
20201041932	IPAMERI	IP12376252	CRISTALINA S2	10/10/2020 09:44	10/10/2020 11:12	10/10/2020 09:44	10/10/2020 11:12	1,45	20	29,09	CHI
20201041936	PARAUNA	RP21008163	FIRMINOPOLIS S2	10/10/2020 09:45	10/10/2020 11:46	10/10/2020 09:45	10/10/2020 11:46	2,01	1	2,01	CHI
20201041943	MINACU	IH12088797	MINACU	10/10/2020 09:47	10/10/2020 11:41	10/10/2020 09:47	10/10/2020 11:41	1,89	163	308,61	CHI
20201042263	GOIAS	GS12237058	ITAPURANGA	10/10/2020 09:49	10/10/2020 12:59	10/10/2020 09:49	10/10/2020 12:59	3,16	2	6,33	CHI
20201041961	NIQUELANDIA	NQ10374709	NIQUELANDIA SUBTRANSMISSAO	10/10/2020 09:49	10/10/2020 23:32	10/10/2020 09:49	10/10/2020 23:32	2,74	314	861,23	CHI
20201041961	NIQUELANDIA	NQ10374709	NIQUELANDIA SUBTRANSMISSAO	10/10/2020 09:49	10/10/2020 23:32	10/10/2020 09:49	10/10/2020 16:36	6,79	270	1834,13	CHI
20201041961	NIQUELANDIA	NQ10374709	NIQUELANDIA SUBTRANSMISSAO	10/10/2020 09:49	10/10/2020 23:32	10/10/2020 09:49	10/10/2020 23:32	13,72	213	2921,95	CHI
20201041952	PIRACANJUBA	PJ21094364	CALDAS NOVAS S1	10/10/2020 09:50	10/10/2020 10:53	10/10/2020 09:50	10/10/2020 10:53	1,04	1	1,04	CHI
202010189215	MINACU	IH11262531	MINACU	10/10/2020 09:50	10/10/2020 10:57	10/10/2020 09:50	10/10/2020 10:57	1,11	69	76,93	CHI
20201041958	VILA PROPICIO	PV21087275	GOIANESIA S1	10/10/2020 09:51	10/10/2020 12:35	10/10/2020 09:51	10/10/2020 12:35	2,73	1	2,73	CHI
20201045074	MINEIROS	MY12193783	PARQUE DAS EMAS	10/10/2020 09:53	10/10/2020 22:57	10/10/2020 09:53	10/10/2020 22:57	13,05	2	26,11	CHI
20201041968	AVELINOPOLIS	AC12391412	ANICUNS	10/10/2020 09:55	10/10/2020 14:33	10/10/2020 09:55	10/10/2020 14:33	4,63	1	4,63	CHI
20201041968	ANICUNS	AC12391412	ANICUNS	10/10/2020 09:55	10/10/2020 14:33	10/10/2020 09:55	10/10/2020 14:33	4,63	28	129,62	CHI
20201041971	LUZIANIA	LZ12074642	RIO VERMELHO	10/10/2020 09:55	10/10/2020 11:20	10/10/2020 09:55	10/10/2020 11:20	1,41	7	9,85	CHI
20201042109	CATALAO	CT12061098	CATALAO S1	10/10/2020 09:58	10/10/2020 12:54	10/10/2020 09:58	10/10/2020 12:54	2,93	6	17,60	CHI
20201042109	GOIANDIRA	CT12061098	CATALAO S1	10/10/2020 09:58	10/10/2020 12:54	10/10/2020 09:58	10/10/2020 12:54	2,93	10	29,33	CHI
20201041985	MUTUNOPOLIS	MU21000006	MARA ROSA	10/10/2020 09:58	10/10/2020 11:20	10/10/2020 09:58	10/10/2020 11:20	1,35	1	1,35	CHI
2020101000008	ITUMBIARA	00230444	BOM JESUS DE GOIAS	10/10/2020 10:01	10/10/2020 10:07	10/10/2020 10:01	10/10/2020 10:07	0,10	4	0,40	CHI
20201042039	RIO VERDE	RV11025923	RIO VERDE S1	10/10/2020 10:01	10/10/2020 13:36	10/10/2020 10:01	10/10/2020 13:36	3,58	116	415,41	CHI
20201042115	BOM JESUS DE GOIAS	BJ12000149RE	BOM JESUS DE GOIAS	10/10/2020 10:01	10/10/2020 12:17	10/10/2020 10:01	10/10/2020 12:17	2,25	18	40,57	CHI
20201042001	SAO JOAO D ALIANCA	10022310515	SAO JOAO D ALIANCA	10/10/2020 10:02	10/10/2020 10:38	10/10/2020 10:02	10/10/2020 10:38	0,59	1	0,59	CHI
20201042006	NOVA CRIXAS	NA21349235	NOVA CRIXAS	10/10/2020 10:06	10/10/2020 15:45	10/10/2020 10:06	10/10/2020 15:45	5,65	1	5,65	CHI
20201042008	ALVORADA DO NORTE	10000748720	IACIARA S2	10/10/2020 10:06	10/10/2020 12:10	10/10/2020 10:06	10/10/2020 12:10	2,06	1	2,06	CHI
20201042020	ANAPOLIS	20114989	JUNDAIAI S2	10/10/2020 10:10	10/10/2020 12:50	10/10/2020 10:10	10/10/2020 12:50	2,66	1	2,66	CHI
20201042021	VILA PROPICIO	BA12248765	BARRO ALTO	10/10/2020 10:10	10/10/2020 11:39	10/10/2020 10:10	10/10/2020 11:39	1,47	8	11,78	CHI
20201042022	FIRMINOPOLIS	2940001437	FIRMINOPOLIS S1	10/10/2020 10:11	10/10/2020 19:28	10/10/2020 10:11	10/10/2020 19:28	9,29	1	9,29	CHI
20201042173	CATALAO	CT12266143	CATALAO S1	10/10/2020 10:12	10/10/2020 12:10	10/10/2020 10:12	10/10/2020 12:10	1,96	3	5,89	CHI
20201042032	PIRANHAS	PH12247811	PIRANHAS	10/10/2020 10:13	10/10/2020 16:05	10/10/2020 10:13	10/10/2020 16:05	5,86	3	17,59	CHI
20201042036	ITARUMA	IJ21248360	ITAJA S2	10/10/2020 10:13	10/10/2020 16:19	10/10/2020 10:13	10/10/2020 16:19	6,08	1	6,08	CHI
20201042042	CACHOEIRA ALTA	CA21182119	CACHOEIRA ALTA	10/10/2020 10:16	10/10/2020 21:16	10/10/2020 10:16	10/10/2020 20:58	10,69	1	10,69	CHI
20201042042	CACHOEIRA ALTA	CA21337584	CACHOEIRA ALTA	10/10/2020 10:16	10/10/2020 21:16	10/10/2020 10:16	10/10/2020 21:16	11,00	1	11,00	CHI
20201042048	TURVELANDIA	TD21303730	RIO DOS BOIS	10/10/2020 10:17	11/10/2020 11:56	10/10/2020 10:17	11/10/2020 11:56	25,64	1	25,64	CHI
20201042051	MONTIVIDIU	MV12200186	MONTIVIDIU T	10/10/2020 10:18	10/10/2020 19:16	10/10/2020 10:18	10/10/2020 19:16	8,96	14	125,49	CHI
20201042051	CAIAPONIA	MV12200186	MONTIVIDIU T	10/10/2020 10:18	10/10/2020 19:16	10/10/2020 10:18	10/10/2020 19:16	8,96	6	53,78	CHI
20201042058	RIO VERDE	RV11228270	MONTIVIDIU T	10/10/2020 10:19	11/10/2020 09:19	10/10/2020 10:19	11/10/2020 09:19	23,00	1	23,00	CHI
20201042060	SAO JOAO D ALIANCA	3840011289	SAO JOAO D ALIANCA	10/10/2020 10:19	10/10/2020 11:46	10/10/2020 10:19	10/10/2020 11:46	1,44	1	1,44	CHI
20201042066	SANTA HELENA DE GOIAS	400128767	IPEGUARI	10/10/2020 10:20	10/10/2020 17:28	10/10/2020 10:20	10/10/2020 17:28	7,13	1	7,13	CHI
20201042070	SAO JOAO D ALIANCA	3840016846	SAO JOAO D ALIANCA	10/10/2020 10:21	10/10/2020 11:53	10/10/2020 10:21	10/10/2020 11:53	1,52	1	1,52	CHI
20201042071	SAO MIGUEL DO ARAGUAIA	SM12128351	SAO MIGUEL DO ARAGUAIA	10/10/2020 10:22	10/10/2020 12:19	10/10/2020 10:22	10/10/2020 12:19	1,94	20	38,74	CHI
20201042078	FLORES DE GOIAS	FB12344120	FLORES DE GOIAS	10/10/2020 10:25	10/10/2020 17:10	10/10/2020 10:25	10/10/2020 17:10	6,74	1	6,74	CHI
20201042082	CACU	CC21293987	CACHOEIRA ALTA	10/10/2020 10:29	10/10/2020 14:05	10/10/2020 10:29	10/10/2020 14:05	3,59	1	3,59	CHI
20201042087	PORANGATU	PO12136349	NOVO PLANALTO	10/10/2020 10:30	10/10/2020 15:43	10/10/2020 10:30	10/10/2020 15:43	5,21	23	119,81	CHI
20201042095	MINACU	4020034711	MINACU	10/10/2020 10:31	11/10/2020 11:30	10/10/2020 10:31	11/10/2020 11:30	24,97	0	0,00	CHI
20201042097	CALDAS NOVAS	760142774	SERRA DE CALDAS	10/10/2020 10:32	10/10/2020 12:12	10/10/2020 10:32	10/10/2020 12:12	1,66	1	1,66	CHI
20201042100	IACIARA	IA21046252	IACIARA S2	10/10/2020 10:33	10/10/2020 14:34	10/10/2020 10:33	10/10/2020 14:34	4,01	1	4,01	CHI
20201042111	ANAPOLIS	10012145970	ANAPOLIS UNIVERSITARIO S2	10/10/2020 10:36	10/10/2020 11:57	10/10/2020 10:36	10/10/2020 11:57	1,34	1	1,34	CHI
20201042112	ORIZONA	OZ21114915	PIRES DO RIO S2	10/10/2020 10:36	10/10/2020 12:04	10/10/2020 10:36	10/10/2020 12:04	1,45	1	1,45	CHI
20201042113	JATAI	JT21374221	JATAI S1	10/10/2020 10:36	10/10/2020 15:34	10/10/2020 10:36	10/10/2020 15:34	4,95	1	4,95	CHI
20201042334	MINACU	IH12334428	MINACU	10/10/2020 10:38	10/10/2020 20:19	10/10/2020 10:38	10/10/2020 13:29	2,85	84	239,31	CHI
20201042334	MINACU	IH12334428	MINACU	10/10/2020 10:38	10/10/2020 20:19	10/10/2020 10:38	10/10/2020 20:19	9,70	103	998,67	CHI
20201042119	CACHOEIRA ALTA	CA21196168	CACHOEIRA ALTA	10/10/2020 10:38	10/10/2020 11:58	10/10/2020 10:38	10/10/2020 11:58	1,32	1	1,32	CHI
20201042121	SANTA TEREZA DE GOIAS	SE12053814	MARA ROSA	10/10/2020 10:39	10/10/2020 11:51	10/10/2020 10:39	10/10/2020 11:51	1,19	4	4,76	CHI
20201042121	ESTRELA DO NORTE	SE12053814	MARA ROSA	10/10/2020 10:39	10/10/2020 11:51	10/10/2020 10:39	10/10/2020 11:51	1,19	3	3,57	CHI
20201042126	SAO MIGUEL DO ARAGUAIA	SM12064251	SAO MIGUEL DO ARAGUAIA	10/10/2020 10:40	10/10/2020 15:01	10/10/2020 10:40	10/10/2020 15:01	4,35	77	334,97	CHI
20201042493	QUIRINOPOLIS	QI12240330	QUIRINOPOLIS	10/10/2020 10:41	10/10/2020 14:32	10/10/2020 10:41	10/10/2020 14:32	3,84	261	1002,02	CHI

20201042252	RIO VERDE	RV11295088	RIO VERDE S1	10/10/2020 10:44	10/10/2020 12:42	10/10/2020 10:44	10/10/2020 12:42	1,96	106	207,67	CHI
20201042143	SANTA TEREZA DE GOIAS	SE12390458	MARA ROSA	10/10/2020 10:47	10/10/2020 15:14	10/10/2020 10:47	10/10/2020 15:14	4,45	11	48,91	CHI
20201042593	BOM JESUS DE GOIAS	BJ12352647LD	BOM JESUS DE GOIAS	10/10/2020 10:47	10/10/2020 14:05	10/10/2020 10:47	10/10/2020 14:05	3,29	3	9,86	CHI
20201042155	EDEIA	10020280155	EDEIA	10/10/2020 10:49	10/10/2020 12:32	10/10/2020 10:49	10/10/2020 12:32	1,72	1	1,72	CHI
20201042658	MINACU	IH12375476	MINACU	10/10/2020 10:51	10/10/2020 14:18	10/10/2020 10:51	10/10/2020 14:18	3,44	49	168,67	CHI
20201044071	SAO MIGUEL DO ARAGUAIA	SM12000068	SAO MIGUEL DO ARAGUAIA	10/10/2020 10:53	11/10/2020 20:47	10/10/2020 10:53	11/10/2020 20:47	33,90	2	67,79	CHI
20201042176	NOVO PLANALTO	TA12354463	NOVO PLANALTO	10/10/2020 10:54	10/10/2020 12:16	10/10/2020 10:54	10/10/2020 12:16	1,35	6	8,10	CHI
20201042241	MINEIROS	MY12045367RE	PARQUE DAS EMAS	10/10/2020 10:55	11/10/2020 00:37	10/10/2020 10:55	10/10/2020 16:15	5,33	13	69,32	CHI
20201042241	MINEIROS	MY12045367RE	PARQUE DAS EMAS	10/10/2020 10:55	11/10/2020 00:37	10/10/2020 10:55	10/10/2020 23:33	12,63	8	101,00	CHI
20201042241	MINEIROS	MY12045367RE	PARQUE DAS EMAS	10/10/2020 10:55	11/10/2020 00:37	10/10/2020 10:55	11/10/2020 00:37	13,70	5	68,50	CHI
20201042184	ALEXANIA	7850002440	ALEXANIA	10/10/2020 10:57	10/10/2020 12:53	10/10/2020 10:57	10/10/2020 12:53	1,93	1	1,93	CHI
20201042187	RIO VERDE	RV21260621	RIO VERDE S2	10/10/2020 10:57	10/10/2020 17:07	10/10/2020 10:57	10/10/2020 17:07	6,16	1	6,16	CHI
20201042188	MINACU	IH16401678	MINACU	10/10/2020 10:57	10/10/2020 20:19	10/10/2020 10:57	10/10/2020 15:50	0,07	2280	169,73	CHI
20201042188	MINACU	IH16401678	MINACU	10/10/2020 10:57	10/10/2020 20:19	10/10/2020 10:57	10/10/2020 20:19	9,37	171	1602,41	CHI
20201042188	MINACU	IH16401678	MINACU	10/10/2020 10:57	10/10/2020 20:19	10/10/2020 15:50	10/10/2020 20:19	4,49	142	637,62	CHI
20201042188	MINACU	IH16401678	MINACU	10/10/2020 10:57	10/10/2020 20:19	10/10/2020 19:55	10/10/2020 20:19	0,40	2443	984,66	CHI
20201042191	RIO VERDE	RV21172879	CABRIUVA S1	10/10/2020 10:58	10/10/2020 23:39	10/10/2020 10:58	10/10/2020 23:39	12,68	1	12,68	CHI
20201042194	ANAPOLIS	20634341	JUNDIAI S1	10/10/2020 10:59	10/10/2020 12:52	10/10/2020 10:59	10/10/2020 12:52	1,87	1	1,87	CHI
20201042195	NOVA CRIXAS	8570037316	NOVA CRIXAS	10/10/2020 10:59	10/10/2020 11:47	10/10/2020 10:59	10/10/2020 11:47	0,79	1	0,79	CHI
20201042201	PARAUNA	PU21336681	PARAUNA	10/10/2020 11:01	10/10/2020 17:11	10/10/2020 11:01	10/10/2020 17:11	6,16	1	6,16	CHI
20201042206	MINACU	4020026982	MINACU	10/10/2020 11:01	11/10/2020 12:20	10/10/2020 11:01	11/10/2020 12:20	25,30	1	25,30	CHI
20201042207	EDEALINA	1130000518	PONTALINA	10/10/2020 11:02	10/10/2020 12:55	10/10/2020 11:02	10/10/2020 12:55	1,88	1	1,88	CHI
20201042210	MUTUNOPOLIS	MU21246502	MARA ROSA	10/10/2020 11:02	10/10/2020 13:05	10/10/2020 11:02	10/10/2020 13:05	2,04	1	2,04	CHI
20201042215	HIDROLINA	HL11000006	URUACU	10/10/2020 11:03	10/10/2020 17:28	10/10/2020 11:03	10/10/2020 17:28	6,40	119	761,93	CHI
20201042222	CATALAO	CT11333743	CATALAO S2	10/10/2020 11:05	10/10/2020 11:47	10/10/2020 11:05	10/10/2020 11:47	0,70	7	4,88	CHI
20201042226	PARAUNA	PU21295884	ACREUNA	10/10/2020 11:05	10/10/2020 14:06	10/10/2020 11:05	10/10/2020 14:06	3,02	1	3,02	CHI
20201042233	GOIANESIA	10001665071	GOIANESIA S2	10/10/2020 11:07	10/10/2020 12:51	10/10/2020 11:07	10/10/2020 12:51	1,72	1	1,72	CHI
20201042247	CRISTALINA	KR21163716	CRISTALINA S2	10/10/2020 11:10	10/10/2020 12:39	10/10/2020 11:10	10/10/2020 12:39	1,47	1	1,47	CHI
20201042249	ARAGARCAS	AG12000012	ARAGARCAS	10/10/2020 11:12	10/10/2020 13:08	10/10/2020 11:12	10/10/2020 13:08	1,93	42	81,16	CHI
20201042250	ARAGARCAS	ME12095835	IPORA	10/10/2020 11:12	10/10/2020 14:15	10/10/2020 11:12	10/10/2020 14:15	3,05	52	158,38	CHI
20201042250	MONTES CLAROS DE GOIAS	ME12095835	IPORA	10/10/2020 11:12	10/10/2020 14:15	10/10/2020 11:12	10/10/2020 14:15	3,05	8	24,37	CHI
20201042250	BOM JARDIM DE GOIAS	ME12095835	IPORA	10/10/2020 11:12	10/10/2020 14:15	10/10/2020 11:12	10/10/2020 14:15	3,05	2	6,09	CHI
20201042487	GOIATUBA	GT12041277	GOIATUBA S2	10/10/2020 11:13	10/10/2020 14:51	10/10/2020 11:13	10/10/2020 14:51	3,63	3	10,90	CHI
20201043063	SAO MIGUEL DO ARAGUAIA	SM12096089RE	SAO MIGUEL DO ARAGUAIA	10/10/2020 11:14	11/10/2020 11:20	10/10/2020 11:14	11/10/2020 11:20	24,09	27	650,45	CHI
20201042269	AGUA FRIA DE GOIAS	TL21242866	SAO JOAO D ALIANCA	10/10/2020 11:17	11/10/2020 01:20	10/10/2020 11:17	11/10/2020 01:20	14,05	2	28,09	CHI
20201042277	CAMPINACU	UC12197189	PORANGATU	10/10/2020 11:19	10/10/2020 12:01	10/10/2020 11:19	10/10/2020 12:01	0,69	67	46,40	CHI
20201042278	TROMBAS	2560008070	PORANGATU	10/10/2020 11:19	11/10/2020 08:55	10/10/2020 11:19	11/10/2020 08:55	21,59	1	21,59	CHI
20201042283	LUZIANIA	LZ11304792	RIO VERMELHO	10/10/2020 11:21	10/10/2020 12:27	10/10/2020 11:21	10/10/2020 12:27	1,10	47	51,58	CHI
202010189147	BONFINOPOLIS	TA10400556	NOVO PLANALTO	10/10/2020 11:22	10/10/2020 15:43	10/10/2020 11:22	10/10/2020 15:43	4,35	1	4,35	CHI
202010189147	BONOPOLIS	TA10400556	NOVO PLANALTO	10/10/2020 11:22	10/10/2020 15:43	10/10/2020 11:22	10/10/2020 15:43	4,35	53	230,46	CHI
202010189147	PORANGATU	TA10400556	NOVO PLANALTO	10/10/2020 11:22	10/10/2020 15:43	10/10/2020 11:22	10/10/2020 15:43	4,35	145	630,51	CHI
20201042295	SILVANIA	SV21192057	DAIA S2	10/10/2020 11:22	10/10/2020 13:22	10/10/2020 11:22	10/10/2020 13:22	1,99	1	1,99	CHI
20201042296	RIO VERDE	RV21076339	RIO VERDE S1	10/10/2020 11:23	11/10/2020 15:41	10/10/2020 11:23	11/10/2020 15:41	28,30	1	28,30	CHI
20201042297	JATAI	290187758	JATAI S3	10/10/2020 11:23	10/10/2020 14:26	10/10/2020 11:23	10/10/2020 14:26	3,04	1	3,04	CHI
20201042299	CAMPO ALEGRE DE GOIAS	CM12420390	CAMPO ALEGRE DE GOIAS	10/10/2020 11:23	10/10/2020 16:12	10/10/2020 11:23	10/10/2020 16:12	4,81	24	115,54	CHI
20201042301	CORUMBA DE GOIAS	CB12065715	CORUMBA	10/10/2020 11:23	10/10/2020 13:30	10/10/2020 11:23	10/10/2020 13:30	2,10	32	67,21	CHI
20201042662	SANTA FE DE GOIAS	RN12206969	JUSSARA	10/10/2020 11:24	10/10/2020 17:25	10/10/2020 11:24	10/10/2020 17:25	6,01	3	18,02	CHI
20201042305	CRISTALINA	KR11365903	PAMPLONA	10/10/2020 11:24	10/10/2020 12:05	10/10/2020 11:24	10/10/2020 12:05	0,67	22	14,79	CHI
20201042330	ABADIANIA	AA12327809	DAIA S2	10/10/2020 11:25	10/10/2020 12:59	10/10/2020 11:25	10/10/2020 12:59	1,56	14	21,79	CHI
20201042309	PORANGATU	PO11000002	PORANGATU	10/10/2020 11:25	10/10/2020 14:31	10/10/2020 11:25	10/10/2020 14:31	3,09	118	364,59	CHI
20201042311	GOIANESIA	550050670	GOIANESIA S2	10/10/2020 11:26	10/10/2020 18:37	10/10/2020 11:26	10/10/2020 18:37	7,18	1	7,18	CHI
20201042313	JATAI	JT21138855	JATAI S1	10/10/2020 11:26	10/10/2020 13:40	10/10/2020 11:26	10/10/2020 13:40	2,23	1	2,23	CHI
20201042760	SAO MIGUEL DO ARAGUAIA	SM12143671	SAO MIGUEL DO ARAGUAIA	10/10/2020 11:28	10/10/2020 14:37	10/10/2020 11:28	10/10/2020 14:37	3,14	275	864,80	CHI
20201042328	RIO VERDE	10013188028	RIO VERDE S2	10/10/2020 11:28	11/10/2020 09:09	10/10/2020 11:28	11/10/2020 09:09	21,67	1	21,67	CHI
20201042350	CALDAS NOVAS	CN21352168	SERRA DE CALDAS	10/10/2020 11:34	10/10/2020 13:07	10/10/2020 11:34	10/10/2020 13:07	1,54	2	3,08	CHI
20201042356	ANAPOLIS	AN21017713	ANAPOLIS UNIVERSITARIO S2	10/10/2020 11:36	10/10/2020 13:42	10/10/2020 11:36	10/10/2020 13:42	2,10	2	4,20	CHI
20201042358	EDEIA	EA21126510	EDEIA	10/10/2020 11:36	10/10/2020 13:51	10/10/2020 11:36	10/10/2020 13:51	2,24	1	2,24	CHI
20201042362	FLORES DE GOIAS	FB21409990	FLORES DE GOIAS	10/10/2020 11:37	10/10/2020 20:14	10/10/2020 11:37	10/10/2020 20:14	8,61	1	8,61	CHI

20201042371	ANAPOLIS	20101417	JUNDIAI S2	10/10/2020 11:38	10/10/2020 13:25	10/10/2020 11:38	10/10/2020 13:25	1,78	1	1,78	CHI
20201042379	ITABERAI	IB21336394	ITABERAI S1	10/10/2020 11:40	10/10/2020 13:44	10/10/2020 11:40	10/10/2020 13:44	2,06	1	2,06	CHI
20201046196	MINACU	IH12348089	MINACU	10/10/2020 11:41	11/10/2020 10:55	10/10/2020 11:41	11/10/2020 10:55	23,23	12	278,71	CHI
202010189151	SAO MIGUEL DO ARAGUAIA	SM12350501	SAO MIGUEL DO ARAGUAIA	10/10/2020 11:42	10/10/2020 15:02	10/10/2020 11:42	10/10/2020 15:02	3,33	6	20,00	CHI
20201042509	MOZARLANDIA	MZ12060054	MOZARLANDIA	10/10/2020 11:45	10/10/2020 12:49	10/10/2020 11:45	10/10/2020 12:49	1,06	774	817,43	CHI
20201042413	VILA BOA	2880012230	IACIARA S2	10/10/2020 11:48	10/10/2020 17:01	10/10/2020 11:48	10/10/2020 17:01	5,21	1	5,21	CHI
20201042452	RUBIATABA	RB12392305	RUBIATABA	10/10/2020 11:49	11/10/2020 02:28	10/10/2020 11:49	10/10/2020 16:33	4,74	4	18,95	CHI
20201042452	RUBIATABA	RB12392305	RUBIATABA	10/10/2020 11:49	11/10/2020 02:28	10/10/2020 11:49	10/10/2020 17:51	6,03	6	36,16	CHI
20201042452	RUBIATABA	6567240	RUBIATABA	10/10/2020 11:49	11/10/2020 02:28	10/10/2020 14:42	10/10/2020 17:51	3,14	2	6,28	CHI
20201042452	RUBIATABA	RB12392305	RUBIATABA	10/10/2020 11:49	11/10/2020 02:28	10/10/2020 11:49	10/10/2020 20:22	8,54	3	25,61	CHI
20201042452	RUBIATABA	6567240	RUBIATABA	10/10/2020 11:49	11/10/2020 02:28	10/10/2020 23:51	11/10/2020 01:08	1,28	6	7,69	CHI
20201042452	RUBIATABA	RB21200945	RUBIATABA	10/10/2020 11:49	11/10/2020 02:28	10/10/2020 20:23	11/10/2020 02:12	5,82	1	5,82	CHI
20201042452	RUBIATABA	RB21200938	RUBIATABA	10/10/2020 11:49	11/10/2020 02:28	10/10/2020 20:23	11/10/2020 02:28	6,09	2	12,17	CHI
20201043564	JATAI	SX12205192RE	JATAI S1	10/10/2020 11:50	10/10/2020 17:59	10/10/2020 11:50	10/10/2020 17:59	6,15	3	18,44	CHI
20201043564	SERRANOPOLIS	SX12205192RE	JATAI S1	10/10/2020 11:50	10/10/2020 17:59	10/10/2020 11:50	10/10/2020 17:59	6,15	18	110,61	CHI
20201042424	NOVO PLANALTO	TA11292348	NOVO PLANALTO	10/10/2020 11:50	10/10/2020 22:22	10/10/2020 11:50	10/10/2020 22:22	10,53	61	642,04	CHI
20201042428	PLANALTINA	PI21167020	PLANALTINA	10/10/2020 11:52	10/10/2020 17:03	10/10/2020 11:52	10/10/2020 17:03	5,18	4	20,73	CHI
20201042444	ANICUNS	1220015262	ANICUNS	10/10/2020 11:54	10/10/2020 13:50	10/10/2020 11:54	10/10/2020 13:50	1,94	1	1,94	CHI
20201042455	NOVO GAMA	2900110690	PACAEMBU S2	10/10/2020 11:56	10/10/2020 13:29	10/10/2020 11:56	10/10/2020 13:29	1,55	1	1,55	CHI
20201042457	SANTO ANTONIO DA BARRA	BZ21207512	ACREUNA	10/10/2020 11:57	10/10/2020 16:31	10/10/2020 11:57	10/10/2020 16:31	4,56	2	9,12	CHI
20201042460	PADRE BERNARDO	2760051025	PADRE BERNARDO	10/10/2020 11:58	10/10/2020 14:23	10/10/2020 11:58	10/10/2020 14:23	2,41	1	2,41	CHI
20201042550	COLINAS DO SUL	TI12162624	NIQUELANDIA SUBTRANSMISSAO	10/10/2020 11:59	10/10/2020 19:29	10/10/2020 11:59	10/10/2020 19:29	7,49	12	89,87	CHI
20201042550	CAVALCANTE	TI12162624	NIQUELANDIA SUBTRANSMISSAO	10/10/2020 11:59	10/10/2020 19:29	10/10/2020 11:59	10/10/2020 19:29	7,49	20	149,78	CHI
20201042484	MINACU	4020039411	MINACU	10/10/2020 12:01	12/10/2020 08:43	10/10/2020 12:01	12/10/2020 08:43	44,69	1	44,69	CHI
20201042501	ITUMBIARA	IT21007655	ITUMBIARA VELHA S1	10/10/2020 12:04	10/10/2020 13:21	10/10/2020 12:04	10/10/2020 13:21	1,28	1	1,28	CHI
20201042691	MINACU	IH12132432	MINACU	10/10/2020 12:06	11/10/2020 00:30	10/10/2020 12:06	11/10/2020 00:30	12,39	106	1313,37	CHI
20201042691	CAMPINACU	IH12132432	MINACU	10/10/2020 12:06	11/10/2020 00:30	10/10/2020 12:06	11/10/2020 00:30	12,39	22	272,59	CHI
20201042520	LUZIANIA	LZ21153820	CRISTALINA S2	10/10/2020 12:08	10/10/2020 15:20	10/10/2020 12:08	10/10/2020 15:20	3,19	2	6,39	CHI
20201042767	ORIZONA	OZ12000353LD	PIRES DO RIO S1	10/10/2020 12:09	10/10/2020 15:42	10/10/2020 12:09	10/10/2020 15:42	3,55	35	124,15	CHI
20201042531	VILA BOA	VB21235777	IACIARA S2	10/10/2020 12:10	10/10/2020 18:11	10/10/2020 12:10	10/10/2020 18:11	6,01	1	6,01	CHI
20201042617	NOVO PLANALTO	TA12391925	SAO MIGUEL DO ARAGUAIA	10/10/2020 12:17	10/10/2020 14:25	10/10/2020 12:17	10/10/2020 14:25	2,13	8	17,04	CHI
20201042558	CALDAS NOVAS	760153541	SERRA DE CALDAS	10/10/2020 12:18	10/10/2020 15:36	10/10/2020 12:18	10/10/2020 15:36	3,30	1	3,30	CHI
20201042559	MORRINHOS	MR21184898	MORRINHOS	10/10/2020 12:18	10/10/2020 14:30	10/10/2020 12:18	10/10/2020 14:30	2,19	1	2,19	CHI
20201042937	MINACU	IH12129795	MINACU	10/10/2020 12:18	10/10/2020 17:58	10/10/2020 12:18	10/10/2020 17:58	5,66	31	175,42	CHI
20201042569	CAMPINACU	UC12197189	PORANGATU	10/10/2020 12:20	10/10/2020 14:28	10/10/2020 12:20	10/10/2020 14:28	2,12	67	142,23	CHI
20201042577	RIO VERDE	RV21222625	RIO VERDE S1	10/10/2020 12:22	10/10/2020 16:20	10/10/2020 12:22	10/10/2020 16:20	3,96	1	3,96	CHI
20201042578	ANAPOLIS	20672147	DAIA S1	10/10/2020 12:22	10/10/2020 14:05	10/10/2020 12:22	10/10/2020 14:05	1,71	1	1,71	CHI
20201042758	NOVO PLANALTO	TA12369993	NOVO PLANALTO	10/10/2020 12:25	10/10/2020 15:53	10/10/2020 12:25	10/10/2020 15:53	3,46	11	38,04	CHI
20201042594	JARAGUA	JA21027417	SAO FRANCISCO DE GOIAS	10/10/2020 12:27	10/10/2020 14:56	10/10/2020 12:27	10/10/2020 14:56	2,47	5	12,37	CHI
20201042666	MINACU	IH12236222	MINACU	10/10/2020 12:27	10/10/2020 14:58	10/10/2020 12:27	10/10/2020 14:58	2,50	19	47,55	CHI
20201042597	PARAUNA	980049489	PARAUNA	10/10/2020 12:27	10/10/2020 15:56	10/10/2020 12:27	10/10/2020 15:56	3,47	1	3,47	CHI
20201042609	TROMBAS	TB21156807	PORANGATU	10/10/2020 12:30	10/10/2020 13:41	10/10/2020 12:30	10/10/2020 13:41	1,17	73	85,73	CHI
20201042956	SAO MIGUEL DO ARAGUAIA	SM120117268	SAO MIGUEL DO ARAGUAIA	10/10/2020 12:30	11/10/2020 18:30	10/10/2020 12:30	11/10/2020 18:30	29,99	9	269,92	CHI
20201044082	BOM JESUS DE GOIAS	BJ21000158	BOM JESUS DE GOIAS	10/10/2020 12:32	10/10/2020 18:06	10/10/2020 12:32	10/10/2020 18:06	5,55	1	5,55	CHI
20201042620	MINEIROS	MY12296303	PARQUE DAS EMAS	10/10/2020 12:33	10/10/2020 15:11	10/10/2020 12:33	10/10/2020 15:11	2,62	4	10,47	CHI
20201042787	MINACU	IH12181712	MINACU	10/10/2020 12:34	10/10/2020 23:13	10/10/2020 12:34	10/10/2020 23:13	10,65	74	787,73	CHI
20201042638	CABECEIRAS	CW21371006	ITUIQUIRA	10/10/2020 12:37	10/10/2020 14:10	10/10/2020 12:37	10/10/2020 14:10	1,54	2	3,09	CHI
20201042642	CAMPINACU	UC12285921	PORANGATU	10/10/2020 12:38	10/10/2020 19:34	10/10/2020 12:38	10/10/2020 19:34	6,93	42	290,92	CHI
20201042915	ITUMBIARA	IT12309906	CACHOEIRA DOURADA	10/10/2020 12:39	10/10/2020 18:45	10/10/2020 12:39	10/10/2020 18:45	6,10	4	24,39	CHI
20201044316	MINACU	IH12397473	MINACU	10/10/2020 12:39	10/10/2020 18:56	10/10/2020 12:39	10/10/2020 18:56	6,28	8	50,23	CHI
20201042648	ITARUMA	IM12041685	CACHOEIRA ALTA	10/10/2020 12:40	10/10/2020 15:57	10/10/2020 12:40	10/10/2020 15:57	3,27	5	16,37	CHI
20201042655	VICENTINOPOLIS	1970000147	VICENTINOPOLIS	10/10/2020 12:42	10/10/2020 14:10	10/10/2020 12:42	10/10/2020 14:10	1,47	1	1,47	CHI
20201053848	ALEXANIA	480006593	ALEXANIA	10/10/2020 12:43	11/10/2020 16:17	10/10/2020 12:43	11/10/2020 16:17	27,55	1	27,55	CHI
20201043580	ITAPACI	IW12330086	ITAPACI	10/10/2020 12:44	10/10/2020 20:57	10/10/2020 12:44	10/10/2020 20:57	8,21	11	90,28	CHI
20201044285	PORANGATU	TA12114216	NOVO PLANALTO	10/10/2020 12:44	11/10/2020 14:26	10/10/2020 12:44	11/10/2020 14:26	25,69	6	154,14	CHI
20201042663	QUIRINOPOLIS	QI12371292	QUIRINOPOLIS	10/10/2020 12:45	10/10/2020 17:25	10/10/2020 12:45	10/10/2020 17:25	4,65	1	4,65	CHI
20201042667	AMORINOPOLIS	AM21284841	IPORA	10/10/2020 12:47	10/10/2020 17:57	10/10/2020 12:47	10/10/2020 17:57	5,16	2	10,33	CHI
20201042669	ARUANA	2380011194	ARUANA	10/10/2020 12:47	10/10/2020 18:35	10/10/2020 12:47	10/10/2020 18:35	5,79	1	5,79	CHI

20201042678	RIO VERDE	RV12295090	RIO VERDE S1	10/10/2020 12:49	10/10/2020 13:48	10/10/2020 12:49	10/10/2020 13:48	0,98	464	454,98	CHI
20201042711	CRIXAS	CX12151609RE	SANTA TEREZINHA	10/10/2020 12:49	11/10/2020 20:53	10/10/2020 12:49	11/10/2020 03:08	14,30	6	85,82	CHI
20201042711	CRIXAS	CX12151609RE	SANTA TEREZINHA	10/10/2020 12:49	11/10/2020 20:53	10/10/2020 14:39	11/10/2020 03:08	12,48	5	62,40	CHI
20201042711	CRIXAS	CX12151609RE	SANTA TEREZINHA	10/10/2020 12:49	11/10/2020 20:53	10/10/2020 12:49	11/10/2020 18:15	29,42	10	294,22	CHI
20201042711	CRIXAS	CX12151609RE	SANTA TEREZINHA	10/10/2020 12:49	11/10/2020 20:53	11/10/2020 03:24	11/10/2020 18:15	14,84	11	163,29	CHI
20201042711	CRIXAS	CX12234614LD	SANTA TEREZINHA	10/10/2020 12:49	11/10/2020 20:53	10/10/2020 14:39	11/10/2020 18:30	27,86	7	195,00	CHI
20201042711	CRIXAS	CX12151609RE	SANTA TEREZINHA	10/10/2020 12:49	11/10/2020 20:53	10/10/2020 14:39	11/10/2020 20:53	30,23	8	241,81	CHI
20201042992	CAVALCANTE	CJ11320542	FLORES DE GOIAS	10/10/2020 12:50	11/10/2020 01:55	10/10/2020 12:50	11/10/2020 01:55	13,08	164	2144,30	CHI
20201042685	IPAMERI	IP21133652	CRISTALINA S2	10/10/2020 12:51	10/10/2020 14:41	10/10/2020 12:51	10/10/2020 14:41	1,83	1	1,83	CHI
20201042689	PALESTINA DE GOIAS	PY11223108	PALESTINA	10/10/2020 12:52	10/10/2020 15:59	10/10/2020 12:52	10/10/2020 15:59	3,11	71	220,93	CHI
20201042693	SANTA HELENA DE GOIAS	400130804	IPEGUARI	10/10/2020 12:52	10/10/2020 22:52	10/10/2020 12:52	10/10/2020 22:52	9,99	1	9,99	CHI
20201042696	CACU	CC21323961	CACHOEIRA ALTA	10/10/2020 12:53	10/10/2020 15:10	10/10/2020 12:53	10/10/2020 15:10	2,27	1	2,27	CHI
20201042698	TAQUARAL DE GOIAS	340014880	ITABERAI S1	10/10/2020 12:54	10/10/2020 14:50	10/10/2020 12:54	10/10/2020 14:50	1,93	1	1,93	CHI
20201042893	CAMPINACU	IH12360453	MINACU	10/10/2020 12:54	11/10/2020 02:01	10/10/2020 12:54	11/10/2020 02:01	13,10	5	65,51	CHI
20201042893	MINACU	IH12360453	MINACU	10/10/2020 12:54	11/10/2020 02:01	10/10/2020 12:54	11/10/2020 02:01	13,10	72	943,32	CHI
20201042706	CACU	CC21047678	CACHOEIRA ALTA	10/10/2020 12:56	11/10/2020 07:50	10/10/2020 12:56	11/10/2020 07:50	18,89	2	37,77	CHI
20201042781	ITAGUARU	HE12310819	ITAPURANGA	10/10/2020 12:57	10/10/2020 15:26	10/10/2020 12:57	10/10/2020 15:26	2,47	12	29,68	CHI
20201042781	HEITORAI	HE12310819	ITAPURANGA	10/10/2020 12:57	10/10/2020 15:26	10/10/2020 12:57	10/10/2020 15:26	2,47	10	24,73	CHI
20201042715	ITABERAI	IB21299690	ITABERAI S2	10/10/2020 12:58	10/10/2020 14:17	10/10/2020 12:58	10/10/2020 14:17	1,31	1	1,31	CHI
20201042716	MATRINCHA	4380018016	MATRINCHA	10/10/2020 12:58	10/10/2020 15:47	10/10/2020 12:58	10/10/2020 15:47	2,81	1	2,81	CHI
20201042717	CAMPOS BELOS	CH12261966	SAO DOMINGOS	10/10/2020 12:58	10/10/2020 15:10	10/10/2020 12:58	10/10/2020 15:10	2,19	7	15,34	CHI
20201042721	ALEXANIA	10013457835	ALEXANIA	10/10/2020 12:59	10/10/2020 18:00	10/10/2020 12:59	10/10/2020 18:00	5,01	1	5,01	CHI
20201043078	AGUA FRIA DE GOIAS	TL12151992	SAO JOAO D ALIANCA	10/10/2020 12:59	10/10/2020 16:51	10/10/2020 12:59	10/10/2020 16:51	3,86	5	19,29	CHI
20201042733	RIO VERDE	RV12306621	RIO VERDE S2	10/10/2020 13:01	11/10/2020 08:25	10/10/2020 13:01	11/10/2020 08:25	19,39	1	19,39	CHI
20201042736	SANTA HELENA DE GOIAS	SH12000189LD	IPEGUARI	10/10/2020 13:02	10/10/2020 18:27	10/10/2020 13:02	10/10/2020 18:19	5,30	1	5,30	CHI
20201042736	SANTA HELENA DE GOIAS	SH13387443	SANTA HELENA S1	10/10/2020 13:02	10/10/2020 18:27	10/10/2020 16:02	10/10/2020 18:27	2,42	1	2,42	CHI
20201042739	GOIANIA	GN11041237	GOIANIA LESTE S3	10/10/2020 13:02	10/10/2020 14:01	10/10/2020 13:02	10/10/2020 14:01	0,98	168	164,22	CHI
20201042742	ITAPACI	100039390	ITAPACI	10/10/2020 13:02	10/10/2020 20:52	10/10/2020 13:02	10/10/2020 20:52	7,82	1	7,82	CHI
20201042834	CRISTALINA	KR11206727	PAMPLONA	10/10/2020 13:03	10/10/2020 14:36	10/10/2020 13:03	10/10/2020 14:36	1,54	196	302,00	CHI
20201042752	TRINDADE	TR11383861	GOYA S2	10/10/2020 13:05	10/10/2020 13:45	10/10/2020 13:05	10/10/2020 13:45	0,66	94	62,43	CHI
20201042755	JAUPACI	JP12193319	IPORA	10/10/2020 13:05	10/10/2020 15:57	10/10/2020 13:05	10/10/2020 15:57	2,85	4	11,42	CHI
20201042826	PIRACANJUBA	MR12000060RE	MORRINHOS	10/10/2020 13:09	10/10/2020 14:49	10/10/2020 13:09	10/10/2020 14:49	1,67	7	11,66	CHI
20201042826	MAIRIPOTABA	MR12000060RE	MORRINHOS	10/10/2020 13:09	10/10/2020 14:49	10/10/2020 13:09	10/10/2020 14:49	1,67	15	24,98	CHI
20201042826	PONTALINA	MR12000060RE	MORRINHOS	10/10/2020 13:09	10/10/2020 14:49	10/10/2020 13:09	10/10/2020 14:49	1,67	11	18,32	CHI
20201042826	MORRINHOS	MR12000060RE	MORRINHOS	10/10/2020 13:09	10/10/2020 14:49	10/10/2020 13:09	10/10/2020 14:49	1,67	35	58,29	CHI
20201042855	ITARUMA	IM12058060	CACHOEIRA ALTA	10/10/2020 13:10	10/10/2020 16:56	10/10/2020 13:10	10/10/2020 16:56	3,76	16	60,23	CHI
20201042772	GOIANIRA	390056534	GOIANIRA	10/10/2020 13:10	10/10/2020 13:25	10/10/2020 13:10	10/10/2020 13:25	0,24	1	0,24	CHI
20201042783	ITABERAI	IB21093892	ITABERAI S1	10/10/2020 13:12	10/10/2020 15:11	10/10/2020 13:12	10/10/2020 15:11	1,97	1	1,97	CHI
20201042789	IPORA	IR21074003	IPORA	10/10/2020 13:14	10/10/2020 16:36	10/10/2020 13:14	10/10/2020 16:36	3,37	1	3,37	CHI
20201042795	BOM JESUS DE GOIAS	BJ12392118	BOM JESUS DE GOIAS	10/10/2020 13:15	10/10/2020 17:56	10/10/2020 13:15	10/10/2020 17:56	4,68	3	14,03	CHI
20201042803	RIO VERDE	RV12260596	CABRIUVA S2	10/10/2020 13:16	10/10/2020 22:47	10/10/2020 13:16	10/10/2020 22:47	9,51	1	9,51	CHI
20201040865	JATAI	JT12260426RE	JATAI S1	10/10/2020 13:18	13/10/2020 03:47	10/10/2020 13:19	10/10/2020 15:07	1,81	101	182,81	CHI
20201040865	JATAI	JT12260426RE	JATAI S1	10/10/2020 13:18	13/10/2020 03:47	11/10/2020 16:31	11/10/2020 18:14	1,71	101	172,85	CHI
20201040865	SERRANOPOLIS	JT10274087	JATAI S1	10/10/2020 13:18	13/10/2020 03:47	11/10/2020 18:25	11/10/2020 18:28	0,05	3067	154,20	CHI
20201040865	ITARUMA	JT10274087	JATAI S1	10/10/2020 13:18	13/10/2020 03:47	11/10/2020 18:25	11/10/2020 18:28	0,05	1	0,05	CHI
20201040865	JATAI	JT10274087	JATAI S1	10/10/2020 13:18	13/10/2020 03:47	11/10/2020 18:25	11/10/2020 18:28	0,05	271	13,63	CHI
20201040865	SERRANOPOLIS	JT10274087	JATAI S1	10/10/2020 13:18	13/10/2020 03:47	11/10/2020 18:25	11/10/2020 18:28	0,05	20	1,01	CHI
20201040865	APORE	JT10274087	JATAI S1	10/10/2020 13:18	13/10/2020 03:47	11/10/2020 18:25	11/10/2020 18:28	0,05	7	0,35	CHI
20201040865	SERRANOPOLIS	JT10274087	JATAI S1	10/10/2020 13:18	13/10/2020 03:47	11/10/2020 18:25	11/10/2020 18:28	0,05	61	3,07	CHI
20201040865	JATAI	JT10274087	JATAI S1	10/10/2020 13:18	13/10/2020 03:47	11/10/2020 18:25	11/10/2020 18:28	0,05	54	2,71	CHI
20201040865	SERRANOPOLIS	JT10274087	JATAI S1	10/10/2020 13:18	13/10/2020 03:47	11/10/2020 18:25	11/10/2020 18:28	0,05	115	5,78	CHI
20201040865	JATAI	JT13374281	JATAI S1	10/10/2020 13:18	13/10/2020 03:47	12/10/2020 13:18	12/10/2020 13:15	47,96	1	47,96	CHI
20201040865	JATAI	JT13374281	JATAI S1	10/10/2020 13:18	13/10/2020 03:47	11/10/2020 16:31	12/10/2020 13:15	20,73	2	41,47	CHI
20201040865	JATAI	JT12260426RE	JATAI S1	10/10/2020 13:18	13/10/2020 03:47	12/10/2020 13:18	12/10/2020 14:48	1,49	101	150,18	CHI
20201040865	JATAI	JT13374281	JATAI S1	10/10/2020 13:18	13/10/2020 03:47	12/10/2020 13:18	12/10/2020 15:03	1,74	2	3,48	CHI
20201040865	JATAI	JT12260426RE	JATAI S1	10/10/2020 13:18	13/10/2020 03:47	12/10/2020 13:18	12/10/2020 15:35	2,27	1	2,27	CHI
20201040865	JATAI	JT12260426RE	JATAI S1	10/10/2020 13:18	13/10/2020 03:47	12/10/2020 15:06	12/10/2020 15:35	0,48	101	48,54	CHI
20201040865	JATAI	JT13374281	JATAI S1	10/10/2020 13:18	13/10/2020 03:47	12/10/2020 13:18	12/10/2020 21:27	8,14	1	8,14	CHI

20201040865	JATAI	8045607	JATAI S1	10/10/2020 13:18	13/10/2020 03:47	12/10/2020 15:06	12/10/2020 21:34	6,48	3	19,43	CHI
20201040865	JATAI	8046091	JATAI S1	10/10/2020 13:18	13/10/2020 03:47	12/10/2020 15:06	13/10/2020 03:47	12,69	3	38,08	CHI
20201043682	TROMBAS	MX12240692	PORANGATU	10/10/2020 13:19	10/10/2020 20:45	10/10/2020 13:19	10/10/2020 20:45	7,43	1	7,43	CHI
20201043682	MONTIVIDIU DO NORTE	MX12240692	PORANGATU	10/10/2020 13:19	10/10/2020 20:45	10/10/2020 13:19	10/10/2020 20:45	7,43	2	14,86	CHI
20201044085	RIO VERDE	RV10400628	MONTIVIDIU T	10/10/2020 13:19	14/10/2020 17:01	10/10/2020 16:20	10/10/2020 21:26	5,11	4	20,43	CHI
20201044085	RIO VERDE	RV13357266	MONTIVIDIU T	10/10/2020 13:19	14/10/2020 17:01	10/10/2020 13:19	10/10/2020 22:00	8,69	4	34,76	CHI
20201044085	RIO VERDE	RV10400628	MONTIVIDIU T	10/10/2020 13:19	14/10/2020 17:01	11/10/2020 00:39	11/10/2020 00:46	0,12	8	0,95	CHI
20201044085	RIO VERDE	RV13357265	MONTIVIDIU T	10/10/2020 13:19	14/10/2020 17:01	10/10/2020 13:19	11/10/2020 08:47	19,47	13	253,15	CHI
20201044085	MONTIVIDIU	RV12219433LD	MONTIVIDIU T	10/10/2020 13:19	14/10/2020 17:01	10/10/2020 16:20	11/10/2020 16:54	24,58	30	737,33	CHI
20201044085	RIO VERDE	RV12219433LD	MONTIVIDIU T	10/10/2020 13:19	14/10/2020 17:01	10/10/2020 16:20	11/10/2020 16:54	24,58	12	294,93	CHI
20201044085	RIO VERDE	RV10400628	MONTIVIDIU T	10/10/2020 13:19	14/10/2020 17:01	12/10/2020 19:50	12/10/2020 19:53	0,05	38	1,96	CHI
20201044085	MONTIVIDIU	RV10400628	MONTIVIDIU T	10/10/2020 13:19	14/10/2020 17:01	12/10/2020 19:50	12/10/2020 19:53	0,05	31	1,60	CHI
20201044085	RIO VERDE	RV12207197	MONTIVIDIU T	10/10/2020 13:19	14/10/2020 17:01	10/10/2020 16:20	12/10/2020 22:40	54,34	3	163,01	CHI
20201044085	RIO VERDE	RV12207197	MONTIVIDIU T	10/10/2020 13:19	14/10/2020 17:01	10/10/2020 16:20	12/10/2020 23:36	55,28	2	110,56	CHI
20201044085	RIO VERDE	RV12207197	MONTIVIDIU T	10/10/2020 13:19	14/10/2020 17:01	11/10/2020 21:35	12/10/2020 23:36	26,03	1	26,03	CHI
20201044085	RIO VERDE	RV12207197	MONTIVIDIU T	10/10/2020 13:19	14/10/2020 17:01	12/10/2020 22:48	12/10/2020 23:36	0,80	2	1,61	CHI
20201044085	RIO VERDE	RV12080121	MONTIVIDIU T	10/10/2020 13:19	14/10/2020 17:01	10/10/2020 13:19	13/10/2020 10:38	69,31	1	69,31	CHI
20201044085	RIO VERDE	RV12207197	MONTIVIDIU T	10/10/2020 13:19	14/10/2020 17:01	10/10/2020 16:20	14/10/2020 00:22	80,04	12	960,50	CHI
20201044085	RIO VERDE	RV12207197	MONTIVIDIU T	10/10/2020 13:19	14/10/2020 17:01	12/10/2020 22:48	14/10/2020 00:22	25,56	1	25,56	CHI
20201044085	RIO VERDE	RV12207197	MONTIVIDIU T	10/10/2020 13:19	14/10/2020 17:01	13/10/2020 02:27	14/10/2020 00:22	21,92	3	65,75	CHI
20201044085	RIO VERDE	RV12207197	MONTIVIDIU T	10/10/2020 13:19	14/10/2020 17:01	13/10/2020 02:27	14/10/2020 17:01	38,56	2	77,12	CHI
20201042817	ARAGARCAS	AG12000006	ARAGARCAS	10/10/2020 13:20	10/10/2020 14:43	10/10/2020 13:20	10/10/2020 14:43	1,38	42	57,83	CHI
20201042819	ARAGUAPAZ	AZ11236741	GOIAS	10/10/2020 13:20	10/10/2020 17:23	10/10/2020 13:20	10/10/2020 17:23	4,04	1	4,04	CHI
20201042823	SAO MIGUEL DO ARAGUAIA	SM12074386RE	SAO MIGUEL DO ARAGUAIA	10/10/2020 13:21	11/10/2020 15:27	10/10/2020 13:21	11/10/2020 11:53	22,53	18	405,54	CHI
20201042823	NOVO PLANALTO	SM12074386RE	SAO MIGUEL DO ARAGUAIA	10/10/2020 13:21	11/10/2020 15:27	10/10/2020 13:21	11/10/2020 11:53	22,53	6	135,18	CHI
20201042823	SAO MIGUEL DO ARAGUAIA	SM12074386RE	SAO MIGUEL DO ARAGUAIA	10/10/2020 13:21	11/10/2020 15:27	10/10/2020 13:21	11/10/2020 13:30	24,14	57	1376,25	CHI
20201042823	SAO MIGUEL DO ARAGUAIA	SM12074386RE	SAO MIGUEL DO ARAGUAIA	10/10/2020 13:21	11/10/2020 15:27	10/10/2020 13:21	11/10/2020 14:43	25,36	28	710,06	CHI
20201042823	SAO MIGUEL DO ARAGUAIA	SM12074386RE	SAO MIGUEL DO ARAGUAIA	10/10/2020 13:21	11/10/2020 15:27	10/10/2020 13:21	11/10/2020 15:26	26,09	11	286,95	CHI
20201042823	SAO MIGUEL DO ARAGUAIA	SM12074386RE	SAO MIGUEL DO ARAGUAIA	10/10/2020 13:21	11/10/2020 15:27	10/10/2020 13:21	11/10/2020 15:27	26,09	8	208,73	CHI
20201042823	SAO MIGUEL DO ARAGUAIA	SM12074386RE	SAO MIGUEL DO ARAGUAIA	10/10/2020 13:21	11/10/2020 15:27	10/10/2020 13:21	11/10/2020 15:27	26,10	13	339,26	CHI
20201042827	INHUMAS	10008633060	INHUMAS S2	10/10/2020 13:22	10/10/2020 14:48	10/10/2020 13:22	10/10/2020 14:48	1,42	1	1,42	CHI
20201043687	TROMBAS	TB12137675	PORANGATU	10/10/2020 13:23	10/10/2020 17:55	10/10/2020 13:23	10/10/2020 17:55	4,53	8	36,23	CHI
20201044167	RIO VERDE	RV12038433	CABRIUVA S2	10/10/2020 13:23	11/10/2020 21:30	10/10/2020 13:23	10/10/2020 20:33	7,17	5	35,83	CHI
20201044167	RIO VERDE	RV13020016	CABRIUVA S2	10/10/2020 13:23	11/10/2020 21:30	10/10/2020 13:23	10/10/2020 23:38	10,24	56	573,56	CHI
20201044167	RIO VERDE	RV12091865	CABRIUVA S2	10/10/2020 13:23	11/10/2020 21:30	10/10/2020 13:23	11/10/2020 21:30	32,11	3	96,33	CHI
20201046199	MINACU	IH12236142	MINACU	10/10/2020 13:23	11/10/2020 16:19	10/10/2020 13:23	11/10/2020 16:19	26,92	28	753,79	CHI
20201042837	ARAGARCAS	1820002850	ARAGARCAS	10/10/2020 13:24	10/10/2020 15:35	10/10/2020 13:24	10/10/2020 15:35	2,18	1	2,18	CHI
20201045295	MINACU	IH12245144	MINACU	10/10/2020 13:24	11/10/2020 02:40	10/10/2020 13:24	11/10/2020 02:40	13,26	6	79,55	CHI
20201045312	PORANGATU	PO12217305	PORANGATU	10/10/2020 13:25	10/10/2020 21:38	10/10/2020 13:25	10/10/2020 21:38	8,21	24	197,01	CHI
20201042843	ITARUMA	IM12239562	ITAJA S2	10/10/2020 13:25	10/10/2020 16:59	10/10/2020 13:25	10/10/2020 16:59	3,56	3	10,68	CHI
20201042848	PORANGATU	PO12052522	PORANGATU	10/10/2020 13:26	10/10/2020 20:46	10/10/2020 13:26	10/10/2020 20:46	7,33	61	447,27	CHI
20201043070	SAO JOAO D ALIANCA	JL12117446	SAO JOAO D ALIANCA	10/10/2020 13:28	10/10/2020 15:57	10/10/2020 13:28	10/10/2020 15:57	2,48	26	64,40	CHI
20201043070	AGUA FRIA DE GOIAS	JL12117446	SAO JOAO D ALIANCA	10/10/2020 13:28	10/10/2020 15:57	10/10/2020 13:28	10/10/2020 15:57	2,48	20	49,54	CHI
20201043132	MINEIROS	MY12303343RE	PARQUE DAS EMAS	10/10/2020 13:28	10/10/2020 17:08	10/10/2020 13:28	10/10/2020 17:08	3,66	25	91,46	CHI
20201042854	DOVERLANDIA	DV21156478	CAIAPONIA	10/10/2020 13:28	10/10/2020 18:41	10/10/2020 13:28	10/10/2020 18:41	5,21	1	5,21	CHI
20201043434	TROMBAS	TB12345570	PORANGATU	10/10/2020 13:31	10/10/2020 19:05	10/10/2020 13:31	10/10/2020 19:05	5,56	16	88,96	CHI
20201045713	SILVANIA	SV12131990	VIANOPOLIS	10/10/2020 13:34	10/10/2020 23:15	10/10/2020 13:34	10/10/2020 23:15	9,68	32	309,71	CHI
20201044072	AVELINOPOLIS	AV11108977	ANICUNS	10/10/2020 13:35	10/10/2020 17:12	10/10/2020 13:35	10/10/2020 17:12	3,61	54	194,81	CHI
20201042883	ANAPOLIS	20965904	ANAPOLIS UNIVERSITARIO S2	10/10/2020 13:36	10/10/2020 14:47	10/10/2020 13:36	10/10/2020 14:47	1,17	1	1,17	CHI
20201042886	CALDAS NOVAS	760168210	SERRA DE CALDAS	10/10/2020 13:37	10/10/2020 16:46	10/10/2020 13:37	10/10/2020 16:46	3,14	1	3,14	CHI
20201042889	ITARUMA	IM21239560	CACHOEIRA ALTA	10/10/2020 13:39	11/10/2020 11:44	10/10/2020 13:39	11/10/2020 11:44	22,07	2	44,14	CHI
202010189204	LUZIANIA	LZ10414106	MARAJOARA	10/10/2020 13:40	10/10/2020 16:18	10/10/2020 13:40	10/10/2020 16:01	2,36	4	9,46	CHI
202010189204	LUZIANIA	LZ10414106	MARAJOARA	10/10/2020 13:40	10/10/2020 16:18	10/10/2020 13:40	10/10/2020 16:18	2,64	11	29,05	CHI
20201042894	FORMOSA	FA31028893	ITUIQUIRA	10/10/2020 13:41	10/10/2020 14:49	10/10/2020 13:41	10/10/2020 14:49	1,12	1	1,12	CHI
20201042896	ITAPURANGA	IK21325991	ITAPURANGA	10/10/2020 13:42	10/10/2020 17:33	10/10/2020 13:42	10/10/2020 17:33	3,83	1	3,83	CHI
20201042901	LUZIANIA	LZ21209468	MARAJOARA	10/10/2020 13:44	10/10/2020 15:19	10/10/2020 13:44	10/10/2020 15:19	1,58	1	1,58	CHI
20201042907	LUZIANIA	LZ21261348	MARAJOARA	10/10/2020 13:45	10/10/2020 15:13	10/10/2020 13:45	10/10/2020 15:13	1,45	2	2,91	CHI
20201042913	APARECIDA DE GOIANIA	10008748231	INDEPENDENCIA S1	10/10/2020 13:47	10/10/2020 15:17	10/10/2020 13:47	10/10/2020 15:17	1,50	1	1,50	CHI

202010157083	JANDAIA	PL16407314	PALMEIRAS	10/10/2020 13:48	10/10/2020 18:14	10/10/2020 13:48	10/10/2020 14:01	0,22	1	0,22	CHI
202010157083	PALMEIRAS DE GOIAS	PL16407314	PALMEIRAS	10/10/2020 13:48	10/10/2020 18:14	10/10/2020 13:48	10/10/2020 14:01	0,22	112	24,27	CHI
202010157083	PALESTINA DE GOIAS	PL16409820	PALMEIRAS	10/10/2020 13:48	10/10/2020 18:14	10/10/2020 13:48	10/10/2020 14:03	0,25	1	0,25	CHI
202010157083	PALMINOPOLIS	PL16409820	PALMEIRAS	10/10/2020 13:48	10/10/2020 18:14	10/10/2020 13:48	10/10/2020 14:03	0,25	15	3,70	CHI
202010157083	PALMEIRAS DE GOIAS	PL16409820	PALMEIRAS	10/10/2020 13:48	10/10/2020 18:14	10/10/2020 13:48	10/10/2020 14:03	0,25	99	24,45	CHI
202010157083	JANDAIA	PL16409820	PALMEIRAS	10/10/2020 13:48	10/10/2020 18:14	10/10/2020 13:48	10/10/2020 14:03	0,25	133	32,84	CHI
202010157083	INDIARA	00190416	PALMEIRAS	10/10/2020 13:48	10/10/2020 18:14	10/10/2020 13:48	10/10/2020 15:48	2,00	182	363,44	CHI
202010157083	JANDAIA	00190416	PALMEIRAS	10/10/2020 13:48	10/10/2020 18:14	10/10/2020 13:48	10/10/2020 15:48	2,00	2124	4241,51	CHI
202010157083	PALMEIRAS DE GOIAS	00190416	PALMEIRAS	10/10/2020 13:48	10/10/2020 18:14	10/10/2020 13:48	10/10/2020 15:48	2,00	38	75,88	CHI
202010157083	PARAUNA	00190416	PALMEIRAS	10/10/2020 13:48	10/10/2020 18:14	10/10/2020 13:48	10/10/2020 15:48	2,00	53	105,84	CHI
202010157083	JANDAIA	00190416	PALMEIRAS	10/10/2020 13:48	10/10/2020 18:14	10/10/2020 13:48	10/10/2020 18:14	4,43	840	3720,50	CHI
20201043822	CAVALCANTE	CJ11257477	FLORES DE GOIAS	10/10/2020 13:50	11/10/2020 03:58	10/10/2020 13:50	11/10/2020 03:58	14,13	87	1229,02	CHI
20201042935	VIANOPOLIS	VN21013833	VIANOPOLIS	10/10/2020 13:52	10/10/2020 15:43	10/10/2020 13:52	10/10/2020 15:43	1,85	1	1,85	CHI
20201042950	SILVANIA	SV21151525	VIANOPOLIS	10/10/2020 13:55	10/10/2020 15:55	10/10/2020 13:55	10/10/2020 15:55	1,99	1	1,99	CHI
20201043326	TRINDADE	TR11323005	GOYA S2	10/10/2020 13:55	10/10/2020 16:10	10/10/2020 13:55	10/10/2020 16:10	2,24	144	323,00	CHI
20201042954	CIDADE OCIDENTAL	10019762931	MARAJOARA	10/10/2020 13:55	10/10/2020 14:43	10/10/2020 13:55	10/10/2020 14:43	0,79	1	0,79	CHI
20201042955	LUZIANIA	LZ11348522	RIO VERMELHO	10/10/2020 13:55	10/10/2020 15:47	10/10/2020 13:55	10/10/2020 15:47	1,85	5	9,27	CHI
20201042962	MINEIROS	MY21253763	PARQUE DAS EMAS	10/10/2020 13:57	10/10/2020 15:08	10/10/2020 13:57	10/10/2020 15:08	1,17	1	1,17	CHI
20201042970	PORANGATU	PO21137025	PORANGATU	10/10/2020 14:00	11/10/2020 00:47	10/10/2020 14:00	11/10/2020 00:47	10,78	1	10,78	CHI
20201042972	AGUAS LINDAS DE GOIAS	4830167131	AGUAS LINDAS DE GOIAS S1	10/10/2020 14:00	10/10/2020 15:08	10/10/2020 14:00	10/10/2020 15:08	1,12	1	1,12	CHI
20201042973	GOIAS	GS12274406	ITABERAÍ S1	10/10/2020 14:01	10/10/2020 20:38	10/10/2020 14:01	10/10/2020 20:38	6,62	2	13,24	CHI
20201043024	TERESINA DE GOIAS	TE11320541	FLORES DE GOIAS	10/10/2020 14:01	10/10/2020 20:20	10/10/2020 14:01	10/10/2020 20:20	6,31	44	277,53	CHI
20201042980	LEOPOLDO DE BULHOES	LB21348673	DAIA S2	10/10/2020 14:02	10/10/2020 16:32	10/10/2020 14:02	10/10/2020 16:32	2,48	10	24,84	CHI
20201043069	SAO MIGUEL DO ARAGUAIA	SM10388763	SAO MIGUEL DO ARAGUAIA	10/10/2020 14:03	12/10/2020 13:51	10/10/2020 14:03	10/10/2020 21:08	7,08	55	389,17	CHI
20201043069	SAO MIGUEL DO ARAGUAIA	SM10388763	SAO MIGUEL DO ARAGUAIA	10/10/2020 14:03	12/10/2020 13:51	10/10/2020 21:09	10/10/2020 22:19	1,16	49	56,91	CHI
20201043069	SAO MIGUEL DO ARAGUAIA	SM10388763	SAO MIGUEL DO ARAGUAIA	10/10/2020 14:03	12/10/2020 13:51	10/10/2020 22:21	11/10/2020 01:10	2,82	37	104,16	CHI
20201043069	SAO MIGUEL DO ARAGUAIA	SM10388763	SAO MIGUEL DO ARAGUAIA	10/10/2020 14:03	12/10/2020 13:51	11/10/2020 09:51	11/10/2020 10:35	0,72	37	26,56	CHI
20201043069	SAO MIGUEL DO ARAGUAIA	SM10388763	SAO MIGUEL DO ARAGUAIA	10/10/2020 14:03	12/10/2020 13:51	11/10/2020 12:08	11/10/2020 12:24	0,27	37	9,97	CHI
20201043069	SAO MIGUEL DO ARAGUAIA	SM10388763	SAO MIGUEL DO ARAGUAIA	10/10/2020 14:03	12/10/2020 13:51	11/10/2020 15:38	11/10/2020 15:56	0,30	37	10,98	CHI
20201043069	SAO MIGUEL DO ARAGUAIA	SM10388763	SAO MIGUEL DO ARAGUAIA	10/10/2020 14:03	12/10/2020 13:51	10/10/2020 14:03	12/10/2020 00:04	34,01	29	986,17	CHI
20201043069	SAO MIGUEL DO ARAGUAIA	SM13390126	SAO MIGUEL DO ARAGUAIA	10/10/2020 14:03	12/10/2020 13:51	10/10/2020 21:09	12/10/2020 00:04	26,91	6	161,44	CHI
20201043069	SAO MIGUEL DO ARAGUAIA	SM13390126	SAO MIGUEL DO ARAGUAIA	10/10/2020 14:03	12/10/2020 13:51	10/10/2020 22:21	12/10/2020 00:04	25,71	12	308,48	CHI
20201043069	SAO MIGUEL DO ARAGUAIA	SM13390126	SAO MIGUEL DO ARAGUAIA	10/10/2020 14:03	12/10/2020 13:51	11/10/2020 09:51	12/10/2020 00:04	14,20	8	113,62	CHI
20201043069	SAO MIGUEL DO ARAGUAIA	SM10388763	SAO MIGUEL DO ARAGUAIA	10/10/2020 14:03	12/10/2020 13:51	10/10/2020 14:03	12/10/2020 01:20	35,27	127	4479,33	CHI
20201043069	SAO MIGUEL DO ARAGUAIA	SM10388763	SAO MIGUEL DO ARAGUAIA	10/10/2020 14:03	12/10/2020 13:51	10/10/2020 14:03	12/10/2020 01:25	35,35	117	4136,41	CHI
20201043069	SAO MIGUEL DO ARAGUAIA	SM10388763	SAO MIGUEL DO ARAGUAIA	10/10/2020 14:03	12/10/2020 13:51	12/10/2020 01:26	12/10/2020 01:55	0,49	219	107,25	CHI
20201043069	SAO MIGUEL DO ARAGUAIA	SM10388763	SAO MIGUEL DO ARAGUAIA	10/10/2020 14:03	12/10/2020 13:51	12/10/2020 05:04	12/10/2020 09:24	4,32	49	211,91	CHI
20201043069	SAO MIGUEL DO ARAGUAIA	SM10388763	SAO MIGUEL DO ARAGUAIA	10/10/2020 14:03	12/10/2020 13:51	12/10/2020 05:04	12/10/2020 09:43	4,64	170	789,04	CHI
20201043069	SAO MIGUEL DO ARAGUAIA	SM13380422	SAO MIGUEL DO ARAGUAIA	10/10/2020 14:03	12/10/2020 13:51	12/10/2020 01:26	12/10/2020 10:58	9,54	21	200,38	CHI
20201043069	SAO MIGUEL DO ARAGUAIA	SM13182436	SAO MIGUEL DO ARAGUAIA	10/10/2020 14:03	12/10/2020 13:51	12/10/2020 01:26	12/10/2020 11:26	10,00	34	339,99	CHI
20201043069	SAO MIGUEL DO ARAGUAIA	SM13241984	SAO MIGUEL DO ARAGUAIA	10/10/2020 14:03	12/10/2020 13:51	12/10/2020 01:26	12/10/2020 13:51	12,42	62	770,21	CHI
20201043015	FORMOSA	03740444	ITUIQUIRA	10/10/2020 14:05	10/10/2020 20:44	10/10/2020 14:05	10/10/2020 15:23	1,30	3	3,91	CHI
20201043015	CABECEIRAS	FA10413224	ITUIQUIRA	10/10/2020 14:05	10/10/2020 20:44	10/10/2020 14:05	10/10/2020 20:44	6,65	147	977,35	CHI
20201043015	FORMOSA	FA10413224	ITUIQUIRA	10/10/2020 14:05	10/10/2020 20:44	10/10/2020 14:05	10/10/2020 20:44	6,65	30	199,46	CHI
20201042984	CACHOEIRA ALTA	CA11370060	CACHOEIRA ALTA	10/10/2020 14:05	10/10/2020 16:49	10/10/2020 14:05	10/10/2020 16:49	2,72	84	228,39	CHI
20201042987	SENADOR CANEDO	10027075549	SENADOR CANEDO	10/10/2020 14:06	10/10/2020 15:21	10/10/2020 14:06	10/10/2020 15:21	1,24	1	1,24	CHI
20201043008	APORE	AE12340774	ITAÍJA S2	10/10/2020 14:09	10/10/2020 19:55	10/10/2020 14:09	10/10/2020 19:55	5,76	1	5,76	CHI
20201043017	CACU	CC2132238	CACHOEIRA ALTA	10/10/2020 14:11	10/10/2020 17:42	10/10/2020 14:11	10/10/2020 17:42	3,51	1	3,51	CHI
20201043021	GOIANIA	13467530	XAVANTES	10/10/2020 14:12	10/10/2020 16:17	10/10/2020 14:12	10/10/2020 16:17	2,07	1	2,07	CHI
20201043665	LUZIANIA	01090414	MARAJOARA	10/10/2020 14:12	11/10/2020 00:07	10/10/2020 14:12	10/10/2020 18:25	4,20	1	4,20	CHI
20201043665	LUZIANIA	KR10400735	MARAJOARA	10/10/2020 14:12	11/10/2020 00:07	10/10/2020 18:51	10/10/2020 22:18	3,44	2	6,87	CHI
20201043665	LUZIANIA	01090414	MARAJOARA	10/10/2020 14:12	11/10/2020 00:07	10/10/2020 22:12	10/10/2020 22:18	0,09	330	29,33	CHI
20201043665	CRISTALINA	01090414	MARAJOARA	10/10/2020 14:12	11/10/2020 00:07	10/10/2020 22:12	10/10/2020 22:18	0,09	1	0,09	CHI
20201043665	LUZIANIA	01090414	MARAJOARA	10/10/2020 14:12	11/10/2020 00:07	10/10/2020 17:47	10/10/2020 23:03	5,27	4	21,08	CHI
20201043665	LUZIANIA	01090414	MARAJOARA	10/10/2020 14:12	11/10/2020 00:07	10/10/2020 17:47	11/10/2020 00:01	6,24	5	31,18	CHI
20201043665	LUZIANIA	01090414	MARAJOARA	10/10/2020 14:12	11/10/2020 00:07	10/10/2020 17:47	11/10/2020 00:07	6,33	6	37,99	CHI
20201043879	FORMOSA	03740424	ITUIQUIRA	10/10/2020 14:15	10/10/2020 21:28	10/10/2020 14:15	10/10/2020 21:28	7,22	4	28,87	CHI
20201043879	CABECEIRAS	03740424	ITUIQUIRA	10/10/2020 14:15	10/10/2020 21:28	10/10/2020 14:15	10/10/2020 21:28	7,22	41	295,88	CHI

20201043879	CABECEIRAS	FA13262130	ITUIQUIRA	10/10/2020 14:15	10/10/2020 21:28	10/10/2020 18:41	10/10/2020 21:28	2,78	11	30,56	CHI
20201043823	FORMOSA	03740214	ITUIQUIRA	10/10/2020 14:16	11/10/2020 09:58	10/10/2020 14:16	10/10/2020 14:31	0,25	5207	1317,66	CHI
20201043823	FORMOSA	03740214	ITUIQUIRA	10/10/2020 14:16	11/10/2020 09:58	10/10/2020 14:33	10/10/2020 14:36	0,05	5207	260,35	CHI
20201043823	FORMOSA	FA16407043	ITUIQUIRA	10/10/2020 14:16	11/10/2020 09:58	10/10/2020 14:16	10/10/2020 14:49	0,55	324	178,65	CHI
20201043823	FORMOSA	FA16407043	ITUIQUIRA	10/10/2020 14:16	11/10/2020 09:58	10/10/2020 14:30	10/10/2020 14:49	0,32	6	1,89	CHI
20201043823	FORMOSA	03740214	ITUIQUIRA	10/10/2020 14:16	11/10/2020 09:58	10/10/2020 14:16	10/10/2020 15:00	0,75	4390	3279,09	CHI
20201043823	FORMOSA	FA10376698	ITUIQUIRA	10/10/2020 14:16	11/10/2020 09:58	10/10/2020 14:30	10/10/2020 15:00	0,51	21	10,72	CHI
20201043823	FORMOSA	FA16407040	ITUIQUIRA	10/10/2020 14:16	11/10/2020 09:58	10/10/2020 14:30	10/10/2020 15:00	0,51	401	203,62	CHI
20201043823	FORMOSA	03740214	ITUIQUIRA	10/10/2020 14:16	11/10/2020 09:58	10/10/2020 14:16	10/10/2020 15:23	1,13	1960	2213,71	CHI
20201043823	FORMOSA	FA16407040	ITUIQUIRA	10/10/2020 14:16	11/10/2020 09:58	10/10/2020 14:30	10/10/2020 15:23	0,89	206	183,40	CHI
20201043823	FORMOSA	03740214	ITUIQUIRA	10/10/2020 14:16	11/10/2020 09:58	10/10/2020 14:33	10/10/2020 15:23	0,85	69	58,38	CHI
20201043823	FORMOSA	FA16407040	ITUIQUIRA	10/10/2020 14:16	11/10/2020 09:58	10/10/2020 15:01	10/10/2020 15:23	0,36	3564	1295,91	CHI
20201043823	FORMOSA	03740214	ITUIQUIRA	10/10/2020 14:16	11/10/2020 09:58	10/10/2020 15:02	10/10/2020 15:23	0,36	5207	1862,95	CHI
20201043823	FORMOSA	FA16416902	ITUIQUIRA	10/10/2020 14:16	11/10/2020 09:58	10/10/2020 15:01	10/10/2020 19:29	4,46	757	3376,64	CHI
20201043823	FORMOSA	FA10376698	ITUIQUIRA	10/10/2020 14:16	11/10/2020 09:58	10/10/2020 19:06	10/10/2020 19:30	0,39	71	27,79	CHI
20201043823	FORMOSA	FA13062363	ITUIQUIRA	10/10/2020 14:16	11/10/2020 09:58	10/10/2020 15:01	11/10/2020 09:58	18,94	491	9298,86	CHI
2020101000165	FORMOSA	03740214	ITUIQUIRA	10/10/2020 14:16	10/10/2020 14:25	10/10/2020 14:16	10/10/2020 14:25	0,15	703	108,38	CHI
2020101000170	CABECEIRAS	22101	ITUIQUIRA	10/10/2020 14:16	10/10/2020 14:57	10/10/2020 14:16	10/10/2020 14:24	0,13	2984	397,87	CHI
2020101000170	DISTRITO FEDERAL	22101	ITUIQUIRA	10/10/2020 14:16	10/10/2020 14:57	10/10/2020 14:16	10/10/2020 14:24	0,13	1	0,13	CHI
2020101000170	FORMOSA	03740424	ITUIQUIRA	10/10/2020 14:16	10/10/2020 14:57	10/10/2020 14:16	10/10/2020 14:25	0,15	2	0,31	CHI
2020101000170	FORMOSA	03740414	ITUIQUIRA	10/10/2020 14:16	10/10/2020 14:57	10/10/2020 14:16	10/10/2020 14:25	0,15	33	5,08	CHI
2020101000170	CABECEIRAS	03740424	ITUIQUIRA	10/10/2020 14:16	10/10/2020 14:57	10/10/2020 14:16	10/10/2020 14:25	0,15	11	1,69	CHI
2020101000170	DISTRITO FEDERAL	03740414	ITUIQUIRA	10/10/2020 14:16	10/10/2020 14:57	10/10/2020 14:16	10/10/2020 14:25	0,15	2	0,31	CHI
2020101000170	CABECEIRAS	ITQ-TR1	ITUIQUIRA	10/10/2020 14:16	10/10/2020 14:57	10/10/2020 14:17	10/10/2020 14:25	0,13	199	25,70	CHI
2020101000170	FORMOSA	ITQ-TR1	ITUIQUIRA	10/10/2020 14:16	10/10/2020 14:57	10/10/2020 14:17	10/10/2020 14:25	0,13	2	0,26	CHI
2020101000170	FORMOSA	ITQ-TR6	ITUIQUIRA	10/10/2020 14:16	10/10/2020 14:57	10/10/2020 14:17	10/10/2020 14:25	0,13	15976	2054,69	CHI
2020101000170	FORMOSA	ITQ-TR1	ITUIQUIRA	10/10/2020 14:16	10/10/2020 14:57	10/10/2020 14:17	10/10/2020 14:27	0,17	584	99,12	CHI
2020101000170	FLORES DE GOIAS	ITQ-TR1	ITUIQUIRA	10/10/2020 14:16	10/10/2020 14:57	10/10/2020 14:17	10/10/2020 14:27	0,17	3	0,51	CHI
2020101000170	FORMOSA	ITQ-TR1	ITUIQUIRA	10/10/2020 14:16	10/10/2020 14:57	10/10/2020 14:17	10/10/2020 14:27	0,17	2528	429,06	CHI
2020101000170	VILA BOA	ITQ-TR1	ITUIQUIRA	10/10/2020 14:16	10/10/2020 14:57	10/10/2020 14:17	10/10/2020 14:27	0,17	4	0,68	CHI
2020101000170	SAO JOAO D ALIANCA	ITQ-TR1	ITUIQUIRA	10/10/2020 14:16	10/10/2020 14:57	10/10/2020 14:17	10/10/2020 14:27	0,17	226	38,36	CHI
2020101000170	FORMOSA	ITQ-TR1	ITUIQUIRA	10/10/2020 14:16	10/10/2020 14:57	10/10/2020 14:17	10/10/2020 14:27	0,17	813	137,98	CHI
2020101000170	VILA BOA	ITQ-TR1	ITUIQUIRA	10/10/2020 14:16	10/10/2020 14:57	10/10/2020 14:17	10/10/2020 14:27	0,17	209	35,47	CHI
2020101000170	CABECEIRAS	ITQ-TR1	ITUIQUIRA	10/10/2020 14:16	10/10/2020 14:57	10/10/2020 14:17	10/10/2020 14:27	0,17	40	6,79	CHI
2020101000170	VILA BOA	ITQ-TR1	ITUIQUIRA	10/10/2020 14:16	10/10/2020 14:57	10/10/2020 14:17	10/10/2020 14:27	0,17	6	1,02	CHI
2020101000170	DISTRITO FEDERAL	ITQ-TR1	ITUIQUIRA	10/10/2020 14:16	10/10/2020 14:57	10/10/2020 14:17	10/10/2020 14:27	0,17	1	0,17	CHI
2020101000170	ITARUMA	ITQ-TR6	ITUIQUIRA	10/10/2020 14:16	10/10/2020 14:57	10/10/2020 14:17	10/10/2020 14:57	0,66	3	1,99	CHI
2020101000170	FORMOSA	ITQ-TR6	ITUIQUIRA	10/10/2020 14:16	10/10/2020 14:57	10/10/2020 14:17	10/10/2020 14:57	0,66	9343	6187,14	CHI
20201043071	GOIANIA	GN11039608	CAMPINAS S1	10/10/2020 14:16	10/10/2020 15:05	10/10/2020 14:16	10/10/2020 15:05	0,81	148	119,76	CHI
20201043035	PORANGATU	PO12208546	PORANGATU	10/10/2020 14:17	10/10/2020 20:34	10/10/2020 14:17	10/10/2020 20:34	6,28	1	6,28	CHI
20201043535	FORMOSA	FA10396032	ITUIQUIRA	10/10/2020 14:17	10/10/2020 17:36	10/10/2020 14:17	10/10/2020 14:58	0,68	1649	1125,44	CHI
20201043535	FORMOSA	FA16408538	ITUIQUIRA	10/10/2020 14:17	10/10/2020 17:36	10/10/2020 14:17	10/10/2020 14:58	0,69	1258	865,92	CHI
20201043535	FORMOSA	FA16407055	ITUIQUIRA	10/10/2020 14:17	10/10/2020 17:36	10/10/2020 14:17	10/10/2020 16:40	2,38	653	1552,69	CHI
20201043535	FORMOSA	FA10407039	ITUIQUIRA	10/10/2020 14:17	10/10/2020 17:36	10/10/2020 14:17	10/10/2020 16:50	2,54	546	1388,96	CHI
20201043535	FORMOSA	FA16407044	ITUIQUIRA	10/10/2020 14:17	10/10/2020 17:36	10/10/2020 14:17	10/10/2020 16:50	2,55	1327	3383,48	CHI
20201043535	FORMOSA	FA12062361LD	ITUIQUIRA	10/10/2020 14:17	10/10/2020 17:36	10/10/2020 14:17	10/10/2020 17:36	3,32	552	1833,56	CHI
20201043094	FORMOSO	TB12185306	PORANGATU	10/10/2020 14:18	10/10/2020 17:05	10/10/2020 14:18	10/10/2020 17:05	2,78	1	2,78	CHI
20201043094	TROMBAS	TB12185306	PORANGATU	10/10/2020 14:18	10/10/2020 17:05	10/10/2020 14:18	10/10/2020 17:05	2,78	10	27,83	CHI
20201043042	LEOPOLDO DE BULHOES	LB21279306	DAIA S2	10/10/2020 14:18	10/10/2020 16:53	10/10/2020 14:18	10/10/2020 16:53	2,58	1	2,58	CHI
20201043048	FORMOSO	FO11000010	PORANGATU	10/10/2020 14:19	10/10/2020 19:52	10/10/2020 14:19	10/10/2020 19:52	5,54	78	432,27	CHI
20201044462	BOM JESUS DE GOIAS	BJ12068991	BOM JESUS DE GOIAS	10/10/2020 14:20	10/10/2020 19:34	10/10/2020 14:20	10/10/2020 19:34	5,23	10	52,31	CHI
20201044164	APARECIDA DO RIO DOCE	AW11136119	CACHOEIRA ALTA	10/10/2020 14:22	11/10/2020 08:32	10/10/2020 14:22	11/10/2020 08:32	18,16	105	1906,48	CHI
20201043068	GOIANIA	GN12045320LD	GOYA S2	10/10/2020 14:23	10/10/2020 15:31	10/10/2020 14:23	10/10/2020 15:31	1,13	39	43,93	CHI
20201043215	PARAUNA	PU12205939	PARAUNA	10/10/2020 14:24	10/10/2020 18:07	10/10/2020 14:24	10/10/2020 18:07	3,71	8	29,67	CHI
20201043086	GOIANIA	GN21031705	GOYA S2	10/10/2020 14:24	10/10/2020 17:09	10/10/2020 14:24	10/10/2020 17:09	2,74	1	2,74	CHI
20201043111	ITUMBIARA	BJ12039450	BOM JESUS DE GOIAS	10/10/2020 14:25	10/10/2020 16:14	10/10/2020 14:25	10/10/2020 16:14	1,81	5	9,04	CHI
20201043087	MOSSAMEDES	MD21295002	ITABERAÍ S2	10/10/2020 14:26	10/10/2020 16:07	10/10/2020 14:26	10/10/2020 16:07	1,68	1	1,68	CHI
20201043392	PLANALTINA	PI12056837	PLANALTINA	10/10/2020 14:27	10/10/2020 19:27	10/10/2020 14:27	10/10/2020 19:27	5,01	865	4334,13	CHI

20201043100	PIRENOPOLIS	PV21158643	CORUMBA	10/10/2020 14:27	10/10/2020 16:59	10/10/2020 14:27	10/10/2020 16:59	2,52	3	7,56	CHI
20201043107	GOIANIA	GN11002539	FERROVIARIO S1	10/10/2020 14:28	10/10/2020 17:33	10/10/2020 14:28	10/10/2020 17:33	3,08	104	320,26	CHI
20201043146	ORIZONA	OZ12109773	VIANOPOLIS	10/10/2020 14:28	10/10/2020 18:43	10/10/2020 14:28	10/10/2020 18:43	4,24	16	67,81	CHI
20201043120	PORANGATU	PO21094116	PORANGATU	10/10/2020 14:29	10/10/2020 22:14	10/10/2020 14:29	10/10/2020 22:14	7,74	1	7,74	CHI
20201043509	LUZIANIA	LZ11000039	RIO VERMELHO	10/10/2020 14:29	11/10/2020 04:31	10/10/2020 14:29	11/10/2020 04:31	14,02	164	2299,87	CHI
20201043135	SANTO ANTONIO DO DESCOBERTO	SN12389385	MARAJOARA	10/10/2020 14:29	10/10/2020 16:15	10/10/2020 14:29	10/10/2020 16:15	1,75	78	136,72	CHI
20201043135	ALEXANIA	SN12389385	MARAJOARA	10/10/2020 14:29	10/10/2020 16:15	10/10/2020 14:29	10/10/2020 16:15	1,75	4	7,01	CHI
20201043135	DISTRITO FEDERAL	SN12389385	MARAJOARA	10/10/2020 14:29	10/10/2020 16:15	10/10/2020 14:29	10/10/2020 16:15	1,75	3	5,26	CHI
20201043154	LUZIANIA	04210244	RIO VERMELHO	10/10/2020 14:32	11/10/2020 21:18	10/10/2020 15:09	10/10/2020 15:16	0,11	3295	378,92	CHI
20201043154	LUZIANIA	LZ16410102	RIO VERMELHO	10/10/2020 14:32	11/10/2020 21:18	10/10/2020 15:09	10/10/2020 20:57	5,80	737	4277,26	CHI
20201043154	LUZIANIA	20523491	RIO VERMELHO	10/10/2020 14:32	11/10/2020 21:18	10/10/2020 15:09	10/10/2020 21:32	6,39	33	210,79	CHI
20201043154	LUZIANIA	LZ10396081	RIO VERMELHO	10/10/2020 14:32	11/10/2020 21:18	10/10/2020 14:32	10/10/2020 21:35	7,05	212	1494,60	CHI
20201043154	LUZIANIA	LZ10396081	RIO VERMELHO	10/10/2020 14:32	11/10/2020 21:18	10/10/2020 14:32	11/10/2020 18:17	27,76	14	388,63	CHI
20201043154	LUZIANIA	LZ10396081	RIO VERMELHO	10/10/2020 14:32	11/10/2020 21:18	10/10/2020 14:32	11/10/2020 19:06	28,58	31	886,05	CHI
20201043154	LUZIANIA	LZ10396081	RIO VERMELHO	10/10/2020 14:32	11/10/2020 21:18	10/10/2020 14:32	11/10/2020 21:18	30,77	597	18368,03	CHI
20201043154	LUZIANIA	LZ10396081	RIO VERMELHO	10/10/2020 14:32	11/10/2020 21:18	11/10/2020 21:12	11/10/2020 21:18	0,10	57	5,73	CHI
20201043145	SAO FRANCISCO DE GOIAS	SF21381360	SAO FRANCISCO DE GOIAS	10/10/2020 14:33	10/10/2020 20:20	10/10/2020 14:33	10/10/2020 20:20	5,77	1	5,77	CHI
20201043157	ITAPURANGA	IK12364712	ITAPURANGA	10/10/2020 14:35	10/10/2020 18:48	10/10/2020 14:35	10/10/2020 18:48	4,20	4	16,82	CHI
20201043158	LUZIANIA	LZ11061777	MARAJOARA	10/10/2020 14:35	10/10/2020 15:52	10/10/2020 14:35	10/10/2020 15:52	1,27	26	33,01	CHI
2020101000184	CAVALCANTE	34301	SAO DOMINGOS	10/10/2020 14:36	10/10/2020 14:54	10/10/2020 14:36	10/10/2020 14:54	0,30	241	72,30	CHI
2020101000184	DIVINOPOLIS DE GOIAS	02090414	SAO DOMINGOS	10/10/2020 14:36	10/10/2020 14:54	10/10/2020 14:36	10/10/2020 14:54	0,30	2294	688,20	CHI
2020101000184	MONTE ALEGRE DE GOIAS	34301	SAO DOMINGOS	10/10/2020 14:36	10/10/2020 14:54	10/10/2020 14:36	10/10/2020 14:54	0,30	2023	606,90	CHI
2020101000184	CAMPOS BELOS	02090414	SAO DOMINGOS	10/10/2020 14:36	10/10/2020 14:54	10/10/2020 14:36	10/10/2020 14:54	0,30	102	30,60	CHI
2020101000184	MONTE ALEGRE DE GOIAS	02090414	SAO DOMINGOS	10/10/2020 14:36	10/10/2020 14:54	10/10/2020 14:36	10/10/2020 14:54	0,30	156	46,80	CHI
2020101000184	SAO DOMINGOS	02090414	SAO DOMINGOS	10/10/2020 14:36	10/10/2020 14:54	10/10/2020 14:36	10/10/2020 14:54	0,30	451	135,30	CHI
2020101000184	MONTE ALEGRE DE GOIAS	07601	SAO DOMINGOS	10/10/2020 14:36	10/10/2020 14:54	10/10/2020 14:36	10/10/2020 14:54	0,30	58	17,40	CHI
2020101000184	CAMPOS BELOS	07632	SAO DOMINGOS	10/10/2020 14:36	10/10/2020 14:54	10/10/2020 14:36	10/10/2020 14:54	0,30	156	46,80	CHI
2020101000184	NOVA ROMA	34301	SAO DOMINGOS	10/10/2020 14:36	10/10/2020 14:54	10/10/2020 14:36	10/10/2020 14:54	0,30	58	17,40	CHI
2020101000184	CAMPOS BELOS	07602	SAO DOMINGOS	10/10/2020 14:36	10/10/2020 14:54	10/10/2020 14:36	10/10/2020 14:54	0,30	2827	848,10	CHI
2020101000184	CAMPOS BELOS	07601	SAO DOMINGOS	10/10/2020 14:36	10/10/2020 14:54	10/10/2020 14:36	10/10/2020 14:54	0,30	4732	1419,60	CHI
20201043163	ANAPOLIS	20645247	ANAPOLIS UNIVERSITARIO S2	10/10/2020 14:36	10/10/2020 15:41	10/10/2020 14:36	10/10/2020 15:41	1,07	1	1,07	CHI
20201043508	GUARANI DE GOIAS	02090424	SAO DOMINGOS	10/10/2020 14:37	10/10/2020 14:55	10/10/2020 14:38	10/10/2020 14:55	0,29	154	44,62	CHI
20201043508	SAO DOMINGOS	02090424	SAO DOMINGOS	10/10/2020 14:37	10/10/2020 14:55	10/10/2020 14:38	10/10/2020 14:55	0,29	1029	298,12	CHI
20201043508	SAO DOMINGOS	02090424	SAO DOMINGOS	10/10/2020 14:37	10/10/2020 14:55	10/10/2020 14:51	10/10/2020 14:55	0,06	1	0,06	CHI
20201043508	SAO DOMINGOS	02090214	SAO DOMINGOS	10/10/2020 14:37	10/10/2020 14:55	10/10/2020 14:37	10/10/2020 14:55	0,30	2437	731,10	CHI
20201043814	LUZIANIA	LZ12084532	MARAJOARA	10/10/2020 14:40	10/10/2020 18:57	10/10/2020 14:40	10/10/2020 18:57	4,28	71	303,82	CHI
20201043209	ITUMBIARA	690131550	ITUMBIARA VELHA S1	10/10/2020 14:43	10/10/2020 15:30	10/10/2020 14:43	10/10/2020 15:30	0,78	1	0,78	CHI
20201043211	MINEIROS	MY21301803	PARQUE DAS EMAS	10/10/2020 14:43	10/10/2020 18:59	10/10/2020 14:43	10/10/2020 18:59	4,25	1	4,25	CHI
20201043214	MAURILANDIA	1040039720	RIO DOS BOIS	10/10/2020 14:44	11/10/2020 10:46	10/10/2020 14:44	11/10/2020 10:46	20,03	1	20,03	CHI
20201043235	LUZIANIA	LZ10404160	RIO VERMELHO	10/10/2020 14:45	11/10/2020 18:17	10/10/2020 14:45	10/10/2020 15:47	1,03	10	10,32	CHI
20201043235	LUZIANIA	LZ10404160	RIO VERMELHO	10/10/2020 14:45	11/10/2020 18:17	10/10/2020 17:10	10/10/2020 17:24	0,24	10	2,36	CHI
20201043235	LUZIANIA	LZ10404160	RIO VERMELHO	10/10/2020 14:45	11/10/2020 18:17	10/10/2020 19:14	10/10/2020 19:33	0,32	10	3,20	CHI
20201043235	LUZIANIA	LZ10404160	RIO VERMELHO	10/10/2020 14:45	11/10/2020 18:17	11/10/2020 08:18	11/10/2020 08:32	0,23	10	2,27	CHI
20201043235	LUZIANIA	LZ10404160	RIO VERMELHO	10/10/2020 14:45	11/10/2020 18:17	11/10/2020 09:51	11/10/2020 10:06	0,24	10	2,38	CHI
20201043235	LUZIANIA	LZ10404160	RIO VERMELHO	10/10/2020 14:45	11/10/2020 18:17	11/10/2020 13:55	11/10/2020 14:22	0,45	10	4,54	CHI
20201043235	LUZIANIA	LZ12128773LD	RIO VERMELHO	10/10/2020 14:45	11/10/2020 18:17	10/10/2020 14:45	11/10/2020 17:46	27,02	17	459,27	CHI
20201043235	LUZIANIA	LZ12128773LD	RIO VERMELHO	10/10/2020 14:45	11/10/2020 18:17	10/10/2020 14:45	11/10/2020 17:46	27,02	44	1188,76	CHI
20201043235	LUZIANIA	LZ12128845LD	RIO VERMELHO	10/10/2020 14:45	11/10/2020 18:17	10/10/2020 14:45	11/10/2020 17:46	27,02	83	2242,54	CHI
20201043235	LUZIANIA	LZ12128773LD	RIO VERMELHO	10/10/2020 14:45	11/10/2020 18:17	10/10/2020 14:45	11/10/2020 18:16	27,52	21	577,89	CHI
20201043235	LUZIANIA	LZ12128773LD	RIO VERMELHO	10/10/2020 14:45	11/10/2020 18:17	10/10/2020 14:45	11/10/2020 18:16	27,52	11	302,72	CHI
20201043235	LUZIANIA	LZ12128773LD	RIO VERMELHO	10/10/2020 14:45	11/10/2020 18:17	10/10/2020 14:45	11/10/2020 18:16	27,52	23	633,03	CHI
20201043235	LUZIANIA	LZ12128773LD	RIO VERMELHO	10/10/2020 14:45	11/10/2020 18:17	10/10/2020 14:45	11/10/2020 18:16	27,52	13	357,82	CHI
20201043235	LUZIANIA	LZ12128773LD	RIO VERMELHO	10/10/2020 14:45	11/10/2020 18:17	10/10/2020 14:45	11/10/2020 18:16	27,53	13	357,87	CHI
20201043235	LUZIANIA	LZ12128773LD	RIO VERMELHO	10/10/2020 14:45	11/10/2020 18:17	10/10/2020 14:45	11/10/2020 18:17	27,53	28	770,83	CHI
20201043224	POSSE	5140001863	IACIARA S2	10/10/2020 14:45	10/10/2020 18:13	10/10/2020 14:45	10/10/2020 18:13	3,46	1	3,46	CHI
20201043871	CAMPINACU	UC12244555	PORANGATU	10/10/2020 14:46	10/10/2020 22:04	10/10/2020 14:46	10/10/2020 22:04	7,29	16	116,61	CHI
20201044068	VALPARAISO DE GOIAS	VA11192866	MARAJOARA	10/10/2020 14:46	10/10/2020 18:07	10/10/2020 14:46	10/10/2020 18:07	3,34	58	193,45	CHI
20201043239	PLANALTINA	PI11164641	PLANALTINA	10/10/2020 14:47	10/10/2020 17:35	10/10/2020 14:47	10/10/2020 17:35	2,79	93	259,70	CHI

20201043242	GOIANIA	GN11188915	GOYA S2	10/10/2020 14:47	10/10/2020 17:16	10/10/2020 14:47	10/10/2020 17:16	2,47	8	19,78	CHI
20201043553	PARAUNA	PU12357332	PARAUNA	10/10/2020 14:48	10/10/2020 19:34	10/10/2020 14:48	10/10/2020 19:34	4,76	30	142,83	CHI
20201043553	JANDAIA	PU12357332	PARAUNA	10/10/2020 14:48	10/10/2020 19:34	10/10/2020 14:48	10/10/2020 19:34	4,76	3	14,28	CHI
20201043774	SAO JOAO D ALIANCA	JL12237037	ITUIQUIRA	10/10/2020 14:48	10/10/2020 18:36	10/10/2020 14:48	10/10/2020 18:36	3,79	21	79,64	CHI
20201043329	ITAPACI	IW12151883	ITAPACI	10/10/2020 14:49	10/10/2020 19:12	10/10/2020 14:49	10/10/2020 19:12	4,38	4	17,52	CHI
20201043258	SANTO ANTONIO DO DESCOBERTO	LA12313875	AGUAS LINDAS DE GOIAS S1	10/10/2020 14:49	10/10/2020 16:33	10/10/2020 14:49	10/10/2020 16:33	1,73	18	31,14	CHI
20201043258	COCALZINHO DE GOIAS	LA12313875	AGUAS LINDAS DE GOIAS S1	10/10/2020 14:49	10/10/2020 16:33	10/10/2020 14:49	10/10/2020 16:33	1,73	1	1,73	CHI
20201043258	AGUAS LINDAS DE GOIAS	LA12313875	AGUAS LINDAS DE GOIAS S1	10/10/2020 14:49	10/10/2020 16:33	10/10/2020 14:49	10/10/2020 16:33	1,73	95	164,35	CHI
20201043269	AGUAS LINDAS DE GOIAS	LA11133126	AGUAS LINDAS DE GOIAS S2	10/10/2020 14:50	10/10/2020 16:53	10/10/2020 14:50	10/10/2020 16:53	2,04	55	112,17	CHI
20201043271	VILA BOA	2880008196	IACIARA S2	10/10/2020 14:50	10/10/2020 16:40	10/10/2020 14:50	10/10/2020 16:40	1,82	1	1,82	CHI
20201043279	TERESINA DE GOIAS	TE12257470	FLORES DE GOIAS	10/10/2020 14:51	10/10/2020 22:44	10/10/2020 14:51	10/10/2020 22:44	7,87	95	747,44	CHI
20201043288	TRINDADE	40050804	TRINDADE	10/10/2020 14:52	10/10/2020 17:30	10/10/2020 14:52	10/10/2020 17:30	2,62	1	2,62	CHI
20201043294	APORE	AE21107347	ITAJA S1	10/10/2020 14:53	10/10/2020 20:59	10/10/2020 14:53	10/10/2020 20:59	6,09	1	6,09	CHI
20201044364	LUZIANIA	LZ12388659	MARAJOARA	10/10/2020 14:53	10/10/2020 20:26	10/10/2020 14:53	10/10/2020 20:26	5,53	3	16,60	CHI
20201044364	VALPARAISO DE GOIAS	LZ12388659	MARAJOARA	10/10/2020 14:53	10/10/2020 20:26	10/10/2020 14:53	10/10/2020 20:26	5,53	22	121,76	CHI
20201043312	CAMPINORTE	CR12068033	MARA ROSA	10/10/2020 14:54	10/10/2020 19:24	10/10/2020 14:54	10/10/2020 19:24	4,49	2	8,97	CHI
20201043316	CRISTALINA	KR12170316	PAMPLONA	10/10/2020 14:55	10/10/2020 16:35	10/10/2020 14:55	10/10/2020 16:35	1,66	1	1,66	CHI
20201043645	FORMOSA	FA12164673	ITUIQUIRA	10/10/2020 14:55	10/10/2020 17:36	10/10/2020 14:55	10/10/2020 17:36	2,67	688	1838,11	CHI
20201043341	CRISTALINA	1060098821	CRISTALINA S1	10/10/2020 14:58	10/10/2020 16:02	10/10/2020 14:58	10/10/2020 16:02	1,07	1	1,07	CHI
20201044230	LUZIANIA	LZ11370789	MARAJOARA	10/10/2020 14:59	10/10/2020 21:10	10/10/2020 14:59	10/10/2020 21:10	6,18	53	327,58	CHI
20201043349	SANTA TEREZA DE GOIAS	SE21041356	MARA ROSA	10/10/2020 14:59	10/10/2020 18:17	10/10/2020 14:59	10/10/2020 18:17	3,29	1	3,29	CHI
20201043359	SILVANIA	SV12205374	VIANOPOLIS	10/10/2020 15:00	10/10/2020 16:01	10/10/2020 15:00	10/10/2020 16:01	1,00	3	3,01	CHI
20201043928	VALPARAISO DE GOIAS	VA12169007	MARAJOARA	10/10/2020 15:00	10/10/2020 19:00	10/10/2020 15:00	10/10/2020 19:00	3,98	195	777,07	CHI
20201043364	PARAUNA	PU12233958	MONTIVIDIU T	10/10/2020 15:01	10/10/2020 18:33	10/10/2020 15:01	10/10/2020 18:33	3,52	8	28,20	CHI
20201043691	SAO DOMINGOS	O2090424	SAO DOMINGOS	10/10/2020 15:01	10/10/2020 21:27	10/10/2020 15:01	10/10/2020 21:04	6,04	534	3227,14	CHI
20201043691	GUARANI DE GOIAS	O2090424	SAO DOMINGOS	10/10/2020 15:01	10/10/2020 21:27	10/10/2020 15:01	10/10/2020 21:04	6,04	2	12,09	CHI
20201043691	GUARANI DE GOIAS	SD10401447	SAO DOMINGOS	10/10/2020 15:01	10/10/2020 21:27	10/10/2020 15:01	10/10/2020 21:27	6,42	152	975,54	CHI
20201043691	SAO DOMINGOS	SD10401447	SAO DOMINGOS	10/10/2020 15:01	10/10/2020 21:27	10/10/2020 15:01	10/10/2020 21:27	6,42	481	3087,08	CHI
20201043691	MONTE ALEGRE DE GOIAS	SD10401447	SAO DOMINGOS	10/10/2020 15:01	10/10/2020 21:27	10/10/2020 16:35	10/10/2020 21:27	4,85	1	4,85	CHI
20201043691	SAO DOMINGOS	SD10401447	SAO DOMINGOS	10/10/2020 15:01	10/10/2020 21:27	10/10/2020 16:35	10/10/2020 21:27	4,85	181	878,00	CHI
20201043691	NOVA ROMA	SD10401447	SAO DOMINGOS	10/10/2020 15:01	10/10/2020 21:27	10/10/2020 16:35	10/10/2020 21:27	4,85	3	14,55	CHI
20201046156	SAO DOMINGOS	SD12332852	SAO DOMINGOS	10/10/2020 15:01	11/10/2020 15:36	10/10/2020 15:01	11/10/2020 15:00	23,97	3	71,92	CHI
20201046156	SAO DOMINGOS	SD21108992	SAO DOMINGOS	10/10/2020 15:01	11/10/2020 15:36	10/10/2020 15:01	11/10/2020 15:05	24,05	1	24,05	CHI
20201046156	SAO DOMINGOS	SD21347118	SAO DOMINGOS	10/10/2020 15:01	11/10/2020 15:36	10/10/2020 15:01	11/10/2020 15:17	24,27	1	24,27	CHI
20201046156	SAO DOMINGOS	SD21252654	SAO DOMINGOS	10/10/2020 15:01	11/10/2020 15:36	10/10/2020 15:01	11/10/2020 15:26	24,41	1	24,41	CHI
20201046156	SAO DOMINGOS	SD21134782	SAO DOMINGOS	10/10/2020 15:01	11/10/2020 15:36	10/10/2020 15:01	11/10/2020 15:36	24,58	2	49,16	CHI
20201043801	CIDADE OCIDENTAL	DH11183826	MARAJOARA	10/10/2020 15:02	10/10/2020 19:23	10/10/2020 15:02	10/10/2020 19:23	4,34	85	368,57	CHI
20201043376	GOIANIA	14555815	CAMPINAS S1	10/10/2020 15:03	10/10/2020 16:39	10/10/2020 15:03	10/10/2020 16:39	1,60	1	1,60	CHI
20201043382	TRINDADE	TR21022422	TRINDADE	10/10/2020 15:03	10/10/2020 16:52	10/10/2020 15:03	10/10/2020 16:52	1,81	1	1,81	CHI
20201043394	URUACU	10014391820	URUACU	10/10/2020 15:04	10/10/2020 19:13	10/10/2020 15:04	10/10/2020 19:13	4,13	1	4,13	CHI
20201043762	CIDADE OCIDENTAL	DH12370803	MARAJOARA	10/10/2020 15:05	10/10/2020 19:54	10/10/2020 15:05	10/10/2020 17:28	2,37	131	310,54	CHI
20201043762	CIDADE OCIDENTAL	DH11292246	MARAJOARA	10/10/2020 15:05	10/10/2020 19:54	10/10/2020 15:05	10/10/2020 19:54	4,81	128	615,22	CHI
20201043401	ARAGARCAS	AG12000006	ARAGARCAS	10/10/2020 15:06	10/10/2020 17:17	10/10/2020 15:06	10/10/2020 17:17	2,18	42	91,58	CHI
20201043435	CORUMBA DE GOIAS	O3240214	CORUMBA	10/10/2020 15:06	10/10/2020 16:38	10/10/2020 15:06	10/10/2020 16:10	1,07	7	7,51	CHI
20201043435	CORUMBA DE GOIAS	O3240214	CORUMBA	10/10/2020 15:06	10/10/2020 16:38	10/10/2020 15:06	10/10/2020 16:38	1,53	356	544,28	CHI
20201043435	ALEXANIA	O3240214	CORUMBA	10/10/2020 15:06	10/10/2020 16:38	10/10/2020 15:06	10/10/2020 16:38	1,53	860	1314,84	CHI
20201043435	CORUMBA DE GOIAS	O3240416	CORUMBA	10/10/2020 15:06	10/10/2020 16:38	10/10/2020 16:10	10/10/2020 16:38	0,46	4	1,82	CHI
20201043435	ALEXANIA	O3240416	CORUMBA	10/10/2020 15:06	10/10/2020 16:38	10/10/2020 16:10	10/10/2020 16:38	0,46	31	14,13	CHI
20201043405	GOIANIA	12863622	XAVANTES	10/10/2020 15:06	10/10/2020 17:15	10/10/2020 15:06	10/10/2020 17:15	2,14	1	2,14	CHI
20201043546	CIDADE OCIDENTAL	DH11172222	MARAJOARA	10/10/2020 15:08	10/10/2020 18:43	10/10/2020 15:08	10/10/2020 18:43	3,57	108	386,10	CHI
20201043422	NEROPOLIS	NR21324582	NEROPOLIS S2	10/10/2020 15:09	10/10/2020 18:52	10/10/2020 15:09	10/10/2020 18:52	3,71	4	14,85	CHI
20201043569	LUZIANIA	LZ12041547	RIO VERMELHO	10/10/2020 15:09	10/10/2020 22:06	10/10/2020 15:09	10/10/2020 20:04	4,92	428	2106,83	CHI
20201043569	LUZIANIA	LZ12041547	RIO VERMELHO	10/10/2020 15:09	10/10/2020 22:06	10/10/2020 15:09	10/10/2020 22:06	6,96	103	716,71	CHI
20201043478	MONTE ALEGRE DE GOIAS	MA12212699	SAO DOMINGOS	10/10/2020 15:09	10/10/2020 17:41	10/10/2020 15:09	10/10/2020 17:41	2,52	66	166,28	CHI
20201043515	BOM JARDIM DE GOIAS	BM12208862	BOM JARDIM	10/10/2020 15:10	11/10/2020 00:42	10/10/2020 15:10	10/10/2020 20:12	5,04	27	135,96	CHI
20201043515	BOM JARDIM DE GOIAS	BM12228037LD	BOM JARDIM	10/10/2020 15:10	11/10/2020 00:42	10/10/2020 15:10	10/10/2020 23:43	8,56	5	42,79	CHI
20201043515	BOM JARDIM DE GOIAS	BM12228032LD	BOM JARDIM	10/10/2020 15:10	11/10/2020 00:42	10/10/2020 15:10	11/10/2020 00:42	9,54	1	9,54	CHI
20201043439	SANTA HELENA DE GOIAS	10002640390	IPEGUARI	10/10/2020 15:12	10/10/2020 18:45	10/10/2020 15:12	10/10/2020 18:45	3,55	1	3,55	CHI

20201050489	SAO MIGUEL DO ARAGUAIA	SM12000010	SAO MIGUEL DO ARAGUAIA	10/10/2020 15:12	11/10/2020 17:45	10/10/2020 15:12	11/10/2020 10:54	19,70	158	3113,17	CHI
20201050489	SAO MIGUEL DO ARAGUAIA	SM12220639LD	SAO MIGUEL DO ARAGUAIA	10/10/2020 15:12	11/10/2020 17:45	10/10/2020 15:12	11/10/2020 17:45	26,56	105	2788,77	CHI
20201043443	NOVO GAMA	LZ12389566	PACAEMBU S2	10/10/2020 15:12	10/10/2020 18:59	10/10/2020 15:12	10/10/2020 18:59	3,78	3	11,33	CHI
20201043443	LUZIANIA	LZ12389566	PACAEMBU S2	10/10/2020 15:12	10/10/2020 18:59	10/10/2020 15:12	10/10/2020 18:59	3,78	17	64,18	CHI
20201043721	LUZIANIA	LZ12396833	MARAJOARA	10/10/2020 15:12	11/10/2020 14:08	10/10/2020 15:12	11/10/2020 14:08	22,93	19	435,59	CHI
20201043573	AVELINOPOLIS	AC12391412	ANICUNS	10/10/2020 15:14	10/10/2020 18:22	10/10/2020 15:14	10/10/2020 18:22	3,13	1	3,13	CHI
20201043573	ANICUNS	AC12391412	ANICUNS	10/10/2020 15:14	10/10/2020 18:22	10/10/2020 15:14	10/10/2020 18:22	3,13	28	87,72	CHI
20201043480	CATALAO	1990095700	CATALAO S2	10/10/2020 15:16	10/10/2020 17:24	10/10/2020 15:16	10/10/2020 17:24	2,13	1	2,13	CHI
20201043482	BURITINOPOLIS	05690214	SANTA RITA DO ARAGUAIA	10/10/2020 15:16	10/10/2020 16:16	10/10/2020 15:16	10/10/2020 16:16	0,99	1	0,99	CHI
20201043482	MINEIROS	05690214	SANTA RITA DO ARAGUAIA	10/10/2020 15:16	10/10/2020 16:16	10/10/2020 15:16	10/10/2020 16:16	0,99	11	10,91	CHI
20201043482	SANTA RITA DO ARAGUAIA	05690214	SANTA RITA DO ARAGUAIA	10/10/2020 15:16	10/10/2020 16:16	10/10/2020 15:16	10/10/2020 16:16	0,99	1212	1201,56	CHI
20201044245	FORMOSA	FB12390645	IACIARA S2	10/10/2020 15:18	10/10/2020 18:17	10/10/2020 15:18	10/10/2020 18:17	2,97	1	2,97	CHI
20201044245	FLORES DE GOIAS	FB12390645	IACIARA S2	10/10/2020 15:18	10/10/2020 18:17	10/10/2020 15:18	10/10/2020 18:17	2,97	169	502,63	CHI
20201044245	VILA BOA	FB12390645	IACIARA S2	10/10/2020 15:18	10/10/2020 18:17	10/10/2020 15:18	10/10/2020 18:17	2,97	4	11,90	CHI
20201043514	AGUA FRIA DE GOIAS	TL21106926	SAO JOAO D ALIANCA	10/10/2020 15:20	11/10/2020 19:05	10/10/2020 15:20	11/10/2020 19:05	27,74	2	55,48	CHI
20201043523	CORUMBAIBA	10019236199	VILA CORUMBA	10/10/2020 15:21	10/10/2020 20:03	10/10/2020 15:21	10/10/2020 20:03	4,70	1	4,70	CHI
20201043527	LUZIANIA	LZ11061746	RIO VERMELHO	10/10/2020 15:21	10/10/2020 19:52	10/10/2020 15:21	10/10/2020 19:52	4,51	35	157,68	CHI
20201043528	CORUMBA DE GOIAS	SN12382264	ALEXANIA	10/10/2020 15:21	10/10/2020 18:41	10/10/2020 15:21	10/10/2020 18:41	3,32	13	43,17	CHI
20201043528	SANTO ANTONIO DO DESCOBERTO	SN12382264	ALEXANIA	10/10/2020 15:21	10/10/2020 18:41	10/10/2020 15:21	10/10/2020 18:41	3,32	14	46,50	CHI
20201043531	RIO VERDE	RV21271634	CABRIUVA S2	10/10/2020 15:22	11/10/2020 17:18	10/10/2020 15:22	11/10/2020 17:18	25,93	1	25,93	CHI
2020101000010	GOIATUBA	00230424	BOM JESUS DE GOIAS	10/10/2020 15:23	10/10/2020 15:26	10/10/2020 15:23	10/10/2020 15:26	0,05	26	1,30	CHI
2020101000010	ITUMBIARA	00230424	BOM JESUS DE GOIAS	10/10/2020 15:23	10/10/2020 15:26	10/10/2020 15:23	10/10/2020 15:26	0,05	3	0,15	CHI
2020101000010	GOIATUBA	45801	BOM JESUS DE GOIAS	10/10/2020 15:23	10/10/2020 15:26	10/10/2020 15:23	10/10/2020 15:26	0,05	132	6,60	CHI
2020101000010	BOM JESUS DE GOIAS	00230424	BOM JESUS DE GOIAS	10/10/2020 15:23	10/10/2020 15:26	10/10/2020 15:23	10/10/2020 15:26	0,05	22	1,10	CHI
2020101000010	GOIATUBA	45802	BOM JESUS DE GOIAS	10/10/2020 15:23	10/10/2020 15:26	10/10/2020 15:23	10/10/2020 15:26	0,05	102	5,10	CHI
20201043622	VALPARAISO DE GOIAS	VA11149838	MARAJOARA	10/10/2020 15:23	10/10/2020 17:04	10/10/2020 15:23	10/10/2020 17:04	1,67	71	118,63	CHI
20201043539	COCALZINHO DE GOIAS	ZN11200905	AGUAS LINDAS DE GOIAS S2	10/10/2020 15:24	10/10/2020 18:09	10/10/2020 15:24	10/10/2020 18:09	2,75	39	107,37	CHI
20201042181	ITUMBIARA	IT11143878	ITUMBIARA VELHA S1	10/10/2020 15:24	11/10/2020 04:26	10/10/2020 15:24	11/10/2020 04:26	13,02	95	1237,24	CHI
20201041219	SANTO ANTONIO DA BARRA	BZ12295804	ACREUNA	10/10/2020 15:26	11/10/2020 13:55	10/10/2020 15:26	10/10/2020 15:33	0,11	6	0,65	CHI
20201041219	SANTO ANTONIO DA BARRA	BZ16418419	ACREUNA	10/10/2020 15:26	11/10/2020 13:55	10/10/2020 15:26	10/10/2020 20:44	5,29	2	10,58	CHI
20201041219	SANTO ANTONIO DA BARRA	BZ12295804	ACREUNA	10/10/2020 15:26	11/10/2020 13:55	10/10/2020 23:10	10/10/2020 23:48	0,64	6	3,86	CHI
20201041219	SANTO ANTONIO DA BARRA	BZ16418419	ACREUNA	10/10/2020 15:26	11/10/2020 13:55	10/10/2020 23:10	10/10/2020 23:50	0,67	2	1,34	CHI
20201041219	RIO VERDE	BZ12295789LD	ACREUNA	10/10/2020 15:26	11/10/2020 13:55	10/10/2020 15:26	11/10/2020 09:48	18,36	2	36,72	CHI
20201041219	SANTO ANTONIO DA BARRA	BZ12295789LD	ACREUNA	10/10/2020 15:26	11/10/2020 13:55	10/10/2020 15:26	11/10/2020 09:48	18,36	2	36,72	CHI
20201041219	SANTO ANTONIO DA BARRA	RV12033158	ACREUNA	10/10/2020 15:26	11/10/2020 13:55	10/10/2020 15:26	11/10/2020 11:01	19,59	1	19,59	CHI
20201041219	RIO VERDE	BZ12295789LD	ACREUNA	10/10/2020 15:26	11/10/2020 13:55	10/10/2020 15:26	11/10/2020 13:55	22,48	8	179,86	CHI
20201041219	SANTA HELENA DE GOIAS	BZ12295789LD	ACREUNA	10/10/2020 15:26	11/10/2020 13:55	10/10/2020 15:26	11/10/2020 13:55	22,48	5	112,41	CHI
20201041219	SANTO ANTONIO DA BARRA	BZ12295789LD	ACREUNA	10/10/2020 15:26	11/10/2020 13:55	10/10/2020 15:26	11/10/2020 13:55	22,48	2	44,96	CHI
20201043563	APARECIDA DE GOIANIA	12963963	INDEPENDENCIA S1	10/10/2020 15:26	10/10/2020 17:11	10/10/2020 15:26	10/10/2020 17:11	1,75	1	1,75	CHI
20201043795	NEROPOLIS	NR12247250	NEROPOLIS S2	10/10/2020 15:27	10/10/2020 18:16	10/10/2020 15:27	10/10/2020 18:16	2,81	9	25,30	CHI
20201043574	IPAMERI	IP21058235	IPAMERI	10/10/2020 15:27	10/10/2020 18:01	10/10/2020 15:27	10/10/2020 18:01	2,55	1	2,55	CHI
20201043577	CAVALCANTE	CJ11255469	FLORES DE GOIAS	10/10/2020 15:28	10/10/2020 17:54	10/10/2020 15:28	10/10/2020 17:54	2,43	64	155,64	CHI
20201044045	TURVANIA	EU12246749	ACREUNA	10/10/2020 15:28	11/10/2020 14:02	10/10/2020 15:28	10/10/2020 18:20	2,86	1	2,86	CHI
20201044045	TURVELANDIA	EU12246749	ACREUNA	10/10/2020 15:28	11/10/2020 14:02	10/10/2020 15:28	10/10/2020 18:20	2,86	6	17,14	CHI
20201044045	EDEIA	EU12246749	ACREUNA	10/10/2020 15:28	11/10/2020 14:02	10/10/2020 15:28	10/10/2020 18:20	2,86	4	11,43	CHI
20201044045	ACREUNA	EU12246749	ACREUNA	10/10/2020 15:28	11/10/2020 14:02	10/10/2020 15:28	10/10/2020 19:38	4,16	3	12,48	CHI
20201044045	EDEIA	EU12246749	ACREUNA	10/10/2020 15:28	11/10/2020 14:02	10/10/2020 15:28	10/10/2020 21:57	6,48	9	58,34	CHI
20201044045	TURVELANDIA	EU12246749	ACREUNA	10/10/2020 15:28	11/10/2020 14:02	10/10/2020 15:28	10/10/2020 21:57	6,48	19	123,17	CHI
20201044045	ACREUNA	EU12246749	ACREUNA	10/10/2020 15:28	11/10/2020 14:02	10/10/2020 15:28	11/10/2020 13:45	22,28	6	133,67	CHI
20201044045	ACREUNA	EU12246749	ACREUNA	10/10/2020 15:28	11/10/2020 14:02	10/10/2020 15:28	11/10/2020 14:02	22,57	2	45,14	CHI
20201043587	LUZIANIA	LZ11304792	RIO VERMELHO	10/10/2020 15:29	10/10/2020 17:57	10/10/2020 15:29	10/10/2020 17:57	2,46	47	115,74	CHI
20201043603	PLANALTINA	PI11043458	PLANALTINA	10/10/2020 15:30	10/10/2020 16:42	10/10/2020 15:30	10/10/2020 16:42	1,18	33	39,07	CHI
20201043607	FORMOSA	610293874	ITUIQUIRA	10/10/2020 15:31	11/10/2020 16:24	10/10/2020 15:31	11/10/2020 16:24	24,88	1	24,88	CHI
20201043618	APARECIDA DE GOIANIA	15556712	INDEPENDENCIA S2	10/10/2020 15:32	10/10/2020 16:35	10/10/2020 15:32	10/10/2020 16:35	1,05	1	1,05	CHI
20201043625	SAO JOAO D ALIANCA	JL12238305	ITUIQUIRA	10/10/2020 15:32	10/10/2020 19:24	10/10/2020 15:32	10/10/2020 19:24	3,86	30	115,71	CHI
20201043629	PIRENOPOLIS	10030730595	CORUMBA	10/10/2020 15:32	10/10/2020 17:36	10/10/2020 15:32	10/10/2020 17:36	2,06	1	2,06	CHI
20201043639	MATRINCHA	MP12158196	MATRINCHA	10/10/2020 15:33	10/10/2020 17:29	10/10/2020 15:33	10/10/2020 17:29	1,92	95	182,56	CHI
20201043644	CACHOEIRA ALTA	10015297860	CACHOEIRA ALTA	10/10/2020 15:34	10/10/2020 22:48	10/10/2020 15:34	10/10/2020 22:48	7,22	1	7,22	CHI

20201043679	SANTO ANTONIO DO DESCOBERTO	SN11047622	AGUAS LINDAS DE GOIAS S2	10/10/2020 15:35	10/10/2020 19:33	10/10/2020 15:35	10/10/2020 19:33	3,96	37	146,50	CHI
20201043653	ACREUNA	EU12301057	ACREUNA	10/10/2020 15:35	10/10/2020 17:08	10/10/2020 15:35	10/10/2020 17:08	1,54	29	44,58	CHI
20201043988	COCALZINHO DE GOIAS	ZN12320107	AGUAS LINDAS DE GOIAS S1	10/10/2020 15:36	10/10/2020 17:50	10/10/2020 15:36	10/10/2020 17:50	2,23	14	31,23	CHI
20201044955	ALEXANIA	AX11334294	ALEXANIA	10/10/2020 15:36	10/10/2020 21:04	10/10/2020 15:36	10/10/2020 21:04	5,46	52	283,69	CHI
20201043699	IPAMERI	IP12079464	CAMPO ALEGRE DE GOIAS	10/10/2020 15:37	10/10/2020 18:00	10/10/2020 15:37	10/10/2020 18:00	2,38	4	9,53	CHI
20201043672	FORMOSA	FA12042010	ITUIQUIRA	10/10/2020 15:37	11/10/2020 03:41	10/10/2020 15:37	11/10/2020 03:41	12,05	21	253,10	CHI
20201043673	MAURILANDIA	1040003350	RIO DOS BOIS	10/10/2020 15:37	11/10/2020 12:04	10/10/2020 15:37	11/10/2020 12:04	20,43	1	20,43	CHI
20201044115	JESUPOLIS	04740414	SAO FRANCISCO DE GOIAS	10/10/2020 15:38	10/10/2020 20:06	10/10/2020 15:38	10/10/2020 18:32	2,88	38	109,61	CHI
20201044115	SAO FRANCISCO DE GOIAS	JE13414288	SAO FRANCISCO DE GOIAS	10/10/2020 15:38	10/10/2020 20:06	10/10/2020 15:38	10/10/2020 19:33	3,91	43	168,20	CHI
20201044115	JESUPOLIS	JE13414288	SAO FRANCISCO DE GOIAS	10/10/2020 15:38	10/10/2020 20:06	10/10/2020 15:38	10/10/2020 19:33	3,91	23	89,97	CHI
20201044115	SAO FRANCISCO DE GOIAS	JE13414288	SAO FRANCISCO DE GOIAS	10/10/2020 15:38	10/10/2020 20:06	10/10/2020 18:11	10/10/2020 19:33	1,38	29	39,95	CHI
20201044115	JESUPOLIS	JE13414288	SAO FRANCISCO DE GOIAS	10/10/2020 15:38	10/10/2020 20:06	10/10/2020 18:11	10/10/2020 19:33	1,38	1	1,38	CHI
20201044115	JESUPOLIS	SF12007210	SAO FRANCISCO DE GOIAS	10/10/2020 15:38	10/10/2020 20:06	10/10/2020 15:38	10/10/2020 20:06	4,47	14	62,54	CHI
20201044115	SAO FRANCISCO DE GOIAS	SF12007210	SAO FRANCISCO DE GOIAS	10/10/2020 15:38	10/10/2020 20:06	10/10/2020 15:38	10/10/2020 20:06	4,47	1	4,47	CHI
20201044115	SAO FRANCISCO DE GOIAS	SF12007210	SAO FRANCISCO DE GOIAS	10/10/2020 15:38	10/10/2020 20:06	10/10/2020 18:11	10/10/2020 20:06	1,93	10	19,33	CHI
20201044115	JESUPOLIS	SF12007210	SAO FRANCISCO DE GOIAS	10/10/2020 15:38	10/10/2020 20:06	10/10/2020 18:11	10/10/2020 20:06	1,93	12	23,20	CHI
20201043834	VALPARAISO DE GOIAS	VA11149894	MARAJOARA	10/10/2020 15:40	10/10/2020 17:30	10/10/2020 15:40	10/10/2020 17:30	1,82	65	118,37	CHI
20201043758	LUZIANIA	LZ11029350	RIO VERMELHO	10/10/2020 15:41	10/10/2020 17:02	10/10/2020 15:41	10/10/2020 17:02	1,34	215	288,04	CHI
20201043827	EDEIA	EA12257969	RIO DOS BOIS	10/10/2020 15:41	10/10/2020 17:56	10/10/2020 15:41	10/10/2020 17:56	2,24	2	4,48	CHI
20201045244	LUZIANIA	LZ11051977	PACAEMBU S2	10/10/2020 15:42	10/10/2020 21:18	10/10/2020 15:42	10/10/2020 21:18	5,59	10	55,91	CHI
20201047973	ITARUMA	IJ12191584	CACHOEIRA ALTA	10/10/2020 15:42	11/10/2020 13:10	10/10/2020 15:42	11/10/2020 13:10	21,46	1	21,46	CHI
20201047973	ITAJA	IJ12191584	CACHOEIRA ALTA	10/10/2020 15:42	11/10/2020 13:10	10/10/2020 15:42	11/10/2020 13:10	21,46	3	64,37	CHI
20201043724	SILVANIA	SV12265097	VIANOPOLIS	10/10/2020 15:44	10/10/2020 23:57	10/10/2020 15:44	10/10/2020 23:57	8,21	1	8,21	CHI
20201043729	SANTA HELENA DE GOIAS	400083176	IPEGUARI	10/10/2020 15:44	10/10/2020 20:07	10/10/2020 15:44	10/10/2020 20:07	4,38	1	4,38	CHI
20201043731	PIRENOPOLIS	PV21031645	CORUMBA	10/10/2020 15:44	10/10/2020 18:00	10/10/2020 15:44	10/10/2020 18:00	2,25	1	2,25	CHI
20201043733	PIRENOPOLIS	PV21121853	CORUMBA	10/10/2020 15:44	10/10/2020 20:29	10/10/2020 15:44	10/10/2020 20:29	4,74	2	9,47	CHI
20201043743	CAIAPONIA	CP12235316	PIRANHAS	10/10/2020 15:46	10/10/2020 16:56	10/10/2020 15:46	10/10/2020 16:56	1,16	6	6,97	CHI
20201043748	PONTALINA	PK21223285	VICENTINOPOLIS	10/10/2020 15:46	10/10/2020 18:52	10/10/2020 15:46	10/10/2020 18:52	3,09	1	3,09	CHI
20201044456	MONTIVIDIU DO NORTE	MX12226413RE	PORANGATU	10/10/2020 15:46	10/10/2020 22:25	10/10/2020 15:46	10/10/2020 22:25	6,64	40	265,43	CHI
20201043761	BURITI ALEGRE	BG11203285	ALTO BURITI	10/10/2020 15:49	11/10/2020 17:48	10/10/2020 15:49	11/10/2020 17:48	25,98	32	831,40	CHI
20201044075	DIVINOPOLIS DE GOIAS	GH12088002	SAO DOMINGOS	10/10/2020 15:50	11/10/2020 02:04	10/10/2020 15:50	11/10/2020 02:04	10,24	50	511,92	CHI
20201044075	SAO DOMINGOS	GH12088002	SAO DOMINGOS	10/10/2020 15:50	11/10/2020 02:04	10/10/2020 15:50	11/10/2020 02:04	10,24	172	1760,99	CHI
20201043780	ANAPOLIS	AN12377725	ANAPOLIS UNIVERSITARIO S2	10/10/2020 15:51	10/10/2020 18:06	10/10/2020 15:51	10/10/2020 18:06	2,24	23	51,49	CHI
20201045343	MINACU	IH12348012	MINACU	10/10/2020 15:52	10/10/2020 22:47	10/10/2020 15:52	10/10/2020 22:47	6,91	16	110,50	CHI
20201043787	ANAPOLIS	AN21000826	ANAPOLIS UNIVERSITARIO S2	10/10/2020 15:52	10/10/2020 17:06	10/10/2020 15:52	10/10/2020 17:06	1,22	1	1,22	CHI
20201043848	HEITORAI	HE12250701	ITAPURANGA	10/10/2020 15:55	12/10/2020 11:20	10/10/2020 15:55	12/10/2020 11:20	43,41	6	260,45	CHI
20201043848	GOIAS	HE12250701	ITAPURANGA	10/10/2020 15:55	12/10/2020 11:20	10/10/2020 15:55	12/10/2020 11:20	43,41	15	651,12	CHI
20201043800	CACU	CC21214274	CACHOEIRA ALTA	10/10/2020 15:55	11/10/2020 02:27	10/10/2020 15:55	11/10/2020 02:27	10,52	1	10,52	CHI
20201043803	TRINDADE	40170639	TRINDADE	10/10/2020 15:55	10/10/2020 17:13	10/10/2020 15:55	10/10/2020 17:13	1,29	1	1,29	CHI
20201043807	ITARUMA	IM21097059	CACHOEIRA ALTA	10/10/2020 15:56	10/10/2020 17:15	10/10/2020 15:56	10/10/2020 17:15	1,31	1	1,31	CHI
20201043821	ORIZONA	OZ12114492	PIRES DO RIO S2	10/10/2020 15:58	10/10/2020 19:59	10/10/2020 15:58	10/10/2020 19:59	4,01	8	32,09	CHI
20201043831	MONTES CLAROS DE GOIAS	ME12380972	IPORA	10/10/2020 16:00	10/10/2020 20:18	10/10/2020 16:00	10/10/2020 20:18	4,30	8	34,39	CHI
20201044908	LUZIANIA	LZ11169002	MARAJOARA	10/10/2020 16:00	10/10/2020 22:55	10/10/2020 16:00	10/10/2020 22:55	6,91	36	248,88	CHI
20201043853	MORRINHOS	MR21112471	MORRINHOS	10/10/2020 16:04	10/10/2020 16:56	10/10/2020 16:04	10/10/2020 16:56	0,86	1	0,86	CHI
20201043854	FAINA	FC12029561	GOIAS	10/10/2020 16:04	10/10/2020 18:13	10/10/2020 16:04	10/10/2020 18:13	2,14	5	10,71	CHI
20201043858	DOVERLANDIA	10016836896	CAIAPONIA	10/10/2020 16:05	10/10/2020 16:41	10/10/2020 16:05	10/10/2020 16:41	0,60	1	0,60	CHI
20201044361	VALPARAISO DE GOIAS	VA12290727	MARAJOARA	10/10/2020 16:05	10/10/2020 19:05	10/10/2020 16:05	10/10/2020 19:05	2,99	40	119,43	CHI
20201043876	RIO VERDE	RV21306405	CABRIUVA S2	10/10/2020 16:07	11/10/2020 22:41	10/10/2020 16:07	11/10/2020 22:41	30,56	1	30,56	CHI
20201044771	TERESINA DE GOIAS	TE11047978	FLORES DE GOIAS	10/10/2020 16:07	10/10/2020 20:39	10/10/2020 16:07	10/10/2020 20:39	4,52	144	651,32	CHI
20201043894	PLANALTINA	PI10400576	PLANALTINA	10/10/2020 16:10	11/10/2020 23:51	10/10/2020 16:10	10/10/2020 22:39	6,50	3	19,49	CHI
20201043894	PLANALTINA	PI10400576	PLANALTINA	10/10/2020 16:10	11/10/2020 23:51	10/10/2020 16:11	10/10/2020 22:39	6,48	9	58,31	CHI
20201043894	PADRE BERNARDO	PI10400576	PLANALTINA	10/10/2020 16:10	11/10/2020 23:51	10/10/2020 16:10	11/10/2020 08:32	16,38	4	65,53	CHI
20201043894	PLANALTINA	PI10400576	PLANALTINA	10/10/2020 16:10	11/10/2020 23:51	10/10/2020 16:10	11/10/2020 08:32	16,38	27	442,30	CHI
20201043894	PADRE BERNARDO	PI10400576	PLANALTINA	10/10/2020 16:10	11/10/2020 23:51	10/10/2020 16:11	11/10/2020 08:32	16,36	9	147,28	CHI
20201043894	PLANALTINA	PI10400576	PLANALTINA	10/10/2020 16:10	11/10/2020 23:51	10/10/2020 16:11	11/10/2020 08:32	16,36	85	1390,98	CHI
20201043894	PLANALTINA	PI10400576	PLANALTINA	10/10/2020 16:10	11/10/2020 23:51	10/10/2020 16:10	11/10/2020 14:24	22,24	4	88,94	CHI
20201043894	PLANALTINA	PI10400576	PLANALTINA	10/10/2020 16:10	11/10/2020 23:51	10/10/2020 16:11	11/10/2020 14:24	22,22	2	44,44	CHI
20201043894	PLANALTINA	PI10400576	PLANALTINA	10/10/2020 16:10	11/10/2020 23:51	11/10/2020 14:26	11/10/2020 14:59	0,56	6	3,38	CHI

20201043894	PLANALTINA	PI12355798	PLANALTINA	10/10/2020 16:10	11/10/2020 23:51	10/10/2020 16:10	11/10/2020 16:58	24,81	54	1339,70	CHI
20201043894	PLANALTINA	PI12355789	PLANALTINA	10/10/2020 16:10	11/10/2020 23:51	10/10/2020 16:10	11/10/2020 17:41	25,53	9	229,75	CHI
20201043894	PLANALTINA	PI10400576	PLANALTINA	10/10/2020 16:10	11/10/2020 23:51	10/10/2020 16:10	11/10/2020 23:13	31,05	9	279,48	CHI
20201043894	PADRE BERNARDO	PI10400576	PLANALTINA	10/10/2020 16:10	11/10/2020 23:51	10/10/2020 16:11	11/10/2020 23:13	31,04	3	93,11	CHI
20201043894	PLANALTINA	PI10400576	PLANALTINA	10/10/2020 16:10	11/10/2020 23:51	10/10/2020 16:11	11/10/2020 23:13	31,04	52	1613,89	CHI
20201043894	PLANALTINA	PI10400576	PLANALTINA	10/10/2020 16:10	11/10/2020 23:51	11/10/2020 20:14	11/10/2020 23:13	2,97	69	205,24	CHI
20201043894	PLANALTINA	PI12356185	PLANALTINA	10/10/2020 16:10	11/10/2020 23:51	10/10/2020 16:11	11/10/2020 23:39	31,47	1	31,47	CHI
20201043894	PLANALTINA	PI12088243	PLANALTINA	10/10/2020 16:10	11/10/2020 23:51	10/10/2020 16:11	11/10/2020 23:51	31,67	2	63,34	CHI
20201044026	LUZIANIA	LZ12041471	RIO VERMELHO	10/10/2020 16:10	10/10/2020 20:27	10/10/2020 16:10	10/10/2020 20:27	4,28	13	55,60	CHI
20201043890	GOIANIA	GN12387059	CARAJAS S1	10/10/2020 16:11	10/10/2020 17:43	10/10/2020 16:11	10/10/2020 17:43	1,53	59	90,47	CHI
20201044101	JATAI	04070224	JATAI S1	10/10/2020 16:11	13/10/2020 09:25	10/10/2020 16:11	10/10/2020 21:58	5,78	288	1663,52	CHI
20201044101	SERRANOPOLIS	JT12196200LD	JATAI S1	10/10/2020 16:11	13/10/2020 09:25	10/10/2020 16:11	10/10/2020 23:53	7,69	5	38,47	CHI
20201044101	JATAI	04070224	JATAI S1	10/10/2020 16:11	13/10/2020 09:25	10/10/2020 23:54	11/10/2020 00:42	0,80	299	239,95	CHI
20201044101	JATAI	JT12196200LD	JATAI S1	10/10/2020 16:11	13/10/2020 09:25	10/10/2020 23:54	11/10/2020 09:02	9,14	2	18,27	CHI
20201044101	JATAI	JT13196035	JATAI S1	10/10/2020 16:11	13/10/2020 09:25	10/10/2020 23:54	11/10/2020 11:00	11,10	37	410,70	CHI
20201044101	SERRANOPOLIS	JT13196035	JATAI S1	10/10/2020 16:11	13/10/2020 09:25	10/10/2020 23:54	11/10/2020 11:00	11,10	16	177,60	CHI
20201044101	JATAI	JT12196200LD	JATAI S1	10/10/2020 16:11	13/10/2020 09:25	10/10/2020 16:11	11/10/2020 15:22	23,17	17	393,89	CHI
20201044101	SERRANOPOLIS	JT12196200LD	JATAI S1	10/10/2020 16:11	13/10/2020 09:25	10/10/2020 16:11	11/10/2020 15:22	23,17	2	46,34	CHI
20201044101	JATAI	JT13196035	JATAI S1	10/10/2020 16:11	13/10/2020 09:25	10/10/2020 23:54	11/10/2020 15:22	15,47	33	510,50	CHI
20201044101	JATAI	04070224	JATAI S1	10/10/2020 16:11	13/10/2020 09:25	10/10/2020 23:54	11/10/2020 15:22	15,47	6	92,82	CHI
20201044101	JATAI	JT12196200LD	JATAI S1	10/10/2020 16:11	13/10/2020 09:25	10/10/2020 16:11	11/10/2020 17:46	25,57	6	153,41	CHI
20201044101	JATAI	04070224	JATAI S1	10/10/2020 16:11	13/10/2020 09:25	10/10/2020 23:54	11/10/2020 17:46	17,87	1	17,87	CHI
20201044101	JATAI	04070224	JATAI S1	10/10/2020 16:11	13/10/2020 09:25	11/10/2020 11:00	11/10/2020 17:46	6,77	299	2023,23	CHI
20201044101	JATAI	04070224	JATAI S1	10/10/2020 16:11	13/10/2020 09:25	11/10/2020 11:00	12/10/2020 17:13	30,23	2	60,46	CHI
20201044101	JATAI	JT12196200LD	JATAI S1	10/10/2020 16:11	13/10/2020 09:25	10/10/2020 16:11	12/10/2020 21:59	53,79	6	322,77	CHI
20201044101	JATAI	JT13196035	JATAI S1	10/10/2020 16:11	13/10/2020 09:25	10/10/2020 23:54	12/10/2020 21:59	46,09	12	553,13	CHI
20201044101	JATAI	JT13196035	JATAI S1	10/10/2020 16:11	13/10/2020 09:25	10/10/2020 23:54	12/10/2020 23:35	47,69	13	619,96	CHI
20201044101	SERRANOPOLIS	JT13196035	JATAI S1	10/10/2020 16:11	13/10/2020 09:25	10/10/2020 23:54	12/10/2020 23:35	47,69	8	381,51	CHI
20201044101	SERRANOPOLIS	JT12196200LD	JATAI S1	10/10/2020 16:11	13/10/2020 09:25	10/10/2020 16:11	13/10/2020 00:39	56,46	1	56,46	CHI
20201044101	SERRANOPOLIS	JT12219337RE	JATAI S1	10/10/2020 16:11	13/10/2020 09:25	10/10/2020 23:54	13/10/2020 00:39	48,76	6	292,54	CHI
20201044101	JATAI	JT12196200LD	JATAI S1	10/10/2020 16:11	13/10/2020 09:25	10/10/2020 16:11	13/10/2020 09:25	65,23	74	4826,69	CHI
20201044101	SERRANOPOLIS	JT12196200LD	JATAI S1	10/10/2020 16:11	13/10/2020 09:25	10/10/2020 16:11	13/10/2020 09:25	65,23	23	1500,19	CHI
20201044101	JATAI	SX12080873RE	JATAI S1	10/10/2020 16:11	13/10/2020 09:25	10/10/2020 23:54	13/10/2020 09:25	57,52	3	172,57	CHI
20201044101	SERRANOPOLIS	SX12080873RE	JATAI S1	10/10/2020 16:11	13/10/2020 09:25	10/10/2020 23:54	13/10/2020 09:25	57,52	2	115,05	CHI
20201044039	CIDADE OCIDENTAL	DH11183856	MARAUOARA	10/10/2020 16:13	10/10/2020 21:34	10/10/2020 16:13	10/10/2020 21:34	5,34	169	902,23	CHI
20201043943	PADRE BERNARDO	PB12163215	PADRE BERNARDO	10/10/2020 16:14	11/10/2020 06:03	10/10/2020 16:14	10/10/2020 18:52	2,63	1	2,63	CHI
20201043943	PADRE BERNARDO	PB12163215	PADRE BERNARDO	10/10/2020 16:14	11/10/2020 06:03	10/10/2020 16:14	10/10/2020 20:40	4,43	32	141,77	CHI
20201043943	DISTRITO FEDERAL	PB12163215	PADRE BERNARDO	10/10/2020 16:14	11/10/2020 06:03	10/10/2020 16:14	11/10/2020 06:03	13,82	3	41,47	CHI
20201043943	PADRE BERNARDO	PB12163215	PADRE BERNARDO	10/10/2020 16:14	11/10/2020 06:03	10/10/2020 16:14	11/10/2020 06:03	13,82	247	3414,71	CHI
20201043907	CACU	CC21340927	CACHOEIRA ALTA	10/10/2020 16:14	11/10/2020 01:06	10/10/2020 16:14	11/10/2020 01:06	8,86	1	8,86	CHI
20201043912	ITABERAI	IB21274495	ITABERAI S1	10/10/2020 16:15	10/10/2020 17:39	10/10/2020 16:15	10/10/2020 17:39	1,40	1	1,40	CHI
20201043925	JATAI	290281647	JATAI S3	10/10/2020 16:16	10/10/2020 16:54	10/10/2020 16:16	10/10/2020 16:54	0,62	1	0,62	CHI
20201043927	ABADIANIA	AA21127334	DAIA S2	10/10/2020 16:17	10/10/2020 18:42	10/10/2020 16:17	10/10/2020 18:42	2,42	1	2,42	CHI
20201045662	PALMEIRAS DE GOIAS	PL21189967	PALMEIRAS	10/10/2020 16:17	11/10/2020 07:31	10/10/2020 16:17	11/10/2020 07:31	15,22	1	15,22	CHI
20201043934	MUNDO NOVO DE GOIAS	4240022801	NOVA CRIXAS	10/10/2020 16:18	10/10/2020 21:23	10/10/2020 16:18	10/10/2020 21:23	5,08	1	5,08	CHI
20201043937	BONOPOLIS	BX21236520	SAO MIGUEL DO ARAGUAIA	10/10/2020 16:18	10/10/2020 19:33	10/10/2020 16:18	10/10/2020 19:33	3,24	1	3,24	CHI
20201044008	CALDAS NOVAS	CN12246620	SERRA DE CALDAS	10/10/2020 16:20	10/10/2020 17:45	10/10/2020 16:20	10/10/2020 17:45	1,41	1049	1478,80	CHI
20201043946	PADRE BERNARDO	PB12382216	PADRE BERNARDO	10/10/2020 16:21	11/10/2020 10:59	10/10/2020 16:21	11/10/2020 10:59	18,63	7	130,40	CHI
20201043946	COCALZINHO DE GOIAS	PB12382216	PADRE BERNARDO	10/10/2020 16:21	11/10/2020 10:59	10/10/2020 16:21	11/10/2020 10:59	18,63	1	18,63	CHI
20201043947	SAO JOAO D ALIANCA	3840006294	SAO JOAO D ALIANCA	10/10/2020 16:21	11/10/2020 18:06	10/10/2020 16:21	11/10/2020 18:06	25,74	1	25,74	CHI
20201043955	CALDAS NOVAS	8059813	SERRA DE CALDAS	10/10/2020 16:22	11/10/2020 14:27	10/10/2020 16:22	10/10/2020 18:34	2,20	135	297,00	CHI
20201043955	CALDAS NOVAS	CN12363790	SERRA DE CALDAS	10/10/2020 16:22	11/10/2020 14:27	10/10/2020 16:22	10/10/2020 18:39	2,29	9	20,60	CHI
20201043955	CALDAS NOVAS	CN12213964RE	SERRA DE CALDAS	10/10/2020 16:22	11/10/2020 14:27	10/10/2020 16:22	10/10/2020 20:44	4,37	12	52,44	CHI
20201043955	CALDAS NOVAS	CN12213964RE	SERRA DE CALDAS	10/10/2020 16:22	11/10/2020 14:27	10/10/2020 19:57	10/10/2020 20:44	0,78	1	0,78	CHI
20201043955	CALDAS NOVAS	CN12213964RE	SERRA DE CALDAS	10/10/2020 16:22	11/10/2020 14:27	10/10/2020 16:22	11/10/2020 14:27	22,09	147	3247,88	CHI
20201043955	CALDAS NOVAS	CN12213964RE	SERRA DE CALDAS	10/10/2020 16:22	11/10/2020 14:27	10/10/2020 19:57	11/10/2020 14:27	18,51	3	55,52	CHI
20201043755	LUZIANIA	20462797	RIO VERMELHO	10/10/2020 16:24	10/10/2020 17:39	10/10/2020 16:24	10/10/2020 17:39	1,24	160	198,04	CHI
20201044280	QUIRINOPOLIS	QI12296643	QUIRINGOPOLIS	10/10/2020 16:24	10/10/2020 19:30	10/10/2020 16:24	10/10/2020 19:30	3,09	6	18,51	CHI

20201043965	TRINDADE	TR11291620	TRINDADE	10/10/2020 16:25	10/10/2020 18:01	10/10/2020 16:25	10/10/2020 18:01	1,59	55	87,48	CHI
20201043967	GOIANIRA	GR12321567	MEIA PONTE	10/10/2020 16:25	10/10/2020 18:24	10/10/2020 16:25	10/10/2020 18:24	1,97	54	106,23	CHI
20201043967	GOIANIA	GR12321567	MEIA PONTE	10/10/2020 16:25	10/10/2020 18:24	10/10/2020 16:25	10/10/2020 18:24	1,97	11	21,64	CHI
20201043981	GUAPO	GA21000244	GUAPO S1	10/10/2020 16:27	10/10/2020 18:47	10/10/2020 16:27	10/10/2020 18:47	2,33	1	2,33	CHI
20201044252	CORUMBA DE GOIAS	ZN12302374	COCALZINHO	10/10/2020 16:27	10/10/2020 17:54	10/10/2020 16:27	10/10/2020 17:54	1,44	1	1,44	CHI
20201044252	COCALZINHO DE GOIAS	ZN12302374	COCALZINHO	10/10/2020 16:27	10/10/2020 17:54	10/10/2020 16:27	10/10/2020 17:54	1,44	7	10,08	CHI
20201044156	ARUANA	AK11183262	ARUANA	10/10/2020 16:27	10/10/2020 18:11	10/10/2020 16:27	10/10/2020 18:11	1,72	91	156,60	CHI
20201044124	RIO VERDE	RV11000162	RIO VERDE S2	10/10/2020 16:27	11/10/2020 01:34	10/10/2020 16:27	11/10/2020 01:34	9,10	133	1210,78	CHI
20201043987	FORMOSA	FA11000069	ITUIQUIRA	10/10/2020 16:27	10/10/2020 21:01	10/10/2020 16:27	10/10/2020 21:01	4,55	206	937,87	CHI
20201045432	FORMOSA	610278861	ITUIQUIRA	10/10/2020 16:27	10/10/2020 21:28	10/10/2020 16:27	10/10/2020 21:28	5,00	1	5,00	CHI
20201043992	SAO MIGUEL DO ARAGUAIA	830035746	SAO MIGUEL DO ARAGUAIA	10/10/2020 16:28	11/10/2020 04:45	10/10/2020 16:28	11/10/2020 04:45	12,28	1	12,28	CHI
20201044028	SANTA CRUZ DE GOIAS	BC12389804	PIRES DO RIO S2	10/10/2020 16:29	10/10/2020 19:03	10/10/2020 16:29	10/10/2020 19:03	2,57	22	56,47	CHI
20201044014	PORANGATU	PO21256395	NOVO PLANALTO	10/10/2020 16:30	11/10/2020 02:58	10/10/2020 16:30	11/10/2020 02:58	10,45	1	10,45	CHI
20201044020	IPAMERI	IP11203213	IPAMERI	10/10/2020 16:31	10/10/2020 18:58	10/10/2020 16:31	10/10/2020 18:58	2,44	54	131,55	CHI
20201044050	RIO VERDE	RV11000153	CABRIUVA S1	10/10/2020 16:33	11/10/2020 00:21	10/10/2020 16:33	11/10/2020 00:21	7,80	143	1115,40	CHI
20201044038	TAQUARAL DE GOIAS	TQ12008863	INHUMAS S1	10/10/2020 16:33	10/10/2020 18:22	10/10/2020 16:33	10/10/2020 18:22	1,80	7	12,62	CHI
20201044566	PALESTINA DE GOIAS	PY12396120	PALESTINA	10/10/2020 16:34	10/10/2020 20:21	10/10/2020 16:34	10/10/2020 20:21	3,78	11	41,58	CHI
20201044042	RIO QUENTE	RQ12316156	VILA CORUMBA	10/10/2020 16:34	10/10/2020 23:22	10/10/2020 16:34	10/10/2020 23:22	6,80	2	13,59	CHI
20201044240	LUZIANIA	LZ12261750	CRISTALINA S2	10/10/2020 16:35	10/10/2020 20:53	10/10/2020 16:35	10/10/2020 20:53	4,29	6	25,74	CHI
20201044338	INHUMAS	DL12098268	INHUMAS S1	10/10/2020 16:37	10/10/2020 19:43	10/10/2020 16:37	10/10/2020 19:43	3,09	52	160,71	CHI
20201044338	DAMOLANDIA	DL12098268	INHUMAS S1	10/10/2020 16:37	10/10/2020 19:43	10/10/2020 16:37	10/10/2020 19:43	3,09	6	18,54	CHI
20201044074	ALVORADA DO NORTE	6072698	IACIARA S2	10/10/2020 16:38	10/10/2020 18:10	10/10/2020 16:38	10/10/2020 18:10	1,53	1	1,53	CHI
20201044165	CORUMBA DE GOIAS	AX10404067	CORUMBA	10/10/2020 16:39	11/10/2020 21:30	10/10/2020 16:39	10/10/2020 19:57	3,31	4	13,24	CHI
20201044165	ALEXANIA	AX10404067	CORUMBA	10/10/2020 16:39	11/10/2020 21:30	10/10/2020 16:39	10/10/2020 19:57	3,31	74	245,00	CHI
20201044165	ALEXANIA	AX10404067	CORUMBA	10/10/2020 16:39	11/10/2020 21:30	10/10/2020 21:36	10/10/2020 22:58	1,38	74	102,12	CHI
20201044165	CORUMBA DE GOIAS	AX10404067	CORUMBA	10/10/2020 16:39	11/10/2020 21:30	10/10/2020 21:36	10/10/2020 22:58	1,38	4	5,52	CHI
20201044165	CORUMBA DE GOIAS	03240416	CORUMBA	10/10/2020 16:39	11/10/2020 21:30	10/10/2020 21:52	10/10/2020 22:58	1,11	15	16,69	CHI
20201044165	ALEXANIA	03240416	CORUMBA	10/10/2020 16:39	11/10/2020 21:30	10/10/2020 21:52	10/10/2020 22:58	1,11	795	884,66	CHI
20201044165	CORUMBA DE GOIAS	AX10404067	CORUMBA	10/10/2020 16:39	11/10/2020 21:30	11/10/2020 04:02	11/10/2020 08:05	4,04	4	16,16	CHI
20201044165	ALEXANIA	AX10404067	CORUMBA	10/10/2020 16:39	11/10/2020 21:30	11/10/2020 04:02	11/10/2020 08:05	4,04	18	72,73	CHI
20201044165	ALEXANIA	AX12308913	CORUMBA	10/10/2020 16:39	11/10/2020 21:30	11/10/2020 04:02	11/10/2020 09:40	5,62	55	309,34	CHI
20201044165	ALEXANIA	AX12312014	CORUMBA	10/10/2020 16:39	11/10/2020 21:30	11/10/2020 04:02	11/10/2020 10:18	6,27	1	6,27	CHI
20201044165	ALEXANIA	AX10404067	CORUMBA	10/10/2020 16:39	11/10/2020 21:30	10/10/2020 16:39	11/10/2020 21:27	28,80	21	604,79	CHI
20201044165	CORUMBA DE GOIAS	AX10404067	CORUMBA	10/10/2020 16:39	11/10/2020 21:30	10/10/2020 16:39	11/10/2020 21:27	28,80	348	10022,21	CHI
20201044165	ALEXANIA	AX12377760	CORUMBA	10/10/2020 16:39	11/10/2020 21:30	10/10/2020 16:39	11/10/2020 21:30	28,86	1	28,86	CHI
20201044089	PORANGATU	PO11020802	PORANGATU	10/10/2020 16:40	11/10/2020 11:43	10/10/2020 16:40	11/10/2020 11:43	19,04	65	1237,74	CHI
20201044098	SAO SIMAO	SO21392810	CACHOEIRA ALTA	10/10/2020 16:41	10/10/2020 21:10	10/10/2020 16:41	10/10/2020 21:10	4,48	1	4,48	CHI
20201044116	CRIXAS	10023602455	SANTA TEREZINHA	10/10/2020 16:43	10/10/2020 21:48	10/10/2020 16:43	10/10/2020 21:48	5,08	1	5,08	CHI
20201045508	PORANGATU	PO12050744	PORANGATU	10/10/2020 16:44	10/10/2020 22:08	10/10/2020 16:44	10/10/2020 22:08	5,40	4	21,59	CHI
20201044211	CALDAS NOVAS	CN11213910	SERRA DE CALDAS	10/10/2020 16:44	10/10/2020 19:29	10/10/2020 16:44	10/10/2020 19:29	2,74	98	268,82	CHI
20201044122	PARANAIGUARA	QI12276207RE	QUIRINOPOLIS	10/10/2020 16:44	11/10/2020 09:45	10/10/2020 16:44	11/10/2020 09:45	17,01	5	85,03	CHI
20201044122	QUIRINOPOLIS	QI12276207RE	QUIRINOPOLIS	10/10/2020 16:44	11/10/2020 09:45	10/10/2020 16:44	11/10/2020 09:45	17,01	51	867,28	CHI
20201044734	SAO JOAO D ALIANCA	JL11242841	SAO JOAO D ALIANCA	10/10/2020 16:45	10/10/2020 21:13	10/10/2020 16:45	10/10/2020 21:13	4,46	42	187,41	CHI
20201044130	PALMEIRAS DE GOIAS	PL11000003	PALMEIRAS	10/10/2020 16:46	10/10/2020 18:00	10/10/2020 16:46	10/10/2020 18:00	1,23	175	215,74	CHI
20201044141	PADRE BERNARDO	PB12089675	PADRE BERNARDO	10/10/2020 16:47	10/10/2020 18:22	10/10/2020 16:47	10/10/2020 18:22	1,58	238	375,25	CHI
20201044146	COCALZINHO DE GOIAS	ZN11209286	COCALZINHO	10/10/2020 16:48	10/10/2020 21:55	10/10/2020 16:48	10/10/2020 21:55	5,11	57	291,54	CHI
20201044820	VALPARAISO DE GOIAS	VA11170198	PACAEMBU S1	10/10/2020 16:49	10/10/2020 19:51	10/10/2020 16:49	10/10/2020 19:51	3,03	98	297,24	CHI
202010180184	NOVA ROMA	03430216	SAO DOMINGOS	10/10/2020 16:50	10/10/2020 22:24	10/10/2020 16:50	10/10/2020 22:24	5,56	58	322,75	CHI
202010180184	CAVALCANTE	03430216	SAO DOMINGOS	10/10/2020 16:50	10/10/2020 22:24	10/10/2020 16:50	10/10/2020 22:24	5,56	241	1341,10	CHI
202010180184	MONTE ALEGRE DE GOIAS	03430216	SAO DOMINGOS	10/10/2020 16:50	10/10/2020 22:24	10/10/2020 16:50	10/10/2020 22:24	5,56	2023	11257,43	CHI
20201044163	MINEIROS	MY12296303	PARQUE DAS EMAS	10/10/2020 16:51	10/10/2020 19:21	10/10/2020 16:51	10/10/2020 19:21	2,50	3	7,50	CHI
20201044160	RIO VERDE	RV12205429RE	MONTIVIDUIU T	10/10/2020 16:51	10/10/2020 22:01	10/10/2020 16:51	10/10/2020 22:01	5,16	2	10,32	CHI
20201044169	JATAI	JT11154015	JATAI S3	10/10/2020 16:52	10/10/2020 21:14	10/10/2020 16:52	10/10/2020 21:14	4,35	107	465,51	CHI
20201044844	PADRE BERNARDO	PB12275452	PADRE BERNARDO	10/10/2020 16:55	11/10/2020 12:46	10/10/2020 16:55	11/10/2020 12:46	19,86	29	575,83	CHI
20201044844	PADRE BERNARDO	PB12163217	PADRE BERNARDO	10/10/2020 16:55	11/10/2020 12:46	11/10/2020 01:26	11/10/2020 12:46	11,33	94	1065,26	CHI
20201044206	SAO JOAO D ALIANCA	JL21203976	SAO JOAO D ALIANCA	10/10/2020 16:56	11/10/2020 21:25	10/10/2020 16:56	11/10/2020 21:25	28,47	1	28,47	CHI
20201044208	ITUMBIARA	BG12273858	ITUMBIARA VELHA S2	10/10/2020 16:56	10/10/2020 18:49	10/10/2020 16:56	10/10/2020 18:49	1,87	13	24,34	CHI
20201044218	LUZIANIA	120249947	RIO VERMELHO	10/10/2020 16:58	10/10/2020 23:43	10/10/2020 16:58	10/10/2020 23:43	6,74	1	6,74	CHI

20201044341	GAMELEIRA DE GOIAS	SV12125365	DAIA S2	10/10/2020 16:59	10/10/2020 23:21	10/10/2020 16:59	10/10/2020 23:21	6,35	6	38,13	CHI
20201044229	ARAGARCAS	AG11000016	ARAGARCAS	10/10/2020 17:00	10/10/2020 20:02	10/10/2020 17:00	10/10/2020 20:02	3,03	124	375,41	CHI
20201045543	SANTO ANTONIO DO DESCOBERTO	SN12275494	MARAJOARA	10/10/2020 17:04	12/10/2020 12:29	10/10/2020 17:04	12/10/2020 12:29	43,41	8	347,31	CHI
20201044253	SITIO D ABADIA	SI21195836	IACIARA S2	10/10/2020 17:05	10/10/2020 19:11	10/10/2020 17:05	10/10/2020 19:11	2,11	1	2,11	CHI
20201044256	ANAPOLIS	21199814	ANAPOLIS UNIVERSITARIO S2	10/10/2020 17:05	10/10/2020 18:12	10/10/2020 17:05	10/10/2020 18:12	1,11	1	1,11	CHI
20201044258	ITABERAI	19614267	ITABERAI S1	10/10/2020 17:06	12/10/2020 09:46	10/10/2020 17:06	12/10/2020 09:46	40,66	4	162,63	CHI
20201044269	JATAI	290244717	JATAI S3	10/10/2020 17:08	10/10/2020 22:35	10/10/2020 17:08	10/10/2020 22:35	5,44	1	5,44	CHI
20201044626	PLANALTINA	PI12211522	PADRE BERNARDO	10/10/2020 17:08	12/10/2020 08:22	10/10/2020 17:08	12/10/2020 08:22	39,23	25	980,65	CHI
20201044275	CUMARI	CY21317592	CATALAO S2	10/10/2020 17:09	10/10/2020 18:51	10/10/2020 17:09	10/10/2020 18:51	1,70	1	1,70	CHI
20201044278	INHUMAS	IN21195667	INHUMAS S1	10/10/2020 17:09	10/10/2020 21:23	10/10/2020 17:09	10/10/2020 21:23	4,22	1	4,22	CHI
20201044283	JUSSARA	JR11406357	JUSSARA	10/10/2020 17:10	11/10/2020 04:48	10/10/2020 17:10	11/10/2020 04:48	11,62	3	34,87	CHI
20201044290	ITARUMA	IM21160688	CACHOEIRA ALTA	10/10/2020 17:12	11/10/2020 10:50	10/10/2020 17:12	11/10/2020 10:50	17,63	1	17,63	CHI
20201044401	CIDADE OCIDENTAL	DH11261695	MARAJOARA	10/10/2020 17:12	10/10/2020 21:20	10/10/2020 17:12	10/10/2020 21:20	4,13	106	437,25	CHI
20201044294	MINACU	IH12262532	MINACU	10/10/2020 17:12	10/10/2020 19:09	10/10/2020 17:12	10/10/2020 19:09	1,94	69	133,65	CHI
20201044295	IPAMERI	IP12000023	IPAMERI	10/10/2020 17:13	10/10/2020 18:58	10/10/2020 17:13	10/10/2020 18:58	1,75	74	129,36	CHI
20201044306	JATAI	JT11357725	JATAI S1	10/10/2020 17:14	11/10/2020 10:36	10/10/2020 17:14	11/10/2020 10:36	17,36	1	17,36	CHI
20201044315	LUZIANIA	LZ11201468	RIO VERMELHO	10/10/2020 17:15	11/10/2020 11:15	10/10/2020 17:15	11/10/2020 11:15	18,00	58	1043,90	CHI
20201044374	MONTE ALEGRE DE GOIAS	00760214	SAO DOMINGOS	10/10/2020 17:15	10/10/2020 21:08	10/10/2020 17:15	10/10/2020 21:08	0,38	41	15,61	CHI
20201044374	CAMPOS BELOS	00760214	SAO DOMINGOS	10/10/2020 17:15	10/10/2020 21:08	10/10/2020 17:15	10/10/2020 21:08	0,38	3394	1292,55	CHI
20201044374	MONTE ALEGRE DE GOIAS	00760214	SAO DOMINGOS	10/10/2020 17:15	10/10/2020 21:08	10/10/2020 17:15	10/10/2020 21:08	3,89	17	66,18	CHI
20201044374	CAMPOS BELOS	00760214	SAO DOMINGOS	10/10/2020 17:15	10/10/2020 21:08	10/10/2020 17:15	10/10/2020 21:08	3,89	1345	5235,79	CHI
20201044476	PLANALTINA	PI11164572	PLANALTINA	10/10/2020 17:15	10/10/2020 18:24	10/10/2020 17:15	10/10/2020 18:24	1,14	88	100,39	CHI
20201044319	FORMOSA	04920224	SAO JOAO D ALIANCA	10/10/2020 17:15	11/10/2020 04:26	10/10/2020 17:15	11/10/2020 04:26	11,18	115	1285,25	CHI
20201044327	VICENTINOPOLIS	VI11095407	VICENTINOPOLIS	10/10/2020 17:17	10/10/2020 18:24	10/10/2020 17:17	10/10/2020 18:24	1,11	119	131,50	CHI
20201044329	MINEIROS	MY12209687	PARQUE DAS EMAS	10/10/2020 17:17	10/10/2020 20:30	10/10/2020 17:17	10/10/2020 20:30	3,22	9	28,95	CHI
20201044473	CACHOEIRA ALTA	QI12189166	CACHOEIRA ALTA	10/10/2020 17:17	11/10/2020 03:02	10/10/2020 17:17	11/10/2020 03:02	9,74	3	29,21	CHI
20201044473	QUIRINOPOLIS	QI12189166	CACHOEIRA ALTA	10/10/2020 17:17	11/10/2020 03:02	10/10/2020 17:17	11/10/2020 03:02	9,74	2	19,47	CHI
20201044331	PORTEIRAO	CL21305978	RIO DOS BOIS	10/10/2020 17:17	11/10/2020 13:04	10/10/2020 17:17	11/10/2020 13:04	19,77	1	19,77	CHI
20201044339	LUZIANIA	LZ11288039	RIO VERMELHO	10/10/2020 17:19	11/10/2020 10:29	10/10/2020 17:19	11/10/2020 10:29	17,16	3	51,49	CHI
20201044214	ARENOPOLIS	AY13204816	IPORA	10/10/2020 17:19	10/10/2020 20:42	10/10/2020 17:19	10/10/2020 20:42	1,72	1	1,72	CHI
20201044214	MONTES CLAROS DE GOIAS	AY13204816	IPORA	10/10/2020 17:19	10/10/2020 20:42	10/10/2020 17:19	10/10/2020 20:42	1,72	83	142,83	CHI
20201044214	ARENOPOLIS	AY13259342	IPORA	10/10/2020 17:19	10/10/2020 20:42	10/10/2020 17:19	10/10/2020 20:42	3,00	49	146,84	CHI
20201044214	PIRANHAS	AY13259342	IPORA	10/10/2020 17:19	10/10/2020 20:42	10/10/2020 17:19	10/10/2020 20:42	3,00	1	3,00	CHI
20201044214	PIRANHAS	AY18223147TS	IPORA	10/10/2020 17:19	10/10/2020 20:42	10/10/2020 17:19	10/10/2020 20:42	3,38	1	3,38	CHI
20201044214	ARENOPOLIS	AY18223147TS	IPORA	10/10/2020 17:19	10/10/2020 20:42	10/10/2020 17:19	10/10/2020 20:42	3,38	58	196,14	CHI
20201044214	MONTES CLAROS DE GOIAS	AY18223147TS	IPORA	10/10/2020 17:19	10/10/2020 20:42	10/10/2020 17:19	10/10/2020 20:42	3,38	1	3,38	CHI
20201044371	GOIANIA	13869280	GOYA S1	10/10/2020 17:21	10/10/2020 19:29	10/10/2020 17:21	10/10/2020 19:29	2,12	1	2,12	CHI
20201044372	GOIAS	GS13220398	ITABERAI S1	10/10/2020 17:21	10/10/2020 20:19	10/10/2020 17:21	10/10/2020 20:19	2,95	179	528,85	CHI
20201044372	ITABERAI	GS13220398	ITABERAI S1	10/10/2020 17:21	10/10/2020 20:19	10/10/2020 17:21	10/10/2020 20:19	2,95	3	8,86	CHI
20201044391	LUZIANIA	LZ11183515	RIO VERMELHO	10/10/2020 17:25	10/10/2020 18:01	10/10/2020 17:25	10/10/2020 18:01	0,60	81	48,42	CHI
20201044406	CATALAO	CT21344422	CATALAO S1	10/10/2020 17:26	10/10/2020 18:21	10/10/2020 17:26	10/10/2020 18:21	0,90	1	0,90	CHI
20201044410	AMORINOPOLIS	AM21287188	IPORA	10/10/2020 17:27	10/10/2020 18:49	10/10/2020 17:27	10/10/2020 18:49	1,36	1	1,36	CHI
20201044454	PADRE BERNARDO	PB10400753	PADRE BERNARDO	10/10/2020 17:27	11/10/2020 01:23	10/10/2020 17:27	10/10/2020 22:56	5,48	4	21,91	CHI
20201044454	PLANALTINA	PB12290522LD	PADRE BERNARDO	10/10/2020 17:27	11/10/2020 01:23	10/10/2020 17:27	11/10/2020 01:23	7,92	11	87,16	CHI
20201044454	PADRE BERNARDO	PB12290522LD	PADRE BERNARDO	10/10/2020 17:27	11/10/2020 01:23	10/10/2020 17:27	11/10/2020 01:23	7,92	107	847,80	CHI
20201044415	SANTO ANTONIO DO DESCOBERTO	SN21093531	ALEXANIA	10/10/2020 17:28	11/10/2020 10:01	10/10/2020 17:28	11/10/2020 10:01	16,55	1	16,55	CHI
20201044416	MONTIVIDIU	MV21267665	MONTIVIDIU T	10/10/2020 17:28	11/10/2020 00:32	10/10/2020 17:28	11/10/2020 00:32	7,06	1	7,06	CHI
20201044418	SAO LUIS DE MONTES BELOS	SL12000068	SAO LUIZ DOS MONTES BELOS	10/10/2020 17:28	10/10/2020 19:06	10/10/2020 17:28	10/10/2020 19:06	1,62	87	140,82	CHI
20201044428	JATAI	AW21352827	JATAI S1	10/10/2020 17:31	10/10/2020 19:06	10/10/2020 17:31	10/10/2020 19:06	1,58	1	1,58	CHI
20201044426	CRISTALINA	KR21348833	CRISTALINA S1	10/10/2020 17:31	10/10/2020 22:03	10/10/2020 17:31	10/10/2020 22:03	4,52	2	9,05	CHI
20201044429	JATAI	JT21324678	JATAI S3	10/10/2020 17:31	11/10/2020 06:49	10/10/2020 17:31	11/10/2020 06:49	13,29	1	13,29	CHI
20201044433	AGUA FRIA DE GOIAS	TL21321709	SAO JOAO D ALIANCA	10/10/2020 17:33	11/10/2020 19:49	10/10/2020 17:33	11/10/2020 19:49	26,27	1	26,27	CHI
20201044434	LUZIANIA	120161825	RIO VERMELHO	10/10/2020 17:33	10/10/2020 21:48	10/10/2020 17:33	10/10/2020 21:48	4,25	1	4,25	CHI
20201044439	TERESINA DE GOIAS	2650002779	FLORES DE GOIAS	10/10/2020 17:34	10/10/2020 23:22	10/10/2020 17:34	10/10/2020 23:22	5,80	1	5,80	CHI
202010189154	CEZARINA	CZ21138622	CEZARINA	10/10/2020 17:34	13/10/2020 13:53	10/10/2020 17:34	13/10/2020 13:53	68,32	1	68,32	CHI
20201045118	NIQUELANDIA	NQ12213117	NIQUELANDIA SUBTRANSMISSAO	10/10/2020 17:34	11/10/2020 21:46	10/10/2020 17:34	11/10/2020 21:46	28,19	17	479,18	CHI
20201044446	CATALAO	IP12222966	IPAMERI	10/10/2020 17:35	10/10/2020 20:10	10/10/2020 17:35	10/10/2020 20:10	2,58	2	5,17	CHI
20201044446	IPAMERI	IP12222966	IPAMERI	10/10/2020 17:35	10/10/2020 20:10	10/10/2020 17:35	10/10/2020 20:10	2,58	5	12,92	CHI

20201044449	TEREZOPOLIS DE GOIAS	GP31029283	JUNDIAI S1	10/10/2020 17:36	10/10/2020 18:40	10/10/2020 17:36	10/10/2020 18:40	1,05	1	1,05	CHI
20201044455	ITUMBIARA	IT21122339	ITUMBIARA VELHA S2	10/10/2020 17:38	10/10/2020 23:52	10/10/2020 17:38	10/10/2020 23:52	6,22	1	6,22	CHI
20201044555	MOZARLANDIA	01330434	MOZARLANDIA	10/10/2020 17:39	11/10/2020 13:04	10/10/2020 17:39	10/10/2020 22:12	4,54	25	113,51	CHI
20201044555	MOZARLANDIA	MZ13220573	MOZARLANDIA	10/10/2020 17:39	11/10/2020 13:04	10/10/2020 17:40	10/10/2020 22:12	4,52	1	4,52	CHI
20201044555	MOZARLANDIA	01330434	MOZARLANDIA	10/10/2020 17:39	11/10/2020 13:04	10/10/2020 17:39	11/10/2020 12:31	18,86	26	490,40	CHI
20201044555	MOZARLANDIA	01330434	MOZARLANDIA	10/10/2020 17:39	11/10/2020 13:04	10/10/2020 17:39	11/10/2020 13:04	19,41	21	407,66	CHI
20201045620	MINACU	IH12236242	MINACU	10/10/2020 17:39	10/10/2020 22:37	10/10/2020 17:39	10/10/2020 22:37	4,95	9	44,59	CHI
20201044935	PADRE BERNARDO	PB12305104	PADRE BERNARDO	10/10/2020 17:41	10/10/2020 19:37	10/10/2020 17:41	10/10/2020 19:37	1,93	182	350,40	CHI
20201044479	FORMOSA	FA11000071	ITUIQUIRA	10/10/2020 17:42	10/10/2020 18:43	10/10/2020 17:42	10/10/2020 18:43	1,01	286	289,02	CHI
20201044528	CRISTALINA	KR12339703	PAMPLONA	10/10/2020 17:44	11/10/2020 01:29	10/10/2020 17:44	11/10/2020 01:29	7,74	2	15,48	CHI
20201044532	RIO VERDE	QI12126503	QUIRINOPOLIS	10/10/2020 17:45	11/10/2020 09:17	10/10/2020 17:45	11/10/2020 09:17	15,52	5	77,59	CHI
20201044532	CACHOEIRA ALTA	QI12126503	QUIRINOPOLIS	10/10/2020 17:45	11/10/2020 09:17	10/10/2020 17:45	11/10/2020 09:17	15,52	8	124,14	CHI
20201044535	MINACU	4020034528	MINACU	10/10/2020 17:46	12/10/2020 14:48	10/10/2020 17:46	12/10/2020 14:48	45,03	1	45,03	CHI
20201044546	FAZENDA NOVA	FN12073782	IPORA	10/10/2020 17:47	10/10/2020 22:21	10/10/2020 17:47	10/10/2020 22:21	4,56	9	41,02	CHI
20201044665	VALPARAISO DE GOIAS	VA11149894	MARAJOARA	10/10/2020 17:47	10/10/2020 20:45	10/10/2020 17:47	10/10/2020 20:45	2,95	65	191,84	CHI
20201044716	PEROLANDIA	DP11382613	JATAI S1	10/10/2020 17:49	11/10/2020 08:48	10/10/2020 17:49	11/10/2020 08:48	14,98	25	374,51	CHI
20201044622	FORMOSA	FA11131864	ITUIQUIRA	10/10/2020 17:49	11/10/2020 01:11	10/10/2020 17:49	11/10/2020 01:11	7,35	69	507,36	CHI
20201044564	AGUAS LINDAS DE GOIAS	10014630670	AGUAS LINDAS DE GOIAS S1	10/10/2020 17:50	10/10/2020 19:30	10/10/2020 17:50	10/10/2020 19:30	1,65	1	1,65	CHI
20201044689	JARAGUA	JA12298107	JARAGUA	10/10/2020 17:52	10/10/2020 19:41	10/10/2020 17:52	10/10/2020 19:41	1,80	3	5,41	CHI
20201044574	PORANGATU	PO21339763	PORANGATU	10/10/2020 17:53	10/10/2020 22:34	10/10/2020 17:53	10/10/2020 22:34	4,68	1	4,68	CHI
20201044614	MARA ROSA	CR10409516	MARA ROSA	10/10/2020 17:54	12/10/2020 19:30	10/10/2020 17:54	10/10/2020 19:49	1,92	11	21,11	CHI
20201044614	URUACU	CR10409516	MARA ROSA	10/10/2020 17:54	12/10/2020 19:30	10/10/2020 17:54	10/10/2020 19:49	1,92	1	1,92	CHI
20201044614	CAMPINORTE	CR10409516	MARA ROSA	10/10/2020 17:54	12/10/2020 19:30	10/10/2020 17:54	10/10/2020 19:49	1,92	44	84,43	CHI
20201044614	CAMPINORTE	CR13291044	MARA ROSA	10/10/2020 17:54	12/10/2020 19:30	10/10/2020 17:54	10/10/2020 22:46	4,86	35	169,98	CHI
20201044614	URUACU	CR13291044	MARA ROSA	10/10/2020 17:54	12/10/2020 19:30	10/10/2020 17:54	10/10/2020 22:46	4,86	1	4,86	CHI
20201044614	CAMPINORTE	CR13291044	MARA ROSA	10/10/2020 17:54	12/10/2020 19:30	10/10/2020 19:43	10/10/2020 22:46	3,05	22	67,04	CHI
20201044614	CAMPINACU	CR13291044	MARA ROSA	10/10/2020 17:54	12/10/2020 19:30	10/10/2020 19:43	10/10/2020 22:46	3,05	11	33,52	CHI
20201044614	CAMPINORTE	CR13384915	MARA ROSA	10/10/2020 17:54	12/10/2020 19:30	10/10/2020 17:54	11/10/2020 17:19	23,41	7	163,90	CHI
20201044614	FORMOSO	CR12275188LD	MARA ROSA	10/10/2020 17:54	12/10/2020 19:30	10/10/2020 17:54	12/10/2020 19:30	49,59	3	148,76	CHI
20201044613	FORMOSA	10007222589	ITUIQUIRA	10/10/2020 17:55	10/10/2020 23:34	10/10/2020 17:55	10/10/2020 23:34	5,64	1	5,64	CHI
20201044618	ORIZONA	OZ12113013	PIRES DO RIO S2	10/10/2020 17:56	10/10/2020 20:50	10/10/2020 17:56	10/10/2020 20:50	2,89	10	28,93	CHI
202010175397	QUIRINOPOLIS	QI12303092LD	QUIRINOPOLIS	10/10/2020 17:58	11/10/2020 00:39	10/10/2020 17:58	11/10/2020 00:39	6,68	203	1355,87	CHI
20201044638	PIRENOPOLIS	PV21185604	COCALZINHO	10/10/2020 18:00	10/10/2020 23:09	10/10/2020 18:00	10/10/2020 23:09	5,14	2	10,28	CHI
202010189156	QUIRINOPOLIS	QI12279816	QUIRINOPOLIS	10/10/2020 18:00	10/10/2020 23:03	10/10/2020 18:00	10/10/2020 23:03	5,04	11	55,39	CHI
20201045117	PADRE BERNARDO	PB12313846LD	PADRE BERNARDO	10/10/2020 18:01	11/10/2020 09:29	10/10/2020 18:01	11/10/2020 09:29	15,46	7	108,25	CHI
20201044671	CUMARI	CY12306655	CATALAO S1	10/10/2020 18:01	10/10/2020 19:36	10/10/2020 18:01	10/10/2020 19:36	1,58	71	112,12	CHI
20201045251	MAURILANDIA	ML13402294	SANTA HELENA S1	10/10/2020 18:01	10/10/2020 19:45	10/10/2020 18:01	10/10/2020 19:45	1,74	6	10,44	CHI
20201045251	RIO VERDE	ML13402294	SANTA HELENA S1	10/10/2020 18:01	10/10/2020 19:45	10/10/2020 18:01	10/10/2020 19:45	1,74	48	83,53	CHI
20201045251	RIO VERDE	ML13402294	SANTA HELENA S1	10/10/2020 18:01	10/10/2020 19:45	10/10/2020 18:01	10/10/2020 19:45	1,74	391	680,45	CHI
20201045251	RIO VERDE	ML13402294	SANTA HELENA S1	10/10/2020 18:01	10/10/2020 19:45	10/10/2020 18:01	10/10/2020 19:45	1,74	26	45,25	CHI
20201045251	QUIRINOPOLIS	ML13402294	SANTA HELENA S1	10/10/2020 18:01	10/10/2020 19:45	10/10/2020 18:01	10/10/2020 19:45	1,74	10	17,40	CHI
20201044646	MINACU	4020020888	MINACU	10/10/2020 18:02	11/10/2020 06:21	10/10/2020 18:02	11/10/2020 06:21	12,31	1	12,31	CHI
20201044648	ALEXANIA	AX11114210	ALEXANIA	10/10/2020 18:03	10/10/2020 21:00	10/10/2020 18:03	10/10/2020 21:00	2,95	66	194,57	CHI
20201046034	FORMOSA	610267875	ITUIQUIRA	10/10/2020 18:03	10/10/2020 23:21	10/10/2020 18:03	10/10/2020 23:21	5,29	1	5,29	CHI
20201044652	SANTO ANTONIO DO DESCOBERTO	2210121900	ALEXANIA	10/10/2020 18:03	10/10/2020 22:16	10/10/2020 18:03	10/10/2020 22:16	4,21	1	4,21	CHI
20201045046	SAO MIGUEL DO ARAGUAIA	SM12192361	SAO MIGUEL DO ARAGUAIA	10/10/2020 18:04	10/10/2020 20:15	10/10/2020 18:04	10/10/2020 20:15	2,18	169	368,37	CHI
20201044664	ITUMBIARA	IT11203294	ITUMBIARA NOVA	10/10/2020 18:05	11/10/2020 13:42	10/10/2020 18:05	11/10/2020 13:42	19,61	85	1667,16	CHI
20201044666	JANDAIA	JD21028293	PALMEIRAS	10/10/2020 18:06	10/10/2020 19:37	10/10/2020 18:06	10/10/2020 19:37	1,52	1	1,52	CHI
202010180233	QUIRINOPOLIS	QI12091005	QUIRINOPOLIS	10/10/2020 18:06	10/10/2020 22:27	10/10/2020 18:06	10/10/2020 22:27	4,34	7	30,37	CHI
20201044673	PALESTINA DE GOIAS	3370011369	PALESTINA	10/10/2020 18:08	11/10/2020 01:00	10/10/2020 18:08	11/10/2020 01:00	6,87	1	6,87	CHI
20201044675	PORANGATU	840048415	PORANGATU	10/10/2020 18:08	10/10/2020 23:58	10/10/2020 18:08	10/10/2020 23:58	5,83	1	5,83	CHI
20201044680	GOIATUBA	JV21293222	BOM JESUS DE GOIAS	10/10/2020 18:08	10/10/2020 23:39	10/10/2020 18:08	10/10/2020 23:39	5,50	1	5,50	CHI
20201044683	SAO FRANCISCO DE GOIAS	SF21236652	SAO FRANCISCO DE GOIAS	10/10/2020 18:09	10/10/2020 20:12	10/10/2020 18:09	10/10/2020 20:12	2,05	1	2,05	CHI
20201045028	FAZENDA NOVA	JP12089836	IPORA	10/10/2020 18:09	10/10/2020 22:23	10/10/2020 18:09	10/10/2020 22:23	4,22	99	417,53	CHI
20201044692	CAMPOS BELOS	CH12130297	SAO DOMINGOS	10/10/2020 18:11	11/10/2020 00:12	10/10/2020 18:11	11/10/2020 00:12	6,01	5	30,07	CHI
20201044697	PARANAIGUARA	CA12081277	CACHOEIRA ALTA	10/10/2020 18:12	10/10/2020 23:06	10/10/2020 18:12	10/10/2020 23:06	4,90	2	9,79	CHI
20201044707	GOIANIA	10008579502	GOYA S1	10/10/2020 18:14	10/10/2020 19:46	10/10/2020 18:14	10/10/2020 19:46	1,52	1	1,52	CHI
20201045404	FORMOSO	TB12185306	PORANGATU	10/10/2020 18:15	11/10/2020 09:47	10/10/2020 18:15	11/10/2020 09:47	15,52	1	15,52	CHI

20201045404	TROMBAS	TB12185306	PORANGATU	10/10/2020 18:15	11/10/2020 09:47	10/10/2020 18:15	11/10/2020 09:47	15,52	10	155,18	CHI
20201044722	SANTA CRUZ DE GOIAS	BC21253972	PIRES DO RIO S2	10/10/2020 18:17	10/10/2020 21:19	10/10/2020 18:17	10/10/2020 21:19	3,03	2	6,05	CHI
20201044781	LUZIANIA	LZ12351406RE	MARAJOARA	10/10/2020 18:18	10/10/2020 20:50	10/10/2020 18:18	10/10/2020 20:50	2,52	100	252,08	CHI
20201044736	PLANALTINA	PI21400951	PLANALTINA	10/10/2020 18:19	10/10/2020 21:39	10/10/2020 18:19	10/10/2020 21:39	3,32	2	6,64	CHI
20201044740	VALPARAISO DE GOIAS	VA11192832	MARAJOARA	10/10/2020 18:19	10/10/2020 21:45	10/10/2020 18:19	10/10/2020 21:45	3,42	19	64,96	CHI
20201044744	VARJAO	940007400	GUAPO S2	10/10/2020 18:20	10/10/2020 19:52	10/10/2020 18:20	10/10/2020 19:52	1,52	1	1,52	CHI
20201044747	APARECIDA DE GOIANIA	200621970	ANHANGUERA	10/10/2020 18:21	10/10/2020 19:49	10/10/2020 18:21	10/10/2020 19:49	1,46	1	1,46	CHI
20201044750	VARJAO	10016685154	GUAPO S2	10/10/2020 18:21	10/10/2020 20:09	10/10/2020 18:21	10/10/2020 20:09	1,79	1	1,79	CHI
20201044779	GOIANIRA	CK12152032	GOIANIRA	10/10/2020 18:23	10/10/2020 20:12	10/10/2020 18:23	10/10/2020 20:12	1,81	5	9,06	CHI
20201044773	AGUA FRIA DE GOIAS	TL12164607	SAO JOAO D ALIANCA	10/10/2020 18:23	11/10/2020 11:36	10/10/2020 18:23	11/10/2020 11:36	17,21	17	292,58	CHI
20201044764	CIDADE OCIDENTAL	2680143705	MARAJOARA	10/10/2020 18:23	10/10/2020 23:46	10/10/2020 18:23	10/10/2020 23:46	5,37	1	5,37	CHI
20201044766	RIO VERDE	630101425	CABRIUVA S1	10/10/2020 18:24	11/10/2020 07:11	10/10/2020 18:24	11/10/2020 07:11	12,78	1	12,78	CHI
20201044772	RIO VERDE	RV121237197	CABRIUVA S2	10/10/2020 18:24	11/10/2020 10:53	10/10/2020 18:24	11/10/2020 10:53	16,47	1	16,47	CHI
20201044777	INHUMAS	30091720	INHUMAS S2	10/10/2020 18:25	10/10/2020 19:56	10/10/2020 18:25	10/10/2020 19:56	1,51	1	1,51	CHI
20201044786	BONOPOLIS	BX21168222	SAO MIGUEL DO ARAGUAIA	10/10/2020 18:27	10/10/2020 21:05	10/10/2020 18:27	10/10/2020 21:05	2,63	1	2,63	CHI
20201045196	JATAI	SX12205192RE	JATAI S1	10/10/2020 18:28	10/10/2020 23:50	10/10/2020 18:28	10/10/2020 23:50	5,36	3	16,09	CHI
20201045196	SERRANOPOLIS	SX12205192RE	JATAI S1	10/10/2020 18:28	10/10/2020 23:50	10/10/2020 18:28	10/10/2020 23:50	5,36	17	91,20	CHI
20201044803	RIO VERDE	RV21213344	MONTIVIDIU T	10/10/2020 18:29	11/10/2020 10:56	10/10/2020 18:29	11/10/2020 10:56	16,45	1	16,45	CHI
20201044805	VICENTINOPOLIS	1970008523	VICENTINOPOLIS	10/10/2020 18:29	10/10/2020 19:45	10/10/2020 18:29	10/10/2020 19:45	1,25	1	1,25	CHI
20201044816	PALMEIRAS DE GOIAS	10022637670	PALMEIRAS	10/10/2020 18:31	11/10/2020 07:07	10/10/2020 18:31	11/10/2020 07:07	12,59	1	12,59	CHI
20201044826	GUARANI DE GOIAS	GY12180586	IACIARA S1	10/10/2020 18:32	10/10/2020 20:41	10/10/2020 18:32	10/10/2020 20:41	2,15	14	30,10	CHI
20201044834	LUZIANIA	LZ21290489	RIO VERMELHO	10/10/2020 18:33	10/10/2020 20:59	10/10/2020 18:33	10/10/2020 20:59	2,42	1	2,42	CHI
20201045108	RIO VERDE	ML12301197	SANTA HELENA S1	10/10/2020 18:34	11/10/2020 15:27	10/10/2020 18:34	11/10/2020 15:27	20,87	4	83,49	CHI
20201045108	MAURILANDIA	ML12301197	SANTA HELENA S1	10/10/2020 18:34	11/10/2020 15:27	10/10/2020 18:34	11/10/2020 15:27	20,87	5	104,36	CHI
20201044846	PONTALINA	PK12312433	PONTALINA	10/10/2020 18:35	10/10/2020 19:56	10/10/2020 18:35	10/10/2020 19:47	1,20	128	153,56	CHI
20201044846	PONTALINA	PK11171688	PONTALINA	10/10/2020 18:35	10/10/2020 19:56	10/10/2020 19:50	10/10/2020 19:56	0,10	128	12,69	CHI
20201044847	FORMOSA	FA11096270	ITUIQUIRA	10/10/2020 18:35	11/10/2020 13:06	10/10/2020 18:35	11/10/2020 13:06	18,51	144	2665,40	CHI
20201044854	ITARUMA	IM21122679	CACHOEIRA ALTA	10/10/2020 18:36	11/10/2020 14:47	10/10/2020 18:36	11/10/2020 14:47	20,19	1	20,19	CHI
20201044855	ARAGARCAS	1820034693	ARAGARCAS	10/10/2020 18:36	10/10/2020 23:52	10/10/2020 18:36	10/10/2020 23:52	5,26	1	5,26	CHI
20201044869	PIRENOPOLIS	PV21064081	CORUMBA	10/10/2020 18:38	10/10/2020 20:15	10/10/2020 18:38	10/10/2020 20:15	1,61	1	1,61	CHI
20201044922	ITUMBARA	IT12000128	PARANAIBA	10/10/2020 18:40	10/10/2020 19:31	10/10/2020 18:40	10/10/2020 19:31	0,85	294	248,76	CHI
20201044891	GOIANIA	10145667	AEROPORTO S2	10/10/2020 18:40	10/10/2020 19:51	10/10/2020 18:40	10/10/2020 19:51	1,17	1	1,17	CHI
20201044899	QUIRINOPOLIS	QI21054926	QUIRINOPOLIS	10/10/2020 18:42	10/10/2020 20:09	10/10/2020 18:42	10/10/2020 20:09	1,44	1	1,44	CHI
20201044901	CALDAS NOVAS	CN11142403	CALDAS NOVAS S2	10/10/2020 18:42	10/10/2020 20:34	10/10/2020 18:42	10/10/2020 20:34	1,85	52	96,27	CHI
20201044903	TERESINA DE GOIAS	TE21321596	FLORES DE GOIAS	10/10/2020 18:43	10/10/2020 21:25	10/10/2020 18:43	10/10/2020 21:25	2,70	1	2,70	CHI
20201044910	VIANOPOLIS	510028690	VIANOPOLIS	10/10/2020 18:43	10/10/2020 21:13	10/10/2020 18:43	10/10/2020 21:13	2,49	1	2,49	CHI
20201044914	APARECIDA DE GOIANIA	10024357071	ATLANTICO S3	10/10/2020 18:43	10/10/2020 19:38	10/10/2020 18:43	10/10/2020 19:38	0,90	1	0,90	CHI
20201044915	GOIANIA	17335413	FERROVIARIO S1	10/10/2020 18:44	10/10/2020 20:25	10/10/2020 18:44	10/10/2020 20:25	1,68	1	1,68	CHI
20201044916	ANAPOLIS	AN11273253	ANAPOLIS UNIVERSITARIO S2	10/10/2020 18:44	10/10/2020 20:56	10/10/2020 18:44	10/10/2020 20:56	2,19	9	19,71	CHI
20201044931	ABADIANIA	AA21290504	DAIA S2	10/10/2020 18:47	11/10/2020 08:20	10/10/2020 18:47	11/10/2020 08:20	13,55	5	67,75	CHI
20201044933	CAMPOS VERDES	VD11049793	SANTA TEREZINHA	10/10/2020 18:47	10/10/2020 22:10	10/10/2020 18:47	10/10/2020 22:10	3,37	79	266,47	CHI
20201044939	GOIANIA	11691130	FERROVIARIO S1	10/10/2020 18:48	10/10/2020 22:11	10/10/2020 18:48	10/10/2020 22:11	3,37	1	3,37	CHI
20201044950	JATAI	JT21260284	JATAI S1	10/10/2020 18:50	10/10/2020 23:36	10/10/2020 18:50	10/10/2020 23:36	4,76	1	4,76	CHI
20201044965	PIRENOPOLIS	PV21322558	CORUMBA	10/10/2020 18:52	10/10/2020 22:43	10/10/2020 18:52	10/10/2020 22:43	3,84	2	7,67	CHI
20201044967	RIO VERDE	MV12062721	MONTIVIDIU T	10/10/2020 18:52	11/10/2020 14:31	10/10/2020 18:52	11/10/2020 14:31	19,63	2	39,27	CHI
20201044967	MONTIVIDIU	MV12062721	MONTIVIDIU T	10/10/2020 18:52	11/10/2020 14:31	10/10/2020 18:52	11/10/2020 14:31	19,63	1	19,63	CHI
20201044983	ALEXANIA	AX12402044	ALEXANIA	10/10/2020 18:53	11/10/2020 12:59	10/10/2020 18:53	11/10/2020 12:59	18,10	142	2569,73	CHI
20201044976	NOVO GAMA	4990093903	PACAEMBU S1	10/10/2020 18:54	10/10/2020 21:48	10/10/2020 18:54	10/10/2020 21:48	2,89	1	2,89	CHI
20201044977	MARA ROSA	MQ21243283	SANTA TEREZINHA	10/10/2020 18:54	10/10/2020 22:43	10/10/2020 18:54	10/10/2020 22:43	3,80	1	3,80	CHI
20201045056	PARAUNA	PU12079039	PARAUNA	10/10/2020 18:56	10/10/2020 21:52	10/10/2020 18:56	10/10/2020 21:52	2,92	38	110,85	CHI
20201044988	PIRENOPOLIS	PV21302215	CORUMBA	10/10/2020 18:57	10/10/2020 21:19	10/10/2020 18:57	10/10/2020 21:19	2,36	1	2,36	CHI
20201046774	FORMOSA	10007314270	ITUIQUIRA	10/10/2020 18:57	11/10/2020 04:58	10/10/2020 18:57	11/10/2020 04:58	10,01	1	10,01	CHI
20201045005	URUACU	CR12306793	CAMPINORTE	10/10/2020 18:59	10/10/2020 20:58	10/10/2020 18:59	10/10/2020 20:58	1,98	119	235,55	CHI
20201045017	SAO JOAO DA PARAUNA	RP10414956	FIRMINOPOLIS S2	10/10/2020 18:59	11/10/2020 13:50	10/10/2020 18:59	10/10/2020 20:36	1,62	14	22,69	CHI
20201045017	SAO JOAO DA PARAUNA	RP10414956	FIRMINOPOLIS S2	10/10/2020 18:59	11/10/2020 13:50	11/10/2020 10:11	11/10/2020 11:07	0,93	14	13,02	CHI
20201045017	SAO JOAO DA PARAUNA	RP10414956	FIRMINOPOLIS S2	10/10/2020 18:59	11/10/2020 13:50	10/10/2020 18:59	11/10/2020 13:08	18,15	14	254,15	CHI
20201045017	PALMINOPOLIS	RP10414956	FIRMINOPOLIS S2	10/10/2020 18:59	11/10/2020 13:50	10/10/2020 18:59	11/10/2020 13:50	18,84	1	18,84	CHI
20201045004	ARAGOIANIA	AO21091703	GUAPO S2	10/10/2020 19:00	10/10/2020 20:44	10/10/2020 19:00	10/10/2020 20:44	1,73	1	1,73	CHI

20201045009	SENADOR CANEDO	190131720	SENADOR CANEDO	10/10/2020 19:00	10/10/2020 20:34	10/10/2020 19:00	10/10/2020 20:34	1,56	1	1,56	CHI
20201045035	ITUMBIARA	CD12000188	CACHOEIRA DOURADA	10/10/2020 19:03	10/10/2020 22:08	10/10/2020 19:03	10/10/2020 22:08	3,08	2	6,15	CHI
20201045035	CACHOEIRA DOURADA	CD12000188	CACHOEIRA DOURADA	10/10/2020 19:03	10/10/2020 22:08	10/10/2020 19:03	10/10/2020 22:08	3,08	8	24,60	CHI
20201045036	GOIANESIA	GE21115060	GOIANESIA S2	10/10/2020 19:03	10/10/2020 19:47	10/10/2020 19:03	10/10/2020 19:47	0,73	1	0,73	CHI
20201045037	CALDAS NOVAS	CN21000009	SERRA DE CALDAS	10/10/2020 19:03	10/10/2020 20:29	10/10/2020 19:03	10/10/2020 20:29	1,42	1	1,42	CHI
20201046047	LUZIANIA	LZ12237925	MARAJÓARA	10/10/2020 19:04	11/10/2020 08:15	10/10/2020 19:04	11/10/2020 08:15	13,18	42	553,52	CHI
20201045042	ARUANA	AK21311216	ARUANA	10/10/2020 19:04	10/10/2020 22:07	10/10/2020 19:04	10/10/2020 22:07	3,04	1	3,04	CHI
20201045063	LUZIANIA	LZ12383049	CRISTALINA S2	10/10/2020 19:04	11/10/2020 00:31	10/10/2020 19:04	11/10/2020 00:31	5,44	126	685,19	CHI
20201045060	PIRENÓPOLIS	PV21366525	CORUMBA	10/10/2020 19:08	10/10/2020 21:45	10/10/2020 19:08	10/10/2020 21:45	2,61	2	5,22	CHI
20201045064	BARRO ALTO	BA18000051FS	BARRO ALTO	10/10/2020 19:09	11/10/2020 08:03	10/10/2020 19:09	11/10/2020 08:03	12,89	130	1676,02	CHI
20201045064	NIQUELANDIA	BA18000051FS	BARRO ALTO	10/10/2020 19:09	11/10/2020 08:03	10/10/2020 19:09	11/10/2020 08:03	12,89	122	1572,88	CHI
20201045228	VALPARAISO DE GOIAS	VA11169010	MARAJÓARA	10/10/2020 19:10	10/10/2020 21:50	10/10/2020 19:10	10/10/2020 21:50	2,65	74	196,24	CHI
20201045073	APARECIDA DE GOIANIA	AP11234816	INDEPENDENCIA S1	10/10/2020 19:11	10/10/2020 20:09	10/10/2020 19:11	10/10/2020 20:09	0,97	77	74,35	CHI
20201045077	LUZIANIA	LZ12336006	VIANÓPOLIS	10/10/2020 19:12	11/10/2020 00:12	10/10/2020 19:12	11/10/2020 00:12	5,00	109	544,79	CHI
20201051755	PADRE BERNARDO	PB12389380	PADRE BERNARDO	10/10/2020 19:12	11/10/2020 14:02	10/10/2020 19:12	11/10/2020 14:02	18,83	12	225,97	CHI
20201045080	ITUMBIARA	IT121000340	PARANAIBA	10/10/2020 19:12	10/10/2020 20:50	10/10/2020 19:12	10/10/2020 20:50	1,63	1	1,63	CHI
20201045173	CEZARINA	CZ12010861	CEZARINA	10/10/2020 19:12	11/10/2020 03:20	10/10/2020 19:12	11/10/2020 03:20	8,12	6	48,74	CHI
20201045087	ITABERAI	50068003	ITABERAI S2	10/10/2020 19:13	10/10/2020 22:19	10/10/2020 19:13	10/10/2020 22:19	3,10	1	3,10	CHI
20201045089	CAMPINORTE	MQ21220623	MARA ROSA	10/10/2020 19:13	10/10/2020 21:01	10/10/2020 19:13	10/10/2020 21:01	1,79	1	1,79	CHI
20201045095	GOIANIRA	GR21046615	MEIA PONTE	10/10/2020 19:14	10/10/2020 23:30	10/10/2020 19:14	10/10/2020 23:30	4,25	1	4,25	CHI
20201045102	PARAUNA	PU12417199	MONTIVÍDIU T	10/10/2020 19:16	12/10/2020 17:08	10/10/2020 19:16	11/10/2020 02:13	6,94	3	20,83	CHI
20201045102	PARAUNA	PU12417199	MONTIVÍDIU T	10/10/2020 19:16	12/10/2020 17:08	10/10/2020 19:16	12/10/2020 17:08	45,86	3	137,59	CHI
20201045337	PALMEIRAS DE GOIAS	PL11312588	PALMEIRAS	10/10/2020 19:18	11/10/2020 00:07	10/10/2020 19:18	11/10/2020 00:07	4,81	405	1947,15	CHI
20201045113	ARAGUAPAZ	10011026055	MOZARLANDIA	10/10/2020 19:18	11/10/2020 02:07	10/10/2020 19:18	11/10/2020 02:07	6,80	1	6,80	CHI
20201044091	SILVANIA	SV21324247	VIANÓPOLIS	10/10/2020 19:19	10/10/2020 21:55	10/10/2020 19:19	10/10/2020 21:55	2,59	5	12,95	CHI
20201045116	LUZIANIA	LZ12032018	RIO VERMELHO	10/10/2020 19:19	10/10/2020 21:19	10/10/2020 19:19	10/10/2020 21:19	1,99	3	5,96	CHI
20201045129	VARJAO	VJ21315900	GUAPÓ S2	10/10/2020 19:22	11/10/2020 00:12	10/10/2020 19:22	11/10/2020 00:12	4,83	1	4,83	CHI
20201045137	MUNDO NOVO DE GOIAS	MH12060624	NOVA CRIXAS	10/10/2020 19:22	10/10/2020 23:22	10/10/2020 19:22	10/10/2020 23:22	3,99	3	11,97	CHI
20201045136	CAIAPONIA	CP12248981	CAIAPONIA	10/10/2020 19:23	11/10/2020 04:52	10/10/2020 19:23	11/10/2020 04:52	9,47	8	75,78	CHI
20201045374	PLANALTINA	10027446636	PLANALTINA	10/10/2020 19:23	11/10/2020 09:21	10/10/2020 19:23	11/10/2020 09:21	13,96	1	13,96	CHI
20201045143	PORANGATU	PO21290392	PORANGATU	10/10/2020 19:24	10/10/2020 23:06	10/10/2020 19:24	10/10/2020 23:06	3,69	1	3,69	CHI
20201045146	ANAPOLIS	20707733	ANAPOLIS UNIVERSITARIO S2	10/10/2020 19:25	10/10/2020 21:16	10/10/2020 19:25	10/10/2020 21:16	1,85	1	1,85	CHI
20201045150	LUZIANIA	LZ12330783RE	MARAJÓARA	10/10/2020 19:25	11/10/2020 00:08	10/10/2020 19:25	11/10/2020 00:08	4,70	208	977,72	CHI
20201045158	VICENTINÓPOLIS	VI12352542	VICENTINÓPOLIS	10/10/2020 19:27	10/10/2020 21:18	10/10/2020 19:27	10/10/2020 21:18	1,85	12	22,17	CHI
20201045158	EDEIA	VI12352542	VICENTINÓPOLIS	10/10/2020 19:27	10/10/2020 21:18	10/10/2020 19:27	10/10/2020 21:18	1,85	3	5,54	CHI
20201045689	PARAUNA	CG12018656LD	FIRMINÓPOLIS S2	10/10/2020 19:29	11/10/2020 17:31	10/10/2020 19:29	11/10/2020 17:31	22,03	32	704,91	CHI
20201045689	CACHOEIRA DE GOIAS	CG12018656LD	FIRMINÓPOLIS S2	10/10/2020 19:29	11/10/2020 17:31	10/10/2020 19:29	11/10/2020 17:31	22,03	90	1982,55	CHI
20201045689	AURILANDIA	CG12018656LD	FIRMINÓPOLIS S2	10/10/2020 19:29	11/10/2020 17:31	10/10/2020 19:29	11/10/2020 17:31	22,03	2	44,06	CHI
20201045169	MONTIVÍDIU DO NORTE	MX12377673	PORANGATU	10/10/2020 19:29	11/10/2020 22:05	10/10/2020 19:29	11/10/2020 22:05	26,59	1	26,59	CHI
20201045185	INDIARA	IY10395372	CEZARINA	10/10/2020 19:30	10/10/2020 19:35	10/10/2020 19:30	10/10/2020 19:35	0,08	44	3,59	CHI
20201045179	MAMBAI	4970000099	IACIARA S2	10/10/2020 19:31	10/10/2020 21:00	10/10/2020 19:31	10/10/2020 21:00	1,48	1	1,48	CHI
20201045183	APARECIDA DE GOIANIA	AP21373840	INDEPENDENCIA S1	10/10/2020 19:32	10/10/2020 21:20	10/10/2020 19:32	10/10/2020 21:20	1,79	1	1,79	CHI
20201045363	GUAPÓ	GA12276655	GUAPÓ S2	10/10/2020 19:33	10/10/2020 21:30	10/10/2020 19:33	10/10/2020 21:30	1,94	45	87,14	CHI
20201045194	CIDADE OCIDENTAL	2680187848	MARAJÓARA	10/10/2020 19:34	10/10/2020 22:34	10/10/2020 19:34	10/10/2020 22:34	2,99	1	2,99	CHI
20201045198	VILA PROPICIO	04560224	BARRO ALTO	10/10/2020 19:35	12/10/2020 17:27	10/10/2020 19:35	11/10/2020 01:30	5,91	30	177,42	CHI
20201045198	MIMOSO DE GOIAS	04560224	BARRO ALTO	10/10/2020 19:35	12/10/2020 17:27	10/10/2020 19:35	11/10/2020 01:30	5,91	3	17,74	CHI
20201045198	NIQUELANDIA	04560224	BARRO ALTO	10/10/2020 19:35	12/10/2020 17:27	10/10/2020 19:35	11/10/2020 01:30	5,91	926	5476,26	CHI
20201045198	MIMOSO DE GOIAS	04560224	BARRO ALTO	10/10/2020 19:35	12/10/2020 17:27	11/10/2020 12:19	11/10/2020 13:18	0,97	4	3,89	CHI
20201045198	VILA PROPICIO	04560224	BARRO ALTO	10/10/2020 19:35	12/10/2020 17:27	11/10/2020 12:19	11/10/2020 13:18	0,97	31	30,12	CHI
20201045198	NIQUELANDIA	04560224	BARRO ALTO	10/10/2020 19:35	12/10/2020 17:27	11/10/2020 12:19	11/10/2020 13:18	0,97	290	281,78	CHI
20201045198	NIQUELANDIA	NQ13031021	BARRO ALTO	10/10/2020 19:35	12/10/2020 17:27	11/10/2020 12:21	11/10/2020 13:18	0,95	16	15,20	CHI
20201045198	MIMOSO DE GOIAS	04560224	BARRO ALTO	10/10/2020 19:35	12/10/2020 17:27	11/10/2020 18:13	11/10/2020 22:05	3,88	4	15,52	CHI
20201045198	VILA PROPICIO	04560224	BARRO ALTO	10/10/2020 19:35	12/10/2020 17:27	11/10/2020 18:13	11/10/2020 22:05	3,88	31	120,31	CHI
20201045198	NIQUELANDIA	04560224	BARRO ALTO	10/10/2020 19:35	12/10/2020 17:27	11/10/2020 18:13	11/10/2020 22:05	3,88	304	1179,86	CHI
20201045198	NIQUELANDIA	04564114	BARRO ALTO	10/10/2020 19:35	12/10/2020 17:27	11/10/2020 18:15	11/10/2020 22:05	3,83	2	7,67	CHI
20201045198	NIQUELANDIA	04564114	BARRO ALTO	10/10/2020 19:35	12/10/2020 17:27	11/10/2020 18:15	11/10/2020 22:05	3,83	168	644,09	CHI
20201045198	VILA PROPICIO	04564114	BARRO ALTO	10/10/2020 19:35	12/10/2020 17:27	11/10/2020 18:15	11/10/2020 22:05	3,83	4	15,34	CHI
20201045198	NIQUELANDIA	NQ10403941	BARRO ALTO	10/10/2020 19:35	12/10/2020 17:27	11/10/2020 03:53	11/10/2020 23:12	19,32	1	19,32	CHI

20201045198	NIQUELANDIA	NQ10403941	BARRO ALTO	10/10/2020 19:35	12/10/2020 17:27	11/10/2020 03:53	11/10/2020 23:41	19,80	730	14454,41	CHI
20201045198	NIQUELANDIA	BA10400443	BARRO ALTO	10/10/2020 19:35	12/10/2020 17:27	12/10/2020 00:01	12/10/2020 02:19	2,30	4	9,19	CHI
20201045198	BARRO ALTO	BA10400443	BARRO ALTO	10/10/2020 19:35	12/10/2020 17:27	12/10/2020 00:01	12/10/2020 02:19	2,30	57	130,93	CHI
20201045198	VILA PROPICIO	BA10400443	BARRO ALTO	10/10/2020 19:35	12/10/2020 17:27	12/10/2020 00:01	12/10/2020 02:19	2,30	23	52,83	CHI
20201045198	NIQUELANDIA	BA10400443	BARRO ALTO	10/10/2020 19:35	12/10/2020 17:27	12/10/2020 00:01	12/10/2020 02:19	2,30	1	2,30	CHI
20201045198	NIQUELANDIA	NQ13221605	BARRO ALTO	10/10/2020 19:35	12/10/2020 17:27	12/10/2020 00:00	12/10/2020 03:22	3,36	9	30,28	CHI
20201045198	NIQUELANDIA	NQ13035665	BARRO ALTO	10/10/2020 19:35	12/10/2020 17:27	12/10/2020 00:00	12/10/2020 05:28	5,47	110	601,52	CHI
20201045198	NIQUELANDIA	NQ10403941	BARRO ALTO	10/10/2020 19:35	12/10/2020 17:27	11/10/2020 03:53	12/10/2020 05:45	25,86	2	51,73	CHI
20201045198	NIQUELANDIA	NQ13031021	BARRO ALTO	10/10/2020 19:35	12/10/2020 17:27	11/10/2020 11:09	12/10/2020 05:45	18,61	2	37,22	CHI
20201045198	NIQUELANDIA	NQ12292484LD	BARRO ALTO	10/10/2020 19:35	12/10/2020 17:27	12/10/2020 00:00	12/10/2020 05:57	5,95	611	3634,60	CHI
20201045198	NIQUELANDIA	NQ10403941	BARRO ALTO	10/10/2020 19:35	12/10/2020 17:27	11/10/2020 03:53	12/10/2020 11:50	31,94	10	319,42	CHI
20201045198	NIQUELANDIA	NQ13212750	BARRO ALTO	10/10/2020 19:35	12/10/2020 17:27	12/10/2020 12:34	12/10/2020 12:55	0,35	731	257,68	CHI
20201045198	NIQUELANDIA	04560224	BARRO ALTO	10/10/2020 19:35	12/10/2020 17:27	12/10/2020 17:00	12/10/2020 17:27	0,45	1050	472,50	CHI
20201045198	MIMOSO DE GOIAS	04560224	BARRO ALTO	10/10/2020 19:35	12/10/2020 17:27	12/10/2020 17:00	12/10/2020 17:27	0,45	4	1,80	CHI
20201045198	VILA PROPICIO	04560224	BARRO ALTO	10/10/2020 19:35	12/10/2020 17:27	12/10/2020 17:00	12/10/2020 17:27	0,45	31	13,95	CHI
20201045201	PADRE BERNARDO	2760010138	PADRE BERNARDO	10/10/2020 19:36	11/10/2020 17:11	10/10/2020 19:36	11/10/2020 17:11	21,57	1	21,57	CHI
20201045298	SAO JOAO DA PARAUNA	RP12076382RE	FIRMINOPOLIS S2	10/10/2020 19:37	13/10/2020 11:36	10/10/2020 19:37	11/10/2020 00:40	5,06	40	202,26	CHI
20201045298	SAO JOAO DA PARAUNA	RP12076382RE	FIRMINOPOLIS S2	10/10/2020 19:37	13/10/2020 11:36	10/10/2020 19:37	12/10/2020 18:12	46,59	14	652,26	CHI
20201045298	SAO JOAO DA PARAUNA	RP12076382RE	FIRMINOPOLIS S2	10/10/2020 19:37	13/10/2020 11:36	10/10/2020 19:37	13/10/2020 11:36	63,98	7	447,85	CHI
20201045298	SAO JOAO DA PARAUNA	RP12076382RE	FIRMINOPOLIS S2	10/10/2020 19:37	13/10/2020 11:36	12/10/2020 23:08	13/10/2020 11:36	12,46	54	673,03	CHI
20201045799	DISTRITO FEDERAL	FA12322759	ITIQUEIRA	10/10/2020 19:39	11/10/2020 02:06	10/10/2020 19:39	11/10/2020 02:06	6,44	1	6,44	CHI
20201045799	FORMOSA	FA12322759	ITIQUEIRA	10/10/2020 19:39	11/10/2020 02:06	10/10/2020 19:39	11/10/2020 02:06	6,44	36	231,72	CHI
20201045221	MINACU	IH21248578	MINACU	10/10/2020 19:40	12/10/2020 14:54	10/10/2020 19:40	12/10/2020 14:54	43,22	2	86,44	CHI
20201045226	ALEXANIA	10003203881	ALEXANIA	10/10/2020 19:41	10/10/2020 21:39	10/10/2020 19:41	10/10/2020 21:39	1,95	1	1,95	CHI
20201045229	ITABERAI	10006951706	ITABERAI S2	10/10/2020 19:42	10/10/2020 22:43	10/10/2020 19:42	10/10/2020 22:43	3,01	1	3,01	CHI
20201045769	ABADIANIA	AA12413563	DAIA S2	10/10/2020 19:46	11/10/2020 01:59	10/10/2020 19:46	11/10/2020 01:59	6,22	83	515,91	CHI
202010189381	GOIANESIA	GE11273351	GOIANESIA S2	10/10/2020 19:47	10/10/2020 21:33	10/10/2020 19:47	10/10/2020 21:33	1,78	136	242,34	CHI
20201045248	MORRINHOS	MR21363998	MORRINHOS	10/10/2020 19:47	10/10/2020 22:15	10/10/2020 19:47	10/10/2020 22:15	2,47	1	2,47	CHI
20201045407	MAURILANDIA	ML21205447	SANTA HELENA S1	10/10/2020 19:47	11/10/2020 03:57	10/10/2020 19:47	11/10/2020 03:57	8,16	1	8,16	CHI
20201045252	PALMEIRAS DE GOIAS	10030050420	PALMEIRAS	10/10/2020 19:47	11/10/2020 11:40	10/10/2020 19:47	11/10/2020 11:40	15,88	1	15,88	CHI
20201045449	PADRE BERNARDO	PB12317821	PADRE BERNARDO	10/10/2020 19:49	11/10/2020 08:03	10/10/2020 19:49	11/10/2020 08:03	12,22	65	794,48	CHI
20201045271	RIO VERDE	10000976995	RIO VERDE S2	10/10/2020 19:50	11/10/2020 16:30	10/10/2020 19:50	11/10/2020 16:30	20,66	1	20,66	CHI
20201045272	ITAPACI	IW21335694	ITAPACI	10/10/2020 19:50	10/10/2020 22:52	10/10/2020 19:50	10/10/2020 22:52	3,03	1	3,03	CHI
20201045274	SANTA RITA DO NOVO DESTINO	BA21286918	BARRO ALTO	10/10/2020 19:51	12/10/2020 11:56	10/10/2020 19:51	12/10/2020 11:56	40,08	1	40,08	CHI
20201045282	INDIARA	IY10395372	CEZARINA	10/10/2020 19:52	11/10/2020 19:46	10/10/2020 19:52	10/10/2020 22:38	2,76	21	57,99	CHI
20201045282	INDIARA	IY10395372	CEZARINA	10/10/2020 19:52	11/10/2020 19:46	10/10/2020 19:52	10/10/2020 23:40	3,80	4	15,21	CHI
20201045282	INDIARA	IY10395372	CEZARINA	10/10/2020 19:52	11/10/2020 19:46	10/10/2020 19:52	11/10/2020 01:03	5,17	12	62,09	CHI
20201045282	INDIARA	IY10395372	CEZARINA	10/10/2020 19:52	11/10/2020 19:46	10/10/2020 19:52	11/10/2020 01:50	5,97	1	5,97	CHI
20201045282	INDIARA	IY12206402	CEZARINA	10/10/2020 19:52	11/10/2020 19:46	10/10/2020 19:52	11/10/2020 19:46	23,89	4	95,56	CHI
202010175329	AGUA FRIA DE GOIAS	JL12270094	SAO JOAO D ALIANCA	10/10/2020 19:53	12/10/2020 13:28	10/10/2020 19:53	12/10/2020 13:28	41,59	1	41,59	CHI
202010175329	SAO JOAO D ALIANCA	JL12270094	SAO JOAO D ALIANCA	10/10/2020 19:53	12/10/2020 13:28	10/10/2020 19:53	12/10/2020 13:28	41,59	8	332,73	CHI
20201045286	PADRE BERNARDO	PB12045569	PADRE BERNARDO	10/10/2020 19:53	11/10/2020 11:22	10/10/2020 19:53	11/10/2020 11:22	15,47	43	665,21	CHI
20201045300	BARRO ALTO	BA10403917	BARRO ALTO	10/10/2020 19:54	11/10/2020 16:18	10/10/2020 19:54	11/10/2020 10:28	14,57	174	2534,60	CHI
20201045300	BARRO ALTO	BA12381273LD	BARRO ALTO	10/10/2020 19:54	11/10/2020 16:18	10/10/2020 19:54	11/10/2020 13:02	17,14	570	9769,17	CHI
20201045300	BARRO ALTO	BA10403917	BARRO ALTO	10/10/2020 19:54	11/10/2020 16:18	11/10/2020 11:07	11/10/2020 13:02	1,91	174	333,02	CHI
20201045300	BARRO ALTO	BA12382467	BARRO ALTO	10/10/2020 19:54	11/10/2020 16:18	10/10/2020 19:54	11/10/2020 16:18	20,40	15	306,06	CHI
20201045302	TRINDADE	10024348293	TRINDADE	10/10/2020 19:56	10/10/2020 21:03	10/10/2020 19:56	10/10/2020 21:03	1,12	1	1,12	CHI
20201045522	ALEXANIA	AX12374674	ALEXANIA	10/10/2020 19:56	10/10/2020 22:22	10/10/2020 19:56	10/10/2020 22:22	2,42	8	19,34	CHI
20201045522	CORUMBA DE GOIAS	AX12374674	ALEXANIA	10/10/2020 19:56	10/10/2020 22:22	10/10/2020 19:56	10/10/2020 22:22	2,42	2	4,83	CHI
20201045307	FORMOSA	10004005633	ITIQUEIRA	10/10/2020 19:57	11/10/2020 14:15	10/10/2020 19:57	11/10/2020 14:15	18,30	1	18,30	CHI
20201045309	MONTES CLAROS DE GOIAS	ME21231178	ARENOPOLIS	10/10/2020 19:57	11/10/2020 01:45	10/10/2020 19:57	11/10/2020 01:45	5,80	1	5,80	CHI
20201045320	FORMOSA	610317258	ITIQUEIRA	10/10/2020 19:59	11/10/2020 17:20	10/10/2020 19:59	11/10/2020 17:20	21,33	1	21,33	CHI
20201045325	CATURAI	CK21326274	INHUMAS S1	10/10/2020 20:00	10/10/2020 23:49	10/10/2020 20:00	10/10/2020 23:49	3,80	1	3,80	CHI
20201046113	INDIARA	IY11393274	EDEIA	10/10/2020 20:01	11/10/2020 22:11	10/10/2020 20:01	11/10/2020 22:11	26,16	54	1412,63	CHI
20201045422	FORMOSA	FA12383233	ITIQUEIRA	10/10/2020 20:01	12/10/2020 04:32	10/10/2020 20:01	12/10/2020 04:32	32,51	71	2308,09	CHI
20201048795	PALMEIRAS DE GOIAS	PL12051400	PALMEIRAS	10/10/2020 20:01	11/10/2020 08:33	10/10/2020 20:01	11/10/2020 08:33	12,52	112	1402,61	CHI
20201045334	TRES RANCHOS	TH11389974	CATALAO S1	10/10/2020 20:02	10/10/2020 22:53	10/10/2020 20:02	10/10/2020 22:53	2,85	5	14,24	CHI
20201045367	ALVORADA DO NORTE	AQ13000004	IACIARA S2	10/10/2020 20:03	11/10/2020 02:05	10/10/2020 22:43	11/10/2020 01:38	2,92	1535	4477,08	CHI

20201045367	SIMOLANDIA	AQ13000004	IACIARA S2	10/10/2020 20:03	11/10/2020 02:05	10/10/2020 22:43	11/10/2020 01:38	2,92	1	2,92	CHI
20201045367	BURITINOPOLIS	00010214	IACIARA S2	10/10/2020 20:03	11/10/2020 02:05	10/10/2020 20:03	11/10/2020 02:05	6,04	1058	6388,26	CHI
20201045367	ALVORADA DO NORTE	00010214	IACIARA S2	10/10/2020 20:03	11/10/2020 02:05	10/10/2020 20:03	11/10/2020 02:05	6,04	1	6,04	CHI
20201045367	SIMOLANDIA	00010214	IACIARA S2	10/10/2020 20:03	11/10/2020 02:05	10/10/2020 20:03	11/10/2020 02:05	6,04	2172	13114,66	CHI
20201045367	POSSE	00010214	IACIARA S2	10/10/2020 20:03	11/10/2020 02:05	10/10/2020 20:03	11/10/2020 02:05	6,04	111	670,22	CHI
20201045340	TRINDADE	40011306	TRINDADE	10/10/2020 20:04	10/10/2020 21:08	10/10/2020 20:04	10/10/2020 21:08	1,06	1	1,06	CHI
20201045341	SENADOR CANEDO	10020432125	SENADOR CANEDO	10/10/2020 20:04	10/10/2020 20:46	10/10/2020 20:04	10/10/2020 20:46	0,70	1	0,70	CHI
20201045345	ITUMBIARA	IT21000138	PARANAIBA	10/10/2020 20:05	11/10/2020 00:00	10/10/2020 20:05	11/10/2020 00:00	3,91	1	3,91	CHI
20201045347	AGUAS LINDAS DE GOIAS	4830376030	AGUAS LINDAS DE GOIAS S1	10/10/2020 20:05	10/10/2020 21:49	10/10/2020 20:05	10/10/2020 21:49	1,72	1	1,72	CHI
20201045350	BOM JESUS DE GOIAS	BJ21068962	BOM JESUS DE GOIAS	10/10/2020 20:06	11/10/2020 08:41	10/10/2020 20:06	11/10/2020 08:41	12,58	1	12,58	CHI
20201045896	INDIARA	IY12205923	EDEIA	10/10/2020 20:06	11/10/2020 11:57	10/10/2020 20:06	11/10/2020 11:57	15,84	33	522,87	CHI
20201045896	PALMEIRAS DE GOIAS	IY12205923	EDEIA	10/10/2020 20:06	11/10/2020 11:57	10/10/2020 20:06	11/10/2020 11:57	15,84	5	79,22	CHI
202010189149	GUAPO	GA21217771	GUAPO S2	10/10/2020 20:07	10/10/2020 21:12	10/10/2020 20:07	10/10/2020 21:12	1,08	1	1,08	CHI
20201045368	VILA PROPICIO	03620214	GOIANESIA S1	10/10/2020 20:07	11/10/2020 17:41	10/10/2020 20:07	10/10/2020 22:33	2,44	51	124,51	CHI
20201045368	BARRO ALTO	03620214	GOIANESIA S1	10/10/2020 20:07	11/10/2020 17:41	10/10/2020 20:07	10/10/2020 22:33	2,44	128	312,50	CHI
20201045368	GOIANESIA	03620214	GOIANESIA S1	10/10/2020 20:07	11/10/2020 17:41	10/10/2020 20:07	10/10/2020 22:33	2,44	105	256,35	CHI
20201045368	BARRO ALTO	03620214	GOIANESIA S1	10/10/2020 20:07	11/10/2020 17:41	10/10/2020 20:08	10/10/2020 22:33	2,43	1	2,43	CHI
20201045368	VILA PROPICIO	03620214	GOIANESIA S1	10/10/2020 20:07	11/10/2020 17:41	10/10/2020 20:08	10/10/2020 22:33	2,43	1	2,43	CHI
20201045368	GOIANESIA	03620214	GOIANESIA S1	10/10/2020 20:07	11/10/2020 17:41	10/10/2020 20:08	10/10/2020 22:33	2,43	8	19,42	CHI
20201045368	VILA PROPICIO	03620214	GOIANESIA S1	10/10/2020 20:07	11/10/2020 17:41	10/10/2020 20:07	10/10/2020 23:18	3,18	6	19,09	CHI
20201045368	BARRO ALTO	03620214	GOIANESIA S1	10/10/2020 20:07	11/10/2020 17:41	11/10/2020 00:17	11/10/2020 02:15	1,95	129	251,87	CHI
20201045368	GOIANESIA	03620214	GOIANESIA S1	10/10/2020 20:07	11/10/2020 17:41	11/10/2020 00:17	11/10/2020 02:15	1,95	113	220,63	CHI
20201045368	VILA PROPICIO	03620214	GOIANESIA S1	10/10/2020 20:07	11/10/2020 17:41	11/10/2020 00:17	11/10/2020 02:15	1,95	58	113,24	CHI
20201045368	GOIANESIA	03620214	GOIANESIA S1	10/10/2020 20:07	11/10/2020 17:41	11/10/2020 02:58	11/10/2020 03:28	0,50	113	56,28	CHI
20201045368	VILA PROPICIO	03620214	GOIANESIA S1	10/10/2020 20:07	11/10/2020 17:41	11/10/2020 02:58	11/10/2020 03:28	0,50	58	28,89	CHI
20201045368	BARRO ALTO	03620214	GOIANESIA S1	10/10/2020 20:07	11/10/2020 17:41	11/10/2020 02:58	11/10/2020 03:28	0,50	129	64,25	CHI
20201045368	VILA PROPICIO	03620214	GOIANESIA S1	10/10/2020 20:07	11/10/2020 17:41	10/10/2020 20:07	11/10/2020 16:38	20,51	469	9621,01	CHI
20201045368	COCALZINHO DE GOIAS	03620214	GOIANESIA S1	10/10/2020 20:07	11/10/2020 17:41	10/10/2020 20:07	11/10/2020 17:23	21,27	1	21,27	CHI
20201045368	VILA PROPICIO	03620214	GOIANESIA S1	10/10/2020 20:07	11/10/2020 17:41	10/10/2020 20:07	11/10/2020 17:23	21,27	376	7996,48	CHI
20201045368	PADRE BERNARDO	03620214	GOIANESIA S1	10/10/2020 20:07	11/10/2020 17:41	10/10/2020 20:07	11/10/2020 17:23	21,27	11	233,94	CHI
20201045368	VILA PROPICIO	03620214	GOIANESIA S1	10/10/2020 20:07	11/10/2020 17:41	10/10/2020 20:07	11/10/2020 17:41	21,56	19	409,72	CHI
20201045358	ITUMBIARA	IT21309841	PARANAIBA	10/10/2020 20:07	10/10/2020 21:26	10/10/2020 20:07	10/10/2020 21:26	1,31	1	1,31	CHI
20201045360	CRISTALINA	KR11032815	PAMPLONA	10/10/2020 20:07	10/10/2020 21:49	10/10/2020 20:07	10/10/2020 21:49	1,69	71	119,89	CHI
20201045411	ARUANA	AK12157845	MOZARLANDIA	10/10/2020 20:09	11/10/2020 08:28	10/10/2020 20:09	11/10/2020 08:28	12,31	62	763,24	CHI
20201045373	GOIANIA	12592511	FERROVIARIO S3	10/10/2020 20:10	10/10/2020 21:13	10/10/2020 20:10	10/10/2020 21:13	1,04	1	1,04	CHI
202010189382	BARRO ALTO	BA21342222	GOIANESIA S1	10/10/2020 20:13	10/10/2020 21:33	10/10/2020 20:13	10/10/2020 21:33	1,33	1	1,33	CHI
20201045500	VARIAO	VJ12402746	GUAPO S2	10/10/2020 20:15	11/10/2020 00:12	10/10/2020 20:15	11/10/2020 00:12	3,95	38	150,10	CHI
20201049624	TURVANIA	8081784	FIRMINOPOLIS S1	10/10/2020 20:15	11/10/2020 16:23	10/10/2020 20:15	11/10/2020 16:23	20,12	1	20,12	CHI
20201049624	FIRMINOPOLIS	8081784	FIRMINOPOLIS S1	10/10/2020 20:15	11/10/2020 16:23	10/10/2020 20:15	11/10/2020 16:23	20,12	34	684,18	CHI
20201045410	CUMARI	CY21316043	CATALAO S1	10/10/2020 20:20	11/10/2020 01:26	10/10/2020 20:20	11/10/2020 01:26	5,10	5	25,49	CHI
20201045465	CALDAS NOVAS	CN12097372	SERRA DE CALDAS	10/10/2020 20:23	10/10/2020 22:23	10/10/2020 20:23	10/10/2020 22:23	2,00	82	163,84	CHI
20201045479	CEZARINA	CZ11076512	CEZARINA	10/10/2020 20:24	11/10/2020 11:34	10/10/2020 20:24	11/10/2020 11:34	15,17	272	4126,24	CHI
20201045424	LUZIANIA	LZ11348522	RIO VERMELHO	10/10/2020 20:24	11/10/2020 13:41	10/10/2020 20:24	11/10/2020 13:27	17,05	5	85,25	CHI
20201045424	LUZIANIA	LZ12348523	RIO VERMELHO	10/10/2020 20:24	11/10/2020 13:41	11/10/2020 12:29	11/10/2020 13:41	1,20	4	4,81	CHI
20201045440	BARRO ALTO	BA10400443	BARRO ALTO	10/10/2020 20:25	11/10/2020 19:29	10/10/2020 20:25	11/10/2020 11:33	15,15	8	121,17	CHI
20201045440	BARRO ALTO	BA10400443	BARRO ALTO	10/10/2020 20:25	11/10/2020 19:29	10/10/2020 20:25	11/10/2020 19:29	23,06	50	1153,25	CHI
20201045440	NIQUELANDIA	BA10400443	BARRO ALTO	10/10/2020 20:25	11/10/2020 19:29	10/10/2020 20:25	11/10/2020 19:29	23,06	4	92,26	CHI
20201045440	VILA PROPICIO	BA10400443	BARRO ALTO	10/10/2020 20:25	11/10/2020 19:29	10/10/2020 20:25	11/10/2020 19:29	23,06	25	576,62	CHI
20201045433	FORMOSO	FO21256403	MARA ROSA	10/10/2020 20:26	10/10/2020 22:13	10/10/2020 20:26	10/10/2020 22:13	1,77	1	1,77	CHI
20201045518	CACHOEIRA DE GOIAS	CG12382596	FIRMINOPOLIS S2	10/10/2020 20:29	11/10/2020 18:54	10/10/2020 20:29	11/10/2020 18:54	22,40	2	44,80	CHI
20201045518	MOIPORA	CG12382596	FIRMINOPOLIS S2	10/10/2020 20:29	11/10/2020 18:54	10/10/2020 20:29	11/10/2020 18:54	22,40	1	22,40	CHI
20201045518	AURILANDIA	CG12382596	FIRMINOPOLIS S2	10/10/2020 20:29	11/10/2020 18:54	10/10/2020 20:29	11/10/2020 18:54	22,40	24	537,65	CHI
20201045447	GOIANIA	GN11041237	GOIANIA LESTE S3	10/10/2020 20:31	10/10/2020 21:47	10/10/2020 20:31	10/10/2020 21:47	1,26	168	212,24	CHI
20201045555	ALVORADA DO NORTE	00010424	IACIARA S2	10/10/2020 20:32	11/10/2020 20:58	10/10/2020 20:32	11/10/2020 02:35	6,05	3	18,14	CHI
20201045555	SIMOLANDIA	00010424	IACIARA S2	10/10/2020 20:32	11/10/2020 20:58	10/10/2020 20:32	11/10/2020 02:35	6,05	70	423,29	CHI
20201045555	POSSE	00010424	IACIARA S2	10/10/2020 20:32	11/10/2020 20:58	10/10/2020 20:32	11/10/2020 03:51	7,31	27	197,46	CHI
20201045555	SIMOLANDIA	00010424	IACIARA S2	10/10/2020 20:32	11/10/2020 20:58	10/10/2020 20:32	11/10/2020 03:51	7,31	91	665,51	CHI
20201045555	POSSE	00010424	IACIARA S2	10/10/2020 20:32	11/10/2020 20:58	11/10/2020 05:57	11/10/2020 06:18	0,36	27	9,64	CHI

20201045555	ALVORADA DO NORTE	00010424	IACIARA S2	10/10/2020 20:32	11/10/2020 20:58	11/10/2020 05:57	11/10/2020 06:18	0,36	3	1,07	CHI
20201045555	SIMOLANDIA	00010424	IACIARA S2	10/10/2020 20:32	11/10/2020 20:58	11/10/2020 05:57	11/10/2020 06:18	0,36	161	57,47	CHI
20201045555	SIMOLANDIA	00010424	IACIARA S2	10/10/2020 20:32	11/10/2020 20:58	10/10/2020 20:32	11/10/2020 20:58	24,44	88	2150,67	CHI
20201045555	POSSE	00010424	IACIARA S2	10/10/2020 20:32	11/10/2020 20:58	10/10/2020 20:32	11/10/2020 20:58	24,44	55	1344,17	CHI
20201045454	JARAGUA	10005340991	JARAGUA	10/10/2020 20:33	10/10/2020 21:47	10/10/2020 20:33	10/10/2020 21:47	1,23	1	1,23	CHI
20201045457	MAMBAI	MB12344322RE	IACIARA S2	10/10/2020 20:33	10/10/2020 21:52	10/10/2020 20:33	10/10/2020 21:52	1,31	130	170,37	CHI
20201045457	BURITINOPOLIS	MB12344322RE	IACIARA S2	10/10/2020 20:33	10/10/2020 21:52	10/10/2020 20:33	10/10/2020 21:52	1,31	30	39,32	CHI
20201045459	MONTES CLAROS DE GOIAS	ME11334793	IPORA	10/10/2020 20:33	11/10/2020 00:46	10/10/2020 20:33	11/10/2020 00:46	4,21	60	252,53	CHI
20201045466	MUNDO NOVO DE GOIAS	MH12125309	NOVA CRIXAS	10/10/2020 20:35	11/10/2020 19:36	10/10/2020 20:35	11/10/2020 01:55	5,33	2	10,67	CHI
20201045466	MUNDO NOVO DE GOIAS	MH12125309	NOVA CRIXAS	10/10/2020 20:35	11/10/2020 19:36	10/10/2020 20:35	11/10/2020 19:36	23,02	1	23,02	CHI
20201045466	NOVA CRIXAS	MH12125309	NOVA CRIXAS	10/10/2020 20:35	11/10/2020 19:36	10/10/2020 20:35	11/10/2020 19:36	23,02	3	69,05	CHI
20201045471	LUZIANIA	10028850970	RIO VERMELHO	10/10/2020 20:37	10/10/2020 22:47	10/10/2020 20:37	10/10/2020 22:47	2,16	1	2,16	CHI
20201053659	FIRMINOPOLIS	FR21388900	FIRMINOPOLIS S1	10/10/2020 20:37	11/10/2020 23:26	10/10/2020 20:37	11/10/2020 23:26	26,81	2	53,61	CHI
20201052376	CEZARINA	IY12010392	EDEIA	10/10/2020 20:38	11/10/2020 16:52	10/10/2020 20:38	11/10/2020 16:52	20,24	6	121,45	CHI
20201052376	INDIARA	IY12010392	EDEIA	10/10/2020 20:38	11/10/2020 16:52	10/10/2020 20:38	11/10/2020 16:52	20,24	7	141,69	CHI
20201045969	PARAUNA	PU12194227RE	PARAUNA	10/10/2020 20:45	11/10/2020 07:15	10/10/2020 20:45	11/10/2020 07:15	10,50	14	147,00	CHI
20201045969	SAO JOAO DA PARAUNA	PU12194227RE	PARAUNA	10/10/2020 20:45	11/10/2020 07:15	10/10/2020 20:45	11/10/2020 07:15	10,50	51	535,49	CHI
20201045512	JANDAIA	JD10409251	PALMEIRAS	10/10/2020 20:46	11/10/2020 03:31	10/10/2020 20:46	10/10/2020 03:31	0,08	351	28,76	CHI
20201045512	JANDAIA	JD10400715	PALMEIRAS	10/10/2020 20:46	11/10/2020 03:31	10/10/2020 20:46	10/10/2020 20:52	0,10	489	47,81	CHI
20201045512	PALMEIRAS DE GOIAS	PL10406637	PALMEIRAS	10/10/2020 20:46	11/10/2020 03:31	10/10/2020 20:46	10/10/2020 22:30	1,73	11	18,98	CHI
20201045512	PALMEIRAS DE GOIAS	PL13126035	PALMEIRAS	10/10/2020 20:46	11/10/2020 03:31	10/10/2020 20:46	11/10/2020 03:01	6,24	7	43,70	CHI
20201045512	PALMEIRAS DE GOIAS	PL13126036	PALMEIRAS	10/10/2020 20:46	11/10/2020 03:31	10/10/2020 20:46	11/10/2020 03:26	6,66	5	33,30	CHI
20201045512	JANDAIA	PL10400683	PALMEIRAS	10/10/2020 20:46	11/10/2020 03:31	10/10/2020 20:46	11/10/2020 03:31	6,75	27	182,29	CHI
20201045512	PALMEIRAS DE GOIAS	03300434	PALMEIRAS	10/10/2020 20:46	11/10/2020 03:31	10/10/2020 20:46	11/10/2020 03:31	6,75	38	256,56	CHI
20201045512	JANDAIA	03300434	PALMEIRAS	10/10/2020 20:46	11/10/2020 03:31	10/10/2020 20:46	11/10/2020 03:31	6,75	2108	14232,51	CHI
20201045512	PARAUNA	03300434	PALMEIRAS	10/10/2020 20:46	11/10/2020 03:31	10/10/2020 20:46	11/10/2020 03:31	6,75	53	357,84	CHI
20201045512	PALMEIRAS DE GOIAS	PL10400683	PALMEIRAS	10/10/2020 20:46	11/10/2020 03:31	10/10/2020 20:46	11/10/2020 03:31	6,75	3	20,25	CHI
20201045512	INDIARA	03300434	PALMEIRAS	10/10/2020 20:46	11/10/2020 03:31	10/10/2020 20:46	11/10/2020 03:31	6,75	133	897,97	CHI
20201049493	PALMINOPOLIS	03140203	PALMEIRAS	10/10/2020 20:47	11/10/2020 09:38	10/10/2020 20:47	11/10/2020 09:38	12,84	88	1130,04	CHI
20201049493	PALMEIRAS DE GOIAS	03140203	PALMEIRAS	10/10/2020 20:47	11/10/2020 09:38	10/10/2020 20:47	11/10/2020 09:38	12,84	82	1052,99	CHI
20201049493	PALMINOPOLIS	03140203	PALMEIRAS	10/10/2020 20:47	11/10/2020 09:38	10/10/2020 20:47	11/10/2020 09:38	12,84	1516	19467,55	CHI
20201045514	ESTRELA DO NORTE	ET12136395	MARA ROSA	10/10/2020 20:49	11/10/2020 01:18	10/10/2020 20:49	11/10/2020 01:18	4,48	11	49,25	CHI
20201045514	MARA ROSA	ET12136395	MARA ROSA	10/10/2020 20:49	11/10/2020 01:18	10/10/2020 20:49	11/10/2020 01:18	4,48	9	40,30	CHI
20201045517	URUACU	UR12317135	URUACU	10/10/2020 20:49	10/10/2020 22:42	10/10/2020 20:49	10/10/2020 22:42	1,87	11	20,61	CHI
20201048790	FIRMINOPOLIS	TV18005554TS	FIRMINOPOLIS S1	10/10/2020 20:50	11/10/2020 23:19	10/10/2020 20:50	11/10/2020 23:19	26,48	2	52,96	CHI
20201048790	TURVANIA	TV18005554TS	FIRMINOPOLIS S1	10/10/2020 20:50	11/10/2020 23:19	10/10/2020 20:50	11/10/2020 23:19	26,48	46	1218,13	CHI
20201045550	BOM JESUS DE GOIAS	IT12034458RE	CACHOEIRA DOURADA	10/10/2020 20:50	10/10/2020 23:05	10/10/2020 20:50	10/10/2020 23:05	2,24	3	6,72	CHI
20201045550	ITUMBARA	IT12034458RE	CACHOEIRA DOURADA	10/10/2020 20:50	10/10/2020 23:05	10/10/2020 20:50	10/10/2020 23:05	2,24	65	145,58	CHI
20201045550	PANAMA	IT12034458RE	CACHOEIRA DOURADA	10/10/2020 20:50	10/10/2020 23:05	10/10/2020 20:50	10/10/2020 23:05	2,24	11	24,64	CHI
20201049241	COCALZINHO DE GOIAS	CB12051786LD	GOIANESIA S1	10/10/2020 20:53	11/10/2020 12:38	10/10/2020 20:53	11/10/2020 12:38	15,75	124	1952,66	CHI
20201045567	PORANGATU	PO12384305	PORANGATU	10/10/2020 20:54	11/10/2020 09:14	10/10/2020 20:54	11/10/2020 09:14	12,33	5	61,63	CHI
20201045538	ITABERAÍ	IB21171742	ITABERAÍ S2	10/10/2020 20:55	10/10/2020 23:22	10/10/2020 20:55	10/10/2020 23:22	2,45	1	2,45	CHI
20201045546	BURITINOPOLIS	MB12314303	IACIARA S2	10/10/2020 20:58	10/10/2020 22:48	10/10/2020 20:58	10/10/2020 22:48	1,83	2	3,67	CHI
20201045546	MAMBAI	MB12314303	IACIARA S2	10/10/2020 20:58	10/10/2020 22:48	10/10/2020 20:58	10/10/2020 22:48	1,83	4	7,33	CHI
20201045556	MONTIVÍDIU DO NORTE	MX11362117	PORANGATU	10/10/2020 20:59	11/10/2020 11:15	10/10/2020 20:59	11/10/2020 11:15	14,25	1	14,25	CHI
20201045559	RIO VERDE	630103940	CABRIUVA S1	10/10/2020 21:00	11/10/2020 11:42	10/10/2020 21:00	11/10/2020 11:42	14,69	1	14,69	CHI
20201045560	GOIANIA	GN11191033	CARAJAS S1	10/10/2020 21:00	10/10/2020 23:55	10/10/2020 21:00	10/10/2020 23:55	2,91	95	276,03	CHI
20201048702	BARRO ALTO	BA12000049	BARRO ALTO	10/10/2020 21:00	11/10/2020 17:10	10/10/2020 21:00	11/10/2020 17:10	20,15	7	141,05	CHI
20201045634	URUACU	UR12390448	URUACU	10/10/2020 21:02	11/10/2020 00:08	10/10/2020 21:02	11/10/2020 00:08	3,09	106	327,42	CHI
20201045578	SAO MIGUEL DO ARAGUAIA	6350000361	SAO MIGUEL DO ARAGUAIA	10/10/2020 21:03	11/10/2020 05:19	10/10/2020 21:03	11/10/2020 05:19	8,26	1	8,26	CHI
20201046159	GOIANIA	GN12198165	GOYA S1	10/10/2020 21:04	11/10/2020 00:13	10/10/2020 21:04	11/10/2020 00:13	3,14	361	1135,04	CHI
20201045582	URUACU	UR11221613	URUACU	10/10/2020 21:04	11/10/2020 22:28	10/10/2020 21:04	11/10/2020 22:28	25,38	34	863,05	CHI
20201045587	FORMOSA	FA11257809	ITUIQUIRA	10/10/2020 21:06	11/10/2020 00:44	10/10/2020 21:06	11/10/2020 00:44	3,63	30	108,93	CHI
20201045591	GOIANIA	13078756	GOYA S1	10/10/2020 21:07	10/10/2020 23:48	10/10/2020 21:07	10/10/2020 23:48	2,67	1	2,67	CHI
20201048349	FORMOSA	FA12072571	ITUIQUIRA	10/10/2020 21:08	11/10/2020 20:35	10/10/2020 21:08	11/10/2020 20:35	23,45	11	257,93	CHI
20201052377	CEZARINA	IY12010807	EDEIA	10/10/2020 21:09	11/10/2020 14:30	10/10/2020 21:09	11/10/2020 14:30	17,35	1	17,35	CHI
20201052377	INDIARA	IY12010807	EDEIA	10/10/2020 21:09	11/10/2020 14:30	10/10/2020 21:09	11/10/2020 14:30	17,35	32	555,17	CHI
20201045605	GOIANIA	GN12051055	CAMPINAS S2	10/10/2020 21:11	11/10/2020 03:40	10/10/2020 21:11	11/10/2020 03:40	6,49	93	603,29	CHI

20201045609	SAO JOAO DA PARAUNA	FR21076469	FIRMINOPOLIS S2	10/10/2020 21:12	11/10/2020 17:37	10/10/2020 21:12	11/10/2020 17:37	20,41	1	20,41	CHI
20201050351	FIRMINOPOLIS	FR12105314	FIRMINOPOLIS S1	10/10/2020 21:13	11/10/2020 16:30	10/10/2020 21:13	11/10/2020 16:30	19,27	2	38,55	CHI
20201045728	TURVANIA	TV12215375	FIRMINOPOLIS S1	10/10/2020 21:14	11/10/2020 23:58	10/10/2020 21:14	11/10/2020 23:58	26,73	4	106,92	CHI
20201045018	CALDAS NOVAS	CN11164890	CALDAS NOVAS S1	10/10/2020 21:14	11/10/2020 01:05	10/10/2020 21:14	11/10/2020 01:05	3,84	72	276,46	CHI
20201045621	VICENTINOPOLIS	VI21208178	VICENTINOPOLIS	10/10/2020 21:15	10/10/2020 21:35	10/10/2020 21:15	10/10/2020 21:35	0,33	1	0,33	CHI
20201049533	FIRMINOPOLIS	FR12013010	FIRMINOPOLIS S1	10/10/2020 21:16	11/10/2020 15:51	10/10/2020 21:16	11/10/2020 15:51	18,58	5	92,90	CHI
20201045701	GOIANIA	GN11001459	GOYA S1	10/10/2020 21:16	11/10/2020 15:12	10/10/2020 21:16	11/10/2020 15:12	17,93	170	3047,82	CHI
20201045633	TRINDADE	40047179	TRINDADE	10/10/2020 21:20	10/10/2020 23:02	10/10/2020 21:20	10/10/2020 23:02	1,70	1	1,70	CHI
20201045707	SAO MIGUEL DO ARAGUAIA	SM11242037	SAO MIGUEL DO ARAGUAIA	10/10/2020 21:26	11/10/2020 00:18	10/10/2020 21:26	11/10/2020 00:18	2,85	116	330,89	CHI
20201045686	SAO FRANCISCO DE GOIAS	PV12289656	SAO FRANCISCO DE GOIAS	10/10/2020 21:27	11/10/2020 00:33	10/10/2020 21:27	11/10/2020 00:33	3,09	7	21,61	CHI
20201045688	GOIANIA	GN12172993	GOIANIA LESTE S2	10/10/2020 21:28	11/10/2020 00:09	10/10/2020 21:28	11/10/2020 00:09	2,68	120	321,97	CHI
20201046466	GOIANIA	GN12073228	GOYA S1	10/10/2020 21:32	11/10/2020 11:34	10/10/2020 21:32	11/10/2020 11:34	14,03	21	294,55	CHI
20201045726	LUZIANIA	LZ21290489	RIO VERMELHO	10/10/2020 21:33	11/10/2020 09:19	10/10/2020 21:33	11/10/2020 09:19	11,77	1	11,77	CHI
20201045995	ARAGOIANIA	AO12291291	GUAPO S2	10/10/2020 21:33	11/10/2020 01:13	10/10/2020 21:33	11/10/2020 01:13	3,67	48	175,93	CHI
20201045995	HIDROLANDIA	AO12291291	GUAPO S2	10/10/2020 21:33	11/10/2020 01:13	10/10/2020 21:33	11/10/2020 01:13	3,67	2	7,33	CHI
20201045738	ABADIA DE GOIAS	TR31052042	CARAJAS S1	10/10/2020 21:34	10/10/2020 23:57	10/10/2020 21:34	10/10/2020 23:57	2,38	1	2,38	CHI
20201045951	SAO LUIS DE MONTES BELOS	SL12076410	SAO LUIZ DOS MONTES BELOS	10/10/2020 21:34	11/10/2020 13:34	10/10/2020 21:34	11/10/2020 13:34	16,01	33	528,18	CHI
20201046119	GOIANIA	GN12217572	CARAJAS S2	10/10/2020 21:35	11/10/2020 01:34	10/10/2020 21:35	11/10/2020 01:34	3,97	538	2134,81	CHI
20201045761	PALMEIRAS DE GOIAS	PL21312516	PALMEIRAS	10/10/2020 21:39	11/10/2020 01:42	10/10/2020 21:39	11/10/2020 01:42	4,04	0	0,00	CHI
20201045770	ABADIANIA	AA11308961	DAIA S2	10/10/2020 21:41	11/10/2020 07:31	10/10/2020 21:41	11/10/2020 07:31	9,83	19	186,71	CHI
20201045771	GUAPO	GA12008565	GUAPO S2	10/10/2020 21:41	10/10/2020 22:50	10/10/2020 21:41	10/10/2020 22:50	1,14	3	3,41	CHI
20201045771	VARJAO	GA12008565	GUAPO S2	10/10/2020 21:41	10/10/2020 22:50	10/10/2020 21:41	10/10/2020 22:50	1,14	3	3,41	CHI
20201045779	GUAPO	GA31036349	GUAPO S2	10/10/2020 21:42	11/10/2020 15:47	10/10/2020 21:42	11/10/2020 15:47	18,07	1	18,07	CHI
20201045828	ALTO PARAISO DE GOIAS	JL10400369	SAO JOAO D ALIANCA	10/10/2020 21:43	11/10/2020 16:16	10/10/2020 21:43	10/10/2020 21:52	0,15	246	36,63	CHI
20201045828	ALTO PARAISO DE GOIAS	BF10400373	SAO JOAO D ALIANCA	10/10/2020 21:43	11/10/2020 16:16	10/10/2020 21:43	10/10/2020 21:52	0,15	9	1,34	CHI
20201045828	ALTO PARAISO DE GOIAS	JL10400375	SAO JOAO D ALIANCA	10/10/2020 21:43	11/10/2020 16:16	10/10/2020 21:43	11/10/2020 08:41	10,81	10	108,08	CHI
20201045828	SAO JOAO D ALIANCA	JL10400375	SAO JOAO D ALIANCA	10/10/2020 21:43	11/10/2020 16:16	10/10/2020 21:43	11/10/2020 08:41	10,81	3	32,42	CHI
20201045828	SAO JOAO D ALIANCA	JL13080936	SAO JOAO D ALIANCA	10/10/2020 21:43	11/10/2020 16:16	11/10/2020 09:31	11/10/2020 13:29	3,98	2	7,96	CHI
20201045828	SAO JOAO D ALIANCA	JL10400375	SAO JOAO D ALIANCA	10/10/2020 21:43	11/10/2020 16:16	10/10/2020 21:52	11/10/2020 14:06	16,22	92	1491,98	CHI
20201045828	ALTO PARAISO DE GOIAS	JL10400375	SAO JOAO D ALIANCA	10/10/2020 21:43	11/10/2020 16:16	10/10/2020 21:52	11/10/2020 14:06	16,22	1	16,22	CHI
20201045828	SAO JOAO D ALIANCA	JL10400375	SAO JOAO D ALIANCA	10/10/2020 21:43	11/10/2020 16:16	10/10/2020 21:52	11/10/2020 14:34	16,69	43	717,65	CHI
20201045828	SAO JOAO D ALIANCA	JL10400375	SAO JOAO D ALIANCA	10/10/2020 21:43	11/10/2020 16:16	10/10/2020 21:52	11/10/2020 15:06	17,23	6	103,37	CHI
20201045828	SAO JOAO D ALIANCA	JL10400375	SAO JOAO D ALIANCA	10/10/2020 21:43	11/10/2020 16:16	10/10/2020 21:52	11/10/2020 16:16	18,39	163	2997,80	CHI
20201045828	ALTO PARAISO DE GOIAS	JL10400375	SAO JOAO D ALIANCA	10/10/2020 21:43	11/10/2020 16:16	10/10/2020 21:52	11/10/2020 16:16	18,39	2	36,78	CHI
20201045828	ALTO PARAISO DE GOIAS	JL10400375	SAO JOAO D ALIANCA	10/10/2020 21:43	11/10/2020 16:16	11/10/2020 15:36	11/10/2020 16:16	0,66	1	0,66	CHI
20201045828	SAO JOAO D ALIANCA	JL10400375	SAO JOAO D ALIANCA	10/10/2020 21:43	11/10/2020 16:16	11/10/2020 15:36	11/10/2020 16:16	0,66	141	92,98	CHI
20201045782	GOIANIA	12442446	GOIANIA LESTE S2	10/10/2020 21:43	10/10/2020 22:59	10/10/2020 21:43	10/10/2020 22:59	1,25	1	1,25	CHI
20201045783	GOIANIA	13080090	GOYA S1	10/10/2020 21:44	11/10/2020 16:18	10/10/2020 21:44	11/10/2020 16:18	18,56	1	18,56	CHI
20201046192	APARECIDA DE GOIANIA	GN10383651	ATLANTICO S1	10/10/2020 21:44	11/10/2020 01:36	10/10/2020 21:44	10/10/2020 21:48	0,06	1047	61,95	CHI
20201046192	GOIANIA	GN10383651	ATLANTICO S1	10/10/2020 21:44	11/10/2020 01:36	10/10/2020 21:44	10/10/2020 21:48	0,06	7803	461,68	CHI
20201046192	GOIANIA	GN16421014	ATLANTICO S1	10/10/2020 21:44	11/10/2020 01:36	10/10/2020 21:44	10/10/2020 21:49	0,08	2312	180,46	CHI
20201046192	GOIANIA	GN16407279	ATLANTICO S1	10/10/2020 21:44	11/10/2020 01:36	10/10/2020 21:44	10/10/2020 21:49	0,06	1658	100,86	CHI
20201046192	GOIANIA	00602204	ATLANTICO S3	10/10/2020 21:44	11/10/2020 01:36	10/10/2020 21:44	10/10/2020 21:49	0,08	2047	159,78	CHI
20201046192	GOIANIA	00602204	ATLANTICO S2	10/10/2020 21:44	11/10/2020 01:36	10/10/2020 21:44	10/10/2020 21:49	0,08	2946	229,95	CHI
20201046192	GOIANIA	GN16407221	ATLANTICO S1	10/10/2020 21:44	11/10/2020 01:36	10/10/2020 21:44	10/10/2020 21:49	0,07	2576	175,31	CHI
20201046192	APARECIDA DE GOIANIA	AP16401529	ATLANTICO S1	10/10/2020 21:44	11/10/2020 01:36	10/10/2020 21:44	10/10/2020 21:50	0,08	2430	202,50	CHI
20201046192	APARECIDA DE GOIANIA	GN16427480	ATLANTICO S1	10/10/2020 21:44	11/10/2020 01:36	10/10/2020 21:44	10/10/2020 21:50	0,10	2606	250,47	CHI
20201046192	GOIANIA	GN16427480	ATLANTICO S1	10/10/2020 21:44	11/10/2020 01:36	10/10/2020 21:44	10/10/2020 21:50	0,10	2	0,19	CHI
20201046192	GOIANIA	GN16409631	ATLANTICO S1	10/10/2020 21:44	11/10/2020 01:36	10/10/2020 21:47	10/10/2020 21:57	0,18	763	135,43	CHI
20201046192	GOIANIA	GN10385818	ATLANTICO S2	10/10/2020 21:44	11/10/2020 01:36	10/10/2020 21:44	10/10/2020 22:08	0,39	3548	1400,47	CHI
20201046192	APARECIDA DE GOIANIA	00572214	REAL S2	10/10/2020 21:44	11/10/2020 01:36	10/10/2020 22:30	10/10/2020 22:33	0,06	1923	108,97	CHI
20201046192	APARECIDA DE GOIANIA	AP16407501	REAL S2	10/10/2020 21:44	11/10/2020 01:36	10/10/2020 22:30	10/10/2020 22:33	0,06	5669	346,44	CHI
20201046192	GOIANIA	AP16407501	REAL S2	10/10/2020 21:44	11/10/2020 01:36	10/10/2020 22:30	10/10/2020 22:33	0,06	1192	72,84	CHI
20201046192	APARECIDA DE GOIANIA	00572214	REAL S2	10/10/2020 21:44	11/10/2020 01:36	10/10/2020 22:30	10/10/2020 22:34	0,07	2252	153,89	CHI
20201046192	GOIANIA	GN16404324	ATLANTICO S1	10/10/2020 21:44	11/10/2020 01:36	10/10/2020 21:44	10/10/2020 22:38	0,89	785	697,12	CHI
20201046192	GOIANIA	GN16404324	ATLANTICO S1	10/10/2020 21:44	11/10/2020 01:36	10/10/2020 21:44	10/10/2020 22:38	0,86	658	562,77	CHI
20201046192	APARECIDA DE GOIANIA	AP16407250	REAL S2	10/10/2020 21:44	11/10/2020 01:36	10/10/2020 22:35	10/10/2020 22:39	0,08	672	51,33	CHI
20201046192	APARECIDA DE GOIANIA	AP16401530	REAL S2	10/10/2020 21:44	11/10/2020 01:36	10/10/2020 22:35	10/10/2020 22:40	0,09	2835	257,51	CHI

20201046192	GOIANIA	00612214	CAMPINAS S2	10/10/2020 21:44	11/10/2020 01:36	10/10/2020 22:51	10/10/2020 22:54	0,05	1080	56,40	CHI
20201046192	GOIANIA	GN10385845	CAMPINAS S2	10/10/2020 21:44	11/10/2020 01:36	10/10/2020 22:51	10/10/2020 22:54	0,06	1443	83,77	CHI
20201046192	GOIANIA	GN16409708	ATLANTICO S1	10/10/2020 21:44	11/10/2020 01:36	10/10/2020 21:45	10/10/2020 23:33	1,79	1868	3343,20	CHI
20201046192	GOIANIA	GN10385831	ATLANTICO S1	10/10/2020 21:44	11/10/2020 01:36	10/10/2020 23:06	10/10/2020 23:33	0,44	3288	1462,25	CHI
20201046192	GOIANIA	GN16415890	ATLANTICO S1	10/10/2020 21:44	11/10/2020 01:36	10/10/2020 21:44	11/10/2020 01:36	3,87	205	792,89	CHI
20201045786	URUACU	UR11135596	URUACU	10/10/2020 21:44	11/10/2020 06:53	10/10/2020 21:44	11/10/2020 06:53	9,14	189	1727,57	CHI
20201047273	MOIPORA	IV12201972	IPORA	10/10/2020 21:45	11/10/2020 09:43	10/10/2020 21:45	11/10/2020 09:43	11,97	7	83,82	CHI
20201047273	IVOLANDIA	IV12201972	IPORA	10/10/2020 21:45	11/10/2020 09:43	10/10/2020 21:45	11/10/2020 09:43	11,97	2	23,95	CHI
20201047442	CABECEIRAS	CW13381518	ITUIQUIRA	10/10/2020 21:46	12/10/2020 06:45	10/10/2020 21:46	12/10/2020 06:45	32,99	5	164,97	CHI
20201045800	BOM JESUS DE GOIAS	BJ12062918	RIO DOS BOIS	10/10/2020 21:46	11/10/2020 22:41	10/10/2020 21:46	11/10/2020 22:41	24,91	2	49,83	CHI
20201048239	URUACU	UR12262681	URUACU	10/10/2020 21:46	11/10/2020 08:31	10/10/2020 21:46	11/10/2020 08:31	10,74	48	515,55	CHI
20201045831	GOIANIA	14980861	CARAJAS S2	10/10/2020 21:47	11/10/2020 16:36	10/10/2020 21:47	11/10/2020 16:36	18,82	1	18,82	CHI
20201045864	CAMPESTRE DE GOIAS	GC21000154	TRINDADE	10/10/2020 21:48	11/10/2020 02:24	10/10/2020 21:48	11/10/2020 02:24	4,59	1	4,59	CHI
20201045899	IVOLANDIA	IV10404257	IPORA	10/10/2020 21:50	10/10/2020 21:54	10/10/2020 21:50	10/10/2020 21:54	0,08	135	10,31	CHI
20201045899	MOIPORA	IV10404257	IPORA	10/10/2020 21:50	10/10/2020 21:54	10/10/2020 21:50	10/10/2020 21:54	0,08	20	1,53	CHI
20201045899	ISRAELANDIA	IV10404257	IPORA	10/10/2020 21:50	10/10/2020 21:54	10/10/2020 21:50	10/10/2020 21:54	0,08	4	0,31	CHI
20201050250	PALMINOPOLIS	FR12096839RE	FIRMINOPOLIS S1	10/10/2020 21:50	11/10/2020 21:04	10/10/2020 21:50	11/10/2020 21:04	23,23	1	23,23	CHI
20201050250	SAO JOAO DA PARAUNA	FR12096839RE	FIRMINOPOLIS S1	10/10/2020 21:50	11/10/2020 21:04	10/10/2020 21:50	11/10/2020 21:04	23,23	17	394,89	CHI
20201050250	FIRMINOPOLIS	FR12096839RE	FIRMINOPOLIS S1	10/10/2020 21:50	11/10/2020 21:04	10/10/2020 21:50	11/10/2020 21:04	23,23	68	1579,56	CHI
20201046116	CAMPOS BELOS	CH12091794LD	SAO DOMINGOS	10/10/2020 21:50	10/10/2020 23:35	10/10/2020 21:50	10/10/2020 23:35	1,74	601	1048,58	CHI
20201045902	APARECIDA DE GOIANIA	10030347	REAL S2	10/10/2020 21:52	11/10/2020 00:19	10/10/2020 21:52	11/10/2020 00:19	2,45	1	2,45	CHI
20201046130	GOIANIA	GN11237544	GOYA S2	10/10/2020 21:52	11/10/2020 03:03	10/10/2020 21:52	11/10/2020 03:03	5,18	91	471,25	CHI
20201046025	GOIANIA	GN12002171LD	CAMPINAS S1	10/10/2020 21:52	11/10/2020 09:27	10/10/2020 21:52	11/10/2020 09:27	11,58	1702	19702,07	CHI
20201046025	GOIANIA	GN12002171LD	CAMPINAS S1	10/10/2020 21:52	11/10/2020 09:27	10/10/2020 21:54	11/10/2020 09:27	11,54	317	3656,68	CHI
20201047465	GOIANIA	GN11281244	CAMPINAS S1	10/10/2020 21:52	11/10/2020 10:15	10/10/2020 21:52	11/10/2020 10:15	12,38	221	2735,00	CHI
20201047524	LUZIANIA	LZ11128758	RIO VERMELHO	10/10/2020 21:52	11/10/2020 08:52	10/10/2020 21:52	11/10/2020 08:52	10,99	84	923,21	CHI
20201047770	PALMEIRAS DE GOIAS	04880216	PALMEIRAS	10/10/2020 21:52	11/10/2020 04:00	10/10/2020 21:52	11/10/2020 04:00	6,13	341	2091,18	CHI
20201047770	CEZARINA	04880216	PALMEIRAS	10/10/2020 21:52	11/10/2020 04:00	10/10/2020 21:52	11/10/2020 04:00	6,13	5	30,66	CHI
20201045917	PONTALINA	210069302	PONTALINA	10/10/2020 21:53	10/10/2020 22:28	10/10/2020 21:53	10/10/2020 22:28	0,59	1	0,59	CHI
20201045928	GOIANIA	40105179	GOYA S1	10/10/2020 21:54	11/10/2020 11:20	10/10/2020 21:54	11/10/2020 11:20	13,43	1	13,43	CHI
20201045950	ABADIA DE GOIAS	AO12007317	INDEPENDENCIA S2	10/10/2020 21:55	11/10/2020 21:06	10/10/2020 21:55	11/10/2020 21:06	23,17	2	46,33	CHI
20201046663	SAO LUIS DE MONTES BELOS	SL12180010	SAO LUIZ DOS MONTES BELOS	10/10/2020 21:56	11/10/2020 02:33	10/10/2020 21:56	11/10/2020 02:33	4,61	571	2634,85	CHI
20201048302	JANDAIA	JD12083934	PALMEIRAS	10/10/2020 21:59	11/10/2020 10:07	10/10/2020 21:59	11/10/2020 10:07	12,13	13	157,71	CHI
20201046026	GOIANIA	10020795945	GOIANIA LESTE S1	10/10/2020 21:59	11/10/2020 00:20	10/10/2020 21:59	11/10/2020 00:20	2,34	1	2,34	CHI
20201046063	GOIANIA	GN12076674	CARAJAS S1	10/10/2020 22:00	10/10/2020 23:37	10/10/2020 22:00	10/10/2020 23:37	1,61	928	1498,46	CHI
202010189404	CORREGO DO OURO	00490414	FIRMINOPOLIS S2	10/10/2020 22:01	11/10/2020 13:59	10/10/2020 22:01	11/10/2020 03:49	5,80	1048	6075,49	CHI
202010189404	BURITI DE GOIAS	00490414	FIRMINOPOLIS S2	10/10/2020 22:01	11/10/2020 13:59	10/10/2020 22:01	11/10/2020 03:49	5,80	32	185,51	CHI
202010189404	SAO LUIS DE MONTES BELOS	00490414	FIRMINOPOLIS S2	10/10/2020 22:01	11/10/2020 13:59	10/10/2020 22:01	11/10/2020 03:49	5,80	46	266,67	CHI
202010189404	NOVO BRASIL	00490414	FIRMINOPOLIS S2	10/10/2020 22:01	11/10/2020 13:59	10/10/2020 22:01	11/10/2020 03:49	5,80	16	92,76	CHI
202010189404	FAZENDA NOVA	00490414	FIRMINOPOLIS S2	10/10/2020 22:01	11/10/2020 13:59	10/10/2020 22:01	11/10/2020 03:49	5,80	37	214,50	CHI
202010189404	CORREGO DO OURO	00490414	FIRMINOPOLIS S2	10/10/2020 22:01	11/10/2020 13:59	10/10/2020 22:01	11/10/2020 03:49	5,80	29	168,12	CHI
202010189404	SAO LUIS DE MONTES BELOS	00490414	FIRMINOPOLIS S2	10/10/2020 22:01	11/10/2020 13:59	10/10/2020 22:01	11/10/2020 03:49	5,80	3	17,39	CHI
202010189404	ADELANDIA	00490414	FIRMINOPOLIS S2	10/10/2020 22:01	11/10/2020 13:59	10/10/2020 22:01	11/10/2020 03:49	5,80	1011	5860,99	CHI
202010189404	ANICUNS	00490414	FIRMINOPOLIS S2	10/10/2020 22:01	11/10/2020 13:59	10/10/2020 22:01	11/10/2020 03:49	5,80	334	1936,27	CHI
202010189404	SANCLERLANDIA	00490414	FIRMINOPOLIS S2	10/10/2020 22:01	11/10/2020 13:59	10/10/2020 22:01	11/10/2020 03:49	5,80	8	46,38	CHI
202010189404	SANCLERLANDIA	00490414	FIRMINOPOLIS S2	10/10/2020 22:01	11/10/2020 13:59	10/10/2020 22:01	11/10/2020 03:49	5,80	319	1849,31	CHI
202010189404	BURITI DE GOIAS	00490414	FIRMINOPOLIS S2	10/10/2020 22:01	11/10/2020 13:59	10/10/2020 22:01	11/10/2020 03:49	5,80	318	1843,52	CHI
202010189404	SANCLERLANDIA	00490414	FIRMINOPOLIS S2	10/10/2020 22:01	11/10/2020 13:59	10/10/2020 22:01	11/10/2020 03:49	5,80	3057	17722,11	CHI
202010189404	SAO LUIS DE MONTES BELOS	00490414	FIRMINOPOLIS S2	10/10/2020 22:01	11/10/2020 13:59	10/10/2020 22:01	11/10/2020 03:49	5,80	60	347,83	CHI
202010189404	SAO LUIS DE MONTES BELOS	00490414	FIRMINOPOLIS S2	10/10/2020 22:01	11/10/2020 13:59	10/10/2020 22:01	11/10/2020 03:49	5,80	67	388,41	CHI
202010189404	MOSSAMEDES	00490414	FIRMINOPOLIS S2	10/10/2020 22:01	11/10/2020 13:59	10/10/2020 22:01	11/10/2020 03:49	5,80	103	597,11	CHI
202010189404	TURVANIA	00490414	FIRMINOPOLIS S2	10/10/2020 22:01	11/10/2020 13:59	10/10/2020 22:01	11/10/2020 03:49	5,80	2	11,59	CHI
202010189404	MOSSAMEDES	00490414	FIRMINOPOLIS S2	10/10/2020 22:01	11/10/2020 13:59	10/10/2020 22:01	11/10/2020 03:49	5,80	30	173,92	CHI
202010189404	SAO LUIS DE MONTES BELOS	00490414	FIRMINOPOLIS S2	10/10/2020 22:01	11/10/2020 13:59	10/10/2020 22:01	11/10/2020 03:49	5,80	7	40,58	CHI
202010189404	SANCLERLANDIA	00490414	FIRMINOPOLIS S2	10/10/2020 22:01	11/10/2020 13:59	10/10/2020 22:01	11/10/2020 03:49	5,80	11	63,77	CHI
202010189404	ADELANDIA	00490414	FIRMINOPOLIS S2	10/10/2020 22:01	11/10/2020 13:59	10/10/2020 22:01	11/10/2020 03:49	5,80	5	28,99	CHI
202010189404	BURITI DE GOIAS	00490414	FIRMINOPOLIS S2	10/10/2020 22:01	11/10/2020 13:59	10/10/2020 22:01	11/10/2020 03:49	5,80	63	365,23	CHI
202010189404	SANCLERLANDIA	00490414	FIRMINOPOLIS S2	10/10/2020 22:01	11/10/2020 13:59	10/10/2020 22:01	11/10/2020 03:49	5,80	1	5,80	CHI

202010189404	CORREGO DO OURO	00490414	FIRMINOPOLIS S2	10/10/2020 22:01	11/10/2020 13:59	10/10/2020 22:01	11/10/2020 03:49	5,80	2	11,59	CHI
202010189404	AURILANDIA	00490414	FIRMINOPOLIS S2	10/10/2020 22:01	11/10/2020 13:59	10/10/2020 22:01	11/10/2020 03:49	5,80	1	5,80	CHI
202010189404	CORREGO DO OURO	00490414	FIRMINOPOLIS S2	10/10/2020 22:01	11/10/2020 13:59	10/10/2020 22:01	11/10/2020 03:49	5,80	109	631,90	CHI
202010189404	BURITI DE GOIAS	00490414	FIRMINOPOLIS S2	10/10/2020 22:01	11/10/2020 13:59	10/10/2020 22:01	11/10/2020 03:49	5,80	2	11,59	CHI
202010189404	SAO LUIS DE MONTES BELOS	00490414	FIRMINOPOLIS S2	10/10/2020 22:01	11/10/2020 13:59	10/10/2020 22:01	11/10/2020 03:49	5,80	182	1055,09	CHI
202010189404	SANCLERLANDIA	00490414	FIRMINOPOLIS S2	10/10/2020 22:01	11/10/2020 13:59	10/10/2020 22:01	11/10/2020 03:49	5,80	30	173,92	CHI
202010189404	FIRMINOPOLIS	00490414	FIRMINOPOLIS S2	10/10/2020 22:01	11/10/2020 13:59	10/10/2020 22:01	11/10/2020 03:49	5,80	1	5,80	CHI
202010189404	SANCLERLANDIA	00490414	FIRMINOPOLIS S2	10/10/2020 22:01	11/10/2020 13:59	10/10/2020 22:01	11/10/2020 03:49	5,80	7	40,58	CHI
202010189404	SAO LUIS DE MONTES BELOS	00490414	FIRMINOPOLIS S2	10/10/2020 22:01	11/10/2020 13:59	10/10/2020 22:01	11/10/2020 03:49	5,80	2	11,59	CHI
202010189404	BURITI DE GOIAS	00490414	FIRMINOPOLIS S2	10/10/2020 22:01	11/10/2020 13:59	10/10/2020 22:01	11/10/2020 03:49	5,80	1198	6945,07	CHI
202010189404	MOSSAMEDES	00490414	FIRMINOPOLIS S2	10/10/2020 22:01	11/10/2020 13:59	10/10/2020 22:01	11/10/2020 03:49	5,80	4	23,19	CHI
202010189404	MOSSAMEDES	00490414	FIRMINOPOLIS S2	10/10/2020 22:01	11/10/2020 13:59	10/10/2020 22:01	11/10/2020 03:49	5,80	1885	10927,76	CHI
202010189404	SANCLERLANDIA	00490414	FIRMINOPOLIS S2	10/10/2020 22:01	11/10/2020 13:59	10/10/2020 22:01	11/10/2020 03:49	5,80	18	104,35	CHI
202010189404	MOSSAMEDES	00490414	FIRMINOPOLIS S2	10/10/2020 22:01	11/10/2020 13:59	10/10/2020 22:01	11/10/2020 03:49	5,80	5	28,99	CHI
202010189404	MOSSAMEDES	00490414	FIRMINOPOLIS S2	10/10/2020 22:01	11/10/2020 13:59	10/10/2020 22:01	11/10/2020 03:49	5,80	4	23,19	CHI
202010189404	SANCLERLANDIA	00490414	FIRMINOPOLIS S2	10/10/2020 22:01	11/10/2020 13:59	10/10/2020 22:01	11/10/2020 03:49	5,80	732	4243,57	CHI
202010189404	ADELANDIA	00490414	FIRMINOPOLIS S2	10/10/2020 22:01	11/10/2020 13:59	10/10/2020 22:01	11/10/2020 03:49	5,80	106	614,51	CHI
202010189404	SANCLERLANDIA	SL13024063	FIRMINOPOLIS S2	10/10/2020 22:01	11/10/2020 13:59	11/10/2020 04:53	11/10/2020 12:13	7,33	3057	22412,90	CHI
202010189404	ANICUNS	SL13024063	FIRMINOPOLIS S2	10/10/2020 22:01	11/10/2020 13:59	11/10/2020 04:53	11/10/2020 12:13	7,33	334	2448,78	CHI
202010189404	AURILANDIA	SL13024063	FIRMINOPOLIS S2	10/10/2020 22:01	11/10/2020 13:59	11/10/2020 04:53	11/10/2020 12:13	7,33	1	7,33	CHI
202010189404	SANCLERLANDIA	SL13024063	FIRMINOPOLIS S2	10/10/2020 22:01	11/10/2020 13:59	11/10/2020 04:53	11/10/2020 12:13	7,33	298	2184,84	CHI
202010189404	SANCLERLANDIA	SL13024063	FIRMINOPOLIS S2	10/10/2020 22:01	11/10/2020 13:59	11/10/2020 04:53	11/10/2020 12:13	7,33	7	51,32	CHI
202010189404	SANCLERLANDIA	SL13024063	FIRMINOPOLIS S2	10/10/2020 22:01	11/10/2020 13:59	11/10/2020 04:53	11/10/2020 12:13	7,33	732	5366,78	CHI
202010189404	ADELANDIA	SL13024063	FIRMINOPOLIS S2	10/10/2020 22:01	11/10/2020 13:59	11/10/2020 04:53	11/10/2020 12:13	7,33	106	777,16	CHI
202010189404	MOSSAMEDES	SL13024063	FIRMINOPOLIS S2	10/10/2020 22:01	11/10/2020 13:59	11/10/2020 04:53	11/10/2020 12:13	7,33	103	755,16	CHI
202010189404	MOSSAMEDES	SL13024063	FIRMINOPOLIS S2	10/10/2020 22:01	11/10/2020 13:59	11/10/2020 04:53	11/10/2020 12:13	7,33	5	36,66	CHI
202010189404	BURITI DE GOIAS	SL13024063	FIRMINOPOLIS S2	10/10/2020 22:01	11/10/2020 13:59	11/10/2020 04:53	11/10/2020 12:13	7,33	2	14,66	CHI
202010189404	SANCLERLANDIA	SL13024063	FIRMINOPOLIS S2	10/10/2020 22:01	11/10/2020 13:59	11/10/2020 04:53	11/10/2020 12:13	7,33	30	219,95	CHI
202010189404	SAO LUIS DE MONTES BELOS	SL13024063	FIRMINOPOLIS S2	10/10/2020 22:01	11/10/2020 13:59	11/10/2020 04:53	11/10/2020 12:13	7,33	46	337,26	CHI
202010189404	ADELANDIA	SL13024063	FIRMINOPOLIS S2	10/10/2020 22:01	11/10/2020 13:59	11/10/2020 04:53	11/10/2020 12:13	7,33	5	36,66	CHI
202010189404	SANCLERLANDIA	SL13024063	FIRMINOPOLIS S2	10/10/2020 22:01	11/10/2020 13:59	11/10/2020 04:53	11/10/2020 12:13	7,33	8	58,65	CHI
202010189404	SAO LUIS DE MONTES BELOS	SL13024063	FIRMINOPOLIS S2	10/10/2020 22:01	11/10/2020 13:59	11/10/2020 04:53	11/10/2020 12:13	7,33	67	491,22	CHI
202010189404	SANCLERLANDIA	SL13024063	FIRMINOPOLIS S2	10/10/2020 22:01	11/10/2020 13:59	11/10/2020 04:53	11/10/2020 12:13	7,33	11	80,65	CHI
202010189404	SAO LUIS DE MONTES BELOS	SL13024063	FIRMINOPOLIS S2	10/10/2020 22:01	11/10/2020 13:59	11/10/2020 04:53	11/10/2020 12:13	7,33	2	14,66	CHI
202010189404	BURITI DE GOIAS	SL13024063	FIRMINOPOLIS S2	10/10/2020 22:01	11/10/2020 13:59	11/10/2020 04:53	11/10/2020 12:13	7,33	1198	8783,34	CHI
202010189404	ADELANDIA	SL13024063	FIRMINOPOLIS S2	10/10/2020 22:01	11/10/2020 13:59	11/10/2020 04:53	11/10/2020 12:13	7,33	1011	7412,31	CHI
202010189404	MOSSAMEDES	SL13024063	FIRMINOPOLIS S2	10/10/2020 22:01	11/10/2020 13:59	11/10/2020 04:53	11/10/2020 12:13	7,33	3	21,99	CHI
202010189404	SANCLERLANDIA	SL13024063	FIRMINOPOLIS S2	10/10/2020 22:01	11/10/2020 13:59	11/10/2020 04:53	11/10/2020 12:13	7,33	1	7,33	CHI
202010189404	SANCLERLANDIA	SL13024063	FIRMINOPOLIS S2	10/10/2020 22:01	11/10/2020 13:59	11/10/2020 04:53	11/10/2020 12:13	7,33	18	131,97	CHI
202010189404	BURITI DE GOIAS	SL13024063	FIRMINOPOLIS S2	10/10/2020 22:01	11/10/2020 13:59	11/10/2020 04:53	11/10/2020 12:13	7,33	214	1568,98	CHI
202010189404	CORREGO DO OURO	SL13024063	FIRMINOPOLIS S2	10/10/2020 22:01	11/10/2020 13:59	11/10/2020 04:53	11/10/2020 12:13	7,33	29	212,62	CHI
202010189404	TURVANIA	SL13024063	FIRMINOPOLIS S2	10/10/2020 22:01	11/10/2020 13:59	11/10/2020 04:53	11/10/2020 12:13	7,33	2	14,66	CHI
202010189404	MOSSAMEDES	SL13024063	FIRMINOPOLIS S2	10/10/2020 22:01	11/10/2020 13:59	11/10/2020 04:53	11/10/2020 12:13	7,33	30	219,95	CHI
202010189404	MOSSAMEDES	SL13024063	FIRMINOPOLIS S2	10/10/2020 22:01	11/10/2020 13:59	11/10/2020 04:53	11/10/2020 12:13	7,33	4	29,33	CHI
202010189404	MOSSAMEDES	SL13024063	FIRMINOPOLIS S2	10/10/2020 22:01	11/10/2020 13:59	11/10/2020 04:53	11/10/2020 12:13	7,33	1885	13820,19	CHI
202010189404	SAO LUIS DE MONTES BELOS	SL13024063	FIRMINOPOLIS S2	10/10/2020 22:01	11/10/2020 13:59	11/10/2020 04:53	11/10/2020 12:13	7,33	170	1246,38	CHI
202010189404	SAO LUIS DE MONTES BELOS	SL13024063	FIRMINOPOLIS S2	10/10/2020 22:01	11/10/2020 13:59	11/10/2020 04:53	11/10/2020 12:13	7,33	60	439,90	CHI
202010189404	FIRMINOPOLIS	02020414	FIRMINOPOLIS S2	10/10/2020 22:01	11/10/2020 13:59	11/10/2020 12:07	11/10/2020 12:13	0,10	1	0,10	CHI
202010189404	SAO LUIS DE MONTES BELOS	02020414	FIRMINOPOLIS S2	10/10/2020 22:01	11/10/2020 13:59	11/10/2020 12:07	11/10/2020 12:13	0,10	12	1,14	CHI
202010189404	SANCLERLANDIA	SC12125685	FIRMINOPOLIS S2	10/10/2020 22:01	11/10/2020 13:59	11/10/2020 04:53	11/10/2020 13:59	9,10	1	9,10	CHI
20201046061	URUACU	640050001	URUACU	10/10/2020 22:03	11/10/2020 10:40	10/10/2020 22:03	11/10/2020 10:40	12,62	1	12,62	CHI
20201046312	APARECIDA DE GOIANIA	AP11168661	INDEPENDENCIA S1	10/10/2020 22:04	11/10/2020 01:15	10/10/2020 22:04	11/10/2020 01:15	3,18	158	501,83	CHI
20201046632	APARECIDA DE GOIANIA	AP12000026	INDEPENDENCIA S1	10/10/2020 22:04	11/10/2020 00:41	10/10/2020 22:04	11/10/2020 00:41	2,61	436	1137,72	CHI
20201046088	COCALZINHO DE GOIAS	ZN12144220	COCALZINHO	10/10/2020 22:05	11/10/2020 17:29	10/10/2020 22:05	11/10/2020 17:29	19,39	1	19,39	CHI
20201046221	GOIANIA	GN11138766	CARAJAS S1	10/10/2020 22:05	11/10/2020 00:36	10/10/2020 22:05	11/10/2020 00:36	2,51	119	298,33	CHI
20201048415	PALMEIRAS DE GOIAS	PL12000126	PALMEIRAS	10/10/2020 22:05	11/10/2020 08:17	10/10/2020 22:05	11/10/2020 08:17	10,19	14	142,64	CHI
20201046167	URUACU	UR12003415	URUACU	10/10/2020 22:12	10/10/2020 23:51	10/10/2020 22:12	10/10/2020 23:51	1,65	25	41,17	CHI
20201048514	SANTA RITA DO NOVO DESTINO	BA12208877	BARRO ALTO	10/10/2020 22:13	11/10/2020 16:37	10/10/2020 22:13	11/10/2020 16:37	18,40	29	533,55	CHI

20201046183	ALVORADA DO NORTE	SI11164527	IACIARA S2	10/10/2020 22:14	12/10/2020 09:27	10/10/2020 22:14	12/10/2020 09:27	35,20	7	246,43	CHI
20201046187	APARECIDA DE GOIANIA	AP11000063	ANHANGUERA	10/10/2020 22:15	10/10/2020 23:44	10/10/2020 22:15	10/10/2020 23:44	1,50	155	231,85	CHI
20201046193	RIO VERDE	630524245	RIO VERDE S2	10/10/2020 22:15	11/10/2020 11:30	10/10/2020 22:15	11/10/2020 11:30	13,24	1	13,24	CHI
20201046355	MAURILANDIA	ML12286261	RIO DOS BOIS	10/10/2020 22:15	11/10/2020 04:39	10/10/2020 22:15	11/10/2020 04:39	6,39	45	287,42	CHI
2020101000213	SAO JOAO D ALIANCA	02830414	FLORES DE GOIAS	10/10/2020 22:17	10/10/2020 22:22	10/10/2020 22:17	10/10/2020 22:22	0,08	106	8,83	CHI
2020101000213	FLORES DE GOIAS	02830414	FLORES DE GOIAS	10/10/2020 22:17	10/10/2020 22:22	10/10/2020 22:17	10/10/2020 22:22	0,08	2338	194,83	CHI
2020101000213	NOVA ROMA	02830414	FLORES DE GOIAS	10/10/2020 22:17	10/10/2020 22:22	10/10/2020 22:17	10/10/2020 22:22	0,08	2	0,17	CHI
20201046364	FAZENDA NOVA	JP10396034	IPORA	10/10/2020 22:17	11/10/2020 10:01	10/10/2020 22:17	11/10/2020 02:57	4,67	21	98,04	CHI
20201046364	JAUPACI	JP10396034	IPORA	10/10/2020 22:17	11/10/2020 10:01	10/10/2020 22:17	11/10/2020 02:57	4,67	59	275,45	CHI
20201046364	JAUPACI	JP13380831	IPORA	10/10/2020 22:17	11/10/2020 10:01	10/10/2020 22:17	11/10/2020 04:59	6,71	16	107,32	CHI
20201046364	DIORAMA	JP13380831	IPORA	10/10/2020 22:17	11/10/2020 10:01	10/10/2020 22:17	11/10/2020 04:59	6,71	3	20,12	CHI
20201046364	DIORAMA	JP12026238LD	IPORA	10/10/2020 22:17	11/10/2020 10:01	10/10/2020 22:17	11/10/2020 09:24	11,12	9	100,05	CHI
20201046364	JAUPACI	JP12026238LD	IPORA	10/10/2020 22:17	11/10/2020 10:01	10/10/2020 22:17	11/10/2020 09:24	11,12	1	11,12	CHI
20201046364	JAUPACI	JP12380852	IPORA	10/10/2020 22:17	11/10/2020 10:01	10/10/2020 22:17	11/10/2020 10:01	11,74	5	58,70	CHI
20201048187	NAZARIO	PL12186333	PALMEIRAS	10/10/2020 22:17	11/10/2020 13:12	10/10/2020 22:17	11/10/2020 13:12	14,90	4	59,61	CHI
20201048187	PALMEIRAS DE GOIAS	PL12186333	PALMEIRAS	10/10/2020 22:17	11/10/2020 13:12	10/10/2020 22:17	11/10/2020 13:12	14,90	19	283,16	CHI
20201046222	ANAPOLIS	21014917	JUNDIAI S1	10/10/2020 22:19	10/10/2020 23:38	10/10/2020 22:19	10/10/2020 23:38	1,31	1	1,31	CHI
20201046223	LUZIANIA	10000404797	RIO VERMELHO	10/10/2020 22:19	10/10/2020 23:33	10/10/2020 22:19	10/10/2020 23:33	1,23	1	1,23	CHI
20201046280	SANTO ANTONIO DE GOIAS	BW12406479	NEROPOLIS S1	10/10/2020 22:20	11/10/2020 18:35	10/10/2020 22:20	11/10/2020 18:35	20,25	21	425,16	CHI
20201046313	SANTO ANTONIO DE GOIAS	BW16407507	NEROPOLIS S1	10/10/2020 22:20	10/10/2020 23:20	10/10/2020 22:20	10/10/2020 23:20	1,00	300	300,25	CHI
20201046313	NEROPOLIS	BW16407507	NEROPOLIS S1	10/10/2020 22:20	10/10/2020 23:20	10/10/2020 22:20	10/10/2020 23:20	1,00	17	17,01	CHI
20201046313	GOIANIA	BW16407507	NEROPOLIS S1	10/10/2020 22:20	10/10/2020 23:20	10/10/2020 22:20	10/10/2020 23:20	1,00	124	124,10	CHI
20201048445	VARJAO	VJ12061544	GUAPO S2	10/10/2020 22:20	11/10/2020 09:09	10/10/2020 22:20	11/10/2020 09:09	10,81	19	205,37	CHI
20201048445	GUAPO	VJ12061544	GUAPO S2	10/10/2020 22:20	11/10/2020 09:09	10/10/2020 22:20	11/10/2020 09:09	10,81	1	10,81	CHI
20201046802	RIO VERDE	RV12207146	MONTIVIDIU T	10/10/2020 22:21	11/10/2020 01:09	10/10/2020 22:21	11/10/2020 01:09	2,80	2	5,59	CHI
20201046564	APARECIDA DE GOIANIA	AP12130349	INDEPENDENCIA S2	10/10/2020 22:22	11/10/2020 00:39	10/10/2020 22:22	11/10/2020 00:39	2,28	622	1418,85	CHI
20201046300	GOIANIA	GN11043928	ATLANTICO S2	10/10/2020 22:23	11/10/2020 11:54	10/10/2020 22:23	11/10/2020 11:54	13,50	85	1147,78	CHI
20201046489	APARECIDA DE GOIANIA	AP12058739	INDEPENDENCIA S1	10/10/2020 22:24	11/10/2020 00:51	10/10/2020 22:24	11/10/2020 00:51	2,44	360	878,10	CHI
20201046325	SAO LUIS DE MONTES BELOS	SL10394730	SAO LUIZ DOS MONTES BELOS	10/10/2020 22:24	11/10/2020 13:32	10/10/2020 22:28	10/10/2020 22:34	0,10	347	32,97	CHI
20201046325	SAO LUIS DE MONTES BELOS	SL16407327	SAO LUIZ DOS MONTES BELOS	10/10/2020 22:24	11/10/2020 13:32	10/10/2020 22:24	11/10/2020 13:29	15,07	71	1069,79	CHI
20201046325	SAO LUIS DE MONTES BELOS	SL10403940	SAO LUIZ DOS MONTES BELOS	10/10/2020 22:24	11/10/2020 13:32	10/10/2020 22:24	11/10/2020 13:32	15,12	307	4643,37	CHI
20201046325	AURILANDIA	SL10403940	SAO LUIZ DOS MONTES BELOS	10/10/2020 22:24	11/10/2020 13:32	10/10/2020 22:24	11/10/2020 13:32	15,12	33	499,12	CHI
20201046325	FIRMINOPOLIS	SL10403940	SAO LUIZ DOS MONTES BELOS	10/10/2020 22:24	11/10/2020 13:32	10/10/2020 22:24	11/10/2020 13:32	15,12	115	1739,37	CHI
20201046325	MOIPORA	SL10403940	SAO LUIZ DOS MONTES BELOS	10/10/2020 22:24	11/10/2020 13:32	10/10/2020 22:24	11/10/2020 13:32	15,12	27	408,37	CHI
20201046325	SANCLERLANDIA	SL10403940	SAO LUIZ DOS MONTES BELOS	10/10/2020 22:24	11/10/2020 13:32	10/10/2020 22:24	11/10/2020 13:32	15,12	37	559,62	CHI
20201046325	CORREGO DO OURO	SL10403940	SAO LUIZ DOS MONTES BELOS	10/10/2020 22:24	11/10/2020 13:32	10/10/2020 22:24	11/10/2020 13:32	15,12	342	5172,75	CHI
20201046304	APARECIDA DE GOIANIA	AP11140191	INDEPENDENCIA S2	10/10/2020 22:25	11/10/2020 04:36	10/10/2020 22:25	11/10/2020 04:36	6,17	105	648,14	CHI
20201046289	NOVO PLANALTO	SM21020763	NOVO PLANALTO	10/10/2020 22:27	10/10/2020 23:56	10/10/2020 22:27	10/10/2020 23:56	1,48	1	1,48	CHI
20201046303	GOIANIA	GN11043946	CARAJAS S2	10/10/2020 22:29	11/10/2020 16:20	10/10/2020 22:29	11/10/2020 16:20	17,86	250	4464,03	CHI
20201046316	ISRAELANDIA	IS21101647	IPORA	10/10/2020 22:31	11/10/2020 09:42	10/10/2020 22:31	11/10/2020 09:42	11,18	1	11,18	CHI
20201046317	APARECIDA DE GOIANIA	2001113360	INDEPENDENCIA S2	10/10/2020 22:31	11/10/2020 12:12	10/10/2020 22:31	11/10/2020 12:12	13,68	1	13,68	CHI
20201046318	GOIANIA	GN21064340	CARAJAS S1	10/10/2020 22:31	11/10/2020 16:42	10/10/2020 22:31	11/10/2020 16:42	18,18	1	18,18	CHI
20201046666	APARECIDA DE GOIANIA	AP12000206	INDEPENDENCIA S1	10/10/2020 22:32	11/10/2020 00:36	10/10/2020 22:32	11/10/2020 00:36	2,07	94	194,37	CHI
20201050193	MOIPORA	MO12073400	IPORA	10/10/2020 22:33	11/10/2020 13:58	10/10/2020 22:33	11/10/2020 13:58	15,41	29	446,94	CHI
20201050193	ISRAELANDIA	MO12073400	IPORA	10/10/2020 22:33	11/10/2020 13:58	10/10/2020 22:33	11/10/2020 13:58	15,41	15	231,18	CHI
20201048220	PALMEIRAS DE GOIAS	CZ12000022LD	CEZARINA	10/10/2020 22:34	12/10/2020 15:00	10/10/2020 22:34	11/10/2020 12:50	14,26	1	14,26	CHI
20201048220	CEZARINA	CZ12000022LD	CEZARINA	10/10/2020 22:34	12/10/2020 15:00	10/10/2020 22:34	11/10/2020 12:50	14,26	46	656,05	CHI
20201048220	INDIARA	CZ12000022LD	CEZARINA	10/10/2020 22:34	12/10/2020 15:00	10/10/2020 22:34	11/10/2020 12:50	14,26	9	128,36	CHI
20201048220	CEZARINA	CZ16404917	CEZARINA	10/10/2020 22:34	12/10/2020 15:00	11/10/2020 12:51	11/10/2020 16:24	3,53	10	35,35	CHI
20201048220	CEZARINA	CZ16404917	CEZARINA	10/10/2020 22:34	12/10/2020 15:00	11/10/2020 14:42	11/10/2020 16:24	1,70	598	1014,44	CHI
20201048220	CEZARINA	CZ12126201LD	CEZARINA	10/10/2020 22:34	12/10/2020 15:00	11/10/2020 12:51	11/10/2020 17:14	4,37	17	74,29	CHI
20201048220	INDIARA	CZ12126201LD	CEZARINA	10/10/2020 22:34	12/10/2020 15:00	11/10/2020 12:51	11/10/2020 17:14	4,37	1	4,37	CHI
20201048220	PALMEIRAS DE GOIAS	CZ12126201LD	CEZARINA	10/10/2020 22:34	12/10/2020 15:00	11/10/2020 12:51	11/10/2020 17:14	4,37	2	8,74	CHI
20201048220	PALMEIRAS DE GOIAS	CZ12126201LD	CEZARINA	10/10/2020 22:34	12/10/2020 15:00	11/10/2020 12:51	12/10/2020 08:37	19,76	1	19,76	CHI
20201048220	CEZARINA	CZ12126201LD	CEZARINA	10/10/2020 22:34	12/10/2020 15:00	11/10/2020 12:51	12/10/2020 15:00	26,13	2	52,27	CHI
20201048220	INDIARA	CZ12126201LD	CEZARINA	10/10/2020 22:34	12/10/2020 15:00	11/10/2020 12:51	12/10/2020 15:00	26,13	5	130,67	CHI
20201054322	CEZARINA	CZ11314978	CEZARINA	10/10/2020 22:35	11/10/2020 18:37	10/10/2020 22:35	11/10/2020 18:37	20,04	52	1042,04	CHI
20201047200	VARJAO	VJ12061520	GUAPO S2	10/10/2020 22:35	11/10/2020 02:16	10/10/2020 22:35	11/10/2020 02:16	3,67	6	22,00	CHI

20201046374	APARECIDA DE GOIANIA	AP11376804	INDEPENDENCIA S2	10/10/2020 22:37	11/10/2020 11:20	10/10/2020 22:37	11/10/2020 11:20	12,71	91	1156,94	CHI
20201046495	APARECIDA DE GOIANIA	AP16401562	ANHANGUERA	10/10/2020 22:37	11/10/2020 10:35	10/10/2020 22:37	10/10/2020 22:40	0,05	266	13,45	CHI
20201046495	APARECIDA DE GOIANIA	AP16434301	ANHANGUERA	10/10/2020 22:37	11/10/2020 10:35	10/10/2020 22:37	10/10/2020 22:41	0,06	2111	127,83	CHI
20201046495	APARECIDA DE GOIANIA	AP10383623	ANHANGUERA	10/10/2020 22:37	11/10/2020 10:35	10/10/2020 22:37	10/10/2020 22:44	0,11	899	96,14	CHI
20201046495	APARECIDA DE GOIANIA	AP16401566	ANHANGUERA	10/10/2020 22:37	11/10/2020 10:35	10/10/2020 22:37	10/10/2020 22:46	0,14	1763	254,66	CHI
20201046495	HIDROLANDIA	AP16401506	ANHANGUERA	10/10/2020 22:37	11/10/2020 10:35	10/10/2020 22:37	10/10/2020 22:47	0,16	2140	340,02	CHI
20201046495	APARECIDA DE GOIANIA	AP16401506	ANHANGUERA	10/10/2020 22:37	11/10/2020 10:35	10/10/2020 22:37	10/10/2020 22:47	0,16	9	1,43	CHI
20201046495	APARECIDA DE GOIANIA	AP13402107	ANHANGUERA	10/10/2020 22:37	11/10/2020 10:35	11/10/2020 04:23	11/10/2020 05:42	1,32	1231	1620,47	CHI
20201046495	APARECIDA DE GOIANIA	AP10407693	ANHANGUERA	10/10/2020 22:37	11/10/2020 10:35	10/10/2020 22:37	11/10/2020 10:35	11,96	1122	13422,24	CHI
20201046382	CRISTALINA	1060016180	CRISTALINA S1	10/10/2020 22:38	11/10/2020 00:32	10/10/2020 22:38	11/10/2020 00:32	1,90	1	1,90	CHI
20201046389	APARECIDA DE GOIANIA	16694600	ATLANTICO S2	10/10/2020 22:39	11/10/2020 09:26	10/10/2020 22:39	11/10/2020 09:26	10,78	1	10,78	CHI
20201047348	PALMEIRAS DE GOIAS	PL12349324	PALMEIRAS	10/10/2020 22:40	11/10/2020 02:57	10/10/2020 22:40	11/10/2020 02:57	4,28	187	800,93	CHI
20201046406	CAMPESTRE DE GOIAS	GC21005190	TRINDADE	10/10/2020 22:40	11/10/2020 08:09	10/10/2020 22:40	11/10/2020 08:09	9,48	1	9,48	CHI
20201046611	CACHOEIRA ALTA	CA12200034	CACHOEIRA ALTA	10/10/2020 22:40	11/10/2020 05:17	10/10/2020 22:40	11/10/2020 05:17	6,60	3	19,80	CHI
20201046417	GOIANIA	11373167	GOYA S1	10/10/2020 22:41	11/10/2020 15:38	10/10/2020 22:41	11/10/2020 15:38	16,94	1	16,94	CHI
20201046422	APARECIDA DE GOIANIA	16250771	INDEPENDENCIA S1	10/10/2020 22:41	11/10/2020 06:13	10/10/2020 22:41	11/10/2020 06:13	7,52	1	7,52	CHI
20201048045	APARECIDA DE GOIANIA	AP16401530	REAL S2	10/10/2020 22:41	11/10/2020 09:19	10/10/2020 22:41	11/10/2020 05:59	7,29	2835	20656,91	CHI
20201048045	APARECIDA DE GOIANIA	AP16401530	REAL S2	10/10/2020 22:41	11/10/2020 09:19	11/10/2020 07:25	11/10/2020 09:19	1,91	2835	5414,06	CHI
20201046833	TRINDADE	TR11107252	TRINDADE	10/10/2020 22:43	11/10/2020 01:02	10/10/2020 22:43	11/10/2020 01:02	2,31	208	481,17	CHI
20201046453	VALPARAISO DE GOIAS	10004239510	PACAEMBU S2	10/10/2020 22:44	11/10/2020 01:47	10/10/2020 22:44	11/10/2020 01:47	3,03	1	3,03	CHI
20201046460	APARECIDA DE GOIANIA	AP11168685	ANHANGUERA	10/10/2020 22:45	11/10/2020 01:46	10/10/2020 22:45	11/10/2020 01:46	3,00	227	681,95	CHI
20201046469	FORMOSA	610109856	ITUIQUIRA	10/10/2020 22:47	11/10/2020 12:13	10/10/2020 22:47	11/10/2020 12:13	13,44	1	13,44	CHI
20201046478	FORMOSO	FO21262660	PORANGATU	10/10/2020 22:47	11/10/2020 00:07	10/10/2020 22:47	11/10/2020 00:07	1,32	1	1,32	CHI
20201046479	ITUMBIARA	690377903	PARANAIBA	10/10/2020 22:47	11/10/2020 04:06	10/10/2020 22:47	11/10/2020 04:06	5,30	1	5,30	CHI
20201048971	GUAPO	GA12276655	GUAPO S2	10/10/2020 22:48	11/10/2020 09:47	10/10/2020 22:48	11/10/2020 09:47	10,97	45	493,73	CHI
2020101000097	GOIANIA	00592284	FERROVIARIO S3	10/10/2020 22:49	10/10/2020 22:53	10/10/2020 22:49	10/10/2020 22:53	0,07	3309	220,60	CHI
20201046483	NIQUELANDIA	NQ21147005	URUACU	10/10/2020 22:49	12/10/2020 10:17	10/10/2020 22:49	12/10/2020 10:17	35,46	2	70,92	CHI
20201046486	ALEXANIA	AX12216776	ALEXANIA	10/10/2020 22:49	11/10/2020 19:57	11/10/2020 16:00	11/10/2020 19:42	3,72	91	338,19	CHI
20201046486	ALEXANIA	AX11185413	ALEXANIA	10/10/2020 22:49	11/10/2020 19:57	10/10/2020 22:49	11/10/2020 19:57	21,14	113	2388,51	CHI
20201046488	SAO MIGUEL DO PASSA QUATRO	SQ12355286	CRISTIANOPOLIS	10/10/2020 22:49	11/10/2020 02:52	10/10/2020 22:49	11/10/2020 02:52	4,05	1	4,05	CHI
20201046490	NOVA AURORA	NE12143243	CATALAO S1	10/10/2020 22:49	11/10/2020 01:20	10/10/2020 22:49	11/10/2020 01:20	2,51	5	12,53	CHI
20201046596	GOIANIA	00580214	GOIANIA LESTE S1	10/10/2020 22:50	11/10/2020 08:37	10/10/2020 22:50	10/10/2020 22:54	0,07	1084	78,29	CHI
20201046596	GOIANIA	00580214	GOIANIA LESTE S1	10/10/2020 22:50	11/10/2020 08:37	10/10/2020 22:50	10/10/2020 22:54	0,08	1220	96,92	CHI
20201046596	GOIANIA	00580214	GOIANIA LESTE S1	10/10/2020 22:50	11/10/2020 08:37	10/10/2020 22:50	11/10/2020 04:36	5,77	390	2251,92	CHI
20201046596	GOIANIA	00580214	GOIANIA LESTE S1	10/10/2020 22:50	11/10/2020 08:37	10/10/2020 22:50	11/10/2020 08:36	9,78	1658	16214,78	CHI
20201046596	GOIANIA	00580214	GOIANIA LESTE S3	10/10/2020 22:50	11/10/2020 08:37	10/10/2020 22:51	11/10/2020 08:36	9,76	6818	66511,48	CHI
20201046596	GOIANIA	GN16407242	SENADOR CANEDO	10/10/2020 22:50	11/10/2020 08:37	10/10/2020 22:58	11/10/2020 08:37	9,66	1139	11000,53	CHI
20201046932	GOIANIA	GN12150255	GOYA S2	10/10/2020 22:50	11/10/2020 08:47	10/10/2020 22:50	11/10/2020 08:47	9,95	182	1810,45	CHI
20201048036	GOIANIA	GN11140447	GOIANIA LESTE S3	10/10/2020 22:51	11/10/2020 13:42	10/10/2020 22:51	11/10/2020 13:42	14,84	95	1410,01	CHI
20201048273	GOIANIA	GN12323013	GOIANIA LESTE S3	10/10/2020 22:51	11/10/2020 09:48	10/10/2020 22:51	11/10/2020 09:48	10,94	1035	11325,20	CHI
20201046668	TRINDADE	TR32050488	TRINDADE	10/10/2020 22:51	11/10/2020 04:27	10/10/2020 22:51	11/10/2020 04:27	5,59	15	83,78	CHI
20201047911	GOIANIA	GN12000477	FERROVIARIO S1	10/10/2020 22:52	11/10/2020 11:33	10/10/2020 22:52	11/10/2020 11:33	12,69	562	7129,91	CHI
20201047155	APARECIDA DE GOIANIA	HD10400765	INDEPENDENCIA S1	10/10/2020 22:52	11/10/2020 12:55	10/10/2020 22:52	11/10/2020 10:07	11,24	3	33,73	CHI
20201047155	HIDROLANDIA	HD10400765	INDEPENDENCIA S1	10/10/2020 22:52	11/10/2020 12:55	10/10/2020 22:52	11/10/2020 10:07	11,24	27	303,53	CHI
20201047155	HIDROLANDIA	HD10400765	INDEPENDENCIA S1	10/10/2020 22:52	11/10/2020 12:55	10/10/2020 22:52	11/10/2020 12:02	13,16	24	315,91	CHI
20201047155	ARAGOIANIA	HD10400765	INDEPENDENCIA S1	10/10/2020 22:52	11/10/2020 12:55	10/10/2020 22:52	11/10/2020 12:02	13,16	5	65,81	CHI
20201047155	ARAGOIANIA	HD13402872	INDEPENDENCIA S1	10/10/2020 22:52	11/10/2020 12:55	10/10/2020 22:52	11/10/2020 12:55	14,04	31	435,12	CHI
20201047155	HIDROLANDIA	HD13402872	INDEPENDENCIA S1	10/10/2020 22:52	11/10/2020 12:55	10/10/2020 22:52	11/10/2020 12:55	14,04	503	7060,16	CHI
20201048049	APARECIDA DE GOIANIA	AP10416504	REAL S1	10/10/2020 22:53	11/10/2020 10:14	10/10/2020 22:53	11/10/2020 10:14	11,35	1020	11577,00	CHI
2020101000104	APARECIDA DE GOIANIA	00570244	REAL S1	10/10/2020 22:53	10/10/2020 23:04	10/10/2020 22:53	10/10/2020 23:04	0,18	5482	1005,03	CHI
20201046598	GOIANIA	GN11062748	CARAJAS S2	10/10/2020 22:53	11/10/2020 03:00	10/10/2020 22:53	11/10/2020 03:00	4,11	156	641,77	CHI
20201046909	ABADIA DE GOIAS	AO16423874	INDEPENDENCIA S2	10/10/2020 22:53	11/10/2020 01:30	10/10/2020 22:53	10/10/2020 23:37	0,73	1293	939,22	CHI
20201046909	GUAPO	AO16423874	INDEPENDENCIA S2	10/10/2020 22:53	11/10/2020 01:30	10/10/2020 22:53	10/10/2020 23:37	0,73	14	10,17	CHI
20201046909	GOIANIA	AO16423874	INDEPENDENCIA S2	10/10/2020 22:53	11/10/2020 01:30	10/10/2020 22:53	10/10/2020 23:37	0,73	10	7,26	CHI
20201046909	ARAGOIANIA	AO16423874	INDEPENDENCIA S2	10/10/2020 22:53	11/10/2020 01:30	10/10/2020 22:53	10/10/2020 23:37	0,73	510	370,46	CHI
20201046909	APARECIDA DE GOIANIA	AO16423874	INDEPENDENCIA S2	10/10/2020 22:53	11/10/2020 01:30	10/10/2020 22:53	10/10/2020 23:37	0,73	709	515,01	CHI
20201046909	APARECIDA DE GOIANIA	AP13401618	INDEPENDENCIA S2	10/10/2020 22:53	11/10/2020 01:30	10/10/2020 22:53	11/10/2020 01:28	2,58	5347	13805,66	CHI
20201046909	GOIANIA	AP13401618	INDEPENDENCIA S2	10/10/2020 22:53	11/10/2020 01:30	10/10/2020 22:53	11/10/2020 01:28	2,58	1168	3015,71	CHI

20201046909	GOIANIA	AO10396192	INDEPENDENCIA S2	10/10/2020 22:53	11/10/2020 01:30	10/10/2020 23:45	11/10/2020 01:29	1,74	8	13,91	CHI
20201046909	ARAGOIANIA	AO10396192	INDEPENDENCIA S2	10/10/2020 22:53	11/10/2020 01:30	10/10/2020 23:45	11/10/2020 01:29	1,74	6	10,43	CHI
20201046909	ABADIA DE GOIAS	AO10396192	INDEPENDENCIA S2	10/10/2020 22:53	11/10/2020 01:30	10/10/2020 23:45	11/10/2020 01:29	1,74	1204	2092,95	CHI
20201046909	APARECIDA DE GOIANIA	AP10400802	INDEPENDENCIA S2	10/10/2020 22:53	11/10/2020 01:30	10/10/2020 23:46	11/10/2020 01:30	1,73	663	1146,44	CHI
20201046597	SAO JOAO D ALIANCA	FB10407036	FLORES DE GOIAS	10/10/2020 22:54	10/10/2020 22:59	10/10/2020 22:54	10/10/2020 22:58	0,05	59	3,23	CHI
20201046597	FLORES DE GOIAS	FB10407036	FLORES DE GOIAS	10/10/2020 22:54	10/10/2020 22:59	10/10/2020 22:54	10/10/2020 22:58	0,05	578	31,63	CHI
20201046597	FLORES DE GOIAS	FB10408311	FLORES DE GOIAS	10/10/2020 22:54	10/10/2020 22:59	10/10/2020 22:54	10/10/2020 22:59	0,07	412	28,50	CHI
20201046597	NOVA ROMA	FB10408311	FLORES DE GOIAS	10/10/2020 22:54	10/10/2020 22:59	10/10/2020 22:54	10/10/2020 22:59	0,07	2	0,14	CHI
20201046597	SAO JOAO D ALIANCA	FB10408311	FLORES DE GOIAS	10/10/2020 22:54	10/10/2020 22:59	10/10/2020 22:54	10/10/2020 22:59	0,07	46	3,18	CHI
20201046555	APARECIDA DE GOIANIA	200109030	INDEPENDENCIA S1	10/10/2020 22:56	11/10/2020 14:03	10/10/2020 22:56	11/10/2020 14:03	15,11	1	15,11	CHI
20201046761	GOIANIA	GN13410488	CAMPINAS S1	10/10/2020 22:56	11/10/2020 12:18	10/10/2020 22:56	11/10/2020 12:18	13,37	1455	19446,48	CHI
20201046573	APARECIDA DE GOIANIA	13517314	INDEPENDENCIA S2	10/10/2020 22:57	11/10/2020 11:16	10/10/2020 22:57	11/10/2020 11:16	12,31	1	12,31	CHI
20201046578	GOIANIA	16923900	GOIANIA LESTE S3	10/10/2020 22:58	10/10/2020 23:23	10/10/2020 22:58	10/10/2020 23:23	0,43	1	0,43	CHI
20201046579	NEROPOLIS	NR12317362	NEROPOLIS S2	10/10/2020 22:58	11/10/2020 07:03	10/10/2020 22:58	11/10/2020 07:03	8,08	2	16,16	CHI
20201050252	NEROPOLIS	NR12009860	NEROPOLIS S2	10/10/2020 22:58	11/10/2020 12:46	10/10/2020 22:58	11/10/2020 12:46	13,79	4	55,15	CHI
20201046796	GOIANIA	GN12042244	ATLANTICO S3	10/10/2020 22:59	11/10/2020 08:14	10/10/2020 22:59	11/10/2020 08:14	9,25	131	1211,20	CHI
20201046577	GOIANIA	02402224	AEROPORTO S2	10/10/2020 22:59	11/10/2020 09:54	10/10/2020 23:26	10/10/2020 23:31	0,08	3872	319,44	CHI
20201046577	GOIANIA	02402224	ATLANTICO S1	10/10/2020 22:59	11/10/2020 09:54	10/10/2020 23:26	10/10/2020 23:31	0,08	1330	109,73	CHI
20201046577	GOIANIA	02402204	AEROPORTO S2	10/10/2020 22:59	11/10/2020 09:54	10/10/2020 22:59	11/10/2020 01:43	2,74	248	680,07	CHI
20201046577	GOIANIA	02402224	AEROPORTO S2	10/10/2020 22:59	11/10/2020 09:54	10/10/2020 23:26	11/10/2020 09:54	10,46	637	6660,37	CHI
20201048094	GOIANIA	GN13063600	AEROPORTO S2	10/10/2020 22:59	11/10/2020 10:04	10/10/2020 22:59	11/10/2020 10:04	11,09	64	709,78	CHI
20201047120	GOIANIA	GN11151324	MEIA PONTE	10/10/2020 22:59	11/10/2020 03:48	10/10/2020 22:59	11/10/2020 03:48	4,81	175	841,99	CHI
20201046595	GOIANIA	10700067	ATLANTICO S3	10/10/2020 22:59	11/10/2020 15:22	10/10/2020 22:59	11/10/2020 15:22	16,38	1	16,38	CHI
20201046803	GOIANIA	GN11068952	GOIANIA LESTE S3	10/10/2020 22:59	11/10/2020 01:17	10/10/2020 22:59	11/10/2020 01:17	2,28	183	418,10	CHI
20201046613	ANAPOLIS	AN11000346	ANAPOLIS UNIVERSITARIO S2	10/10/2020 23:01	11/10/2020 00:41	10/10/2020 23:01	11/10/2020 00:41	1,67	35	58,31	CHI
20201046619	SANTA RITA DO NOVO DESTINO	BA21156227	BARRO ALTO	10/10/2020 23:01	12/10/2020 13:04	10/10/2020 23:01	12/10/2020 13:04	38,04	2	76,09	CHI
20201047037	GOIANIA	GN11001444	GOYA S1	10/10/2020 23:03	11/10/2020 10:49	10/10/2020 23:03	11/10/2020 10:49	11,76	203	2387,62	CHI
20201046640	BRITANIA	BT11165325	BRITANIA	10/10/2020 23:03	11/10/2020 03:38	10/10/2020 23:03	11/10/2020 03:38	4,57	42	191,82	CHI
20201047154	VARJAO	VJ12066127	GUAPO S2	10/10/2020 23:05	11/10/2020 03:18	10/10/2020 23:05	11/10/2020 03:18	4,20	31	130,33	CHI
20201046687	APARECIDA DE GOIANIA	10003278377	REAL S1	10/10/2020 23:09	11/10/2020 09:52	10/10/2020 23:09	11/10/2020 09:52	10,71	1	10,71	CHI
20201046701	ANAPOLIS	AN12385391	ANAPOLIS UNIVERSITARIO S2	10/10/2020 23:10	11/10/2020 00:39	10/10/2020 23:10	11/10/2020 00:39	1,47	45	66,35	CHI
20201046719	TRINDADE	TR21323751	TRINDADE	10/10/2020 23:11	11/10/2020 16:58	10/10/2020 23:11	11/10/2020 16:58	17,77	1	17,77	CHI
202010174499	APARECIDA DE GOIANIA	AP12356820	INDEPENDENCIA S2	10/10/2020 23:12	11/10/2020 15:11	10/10/2020 23:12	11/10/2020 15:11	15,99	308	4924,58	CHI
20201047269	APARECIDA DE GOIANIA	AP11072159	INDEPENDENCIA S1	10/10/2020 23:12	11/10/2020 02:09	10/10/2020 23:12	11/10/2020 02:09	2,94	156	459,20	CHI
20201046757	ANAPOLIS	AN21335140	ANAPOLIS UNIVERSITARIO S2	10/10/2020 23:14	11/10/2020 12:25	10/10/2020 23:14	11/10/2020 12:25	13,18	1	13,18	CHI
20201046764	SANTA BARBARA DE GOIAS	SB12186355	TRINDADE	10/10/2020 23:14	11/10/2020 16:00	10/10/2020 23:14	11/10/2020 16:00	16,75	9	150,76	CHI
20201047234	GOIANIA	GN12161641	AEROPORTO S2	10/10/2020 23:16	11/10/2020 09:23	10/10/2020 23:16	11/10/2020 09:23	10,11	75	758,10	CHI
20201047300	GOIANIA	GN11002182	FERROVIARIO S1	10/10/2020 23:16	11/10/2020 07:10	10/10/2020 23:16	11/10/2020 07:10	7,89	157	1238,12	CHI
20201049173	SAO JOAO D ALIANCA	JL12049201	SAO JOAO D ALIANCA	10/10/2020 23:17	11/10/2020 11:29	10/10/2020 23:17	11/10/2020 11:29	12,20	95	1158,68	CHI
20201047209	GOIANIA	GN16427482	CAMPINAS S1	10/10/2020 23:17	11/10/2020 09:13	10/10/2020 23:17	11/10/2020 09:13	9,92	1673	16604,52	CHI
20201046810	SILVANIA	SV21020095	VIANOPOLIS	10/10/2020 23:18	11/10/2020 01:49	10/10/2020 23:18	11/10/2020 01:49	2,51	1	2,51	CHI
20201046824	GAMELEIRA DE GOIAS	SV21093699	DAIA S2	10/10/2020 23:19	11/10/2020 00:57	10/10/2020 23:19	11/10/2020 00:57	1,62	2	3,25	CHI
20201046827	NOVA VENEZA	NV21029550	INHUMAS S1	10/10/2020 23:19	11/10/2020 08:04	10/10/2020 23:19	11/10/2020 08:04	8,74	1	8,74	CHI
20201046852	PORANGATU	PO12057986	PORANGATU	10/10/2020 23:20	11/10/2020 08:13	10/10/2020 23:20	11/10/2020 08:13	8,88	156	1385,37	CHI
20201046835	GOIANIA	14422955	INDEPENDENCIA S2	10/10/2020 23:20	11/10/2020 14:00	10/10/2020 23:20	11/10/2020 14:00	14,66	1	14,66	CHI
20201046849	CATURAI	CK12071217	ARACU	10/10/2020 23:21	11/10/2020 11:43	10/10/2020 23:21	11/10/2020 11:43	12,36	5	61,80	CHI
20201046855	TEREZOPOLIS DE GOIAS	TJ12273371	DAIA S2	10/10/2020 23:21	11/10/2020 13:34	10/10/2020 23:21	11/10/2020 13:34	14,21	33	469,01	CHI
20201046858	GOIANIA	GN12000367	CAMPINAS S3	10/10/2020 23:22	11/10/2020 08:15	10/10/2020 23:22	11/10/2020 08:15	8,88	205	1820,97	CHI
20201047214	GOIANIA	GN12378780	CARAJAS S2	10/10/2020 23:22	11/10/2020 04:28	10/10/2020 23:22	11/10/2020 04:28	5,09	589	2997,85	CHI
20201047323	GOIANIA	GN11000705	ATLANTICO S2	10/10/2020 23:23	11/10/2020 07:18	10/10/2020 23:23	11/10/2020 07:18	7,92	171	1353,75	CHI
20201047525	TRINDADE	TR11350408	TRINDADE	10/10/2020 23:23	11/10/2020 03:17	10/10/2020 23:23	11/10/2020 03:17	3,89	77	299,38	CHI
20201047418	GOIANIA	GN11001261	CAMPINAS S1	10/10/2020 23:25	11/10/2020 08:17	10/10/2020 23:25	11/10/2020 08:17	8,86	131	1160,04	CHI
20201047070	FORMOSA	03740444	ITUIQUIRA	10/10/2020 23:26	11/10/2020 13:59	10/10/2020 23:26	11/10/2020 00:51	1,42	1	1,42	CHI
20201047070	FORMOSA	03740444	ITUIQUIRA	10/10/2020 23:26	11/10/2020 13:59	10/10/2020 23:27	11/10/2020 00:51	1,39	2	2,78	CHI
20201047070	FORMOSA	03740444	ITUIQUIRA	10/10/2020 23:26	11/10/2020 13:59	11/10/2020 08:49	11/10/2020 10:02	1,21	3	3,64	CHI
20201047070	FORMOSA	03740444	ITUIQUIRA	10/10/2020 23:26	11/10/2020 13:59	10/10/2020 23:26	11/10/2020 13:59	14,55	23	334,58	CHI
20201047070	CABECEIRAS	03740444	ITUIQUIRA	10/10/2020 23:26	11/10/2020 13:59	10/10/2020 23:26	11/10/2020 13:59	14,55	113	1643,80	CHI
20201047070	FORMOSA	FA13342402	ITUIQUIRA	10/10/2020 23:26	11/10/2020 13:59	10/10/2020 23:27	11/10/2020 13:59	14,52	3	43,55	CHI

20201047070	FORMOSA	03740444	ITUIQUIRA	10/10/2020 23:26	11/10/2020 13:59	10/10/2020 23:27	11/10/2020 13:59	14,52	4	58,07	CHI
20201047070	CABECEIRAS	FA13342402	ITUIQUIRA	10/10/2020 23:26	11/10/2020 13:59	10/10/2020 23:27	11/10/2020 13:59	14,52	34	493,61	CHI
20201046997	FORMOSA	03740234	ITUIQUIRA	10/10/2020 23:26	10/10/2020 23:32	10/10/2020 23:26	10/10/2020 23:32	0,11	15099	1593,78	CHI
20201046997	ITARUMA	03740234	ITUIQUIRA	10/10/2020 23:26	10/10/2020 23:32	10/10/2020 23:26	10/10/2020 23:32	0,11	3	0,32	CHI
20201046922	GOIANIA	14471140	AEROPORTO S2	10/10/2020 23:27	11/10/2020 15:22	10/10/2020 23:27	11/10/2020 15:22	15,91	1	15,91	CHI
20201050157	GOIAS	IU12073717	MATRINCHA	10/10/2020 23:27	12/10/2020 09:27	10/10/2020 23:27	12/10/2020 09:27	33,99	21	713,72	CHI
20201050157	ITAPIRAPUA	IU12073717	MATRINCHA	10/10/2020 23:27	12/10/2020 09:27	10/10/2020 23:27	12/10/2020 09:27	33,99	27	917,64	CHI
20201046976	HEITORAI	HE13307315	ITABERAI S1	10/10/2020 23:28	11/10/2020 20:39	10/10/2020 23:28	11/10/2020 15:50	16,38	2	32,77	CHI
20201046976	HEITORAI	00880424	ITABERAI S1	10/10/2020 23:28	11/10/2020 20:39	10/10/2020 23:28	11/10/2020 15:50	16,38	25	409,57	CHI
20201046976	ITABERAI	HE13307315	ITABERAI S1	10/10/2020 23:28	11/10/2020 20:39	10/10/2020 23:28	11/10/2020 15:50	16,38	5	81,91	CHI
20201046976	ITABERAI	00880424	ITABERAI S1	10/10/2020 23:28	11/10/2020 20:39	10/10/2020 23:28	11/10/2020 15:50	16,38	223	3653,36	CHI
20201046976	GOIAS	00880424	ITABERAI S1	10/10/2020 23:28	11/10/2020 20:39	10/10/2020 23:28	11/10/2020 15:50	16,38	39	638,93	CHI
20201046976	GOIAS	IB13140204	ITABERAI S1	10/10/2020 23:28	11/10/2020 20:39	10/10/2020 23:28	11/10/2020 18:14	18,77	37	694,53	CHI
20201046976	GOIAS	00880424	ITABERAI S1	10/10/2020 23:28	11/10/2020 20:39	10/10/2020 23:28	11/10/2020 18:14	18,77	3	56,31	CHI
20201046976	ITABERAI	IB13140204	ITABERAI S1	10/10/2020 23:28	11/10/2020 20:39	10/10/2020 23:28	11/10/2020 18:14	18,77	70	1313,98	CHI
20201046976	ITABERAI	00880424	ITABERAI S1	10/10/2020 23:28	11/10/2020 20:39	10/10/2020 23:28	11/10/2020 18:14	18,77	452	8484,54	CHI
20201046976	ITABERAI	00880424	ITABERAI S1	10/10/2020 23:28	11/10/2020 20:39	10/10/2020 23:28	11/10/2020 20:39	21,20	26	551,07	CHI
2020101000221	FORMOSA	03740424	ITUIQUIRA	10/10/2020 23:28	10/10/2020 23:32	10/10/2020 23:28	10/10/2020 23:32	0,07	6	0,40	CHI
2020101000221	DISTRITO FEDERAL	22101	ITUIQUIRA	10/10/2020 23:28	10/10/2020 23:32	10/10/2020 23:28	10/10/2020 23:32	0,07	1	0,07	CHI
2020101000221	CABECEIRAS	22101	ITUIQUIRA	10/10/2020 23:28	10/10/2020 23:32	10/10/2020 23:28	10/10/2020 23:32	0,07	2984	198,93	CHI
2020101000221	CABECEIRAS	03740424	ITUIQUIRA	10/10/2020 23:28	10/10/2020 23:32	10/10/2020 23:28	10/10/2020 23:32	0,07	52	3,47	CHI
20201047297	GOIANIA	00610284	CAMPINAS S2	10/10/2020 23:28	11/10/2020 02:56	10/10/2020 23:28	10/10/2020 23:38	0,17	4787	809,80	CHI
20201047297	GOIANIA	GN16409434	CAMPINAS S2	10/10/2020 23:28	11/10/2020 02:56	10/10/2020 23:44	10/10/2020 23:49	0,09	3169	295,77	CHI
20201047297	GOIANIA	GN10380036	CAMPINAS S2	10/10/2020 23:28	11/10/2020 02:56	10/10/2020 23:53	11/10/2020 02:54	3,02	1857	5609,17	CHI
20201047297	GOIANIA	GN10385852	CAMPINAS S2	10/10/2020 23:28	11/10/2020 02:56	10/10/2020 23:53	11/10/2020 02:56	3,05	1312	3996,86	CHI
20201047703	GOIANIA	GN11001436	FERROVIARIO S2	10/10/2020 23:28	11/10/2020 09:54	10/10/2020 23:28	11/10/2020 09:54	10,42	146	1522,01	CHI
20201047440	NOVA VENEZA	BR10401467	INHUMAS S1	10/10/2020 23:28	11/10/2020 08:05	10/10/2020 23:28	11/10/2020 08:05	8,60	7	60,23	CHI
20201047440	BRAZABRANTES	BR10401467	INHUMAS S1	10/10/2020 23:28	11/10/2020 08:05	10/10/2020 23:28	11/10/2020 08:05	8,60	81	696,89	CHI
20201046944	MOSSAMEDES	MD12120924	ITABERAI S2	10/10/2020 23:29	11/10/2020 11:34	10/10/2020 23:29	11/10/2020 11:34	12,08	50	603,93	CHI
20201046953	GOIANIA	10834904	GOIANIA LESTE S1	10/10/2020 23:30	11/10/2020 03:47	10/10/2020 23:30	11/10/2020 03:47	4,28	1	4,28	CHI
20201046964	GOIANIA	11599522	CAMPINAS S2	10/10/2020 23:30	11/10/2020 16:19	10/10/2020 23:30	11/10/2020 16:19	16,80	1	16,80	CHI
2020101000124	GOIANIA	00592244	FERROVIARIO S3	10/10/2020 23:32	10/10/2020 23:35	10/10/2020 23:32	10/10/2020 23:35	0,05	5518	275,90	CHI
202010189159	NOVO BRASIL	NB12020225	JUSSARA	10/10/2020 23:33	11/10/2020 08:19	10/10/2020 23:33	11/10/2020 08:19	8,75	40	350,04	CHI
202010189159	JUSSARA	NB12020225	JUSSARA	10/10/2020 23:33	11/10/2020 08:19	10/10/2020 23:33	11/10/2020 08:19	8,75	1	8,75	CHI
202010189159	HEITORAI	NB12020225	JUSSARA	10/10/2020 23:33	11/10/2020 08:19	10/10/2020 23:33	11/10/2020 08:19	8,75	1	8,75	CHI
202010189159	FAZENDA NOVA	NB12020225	JUSSARA	10/10/2020 23:33	11/10/2020 08:19	10/10/2020 23:33	11/10/2020 08:19	8,75	38	332,54	CHI
20201046993	GOIANIA	GN12001259	ATLANTICO S2	10/10/2020 23:34	11/10/2020 02:17	10/10/2020 23:34	11/10/2020 02:17	2,71	260	704,60	CHI
20201047828	GOIANIA	GN11002453	CAMPINAS S2	10/10/2020 23:34	11/10/2020 12:15	10/10/2020 23:34	11/10/2020 12:15	12,67	92	1166,07	CHI
20201047460	APARECIDA DE GOIANIA	AP11058730	INDEPENDENCIA S2	10/10/2020 23:35	11/10/2020 10:29	10/10/2020 23:35	11/10/2020 10:29	10,90	86	937,33	CHI
20201048108	GOIANIA	GN13383680B	MEIA PONTE	10/10/2020 23:37	11/10/2020 11:28	10/10/2020 23:37	11/10/2020 08:39	9,03	1387	12527,31	CHI
20201048108	GOIANIA	GN10384933	MEIA PONTE	10/10/2020 23:37	11/10/2020 11:28	10/10/2020 23:37	11/10/2020 08:43	9,11	4207	38307,07	CHI
20201048108	GOIANIA	GN16409239	MEIA PONTE	10/10/2020 23:37	11/10/2020 11:28	10/10/2020 23:37	11/10/2020 09:37	10,00	1651	16503,58	CHI
20201048108	GOIANIA	GN13271861	MEIA PONTE	10/10/2020 23:37	11/10/2020 11:28	10/10/2020 23:37	11/10/2020 11:28	11,85	285	3378,36	CHI
20201047025	APARECIDA DE GOIANIA	12281876	INDEPENDENCIA S2	10/10/2020 23:37	11/10/2020 07:32	10/10/2020 23:37	11/10/2020 07:32	7,91	1	7,91	CHI
20201047038	GOIANIA	14534836	ATLANTICO S2	10/10/2020 23:38	11/10/2020 14:10	10/10/2020 23:38	11/10/2020 14:10	14,53	1	14,53	CHI
20201047215	GOIANIA	GN11002433	ATLANTICO S2	10/10/2020 23:38	11/10/2020 07:48	10/10/2020 23:38	11/10/2020 07:48	8,16	154	1256,47	CHI
20201047560	GOIANIA	GN11002096	FERROVIARIO S3	10/10/2020 23:39	11/10/2020 10:35	10/10/2020 23:39	11/10/2020 10:35	10,93	157	1716,05	CHI
20201047390	GOIANIA	GN11001233	GOIANIA LESTE S1	10/10/2020 23:39	11/10/2020 08:50	10/10/2020 23:39	11/10/2020 08:50	9,18	59	541,39	CHI
20201047057	TRINDADE	TR31050485	TRINDADE	10/10/2020 23:39	11/10/2020 17:18	10/10/2020 23:39	11/10/2020 17:18	17,64	1	17,64	CHI
20201048027	GOIANESIA	GE11285293	GOIANESIA S2	10/10/2020 23:40	11/10/2020 06:57	10/10/2020 23:40	11/10/2020 06:57	7,28	66	480,46	CHI
20201047147	GOIANIA	GN12042847	FERROVIARIO S2	10/10/2020 23:40	11/10/2020 04:21	10/10/2020 23:40	11/10/2020 04:21	4,68	508	2374,90	CHI
20201047092	GOIANIA	GN21000052	GOYA S1	10/10/2020 23:42	11/10/2020 15:28	10/10/2020 23:42	11/10/2020 15:28	15,76	1	15,76	CHI
20201047094	BELA VISTA DE GOIAS	240063879	BELA VISTA S2	10/10/2020 23:42	11/10/2020 08:36	10/10/2020 23:42	11/10/2020 08:36	8,89	1	8,89	CHI
20201047100	GOIANIA	10138675	AEROPORTO S2	10/10/2020 23:43	11/10/2020 16:32	10/10/2020 23:43	11/10/2020 16:32	16,81	1	16,81	CHI
20201047172	BELA VISTA DE GOIAS	BV13402726	BELA VISTA S2	10/10/2020 23:43	11/10/2020 10:51	11/10/2020 01:40	11/10/2020 08:04	6,40	1006	6440,64	CHI
20201047172	BELA VISTA DE GOIAS	BV13138924	BELA VISTA S2	10/10/2020 23:43	11/10/2020 10:51	11/10/2020 08:51	11/10/2020 08:57	0,09	1006	91,66	CHI
20201047172	BELA VISTA DE GOIAS	BV10400380	BELA VISTA S2	10/10/2020 23:43	11/10/2020 10:51	10/10/2020 23:43	11/10/2020 09:44	10,02	6	60,13	CHI
20201047172	SAO MIGUEL DO PASSA QUATRO	BV13071540	BELA VISTA S2	10/10/2020 23:43	11/10/2020 10:51	10/10/2020 23:43	11/10/2020 10:51	11,14	20	222,75	CHI

20201047172	SILVANIA	BV10400380	BELA VISTA S2	10/10/2020 23:43	11/10/2020 10:51	10/10/2020 23:43	11/10/2020 10:51	11,14	89	991,24	CHI
20201047172	SILVANIA	BV13071540	BELA VISTA S2	10/10/2020 23:43	11/10/2020 10:51	10/10/2020 23:43	11/10/2020 10:51	11,14	5	55,69	CHI
20201047172	CALDAZINHA	BV10400380	BELA VISTA S2	10/10/2020 23:43	11/10/2020 10:51	10/10/2020 23:43	11/10/2020 10:51	11,14	6	66,83	CHI
20201047172	BELA VISTA DE GOIAS	BV10400380	BELA VISTA S2	10/10/2020 23:43	11/10/2020 10:51	10/10/2020 23:43	11/10/2020 10:51	11,14	418	4655,48	CHI
20201047172	BELA VISTA DE GOIAS	BV13071540	BELA VISTA S2	10/10/2020 23:43	11/10/2020 10:51	10/10/2020 23:43	11/10/2020 10:51	11,14	35	389,81	CHI
20201047172	SAO MIGUEL DO PASSA QUATRO	BV10400380	BELA VISTA S2	10/10/2020 23:43	11/10/2020 10:51	10/10/2020 23:43	11/10/2020 10:51	11,14	135	1503,56	CHI
20201047617	GOIANIA	GN12326216	FERROVIARIO S1	10/10/2020 23:44	11/10/2020 07:45	10/10/2020 23:44	11/10/2020 07:45	8,01	253	2025,76	CHI
20201047389	GOIANIA	GN11043345	GOIANIA LESTE S3	10/10/2020 23:45	11/10/2020 11:19	10/10/2020 23:45	11/10/2020 11:19	11,56	123	1422,29	CHI
20201047788	GOIANIA	GN11000047	FERROVIARIO S3	10/10/2020 23:45	11/10/2020 06:00	10/10/2020 23:45	11/10/2020 06:00	6,23	65	405,26	CHI
20201047159	URUACU	CR12306793	CAMPINORTE	10/10/2020 23:45	11/10/2020 02:00	10/10/2020 23:45	11/10/2020 02:00	2,23	47	104,98	CHI
20201047141	PALMEIRAS DE GOIAS	PL12345461	PALMEIRAS	10/10/2020 23:47	11/10/2020 05:37	10/10/2020 23:47	11/10/2020 05:37	5,83	1	5,83	CHI
20201047272	GOIANIA	GN12000343	GOIANIA LESTE S2	10/10/2020 23:48	11/10/2020 02:18	10/10/2020 23:48	11/10/2020 02:18	2,49	565	1407,32	CHI
20201047169	CAMPOS VERDES	VD11049793	SANTA TEREZINHA	10/10/2020 23:50	11/10/2020 01:32	10/10/2020 23:50	11/10/2020 01:32	1,69	79	133,42	CHI
20201047178	APARECIDA DE GOIANIA	200556400	INDEPENDENCIA S1	10/10/2020 23:51	11/10/2020 17:04	10/10/2020 23:51	11/10/2020 17:04	17,21	1	17,21	CHI
20201048065	TRINDADE	TR12001811	GOYA S1	10/10/2020 23:51	11/10/2020 06:49	10/10/2020 23:51	11/10/2020 06:49	6,96	24	167,07	CHI
20201047187	FORMOSO	FO11181124	PORANGATU	10/10/2020 23:52	11/10/2020 01:33	10/10/2020 23:52	11/10/2020 01:33	1,68	103	173,33	CHI
20201047216	TAQUARAL DE GOIAS	TQ16409812	ITABERAI S1	10/10/2020 23:53	11/10/2020 16:05	10/10/2020 23:53	11/10/2020 00:48	0,91	1743	1578,87	CHI
20201047216	ITAUUCU	IB10400386	ITABERAI S1	10/10/2020 23:53	11/10/2020 16:05	10/10/2020 23:53	11/10/2020 08:12	8,32	93	773,91	CHI
20201047216	ITAUUCU	IB10400717	ITABERAI S1	10/10/2020 23:53	11/10/2020 16:05	10/10/2020 23:53	11/10/2020 15:42	15,81	1	15,81	CHI
20201047216	ITABERAI	IB10400717	ITABERAI S1	10/10/2020 23:53	11/10/2020 16:05	10/10/2020 23:53	11/10/2020 15:42	15,81	1	15,81	CHI
20201047216	TAQUARAL DE GOIAS	IB10400717	ITABERAI S1	10/10/2020 23:53	11/10/2020 16:05	10/10/2020 23:53	11/10/2020 15:42	15,81	2	31,62	CHI
20201047216	TAQUARAL DE GOIAS	TQ13162951	ITABERAI S1	10/10/2020 23:53	11/10/2020 16:05	10/10/2020 23:53	11/10/2020 16:05	16,20	1	16,20	CHI
20201047216	ITABERAI	IB10400717	ITABERAI S1	10/10/2020 23:53	11/10/2020 16:05	10/10/2020 23:53	11/10/2020 16:05	16,20	3	48,61	CHI
20201047216	TAQUARAL DE GOIAS	IB10400717	ITABERAI S1	10/10/2020 23:53	11/10/2020 16:05	10/10/2020 23:53	11/10/2020 16:05	16,20	140	2268,43	CHI
20201047267	GOIANIA	00580264	GOIANIA LESTE S1	10/10/2020 23:54	10/10/2020 23:59	10/10/2020 23:54	10/10/2020 23:58	0,06	7599	491,82	CHI
20201047267	SENADOR CANEDO	00580264	GOIANIA LESTE S1	10/10/2020 23:54	10/10/2020 23:59	10/10/2020 23:54	10/10/2020 23:58	0,06	2330	150,80	CHI
20201047267	SENADOR CANEDO	SW10404124	GOIANIA LESTE S1	10/10/2020 23:54	10/10/2020 23:59	10/10/2020 23:54	10/10/2020 23:59	0,09	1689	155,29	CHI
20201047267	GOIANIA	SW10404124	GOIANIA LESTE S1	10/10/2020 23:54	10/10/2020 23:59	10/10/2020 23:54	10/10/2020 23:59	0,09	76	6,99	CHI
20201047213	RIO VERDE	630186121	MONTIVIDIU T	10/10/2020 23:54	11/10/2020 18:51	10/10/2020 23:54	11/10/2020 18:51	18,94	1	18,94	CHI
20201047221	APARECIDA DE GOIANIA	AP11350566	INDEPENDENCIA S1	10/10/2020 23:56	11/10/2020 11:10	10/10/2020 23:56	11/10/2020 11:10	11,23	114	1280,06	CHI
20201047227	NOVO BRASIL	NB12092962	MATRINCHA	10/10/2020 23:56	13/10/2020 20:28	10/10/2020 23:56	11/10/2020 13:20	13,39	4	53,56	CHI
20201047227	NOVO BRASIL	NB12092962	MATRINCHA	10/10/2020 23:56	13/10/2020 20:28	12/10/2020 12:33	12/10/2020 13:30	0,94	4	3,78	CHI
20201047227	GOIAS	NB12113795LD	MATRINCHA	10/10/2020 23:56	13/10/2020 20:28	10/10/2020 23:56	12/10/2020 15:57	40,01	3	120,02	CHI
20201047227	NOVO BRASIL	NB12092962	MATRINCHA	10/10/2020 23:56	13/10/2020 20:28	12/10/2020 19:40	12/10/2020 22:55	3,25	4	13,00	CHI
20201047227	NOVO BRASIL	NB12113795LD	MATRINCHA	10/10/2020 23:56	13/10/2020 20:28	10/10/2020 23:56	13/10/2020 17:18	65,36	1	65,36	CHI
20201047227	ITAPIRAPUA	NB12113795LD	MATRINCHA	10/10/2020 23:56	13/10/2020 20:28	10/10/2020 23:56	13/10/2020 17:18	65,36	1	65,36	CHI
20201047227	GOIAS	NB12113795LD	MATRINCHA	10/10/2020 23:56	13/10/2020 20:28	12/10/2020 16:13	13/10/2020 17:18	25,09	2	50,18	CHI
20201047227	GOIAS	NB12113795LD	MATRINCHA	10/10/2020 23:56	13/10/2020 20:28	12/10/2020 16:13	13/10/2020 20:28	28,25	1	28,25	CHI
20201047227	GOIAS	NB12113795LD	MATRINCHA	10/10/2020 23:56	13/10/2020 20:28	13/10/2020 18:10	13/10/2020 20:28	2,30	2	4,60	CHI
20201047227	ITAPIRAPUA	NB12113795LD	MATRINCHA	10/10/2020 23:56	13/10/2020 20:28	13/10/2020 18:10	13/10/2020 20:28	2,30	1	2,30	CHI
20201047227	NOVO BRASIL	NB12113795LD	MATRINCHA	10/10/2020 23:56	13/10/2020 20:28	13/10/2020 18:10	13/10/2020 20:28	2,30	1	2,30	CHI
20201047239	SANTA BARBARA DE GOIAS	TR12277048	TRINDADE	10/10/2020 23:57	11/10/2020 04:38	10/10/2020 23:57	11/10/2020 04:38	4,67	24	112,09	CHI
20201047239	GOIANIRA	TR12277048	TRINDADE	10/10/2020 23:57	11/10/2020 04:38	10/10/2020 23:57	11/10/2020 04:38	4,67	27	126,11	CHI
20201047239	CATURAI	TR12277048	TRINDADE	10/10/2020 23:57	11/10/2020 04:38	10/10/2020 23:57	11/10/2020 04:38	4,67	9	42,04	CHI
20201047239	TRINDADE	TR12277048	TRINDADE	10/10/2020 23:57	11/10/2020 04:38	10/10/2020 23:57	11/10/2020 04:38	4,67	17	79,40	CHI
20201047258	SAO LUIS DE MONTES BELOS	500072760	SAO LUIZ DOS MONTES BELOS	10/10/2020 23:59	12/10/2020 08:02	10/10/2020 23:59	12/10/2020 08:02	32,03	1	32,03	CHI
20201047260	ANAPOLIS	10018613681	ANAPOLIS UNIVERSITARIO S1	11/10/2020 00:00	11/10/2020 01:48	11/10/2020 00:00	11/10/2020 01:48	1,79	1	1,79	CHI
20201047312	FORMOSA	10002931719	ITUIQUIRA	11/10/2020 00:06	11/10/2020 10:48	11/10/2020 00:06	11/10/2020 10:48	10,70	1	10,70	CHI
20201047313	PALMEIRAS DE GOIAS	10010500446	PALMEIRAS	11/10/2020 00:06	11/10/2020 07:42	11/10/2020 00:06	11/10/2020 07:42	7,60	1	7,60	CHI
20201047322	CAMPESTRE DE GOIAS	GC21185462	TRINDADE	11/10/2020 00:07	11/10/2020 09:45	11/10/2020 00:07	11/10/2020 09:45	9,62	1	9,62	CHI
20201047328	ANAPOLIS	AN11077943	ANAPOLIS UNIVERSITARIO S2	11/10/2020 00:08	11/10/2020 01:36	11/10/2020 00:08	11/10/2020 01:36	1,45	74	107,38	CHI
20201048010	ITAPURANGA	ITG-TR1	ITAPURANGA	11/10/2020 00:08	11/10/2020 00:18	11/10/2020 00:08	11/10/2020 00:18	0,16	199	31,73	CHI
20201048010	HEITORAI	ITG-TR1	ITAPURANGA	11/10/2020 00:08	11/10/2020 00:18	11/10/2020 00:08	11/10/2020 00:18	0,16	36	5,74	CHI
20201048010	MORRO AGUDO DE GOIAS	ITG-TR1	ITAPURANGA	11/10/2020 00:08	11/10/2020 00:18	11/10/2020 00:08	11/10/2020 00:18	0,16	9	1,44	CHI
20201048010	ITAPURANGA	ITG-TR1	ITAPURANGA	11/10/2020 00:08	11/10/2020 00:18	11/10/2020 00:08	11/10/2020 00:18	0,16	1	0,16	CHI
20201047361	NOVA IGUAÇU DE GOIAS	MQ10403947	MARA ROSA	11/10/2020 00:10	11/10/2020 12:56	11/10/2020 00:10	11/10/2020 08:37	8,44	12	101,34	CHI
20201047361	MARA ROSA	MQ10403947	MARA ROSA	11/10/2020 00:10	11/10/2020 12:56	11/10/2020 00:10	11/10/2020 08:37	8,44	171	1444,05	CHI
20201047361	ALTO HORIZONTE	MQ13023845	MARA ROSA	11/10/2020 00:10	11/10/2020 12:56	11/10/2020 00:10	11/10/2020 11:47	11,62	12	139,48	CHI

20201047361	MARA ROSA	MQ13023845	MARA ROSA	11/10/2020 00:10	11/10/2020 12:56	11/10/2020 00:10	11/10/2020 11:47	11,62	33	383,58	CHI
20201047361	URUACU	MQ13023845	MARA ROSA	11/10/2020 00:10	11/10/2020 12:56	11/10/2020 00:10	11/10/2020 11:47	11,62	1	11,62	CHI
20201047361	NOVA IGUAÇU DE GOIAS	AJ12143571RE	MARA ROSA	11/10/2020 00:10	11/10/2020 12:56	11/10/2020 00:10	11/10/2020 12:26	12,28	12	147,32	CHI
20201047361	MARA ROSA	AJ12143571RE	MARA ROSA	11/10/2020 00:10	11/10/2020 12:56	11/10/2020 00:10	11/10/2020 12:26	12,28	5	61,38	CHI
20201047361	ALTO HORIZONTE	AJ12143571RE	MARA ROSA	11/10/2020 00:10	11/10/2020 12:56	11/10/2020 00:10	11/10/2020 12:26	12,28	37	454,24	CHI
20201047361	ALTO HORIZONTE	AJ12384910RE	MARA ROSA	11/10/2020 00:10	11/10/2020 12:56	11/10/2020 00:10	11/10/2020 12:56	12,76	36	459,44	CHI
20201047361	MARA ROSA	AJ12384910RE	MARA ROSA	11/10/2020 00:10	11/10/2020 12:56	11/10/2020 00:10	11/10/2020 12:56	12,76	5	63,81	CHI
20201049924	MARA ROSA	MQ21187982	MARA ROSA	11/10/2020 00:10	11/10/2020 20:38	11/10/2020 00:10	11/10/2020 20:38	20,46	1	20,46	CHI
20201047345	ITABERAÍ	IB12284866	ITABERAÍ S1	11/10/2020 00:11	11/10/2020 10:48	11/10/2020 00:11	11/10/2020 10:48	10,61	3	31,82	CHI
20201047357	ITAPURANGA	IK11124726	ITAPURANGA	11/10/2020 00:12	11/10/2020 02:09	11/10/2020 00:12	11/10/2020 02:09	1,94	34	65,79	CHI
20201047386	SAO JOAO D ALIANCA	FB10407036	FLORES DE GOIAS	11/10/2020 00:13	11/10/2020 09:32	11/10/2020 00:13	11/10/2020 00:16	0,05	3	0,15	CHI
20201047386	FLORES DE GOIAS	FB10407036	FLORES DE GOIAS	11/10/2020 00:13	11/10/2020 09:32	11/10/2020 00:13	11/10/2020 02:24	2,19	415	909,89	CHI
20201047386	SAO JOAO D ALIANCA	FB10407036	FLORES DE GOIAS	11/10/2020 00:13	11/10/2020 09:32	11/10/2020 00:13	11/10/2020 02:24	2,19	32	70,16	CHI
20201047386	FLORES DE GOIAS	FB10407036	FLORES DE GOIAS	11/10/2020 00:13	11/10/2020 09:32	11/10/2020 00:16	11/10/2020 02:24	2,14	1	2,14	CHI
20201047386	SAO JOAO D ALIANCA	FB10407036	FLORES DE GOIAS	11/10/2020 00:13	11/10/2020 09:32	11/10/2020 00:16	11/10/2020 02:24	2,14	1	2,14	CHI
20201047386	SAO JOAO D ALIANCA	FB13252829	FLORES DE GOIAS	11/10/2020 00:13	11/10/2020 09:32	11/10/2020 00:13	11/10/2020 07:54	7,70	46	354,10	CHI
20201047386	FLORES DE GOIAS	FB10407036	FLORES DE GOIAS	11/10/2020 00:13	11/10/2020 09:32	11/10/2020 00:13	11/10/2020 07:54	7,70	4	30,79	CHI
20201047386	NOVA ROMA	FB13252829	FLORES DE GOIAS	11/10/2020 00:13	11/10/2020 09:32	11/10/2020 00:13	11/10/2020 07:54	7,70	2	15,40	CHI
20201047386	FLORES DE GOIAS	FB13252829	FLORES DE GOIAS	11/10/2020 00:13	11/10/2020 09:32	11/10/2020 00:13	11/10/2020 07:54	7,70	411	3163,79	CHI
20201047386	FLORES DE GOIAS	FB12250123	FLORES DE GOIAS	11/10/2020 00:13	11/10/2020 09:32	11/10/2020 00:13	11/10/2020 08:38	8,43	95	800,45	CHI
20201047386	SAO JOAO D ALIANCA	FB12250123	FLORES DE GOIAS	11/10/2020 00:13	11/10/2020 09:32	11/10/2020 00:13	11/10/2020 08:38	8,43	20	168,52	CHI
20201047386	FLORES DE GOIAS	FB12250123	FLORES DE GOIAS	11/10/2020 00:13	11/10/2020 09:32	11/10/2020 00:13	11/10/2020 09:32	9,33	63	587,81	CHI
20201047362	SENADOR CANEDO	SW11095087	SENADOR CANEDO	11/10/2020 00:13	11/10/2020 02:50	11/10/2020 00:13	11/10/2020 02:50	2,61	67	174,63	CHI
20201048071	PIRACANJUBA	PJ12212173	PIRACANJUBA	11/10/2020 00:15	11/10/2020 07:27	11/10/2020 00:15	11/10/2020 07:27	7,18	21	150,88	CHI
20201047607	GOIANIA	GN11000961	CAMPINAS S1	11/10/2020 00:16	11/10/2020 09:30	11/10/2020 00:16	11/10/2020 09:30	9,22	158	1457,51	CHI
20201047446	GOIAS	GS16427000	GOIAS	11/10/2020 00:22	11/10/2020 11:35	11/10/2020 00:22	11/10/2020 02:04	1,70	838	1422,04	CHI
20201047446	GOIAS	GS10404078	GOIAS	11/10/2020 00:22	11/10/2020 11:35	11/10/2020 03:16	11/10/2020 04:53	1,62	160	258,58	CHI
20201047446	GOIAS	GS10404079	GOIAS	11/10/2020 00:22	11/10/2020 11:35	11/10/2020 00:22	11/10/2020 08:28	8,10	58	469,90	CHI
20201047446	GOIAS	GS16427000	GOIAS	11/10/2020 00:22	11/10/2020 11:35	11/10/2020 00:22	11/10/2020 11:35	11,22	427	4791,77	CHI
20201047423	CAMPO LIMPO	AN12267911	ANAPOLIS UNIVERSITARIO S2	11/10/2020 00:23	11/10/2020 08:55	11/10/2020 00:23	11/10/2020 08:55	8,52	2	17,04	CHI
20201047423	ANAPOLIS	AN12267911	ANAPOLIS UNIVERSITARIO S2	11/10/2020 00:23	11/10/2020 08:55	11/10/2020 00:23	11/10/2020 08:55	8,52	43	366,35	CHI
20201047430	NEROPOLIS	160028711	NEROPOLIS S2	11/10/2020 00:25	11/10/2020 15:23	11/10/2020 00:25	11/10/2020 15:23	14,96	1	14,96	CHI
20201047439	GOIANIA	14760289	GOYA S2	11/10/2020 00:26	11/10/2020 14:58	11/10/2020 00:26	11/10/2020 14:58	14,53	1	14,53	CHI
20201047471	APARECIDA DE GOIANIA	AP21140208	REAL S2	11/10/2020 00:33	11/10/2020 15:25	11/10/2020 00:33	11/10/2020 15:25	14,85	1	14,85	CHI
20201047473	SENADOR CANEDO	SW11373087	SENADOR CANEDO	11/10/2020 00:34	11/10/2020 12:59	11/10/2020 00:34	11/10/2020 12:59	12,41	165	2048,34	CHI
20201047478	GOIANIA	10965270	CAMPINAS S3	11/10/2020 00:35	11/10/2020 17:56	11/10/2020 00:35	11/10/2020 17:56	17,34	1	17,34	CHI
20201047479	GOIANIA	GN16424513	ATLANTICO S2	11/10/2020 00:36	11/10/2020 09:18	11/10/2020 00:36	11/10/2020 09:18	8,70	930	8087,64	CHI
20201053219	AURILANDIA	AI12000002	FIRMINOPOLIS S2	11/10/2020 00:36	11/10/2020 19:59	11/10/2020 00:36	11/10/2020 19:59	19,37	30	581,12	CHI
20201053219	FIRMINOPOLIS	AI12000002	FIRMINOPOLIS S2	11/10/2020 00:36	11/10/2020 19:59	11/10/2020 00:36	11/10/2020 19:59	19,37	17	329,30	CHI
20201052179	ITAPURANGA	170059923	ITAPURANGA	11/10/2020 00:40	11/10/2020 13:35	11/10/2020 00:40	11/10/2020 13:35	12,91	1	12,91	CHI
20201047507	GOIANIA	11586783	CAMPINAS S2	11/10/2020 00:40	11/10/2020 17:48	11/10/2020 00:40	11/10/2020 17:48	17,13	1	17,13	CHI
20201047921	GOIANIA	GN11090175	MEIA PONTE	11/10/2020 00:41	11/10/2020 09:51	11/10/2020 00:41	11/10/2020 09:51	9,15	194	1775,85	CHI
20201047518	GOIANIA	GN21052654	MEIA PONTE	11/10/2020 00:42	11/10/2020 11:02	11/10/2020 00:42	11/10/2020 11:02	10,33	2	20,67	CHI
20201047519	SANTA TEREZINHA DE GOIAS	2480000261	SANTA TEREZINHA	11/10/2020 00:42	11/10/2020 04:52	11/10/2020 00:42	11/10/2020 04:52	4,17	1	4,17	CHI
20201052688	VALPARAISO DE GOIAS	VA12169007	MARAJOARA	11/10/2020 00:44	11/10/2020 15:33	11/10/2020 00:44	11/10/2020 15:33	14,81	195	2888,27	CHI
20201048862	PALMEIRAS DE GOIAS	PL12000053	PALMEIRAS	11/10/2020 00:45	11/10/2020 11:08	11/10/2020 00:45	11/10/2020 11:08	10,38	26	269,86	CHI
20201048252	INHUMAS	IN12021337	INHUMAS S2	11/10/2020 00:46	11/10/2020 06:59	11/10/2020 00:46	11/10/2020 06:59	6,21	6	37,23	CHI
20201047556	APARECIDA DE GOIANIA	AP21101943	CEPAIGO S1	11/10/2020 00:47	11/10/2020 12:19	11/10/2020 00:47	11/10/2020 12:19	11,53	1	11,53	CHI
20201047574	GOIANIA	GN16401533	XAVANTES	11/10/2020 00:47	11/10/2020 08:56	11/10/2020 00:47	11/10/2020 02:15	1,47	536	788,81	CHI
20201047574	GOIANIA	GN12213742LD	XAVANTES	11/10/2020 00:47	11/10/2020 08:56	11/10/2020 00:47	11/10/2020 04:00	3,22	2639	8491,72	CHI
20201047574	GOIANIA	GN10407685	XAVANTES	11/10/2020 00:47	11/10/2020 08:56	11/10/2020 00:47	11/10/2020 08:47	7,99	283	2262,51	CHI
20201047574	GOIANIA	GN12213741	XAVANTES	11/10/2020 00:47	11/10/2020 08:56	11/10/2020 00:47	11/10/2020 08:56	8,14	501	4078,70	CHI
20201048053	GOIAS	GS12220332	GOIAS	11/10/2020 00:49	11/10/2020 09:02	11/10/2020 00:49	11/10/2020 09:02	8,22	271	2226,57	CHI
20201047566	PALMEIRAS DE GOIAS	PL21000011	PALMEIRAS	11/10/2020 00:49	12/10/2020 08:08	11/10/2020 00:49	12/10/2020 08:08	31,31	2	62,61	CHI
20201047599	BELA VISTA DE GOIAS	BV12010767RE	BELA VISTA S1	11/10/2020 00:50	11/10/2020 03:44	11/10/2020 00:50	11/10/2020 03:44	2,89	182	526,74	CHI
20201048734	MIMOSO DE GOIAS	MJ12304747	PADRE BERNARDO	11/10/2020 00:50	11/10/2020 15:50	11/10/2020 00:50	11/10/2020 15:50	14,99	7	104,93	CHI
20201048362	LEOPOLDO DE BULHOES	AN12261182	JUNDIAI S1	11/10/2020 00:58	11/10/2020 07:30	11/10/2020 00:58	11/10/2020 07:30	6,52	5	32,61	CHI
20201048362	GOIANAPOLIS	AN12261182	JUNDIAI S1	11/10/2020 00:58	11/10/2020 07:30	11/10/2020 00:58	11/10/2020 07:30	6,52	9	58,70	CHI

20201048362	ANAPOLIS	AN12261182	JUNDIAI S1	11/10/2020 00:58	11/10/2020 07:30	11/10/2020 00:58	11/10/2020 07:30	6,52	152	991,34	CHI
20201048785	LUZIANIA	LZ12336006	VIANOPOLIS	11/10/2020 01:01	11/10/2020 11:04	11/10/2020 01:01	11/10/2020 11:04	10,05	109	1095,45	CHI
20201047611	CALDAS NOVAS	CN21363689	CALDAS NOVAS S2	11/10/2020 01:01	11/10/2020 02:17	11/10/2020 01:01	11/10/2020 02:17	1,26	1	1,26	CHI
20201047623	SENADOR CANEDO	SW12402764	SENADOR CANEDO	11/10/2020 01:05	11/10/2020 04:38	11/10/2020 01:05	11/10/2020 04:38	3,54	390	1379,95	CHI
20201049875	NEROPOLIS	GN12000859LD	XAVANTES	11/10/2020 01:06	11/10/2020 14:34	11/10/2020 01:06	11/10/2020 14:34	13,46	18	242,33	CHI
20201049875	GOIANIA	GN12000859LD	XAVANTES	11/10/2020 01:06	11/10/2020 14:34	11/10/2020 01:06	11/10/2020 14:34	13,46	4	53,85	CHI
20201048946	BRAZABRANTES	03920224	NEROPOLIS S1	11/10/2020 01:06	11/10/2020 07:51	11/10/2020 01:06	11/10/2020 07:51	6,74	307	2070,63	CHI
20201048946	NOVA VENEZA	03920224	NEROPOLIS S1	11/10/2020 01:06	11/10/2020 07:51	11/10/2020 01:06	11/10/2020 07:51	6,74	3	20,23	CHI
20201047846	TRINDADE	TR11107252	TRINDADE	11/10/2020 01:08	11/10/2020 07:15	11/10/2020 01:08	11/10/2020 07:15	6,11	208	1271,23	CHI
20201047780	GOIANIA	GN12059985	REAL S1	11/10/2020 01:13	11/10/2020 08:26	11/10/2020 01:13	11/10/2020 08:26	7,21	297	2141,29	CHI
20201047923	PIRANHAS	PH12184343	ARENOPOLIS	11/10/2020 01:13	11/10/2020 07:39	11/10/2020 01:13	11/10/2020 07:39	6,42	3	19,26	CHI
20201047658	APARECIDA DE GOIANIA	200041241	CEPAIGO S1	11/10/2020 01:15	11/10/2020 12:22	11/10/2020 01:15	11/10/2020 12:22	11,11	1	11,11	CHI
20201047768	GOIANIA	GN10380022	FERROVIARIO S1	11/10/2020 01:20	11/10/2020 07:49	11/10/2020 01:20	11/10/2020 01:31	0,19	5771	1078,86	CHI
20201047768	GOIANIA	GN10394639	FERROVIARIO S1	11/10/2020 01:20	11/10/2020 07:49	11/10/2020 01:20	11/10/2020 04:46	3,44	2190	7524,47	CHI
20201047768	GOIANIA	GN16413630	FERROVIARIO S1	11/10/2020 01:20	11/10/2020 07:49	11/10/2020 01:20	11/10/2020 07:21	6,01	2761	16605,88	CHI
20201047768	GOIANIA	GN16415979	FERROVIARIO S1	11/10/2020 01:20	11/10/2020 07:49	11/10/2020 01:20	11/10/2020 07:49	6,49	2761	17907,39	CHI
20201047815	GOIANIA	GN11002675	ATLANTICO S2	11/10/2020 01:21	11/10/2020 13:12	11/10/2020 01:21	11/10/2020 13:12	11,84	84	994,96	CHI
20201047938	GOIANIA	GN11347331	GOYA S1	11/10/2020 01:22	11/10/2020 09:39	11/10/2020 01:22	11/10/2020 09:39	8,27	172	1423,01	CHI
20201047700	ANAPOLIS	AN11004087	ANAPOLIS UNIVERSITARIO S2	11/10/2020 01:23	11/10/2020 09:35	11/10/2020 01:23	11/10/2020 09:35	8,19	134	1097,80	CHI
20201047701	GOIANIA	13885984	GOYA S2	11/10/2020 01:23	11/10/2020 14:40	11/10/2020 01:23	11/10/2020 14:40	13,27	1	13,27	CHI
20201047729	SAO LUIS DE MONTES BELOS	SL21146011	SAO LUIZ DOS MONTES BELOS	11/10/2020 01:32	11/10/2020 17:56	11/10/2020 01:32	11/10/2020 17:56	16,39	1	16,39	CHI
20201049207	BELA VISTA DE GOIAS	BV12030209	BELA VISTA S1	11/10/2020 01:33	11/10/2020 09:47	11/10/2020 01:33	11/10/2020 09:47	8,22	5	41,11	CHI
20201047744	PLANALTINA	PI12085617RE	PLANALTINA	11/10/2020 01:36	11/10/2020 04:42	11/10/2020 01:36	11/10/2020 04:42	3,10	415	1284,77	CHI
20201047781	AMERICANO DO BRASIL	IB10395408	ITABERAI S2	11/10/2020 01:36	11/10/2020 11:51	11/10/2020 01:36	11/10/2020 11:51	10,26	12	123,12	CHI
20201047781	ITABERAI	IB10395408	ITABERAI S2	11/10/2020 01:36	11/10/2020 11:51	11/10/2020 01:36	11/10/2020 11:51	10,26	363	3724,48	CHI
20201047749	SAO LUIS DE MONTES BELOS	500050065	SAO LUIZ DOS MONTES BELOS	11/10/2020 01:38	11/10/2020 16:19	11/10/2020 01:38	11/10/2020 16:19	14,68	1	14,68	CHI
20201048658	COCALZINHO DE GOIAS	ZN12320107	AGUAS LINDAS DE GOIAS S1	11/10/2020 01:40	11/10/2020 09:34	11/10/2020 01:40	11/10/2020 09:34	7,89	14	110,47	CHI
20201050242	FLORES DE GOIAS	FB21085507	FLORES DE GOIAS	11/10/2020 01:41	11/10/2020 13:37	11/10/2020 01:41	11/10/2020 13:37	11,93	1	11,93	CHI
20201048030	SENADOR CANEDO	SW11199137	SENADOR CANEDO	11/10/2020 01:42	11/10/2020 08:13	11/10/2020 01:42	11/10/2020 08:13	6,51	163	1061,54	CHI
20201048385	ITAPACI	RB12003338	RUBIATABA	11/10/2020 01:44	11/10/2020 07:51	11/10/2020 01:44	11/10/2020 07:51	6,12	10	61,16	CHI
20201048385	RUBIATABA	RB12003338	RUBIATABA	11/10/2020 01:44	11/10/2020 07:51	11/10/2020 01:44	11/10/2020 07:51	6,12	128	782,79	CHI
20201048385	IPIRANGA DE GOIAS	RB12003338	RUBIATABA	11/10/2020 01:44	11/10/2020 07:51	11/10/2020 01:44	11/10/2020 07:51	6,12	1	6,12	CHI
20201048697	LUZIANIA	00060224	MARAJOARA	11/10/2020 01:45	11/10/2020 22:32	11/10/2020 11:08	11/10/2020 11:11	0,05	2796	144,46	CHI
20201048697	VALPARAISO DE GOIAS	00060224	MARAJOARA	11/10/2020 01:45	11/10/2020 22:32	11/10/2020 11:08	11/10/2020 11:11	0,05	3400	175,67	CHI
20201048697	LUZIANIA	00060224	MARAJOARA	11/10/2020 01:45	11/10/2020 22:32	11/10/2020 14:34	11/10/2020 14:41	0,13	2796	360,37	CHI
20201048697	VALPARAISO DE GOIAS	00060224	MARAJOARA	11/10/2020 01:45	11/10/2020 22:32	11/10/2020 14:34	11/10/2020 14:41	0,13	3400	438,22	CHI
20201048697	LUZIANIA	00060224	MARAJOARA	11/10/2020 01:45	11/10/2020 22:32	11/10/2020 17:27	11/10/2020 17:34	0,12	2796	333,19	CHI
20201048697	VALPARAISO DE GOIAS	00060224	MARAJOARA	11/10/2020 01:45	11/10/2020 22:32	11/10/2020 17:27	11/10/2020 17:34	0,12	3400	405,17	CHI
20201048697	VALPARAISO DE GOIAS	00060224	MARAJOARA	11/10/2020 01:45	11/10/2020 22:32	11/10/2020 20:53	11/10/2020 20:56	0,05	3400	170,00	CHI
20201048697	LUZIANIA	00060224	MARAJOARA	11/10/2020 01:45	11/10/2020 22:32	11/10/2020 20:53	11/10/2020 20:56	0,05	2008	100,40	CHI
20201048697	LUZIANIA	LZ16410111	MARAJOARA	11/10/2020 01:45	11/10/2020 22:32	11/10/2020 20:52	11/10/2020 20:58	0,10	362	37,21	CHI
20201048697	LUZIANIA	XX28254831	MARAJOARA	11/10/2020 01:45	11/10/2020 22:32	11/10/2020 20:52	11/10/2020 21:52	1,01	426	429,08	CHI
20201048697	LUZIANIA	LZ12370738LD	MARAJOARA	11/10/2020 01:45	11/10/2020 22:32	11/10/2020 01:45	11/10/2020 22:17	20,53	1154	23691,62	CHI
20201048697	LUZIANIA	LZ12370738LD	MARAJOARA	11/10/2020 01:45	11/10/2020 22:32	11/10/2020 10:17	11/10/2020 22:17	11,99	233	2793,93	CHI
20201048697	LUZIANIA	LZ12370738LD	MARAJOARA	11/10/2020 01:45	11/10/2020 22:32	11/10/2020 01:45	11/10/2020 22:29	20,74	138	2861,78	CHI
20201048697	LUZIANIA	LZ12370738LD	MARAJOARA	11/10/2020 01:45	11/10/2020 22:32	11/10/2020 01:45	11/10/2020 22:32	20,79	162	3368,11	CHI
20201048386	APARECIDA DE GOIANIA	AP11168962	INDEPENDENCIA S1	11/10/2020 01:49	11/10/2020 09:17	11/10/2020 01:49	11/10/2020 09:17	7,46	54	403,10	CHI
20201047879	ITAPIRAPUA	02700414	BRITANIA	11/10/2020 01:52	12/10/2020 17:46	11/10/2020 01:52	11/10/2020 09:08	7,28	1	7,28	CHI
20201047879	SANTA FE DE GOIAS	02700414	BRITANIA	11/10/2020 01:52	12/10/2020 17:46	11/10/2020 01:52	11/10/2020 09:08	7,28	31	225,64	CHI
20201047879	JUSSARA	02700414	BRITANIA	11/10/2020 01:52	12/10/2020 17:46	11/10/2020 01:52	11/10/2020 09:08	7,28	8	58,23	CHI
20201047879	SANTA FE DE GOIAS	RN13080949	BRITANIA	11/10/2020 01:52	12/10/2020 17:46	11/10/2020 01:52	11/10/2020 10:26	8,57	15	128,51	CHI
20201047879	JUSSARA	RN13080949	BRITANIA	11/10/2020 01:52	12/10/2020 17:46	11/10/2020 01:52	11/10/2020 10:26	8,57	1	8,57	CHI
20201047879	SANTA FE DE GOIAS	RN13090838	BRITANIA	11/10/2020 01:52	12/10/2020 17:46	11/10/2020 01:52	12/10/2020 17:46	39,91	13	518,82	CHI
20201047795	ANAPOLIS	20078833	ANAPOLIS UNIVERSITARIO S2	11/10/2020 01:55	11/10/2020 12:45	11/10/2020 01:55	11/10/2020 12:45	10,82	1	10,82	CHI
20201047796	ORIZONA	OZ11140712	PIRES DO RIO S2	11/10/2020 01:57	11/10/2020 07:11	11/10/2020 01:57	11/10/2020 07:11	5,23	150	784,83	CHI
20201047797	PLANALTINA	PI12375539	PLANALTINA	11/10/2020 01:57	11/10/2020 07:55	11/10/2020 01:57	11/10/2020 07:55	5,96	42	250,31	CHI
20201047811	RIO VERDE	RV11000162	RIO VERDE S2	11/10/2020 01:58	11/10/2020 03:52	11/10/2020 01:58	11/10/2020 03:52	1,89	133	250,89	CHI
20201048124	LUZIANIA	LZ12370656	RIO VERMELHO	11/10/2020 01:59	11/10/2020 08:42	11/10/2020 01:59	11/10/2020 08:42	6,72	52	349,19	CHI

20201047806	SAO FRANCISCO DE GOIAS	SF11253269	SAO FRANCISCO DE GOIAS	11/10/2020 01:59	11/10/2020 08:47	11/10/2020 01:59	11/10/2020 08:47	6,80	23	156,38	CHI
20201047820	SANTO ANTONIO DO DESCOBERTO	SN21313609	AGUAS LINDAS DE GOIAS S2	11/10/2020 02:03	11/10/2020 11:08	11/10/2020 02:03	11/10/2020 11:08	9,08	1	9,08	CHI
20201047821	JARAGUA	JA12205735	JARAGUA	11/10/2020 02:03	11/10/2020 08:38	11/10/2020 02:03	11/10/2020 08:38	6,59	260	1714,34	CHI
20201050618	JARAGUA	JA11065872	JARAGUA	11/10/2020 02:03	12/10/2020 01:10	11/10/2020 02:03	12/10/2020 01:10	23,12	112	2589,84	CHI
20201047824	URUACU	640027519	URUACU	11/10/2020 02:03	12/10/2020 06:52	11/10/2020 02:03	12/10/2020 06:52	28,82	1	28,82	CHI
20201047832	SANTO ANTONIO DO DESCOBERTO	AX10394596	ALEXANIA	11/10/2020 02:05	11/10/2020 15:30	11/10/2020 02:05	11/10/2020 06:25	4,35	2	8,69	CHI
20201047832	ALEXANIA	AX10394596	ALEXANIA	11/10/2020 02:05	11/10/2020 15:30	11/10/2020 02:05	11/10/2020 06:25	4,35	4	17,38	CHI
20201047832	ALEXANIA	AX10394596	ALEXANIA	11/10/2020 02:05	11/10/2020 15:30	11/10/2020 02:05	11/10/2020 10:26	8,36	8	66,86	CHI
20201047832	ALEXANIA	AX10394596	ALEXANIA	11/10/2020 02:05	11/10/2020 15:30	11/10/2020 02:05	11/10/2020 13:52	11,79	5	58,93	CHI
20201047832	ALEXANIA	AX12377762RE	ALEXANIA	11/10/2020 02:05	11/10/2020 15:30	11/10/2020 02:05	11/10/2020 15:20	13,25	39	516,73	CHI
20201047832	CORUMBA DE GOIAS	AX12377762RE	ALEXANIA	11/10/2020 02:05	11/10/2020 15:30	11/10/2020 02:05	11/10/2020 15:20	13,25	5	66,25	CHI
20201047832	SANTO ANTONIO DO DESCOBERTO	AX12211853LD	ALEXANIA	11/10/2020 02:05	11/10/2020 15:30	11/10/2020 02:05	11/10/2020 15:30	13,42	1	13,42	CHI
20201047832	ALEXANIA	AX12211853LD	ALEXANIA	11/10/2020 02:05	11/10/2020 15:30	11/10/2020 02:05	11/10/2020 15:30	13,42	96	1287,92	CHI
20201047832	CORUMBA DE GOIAS	AX12211853LD	ALEXANIA	11/10/2020 02:05	11/10/2020 15:30	11/10/2020 02:05	11/10/2020 15:30	13,42	2	26,83	CHI
20201047829	GOIANIRA	390066310	GOIANIRA	11/10/2020 02:07	11/10/2020 14:11	11/10/2020 02:07	11/10/2020 14:11	12,06	1	12,06	CHI
20201049635	ITAJA	IM12303219	CACHOEIRA ALTA	11/10/2020 02:08	11/10/2020 18:17	11/10/2020 02:08	11/10/2020 18:17	16,14	5	80,72	CHI
20201049635	ITARUMA	IM12303219	CACHOEIRA ALTA	11/10/2020 02:08	11/10/2020 18:17	11/10/2020 02:08	11/10/2020 18:17	16,14	2	32,29	CHI
20201047839	CRISTALINA	KR10400736	CRISTALINA S2	11/10/2020 02:08	11/10/2020 12:16	11/10/2020 02:08	11/10/2020 08:40	6,53	6	39,20	CHI
20201047839	IPAMERI	KR10400736	CRISTALINA S2	11/10/2020 02:08	11/10/2020 12:16	11/10/2020 02:08	11/10/2020 08:40	6,53	13	84,93	CHI
20201047839	IPAMERI	KR10400736	CRISTALINA S2	11/10/2020 02:08	11/10/2020 12:16	11/10/2020 02:08	11/10/2020 12:16	10,13	1	10,13	CHI
20201046891	NOVO PLANALTO	TA12369993	NOVO PLANALTO	11/10/2020 02:14	13/10/2020 01:11	11/10/2020 02:14	11/10/2020 15:00	12,77	3	38,30	CHI
20201046891	NOVO PLANALTO	TA12369993	NOVO PLANALTO	11/10/2020 02:14	13/10/2020 01:11	11/10/2020 02:14	11/10/2020 16:22	14,13	41	579,44	CHI
20201046891	NOVO PLANALTO	TA12369993	NOVO PLANALTO	11/10/2020 02:14	13/10/2020 01:11	11/10/2020 02:14	11/10/2020 16:22	5,66	5	28,30	CHI
20201046891	NOVO PLANALTO	TA12369993	NOVO PLANALTO	11/10/2020 02:14	13/10/2020 01:11	11/10/2020 16:24	11/10/2020 16:56	0,54	3	1,62	CHI
20201046891	NOVO PLANALTO	TA13313443	NOVO PLANALTO	11/10/2020 02:14	13/10/2020 01:11	11/10/2020 16:24	12/10/2020 09:04	16,67	4	66,70	CHI
20201046891	NOVO PLANALTO	TA12369993	NOVO PLANALTO	11/10/2020 02:14	13/10/2020 01:11	12/10/2020 09:28	12/10/2020 09:34	0,11	3	0,32	CHI
20201046891	NOVO PLANALTO	TA12369993	NOVO PLANALTO	11/10/2020 02:14	13/10/2020 01:11	12/10/2020 14:37	12/10/2020 15:24	0,78	3	2,34	CHI
20201046891	NOVO PLANALTO	TA21170063	NOVO PLANALTO	11/10/2020 02:14	13/10/2020 01:11	12/10/2020 09:23	12/10/2020 19:34	10,19	1	10,19	CHI
20201046891	NOVO PLANALTO	TA12369993	NOVO PLANALTO	11/10/2020 02:14	13/10/2020 01:11	11/10/2020 02:14	12/10/2020 23:51	45,62	3	136,87	CHI
20201046891	NOVO PLANALTO	TA13313443	NOVO PLANALTO	11/10/2020 02:14	13/10/2020 01:11	12/10/2020 09:23	12/10/2020 23:51	14,47	3	43,42	CHI
20201046891	NOVO PLANALTO	TA13139157	NOVO PLANALTO	11/10/2020 02:14	13/10/2020 01:11	11/10/2020 16:24	13/10/2020 01:11	32,79	42	1377,16	CHI
20201048494	GOIANIA	GN11041780	FERROVIARIO S2	11/10/2020 02:14	11/10/2020 09:08	11/10/2020 02:14	11/10/2020 09:08	6,90	86	593,04	CHI
20201047852	CRISTALINA	KR21261610	CRISTALINA S2	11/10/2020 02:15	11/10/2020 04:54	11/10/2020 02:15	11/10/2020 04:54	2,64	3	7,91	CHI
20201047997	CAMPINORTE	03260506	CAMPINORTE	11/10/2020 02:29	11/10/2020 05:20	11/10/2020 02:29	11/10/2020 05:20	2,85	2070	5899,50	CHI
20201047997	NOVA IGUACU DE GOIAS	03260506	CAMPINORTE	11/10/2020 02:29	11/10/2020 05:20	11/10/2020 02:29	11/10/2020 05:20	2,85	23	65,55	CHI
20201047997	URUACU	03260506	CAMPINORTE	11/10/2020 02:29	11/10/2020 05:20	11/10/2020 02:29	11/10/2020 05:20	2,86	540	1543,50	CHI
20201047997	CAMPINORTE	03260506	CAMPINORTE	11/10/2020 02:29	11/10/2020 05:20	11/10/2020 02:29	11/10/2020 05:20	2,86	2375	6788,54	CHI
20201047997	MARA ROSA	03260506	CAMPINORTE	11/10/2020 02:29	11/10/2020 05:20	11/10/2020 02:29	11/10/2020 05:20	2,86	1	2,86	CHI
20201047997	NOVA IGUACU DE GOIAS	03260506	CAMPINORTE	11/10/2020 02:29	11/10/2020 05:20	11/10/2020 02:29	11/10/2020 05:20	2,86	131	374,44	CHI
2020101100125	CAMPINORTE	03260224	CAMPINORTE	11/10/2020 02:29	11/10/2020 05:20	11/10/2020 02:29	11/10/2020 05:20	2,85	2	5,70	CHI
2020101100125	URUACU	03260224	CAMPINORTE	11/10/2020 02:29	11/10/2020 05:20	11/10/2020 02:29	11/10/2020 05:20	2,85	9	25,65	CHI
20201050042	GOIANIA	GN11281915	CARAJAS S2	11/10/2020 02:31	11/10/2020 13:27	11/10/2020 02:31	11/10/2020 13:27	10,92	58	633,25	CHI
20201047893	CRISTALINA	KR10413343	PAMPLONA	11/10/2020 02:32	11/10/2020 12:07	11/10/2020 02:32	11/10/2020 02:35	0,06	46	2,57	CHI
20201047893	CRISTALINA	03460414	PAMPLONA	11/10/2020 02:32	11/10/2020 12:07	11/10/2020 02:32	11/10/2020 08:19	5,79	12	69,44	CHI
20201047893	CRISTALINA	KR10409766	PAMPLONA	11/10/2020 02:32	11/10/2020 12:07	11/10/2020 02:32	11/10/2020 08:32	6,00	4	24,02	CHI
20201047893	LUZIANIA	KR10409766	PAMPLONA	11/10/2020 02:32	11/10/2020 12:07	11/10/2020 02:32	11/10/2020 08:32	6,00	76	456,30	CHI
20201047893	CRISTALINA	KR13118895	PAMPLONA	11/10/2020 02:32	11/10/2020 12:07	11/10/2020 02:32	11/10/2020 10:32	8,00	4	32,01	CHI
20201047893	CRISTALINA	KR13118894	PAMPLONA	11/10/2020 02:32	11/10/2020 12:07	11/10/2020 02:32	11/10/2020 12:07	9,59	29	278,01	CHI
20201047893	LUZIANIA	KR13118894	PAMPLONA	11/10/2020 02:32	11/10/2020 12:07	11/10/2020 02:32	11/10/2020 12:07	9,59	1	9,59	CHI
20201047890	QUIRINOPOLIS	QI21091046	QUIRINOPOLIS	11/10/2020 02:35	11/10/2020 08:07	11/10/2020 02:35	11/10/2020 08:07	5,53	1	5,53	CHI
20201047894	CUMARI	CY12078706	CATALAO S1	11/10/2020 02:38	11/10/2020 09:14	11/10/2020 02:38	11/10/2020 09:14	6,60	9	59,38	CHI
20201048149	ITABERAI	II10400782	ITABERAI S1	11/10/2020 02:52	11/10/2020 16:05	11/10/2020 02:52	11/10/2020 08:08	5,26	6	31,58	CHI
20201048149	JARAGUA	II10400782	ITABERAI S1	11/10/2020 02:52	11/10/2020 16:05	11/10/2020 02:52	11/10/2020 08:08	5,26	233	1226,49	CHI
20201048149	ITAGUARI	II10400782	ITABERAI S1	11/10/2020 02:52	11/10/2020 16:05	11/10/2020 02:52	11/10/2020 08:08	5,26	52	273,72	CHI
20201048149	TAQUARAL DE GOIAS	II10400782	ITABERAI S1	11/10/2020 02:52	11/10/2020 16:05	11/10/2020 02:52	11/10/2020 08:08	5,26	171	900,13	CHI
20201048149	TAQUARAL DE GOIAS	II10400782	ITABERAI S1	11/10/2020 02:52	11/10/2020 16:05	11/10/2020 02:52	11/10/2020 16:05	13,23	1743	23052,63	CHI
20201048612	SAO MIGUEL DO ARAGUAIA	SQ10400685	CRISTIANOPOLIS	11/10/2020 02:56	11/10/2020 08:31	11/10/2020 02:56	11/10/2020 08:31	5,60	0	0,00	CHI
20201048612	VIANOPOLIS	SQ10400685	CRISTIANOPOLIS	11/10/2020 02:56	11/10/2020 08:31	11/10/2020 02:56	11/10/2020 08:31	5,60	36	201,55	CHI

20201048612	SAO MIGUEL DO PASSA QUATRO	SQ10400685	CRISTIANOPOLIS	11/10/2020 02:56	11/10/2020 08:31	11/10/2020 02:56	11/10/2020 08:31	5,60	162	906,97	CHI
20201048073	LUZIANIA	LZ12041471	RIO VERMELHO	11/10/2020 02:57	11/10/2020 09:16	11/10/2020 02:57	11/10/2020 09:16	6,31	13	82,03	CHI
20201047943	CATURAI	CK12326309	INHUMAS S1	11/10/2020 03:08	11/10/2020 10:56	11/10/2020 03:08	11/10/2020 10:56	7,81	28	218,61	CHI
20201047943	INHUMAS	CK12326309	INHUMAS S1	11/10/2020 03:08	11/10/2020 10:56	11/10/2020 03:08	11/10/2020 10:56	7,81	2	15,61	CHI
20201048733	AURILANDIA	6629914	FIRMINOPOLIS S2	11/10/2020 03:09	11/10/2020 13:33	11/10/2020 03:09	11/10/2020 13:31	10,36	95	984,60	CHI
20201048733	FIRMINOPOLIS	AI10401490	FIRMINOPOLIS S2	11/10/2020 03:09	11/10/2020 13:33	11/10/2020 03:09	11/10/2020 13:33	10,40	4	41,59	CHI
20201048733	AURILANDIA	AI10401490	FIRMINOPOLIS S2	11/10/2020 03:09	11/10/2020 13:33	11/10/2020 03:09	11/10/2020 13:33	10,40	106	1102,22	CHI
20201048733	FIRMINOPOLIS	AI10401490	FIRMINOPOLIS S2	11/10/2020 03:09	11/10/2020 13:33	11/10/2020 09:27	11/10/2020 13:33	4,09	11	44,98	CHI
20201048733	AURILANDIA	AI10401490	FIRMINOPOLIS S2	11/10/2020 03:09	11/10/2020 13:33	11/10/2020 09:27	11/10/2020 13:33	4,09	14	57,24	CHI
20201047952	ARAGARCAS	ME10400718	IPORA	11/10/2020 03:09	11/10/2020 12:00	11/10/2020 03:09	11/10/2020 08:18	5,15	3	15,45	CHI
20201047952	MONTES CLAROS DE GOIAS	ME10400718	IPORA	11/10/2020 03:09	11/10/2020 12:00	11/10/2020 03:09	11/10/2020 08:18	5,15	600	3089,50	CHI
20201047952	MONTES CLAROS DE GOIAS	ME10400718	IPORA	11/10/2020 03:09	11/10/2020 12:00	11/10/2020 03:11	11/10/2020 08:18	5,12	1	5,12	CHI
20201047952	ARAGARCAS	AG12060894LD	IPORA	11/10/2020 03:09	11/10/2020 12:00	11/10/2020 03:09	11/10/2020 11:23	8,23	45	370,54	CHI
20201047952	MONTES CLAROS DE GOIAS	AG12060894LD	IPORA	11/10/2020 03:09	11/10/2020 12:00	11/10/2020 03:09	11/10/2020 11:23	8,23	2	16,47	CHI
20201047952	BOM JARDIM DE GOIAS	BM12223179LD	IPORA	11/10/2020 03:09	11/10/2020 12:00	11/10/2020 03:09	11/10/2020 12:00	8,84	2	17,68	CHI
20201047952	ARAGARCAS	BM12223179LD	IPORA	11/10/2020 03:09	11/10/2020 12:00	11/10/2020 03:09	11/10/2020 12:00	8,84	4	35,35	CHI
20201047955	PORANGATU	PO11056154	PORANGATU	11/10/2020 03:18	11/10/2020 10:16	11/10/2020 03:18	11/10/2020 10:16	6,96	95	660,80	CHI
20201047961	PIRACANJUBA	PJ12420391	ROCHEDO	11/10/2020 03:24	11/10/2020 08:03	11/10/2020 03:24	11/10/2020 08:03	4,65	8	37,18	CHI
20201047970	ANAPOLIS	AN12270460	ANAPOLIS UNIVERSITARIO S2	11/10/2020 03:27	11/10/2020 04:31	11/10/2020 03:27	11/10/2020 04:31	1,05	74	78,05	CHI
20201047974	ANAPOLIS	AN12000105	ANAPOLIS UNIVERSITARIO S2	11/10/2020 03:30	11/10/2020 08:37	11/10/2020 03:30	11/10/2020 08:37	5,11	53	270,84	CHI
20201048087	GOIANIA	GN11000652	ATLANTICO S2	11/10/2020 03:35	11/10/2020 12:14	11/10/2020 03:35	11/10/2020 12:14	8,64	138	1192,09	CHI
20201047991	ACREUNA	EU12301057	ACREUNA	11/10/2020 03:42	11/10/2020 05:12	11/10/2020 03:42	11/10/2020 05:12	1,50	29	43,47	CHI
20201049278	NOVO PLANALTO	TA12192342	NOVO PLANALTO	11/10/2020 03:42	11/10/2020 11:43	11/10/2020 03:42	11/10/2020 11:43	8,01	1	8,01	CHI
20201049278	PORANGATU	TA12192342	NOVO PLANALTO	11/10/2020 03:42	11/10/2020 11:43	11/10/2020 03:42	11/10/2020 11:43	8,01	7	56,05	CHI
20201050294	CALDAZINHA	BV12170679	CEPAIGO S2	11/10/2020 03:42	11/10/2020 09:57	11/10/2020 03:42	11/10/2020 09:57	6,24	11	68,60	CHI
20201048003	SILVANIA	SV12172117	DAIA S2	11/10/2020 03:49	11/10/2020 14:38	11/10/2020 03:49	11/10/2020 10:49	6,99	10	69,89	CHI
20201048003	BELA VISTA DE GOIAS	SV12172117	DAIA S2	11/10/2020 03:49	11/10/2020 14:38	11/10/2020 03:49	11/10/2020 13:54	10,07	1	10,07	CHI
20201048003	SILVANIA	SV12172117	DAIA S2	11/10/2020 03:49	11/10/2020 14:38	11/10/2020 03:49	11/10/2020 13:54	10,07	34	342,50	CHI
20201048003	SILVANIA	SV12172117	DAIA S2	11/10/2020 03:49	11/10/2020 14:38	11/10/2020 03:49	11/10/2020 14:38	10,81	128	1384,07	CHI
20201048003	BELA VISTA DE GOIAS	SV12172117	DAIA S2	11/10/2020 03:49	11/10/2020 14:38	11/10/2020 03:49	11/10/2020 14:38	10,81	7	75,69	CHI
20201049584	CORUMBA DE GOIAS	CB12161727	CORUMBA	11/10/2020 03:53	11/10/2020 08:56	11/10/2020 03:53	11/10/2020 08:56	5,04	310	1562,14	CHI
20201048029	ANAPOLIS	AN11335077	ANAPOLIS UNIVERSITARIO S2	11/10/2020 03:56	11/10/2020 11:13	11/10/2020 03:56	11/10/2020 11:13	7,27	33	239,90	CHI
20201049670	ITAPURANGA	IK11274570	ITAPURANGA	11/10/2020 03:57	11/10/2020 11:13	11/10/2020 03:57	11/10/2020 11:13	7,26	78	566,48	CHI
20201048016	ALEXANIA	AX21318552	ALEXANIA	11/10/2020 03:58	12/10/2020 06:45	11/10/2020 03:58	12/10/2020 06:45	26,77	1	26,77	CHI
20201052525	GOIANIA	GN12000609	CAMPINAS S3	11/10/2020 03:59	11/10/2020 13:53	11/10/2020 03:59	11/10/2020 13:53	9,90	49	484,87	CHI
20201048019	IPORA	IR12014524	IPORA	11/10/2020 04:01	11/10/2020 07:35	11/10/2020 04:01	11/10/2020 07:35	3,57	3	10,70	CHI
20201048019	DIORAMA	IR12014524	IPORA	11/10/2020 04:01	11/10/2020 07:35	11/10/2020 04:01	11/10/2020 07:35	3,57	4	14,26	CHI
20201048023	SAO LUIZ DO NORTE	SZ10410838	ITAPACI	11/10/2020 04:04	11/10/2020 15:58	11/10/2020 04:04	11/10/2020 08:50	4,76	123	585,34	CHI
20201048023	GOIANESIA	SZ13201740	ITAPACI	11/10/2020 04:04	11/10/2020 15:58	11/10/2020 04:04	11/10/2020 11:38	7,57	9	68,17	CHI
20201048023	SAO LUIZ DO NORTE	SZ13201740	ITAPACI	11/10/2020 04:04	11/10/2020 15:58	11/10/2020 04:04	11/10/2020 11:38	7,57	31	234,82	CHI
20201048023	SANTA ISABEL	SZ13201740	ITAPACI	11/10/2020 04:04	11/10/2020 15:58	11/10/2020 04:04	11/10/2020 11:38	7,57	4	30,30	CHI
20201048023	GOIANESIA	GE12280193LD	ITAPACI	11/10/2020 04:04	11/10/2020 15:58	11/10/2020 04:04	11/10/2020 14:45	10,69	2	21,37	CHI
20201048023	SANTA ISABEL	GE12280193LD	ITAPACI	11/10/2020 04:04	11/10/2020 15:58	11/10/2020 04:04	11/10/2020 14:45	10,69	1	10,69	CHI
20201048023	GOIANESIA	GE13384329	ITAPACI	11/10/2020 04:04	11/10/2020 15:58	11/10/2020 04:04	11/10/2020 15:58	11,90	1	11,90	CHI
20201048021	GOIANAPOLIS	GP11037869	DAIA S2	11/10/2020 04:04	11/10/2020 16:00	11/10/2020 04:04	11/10/2020 16:00	11,92	120	1430,27	CHI
20201049393	SANTO ANTONIO DE GOIAS	BW16407507	NEROPOLIS S1	11/10/2020 04:09	11/10/2020 11:25	11/10/2020 04:09	11/10/2020 11:25	7,26	613	4448,85	CHI
20201049393	GOIANIA	BW16407507	NEROPOLIS S1	11/10/2020 04:09	11/10/2020 11:25	11/10/2020 04:09	11/10/2020 11:25	7,26	99	718,49	CHI
20201049393	NOVA VENEZA	BW16407507	NEROPOLIS S1	11/10/2020 04:09	11/10/2020 11:25	11/10/2020 04:09	11/10/2020 11:25	7,26	1	7,26	CHI
20201049393	NEROPOLIS	BW16407507	NEROPOLIS S1	11/10/2020 04:09	11/10/2020 11:25	11/10/2020 04:09	11/10/2020 11:25	7,26	17	123,38	CHI
20201048664	FORMOSA	FA12262411	ITUIQUIRA	11/10/2020 04:14	11/10/2020 20:04	11/10/2020 04:14	11/10/2020 20:04	15,82	5	79,10	CHI
20201050370	NOVO PLANALTO	TA11265175	NOVO PLANALTO	11/10/2020 04:16	12/10/2020 15:38	11/10/2020 04:16	12/10/2020 15:38	35,36	58	2050,83	CHI
20201049376	GOIANIA	GN11000923	CAMPINAS S2	11/10/2020 04:20	11/10/2020 09:51	11/10/2020 04:20	11/10/2020 09:51	5,50	142	781,08	CHI
20201048139	NAZARIO	NZ12259104	ANICUNS	11/10/2020 04:22	11/10/2020 10:56	11/10/2020 04:22	11/10/2020 10:56	6,55	3	19,66	CHI
20201048139	ANICUNS	NZ12259104	ANICUNS	11/10/2020 04:22	11/10/2020 10:56	11/10/2020 04:22	11/10/2020 10:56	6,55	34	222,79	CHI
20201049648	ABADIANIA	AA12285384	ANAPOLIS UNIVERSITARIO S1	11/10/2020 04:23	11/10/2020 10:09	11/10/2020 04:23	11/10/2020 10:09	5,76	139	800,83	CHI
20201049648	GAMELEIRA DE GOIAS	AA12285384	ANAPOLIS UNIVERSITARIO S1	11/10/2020 04:23	11/10/2020 10:09	11/10/2020 04:23	11/10/2020 10:09	5,76	1	5,76	CHI
20201048982	ANAPOLIS	AN12319693	ANAPOLIS UNIVERSITARIO S2	11/10/2020 04:24	11/10/2020 09:40	11/10/2020 04:24	11/10/2020 09:40	5,27	615	3239,00	CHI
20201048058	BARRO ALTO	BA21342222	GOIANESIA S1	11/10/2020 04:24	11/10/2020 14:08	11/10/2020 04:24	11/10/2020 14:08	9,73	1	9,73	CHI

20201048059	TURVELANDIA	10015004242	RIO DOS BOIS	11/10/2020 04:24	11/10/2020 15:28	11/10/2020 04:24	11/10/2020 15:28	11,06	1	11,06	CHI
20201048062	COCALZINHO DE GOIAS	CB12028344	COCALZINHO	11/10/2020 04:26	11/10/2020 09:33	11/10/2020 04:26	11/10/2020 09:33	5,11	4	20,45	CHI
20201048704	FORMOSO	SE12033994RE	MARA ROSA	11/10/2020 04:28	11/10/2020 10:09	11/10/2020 04:28	11/10/2020 10:09	5,67	97	550,37	CHI
20201050883	GOIANIA	GN11291335	INDEPENDENCIA S2	11/10/2020 04:32	11/10/2020 17:41	11/10/2020 04:32	11/10/2020 17:41	13,15	43	565,56	CHI
20201050319	SILVANIA	SV12033468	DAIA S2	11/10/2020 04:33	11/10/2020 10:14	11/10/2020 04:33	11/10/2020 10:14	5,68	138	783,69	CHI
20201050319	GAMELEIRA DE GOIAS	SV12033468	DAIA S2	11/10/2020 04:33	11/10/2020 10:14	11/10/2020 04:33	11/10/2020 10:14	5,68	15	85,18	CHI
20201048076	SAO DOMINGOS	SD12384774	SAO DOMINGOS	11/10/2020 04:37	11/10/2020 10:02	11/10/2020 04:37	11/10/2020 10:02	5,41	84	454,04	CHI
20201048089	IPAMERI	IP12337197	IPAMERI	11/10/2020 04:43	11/10/2020 08:29	11/10/2020 04:43	11/10/2020 08:29	3,75	9	33,76	CHI
20201048089	CORUMBAIBA	IP12337197	IPAMERI	11/10/2020 04:43	11/10/2020 08:29	11/10/2020 04:43	11/10/2020 08:29	3,75	3	11,25	CHI
20201048091	TRINDADE	TR11350408	TRINDADE	11/10/2020 04:44	11/10/2020 11:12	11/10/2020 04:44	11/10/2020 11:12	6,47	77	497,87	CHI
20201048725	MORRO AGUDO DE GOIAS	MS12036227	ITAPURANGA	11/10/2020 04:49	11/10/2020 08:07	11/10/2020 04:49	11/10/2020 08:07	3,30	20	66,00	CHI
20201048725	FAINA	MS12036227	ITAPURANGA	11/10/2020 04:49	11/10/2020 08:07	11/10/2020 04:49	11/10/2020 08:07	3,30	11	36,30	CHI
20201049685	MOSSAMEDES	MD21009323	FIRMINOPOLIS S2	11/10/2020 04:53	12/10/2020 12:38	11/10/2020 04:53	12/10/2020 12:38	31,75	1	31,75	CHI
20201049766	BURITI DE GOIAS	BS11045643	FIRMINOPOLIS S2	11/10/2020 04:53	11/10/2020 23:58	11/10/2020 04:53	11/10/2020 23:58	19,08	104	1984,52	CHI
20201052228	SANCLERLANDIA	SC21005415	FIRMINOPOLIS S2	11/10/2020 04:53	11/10/2020 15:17	11/10/2020 04:53	11/10/2020 15:17	10,40	1	10,40	CHI
20201052330	SANCLERLANDIA	SC12008814	FIRMINOPOLIS S2	11/10/2020 04:53	11/10/2020 15:22	11/10/2020 04:53	11/10/2020 15:22	10,48	19	199,16	CHI
20201049014	ANAPOLIS	AN12258395	JUNDIAI S2	11/10/2020 04:53	11/10/2020 08:19	11/10/2020 04:53	11/10/2020 08:19	3,43	13	44,56	CHI
20201048110	INHUMAS	30017014	INHUMAS S2	11/10/2020 04:54	11/10/2020 14:43	11/10/2020 04:54	11/10/2020 14:43	9,80	1	9,80	CHI
20201048111	COCALZINHO DE GOIAS	ZN11215169	COCALZINHO	11/10/2020 04:54	11/10/2020 12:35	11/10/2020 04:54	11/10/2020 12:35	7,67	6	46,02	CHI
20201048114	QUIRINOPOLIS	QI12116521LD	QUIRINOPOLIS	11/10/2020 04:57	11/10/2020 08:15	11/10/2020 04:57	11/10/2020 08:15	3,30	8	26,40	CHI
20201049358	MINACU	IH12397473	MINACU	11/10/2020 05:02	11/10/2020 12:49	11/10/2020 05:02	11/10/2020 12:49	7,78	8	62,21	CHI
20201050024	GOIANIA	GN11144798	ATLANTICO S3	11/10/2020 05:03	11/10/2020 11:11	11/10/2020 05:03	11/10/2020 11:11	6,12	126	771,26	CHI
20201048559	LUZIANIA	LZ12000383	MARAJOARA	11/10/2020 05:05	11/10/2020 07:17	11/10/2020 05:05	11/10/2020 07:17	2,20	1049	2305,18	CHI
20201048435	MUTUNOPOLIS	PO12391912	PORANGATU	11/10/2020 05:05	11/10/2020 11:43	11/10/2020 05:05	11/10/2020 11:43	6,62	9	59,60	CHI
20201048435	PORANGATU	PO12391912	PORANGATU	11/10/2020 05:05	11/10/2020 11:43	11/10/2020 05:05	11/10/2020 11:43	6,62	63	417,18	CHI
20201048135	AGUAS LINDAS DE GOIAS	LA11133126	AGUAS LINDAS DE GOIAS S2	11/10/2020 05:06	11/10/2020 09:23	11/10/2020 05:06	11/10/2020 09:23	4,27	55	235,08	CHI
20201049392	CAMPESTRE DE GOIAS	GC12000278	TRINDADE	11/10/2020 05:06	11/10/2020 08:41	11/10/2020 05:06	11/10/2020 08:41	3,57	9	32,13	CHI
20201048600	CAMPINORTE	UR12074233RE	URUACU	11/10/2020 05:07	11/10/2020 09:02	11/10/2020 05:07	11/10/2020 09:02	3,90	22	85,90	CHI
20201048600	URUACU	UR12074233RE	URUACU	11/10/2020 05:07	11/10/2020 09:02	11/10/2020 05:07	11/10/2020 09:02	3,90	97	378,73	CHI
20201050441	JATAI	CC12235896	CACHOEIRA ALTA	11/10/2020 05:08	11/10/2020 10:11	11/10/2020 05:08	11/10/2020 10:11	5,04	9	45,40	CHI
20201050441	CACU	CC12235896	CACHOEIRA ALTA	11/10/2020 05:08	11/10/2020 10:11	11/10/2020 05:08	11/10/2020 10:11	5,04	16	80,72	CHI
20201048141	PALMEIRAS DE GOIAS	PL21034687	PALMEIRAS	11/10/2020 05:09	11/10/2020 19:58	11/10/2020 05:09	11/10/2020 19:58	14,82	2	29,63	CHI
20201048144	GOIANIA	GN21000125	XAVANTES	11/10/2020 05:10	11/10/2020 10:17	11/10/2020 05:10	11/10/2020 10:17	5,11	2	10,22	CHI
20201049269	GOIANIA	GN12199763	CARAJAS S1	11/10/2020 05:11	11/10/2020 08:43	11/10/2020 05:11	11/10/2020 08:43	3,53	182	642,97	CHI
20201048161	NOVO GAMA	03860224	PACAEMBU S1	11/10/2020 05:12	11/10/2020 09:13	11/10/2020 05:12	11/10/2020 07:54	2,70	2120	5719,88	CHI
20201048161	NOVO GAMA	03860224	PACAEMBU S1	11/10/2020 05:12	11/10/2020 09:13	11/10/2020 05:12	11/10/2020 08:50	3,62	4159	15059,05	CHI
20201048161	NOVO GAMA	03860224	PACAEMBU S1	11/10/2020 05:12	11/10/2020 09:13	11/10/2020 05:12	11/10/2020 09:13	4,01	2799	11227,10	CHI
20201048161	SANTO ANTONIO DO DESCOBERTO	03860224	PACAEMBU S1	11/10/2020 05:12	11/10/2020 09:13	11/10/2020 05:12	11/10/2020 09:13	4,01	30	120,33	CHI
20201048161	SANTO ANTONIO DO DESCOBERTO	NJ10406852	PACAEMBU S1	11/10/2020 05:12	11/10/2020 09:13	11/10/2020 05:12	11/10/2020 09:13	4,01	1	4,01	CHI
20201048161	NOVO GAMA	NJ10406852	PACAEMBU S1	11/10/2020 05:12	11/10/2020 09:13	11/10/2020 05:12	11/10/2020 09:13	4,01	4240	17007,11	CHI
20201048153	CAIAPONIA	930040788	CAIAPONIA	11/10/2020 05:13	11/10/2020 09:07	11/10/2020 05:13	11/10/2020 09:07	3,90	1	3,90	CHI
20201049524	OURO VERDE DE GOIAS	OV11090474	NEROPOLIS S1	11/10/2020 05:15	11/10/2020 13:35	11/10/2020 05:15	11/10/2020 13:35	8,33	127	1057,70	CHI
20201048167	VIANOPOLIS	VN21037575	VIANOPOLIS	11/10/2020 05:19	11/10/2020 08:53	11/10/2020 05:19	11/10/2020 08:53	3,56	1	3,56	CHI
20201048773	GOIANIA	GN12387059	CARAJAS S1	11/10/2020 05:20	11/10/2020 10:05	11/10/2020 05:20	11/10/2020 10:05	4,74	59	279,56	CHI
202010189161	NAZARIO	NZ12382571	ANICUNS	11/10/2020 05:20	11/10/2020 11:30	11/10/2020 05:20	11/10/2020 11:30	6,15	29	178,46	CHI
202010189161	TURVANIA	NZ12382571	ANICUNS	11/10/2020 05:20	11/10/2020 11:30	11/10/2020 05:20	11/10/2020 11:30	6,15	14	86,15	CHI
20201048520	TURVANIA	TV12005582	FIRMINOPOLIS S2	11/10/2020 05:21	11/10/2020 15:55	11/10/2020 05:21	11/10/2020 15:55	10,56	50	528,17	CHI
20201048429	ITABERAI	GS12310396	ITABERAI S1	11/10/2020 05:21	11/10/2020 08:24	11/10/2020 05:21	11/10/2020 08:24	3,04	2	6,09	CHI
20201048429	GOIAS	GS12310396	ITABERAI S1	11/10/2020 05:21	11/10/2020 08:24	11/10/2020 05:21	11/10/2020 08:24	3,04	45	136,99	CHI
20201048180	NOVO GAMA	NJ11162881	PACAEMBU S1	11/10/2020 05:23	11/10/2020 23:13	11/10/2020 05:23	11/10/2020 23:13	17,82	113	2014,19	CHI
20201048181	AGUAS LINDAS DE GOIAS	LA11101133	AGUAS LINDAS DE GOIAS S1	11/10/2020 05:24	11/10/2020 12:11	11/10/2020 05:24	11/10/2020 12:11	6,78	303	2053,83	CHI
20201048218	GOIAS	GS12310766	GOIAS	11/10/2020 05:25	11/10/2020 08:36	11/10/2020 05:25	11/10/2020 08:36	3,18	17	54,01	CHI
202010175600	GOIANIA	GN12001517	XAVANTES	11/10/2020 05:25	11/10/2020 09:02	11/10/2020 05:25	11/10/2020 09:02	3,62	750	2713,96	CHI
20201048191	VARJAO	VJ21000170	GUAPO S2	11/10/2020 05:26	11/10/2020 10:54	11/10/2020 05:26	11/10/2020 10:54	5,46	1	5,46	CHI
20201051221	ANAPOLIS	AN11077943	ANAPOLIS UNIVERSITARIO S2	11/10/2020 05:27	11/10/2020 12:10	11/10/2020 05:27	11/10/2020 12:10	6,72	74	497,03	CHI
20201051205	GOIANIA	GN11001107	GOYA S1	11/10/2020 05:27	11/10/2020 12:05	11/10/2020 05:27	11/10/2020 12:05	6,63	24	159,13	CHI
20201048196	CORUMBA DE GOIAS	CB12297741	CORUMBA	11/10/2020 05:27	11/10/2020 14:42	11/10/2020 05:27	11/10/2020 14:42	9,23	12	110,81	CHI
20201048203	DISTRITO FEDERAL	FA12383392	ITUIQUIRA	11/10/2020 05:31	11/10/2020 11:14	11/10/2020 05:31	11/10/2020 11:14	5,70	2	11,41	CHI

20201048203	FORMOSA	FA12383392	ITUIQUIRA	11/10/2020 05:31	11/10/2020 11:14	11/10/2020 05:31	11/10/2020 11:14	5,70	1	5,70	CHI
20201046029	BARRO ALTO	NQ12146903RE	URUACU	11/10/2020 05:34	11/10/2020 09:17	11/10/2020 05:34	11/10/2020 09:17	3,71	1	3,71	CHI
20201046029	NIQUELANDIA	NQ12146903RE	URUACU	11/10/2020 05:34	11/10/2020 09:17	11/10/2020 05:34	11/10/2020 09:17	3,71	98	363,96	CHI
20201048211	FAINA	GS12042217	GOIAS	11/10/2020 05:35	11/10/2020 11:04	11/10/2020 05:35	11/10/2020 11:04	5,47	75	410,54	CHI
20201048881	JAUPACI	IS12108448	IPORA	11/10/2020 05:37	11/10/2020 11:20	11/10/2020 05:37	11/10/2020 11:20	5,71	3	17,14	CHI
20201048881	ISRAELANDIA	IS12108448	IPORA	11/10/2020 05:37	11/10/2020 11:20	11/10/2020 05:37	11/10/2020 11:20	5,71	13	74,26	CHI
20201048365	PORANGATU	PO12048411	PORANGATU	11/10/2020 05:39	11/10/2020 08:00	11/10/2020 05:39	11/10/2020 08:00	2,34	17	39,84	CHI
20201048950	GOIANIA	GN11199202	GOIANIA LESTE S2	11/10/2020 05:40	11/10/2020 13:17	11/10/2020 05:40	11/10/2020 13:17	7,61	32	243,58	CHI
20201048230	PALMEIRAS DE GOIAS	PL12308411	PALMEIRAS	11/10/2020 05:40	11/10/2020 13:40	11/10/2020 05:40	11/10/2020 11:26	5,76	172	990,34	CHI
20201048230	PALMEIRAS DE GOIAS	PL12308411	PALMEIRAS	11/10/2020 05:40	11/10/2020 13:40	11/10/2020 11:29	11/10/2020 13:14	1,75	7	12,23	CHI
20201048230	PALMEIRAS DE GOIAS	PL12090322LD	PALMEIRAS	11/10/2020 05:40	11/10/2020 13:40	11/10/2020 11:29	11/10/2020 13:40	2,18	164	357,98	CHI
20201048754	SANTA TEREZINHA DE GOIAS	SG12202092	SANTA TEREZINHA	11/10/2020 05:41	11/10/2020 15:05	11/10/2020 05:41	11/10/2020 15:05	9,40	6	56,38	CHI
20201048699	SILVANIA	SV12285478	VIANOPOLIS	11/10/2020 05:41	11/10/2020 09:34	11/10/2020 05:41	11/10/2020 09:34	3,87	77	298,29	CHI
20201052182	BURITINOPOLIS	AQ12302819	IACIARA S2	11/10/2020 05:43	11/10/2020 23:28	11/10/2020 05:43	11/10/2020 23:28	17,75	5	88,73	CHI
20201052182	ALVORADA DO NORTE	AQ12302819	IACIARA S2	11/10/2020 05:43	11/10/2020 23:28	11/10/2020 05:43	11/10/2020 23:28	17,75	8	141,97	CHI
20201050382	CRIXAS	NA12057181	MOZARLANDIA	11/10/2020 05:43	11/10/2020 22:15	11/10/2020 05:43	11/10/2020 22:15	16,53	2	33,05	CHI
20201050382	NOVA CRIXAS	NA12057181	MOZARLANDIA	11/10/2020 05:43	11/10/2020 22:15	11/10/2020 05:43	11/10/2020 22:15	16,53	54	892,38	CHI
20201048242	ITABERAI	IB12124892	ITABERA S2	11/10/2020 05:44	11/10/2020 06:50	11/10/2020 05:44	11/10/2020 06:50	1,09	12	13,11	CHI
20201048244	ANAPOLIS	AN11000852	ANAPOLIS UNIVERSITARIO S2	11/10/2020 05:44	11/10/2020 08:25	11/10/2020 05:44	11/10/2020 08:25	2,67	28	74,75	CHI
20201048243	QUIRINOPOLIS	QI21116468	QUIRINOPOLIS	11/10/2020 05:44	11/10/2020 09:39	11/10/2020 05:44	11/10/2020 09:39	3,90	1	3,90	CHI
20201048246	FAINA	FC12158851	GOIAS	11/10/2020 05:45	11/10/2020 07:18	11/10/2020 05:45	11/10/2020 07:18	1,54	5	7,71	CHI
20201048253	GOIANIA	GN21028407	XAVANTES	11/10/2020 05:47	11/10/2020 09:37	11/10/2020 05:47	11/10/2020 09:37	3,83	1	3,83	CHI
20201050569	GOIANIA	GN11001194	AEROPORTO S2	11/10/2020 05:47	11/10/2020 14:10	11/10/2020 05:47	11/10/2020 14:10	8,38	76	636,67	CHI
20201048259	SANTA TEREZA DE GOIAS	O4140224	PORANGATU	11/10/2020 05:48	11/10/2020 08:35	11/10/2020 05:48	11/10/2020 08:35	2,79	4	11,15	CHI
20201048259	PORANGATU	O4140224	PORANGATU	11/10/2020 05:48	11/10/2020 08:35	11/10/2020 05:48	11/10/2020 08:35	2,79	902	2513,32	CHI
20201048259	MONTIVIDIU DO NORTE	O4140224	PORANGATU	11/10/2020 05:48	11/10/2020 08:35	11/10/2020 05:48	11/10/2020 08:35	2,79	5	13,93	CHI
20201048259	TROMBAS	O4140224	PORANGATU	11/10/2020 05:48	11/10/2020 08:35	11/10/2020 05:48	11/10/2020 08:35	2,79	156	434,68	CHI
20201048780	NAZARIO	PL12067650	ANICUNS	11/10/2020 05:50	11/10/2020 09:03	11/10/2020 05:50	11/10/2020 09:03	3,21	6	19,28	CHI
20201048780	PALMEIRAS DE GOIAS	PL12067650	ANICUNS	11/10/2020 05:50	11/10/2020 09:03	11/10/2020 05:50	11/10/2020 09:03	3,21	63	202,39	CHI
20201048271	PIRENOPOLIS	PV11057886	CORUMBA	11/10/2020 05:51	11/10/2020 08:31	11/10/2020 05:51	11/10/2020 08:31	2,66	102	271,18	CHI
20201055051	ITABERAI	AV12272362	ANICUNS	11/10/2020 05:52	12/10/2020 11:26	11/10/2020 05:52	12/10/2020 11:26	29,56	17	502,51	CHI
20201055051	ARACU	AV12272362	ANICUNS	11/10/2020 05:52	12/10/2020 11:26	11/10/2020 05:52	12/10/2020 11:26	29,56	4	118,24	CHI
20201048276	POSSE	PS12000018	IACIARA S2	11/10/2020 05:52	11/10/2020 09:20	11/10/2020 05:52	11/10/2020 09:20	3,46	286	988,53	CHI
20201049997	GOIANIA	GN12167392	CAMPINAS S2	11/10/2020 05:54	11/10/2020 10:58	11/10/2020 05:54	11/10/2020 10:58	5,06	75	379,48	CHI
20201048280	CATURAI	CK11037385	INHUMAS S1	11/10/2020 05:54	11/10/2020 09:43	11/10/2020 05:54	11/10/2020 09:43	3,80	119	452,76	CHI
20201048912	PIRENOPOLIS	PV12384899	CORUMBA	11/10/2020 05:55	11/10/2020 13:35	11/10/2020 05:55	11/10/2020 13:35	7,66	14	107,27	CHI
20201048285	CAMPO ALEGRE DE GOIAS	CM12420390	CAMPO ALEGRE DE GOIAS	11/10/2020 05:55	11/10/2020 09:46	11/10/2020 05:55	11/10/2020 09:46	3,84	7	26,87	CHI
20201050762	CAMPO ALEGRE DE GOIAS	CM21073563	CAMPO ALEGRE DE GOIAS	11/10/2020 05:55	11/10/2020 12:48	11/10/2020 05:55	11/10/2020 12:48	6,87	1	6,87	CHI
20201048317	CAMPINACU	O4690224	MARA ROSA	11/10/2020 05:56	12/10/2020 18:01	11/10/2020 05:56	11/10/2020 09:17	3,35	280	936,76	CHI
20201048317	URUACU	O4690224	MARA ROSA	11/10/2020 05:56	12/10/2020 18:01	11/10/2020 05:56	11/10/2020 09:17	3,35	260	869,84	CHI
20201048317	CAMPINORTE	O4690224	MARA ROSA	11/10/2020 05:56	12/10/2020 18:01	11/10/2020 05:56	11/10/2020 09:17	3,35	115	384,74	CHI
20201048317	CAMPINACU	O4690224	MARA ROSA	11/10/2020 05:56	12/10/2020 18:01	11/10/2020 11:20	11/10/2020 12:46	1,42	280	398,77	CHI
20201048317	CAMPINORTE	O4690224	MARA ROSA	11/10/2020 05:56	12/10/2020 18:01	11/10/2020 11:20	11/10/2020 12:46	1,42	115	163,78	CHI
20201048317	URUACU	O4690224	MARA ROSA	11/10/2020 05:56	12/10/2020 18:01	11/10/2020 11:20	11/10/2020 12:46	1,42	260	370,28	CHI
20201048317	CAMPINORTE	O4690224	MARA ROSA	11/10/2020 05:56	12/10/2020 18:01	11/10/2020 05:56	11/10/2020 16:07	10,18	10	101,82	CHI
20201048317	URUACU	O4690224	MARA ROSA	11/10/2020 05:56	12/10/2020 18:01	11/10/2020 05:56	11/10/2020 16:07	10,18	14	142,54	CHI
20201048317	CAMPINORTE	O4690224	MARA ROSA	11/10/2020 05:56	12/10/2020 18:01	11/10/2020 05:56	11/10/2020 17:20	11,39	17	193,70	CHI
20201048317	URUACU	O4690224	MARA ROSA	11/10/2020 05:56	12/10/2020 18:01	11/10/2020 18:13	11/10/2020 21:01	2,80	14	39,25	CHI
20201048317	CAMPINORTE	O4690224	MARA ROSA	11/10/2020 05:56	12/10/2020 18:01	11/10/2020 18:13	11/10/2020 21:01	2,80	11	30,84	CHI
20201048317	URUACU	O4690224	MARA ROSA	11/10/2020 05:56	12/10/2020 18:01	11/10/2020 18:13	12/10/2020 01:00	6,79	18	122,24	CHI
20201048317	CAMPINORTE	O4690224	MARA ROSA	11/10/2020 05:56	12/10/2020 18:01	11/10/2020 18:13	12/10/2020 01:00	6,79	64	434,63	CHI
20201048317	URUACU	O4690224	MARA ROSA	11/10/2020 05:56	12/10/2020 18:01	11/10/2020 18:13	12/10/2020 11:32	17,31	177	3063,58	CHI
20201048317	CAMPINORTE	O4690224	MARA ROSA	11/10/2020 05:56	12/10/2020 18:01	11/10/2020 18:13	12/10/2020 11:32	17,31	23	398,09	CHI
20201048317	URUACU	O4690224	MARA ROSA	11/10/2020 05:56	12/10/2020 18:01	11/10/2020 18:13	12/10/2020 14:47	20,57	16	329,07	CHI
20201048317	CAMPINORTE	O4690224	MARA ROSA	11/10/2020 05:56	12/10/2020 18:01	11/10/2020 18:13	12/10/2020 14:47	20,57	24	493,60	CHI
20201048317	CAMPINORTE	O4690224	MARA ROSA	11/10/2020 05:56	12/10/2020 18:01	11/10/2020 05:56	12/10/2020 17:22	35,44	28	992,19	CHI
20201048317	URUACU	O4690224	MARA ROSA	11/10/2020 05:56	12/10/2020 18:01	11/10/2020 05:56	12/10/2020 18:01	36,07	106	3823,60	CHI
20201048317	CAMPINORTE	O4690224	MARA ROSA	11/10/2020 05:56	12/10/2020 18:01	11/10/2020 05:56	12/10/2020 18:01	36,07	32	1154,29	CHI

20201050450	GOIANIA	GN12198165	GOYA S1	11/10/2020 05:57	11/10/2020 10:59	11/10/2020 05:57	11/10/2020 10:59	5,03	189	949,78	CHI
20201052258	TURVANIA	TV12005573	FIRMINOPOLIS S2	11/10/2020 05:58	11/10/2020 16:00	11/10/2020 05:58	11/10/2020 16:00	10,02	54	541,29	CHI
20201052258	NAZARIO	TV12005573	FIRMINOPOLIS S2	11/10/2020 05:58	11/10/2020 16:00	11/10/2020 05:58	11/10/2020 16:00	10,02	6	60,14	CHI
20201052258	PALMEIRAS DE GOIAS	TV12005573	FIRMINOPOLIS S2	11/10/2020 05:58	11/10/2020 16:00	11/10/2020 05:58	11/10/2020 16:00	10,02	48	481,15	CHI
20201052258	PALMINOPOLIS	TV12005573	FIRMINOPOLIS S2	11/10/2020 05:58	11/10/2020 16:00	11/10/2020 05:58	11/10/2020 16:00	10,02	44	441,05	CHI
20201048298	ITAPACI	100023897	ITAPACI	11/10/2020 05:58	11/10/2020 07:48	11/10/2020 05:58	11/10/2020 07:48	1,82	1	1,82	CHI
20201048303	CAMPOS BELOS	820020552	SAO DOMINGOS	11/10/2020 05:59	11/10/2020 07:51	11/10/2020 05:59	11/10/2020 07:51	1,87	1	1,87	CHI
20201045256	PADRE BERNARDO	PB12152732	PADRE BERNARDO	11/10/2020 05:59	11/10/2020 11:03	11/10/2020 05:59	11/10/2020 11:03	5,05	14	70,75	CHI
20201049776	ITABERAI	IB11078571	ITABERAI S2	11/10/2020 05:59	11/10/2020 10:40	11/10/2020 05:59	11/10/2020 10:40	4,67	75	350,21	CHI
20201048312	TRINDADE	TR21000077	TRINDADE	11/10/2020 06:00	11/10/2020 10:47	11/10/2020 06:00	11/10/2020 10:47	4,78	1	4,78	CHI
20201048314	APARECIDA DE GOIANIA	200071749	INDEPENDENCIA S1	11/10/2020 06:00	11/10/2020 12:48	11/10/2020 06:00	11/10/2020 12:48	6,79	1	6,79	CHI
20201052443	MOSSAMEDES	MD12304601	ANICUNS	11/10/2020 06:01	11/10/2020 13:19	11/10/2020 06:01	11/10/2020 13:19	7,29	2	14,59	CHI
20201052443	ADELANDIA	MD12304601	ANICUNS	11/10/2020 06:01	11/10/2020 13:19	11/10/2020 06:01	11/10/2020 13:19	7,29	29	211,50	CHI
20201048323	FLORES DE GOIAS	FB12044974RE	IACIARA S2	11/10/2020 06:01	11/10/2020 09:57	11/10/2020 06:01	11/10/2020 09:57	3,92	245	961,15	CHI
20201048323	FORMOSA	FB12044974RE	IACIARA S2	11/10/2020 06:01	11/10/2020 09:57	11/10/2020 06:01	11/10/2020 09:57	3,92	1	3,92	CHI
20201048323	VILA BOA	FB12044974RE	IACIARA S2	11/10/2020 06:01	11/10/2020 09:57	11/10/2020 06:01	11/10/2020 09:57	3,92	4	15,69	CHI
20201050642	NIQUELANDIA	NQ12317147	NIQUELANDIA SUBTRANSMISSAO	11/10/2020 06:02	11/10/2020 11:08	11/10/2020 06:02	11/10/2020 11:08	5,10	293	1493,00	CHI
20201048312	PADRE BERNARDO	8525556	PADRE BERNARDO	11/10/2020 06:02	11/10/2020 12:54	11/10/2020 06:02	11/10/2020 12:54	6,86	2	13,72	CHI
20201050898	IVOLANDIA	IV12256504	IPORA	11/10/2020 06:02	13/10/2020 17:41	11/10/2020 06:02	13/10/2020 17:41	59,63	18	1073,41	CHI
20201048330	SAO LUIS DE MONTES BELOS	SL21390951	FIRMINOPOLIS S1	11/10/2020 06:03	12/10/2020 10:46	11/10/2020 06:03	12/10/2020 10:46	28,71	1	28,71	CHI
20201050682	ITAPIRAPUA	IU12018810	MATRINCHA	11/10/2020 06:04	11/10/2020 10:18	11/10/2020 06:04	11/10/2020 10:18	4,22	27	114,06	CHI
20201049250	ITAPIRAPUA	IU12014779	MATRINCHA	11/10/2020 06:04	12/10/2020 00:07	11/10/2020 06:04	12/10/2020 00:07	18,04	12	216,44	CHI
20201048342	ITUMBIARA	IT11273965	PARANAIBA	11/10/2020 06:05	11/10/2020 11:21	11/10/2020 06:05	11/10/2020 11:21	5,26	30	157,92	CHI
20201049321	PARAUNA	JD12008606	PALMEIRAS	11/10/2020 06:05	11/10/2020 09:17	11/10/2020 06:05	11/10/2020 09:17	3,20	6	19,18	CHI
20201049321	JANDAIA	JD12008606	PALMEIRAS	11/10/2020 06:05	11/10/2020 09:17	11/10/2020 06:05	11/10/2020 09:17	3,20	85	271,72	CHI
20201048346	RIO VERDE	QI31191871	QUIRINOPOLIS	11/10/2020 06:06	11/10/2020 10:22	11/10/2020 06:06	11/10/2020 10:22	4,27	1	4,27	CHI
20201050040	CEZARINA	CZ11144362	CEZARINA	11/10/2020 06:06	11/10/2020 16:51	11/10/2020 06:06	11/10/2020 16:51	10,75	146	1569,66	CHI
20201048959	PIRANHAS	PH12024553	ARENOPOLIS	11/10/2020 06:07	11/10/2020 08:50	11/10/2020 06:07	11/10/2020 08:50	2,71	6	16,26	CHI
20201048358	BALIZA	BM12390150	BOM JARDIM	11/10/2020 06:07	11/10/2020 07:25	11/10/2020 06:07	11/10/2020 07:25	1,29	42	54,25	CHI
20201048358	BOM JARDIM DE GOIAS	BM12390150	BOM JARDIM	11/10/2020 06:07	11/10/2020 07:25	11/10/2020 06:07	11/10/2020 07:25	1,29	9	11,63	CHI
20201048748	APARECIDA DE GOIANIA	AP11229279	REAL S2	11/10/2020 06:07	11/10/2020 08:54	11/10/2020 06:07	11/10/2020 08:54	2,77	2	5,54	CHI
20201048361	MONTE ALEGRE DE GOIAS	MA12285604	SAO DOMINGOS	11/10/2020 06:07	11/10/2020 09:17	11/10/2020 06:07	11/10/2020 09:17	3,15	2	6,30	CHI
20201048372	CRISTALINA	KR12320036	CRISTALINA S2	11/10/2020 06:09	11/10/2020 08:23	11/10/2020 06:09	11/10/2020 08:23	2,22	11	24,45	CHI
20201048373	CRIXAS	CX21342232	SERRA DO OURO	11/10/2020 06:09	11/10/2020 22:54	11/10/2020 06:09	11/10/2020 22:54	16,74	1	16,74	CHI
20201049990	SAO LUIS DE MONTES BELOS	SL12019284	SAO LUIZ DOS MONTES BELOS	11/10/2020 06:10	11/10/2020 14:09	11/10/2020 06:10	11/10/2020 14:09	7,97	56	446,44	CHI
20201049990	SANCLERLANDIA	SL12019284	SAO LUIZ DOS MONTES BELOS	11/10/2020 06:10	11/10/2020 14:09	11/10/2020 06:10	11/10/2020 14:09	7,97	28	223,22	CHI
20201050895	ALEXANIA	AX12000019LD	ALEXANIA	11/10/2020 06:11	11/10/2020 14:07	11/10/2020 06:11	11/10/2020 14:07	7,93	118	935,54	CHI
20201051508	GUARINOS	GF12237440	SANTA TEREZINHA	11/10/2020 06:12	11/10/2020 18:39	11/10/2020 06:12	11/10/2020 18:39	12,44	11	136,82	CHI
202010189162	PARAUNA	PU12336680	PARAUNA	11/10/2020 06:13	12/10/2020 04:30	11/10/2020 06:13	12/10/2020 04:30	22,27	41	913,26	CHI
20201048399	CRIXAS	CX21342314	SERRA DO OURO	11/10/2020 06:13	11/10/2020 19:16	11/10/2020 06:13	11/10/2020 19:16	13,04	1	13,04	CHI
20201049799	URUACU	CR12282384	MARA ROSA	11/10/2020 06:14	11/10/2020 21:05	11/10/2020 06:14	11/10/2020 21:05	14,85	5	74,25	CHI
20201049799	CAMPINORTE	CR12282384	MARA ROSA	11/10/2020 06:14	11/10/2020 21:05	11/10/2020 06:14	11/10/2020 21:05	14,85	1	14,85	CHI
20201048972	GOIANIA	GN11001889	GOIANIA LESTE S3	11/10/2020 06:14	11/10/2020 08:13	11/10/2020 06:14	11/10/2020 08:13	1,97	82	161,86	CHI
20201050827	ABADIANIA	AA12180462	DAIA S2	11/10/2020 06:14	11/10/2020 11:10	11/10/2020 06:14	11/10/2020 11:10	4,92	5	24,60	CHI
20201049265	URUACU	UR12317135	URUACU	11/10/2020 06:15	11/10/2020 09:49	11/10/2020 06:15	11/10/2020 09:49	3,56	11	39,18	CHI
20201048416	RIO VERDE	RV12030057	MONTIVIDIU T	11/10/2020 06:15	11/10/2020 12:30	11/10/2020 06:15	11/10/2020 12:30	6,24	14	87,40	CHI
20201048417	PIRENOPOLIS	PV11388816	SAO FRANCISCO DE GOIAS	11/10/2020 06:15	11/10/2020 09:13	11/10/2020 06:15	11/10/2020 09:13	2,96	68	201,19	CHI
20201049043	FAZENDA NOVA	FN11250939	JUSSARA	11/10/2020 06:15	11/10/2020 10:45	11/10/2020 06:15	11/10/2020 10:45	4,49	49	219,98	CHI
20201049579	AGUA FRIA DE GOIAS	TL12048061	SAO JOAO D ALIANCA	11/10/2020 06:16	11/10/2020 16:19	11/10/2020 06:16	11/10/2020 16:19	10,05	56	562,77	CHI
20201048487	GUAPO	GA12024076	GUAPO S2	11/10/2020 06:16	11/10/2020 08:11	11/10/2020 06:16	11/10/2020 08:11	1,91	21	40,06	CHI
20201052750	CAMPINORTE	CR12243572	CAMPINORTE	11/10/2020 06:16	11/10/2020 21:25	11/10/2020 06:16	11/10/2020 21:25	15,14	16	242,17	CHI
20201049092	SENADOR CANEDO	SW12386812	SENADOR CANEDO	11/10/2020 06:17	11/10/2020 09:46	11/10/2020 06:17	11/10/2020 09:46	3,48	91	316,93	CHI
20201048654	VARJAO	VJ32066141	GUAPO S2	11/10/2020 06:18	11/10/2020 10:12	11/10/2020 06:18	11/10/2020 10:12	3,89	5	19,47	CHI
20201048654	GUAPO	VJ32066141	GUAPO S2	11/10/2020 06:18	11/10/2020 10:12	11/10/2020 06:18	11/10/2020 10:12	3,89	3	11,68	CHI
20201048438	APARECIDA DE GOIANIA	AP11391739	INDEPENDENCIA S2	11/10/2020 06:18	11/10/2020 09:32	11/10/2020 06:18	11/10/2020 09:32	3,23	77	248,41	CHI
20201048440	ABADIANIA	AN12319767	ANAPOLIS UNIVERSITARIO S2	11/10/2020 06:18	11/10/2020 13:37	11/10/2020 06:18	11/10/2020 13:37	7,31	9	65,75	CHI
20201048442	NOVA ROMA	ND12392238	IACIARA S2	11/10/2020 06:18	11/10/2020 09:31	11/10/2020 06:18	11/10/2020 09:31	3,20	243	778,61	CHI
20201047467	PORANGATU	O1520234	PORANGATU	11/10/2020 06:18	11/10/2020 13:30	11/10/2020 08:50	11/10/2020 08:56	0,11	7737	814,53	CHI

20201047467	PORANGATU	PO12000056	PORANGATU	11/10/2020 06:18	11/10/2020 13:30	11/10/2020 06:18	11/10/2020 13:04	6,77	134	906,55	CHI
20201047467	PORANGATU	PO12000056	PORANGATU	11/10/2020 06:18	11/10/2020 13:30	11/10/2020 06:18	11/10/2020 13:30	7,18	72	517,30	CHI
20201048453	QUIRINOPOLIS	QI31191838	QUIRINOPOLIS	11/10/2020 06:20	11/10/2020 08:52	11/10/2020 06:20	11/10/2020 08:52	2,54	1	2,54	CHI
20201049049	SAO MIGUEL DO PASSA QUATRO	BV12060450	CRISTIANOPOLIS	11/10/2020 06:20	11/10/2020 08:36	11/10/2020 06:20	11/10/2020 08:36	2,26	5	11,31	CHI
20201048460	PILAR DE GOIAS	GG12171805RE	SANTA TEREZINHA	11/10/2020 06:20	11/10/2020 13:41	11/10/2020 06:20	11/10/2020 13:41	7,34	60	440,27	CHI
20201048460	SANTA TEREZINHA DE GOIAS	GG12171805RE	SANTA TEREZINHA	11/10/2020 06:20	11/10/2020 13:41	11/10/2020 06:20	11/10/2020 13:41	7,34	46	337,54	CHI
20201048461	TRINDADE	TR21215868	GOYA S2	11/10/2020 06:21	11/10/2020 08:58	11/10/2020 06:21	11/10/2020 08:58	2,62	1	2,62	CHI
20201048462	JARAGUA	JA12247701	GOIANESIA S2	11/10/2020 06:21	11/10/2020 11:21	11/10/2020 06:21	11/10/2020 11:21	5,00	6	29,99	CHI
20201052415	CRISTALINA	KR12110413	CRISTALINA S2	11/10/2020 06:21	11/10/2020 14:41	11/10/2020 06:21	11/10/2020 14:41	8,33	6	49,97	CHI
20201049037	GUARANI DE GOIAS	PS12218767RE	IACIARA S2	11/10/2020 06:21	11/10/2020 08:12	11/10/2020 06:21	11/10/2020 08:12	1,84	102	187,99	CHI
20201049037	POSSE	PS12218767RE	IACIARA S2	11/10/2020 06:21	11/10/2020 08:12	11/10/2020 06:21	11/10/2020 08:12	1,84	1252	2307,51	CHI
20201048467	CALDAS NOVAS	CN11097375	SERRA DE CALDAS	11/10/2020 06:21	11/10/2020 08:26	11/10/2020 06:21	11/10/2020 08:26	2,07	82	169,67	CHI
20201048469	RIO VERDE	RV21123260	ACREUNA	11/10/2020 06:22	11/10/2020 17:21	11/10/2020 06:22	11/10/2020 17:21	10,98	1	10,98	CHI
20201045472	FIRMINOPOLIS	FR12061354	FIRMINOPOLIS S1	11/10/2020 06:22	11/10/2020 14:31	11/10/2020 06:22	11/10/2020 14:31	8,14	20	162,85	CHI
20201048987	NIQUELANDIA	NQ12396806	URUACU	11/10/2020 06:22	11/10/2020 11:23	11/10/2020 06:22	11/10/2020 11:23	5,00	73	365,26	CHI
20201050082	SENADOR CANEDO	SW12265643	SENADOR CANEDO	11/10/2020 06:23	11/10/2020 10:11	11/10/2020 06:23	11/10/2020 10:11	3,80	140	532,04	CHI
20201050706	APARECIDA DE GOIANIA	AP11251490	INDEPENDENCIA S1	11/10/2020 06:25	11/10/2020 10:16	11/10/2020 06:25	11/10/2020 10:16	3,84	179	686,81	CHI
20201049534	CACHOEIRA ALTA	QI12279622	QUIRINOPOLIS	11/10/2020 06:26	11/10/2020 10:00	11/10/2020 06:26	11/10/2020 10:00	3,56	14	49,89	CHI
20201050031	GOIANIA	GN12000703	REAL S2	11/10/2020 06:27	11/10/2020 17:20	11/10/2020 06:27	11/10/2020 17:03	10,59	69	730,92	CHI
20201050031	GOIANIA	GN12000703	REAL S2	11/10/2020 06:27	11/10/2020 17:20	11/10/2020 06:27	11/10/2020 17:20	10,87	1	10,87	CHI
20201048525	GOIANIA	GN12002244	GOIANIA LESTE S1	11/10/2020 06:28	11/10/2020 11:28	11/10/2020 06:28	11/10/2020 11:28	5,00	1288	6435,35	CHI
20201049473	BELA VISTA DE GOIAS	BV12402719RE	BELA VISTA S1	11/10/2020 06:28	11/10/2020 08:49	11/10/2020 06:28	11/10/2020 08:49	2,35	169	396,35	CHI
20201049379	GOIANIA	GN11162013	FERROVIARIO S3	11/10/2020 06:28	11/10/2020 09:01	11/10/2020 06:28	11/10/2020 09:01	2,54	71	180,26	CHI
20201048538	ITABERAI	IB12102567	ITABERAI S1	11/10/2020 06:29	11/10/2020 19:41	11/10/2020 06:29	11/10/2020 19:41	13,19	4	52,76	CHI
20201048538	ITAUUCU	IB12102567	ITABERAI S1	11/10/2020 06:29	11/10/2020 19:41	11/10/2020 06:29	11/10/2020 19:41	13,19	2	26,38	CHI
20201048540	SAO MIGUEL DO ARAGUAIA	SM12192361	SAO MIGUEL DO ARAGUAIA	11/10/2020 06:29	11/10/2020 12:06	11/10/2020 06:29	11/10/2020 12:06	5,60	169	946,78	CHI
20201052809	JAUPACI	JP12074031	IPORA	11/10/2020 06:30	11/10/2020 18:44	11/10/2020 06:30	11/10/2020 18:44	12,23	3	36,68	CHI
20201048551	SANTA HELENA DE GOIAS	SH21126145	ACREUNA	11/10/2020 06:30	11/10/2020 08:03	11/10/2020 06:30	11/10/2020 08:03	1,54	1	1,54	CHI
20201052476	HIDROLANDIA	HD12038564	GUAPO S2	11/10/2020 06:31	11/10/2020 15:48	11/10/2020 06:31	11/10/2020 15:48	9,28	9	83,51	CHI
20201048562	LUZIANIA	LZ12245503	MARAJOARA	11/10/2020 06:31	11/10/2020 17:30	11/10/2020 06:31	11/10/2020 17:30	10,98	1	10,98	CHI
20201049825	ISRAELANDIA	IS11042833	IPORA	11/10/2020 06:31	11/10/2020 16:58	11/10/2020 06:31	11/10/2020 16:58	10,44	49	511,70	CHI
20201048565	ALVORADA DO NORTE	AQ11180843	IACIARA S2	11/10/2020 06:31	11/10/2020 10:49	11/10/2020 06:31	11/10/2020 10:49	4,29	50	214,57	CHI
20201048570	BELA VISTA DE GOIAS	BV21349059	BELA VISTA S1	11/10/2020 06:32	11/10/2020 10:06	11/10/2020 06:32	11/10/2020 10:06	3,56	1	3,56	CHI
20201050627	ANAPOLIS	AN12384148	ANAPOLIS UNIVERSITARIO S2	11/10/2020 06:33	11/10/2020 10:11	11/10/2020 06:33	11/10/2020 10:11	3,63	7	25,43	CHI
20201048582	APARECIDA DE GOIANIA	13550950	INDEPENDENCIA S2	11/10/2020 06:33	11/10/2020 12:58	11/10/2020 06:33	11/10/2020 12:58	6,41	1	6,41	CHI
20201050280	BELA VISTA DE GOIAS	BV12242077	BELA VISTA S1	11/10/2020 06:33	11/10/2020 15:43	11/10/2020 06:33	11/10/2020 15:43	9,16	29	265,71	CHI
20201049494	INDIARA	PL12349352	PALMEIRAS	11/10/2020 06:33	11/10/2020 16:34	11/10/2020 06:33	11/10/2020 16:34	10,00	3	30,01	CHI
20201049494	PALMEIRAS DE GOIAS	PL12349352	PALMEIRAS	11/10/2020 06:33	11/10/2020 16:34	11/10/2020 06:33	11/10/2020 16:34	10,00	67	670,30	CHI
20201050485	SANTA RITA DO NOVO DESTINO	DF12194371	BARRO ALTO	11/10/2020 06:34	11/10/2020 12:58	11/10/2020 06:34	11/10/2020 12:58	6,38	32	204,28	CHI
20201050485	BARRO ALTO	DF12194371	BARRO ALTO	11/10/2020 06:34	11/10/2020 12:58	11/10/2020 06:34	11/10/2020 12:58	6,38	67	427,72	CHI
20201050085	SILVANIA	SV12171341RE	DAIA S2	11/10/2020 06:35	11/10/2020 12:03	11/10/2020 06:35	11/10/2020 12:03	5,46	25	136,39	CHI
20201050085	BELA VISTA DE GOIAS	SV12171341RE	DAIA S2	11/10/2020 06:35	11/10/2020 12:03	11/10/2020 06:35	11/10/2020 12:03	5,46	1	5,46	CHI
20201050085	CALDASINHA	SV12171341RE	DAIA S2	11/10/2020 06:35	11/10/2020 12:03	11/10/2020 06:35	11/10/2020 12:03	5,46	22	120,02	CHI
20201048604	NAZARIO	NZ21289748	ANICUNS	11/10/2020 06:35	12/10/2020 10:05	11/10/2020 06:35	12/10/2020 10:05	27,49	1	27,49	CHI
20201050882	GUAPO	GA12310250	GUAPO S1	11/10/2020 06:36	11/10/2020 11:21	11/10/2020 06:36	11/10/2020 11:21	4,75	3	14,24	CHI
20201048616	CRISTALINA	KR21110410	CRISTALINA S2	11/10/2020 06:37	11/10/2020 13:19	11/10/2020 06:37	11/10/2020 13:19	6,70	1	6,70	CHI
20201048903	FORMOSO	FO12391929	PORANGATU	11/10/2020 06:37	11/10/2020 09:10	11/10/2020 06:37	11/10/2020 09:10	2,55	11	28,00	CHI
20201049022	MUTUNOPOLIS	MU12391658	MARA ROSA	11/10/2020 06:37	11/10/2020 12:18	11/10/2020 06:37	11/10/2020 12:18	5,67	34	192,78	CHI
20201049367	APARECIDA DE GOIANIA	AP11169517	INDEPENDENCIA S2	11/10/2020 06:38	11/10/2020 14:54	11/10/2020 06:38	11/10/2020 14:54	8,27	59	487,72	CHI
20201051030	ITAIA	IM12148585	CACHOEIRA ALTA	11/10/2020 06:38	11/10/2020 15:42	11/10/2020 06:38	11/10/2020 15:42	9,06	11	99,66	CHI
20201049852	ANAPOLIS	AN11210680	JUNDIAI S1	11/10/2020 06:38	11/10/2020 10:12	11/10/2020 06:38	11/10/2020 10:12	3,55	30	106,54	CHI
20201048640	APARECIDA DE GOIANIA	14506038	INDEPENDENCIA S2	11/10/2020 06:39	11/10/2020 12:30	11/10/2020 06:39	11/10/2020 12:30	5,84	1	5,84	CHI
20201051100	SAO MIGUEL DO ARAGUAIA	SM12020044	SAO MIGUEL DO ARAGUAIA	11/10/2020 06:39	11/10/2020 12:03	11/10/2020 06:39	11/10/2020 12:03	5,39	3	16,17	CHI
20201048646	SANTA TEREZINHA DE GOIAS	SG11072141	SANTA TEREZINHA	11/10/2020 06:40	11/10/2020 11:46	11/10/2020 06:40	11/10/2020 11:46	5,10	98	499,66	CHI
20201057527	PALMEIRAS DE GOIAS	PL21147535	PALMEIRAS	11/10/2020 06:40	12/10/2020 08:30	11/10/2020 06:40	12/10/2020 08:30	25,83	1	25,83	CHI
20201052107	ITAPURANGA	HE12023237	ITAPURANGA	11/10/2020 06:40	11/10/2020 15:26	11/10/2020 06:40	11/10/2020 15:26	8,76	18	157,66	CHI
20201052107	HEITORAI	HE12023237	ITAPURANGA	11/10/2020 06:40	11/10/2020 15:26	11/10/2020 06:40	11/10/2020 15:26	8,76	41	359,10	CHI
20201050310	ANICUNS	AC12000067	ANICUNS	11/10/2020 06:40	11/10/2020 10:49	11/10/2020 06:40	11/10/2020 10:49	4,13	15	62,02	CHI

20201052080	GOIANIA	GN12333039	MEIA PONTE	11/10/2020 06:41	11/10/2020 13:05	11/10/2020 06:41	11/10/2020 13:05	6,40	1549	9913,60	CHI
20201051860	GOIANIA	GN12168544	ATLANTICO S3	11/10/2020 06:41	11/10/2020 13:10	11/10/2020 06:41	11/10/2020 13:10	6,48	132	855,65	CHI
20201049775	GOIANIA	GN11002249	REAL S2	11/10/2020 06:41	11/10/2020 09:41	11/10/2020 06:41	11/10/2020 09:41	2,99	136	406,90	CHI
20201049195	ABADIANA	AA12050405	ANAPOLIS UNIVERSITARIO S1	11/10/2020 06:42	12/10/2020 12:03	11/10/2020 06:42	12/10/2020 10:53	28,18	14	394,55	CHI
20201049195	ABADIANA	AA12050405	ANAPOLIS UNIVERSITARIO S1	11/10/2020 06:42	12/10/2020 12:03	11/10/2020 06:42	12/10/2020 12:03	29,36	1	29,36	CHI
20201049195	ABADIANA	AA12050405	ANAPOLIS UNIVERSITARIO S1	11/10/2020 06:42	12/10/2020 12:03	12/10/2020 11:47	12/10/2020 12:03	0,27	14	3,82	CHI
20201048670	SANTA RITA DO ARAGUAIA	SU11000002	SANTA RITA DO ARAGUAIA	11/10/2020 06:42	11/10/2020 07:46	11/10/2020 06:42	11/10/2020 07:46	1,06	61	64,76	CHI
20201048674	ITABERAI	IB12009470	ITABERAI S2	11/10/2020 06:42	11/10/2020 16:00	11/10/2020 06:42	11/10/2020 16:00	9,29	6	55,73	CHI
20201048678	ALEXANIA	AX21146844	ALEXANIA	11/10/2020 06:43	12/10/2020 08:59	11/10/2020 06:43	12/10/2020 08:59	26,26	1	26,26	CHI
20201048682	SANTA CRUZ DE GOIAS	PR12051686	PIRES DO RIO S2	11/10/2020 06:43	11/10/2020 09:41	11/10/2020 06:43	11/10/2020 09:41	2,96	23	68,14	CHI
20201048682	PIRES DO RIO	PR12051686	PIRES DO RIO S2	11/10/2020 06:43	11/10/2020 09:41	11/10/2020 06:43	11/10/2020 09:41	2,96	1	2,96	CHI
20201048684	MARA ROSA	MQ21164493	MARA ROSA	11/10/2020 06:43	11/10/2020 10:17	11/10/2020 06:43	11/10/2020 10:17	3,56	1	3,56	CHI
20201048685	CACHOEIRA ALTA	CA21116593	CACHOEIRA ALTA	11/10/2020 06:43	11/10/2020 10:49	11/10/2020 06:43	11/10/2020 10:49	4,09	1	4,09	CHI
20201050975	GOIANIA	GN12001865	CARAJAS S1	11/10/2020 06:43	11/10/2020 11:49	11/10/2020 06:43	11/10/2020 11:49	5,09	307	1563,57	CHI
20201048688	GOIANIA	GN21251885	CAMPINAS S1	11/10/2020 06:43	11/10/2020 15:08	11/10/2020 06:43	11/10/2020 15:08	8,41	1	8,41	CHI
20201051368	VALPARAISO DE GOIAS	VA11206773	PACAEMBU S2	11/10/2020 06:43	11/10/2020 12:45	11/10/2020 06:43	11/10/2020 12:45	6,02	74	445,71	CHI
20201051774	GOIANIA	10660999	AEROPORTO S2	11/10/2020 06:44	11/10/2020 13:56	11/10/2020 06:44	11/10/2020 13:56	7,20	1	7,20	CHI
20201048707	CRISTALINA	KR21206514	PAMPLONA	11/10/2020 06:44	11/10/2020 11:26	11/10/2020 06:44	11/10/2020 11:26	4,68	1	4,68	CHI
20201051162	JARAGUA	JA12382429	JARAGUA	11/10/2020 06:45	11/10/2020 11:03	11/10/2020 06:45	11/10/2020 11:03	4,29	19	81,53	CHI
20201050239	SILVANIA	SV12265337	VIANOPOLIS	11/10/2020 06:45	11/10/2020 09:57	11/10/2020 06:45	11/10/2020 09:57	3,19	11	35,10	CHI
20201048720	NOVA CRIXAS	NA12091638	NOVA CRIXAS	11/10/2020 06:46	11/10/2020 09:28	11/10/2020 06:46	11/10/2020 09:28	2,70	9	24,27	CHI
20201049712	FORMOSA	FA12071400	SAO JOAO D ALIANCA	11/10/2020 06:47	11/10/2020 15:09	11/10/2020 06:47	11/10/2020 15:09	8,36	8	66,89	CHI
20201048730	GOIANIA	13320919	CARAJAS S2	11/10/2020 06:47	11/10/2020 15:32	11/10/2020 06:47	11/10/2020 15:32	8,74	1	8,74	CHI
20201048731	PIRES DO RIO	OZ12402559	PIRES DO RIO S2	11/10/2020 06:47	11/10/2020 08:54	11/10/2020 06:47	11/10/2020 08:54	2,11	2	4,22	CHI
20201048731	ORIZONA	OZ12402559	PIRES DO RIO S2	11/10/2020 06:47	11/10/2020 08:54	11/10/2020 06:47	11/10/2020 08:54	2,11	3	6,33	CHI
20201054638	TRINDADE	TR32053106	TRINDADE	11/10/2020 06:47	11/10/2020 17:59	11/10/2020 06:47	11/10/2020 17:59	11,19	4	44,75	CHI
20201048738	GOIANIA	GN11001477	AEROPORTO S3	11/10/2020 06:47	11/10/2020 11:56	11/10/2020 06:47	11/10/2020 11:56	5,14	26	133,65	CHI
20201048742	APARECIDA DE GOIANIA	AP12058868	INDEPENDENCIA S1	11/10/2020 06:47	11/10/2020 09:51	11/10/2020 06:47	11/10/2020 09:51	3,05	4	12,20	CHI
20201048746	MARA ROSA	2260031943	MARA ROSA	11/10/2020 06:48	11/10/2020 10:19	11/10/2020 06:48	11/10/2020 10:19	3,51	1	3,51	CHI
20201048747	Terezopolis de Goias	TJ12080977	JUNDIAI S2	11/10/2020 06:48	11/10/2020 15:00	11/10/2020 06:48	11/10/2020 15:00	8,19	4	32,77	CHI
20201051190	ITAPURANGA	IK12071747	ITAPURANGA	11/10/2020 06:48	11/10/2020 18:40	11/10/2020 06:48	11/10/2020 18:40	11,85	55	651,89	CHI
20201048765	ALTO PARAISO DE GOIAS	BF12224063	SAO JOAO D ALIANCA	11/10/2020 06:50	11/10/2020 16:29	11/10/2020 06:50	11/10/2020 16:29	9,65	1	9,65	CHI
20201048775	PIRACANJUBA	PI12226339	PIRACANJUBA	11/10/2020 06:50	11/10/2020 08:07	11/10/2020 06:50	11/10/2020 08:07	1,27	62	78,79	CHI
20201048796	GOIAS	GS12220409RE	GOIAS	11/10/2020 06:52	11/10/2020 10:56	11/10/2020 06:52	11/10/2020 10:56	4,05	81	328,43	CHI
20201048796	FAINA	GS12220409RE	GOIAS	11/10/2020 06:52	11/10/2020 10:56	11/10/2020 06:52	11/10/2020 10:56	4,05	1	4,05	CHI
20201048814	CORUMBA DE GOIAS	260010777	CORUMBA	11/10/2020 06:53	12/10/2020 00:52	11/10/2020 06:53	12/10/2020 00:52	17,97	1	17,97	CHI
20201048815	GOIANIA	GN12395829	XAVANTES	11/10/2020 06:53	11/10/2020 11:51	11/10/2020 06:53	11/10/2020 11:51	4,96	146	723,55	CHI
20201048825	PARAUNA	PU21288599	MONTIVIDIU T	11/10/2020 06:54	12/10/2020 19:07	11/10/2020 06:54	12/10/2020 19:07	36,21	1	36,21	CHI
20201049348	MONTES CLAROS DE GOIAS	ME12074392	IPORA	11/10/2020 06:54	11/10/2020 11:01	11/10/2020 06:54	11/10/2020 11:01	4,11	4	16,43	CHI
20201047763	ANAPOLIS	AN12000018	ANAPOLIS UNIVERSITARIO S2	11/10/2020 06:54	11/10/2020 08:50	11/10/2020 06:54	11/10/2020 08:50	1,92	530	1018,48	CHI
20201052753	NOVA IGUAQU DE GOIAS	NH21271727	CAMPINORTE	11/10/2020 06:54	12/10/2020 15:25	11/10/2020 06:54	12/10/2020 15:25	32,50	2	65,00	CHI
20201049513	GOIANIA	GN16407251	FERROVIARIO S3	11/10/2020 06:55	11/10/2020 12:47	11/10/2020 09:50	11/10/2020 11:14	1,40	1216	1699,02	CHI
20201049513	GOIANIA	GN16407251	FERROVIARIO S3	11/10/2020 06:55	11/10/2020 12:47	11/10/2020 06:55	11/10/2020 12:47	5,87	47	275,93	CHI
20201049513	GOIANIA	GN16407251	FERROVIARIO S3	11/10/2020 06:55	11/10/2020 12:47	11/10/2020 09:50	11/10/2020 12:47	2,94	419	1233,61	CHI
20201050467	GOIANIA	GN11000023	FERROVIARIO S3	11/10/2020 06:55	11/10/2020 09:57	11/10/2020 06:55	11/10/2020 09:57	3,04	92	279,78	CHI
20201054166	ABADIA DE GOIAS	LG12335565	CARAJAS S1	11/10/2020 06:55	11/10/2020 19:44	11/10/2020 06:55	11/10/2020 19:44	12,81	6	76,87	CHI
20201048839	SILVANIA	SV12400022	VIANOPOLIS	11/10/2020 06:55	11/10/2020 11:02	11/10/2020 06:55	11/10/2020 11:02	4,11	29	119,05	CHI
20201048845	RUBIATABA	RB12114265RE	RUBIATABA	11/10/2020 06:56	11/10/2020 10:15	11/10/2020 06:56	11/10/2020 10:15	3,31	84	278,18	CHI
20201048845	NOVA AMERICA	RB12114265RE	RUBIATABA	11/10/2020 06:56	11/10/2020 10:15	11/10/2020 06:56	11/10/2020 10:15	3,31	19	62,92	CHI
20201048845	CRIXAS	RB12114265RE	RUBIATABA	11/10/2020 06:56	11/10/2020 10:15	11/10/2020 06:56	11/10/2020 10:15	3,31	1	3,31	CHI
20201050698	PALMEIRAS DE GOIAS	PL12000106	PALMEIRAS	11/10/2020 06:56	11/10/2020 14:12	11/10/2020 06:56	11/10/2020 14:12	7,26	7	50,81	CHI
20201056321	CAMPINORTE	CR21202131	CAMPINORTE	11/10/2020 06:56	12/10/2020 08:56	11/10/2020 06:56	12/10/2020 08:56	25,99	1	25,99	CHI
20201049636	FORMOSA	FA11383285	ITUIQUIRA	11/10/2020 06:56	11/10/2020 15:33	11/10/2020 06:56	11/10/2020 15:33	8,61	155	1334,12	CHI
20201048852	RUBIATABA	RB12246312	RUBIATABA	11/10/2020 06:56	11/10/2020 09:16	11/10/2020 06:56	11/10/2020 09:16	2,32	324	752,67	CHI
20201048857	DAMIANOPOLIS	DA12204799RE	IACIARA S2	11/10/2020 06:56	11/10/2020 08:30	11/10/2020 06:56	11/10/2020 08:30	1,56	343	534,22	CHI
20201054090	BRITANIA	BT21038794	BRITANIA	11/10/2020 06:56	12/10/2020 18:24	11/10/2020 06:56	12/10/2020 11:49	28,87	1	28,87	CHI
20201054090	ARUANA	AK12016455	BRITANIA	11/10/2020 06:56	12/10/2020 18:24	12/10/2020 16:44	12/10/2020 18:24	1,67	2	3,34	CHI
20201048873	BELA VISTA DE GOIAS	BV12037728	BELA VISTA S1	11/10/2020 06:57	11/10/2020 10:59	11/10/2020 06:57	11/10/2020 10:59	4,02	2	8,04	CHI

20201049526	MINACU	IH12360453	MINACU	11/10/2020 06:57	11/10/2020 22:46	11/10/2020 06:57	11/10/2020 11:13	4,26	13	55,32	CHI
20201049526	MINACU	IH12360453	MINACU	11/10/2020 06:57	11/10/2020 22:46	11/10/2020 06:57	11/10/2020 22:46	15,82	59	933,17	CHI
20201049526	CAMPINACU	IH12360453	MINACU	11/10/2020 06:57	11/10/2020 22:46	11/10/2020 06:57	11/10/2020 22:46	15,82	5	79,08	CHI
20201049526	MINACU	IH12360453	MINACU	11/10/2020 06:57	11/10/2020 22:46	11/10/2020 20:09	11/10/2020 22:46	2,62	13	34,05	CHI
20201048876	BURITINOPOLIS	MB11037521	IACIARA S2	11/10/2020 06:58	11/10/2020 09:35	11/10/2020 06:58	11/10/2020 09:35	2,62	2	5,23	CHI
20201050277	SILVANIA	SV12326176	VIANOPOLIS	11/10/2020 06:58	11/10/2020 19:20	11/10/2020 06:58	11/10/2020 19:20	12,36	8	98,87	CHI
20201048882	BELA VISTA DE GOIAS	BV11323326	BELA VISTA S1	11/10/2020 06:58	11/10/2020 13:59	11/10/2020 06:58	11/10/2020 13:59	7,01	91	637,61	CHI
20201048887	GOIANIA	GN11158112	GOYA S2	11/10/2020 06:59	11/10/2020 12:28	11/10/2020 06:59	11/10/2020 12:28	5,48	13	71,28	CHI
20201049772	GOIANIA	GN12001444	CAMPINAS S1	11/10/2020 06:59	11/10/2020 10:04	11/10/2020 06:59	11/10/2020 10:04	3,08	89	274,37	CHI
20201052745	NIQUELANDIA	NQ12398050	URUACU	11/10/2020 06:59	12/10/2020 10:08	11/10/2020 06:59	12/10/2020 10:08	27,15	4	108,60	CHI
20201048899	CACHOEIRA ALTA	CA21200778	QUIRINOPOLIS	11/10/2020 06:59	11/10/2020 13:17	11/10/2020 06:59	11/10/2020 13:17	6,29	2	12,57	CHI
20201048904	GOIANESIA	550027890	GOIANESIA S2	11/10/2020 07:00	11/10/2020 10:00	11/10/2020 07:00	11/10/2020 10:00	3,00	1	3,00	CHI
20201051320	GOIANESIA	GE12255984	GOIANESIA S2	11/10/2020 07:00	12/10/2020 13:32	11/10/2020 07:00	12/10/2020 13:32	30,53	19	580,11	CHI
20201051111	SAO JOAO D ALIANCA	JL12106845	SAO JOAO D ALIANCA	11/10/2020 07:01	12/10/2020 00:47	11/10/2020 07:01	12/10/2020 00:47	17,77	15	266,48	CHI
20201048913	GOIANIA	GN11000162	AEROPORTO S1	11/10/2020 07:01	11/10/2020 11:37	11/10/2020 07:01	11/10/2020 11:37	4,60	76	349,30	CHI
20201048920	SANTA RITA DO ARAGUAIA	SU11256927	SANTA RITA DO ARAGUAIA	11/10/2020 07:01	11/10/2020 09:49	11/10/2020 07:01	11/10/2020 09:49	2,79	1	2,79	CHI
20201049425	SAO MIGUEL DO ARAGUAIA	SM12113573	SAO MIGUEL DO ARAGUAIA	11/10/2020 07:02	11/10/2020 23:30	11/10/2020 07:02	11/10/2020 23:30	16,47	8	131,72	CHI
20201049217	NOVA ROMA	ND12394116	IACIARA S2	11/10/2020 07:02	11/10/2020 17:55	11/10/2020 07:02	11/10/2020 17:55	10,89	5	54,45	CHI
20201049217	SAO JOAO D ALIANCA	ND12394116	IACIARA S2	11/10/2020 07:02	11/10/2020 17:55	11/10/2020 07:02	11/10/2020 17:55	10,89	15	163,34	CHI
20201048924	ITAPURANGA	IK12021637	ITAPURANGA	11/10/2020 07:02	11/10/2020 10:04	11/10/2020 07:02	11/10/2020 10:04	3,03	49	148,36	CHI
20201050008	NOVA CRIXAS	CX12201615LD	SERRA DO OURO	11/10/2020 07:02	11/10/2020 19:16	11/10/2020 07:02	11/10/2020 19:16	12,23	6	73,36	CHI
20201050008	CRIXAS	CX12201615LD	SERRA DO OURO	11/10/2020 07:02	11/10/2020 19:16	11/10/2020 07:02	11/10/2020 19:16	12,23	142	1736,23	CHI
20201049503	COCALZINHO DE GOIAS	LA12313875	AGUAS LINDAS DE GOIAS S1	11/10/2020 07:03	11/10/2020 09:21	11/10/2020 07:03	11/10/2020 09:21	2,30	1	2,30	CHI
20201049503	AGUAS LINDAS DE GOIAS	LA12313875	AGUAS LINDAS DE GOIAS S1	11/10/2020 07:03	11/10/2020 09:21	11/10/2020 07:03	11/10/2020 09:21	2,30	95	218,32	CHI
20201049503	SANTO ANTONIO DO DESCOBERTO	LA12313875	AGUAS LINDAS DE GOIAS S1	11/10/2020 07:03	11/10/2020 09:21	11/10/2020 07:03	11/10/2020 09:21	2,30	18	41,36	CHI
20201050694	NOVA AMERICA	NM11047535	RUBIATABA	11/10/2020 07:03	12/10/2020 01:52	11/10/2020 07:03	12/10/2020 01:52	18,81	92	1730,34	CHI
20201048951	NAZARIO	NZ21167170	ANICUNS	11/10/2020 07:04	11/10/2020 18:52	11/10/2020 07:04	11/10/2020 18:52	11,79	1	11,79	CHI
20201052981	PALMEIRAS DE GOIAS	PL12000095	PALMEIRAS	11/10/2020 07:05	11/10/2020 15:14	11/10/2020 07:05	11/10/2020 15:14	8,15	12	97,76	CHI
20201048957	SAO LUIS DE MONTES BELOS	500041386	SAO LUIZ DOS MONTES BELOS	11/10/2020 07:05	11/10/2020 18:51	11/10/2020 07:05	11/10/2020 18:51	11,76	1	11,76	CHI
20201048961	JARAGUA	JA21140519	JARAGUA	11/10/2020 07:05	11/10/2020 11:14	11/10/2020 07:05	11/10/2020 11:14	4,14	1	4,14	CHI
20201050432	GOIANIA	GN12151339	MEIA PONTE	11/10/2020 07:06	11/10/2020 10:55	11/10/2020 07:06	11/10/2020 10:55	3,81	298	1136,37	CHI
20201050971	TROMBAS	MX12240692	PORANGATU	11/10/2020 07:06	11/10/2020 14:24	11/10/2020 07:06	11/10/2020 14:24	7,30	1	7,30	CHI
20201050971	MONTIVIDIU DO NORTE	MX12240692	PORANGATU	11/10/2020 07:06	11/10/2020 14:24	11/10/2020 07:06	11/10/2020 14:24	7,30	2	14,59	CHI
20201048968	GOIANIA	14338830	CARAJAS S2	11/10/2020 07:06	11/10/2020 21:58	11/10/2020 07:06	11/10/2020 21:58	14,86	1	14,86	CHI
20201048969	ALEXANIA	AX12114206	ALEXANIA	11/10/2020 07:06	11/10/2020 13:12	11/10/2020 07:06	11/10/2020 13:12	6,09	111	676,27	CHI
20201048970	LUZIANIA	120323412	RIO VERMELHO	11/10/2020 07:06	11/10/2020 10:44	11/10/2020 07:06	11/10/2020 10:44	3,62	1	3,62	CHI
20201048977	HIDROLANDIA	HD12365522	CEPAIGO S2	11/10/2020 07:07	11/10/2020 09:04	11/10/2020 07:07	11/10/2020 09:04	1,94	135	262,54	CHI
20201052548	GOIANIA	GN12167861	GOYA S2	11/10/2020 07:07	11/10/2020 12:09	11/10/2020 07:07	11/10/2020 12:09	5,02	111	556,91	CHI
20201048984	PIRANHAS	PH21209431	PIRANHAS	11/10/2020 07:07	11/10/2020 11:51	11/10/2020 07:07	11/10/2020 11:51	4,72	1	4,72	CHI
20201051985	CORUMBA DE GOIAS	ZN12394288	COCALZINHO	11/10/2020 07:08	11/10/2020 23:18	11/10/2020 07:08	11/10/2020 23:18	16,17	11	177,83	CHI
20201051985	COCALZINHO DE GOIAS	ZN12394288	COCALZINHO	11/10/2020 07:08	11/10/2020 23:18	11/10/2020 07:08	11/10/2020 23:18	16,17	2	32,33	CHI
20201051092	RUBIATABA	RB12194747	RUBIATABA	11/10/2020 07:08	11/10/2020 19:30	11/10/2020 07:08	11/10/2020 19:30	12,37	11	136,02	CHI
20201051703	ALTO HORIZONTE	AJ12232302	SANTA TEREZINHA	11/10/2020 07:08	12/10/2020 10:04	11/10/2020 07:08	12/10/2020 10:04	26,93	9	242,37	CHI
20201051703	CAMPOS VERDES	AJ12232302	SANTA TEREZINHA	11/10/2020 07:08	12/10/2020 10:04	11/10/2020 07:08	12/10/2020 10:04	26,93	5	134,65	CHI
20201048990	EDEIA	EA11190306	EDEIA	11/10/2020 07:08	11/10/2020 08:44	11/10/2020 07:08	11/10/2020 08:44	1,59	90	143,40	CHI
20201048993	SENADOR CANEDO	SW12094869	SENADOR CANEDO	11/10/2020 07:08	11/10/2020 09:44	11/10/2020 07:08	11/10/2020 09:44	2,59	17	44,03	CHI
20201049003	CRISTIANOPOLIS	BV13203244	CRISTIANOPOLIS	11/10/2020 07:09	11/10/2020 12:08	11/10/2020 07:09	11/10/2020 12:08	4,99	6	29,94	CHI
20201049003	BELA VISTA DE GOIAS	BV13203244	CRISTIANOPOLIS	11/10/2020 07:09	11/10/2020 12:08	11/10/2020 07:09	11/10/2020 12:08	4,99	21	104,79	CHI
20201049003	SAO MIGUEL DO PASSA QUATRO	BV13203244	CRISTIANOPOLIS	11/10/2020 07:09	11/10/2020 12:08	11/10/2020 07:09	11/10/2020 12:08	4,99	4	19,96	CHI
20201049003	BELA VISTA DE GOIAS	BV13203244	CRISTIANOPOLIS	11/10/2020 07:09	11/10/2020 12:08	11/10/2020 10:18	11/10/2020 12:08	1,84	9	16,55	CHI
20201049010	JUSSARA	JR12011813	BRITANIA	11/10/2020 07:09	11/10/2020 13:57	11/10/2020 07:09	11/10/2020 13:57	6,79	30	203,78	CHI
20201049822	OURO VERDE DE GOIAS	OV12215905	NEROPOLIS S2	11/10/2020 07:09	11/10/2020 10:54	11/10/2020 07:09	11/10/2020 10:54	3,74	2	7,48	CHI
20201049018	LUZIANIA	LZ11313604	CRISTALINA S2	11/10/2020 07:09	11/10/2020 16:51	11/10/2020 07:09	11/10/2020 16:51	9,69	3	29,06	CHI
20201049027	CACHOEIRA ALTA	CA21200031	CACHOEIRA ALTA	11/10/2020 07:10	11/10/2020 13:59	11/10/2020 07:10	11/10/2020 13:59	6,81	1	6,81	CHI
20201049843	NOVA CRIXAS	NA12086286	NOVA CRIXAS	11/10/2020 07:10	11/10/2020 10:42	11/10/2020 07:10	11/10/2020 10:42	3,52	9	31,69	CHI
20201049030	ITARUMA	IM21341865	CACHOEIRA ALTA	11/10/2020 07:10	11/10/2020 13:49	11/10/2020 07:10	11/10/2020 13:49	6,64	1	6,64	CHI
20201049031	ITABERAI	IB12398749	ITABERAI S1	11/10/2020 07:10	11/10/2020 21:17	11/10/2020 07:10	11/10/2020 21:17	14,10	1	14,10	CHI
20201049032	ITAGUARI	JA12300163	ITABERAI S1	11/10/2020 07:11	12/10/2020 07:30	11/10/2020 07:11	12/10/2020 07:30	24,32	12	291,79	CHI

20201050573	GOIANIA	GN11040696	ATLANTICO S2	11/10/2020 07:11	11/10/2020 14:59	11/10/2020 07:11	11/10/2020 14:59	7,80	169	1317,92	CHI
20201049035	NOVO GAMA	NU12261824	MARAJOARA	11/10/2020 07:11	11/10/2020 09:22	11/10/2020 07:11	11/10/2020 09:22	2,18	121	263,44	CHI
20201050719	ALVORADA DO NORTE	AQ11043474	IACIARA S2	11/10/2020 07:11	11/10/2020 11:05	11/10/2020 07:11	11/10/2020 11:05	3,89	235	914,15	CHI
20201050546	ALEXANIA	AX12000041	ALEXANIA	11/10/2020 07:11	11/10/2020 14:04	11/10/2020 07:11	11/10/2020 14:04	6,87	89	611,16	CHI
20201052575	ANICUNS	AC12308546	ANICUNS	11/10/2020 07:12	11/10/2020 19:02	11/10/2020 07:12	11/10/2020 19:02	11,83	13	153,78	CHI
20201053286	SAO MIGUEL DO ARAGUAIA	SM12253876	SAO MIGUEL DO ARAGUAIA	11/10/2020 07:12	12/10/2020 17:32	11/10/2020 07:12	12/10/2020 17:32	34,33	3	102,98	CHI
20201051198	APARECIDA DE GOIANIA	AP11004908	INDEPENDENCIA S2	11/10/2020 07:13	11/10/2020 11:47	11/10/2020 07:13	11/10/2020 11:47	4,56	87	396,31	CHI
20201049066	FORMOSA	PI12122031	PLANALTINA	11/10/2020 07:14	11/10/2020 10:01	11/10/2020 07:14	11/10/2020 10:01	2,78	3	8,35	CHI
20201050885	CAMPINORTE	CR11000026	CAMPINORTE	11/10/2020 07:14	11/10/2020 12:40	11/10/2020 07:14	11/10/2020 12:40	5,44	92	500,79	CHI
20201049899	OURO VERDE DE GOIAS	OV12312024	NEROPOLIS S1	11/10/2020 07:14	11/10/2020 12:01	11/10/2020 07:14	11/10/2020 12:01	4,78	10	47,80	CHI
20201051451	FAINA	FC12147796	GOIAS	11/10/2020 07:15	11/10/2020 11:29	11/10/2020 07:15	11/10/2020 11:29	4,23	6	25,38	CHI
20201049083	CROMINIA	CQ12037354	ROCHEDO	11/10/2020 07:15	11/10/2020 09:22	11/10/2020 07:15	11/10/2020 09:22	2,11	1	2,11	CHI
20201049087	QUIRINOPOLIS	QI12326802	QUIRINOPOLIS	11/10/2020 07:15	11/10/2020 11:48	11/10/2020 07:15	11/10/2020 11:48	4,53	25	113,34	CHI
20201054610	TRINDADE	TR12323750	TRINDADE	11/10/2020 07:16	11/10/2020 16:58	11/10/2020 07:16	11/10/2020 16:58	9,69	2	19,38	CHI
20201052073	PORANGATU	PO12349236	MARA ROSA	11/10/2020 07:16	11/10/2020 23:22	11/10/2020 07:16	11/10/2020 23:22	16,09	7	112,64	CHI
20201049999	APARECIDA DE GOIANIA	AP11075390	INDEPENDENCIA S2	11/10/2020 07:16	11/10/2020 09:35	11/10/2020 07:16	11/10/2020 09:35	2,31	77	178,06	CHI
20201050216	MONTES CLAROS DE GOIAS	JR12121207	BRITANIA	11/10/2020 07:16	12/10/2020 10:43	11/10/2020 07:16	12/10/2020 10:43	27,43	51	1399,14	CHI
20201050216	JUSSARA	JR12121207	BRITANIA	11/10/2020 07:16	12/10/2020 10:43	11/10/2020 07:16	12/10/2020 10:43	27,43	72	1975,26	CHI
20201049101	POSSE	PS12217661	IACIARA S2	11/10/2020 07:17	11/10/2020 09:40	11/10/2020 07:17	11/10/2020 09:40	2,38	45	107,20	CHI
20201049170	JANDAIA	JD12003211	PALMEIRAS	11/10/2020 07:17	11/10/2020 08:13	11/10/2020 07:17	11/10/2020 08:13	0,93	10	9,32	CHI
20201049170	PALMEIRAS DE GOIAS	JD12003211	PALMEIRAS	11/10/2020 07:17	11/10/2020 08:13	11/10/2020 07:17	11/10/2020 08:13	0,93	4	3,73	CHI
20201049170	PALMINOPOLIS	JD12003211	PALMEIRAS	11/10/2020 07:17	11/10/2020 08:13	11/10/2020 07:17	11/10/2020 08:13	0,93	15	13,98	CHI
20201049521	ORIZONA	OZ12404724	PIRES DO RIO S1	11/10/2020 07:17	11/10/2020 09:47	11/10/2020 07:17	11/10/2020 09:47	2,50	24	59,90	CHI
20201049110	SAO JOAO DA PARAUNA	PU12361902	PARAUNA	11/10/2020 07:17	12/10/2020 02:08	11/10/2020 07:17	12/10/2020 02:08	18,84	16	301,49	CHI
20201049124	JATAI	JT12000151	JATAI S3	11/10/2020 07:18	11/10/2020 08:10	11/10/2020 07:18	11/10/2020 08:10	0,87	157	137,33	CHI
20201050243	FLORES DE GOIAS	FB12085509	FLORES DE GOIAS	11/10/2020 07:18	11/10/2020 13:06	11/10/2020 07:18	11/10/2020 13:06	5,80	8	46,38	CHI
20201049385	GOIANIA	GN11269515	CARAJAS S2	11/10/2020 07:18	11/10/2020 11:42	11/10/2020 07:18	11/10/2020 11:42	4,40	125	549,48	CHI
20201052328	BELA VISTA DE GOIAS	BV12103250	SENADOR CANEDO	11/10/2020 07:18	11/10/2020 13:25	11/10/2020 07:18	11/10/2020 13:25	6,11	18	109,98	CHI
20201052328	CALDAZINHA	BV12103250	SENADOR CANEDO	11/10/2020 07:18	11/10/2020 13:25	11/10/2020 07:18	11/10/2020 13:25	6,11	1	6,11	CHI
20201049131	BARRO ALTO	BA12157616	BARRO ALTO	11/10/2020 07:18	11/10/2020 21:30	11/10/2020 07:18	11/10/2020 21:30	14,19	5	70,96	CHI
20201049679	GOIANIA	GN11000839	GOIANIA LESTE S2	11/10/2020 07:18	11/10/2020 08:49	11/10/2020 07:18	11/10/2020 08:49	1,50	72	108,04	CHI
20201050480	GOIANIA	SW12356900	SENADOR CANEDO	11/10/2020 07:19	11/10/2020 12:02	11/10/2020 07:19	11/10/2020 12:02	4,71	176	828,91	CHI
20201049147	MINACU	IH21236247	MINACU	11/10/2020 07:19	12/10/2020 16:24	11/10/2020 07:19	12/10/2020 16:24	33,07	1	33,07	CHI
20201052729	FLORES DE GOIAS	AQ12322731	IACIARA S2	11/10/2020 07:19	11/10/2020 20:37	11/10/2020 07:19	11/10/2020 14:57	7,63	7	53,38	CHI
20201052729	ALVORADA DO NORTE	AQ12322731	IACIARA S2	11/10/2020 07:19	11/10/2020 20:37	11/10/2020 07:19	11/10/2020 14:57	7,63	2	15,25	CHI
20201052729	ALVORADA DO NORTE	AQ12322731	IACIARA S2	11/10/2020 07:19	11/10/2020 20:37	11/10/2020 12:10	11/10/2020 14:57	2,79	3	8,37	CHI
20201052729	FLORES DE GOIAS	AQ12322731	IACIARA S2	11/10/2020 07:19	11/10/2020 20:37	11/10/2020 07:19	11/10/2020 19:52	12,54	7	87,77	CHI
20201052729	ALVORADA DO NORTE	FB13044952	IACIARA S2	11/10/2020 07:19	11/10/2020 20:37	11/10/2020 12:10	11/10/2020 19:52	7,70	51	392,91	CHI
20201052729	FLORES DE GOIAS	FB13044952	IACIARA S2	11/10/2020 07:19	11/10/2020 20:37	11/10/2020 12:10	11/10/2020 19:52	7,70	27	208,01	CHI
20201052729	ALVORADA DO NORTE	AQ12322731	IACIARA S2	11/10/2020 07:19	11/10/2020 20:37	11/10/2020 07:19	11/10/2020 20:37	13,29	23	305,66	CHI
20201052729	ALVORADA DO NORTE	AQ12204159	IACIARA S2	11/10/2020 07:19	11/10/2020 20:37	11/10/2020 12:10	11/10/2020 20:37	8,45	1	8,45	CHI
2020101100100	JARAGUA	031604128	SAO FRANCISCO DE GOIAS	11/10/2020 07:20	11/10/2020 08:47	11/10/2020 07:20	11/10/2020 08:47	1,46	22	32,20	CHI
2020101100100	PETROLINA DE GOIAS	031604128	SAO FRANCISCO DE GOIAS	11/10/2020 07:20	11/10/2020 08:47	11/10/2020 07:20	11/10/2020 08:47	1,46	3	4,39	CHI
2020101100100	SAO FRANCISCO DE GOIAS	031604128	SAO FRANCISCO DE GOIAS	11/10/2020 07:20	11/10/2020 08:47	11/10/2020 07:20	11/10/2020 08:47	1,46	21	30,74	CHI
2020101100100	JESUPOLIS	031604128	SAO FRANCISCO DE GOIAS	11/10/2020 07:20	11/10/2020 08:47	11/10/2020 07:20	11/10/2020 08:47	1,46	796	1165,03	CHI
2020101100100	PETROLINA DE GOIAS	031604128	SAO FRANCISCO DE GOIAS	11/10/2020 07:20	11/10/2020 08:47	11/10/2020 07:20	11/10/2020 08:47	1,46	3	4,39	CHI
2020101100100	SAO FRANCISCO DE GOIAS	031604128	SAO FRANCISCO DE GOIAS	11/10/2020 07:20	11/10/2020 08:47	11/10/2020 07:20	11/10/2020 08:47	1,46	76	111,23	CHI
2020101100100	JESUPOLIS	031604128	SAO FRANCISCO DE GOIAS	11/10/2020 07:20	11/10/2020 08:47	11/10/2020 07:20	11/10/2020 08:47	1,46	155	226,86	CHI
2020101100100	SAO FRANCISCO DE GOIAS	031604128	SAO FRANCISCO DE GOIAS	11/10/2020 07:20	11/10/2020 08:47	11/10/2020 07:20	11/10/2020 08:47	1,46	2	2,93	CHI
2020101100100	PIRENOPOLIS	031604128	SAO FRANCISCO DE GOIAS	11/10/2020 07:20	11/10/2020 08:47	11/10/2020 07:20	11/10/2020 08:47	1,46	1	1,46	CHI
2020101100100	PETROLINA DE GOIAS	031604128	SAO FRANCISCO DE GOIAS	11/10/2020 07:20	11/10/2020 08:47	11/10/2020 07:20	11/10/2020 08:47	1,46	1	1,46	CHI
2020101100100	PIRENOPOLIS	031604128	SAO FRANCISCO DE GOIAS	11/10/2020 07:20	11/10/2020 08:47	11/10/2020 07:20	11/10/2020 08:47	1,46	336	491,77	CHI
2020101100100	PETROLINA DE GOIAS	031604128	SAO FRANCISCO DE GOIAS	11/10/2020 07:20	11/10/2020 08:47	11/10/2020 07:20	11/10/2020 08:47	1,46	13	19,03	CHI
2020101100100	SAO FRANCISCO DE GOIAS	031604128	SAO FRANCISCO DE GOIAS	11/10/2020 07:20	11/10/2020 08:47	11/10/2020 07:20	11/10/2020 08:47	1,46	1	1,46	CHI
2020101100100	PIRENOPOLIS	031604128	SAO FRANCISCO DE GOIAS	11/10/2020 07:20	11/10/2020 08:47	11/10/2020 07:20	11/10/2020 08:47	1,46	1138	1665,59	CHI
20201052810	JAUPACI	JP12028023	IPORA	11/10/2020 07:20	11/10/2020 22:05	11/10/2020 07:20	11/10/2020 22:05	14,74	7	103,16	CHI
20201049575	FLORES DE GOIAS	FB12204157	FLORES DE GOIAS	11/10/2020 07:21	11/10/2020 12:02	11/10/2020 07:21	11/10/2020 12:02	4,68	13	60,88	CHI
20201051223	IVOLANDIA	IV12381057	IPORA	11/10/2020 07:21	11/10/2020 11:05	11/10/2020 07:21	11/10/2020 11:05	3,73	8	29,87	CHI

20201049163	ITAPURANGA	10017137878	ITAPURANGA	11/10/2020 07:21	11/10/2020 17:29	11/10/2020 07:21	11/10/2020 17:29	10,13	1	10,13	CHI
20201049164	GOIANIA	11871714	REAL S1	11/10/2020 07:21	11/10/2020 10:18	11/10/2020 07:21	11/10/2020 10:18	2,95	1	2,95	CHI
20201049175	CABECEIRAS	CW12042593LD	ITUIQUIRA	11/10/2020 07:21	11/10/2020 09:00	11/10/2020 07:21	11/10/2020 09:00	1,64	233	381,28	CHI
20201049188	TURVANIA	TV12005545LD	FIRMINOPOLIS S2	11/10/2020 07:22	11/10/2020 13:55	11/10/2020 07:22	11/10/2020 13:55	6,54	686	4486,44	CHI
20201050792	BELA VISTA DE GOIAS	BV11045929	BELA VISTA S1	11/10/2020 07:22	11/10/2020 14:14	11/10/2020 07:22	11/10/2020 14:14	6,86	100	685,56	CHI
20201051052	DIVINOPOLIS DE GOIAS	GH12398369	SAO DOMINGOS	11/10/2020 07:22	11/10/2020 18:58	11/10/2020 07:22	11/10/2020 12:24	5,03	20	100,66	CHI
20201051052	SAO DOMINGOS	GH12398369	SAO DOMINGOS	11/10/2020 07:22	11/10/2020 18:58	11/10/2020 07:22	11/10/2020 12:24	5,03	10	50,33	CHI
20201051052	DIVINOPOLIS DE GOIAS	GH12398369	SAO DOMINGOS	11/10/2020 07:22	11/10/2020 18:58	11/10/2020 15:08	11/10/2020 16:32	1,41	20	28,16	CHI
20201051052	SAO DOMINGOS	GH12398369	SAO DOMINGOS	11/10/2020 07:22	11/10/2020 18:58	11/10/2020 15:08	11/10/2020 16:32	1,41	10	14,08	CHI
20201051052	DIVINOPOLIS DE GOIAS	GH12398369	SAO DOMINGOS	11/10/2020 07:22	11/10/2020 18:58	11/10/2020 07:22	11/10/2020 18:58	11,59	1	11,59	CHI
20201051052	SAO DOMINGOS	GH12398369	SAO DOMINGOS	11/10/2020 07:22	11/10/2020 18:58	11/10/2020 07:22	11/10/2020 18:58	11,59	9	104,33	CHI
20201051340	MORRO AGUDO DE GOIAS	RB12156050	RUBIATABA	11/10/2020 07:22	11/10/2020 10:58	11/10/2020 07:22	11/10/2020 10:58	3,58	10	35,84	CHI
20201051340	RUBIATABA	RB12156050	RUBIATABA	11/10/2020 07:22	11/10/2020 10:58	11/10/2020 07:22	11/10/2020 10:58	3,58	20	71,68	CHI
20201049734	POSSE	PS12394132	IACIARA S2	11/10/2020 07:23	11/10/2020 16:40	11/10/2020 07:23	11/10/2020 16:40	9,28	13	120,62	CHI
20201049496	SANTA BARBARA DE GOIAS	SB12233412	ANICUNS	11/10/2020 07:23	11/10/2020 10:02	11/10/2020 07:23	11/10/2020 10:02	2,64	20	52,88	CHI
20201056261	CAMPINORTE	CR121235626	CAMPINORTE	11/10/2020 07:24	12/10/2020 09:53	11/10/2020 07:24	12/10/2020 09:53	26,48	1	26,48	CHI
20201050507	PADRE BERNARDO	ZN12302505RE	COCALZINHO	11/10/2020 07:24	11/10/2020 14:44	11/10/2020 07:24	11/10/2020 14:44	7,33	1	7,33	CHI
20201050507	COCALZINHO DE GOIAS	ZN12302505RE	COCALZINHO	11/10/2020 07:24	11/10/2020 14:44	11/10/2020 07:24	11/10/2020 14:44	7,33	39	285,71	CHI
20201049218	JARAGUA	10001779255	JARAGUA	11/10/2020 07:24	11/10/2020 13:05	11/10/2020 07:24	11/10/2020 13:05	5,67	1	5,67	CHI
20201049239	FORMOSA	610320634	ITUIQUIRA	11/10/2020 07:26	12/10/2020 08:41	11/10/2020 07:26	12/10/2020 08:41	25,24	1	25,24	CHI
20201049245	ITARUMA	IM11166069	CACHOEIRA ALTA	11/10/2020 07:26	11/10/2020 10:10	11/10/2020 07:26	11/10/2020 10:10	2,72	75	204,27	CHI
20201050746	FORMOSA	FA11361420	ITUIQUIRA	11/10/2020 07:26	11/10/2020 13:18	11/10/2020 07:26	11/10/2020 13:18	5,86	76	445,13	CHI
20201049731	ITABERAI	IB12090330	ANICUNS	11/10/2020 07:27	11/10/2020 10:08	11/10/2020 07:27	11/10/2020 10:08	2,68	8	21,46	CHI
20201049257	CALDAS NOVAS	CN11354115	SERRA DE CALDAS	11/10/2020 07:27	11/10/2020 10:14	11/10/2020 07:27	11/10/2020 10:14	2,78	112	311,58	CHI
20201049440	IPORA	IR12202000	ARENOPOLIS	11/10/2020 07:27	11/10/2020 15:33	11/10/2020 07:27	11/10/2020 15:33	8,10	8	64,79	CHI
20201049262	AURILANDIA	AI21194045	FIRMINOPOLIS S2	11/10/2020 07:27	11/10/2020 16:38	11/10/2020 07:27	11/10/2020 16:38	9,17	1	9,17	CHI
20201049263	NOVO BRASIL	NB12020254	JUSSARA	11/10/2020 07:27	12/10/2020 19:24	11/10/2020 07:27	12/10/2020 19:24	35,95	24	862,71	CHI
20201049263	ITAPIRAPUA	NB12020254	JUSSARA	11/10/2020 07:27	12/10/2020 19:24	11/10/2020 07:27	12/10/2020 19:24	35,95	4	143,78	CHI
20201049264	HIDROLANDIA	HD32007352	GUAPO S2	11/10/2020 07:27	11/10/2020 11:16	11/10/2020 07:27	11/10/2020 11:16	3,81	20	76,11	CHI
20201049407	MONTIVIDIU DO NORTE	MX12203423	PORANGATU	11/10/2020 07:27	11/10/2020 12:31	11/10/2020 07:27	11/10/2020 12:31	5,05	17	85,89	CHI
20201049276	BURITI ALEGRE	BG12143977	ITUMBIARA VELHA S2	11/10/2020 07:28	11/10/2020 10:08	11/10/2020 07:28	11/10/2020 10:08	2,66	180	479,10	CHI
20201049611	GOIANIA	GN11000813	GOIANIA LESTE S1	11/10/2020 07:31	11/10/2020 09:08	11/10/2020 07:31	11/10/2020 09:08	1,62	141	227,87	CHI
20201051137	GOIANIRA	GR12272374LD	MEIA PONTE	11/10/2020 07:31	11/10/2020 12:29	11/10/2020 07:31	11/10/2020 12:29	4,96	8	39,64	CHI
20201049313	NIQUELANDIA	NQ12375602	URUACU	11/10/2020 07:31	11/10/2020 13:13	11/10/2020 07:31	11/10/2020 13:13	5,69	34	193,37	CHI
20201049316	NOVA CRIXAS	NA21078555	NOVA CRIXAS	11/10/2020 07:31	11/10/2020 15:49	11/10/2020 07:31	11/10/2020 15:49	8,28	1	8,28	CHI
20201049319	FIRMINOPOLIS	900028166	FIRMINOPOLIS S1	11/10/2020 07:32	11/10/2020 18:06	11/10/2020 07:32	11/10/2020 18:06	10,56	1	10,56	CHI
20201049322	MINACU	CR12234940	PORANGATU	11/10/2020 07:32	12/10/2020 16:04	11/10/2020 07:32	12/10/2020 16:04	32,52	8	260,18	CHI
20201050446	PETROLINA DE GOIAS	PG12033256	PETROLINA	11/10/2020 07:32	13/10/2020 22:35	11/10/2020 07:32	12/10/2020 10:45	27,21	16	435,30	CHI
20201050446	PETROLINA DE GOIAS	PG12033256	PETROLINA	11/10/2020 07:32	13/10/2020 22:35	11/10/2020 07:32	12/10/2020 18:28	34,92	6	209,52	CHI
20201050446	PETROLINA DE GOIAS	PG12033256	PETROLINA	11/10/2020 07:32	13/10/2020 22:35	11/10/2020 07:32	13/10/2020 21:20	61,79	6	370,72	CHI
20201050446	PETROLINA DE GOIAS	PG12033256	PETROLINA	11/10/2020 07:32	13/10/2020 22:35	12/10/2020 15:49	13/10/2020 21:20	29,51	5	147,53	CHI
20201050446	PETROLINA DE GOIAS	PG12033256	PETROLINA	11/10/2020 07:32	13/10/2020 22:35	13/10/2020 21:22	13/10/2020 22:05	0,72	10	7,22	CHI
20201050446	PETROLINA DE GOIAS	PG12033256	PETROLINA	11/10/2020 07:32	13/10/2020 22:35	12/10/2020 15:49	13/10/2020 22:10	30,34	1	30,34	CHI
20201050446	PETROLINA DE GOIAS	PG21116312	PETROLINA	11/10/2020 07:32	13/10/2020 22:35	13/10/2020 21:03	13/10/2020 22:12	1,15	0	0,00	CHI
20201050446	PETROLINA DE GOIAS	PG12033256	PETROLINA	11/10/2020 07:32	13/10/2020 22:35	12/10/2020 15:49	13/10/2020 22:14	30,42	2	60,84	CHI
20201050446	PETROLINA DE GOIAS	PG12033256	PETROLINA	11/10/2020 07:32	13/10/2020 22:35	12/10/2020 15:49	13/10/2020 22:18	30,48	1	30,48	CHI
20201050446	PETROLINA DE GOIAS	PG12033256	PETROLINA	11/10/2020 07:32	13/10/2020 22:35	12/10/2020 15:49	13/10/2020 22:20	30,52	1	30,52	CHI
20201050446	PETROLINA DE GOIAS	PG12033256	PETROLINA	11/10/2020 07:32	13/10/2020 22:35	12/10/2020 15:49	13/10/2020 22:25	30,59	2	61,18	CHI
20201050446	PETROLINA DE GOIAS	PG12033256	PETROLINA	11/10/2020 07:32	13/10/2020 22:35	12/10/2020 15:49	13/10/2020 22:28	30,65	2	61,29	CHI
20201050446	PETROLINA DE GOIAS	PG12033256	PETROLINA	11/10/2020 07:32	13/10/2020 22:35	12/10/2020 15:49	13/10/2020 22:32	30,71	1	30,71	CHI
20201050446	PETROLINA DE GOIAS	PG12033256	PETROLINA	11/10/2020 07:32	13/10/2020 22:35	12/10/2020 15:49	13/10/2020 22:35	30,76	1	30,76	CHI
20201052994	GOIANIRA	GR11329385	GOIANIRA	11/10/2020 07:33	11/10/2020 13:24	11/10/2020 07:33	11/10/2020 13:24	5,84	160	934,76	CHI
20201050495	GOIANIA	GN12000076	FERROVIARIO S3	11/10/2020 07:34	11/10/2020 10:47	11/10/2020 07:34	11/10/2020 10:47	3,21	96	308,48	CHI
20201049342	MUTUNOPOLIS	MU12127951	MARA ROSA	11/10/2020 07:34	11/10/2020 16:18	11/10/2020 07:34	11/10/2020 16:18	8,73	4	34,91	CHI
20201049343	SILVANIA	SV12382750	DAIA S2	11/10/2020 07:34	11/10/2020 18:02	11/10/2020 07:34	11/10/2020 18:02	10,46	2	20,92	CHI
20201049345	CACHOEIRA ALTA	CA21360675	CACHOEIRA ALTA	11/10/2020 07:34	11/10/2020 08:43	11/10/2020 07:34	11/10/2020 08:43	1,14	3	3,43	CHI
20201050245	FLORES DE GOIAS	FB12257743	FLORES DE GOIAS	11/10/2020 07:35	12/10/2020 08:55	11/10/2020 07:35	12/10/2020 08:55	25,33	8	202,67	CHI
20201049366	PIRENOPOLIS	PV21185599	COCALZINHO	11/10/2020 07:35	11/10/2020 10:59	11/10/2020 07:35	11/10/2020 10:59	3,39	2	6,78	CHI

20201050778	GOIANIA	GN11043282	CAMPINAS S3	11/10/2020 07:35	11/10/2020 11:16	11/10/2020 07:35	11/10/2020 11:16	3,67	63	231,35	CHI
20201049371	PALMEIRAS DE GOIAS	10029811382	PALMEIRAS	11/10/2020 07:35	12/10/2020 14:13	11/10/2020 07:35	12/10/2020 14:13	30,62	1	30,62	CHI
20201052085	LUZIANIA	LZ11000292	MARAJOARA	11/10/2020 07:37	11/10/2020 14:45	11/10/2020 07:37	11/10/2020 14:45	7,13	137	976,77	CHI
20201049511	GOIANIA	GN11001701	CAMPINAS S1	11/10/2020 07:37	11/10/2020 10:25	11/10/2020 07:37	11/10/2020 10:25	2,79	153	427,51	CHI
20201055154	SAO JOAO DA PARAUNA	RP12007921	PARAUNA	11/10/2020 07:37	11/10/2020 19:49	11/10/2020 07:37	11/10/2020 19:49	12,18	14	170,58	CHI
20201050276	GOIANIRA	GR12343414	GOIANIRA	11/10/2020 07:39	11/10/2020 11:35	11/10/2020 07:39	11/10/2020 11:35	3,93	209	821,49	CHI
20201050201	GOIANIA	GN12001162	AEROPORTO S1	11/10/2020 07:39	11/10/2020 10:14	11/10/2020 07:39	11/10/2020 10:14	2,58	48	123,77	CHI
20201052856	TURVANIA	AC12382573	ANICUNS	11/10/2020 07:39	11/10/2020 17:36	11/10/2020 07:39	11/10/2020 17:36	9,95	23	228,74	CHI
20201052856	ANICUNS	AC12382573	ANICUNS	11/10/2020 07:39	11/10/2020 17:36	11/10/2020 07:39	11/10/2020 17:36	9,95	1	9,95	CHI
20201052856	NAZARIO	AC12382573	ANICUNS	11/10/2020 07:39	11/10/2020 17:36	11/10/2020 07:39	11/10/2020 17:36	9,95	1	9,95	CHI
20201049413	GOIANIA	12281943	GOIANIA LESTE S2	11/10/2020 07:39	11/10/2020 12:12	11/10/2020 07:39	11/10/2020 12:12	4,54	1	4,54	CHI
20201052445	AMERICANO DO BRASIL	KB12000066	ANICUNS	11/10/2020 07:39	12/10/2020 07:06	11/10/2020 07:39	12/10/2020 07:06	23,44	6	140,62	CHI
20201050403	AGUAS LINDAS DE GOIAS	LA12412178	AGUAS LINDAS DE GOIAS S1	11/10/2020 07:39	11/10/2020 10:18	11/10/2020 07:39	11/10/2020 10:18	2,64	11	28,99	CHI
20201052054	MUTUNOPOLIS	MU12086704	MARA ROSA	11/10/2020 07:40	11/10/2020 15:14	11/10/2020 07:40	11/10/2020 15:14	7,57	4	30,27	CHI
20201044620	FORMOSA	FA10396080	ITUIQUIRA	11/10/2020 07:40	12/10/2020 09:42	11/10/2020 14:41	11/10/2020 15:56	1,24	7	8,68	CHI
20201044620	FORMOSA	FA10396080	ITUIQUIRA	11/10/2020 07:40	12/10/2020 09:42	11/10/2020 14:41	12/10/2020 04:55	14,22	157	2233,28	CHI
20201044620	DISTRITO FEDERAL	FA10396080	ITUIQUIRA	11/10/2020 07:40	12/10/2020 09:42	11/10/2020 14:41	12/10/2020 04:55	14,22	1	14,22	CHI
20201044620	CABECEIRAS	FA10396080	ITUIQUIRA	11/10/2020 07:40	12/10/2020 09:42	11/10/2020 14:41	12/10/2020 04:55	14,22	23	327,17	CHI
20201044620	FORMOSA	FA13107826	ITUIQUIRA	11/10/2020 07:40	12/10/2020 09:42	11/10/2020 14:44	12/10/2020 04:55	14,19	10	141,89	CHI
20201044620	FORMOSA	FA12302845	ITUIQUIRA	11/10/2020 07:40	12/10/2020 09:42	11/10/2020 07:40	12/10/2020 09:42	26,03	7	182,18	CHI
20201044620	CABECEIRAS	FA12302845	ITUIQUIRA	11/10/2020 07:40	12/10/2020 09:42	11/10/2020 07:40	12/10/2020 09:42	26,03	7	182,18	CHI
20201044620	FORMOSA	FA12302845	ITUIQUIRA	11/10/2020 07:40	12/10/2020 09:42	11/10/2020 11:16	12/10/2020 09:42	22,44	12	269,24	CHI
20201044620	CABECEIRAS	FA12302845	ITUIQUIRA	11/10/2020 07:40	12/10/2020 09:42	11/10/2020 11:16	12/10/2020 09:42	22,44	10	224,37	CHI
20201049428	ARENOPOLIS	PH12023602	PIRANHAS	11/10/2020 07:40	11/10/2020 11:38	11/10/2020 07:40	11/10/2020 11:38	3,95	6	23,71	CHI
20201049428	PIRANHAS	PH12023602	PIRANHAS	11/10/2020 07:40	11/10/2020 11:38	11/10/2020 07:40	11/10/2020 11:38	3,95	9	35,57	CHI
20201049429	SENADOR CANEDO	SW12391634	SENADOR CANEDO	11/10/2020 07:40	11/10/2020 09:53	11/10/2020 07:40	11/10/2020 09:53	2,20	16	35,23	CHI
20201049434	GOIANIA	GN11001554	GOIANIA LESTE S1	11/10/2020 07:41	11/10/2020 16:09	11/10/2020 07:41	11/10/2020 16:09	8,47	104	880,50	CHI
20201048257	SAO JOAO D ALIANCA	FA13361342	ITUIQUIRA	11/10/2020 07:42	11/10/2020 16:21	11/10/2020 07:42	11/10/2020 16:21	8,66	226	1956,85	CHI
20201048257	FORMOSA	FA13361342	ITUIQUIRA	11/10/2020 07:42	11/10/2020 16:21	11/10/2020 07:42	11/10/2020 16:21	8,66	582	5039,31	CHI
20201048257	VILA BOA	FA13361342	ITUIQUIRA	11/10/2020 07:42	11/10/2020 16:21	11/10/2020 07:42	11/10/2020 16:21	8,66	6	51,95	CHI
20201048257	FLORES DE GOIAS	FA13361342	ITUIQUIRA	11/10/2020 07:42	11/10/2020 16:21	11/10/2020 07:42	11/10/2020 16:21	8,66	3	25,98	CHI
20201049446	SAO MIGUEL DO ARAGUAIA	SM12013040	SAO MIGUEL DO ARAGUAIA	11/10/2020 07:42	12/10/2020 14:45	11/10/2020 07:42	12/10/2020 14:45	31,05	1	31,05	CHI
20201049450	APARECIDA DE GOIANIA	200262385	INDEPENDENCIA S1	11/10/2020 07:42	11/10/2020 11:26	11/10/2020 07:42	11/10/2020 11:26	3,73	1	3,73	CHI
20201049886	GOIANIA	GN12042924	FERROVIARIO S2	11/10/2020 07:42	11/10/2020 10:00	11/10/2020 07:42	11/10/2020 10:00	2,29	120	274,67	CHI
20201050154	FAINA	FC12147804	GOIAS	11/10/2020 07:44	11/10/2020 12:25	11/10/2020 07:44	11/10/2020 12:25	4,68	42	196,75	CHI
20201050154	GOIAS	FC12147804	GOIAS	11/10/2020 07:44	11/10/2020 12:25	11/10/2020 07:44	11/10/2020 12:25	4,68	2	9,37	CHI
20201051196	ITARUMA	IM12058060	CACHOEIRA ALTA	11/10/2020 07:44	11/10/2020 11:49	11/10/2020 07:44	11/10/2020 11:49	4,07	18	73,31	CHI
20201049484	AGUA FRIA DE GOIAS	TL12161803	SAO JOAO D ALIANCA	11/10/2020 07:45	11/10/2020 21:13	11/10/2020 07:45	11/10/2020 21:13	13,46	1	13,46	CHI
20201049944	FAZENDA NOVA	FN11019360	JUSSARA	11/10/2020 07:45	11/10/2020 18:23	11/10/2020 07:45	11/10/2020 18:23	10,63	95	1009,74	CHI
20201051362	LUZIANIA	LZ12351401RE	MARAJOARA	11/10/2020 07:45	11/10/2020 20:32	11/10/2020 07:45	11/10/2020 20:32	12,77	32	408,66	CHI
20201051157	AGUA FRIA DE GOIAS	TL12208773	SAO JOAO D ALIANCA	11/10/2020 07:46	11/10/2020 13:09	11/10/2020 07:46	11/10/2020 13:09	5,37	14	75,23	CHI
20201051157	MIMOSO DE GOIAS	TL12208773	SAO JOAO D ALIANCA	11/10/2020 07:46	11/10/2020 13:09	11/10/2020 07:46	11/10/2020 13:09	5,37	29	155,84	CHI
20201052088	JARAGUA	JA12000117	JARAGUA	11/10/2020 07:47	11/10/2020 11:50	11/10/2020 07:47	11/10/2020 11:50	4,04	2	8,07	CHI
20201053929	PETROLINA DE GOIAS	PG12015850	PETROLINA	11/10/2020 07:48	11/10/2020 15:21	11/10/2020 07:48	11/10/2020 15:21	7,55	147	1109,32	CHI
20201049515	PARAUNA	PU12380688	MONTIVIDIU T	11/10/2020 07:48	12/10/2020 17:36	11/10/2020 07:48	12/10/2020 17:36	33,79	2	67,59	CHI
20201050665	AGUA FRIA DE GOIAS	NQ12140182	SAO JOAO D ALIANCA	11/10/2020 07:49	11/10/2020 18:27	11/10/2020 07:49	11/10/2020 18:27	10,63	71	754,81	CHI
20201050665	NIQUELANDIA	NQ12140182	SAO JOAO D ALIANCA	11/10/2020 07:49	11/10/2020 18:27	11/10/2020 07:49	11/10/2020 18:27	10,63	5	53,16	CHI
20201050021	JARAGUA	JA12033436	JARAGUA	11/10/2020 07:49	11/10/2020 10:00	11/10/2020 07:49	11/10/2020 10:00	2,17	19	41,32	CHI
20201053053	GOIAS	GS12087829	ITABERAÍ S1	11/10/2020 07:49	12/10/2020 12:26	11/10/2020 07:49	12/10/2020 10:37	26,79	3	80,36	CHI
20201053053	GOIAS	GS12087829	ITABERAÍ S1	11/10/2020 07:49	12/10/2020 12:26	11/10/2020 07:49	12/10/2020 12:26	28,60	1	28,60	CHI
20201049539	GOIANIA	GN12396183	GOYA S1	11/10/2020 07:50	11/10/2020 14:52	11/10/2020 07:50	11/10/2020 14:52	7,03	63	442,96	CHI
20201051458	GOIANIA	GN11002160	FERROVIARIO S2	11/10/2020 07:50	11/10/2020 11:09	11/10/2020 07:50	11/10/2020 11:09	3,31	65	215,08	CHI
20201049544	GOIANAPOLIS	GP21077909	JUNDIAI S1	11/10/2020 07:50	11/10/2020 10:35	11/10/2020 07:50	11/10/2020 10:35	2,74	1	2,74	CHI
20201052966	APARECIDA DE GOIANIA	AP11397541	REAL S2	11/10/2020 07:51	11/10/2020 14:37	11/10/2020 07:51	11/10/2020 14:37	6,76	27	182,60	CHI
20201049552	APARECIDA DE GOIANIA	17158266	INDEPENDENCIA S2	11/10/2020 07:51	11/10/2020 12:02	11/10/2020 07:51	11/10/2020 12:02	4,18	1	4,18	CHI
20201050652	GOIANIA	TR12001815	TRINDADE	11/10/2020 07:51	11/10/2020 10:32	11/10/2020 07:51	11/10/2020 10:32	2,67	7	18,69	CHI
20201050652	TRINDADE	TR12001815	TRINDADE	11/10/2020 07:51	11/10/2020 10:32	11/10/2020 07:51	11/10/2020 10:32	2,67	2	5,34	CHI
20201051247	JARAGUA	70049476	JARAGUA	11/10/2020 07:52	11/10/2020 19:27	11/10/2020 07:52	11/10/2020 19:27	11,58	1	11,58	CHI

20201049572	NOVO GAMA	NJ11052699	PACAEMBU S1	11/10/2020 07:52	11/10/2020 11:30	11/10/2020 07:52	11/10/2020 11:30	3,64	153	556,71	CHI
20201051616	GOIAS	GS12220493LD	MATRINCHA	11/10/2020 07:52	11/10/2020 14:48	11/10/2020 07:52	11/10/2020 14:48	6,93	14	96,96	CHI
20201049587	UIRAPURU	UP21283772	SANTA TEREZINHA	11/10/2020 07:53	11/10/2020 11:31	11/10/2020 07:53	11/10/2020 11:31	3,62	1	3,62	CHI
20201049588	ABADIANIA	AA21127322	ANAPOLIS UNIVERSITARIO S1	11/10/2020 07:53	12/10/2020 19:44	11/10/2020 07:53	12/10/2020 18:58	35,08	1	35,08	CHI
20201049588	ABADIANIA	AA12348133	ANAPOLIS UNIVERSITARIO S1	11/10/2020 07:53	12/10/2020 19:44	12/10/2020 16:51	12/10/2020 19:44	2,89	15	43,33	CHI
20201049595	SENADOR CANEDO	10024933552	SENADOR CANEDO	11/10/2020 07:54	11/10/2020 11:05	11/10/2020 07:54	11/10/2020 11:05	3,18	1	3,18	CHI
20201049596	ANICUNS	AC11098894	ANICUNS	11/10/2020 07:54	11/10/2020 10:29	11/10/2020 07:54	11/10/2020 10:29	2,58	147	378,53	CHI
20201049903	ARAGOIANIA	AO12291291	GUAPO S2	11/10/2020 07:54	11/10/2020 09:44	11/10/2020 07:54	11/10/2020 09:44	1,82	48	87,25	CHI
20201049903	HIDROLANDIA	AO12291291	GUAPO S2	11/10/2020 07:54	11/10/2020 09:44	11/10/2020 07:54	11/10/2020 09:44	1,82	2	3,64	CHI
20201053158	FORMOSA	FA11000045	ITUIQUIRA	11/10/2020 07:54	11/10/2020 16:55	11/10/2020 07:54	11/10/2020 16:55	9,00	10	90,01	CHI
20201049621	JATAI	JT11036331	JATAI S3	11/10/2020 07:55	11/10/2020 09:40	11/10/2020 07:55	11/10/2020 09:40	1,74	179	311,06	CHI
20201049622	VIANOPOLIS	VN12093853	VIANOPOLIS	11/10/2020 07:55	11/10/2020 12:03	11/10/2020 07:55	11/10/2020 12:03	4,14	8	33,09	CHI
20201050342	APARECIDA DE GOIANIA	AP11157736	INDEPENDENCIA S1	11/10/2020 07:55	11/10/2020 10:01	11/10/2020 07:55	11/10/2020 10:01	2,09	62	129,29	CHI
20201049626	CACHOEIRA DOURADA	CD21000046	CACHOEIRA DOURADA	11/10/2020 07:55	11/10/2020 09:31	11/10/2020 07:55	11/10/2020 09:31	1,58	1	1,58	CHI
20201052789	ITAPIRAPUA	IU11000009	MATRINCHA	11/10/2020 07:56	11/10/2020 22:27	11/10/2020 07:56	11/10/2020 22:27	14,51	84	1219,03	CHI
20201053688	IVOLANDIA	IV12223012	IPORA	11/10/2020 07:56	11/10/2020 14:29	11/10/2020 07:56	11/10/2020 14:29	6,54	11	71,97	CHI
20201049637	DAMOLANDIA	DL11064934	INHUMAS S1	11/10/2020 07:56	11/10/2020 13:48	11/10/2020 07:56	11/10/2020 13:48	5,86	112	655,95	CHI
20201049639	APARECIDA DE GOIANIA	13786120	INDEPENDENCIA S2	11/10/2020 07:56	11/10/2020 12:56	11/10/2020 07:56	11/10/2020 12:56	4,99	1	4,99	CHI
20201051477	NAZARIO	NZ12000021	ANICUNS	11/10/2020 07:56	11/10/2020 10:57	11/10/2020 07:56	11/10/2020 10:57	3,00	2	6,01	CHI
20201051477	PALMEIRAS DE GOIAS	NZ12000021	ANICUNS	11/10/2020 07:56	11/10/2020 10:57	11/10/2020 07:56	11/10/2020 10:57	3,00	19	57,07	CHI
20201049645	ITARUMA	IM12295758	CACHOEIRA ALTA	11/10/2020 07:57	11/10/2020 11:42	11/10/2020 07:57	11/10/2020 11:42	3,74	3	11,23	CHI
20201049574	PORANGATU	PO21151762	PORANGATU	11/10/2020 07:57	11/10/2020 12:20	11/10/2020 07:57	11/10/2020 12:20	4,38	1	4,38	CHI
20201052956	CRISTALINA	KR12290773	CRISTALINA S2	11/10/2020 07:57	11/10/2020 16:34	11/10/2020 07:57	11/10/2020 16:34	8,60	5	43,01	CHI
20201052956	LUZIANIA	KR12290773	CRISTALINA S2	11/10/2020 07:57	11/10/2020 16:34	11/10/2020 07:57	11/10/2020 16:34	8,60	3	25,81	CHI
20201051571	FORMOSA	8089902	SAO JOAO D ALIANCA	11/10/2020 07:58	11/10/2020 23:50	11/10/2020 07:58	11/10/2020 23:50	15,87	187	2967,59	CHI
20201051571	FORMOSA	8089902	SAO JOAO D ALIANCA	11/10/2020 07:58	11/10/2020 23:50	11/10/2020 17:45	11/10/2020 23:50	6,07	1	6,07	CHI
20201051571	FORMOSA	8089902	SAO JOAO D ALIANCA	11/10/2020 07:58	11/10/2020 23:50	11/10/2020 21:15	11/10/2020 23:50	2,58	124	320,40	CHI
20201052635	BARRO ALTO	BA21095402	BARRO ALTO	11/10/2020 07:58	12/10/2020 15:53	11/10/2020 07:58	12/10/2020 15:53	31,91	2	63,82	CHI
20201051727	LUZIANIA	LZ12362598	VIANOPOLIS	11/10/2020 07:58	11/10/2020 17:11	11/10/2020 07:58	11/10/2020 17:11	9,21	27	248,57	CHI
20201050926	GOIANIA	GN11002414	FERROVIARIO S1	11/10/2020 07:58	11/10/2020 14:15	11/10/2020 07:58	11/10/2020 14:15	6,28	74	464,84	CHI
20201049674	CALDAS NOVAS	CN11309401	CALDAS NOVAS S2	11/10/2020 07:58	11/10/2020 10:19	11/10/2020 07:58	11/10/2020 10:19	2,34	49	114,51	CHI
20201049674	APARECIDA DE GOIANIA	10023129008	INDEPENDENCIA S2	11/10/2020 07:59	11/10/2020 18:17	11/10/2020 07:59	11/10/2020 18:17	10,30	1	10,30	CHI
20201049682	APARECIDA DE GOIANIA	10023930347	INDEPENDENCIA S2	11/10/2020 07:59	11/10/2020 16:16	11/10/2020 07:59	11/10/2020 16:16	8,27	1	8,27	CHI
20201050202	ALEXANIA	AX11101793	ALEXANIA	11/10/2020 07:59	11/10/2020 21:32	11/10/2020 07:59	11/10/2020 21:32	13,54	47	636,30	CHI
20201051485	ARENOPOLIS	AY12027366	ARENOPOLIS	11/10/2020 07:59	11/10/2020 12:04	11/10/2020 07:59	11/10/2020 12:04	4,07	4	16,27	CHI
20201051485	PIRANHAS	AY12027366	ARENOPOLIS	11/10/2020 07:59	11/10/2020 12:04	11/10/2020 07:59	11/10/2020 12:04	4,07	3	12,20	CHI
20201050823	GOIANIA	GN12051593	GOIANIA LESTE S3	11/10/2020 08:00	11/10/2020 12:52	11/10/2020 08:00	11/10/2020 12:43	4,71	47	221,28	CHI
20201050823	GOIANIA	GN21291434	GOIANIA LESTE S3	11/10/2020 08:00	11/10/2020 12:52	11/10/2020 08:00	11/10/2020 12:52	4,87	1	4,87	CHI
20201051178	ITAPURANGA	IK12311324	ITAPURANGA	11/10/2020 08:00	11/10/2020 12:56	11/10/2020 08:00	11/10/2020 12:56	4,92	6	29,54	CHI
20201049706	DIVINOPOLIS DE GOIAS	GH21170201	SAO DOMINGOS	11/10/2020 08:01	11/10/2020 14:03	11/10/2020 08:01	11/10/2020 14:03	6,03	1	6,03	CHI
20201051465	FORMOSA	FA12053601RE	ITUIQUIRA	11/10/2020 08:01	11/10/2020 12:25	11/10/2020 08:01	11/10/2020 12:25	4,39	36	158,08	CHI
20201049711	FORMOSA	FA21180826	SAO JOAO D ALIANCA	11/10/2020 08:01	12/10/2020 10:03	11/10/2020 08:01	12/10/2020 10:03	26,02	1	26,02	CHI
20201052772	GOIANIA	GN12158147	GOYA S2	11/10/2020 08:02	11/10/2020 17:19	11/10/2020 08:02	11/10/2020 17:19	9,29	145	1346,85	CHI
20201054918	FORMOSA	FA11302888	ITUIQUIRA	11/10/2020 08:02	11/10/2020 22:50	11/10/2020 08:02	11/10/2020 22:50	14,80	64	947,11	CHI
20201049722	GOIANIRA	GR21011855	NEROPOLIS S1	11/10/2020 08:02	11/10/2020 09:08	11/10/2020 08:02	11/10/2020 09:08	1,10	1	1,10	CHI
20201049724	BOM JARDIM DE GOIAS	BM12358756	BOM JARDIM	11/10/2020 08:02	11/10/2020 12:04	11/10/2020 08:02	11/10/2020 12:04	4,03	2	8,05	CHI
20201049733	APARECIDA DE GOIANIA	10012473837	INDEPENDENCIA S2	11/10/2020 08:03	11/10/2020 11:29	11/10/2020 08:03	11/10/2020 11:29	3,43	1	3,43	CHI
20201049735	MONTE ALEGRE DE GOIAS	CH12164564	SAO DOMINGOS	11/10/2020 08:03	11/10/2020 09:39	11/10/2020 08:03	11/10/2020 09:39	1,60	1	1,60	CHI
20201049735	CAMPOS BELOS	CH12164564	SAO DOMINGOS	11/10/2020 08:03	11/10/2020 09:39	11/10/2020 08:03	11/10/2020 09:39	1,60	45	71,82	CHI
20201049740	VARJAO	VJ31099612	GUAPO S2	11/10/2020 08:03	11/10/2020 12:17	11/10/2020 08:03	11/10/2020 12:17	4,22	1	4,22	CHI
20201049741	NIQUELANDIA	NQ12374749	URUACU	11/10/2020 08:03	11/10/2020 14:18	11/10/2020 08:03	11/10/2020 14:18	6,23	2	12,47	CHI
20201050383	AMERICANO DO BRASIL	AC12304494	ANICUNS	11/10/2020 08:03	11/10/2020 12:16	11/10/2020 08:03	11/10/2020 12:16	4,20	14	58,81	CHI
20201050383	ANICUNS	AC12304494	ANICUNS	11/10/2020 08:03	11/10/2020 12:16	11/10/2020 08:03	11/10/2020 12:16	4,20	1	4,20	CHI
20201051044	ORIZONA	OZ12083185	PIRES DO RIO S1	11/10/2020 08:04	11/10/2020 10:30	11/10/2020 08:04	11/10/2020 10:30	2,42	3	7,27	CHI
20201049757	BELA VISTA DE GOIAS	BV12000073	BELA VISTA S1	11/10/2020 08:04	11/10/2020 12:25	11/10/2020 08:04	11/10/2020 12:25	4,34	6	26,03	CHI
20201050637	GOIANIA	GN11003166	CAMPINAS S2	11/10/2020 08:04	11/10/2020 11:21	11/10/2020 08:04	11/10/2020 11:21	3,27	102	333,31	CHI
20201051236	ITAGUARU	IC12219948	ITABERAI S1	11/10/2020 08:05	11/10/2020 12:13	11/10/2020 08:05	11/10/2020 12:13	4,13	11	45,40	CHI
20201049777	IPORA	IR21014427	IPORA	11/10/2020 08:05	11/10/2020 17:02	11/10/2020 08:05	11/10/2020 17:02	8,95	1	8,95	CHI

20201049915	APARECIDA DE GOIANIA	AP11161103	INDEPENDENCIA S2	11/10/2020 08:06	11/10/2020 10:09	11/10/2020 08:06	11/10/2020 10:09	2,04	178	363,71	CHI
20201051754	GOIANIA	GN12023388	REAL S1	11/10/2020 08:06	11/10/2020 14:11	11/10/2020 08:06	11/10/2020 14:11	6,07	82	497,90	CHI
20201051217	ITAPIRAPUA	IU12206883	MATRINCHA	11/10/2020 08:06	11/10/2020 11:26	11/10/2020 08:06	11/10/2020 11:26	3,32	12	39,86	CHI
20201049797	BOM JARDIM DE GOIAS	BM12064233	BOM JARDIM	11/10/2020 08:06	11/10/2020 10:35	11/10/2020 08:06	11/10/2020 10:35	2,47	6	14,80	CHI
20201052886	AURILANDIA	AI12000021	FIRMINOPOLIS S2	11/10/2020 08:07	11/10/2020 16:16	11/10/2020 08:07	11/10/2020 16:16	8,15	9	73,34	CHI
20201050830	INHUMAS	IN11162061	INHUMAS S2	11/10/2020 08:07	11/10/2020 12:10	11/10/2020 08:07	11/10/2020 12:10	4,05	104	420,85	CHI
20201051248	JARAGUA	JA12278888	JARAGUA	11/10/2020 08:07	11/10/2020 22:30	11/10/2020 08:07	11/10/2020 22:30	14,38	2	28,76	CHI
20201050539	SENADOR CANEDO	SW12366009	SENADOR CANEDO	11/10/2020 08:07	11/10/2020 15:03	11/10/2020 08:07	11/10/2020 15:03	6,93	188	1302,63	CHI
20201049808	MORRINHOS	10015035865	MORRINHOS	11/10/2020 08:07	11/10/2020 09:43	11/10/2020 08:07	11/10/2020 09:43	1,59	1	1,59	CHI
20201049851	LUZIANIA	LZ12032018	RIO VERMELHO	11/10/2020 08:07	11/10/2020 23:33	11/10/2020 08:07	11/10/2020 23:33	15,42	3	46,27	CHI
20201049814	URUACU	UR11086240	URUACU	11/10/2020 08:07	11/10/2020 12:39	11/10/2020 08:07	11/10/2020 12:39	4,52	60	271,33	CHI
20201050466	URUACU	UR12213199	URUACU	11/10/2020 08:08	11/10/2020 15:33	11/10/2020 08:08	11/10/2020 15:33	7,42	107	793,55	CHI
20201050333	SAO MIGUEL DO ARAGUAIA	SM11242037	SAO MIGUEL DO ARAGUAIA	11/10/2020 08:08	11/10/2020 14:09	11/10/2020 08:08	11/10/2020 14:09	6,00	116	696,55	CHI
20201049835	SILVANIA	SV12205351	VIANOPOLIS	11/10/2020 08:08	11/10/2020 13:30	11/10/2020 08:08	11/10/2020 13:30	5,35	42	224,77	CHI
20201049842	POSSE	PS21362785	IACIARA S2	11/10/2020 08:09	11/10/2020 15:53	11/10/2020 08:09	11/10/2020 15:53	7,73	1	7,73	CHI
20201049844	INHUMAS	10003454205	INHUMAS S2	11/10/2020 08:09	11/10/2020 17:22	11/10/2020 08:09	11/10/2020 17:22	9,22	1	9,22	CHI
20201049910	APARECIDA DE GOIANIA	AP11149655	INDEPENDENCIA S2	11/10/2020 08:10	11/10/2020 10:53	11/10/2020 08:10	11/10/2020 10:53	2,70	179	484,05	CHI
20201049863	APARECIDA DE GOIANIA	10010208737	INDEPENDENCIA S2	11/10/2020 08:11	11/10/2020 11:42	11/10/2020 08:11	11/10/2020 11:42	3,52	1	3,52	CHI
20201049870	SAO DOMINGOS	8680010858	SAO DOMINGOS	11/10/2020 08:11	11/10/2020 21:23	11/10/2020 08:11	11/10/2020 21:23	13,19	1	13,19	CHI
20201049891	PLANALTINA	PI11043458	PLANALTINA	11/10/2020 08:12	11/10/2020 13:02	11/10/2020 08:12	11/10/2020 13:02	4,82	33	159,01	CHI
20201047876	APARECIDA DE GOIANIA	AP11131340	REAL S1	11/10/2020 08:13	11/10/2020 08:20	11/10/2020 08:13	11/10/2020 08:20	0,12	205	24,66	CHI
20201052707	GAMELEIRA DE GOIAS	SV12077018	DAIA S2	11/10/2020 08:13	11/10/2020 13:42	11/10/2020 08:13	11/10/2020 13:42	5,48	3	16,44	CHI
20201049906	INHUMAS	IN21132788	INHUMAS S2	11/10/2020 08:14	11/10/2020 15:44	11/10/2020 08:14	11/10/2020 15:44	7,50	2	15,00	CHI
20201049908	LEOPOLDO DE BULHOES	LB21109075	DAIA S2	11/10/2020 08:14	11/10/2020 10:15	11/10/2020 08:14	11/10/2020 10:15	2,01	1	2,01	CHI
20201049913	CALDAS NOVAS	CN21354086	SERRA DE CALDAS	11/10/2020 08:14	11/10/2020 09:14	11/10/2020 08:14	11/10/2020 09:14	0,99	2	1,99	CHI
20201049914	LEOPOLDO DE BULHOES	LB12040371	DAIA S2	11/10/2020 08:14	11/10/2020 10:27	11/10/2020 08:14	11/10/2020 10:27	2,21	6	13,25	CHI
20201049922	PIRACANJUBA	PI21111807	PIRACANJUBA	11/10/2020 08:15	11/10/2020 10:33	11/10/2020 08:15	11/10/2020 10:33	2,30	1	2,30	CHI
20201049926	ANAPOLIS	20121751	ANAPOLIS UNIVERSITARIO S2	11/10/2020 08:15	11/10/2020 15:19	11/10/2020 08:15	11/10/2020 15:19	7,06	1	7,06	CHI
20201049933	SAO JOAO DA PARAUNA	FR12395091	FIRMINOPOLIS S2	11/10/2020 08:15	11/10/2020 17:06	11/10/2020 08:15	11/10/2020 17:06	8,83	4	35,34	CHI
20201049936	SENADOR CANEDO	SW11265027	CEPAIGO S1	11/10/2020 08:16	11/10/2020 10:33	11/10/2020 08:16	11/10/2020 10:33	2,28	12	27,38	CHI
20201049937	BELA VISTA DE GOIAS	BV12011059	BELA VISTA S1	11/10/2020 08:16	11/10/2020 11:10	11/10/2020 08:16	11/10/2020 11:10	2,90	31	89,83	CHI
20201049950	GUAPO	GA12391175	GUAPO S2	11/10/2020 08:17	11/10/2020 12:37	11/10/2020 08:17	11/10/2020 12:37	4,33	7	30,32	CHI
20201049951	PIRENOPOLIS	PV12295561	CORUMBA	11/10/2020 08:17	11/10/2020 09:04	11/10/2020 08:17	11/10/2020 09:04	0,78	31	24,19	CHI
20201049951	CORUMBA DE GOIAS	PV12295561	CORUMBA	11/10/2020 08:17	11/10/2020 09:04	11/10/2020 08:17	11/10/2020 09:04	0,78	4	3,12	CHI
20201049953	ORIZONA	2060010350	PIRES DO RIO S2	11/10/2020 08:17	11/10/2020 09:44	11/10/2020 08:17	11/10/2020 09:44	1,45	1	1,45	CHI
20201049954	SAO MIGUEL DO PASSA QUATRO	1490009969	CRISTIANOPOLIS	11/10/2020 08:17	11/10/2020 11:17	11/10/2020 08:17	11/10/2020 11:17	2,99	1	2,99	CHI
20201050869	SILVANIA	SV12032728	DAIA S2	11/10/2020 08:17	11/10/2020 11:10	11/10/2020 08:17	11/10/2020 11:10	2,87	19	54,60	CHI
20201049970	SILVANIA	SV21011231	DAIA S2	11/10/2020 08:17	11/10/2020 14:27	11/10/2020 08:17	11/10/2020 14:27	6,15	1	6,15	CHI
20201049983	SILVANIA	SV21011229	DAIA S2	11/10/2020 08:17	11/10/2020 09:14	11/10/2020 08:17	11/10/2020 09:14	0,94	1	0,94	CHI
20201049959	PALMEIRAS DE GOIAS	PL21000226	PALMEIRAS	11/10/2020 08:17	12/10/2020 10:56	11/10/2020 08:17	12/10/2020 10:56	26,64	1	26,64	CHI
20201048481	GOIAS	GS10403938	GOIAS	11/10/2020 08:18	11/10/2020 18:21	11/10/2020 08:18	11/10/2020 08:22	0,08	376	29,35	CHI
20201048481	GOIAS	GS16409746	GOIAS	11/10/2020 08:18	11/10/2020 18:21	11/10/2020 08:25	11/10/2020 08:41	0,27	376	100,89	CHI
20201048481	ITAPIRAPUA	IU10395413	MATRINCHA	11/10/2020 08:18	11/10/2020 18:21	11/10/2020 08:44	11/10/2020 08:50	0,10	127	13,30	CHI
20201048481	NOVO BRASIL	IU10395413	MATRINCHA	11/10/2020 08:18	11/10/2020 18:21	11/10/2020 08:44	11/10/2020 08:50	0,10	31	3,25	CHI
20201048481	GOIAS	IU10395413	MATRINCHA	11/10/2020 08:18	11/10/2020 18:21	11/10/2020 08:44	11/10/2020 08:50	0,10	452	47,33	CHI
20201048481	GOIAS	GS10403938	GOIAS	11/10/2020 08:18	11/10/2020 18:21	11/10/2020 08:18	11/10/2020 09:40	1,37	169	230,87	CHI
20201048481	GOIAS	GS16409746	GOIAS	11/10/2020 08:18	11/10/2020 18:21	11/10/2020 08:44	11/10/2020 11:22	2,64	111	292,49	CHI
20201048481	GOIAS	GS10403938	GOIAS	11/10/2020 08:18	11/10/2020 18:21	11/10/2020 11:28	11/10/2020 11:43	0,25	169	41,87	CHI
20201048481	GOIAS	GS10403938	GOIAS	11/10/2020 08:18	11/10/2020 18:21	11/10/2020 08:18	11/10/2020 12:40	4,38	49	214,48	CHI
20201048481	GOIAS	GS10403938	GOIAS	11/10/2020 08:18	11/10/2020 18:21	11/10/2020 08:18	11/10/2020 17:51	9,56	30	286,80	CHI
20201048481	GOIAS	GS10392064	GOIAS	11/10/2020 08:18	11/10/2020 18:21	11/10/2020 08:44	11/10/2020 17:52	9,13	265	2419,52	CHI
20201048481	GOIAS	GS10403938	GOIAS	11/10/2020 08:18	11/10/2020 18:21	11/10/2020 08:18	11/10/2020 17:53	9,60	316	3032,28	CHI
20201048481	GOIAS	GS13220471	GOIAS	11/10/2020 08:18	11/10/2020 18:21	11/10/2020 18:15	11/10/2020 18:21	0,10	111	10,95	CHI
20201049973	APARECIDA DE GOIANIA	13753400	INDEPENDENCIA S1	11/10/2020 08:18	11/10/2020 19:06	11/10/2020 08:18	11/10/2020 19:06	10,79	1	10,79	CHI
20201052084	SILVANIA	SV12058432	DAIA S2	11/10/2020 08:19	11/10/2020 18:54	11/10/2020 08:19	11/10/2020 18:54	10,58	10	105,79	CHI
20201051776	PETROLINA DE GOIAS	PG12273266	PETROLINA	11/10/2020 08:19	11/10/2020 14:44	11/10/2020 08:19	11/10/2020 14:44	6,41	16	102,54	CHI
20201049987	GOIANIA	10017690	CARAJAS S2	11/10/2020 08:19	11/10/2020 19:25	11/10/2020 08:19	11/10/2020 19:25	11,09	1	11,09	CHI
20201050047	ALEXANIA	AX12248870	ALEXANIA	11/10/2020 08:19	11/10/2020 18:01	11/10/2020 08:19	11/10/2020 18:01	9,68	36	348,65	CHI

20201052864	HIDROLANDIA	HD12200115	CEPAIGO S2	11/10/2020 08:19	11/10/2020 16:50	11/10/2020 08:19	11/10/2020 16:50	8,50	9	76,51	CHI
20201049993	BOM JARDIM DE GOIAS	BM12208862	BOM JARDIM	11/10/2020 08:20	11/10/2020 10:47	11/10/2020 08:20	11/10/2020 10:47	2,44	33	80,67	CHI
20201049994	RIO VERDE	RV12260653	CABRIUVA S2	11/10/2020 08:20	11/10/2020 13:13	11/10/2020 08:20	11/10/2020 13:13	4,88	1	4,88	CHI
20201050870	PILAR DE GOIAS	GG12166527	SANTA TEREZINHA	11/10/2020 08:20	11/10/2020 15:24	11/10/2020 08:20	11/10/2020 15:24	7,06	13	91,74	CHI
20201050870	SANTA TEREZINHA DE GOIAS	GG12166527	SANTA TEREZINHA	11/10/2020 08:20	11/10/2020 15:24	11/10/2020 08:20	11/10/2020 15:24	7,06	8	56,46	CHI
20201050004	PONTALINA	PK12028541	GOIATUBA S1	11/10/2020 08:20	11/10/2020 10:21	11/10/2020 08:20	11/10/2020 10:21	2,00	5	10,00	CHI
20201050010	FORMOSA	FA21247779	ITUIQUIRA	11/10/2020 08:21	12/10/2020 10:33	11/10/2020 08:21	12/10/2020 10:33	26,19	1	26,19	CHI
20201050203	GOIANIA	GN11001162	CAMPINAS S3	11/10/2020 08:21	11/10/2020 12:14	11/10/2020 08:21	11/10/2020 12:14	3,88	79	306,30	CHI
20201050016	PETROLINA DE GOIAS	PG11129393	PETROLINA	11/10/2020 08:21	11/10/2020 16:06	11/10/2020 08:21	11/10/2020 16:06	7,74	156	1206,92	CHI
20201051689	POSSE	PS12133567RE	IACIARA S2	11/10/2020 08:21	11/10/2020 10:55	11/10/2020 08:21	11/10/2020 10:55	2,55	22	56,14	CHI
20201046804	PIRACANJUBA	BV12018394	BELA VISTA S1	11/10/2020 08:22	11/10/2020 09:20	11/10/2020 08:22	11/10/2020 09:20	0,96	33	31,66	CHI
20201046804	BELA VISTA DE GOIAS	BV12018394	BELA VISTA S1	11/10/2020 08:22	11/10/2020 09:20	11/10/2020 08:22	11/10/2020 09:20	0,96	3	2,88	CHI
20201050977	GOIANIA	GN11282006	FERROVIARIO S1	11/10/2020 08:22	11/10/2020 11:26	11/10/2020 08:22	11/10/2020 11:26	3,06	95	290,54	CHI
20201050030	SILVANIA	SV12288450	VIANOPOLIS	11/10/2020 08:22	11/10/2020 11:52	11/10/2020 08:22	11/10/2020 11:52	3,49	1	3,49	CHI
20201050032	TURVANIA	TV21215389	FIRMINOPOLIS S2	11/10/2020 08:22	11/10/2020 16:44	11/10/2020 08:22	11/10/2020 16:44	8,36	2	16,71	CHI
20201051081	GOIANIA	GN12372441	GOIANIA LESTE S2	11/10/2020 08:22	11/10/2020 12:56	11/10/2020 08:22	11/10/2020 12:56	4,56	67	305,26	CHI
20201051628	VALPARAISO DE GOIAS	VA11397444	PACAEMBU S1	11/10/2020 08:22	11/10/2020 13:24	11/10/2020 08:22	11/10/2020 13:24	5,02	340	1706,42	CHI
20201051493	SANTA TEREZA DE GOIAS	SE12352924	MARA ROSA	11/10/2020 08:23	11/10/2020 13:12	11/10/2020 08:23	11/10/2020 13:12	4,81	1	4,81	CHI
20201051493	MUTUNOPOLIS	SE12352924	MARA ROSA	11/10/2020 08:23	11/10/2020 13:12	11/10/2020 08:23	11/10/2020 13:12	4,81	6	28,88	CHI
20201050044	APARECIDA DE GOIANIA	200223574	INDEPENDENCIA S2	11/10/2020 08:23	11/10/2020 20:23	11/10/2020 08:23	11/10/2020 20:23	11,99	1	11,99	CHI
20201050054	ANAPOLIS	21263243	ANAPOLIS UNIVERSITARIO S2	11/10/2020 08:24	11/10/2020 12:32	11/10/2020 08:24	11/10/2020 12:32	4,12	1	4,12	CHI
20201050055	URUACU	640078059	URUACU	11/10/2020 08:24	11/10/2020 16:18	11/10/2020 08:24	11/10/2020 16:18	7,89	1	7,89	CHI
20201050056	PALMEIRAS DE GOIAS	PL12118508	PALMEIRAS	11/10/2020 08:24	12/10/2020 11:50	11/10/2020 08:24	12/10/2020 11:30	27,09	2	54,18	CHI
20201050056	PALMEIRAS DE GOIAS	PL12118508	PALMEIRAS	11/10/2020 08:24	12/10/2020 11:50	11/10/2020 08:24	12/10/2020 11:50	27,42	1	27,42	CHI
20201050916	HIDROLANDIA	HD12017193	PONTALINA	11/10/2020 08:25	11/10/2020 18:15	11/10/2020 08:25	11/10/2020 18:15	9,83	13	127,82	CHI
20201050828	GOIANIA	GN11001832	AEROPORTO S2	11/10/2020 08:25	11/10/2020 11:08	11/10/2020 08:25	11/10/2020 11:08	2,72	74	201,03	CHI
20201050068	GOIANIA	11312427	ATLANTICO S3	11/10/2020 08:25	11/10/2020 14:25	11/10/2020 08:25	11/10/2020 14:25	5,99	1	5,99	CHI
20201050072	SAO MIGUEL DO ARAGUAIA	SM12211095	SAO MIGUEL DO ARAGUAIA	11/10/2020 08:25	11/10/2020 12:51	11/10/2020 08:25	11/10/2020 12:51	4,42	128	565,69	CHI
20201050078	RIO VERDE	RV12000299	RIO VERDE S1	11/10/2020 08:26	11/10/2020 12:58	11/10/2020 08:26	11/10/2020 12:58	4,53	6	27,17	CHI
20201050080	SILVANIA	SV21075485	VIANOPOLIS	11/10/2020 08:26	11/10/2020 13:20	11/10/2020 08:26	11/10/2020 13:20	4,89	1	4,89	CHI
20201055865	SAO LUIS DE MONTES BELOS	500047662	SAO LUIZ DOS MONTES BELOS	11/10/2020 08:26	11/10/2020 21:12	11/10/2020 08:26	11/10/2020 21:12	12,76	1	12,76	CHI
20201050089	ARAGUAPAZ	AZ11328972	MOZARLANDIA	11/10/2020 08:26	11/10/2020 11:14	11/10/2020 08:26	11/10/2020 11:14	2,79	1	2,79	CHI
20201050094	BALIZA	BH11334486	BOM JARDIM	11/10/2020 08:27	11/10/2020 13:03	11/10/2020 08:27	11/10/2020 13:03	4,59	1	4,59	CHI
20201047506	ITAPURANGA	170030490	ITAPURANGA	11/10/2020 08:27	11/10/2020 11:40	11/10/2020 08:27	11/10/2020 11:40	3,22	1	3,22	CHI
20201050359	ALVORADA DO NORTE	AQ12168089	IACIARA S2	11/10/2020 08:27	12/10/2020 08:33	11/10/2020 08:27	12/10/2020 08:33	24,09	8	192,71	CHI
20201050098	IVOLANDIA	MO12374904	IPORA	11/10/2020 08:27	11/10/2020 15:19	11/10/2020 08:27	11/10/2020 15:19	6,86	1	6,86	CHI
20201050098	MOIPORA	MO12374904	IPORA	11/10/2020 08:27	11/10/2020 15:19	11/10/2020 08:27	11/10/2020 15:19	6,86	1	6,86	CHI
20201050104	GOIAS	GS21161690	ITABERAIS S1	11/10/2020 08:28	12/10/2020 08:13	11/10/2020 08:28	12/10/2020 08:13	23,74	2	47,49	CHI
20201050128	LUZIANIA	LZ11133208	RIO VERMELHO	11/10/2020 08:28	11/10/2020 14:49	11/10/2020 08:28	11/10/2020 14:49	6,34	30	190,17	CHI
20201050680	CORUMBA DE GOIAS	AX12095958	CORUMBA	11/10/2020 08:28	11/10/2020 15:46	11/10/2020 08:28	11/10/2020 15:46	7,29	3	21,86	CHI
20201050680	ALEXANIA	AX12095958	CORUMBA	11/10/2020 08:28	11/10/2020 15:46	11/10/2020 08:28	11/10/2020 15:46	7,29	7	51,01	CHI
20201050131	NEROPOLIS	NR21009245	NEROPOLIS S2	11/10/2020 08:28	11/10/2020 17:46	11/10/2020 08:28	11/10/2020 17:46	9,29	1	9,29	CHI
20201050133	GOIANIA	13914820	MEIA PONTE	11/10/2020 08:28	11/10/2020 17:51	11/10/2020 08:28	11/10/2020 17:51	9,37	1	9,37	CHI
20201050136	CAMPINORTE	MQ21000006	MARA ROSA	11/10/2020 08:29	12/10/2020 18:38	11/10/2020 08:29	12/10/2020 18:38	34,15	1	34,15	CHI
20201052498	CORUMBA DE GOIAS	CB12155979	CORUMBA	11/10/2020 08:29	11/10/2020 16:07	11/10/2020 08:29	11/10/2020 16:07	7,63	14	106,81	CHI
20201051623	ANICUNS	AC11000010	ANICUNS	11/10/2020 08:29	11/10/2020 17:16	11/10/2020 08:29	11/10/2020 17:16	8,78	127	1114,53	CHI
20201051073	SAO FRANCISCO DE GOIAS	SF12026053	SAO FRANCISCO DE GOIAS	11/10/2020 08:29	11/10/2020 11:23	11/10/2020 08:29	11/10/2020 11:23	2,89	10	28,91	CHI
20201050783	RIO VERDE	RV12207146	MONTIVIDIU T	11/10/2020 08:30	11/10/2020 11:29	11/10/2020 08:30	11/10/2020 11:29	2,98	3	8,93	CHI
20201050151	CATALAO	CT21192574	CATALAO S1	11/10/2020 08:30	11/10/2020 10:03	11/10/2020 08:30	11/10/2020 10:03	1,54	2	3,08	CHI
20201050278	AURILANDIA	AI12026122	FIRMINOPOLIS S2	11/10/2020 08:31	11/10/2020 15:45	11/10/2020 08:31	11/10/2020 15:45	7,23	3	21,70	CHI
20201050159	CRISTALINA	03940216	CRISTALINA S2	11/10/2020 08:31	11/10/2020 11:34	11/10/2020 08:31	11/10/2020 11:34	3,05	262	798,52	CHI
20201050164	GOIANIA	13267670	FERROVIARIO S1	11/10/2020 08:31	11/10/2020 17:38	11/10/2020 08:31	11/10/2020 17:38	9,11	1	9,11	CHI
20201050240	GUARAITA	GK12299349	ITAPURANGA	11/10/2020 08:32	11/10/2020 10:54	11/10/2020 08:32	11/10/2020 10:54	2,36	25	59,09	CHI
20201051670	GOIANIA	GN12000407	FERROVIARIO S3	11/10/2020 08:32	11/10/2020 11:43	11/10/2020 08:32	11/10/2020 11:43	3,18	23	73,10	CHI
20201054476	IVOLANDIA	IV12165764	IPORA	11/10/2020 08:32	13/10/2020 22:51	11/10/2020 08:32	13/10/2020 22:40	62,13	4	248,51	CHI
20201054476	IVOLANDIA	IV12165764	IPORA	11/10/2020 08:32	13/10/2020 22:51	11/10/2020 08:32	13/10/2020 22:51	62,31	1	62,31	CHI
20201054476	PARAUNA	IV12165764	IPORA	11/10/2020 08:32	13/10/2020 22:51	11/10/2020 08:32	13/10/2020 22:51	62,31	1	62,31	CHI
20201050178	CAMPESTRE DE GOIAS	GC12046108	TRINDADE	11/10/2020 08:32	11/10/2020 12:14	11/10/2020 08:32	11/10/2020 12:14	3,69	2	7,38	CHI

20201050183	TROMBAS	TB21318373	PORANGATU	11/10/2020 08:32	11/10/2020 21:17	11/10/2020 08:32	11/10/2020 21:17	12,74	1	12,74	CHI
20201052637	CAMPINORTE	2040017600	CAMPINORTE	11/10/2020 08:33	11/10/2020 22:45	11/10/2020 08:33	11/10/2020 22:45	14,19	1	14,19	CHI
20201052126	GOIANIA	GN12001191	ATLANTICO S1	11/10/2020 08:33	11/10/2020 15:20	11/10/2020 08:33	11/10/2020 15:20	6,77	320	2165,87	CHI
20201051082	BRAZABRANTES	BR12403717	NEROPOLIS S1	11/10/2020 08:35	11/10/2020 11:15	11/10/2020 08:35	11/10/2020 11:15	2,67	19	50,65	CHI
20201053453	JARAGUA	JA11000023	JARAGUA	11/10/2020 08:36	11/10/2020 16:11	11/10/2020 08:36	11/10/2020 16:11	7,58	31	235,08	CHI
20201050231	SENADOR CANEDO	SW11343405	SENADOR CANEDO	11/10/2020 08:36	11/10/2020 13:48	11/10/2020 08:36	11/10/2020 13:48	5,18	89	461,44	CHI
20201050235	NOVA ROMA	ND21286025	IACIARA S2	11/10/2020 08:37	11/10/2020 10:38	11/10/2020 08:37	11/10/2020 10:38	2,01	1	2,01	CHI
20201050257	PALMEIRAS DE GOIAS	PL21346637	PALMEIRAS	11/10/2020 08:37	11/10/2020 17:23	11/10/2020 08:37	11/10/2020 17:23	8,75	1	8,75	CHI
20201050259	PALMEIRAS DE GOIAS	PL12022069	PALMEIRAS	11/10/2020 08:38	11/10/2020 15:47	11/10/2020 08:38	11/10/2020 15:47	7,14	2	14,29	CHI
20201051076	BURITINOPOLIS	BQ12149627	IACIARA S2	11/10/2020 08:38	11/10/2020 12:12	11/10/2020 08:38	11/10/2020 12:12	3,55	120	426,47	CHI
20201050268	ITUMBIARA	BJ21039588	BOM JESUS DE GOIAS	11/10/2020 08:39	11/10/2020 12:06	11/10/2020 08:39	11/10/2020 12:06	3,45	1	3,45	CHI
20201050269	FAINA	FC21236896	GOIAS	11/10/2020 08:39	12/10/2020 11:45	11/10/2020 08:39	12/10/2020 11:45	27,10	1	27,10	CHI
20201050270	GOIANESIA	GE12000033	GOIANESIA S1	11/10/2020 08:39	11/10/2020 19:55	11/10/2020 08:39	11/10/2020 19:55	11,26	1	11,26	CHI
20201050271	GOIANIA	10012753414	REAL S1	11/10/2020 08:39	11/10/2020 11:14	11/10/2020 08:39	11/10/2020 11:14	2,58	1	2,58	CHI
20201050273	MIMOSO DE GOIAS	MJ12165657	PADRE BERNARDO	11/10/2020 08:39	11/10/2020 14:49	11/10/2020 08:39	11/10/2020 14:49	6,16	31	191,00	CHI
20201051490	IVOLANDIA	IV12037918	IPORA	11/10/2020 08:39	11/10/2020 14:50	11/10/2020 08:39	11/10/2020 14:50	6,18	11	67,96	CHI
20201050281	GOIANIA	12717204	GOIANIA LESTE S1	11/10/2020 08:40	11/10/2020 13:50	11/10/2020 08:40	11/10/2020 13:50	5,16	1	5,16	CHI
20201050853	PALMEIRAS DE GOIAS	PL12000164	PALMEIRAS	11/10/2020 08:40	11/10/2020 13:40	11/10/2020 08:40	11/10/2020 13:40	4,99	5	24,95	CHI
20201050508	GOIANIA	GN11002462	GOIANIA LESTE S1	11/10/2020 08:40	11/10/2020 11:40	11/10/2020 08:40	11/10/2020 11:40	2,99	104	310,79	CHI
20201052272	SAO MIGUEL DO ARAGUAIA	SM12143671	SAO MIGUEL DO ARAGUAIA	11/10/2020 08:41	11/10/2020 13:34	11/10/2020 08:41	11/10/2020 13:34	4,88	275	1342,53	CHI
20201050296	QUIRINOPOLIS	QI12091059	QUIRINOPOLIS	11/10/2020 08:41	11/10/2020 09:48	11/10/2020 08:41	11/10/2020 09:48	1,11	4	4,44	CHI
20201050303	CRISTALINA	KR21180404	CRISTALINA S2	11/10/2020 08:41	11/10/2020 12:40	11/10/2020 08:41	11/10/2020 12:40	3,97	1	3,97	CHI
20201050305	GOIANIA	11372333	CAMPINAS S2	11/10/2020 08:41	11/10/2020 17:00	11/10/2020 08:41	11/10/2020 17:00	8,30	1	8,30	CHI
20201050306	ITAPURANGA	IK21064442	ITAPURANGA	11/10/2020 08:41	11/10/2020 15:59	11/10/2020 08:41	11/10/2020 15:59	7,29	1	7,29	CHI
20201051492	GOIANIA	GN11173029	CARAJAS S1	11/10/2020 08:42	11/10/2020 13:07	11/10/2020 08:42	11/10/2020 13:07	4,41	71	313,25	CHI
20201050320	NEROPOLIS	160079743	NEROPOLIS S2	11/10/2020 08:42	11/10/2020 14:09	11/10/2020 08:42	11/10/2020 14:09	5,44	1	5,44	CHI
20201046234	MONTIVIDU DO NORTE	MX12270942	PORANGATU	11/10/2020 08:42	11/10/2020 13:04	11/10/2020 08:42	11/10/2020 13:04	4,36	51	222,13	CHI
20201053081	SAO LUIS DE MONTES BELOS	SL11259147	SAO LUIZ DOS MONTES BELOS	11/10/2020 08:44	11/10/2020 17:28	11/10/2020 08:44	11/10/2020 17:28	8,73	42	366,77	CHI
20201050347	ALVORADA DO NORTE	AQ12160975	IACIARA S2	11/10/2020 08:44	11/10/2020 11:34	11/10/2020 08:44	11/10/2020 11:34	2,83	17	48,12	CHI
20201050348	ITARUMA	IM21099179	CACHOEIRA ALTA	11/10/2020 08:44	11/10/2020 10:28	11/10/2020 08:44	11/10/2020 10:28	1,73	1	1,73	CHI
20201050812	GOIANIA	GN12000438	GOIANIA LESTE S1	11/10/2020 08:44	11/10/2020 10:30	11/10/2020 08:44	11/10/2020 10:30	1,76	777	1368,82	CHI
20201050356	GOIATUBA	GT21190836	GOIATUBA S2	11/10/2020 08:44	11/10/2020 09:57	11/10/2020 08:44	11/10/2020 09:57	1,21	1	1,21	CHI
20201050357	RIO VERDE	RV12123331	RIO VERDE S1	11/10/2020 08:44	11/10/2020 11:08	11/10/2020 08:44	11/10/2020 11:08	2,39	41	98,15	CHI
20201050373	VALPARAISO DE GOIAS	2860042757	MARAJOARA	11/10/2020 08:45	11/10/2020 18:54	11/10/2020 08:45	11/10/2020 18:54	10,14	1	10,14	CHI
20201050754	GOIANIA	GN11001483	CAMPINAS S1	11/10/2020 08:46	11/10/2020 13:18	11/10/2020 11:17	11/10/2020 12:44	1,45	101	146,31	CHI
20201050754	GOIANIA	GN12001247	CAMPINAS S1	11/10/2020 08:46	11/10/2020 13:18	11/10/2020 08:46	11/10/2020 13:18	4,53	131	593,39	CHI
20201050394	BELA VISTA DE GOIAS	240060362	BELA VISTA S1	11/10/2020 08:46	11/10/2020 17:00	11/10/2020 08:46	11/10/2020 17:00	8,22	1	8,22	CHI
20201054774	FAZENDA NOVA	FN12082334	IPORA	11/10/2020 08:47	12/10/2020 13:19	11/10/2020 08:47	12/10/2020 13:19	28,53	11	313,85	CHI
20201054774	ISRAELANDIA	FN12082334	IPORA	11/10/2020 08:47	12/10/2020 13:19	11/10/2020 08:47	12/10/2020 13:19	28,53	2	57,06	CHI
20201050399	GOIANIA	12331594	GOIANIA LESTE S1	11/10/2020 08:47	11/10/2020 11:39	11/10/2020 08:47	11/10/2020 11:39	2,87	1	2,87	CHI
20201052875	LUZIANIA	L212041546	RIO VERMELHO	11/10/2020 08:48	11/10/2020 12:57	11/10/2020 08:48	11/10/2020 12:57	4,15	251	1040,81	CHI
20201050412	GOIANIA	15940871	GOYA S2	11/10/2020 08:48	11/10/2020 18:08	11/10/2020 08:48	11/10/2020 18:08	9,33	1	9,33	CHI
20201054726	SAO LUIZ DO NORTE	S211090339	ITAPACI	11/10/2020 08:48	11/10/2020 22:46	11/10/2020 08:48	11/10/2020 22:46	13,96	177	2471,07	CHI
20201050417	MAMBAI	MB12314303	IACIARA S2	11/10/2020 08:48	12/10/2020 09:19	11/10/2020 08:48	12/10/2020 09:07	24,31	3	72,92	CHI
20201050417	BURITINOPOLIS	MB12314303	IACIARA S2	11/10/2020 08:48	12/10/2020 09:19	11/10/2020 08:48	12/10/2020 09:07	24,31	2	48,61	CHI
20201050417	MAMBAI	MB12314303	IACIARA S2	11/10/2020 08:48	12/10/2020 09:19	11/10/2020 08:48	12/10/2020 09:19	24,51	1	24,51	CHI
20201050418	FLORES DE GOIAS	FB12211536	IACIARA S2	11/10/2020 08:48	13/10/2020 13:08	11/10/2020 08:48	12/10/2020 20:04	35,26	65	2291,79	CHI
20201050418	FLORES DE GOIAS	FB12211536	IACIARA S2	11/10/2020 08:48	13/10/2020 13:08	11/10/2020 08:48	13/10/2020 13:08	52,34	53	2773,89	CHI
20201050418	FLORES DE GOIAS	FB12211536	IACIARA S2	11/10/2020 08:48	13/10/2020 13:08	13/10/2020 10:48	13/10/2020 13:08	2,33	65	151,70	CHI
20201050423	INHUMAS	30089785	INHUMAS S2	11/10/2020 08:49	12/10/2020 00:54	11/10/2020 08:49	12/10/2020 00:54	16,08	1	16,08	CHI
20201052453	ADELANDIA	MD12304614	ANICUNS	11/10/2020 08:50	11/10/2020 14:01	11/10/2020 08:50	11/10/2020 14:01	5,18	2	10,35	CHI
20201052453	MOSSAMEDES	MD12304614	ANICUNS	11/10/2020 08:50	11/10/2020 14:01	11/10/2020 08:50	11/10/2020 14:01	5,18	7	36,24	CHI
20201050435	BELA VISTA DE GOIAS	BV31065594	BELA VISTA S1	11/10/2020 08:50	11/10/2020 20:01	11/10/2020 08:50	11/10/2020 20:01	11,18	1	11,18	CHI
20201050436	CATURAI	CK21246885	ARACU	11/10/2020 08:50	11/10/2020 12:54	11/10/2020 08:50	11/10/2020 12:54	4,06	1	4,06	CHI
20201050437	NOVA ROMA	TE12237605RE	FLORES DE GOIAS	11/10/2020 08:50	11/10/2020 10:23	11/10/2020 08:50	11/10/2020 10:23	1,54	32	49,31	CHI
20201050437	TERESINA DE GOIAS	TE12237605RE	FLORES DE GOIAS	11/10/2020 08:50	11/10/2020 10:23	11/10/2020 08:50	11/10/2020 10:23	1,54	216	332,82	CHI
20201050438	GOIANIA	10228664	AEROPORTO S2	11/10/2020 08:50	11/10/2020 17:33	11/10/2020 08:50	11/10/2020 17:33	8,72	1	8,72	CHI
20201050559	TAQUARAL DE GOIAS	II12217217	ITABERAÍ S1	11/10/2020 08:50	11/10/2020 10:36	11/10/2020 08:50	11/10/2020 10:36	1,75	47	82,35	CHI

20201050559	ITAGUARI	II12217217	ITABERAI S1	11/10/2020 08:50	11/10/2020 10:36	11/10/2020 08:50	11/10/2020 10:36	1,75	42	73,59	CHI
20201050559	ITABERAI	II12217217	ITABERAI S1	11/10/2020 08:50	11/10/2020 10:36	11/10/2020 08:50	11/10/2020 10:36	1,75	22	38,55	CHI
20201050655	NOVA ROMA	ND12256420	IACIARA S2	11/10/2020 08:51	11/10/2020 13:33	11/10/2020 08:51	11/10/2020 13:33	4,70	30	140,93	CHI
20201051241	GOIANESIA	GE12000231	GOIANESIA S2	11/10/2020 08:51	11/10/2020 20:53	11/10/2020 08:51	11/10/2020 20:53	12,03	5	60,15	CHI
20201050738	PIRENOPOLIS	PV12382128	SAO FRANCISCO DE GOIAS	11/10/2020 08:51	11/10/2020 12:14	11/10/2020 08:51	11/10/2020 12:14	3,38	19	64,17	CHI
20201050453	GOIANIA	10019784048	GOYA S1	11/10/2020 08:51	11/10/2020 16:28	11/10/2020 08:51	11/10/2020 16:28	7,61	1	7,61	CHI
20201051583	ITABERAI	IB12364800	ITABERAI S2	11/10/2020 08:51	11/10/2020 16:13	11/10/2020 08:51	11/10/2020 16:13	7,35	64	470,67	CHI
20201050470	VIANOPOLIS	VN12337836LD	VIANOPOLIS	11/10/2020 08:52	11/10/2020 10:17	11/10/2020 08:52	11/10/2020 10:17	1,41	63	89,01	CHI
20201050471	GOIANIA	GN21000515	CAMPINAS S1	11/10/2020 08:52	11/10/2020 18:49	11/10/2020 08:52	11/10/2020 18:49	9,95	1	9,95	CHI
20201052873	COCAZINHO DE GOIAS	ZN12068089	AGUAS LINDAS DE GOIAS S2	11/10/2020 08:52	11/10/2020 17:20	11/10/2020 08:52	11/10/2020 17:20	8,45	8	67,64	CHI
20201050488	PIRACANJUBA	BV21053400	BELA VISTA S1	11/10/2020 08:53	11/10/2020 12:04	11/10/2020 08:53	11/10/2020 12:04	3,17	1	3,17	CHI
20201052869	NIQUELANDIA	NQ12264199	URUACU	11/10/2020 08:54	11/10/2020 16:19	11/10/2020 08:54	11/10/2020 16:19	7,42	11	81,58	CHI
202010189181	CRIXAS	CX12392063	SANTA TEREZINHA	11/10/2020 08:54	11/10/2020 20:43	11/10/2020 08:54	11/10/2020 20:43	11,81	29	342,56	CHI
202010189181	ITAPACI	CX12392063	SANTA TEREZINHA	11/10/2020 08:54	11/10/2020 20:43	11/10/2020 08:54	11/10/2020 20:43	11,81	4	47,25	CHI
20201050504	SILVANIA	SV21137453	VIANOPOLIS	11/10/2020 08:54	11/10/2020 17:22	11/10/2020 08:54	11/10/2020 17:22	8,46	1	8,46	CHI
20201050509	GOIAS	GS12234131	GOIAS	11/10/2020 08:55	11/10/2020 12:01	11/10/2020 08:55	11/10/2020 12:01	3,09	11	33,99	CHI
20201051012	GAMELEIRA DE GOIAS	SV12062620	DAIA S2	11/10/2020 08:55	11/10/2020 12:44	11/10/2020 08:55	11/10/2020 12:44	3,80	5	19,02	CHI
20201052434	JAUPACI	JP12349650	IPORA	11/10/2020 08:56	11/10/2020 17:09	11/10/2020 08:56	11/10/2020 17:09	8,21	13	106,76	CHI
20201055052	AVELINOPOLIS	AV12019687	ANICUNS	11/10/2020 08:56	11/10/2020 21:54	11/10/2020 08:56	11/10/2020 21:54	12,96	8	103,67	CHI
20201050526	PIRENOPOLIS	PV21147171	CORUMBA	11/10/2020 08:57	11/10/2020 10:17	11/10/2020 08:57	11/10/2020 10:17	1,33	2	2,66	CHI
20201050529	JAUPACI	JP12358470	IPORA	11/10/2020 08:57	12/10/2020 08:32	11/10/2020 08:57	12/10/2020 08:32	23,58	7	165,05	CHI
20201050530	GOIANIA	GN21251455	ATLANTICO S3	11/10/2020 08:57	11/10/2020 16:36	11/10/2020 08:57	11/10/2020 16:36	7,64	1	7,64	CHI
20201050531	LUZIANIA	LZ21230215	RIO VERMELHO	11/10/2020 08:57	11/10/2020 13:11	11/10/2020 08:57	11/10/2020 13:11	4,23	1	4,23	CHI
20201051284	PADRE BERNARDO	PB12376761	PADRE BERNARDO	11/10/2020 08:57	11/10/2020 12:57	11/10/2020 08:57	11/10/2020 12:57	3,99	5	19,96	CHI
20201051284	VILA PROPICIO	PB12376761	PADRE BERNARDO	11/10/2020 08:57	11/10/2020 12:57	11/10/2020 08:57	11/10/2020 12:57	3,99	1	3,99	CHI
20201050533	VARJAO	VJ21412721	GUAPU S2	11/10/2020 08:57	11/10/2020 12:32	11/10/2020 08:57	11/10/2020 12:32	3,57	1	3,57	CHI
20201050534	FORMOSA	FA213399147	ITUIQUIRA	11/10/2020 08:57	11/10/2020 18:42	11/10/2020 08:57	11/10/2020 18:42	9,74	1	9,74	CHI
20201050536	GOIAS	2830001091	ITABERAI S1	11/10/2020 08:57	12/10/2020 07:36	11/10/2020 08:57	12/10/2020 07:36	22,64	1	22,64	CHI
20201050542	VILA BOA	VB12204775RE	ITUIQUIRA	11/10/2020 08:58	11/10/2020 18:39	11/10/2020 08:58	11/10/2020 18:39	9,67	178	1722,10	CHI
20201050542	FORMOSA	VB12204775RE	ITUIQUIRA	11/10/2020 08:58	11/10/2020 18:39	11/10/2020 08:58	11/10/2020 18:39	9,67	62	599,83	CHI
20201050543	MARA ROSA	ET21252375	MARA ROSA	11/10/2020 08:58	11/10/2020 12:07	11/10/2020 08:58	11/10/2020 12:07	3,14	1	3,14	CHI
20201050548	BOM JARDIM DE GOIAS	BM12325755	BOM JARDIM	11/10/2020 08:58	11/10/2020 10:45	11/10/2020 08:58	11/10/2020 10:45	1,77	6	10,61	CHI
20201050987	ITUMBIARA	IT12265489	ITUMBIARA NOVA	11/10/2020 08:59	11/10/2020 14:18	11/10/2020 08:59	11/10/2020 14:18	5,32	163	866,39	CHI
20201050557	PALMEIRAS DE GOIAS	PL21067825	PALMEIRAS	11/10/2020 08:59	12/10/2020 15:38	11/10/2020 08:59	12/10/2020 15:38	30,64	1	30,64	CHI
20201051599	RUBIATABA	RB11283449	RUBIATABA	11/10/2020 08:59	11/10/2020 15:29	11/10/2020 08:59	11/10/2020 15:29	6,49	163	1057,55	CHI
20201050562	FORMOSA	FA12278155	ITUIQUIRA	11/10/2020 08:59	11/10/2020 20:41	11/10/2020 08:59	11/10/2020 20:41	11,69	32	373,98	CHI
20201050562	VILA BOA	FA12278155	ITUIQUIRA	11/10/2020 08:59	11/10/2020 20:41	11/10/2020 08:59	11/10/2020 20:41	11,69	4	46,75	CHI
20201050568	CRISTALINA	KR12097123	CRISTALINA S2	11/10/2020 09:00	11/10/2020 15:55	11/10/2020 09:00	11/10/2020 15:55	6,91	3	20,74	CHI
20201050575	PORANGATU	PO21100769	PORANGATU	11/10/2020 09:00	11/10/2020 13:16	11/10/2020 09:00	11/10/2020 13:16	4,26	1	4,26	CHI
20201050578	SAO MIGUEL DO PASSA QUATRO	SQ21070836	CRISTIANOPOLIS	11/10/2020 09:00	11/10/2020 21:21	11/10/2020 09:00	11/10/2020 21:21	12,33	1	12,33	CHI
20201050582	GOIAS	GS21259599	GOIAS	11/10/2020 09:01	12/10/2020 14:14	11/10/2020 09:01	12/10/2020 14:14	29,22	2	58,43	CHI
20201050601	ITABERAI	IB12108166	ITABERAI S2	11/10/2020 09:01	11/10/2020 11:35	11/10/2020 09:01	11/10/2020 11:35	2,56	2	5,12	CHI
20201051415	GOIANIA	GN11162084	FERROVIARIO S3	11/10/2020 09:01	11/10/2020 12:48	11/10/2020 09:01	11/10/2020 12:48	3,77	53	200,03	CHI
20201050602	ARAGARCAS	10017360844	ARAGARCAS	11/10/2020 09:01	11/10/2020 16:05	11/10/2020 09:01	11/10/2020 16:05	7,07	1	7,07	CHI
20201051440	ANAPOLIS	AN11019594	ANAPOLIS UNIVERSITARIO S2	11/10/2020 09:02	11/10/2020 11:58	11/10/2020 09:02	11/10/2020 11:58	2,93	41	120,26	CHI
20201051552	PLANALTINA	PI12211502	PLANALTINA	11/10/2020 09:02	11/10/2020 12:13	11/10/2020 09:02	11/10/2020 12:13	3,17	184	583,18	CHI
20201050622	INHUMAS	30089750	INHUMAS S2	11/10/2020 09:03	11/10/2020 17:29	11/10/2020 09:03	11/10/2020 17:29	8,43	1	8,43	CHI
20201050629	ANAPOLIS	20756732	ANAPOLIS UNIVERSITARIO S2	11/10/2020 09:03	11/10/2020 16:28	11/10/2020 09:03	11/10/2020 16:28	7,40	1	7,40	CHI
20201052482	VALPARAISO DE GOIAS	VA11350306	PACAEMBU S1	11/10/2020 09:04	11/10/2020 13:52	11/10/2020 09:04	11/10/2020 13:52	4,80	86	412,63	CHI
20201050644	JUSSARA	JR12198864	JUSSARA	11/10/2020 09:05	11/10/2020 17:30	11/10/2020 12:12	11/10/2020 12:58	0,78	66	51,52	CHI
20201050644	JUSSARA	JR11183447	JUSSARA	11/10/2020 09:05	11/10/2020 17:30	11/10/2020 09:05	11/10/2020 17:30	8,43	77	648,75	CHI
20201050648	CACHEOIRA DE GOIAS	CG12289761	FIRMINOPOLIS S2	11/10/2020 09:05	12/10/2020 12:43	11/10/2020 09:05	12/10/2020 12:43	27,63	18	497,27	CHI
20201050651	PALMEIRAS DE GOIAS	PL21051212	PALMEIRAS	11/10/2020 09:05	12/10/2020 09:05	11/10/2020 09:05	12/10/2020 09:05	23,98	1	23,98	CHI
20201051175	ANICUNS	NZ12299085	ANICUNS	11/10/2020 09:06	11/10/2020 11:19	11/10/2020 09:06	11/10/2020 11:19	2,21	3	6,64	CHI
20201051175	NAZARIO	NZ12299085	ANICUNS	11/10/2020 09:06	11/10/2020 11:19	11/10/2020 09:06	11/10/2020 11:19	2,21	10	22,12	CHI
20201050658	TROMBAS	TB12181723	PORANGATU	11/10/2020 09:06	11/10/2020 10:34	11/10/2020 09:06	11/10/2020 10:34	1,46	160	233,11	CHI
20201050820	PIRENOPOLIS	PV21228655	CORUMBA	11/10/2020 09:06	11/10/2020 11:28	11/10/2020 09:06	11/10/2020 11:28	2,36	2	4,71	CHI
20201050659	PALMEIRAS DE GOIAS	PL12127074	PALMEIRAS	11/10/2020 09:06	12/10/2020 08:24	11/10/2020 09:06	12/10/2020 08:24	23,29	2	46,58	CHI

20201050661	LEOPOLDO DE BULHOES	LB12151171	DAIA S2	11/10/2020 09:06	11/10/2020 10:55	11/10/2020 09:06	11/10/2020 10:55	1,80	149	268,74	CHI
20201050670	MONTE ALEGRE DE GOIAS	MA12218640	SAO DOMINGOS	11/10/2020 09:07	11/10/2020 12:46	11/10/2020 09:07	11/10/2020 12:46	3,65	5	18,24	CHI
20201050670	CAMPOS BELOS	MA12218640	SAO DOMINGOS	11/10/2020 09:07	11/10/2020 12:46	11/10/2020 09:07	11/10/2020 12:46	3,65	2	7,30	CHI
20201050729	SIMOLANDIA	SA12099890	IACIARA S2	11/10/2020 09:07	11/10/2020 11:46	11/10/2020 09:07	11/10/2020 11:46	2,65	320	847,02	CHI
20201050685	ANAPOLIS	21017736	ANAPOLIS UNIVERSITARIO S2	11/10/2020 09:08	11/10/2020 20:37	11/10/2020 09:08	11/10/2020 20:37	11,48	1	11,48	CHI
20201051596	ITABERAI	IB12300330	ITABERAI S2	11/10/2020 09:08	11/10/2020 11:48	11/10/2020 09:08	11/10/2020 11:48	2,66	14	37,24	CHI
20201052696	IACIARA	IA11287898	IACIARA S1	11/10/2020 09:08	11/10/2020 13:52	11/10/2020 09:08	11/10/2020 13:52	4,72	33	155,77	CHI
20201051438	CAMPOS BELOS	CH12000001	SAO DOMINGOS	11/10/2020 09:08	11/10/2020 10:35	11/10/2020 09:08	11/10/2020 10:35	1,43	44	63,14	CHI
20201052449	ANICUNS	AC12304531	ANICUNS	11/10/2020 09:09	12/10/2020 01:13	11/10/2020 09:09	12/10/2020 01:13	16,06	5	80,31	CHI
20201050700	GAMELEIRA DE GOIAS	GL12319239	DAIA S2	11/10/2020 09:09	12/10/2020 06:12	11/10/2020 09:09	12/10/2020 06:12	21,04	1	21,04	CHI
20201050700	SILVANIA	GL12319239	DAIA S2	11/10/2020 09:09	12/10/2020 06:12	11/10/2020 09:09	12/10/2020 06:12	21,04	2	42,09	CHI
20201050705	ABADIA DE GOIAS	5584370804	CARAJAS S1	11/10/2020 09:09	11/10/2020 20:50	11/10/2020 09:09	11/10/2020 20:50	11,67	1	11,67	CHI
20201050711	GOUVELANDIA	QI32050838	QUIRINOPOLIS	11/10/2020 09:10	11/10/2020 10:08	11/10/2020 09:10	11/10/2020 10:08	0,96	2	1,93	CHI
20201050718	SILVANIA	10016409289	VIANOPOLIS	11/10/2020 09:10	11/10/2020 10:47	11/10/2020 09:10	11/10/2020 10:47	1,61	1	1,61	CHI
20201050720	QUIRINOPOLIS	QI12326606	CACHOEIRA ALTA	11/10/2020 09:10	11/10/2020 18:32	11/10/2020 09:10	11/10/2020 18:32	9,37	1	9,37	CHI
20201050726	GOIANIA	13853788	CARAJAS S1	11/10/2020 09:10	11/10/2020 19:42	11/10/2020 09:10	11/10/2020 19:42	10,52	1	10,52	CHI
20201050732	GOIAS	GS11124758	GOIAS	11/10/2020 09:11	11/10/2020 10:15	11/10/2020 09:11	11/10/2020 10:15	1,07	74	78,95	CHI
20201050733	GOIAS	GS21157048	GOIAS	11/10/2020 09:11	11/10/2020 15:25	11/10/2020 09:11	11/10/2020 15:25	6,23	1	6,23	CHI
20201050744	ANAPOLIS	10030118237	ANAPOLIS UNIVERSITARIO S2	11/10/2020 09:11	11/10/2020 19:12	11/10/2020 09:11	11/10/2020 19:12	10,01	1	10,01	CHI
20201052691	INDIARA	EA12056544	EDEIA	11/10/2020 09:12	11/10/2020 15:18	11/10/2020 09:12	11/10/2020 15:18	6,09	10	60,91	CHI
20201050765	ITAPURANGA	170048858	ITAPURANGA	11/10/2020 09:13	11/10/2020 15:37	11/10/2020 09:13	11/10/2020 15:37	6,39	1	6,39	CHI
20201052559	ANAPOLIS	AN11135754	ANAPOLIS UNIVERSITARIO S2	11/10/2020 09:13	11/10/2020 13:11	11/10/2020 09:13	11/10/2020 13:11	3,95	133	525,65	CHI
20201050768	ANAPOLIS	20521121	ANAPOLIS UNIVERSITARIO S2	11/10/2020 09:13	11/10/2020 14:17	11/10/2020 09:13	11/10/2020 14:17	5,05	1	5,05	CHI
20201050779	SENADOR CANEDO	SW21094027	CEPAIGO S2	11/10/2020 09:15	11/10/2020 10:52	11/10/2020 09:15	11/10/2020 10:52	1,61	2	3,23	CHI
20201049900	MINACU	IH12151066LD	MINACU	11/10/2020 09:16	12/10/2020 13:10	11/10/2020 09:16	11/10/2020 19:17	10,03	258	2587,60	CHI
20201049900	MINACU	IH12151066LD	MINACU	11/10/2020 09:16	12/10/2020 13:10	11/10/2020 19:33	12/10/2020 13:10	17,61	258	4542,09	CHI
20201051679	GOIANIA	GN12002287	XAVANTES	11/10/2020 09:16	11/10/2020 12:22	11/10/2020 09:16	11/10/2020 12:22	3,10	34	105,31	CHI
20201053358	URUACU	20121632	URUACU	11/10/2020 09:16	11/10/2020 13:58	11/10/2020 09:16	11/10/2020 13:58	4,69	48	225,21	CHI
20201050813	ITAJA	IJ12000046	CACHOEIRA ALTA	11/10/2020 09:16	11/10/2020 13:04	11/10/2020 09:16	11/10/2020 13:04	3,79	2	7,58	CHI
20201051916	JARAGUA	JA12297943	JARAGUA	11/10/2020 09:16	11/10/2020 11:16	11/10/2020 09:16	11/10/2020 11:16	1,98	21	41,67	CHI
20201050832	GOIANIA	12338205	CAMPINAS S1	11/10/2020 09:17	11/10/2020 16:45	11/10/2020 09:17	11/10/2020 16:45	7,45	1	7,45	CHI
20201050835	RIO VERDE	RV21153897	RIO VERDE S2	11/10/2020 09:18	11/10/2020 12:32	11/10/2020 09:18	11/10/2020 12:32	3,23	1	3,23	CHI
20201050837	SAO JOAO DA PARAUNA	RP21102382	FIRMINOPOLIS S2	11/10/2020 09:18	12/10/2020 17:04	11/10/2020 09:18	12/10/2020 17:04	31,76	1	31,76	CHI
20201050838	CAMPESTRE DE GOIAS	GC21185463	TRINDADE	11/10/2020 09:18	11/10/2020 12:45	11/10/2020 09:18	11/10/2020 12:45	3,44	1	3,44	CHI
20201050743	GOIANIA	GN10380028	ATLANTICO S1	11/10/2020 09:18	11/10/2020 09:23	11/10/2020 09:18	11/10/2020 09:23	0,08	1658	137,71	CHI
20201051886	LUZIANIA	KR12163676RE	PAMPLONA	11/10/2020 09:18	11/10/2020 18:38	11/10/2020 09:18	11/10/2020 18:38	9,32	2	18,64	CHI
20201051886	DISTRITO FEDERAL	KR12163676RE	PAMPLONA	11/10/2020 09:18	11/10/2020 18:38	11/10/2020 09:18	11/10/2020 18:38	9,32	2	18,64	CHI
20201051886	CRISTALINA	KR12163676RE	PAMPLONA	11/10/2020 09:18	11/10/2020 18:38	11/10/2020 09:18	11/10/2020 18:38	9,32	26	242,31	CHI
20201050846	APARECIDA DE GOIANIA	10003837856	INDEPENDENCIA S1	11/10/2020 09:18	11/10/2020 12:59	11/10/2020 09:18	11/10/2020 12:59	3,67	1	3,67	CHI
20201050848	PIRENOPOLIS	PV11190623	CORUMBA	11/10/2020 09:19	11/10/2020 21:37	11/10/2020 09:19	11/10/2020 21:37	12,30	18	221,40	CHI
20201052113	CIDADE OCIDENTAL	DH11199624	MARAJOARA	11/10/2020 09:19	11/10/2020 16:07	11/10/2020 09:19	11/10/2020 16:07	6,80	81	550,44	CHI
20201051339	LUZIANIA	LZ11348212	MARAJOARA	11/10/2020 09:19	12/10/2020 00:14	11/10/2020 09:19	12/10/2020 00:14	14,91	89	1326,77	CHI
20201052477	ARAGOIANIA	AO32000366	GUAPO S2	11/10/2020 09:19	11/10/2020 14:30	11/10/2020 09:19	11/10/2020 14:30	5,17	3	15,52	CHI
20201050858	GOIANIA	14691127	CAMPINAS S2	11/10/2020 09:19	11/10/2020 16:39	11/10/2020 09:19	11/10/2020 16:39	7,32	1	7,32	CHI
20201055818	SAO LUIS DE MONTES BELOS	SL12145942	SAO LUIZ DOS MONTES BELOS	11/10/2020 09:20	11/10/2020 20:00	11/10/2020 09:20	11/10/2020 20:00	10,67	9	96,00	CHI
20201051114	SANTA TEREZINHA DE GOIAS	SG12213046	SANTA TEREZINHA	11/10/2020 09:20	11/10/2020 18:06	11/10/2020 09:20	11/10/2020 18:06	8,76	9	78,82	CHI
20201051114	CAMPOS VERDES	SG12213046	SANTA TEREZINHA	11/10/2020 09:20	11/10/2020 18:06	11/10/2020 09:20	11/10/2020 18:06	8,76	9	78,82	CHI
20201050877	SILVANIA	SV12403479	VIANOPOLIS	11/10/2020 09:21	11/10/2020 15:56	11/10/2020 09:21	11/10/2020 15:56	6,58	3	19,74	CHI
20201051179	GOIANIA	GN12283029LD	XAVANTES	11/10/2020 09:21	11/10/2020 14:47	11/10/2020 09:21	11/10/2020 14:47	5,44	760	4136,30	CHI
20201050887	SILVANIA	SV21150113	VIANOPOLIS	11/10/2020 09:22	11/10/2020 12:50	11/10/2020 09:22	11/10/2020 12:50	3,46	1	3,46	CHI
20201050890	FAINA	FC11272619	GOIAS	11/10/2020 09:22	11/10/2020 13:45	11/10/2020 09:22	11/10/2020 13:45	4,38	1	4,38	CHI
20201050892	FORMOSA	FA21091753	ITUIQUIRA	11/10/2020 09:22	11/10/2020 20:35	11/10/2020 09:22	11/10/2020 20:35	11,21	1	11,21	CHI
20201050893	RIO VERDE	630051306	RIO VERDE S1	11/10/2020 09:22	11/10/2020 19:10	11/10/2020 09:22	11/10/2020 19:10	9,79	1	9,79	CHI
20201051094	URUACU	UR12291075RE	URUACU	11/10/2020 09:22	11/10/2020 22:28	11/10/2020 09:22	11/10/2020 22:28	13,09	55	719,68	CHI
20201053059	PALMEIRAS DE GOIAS	PL12085247	PALMEIRAS	11/10/2020 09:22	11/10/2020 15:38	11/10/2020 09:22	11/10/2020 15:38	6,25	10	62,51	CHI
20201050912	APARECIDA DE GOIANIA	200648986	INDEPENDENCIA S2	11/10/2020 09:23	11/10/2020 13:53	11/10/2020 09:23	11/10/2020 13:53	4,49	1	4,49	CHI
20201050915	PIRACANJUBA	PJ12263447	PIRACANJUBA	11/10/2020 09:23	11/10/2020 12:17	11/10/2020 09:23	11/10/2020 12:17	2,89	2	5,78	CHI
20201050914	CALDAZINHA	LB12200125	CEPAIGO S2	11/10/2020 09:23	11/10/2020 12:15	11/10/2020 09:23	11/10/2020 12:15	2,85	3	8,56	CHI

20201050919	CORUMBA DE GOIAS	CB21172023	ALEXANIA	11/10/2020 09:23	12/10/2020 11:27	11/10/2020 09:23	12/10/2020 11:27	26,05	1	26,05	CHI
20201054111	JUSSARA	JR12101204	JUSSARA	11/10/2020 09:23	11/10/2020 21:22	11/10/2020 09:23	11/10/2020 21:22	11,97	30	359,02	CHI
20201050928	ANICUNS	AC21143015	ANICUNS	11/10/2020 09:24	12/10/2020 14:21	11/10/2020 09:24	12/10/2020 14:21	28,94	1	28,94	CHI
20201050931	GOIAS	10003900000	GOIAS	11/10/2020 09:24	12/10/2020 10:12	11/10/2020 09:24	12/10/2020 10:12	24,79	1	24,79	CHI
20201051378	SILVANIA	SV12117217	DAIA S2	11/10/2020 09:24	11/10/2020 12:08	11/10/2020 09:24	11/10/2020 12:08	2,72	19	51,64	CHI
20201050935	LUZIANIA	LZ11290811	RIO VERMELHO	11/10/2020 09:25	11/10/2020 17:25	11/10/2020 09:25	11/10/2020 17:25	8,00	18	144,02	CHI
20201050939	COCALZINHO DE GOIAS	ZN12125093	AGUAS LINDAS DE GOIAS S2	11/10/2020 09:25	11/10/2020 13:58	11/10/2020 09:25	11/10/2020 13:58	4,54	6	27,25	CHI
20201050943	FIRMINOPOLIS	10017100028	FIRMINOPOLIS S1	11/10/2020 09:25	11/10/2020 14:57	11/10/2020 09:25	11/10/2020 14:57	5,53	1	5,53	CHI
20201050962	GOIANIA	12532228	GOIANIA LESTE S2	11/10/2020 09:26	11/10/2020 19:05	11/10/2020 09:26	11/10/2020 19:05	9,65	1	9,65	CHI
20201050927	PLANALTINA	PI21168624	PLANALTINA	11/10/2020 09:26	12/10/2020 07:50	11/10/2020 09:26	12/10/2020 07:50	22,39	1	22,39	CHI
20201045269	PARAUNA	PU12159023	PARAUNA	11/10/2020 09:27	11/10/2020 15:42	11/10/2020 09:27	11/10/2020 15:42	6,26	3	18,79	CHI
20201045269	PARAUNA	PU12159023	PARAUNA	11/10/2020 09:27	11/10/2020 15:42	11/10/2020 09:28	11/10/2020 15:42	6,25	1	6,25	CHI
20201051846	ITAGUARU	IC12068838	ITABERAI S1	11/10/2020 09:27	11/10/2020 12:51	11/10/2020 09:27	11/10/2020 12:51	3,40	12	40,75	CHI
20201050982	ANAPOLIS	20648765	ANAPOLIS UNIVERSITARIO S2	11/10/2020 09:27	11/10/2020 16:22	11/10/2020 09:27	11/10/2020 16:22	6,90	1	6,90	CHI
20201050989	CALDAZINHA	DE21168769	CEPAIGO S2	11/10/2020 09:28	11/10/2020 11:46	11/10/2020 09:28	11/10/2020 11:46	2,30	1	2,30	CHI
20201053983	ITAGUARU	IC12307618	ITAPURANGA	11/10/2020 09:28	11/10/2020 17:11	11/10/2020 09:28	11/10/2020 17:11	7,71	7	53,96	CHI
20201050995	CRISTALINA	KR12348546RE	PAMPLONA	11/10/2020 09:28	11/10/2020 15:25	11/10/2020 09:28	11/10/2020 15:25	5,94	25	148,56	CHI
20201050998	MONTE ALEGRE DE GOIAS	1620001795	SAO DOMINGOS	11/10/2020 09:28	11/10/2020 13:54	11/10/2020 09:28	11/10/2020 13:54	4,42	1	4,42	CHI
20201053085	LUZIANIA	LZ12041474	RIO VERMELHO	11/10/2020 09:29	11/10/2020 16:19	11/10/2020 09:29	11/10/2020 16:19	6,83	12	81,93	CHI
20201052142	JAUPACI	JP12349721	IPORA	11/10/2020 09:29	11/10/2020 17:57	11/10/2020 09:29	11/10/2020 17:57	8,46	7	59,22	CHI
20201051015	PALMEIRAS DE GOIAS	PL21361924	PALMEIRAS	11/10/2020 09:30	12/10/2020 09:35	11/10/2020 09:30	12/10/2020 09:35	24,08	1	24,08	CHI
20201051016	AGUA FRIA DE GOIAS	TL21205626	SAO JOAO D ALIANCA	11/10/2020 09:30	12/10/2020 10:11	11/10/2020 09:30	12/10/2020 10:11	24,68	1	24,68	CHI
202010189175	GUARINOS	GF21244482	SANTA TEREZINHA	11/10/2020 09:30	11/10/2020 22:22	11/10/2020 09:30	11/10/2020 22:22	12,85	2	25,70	CHI
20201051035	POSSE	1480038420	IACIARA S2	11/10/2020 09:32	11/10/2020 18:41	11/10/2020 09:32	11/10/2020 18:41	9,15	1	9,15	CHI
20201051074	APARECIDA DE GOIANIA	AP11004868	ATLANTICO S1	11/10/2020 09:34	11/10/2020 09:55	11/10/2020 09:34	11/10/2020 09:55	0,35	140	48,34	CHI
20201051077	GOIANIA	10079968	CAMPINAS S1	11/10/2020 09:34	11/10/2020 23:23	11/10/2020 09:34	11/10/2020 23:23	13,81	1	13,81	CHI
20201054112	MATRINCHA	MP12206480	MATRINCHA	11/10/2020 09:34	12/10/2020 11:15	11/10/2020 09:34	12/10/2020 11:15	25,69	16	410,99	CHI
20201051079	RUBIATABA	10008527294	RUBIATABA	11/10/2020 09:34	12/10/2020 18:38	11/10/2020 09:34	12/10/2020 18:38	33,06	1	33,06	CHI
20201051080	ITABERAI	IB21018337	ITABERAI S2	11/10/2020 09:34	11/10/2020 12:25	11/10/2020 09:34	11/10/2020 12:25	2,84	1	2,84	CHI
20201051083	CAMPO LIMPO	AN21058912	NEROPOLIS S1	11/10/2020 09:34	11/10/2020 17:56	11/10/2020 09:34	11/10/2020 17:56	8,35	1	8,35	CHI
20201051095	GAMELEIRA DE GOIAS	AA12295623	ANAPOLIS UNIVERSITARIO S1	11/10/2020 09:35	11/10/2020 19:07	11/10/2020 09:35	11/10/2020 19:07	9,52	28	266,51	CHI
20201051095	ABADIANIA	AA12295623	ANAPOLIS UNIVERSITARIO S1	11/10/2020 09:35	11/10/2020 19:07	11/10/2020 09:35	11/10/2020 19:07	9,52	7	66,63	CHI
20201051102	ITAIA	IJ12088193	CACHOEIRA ALTA	11/10/2020 09:36	11/10/2020 14:22	11/10/2020 09:36	11/10/2020 14:22	4,76	4	19,03	CHI
20201054306	SANTA ROSA DE GOIAS	SR12332599	INHUMAS S1	11/10/2020 09:36	11/10/2020 16:56	11/10/2020 09:36	11/10/2020 16:56	7,32	5	36,60	CHI
20201051113	PADRE BERNARDO	2800005501	PADRE BERNARDO	11/10/2020 09:37	11/10/2020 12:12	11/10/2020 09:37	11/10/2020 12:12	2,58	1	2,58	CHI
20201051539	NOVA CRIXAS	NA12330161	NOVA CRIXAS	11/10/2020 09:37	11/10/2020 14:24	11/10/2020 09:37	11/10/2020 14:24	4,78	4	19,11	CHI
20201051129	PONTALINA	MI21021933	PONTALINA	11/10/2020 09:38	11/10/2020 11:35	11/10/2020 09:38	11/10/2020 11:35	1,95	1	1,95	CHI
20201054956	NEROPOLIS	TJ12319657	DAIA S2	11/10/2020 09:38	11/10/2020 18:17	11/10/2020 09:38	11/10/2020 18:17	8,65	3	25,94	CHI
20201054956	TEREZOPOLIS DE GOIAS	TJ12319657	DAIA S2	11/10/2020 09:38	11/10/2020 18:17	11/10/2020 09:38	11/10/2020 18:17	8,65	1	8,65	CHI
20201051133	PETROLINA DE GOIAS	PG21353355	PETROLINA	11/10/2020 09:38	11/10/2020 14:28	11/10/2020 09:38	11/10/2020 14:28	4,82	1	4,82	CHI
20201051141	APARECIDA DE GOIANIA	13442624	ATLANTICO S3	11/10/2020 09:39	11/10/2020 15:21	11/10/2020 09:39	11/10/2020 15:21	5,70	1	5,70	CHI
20201051733	PETROLINA DE GOIAS	PG12010184	PETROLINA	11/10/2020 09:39	11/10/2020 21:38	11/10/2020 09:39	11/10/2020 21:38	11,98	19	227,60	CHI
20201051145	IPAMERI	IP11000020	IPAMERI	11/10/2020 09:39	11/10/2020 14:05	11/10/2020 09:39	11/10/2020 13:57	4,31	74	318,65	CHI
20201051145	IPAMERI	IP12404712	IPAMERI	11/10/2020 09:39	11/10/2020 14:05	11/10/2020 11:42	11/10/2020 14:05	2,39	64	152,85	CHI
20201051161	QUIRINOPOLIS	QI12370013	CACHOEIRA ALTA	11/10/2020 09:40	11/10/2020 12:52	11/10/2020 09:40	11/10/2020 12:52	3,19	5	15,97	CHI
20201053452	JARAGUA	JA12273085	JARAGUA	11/10/2020 09:40	11/10/2020 20:30	11/10/2020 09:40	11/10/2020 20:30	10,82	9	97,41	CHI
20201052030	PETROLINA DE GOIAS	PG12297874	PETROLINA	11/10/2020 09:40	11/10/2020 20:38	11/10/2020 09:40	11/10/2020 20:38	10,96	14	153,38	CHI
20201052413	JESUPOLIS	JE12298004	SAO FRANCISCO DE GOIAS	11/10/2020 09:40	11/10/2020 13:05	11/10/2020 09:40	11/10/2020 13:05	3,40	15	51,02	CHI
20201051592	SAO FRANCISCO DE GOIAS	SF12297994	SAO FRANCISCO DE GOIAS	11/10/2020 09:41	11/10/2020 12:22	11/10/2020 09:41	11/10/2020 12:22	2,67	19	50,74	CHI
20201051742	TRINDADE	TR12000048	TRINDADE	11/10/2020 09:41	11/10/2020 12:08	11/10/2020 09:41	11/10/2020 12:08	2,44	6	14,61	CHI
20201051187	ANAPOLIS	20497040	JUNDIAI S2	11/10/2020 09:41	12/10/2020 09:00	11/10/2020 09:41	12/10/2020 09:00	23,30	1	23,30	CHI
20201051640	JANDAIA	JD12008606	PALMEIRAS	11/10/2020 09:43	11/10/2020 17:06	11/10/2020 09:43	11/10/2020 17:06	7,39	85	628,34	CHI
20201051640	PARAUNA	JD12008606	PALMEIRAS	11/10/2020 09:43	11/10/2020 17:06	11/10/2020 09:43	11/10/2020 17:06	7,39	6	44,35	CHI
20201051222	SAO JOAO D ALIANCA	JL11218481	SAO JOAO D ALIANCA	11/10/2020 09:44	12/10/2020 01:24	11/10/2020 09:44	12/10/2020 01:24	15,66	2	31,33	CHI
20201051237	PETROLINA DE GOIAS	PG21155182	PETROLINA	11/10/2020 09:45	12/10/2020 10:32	11/10/2020 09:45	12/10/2020 10:32	24,77	1	24,77	CHI
20201051526	ANICUNS	AC12035306	ANICUNS	11/10/2020 09:45	11/10/2020 21:19	11/10/2020 09:45	11/10/2020 21:19	11,55	20	231,08	CHI
20201052309	SILVANIA	LB12319536	DAIA S2	11/10/2020 09:46	11/10/2020 15:52	11/10/2020 09:46	11/10/2020 15:52	6,09	44	268,18	CHI
20201052982	GOIANIA	GN21042222	CAMPINAS S1	11/10/2020 09:46	11/10/2020 14:45	11/10/2020 09:46	11/10/2020 14:45	4,97	14	69,61	CHI

20201051261	GOIANIA	10108907	ATLANTICO S1	11/10/2020 09:46	11/10/2020 16:55	11/10/2020 09:46	11/10/2020 16:55	7,14	1	7,14	CHI
20201051262	FORMOSA	FA21329826	ITUIQUIRA	11/10/2020 09:46	11/10/2020 18:38	11/10/2020 09:46	11/10/2020 18:38	8,85	1	8,85	CHI
20201051267	NOVO GAMA	NJ12344854	PACAEMBU S1	11/10/2020 09:47	11/10/2020 17:27	11/10/2020 09:47	11/10/2020 17:27	7,66	234	1793,15	CHI
20201055111	MONTES CLAROS DE GOIAS	ME21138656	IPORA	11/10/2020 09:47	11/10/2020 22:17	11/10/2020 09:47	11/10/2020 22:17	12,49	1	12,49	CHI
20201051280	GOIANIA	11738182	REAL S1	11/10/2020 09:48	11/10/2020 12:49	11/10/2020 09:48	11/10/2020 12:49	3,02	1	3,02	CHI
20201045768	GOIANIA	GN12021474	GOYA S1	11/10/2020 09:48	11/10/2020 22:17	11/10/2020 09:48	11/10/2020 22:17	12,48	5	62,41	CHI
20201051370	GOIANIA	GN11001030	ATLANTICO S1	11/10/2020 09:48	11/10/2020 14:29	11/10/2020 09:48	11/10/2020 14:29	4,68	106	496,08	CHI
20201051292	MORRINHOS	MR21329031	MORRINHOS	11/10/2020 09:48	11/10/2020 10:32	11/10/2020 09:48	11/10/2020 10:32	0,72	1	0,72	CHI
20201052796	PORANGATU	PO12189555	PORANGATU	11/10/2020 09:49	11/10/2020 14:55	11/10/2020 09:49	11/10/2020 14:55	5,10	8	40,80	CHI
20201052861	NAZARIO	NZ12299080	ANICUNS	11/10/2020 09:49	12/10/2020 09:19	11/10/2020 09:49	12/10/2020 09:19	23,50	4	94,00	CHI
20201057327	PARAUNA	PU12035191	PARAUNA	11/10/2020 09:49	12/10/2020 12:06	11/10/2020 09:49	12/10/2020 12:06	26,27	3	78,82	CHI
20201051304	PADRE BERNARDO	PB21183992	PADRE BERNARDO	11/10/2020 09:49	11/10/2020 11:51	11/10/2020 09:49	11/10/2020 11:51	2,02	1	2,02	CHI
20201054907	MINACU	IH12132449	MINACU	11/10/2020 09:49	11/10/2020 23:50	11/10/2020 09:49	11/10/2020 23:50	14,01	4	56,02	CHI
20201051313	GOIANIA	12778140	MEIA PONTE	11/10/2020 09:49	11/10/2020 15:27	11/10/2020 09:49	11/10/2020 15:27	5,62	1	5,62	CHI
20201051316	SILVANIA	SV12131990	VIANOPOLIS	11/10/2020 09:50	11/10/2020 17:00	11/10/2020 09:50	11/10/2020 17:00	7,16	35	250,71	CHI
20201051317	BARRO ALTO	BA12132080	GOIANESIA S1	11/10/2020 09:50	11/10/2020 19:53	11/10/2020 09:50	11/10/2020 19:53	10,05	5	50,23	CHI
20201051318	LUZIANIA	LZ11216266	RIO VERMELHO	11/10/2020 09:50	11/10/2020 12:01	11/10/2020 09:50	11/10/2020 12:01	2,18	144	313,72	CHI
20201052865	GUAPO	GA12266688	GUAPO S2	11/10/2020 09:50	11/10/2020 14:17	11/10/2020 09:50	11/10/2020 14:17	4,44	22	97,74	CHI
20201052865	VARJAO	GA12266688	GUAPO S2	11/10/2020 09:50	11/10/2020 14:17	11/10/2020 09:50	11/10/2020 14:17	4,44	10	44,43	CHI
20201052865	ARAGOIANIA	GA12266688	GUAPO S2	11/10/2020 09:50	11/10/2020 14:17	11/10/2020 09:50	11/10/2020 14:17	4,44	1	4,44	CHI
20201052927	GOIANIA	GN11219052	GOIANIA LESTE S3	11/10/2020 09:51	11/10/2020 18:20	11/10/2020 09:51	11/10/2020 18:20	8,48	59	500,55	CHI
20201051354	NIQUELANDIA	NQ12398049	URUACU	11/10/2020 09:51	12/10/2020 12:04	11/10/2020 09:51	12/10/2020 12:04	26,21	38	996,02	CHI
20201051335	PADRE BERNARDO	PB11313897	PADRE BERNARDO	11/10/2020 09:51	11/10/2020 13:32	11/10/2020 09:51	11/10/2020 13:32	3,67	52	191,09	CHI
20201051343	SANTA HELENA DE GOIAS	400064534	IPEGUARI	11/10/2020 09:52	11/10/2020 21:05	11/10/2020 09:52	11/10/2020 21:05	11,22	1	11,22	CHI
20201051344	MONTIVIDIU	MV21153926	MONTIVIDIU T	11/10/2020 09:52	11/10/2020 13:57	11/10/2020 09:52	11/10/2020 13:57	4,08	1	4,08	CHI
20201052742	GOIANAPOLIS	GP12351033	DAIA S2	11/10/2020 09:53	11/10/2020 15:02	11/10/2020 09:53	11/10/2020 15:02	5,15	23	118,46	CHI
20201053282	ITAPIRAPUA	IU12057824	MATRINCHA	11/10/2020 09:53	11/10/2020 23:00	11/10/2020 09:53	11/10/2020 23:00	13,11	47	616,39	CHI
20201051356	NOVO GAMA	NJ11183662	PACAEMBU S2	11/10/2020 09:53	12/10/2020 04:05	11/10/2020 09:53	12/10/2020 04:05	18,20	205	3730,09	CHI
20201051359	GOIANIA	13289690	CAMPINAS S2	11/10/2020 09:53	11/10/2020 21:46	11/10/2020 09:53	11/10/2020 21:46	11,87	1	11,87	CHI
20201051986	FIRMINOPOLIS	FR12076427	FIRMINOPOLIS S1	11/10/2020 09:53	11/10/2020 16:14	11/10/2020 09:53	11/10/2020 16:14	6,34	58	367,64	CHI
20201051364	JATAI	JT11184206	JATAI S3	11/10/2020 09:53	11/10/2020 12:38	11/10/2020 09:53	11/10/2020 12:38	2,73	85	232,38	CHI
20201051366	SENADOR CANEDO	17058028	GOIANIA LESTE S1	11/10/2020 09:54	11/10/2020 12:16	11/10/2020 09:54	11/10/2020 12:16	2,36	1	2,36	CHI
20201051369	FORMOSA	FA21091068	ITUIQUIRA	11/10/2020 09:54	12/10/2020 12:11	11/10/2020 09:54	12/10/2020 12:11	26,28	2	52,56	CHI
20201051377	ANAPOLIS	20062825	ANAPOLIS UNIVERSITARIO S2	11/10/2020 09:54	11/10/2020 15:38	11/10/2020 09:54	11/10/2020 15:38	5,72	1	5,72	CHI
20201051382	GOIANIA	GN12051679	MEIA PONTE	11/10/2020 09:54	11/10/2020 19:23	11/10/2020 09:54	11/10/2020 19:23	9,47	1	9,47	CHI
20201052370	GOIANIA	GN11051585	FERROVIARIO S2	11/10/2020 09:55	11/10/2020 15:00	11/10/2020 09:55	11/10/2020 15:00	5,08	45	228,64	CHI
20201051385	PLANALTINA	PI12131795	PLANALTINA	11/10/2020 09:55	11/10/2020 14:00	11/10/2020 09:55	11/10/2020 14:00	4,08	7	28,56	CHI
20201054698	SAO JOAO DA PARAUNA	RP21299069	PARAUNA	11/10/2020 09:55	12/10/2020 19:00	11/10/2020 09:55	12/10/2020 19:00	33,09	1	33,09	CHI
20201051388	GOIANIA	11936022	GOYA S2	11/10/2020 09:55	11/10/2020 20:17	11/10/2020 09:55	11/10/2020 20:17	10,36	1	10,36	CHI
20201051389	INHUMAS	30053109	INHUMAS S2	11/10/2020 09:55	11/10/2020 16:51	11/10/2020 09:55	11/10/2020 16:51	6,92	1	6,92	CHI
20201051390	ITABERAI	IB11359459	ITABERAI S2	11/10/2020 09:55	11/10/2020 13:40	11/10/2020 09:55	11/10/2020 13:40	3,74	1	3,74	CHI
20201051395	LUZIANIA	LZ21059658	CRISTALINA S2	11/10/2020 09:56	11/10/2020 18:19	11/10/2020 09:56	11/10/2020 18:19	8,40	1	8,40	CHI
20201054909	GOIANIA	GN11000528	AEROPORTO S2	11/10/2020 09:56	11/10/2020 21:28	11/10/2020 09:56	11/10/2020 21:28	11,54	48	553,71	CHI
20201051401	PEROLANDIA	JT13423412	PARQUE DAS EMAS	11/10/2020 09:56	11/10/2020 17:39	11/10/2020 09:56	11/10/2020 17:39	7,72	3	23,16	CHI
20201051401	JATAI	JT13423412	PARQUE DAS EMAS	11/10/2020 09:56	11/10/2020 17:39	11/10/2020 09:56	11/10/2020 17:39	7,72	21	162,14	CHI
20201051403	APARECIDA DE GOIANIA	200035514	ANHANGUERA	11/10/2020 09:56	11/10/2020 17:24	11/10/2020 09:56	11/10/2020 17:24	7,45	1	7,45	CHI
20201051404	ANAPOLIS	10032398911	ANAPOLIS UNIVERSITARIO S2	11/10/2020 09:56	11/10/2020 15:29	11/10/2020 09:56	11/10/2020 15:29	5,53	1	5,53	CHI
20201051690	GOIANIA	GN12098424	XAVANTES	11/10/2020 09:57	11/10/2020 14:42	11/10/2020 09:57	11/10/2020 14:42	4,75	19	90,18	CHI
20201053099	NEROPOLIS	NR11092583	NEROPOLIS S2	11/10/2020 09:57	11/10/2020 13:33	11/10/2020 09:57	11/10/2020 13:33	3,59	164	589,49	CHI
20201051414	ANAPOLIS	20951048	ANAPOLIS UNIVERSITARIO S2	11/10/2020 09:57	11/10/2020 20:48	11/10/2020 09:57	11/10/2020 20:48	10,84	1	10,84	CHI
20201051419	GOIANIA	11776183	REAL S1	11/10/2020 09:58	11/10/2020 15:23	11/10/2020 09:58	11/10/2020 15:23	5,41	1	5,41	CHI
20201051600	PADRE BERNARDO	PB12317821	PADRE BERNARDO	11/10/2020 09:58	11/10/2020 13:31	11/10/2020 09:58	11/10/2020 13:31	3,54	87	308,29	CHI
20201051425	ITAPACI	100079210	ITAPACI	11/10/2020 09:58	11/10/2020 19:42	11/10/2020 09:58	11/10/2020 19:42	9,72	1	9,72	CHI
20201051426	INHUMAS	30089761	INHUMAS S2	11/10/2020 09:58	12/10/2020 05:41	11/10/2020 09:58	12/10/2020 05:41	19,70	1	19,70	CHI
20201051995	SANTA BARBARA DE GOIAS	TR12043820	TRINDADE	11/10/2020 09:58	11/10/2020 13:06	11/10/2020 09:58	11/10/2020 13:06	3,12	11	34,30	CHI
20201051995	TRINDADE	TR12043820	TRINDADE	11/10/2020 09:58	11/10/2020 13:06	11/10/2020 09:58	11/10/2020 13:06	3,12	2	6,24	CHI
20201048214	GOIANIA	GN11247727	GOIANIA LESTE S3	11/10/2020 09:59	11/10/2020 10:19	11/10/2020 09:59	11/10/2020 10:19	0,33	164	54,71	CHI
20201051435	GOIANIA	11195757	ATLANTICO S1	11/10/2020 09:59	11/10/2020 17:21	11/10/2020 09:59	11/10/2020 17:21	7,36	1	7,36	CHI

20201051437	SANTA HELENA DE GOIAS	SH12000204	SANTA HELENA S1	11/10/2020 09:59	11/10/2020 20:01	11/10/2020 09:59	11/10/2020 20:01	10,03	1	10,03	CHI
20201051439	ITUMBIARA	690215927	ITUMBIARA NOVA	11/10/2020 09:59	11/10/2020 12:38	11/10/2020 09:59	11/10/2020 12:38	2,64	1	2,64	CHI
20201051445	LUZIANIA	120313832	RIO VERMELHO	11/10/2020 09:59	11/10/2020 16:11	11/10/2020 09:59	11/10/2020 16:11	6,19	1	6,19	CHI
20201051460	ANAPOLIS	AN11394297	JUNDIAI S1	11/10/2020 10:00	11/10/2020 18:21	11/10/2020 10:00	11/10/2020 18:21	8,36	25	208,95	CHI
20201051531	ALTO PARAISO DE GOIAS	BF10400692	FLORES DE GOIAS	11/10/2020 10:00	11/10/2020 17:00	11/10/2020 10:00	11/10/2020 15:09	5,15	11	56,67	CHI
20201051531	SAO JOAO D ALIANCA	BF10400692	FLORES DE GOIAS	11/10/2020 10:00	11/10/2020 17:00	11/10/2020 10:00	11/10/2020 17:00	7,01	2	14,01	CHI
20201051531	ALTO PARAISO DE GOIAS	BF10400692	FLORES DE GOIAS	11/10/2020 10:00	11/10/2020 17:00	11/10/2020 10:00	11/10/2020 17:00	7,01	213	1492,54	CHI
20201051955	VIANOPOLIS	VN12063224	VIANOPOLIS	11/10/2020 10:01	11/10/2020 14:15	11/10/2020 10:01	11/10/2020 14:15	4,23	6	25,39	CHI
20201051480	URUACU	UR21361496	URUACU	11/10/2020 10:01	12/10/2020 11:22	11/10/2020 10:01	12/10/2020 11:22	25,34	1	25,34	CHI
20201052297	ALEXANIA	AX12000165	ALEXANIA	11/10/2020 10:01	11/10/2020 15:39	11/10/2020 10:01	11/10/2020 15:39	5,62	2	11,25	CHI
20201052297	ABADIANIA	AX12000165	ALEXANIA	11/10/2020 10:01	11/10/2020 15:39	11/10/2020 10:01	11/10/2020 15:39	5,62	8	44,99	CHI
20201052297	CORUMBA DE GOIAS	AX12000165	ALEXANIA	11/10/2020 10:01	11/10/2020 15:39	11/10/2020 10:01	11/10/2020 15:39	5,62	64	359,91	CHI
20201052987	ALEXANIA	AX11014149	ALEXANIA	11/10/2020 10:01	11/10/2020 22:57	11/10/2020 10:01	11/10/2020 22:57	12,92	53	684,86	CHI
20201051900	SAO MIGUEL DO ARAGUAIA	SM12252458	SAO MIGUEL DO ARAGUAIA	11/10/2020 10:01	11/10/2020 16:01	11/10/2020 10:01	11/10/2020 16:01	5,99	5	29,93	CHI
20201051512	MARA ROSA	MQ21125503	MARA ROSA	11/10/2020 10:03	11/10/2020 23:08	11/10/2020 10:03	11/10/2020 23:08	13,08	1	13,08	CHI
20201051515	SANTO ANTONIO DE GOIAS	1360000772	NEROPOLIS S1	11/10/2020 10:03	12/10/2020 08:31	11/10/2020 10:03	12/10/2020 08:31	22,46	1	22,46	CHI
20201051516	PIRENOPOLIS	PV21273400	SAO FRANCISCO DE GOIAS	11/10/2020 10:03	11/10/2020 20:20	11/10/2020 10:03	11/10/2020 20:20	10,28	2	20,55	CHI
202010179937	ARUANA	AK12292820	BRITANIA	11/10/2020 10:03	12/10/2020 16:26	11/10/2020 10:03	12/10/2020 16:26	30,38	4	121,50	CHI
20201051098	PADRE BERNARDO	PB12290522LD	PADRE BERNARDO	11/10/2020 10:03	12/10/2020 01:47	11/10/2020 10:03	12/10/2020 01:47	15,74	106	1668,06	CHI
20201051098	PLANALTINA	PB12290522LD	PADRE BERNARDO	11/10/2020 10:03	12/10/2020 01:47	11/10/2020 10:03	12/10/2020 01:47	15,74	11	173,10	CHI
20201051098	PADRE BERNARDO	PB12290522LD	PADRE BERNARDO	11/10/2020 10:03	12/10/2020 01:47	11/10/2020 19:23	12/10/2020 01:47	6,41	1	6,41	CHI
20201051520	GOIANIA	13237755	REAL S1	11/10/2020 10:04	11/10/2020 15:34	11/10/2020 10:04	11/10/2020 15:34	5,50	1	5,50	CHI
20201051523	GOIANIA	15024015	GOYA S1	11/10/2020 10:04	11/10/2020 16:25	11/10/2020 10:04	11/10/2020 16:25	6,35	1	6,35	CHI
20201051524	BOM JARDIM DE GOIAS	BM21233791	BOM JARDIM	11/10/2020 10:04	11/10/2020 13:23	11/10/2020 10:04	11/10/2020 13:23	3,31	1	3,31	CHI
20201051528	GOIATUBA	GT12000131	GOIATUBA S2	11/10/2020 10:04	11/10/2020 11:53	11/10/2020 10:04	11/10/2020 11:53	1,81	7	12,66	CHI
20201051532	ANAPOLIS	21126161	JUNDIAI S1	11/10/2020 10:04	11/10/2020 21:34	11/10/2020 10:04	11/10/2020 21:34	11,49	1	11,49	CHI
20201052010	GOIANIA	GN12135067	GOYA S1	11/10/2020 10:04	11/10/2020 12:26	11/10/2020 10:04	11/10/2020 12:26	2,35	878	2067,20	CHI
20201055543	ANICUNS	AC12073814	ANICUNS	11/10/2020 10:05	12/10/2020 03:38	11/10/2020 10:05	12/10/2020 03:38	17,55	10	175,47	CHI
20201051540	MAURILANDIA	ML21303313	RIO DOS BOIS	11/10/2020 10:05	11/10/2020 14:23	11/10/2020 10:05	11/10/2020 14:23	4,30	2	8,59	CHI
20201051542	NOVA CRIXAS	NA21055715	MOZARLANDIA	11/10/2020 10:05	11/10/2020 23:34	11/10/2020 10:05	11/10/2020 23:34	13,48	1	13,48	CHI
20201051547	JUSSARA	RN21138486	BRITANIA	11/10/2020 10:05	12/10/2020 14:15	11/10/2020 10:05	12/10/2020 14:15	28,16	2	56,31	CHI
20201051556	PETROLINA DE GOIAS	PG21015836	PETROLINA	11/10/2020 10:06	11/10/2020 23:02	11/10/2020 10:06	11/10/2020 23:02	12,93	2	25,85	CHI
20201052794	ANAPOLIS	AN12382358	ANAPOLIS UNIVERSITARIO S2	11/10/2020 10:07	11/10/2020 14:30	11/10/2020 10:07	11/10/2020 14:30	4,38	163	714,21	CHI
20201051566	CALDAS NOVAS	CN12213952	CALDAS NOVAS S1	11/10/2020 10:07	11/10/2020 11:12	11/10/2020 10:07	11/10/2020 11:12	1,08	66	71,26	CHI
20201051570	GOUVELANDIA	QJ21000306	QUIRINOPOLIS	11/10/2020 10:07	11/10/2020 11:51	11/10/2020 10:07	11/10/2020 11:51	1,73	1	1,73	CHI
20201051572	APARECIDA DE GOIANIA	12810228	REAL S1	11/10/2020 10:07	11/10/2020 10:47	11/10/2020 10:07	11/10/2020 10:47	0,66	1	0,66	CHI
20201051579	GOIANIA	11918100	CAMPINAS S2	11/10/2020 10:07	11/10/2020 20:52	11/10/2020 10:07	11/10/2020 20:52	10,73	1	10,73	CHI
20201051591	GOIANIA	11275315	REAL S2	11/10/2020 10:08	11/10/2020 14:39	11/10/2020 10:08	11/10/2020 14:39	4,52	1	4,52	CHI
20201055112	MONTES CLAROS DE GOIAS	ME21357465	IPORA	11/10/2020 10:08	11/10/2020 23:27	11/10/2020 10:08	11/10/2020 23:27	13,31	1	13,31	CHI
20201051595	PLANALTINA	PI21202844	PADRE BERNARDO	11/10/2020 10:08	12/10/2020 09:09	11/10/2020 10:08	12/10/2020 09:09	23,01	1	23,01	CHI
20201053040	JESUPOLIS	JE11026781	SAO FRANCISCO DE GOIAS	11/10/2020 10:09	11/10/2020 13:33	11/10/2020 10:09	11/10/2020 13:33	3,40	67	227,80	CHI
20201051605	ANICUNS	AC21215373	ANICUNS	11/10/2020 10:09	12/10/2020 10:28	11/10/2020 10:09	12/10/2020 10:28	24,31	1	24,31	CHI
20201051610	RIO VERDE	RV12388326	RIO VERDE S1	11/10/2020 10:09	11/10/2020 22:47	11/10/2020 10:09	11/10/2020 22:47	12,63	18	227,26	CHI
20201051629	DAMIANOPOLIS	5150001781	IACIARA S2	11/10/2020 10:09	11/10/2020 10:36	11/10/2020 10:09	11/10/2020 10:36	0,44	1	0,44	CHI
20201053079	JAUPACI	JP12068182	IPORA	11/10/2020 10:09	12/10/2020 09:08	11/10/2020 10:09	12/10/2020 09:08	22,97	4	91,87	CHI
20201051617	NOVA ROMA	ND11078486	IACIARA S2	11/10/2020 10:10	11/10/2020 11:30	11/10/2020 10:10	11/10/2020 11:30	1,33	48	63,89	CHI
20201051625	MORRINHOS	MR12118544	MORRINHOS	11/10/2020 10:10	11/10/2020 12:15	11/10/2020 10:10	11/10/2020 12:15	2,07	4	8,29	CHI
20201051627	GOIANIA	14355802	FERROVIARIO S1	11/10/2020 10:10	11/10/2020 20:13	11/10/2020 10:10	11/10/2020 20:13	10,04	1	10,04	CHI
20201053477	JESUPOLIS	SF12007222	SAO FRANCISCO DE GOIAS	11/10/2020 10:11	11/10/2020 15:15	11/10/2020 10:11	11/10/2020 15:15	5,06	20	101,29	CHI
20201053477	JARAGUA	SF12007222	SAO FRANCISCO DE GOIAS	11/10/2020 10:11	11/10/2020 15:15	11/10/2020 10:11	11/10/2020 15:15	5,06	2	10,13	CHI
20201056820	MARA ROSA	MQ12251030	SANTA TEREZINHA	11/10/2020 10:11	12/10/2020 20:55	11/10/2020 10:11	12/10/2020 20:55	34,73	2	69,45	CHI
20201051636	PIRENOPOLIS	PV21194533	SAO FRANCISCO DE GOIAS	11/10/2020 10:11	11/10/2020 20:57	11/10/2020 10:11	11/10/2020 20:57	10,76	2	21,51	CHI
20201051642	GOIANIA	GN11000832	GOIANIA LESTE S1	11/10/2020 10:11	11/10/2020 12:43	11/10/2020 10:11	11/10/2020 12:43	2,52	88	221,98	CHI
20201051648	LUZIANIA	LZ21120160	MARAJOARA	11/10/2020 10:12	11/10/2020 17:15	11/10/2020 10:12	11/10/2020 17:15	7,04	1	7,04	CHI
20201051650	APARECIDA DE GOIANIA	13809222	ANHANGUERA	11/10/2020 10:13	11/10/2020 18:38	11/10/2020 10:13	11/10/2020 18:38	8,42	1	8,42	CHI
202010182182	GOIANIA	GN10400446	FERROVIARIO S3	11/10/2020 10:13	11/10/2020 12:47	11/10/2020 10:13	11/10/2020 11:05	0,87	884	768,10	CHI
202010182182	GOIANIA	GN10383777	FERROVIARIO S3	11/10/2020 10:13	11/10/2020 12:47	11/10/2020 10:13	11/10/2020 11:14	1,03	107	109,68	CHI
202010182182	GOIANIA	GN13407251B	FERROVIARIO S3	11/10/2020 10:13	11/10/2020 12:47	11/10/2020 10:13	11/10/2020 12:47	2,57	92	236,62	CHI

20201051653	RIO VERDE	RV21159311	CABRIUVA S2	11/10/2020 10:13	12/10/2020 07:55	11/10/2020 10:13	12/10/2020 07:55	21,70	1	21,70	CHI
20201052612	GUAPO	GA12031766	GUAPO S2	11/10/2020 10:13	11/10/2020 13:32	11/10/2020 10:13	11/10/2020 13:32	3,31	4	13,24	CHI
20201051659	SAO LUIS DE MONTES BELOS	SL12383510	SAO LUIZ DOS MONTES BELOS	11/10/2020 10:13	11/10/2020 19:02	11/10/2020 10:13	11/10/2020 19:02	8,81	6	52,88	CHI
20201051672	TRINDADE	40049656	TRINDADE	11/10/2020 10:14	11/10/2020 11:53	11/10/2020 10:14	11/10/2020 11:53	1,64	1	1,64	CHI
20201053498	JAUPACI	JP12316474RE	IPORA	11/10/2020 10:15	12/10/2020 10:28	11/10/2020 10:15	12/10/2020 10:28	24,21	47	1137,84	CHI
20201053498	DIORAMA	JP12316474RE	IPORA	11/10/2020 10:15	12/10/2020 10:28	11/10/2020 10:15	12/10/2020 10:28	24,21	12	290,51	CHI
20201051676	JARAGUA	GE21000344	GOIANESIA S2	11/10/2020 10:15	11/10/2020 22:42	11/10/2020 10:15	11/10/2020 22:42	12,44	1	12,44	CHI
20201055499	PIRENOPOLIS	PV12289876	SAO FRANCISCO DE GOIAS	11/10/2020 10:15	11/10/2020 19:47	11/10/2020 10:15	11/10/2020 19:47	9,52	14	133,26	CHI
20201052223	GAMELEIRA DE GOIAS	SV12051679	DAIA S2	11/10/2020 10:15	11/10/2020 14:17	11/10/2020 10:15	11/10/2020 14:17	4,02	4	16,07	CHI
20201052223	SILVANIA	SV12051679	DAIA S2	11/10/2020 10:15	11/10/2020 14:17	11/10/2020 10:15	11/10/2020 14:17	4,02	15	60,26	CHI
20201051773	BELA VISTA DE GOIAS	BV12242097	BELA VISTA S1	11/10/2020 10:16	11/10/2020 11:37	11/10/2020 10:16	11/10/2020 11:37	1,36	11	14,92	CHI
20201051688	FORMOSO	FO21145444	PORANGATU	11/10/2020 10:16	11/10/2020 12:17	11/10/2020 10:16	11/10/2020 12:17	2,01	1	2,01	CHI
20201051692	GOIANIA	GN21066331	ATLANTICO S1	11/10/2020 10:16	11/10/2020 19:42	11/10/2020 10:16	11/10/2020 19:42	9,42	2	18,85	CHI
20201052805	GOIAS	GS11124759	GOIAS	11/10/2020 10:17	11/10/2020 13:02	11/10/2020 10:17	11/10/2020 13:02	2,75	64	175,86	CHI
20201053004	FORMOSA	FA32042639	ITUIQUIRA	11/10/2020 10:17	12/10/2020 21:50	11/10/2020 10:17	12/10/2020 21:50	35,55	15	533,23	CHI
20201053004	FORMOSA	FA32042639	ITUIQUIRA	11/10/2020 10:17	12/10/2020 21:50	11/10/2020 14:52	12/10/2020 21:50	30,96	5	154,79	CHI
20201051704	FORMOSA	2870000280	ITUIQUIRA	11/10/2020 10:17	11/10/2020 22:13	11/10/2020 10:17	11/10/2020 22:13	11,92	1	11,92	CHI
20201051707	HIDROLANDIA	HD21273628	PONTALINA	11/10/2020 10:17	11/10/2020 19:34	11/10/2020 10:17	11/10/2020 19:34	9,27	1	9,27	CHI
20201051716	FORMOSA	FA21146169	ITUIQUIRA	11/10/2020 10:18	13/10/2020 08:00	11/10/2020 10:18	13/10/2020 08:00	45,69	2	91,38	CHI
20201051728	AGUAS LINDAS DE GOIAS	4830116755	AGUAS LINDAS DE GOIAS S1	11/10/2020 10:18	11/10/2020 11:51	11/10/2020 10:18	11/10/2020 11:51	1,54	1	1,54	CHI
20201051730	IACIARA	6910000567	IACIARA S1	11/10/2020 10:19	11/10/2020 22:01	11/10/2020 10:19	11/10/2020 22:01	11,70	1	11,70	CHI
20201051740	ANAPOLIS	TJ21353473	DAIA S2	11/10/2020 10:20	11/10/2020 17:16	11/10/2020 10:20	11/10/2020 17:16	6,93	1	6,93	CHI
20201051743	SANTA CRUZ DE GOIAS	BC12389809	PIRES DO RIO S2	11/10/2020 10:20	11/10/2020 13:07	11/10/2020 10:20	11/10/2020 13:07	2,78	9	25,02	CHI
20201051744	SENADOR CANEDO	10026320787	SENADOR CANEDO	11/10/2020 10:20	11/10/2020 11:48	11/10/2020 10:20	11/10/2020 11:48	1,46	1	1,46	CHI
20201052573	ALVORADA DO NORTE	AQ11060067	IACIARA S2	11/10/2020 10:20	11/10/2020 11:50	11/10/2020 10:20	11/10/2020 11:50	1,49	132	196,42	CHI
20201054892	FORMOSA	FA11046281	ITUIQUIRA	11/10/2020 10:21	11/10/2020 18:56	11/10/2020 10:21	11/10/2020 18:56	8,58	200	1715,06	CHI
20201051777	RIO VERDE	20420826	MONTIVIDIU T	11/10/2020 10:22	11/10/2020 18:00	11/10/2020 10:22	11/10/2020 18:00	7,63	1	7,63	CHI
20201051778	GOIAS	GS21183471	ITABERAI S1	11/10/2020 10:22	12/10/2020 13:32	11/10/2020 10:22	12/10/2020 13:32	27,16	2	54,32	CHI
20201051982	APARECIDA DE GOIANIA	AP11167674	INDEPENDENCIA S2	11/10/2020 10:22	11/10/2020 14:37	11/10/2020 10:22	11/10/2020 14:37	4,24	47	199,33	CHI
20201052692	GOIANIA	GN12158394	GOIANIA LESTE S3	11/10/2020 10:22	11/10/2020 12:46	11/10/2020 10:22	11/10/2020 12:46	2,39	86	205,16	CHI
20201051793	RIO VERDE	RV12260707	CABRIUVA S1	11/10/2020 10:23	11/10/2020 13:31	11/10/2020 10:23	11/10/2020 13:31	3,13	1	3,13	CHI
20201052655	BARRO ALTO	BA21144531	BARRO ALTO	11/10/2020 10:23	12/10/2020 09:07	11/10/2020 10:23	12/10/2020 09:07	22,72	2	45,44	CHI
20201051803	DIORAMA	DI12063493RE	IPORA	11/10/2020 10:24	11/10/2020 13:52	11/10/2020 10:24	11/10/2020 13:52	3,47	38	131,68	CHI
20201051803	MONTES CLAROS DE GOIAS	DI12063493RE	IPORA	11/10/2020 10:24	11/10/2020 13:52	11/10/2020 10:24	11/10/2020 13:52	3,47	7	24,26	CHI
20201051803	IPORA	DI12063493RE	IPORA	11/10/2020 10:24	11/10/2020 13:52	11/10/2020 10:24	11/10/2020 13:52	3,47	3	10,40	CHI
20201054935	ITAPURANGA	IK11108192	ITAPURANGA	11/10/2020 10:24	11/10/2020 19:28	11/10/2020 10:24	11/10/2020 19:28	9,06	128	1160,28	CHI
20201051806	GOIANIA	12453043	XAVANTES	11/10/2020 10:24	11/10/2020 22:23	11/10/2020 10:24	11/10/2020 22:23	11,98	1	11,98	CHI
20201051808	NEROPOLIS	160057073	NEROPOLIS S2	11/10/2020 10:24	11/10/2020 11:41	11/10/2020 10:24	11/10/2020 11:41	1,28	1	1,28	CHI
20201051822	EDEIA	EA21007676	RIO DOS BOIS	11/10/2020 10:25	11/10/2020 11:57	11/10/2020 10:25	11/10/2020 11:57	1,53	1	1,53	CHI
20201053753	GOIAS	GS11307389	GOIAS	11/10/2020 10:25	11/10/2020 14:50	11/10/2020 10:25	11/10/2020 14:50	4,42	85	375,35	CHI
20201051761	FLORES DE GOIAS	FB12249653	FLORES DE GOIAS	11/10/2020 10:25	11/10/2020 10:48	11/10/2020 10:25	11/10/2020 10:48	0,38	149	56,62	CHI
20201052654	GOIANIA	GN11267331	GOYA S1	11/10/2020 10:25	11/10/2020 16:28	11/10/2020 10:25	11/10/2020 16:28	6,04	140	845,06	CHI
20201051845	ANAPOLIS	21055683	ANAPOLIS UNIVERSITARIO S1	11/10/2020 10:26	11/10/2020 17:54	11/10/2020 10:26	11/10/2020 17:54	7,46	1	7,46	CHI
20201051848	PADRE BERNARDO	PB12104242	PADRE BERNARDO	11/10/2020 10:26	11/10/2020 13:50	11/10/2020 10:26	11/10/2020 13:50	3,39	4	13,57	CHI
20201051862	APARECIDA DE GOIANIA	14494644	INDEPENDENCIA S2	11/10/2020 10:27	11/10/2020 16:58	11/10/2020 10:27	11/10/2020 16:58	6,51	1	6,51	CHI
20201051865	MOIPORA	MO11349677	IPORA	11/10/2020 10:27	11/10/2020 13:37	11/10/2020 10:27	11/10/2020 13:37	3,15	33	104,10	CHI
20201051867	ITABERAI	10003668698	ITABERAI S2	11/10/2020 10:27	11/10/2020 15:55	11/10/2020 10:27	11/10/2020 15:55	5,46	1	5,46	CHI
20201051870	JESUPOLIS	SF21170301	SAO FRANCISCO DE GOIAS	11/10/2020 10:27	11/10/2020 14:19	11/10/2020 10:27	11/10/2020 14:19	3,85	1	3,85	CHI
20201051871	GOIATUBA	BJ21030810	RIO DOS BOIS	11/10/2020 10:28	12/10/2020 08:06	11/10/2020 10:28	12/10/2020 08:06	21,63	2	43,27	CHI
20201055104	MONTES CLAROS DE GOIAS	ME12088922	IPORA	11/10/2020 10:28	11/10/2020 21:05	11/10/2020 10:28	11/10/2020 21:05	10,61	17	180,39	CHI
20201051889	LUZIANIA	LZ11051977	PACAEMBU S2	11/10/2020 10:28	11/10/2020 15:08	11/10/2020 10:28	11/10/2020 15:08	4,65	10	46,51	CHI
20201052800	PALMINOPOLIS	PP12233526	PALMEIRAS	11/10/2020 10:28	12/10/2020 00:51	11/10/2020 10:28	12/10/2020 00:51	14,37	30	431,01	CHI
20201051912	FORMOSA	FA21116867	ITUIQUIRA	11/10/2020 10:31	12/10/2020 03:11	11/10/2020 10:31	12/10/2020 03:11	16,66	1	16,66	CHI
20201051947	RUBIATABA	RB12241451	RUBIATABA	11/10/2020 10:31	11/10/2020 14:05	11/10/2020 10:31	11/10/2020 14:05	3,56	10	35,61	CHI
20201051930	FAINA	FC21148743	GOIAS	11/10/2020 10:32	12/10/2020 13:21	11/10/2020 10:32	12/10/2020 13:21	26,81	1	26,81	CHI
20201051934	TRINDADE	40045705	TRINDADE	11/10/2020 10:33	12/10/2020 07:18	11/10/2020 10:33	12/10/2020 07:18	20,75	1	20,75	CHI
20201054707	CACHOEIRA DE GOIAS	CG12206081	FIRMINOPOLIS S2	11/10/2020 10:33	11/10/2020 19:28	11/10/2020 10:33	11/10/2020 19:28	8,91	8	71,25	CHI
20201051973	FAINA	FC12199793	GOIAS	11/10/2020 10:33	11/10/2020 13:18	11/10/2020 10:33	11/10/2020 13:18	2,74	17	46,56	CHI

20201051946	NOVO PLANALTO	SM12245706RE	SAO MIGUEL DO ARAGUAIA	11/10/2020 10:33	11/10/2020 15:07	11/10/2020 10:33	11/10/2020 15:07	4,55	26	118,42	CHI
20201051946	SAO MIGUEL DO ARAGUAIA	SM12245706RE	SAO MIGUEL DO ARAGUAIA	11/10/2020 10:33	11/10/2020 15:07	11/10/2020 10:33	11/10/2020 15:07	4,55	10	45,54	CHI
20201051951	TRINDADE	14123903	GOYA S2	11/10/2020 10:34	11/10/2020 13:51	11/10/2020 10:34	11/10/2020 13:51	3,28	1	3,28	CHI
20201051953	GOIANIA	10492203	GOIANIA LESTE S3	11/10/2020 10:34	11/10/2020 16:06	11/10/2020 10:34	11/10/2020 16:06	5,53	1	5,53	CHI
20201051954	POSSE	PS12255357	IACIARA S2	11/10/2020 10:34	11/10/2020 11:32	11/10/2020 10:34	11/10/2020 11:32	0,96	5	4,80	CHI
20201051962	ITUMBIARA	BG12000148	ITUMBIARA VELHA S2	11/10/2020 10:35	11/10/2020 20:54	11/10/2020 10:35	11/10/2020 20:54	10,33	4	41,31	CHI
20201051968	SANTA RITA DO ARAGUAIA	SU12301951	SANTA RITA DO ARAGUAIA	11/10/2020 10:36	11/10/2020 12:42	11/10/2020 10:36	11/10/2020 12:42	2,10	6	12,59	CHI
20201051969	SILVANIA	SV21012009	VIANOPOLIS	11/10/2020 10:36	11/10/2020 11:37	11/10/2020 10:36	11/10/2020 11:37	1,02	1	1,02	CHI
20201052440	CRIXAS	CX12248236	SERRA DO OURO	11/10/2020 10:36	11/10/2020 14:59	11/10/2020 10:36	11/10/2020 14:59	4,38	5	21,90	CHI
20201051983	URUACU	640027611	URUACU	11/10/2020 10:37	12/10/2020 12:36	11/10/2020 10:37	12/10/2020 12:36	25,98	1	25,98	CHI
20201051984	GOIANIA	13461333	XAVANTES	11/10/2020 10:37	11/10/2020 22:37	11/10/2020 10:37	11/10/2020 22:37	12,00	1	12,00	CHI
20201051988	CRISTALINA	KR12163740	CRISTALINA S2	11/10/2020 10:37	11/10/2020 14:36	11/10/2020 10:37	11/10/2020 14:36	3,97	9	35,77	CHI
20201051996	LUZIANIA	120297826	RIO VERMELHO	11/10/2020 10:38	11/10/2020 15:29	11/10/2020 10:38	11/10/2020 15:29	4,85	1	4,85	CHI
20201052001	SENADOR CANEDO	SW31079101	SENADOR CANEDO	11/10/2020 10:38	11/10/2020 12:55	11/10/2020 10:38	11/10/2020 12:55	2,27	8	18,20	CHI
20201052253	CAMPESTRE DE GOIAS	GC12000124	TRINDADE	11/10/2020 10:39	11/10/2020 14:31	11/10/2020 10:39	11/10/2020 14:31	3,86	16	61,84	CHI
20201052009	LUZIANIA	LZ21145569	CRISTALINA S2	11/10/2020 10:39	11/10/2020 21:52	11/10/2020 10:39	11/10/2020 21:52	11,22	1	11,22	CHI
20201052021	CORUMBA DE GOIAS	CB12062143	CORUMBA	11/10/2020 10:40	11/10/2020 15:10	11/10/2020 10:40	11/10/2020 15:10	4,50	25	112,47	CHI
20201052025	CAMPINACU	UC12197187	PORANGATU	11/10/2020 10:40	12/10/2020 10:25	11/10/2020 10:40	12/10/2020 10:25	23,75	28	664,95	CHI
20201053447	PORANGATU	PO12020945	PORANGATU	11/10/2020 10:40	11/10/2020 16:26	11/10/2020 10:40	11/10/2020 16:26	5,76	6	34,53	CHI
20201052499	APARECIDA DE GOIANIA	AP11227511	INDEPENDENCIA S1	11/10/2020 10:41	11/10/2020 12:24	11/10/2020 10:41	11/10/2020 12:24	1,71	68	116,47	CHI
20201052041	GOIANIA	10005111305	CARAJAS S1	11/10/2020 10:41	11/10/2020 21:23	11/10/2020 10:41	11/10/2020 21:23	10,69	1	10,69	CHI
20201052053	MINACU	4020062652	MINACU	11/10/2020 10:42	12/10/2020 16:37	11/10/2020 10:42	12/10/2020 16:37	29,92	1	29,92	CHI
20201052125	APARECIDA DE GOIANIA	AP11007824	ANHANGUERA	11/10/2020 10:43	11/10/2020 12:52	11/10/2020 10:43	11/10/2020 12:52	2,14	263	563,33	CHI
20201052175	ARAGOIANIA	AO32000298	GUAPO S2	11/10/2020 10:43	11/10/2020 14:15	11/10/2020 10:43	11/10/2020 14:15	3,52	7	24,67	CHI
20201052780	JAU PACI	JP12193319	IPORA	11/10/2020 10:43	13/10/2020 15:02	11/10/2020 10:43	13/10/2020 15:02	52,32	4	209,28	CHI
20201052074	AMORINOPOLIS	AM21284841	IPORA	11/10/2020 10:44	12/10/2020 09:06	11/10/2020 10:44	12/10/2020 09:06	22,36	2	44,72	CHI
20201052090	RIO VERDE	RV21271614	RIO VERDE S1	11/10/2020 10:45	11/10/2020 14:22	11/10/2020 10:45	11/10/2020 14:22	3,61	6	21,67	CHI
20201052420	GOIANIA	GN11002373	FERROVIARIO S3	11/10/2020 10:46	11/10/2020 14:38	11/10/2020 10:46	11/10/2020 14:38	3,86	80	308,49	CHI
20201052109	MONTES CLAROS DE GOIAS	ME12004038	IPORA	11/10/2020 10:46	12/10/2020 07:42	11/10/2020 10:46	12/10/2020 07:42	20,92	1	20,92	CHI
20201052497	CATURAI	AV12272366	ANICUNS	11/10/2020 10:47	11/10/2020 20:19	11/10/2020 10:47	11/10/2020 20:19	9,52	9	85,72	CHI
20201052497	AVELINOPOLIS	AV12272366	ANICUNS	11/10/2020 10:47	11/10/2020 20:19	11/10/2020 10:47	11/10/2020 20:19	9,52	5	47,62	CHI
20201053617	SANTA BARBARA DE GOIAS	SB12323219	TRINDADE	11/10/2020 10:47	11/10/2020 16:44	11/10/2020 10:47	11/10/2020 16:44	5,94	7	41,58	CHI
20201053617	TRINDADE	SB12323219	TRINDADE	11/10/2020 10:47	11/10/2020 16:44	11/10/2020 10:47	11/10/2020 16:44	5,94	6	35,64	CHI
20201052929	CAMPINACU	UC12239716	PORANGATU	11/10/2020 10:50	11/10/2020 20:55	11/10/2020 10:50	11/10/2020 20:55	10,08	35	352,78	CHI
20201052157	GOIANIA	13583712	GOYA S1	11/10/2020 10:51	11/10/2020 16:28	11/10/2020 10:51	11/10/2020 16:28	5,61	1	5,61	CHI
20201052709	FIRMINOPOLIS	FR12081367	FIRMINOPOLIS S1	11/10/2020 10:51	11/10/2020 17:35	11/10/2020 10:51	11/10/2020 17:35	6,72	5	33,60	CHI
20201050872	CACHOEIRA DE GOIAS	CG12361874	FIRMINOPOLIS S2	11/10/2020 10:51	11/10/2020 18:20	11/10/2020 10:51	11/10/2020 18:20	7,47	126	941,01	CHI
20201052456	PONTALINA	PK12000100	PONTALINA	11/10/2020 10:51	11/10/2020 11:39	11/10/2020 10:51	11/10/2020 11:39	0,79	11	8,64	CHI
20201053977	LUZIANIA	LZ11128758	RIO VERMELHO	11/10/2020 10:52	11/10/2020 17:09	11/10/2020 10:52	11/10/2020 17:09	6,28	84	527,38	CHI
20201053294	ARAGOIANIA	AO11251586	GUAPO S2	11/10/2020 10:53	11/10/2020 15:59	11/10/2020 10:53	11/10/2020 15:59	5,09	22	112,01	CHI
20201052185	ISRAELANDIA	IS21218990	IPORA	11/10/2020 10:53	11/10/2020 13:27	11/10/2020 10:53	11/10/2020 13:27	2,56	1	2,56	CHI
20201052186	NOVA CRIXAS	NA11207481	NOVA CRIXAS	11/10/2020 10:53	12/10/2020 12:44	11/10/2020 10:53	12/10/2020 12:44	25,84	41	1059,27	CHI
20201052187	GOIANIA	16882866	GOYA S2	11/10/2020 10:53	11/10/2020 17:55	11/10/2020 10:53	11/10/2020 17:55	7,02	1	7,02	CHI
20201052189	PALMINOPOLIS	PP21026127	PALMEIRAS	11/10/2020 10:54	12/10/2020 12:26	11/10/2020 10:54	12/10/2020 12:26	25,53	1	25,53	CHI
20201052197	APARECIDA DE GOIANIA	14766292	REAL S2	11/10/2020 10:54	11/10/2020 16:39	11/10/2020 10:54	11/10/2020 16:39	5,74	1	5,74	CHI
20201052198	SILVANIA	LB12319538	DAIA S2	11/10/2020 10:54	11/10/2020 13:34	11/10/2020 10:54	11/10/2020 13:34	2,65	1	2,65	CHI
20201052199	GOIANIA	11445488	GOIANIA LESTE S1	11/10/2020 10:54	11/10/2020 15:48	11/10/2020 10:54	11/10/2020 15:48	4,89	1	4,89	CHI
20201052204	ITABERAI	50013099	ITABERAI S2	11/10/2020 10:55	12/10/2020 03:11	11/10/2020 10:55	12/10/2020 03:11	16,26	1	16,26	CHI
20201052206	GOIANIA	10017545836	GOYA S1	11/10/2020 10:55	11/10/2020 15:52	11/10/2020 10:55	11/10/2020 15:52	4,94	1	4,94	CHI
20201052212	PORANGATU	PO21290392	PORANGATU	11/10/2020 10:56	11/10/2020 13:35	11/10/2020 10:56	11/10/2020 13:35	2,66	1	2,66	CHI
20201052246	ANAPOLIS	21266049	ANAPOLIS UNIVERSITARIO S2	11/10/2020 10:58	11/10/2020 19:45	11/10/2020 10:58	11/10/2020 19:45	8,78	1	8,78	CHI
20201052256	ITAPURANGA	IK12100726	ITAPURANGA	11/10/2020 10:59	11/10/2020 16:41	11/10/2020 10:59	11/10/2020 16:41	5,69	6	34,15	CHI
20201052260	ANICUNS	910030261	ANICUNS	11/10/2020 10:59	12/10/2020 16:34	11/10/2020 10:59	12/10/2020 16:34	29,57	1	29,57	CHI
20201052269	FORMOSA	FA21106879	ITUIQUIRA	11/10/2020 11:00	12/10/2020 13:30	11/10/2020 11:00	12/10/2020 13:30	26,49	1	26,49	CHI
20201055308	MATRINCHA	MP12165386	MOZARLANDIA	11/10/2020 11:00	11/10/2020 20:48	11/10/2020 11:00	11/10/2020 20:48	9,78	2	19,57	CHI
20201052280	GOIANESIA	GE11090284	GOIANESIA S2	11/10/2020 11:01	11/10/2020 14:35	11/10/2020 11:01	11/10/2020 14:35	3,55	242	859,84	CHI
20201053434	TRINDADE	TR32011387	TRINDADE	11/10/2020 11:02	11/10/2020 23:35	11/10/2020 11:02	11/10/2020 23:35	12,55	2	25,10	CHI
20201052285	MONTE ALEGRE DE GOIAS	MA12252663	SAO DOMINGOS	11/10/2020 11:02	11/10/2020 12:37	11/10/2020 11:02	11/10/2020 12:37	1,58	5	7,91	CHI

20201052287	LUZIANIA	LZ21228865	PACAEMBU S2	11/10/2020 11:02	11/10/2020 16:10	11/10/2020 11:02	11/10/2020 16:10	5,13	2	10,26	CHI
20201052300	ITABERAI	IB11337337	ITABERAI S1	11/10/2020 11:03	12/10/2020 09:42	11/10/2020 11:03	12/10/2020 09:42	22,65	1	22,65	CHI
20201052311	SANTA BARBARA DE GOIAS	SB21259082	TRINDADE	11/10/2020 11:04	11/10/2020 14:26	11/10/2020 11:04	11/10/2020 14:26	3,37	5	16,83	CHI
20201052312	ANAPOLIS	AN11000290	JUNDIAI S2	11/10/2020 11:04	11/10/2020 17:01	11/10/2020 11:04	11/10/2020 17:01	5,95	75	446,21	CHI
20201052327	JATAI	JT21326424	JATAI S3	11/10/2020 11:04	11/10/2020 13:42	11/10/2020 11:04	11/10/2020 13:42	2,62	1	2,62	CHI
20201052322	ITAPIRAPUA	IU21286031	MATRINCHA	11/10/2020 11:04	12/10/2020 10:26	11/10/2020 11:04	12/10/2020 10:26	23,36	1	23,36	CHI
20201052324	RIO VERDE	RV21322241	RIO VERDE S1	11/10/2020 11:04	11/10/2020 22:15	11/10/2020 11:04	11/10/2020 22:15	11,17	1	11,17	CHI
20201052454	ANICUNS	AC12304530	ANICUNS	11/10/2020 11:05	11/10/2020 12:45	11/10/2020 11:05	11/10/2020 12:45	1,66	1	1,66	CHI
20201052454	MOSSAMEDES	AC12304530	ANICUNS	11/10/2020 11:05	11/10/2020 12:45	11/10/2020 11:05	11/10/2020 12:45	1,66	5	8,32	CHI
20201052481	ARACU	AR12355884	ARACU	11/10/2020 11:05	11/10/2020 18:29	11/10/2020 11:05	11/10/2020 18:29	7,38	4	29,54	CHI
20201052355	BOM JARDIM DE GOIAS	BM21155710	BOM JARDIM	11/10/2020 11:06	11/10/2020 12:24	11/10/2020 11:06	11/10/2020 12:24	1,29	1	1,29	CHI
20201052363	TROMBAS	TB21324030	PORANGATU	11/10/2020 11:07	11/10/2020 14:15	11/10/2020 11:07	11/10/2020 14:15	3,13	1	3,13	CHI
20201052371	GOIANIA	15146200	FERROVIARIO S1	11/10/2020 11:08	11/10/2020 21:06	11/10/2020 11:08	11/10/2020 21:06	9,96	1	9,96	CHI
20201052385	AGUAS LINDAS DE GOIAS	4830059796	AGUAS LINDAS DE GOIAS S1	11/10/2020 11:09	11/10/2020 12:54	11/10/2020 11:09	11/10/2020 12:54	1,75	1	1,75	CHI
20201053682	GOIAS	GS12124776	GOIAS	11/10/2020 11:09	12/10/2020 11:15	11/10/2020 11:09	12/10/2020 11:15	24,09	31	746,65	CHI
2020105649	SANTA ROSA DE GOIAS	SR12240520	INHUMAS S1	11/10/2020 11:10	12/10/2020 01:17	11/10/2020 11:10	12/10/2020 01:17	14,12	3	42,35	CHI
20201052424	CABECEIRAS	CW21151429	ITUIQUIRA	11/10/2020 11:10	11/10/2020 18:29	11/10/2020 11:10	11/10/2020 18:29	7,31	1	7,31	CHI
20201052425	APARECIDA DE GOIANIA	AP11004667	INDEPENDENCIA S2	11/10/2020 11:10	11/10/2020 14:21	11/10/2020 11:10	11/10/2020 14:21	3,18	130	413,04	CHI
20201052428	RIO VERDE	RV12214221	MONTIVIDIU T	11/10/2020 11:10	11/10/2020 17:14	11/10/2020 11:10	11/10/2020 17:14	6,05	1	6,05	CHI
20201052429	PALMEIRAS DE GOIAS	PL21341642	PALMEIRAS	11/10/2020 11:10	12/10/2020 07:28	11/10/2020 11:10	12/10/2020 07:28	20,28	1	20,28	CHI
20201052435	IVOLANDIA	IV12374885	IPORA	11/10/2020 11:11	11/10/2020 16:44	11/10/2020 11:11	11/10/2020 16:44	5,54	1	5,54	CHI
20201052435	MOIPORA	IV12374885	IPORA	11/10/2020 11:11	11/10/2020 16:44	11/10/2020 11:11	11/10/2020 16:44	5,54	1	5,54	CHI
20201052439	FORMOSA	610336113	ITUIQUIRA	11/10/2020 11:11	12/10/2020 08:27	11/10/2020 11:11	12/10/2020 08:27	21,25	1	21,25	CHI
20201052441	QUIRINOPOLIS	QI21093066	QUIRINOPOLIS	11/10/2020 11:12	11/10/2020 15:59	11/10/2020 11:12	11/10/2020 15:59	4,78	1	4,78	CHI
20201052460	GOIANIA	10016828508	CARAJAS S1	11/10/2020 11:12	11/10/2020 20:59	11/10/2020 11:12	11/10/2020 20:59	9,77	1	9,77	CHI
20201052649	GOIANIA	15968352	GOYA S2	11/10/2020 11:13	11/10/2020 15:00	11/10/2020 11:13	11/10/2020 15:00	3,80	1	3,80	CHI
20201052465	CRISTALINA	KR12168277	PAMPLONA	11/10/2020 11:13	11/10/2020 15:45	11/10/2020 11:13	11/10/2020 15:45	4,53	5	22,66	CHI
20201054127	BRITANIA	AK12028880	BRITANIA	11/10/2020 11:13	11/10/2020 19:28	11/10/2020 11:13	11/10/2020 19:28	8,25	1	8,25	CHI
20201054127	ARUANA	AK12028880	BRITANIA	11/10/2020 11:13	11/10/2020 19:28	11/10/2020 11:13	11/10/2020 19:28	8,25	12	98,97	CHI
20201052471	GOIANIA	12962200	CARAJAS S1	11/10/2020 11:13	11/10/2020 15:56	11/10/2020 11:13	11/10/2020 15:56	4,71	1	4,71	CHI
20201052483	URUACU	640072331	URUACU	11/10/2020 11:14	11/10/2020 17:02	11/10/2020 11:14	11/10/2020 17:02	5,79	1	5,79	CHI
20201052679	NOVA ROMA	FB10407036	FLORES DE GOIAS	11/10/2020 11:15	11/10/2020 11:19	11/10/2020 11:15	11/10/2020 11:19	0,07	2	0,13	CHI
20201052679	FLORES DE GOIAS	FB10407036	FLORES DE GOIAS	11/10/2020 11:15	11/10/2020 11:19	11/10/2020 11:15	11/10/2020 11:19	0,07	412	26,78	CHI
20201052679	SAO JOAO D ALIANCA	FB10407036	FLORES DE GOIAS	11/10/2020 11:15	11/10/2020 11:19	11/10/2020 11:15	11/10/2020 11:19	0,07	46	2,99	CHI
20201052502	MAMOS DE GOIAS	MJ21377238	PADRE BERNARDO	11/10/2020 11:16	11/10/2020 16:43	11/10/2020 11:16	11/10/2020 16:43	5,44	1	5,44	CHI
20201052510	ITARUMA	IM21039432	CACHOEIRA ALTA	11/10/2020 11:17	11/10/2020 13:37	11/10/2020 11:17	11/10/2020 13:37	2,32	2	4,64	CHI
20201052522	PALMINOPOLIS	PP21259847	PALMEIRAS	11/10/2020 11:18	12/10/2020 11:52	11/10/2020 11:18	12/10/2020 11:52	24,55	1	24,55	CHI
20201052524	PIRENOPOLIS	PV21194531	CORUMBA	11/10/2020 11:19	11/10/2020 16:04	11/10/2020 11:19	11/10/2020 16:04	4,75	4	19,00	CHI
20201052841	PIRENOPOLIS	PV12000030	CORUMBA	11/10/2020 11:20	11/10/2020 13:33	11/10/2020 11:20	11/10/2020 13:33	2,21	19	41,94	CHI
20201053144	LEOPOLDO DE BULHOES	LB12353165	DAIA S2	11/10/2020 11:20	11/10/2020 17:10	11/10/2020 11:20	11/10/2020 17:10	5,82	15	87,35	CHI
20201052645	NOVA CRIXAS	NA12321769	MOZARLANDIA	11/10/2020 11:21	11/10/2020 19:50	11/10/2020 11:21	11/10/2020 19:50	8,48	10	84,79	CHI
20201052557	URUACU	UR21283885	URUACU	11/10/2020 11:21	12/10/2020 12:30	11/10/2020 11:21	12/10/2020 12:30	25,14	1	25,14	CHI
20201052562	SAO MIGUEL DO ARAGUAIA	830038711	SAO MIGUEL DO ARAGUAIA	11/10/2020 11:22	12/10/2020 17:11	11/10/2020 11:22	12/10/2020 17:11	29,82	1	29,82	CHI
20201052565	SANTA BARBARA DE GOIAS	SB21016389	ANICUNS	11/10/2020 11:22	11/10/2020 15:38	11/10/2020 11:22	11/10/2020 15:38	4,26	1	4,26	CHI
20201052567	MORRINHOS	150060774	MORRINHOS	11/10/2020 11:22	11/10/2020 12:51	11/10/2020 11:22	11/10/2020 12:51	1,47	1	1,47	CHI
20201052568	PROFESSOR JAMIL SAFADY	MI21000199	PONTALINA	11/10/2020 11:22	11/10/2020 16:08	11/10/2020 11:22	11/10/2020 16:08	4,76	1	4,76	CHI
20201052569	ANICUNS	AC21104844	ANICUNS	11/10/2020 11:22	12/10/2020 05:06	11/10/2020 11:22	12/10/2020 05:06	17,72	1	17,72	CHI
20201052570	ARAGOIANIA	AO32095549	GUAPU S2	11/10/2020 11:22	11/10/2020 19:56	11/10/2020 11:22	11/10/2020 19:56	8,56	4	34,23	CHI
20201052572	GOIANIA	13975160	GOYA S2	11/10/2020 11:22	11/10/2020 15:51	11/10/2020 11:22	11/10/2020 15:51	4,47	1	4,47	CHI
20201052909	PIRENOPOLIS	PV12099908	CORUMBA	11/10/2020 11:23	11/10/2020 17:38	11/10/2020 11:23	11/10/2020 17:38	6,25	11	68,73	CHI
20201052579	BRAZABRANTES	BR21360477	INHUMAS S1	11/10/2020 11:23	12/10/2020 09:37	11/10/2020 11:23	12/10/2020 09:37	22,23	1	22,23	CHI
20201052583	BELA VISTA DE GOIAS	240054490	BELA VISTA S1	11/10/2020 11:23	11/10/2020 23:33	11/10/2020 11:23	11/10/2020 23:33	12,17	1	12,17	CHI
20201052585	GOIANIA	GN12056073	CAMPINAS S2	11/10/2020 11:24	11/10/2020 20:31	11/10/2020 11:24	11/10/2020 20:31	9,11	1	9,11	CHI
20201048545	SENADOR CANEDO	SW11209176	CEPAIGO S2	11/10/2020 11:24	11/10/2020 11:56	11/10/2020 11:24	11/10/2020 11:56	0,53	15	7,95	CHI
20201052586	SILVANIA	SV21167468	DAIA S2	11/10/2020 11:24	11/10/2020 23:15	11/10/2020 11:24	11/10/2020 23:15	11,85	1	11,85	CHI
20201052592	NOVO GAMA	NJ11183841	PACAEMBU S1	11/10/2020 11:25	11/10/2020 12:10	11/10/2020 11:25	11/10/2020 12:10	0,75	135	101,14	CHI
20201052594	APARECIDA DE GOIANIA	12561253	INDEPENDENCIA S2	11/10/2020 11:25	11/10/2020 14:34	11/10/2020 11:25	11/10/2020 14:34	3,15	1	3,15	CHI
20201052595	SAO DOMINGOS	SD21344051	SAO DOMINGOS	11/10/2020 11:25	11/10/2020 17:52	11/10/2020 11:25	11/10/2020 17:52	6,44	1	6,44	CHI

20201052605	PIRENOPOLIS	PV21245637	SAO FRANCISCO DE GOIAS	11/10/2020 11:26	11/10/2020 22:13	11/10/2020 11:26	11/10/2020 22:13	10,78	2	21,56	CHI
20201052611	ITAGUARU	230001490	ITABERAI S1	11/10/2020 11:27	12/10/2020 09:58	11/10/2020 11:27	12/10/2020 09:58	22,51	1	22,51	CHI
20201052623	CALDAS NOVAS	10006772577	CALDAS NOVAS S1	11/10/2020 11:28	11/10/2020 15:03	11/10/2020 11:28	11/10/2020 15:03	3,58	1	3,58	CHI
20201053234	GOIANIA	GN11002375	FERROVIARIO S3	11/10/2020 11:28	11/10/2020 15:59	11/10/2020 11:28	11/10/2020 15:59	4,51	173	779,80	CHI
20201052630	FORMOSA	FA12302750	ITUIQUIRA	11/10/2020 11:28	12/10/2020 10:47	11/10/2020 11:28	12/10/2020 10:47	23,31	4	93,22	CHI
20201053537	PIRENOPOLIS	PV12056014	CORUMBA	11/10/2020 11:28	11/10/2020 17:15	11/10/2020 11:28	11/10/2020 17:15	5,77	48	277,04	CHI
20201052755	CAMPINORTE	CR12101054	CAMPINORTE	11/10/2020 11:28	11/10/2020 20:45	11/10/2020 11:28	11/10/2020 20:45	9,27	6	55,61	CHI
20201052644	SAO MIGUEL DO ARAGUAIA	SM12099607	SAO MIGUEL DO ARAGUAIA	11/10/2020 11:30	11/10/2020 15:33	11/10/2020 11:30	11/10/2020 15:33	4,06	2	8,12	CHI
20201052646	NOVO GAMA	NJ11183657	PACAEMBU S1	11/10/2020 11:30	11/10/2020 15:14	11/10/2020 11:30	11/10/2020 15:14	3,73	145	541,17	CHI
20201051234	BELA VISTA DE GOIAS	BV31097942	BELA VISTA S1	11/10/2020 11:30	11/10/2020 11:44	11/10/2020 11:30	11/10/2020 11:44	0,23	1	0,23	CHI
20201052651	NEROPOLIS	160038868	NEROPOLIS S2	11/10/2020 11:30	11/10/2020 16:42	11/10/2020 11:30	11/10/2020 16:42	5,19	1	5,19	CHI
20201055110	MONTES CLAROS DE GOIAS	ME12207822	IPORA	11/10/2020 11:30	11/10/2020 19:55	11/10/2020 11:30	11/10/2020 19:55	8,40	28	235,30	CHI
20201052672	CALDAZINHA	BV12059740	CEPAIGO S2	11/10/2020 11:31	11/10/2020 15:53	11/10/2020 11:31	11/10/2020 15:53	4,36	19	82,77	CHI
20201052675	BURITINOPOLIS	BQ21262389	IACIARA S2	11/10/2020 11:31	11/10/2020 12:22	11/10/2020 11:31	11/10/2020 12:22	0,84	1	0,84	CHI
20201052676	RIO VERDE	10013469710	CABRIUVA S2	11/10/2020 11:31	11/10/2020 17:01	11/10/2020 11:31	11/10/2020 17:01	5,49	1	5,49	CHI
20201053166	ESTRELA DO NORTE	ET12143705	MARA ROSA	11/10/2020 11:33	11/10/2020 14:50	11/10/2020 11:33	11/10/2020 14:50	3,28	9	29,55	CHI
20201053166	FORMOSO	ET12143705	MARA ROSA	11/10/2020 11:33	11/10/2020 14:50	11/10/2020 11:33	11/10/2020 14:50	3,28	7	22,98	CHI
20201052703	TURVANIA	TV21003667	FIRMINOPOLIS S2	11/10/2020 11:33	11/10/2020 16:46	11/10/2020 11:33	11/10/2020 16:46	5,21	3	15,62	CHI
20201052704	ANAPOLIS	AN21032557	NEROPOLIS S1	11/10/2020 11:33	11/10/2020 21:00	11/10/2020 11:33	11/10/2020 21:00	9,44	1	9,44	CHI
20201052706	JOVIANIA	JV12038978	VICENTINOPOLIS	11/10/2020 11:34	11/10/2020 14:09	11/10/2020 11:34	11/10/2020 14:09	2,58	2	5,16	CHI
20201052711	COCALZINHO DE GOIAS	ZN21388217	COCALZINHO	11/10/2020 11:34	11/10/2020 19:58	11/10/2020 11:34	11/10/2020 19:58	8,39	1	8,39	CHI
20201052715	APARECIDA DE GOIANIA	200105668	INDEPENDENCIA S2	11/10/2020 11:35	11/10/2020 17:45	11/10/2020 11:35	11/10/2020 17:45	6,16	1	6,16	CHI
20201052716	TRINDADE	40047672	TRINDADE	11/10/2020 11:35	11/10/2020 12:24	11/10/2020 11:35	11/10/2020 12:24	0,81	1	0,81	CHI
20201050346	GOIANIA	GN21059986	REAL S1	11/10/2020 11:37	11/10/2020 12:06	11/10/2020 11:37	11/10/2020 12:06	0,48	5	2,42	CHI
20201052737	ITAPURANGA	170005318	ITAPURANGA	11/10/2020 11:37	12/10/2020 14:01	11/10/2020 11:37	12/10/2020 14:01	26,40	1	26,40	CHI
20201052740	PLANALTINA	2960035258	PLANALTINA	11/10/2020 11:37	12/10/2020 07:57	11/10/2020 11:37	12/10/2020 07:57	20,33	1	20,33	CHI
20201053000	GOIANIA	GN11001997	AEROPORTO S2	11/10/2020 11:37	11/10/2020 13:30	11/10/2020 11:37	11/10/2020 13:30	1,87	104	194,22	CHI
20201052754	INHUMAS	IN21095669	INHUMAS S2	11/10/2020 11:38	11/10/2020 20:29	11/10/2020 11:38	11/10/2020 20:29	8,85	1	8,85	CHI
20201052770	ITAGUARI	770003783	ITABERAI S1	11/10/2020 11:38	12/10/2020 08:55	11/10/2020 11:38	12/10/2020 08:55	21,27	1	21,27	CHI
20201052774	ITAPIRAPUA	IU21072453	MATRINCHA	11/10/2020 11:38	12/10/2020 16:59	11/10/2020 11:38	12/10/2020 16:59	29,34	1	29,34	CHI
20201052775	ANAPOLIS	21019952	JUNDIAI S1	11/10/2020 11:38	11/10/2020 17:10	11/10/2020 11:38	11/10/2020 17:10	5,52	1	5,52	CHI
20201052781	SAO JOAO DA PARAUNA	1000000221	FIRMINOPOLIS S2	11/10/2020 11:39	12/10/2020 09:21	11/10/2020 11:39	12/10/2020 09:21	21,70	1	21,70	CHI
20201052784	RIO VERDE	10024803110	CABRIUVA S1	11/10/2020 11:39	11/10/2020 21:00	11/10/2020 11:39	11/10/2020 21:00	9,34	1	9,34	CHI
20201052795	NOVO GAMA	4990043298	PACAEMBU S1	11/10/2020 11:40	11/10/2020 12:55	11/10/2020 11:40	11/10/2020 12:55	1,23	1	1,23	CHI
20201052816	RIO VERDE	10030266600	RIO VERDE S2	11/10/2020 11:42	12/10/2020 08:53	11/10/2020 11:42	12/10/2020 08:53	21,17	1	21,17	CHI
20201052818	GOIANIA	11713148	GOYA S1	11/10/2020 11:42	11/10/2020 16:17	11/10/2020 11:42	11/10/2020 16:17	4,57	1	4,57	CHI
20201052822	GOIANIA	13206230	FERROVIARIO S3	11/10/2020 11:43	11/10/2020 20:03	11/10/2020 11:43	11/10/2020 20:03	8,32	1	8,32	CHI
20201052824	ITAPURANGA	IK12274566	ITAPURANGA	11/10/2020 11:43	11/10/2020 21:55	11/10/2020 11:43	11/10/2020 20:27	8,72	2	17,44	CHI
20201052824	ITAPURANGA	IK21113434	ITAPURANGA	11/10/2020 11:43	11/10/2020 21:55	11/10/2020 11:43	11/10/2020 21:55	10,19	1	10,19	CHI
20201052826	APARECIDA DE GOIANIA	AP21279332	INDEPENDENCIA S1	11/10/2020 11:43	11/10/2020 16:13	11/10/2020 11:43	11/10/2020 16:13	4,48	1	4,48	CHI
20201053371	GOIANIA	GN11000705	ATLANTICO S2	11/10/2020 11:43	11/10/2020 16:04	11/10/2020 11:43	11/10/2020 16:04	4,33	171	741,14	CHI
20201052829	ITABERAI	IB21000027	ITABERAI S2	11/10/2020 11:44	11/10/2020 16:48	11/10/2020 11:44	11/10/2020 16:48	5,06	1	5,06	CHI
20201052831	NOVA ROMA	ND12392238	IACIARA S2	11/10/2020 11:44	11/10/2020 17:04	11/10/2020 11:44	11/10/2020 17:04	5,32	243	1293,84	CHI
20201052833	GOIANIA	13810870	GOIANIA LESTE S1	11/10/2020 11:44	11/10/2020 17:02	11/10/2020 11:44	11/10/2020 17:02	5,29	1	5,29	CHI
20201056312	CAMPINORTE	CR12086295	CAMPINORTE	11/10/2020 11:45	12/10/2020 11:16	11/10/2020 11:45	12/10/2020 11:16	23,51	1	23,51	CHI
20201056312	URUACU	CR12086295	CAMPINORTE	11/10/2020 11:45	12/10/2020 11:16	11/10/2020 11:45	12/10/2020 11:16	23,51	4	94,04	CHI
20201052939	ABADIANIA	AA21184727	ANAPOLIS UNIVERSITARIO S1	11/10/2020 11:45	12/10/2020 08:17	11/10/2020 11:45	12/10/2020 08:17	20,52	1	20,52	CHI
20201053118	SILVANIA	SV12205360	VIANOPOLIS	11/10/2020 11:46	11/10/2020 13:42	11/10/2020 11:46	11/10/2020 13:42	1,93	5	9,66	CHI
20201052846	PALMINOPOLIS	PP21353628	PALMEIRAS	11/10/2020 11:46	12/10/2020 10:50	11/10/2020 11:46	12/10/2020 10:50	23,05	1	23,05	CHI
20201056710	ANICUNS	AC21035003	ANICUNS	11/10/2020 11:47	12/10/2020 04:35	11/10/2020 11:47	12/10/2020 04:35	16,80	1	16,80	CHI
20201052849	ITAPURANGA	IK21124268	ITAPURANGA	11/10/2020 11:47	12/10/2020 14:14	11/10/2020 11:47	12/10/2020 14:14	26,45	1	26,45	CHI
20201052850	FLORES DE GOIAS	FB21180696	FLORES DE GOIAS	11/10/2020 11:47	12/10/2020 09:50	11/10/2020 11:47	12/10/2020 09:50	22,04	1	22,04	CHI
20201055456	SAO JOAO D ALIANCA	JL12049201	SAO JOAO D ALIANCA	11/10/2020 11:47	11/10/2020 20:27	11/10/2020 11:47	11/10/2020 20:27	8,66	95	822,38	CHI
20201054699	SAO JOAO DA PARAUNA	RP21299070	PARAUNA	11/10/2020 11:48	12/10/2020 19:15	11/10/2020 11:48	12/10/2020 19:15	31,44	1	31,44	CHI
20201054369	RUBIATABA	RB12156050	RUBIATABA	11/10/2020 11:50	11/10/2020 18:26	11/10/2020 11:50	11/10/2020 18:26	6,60	20	131,98	CHI
20201054369	MORRO AGUDO DE GOIAS	RB12156050	RUBIATABA	11/10/2020 11:50	11/10/2020 18:26	11/10/2020 11:50	11/10/2020 18:26	6,60	10	65,99	CHI
20201052889	GOIANIA	11048505	REAL S1	11/10/2020 11:51	11/10/2020 16:29	11/10/2020 11:51	11/10/2020 16:29	4,62	1	4,62	CHI
20201052890	CATALAO	CT21327337	CATALAO S1	11/10/2020 11:51	11/10/2020 13:04	11/10/2020 11:51	11/10/2020 13:04	1,21	1	1,21	CHI

20201052892	URUTAI	UT21186598	URUTAI	11/10/2020 11:51	11/10/2020 15:10	11/10/2020 11:51	11/10/2020 15:10	3,30	1	3,30	CHI
20201052893	PALMINOPOLIS	PL12051259	FIRMINOPOLIS S2	11/10/2020 11:52	12/10/2020 15:52	11/10/2020 11:52	12/10/2020 15:30	27,63	2	55,27	CHI
20201052893	TURVANIA	PL12051259	FIRMINOPOLIS S2	11/10/2020 11:52	12/10/2020 15:52	11/10/2020 11:52	12/10/2020 15:30	27,63	2	55,27	CHI
20201052893	PALMINOPOLIS	PL12051259	FIRMINOPOLIS S2	11/10/2020 11:52	12/10/2020 15:52	11/10/2020 11:52	12/10/2020 15:52	28,01	1	28,01	CHI
20201052900	ITAUCU	IX21013774	INHUMAS S2	11/10/2020 11:52	12/10/2020 11:15	11/10/2020 11:52	12/10/2020 11:15	23,37	1	23,37	CHI
20201052901	BELA VISTA DE GOIAS	240005326	BELA VISTA S1	11/10/2020 11:52	11/10/2020 17:27	11/10/2020 11:52	11/10/2020 17:27	5,57	1	5,57	CHI
20201052904	ITAGUARI	770014409	ITABERAI S1	11/10/2020 11:52	11/10/2020 14:59	11/10/2020 11:52	11/10/2020 14:59	3,10	1	3,10	CHI
20201052905	PLANALTINA	2960043590	PLANALTINA	11/10/2020 11:52	12/10/2020 12:34	11/10/2020 11:52	12/10/2020 12:34	24,68	1	24,68	CHI
20201055948	ALVORADA DO NORTE	AQ12184985	IACIARA S2	11/10/2020 11:53	12/10/2020 00:23	11/10/2020 11:53	12/10/2020 00:23	12,50	32	399,91	CHI
20201052912	GOIANIA	12530748	CAMPINAS S1	11/10/2020 11:53	11/10/2020 13:38	11/10/2020 11:53	11/10/2020 13:38	1,74	1	1,74	CHI
20201052913	SANTA CRUZ DE GOIAS	BC21250243	PIRES DO RIO S2	11/10/2020 11:54	11/10/2020 17:48	11/10/2020 11:54	11/10/2020 17:48	5,90	1	5,90	CHI
20201052916	POSSE	PS21232207	IACIARA S2	11/10/2020 11:54	11/10/2020 12:50	11/10/2020 11:54	11/10/2020 12:50	0,93	1	0,93	CHI
20201052917	CATURAI	CK12097708LD	ARACU	11/10/2020 11:54	11/10/2020 11:58	11/10/2020 11:54	11/10/2020 11:58	0,07	1	0,07	CHI
20201052919	HIDROLANDIA	HD12320397	PONTALINA	11/10/2020 11:54	11/10/2020 18:09	11/10/2020 11:54	11/10/2020 18:09	6,24	1	6,24	CHI
20201053171	HIDROLANDIA	HD12090163	PONTALINA	11/10/2020 11:54	11/10/2020 19:57	11/10/2020 11:54	11/10/2020 19:57	8,04	3	24,12	CHI
20201054627	RIO VERDE	RV12092821	MONTIVIDIU T	11/10/2020 11:55	11/10/2020 22:26	11/10/2020 11:55	11/10/2020 22:26	10,51	11	115,60	CHI
20201052936	TRINDADE	TR21281151	GOYA S1	11/10/2020 11:56	11/10/2020 19:55	11/10/2020 11:56	11/10/2020 19:55	7,97	1	7,97	CHI
20201052945	PETROLINA DE GOIAS	320006104	PETROLINA	11/10/2020 11:58	11/10/2020 19:28	11/10/2020 11:58	11/10/2020 19:28	7,49	1	7,49	CHI
20201052952	PETROLINA DE GOIAS	PG21336293	PETROLINA	11/10/2020 11:59	11/10/2020 23:54	11/10/2020 11:59	11/10/2020 23:54	11,92	1	11,92	CHI
20201052957	ITAPURANGA	HE12250703LD	ITAPURANGA	11/10/2020 11:59	11/10/2020 18:40	11/10/2020 11:59	11/10/2020 18:40	6,67	11	73,41	CHI
20201053163	BELA VISTA DE GOIAS	BV12402769	BELA VISTA S1	11/10/2020 11:59	11/10/2020 17:13	11/10/2020 11:59	11/10/2020 17:13	5,22	9	47,00	CHI
20201054764	NOVA CRIXAS	NA12040307	NOVA CRIXAS	11/10/2020 12:00	11/10/2020 22:16	11/10/2020 12:00	11/10/2020 22:16	10,26	5	51,32	CHI
20201052964	CEZARINA	CZ11252465	CEZARINA	11/10/2020 12:00	11/10/2020 13:52	11/10/2020 12:00	11/10/2020 13:52	1,87	179	334,93	CHI
20201052967	FORMOSA	10008433273	ITUIQUIRA	11/10/2020 12:00	11/10/2020 22:18	11/10/2020 12:00	11/10/2020 22:18	10,30	1	10,30	CHI
20201052968	SANTA HELENA DE GOIAS	SH21000255	RIO DOS BOIS	11/10/2020 12:00	11/10/2020 17:50	11/10/2020 12:00	11/10/2020 17:50	5,82	3	17,46	CHI
20201052973	SILVANIA	SV12013818	VIANOPOLIS	11/10/2020 12:01	11/10/2020 22:04	11/10/2020 12:01	11/10/2020 22:04	10,04	3	30,11	CHI
20201053297	APARECIDA DE GOIANIA	AP11024850	INDEPENDENCIA S1	11/10/2020 12:02	11/10/2020 13:34	11/10/2020 12:02	11/10/2020 13:34	1,53	263	403,05	CHI
20201053692	PARAUNA	IV12011809	IPORA	11/10/2020 12:02	12/10/2020 18:08	11/10/2020 12:02	12/10/2020 18:08	30,10	2	60,19	CHI
20201052980	NOVO GAMA	4990013932	PACAEMBU S1	11/10/2020 12:02	11/10/2020 13:39	11/10/2020 12:02	11/10/2020 13:39	1,60	1	1,60	CHI
20201060234	MOSSAMEDES	MD12121049	ITABERAI S2	11/10/2020 12:03	12/10/2020 18:04	11/10/2020 12:03	12/10/2020 18:04	30,03	25	750,70	CHI
20201052983	LUZIANIA	LZ21214922	RIO VERMELHO	11/10/2020 12:03	11/10/2020 18:24	11/10/2020 12:03	11/10/2020 18:24	6,35	1	6,35	CHI
20201052985	POSSE	6257681	IACIARA S2	11/10/2020 12:03	11/10/2020 17:31	11/10/2020 12:03	11/10/2020 17:31	5,46	2	10,91	CHI
20201052988	ANAPOLIS	20055481	ANAPOLIS UNIVERSITARIO S2	11/10/2020 12:04	11/10/2020 21:40	11/10/2020 12:04	11/10/2020 21:40	9,60	1	9,60	CHI
20201052998	ANAPOLIS	21025770	ANAPOLIS UNIVERSITARIO S2	11/10/2020 12:05	12/10/2020 00:16	11/10/2020 12:05	12/10/2020 00:16	12,18	1	12,18	CHI
20201055194	FAZENDA NOVA	FN12371907	IPORA	11/10/2020 12:06	12/10/2020 15:10	11/10/2020 12:06	12/10/2020 15:10	27,06	5	135,32	CHI
20201053008	VILA BOA	10002607784	IACIARA S2	11/10/2020 12:07	12/10/2020 07:32	11/10/2020 12:07	12/10/2020 07:32	19,41	1	19,41	CHI
20201053012	SAO LUIS DE MONTES BELOS	10012968518	SAO LUIZ DOS MONTES BELOS	11/10/2020 12:07	12/10/2020 14:48	11/10/2020 12:07	12/10/2020 14:48	26,67	1	26,67	CHI
20201053176	PALMINOPOLIS	PP12118035	PALMEIRAS	11/10/2020 12:08	12/10/2020 10:00	11/10/2020 12:08	12/10/2020 10:00	21,86	7	153,01	CHI
20201055450	PALMINOPOLIS	JD12003211	PALMEIRAS	11/10/2020 12:10	12/10/2020 12:56	11/10/2020 12:10	12/10/2020 12:56	24,77	15	371,48	CHI
20201055450	JANDAIA	JD12003211	PALMEIRAS	11/10/2020 12:10	12/10/2020 12:56	11/10/2020 12:10	12/10/2020 12:56	24,77	10	247,65	CHI
20201055450	PALMEIRAS DE GOIAS	JD12003211	PALMEIRAS	11/10/2020 12:10	12/10/2020 12:56	11/10/2020 12:10	12/10/2020 12:56	24,77	4	99,06	CHI
20201053508	NOVO BRASIL	NB11220285	JUSSARA	11/10/2020 12:10	11/10/2020 21:45	11/10/2020 12:10	11/10/2020 21:45	9,58	92	881,36	CHI
20201053030	LUZIANIA	LZ21261514	RIO VERMELHO	11/10/2020 12:10	12/10/2020 01:12	11/10/2020 12:10	12/10/2020 01:12	13,03	1	13,03	CHI
20201053073	FAINA	FC12299839	GOIAS	11/10/2020 12:11	11/10/2020 21:17	11/10/2020 12:11	11/10/2020 21:17	9,10	14	127,40	CHI
20201053038	IPAMERI	IP21231605	IPAMERI	11/10/2020 12:11	11/10/2020 17:14	11/10/2020 12:11	11/10/2020 17:14	5,04	1	5,04	CHI
20201053048	CIDADE OCIDENTAL	LZ21084505	MARAJOARA	11/10/2020 12:13	11/10/2020 18:30	11/10/2020 12:13	11/10/2020 18:30	6,29	1	6,29	CHI
20201053052	HEITORAI	360006346	ITAPURANGA	11/10/2020 12:13	12/10/2020 11:46	11/10/2020 12:13	12/10/2020 11:46	23,54	1	23,54	CHI
20201053054	NAZARIO	SB12206084	TRINDADE	11/10/2020 12:13	11/10/2020 15:33	11/10/2020 12:13	11/10/2020 15:33	3,32	1	3,32	CHI
20201053054	SANTA BARBARA DE GOIAS	SB12206084	TRINDADE	11/10/2020 12:13	11/10/2020 15:33	11/10/2020 12:13	11/10/2020 15:33	3,32	5	16,62	CHI
20201053056	SAO LUIS DE MONTES BELOS	500127037	SAO LUIZ DOS MONTES BELOS	11/10/2020 12:13	11/10/2020 17:19	11/10/2020 12:13	11/10/2020 17:19	5,08	1	5,08	CHI
20201053057	BONFINOPOLIS	LB21060858	GOIANIA LESTE S2	11/10/2020 12:14	11/10/2020 13:16	11/10/2020 12:14	11/10/2020 13:16	1,03	1	1,03	CHI
20201053061	GOIANIA	10721990	ATLANTICO S2	11/10/2020 12:14	11/10/2020 17:10	11/10/2020 12:14	11/10/2020 17:10	4,92	1	4,92	CHI
20201053322	ALVORADA DO NORTE	AQ11060067	IACIARA S2	11/10/2020 12:16	11/10/2020 20:27	11/10/2020 12:16	11/10/2020 20:27	8,18	132	1079,32	CHI
20201056816	PALMEIRAS DE GOIAS	PL21125159	PALMEIRAS	11/10/2020 12:18	12/10/2020 08:56	11/10/2020 12:18	12/10/2020 08:56	20,62	2	41,25	CHI
20201053093	URUACU	640129304	URUACU	11/10/2020 12:18	12/10/2020 01:39	11/10/2020 12:18	12/10/2020 01:39	13,35	1	13,35	CHI
20201053096	GOIANIA	12150861	ATLANTICO S2	11/10/2020 12:19	11/10/2020 21:40	11/10/2020 12:19	11/10/2020 21:40	9,35	1	9,35	CHI
20201053225	PALMEIRAS DE GOIAS	IY12158920LD	EDEIA	11/10/2020 12:19	11/10/2020 18:50	11/10/2020 12:19	11/10/2020 18:50	6,50	5	32,50	CHI
20201053225	INDIARA	IY12158920LD	EDEIA	11/10/2020 12:19	11/10/2020 18:50	11/10/2020 12:19	11/10/2020 18:50	6,50	27	175,52	CHI

20201053103	AGUAS LINDAS DE GOIAS	LA12044225	AGUAS LINDAS DE GOIAS S2	11/10/2020 12:20	11/10/2020 14:14	11/10/2020 12:20	11/10/2020 14:14	1,89	62	117,39	CHI
20201053112	ANICUNS	AC12304607	FIRMINOPOLIS S2	11/10/2020 12:21	12/10/2020 10:36	11/10/2020 12:21	12/10/2020 10:36	22,24	3	66,71	CHI
20201052423	GOIANIA	GN11002374	FERROVIARIO S3	11/10/2020 12:23	11/10/2020 12:43	11/10/2020 12:23	11/10/2020 12:43	0,32	96	30,88	CHI
20201053126	IPORA	IR21073999	IPORA	11/10/2020 12:24	11/10/2020 23:59	11/10/2020 12:24	11/10/2020 23:59	11,58	1	11,58	CHI
20201053128	GOIANIA	GN12100381	XAVANTES	11/10/2020 12:24	12/10/2020 01:23	11/10/2020 12:24	12/10/2020 01:23	12,98	1	12,98	CHI
20201053795	ARAGOIANIA	AO12000038	GUAPO S2	11/10/2020 12:25	11/10/2020 18:28	11/10/2020 12:25	11/10/2020 18:28	6,05	111	671,09	CHI
20201053189	DAMIANOPOLIS	DA16408309	IACIARA S2	11/10/2020 12:25	11/10/2020 22:23	11/10/2020 12:25	11/10/2020 15:11	2,76	134	370,51	CHI
20201053189	SITIO D ABADIA	DA16408309	IACIARA S2	11/10/2020 12:25	11/10/2020 22:23	11/10/2020 12:25	11/10/2020 15:11	2,76	274	757,61	CHI
20201053189	ALVORADA DO NORTE	AQ10408125	IACIARA S2	11/10/2020 12:25	11/10/2020 22:23	11/10/2020 12:25	11/10/2020 16:34	4,15	13	53,99	CHI
20201053189	SITIO D ABADIA	SI16407021	IACIARA S2	11/10/2020 12:25	11/10/2020 22:23	11/10/2020 12:25	11/10/2020 17:37	5,21	93	484,48	CHI
20201053189	SITIO D ABADIA	SI13243067	IACIARA S2	11/10/2020 12:25	11/10/2020 22:23	11/10/2020 12:25	11/10/2020 18:39	6,23	4	24,93	CHI
20201053189	ALVORADA DO NORTE	SI13243067	IACIARA S2	11/10/2020 12:25	11/10/2020 22:23	11/10/2020 12:25	11/10/2020 18:39	6,23	63	392,63	CHI
20201053189	SITIO D ABADIA	SI13303999	IACIARA S2	11/10/2020 12:25	11/10/2020 22:23	11/10/2020 12:25	11/10/2020 18:45	6,33	488	3088,77	CHI
20201053189	SITIO D ABADIA	AQ10408125	IACIARA S2	11/10/2020 12:25	11/10/2020 22:23	11/10/2020 12:25	11/10/2020 19:59	7,56	116	877,28	CHI
20201053189	SITIO D ABADIA	SI13394114	IACIARA S2	11/10/2020 12:25	11/10/2020 22:23	11/10/2020 12:25	11/10/2020 19:59	7,56	33	249,57	CHI
20201053189	DAMIANOPOLIS	DA16408304	IACIARA S2	11/10/2020 12:25	11/10/2020 22:23	11/10/2020 18:49	11/10/2020 19:59	1,16	28	32,58	CHI
20201053189	SITIO D ABADIA	DA16408304	IACIARA S2	11/10/2020 12:25	11/10/2020 22:23	11/10/2020 18:49	11/10/2020 19:59	1,16	80	93,09	CHI
20201053189	DAMIANOPOLIS	DA16408304	IACIARA S2	11/10/2020 12:25	11/10/2020 22:23	11/10/2020 18:49	11/10/2020 19:59	1,16	851	990,23	CHI
20201053189	SITIO D ABADIA	DA16408304	IACIARA S2	11/10/2020 12:25	11/10/2020 22:23	11/10/2020 18:49	11/10/2020 19:59	1,16	169	196,65	CHI
20201053189	SITIO D ABADIA	DA16408304	IACIARA S2	11/10/2020 12:25	11/10/2020 22:23	11/10/2020 18:49	11/10/2020 19:59	1,16	48	55,85	CHI
20201053189	SITIO D ABADIA	SI13303997	IACIARA S2	11/10/2020 12:25	11/10/2020 22:23	11/10/2020 21:26	11/10/2020 21:37	0,18	332	59,11	CHI
20201053189	SITIO D ABADIA	SI13394111	IACIARA S2	11/10/2020 12:25	11/10/2020 22:23	11/10/2020 18:49	11/10/2020 21:56	3,12	156	486,24	CHI
20201053189	SITIO D ABADIA	SI16419140	IACIARA S2	11/10/2020 12:25	11/10/2020 22:23	11/10/2020 22:01	11/10/2020 22:05	0,08	274	22,38	CHI
20201053189	DAMIANOPOLIS	SI16419140	IACIARA S2	11/10/2020 12:25	11/10/2020 22:23	11/10/2020 22:01	11/10/2020 22:05	0,08	134	10,94	CHI
20201053189	SITIO D ABADIA	SI12394112LD	IACIARA S2	11/10/2020 12:25	11/10/2020 22:23	11/10/2020 12:25	11/10/2020 22:10	9,75	41	399,57	CHI
20201053189	SITIO D ABADIA	SI13303998	IACIARA S2	11/10/2020 12:25	11/10/2020 22:23	11/10/2020 22:01	11/10/2020 22:23	0,37	93	34,38	CHI
20201053140	PORANGATU	PO11079338	PORANGATU	11/10/2020 12:25	11/10/2020 15:27	11/10/2020 12:25	11/10/2020 15:27	3,02	99	299,28	CHI
20201054287	CRISTALINA	KR12304816	CRISTALINA S2	11/10/2020 12:25	11/10/2020 17:43	11/10/2020 12:25	11/10/2020 17:43	5,29	15	79,30	CHI
20201056771	SILVANIA	SV12282724	VIANOPOLIS	11/10/2020 12:25	12/10/2020 09:07	11/10/2020 12:25	12/10/2020 09:07	20,69	3	62,06	CHI
20201053139	FORMOSA	FA21153691	ITUIQUIRA	11/10/2020 12:26	11/10/2020 21:45	11/10/2020 12:26	11/10/2020 21:45	9,32	1	9,32	CHI
20201058287	SAO LUIS DE MONTES BELOS	SL12289750	FIRMINOPOLIS S2	11/10/2020 12:26	12/10/2020 09:39	11/10/2020 12:26	12/10/2020 09:39	21,21	3	63,62	CHI
20201058287	TURVANIA	SL12289750	FIRMINOPOLIS S2	11/10/2020 12:26	12/10/2020 09:39	11/10/2020 12:26	12/10/2020 09:39	21,21	2	42,42	CHI
20201053150	APARECIDA DE GOIANIA	200172256	INDEPENDENCIA S1	11/10/2020 12:27	11/10/2020 16:34	11/10/2020 12:27	11/10/2020 16:34	4,10	1	4,10	CHI
20201053428	ITABERAÍ	IB12108138	ITABERAÍ S2	11/10/2020 12:27	11/10/2020 18:09	11/10/2020 12:27	11/10/2020 18:09	5,69	28	159,19	CHI
20201054852	TURVANIA	NZ12382570	ANICUNS	11/10/2020 12:28	11/10/2020 17:58	11/10/2020 12:28	11/10/2020 17:58	5,49	4	21,96	CHI
20201054852	NAZARIO	NZ12382570	ANICUNS	11/10/2020 12:28	11/10/2020 17:58	11/10/2020 12:28	11/10/2020 17:58	5,49	5	27,45	CHI
20201053440	PIRANHAS	PH12023602	PIRANHAS	11/10/2020 12:28	11/10/2020 16:59	11/10/2020 12:28	11/10/2020 16:59	4,50	9	40,54	CHI
20201053440	ARENOPOLIS	PH12023602	PIRANHAS	11/10/2020 12:28	11/10/2020 16:59	11/10/2020 12:28	11/10/2020 16:59	4,50	6	27,02	CHI
20201053324	MOSSAMEDES	SC12164006	FIRMINOPOLIS S2	11/10/2020 12:28	12/10/2020 23:15	11/10/2020 12:28	12/10/2020 23:15	34,77	12	417,24	CHI
20201053168	CRISTALINA	10031487759	CRISTALINA S2	11/10/2020 12:28	11/10/2020 16:10	11/10/2020 12:28	11/10/2020 16:10	3,68	1	3,68	CHI
20201053177	NOVO GAMA	4990062219	PACAEMBU S1	11/10/2020 12:30	11/10/2020 13:23	11/10/2020 12:30	11/10/2020 13:23	0,88	1	0,88	CHI
20201053182	ALVORADA DO NORTE	AQ11195996	IACIARA S2	11/10/2020 12:31	11/10/2020 20:51	11/10/2020 12:31	11/10/2020 20:51	8,33	170	1416,29	CHI
20201054661	NEROPOLIS	NR12385114	NEROPOLIS S2	11/10/2020 12:31	11/10/2020 19:02	11/10/2020 12:31	11/10/2020 19:02	6,50	3	19,51	CHI
20201053949	GOIANIA	GN11000922	CAMPINAS S2	11/10/2020 12:32	11/10/2020 15:21	11/10/2020 12:32	11/10/2020 15:21	2,80	104	291,26	CHI
20201053631	TROMBAS	TB12185402	PORANGATU	11/10/2020 12:33	11/10/2020 19:09	11/10/2020 12:33	11/10/2020 19:09	6,60	3	19,80	CHI
20201053206	UIRAPURU	UP21181498	SANTA TEREZINHA	11/10/2020 12:33	11/10/2020 14:33	11/10/2020 12:33	11/10/2020 14:33	1,99	1	1,99	CHI
20201053207	GOIANIA	11045723	GOYA S2	11/10/2020 12:33	11/10/2020 22:33	11/10/2020 12:33	11/10/2020 22:33	9,98	1	9,98	CHI
20201053212	SAO DOMINGOS	SD12268132	SAO DOMINGOS	11/10/2020 12:34	11/10/2020 17:29	11/10/2020 12:34	11/10/2020 17:29	4,91	35	171,79	CHI
20201053216	APARECIDA DE GOIANIA	13548773	INDEPENDENCIA S1	11/10/2020 12:35	11/10/2020 18:22	11/10/2020 12:35	11/10/2020 18:22	5,78	1	5,78	CHI
20201052419	ALEXANIA	AX12326379	ALEXANIA	11/10/2020 12:35	11/10/2020 23:29	11/10/2020 12:35	11/10/2020 23:29	10,89	106	1154,31	CHI
20201053230	APARECIDA DE GOIANIA	14419622	INDEPENDENCIA S2	11/10/2020 12:37	11/10/2020 18:43	11/10/2020 12:37	11/10/2020 18:43	6,09	1	6,09	CHI
20201053238	CORREGO DO OURO	CO12376358	FIRMINOPOLIS S2	11/10/2020 12:38	12/10/2020 08:42	11/10/2020 12:38	12/10/2020 08:42	20,05	21	421,13	CHI
20201053238	BURITI DE GOIAS	CO12376358	FIRMINOPOLIS S2	11/10/2020 12:38	12/10/2020 08:42	11/10/2020 12:38	12/10/2020 08:42	20,05	32	641,72	CHI
20201053250	GOIANIA	12533208	GOIANIA LESTE S3	11/10/2020 12:39	11/10/2020 18:02	11/10/2020 12:39	11/10/2020 18:02	5,37	1	5,37	CHI
20201053555	ABADIANIA	AA12180462	DAIA S2	11/10/2020 12:40	11/10/2020 17:49	11/10/2020 12:40	11/10/2020 17:49	5,13	2	10,27	CHI
20201053260	POSSE	PS21222309	IACIARA S2	11/10/2020 12:41	11/10/2020 13:30	11/10/2020 12:41	11/10/2020 13:30	0,81	2	1,63	CHI
20201053262	LUZIANIA	120304491	RIO VERMELHO	11/10/2020 12:41	11/10/2020 19:02	11/10/2020 12:41	11/10/2020 19:02	6,36	1	6,36	CHI
20201053309	CRISTALINA	KR12305009	PAMPLONA	11/10/2020 12:41	11/10/2020 14:44	11/10/2020 12:41	11/10/2020 14:44	2,04	6	12,26	CHI

20201053270	SAO MIGUEL DO ARAGUAIA	SM21374523	NOVA CRIXAS	11/10/2020 12:42	12/10/2020 17:28	11/10/2020 12:42	12/10/2020 17:28	28,76	1	28,76	CHI
20201054630	GOIANIA	GN12000325	GOIANIA LESTE S3	11/10/2020 12:46	11/10/2020 18:20	11/10/2020 12:46	11/10/2020 18:20	5,56	1	5,56	CHI
20201053308	GOIANIA	15540108	CAMPINAS S3	11/10/2020 12:47	11/10/2020 19:38	11/10/2020 12:47	11/10/2020 19:38	6,84	1	6,84	CHI
20201053310	SAO LUIS DE MONTES BELOS	SL21168642	FIRMINOPOLIS S2	11/10/2020 12:47	11/10/2020 20:32	11/10/2020 12:47	11/10/2020 20:32	7,74	1	7,74	CHI
20201053313	CALDAS NOVAS	10023929330	SERRA DE CALDAS	11/10/2020 12:47	11/10/2020 15:55	11/10/2020 12:47	11/10/2020 15:55	3,12	1	3,12	CHI
20201053314	APARECIDA DE GOIANIA	10018188603	INDEPENDENCIA S1	11/10/2020 12:47	11/10/2020 18:50	11/10/2020 12:47	11/10/2020 18:50	6,03	1	6,03	CHI
20201053326	APARECIDA DE GOIANIA	16465775	REAL S2	11/10/2020 12:49	11/10/2020 17:01	11/10/2020 12:49	11/10/2020 17:01	4,19	1	4,19	CHI
20201053327	ITUMBIARA	IT12352618	PARANAIBA	11/10/2020 12:49	11/10/2020 17:59	11/10/2020 12:49	11/10/2020 17:59	5,15	1	5,15	CHI
20201055467	FAZENDA NOVA	FN12390138	IPORA	11/10/2020 12:51	12/10/2020 15:58	11/10/2020 12:51	12/10/2020 15:58	27,10	7	189,71	CHI
20201053978	ANICUNS	AC12299011	FIRMINOPOLIS S2	11/10/2020 12:52	11/10/2020 22:12	11/10/2020 12:52	11/10/2020 22:12	9,32	10	93,21	CHI
20201053255	SANCLERLANDIA	SC12005464	FIRMINOPOLIS S2	11/10/2020 12:52	11/10/2020 14:08	11/10/2020 12:52	11/10/2020 14:08	1,25	10	12,52	CHI
20201053551	NOVA VENEZA	BW12100382	NEROPOLIS S1	11/10/2020 12:53	11/10/2020 15:35	11/10/2020 12:53	11/10/2020 15:35	2,69	1	2,69	CHI
20201053551	SANTO ANTONIO DE GOIAS	BW12100382	NEROPOLIS S1	11/10/2020 12:53	11/10/2020 15:35	11/10/2020 12:53	11/10/2020 15:35	2,69	39	105,07	CHI
20201053551	NEROPOLIS	BW12100382	NEROPOLIS S1	11/10/2020 12:53	11/10/2020 15:35	11/10/2020 12:53	11/10/2020 15:35	2,69	17	45,80	CHI
20201053403	INHUMAS	IN11162061	INHUMAS S2	11/10/2020 12:54	11/10/2020 18:06	11/10/2020 12:54	11/10/2020 18:06	5,19	104	540,11	CHI
20201053372	IACIARA	IA12281603	IACIARA S2	11/10/2020 12:55	11/10/2020 21:03	11/10/2020 12:55	11/10/2020 21:03	8,12	1	8,12	CHI
20201053373	MINEIROS	10013421369	PARQUE DAS EMAS	11/10/2020 12:55	11/10/2020 15:02	11/10/2020 12:55	11/10/2020 15:02	2,10	1	2,10	CHI
20201053378	GOIANIA	11603197	GOIANIA LESTE S3	11/10/2020 12:56	11/10/2020 14:58	11/10/2020 12:56	11/10/2020 14:58	2,02	1	2,02	CHI
20201053381	GOIANIA	13281227	REAL S1	11/10/2020 12:57	11/10/2020 16:49	11/10/2020 12:57	11/10/2020 16:49	3,86	1	3,86	CHI
20201056817	PALMEIRAS DE GOIAS	PL21118582	PALMEIRAS	11/10/2020 12:57	12/10/2020 09:10	11/10/2020 12:57	12/10/2020 09:10	20,20	1	20,20	CHI
20201053387	GOIANIA	12054392	REAL S1	11/10/2020 12:58	11/10/2020 17:26	11/10/2020 12:58	11/10/2020 17:26	4,46	1	4,46	CHI
20201053388	GOIANIA	14711771	CARAJAS S1	11/10/2020 12:58	11/10/2020 19:03	11/10/2020 12:58	11/10/2020 19:03	6,08	1	6,08	CHI
20201053401	ANAPOLIS	20503428	JUNDAI S2	11/10/2020 13:00	11/10/2020 20:19	11/10/2020 13:00	11/10/2020 20:19	7,32	1	7,32	CHI
20201053438	ITAUCU	IN12028765	INHUMAS S2	11/10/2020 13:01	12/10/2020 00:30	11/10/2020 13:01	12/10/2020 00:30	11,48	33	378,70	CHI
20201053438	SANTA ROSA DE GOIAS	IN12028765	INHUMAS S2	11/10/2020 13:01	12/10/2020 00:30	11/10/2020 13:01	12/10/2020 00:30	11,48	10	114,76	CHI
20201053438	INHUMAS	IN12028765	INHUMAS S2	11/10/2020 13:01	12/10/2020 00:30	11/10/2020 13:01	12/10/2020 00:30	11,48	2	22,95	CHI
20201053419	TACUARAL DE GOIAS	TQ21000091	ITABERA S2	11/10/2020 13:02	12/10/2020 10:29	11/10/2020 13:02	12/10/2020 10:29	21,45	1	21,45	CHI
20201053427	VARJAO	VJ21113895	GUAPO S2	11/10/2020 13:02	12/10/2020 07:53	11/10/2020 13:02	12/10/2020 07:53	18,84	1	18,84	CHI
20201053430	APARECIDA DE GOIANIA	AP21101943	CEPAIGO S1	11/10/2020 13:03	11/10/2020 14:32	11/10/2020 13:03	11/10/2020 14:32	1,48	1	1,48	CHI
20201053435	LUZIANIA	120102584	RIO VERMELHO	11/10/2020 13:03	11/10/2020 21:23	11/10/2020 13:03	11/10/2020 21:23	8,32	1	8,32	CHI
20201053437	MINACU	IH12250175	MINACU	11/10/2020 13:03	12/10/2020 10:40	11/10/2020 13:03	12/10/2020 10:40	21,60	3	64,81	CHI
20201053515	PALMEIRAS DE GOIAS	PL12390265	PALMEIRAS	11/10/2020 13:03	11/10/2020 17:17	11/10/2020 13:03	11/10/2020 17:17	4,22	5	21,09	CHI
20201053445	CORUMBA DE GOIAS	CB21141563	CORUMBA	11/10/2020 13:05	11/10/2020 23:42	11/10/2020 13:05	11/10/2020 23:42	10,60	1	10,60	CHI
20201053603	CRISTALINA	KR12171076	CRISTALINA S2	11/10/2020 13:06	11/10/2020 15:12	11/10/2020 13:06	11/10/2020 15:12	2,10	7	14,69	CHI
20201053602	ANICUNS	AC12304664	FIRMINOPOLIS S2	11/10/2020 13:06	12/10/2020 01:30	11/10/2020 13:06	12/10/2020 01:30	12,39	14	173,53	CHI
20201054004	FLORES DE GOIAS	FB10408311	FLORES DE GOIAS	11/10/2020 13:06	11/10/2020 19:21	11/10/2020 13:06	11/10/2020 19:21	6,24	402	2508,59	CHI
20201056293	NOVA ROMA	FB12314707	FLORES DE GOIAS	11/10/2020 13:06	12/10/2020 12:11	11/10/2020 13:06	12/10/2020 12:11	23,07	2	46,14	CHI
20201056293	SAO JOAO D ALIANCA	FB12314707	FLORES DE GOIAS	11/10/2020 13:06	12/10/2020 12:11	11/10/2020 13:06	12/10/2020 12:11	23,07	46	1061,19	CHI
20201053459	DOVERLANDIA	DV21154353	CAIAPONIA	11/10/2020 13:06	11/10/2020 16:54	11/10/2020 13:06	11/10/2020 16:54	3,78	1	3,78	CHI
20201053479	NOVO BRASIL	NB12378883	JUSSARA	11/10/2020 13:08	13/10/2020 15:20	11/10/2020 13:08	13/10/2020 15:20	50,19	5	250,96	CHI
20201053480	RIO VERDE	630245411	RIO VERDE S1	11/10/2020 13:08	12/10/2020 00:08	11/10/2020 13:08	12/10/2020 00:08	10,99	1	10,99	CHI
20201056603	FAINA	FC12299837	GOIAS	11/10/2020 13:10	11/10/2020 22:06	11/10/2020 13:10	11/10/2020 22:06	8,92	7	62,46	CHI
20201053487	MOZARLANDIA	410010121	MOZARLANDIA	11/10/2020 13:11	11/10/2020 18:13	11/10/2020 13:11	11/10/2020 18:13	5,03	1	5,03	CHI
20201054224	GOIANIA	GN12267330	GOYA S1	11/10/2020 13:11	11/10/2020 16:28	11/10/2020 13:11	11/10/2020 16:28	3,28	4	13,11	CHI
20201053494	CATALAO	CT21237602	CATALAO S1	11/10/2020 13:12	11/10/2020 16:50	11/10/2020 13:12	11/10/2020 16:50	3,63	1	3,63	CHI
20201053495	ANAPOLIS	AN21191256	ANAPOLIS UNIVERSITARIO S2	11/10/2020 13:12	11/10/2020 19:28	11/10/2020 13:12	11/10/2020 19:28	6,26	1	6,26	CHI
20201053503	MONTA ALEGRE DE GOIAS	MA21252664	SAO DOMINGOS	11/10/2020 13:13	11/10/2020 14:32	11/10/2020 13:13	11/10/2020 14:32	1,31	1	1,31	CHI
20201053518	QUIRINOPOLIS	QI31249039	QUIRINOPOLIS	11/10/2020 13:15	11/10/2020 15:33	11/10/2020 13:15	11/10/2020 15:33	2,29	1	2,29	CHI
20201053530	RIO VERDE	RV21191768	MONTIVIDIU T	11/10/2020 13:17	11/10/2020 18:06	11/10/2020 13:17	11/10/2020 18:06	4,80	1	4,80	CHI
20201053535	APARECIDA DE GOIANIA	13434070	INDEPENDENCIA S1	11/10/2020 13:18	11/10/2020 19:14	11/10/2020 13:18	11/10/2020 19:14	5,92	1	5,92	CHI
20201055486	ABADIANIA	AA12057569	ANAPOLIS UNIVERSITARIO S1	11/10/2020 13:19	12/10/2020 08:17	11/10/2020 13:19	12/10/2020 08:17	18,97	8	151,74	CHI
20201053541	ITAPACI	IW11025399	RUBIATABA	11/10/2020 13:19	12/10/2020 16:37	11/10/2020 13:19	12/10/2020 16:37	27,29	10	272,92	CHI
20201053543	PARAUNA	980013446	PARAUNA	11/10/2020 13:19	12/10/2020 13:02	11/10/2020 13:19	12/10/2020 13:02	23,71	1	23,71	CHI
20201055097	CRIXAS	CX12391853	RUBIATABA	11/10/2020 13:20	12/10/2020 02:00	11/10/2020 13:20	12/10/2020 02:00	12,67	9	113,99	CHI
20201053548	AMERICANO DO BRASIL	KB21152959	ANICUNS	11/10/2020 13:20	12/10/2020 07:22	11/10/2020 13:20	12/10/2020 07:22	18,03	1	18,03	CHI
20201054061	CAIAPONIA	CP12334323	PIRANHAS	11/10/2020 13:20	11/10/2020 19:53	11/10/2020 13:20	11/10/2020 19:53	6,54	7	45,80	CHI
20201053553	MOSSAMEDES	MD21343868	ITABERA S2	11/10/2020 13:20	13/10/2020 08:23	11/10/2020 13:20	13/10/2020 08:23	43,04	1	43,04	CHI
20201053557	GOIANIA	GN11000816	XAVANTES	11/10/2020 13:21	11/10/2020 15:57	11/10/2020 13:21	11/10/2020 15:57	2,60	85	220,93	CHI

20201053558	PIRENOPOLIS	PV21123732	CORUMBA	11/10/2020 13:21	11/10/2020 17:55	11/10/2020 13:21	11/10/2020 17:55	4,56	1	4,56	CHI
20201052233	APARECIDA DE GOIANIA	AP13001020	REAL S1	11/10/2020 13:22	11/10/2020 17:14	11/10/2020 13:22	11/10/2020 17:14	3,86	365	1409,00	CHI
20201053564	PIRANHAS	PH12074241	ARENOPOLIS	11/10/2020 13:22	11/10/2020 17:53	11/10/2020 13:22	11/10/2020 17:53	4,51	7	31,56	CHI
20201053568	GOIANIA	12353577	CAMPINAS S2	11/10/2020 13:22	11/10/2020 22:54	11/10/2020 13:22	11/10/2020 22:54	9,52	1	9,52	CHI
20201053569	GOIANIA	15285923	MEIA PONTE	11/10/2020 13:23	11/10/2020 15:47	11/10/2020 13:23	11/10/2020 15:47	2,40	1	2,40	CHI
20201053571	SAO MIGUEL DO PASSA QUATRO	SQ21188538	CRISTIANOPOLIS	11/10/2020 13:23	12/10/2020 09:59	11/10/2020 13:23	12/10/2020 09:59	20,59	1	20,59	CHI
20201053578	AMARALINA	LC21250132	MARA ROSA	11/10/2020 13:24	12/10/2020 17:40	11/10/2020 13:24	12/10/2020 17:40	28,26	1	28,26	CHI
20201053580	ITAPURANGA	GK12023079	ITAPURANGA	11/10/2020 13:24	11/10/2020 20:46	11/10/2020 13:24	11/10/2020 20:46	7,36	3	22,08	CHI
20201053581	BOM JESUS DE GOIAS	4060000220	BOM JESUS DE GOIAS	11/10/2020 13:24	11/10/2020 21:29	11/10/2020 13:24	11/10/2020 21:29	8,08	1	8,08	CHI
20201053590	BELA VISTA DE GOIAS	BV12006333	CEPAIGO S2	11/10/2020 13:25	11/10/2020 16:26	11/10/2020 13:25	11/10/2020 16:26	3,01	1	3,01	CHI
20201053593	GOIANIA	11137460	CAMPINAS S3	11/10/2020 13:25	11/10/2020 20:03	11/10/2020 13:25	11/10/2020 20:03	6,62	1	6,62	CHI
20201053599	PALMEIRAS DE GOIAS	PL21000225	PALMEIRAS	11/10/2020 13:26	12/10/2020 09:50	11/10/2020 13:26	12/10/2020 09:50	20,39	1	20,39	CHI
20201053606	GOIANIA	14029339	CARAJAS S1	11/10/2020 13:28	11/10/2020 19:56	11/10/2020 13:28	11/10/2020 19:56	6,46	1	6,46	CHI
20201053628	LUZIANIA	120111410	RIO VERMELHO	11/10/2020 13:30	11/10/2020 21:57	11/10/2020 13:30	11/10/2020 21:57	8,43	1	8,43	CHI
20201053385	PALMEIRAS DE GOIAS	PL21398509	PALMEIRAS	11/10/2020 13:32	12/10/2020 10:26	11/10/2020 13:32	12/10/2020 10:26	20,90	2	41,80	CHI
20201053637	ARAGOIANIA	AO21219129	GUAPO S2	11/10/2020 13:32	11/10/2020 19:14	11/10/2020 13:32	11/10/2020 19:14	5,69	1	5,69	CHI
20201053645	GOIANIA	10179355	FERROVIARIO S1	11/10/2020 13:33	11/10/2020 17:20	11/10/2020 13:33	11/10/2020 17:20	3,78	1	3,78	CHI
20201054684	MONTES CLAROS DE GOIAS	ME12210017	IPORA	11/10/2020 13:33	11/10/2020 18:20	11/10/2020 13:33	11/10/2020 18:20	4,78	24	114,81	CHI
20201054202	MARA ROSA	MQ12003811	MARA ROSA	11/10/2020 13:34	11/10/2020 19:26	11/10/2020 13:34	11/10/2020 19:26	5,86	66	387,07	CHI
20201053916	SANTA TEREZINHA DE GOIAS	VD12265513	SANTA TEREZINHA	11/10/2020 13:34	11/10/2020 17:04	11/10/2020 13:34	11/10/2020 17:04	3,49	2	6,98	CHI
20201053916	CAMPOS VERDES	VD12265513	SANTA TEREZINHA	11/10/2020 13:34	11/10/2020 17:04	11/10/2020 13:34	11/10/2020 17:04	3,49	2	6,98	CHI
20201053654	SENADOR CANEDO	SW21380147	CEPAIGO S2	11/10/2020 13:34	11/10/2020 17:12	11/10/2020 13:34	11/10/2020 17:12	3,63	2	7,25	CHI
20201054458	SANTA HELENA DE GOIAS	RV12026891	SANTA HELENA S1	11/10/2020 13:35	11/10/2020 19:52	11/10/2020 13:35	11/10/2020 19:52	6,27	1	6,27	CHI
20201054458	MAURILANDIA	RV12026891	SANTA HELENA S1	11/10/2020 13:35	11/10/2020 19:52	11/10/2020 13:35	11/10/2020 19:52	6,27	5	31,34	CHI
20201053667	RUBIATABA	RB11003300	RUBIATABA	11/10/2020 13:36	11/10/2020 22:28	11/10/2020 13:36	11/10/2020 22:28	8,85	73	646,41	CHI
20201053669	SILVANIA	SV21012009	VIANOPOLIS	11/10/2020 13:37	11/10/2020 16:16	11/10/2020 13:37	11/10/2020 16:16	2,64	1	2,64	CHI
20201053674	SANTA RITA DO NOVO DESTINO	DF11315607	BARRO ALTO	11/10/2020 13:38	12/10/2020 10:05	11/10/2020 13:38	12/10/2020 10:05	20,45	1	20,45	CHI
20201053680	PADRE BERNARDO	PB12330893	PADRE BERNARDO	11/10/2020 13:39	11/10/2020 15:21	11/10/2020 13:39	11/10/2020 15:21	1,69	3	5,08	CHI
20201053686	GOIANIA	14950480	FERROVIARIO S1	11/10/2020 13:39	12/10/2020 01:17	11/10/2020 13:39	12/10/2020 01:17	11,64	1	11,64	CHI
20201054877	ANICUNS	AC12323544	ANICUNS	11/10/2020 13:39	11/10/2020 18:59	11/10/2020 13:39	11/10/2020 18:59	5,32	163	867,11	CHI
20201053695	OURO VERDE DE GOIAS	OV21098148	NEROPOLIS S1	11/10/2020 13:39	11/10/2020 22:07	11/10/2020 13:39	11/10/2020 22:07	8,45	1	8,45	CHI
20201053696	GOIANIA	13133202	CAMPINAS S1	11/10/2020 13:39	11/10/2020 21:22	11/10/2020 13:39	11/10/2020 21:22	7,70	1	7,70	CHI
20201053697	SILVANIA	SV12389506	VIANOPOLIS	11/10/2020 13:40	11/10/2020 15:32	11/10/2020 13:40	11/10/2020 15:32	1,87	5	9,33	CHI
20201054194	SILVANIA	SV21320383	VIANOPOLIS	11/10/2020 13:40	11/10/2020 15:51	11/10/2020 13:40	11/10/2020 15:51	2,18	3	6,55	CHI
20201053705	MAURILANDIA	ML12402293LD	RIO DOS BOIS	11/10/2020 13:41	11/10/2020 15:20	11/10/2020 13:41	11/10/2020 15:02	1,35	1	1,35	CHI
20201053705	MAURILANDIA	ML10416726	RIO DOS BOIS	11/10/2020 13:41	11/10/2020 15:20	11/10/2020 15:17	11/10/2020 15:20	0,05	2	0,11	CHI
20201054298	SANTO ANTONIO DE GOIAS	GN12001842	NEROPOLIS S1	11/10/2020 13:41	11/10/2020 16:50	11/10/2020 13:41	11/10/2020 16:50	3,14	2	6,28	CHI
20201054298	GOIANIA	GN12001842	NEROPOLIS S1	11/10/2020 13:41	11/10/2020 16:50	11/10/2020 13:41	11/10/2020 16:50	3,14	9	28,28	CHI
20201056984	FIRMINOPOLIS	SL12072420	SAO LUIZ DOS MONTES BELOS	11/10/2020 13:41	12/10/2020 00:08	11/10/2020 13:41	12/10/2020 00:08	10,44	45	469,90	CHI
20201053706	CATALAO	CT21270758	CATALAO S1	11/10/2020 13:41	11/10/2020 19:05	11/10/2020 13:41	11/10/2020 19:05	5,39	1	5,39	CHI
20201053708	POSSE	PS21222350	IACIARA S2	11/10/2020 13:42	11/10/2020 18:08	11/10/2020 13:42	11/10/2020 18:08	4,43	1	4,43	CHI
20201053800	FIRMINOPOLIS	AI12391402	FIRMINOPOLIS S2	11/10/2020 13:42	12/10/2020 14:45	11/10/2020 13:42	12/10/2020 14:45	25,04	11	275,49	CHI
20201053800	AURILANDIA	AI12391402	FIRMINOPOLIS S2	11/10/2020 13:42	12/10/2020 14:45	11/10/2020 13:42	12/10/2020 14:45	25,04	14	350,62	CHI
20201053713	PARAUNA	RP21102348	PARAUNA	11/10/2020 13:43	12/10/2020 16:09	11/10/2020 13:43	12/10/2020 16:09	26,44	1	26,44	CHI
20201053715	BRAZABRANTES	BR21018149	NEROPOLIS S1	11/10/2020 13:43	11/10/2020 15:21	11/10/2020 13:43	11/10/2020 15:21	1,62	3	4,85	CHI
20201053721	VALPARAISO DE GOIAS	2860047287	MARAJOARA	11/10/2020 13:44	12/10/2020 02:05	11/10/2020 13:44	12/10/2020 02:05	12,34	1	12,34	CHI
20201053727	GOIANIA	11069351	CAMPINAS S3	11/10/2020 13:45	12/10/2020 01:37	11/10/2020 13:45	12/10/2020 01:37	11,87	1	11,87	CHI
20201053728	GOIANESIA	550173857	GOIANESIA S2	11/10/2020 13:45	12/10/2020 14:14	11/10/2020 13:45	12/10/2020 14:14	24,47	1	24,47	CHI
20201053730	BELA VISTA DE GOIAS	BV21012789	BELA VISTA S2	11/10/2020 13:45	11/10/2020 15:52	11/10/2020 13:45	11/10/2020 15:52	2,10	3	6,31	CHI
20201054385	GOIANIA	GN11374156	MEIA PONTE	11/10/2020 13:46	11/10/2020 20:13	11/10/2020 13:46	11/10/2020 20:13	6,44	143	921,04	CHI
20201054676	ALEXANIA	AX12114206	ALEXANIA	11/10/2020 13:47	11/10/2020 19:07	11/10/2020 13:47	11/10/2020 19:07	5,33	111	591,17	CHI
20201054936	NOVA IGUACU DE GOIAS	CX12201729LD	RUBIATABA	11/10/2020 13:47	11/10/2020 22:36	11/10/2020 13:47	11/10/2020 22:36	8,80	1	8,80	CHI
20201054936	CRIXAS	CX12201729LD	RUBIATABA	11/10/2020 13:47	11/10/2020 22:36	11/10/2020 13:47	11/10/2020 22:36	8,80	241	2121,13	CHI
20201053775	COCALZINHO DE GOIAS	ZN12302266	COCALZINHO	11/10/2020 13:50	11/10/2020 18:57	11/10/2020 13:50	11/10/2020 18:57	5,10	8	40,81	CHI
20201053780	APARECIDA DE GOIANIA	13891455	ANHANGUERA	11/10/2020 13:51	11/10/2020 19:58	11/10/2020 13:51	11/10/2020 19:58	6,11	1	6,11	CHI
20201053791	GOIAS	GS11220244	GOIAS	11/10/2020 13:53	11/10/2020 15:56	11/10/2020 13:53	11/10/2020 15:56	2,04	2	4,08	CHI
20201054038	NIQUELANDIA	NQ12293886	URUACU	11/10/2020 13:54	14/10/2020 11:20	11/10/2020 13:54	12/10/2020 13:24	23,50	10	235,01	CHI
20201054038	NIQUELANDIA	NQ12375602	URUACU	11/10/2020 13:54	14/10/2020 11:20	13/10/2020 21:04	13/10/2020 23:03	1,98	20	39,54	CHI

20201054038	NIQUELANDIA	NQ12056787RE	URUACU	11/10/2020 13:54	14/10/2020 11:20	14/10/2020 01:12	14/10/2020 01:52	0,68	4	2,72	CHI
20201054038	NIQUELANDIA	NQ12201753LD	URUACU	11/10/2020 13:54	14/10/2020 11:20	14/10/2020 00:11	14/10/2020 02:10	1,99	38	75,55	CHI
20201054038	NIQUELANDIA	NQ12201753LD	URUACU	11/10/2020 13:54	14/10/2020 11:20	14/10/2020 00:11	14/10/2020 02:39	2,46	20	49,28	CHI
20201054038	NIQUELANDIA	NQ12293886	URUACU	11/10/2020 13:54	14/10/2020 11:20	13/10/2020 16:02	14/10/2020 04:11	12,14	3	36,43	CHI
20201054038	NIQUELANDIA	NQ12293886	URUACU	11/10/2020 13:54	14/10/2020 11:20	13/10/2020 21:04	14/10/2020 04:11	7,10	7	49,71	CHI
20201054038	NIQUELANDIA	NQ12293886	URUACU	11/10/2020 13:54	14/10/2020 11:20	11/10/2020 13:54	14/10/2020 11:20	69,43	4	277,71	CHI
20201053797	PADRE BERNARDO	PB21148893	PADRE BERNARDO	11/10/2020 13:54	11/10/2020 15:04	11/10/2020 13:54	11/10/2020 15:04	1,15	1	1,15	CHI
20201053799	RIO VERDE	630229685	RIO VERDE S1	11/10/2020 13:55	12/10/2020 10:32	11/10/2020 13:55	12/10/2020 10:32	20,61	1	20,61	CHI
20201055033	CORREGO DO OURO	CO12186499	FIRMINOPOLIS S2	11/10/2020 13:55	12/10/2020 07:01	11/10/2020 13:55	12/10/2020 07:01	17,09	123	2101,97	CHI
20201053807	RIO VERDE	10020809741	CABRIUVA S1	11/10/2020 13:56	12/10/2020 00:42	11/10/2020 13:56	12/10/2020 00:42	10,76	1	10,76	CHI
20201053823	PONTALINA	PK12263674	GOIATUBA S1	11/10/2020 14:00	11/10/2020 15:55	11/10/2020 14:00	11/10/2020 15:55	1,92	3	5,76	CHI
20201054235	LEOPOLDO DE BULHOES	LB12353166	DAIA S2	11/10/2020 14:00	11/10/2020 16:21	11/10/2020 14:00	11/10/2020 16:21	2,34	4	9,35	CHI
20201053847	TURVANIA	TV11005733	FIRMINOPOLIS S2	11/10/2020 14:02	11/10/2020 21:14	11/10/2020 14:02	11/10/2020 21:14	7,20	124	892,66	CHI
20201053852	SAO FRANCISCO DE GOIAS	490004647	SAO FRANCISCO DE GOIAS	11/10/2020 14:03	11/10/2020 17:30	11/10/2020 14:03	11/10/2020 17:30	3,45	1	3,45	CHI
20201053859	MAURILANDIA	10029623934	RIO DOS BOIS	11/10/2020 14:04	11/10/2020 22:39	11/10/2020 14:04	11/10/2020 22:39	8,59	1	8,59	CHI
20201053860	FLORES DE GOIAS	FB21243022	FLORES DE GOIAS	11/10/2020 14:04	11/10/2020 21:26	11/10/2020 14:04	11/10/2020 21:26	7,36	2	14,71	CHI
20201053861	JUSSARA	JR21292732	BRITANIA	11/10/2020 14:04	12/10/2020 23:53	11/10/2020 14:04	12/10/2020 20:30	30,42	1	30,42	CHI
20201053861	JUSSARA	JR12038166	BRITANIA	11/10/2020 14:04	12/10/2020 23:53	12/10/2020 20:29	12/10/2020 23:53	3,40	1	3,40	CHI
20201053863	JESUPOLIS	SF21000117	SAO FRANCISCO DE GOIAS	11/10/2020 14:05	11/10/2020 17:42	11/10/2020 14:05	11/10/2020 17:42	3,62	1	3,62	CHI
20201053864	CAIAPONIA	CP21346551	CAIAPONIA	11/10/2020 14:05	11/10/2020 16:50	11/10/2020 14:05	11/10/2020 16:50	2,75	1	2,75	CHI
20201053869	GOIANIA	10454305	AEROPORTO S1	11/10/2020 14:06	11/10/2020 16:44	11/10/2020 14:06	11/10/2020 16:44	2,63	1	2,63	CHI
20201053870	RIO VERDE	RV21242665	CABRIUVA S2	11/10/2020 14:06	12/10/2020 07:58	11/10/2020 14:06	12/10/2020 07:58	17,86	1	17,86	CHI
20201053871	BELA VISTA DE GOIAS	240089583	BELA VISTA S1	11/10/2020 14:06	12/10/2020 00:26	11/10/2020 14:06	12/10/2020 00:26	10,33	1	10,33	CHI
20201054849	TURVANIA	TV12005545LD	FIRMINOPOLIS S2	11/10/2020 14:06	11/10/2020 21:14	11/10/2020 14:06	11/10/2020 21:14	7,13	562	4007,53	CHI
20201054849	TURVANIA	03000224	FIRMINOPOLIS S2	11/10/2020 14:06	11/10/2020 21:14	11/10/2020 20:12	11/10/2020 21:14	1,03	835	857,27	CHI
20201053875	GOIANIA	10006274267	XAVANTES	11/10/2020 14:07	11/10/2020 18:45	11/10/2020 14:07	11/10/2020 18:45	4,62	1	4,62	CHI
20201053885	FORMOSA	610265775	ITUIQUIRA	11/10/2020 14:09	12/10/2020 03:14	11/10/2020 14:09	12/10/2020 03:14	13,07	1	13,07	CHI
20201053887	BALIZA	BH12360382	BOM JARDIM	11/10/2020 14:10	11/10/2020 16:40	11/10/2020 14:10	11/10/2020 16:40	2,50	3	7,49	CHI
20201053899	CRIXAS	CX12399926	RUBIATABA	11/10/2020 14:13	12/10/2020 02:17	11/10/2020 14:13	12/10/2020 02:17	12,06	18	217,07	CHI
20201053900	LUZIANIA	120230501	RIO VERMELHO	11/10/2020 14:13	11/10/2020 18:16	11/10/2020 14:13	11/10/2020 18:16	4,04	1	4,04	CHI
20201056068	GOIANIA	GN11169165	FERROVIARIO S1	11/10/2020 14:13	11/10/2020 21:02	11/10/2020 14:13	11/10/2020 21:02	6,81	70	476,58	CHI
20201053910	ANAPOLIS	AN21096765	JUNDIAI S2	11/10/2020 14:14	11/10/2020 22:21	11/10/2020 14:14	11/10/2020 22:21	8,10	1	8,10	CHI
20201056395	BURITI DE GOIAS	BS21308376	FIRMINOPOLIS S2	11/10/2020 14:15	13/10/2020 03:32	11/10/2020 14:15	13/10/2020 03:32	37,28	2	74,56	CHI
20201053914	RIO VERDE	630507764	RIO VERDE S1	11/10/2020 14:15	11/10/2020 22:59	11/10/2020 14:15	11/10/2020 22:59	8,72	1	8,72	CHI
20201054500	VALPARAISO DE GOIAS	VA12381888	MARAJOARA	11/10/2020 14:15	11/10/2020 17:36	11/10/2020 14:15	11/10/2020 17:36	3,34	631	2104,74	CHI
20201053920	APARECIDA DE GOIANIA	200131023	INDEPENDENCIA S2	11/10/2020 14:16	11/10/2020 17:58	11/10/2020 14:16	11/10/2020 17:58	3,69	1	3,69	CHI
20201053921	GOIATUBA	BJ11030849	RIO DOS BOIS	11/10/2020 14:16	12/10/2020 01:34	11/10/2020 14:16	12/10/2020 01:34	11,28	86	970,39	CHI
20201052671	GOIANIA	GN11002414	FERROVIARIO S1	11/10/2020 14:17	11/10/2020 15:35	11/10/2020 14:17	11/10/2020 15:35	1,30	74	96,20	CHI
20201053922	HIDROLANDIA	HD31085408	CEPAIGO S2	11/10/2020 14:17	12/10/2020 12:57	11/10/2020 14:17	12/10/2020 12:43	22,43	1	22,43	CHI
20201053922	HIDROLANDIA	HD12040938LD	CEPAIGO S2	11/10/2020 14:17	12/10/2020 12:57	12/10/2020 10:23	12/10/2020 12:51	2,47	74	182,94	CHI
20201053922	HIDROLANDIA	HD12310187	CEPAIGO S2	11/10/2020 14:17	12/10/2020 12:57	12/10/2020 10:45	12/10/2020 12:57	2,21	3	6,62	CHI
20201053931	NEROPOLIS	NR21272392	NEROPOLIS S2	11/10/2020 14:19	12/10/2020 08:58	11/10/2020 14:19	12/10/2020 08:58	18,64	1	18,64	CHI
20201051920	SANTA ROSA DE GOIAS	SR12107586	INHUMAS S1	11/10/2020 14:23	11/10/2020 23:04	11/10/2020 14:23	11/10/2020 23:04	8,68	62	538,04	CHI
20201053945	CIDADE OCIDENTAL	LZ12084504	MARAJOARA	11/10/2020 14:23	11/10/2020 18:30	11/10/2020 14:23	11/10/2020 18:30	4,12	1	4,12	CHI
20201054414	ALEXANIA	AX12401984	ALEXANIA	11/10/2020 14:23	11/10/2020 17:53	11/10/2020 14:23	11/10/2020 17:53	3,49	12	41,91	CHI
20201053947	APARECIDA DE GOIANIA	13429590	INDEPENDENCIA S1	11/10/2020 14:23	11/10/2020 19:22	11/10/2020 14:23	11/10/2020 19:22	4,97	1	4,97	CHI
20201053953	ITUMBIARA	IT11255160	ITUMBIARA NOVA	11/10/2020 14:26	11/10/2020 15:19	11/10/2020 14:26	11/10/2020 15:19	0,88	104	91,14	CHI
20201054279	HIDROLANDIA	HD12365522	CEPAIGO S2	11/10/2020 14:26	11/10/2020 18:16	11/10/2020 14:26	11/10/2020 18:16	3,82	135	516,34	CHI
20201054521	GOIANIA	GN11043933	GOYA S2	11/10/2020 14:27	11/10/2020 17:29	11/10/2020 14:27	11/10/2020 17:29	3,02	65	196,53	CHI
20201053961	FORMOSA	10010494926	ITUIQUIRA	11/10/2020 14:27	12/10/2020 15:14	11/10/2020 14:27	12/10/2020 15:14	24,77	1	24,77	CHI
20201053965	SANCLERLANDIA	SC12102362	FIRMINOPOLIS S2	11/10/2020 14:28	11/10/2020 17:30	11/10/2020 14:28	11/10/2020 17:30	3,03	211	638,92	CHI
20201053967	BOM JESUS DE GOIAS	BJ21030767	RIO DOS BOIS	11/10/2020 14:28	11/10/2020 19:43	11/10/2020 14:28	11/10/2020 19:43	5,24	1	5,24	CHI
20201054979	GOIANIA	GN11043838	GOIANIA LESTE S3	11/10/2020 14:28	11/10/2020 17:27	11/10/2020 14:28	11/10/2020 17:27	2,97	53	157,29	CHI
20201053971	SAO LUIS DE MONTES BELOS	SL12019499	SAO LUIZ DOS MONTES BELOS	11/10/2020 14:29	12/10/2020 08:22	11/10/2020 14:29	12/10/2020 08:22	17,88	24	429,04	CHI
20201056557	SAO JOAO D ALIANCA	JL12268110	FLORES DE GOIAS	11/10/2020 14:30	12/10/2020 10:16	11/10/2020 14:30	12/10/2020 10:16	19,76	9	177,82	CHI
20201053986	CAMPO LIMPO	AN21055362	NEROPOLIS S1	11/10/2020 14:30	11/10/2020 20:27	11/10/2020 14:30	11/10/2020 20:27	5,94	5	29,69	CHI
20201053987	PORANGATU	PO11166523	PORANGATU	11/10/2020 14:31	11/10/2020 22:08	11/10/2020 14:31	11/10/2020 22:08	7,62	107	814,98	CHI
20201054448	FORMOSA	CW12154467	ITUIQUIRA	11/10/2020 14:31	11/10/2020 19:25	11/10/2020 14:31	11/10/2020 19:25	4,90	3	14,69	CHI

20201054448	CABECEIRAS	CW12154467	ITUIQUIRA	11/10/2020 14:31	11/10/2020 19:25	11/10/2020 14:31	11/10/2020 19:25	4,90	36	176,32	CHI
20201055745	SILVANIA	SV12382774	DAIA S2	11/10/2020 14:31	12/10/2020 09:37	11/10/2020 14:31	12/10/2020 09:37	19,09	7	133,62	CHI
20201058183	AURILANDIA	AI11032154	FIRMINOPOLIS S2	11/10/2020 14:31	12/10/2020 08:55	11/10/2020 14:31	12/10/2020 08:55	18,38	40	735,36	CHI
20201054382	URUACU	UR12201700	URUACU	11/10/2020 14:32	11/10/2020 19:39	11/10/2020 14:32	11/10/2020 19:39	5,10	41	209,27	CHI
20201054932	AURILANDIA	AI12039582LD	FIRMINOPOLIS S2	11/10/2020 14:32	12/10/2020 14:45	11/10/2020 14:32	12/10/2020 14:45	24,20	6	145,21	CHI
20201054003	CACHOEIRA DOURADA	CD21154218	CACHOEIRA DOURADA	11/10/2020 14:33	11/10/2020 23:04	11/10/2020 14:33	11/10/2020 23:04	8,52	1	8,52	CHI
20201054010	FORMOSA	10021447010	ITUIQUIRA	11/10/2020 14:34	11/10/2020 23:15	11/10/2020 14:34	11/10/2020 23:15	8,68	1	8,68	CHI
20201056982	SAO LUIS DE MONTES BELOS	SL12306929	SAO LUIZ DOS MONTES BELOS	11/10/2020 14:35	12/10/2020 00:23	11/10/2020 14:35	12/10/2020 00:23	9,80	22	215,58	CHI
20201056982	FIRMINOPOLIS	SL12306929	SAO LUIZ DOS MONTES BELOS	11/10/2020 14:35	12/10/2020 00:23	11/10/2020 14:35	12/10/2020 00:23	9,80	41	401,77	CHI
20201056627	SANCLERLANDIA	SL12019284	SAO LUIZ DOS MONTES BELOS	11/10/2020 14:35	12/10/2020 08:22	11/10/2020 14:35	12/10/2020 08:22	17,78	28	497,75	CHI
20201056627	SAO LUIS DE MONTES BELOS	SL12019284	SAO LUIZ DOS MONTES BELOS	11/10/2020 14:35	12/10/2020 08:22	11/10/2020 14:35	12/10/2020 08:22	17,78	35	622,19	CHI
20201054018	FORMOSA	10010494489	ITUIQUIRA	11/10/2020 14:35	12/10/2020 14:39	11/10/2020 14:35	12/10/2020 14:39	24,06	1	24,06	CHI
20201054782	ALEXANIA	AX12000041	ALEXANIA	11/10/2020 14:36	11/10/2020 19:31	11/10/2020 14:36	11/10/2020 19:31	4,91	89	437,36	CHI
20201054027	PLANALTINA	PI21359581	PLANALTINA	11/10/2020 14:36	12/10/2020 07:13	11/10/2020 14:36	12/10/2020 07:13	16,60	1	16,60	CHI
20201054034	POSSE	PS21132033	IACIARA S2	11/10/2020 14:38	11/10/2020 15:21	11/10/2020 14:38	11/10/2020 15:21	0,71	1	0,71	CHI
20201054036	MINACU	4020070107	MINACU	11/10/2020 14:38	12/10/2020 17:15	11/10/2020 14:38	12/10/2020 17:15	26,61	1	26,61	CHI
20201054451	SAO MIGUEL DO ARAGUAIA	SM12393978	SAO MIGUEL DO ARAGUAIA	11/10/2020 14:38	12/10/2020 04:14	11/10/2020 14:38	12/10/2020 04:14	13,59	59	801,96	CHI
20201054040	POSSE	PS21232217	IACIARA S2	11/10/2020 14:38	11/10/2020 14:53	11/10/2020 14:38	11/10/2020 14:53	0,23	2	0,47	CHI
20201054148	MOSSAMEDES	MD12120930	ITABERAÍ S2	11/10/2020 14:39	12/10/2020 14:53	11/10/2020 14:39	12/10/2020 14:53	24,23	11	266,53	CHI
20201054424	CORREGO DO OURO	CO12383517	FIRMINOPOLIS S2	11/10/2020 14:39	12/10/2020 09:36	11/10/2020 14:39	12/10/2020 09:36	18,94	8	151,52	CHI
20201054049	SILVANIA	SV21187065	BELA VISTA S2	11/10/2020 14:40	11/10/2020 22:56	11/10/2020 14:40	11/10/2020 22:56	8,27	1	8,27	CHI
20201054052	POSSE	PS21232289	IACIARA S2	11/10/2020 14:40	11/10/2020 15:12	11/10/2020 14:40	11/10/2020 15:12	0,53	1	0,53	CHI
20201053142	SAO LUIS DE MONTES BELOS	DN12391399	FIRMINOPOLIS S2	11/10/2020 14:40	12/10/2020 09:18	11/10/2020 14:40	12/10/2020 09:18	18,63	6	111,77	CHI
20201053142	ADELANDIA	DN12391399	FIRMINOPOLIS S2	11/10/2020 14:40	12/10/2020 09:18	11/10/2020 14:40	12/10/2020 09:18	18,63	1	18,63	CHI
20201054062	POSSE	PS21318299	IACIARA S2	11/10/2020 14:40	11/10/2020 15:06	11/10/2020 14:40	11/10/2020 15:06	0,42	1	0,42	CHI
20201054063	FORMOSA	610071944	ITUIQUIRA	11/10/2020 14:41	12/10/2020 15:31	11/10/2020 14:41	12/10/2020 15:31	24,83	1	24,83	CHI
20201054067	CRIXAS	CX21244070	SANTA TEREZINHA	11/10/2020 14:41	11/10/2020 22:22	11/10/2020 14:41	11/10/2020 22:22	7,67	2	15,34	CHI
20201054070	ANAPOLIS	21056523	JUNDIAI S1	11/10/2020 14:42	11/10/2020 23:56	11/10/2020 14:42	11/10/2020 23:56	9,23	1	9,23	CHI
20201054155	SANCLERLANDIA	SC12206339	FIRMINOPOLIS S2	11/10/2020 14:42	12/10/2020 10:37	11/10/2020 14:42	12/10/2020 10:37	19,90	5	99,50	CHI
20201054614	SAO LUIS DE MONTES BELOS	SL12021470	SAO LUIZ DOS MONTES BELOS	11/10/2020 14:43	11/10/2020 23:26	11/10/2020 14:43	11/10/2020 23:26	8,71	38	331,09	CHI
20201054157	VALPARAISO DE GOIAS	2860188284	PACAEMBU S1	11/10/2020 14:44	11/10/2020 17:29	11/10/2020 14:44	11/10/2020 17:29	2,75	1	2,75	CHI
20201054946	GOIANIA	GN11023418	REAL S1	11/10/2020 14:45	12/10/2020 00:01	11/10/2020 14:45	12/10/2020 00:01	9,26	82	759,43	CHI
20201054273	FAINA	FC12071269	GOIAS	11/10/2020 14:46	11/10/2020 19:44	11/10/2020 14:46	11/10/2020 19:44	4,95	7	34,67	CHI
20201054462	SILVANIA	SV12161557	DAIA S2	11/10/2020 14:47	12/10/2020 00:35	11/10/2020 14:47	12/10/2020 00:35	9,80	10	97,99	CHI
20201054184	FORMOSA	FA21180919	SAO JOAO D ALIANCA	11/10/2020 14:47	12/10/2020 12:07	11/10/2020 14:47	12/10/2020 12:07	21,33	1	21,33	CHI
20201054220	GOIANIA	17249594	FERROVIARIO S3	11/10/2020 14:52	11/10/2020 19:45	11/10/2020 14:52	11/10/2020 19:45	4,88	1	4,88	CHI
20201055747	FAINA	MP12194509	MATRINCHA	11/10/2020 14:53	12/10/2020 08:20	11/10/2020 14:53	12/10/2020 08:20	17,45	3	52,35	CHI
20201055747	MATRINCHA	MP12194509	MATRINCHA	11/10/2020 14:53	12/10/2020 08:20	11/10/2020 14:53	12/10/2020 08:20	17,45	3	52,35	CHI
20201054388	GOIANIA	GN11002160	FERROVIARIO S2	11/10/2020 14:53	11/10/2020 22:20	11/10/2020 14:53	11/10/2020 22:20	7,45	65	484,38	CHI
20201056108	GOIANIA	GN11001520	AEROPORTO S3	11/10/2020 14:53	11/10/2020 21:16	11/10/2020 14:53	11/10/2020 21:16	6,37	38	242,17	CHI
20201054232	SENADOR CANEDO	10014859414	SENADOR CANEDO	11/10/2020 14:54	11/10/2020 16:05	11/10/2020 14:54	11/10/2020 16:05	1,18	1	1,18	CHI
20201054242	CACU	CC21295775	CACHOEIRA ALTA	11/10/2020 14:56	11/10/2020 15:11	11/10/2020 14:56	11/10/2020 15:11	0,25	1	0,25	CHI
20201055018	ALVORADA DO NORTE	AQ12257608	FLORES DE GOIAS	11/10/2020 14:56	12/10/2020 12:49	11/10/2020 14:56	12/10/2020 12:49	21,87	10	218,74	CHI
20201055018	IACIARA	AQ12257608	FLORES DE GOIAS	11/10/2020 14:56	12/10/2020 12:49	11/10/2020 14:56	12/10/2020 12:49	21,87	4	87,50	CHI
20201055018	POSSE	AQ12257608	FLORES DE GOIAS	11/10/2020 14:56	12/10/2020 12:49	11/10/2020 14:56	12/10/2020 12:49	21,87	2	43,75	CHI
20201054246	SILVANIA	SV12317621	DAIA S2	11/10/2020 14:56	11/10/2020 21:52	11/10/2020 14:56	11/10/2020 21:52	6,92	1	6,92	CHI
20201054264	BARRO ALTO	BA21342222	GOIANESIA S1	11/10/2020 14:57	13/10/2020 13:52	11/10/2020 14:57	13/10/2020 13:52	46,93	1	46,93	CHI
20201054270	JARAGUA	JA12353260	GOIANESIA S2	11/10/2020 14:57	11/10/2020 21:42	11/10/2020 14:57	11/10/2020 21:42	6,74	183	1233,67	CHI
20201055118	MONTES CLAROS DE GOIAS	ME12204930	IPORA	11/10/2020 14:57	11/10/2020 18:40	11/10/2020 14:57	11/10/2020 18:40	3,70	4	14,81	CHI
20201054274	GOIANIA	GN12001780	GOYA S1	11/10/2020 14:58	11/10/2020 17:16	11/10/2020 14:58	11/10/2020 17:16	2,30	42	96,41	CHI
20201054665	SAO LUIS DE MONTES BELOS	SC12299040	FIRMINOPOLIS S2	11/10/2020 14:58	11/10/2020 18:23	11/10/2020 14:58	11/10/2020 18:23	3,41	47	160,22	CHI
20201054665	SANCLERLANDIA	SC12299040	FIRMINOPOLIS S2	11/10/2020 14:58	11/10/2020 18:23	11/10/2020 14:58	11/10/2020 18:23	3,41	1	3,41	CHI
20201054288	GOIAS	90029124	GOIAS	11/10/2020 15:00	11/10/2020 20:42	11/10/2020 15:00	11/10/2020 20:42	5,70	1	5,70	CHI
20201054292	GOIANIA	17111511	MEIA PONTE	11/10/2020 15:00	12/10/2020 01:28	11/10/2020 15:00	12/10/2020 01:28	10,45	1	10,45	CHI
20201054304	CALDAS NOVAS	CN11363740	CALDAS NOVAS S1	11/10/2020 15:03	11/10/2020 22:56	11/10/2020 15:03	11/10/2020 21:52	6,81	13	88,52	CHI
20201054304	CALDAS NOVAS	CN12332905	CALDAS NOVAS S1	11/10/2020 15:03	11/10/2020 22:56	11/10/2020 15:03	11/10/2020 22:56	4,20	17	71,43	CHI
20201054311	BELA VISTA DE GOIAS	240044976	BELA VISTA S1	11/10/2020 15:04	11/10/2020 20:43	11/10/2020 15:04	11/10/2020 20:43	5,64	1	5,64	CHI
20201054367	MUTUNOPOLIS	MU21132172	MARA ROSA	11/10/2020 15:07	11/10/2020 16:58	11/10/2020 15:07	11/10/2020 16:58	1,84	1	1,84	CHI

20201054370	COCALZINHO DE GOIAS	10002300662	GOIANESIA S1	11/10/2020 15:07	12/10/2020 12:50	11/10/2020 15:07	12/10/2020 12:50	21,72	1	21,72	CHI
20201054379	PALMEIRAS DE GOIAS	PL21239704	PALMEIRAS	11/10/2020 15:09	12/10/2020 07:53	11/10/2020 15:09	12/10/2020 07:53	16,72	1	16,72	CHI
20201054381	ANAPOLIS	AN21262483	NEROPOLIS S1	11/10/2020 15:09	11/10/2020 23:14	11/10/2020 15:09	11/10/2020 23:14	8,07	1	8,07	CHI
20201056129	URUACU	640094004	URUACU	11/10/2020 15:09	11/10/2020 20:40	11/10/2020 15:09	11/10/2020 20:40	5,50	1	5,50	CHI
20201054387	RIO VERDE	RV12301243	CABRIUVA S2	11/10/2020 15:10	12/10/2020 08:32	11/10/2020 15:10	12/10/2020 08:32	17,35	1	17,35	CHI
20201054550	MINEIROS	02430414	CHAPADAO DO CEU	11/10/2020 15:11	11/10/2020 15:15	11/10/2020 15:11	11/10/2020 15:15	0,08	26	2,01	CHI
20201054550	SERRANOPOLIS	02430414	CHAPADAO DO CEU	11/10/2020 15:11	11/10/2020 15:15	11/10/2020 15:11	11/10/2020 15:15	0,08	84	6,51	CHI
20201054550	CHAPADAO DO CEU	02430414	CHAPADAO DO CEU	11/10/2020 15:11	11/10/2020 15:15	11/10/2020 15:11	11/10/2020 15:15	0,08	11	0,85	CHI
20201054395	GOIANIA	11329798	CARAJAS S2	11/10/2020 15:12	12/10/2020 02:04	11/10/2020 15:12	12/10/2020 02:04	10,85	1	10,85	CHI
20201054402	ARAGARCAS	1820011073	ARAGARCAS	11/10/2020 15:13	11/10/2020 16:37	11/10/2020 15:13	11/10/2020 16:37	1,39	1	1,39	CHI
20201056376	SANTA TEREZINHA DE GOIAS	SG12337610	SANTA TEREZINHA	11/10/2020 15:14	12/10/2020 10:35	11/10/2020 15:14	12/10/2020 10:35	19,35	6	116,09	CHI
20201054406	IVOLANDIA	IV11256515	IPORA	11/10/2020 15:14	14/10/2020 01:21	11/10/2020 15:14	14/10/2020 01:21	58,10	2	116,20	CHI
20201054407	SANCLERLANDIA	SC21229878	FIRMINOPOLIS S2	11/10/2020 15:14	12/10/2020 12:25	11/10/2020 15:14	12/10/2020 12:25	21,17	1	21,17	CHI
20201055887	GOIANIA	GN11002544	CAMPINAS S2	11/10/2020 15:16	11/10/2020 19:58	11/10/2020 15:16	11/10/2020 19:58	4,69	159	746,24	CHI
20201054421	SANTA ROSA DE GOIAS	SR21117283	INHUMAS S1	11/10/2020 15:17	12/10/2020 12:10	11/10/2020 15:17	12/10/2020 12:10	20,88	2	41,77	CHI
20201055091	CRISTALINA	KR12230156	PAMPLONA	11/10/2020 15:17	12/10/2020 10:24	11/10/2020 15:17	12/10/2020 10:24	19,12	13	248,51	CHI
20201054435	FORMOSA	FA21096304	SAO JOAO D ALIANCA	11/10/2020 15:19	11/10/2020 16:06	11/10/2020 15:19	11/10/2020 16:06	0,78	2	1,57	CHI
20201050657	CAMPINORTE	CR11003478	CAMPINORTE	11/10/2020 15:20	11/10/2020 15:59	11/10/2020 15:20	11/10/2020 15:59	0,65	90	58,52	CHI
20201054474	ITUMBIARA	IT12033831	ITUMBIARA VELHA S1	11/10/2020 15:21	11/10/2020 17:04	11/10/2020 15:21	11/10/2020 17:04	1,71	139	238,19	CHI
20201054453	APARECIDA DE GOIANIA	200265570	INDEPENDENCIA S1	11/10/2020 15:22	11/10/2020 19:30	11/10/2020 15:22	11/10/2020 19:30	4,12	1	4,12	CHI
20201056171	FORMOSA	FA12366173	ITUIQUIRA	11/10/2020 15:22	12/10/2020 05:30	11/10/2020 15:22	12/10/2020 05:30	14,12	2	28,24	CHI
20201054518	VALPARAISO DE GOIAS	VA11206773	PACAEMBU S2	11/10/2020 15:23	11/10/2020 21:11	11/10/2020 15:23	11/10/2020 21:11	5,80	74	428,95	CHI
20201054461	DOVERLANDIA	DV21207930	PARQUE DAS EMAS	11/10/2020 15:23	11/10/2020 18:54	11/10/2020 15:23	11/10/2020 18:54	3,50	1	3,50	CHI
20201054464	BONOPOLIS	BX21198507	SAO MIGUEL DO ARAGUAIA	11/10/2020 15:24	12/10/2020 10:07	11/10/2020 15:24	12/10/2020 10:07	18,71	1	18,71	CHI
20201054465	LUZIANIA	120023969	RIO VERMELHO	11/10/2020 15:24	11/10/2020 22:26	11/10/2020 15:24	11/10/2020 22:26	7,03	1	7,03	CHI
20201054584	APARECIDA DE GOIANIA	AP11007353	INDEPENDENCIA S1	11/10/2020 15:24	11/10/2020 17:03	11/10/2020 15:24	11/10/2020 17:03	1,64	216	353,46	CHI
20201054477	FORMOSA	FA12381543	ITUIQUIRA	11/10/2020 15:25	11/10/2020 17:51	11/10/2020 15:25	11/10/2020 17:51	2,42	4	9,67	CHI
20201055637	SANTA HELENA DE GOIAS	TD12226264	RIO DOS BOIS	11/10/2020 15:28	11/10/2020 21:10	11/10/2020 15:28	11/10/2020 21:10	5,70	3	17,10	CHI
20201055637	TURVELANDIA	TD12226264	RIO DOS BOIS	11/10/2020 15:28	11/10/2020 21:10	11/10/2020 15:28	11/10/2020 21:10	5,70	83	473,01	CHI
20201054489	GOIANIA	10019368605	GOIANIA LESTE S3	11/10/2020 15:28	11/10/2020 17:45	11/10/2020 15:28	11/10/2020 17:45	2,27	1	2,27	CHI
20201054491	ORIZONA	OZ21231569	VIANOPOLIS	11/10/2020 15:29	11/10/2020 16:53	11/10/2020 15:29	11/10/2020 16:53	1,40	1	1,40	CHI
20201059604	GOIAS	GS12145455	MATRINCHA	11/10/2020 15:29	12/10/2020 14:46	11/10/2020 15:29	12/10/2020 14:46	23,27	3	69,82	CHI
20201054505	GOIAS	GS21220445	GOIAS	11/10/2020 15:31	11/10/2020 17:01	11/10/2020 15:31	11/10/2020 17:01	1,50	1	1,50	CHI
20201054509	ANAPOLIS	20015872	ANAPOLIS UNIVERSITARIO S2	11/10/2020 15:31	11/10/2020 22:13	11/10/2020 15:31	11/10/2020 22:13	6,69	1	6,69	CHI
20201055077	GOIANIA	GN11000594	AEROPORTO S2	11/10/2020 15:31	11/10/2020 18:11	11/10/2020 15:31	11/10/2020 18:11	2,66	93	246,94	CHI
20201054512	CORREGO DO OURO	CO12054660	FIRMINOPOLIS S2	11/10/2020 15:31	13/10/2020 03:32	11/10/2020 15:31	13/10/2020 03:32	36,00	5	180,01	CHI
20201054515	CALDAS NOVAS	CN12213964RE	SERRA DE CALDAS	11/10/2020 15:32	11/10/2020 17:48	11/10/2020 15:32	11/10/2020 17:48	2,26	165	373,18	CHI
20201055969	SAO LUIS DE MONTES BELOS	SL12024333	FIRMINOPOLIS S2	11/10/2020 15:35	12/10/2020 15:10	11/10/2020 15:35	12/10/2020 15:10	23,58	9	212,21	CHI
20201054530	MINACU	IH12396742	MINACU	11/10/2020 15:35	12/10/2020 12:27	11/10/2020 15:35	12/10/2020 12:27	20,86	43	896,91	CHI
20201054537	SILVANIA	SV21196565	DAIA S2	11/10/2020 15:37	12/10/2020 04:29	11/10/2020 15:37	12/10/2020 04:29	12,87	1	12,87	CHI
20201054541	ALEXANIA	480071500	ALEXANIA	11/10/2020 15:37	11/10/2020 22:32	11/10/2020 15:37	11/10/2020 22:32	6,91	1	6,91	CHI
20201054542	CACU	CC12028258	CACHOEIRA ALTA	11/10/2020 15:37	11/10/2020 18:29	11/10/2020 15:37	11/10/2020 18:29	2,85	60	171,10	CHI
20201054542	QUIRINOPOLIS	CC12028258	CACHOEIRA ALTA	11/10/2020 15:37	11/10/2020 18:29	11/10/2020 15:37	11/10/2020 18:29	2,85	1	2,85	CHI
20201054547	CRISTALINA	KR11170474	CRISTALINA S2	11/10/2020 15:38	12/10/2020 02:56	11/10/2020 15:38	12/10/2020 02:56	11,30	1	11,30	CHI
20201054551	PIRANHAS	PH12079541	PIRANHAS	11/10/2020 15:39	11/10/2020 19:18	11/10/2020 15:39	11/10/2020 19:18	3,64	2	7,28	CHI
20201054554	RIO VERDE	RV21029042	SANTA HELENA S1	11/10/2020 15:40	12/10/2020 00:11	11/10/2020 15:40	12/10/2020 00:11	8,51	1	8,51	CHI
20201054801	ANAPOLIS	AN11189929	ANAPOLIS UNIVERSITARIO S2	11/10/2020 15:40	11/10/2020 17:15	11/10/2020 15:40	11/10/2020 17:15	1,58	57	89,98	CHI
20201054560	GOIANIA	11491279	AEROPORTO S2	11/10/2020 15:40	11/10/2020 22:50	11/10/2020 15:40	11/10/2020 22:50	7,15	1	7,15	CHI
20201055512	ANAPOLIS	AN12107991	JUNDIAI S2	11/10/2020 15:41	11/10/2020 19:07	11/10/2020 15:41	11/10/2020 19:07	3,42	268	917,75	CHI
20201054567	INHUMAS	30021443	INHUMAS S2	11/10/2020 15:41	12/10/2020 10:45	11/10/2020 15:41	12/10/2020 10:45	19,05	1	19,05	CHI
20201054615	GUAPO	GA12266688	GUAPO S2	11/10/2020 15:42	11/10/2020 18:04	11/10/2020 15:42	11/10/2020 18:04	2,35	22	51,80	CHI
20201054615	ARAGOIANIA	GA12266688	GUAPO S2	11/10/2020 15:42	11/10/2020 18:04	11/10/2020 15:42	11/10/2020 18:04	2,35	1	2,35	CHI
20201054615	VARJAO	GA12266688	GUAPO S2	11/10/2020 15:42	11/10/2020 18:04	11/10/2020 15:42	11/10/2020 18:04	2,35	10	23,54	CHI
20201054577	MUTUNOPOLIS	MU21357174	MARA ROSA	11/10/2020 15:43	11/10/2020 21:36	11/10/2020 15:43	11/10/2020 21:36	5,88	1	5,88	CHI
20201054587	DAMOLANDIA	DL11064934	INHUMAS S1	11/10/2020 15:45	11/10/2020 17:36	11/10/2020 15:45	11/10/2020 17:36	1,84	112	206,36	CHI
20201054912	SANCLERLANDIA	SC12383552	FIRMINOPOLIS S2	11/10/2020 15:45	11/10/2020 23:23	11/10/2020 15:45	11/10/2020 23:23	7,62	10	76,24	CHI
20201054724	NOVA AMERICA	NM12075610	RUBIATABA	11/10/2020 15:46	12/10/2020 11:25	11/10/2020 15:46	12/10/2020 11:25	19,65	13	255,42	CHI
20201054591	JATAI	290173887	JATAI S2	11/10/2020 15:46	12/10/2020 08:56	11/10/2020 15:46	12/10/2020 08:56	17,16	1	17,16	CHI

20201054593	FLORES DE GOIAS	FB11286803	FLORES DE GOIAS	11/10/2020 15:46	12/10/2020 16:39	11/10/2020 15:46	12/10/2020 16:39	24,87	1	24,87	CHI
20201054767	PROFESSOR JAMIL SAFADY	JS12000104	ROCHEDO	11/10/2020 15:47	11/10/2020 17:12	11/10/2020 15:47	11/10/2020 17:12	1,41	17	23,96	CHI
20201054600	POSSE	1480022930	IACIARA S2	11/10/2020 15:47	11/10/2020 19:17	11/10/2020 15:47	11/10/2020 19:17	3,49	1	3,49	CHI
20201054604	GOIANIA	13095304	CAMPINAS S2	11/10/2020 15:48	11/10/2020 22:52	11/10/2020 15:48	11/10/2020 22:52	7,06	1	7,06	CHI
20201055993	RUBIATABA	RB12161662	RUBIATABA	11/10/2020 15:48	12/10/2020 03:12	11/10/2020 15:48	12/10/2020 03:12	11,40	32	364,66	CHI
20201055993	ITAPACI	RB12161662	RUBIATABA	11/10/2020 15:48	12/10/2020 03:12	11/10/2020 15:48	12/10/2020 03:12	11,40	10	113,96	CHI
20201054613	BONOPOLIS	BX12198522	SAO MIGUEL DO ARAGUAIA	11/10/2020 15:49	12/10/2020 07:48	11/10/2020 15:49	12/10/2020 07:48	15,97	2	31,94	CHI
20201054616	ITAJA	IJ11326832	ITAJA S2	11/10/2020 15:50	12/10/2020 11:08	11/10/2020 15:50	12/10/2020 11:08	19,30	61	1177,16	CHI
20201054624	COCALZINHO DE GOIAS	ZN12302518	COCALZINHO	11/10/2020 15:51	11/10/2020 22:48	11/10/2020 15:51	11/10/2020 22:48	6,94	2	13,88	CHI
20201054625	SILVANIA	SV21075485	VIANOPOLIS	11/10/2020 15:51	11/10/2020 21:46	11/10/2020 15:51	11/10/2020 21:46	5,91	1	5,91	CHI
20201054629	SAO JOAO DA PARAUNA	FR21032173	FIRMINOPOLIS S2	11/10/2020 15:52	12/10/2020 22:34	11/10/2020 15:52	12/10/2020 22:34	30,69	1	30,69	CHI
20201054639	CROMINIA	CQ21161575	PONTALINA	11/10/2020 15:54	11/10/2020 18:54	11/10/2020 15:54	11/10/2020 18:54	3,00	1	3,00	CHI
20201054643	ITABERAI	IB21108172	ITABERAI S1	11/10/2020 15:54	12/10/2020 09:15	11/10/2020 15:54	12/10/2020 09:15	17,34	5	86,70	CHI
20201054645	LUZIANIA	LZ21151877	MARAJUARA	11/10/2020 15:55	11/10/2020 22:02	11/10/2020 15:55	11/10/2020 22:02	6,12	1	6,12	CHI
20201054646	SANCLERLANDIA	SC12299037	FIRMINOPOLIS S2	11/10/2020 15:55	13/10/2020 05:50	11/10/2020 15:55	13/10/2020 05:50	37,91	1	37,91	CHI
20201056323	MATRINCHA	MP11073657	MATRINCHA	11/10/2020 15:56	12/10/2020 01:19	11/10/2020 15:56	12/10/2020 01:19	9,38	76	713,03	CHI
20201054655	CRISTALINA	KR21025855	PAMPLONA	11/10/2020 15:56	11/10/2020 23:34	11/10/2020 15:56	11/10/2020 23:34	7,63	1	7,63	CHI
20201054658	ITABERAI	IB21274526	ITABERAI S1	11/10/2020 15:56	12/10/2020 12:47	11/10/2020 15:56	12/10/2020 12:47	20,84	1	20,84	CHI
20201055318	ANAPOLIS	AN12382358	ANAPOLIS UNIVERSITARIO S2	11/10/2020 15:57	11/10/2020 18:49	11/10/2020 15:57	11/10/2020 18:49	2,86	163	466,18	CHI
20201055672	ABADIANIA	AX12000165	ALEXANIA	11/10/2020 15:57	11/10/2020 19:22	11/10/2020 15:57	11/10/2020 19:22	3,41	8	27,26	CHI
20201055672	CORUMBA DE GOIAS	AX12000165	ALEXANIA	11/10/2020 15:57	11/10/2020 19:22	11/10/2020 15:57	11/10/2020 19:22	3,41	64	218,12	CHI
20201055672	ALEXANIA	AX12000165	ALEXANIA	11/10/2020 15:57	11/10/2020 19:22	11/10/2020 15:57	11/10/2020 19:22	3,41	2	6,82	CHI
20201054667	ITAGUARU	I0005028106	JARAGUA	11/10/2020 15:57	12/10/2020 01:18	11/10/2020 15:57	12/10/2020 01:18	9,34	1	9,34	CHI
20201054581	SANCLERLANDIA	SC10407339	FIRMINOPOLIS S2	11/10/2020 16:02	11/10/2020 22:28	11/10/2020 17:31	11/10/2020 17:36	0,09	76	6,90	CHI
20201054581	SAO LUIS DE MONTES BELOS	SC10407339	FIRMINOPOLIS S2	11/10/2020 16:02	11/10/2020 22:28	11/10/2020 17:31	11/10/2020 17:36	0,09	2	0,18	CHI
20201054581	SANCLERLANDIA	19860152	FIRMINOPOLIS S2	11/10/2020 16:02	11/10/2020 22:28	11/10/2020 16:02	11/10/2020 17:40	1,63	11	17,88	CHI
20201054581	SANCLERLANDIA	SC12005464	FIRMINOPOLIS S2	11/10/2020 16:02	11/10/2020 22:28	11/10/2020 17:41	11/10/2020 22:28	4,79	8	38,34	CHI
20201054581	SANCLERLANDIA	SC12005464	FIRMINOPOLIS S2	11/10/2020 16:02	11/10/2020 22:28	11/10/2020 20:02	11/10/2020 22:28	2,43	2	4,86	CHI
20201054695	FORMOSO	2410011543	PORANGATU	11/10/2020 16:03	11/10/2020 19:29	11/10/2020 16:03	11/10/2020 19:29	3,43	1	3,43	CHI
20201054706	PORANGATU	PO12208396	PORANGATU	11/10/2020 16:03	11/10/2020 16:54	11/10/2020 16:03	11/10/2020 16:54	0,84	1	0,84	CHI
20201054714	GOIANIA	GN12395991	XAVANTES	11/10/2020 16:05	11/10/2020 20:40	11/10/2020 16:05	11/10/2020 20:40	4,58	6	27,49	CHI
20201054714	NEROPOLIS	GN12395991	XAVANTES	11/10/2020 16:05	11/10/2020 20:40	11/10/2020 16:05	11/10/2020 20:40	4,58	11	50,40	CHI
20201054725	BELA VISTA DE GOIAS	BV31207520	BELA VISTA S1	11/10/2020 16:07	12/10/2020 03:55	11/10/2020 16:07	12/10/2020 03:55	11,79	1	11,79	CHI
20201055501	ITAPIRAPUA	IU12087963	MATRINCHA	11/10/2020 16:08	11/10/2020 20:18	11/10/2020 16:08	11/10/2020 20:18	4,15	44	182,69	CHI
20201056328	SANCLERLANDIA	SC12204364	FIRMINOPOLIS S2	11/10/2020 16:09	12/10/2020 12:53	11/10/2020 16:09	12/10/2020 12:53	20,73	2	41,46	CHI
20201056130	URUACU	640093619	URUACU	11/10/2020 16:09	11/10/2020 21:30	11/10/2020 16:09	11/10/2020 21:30	5,34	1	5,34	CHI
20201054737	GOIANIA	12261075	CAMPINAS S1	11/10/2020 16:09	12/10/2020 03:20	11/10/2020 16:09	12/10/2020 03:20	11,17	1	11,17	CHI
20201054753	IPORA	6527127	ARENOPOLIS	11/10/2020 16:12	11/10/2020 20:35	11/10/2020 16:12	11/10/2020 20:35	4,38	8	35,07	CHI
20201054756	APORE	04320214	ITAJA S1	11/10/2020 16:12	12/10/2020 17:34	11/10/2020 16:12	11/10/2020 19:30	3,29	88	289,45	CHI
20201054756	SERRANOPOLIS	04320214	ITAJA S1	11/10/2020 16:12	12/10/2020 17:34	11/10/2020 16:12	11/10/2020 19:30	3,29	7	23,02	CHI
20201054756	APORE	AE13365052	ITAJA S1	11/10/2020 16:12	12/10/2020 17:34	11/10/2020 16:12	11/10/2020 20:59	4,78	4	19,13	CHI
20201054756	SERRANOPOLIS	SX12264283	ITAJA S1	11/10/2020 16:12	12/10/2020 17:34	11/10/2020 16:12	12/10/2020 10:32	18,33	1	18,33	CHI
20201054756	SERRANOPOLIS	SX12264283	ITAJA S1	11/10/2020 16:12	12/10/2020 17:34	12/10/2020 11:50	12/10/2020 12:10	0,34	2	0,67	CHI
20201054756	SERRANOPOLIS	SX13214305	ITAJA S1	11/10/2020 16:12	12/10/2020 17:34	11/10/2020 16:12	12/10/2020 17:34	25,36	13	329,64	CHI
20201054756	SERRANOPOLIS	SX13214305	ITAJA S1	11/10/2020 16:12	12/10/2020 17:34	12/10/2020 11:50	12/10/2020 17:34	5,72	1	5,72	CHI
20201055160	PIRENOPOLIS	PV12000030	CORUMBA	11/10/2020 16:13	11/10/2020 18:43	11/10/2020 16:13	11/10/2020 18:43	2,49	19	47,40	CHI
20201054758	GOIANIA	11831467	REAL S1	11/10/2020 16:13	12/10/2020 01:57	11/10/2020 16:13	12/10/2020 01:57	9,73	1	9,73	CHI
20201054944	NIQUELANDIA	NQ12398039	NIQUELANDIA SUBTRANSMISSAO	11/10/2020 16:14	14/10/2020 11:59	11/10/2020 16:14	14/10/2020 11:59	67,74	51	3454,81	CHI
20201054776	PETROLINA DE GOIAS	PG11273348	PETROLINA	11/10/2020 16:15	11/10/2020 16:59	11/10/2020 16:15	11/10/2020 16:59	0,72	81	58,12	CHI
20201054777	CAMPESTRE DE GOIAS	1230001302	TRINDADE	11/10/2020 16:16	11/10/2020 19:58	11/10/2020 16:16	11/10/2020 19:58	3,70	1	3,70	CHI
20201054779	BELA VISTA DE GOIAS	BV21324936	BELA VISTA S1	11/10/2020 16:16	11/10/2020 23:22	11/10/2020 16:16	11/10/2020 23:22	7,10	1	7,10	CHI
20201054786	MINACU	4020069397	MINACU	11/10/2020 16:17	12/10/2020 16:14	11/10/2020 16:17	12/10/2020 16:14	23,94	1	23,94	CHI
20201054848	SILVANIA	SV12389457	DAIA S2	11/10/2020 16:18	11/10/2020 23:48	11/10/2020 16:18	11/10/2020 23:48	7,49	9	67,44	CHI
20201054797	GOIANIA	12706371	GOYA S1	11/10/2020 16:18	11/10/2020 18:24	11/10/2020 16:18	11/10/2020 18:24	2,09	1	2,09	CHI
20201056655	HEITORAI	7543290	ITAPURANGA	11/10/2020 16:21	12/10/2020 10:18	11/10/2020 16:21	12/10/2020 10:18	17,95	30	538,51	CHI
20201054861	BELA VISTA DE GOIAS	BV21072738	CEPAIGO S2	11/10/2020 16:23	11/10/2020 21:47	11/10/2020 16:23	11/10/2020 21:47	5,39	2	10,78	CHI
20201054862	CACHOEIRA ALTA	1090036829	CACHOEIRA ALTA	11/10/2020 16:23	11/10/2020 17:43	11/10/2020 16:23	11/10/2020 17:43	1,32	1	1,32	CHI
20201054867	TURVANIA	TV21005781	FIRMINOPOLIS S2	11/10/2020 16:24	12/10/2020 08:44	11/10/2020 16:24	12/10/2020 08:44	16,32	1	16,32	CHI

20201057524	ANICUNS	10024801184	FIRMINOPOLIS S2	11/10/2020 16:25	12/10/2020 17:46	11/10/2020 16:25	12/10/2020 17:46	25,34	1	25,34	CHI
20201054876	BOM JARDIM DE GOIAS	BM12365303	BOM JARDIM	11/10/2020 16:25	12/10/2020 00:48	11/10/2020 16:25	12/10/2020 00:48	8,37	1	8,37	CHI
20201055204	TAQUARAL DE GOIAS	TQ12376431	ITABERAI S1	11/10/2020 16:26	11/10/2020 18:24	11/10/2020 16:26	11/10/2020 18:24	1,97	21	41,27	CHI
20201054885	GOIANIRA	GR11205661	GOIANIRA	11/10/2020 16:26	11/10/2020 17:38	11/10/2020 16:26	11/10/2020 17:38	1,19	114	136,14	CHI
20201056763	PALMEIRAS DE GOIAS	PL21010896	PALMEIRAS	11/10/2020 16:26	12/10/2020 08:45	11/10/2020 16:26	12/10/2020 08:45	16,31	1	16,31	CHI
20201054889	PALMEIRAS DE GOIAS	10000279780	PALMEIRAS	11/10/2020 16:26	12/10/2020 17:14	11/10/2020 16:26	12/10/2020 17:14	24,79	1	24,79	CHI
20201054891	SANCLERLANDIA	SC21206475	FIRMINOPOLIS S2	11/10/2020 16:26	12/10/2020 16:30	11/10/2020 16:26	12/10/2020 16:30	24,06	1	24,06	CHI
20201054902	CRISTALINA	KR11171014	CRISTALINA S2	11/10/2020 16:29	12/10/2020 07:53	11/10/2020 16:29	12/10/2020 07:53	15,40	1	15,40	CHI
20201054905	RIO VERDE	10016798072	RIO VERDE S2	11/10/2020 16:29	11/10/2020 18:25	11/10/2020 16:29	11/10/2020 18:25	1,93	1	1,93	CHI
20201054908	RIO VERDE	RV21260770	RIO VERDE S1	11/10/2020 16:29	11/10/2020 18:43	11/10/2020 16:29	11/10/2020 18:43	2,23	1	2,23	CHI
20201054920	GOIAS	GS21241337	MATRINCHA	11/10/2020 16:30	11/10/2020 18:42	11/10/2020 16:30	11/10/2020 18:42	2,18	1	2,18	CHI
20201054925	POSSE	PS12195787	IACIARA S2	11/10/2020 16:31	12/10/2020 10:48	11/10/2020 16:31	12/10/2020 10:48	18,29	1	18,29	CHI
20201054972	MIMOSO DE GOIAS	MJ12377249	PADRE BERNARDO	11/10/2020 16:31	12/10/2020 15:08	11/10/2020 16:31	11/10/2020 22:55	6,39	3	19,17	CHI
20201054972	MIMOSO DE GOIAS	MJ12377249	PADRE BERNARDO	11/10/2020 16:31	12/10/2020 15:08	11/10/2020 16:31	11/10/2020 23:44	7,21	4	28,82	CHI
20201054972	MIMOSO DE GOIAS	MJ12377249	PADRE BERNARDO	11/10/2020 16:31	12/10/2020 15:08	11/10/2020 16:31	12/10/2020 15:08	22,62	11	248,81	CHI
20201054947	MORRINHOS	MR11343159	MORRINHOS	11/10/2020 16:34	11/10/2020 18:53	11/10/2020 16:34	11/10/2020 18:53	2,31	104	239,95	CHI
20201054954	BELA VISTA DE GOIAS	BV12031626	BELA VISTA S1	11/10/2020 16:35	11/10/2020 18:56	11/10/2020 16:35	11/10/2020 18:56	2,34	3	7,02	CHI
20201054969	GOIANIA	10014869614	GOYA S2	11/10/2020 16:38	11/10/2020 20:17	11/10/2020 16:38	11/10/2020 20:17	3,64	1	3,64	CHI
20201054974	RIO VERDE	RV21160726	CABRIUVA S2	11/10/2020 16:39	11/10/2020 19:21	11/10/2020 16:39	11/10/2020 19:21	2,69	1	2,69	CHI
20201055653	ARAGOIANIA	AO32000298	GUAPO S2	11/10/2020 16:39	11/10/2020 19:12	11/10/2020 16:39	11/10/2020 19:12	2,54	7	17,76	CHI
20201054977	INHUMAS	IN21381644	INHUMAS S2	11/10/2020 16:40	12/10/2020 12:48	11/10/2020 16:40	12/10/2020 12:48	20,13	2	40,26	CHI
20201054983	NIQUELANDIA	NQ12237523	URUCU	11/10/2020 16:40	12/10/2020 12:43	11/10/2020 16:40	12/10/2020 12:43	20,03	15	300,52	CHI
20201055017	IPAMERI	KR10414276	CRISTALINA S1	11/10/2020 16:41	12/10/2020 13:00	11/10/2020 16:41	11/10/2020 21:40	4,98	1	4,98	CHI
20201055017	CRISTALINA	KR10414276	CRISTALINA S1	11/10/2020 16:41	12/10/2020 13:00	11/10/2020 16:41	11/10/2020 21:40	4,98	14	69,70	CHI
20201055017	CRISTALINA	KR10414276	CRISTALINA S1	11/10/2020 16:41	12/10/2020 13:00	11/10/2020 16:44	12/10/2020 02:11	9,46	11	104,04	CHI
20201055017	CRISTALINA	KR10414276	CRISTALINA S1	11/10/2020 16:41	12/10/2020 13:00	11/10/2020 16:44	12/10/2020 11:11	18,45	2	36,91	CHI
20201055017	CRISTALINA	KR10414276	CRISTALINA S1	11/10/2020 16:41	12/10/2020 13:00	12/10/2020 11:07	12/10/2020 11:11	0,07	11	0,80	CHI
20201055017	CRISTALINA	KR10414276	CRISTALINA S1	11/10/2020 16:41	12/10/2020 13:00	11/10/2020 16:41	12/10/2020 13:00	20,31	283	5747,57	CHI
20201055017	IPAMERI	KR10414276	CRISTALINA S1	11/10/2020 16:41	12/10/2020 13:00	11/10/2020 16:41	12/10/2020 13:00	20,31	5	101,55	CHI
20201055017	IPAMERI	KR10414292	CRISTALINA S1	11/10/2020 16:41	12/10/2020 13:00	12/10/2020 12:53	12/10/2020 13:00	0,11	1	0,11	CHI
20201055017	CRISTALINA	KR10414292	CRISTALINA S1	11/10/2020 16:41	12/10/2020 13:00	12/10/2020 12:53	12/10/2020 13:00	0,11	14	1,50	CHI
20201054990	UIRAPURU	UP21082364	NOVA CRIXAS	11/10/2020 16:42	11/10/2020 22:22	11/10/2020 16:42	11/10/2020 22:22	5,66	2	11,32	CHI
20201054997	CHAPADA DO CEU	DJ12248471	CHAPADA DO CEU	11/10/2020 16:42	11/10/2020 23:29	11/10/2020 16:42	11/10/2020 23:29	6,77	7	47,40	CHI
20201054996	UIRAPURU	UP12294696	NOVA CRIXAS	11/10/2020 16:43	11/10/2020 21:24	11/10/2020 16:43	11/10/2020 21:24	4,67	4	18,70	CHI
20201054996	AMARALINA	UP12294696	NOVA CRIXAS	11/10/2020 16:43	11/10/2020 21:24	11/10/2020 16:43	11/10/2020 21:24	4,67	54	252,44	CHI
20201054996	SANTA TEREZINHA DE GOIAS	UP12294696	NOVA CRIXAS	11/10/2020 16:43	11/10/2020 21:24	11/10/2020 16:43	11/10/2020 21:24	4,67	1	4,67	CHI
20201054996	MARA ROSA	UP12294696	NOVA CRIXAS	11/10/2020 16:43	11/10/2020 21:24	11/10/2020 16:43	11/10/2020 21:24	4,67	43	201,01	CHI
20201055003	ITAJA	IJ12214312	ITAJA S2	11/10/2020 16:44	11/10/2020 17:28	11/10/2020 16:44	11/10/2020 17:28	0,73	5	3,65	CHI
20201055007	URUTAI	UT21199346	URUTAI	11/10/2020 16:44	11/10/2020 17:38	11/10/2020 16:44	11/10/2020 17:38	0,89	1	0,89	CHI
20201055022	GOIANIA	14881032	MEIA PONTE	11/10/2020 16:47	11/10/2020 19:05	11/10/2020 16:47	11/10/2020 19:05	2,29	1	2,29	CHI
20201055403	JARAGUA	JA12297837	JARAGUA	11/10/2020 16:47	12/10/2020 07:26	11/10/2020 16:47	12/10/2020 07:26	14,64	9	131,74	CHI
20201055026	GOIANIA	10011062582	GOYA S1	11/10/2020 16:48	11/10/2020 20:01	11/10/2020 16:48	11/10/2020 20:01	3,22	1	3,22	CHI
20201056198	SANTA ISABEL	GE12191489	ITAPACI	11/10/2020 16:48	12/10/2020 12:17	11/10/2020 16:48	12/10/2020 12:17	19,48	3	58,44	CHI
20201055037	ITAPURANGA	IK21064442	ITAPURANGA	11/10/2020 16:49	11/10/2020 23:52	11/10/2020 16:49	11/10/2020 23:52	7,04	1	7,04	CHI
20201054768	SENADOR CANEDO	SW11199137	SENADOR CANEDO	11/10/2020 16:49	11/10/2020 17:54	11/10/2020 16:49	11/10/2020 17:54	1,08	163	175,59	CHI
20201055521	MOSSAMEDES	SC16407337	FIRMINOPOLIS S2	11/10/2020 16:50	11/10/2020 17:55	11/10/2020 16:50	11/10/2020 17:55	1,07	4	4,29	CHI
20201055521	SANCLERLANDIA	SC16407337	FIRMINOPOLIS S2	11/10/2020 16:50	11/10/2020 17:55	11/10/2020 16:50	11/10/2020 17:55	1,07	163	174,86	CHI
20201055063	ALEXANIA	AX12061983	ALEXANIA	11/10/2020 16:52	12/10/2020 02:15	11/10/2020 16:52	12/10/2020 02:15	9,38	15	140,65	CHI
20201055063	CORUMBA DE GOIAS	AX12061983	ALEXANIA	11/10/2020 16:52	12/10/2020 02:15	11/10/2020 16:52	12/10/2020 02:15	9,38	1	9,38	CHI
20201055067	NOVO GAMA	NJ12379164	PACAEMBU S1	11/10/2020 16:53	11/10/2020 23:50	11/10/2020 16:53	11/10/2020 23:50	6,95	23	159,80	CHI
20201055200	PADRE BERNARDO	PB12333235	PADRE BERNARDO	11/10/2020 16:54	11/10/2020 20:50	11/10/2020 16:54	11/10/2020 19:28	2,56	1	2,56	CHI
20201055200	PADRE BERNARDO	PB12333235	PADRE BERNARDO	11/10/2020 16:54	11/10/2020 20:50	11/10/2020 16:54	11/10/2020 20:50	3,93	23	90,38	CHI
20201055092	GOIANIA	10014533136	CARAJAS S1	11/10/2020 16:57	11/10/2020 22:42	11/10/2020 16:57	11/10/2020 22:42	5,75	1	5,75	CHI
20201055106	APORE	IJ12194905	ITAJA S2	11/10/2020 16:59	11/10/2020 18:43	11/10/2020 16:59	11/10/2020 18:43	1,73	1	1,73	CHI
20201055106	ITAJA	IJ12194905	ITAJA S2	11/10/2020 16:59	11/10/2020 18:43	11/10/2020 16:59	11/10/2020 18:43	1,73	34	58,79	CHI
20201055107	PIRACANJUBA	PJ21419762	PIRACANJUBA	11/10/2020 16:59	11/10/2020 18:30	11/10/2020 16:59	11/10/2020 18:30	1,51	1	1,51	CHI
20201055108	MONTE ALEGRE DE GOIAS	GH12261967	SAO DOMINGOS	11/10/2020 16:59	11/10/2020 19:31	11/10/2020 16:59	11/10/2020 19:31	2,52	1	2,52	CHI
20201055108	DIVINOPOLIS DE GOIAS	GH12261967	SAO DOMINGOS	11/10/2020 16:59	11/10/2020 19:31	11/10/2020 16:59	11/10/2020 19:31	2,52	1	2,52	CHI

20201044807	ITAPIRAPUA	GS13250836	MATRINCHA	11/10/2020 17:00	11/10/2020 17:06	11/10/2020 17:00	11/10/2020 17:06	0,11	9	0,96	CHI
20201044807	GOIAS	GS13250836	MATRINCHA	11/10/2020 17:00	11/10/2020 17:06	11/10/2020 17:00	11/10/2020 17:06	0,11	21	2,25	CHI
20201055123	FAINA	MP12096007	MATRINCHA	11/10/2020 17:00	12/10/2020 10:05	11/10/2020 17:00	12/10/2020 10:05	17,08	8	136,61	CHI
20201055124	PADRE BERNARDO	6761838	PADRE BERNARDO	11/10/2020 17:00	11/10/2020 20:50	11/10/2020 17:00	11/10/2020 20:50	3,82	36	137,54	CHI
20201055125	MINACU	IH12236142	MINACU	11/10/2020 17:00	12/10/2020 13:49	11/10/2020 17:00	12/10/2020 13:49	20,80	28	582,42	CHI
20201055126	CEZARINA	CZ11186432	CEZARINA	11/10/2020 17:01	11/10/2020 20:23	11/10/2020 17:01	11/10/2020 20:23	3,37	159	535,26	CHI
20201055132	PARANAIGUARA	PC12191592	CACHOEIRA ALTA	11/10/2020 17:02	11/10/2020 18:08	11/10/2020 17:02	11/10/2020 18:08	1,10	149	163,16	CHI
20201055133	GOIANIA	12459320	CARAJAS S1	11/10/2020 17:02	12/10/2020 00:30	11/10/2020 17:02	12/10/2020 00:30	7,46	1	7,46	CHI
20201055134	GOIAS	GS21157082	GOIAS	11/10/2020 17:02	12/10/2020 16:57	11/10/2020 17:02	12/10/2020 16:57	23,91	1	23,91	CHI
20201055135	ARAGOIANIA	AO31097630	GUAPO S2	11/10/2020 17:02	11/10/2020 19:35	11/10/2020 17:02	11/10/2020 19:35	2,54	1	2,54	CHI
20201055136	GOIANIA	15883152	GOYA S2	11/10/2020 17:02	12/10/2020 02:22	11/10/2020 17:02	12/10/2020 02:22	9,33	1	9,33	CHI
20201055145	CALDAZINHA	DE11322395	SENADOR CANEDO	11/10/2020 17:04	12/10/2020 01:50	11/10/2020 17:04	12/10/2020 01:50	8,75	35	306,37	CHI
20201055147	GOIANIA	GN11120283	GOIANIA LESTE S3	11/10/2020 17:05	11/10/2020 18:45	11/10/2020 17:05	11/10/2020 18:45	1,65	107	176,97	CHI
20201055706	GOIANIA	10003340749	MEIA PONTE	11/10/2020 17:05	11/10/2020 20:47	11/10/2020 17:05	11/10/2020 20:47	3,70	1	3,70	CHI
20201055531	SAO SIMAO	SO11194915	CACHOEIRA ALTA	11/10/2020 17:06	12/10/2020 06:38	11/10/2020 17:06	12/10/2020 06:38	13,53	72	974,22	CHI
20201058318	SANTA RITA DO NOVO DESTINO	DF11315599	BARRO ALTO	11/10/2020 17:07	12/10/2020 10:56	11/10/2020 17:07	12/10/2020 10:56	17,81	1	17,81	CHI
20201055159	GOIANIA	15957561	CARAJAS S2	11/10/2020 17:07	11/10/2020 19:22	11/10/2020 17:07	11/10/2020 19:22	2,25	1	2,25	CHI
20201055162	TURVANIA	TV12006095	FIRMINOPOLIS S2	11/10/2020 17:07	12/10/2020 12:56	11/10/2020 17:07	12/10/2020 12:56	19,81	2	39,62	CHI
20201056140	MARA ROSA	MQ12120038	MARA ROSA	11/10/2020 17:07	12/10/2020 18:30	11/10/2020 17:07	12/10/2020 18:30	25,37	2	50,74	CHI
20201055168	NOVO GAMA	2460083770	PACAEMBU S1	11/10/2020 17:08	11/10/2020 20:41	11/10/2020 17:08	11/10/2020 20:41	3,55	1	3,55	CHI
20201055206	CHAPADAO DO CEU	DJ12153959	CHAPADAO DO CEU	11/10/2020 17:08	11/10/2020 23:58	11/10/2020 17:08	11/10/2020 23:58	6,82	7	47,76	CHI
20201055173	INHUMAS	30102947	INHUMAS S2	11/10/2020 17:08	12/10/2020 10:15	11/10/2020 17:08	12/10/2020 10:15	17,10	1	17,10	CHI
20201055181	BONFINOPOLIS	920009888	CEPAIGO S2	11/10/2020 17:10	11/10/2020 20:26	11/10/2020 17:10	11/10/2020 20:26	3,26	1	3,26	CHI
20201055185	CEZARINA	CZ12000022LD	CEZARINA	11/10/2020 17:11	12/10/2020 15:00	11/10/2020 17:11	12/10/2020 00:32	7,35	2	14,70	CHI
20201055185	CEZARINA	CZ12000022LD	CEZARINA	11/10/2020 17:11	12/10/2020 15:00	11/10/2020 21:10	12/10/2020 00:32	3,36	8	26,85	CHI
20201055185	CEZARINA	CZ12000022LD	CEZARINA	11/10/2020 17:11	12/10/2020 15:00	11/10/2020 17:11	12/10/2020 08:37	15,44	3	46,32	CHI
20201055185	PALMEIRAS DE GOIAS	CZ12000022LD	CEZARINA	11/10/2020 17:11	12/10/2020 15:00	11/10/2020 17:11	12/10/2020 08:37	15,44	1	15,44	CHI
20201055185	PALMEIRAS DE GOIAS	CZ13031806	CEZARINA	11/10/2020 17:11	12/10/2020 15:00	11/10/2020 21:10	12/10/2020 08:37	11,45	17	194,57	CHI
20201055185	CEZARINA	CZ13031806	CEZARINA	11/10/2020 17:11	12/10/2020 15:00	11/10/2020 21:10	12/10/2020 08:37	11,45	26	297,57	CHI
20201055185	INDIARA	CZ12000022LD	CEZARINA	11/10/2020 17:11	12/10/2020 15:00	11/10/2020 17:11	12/10/2020 15:00	21,81	2	43,63	CHI
20201055185	CEZARINA	CZ12000022LD	CEZARINA	11/10/2020 17:11	12/10/2020 15:00	11/10/2020 17:11	12/10/2020 15:00	21,81	1	21,81	CHI
20201055185	INDIARA	CZ12126201LD	CEZARINA	11/10/2020 17:11	12/10/2020 15:00	11/10/2020 21:10	12/10/2020 15:00	17,82	2	35,64	CHI
20201055185	PALMEIRAS DE GOIAS	CZ12126201LD	CEZARINA	11/10/2020 17:11	12/10/2020 15:00	11/10/2020 21:10	12/10/2020 15:00	17,82	1	17,82	CHI
20201055185	CEZARINA	CZ12126201LD	CEZARINA	11/10/2020 17:11	12/10/2020 15:00	11/10/2020 21:10	12/10/2020 15:00	17,82	36	641,45	CHI
20201055192	RIO VERDE	RV11271724	RIO VERDE S1	11/10/2020 17:11	11/10/2020 18:32	11/10/2020 17:11	11/10/2020 18:32	1,34	46	61,51	CHI
20201055195	GOIANIA	13782678	FERROVIARIO S3	11/10/2020 17:12	11/10/2020 21:07	11/10/2020 17:12	11/10/2020 21:07	3,91	1	3,91	CHI
20201055638	GUAPO	GA11356695	GUAPO S1	11/10/2020 17:12	11/10/2020 22:08	11/10/2020 17:12	11/10/2020 22:08	4,93	84	413,84	CHI
20201055518	ITAJA	IJ12202625RE	ITAJA S2	11/10/2020 17:13	12/10/2020 03:27	11/10/2020 17:13	12/10/2020 03:27	10,23	19	194,36	CHI
20201055518	APORE	IJ12202625RE	ITAJA S2	11/10/2020 17:13	12/10/2020 03:27	11/10/2020 17:13	12/10/2020 03:27	10,23	4	40,92	CHI
20201055202	PORANGATU	840047691	PORANGATU	11/10/2020 17:14	12/10/2020 08:04	11/10/2020 17:14	12/10/2020 08:04	14,83	1	14,83	CHI
20201055209	GOIANIA	15940100	FERROVIARIO S2	11/10/2020 17:15	11/10/2020 22:58	11/10/2020 17:15	11/10/2020 22:58	5,71	1	5,71	CHI
20201055626	CEZARINA	CZ12000018	CEZARINA	11/10/2020 17:16	12/10/2020 13:15	11/10/2020 17:16	12/10/2020 13:15	19,98	9	179,83	CHI
20201055214	APARECIDA DE GOIANIA	16182248	INDEPENDENCIA S2	11/10/2020 17:16	12/10/2020 01:00	11/10/2020 17:16	12/10/2020 01:00	7,73	1	7,73	CHI
20201055215	CHAPADAO DO CEU	DJ12160247	CHAPADAO DO CEU	11/10/2020 17:16	12/10/2020 08:25	12/10/2020 06:31	12/10/2020 06:58	0,44	1	0,44	CHI
20201055215	CHAPADAO DO CEU	DJ12341142LD	CHAPADAO DO CEU	11/10/2020 17:16	12/10/2020 08:25	11/10/2020 17:16	12/10/2020 08:25	15,15	2	30,31	CHI
20201055218	ANAPOLIS	21133517	ANAPOLIS UNIVERSITARIO S2	11/10/2020 17:16	12/10/2020 00:53	11/10/2020 17:16	12/10/2020 00:53	7,60	1	7,60	CHI
20201055220	JARAGUA	JA21157783	JARAGUA	11/10/2020 17:17	12/10/2020 10:39	11/10/2020 17:17	12/10/2020 10:39	17,36	1	17,36	CHI
20201055228	NOVA ROMA	8720005480	IACIARA S2	11/10/2020 17:18	12/10/2020 02:37	11/10/2020 17:18	12/10/2020 02:37	9,31	1	9,31	CHI
20201055495	CERES	RB12363545	RUBIATABA	11/10/2020 17:18	12/10/2020 16:08	11/10/2020 17:18	12/10/2020 16:08	22,83	7	159,79	CHI
20201055230	ITARUMA	IM21122614	CACHOEIRA ALTA	11/10/2020 17:18	12/10/2020 18:00	11/10/2020 17:18	12/10/2020 18:00	24,69	1	24,69	CHI
20201056898	ALEXANIA	AX12061884	ALEXANIA	11/10/2020 17:19	12/10/2020 03:24	11/10/2020 17:19	12/10/2020 03:24	10,07	16	161,15	CHI
20201055245	MORRINHOS	MR12392160	MORRINHOS	11/10/2020 17:19	11/10/2020 18:07	11/10/2020 17:19	11/10/2020 18:07	0,79	4	3,14	CHI
20201056412	CRIXAS	CX12145539	RUBIATABA	11/10/2020 17:20	11/10/2020 22:45	11/10/2020 17:20	11/10/2020 22:45	5,41	19	102,88	CHI
20201055254	MOIPORA	CO12300416	SAO LUIZ DOS MONTES BELOS	11/10/2020 17:21	12/10/2020 15:48	11/10/2020 17:21	12/10/2020 15:48	22,44	1	22,44	CHI
20201056446	CORUMBA DE GOIAS	CB12302158	ALEXANIA	11/10/2020 17:21	12/10/2020 11:27	11/10/2020 17:21	12/10/2020 11:27	18,09	6	108,57	CHI
20201055260	PORANGATU	PO21312736	NOVO PLANALTO	11/10/2020 17:22	12/10/2020 08:10	11/10/2020 17:22	12/10/2020 08:10	14,80	1	14,80	CHI
20201055421	BELA VISTA DE GOIAS	BV12000039	BELA VISTA S1	11/10/2020 17:22	11/10/2020 19:59	11/10/2020 17:22	11/10/2020 19:59	2,61	8	20,85	CHI
20201055264	GAMELEIRA DE GOIAS	SV31062619	DAIA S2	11/10/2020 17:23	12/10/2020 05:08	11/10/2020 17:23	12/10/2020 05:08	11,74	2	23,49	CHI

20201055265	CEZARINA	1650008469	CEZARINA	11/10/2020 17:23	12/10/2020 19:57	11/10/2020 17:23	12/10/2020 19:57	26,57	1	26,57	CHI
20201055266	CHAPADAO DO CEU	DJ21166273	CHAPADAO DO CEU	11/10/2020 17:23	12/10/2020 00:54	11/10/2020 17:23	12/10/2020 00:54	7,50	2	15,01	CHI
20201055267	NAZARIO	NZ21238194	ANICUNS	11/10/2020 17:23	12/10/2020 11:16	11/10/2020 17:23	12/10/2020 11:16	17,87	1	17,87	CHI
20201055271	IPORA	730046874	IPORA	11/10/2020 17:24	11/10/2020 18:21	11/10/2020 17:24	11/10/2020 18:21	0,95	1	0,95	CHI
20201055273	CALDAZINHA	DE11248047	CEPAIGO S2	11/10/2020 17:24	11/10/2020 19:15	11/10/2020 17:24	11/10/2020 19:15	1,85	37	68,28	CHI
20201055274	ITUMBARA	IT21122339	ITUMBARA VELHA S2	11/10/2020 17:24	11/10/2020 19:17	11/10/2020 17:24	11/10/2020 19:17	1,87	1	1,87	CHI
20201055394	PALMEIRAS DE GOIAS	PP12005727	FIRMINOPOLIS S2	11/10/2020 17:24	12/10/2020 03:34	11/10/2020 17:24	12/10/2020 02:39	9,25	12	110,99	CHI
20201055394	PALMINOPOLIS	PP12005727	FIRMINOPOLIS S2	11/10/2020 17:24	12/10/2020 03:34	11/10/2020 17:24	12/10/2020 02:39	9,25	42	388,46	CHI
20201055394	PALMEIRAS DE GOIAS	PP12005727	FIRMINOPOLIS S2	11/10/2020 17:24	12/10/2020 03:34	11/10/2020 17:24	12/10/2020 03:34	10,16	1	10,16	CHI
20201055279	SANTO ANTONIO DO DESCOBERTO	SN21199701	MARAJOARA	11/10/2020 17:24	12/10/2020 09:46	11/10/2020 17:24	12/10/2020 09:46	16,35	1	16,35	CHI
20201055280	GOIANIA	11938780	CAMPINAS S3	11/10/2020 17:24	12/10/2020 03:01	11/10/2020 17:24	12/10/2020 03:01	9,62	1	9,62	CHI
20201055281	CUMARI	CY12000316	CATALAO S1	11/10/2020 17:24	11/10/2020 19:01	11/10/2020 17:24	11/10/2020 19:01	1,60	2	3,20	CHI
20201056218	CRISTALINA	KR12389576	CRISTALINA S2	11/10/2020 17:25	11/10/2020 20:55	11/10/2020 17:25	11/10/2020 20:55	3,49	3	10,48	CHI
20201055285	SAO DOMINGOS	8680005772	SAO DOMINGOS	11/10/2020 17:25	11/10/2020 22:22	11/10/2020 17:25	11/10/2020 22:22	4,94	1	4,94	CHI
20201055349	NIQUELANDIA	NQ12378056	NIQUELANDIA SUBTRANSMISSAO	11/10/2020 17:26	13/10/2020 10:47	11/10/2020 17:26	13/10/2020 10:47	41,35	5	206,74	CHI
20201057038	ANICUNS	AC12075338	FIRMINOPOLIS S2	11/10/2020 17:27	12/10/2020 07:21	11/10/2020 17:27	12/10/2020 07:21	13,90	16	222,35	CHI
20201055312	APARECIDA DE GOIANIA	13447403	INDEPENDENCIA S1	11/10/2020 17:28	11/10/2020 22:24	11/10/2020 17:28	11/10/2020 22:24	4,93	1	4,93	CHI
20201055321	PIRANHAS	PH21187424	CAIAPONIA	11/10/2020 17:29	12/10/2020 03:10	11/10/2020 17:29	12/10/2020 03:10	9,68	1	9,68	CHI
20201056430	JATAI	JT12248447	JATAI S3	11/10/2020 17:32	11/10/2020 22:29	11/10/2020 17:32	11/10/2020 22:29	4,94	2	9,88	CHI
20201055372	MINEIROS	01140434	PARQUE DAS EMAS	11/10/2020 17:32	11/10/2020 18:43	11/10/2020 17:32	11/10/2020 18:43	1,18	94	110,55	CHI
20201055339	PIRANHAS	1930034845	PIRANHAS	11/10/2020 17:33	11/10/2020 18:29	11/10/2020 17:33	11/10/2020 18:29	0,93	1	0,93	CHI
20201055342	PALMEIRAS DE GOIAS	PL21333078	PALMEIRAS	11/10/2020 17:33	11/10/2020 21:57	11/10/2020 17:33	11/10/2020 21:57	4,39	1	4,39	CHI
20201055343	GOIAS	90065440	GOIAS	11/10/2020 17:33	12/10/2020 12:39	11/10/2020 17:33	12/10/2020 12:39	19,10	1	19,10	CHI
20201055659	ITARUMA	IM11182048	CACHOEIRA ALTA	11/10/2020 17:34	12/10/2020 13:39	11/10/2020 17:34	12/10/2020 13:39	20,08	66	1325,22	CHI
20201055353	PALMEIRAS DE GOIAS	PL12048169	PALMEIRAS	11/10/2020 17:35	11/10/2020 20:54	11/10/2020 17:35	11/10/2020 20:54	3,31	19	62,90	CHI
20201056622	NOVO BRASIL	NB12117290	JUSSARA	11/10/2020 17:36	12/10/2020 16:40	11/10/2020 17:36	12/10/2020 16:40	23,06	5	115,31	CHI
20201056622	FAZENDA NOVA	NB12117290	JUSSARA	11/10/2020 17:36	12/10/2020 16:40	11/10/2020 17:36	12/10/2020 16:40	23,06	4	92,25	CHI
20201055356	VARJAO	940010185	GUAPO S2	11/10/2020 17:36	12/10/2020 09:01	11/10/2020 17:36	12/10/2020 09:01	15,41	1	15,41	CHI
20201056411	VARJAO	940010987	GUAPO S2	11/10/2020 17:36	12/10/2020 09:23	11/10/2020 17:36	12/10/2020 09:23	15,78	1	15,78	CHI
20201055728	ITARUMA	IJ12107422LD	ITAJA S2	11/10/2020 17:37	12/10/2020 02:29	11/10/2020 17:37	12/10/2020 02:29	8,87	36	319,18	CHI
20201055376	INDIARA	EA12056544	EDEIA	11/10/2020 17:37	11/10/2020 22:18	11/10/2020 17:37	11/10/2020 22:18	4,67	10	46,69	CHI
20201055365	PALMEIRAS DE GOIAS	PL21312609	PALMEIRAS	11/10/2020 17:37	12/10/2020 08:38	11/10/2020 17:37	12/10/2020 08:38	15,00	1	15,00	CHI
20201055473	ANAPOLIS	AN12370346	ANAPOLIS UNIVERSITARIO S2	11/10/2020 17:38	11/10/2020 19:06	11/10/2020 17:38	11/10/2020 19:06	1,45	402	583,24	CHI
20201055853	SANTA RITA DO ARAGUAIA	SU11271642	SANTA RITA DO ARAGUAIA	11/10/2020 17:39	12/10/2020 08:44	11/10/2020 17:39	12/10/2020 08:44	15,08	83	1251,66	CHI
20201055382	DIVINOPOLIS DE GOIAS	2570008558	SAO DOMINGOS	11/10/2020 17:39	11/10/2020 20:07	11/10/2020 17:39	11/10/2020 20:07	2,45	1	2,45	CHI
20201055383	CORREGO DO OURO	CO21321855	FIRMINOPOLIS S2	11/10/2020 17:39	12/10/2020 07:49	11/10/2020 17:39	12/10/2020 07:49	14,15	1	14,15	CHI
20201055742	CEZARINA	CZ12000019	CEZARINA	11/10/2020 17:40	12/10/2020 12:47	11/10/2020 17:40	12/10/2020 12:47	19,12	9	172,05	CHI
20201055742	VARJAO	CZ12000019	CEZARINA	11/10/2020 17:40	12/10/2020 12:47	11/10/2020 17:40	12/10/2020 12:47	19,12	8	152,93	CHI
20201055944	JATAI	JT11274028	JATAI S2	11/10/2020 17:40	12/10/2020 03:07	11/10/2020 17:40	12/10/2020 03:07	9,44	103	971,89	CHI
20201055399	COCALZINHO DE GOIAS	ZN21125079	AGUAS LINDAS DE GOIAS S2	11/10/2020 17:41	11/10/2020 19:11	11/10/2020 17:41	11/10/2020 19:11	1,49	1	1,49	CHI
20201055407	GOIANESIA	GE21000223	GOIANESIA S2	11/10/2020 17:42	12/10/2020 00:36	11/10/2020 17:42	12/10/2020 00:36	6,89	1	6,89	CHI
20201055409	SAO FRANCISCO DE GOIAS	490011070	SAO FRANCISCO DE GOIAS	11/10/2020 17:42	12/10/2020 12:41	11/10/2020 17:42	12/10/2020 12:41	18,97	1	18,97	CHI
20201056458	TRINDADE	TR12382768	TRINDADE	11/10/2020 17:43	11/10/2020 21:09	11/10/2020 17:43	11/10/2020 21:09	3,42	382	1307,29	CHI
20201055422	INDIARA	IY21078045	EDEIA	11/10/2020 17:43	12/10/2020 17:21	11/10/2020 17:43	12/10/2020 17:21	23,62	1	23,62	CHI
20201055423	RIO VERDE	RV21301734	ACREUNA	11/10/2020 17:43	11/10/2020 21:47	11/10/2020 17:43	11/10/2020 21:47	4,05	2	8,10	CHI
20201056961	SANTA RITA DO ARAGUAIA	SU21142752	SANTA RITA DO ARAGUAIA	11/10/2020 17:44	12/10/2020 14:50	11/10/2020 17:44	12/10/2020 14:50	21,09	1	21,09	CHI
20201055474	BARRO ALTO	BA21095438	BARRO ALTO	11/10/2020 17:48	12/10/2020 19:49	11/10/2020 17:48	12/10/2020 19:49	26,01	1	26,01	CHI
20201056741	MINEIROS	MY12043894RE	PARQUE DAS EMAS	11/10/2020 17:49	12/10/2020 09:37	11/10/2020 17:49	12/10/2020 00:51	7,05	6	42,29	CHI
20201056741	MINEIROS	MY12043894RE	PARQUE DAS EMAS	11/10/2020 17:49	12/10/2020 09:37	12/10/2020 00:52	12/10/2020 09:10	8,30	4	33,19	CHI
20201056741	MINEIROS	MY13360827	PARQUE DAS EMAS	11/10/2020 17:49	12/10/2020 09:37	11/10/2020 17:49	12/10/2020 09:37	15,80	83	1311,52	CHI
20201055481	PIRANHAS	PH12317697	PIRANHAS	11/10/2020 17:49	12/10/2020 08:12	11/10/2020 17:49	12/10/2020 08:12	14,37	2	28,75	CHI
20201055481	BOM JARDIM DE GOIAS	PH12317697	PIRANHAS	11/10/2020 17:49	12/10/2020 08:12	11/10/2020 17:49	12/10/2020 08:12	14,37	2	28,75	CHI
20201055555	FORMOSA	FA12204709	ITUIQUIRA	11/10/2020 17:52	11/10/2020 22:27	11/10/2020 17:52	11/10/2020 22:27	4,57	5	22,85	CHI
20201055503	GOIANIA	13603966	MEIA PONTE	11/10/2020 17:53	12/10/2020 03:36	11/10/2020 17:53	12/10/2020 03:36	9,71	1	9,71	CHI
20201055510	CACHU	00270434	CACHOEIRA ALTA	11/10/2020 17:54	11/10/2020 23:09	11/10/2020 17:54	11/10/2020 23:09	5,25	3	15,74	CHI
20201055510	CACHOEIRA ALTA	00270434	CACHOEIRA ALTA	11/10/2020 17:54	11/10/2020 23:09	11/10/2020 17:54	11/10/2020 23:09	5,25	4	20,98	CHI
20201055511	SERRANOPOLIS	SX12372554	JATAI S1	11/10/2020 17:54	11/10/2020 20:18	11/10/2020 17:54	11/10/2020 20:18	2,40	7	16,77	CHI
20201055514	MINEIROS	MY12209687	PARQUE DAS EMAS	11/10/2020 17:54	12/10/2020 09:08	11/10/2020 17:54	12/10/2020 09:08	15,22	9	136,99	CHI

20201055520	SANTA TEREZA DE GOIAS	2430015062	MARA ROSA	11/10/2020 17:56	11/10/2020 19:05	11/10/2020 17:56	11/10/2020 19:05	1,15	1	1,15	CHI
20201055537	PORANGATU	PO11252131	PORANGATU	11/10/2020 17:56	12/10/2020 06:11	11/10/2020 17:56	12/10/2020 06:11	12,25	59	722,68	CHI
20201055525	MOIPORA	IS12233003	IPORA	11/10/2020 17:56	11/10/2020 22:52	11/10/2020 17:56	11/10/2020 22:52	4,92	7	34,47	CHI
20201055528	SAO JOAO D ALIANCA	JL21320608	SAO JOAO D ALIANCA	11/10/2020 17:57	12/10/2020 09:37	11/10/2020 17:57	12/10/2020 09:37	15,66	1	15,66	CHI
20201055538	GAMELEIRA DE GOIAS	SV21166981	DAIA S2	11/10/2020 17:58	12/10/2020 01:54	11/10/2020 17:58	12/10/2020 01:54	7,92	1	7,92	CHI
20201055539	UIRAPURU	UP12391846	SANTA TEREZINHA	11/10/2020 17:58	12/10/2020 04:11	11/10/2020 17:58	12/10/2020 04:11	10,20	10	102,01	CHI
20201057742	ABADIANIA	AA12413563	DAIA S2	11/10/2020 17:59	12/10/2020 10:16	11/10/2020 17:59	12/10/2020 10:16	16,27	47	764,70	CHI
20201055883	SERRANOPOLIS	SX12267557	JATAI S1	11/10/2020 18:00	12/10/2020 01:07	11/10/2020 18:00	12/10/2020 01:07	7,11	25	177,65	CHI
20201055725	SERRANOPOLIS	SX12013892RE	JATAI S1	11/10/2020 18:00	13/10/2020 15:52	11/10/2020 18:00	13/10/2020 01:50	31,82	56	1781,81	CHI
20201055725	SERRANOPOLIS	SX12086163LD	JATAI S1	11/10/2020 18:00	13/10/2020 15:52	11/10/2020 18:00	13/10/2020 14:52	44,86	46	2063,70	CHI
20201055725	JATAI	SX12348950LD	JATAI S1	11/10/2020 18:00	13/10/2020 15:52	11/10/2020 18:00	13/10/2020 15:52	45,86	13	596,20	CHI
20201055725	SERRANOPOLIS	SX12348950LD	JATAI S1	11/10/2020 18:00	13/10/2020 15:52	11/10/2020 18:00	13/10/2020 15:52	45,86	39	1788,61	CHI
20201056493	MINACU	IH11063603	MINACU	11/10/2020 18:01	11/10/2020 22:35	11/10/2020 18:01	11/10/2020 22:35	4,57	142	648,39	CHI
20201055585	NAZARIO	NZ21314471	ANICUNS	11/10/2020 18:02	12/10/2020 12:05	11/10/2020 18:02	12/10/2020 12:05	18,04	1	18,04	CHI
20201055636	JATAI	01030404	JATAI S1	11/10/2020 18:02	12/10/2020 02:40	11/10/2020 18:02	12/10/2020 01:59	7,94	1	7,94	CHI
20201055636	JATAI	01030404	JATAI S1	11/10/2020 18:02	12/10/2020 02:40	11/10/2020 18:02	12/10/2020 02:13	8,17	8	65,34	CHI
20201055636	JATAI	01030404	JATAI S1	11/10/2020 18:02	12/10/2020 02:40	11/10/2020 18:02	12/10/2020 02:22	8,32	3	24,96	CHI
20201055636	JATAI	JT10400617	JATAI S1	11/10/2020 18:02	12/10/2020 02:40	11/10/2020 18:02	12/10/2020 02:27	8,41	111	933,48	CHI
20201055636	PEROLANDIA	JT10400617	JATAI S1	11/10/2020 18:02	12/10/2020 02:40	11/10/2020 18:02	12/10/2020 02:40	8,62	9	77,61	CHI
20201055636	JATAI	JT10400617	JATAI S1	11/10/2020 18:02	12/10/2020 02:40	11/10/2020 18:02	12/10/2020 02:40	8,62	149	1284,84	CHI
20201056232	GOIAS	GS21054649	GOIAS	11/10/2020 18:03	12/10/2020 11:54	11/10/2020 18:03	12/10/2020 11:54	17,85	1	17,85	CHI
20201055596	SANTA HELENA DE GOIAS	SH21296180	IPEGUARI	11/10/2020 18:03	11/10/2020 21:51	11/10/2020 18:03	11/10/2020 21:51	3,80	1	3,80	CHI
20201055592	SANTA RITA DO ARAGUAIA	SU11050002	SANTA RITA DO ARAGUAIA	11/10/2020 18:03	11/10/2020 19:46	11/10/2020 18:03	11/10/2020 19:46	1,71	120	204,73	CHI
20201055773	AGUA FRIA DE GOIAS	TL12279981	SAO JOAO D ALIANCA	11/10/2020 18:04	11/10/2020 22:07	11/10/2020 18:04	11/10/2020 22:07	4,04	42	169,74	CHI
20201055601	GOIANIA	10029519959	CARAJAS S1	11/10/2020 18:05	11/10/2020 20:02	11/10/2020 18:05	11/10/2020 20:02	1,94	1	1,94	CHI
20201055602	PLANALTINA	10031528986	PLANALTINA	11/10/2020 18:05	12/10/2020 17:08	11/10/2020 18:05	12/10/2020 17:08	23,04	1	23,04	CHI
20201055603	LUZIANIA	LZ21120160	MARAJOARA	11/10/2020 18:06	11/10/2020 21:08	11/10/2020 18:06	11/10/2020 21:08	3,03	1	3,03	CHI
20201055606	BELA VISTA DE GOIAS	BV21406411	BELA VISTA S1	11/10/2020 18:06	12/10/2020 08:36	11/10/2020 18:06	12/10/2020 08:36	14,50	1	14,50	CHI
20201055608	IPORA	730073221	IPORA	11/10/2020 18:06	12/10/2020 00:52	11/10/2020 18:06	12/10/2020 00:52	6,77	1	6,77	CHI
20201055609	GOIANIA	11112530	FERROVIARIO S2	11/10/2020 18:06	12/10/2020 00:41	11/10/2020 18:06	12/10/2020 00:41	6,58	1	6,58	CHI
20201055610	ITARUMA	IM21097059	CACHOEIRA ALTA	11/10/2020 18:06	12/10/2020 18:15	11/10/2020 18:06	12/10/2020 18:15	24,15	1	24,15	CHI
20201055617	AGUA FRIA DE GOIAS	TL21322494	SAO JOAO D ALIANCA	11/10/2020 18:07	12/10/2020 12:04	11/10/2020 18:07	12/10/2020 12:04	17,95	3	53,84	CHI
20201056219	FLORES DE GOIAS	FB12180679	FLORES DE GOIAS	11/10/2020 18:07	12/10/2020 09:29	11/10/2020 18:07	12/10/2020 09:29	15,35	6	92,12	CHI
20201057264	MINEIROS	SU12184127	SANTA RITA DO ARAGUAIA	11/10/2020 18:07	12/10/2020 16:49	11/10/2020 18:07	12/10/2020 16:49	22,69	14	317,61	CHI
20201055622	FORMOSA	FA21000077	ITUIQUIRA	11/10/2020 18:07	11/10/2020 19:19	11/10/2020 18:07	11/10/2020 19:19	1,19	1	1,19	CHI
20201056556	PARANAIGUARA	PC12000073	CACHOEIRA ALTA	11/10/2020 18:08	12/10/2020 15:05	11/10/2020 18:08	12/10/2020 10:10	16,02	13	208,32	CHI
20201056556	PARANAIGUARA	PC12000073	CACHOEIRA ALTA	11/10/2020 18:08	12/10/2020 15:05	11/10/2020 18:08	12/10/2020 11:19	17,18	6	103,10	CHI
20201056556	PARANAIGUARA	PC12000073	CACHOEIRA ALTA	11/10/2020 18:08	12/10/2020 15:05	11/10/2020 18:08	12/10/2020 14:55	20,79	2	41,58	CHI
20201056556	CACHOEIRA ALTA	PC12000073	CACHOEIRA ALTA	11/10/2020 18:08	12/10/2020 15:05	11/10/2020 18:08	12/10/2020 15:05	20,95	8	167,63	CHI
20201056556	PARANAIGUARA	PC12000073	CACHOEIRA ALTA	11/10/2020 18:08	12/10/2020 15:05	11/10/2020 18:08	12/10/2020 15:05	20,95	3	62,86	CHI
20201055639	PADRE BERNARDO	3160010520	PADRE BERNARDO	11/10/2020 18:09	11/10/2020 22:39	11/10/2020 18:09	11/10/2020 22:39	4,49	1	4,49	CHI
20201055648	ANAPOLIS	20378105	ANAPOLIS UNIVERSITARIO S1	11/10/2020 18:10	11/10/2020 21:01	11/10/2020 18:10	11/10/2020 21:01	2,84	1	2,84	CHI
20201055651	ALTO HORIZONTE	9640006070	SANTA TEREZINHA	11/10/2020 18:11	13/10/2020 09:54	11/10/2020 18:11	13/10/2020 09:54	39,71	1	39,71	CHI
20201055655	ITUMBIARA	BG12257085	ITUMBIARA VELHA S2	11/10/2020 18:12	12/10/2020 03:49	11/10/2020 18:12	12/10/2020 03:49	9,63	4	38,51	CHI
20201055655	BURITI ALEGRE	BG12257085	ITUMBIARA VELHA S2	11/10/2020 18:12	12/10/2020 03:49	11/10/2020 18:12	12/10/2020 03:49	9,63	4	38,51	CHI
20201055657	RIO VERDE	RV21065048	MONTIVIDIU T	11/10/2020 18:12	12/10/2020 07:36	11/10/2020 18:12	12/10/2020 07:36	13,40	1	13,40	CHI
20201057266	PARANAIGUARA	PC12000018	CACHOEIRA ALTA	11/10/2020 18:12	12/10/2020 14:55	11/10/2020 18:12	12/10/2020 10:10	15,96	4	63,84	CHI
20201057266	SAO SIMAO	PC12000018	CACHOEIRA ALTA	11/10/2020 18:12	12/10/2020 14:55	11/10/2020 18:12	12/10/2020 10:10	15,96	7	111,73	CHI
20201057266	SAO SIMAO	PC12000018	CACHOEIRA ALTA	11/10/2020 18:12	12/10/2020 14:55	12/10/2020 09:17	12/10/2020 10:10	0,89	3	2,66	CHI
20201057266	PARANAIGUARA	PC12000018	CACHOEIRA ALTA	11/10/2020 18:12	12/10/2020 14:55	12/10/2020 09:17	12/10/2020 10:10	0,89	6	5,31	CHI
20201057266	PARANAIGUARA	PC13107416	CACHOEIRA ALTA	11/10/2020 18:12	12/10/2020 14:55	12/10/2020 11:49	12/10/2020 14:55	3,11	6	18,65	CHI
20201056397	CORREGO DO OURO	CO12206018RE	FIRMINOPOLIS S2	11/10/2020 18:13	13/10/2020 18:45	11/10/2020 18:13	13/10/2020 03:32	33,32	83	2765,21	CHI
20201056397	BURITI DE GOIAS	CO12206018RE	FIRMINOPOLIS S2	11/10/2020 18:13	13/10/2020 18:45	11/10/2020 18:13	13/10/2020 03:32	33,32	22	732,95	CHI
20201056397	BURITI DE GOIAS	CO12206018RE	FIRMINOPOLIS S2	11/10/2020 18:13	13/10/2020 18:45	11/10/2020 18:13	13/10/2020 18:45	48,53	38	1844,23	CHI
20201056397	NOVO BRASIL	CO12206018RE	FIRMINOPOLIS S2	11/10/2020 18:13	13/10/2020 18:45	11/10/2020 18:13	13/10/2020 18:45	48,53	16	776,52	CHI
20201056160	AURILANDIA	CG12391407	FIRMINOPOLIS S2	11/10/2020 18:13	12/10/2020 10:30	11/10/2020 18:13	12/10/2020 10:30	16,29	2	32,58	CHI
20201056160	PARAUNA	CG12391407	FIRMINOPOLIS S2	11/10/2020 18:13	12/10/2020 10:30	11/10/2020 18:13	12/10/2020 10:30	16,29	32	521,24	CHI
20201056160	CACHOEIRA DE GOIAS	CG12391407	FIRMINOPOLIS S2	11/10/2020 18:13	12/10/2020 10:30	11/10/2020 18:13	12/10/2020 10:30	16,29	69	1123,91	CHI

20201055684	SERRANOPOLIS	DJ12164269	CHAPADAO DO CEU	11/10/2020 18:13	12/10/2020 09:15	11/10/2020 18:13	12/10/2020 09:15	15,03	5	75,15	CHI
20201056353	CACHOEIRA ALTA	CA12296649	CACHOEIRA ALTA	11/10/2020 18:13	11/10/2020 21:40	11/10/2020 18:13	11/10/2020 21:40	3,45	498	1716,44	CHI
20201062596	CAMPINACU	CR13410864	MARA ROSA	11/10/2020 18:13	13/10/2020 21:23	11/10/2020 18:13	13/10/2020 21:23	51,16	280	14326,04	CHI
20201062596	URUACU	CR13410864	MARA ROSA	11/10/2020 18:13	13/10/2020 21:23	11/10/2020 18:13	13/10/2020 21:23	51,16	49	2507,06	CHI
20201062596	CAMPINORTE	CR13410864	MARA ROSA	11/10/2020 18:13	13/10/2020 21:23	11/10/2020 18:13	13/10/2020 21:23	51,16	3	153,49	CHI
20201055680	JARAGUA	JA21360286	GOIANESIA S2	11/10/2020 18:14	12/10/2020 11:46	11/10/2020 18:14	12/10/2020 11:46	17,53	1	17,53	CHI
20201055687	GOIANIA	GN11058033	GOYA S1	11/10/2020 18:14	12/10/2020 01:48	11/10/2020 18:14	12/10/2020 01:48	7,55	64	483,48	CHI
20201055690	ANAPOLIS	20209575	ANAPOLIS UNIVERSITARIO S2	11/10/2020 18:15	12/10/2020 04:09	11/10/2020 18:15	12/10/2020 04:09	9,90	1	9,90	CHI
20201056123	MINACU	IH12182357	MINACU	11/10/2020 18:15	12/10/2020 09:17	11/10/2020 18:15	12/10/2020 09:17	15,02	2	30,04	CHI
20201055698	BELA VISTA DE GOIAS	BV31045549	BELA VISTA S1	11/10/2020 18:16	12/10/2020 02:12	11/10/2020 18:16	12/10/2020 02:12	7,93	1	7,93	CHI
20201055707	CAMPOS BELOS	CH21327654	SAO DOMINGOS	11/10/2020 18:17	11/10/2020 19:23	11/10/2020 18:17	11/10/2020 19:23	1,10	1	1,10	CHI
20201056064	NOVO BRASIL	NB12116366	JUSSARA	11/10/2020 18:17	12/10/2020 20:05	11/10/2020 18:17	12/10/2020 20:05	25,79	13	335,28	CHI
20201055710	AGUA FRIA DE GOIAS	TL12394136	SAO JOAO D ALIANCA	11/10/2020 18:17	12/10/2020 08:11	11/10/2020 18:17	12/10/2020 08:11	13,89	6	83,34	CHI
20201055712	AGUA FRIA DE GOIAS	TL12128505	SAO JOAO D ALIANCA	11/10/2020 18:17	11/10/2020 22:53	11/10/2020 18:17	11/10/2020 22:53	4,59	1	4,59	CHI
20201055729	GUARAITA	GS10405726	GOIAS	11/10/2020 18:18	12/10/2020 02:55	11/10/2020 18:18	11/10/2020 20:28	2,17	2	4,34	CHI
20201055729	GOIAS	GS10405726	GOIAS	11/10/2020 18:18	12/10/2020 02:55	11/10/2020 18:18	11/10/2020 20:28	2,17	62	134,64	CHI
20201055729	ITAPURANGA	GS10405726	GOIAS	11/10/2020 18:18	12/10/2020 02:55	11/10/2020 18:18	11/10/2020 20:28	2,17	2	4,34	CHI
20201055729	GOIAS	GS10405726	GOIAS	11/10/2020 18:18	12/10/2020 02:55	11/10/2020 18:18	11/10/2020 21:48	3,50	10	35,03	CHI
20201055729	HEITORAI	IK12299970LD	GOIAS	11/10/2020 18:18	12/10/2020 02:55	11/10/2020 18:18	12/10/2020 02:44	8,43	33	278,29	CHI
20201055729	GOIAS	IK12299970LD	GOIAS	11/10/2020 18:18	12/10/2020 02:55	11/10/2020 18:18	12/10/2020 02:44	8,43	10	84,33	CHI
20201055729	ITABERAI	IK12250721	GOIAS	11/10/2020 18:18	12/10/2020 02:55	11/10/2020 18:18	12/10/2020 02:55	8,62	3	25,86	CHI
20201055729	GOIAS	IK12250721	GOIAS	11/10/2020 18:18	12/10/2020 02:55	11/10/2020 18:18	12/10/2020 02:55	8,62	14	120,67	CHI
20201055729	ITAPURANGA	IK12250721	GOIAS	11/10/2020 18:18	12/10/2020 02:55	11/10/2020 18:18	12/10/2020 02:55	8,62	3	25,86	CHI
20201055888	PLANALTINA	PI12248182	PLANALTINA	11/10/2020 18:18	12/10/2020 10:00	11/10/2020 18:18	12/10/2020 10:00	15,69	27	423,64	CHI
20201055719	PORANGATU	PO21051887	NOVO PLANALTO	11/10/2020 18:19	12/10/2020 09:14	11/10/2020 18:19	12/10/2020 09:14	14,91	1	14,91	CHI
20201055721	SANTA RITA DO ARAGUAIA	SU21055300	SANTA RITA DO ARAGUAIA	11/10/2020 18:19	12/10/2020 16:45	11/10/2020 18:19	12/10/2020 16:45	22,43	1	22,43	CHI
20201055722	SANTA HELENA DE GOIAS	SH21301397	ACREUNA	11/10/2020 18:19	12/10/2020 01:43	11/10/2020 18:19	12/10/2020 01:43	7,39	1	7,39	CHI
20201055988	LUZIANIA	LZ11372269	MARAJOARA	11/10/2020 18:19	11/10/2020 22:35	11/10/2020 18:19	11/10/2020 22:35	4,25	246	1046,66	CHI
20201055750	CACU	CC12000090	CACHOEIRA ALTA	11/10/2020 18:22	11/10/2020 19:55	11/10/2020 18:22	11/10/2020 19:55	1,54	133	205,04	CHI
20201055758	MATRINCHA	MP12299692	MATRINCHA	11/10/2020 18:23	12/10/2020 16:08	11/10/2020 18:23	12/10/2020 16:08	21,74	4	86,98	CHI
20201056615	SAO LUIS DE MONTES BELOS	SL12003960	SAO LUIZ DOS MONTES BELOS	11/10/2020 18:23	11/10/2020 22:38	11/10/2020 18:23	11/10/2020 22:38	4,24	253	1071,74	CHI
20201055765	ITAJA	IM12038900	CACHOEIRA ALTA	11/10/2020 18:24	13/10/2020 15:34	11/10/2020 18:24	12/10/2020 17:50	23,42	3	70,27	CHI
20201055765	ITAJA	IM12038900	CACHOEIRA ALTA	11/10/2020 18:24	13/10/2020 15:34	12/10/2020 17:56	13/10/2020 11:03	17,12	1	17,12	CHI
20201055765	ITAJA	IJ12267513LD	CACHOEIRA ALTA	11/10/2020 18:24	13/10/2020 15:34	12/10/2020 17:56	13/10/2020 15:34	21,63	2	43,26	CHI
20201056903	ALTO HORIZONTE	AJ21266639	SANTA TEREZINHA	11/10/2020 18:25	12/10/2020 11:45	11/10/2020 18:25	12/10/2020 11:45	17,33	1	17,33	CHI
20201055780	IPORA	IR21091424	IPORA	11/10/2020 18:25	11/10/2020 22:28	11/10/2020 18:25	11/10/2020 22:28	4,04	1	4,04	CHI
20201056222	CEZARINA	CZ11215300	CEZARINA	11/10/2020 18:25	12/10/2020 15:50	11/10/2020 18:25	12/10/2020 15:50	21,41	50	1070,29	CHI
20201056278	MINEIROS	MY13416713B	PARQUE DAS EMAS	11/10/2020 18:26	12/10/2020 16:45	11/10/2020 18:26	11/10/2020 23:22	4,93	823	4056,93	CHI
20201056278	MINEIROS	MY10401492	PARQUE DAS EMAS	11/10/2020 18:26	12/10/2020 16:45	11/10/2020 18:26	11/10/2020 23:37	5,18	2	10,36	CHI
20201056278	MINEIROS	MY11480241	PARQUE DAS EMAS	11/10/2020 18:26	12/10/2020 16:45	12/10/2020 11:19	12/10/2020 13:59	2,68	10	26,79	CHI
20201056278	MINEIROS	MY13302985	PARQUE DAS EMAS	11/10/2020 18:26	12/10/2020 16:45	12/10/2020 14:53	12/10/2020 15:06	0,23	2	0,45	CHI
20201056278	MINEIROS	MY10401492	PARQUE DAS EMAS	11/10/2020 18:26	12/10/2020 16:45	12/10/2020 16:33	12/10/2020 16:45	0,19	825	157,67	CHI
20201055792	MIMOSO DE GOIAS	PB12376742	PADRE BERNARDO	11/10/2020 18:26	12/10/2020 10:07	11/10/2020 18:26	12/10/2020 10:07	15,67	1	15,67	CHI
20201055801	MINEIROS	MY18209668TS	PARQUE DAS EMAS	11/10/2020 18:27	12/10/2020 08:27	11/10/2020 18:27	12/10/2020 08:27	13,99	91	1273,52	CHI
20201055796	SAO FRANCISCO DE GOIAS	PV21021304	SAO FRANCISCO DE GOIAS	11/10/2020 18:27	12/10/2020 00:39	11/10/2020 18:27	12/10/2020 00:39	6,19	1	6,19	CHI
20201055797	ITABERAI	IB21300326	ITABERAI S2	11/10/2020 18:27	11/10/2020 19:31	11/10/2020 18:27	11/10/2020 19:31	1,06	3	3,18	CHI
20201055819	CACHOEIRA ALTA	CA10409334	CACHOEIRA ALTA	11/10/2020 18:29	12/10/2020 12:15	11/10/2020 18:29	11/10/2020 20:21	1,88	2	3,75	CHI
20201055819	CACHOEIRA ALTA	CA10409334	CACHOEIRA ALTA	11/10/2020 18:29	12/10/2020 12:15	11/10/2020 18:29	11/10/2020 20:43	2,24	113	253,43	CHI
20201055819	CACHOEIRA ALTA	CA10409334	CACHOEIRA ALTA	11/10/2020 18:29	12/10/2020 12:15	11/10/2020 22:29	11/10/2020 22:56	0,44	113	49,81	CHI
20201055819	CACHOEIRA ALTA	CA10409334	CACHOEIRA ALTA	11/10/2020 18:29	12/10/2020 12:15	11/10/2020 18:29	12/10/2020 12:15	17,77	16	284,25	CHI
20201055819	CACU	CA13161862	CACHOEIRA ALTA	11/10/2020 18:29	12/10/2020 12:15	11/10/2020 18:29	12/10/2020 12:15	17,77	14	248,72	CHI
20201055819	CACU	CA10409334	CACHOEIRA ALTA	11/10/2020 18:29	12/10/2020 12:15	11/10/2020 18:29	12/10/2020 12:15	17,77	40	710,63	CHI
20201055819	ITARUMA	CA13161862	CACHOEIRA ALTA	11/10/2020 18:29	12/10/2020 12:15	11/10/2020 18:29	12/10/2020 12:15	17,77	7	124,36	CHI
20201055819	CACHOEIRA ALTA	CA13161862	CACHOEIRA ALTA	11/10/2020 18:29	12/10/2020 12:15	11/10/2020 22:29	12/10/2020 12:15	13,75	2	27,50	CHI
20201055813	ANAPOLIS	AN21267893	ANAPOLIS UNIVERSITARIO S2	11/10/2020 18:29	12/10/2020 00:47	11/10/2020 18:29	12/10/2020 00:47	6,29	1	6,29	CHI
20201055886	SANTA HELENA DE GOIAS	SH21296193	IPEGUARI	11/10/2020 18:30	11/10/2020 23:09	11/10/2020 18:30	11/10/2020 23:09	4,65	1	4,65	CHI
20201055829	MONTES CLAROS DE GOIAS	ME21354606	BRITANIA	11/10/2020 18:30	12/10/2020 02:16	11/10/2020 18:30	12/10/2020 02:16	7,75	1	7,75	CHI
20201055831	VARJAO	VJ11362522	GUAPO S2	11/10/2020 18:31	12/10/2020 00:11	11/10/2020 18:31	12/10/2020 00:11	5,66	1	5,66	CHI

20201055861	SILVANIA	05400224	VIANOPOLIS	11/10/2020 18:32	11/10/2020 20:32	11/10/2020 18:32	11/10/2020 20:32	2,00	107	213,79	CHI
20201055861	LUZIANIA	05400224	VIANOPOLIS	11/10/2020 18:32	11/10/2020 20:32	11/10/2020 18:32	11/10/2020 20:32	2,00	216	431,58	CHI
20201055844	GOIANIA	10934534	FERROVIARIO S2	11/10/2020 18:32	12/10/2020 04:43	11/10/2020 18:32	12/10/2020 04:43	10,18	1	10,18	CHI
20201056605	ANICUNS	AC12304663	FIRMINOPOLIS S2	11/10/2020 18:33	12/10/2020 00:23	11/10/2020 18:33	12/10/2020 00:23	5,83	11	64,15	CHI
20201056535	LUZIANIA	LZ12128845LD	RIO VERMELHO	11/10/2020 18:34	11/10/2020 22:30	11/10/2020 18:34	11/10/2020 22:30	3,93	83	326,14	CHI
20201056856	INHUMAS	IN11322871	INHUMAS S2	11/10/2020 18:34	11/10/2020 23:55	11/10/2020 18:34	11/10/2020 23:55	5,34	95	507,46	CHI
20201055989	JATAI	JT16413579	JATAI S3	11/10/2020 18:34	12/10/2020 00:35	11/10/2020 18:34	11/10/2020 19:44	1,16	1608	1863,49	CHI
20201055989	JATAI	JT13234530	JATAI S3	11/10/2020 18:34	12/10/2020 00:35	11/10/2020 18:34	12/10/2020 00:35	6,02	9	54,17	CHI
20201056552	GUAPO	VJ12034625	GUAPO S2	11/10/2020 18:35	12/10/2020 02:30	11/10/2020 18:35	12/10/2020 00:29	5,90	2	11,80	CHI
20201056552	VARIAO	VJ12034625	GUAPO S2	11/10/2020 18:35	12/10/2020 02:30	11/10/2020 18:35	12/10/2020 00:29	5,90	8	47,19	CHI
20201056552	ARAGOIANIA	VJ12034625	GUAPO S2	11/10/2020 18:35	12/10/2020 02:30	11/10/2020 18:35	12/10/2020 00:29	5,90	1	5,90	CHI
20201056552	VARIAO	GA12266688	GUAPO S2	11/10/2020 18:35	12/10/2020 02:30	12/10/2020 01:50	12/10/2020 02:30	0,68	8	5,44	CHI
20201056552	GUAPO	GA12266688	GUAPO S2	11/10/2020 18:35	12/10/2020 02:30	12/10/2020 01:50	12/10/2020 02:30	0,68	2	1,36	CHI
20201056552	ARAGOIANIA	GA12266688	GUAPO S2	11/10/2020 18:35	12/10/2020 02:30	12/10/2020 01:50	12/10/2020 02:30	0,68	1	0,68	CHI
20201056552	GUAPO	GA12266688	GUAPO S2	11/10/2020 18:35	12/10/2020 02:30	12/10/2020 02:21	12/10/2020 02:30	0,16	19	3,02	CHI
20201056552	VARIAO	GA12266688	GUAPO S2	11/10/2020 18:35	12/10/2020 02:30	12/10/2020 02:21	12/10/2020 02:30	0,16	2	0,32	CHI
20201056552	GUAPO	GA12266688	GUAPO S2	11/10/2020 18:35	12/10/2020 02:30	12/10/2020 02:24	12/10/2020 02:30	0,11	1	0,11	CHI
20201055879	TRINDADE	TR31050485	TRINDADE	11/10/2020 18:35	11/10/2020 21:16	11/10/2020 18:35	11/10/2020 21:16	2,68	1	2,68	CHI
20201055881	FORMOSA	FA12236475	ITUIQUIRA	11/10/2020 18:35	12/10/2020 04:58	11/10/2020 18:35	12/10/2020 04:58	10,38	7	72,63	CHI
20201055885	GOIANIA	12080858	GOYA S1	11/10/2020 18:35	11/10/2020 21:28	11/10/2020 18:35	11/10/2020 21:28	2,87	1	2,87	CHI
20201055889	FORMOSA	FA11100256	ITUIQUIRA	11/10/2020 18:35	12/10/2020 17:29	11/10/2020 18:35	12/10/2020 17:29	22,90	15	343,50	CHI
20201055890	SENADOR CANEDO	10006869120	SENADOR CANEDO	11/10/2020 18:35	11/10/2020 21:53	11/10/2020 18:35	11/10/2020 21:53	3,29	1	3,29	CHI
20201056118	CACU	CC11058968	CACHOEIRA ALTA	11/10/2020 18:36	11/10/2020 20:32	11/10/2020 18:36	11/10/2020 20:32	1,93	210	404,48	CHI
20201056617	PALMEIRAS DE GOIAS	PL11061355	PALMEIRAS	11/10/2020 18:36	11/10/2020 22:23	11/10/2020 18:36	11/10/2020 22:23	3,78	184	694,65	CHI
20201055899	SANTO ANTONIO DO DESCOBERTO	SN12064481LD	MARAJOARA	11/10/2020 18:37	11/10/2020 22:25	11/10/2020 18:37	11/10/2020 22:25	3,80	48	182,37	CHI
20201055906	RIO VERDE	RV21023860	RIO VERDE S2	11/10/2020 18:37	12/10/2020 07:33	11/10/2020 18:37	12/10/2020 07:33	12,92	1	12,92	CHI
20201056932	JATAI	JT11274030	JATAI S2	11/10/2020 18:37	11/10/2020 23:13	11/10/2020 18:37	11/10/2020 23:13	4,59	103	472,68	CHI
20201054147	ABADIANIA	AX12258506	ALEXANIA	11/10/2020 18:38	11/10/2020 21:14	11/10/2020 18:38	11/10/2020 21:14	2,60	6	15,60	CHI
20201054147	ALEXANIA	AX12258506	ALEXANIA	11/10/2020 18:38	11/10/2020 21:14	11/10/2020 18:38	11/10/2020 21:14	2,60	42	109,19	CHI
20201056161	ITAJA	IJ11153968	ITAJA S2	11/10/2020 18:38	12/10/2020 04:21	11/10/2020 18:38	12/10/2020 04:21	9,70	148	1436,09	CHI
20201055922	ALTO PARAISO DE GOIAS	BF21224073	SAO JOAO D ALIANCA	11/10/2020 18:38	11/10/2020 21:27	11/10/2020 18:38	11/10/2020 21:27	2,80	1	2,80	CHI
20201055926	NOVA CRIXAS	NA12380421	NOVA CRIXAS	11/10/2020 18:39	11/10/2020 23:00	11/10/2020 18:39	11/10/2020 23:00	4,35	27	117,43	CHI
20201055928	TRINDADE	40065777	GOYA S1	11/10/2020 18:39	12/10/2020 09:32	11/10/2020 18:39	12/10/2020 09:32	14,88	1	14,88	CHI
20201056040	TRINDADE	GR11242160	GOIANIRA	11/10/2020 18:39	11/10/2020 19:14	11/10/2020 18:39	11/10/2020 19:14	0,57	142	80,90	CHI
202010160950	JATAI	JT12361791	JATAI S2	11/10/2020 18:40	12/10/2020 07:30	11/10/2020 18:40	12/10/2020 07:30	12,83	28	359,24	CHI
20201055953	LUZIANIA	LZ21214922	RIO VERMELHO	11/10/2020 18:41	12/10/2020 09:49	11/10/2020 18:41	12/10/2020 09:49	15,12	1	15,12	CHI
20201055955	CRISTALINA	10006633763	CRISTALINA S1	11/10/2020 18:41	11/10/2020 19:39	11/10/2020 18:41	11/10/2020 19:39	0,95	1	0,95	CHI
20201056564	CHAPADAO DO CEU	DJ12303888	CHAPADAO DO CEU	11/10/2020 18:42	12/10/2020 00:29	11/10/2020 18:42	12/10/2020 00:29	5,78	4	23,12	CHI
20201055963	JATAI	JT21106076	JATAI S1	11/10/2020 18:42	12/10/2020 09:04	11/10/2020 18:42	12/10/2020 09:04	14,36	1	14,36	CHI
20201055967	RIO VERDE	630564437	RIO VERDE S2	11/10/2020 18:42	11/10/2020 20:15	11/10/2020 18:42	11/10/2020 20:15	1,54	1	1,54	CHI
20201055970	SANTA HELENA DE GOIAS	SH21283197	IPEGUARI	11/10/2020 18:42	11/10/2020 23:46	11/10/2020 18:42	11/10/2020 23:46	5,05	1	5,05	CHI
20201056431	JATAI	JT12324722	JATAI S1	11/10/2020 18:42	12/10/2020 13:12	11/10/2020 18:42	12/10/2020 13:12	18,49	2	36,98	CHI
20201055985	ARAGOIANIA	10018763268	GUAPO S2	11/10/2020 18:43	11/10/2020 21:29	11/10/2020 18:43	11/10/2020 21:29	2,76	1	2,76	CHI
20201055995	GOIANIA	12498520	ATLANTICO S1	11/10/2020 18:44	12/10/2020 05:03	11/10/2020 18:44	12/10/2020 05:03	10,30	1	10,30	CHI
20201055997	VALPARAISO DE GOIAS	VA11172168	PACAEMBU S2	11/10/2020 18:45	12/10/2020 03:30	11/10/2020 18:45	12/10/2020 03:30	8,75	154	1347,54	CHI
20201056003	ANAPOLIS	AN21239270	ANAPOLIS UNIVERSITARIO S2	11/10/2020 18:45	11/10/2020 22:23	11/10/2020 18:45	11/10/2020 22:23	3,62	3	10,87	CHI
20201056008	JATAI	290058788	JATAI S3	11/10/2020 18:46	12/10/2020 06:19	11/10/2020 18:46	12/10/2020 06:19	11,54	1	11,54	CHI
20201056142	ALEXANIA	AX11382414	ALEXANIA	11/10/2020 18:46	11/10/2020 22:29	11/10/2020 18:46	11/10/2020 22:29	3,70	74	273,92	CHI
20201056291	FORMOSA	VB12262281	ITUIQUIRA	11/10/2020 18:47	12/10/2020 00:14	11/10/2020 18:47	12/10/2020 00:14	5,45	16	87,19	CHI
20201056014	NOVA ROMA	ND12268131	IACIARA S2	11/10/2020 18:47	12/10/2020 05:07	11/10/2020 18:47	12/10/2020 05:07	10,33	3	30,98	CHI
20201056021	ITAPURANGA	10001096697	ITAPURANGA	11/10/2020 18:48	12/10/2020 02:42	11/10/2020 18:48	12/10/2020 02:42	7,90	1	7,90	CHI
20201056026	PIRENOPOLIS	PV21141692	CORUMBA	11/10/2020 18:49	11/10/2020 21:21	11/10/2020 18:49	11/10/2020 21:21	2,53	1	2,53	CHI
20201056042	TRINDADE	10030659688	GOYA S2	11/10/2020 18:50	12/10/2020 04:53	11/10/2020 18:50	12/10/2020 04:53	10,05	1	10,05	CHI
20201056045	ITAJA	2300021888	ITAJA S2	11/10/2020 18:50	12/10/2020 08:37	11/10/2020 18:50	12/10/2020 08:37	13,77	1	13,77	CHI
20201056049	EDEALINA	ED21000002	PONTALINA	11/10/2020 18:51	11/10/2020 20:28	11/10/2020 18:51	11/10/2020 20:28	1,62	1	1,62	CHI
20201056057	VILA BOA	FA21009116	ITUIQUIRA	11/10/2020 18:52	12/10/2020 10:34	11/10/2020 18:52	12/10/2020 10:34	15,70	1	15,70	CHI
20201056059	FLORES DE GOIAS	FB21204171	FLORES DE GOIAS	11/10/2020 18:52	11/10/2020 22:04	11/10/2020 18:52	11/10/2020 22:04	3,20	1	3,20	CHI
20201056065	FORMOSA	FA21257647	ITUIQUIRA	11/10/2020 18:53	12/10/2020 09:11	11/10/2020 18:53	12/10/2020 09:11	14,30	1	14,30	CHI

20201056073	GOIAS	GS12188132	GOIAS	11/10/2020 18:54	12/10/2020 08:31	11/10/2020 18:54	12/10/2020 08:31	13,61	26	353,94	CHI
20201056086	CALDAS NOVAS	10018164968	SERRA DE CALDAS	11/10/2020 18:56	11/10/2020 21:48	11/10/2020 18:56	11/10/2020 21:48	2,86	1	2,86	CHI
20201057178	PEROLANDIA	JT13423412	PARQUE DAS EMAS	11/10/2020 18:57	12/10/2020 08:51	11/10/2020 18:57	12/10/2020 08:51	13,90	5	69,49	CHI
20201057178	JATAI	JT13423412	PARQUE DAS EMAS	11/10/2020 18:57	12/10/2020 08:51	11/10/2020 18:57	12/10/2020 08:51	13,90	20	277,96	CHI
20201056097	SAO MIGUEL DO ARAGUAIA	10030438827	SAO MIGUEL DO ARAGUAIA	11/10/2020 18:57	12/10/2020 12:44	11/10/2020 18:57	12/10/2020 12:44	17,78	1	17,78	CHI
20201056380	QUIRINOPOLIS	CC12028258	CACHOEIRA ALTA	11/10/2020 18:57	12/10/2020 12:46	11/10/2020 18:57	12/10/2020 12:46	17,81	1	17,81	CHI
20201056380	CACU	CC12028258	CACHOEIRA ALTA	11/10/2020 18:57	12/10/2020 12:46	11/10/2020 18:57	12/10/2020 12:46	17,81	59	1050,63	CHI
20201056286	MINEIROS	MY12377570	PARQUE DAS EMAS	11/10/2020 18:58	11/10/2020 21:36	11/10/2020 18:58	11/10/2020 21:36	2,62	168	440,53	CHI
20201056798	SANTO ANTONIO DO DESCOBERTO	AX12376529	ALEXANIA	11/10/2020 18:58	11/10/2020 23:32	11/10/2020 18:58	11/10/2020 23:32	4,55	1	4,55	CHI
20201056798	ALEXANIA	AX12376529	ALEXANIA	11/10/2020 18:58	11/10/2020 23:32	11/10/2020 18:58	11/10/2020 23:32	4,55	11	50,07	CHI
20201056111	SANTA RITA DO ARAGUAIA	2130005737	SANTA RITA DO ARAGUAIA	11/10/2020 18:59	12/10/2020 01:39	11/10/2020 18:59	12/10/2020 01:39	6,66	1	6,66	CHI
20201056122	VIANOPOLIS	VN12011449	VIANOPOLIS	11/10/2020 19:00	12/10/2020 00:30	11/10/2020 19:00	12/10/2020 00:30	5,49	1	5,49	CHI
20201056127	CALDAS NOVAS	CN12213964RE	SERRA DE CALDAS	11/10/2020 19:00	12/10/2020 13:25	11/10/2020 19:00	11/10/2020 22:38	3,63	1	3,63	CHI
20201056127	CALDAS NOVAS	CN12213964RE	SERRA DE CALDAS	11/10/2020 19:00	12/10/2020 13:25	11/10/2020 19:00	12/10/2020 09:21	14,35	5	71,75	CHI
20201056127	CALDAS NOVAS	CN12213964RE	SERRA DE CALDAS	11/10/2020 19:00	12/10/2020 13:25	11/10/2020 22:38	12/10/2020 09:21	10,72	1	10,72	CHI
20201056127	CALDAS NOVAS	CN12213964RE	SERRA DE CALDAS	11/10/2020 19:00	12/10/2020 13:25	12/10/2020 09:27	12/10/2020 12:31	3,08	3	9,24	CHI
20201056127	CALDAS NOVAS	CN12298653	SERRA DE CALDAS	11/10/2020 19:00	12/10/2020 13:25	12/10/2020 09:27	12/10/2020 12:50	3,40	1	3,40	CHI
20201056127	CALDAS NOVAS	CN12088408	SERRA DE CALDAS	11/10/2020 19:00	12/10/2020 13:25	12/10/2020 09:27	12/10/2020 12:51	3,41	2	6,81	CHI
20201056127	CALDAS NOVAS	CN12363792	SERRA DE CALDAS	11/10/2020 19:00	12/10/2020 13:25	11/10/2020 19:00	12/10/2020 12:54	17,90	26	465,35	CHI
20201056127	CALDAS NOVAS	CN12363789	SERRA DE CALDAS	11/10/2020 19:00	12/10/2020 13:25	11/10/2020 22:38	12/10/2020 13:07	14,49	2	28,97	CHI
20201056127	CALDAS NOVAS	CN12025381	SERRA DE CALDAS	11/10/2020 19:00	12/10/2020 13:25	11/10/2020 19:00	12/10/2020 13:25	18,40	3	55,21	CHI
20201056375	RIO VERDE	RV12249020	CABRIUVA S2	11/10/2020 19:01	11/10/2020 20:52	11/10/2020 19:01	11/10/2020 20:52	1,84	2	3,67	CHI
20201047284	GOIANIA	GN11031172	CAMPINAS S2	11/10/2020 19:03	11/10/2020 21:57	11/10/2020 19:03	11/10/2020 21:57	2,89	47	135,62	CHI
20201056153	AGUAS LINDAS DE GOIAS	LA11164940	AGUAS LINDAS DE GOIAS S1	11/10/2020 19:05	11/10/2020 19:59	11/10/2020 19:05	11/10/2020 19:59	0,89	63	56,12	CHI
20201056158	PIRANHAS	1930039089	PIRANHAS	11/10/2020 19:06	11/10/2020 20:49	11/10/2020 19:06	11/10/2020 20:49	1,71	1	1,71	CHI
20201056209	ITABERAÍ	IB12410173	ITABERAÍ S2	11/10/2020 19:06	11/10/2020 22:08	11/10/2020 19:06	11/10/2020 22:08	3,02	23	69,50	CHI
20201056910	SAO LUIS DE MONTES BELOS	SL32145922	SAO LUIZ DOS MONTES BELOS	11/10/2020 19:07	12/10/2020 01:26	11/10/2020 19:07	12/10/2020 01:26	6,32	12	75,78	CHI
20201056165	MINEIROS	MY21301803	PARQUE DAS EMAS	11/10/2020 19:07	12/10/2020 02:11	11/10/2020 19:07	12/10/2020 02:11	7,06	1	7,06	CHI
20201056168	CACHOEIRA ALTA	CA21349523	CACHOEIRA ALTA	11/10/2020 19:07	12/10/2020 11:26	11/10/2020 19:07	12/10/2020 11:26	16,31	1	16,31	CHI
20201056173	JATAI	JT12184194	JATAI S1	11/10/2020 19:08	12/10/2020 01:40	11/10/2020 19:08	12/10/2020 01:40	6,53	12	78,32	CHI
20201056177	BARRO ALTO	SJ12006466	GOIANESIA S1	11/10/2020 19:08	12/10/2020 07:24	11/10/2020 19:08	12/10/2020 07:24	12,25	1	12,25	CHI
20201056177	GOIANESIA	SJ12006466	GOIANESIA S1	11/10/2020 19:08	12/10/2020 07:24	11/10/2020 19:08	12/10/2020 07:24	12,25	8	98,02	CHI
20201056177	VILA PROPICIO	SJ12006466	GOIANESIA S1	11/10/2020 19:08	12/10/2020 07:24	11/10/2020 19:08	12/10/2020 07:24	12,25	1	12,25	CHI
20201056180	PROFESSOR JAMIL SAFADY	PJ12083291	ROCHEDO	11/10/2020 19:08	11/10/2020 21:23	11/10/2020 19:08	11/10/2020 21:23	2,23	1	2,23	CHI
20201056463	APARECIDA DO RIO DOCE	JT12081473	JATAI S1	11/10/2020 19:08	12/10/2020 13:31	11/10/2020 19:08	12/10/2020 11:57	16,80	9	151,21	CHI
20201056463	APARECIDA DO RIO DOCE	JT12081473	JATAI S1	11/10/2020 19:08	12/10/2020 13:31	11/10/2020 19:08	12/10/2020 13:31	18,37	1	18,37	CHI
20201056190	MINEIROS	MY12322341	PARQUE DAS EMAS	11/10/2020 19:10	12/10/2020 10:06	11/10/2020 19:10	12/10/2020 10:06	14,92	1	14,92	CHI
20201057113	MINEIROS	MY12209755	PARQUE DAS EMAS	11/10/2020 19:10	12/10/2020 12:35	11/10/2020 19:10	12/10/2020 12:35	17,40	17	295,85	CHI
20201056193	SAO JOAO D ALIANCA	FB11314699	IACIARA S2	11/10/2020 19:11	12/10/2020 12:35	11/10/2020 19:11	12/10/2020 12:35	17,40	6	104,38	CHI
20201056738	GOIANIA	10008828871	AEROPORTO S2	11/10/2020 19:11	11/10/2020 21:48	11/10/2020 19:11	11/10/2020 21:48	2,63	1	2,63	CHI
20201056657	LAGOA SANTA	LS11234373	ITAJA S2	11/10/2020 19:12	12/10/2020 17:42	11/10/2020 19:12	12/10/2020 17:42	22,49	62	1394,29	CHI
20201056212	ARENOPOLIS	AY21235882	IPORA	11/10/2020 19:14	12/10/2020 08:27	11/10/2020 19:14	12/10/2020 08:27	13,21	1	13,21	CHI
20201056215	MINACU	4020060035	MINACU	11/10/2020 19:14	12/10/2020 17:47	11/10/2020 19:14	12/10/2020 17:47	22,54	1	22,54	CHI
20201056963	SANTA RITA DO ARAGUAIA	SU12202828	SANTA RITA DO ARAGUAIA	11/10/2020 19:14	12/10/2020 16:00	11/10/2020 19:14	12/10/2020 16:00	20,75	4	83,02	CHI
20201056217	INACIOLANDIA	ID21341689	QUIRINOPOLIS	11/10/2020 19:14	11/10/2020 21:42	11/10/2020 19:14	11/10/2020 21:42	2,45	10	24,54	CHI
20201056220	VIANOPOLIS	VN12194266	VIANOPOLIS	11/10/2020 19:15	11/10/2020 23:53	11/10/2020 19:15	11/10/2020 23:53	4,63	5	23,16	CHI
20201057325	GOIAS	GS12183219	GOIAS	11/10/2020 19:16	12/10/2020 09:47	11/10/2020 19:16	12/10/2020 09:47	14,51	4	58,05	CHI
20201056229	JATAI	JT21374219	JATAI S1	11/10/2020 19:16	12/10/2020 00:56	11/10/2020 19:16	12/10/2020 00:56	5,66	1	5,66	CHI
20201056236	GOIANIA	12668102	ATLANTICO S3	11/10/2020 19:18	12/10/2020 07:50	11/10/2020 19:18	12/10/2020 07:50	12,52	1	12,52	CHI
20201056240	ITAPURANGA	IK21187020	ITAPURANGA	11/10/2020 19:19	11/10/2020 21:42	11/10/2020 19:19	11/10/2020 21:42	2,38	1	2,38	CHI
20201056241	PORANGATU	840148215	PORANGATU	11/10/2020 19:19	12/10/2020 00:23	11/10/2020 19:19	12/10/2020 00:23	5,06	1	5,06	CHI
20201056245	SERRANOPOLIS	SX11129744	JATAI S1	11/10/2020 19:19	12/10/2020 10:19	11/10/2020 19:19	12/10/2020 10:19	14,99	59	884,31	CHI
20201056246	JUSSARA	1290058559	JUSSARA	11/10/2020 19:19	12/10/2020 10:30	11/10/2020 19:19	12/10/2020 10:30	15,18	1	15,18	CHI
20201056250	TRINDADE	40238313	TRINDADE	11/10/2020 19:20	11/10/2020 23:51	11/10/2020 19:20	11/10/2020 23:51	4,51	1	4,51	CHI
20201056256	ALEXANIA	AX21190675	ALEXANIA	11/10/2020 19:20	12/10/2020 09:41	11/10/2020 19:20	12/10/2020 09:41	14,33	1	14,33	CHI
20201056257	PIRACANJUBA	PJ12212220	PIRACANJUBA	11/10/2020 19:21	11/10/2020 20:58	11/10/2020 19:21	11/10/2020 20:58	1,61	16	25,70	CHI
20201056258	GOIANIA	16069833	GOIANIA LESTE S1	11/10/2020 19:21	11/10/2020 23:32	11/10/2020 19:21	11/10/2020 23:32	4,17	1	4,17	CHI
20201056260	BELA VISTA DE GOIAS	10021851903	BELA VISTA S1	11/10/2020 19:21	12/10/2020 00:11	11/10/2020 19:21	12/10/2020 00:11	4,82	1	4,82	CHI

20201056268	JATAI	JT12211164	JATAI S2	11/10/2020 19:22	12/10/2020 08:00	11/10/2020 19:22	12/10/2020 08:00	12,62	10	126,20	CHI
20201056272	ANICUNS	8687136	ANICUNS	11/10/2020 19:23	11/10/2020 19:51	11/10/2020 19:23	11/10/2020 19:51	0,46	11	5,04	CHI
20201056273	INHUMAS	IN21326241	INHUMAS S2	11/10/2020 19:23	12/10/2020 08:28	11/10/2020 19:23	12/10/2020 08:28	13,07	2	26,14	CHI
20201057497	JATAI	JT12035975	CACHOEIRA ALTA	11/10/2020 19:24	12/10/2020 21:48	11/10/2020 19:24	12/10/2020 21:48	26,40	5	131,99	CHI
20201056304	SANTA TEREZINHA DE GOIAS	VD21265514	SANTA TEREZINHA	11/10/2020 19:27	12/10/2020 00:53	11/10/2020 19:27	12/10/2020 00:53	5,43	1	5,43	CHI
20201056545	SANTA RITA DO ARAGUAIA	SU12306464	SANTA RITA DO ARAGUAIA	11/10/2020 19:27	12/10/2020 09:25	11/10/2020 19:27	12/10/2020 09:25	13,96	77	1075,01	CHI
20201056528	PORTELANDIA	PW12219564	PARQUE DAS EMAS	11/10/2020 19:29	12/10/2020 09:26	11/10/2020 19:29	12/10/2020 09:26	13,95	12	167,37	CHI
20201056528	MINEIROS	PW12219564	PARQUE DAS EMAS	11/10/2020 19:29	12/10/2020 09:26	11/10/2020 19:29	12/10/2020 09:26	13,95	7	97,63	CHI
20201056327	JARAGUA	70015650	JARAGUA	11/10/2020 19:29	12/10/2020 07:17	11/10/2020 19:29	12/10/2020 07:17	11,79	1	11,79	CHI
20201056539	CACHOEIRA ALTA	CA11000016	CACHOEIRA ALTA	11/10/2020 19:30	11/10/2020 23:42	11/10/2020 19:30	11/10/2020 23:42	4,20	166	696,97	CHI
20201056348	CEZARINA	10023193032	CEZARINA	11/10/2020 19:32	12/10/2020 10:55	11/10/2020 19:32	12/10/2020 10:55	15,38	1	15,38	CHI
20201057554	NOVO BRASIL	NB12020215	JUSSARA	11/10/2020 19:33	12/10/2020 10:35	11/10/2020 19:33	12/10/2020 10:35	15,03	23	345,60	CHI
20201056362	NOVA ROMA	5610000640	IACIARA S2	11/10/2020 19:34	12/10/2020 12:07	11/10/2020 19:34	12/10/2020 12:07	16,55	1	16,55	CHI
20201056363	ANAPOLIS	21060976	ANAPOLIS UNIVERSITARIO S2	11/10/2020 19:34	12/10/2020 10:26	11/10/2020 19:34	12/10/2020 10:26	14,87	1	14,87	CHI
20201056365	SAO DOMINGOS	GH21290050	SAO DOMINGOS	11/10/2020 19:34	11/10/2020 22:53	11/10/2020 19:34	11/10/2020 22:53	3,31	2	6,62	CHI
20201056367	ARAGOIANIA	680037895	GUAPU S2	11/10/2020 19:34	11/10/2020 20:53	11/10/2020 19:34	11/10/2020 20:53	1,31	1	1,31	CHI
20201056372	SANTA HELENA DE GOIAS	SH21296175	IPEGUARI	11/10/2020 19:35	11/10/2020 20:36	11/10/2020 19:35	11/10/2020 20:36	1,01	1	1,01	CHI
20201056373	PALMEIRAS DE GOIAS	590060120	PALMEIRAS	11/10/2020 19:35	12/10/2020 15:51	11/10/2020 19:35	12/10/2020 15:51	20,26	1	20,26	CHI
20201056377	CATALAO	CT11281462	CATALAO S2	11/10/2020 19:36	11/10/2020 20:49	11/10/2020 19:36	11/10/2020 20:49	1,22	121	147,08	CHI
20201056389	GOIANESIA	3560000425	GOIANESIA S1	11/10/2020 19:39	11/10/2020 21:36	11/10/2020 19:39	11/10/2020 21:36	1,94	1	1,94	CHI
20201056390	GAMELEIRA DE GOIAS	SV21141735	DAIA S2	11/10/2020 19:40	12/10/2020 03:50	11/10/2020 19:40	12/10/2020 03:50	8,16	1	8,16	CHI
20201056405	HIDROLANDIA	HD12320397	PONTALINA	11/10/2020 19:42	11/10/2020 23:03	11/10/2020 19:42	11/10/2020 23:03	3,35	1	3,35	CHI
20201056415	LUZIANIA	LZ11128815	RIO VERMELHO	11/10/2020 19:44	12/10/2020 11:14	11/10/2020 19:44	12/10/2020 11:14	15,50	28	433,98	CHI
20201056409	JUSSARA	JR12120981LD	BRITANIA	11/10/2020 19:44	12/10/2020 12:59	11/10/2020 19:44	12/10/2020 12:59	17,25	1	17,25	CHI
20201056410	TRINDADE	12763858	GOYA S2	11/10/2020 19:45	12/10/2020 05:51	11/10/2020 19:45	12/10/2020 05:51	10,10	1	10,10	CHI
20201056418	PLANALTINA	PI11354356	PADRE BERNARDO	11/10/2020 19:47	12/10/2020 09:43	11/10/2020 19:47	12/10/2020 09:43	13,93	2	27,86	CHI
20201056420	CACU	1140039912	CACHOEIRA ALTA	11/10/2020 19:47	12/10/2020 09:46	11/10/2020 19:47	12/10/2020 09:46	13,97	1	13,97	CHI
20201056421	LUZIANIA	LZ21065580	CRISTALINA S2	11/10/2020 19:47	11/10/2020 22:51	11/10/2020 19:47	11/10/2020 22:51	3,05	1	3,05	CHI
20201056429	MINEIROS	1390005826	PARQUE DAS EMAS	11/10/2020 19:49	12/10/2020 08:23	11/10/2020 19:49	12/10/2020 08:23	12,56	1	12,56	CHI
20201056813	CACU	CC11102485	CACHOEIRA ALTA	11/10/2020 19:49	12/10/2020 08:20	11/10/2020 19:49	12/10/2020 08:20	12,51	106	1325,59	CHI
20201056700	JATAI	JT11136097	JATAI S3	11/10/2020 19:51	11/10/2020 21:38	11/10/2020 19:51	11/10/2020 21:38	1,77	160	283,29	CHI
20201056456	FORMOSO	TB12185306	PORANGATU	11/10/2020 19:52	11/10/2020 22:39	11/10/2020 19:52	11/10/2020 22:39	2,78	1	2,78	CHI
20201056456	TROMBAS	TB12185306	PORANGATU	11/10/2020 19:52	11/10/2020 22:39	11/10/2020 19:52	11/10/2020 22:39	2,78	10	27,78	CHI
20201057472	CACHOEIRA ALTA	CA21127198	CACHOEIRA ALTA	11/10/2020 19:52	12/10/2020 15:54	11/10/2020 19:52	12/10/2020 15:54	20,03	1	20,03	CHI
20201056454	MOZARLANDIA	MZ12057415	MOZARLANDIA	11/10/2020 19:52	12/10/2020 02:57	11/10/2020 19:52	12/10/2020 02:57	7,08	2	14,17	CHI
20201056525	JATAI	JT12000156	JATAI S2	11/10/2020 19:53	12/10/2020 07:07	11/10/2020 19:53	12/10/2020 07:07	11,22	4	44,90	CHI
20201056477	PONTALINA	PK12263674	GOIATUBA S1	11/10/2020 19:54	12/10/2020 13:07	11/10/2020 19:54	12/10/2020 13:07	17,21	3	51,62	CHI
20201056479	RIO VERDE	10006381837	RIO VERDE S1	11/10/2020 19:55	11/10/2020 22:50	11/10/2020 19:55	11/10/2020 22:50	2,91	1	2,91	CHI
20201056480	CABECEIRAS	CW21247891	ITUIQUIRA	11/10/2020 19:55	11/10/2020 22:47	11/10/2020 19:55	11/10/2020 22:47	2,86	1	2,86	CHI
20201056486	ALEXANIA	AX21048556	ALEXANIA	11/10/2020 19:56	12/10/2020 11:20	11/10/2020 19:56	12/10/2020 11:20	15,40	1	15,40	CHI
20201056494	NOVO GAMA	2460033315	PACAEMBU S1	11/10/2020 19:57	12/10/2020 02:06	11/10/2020 19:57	12/10/2020 02:06	6,14	1	6,14	CHI
20201056690	ALEXANIA	AX12000041	ALEXANIA	11/10/2020 19:57	11/10/2020 22:08	11/10/2020 19:57	11/10/2020 22:08	2,17	89	193,11	CHI
20201056501	FORMOSA	FA12270579	ITUIQUIRA	11/10/2020 19:58	12/10/2020 11:09	11/10/2020 19:58	12/10/2020 11:09	15,17	5	75,87	CHI
20201056504	GOIANIRA	390091170	GOIANIRA	11/10/2020 19:58	11/10/2020 22:53	11/10/2020 19:58	11/10/2020 22:53	2,90	1	2,90	CHI
20201056513	CEZARINA	CZ21358206	CEZARINA	11/10/2020 20:00	12/10/2020 18:25	11/10/2020 20:00	12/10/2020 18:25	22,40	1	22,40	CHI
20201056515	SANTA RITA DO ARAGUAIA	10007195000	SANTA RITA DO ARAGUAIA	11/10/2020 20:01	12/10/2020 00:53	11/10/2020 20:01	12/10/2020 00:53	4,86	1	4,86	CHI
20201056519	JATAI	JT12219466	JATAI S3	11/10/2020 20:01	12/10/2020 15:00	11/10/2020 20:01	12/10/2020 15:00	18,98	2	37,97	CHI
20201056520	GOIANIA	12666592	ATLANTICO S3	11/10/2020 20:01	12/10/2020 01:02	11/10/2020 20:01	12/10/2020 01:02	5,00	1	5,00	CHI
202010161468	JARAGUA	JA11000023	JARAGUA	11/10/2020 20:01	12/10/2020 11:11	11/10/2020 20:01	12/10/2020 11:11	15,15	31	469,68	CHI
20201056526	GOIANIA	13995777	CARAJAS S1	11/10/2020 20:03	12/10/2020 00:09	11/10/2020 20:03	12/10/2020 00:09	4,10	1	4,10	CHI
20201056527	NOVA CRIXAS	NA12086286	NOVA CRIXAS	11/10/2020 20:03	12/10/2020 03:54	11/10/2020 20:03	12/10/2020 03:54	7,84	9	70,59	CHI
20201056650	PARANAIGUARA	PC12070705	QUIRINOPOLIS	11/10/2020 20:04	12/10/2020 00:26	11/10/2020 20:04	12/10/2020 00:26	4,36	36	157,10	CHI
20201056532	CORUMBA DE GOIAS	CB21319699	ALEXANIA	11/10/2020 20:04	12/10/2020 13:24	11/10/2020 20:04	12/10/2020 13:24	17,33	1	17,33	CHI
20201056538	ITAPACI	100079210	ITAPACI	11/10/2020 20:05	12/10/2020 02:46	11/10/2020 20:05	12/10/2020 02:46	6,68	1	6,68	CHI
20201056540	ISRAELANDIA	IS21119135	IPORA	11/10/2020 20:05	12/10/2020 16:48	11/10/2020 20:05	12/10/2020 16:48	20,71	1	20,71	CHI
20201056542	QUIRINOPOLIS	80072173	QUIRINOPOLIS	11/10/2020 20:05	12/10/2020 00:29	11/10/2020 20:05	12/10/2020 00:29	4,39	1	4,39	CHI
20201056567	GOIANIA	GN11001261	CAMPINAS S1	11/10/2020 20:06	11/10/2020 21:01	11/10/2020 20:06	11/10/2020 21:01	0,92	131	120,12	CHI
20201056547	MORRINHOS	MR12044931	GOIATUBA S2	11/10/2020 20:06	11/10/2020 22:35	11/10/2020 20:06	11/10/2020 22:35	2,47	1	2,47	CHI

20201056547	GOIATUBA	MR12044931	GOIATUBA S2	11/10/2020 20:06	11/10/2020 22:35	11/10/2020 20:06	11/10/2020 22:35	2,47	8	19,78	CHI
20201056549	MINEIROS	MY12324492	PARQUE DAS EMAS	11/10/2020 20:06	12/10/2020 08:12	11/10/2020 20:06	12/10/2020 08:12	12,09	1	12,09	CHI
20201056559	VILA PROPICIO	NP12402058	GOIANESIA S1	11/10/2020 20:09	12/10/2020 15:08	11/10/2020 20:09	12/10/2020 15:08	18,98	95	1803,02	CHI
20201056559	COCALZINHO DE GOIAS	NP12402058	GOIANESIA S1	11/10/2020 20:09	12/10/2020 15:08	11/10/2020 20:09	12/10/2020 15:08	18,98	1	18,98	CHI
20201056559	PADRE BERNARDO	NP12402058	GOIANESIA S1	11/10/2020 20:09	12/10/2020 15:08	11/10/2020 20:09	12/10/2020 15:08	18,98	11	208,77	CHI
20201056604	SANTA RITA DO ARAGUAIA	SU12248425	SANTA RITA DO ARAGUAIA	11/10/2020 20:09	11/10/2020 23:44	11/10/2020 20:09	11/10/2020 23:44	3,57	136	486,05	CHI
20201056604	MINEIROS	SU12248425	SANTA RITA DO ARAGUAIA	11/10/2020 20:09	11/10/2020 23:44	11/10/2020 20:09	11/10/2020 23:44	3,57	11	39,31	CHI
20201056604	BURITINOPOLIS	SU12248425	SANTA RITA DO ARAGUAIA	11/10/2020 20:09	11/10/2020 23:44	11/10/2020 20:09	11/10/2020 23:44	3,57	1	3,57	CHI
20201056656	NAZARIO	10010972330	ANICUNS	11/10/2020 20:10	12/10/2020 18:24	11/10/2020 20:10	12/10/2020 18:24	22,24	1	22,24	CHI
20201056570	ITAJA	IJ12184035	ITAJA S2	11/10/2020 20:12	12/10/2020 21:29	11/10/2020 20:12	12/10/2020 21:29	25,28	1	25,28	CHI
20201056580	SILVANIA	SV21033245	VIANOPOLIS	11/10/2020 20:13	12/10/2020 09:53	11/10/2020 20:13	12/10/2020 09:53	13,65	1	13,65	CHI
20201056752	SANTA HELENA DE GOIAS	SH12000009	IPEGUARI	11/10/2020 20:14	11/10/2020 22:23	11/10/2020 20:14	11/10/2020 22:23	2,15	180	386,60	CHI
20201056585	GOIAS	GS21183458	GOIAS	11/10/2020 20:14	12/10/2020 13:44	11/10/2020 20:14	12/10/2020 13:44	17,49	1	17,49	CHI
20201056808	ALEXANIA	AX11114210	ALEXANIA	11/10/2020 20:14	11/10/2020 23:11	11/10/2020 20:14	11/10/2020 23:11	2,94	66	193,75	CHI
20201056588	IPORA	IR21188350	ARENOPOLIS	11/10/2020 20:15	12/10/2020 08:07	11/10/2020 20:15	12/10/2020 08:07	11,87	1	11,87	CHI
20201056666	CORUMBA DE GOIAS	CB12089823	ALEXANIA	11/10/2020 20:16	11/10/2020 23:11	11/10/2020 20:16	11/10/2020 23:11	2,91	11	32,06	CHI
20201056666	ABADIANIA	CB12089823	ALEXANIA	11/10/2020 20:16	11/10/2020 23:11	11/10/2020 20:16	11/10/2020 23:11	2,91	8	23,32	CHI
20201057849	GOIAS	GS12070348	GOIAS	11/10/2020 20:17	12/10/2020 09:43	11/10/2020 20:17	12/10/2020 09:43	13,42	6	80,51	CHI
20201056751	SANTA RITA DO ARAGUAIA	SU11274090	SANTA RITA DO ARAGUAIA	11/10/2020 20:19	12/10/2020 09:59	11/10/2020 20:19	12/10/2020 09:59	13,66	90	1229,60	CHI
20201056616	TURVANIA	TV21308570	FIRMINOPOLIS S2	11/10/2020 20:20	12/10/2020 09:08	11/10/2020 20:20	12/10/2020 09:08	12,79	1	12,79	CHI
20201056644	NOVA IGUAU DE GOIAS	AJ12040664	SANTA TEREZINHA	11/10/2020 20:23	12/10/2020 11:47	11/10/2020 20:23	12/10/2020 11:47	15,39	2	30,78	CHI
20201056644	ALTO HORIZONTE	AJ12040664	SANTA TEREZINHA	11/10/2020 20:23	12/10/2020 11:47	11/10/2020 20:23	12/10/2020 11:47	15,39	5	76,96	CHI
20201056636	SERRANOPOLIS	SX12165995	CHAPADA DO CEU	11/10/2020 20:24	13/10/2020 11:09	11/10/2020 20:24	13/10/2020 11:09	38,73	4	154,94	CHI
20201057127	PARANAIGUARA	PC11265858	CACHOEIRA ALTA	11/10/2020 20:25	12/10/2020 09:49	11/10/2020 20:25	12/10/2020 09:49	13,40	95	1272,92	CHI
20201056645	AGUAS LINDAS DE GOIAS	LA12412179	AGUAS LINDAS DE GOIAS S1	11/10/2020 20:27	11/10/2020 22:43	11/10/2020 20:27	11/10/2020 22:43	2,26	1	2,26	CHI
20201056647	GOIANIA	10938989	FERROVIARIO S1	11/10/2020 20:29	12/10/2020 07:21	11/10/2020 20:29	12/10/2020 07:21	10,87	1	10,87	CHI
20201056653	PORTELANDIA	PW12060871	PARQUE DAS EMAS	11/10/2020 20:30	12/10/2020 18:34	11/10/2020 20:30	12/10/2020 18:34	22,05	5	110,25	CHI
20201057321	MINEIROS	PW10406624	PARQUE DAS EMAS	11/10/2020 20:36	12/10/2020 10:48	11/10/2020 20:36	12/10/2020 10:48	14,20	61	866,28	CHI
20201057321	PORTELANDIA	PW10406624	PARQUE DAS EMAS	11/10/2020 20:36	12/10/2020 10:48	11/10/2020 20:36	12/10/2020 10:48	14,20	3	42,60	CHI
20201056670	CABECEIRAS	CW21146050	ITUIQUIRA	11/10/2020 20:37	11/10/2020 23:06	11/10/2020 20:37	11/10/2020 23:06	2,48	1	2,48	CHI
20201056722	ABADIANIA	AA12258352	ANAPOLIS UNIVERSITARIO S1	11/10/2020 20:37	11/10/2020 22:50	11/10/2020 20:37	11/10/2020 22:50	2,21	9	19,86	CHI
20201056722	CORUMBA DE GOIAS	AA12258352	ANAPOLIS UNIVERSITARIO S1	11/10/2020 20:37	11/10/2020 22:50	11/10/2020 20:37	11/10/2020 22:50	2,21	2	4,41	CHI
20201056821	ALEXANIA	AX12402044	ALEXANIA	11/10/2020 20:37	12/10/2020 07:38	11/10/2020 20:37	12/10/2020 07:38	11,00	142	1562,51	CHI
20201056675	CRIXAS	2490020943	SERRA DO OURO	11/10/2020 20:38	12/10/2020 08:52	11/10/2020 20:38	12/10/2020 08:52	12,23	1	12,23	CHI
20201056676	ANAPOLIS	20927423	ANAPOLIS UNIVERSITARIO S2	11/10/2020 20:38	12/10/2020 02:20	11/10/2020 20:38	12/10/2020 02:20	5,69	1	5,69	CHI
20201058055	MINEIROS	MY12303343RE	PARQUE DAS EMAS	11/10/2020 20:38	12/10/2020 10:56	11/10/2020 20:38	12/10/2020 10:56	14,29	32	457,35	CHI
20201057023	LUZIANIA	LZ12336006	VIANOPOLIS	11/10/2020 20:38	12/10/2020 08:08	11/10/2020 20:38	12/10/2020 08:08	11,49	109	1252,08	CHI
20201056685	ARAGOIANIA	680039879	GUAPO S2	11/10/2020 20:40	11/10/2020 23:39	11/10/2020 20:40	11/10/2020 23:39	2,98	1	2,98	CHI
20201057063	CACHOEIRA ALTA	CA12011542	CACHOEIRA ALTA	11/10/2020 20:40	12/10/2020 10:47	11/10/2020 20:40	12/10/2020 10:47	14,11	10	141,07	CHI
20201056329	APARECIDA DE GOIANIA	AP11166595	INDEPENDENCIA S2	11/10/2020 20:42	11/10/2020 21:03	11/10/2020 20:42	11/10/2020 21:03	0,34	90	30,42	CHI
20201056701	JATAI	AW21352827	JATAI S1	11/10/2020 20:43	12/10/2020 06:56	11/10/2020 20:43	12/10/2020 06:56	10,21	1	10,21	CHI
20201056697	GOIANIA	15216019	GOYA S2	11/10/2020 20:43	12/10/2020 03:00	11/10/2020 20:43	12/10/2020 03:00	6,28	1	6,28	CHI
20201056708	GOIANIA	10021262878	CARAJAS S2	11/10/2020 20:45	11/10/2020 22:44	11/10/2020 20:45	11/10/2020 22:44	1,97	1	1,97	CHI
20201057106	SANTA RITA DO ARAGUAIA	SU12050000	SANTA RITA DO ARAGUAIA	11/10/2020 20:46	12/10/2020 16:02	11/10/2020 20:46	12/10/2020 16:02	19,25	121	2329,42	CHI
20201056712	SAO MIGUEL DO ARAGUAIA	SM21328603	SAO MIGUEL DO ARAGUAIA	11/10/2020 20:47	12/10/2020 07:05	11/10/2020 20:47	12/10/2020 07:05	10,30	1	10,30	CHI
20201056720	QUIRINOPOLIS	QI12371291	QUIRINOPOLIS	11/10/2020 20:49	11/10/2020 22:25	11/10/2020 20:49	11/10/2020 22:25	1,60	4	6,40	CHI
20201057224	MINEIROS	MY12149301RE	PARQUE DAS EMAS	11/10/2020 20:52	12/10/2020 09:56	11/10/2020 20:52	12/10/2020 09:56	13,05	18	234,99	CHI
20201057224	PEROLANDIA	MY12149301RE	PARQUE DAS EMAS	11/10/2020 20:52	12/10/2020 09:56	11/10/2020 20:52	12/10/2020 09:56	13,05	1	13,05	CHI
20201056725	MONTIVIDIU DO NORTE	9670012253	PORANGATU	11/10/2020 20:52	12/10/2020 22:28	11/10/2020 20:52	12/10/2020 22:28	25,59	1	25,59	CHI
20201058819	SANCLERLANDIA	SC12391511	FIRMINOPOLIS S2	11/10/2020 20:54	12/10/2020 23:08	11/10/2020 20:54	12/10/2020 23:08	26,23	10	262,30	CHI
20201056733	RIO VERDE	630357158	RIO VERDE S1	11/10/2020 20:55	12/10/2020 08:42	11/10/2020 20:55	12/10/2020 08:42	11,77	1	11,77	CHI
20201056737	ANAPOLIS	10002802080	ANAPOLIS UNIVERSITARIO S1	11/10/2020 20:59	12/10/2020 01:09	11/10/2020 20:59	12/10/2020 01:09	4,16	1	4,16	CHI
20201056743	APARECIDA DE GOIANIA	10021293420	INDEPENDENCIA S1	11/10/2020 21:00	12/10/2020 00:24	11/10/2020 21:00	12/10/2020 00:24	3,39	1	3,39	CHI
20201056744	CRISTALINA	KR21133600	PAMPLONA	11/10/2020 21:00	12/10/2020 11:15	11/10/2020 21:00	12/10/2020 11:15	14,25	3	42,76	CHI
20201056745	PIRENOPOLIS	PV21171449	CORUMBA	11/10/2020 21:00	11/10/2020 22:51	11/10/2020 21:00	11/10/2020 22:51	1,84	3	5,51	CHI
20201057884	MINEIROS	MY12305765	PARQUE DAS EMAS	11/10/2020 21:02	12/10/2020 09:40	11/10/2020 21:02	12/10/2020 09:40	12,63	6	75,77	CHI
20201056749	NOVA CRIXAS	NA12057227	MOZARLANDIA	11/10/2020 21:03	12/10/2020 00:31	11/10/2020 21:03	12/10/2020 00:31	3,47	7	24,27	CHI
20201056758	LUZIANIA	LZ12200111	VIANOPOLIS	11/10/2020 21:06	12/10/2020 02:41	11/10/2020 21:06	12/10/2020 02:41	5,57	20	111,48	CHI

20201056761	NEROPOLIS	GN21049433	XAVANTES	11/10/2020 21:07	12/10/2020 12:10	11/10/2020 21:07	12/10/2020 12:10	15,04	3	45,13	CHI
20201056767	APARECIDA DE GOIANIA	10007829092	ANHANGUERA	11/10/2020 21:10	12/10/2020 18:50	11/10/2020 21:10	12/10/2020 18:50	21,67	1	21,67	CHI
20201056770	ITARUMA	IM21066511	CACHOEIRA ALTA	11/10/2020 21:11	12/10/2020 19:15	11/10/2020 21:11	12/10/2020 19:15	22,06	1	22,06	CHI
20201056780	APARECIDA DE GOIANIA	200618921	ANHANGUERA	11/10/2020 21:15	11/10/2020 22:52	11/10/2020 21:15	11/10/2020 22:52	1,61	1	1,61	CHI
20201056781	ALEXANIA	AX21028787	ALEXANIA	11/10/2020 21:15	12/10/2020 11:03	11/10/2020 21:15	12/10/2020 11:03	13,78	1	13,78	CHI
20201056783	NIQUELANDIA	NQ21135528	URUACU	11/10/2020 21:16	12/10/2020 18:13	11/10/2020 21:16	12/10/2020 18:13	20,95	1	20,95	CHI
20201057402	SANTA RITA DO ARAGUAIA	SU12374325RE	SANTA RITA DO ARAGUAIA	11/10/2020 21:16	12/10/2020 14:28	11/10/2020 21:16	12/10/2020 14:28	17,19	29	498,59	CHI
20201056786	QUIRINOPOLIS	80005470	QUIRINOPOLIS	11/10/2020 21:17	12/10/2020 08:46	11/10/2020 21:17	12/10/2020 08:46	11,48	1	11,48	CHI
20201056791	GOIAS	GS21210648	GOIAS	11/10/2020 21:19	12/10/2020 13:30	11/10/2020 21:19	12/10/2020 13:30	16,17	1	16,17	CHI
20201056793	GOIANIA	11122766	ATLANTICO S1	11/10/2020 21:20	12/10/2020 00:12	11/10/2020 21:20	12/10/2020 00:12	2,86	1	2,86	CHI
20201056811	QUIRINOPOLIS	QI12000060	QUIRINOPOLIS	11/10/2020 21:21	11/10/2020 23:43	11/10/2020 21:21	11/10/2020 23:43	2,36	7	16,55	CHI
20201057130	VARIAO	VJ32066237	GUAPO S2	11/10/2020 21:24	12/10/2020 05:01	11/10/2020 21:24	12/10/2020 05:01	7,61	77	586,33	CHI
20201056828	NOVO GAMA	03860234	PACAEMBU S1	11/10/2020 21:31	11/10/2020 22:13	11/10/2020 21:31	11/10/2020 21:34	0,05	99	5,25	CHI
20201056828	NOVO GAMA	03860234	PACAEMBU S1	11/10/2020 21:31	11/10/2020 22:13	11/10/2020 21:31	11/10/2020 21:36	0,08	74	6,27	CHI
20201056828	LUZIANIA	03860234	PACAEMBU S2	11/10/2020 21:31	11/10/2020 22:13	11/10/2020 21:31	11/10/2020 21:37	0,10	198	19,09	CHI
20201056828	NOVO GAMA	03860234	PACAEMBU S2	11/10/2020 21:31	11/10/2020 22:13	11/10/2020 21:31	11/10/2020 21:37	0,10	108	10,41	CHI
20201056828	NOVO GAMA	03860234	PACAEMBU S1	11/10/2020 21:31	11/10/2020 22:13	11/10/2020 21:31	11/10/2020 21:37	0,10	1	0,10	CHI
20201056828	NOVO GAMA	03860234	PACAEMBU S1	11/10/2020 21:31	11/10/2020 22:13	11/10/2020 21:31	11/10/2020 22:13	0,69	946	652,74	CHI
20201056938	GOIANIA	GN12000003	AEROPORTO S2	11/10/2020 21:38	11/10/2020 23:31	11/10/2020 21:38	11/10/2020 23:31	1,88	164	308,78	CHI
20201056831	MINEIROS	MY12332634RE	PARQUE DAS EMAS	11/10/2020 21:38	13/10/2020 00:56	11/10/2020 21:38	13/10/2020 00:56	27,29	9	245,61	CHI
20201057223	RIO VERDE	CA12041724	CACHOEIRA ALTA	11/10/2020 21:42	12/10/2020 15:50	11/10/2020 21:42	12/10/2020 11:35	13,89	3	41,67	CHI
20201057223	CACHOEIRA ALTA	CA12041724	CACHOEIRA ALTA	11/10/2020 21:42	12/10/2020 15:50	11/10/2020 21:42	12/10/2020 11:35	13,89	4	55,55	CHI
20201057223	CACHOEIRA ALTA	CA12326946	CACHOEIRA ALTA	11/10/2020 21:42	12/10/2020 15:50	11/10/2020 21:42	12/10/2020 15:26	17,74	2	35,48	CHI
20201057223	CACHOEIRA ALTA	CA12112431	CACHOEIRA ALTA	11/10/2020 21:42	12/10/2020 15:50	11/10/2020 21:42	12/10/2020 15:50	18,14	2	36,29	CHI
20201057223	RIO VERDE	CA12112431	CACHOEIRA ALTA	11/10/2020 21:42	12/10/2020 15:50	11/10/2020 21:42	12/10/2020 15:50	18,14	3	54,43	CHI
20201056839	QUIRINOPOLIS	QI32058080	QUIRINOPOLIS	11/10/2020 21:42	12/10/2020 04:02	11/10/2020 21:42	12/10/2020 04:02	6,33	10	63,29	CHI
20201057427	CACHOEIRA DE GOIAS	CG12165605	FIRMINOPOLIS S2	11/10/2020 21:45	12/10/2020 16:27	11/10/2020 21:45	12/10/2020 16:27	18,70	9	168,28	CHI
20201056851	AGUAS LINDAS DE GOIAS	4830050318	AGUAS LINDAS DE GOIAS S1	11/10/2020 21:46	11/10/2020 23:23	11/10/2020 21:46	11/10/2020 23:23	1,60	1	1,60	CHI
20201056854	PALMEIRAS DE GOIAS	PL12000120	PALMEIRAS	11/10/2020 21:48	12/10/2020 13:18	11/10/2020 21:48	12/10/2020 13:18	15,49	2	30,97	CHI
20201056855	GOIAS	GS12378885	MATRINCHA	11/10/2020 21:49	13/10/2020 21:50	11/10/2020 21:49	13/10/2020 21:50	48,01	3	144,04	CHI
20201057355	GOIANESIA	BA12258276	GOIANESIA S1	11/10/2020 21:49	12/10/2020 07:24	11/10/2020 21:49	12/10/2020 07:24	9,57	79	755,96	CHI
20201057355	VILA PROPICIO	BA12258276	GOIANESIA S1	11/10/2020 21:49	12/10/2020 07:24	11/10/2020 21:49	12/10/2020 07:24	9,57	3	28,71	CHI
20201056859	GOIANIA	GN11247991	GOIANIA LESTE S3	11/10/2020 21:51	12/10/2020 02:02	11/10/2020 21:51	12/10/2020 02:02	4,17	120	500,63	CHI
20201057588	ITAPIRAPUA	IU12034913	MATRINCHA	11/10/2020 21:51	12/10/2020 10:40	11/10/2020 21:51	12/10/2020 10:40	12,80	7	89,63	CHI
20201056864	CALDAS NOVAS	CN12223541	SERRA DE CALDAS	11/10/2020 21:54	12/10/2020 02:36	11/10/2020 21:54	12/10/2020 01:39	3,76	196	736,69	CHI
20201056864	CALDAS NOVAS	CN11142402	SERRA DE CALDAS	11/10/2020 21:54	12/10/2020 02:36	11/10/2020 21:54	12/10/2020 02:36	4,70	70	329,06	CHI
20201056866	GOIANIA	10014224290	CARAJAS S1	11/10/2020 21:55	12/10/2020 02:10	11/10/2020 21:55	12/10/2020 02:10	4,24	1	4,24	CHI
20201056869	GOIANESIA	550140256	GOIANESIA S2	11/10/2020 21:56	12/10/2020 17:03	11/10/2020 21:56	12/10/2020 17:03	19,11	1	19,11	CHI
20201056874	JATAI	290247986	JATAI S2	11/10/2020 21:57	12/10/2020 01:51	11/10/2020 21:57	12/10/2020 01:51	3,89	1	3,89	CHI
20201056876	GOIAS	GS11082077	GOIAS	11/10/2020 21:58	12/10/2020 16:31	11/10/2020 21:58	12/10/2020 16:31	18,54	2	37,07	CHI
20201056877	GOIANIA	11889652	CAMPINAS S2	11/10/2020 21:59	12/10/2020 05:31	11/10/2020 21:59	12/10/2020 05:31	7,53	1	7,53	CHI
20201056885	MINACU	4020015110	MINACU	11/10/2020 22:04	12/10/2020 18:07	11/10/2020 22:04	12/10/2020 18:07	20,04	1	20,04	CHI
20201056886	RIO VERDE	SH21149506	RIO VERDE S1	11/10/2020 22:05	11/10/2020 23:40	11/10/2020 22:05	11/10/2020 23:40	1,58	1	1,58	CHI
20201056887	MAURILANDIA	1040029349	RIO DOS BOIS	11/10/2020 22:05	12/10/2020 08:21	11/10/2020 22:05	12/10/2020 08:21	10,26	1	10,26	CHI
20201057967	FIRMINOPOLIS	FR12000056	FIRMINOPOLIS S1	11/10/2020 22:11	13/10/2020 17:55	11/10/2020 22:11	12/10/2020 15:32	17,33	20	346,69	CHI
20201057967	SAO JOAO DA PARAUNA	FR12000056	FIRMINOPOLIS S1	11/10/2020 22:11	13/10/2020 17:55	11/10/2020 22:11	12/10/2020 17:57	19,76	5	98,78	CHI
20201057967	FIRMINOPOLIS	FR12000056	FIRMINOPOLIS S1	11/10/2020 22:11	13/10/2020 17:55	11/10/2020 22:11	12/10/2020 17:57	19,76	4	79,02	CHI
20201057967	FIRMINOPOLIS	FR12000056	FIRMINOPOLIS S1	11/10/2020 22:11	13/10/2020 17:55	11/10/2020 22:11	12/10/2020 19:12	21,00	6	126,03	CHI
20201057967	SAO JOAO DA PARAUNA	FR12000056	FIRMINOPOLIS S1	11/10/2020 22:11	13/10/2020 17:55	11/10/2020 22:11	12/10/2020 19:12	21,00	3	63,01	CHI
20201057967	PALMINOPOLIS	FR12000056	FIRMINOPOLIS S1	11/10/2020 22:11	13/10/2020 17:55	11/10/2020 22:11	12/10/2020 19:12	21,00	1	21,00	CHI
20201057967	FIRMINOPOLIS	FR12096839RE	FIRMINOPOLIS S1	11/10/2020 22:11	13/10/2020 17:55	12/10/2020 21:52	12/10/2020 21:57	0,08	40	3,31	CHI
20201057967	FIRMINOPOLIS	FR12096839RE	FIRMINOPOLIS S1	11/10/2020 22:11	13/10/2020 17:55	12/10/2020 21:59	13/10/2020 09:19	11,34	40	453,58	CHI
20201057967	FIRMINOPOLIS	FR12000056	FIRMINOPOLIS S1	11/10/2020 22:11	13/10/2020 17:55	12/10/2020 21:51	13/10/2020 12:24	14,56	20	291,17	CHI
20201057967	SAO JOAO DA PARAUNA	FR12000056	FIRMINOPOLIS S1	11/10/2020 22:11	13/10/2020 17:55	11/10/2020 22:11	13/10/2020 17:55	43,72	9	393,46	CHI
20201057967	SAO JOAO DA PARAUNA	FR13206000	FIRMINOPOLIS S1	11/10/2020 22:11	13/10/2020 17:55	12/10/2020 21:51	13/10/2020 17:55	20,07	8	160,52	CHI
20201057967	PALMINOPOLIS	FR13206000	FIRMINOPOLIS S1	11/10/2020 22:11	13/10/2020 17:55	12/10/2020 21:51	12/10/2020 17:55	20,07	1	20,07	CHI
20201057967	FIRMINOPOLIS	FR13206000	FIRMINOPOLIS S1	11/10/2020 22:11	13/10/2020 17:55	12/10/2020 21:51	13/10/2020 17:55	20,07	10	200,66	CHI
20201056897	GOIANIA	10004238794	GOIANIA LESTE S3	11/10/2020 22:12	12/10/2020 04:20	11/10/2020 22:12	12/10/2020 04:20	6,12	1	6,12	CHI

20201056908	CRISTALINA	KR21385519	CRISTALINA S2	11/10/2020 22:16	12/10/2020 00:00	11/10/2020 22:16	12/10/2020 00:00	1,72	2	3,44	CHI
20201056911	GOIANIA	GN11001520	AEROPORTO S3	11/10/2020 22:17	12/10/2020 05:17	11/10/2020 22:17	12/10/2020 05:17	6,99	38	265,46	CHI
20201056912	CORUMBAIBA	NE12377067	CATALAO S1	11/10/2020 22:18	12/10/2020 00:58	11/10/2020 22:18	12/10/2020 00:58	2,66	15	39,88	CHI
20201056912	NOVA AURORA	NE12377067	CATALAO S1	11/10/2020 22:18	12/10/2020 00:58	11/10/2020 22:18	12/10/2020 00:58	2,66	10	26,59	CHI
20201056913	QUIRINOPOLIS	80014872	QUIRINOPOLIS	11/10/2020 22:18	12/10/2020 10:55	11/10/2020 22:18	12/10/2020 10:55	12,60	1	12,60	CHI
20201056920	LUZIANIA	LZ11183958	RIO VERMELHO	11/10/2020 22:24	12/10/2020 01:12	11/10/2020 22:24	12/10/2020 01:12	2,79	14	39,02	CHI
20201056925	CRISTALINA	KR11276403	CRISTALINA S2	11/10/2020 22:29	11/10/2020 23:45	11/10/2020 22:29	11/10/2020 23:45	1,27	1	1,27	CHI
20201056927	PALMEIRAS DE GOIAS	PL12011094	PALMEIRAS	11/10/2020 22:31	12/10/2020 06:58	11/10/2020 22:31	12/10/2020 06:58	8,45	3	25,34	CHI
20201056928	VALPARAISO DE GOIAS	VA12199531LD	PACAEMBU S1	11/10/2020 22:31	12/10/2020 03:14	11/10/2020 22:31	12/10/2020 03:14	4,73	27	127,63	CHI
20201057436	GOIAS	GS12188167	MATRINCHA	11/10/2020 22:31	12/10/2020 09:38	11/10/2020 22:31	12/10/2020 09:38	11,11	18	200,01	CHI
20201056937	PIRENOPOLIS	PV21245637	SAO FRANCISCO DE GOIAS	11/10/2020 22:34	12/10/2020 07:56	11/10/2020 22:34	12/10/2020 07:56	9,35	2	18,71	CHI
20201056945	SAO LUIS DE MONTES BELOS	SL11000014	SAO LUIZ DOS MONTES BELOS	11/10/2020 22:38	12/10/2020 05:06	11/10/2020 22:38	12/10/2020 05:06	6,46	154	995,57	CHI
20201056948	SANTA HELENA DE GOIAS	RV12360557	IPEGUARI	11/10/2020 22:38	12/10/2020 01:56	11/10/2020 22:38	12/10/2020 01:56	3,29	1	3,29	CHI
20201056952	QUIRINOPOLIS	QI12226698	SANTA HELENA S1	11/10/2020 22:39	12/10/2020 07:57	11/10/2020 22:39	12/10/2020 07:57	9,29	6	55,74	CHI
20201056956	MONTES CLAROS DE GOIAS	ME21139480	BRITANIA	11/10/2020 22:48	12/10/2020 03:33	11/10/2020 22:48	12/10/2020 03:33	4,75	57	270,66	CHI
20201056989	SAO DOMINGOS	SD12322677	SAO DOMINGOS	11/10/2020 22:48	12/10/2020 09:42	11/10/2020 22:48	12/10/2020 09:42	10,90	36	392,32	CHI
20201056989	NOVA ROMA	SD12322677	SAO DOMINGOS	11/10/2020 22:48	12/10/2020 09:42	11/10/2020 22:48	12/10/2020 09:42	10,90	3	32,69	CHI
20201056989	MONTES ALEGRE DE GOIAS	SD12322677	SAO DOMINGOS	11/10/2020 22:48	12/10/2020 09:42	11/10/2020 22:48	12/10/2020 09:42	10,90	1	10,90	CHI
20201058044	COLINAS DO SUL	TI12156216RE	MINACU	11/10/2020 22:53	12/10/2020 09:41	11/10/2020 22:53	12/10/2020 09:41	10,79	34	366,87	CHI
20201058044	CAVALCANTE	TI12156216RE	MINACU	11/10/2020 22:53	12/10/2020 09:41	11/10/2020 22:53	12/10/2020 09:41	10,79	67	722,95	CHI
20201057011	AVELINOPOLIS	AV21019689	ANICUNS	11/10/2020 22:56	12/10/2020 15:31	11/10/2020 22:56	12/10/2020 15:31	16,57	1	16,57	CHI
20201057044	ALEXANIA	AX11382414	ALEXANIA	11/10/2020 22:57	12/10/2020 02:48	11/10/2020 22:57	12/10/2020 02:48	3,85	74	284,80	CHI
20201057003	ITABERAI	IB11000004	ITABERAI S2	11/10/2020 23:00	12/10/2020 01:20	11/10/2020 23:00	12/10/2020 01:20	2,32	167	388,04	CHI
20201056996	LUZIANIA	LZ11169019	MARAJOARA	11/10/2020 23:06	11/10/2020 23:15	11/10/2020 23:06	11/10/2020 23:15	0,14	62	8,68	CHI
20201057001	GOIATUBA	140037100	GOIATUBA S2	11/10/2020 23:10	12/10/2020 14:10	11/10/2020 23:10	12/10/2020 14:10	15,00	1	15,00	CHI
20201057007	SILVANIA	660032399	VIANOPOLIS	11/10/2020 23:13	12/10/2020 03:14	11/10/2020 23:13	12/10/2020 03:14	4,01	1	4,01	CHI
20201057008	ANAPOLIS	10000274800	ANAPOLIS UNIVERSITARIO S2	11/10/2020 23:13	12/10/2020 00:56	11/10/2020 23:13	12/10/2020 00:56	1,70	1	1,70	CHI
20201060512	AVELINOPOLIS	AV21019693	ANICUNS	11/10/2020 23:15	12/10/2020 16:12	11/10/2020 23:15	12/10/2020 16:12	16,94	2	33,87	CHI
20201057017	GOIANIA	17252155	CAMPINAS S2	11/10/2020 23:17	12/10/2020 02:02	11/10/2020 23:17	12/10/2020 02:02	2,74	1	2,74	CHI
20201057026	GOIANIA	10401659	GOIANIA LESTE S2	11/10/2020 23:27	12/10/2020 08:58	11/10/2020 23:27	12/10/2020 08:58	9,50	1	9,50	CHI
20201057028	CAMPOS VERDES	VD12136358	SANTA TEREZINHA	11/10/2020 23:29	12/10/2020 14:35	11/10/2020 23:29	12/10/2020 03:54	4,41	189	833,70	CHI
20201057028	CAMPOS VERDES	VD11322606	SANTA TEREZINHA	11/10/2020 23:29	12/10/2020 14:35	11/10/2020 23:29	12/10/2020 14:35	15,09	87	1312,85	CHI
20201057029	PORANGATU	PO12208367	PORANGATU	11/10/2020 23:33	12/10/2020 03:53	11/10/2020 23:33	12/10/2020 03:53	4,32	107	462,30	CHI
20201057036	ALEXANIA	CB12114195	CORUMBA	11/10/2020 23:40	12/10/2020 03:05	11/10/2020 23:40	12/10/2020 03:05	3,41	11	37,50	CHI
20201057036	CORUMBA DE GOIAS	CB12114195	CORUMBA	11/10/2020 23:40	12/10/2020 03:05	11/10/2020 23:40	12/10/2020 03:05	3,41	29	98,87	CHI
20201057064	GOIANIA	GN11160698	REAL S2	11/10/2020 23:42	12/10/2020 03:45	11/10/2020 23:42	12/10/2020 03:45	4,06	84	340,90	CHI
20201057382	SAO MIGUEL DO ARAGUAIA	SM11253871	SAO MIGUEL DO ARAGUAIA	11/10/2020 23:44	12/10/2020 11:03	11/10/2020 23:44	12/10/2020 11:03	11,33	103	1166,56	CHI
20201057058	GOIANIA	GN11038381	GOYA S1	11/10/2020 23:51	12/10/2020 04:18	11/10/2020 23:51	12/10/2020 04:18	4,45	64	284,75	CHI
20201057052	GOIANAPOLIS	10016332995	DAIA S2	11/10/2020 23:54	12/10/2020 08:23	11/10/2020 23:54	12/10/2020 08:23	8,48	1	8,48	CHI
20201057061	PIRACANJUBA	PJ12030030	CRISTIANOPOLIS	11/10/2020 23:59	12/10/2020 03:41	11/10/2020 23:59	12/10/2020 03:41	3,68	11	40,53	CHI
20201057065	SANCLERLANDIA	SC21259974	FIRMINOPOLIS S2	12/10/2020 00:04	12/10/2020 07:26	12/10/2020 00:04	12/10/2020 07:26	7,36	1	7,36	CHI
20201057066	BARRO ALTO	10000746060	BARRO ALTO	12/10/2020 00:05	13/10/2020 11:11	12/10/2020 00:05	13/10/2020 11:11	35,10	1	35,10	CHI
20201057067	TURVANIA	TV12393174	FIRMINOPOLIS S1	12/10/2020 00:07	12/10/2020 10:01	12/10/2020 00:07	12/10/2020 10:01	9,89	1	9,89	CHI
20201057079	CALDAS NOVAS	CN12404748	CALDAS NOVAS S1	12/10/2020 00:20	12/10/2020 01:39	12/10/2020 00:20	12/10/2020 01:39	1,31	6	7,86	CHI
20201057079	RIO QUENTE	CN12404748	CALDAS NOVAS S1	12/10/2020 00:20	12/10/2020 01:39	12/10/2020 00:20	12/10/2020 01:39	1,31	41	53,71	CHI
20201057083	SANCLERLANDIA	SL12145801	FIRMINOPOLIS S2	12/10/2020 00:26	12/10/2020 11:49	12/10/2020 00:26	12/10/2020 11:49	11,38	3	34,14	CHI
20201057084	QUIRINOPOLIS	80084576	QUIRINOPOLIS	12/10/2020 00:27	12/10/2020 01:39	12/10/2020 00:27	12/10/2020 01:39	1,19	1	1,19	CHI
20201057443	SAO MIGUEL DO ARAGUAIA	SM12113573	SAO MIGUEL DO ARAGUAIA	12/10/2020 00:30	12/10/2020 12:44	12/10/2020 00:30	12/10/2020 12:44	12,22	8	97,77	CHI
20201057670	SERRANOPOLIS	SX12216620	JATAI S1	12/10/2020 00:32	12/10/2020 11:55	12/10/2020 00:32	12/10/2020 11:55	11,38	5	56,88	CHI
20201059030	JARAGUA	JA21278874	JARAGUA	12/10/2020 00:43	12/10/2020 16:23	12/10/2020 00:43	12/10/2020 16:23	15,65	1	15,65	CHI
20201057105	SAO FRANCISCO DE GOIAS	10023104200	SAO FRANCISCO DE GOIAS	12/10/2020 00:44	12/10/2020 14:01	12/10/2020 00:44	12/10/2020 14:01	13,28	1	13,28	CHI
20201057109	VIANOPOLIS	VN21325250	VIANOPOLIS	12/10/2020 00:47	12/10/2020 01:10	12/10/2020 00:47	12/10/2020 01:10	0,38	1	0,38	CHI
20201057110	JARAGUA	70003968	JARAGUA	12/10/2020 00:49	12/10/2020 14:03	12/10/2020 00:49	12/10/2020 14:03	13,23	1	13,23	CHI
20201057114	RIO VERDE	RV11000033	RIO VERDE S2	12/10/2020 01:01	12/10/2020 05:41	12/10/2020 01:01	12/10/2020 05:41	4,66	99	461,81	CHI
20201059213	ALEXANIA	AX11101793	ALEXANIA	12/10/2020 01:01	12/10/2020 13:49	12/10/2020 01:01	12/10/2020 13:49	12,78	47	600,84	CHI
20201057207	NOVA AURORA	NE12143243	CATALAO S1	12/10/2020 01:20	12/10/2020 08:41	12/10/2020 01:20	12/10/2020 08:41	7,34	5	36,70	CHI
20201059442	SANTA FE DE GOIAS	RN12378850	BRITANIA	12/10/2020 01:49	12/10/2020 16:55	12/10/2020 01:49	12/10/2020 16:55	15,08	19	286,59	CHI
20201057136	RIO VERDE	RV21306393	CABRIUVA S2	12/10/2020 01:53	12/10/2020 10:11	12/10/2020 01:53	12/10/2020 10:11	8,30	1	8,30	CHI

20201057156	CALDAS NOVAS	CN11213949	SERRA DE CALDAS	12/10/2020 02:00	12/10/2020 13:31	12/10/2020 02:00	12/10/2020 13:31	11,52	97	1117,12	CHI
20201057138	PIRENOPOLIS	PV21287799	CORUMBA	12/10/2020 02:03	12/10/2020 04:30	12/10/2020 02:03	12/10/2020 04:30	2,45	2	4,90	CHI
20201057145	NOVO GAMA	2460191530	PACAEMBU S2	12/10/2020 02:30	12/10/2020 10:04	12/10/2020 02:30	12/10/2020 10:04	7,56	1	7,56	CHI
20201057150	URUACU	640039182	URUACU	12/10/2020 02:55	12/10/2020 06:18	12/10/2020 02:55	12/10/2020 06:18	3,37	1	3,37	CHI
20201057154	ITAPURANGA	IK12250721	GOIAS	12/10/2020 03:14	12/10/2020 07:49	12/10/2020 03:14	12/10/2020 07:49	4,57	3	13,71	CHI
20201057154	GOIAS	IK12250721	GOIAS	12/10/2020 03:14	12/10/2020 07:49	12/10/2020 03:14	12/10/2020 07:49	4,57	14	63,99	CHI
20201057154	ITABERAI	IK12250721	GOIAS	12/10/2020 03:14	12/10/2020 07:49	12/10/2020 03:14	12/10/2020 07:49	4,57	3	13,71	CHI
20201057159	NOVA CRIXAS	8570016751	NOVA CRIXAS	12/10/2020 03:33	12/10/2020 05:41	12/10/2020 03:33	12/10/2020 05:41	2,12	1	2,12	CHI
20201057160	CAIAPONIA	CP12204882	CAIAPONIA	12/10/2020 03:37	12/10/2020 16:56	12/10/2020 03:37	12/10/2020 16:56	13,32	1	13,32	CHI
20201057160	CAIAPONIA	CP12204882	CAIAPONIA	12/10/2020 03:37	12/10/2020 16:56	12/10/2020 10:49	12/10/2020 16:56	6,13	1	6,13	CHI
20201057162	ITABERAI	IB21210460	ITABERAI S1	12/10/2020 03:40	12/10/2020 15:36	12/10/2020 03:40	12/10/2020 15:36	11,93	1	11,93	CHI
20201057350	BELA VISTA DE GOIAS	SQ12066252	BELA VISTA S1	12/10/2020 03:56	12/10/2020 09:42	12/10/2020 03:56	12/10/2020 09:42	5,77	4	23,06	CHI
20201059799	ABADIANIA	AA12291825	ANAPOLIS UNIVERSITARIO S1	12/10/2020 03:57	12/10/2020 13:42	12/10/2020 03:57	12/10/2020 13:42	9,74	8	77,90	CHI
20201059799	GAMELEIRA DE GOIAS	AA12291825	ANAPOLIS UNIVERSITARIO S1	12/10/2020 03:57	12/10/2020 13:42	12/10/2020 03:57	12/10/2020 13:42	9,74	1	9,74	CHI
20201057245	CAMPOS VERDES	SG12202098RE	SANTA TEREZINHA	12/10/2020 04:01	12/10/2020 10:54	12/10/2020 04:01	12/10/2020 10:54	6,88	41	282,21	CHI
20201057245	SANTA TEREZINHA DE GOIAS	SG12202098RE	SANTA TEREZINHA	12/10/2020 04:01	12/10/2020 10:54	12/10/2020 04:01	12/10/2020 10:54	6,88	143	984,28	CHI
20201057245	UIRAPURU	SG12202098RE	SANTA TEREZINHA	12/10/2020 04:01	12/10/2020 10:54	12/10/2020 04:01	12/10/2020 10:54	6,88	62	426,75	CHI
20201057170	SANTA HELENA DE GOIAS	SH21024972	IPEGUARI	12/10/2020 04:01	12/10/2020 12:01	12/10/2020 04:01	12/10/2020 12:01	7,98	1	7,98	CHI
20201057257	ITABERAI	IB12220379	ITABERAI S1	12/10/2020 04:16	12/10/2020 08:23	12/10/2020 04:16	12/10/2020 08:23	4,12	58	238,67	CHI
20201060758	SANCLERLANDIA	SC12391519	FIRMINOPOLIS S2	12/10/2020 04:18	12/10/2020 16:40	12/10/2020 04:18	12/10/2020 16:40	12,36	1	12,36	CHI
20201060758	SAO LUIS DE MONTES BELOS	SC12391519	FIRMINOPOLIS S2	12/10/2020 04:18	12/10/2020 16:40	12/10/2020 04:18	12/10/2020 16:40	12,36	2	24,73	CHI
20201057042	MINEIROS	MY13205150	PARQUE DAS EMAS	12/10/2020 04:20	12/10/2020 11:18	12/10/2020 04:20	12/10/2020 06:23	2,05	4	8,19	CHI
20201057042	MINEIROS	MY13205150	PARQUE DAS EMAS	12/10/2020 04:20	12/10/2020 11:18	12/10/2020 06:29	12/10/2020 10:49	4,33	5	21,66	CHI
20201057042	MINEIROS	MY13209820	PARQUE DAS EMAS	12/10/2020 04:20	12/10/2020 11:18	12/10/2020 04:20	12/10/2020 11:18	6,97	1	6,97	CHI
20201057177	JARAGUA	JA21297423	GOIANESIA S2	12/10/2020 04:23	12/10/2020 12:34	12/10/2020 04:23	12/10/2020 12:34	8,18	1	8,18	CHI
20201057179	GOIATUBA	GT12052919	GOIATUBA S1	12/10/2020 04:26	12/10/2020 06:08	12/10/2020 04:26	12/10/2020 06:08	1,70	3	5,09	CHI
20201057185	GOIAS	GS12380855	MATRINCHA	12/10/2020 04:36	12/10/2020 13:59	12/10/2020 04:36	12/10/2020 13:59	9,37	13	121,84	CHI
20201057218	URUACU	UR12074233RE	URUACU	12/10/2020 04:45	12/10/2020 08:11	12/10/2020 04:45	12/10/2020 08:11	3,43	97	332,98	CHI
20201057218	CAMPINORTE	UR12074233RE	URUACU	12/10/2020 04:45	12/10/2020 08:11	12/10/2020 04:45	12/10/2020 08:11	3,43	22	75,52	CHI
20201059728	PLANALTIMA	PI12324338	SAO JOAO D ALIANCA	12/10/2020 04:49	12/10/2020 19:49	12/10/2020 04:49	12/10/2020 19:49	14,99	6	89,94	CHI
20201059157	MINEIROS	MY12024312RE	PARQUE DAS EMAS	12/10/2020 04:49	12/10/2020 13:27	12/10/2020 04:49	12/10/2020 13:27	8,62	69	594,82	CHI
20201059157	SANTA RITA DO ARAGUAIA	MY12024312RE	PARQUE DAS EMAS	12/10/2020 04:49	12/10/2020 13:27	12/10/2020 04:49	12/10/2020 13:27	8,62	16	137,93	CHI
20201057232	RIO VERDE	RV12207146	MONTIVIDIU T	12/10/2020 04:51	12/10/2020 08:28	12/10/2020 04:51	12/10/2020 08:28	3,62	17	61,46	CHI
20201057296	URUACU	UR12317135	URUACU	12/10/2020 04:54	12/10/2020 10:01	12/10/2020 04:54	12/10/2020 10:01	5,10	11	56,11	CHI
20201057194	BRAZABRANTES	BR12011956	NEROPOLIS S1	12/10/2020 04:57	12/10/2020 07:18	12/10/2020 04:57	12/10/2020 07:18	2,34	4	9,34	CHI
20201057194	NOVA VENEZA	BR12011956	NEROPOLIS S1	12/10/2020 04:57	12/10/2020 07:18	12/10/2020 04:57	12/10/2020 07:18	2,34	1	2,34	CHI
20201057538	NOVO PLANALTO	SM12074386RE	SAO MIGUEL DO ARAGUAIA	12/10/2020 05:01	12/10/2020 09:34	12/10/2020 05:01	12/10/2020 09:34	4,55	6	27,30	CHI
20201057538	SAO MIGUEL DO ARAGUAIA	SM12074386RE	SAO MIGUEL DO ARAGUAIA	12/10/2020 05:01	12/10/2020 09:34	12/10/2020 05:01	12/10/2020 09:34	4,55	135	614,21	CHI
20201057198	PROFESSOR JAMIL SAFADY	JS21083309	ROCHEDO	12/10/2020 05:07	12/10/2020 09:14	12/10/2020 05:07	12/10/2020 09:14	4,11	1	4,11	CHI
20201057652	CEZARINA	CZ12233347	CEZARINA	12/10/2020 05:07	12/10/2020 13:52	12/10/2020 05:07	12/10/2020 13:52	8,74	3	26,21	CHI
20201057243	FAZENDA NOVA	FN12073183	BRITANIA	12/10/2020 05:18	12/10/2020 08:16	12/10/2020 05:18	12/10/2020 08:16	2,96	69	204,05	CHI
20201057210	ARAGARCAS	AG12380911	ARAGARCAS	12/10/2020 05:27	12/10/2020 15:09	12/10/2020 05:27	12/10/2020 15:09	9,70	1	9,70	CHI
20201057213	AMARALINA	LC12308825	MARA ROSA	12/10/2020 05:29	12/10/2020 13:09	12/10/2020 05:29	12/10/2020 13:09	7,66	6	45,97	CHI
20201057214	POSSE	PS12255382	IACIARA S2	12/10/2020 05:30	12/10/2020 08:06	12/10/2020 05:30	12/10/2020 08:06	2,59	38	98,29	CHI
20201057215	CORUMBAIBA	CI21127892	VILA CORUMBA	12/10/2020 05:30	12/10/2020 07:27	12/10/2020 05:30	12/10/2020 07:27	1,94	1	1,94	CHI
20201057217	SAO MIGUEL DO ARAGUAIA	SM12393978	SAO MIGUEL DO ARAGUAIA	12/10/2020 05:32	12/10/2020 14:51	12/10/2020 05:32	12/10/2020 14:51	9,31	59	549,55	CHI
20201059450	SANTA RITA DO ARAGUAIA	SU12296483	SANTA RITA DO ARAGUAIA	12/10/2020 05:35	12/10/2020 13:46	12/10/2020 05:35	12/10/2020 13:46	8,17	6	49,03	CHI
20201057222	GAMELEIRA DE GOIAS	SV31194660	ANAPOLIS UNIVERSITARIO S2	12/10/2020 05:37	12/10/2020 08:18	12/10/2020 05:37	12/10/2020 08:18	2,68	1	2,68	CHI
20201057225	CALDAS NOVAS	PI12249830	CALDAS NOVAS S1	12/10/2020 05:39	12/10/2020 07:57	12/10/2020 05:39	12/10/2020 07:57	2,29	5	11,43	CHI
20201057225	PIRACANJUBA	PI12249830	CALDAS NOVAS S1	12/10/2020 05:39	12/10/2020 07:57	12/10/2020 05:39	12/10/2020 07:57	2,29	35	80,04	CHI
20201057225	SANTA CRUZ DE GOIAS	PI12249830	CALDAS NOVAS S1	12/10/2020 05:39	12/10/2020 07:57	12/10/2020 05:39	12/10/2020 07:57	2,29	1	2,29	CHI
20201057227	JARAGUA	JA12273009	JARAGUA	12/10/2020 05:41	12/10/2020 13:10	12/10/2020 05:41	12/10/2020 13:10	7,48	11	82,30	CHI
20201057431	DIVINOPOLIS DE GOIAS	GH12398369	SAO DOMINGOS	12/10/2020 05:45	12/10/2020 10:55	12/10/2020 05:45	12/10/2020 10:55	5,15	21	108,23	CHI
20201057431	SAO DOMINGOS	GH12398369	SAO DOMINGOS	12/10/2020 05:45	12/10/2020 10:55	12/10/2020 05:45	12/10/2020 10:55	5,15	19	97,92	CHI
20201057236	ITARUMA	IM21303246	CACHOEIRA ALTA	12/10/2020 05:51	12/10/2020 13:02	12/10/2020 05:51	12/10/2020 10:20	4,48	1	4,48	CHI
20201057236	ITARUMA	IM12303220	CACHOEIRA ALTA	12/10/2020 05:51	12/10/2020 13:02	12/10/2020 10:17	12/10/2020 12:27	2,17	1	2,17	CHI
20201057236	ITARUMA	IM12107399	CACHOEIRA ALTA	12/10/2020 05:51	12/10/2020 13:02	12/10/2020 12:52	12/10/2020 13:02	0,17	4	0,68	CHI

20201057330	TURVANIA	TV12111577	FIRMINOPOLIS S1	12/10/2020 05:51	12/10/2020 07:46	12/10/2020 05:51	12/10/2020 07:46	1,90	8	15,23	CHI
20201057330	FIRMINOPOLIS	TV12111577	FIRMINOPOLIS S1	12/10/2020 05:51	12/10/2020 07:46	12/10/2020 05:51	12/10/2020 07:46	1,90	2	3,81	CHI
20201057239	APARECIDA DE GOIANIA	AP11046363	INDEPENDENCIA S1	12/10/2020 05:52	12/10/2020 07:25	12/10/2020 05:52	12/10/2020 07:25	1,55	177	273,51	CHI
20201057241	FORMOSA	FA31042719	SAO JOAO D ALIANCA	12/10/2020 05:53	12/10/2020 11:08	12/10/2020 05:53	12/10/2020 11:08	5,25	1	5,25	CHI
20201057244	SANTA ROSA DE GOIAS	SR12240520	INHUMAS S1	12/10/2020 05:54	12/10/2020 13:50	12/10/2020 05:54	12/10/2020 13:50	7,92	3	23,76	CHI
20201057175	ALEXANIA	AX21070945	ALEXANIA	12/10/2020 05:55	12/10/2020 14:33	12/10/2020 05:55	12/10/2020 14:33	8,62	1	8,62	CHI
20201057246	SANTA TEREZA DE GOIAS	SE12053812	MARA ROSA	12/10/2020 05:56	12/10/2020 11:32	12/10/2020 05:56	12/10/2020 11:32	5,60	3	16,80	CHI
20201057248	SANCLERLANDIA	SC21229499	FIRMINOPOLIS S2	12/10/2020 05:59	13/10/2020 11:54	12/10/2020 05:59	13/10/2020 11:54	29,91	1	29,91	CHI
20201057250	PIRENOPOLIS	PV21158643	CORUMBA	12/10/2020 06:00	12/10/2020 08:38	12/10/2020 06:00	12/10/2020 08:38	2,62	3	7,87	CHI
20201057986	PIRANHAS	PH12184391	PIRANHAS	12/10/2020 06:02	12/10/2020 11:50	12/10/2020 06:02	12/10/2020 11:50	5,79	45	260,56	CHI
20201057253	GOIANIA	17374595	XAVANTES	12/10/2020 06:03	12/10/2020 11:55	12/10/2020 06:03	12/10/2020 11:55	5,86	1	5,86	CHI
20201057254	SANTA ROSA DE GOIAS	SR12107586	INHUMAS S1	12/10/2020 06:04	12/10/2020 08:17	12/10/2020 06:04	12/10/2020 08:17	2,22	62	137,64	CHI
20201058308	MINEIROS	SU12302010	SANTA RITA DO ARAGUAIA	12/10/2020 06:05	12/10/2020 13:24	12/10/2020 06:05	12/10/2020 13:24	7,31	1	7,31	CHI
20201058308	SANTA RITA DO ARAGUAIA	SU12302010	SANTA RITA DO ARAGUAIA	12/10/2020 06:05	12/10/2020 13:24	12/10/2020 06:05	12/10/2020 13:24	7,31	5	36,57	CHI
20201057261	COLINAS DO SUL	TI12155523RE	MINACU	12/10/2020 06:05	12/10/2020 08:43	12/10/2020 06:05	12/10/2020 08:43	2,62	18	47,23	CHI
20201057267	ITAPIRAPUA	IU11057823	MATRINCHA	12/10/2020 06:06	12/10/2020 07:33	12/10/2020 06:06	12/10/2020 07:33	1,43	25	35,85	CHI
20201057272	GOIANIA	10003819483	GOYA S1	12/10/2020 06:08	12/10/2020 09:07	12/10/2020 06:08	12/10/2020 09:07	2,98	1	2,98	CHI
20201057273	SAO LUIS DE MONTES BELOS	SL21304419	SAO LUIZ DOS MONTES BELOS	12/10/2020 06:08	12/10/2020 12:40	12/10/2020 06:08	12/10/2020 12:40	6,52	1	6,52	CHI
20201058173	ITAJA	IM12148585	CACHOEIRA ALTA	12/10/2020 06:09	12/10/2020 22:33	12/10/2020 06:09	12/10/2020 22:33	16,38	11	180,22	CHI
20201057275	CALDAS NOVAS	760214840	SERRA DE CALDAS	12/10/2020 06:10	12/10/2020 09:04	12/10/2020 06:10	12/10/2020 09:04	2,90	1	2,90	CHI
20201058886	JAUPACI	JP12123940	IPORA	12/10/2020 06:10	12/10/2020 12:10	12/10/2020 06:10	12/10/2020 12:10	5,99	12	71,89	CHI
20201057360	JUSSARA	JR12101204	JUSSARA	12/10/2020 06:10	12/10/2020 10:16	12/10/2020 06:10	12/10/2020 10:16	4,08	30	122,55	CHI
20201057278	PALESTINA DE GOIAS	PY12395426	PALESTINA	12/10/2020 06:10	12/10/2020 11:00	12/10/2020 06:10	12/10/2020 11:00	4,82	2	9,63	CHI
20201057280	NOVA CRIXAS	NA12087039	NOVA CRIXAS	12/10/2020 06:11	12/10/2020 11:39	12/10/2020 06:11	12/10/2020 11:39	5,46	4	21,85	CHI
20201057281	PLANALTINA	PB12111398	PADRE BERNARDO	12/10/2020 06:11	12/10/2020 10:02	12/10/2020 06:11	12/10/2020 10:02	3,85	8	30,76	CHI
20201057281	PADRE BERNARDO	PB12111398	PADRE BERNARDO	12/10/2020 06:11	12/10/2020 10:02	12/10/2020 06:11	12/10/2020 10:02	3,85	60	230,72	CHI
20201057283	INHUMAS	30044200	INHUMAS S2	12/10/2020 06:11	12/10/2020 11:31	12/10/2020 06:11	12/10/2020 11:31	5,32	1	5,32	CHI
20201057308	NOVA CRIXAS	NA12078447	NOVA CRIXAS	12/10/2020 06:12	12/10/2020 09:21	12/10/2020 06:12	12/10/2020 09:21	3,13	19	59,55	CHI
20201057308	CRIXAS	NA12078447	NOVA CRIXAS	12/10/2020 06:12	12/10/2020 09:21	12/10/2020 06:12	12/10/2020 09:21	3,13	18	56,42	CHI
20201059180	CORUMBA DE GOIAS	260008886	CORUMBA	12/10/2020 06:14	12/10/2020 15:38	12/10/2020 06:14	12/10/2020 15:38	9,40	1	9,40	CHI
20201057669	FORMOSA	FA11046850	ITUIQUIRA	12/10/2020 06:16	12/10/2020 08:37	12/10/2020 06:16	12/10/2020 08:37	2,35	201	472,13	CHI
20201058320	ITARUMA	IM12226503	CACHOEIRA ALTA	12/10/2020 06:16	13/10/2020 19:07	12/10/2020 06:16	12/10/2020 15:33	9,27	10	92,68	CHI
20201058320	ITARUMA	IM12226503	CACHOEIRA ALTA	12/10/2020 06:16	13/10/2020 19:07	12/10/2020 15:34	13/10/2020 19:07	27,56	11	303,13	CHI
20201057367	SANTA TEREZINHA DE GOIAS	SG12201777	SANTA TEREZINHA	12/10/2020 06:17	12/10/2020 08:19	12/10/2020 06:17	12/10/2020 08:19	2,02	6	12,14	CHI
20201057299	SIMOLANDIA	SA12319168	IACIARA S2	12/10/2020 06:17	12/10/2020 17:04	12/10/2020 06:17	12/10/2020 17:04	10,77	4	43,08	CHI
20201057301	CAIAPONIA	CP12245300	CAIAPONIA	12/10/2020 06:18	12/10/2020 07:21	12/10/2020 06:18	12/10/2020 07:21	1,04	38	39,56	CHI
20201057972	SERRANOPOLIS	SK12260467	JATAI S1	12/10/2020 06:18	12/10/2020 13:37	12/10/2020 06:18	12/10/2020 13:37	7,31	8	58,45	CHI
20201057303	GOIANAPOLIS	20442087	JUNDIAI S1	12/10/2020 06:18	12/10/2020 09:46	12/10/2020 06:18	12/10/2020 09:46	3,45	1	3,45	CHI
20201057304	ACREUNA	10021784718	ACREUNA	12/10/2020 06:18	12/10/2020 08:30	12/10/2020 06:18	12/10/2020 08:30	2,18	1	2,18	CHI
20201057306	GOIATUBA	GT12263918	BOM JESUS DE GOIAS	12/10/2020 06:19	12/10/2020 10:31	12/10/2020 06:19	12/10/2020 10:31	4,19	3	12,58	CHI
20201057734	PALMEIRAS DE GOIAS	TV12005728	FIRMINOPOLIS S2	12/10/2020 06:19	12/10/2020 14:01	12/10/2020 06:19	12/10/2020 14:01	7,69	5	38,46	CHI
20201057734	TURVANIA	TV12005728	FIRMINOPOLIS S2	12/10/2020 06:19	12/10/2020 14:01	12/10/2020 06:19	12/10/2020 14:01	7,69	3	23,08	CHI
20201057311	SAO JOAO D ALIANCA	JL12049201	SAO JOAO D ALIANCA	12/10/2020 06:19	12/10/2020 09:00	12/10/2020 06:19	12/10/2020 09:00	2,67	95	253,36	CHI
20201057313	APARECIDA DE GOIANIA	AP12051715	ATLANTICO S2	12/10/2020 06:20	12/10/2020 08:42	12/10/2020 06:20	12/10/2020 08:42	2,35	399	939,09	CHI
20201057316	PONTALINA	PK12312433	PONTALINA	12/10/2020 06:21	12/10/2020 12:00	12/10/2020 06:21	12/10/2020 12:00	5,64	128	721,99	CHI
20201057773	INHUMAS	IN11322871	INHUMAS S2	12/10/2020 06:21	12/10/2020 09:19	12/10/2020 06:21	12/10/2020 09:19	2,96	95	280,80	CHI
20201057318	CACHOEIRA ALTA	CA12384078	CACHOEIRA ALTA	12/10/2020 06:22	12/10/2020 14:19	12/10/2020 06:22	12/10/2020 14:19	7,95	1	7,95	CHI
20201057318	CACHOEIRA ALTA	CA12384078	CACHOEIRA ALTA	12/10/2020 06:22	12/10/2020 14:19	12/10/2020 06:22	12/10/2020 14:19	7,95	7	55,62	CHI
20201057323	LUZIANIA	LZ12376188	RIO VERMELHO	12/10/2020 06:25	12/10/2020 11:47	12/10/2020 06:25	12/10/2020 11:47	5,36	5	26,80	CHI
20201057333	SANCLERLANDIA	SC21192126	FIRMINOPOLIS S2	12/10/2020 06:28	12/10/2020 15:21	12/10/2020 06:28	12/10/2020 15:21	8,88	1	8,88	CHI
20201057335	CALDAS NOVAS	CN12404748	CALDAS NOVAS S1	12/10/2020 06:29	12/10/2020 10:47	12/10/2020 06:29	12/10/2020 10:47	4,29	6	25,72	CHI
20201057335	RIO QUENTE	CN12404748	CALDAS NOVAS S1	12/10/2020 06:29	12/10/2020 10:47	12/10/2020 06:29	12/10/2020 10:47	4,29	41	175,74	CHI
20201057556	ITABERAI	IB12000035LD	ITABERAI S2	12/10/2020 06:29	12/10/2020 10:58	12/10/2020 06:29	12/10/2020 10:58	4,47	61	272,69	CHI
20201057343	GOIAS	GS11037807	ITABERAI S1	12/10/2020 06:31	12/10/2020 11:18	12/10/2020 06:31	12/10/2020 11:18	4,78	14	66,87	CHI
20201058775	PADRE BERNARDO	PB12377650	PADRE BERNARDO	12/10/2020 06:31	12/10/2020 14:29	12/10/2020 06:31	12/10/2020 14:29	7,95	6	47,71	CHI
20201057348	GOIANIA	15893157	GOIANIA LESTE S3	12/10/2020 06:33	12/10/2020 08:43	12/10/2020 06:33	12/10/2020 08:43	2,17	1	2,17	CHI
20201057882	SANTA TEREZINHA DE GOIAS	SG12309692	SANTA TEREZINHA	12/10/2020 06:34	12/10/2020 15:07	12/10/2020 06:34	12/10/2020 15:07	8,54	6	51,25	CHI
20201057356	GOIANIA	10554300	REAL S2	12/10/2020 06:34	12/10/2020 08:31	12/10/2020 06:34	12/10/2020 08:31	1,94	1	1,94	CHI

20201058156	GOIAS	IK12274571	GOIAS	12/10/2020 06:35	12/10/2020 13:55	12/10/2020 06:35	12/10/2020 13:55	7,33	4	29,33	CHI
20201057358	PIRENOPOLIS	PV21287466	SAO FRANCISCO DE GOIAS	12/10/2020 06:35	12/10/2020 09:18	12/10/2020 06:35	12/10/2020 09:18	2,71	1	2,71	CHI
20201057593	MORRO AGUDO DE GOIAS	RB12372516	RUBIATABA	12/10/2020 06:37	12/10/2020 11:46	12/10/2020 06:37	12/10/2020 11:46	5,15	14	72,06	CHI
20201057593	RUBIATABA	RB12372516	RUBIATABA	12/10/2020 06:37	12/10/2020 11:46	12/10/2020 06:37	12/10/2020 11:46	5,15	156	803,01	CHI
20201057593	ARAGUAPAZ	RB12372516	RUBIATABA	12/10/2020 06:37	12/10/2020 11:46	12/10/2020 06:37	12/10/2020 11:46	5,15	1	5,15	CHI
20201057363	ANAPOLIS	20485980	JUNDAI S1	12/10/2020 06:37	12/10/2020 10:30	12/10/2020 06:37	12/10/2020 10:30	3,88	1	3,88	CHI
20201057364	FORMOSO	FO21295155	MARA ROSA	12/10/2020 06:37	12/10/2020 09:08	12/10/2020 06:37	12/10/2020 09:08	2,51	1	2,51	CHI
20201057365	QUIRINOPOLIS	QI12260995	QUIRINOPOLIS	12/10/2020 06:37	12/10/2020 08:44	12/10/2020 06:37	12/10/2020 08:44	2,10	2	4,21	CHI
20201057366	GOIANIA	14689923	GOYA S2	12/10/2020 06:37	12/10/2020 08:37	12/10/2020 06:37	12/10/2020 08:37	1,98	1	1,98	CHI
20201057368	IACIARA	ND12046258	IACIARA S2	12/10/2020 06:38	12/10/2020 10:11	12/10/2020 06:38	12/10/2020 09:10	2,52	2	5,04	CHI
20201057368	NOVA ROMA	ND12046258	IACIARA S2	12/10/2020 06:38	12/10/2020 10:11	12/10/2020 06:38	12/10/2020 09:10	2,52	3	7,56	CHI
20201057368	NOVA ROMA	ND12046258	IACIARA S2	12/10/2020 06:38	12/10/2020 10:11	12/10/2020 06:38	12/10/2020 10:11	3,54	1	3,54	CHI
20201057371	SANCLERLANDIA	SC21381776	FIRMINOPOLIS S2	12/10/2020 06:39	12/10/2020 14:57	12/10/2020 06:39	12/10/2020 14:57	8,29	1	8,29	CHI
20201057528	CORUMBA DE GOIAS	CB12089823	ALEXANIA	12/10/2020 06:40	12/10/2020 09:05	12/10/2020 06:40	12/10/2020 09:05	2,41	11	26,47	CHI
20201057528	ABADIANIA	CB12089823	ALEXANIA	12/10/2020 06:40	12/10/2020 09:05	12/10/2020 06:40	12/10/2020 09:05	2,41	8	19,25	CHI
20201057375	MONTES CLAROS DE GOIAS	ME12014449	IPORA	12/10/2020 06:40	12/10/2020 12:14	12/10/2020 06:40	12/10/2020 12:14	5,55	4	22,20	CHI
20201057444	VARJAO	GA12054286LD	GUAPO S2	12/10/2020 06:41	12/10/2020 12:44	12/10/2020 06:41	12/10/2020 12:44	6,06	10	60,56	CHI
20201057444	GUAPO	GA12054286LD	GUAPO S2	12/10/2020 06:41	12/10/2020 12:44	12/10/2020 06:41	12/10/2020 12:44	6,06	16	96,90	CHI
20201057444	ARAGOIANIA	GA12054286LD	GUAPO S2	12/10/2020 06:41	12/10/2020 12:44	12/10/2020 06:41	12/10/2020 12:44	6,06	1	6,06	CHI
20201057377	GOIANIA	13634641	XAVANTES	12/10/2020 06:41	12/10/2020 08:58	12/10/2020 06:41	12/10/2020 08:58	2,28	1	2,28	CHI
20201058323	INHUMAS	IN12319565	ARACU	12/10/2020 06:41	12/10/2020 10:16	12/10/2020 06:41	12/10/2020 10:16	3,58	5	17,89	CHI
20201057379	SANTA HELENA DE GOIAS	SH12301407	SANTA HELENA S1	12/10/2020 06:41	12/10/2020 11:02	12/10/2020 06:41	12/10/2020 11:02	4,34	10	43,41	CHI
20201057379	RIO VERDE	SH12301407	SANTA HELENA S1	12/10/2020 06:41	12/10/2020 11:02	12/10/2020 06:41	12/10/2020 11:02	4,34	3	13,02	CHI
20201058899	PALMEIRAS DE GOIAS	PL12233331	PALMEIRAS	12/10/2020 06:41	12/10/2020 11:46	12/10/2020 06:41	12/10/2020 11:46	5,07	7	35,50	CHI
20201058671	JUSSARA	JR12019318	JUSSARA	12/10/2020 06:43	12/10/2020 11:50	12/10/2020 06:43	12/10/2020 11:50	5,11	13	66,40	CHI
20201057392	TROMBAS	TB21324030	PORANGATU	12/10/2020 06:44	12/10/2020 07:58	12/10/2020 06:44	12/10/2020 07:58	1,23	1	1,23	CHI
20201057991	PIRANHAS	PH12207935	PIRANHAS	12/10/2020 06:45	12/10/2020 09:55	12/10/2020 06:45	12/10/2020 09:55	3,17	4	12,66	CHI
20201057397	GOIANIA	12498520	ATLANTICO S1	12/10/2020 06:45	12/10/2020 09:26	12/10/2020 06:45	12/10/2020 09:26	2,68	1	2,68	CHI
20201057399	GOIANIA	11938780	CAMPINAS S3	12/10/2020 06:45	12/10/2020 09:32	12/10/2020 06:45	12/10/2020 09:32	2,77	1	2,77	CHI
20201057405	GOIANIA	14498789	SENADOR CANEDO	12/10/2020 06:47	12/10/2020 09:03	12/10/2020 06:47	12/10/2020 09:03	2,26	1	2,26	CHI
20201057406	GOIATUBA	MR12044931	GOIATUBA S2	12/10/2020 06:47	12/10/2020 16:40	12/10/2020 06:47	12/10/2020 16:40	9,88	8	79,04	CHI
20201057406	MORRINHOS	MR12044931	GOIATUBA S2	12/10/2020 06:47	12/10/2020 16:40	12/10/2020 06:47	12/10/2020 16:40	9,88	1	9,88	CHI
20201057410	NOVA CRIXAS	NA12038063	MOZARLANDIA	12/10/2020 06:47	12/10/2020 09:00	12/10/2020 06:47	12/10/2020 09:00	2,20	8	17,61	CHI
20201057409	SANTA RITA DO ARAGUAIA	SU12027942	SANTA RITA DO ARAGUAIA	12/10/2020 06:48	13/10/2020 09:43	12/10/2020 06:48	13/10/2020 09:43	26,91	1	26,91	CHI
20201057412	JATAI	JT21358110	JATAI S3	12/10/2020 06:48	12/10/2020 07:54	12/10/2020 06:48	12/10/2020 07:54	1,09	1	1,09	CHI
20201057964	ALEXANIA	AX12221454	ALEXANIA	12/10/2020 06:48	12/10/2020 11:26	12/10/2020 06:48	12/10/2020 11:26	4,62	63	291,11	CHI
20201057416	BONOPOLIS	BX21244254	SAO MIGUEL DO ARAGUAIA	12/10/2020 06:49	12/10/2020 09:05	12/10/2020 06:49	12/10/2020 09:05	2,25	1	2,25	CHI
20201057417	ITAPACI	IW12379430	ITAPACI	12/10/2020 06:49	12/10/2020 08:44	12/10/2020 06:49	12/10/2020 08:44	1,90	2	3,80	CHI
20201057418	ITARUMA	IM12239553	ITAJA S2	12/10/2020 06:50	12/10/2020 14:44	12/10/2020 06:50	12/10/2020 14:44	7,90	2	15,79	CHI
20201057419	GOIANIA	13926354	CARAJAS S1	12/10/2020 06:50	12/10/2020 10:05	12/10/2020 06:50	12/10/2020 10:05	3,25	1	3,25	CHI
20201057422	GOIANIA	16388665	FERROVIARIO S2	12/10/2020 06:50	12/10/2020 08:34	12/10/2020 06:50	12/10/2020 08:34	1,72	1	1,72	CHI
20201057430	GOIANIA	16201772	GOYA S2	12/10/2020 06:52	12/10/2020 09:58	12/10/2020 06:52	12/10/2020 09:58	3,10	1	3,10	CHI
20201057432	ORIZONA	OZ12000353LD	PIRES DO RIO S1	12/10/2020 06:52	12/10/2020 08:43	12/10/2020 06:52	12/10/2020 08:43	1,84	35	64,41	CHI
20201057433	DAMIANOPOLIS	DA21253897	IACIARA S2	12/10/2020 06:52	12/10/2020 17:31	12/10/2020 06:52	12/10/2020 17:31	10,64	1	10,64	CHI
20201057434	GOIANIA	10644441	AEROPORTO S3	12/10/2020 06:52	12/10/2020 08:50	12/10/2020 06:52	12/10/2020 08:50	1,95	1	1,95	CHI
20201059518	SANCLERLANDIA	SC12102362	FIRMINOPOLIS S2	12/10/2020 06:53	12/10/2020 15:32	12/10/2020 06:53	12/10/2020 15:32	8,65	211	1824,56	CHI
20201057438	GUARANI DE GOIAS	GY21218423	IACIARA S1	12/10/2020 06:53	12/10/2020 09:45	12/10/2020 06:53	12/10/2020 09:45	2,85	1	2,85	CHI
20201059987	BARRO ALTO	BA12000032	BARRO ALTO	12/10/2020 06:54	12/10/2020 17:12	12/10/2020 06:54	12/10/2020 17:12	10,30	3	30,89	CHI
20201057440	IACIARA	IA21373149	IACIARA S1	12/10/2020 06:54	12/10/2020 11:31	12/10/2020 06:54	12/10/2020 11:31	4,61	1	4,61	CHI
20201057445	ALVORADA DO NORTE	6072698	IACIARA S2	12/10/2020 06:54	12/10/2020 21:18	12/10/2020 06:54	12/10/2020 21:18	14,38	1	14,38	CHI
20201057447	CRISTALINA	KR21168492	PAMPLONA	12/10/2020 06:55	12/10/2020 10:05	12/10/2020 06:55	12/10/2020 10:05	3,16	1	3,16	CHI
20201057453	PIRENOPOLIS	PV12357379	CORUMBA	12/10/2020 06:56	12/10/2020 09:14	12/10/2020 06:56	12/10/2020 09:14	2,30	1	2,30	CHI
20201057641	CORUMBA DE GOIAS	ZN12394289	COCALZINHO	12/10/2020 06:56	12/10/2020 11:43	12/10/2020 06:56	12/10/2020 11:43	4,78	4	19,12	CHI
20201057641	COCALZINHO DE GOIAS	ZN12394289	COCALZINHO	12/10/2020 06:56	12/10/2020 11:43	12/10/2020 06:56	12/10/2020 11:43	4,78	3	14,34	CHI
202010189494	MONTES CLAROS DE GOIAS	ME12380972	IPORA	12/10/2020 06:56	13/10/2020 19:03	12/10/2020 06:56	13/10/2020 12:41	29,75	7	208,28	CHI
202010189494	MONTES CLAROS DE GOIAS	ME12380972	IPORA	12/10/2020 06:56	13/10/2020 19:03	12/10/2020 06:56	13/10/2020 19:03	36,11	1	36,11	CHI
20201057828	INHUMAS	IN11313203	INHUMAS S2	12/10/2020 06:56	12/10/2020 10:26	12/10/2020 06:56	12/10/2020 10:26	3,49	54	188,63	CHI
20201057908	CEZARINA	CZ12206465	CEZARINA	12/10/2020 06:56	12/10/2020 14:16	12/10/2020 06:56	12/10/2020 14:16	7,32	7	51,23	CHI

20201057460	CORUMBA DE GOIAS	AX12095958	CORUMBA	12/10/2020 06:57	12/10/2020 09:15	12/10/2020 06:57	12/10/2020 09:15	2,30	2	4,60	CHI
20201057460	ALEXANIA	AX12095958	CORUMBA	12/10/2020 06:57	12/10/2020 09:15	12/10/2020 06:57	12/10/2020 09:15	2,30	7	16,10	CHI
20201057461	COCALZINHO DE GOIAS	ZN21149034	AGUAS LINDAS DE GOIAS S2	12/10/2020 06:57	12/10/2020 08:24	12/10/2020 06:57	12/10/2020 08:24	1,45	3	4,34	CHI
20201057462	GOIANIA	10238621	CAMPINAS S3	12/10/2020 06:57	12/10/2020 10:41	12/10/2020 06:57	12/10/2020 10:41	3,73	1	3,73	CHI
20201057463	DOVERLANDIA	DV12217564	CAIAPONIA	12/10/2020 06:57	12/10/2020 10:20	12/10/2020 06:57	12/10/2020 10:20	3,39	7	23,72	CHI
20201057907	SERRANOPOLIS	SX12267557	JATAI S1	12/10/2020 06:57	12/10/2020 16:24	12/10/2020 06:57	12/10/2020 16:24	9,44	25	236,08	CHI
20201057465	PIRACANJUBA	PJ21097882	BELA VISTA S1	12/10/2020 06:57	12/10/2020 09:28	12/10/2020 06:57	12/10/2020 09:28	2,51	1	2,51	CHI
20201057557	ANAPOLIS	AN12000327	JUNDIAI S1	12/10/2020 06:58	12/10/2020 14:01	12/10/2020 06:58	12/10/2020 14:01	7,06	7	49,41	CHI
20201057470	LUZIANIA	LZ21336028	PAMPLONA	12/10/2020 06:58	12/10/2020 08:29	12/10/2020 06:58	12/10/2020 08:29	1,51	1	1,51	CHI
20201057478	ALVORADA DO NORTE	AQ11347073	IACIARA S2	12/10/2020 06:59	12/10/2020 19:45	12/10/2020 06:59	12/10/2020 19:45	12,77	1	12,77	CHI
20201058293	COLINAS DO SUL	TI12237626RE	MINACU	12/10/2020 06:59	12/10/2020 11:11	12/10/2020 06:59	12/10/2020 11:11	4,19	42	175,99	CHI
20201058293	URUACU	TI12237626RE	MINACU	12/10/2020 06:59	12/10/2020 11:11	12/10/2020 06:59	12/10/2020 11:11	4,19	1	4,19	CHI
20201057480	MONTE ALEGRE DE GOIAS	CH21208800	SAO DOMINGOS	12/10/2020 06:59	12/10/2020 08:20	12/10/2020 06:59	12/10/2020 08:20	1,34	1	1,34	CHI
20201057481	QUIRINOPOLIS	QI12207068	QUIRINOPOLIS	12/10/2020 07:00	12/10/2020 09:26	12/10/2020 07:00	12/10/2020 09:26	2,43	2	4,86	CHI
20201058853	SERRANOPOLIS	SX12205266	JATAI S1	12/10/2020 07:00	12/10/2020 11:08	12/10/2020 07:00	12/10/2020 11:08	4,12	7	28,87	CHI
20201057485	SANTO ANTONIO DO DESCOBERTO	SN12078146	MARAUARA	12/10/2020 07:00	12/10/2020 11:38	12/10/2020 07:00	12/10/2020 11:38	4,62	1	4,62	CHI
20201057619	PIRENOPOLIS	PV12352327	CORUMBA	12/10/2020 07:01	12/10/2020 11:04	12/10/2020 07:01	12/10/2020 11:04	4,05	18	72,84	CHI
20201057490	PADRE BERNARDO	PB12305130	PADRE BERNARDO	12/10/2020 07:01	12/10/2020 15:27	12/10/2020 07:01	12/10/2020 15:27	8,42	1	8,42	CHI
20201057498	ITUMBIARA	690377540	ITUMBIARA NOVA	12/10/2020 07:02	12/10/2020 12:35	12/10/2020 07:02	12/10/2020 12:35	5,54	1	5,54	CHI
20201060850	FIRMINOPOLIS	FR21283487	FIRMINOPOLIS S1	12/10/2020 07:02	12/10/2020 19:40	12/10/2020 07:02	12/10/2020 19:40	12,62	1	12,62	CHI
20201058737	PALMEIRAS DE GOIAS	PL12007344	PALMEIRAS	12/10/2020 07:02	12/10/2020 10:15	12/10/2020 07:02	12/10/2020 10:15	3,20	3	9,60	CHI
20201057502	GOIANIA	GN11001520	AEROPORTO S3	12/10/2020 07:03	12/10/2020 09:27	12/10/2020 07:03	12/10/2020 09:27	2,40	38	91,22	CHI
20201057503	SERRANOPOLIS	SX21216641	JATAI S1	12/10/2020 07:03	12/10/2020 11:12	12/10/2020 07:03	12/10/2020 11:12	4,15	3	12,45	CHI
20201057615	ALEXANIA	AX12326379	ALEXANIA	12/10/2020 07:04	12/10/2020 11:07	12/10/2020 07:04	12/10/2020 11:07	4,04	104	420,51	CHI
20201057510	GOIANIA	GN12035286	GOIANIA LESTE S2	12/10/2020 07:04	12/10/2020 09:29	12/10/2020 07:04	12/10/2020 09:29	2,41	546	1315,10	CHI
20201057511	GOIANESIA	10027139059	GOIANESIA S2	12/10/2020 07:04	12/10/2020 16:06	12/10/2020 07:04	12/10/2020 16:06	9,02	1	9,02	CHI
20201057512	GOIAS	90080348	GOIAS	12/10/2020 07:04	12/10/2020 18:44	12/10/2020 07:04	12/10/2020 18:44	11,67	1	11,67	CHI
20201056777	ALEXANIA	AX12071331	ALEXANIA	12/10/2020 07:05	12/10/2020 12:40	12/10/2020 07:05	12/10/2020 10:30	3,42	0	0,00	CHI
20201056777	ALEXANIA	AX12071331	ALEXANIA	12/10/2020 07:05	12/10/2020 12:40	12/10/2020 07:05	12/10/2020 11:19	4,24	3	12,72	CHI
20201056777	ALEXANIA	AX12071331	ALEXANIA	12/10/2020 07:05	12/10/2020 12:40	12/10/2020 10:30	12/10/2020 11:19	0,82	2	1,65	CHI
20201056777	ALEXANIA	AX12071331	ALEXANIA	12/10/2020 07:05	12/10/2020 12:40	12/10/2020 12:10	12/10/2020 12:31	0,36	5	1,82	CHI
20201056777	ALEXANIA	AX21071320	ALEXANIA	12/10/2020 07:05	12/10/2020 12:40	12/10/2020 11:30	12/10/2020 12:40	1,17	1	1,17	CHI
20201057516	GOIANIA	13150236	CAMPINAS S3	12/10/2020 07:05	12/10/2020 09:03	12/10/2020 07:05	12/10/2020 09:03	1,96	1	1,96	CHI
20201057518	GOIANIA	17464833	GOYA S2	12/10/2020 07:05	12/10/2020 08:36	12/10/2020 07:05	12/10/2020 08:36	1,51	1	1,51	CHI
20201058776	PADRE BERNARDO	PB12377642	PADRE BERNARDO	12/10/2020 07:05	12/10/2020 11:06	12/10/2020 07:05	12/10/2020 11:06	4,00	3	12,01	CHI
20201057523	RIO VERDE	RV12260723	RIO VERDE S1	12/10/2020 07:06	12/10/2020 18:04	12/10/2020 07:06	12/10/2020 18:04	10,97	27	296,31	CHI
20201057523	SANTA HELENA DE GOIAS	RV12260723	RIO VERDE S1	12/10/2020 07:06	12/10/2020 18:04	12/10/2020 07:06	12/10/2020 18:04	10,97	11	120,72	CHI
20201057529	PALMEIRAS DE GOIAS	PL12000032	PALMEIRAS	12/10/2020 07:06	12/10/2020 08:51	12/10/2020 07:06	12/10/2020 08:51	1,74	4	6,97	CHI
20201057530	CATALAO	1990085869	CATALAO S2	12/10/2020 07:06	12/10/2020 08:28	12/10/2020 07:06	12/10/2020 08:28	1,35	1	1,35	CHI
20201059001	ARAGOIANIA	AO12353129	GUAPO S2	12/10/2020 07:07	12/10/2020 11:48	12/10/2020 07:07	12/10/2020 11:48	4,68	10	46,76	CHI
20201058602	ALEXANIA	AX11273229	ALEXANIA	12/10/2020 07:07	12/10/2020 10:52	12/10/2020 07:07	12/10/2020 10:52	3,74	15	56,04	CHI
20201059431	ITARUMA	IM12226504	CACHOEIRA ALTA	12/10/2020 07:08	13/10/2020 12:03	12/10/2020 07:08	13/10/2020 12:03	28,92	3	86,77	CHI
20201057564	PORTELANDIA	PW12303429	PARQUE DAS EMAS	12/10/2020 07:10	12/10/2020 12:43	12/10/2020 07:10	12/10/2020 12:43	5,55	9	49,95	CHI
20201057544	GOIANIA	13472483	MEIA PONTE	12/10/2020 07:10	12/10/2020 12:37	12/10/2020 07:10	12/10/2020 12:37	5,45	1	5,45	CHI
20201057546	SANTO ANTONIO DO DESCOBERTO	LA12401730	AGUAS LINDAS DE GOIAS S1	12/10/2020 07:10	12/10/2020 10:57	12/10/2020 07:10	12/10/2020 10:57	3,77	8	30,17	CHI
20201057547	SANCLERLANDIA	SC12299153	FIRMINOPOLIS S2	12/10/2020 07:10	13/10/2020 11:26	12/10/2020 07:10	13/10/2020 11:26	28,25	4	113,01	CHI
20201057551	CORREGO DO OURO	CO12319967	FIRMINOPOLIS S2	12/10/2020 07:11	12/10/2020 16:36	12/10/2020 07:11	12/10/2020 16:36	9,41	3	28,23	CHI
20201058777	PADRE BERNARDO	PB12111395	PADRE BERNARDO	12/10/2020 07:12	12/10/2020 13:16	12/10/2020 07:12	12/10/2020 13:16	6,07	4	24,27	CHI
20201058777	PLANALTINA	PB12111395	PADRE BERNARDO	12/10/2020 07:12	12/10/2020 13:16	12/10/2020 07:12	12/10/2020 13:16	6,07	2	12,13	CHI
20201057561	PALMEIRAS DE GOIAS	PL11276916	PALMEIRAS	12/10/2020 07:12	12/10/2020 14:25	12/10/2020 07:12	12/10/2020 14:25	7,21	1	7,21	CHI
20201059389	CORREGO DO OURO	CO11414464	FIRMINOPOLIS S2	12/10/2020 07:12	12/10/2020 15:08	12/10/2020 07:12	12/10/2020 15:08	7,92	13	103,00	CHI
20201057562	CAVALCANTE	CJ12329689	FLORES DE GOIAS	12/10/2020 07:12	12/10/2020 09:48	12/10/2020 07:12	12/10/2020 09:48	2,59	5	12,94	CHI
20201057563	QUIRINOPOLIS	QI21157461	QUIRINOPOLIS	12/10/2020 07:12	12/10/2020 08:53	12/10/2020 07:12	12/10/2020 08:53	1,67	3	5,01	CHI
20201057566	ARAGUAPAZ	AZ21353030	MOZARLANDIA	12/10/2020 07:13	12/10/2020 08:42	12/10/2020 07:13	12/10/2020 08:42	1,48	1	1,48	CHI
20201057567	ALEXANIA	AX31082612	CORUMBA	12/10/2020 07:13	12/10/2020 12:13	12/10/2020 07:13	12/10/2020 12:13	4,99	1	4,99	CHI
20201057568	CORUMBA DE GOIAS	CB12382148	CORUMBA	12/10/2020 07:13	12/10/2020 17:17	12/10/2020 07:13	12/10/2020 17:17	10,06	3	30,18	CHI
20201057911	FAZENDA NOVA	FN12113973	IPORA	12/10/2020 07:14	12/10/2020 14:05	12/10/2020 07:14	12/10/2020 14:05	6,84	10	68,39	CHI
20201057911	ISRAELANDIA	FN12113973	IPORA	12/10/2020 07:14	12/10/2020 14:05	12/10/2020 07:14	12/10/2020 14:05	6,84	2	13,68	CHI

20201057576	FIRMINOPOLIS	AI21125194	FIRMINOPOLIS S2	12/10/2020 07:14	12/10/2020 14:49	12/10/2020 07:14	12/10/2020 14:49	7,57	1	7,57	CHI
20201059884	ITARUMA	IM12074941RE	CACHEOIRA ALTA	12/10/2020 07:14	13/10/2020 12:53	12/10/2020 07:14	13/10/2020 12:53	29,64	21	622,37	CHI
20201057580	SENADOR CANEDO	13378119	GOIANIA LESTE S2	12/10/2020 07:15	12/10/2020 08:25	12/10/2020 07:15	12/10/2020 08:25	1,17	1	1,17	CHI
20201057583	GOIANIA	10939908	FERROVIARIO S1	12/10/2020 07:16	12/10/2020 08:00	12/10/2020 07:16	12/10/2020 08:00	0,73	1	0,73	CHI
20201057587	ITAJA	IJ12370148	ITAJA S2	12/10/2020 07:16	12/10/2020 10:31	12/10/2020 07:16	12/10/2020 10:31	3,24	2	6,47	CHI
20201057591	ANAPOLIS	AN11135750	ANAPOLIS UNIVERSITARIO S1	12/10/2020 07:17	12/10/2020 09:05	12/10/2020 07:17	12/10/2020 09:05	1,79	171	306,18	CHI
20201057594	GOIANIA	11958686	FERROVIARIO S2	12/10/2020 07:18	12/10/2020 09:22	12/10/2020 07:18	12/10/2020 09:22	2,06	1	2,06	CHI
20201057597	MOZARLANDIA	MZ12181384	MOZARLANDIA	12/10/2020 07:18	12/10/2020 10:50	12/10/2020 07:18	12/10/2020 10:50	3,52	5	17,62	CHI
20201058006	CAMPO LIMPO	AN12267847	NEROPOLIS S1	12/10/2020 07:19	12/10/2020 09:03	12/10/2020 07:19	12/10/2020 09:03	1,73	62	107,26	CHI
20201057602	GOIANIA	10994476	FERROVIARIO S2	12/10/2020 07:19	12/10/2020 10:36	12/10/2020 07:19	12/10/2020 10:36	3,27	1	3,27	CHI
20201057607	SANTA RITA DO ARAGUAIA	SU12202817	SANTA RITA DO ARAGUAIA	12/10/2020 07:20	13/10/2020 08:26	12/10/2020 07:20	13/10/2020 08:26	25,10	1	25,10	CHI
20201057608	NOVO BRASIL	1460002389	JUSSARA	12/10/2020 07:20	13/10/2020 11:17	12/10/2020 07:20	13/10/2020 11:17	27,94	1	27,94	CHI
20201057610	RIO VERDE	630173035	RIO VERDE S1	12/10/2020 07:21	12/10/2020 12:39	12/10/2020 07:21	12/10/2020 12:39	5,30	1	5,30	CHI
20201057612	PORTO LINDIA	PW12301806	PARQUE DAS EMAS	12/10/2020 07:21	12/10/2020 17:01	12/10/2020 07:21	12/10/2020 17:01	9,67	5	48,33	CHI
20201057617	LUZIANIA	LZ12200111	VIANOPOLIS	12/10/2020 07:21	12/10/2020 16:23	12/10/2020 07:21	12/10/2020 16:23	9,02	11	99,26	CHI
20201057617	LUZIANIA	LZ12200111	VIANOPOLIS	12/10/2020 07:21	12/10/2020 16:23	12/10/2020 09:39	12/10/2020 16:23	6,74	9	60,62	CHI
20201057941	VICENTINOPOLIS	VI12218178	VICENTINOPOLIS	12/10/2020 07:22	12/10/2020 09:08	12/10/2020 07:22	12/10/2020 09:08	1,75	5	8,77	CHI
20201057624	MINEIROS	MY12385364	PARQUE DAS EMAS	12/10/2020 07:23	12/10/2020 17:20	12/10/2020 07:23	12/10/2020 17:20	9,95	1	9,95	CHI
20201057627	BOM JARDIM DE GOIAS	1880032883	BOM JARDIM	12/10/2020 07:23	12/10/2020 08:48	12/10/2020 07:23	12/10/2020 08:48	1,41	1	1,41	CHI
20201058215	MONTIVIDIU DO NORTE	MX12192265	PORANGATU	12/10/2020 07:24	12/10/2020 11:39	12/10/2020 07:24	12/10/2020 11:39	4,25	65	276,09	CHI
20201057634	FLORES DE GOIAS	FB21143271	IACIARA S2	12/10/2020 07:24	13/10/2020 00:50	12/10/2020 07:24	13/10/2020 00:50	17,42	1	17,42	CHI
20201057635	GOIANIA	12024089	REAL S1	12/10/2020 07:24	12/10/2020 10:57	12/10/2020 07:24	12/10/2020 10:57	3,54	1	3,54	CHI
20201057643	CHAPADAO DO CEU	DJ21131948	CHAPADAO DO CEU	12/10/2020 07:26	12/10/2020 18:10	12/10/2020 07:26	12/10/2020 18:10	10,73	1	10,73	CHI
20201057649	JATAI	JT12013872LD	JATAI S2	12/10/2020 07:27	12/10/2020 12:20	12/10/2020 07:27	12/10/2020 12:20	4,87	1	4,87	CHI
20201057655	INHUMAS	IN21152035	INHUMAS S1	12/10/2020 07:28	12/10/2020 09:23	12/10/2020 07:28	12/10/2020 09:23	1,91	1	1,91	CHI
20201057983	URUACU	UR12245232RE	URUACU	12/10/2020 07:28	12/10/2020 10:11	12/10/2020 07:28	12/10/2020 10:11	2,71	9	24,38	CHI
20201057658	GOIANIA	10024920361	GOYA S2	12/10/2020 07:28	12/10/2020 09:23	12/10/2020 07:28	12/10/2020 09:23	1,90	1	1,90	CHI
20201057660	APARECIDA DE GOIANIA	14732440	REAL S1	12/10/2020 07:29	12/10/2020 09:49	12/10/2020 07:29	12/10/2020 09:49	2,33	1	2,33	CHI
20201057664	GOIANIA	10922088	GOIANIA LESTE S2	12/10/2020 07:29	12/10/2020 10:20	12/10/2020 07:29	12/10/2020 10:20	2,83	1	2,83	CHI
20201057942	SANTA RITA DO ARAGUAIA	SU11148197	SANTA RITA DO ARAGUAIA	12/10/2020 07:30	12/10/2020 11:12	12/10/2020 07:30	12/10/2020 11:12	3,70	159	587,68	CHI
20201057288	CORUMBA DE GOIAS	CB21146773	CORUMBA	12/10/2020 07:30	12/10/2020 09:58	12/10/2020 07:30	12/10/2020 09:58	2,46	3	7,38	CHI
20201060415	FORMOSA	FA12213620	SAO JOAO D ALIANCA	12/10/2020 07:31	13/10/2020 02:42	12/10/2020 07:31	13/10/2020 02:42	19,18	3	57,54	CHI
20201057677	FORMOSA	10023453972	ITUIQUIRA	12/10/2020 07:31	12/10/2020 12:21	12/10/2020 07:31	12/10/2020 12:21	4,83	1	4,83	CHI
20201056332	ABADIANIA	AA21406504	ANAPOLIS UNIVERSITARIO S1	12/10/2020 07:32	12/10/2020 14:06	12/10/2020 07:32	12/10/2020 14:06	6,56	1	6,56	CHI
20201057681	ALEXANIA	AX21302163	ALEXANIA	12/10/2020 07:32	12/10/2020 12:49	12/10/2020 07:32	12/10/2020 12:49	5,27	1	5,27	CHI
20201057682	GOIAS	GS12250574	GOIAS	12/10/2020 07:32	12/10/2020 10:52	12/10/2020 07:32	12/10/2020 10:52	3,32	8	26,57	CHI
20201057683	GOIANIA	GN12098425	CEPAIGO S1	12/10/2020 07:32	12/10/2020 11:03	12/10/2020 07:32	12/10/2020 11:03	3,50	126	441,39	CHI
20201059034	MINEIROS	MY21197242	PARQUE DAS EMAS	12/10/2020 07:33	12/10/2020 11:20	12/10/2020 07:33	12/10/2020 11:20	3,78	1	3,78	CHI
20201057692	SENADOR CANEDO	GN12214702	GOIANIA LESTE S3	12/10/2020 07:33	12/10/2020 09:43	12/10/2020 07:33	12/10/2020 09:43	2,15	7	15,08	CHI
20201057692	GOIANIA	GN12214702	GOIANIA LESTE S3	12/10/2020 07:33	12/10/2020 09:43	12/10/2020 07:33	12/10/2020 09:43	2,15	95	204,70	CHI
20201057693	SILVANIA	SV21187058	VIANOPOLIS	12/10/2020 07:33	12/10/2020 09:57	12/10/2020 07:33	12/10/2020 09:57	2,38	1	2,38	CHI
20201057695	ITAJA	IJ12370163	ITAJA S2	12/10/2020 07:34	12/10/2020 09:40	12/10/2020 07:34	12/10/2020 09:40	2,09	1	2,09	CHI
20201057699	PORANGATU	PO21012475	PORANGATU	12/10/2020 07:34	12/10/2020 11:16	12/10/2020 07:34	12/10/2020 11:16	3,69	1	3,69	CHI
20201057701	MINEIROS	MY21126518	PARQUE DAS EMAS	12/10/2020 07:34	12/10/2020 15:49	12/10/2020 07:34	12/10/2020 15:49	8,24	1	8,24	CHI
20201057710	SANTA RITA DO ARAGUAIA	SU12184124	SANTA RITA DO ARAGUAIA	12/10/2020 07:35	13/10/2020 13:08	12/10/2020 07:35	13/10/2020 13:08	29,54	1	29,54	CHI
20201057715	GOIANIA	14701960	MEIA PONTE	12/10/2020 07:36	12/10/2020 10:45	12/10/2020 07:36	12/10/2020 10:45	3,14	1	3,14	CHI
20201057720	GOIANIA	14389617	XAVANTES	12/10/2020 07:37	12/10/2020 10:40	12/10/2020 07:37	12/10/2020 10:40	3,05	1	3,05	CHI
20201058087	BELA VISTA DE GOIAS	BV12000039	BELA VISTA S1	12/10/2020 07:37	12/10/2020 17:24	12/10/2020 07:37	12/10/2020 17:07	9,51	4	38,04	CHI
20201058087	BELA VISTA DE GOIAS	BV12000039	BELA VISTA S1	12/10/2020 07:37	12/10/2020 17:24	12/10/2020 07:37	12/10/2020 17:24	9,78	4	39,14	CHI
20201057725	FORMOSA	FA11236410	ITUIQUIRA	12/10/2020 07:37	12/10/2020 17:55	12/10/2020 07:37	12/10/2020 17:55	10,29	1	10,29	CHI
20201057726	NOVO GAMA	2460019653	PACAEMBU S1	12/10/2020 07:37	12/10/2020 12:24	12/10/2020 07:37	12/10/2020 12:24	4,77	1	4,77	CHI
20201057727	JUSSARA	JR21148862	JUSSARA	12/10/2020 07:37	12/10/2020 14:30	12/10/2020 07:37	12/10/2020 14:30	6,87	2	13,73	CHI
20201057730	ARAGUAPAZ	AZ12210554	MOZARLANDIA	12/10/2020 07:38	12/10/2020 11:46	12/10/2020 07:38	12/10/2020 11:46	4,13	2	8,26	CHI
20201057779	SENADOR CANEDO	SW12079057	CEPAIGO S2	12/10/2020 07:38	12/10/2020 10:24	12/10/2020 07:38	12/10/2020 10:24	2,76	119	328,54	CHI
20201057749	GOIANIA	GN11051623	GOYA S1	12/10/2020 07:39	12/10/2020 11:26	12/10/2020 07:39	12/10/2020 11:26	3,78	5	18,91	CHI
20201057754	SILVANIA	SV21066024	DAIA S2	12/10/2020 07:39	12/10/2020 09:48	12/10/2020 07:39	12/10/2020 09:48	2,14	1	2,14	CHI
20201057756	NOVO BRASIL	NB21376303	MATRINCHA	12/10/2020 07:40	12/10/2020 16:49	12/10/2020 07:40	12/10/2020 16:49	9,15	1	9,15	CHI
20201057758	CABECEIRAS	CW12042593LD	ITUIQUIRA	12/10/2020 07:40	12/10/2020 17:14	12/10/2020 07:40	12/10/2020 17:14	9,55	233	2225,80	CHI

20201057767	PADRE BERNARDO	PB12163212	PADRE BERNARDO	12/10/2020 07:42	12/10/2020 11:06	12/10/2020 07:42	12/10/2020 11:06	3,39	30	101,84	CHI
20201057946	FORMOSO	FO12185313	PORANGATU	12/10/2020 07:42	12/10/2020 09:26	12/10/2020 07:42	12/10/2020 09:26	1,72	10	17,22	CHI
20201057780	PARANAIGUARA	PC21100295	CACHOEIRA ALTA	12/10/2020 07:43	12/10/2020 16:47	12/10/2020 07:43	12/10/2020 16:47	9,06	1	9,06	CHI
20201057916	ABADIANA	SV12158398	ANAPOLIS UNIVERSITARIO S1	12/10/2020 07:43	12/10/2020 15:00	12/10/2020 07:43	12/10/2020 15:00	7,27	5	36,35	CHI
20201057916	GAMELEIRA DE GOIAS	SV12158398	ANAPOLIS UNIVERSITARIO S1	12/10/2020 07:43	12/10/2020 15:00	12/10/2020 07:43	12/10/2020 15:00	7,27	6	43,62	CHI
20201060119	PILAR DE GOIAS	GG12166527	SANTA TEREZINHA	12/10/2020 07:44	12/10/2020 16:37	12/10/2020 07:44	12/10/2020 16:37	8,88	13	115,45	CHI
20201060119	SANTA TEREZINHA DE GOIAS	GG12166527	SANTA TEREZINHA	12/10/2020 07:44	12/10/2020 16:37	12/10/2020 07:44	12/10/2020 16:37	8,88	8	71,05	CHI
20201057860	VICENTINOPOLIS	CL12230806RE	RIO DOS BOIS	12/10/2020 07:45	12/10/2020 10:49	12/10/2020 07:45	12/10/2020 10:49	3,06	4	12,23	CHI
20201057860	PORTEIRAO	CL12230806RE	RIO DOS BOIS	12/10/2020 07:45	12/10/2020 10:49	12/10/2020 07:45	12/10/2020 10:49	3,06	4	12,23	CHI
20201057860	EDEIA	CL12230806RE	RIO DOS BOIS	12/10/2020 07:45	12/10/2020 10:49	12/10/2020 07:45	12/10/2020 10:49	3,06	2	6,12	CHI
20201057791	CORREGO DO OURO	CO21000005	FIRMINOPOLIS S2	12/10/2020 07:45	13/10/2020 09:03	12/10/2020 07:45	13/10/2020 09:03	25,29	2	50,57	CHI
20201057796	SANCLERLANDIA	SC21299154	FIRMINOPOLIS S2	12/10/2020 07:46	14/10/2020 04:05	12/10/2020 07:46	14/10/2020 04:05	44,31	1	44,31	CHI
20201057797	COCALZINHO DE GOIAS	CB12394345	COCALZINHO	12/10/2020 07:46	12/10/2020 11:43	12/10/2020 07:46	12/10/2020 11:43	3,94	2	7,89	CHI
20201057797	CORUMBA DE GOIAS	CB12394345	COCALZINHO	12/10/2020 07:46	12/10/2020 11:43	12/10/2020 07:46	12/10/2020 11:43	3,94	12	47,33	CHI
20201057800	SANTA ROSA DE GOIAS	SR21154966	INHUMAS S2	12/10/2020 07:46	12/10/2020 12:29	12/10/2020 07:46	12/10/2020 12:29	4,71	1	4,71	CHI
20201057810	CHAPADAO DO CEU	9880016706	CHAPADAO DO CEU	12/10/2020 07:47	13/10/2020 06:55	12/10/2020 07:47	13/10/2020 06:55	23,12	1	23,12	CHI
20201057816	GOIANIA	13770329	FERROVIARIO S1	12/10/2020 07:48	12/10/2020 09:49	12/10/2020 07:48	12/10/2020 09:49	2,01	1	2,01	CHI
20201057817	ITABERAI	IB21353074	ITABERAI S2	12/10/2020 07:48	12/10/2020 13:44	12/10/2020 07:48	12/10/2020 13:44	5,93	1	5,93	CHI
20201057822	GOIANIA	14348263	GOYA S2	12/10/2020 07:48	12/10/2020 08:57	12/10/2020 07:48	12/10/2020 08:57	1,14	1	1,14	CHI
20201057823	GOIANIA	10955240	FERROVIARIO S1	12/10/2020 07:48	12/10/2020 11:22	12/10/2020 07:48	12/10/2020 11:22	3,56	1	3,56	CHI
20201058018	ANICUNS	AC21278671	FIRMINOPOLIS S2	12/10/2020 07:48	12/10/2020 11:21	12/10/2020 07:48	12/10/2020 11:21	3,54	1	3,54	CHI
20201057827	GOIANIA	GN21347769	CAMPINAS S2	12/10/2020 07:49	12/10/2020 11:55	12/10/2020 07:49	12/10/2020 11:55	4,10	2	8,20	CHI
20201058505	SANTA RITA DO ARAGUAIA	SU12306507RE	SANTA RITA DO ARAGUAIA	12/10/2020 07:50	12/10/2020 15:07	12/10/2020 07:50	12/10/2020 15:07	7,28	15	109,24	CHI
20201057833	LUZIANIA	120344683	RIO VERMELHO	12/10/2020 07:50	12/10/2020 12:36	12/10/2020 07:50	12/10/2020 12:36	4,77	1	4,77	CHI
20201057834	PORANGATU	PO21208395	PORANGATU	12/10/2020 07:50	12/10/2020 09:36	12/10/2020 07:50	12/10/2020 09:36	1,76	1	1,76	CHI
20201057835	QUIRINOPOLIS	QI11341060	QUIRINOPOLIS	12/10/2020 07:50	12/10/2020 09:15	12/10/2020 07:50	12/10/2020 09:15	1,41	27	38,09	CHI
20201057837	ITAPIRAPUA	IU12207279	MATRINCHA	12/10/2020 07:50	12/10/2020 23:14	12/10/2020 07:50	12/10/2020 23:14	15,39	1	15,39	CHI
20201058453	ITAPACI	IW12243655	ITAPACI	12/10/2020 07:51	12/10/2020 15:09	12/10/2020 07:51	12/10/2020 15:09	7,30	3	21,89	CHI
20201057839	GOIANIA	10004709126	CARAJAS S1	12/10/2020 07:51	12/10/2020 10:04	12/10/2020 07:51	12/10/2020 10:04	2,21	1	2,21	CHI
20201057841	SERRANOPOLIS	SX21264459	JATAI S1	12/10/2020 07:51	12/10/2020 12:39	12/10/2020 07:51	12/10/2020 12:39	4,79	1	4,79	CHI
20201057851	PALMEIRAS DE GOIAS	PL21126211	PALMEIRAS	12/10/2020 07:52	12/10/2020 09:30	12/10/2020 07:52	12/10/2020 09:30	1,63	1	1,63	CHI
20201057865	GOIANIA	14709168	REAL S2	12/10/2020 07:53	12/10/2020 09:19	12/10/2020 07:53	12/10/2020 09:19	1,42	1	1,42	CHI
20201057866	GOIANIA	13181762	XAVANTES	12/10/2020 07:53	12/10/2020 09:30	12/10/2020 07:53	12/10/2020 09:30	1,61	1	1,61	CHI
20201057867	URUACU	640027519	URUACU	12/10/2020 07:53	12/10/2020 15:57	12/10/2020 07:53	12/10/2020 15:57	8,06	1	8,06	CHI
20201058100	FORMOSA	FA12357434	SAO JOAO D ALIANCA	12/10/2020 07:54	12/10/2020 11:53	12/10/2020 07:54	12/10/2020 11:53	3,98	5	19,88	CHI
20201057878	RIO VERDE	RV21020019	CABRIUVA S2	12/10/2020 07:54	12/10/2020 09:43	12/10/2020 07:54	12/10/2020 09:43	1,81	1	1,81	CHI
20201058799	ITAJA	IJ12086739	ITAJA S2	12/10/2020 07:54	12/10/2020 10:47	12/10/2020 07:54	12/10/2020 10:47	2,87	2	5,75	CHI
20201058380	GOIANESIA	GE12221555	GOIANESIA S2	12/10/2020 07:55	12/10/2020 15:05	12/10/2020 07:55	12/10/2020 15:05	7,17	755	5409,78	CHI
20201057883	GOIANIA	17289750	GOYA S1	12/10/2020 07:55	12/10/2020 10:37	12/10/2020 07:55	12/10/2020 10:37	2,69	1	2,69	CHI
20201058180	PADRE BERNARDO	PB12382941	PADRE BERNARDO	12/10/2020 07:56	12/10/2020 14:07	12/10/2020 07:56	12/10/2020 14:07	6,18	3	18,54	CHI
20201057886	AGUA FRIA DE GOIAS	TL21211516	SAO JOAO D ALIANCA	12/10/2020 07:56	12/10/2020 13:03	12/10/2020 07:56	12/10/2020 13:03	5,11	1	5,11	CHI
20201057887	ITABERAI	50028315	ITABERAI S2	12/10/2020 07:56	12/10/2020 10:35	12/10/2020 07:56	12/10/2020 10:35	2,64	1	2,64	CHI
20201058830	BELA VISTA DE GOIAS	BV12249988	BELA VISTA S2	12/10/2020 07:57	12/10/2020 12:33	12/10/2020 07:57	12/10/2020 12:33	4,60	20	91,92	CHI
20201057897	CRISTALINA	KR21133635	CRISTALINA S2	12/10/2020 07:57	12/10/2020 11:30	12/10/2020 07:57	12/10/2020 11:30	3,54	1	3,54	CHI
20201057899	GOIANIA	10006537853	GOYA S1	12/10/2020 07:57	12/10/2020 14:01	12/10/2020 07:57	12/10/2020 14:01	6,05	1	6,05	CHI
20201057903	PIRENOPOLIS	PV21194533	SAO FRANCISCO DE GOIAS	12/10/2020 07:58	12/10/2020 08:22	12/10/2020 07:58	12/10/2020 08:22	0,40	2	0,79	CHI
20201057909	BELA VISTA DE GOIAS	240022580	BELA VISTA S1	12/10/2020 07:59	12/10/2020 10:09	12/10/2020 07:59	12/10/2020 10:09	2,16	1	2,16	CHI
20201057918	SILVANIA	SV21320383	VIANOPOLIS	12/10/2020 08:00	12/10/2020 10:27	12/10/2020 08:00	12/10/2020 10:27	2,45	3	7,34	CHI
20201058203	CRISTALINA	KR12160258	CRISTALINA S2	12/10/2020 08:00	12/10/2020 14:39	12/10/2020 08:00	12/10/2020 14:39	6,64	2	13,28	CHI
20201059333	SANCLERLANDIA	SC12206497	FIRMINOPOLIS S2	12/10/2020 08:00	12/10/2020 15:25	12/10/2020 08:00	12/10/2020 15:25	7,41	76	563,08	CHI
20201059333	MOSSAMEDES	SC12206497	FIRMINOPOLIS S2	12/10/2020 08:00	12/10/2020 15:25	12/10/2020 08:00	12/10/2020 15:25	7,41	3	22,23	CHI
20201057923	PLANALTINA	PI12105578	PLANALTINA	12/10/2020 08:00	12/10/2020 15:53	12/10/2020 08:00	12/10/2020 15:53	7,87	11	86,60	CHI
20201057925	GOIANIA	14328800	CARAJAS S2	12/10/2020 08:00	12/10/2020 09:42	12/10/2020 08:00	12/10/2020 09:42	1,69	1	1,69	CHI
20201057927	BURITINOPOLIS	MB21128060	IACIARA S2	12/10/2020 08:01	12/10/2020 10:49	12/10/2020 08:01	12/10/2020 10:49	2,80	3	8,39	CHI
20201057928	GOIANIA	GN12096079	GOYA S2	12/10/2020 08:01	12/10/2020 13:56	12/10/2020 08:01	12/10/2020 13:56	5,93	152	900,77	CHI
20201057928	GOIANIA	GN12096079	GOYA S2	12/10/2020 08:01	12/10/2020 13:56	12/10/2020 08:01	12/10/2020 13:56	5,93	152	900,77	CHI
20201057996	FORMOSA	FA12322723	ITUIQUIRA	12/10/2020 08:01	12/10/2020 11:23	12/10/2020 08:01	12/10/2020 11:23	3,36	26	87,32	CHI
20201057932	PARANAIGUARA	PC12000086	QUIRINOPOLIS	12/10/2020 08:01	12/10/2020 11:06	12/10/2020 08:01	12/10/2020 11:06	3,07	2	6,14	CHI

20201057934	SAO LUIS DE MONTES BELOS	SL21180347	SAO LUIZ DOS MONTES BELOS	12/10/2020 08:02	12/10/2020 11:47	12/10/2020 08:02	12/10/2020 11:47	3,75	1	3,75	CHI
20201058930	TRINDADE	TR11000034	TRINDADE	12/10/2020 08:02	12/10/2020 10:39	12/10/2020 08:02	12/10/2020 10:39	2,61	123	321,34	CHI
20201057936	URUACU	640038384	URUACU	12/10/2020 08:02	12/10/2020 09:28	12/10/2020 08:02	12/10/2020 09:28	1,43	1	1,43	CHI
20201057940	GOIANIA	11663420	ATLANTICO S2	12/10/2020 08:03	12/10/2020 10:21	12/10/2020 08:03	12/10/2020 10:21	2,29	1	2,29	CHI
20201057948	ITUMBIARA	IT21409285	PARANAIBA	12/10/2020 08:04	12/10/2020 09:28	12/10/2020 08:04	12/10/2020 09:28	1,39	1	1,39	CHI
20201058105	PLANALTINA	PI12117128	SAO JOAO D ALIANCA	12/10/2020 08:04	12/10/2020 10:47	12/10/2020 08:04	12/10/2020 10:47	2,70	9	24,33	CHI
20201059754	PLANALTINA	PI12359115	SAO JOAO D ALIANCA	12/10/2020 08:05	12/10/2020 22:14	12/10/2020 08:05	12/10/2020 22:14	14,15	6	84,90	CHI
20201059377	VILA PROPICIO	NP12228397	GOIANESIA S1	12/10/2020 08:05	12/10/2020 19:35	12/10/2020 08:05	12/10/2020 19:35	11,50	3	34,49	CHI
20201060223	GOIAS	GS12206789	GOIAS	12/10/2020 08:05	12/10/2020 17:01	12/10/2020 08:05	12/10/2020 17:01	8,93	5	44,64	CHI
20201057957	AGUAS LINDAS DE GOIAS	LA12412179	AGUAS LINDAS DE GOIAS S1	12/10/2020 08:05	12/10/2020 12:19	12/10/2020 08:05	12/10/2020 12:19	4,23	1	4,23	CHI
20201058915	MINEIROS	MY13274099	PARQUE DAS EMAS	12/10/2020 08:05	12/10/2020 13:47	12/10/2020 08:05	12/10/2020 13:47	5,69	12	68,27	CHI
20201058915	MINEIROS	MY13274099	PARQUE DAS EMAS	12/10/2020 08:05	12/10/2020 13:47	12/10/2020 12:40	12/10/2020 13:47	1,10	79	87,27	CHI
20201057959	ANAPOLIS	20525485	ANAPOLIS UNIVERSITARIO S2	12/10/2020 08:06	12/10/2020 10:01	12/10/2020 08:06	12/10/2020 10:01	1,92	1	1,92	CHI
20201058088	PARANAIGUARA	PC12100499	QUIRINOPOLIS	12/10/2020 08:06	12/10/2020 12:59	12/10/2020 08:06	12/10/2020 12:59	4,88	1	4,88	CHI
20201058088	QUIRINOPOLIS	PC12100499	QUIRINOPOLIS	12/10/2020 08:06	12/10/2020 12:59	12/10/2020 08:06	12/10/2020 12:59	4,88	3	14,63	CHI
20201057966	GOIANIA	14450252	FERROVIARIO S2	12/10/2020 08:06	12/10/2020 09:24	12/10/2020 08:06	12/10/2020 09:24	1,29	1	1,29	CHI
20201057969	SENADOR CANEDO	190083487	SENADOR CANEDO	12/10/2020 08:07	12/10/2020 09:38	12/10/2020 08:07	12/10/2020 09:38	1,52	1	1,52	CHI
20201057974	LUZIANIA	LZ21313598	PAMPLONA	12/10/2020 08:07	12/10/2020 09:58	12/10/2020 08:07	12/10/2020 09:58	1,83	1	1,83	CHI
20201057975	LUZIANIA	LZ11149779	MARAJOARA	12/10/2020 08:08	12/10/2020 09:41	12/10/2020 08:08	12/10/2020 09:41	1,55	176	272,80	CHI
20201058300	MINEIROS	MY12348107	PARQUE DAS EMAS	12/10/2020 08:08	12/10/2020 10:42	12/10/2020 08:08	12/10/2020 10:42	2,56	11	28,17	CHI
20201057978	ALVORADA DO NORTE	AQ21159883	IACIARA S2	12/10/2020 08:08	12/10/2020 10:07	12/10/2020 08:08	12/10/2020 10:07	1,98	1	1,98	CHI
20201058384	ITAJA	IJ10352433	ITAJA S2	12/10/2020 08:11	12/10/2020 12:34	12/10/2020 08:11	12/10/2020 12:34	4,39	15	65,90	CHI
20201058000	PIRENOPOLIS	PV21172900	CORUMBA	12/10/2020 08:11	12/10/2020 10:01	12/10/2020 08:11	12/10/2020 10:01	1,83	2	3,65	CHI
20201058002	MINEIROS	MY12264536LD	PARQUE DAS EMAS	12/10/2020 08:11	12/10/2020 19:23	12/10/2020 08:11	12/10/2020 19:23	11,19	1	11,19	CHI
20201058005	CAMPESTRE DE GOIAS	GC12046108	TRINDADE	12/10/2020 08:11	12/10/2020 11:09	12/10/2020 08:11	12/10/2020 11:09	2,95	4	11,81	CHI
20201058007	SAO JOAO D ALIANCA	JL21106967	SAO JOAO D ALIANCA	12/10/2020 08:11	12/10/2020 12:35	12/10/2020 08:11	12/10/2020 12:35	4,39	1	4,39	CHI
20201058008	GOIANIA	10748921	CAMPINAS S1	12/10/2020 08:11	12/10/2020 09:15	12/10/2020 08:11	12/10/2020 09:15	1,05	1	1,05	CHI
20201058009	BELA VISTA DE GOIAS	BV31065594	BELA VISTA S1	12/10/2020 08:12	12/10/2020 12:09	12/10/2020 08:12	12/10/2020 12:09	3,95	1	3,95	CHI
20201058010	CAMPOS BELOS	CH21320565	SAO DOMINGOS	12/10/2020 08:12	12/10/2020 09:51	12/10/2020 08:12	12/10/2020 09:51	1,64	1	1,64	CHI
20201058011	SAO JOAO D ALIANCA	JL21266375	ITUIQUIRA	12/10/2020 08:12	12/10/2020 20:01	12/10/2020 08:12	12/10/2020 20:01	11,81	1	11,81	CHI
20201058016	AURILANDIA	AI12383536	FIRMINOPOLIS S2	12/10/2020 08:13	12/10/2020 12:10	12/10/2020 08:13	12/10/2020 12:10	3,95	3	11,84	CHI
20201059237	ANICUNS	AC21144856	FIRMINOPOLIS S2	12/10/2020 08:13	12/10/2020 11:38	12/10/2020 08:13	12/10/2020 11:38	3,41	1	3,41	CHI
20201058027	APARECIDA DE GOIANIA	10006594083	INDEPENDENCIA S1	12/10/2020 08:13	12/10/2020 10:35	12/10/2020 08:13	12/10/2020 10:35	2,35	1	2,35	CHI
20201058041	ITAUCU	IX11000012	INHUMAS S1	12/10/2020 08:14	12/10/2020 13:11	12/10/2020 08:14	12/10/2020 13:11	4,94	20	98,70	CHI
20201058045	COCALZINHO DE GOIAS	ZN12144220	COCALZINHO	12/10/2020 08:15	12/10/2020 12:23	12/10/2020 08:15	12/10/2020 12:23	4,13	1	4,13	CHI
20201058050	APARECIDA DE GOIANIA	200547434	INDEPENDENCIA S1	12/10/2020 08:15	12/10/2020 09:42	12/10/2020 08:15	12/10/2020 09:42	1,44	1	1,44	CHI
20201058051	GOIANIA	14706726	GOYA S2	12/10/2020 08:15	12/10/2020 09:54	12/10/2020 08:15	12/10/2020 09:54	1,63	1	1,63	CHI
20201058054	ANAPOLIS	10007298887	JUNDIAI S1	12/10/2020 08:16	12/10/2020 12:15	12/10/2020 08:16	12/10/2020 12:15	3,97	1	3,97	CHI
20201058056	GOIANIA	14577197	GOYA S2	12/10/2020 08:17	12/10/2020 12:49	12/10/2020 08:17	12/10/2020 12:49	4,53	1	4,53	CHI
20201058057	SAO JOAO D ALIANCA	10019443577	SAO JOAO D ALIANCA	12/10/2020 08:17	12/10/2020 13:03	12/10/2020 08:17	12/10/2020 13:03	4,76	1	4,76	CHI
20201058066	ANAPOLIS	AN21072950	DAIA S1	12/10/2020 08:19	12/10/2020 12:04	12/10/2020 08:19	12/10/2020 12:04	3,74	1	3,74	CHI
20201058068	GOIANIA	14016205	CARAJAS S1	12/10/2020 08:19	12/10/2020 09:35	12/10/2020 08:19	12/10/2020 09:35	1,25	1	1,25	CHI
20201058069	SAO LUIZ DO NORTE	SZ21163029	ITAPACI	12/10/2020 08:19	12/10/2020 18:24	12/10/2020 08:19	12/10/2020 18:24	10,07	1	10,07	CHI
20201058071	NOVO GAMA	2460062819	PACAEMBU S1	12/10/2020 08:20	12/10/2020 11:19	12/10/2020 08:20	12/10/2020 11:19	2,98	1	2,98	CHI
20201058079	GOIANIA	14077371	CAMPINAS S2	12/10/2020 08:21	12/10/2020 09:56	12/10/2020 08:21	12/10/2020 09:56	1,57	1	1,57	CHI
20201058081	INHUMAS	30123318	INHUMAS S2	12/10/2020 08:22	12/10/2020 12:35	12/10/2020 08:22	12/10/2020 12:35	4,22	1	4,22	CHI
20201058086	GOIANIA	10000619556	XAVANTES	12/10/2020 08:22	12/10/2020 12:19	12/10/2020 08:22	12/10/2020 12:19	3,94	1	3,94	CHI
20201058430	ARAGARCAS	AG11000004	ARAGARCAS	12/10/2020 08:22	12/10/2020 10:46	12/10/2020 08:22	12/10/2020 10:46	2,39	112	267,21	CHI
20201059856	BARRO ALTO	BA12258276	GOIANESIA S1	12/10/2020 08:23	12/10/2020 13:32	12/10/2020 08:23	12/10/2020 13:32	5,15	14	72,07	CHI
20201059856	GOIANESIA	BA12258276	GOIANESIA S1	12/10/2020 08:23	12/10/2020 13:32	12/10/2020 08:23	12/10/2020 13:32	5,15	103	530,25	CHI
20201059856	VILA PROPICIO	BA12258276	GOIANESIA S1	12/10/2020 08:23	12/10/2020 13:32	12/10/2020 08:23	12/10/2020 13:32	5,15	11	56,63	CHI
20201059175	CORUMBA DE GOIAS	CB21191466	CORUMBA	12/10/2020 08:23	12/10/2020 13:18	12/10/2020 08:23	12/10/2020 13:18	4,91	3	14,74	CHI
20201058096	MINEIROS	MY12278361	PARQUE DAS EMAS	12/10/2020 08:23	13/10/2020 10:55	12/10/2020 08:23	13/10/2020 10:55	26,53	3	79,58	CHI
20201058681	MINEIROS	MY11241804	PARQUE DAS EMAS	12/10/2020 08:23	12/10/2020 13:50	12/10/2020 08:23	12/10/2020 13:50	5,44	78	424,43	CHI
20201058099	MINACU	IH12230499	MINACU	12/10/2020 08:23	12/10/2020 11:23	12/10/2020 08:23	12/10/2020 11:23	2,99	40	119,63	CHI
2020101200114	NOVA AMERICA	MZ10400739	RUBIATABA	12/10/2020 08:23	12/10/2020 08:49	12/10/2020 08:23	12/10/2020 08:27	0,07	197	13,02	CHI
2020101200114	NOVA CRIXAS	MZ10400739	RUBIATABA	12/10/2020 08:23	12/10/2020 08:49	12/10/2020 08:23	12/10/2020 08:27	0,07	1	0,07	CHI
2020101200114	CRIXAS	MZ10400739	RUBIATABA	12/10/2020 08:23	12/10/2020 08:49	12/10/2020 08:23	12/10/2020 08:27	0,07	588	38,87	CHI

2020101200114	MOZARLANDIA	MZ10400739	RUBIATABA	12/10/2020 08:23	12/10/2020 08:49	12/10/2020 08:23	12/10/2020 08:27	0,07	4	0,26	CHI
2020101200114	NOVA IGUACU DE GOIAS	MZ10400739	RUBIATABA	12/10/2020 08:23	12/10/2020 08:49	12/10/2020 08:23	12/10/2020 08:27	0,07	1	0,07	CHI
2020101200114	RUBIATABA	MZ10400739	RUBIATABA	12/10/2020 08:23	12/10/2020 08:49	12/10/2020 08:23	12/10/2020 08:27	0,07	8	0,53	CHI
2020101200114	ARAGUAPAZ	MZ10400739	RUBIATABA	12/10/2020 08:23	12/10/2020 08:49	12/10/2020 08:23	12/10/2020 08:27	0,07	104	6,88	CHI
2020101200114	CRIXAS	MS16427007	RUBIATABA	12/10/2020 08:23	12/10/2020 08:49	12/10/2020 08:23	12/10/2020 08:29	0,10	1	0,10	CHI
2020101200114	MORRO AGUDO DE GOIAS	MS16427007	RUBIATABA	12/10/2020 08:23	12/10/2020 08:49	12/10/2020 08:23	12/10/2020 08:29	0,10	3	0,29	CHI
2020101200114	NOVA AMERICA	MS16427007	RUBIATABA	12/10/2020 08:23	12/10/2020 08:49	12/10/2020 08:23	12/10/2020 08:29	0,10	23	2,25	CHI
2020101200114	RUBIATABA	MS16427007	RUBIATABA	12/10/2020 08:23	12/10/2020 08:49	12/10/2020 08:23	12/10/2020 08:29	0,10	3849	376,35	CHI
2020101200114	RUBIATABA	01635114	RUBIATABA	12/10/2020 08:23	12/10/2020 08:49	12/10/2020 08:23	12/10/2020 08:30	0,11	1	0,11	CHI
2020101200114	RUBIATABA	01635114	RUBIATABA	12/10/2020 08:23	12/10/2020 08:49	12/10/2020 08:23	12/10/2020 08:30	0,11	135	14,33	CHI
2020101200114	CERES	01635114	RUBIATABA	12/10/2020 08:23	12/10/2020 08:49	12/10/2020 08:23	12/10/2020 08:30	0,11	21	2,23	CHI
2020101200114	NOVA GLORIA	01635114	RUBIATABA	12/10/2020 08:23	12/10/2020 08:49	12/10/2020 08:23	12/10/2020 08:30	0,11	73	7,75	CHI
2020101200114	ITAPACI	01635114	RUBIATABA	12/10/2020 08:23	12/10/2020 08:49	12/10/2020 08:23	12/10/2020 08:30	0,11	10	1,06	CHI
2020101200114	IPIRANGA DE GOIAS	01635114	RUBIATABA	12/10/2020 08:23	12/10/2020 08:49	12/10/2020 08:23	12/10/2020 08:30	0,11	34	3,61	CHI
2020101200114	IPIRANGA DE GOIAS	01635114	RUBIATABA	12/10/2020 08:23	12/10/2020 08:49	12/10/2020 08:23	12/10/2020 08:32	0,15	3	0,45	CHI
2020101200114	CARMO DO RIO VERDE	01635114	RUBIATABA	12/10/2020 08:23	12/10/2020 08:49	12/10/2020 08:23	12/10/2020 08:32	0,15	3	0,45	CHI
2020101200114	SAO PATRICIO	01635114	RUBIATABA	12/10/2020 08:23	12/10/2020 08:49	12/10/2020 08:23	12/10/2020 08:32	0,15	20	2,99	CHI
2020101200114	RUBIATABA	01635114	RUBIATABA	12/10/2020 08:23	12/10/2020 08:49	12/10/2020 08:23	12/10/2020 08:32	0,15	4489	670,86	CHI
2020101200114	CERES	01635114	RUBIATABA	12/10/2020 08:23	12/10/2020 08:49	12/10/2020 08:23	12/10/2020 08:32	0,15	20	2,99	CHI
2020101200114	RUBIATABA	01635114	RUBIATABA	12/10/2020 08:23	12/10/2020 08:49	12/10/2020 08:23	12/10/2020 08:33	0,16	793	129,74	CHI
2020101200114	NOVA AMERICA	01635114	RUBIATABA	12/10/2020 08:23	12/10/2020 08:49	12/10/2020 08:23	12/10/2020 08:36	0,20	41	8,36	CHI
2020101200114	RUBIATABA	01635114	RUBIATABA	12/10/2020 08:23	12/10/2020 08:49	12/10/2020 08:23	12/10/2020 08:36	0,20	108	22,02	CHI
2020101200114	GUARINOS	01635114	RUBIATABA	12/10/2020 08:23	12/10/2020 08:49	12/10/2020 08:23	12/10/2020 08:49	0,43	11	4,76	CHI
2020101200114	CRIXAS	01635114	RUBIATABA	12/10/2020 08:23	12/10/2020 08:49	12/10/2020 08:23	12/10/2020 08:49	0,43	28	12,12	CHI
2020101200114	RUBIATABA	01635114	RUBIATABA	12/10/2020 08:23	12/10/2020 08:49	12/10/2020 08:23	12/10/2020 08:49	0,43	1	0,43	CHI
2020101200114	ITAPACI	01635114	RUBIATABA	12/10/2020 08:23	12/10/2020 08:49	12/10/2020 08:23	12/10/2020 08:49	0,43	152	65,78	CHI
2020101200114	NOVA AMERICA	01635114	RUBIATABA	12/10/2020 08:23	12/10/2020 08:49	12/10/2020 08:23	12/10/2020 08:49	0,43	825	357,04	CHI
2020101200114	NOVA AMERICA	NM10400420	RUBIATABA	12/10/2020 08:23	12/10/2020 08:49	12/10/2020 08:23	12/10/2020 08:49	0,43	1	0,43	CHI
20201058107	SANTA TEREZINHA DE GOIAS	2480017625	SANTA TEREZINHA	12/10/2020 08:24	12/10/2020 17:02	12/10/2020 08:24	12/10/2020 17:02	8,63	1	8,63	CHI
20201058108	GOIANIA	12137078	GOIANIA LESTE S2	12/10/2020 08:24	12/10/2020 10:12	12/10/2020 08:24	12/10/2020 10:12	1,79	1	1,79	CHI
20201058110	GOIANIA	13661991	ATLANTICO S1	12/10/2020 08:24	12/10/2020 10:19	12/10/2020 08:24	12/10/2020 10:19	1,91	1	1,91	CHI
20201058113	SAO JOAO D ALIANCA	JL12240222LD	SAO JOAO D ALIANCA	12/10/2020 08:25	12/10/2020 14:45	12/10/2020 08:25	12/10/2020 14:45	6,34	3	19,02	CHI
20201058113	SAO JOAO D ALIANCA	JL12240222LD	SAO JOAO D ALIANCA	12/10/2020 08:25	12/10/2020 14:45	12/10/2020 13:10	12/10/2020 14:45	1,58	11	17,38	CHI
20201058123	POSSE	PS21123499	IACIARA S2	12/10/2020 08:26	12/10/2020 09:47	12/10/2020 08:26	12/10/2020 09:47	1,34	1	1,34	CHI
20201058125	SAO MIGUEL DO ARAGUAIA	SM12262763	SAO MIGUEL DO ARAGUAIA	12/10/2020 08:26	12/10/2020 12:47	12/10/2020 08:26	12/10/2020 12:47	4,34	2	8,68	CHI
20201058127	MORRO AGUDO DE GOIAS	3690002975	ITAPURANGA	12/10/2020 08:26	12/10/2020 16:00	12/10/2020 08:26	12/10/2020 16:00	7,55	1	7,55	CHI
20201058130	ITABERAI	10000184169	ITABERAI S2	12/10/2020 08:26	12/10/2020 11:20	12/10/2020 08:26	12/10/2020 11:20	2,88	1	2,88	CHI
20201058132	GOIANIA	GN12265077	REAL S1	12/10/2020 08:27	12/10/2020 11:54	12/10/2020 08:27	12/10/2020 11:54	3,45	90	310,38	CHI
20201058138	BARRO ALTO	BA21345452	BARRO ALTO	12/10/2020 08:27	12/10/2020 12:23	12/10/2020 08:27	12/10/2020 12:23	3,92	2	7,84	CHI
20201058139	SANTA TEREZINHA DE GOIAS	SG21153352	SANTA TEREZINHA	12/10/2020 08:28	12/10/2020 16:01	12/10/2020 08:28	12/10/2020 16:01	7,54	1	7,54	CHI
20201058140	ALEXANIA	AX12388455	CORUMBA	12/10/2020 08:28	12/10/2020 14:26	12/10/2020 08:28	12/10/2020 14:26	5,95	1	5,95	CHI
20201058162	JARAGUA	70065561	JARAGUA	12/10/2020 08:29	12/10/2020 08:57	12/10/2020 08:29	12/10/2020 08:57	0,45	1	0,45	CHI
202010189412	FLORES DE GOIAS	FB12287910LD	IACIARA S2	12/10/2020 08:29	12/10/2020 13:16	12/10/2020 08:29	12/10/2020 13:16	4,77	4	19,08	CHI
20201058152	CRISTALINA	KR11276404	CRISTALINA S2	12/10/2020 08:29	12/10/2020 13:55	12/10/2020 08:29	12/10/2020 13:55	5,42	1	5,42	CHI
20201058154	BARRO ALTO	BA21064552	BARRO ALTO	12/10/2020 08:30	12/10/2020 18:17	12/10/2020 08:30	12/10/2020 18:17	9,78	1	9,78	CHI
20201058155	PADRE BERNARDO	2760050513	PADRE BERNARDO	12/10/2020 08:30	12/10/2020 13:16	12/10/2020 08:30	12/10/2020 13:16	4,77	1	4,77	CHI
20201058161	GOIANIA	14917040	XAVANTES	12/10/2020 08:30	12/10/2020 09:58	12/10/2020 08:30	12/10/2020 09:58	1,45	1	1,45	CHI
20201060658	MINEIROS	MY12322037	PARQUE DAS EMAS	12/10/2020 08:32	12/10/2020 17:49	12/10/2020 08:32	12/10/2020 17:49	9,27	2	18,55	CHI
20201058181	LUZIANIA	10019840371	MARAJOARA	12/10/2020 08:33	12/10/2020 10:49	12/10/2020 08:33	12/10/2020 10:49	2,26	1	2,26	CHI
20201058201	GOIANIA	15024015	GOYA S1	12/10/2020 08:34	12/10/2020 09:50	12/10/2020 08:34	12/10/2020 09:50	1,26	1	1,26	CHI
20201058497	CAMPINORTE	UR12074233RE	URUACU	12/10/2020 08:35	12/10/2020 12:12	12/10/2020 08:35	12/10/2020 12:12	3,61	22	79,41	CHI
20201058497	URUACU	UR12074233RE	URUACU	12/10/2020 08:35	12/10/2020 12:12	12/10/2020 08:35	12/10/2020 12:12	3,61	95	342,90	CHI
20201058212	RIO VERDE	10010771890	RIO VERDE S1	12/10/2020 08:35	12/10/2020 11:10	12/10/2020 08:35	12/10/2020 11:10	2,57	1	2,57	CHI
20201058218	ITAPIRAPUA	IU12209220	MATRINCHA	12/10/2020 08:36	12/10/2020 11:29	12/10/2020 08:36	12/10/2020 11:29	2,88	6	17,26	CHI
20201058219	PADRE BERNARDO	PB21377643	PADRE BERNARDO	12/10/2020 08:36	12/10/2020 16:20	12/10/2020 08:36	12/10/2020 16:20	7,72	1	7,72	CHI
20201058222	GOIANIA	11863950	CAMPINAS S2	12/10/2020 08:36	12/10/2020 10:34	12/10/2020 08:36	12/10/2020 10:34	1,95	1	1,95	CHI
20201058223	ITABERAI	IB12210492	ITABERAI S1	12/10/2020 08:37	12/10/2020 10:24	12/10/2020 08:37	12/10/2020 10:24	1,78	3	5,34	CHI
20201058226	ALVORADA DO NORTE	1510009003	IACIARA S2	12/10/2020 08:37	12/10/2020 15:48	12/10/2020 08:37	12/10/2020 15:48	7,17	1	7,17	CHI

20201058227	RIO VERDE	RV21345380	RIO VERDE S2	12/10/2020 08:37	12/10/2020 10:37	12/10/2020 08:37	12/10/2020 10:37	1,99	1	1,99	CHI
20201058228	SAO JOAO DA PARAUNA	1000010410	FIRMINOPOLIS S2	12/10/2020 08:37	12/10/2020 10:37	12/10/2020 08:37	12/10/2020 10:37	2,00	1	2,00	CHI
20201060213	SERRANOPOLIS	DJ12164065	CHAPADAO DO CEU	12/10/2020 08:37	13/10/2020 21:17	12/10/2020 08:37	13/10/2020 21:17	36,66	2	73,31	CHI
20201058235	BARRO ALTO	BA21353305	BARRO ALTO	12/10/2020 08:38	12/10/2020 19:39	12/10/2020 08:38	12/10/2020 19:39	11,01	1	11,01	CHI
20201058243	GOIANIA	17132230	GOIANIA LESTE S1	12/10/2020 08:39	12/10/2020 11:09	12/10/2020 08:39	12/10/2020 11:09	2,49	1	2,49	CHI
20201058245	MINEIROS	MY21301823	PARQUE DAS EMAS	12/10/2020 08:39	12/10/2020 10:54	12/10/2020 08:39	12/10/2020 10:54	2,24	1	2,24	CHI
20201058246	GOIANIA	13970641	MEIA PONTE	12/10/2020 08:39	12/10/2020 12:11	12/10/2020 08:39	12/10/2020 12:11	3,52	1	3,52	CHI
20201058247	SANTA RITA DO ARAGUAIA	SU21184157	SANTA RITA DO ARAGUAIA	12/10/2020 08:40	12/10/2020 20:29	12/10/2020 08:40	12/10/2020 20:29	11,81	1	11,81	CHI
20201058248	VALPARAISO DE GOIAS	3350021680	PACAEMBU S1	12/10/2020 08:40	12/10/2020 12:05	12/10/2020 08:40	12/10/2020 12:05	3,41	1	3,41	CHI
20201058249	IACIARA	1550023047	IACIARA S1	12/10/2020 08:40	12/10/2020 12:13	12/10/2020 08:40	12/10/2020 12:13	3,54	1	3,54	CHI
20201058683	MAMBAI	BQ12194634	IACIARA S2	12/10/2020 08:41	12/10/2020 10:04	12/10/2020 08:41	12/10/2020 10:04	1,38	1	1,38	CHI
20201058683	BURITINOPOLIS	BQ12194634	IACIARA S2	12/10/2020 08:41	12/10/2020 10:04	12/10/2020 08:41	12/10/2020 10:04	1,38	51	70,49	CHI
20201058255	SAO LUIZ DO NORTE	SZ12356538	ITAPACI	12/10/2020 08:41	12/10/2020 21:14	12/10/2020 08:41	12/10/2020 21:14	12,55	5	62,74	CHI
20201058257	GOIANIA	11693800	CAMPINAS S2	12/10/2020 08:41	12/10/2020 11:41	12/10/2020 08:41	12/10/2020 11:41	2,99	1	2,99	CHI
20201058258	MINEIROS	MY12193782	PARQUE DAS EMAS	12/10/2020 08:41	12/10/2020 19:50	12/10/2020 08:41	12/10/2020 19:50	11,14	5	55,71	CHI
20201058309	SERRANOPOLIS	SX12361089	JATAI S1	12/10/2020 08:41	12/10/2020 10:20	12/10/2020 08:41	12/10/2020 10:20	1,64	2	3,27	CHI
20201059062	CAMPINACU	UC12239716	PORANGATU	12/10/2020 08:43	12/10/2020 11:35	12/10/2020 08:43	12/10/2020 11:35	2,85	35	99,92	CHI
20201059720	FLORES DE GOIAS	FB11315830	FLORES DE GOIAS	12/10/2020 08:43	13/10/2020 02:46	12/10/2020 08:43	13/10/2020 02:46	18,04	36	649,34	CHI
20201058278	ITUMBIARA	IT121273963	PARANAIBA	12/10/2020 08:43	12/10/2020 09:54	12/10/2020 08:43	12/10/2020 09:54	1,17	1	1,17	CHI
20201058283	APARECIDA DE GOIANIA	200135326	INDEPENDENCIA S2	12/10/2020 08:44	12/10/2020 10:52	12/10/2020 08:44	12/10/2020 10:52	2,13	1	2,13	CHI
20201058284	QUIRINOPOLIS	10003713332	QUIRINOPOLIS	12/10/2020 08:44	12/10/2020 10:24	12/10/2020 08:44	12/10/2020 10:24	1,66	1	1,66	CHI
20201058286	CAMPOS VERDES	3790033970	SANTA TEREZINHA	12/10/2020 08:44	12/10/2020 21:04	12/10/2020 08:44	12/10/2020 21:04	12,32	1	12,32	CHI
20201058298	SANTO ANTONIO DE GOIAS	GR12033366	NEROPOLIS S1	12/10/2020 08:45	12/10/2020 10:15	12/10/2020 08:45	12/10/2020 10:15	1,49	1	1,49	CHI
20201058299	BRAZABRANTES	BR12011938	NEROPOLIS S1	12/10/2020 08:45	12/10/2020 11:07	12/10/2020 08:45	12/10/2020 11:07	2,35	5	11,76	CHI
20201058304	ITAPURANGA	170041682	ITAPURANGA	12/10/2020 08:46	12/10/2020 10:22	12/10/2020 08:46	12/10/2020 10:22	1,59	1	1,59	CHI
20201058306	ALEXANIA	480020097	ALEXANIA	12/10/2020 08:46	12/10/2020 12:59	12/10/2020 08:46	12/10/2020 12:59	4,21	1	4,21	CHI
20201058321	MORRINHOS	150174597	MORRINHOS	12/10/2020 08:47	12/10/2020 09:32	12/10/2020 08:47	12/10/2020 09:32	0,74	1	0,74	CHI
20201058328	GUARANI DE GOIAS	GY12271764	IACIARA S1	12/10/2020 08:48	12/10/2020 10:30	12/10/2020 08:48	12/10/2020 10:30	1,70	4	6,79	CHI
20201058332	POSSE	PS21264546	IACIARA S2	12/10/2020 08:48	12/10/2020 10:17	12/10/2020 08:48	12/10/2020 10:17	1,47	1	1,47	CHI
20201058338	NOVA ROMA	ND21257657	IACIARA S2	12/10/2020 08:49	12/10/2020 11:03	12/10/2020 08:49	12/10/2020 11:03	2,23	1	2,23	CHI
20201058339	JARAGUA	70063783	JARAGUA	12/10/2020 08:49	12/10/2020 14:00	12/10/2020 08:49	12/10/2020 14:00	5,18	1	5,18	CHI
20201058340	GOIANIA	12548650	ATLANTICO S3	12/10/2020 08:49	12/10/2020 10:12	12/10/2020 08:49	12/10/2020 10:12	1,38	1	1,38	CHI
20201058341	GOIANIA	14312785	GOYA S1	12/10/2020 08:49	12/10/2020 10:54	12/10/2020 08:49	12/10/2020 10:54	2,08	1	2,08	CHI
20201058352	JAUPACI	JP12358470	IPORA	12/10/2020 08:50	12/10/2020 10:43	12/10/2020 08:50	12/10/2020 10:43	1,88	7	13,13	CHI
20201058766	ALEXANIA	CB12295651	ALEXANIA	12/10/2020 08:50	12/10/2020 12:18	12/10/2020 08:50	12/10/2020 12:18	3,45	2	6,90	CHI
20201058766	CORUMBA DE GOIAS	CB12295651	ALEXANIA	12/10/2020 08:50	12/10/2020 12:18	12/10/2020 08:50	12/10/2020 12:18	3,45	9	31,07	CHI
20201058355	AGUA FRIA DE GOIAS	JL21164678	SAO JOAO D ALIANCA	12/10/2020 08:50	12/10/2020 14:14	12/10/2020 08:50	12/10/2020 14:14	5,38	1	5,38	CHI
20201058363	CRIXAS	CX12318761	RUBIATABA	12/10/2020 08:51	12/10/2020 13:33	12/10/2020 08:51	12/10/2020 13:33	4,69	6	28,15	CHI
20201058367	VIANOPOLIS	VN21105251	VIANOPOLIS	12/10/2020 08:51	12/10/2020 10:21	12/10/2020 08:51	12/10/2020 10:21	1,48	1	1,48	CHI
20201058369	BOM JESUS DE GOIAS	DM12303633LD	RIO DOS BOIS	12/10/2020 08:52	12/10/2020 23:42	12/10/2020 08:52	12/10/2020 23:42	14,84	7	103,91	CHI
20201058371	DAVINOPOLIS	OU21000006	CATALAO S1	12/10/2020 08:52	12/10/2020 11:24	12/10/2020 08:52	12/10/2020 11:24	2,53	2	5,06	CHI
20201058374	INHUMAS	IN31098256	INHUMAS S2	12/10/2020 08:52	12/10/2020 13:38	12/10/2020 08:52	12/10/2020 13:38	4,76	4	19,04	CHI
20201058377	SILVANIA	SV21146437	DAIA S2	12/10/2020 08:52	12/10/2020 11:13	12/10/2020 08:52	12/10/2020 11:13	2,34	1	2,34	CHI
20201058399	SÍTIO D ABADIA	SI12329755	IACIARA S2	12/10/2020 08:53	12/10/2020 14:03	12/10/2020 08:53	12/10/2020 14:03	5,16	11	56,81	CHI
20201058386	LUZIANIA	120203170	RIO VERMELHO	12/10/2020 08:53	12/10/2020 13:21	12/10/2020 08:53	12/10/2020 13:21	4,46	1	4,46	CHI
20201058392	GOIANIA	14672420	FERROVIARIO S1	12/10/2020 08:53	12/10/2020 10:37	12/10/2020 08:53	12/10/2020 10:37	1,72	1	1,72	CHI
20201059253	ITABERAI	IB12274525	ITABERAI S1	12/10/2020 08:54	12/10/2020 12:47	12/10/2020 08:54	12/10/2020 12:47	3,88	5	19,40	CHI
20201059672	RUBIATABA	RB12161662	RUBIATABA	12/10/2020 08:54	12/10/2020 17:21	12/10/2020 08:54	12/10/2020 17:21	8,44	32	270,21	CHI
20201059672	ITAPACI	RB12161662	RUBIATABA	12/10/2020 08:54	12/10/2020 17:21	12/10/2020 08:54	12/10/2020 17:21	8,44	10	84,44	CHI
20201058398	GOIANIA	10013033580	ATLANTICO S1	12/10/2020 08:54	12/10/2020 10:51	12/10/2020 08:54	12/10/2020 10:51	1,94	1	1,94	CHI
20201058401	MUTUNOPOLIS	MU11394518	MARA ROSA	12/10/2020 08:55	12/10/2020 13:19	12/10/2020 08:55	12/10/2020 13:19	4,40	1	4,40	CHI
20201058405	RIO VERDE	630059196	RIO VERDE S2	12/10/2020 08:55	12/10/2020 15:06	12/10/2020 08:55	12/10/2020 15:06	6,18	1	6,18	CHI
20201058406	PALMEIRAS DE GOIAS	PL12000239	PALMEIRAS	12/10/2020 08:55	12/10/2020 09:01	12/10/2020 08:55	12/10/2020 09:01	0,09	19	1,62	CHI
20201058910	PARAUNA	PU12301167	ACREUNA	12/10/2020 08:56	12/10/2020 11:10	12/10/2020 08:56	12/10/2020 11:10	2,22	15	33,37	CHI
20201058420	RIO VERDE	RV12098538	MONTIVIDIU T	12/10/2020 08:57	12/10/2020 12:21	12/10/2020 08:57	12/10/2020 12:21	3,40	1	3,40	CHI
20201058418	PARANAIGUARA	PC21204116	QUIRINOPOLIS	12/10/2020 08:57	12/10/2020 12:05	12/10/2020 08:57	12/10/2020 12:05	3,12	1	3,12	CHI
20201058421	MARA ROSA	2260020647	MARA ROSA	12/10/2020 08:57	12/10/2020 16:24	12/10/2020 08:57	12/10/2020 16:24	7,44	1	7,44	CHI
20201058423	GOIANIA	16608380	MEIA PONTE	12/10/2020 08:58	12/10/2020 15:01	12/10/2020 08:58	12/10/2020 15:01	6,05	1	6,05	CHI

202010189400	NIQUELANDIA	NQ10401438	NIQUELANDIA SUBTRANSMISSAO	12/10/2020 08:58	13/10/2020 01:41	12/10/2020 08:58	13/10/2020 01:41	16,71	72	1203,10	CHI
20201058432	PORANGATU	PO12285190	PORANGATU	12/10/2020 08:59	12/10/2020 12:17	12/10/2020 08:59	12/10/2020 12:17	3,31	4	13,24	CHI
20201058433	JATAI	JT21234350	JATAI S2	12/10/2020 08:59	12/10/2020 09:54	12/10/2020 08:59	12/10/2020 09:54	0,91	1	0,91	CHI
20201058436	CROMINIA	CQ21155500	PONTALINA	12/10/2020 08:59	12/10/2020 10:45	12/10/2020 08:59	12/10/2020 10:45	1,76	1	1,76	CHI
20201058437	RIO VERDE	RV12038461	MONTIVIDIU T	12/10/2020 08:59	12/10/2020 17:31	12/10/2020 08:59	12/10/2020 17:31	8,53	1	8,53	CHI
20201058438	CRIXAS	CX21278328	RUBIATABA	12/10/2020 09:00	12/10/2020 14:09	12/10/2020 09:00	12/10/2020 14:09	5,14	1	5,14	CHI
20201058598	TRINDADE	TR12161132	TRINDADE	12/10/2020 09:00	12/10/2020 10:05	12/10/2020 09:00	12/10/2020 10:05	1,08	421	453,04	CHI
20201058441	JESUPOLIS	SF21000150	SAO FRANCISCO DE GOIAS	12/10/2020 09:00	12/10/2020 16:30	12/10/2020 09:00	12/10/2020 16:30	7,49	1	7,49	CHI
20201058545	RUBIATABA	RB12187182	RUBIATABA	12/10/2020 09:00	12/10/2020 10:48	12/10/2020 09:00	12/10/2020 10:48	1,79	11	19,67	CHI
20201058470	ANAPOLIS	AN11000302	ANAPOLIS UNIVERSITARIO S2	12/10/2020 09:01	12/10/2020 11:05	12/10/2020 09:01	12/10/2020 11:05	2,08	140	291,36	CHI
20201058543	APORE	AE12059186	ITAJA S1	12/10/2020 09:02	12/10/2020 23:22	12/10/2020 09:02	12/10/2020 23:22	14,33	4	57,30	CHI
20201058458	GOIANIA	11152199	CAMPINAS S2	12/10/2020 09:02	12/10/2020 11:37	12/10/2020 09:02	12/10/2020 11:37	2,57	1	2,57	CHI
20201058975	CHAPADAO DO CEU	DJ12303888	CHAPADAO DO CEU	12/10/2020 09:02	13/10/2020 21:11	12/10/2020 09:02	13/10/2020 21:11	36,14	4	144,58	CHI
20201060631	CABECEIRAS	CW12218489	ITUIQUIRA	12/10/2020 09:02	12/10/2020 18:31	12/10/2020 09:02	12/10/2020 18:31	9,47	10	94,67	CHI
20201059399	MINEIROS	MY12070299	PARQUE DAS EMAS	12/10/2020 09:03	12/10/2020 13:09	12/10/2020 09:03	12/10/2020 13:09	4,09	28	114,41	CHI
20201058472	GOIANIA	GN12042170	GOIANIA LESTE S2	12/10/2020 09:03	12/10/2020 10:48	12/10/2020 09:03	12/10/2020 10:48	1,73	16	27,76	CHI
20201058481	POSSE	PS21195895	IACIARA S2	12/10/2020 09:04	12/10/2020 11:45	12/10/2020 09:04	12/10/2020 11:45	2,68	1	2,68	CHI
20201058483	CRISTALINA	7500989	PAMPLONA	12/10/2020 09:04	12/10/2020 14:10	12/10/2020 09:04	12/10/2020 14:10	5,10	1	5,10	CHI
20201058482	JATAI	JT21362998	JATAI S2	12/10/2020 09:04	12/10/2020 11:59	12/10/2020 09:04	12/10/2020 11:59	2,91	1	2,91	CHI
20201058485	PONTALINA	AD12108919	GOIATUBA S1	12/10/2020 09:04	12/10/2020 12:40	12/10/2020 09:04	12/10/2020 12:40	3,59	3	10,76	CHI
20201058485	ALOANDIA	AD12108919	GOIATUBA S1	12/10/2020 09:04	12/10/2020 12:40	12/10/2020 09:04	12/10/2020 12:40	3,59	11	39,44	CHI
20201058490	PIRACANJUBA	PJ21040795	BELA VISTA S1	12/10/2020 09:05	12/10/2020 15:18	12/10/2020 09:05	12/10/2020 15:18	6,21	1	6,21	CHI
20201058503	SAO LUIS DE MONTES BELOS	SL12021470	SAO LUIZ DOS MONTES BELOS	12/10/2020 09:06	12/10/2020 11:47	12/10/2020 09:06	12/10/2020 11:47	2,68	37	99,01	CHI
20201058510	VILA PROPICIO	PV21115146	GOIANESIA S1	12/10/2020 09:07	13/10/2020 09:08	12/10/2020 09:07	13/10/2020 09:08	24,02	1	24,02	CHI
20201058517	GOIANIA	11319008	XAVANTES	12/10/2020 09:07	12/10/2020 11:57	12/10/2020 09:07	12/10/2020 11:57	2,82	1	2,82	CHI
20201057395	GOIANIA	GN11193034	GOIANIA LESTE S2	12/10/2020 09:08	12/10/2020 11:59	12/10/2020 09:08	12/10/2020 11:59	2,85	76	216,60	CHI
20201058520	VARJAO	VJ31033335	GUAPO S2	12/10/2020 09:08	12/10/2020 10:16	12/10/2020 09:08	12/10/2020 10:16	1,13	3	3,40	CHI
20201058522	MINEIROS	MY21322104	PARQUE DAS EMAS	12/10/2020 09:08	12/10/2020 10:00	12/10/2020 09:08	12/10/2020 10:00	0,86	1	0,86	CHI
20201058531	ANAPOLIS	20853257	ANAPOLIS UNIVERSITARIO S2	12/10/2020 09:08	12/10/2020 10:52	12/10/2020 09:08	12/10/2020 10:52	1,72	1	1,72	CHI
20201058538	ITABERAI	IB12086200	ITABERAI S1	12/10/2020 09:09	12/10/2020 12:16	12/10/2020 09:09	12/10/2020 12:16	3,11	8	24,85	CHI
20201058863	ANAPOLIS	AN11264484	ANAPOLIS UNIVERSITARIO S2	12/10/2020 09:09	12/10/2020 11:09	12/10/2020 09:09	12/10/2020 11:09	1,99	65	129,22	CHI
20201058541	LUZIANIA	LZ12164807	CRISTALINA S2	12/10/2020 09:09	12/10/2020 11:22	12/10/2020 09:09	12/10/2020 11:22	2,20	2	4,41	CHI
20201058542	MORRINHOS	150104388	MORRINHOS	12/10/2020 09:09	12/10/2020 14:18	12/10/2020 09:09	12/10/2020 14:18	5,14	1	5,14	CHI
20201058548	GUARINOS	9210000218	SANTA TEREZINHA	12/10/2020 09:10	13/10/2020 11:42	12/10/2020 09:10	13/10/2020 11:42	26,52	1	26,52	CHI
20201058550	ARUANA	AK21016470	ARUANA	12/10/2020 09:10	12/10/2020 15:31	12/10/2020 09:10	12/10/2020 15:31	6,33	1	6,33	CHI
20201059088	BURITI DE GOIAS	CO12048391	FIRMINOPOLIS S2	12/10/2020 09:11	12/10/2020 14:40	12/10/2020 09:11	12/10/2020 14:40	5,47	28	153,14	CHI
20201058567	SILVANIA	SV12330380	DAIA S2	12/10/2020 09:13	12/10/2020 12:10	12/10/2020 09:13	12/10/2020 12:10	2,95	2	5,89	CHI
20201058577	ALEXANIA	AX12000108	CORUMBA	12/10/2020 09:14	12/10/2020 12:57	12/10/2020 09:14	12/10/2020 12:57	3,72	11	40,87	CHI
20201058577	CORUMBA DE GOIAS	AX12000108	CORUMBA	12/10/2020 09:14	12/10/2020 12:57	12/10/2020 09:14	12/10/2020 12:57	3,72	4	14,86	CHI
20201058595	CAMPO ALEGRE DE GOIAS	CM21073555	CAMPO ALEGRE DE GOIAS	12/10/2020 09:15	12/10/2020 11:17	12/10/2020 09:15	12/10/2020 11:17	2,02	1	2,02	CHI
20201058597	ITAJA	IJ21370169	CACHOEIRA ALTA	12/10/2020 09:16	13/10/2020 04:11	12/10/2020 09:16	13/10/2020 04:11	18,91	1	18,91	CHI
20201058599	PIRACANJUBA	240077611	BELA VISTA S1	12/10/2020 09:16	12/10/2020 16:20	12/10/2020 09:16	12/10/2020 16:20	7,06	1	7,06	CHI
20201058601	SANTO ANTONIO DE GOIAS	GR12002127	NEROPOLIS S1	12/10/2020 09:16	12/10/2020 12:15	12/10/2020 09:16	12/10/2020 12:15	2,97	1	2,97	CHI
20201056591	TROMBAS	TB12051886	PORANGATU	12/10/2020 09:17	12/10/2020 16:13	12/10/2020 09:17	12/10/2020 16:13	6,92	25	173,10	CHI
20201056591	FORMOSO	TB12051886	PORANGATU	12/10/2020 09:17	12/10/2020 16:13	12/10/2020 09:17	12/10/2020 16:13	6,92	2	13,85	CHI
20201058610	PALMEIRAS DE GOIAS	PL12000180	PALMEIRAS	12/10/2020 09:18	12/10/2020 16:38	12/10/2020 09:18	12/10/2020 16:38	7,33	1	7,33	CHI
20201058611	SAO LUIS DE MONTES BELOS	500004122	SAO LUIZ DOS MONTES BELOS	12/10/2020 09:18	12/10/2020 18:33	12/10/2020 09:18	12/10/2020 18:33	9,24	1	9,24	CHI
20201058613	GOIANIA	GN21066544	MEIA PONTE	12/10/2020 09:18	12/10/2020 11:00	12/10/2020 09:18	12/10/2020 11:00	1,69	1	1,69	CHI
20201058614	VALPARAISO DE GOIAS	VA12290858LD	PACAEMBU S1	12/10/2020 09:18	12/10/2020 14:35	12/10/2020 09:18	12/10/2020 14:35	5,28	24	126,70	CHI
20201058621	URUACU	CR21181432	CAMPINORTE	12/10/2020 09:18	12/10/2020 15:17	12/10/2020 09:18	12/10/2020 15:17	5,97	25	149,35	CHI
20201058738	MINEIROS	MY12241778	PARQUE DAS EMAS	12/10/2020 09:18	12/10/2020 12:20	12/10/2020 09:18	12/10/2020 12:20	3,02	12	36,28	CHI
20201058622	CALDAS NOVAS	CN11041899	SERRA DE CALDAS	12/10/2020 09:18	12/10/2020 10:37	12/10/2020 09:18	12/10/2020 10:37	1,30	140	182,47	CHI
20201058624	MINACU	IH21130494	MINACU	12/10/2020 09:18	12/10/2020 15:35	12/10/2020 09:18	12/10/2020 15:35	6,27	1	6,27	CHI
20201058629	MAURILANDIA	ML21306550	RIO DOS BOIS	12/10/2020 09:20	12/10/2020 12:04	12/10/2020 09:20	12/10/2020 12:04	2,72	2	5,44	CHI
20201058636	CORREGO DO OURO	CO12011431	FIRMINOPOLIS S2	12/10/2020 09:21	13/10/2020 08:53	12/10/2020 09:21	13/10/2020 08:53	23,53	1	23,53	CHI
20201058760	MINEIROS	MY12325793	PARQUE DAS EMAS	12/10/2020 09:21	12/10/2020 10:37	12/10/2020 09:21	12/10/2020 10:37	1,26	3	3,79	CHI
20201058945	SAO LUIS DE MONTES BELOS	SL32145763	SAO LUIZ DOS MONTES BELOS	12/10/2020 09:21	12/10/2020 14:29	12/10/2020 09:21	12/10/2020 14:29	5,12	3	15,37	CHI
20201058643	PIRACANJUBA	PJ31209198	BELA VISTA S1	12/10/2020 09:21	12/10/2020 10:59	12/10/2020 09:21	12/10/2020 10:59	1,62	1	1,62	CHI

20201058646	SANTA RITA DO ARAGUAIA	SU12184139	SANTA RITA DO ARAGUAIA	12/10/2020 09:22	13/10/2020 18:39	12/10/2020 09:22	13/10/2020 18:39	33,27	1	33,27	CHI
20201058649	ALVORADA DO NORTE	AQ21238726	IACIARA S2	12/10/2020 09:22	12/10/2020 10:29	12/10/2020 09:22	12/10/2020 10:29	1,10	1	1,10	CHI
20201058650	CAMPO ALEGRE DE GOIAS	CM12164124	CAMPO ALEGRE DE GOIAS	12/10/2020 09:23	12/10/2020 10:14	12/10/2020 09:23	12/10/2020 10:14	0,85	14	11,88	CHI
20201058652	ORIZONA	OZ12014690	VIANOPOLIS	12/10/2020 09:23	12/10/2020 10:24	12/10/2020 09:23	12/10/2020 10:24	1,01	2	2,02	CHI
20201058653	CORUMBA DE GOIAS	CB21317773	CORUMBA	12/10/2020 09:23	12/10/2020 18:47	12/10/2020 09:23	12/10/2020 18:47	9,39	1	9,39	CHI
20201058657	GOIANIA	10880653	GOIANIA LESTE S1	12/10/2020 09:24	12/10/2020 11:34	12/10/2020 09:24	12/10/2020 11:34	2,17	1	2,17	CHI
20201058661	LUZIANIA	LZ21153836	MARAJOARA	12/10/2020 09:25	12/10/2020 11:30	12/10/2020 09:25	12/10/2020 11:30	2,08	1	2,08	CHI
20201058663	NOVA CRIXAS	NA11229705	NOVA CRIXAS	12/10/2020 09:25	12/10/2020 12:09	12/10/2020 09:25	12/10/2020 12:09	2,72	1	2,72	CHI
20201059134	SANTA RITA DO ARAGUAIA	SU11271642	SANTA RITA DO ARAGUAIA	12/10/2020 09:27	12/10/2020 12:50	12/10/2020 09:27	12/10/2020 12:50	3,38	83	280,52	CHI
20201058669	INHUMAS	30099341	INHUMAS S2	12/10/2020 09:27	12/10/2020 11:02	12/10/2020 09:27	12/10/2020 11:02	1,57	1	1,57	CHI
20201058672	ALEXANIA	AX12377760	CORUMBA	12/10/2020 09:27	12/10/2020 18:28	12/10/2020 09:27	12/10/2020 18:28	9,02	1	9,02	CHI
20201058673	PADRE BERNARDO	PB21336702	PADRE BERNARDO	12/10/2020 09:28	12/10/2020 13:30	12/10/2020 09:28	12/10/2020 13:30	4,03	1	4,03	CHI
20201057385	MORRINHOS	MR13393854	MORRINHOS	12/10/2020 09:28	12/10/2020 14:17	12/10/2020 09:28	12/10/2020 14:17	4,82	7	33,73	CHI
20201058677	GOIANIA	14318945	XAVANTES	12/10/2020 09:28	12/10/2020 11:11	12/10/2020 09:28	12/10/2020 11:11	1,70	1	1,70	CHI
20201058678	URUACU	5940000415	URUACU	12/10/2020 09:28	12/10/2020 18:56	12/10/2020 09:28	12/10/2020 18:56	9,45	1	9,45	CHI
20201061416	CAMPINORTE	CR12028610	CAMPINORTE	12/10/2020 09:29	12/10/2020 21:23	12/10/2020 09:29	12/10/2020 21:23	11,90	2	23,80	CHI
20201058680	GOIANIA	11248737	GOIANIA LESTE S1	12/10/2020 09:29	12/10/2020 11:18	12/10/2020 09:29	12/10/2020 11:18	1,82	1	1,82	CHI
20201058685	CERES	RB12392307	RUBIATABA	12/10/2020 09:29	12/10/2020 13:11	12/10/2020 09:29	12/10/2020 13:11	3,69	10	36,86	CHI
20201058685	RUBIATABA	RB12392307	RUBIATABA	12/10/2020 09:29	12/10/2020 13:11	12/10/2020 09:29	12/10/2020 13:11	3,69	10	36,86	CHI
20201058688	VARJAO	940005748	GUAPO S2	12/10/2020 09:30	12/10/2020 15:44	12/10/2020 09:30	12/10/2020 15:44	6,23	1	6,23	CHI
20201058694	SILVANIA	SV21284545	DAIA S2	12/10/2020 09:31	12/10/2020 11:32	12/10/2020 09:31	12/10/2020 11:32	2,01	1	2,01	CHI
20201058696	ARAGOIANIA	AO21291612	GUAPO S2	12/10/2020 09:31	12/10/2020 11:53	12/10/2020 09:31	12/10/2020 11:53	2,36	2	4,72	CHI
20201058702	SANTA HELENA DE GOIAS	SH12271534LD	IPEGUARI	12/10/2020 09:32	12/10/2020 12:45	12/10/2020 09:32	12/10/2020 12:45	3,22	310	997,17	CHI
20201058712	GOIANIA	14867205	MEIA PONTE	12/10/2020 09:33	12/10/2020 14:01	12/10/2020 09:33	12/10/2020 14:01	4,46	1	4,46	CHI
20201058715	FORMOSA	610242763	ITUIQUIRA	12/10/2020 09:33	12/10/2020 20:27	12/10/2020 09:33	12/10/2020 20:27	10,90	1	10,90	CHI
20201058720	GUAPO	GA21000072	GUAPO S2	12/10/2020 09:34	12/10/2020 10:36	12/10/2020 09:34	12/10/2020 10:36	1,03	1	1,03	CHI
20201058724	ANAPOLIS	20170245	ANAPOLIS UNIVERSITARIO S2	12/10/2020 09:34	12/10/2020 11:22	12/10/2020 09:34	12/10/2020 11:22	1,79	1	1,79	CHI
20201059265	MINEIROS	MY11377571	PARQUE DAS EMAS	12/10/2020 09:35	12/10/2020 13:10	12/10/2020 09:35	12/10/2020 13:10	3,58	50	178,78	CHI
20201058900	QUIRINOPOLIS	QI12301528	QUIRINOPOLIS	12/10/2020 09:35	12/10/2020 11:33	12/10/2020 09:35	12/10/2020 11:33	1,96	6	11,74	CHI
20201058916	ANICUNS	AC11031057	ANICUNS	12/10/2020 09:36	12/10/2020 11:49	12/10/2020 09:36	12/10/2020 11:49	2,20	89	196,10	CHI
20201058740	ABADIANIA	AA21353241	ANAPOLIS UNIVERSITARIO S1	12/10/2020 09:36	12/10/2020 13:25	12/10/2020 09:36	12/10/2020 13:25	3,80	2	7,60	CHI
20201058743	ITUMBIARA	IT12296841	PARANAIBA	12/10/2020 09:37	12/10/2020 10:56	12/10/2020 09:37	12/10/2020 10:56	1,31	6	7,86	CHI
20201061121	MINEIROS	MY12166286RE	CHAPADAO DO CEU	12/10/2020 09:37	13/10/2020 22:15	12/10/2020 09:37	13/10/2020 22:15	36,63	6	219,76	CHI
20201061121	SERRANOPOLIS	MY12166286RE	CHAPADAO DO CEU	12/10/2020 09:37	13/10/2020 22:15	12/10/2020 09:37	13/10/2020 22:15	36,63	10	366,26	CHI
20201058759	BRITANIA	BT21101966	BRITANIA	12/10/2020 09:39	12/10/2020 18:23	12/10/2020 09:39	12/10/2020 18:23	8,72	1	8,72	CHI
20201058765	JATAI	JT12187731	JATAI S2	12/10/2020 09:40	13/10/2020 14:14	12/10/2020 09:40	13/10/2020 14:14	28,57	3	85,71	CHI
20201058769	RIO VERDE	RV21104911	RIO VERDE S1	12/10/2020 09:40	12/10/2020 17:39	12/10/2020 09:40	12/10/2020 17:39	7,97	1	7,97	CHI
20201058770	PLANALTINA	2960247500	PLANALTINA	12/10/2020 09:40	12/10/2020 18:28	12/10/2020 09:40	12/10/2020 18:28	8,78	1	8,78	CHI
20201058782	SAO JOAO D ALIANCA	JL12218655	SAO JOAO D ALIANCA	12/10/2020 09:41	12/10/2020 11:35	12/10/2020 09:41	12/10/2020 11:35	1,88	2	3,77	CHI
20201058781	GOIANIA	GN21000016	FERROVIARIO S3	12/10/2020 09:42	12/10/2020 14:51	12/10/2020 09:42	12/10/2020 14:51	5,15	1	5,15	CHI
20201058783	GOIANIA	13490850	REAL S1	12/10/2020 09:42	12/10/2020 11:48	12/10/2020 09:42	12/10/2020 11:48	2,10	1	2,10	CHI
20201058793	MINACU	IH11182998	MINACU	12/10/2020 09:42	12/10/2020 21:05	12/10/2020 09:42	12/10/2020 21:05	11,37	2	22,74	CHI
20201058792	PALMEIRAS DE GOIAS	PL12000270	PALMEIRAS	12/10/2020 09:42	12/10/2020 09:57	12/10/2020 09:42	12/10/2020 09:57	0,23	49	11,49	CHI
20201058795	VALPARAISO DE GOIAS	2860072348	PACAEMBU S2	12/10/2020 09:43	12/10/2020 17:50	12/10/2020 09:43	12/10/2020 17:50	8,12	1	8,12	CHI
20201058798	CABECEIRAS	CW21381539	ITUIQUIRA	12/10/2020 09:43	12/10/2020 14:11	12/10/2020 09:43	12/10/2020 14:11	4,46	2	8,92	CHI
20201058800	LEOPOLDO DE BULHOES	LB12321544	DAIA S2	12/10/2020 09:43	12/10/2020 12:26	12/10/2020 09:43	12/10/2020 12:26	2,71	2	5,41	CHI
20201058803	SANTO ANTONIO DE GOIAS	BW21133465	NEROPOLIS S1	12/10/2020 09:44	12/10/2020 11:36	12/10/2020 09:44	12/10/2020 11:36	1,86	1	1,86	CHI
20201058805	CORUMBA DE GOIAS	CB21312053	CORUMBA	12/10/2020 09:44	12/10/2020 19:29	12/10/2020 09:44	12/10/2020 19:29	9,74	1	9,74	CHI
20201058807	ANICUNS	910042342	ANICUNS	12/10/2020 09:44	12/10/2020 11:50	12/10/2020 09:44	12/10/2020 11:50	2,09	1	2,09	CHI
20201058809	BELA VISTA DE GOIAS	BV11207468	BELA VISTA S1	12/10/2020 09:45	12/10/2020 11:47	12/10/2020 09:45	12/10/2020 11:47	2,03	19	38,57	CHI
20201058823	PORANGATU	PO21137655	PORANGATU	12/10/2020 09:46	12/10/2020 10:31	12/10/2020 09:46	12/10/2020 10:31	0,73	1	0,73	CHI
20201058826	APARECIDA DE GOIANIA	200008791	INDEPENDENCIA S2	12/10/2020 09:47	12/10/2020 12:39	12/10/2020 09:47	12/10/2020 12:39	2,85	1	2,85	CHI
20201059196	ITAPIRAPUA	IU12378884	MATRINCHA	12/10/2020 09:48	12/10/2020 13:05	12/10/2020 09:48	12/10/2020 13:05	3,28	1	3,28	CHI
20201058831	QUIRINOPOLIS	QI31054864	QUIRINOPOLIS	12/10/2020 09:48	12/10/2020 23:15	12/10/2020 09:48	12/10/2020 23:15	13,44	1	13,44	CHI
20201060444	VILA PROPICIO	NP12327883	GOIANESIA S1	12/10/2020 09:48	13/10/2020 10:06	12/10/2020 09:48	13/10/2020 10:06	24,29	14	340,03	CHI
20201058834	PIRANHAS	PH21023561	PIRANHAS	12/10/2020 09:49	12/10/2020 11:37	12/10/2020 09:49	12/10/2020 11:37	1,80	1	1,80	CHI
20201058839	JATAI	JT21104652	JATAI S1	12/10/2020 09:49	12/10/2020 14:13	12/10/2020 09:49	12/10/2020 14:13	4,39	1	4,39	CHI
20201058841	ANAPOLIS	21262007	ANAPOLIS UNIVERSITARIO S1	12/10/2020 09:49	12/10/2020 12:27	12/10/2020 09:49	12/10/2020 12:27	2,62	1	2,62	CHI

20201058850	BALIZA	BH21253705	BOM JARDIM	12/10/2020 09:51	12/10/2020 12:38	12/10/2020 09:51	12/10/2020 12:38	2,77	1	2,77	CHI
20201058852	SAO DOMINGOS	10023968417	SAO DOMINGOS	12/10/2020 09:51	12/10/2020 13:19	12/10/2020 09:51	12/10/2020 13:19	3,45	1	3,45	CHI
20201058855	GOIANIA	14467458	MEIA PONTE	12/10/2020 09:52	12/10/2020 15:11	12/10/2020 09:52	12/10/2020 15:11	5,31	1	5,31	CHI
20201058859	PIRACANJUBA	PI21056753	CALDAS NOVAS S1	12/10/2020 09:53	12/10/2020 12:11	12/10/2020 09:53	12/10/2020 12:11	2,29	1	2,29	CHI
20201058861	CORUMBA DE GOIAS	CB21078305	CORUMBA	12/10/2020 09:53	12/10/2020 20:22	12/10/2020 09:53	12/10/2020 20:22	10,47	1	10,47	CHI
20201058862	JANDAIA	JD21026383	PALMEIRAS	12/10/2020 09:54	12/10/2020 14:34	12/10/2020 09:54	12/10/2020 14:34	4,66	1	4,66	CHI
20201063513	ITAJA	XX12379591	CACHOEIRA ALTA	12/10/2020 09:54	13/10/2020 11:13	12/10/2020 09:54	13/10/2020 11:13	25,30	1	25,30	CHI
20201058866	JATAI	10018964590	JATAI S3	12/10/2020 09:55	12/10/2020 13:22	12/10/2020 09:55	12/10/2020 13:22	3,44	1	3,44	CHI
20201059413	MINEIROS	PW12374393	PARQUE DAS EMAS	12/10/2020 09:55	12/10/2020 14:56	12/10/2020 09:55	12/10/2020 14:56	5,00	4	20,01	CHI
20201059514	SAO JOAO D ALIANCA	JL12383338	SAO JOAO D ALIANCA	12/10/2020 09:55	12/10/2020 17:17	12/10/2020 09:55	12/10/2020 17:17	7,35	39	286,73	CHI
20201058869	NIQUELANDIA	NQ12262929	URUACU	12/10/2020 09:56	12/10/2020 16:32	12/10/2020 09:56	12/10/2020 16:32	6,60	3	19,79	CHI
20201058874	ANAPOLIS	20513148	ANAPOLIS UNIVERSITARIO S2	12/10/2020 09:56	12/10/2020 14:31	12/10/2020 09:56	12/10/2020 14:31	4,58	1	4,58	CHI
20201058875	COCALZINHO DE GOIAS	10008535815	AGUAS LINDAS DE GOIAS S2	12/10/2020 09:56	12/10/2020 11:11	12/10/2020 09:56	12/10/2020 11:11	1,24	1	1,24	CHI
20201058878	BURITI ALEGRE	BG21293354	ITUMBIAARA VELHA S2	12/10/2020 09:57	12/10/2020 12:41	12/10/2020 09:57	12/10/2020 12:41	2,73	1	2,73	CHI
20201058880	QUIRINOPOLIS	80072173	QUIRINOPOLIS	12/10/2020 09:57	12/10/2020 22:12	12/10/2020 09:57	12/10/2020 22:12	12,25	1	12,25	CHI
202010189296	JANDAIA	PL12189969	PALMEIRAS	12/10/2020 09:58	12/10/2020 13:33	12/10/2020 09:58	12/10/2020 13:33	3,59	5	17,95	CHI
20201059401	JUSSARA	JR12259693	JUSSARA	12/10/2020 10:00	12/10/2020 15:04	12/10/2020 10:00	12/10/2020 15:04	5,07	3	15,22	CHI
20201058897	GOIATUBA	140119486	GOIATUBA S2	12/10/2020 10:00	12/10/2020 16:14	12/10/2020 10:00	12/10/2020 16:14	6,23	1	6,23	CHI
20201058901	GOIANIA	GN11191228	CARAJAS S1	12/10/2020 10:01	12/10/2020 12:39	12/10/2020 10:01	12/10/2020 12:39	2,63	149	391,33	CHI
20201058905	CHAPADAO DO CEU	DJ12248365	CHAPADAO DO CEU	12/10/2020 10:02	12/10/2020 22:17	12/10/2020 10:02	12/10/2020 22:17	12,24	3	36,73	CHI
20201058909	TRINDADE	TR12251665	TRINDADE	12/10/2020 10:02	12/10/2020 17:53	12/10/2020 10:02	12/10/2020 17:53	7,84	1	7,84	CHI
20201058952	MINEIROS	MY12043894RE	PARQUE DAS EMAS	12/10/2020 10:03	13/10/2020 09:29	12/10/2020 10:03	12/10/2020 19:23	9,33	63	587,88	CHI
20201058952	MINEIROS	MY12043894RE	PARQUE DAS EMAS	12/10/2020 10:03	13/10/2020 09:29	12/10/2020 10:03	12/10/2020 21:07	11,07	23	254,58	CHI
20201058952	MINEIROS	MY12043894RE	PARQUE DAS EMAS	12/10/2020 10:03	13/10/2020 09:29	12/10/2020 10:03	12/10/2020 22:29	12,44	7	87,11	CHI
20201058952	MINEIROS	MY12043894RE	PARQUE DAS EMAS	12/10/2020 10:03	13/10/2020 09:29	12/10/2020 10:03	13/10/2020 00:55	14,87	4	59,50	CHI
20201058952	MINEIROS	MY12043894RE	PARQUE DAS EMAS	12/10/2020 10:03	13/10/2020 09:29	12/10/2020 10:03	13/10/2020 09:29	23,43	5	117,17	CHI
20201058914	ANAPOLIS	20445994	ANAPOLIS UNIVERSITARIO S1	12/10/2020 10:03	12/10/2020 12:19	12/10/2020 10:03	12/10/2020 12:19	2,26	1	2,26	CHI
20201058917	BELA VISTA DE GOIAS	240077362	BELA VISTA S1	12/10/2020 10:03	12/10/2020 12:31	12/10/2020 10:03	12/10/2020 12:31	2,45	1	2,45	CHI
20201060430	MINEIROS	MY12240339	PARQUE DAS EMAS	12/10/2020 10:03	12/10/2020 17:44	12/10/2020 10:03	12/10/2020 17:44	7,67	2	15,34	CHI
20201058920	GOIATUBA	GT21052726	GOIATUBA S2	12/10/2020 10:03	12/10/2020 16:37	12/10/2020 10:03	12/10/2020 16:37	6,55	1	6,55	CHI
20201058923	NOVA CRIXAS	NA11229697	NOVA CRIXAS	12/10/2020 10:04	12/10/2020 21:45	12/10/2020 10:04	12/10/2020 21:45	11,68	1	11,68	CHI
20201058923	MINEIROS	MY12209687	PARQUE DAS EMAS	12/10/2020 10:04	12/10/2020 16:55	12/10/2020 13:16	12/10/2020 14:20	1,05	1	1,05	CHI
20201058923	MINEIROS	MY12260481LD	PARQUE DAS EMAS	12/10/2020 10:04	12/10/2020 16:55	12/10/2020 10:04	12/10/2020 16:55	6,86	8	54,86	CHI
20201058925	SANTA HELENA DE GOIAS	SH21283204	IPEGUARI	12/10/2020 10:04	12/10/2020 14:30	12/10/2020 10:04	12/10/2020 14:30	4,42	1	4,42	CHI
20201058927	SANTO ANTONIO DE GOIAS	10021336316	NEROPOLIS S1	12/10/2020 10:04	12/10/2020 12:21	12/10/2020 10:04	12/10/2020 12:21	2,27	1	2,27	CHI
20201058931	INACIOLANDIA	ID11304144	CACHOEIRA DOURADA	12/10/2020 10:05	12/10/2020 14:32	12/10/2020 10:05	12/10/2020 14:32	4,45	2	8,90	CHI
20201058933	ITAUUCU	10014744650	INHUMAS S1	12/10/2020 10:05	12/10/2020 12:47	12/10/2020 10:05	12/10/2020 12:47	2,69	1	2,69	CHI
20201059176	CORUMBA DE GOIAS	CB21141604	CORUMBA	12/10/2020 10:06	12/10/2020 14:08	12/10/2020 10:06	12/10/2020 14:08	4,03	1	4,03	CHI
20201058953	CRISTALINA	KR21184970	CRISTALINA S1	12/10/2020 10:08	12/10/2020 11:56	12/10/2020 10:08	12/10/2020 11:56	1,79	1	1,79	CHI
20201058959	RIO VERDE	RV12207146	MONTIVIDIU T	12/10/2020 10:09	12/10/2020 15:22	12/10/2020 10:09	12/10/2020 15:22	5,22	1	5,22	CHI
20201059149	MOZARLANDIA	MZ12057415	MOZARLANDIA	12/10/2020 10:09	13/10/2020 08:05	12/10/2020 10:09	13/10/2020 08:05	21,93	2	43,86	CHI
20201058963	ANAPOLIS	20868480	ANAPOLIS UNIVERSITARIO S1	12/10/2020 10:09	12/10/2020 14:54	12/10/2020 10:09	12/10/2020 14:54	4,74	1	4,74	CHI
20201058968	JUSSARA	10020088530	JUSSARA	12/10/2020 10:09	12/10/2020 17:32	12/10/2020 10:09	12/10/2020 17:32	7,37	1	7,37	CHI
20201058974	AMARALINA	MQ21168859	MARA ROSA	12/10/2020 10:11	12/10/2020 16:31	12/10/2020 10:11	12/10/2020 16:31	6,33	1	6,33	CHI
20201058976	IPORA	730146224	IPORA	12/10/2020 10:11	13/10/2020 17:37	12/10/2020 10:11	13/10/2020 17:37	31,43	1	31,43	CHI
20201058980	GOIAS	GS11162386	MATRINCHA	12/10/2020 10:12	12/10/2020 12:36	12/10/2020 10:12	12/10/2020 12:36	2,40	1	2,40	CHI
20201058981	GOIANIA	16887268	GOYA S1	12/10/2020 10:12	12/10/2020 10:55	12/10/2020 10:12	12/10/2020 10:55	0,71	1	0,71	CHI
20201058984	AGUAS LINDAS DE GOIAS	LA11128741	AGUAS LINDAS DE GOIAS S1	12/10/2020 10:12	12/10/2020 13:23	12/10/2020 10:12	12/10/2020 13:23	3,17	84	266,40	CHI
20201058985	MONTIVIDIU	MV21075302	MONTIVIDIU T	12/10/2020 10:12	12/10/2020 12:14	12/10/2020 10:12	12/10/2020 12:14	2,02	1	2,02	CHI
20201058987	PLANALTINA	PI12161667	PLANALTINA	12/10/2020 10:13	12/10/2020 21:51	12/10/2020 10:13	12/10/2020 21:51	11,63	2	23,27	CHI
20201059274	COLINAS DO SUL	TI12295044RE	MINACU	12/10/2020 10:14	14/10/2020 23:40	12/10/2020 10:14	13/10/2020 20:03	33,82	2	67,64	CHI
20201059274	CAVALCANTE	TI12295044RE	MINACU	12/10/2020 10:14	14/10/2020 23:40	12/10/2020 10:14	13/10/2020 20:03	33,82	13	439,63	CHI
20201059274	CAVALCANTE	TI12295044RE	MINACU	12/10/2020 10:14	14/10/2020 23:40	12/10/2020 14:50	13/10/2020 20:03	29,22	41	1197,94	CHI
20201059274	COLINAS DO SUL	TI12295044RE	MINACU	12/10/2020 10:14	14/10/2020 23:40	12/10/2020 14:50	13/10/2020 20:03	29,22	2	58,44	CHI
20201059274	CAVALCANTE	TI12295044RE	MINACU	12/10/2020 10:14	14/10/2020 23:40	12/10/2020 10:14	14/10/2020 23:40	61,43	7	430,03	CHI
20201059274	COLINAS DO SUL	TI12295044RE	MINACU	12/10/2020 10:14	14/10/2020 23:40	12/10/2020 10:14	14/10/2020 23:40	61,43	4	245,73	CHI
20201059274	CAVALCANTE	TI12295044RE	MINACU	12/10/2020 10:14	14/10/2020 23:40	14/10/2020 12:37	14/10/2020 23:40	11,04	12	132,45	CHI
20201058991	MONTIVIDIU	2840022856	MONTIVIDIU T	12/10/2020 10:14	12/10/2020 11:31	12/10/2020 10:14	12/10/2020 11:31	1,29	1	1,29	CHI

20201058995	JANDAIA	JD21268388	PALMEIRAS	12/10/2020 10:14	12/10/2020 17:03	12/10/2020 10:14	12/10/2020 17:03	6,81	1	6,81	CHI
20201058996	ACREUNA	2440047849	ACREUNA	12/10/2020 10:14	12/10/2020 14:38	12/10/2020 10:14	12/10/2020 14:38	4,39	1	4,39	CHI
20201058999	GOIANIA	10614620	AEROPORTO S2	12/10/2020 10:15	12/10/2020 11:23	12/10/2020 10:15	12/10/2020 11:23	1,13	1	1,13	CHI
20201059000	SENADOR CANEDO	10015635625	SENADOR CANEDO	12/10/2020 10:15	12/10/2020 11:25	12/10/2020 10:15	12/10/2020 11:25	1,16	1	1,16	CHI
20201059003	MONTES CLAROS DE GOIAS	ME21148258	ARENOPOLIS	12/10/2020 10:15	12/10/2020 14:20	12/10/2020 10:15	12/10/2020 14:20	4,07	1	4,07	CHI
20201059004	MINEIROS	1390031801	PARQUE DAS EMAS	12/10/2020 10:15	13/10/2020 09:18	12/10/2020 10:15	13/10/2020 09:18	23,04	1	23,04	CHI
20201059012	ALVORADA DO NORTE	SI21244037	IACIARA S2	12/10/2020 10:17	12/10/2020 19:32	12/10/2020 10:17	12/10/2020 19:32	9,25	1	9,25	CHI
20201059014	SANTA HELENA DE GOIAS	400128767	IPEGUARI	12/10/2020 10:17	12/10/2020 11:37	12/10/2020 10:17	12/10/2020 11:37	1,32	1	1,32	CHI
20201059016	CALDAS NOVAS	CN11363740	CALDAS NOVAS S1	12/10/2020 10:17	12/10/2020 13:57	12/10/2020 10:17	12/10/2020 13:57	3,65	13	47,46	CHI
20201059020	FORMOSA	FA12404498	ITUIQUIRA	12/10/2020 10:18	12/10/2020 23:48	12/10/2020 10:18	12/10/2020 23:48	13,49	1	13,49	CHI
20201059023	COCALZINHO DE GOIAS	ZN12297779	COCALZINHO	12/10/2020 10:19	12/10/2020 18:33	12/10/2020 10:19	12/10/2020 18:33	8,23	1	8,23	CHI
20201059025	LEOPOLDO DE BULHOES	LB12048295	DAIA S2	12/10/2020 10:19	12/10/2020 11:33	12/10/2020 10:19	12/10/2020 11:33	1,23	117	143,68	CHI
20201059035	MINEIROS	MY21248769	PARQUE DAS EMAS	12/10/2020 10:20	12/10/2020 11:33	12/10/2020 10:20	12/10/2020 11:33	1,21	1	1,21	CHI
20201059033	ALEXANIA	AX21072795	ALEXANIA	12/10/2020 10:20	12/10/2020 13:11	12/10/2020 10:20	12/10/2020 13:11	2,84	2	5,68	CHI
20201059042	SAO LUIS DE MONTES BELOS	SL11000027	SAO LUIZ DOS MONTES BELOS	12/10/2020 10:22	12/10/2020 11:59	12/10/2020 10:22	12/10/2020 11:59	1,61	82	131,81	CHI
20201059043	BONFINOPOLIS	GP12241545	DAIA S2	12/10/2020 10:22	12/10/2020 15:22	12/10/2020 10:22	12/10/2020 15:22	4,99	1	4,99	CHI
20201059047	GUAPO	10020716158	GUAPO S1	12/10/2020 10:23	12/10/2020 12:23	12/10/2020 10:23	12/10/2020 12:23	1,99	1	1,99	CHI
20201059051	ANICUNS	AC21186917	ANICUNS	12/10/2020 10:23	12/10/2020 13:46	12/10/2020 10:23	12/10/2020 13:46	3,37	1	3,37	CHI
20201059059	SANTA HELENA DE GOIAS	400036370	IPEGUARI	12/10/2020 10:24	12/10/2020 13:04	12/10/2020 10:24	12/10/2020 13:04	2,66	1	2,66	CHI
20201059061	MAURILANDIA	ML12360629	RIO DOS BOIS	12/10/2020 10:24	12/10/2020 18:33	12/10/2020 10:24	12/10/2020 18:33	8,14	1	8,14	CHI
20201059069	GOIANIA	10010396878	XAVANTES	12/10/2020 10:26	12/10/2020 13:18	12/10/2020 10:26	12/10/2020 13:18	2,86	1	2,86	CHI
20201059434	TRINDADE	TR11170660	TRINDADE	12/10/2020 10:26	12/10/2020 12:28	12/10/2020 10:26	12/10/2020 12:28	2,02	28	56,61	CHI
20201059080	JATAI	JT21191105	JATAI S2	12/10/2020 10:29	12/10/2020 11:04	12/10/2020 10:29	12/10/2020 11:04	0,57	1	0,57	CHI
20201059083	NOVA CRIXAS	NA21230412	NOVA CRIXAS	12/10/2020 10:30	12/10/2020 15:57	12/10/2020 10:30	12/10/2020 15:57	5,45	1	5,45	CHI
20201059084	PIRACANJUBA	PJ21171547	PIRACANJUBA	12/10/2020 10:30	12/10/2020 12:57	12/10/2020 10:30	12/10/2020 12:57	2,44	1	2,44	CHI
20201059085	FLORES DE GOIAS	FB11285964	FLORES DE GOIAS	12/10/2020 10:30	12/10/2020 20:50	12/10/2020 10:30	12/10/2020 20:50	10,32	1	10,32	CHI
20201059086	ORIZONA	OZ12000353LD	PRES DO RIO S1	12/10/2020 10:31	12/10/2020 11:31	12/10/2020 10:31	12/10/2020 11:31	1,00	35	34,93	CHI
20201059090	RIO VERDE	MV12301550	MONTIVIDIU T	12/10/2020 10:31	13/10/2020 13:17	12/10/2020 10:31	12/10/2020 14:24	3,87	1	3,87	CHI
20201059090	MONTIVIDIU	MV12301550	MONTIVIDIU T	12/10/2020 10:31	13/10/2020 13:17	12/10/2020 10:31	12/10/2020 14:24	3,87	1	3,87	CHI
20201059090	MONTIVIDIU	MV12062721	MONTIVIDIU T	12/10/2020 10:31	13/10/2020 13:17	12/10/2020 10:31	13/10/2020 13:17	22,66	1	22,66	CHI
20201059090	RIO VERDE	MV12062721	MONTIVIDIU T	12/10/2020 10:31	13/10/2020 13:17	12/10/2020 10:31	13/10/2020 13:17	22,66	1	22,66	CHI
20201059090	RIO VERDE	MV12062721	MONTIVIDIU T	12/10/2020 10:31	13/10/2020 13:17	12/10/2020 17:12	13/10/2020 13:17	20,09	1	20,09	CHI
20201059091	ITUMBIARA	IT12034458RE	CACHOEIRA DOURADA	12/10/2020 10:32	12/10/2020 23:15	12/10/2020 10:32	12/10/2020 23:15	12,72	65	826,93	CHI
20201059091	PANAMA	IT12034458RE	CACHOEIRA DOURADA	12/10/2020 10:32	12/10/2020 23:15	12/10/2020 10:32	12/10/2020 23:15	12,72	13	165,39	CHI
20201059091	BOM JESUS DE GOIAS	IT12034458RE	CACHOEIRA DOURADA	12/10/2020 10:32	12/10/2020 23:15	12/10/2020 10:32	12/10/2020 23:15	12,72	3	38,17	CHI
20201059092	POSSE	1480033379	IACIARA S2	12/10/2020 10:32	12/10/2020 11:47	12/10/2020 10:32	12/10/2020 11:47	1,25	1	1,25	CHI
20201059100	CACU	CC21017245	CACHOEIRA ALTA	12/10/2020 10:32	12/10/2020 18:09	12/10/2020 10:32	12/10/2020 18:09	7,61	1	7,61	CHI
20201056891	COLINAS DO SUL	TI13265471	MINACU	12/10/2020 10:32	16/10/2020 17:22	12/10/2020 10:32	16/10/2020 11:36	97,05	1	97,05	CHI
20201056891	COLINAS DO SUL	TI13340353	MINACU	12/10/2020 10:32	16/10/2020 17:22	12/10/2020 10:32	16/10/2020 17:22	102,82	4	411,28	CHI
20201059117	CAIAPONIA	CP12390177	CAIAPONIA	12/10/2020 10:34	12/10/2020 12:07	12/10/2020 10:34	12/10/2020 12:07	1,55	7	10,82	CHI
20201060590	FLORES DE GOIAS	FB12329779	FLORES DE GOIAS	12/10/2020 10:34	12/10/2020 18:10	12/10/2020 10:34	12/10/2020 18:10	7,59	7	53,16	CHI
20201059120	CAIAPONIA	CP21119601	CAIAPONIA	12/10/2020 10:34	12/10/2020 14:36	12/10/2020 10:34	12/10/2020 14:36	4,03	1	4,03	CHI
20201059121	GOIANIA	11035109	AEROPORTO S1	12/10/2020 10:34	12/10/2020 12:22	12/10/2020 10:34	12/10/2020 12:22	1,79	1	1,79	CHI
20201059129	SANTA RITA DO ARAGUAIA	10000361397	SANTA RITA DO ARAGUAIA	12/10/2020 10:36	12/10/2020 23:49	12/10/2020 10:36	12/10/2020 23:49	13,21	1	13,21	CHI
20201059130	SANTA RITA DO ARAGUAIA	SU12301955	SANTA RITA DO ARAGUAIA	12/10/2020 10:36	12/10/2020 21:45	12/10/2020 10:36	12/10/2020 21:45	11,14	5	55,69	CHI
20201059144	FAINA	GS10400720	GOIAS	12/10/2020 10:36	13/10/2020 11:00	12/10/2020 10:36	12/10/2020 12:55	2,31	71	164,29	CHI
20201059144	GOIAS	GS10400720	GOIAS	12/10/2020 10:36	13/10/2020 11:00	12/10/2020 10:36	12/10/2020 12:55	2,31	79	182,80	CHI
20201059144	FAINA	GS10400720	GOIAS	12/10/2020 10:36	13/10/2020 11:00	12/10/2020 10:37	12/10/2020 12:55	2,31	7	16,18	CHI
20201059144	GOIAS	GS10400720	GOIAS	12/10/2020 10:36	13/10/2020 11:00	12/10/2020 10:37	12/10/2020 12:55	2,31	3	6,93	CHI
20201059144	FAINA	GS10400720	GOIAS	12/10/2020 10:36	13/10/2020 11:00	12/10/2020 10:36	12/10/2020 16:50	6,23	307	1912,18	CHI
20201059144	GOIAS	GS10400720	GOIAS	12/10/2020 10:36	13/10/2020 11:00	12/10/2020 10:36	12/10/2020 16:50	6,23	2	12,46	CHI
20201059144	FAINA	GS10400720	GOIAS	12/10/2020 10:36	13/10/2020 11:00	12/10/2020 10:37	12/10/2020 16:50	6,23	27	168,11	CHI
20201059144	GOIAS	GOA-TR1	GOIAS	12/10/2020 10:36	13/10/2020 11:00	12/10/2020 19:01	12/10/2020 19:05	0,07	6197	420,02	CHI
20201059144	GOIAS	GOA-TR1	GOIAS	12/10/2020 10:36	13/10/2020 11:00	12/10/2020 19:01	12/10/2020 19:05	0,07	4383	297,07	CHI
20201059144	GOIAS	GOA-TR1	GOIAS	12/10/2020 10:36	13/10/2020 11:00	12/10/2020 19:04	13/10/2020 10:57	15,88	41	651,01	CHI
20201059144	GOIAS	00710414	GOIAS	12/10/2020 10:36	13/10/2020 11:00	12/10/2020 19:11	13/10/2020 10:57	15,77	174	2743,40	CHI
20201059144	ITABERAI	00710414	GOIAS	12/10/2020 10:36	13/10/2020 11:00	12/10/2020 19:11	13/10/2020 10:57	15,77	3	47,30	CHI
20201059144	HEITORAI	00710414	GOIAS	12/10/2020 10:36	13/10/2020 11:00	12/10/2020 19:11	13/10/2020 10:57	15,77	26	409,93	CHI

20201059144	ITAPURANGA	00710414	GOIAS	12/10/2020 10:36	13/10/2020 11:00	12/10/2020 19:11	13/10/2020 10:57	15,77	4	63,07	CHI
20201059144	GUARAITA	00710414	GOIAS	12/10/2020 10:36	13/10/2020 11:00	12/10/2020 19:11	13/10/2020 10:57	15,77	2	31,53	CHI
20201059144	FAINA	GOA-TR1	GOIAS	12/10/2020 10:36	13/10/2020 11:00	12/10/2020 19:04	13/10/2020 11:00	15,93	413	6579,66	CHI
20201059144	GOIAS	GOA-TR1	GOIAS	12/10/2020 10:36	13/10/2020 11:00	12/10/2020 19:04	13/10/2020 11:00	15,93	360	5735,30	CHI
20201059132	GOIANIA	15918166	MEIA PONTE	12/10/2020 10:37	12/10/2020 13:32	12/10/2020 10:37	12/10/2020 13:32	2,92	1	2,92	CHI
20201059135	ANAPOLIS	20427839	ANAPOLIS UNIVERSITARIO S2	12/10/2020 10:37	12/10/2020 14:02	12/10/2020 10:37	12/10/2020 14:02	3,42	1	3,42	CHI
20201059136	CAIAPONIA	CP11397345	CAIAPONIA	12/10/2020 10:37	12/10/2020 13:18	12/10/2020 10:37	12/10/2020 13:18	2,67	3	8,01	CHI
20201059138	CATALAO	1990262998	CATALAO S2	12/10/2020 10:38	12/10/2020 11:31	12/10/2020 10:38	12/10/2020 11:31	0,88	1	0,88	CHI
20201059139	LUZIANIA	LZ21000518	MARAJOARA	12/10/2020 10:38	12/10/2020 13:41	12/10/2020 10:38	12/10/2020 13:41	3,05	1	3,05	CHI
20201059147	GOIANIA	GN11037428	XAVANTES	12/10/2020 10:39	12/10/2020 14:28	12/10/2020 10:39	12/10/2020 14:28	3,81	89	338,87	CHI
20201059727	SAO LUIS DE MONTES BELOS	TV12145806	FIRMINOPOLIS S2	12/10/2020 10:40	12/10/2020 14:23	12/10/2020 10:40	12/10/2020 14:23	3,72	1	3,72	CHI
20201059154	ANAPOLIS	20122792	ANAPOLIS UNIVERSITARIO S2	12/10/2020 10:40	12/10/2020 15:33	12/10/2020 10:40	12/10/2020 15:33	4,87	1	4,87	CHI
20201059153	PALMEIRAS DE GOIAS	PL12000058	PALMEIRAS	12/10/2020 10:40	12/10/2020 10:47	12/10/2020 10:40	12/10/2020 10:47	0,10	6	0,62	CHI
20201059160	CIDADE OCIDENTAL	2680122490	MARAJOARA	12/10/2020 10:41	12/10/2020 14:50	12/10/2020 10:41	12/10/2020 14:50	4,14	1	4,14	CHI
20201059158	APARECIDA DE GOIANIA	10027328463	INDEPENDENCIA S2	12/10/2020 10:41	12/10/2020 13:50	12/10/2020 10:41	12/10/2020 13:50	3,14	1	3,14	CHI
20201059159	SANTA TEREZINHA DE GOIAS	2480022270	SANTA TEREZINHA	12/10/2020 10:41	12/10/2020 15:21	12/10/2020 10:41	12/10/2020 15:21	4,65	1	4,65	CHI
20201059169	GOIANIA	10017178256	GOYA S2	12/10/2020 10:42	12/10/2020 15:13	12/10/2020 10:42	12/10/2020 15:13	4,51	1	4,51	CHI
20201059185	LUZIANIA	10028569685	MARAJOARA	12/10/2020 10:46	12/10/2020 12:33	12/10/2020 10:46	12/10/2020 12:33	1,77	1	1,77	CHI
20201059187	GOIANIA	10009835588	GOIANIA LESTE S2	12/10/2020 10:47	12/10/2020 12:43	12/10/2020 10:47	12/10/2020 12:43	1,93	1	1,93	CHI
20201059193	HIDROLANDIA	HD12320390	PONTALINA	12/10/2020 10:48	12/10/2020 17:02	12/10/2020 10:48	12/10/2020 17:02	6,23	1	6,23	CHI
20201059193	VARJAO	HD12320390	PONTALINA	12/10/2020 10:48	12/10/2020 17:02	12/10/2020 10:48	12/10/2020 17:02	6,23	1	6,23	CHI
20201059809	ITAPIRAPUA	IU21140494	MATRINCHA	12/10/2020 10:48	12/10/2020 13:43	12/10/2020 10:48	12/10/2020 13:43	2,91	3	8,74	CHI
20201059197	ITAJA	IJ13131612	CACHOEIRA ALTA	12/10/2020 10:48	13/10/2020 22:17	12/10/2020 10:48	13/10/2020 22:17	35,48	24	851,53	CHI
20201059197	ITARUMA	IJ13131612	CACHOEIRA ALTA	12/10/2020 10:48	13/10/2020 22:17	12/10/2020 10:48	13/10/2020 22:17	35,48	2	70,96	CHI
20201059197	LAGOA SANTA	IJ13131612	CACHOEIRA ALTA	12/10/2020 10:48	13/10/2020 22:17	12/10/2020 10:48	13/10/2020 22:17	35,48	13	461,24	CHI
20201059198	SANTA TEREZINHA DE GOIAS	SG21147074	SANTA TEREZINHA	12/10/2020 10:49	12/10/2020 15:58	12/10/2020 10:49	12/10/2020 15:58	5,15	1	5,15	CHI
20201059203	SENADOR CANEDO	SW12079057	CEPAIGO S2	12/10/2020 10:49	12/10/2020 12:15	12/10/2020 10:49	12/10/2020 12:15	1,42	119	169,44	CHI
20201059215	GOIANIA	14037725	ATLANTICO S1	12/10/2020 10:50	12/10/2020 12:19	12/10/2020 10:50	12/10/2020 12:19	1,48	1	1,48	CHI
20201059224	SILVANIA	SV12229372	VIANOPOLIS	12/10/2020 10:52	12/10/2020 10:56	12/10/2020 10:52	12/10/2020 10:56	0,07	4	0,26	CHI
20201058758	SENADOR CANEDO	SW11141246	SENADOR CANEDO	12/10/2020 10:53	12/10/2020 14:55	12/10/2020 11:09	12/10/2020 14:21	3,20	183	585,50	CHI
20201058758	SENADOR CANEDO	SW11079075	SENADOR CANEDO	12/10/2020 10:53	12/10/2020 14:55	12/10/2020 10:53	12/10/2020 14:55	4,05	93	376,49	CHI
20201059228	TRINDADE	TR31050484	TRINDADE	12/10/2020 10:53	12/10/2020 16:30	12/10/2020 10:53	12/10/2020 12:36	1,71	1	1,71	CHI
20201059228	TRINDADE	TR31050484	TRINDADE	12/10/2020 10:53	12/10/2020 16:30	12/10/2020 12:37	12/10/2020 16:30	3,88	1	3,88	CHI
20201060640	AGUA FRIA DE GOIAS	TL12394165	SAO JOAO D ALIANCA	12/10/2020 10:53	12/10/2020 16:19	12/10/2020 10:53	12/10/2020 16:19	5,43	20	108,52	CHI
20201059234	PLANALANDIA	DL31055054	INHUMAS S1	12/10/2020 10:54	12/10/2020 11:46	12/10/2020 10:54	12/10/2020 11:46	0,86	1	0,86	CHI
20201059235	GOIANIA	12561617	FERROVIARIO S1	12/10/2020 10:54	12/10/2020 12:06	12/10/2020 10:54	12/10/2020 12:06	1,20	1	1,20	CHI
20201059241	SENADOR CANEDO	190029043	SENADOR CANEDO	12/10/2020 10:55	12/10/2020 13:23	12/10/2020 10:55	12/10/2020 13:23	2,46	1	2,46	CHI
20201059297	ANICUNS	AC11000019	ANICUNS	12/10/2020 10:55	12/10/2020 12:07	12/10/2020 10:55	12/10/2020 12:07	1,18	100	118,42	CHI
20201059756	PLANALANDIA	PI12324319	SAO JOAO D ALIANCA	12/10/2020 10:56	12/10/2020 18:51	12/10/2020 10:56	12/10/2020 18:51	7,91	6	47,48	CHI
20201059250	RIO VERDE	RV21073303	MONTIVIDIU T	12/10/2020 10:56	12/10/2020 13:36	12/10/2020 10:56	12/10/2020 13:36	2,66	1	2,66	CHI
20201059252	SENADOR CANEDO	190069375	SENADOR CANEDO	12/10/2020 10:56	12/10/2020 12:28	12/10/2020 10:56	12/10/2020 12:28	1,52	1	1,52	CHI
20201059258	SERRANOPOLIS	DJ12164061	CHAPADAO DO CEU	12/10/2020 10:57	13/10/2020 15:07	12/10/2020 10:57	13/10/2020 15:07	28,16	2	56,32	CHI
20201059271	GOIANIA	15107735	REAL S1	12/10/2020 11:00	12/10/2020 12:11	12/10/2020 11:00	12/10/2020 12:11	1,19	1	1,19	CHI
20201059273	JATAI	JT12347805	MONTIVIDIU T	12/10/2020 11:00	12/10/2020 13:12	12/10/2020 11:00	12/10/2020 13:12	2,19	1	2,19	CHI
20201059276	GOIANIA	10011403584	CARAJAS S2	12/10/2020 11:01	12/10/2020 12:35	12/10/2020 11:01	12/10/2020 12:35	1,56	1	1,56	CHI
20201059279	SANTA HELENA DE GOIAS	400138323	IPEGUARI	12/10/2020 11:01	12/10/2020 14:10	12/10/2020 11:01	12/10/2020 14:10	3,13	1	3,13	CHI
20201059287	CAMPO LIMPO	AN12357374	NEROPOLIS S1	12/10/2020 11:03	12/10/2020 12:03	12/10/2020 11:03	12/10/2020 12:03	0,99	13	12,84	CHI
20201059292	CACU	1140030568	CACHOEIRA ALTA	12/10/2020 11:05	12/10/2020 15:32	12/10/2020 11:05	12/10/2020 15:32	4,45	1	4,45	CHI
20201059298	ANICUNS	910005114	ANICUNS	12/10/2020 11:05	12/10/2020 13:47	12/10/2020 11:05	12/10/2020 13:47	2,70	1	2,70	CHI
20201059299	HIDROLANDIA	HD21273628	PONTALINA	12/10/2020 11:06	12/10/2020 20:32	12/10/2020 11:06	12/10/2020 20:32	9,43	1	9,43	CHI
20201059289	GOIATUBA	BJ13000022	BOM JESUS DE GOIAS	12/10/2020 11:07	12/10/2020 12:40	12/10/2020 11:07	12/10/2020 12:40	1,55	40	61,90	CHI
20201059310	ABADIANIA	AA21144214	DAIA S2	12/10/2020 11:07	12/10/2020 14:46	12/10/2020 11:07	12/10/2020 14:46	3,64	1	3,64	CHI
20201059437	CACHOEIRA ALTA	CA12301755	CACHOEIRA ALTA	12/10/2020 11:08	12/10/2020 14:32	12/10/2020 11:08	12/10/2020 14:32	3,40	14	47,53	CHI
20201059360	GOIANIA	15614037	GOIANIA LESTE S1	12/10/2020 11:08	12/10/2020 11:52	12/10/2020 11:08	12/10/2020 11:52	0,72	1	0,72	CHI
20201059246	ITARUMA	IM13296707	ITAJA S2	12/10/2020 11:10	12/10/2020 12:58	12/10/2020 11:10	12/10/2020 12:58	1,80	34	61,21	CHI
20201059367	GOIANIA	10992157	FERROVIARIO S1	12/10/2020 11:10	12/10/2020 14:45	12/10/2020 11:10	12/10/2020 14:45	3,58	1	3,58	CHI
20201059370	QUIRINOPOLIS	QI12191861	QUIRINOPOLIS	12/10/2020 11:10	12/10/2020 13:25	12/10/2020 11:10	12/10/2020 13:25	2,24	1	2,24	CHI
20201059371	FIRMINOPOLIS	FR21388900	FIRMINOPOLIS S1	12/10/2020 11:11	12/10/2020 12:25	12/10/2020 11:11	12/10/2020 12:25	1,24	2	2,48	CHI

20201060436	ITAGUARU	IC12307618	ITAPURANGA	12/10/2020 11:12	12/10/2020 15:42	12/10/2020 11:12	12/10/2020 15:42	4,49	7	31,43	CHI
20201059383	BARRO ALTO	1150015898	BARRO ALTO	12/10/2020 11:14	13/10/2020 09:57	12/10/2020 11:14	13/10/2020 09:57	22,71	1	22,71	CHI
20201059384	FORMOSA	FA11357441	SAO JOAO D ALIANCA	12/10/2020 11:14	12/10/2020 20:29	12/10/2020 11:14	12/10/2020 20:29	9,24	1	9,24	CHI
20201060385	MINACU	CR12247077	PORANGATU	12/10/2020 11:14	12/10/2020 16:46	12/10/2020 11:14	12/10/2020 16:46	5,52	1	5,52	CHI
20201060385	CAMPINORTE	CR12247077	PORANGATU	12/10/2020 11:14	12/10/2020 16:46	12/10/2020 11:14	12/10/2020 16:46	5,52	7	38,63	CHI
20201059813	SERRANOPOLIS	SX12205192RE	JATAI S1	12/10/2020 11:15	12/10/2020 14:41	12/10/2020 11:15	12/10/2020 14:41	3,42	18	61,65	CHI
20201059813	JATAI	SX12205192RE	JATAI S1	12/10/2020 11:15	12/10/2020 14:41	12/10/2020 11:15	12/10/2020 14:41	3,42	3	10,27	CHI
20201059398	PIRES DO RIO	PR12000071	PIRES DO RIO S1	12/10/2020 11:16	12/10/2020 12:52	12/10/2020 11:16	12/10/2020 12:52	1,60	74	118,34	CHI
20201059407	SAO JOAO D ALIANCA	JL12146125	SAO JOAO D ALIANCA	12/10/2020 11:17	12/10/2020 13:12	12/10/2020 11:17	12/10/2020 13:12	1,91	3	5,72	CHI
20201059418	ANAPOLIS	AN21347852	ANAPOLIS UNIVERSITARIO S2	12/10/2020 11:20	12/10/2020 13:08	12/10/2020 11:20	12/10/2020 13:08	1,79	1	1,79	CHI
20201059992	MINEIROS	MY12195611	PARQUE DAS EMAS	12/10/2020 11:21	12/10/2020 20:42	12/10/2020 11:21	12/10/2020 20:42	9,34	6	56,06	CHI
20201059422	JATAI	JT21324824	JATAI S1	12/10/2020 11:21	13/10/2020 11:48	12/10/2020 11:21	13/10/2020 11:48	24,43	1	24,43	CHI
20201059430	GAMELEIRA DE GOIAS	SV31090412	ANAPOLIS UNIVERSITARIO S1	12/10/2020 11:22	12/10/2020 16:01	12/10/2020 11:22	12/10/2020 16:01	4,63	1	4,63	CHI
20201059750	AMARALINA	LC12170975	MARA ROSA	12/10/2020 11:23	12/10/2020 14:56	12/10/2020 11:23	12/10/2020 14:56	3,55	11	39,02	CHI
20201059438	GOIANIA	GN21140270	GOIANIA LESTE S3	12/10/2020 11:23	12/10/2020 13:27	12/10/2020 11:23	12/10/2020 13:27	2,05	5	10,27	CHI
20201059443	LUZIANIA	LZ11313604	CRISTALINA S2	12/10/2020 11:24	12/10/2020 16:35	12/10/2020 11:24	12/10/2020 16:35	5,17	3	15,52	CHI
20201059445	ITAGUARU	230013600	ITABERAI S1	12/10/2020 11:24	12/10/2020 14:49	12/10/2020 11:24	12/10/2020 14:49	3,41	1	3,41	CHI
20201060843	SAO JOAO D ALIANCA	JL12180616	SAO JOAO D ALIANCA	12/10/2020 11:25	12/10/2020 17:40	12/10/2020 11:25	12/10/2020 17:40	6,25	5	31,25	CHI
20201059500	GOIANIA	GN11241440	GOIANIA LESTE S3	12/10/2020 11:25	12/10/2020 12:44	12/10/2020 11:25	12/10/2020 12:44	1,31	57	74,83	CHI
20201059454	JARAGUA	JA21148826	JARAGUA	12/10/2020 11:27	12/10/2020 14:45	12/10/2020 11:27	12/10/2020 14:45	3,29	3	9,87	CHI
20201059457	VILA PROPICIO	PV21150313	GOIANESIA S2	12/10/2020 11:29	13/10/2020 20:05	12/10/2020 11:29	13/10/2020 20:05	32,61	1	32,61	CHI
20201059458	PIRACANJUBA	PJ21106600	PIRACANJUBA	12/10/2020 11:29	12/10/2020 13:36	12/10/2020 11:29	12/10/2020 13:36	2,11	1	2,11	CHI
20201059459	CAVALCANTE	740012964	FLORES DE GOIAS	12/10/2020 11:29	12/10/2020 15:27	12/10/2020 11:29	12/10/2020 15:27	3,96	1	3,96	CHI
20201059463	MONTIVIDIU DO NORTE	9670001024	PORANGATU	12/10/2020 11:29	12/10/2020 23:30	12/10/2020 11:29	12/10/2020 23:30	12,01	1	12,01	CHI
20201059466	SANCLERLANDIA	SC12154609	FIRMINOPOLIS S2	12/10/2020 11:30	12/10/2020 16:35	12/10/2020 11:30	12/10/2020 16:35	5,07	1	5,07	CHI
20201059481	CORREGO DO OURO	CO21019819	SAO LUIZ DOS MONTES BELOS	12/10/2020 11:33	13/10/2020 11:11	12/10/2020 11:33	13/10/2020 11:11	23,63	1	23,63	CHI
20201059488	FLORES DE GOIAS	FB21334129	FLORES DE GOIAS	12/10/2020 11:34	12/10/2020 18:47	12/10/2020 11:34	12/10/2020 18:47	7,22	1	7,22	CHI
20201059491	PIRANHAS	PH21023558	PIRANHAS	12/10/2020 11:34	12/10/2020 15:22	12/10/2020 11:34	12/10/2020 15:22	3,79	1	3,79	CHI
20201059502	FORMOSA	FA21146155	ITUIQUIRA	12/10/2020 11:36	13/10/2020 00:53	12/10/2020 11:36	13/10/2020 00:53	13,28	1	13,28	CHI
20201059503	RIO VERDE	630023890	RIO VERDE S2	12/10/2020 11:36	12/10/2020 19:04	12/10/2020 11:36	12/10/2020 19:04	7,47	1	7,47	CHI
20201059504	PALMEIRAS DE GOIAS	PL12000032	PALMEIRAS	12/10/2020 11:36	13/10/2020 01:51	12/10/2020 11:36	13/10/2020 01:51	14,25	6	85,48	CHI
20201059508	GOIANIA	11200546	ATLANTICO S1	12/10/2020 11:36	12/10/2020 12:43	12/10/2020 11:36	12/10/2020 12:43	1,11	1	1,11	CHI
20201059511	CRISTALINA	KR21245991	CRISTALINA S2	12/10/2020 11:38	12/10/2020 13:41	12/10/2020 11:38	12/10/2020 13:41	2,05	2	4,10	CHI
20201059606	SANTO ANTONIO DE GOIAS	BR12166574	NEROPOLIS S1	12/10/2020 11:38	12/10/2020 13:51	12/10/2020 11:38	12/10/2020 13:51	2,20	3	6,60	CHI
20201059606	BRAZABRANTES	BR12166574	NEROPOLIS S1	12/10/2020 11:38	12/10/2020 13:51	12/10/2020 11:38	12/10/2020 13:51	2,20	2	4,40	CHI
20201059606	GOIANIRA	BR12166574	NEROPOLIS S1	12/10/2020 11:38	12/10/2020 13:51	12/10/2020 11:38	12/10/2020 13:51	2,20	18	39,61	CHI
20201060208	SANTA TEREZINHA DE GOIAS	SG12213046	SANTA TEREZINHA	12/10/2020 11:39	12/10/2020 18:14	12/10/2020 11:39	12/10/2020 18:14	6,58	9	59,18	CHI
20201060208	CAMPOS VERDES	SG12213046	SANTA TEREZINHA	12/10/2020 11:39	12/10/2020 18:14	12/10/2020 11:39	12/10/2020 18:14	6,58	9	59,18	CHI
20201059517	MONTES CLAROS DE GOIAS	ME12241291	BRITANIA	12/10/2020 11:39	14/10/2020 09:30	12/10/2020 11:39	14/10/2020 09:30	45,85	37	1696,33	CHI
20201059519	SENADOR CANEDO	10010538842	SENADOR CANEDO	12/10/2020 11:39	12/10/2020 13:19	12/10/2020 11:39	12/10/2020 13:19	1,66	1	1,66	CHI
20201059520	AURILANDIA	CG12391526	FIRMINOPOLIS S2	12/10/2020 11:40	13/10/2020 19:12	12/10/2020 11:40	13/10/2020 19:12	31,52	1	31,52	CHI
20201059520	CACHOEIRA DE GOIAS	CG12391526	FIRMINOPOLIS S2	12/10/2020 11:40	13/10/2020 19:12	12/10/2020 11:40	13/10/2020 19:12	28,01	8	224,04	CHI
20201059520	AURILANDIA	CG12391526	FIRMINOPOLIS S2	12/10/2020 11:40	13/10/2020 19:12	12/10/2020 11:40	13/10/2020 19:12	28,01	1	28,01	CHI
20201059520	PARAUNA	CG12391526	FIRMINOPOLIS S2	12/10/2020 11:40	13/10/2020 19:12	12/10/2020 11:40	13/10/2020 19:12	28,01	27	756,14	CHI
20201059521	FORMOSA	610061446	ITUIQUIRA	12/10/2020 11:40	12/10/2020 20:23	12/10/2020 11:40	12/10/2020 20:23	8,70	1	8,70	CHI
20201059524	TRINDADE	10011875621	GOYA S2	12/10/2020 11:41	12/10/2020 15:35	12/10/2020 11:41	12/10/2020 15:35	3,89	1	3,89	CHI
20201059525	GOIANIA	GN12217332	INDEPENDENCIA S2	12/10/2020 11:41	12/10/2020 15:13	12/10/2020 11:41	12/10/2020 15:13	3,54	4	14,15	CHI
20201059528	GOIANIA	10493189	GOIANIA LESTE S3	12/10/2020 11:42	12/10/2020 13:48	12/10/2020 11:42	12/10/2020 13:48	2,10	1	2,10	CHI
20201060342	PORTELANDIA	PW12248465RE	PARQUE DAS EMAS	12/10/2020 11:43	12/10/2020 21:01	12/10/2020 11:43	12/10/2020 21:01	9,30	11	102,27	CHI
20201060589	FLORES DE GOIAS	FB12417060	FLORES DE GOIAS	12/10/2020 11:44	12/10/2020 19:19	12/10/2020 11:44	12/10/2020 19:19	7,58	15	113,68	CHI
20201059542	BONOPOLIS	BX21123195	SAO MIGUEL DO ARAGUAIA	12/10/2020 11:45	12/10/2020 15:12	12/10/2020 11:45	12/10/2020 15:12	3,44	1	3,44	CHI
20201059543	SAO LUIZ DE MONTES BELOS	6854930	SAO LUIZ DOS MONTES BELOS	12/10/2020 11:45	13/10/2020 15:06	12/10/2020 11:45	13/10/2020 15:06	27,34	1	27,34	CHI
20201059544	FORMOSA	10030948566	ITUIQUIRA	12/10/2020 11:45	13/10/2020 02:42	12/10/2020 11:45	13/10/2020 02:42	14,94	1	14,94	CHI
20201059550	TURVANIA	TV21233398	FIRMINOPOLIS S2	12/10/2020 11:46	12/10/2020 16:31	12/10/2020 11:46	12/10/2020 16:31	4,74	1	4,74	CHI
20201059551	APARECIDA DE GOIANIA	11813398	INDEPENDENCIA S1	12/10/2020 11:46	12/10/2020 16:08	12/10/2020 11:46	12/10/2020 16:08	4,35	1	4,35	CHI
20201059559	MAMBAI	4980000539	IACIARA S2	12/10/2020 11:48	12/10/2020 19:00	12/10/2020 11:48	12/10/2020 19:00	7,20	1	7,20	CHI
20201059560	CACHOEIRA DOURADA	130017887	CACHOEIRA DOURADA	12/10/2020 11:48	12/10/2020 12:48	12/10/2020 11:48	12/10/2020 12:48	0,99	1	0,99	CHI
20201059567	RIO VERDE	10005646667	RIO VERDE S1	12/10/2020 11:50	12/10/2020 14:09	12/10/2020 11:50	12/10/2020 14:09	2,31	1	2,31	CHI

20201058836	JATAI	JT10400617	JATAI S1	12/10/2020 11:51	14/10/2020 09:25	12/10/2020 11:51	12/10/2020 12:22	0,51	136	69,17	CHI
20201058836	PEROLANDIA	JT10400617	JATAI S1	12/10/2020 11:51	14/10/2020 09:25	12/10/2020 11:51	12/10/2020 12:22	0,51	7	3,56	CHI
20201058836	JATAI	JT13337013	JATAI S1	12/10/2020 11:51	14/10/2020 09:25	12/10/2020 11:51	12/10/2020 14:33	2,70	25	67,38	CHI
20201058836	JATAI	JT10413490	JATAI S1	12/10/2020 11:51	14/10/2020 09:25	12/10/2020 11:51	13/10/2020 07:02	19,17	25	479,33	CHI
20201058836	JATAI	JT10413490	JATAI S1	12/10/2020 11:51	14/10/2020 09:25	12/10/2020 11:51	13/10/2020 09:48	21,93	2	43,87	CHI
20201058836	JATAI	JT10413490	JATAI S1	12/10/2020 11:51	14/10/2020 09:25	13/10/2020 09:01	13/10/2020 09:48	0,77	40	30,91	CHI
20201058836	JATAI	JT12324839LD	JATAI S1	12/10/2020 11:51	14/10/2020 09:25	12/10/2020 15:50	13/10/2020 23:53	32,05	7	224,36	CHI
20201058836	JATAI	JT10400238	JATAI S1	12/10/2020 11:51	14/10/2020 09:25	13/10/2020 09:01	14/10/2020 00:29	15,47	30	463,99	CHI
20201058836	JATAI	JT12241750	JATAI S1	12/10/2020 11:51	14/10/2020 09:25	14/10/2020 00:03	14/10/2020 05:29	5,43	1	5,43	CHI
20201058836	SERRANOPOLIS	JT13214519	JATAI S1	12/10/2020 11:51	14/10/2020 09:25	14/10/2020 08:47	14/10/2020 09:12	0,41	6	2,44	CHI
20201058836	JATAI	JT13214519	JATAI S1	12/10/2020 11:51	14/10/2020 09:25	14/10/2020 08:47	14/10/2020 09:12	0,41	1	0,41	CHI
20201058836	JATAI	JT12324839LD	JATAI S1	12/10/2020 11:51	14/10/2020 09:25	14/10/2020 00:03	14/10/2020 09:25	9,36	7	65,53	CHI
20201059579	GOIANIA	10589430	ATLANTICO S2	12/10/2020 11:53	12/10/2020 12:54	12/10/2020 11:53	12/10/2020 12:54	1,00	1	1,00	CHI
20201059583	GOIANIA	GN11089901	ATLANTICO S2	12/10/2020 11:54	12/10/2020 14:39	12/10/2020 11:54	12/10/2020 14:39	2,75	31	85,21	CHI
20201059589	MONTE ALEGRE DE GOIAS	MA21265754	SAO DOMINGOS	12/10/2020 11:55	12/10/2020 13:12	12/10/2020 11:55	12/10/2020 13:12	1,28	1	1,28	CHI
20201059592	GOIANIA	15103973	GOYA S2	12/10/2020 11:55	12/10/2020 15:51	12/10/2020 11:55	12/10/2020 15:51	3,92	1	3,92	CHI
20201059596	AURILANDIA	A112377187	FIRMINOPOLIS S2	12/10/2020 11:56	12/10/2020 18:02	12/10/2020 11:56	12/10/2020 18:02	6,09	11	67,00	CHI
20201059598	LEOPOLDO DE BULHOES	LB12048295	DAIA S2	12/10/2020 11:56	12/10/2020 19:25	12/10/2020 11:56	12/10/2020 13:50	1,89	117	220,84	CHI
20201059598	LEOPOLDO DE BULHOES	LB12048295	DAIA S2	12/10/2020 11:56	12/10/2020 19:25	12/10/2020 14:18	12/10/2020 16:03	1,75	43	75,37	CHI
20201059598	LEOPOLDO DE BULHOES	LB12342009	DAIA S2	12/10/2020 11:56	12/10/2020 19:25	12/10/2020 14:18	12/10/2020 18:25	4,12	54	222,25	CHI
20201059598	LEOPOLDO DE BULHOES	LB12334833	DAIA S2	12/10/2020 11:56	12/10/2020 19:25	12/10/2020 14:18	12/10/2020 19:25	5,12	20	102,35	CHI
20201059599	GOIANIA	10000877059	CAMPINAS S2	12/10/2020 11:56	12/10/2020 15:29	12/10/2020 11:56	12/10/2020 15:29	3,54	1	3,54	CHI
20201059625	CAMPESTRE DE GOIAS	GC21028963	TRINDADE	12/10/2020 12:01	12/10/2020 14:47	12/10/2020 12:01	12/10/2020 14:47	2,76	2	5,53	CHI
20201059627	LUZIANIA	120142685	RIO VERMELHO	12/10/2020 12:01	12/10/2020 13:02	12/10/2020 12:01	12/10/2020 13:02	1,01	1	1,01	CHI
20201059628	GOIANIA	10655773	CAMPINAS S3	12/10/2020 12:01	12/10/2020 14:32	12/10/2020 12:01	12/10/2020 14:32	2,51	1	2,51	CHI
20201060077	PLANALTINA	PI11164579	PLANALTINA	12/10/2020 12:01	12/10/2020 16:48	12/10/2020 12:01	12/10/2020 16:48	4,77	103	491,42	CHI
20201059630	GOIANIA	14123009	CARAJAS S1	12/10/2020 12:01	12/10/2020 14:07	12/10/2020 12:01	12/10/2020 14:07	2,09	1	2,09	CHI
20201059632	TRINDADE	40068614	GOYA S1	12/10/2020 12:02	12/10/2020 14:55	12/10/2020 12:02	12/10/2020 14:55	2,88	1	2,88	CHI
20201059635	AGUAS LINDAS DE GOIAS	4830151305	AGUAS LINDAS DE GOIAS S1	12/10/2020 12:03	12/10/2020 13:49	12/10/2020 12:03	12/10/2020 13:49	1,77	1	1,77	CHI
20201059924	APARECIDA DE GOIANIA	AP11005001	REAL S2	12/10/2020 12:04	12/10/2020 13:54	12/10/2020 12:04	12/10/2020 13:54	1,83	101	184,61	CHI
20201059643	ARAGUAPAZ	AZ21259656	MOZARLANDIA	12/10/2020 12:05	12/10/2020 12:52	12/10/2020 12:05	12/10/2020 12:52	0,78	1	0,78	CHI
20201059651	LUZIANIA	LZ21065580	CRISTALINA S2	12/10/2020 12:06	12/10/2020 15:26	12/10/2020 12:06	12/10/2020 15:26	3,32	1	3,32	CHI
20201059673	FORMOSA	03740454	ITIQUEIRA	12/10/2020 12:06	12/10/2020 22:13	12/10/2020 12:06	12/10/2020 13:23	1,28	7	8,95	CHI
20201059673	VILA BOA	03740454	ITIQUEIRA	12/10/2020 12:06	12/10/2020 22:13	12/10/2020 12:06	12/10/2020 13:28	1,36	200	271,11	CHI
20201059673	FORMOSA	03740454	ITIQUEIRA	12/10/2020 12:06	12/10/2020 22:13	12/10/2020 12:06	12/10/2020 13:28	1,36	589	798,42	CHI
20201059673	FLORES DE GOIAS	FB10408313	IACIARA S2	12/10/2020 12:06	12/10/2020 22:13	12/10/2020 13:25	12/10/2020 13:28	0,05	72	3,72	CHI
20201059673	VILA BOA	FB10408313	IACIARA S2	12/10/2020 12:06	12/10/2020 22:13	12/10/2020 13:25	12/10/2020 13:28	0,05	1382	71,40	CHI
20201059673	VILA BOA	FB10408313	IACIARA S2	12/10/2020 12:06	12/10/2020 22:13	12/10/2020 13:25	12/10/2020 13:28	0,05	60	3,10	CHI
20201059673	VILA BOA	FA10401450	ITIQUEIRA	12/10/2020 12:06	12/10/2020 22:13	12/10/2020 12:06	12/10/2020 13:28	1,37	7	9,57	CHI
20201059673	FORMOSA	FA10401450	ITIQUEIRA	12/10/2020 12:06	12/10/2020 22:13	12/10/2020 12:06	12/10/2020 13:28	1,37	445	608,29	CHI
20201059673	VILA BOA	FB10408313	IACIARA S2	12/10/2020 12:06	12/10/2020 22:13	12/10/2020 13:34	12/10/2020 13:53	0,32	63	20,35	CHI
20201059673	FLORES DE GOIAS	FB10408313	IACIARA S2	12/10/2020 12:06	12/10/2020 22:13	12/10/2020 13:34	12/10/2020 13:53	0,32	72	23,26	CHI
20201059673	FORMOSA	03740454	ITIQUEIRA	12/10/2020 12:06	12/10/2020 22:13	12/10/2020 12:06	12/10/2020 19:17	7,17	150	1075,46	CHI
20201059673	FORMOSA	03740454	ITIQUEIRA	12/10/2020 12:06	12/10/2020 22:13	12/10/2020 12:06	12/10/2020 20:00	7,89	1312	10353,50	CHI
20201059673	DISTRITO FEDERAL	03740454	ITIQUEIRA	12/10/2020 12:06	12/10/2020 22:13	12/10/2020 12:06	12/10/2020 20:00	7,89	1	7,89	CHI
20201059673	CABECEIRAS	03740454	ITIQUEIRA	12/10/2020 12:06	12/10/2020 22:13	12/10/2020 12:06	12/10/2020 20:00	7,89	23	181,50	CHI
20201059673	FORMOSA	FA10410992	ITIQUEIRA	12/10/2020 12:06	12/10/2020 22:13	12/10/2020 13:35	12/10/2020 20:11	6,60	85	560,88	CHI
20201059673	VILA BOA	FB10408313	IACIARA S2	12/10/2020 12:06	12/10/2020 22:13	12/10/2020 13:34	12/10/2020 22:13	8,65	1382	11955,07	CHI
20201059766	SAO JOAO D ALIANCA	JL12268110	FLORES DE GOIAS	12/10/2020 12:08	12/10/2020 14:49	12/10/2020 12:08	12/10/2020 14:49	2,68	9	24,14	CHI
20201059659	ANICUNS	AC12166908	FIRMINOPOLIS S2	12/10/2020 12:10	12/10/2020 15:31	12/10/2020 12:10	12/10/2020 15:31	3,35	1	3,35	CHI
20201059662	GOIANIA	GN11347726	CARAJAS S2	12/10/2020 12:10	12/10/2020 16:23	12/10/2020 12:10	12/10/2020 16:23	4,21	9	37,86	CHI
20201059863	GOIANIA	GN11374095	GOYA S1	12/10/2020 12:10	12/10/2020 17:51	12/10/2020 12:10	12/10/2020 17:51	5,67	68	385,69	CHI
20201059670	MINACU	IH12250175	MINACU	12/10/2020 12:12	13/10/2020 10:00	12/10/2020 12:12	13/10/2020 10:00	21,79	3	65,38	CHI
20201059679	MIMOSO DE GOIAS	MJ12304747	PADRE BERNARDO	12/10/2020 12:15	12/10/2020 18:19	12/10/2020 12:15	12/10/2020 18:19	6,06	9	54,55	CHI
20201059714	CRIXAS	CX12321023	SANTA TEREZINHA	12/10/2020 12:15	12/10/2020 13:56	12/10/2020 12:15	12/10/2020 13:56	1,68	12	20,11	CHI
20201059683	INHUMAS	10009135543	INHUMAS S2	12/10/2020 12:15	12/10/2020 14:09	12/10/2020 12:15	12/10/2020 14:09	1,89	1	1,89	CHI
20201060304	INDIARA	IY12039705	EDEIA	12/10/2020 12:15	12/10/2020 18:05	12/10/2020 12:15	12/10/2020 18:05	5,82	3	17,45	CHI
20201060304	ACREUNA	IY12039705	EDEIA	12/10/2020 12:15	12/10/2020 18:05	12/10/2020 12:15	12/10/2020 18:05	5,82	7	40,73	CHI

20201059688	ALVORADA DO NORTE	SI12248880	IACIARA S2	12/10/2020 12:16	12/10/2020 20:13	12/10/2020 12:16	12/10/2020 20:13	7,95	3	23,84	CHI
20201060935	MONTES CLAROS DE GOIAS	ME12038971	IPORA	12/10/2020 12:16	12/10/2020 18:36	12/10/2020 12:16	12/10/2020 18:36	6,33	19	120,28	CHI
20201059692	APARECIDA DE GOIANIA	200199080	ANHANGUERA	12/10/2020 12:16	12/10/2020 15:24	12/10/2020 12:16	12/10/2020 15:24	3,13	1	3,13	CHI
20201059693	GOIANIA	12186612	GOIANIA LESTE S1	12/10/2020 12:16	12/10/2020 15:18	12/10/2020 12:16	12/10/2020 15:18	3,02	1	3,02	CHI
20201059696	DIORAMA	DI12245747	IPORA	12/10/2020 12:17	12/10/2020 15:49	12/10/2020 12:17	12/10/2020 15:49	3,52	1	3,52	CHI
20201059698	APARECIDA DE GOIANIA	13351837	INDEPENDENCIA S1	12/10/2020 12:17	12/10/2020 14:53	12/10/2020 12:17	12/10/2020 14:53	2,60	1	2,60	CHI
20201059941	PIRENOPOLIS	PV12352327	CORUMBA	12/10/2020 12:18	12/10/2020 15:21	12/10/2020 12:18	12/10/2020 15:21	3,05	18	54,88	CHI
20201059703	QUIRINOPOLIS	80156228	QUIRINOPOLIS	12/10/2020 12:18	12/10/2020 20:27	12/10/2020 12:18	12/10/2020 20:27	8,14	1	8,14	CHI
20201059706	SERRANOPOLIS	3000009113	JATAI S1	12/10/2020 12:18	12/10/2020 14:26	12/10/2020 12:18	12/10/2020 14:26	2,12	1	2,12	CHI
20201059709	CATALAO	CT21075575	CATALAO S1	12/10/2020 12:19	12/10/2020 14:17	12/10/2020 12:19	12/10/2020 14:17	1,97	1	1,97	CHI
20201059708	VILA BOA	10024853940	IACIARA S2	12/10/2020 12:19	12/10/2020 16:37	12/10/2020 12:19	12/10/2020 16:37	4,30	1	4,30	CHI
20201059710	JATAI	JT21138949	JATAI S1	12/10/2020 12:19	13/10/2020 11:37	12/10/2020 12:19	13/10/2020 11:37	23,29	1	23,29	CHI
20201059718	GOIANIA	12866726	XAVANTES	12/10/2020 12:21	12/10/2020 15:13	12/10/2020 12:21	12/10/2020 15:13	2,86	1	2,86	CHI
20201059719	URUACU	UR21088761	CAMPINORTE	12/10/2020 12:21	12/10/2020 19:08	12/10/2020 12:21	12/10/2020 19:08	6,78	1	6,78	CHI
20201059721	GOIANIA	GN11001520	AEROPORTO S3	12/10/2020 12:22	12/10/2020 16:02	12/10/2020 12:22	12/10/2020 16:02	3,66	38	139,20	CHI
20201059724	CAMPESTRE DE GOIAS	GC21009582	TRINDADE	12/10/2020 12:22	12/10/2020 15:29	12/10/2020 12:22	12/10/2020 15:29	3,10	1	3,10	CHI
20201060271	TURVANIA	TV21145850	FIRMINOPOLIS S2	12/10/2020 12:23	12/10/2020 14:41	12/10/2020 12:23	12/10/2020 14:41	2,29	1	2,29	CHI
20201059971	CACU	CA12196122	CACHOEIRA ALTA	12/10/2020 12:24	12/10/2020 21:28	12/10/2020 12:24	12/10/2020 21:28	9,05	40	362,16	CHI
20201059857	RIO VERDE	RV12260655	RIO VERDE S1	12/10/2020 12:26	12/10/2020 14:32	12/10/2020 12:26	12/10/2020 14:32	2,10	18	37,73	CHI
20201059739	NAZARIO	NZ21000008	ANICUNS	12/10/2020 12:26	12/10/2020 15:24	12/10/2020 12:26	12/10/2020 15:24	2,96	1	2,96	CHI
20201059752	NIQUELANDIA	NQ21256594	NIQUELANDIA SUBTRANSMISSAO	12/10/2020 12:30	13/10/2020 19:59	12/10/2020 12:30	13/10/2020 19:59	31,48	1	31,48	CHI
20201059753	BRAZABRANTES	BR21010307	INHUMAS S1	12/10/2020 12:30	12/10/2020 14:22	12/10/2020 12:30	12/10/2020 14:22	1,85	1	1,85	CHI
20201059759	IACIARA	IA21184991	IACIARA S2	12/10/2020 12:31	12/10/2020 17:19	12/10/2020 12:31	12/10/2020 17:19	4,79	1	4,79	CHI
20201059761	GOIANIA	14552267	GOIANIA LESTE S1	12/10/2020 12:31	12/10/2020 14:22	12/10/2020 12:31	12/10/2020 14:22	1,84	1	1,84	CHI
20201059762	MATRINCHA	MP12362399	MATRINCHA	12/10/2020 12:31	12/10/2020 16:54	12/10/2020 12:31	12/10/2020 16:54	4,38	4	17,50	CHI
20201059773	CATALAO	CT11000043	CATALAO S2	12/10/2020 12:33	12/10/2020 14:27	12/10/2020 12:33	12/10/2020 14:27	1,88	88	165,88	CHI
20201059780	TRINDADE	10031805165	TRINDADE	12/10/2020 12:35	12/10/2020 15:08	12/10/2020 12:35	12/10/2020 15:08	2,55	1	2,55	CHI
20201059778	SANCLERLANDIA	SC21343818	SAO LUIZ DOS MONTES BELOS	12/10/2020 12:35	13/10/2020 17:35	12/10/2020 12:35	13/10/2020 17:35	28,99	1	28,99	CHI
20201059783	SAO DOMINGOS	SD11151619	SAO DOMINGOS	12/10/2020 12:35	12/10/2020 23:28	12/10/2020 12:35	12/10/2020 23:28	10,88	341	3708,38	CHI
20201059786	LUZIANIA	LZ12230287	MARAJOARA	12/10/2020 12:35	12/10/2020 13:14	12/10/2020 12:35	12/10/2020 13:14	0,64	6	3,83	CHI
20201059792	VALPARAISO DE GOIAS	10001023207	PACAEMBU S2	12/10/2020 12:36	12/10/2020 15:51	12/10/2020 12:36	12/10/2020 15:51	3,24	1	3,24	CHI
20201060083	CACHOEIRA ALTA	CA12011542	CACHOEIRA ALTA	12/10/2020 12:36	12/10/2020 17:23	12/10/2020 12:36	12/10/2020 17:23	4,77	10	47,73	CHI
20201059797	SAO JOAO D ALIANCA	JL11238302	ITIQUEIRA	12/10/2020 12:37	12/10/2020 20:21	12/10/2020 12:37	12/10/2020 20:21	7,73	1	7,73	CHI
20201059798	VILA BOA	10003234647	IACIARA S2	12/10/2020 12:37	12/10/2020 16:54	12/10/2020 12:37	12/10/2020 16:54	4,27	1	4,27	CHI
20201059802	AGUA FRIA DE GOIAS	PI12067431	SAO JOAO D ALIANCA	12/10/2020 12:39	12/10/2020 20:16	12/10/2020 12:39	12/10/2020 20:16	7,62	11	83,79	CHI
20201060202	GOIANAPOLIS	LB12205831	DAIA S2	12/10/2020 12:45	12/10/2020 16:58	12/10/2020 12:45	12/10/2020 16:58	4,20	1	4,20	CHI
20201060202	LEOPOLDO DE BULHOES	LB12205831	DAIA S2	12/10/2020 12:45	12/10/2020 16:58	12/10/2020 12:45	12/10/2020 16:58	4,20	22	92,42	CHI
20201059861	ITAUCU	IX21102568	ITABERAI S1	12/10/2020 12:48	12/10/2020 19:37	12/10/2020 12:48	12/10/2020 19:37	6,80	1	6,80	CHI
20201059864	FORMOSA	FA11357515	SAO JOAO D ALIANCA	12/10/2020 12:49	12/10/2020 19:30	12/10/2020 12:49	12/10/2020 19:30	6,69	1	6,69	CHI
20201059866	SAO LUIS DE MONTES BELOS	SL21180338	FIRMINOPOLIS S2	12/10/2020 12:49	13/10/2020 13:27	12/10/2020 12:49	13/10/2020 13:27	24,63	1	24,63	CHI
20201059869	GOIANIA	13055823	GOYA S2	12/10/2020 12:50	12/10/2020 16:37	12/10/2020 12:50	12/10/2020 16:37	3,77	1	3,77	CHI
20201059872	SAO JOAO D ALIANCA	JL12266381	SAO JOAO D ALIANCA	12/10/2020 12:50	12/10/2020 17:24	12/10/2020 12:50	12/10/2020 17:24	4,55	1	4,55	CHI
20201059877	FORMOSA	FA21218427	ITIQUEIRA	12/10/2020 12:51	12/10/2020 14:10	12/10/2020 12:51	12/10/2020 14:10	1,31	2	2,62	CHI
20201059883	NIQUELANDIA	NQ12371150	SAO JOAO D ALIANCA	12/10/2020 12:53	13/10/2020 15:01	12/10/2020 12:53	13/10/2020 15:01	26,13	26	679,32	CHI
20201059994	CEZARINA	CZ11000002	CEZARINA	12/10/2020 12:53	12/10/2020 18:41	12/10/2020 12:53	12/10/2020 18:41	5,79	111	642,97	CHI
20201059889	MINEIROS	MY12296301	PARQUE DAS EMAS	12/10/2020 12:54	13/10/2020 13:58	12/10/2020 12:54	13/10/2020 13:58	25,07	1	25,07	CHI
20201060006	GOIAS	HE12250700	ITAPURANGA	12/10/2020 12:59	12/10/2020 15:52	12/10/2020 12:59	12/10/2020 15:52	2,87	9	25,84	CHI
20201060006	HEITORAI	HE12250700	ITAPURANGA	12/10/2020 12:59	12/10/2020 15:52	12/10/2020 12:59	12/10/2020 15:52	2,87	6	17,22	CHI
20201059911	MOZARLANDIA	MZ21300475	MOZARLANDIA	12/10/2020 13:00	12/10/2020 15:42	12/10/2020 13:00	12/10/2020 15:42	2,68	1	2,68	CHI
20201060490	MONTIVIDIU DO NORTE	MX12364202	PORANGATU	12/10/2020 13:02	12/10/2020 19:32	12/10/2020 13:02	12/10/2020 19:32	6,50	24	155,94	CHI
20201059926	ALEXANIA	AX12000108	CORUMBA	12/10/2020 13:04	13/10/2020 17:22	12/10/2020 13:04	13/10/2020 17:22	28,31	10	283,05	CHI
20201059926	CORUMBA DE GOIAS	AX12000108	CORUMBA	12/10/2020 13:04	13/10/2020 17:22	12/10/2020 13:04	13/10/2020 17:22	28,31	4	113,22	CHI
20201059926	ALEXANIA	AX12000108	CORUMBA	12/10/2020 13:04	13/10/2020 17:22	12/10/2020 15:30	13/10/2020 17:22	25,87	1	25,87	CHI
20201059927	APARECIDA DE GOIANIA	200519153	INDEPENDENCIA S2	12/10/2020 13:04	12/10/2020 14:20	12/10/2020 13:04	12/10/2020 14:20	1,27	1	1,27	CHI
20201059933	MINEIROS	MY12305765	PARQUE DAS EMAS	12/10/2020 13:06	13/10/2020 11:28	12/10/2020 13:06	13/10/2020 11:28	22,36	6	134,17	CHI
20201059939	GOIANIA	10028271708	GOIANIA LESTE S1	12/10/2020 13:07	12/10/2020 14:43	12/10/2020 13:07	12/10/2020 14:43	1,60	1	1,60	CHI
20201059942	ORIZONA	OZ12404726	PIRES DO RIO S1	12/10/2020 13:07	12/10/2020 16:15	12/10/2020 13:07	12/10/2020 16:10	3,04	9	27,39	CHI
20201059942	ORIZONA	OZ12000353LD	PIRES DO RIO S1	12/10/2020 13:07	12/10/2020 16:15	12/10/2020 15:07	12/10/2020 16:15	1,12	35	39,11	CHI

20201059943	JARAGUA	70030182	JARAGUA	12/10/2020 13:07	12/10/2020 16:01	12/10/2020 13:07	12/10/2020 16:01	2,89	1	2,89	CHI
20201059953	MINACU	IH12397473	MINACU	12/10/2020 13:09	13/10/2020 00:59	12/10/2020 18:54	12/10/2020 19:16	0,38	5	1,90	CHI
20201059953	MINACU	IH12397473	MINACU	12/10/2020 13:09	13/10/2020 00:59	12/10/2020 13:09	13/10/2020 00:59	11,82	2	23,65	CHI
20201059953	MINACU	IH12397473	MINACU	12/10/2020 13:09	13/10/2020 00:59	12/10/2020 20:59	13/10/2020 00:59	4,00	5	20,00	CHI
20201060026	QUIRINOPOLIS	CC12028258	CACHOEIRA ALTA	12/10/2020 13:10	12/10/2020 19:51	12/10/2020 13:10	12/10/2020 19:51	6,68	1	6,68	CHI
20201060026	CACU	CC12028258	CACHOEIRA ALTA	12/10/2020 13:10	12/10/2020 19:51	12/10/2020 13:10	12/10/2020 19:51	6,68	60	400,85	CHI
20201059958	GOIAS	GS21183010	ITABERAI S1	12/10/2020 13:11	12/10/2020 14:24	12/10/2020 13:11	12/10/2020 14:24	1,21	1	1,21	CHI
20201059969	CORREGO DO OURO	CO12028902	SAO LUIZ DOS MONTES BELOS	12/10/2020 13:13	14/10/2020 09:52	12/10/2020 13:13	14/10/2020 09:52	44,65	54	2411,23	CHI
20201059974	PADRE BERNARDO	PB12377649	PADRE BERNARDO	12/10/2020 13:14	12/10/2020 15:50	12/10/2020 13:14	12/10/2020 15:50	2,60	1	2,60	CHI
20201059975	SAO JOAO DA PARAUNA	RP21167309	PARAUNA	12/10/2020 13:14	13/10/2020 13:42	12/10/2020 13:14	13/10/2020 13:42	24,46	1	24,46	CHI
20201059976	CACHOEIRA ALTA	CA21071631	CACHOEIRA ALTA	12/10/2020 13:14	12/10/2020 22:01	12/10/2020 13:14	12/10/2020 22:01	8,77	1	8,77	CHI
20201060322	GOIANIA	GN11169942	CAMPINAS S1	12/10/2020 13:14	12/10/2020 15:39	12/10/2020 13:14	12/10/2020 15:39	2,41	40	96,29	CHI
20201059979	MAURILANDIA	1040029349	RIO DOS BOIS	12/10/2020 13:15	12/10/2020 18:30	12/10/2020 13:15	12/10/2020 18:30	5,25	1	5,25	CHI
20201060219	AMERICANO DO BRASIL	KB11000005	ANICUNS	12/10/2020 13:15	12/10/2020 18:24	12/10/2020 13:15	12/10/2020 18:24	5,14	117	601,38	CHI
20201059991	GOIANIA	10779449	CARAJAS S1	12/10/2020 13:17	12/10/2020 15:01	12/10/2020 13:17	12/10/2020 15:01	1,73	1	1,73	CHI
20201060005	CEZARINA	CZ21085425	CEZARINA	12/10/2020 13:19	13/10/2020 15:20	12/10/2020 13:19	13/10/2020 15:20	26,03	1	26,03	CHI
20201060008	FORMOSA	FA11397824	ITUIQUIRA	12/10/2020 13:19	12/10/2020 23:41	12/10/2020 13:19	12/10/2020 23:41	10,36	1	10,36	CHI
20201060074	ANAPOLIS	AN11000067	ANAPOLIS UNIVERSITARIO S2	12/10/2020 13:20	12/10/2020 16:58	12/10/2020 13:20	12/10/2020 16:58	3,62	114	412,71	CHI
20201060017	CATALAO	CT12130955LD	CATALAO S1	12/10/2020 13:21	12/10/2020 16:34	12/10/2020 13:21	12/10/2020 16:34	3,21	5	16,04	CHI
20201060017	DISTRITO FEDERAL	CT12130955LD	CATALAO S1	12/10/2020 13:21	12/10/2020 16:34	12/10/2020 13:21	12/10/2020 16:34	3,21	1	3,21	CHI
20201060020	GOIANIA	12945171	ATLANTICO S1	12/10/2020 13:22	12/10/2020 15:11	12/10/2020 13:22	12/10/2020 15:11	1,81	1	1,81	CHI
20201060354	CAIAPONIA	CP12390177	CAIAPONIA	12/10/2020 13:22	12/10/2020 15:31	12/10/2020 13:22	12/10/2020 15:31	2,14	7	14,99	CHI
20201060400	FORMOSA	FB12321129	IACIARA S2	12/10/2020 13:24	12/10/2020 18:15	12/10/2020 13:24	12/10/2020 18:15	4,85	1	4,85	CHI
20201060400	VILA BOA	FB12321129	IACIARA S2	12/10/2020 13:24	12/10/2020 18:15	12/10/2020 13:24	12/10/2020 18:15	4,85	4	19,39	CHI
20201060400	FLORES DE GOIAS	FB12321129	IACIARA S2	12/10/2020 13:24	12/10/2020 18:15	12/10/2020 13:24	12/10/2020 18:15	4,85	7	33,93	CHI
20201060033	INHUMAS	30058946	INHUMAS S2	12/10/2020 13:26	12/10/2020 15:06	12/10/2020 13:26	12/10/2020 15:06	1,66	1	1,66	CHI
20201060619	INDIARA	EA12056544	EDEIA	12/10/2020 13:26	12/10/2020 19:54	12/10/2020 13:26	12/10/2020 19:54	6,46	10	64,57	CHI
20201060039	HIDROLANDIA	HD11000137	ANHANGUERA	12/10/2020 13:28	12/10/2020 15:46	12/10/2020 13:28	12/10/2020 15:46	2,30	60	137,93	CHI
20201060040	ALEXANIA	480046827	ALEXANIA	12/10/2020 13:28	12/10/2020 15:34	12/10/2020 13:28	12/10/2020 15:34	2,10	1	2,10	CHI
20201060042	GOIANIA	10015205400	CARAJAS S2	12/10/2020 13:28	12/10/2020 15:24	12/10/2020 13:28	12/10/2020 15:24	1,93	1	1,93	CHI
20201060043	CATALAO	CT12010458	CATALAO S2	12/10/2020 13:29	12/10/2020 14:31	12/10/2020 13:29	12/10/2020 14:31	1,03	7	7,20	CHI
20201060043	CUMARI	CT12010458	CATALAO S2	12/10/2020 13:29	12/10/2020 14:31	12/10/2020 13:29	12/10/2020 14:31	1,03	10	10,28	CHI
20201060044	JARAGUA	JA21158313	JARAGUA	12/10/2020 13:29	12/10/2020 17:20	12/10/2020 13:29	12/10/2020 17:20	3,85	2	7,70	CHI
20201060054	TRINDADE	10012516315	GOYA S2	12/10/2020 13:33	12/10/2020 17:17	12/10/2020 13:33	12/10/2020 17:17	3,72	1	3,72	CHI
20201060057	NOVA CRIXAS	NA21125336	NOVA CRIXAS	12/10/2020 13:34	12/10/2020 21:22	12/10/2020 13:34	12/10/2020 21:22	7,80	1	7,80	CHI
20201060058	TAQUARAL DE GOIAS	TQ11352484	ITABERAI S1	12/10/2020 13:34	12/10/2020 17:18	12/10/2020 13:34	12/10/2020 17:18	3,73	71	264,95	CHI
20201060062	DOVERLANDIA	DV21137985	CAIAPONIA	12/10/2020 13:35	12/10/2020 14:44	12/10/2020 13:35	12/10/2020 14:44	1,15	1	1,15	CHI
20201060847	CAMPOS VERDES	AJ12232302	SANTA TEREZINHA	12/10/2020 13:36	12/10/2020 21:38	12/10/2020 13:36	12/10/2020 21:38	8,03	5	40,13	CHI
20201060847	ALTO HORIZONTE	AJ12232302	SANTA TEREZINHA	12/10/2020 13:36	12/10/2020 21:38	12/10/2020 13:36	12/10/2020 21:38	8,03	9	72,24	CHI
20201060268	ITAJA	IJ12202743	ITAJA S2	12/10/2020 13:38	13/10/2020 06:21	12/10/2020 13:38	13/10/2020 06:21	16,71	6	100,27	CHI
20201060090	ALEXANIA	10011136829	ALEXANIA	12/10/2020 13:38	12/10/2020 19:38	12/10/2020 13:38	12/10/2020 19:38	5,99	1	5,99	CHI
20201060094	ABADIANIA	AA12258362	ANAPOLIS UNIVERSITARIO S1	12/10/2020 13:39	12/10/2020 15:02	12/10/2020 13:39	12/10/2020 15:02	1,37	308	422,82	CHI
20201060414	ABADIANIA	10009450228	ANAPOLIS UNIVERSITARIO S1	12/10/2020 13:39	12/10/2020 16:29	12/10/2020 13:39	12/10/2020 16:29	2,82	1	2,82	CHI
20201060099	CACHOEIRA ALTA	CA21031499	CACHOEIRA ALTA	12/10/2020 13:40	12/10/2020 22:32	12/10/2020 13:40	12/10/2020 22:32	8,85	1	8,85	CHI
20201060100	VALPARAISO DE GOIAS	VA21244586	PACAEMBU S1	12/10/2020 13:40	12/10/2020 16:23	12/10/2020 13:40	12/10/2020 16:23	2,70	1	2,70	CHI
20201060105	RUBIATABA	RB12156050	RUBIATABA	12/10/2020 13:42	12/10/2020 17:59	12/10/2020 13:42	12/10/2020 17:59	4,28	5	21,39	CHI
20201060105	MORRO AGUDO DE GOIAS	RB12156050	RUBIATABA	12/10/2020 13:42	12/10/2020 17:59	12/10/2020 13:42	12/10/2020 17:59	4,28	3	12,83	CHI
20201060109	SANTO ANTONIO DE GOIAS	GR21024348	NEROPOLIS S1	12/10/2020 13:42	12/10/2020 14:54	12/10/2020 13:42	12/10/2020 14:54	1,19	1	1,19	CHI
20201060113	CIDADE OCIDENTAL	DH12261428	MARAJOARA	12/10/2020 13:42	12/10/2020 15:27	12/10/2020 13:42	12/10/2020 15:27	1,73	21	36,43	CHI
20201060122	MONTES CLAROS DE GOIAS	ME10400384	IPORA	12/10/2020 13:43	12/10/2020 23:48	12/10/2020 13:43	12/10/2020 16:58	3,26	1	3,26	CHI
20201060122	MONTES CLAROS DE GOIAS	ME10400384	IPORA	12/10/2020 13:43	12/10/2020 23:48	12/10/2020 13:43	12/10/2020 23:48	10,10	233	2352,59	CHI
20201060116	APARECIDA DE GOIANIA	11066696	ATLANTICO S1	12/10/2020 13:43	12/10/2020 15:09	12/10/2020 13:43	12/10/2020 15:09	1,42	1	1,42	CHI
20201060118	PADRE BERNARDO	10004303073	PADRE BERNARDO	12/10/2020 13:44	12/10/2020 14:45	12/10/2020 13:44	12/10/2020 14:45	1,01	1	1,01	CHI
20201060121	PADRE BERNARDO	PB21086411	PADRE BERNARDO	12/10/2020 13:44	12/10/2020 17:28	12/10/2020 13:44	12/10/2020 17:28	3,73	1	3,73	CHI
202010189510	SAO MIGUEL DO ARAGUAIA	SM10406657	SAO MIGUEL DO ARAGUAIA	12/10/2020 13:45	12/10/2020 22:12	12/10/2020 20:05	12/10/2020 20:10	0,09	1055	92,02	CHI
202010189510	NOVA CRIXAS	SM10406657	SAO MIGUEL DO ARAGUAIA	12/10/2020 13:45	12/10/2020 22:12	12/10/2020 20:05	12/10/2020 20:10	0,09	1	0,09	CHI
202010189510	SAO MIGUEL DO ARAGUAIA	SM12113573	SAO MIGUEL DO ARAGUAIA	12/10/2020 13:45	12/10/2020 22:12	12/10/2020 13:45	12/10/2020 22:12	8,45	8	67,59	CHI
202010189510	SAO MIGUEL DO ARAGUAIA	01710414	SAO MIGUEL DO ARAGUAIA	12/10/2020 13:45	12/10/2020 22:12	12/10/2020 20:25	12/10/2020 22:12	1,79	1	1,79	CHI

20201060139	CRISTALINA	KR21240980	CRISTALINA S1	12/10/2020 13:45	12/10/2020 17:03	12/10/2020 13:45	12/10/2020 17:03	3,29	1	3,29	CHI
20201060140	ANAPOLIS	20093858	ANAPOLIS UNIVERSITARIO S2	12/10/2020 13:46	12/10/2020 14:42	12/10/2020 13:46	12/10/2020 14:42	0,93	1	0,93	CHI
20201060141	PALMEIRAS DE GOIAS	590012526	PALMEIRAS	12/10/2020 13:47	12/10/2020 17:16	12/10/2020 13:47	12/10/2020 17:16	3,48	1	3,48	CHI
20201060142	RIO VERDE	CP12076264	MONTIVIDIU T	12/10/2020 13:48	13/10/2020 14:30	12/10/2020 13:48	13/10/2020 13:50	24,04	12	288,50	CHI
20201060142	JATAI	CP12076264	MONTIVIDIU T	12/10/2020 13:48	13/10/2020 14:30	12/10/2020 13:48	13/10/2020 13:50	24,04	7	168,29	CHI
20201060142	CAIAPONIA	CP12076264	MONTIVIDIU T	12/10/2020 13:48	13/10/2020 14:30	12/10/2020 13:48	13/10/2020 13:50	24,04	52	1250,15	CHI
20201060142	CAIAPONIA	CP12076264	MONTIVIDIU T	12/10/2020 13:48	13/10/2020 14:30	12/10/2020 22:00	13/10/2020 13:50	15,84	3	47,53	CHI
20201060142	MONTIVIDIU	CP12076264	MONTIVIDIU T	12/10/2020 13:48	13/10/2020 14:30	12/10/2020 13:48	13/10/2020 14:30	24,71	2	49,42	CHI
20201060142	CAIAPONIA	CP12076264	MONTIVIDIU T	12/10/2020 13:48	13/10/2020 14:30	12/10/2020 13:48	13/10/2020 14:30	24,71	21	518,89	CHI
20201060142	CAIAPONIA	CP12076264	MONTIVIDIU T	12/10/2020 13:48	13/10/2020 14:30	12/10/2020 22:00	13/10/2020 14:30	16,51	2	33,02	CHI
20201060147	GOIANIRA	GR21313315	GOIANIRA	12/10/2020 13:49	12/10/2020 15:11	12/10/2020 13:49	12/10/2020 15:11	1,36	1	1,36	CHI
20201060150	FORMOSA	FA21041998	ITUIQUIRA	12/10/2020 13:50	13/10/2020 07:45	12/10/2020 13:50	13/10/2020 07:45	17,91	1	17,91	CHI
20201060153	SENADOR CANEDO	190037544	SENADOR CANEDO	12/10/2020 13:50	12/10/2020 14:51	12/10/2020 13:50	12/10/2020 14:51	1,01	1	1,01	CHI
20201060154	IACIARA	IA12256647	IACIARA S1	12/10/2020 13:50	12/10/2020 16:12	12/10/2020 13:50	12/10/2020 15:42	1,85	91	168,38	CHI
20201060154	IACIARA	IA11288409	IACIARA S1	12/10/2020 13:50	12/10/2020 16:12	12/10/2020 13:50	12/10/2020 16:12	2,36	33	77,93	CHI
20201060160	APARECIDA DE GOIANIA	14842828	INDEPENDENCIA S2	12/10/2020 13:52	12/10/2020 16:48	12/10/2020 13:52	12/10/2020 16:48	2,93	1	2,93	CHI
20201060167	SAO LUIS DE MONTES BELOS	SL21003642	FIRMINOPOLIS S2	12/10/2020 13:53	13/10/2020 16:13	12/10/2020 13:53	13/10/2020 16:13	26,33	1	26,33	CHI
20201060324	SANTA RITA DO ARAGUAIA	MY12153058RE	PARQUE DAS EMAS	12/10/2020 13:53	12/10/2020 16:22	12/10/2020 13:53	12/10/2020 16:22	2,47	8	19,74	CHI
20201060324	MINEIROS	MY12153058RE	PARQUE DAS EMAS	12/10/2020 13:53	12/10/2020 16:22	12/10/2020 13:53	12/10/2020 16:22	2,47	13	32,08	CHI
20201060172	PIRANHAS	1930005894	PIRANHAS	12/10/2020 13:54	12/10/2020 20:13	12/10/2020 13:54	12/10/2020 20:13	6,31	1	6,31	CHI
20201060179	BELA VISTA DE GOIAS	BV21258422	BELA VISTA S2	12/10/2020 13:56	12/10/2020 15:20	12/10/2020 13:56	12/10/2020 15:20	1,38	1	1,38	CHI
20201060946	SANTA RITA DO ARAGUAIA	SU11050002	SANTA RITA DO ARAGUAIA	12/10/2020 13:58	12/10/2020 19:06	12/10/2020 13:58	12/10/2020 19:06	5,12	120	614,63	CHI
20201060190	GOIAS	GS12060919	GOIAS	12/10/2020 13:59	12/10/2020 16:13	12/10/2020 13:59	12/10/2020 16:13	2,23	5	11,15	CHI
20201060193	FORMOSO	FO21321038	PORANGATU	12/10/2020 13:59	12/10/2020 17:22	12/10/2020 13:59	12/10/2020 17:22	3,37	1	3,37	CHI
20201060196	INHUMAS	10009277798	INHUMAS S2	12/10/2020 14:00	12/10/2020 15:39	12/10/2020 14:00	12/10/2020 15:39	1,65	1	1,65	CHI
20201060199	LUZIANIA	LZ21373000	MARAJOARA	12/10/2020 14:01	12/10/2020 15:30	12/10/2020 14:01	12/10/2020 15:30	1,48	1	1,48	CHI
20201060192	VILA PROPICIO	GE12196931	GOIANESIA S1	12/10/2020 14:02	12/10/2020 16:45	12/10/2020 14:02	12/10/2020 16:45	2,71	9	24,35	CHI
20201062220	APORE	AE12000052	ITAJA S1	12/10/2020 14:03	12/10/2020 22:07	12/10/2020 14:03	12/10/2020 22:07	8,05	13	104,68	CHI
20201060215	JARAGUA	JA21273410	JARAGUA	12/10/2020 14:04	12/10/2020 16:56	12/10/2020 14:04	12/10/2020 16:56	2,86	7	19,99	CHI
20201060220	SANTA RITA DO ARAGUAIA	SU11256813	SANTA RITA DO ARAGUAIA	12/10/2020 14:06	13/10/2020 10:15	12/10/2020 14:06	13/10/2020 10:15	20,15	1	20,15	CHI
20201060222	PADRE BERNARDO	PB21377637	PADRE BERNARDO	12/10/2020 14:06	12/10/2020 15:32	12/10/2020 14:06	12/10/2020 15:32	1,42	1	1,42	CHI
20201060227	HIDROLANDIA	HD12006326	CEPAIGO S2	12/10/2020 14:09	12/10/2020 17:05	12/10/2020 14:09	12/10/2020 17:05	2,93	22	64,36	CHI
20201060228	GOIANIA	13965645	ATLANTICO S1	12/10/2020 14:09	12/10/2020 15:10	12/10/2020 14:09	12/10/2020 15:10	1,01	1	1,01	CHI
20201060252	SANCLERLANDIA	SL12145801	FIRMINOPOLIS S2	12/10/2020 14:11	12/10/2020 15:41	12/10/2020 14:11	12/10/2020 15:41	1,50	3	4,49	CHI
20201056698	JARAGUA	JA11006450	JARAGUA	12/10/2020 14:12	12/10/2020 17:36	12/10/2020 14:12	12/10/2020 17:36	3,39	60	203,52	CHI
20201060250	PETROLINA DE GOIAS	320026759	PETROLINA	12/10/2020 14:14	12/10/2020 16:00	12/10/2020 14:14	12/10/2020 16:00	1,77	1	1,77	CHI
20201060253	GOIANIA	GN21151552	CEPAIGO S1	12/10/2020 14:14	12/10/2020 15:42	12/10/2020 14:14	12/10/2020 15:42	1,46	1	1,46	CHI
20201060254	GOIANIA	17383365	GOYA S1	12/10/2020 14:14	12/10/2020 16:13	12/10/2020 14:14	12/10/2020 16:13	1,98	1	1,98	CHI
20201060255	GOIANIA	10008812606	GOYA S1	12/10/2020 14:14	12/10/2020 14:41	12/10/2020 14:14	12/10/2020 14:41	0,44	1	0,44	CHI
20201060263	POSSE	PS21143467	IACIARA S2	12/10/2020 14:16	12/10/2020 16:02	12/10/2020 14:16	12/10/2020 16:02	1,76	1	1,76	CHI
20201060278	ITAPACI	100078140	ITAPACI	12/10/2020 14:19	12/10/2020 17:58	12/10/2020 14:19	12/10/2020 17:58	3,64	1	3,64	CHI
20201060279	CATALAO	CT12266116	CATALAO S1	12/10/2020 14:20	12/10/2020 15:19	12/10/2020 14:20	12/10/2020 15:19	0,97	3	2,91	CHI
20201060299	CACU	CC11092324	CACHOEIRA ALTA	12/10/2020 14:20	12/10/2020 17:54	12/10/2020 14:20	12/10/2020 17:54	3,55	114	404,89	CHI
20201060283	GOIAS	GS21124773	ITABERAI S2	12/10/2020 14:21	12/10/2020 16:57	12/10/2020 14:21	12/10/2020 16:57	2,60	1	2,60	CHI
20201060284	CHAPADAO DO CEU	DJ21284820	CHAPADAO DO CEU	12/10/2020 14:21	13/10/2020 11:50	12/10/2020 14:21	13/10/2020 11:50	21,48	1	21,48	CHI
20201060285	AGUAS LINDAS DE GOIAS	4830334620	AGUAS LINDAS DE GOIAS S1	12/10/2020 14:21	12/10/2020 16:02	12/10/2020 14:21	12/10/2020 16:02	1,68	1	1,68	CHI
20201060395	MARA ROSA	MQ12365605	MARA ROSA	12/10/2020 14:22	12/10/2020 18:43	12/10/2020 14:22	12/10/2020 18:43	4,35	8	34,78	CHI
20201060288	ANAPOLIS	21182371	ANAPOLIS UNIVERSITARIO S2	12/10/2020 14:22	12/10/2020 14:56	12/10/2020 14:22	12/10/2020 14:56	0,56	1	0,56	CHI
20201060341	MINEIROS	MY12347908	PARQUE DAS EMAS	12/10/2020 14:23	13/10/2020 20:53	12/10/2020 14:23	13/10/2020 20:53	30,49	4	121,94	CHI
20201061155	MINEIROS	MY12377570	PARQUE DAS EMAS	12/10/2020 14:24	12/10/2020 18:55	12/10/2020 14:24	12/10/2020 18:55	4,51	168	758,33	CHI
20201060298	ANAPOLIS	AN21255925	JUNDIAI S1	12/10/2020 14:24	12/10/2020 15:05	12/10/2020 14:24	12/10/2020 15:05	0,67	1	0,67	CHI
20201060301	SERRANOPOLIS	JT12260431RE	JATAI S1	12/10/2020 14:25	12/10/2020 20:04	12/10/2020 14:25	12/10/2020 20:04	5,64	19	107,25	CHI
20201060301	JATAI	JT12260431RE	JATAI S1	12/10/2020 14:25	12/10/2020 20:04	12/10/2020 14:25	12/10/2020 20:04	5,64	20	112,90	CHI
20201060431	CACU	CC11102485	CACHOEIRA ALTA	12/10/2020 14:25	12/10/2020 17:31	12/10/2020 14:25	12/10/2020 17:31	3,09	106	327,95	CHI
20201060307	HIDROLANDIA	HD21007430	CEPAIGO S2	12/10/2020 14:26	12/10/2020 16:55	12/10/2020 14:26	12/10/2020 16:55	2,48	1	2,48	CHI
20201060343	EDEIA	00500424	EDEIA	12/10/2020 14:29	12/10/2020 17:00	12/10/2020 14:29	12/10/2020 14:32	0,06	450	27,00	CHI
20201060343	INDIARA	00500424	EDEIA	12/10/2020 14:29	12/10/2020 17:00	12/10/2020 14:29	12/10/2020 14:32	0,06	8	0,48	CHI
20201060343	INDIARA	IY10400410	EDEIA	12/10/2020 14:29	12/10/2020 17:00	12/10/2020 14:29	12/10/2020 14:33	0,07	5	0,37	CHI

20201060343	INDIARA	IY10400609	CEZARINA	12/10/2020 14:29	12/10/2020 17:00	12/10/2020 14:30	12/10/2020 15:45	1,25	11	13,71	CHI
20201060343	INDIARA	IY13377178	CEZARINA	12/10/2020 14:29	12/10/2020 17:00	12/10/2020 14:30	12/10/2020 16:27	1,94	12	23,23	CHI
20201060343	INDIARA	IY13312584	CEZARINA	12/10/2020 14:29	12/10/2020 17:00	12/10/2020 16:52	12/10/2020 17:00	0,13	23	2,90	CHI
20201060318	PIRES DO RIO	PR16429518	PIRES DO RIO S1	12/10/2020 14:29	12/10/2020 17:30	12/10/2020 14:29	12/10/2020 17:30	3,02	61	184,37	CHI
20201060320	SAO LUIS DE MONTES BELOS	500000621	SAO LUIZ DOS MONTES BELOS	12/10/2020 14:29	12/10/2020 20:23	12/10/2020 14:29	12/10/2020 20:23	5,90	1	5,90	CHI
20201060321	ALEXANIA	AX21082620	ALEXANIA	12/10/2020 14:30	12/10/2020 20:42	12/10/2020 14:30	12/10/2020 20:42	6,20	5	30,98	CHI
20201060330	GOIANESIA	GE21000263	GOIANESIA S2	12/10/2020 14:33	12/10/2020 22:00	12/10/2020 14:33	12/10/2020 22:00	7,44	1	7,44	CHI
20201061659	PETROLINA DE GOIAS	PG11129393	PETROLINA	12/10/2020 14:35	13/10/2020 02:14	12/10/2020 14:35	13/10/2020 02:14	11,64	156	1815,93	CHI
20201060348	CRISTALINA	KR21171015	CRISTALINA S1	12/10/2020 14:37	12/10/2020 16:51	12/10/2020 14:37	12/10/2020 16:51	2,23	1	2,23	CHI
20201060384	SANTO ANTONIO DO DESCOBERTO	AX12402045	ALEXANIA	12/10/2020 14:37	12/10/2020 16:09	12/10/2020 14:37	12/10/2020 16:09	1,53	1	1,53	CHI
20201060384	ALEXANIA	AX12402045	ALEXANIA	12/10/2020 14:37	12/10/2020 16:09	12/10/2020 14:37	12/10/2020 16:09	1,53	205	313,99	CHI
20201060352	GOIANIA	11082926	FERROVIARIO S2	12/10/2020 14:37	12/10/2020 15:59	12/10/2020 14:37	12/10/2020 15:59	1,36	1	1,36	CHI
20201060355	SEADOR CANEDO	13438414	GOIANIA LESTE S1	12/10/2020 14:38	12/10/2020 15:25	12/10/2020 14:38	12/10/2020 15:25	0,78	1	0,78	CHI
20201060356	QUIRINOPOLIS	10016658769	QUIRINOPOLIS	12/10/2020 14:38	13/10/2020 01:33	12/10/2020 14:38	13/10/2020 01:33	10,92	1	10,92	CHI
20201062305	MINACU	IH12236142	MINACU	12/10/2020 14:39	13/10/2020 02:03	12/10/2020 14:39	13/10/2020 02:03	11,40	28	319,12	CHI
20201060363	NOVO GAMA	4990038916	PACAEMBU S1	12/10/2020 14:39	12/10/2020 15:51	12/10/2020 14:39	12/10/2020 15:51	1,19	1	1,19	CHI
20201061271	CACU	CA12384078	CACHOEIRA ALTA	12/10/2020 14:39	12/10/2020 23:52	12/10/2020 14:39	12/10/2020 23:52	9,21	1	9,21	CHI
20201061271	CACHOEIRA ALTA	CA12384078	CACHOEIRA ALTA	12/10/2020 14:39	12/10/2020 23:52	12/10/2020 14:39	12/10/2020 23:52	9,21	8	73,66	CHI
20201060369	GOIAS	GS21148719	GOIAS	12/10/2020 14:41	12/10/2020 17:33	12/10/2020 14:41	12/10/2020 17:33	2,86	1	2,86	CHI
20201061527	PEROLANDIA	JT13423412	PARQUE DAS EMAS	12/10/2020 14:41	14/10/2020 15:06	12/10/2020 14:41	12/10/2020 18:57	4,26	1	4,26	CHI
20201061527	PEROLANDIA	JT13423412	PARQUE DAS EMAS	12/10/2020 14:41	14/10/2020 15:06	13/10/2020 09:17	13/10/2020 09:20	0,06	1	0,06	CHI
20201061527	JATAI	MY10409364	PARQUE DAS EMAS	12/10/2020 14:41	14/10/2020 15:06	13/10/2020 09:17	13/10/2020 10:48	1,52	6	9,12	CHI
20201061527	MINEIROS	MY10409364	PARQUE DAS EMAS	12/10/2020 14:41	14/10/2020 15:06	13/10/2020 09:17	13/10/2020 10:48	1,52	30	45,58	CHI
20201061527	PEROLANDIA	JT13423412	PARQUE DAS EMAS	12/10/2020 14:41	14/10/2020 15:06	12/10/2020 14:41	14/10/2020 15:06	48,42	13	629,48	CHI
20201061527	MINEIROS	JT13423412	PARQUE DAS EMAS	12/10/2020 14:41	14/10/2020 15:06	12/10/2020 14:41	14/10/2020 15:06	48,42	1	48,42	CHI
20201061527	JATAI	JT13423412	PARQUE DAS EMAS	12/10/2020 14:41	14/10/2020 15:06	12/10/2020 14:41	14/10/2020 15:06	48,42	23	1113,70	CHI
20201061527	PEROLANDIA	JT13423412	PARQUE DAS EMAS	12/10/2020 14:41	14/10/2020 15:06	12/10/2020 18:57	14/10/2020 15:06	44,16	5	220,81	CHI
20201060373	GOIANIA	14479977	CAMPINAS S3	12/10/2020 14:42	12/10/2020 15:55	12/10/2020 14:42	12/10/2020 15:55	1,22	1	1,22	CHI
20201060413	PORTELANDIA	PW12303420	PARQUE DAS EMAS	12/10/2020 14:42	12/10/2020 18:55	12/10/2020 14:42	12/10/2020 18:55	4,21	14	58,87	CHI
20201060377	GOIANIRA	10021092786	MEIA PONTE	12/10/2020 14:42	12/10/2020 16:15	12/10/2020 14:42	12/10/2020 16:15	1,54	1	1,54	CHI
20201060486	PLANALTINA	PI12211522	PADRE BERNARDO	12/10/2020 14:43	13/10/2020 11:49	12/10/2020 14:43	13/10/2020 11:49	21,08	25	527,11	CHI
20201060399	ITAJA	IJ10400571	ITAJA S2	12/10/2020 14:44	13/10/2020 01:42	12/10/2020 14:44	13/10/2020 00:53	10,16	4	40,66	CHI
20201060399	ITAJA	IJ10352428	ITAJA S2	12/10/2020 14:44	13/10/2020 01:42	12/10/2020 14:44	13/10/2020 01:42	10,98	5	54,88	CHI
20201060387	ABADIA DE GOIAS	LG21130143	CARAJAS S1	12/10/2020 14:46	12/10/2020 16:51	12/10/2020 14:46	12/10/2020 16:51	2,07	2	4,14	CHI
20201060401	CALDAZINHA	DE21279278	CEPAIGO S2	12/10/2020 14:48	12/10/2020 15:35	12/10/2020 14:48	12/10/2020 15:35	0,77	1	0,77	CHI
20201060724	PORTELANDIA	PW12303429	PARQUE DAS EMAS	12/10/2020 14:49	12/10/2020 21:38	12/10/2020 14:49	12/10/2020 21:38	6,81	3	20,43	CHI
20201060405	ANAPOLIS	20508037	ANAPOLIS UNIVERSITARIO S2	12/10/2020 14:49	12/10/2020 16:07	12/10/2020 14:49	12/10/2020 16:07	1,30	1	1,30	CHI
20201060407	CRISTALINA	KR12230156	PAMPLONA	12/10/2020 14:49	12/10/2020 16:19	12/10/2020 14:49	12/10/2020 16:19	1,49	22	32,71	CHI
20201060411	ITABERAI	IB12078567	ITABERAI S1	12/10/2020 14:51	12/10/2020 16:41	12/10/2020 14:51	12/10/2020 16:41	1,83	7	12,83	CHI
20201060419	PALMINOPOLIS	PP21259234	PALMEIRAS	12/10/2020 14:52	12/10/2020 17:40	12/10/2020 14:52	12/10/2020 17:40	2,79	2	5,58	CHI
20201060422	FLORES DE GOIAS	FB21342371	IACIARA S2	12/10/2020 14:53	12/10/2020 23:27	12/10/2020 14:53	12/10/2020 23:27	8,55	1	8,55	CHI
20201060423	ITAPURANGA	IK21186788	ITAPURANGA	12/10/2020 14:54	12/10/2020 17:25	12/10/2020 14:54	12/10/2020 17:25	2,51	1	2,51	CHI
20201059726	GOIANIA	GN11002414	FERROVIARIO S1	12/10/2020 14:55	12/10/2020 15:14	12/10/2020 14:55	12/10/2020 15:14	0,32	74	23,43	CHI
20201060428	CRISTALINA	KR21323364	CRISTALINA S1	12/10/2020 14:55	12/10/2020 17:36	12/10/2020 14:55	12/10/2020 17:36	2,68	2	5,36	CHI
20201060429	CAMPINACU	UC12197187	PORANGATU	12/10/2020 14:55	13/10/2020 14:10	12/10/2020 14:55	13/10/2020 14:10	23,24	28	650,77	CHI
20201060432	CRISTALINA	KR21248718	CRISTALINA S2	12/10/2020 14:56	12/10/2020 16:47	12/10/2020 14:56	12/10/2020 16:47	1,84	3	5,51	CHI
20201060437	GOIAS	GS11068585	MATRINCHA	12/10/2020 14:58	13/10/2020 10:26	12/10/2020 14:58	13/10/2020 10:26	19,45	1	19,45	CHI
20201060442	PLANALTINA	PI11000032	PLANALTINA	12/10/2020 14:59	12/10/2020 17:21	12/10/2020 14:59	12/10/2020 17:21	2,36	338	796,37	CHI
20201060455	NEROPOLIS	NR10406876	NEROPOLIS S2	12/10/2020 15:00	13/10/2020 18:08	12/10/2020 15:00	12/10/2020 15:39	0,64	4	2,55	CHI
20201060455	GOIANIA	NR10406876	NEROPOLIS S2	12/10/2020 15:00	13/10/2020 18:08	12/10/2020 15:00	12/10/2020 15:39	0,64	209	133,24	CHI
20201060455	NEROPOLIS	NR10406876	NEROPOLIS S2	12/10/2020 15:00	13/10/2020 18:08	12/10/2020 16:39	12/10/2020 16:56	0,28	4	1,12	CHI
20201060455	GOIANIA	NR10406876	NEROPOLIS S2	12/10/2020 15:00	13/10/2020 18:08	12/10/2020 16:39	12/10/2020 16:56	0,28	209	58,64	CHI
20201060455	TEREZOPOLIS DE GOIAS	GN12002673LD	NEROPOLIS S2	12/10/2020 15:00	13/10/2020 18:08	12/10/2020 15:00	12/10/2020 18:00	2,99	1	2,99	CHI
20201060455	GOIANIA	GN12002673LD	NEROPOLIS S2	12/10/2020 15:00	13/10/2020 18:08	12/10/2020 15:00	12/10/2020 18:00	2,99	1	2,99	CHI
20201060455	NEROPOLIS	GN12002673LD	NEROPOLIS S2	12/10/2020 15:00	13/10/2020 18:08	12/10/2020 15:00	12/10/2020 18:00	2,99	34	101,53	CHI
20201060455	NEROPOLIS	NR12000031	NEROPOLIS S2	12/10/2020 15:00	13/10/2020 18:08	12/10/2020 15:00	12/10/2020 20:27	5,44	6	32,63	CHI
20201060455	GOIANIA	NR12000031	NEROPOLIS S2	12/10/2020 15:00	13/10/2020 18:08	12/10/2020 15:00	12/10/2020 20:27	5,44	10	54,39	CHI
20201060455	NEROPOLIS	NR12000031	NEROPOLIS S2	12/10/2020 15:00	13/10/2020 18:08	12/10/2020 15:00	13/10/2020 18:08	27,13	13	352,66	CHI

20201060455	GOIANIA	NR12000031	NEROPOLIS S2	12/10/2020 15:00	13/10/2020 18:08	12/10/2020 15:00	13/10/2020 18:08	27,13	11	298,40	CHI
20201060455	NEROPOLIS	NR12000031	NEROPOLIS S2	12/10/2020 15:00	13/10/2020 18:08	13/10/2020 17:40	13/10/2020 18:08	0,47	6	2,85	CHI
20201060455	GOIANIA	NR12000031	NEROPOLIS S2	12/10/2020 15:00	13/10/2020 18:08	13/10/2020 17:40	13/10/2020 18:08	0,47	10	4,75	CHI
20201061306	OURO VERDE DE GOIAS	OV12130762LD	NEROPOLIS S1	12/10/2020 15:01	13/10/2020 04:14	12/10/2020 15:01	13/10/2020 04:14	13,22	32	422,99	CHI
20201060452	NOVO BRASIL	NB12378823	JUSSARA	12/10/2020 15:01	12/10/2020 19:27	12/10/2020 15:01	12/10/2020 19:27	4,43	1	4,43	CHI
20201060453	RIO VERDE	630200257	RIO VERDE S1	12/10/2020 15:01	12/10/2020 16:10	12/10/2020 15:01	12/10/2020 16:10	1,13	1	1,13	CHI
20201060460	ITABERAÍ	IX21012963	INHUMAS S1	12/10/2020 15:02	12/10/2020 16:37	12/10/2020 15:02	12/10/2020 16:37	1,58	1	1,58	CHI
20201060484	MORRINHOS	MR12125522	MORRINHOS	12/10/2020 15:02	12/10/2020 16:31	12/10/2020 15:02	12/10/2020 16:31	1,47	30	44,17	CHI
20201060458	ARAGOIANIA	10006231894	GUAPO S2	12/10/2020 15:02	12/10/2020 17:47	12/10/2020 15:02	12/10/2020 17:47	2,74	1	2,74	CHI
20201060461	CAMPINORTE	2040013897	CAMPINORTE	12/10/2020 15:02	13/10/2020 00:22	12/10/2020 15:02	13/10/2020 00:22	9,32	1	9,32	CHI
20201060677	CACHOEIRA DE GOIAS	CG12018660	FIRMINOPOLIS S2	12/10/2020 15:03	13/10/2020 10:02	12/10/2020 15:03	13/10/2020 10:02	18,98	38	721,34	CHI
20201060466	SANTA RITA DO NOVO DESTINO	DF11315670	BARRO ALTO	12/10/2020 15:05	13/10/2020 07:49	12/10/2020 15:05	13/10/2020 07:49	16,73	2	33,45	CHI
20201060470	GOIANIA	10826439	GOIANIA LESTE S2	12/10/2020 15:06	12/10/2020 16:38	12/10/2020 15:06	12/10/2020 16:38	1,52	1	1,52	CHI
20201060475	MORRINHOS	MR12223469	MORRINHOS	12/10/2020 15:08	12/10/2020 17:09	12/10/2020 15:08	12/10/2020 17:09	2,00	20	40,01	CHI
20201062108	ITAPACI	IW11056081	ITAPACI	12/10/2020 15:11	13/10/2020 03:55	12/10/2020 15:11	13/10/2020 03:55	12,72	210	2670,62	CHI
20201060487	APARECIDA DE GOIANIA	AP11164450	INDEPENDENCIA S2	12/10/2020 15:13	12/10/2020 17:21	12/10/2020 15:13	12/10/2020 17:21	2,13	158	335,79	CHI
20201060491	CACU	CC21341003	CACHOEIRA ALTA	12/10/2020 15:15	12/10/2020 20:10	12/10/2020 15:15	12/10/2020 20:10	4,91	2	9,82	CHI
20201060515	FIRMINOPOLIS	FR12079141	FIRMINOPOLIS S1	12/10/2020 15:17	12/10/2020 18:42	12/10/2020 15:17	12/10/2020 18:42	3,40	2	6,81	CHI
20201061318	SAO JOAO D ALIANCA	JL12146125	SAO JOAO D ALIANCA	12/10/2020 15:19	12/10/2020 18:30	12/10/2020 15:19	12/10/2020 18:30	3,18	3	9,54	CHI
20201060522	CRISTALINA	KR21336015	CRISTALINA S2	12/10/2020 15:19	12/10/2020 16:04	12/10/2020 15:19	12/10/2020 16:04	0,74	2	1,48	CHI
20201060523	LUZIANIA	LZ21120161	RIO VERMELHO	12/10/2020 15:19	12/10/2020 16:06	12/10/2020 15:19	12/10/2020 16:06	0,77	1	0,77	CHI
20201060524	PADRE BERNARDO	PB21111366	PADRE BERNARDO	12/10/2020 15:19	12/10/2020 15:53	12/10/2020 15:19	12/10/2020 15:53	0,55	1	0,55	CHI
20201060530	CRISTALINA	KR21245991	CRISTALINA S2	12/10/2020 15:22	12/10/2020 18:15	12/10/2020 15:22	12/10/2020 18:15	2,88	2	5,75	CHI
20201060537	GOIANIA	14082780	MEIA PONTE	12/10/2020 15:24	12/10/2020 17:09	12/10/2020 15:24	12/10/2020 17:09	1,74	1	1,74	CHI
20201060538	ITAUCU	1860000505	INHUMAS S1	12/10/2020 15:24	12/10/2020 17:21	12/10/2020 15:24	12/10/2020 17:21	1,94	1	1,94	CHI
20201060539	INDIARA	IY21154100	CEZARINA	12/10/2020 15:24	12/10/2020 19:15	12/10/2020 15:24	12/10/2020 19:15	3,84	1	3,84	CHI
20201060542	RIO VERDE	RV21289597	RIO VERDE S1	12/10/2020 15:25	12/10/2020 17:27	12/10/2020 15:25	12/10/2020 17:27	2,03	1	2,03	CHI
20201060546	GOIANIA	8519025	XAVANTES	12/10/2020 15:25	12/10/2020 17:09	12/10/2020 15:25	12/10/2020 17:09	1,72	15	25,86	CHI
20201060708	ALTO PARAISO DE GOIAS	BF10395392	NIQUELANDIA SUBTRANSMISSAO	12/10/2020 15:25	13/10/2020 15:37	12/10/2020 15:25	12/10/2020 16:03	0,63	5	3,14	CHI
20201060708	ALTO PARAISO DE GOIAS	BF10400725	NIQUELANDIA SUBTRANSMISSAO	12/10/2020 15:25	13/10/2020 15:37	12/10/2020 15:25	12/10/2020 16:06	0,68	1	0,68	CHI
20201060708	COLINAS DO SUL	BF10400725	NIQUELANDIA SUBTRANSMISSAO	12/10/2020 15:25	13/10/2020 15:37	12/10/2020 15:25	12/10/2020 16:06	0,68	7	4,79	CHI
20201060708	COLINAS DO SUL	TI10398398	NIQUELANDIA SUBTRANSMISSAO	12/10/2020 15:25	13/10/2020 15:37	12/10/2020 15:25	12/10/2020 16:17	0,86	89	76,79	CHI
20201060708	COLINAS DO SUL	TI10398398	NIQUELANDIA SUBTRANSMISSAO	12/10/2020 15:25	13/10/2020 15:37	12/10/2020 16:08	12/10/2020 16:17	0,15	1054	155,46	CHI
20201060708	ALTO PARAISO DE GOIAS	NQ10383169	NIQUELANDIA SUBTRANSMISSAO	12/10/2020 15:25	13/10/2020 15:37	12/10/2020 15:25	12/10/2020 17:30	2,07	1	2,07	CHI
20201060708	ALTO PARAISO DO SUL	NQ10383169	NIQUELANDIA SUBTRANSMISSAO	12/10/2020 15:25	13/10/2020 15:37	12/10/2020 15:25	12/10/2020 17:30	2,07	2	4,14	CHI
20201060708	NIQUELANDIA	NQ10383169	NIQUELANDIA SUBTRANSMISSAO	12/10/2020 15:25	13/10/2020 15:37	12/10/2020 15:25	12/10/2020 17:30	2,07	9	18,65	CHI
20201060708	COLINAS DO SUL	TI10400728	NIQUELANDIA SUBTRANSMISSAO	12/10/2020 15:25	13/10/2020 15:37	12/10/2020 16:20	12/10/2020 17:43	1,37	1143	1566,23	CHI
20201060708	COLINAS DO SUL	TI10396052	MINACU	12/10/2020 15:25	13/10/2020 15:37	12/10/2020 15:25	12/10/2020 17:43	2,30	271	624,05	CHI
20201060708	ALTO PARAISO DE GOIAS	BF10400725	NIQUELANDIA SUBTRANSMISSAO	12/10/2020 15:25	13/10/2020 15:37	12/10/2020 16:20	12/10/2020 23:03	6,71	2	13,42	CHI
20201060708	ALTO PARAISO DE GOIAS	TI13256717	NIQUELANDIA SUBTRANSMISSAO	12/10/2020 15:25	13/10/2020 15:37	12/10/2020 16:20	13/10/2020 15:37	23,28	24	558,78	CHI
20201060708	CAVALCANTE	TI13256717	NIQUELANDIA SUBTRANSMISSAO	12/10/2020 15:25	13/10/2020 15:37	12/10/2020 16:20	13/10/2020 15:37	23,28	58	1350,39	CHI
20201060708	COLINAS DO SUL	TI13256717	NIQUELANDIA SUBTRANSMISSAO	12/10/2020 15:25	13/10/2020 15:37	12/10/2020 16:20	13/10/2020 15:37	23,28	74	1722,91	CHI
20201060708	NIQUELANDIA	TI13256717	NIQUELANDIA SUBTRANSMISSAO	12/10/2020 15:25	13/10/2020 15:37	12/10/2020 16:20	13/10/2020 15:37	23,28	4	93,13	CHI
20201060547	PADRE BERNARDO	2760052856	PADRE BERNARDO	12/10/2020 15:25	13/10/2020 07:29	12/10/2020 15:25	13/10/2020 07:29	16,07	1	16,07	CHI
20201060548	VALPARAISO DE GOIAS	VA11192936	PACAEMBU S1	12/10/2020 15:25	12/10/2020 17:15	12/10/2020 15:25	12/10/2020 17:15	1,82	7	12,74	CHI
20201060550	CRIXAS	CX21346649	SANTA TEREZINHA	12/10/2020 15:25	12/10/2020 20:27	12/10/2020 15:25	12/10/2020 20:27	5,02	1	5,02	CHI
20201060554	ITAPURANGA	170055607	ITAPURANGA	12/10/2020 15:27	12/10/2020 19:36	12/10/2020 15:27	12/10/2020 19:36	4,14	1	4,14	CHI
20201060768	JUSSARA	JR12259693	JUSSARA	12/10/2020 15:27	13/10/2020 10:15	12/10/2020 15:27	13/10/2020 10:15	18,79	3	56,38	CHI
20201062539	ISRAELANDIA	FN12082334	IPORA	12/10/2020 15:27	12/10/2020 22:11	12/10/2020 15:27	12/10/2020 22:11	6,72	2	13,44	CHI
20201062539	FAZENDA NOVA	FN12082334	IPORA	12/10/2020 15:27	12/10/2020 22:11	12/10/2020 15:27	12/10/2020 22:11	6,72	11	73,92	CHI
20201060580	PIRANHAS	05560414	PIRANHAS	12/10/2020 15:28	13/10/2020 00:01	12/10/2020 15:28	12/10/2020 17:13	1,75	32	56,06	CHI
20201060580	CAIAPONIA	05560414	PIRANHAS	12/10/2020 15:28	13/10/2020 00:01	12/10/2020 15:28	12/10/2020 17:13	1,75	10	17,52	CHI
20201060580	PIRANHAS	05560414	PIRANHAS	12/10/2020 15:28	13/10/2020 00:01	12/10/2020 15:31	12/10/2020 17:13	1,70	1	1,70	CHI
20201060580	CAIAPONIA	05560414	PIRANHAS	12/10/2020 15:28	13/10/2020 00:01	12/10/2020 15:28	12/10/2020 18:04	2,61	34	88,73	CHI
20201060580	PIRANHAS	05560414	PIRANHAS	12/10/2020 15:28	13/10/2020 00:01	12/10/2020 15:28	12/10/2020 18:04	2,61	2	5,22	CHI
20201060580	CAIAPONIA	05560414	PIRANHAS	12/10/2020 15:28	13/10/2020 00:01	12/10/2020 15:28	12/10/2020 20:40	5,20	28	145,70	CHI
20201060580	CAIAPONIA	05560414	PIRANHAS	12/10/2020 15:28	13/10/2020 00:01	12/10/2020 15:28	12/10/2020 22:44	7,27	3	21,82	CHI
20201060580	CAIAPONIA	05560414	PIRANHAS	12/10/2020 15:28	13/10/2020 00:01	12/10/2020 15:28	12/10/2020 23:17	7,82	8	62,60	CHI

20201060580	CAIAPONIA	05560414	PIRANHAS	12/10/2020 15:28	13/10/2020 00:01	12/10/2020 15:28	13/10/2020 00:01	8,56	3	25,67	CHI
20201061599	SANCLERLANDIA	SC12206497	FIRMINOPOLIS S2	12/10/2020 15:30	13/10/2020 18:00	12/10/2020 15:30	12/10/2020 22:19	6,83	76	518,81	CHI
20201061599	MOSSAMEDES	SC12206497	FIRMINOPOLIS S2	12/10/2020 15:30	13/10/2020 18:00	12/10/2020 15:30	12/10/2020 22:19	6,83	3	20,48	CHI
20201061599	MOSSAMEDES	SC12206497	FIRMINOPOLIS S2	12/10/2020 15:30	13/10/2020 18:00	12/10/2020 22:54	13/10/2020 15:14	16,34	3	49,01	CHI
20201061599	SANCLERLANDIA	SC12206497	FIRMINOPOLIS S2	12/10/2020 15:30	13/10/2020 18:00	12/10/2020 22:54	13/10/2020 15:14	16,34	75	1225,23	CHI
20201061599	SANCLERLANDIA	6580044	FIRMINOPOLIS S2	12/10/2020 15:30	13/10/2020 18:00	12/10/2020 22:54	13/10/2020 18:00	19,10	1	19,10	CHI
20201060569	GOIANIA	14238688	FERROVIARIO S3	12/10/2020 15:31	12/10/2020 17:31	12/10/2020 15:31	12/10/2020 17:31	1,99	1	1,99	CHI
20201060578	PIRENOPOLIS	PV12352327	CORUMBA	12/10/2020 15:32	12/10/2020 17:55	12/10/2020 15:32	12/10/2020 17:55	2,38	18	42,82	CHI
20201060576	GOIANIA	10783866	CARAJAS S1	12/10/2020 15:33	12/10/2020 16:44	12/10/2020 15:33	12/10/2020 16:44	1,17	1	1,17	CHI
20201060642	TEREZOPOLIS DE GOIAS	TJ12353408	DAIA S2	12/10/2020 15:34	12/10/2020 16:52	12/10/2020 15:34	12/10/2020 16:52	1,28	1	1,28	CHI
20201060642	GOIANAPOLIS	TJ12353408	DAIA S2	12/10/2020 15:34	12/10/2020 16:52	12/10/2020 15:34	12/10/2020 16:52	1,28	3	3,85	CHI
20201060586	GOIANIA	15581457	GOIANIA LESTE S3	12/10/2020 15:35	12/10/2020 16:39	12/10/2020 15:35	12/10/2020 16:39	1,06	1	1,06	CHI
20201060588	SENADOR CANEDO	190059450	SENADOR CANEDO	12/10/2020 15:35	12/10/2020 15:58	12/10/2020 15:35	12/10/2020 15:58	0,37	1	0,37	CHI
20201062320	NIQUELANDIA	NQ13243371	URUACU	12/10/2020 15:37	13/10/2020 14:01	12/10/2020 15:37	12/10/2020 20:23	4,77	342	1630,10	CHI
20201062320	URUACU	UR13262936	URUACU	12/10/2020 15:37	13/10/2020 14:01	13/10/2020 10:46	13/10/2020 13:27	2,67	43	114,75	CHI
20201062320	NIQUELANDIA	NQ13243371	URUACU	12/10/2020 15:37	13/10/2020 14:01	12/10/2020 22:15	13/10/2020 13:56	15,70	461	7237,06	CHI
20201062320	NIQUELANDIA	NQ10400421	URUACU	12/10/2020 15:37	13/10/2020 14:01	12/10/2020 15:37	13/10/2020 14:01	22,41	423	9479,78	CHI
20201062320	MARA ROSA	NQ10400421	URUACU	12/10/2020 15:37	13/10/2020 14:01	12/10/2020 15:37	13/10/2020 14:01	22,41	1	22,41	CHI
20201062320	BARRO ALTO	NQ10400421	URUACU	12/10/2020 15:37	13/10/2020 14:01	12/10/2020 15:37	13/10/2020 14:01	22,41	1	22,41	CHI
20201060605	AMARALINA	LC21308846	MARA ROSA	12/10/2020 15:37	12/10/2020 18:08	12/10/2020 15:37	12/10/2020 18:08	2,51	1	2,51	CHI
20201060611	SANTO ANTONIO DO DESCOBERTO	SN12275494	MARAOARA	12/10/2020 15:39	13/10/2020 19:16	12/10/2020 15:39	13/10/2020 19:16	27,62	8	220,94	CHI
20201060633	ITABERAI	IB12210550	ITABERAI S1	12/10/2020 15:39	12/10/2020 17:05	12/10/2020 15:39	12/10/2020 17:05	1,43	35	50,11	CHI
20201060633	GOIAS	IB12210550	ITABERAI S1	12/10/2020 15:39	12/10/2020 17:05	12/10/2020 15:39	12/10/2020 17:05	1,43	3	4,29	CHI
20201060802	NEROPOLIS	NR12000048	NEROPOLIS S2	12/10/2020 15:39	13/10/2020 00:56	12/10/2020 15:39	13/10/2020 00:56	9,27	17	157,59	CHI
20201060620	FAZENDA NOVA	FN11371908	IPORA	12/10/2020 15:40	13/10/2020 14:56	12/10/2020 15:40	13/10/2020 14:56	23,27	1	23,27	CHI
20201060643	CALDAS NOVAS	00320424	CALDAS NOVAS S1	12/10/2020 15:42	13/10/2020 17:32	12/10/2020 15:42	12/10/2020 17:39	1,96	26	50,91	CHI
20201060643	CALDAS NOVAS	CN13309448	CALDAS NOVAS S1	12/10/2020 15:42	13/10/2020 17:32	12/10/2020 18:09	12/10/2020 21:16	3,11	26	80,98	CHI
20201060643	CALDAS NOVAS	CN13363693	CALDAS NOVAS S1	12/10/2020 15:42	13/10/2020 17:32	12/10/2020 15:42	12/10/2020 21:30	5,80	7	40,61	CHI
20201060643	RIO QUENTE	CN13363693	CALDAS NOVAS S1	12/10/2020 15:42	13/10/2020 17:32	12/10/2020 15:42	12/10/2020 21:30	5,80	41	237,87	CHI
20201060643	RIO QUENTE	CN13223363	CALDAS NOVAS S1	12/10/2020 15:42	13/10/2020 17:32	12/10/2020 15:42	12/10/2020 21:46	6,08	2	12,15	CHI
20201060643	CALDAS NOVAS	CN13309448	CALDAS NOVAS S1	12/10/2020 15:42	13/10/2020 17:32	12/10/2020 21:50	12/10/2020 23:02	1,20	26	31,18	CHI
20201060643	RIO QUENTE	CN13363693	CALDAS NOVAS S1	12/10/2020 15:42	13/10/2020 17:32	12/10/2020 21:50	13/10/2020 09:58	12,13	41	497,46	CHI
20201060643	CALDAS NOVAS	CN13363693	CALDAS NOVAS S1	12/10/2020 15:42	13/10/2020 17:32	12/10/2020 21:50	13/10/2020 09:58	12,13	7	84,93	CHI
20201060643	RIO QUENTE	CN13223363	CALDAS NOVAS S1	12/10/2020 15:42	13/10/2020 17:32	12/10/2020 21:50	13/10/2020 17:32	19,71	2	39,41	CHI
20201060651	NEROPOLIS	NR12247250	NEROPOLIS S2	12/10/2020 15:42	12/10/2020 21:21	12/10/2020 15:42	12/10/2020 21:21	5,64	9	50,74	CHI
20201061859	JATAI	JT11234295	JATAI S3	12/10/2020 15:43	13/10/2020 04:06	12/10/2020 15:43	13/10/2020 04:06	12,38	97	1201,16	CHI
20201060752	CRISTALINA	IP12165527	CRISTALINA S1	12/10/2020 15:43	12/10/2020 19:13	12/10/2020 15:43	12/10/2020 19:13	3,49	15	52,32	CHI
20201060641	ITAJA	IJ21000009	ITAJA S2	12/10/2020 15:44	13/10/2020 07:20	12/10/2020 15:44	13/10/2020 07:20	15,60	1	15,60	CHI
20201060725	ANAPOLIS	AN11000290	JUNDIAI S2	12/10/2020 15:44	12/10/2020 17:01	12/10/2020 15:44	12/10/2020 17:01	1,27	75	95,23	CHI
20201060650	BELA VISTA DE GOIAS	BV31097874	BELA VISTA S1	12/10/2020 15:46	12/10/2020 16:47	12/10/2020 15:46	12/10/2020 16:47	1,01	1	1,01	CHI
20201060652	AGUAS LINDAS DE GOIAS	LA11060367	AGUAS LINDAS DE GOIAS S1	12/10/2020 15:46	12/10/2020 17:39	12/10/2020 15:46	12/10/2020 17:39	1,87	23	42,98	CHI
20201060655	JARAGUA	10003047596	JARAGUA	12/10/2020 15:47	12/10/2020 17:45	12/10/2020 15:47	12/10/2020 17:45	1,96	1	1,96	CHI
20201060661	NEROPOLIS	NR21000095	NEROPOLIS S2	12/10/2020 15:49	12/10/2020 22:01	12/10/2020 15:49	12/10/2020 22:01	6,20	1	6,20	CHI
20201060662	SAO JOAO D ALIANCA	6915031	SAO JOAO D ALIANCA	12/10/2020 15:49	12/10/2020 19:50	12/10/2020 15:49	12/10/2020 19:50	4,02	2	8,03	CHI
20201060753	NEROPOLIS	NR11167732	NEROPOLIS S2	12/10/2020 15:49	12/10/2020 17:35	12/10/2020 15:49	12/10/2020 17:35	1,76	119	209,41	CHI
20201063131	SANCLERLANDIA	SC12299151	FIRMINOPOLIS S2	12/10/2020 15:51	12/10/2020 23:46	12/10/2020 15:51	12/10/2020 23:46	7,92	5	39,58	CHI
20201060679	GOIANIA	12567772	ATLANTICO S3	12/10/2020 15:52	12/10/2020 18:53	12/10/2020 15:52	12/10/2020 18:53	3,01	1	3,01	CHI
20201060680	ITAJA	IJ21226577	ITAJA S2	12/10/2020 15:52	13/10/2020 08:00	12/10/2020 15:52	13/10/2020 08:00	16,13	1	16,13	CHI
20201060683	APARECIDA DE GOIANIA	AP12402785	INDEPENDENCIA S2	12/10/2020 15:52	12/10/2020 19:29	12/10/2020 15:52	12/10/2020 19:29	3,60	1	3,60	CHI
20201060685	GOIANIA	13426916	ATLANTICO S1	12/10/2020 15:53	12/10/2020 16:55	12/10/2020 15:53	12/10/2020 16:55	1,03	1	1,03	CHI
20201060687	SANTA FE DE GOIAS	RN12123453	BRITANIA	12/10/2020 15:53	12/10/2020 17:58	12/10/2020 15:53	12/10/2020 17:58	2,07	2	4,14	CHI
20201060728	DIVINOPOLIS DE GOIAS	GH12151237	SAO DOMINGOS	12/10/2020 15:54	12/10/2020 17:34	12/10/2020 15:54	12/10/2020 17:34	1,65	29	47,90	CHI
20201060728	SAO DOMINGOS	GH12151237	SAO DOMINGOS	12/10/2020 15:54	12/10/2020 17:34	12/10/2020 15:54	12/10/2020 17:34	1,65	21	34,69	CHI
20201061894	MORRINHOS	150180883	MORRINHOS	12/10/2020 15:55	12/10/2020 23:21	12/10/2020 15:55	12/10/2020 23:21	7,43	1	7,43	CHI
20201060739	IACIARA	1550001787	IACIARA S1	12/10/2020 15:57	12/10/2020 18:32	12/10/2020 15:57	12/10/2020 18:32	2,57	1	2,57	CHI
20201060743	ARAGARCAS	BM11358821	BOM JARDIM	12/10/2020 15:58	12/10/2020 18:25	12/10/2020 15:58	12/10/2020 18:25	2,45	1	2,45	CHI
20201060744	MINACU	IH21279360	MINACU	12/10/2020 15:58	13/10/2020 13:14	12/10/2020 15:58	13/10/2020 13:14	21,26	1	21,26	CHI
20201060747	POSSE	PS11352151	IACIARA S2	12/10/2020 15:59	12/10/2020 19:52	12/10/2020 15:59	12/10/2020 19:52	3,88	2	7,76	CHI

20201060776	QUIRINOPOLIS	QI11371206	QUIRINOPOLIS	12/10/2020 16:03	12/10/2020 19:47	12/10/2020 16:03	12/10/2020 19:47	3,72	64	238,08	CHI
20201060774	ANAPOLIS	AN12000076	JUNDIAI S2	12/10/2020 16:04	12/10/2020 20:32	12/10/2020 16:04	12/10/2020 20:32	4,45	1	4,45	CHI
20201061047	NEROPOLIS	NR12317440	NEROPOLIS S2	12/10/2020 16:05	12/10/2020 18:16	12/10/2020 16:05	12/10/2020 18:16	2,17	40	86,68	CHI
20201060779	RIO VERDE	630034631	RIO VERDE S2	12/10/2020 16:06	13/10/2020 16:00	12/10/2020 16:06	13/10/2020 16:00	23,90	1	23,90	CHI
20201060780	INHUMAS	IN11000067	INHUMAS S2	12/10/2020 16:06	12/10/2020 17:45	12/10/2020 16:06	12/10/2020 17:45	1,64	142	233,47	CHI
20201060783	NOVO GAMA	2460055852	PACAEMBU S1	12/10/2020 16:06	12/10/2020 17:51	12/10/2020 16:06	12/10/2020 17:51	1,74	1	1,74	CHI
20201060785	SAO DOMINGOS	ND10416743	IACIARA S2	12/10/2020 16:06	12/10/2020 18:16	12/10/2020 16:06	12/10/2020 18:16	2,15	3	6,46	CHI
20201060785	NOVA ROMA	ND10416743	IACIARA S2	12/10/2020 16:06	12/10/2020 18:16	12/10/2020 16:06	12/10/2020 18:16	2,15	8	17,22	CHI
20201061057	SAO JOAO DA PARAUNA	FR12040685	FIRMINOPOLIS S2	12/10/2020 16:07	12/10/2020 21:21	12/10/2020 16:07	12/10/2020 21:21	5,22	6	31,33	CHI
20201060818	MORRINHOS	MR12251748RE	MORRINHOS	12/10/2020 16:08	13/10/2020 13:04	12/10/2020 16:08	12/10/2020 19:57	3,82	1	3,82	CHI
20201060818	MORRINHOS	MR12251748RE	MORRINHOS	12/10/2020 16:08	13/10/2020 13:04	12/10/2020 16:08	12/10/2020 21:06	4,97	4	19,87	CHI
20201060818	MORRINHOS	MR12249909LD	MORRINHOS	12/10/2020 16:08	13/10/2020 13:04	12/10/2020 21:32	12/10/2020 21:41	0,15	4	0,60	CHI
20201060818	MORRINHOS	MR12251748RE	MORRINHOS	12/10/2020 16:08	13/10/2020 13:04	12/10/2020 16:08	12/10/2020 22:04	5,95	2	11,90	CHI
20201060818	MORRINHOS	MR21307871	MORRINHOS	12/10/2020 16:08	13/10/2020 13:04	12/10/2020 22:13	13/10/2020 12:43	14,49	1	14,49	CHI
20201060818	MORRINHOS	MR21249912	MORRINHOS	12/10/2020 16:08	13/10/2020 13:04	12/10/2020 22:13	13/10/2020 13:04	14,86	1	14,86	CHI
20201060794	LUZIANIA	KR12330533	CRISTALINA S1	12/10/2020 16:08	12/10/2020 20:03	12/10/2020 16:08	12/10/2020 20:03	3,91	8	31,26	CHI
20201060794	CRISTALINA	KR12330533	CRISTALINA S1	12/10/2020 16:08	12/10/2020 20:03	12/10/2020 16:08	12/10/2020 20:03	3,91	34	132,87	CHI
20201060794	IPAMERI	KR12330533	CRISTALINA S1	12/10/2020 16:08	12/10/2020 20:03	12/10/2020 16:08	12/10/2020 20:03	3,91	1	3,91	CHI
20201060797	NOVO GAMA	2460058403	PACAEMBU S2	12/10/2020 16:09	12/10/2020 22:43	12/10/2020 16:09	12/10/2020 22:43	6,57	1	6,57	CHI
20201060806	MINEIROS	MY12390605RE	PARQUE DAS EMAS	12/10/2020 16:10	13/10/2020 14:10	12/10/2020 16:10	13/10/2020 14:10	22,00	14	307,94	CHI
20201060808	GOIANIA	12081516	GOYA S1	12/10/2020 16:10	12/10/2020 17:01	12/10/2020 16:10	12/10/2020 17:01	0,84	1	0,84	CHI
20201060810	PONTALINA	JV12052751	GOIATUBA S1	12/10/2020 16:11	12/10/2020 17:07	12/10/2020 16:11	12/10/2020 17:07	0,93	18	16,74	CHI
20201060836	MONTA ALEGRE DE GOIAS	SD21195789	SAO DOMINGOS	12/10/2020 16:12	12/10/2020 19:07	12/10/2020 16:12	12/10/2020 19:07	2,92	1	2,92	CHI
20201060817	PIRANHAS	PH21023558	PIRANHAS	12/10/2020 16:13	12/10/2020 21:32	12/10/2020 16:13	12/10/2020 21:32	5,31	1	5,31	CHI
20201060820	GOIANIA	10006720992	INDEPENDENCIA S1	12/10/2020 16:13	12/10/2020 17:51	12/10/2020 16:13	12/10/2020 17:51	1,62	1	1,62	CHI
20201061422	MINEIROS	MY12402484	PARQUE DAS EMAS	12/10/2020 16:13	12/10/2020 20:32	12/10/2020 16:13	12/10/2020 20:32	4,30	78	335,75	CHI
20201060824	PALESTINA DE GOIAS	CP16410129	PALESTINA	12/10/2020 16:15	12/10/2020 20:18	12/10/2020 16:15	12/10/2020 16:46	0,51	87	44,71	CHI
20201060824	CAIAPONIA	CP16410129	PALESTINA	12/10/2020 16:15	12/10/2020 20:18	12/10/2020 16:15	12/10/2020 16:46	0,51	217	111,51	CHI
20201060824	PALESTINA DE GOIAS	03800226	PALESTINA	12/10/2020 16:15	12/10/2020 20:18	12/10/2020 16:15	12/10/2020 20:18	4,04	249	1007,07	CHI
20201060824	CAIAPONIA	03800226	PALESTINA	12/10/2020 16:15	12/10/2020 20:18	12/10/2020 16:15	12/10/2020 20:18	4,04	252	1019,20	CHI
20201060824	PALESTINA DE GOIAS	PY10406617	PALESTINA	12/10/2020 16:15	12/10/2020 20:18	12/10/2020 16:15	12/10/2020 20:18	3,53	13	45,95	CHI
20201060825	GOIANIA	10721990	ATLANTICO S2	12/10/2020 16:15	12/10/2020 18:34	12/10/2020 16:15	12/10/2020 18:34	2,31	1	2,31	CHI
20201061176	JUSSARA	JR12011813	BRITANIA	12/10/2020 16:15	13/10/2020 01:13	12/10/2020 16:15	13/10/2020 01:13	8,95	29	259,65	CHI
20201060833	ANAPOLIS	AN11217417	ANAPOLIS UNIVERSITARIO S2	12/10/2020 16:16	12/10/2020 19:06	12/10/2020 16:16	12/10/2020 19:06	2,83	83	234,77	CHI
20201060834	ITABERAI	IB21183027	ITABERAI S1	12/10/2020 16:16	12/10/2020 20:56	12/10/2020 16:16	12/10/2020 20:56	4,66	1	4,66	CHI
20201060976	GOIAS	HE12250700	ITAPURANGA	12/10/2020 16:16	12/10/2020 19:06	12/10/2020 16:16	12/10/2020 19:06	2,82	9	25,38	CHI
20201060976	HEITORAI	HE12250700	ITAPURANGA	12/10/2020 16:16	12/10/2020 19:06	12/10/2020 16:16	12/10/2020 19:06	2,82	6	16,92	CHI
20201060848	CACHOEIRA ALTA	CA21360675	CACHOEIRA ALTA	12/10/2020 16:18	13/10/2020 00:35	12/10/2020 16:18	13/10/2020 00:35	8,28	3	24,84	CHI
20201060849	GOIANIRA	10005372109	GOIANIRA	12/10/2020 16:18	12/10/2020 17:34	12/10/2020 16:18	12/10/2020 17:34	1,26	1	1,26	CHI
20201060884	FORMOSA	FA11046850	ITUIQUIRA	12/10/2020 16:18	12/10/2020 16:48	12/10/2020 16:18	12/10/2020 16:48	0,49	201	99,27	CHI
20201060861	MINEIROS	MY21278374	PARQUE DAS EMAS	12/10/2020 16:19	13/10/2020 10:27	12/10/2020 16:19	13/10/2020 10:27	18,12	1	18,12	CHI
20201061103	COCALZINHO DE GOIAS	ZN12320107	AGUAS LINDAS DE GOIAS S1	12/10/2020 16:21	12/10/2020 18:15	12/10/2020 16:21	12/10/2020 18:15	1,90	14	26,59	CHI
20201060869	CORUMBA DE GOIAS	CB21102095	COCALZINHO	12/10/2020 16:21	12/10/2020 18:40	12/10/2020 16:21	12/10/2020 18:40	2,30	1	2,30	CHI
20201061010	ANAPOLIS	AN12353433	JUNDIAI S1	12/10/2020 16:22	12/10/2020 18:18	12/10/2020 16:22	12/10/2020 18:18	1,93	5	9,64	CHI
20201060875	CRISTALINA	KR21184844	CRISTALINA S1	12/10/2020 16:22	12/10/2020 18:18	12/10/2020 16:22	12/10/2020 18:18	1,92	1	1,92	CHI
20201060876	GOIANIA	GN12340461	XAVANTES	12/10/2020 16:23	12/10/2020 19:06	12/10/2020 16:23	12/10/2020 19:06	2,72	84	228,18	CHI
20201061332	OURO VERDE DE GOIAS	OV12312024	NEROPOLIS S1	12/10/2020 16:23	12/10/2020 19:21	12/10/2020 16:23	12/10/2020 19:21	2,96	10	29,62	CHI
20201060885	CAIAPONIA	CP12200120	CAIAPONIA	12/10/2020 16:24	12/10/2020 20:22	12/10/2020 16:24	12/10/2020 20:22	3,96	1	3,96	CHI
20201060887	GOIANIA	16592797	CARAJAS S1	12/10/2020 16:24	12/10/2020 17:37	12/10/2020 16:24	12/10/2020 17:37	1,21	1	1,21	CHI
20201060391	SAO MIGUEL DO ARAGUAIA	SM12393948	SAO MIGUEL DO ARAGUAIA	12/10/2020 16:24	12/10/2020 19:28	12/10/2020 16:24	12/10/2020 19:28	3,06	30	91,81	CHI
20201060894	DAMOLANDIA	10004844759	INHUMAS S1	12/10/2020 16:25	12/10/2020 17:18	12/10/2020 16:25	12/10/2020 17:18	0,87	1	0,87	CHI
20201060895	PETROLINA DE GOIAS	DL10423890	INHUMAS S1	12/10/2020 16:26	12/10/2020 23:09	12/10/2020 16:26	12/10/2020 23:09	6,73	6	40,38	CHI
20201060895	DAMOLANDIA	DL10423890	INHUMAS S1	12/10/2020 16:26	12/10/2020 23:09	12/10/2020 16:26	12/10/2020 23:09	6,73	84	565,34	CHI
20201060895	OURO VERDE DE GOIAS	DL10423890	INHUMAS S1	12/10/2020 16:26	12/10/2020 23:09	12/10/2020 16:26	12/10/2020 23:09	6,73	136	915,32	CHI
20201060895	OURO VERDE DE GOIAS	DL10423890	INHUMAS S1	12/10/2020 16:26	12/10/2020 23:09	12/10/2020 21:52	12/10/2020 23:09	1,29	3	3,87	CHI
20201060901	FORMOSA	610120852	ITUIQUIRA	12/10/2020 16:27	12/10/2020 17:25	12/10/2020 16:27	12/10/2020 17:25	0,97	1	0,97	CHI
20201060909	PLANALTINA	PI12248188	PLANALTINA	12/10/2020 16:29	12/10/2020 19:48	12/10/2020 16:29	12/10/2020 19:48	3,32	5	16,58	CHI
20201060910	LUZIANIA	LZ12092906	MARAJOARA	12/10/2020 16:29	13/10/2020 02:40	12/10/2020 16:29	13/10/2020 02:40	10,19	26	264,97	CHI

20201060913	CRISTALINA	KR12335919	PAMPLONA	12/10/2020 16:30	13/10/2020 09:25	12/10/2020 16:30	13/10/2020 09:25	16,91	2	33,83	CHI
20201060982	VICENTINOPOLIS	VI12335578	VICENTINOPOLIS	12/10/2020 16:30	13/10/2020 14:17	12/10/2020 16:30	13/10/2020 14:17	21,77	10	217,74	CHI
20201060982	PONTALINA	VI12335578	VICENTINOPOLIS	12/10/2020 16:30	13/10/2020 14:17	12/10/2020 16:30	13/10/2020 14:17	21,77	3	65,32	CHI
20201060917	RIO VERDE	RV21091960	CABRIUVA S2	12/10/2020 16:30	12/10/2020 19:24	12/10/2020 16:30	12/10/2020 19:24	2,89	1	2,89	CHI
20201061226	CAMPO LIMPO	AN12084813	NEROPOLIS S1	12/10/2020 16:32	13/10/2020 18:20	12/10/2020 16:32	13/10/2020 18:20	25,80	64	1651,47	CHI
20201061226	OURO VERDE DE GOIAS	AN12084813	NEROPOLIS S1	12/10/2020 16:32	13/10/2020 18:20	12/10/2020 16:32	13/10/2020 18:20	25,80	1	25,80	CHI
20201060921	ALVORADA DO NORTE	1510022366	IACIARA S2	12/10/2020 16:32	12/10/2020 18:32	12/10/2020 16:32	12/10/2020 18:32	1,99	1	1,99	CHI
20201060922	INDIARA	IY21132063	PALMEIRAS	12/10/2020 16:32	12/10/2020 20:27	12/10/2020 16:32	12/10/2020 20:27	3,91	1	3,91	CHI
20201060926	MINACU	4020027287	MINACU	12/10/2020 16:33	12/10/2020 21:36	12/10/2020 16:33	12/10/2020 21:36	5,05	1	5,05	CHI
20201060934	ALTO PARAISO DE GOIAS	BF21129911	FLORES DE GOIAS	12/10/2020 16:34	12/10/2020 17:49	12/10/2020 16:34	12/10/2020 17:49	1,24	1	1,24	CHI
20201062551	INDIARA	IY12395106	EDEIA	12/10/2020 16:35	13/10/2020 20:13	12/10/2020 16:35	12/10/2020 22:21	5,77	269	1551,98	CHI
20201062551	INDIARA	IY12395106	EDEIA	12/10/2020 16:35	13/10/2020 20:13	12/10/2020 21:05	12/10/2020 22:21	1,27	12	15,25	CHI
20201062551	INDIARA	JD12005508LD	PALMEIRAS	12/10/2020 16:35	13/10/2020 20:13	12/10/2020 21:37	13/10/2020 14:30	16,88	5	84,38	CHI
20201062551	JANDAIA	JD12005508LD	PALMEIRAS	12/10/2020 16:35	13/10/2020 20:13	12/10/2020 21:37	13/10/2020 14:30	16,88	15	253,15	CHI
20201062551	INDIARA	JD12005508LD	PALMEIRAS	12/10/2020 16:35	13/10/2020 20:13	12/10/2020 21:37	13/10/2020 20:13	22,59	44	994,09	CHI
20201062551	JANDAIA	JD12005508LD	PALMEIRAS	12/10/2020 16:35	13/10/2020 20:13	12/10/2020 21:37	13/10/2020 20:13	22,59	1	22,59	CHI
20201060940	APARECIDA DE GOIANIA	200495835	ANHANGUERA	12/10/2020 16:35	12/10/2020 17:22	12/10/2020 16:35	12/10/2020 17:22	0,77	1	0,77	CHI
20201060941	BRAZABRANTES	DL12009522	INHUMAS S1	12/10/2020 16:35	13/10/2020 01:13	12/10/2020 16:35	13/10/2020 01:13	8,62	43	370,76	CHI
20201060941	NOVA VENEZA	DL12009522	INHUMAS S1	12/10/2020 16:35	13/10/2020 01:13	12/10/2020 16:35	13/10/2020 01:13	8,62	31	267,29	CHI
20201060941	DAMOLANDIA	DL12009522	INHUMAS S1	12/10/2020 16:35	13/10/2020 01:13	12/10/2020 16:35	13/10/2020 01:13	8,62	17	146,58	CHI
20201060942	CATURAI	CK21379659	INHUMAS S1	12/10/2020 16:35	12/10/2020 18:01	12/10/2020 16:35	12/10/2020 18:01	1,42	1	1,42	CHI
20201060943	GOIANIA	GN11002292	CAMPINAS S3	12/10/2020 16:35	12/10/2020 18:00	12/10/2020 16:35	12/10/2020 18:00	1,40	20	28,03	CHI
20201063134	SAANCLERLANDIA	SC12016782	FIRMINOPOLIS S2	12/10/2020 16:36	12/10/2020 23:41	12/10/2020 16:36	12/10/2020 23:41	7,08	14	99,06	CHI
20201060950	DOVERLANDIA	DV11259473	CAIAPONIA	12/10/2020 16:38	12/10/2020 19:41	12/10/2020 16:38	12/10/2020 19:41	3,04	77	234,17	CHI
20201061805	NEROPOLIS	20044943	NEROPOLIS S2	12/10/2020 16:38	13/10/2020 03:52	12/10/2020 16:38	13/10/2020 03:52	11,23	34	381,99	CHI
20201061805	SANTO ANTONIO DE GOIAS	20044943	NEROPOLIS S2	12/10/2020 16:38	13/10/2020 03:52	12/10/2020 16:38	13/10/2020 03:52	11,23	4	44,94	CHI
20201060952	ORIZONA	OZ21205082	PIRES DO RIO S2	12/10/2020 16:38	12/10/2020 17:55	12/10/2020 16:38	12/10/2020 17:55	1,27	1	1,27	CHI
20201062457	PEROLANDIA	DP12210131RE	PARQUE DAS EMAS	12/10/2020 16:38	12/10/2020 22:43	12/10/2020 16:38	12/10/2020 22:43	6,07	5	30,35	CHI
20201062457	PORTELANDIA	DP12210131RE	PARQUE DAS EMAS	12/10/2020 16:38	12/10/2020 22:43	12/10/2020 16:38	12/10/2020 22:43	6,07	1	6,07	CHI
20201062457	MINEIROS	DP12210131RE	PARQUE DAS EMAS	12/10/2020 16:38	12/10/2020 22:43	12/10/2020 16:38	12/10/2020 22:43	6,07	13	78,90	CHI
20201060955	PETROLINA DE GOIAS	01450224	PETROLINA	12/10/2020 16:38	13/10/2020 13:49	12/10/2020 16:38	12/10/2020 17:40	1,03	608	626,75	CHI
20201060955	PETROLINA DE GOIAS	01450224	PETROLINA	12/10/2020 16:38	13/10/2020 13:49	12/10/2020 16:38	12/10/2020 18:20	1,68	387	651,99	CHI
20201060955	PETROLINA DE GOIAS	PG10411504	PETROLINA	12/10/2020 16:38	13/10/2020 13:49	12/10/2020 17:38	12/10/2020 18:20	0,70	67	46,96	CHI
20201060955	PETROLINA DE GOIAS	01450224	PETROLINA	12/10/2020 16:38	13/10/2020 13:49	12/10/2020 16:38	12/10/2020 19:22	2,73	250	681,94	CHI
20201060955	PETROLINA DE GOIAS	PG16411514	PETROLINA	12/10/2020 16:38	13/10/2020 13:49	12/10/2020 17:38	12/10/2020 19:22	1,74	30	52,32	CHI
20201060955	PETROLINA DE GOIAS	01450224	PETROLINA	12/10/2020 16:38	13/10/2020 13:49	12/10/2020 21:14	12/10/2020 21:49	0,60	1342	802,59	CHI
20201060955	PETROLINA DE GOIAS	01450224	PETROLINA	12/10/2020 16:38	13/10/2020 13:49	12/10/2020 23:53	13/10/2020 00:07	0,23	1344	313,60	CHI
20201060955	PETROLINA DE GOIAS	01450224	PETROLINA	12/10/2020 16:38	13/10/2020 13:49	12/10/2020 16:38	13/10/2020 12:40	20,02	38	760,89	CHI
20201060955	PETROLINA DE GOIAS	PG16411514	PETROLINA	12/10/2020 16:38	13/10/2020 13:49	12/10/2020 17:38	13/10/2020 12:40	19,04	3	57,12	CHI
20201060955	PETROLINA DE GOIAS	01450224	PETROLINA	12/10/2020 16:38	13/10/2020 13:49	12/10/2020 16:38	13/10/2020 13:25	20,77	86	1786,22	CHI
20201060955	PETROLINA DE GOIAS	PG16411514	PETROLINA	12/10/2020 16:38	13/10/2020 13:49	12/10/2020 17:38	13/10/2020 13:25	19,79	10	197,86	CHI
20201060955	PETROLINA DE GOIAS	01450224	PETROLINA	12/10/2020 16:38	13/10/2020 13:49	12/10/2020 16:38	13/10/2020 13:49	21,18	94	1990,53	CHI
20201060955	SAO FRANCISCO DE GOIAS	01450224	PETROLINA	12/10/2020 16:38	13/10/2020 13:49	12/10/2020 16:38	13/10/2020 13:49	21,18	22	465,87	CHI
20201060955	PETROLINA DE GOIAS	PG16411514	PETROLINA	12/10/2020 16:38	13/10/2020 13:49	12/10/2020 17:38	13/10/2020 13:49	20,19	4	80,77	CHI
20201060955	SAO FRANCISCO DE GOIAS	PG16411514	PETROLINA	12/10/2020 16:38	13/10/2020 13:49	12/10/2020 17:38	13/10/2020 13:49	20,19	12	242,30	CHI
20201060956	CAIAPONIA	DV12023480	CAIAPONIA	12/10/2020 16:39	13/10/2020 18:23	12/10/2020 16:39	13/10/2020 03:28	10,83	8	86,61	CHI
20201060956	DOVERLANDIA	DV12023480	CAIAPONIA	12/10/2020 16:39	13/10/2020 18:23	12/10/2020 16:39	13/10/2020 03:28	10,83	5	54,13	CHI
20201060956	DOVERLANDIA	DV12023480	CAIAPONIA	12/10/2020 16:39	13/10/2020 18:23	12/10/2020 16:39	13/10/2020 18:23	25,74	1	25,74	CHI
20201060956	CAIAPONIA	DV12023480	CAIAPONIA	12/10/2020 16:39	13/10/2020 18:23	12/10/2020 16:39	13/10/2020 18:23	25,74	127	3268,63	CHI
20201060956	PIRANHAS	DV12091431LD	CAIAPONIA	12/10/2020 16:39	13/10/2020 18:23	12/10/2020 16:39	13/10/2020 18:23	25,74	77	1981,77	CHI
20201060956	CAIAPONIA	DV12091431LD	CAIAPONIA	12/10/2020 16:39	13/10/2020 18:23	12/10/2020 16:39	13/10/2020 18:23	25,74	10	257,37	CHI
20201060956	DOVERLANDIA	DV12091431LD	CAIAPONIA	12/10/2020 16:39	13/10/2020 18:23	13/10/2020 03:28	13/10/2020 18:23	14,91	1	14,91	CHI
20201060968	GOIANIA	GN11168927	GOYA S1	12/10/2020 16:39	12/10/2020 18:24	12/10/2020 16:39	12/10/2020 18:24	1,74	159	276,66	CHI
20201061085	MORRINHOS	MR12024156	MORRINHOS	12/10/2020 16:39	12/10/2020 18:50	12/10/2020 16:39	12/10/2020 18:50	2,17	6	13,00	CHI
20201061518	OURO VERDE DE GOIAS	NR12319494	NEROPOLIS S2	12/10/2020 16:39	12/10/2020 21:24	12/10/2020 16:39	12/10/2020 21:24	4,73	13	61,54	CHI
20201063175	SANTA RITA DO ARAGUAIA	SU12374325RE	SANTA RITA DO ARAGUAIA	12/10/2020 16:44	13/10/2020 07:25	12/10/2020 16:44	13/10/2020 07:25	14,68	29	425,82	CHI
20201060990	VILA PROPICIO	NP11228735	GOIANESIA S1	12/10/2020 16:44	14/10/2020 09:37	12/10/2020 16:44	14/10/2020 09:37	40,87	1	40,87	CHI
20201061018	JOVIANIA	01040224	GOIATUBA S1	12/10/2020 16:45	12/10/2020 19:41	12/10/2020 16:45	12/10/2020 17:48	1,05	112	117,63	CHI

20201061018	PONTALINA	01040224	GOIATUBA S1	12/10/2020 16:45	12/10/2020 19:41	12/10/2020 16:45	12/10/2020 17:48	1,05	16	16,80	CHI
20201061018	JOVIANIA	01040224	GOIATUBA S1	12/10/2020 16:45	12/10/2020 19:41	12/10/2020 16:46	12/10/2020 17:48	1,03	2	2,07	CHI
20201061018	GOIATUBA	01040224	GOIATUBA S1	12/10/2020 16:45	12/10/2020 19:41	12/10/2020 16:45	12/10/2020 18:34	1,82	16	29,14	CHI
20201061018	JOVIANIA	01040224	GOIATUBA S1	12/10/2020 16:45	12/10/2020 19:41	12/10/2020 16:45	12/10/2020 18:34	1,82	582	1060,05	CHI
20201061018	JOVIANIA	01040224	GOIATUBA S1	12/10/2020 16:45	12/10/2020 19:41	12/10/2020 16:45	12/10/2020 19:23	2,63	1	2,63	CHI
20201061018	JOVIANIA	01040224	GOIATUBA S1	12/10/2020 16:45	12/10/2020 19:41	12/10/2020 16:45	12/10/2020 19:29	2,74	362	991,28	CHI
20201061018	JOVIANIA	01040224	GOIATUBA S1	12/10/2020 16:45	12/10/2020 19:41	12/10/2020 16:45	12/10/2020 19:37	2,86	149	426,26	CHI
20201061018	JOVIANIA	01040224	GOIATUBA S1	12/10/2020 16:45	12/10/2020 19:41	12/10/2020 16:45	12/10/2020 19:41	2,93	134	392,88	CHI
20201061863	SANTA HELENA DE GOIAS	SH11160722	IPEGUARI	12/10/2020 16:45	13/10/2020 00:10	12/10/2020 16:45	13/10/2020 00:10	7,40	79	584,78	CHI
20201060999	ITUMBIARA	IT21389734	ITUMBIARA VELHA S1	12/10/2020 16:46	12/10/2020 21:07	12/10/2020 16:46	12/10/2020 21:07	4,34	1	4,34	CHI
20201061006	SAO LUIS DE MONTES BELOS	SL31076491	SAO LUIZ DOS MONTES BELOS	12/10/2020 16:47	12/10/2020 22:10	12/10/2020 16:47	12/10/2020 22:10	5,38	1	5,38	CHI
20201061633	JATAI	JT11274030	JATAI S2	12/10/2020 16:47	13/10/2020 07:15	12/10/2020 16:47	13/10/2020 07:15	14,46	103	1489,69	CHI
20201062207	NIQUELANDIA	BA18000051FS	BARRO ALTO	12/10/2020 16:48	13/10/2020 00:32	12/10/2020 16:48	13/10/2020 00:32	7,73	122	942,82	CHI
20201062207	BARRO ALTO	BA18000051FS	BARRO ALTO	12/10/2020 16:48	13/10/2020 00:32	12/10/2020 16:48	13/10/2020 00:32	7,73	130	1004,65	CHI
20201061017	PADRE BERNARDO	PB21234560	PADRE BERNARDO	12/10/2020 16:48	12/10/2020 20:27	12/10/2020 16:48	12/10/2020 20:27	3,64	1	3,64	CHI
20201061100	GOIANIA	GN12000838	FERROVIARIO S2	12/10/2020 16:49	12/10/2020 18:31	12/10/2020 16:49	12/10/2020 18:31	1,69	599	1009,81	CHI
20201061029	CAMPO LIMPO	AN12267847	NEROPOLIS S1	12/10/2020 16:50	12/10/2020 18:35	12/10/2020 16:50	12/10/2020 18:35	1,74	62	107,83	CHI
20201061031	CABECEIRAS	CW21157340	ITUIQUIRA	12/10/2020 16:50	12/10/2020 19:31	12/10/2020 16:50	12/10/2020 19:31	2,67	1	2,67	CHI
20201061040	GOIANIA	10514648	GOIANIA LESTE S1	12/10/2020 16:51	12/10/2020 19:05	12/10/2020 16:51	12/10/2020 19:05	2,22	1	2,22	CHI
20201061042	INHUMAS	IN11146598	INHUMAS S2	12/10/2020 16:52	12/10/2020 18:47	12/10/2020 16:52	12/10/2020 18:47	1,91	94	179,98	CHI
20201061044	URUACU	UR12049780	URUACU	12/10/2020 16:52	12/10/2020 18:38	12/10/2020 16:52	12/10/2020 18:38	1,76	189	332,59	CHI
20201059464	GOIAS	IB13200314	ITABERAÍ S1	12/10/2020 16:53	12/10/2020 21:15	12/10/2020 16:53	12/10/2020 21:00	4,12	9	37,10	CHI
20201059464	ITABERAÍ	IB13200314	ITABERAÍ S1	12/10/2020 16:53	12/10/2020 21:15	12/10/2020 16:53	12/10/2020 21:00	4,12	26	107,17	CHI
20201059464	ITABERAÍ	00880434	ITABERAÍ S1	12/10/2020 16:53	12/10/2020 21:15	12/10/2020 16:53	12/10/2020 21:15	4,37	25	109,17	CHI
20201059464	GOIAS	00880434	ITABERAÍ S1	12/10/2020 16:53	12/10/2020 21:15	12/10/2020 16:53	12/10/2020 21:15	4,37	179	781,68	CHI
20201059464	GOIAS	00880434	ITABERAÍ S1	12/10/2020 16:53	12/10/2020 21:15	12/10/2020 16:53	12/10/2020 21:15	4,37	2	8,73	CHI
20201059464	ITABERAÍ	00880434	ITABERAÍ S1	12/10/2020 16:53	12/10/2020 21:15	12/10/2020 16:53	12/10/2020 21:15	4,37	3	13,10	CHI
20201059464	ITABERAÍ	IB13200349	ITABERAÍ S1	12/10/2020 16:53	12/10/2020 21:15	12/10/2020 16:53	12/10/2020 21:15	4,37	12	52,40	CHI
20201059464	GOIAS	IB13200349	ITABERAÍ S1	12/10/2020 16:53	12/10/2020 21:15	12/10/2020 16:53	12/10/2020 21:15	4,37	37	161,58	CHI
20201059464	GOIAS	00880434	ITABERAÍ S1	12/10/2020 16:53	12/10/2020 21:15	12/10/2020 16:53	12/10/2020 21:15	4,37	76	331,89	CHI
20201061049	SILVANIA	SV12403479	VIANOPOLIS	12/10/2020 16:53	12/10/2020 19:41	12/10/2020 16:53	12/10/2020 19:41	2,79	3	8,38	CHI
20201061313	PETROLINA DE GOIAS	PG12255953	PETROLINA	12/10/2020 16:53	13/10/2020 11:53	12/10/2020 16:53	13/10/2020 11:53	18,99	119	2260,27	CHI
20201061313	DAMOLANDIA	PG12255953	PETROLINA	12/10/2020 16:53	13/10/2020 11:53	12/10/2020 16:53	13/10/2020 11:53	18,99	1	18,99	CHI
20201061313	OURO VERDE DE GOIAS	PG12255953	PETROLINA	12/10/2020 16:53	13/10/2020 11:53	12/10/2020 16:53	13/10/2020 11:53	18,99	25	474,85	CHI
20201061062	LUZIANIA	10003712506	MARAOARA	12/10/2020 16:54	12/10/2020 18:52	12/10/2020 16:54	12/10/2020 18:52	1,96	1	1,96	CHI
20201061063	NOVA VENEZA	NV12200061	INHUMAS S1	12/10/2020 16:54	12/10/2020 22:12	12/10/2020 16:54	12/10/2020 22:12	5,29	279	1476,14	CHI
20201061065	SANTA RITA DO ARAGUAIA	10029509490	SANTA RITA DO ARAGUAIA	12/10/2020 16:54	13/10/2020 22:57	12/10/2020 16:54	13/10/2020 22:57	30,05	1	30,05	CHI
20201061077	ITAUCU	IX11000001	INHUMAS S1	12/10/2020 16:56	12/10/2020 22:59	12/10/2020 16:56	12/10/2020 22:59	6,04	83	501,53	CHI
20201061522	FORMOSA	FA11046850	ITUIQUIRA	12/10/2020 16:56	12/10/2020 18:19	12/10/2020 16:56	12/10/2020 18:19	1,38	201	277,72	CHI
202010180319	JATAI	JT12306843	JATAI S1	12/10/2020 16:56	13/10/2020 21:59	12/10/2020 16:56	13/10/2020 21:59	29,05	2	58,10	CHI
20201061094	PALMEIRAS DE GOIAS	PL21000162	PALMEIRAS	12/10/2020 16:58	12/10/2020 19:04	12/10/2020 16:58	12/10/2020 19:04	2,09	1	2,09	CHI
20201061097	GOIANIA	11049595	ATLANTICO S1	12/10/2020 16:58	12/10/2020 19:59	12/10/2020 16:58	12/10/2020 19:59	3,00	1	3,00	CHI
20201061099	CAIAPONIA	CP12052996	MONTIVIDIU T	12/10/2020 16:58	12/10/2020 17:51	12/10/2020 16:58	12/10/2020 17:51	0,87	211	183,04	CHI
20201062469	ITAUCU	IN12282891	INHUMAS S2	12/10/2020 16:59	12/10/2020 23:04	12/10/2020 16:59	12/10/2020 23:04	6,08	2	12,16	CHI
20201062469	INHUMAS	IN12282891	INHUMAS S2	12/10/2020 16:59	12/10/2020 23:04	12/10/2020 16:59	12/10/2020 23:04	6,08	33	200,68	CHI
20201061107	FORMOSA	610041782	ITUIQUIRA	12/10/2020 16:59	12/10/2020 20:34	12/10/2020 16:59	12/10/2020 20:34	3,57	1	3,57	CHI
20201061345	DIVINOPOLIS DE GOIAS	GH11063104	SAO DOMINGOS	12/10/2020 17:01	13/10/2020 02:37	12/10/2020 17:01	13/10/2020 02:37	9,60	169	1621,84	CHI
20201061117	RIO VERDE	RV21279459	MONTIVIDIU T	12/10/2020 17:01	12/10/2020 19:13	12/10/2020 17:01	12/10/2020 19:13	2,18	1	2,18	CHI
20201061122	MIMOSO DE GOIAS	MJ12305245	PADRE BERNARDO	12/10/2020 17:02	13/10/2020 16:41	12/10/2020 17:02	12/10/2020 20:47	3,75	12	45,05	CHI
20201061122	MIMOSO DE GOIAS	MJ12305277	PADRE BERNARDO	12/10/2020 17:02	13/10/2020 16:41	12/10/2020 20:50	12/10/2020 21:14	0,39	14	5,45	CHI
20201061122	MIMOSO DE GOIAS	MJ12305245	PADRE BERNARDO	12/10/2020 17:02	13/10/2020 16:41	12/10/2020 17:02	13/10/2020 16:41	23,65	2	47,30	CHI
20201061122	MIMOSO DE GOIAS	MJ12305245	PADRE BERNARDO	12/10/2020 17:02	13/10/2020 16:41	13/10/2020 11:49	13/10/2020 16:41	4,87	12	58,38	CHI
20201061123	APARECIDA DE GOIANIA	14934541	INDEPENDENCIA S2	12/10/2020 17:02	12/10/2020 18:29	12/10/2020 17:02	12/10/2020 18:29	1,45	1	1,45	CHI
20201061647	NEROPOLIS	NR12029257	NEROPOLIS S2	12/10/2020 17:02	12/10/2020 23:43	12/10/2020 17:02	12/10/2020 23:43	6,67	12	80,09	CHI
20201061137	APARECIDA DE GOIANIA	13282438	INDEPENDENCIA S1	12/10/2020 17:04	12/10/2020 17:25	12/10/2020 17:04	12/10/2020 17:25	0,35	1	0,35	CHI
20201062289	RIO VERDE	RV11306305	RIO VERDE S2	12/10/2020 17:04	12/10/2020 20:34	12/10/2020 17:04	12/10/2020 20:34	3,49	106	370,35	CHI
20201061140	GOIANIA	GN12001328	GOIANIA LESTE S1	12/10/2020 17:04	12/10/2020 18:26	12/10/2020 17:04	12/10/2020 18:26	1,36	34	46,17	CHI
20201061141	APARECIDA DE GOIANIA	13994566	INDEPENDENCIA S1	12/10/2020 17:04	12/10/2020 20:19	12/10/2020 17:04	12/10/2020 20:19	3,24	1	3,24	CHI

20201062559	CAMPO LIMPO	OV12033148	NEROPOLIS S1	12/10/2020 17:05	12/10/2020 21:22	12/10/2020 17:05	12/10/2020 21:22	4,28	3	12,85	CHI
20201062559	OURO VERDE DE GOIAS	OV12033148	NEROPOLIS S1	12/10/2020 17:05	12/10/2020 21:22	12/10/2020 17:05	12/10/2020 21:22	4,28	4	17,13	CHI
20201061145	PADRE BERNARDO	PB12290544	PADRE BERNARDO	12/10/2020 17:05	12/10/2020 19:21	12/10/2020 17:05	12/10/2020 19:21	2,26	3	6,78	CHI
20201061151	CAMPO ALEGRE DE GOIAS	CM21155388	CAMPO ALEGRE DE GOIAS	12/10/2020 17:05	12/10/2020 18:00	12/10/2020 17:05	12/10/2020 18:00	0,90	1	0,90	CHI
20201061152	MORRINHOS	MR21182762	MORRINHOS	12/10/2020 17:05	12/10/2020 19:05	12/10/2020 17:05	12/10/2020 19:05	1,98	1	1,98	CHI
20201060618	GOIANIA	GN11000121	GOIANIA LESTE S2	12/10/2020 17:06	12/10/2020 17:13	12/10/2020 17:06	12/10/2020 17:13	0,13	24	3,17	CHI
20201061153	BURITI ALEGRE	BG12257082	ALTO BURITI	12/10/2020 17:06	12/10/2020 19:23	12/10/2020 17:06	12/10/2020 19:23	2,28	29	66,14	CHI
20201061153	MORRINHOS	BG12257082	ALTO BURITI	12/10/2020 17:06	12/10/2020 19:23	12/10/2020 17:06	12/10/2020 19:23	2,28	5	11,40	CHI
20201061156	ANAPOLIS	10030123117	JUNDIAI S2	12/10/2020 17:06	12/10/2020 23:43	12/10/2020 17:06	12/10/2020 23:43	6,61	1	6,61	CHI
20201062042	GOIAS	GS12145455	MATRINCHA	12/10/2020 17:08	13/10/2020 10:38	12/10/2020 17:08	13/10/2020 10:38	17,49	3	52,47	CHI
20201061174	RIO VERDE	RV21255718	CABRIUVA S1	12/10/2020 17:08	12/10/2020 20:35	12/10/2020 17:08	12/10/2020 20:35	3,44	1	3,44	CHI
20201061235	SANCLERLANDIA	SL12145801	FIRMINOPOLIS S2	12/10/2020 17:09	13/10/2020 14:33	12/10/2020 17:09	13/10/2020 14:33	21,39	3	64,18	CHI
20201061183	AMORINOPOLIS	AM11334887	IPORA	12/10/2020 17:10	13/10/2020 00:28	12/10/2020 17:10	13/10/2020 00:28	7,30	74	540,18	CHI
20201061187	APARECIDA DE GOIANIA	14764430	ATLANTICO S2	12/10/2020 17:10	12/10/2020 18:09	12/10/2020 17:10	12/10/2020 18:09	0,97	1	0,97	CHI
20201061196	BARRO ALTO	BA21154635	BARRO ALTO	12/10/2020 17:11	12/10/2020 19:15	12/10/2020 17:11	12/10/2020 19:15	2,05	1	2,05	CHI
20201061902	SANTA FE DE GOIAS	RN11250634	BRITANIA	12/10/2020 17:12	12/10/2020 22:57	12/10/2020 17:12	12/10/2020 22:57	5,75	37	212,63	CHI
20201061706	ANAPOLIS	AN12258234	NEROPOLIS S1	12/10/2020 17:12	12/10/2020 21:30	12/10/2020 17:12	12/10/2020 21:30	4,29	3	12,86	CHI
20201061706	CAMPO LIMPO	AN12258234	NEROPOLIS S1	12/10/2020 17:12	12/10/2020 21:30	12/10/2020 17:12	12/10/2020 21:30	4,29	28	120,05	CHI
20201061970	NOVA VENEZA	NV12000117	INHUMAS S1	12/10/2020 17:12	12/10/2020 20:02	12/10/2020 17:12	12/10/2020 20:02	2,83	68	192,53	CHI
20201061970	INHUMAS	NV12000117	INHUMAS S1	12/10/2020 17:12	12/10/2020 20:02	12/10/2020 17:12	12/10/2020 20:02	2,83	19	53,80	CHI
20201061970	BRAZABRANTES	NV12000117	INHUMAS S1	12/10/2020 17:12	12/10/2020 20:02	12/10/2020 17:12	12/10/2020 20:02	2,83	57	161,39	CHI
20201061206	ITABERAI	IB21218936	ITABERAI S1	12/10/2020 17:13	12/10/2020 17:39	12/10/2020 17:13	12/10/2020 17:39	0,43	1	0,43	CHI
20201061207	APARECIDA DE GOIANIA	200193405	ANHANGUERA	12/10/2020 17:13	12/10/2020 19:58	12/10/2020 17:13	12/10/2020 19:58	2,75	1	2,75	CHI
20201061209	SANTA HELENA DE GOIAS	SH12394803	IPEGUARI	12/10/2020 17:13	13/10/2020 04:52	12/10/2020 17:13	12/10/2020 20:25	3,19	22	70,13	CHI
20201061209	TURVELANDIA	SH12394803	IPEGUARI	12/10/2020 17:13	13/10/2020 04:52	12/10/2020 17:13	12/10/2020 20:25	3,19	2	6,38	CHI
20201061209	SANTA HELENA DE GOIAS	SH12394803	IPEGUARI	12/10/2020 17:13	13/10/2020 04:52	12/10/2020 17:13	12/10/2020 22:27	5,24	35	183,30	CHI
20201061209	TURVELANDIA	SH12394803	IPEGUARI	12/10/2020 17:13	13/10/2020 04:52	12/10/2020 17:13	12/10/2020 22:27	5,24	10	52,37	CHI
20201061209	SANTA HELENA DE GOIAS	SH12394803	IPEGUARI	12/10/2020 17:13	13/10/2020 04:52	12/10/2020 17:13	13/10/2020 04:52	11,65	82	955,60	CHI
20201061209	SANTA HELENA DE GOIAS	SH12295822LD	IPEGUARI	12/10/2020 17:13	13/10/2020 04:52	13/10/2020 00:35	13/10/2020 04:52	4,28	13	55,68	CHI
20201062569	AMORINOPOLIS	AM12133498	IPORA	12/10/2020 17:13	13/10/2020 11:27	12/10/2020 17:13	13/10/2020 03:48	10,57	179	1892,38	CHI
20201062569	AMORINOPOLIS	AM12133498	IPORA	12/10/2020 17:13	13/10/2020 11:27	13/10/2020 04:59	13/10/2020 08:23	3,40	114	387,85	CHI
20201062569	AMORINOPOLIS	AM11231074	IPORA	12/10/2020 17:13	13/10/2020 11:27	13/10/2020 04:59	13/10/2020 11:27	6,46	65	420,04	CHI
20201061211	BRAZABRANTES	BR21109049	INHUMAS S1	12/10/2020 17:13	12/10/2020 18:32	12/10/2020 17:13	12/10/2020 18:32	1,30	3	3,90	CHI
20201061239	MONTIVIDIU	MV10409385	MONTIVIDIU T	12/10/2020 17:14	13/10/2020 13:14	12/10/2020 17:14	12/10/2020 18:54	1,66	10	16,64	CHI
20201061239	RIO VERDE	MV10409385	MONTIVIDIU T	12/10/2020 17:14	13/10/2020 13:14	12/10/2020 17:14	12/10/2020 18:54	1,66	7	11,65	CHI
20201061239	MONTIVIDIU	MV10409385	MONTIVIDIU T	12/10/2020 17:14	13/10/2020 13:14	12/10/2020 20:41	12/10/2020 20:54	0,22	10	2,20	CHI
20201061239	RIO VERDE	MV10409385	MONTIVIDIU T	12/10/2020 17:14	13/10/2020 13:14	12/10/2020 20:41	12/10/2020 20:54	0,22	7	1,54	CHI
20201061239	RIO VERDE	MV10409385	MONTIVIDIU T	12/10/2020 17:14	13/10/2020 13:14	12/10/2020 21:19	12/10/2020 21:26	0,11	7	0,77	CHI
20201061239	MONTIVIDIU	MV10409385	MONTIVIDIU T	12/10/2020 17:14	13/10/2020 13:14	12/10/2020 21:19	12/10/2020 21:26	0,11	10	1,10	CHI
20201061239	RIO VERDE	MV10409385	MONTIVIDIU T	12/10/2020 17:14	13/10/2020 13:14	12/10/2020 17:14	13/10/2020 00:37	7,39	8	59,09	CHI
20201061239	MONTIVIDIU	MV10409385	MONTIVIDIU T	12/10/2020 17:14	13/10/2020 13:14	12/10/2020 17:14	13/10/2020 00:37	7,39	15	110,80	CHI
20201061239	RIO VERDE	MV10409385	MONTIVIDIU T	12/10/2020 17:14	13/10/2020 13:14	13/10/2020 09:11	13/10/2020 09:29	0,30	15	4,43	CHI
20201061239	MONTIVIDIU	MV10409385	MONTIVIDIU T	12/10/2020 17:14	13/10/2020 13:14	13/10/2020 09:11	13/10/2020 09:29	0,30	25	7,39	CHI
20201061239	RIO VERDE	RV12260654LD	MONTIVIDIU T	12/10/2020 17:14	13/10/2020 13:14	12/10/2020 17:14	13/10/2020 13:14	20,00	3	59,99	CHI
20201061216	CRIXAS	2490024663	SERRA DO OURO	12/10/2020 17:15	14/10/2020 14:49	12/10/2020 17:15	14/10/2020 14:49	45,55	1	45,55	CHI
2020101200069	SAO FRANCISCO DE GOIAS	03165126	SAO FRANCISCO DE GOIAS	12/10/2020 17:16	12/10/2020 19:48	12/10/2020 17:16	12/10/2020 19:48	2,54	25	63,40	CHI
2020101200069	PIRENOPOLIS	03165126	SAO FRANCISCO DE GOIAS	12/10/2020 17:16	12/10/2020 19:48	12/10/2020 17:16	12/10/2020 19:48	2,54	1	2,54	CHI
2020101200069	PETROLINA DE GOIAS	03165126	SAO FRANCISCO DE GOIAS	12/10/2020 17:16	12/10/2020 19:48	12/10/2020 17:16	12/10/2020 19:48	2,54	3	7,61	CHI
2020101200069	SAO FRANCISCO DE GOIAS	03165126	SAO FRANCISCO DE GOIAS	12/10/2020 17:16	12/10/2020 19:48	12/10/2020 17:16	12/10/2020 19:48	2,54	1	2,54	CHI
20201061233	FORMOSA	10022051668	ITUIQUIRA	12/10/2020 17:17	12/10/2020 23:39	12/10/2020 17:17	12/10/2020 23:39	6,37	1	6,37	CHI
20201061234	TURVELANDIA	TD12226264	RIO DOS BOIS	12/10/2020 17:17	12/10/2020 20:29	12/10/2020 17:17	12/10/2020 20:29	3,21	78	250,36	CHI
20201061242	APARECIDA DE GOIANIA	15857086	INDEPENDENCIA S1	12/10/2020 17:18	12/10/2020 21:32	12/10/2020 17:18	12/10/2020 21:32	4,23	1	4,23	CHI
20201061508	DOVERLANDIA	DV12341765	CAIAPONIA	12/10/2020 17:19	12/10/2020 22:49	12/10/2020 21:42	12/10/2020 22:42	1,01	146	147,38	CHI
20201061508	DOVERLANDIA	DV11139978	CAIAPONIA	12/10/2020 17:19	12/10/2020 22:49	12/10/2020 17:19	12/10/2020 22:49	5,49	148	813,01	CHI
20201061374	CAIAPONIA	CP12354340	CAIAPONIA	12/10/2020 17:20	13/10/2020 20:41	12/10/2020 17:20	13/10/2020 20:41	27,34	13	355,48	CHI
20201061260	UIRAPURU	UP21083400	SANTA TEREZINHA	12/10/2020 17:20	12/10/2020 19:11	12/10/2020 17:20	12/10/2020 19:11	1,84	1	1,84	CHI
20201062272	NIQUELANDIA	NQ12208518	NIQUELANDIA SUBTRANSMISSAO	12/10/2020 17:20	14/10/2020 11:59	12/10/2020 17:20	13/10/2020 18:35	25,23	1	25,23	CHI
20201062272	NIQUELANDIA	NQ12208518	NIQUELANDIA SUBTRANSMISSAO	12/10/2020 17:20	14/10/2020 11:59	12/10/2020 17:20	14/10/2020 11:59	42,64	94	4007,77	CHI

20201061262	ARAGUAPAZ	AZ11328933	MOZARLANDIA	12/10/2020 17:20	12/10/2020 18:40	12/10/2020 17:20	12/10/2020 18:40	1,32	1	1,32	CHI
20201061270	ALTO PARAISO DE GOIAS	3870010068	FLORES DE GOIAS	12/10/2020 17:22	12/10/2020 18:51	12/10/2020 17:22	12/10/2020 18:51	1,48	1	1,48	CHI
20201061273	SANTA BARBARA DE GOIAS	SB21232787	TRINDADE	12/10/2020 17:23	12/10/2020 20:18	12/10/2020 17:23	12/10/2020 20:18	2,91	1	2,91	CHI
20201061682	MINERIOS	MY12246680	SANTA RITA DO ARAGUAIA	12/10/2020 17:23	12/10/2020 19:53	12/10/2020 17:23	12/10/2020 19:53	2,49	6	14,93	CHI
20201061280	ANAPOLIS	AN21239279	NEROPOLIS S1	12/10/2020 17:24	12/10/2020 19:22	12/10/2020 17:24	12/10/2020 19:22	1,96	3	5,89	CHI
20201060424	RIO VERDE	MV10398076	MONTIVIDIU T	12/10/2020 17:24	12/10/2020 17:38	12/10/2020 17:24	12/10/2020 17:31	0,11	42	4,63	CHI
20201060424	RIO VERDE	MV10398076	MONTIVIDIU T	12/10/2020 17:24	12/10/2020 17:38	12/10/2020 17:24	12/10/2020 17:31	0,11	96	10,59	CHI
20201060424	RIO VERDE	MV10398076	MONTIVIDIU T	12/10/2020 17:24	12/10/2020 17:38	12/10/2020 17:24	12/10/2020 17:31	0,11	28	3,09	CHI
20201060424	MONTIVIDIU	MV10398076	MONTIVIDIU T	12/10/2020 17:24	12/10/2020 17:38	12/10/2020 17:24	12/10/2020 17:31	0,11	32	3,53	CHI
20201060424	RIO VERDE	RV10212406	CABRIUVA S2	12/10/2020 17:24	12/10/2020 17:38	12/10/2020 17:26	12/10/2020 17:33	0,10	60	6,20	CHI
20201060424	RIO VERDE	RV10212406	CABRIUVA S2	12/10/2020 17:24	12/10/2020 17:38	12/10/2020 17:26	12/10/2020 17:38	0,19	76	14,61	CHI
20201060424	RIO VERDE	RV10409400	MONTIVIDIU T	12/10/2020 17:24	12/10/2020 17:38	12/10/2020 17:26	12/10/2020 17:38	0,19	42	8,07	CHI
20201061323	RIO VERDE	RV21296238	MONTIVIDIU T	12/10/2020 17:24	12/10/2020 18:29	12/10/2020 17:24	12/10/2020 18:29	1,07	1	1,07	CHI
20201061469	SANTA HELENA DE GOIAS	SH12271534LD	IPEGUARI	12/10/2020 17:24	12/10/2020 23:00	12/10/2020 17:24	12/10/2020 23:00	5,58	172	960,43	CHI
20201061674	SAO JOAO D ALIANCA	JL12383338	SAO JOAO D ALIANCA	12/10/2020 17:25	12/10/2020 21:17	12/10/2020 17:25	12/10/2020 21:17	3,85	39	150,25	CHI
20201061291	CORUMBA DE GOIAS	260032670	CORUMBA	12/10/2020 17:25	12/10/2020 20:50	12/10/2020 17:25	12/10/2020 20:50	3,40	1	3,40	CHI
20201063254	MONTIVIDIU	MV12054328	MONTIVIDIU T	12/10/2020 17:26	13/10/2020 16:51	12/10/2020 17:26	13/10/2020 13:30	20,05	10	200,55	CHI
20201063254	CAIAPONIA	MV12054328	MONTIVIDIU T	12/10/2020 17:26	13/10/2020 16:51	12/10/2020 17:26	13/10/2020 13:30	20,05	88	1764,84	CHI
20201063254	MONTIVIDIU	MV12054328	MONTIVIDIU T	12/10/2020 17:26	13/10/2020 16:51	13/10/2020 13:44	13/10/2020 16:02	2,29	14	32,01	CHI
20201063254	CAIAPONIA	CP12260986LD	MONTIVIDIU T	12/10/2020 17:26	13/10/2020 16:51	13/10/2020 13:44	13/10/2020 16:51	3,10	55	170,67	CHI
20201061297	VIANOPOLIS	510031780	VIANOPOLIS	12/10/2020 17:26	12/10/2020 21:27	12/10/2020 17:26	12/10/2020 21:27	4,00	1	4,00	CHI
20201062018	IPORA	IR12233159	IPORA	12/10/2020 17:27	12/10/2020 19:43	12/10/2020 17:27	12/10/2020 19:43	2,26	391	884,96	CHI
20201061302	BARRO ALTO	BA21357144	BARRO ALTO	12/10/2020 17:27	13/10/2020 00:07	12/10/2020 17:27	13/10/2020 00:07	6,66	1	6,66	CHI
20201062224	PIRANHAS	PH12024566	ARENOPOLIS	12/10/2020 17:27	13/10/2020 11:07	12/10/2020 17:27	12/10/2020 20:50	3,38	16	54,08	CHI
20201062224	PIRANHAS	PH12024566	ARENOPOLIS	12/10/2020 17:27	13/10/2020 11:07	12/10/2020 17:27	13/10/2020 11:07	17,66	7	123,65	CHI
20201062224	PIRANHAS	PH12024566	ARENOPOLIS	12/10/2020 17:27	13/10/2020 11:07	12/10/2020 20:56	13/10/2020 11:07	14,18	16	226,86	CHI
20201061417	GOIANIRA	GR12346120	MEIA PONTE	12/10/2020 17:28	12/10/2020 18:57	12/10/2020 17:28	12/10/2020 18:57	1,48	288	425,68	CHI
20201061312	TRINDADE	40116141	MEIA PONTE	12/10/2020 17:28	12/10/2020 18:50	12/10/2020 17:28	12/10/2020 18:50	1,36	1	1,36	CHI
20201061315	SAO JOAO DA PARAUNA	FR12395091	FIRMINOPOLIS S2	12/10/2020 17:28	12/10/2020 22:51	12/10/2020 17:28	12/10/2020 22:51	5,38	4	21,52	CHI
20201061317	FORMOSA	10005728884	ITUIQUIRA	12/10/2020 17:28	13/10/2020 11:02	12/10/2020 17:28	13/10/2020 11:02	17,56	1	17,56	CHI
20201061437	TURVANIA	TV12111577	FIRMINOPOLIS S1	12/10/2020 17:29	12/10/2020 19:30	12/10/2020 17:29	12/10/2020 19:30	2,01	8	16,11	CHI
20201061437	FIRMINOPOLIS	TV12111577	FIRMINOPOLIS S1	12/10/2020 17:29	12/10/2020 19:30	12/10/2020 17:29	12/10/2020 19:30	2,01	2	4,03	CHI
20201061327	SANTA BARBARA DE GOIAS	SB11078308	TRINDADE	12/10/2020 17:30	12/10/2020 19:05	12/10/2020 17:30	12/10/2020 19:05	1,58	154	243,32	CHI
20201061329	SANCLERLANDIA	SC21206475	FIRMINOPOLIS S2	12/10/2020 17:30	14/10/2020 01:47	12/10/2020 17:30	14/10/2020 01:47	32,28	1	32,28	CHI
20201061330	CEZARINA	CZ21233410	CEZARINA	12/10/2020 17:30	13/10/2020 15:40	12/10/2020 17:30	13/10/2020 15:40	22,16	1	22,16	CHI
20201061331	APARECIDA DE GOIANIA	200045234	INDEPENDENCIA S1	12/10/2020 17:30	12/10/2020 17:58	12/10/2020 17:30	12/10/2020 17:58	0,46	1	0,46	CHI
20201061479	MONTIVIDIU	05700414	MONTIVIDIU T	12/10/2020 17:31	12/10/2020 22:40	12/10/2020 17:31	12/10/2020 19:32	2,02	4	8,07	CHI
20201061479	RIO VERDE	05700414	MONTIVIDIU T	12/10/2020 17:31	12/10/2020 22:40	12/10/2020 17:31	12/10/2020 19:32	2,02	37	74,63	CHI
20201061479	RIO VERDE	RV13271658	MONTIVIDIU T	12/10/2020 17:31	12/10/2020 22:40	12/10/2020 17:31	12/10/2020 22:40	5,15	13	67,00	CHI
20201063139	SANCLERLANDIA	SC12391519	FIRMINOPOLIS S2	12/10/2020 17:31	13/10/2020 16:30	12/10/2020 17:31	13/10/2020 16:30	22,98	1	22,98	CHI
20201063139	SAO LUIS DE MONTES BELOS	SC12391519	FIRMINOPOLIS S2	12/10/2020 17:31	13/10/2020 16:30	12/10/2020 17:31	13/10/2020 16:30	22,98	2	45,97	CHI
20201061343	SILVANIA	SV12205359	VIANOPOLIS	12/10/2020 17:31	12/10/2020 21:08	12/10/2020 17:31	12/10/2020 21:08	3,60	3	10,80	CHI
20201062049	PALESTINA DE GOIAS	IR12188430	IPORA	12/10/2020 17:32	12/10/2020 21:00	12/10/2020 17:32	12/10/2020 21:00	3,45	45	155,29	CHI
20201062049	AMORINOPOLIS	IR12188430	IPORA	12/10/2020 17:32	12/10/2020 21:00	12/10/2020 17:32	12/10/2020 21:00	3,45	47	162,19	CHI
20201062049	IPORA	IR12188430	IPORA	12/10/2020 17:32	12/10/2020 21:00	12/10/2020 17:32	12/10/2020 21:00	3,45	77	265,71	CHI
20201062049	IVOLANDIA	IR12188430	IPORA	12/10/2020 17:32	12/10/2020 21:00	12/10/2020 17:32	12/10/2020 21:00	3,45	131	452,06	CHI
20201061638	TROMBAS	TB12185402	PORANGATU	12/10/2020 17:33	12/10/2020 21:55	12/10/2020 17:33	12/10/2020 21:55	4,36	3	13,08	CHI
20201061358	MORRINHOS	MR12074752	MORRINHOS	12/10/2020 17:33	12/10/2020 19:17	12/10/2020 17:33	12/10/2020 19:17	1,72	2	3,45	CHI
20201061389	PADRE BERNARDO	PB10383679	PADRE BERNARDO	12/10/2020 17:34	13/10/2020 17:18	12/10/2020 17:34	12/10/2020 20:38	3,07	74	227,43	CHI
20201061389	PADRE BERNARDO	PB10383679	PADRE BERNARDO	12/10/2020 17:34	13/10/2020 17:18	12/10/2020 17:34	12/10/2020 21:24	3,84	10	38,37	CHI
20201061389	PADRE BERNARDO	PB10383679	PADRE BERNARDO	12/10/2020 17:34	13/10/2020 17:18	12/10/2020 23:57	13/10/2020 00:14	0,28	84	23,24	CHI
20201061389	PADRE BERNARDO	PB10383679	PADRE BERNARDO	12/10/2020 17:34	13/10/2020 17:18	13/10/2020 01:07	13/10/2020 01:37	0,51	84	42,82	CHI
20201061389	COCALZINHO DE GOIAS	PB10383679	PADRE BERNARDO	12/10/2020 17:34	13/10/2020 17:18	12/10/2020 17:34	13/10/2020 03:03	9,49	85	806,30	CHI
20201061389	PADRE BERNARDO	PB10383679	PADRE BERNARDO	12/10/2020 17:34	13/10/2020 17:18	12/10/2020 17:34	13/10/2020 03:03	9,49	569	5397,44	CHI
20201061389	DISTRITO FEDERAL	PB10383679	PADRE BERNARDO	12/10/2020 17:34	13/10/2020 17:18	12/10/2020 17:34	13/10/2020 03:03	9,49	3	28,46	CHI
20201061389	PADRE BERNARDO	PB12163212	PADRE BERNARDO	12/10/2020 17:34	13/10/2020 17:18	12/10/2020 17:34	13/10/2020 03:48	10,24	30	307,06	CHI
20201061389	PADRE BERNARDO	PB12000025	PADRE BERNARDO	12/10/2020 17:34	13/10/2020 17:18	12/10/2020 17:34	13/10/2020 04:06	10,54	9	94,83	CHI
20201061389	PADRE BERNARDO	PB10383679	PADRE BERNARDO	12/10/2020 17:34	13/10/2020 17:18	13/10/2020 15:47	13/10/2020 16:00	0,23	130	29,32	CHI

20201061389	PADRE BERNARDO	PB10383679	PADRE BERNARDO	12/10/2020 17:34	13/10/2020 17:18	12/10/2020 17:34	13/10/2020 17:08	23,56	3	70,68	CHI
20201061389	PADRE BERNARDO	PB10383679	PADRE BERNARDO	12/10/2020 17:34	13/10/2020 17:18	13/10/2020 15:47	13/10/2020 17:18	1,51	562	850,02	CHI
20201061389	COCALZINHO DE GOIAS	PB10383679	PADRE BERNARDO	12/10/2020 17:34	13/10/2020 17:18	13/10/2020 15:47	13/10/2020 17:18	1,51	85	128,56	CHI
20201061389	DISTRITO FEDERAL	PB10383679	PADRE BERNARDO	12/10/2020 17:34	13/10/2020 17:18	13/10/2020 15:47	13/10/2020 17:18	1,51	3	4,54	CHI
20201061363	CEZARINA	1650022831	CEZARINA	12/10/2020 17:34	13/10/2020 17:26	12/10/2020 17:34	13/10/2020 17:26	23,86	1	23,86	CHI
20201061365	TRINDADE	11893138	GOYA S1	12/10/2020 17:35	12/10/2020 19:25	12/10/2020 17:35	12/10/2020 19:25	1,84	1	1,84	CHI
20201061368	MOSSAMEDES	MD21343844	FIRMINOPOLIS S2	12/10/2020 17:35	13/10/2020 09:18	12/10/2020 17:35	13/10/2020 09:18	15,71	1	15,71	CHI
20201062465	IVOLANDIA	AM12000005	IPORA	12/10/2020 17:35	14/10/2020 08:52	12/10/2020 17:35	14/10/2020 08:52	39,28	2	78,55	CHI
20201062465	AMORINOPOLIS	AM12000005	IPORA	12/10/2020 17:35	14/10/2020 08:52	12/10/2020 17:35	14/10/2020 08:52	39,28	32	1256,80	CHI
20201061373	CORUMBAIBA	560033692	VILA CORUMBA	12/10/2020 17:35	12/10/2020 22:12	12/10/2020 17:35	12/10/2020 22:12	4,60	1	4,60	CHI
20201061379	LUZIANIA	LZ11313604	CRISTALINA S2	12/10/2020 17:36	12/10/2020 18:47	12/10/2020 17:36	12/10/2020 18:47	1,17	3	3,52	CHI
20201061383	CAMPO LIMPO	AN12258130	NEROPOLIS S1	12/10/2020 17:36	12/10/2020 20:39	12/10/2020 17:36	12/10/2020 20:39	3,04	3	9,12	CHI
20201061988	JUSSARA	JR11259752	BRITANIA	12/10/2020 17:36	12/10/2020 23:11	12/10/2020 17:36	12/10/2020 23:11	5,58	13	72,56	CHI
20201062306	CAIAPONIA	CP12221742	CAIAPONIA	12/10/2020 17:37	13/10/2020 02:11	12/10/2020 17:37	13/10/2020 02:11	8,57	797	6826,75	CHI
20201061397	SANTA TEREZINHA DE GOIAS	GG21181456	SANTA TEREZINHA	12/10/2020 17:38	12/10/2020 21:12	12/10/2020 17:38	12/10/2020 21:12	3,56	1	3,56	CHI
20201061400	JUSSARA	1290047318	JUSSARA	12/10/2020 17:38	13/10/2020 09:12	12/10/2020 17:38	13/10/2020 09:12	15,55	1	15,55	CHI
20201061401	ITAGUARI	II11259559	ITABERAI S1	12/10/2020 17:38	12/10/2020 18:30	12/10/2020 17:38	12/10/2020 18:30	0,85	103	87,86	CHI
20201061411	QUIRINOPOLIS	QI31053167	QUIRINOPOLIS	12/10/2020 17:39	13/10/2020 01:08	12/10/2020 17:39	13/10/2020 01:08	7,47	1	7,47	CHI
20201061413	NEROPOLIS	NR11201595	NEROPOLIS S2	12/10/2020 17:39	12/10/2020 19:23	12/10/2020 17:39	12/10/2020 19:23	1,72	91	156,34	CHI
20201060985	AMORINOPOLIS	AM12390135	IPORA	12/10/2020 17:40	13/10/2020 21:53	12/10/2020 17:40	13/10/2020 21:53	28,22	8	225,73	CHI
20201060985	IVOLANDIA	AM12390135	IPORA	12/10/2020 17:40	13/10/2020 21:53	12/10/2020 17:40	13/10/2020 21:53	28,22	68	1918,71	CHI
20201061717	AMORINOPOLIS	AM11380879	IPORA	12/10/2020 17:41	12/10/2020 23:06	12/10/2020 17:41	12/10/2020 23:06	5,40	79	426,95	CHI
20201061441	CAIAPONIA	MV12260782	MONTIVIDIU T	12/10/2020 17:41	13/10/2020 13:32	12/10/2020 17:41	13/10/2020 13:32	19,84	1	19,84	CHI
20201061441	MONTIVIDIU	MV12260782	MONTIVIDIU T	12/10/2020 17:41	13/10/2020 13:32	12/10/2020 17:41	13/10/2020 13:32	19,84	6	119,01	CHI
20201061442	INACIOLANDIA	CD21000128	CACHOEIRA DOURADA	12/10/2020 17:41	13/10/2020 07:31	12/10/2020 17:41	13/10/2020 07:31	13,82	1	13,82	CHI
20201061448	MAMBAI	1570005919	IACIARA S2	12/10/2020 17:42	12/10/2020 19:56	12/10/2020 17:42	12/10/2020 19:56	2,22	1	2,22	CHI
20201061449	GOIANIA	16695732	XAVANTES	12/10/2020 17:42	12/10/2020 18:35	12/10/2020 17:42	12/10/2020 18:35	0,87	1	0,87	CHI
20201061450	TRINDADE	TR11035155	TRINDADE	12/10/2020 17:43	12/10/2020 22:09	12/10/2020 17:43	12/10/2020 22:09	4,43	25	110,82	CHI
20201061451	GUARAITA	3140002516	ITAPURANGA	12/10/2020 17:43	12/10/2020 19:41	12/10/2020 17:43	12/10/2020 19:41	1,96	1	1,96	CHI
20201061452	SANTO ANTONIO DE GOIAS	NR11246207	NEROPOLIS S2	12/10/2020 17:43	13/10/2020 01:59	12/10/2020 17:43	13/10/2020 01:59	8,27	21	173,73	CHI
20201061455	APARECIDA DE GOIANIA	14676230	REAL S1	12/10/2020 17:43	12/10/2020 20:17	12/10/2020 17:43	12/10/2020 20:17	2,56	1	2,56	CHI
20201062467	SERRANOPOLIS	SX12267557	JATAI S1	12/10/2020 17:44	13/10/2020 18:56	12/10/2020 17:44	13/10/2020 18:56	25,21	25	630,18	CHI
20201061462	COCALZINHO DE GOIAS	ZN21142580	AGUAS LINDAS DE GOIAS S1	12/10/2020 17:44	12/10/2020 18:59	12/10/2020 17:44	12/10/2020 18:59	1,25	1	1,25	CHI
20201061466	SANTA ROSA DE GOIAS	SR12107586	INHUMAS S1	12/10/2020 17:44	13/10/2020 07:59	12/10/2020 17:44	13/10/2020 07:59	14,24	62	882,95	CHI
20201061471	MINACU	IH21192292	MINACU	12/10/2020 17:45	13/10/2020 11:03	12/10/2020 17:45	13/10/2020 11:03	17,30	1	17,30	CHI
20201061480	GOIANIA	GN11213735	GOYA S1	12/10/2020 17:46	13/10/2020 00:09	12/10/2020 17:46	13/10/2020 00:09	6,38	140	892,66	CHI
20201061484	ANAPOLIS	20058585	JUNDIAI S2	12/10/2020 17:46	12/10/2020 21:34	12/10/2020 17:46	12/10/2020 21:34	3,79	1	3,79	CHI
20201061485	RIO VERDE	SH12296215	IPEGUARI	12/10/2020 17:46	12/10/2020 23:06	12/10/2020 17:46	12/10/2020 23:06	5,32	4	21,28	CHI
20201061485	SANTA HELENA DE GOIAS	SH12296215	IPEGUARI	12/10/2020 17:46	12/10/2020 23:06	12/10/2020 17:46	12/10/2020 23:06	5,32	41	218,07	CHI
20201061577	RIO VERDE	RV21246816	RIO VERDE S1	12/10/2020 17:48	13/10/2020 06:07	12/10/2020 17:48	13/10/2020 06:07	12,33	1	12,33	CHI
20201062039	SILVANIA	SV12058432	DAIA S2	12/10/2020 17:48	12/10/2020 22:07	12/10/2020 17:48	12/10/2020 22:07	4,31	10	43,09	CHI
20201061547	JAUPACI	JP10396034	IPORA	12/10/2020 17:48	12/10/2020 23:53	12/10/2020 17:48	12/10/2020 23:53	6,08	81	492,35	CHI
20201061547	FAZENDA NOVA	JP10396034	IPORA	12/10/2020 17:48	12/10/2020 23:53	12/10/2020 17:48	12/10/2020 23:53	6,08	21	127,65	CHI
20201061547	DIORAMA	JP10396034	IPORA	12/10/2020 17:48	12/10/2020 23:53	12/10/2020 17:48	12/10/2020 23:53	6,08	12	72,94	CHI
20201061499	QUIRINOPOLIS	QI21064756	QUIRINOPOLIS	12/10/2020 17:48	13/10/2020 02:46	12/10/2020 17:48	13/10/2020 02:46	8,95	1	8,95	CHI
20201061500	INHUMAS	30089750	INHUMAS S2	12/10/2020 17:48	12/10/2020 22:36	12/10/2020 17:48	12/10/2020 22:36	4,78	1	4,78	CHI
20201061802	PIRES DO RIO	PR12255823	PIRES DO RIO S1	12/10/2020 17:49	12/10/2020 19:31	12/10/2020 17:49	12/10/2020 19:31	1,70	8	13,58	CHI
20201061504	ACREUNA	EU12271441	ACREUNA	12/10/2020 17:49	12/10/2020 20:02	12/10/2020 17:49	12/10/2020 20:02	2,21	283	626,06	CHI
20201061507	ANAPOLIS	21364904	JUNDIAI S1	12/10/2020 17:49	12/10/2020 21:30	12/10/2020 17:49	12/10/2020 21:30	3,67	1	3,67	CHI
20201061516	GOIANIA	14878409	GOIANIA LESTE S2	12/10/2020 17:51	12/10/2020 19:09	12/10/2020 17:51	12/10/2020 19:09	1,30	1	1,30	CHI
20201062863	NEROPOLIS	NR11104451	NEROPOLIS S2	12/10/2020 17:51	13/10/2020 06:57	12/10/2020 17:51	13/10/2020 06:57	13,10	18	235,80	CHI
20201061536	SILVANIA	SV12090745	ANAPOLIS UNIVERSITARIO S2	12/10/2020 17:51	12/10/2020 21:11	12/10/2020 17:51	12/10/2020 21:11	3,33	1	3,33	CHI
20201061536	GAMELEIRA DE GOIAS	SV12090745	ANAPOLIS UNIVERSITARIO S2	12/10/2020 17:51	12/10/2020 21:11	12/10/2020 17:51	12/10/2020 21:11	3,33	11	36,63	CHI
20201061530	SENADOR CANEDO	16266675	GOIANIA LESTE S2	12/10/2020 17:53	12/10/2020 18:56	12/10/2020 17:53	12/10/2020 18:56	1,05	1	1,05	CHI
20201060338	GOIATUBA	GT12052877	GOIATUBA S1	12/10/2020 17:53	12/10/2020 21:39	12/10/2020 17:53	12/10/2020 21:39	3,75	3	11,25	CHI
20201061538	RIO VERDE	RV21230833	MONTIVIDIU T	12/10/2020 17:54	12/10/2020 18:46	12/10/2020 17:54	12/10/2020 18:46	0,87	1	0,87	CHI
20201061775	AMORINOPOLIS	AM11000001	IPORA	12/10/2020 17:54	12/10/2020 21:16	12/10/2020 17:54	12/10/2020 21:16	3,35	124	415,92	CHI
20201061548	FORMOSO	FO21243350	PORANGATU	12/10/2020 17:54	12/10/2020 19:40	12/10/2020 17:54	12/10/2020 19:40	1,75	1	1,75	CHI

20201062831	AMORINOPOLIS	AM11252385	IPORA	12/10/2020 17:55	13/10/2020 02:02	12/10/2020 17:55	13/10/2020 02:02	8,11	53	429,67	CHI
20201061561	ITABERAI	IB11274215	ITABERAI S2	12/10/2020 17:56	13/10/2020 06:52	12/10/2020 17:56	13/10/2020 06:52	12,93	89	1150,94	CHI
20201061563	CRISTALINA	KR11276404	CRISTALINA S2	12/10/2020 17:56	12/10/2020 21:10	12/10/2020 17:56	12/10/2020 21:10	3,23	1	3,23	CHI
20201062543	NIQUELANDIA	NQ11088751	NIQUELANDIA SUBTRANSMISSAO	12/10/2020 17:56	13/10/2020 03:40	12/10/2020 17:56	13/10/2020 03:40	9,73	111	1080,06	CHI
20201061642	JARAGUA	JA10411497	JARAGUA	12/10/2020 17:56	13/10/2020 06:56	12/10/2020 17:56	12/10/2020 18:00	0,06	784	47,48	CHI
20201061642	JARAGUA	JA10411497	JARAGUA	12/10/2020 17:56	13/10/2020 06:56	12/10/2020 17:56	12/10/2020 18:02	0,09	679	59,60	CHI
20201061642	ITAGUARU	JA10411497	JARAGUA	12/10/2020 17:56	13/10/2020 06:56	12/10/2020 17:56	12/10/2020 18:02	0,09	26	2,28	CHI
20201061642	URUANA	JA10411497	JARAGUA	12/10/2020 17:56	13/10/2020 06:56	12/10/2020 17:56	12/10/2020 18:02	0,09	7	0,61	CHI
20201061642	JARAGUA	JA10411497	JARAGUA	12/10/2020 17:56	13/10/2020 06:56	12/10/2020 17:56	12/10/2020 18:02	0,10	487	50,46	CHI
20201061642	JARAGUA	JA10411497	JARAGUA	12/10/2020 17:56	13/10/2020 06:56	12/10/2020 17:56	12/10/2020 18:03	0,11	1096	119,95	CHI
20201061642	JARAGUA	01020214	JARAGUA	12/10/2020 17:56	13/10/2020 06:56	12/10/2020 18:06	12/10/2020 18:15	0,14	3357	485,83	CHI
20201061642	JARAGUA	JA16411484	JARAGUA	12/10/2020 17:56	13/10/2020 06:56	12/10/2020 18:06	12/10/2020 18:16	0,16	1553	245,03	CHI
20201061642	JARAGUA	JA16418506	JARAGUA	12/10/2020 17:56	13/10/2020 06:56	12/10/2020 18:06	12/10/2020 18:18	0,19	220	42,35	CHI
20201061642	JARAGUA	JA16411494	JARAGUA	12/10/2020 17:56	13/10/2020 06:56	12/10/2020 18:06	12/10/2020 18:19	0,20	784	160,07	CHI
20201061642	JARAGUA	JA16411461	JARAGUA	12/10/2020 17:56	13/10/2020 06:56	12/10/2020 18:04	12/10/2020 18:19	0,24	1886	455,78	CHI
20201061642	JARAGUA	JA16411461	JARAGUA	12/10/2020 17:56	13/10/2020 06:56	12/10/2020 18:20	12/10/2020 19:43	1,39	1439	1999,41	CHI
20201061642	JARAGUA	JA13096574	JARAGUA	12/10/2020 17:56	13/10/2020 06:56	12/10/2020 18:20	12/10/2020 22:22	4,03	8	32,25	CHI
20201061642	JARAGUA	JA16411461	JARAGUA	12/10/2020 17:56	13/10/2020 06:56	12/10/2020 22:27	12/10/2020 22:56	0,47	1439	682,73	CHI
20201061642	JARAGUA	JA16411482	JARAGUA	12/10/2020 17:56	13/10/2020 06:56	12/10/2020 18:06	12/10/2020 23:04	4,96	388	1924,26	CHI
20201061642	JARAGUA	JA16411507	JARAGUA	12/10/2020 17:56	13/10/2020 06:56	12/10/2020 23:27	12/10/2020 23:35	0,14	784	113,46	CHI
20201061642	JARAGUA	JA16411482	JARAGUA	12/10/2020 17:56	13/10/2020 06:56	12/10/2020 18:06	13/10/2020 01:23	7,28	154	1121,72	CHI
20201061642	JARAGUA	JA12297465LD	JARAGUA	12/10/2020 17:56	13/10/2020 06:56	12/10/2020 18:06	13/10/2020 01:51	7,75	178	1379,35	CHI
20201061642	PIRENOPOLIS	JA12297465LD	JARAGUA	12/10/2020 17:56	13/10/2020 06:56	12/10/2020 18:06	13/10/2020 01:51	7,75	99	767,17	CHI
20201061642	JARAGUA	JA16411461	JARAGUA	12/10/2020 17:56	13/10/2020 06:56	12/10/2020 23:17	13/10/2020 02:18	3,01	1439	4337,39	CHI
20201061642	JARAGUA	JA16411494	JARAGUA	12/10/2020 17:56	13/10/2020 06:56	12/10/2020 23:27	13/10/2020 02:18	2,85	220	627,49	CHI
20201061642	JARAGUA	JA13096574	JARAGUA	12/10/2020 17:56	13/10/2020 06:56	12/10/2020 22:27	13/10/2020 02:43	4,25	8	34,02	CHI
20201061642	JARAGUA	JA10396178	JARAGUA	12/10/2020 17:56	13/10/2020 06:56	12/10/2020 18:20	13/10/2020 02:49	8,49	487	4133,95	CHI
20201061642	URUANA	JA10396200	JARAGUA	12/10/2020 17:56	13/10/2020 06:56	12/10/2020 18:04	13/10/2020 02:51	8,78	7	61,44	CHI
20201061642	JARAGUA	JA10396200	JARAGUA	12/10/2020 17:56	13/10/2020 06:56	12/10/2020 18:04	13/10/2020 02:51	8,78	376	3300,34	CHI
20201061642	ITAGUARU	JA10396200	JARAGUA	12/10/2020 17:56	13/10/2020 06:56	12/10/2020 18:04	13/10/2020 02:51	8,78	26	228,22	CHI
20201061642	JARAGUA	JA12273009	JARAGUA	12/10/2020 17:56	13/10/2020 06:56	12/10/2020 18:20	13/10/2020 04:07	9,78	12	117,33	CHI
20201061642	JARAGUA	JA10411497	JARAGUA	12/10/2020 17:56	13/10/2020 06:56	12/10/2020 23:27	13/10/2020 06:56	7,49	1024	7668,91	CHI
20201061568	SILVANIA	SV12012003	VIANOPOLIS	12/10/2020 17:57	12/10/2020 22:56	12/10/2020 17:57	12/10/2020 22:56	4,97	2	9,94	CHI
20201061911	INHUMAS	IN12092615	INHUMAS S2	12/10/2020 17:57	13/10/2020 12:19	12/10/2020 17:57	12/10/2020 23:24	5,43	14	76,07	CHI
20201061911	INHUMAS	IN12092615	INHUMAS S2	12/10/2020 17:57	13/10/2020 12:19	13/10/2020 01:40	13/10/2020 12:19	10,66	14	149,22	CHI
20201061573	PIRES DO RIO	6433632	PIRES DO RIO S1	12/10/2020 17:58	12/10/2020 20:42	12/10/2020 17:58	12/10/2020 20:42	2,72	8	21,74	CHI
20201061574	INHUMAS	IX12000030	INHUMAS S1	12/10/2020 17:59	12/10/2020 20:37	12/10/2020 17:59	12/10/2020 20:37	2,63	12	31,58	CHI
20201061574	ITAUCU	IX12000030	INHUMAS S1	12/10/2020 17:59	12/10/2020 20:37	12/10/2020 17:59	12/10/2020 20:37	2,63	4	10,53	CHI
20201062217	RIO VERDE	RV12063315	RIO VERDE S1	12/10/2020 17:59	13/10/2020 06:07	12/10/2020 17:59	13/10/2020 06:07	12,14	19	230,57	CHI
20201062217	RIO VERDE	RV12063315	RIO VERDE S1	12/10/2020 17:59	13/10/2020 06:07	13/10/2020 03:17	13/10/2020 06:07	2,83	2	5,66	CHI
20201061580	PLANALTINA	PI12218586	PLANALTINA	12/10/2020 17:59	12/10/2020 20:49	12/10/2020 17:59	12/10/2020 20:49	2,82	3	8,45	CHI
20201061581	APARECIDA DE GOIANIA	AP11095069	ATLANTICO S2	12/10/2020 17:59	12/10/2020 21:29	12/10/2020 17:59	12/10/2020 21:29	3,48	114	397,26	CHI
20201062887	CACU	CC12360934RE	CACHOEIRA ALTA	12/10/2020 18:00	13/10/2020 09:23	12/10/2020 18:00	13/10/2020 09:23	15,38	6	92,28	CHI
20201061827	PARAUNA	PU11158980	PARAUNA	12/10/2020 18:01	12/10/2020 20:10	12/10/2020 18:01	12/10/2020 20:10	2,14	156	334,40	CHI
20201061593	QUIRINOPOLIS	QI12279492	QUIRINOPOLIS	12/10/2020 18:01	13/10/2020 07:35	12/10/2020 18:01	13/10/2020 07:35	13,56	7	94,92	CHI
20201061593	GOUVELANDIA	QI12279492	QUIRINOPOLIS	12/10/2020 18:01	13/10/2020 07:35	12/10/2020 18:01	13/10/2020 07:35	13,56	2	27,12	CHI
20201061596	ITAGUARU	IC11089314	ITABERAI S1	12/10/2020 18:01	12/10/2020 21:04	12/10/2020 18:01	12/10/2020 21:04	3,04	73	221,66	CHI
20201061597	GOIATUBA	04580214	BOM JESUS DE GOIAS	12/10/2020 18:01	14/10/2020 07:08	12/10/2020 18:01	12/10/2020 20:54	2,88	126	363,40	CHI
20201061597	GOIATUBA	04580214	BOM JESUS DE GOIAS	12/10/2020 18:01	14/10/2020 07:08	12/10/2020 21:04	12/10/2020 21:48	0,73	117	85,21	CHI
20201061597	GOIATUBA	GT13309834	BOM JESUS DE GOIAS	12/10/2020 18:01	14/10/2020 07:08	12/10/2020 21:04	13/10/2020 12:02	14,97	5	74,83	CHI
20201061597	GOIATUBA	GT13332549	BOM JESUS DE GOIAS	12/10/2020 18:01	14/10/2020 07:08	12/10/2020 21:04	13/10/2020 14:40	17,61	9	158,46	CHI
20201061597	GOIATUBA	JV12208104	GOIATUBA S1	12/10/2020 18:01	14/10/2020 07:08	13/10/2020 13:40	14/10/2020 07:08	17,47	14	244,63	CHI
20201061597	JOVIANIA	JV12208104	GOIATUBA S1	12/10/2020 18:01	14/10/2020 07:08	13/10/2020 13:40	14/10/2020 07:08	17,47	5	87,37	CHI
20201061598	GOIANIA	14350592	ATLANTICO S1	12/10/2020 18:02	12/10/2020 19:26	12/10/2020 18:02	12/10/2020 19:26	1,40	1	1,40	CHI
20201061602	APARECIDA DE GOIANIA	AP11350595	ANHANGUERA	12/10/2020 18:02	12/10/2020 20:37	12/10/2020 18:02	12/10/2020 20:37	2,57	56	143,78	CHI
20201061771	PIRANHAS	PH12193383	PIRANHAS	12/10/2020 18:03	13/10/2020 02:11	12/10/2020 18:03	13/10/2020 02:11	8,13	67	544,86	CHI
20201061771	ARENOPOLIS	PH12193383	PIRANHAS	12/10/2020 18:03	13/10/2020 02:11	12/10/2020 18:03	13/10/2020 02:11	8,13	1	8,13	CHI
20201061607	IPORA	IR11005250	IPORA	12/10/2020 18:03	13/10/2020 10:05	12/10/2020 18:03	13/10/2020 10:05	16,03	95	1522,82	CHI

20201061613	IPORA	IR21040130	IPORA	12/10/2020 18:03	12/10/2020 21:04	12/10/2020 18:03	12/10/2020 21:04	3,01	1	3,01	CHI
20201062451	CACHOEIRA DE GOIAS	CG12165605	FIRMINOPOLIS S2	12/10/2020 18:04	13/10/2020 09:31	12/10/2020 18:04	13/10/2020 09:31	15,46	9	139,16	CHI
20201061619	ANAPOLIS	AN21302285	JUNDIAI S1	12/10/2020 18:04	12/10/2020 20:18	12/10/2020 18:04	12/10/2020 20:18	2,23	2	4,45	CHI
20201061637	FORMOSA	FA12361428	SAO JOAO D ALIANCA	12/10/2020 18:07	13/10/2020 11:08	12/10/2020 18:07	13/10/2020 11:08	17,01	2	34,03	CHI
20201061639	ORIZONA	OZ12404726	PIRES DO RIO S1	12/10/2020 18:07	12/10/2020 20:30	12/10/2020 18:07	12/10/2020 20:30	2,37	9	21,35	CHI
20201061643	SANTA HELENA DE GOIAS	400138323	IPEGUARI	12/10/2020 18:08	13/10/2020 08:24	12/10/2020 18:08	13/10/2020 08:24	14,25	1	14,25	CHI
20201062107	INDIARA	IY12186469	EDEIA	12/10/2020 18:11	12/10/2020 23:14	12/10/2020 18:11	12/10/2020 23:14	5,05	224	1130,70	CHI
20201061657	OURO VERDE DE GOIAS	OV21035926	NEROPOLIS S1	12/10/2020 18:11	13/10/2020 12:49	12/10/2020 18:11	13/10/2020 12:49	18,63	1	18,63	CHI
20201062334	RIO VERDE	RV12207146	MONTIVIDIU T	12/10/2020 18:12	12/10/2020 22:49	12/10/2020 18:12	12/10/2020 22:49	4,61	2	9,23	CHI
20201061675	PLANALTINA	PI11164572	PLANALTINA	12/10/2020 18:12	12/10/2020 19:11	12/10/2020 18:12	12/10/2020 19:11	0,98	88	86,12	CHI
20201061676	MORRINHOS	MR21160306	MORRINHOS	12/10/2020 18:12	12/10/2020 20:14	12/10/2020 18:12	12/10/2020 20:14	2,03	1	2,03	CHI
20201061679	GUARANI DE GOIAS	1580002356	IACIARA S1	12/10/2020 18:12	12/10/2020 22:15	12/10/2020 18:12	12/10/2020 22:15	4,04	1	4,04	CHI
20201061690	INHUMAS	IN31098256	INHUMAS S2	12/10/2020 18:14	12/10/2020 20:35	12/10/2020 18:14	12/10/2020 20:35	2,35	4	9,39	CHI
20201062504	INDIARA	IY12205923	EDEIA	12/10/2020 18:14	13/10/2020 22:19	12/10/2020 18:14	12/10/2020 23:23	5,15	6	30,92	CHI
20201062504	INDIARA	IY12205923	EDEIA	12/10/2020 18:14	13/10/2020 22:19	12/10/2020 23:36	13/10/2020 21:49	22,21	4	88,83	CHI
20201062504	PALMEIRAS DE GOIAS	IY12205923	EDEIA	12/10/2020 18:14	13/10/2020 22:19	12/10/2020 18:14	13/10/2020 22:19	28,09	5	140,43	CHI
20201062504	INDIARA	IY12205923	EDEIA	12/10/2020 18:14	13/10/2020 22:19	12/10/2020 18:14	13/10/2020 22:19	28,09	26	730,24	CHI
20201062504	INDIARA	IY13323631	EDEIA	12/10/2020 18:14	13/10/2020 22:19	12/10/2020 23:36	13/10/2020 22:19	22,71	2	45,42	CHI
20201061696	GOIANIRA	10004140379	MEIA PONTE	12/10/2020 18:14	12/10/2020 20:12	12/10/2020 18:14	12/10/2020 20:12	1,96	1	1,96	CHI
20201061750	INDIARA	EA12223551RE	EDEIA	12/10/2020 18:14	12/10/2020 19:47	12/10/2020 18:14	12/10/2020 19:47	1,54	4	6,15	CHI
20201061750	PONTALINA	EA12223551RE	EDEIA	12/10/2020 18:14	12/10/2020 19:47	12/10/2020 18:14	12/10/2020 19:47	1,54	1	1,54	CHI
20201061750	EDEIA	EA12223551RE	EDEIA	12/10/2020 18:14	12/10/2020 19:47	12/10/2020 18:14	12/10/2020 19:47	1,54	63	96,79	CHI
20201061703	IVOLANDIA	10012378087	IPORA	12/10/2020 18:14	13/10/2020 12:05	12/10/2020 18:14	13/10/2020 12:05	17,83	1	17,83	CHI
20201061961	NOVA VENEZA	NR12000052LD	NEROPOLIS S2	12/10/2020 18:17	12/10/2020 22:31	12/10/2020 18:17	12/10/2020 22:31	4,23	3	12,69	CHI
20201061961	OURO VERDE DE GOIAS	NR12000052LD	NEROPOLIS S2	12/10/2020 18:17	12/10/2020 22:31	12/10/2020 18:17	12/10/2020 22:31	4,23	4	16,92	CHI
20201061732	SANTA RITA DO ARAGUAIA	2130009652	SANTA RITA DO ARAGUAIA	12/10/2020 18:17	12/10/2020 19:57	12/10/2020 18:17	12/10/2020 19:57	1,65	1	1,65	CHI
20201061736	CACHOEIRA DE GOIAS	CG21022491	FIRMINOPOLIS S2	12/10/2020 18:18	13/10/2020 19:40	12/10/2020 18:18	13/10/2020 19:40	25,36	1	25,36	CHI
20201061741	EDEALINA	ED21363824	PONTALINA	12/10/2020 18:19	12/10/2020 20:32	12/10/2020 18:19	12/10/2020 20:32	2,21	2	4,43	CHI
20201061744	SAO LUIS DE MONTES BELOS	SL21046826	SAO LUIZ DOS MONTES BELOS	12/10/2020 18:19	13/10/2020 16:46	12/10/2020 18:19	13/10/2020 16:46	22,45	1	22,45	CHI
20201061748	PEROLANDIA	DP11254587	JATAI S1	12/10/2020 18:19	13/10/2020 14:20	12/10/2020 18:19	13/10/2020 14:20	20,00	1	20,00	CHI
20201061753	FORMOSA	610084926	ITUIQUIRA	12/10/2020 18:20	13/10/2020 06:46	12/10/2020 18:20	13/10/2020 06:46	12,44	1	12,44	CHI
20201060595	GOIANESIA	GE11346444	GOIANESIA S2	12/10/2020 18:20	13/10/2020 16:57	12/10/2020 18:20	13/10/2020 16:57	22,62	8	180,97	CHI
20201061761	RIO VERDE	RV21322316	CABRIUVA S2	12/10/2020 18:21	12/10/2020 19:55	12/10/2020 18:21	12/10/2020 19:55	1,57	1	1,57	CHI
20201061762	PIRANHAS	PH21247801	ARENOPOLIS	12/10/2020 18:21	13/10/2020 11:02	12/10/2020 18:21	13/10/2020 11:02	16,68	1	16,68	CHI
202010176604	INDIARA	IY10395372	CEZARINA	12/10/2020 18:23	13/10/2020 23:27	12/10/2020 18:23	13/10/2020 01:57	7,57	21	158,90	CHI
202010176604	INDIARA	IY10395372	CEZARINA	12/10/2020 18:23	13/10/2020 23:27	12/10/2020 18:23	13/10/2020 15:14	20,86	12	250,33	CHI
202010176604	INDIARA	IY10395372	CEZARINA	12/10/2020 18:23	13/10/2020 23:27	12/10/2020 18:23	13/10/2020 17:08	22,76	3	68,29	CHI
202010176604	INDIARA	IY10395372	CEZARINA	12/10/2020 18:23	13/10/2020 23:27	12/10/2020 18:23	13/10/2020 17:27	23,07	6	138,42	CHI
202010176604	INDIARA	IY10395372	CEZARINA	12/10/2020 18:23	13/10/2020 23:27	12/10/2020 18:23	13/10/2020 23:27	29,07	2	58,15	CHI
20201061786	ANAPOLIS	20281419	ANAPOLIS UNIVERSITARIO S2	12/10/2020 18:23	12/10/2020 22:39	12/10/2020 18:23	12/10/2020 22:39	4,26	1	4,26	CHI
20201061789	GOIANIA	GN11390508	FERROVIARIO S1	12/10/2020 18:23	12/10/2020 19:50	12/10/2020 18:23	12/10/2020 19:50	1,44	7	10,08	CHI
20201061794	SAO DOMINGOS	SD12256414	SAO DOMINGOS	12/10/2020 18:23	12/10/2020 21:01	12/10/2020 18:23	12/10/2020 21:01	2,62	3	7,87	CHI
20201061793	GOIANIA	GN11162055	CAMPINAS S3	12/10/2020 18:23	12/10/2020 20:41	12/10/2020 18:23	12/10/2020 20:41	2,29	85	194,39	CHI
20201061796	CORUMBA DE GOIAS	CB31132575	CORUMBA	12/10/2020 18:23	12/10/2020 21:06	12/10/2020 18:23	12/10/2020 21:06	2,70	1	2,70	CHI
20201061799	ITABERAI	IB12102567	ITABERAI S1	12/10/2020 18:24	12/10/2020 19:37	12/10/2020 18:24	12/10/2020 19:37	1,21	4	4,83	CHI
20201061799	ITAUCU	IB12102567	ITABERAI S1	12/10/2020 18:24	12/10/2020 19:37	12/10/2020 18:24	12/10/2020 19:37	1,21	1	1,21	CHI
202010189297	NIQUELANDIA	NQ12182461	NIQUELANDIA SUBTRANSMISSAO	12/10/2020 18:24	13/10/2020 06:00	12/10/2020 18:24	13/10/2020 06:00	11,58	4	46,34	CHI
20201061922	CAIAPONIA	MV12030666	MONTIVIDIU T	12/10/2020 18:25	13/10/2020 15:28	12/10/2020 18:25	13/10/2020 15:28	21,05	17	357,85	CHI
20201061922	MONTIVIDIU	MV12030666	MONTIVIDIU T	12/10/2020 18:25	13/10/2020 15:28	12/10/2020 18:25	13/10/2020 15:28	21,05	22	463,10	CHI
20201061989	OURO VERDE DE GOIAS	OV12115017	NEROPOLIS S1	12/10/2020 18:26	12/10/2020 20:07	12/10/2020 18:26	12/10/2020 20:07	1,68	9	15,10	CHI
20201061920	RIO VERDE	RV12021374	RIO VERDE S1	12/10/2020 18:28	12/10/2020 23:54	12/10/2020 18:28	12/10/2020 23:54	5,43	18	97,74	CHI
20201061888	JARAGUA	JA11370455	JARAGUA	12/10/2020 18:28	12/10/2020 19:55	12/10/2020 18:28	12/10/2020 19:55	1,45	88	127,26	CHI
20201061855	TRINDADE	15732320	GOYA S2	12/10/2020 18:30	12/10/2020 20:43	12/10/2020 18:30	12/10/2020 20:43	2,22	1	2,22	CHI
20201061857	PLANALTINA	PI21136619	PLANALTINA	12/10/2020 18:30	13/10/2020 02:41	12/10/2020 18:30	13/10/2020 02:41	8,18	32	261,72	CHI
20201061971	INDIARA	IY12010846	EDEIA	12/10/2020 18:33	13/10/2020 12:35	12/10/2020 18:33	13/10/2020 12:35	18,02	16	288,38	CHI
20201061885	APARECIDA DE GOIANIA	200078471	INDEPENDENCIA S1	12/10/2020 18:33	12/10/2020 19:47	12/10/2020 18:33	12/10/2020 19:47	1,22	1	1,22	CHI
20201061890	URUACU	UR21141749	URUACU	12/10/2020 18:34	12/10/2020 21:29	12/10/2020 18:34	12/10/2020 21:29	2,92	1	2,92	CHI
20201061934	RIO VERDE	RV12245473	CABRIUVA S2	12/10/2020 18:36	13/10/2020 00:29	12/10/2020 18:36	13/10/2020 00:29	5,87	10	58,72	CHI

20201062292	URUACU	NQ12095766	NIQUELANDIA SUBTRANSMISSAO	12/10/2020 18:36	13/10/2020 06:30	12/10/2020 18:36	13/10/2020 06:30	11,89	3	35,66	CHI
20201062292	NIQUELANDIA	NQ12095766	NIQUELANDIA SUBTRANSMISSAO	12/10/2020 18:36	13/10/2020 06:30	12/10/2020 18:36	13/10/2020 06:30	11,89	73	867,69	CHI
20201061910	ANAPOLIS	AN31009006	ANAPOLIS UNIVERSITARIO S2	12/10/2020 18:37	12/10/2020 21:27	12/10/2020 18:37	12/10/2020 21:27	2,83	5	14,16	CHI
20201061926	CAIAPONIA	CP21334737	CAIAPONIA	12/10/2020 18:38	13/10/2020 17:20	12/10/2020 18:38	13/10/2020 17:20	22,69	1	22,69	CHI
20201062690	ANAPOLIS	OV12384197	NEROPOLIS S1	12/10/2020 18:38	13/10/2020 10:32	12/10/2020 18:38	13/10/2020 10:32	15,89	5	79,45	CHI
20201062690	OURO VERDE DE GOIAS	OV12384197	NEROPOLIS S1	12/10/2020 18:38	13/10/2020 10:32	12/10/2020 18:38	13/10/2020 10:32	15,89	2	31,78	CHI
20201061932	RIO VERDE	10021998270	RIO VERDE S1	12/10/2020 18:39	12/10/2020 22:55	12/10/2020 18:39	12/10/2020 22:55	4,27	1	4,27	CHI
20201063219	RIO VERDE	RV21214197	CABRIUVA S2	12/10/2020 18:39	13/10/2020 08:08	12/10/2020 18:39	13/10/2020 08:08	13,48	1	13,48	CHI
20201061938	PIRENOPOLIS	PV21056024	CORUMBA	12/10/2020 18:39	13/10/2020 12:56	12/10/2020 18:39	13/10/2020 12:56	18,27	2	36,54	CHI
20201062674	IPORA	IR12390098	IPORA	12/10/2020 18:40	14/10/2020 09:28	12/10/2020 18:40	14/10/2020 09:28	38,79	10	387,94	CHI
20201062321	TRINDADE	TR11000044	GOYA S1	12/10/2020 18:41	12/10/2020 20:13	12/10/2020 18:41	12/10/2020 20:13	1,52	91	138,72	CHI
20201062388	OURO VERDE DE GOIAS	OV11217348	NEROPOLIS S1	12/10/2020 18:41	12/10/2020 21:35	12/10/2020 18:41	12/10/2020 21:35	2,90	65	188,34	CHI
20201062193	PILAR DE GOIAS	GG11053233	URUACU	12/10/2020 18:41	13/10/2020 00:15	12/10/2020 18:41	13/10/2020 00:15	5,55	160	888,09	CHI
20201061957	SANTA BARBARA DE GOIAS	SB12186355	TRINDADE	12/10/2020 18:42	12/10/2020 23:07	12/10/2020 18:42	12/10/2020 23:07	4,42	5	22,08	CHI
20201061963	PETROLINA DE GOIAS	PG21353355	PETROLINA	12/10/2020 18:42	13/10/2020 21:39	12/10/2020 18:42	13/10/2020 21:39	26,94	1	26,94	CHI
20201061969	CORUMBAIBA	CI21234680	VILA CORUMBA	12/10/2020 18:42	12/10/2020 23:56	12/10/2020 18:42	12/10/2020 23:56	5,22	2	10,44	CHI
20201062006	JANDAIA	03300434	PALMEIRAS	12/10/2020 18:43	14/10/2020 15:57	12/10/2020 19:43	12/10/2020 19:47	0,06	25	1,44	CHI
20201062006	PALMEIRAS DE GOIAS	03300434	PALMEIRAS	12/10/2020 18:43	14/10/2020 15:57	12/10/2020 19:43	12/10/2020 19:47	0,06	28	1,61	CHI
20201062006	JANDAIA	00190416	PALMEIRAS	12/10/2020 18:43	14/10/2020 15:57	12/10/2020 18:43	12/10/2020 19:51	1,14	350	398,32	CHI
20201062006	PARAUNA	00190416	PALMEIRAS	12/10/2020 18:43	14/10/2020 15:57	12/10/2020 18:43	12/10/2020 19:57	1,24	53	65,73	CHI
20201062006	JANDAIA	00190416	PALMEIRAS	12/10/2020 18:43	14/10/2020 15:57	12/10/2020 18:43	12/10/2020 19:57	1,24	1286	1595,00	CHI
20201062006	INDIARA	00190416	PALMEIRAS	12/10/2020 18:43	14/10/2020 15:57	12/10/2020 18:43	12/10/2020 19:57	1,24	133	164,96	CHI
20201062006	PALMEIRAS DE GOIAS	00190416	PALMEIRAS	12/10/2020 18:43	14/10/2020 15:57	12/10/2020 18:43	12/10/2020 19:57	1,24	38	47,13	CHI
20201062006	JANDAIA	JD10400715	PALMEIRAS	12/10/2020 18:43	14/10/2020 15:57	12/10/2020 18:43	12/10/2020 20:01	1,30	489	637,33	CHI
20201062006	JANDAIA	JD16404918	PALMEIRAS	12/10/2020 18:43	14/10/2020 15:57	12/10/2020 21:56	12/10/2020 23:13	1,29	51	65,73	CHI
20201062006	JANDAIA	JD13000012	PALMEIRAS	12/10/2020 18:43	14/10/2020 15:57	12/10/2020 21:56	13/10/2020 00:05	2,15	309	665,47	CHI
20201062006	PALRESTINA DE GOIAS	PL16409820	PALMEIRAS	12/10/2020 18:43	14/10/2020 15:57	13/10/2020 00:17	13/10/2020 00:21	0,08	1	0,08	CHI
20201062006	PALMEIRAS DE GOIAS	PL16409820	PALMEIRAS	12/10/2020 18:43	14/10/2020 15:57	13/10/2020 00:17	13/10/2020 00:21	0,08	99	7,59	CHI
20201062006	PALMINOPOLIS	PL16409820	PALMEIRAS	12/10/2020 18:43	14/10/2020 15:57	13/10/2020 00:17	13/10/2020 00:21	0,08	15	1,15	CHI
20201062006	JANDAIA	PL16409820	PALMEIRAS	12/10/2020 18:43	14/10/2020 15:57	13/10/2020 00:17	13/10/2020 00:21	0,08	133	10,20	CHI
20201062006	JANDAIA	00190416	PALMEIRAS	12/10/2020 18:43	14/10/2020 15:57	13/10/2020 00:15	13/10/2020 04:00	3,76	1292	4861,15	CHI
20201062006	PALMEIRAS DE GOIAS	00190416	PALMEIRAS	12/10/2020 18:43	14/10/2020 15:57	13/10/2020 00:15	13/10/2020 04:00	3,76	38	142,98	CHI
20201062006	INDIARA	00190416	PALMEIRAS	12/10/2020 18:43	14/10/2020 15:57	13/10/2020 00:15	13/10/2020 04:00	3,76	133	500,41	CHI
20201062006	PARAUNA	00190416	PALMEIRAS	12/10/2020 18:43	14/10/2020 15:57	13/10/2020 00:15	13/10/2020 04:00	3,76	51	191,89	CHI
20201062006	JANDAIA	00190416	PALMEIRAS	12/10/2020 18:43	14/10/2020 15:57	13/10/2020 00:15	13/10/2020 04:16	4,03	351	1413,75	CHI
20201062006	JANDAIA	01380224	PALMEIRAS	12/10/2020 18:43	14/10/2020 15:57	13/10/2020 00:43	13/10/2020 04:16	3,56	133	473,63	CHI
20201062006	PALESTINA DE GOIAS	01380224	PALMEIRAS	12/10/2020 18:43	14/10/2020 15:57	13/10/2020 00:43	13/10/2020 04:16	3,56	1	3,56	CHI
20201062006	PALMINOPOLIS	01380224	PALMEIRAS	12/10/2020 18:43	14/10/2020 15:57	13/10/2020 00:43	13/10/2020 04:16	3,56	15	53,42	CHI
20201062006	PALMEIRAS DE GOIAS	01380224	PALMEIRAS	12/10/2020 18:43	14/10/2020 15:57	13/10/2020 00:43	13/10/2020 04:16	3,56	99	352,55	CHI
20201062006	JANDAIA	JD10400715	PALMEIRAS	12/10/2020 18:43	14/10/2020 15:57	12/10/2020 20:18	13/10/2020 04:29	8,18	4	32,72	CHI
20201062006	JANDAIA	JD12008671	PALMEIRAS	12/10/2020 18:43	14/10/2020 15:57	12/10/2020 21:56	13/10/2020 04:29	6,56	28	183,59	CHI
20201062006	JANDAIA	JD10400715	PALMEIRAS	12/10/2020 18:43	14/10/2020 15:57	12/10/2020 21:56	13/10/2020 04:29	6,56	14	91,80	CHI
20201062006	JANDAIA	JD10400715	PALMEIRAS	12/10/2020 18:43	14/10/2020 15:57	13/10/2020 00:15	13/10/2020 04:29	4,24	443	1879,55	CHI
20201062006	PALMEIRAS DE GOIAS	JD10409251	PALMEIRAS	12/10/2020 18:43	14/10/2020 15:57	13/10/2020 04:29	13/10/2020 13:53	9,39	2	18,78	CHI
20201062006	JANDAIA	20022931	PALMEIRAS	12/10/2020 18:43	14/10/2020 15:57	13/10/2020 05:18	13/10/2020 14:20	9,05	1	9,05	CHI
20201062006	JANDAIA	JD16404918	PALMEIRAS	12/10/2020 18:43	14/10/2020 15:57	13/10/2020 16:00	13/10/2020 16:03	0,06	389	23,66	CHI
20201062006	JANDAIA	JD10409251	PALMEIRAS	12/10/2020 18:43	14/10/2020 15:57	13/10/2020 04:29	13/10/2020 17:57	13,46	36	484,58	CHI
20201062006	JANDAIA	JD10409251	PALMEIRAS	12/10/2020 18:43	14/10/2020 15:57	13/10/2020 18:00	13/10/2020 21:27	3,44	36	123,90	CHI
20201062006	PALMEIRAS DE GOIAS	JD10409251	PALMEIRAS	12/10/2020 18:43	14/10/2020 15:57	13/10/2020 04:29	13/10/2020 22:45	18,26	2	36,52	CHI
20201062006	JANDAIA	JD10409251	PALMEIRAS	12/10/2020 18:43	14/10/2020 15:57	13/10/2020 22:45	13/10/2020 22:53	0,14	36	5,00	CHI
20201062006	JANDAIA	JD10409251	PALMEIRAS	12/10/2020 18:43	14/10/2020 15:57	13/10/2020 04:29	14/10/2020 07:08	26,65	8	213,23	CHI
20201062006	JANDAIA	JD10409251	PALMEIRAS	12/10/2020 18:43	14/10/2020 15:57	13/10/2020 04:29	14/10/2020 08:49	28,33	46	1303,26	CHI
20201062006	PALMEIRAS DE GOIAS	JD10409251	PALMEIRAS	12/10/2020 18:43	14/10/2020 15:57	13/10/2020 04:29	14/10/2020 08:49	28,33	8	226,65	CHI
20201062006	PALMINOPOLIS	JD10409251	PALMEIRAS	12/10/2020 18:43	14/10/2020 15:57	13/10/2020 04:29	14/10/2020 08:49	28,33	15	424,97	CHI
20201062006	PALMEIRAS DE GOIAS	JD10409251	PALMEIRAS	12/10/2020 18:43	14/10/2020 15:57	13/10/2020 04:29	14/10/2020 13:54	33,42	53	1771,10	CHI
20201062006	JANDAIA	JD10409251	PALMEIRAS	12/10/2020 18:43	14/10/2020 15:57	13/10/2020 04:29	14/10/2020 13:54	33,42	12	401,00	CHI
20201062006	PALMEIRAS DE GOIAS	JD10409251	PALMEIRAS	12/10/2020 18:43	14/10/2020 15:57	13/10/2020 04:29	14/10/2020 15:18	34,81	6	208,86	CHI
20201062006	JANDAIA	JD10409251	PALMEIRAS	12/10/2020 18:43	14/10/2020 15:57	13/10/2020 04:29	14/10/2020 15:18	34,81	23	800,64	CHI

20201062006	JANDAIA	JD12005438	PALMEIRAS	12/10/2020 18:43	14/10/2020 15:57	14/10/2020 09:52	14/10/2020 15:19	5,45	8	43,60	CHI
20201062006	JANDAIA	JD10409251	PALMEIRAS	12/10/2020 18:43	14/10/2020 15:57	13/10/2020 04:29	14/10/2020 15:52	35,38	8	283,01	CHI
20201062006	PALMEIRAS DE GOIAS	JD10409251	PALMEIRAS	12/10/2020 18:43	14/10/2020 15:57	13/10/2020 04:29	14/10/2020 15:52	35,38	28	990,52	CHI
20201062006	PALESTINA DE GOIAS	JD10409251	PALMEIRAS	12/10/2020 18:43	14/10/2020 15:57	13/10/2020 04:29	14/10/2020 15:52	35,38	1	35,38	CHI
20201062006	JANDAIA	JD13361634	PALMEIRAS	12/10/2020 18:43	14/10/2020 15:57	14/10/2020 09:52	14/10/2020 15:57	6,08	46	279,87	CHI
20201062006	PALMEIRAS DE GOIAS	JD13361634	PALMEIRAS	12/10/2020 18:43	14/10/2020 15:57	14/10/2020 09:52	14/10/2020 15:57	6,08	8	48,67	CHI
20201062006	PALMINOPOLIS	JD13361634	PALMEIRAS	12/10/2020 18:43	14/10/2020 15:57	14/10/2020 09:52	14/10/2020 15:57	6,08	15	91,26	CHI
20201061976	RIO VERDE	BZ12211442	SANTA HELENA S1	12/10/2020 18:43	12/10/2020 23:32	12/10/2020 18:43	12/10/2020 23:32	4,81	4	19,23	CHI
20201061976	SANTO ANTONIO DA BARRA	BZ12211442	SANTA HELENA S1	12/10/2020 18:43	12/10/2020 23:32	12/10/2020 18:43	12/10/2020 23:32	4,81	20	96,14	CHI
20201062001	CEZARINA	CZ12011071	CEZARINA	12/10/2020 18:43	13/10/2020 08:40	12/10/2020 18:43	13/10/2020 08:40	13,93	4	55,74	CHI
20201063001	PALMEIRAS DE GOIAS	CZ12011071	CEZARINA	12/10/2020 18:43	13/10/2020 08:40	12/10/2020 18:43	13/10/2020 08:40	13,93	4	55,74	CHI
20201062009	ITAUCU	PV12271945	CORUMBA	12/10/2020 18:44	14/10/2020 09:30	12/10/2020 18:44	14/10/2020 09:30	38,77	1	38,77	CHI
20201062009	PIRENOPOLIS	PV12271945	CORUMBA	12/10/2020 18:44	14/10/2020 09:30	12/10/2020 18:44	14/10/2020 09:30	38,77	12	465,19	CHI
20201061980	SANTA RITA DO ARAGUAIA	SU21027484	SANTA RITA DO ARAGUAIA	12/10/2020 18:44	13/10/2020 13:50	12/10/2020 18:44	13/10/2020 13:50	19,10	1	19,10	CHI
20201061984	INHUMAS	10017289260	INHUMAS S2	12/10/2020 18:44	12/10/2020 19:54	12/10/2020 18:44	12/10/2020 19:54	1,16	1	1,16	CHI
20201062013	JATAI	JT12260493	JATAI S1	12/10/2020 18:45	13/10/2020 15:11	12/10/2020 18:45	13/10/2020 15:11	20,42	18	367,60	CHI
20201062284	CEZARINA	CZ12314845	CEZARINA	12/10/2020 18:45	13/10/2020 10:18	12/10/2020 18:45	13/10/2020 10:18	15,54	8	124,31	CHI
20201062286	GUARINOS	01490224	URUACU	12/10/2020 18:45	13/10/2020 18:29	12/10/2020 18:45	13/10/2020 00:15	5,49	11	60,35	CHI
20201062286	PILAR DE GOIAS	01490224	URUACU	12/10/2020 18:45	13/10/2020 18:29	12/10/2020 18:45	13/10/2020 00:15	5,49	393	2156,15	CHI
20201062286	SANTA TEREZINHA DE GOIAS	01490224	URUACU	12/10/2020 18:45	13/10/2020 18:29	12/10/2020 18:45	13/10/2020 00:15	5,49	5	27,43	CHI
20201062286	ITAPACI	01490224	URUACU	12/10/2020 18:45	13/10/2020 18:29	12/10/2020 18:45	13/10/2020 00:15	5,49	2	10,97	CHI
20201062286	PILAR DE GOIAS	GG21340130	URUACU	12/10/2020 18:45	13/10/2020 18:29	12/10/2020 18:45	13/10/2020 18:29	23,72	1	23,72	CHI
20201062000	BRAZABRANTES	380010276	NEROPOLIS S1	12/10/2020 18:46	13/10/2020 01:47	12/10/2020 18:46	13/10/2020 01:47	7,01	1	7,01	CHI
20201062271	NIQUELANDIA	4760001518	NIQUELANDIA SUBTRANSMISSAO	12/10/2020 18:47	13/10/2020 05:05	12/10/2020 18:47	13/10/2020 05:05	10,30	1	10,30	CHI
20201062014	NOVO PLANALTO	2500015859	NOVO PLANALTO	12/10/2020 18:47	12/10/2020 21:07	12/10/2020 18:47	12/10/2020 21:07	2,32	1	2,32	CHI
20201062015	RIO VERDE	RV21271656	RIO VERDE S2	12/10/2020 18:47	12/10/2020 20:59	12/10/2020 18:47	12/10/2020 20:59	2,19	1	2,19	CHI
20201062329	JANDAIA	IY12081489	EDEIA	12/10/2020 18:48	13/10/2020 09:05	12/10/2020 18:48	13/10/2020 09:05	14,28	1	14,28	CHI
20201062329	INDIARA	IY12081489	EDEIA	12/10/2020 18:48	13/10/2020 09:05	12/10/2020 18:48	13/10/2020 09:05	14,28	52	742,68	CHI
20201062329	PALMEIRAS DE GOIAS	IY12081489	EDEIA	12/10/2020 18:48	13/10/2020 09:05	12/10/2020 18:48	13/10/2020 09:05	14,28	1	14,28	CHI
20201062335	JARAGUA	JA11211755	JARAGUA	12/10/2020 18:48	13/10/2020 08:04	12/10/2020 18:48	13/10/2020 08:04	13,26	70	927,99	CHI
20201062037	RIO VERDE	RV21207011	MONTIVIDIU T	12/10/2020 18:49	13/10/2020 13:37	12/10/2020 18:49	13/10/2020 13:37	18,79	1	18,79	CHI
20201063419	MONTES CLAROS DE GOIAS	DI12063493RE	IPORA	12/10/2020 18:49	13/10/2020 20:13	12/10/2020 18:49	13/10/2020 20:13	25,39	7	177,74	CHI
20201063419	IPORA	DI12063493RE	IPORA	12/10/2020 18:49	13/10/2020 20:13	12/10/2020 18:49	13/10/2020 20:13	25,39	3	76,17	CHI
20201063419	DIORAMA	DI12063493RE	IPORA	12/10/2020 18:49	13/10/2020 20:13	12/10/2020 18:49	13/10/2020 20:13	25,39	38	964,86	CHI
20201062044	RIO VERDE	RV21213293	CABRIUVA S2	12/10/2020 18:49	12/10/2020 21:37	12/10/2020 18:49	12/10/2020 21:37	2,79	1	2,79	CHI
20201062279	NIQUELANDIA	NQ11265650	NIQUELANDIA SUBTRANSMISSAO	12/10/2020 18:49	13/10/2020 11:01	12/10/2020 18:49	13/10/2020 11:01	16,20	72	1166,32	CHI
20201062296	DAMOLANDIA	DL11108979	INHUMAS S1	12/10/2020 18:50	12/10/2020 21:21	12/10/2020 18:50	12/10/2020 21:21	2,51	120	301,23	CHI
20201062052	APARECIDA DE GOIANIA	200325498	INDEPENDENCIA S2	12/10/2020 18:51	12/10/2020 22:53	12/10/2020 18:51	12/10/2020 22:53	4,03	1	4,03	CHI
20201062055	ITABERAI	2120000111	ITABERAI S2	12/10/2020 18:51	13/10/2020 08:28	12/10/2020 18:51	13/10/2020 08:28	13,62	1	13,62	CHI
20201062058	FORMOSA	10007174878	ITUIQUIRA	12/10/2020 18:51	12/10/2020 22:39	12/10/2020 18:51	12/10/2020 22:39	3,80	1	3,80	CHI
20201062060	GOIANIA	11702187	ATLANTICO S1	12/10/2020 18:51	12/10/2020 20:42	12/10/2020 18:51	12/10/2020 20:42	1,84	1	1,84	CHI
20201062064	CAMPOS BELOS	CH11261952	SAO DOMINGOS	12/10/2020 18:52	12/10/2020 21:02	12/10/2020 18:52	12/10/2020 21:02	2,17	140	303,22	CHI
20201062544	JARAGUA	JA11022751	JARAGUA	12/10/2020 18:53	13/10/2020 04:03	12/10/2020 18:53	13/10/2020 04:03	9,18	158	1450,04	CHI
20201062081	BRITANIA	BT12041859	BRITANIA	12/10/2020 18:53	13/10/2020 07:11	12/10/2020 18:53	13/10/2020 07:11	12,29	1	12,29	CHI
20201062091	INDIARA	2710022900	EDEIA	12/10/2020 18:55	12/10/2020 22:11	12/10/2020 18:55	12/10/2020 22:11	3,27	1	3,27	CHI
20201062095	APORE	SX12264283	ITAJA S1	12/10/2020 18:55	13/10/2020 09:18	12/10/2020 18:55	13/10/2020 09:18	14,38	1	14,38	CHI
20201062095	SERRANOPOLIS	SX12264283	ITAJA S1	12/10/2020 18:55	13/10/2020 09:18	12/10/2020 18:55	13/10/2020 09:18	14,38	36	517,52	CHI
20201062115	SANTA RITA DO ARAGUAIA	MY12159188	PARQUE DAS EMAS	12/10/2020 18:56	13/10/2020 14:24	12/10/2020 18:56	13/10/2020 14:24	19,46	2	38,92	CHI
20201062115	MINEIROS	MY12159188	PARQUE DAS EMAS	12/10/2020 18:56	13/10/2020 14:24	12/10/2020 18:56	13/10/2020 14:24	19,46	7	136,24	CHI
20201062316	GOIAS	IB12022205	ITABERAI S2	12/10/2020 18:58	13/10/2020 12:17	12/10/2020 18:58	13/10/2020 12:17	17,31	40	692,52	CHI
20201062316	ITABERAI	IB12022205	ITABERAI S2	12/10/2020 18:58	13/10/2020 12:17	12/10/2020 18:58	13/10/2020 12:17	17,31	15	259,70	CHI
20201062128	PIRENOPOLIS	PV12016354	CORUMBA	12/10/2020 18:58	13/10/2020 08:56	12/10/2020 18:58	13/10/2020 08:56	13,96	35	488,55	CHI
20201062130	RIO VERDE	10001102468	RIO VERDE S1	12/10/2020 18:58	13/10/2020 00:29	12/10/2020 18:58	13/10/2020 00:29	5,51	1	5,51	CHI
20201062131	PIRANHAS	PH12335265	PIRANHAS	12/10/2020 18:58	13/10/2020 07:12	12/10/2020 18:58	13/10/2020 07:12	12,22	7	85,54	CHI
20201062135	GOIANIA	11123930	FERROVIARIO S1	12/10/2020 18:59	12/10/2020 20:31	12/10/2020 18:59	12/10/2020 20:31	1,53	1	1,53	CHI
20201062142	ANAPOLIS	21137043	JUNDAI S1	12/10/2020 18:59	13/10/2020 00:58	12/10/2020 18:59	13/10/2020 00:58	5,97	1	5,97	CHI
20201062150	ITUMBIARA	10002459130	ITUMBIARA NOVA	12/10/2020 19:00	12/10/2020 22:25	12/10/2020 19:00	12/10/2020 22:25	3,41	1	3,41	CHI
20201062152	GOIANIA	GN11167644	XAVANTES	12/10/2020 19:00	12/10/2020 22:10	12/10/2020 19:00	12/10/2020 22:10	3,16	125	394,69	CHI

2020101200080	GOIAS	00710214	GOIAS	12/10/2020 19:01	12/10/2020 19:04	12/10/2020 19:01	12/10/2020 19:04	0,05	1	0,05	CHI
20201062156	POSSE	10000889960	IACIARA S2	12/10/2020 19:01	12/10/2020 23:45	12/10/2020 19:01	12/10/2020 23:45	4,73	1	4,73	CHI
20201062159	ANAPOLIS	20845480	ANAPOLIS UNIVERSITARIO S2	12/10/2020 19:01	13/10/2020 07:27	12/10/2020 19:01	13/10/2020 07:27	12,43	1	12,43	CHI
20201062161	NEROPOLIS	160046750	NEROPOLIS S2	12/10/2020 19:01	12/10/2020 21:52	12/10/2020 19:01	12/10/2020 21:52	2,84	1	2,84	CHI
20201062164	SANTA HELENA DE GOIAS	400034270	IPEGUARI	12/10/2020 19:01	13/10/2020 10:10	12/10/2020 19:01	13/10/2020 10:10	15,14	1	15,14	CHI
20201062180	GOIATUBA	VI12381143	VICENTINOPOLIS	12/10/2020 19:03	13/10/2020 00:14	12/10/2020 19:03	13/10/2020 00:14	5,18	3	15,53	CHI
20201062197	RIO VERDE	MV12230886	MONTIVIDIU T	12/10/2020 19:05	12/10/2020 23:12	12/10/2020 19:05	12/10/2020 23:12	4,10	38	155,94	CHI
20201062197	MONTIVIDIU	MV12230886	MONTIVIDIU T	12/10/2020 19:05	12/10/2020 23:12	12/10/2020 19:05	12/10/2020 23:12	4,10	7	28,73	CHI
20201062198	LUZIANIA	LZ11313604	CRISTALINA S2	12/10/2020 19:06	12/10/2020 21:10	12/10/2020 19:06	12/10/2020 21:10	2,07	3	6,20	CHI
20201062212	GOIANIA	10013767699	CAMPINAS S1	12/10/2020 19:08	12/10/2020 21:21	12/10/2020 19:08	12/10/2020 21:21	2,21	1	2,21	CHI
20201062233	HEITORAI	HE12023239	ITAPURANGA	12/10/2020 19:10	12/10/2020 23:36	12/10/2020 19:10	12/10/2020 23:36	4,43	3	13,30	CHI
20201062238	GOIANIA	GN11180088	CARAJAS S2	12/10/2020 19:10	12/10/2020 22:25	12/10/2020 19:10	12/10/2020 22:25	3,24	85	275,52	CHI
20201062380	FORMOSA	FA11140423	ITUIQUIRA	12/10/2020 19:10	12/10/2020 21:27	12/10/2020 19:10	12/10/2020 21:27	2,27	182	412,74	CHI
20201062245	GOIANIA	10485144	GOIANIA LESTE S1	12/10/2020 19:11	12/10/2020 21:32	12/10/2020 19:11	12/10/2020 21:32	2,34	1	2,34	CHI
20201062246	CRISTALINA	KR12219211	CRISTALINA S1	12/10/2020 19:11	12/10/2020 22:05	12/10/2020 19:11	12/10/2020 22:05	2,89	2	5,78	CHI
20201062249	CAIAPONIA	CP21243854	CAIAPONIA	12/10/2020 19:11	13/10/2020 10:39	12/10/2020 19:11	13/10/2020 10:39	15,46	1	15,46	CHI
20201062252	CATALAO	CT12266236RE	CATALAO S1	12/10/2020 19:11	12/10/2020 20:38	12/10/2020 19:11	12/10/2020 20:38	1,44	33	47,55	CHI
20201062324	PORANGATU	PO12139169	PORANGATU	12/10/2020 19:14	12/10/2020 21:40	12/10/2020 19:14	12/10/2020 21:40	2,43	59	143,17	CHI
20201062290	HEITORAI	360004064	ITAPURANGA	12/10/2020 19:15	12/10/2020 20:34	12/10/2020 19:15	12/10/2020 20:34	1,31	1	1,31	CHI
20201062723	JATAI	JT12196087	JATAI S1	12/10/2020 19:15	13/10/2020 10:50	12/10/2020 19:15	13/10/2020 10:50	15,58	4	62,30	CHI
20201062297	SAO JOAO D ALIANCA	3840010133	SAO JOAO D ALIANCA	12/10/2020 19:15	13/10/2020 07:03	12/10/2020 19:15	13/10/2020 07:03	11,78	1	11,78	CHI
20201062299	MONTES CLAROS DE GOIAS	ME12088922	IPORA	12/10/2020 19:16	14/10/2020 10:48	12/10/2020 19:16	14/10/2020 10:48	39,53	17	671,98	CHI
20201062323	GOIANIA	10812740	GOIANIA LESTE S1	12/10/2020 19:19	12/10/2020 21:17	12/10/2020 19:19	12/10/2020 21:17	1,96	1	1,96	CHI
20201062446	IPORA	IR21139414	IPORA	12/10/2020 19:19	13/10/2020 15:58	12/10/2020 19:19	13/10/2020 13:01	17,70	1	17,70	CHI
20201062446	IPORA	IR12381025	IPORA	12/10/2020 19:19	13/10/2020 15:58	12/10/2020 19:19	13/10/2020 14:56	19,61	11	215,68	CHI
20201062446	IPORA	IR21139414	IPORA	12/10/2020 19:19	13/10/2020 15:58	13/10/2020 14:04	13/10/2020 15:58	1,91	1	1,91	CHI
20201062340	ANAPOLIS	10024376742	ANAPOLIS UNIVERSITARIO S2	12/10/2020 19:20	13/10/2020 10:09	12/10/2020 19:20	13/10/2020 10:09	14,81	1	14,81	CHI
20201062347	GOIANIA	14198393	GOIANIA LESTE S3	12/10/2020 19:22	12/10/2020 22:46	12/10/2020 19:22	12/10/2020 22:46	3,40	1	3,40	CHI
20201062354	TAQUARAL DE GOIAS	II21217071	ITABERAÍ S1	12/10/2020 19:22	13/10/2020 16:01	12/10/2020 19:22	13/10/2020 15:20	19,96	1	19,96	CHI
20201062354	TAQUARAL DE GOIAS	II21217067	ITABERAÍ S1	12/10/2020 19:22	13/10/2020 16:01	13/10/2020 13:37	13/10/2020 16:01	2,39	3	7,16	CHI
20201062400	GOIANIRA	GR12346120	MEIA PONTE	12/10/2020 19:24	12/10/2020 21:06	12/10/2020 19:24	12/10/2020 21:06	1,69	288	486,80	CHI
20201062372	INDIARA	EA12070748	EDEIA	12/10/2020 19:25	12/10/2020 21:16	12/10/2020 19:25	12/10/2020 21:16	1,84	1	1,84	CHI
20201062372	EDEIA	EA12070748	EDEIA	12/10/2020 19:25	12/10/2020 21:16	12/10/2020 19:25	12/10/2020 21:16	1,84	3	5,53	CHI
20201062373	SERRANOPOLIS	SX21234358	JATAI S1	12/10/2020 19:25	13/10/2020 00:28	12/10/2020 19:25	13/10/2020 00:28	5,04	1	5,04	CHI
20201062391	MINEIROS	MY12303919RE	PARQUE DAS EMAS	12/10/2020 19:26	12/10/2020 23:41	12/10/2020 19:26	12/10/2020 23:41	4,25	20	84,98	CHI
20201062381	PETROLINA DE GOIAS	SR21019000	INHUMAS S1	12/10/2020 19:26	13/10/2020 22:47	12/10/2020 19:26	13/10/2020 22:47	27,34	1	27,34	CHI
20201062382	AGUAS LINDAS DE GOIAS	4830334620	AGUAS LINDAS DE GOIAS S1	12/10/2020 19:26	12/10/2020 20:40	12/10/2020 19:26	12/10/2020 20:40	1,22	1	1,22	CHI
20201062398	ANAPOLIS	AN21319663	JUNDIAI S1	12/10/2020 19:28	13/10/2020 02:12	12/10/2020 19:28	13/10/2020 02:12	6,72	1	6,72	CHI
20201062401	JARAGUA	70066243	JARAGUA	12/10/2020 19:29	13/10/2020 21:05	12/10/2020 19:29	13/10/2020 21:05	25,59	1	25,59	CHI
20201062411	VALPARAISO DE GOIAS	10008101505	PACAEMBU S1	12/10/2020 19:30	12/10/2020 21:49	12/10/2020 19:30	12/10/2020 21:49	2,31	1	2,31	CHI
20201062412	CAMPOS VERDES	3790005974	SANTA TEREZINHA	12/10/2020 19:30	14/10/2020 00:36	12/10/2020 19:30	14/10/2020 00:36	29,09	1	29,09	CHI
20201062443	FORMOSA	FA11131871	ITUIQUIRA	12/10/2020 19:31	12/10/2020 20:55	12/10/2020 19:31	12/10/2020 20:55	1,40	192	269,07	CHI
20201062424	MINEIROS	MY11377571	PARQUE DAS EMAS	12/10/2020 19:31	12/10/2020 21:17	12/10/2020 19:31	12/10/2020 21:17	1,76	50	87,88	CHI
20201062426	RIO VERDE	RV12345375LD	RIO VERDE S2	12/10/2020 19:32	13/10/2020 10:47	12/10/2020 19:32	13/10/2020 10:47	15,25	2	30,50	CHI
20201062432	ARAGOIANIA	10019013424	GUAPO S2	12/10/2020 19:32	12/10/2020 21:41	12/10/2020 19:32	12/10/2020 21:41	2,14	1	2,14	CHI
20201062437	MONTES CLAROS DE GOIAS	ME12228195	IPORA	12/10/2020 19:33	13/10/2020 09:00	12/10/2020 19:33	13/10/2020 09:00	13,46	7	94,21	CHI
20201062461	GOIANIA	14073419	FERROVIARIO S2	12/10/2020 19:37	12/10/2020 20:37	12/10/2020 19:37	12/10/2020 20:37	1,00	1	1,00	CHI
20201062498	BOM JARDIM DE GOIAS	BM12064260	BOM JARDIM	12/10/2020 19:37	13/10/2020 02:44	12/10/2020 19:37	13/10/2020 02:44	7,11	17	120,94	CHI
20201062466	BARRO ALTO	DF12194371	BARRO ALTO	12/10/2020 19:37	14/10/2020 03:43	12/10/2020 19:37	14/10/2020 03:43	32,09	67	2150,09	CHI
20201062466	SANTA RITA DO NOVO DESTINO	DF12194371	BARRO ALTO	12/10/2020 19:37	14/10/2020 03:43	12/10/2020 19:37	14/10/2020 03:43	32,09	32	1026,91	CHI
20201062545	PETROLINA DE GOIAS	PG11350773	PETROLINA	12/10/2020 19:37	13/10/2020 06:50	12/10/2020 19:37	13/10/2020 06:50	11,20	35	392,01	CHI
20201062471	SAO LUIZ DO NORTE	3090005989	ITAPACI	12/10/2020 19:38	13/10/2020 01:03	12/10/2020 19:38	13/10/2020 01:03	5,41	1	5,41	CHI
20201062712	IPORA	IR11014377	IPORA	12/10/2020 19:39	12/10/2020 21:52	12/10/2020 19:39	12/10/2020 21:52	2,21	91	201,34	CHI
20201062618	PIRES DO RIO	PR11186597	PIRES DO RIO S1	12/10/2020 19:39	13/10/2020 02:08	12/10/2020 19:39	13/10/2020 02:08	6,47	82	530,68	CHI
20201062483	PARAUNA	PU21152649	PARAUNA	12/10/2020 19:40	13/10/2020 20:07	12/10/2020 19:40	13/10/2020 20:07	24,46	1	24,46	CHI
20201062718	INDIARA	IY12010845	EDEIA	12/10/2020 19:41	13/10/2020 12:44	12/10/2020 19:41	13/10/2020 12:44	17,04	10	170,41	CHI
20201062500	FIRMINOPOLIS	FR21277610	SAO LUIZ DOS MONTES BELOS	12/10/2020 19:42	13/10/2020 10:57	12/10/2020 19:42	13/10/2020 10:57	15,24	1	15,24	CHI
20201062552	NIQUELANDIA	NQ12280419	NIQUELANDIA SUBTRANSMISSAO	12/10/2020 19:43	13/10/2020 12:32	12/10/2020 19:43	13/10/2020 12:32	16,81	63	1058,87	CHI

20201062532	NIQUELANDIA	NQ12378011	NIQUELANDIA SUBTRANSMISSAO	12/10/2020 19:44	13/10/2020 09:23	12/10/2020 19:44	13/10/2020 09:23	13,64	2	27,29	CHI
20201062533	GOIAS	GS10396204	GOIAS	12/10/2020 19:45	13/10/2020 20:56	12/10/2020 19:45	12/10/2020 23:57	4,20	158	663,64	CHI
20201062533	GOIAS	GS10396204	GOIAS	12/10/2020 19:45	13/10/2020 20:56	12/10/2020 19:45	13/10/2020 02:03	6,30	18	113,39	CHI
20201062533	GOIAS	GS10396204	GOIAS	12/10/2020 19:45	13/10/2020 20:56	12/10/2020 19:45	13/10/2020 04:36	8,85	25	221,24	CHI
20201062533	GOIAS	GS10396204	GOIAS	12/10/2020 19:45	13/10/2020 20:56	12/10/2020 19:45	13/10/2020 09:15	13,51	105	1418,75	CHI
20201062533	GOIAS	GS10396204	GOIAS	12/10/2020 19:45	13/10/2020 20:56	13/10/2020 09:15	13/10/2020 09:31	0,27	201	53,38	CHI
20201062533	GOIAS	GS10396204	GOIAS	12/10/2020 19:45	13/10/2020 20:56	12/10/2020 19:45	13/10/2020 12:49	17,08	10	170,79	CHI
20201062533	GOIAS	GS10396204	GOIAS	12/10/2020 19:45	13/10/2020 20:56	13/10/2020 13:27	13/10/2020 13:35	0,13	161	20,75	CHI
20201062533	GOIAS	GS10396204	GOIAS	12/10/2020 19:45	13/10/2020 20:56	13/10/2020 13:36	13/10/2020 14:45	1,15	116	133,30	CHI
20201062533	GOIAS	GS13336343	GOIAS	12/10/2020 19:45	13/10/2020 20:56	13/10/2020 13:36	13/10/2020 17:31	3,92	45	176,46	CHI
20201062533	GOIAS	GS13336343	GOIAS	12/10/2020 19:45	13/10/2020 20:56	13/10/2020 15:39	13/10/2020 17:31	1,86	9	16,76	CHI
20201062533	GOIAS	GS13124733	GOIAS	12/10/2020 19:45	13/10/2020 20:56	13/10/2020 15:39	13/10/2020 19:30	3,84	31	118,89	CHI
20201062533	GOIAS	GS13274377	GOIAS	12/10/2020 19:45	13/10/2020 20:56	13/10/2020 09:28	13/10/2020 20:56	11,46	105	1203,18	CHI
20201062528	VALPARAISO DE GOIAS	2860180923	PACAEMBU S2	12/10/2020 19:47	12/10/2020 20:42	12/10/2020 19:47	12/10/2020 20:42	0,91	1	0,91	CHI
20201062529	CATALAO	CT12203060	CATALAO S1	12/10/2020 19:47	12/10/2020 22:27	12/10/2020 19:47	12/10/2020 22:27	2,66	2	5,32	CHI
20201062534	NIQUELANDIA	NQ21378009	NIQUELANDIA SUBTRANSMISSAO	12/10/2020 19:48	14/10/2020 11:59	12/10/2020 19:48	14/10/2020 11:59	40,18	1	40,18	CHI
20201067685	FIRMINOPOLIS	TV12111577	FIRMINOPOLIS S1	12/10/2020 19:48	13/10/2020 15:07	12/10/2020 19:48	13/10/2020 15:07	19,31	2	38,62	CHI
20201067685	TURVANIA	TV12111577	FIRMINOPOLIS S1	12/10/2020 19:48	13/10/2020 15:07	12/10/2020 19:48	13/10/2020 15:07	19,31	8	154,50	CHI
20201062549	MARA ROSA	MQ12051070	MARA ROSA	12/10/2020 19:49	13/10/2020 01:55	12/10/2020 19:49	13/10/2020 01:55	6,10	197	1201,37	CHI
20201062553	SILVANIA	SV21011760	VIANOPOLIS	12/10/2020 19:50	12/10/2020 22:29	12/10/2020 19:50	12/10/2020 22:29	2,65	1	2,65	CHI
20201062557	URUACU	640093218	URUACU	12/10/2020 19:50	13/10/2020 11:08	12/10/2020 19:50	13/10/2020 11:08	15,29	1	15,29	CHI
20201062566	SILVANIA	SV21105270	VIANOPOLIS	12/10/2020 19:51	12/10/2020 22:10	12/10/2020 19:51	12/10/2020 22:10	2,31	2	4,62	CHI
20201062573	MONTIVIDIU	MV21091854	MONTIVIDIU T	12/10/2020 19:53	13/10/2020 12:25	12/10/2020 19:53	13/10/2020 12:25	16,53	1	16,53	CHI
20201062574	NOVO BRASIL	IU12037339	JUSSARA	12/10/2020 19:53	13/10/2020 11:57	12/10/2020 19:53	13/10/2020 11:57	16,06	1	16,06	CHI
20201062574	ITAPIRAPUA	IU12037339	JUSSARA	12/10/2020 19:53	13/10/2020 11:57	12/10/2020 19:53	13/10/2020 11:57	16,06	7	112,41	CHI
20201062578	MINEIROS	MY12301837	PARQUE DAS EMAS	12/10/2020 19:54	13/10/2020 00:46	12/10/2020 19:54	13/10/2020 00:46	4,86	2	9,73	CHI
20201062578	PEROLANDIA	MY12301837	PARQUE DAS EMAS	12/10/2020 19:54	13/10/2020 00:46	13/10/2020 19:54	13/10/2020 00:46	4,86	3	14,59	CHI
20201062580	BOM JARDIM DE GOIAS	BM12333261	BOM JARDIM	12/10/2020 19:54	13/10/2020 10:52	12/10/2020 19:54	13/10/2020 10:52	14,96	1	14,96	CHI
20201062622	FORMOSA	FA11102399	ITUIQUIRA	12/10/2020 19:54	12/10/2020 21:42	12/10/2020 19:54	12/10/2020 21:42	1,79	191	342,74	CHI
20201062585	CAMPESTRE DE GOIAS	1230007468	TRINIDADE	12/10/2020 19:55	12/10/2020 21:57	12/10/2020 19:55	12/10/2020 21:57	2,02	1	2,02	CHI
20201063016	BOM JARDIM DE GOIAS	BM12064233	BOM JARDIM	12/10/2020 19:56	13/10/2020 06:56	12/10/2020 19:56	13/10/2020 06:56	10,99	6	65,96	CHI
20201062819	CAMPINORTE	CR12202139RE	MARA ROSA	12/10/2020 19:57	13/10/2020 09:02	12/10/2020 19:57	13/10/2020 09:02	13,08	32	418,40	CHI
20201062819	URUACU	CR12202139RE	MARA ROSA	12/10/2020 19:57	13/10/2020 09:02	12/10/2020 19:57	13/10/2020 09:02	13,08	106	1385,95	CHI
20201062732	PARAUNA	PU12081329	PARAUNA	12/10/2020 20:00	14/10/2020 05:45	12/10/2020 20:00	13/10/2020 09:52	13,87	6	83,23	CHI
20201062732	PARAUNA	PU12081329	PARAUNA	12/10/2020 20:00	14/10/2020 05:45	12/10/2020 20:00	13/10/2020 10:48	14,81	19	281,40	CHI
20201062732	PARAUNA	PU12081329	PARAUNA	12/10/2020 20:00	14/10/2020 05:45	13/10/2020 09:52	13/10/2020 10:48	0,93	2	1,86	CHI
20201062732	PARAUNA	PU12081329	PARAUNA	12/10/2020 20:00	14/10/2020 05:45	12/10/2020 20:00	13/10/2020 14:00	18,00	11	197,95	CHI
20201062732	PARAUNA	PU12194219LD	PARAUNA	12/10/2020 20:00	14/10/2020 05:45	13/10/2020 09:52	13/10/2020 14:00	4,12	5	20,58	CHI
20201062732	PARAUNA	PU12081329	PARAUNA	12/10/2020 20:00	14/10/2020 05:45	12/10/2020 20:00	14/10/2020 01:03	29,05	2	58,09	CHI
20201062732	PARAUNA	PU12081329	PARAUNA	12/10/2020 20:00	14/10/2020 05:45	12/10/2020 20:00	14/10/2020 04:03	32,05	9	288,42	CHI
20201062732	PARAUNA	PU12299061LD	PARAUNA	12/10/2020 20:00	14/10/2020 05:45	13/10/2020 09:52	14/10/2020 04:03	18,17	1	18,17	CHI
20201062732	PARAUNA	PU12081329	PARAUNA	12/10/2020 20:00	14/10/2020 05:45	12/10/2020 20:00	14/10/2020 04:51	32,85	4	131,38	CHI
20201062732	PARAUNA	PU12081329	PARAUNA	12/10/2020 20:00	14/10/2020 05:45	12/10/2020 20:00	14/10/2020 05:07	33,11	3	99,34	CHI
20201062732	PARAUNA	PU12081329	PARAUNA	12/10/2020 20:00	14/10/2020 05:45	12/10/2020 20:00	14/10/2020 05:45	33,75	1	33,75	CHI
20201062755	JANDAIA	PP12312499RE	PALMEIRAS	12/10/2020 20:01	13/10/2020 15:25	12/10/2020 20:01	13/10/2020 10:26	14,41	29	417,89	CHI
20201062755	PALMINOPOLIS	PP12312499RE	PALMEIRAS	12/10/2020 20:01	13/10/2020 15:25	12/10/2020 20:01	13/10/2020 10:26	14,41	27	389,07	CHI
20201062755	PALMINOPOLIS	PP12307026LD	PALMEIRAS	12/10/2020 20:01	13/10/2020 15:25	12/10/2020 20:01	13/10/2020 15:25	19,39	42	814,58	CHI
20201062628	CAMPINORTE	MQ10400667	MARA ROSA	12/10/2020 20:02	13/10/2020 16:43	12/10/2020 20:02	13/10/2020 15:59	19,96	124	2474,52	CHI
20201062628	MARA ROSA	MQ10400667	MARA ROSA	12/10/2020 20:02	13/10/2020 16:43	12/10/2020 20:02	13/10/2020 15:59	19,96	3	59,87	CHI
20201062628	CAMPINORTE	MQ10400667	MARA ROSA	12/10/2020 20:02	13/10/2020 16:43	12/10/2020 20:02	13/10/2020 15:59	19,96	17	339,25	CHI
20201062628	NOVA IGUACU DE GOIAS	CR12051895RE	MARA ROSA	12/10/2020 20:02	13/10/2020 16:43	12/10/2020 20:02	13/10/2020 16:43	20,68	17	351,50	CHI
20201062628	CAMPINORTE	CR12051895RE	MARA ROSA	12/10/2020 20:02	13/10/2020 16:43	12/10/2020 20:02	13/10/2020 16:43	20,68	17	351,50	CHI
20201062620	PETROLINA DE GOIAS	PG11043940	PETROLINA	12/10/2020 20:04	13/10/2020 18:16	12/10/2020 20:04	13/10/2020 18:16	22,20	49	1087,70	CHI
20201062623	TEREZOPOLIS DE GOIAS	1370007143	DAIA S2	12/10/2020 20:04	12/10/2020 23:14	12/10/2020 20:04	12/10/2020 23:14	3,15	1	3,15	CHI
20201062639	SAO LUIZ DO NORTE	SZ10410838	ITAPACI	12/10/2020 20:06	13/10/2020 13:09	12/10/2020 20:06	13/10/2020 09:04	12,98	123	1596,27	CHI
20201062639	GOIANESIA	SZ13201740	ITAPACI	12/10/2020 20:06	13/10/2020 13:09	12/10/2020 20:06	13/10/2020 10:32	14,43	3	43,30	CHI
20201062639	SAO LUIZ DO NORTE	SZ13201740	ITAPACI	12/10/2020 20:06	13/10/2020 13:09	12/10/2020 20:06	13/10/2020 10:32	14,43	31	447,39	CHI
20201062639	SANTA ISABEL	SZ13201740	ITAPACI	12/10/2020 20:06	13/10/2020 13:09	12/10/2020 20:06	13/10/2020 10:32	14,43	1	14,43	CHI

20201062639	SANTA ISABEL	GE12101186LD	ITAPACI	12/10/2020 20:06	13/10/2020 13:09	12/10/2020 20:06	13/10/2020 12:27	16,35	4	65,39	CHI
20201062639	GOIANESIA	GE12101186LD	ITAPACI	12/10/2020 20:06	13/10/2020 13:09	12/10/2020 20:06	13/10/2020 12:27	16,35	8	130,78	CHI
20201062639	GOIANESIA	GE13384329	ITAPACI	12/10/2020 20:06	13/10/2020 13:09	12/10/2020 20:06	13/10/2020 13:09	17,06	1	17,06	CHI
20201062664	ARAGARCAS	AG11095440	ARAGARCAS	12/10/2020 20:06	13/10/2020 02:21	12/10/2020 20:06	13/10/2020 02:21	6,24	181	1128,89	CHI
20201064576	OURO VERDE DE GOIAS	OV12312024	NEROPOLIS S1	12/10/2020 20:08	13/10/2020 08:50	12/10/2020 20:08	13/10/2020 08:50	12,70	10	126,98	CHI
20201062646	ARAGARCAS	1820035144	ARAGARCAS	12/10/2020 20:09	13/10/2020 09:47	12/10/2020 20:09	13/10/2020 09:47	13,62	1	13,62	CHI
20201062647	INHUMAS	IN21129639	INHUMAS S1	12/10/2020 20:09	13/10/2020 12:30	12/10/2020 20:09	13/10/2020 12:30	16,34	1	16,34	CHI
20201062924	URUACU	UR12380056	URUACU	12/10/2020 20:11	13/10/2020 01:29	12/10/2020 20:11	13/10/2020 01:29	5,30	100	529,78	CHI
20201062722	GOIANIA	GN11001483	CAMPINAS S1	12/10/2020 20:11	12/10/2020 22:03	12/10/2020 20:11	12/10/2020 22:03	1,87	101	188,51	CHI
20201063068	JOVIANIA	JV12000004RE	GOIATUBA S1	12/10/2020 20:12	13/10/2020 12:51	12/10/2020 20:12	13/10/2020 08:41	12,48	15	187,21	CHI
20201063068	GOIATUBA	JV12000004RE	GOIATUBA S1	12/10/2020 20:12	13/10/2020 12:51	12/10/2020 20:12	13/10/2020 12:14	16,02	12	192,29	CHI
20201063068	JOVIANIA	JV12000004RE	GOIATUBA S1	12/10/2020 20:12	13/10/2020 12:51	12/10/2020 20:12	13/10/2020 12:14	16,02	8	128,19	CHI
20201063068	JOVIANIA	JV12000004RE	GOIATUBA S1	12/10/2020 20:12	13/10/2020 12:51	12/10/2020 20:12	13/10/2020 12:51	16,64	8	133,14	CHI
20201063068	GOIATUBA	JV12000004RE	GOIATUBA S1	12/10/2020 20:12	13/10/2020 12:51	12/10/2020 20:12	13/10/2020 12:51	16,64	4	66,57	CHI
20201062680	GOIANIA	10744745	CAMPINAS S1	12/10/2020 20:17	12/10/2020 21:43	12/10/2020 20:17	12/10/2020 21:43	1,43	1	1,43	CHI
20201064779	CAMPINORTE	CR12282384	MARA ROSA	12/10/2020 20:17	13/10/2020 10:33	12/10/2020 20:17	13/10/2020 10:33	14,26	1	14,26	CHI
20201064779	URUACU	CR12282384	MARA ROSA	12/10/2020 20:17	13/10/2020 10:33	12/10/2020 20:17	13/10/2020 10:33	14,26	5	71,30	CHI
20201062683	SAO JOAO DA PARAUNA	RP12323706	FIRMINOPOLIS S2	12/10/2020 20:17	13/10/2020 18:30	12/10/2020 20:17	13/10/2020 18:30	22,21	1	22,21	CHI
20201062685	LUZIANIA	LZ12349077	PAMPLONA	12/10/2020 20:18	12/10/2020 23:52	12/10/2020 20:18	12/10/2020 23:52	3,56	10	35,64	CHI
20201062692	BONFINOPOLIS	BO10402648	CEPAIGO S2	12/10/2020 20:19	13/10/2020 02:22	12/10/2020 20:19	13/10/2020 02:22	6,05	681	4117,59	CHI
20201062692	LEOPOLDO DE BULHOES	BO10402648	CEPAIGO S2	12/10/2020 20:19	13/10/2020 02:22	12/10/2020 20:19	13/10/2020 02:22	6,05	44	266,04	CHI
20201062988	SANCLERLANDIA	SC12008814	FIRMINOPOLIS S2	12/10/2020 20:20	13/10/2020 16:59	12/10/2020 20:20	13/10/2020 16:59	20,64	19	392,08	CHI
20201062694	GOIAS	GS12000010	GOIAS	12/10/2020 20:21	12/10/2020 21:40	12/10/2020 20:21	12/10/2020 21:40	1,32	762	1009,02	CHI
20201062781	NOVA AURORA	NE12143243	CATALAO S1	12/10/2020 20:21	13/10/2020 01:29	12/10/2020 20:21	13/10/2020 01:29	5,14	5	25,69	CHI
20201063965	PIRENOPOLIS	PV12017586	CORUMBA	12/10/2020 20:21	13/10/2020 11:13	12/10/2020 20:21	13/10/2020 11:13	14,85	57	846,67	CHI
20201062704	URUACU	UR12398011	URUACU	12/10/2020 20:22	13/10/2020 00:31	12/10/2020 20:22	13/10/2020 00:31	4,15	4	16,58	CHI
20201062710	ARAGARCAS	10027736510	ARAGARCAS	12/10/2020 20:23	13/10/2020 07:24	12/10/2020 20:23	13/10/2020 07:24	11,01	1	11,01	CHI
2020101200126	NOVA CRIXAS	01710414	SAO MIGUEL DO ARAGUAIA	12/10/2020 20:24	12/10/2020 22:11	12/10/2020 20:24	12/10/2020 22:11	1,78	1	1,78	CHI
2020101200126	SAO MIGUEL DO ARAGUAIA	01710414	SAO MIGUEL DO ARAGUAIA	12/10/2020 20:24	12/10/2020 22:11	12/10/2020 20:24	12/10/2020 22:11	1,78	1265	2255,92	CHI
20201063226	FIRMINOPOLIS	FR11076442	FIRMINOPOLIS S1	12/10/2020 20:25	12/10/2020 23:55	12/10/2020 20:25	12/10/2020 23:55	3,49	141	492,76	CHI
20201062737	GOIANIA	10867399	GOIANIA LESTE S3	12/10/2020 20:28	12/10/2020 21:43	12/10/2020 20:28	12/10/2020 21:43	1,24	1	1,24	CHI
20201062761	URUACU	UR11076068	URUACU	12/10/2020 20:28	13/10/2020 00:31	12/10/2020 20:28	13/10/2020 00:31	4,03	187	754,39	CHI
20201064702	VILA PROPICIO	GE12140828	GOIANESIA S1	12/10/2020 20:30	13/10/2020 18:52	12/10/2020 20:30	13/10/2020 18:52	22,36	16	357,75	CHI
20201064702	GOIANESIA	GE12140828	GOIANESIA S1	12/10/2020 20:30	13/10/2020 18:52	12/10/2020 20:30	13/10/2020 18:52	22,36	2	44,72	CHI
20201062751	ITUMBIAARA	IT11122289	ITUMBIAARA VELHA S1	12/10/2020 20:30	12/10/2020 22:37	12/10/2020 20:30	12/10/2020 22:37	2,10	28	58,84	CHI
20201062758	GOIANESIA	GE11090257	GOIANESIA S1	12/10/2020 20:32	12/10/2020 21:37	12/10/2020 20:32	12/10/2020 21:37	1,08	84	90,84	CHI
20201062760	LEOPOLDO DE BULHOES	LB21040488	DAIA S2	12/10/2020 20:32	13/10/2020 02:10	12/10/2020 20:32	13/10/2020 02:10	5,63	1	5,63	CHI
20201062763	FIRMINOPOLIS	FR21283494	FIRMINOPOLIS S1	12/10/2020 20:32	14/10/2020 04:00	12/10/2020 20:32	14/10/2020 04:00	31,45	1	31,45	CHI
20201062764	CUMARI	CY21064065	CATALAO S2	12/10/2020 20:33	12/10/2020 21:54	12/10/2020 20:33	12/10/2020 21:54	1,34	1	1,34	CHI
20201063018	ANICUNS	AC11000019	ANICUNS	12/10/2020 20:35	12/10/2020 22:48	12/10/2020 20:35	12/10/2020 22:48	2,21	100	221,33	CHI
20201061293	DIVINOPOLIS DE GOIAS	GH12170200LD	SAO DOMINGOS	12/10/2020 20:35	12/10/2020 23:01	12/10/2020 20:35	12/10/2020 23:01	2,43	1	2,43	CHI
20201062778	ABADIA DE GOIAS	10028416498	CARAJAS S1	12/10/2020 20:36	12/10/2020 22:37	12/10/2020 20:36	12/10/2020 22:37	2,00	1	2,00	CHI
20201062798	CORUMBA DE GOIAS	CB12161727	CORUMBA	12/10/2020 20:38	13/10/2020 05:52	12/10/2020 20:38	13/10/2020 05:52	9,23	310	2861,30	CHI
20201062808	URUACU	UR10404192	URUACU	12/10/2020 20:38	14/10/2020 01:11	12/10/2020 20:38	12/10/2020 22:44	2,09	299	624,49	CHI
20201062808	URUACU	UR10404192	URUACU	12/10/2020 20:38	14/10/2020 01:11	13/10/2020 00:38	13/10/2020 00:44	0,10	299	30,15	CHI
20201062808	URUACU	UR10404192	URUACU	12/10/2020 20:38	14/10/2020 01:11	13/10/2020 01:03	13/10/2020 01:10	0,11	299	33,97	CHI
20201062808	URUACU	UR12000045LD	URUACU	12/10/2020 20:38	14/10/2020 01:11	12/10/2020 20:38	13/10/2020 05:02	8,40	17	142,82	CHI
20201062808	URUACU	UR10404192	URUACU	12/10/2020 20:38	14/10/2020 01:11	13/10/2020 08:44	13/10/2020 08:59	0,26	316	81,90	CHI
20201062808	URUACU	UR13308221	URUACU	12/10/2020 20:38	14/10/2020 01:11	12/10/2020 20:38	13/10/2020 16:49	20,18	105	2118,49	CHI
20201062808	URUACU	UR12000045LD	URUACU	12/10/2020 20:38	14/10/2020 01:11	12/10/2020 20:38	13/10/2020 16:49	20,18	23	464,05	CHI
20201062808	HIDROLINA	UR13308221	URUACU	12/10/2020 20:38	14/10/2020 01:11	12/10/2020 20:38	13/10/2020 16:49	20,18	11	221,94	CHI
20201062808	URUACU	UR12000045LD	URUACU	12/10/2020 20:38	14/10/2020 01:11	12/10/2020 20:38	13/10/2020 17:52	21,22	228	4838,73	CHI
20201062808	URUACU	UR10400664	URUACU	12/10/2020 20:38	14/10/2020 01:11	13/10/2020 18:22	13/10/2020 18:27	0,08	228	18,94	CHI
20201062808	URUACU	UR12000045LD	URUACU	12/10/2020 20:38	14/10/2020 01:11	12/10/2020 20:38	13/10/2020 21:30	24,87	25	621,71	CHI
20201062808	URUACU	UR12000045LD	URUACU	12/10/2020 20:38	14/10/2020 01:11	12/10/2020 20:38	14/10/2020 00:31	27,88	8	223,02	CHI
20201062808	URUACU	UR12000045LD	URUACU	12/10/2020 20:38	14/10/2020 01:11	12/10/2020 20:38	14/10/2020 01:11	28,55	6	171,29	CHI
20201062900	CORUMBA DE GOIAS	CB11130884	CORUMBA	12/10/2020 20:39	13/10/2020 00:04	12/10/2020 20:39	13/10/2020 00:04	3,42	140	478,33	CHI
20201062830	SAO MIGUEL DO ARAGUAIA	SM11352926	SAO MIGUEL DO ARAGUAIA	12/10/2020 20:40	12/10/2020 22:34	12/10/2020 20:40	12/10/2020 22:34	1,89	107	202,76	CHI

20201064190	BOM JARDIM DE GOIAS	BM12245130	BOM JARDIM	12/10/2020 20:41	13/10/2020 08:43	12/10/2020 20:41	13/10/2020 08:43	12,02	6	72,11	CHI
20201064190	PIRANHAS	BM12245130	BOM JARDIM	12/10/2020 20:41	13/10/2020 08:43	12/10/2020 20:41	13/10/2020 08:43	12,02	4	48,07	CHI
20201062823	URUACU	UR11356493	URUACU	12/10/2020 20:42	13/10/2020 21:46	12/10/2020 20:42	13/10/2020 21:46	25,06	4	100,25	CHI
20201062939	SAO LUIS DE MONTES BELOS	SL11233479	SAO LUIZ DOS MONTES BELOS	12/10/2020 20:44	13/10/2020 09:21	12/10/2020 20:44	13/10/2020 09:21	12,61	203	2559,66	CHI
20201062840	ANAPOLIS	AN31010174	NEROPOLIS S1	12/10/2020 20:45	13/10/2020 00:09	12/10/2020 20:45	13/10/2020 00:09	3,40	1	3,40	CHI
20201062841	JARAGUA	10011934377	JARAGUA	12/10/2020 20:45	13/10/2020 04:41	12/10/2020 20:45	13/10/2020 04:41	7,93	1	7,93	CHI
20201063081	FIRMINOPOLIS	FR12056267	FIRMINOPOLIS S1	12/10/2020 20:46	12/10/2020 23:15	12/10/2020 20:46	12/10/2020 23:15	2,48	398	988,26	CHI
20201062898	DISTRITO FEDERAL	03590414	CATALAO S1	12/10/2020 20:46	13/10/2020 04:44	12/10/2020 20:46	12/10/2020 20:51	0,07	11	0,81	CHI
20201062898	OUVIDOR	03590414	CATALAO S1	12/10/2020 20:46	13/10/2020 04:44	12/10/2020 20:46	12/10/2020 20:51	0,07	247	18,11	CHI
20201062898	CATALAO	03590414	CATALAO S1	12/10/2020 20:46	13/10/2020 04:44	12/10/2020 20:46	12/10/2020 20:51	0,07	84	6,16	CHI
20201062898	DAVINOPOLIS	03590414	CATALAO S1	12/10/2020 20:46	13/10/2020 04:44	12/10/2020 20:46	12/10/2020 20:51	0,07	337	24,71	CHI
20201062898	TRES RANCHOS	03590414	CATALAO S1	12/10/2020 20:46	13/10/2020 04:44	12/10/2020 20:46	12/10/2020 20:51	0,07	5	0,37	CHI
20201062898	DISTRITO FEDERAL	03590414	CATALAO S1	12/10/2020 20:46	13/10/2020 04:44	12/10/2020 20:47	12/10/2020 20:51	0,06	1	0,06	CHI
20201062898	DAVINOPOLIS	03590414	CATALAO S1	12/10/2020 20:46	13/10/2020 04:44	12/10/2020 20:47	12/10/2020 20:51	0,06	2	0,12	CHI
20201062898	OUVIDOR	03590414	CATALAO S1	12/10/2020 20:46	13/10/2020 04:44	12/10/2020 20:47	12/10/2020 20:51	0,06	1	0,06	CHI
20201062898	CATALAO	03590414	CATALAO S1	12/10/2020 20:46	13/10/2020 04:44	12/10/2020 20:47	12/10/2020 20:51	0,06	1	0,06	CHI
20201062898	DAVINOPOLIS	03590414	CATALAO S1	12/10/2020 20:46	13/10/2020 04:44	12/10/2020 20:46	12/10/2020 20:57	0,18	77	13,73	CHI
20201062898	DAVINOPOLIS	03590414	CATALAO S1	12/10/2020 20:46	13/10/2020 04:44	12/10/2020 20:47	12/10/2020 20:57	0,17	13	2,17	CHI
20201062898	DAVINOPOLIS	03590414	CATALAO S1	12/10/2020 20:46	13/10/2020 04:44	12/10/2020 20:46	12/10/2020 20:57	0,18	102	18,87	CHI
20201062898	DAVINOPOLIS	03590414	CATALAO S1	12/10/2020 20:46	13/10/2020 04:44	12/10/2020 20:46	13/10/2020 04:44	7,96	324	2579,04	CHI
20201062898	OUVIDOR	03590414	CATALAO S1	12/10/2020 20:46	13/10/2020 04:44	12/10/2020 20:46	13/10/2020 04:44	7,96	176	1400,96	CHI
20201062898	DAVINOPOLIS	03590414	CATALAO S1	12/10/2020 20:46	13/10/2020 04:44	12/10/2020 20:47	13/10/2020 04:44	7,95	162	1287,67	CHI
20201062854	CATALAO	1990299535	CATALAO S1	12/10/2020 20:47	13/10/2020 07:28	12/10/2020 20:47	13/10/2020 07:28	10,67	1	10,67	CHI
20201062871	GOIANIA	14338830	CARAJAS S2	12/10/2020 20:48	12/10/2020 22:20	12/10/2020 20:48	12/10/2020 22:20	1,52	1	1,52	CHI
20201062932	APARECIDA DE GOIANIA	AP11007353	INDEPENDENCIA S1	12/10/2020 20:49	12/10/2020 22:36	12/10/2020 20:49	12/10/2020 22:36	1,78	216	385,08	CHI
20201062875	PALMEIRAS DE GOIAS	PL12308381	PALMEIRAS	12/10/2020 20:49	13/10/2020 03:55	12/10/2020 20:49	13/10/2020 03:55	7,10	19	134,87	CHI
20201062894	SANTA TEREZINHA DE GOIAS	SG10394720	SANTA TEREZINHA	12/10/2020 20:49	13/10/2020 19:10	12/10/2020 20:49	12/10/2020 23:29	2,67	208	554,61	CHI
20201062894	PILAR DE GOIAS	SG10394720	SANTA TEREZINHA	12/10/2020 20:49	13/10/2020 19:10	12/10/2020 20:49	12/10/2020 23:29	2,67	13	34,66	CHI
20201062894	CRIXAS	SG10394720	SANTA TEREZINHA	12/10/2020 20:49	13/10/2020 19:10	12/10/2020 20:49	13/10/2020 01:26	4,61	305	1407,57	CHI
20201062894	PILAR DE GOIAS	SG10394720	SANTA TEREZINHA	12/10/2020 20:49	13/10/2020 19:10	12/10/2020 20:49	13/10/2020 01:26	4,61	28	129,22	CHI
20201062894	GUARINOS	SG10394720	SANTA TEREZINHA	12/10/2020 20:49	13/10/2020 19:10	12/10/2020 20:49	13/10/2020 01:26	4,61	921	4250,41	CHI
20201062894	ITAPACI	SG10394720	SANTA TEREZINHA	12/10/2020 20:49	13/10/2020 19:10	12/10/2020 20:49	13/10/2020 01:26	4,61	6	27,69	CHI
20201062894	PILAR DE GOIAS	SG10394720	SANTA TEREZINHA	12/10/2020 20:49	13/10/2020 19:10	13/10/2020 01:26	13/10/2020 01:52	0,43	13	5,63	CHI
20201062894	SANTA TEREZINHA DE GOIAS	SG10394720	SANTA TEREZINHA	12/10/2020 20:49	13/10/2020 19:10	13/10/2020 01:26	13/10/2020 01:52	0,43	208	90,02	CHI
20201062894	PILAR DE GOIAS	SG10394720	SANTA TEREZINHA	12/10/2020 20:49	13/10/2020 19:10	13/10/2020 04:54	13/10/2020 05:13	0,32	13	4,18	CHI
20201062894	SANTA TEREZINHA DE GOIAS	SG10394720	SANTA TEREZINHA	12/10/2020 20:49	13/10/2020 19:10	13/10/2020 04:54	13/10/2020 05:13	0,32	208	66,85	CHI
20201062894	GUARINOS	SG10394720	SANTA TEREZINHA	12/10/2020 20:49	13/10/2020 19:10	12/10/2020 20:49	13/10/2020 17:50	21,02	7	147,15	CHI
20201062894	PILAR DE GOIAS	SG10394720	SANTA TEREZINHA	12/10/2020 20:49	13/10/2020 19:10	12/10/2020 20:49	13/10/2020 17:50	21,02	5	105,10	CHI
20201062894	PILAR DE GOIAS	GG13213130	SANTA TEREZINHA	12/10/2020 20:49	13/10/2020 19:10	13/10/2020 01:52	13/10/2020 17:50	15,97	28	447,23	CHI
20201062894	CRIXAS	GG13213130	SANTA TEREZINHA	12/10/2020 20:49	13/10/2020 19:10	13/10/2020 01:52	13/10/2020 17:50	15,97	280	4472,30	CHI
20201062894	ITAPACI	GG13213130	SANTA TEREZINHA	12/10/2020 20:49	13/10/2020 19:10	13/10/2020 01:52	13/10/2020 17:50	15,97	6	95,83	CHI
20201062894	GUARINOS	GG13213130	SANTA TEREZINHA	12/10/2020 20:49	13/10/2020 19:10	13/10/2020 01:52	13/10/2020 17:50	15,97	875	13975,94	CHI
20201062894	GUARINOS	CX12097448RE	SANTA TEREZINHA	12/10/2020 20:49	13/10/2020 19:10	13/10/2020 01:52	13/10/2020 19:10	17,30	46	795,66	CHI
20201062894	CRIXAS	CX12097448RE	SANTA TEREZINHA	12/10/2020 20:49	13/10/2020 19:10	13/10/2020 01:52	13/10/2020 19:10	17,30	25	432,42	CHI
20201062894	ITAPACI	SG10394720	SANTA TEREZINHA	12/10/2020 20:49	13/10/2020 19:10	13/10/2020 18:31	13/10/2020 19:10	0,65	6	3,88	CHI
20201062894	CRIXAS	SG10394720	SANTA TEREZINHA	12/10/2020 20:49	13/10/2020 19:10	13/10/2020 18:31	13/10/2020 19:10	0,65	280	181,14	CHI
20201062894	PILAR DE GOIAS	SG10394720	SANTA TEREZINHA	12/10/2020 20:49	13/10/2020 19:10	13/10/2020 18:31	13/10/2020 19:10	0,65	46	29,76	CHI
20201062894	GUARINOS	SG10394720	SANTA TEREZINHA	12/10/2020 20:49	13/10/2020 19:10	13/10/2020 18:31	13/10/2020 19:10	0,65	882	570,60	CHI
20201062894	SANTA TEREZINHA DE GOIAS	SG10394720	SANTA TEREZINHA	12/10/2020 20:49	13/10/2020 19:10	13/10/2020 18:31	13/10/2020 19:10	0,65	208	134,56	CHI
20201064567	PALESTINA DE GOIAS	CP12014170	PALESTINA	12/10/2020 20:50	14/10/2020 15:05	12/10/2020 20:50	14/10/2020 15:05	42,24	7	295,69	CHI
20201064567	CAIAPONIA	CP12014170	PALESTINA	12/10/2020 20:50	14/10/2020 15:05	12/10/2020 20:50	14/10/2020 15:05	42,24	2	84,48	CHI
20201062882	FORMOSA	610068880	ITQUIRA	12/10/2020 20:50	13/10/2020 07:49	12/10/2020 20:50	13/10/2020 07:49	10,97	1	10,97	CHI
20201064426	MOSSAMEDES	BS12304459	FIRMINOPOLIS S2	12/10/2020 20:51	14/10/2020 01:15	12/10/2020 20:51	14/10/2020 01:15	28,40	4	113,61	CHI
20201064426	SANCLERLANDIA	BS12304459	FIRMINOPOLIS S2	12/10/2020 20:51	14/10/2020 01:15	12/10/2020 20:51	14/10/2020 01:15	28,40	1	28,40	CHI
20201064426	BURITI DE GOIAS	BS12304459	FIRMINOPOLIS S2	12/10/2020 20:51	14/10/2020 01:15	12/10/2020 20:51	14/10/2020 01:15	28,40	10	284,02	CHI
20201062902	JANDAIA	JD21277532	PALMEIRAS	12/10/2020 20:55	13/10/2020 17:56	12/10/2020 20:55	13/10/2020 17:56	21,01	1	21,01	CHI
20201062908	ITAPACI	IW12333893	ITAPACI	12/10/2020 20:56	13/10/2020 05:38	12/10/2020 20:56	13/10/2020 05:38	8,70	26	226,11	CHI
20201062908	PILAR DE GOIAS	IW12333893	ITAPACI	12/10/2020 20:56	13/10/2020 05:38	12/10/2020 20:56	13/10/2020 05:38	8,70	38	330,47	CHI

20201062913	NEROPOLIS	NR21133828	NEROPOLIS S2	12/10/2020 20:58	13/10/2020 01:05	12/10/2020 20:58	13/10/2020 01:05	4,11	1	4,11	CHI
20201064051	PORTELANDIA	PW12303420	PARQUE DAS EMAS	12/10/2020 20:59	13/10/2020 09:51	12/10/2020 20:59	13/10/2020 09:51	12,86	14	179,98	CHI
20201062950	RUBIATABA	01630414	RUBIATABA	12/10/2020 21:00	13/10/2020 12:09	12/10/2020 21:00	13/10/2020 01:06	4,11	136	559,11	CHI
20201062950	ITAPACI	01630414	RUBIATABA	12/10/2020 21:00	13/10/2020 12:09	12/10/2020 21:00	13/10/2020 01:06	4,11	10	41,11	CHI
20201062950	IPIRANGA DE GOIAS	01630414	RUBIATABA	12/10/2020 21:00	13/10/2020 12:09	12/10/2020 21:00	13/10/2020 01:06	4,11	33	135,67	CHI
20201062950	CERES	01630414	RUBIATABA	12/10/2020 21:00	13/10/2020 12:09	12/10/2020 21:00	13/10/2020 01:06	4,11	19	78,11	CHI
20201062950	IPIRANGA DE GOIAS	01630414	RUBIATABA	12/10/2020 21:00	13/10/2020 12:09	12/10/2020 21:00	13/10/2020 01:06	4,11	1	4,11	CHI
20201062950	RUBIATABA	01630414	RUBIATABA	12/10/2020 21:00	13/10/2020 12:09	12/10/2020 21:00	13/10/2020 01:06	4,11	1	4,11	CHI
20201062950	CERES	01630414	RUBIATABA	12/10/2020 21:00	13/10/2020 12:09	12/10/2020 21:00	13/10/2020 07:54	10,91	2	21,83	CHI
20201062950	RUBIATABA	01630414	RUBIATABA	12/10/2020 21:00	13/10/2020 12:09	12/10/2020 21:00	13/10/2020 07:54	10,91	2	21,83	CHI
20201062950	NOVA GLORIA	01630414	RUBIATABA	12/10/2020 21:00	13/10/2020 12:09	12/10/2020 21:00	13/10/2020 07:54	10,91	27	294,70	CHI
20201062950	IPIRANGA DE GOIAS	01630414	RUBIATABA	12/10/2020 21:00	13/10/2020 12:09	12/10/2020 21:00	13/10/2020 07:54	10,91	2	21,83	CHI
20201062950	NOVA GLORIA	01630414	RUBIATABA	12/10/2020 21:00	13/10/2020 12:09	12/10/2020 21:00	13/10/2020 12:09	15,16	49	742,72	CHI
20201063055	CATALAO	OU10400732	CATALAO S1	12/10/2020 21:02	13/10/2020 08:08	12/10/2020 21:02	13/10/2020 07:59	10,95	2	21,91	CHI
20201063055	OUVIDOR	OU10400732	CATALAO S1	12/10/2020 21:02	13/10/2020 08:08	12/10/2020 21:02	13/10/2020 07:59	10,95	1	10,95	CHI
20201063055	TRES RANCHOS	OU10400732	CATALAO S1	12/10/2020 21:02	13/10/2020 08:08	12/10/2020 21:02	13/10/2020 08:08	11,10	1964	21798,22	CHI
20201063055	CATALAO	OU10400732	CATALAO S1	12/10/2020 21:02	13/10/2020 08:08	12/10/2020 21:02	13/10/2020 08:08	11,10	5	55,49	CHI
20201063055	OUVIDOR	OU10400732	CATALAO S1	12/10/2020 21:02	13/10/2020 08:08	12/10/2020 21:02	13/10/2020 08:08	11,10	2	22,20	CHI
20201063055	TRES RANCHOS	OU10400732	CATALAO S1	12/10/2020 21:02	13/10/2020 08:08	12/10/2020 21:02	13/10/2020 08:08	11,10	397	4406,26	CHI
20201063055	OUVIDOR	OU10400732	CATALAO S1	12/10/2020 21:02	13/10/2020 08:08	12/10/2020 21:02	13/10/2020 08:08	11,10	3	33,30	CHI
20201063055	CUMARI	OU10400732	CATALAO S1	12/10/2020 21:02	13/10/2020 08:08	12/10/2020 21:02	13/10/2020 08:08	11,10	1	11,10	CHI
20201063055	DISTRITO FEDERAL	OU10400732	CATALAO S1	12/10/2020 21:02	13/10/2020 08:08	12/10/2020 21:02	13/10/2020 08:08	11,10	1	11,10	CHI
20201063055	TRES RANCHOS	OU10400732	CATALAO S1	12/10/2020 21:02	13/10/2020 08:08	12/10/2020 21:02	13/10/2020 08:08	11,10	17	188,68	CHI
20201063055	CATALAO	OU10400732	CATALAO S1	12/10/2020 21:02	13/10/2020 08:08	12/10/2020 21:02	13/10/2020 08:08	11,10	230	2552,74	CHI
20201062941	PIRENOPOLIS	220036512	CORUMBA	12/10/2020 21:03	13/10/2020 10:25	12/10/2020 21:03	13/10/2020 10:25	13,36	1	13,36	CHI
20201062942	ALVORADA DO NORTE	1510030922	IACIARA S2	12/10/2020 21:03	12/10/2020 22:39	12/10/2020 21:03	12/10/2020 22:39	1,59	1	1,59	CHI
20201062943	CATALAO	1990091330	CATALAO S2	12/10/2020 21:03	13/10/2020 08:34	12/10/2020 21:03	13/10/2020 08:34	11,50	1	11,50	CHI
20201062945	CAMPO LIMPO	AN21000533	JUNDIAI S1	12/10/2020 21:04	12/10/2020 22:27	12/10/2020 21:04	12/10/2020 22:27	1,38	3	4,13	CHI
20201062946	ARAGARCAS	1820045897	ARAGARCAS	12/10/2020 21:04	13/10/2020 11:14	12/10/2020 21:04	13/10/2020 11:14	14,16	1	14,16	CHI
20201062947	SENADOR CANEDO	190010514	SENADOR CANEDO	12/10/2020 21:04	12/10/2020 22:23	12/10/2020 21:04	12/10/2020 22:23	1,31	1	1,31	CHI
20201064248	ITAPIRAPUA	IU12020177	JUSSARA	12/10/2020 21:04	13/10/2020 07:55	12/10/2020 21:04	13/10/2020 07:55	10,85	92	998,63	CHI
20201062959	CRISTALINA	KR21332528	CRISTALINA S1	12/10/2020 21:04	12/10/2020 23:05	12/10/2020 21:04	12/10/2020 23:05	2,00	1	2,00	CHI
20201063034	SANCLERLANDIA	SC10404262	FIRMINOPOLIS S2	12/10/2020 21:05	14/10/2020 09:22	12/10/2020 21:05	14/10/2020 09:22	36,28	18	653,07	CHI
20201062964	ITAPIRAPUA	IU12067918	MATRINCHA	12/10/2020 21:06	13/10/2020 10:10	12/10/2020 21:06	13/10/2020 10:10	13,07	13	169,86	CHI
20201062974	FIRMINOPOLIS	00490234	FIRMINOPOLIS S1	12/10/2020 21:06	13/10/2020 23:05	12/10/2020 21:06	12/10/2020 21:57	0,86	11	9,47	CHI
20201062974	SAO LUIS DE MONTES BELOS	00490234	FIRMINOPOLIS S1	12/10/2020 21:06	13/10/2020 23:05	12/10/2020 21:06	12/10/2020 21:57	0,86	35	30,13	CHI
20201062974	SAO LUIS DE MONTES BELOS	00490234	FIRMINOPOLIS S1	12/10/2020 21:06	13/10/2020 23:05	12/10/2020 21:06	12/10/2020 22:21	1,26	38	47,74	CHI
20201062974	SAO LUIS DE MONTES BELOS	00490234	FIRMINOPOLIS S1	12/10/2020 21:06	13/10/2020 23:05	12/10/2020 22:17	12/10/2020 22:50	0,53	1	0,53	CHI
20201062974	FIRMINOPOLIS	00490234	FIRMINOPOLIS S1	12/10/2020 21:06	13/10/2020 23:05	12/10/2020 22:17	12/10/2020 22:50	0,53	5	2,67	CHI
20201062974	SAO LUIS DE MONTES BELOS	SL12111560RE	FIRMINOPOLIS S1	12/10/2020 21:06	13/10/2020 23:05	12/10/2020 22:17	13/10/2020 00:18	2,00	29	58,08	CHI
20201062974	FIRMINOPOLIS	SL12111560RE	FIRMINOPOLIS S1	12/10/2020 21:06	13/10/2020 23:05	12/10/2020 22:17	13/10/2020 00:18	2,00	6	12,02	CHI
20201062974	FIRMINOPOLIS	00490234	FIRMINOPOLIS S1	12/10/2020 21:06	13/10/2020 23:05	13/10/2020 01:46	13/10/2020 02:02	0,27	11	2,93	CHI
20201062974	SAO LUIS DE MONTES BELOS	00490234	FIRMINOPOLIS S1	12/10/2020 21:06	13/10/2020 23:05	13/10/2020 01:46	13/10/2020 02:02	0,27	30	7,99	CHI
20201062974	FIRMINOPOLIS	00490234	FIRMINOPOLIS S1	12/10/2020 21:06	13/10/2020 23:05	13/10/2020 02:30	13/10/2020 21:38	19,13	5	95,66	CHI
20201062974	SAO LUIS DE MONTES BELOS	00490234	FIRMINOPOLIS S1	12/10/2020 21:06	13/10/2020 23:05	13/10/2020 02:30	13/10/2020 21:38	19,13	1	19,13	CHI
20201062974	SAO LUIS DE MONTES BELOS	SL12111560RE	FIRMINOPOLIS S1	12/10/2020 21:06	13/10/2020 23:05	13/10/2020 02:30	13/10/2020 22:14	19,74	29	572,38	CHI
20201062974	FIRMINOPOLIS	SL12111560RE	FIRMINOPOLIS S1	12/10/2020 21:06	13/10/2020 23:05	13/10/2020 02:30	13/10/2020 22:14	19,74	6	118,42	CHI
20201062974	TURVANIA	SL16419313	FIRMINOPOLIS S1	12/10/2020 21:06	13/10/2020 23:05	13/10/2020 22:29	13/10/2020 22:33	0,06	8	0,50	CHI
20201062974	SAO LUIS DE MONTES BELOS	SL16419313	FIRMINOPOLIS S1	12/10/2020 21:06	13/10/2020 23:05	13/10/2020 22:29	13/10/2020 22:33	0,06	195	12,08	CHI
20201062974	FIRMINOPOLIS	SL16419313	FIRMINOPOLIS S1	12/10/2020 21:06	13/10/2020 23:05	13/10/2020 22:29	13/10/2020 22:33	0,06	24	1,49	CHI
20201062974	SAO LUIS DE MONTES BELOS	8083625	FIRMINOPOLIS S1	12/10/2020 21:06	13/10/2020 23:05	12/10/2020 22:17	13/10/2020 23:05	24,79	5	123,93	CHI
20201062969	GOIANIA	11026224	FERROVIARIO S3	12/10/2020 21:07	12/10/2020 22:05	12/10/2020 21:07	12/10/2020 22:05	0,96	1	0,96	CHI
20201062977	SANTA RITA DO ARAGUAIA	2130015160	SANTA RITA DO ARAGUAIA	12/10/2020 21:09	13/10/2020 16:43	12/10/2020 21:09	13/10/2020 16:43	19,57	1	19,57	CHI
20201062978	PALMEIRAS DE GOIAS	PL12331634	FIRMINOPOLIS S2	12/10/2020 21:09	13/10/2020 07:59	12/10/2020 21:09	13/10/2020 07:59	10,83	12	129,96	CHI
20201062981	OURO VERDE DE GOIAS	370005200	NEROPOLIS S1	12/10/2020 21:09	13/10/2020 04:20	12/10/2020 21:09	13/10/2020 04:20	7,18	1	7,18	CHI
20201063011	OUVIDOR	02630224	CATALAO S1	12/10/2020 21:09	13/10/2020 19:27	12/10/2020 21:09	13/10/2020 07:58	10,81	2	21,62	CHI
20201063011	OUVIDOR	02630224	CATALAO S1	12/10/2020 21:09	13/10/2020 19:27	13/10/2020 10:33	13/10/2020 11:06	0,55	2	1,09	CHI
20201063011	OUVIDOR	00340424	CATALAO S1	12/10/2020 21:09	13/10/2020 19:27	13/10/2020 16:09	13/10/2020 16:15	0,11	2	0,23	CHI

20201063011	OUIDOR	02630224	CATALAO S1	12/10/2020 21:09	13/10/2020 19:27	12/10/2020 21:09	13/10/2020 18:06	20,95	1	20,95	CHI
20201063011	DAVINOPOLIS	02630224	CATALAO S1	12/10/2020 21:09	13/10/2020 19:27	12/10/2020 21:09	13/10/2020 19:10	22,01	11	242,07	CHI
20201063011	OUIDOR	02630224	CATALAO S1	12/10/2020 21:09	13/10/2020 19:27	12/10/2020 21:09	13/10/2020 19:10	22,01	568	12499,47	CHI
20201063011	TRES RANCHOS	02630224	CATALAO S1	12/10/2020 21:09	13/10/2020 19:27	12/10/2020 21:09	13/10/2020 19:10	22,01	27	594,16	CHI
20201063011	OUIDOR	02630224	CATALAO S1	12/10/2020 21:09	13/10/2020 19:27	12/10/2020 21:09	13/10/2020 19:27	22,29	62	1382,08	CHI
20201062984	CRISTALINA	KR21171016	CRISTALINA S1	12/10/2020 21:09	12/10/2020 22:09	12/10/2020 21:09	12/10/2020 22:09	0,98	2	1,97	CHI
20201063000	FORMOSA	FA12051134	ITUIQUIRA	12/10/2020 21:11	13/10/2020 00:35	12/10/2020 21:11	13/10/2020 00:35	3,39	22	74,48	CHI
20201063059	NOVA AMERICA	NM11047534	RUBIATABA	12/10/2020 21:12	13/10/2020 17:31	12/10/2020 21:12	13/10/2020 17:31	20,30	68	1380,59	CHI
20201063006	ANAPOLIS	10012802369	ANAPOLIS UNIVERSITARIO S2	12/10/2020 21:13	12/10/2020 23:38	12/10/2020 21:13	12/10/2020 23:38	2,41	1	2,41	CHI
20201063021	ANAPOLIS	AN12000076	JUNDIAI S2	12/10/2020 21:17	13/10/2020 00:45	12/10/2020 21:17	13/10/2020 00:45	3,46	1	3,46	CHI
20201065409	SAO LUIS DE MONTES BELOS	SL12006949	SAO LUIZ DOS MONTES BELOS	12/10/2020 21:20	13/10/2020 11:36	12/10/2020 21:20	13/10/2020 11:36	14,26	41	584,58	CHI
20201063443	SAO LUIZ DO NORTE	SZ12090338	ITAPACI	12/10/2020 21:23	13/10/2020 07:12	12/10/2020 21:23	13/10/2020 07:12	9,81	291	2855,28	CHI
20201063192	URUACU	UR11038239	URUACU	12/10/2020 21:23	12/10/2020 23:40	12/10/2020 21:23	12/10/2020 23:40	2,28	113	257,45	CHI
20201063234	TURVELANDIA	TD12226264	RIO DOS BOIS	12/10/2020 21:25	12/10/2020 23:32	12/10/2020 21:25	12/10/2020 23:32	2,11	83	175,38	CHI
20201063234	SANTA HELENA DE GOIAS	TD12226264	RIO DOS BOIS	12/10/2020 21:25	12/10/2020 23:32	12/10/2020 21:25	12/10/2020 23:32	2,11	3	6,34	CHI
20201063060	CAMPINORTE	UR12243244	MARA ROSA	12/10/2020 21:26	13/10/2020 15:25	12/10/2020 21:26	13/10/2020 15:25	17,98	2	35,96	CHI
20201063153	GOIANIA	GN11001274	CAMPINAS S3	12/10/2020 21:26	12/10/2020 23:31	12/10/2020 21:26	12/10/2020 23:31	2,07	102	211,03	CHI
20201064447	MARA ROSA	MQ12208421	MARA ROSA	12/10/2020 21:28	13/10/2020 08:55	12/10/2020 21:28	13/10/2020 08:55	11,45	14	160,29	CHI
20201063065	SAO JOAO DA PARAUNA	1000003386	FIRMINOPOLIS S2	12/10/2020 21:28	13/10/2020 18:40	12/10/2020 21:28	13/10/2020 18:40	21,20	1	21,20	CHI
20201063067	ARAGARCAS	1820017191	ARAGARCAS	12/10/2020 21:28	13/10/2020 12:39	12/10/2020 21:28	13/10/2020 12:39	15,18	1	15,18	CHI
20201063070	GOIANIA	13987355	GOYA S2	12/10/2020 21:28	12/10/2020 23:02	12/10/2020 21:28	12/10/2020 23:02	1,55	1	1,55	CHI
20201063072	ITAPIRAPUA	1420003620	MATRINCHA	12/10/2020 21:28	13/10/2020 08:59	12/10/2020 21:28	13/10/2020 08:59	11,50	1	11,50	CHI
20201063083	SAO LUIS DE MONTES BELOS	SL12146020	SAO LUIZ DOS MONTES BELOS	12/10/2020 21:31	13/10/2020 13:25	12/10/2020 21:31	13/10/2020 13:25	15,90	5	79,49	CHI
20201063090	SANTA RITA DO NOVO DESTINO	GE21241540	BARRO ALTO	12/10/2020 21:33	13/10/2020 18:16	12/10/2020 21:33	13/10/2020 18:16	20,71	2	41,41	CHI
20201063094	CALDAS NOVAS	CN12223436	SERRA DE CALDAS	12/10/2020 21:36	13/10/2020 15:20	13/10/2020 00:02	13/10/2020 02:52	2,82	511	1441,59	CHI
20201063094	CALDAS NOVAS	CN21088188	SERRA DE CALDAS	12/10/2020 21:36	13/10/2020 15:20	12/10/2020 21:36	13/10/2020 15:20	17,73	1	17,73	CHI
20201063172	MINEIROS	MY12377570	PARQUE DAS EMAS	12/10/2020 21:36	13/10/2020 00:18	12/10/2020 21:36	13/10/2020 00:18	2,69	168	452,25	CHI
20201063213	SANTA FE DE GOIAS	01650414	BRITANIA	12/10/2020 21:38	14/10/2020 00:34	12/10/2020 21:38	12/10/2020 21:44	0,10	161	15,97	CHI
20201063213	SANTA FE DE GOIAS	01650414	BRITANIA	12/10/2020 21:38	14/10/2020 00:34	12/10/2020 21:38	12/10/2020 21:41	0,05	0	0,00	CHI
20201063213	SANTA FE DE GOIAS	01650414	BRITANIA	12/10/2020 21:38	14/10/2020 00:34	12/10/2020 21:38	12/10/2020 21:48	0,16	1581	254,28	CHI
20201063213	JUSSARA	01650414	BRITANIA	12/10/2020 21:38	14/10/2020 00:34	12/10/2020 21:38	12/10/2020 21:48	0,16	14	2,25	CHI
20201063213	SANTA FE DE GOIAS	RN11098945	BRITANIA	12/10/2020 21:38	14/10/2020 00:34	13/10/2020 10:16	13/10/2020 15:21	5,08	38	193,08	CHI
20201063213	SANTA FE DE GOIAS	20014791	BRITANIA	12/10/2020 21:38	14/10/2020 00:34	13/10/2020 12:19	13/10/2020 16:01	3,71	161	597,89	CHI
20201063213	SANTA FE DE GOIAS	RN16410139	BRITANIA	12/10/2020 21:38	14/10/2020 00:34	12/10/2020 21:38	13/10/2020 18:09	20,51	85	1743,30	CHI
20201063213	JAUPACI	RN12009757LD	BRITANIA	12/10/2020 21:38	14/10/2020 00:34	12/10/2020 21:38	13/10/2020 19:15	21,62	2	43,24	CHI
20201063213	FAZENDA NOVA	RN12009757LD	BRITANIA	12/10/2020 21:38	14/10/2020 00:34	12/10/2020 21:38	13/10/2020 19:15	21,62	145	3134,98	CHI
20201063213	SANTA FE DE GOIAS	RN12009757LD	BRITANIA	12/10/2020 21:38	14/10/2020 00:34	12/10/2020 21:38	13/10/2020 19:15	21,62	68	1470,20	CHI
20201063213	JUSSARA	RN12009757LD	BRITANIA	12/10/2020 21:38	14/10/2020 00:34	12/10/2020 21:38	13/10/2020 19:15	21,62	325	7026,68	CHI
20201063213	FAZENDA NOVA	RN12009757LD	BRITANIA	12/10/2020 21:38	14/10/2020 00:34	12/10/2020 21:40	13/10/2020 19:15	21,59	67	1446,85	CHI
20201063213	SANTA FE DE GOIAS	01650414	BRITANIA	12/10/2020 21:38	14/10/2020 00:34	12/10/2020 21:38	13/10/2020 19:33	21,91	28	613,47	CHI
20201063213	SANTA FE DE GOIAS	RN16410707	BRITANIA	12/10/2020 21:38	14/10/2020 00:34	13/10/2020 19:35	13/10/2020 19:39	0,08	82	6,38	CHI
20201063213	JUSSARA	RN16408481	BRITANIA	12/10/2020 21:38	14/10/2020 00:34	13/10/2020 19:31	13/10/2020 19:48	0,28	350	99,36	CHI
20201063213	FAZENDA NOVA	RN16408481	BRITANIA	12/10/2020 21:38	14/10/2020 00:34	13/10/2020 19:31	13/10/2020 19:48	0,28	217	61,60	CHI
20201063213	JAUPACI	RN16408481	BRITANIA	12/10/2020 21:38	14/10/2020 00:34	13/10/2020 19:31	13/10/2020 19:48	0,28	2	0,57	CHI
20201063213	SANTA FE DE GOIAS	RN16408481	BRITANIA	12/10/2020 21:38	14/10/2020 00:34	13/10/2020 19:31	13/10/2020 19:48	0,28	97	27,54	CHI
20201063213	JUSSARA	RN16408481	BRITANIA	12/10/2020 21:38	14/10/2020 00:34	13/10/2020 22:00	13/10/2020 23:30	1,50	4	6,00	CHI
20201063213	SANTA FE DE GOIAS	RN16408481	BRITANIA	12/10/2020 21:38	14/10/2020 00:34	13/10/2020 22:00	13/10/2020 23:30	1,50	21	31,48	CHI
20201063213	JUSSARA	RN13008742	BRITANIA	12/10/2020 21:38	14/10/2020 00:34	13/10/2020 22:00	13/10/2020 23:33	1,55	5	7,76	CHI
20201063213	SANTA FE DE GOIAS	RN13008742	BRITANIA	12/10/2020 21:38	14/10/2020 00:34	13/10/2020 22:00	13/10/2020 23:33	1,55	18	27,95	CHI
20201063213	JUSSARA	RN10394715	BRITANIA	12/10/2020 21:38	14/10/2020 00:34	13/10/2020 19:58	14/10/2020 00:34	4,61	195	898,68	CHI
20201063213	FAZENDA NOVA	RN10394715	BRITANIA	12/10/2020 21:38	14/10/2020 00:34	13/10/2020 19:58	14/10/2020 00:34	4,61	129	594,51	CHI
20201063213	SANTA FE DE GOIAS	RN10394715	BRITANIA	12/10/2020 21:38	14/10/2020 00:34	13/10/2020 19:58	14/10/2020 00:34	4,61	12	55,30	CHI
20201063213	JAUPACI	RN10394715	BRITANIA	12/10/2020 21:38	14/10/2020 00:34	13/10/2020 19:58	14/10/2020 00:34	4,61	1	4,61	CHI
20201063112	ARAGARCAS	1820013240	ARAGARCAS	12/10/2020 21:40	13/10/2020 09:36	12/10/2020 21:40	13/10/2020 09:36	11,94	1	11,94	CHI
20201063114	GOIAS	GS12210521	GOIAS	12/10/2020 21:40	13/10/2020 06:23	12/10/2020 21:40	13/10/2020 06:23	8,70	219	1906,03	CHI
20201063550	GOIAS	GS12075645	GOIAS	12/10/2020 21:41	13/10/2020 04:26	12/10/2020 21:41	13/10/2020 04:26	6,73	118	794,66	CHI
20201063120	CATALAO	1990196965	CATALAO S2	12/10/2020 21:42	13/10/2020 11:28	12/10/2020 21:42	13/10/2020 11:28	13,76	1	13,76	CHI
20201066282	PARAUNA	PU12273594	PARAUNA	12/10/2020 21:45	13/10/2020 12:05	12/10/2020 21:45	13/10/2020 12:05	14,32	9	128,90	CHI

20201063167	CRISTALINA	1060064343	CRISTALINA S1	12/10/2020 21:48	12/10/2020 23:14	12/10/2020 21:48	12/10/2020 23:14	1,43	1	1,43	CHI
20201063169	URUACU	UR21232401	URUACU	12/10/2020 21:48	13/10/2020 02:16	12/10/2020 21:48	13/10/2020 02:16	4,46	11	49,07	CHI
20201063259	GOIAS	GS12037513	GOIAS	12/10/2020 21:49	13/10/2020 11:30	12/10/2020 21:49	13/10/2020 03:53	6,08	342	2078,50	CHI
20201063259	GOIAS	GS12037513	GOIAS	12/10/2020 21:49	13/10/2020 11:30	13/10/2020 04:48	13/10/2020 11:30	6,70	342	2291,02	CHI
20201063179	CATALAO	1990144941	CATALAO S2	12/10/2020 21:50	13/10/2020 11:33	12/10/2020 21:50	13/10/2020 11:33	13,72	1	13,72	CHI
20201064343	CORUMBA DE GOIAS	CB12377445	CORUMBA	12/10/2020 21:50	13/10/2020 09:31	12/10/2020 21:50	13/10/2020 09:31	11,68	21	245,20	CHI
20201064062	SAO JOAO DA PARAUNA	RP12076381RE	FIRMINOPOLIS S2	12/10/2020 21:51	13/10/2020 13:19	12/10/2020 21:51	13/10/2020 13:19	15,45	33	509,98	CHI
20201064062	AURILANDIA	RP12076381RE	FIRMINOPOLIS S2	12/10/2020 21:51	13/10/2020 13:19	12/10/2020 21:51	13/10/2020 13:19	15,45	4	61,82	CHI
20201064079	BOM JARDIM DE GOIAS	PH12193387	PIRANHAS	12/10/2020 21:53	13/10/2020 07:37	12/10/2020 21:53	13/10/2020 07:37	9,73	3	29,19	CHI
20201064079	PIRANHAS	PH12193387	PIRANHAS	12/10/2020 21:53	13/10/2020 07:37	12/10/2020 21:53	13/10/2020 07:37	9,73	5	48,65	CHI
20201063236	JESUPOLIS	031604128	SAO FRANCISCO DE GOIAS	12/10/2020 21:54	13/10/2020 11:03	12/10/2020 21:59	12/10/2020 22:04	0,08	980	81,39	CHI
20201063236	PETROLINA DE GOIAS	031604128	SAO FRANCISCO DE GOIAS	12/10/2020 21:54	13/10/2020 11:03	12/10/2020 21:59	12/10/2020 22:04	0,08	1	0,08	CHI
20201063236	SAO FRANCISCO DE GOIAS	031604128	SAO FRANCISCO DE GOIAS	12/10/2020 21:54	13/10/2020 11:03	12/10/2020 21:59	12/10/2020 22:04	0,08	1	0,08	CHI
20201063236	JESUPOLIS	031604128	SAO FRANCISCO DE GOIAS	12/10/2020 21:54	13/10/2020 11:03	12/10/2020 21:59	12/10/2020 22:04	0,08	156	12,96	CHI
20201063236	SAO FRANCISCO DE GOIAS	031604128	SAO FRANCISCO DE GOIAS	12/10/2020 21:54	13/10/2020 11:03	12/10/2020 21:59	12/10/2020 22:04	0,08	87	7,23	CHI
20201063236	JARAGUA	031604128	SAO FRANCISCO DE GOIAS	12/10/2020 21:54	13/10/2020 11:03	12/10/2020 21:59	12/10/2020 22:04	0,08	22	1,83	CHI
20201063236	PIRENOPOLIS	031604128	SAO FRANCISCO DE GOIAS	12/10/2020 21:54	13/10/2020 11:03	12/10/2020 21:55	13/10/2020 02:34	4,64	336	1559,60	CHI
20201063236	PETROLINA DE GOIAS	031604128	SAO FRANCISCO DE GOIAS	12/10/2020 21:54	13/10/2020 11:03	12/10/2020 21:55	13/10/2020 02:34	4,64	3	13,93	CHI
20201063236	SAO FRANCISCO DE GOIAS	031604128	SAO FRANCISCO DE GOIAS	12/10/2020 21:54	13/10/2020 11:03	12/10/2020 21:54	13/10/2020 03:37	5,73	25	143,19	CHI
20201063236	PIRENOPOLIS	031604128	SAO FRANCISCO DE GOIAS	12/10/2020 21:54	13/10/2020 11:03	12/10/2020 21:55	13/10/2020 04:48	6,88	1206	8291,25	CHI
20201063236	SAO FRANCISCO DE GOIAS	031604128	SAO FRANCISCO DE GOIAS	12/10/2020 21:54	13/10/2020 11:03	12/10/2020 21:55	13/10/2020 04:48	6,88	18	123,75	CHI
20201063236	PETROLINA DE GOIAS	031604128	SAO FRANCISCO DE GOIAS	12/10/2020 21:54	13/10/2020 11:03	12/10/2020 21:55	13/10/2020 04:48	6,88	13	89,38	CHI
20201063236	PIRENOPOLIS	031604128	SAO FRANCISCO DE GOIAS	12/10/2020 21:54	13/10/2020 11:03	12/10/2020 21:56	13/10/2020 04:48	6,86	1	6,86	CHI
20201063236	SAO FRANCISCO DE GOIAS	031604128	SAO FRANCISCO DE GOIAS	12/10/2020 21:54	13/10/2020 11:03	12/10/2020 21:56	13/10/2020 04:48	6,86	3	20,58	CHI
20201063236	PIRENOPOLIS	031604128	SAO FRANCISCO DE GOIAS	12/10/2020 21:54	13/10/2020 11:03	12/10/2020 21:54	13/10/2020 11:03	13,16	1	13,16	CHI
20201063236	PETROLINA DE GOIAS	031604128	SAO FRANCISCO DE GOIAS	12/10/2020 21:54	13/10/2020 11:03	12/10/2020 21:54	13/10/2020 11:03	13,16	3	39,49	CHI
20201063201	NOVA VENEZA	NV21272407	INHUMAS S1	12/10/2020 21:55	12/10/2020 23:42	12/10/2020 21:55	12/10/2020 23:42	1,77	3	5,32	CHI
20201063979	BURITI DE GOIAS	BS12215292	FIRMINOPOLIS S2	12/10/2020 21:55	13/10/2020 18:45	12/10/2020 21:55	13/10/2020 18:45	20,82	1	20,82	CHI
20201063344	PIRENOPOLIS	ZN21216908	COCALZINHO	12/10/2020 22:00	13/10/2020 23:58	12/10/2020 22:00	13/10/2020 23:58	25,96	1	25,96	CHI
20201063228	GOIANIA	10007515187	GOIANIA LESTE S3	12/10/2020 22:01	13/10/2020 01:24	12/10/2020 22:01	13/10/2020 01:24	3,37	1	3,37	CHI
20201059569	PALMEIRAS DE GOIAS	PL21085303	PALMEIRAS	12/10/2020 22:06	13/10/2020 10:25	12/10/2020 22:06	13/10/2020 10:25	12,30	2	24,60	CHI
20201063245	FORMOSA	FA21243896	ITUIQUIRA	12/10/2020 22:07	13/10/2020 11:49	12/10/2020 22:07	13/10/2020 11:49	13,70	1	13,70	CHI
20201063244	CAMPO LIMPO	AN21267805	NEROPOLIS S1	12/10/2020 22:07	12/10/2020 23:04	12/10/2020 22:07	12/10/2020 23:04	0,94	1	0,94	CHI
20201063261	PLANALTIMA	10031528986	PLANALTIMA	12/10/2020 22:13	13/10/2020 04:11	12/10/2020 22:13	13/10/2020 04:11	5,96	1	5,96	CHI
20201063264	UIRAPURU	UP11243370	SANTA TEREZINHA	12/10/2020 22:15	13/10/2020 06:34	12/10/2020 22:15	13/10/2020 06:34	8,32	88	731,84	CHI
20201063345	PIRENOPOLIS	PV12244370	COCALZINHO	12/10/2020 22:15	14/10/2020 11:06	12/10/2020 22:15	14/10/2020 11:06	36,85	11	405,34	CHI
20201063271	SANTA FE DE GOIAS	2070007152	BRITANIA	12/10/2020 22:16	13/10/2020 13:30	12/10/2020 22:16	13/10/2020 13:30	15,23	1	15,23	CHI
20201065291	CATALAO	CT10212768	CATALAO S1	12/10/2020 22:16	13/10/2020 09:02	12/10/2020 22:16	13/10/2020 09:02	10,75	439	4720,96	CHI
20201065291	DISTRITO FEDERAL	CT10212768	CATALAO S1	12/10/2020 22:16	13/10/2020 09:02	12/10/2020 22:16	13/10/2020 09:02	10,75	1	10,75	CHI
20201065291	CAMPO ALEGRE DE GOIAS	CT10212768	CATALAO S1	12/10/2020 22:16	13/10/2020 09:02	12/10/2020 22:16	13/10/2020 09:02	10,75	2	21,51	CHI
20201063273	CACHOEIRA ALTA	CA12137736	CACHOEIRA ALTA	12/10/2020 22:17	13/10/2020 11:07	12/10/2020 22:17	13/10/2020 11:07	12,84	4	51,34	CHI
20201063284	ANAPOLIS	10005224029	ANAPOLIS UNIVERSITARIO S2	12/10/2020 22:19	13/10/2020 02:16	12/10/2020 22:19	13/10/2020 02:16	3,95	1	3,95	CHI
20201064021	CAMPINORTE	CR11003478	CAMPINORTE	12/10/2020 22:23	13/10/2020 13:34	12/10/2020 22:23	13/10/2020 13:34	15,17	90	1365,28	CHI
20201063336	CALDAS NOVAS	CN11103228	SERRA DE CALDAS	12/10/2020 22:25	12/10/2020 23:58	12/10/2020 22:25	12/10/2020 23:58	1,55	121	187,35	CHI
20201063294	ARACU	750012596	ARACU	12/10/2020 22:25	13/10/2020 07:24	12/10/2020 22:25	13/10/2020 07:24	8,97	1	8,97	CHI
20201063296	ANAPOLIS	20801336	ANAPOLIS UNIVERSITARIO S2	12/10/2020 22:26	13/10/2020 06:52	12/10/2020 22:26	13/10/2020 06:52	8,43	1	8,43	CHI
20201063299	SANCLERLANDIA	SC12259130	FIRMINOPOLIS S2	12/10/2020 22:27	14/10/2020 18:54	12/10/2020 22:27	14/10/2020 18:54	44,46	1	44,46	CHI
20201063300	CATALAO	1990208748	CATALAO S2	12/10/2020 22:27	13/10/2020 02:18	12/10/2020 22:27	13/10/2020 02:18	3,84	1	3,84	CHI
20201063302	CATALAO	10008393247	CATALAO S1	12/10/2020 22:28	13/10/2020 02:58	12/10/2020 22:28	13/10/2020 02:58	4,50	1	4,50	CHI
20201063445	CRIXAS	CX12102896	SERRA DO OURO	12/10/2020 22:29	13/10/2020 07:42	12/10/2020 22:29	13/10/2020 07:42	9,20	316	2907,73	CHI
20201063311	CATALAO	GD12064004	CATALAO S1	12/10/2020 22:31	13/10/2020 04:48	12/10/2020 22:31	13/10/2020 04:48	6,28	3	18,85	CHI
20201063311	GOIANDIRA	GD12064004	CATALAO S1	12/10/2020 22:31	13/10/2020 04:48	12/10/2020 22:31	13/10/2020 04:48	6,28	2	12,57	CHI
20201063318	CORUMBA DE GOIAS	CB21141563	CORUMBA	12/10/2020 22:33	13/10/2020 11:15	12/10/2020 22:33	13/10/2020 11:15	12,69	1	12,69	CHI
20201063324	CAMPO ALEGRE DE GOIAS	CM12333445RE	CAMPO ALEGRE DE GOIAS	12/10/2020 22:36	13/10/2020 01:47	12/10/2020 22:36	13/10/2020 01:47	3,17	57	180,60	CHI
20201063324	CATALAO	CM12333445RE	CAMPO ALEGRE DE GOIAS	12/10/2020 22:36	13/10/2020 01:47	12/10/2020 22:36	13/10/2020 01:47	3,17	18	57,03	CHI
20201063324	IPAMERI	CM12333445RE	CAMPO ALEGRE DE GOIAS	12/10/2020 22:36	13/10/2020 01:47	12/10/2020 22:36	13/10/2020 01:47	3,17	3	9,51	CHI
20201066707	CAMPINORTE	MQ12220618	MARA ROSA	12/10/2020 22:37	13/10/2020 11:20	12/10/2020 22:37	13/10/2020 11:20	12,71	3	38,12	CHI
20201066707	MARA ROSA	MQ12220618	MARA ROSA	12/10/2020 22:37	13/10/2020 11:20	12/10/2020 22:37	13/10/2020 11:20	12,71	4	50,83	CHI

20201063930	ITAPACI	IW12210233RE	ITAPACI	12/10/2020 22:38	13/10/2020 18:03	12/10/2020 22:38	13/10/2020 08:36	9,97	38	378,81	CHI
20201063930	ITAPACI	IW12210233RE	ITAPACI	12/10/2020 22:38	13/10/2020 18:03	12/10/2020 22:38	13/10/2020 18:03	19,41	75	1455,77	CHI
20201066271	CAIAPONIA	PY18011439TS	PALESTINA	12/10/2020 22:39	13/10/2020 11:33	12/10/2020 22:39	13/10/2020 11:33	12,90	93	1199,47	CHI
20201066271	PALESTINA DE GOIAS	PY18011439TS	PALESTINA	12/10/2020 22:39	13/10/2020 11:33	12/10/2020 22:39	13/10/2020 11:33	12,90	25	322,44	CHI
20201063346	IVOLANDIA	IV21259517	IPORA	12/10/2020 22:46	13/10/2020 20:34	12/10/2020 22:46	13/10/2020 20:34	21,79	1	21,79	CHI
20201063350	BONOPOLIS	BX12263014	SAO MIGUEL DO ARAGUAIA	12/10/2020 22:49	13/10/2020 10:31	12/10/2020 22:49	13/10/2020 10:31	11,69	1	11,69	CHI
20201063356	GOIANIA	11328794	ATLANTICO S2	12/10/2020 22:52	13/10/2020 02:18	12/10/2020 22:52	13/10/2020 02:18	3,42	1	3,42	CHI
20201063363	SANTA FE DE GOIAS	RN21232822	BRITANIA	12/10/2020 22:54	13/10/2020 09:36	12/10/2020 22:54	13/10/2020 09:36	10,69	1	10,69	CHI
20201063367	ITAPURANGA	2780000229	ITAPURANGA	12/10/2020 22:57	13/10/2020 01:47	12/10/2020 22:57	13/10/2020 01:47	2,83	1	2,83	CHI
20201063393	CALDAS NOVAS	CN16418745	SERRA DE CALDAS	12/10/2020 23:02	13/10/2020 09:45	12/10/2020 23:02	12/10/2020 23:06	0,08	876	69,35	CHI
20201063393	CALDAS NOVAS	CN13086374	CALDAS NOVAS S2	12/10/2020 23:02	13/10/2020 09:45	13/10/2020 06:21	13/10/2020 09:34	3,22	1	3,22	CHI
20201063393	CALDAS NOVAS	CN10400778	SERRA DE CALDAS	12/10/2020 23:02	13/10/2020 09:45	12/10/2020 23:02	13/10/2020 09:45	10,72	1826	19578,78	CHI
20201064832	URUACU	UR12288349	URUACU	12/10/2020 23:04	13/10/2020 12:10	12/10/2020 23:04	13/10/2020 12:10	13,09	5	65,45	CHI
20201063382	PIRENOPOLIS	PV21230748	CORUMBA	12/10/2020 23:05	13/10/2020 11:56	12/10/2020 23:05	13/10/2020 11:56	12,85	1	12,85	CHI
20201065808	VILA PROPICIO	ZN12402010RE	COCALZINHO	12/10/2020 23:06	13/10/2020 16:00	12/10/2020 23:06	13/10/2020 16:00	16,89	1	16,89	CHI
20201065808	COCALZINHO DE GOIAS	ZN12402010RE	COCALZINHO	12/10/2020 23:06	13/10/2020 16:00	12/10/2020 23:06	13/10/2020 16:00	16,89	158	2668,49	CHI
20201063395	ITABERAI	IB11227433	ITABERAI S1	12/10/2020 23:08	13/10/2020 10:38	12/10/2020 23:08	13/10/2020 10:38	11,49	1	11,49	CHI
20201063402	NIQUELANDIA	NQ11136474	NIQUELANDIA SUBTRANSMISSAO	12/10/2020 23:10	13/10/2020 06:00	12/10/2020 23:10	13/10/2020 06:00	6,83	141	963,62	CHI
20201063403	SAO LUIS DE MONTES BELOS	500080781	SAO LUIZ DOS MONTES BELOS	12/10/2020 23:10	13/10/2020 08:49	12/10/2020 23:10	13/10/2020 08:49	9,64	1	9,64	CHI
20201064493	TURVANIA	TV12215375	FIRMINOPOLIS S1	12/10/2020 23:11	13/10/2020 10:03	12/10/2020 23:11	13/10/2020 10:03	10,86	4	43,44	CHI
20201063405	CALDAS NOVAS	CN12075111	SERRA DE CALDAS	12/10/2020 23:13	13/10/2020 09:57	12/10/2020 23:13	13/10/2020 09:57	10,73	21	225,34	CHI
20201063407	TRINDADE	TR12185497	GOYA S1	12/10/2020 23:14	12/10/2020 23:49	12/10/2020 23:14	12/10/2020 23:49	0,58	99	57,67	CHI
20201063413	BURITI DE GOIAS	BS21126054	FIRMINOPOLIS S2	12/10/2020 23:17	13/10/2020 17:13	12/10/2020 23:17	13/10/2020 17:13	17,92	1	17,92	CHI
20201063422	TROMBAS	TB12278518	PORANGATU	12/10/2020 23:21	13/10/2020 07:03	12/10/2020 23:21	13/10/2020 07:03	7,69	2	15,39	CHI
20201063540	CALDAS NOVAS	CN11054003	SERRA DE CALDAS	12/10/2020 23:33	13/10/2020 09:21	12/10/2020 23:33	13/10/2020 09:21	9,80	216	2115,96	CHI
20201064547	MONTES CLAROS DE GOIAS	ME12244013	IPORA	12/10/2020 23:34	14/10/2020 05:23	12/10/2020 23:34	14/10/2020 01:15	25,69	6	154,11	CHI
20201064547	MONTES CLAROS DE GOIAS	ME12244013	IPORA	12/10/2020 23:34	14/10/2020 05:23	12/10/2020 23:34	14/10/2020 05:23	29,82	4	119,26	CHI
20201063487	HIDROLANDIA	HD16401513	CEPAIGO S2	12/10/2020 23:40	13/10/2020 01:25	12/10/2020 23:43	12/10/2020 23:46	0,06	1442	81,31	CHI
20201063487	APARECIDA DE GOIANIA	00360434	CEPAIGO S2	12/10/2020 23:40	13/10/2020 01:25	12/10/2020 23:43	12/10/2020 23:48	0,09	1	0,09	CHI
20201063487	HIDROLANDIA	00360434	CEPAIGO S2	12/10/2020 23:40	13/10/2020 01:25	12/10/2020 23:40	13/10/2020 01:18	1,63	2	3,26	CHI
20201063487	APARECIDA DE GOIANIA	00360434	CEPAIGO S2	12/10/2020 23:40	13/10/2020 01:25	12/10/2020 23:40	13/10/2020 01:18	1,63	4	6,52	CHI
20201063487	HIDROLANDIA	00360434	CEPAIGO S2	12/10/2020 23:40	13/10/2020 01:25	12/10/2020 23:40	13/10/2020 01:18	1,64	12	19,63	CHI
20201063487	PIRACANJUBA	00360434	CEPAIGO S2	12/10/2020 23:40	13/10/2020 01:25	12/10/2020 23:43	13/10/2020 01:18	1,59	4	6,36	CHI
20201063487	PROFESSOR JAMIL SAFADY	00360434	CEPAIGO S2	12/10/2020 23:40	13/10/2020 01:25	12/10/2020 23:43	13/10/2020 01:18	1,59	1	1,59	CHI
20201063487	BELA VISTA DE GOIAS	00360434	CEPAIGO S2	12/10/2020 23:40	13/10/2020 01:25	12/10/2020 23:43	13/10/2020 01:18	1,59	9	14,31	CHI
20201063487	HIDROLANDIA	00360434	CEPAIGO S2	12/10/2020 23:40	13/10/2020 01:25	12/10/2020 23:43	13/10/2020 01:18	1,59	4470	7106,06	CHI
20201063487	HIDROLANDIA	00360434	CEPAIGO S2	12/10/2020 23:40	13/10/2020 01:25	12/10/2020 23:43	13/10/2020 01:18	1,59	896	1424,39	CHI
20201063487	HIDROLANDIA	HD10216316	CEPAIGO S2	12/10/2020 23:40	13/10/2020 01:25	12/10/2020 23:43	13/10/2020 01:25	1,71	599	1021,96	CHI
20201063487	ARAGOIANIA	HD10216316	CEPAIGO S2	12/10/2020 23:40	13/10/2020 01:25	12/10/2020 23:43	13/10/2020 01:25	1,71	16	27,30	CHI
20201063454	CALDAS NOVAS	CN12213938	SERRA DE CALDAS	12/10/2020 23:40	13/10/2020 08:21	12/10/2020 23:40	13/10/2020 08:21	8,67	29	251,40	CHI
20201063546	CALDAS NOVAS	CN12354085	SERRA DE CALDAS	12/10/2020 23:41	13/10/2020 07:33	12/10/2020 23:41	13/10/2020 07:33	7,85	242	1899,77	CHI
20201063461	MAURILANDIA	ML12209447	RIO DOS BOIS	12/10/2020 23:44	13/10/2020 00:06	12/10/2020 23:44	13/10/2020 00:06	0,36	211	75,67	CHI
20201063463	GOIANIA	15839072	FERROVIARIO S1	12/10/2020 23:45	13/10/2020 01:07	12/10/2020 23:45	13/10/2020 01:07	1,36	1	1,36	CHI
202010189409	NIQUELANDIA	10007532910	NIQUELANDIA SUBTRANSMISSAO	12/10/2020 23:47	13/10/2020 11:07	12/10/2020 23:47	13/10/2020 11:07	11,34	1	11,34	CHI
20201064017	CAMPOS VERDES	SG12318464	SANTA TEREZINHA	12/10/2020 23:48	13/10/2020 15:28	12/10/2020 23:48	13/10/2020 15:28	15,66	14	219,24	CHI
20201064017	UIRAPURU	SG12318464	SANTA TEREZINHA	12/10/2020 23:48	13/10/2020 15:28	12/10/2020 23:48	13/10/2020 15:28	15,66	13	203,58	CHI
20201064017	SANTA TEREZINHA DE GOIAS	SG12318464	SANTA TEREZINHA	12/10/2020 23:48	13/10/2020 15:28	12/10/2020 23:48	13/10/2020 15:28	15,66	32	501,11	CHI
20201063502	NEROPOLIS	NR11271870	NEROPOLIS S2	12/10/2020 23:57	13/10/2020 01:27	12/10/2020 23:57	13/10/2020 01:27	1,49	35	52,24	CHI
20201063509	GOIANIA	GN11199142	ATLANTICO S3	12/10/2020 23:59	13/10/2020 03:50	12/10/2020 23:59	13/10/2020 03:50	3,84	65	249,74	CHI
20201063510	GOIANIA	GN12207446	ATLANTICO S1	13/10/2020 00:00	13/10/2020 01:03	13/10/2020 00:00	13/10/2020 01:03	1,03	145	150,07	CHI
20201065850	CAMPOS VERDES	VD11049792	SANTA TEREZINHA	13/10/2020 00:05	13/10/2020 16:48	13/10/2020 00:05	13/10/2020 16:48	16,71	137	2289,76	CHI
20201063520	CALDAS NOVAS	CN10409262	CALDAS NOVAS S2	13/10/2020 00:07	13/10/2020 04:39	13/10/2020 00:07	13/10/2020 02:38	2,52	385	968,81	CHI
20201063520	CALDAS NOVAS	CN12051666	CALDAS NOVAS S2	13/10/2020 00:07	13/10/2020 04:39	13/10/2020 00:07	13/10/2020 02:59	2,86	928	2653,82	CHI
20201063520	PIRACANJUBA	CN12200059LD	CALDAS NOVAS S2	13/10/2020 00:07	13/10/2020 04:39	13/10/2020 00:07	13/10/2020 03:15	3,13	2	6,26	CHI
20201063520	CALDAS NOVAS	CN12200059LD	CALDAS NOVAS S2	13/10/2020 00:07	13/10/2020 04:39	13/10/2020 00:07	13/10/2020 03:15	3,13	214	669,94	CHI
20201063520	CALDAS NOVAS	CN10409262	CALDAS NOVAS S2	13/10/2020 00:07	13/10/2020 04:39	13/10/2020 00:07	13/10/2020 04:05	0,09	1527	136,16	CHI
20201063520	PIRACANJUBA	CN10409262	CALDAS NOVAS S2	13/10/2020 00:07	13/10/2020 04:39	13/10/2020 04:00	13/10/2020 04:05	0,09	2	0,18	CHI
20201063520	CALDAS NOVAS	CN10409262	CALDAS NOVAS S2	13/10/2020 00:07	13/10/2020 04:39	13/10/2020 00:07	13/10/2020 04:39	4,53	83	376,27	CHI

20201063519	GOIANIA	GN12150255	GOYA S2	13/10/2020 00:07	13/10/2020 02:09	13/10/2020 00:07	13/10/2020 02:09	2,02	182	367,13	CHI
20201063524	CATALAO	10009695689	CATALAO S2	13/10/2020 00:14	13/10/2020 10:17	13/10/2020 00:14	13/10/2020 10:17	10,05	1	10,05	CHI
20201064146	IPAMERI	IP11375978	IPAMERI	13/10/2020 00:15	13/10/2020 07:57	13/10/2020 00:15	13/10/2020 07:57	7,70	32	246,30	CHI
20201064222	TEREZOPOLIS DE GOIAS	TJ21381463	DAIA S2	13/10/2020 00:19	13/10/2020 09:58	13/10/2020 00:19	13/10/2020 09:58	9,65	1	9,65	CHI
20201063537	SAO MIGUEL DO ARAGUAIA	SM12143671	SAO MIGUEL DO ARAGUAIA	13/10/2020 00:23	13/10/2020 02:16	13/10/2020 00:23	13/10/2020 02:16	1,88	275	516,54	CHI
20201063728	CRISTIANOPOLIS	CF16414886	CRISTIANOPOLIS	13/10/2020 00:23	13/10/2020 03:05	13/10/2020 00:23	13/10/2020 00:26	0,05	434	21,82	CHI
20201063728	CRISTIANOPOLIS	CF10409097	CRISTIANOPOLIS	13/10/2020 00:23	13/10/2020 03:05	13/10/2020 00:23	13/10/2020 00:26	0,06	103	5,92	CHI
20201063728	PIRACANJUBA	CF10409097	CRISTIANOPOLIS	13/10/2020 00:23	13/10/2020 03:05	13/10/2020 00:23	13/10/2020 00:26	0,06	162	9,31	CHI
20201063728	PIRACANJUBA	CF16429520	CRISTIANOPOLIS	13/10/2020 00:23	13/10/2020 03:05	13/10/2020 00:37	13/10/2020 00:44	0,12	162	19,80	CHI
20201063728	CRISTIANOPOLIS	CF16429520	CRISTIANOPOLIS	13/10/2020 00:23	13/10/2020 03:05	13/10/2020 00:37	13/10/2020 00:44	0,12	242	29,58	CHI
20201063728	CRISTIANOPOLIS	CF10429530	CRISTIANOPOLIS	13/10/2020 00:23	13/10/2020 03:05	13/10/2020 00:46	13/10/2020 03:01	2,25	242	544,03	CHI
20201063728	PIRACANJUBA	CF10429530	CRISTIANOPOLIS	13/10/2020 00:23	13/10/2020 03:05	13/10/2020 00:46	13/10/2020 03:01	2,25	162	364,19	CHI
20201063728	CRISTIANOPOLIS	CF16414886	CRISTIANOPOLIS	13/10/2020 00:23	13/10/2020 03:05	13/10/2020 00:37	13/10/2020 03:05	2,47	434	1072,34	CHI
20201063541	ITUMBIARA	690385146	PARANAIBA	13/10/2020 00:26	13/10/2020 01:04	13/10/2020 00:26	13/10/2020 01:04	0,63	1	0,63	CHI
20201063561	GOIANIA	GN12000676	CAMPINAS S1	13/10/2020 00:27	13/10/2020 02:29	13/10/2020 00:27	13/10/2020 02:29	2,03	285	578,39	CHI
20201063659	ANICUNS	AC10417170	ANICUNS	13/10/2020 00:27	13/10/2020 10:18	13/10/2020 00:27	13/10/2020 00:33	0,10	2012	196,73	CHI
20201063659	ANICUNS	AC16410180	ANICUNS	13/10/2020 00:27	13/10/2020 10:18	13/10/2020 00:27	13/10/2020 10:18	9,85	1233	12139,23	CHI
20201063659	TURVANIA	AC16410180	ANICUNS	13/10/2020 00:27	13/10/2020 10:18	13/10/2020 00:27	13/10/2020 10:18	9,85	3	29,54	CHI
20201063562	SANTO ANTONIO DO DESCOBERTO	2210007842	AGUAS LINDAS DE GOIAS S2	13/10/2020 00:43	13/10/2020 07:06	13/10/2020 00:43	13/10/2020 07:06	6,37	1	6,37	CHI
20201063567	IPAMERI	IP12012942	IPAMERI	13/10/2020 00:48	13/10/2020 07:15	13/10/2020 00:48	13/10/2020 07:15	6,44	59	380,04	CHI
20201064830	PALMINOPOLIS	PP11000037	PALMEIRAS	13/10/2020 00:49	13/10/2020 17:42	13/10/2020 00:49	13/10/2020 17:42	16,87	191	3223,02	CHI
20201063574	BRITANIA	BT12060643	BRITANIA	13/10/2020 00:56	13/10/2020 08:08	13/10/2020 00:56	13/10/2020 08:08	7,19	10	71,94	CHI
20201063575	CALDAS NOVAS	760196291	SERRA DE CALDAS	13/10/2020 00:56	13/10/2020 07:51	13/10/2020 00:56	13/10/2020 07:51	6,90	1	6,90	CHI
20201064076	APARECIDA DE GOIANIA	AP12193733	INDEPENDENCIA S1	13/10/2020 01:02	13/10/2020 07:51	13/10/2020 01:02	13/10/2020 07:51	6,81	155	1056,28	CHI
20201064238	IPAMERI	IP12068500	CRISTALINA S2	13/10/2020 01:02	13/10/2020 11:35	13/10/2020 01:02	13/10/2020 11:35	10,55	65	685,59	CHI
20201063682	HIDROLANDIA	03440264	ANHANGUERA	13/10/2020 01:08	13/10/2020 09:45	13/10/2020 01:08	13/10/2020 01:11	0,05	2140	117,11	CHI
20201063682	APARECIDA DE GOIANIA	03440264	ANHANGUERA	13/10/2020 01:08	13/10/2020 09:45	13/10/2020 01:08	13/10/2020 01:11	0,05	3869	211,72	CHI
20201063682	APARECIDA DE GOIANIA	03440264	ANHANGUERA	13/10/2020 01:08	13/10/2020 09:45	13/10/2020 01:08	13/10/2020 01:11	0,06	2075	119,89	CHI
20201063682	APARECIDA DE GOIANIA	03440264	ANHANGUERA	13/10/2020 01:08	13/10/2020 09:45	13/10/2020 01:08	13/10/2020 01:12	0,07	266	19,58	CHI
20201063682	APARECIDA DE GOIANIA	AP16401562	ANHANGUERA	13/10/2020 01:08	13/10/2020 09:45	13/10/2020 07:52	13/10/2020 07:59	0,10	266	27,86	CHI
20201063682	APARECIDA DE GOIANIA	03440264	ANHANGUERA	13/10/2020 01:08	13/10/2020 09:45	13/10/2020 01:08	13/10/2020 09:45	8,62	1944	16750,26	CHI
20201067545	APARECIDA DE GOIANIA	AP11167877	ANHANGUERA	13/10/2020 01:08	13/10/2020 13:43	13/10/2020 01:08	13/10/2020 13:43	12,57	167	2100,02	CHI
20201063598	APARECIDA DE GOIANIA	200024140	INDEPENDENCIA S1	13/10/2020 01:11	13/10/2020 08:09	13/10/2020 01:11	13/10/2020 08:09	6,96	1	6,96	CHI
20201063610	NOVA CRIXAS	NA12035650	NOVA CRIXAS	13/10/2020 01:16	13/10/2020 09:06	13/10/2020 01:16	13/10/2020 09:06	7,82	24	187,69	CHI
20201063610	MUNDO NOVO DE GOIAS	NA12035650	NOVA CRIXAS	13/10/2020 01:16	13/10/2020 09:06	13/10/2020 01:16	13/10/2020 09:06	7,82	7	54,74	CHI
20201063625	GOIANIA	GN11131446	ATLANTICO S3	13/10/2020 01:19	13/10/2020 03:10	13/10/2020 01:19	13/10/2020 03:10	1,84	88	161,48	CHI
20201063677	GOIANIA	GN11042206	ATLANTICO S3	13/10/2020 01:21	13/10/2020 03:23	13/10/2020 01:21	13/10/2020 03:23	2,02	130	262,71	CHI
20201063641	APARECIDA DE GOIANIA	200012680	INDEPENDENCIA S1	13/10/2020 01:22	13/10/2020 09:20	13/10/2020 01:22	13/10/2020 09:20	7,96	1	7,96	CHI
20201063652	APARECIDA DE GOIANIA	10020410857	INDEPENDENCIA S2	13/10/2020 01:26	13/10/2020 07:53	13/10/2020 01:26	13/10/2020 07:53	6,43	1	6,43	CHI
20201063655	ITUMBIARA	IT12221945	CACHOEIRA DOURADA	13/10/2020 01:27	13/10/2020 03:35	13/10/2020 01:27	13/10/2020 03:35	2,13	1	2,13	CHI
20201063658	GOIANIA	12565933	ATLANTICO S2	13/10/2020 01:28	13/10/2020 15:48	13/10/2020 01:28	13/10/2020 15:48	14,32	1	14,32	CHI
20201063668	HIDROLANDIA	HD21291462	CEPAIGO S2	13/10/2020 01:33	13/10/2020 09:03	13/10/2020 01:33	13/10/2020 09:03	7,50	1	7,50	CHI
20201063672	CRISTALINA	KR10414292	CRISTALINA S1	13/10/2020 01:33	13/10/2020 19:52	13/10/2020 01:33	13/10/2020 08:07	4,55	28	127,26	CHI
20201063672	CRISTALINA	KR10395376	CRISTALINA S1	13/10/2020 01:33	13/10/2020 19:52	13/10/2020 01:33	13/10/2020 08:09	6,61	33	218,14	CHI
20201063672	IPAMERI	KR10395376	CRISTALINA S1	13/10/2020 01:33	13/10/2020 19:52	13/10/2020 01:33	13/10/2020 08:09	6,61	6	39,66	CHI
20201063672	IPAMERI	KR10414292	CRISTALINA S1	13/10/2020 01:33	13/10/2020 19:52	13/10/2020 09:02	13/10/2020 09:57	0,91	6	5,45	CHI
20201063672	CRISTALINA	KR10414292	CRISTALINA S1	13/10/2020 01:33	13/10/2020 19:52	13/10/2020 09:02	13/10/2020 09:57	0,91	61	55,39	CHI
20201063672	CRISTALINA	KR10414292	CRISTALINA S1	13/10/2020 01:33	13/10/2020 19:52	13/10/2020 09:59	13/10/2020 10:05	0,09	61	5,37	CHI
20201063672	IPAMERI	KR10414292	CRISTALINA S1	13/10/2020 01:33	13/10/2020 19:52	13/10/2020 09:59	13/10/2020 10:05	0,09	6	0,53	CHI
20201063672	IPAMERI	KR10414292	CRISTALINA S1	13/10/2020 01:33	13/10/2020 19:52	13/10/2020 10:11	13/10/2020 10:27	0,27	6	1,59	CHI
20201063672	CRISTALINA	KR10414292	CRISTALINA S1	13/10/2020 01:33	13/10/2020 19:52	13/10/2020 10:11	13/10/2020 10:27	0,27	61	16,17	CHI
20201063672	CRISTALINA	KR10414292	CRISTALINA S1	13/10/2020 01:33	13/10/2020 19:52	13/10/2020 10:28	13/10/2020 13:34	3,09	48	148,51	CHI
20201063672	IPAMERI	KR10414292	CRISTALINA S1	13/10/2020 01:33	13/10/2020 19:52	13/10/2020 10:28	13/10/2020 13:34	3,09	6	18,56	CHI
20201063672	CRISTALINA	KR12246115LD	CRISTALINA S1	13/10/2020 01:33	13/10/2020 19:52	13/10/2020 01:33	13/10/2020 14:18	12,75	236	3009,85	CHI
20201063672	CRISTALINA	KR12415198LD	CRISTALINA S1	13/10/2020 01:33	13/10/2020 19:52	13/10/2020 10:28	13/10/2020 19:11	8,72	3	26,17	CHI
20201063672	CRISTALINA	KR12415601LD	CRISTALINA S1	13/10/2020 01:33	13/10/2020 19:52	13/10/2020 10:28	13/10/2020 19:52	9,41	10	94,06	CHI
20201063676	ANAPOLIS	20158671	JUNDIAI S1	13/10/2020 01:40	13/10/2020 10:05	13/10/2020 01:40	13/10/2020 10:05	8,41	1	8,41	CHI
20201063687	PIRACANJUBA	PJ21010881	BELA VISTA S1	13/10/2020 01:53	13/10/2020 14:22	13/10/2020 01:53	13/10/2020 14:22	12,47	1	12,47	CHI

20201063630	ITUMBIARA	IT11000064	PARANAIBA	13/10/2020 01:54	13/10/2020 02:05	13/10/2020 01:54	13/10/2020 02:05	0,17	145	24,93	CHI
20201063969	GUARINOS	GF12164878	SANTA TEREZINHA	13/10/2020 01:55	13/10/2020 10:29	13/10/2020 01:55	13/10/2020 10:29	8,56	58	496,40	CHI
20201064123	GOIANIA	AP11180185	INDEPENDENCIA S2	13/10/2020 02:00	13/10/2020 11:49	13/10/2020 02:00	13/10/2020 11:49	9,81	52	510,21	CHI
20201063693	MORRINHOS	150036747	MORRINHOS	13/10/2020 02:01	13/10/2020 04:10	13/10/2020 02:01	13/10/2020 04:10	2,14	1	2,14	CHI
20201063772	APARECIDA DE GOIANIA	AP11207714	INDEPENDENCIA S2	13/10/2020 02:02	13/10/2020 10:57	13/10/2020 02:02	13/10/2020 10:57	8,91	323	2878,74	CHI
20201063695	URUTAI	IP12300933	IPAMERI	13/10/2020 02:08	13/10/2020 07:13	13/10/2020 02:08	13/10/2020 07:13	5,07	3	15,22	CHI
20201063695	IPAMERI	IP12300933	IPAMERI	13/10/2020 02:08	13/10/2020 07:13	13/10/2020 02:08	13/10/2020 07:13	5,07	57	289,21	CHI
20201063983	HEITORAI	HE12250700	ITAPURANGA	13/10/2020 02:14	13/10/2020 11:08	13/10/2020 02:14	13/10/2020 11:08	8,90	6	53,38	CHI
20201063983	GOIAS	HE12250700	ITAPURANGA	13/10/2020 02:14	13/10/2020 11:08	13/10/2020 02:14	13/10/2020 11:08	8,90	9	80,07	CHI
20201064431	PIRES DO RIO	PR12000044RE	PIRES DO RIO S1	13/10/2020 02:20	13/10/2020 19:30	13/10/2020 02:20	13/10/2020 09:10	6,82	1	6,82	CHI
20201064431	PIRES DO RIO	PR12000044RE	PIRES DO RIO S1	13/10/2020 02:20	13/10/2020 19:30	13/10/2020 02:20	13/10/2020 19:15	16,91	10	169,06	CHI
20201064431	ORIZONA	PR12000044RE	PIRES DO RIO S1	13/10/2020 02:20	13/10/2020 19:30	13/10/2020 02:20	13/10/2020 19:15	16,91	11	185,97	CHI
20201064431	PIRES DO RIO	PR12000044RE	PIRES DO RIO S1	13/10/2020 02:20	13/10/2020 19:30	13/10/2020 02:20	13/10/2020 19:30	17,16	68	1166,65	CHI
20201063702	CATALAO	CT1267023	CATALAO S1	13/10/2020 02:26	13/10/2020 07:53	13/10/2020 02:26	13/10/2020 07:53	5,45	1	5,45	CHI
20201067661	JESUPOLIS	SF12066036	SAO FRANCISCO DE GOIAS	13/10/2020 02:46	13/10/2020 12:44	13/10/2020 02:46	13/10/2020 12:44	9,96	16	159,37	CHI
20201065513	MOSSAMEDES	MD12121049	ITABERAIA S2	13/10/2020 02:52	13/10/2020 11:36	13/10/2020 02:52	13/10/2020 11:36	8,73	25	218,22	CHI
20201063731	ITUMBIARA	BG12384546	ITUMBIARA VELHA S2	13/10/2020 03:03	13/10/2020 06:08	13/10/2020 03:03	13/10/2020 06:08	3,08	11	33,84	CHI
20201064672	APARECIDA DE GOIANIA	AP11004868	ATLANTICO S1	13/10/2020 03:05	13/10/2020 08:48	13/10/2020 03:05	13/10/2020 08:48	5,70	140	798,31	CHI
20201063794	BELA VISTA DE GOIAS	BV32051409	BELA VISTA S2	13/10/2020 03:13	13/10/2020 22:43	13/10/2020 03:13	13/10/2020 22:43	19,50	305	5947,33	CHI
20201063743	SILVANIA	SV12403479	VIANOPOLIS	13/10/2020 03:16	13/10/2020 15:34	13/10/2020 03:16	13/10/2020 15:34	12,30	3	36,90	CHI
20201064812	APARECIDA DE GOIANIA	AP12000070	INDEPENDENCIA S2	13/10/2020 03:16	13/10/2020 09:07	13/10/2020 03:16	13/10/2020 09:07	5,84	594	3466,98	CHI
20201064519	GOIANIA	GN12000703	REAL S2	13/10/2020 03:23	13/10/2020 08:32	13/10/2020 03:23	13/10/2020 08:32	5,14	70	360,07	CHI
20201063752	APARECIDA DE GOIANIA	10001083889	REAL S1	13/10/2020 03:27	13/10/2020 07:52	13/10/2020 03:27	13/10/2020 07:52	4,41	1	4,41	CHI
20201063753	GOIANIA	GN11363116	GOIANIA LESTE S2	13/10/2020 03:28	13/10/2020 08:45	13/10/2020 03:28	13/10/2020 08:45	5,28	126	665,56	CHI
20201063757	JARAGUA	70072670	JARAGUA	13/10/2020 03:31	14/10/2020 12:20	13/10/2020 03:31	14/10/2020 12:20	32,82	1	32,82	CHI
20201063762	GOIANIA	10794300	CARAJAS S1	13/10/2020 03:34	13/10/2020 08:55	13/10/2020 03:34	13/10/2020 08:55	5,34	1	5,34	CHI
20201064200	PIRACANJUBA	PJ11263691	PIRACANJUBA	13/10/2020 03:35	13/10/2020 08:00	13/10/2020 03:35	13/10/2020 08:00	4,41	90	396,77	CHI
20201063767	GOIANIA	10857473	GOIANIA LESTE S1	13/10/2020 03:35	13/10/2020 07:43	13/10/2020 03:35	13/10/2020 07:43	4,14	1	4,14	CHI
20201063788	GOIANIA	GN16413794	ATLANTICO S2	13/10/2020 03:42	13/10/2020 10:20	13/10/2020 03:42	13/10/2020 03:51	0,15	864	128,16	CHI
20201063788	GOIANIA	GN16413794	ATLANTICO S2	13/10/2020 03:42	13/10/2020 10:20	13/10/2020 03:42	13/10/2020 03:51	0,15	790	119,60	CHI
20201063788	GOIANIA	GN16413782	ATLANTICO S2	13/10/2020 03:42	13/10/2020 10:20	13/10/2020 04:36	13/10/2020 10:20	5,73	850	4866,96	CHI
20201063779	GOIANIA	GN11199142	ATLANTICO S3	13/10/2020 03:52	13/10/2020 09:34	13/10/2020 03:52	13/10/2020 09:34	5,70	65	370,23	CHI
20201063781	APARECIDA DE GOIANIA	AP11384476	ANHANGUERA	13/10/2020 03:54	13/10/2020 07:01	13/10/2020 03:54	13/10/2020 07:01	3,11	44	136,85	CHI
20201064424	CATALAO	CT12333638RE	CATALAO S1	13/10/2020 03:58	13/10/2020 09:31	13/10/2020 03:58	13/10/2020 09:31	5,55	64	354,92	CHI
20201063790	APARECIDA DE GOIANIA	200298264	INDEPENDENCIA S2	13/10/2020 03:59	13/10/2020 08:50	13/10/2020 03:59	13/10/2020 08:50	4,85	1	4,85	CHI
20201063842	PETROLINA DE GOIAS	PG12216919	PETROLINA	13/10/2020 04:02	13/10/2020 11:37	13/10/2020 04:02	13/10/2020 11:37	7,59	8	60,72	CHI
20201063842	SAO FRANCISCO DE GOIAS	PG12216919	PETROLINA	13/10/2020 04:02	13/10/2020 11:37	13/10/2020 04:02	13/10/2020 11:37	7,59	1	7,59	CHI
20201063800	NIQUELANDIA	NQ11353585	NIQUELANDIA SUBTRANSMISSAO	13/10/2020 04:06	13/10/2020 05:00	13/10/2020 04:06	13/10/2020 05:00	0,90	100	89,67	CHI
20201065264	PIRES DO RIO	OZ12402559	PIRES DO RIO S2	13/10/2020 04:07	13/10/2020 17:07	13/10/2020 04:07	13/10/2020 17:07	12,99	2	25,99	CHI
20201065264	ORIZONA	OZ12402559	PIRES DO RIO S2	13/10/2020 04:07	13/10/2020 17:07	13/10/2020 04:07	13/10/2020 17:07	12,99	3	38,98	CHI
20201063807	GOIANIA	10804559	GOIANIA LESTE S2	13/10/2020 04:12	13/10/2020 06:23	13/10/2020 04:12	13/10/2020 06:23	2,17	1	2,17	CHI
20201063892	SILVANIA	SV12285478	VIANOPOLIS	13/10/2020 04:12	13/10/2020 08:55	13/10/2020 04:12	13/10/2020 08:55	4,71	77	362,48	CHI
20201063814	ORIZONA	OZ12115295	PIRES DO RIO S2	13/10/2020 04:17	13/10/2020 10:32	13/10/2020 04:17	13/10/2020 10:32	6,24	22	137,24	CHI
20201064910	CORUMBA DE GOIAS	CB12382397	CORUMBA	13/10/2020 04:24	13/10/2020 09:59	13/10/2020 04:24	13/10/2020 09:59	5,58	33	184,23	CHI
20201063960	PIRACANJUBA	PJ12212173	PIRACANJUBA	13/10/2020 04:24	13/10/2020 08:54	13/10/2020 04:24	13/10/2020 08:54	4,49	21	94,39	CHI
20201063820	GOIANIA	10008857014	INDEPENDENCIA S2	13/10/2020 04:25	13/10/2020 08:48	13/10/2020 04:25	13/10/2020 08:48	4,38	1	4,38	CHI
20201063840	GOIANIA	GN10403963	XAVANTES	13/10/2020 04:27	13/10/2020 10:08	13/10/2020 04:27	13/10/2020 10:08	5,69	1073	6100,60	CHI
20201063823	GOIANIA	10019907581	GOIANIA LESTE S2	13/10/2020 04:28	13/10/2020 10:05	13/10/2020 04:28	13/10/2020 10:05	5,62	1	5,62	CHI
20201064125	IPAMERI	IP12041051	IPAMERI	13/10/2020 04:28	13/10/2020 06:45	13/10/2020 04:28	13/10/2020 06:45	2,27	7	15,92	CHI
20201065325	GOIANIA	GN11001503	GOIANIA LESTE S1	13/10/2020 04:29	13/10/2020 09:07	13/10/2020 04:29	13/10/2020 09:07	4,62	31	143,24	CHI
20201063828	ANAPOLIS	AN11273391	ANAPOLIS UNIVERSITARIO S2	13/10/2020 04:30	13/10/2020 08:11	13/10/2020 04:30	13/10/2020 08:11	3,68	57	209,89	CHI
20201066129	COCALZINHO DE GOIAS	PV12185533	COCALZINHO	13/10/2020 04:32	13/10/2020 17:37	13/10/2020 04:32	13/10/2020 17:37	13,07	1	13,07	CHI
20201066129	PIRENOPOLIS	PV12185533	COCALZINHO	13/10/2020 04:32	13/10/2020 17:37	13/10/2020 04:32	13/10/2020 17:37	13,07	19	248,41	CHI
20201063830	GOIANIA	GN11241439	GOIANIA LESTE S3	13/10/2020 04:32	13/10/2020 11:46	13/10/2020 04:32	13/10/2020 11:46	7,22	62	447,55	CHI
20201066827	NIQUELANDIA	NQ12359872	BARRO ALTO	13/10/2020 04:33	13/10/2020 12:54	13/10/2020 04:33	13/10/2020 12:54	8,34	15	125,11	CHI
20201063834	SILVANIA	SV21339212	VIANOPOLIS	13/10/2020 04:35	13/10/2020 07:45	13/10/2020 04:35	13/10/2020 07:45	3,16	1	3,16	CHI
20201064280	NOVA GLORIA	IW12078035	ITAPACI	13/10/2020 04:36	13/10/2020 07:53	13/10/2020 04:36	13/10/2020 07:53	3,28	1	3,28	CHI
20201064280	ITAPACI	IW12078035	ITAPACI	13/10/2020 04:36	13/10/2020 07:53	13/10/2020 04:36	13/10/2020 07:53	3,28	21	68,87	CHI

20201063838	APARECIDA DE GOIANIA	200139435	INDEPENDENCIA S1	13/10/2020 04:36	13/10/2020 09:03	13/10/2020 04:36	13/10/2020 09:03	4,44	1	4,44	CHI
20201063841	GOIANIA	10612208	AEROPORTO S2	13/10/2020 04:39	13/10/2020 08:27	13/10/2020 04:39	13/10/2020 08:27	3,79	1	3,79	CHI
20201063843	GOIANIA	10327423	CAMPINAS S1	13/10/2020 04:40	13/10/2020 12:19	13/10/2020 04:40	13/10/2020 12:19	7,64	1	7,64	CHI
20201063844	GOIANIA	10013237231	REAL S2	13/10/2020 04:41	13/10/2020 15:48	13/10/2020 04:41	13/10/2020 15:48	11,12	1	11,12	CHI
20201068286	GOIANIA	AP11134258	ATLANTICO S1	13/10/2020 04:43	13/10/2020 21:09	13/10/2020 04:43	13/10/2020 21:09	16,42	92	1510,36	CHI
20201063847	PIRES DO RIO	PR12000071	PIRES DO RIO S1	13/10/2020 04:44	13/10/2020 07:45	13/10/2020 04:44	13/10/2020 07:45	3,01	20	60,27	CHI
20201064481	GOIANIA	GN12340461	XAVANTES	13/10/2020 04:47	13/10/2020 09:54	13/10/2020 04:47	13/10/2020 09:54	5,13	84	430,57	CHI
20201063869	GOIANIA	00610284	CAMPINAS S2	13/10/2020 04:49	13/10/2020 09:25	13/10/2020 04:49	13/10/2020 04:53	0,07	3033	213,15	CHI
20201063869	GOIANIA	00610284	CAMPINAS S2	13/10/2020 04:49	13/10/2020 09:25	13/10/2020 04:49	13/10/2020 04:54	0,09	111	9,90	CHI
20201063869	GOIANIA	00610284	CAMPINAS S2	13/10/2020 04:49	13/10/2020 09:25	13/10/2020 04:49	13/10/2020 04:54	0,10	1507	145,26	CHI
20201063869	GOIANIA	00610284	CAMPINAS S2	13/10/2020 04:49	13/10/2020 09:25	13/10/2020 04:49	13/10/2020 04:55	0,11	1312	139,58	CHI
20201063869	GOIANIA	00610284	CAMPINAS S2	13/10/2020 04:49	13/10/2020 09:25	13/10/2020 04:49	13/10/2020 04:56	0,11	1857	210,98	CHI
20201063869	GOIANIA	GN16409443	CAMPINAS S2	13/10/2020 04:49	13/10/2020 09:25	13/10/2020 04:57	13/10/2020 06:40	1,72	1857	3188,88	CHI
20201063869	GOIANIA	GN16409443	CAMPINAS S2	13/10/2020 04:49	13/10/2020 09:25	13/10/2020 06:43	13/10/2020 07:42	0,98	952	930,05	CHI
20201063869	GOIANIA	GN16409434	CAMPINAS S2	13/10/2020 04:49	13/10/2020 09:25	13/10/2020 06:43	13/10/2020 09:25	2,70	905	2447,77	CHI
20201063851	CRISTALINA	KR21168492	PAMPLONA	13/10/2020 04:50	13/10/2020 15:19	13/10/2020 04:50	13/10/2020 15:19	10,47	1	10,47	CHI
20201064000	GOIANIA	GN12049002	ATLANTICO S1	13/10/2020 04:51	13/10/2020 07:40	13/10/2020 04:51	13/10/2020 07:40	2,81	144	404,96	CHI
20201067655	SAO FRANCISCO DE GOIAS	SF12090413	SAO FRANCISCO DE GOIAS	13/10/2020 04:52	13/10/2020 15:38	13/10/2020 04:52	13/10/2020 15:38	10,76	4	43,03	CHI
20201067655	JARAGUA	SF12090413	SAO FRANCISCO DE GOIAS	13/10/2020 04:52	13/10/2020 15:38	13/10/2020 04:52	13/10/2020 15:38	10,76	3	32,27	CHI
20201064436	SAO LUIS DE MONTES BELOS	SL12125616	FIRMINOPOLIS S1	13/10/2020 04:53	13/10/2020 22:08	13/10/2020 04:53	13/10/2020 22:08	17,24	10	172,43	CHI
20201064158	GOIANIA	AP12106560	REAL S2	13/10/2020 04:53	13/10/2020 09:52	13/10/2020 04:53	13/10/2020 09:52	4,97	599	2979,86	CHI
20201063863	JUSSARA	JR12055958	JUSSARA	13/10/2020 04:55	13/10/2020 12:52	13/10/2020 04:55	13/10/2020 12:52	7,96	8	63,65	CHI
20201063864	ALOANDIA	AD12349784	GOIATUBA S1	13/10/2020 04:55	13/10/2020 06:24	13/10/2020 04:55	13/10/2020 06:24	1,48	1	1,48	CHI
20201064164	MARA ROSA	CR12161155	MARA ROSA	13/10/2020 04:56	13/10/2020 09:31	13/10/2020 04:56	13/10/2020 09:31	4,58	5	22,92	CHI
20201064164	CAMPINORTE	CR12161155	MARA ROSA	13/10/2020 04:56	13/10/2020 09:31	13/10/2020 04:56	13/10/2020 09:31	4,58	4	18,33	CHI
20201063867	SAO LUIS DE MONTES BELOS	FR12382556	FIRMINOPOLIS S1	13/10/2020 04:56	14/10/2020 01:42	13/10/2020 04:56	14/10/2020 01:42	20,77	2	41,53	CHI
20201063867	FIRMINOPOLIS	FR12382556	FIRMINOPOLIS S1	13/10/2020 04:56	14/10/2020 01:42	13/10/2020 04:56	14/10/2020 01:42	20,77	13	269,95	CHI
20201063902	PORTEIRAO	03274118	RIO DOS BOIS	13/10/2020 05:00	13/10/2020 23:59	13/10/2020 05:00	13/10/2020 05:09	0,15	1	0,15	CHI
20201063902	PORTEIRAO	03274118	RIO DOS BOIS	13/10/2020 05:00	13/10/2020 23:59	13/10/2020 05:00	13/10/2020 05:09	0,15	1611	246,12	CHI
20201063902	TURVELANDIA	03274118	RIO DOS BOIS	13/10/2020 05:00	13/10/2020 23:59	13/10/2020 05:00	13/10/2020 05:09	0,15	541	82,65	CHI
20201063902	TURVELANDIA	03274118	RIO DOS BOIS	13/10/2020 05:00	13/10/2020 23:59	13/10/2020 05:00	13/10/2020 05:09	0,15	1310	200,14	CHI
20201063902	SANTA HELENA DE GOIAS	03274118	RIO DOS BOIS	13/10/2020 05:00	13/10/2020 23:59	13/10/2020 05:00	13/10/2020 05:09	0,15	18	2,75	CHI
20201063902	GOIATUBA	03274118	RIO DOS BOIS	13/10/2020 05:00	13/10/2020 23:59	13/10/2020 05:00	13/10/2020 05:09	0,15	19	2,90	CHI
20201063902	SANTA HELENA DE GOIAS	ML10407164	RIO DOS BOIS	13/10/2020 05:00	13/10/2020 23:59	13/10/2020 05:00	13/10/2020 05:09	0,15	3	0,46	CHI
20201063902	TURVELANDIA	ML10407164	RIO DOS BOIS	13/10/2020 05:00	13/10/2020 23:59	13/10/2020 05:00	13/10/2020 05:09	0,15	89	13,60	CHI
20201063902	TURVELANDIA	03274118	RIO DOS BOIS	13/10/2020 05:00	13/10/2020 23:59	13/10/2020 05:00	13/10/2020 05:09	0,15	1	0,15	CHI
20201063902	EDEIA	03274118	RIO DOS BOIS	13/10/2020 05:00	13/10/2020 23:59	13/10/2020 05:00	13/10/2020 05:09	0,15	52	7,94	CHI
20201063902	ACREUNA	03274118	RIO DOS BOIS	13/10/2020 05:00	13/10/2020 23:59	13/10/2020 05:00	13/10/2020 05:09	0,15	26	3,97	CHI
20201063902	PORTEIRAO	03274118	RIO DOS BOIS	13/10/2020 05:00	13/10/2020 23:59	13/10/2020 05:00	13/10/2020 05:09	0,15	28	4,28	CHI
20201063902	PORTEIRAO	ML10407164	RIO DOS BOIS	13/10/2020 05:00	13/10/2020 23:59	13/10/2020 05:00	13/10/2020 05:09	0,15	9	1,37	CHI
20201063902	PORTEIRAO	03274118	RIO DOS BOIS	13/10/2020 05:00	13/10/2020 23:59	13/10/2020 05:00	13/10/2020 05:09	0,15	7	1,07	CHI
20201063902	ACREUNA	03274118	RIO DOS BOIS	13/10/2020 05:00	13/10/2020 23:59	13/10/2020 05:00	13/10/2020 05:09	0,15	14	2,14	CHI
20201063902	TURVELANDIA	03274118	RIO DOS BOIS	13/10/2020 05:00	13/10/2020 23:59	13/10/2020 05:00	13/10/2020 05:09	0,15	12	1,83	CHI
20201063902	VICENTINOPOLIS	03274118	RIO DOS BOIS	13/10/2020 05:00	13/10/2020 23:59	13/10/2020 05:00	13/10/2020 05:09	0,15	4	0,61	CHI
20201063902	MAURILANDIA	03274118	RIO DOS BOIS	13/10/2020 05:00	13/10/2020 23:59	13/10/2020 05:00	13/10/2020 05:09	0,15	4	0,61	CHI
20201063902	PORTEIRAO	03274118	RIO DOS BOIS	13/10/2020 05:00	13/10/2020 23:59	13/10/2020 05:00	13/10/2020 05:09	0,15	39	5,96	CHI
20201063902	RIO VERDE	03274118	RIO DOS BOIS	13/10/2020 05:00	13/10/2020 23:59	13/10/2020 05:00	13/10/2020 05:18	0,31	22	6,84	CHI
20201063902	MAURILANDIA	03274118	RIO DOS BOIS	13/10/2020 05:00	13/10/2020 23:59	13/10/2020 05:00	13/10/2020 05:18	0,31	2617	813,45	CHI
20201063902	CASTELANDIA	03274118	RIO DOS BOIS	13/10/2020 05:00	13/10/2020 23:59	13/10/2020 05:00	13/10/2020 05:18	0,31	24	7,46	CHI
20201063902	MAURILANDIA	03274118	RIO DOS BOIS	13/10/2020 05:00	13/10/2020 23:59	13/10/2020 05:00	13/10/2020 05:18	0,31	1605	498,89	CHI
20201063902	TURVELANDIA	03274118	RIO DOS BOIS	13/10/2020 05:00	13/10/2020 23:59	13/10/2020 05:00	13/10/2020 05:18	0,31	2	0,62	CHI
20201063902	TURVELANDIA	03274118	RIO DOS BOIS	13/10/2020 05:00	13/10/2020 23:59	13/10/2020 05:00	13/10/2020 05:18	0,31	44	13,68	CHI
20201063902	SANTA HELENA DE GOIAS	03274118	RIO DOS BOIS	13/10/2020 05:00	13/10/2020 23:59	13/10/2020 05:00	13/10/2020 05:18	0,31	51	15,85	CHI
20201063902	SANTA HELENA DE GOIAS	03274118	SANTA HELENA S1	13/10/2020 05:00	13/10/2020 23:59	13/10/2020 05:00	13/10/2020 05:18	0,31	1	0,31	CHI
20201063902	MAURILANDIA	03274118	RIO DOS BOIS	13/10/2020 05:00	13/10/2020 23:59	13/10/2020 05:00	13/10/2020 05:18	0,31	4	1,24	CHI
20201063902	GOIATUBA	03274118	RIO DOS BOIS	13/10/2020 05:00	13/10/2020 23:59	13/10/2020 05:00	13/10/2020 05:48	0,81	5	4,03	CHI
20201063902	CASTELANDIA	03274118	RIO DOS BOIS	13/10/2020 05:00	13/10/2020 23:59	13/10/2020 05:00	13/10/2020 05:48	0,81	1594	1283,61	CHI
20201063902	GOIATUBA	03274118	RIO DOS BOIS	13/10/2020 05:00	13/10/2020 23:59	13/10/2020 05:00	13/10/2020 05:48	0,81	400	322,11	CHI

20201063902	BOM JESUS DE GOIAS	03274118	RIO DOS BOIS	13/10/2020 05:00	13/10/2020 23:59	13/10/2020 05:00	13/10/2020 05:48	0,81	5	4,03	CHI
20201063902	BOM JESUS DE GOIAS	03274118	RIO DOS BOIS	13/10/2020 05:00	13/10/2020 23:59	13/10/2020 05:00	13/10/2020 05:48	0,81	21	16,91	CHI
20201063902	PORTEIRAO	03274118	RIO DOS BOIS	13/10/2020 05:00	13/10/2020 23:59	13/10/2020 05:00	13/10/2020 05:48	0,81	4	3,22	CHI
20201063902	MAURILANDIA	ML10407216	RIO DOS BOIS	13/10/2020 05:00	13/10/2020 23:59	13/10/2020 05:00	13/10/2020 05:48	0,81	13	10,47	CHI
20201063902	MAURILANDIA	03274118	RIO DOS BOIS	13/10/2020 05:00	13/10/2020 23:59	13/10/2020 05:00	13/10/2020 05:48	0,81	2	1,61	CHI
20201063902	PORTEIRAO	03274118	RIO DOS BOIS	13/10/2020 05:00	13/10/2020 23:59	13/10/2020 05:00	13/10/2020 05:48	0,81	2	1,61	CHI
20201063902	PORTEIRAO	03274118	RIO DOS BOIS	13/10/2020 05:00	13/10/2020 23:59	13/10/2020 05:00	13/10/2020 05:48	0,81	7	5,64	CHI
20201063902	CASTELANDIA	03274118	RIO DOS BOIS	13/10/2020 05:00	13/10/2020 23:59	13/10/2020 05:00	13/10/2020 05:48	0,81	1	0,81	CHI
20201063902	PORTEIRAO	03274118	RIO DOS BOIS	13/10/2020 05:00	13/10/2020 23:59	13/10/2020 05:00	13/10/2020 05:48	0,81	6	4,83	CHI
20201063902	GOIATUBA	03274118	RIO DOS BOIS	13/10/2020 05:00	13/10/2020 23:59	13/10/2020 05:00	13/10/2020 05:48	0,81	21	16,91	CHI
20201063902	GOIATUBA	03274118	RIO DOS BOIS	13/10/2020 05:00	13/10/2020 23:59	13/10/2020 05:00	13/10/2020 05:48	0,81	19	15,30	CHI
20201063902	GOIAS	03274118	RIO DOS BOIS	13/10/2020 05:00	13/10/2020 23:59	13/10/2020 05:00	13/10/2020 05:48	0,81	1	0,81	CHI
20201063902	QUIRINOPOLIS	03274118	RIO DOS BOIS	13/10/2020 05:00	13/10/2020 23:59	13/10/2020 05:00	13/10/2020 05:48	0,81	43	34,63	CHI
20201063902	CASTELANDIA	ML10407216	RIO DOS BOIS	13/10/2020 05:00	13/10/2020 23:59	13/10/2020 05:00	13/10/2020 05:48	0,81	2	1,61	CHI
20201063902	MAURILANDIA	03274118	RIO DOS BOIS	13/10/2020 05:00	13/10/2020 23:59	13/10/2020 05:00	13/10/2020 05:48	0,81	4	3,22	CHI
20201063902	MAURILANDIA	SH10418244	SANTA HELENA S1	13/10/2020 05:00	13/10/2020 23:59	13/10/2020 08:07	13/10/2020 08:32	0,41	4	1,65	CHI
20201063902	SANTA HELENA DE GOIAS	SH10418244	SANTA HELENA S1	13/10/2020 05:00	13/10/2020 23:59	13/10/2020 08:07	13/10/2020 08:32	0,41	7	2,88	CHI
20201063902	TURVELANDIA	SH10408098	RIO DOS BOIS	13/10/2020 05:00	13/10/2020 23:59	13/10/2020 08:05	13/10/2020 08:43	0,64	2	1,27	CHI
20201063902	MAURILANDIA	SH10408098	RIO DOS BOIS	13/10/2020 05:00	13/10/2020 23:59	13/10/2020 08:05	13/10/2020 08:43	0,64	2372	1507,54	CHI
20201063902	TURVELANDIA	SH10408098	RIO DOS BOIS	13/10/2020 05:00	13/10/2020 23:59	13/10/2020 08:05	13/10/2020 08:44	0,64	42	26,81	CHI
20201063902	MAURILANDIA	SH10408098	RIO DOS BOIS	13/10/2020 05:00	13/10/2020 23:59	13/10/2020 08:05	13/10/2020 08:44	0,64	1603	1023,25	CHI
20201063902	CASTELANDIA	SH10408098	RIO DOS BOIS	13/10/2020 05:00	13/10/2020 23:59	13/10/2020 08:05	13/10/2020 08:44	0,64	24	15,32	CHI
20201063902	RIO VERDE	SH10408098	RIO DOS BOIS	13/10/2020 05:00	13/10/2020 23:59	13/10/2020 08:05	13/10/2020 08:44	0,64	22	14,04	CHI
20201063902	SANTA HELENA DE GOIAS	SH10408098	RIO DOS BOIS	13/10/2020 05:00	13/10/2020 23:59	13/10/2020 08:05	13/10/2020 08:44	0,64	51	32,56	CHI
20201063902	MAURILANDIA	SH10408098	RIO DOS BOIS	13/10/2020 05:00	13/10/2020 23:59	13/10/2020 08:05	13/10/2020 08:44	0,64	64	40,85	CHI
20201063902	MAURILANDIA	SH10408098	RIO DOS BOIS	13/10/2020 05:00	13/10/2020 23:59	13/10/2020 08:05	13/10/2020 13:19	5,22	4	20,89	CHI
20201063902	SANTA HELENA DE GOIAS	01660424	SANTA HELENA S1	13/10/2020 05:00	13/10/2020 23:59	13/10/2020 17:46	13/10/2020 17:56	0,17	19	3,17	CHI
20201063902	MAURILANDIA	01660424	SANTA HELENA S1	13/10/2020 05:00	13/10/2020 23:59	13/10/2020 17:46	13/10/2020 17:56	0,17	4	0,67	CHI
20201063902	RIO VERDE	01660424	RIO DOS BOIS	13/10/2020 05:00	13/10/2020 23:59	13/10/2020 17:46	13/10/2020 18:12	0,43	22	9,37	CHI
20201063902	TURVELANDIA	01660424	RIO DOS BOIS	13/10/2020 05:00	13/10/2020 23:59	13/10/2020 17:46	13/10/2020 18:12	0,43	39	16,62	CHI
20201063902	SANTA HELENA DE GOIAS	01660424	RIO DOS BOIS	13/10/2020 05:00	13/10/2020 23:59	13/10/2020 17:46	13/10/2020 18:12	0,43	51	21,73	CHI
20201063902	MAURILANDIA	01660424	RIO DOS BOIS	13/10/2020 05:00	13/10/2020 23:59	13/10/2020 17:46	13/10/2020 18:12	0,43	1601	682,20	CHI
20201063902	MAURILANDIA	01660424	RIO DOS BOIS	13/10/2020 05:00	13/10/2020 23:59	13/10/2020 17:46	13/10/2020 18:12	0,43	2617	1115,13	CHI
20201063902	CASTELANDIA	01660424	RIO DOS BOIS	13/10/2020 05:00	13/10/2020 23:59	13/10/2020 17:46	13/10/2020 18:12	0,43	24	10,23	CHI
20201063902	TURVELANDIA	01660424	RIO DOS BOIS	13/10/2020 05:00	13/10/2020 23:59	13/10/2020 17:46	13/10/2020 18:12	0,43	2	0,85	CHI
20201063902	MAURILANDIA	01660424	RIO DOS BOIS	13/10/2020 05:00	13/10/2020 23:59	13/10/2020 18:00	13/10/2020 18:12	0,19	2	0,38	CHI
20201063902	TURVELANDIA	01660424	RIO DOS BOIS	13/10/2020 05:00	13/10/2020 23:59	13/10/2020 18:00	13/10/2020 18:12	0,19	1	0,19	CHI
20201063902	BOM JESUS DE GOIAS	SH10408098	RIO DOS BOIS	13/10/2020 05:00	13/10/2020 23:59	13/10/2020 08:05	13/10/2020 18:21	10,27	1	10,27	CHI
20201063902	MAURILANDIA	SH10408098	RIO DOS BOIS	13/10/2020 05:00	13/10/2020 23:59	13/10/2020 08:05	13/10/2020 18:21	10,27	1	10,27	CHI
20201063902	GOIAS	SH10408098	RIO DOS BOIS	13/10/2020 05:00	13/10/2020 23:59	13/10/2020 08:05	13/10/2020 18:21	10,27	1	10,27	CHI
20201063902	BOM JESUS DE GOIAS	SH10408098	RIO DOS BOIS	13/10/2020 05:00	13/10/2020 23:59	13/10/2020 08:05	13/10/2020 18:21	10,27	3	30,81	CHI
20201063902	QUIRINOPOLIS	SH10408098	RIO DOS BOIS	13/10/2020 05:00	13/10/2020 23:59	13/10/2020 08:05	13/10/2020 18:21	10,27	42	431,28	CHI
20201063902	CASTELANDIA	SH10408098	RIO DOS BOIS	13/10/2020 05:00	13/10/2020 23:59	13/10/2020 08:05	13/10/2020 18:21	10,27	1	10,27	CHI
20201063902	PORTEIRAO	SH10408098	RIO DOS BOIS	13/10/2020 05:00	13/10/2020 23:59	13/10/2020 08:05	13/10/2020 18:21	10,27	6	61,61	CHI
20201063902	PORTEIRAO	SH10408098	RIO DOS BOIS	13/10/2020 05:00	13/10/2020 23:59	13/10/2020 08:05	13/10/2020 18:21	10,27	4	41,07	CHI
20201063902	MAURILANDIA	SH10408098	RIO DOS BOIS	13/10/2020 05:00	13/10/2020 23:59	13/10/2020 08:05	13/10/2020 18:21	10,27	3	30,81	CHI
20201063902	MAURILANDIA	SH10408098	RIO DOS BOIS	13/10/2020 05:00	13/10/2020 23:59	13/10/2020 08:05	13/10/2020 18:21	10,27	12	123,22	CHI
20201063902	GOIATUBA	SH10408098	RIO DOS BOIS	13/10/2020 05:00	13/10/2020 23:59	13/10/2020 08:05	13/10/2020 18:21	10,27	400	4107,44	CHI
20201063902	GOIATUBA	SH10408098	RIO DOS BOIS	13/10/2020 05:00	13/10/2020 23:59	13/10/2020 08:05	13/10/2020 18:21	10,27	19	195,10	CHI
20201063902	GOIATUBA	SH10408098	RIO DOS BOIS	13/10/2020 05:00	13/10/2020 23:59	13/10/2020 08:05	13/10/2020 18:21	10,27	5	51,34	CHI
20201063902	PORTEIRAO	SH10408098	RIO DOS BOIS	13/10/2020 05:00	13/10/2020 23:59	13/10/2020 08:05	13/10/2020 18:21	10,27	2	20,54	CHI
20201063902	CASTELANDIA	SH10408098	RIO DOS BOIS	13/10/2020 05:00	13/10/2020 23:59	13/10/2020 08:05	13/10/2020 18:21	10,27	831	8533,22	CHI
20201063902	CASTELANDIA	SH10408098	RIO DOS BOIS	13/10/2020 05:00	13/10/2020 23:59	13/10/2020 08:05	13/10/2020 18:21	10,27	1	10,27	CHI
20201063902	MAURILANDIA	ML10416726	RIO DOS BOIS	13/10/2020 05:00	13/10/2020 23:59	13/10/2020 18:05	13/10/2020 18:21	0,28	4	1,13	CHI
20201063902	MAURILANDIA	ML10416726	RIO DOS BOIS	13/10/2020 05:00	13/10/2020 23:59	13/10/2020 18:10	13/10/2020 18:21	0,19	2	0,38	CHI
20201063902	SANTA HELENA DE GOIAS	SH10408098	RIO DOS BOIS	13/10/2020 05:00	13/10/2020 23:59	13/10/2020 08:05	13/10/2020 18:22	10,28	16	164,46	CHI
20201063902	TURVELANDIA	SH10408098	RIO DOS BOIS	13/10/2020 05:00	13/10/2020 23:59	13/10/2020 08:05	13/10/2020 18:22	10,28	541	5560,88	CHI
20201063902	GOIATUBA	SH10408098	RIO DOS BOIS	13/10/2020 05:00	13/10/2020 23:59	13/10/2020 08:05	13/10/2020 18:22	10,28	19	195,30	CHI

20201063902	PORTEIRAO	SH10408098	RIO DOS BOIS	13/10/2020 05:00	13/10/2020 23:59	13/10/2020 08:05	13/10/2020 18:22	10,28	1397	14359,61	CHI
20201063902	EDEIA	SH10408098	RIO DOS BOIS	13/10/2020 05:00	13/10/2020 23:59	13/10/2020 08:05	13/10/2020 18:22	10,28	28	287,81	CHI
20201063902	PORTEIRAO	SH10408098	RIO DOS BOIS	13/10/2020 05:00	13/10/2020 23:59	13/10/2020 08:05	13/10/2020 18:22	10,28	6	61,67	CHI
20201063902	VICENTINOPOLIS	SH10408098	RIO DOS BOIS	13/10/2020 05:00	13/10/2020 23:59	13/10/2020 08:05	13/10/2020 18:22	10,28	4	41,12	CHI
20201063902	MAURILANDIA	SH10408098	RIO DOS BOIS	13/10/2020 05:00	13/10/2020 23:59	13/10/2020 08:05	13/10/2020 18:22	10,28	4	41,12	CHI
20201063902	PORTEIRAO	SH10408098	RIO DOS BOIS	13/10/2020 05:00	13/10/2020 23:59	13/10/2020 08:05	13/10/2020 18:22	10,28	24	246,69	CHI
20201063902	PORTEIRAO	SH10408098	RIO DOS BOIS	13/10/2020 05:00	13/10/2020 23:59	13/10/2020 08:05	13/10/2020 18:22	10,28	9	92,51	CHI
20201063902	TURVELANDIA	SH10408098	RIO DOS BOIS	13/10/2020 05:00	13/10/2020 23:59	13/10/2020 08:05	13/10/2020 18:22	10,28	89	914,82	CHI
20201063902	TURVELANDIA	SH10408098	RIO DOS BOIS	13/10/2020 05:00	13/10/2020 23:59	13/10/2020 08:05	13/10/2020 18:22	10,28	1	10,28	CHI
20201063902	TURVELANDIA	SH10408098	RIO DOS BOIS	13/10/2020 05:00	13/10/2020 23:59	13/10/2020 08:05	13/10/2020 18:22	10,28	12	123,35	CHI
20201063902	PORTEIRAO	SH10408098	RIO DOS BOIS	13/10/2020 05:00	13/10/2020 23:59	13/10/2020 08:05	13/10/2020 18:22	10,28	1	10,28	CHI
20201063902	SANTA HELENA DE GOIAS	SH10408098	RIO DOS BOIS	13/10/2020 05:00	13/10/2020 23:59	13/10/2020 08:05	13/10/2020 18:22	10,28	3	30,84	CHI
20201063902	TURVELANDIA	SH10408098	RIO DOS BOIS	13/10/2020 05:00	13/10/2020 23:59	13/10/2020 08:05	13/10/2020 18:22	10,28	926	9518,25	CHI
20201063902	ACREUNA	SH10408098	RIO DOS BOIS	13/10/2020 05:00	13/10/2020 23:59	13/10/2020 08:05	13/10/2020 18:22	10,28	26	267,25	CHI
20201063902	PORTEIRAO	SH10408098	RIO DOS BOIS	13/10/2020 05:00	13/10/2020 23:59	13/10/2020 08:05	13/10/2020 18:22	10,28	36	370,04	CHI
20201063902	TURVELANDIA	SH10408098	SANTA HELENA S1	13/10/2020 05:00	13/10/2020 23:59	13/10/2020 08:05	13/10/2020 19:38	11,54	5	57,69	CHI
20201063902	MAURILANDIA	SH10408098	SANTA HELENA S1	13/10/2020 05:00	13/10/2020 23:59	13/10/2020 08:05	13/10/2020 19:38	11,54	4	46,15	CHI
20201063902	SANTA HELENA DE GOIAS	SH10408098	SANTA HELENA S1	13/10/2020 05:00	13/10/2020 23:59	13/10/2020 08:05	13/10/2020 19:38	11,54	2	23,08	CHI
20201063902	BOM JESUS DE GOIAS	SH10408098	RIO DOS BOIS	13/10/2020 05:00	13/10/2020 23:59	13/10/2020 08:05	13/10/2020 19:50	11,74	15	176,10	CHI
20201063902	CASTELANDIA	SH10408098	RIO DOS BOIS	13/10/2020 05:00	13/10/2020 23:59	13/10/2020 08:05	13/10/2020 19:50	11,74	734	8616,96	CHI
20201063902	PORTEIRAO	DM16407789	RIO DOS BOIS	13/10/2020 05:00	13/10/2020 23:59	13/10/2020 16:22	13/10/2020 19:50	3,45	7	24,18	CHI
20201063902	GOIATUBA	DM16407789	RIO DOS BOIS	13/10/2020 05:00	13/10/2020 23:59	13/10/2020 16:22	13/10/2020 19:50	3,45	21	72,54	CHI
20201063902	BOM JESUS DE GOIAS	DM16407789	RIO DOS BOIS	13/10/2020 05:00	13/10/2020 23:59	13/10/2020 16:22	13/10/2020 19:50	3,45	4	13,82	CHI
20201063902	CASTELANDIA	DM16407789	RIO DOS BOIS	13/10/2020 05:00	13/10/2020 23:59	13/10/2020 16:22	13/10/2020 19:50	3,45	27	93,26	CHI
20201063902	MAURILANDIA	DM16407789	RIO DOS BOIS	13/10/2020 05:00	13/10/2020 23:59	13/10/2020 16:22	13/10/2020 19:50	3,45	1	3,45	CHI
20201063902	TURVELANDIA	TD13406863B	RIO DOS BOIS	13/10/2020 05:00	13/10/2020 23:59	13/10/2020 08:05	13/10/2020 22:56	14,85	384	5702,29	CHI
20201063902	EDEIA	EA16427214	RIO DOS BOIS	13/10/2020 05:00	13/10/2020 23:59	13/10/2020 08:05	13/10/2020 23:59	15,90	23	365,77	CHI
20201063902	ACREUNA	EA16427214	RIO DOS BOIS	13/10/2020 05:00	13/10/2020 23:59	13/10/2020 08:05	13/10/2020 23:59	15,90	12	190,84	CHI
20201063875	CRISTALINA	KR21206514	PAMPLONA	13/10/2020 05:00	13/10/2020 11:55	13/10/2020 05:00	13/10/2020 11:55	6,91	1	6,91	CHI
20201063880	SANTO ANTONIO DO DESCOBERTO	LA12313875	AGUAS LINDAS DE GOIAS S1	13/10/2020 05:01	13/10/2020 07:21	13/10/2020 05:01	13/10/2020 07:21	2,32	18	41,72	CHI
20201063880	COCALZINHO DE GOIAS	LA12313875	AGUAS LINDAS DE GOIAS S1	13/10/2020 05:01	13/10/2020 07:21	13/10/2020 05:01	13/10/2020 07:21	2,32	1	2,32	CHI
20201063880	AGUAS LINDAS DE GOIAS	LA12313875	AGUAS LINDAS DE GOIAS S1	13/10/2020 05:01	13/10/2020 07:21	13/10/2020 05:01	13/10/2020 07:21	2,32	95	220,16	CHI
20201065349	GOIANIA	GN11349980	ATLANTICO S3	13/10/2020 05:02	13/10/2020 12:25	13/10/2020 05:02	13/10/2020 12:25	7,37	50	368,67	CHI
20201064189	PIRES DO RIO	PR12064889LD	PIRES DO RIO S1	13/10/2020 05:07	14/10/2020 05:59	13/10/2020 05:07	13/10/2020 10:44	5,62	698	3920,82	CHI
20201064189	PIRES DO RIO	PR12064889LD	PIRES DO RIO S1	13/10/2020 05:07	14/10/2020 05:59	13/10/2020 08:00	13/10/2020 10:44	2,73	152	415,64	CHI
20201064189	PIRES DO RIO	PR12064889LD	PIRES DO RIO S1	13/10/2020 05:07	14/10/2020 05:59	13/10/2020 05:07	14/10/2020 05:59	24,87	12	298,45	CHI
20201065154	MARA ROSA	AJ12384910RE	MARA ROSA	13/10/2020 05:07	13/10/2020 11:51	13/10/2020 05:07	13/10/2020 11:51	6,72	5	33,62	CHI
20201065154	ALTO HORIZONTE	AJ12384910RE	MARA ROSA	13/10/2020 05:07	13/10/2020 11:51	13/10/2020 05:07	13/10/2020 11:51	6,72	36	242,04	CHI
20201065219	GOIANIA	GN12269050	CARAJAS S2	13/10/2020 05:07	13/10/2020 09:37	13/10/2020 05:07	13/10/2020 09:37	4,49	367	1647,52	CHI
20201063904	ITAPURANGA	IK12364740	ITAPURANGA	13/10/2020 05:08	13/10/2020 09:53	13/10/2020 05:08	13/10/2020 09:53	4,74	12	56,83	CHI
20201063904	MORRO AGUDO DE GOIAS	IK12364740	ITAPURANGA	13/10/2020 05:08	13/10/2020 09:53	13/10/2020 05:08	13/10/2020 09:53	4,74	15	71,04	CHI
20201064492	GOIANIA	GN12002508	ATLANTICO S3	13/10/2020 05:09	13/10/2020 11:18	13/10/2020 05:09	13/10/2020 11:18	6,15	885	5446,44	CHI
20201066588	HIDROLANDIA	HD12000076	INDEPENDENCIA S1	13/10/2020 05:09	13/10/2020 10:39	13/10/2020 05:09	13/10/2020 10:39	5,49	23	126,23	CHI
20201066588	ARAGOIANIA	HD12000076	INDEPENDENCIA S1	13/10/2020 05:09	13/10/2020 10:39	13/10/2020 05:09	13/10/2020 10:39	5,49	12	65,86	CHI
20201063913	SANTA BARBARA DE GOIAS	TR10384949	TRINDADE	13/10/2020 05:10	13/10/2020 08:40	13/10/2020 05:10	13/10/2020 07:38	2,47	173	427,31	CHI
20201063913	TRINDADE	TR10384949	TRINDADE	13/10/2020 05:10	13/10/2020 08:40	13/10/2020 05:10	13/10/2020 07:38	2,47	3896	9623,12	CHI
20201063913	TRINDADE	TR16413212	TRINDADE	13/10/2020 05:10	13/10/2020 08:40	13/10/2020 05:10	13/10/2020 08:40	3,50	1395	4887,15	CHI
20201063909	ORIZONA	LZ12114519	PIRES DO RIO S2	13/10/2020 05:11	13/10/2020 08:20	13/10/2020 05:11	13/10/2020 08:20	3,15	36	113,31	CHI
20201063909	LUZIANIA	LZ12114519	PIRES DO RIO S2	13/10/2020 05:11	13/10/2020 08:20	13/10/2020 05:11	13/10/2020 08:20	3,15	23	72,39	CHI
20201063911	GOIANIA	17432716	GOYA S2	13/10/2020 05:13	13/10/2020 10:15	13/10/2020 05:13	13/10/2020 10:15	5,02	1	5,02	CHI
20201069417	BELA VISTA DE GOIAS	CF12300677	CRISTIANOPOLIS	13/10/2020 05:15	13/10/2020 17:45	13/10/2020 05:15	13/10/2020 17:45	12,49	4	49,95	CHI
20201063919	BELA VISTA DE GOIAS	BV13210300	BELA VISTA S2	13/10/2020 05:17	14/10/2020 15:06	13/10/2020 05:17	13/10/2020 22:43	17,42	79	1376,53	CHI
20201063919	CALDAZINHA	BV13210300	BELA VISTA S2	13/10/2020 05:17	14/10/2020 15:06	13/10/2020 05:17	13/10/2020 22:43	17,42	5	87,12	CHI
20201063919	SAO MIGUEL DO PASSA QUATRO	BV13210300	BELA VISTA S2	13/10/2020 05:17	14/10/2020 15:06	13/10/2020 05:17	13/10/2020 22:43	17,42	42	731,83	CHI
20201063919	SILVANIA	BV13210300	BELA VISTA S2	13/10/2020 05:17	14/10/2020 15:06	13/10/2020 05:17	13/10/2020 22:43	17,42	86	1498,50	CHI
20201063919	SILVANIA	BV13210300	BELA VISTA S2	13/10/2020 05:17	14/10/2020 15:06	13/10/2020 12:16	13/10/2020 22:43	10,43	3	31,30	CHI
20201063919	SAO MIGUEL DO PASSA QUATRO	BV13210300	BELA VISTA S2	13/10/2020 05:17	14/10/2020 15:06	13/10/2020 12:16	13/10/2020 22:43	10,43	7	73,04	CHI
20201063919	CALDAZINHA	BV13210300	BELA VISTA S2	13/10/2020 05:17	14/10/2020 15:06	13/10/2020 12:16	13/10/2020 22:43	10,43	1	10,43	CHI

20201063919	BELA VISTA DE GOIAS	BV13210300	BELA VISTA S2	13/10/2020 05:17	14/10/2020 15:06	13/10/2020 12:16	13/10/2020 22:43	10,43	5	52,17	CHI
20201063919	SAO MIGUEL DO PASSA QUATRO	BV32058332	BELA VISTA S2	13/10/2020 05:17	14/10/2020 15:06	13/10/2020 12:16	13/10/2020 23:32	11,25	37	416,27	CHI
20201063919	BELA VISTA DE GOIAS	BV32051409	BELA VISTA S2	13/10/2020 05:17	14/10/2020 15:06	13/10/2020 23:32	14/10/2020 09:20	9,82	306	3003,39	CHI
20201063919	BELA VISTA DE GOIAS	7787298	BELA VISTA S2	13/10/2020 05:17	14/10/2020 15:06	13/10/2020 12:16	14/10/2020 15:06	26,82	30	804,51	CHI
20201063919	SAO MIGUEL DO PASSA QUATRO	7787298	BELA VISTA S2	13/10/2020 05:17	14/10/2020 15:06	13/10/2020 12:16	14/10/2020 15:06	26,82	49	1314,03	CHI
20201063919	BELA VISTA DE GOIAS	7787298	BELA VISTA S2	13/10/2020 05:17	14/10/2020 15:06	14/10/2020 09:27	14/10/2020 15:06	5,63	5	28,17	CHI
20201063919	SAO MIGUEL DO PASSA QUATRO	7787298	BELA VISTA S2	13/10/2020 05:17	14/10/2020 15:06	14/10/2020 09:27	14/10/2020 15:06	5,63	46	259,15	CHI
20201063924	ACREUNA	EU21335162	RIO DOS BOIS	13/10/2020 05:21	13/10/2020 09:16	13/10/2020 05:21	13/10/2020 09:16	3,90	1	3,90	CHI
20201064648	PIRES DO RIO	PR11043808	PIRES DO RIO S1	13/10/2020 05:22	13/10/2020 12:37	13/10/2020 05:22	13/10/2020 12:37	7,24	209	1513,62	CHI
20201064047	CAIAPONIA	CP12308693	PALESTINA	13/10/2020 05:22	13/10/2020 15:44	13/10/2020 05:22	13/10/2020 15:44	10,35	8	82,81	CHI
20201063934	PORTELANDIA	PW12219564	PARQUE DAS EMAS	13/10/2020 05:25	13/10/2020 11:28	13/10/2020 05:25	13/10/2020 11:28	6,04	11	66,47	CHI
20201063934	MINEIROS	PW12219564	PARQUE DAS EMAS	13/10/2020 05:25	13/10/2020 11:28	13/10/2020 05:25	13/10/2020 11:28	6,04	7	42,30	CHI
20201063712	BOM JESUS DE GOIAS	IT12034458RE	CACHOEIRA DOURADA	13/10/2020 05:25	13/10/2020 09:36	13/10/2020 05:25	13/10/2020 09:36	4,17	3	12,51	CHI
20201063712	PANAMA	IT12034458RE	CACHOEIRA DOURADA	13/10/2020 05:25	13/10/2020 09:36	13/10/2020 05:25	13/10/2020 09:36	4,17	13	54,20	CHI
20201063712	ITUMBIARA	IT12034458RE	CACHOEIRA DOURADA	13/10/2020 05:25	13/10/2020 09:36	13/10/2020 05:25	13/10/2020 09:36	4,17	65	271,01	CHI
20201064182	HIDROLANDIA	AO32000022	GUAPO S2	13/10/2020 05:25	13/10/2020 09:19	13/10/2020 05:25	13/10/2020 09:19	3,88	3	11,65	CHI
20201064182	ARAGOIANIA	AO32000022	GUAPO S2	13/10/2020 05:25	13/10/2020 09:19	13/10/2020 05:25	13/10/2020 09:19	3,88	54	209,71	CHI
20201063936	ARAGUAPAZ	AZ12242480	MOZARLANDIA	13/10/2020 05:26	13/10/2020 07:11	13/10/2020 05:26	13/10/2020 07:11	1,75	16	27,94	CHI
20201063940	MARA ROSA	MQ12051834	MARA ROSA	13/10/2020 05:28	13/10/2020 10:57	13/10/2020 05:28	13/10/2020 10:57	5,48	13	71,21	CHI
20201064640	HIDROLANDIA	7567229	CEPAIGO S1	13/10/2020 05:29	13/10/2020 13:29	13/10/2020 05:29	13/10/2020 13:29	8,00	23	184,04	CHI
20201063948	PIRES DO RIO	PR21431449	PIRES DO RIO S1	13/10/2020 05:31	13/10/2020 18:51	13/10/2020 05:31	13/10/2020 18:51	13,33	1	13,33	CHI
20201064319	GOIANIA	GN11137797	REAL S1	13/10/2020 05:32	13/10/2020 11:04	13/10/2020 05:32	13/10/2020 11:04	5,53	69	381,55	CHI
20201063953	ABADIANIA	AA12384735	DAIA S2	13/10/2020 05:32	13/10/2020 09:16	13/10/2020 05:32	13/10/2020 09:16	3,73	70	260,98	CHI
20201063955	PORTEIRAO	CL21030916	RIO DOS BOIS	13/10/2020 05:33	13/10/2020 09:28	13/10/2020 05:33	13/10/2020 09:28	3,91	1	3,91	CHI
20201067472	PIRES DO RIO	PR12009094LD	PIRES DO RIO S1	13/10/2020 05:33	13/10/2020 19:15	13/10/2020 05:33	13/10/2020 19:15	13,69	64	876,07	CHI
20201064606	NOVA CRIXAS	NA12078447	NOVA CRIXAS	13/10/2020 05:34	13/10/2020 08:36	13/10/2020 05:34	13/10/2020 08:36	3,03	18	54,50	CHI
20201064606	CRIXAS	NA12078447	NOVA CRIXAS	13/10/2020 05:34	13/10/2020 08:36	13/10/2020 05:34	13/10/2020 08:36	3,03	18	54,50	CHI
20201064599	SANTA FE DE GOIAS	RN12362415	BRITANIA	13/10/2020 05:35	14/10/2020 12:53	13/10/2020 05:35	14/10/2020 03:45	22,16	1	22,16	CHI
20201064599	SANTA FE DE GOIAS	RN12362415	BRITANIA	13/10/2020 05:35	14/10/2020 12:53	13/10/2020 05:35	14/10/2020 12:07	30,52	13	396,82	CHI
20201064599	SANTA FE DE GOIAS	RN12362415	BRITANIA	13/10/2020 05:35	14/10/2020 12:53	13/10/2020 05:35	14/10/2020 12:53	31,30	4	125,21	CHI
20201063963	CATALAO	CT12389886	CATALAO S1	13/10/2020 05:35	13/10/2020 08:04	13/10/2020 05:35	13/10/2020 08:04	2,47	3	7,41	CHI
20201064951	MARA ROSA	MQ11072697	MARA ROSA	13/10/2020 05:36	13/10/2020 08:29	13/10/2020 05:36	13/10/2020 08:29	2,88	142	408,61	CHI
20201063967	ITABERAI	19623684	ITABERAI S1	13/10/2020 05:36	13/10/2020 07:40	13/10/2020 05:36	13/10/2020 07:40	2,06	3	6,18	CHI
20201063970	IPAMERI	IP12000088	IPAMERI	13/10/2020 05:37	13/10/2020 08:54	13/10/2020 05:37	13/10/2020 08:54	3,28	16	52,47	CHI
20201064043	CALDAS NOVAS	CN12263786	RIO QUENTE	13/10/2020 05:37	13/10/2020 08:55	13/10/2020 05:37	13/10/2020 08:55	3,29	34	112,02	CHI
20201064043	RIO QUENTE	CN12263786	RIO QUENTE	13/10/2020 05:37	13/10/2020 08:55	13/10/2020 05:37	13/10/2020 08:55	3,29	1	3,29	CHI
20201063972	RUBIATABA	RB12392305	RUBIATABA	13/10/2020 05:37	13/10/2020 19:23	13/10/2020 05:37	13/10/2020 19:23	13,75	6	82,51	CHI
20201063978	SAO DOMINGOS	8680012090	SAO DOMINGOS	13/10/2020 05:40	13/10/2020 12:24	13/10/2020 05:40	13/10/2020 12:24	6,73	1	6,73	CHI
20201063991	ITAUUCU	IX10403955	INHUMAS S1	13/10/2020 05:41	13/10/2020 10:42	13/10/2020 05:41	13/10/2020 10:32	4,86	43	208,91	CHI
20201063991	INHUMAS	IX10403955	INHUMAS S1	13/10/2020 05:41	13/10/2020 10:42	13/10/2020 05:41	13/10/2020 10:32	4,86	45	218,62	CHI
20201063991	ITAUUCU	IX13016042	INHUMAS S1	13/10/2020 05:41	13/10/2020 10:42	13/10/2020 05:41	13/10/2020 10:42	5,02	2	10,03	CHI
20201063991	INHUMAS	IX13016042	INHUMAS S1	13/10/2020 05:41	13/10/2020 10:42	13/10/2020 05:41	13/10/2020 10:42	5,02	105	526,78	CHI
20201063980	CORUMBAIBA	CI12285073	VILA CORUMBA	13/10/2020 05:41	13/10/2020 08:29	13/10/2020 05:41	13/10/2020 08:29	2,79	1	2,79	CHI
20201067435	SAO FRANCISCO DE GOIAS	SF12032711	SAO FRANCISCO DE GOIAS	13/10/2020 05:41	13/10/2020 19:20	13/10/2020 05:41	13/10/2020 19:20	13,64	217	2959,94	CHI
20201064752	MOSSAMEDES	MD12299610	ITABERAI S2	13/10/2020 05:42	13/10/2020 10:29	13/10/2020 05:42	13/10/2020 10:29	4,77	122	582,35	CHI
20201063997	SAO FRANCISCO DE GOIAS	SF21155623	SAO FRANCISCO DE GOIAS	13/10/2020 05:43	14/10/2020 10:51	13/10/2020 05:43	14/10/2020 10:14	28,50	1	28,50	CHI
20201063997	SAO FRANCISCO DE GOIAS	SF12377449	SAO FRANCISCO DE GOIAS	13/10/2020 05:43	14/10/2020 10:51	14/10/2020 07:57	14/10/2020 10:51	2,91	3	8,72	CHI
20201064308	GOIANIA	GN12082031LD	REAL S1	13/10/2020 05:47	13/10/2020 09:38	13/10/2020 05:47	13/10/2020 09:38	3,85	759	2921,31	CHI
20201065006	PETROLINA DE GOIAS	PG12017216	PETROLINA	13/10/2020 05:47	13/10/2020 15:05	13/10/2020 05:47	13/10/2020 15:05	9,29	68	631,64	CHI
20201064618	AMARALINA	LC12182475	SAO MIGUEL DO ARAGUAIA	13/10/2020 05:47	13/10/2020 11:38	13/10/2020 05:47	13/10/2020 11:38	5,84	76	443,63	CHI
20201064007	CRISTALINA	KR12168463	CRISTALINA S1	13/10/2020 05:47	13/10/2020 09:54	13/10/2020 05:47	13/10/2020 09:54	4,10	3	12,31	CHI
20201064015	GUAPO	10020431838	GUAPO S1	13/10/2020 05:50	13/10/2020 07:10	13/10/2020 05:50	13/10/2020 07:10	1,32	1	1,32	CHI
20201067208	CAIAPONIA	MY12184177	PARQUE DAS EMAS	13/10/2020 05:51	14/10/2020 02:56	13/10/2020 05:51	14/10/2020 02:56	21,10	3	63,29	CHI
20201064024	GOIANIA	GN12026284	REAL S1	13/10/2020 05:51	13/10/2020 10:56	13/10/2020 05:51	13/10/2020 10:56	5,07	352	1786,01	CHI
20201067624	IPAMERI	IP12017013	IPAMERI	13/10/2020 05:51	13/10/2020 15:37	13/10/2020 05:51	13/10/2020 15:37	9,75	8	78,02	CHI
20201064028	IVOLANDIA	IV12221784	MONTIVIDIU T	13/10/2020 05:53	13/10/2020 11:10	13/10/2020 05:53	13/10/2020 11:10	5,29	18	95,30	CHI
20201064044	PIRANHAS	PH12215262	PIRANHAS	13/10/2020 05:56	13/10/2020 11:38	13/10/2020 05:56	13/10/2020 11:38	5,69	6	34,13	CHI
20201064045	ITAPACI	IW12032522	RUBIATABA	13/10/2020 05:56	13/10/2020 10:10	13/10/2020 05:56	13/10/2020 10:10	4,22	33	139,20	CHI

20201064045	CRIXAS	IW12032522	RUBIATABA	13/10/2020 05:56	13/10/2020 10:10	13/10/2020 05:56	13/10/2020 10:10	4,22	13	54,84	CHI
20201064045	GUARINOS	IW12032522	RUBIATABA	13/10/2020 05:56	13/10/2020 10:10	13/10/2020 05:56	13/10/2020 10:10	4,22	11	46,40	CHI
20201064046	MORRINHOS	MR12189844	MORRINHOS	13/10/2020 05:57	13/10/2020 08:18	13/10/2020 05:57	13/10/2020 08:18	2,34	5	11,72	CHI
20201064046	PIRACANJUBA	MR12189844	MORRINHOS	13/10/2020 05:57	13/10/2020 08:18	13/10/2020 05:57	13/10/2020 08:18	2,34	2	4,69	CHI
20201064712	GUAPO	GA12276655	GUAPO S2	13/10/2020 05:57	13/10/2020 10:53	13/10/2020 05:57	13/10/2020 10:53	4,92	45	221,62	CHI
20201064454	JARAGUA	JA11000044	JARAGUA	13/10/2020 05:57	13/10/2020 14:44	13/10/2020 05:57	13/10/2020 14:44	8,77	100	877,39	CHI
20201067526	PETROLINA DE GOIAS	PG12111252	PETROLINA	13/10/2020 05:57	13/10/2020 16:25	13/10/2020 05:57	13/10/2020 16:25	10,45	29	303,16	CHI
20201067526	JESUPOLIS	PG12111252	PETROLINA	13/10/2020 05:57	13/10/2020 16:25	13/10/2020 05:57	13/10/2020 16:25	10,45	1	10,45	CHI
20201064053	FORMOSA	FA21146204	ITUIQUIRA	13/10/2020 05:57	13/10/2020 08:56	13/10/2020 05:57	13/10/2020 08:56	2,97	1	2,97	CHI
20201064055	GOIANIA	10798470	CARAJAS S1	13/10/2020 05:58	13/10/2020 10:09	13/10/2020 05:58	13/10/2020 10:09	4,18	1	4,18	CHI
20201063204	PALESTINA DE GOIAS	PY18223011TS	PALESTINA	13/10/2020 05:59	13/10/2020 21:06	13/10/2020 05:59	13/10/2020 21:06	15,11	115	1738,16	CHI
20201064066	ITUMBIARA	IT12390085	ITUMBIARA NOVA	13/10/2020 05:59	13/10/2020 13:39	13/10/2020 05:59	13/10/2020 13:39	7,65	510	3902,07	CHI
20201064066	ITUMBIARA	IT12081092LD	ITUMBIARA NOVA	13/10/2020 05:59	13/10/2020 13:39	13/10/2020 07:40	13/10/2020 13:39	5,98	861	5151,65	CHI
20201066577	AURILANDIA	AI12032163	FIRMINOPOLIS S2	13/10/2020 06:00	13/10/2020 11:50	13/10/2020 06:00	13/10/2020 11:50	5,82	8	46,57	CHI
20201064070	VILA PROPICIO	BA12163310	GOIANESIA S1	13/10/2020 06:01	13/10/2020 07:43	13/10/2020 06:01	13/10/2020 07:43	1,71	11	18,79	CHI
20201064070	GOIANESIA	BA12163310	GOIANESIA S1	13/10/2020 06:01	13/10/2020 07:43	13/10/2020 06:01	13/10/2020 07:43	1,71	2	3,42	CHI
20201064086	IPAMERI	IP12100702	CRISTALINA S2	13/10/2020 06:01	13/10/2020 13:39	13/10/2020 06:01	13/10/2020 13:39	7,62	9	68,58	CHI
20201064086	CRISTALINA	IP12100702	CRISTALINA S2	13/10/2020 06:01	13/10/2020 13:39	13/10/2020 06:01	13/10/2020 13:39	7,62	17	129,54	CHI
20201064397	GOIANIA	GN11350672	ATLANTICO S1	13/10/2020 06:01	13/10/2020 09:27	13/10/2020 06:01	13/10/2020 09:27	3,42	107	365,67	CHI
20201064149	HIDROLANDIA	HD12043710	CEPAIGO S2	13/10/2020 06:02	13/10/2020 08:20	13/10/2020 06:02	13/10/2020 08:20	2,29	24	55,01	CHI
20201064080	ARAGUAPAZ	AZ11235364	MOZARLANDIA	13/10/2020 06:03	13/10/2020 08:21	13/10/2020 06:03	13/10/2020 08:21	2,29	1	2,29	CHI
20201065282	AMERICANO DO BRASIL	KB11000001	ANICUNS	13/10/2020 06:04	13/10/2020 19:28	13/10/2020 06:04	13/10/2020 19:28	13,40	135	1808,59	CHI
20201064903	GOIANIA	GN12047459	AEROPORTO S3	13/10/2020 06:06	13/10/2020 09:30	13/10/2020 06:06	13/10/2020 09:30	3,39	204	691,84	CHI
20201065112	NOVO BRASIL	NB12187510	JUSSARA	13/10/2020 06:07	13/10/2020 15:30	13/10/2020 06:07	13/10/2020 15:30	9,38	16	150,11	CHI
20201064104	ORIZONA	OZ12404724	PIRES DO RIO S1	13/10/2020 06:07	13/10/2020 17:51	13/10/2020 06:07	13/10/2020 17:51	11,73	24	281,50	CHI
20201064109	NIQUELANDIA	NQ11256405	NIQUELANDIA SUBTRANSMISSAO	13/10/2020 06:08	13/10/2020 09:15	13/10/2020 06:08	13/10/2020 09:15	3,10	66	204,89	CHI
20201064497	IPAMERI	IP12311697	IPAMERI	13/10/2020 06:09	13/10/2020 09:11	13/10/2020 06:09	13/10/2020 09:11	3,03	83	251,61	CHI
20201064117	GOIANIA	GN11166596	CAMPINAS S2	13/10/2020 06:09	13/10/2020 10:18	13/10/2020 06:09	13/10/2020 10:18	4,15	104	431,11	CHI
20201067755	GOIAS	GS12076726	GOIAS	13/10/2020 06:10	13/10/2020 17:37	13/10/2020 06:10	13/10/2020 17:37	11,44	14	160,20	CHI
20201064788	GOIANIA	GN12387059	CARAJAS S1	13/10/2020 06:10	13/10/2020 11:11	13/10/2020 06:10	13/10/2020 11:11	5,00	59	295,18	CHI
20201064126	ITABERAI	10002734921	ITABERAI S2	13/10/2020 06:11	13/10/2020 12:09	13/10/2020 06:11	13/10/2020 12:09	5,96	1	5,96	CHI
20201064127	APARECIDA DE GOIANIA	AP12251634	INDEPENDENCIA S2	13/10/2020 06:11	13/10/2020 09:43	13/10/2020 06:11	13/10/2020 09:43	3,53	1	3,53	CHI
20201064129	ITAPACI	IW12379430	ITAPACI	13/10/2020 06:11	13/10/2020 11:23	13/10/2020 06:11	13/10/2020 11:23	5,19	2	10,38	CHI
20201064131	RIO VERDE	RV12260701	CABRIUVA S1	13/10/2020 06:11	13/10/2020 07:58	13/10/2020 06:11	13/10/2020 07:58	1,77	2	3,53	CHI
20201064132	IPORA	IR21014427	IPORA	13/10/2020 06:12	14/10/2020 03:44	13/10/2020 06:12	14/10/2020 03:44	21,53	1	21,53	CHI
20201064140	GOIANIA	12085418	GOYA S1	13/10/2020 06:13	13/10/2020 08:57	13/10/2020 06:13	13/10/2020 08:57	2,73	1	2,73	CHI
20201064141	LUZIANIA	LZ12109847	VIANOPOLIS	13/10/2020 06:13	13/10/2020 12:11	13/10/2020 06:13	13/10/2020 12:11	5,96	6	35,75	CHI
20201064144	PADRE BERNARDO	PB12376763	PADRE BERNARDO	13/10/2020 06:13	13/10/2020 13:50	13/10/2020 06:13	13/10/2020 13:50	7,61	11	83,71	CHI
20201066448	AURILANDIA	AI12215407	FIRMINOPOLIS S2	13/10/2020 06:16	13/10/2020 10:58	13/10/2020 06:16	13/10/2020 10:58	4,70	10	47,03	CHI
20201064856	AMORINOPOLIS	AM11000006	IPORA	13/10/2020 06:17	13/10/2020 17:01	13/10/2020 06:17	13/10/2020 17:01	10,73	88	943,87	CHI
20201064151	DISTRITO FEDERAL	FA12322759	ITUIQUIRA	13/10/2020 06:17	13/10/2020 10:49	13/10/2020 06:17	13/10/2020 10:49	4,52	1	4,52	CHI
20201064151	FORMOSA	FA12322759	ITUIQUIRA	13/10/2020 06:17	13/10/2020 10:49	13/10/2020 06:17	13/10/2020 10:49	4,52	35	158,23	CHI
20201064152	BURITI DE GOIAS	BS12308352	FIRMINOPOLIS S2	13/10/2020 06:17	13/10/2020 23:20	13/10/2020 06:17	13/10/2020 23:20	17,04	4	68,14	CHI
20201064155	ITABERAI	IB11359459	ITABERAI S2	13/10/2020 06:18	13/10/2020 16:34	13/10/2020 06:18	13/10/2020 16:34	10,26	1	10,26	CHI
20201064384	NOVA VENEZA	BR16426719	NEROPOLIS S1	13/10/2020 06:18	13/10/2020 09:55	13/10/2020 06:18	13/10/2020 06:23	0,08	3	0,25	CHI
20201064384	BRAZABRANTES	BR16426719	NEROPOLIS S1	13/10/2020 06:18	13/10/2020 09:55	13/10/2020 06:18	13/10/2020 06:23	0,08	310	25,40	CHI
20201064384	GOIANIRA	BR10413404	NEROPOLIS S1	13/10/2020 06:18	13/10/2020 09:55	13/10/2020 06:18	13/10/2020 08:13	1,92	7	13,46	CHI
20201064384	BRAZABRANTES	BR10413404	NEROPOLIS S1	13/10/2020 06:18	13/10/2020 09:55	13/10/2020 06:18	13/10/2020 08:13	1,92	2	3,84	CHI
20201064384	BRAZABRANTES	BR13016007	NEROPOLIS S1	13/10/2020 06:18	13/10/2020 09:55	13/10/2020 06:18	13/10/2020 09:55	3,61	4	14,45	CHI
20201064384	GOIANIRA	BR13016007	NEROPOLIS S1	13/10/2020 06:18	13/10/2020 09:55	13/10/2020 06:18	13/10/2020 09:55	3,61	22	79,50	CHI
20201064157	APARECIDA DE GOIANIA	10042003	REAL S2	13/10/2020 06:19	13/10/2020 09:54	13/10/2020 06:19	13/10/2020 09:54	3,58	1	3,58	CHI
20201065985	CAIAPONIA	PH12341859	PIRANHAS	13/10/2020 06:19	13/10/2020 14:38	13/10/2020 06:19	13/10/2020 14:38	8,31	7	58,20	CHI
20201064160	CALDAS NOVAS	CN11264996	CALDAS NOVAS S2	13/10/2020 06:19	13/10/2020 12:20	13/10/2020 06:19	13/10/2020 12:20	6,01	45	270,58	CHI
202010189298	DISTRITO FEDERAL	IO12266778	CATALAO S1	13/10/2020 06:20	13/10/2020 12:38	13/10/2020 06:20	13/10/2020 12:38	6,29	1	6,29	CHI
202010189298	DAVINOPOLIS	IO12266778	CATALAO S1	13/10/2020 06:20	13/10/2020 12:38	13/10/2020 06:20	13/10/2020 12:38	6,29	13	81,77	CHI
20201064169	PIRACANJUBA	PI12223308	CALDAS NOVAS S1	13/10/2020 06:20	13/10/2020 11:30	13/10/2020 06:20	13/10/2020 11:30	5,15	19	97,87	CHI
20201064969	HIDROLANDIA	HD11265420	ANHANGUERA	13/10/2020 06:21	13/10/2020 09:34	13/10/2020 06:21	13/10/2020 09:34	3,22	47	151,18	CHI
20201065667	GOIANESIA	GE12000280	GOIANESIA S2	13/10/2020 06:21	13/10/2020 13:14	13/10/2020 06:21	13/10/2020 13:14	6,88	9	61,94	CHI

20201065667	SANTA ISABEL	GE12000280	GOIANESIA S2	13/10/2020 06:21	13/10/2020 13:14	13/10/2020 06:21	13/10/2020 13:14	6,88	1	6,88	CHI
20201064172	ALEXANIA	AX11000032	ALEXANIA	13/10/2020 06:21	13/10/2020 07:35	13/10/2020 06:21	13/10/2020 07:35	1,22	31	37,90	CHI
20201064173	GOIANIA	AP11168557	REAL S2	13/10/2020 06:21	13/10/2020 13:23	13/10/2020 06:21	13/10/2020 13:23	7,02	40	280,74	CHI
20201064176	SENADOR CANEDO	SW11141241	SENADOR CANEDO	13/10/2020 06:23	13/10/2020 09:41	13/10/2020 06:23	13/10/2020 09:41	3,30	172	567,27	CHI
20201064181	POSSE	PS21128046	IACIARA S2	13/10/2020 06:23	13/10/2020 07:58	13/10/2020 06:23	13/10/2020 07:58	1,57	1	1,57	CHI
20201066116	BOBOPOLIS	BX12136924	SAO MIGUEL DO ARAGUAIA	13/10/2020 06:24	13/10/2020 12:02	13/10/2020 06:24	13/10/2020 12:02	5,63	3	16,90	CHI
20201065845	GAMELEIRA DE GOIAS	SV12265413	DAIA S2	13/10/2020 06:24	13/10/2020 21:48	13/10/2020 06:24	13/10/2020 21:48	15,39	5	76,97	CHI
202010189303	CORREGO DO OURO	CO12383509	FIRMINOPOLIS S2	13/10/2020 06:25	13/10/2020 20:07	13/10/2020 06:25	13/10/2020 20:07	13,70	40	547,89	CHI
20201064193	ANAPOLIS	AN12000150	JUNDIAI S2	13/10/2020 06:25	13/10/2020 10:32	13/10/2020 06:25	13/10/2020 10:32	4,10	30	123,05	CHI
202010189399	DIORAMA	DI12066071	ARENOPOLIS	13/10/2020 06:26	14/10/2020 10:57	13/10/2020 06:26	14/10/2020 10:57	28,53	29	827,26	CHI
20201064198	MARA ROSA	MQ11370958	MARA ROSA	13/10/2020 06:26	13/10/2020 10:42	13/10/2020 06:26	13/10/2020 10:42	4,26	65	277,13	CHI
20201064199	GOIANIA	GN11039324	FERROVIARIO S1	13/10/2020 06:26	13/10/2020 10:16	13/10/2020 06:26	13/10/2020 10:16	3,83	20	76,59	CHI
20201064203	ANAPOLIS	AN21258896	JUNDIAI S1	13/10/2020 06:26	13/10/2020 07:24	13/10/2020 06:26	13/10/2020 07:24	0,96	1	0,96	CHI
20201064208	NOVA CRIXAS	NA12090020	NOVA CRIXAS	13/10/2020 06:26	13/10/2020 10:26	13/10/2020 06:26	13/10/2020 10:26	3,99	12	47,86	CHI
20201065263	SAO FRANCISCO DE GOIAS	SF12203675LD	SAO FRANCISCO DE GOIAS	13/10/2020 06:26	14/10/2020 12:31	13/10/2020 06:26	14/10/2020 12:31	30,08	62	1864,91	CHI
20201065263	JARAGUA	SF12203675LD	SAO FRANCISCO DE GOIAS	13/10/2020 06:26	14/10/2020 12:31	13/10/2020 06:26	14/10/2020 12:31	30,08	2	60,16	CHI
20201064215	IPORA	730098345	IPORA	13/10/2020 06:27	13/10/2020 12:14	13/10/2020 06:27	13/10/2020 12:14	5,78	1	5,78	CHI
20201064218	CRIXAS	CX21139791	RUBIATABA	13/10/2020 06:27	14/10/2020 14:43	13/10/2020 06:27	14/10/2020 14:43	32,26	1	32,26	CHI
20201064221	FIRMINOPOLIS	10002596499	FIRMINOPOLIS S1	13/10/2020 06:28	13/10/2020 14:44	13/10/2020 06:28	13/10/2020 14:44	8,27	1	8,27	CHI
20201064224	LUZIANIA	LZ12200111	VIANOPOLIS	13/10/2020 06:28	13/10/2020 09:08	13/10/2020 06:28	13/10/2020 09:08	2,66	11	29,26	CHI
20201064226	GOIANIA	14626690	GOYA S2	13/10/2020 06:28	13/10/2020 13:39	13/10/2020 06:28	13/10/2020 13:39	7,17	1	7,17	CHI
20201064414	ITAPURANGA	IK12311324	ITAPURANGA	13/10/2020 06:29	13/10/2020 09:46	13/10/2020 06:29	13/10/2020 09:46	3,27	6	19,62	CHI
20201064333	MINEIROS	SU12184127	SANTA RITA DO ARAGUAIA	13/10/2020 06:29	13/10/2020 11:18	13/10/2020 06:29	13/10/2020 11:18	4,80	13	62,42	CHI
20201065536	GOIAS	GS11224166	GOIAS	13/10/2020 06:30	13/10/2020 10:10	13/10/2020 06:30	13/10/2020 10:10	3,66	31	113,60	CHI
20201064236	APARECIDA DE GOIANIA	10014829612	ATLANTICO S2	13/10/2020 06:30	13/10/2020 09:16	13/10/2020 06:30	13/10/2020 09:16	2,76	1	2,76	CHI
20201067368	MORRO AGUDO DE GOIAS	RB12292120	RUBIATABA	13/10/2020 06:30	13/10/2020 15:29	13/10/2020 06:30	13/10/2020 15:29	8,97	5	44,86	CHI
20201067368	RUBIATABA	RB12292120	RUBIATABA	13/10/2020 06:30	13/10/2020 15:29	13/10/2020 06:30	13/10/2020 15:29	8,97	4	35,89	CHI
20201065968	GOIANIA	GN12026286	REAL S1	13/10/2020 06:31	13/10/2020 11:07	13/10/2020 06:31	13/10/2020 11:07	4,60	1104	5078,40	CHI
20201064258	FORMOSA	FA21257564	ITUIQUIRA	13/10/2020 06:32	13/10/2020 09:12	13/10/2020 06:32	13/10/2020 09:12	2,66	1	2,66	CHI
20201064616	GOIANIA	GN11163703	CARAJAS S1	13/10/2020 06:33	13/10/2020 08:59	13/10/2020 06:33	13/10/2020 08:59	2,42	194	469,53	CHI
20201064545	PARAUNA	PU11000019	PARAUNA	13/10/2020 06:33	13/10/2020 09:34	13/10/2020 06:33	13/10/2020 09:34	3,00	73	219,26	CHI
20201064923	LEOPOLDO DE BULHOES	SV12383417	DAIA S2	13/10/2020 06:34	13/10/2020 11:00	13/10/2020 06:34	13/10/2020 11:00	4,43	3	13,29	CHI
20201064923	CALDAZINHA	SV12383417	DAIA S2	13/10/2020 06:34	13/10/2020 11:00	13/10/2020 06:34	13/10/2020 11:00	4,43	35	155,05	CHI
20201064923	SILVANIA	SV12383417	DAIA S2	13/10/2020 06:34	13/10/2020 11:00	13/10/2020 06:34	13/10/2020 11:00	4,43	55	243,65	CHI
20201064923	BELA VISTA DE GOIAS	SV12383417	DAIA S2	13/10/2020 06:34	13/10/2020 11:00	13/10/2020 06:34	13/10/2020 11:00	4,43	1	4,43	CHI
20201065798	JARAGUA	JA11140587	JARAGUA	13/10/2020 06:35	13/10/2020 13:08	13/10/2020 06:35	13/10/2020 13:08	6,54	62	405,58	CHI
20201064275	IPORA	IR12334805	IPORA	13/10/2020 06:35	13/10/2020 14:29	13/10/2020 06:35	13/10/2020 14:29	7,90	1	7,90	CHI
20201065172	CRISTIANOPOLIS	CF12265545	CRISTIANOPOLIS	13/10/2020 06:35	13/10/2020 09:53	13/10/2020 06:35	13/10/2020 09:53	3,29	19	62,51	CHI
20201064283	TURVANIA	TV21005758	FIRMINOPOLIS S2	13/10/2020 06:36	14/10/2020 08:35	13/10/2020 06:36	14/10/2020 08:35	25,97	1	25,97	CHI
20201065135	SANTA RITA DO NOVO DESTINO	BA12208877	BARRO ALTO	13/10/2020 06:36	14/10/2020 05:01	13/10/2020 06:36	14/10/2020 05:01	22,40	29	649,65	CHI
20201066462	GOIANIA	GN11160124	CAMPINAS S2	13/10/2020 06:37	13/10/2020 10:46	13/10/2020 06:37	13/10/2020 10:46	4,15	82	340,25	CHI
20201064288	SENADOR CANEDO	SW12392763	SENADOR CANEDO	13/10/2020 06:37	13/10/2020 10:27	13/10/2020 06:37	13/10/2020 10:27	3,83	159	609,01	CHI
20201064996	SAO FRANCISCO DE GOIAS	SF12254540	SAO FRANCISCO DE GOIAS	13/10/2020 06:37	13/10/2020 13:33	13/10/2020 06:37	13/10/2020 13:33	6,93	170	1177,86	CHI
20201062439	TURVANIA	TV12170250	FIRMINOPOLIS S1	13/10/2020 06:37	13/10/2020 12:40	13/10/2020 06:37	13/10/2020 12:40	6,04	3	18,13	CHI
20201068284	PIRES DO RIO	PR11272853	PIRES DO RIO S1	13/10/2020 06:37	13/10/2020 15:49	13/10/2020 06:37	13/10/2020 15:49	9,19	129	1185,19	CHI
20201064299	CRISTALINA	KR12163791	PAMPLONA	13/10/2020 06:37	13/10/2020 09:39	13/10/2020 06:37	13/10/2020 09:39	3,02	31	93,58	CHI
20201064306	GOIANIA	10080399	AEROPORTO S3	13/10/2020 06:38	13/10/2020 09:26	13/10/2020 06:38	13/10/2020 09:26	2,79	1	2,79	CHI
20201065225	SANTO ANTONIO DE GOIAS	BW12232189	NEROPOLIS S1	13/10/2020 06:39	13/10/2020 11:34	13/10/2020 06:39	13/10/2020 11:34	4,91	362	1779,23	CHI
20201064323	CATALAO	GD12377052RE	CATALAO S1	13/10/2020 06:40	13/10/2020 09:59	13/10/2020 06:40	13/10/2020 09:59	3,31	18	59,59	CHI
20201064323	GOIANDIRA	GD12377052RE	CATALAO S1	13/10/2020 06:40	13/10/2020 09:59	13/10/2020 06:40	13/10/2020 09:59	3,31	66	218,50	CHI
20201066491	APARECIDA DE GOIANIA	AP11128008	ANHAGUERA	13/10/2020 06:40	13/10/2020 10:55	13/10/2020 06:40	13/10/2020 10:55	4,24	156	660,88	CHI
20201064844	CATALAO	CT12267145	CATALAO S1	13/10/2020 06:40	13/10/2020 10:02	13/10/2020 06:40	13/10/2020 10:02	3,35	12	40,22	CHI
20201064756	PIRACANJUBA	PJ12000011	PIRACANJUBA	13/10/2020 06:41	13/10/2020 08:00	13/10/2020 06:41	13/10/2020 08:00	1,32	76	100,09	CHI
20201064329	ITABERAI	IB21169300	ITABERAI S1	13/10/2020 06:41	13/10/2020 11:58	13/10/2020 06:41	13/10/2020 11:58	5,28	1	5,28	CHI
20201064523	DIVINOPOLIS DE GOIAS	GH12241928	SAO DOMINGOS	13/10/2020 06:41	13/10/2020 09:31	13/10/2020 06:41	13/10/2020 09:31	2,83	41	115,86	CHI
20201064523	MONTE ALEGRE DE GOIAS	GH12241928	SAO DOMINGOS	13/10/2020 06:41	13/10/2020 09:31	13/10/2020 06:41	13/10/2020 09:31	2,83	2	5,65	CHI
20201064523	SAO DOMINGOS	GH12241928	SAO DOMINGOS	13/10/2020 06:41	13/10/2020 09:31	13/10/2020 06:41	13/10/2020 09:31	2,83	12	33,91	CHI
2020101300074	FAZENDA NOVA	16501	BRITANIA	13/10/2020 06:42	13/10/2020 06:45	13/10/2020 06:42	13/10/2020 06:45	0,05	5	0,25	CHI

2020101300074	JUSSARA	16501	BRITANIA	13/10/2020 06:42	13/10/2020 06:45	13/10/2020 06:42	13/10/2020 06:45	0,05	26	1,30	CHI
2020101300074	JUSSARA	16502	BRITANIA	13/10/2020 06:42	13/10/2020 06:45	13/10/2020 06:42	13/10/2020 06:45	0,05	14	0,70	CHI
2020101300074	SANTA FE DE GOIAS	02700424	BRITANIA	13/10/2020 06:42	13/10/2020 06:45	13/10/2020 06:42	13/10/2020 06:45	0,05	21	1,05	CHI
2020101300074	JUSSARA	02700424	BRITANIA	13/10/2020 06:42	13/10/2020 06:45	13/10/2020 06:42	13/10/2020 06:45	0,05	124	6,20	CHI
2020101300074	SANTA FE DE GOIAS	02700414	BRITANIA	13/10/2020 06:42	13/10/2020 06:45	13/10/2020 06:42	13/10/2020 06:45	0,05	71	3,55	CHI
2020101300074	ITAPIRAPUA	02700414	BRITANIA	13/10/2020 06:42	13/10/2020 06:45	13/10/2020 06:42	13/10/2020 06:45	0,05	2	0,10	CHI
2020101300074	JUSSARA	02700414	BRITANIA	13/10/2020 06:42	13/10/2020 06:45	13/10/2020 06:42	13/10/2020 06:45	0,05	10	0,50	CHI
2020101300074	SANTA FE DE GOIAS	16501	BRITANIA	13/10/2020 06:42	13/10/2020 06:45	13/10/2020 06:42	13/10/2020 06:45	0,05	240	12,00	CHI
2020101300074	SANTA FE DE GOIAS	16502	BRITANIA	13/10/2020 06:42	13/10/2020 06:45	13/10/2020 06:42	13/10/2020 06:45	0,05	1663	83,15	CHI
20201064338	JATAI	290190939	JATAI S3	13/10/2020 06:42	13/10/2020 08:29	13/10/2020 06:42	13/10/2020 08:29	1,78	1	1,78	CHI
20201064346	GOIANIA	10812167	GOIANIA LESTE S1	13/10/2020 06:42	13/10/2020 11:23	13/10/2020 06:42	13/10/2020 11:23	4,67	1	4,67	CHI
20201064347	SANTO ANTONIO DE GOIAS	BW12406479	NEROPOLIS S1	13/10/2020 06:43	13/10/2020 15:21	13/10/2020 06:43	13/10/2020 15:21	8,63	21	181,28	CHI
20201069050	CAMPOS VERDES	VD12049791	SANTA TEREZINHA	13/10/2020 06:43	13/10/2020 17:11	13/10/2020 06:43	13/10/2020 17:11	10,46	14	146,38	CHI
20201065734	APARECIDA DE GOIANIA	AP11161027	REAL S1	13/10/2020 06:43	13/10/2020 11:20	13/10/2020 06:43	13/10/2020 11:20	4,60	90	414,25	CHI
20201064357	SENADOR CANEDO	13392682	SENADOR CANEDO	13/10/2020 06:44	13/10/2020 10:33	13/10/2020 06:44	13/10/2020 10:33	3,81	1	3,81	CHI
20201064358	GOIANIA	GN12056073	CAMPINAS S2	13/10/2020 06:44	13/10/2020 14:42	13/10/2020 06:44	13/10/2020 14:42	7,96	1	7,96	CHI
20201064359	MONTES CLAROS DE GOIAS	ME21135307	IPORA	13/10/2020 06:44	13/10/2020 10:35	13/10/2020 06:44	13/10/2020 10:35	3,84	1	3,84	CHI
20201065221	NOVA VENEZA	NV12000117	INHUMAS S1	13/10/2020 06:44	13/10/2020 11:54	13/10/2020 06:44	13/10/2020 11:54	5,01	77	385,60	CHI
20201065221	INHUMAS	NV12000117	INHUMAS S1	13/10/2020 06:44	13/10/2020 11:54	13/10/2020 06:44	13/10/2020 11:54	5,16	19	98,00	CHI
20201065221	BRAZABRANTES	NV12000117	INHUMAS S1	13/10/2020 06:44	13/10/2020 11:54	13/10/2020 06:44	13/10/2020 11:54	5,16	32	165,05	CHI
20201065221	NOVA VENEZA	NV12000117	INHUMAS S1	13/10/2020 06:44	13/10/2020 11:54	13/10/2020 06:44	13/10/2020 11:54	5,16	9	46,42	CHI
20201065221	BRAZABRANTES	NV12272408	INHUMAS S1	13/10/2020 06:44	13/10/2020 11:54	13/10/2020 09:40	13/10/2020 11:54	2,23	28	62,31	CHI
20201066615	ITABERAI	IB11188029	ITABERAI S2	13/10/2020 06:44	13/10/2020 11:16	13/10/2020 06:44	13/10/2020 11:16	4,52	49	221,43	CHI
20201063737	GOIANIA	GN12144329	CARAJAS S1	13/10/2020 06:45	13/10/2020 11:22	13/10/2020 06:45	13/10/2020 11:22	4,62	108	498,63	CHI
20201064365	TRINDADE	40173069	TRINDADE	13/10/2020 06:45	13/10/2020 10:09	13/10/2020 06:45	13/10/2020 10:09	3,40	1	3,40	CHI
20201064972	ORIZONA	OZ12114531	PIRES DO RIO S2	13/10/2020 06:45	13/10/2020 09:29	13/10/2020 06:45	13/10/2020 09:29	2,73	26	70,86	CHI
20201065061	PIRACANJUBA	PI12212152	PIRACANJUBA	13/10/2020 06:45	13/10/2020 10:33	13/10/2020 06:45	13/10/2020 10:33	3,79	38	144,06	CHI
20201064371	SANTA HELENA DE GOIAS	SH12010246	IPEGUARI	13/10/2020 06:45	13/10/2020 09:27	13/10/2020 06:45	13/10/2020 09:27	2,69	21	56,43	CHI
20201064373	URUACU	UR21350229	URUACU	13/10/2020 06:45	13/10/2020 07:46	13/10/2020 06:45	13/10/2020 07:46	1,00	2	2,00	CHI
20201067425	JARAGUA	JA12000204	JARAGUA	13/10/2020 06:46	13/10/2020 19:28	13/10/2020 06:46	13/10/2020 19:28	12,70	265	3365,35	CHI
20201064380	GOIANIA	GN21350761	REAL S2	13/10/2020 06:46	13/10/2020 11:04	13/10/2020 06:46	13/10/2020 11:04	4,29	1	4,29	CHI
20201064386	MINEIROS	MY12241778	PARQUE DAS EMAS	13/10/2020 06:47	13/10/2020 10:14	13/10/2020 06:47	13/10/2020 10:14	3,44	11	37,87	CHI
20201064479	BELA VISTA DE GOIAS	BV12035058	BELA VISTA S1	13/10/2020 06:48	13/10/2020 08:45	13/10/2020 06:48	13/10/2020 08:45	1,95	6	11,69	CHI
20201064395	ITABERAI	IB12198803	ITABERAI S2	13/10/2020 06:48	13/10/2020 11:25	13/10/2020 06:48	13/10/2020 11:25	4,62	45	208,00	CHI
20201064395	ITABERAI	IB12198803	ITABERAI S2	13/10/2020 06:48	13/10/2020 11:25	13/10/2020 06:48	13/10/2020 11:25	4,62	2	9,24	CHI
20201064395	ITABERAI	IB12198803	ITABERAI S2	13/10/2020 06:48	13/10/2020 11:25	13/10/2020 07:54	13/10/2020 11:25	3,53	10	35,32	CHI
20201064398	ARUANA	AK12404527	MOZARLANDIA	13/10/2020 06:48	13/10/2020 09:40	13/10/2020 06:48	13/10/2020 09:40	2,85	34	96,99	CHI
20201064413	IPAMERA	IP12087055	PIRES DO RIO S2	13/10/2020 06:49	13/10/2020 09:45	13/10/2020 06:49	13/10/2020 09:45	2,93	13	38,14	CHI
20201065355	IPORA	IR12065120	IPORA	13/10/2020 06:49	13/10/2020 15:59	13/10/2020 06:49	13/10/2020 15:59	9,16	7	64,10	CHI
20201064406	APARECIDA DE GOIANIA	200604946	INDEPENDENCIA S1	13/10/2020 06:49	13/10/2020 10:29	13/10/2020 06:49	13/10/2020 10:29	3,66	1	3,66	CHI
20201064408	ANAPOLIS	10018634344	JUNDAI S2	13/10/2020 06:49	13/10/2020 08:51	13/10/2020 06:49	13/10/2020 08:51	2,02	1	2,02	CHI
20201064409	QUIRINOPOLIS	QI21305944	RIO DOS BOIS	13/10/2020 06:49	13/10/2020 10:37	13/10/2020 06:49	13/10/2020 10:37	3,79	1	3,79	CHI
20201067194	PIRENOPOLIS	PV12000072	CORUMBA	13/10/2020 06:49	13/10/2020 23:47	13/10/2020 06:49	13/10/2020 23:47	16,95	13	220,37	CHI
20201064412	MORRINHOS	MR21028283	MORRINHOS	13/10/2020 06:50	13/10/2020 10:27	13/10/2020 06:50	13/10/2020 10:27	3,61	1	3,61	CHI
20201066757	JARAGUA	JA12297982	SAO FRANCISCO DE GOIAS	13/10/2020 06:51	13/10/2020 16:20	13/10/2020 06:51	13/10/2020 16:20	9,47	24	227,30	CHI
20201066757	JESUPOLIS	JA12297982	SAO FRANCISCO DE GOIAS	13/10/2020 06:51	13/10/2020 16:20	13/10/2020 06:51	13/10/2020 16:20	9,47	5	47,35	CHI
20201064807	TRINDADE	TR11107252	TRINDADE	13/10/2020 06:52	13/10/2020 13:40	13/10/2020 06:52	13/10/2020 13:40	6,80	208	1415,04	CHI
20201063704	GOIANIA	GN12001259	ATLANTICO S2	13/10/2020 06:54	13/10/2020 08:21	13/10/2020 06:54	13/10/2020 08:21	1,45	260	376,28	CHI
20201064453	MARA ROSA	10001454496	MARA ROSA	13/10/2020 06:54	13/10/2020 13:06	13/10/2020 06:54	13/10/2020 13:06	6,19	1	6,19	CHI
20201064466	JUSSARA	JR12101204	JUSSARA	13/10/2020 06:56	13/10/2020 09:21	13/10/2020 06:56	13/10/2020 09:21	2,41	30	72,17	CHI
20201064468	APARECIDA DE GOIANIA	200233944	INDEPENDENCIA S1	13/10/2020 06:56	13/10/2020 09:27	13/10/2020 06:56	13/10/2020 09:27	2,50	1	2,50	CHI
20201065283	JARAGUA	JA11095171	JARAGUA	13/10/2020 06:56	13/10/2020 13:57	13/10/2020 06:56	13/10/2020 13:57	7,00	65	455,27	CHI
20201064470	CORUMBA DE GOIAS	CB11215166	CORUMBA	13/10/2020 06:56	13/10/2020 08:51	13/10/2020 06:56	13/10/2020 08:51	1,90	76	144,59	CHI
20201064471	MARA ROSA	MQ21192407	MARA ROSA	13/10/2020 06:56	13/10/2020 14:52	13/10/2020 06:56	13/10/2020 14:52	7,92	1	7,92	CHI
20201064487	ITAPACI	IW21325188	ITAPACI	13/10/2020 06:59	13/10/2020 12:08	13/10/2020 06:59	13/10/2020 12:08	5,14	1	5,14	CHI
20201064489	GOIANIA	13270205	ATLANTICO S1	13/10/2020 06:59	13/10/2020 15:32	13/10/2020 06:59	13/10/2020 15:32	8,53	1	8,53	CHI
20201064491	CRISTALINA	KR12389576	CRISTALINA S2	13/10/2020 07:00	13/10/2020 08:27	13/10/2020 07:00	13/10/2020 08:27	1,45	42	60,81	CHI
20201064494	SAO LUIS DE MONTES BELOS	SL21107305	SAO LUIZ DOS MONTES BELOS	13/10/2020 07:00	13/10/2020 12:31	13/10/2020 07:00	13/10/2020 12:31	5,51	2	11,01	CHI

20201064503	NEROPOLIS	NR12029257	NEROPOLIS S2	13/10/2020 07:01	14/10/2020 01:39	13/10/2020 07:01	14/10/2020 01:39	18,63	7	130,38	CHI
20201064506	MARA ROSA	MQ21055247	MARA ROSA	13/10/2020 07:02	13/10/2020 13:31	13/10/2020 07:02	13/10/2020 13:31	6,48	1	6,48	CHI
20201064507	BURITI ALEGRE	BG21110215	ALTO BURITI	13/10/2020 07:02	13/10/2020 09:46	13/10/2020 07:02	13/10/2020 09:46	2,73	1	2,73	CHI
20201067416	CATALAO	CT12389878	CATALAO S1	13/10/2020 07:02	13/10/2020 17:39	13/10/2020 07:02	13/10/2020 17:39	10,62	10	106,15	CHI
20201065130	CAMPINACU	UC12265729	PORANGATU	13/10/2020 07:02	13/10/2020 09:24	13/10/2020 07:02	13/10/2020 09:24	2,36	27	63,59	CHI
20201064515	GOIANIA	GN11056831	GOIANIA LESTE S1	13/10/2020 07:03	13/10/2020 10:19	13/10/2020 07:03	13/10/2020 10:19	3,26	98	319,53	CHI
20201064520	SENADOR CANEDO	SW12092681	SENADOR CANEDO	13/10/2020 07:03	13/10/2020 10:17	13/10/2020 07:03	13/10/2020 10:17	3,22	64	205,96	CHI
20201064522	MAMBAI	MB11170566	IACIARA S2	13/10/2020 07:04	13/10/2020 08:51	13/10/2020 07:04	13/10/2020 08:51	1,78	3	5,34	CHI
20201068514	CRIXAS	CX12190247	SANTA TEREZINHA	13/10/2020 07:04	13/10/2020 14:57	13/10/2020 07:04	13/10/2020 14:57	7,88	5	39,38	CHI
20201064528	URUACU	UR11384328	URUACU	13/10/2020 07:04	13/10/2020 11:25	13/10/2020 07:04	13/10/2020 11:25	4,34	104	451,16	CHI
20201064598	NOVA VENEZA	NV12010103	INHUMAS S1	13/10/2020 07:04	13/10/2020 10:09	13/10/2020 07:04	13/10/2020 10:09	3,07	2	6,14	CHI
20201064602	BARRO ALTO	BA10403915	BARRO ALTO	13/10/2020 07:05	13/10/2020 17:00	13/10/2020 07:05	13/10/2020 07:08	0,05	1098	57,03	CHI
20201064602	BARRO ALTO	BA10403915	BARRO ALTO	13/10/2020 07:05	13/10/2020 17:00	13/10/2020 07:05	13/10/2020 14:14	7,16	759	5430,86	CHI
20201064602	BARRO ALTO	BA10403915	BARRO ALTO	13/10/2020 07:05	13/10/2020 17:00	13/10/2020 07:11	13/10/2020 14:14	7,04	1098	7734,80	CHI
20201064602	BARRO ALTO	BA10403915	BARRO ALTO	13/10/2020 07:05	13/10/2020 17:00	13/10/2020 14:19	13/10/2020 17:00	2,69	1822	4899,16	CHI
20201064541	IPAMERI	580047982	IPAMERI	13/10/2020 07:05	13/10/2020 13:40	13/10/2020 07:05	13/10/2020 13:40	6,57	1	6,57	CHI
20201064542	GOIANIA	GN21251455	ATLANTICO S3	13/10/2020 07:05	13/10/2020 10:31	13/10/2020 07:05	13/10/2020 10:31	3,42	1	3,42	CHI
20201065280	MONTIVIDIU	MV12267612	MONTIVIDIU T	13/10/2020 07:05	13/10/2020 16:29	13/10/2020 07:05	13/10/2020 16:29	9,39	1	9,39	CHI
20201064557	CATALAO	CT21078237	CATALAO S2	13/10/2020 07:07	13/10/2020 15:14	13/10/2020 07:07	13/10/2020 15:14	8,12	1	8,12	CHI
20201065388	APARECIDA DE GOIANIA	AP11166246	REAL S1	13/10/2020 07:07	13/10/2020 13:33	13/10/2020 07:07	13/10/2020 13:33	6,43	123	790,62	CHI
202010189299	RIO VERDE	CP12147712	CAIAPONIA	13/10/2020 07:07	14/10/2020 10:04	13/10/2020 07:07	14/10/2020 10:04	26,94	4	107,77	CHI
202010189299	JATAI	CP12147712	CAIAPONIA	13/10/2020 07:07	14/10/2020 10:04	13/10/2020 07:07	14/10/2020 10:04	26,94	3	80,83	CHI
20201066373	PALMINOPOLIS	PP12011503	PALMEIRAS	13/10/2020 07:07	13/10/2020 15:32	13/10/2020 07:07	13/10/2020 15:32	8,40	10	84,02	CHI
20201064571	BELA VISTA DE GOIAS	240007487	BELA VISTA S1	13/10/2020 07:08	13/10/2020 08:57	13/10/2020 07:08	13/10/2020 08:57	1,81	1	1,81	CHI
20201067310	FAZENDA NOVA	FN12237035	JUSSARA	13/10/2020 07:08	13/10/2020 14:04	13/10/2020 07:08	13/10/2020 14:04	6,92	7	48,44	CHI
20201069425	PIRES DO RIO	OZ12000351RE	PIRES DO RIO S1	13/10/2020 07:09	13/10/2020 17:51	13/10/2020 07:09	13/10/2020 17:51	10,70	4	42,79	CHI
20201069425	RIZONA	OZ12000351RE	PIRES DO RIO S1	13/10/2020 07:09	13/10/2020 17:51	13/10/2020 07:09	13/10/2020 17:51	10,70	32	342,31	CHI
20201065447	SANTA ROSA DE GOIAS	SR12000047	INHUMAS S1	13/10/2020 07:09	13/10/2020 14:14	13/10/2020 07:09	13/10/2020 14:14	7,07	53	374,96	CHI
20201068005	AMARALINA	LC12266013	MARA ROSA	13/10/2020 07:09	13/10/2020 14:09	13/10/2020 07:09	13/10/2020 14:09	6,99	7	48,93	CHI
20201064643	CACHOEIRA ALTA	CA12327414	CACHOEIRA ALTA	13/10/2020 07:10	13/10/2020 12:20	13/10/2020 07:10	13/10/2020 12:20	5,16	5	25,78	CHI
20201064603	MARA ROSA	ET21256426	MARA ROSA	13/10/2020 07:11	13/10/2020 21:47	13/10/2020 07:11	13/10/2020 21:47	14,60	1	14,60	CHI
20201064652	SAO JOAO D ALIANCA	JL12268110	FLORES DE GOIAS	13/10/2020 07:11	13/10/2020 09:50	13/10/2020 07:11	13/10/2020 09:50	2,64	9	23,76	CHI
20201068897	TRINDADE	TR12005149	TRINDADE	13/10/2020 07:11	13/10/2020 15:49	13/10/2020 07:11	13/10/2020 15:49	8,62	3	25,87	CHI
20201064613	SAO MIGUEL DO ARAGUAIA	SM12020625	SAO MIGUEL DO ARAGUAIA	13/10/2020 07:12	13/10/2020 09:43	13/10/2020 07:12	13/10/2020 09:43	2,52	6	15,10	CHI
20201064615	SANTA CRUZ DE GOIAS	BC31087090	PIRES DO RIO S2	13/10/2020 07:12	13/10/2020 10:00	13/10/2020 07:12	13/10/2020 10:00	2,80	1	2,80	CHI
20201065731	LUZIANIA	OZ12186208	PIRES DO RIO S2	13/10/2020 07:12	13/10/2020 13:33	13/10/2020 07:12	13/10/2020 13:33	6,35	32	203,07	CHI
20201064617	FORMOSA	FA21106955	ITQUIRA	13/10/2020 07:12	13/10/2020 11:41	13/10/2020 07:12	13/10/2020 11:41	4,48	1	4,48	CHI
20201065260	CALDAS NOVAS	CN11223432	SERRA DE CALDAS	13/10/2020 07:12	13/10/2020 09:09	13/10/2020 07:12	13/10/2020 09:09	1,94	59	114,35	CHI
20201070405	SAO MIGUEL DO PASSA QUATRO	VN12117212	PIRES DO RIO S2	13/10/2020 07:13	14/10/2020 07:00	13/10/2020 07:13	14/10/2020 07:00	23,78	2	47,56	CHI
20201070405	VIANOPOLIS	VN12117212	PIRES DO RIO S2	13/10/2020 07:13	14/10/2020 07:00	13/10/2020 07:13	14/10/2020 07:00	23,78	37	879,95	CHI
20201064644	LUZIANIA	LZ12336006	VIANOPOLIS	13/10/2020 07:13	13/10/2020 09:33	13/10/2020 07:13	13/10/2020 09:33	2,32	109	252,70	CHI
20201064645	MUTUNOPOLIS	MU12396743	MARA ROSA	13/10/2020 07:14	13/10/2020 13:12	13/10/2020 07:14	13/10/2020 13:12	5,97	5	29,83	CHI
20201064649	ANAPOLIS	20114989	JUNDIAI S2	13/10/2020 07:14	13/10/2020 10:29	13/10/2020 07:14	13/10/2020 10:29	3,25	1	3,25	CHI
20201066183	CRIXAS	CX12145539	RUBIATABA	13/10/2020 07:14	13/10/2020 14:21	13/10/2020 07:14	13/10/2020 14:21	7,11	19	135,04	CHI
20201064875	TURVELANDIA	SH16402415	IPEGUARI	13/10/2020 07:15	13/10/2020 07:53	13/10/2020 07:15	13/10/2020 07:24	0,16	12	1,86	CHI
20201064875	SANTA HELENA DE GOIAS	SH16402415	IPEGUARI	13/10/2020 07:15	13/10/2020 07:53	13/10/2020 07:15	13/10/2020 07:24	0,16	134	20,81	CHI
20201064875	SANTA HELENA DE GOIAS	SH16402415	IPEGUARI	13/10/2020 07:15	13/10/2020 07:53	13/10/2020 07:15	13/10/2020 07:25	0,18	5	0,89	CHI
20201064875	SANTA HELENA DE GOIAS	05770614	IPEGUARI	13/10/2020 07:15	13/10/2020 07:53	13/10/2020 07:15	13/10/2020 07:46	0,52	4881	2562,52	CHI
20201064875	RIO VERDE	05770614	IPEGUARI	13/10/2020 07:15	13/10/2020 07:53	13/10/2020 07:15	13/10/2020 07:46	0,52	2	1,05	CHI
20201064875	SANTA HELENA DE GOIAS	05770614	IPEGUARI	13/10/2020 07:15	13/10/2020 07:53	13/10/2020 07:15	13/10/2020 07:48	0,56	2009	1133,41	CHI
20201064875	SANTA HELENA DE GOIAS	05770614	IPEGUARI	13/10/2020 07:15	13/10/2020 07:53	13/10/2020 07:15	13/10/2020 07:50	0,60	2451	1463,79	CHI
20201064875	SANTA HELENA DE GOIAS	05770614	IPEGUARI	13/10/2020 07:15	13/10/2020 07:53	13/10/2020 07:15	13/10/2020 07:53	0,63	4162	2634,78	CHI
20201064657	PALMEIRAS DE GOIAS	10022050220	PALMEIRAS	13/10/2020 07:15	13/10/2020 08:59	13/10/2020 07:15	13/10/2020 08:59	1,73	1	1,73	CHI
20201064667	CALDAZINHA	LB12012180	DAIA S2	13/10/2020 07:16	13/10/2020 09:12	13/10/2020 07:16	13/10/2020 09:12	1,93	24	46,29	CHI
20201064667	LEOPOLDO DE BULHOES	LB12012180	DAIA S2	13/10/2020 07:16	13/10/2020 09:12	13/10/2020 07:16	13/10/2020 09:12	1,93	2	3,86	CHI
20201064673	GOIANIA	15684234	GOIANIA LESTE S3	13/10/2020 07:16	13/10/2020 13:44	13/10/2020 07:16	13/10/2020 13:44	6,45	0	0,00	CHI
20201064682	INHUMAS	30124591	INHUMAS S2	13/10/2020 07:17	13/10/2020 17:35	13/10/2020 07:17	13/10/2020 17:35	10,29	1	10,29	CHI
20201064687	AMARALINA	LC21222192	MARA ROSA	13/10/2020 07:17	13/10/2020 11:21	13/10/2020 07:17	13/10/2020 11:21	4,05	1	4,05	CHI

20201064691	LEOPOLDO DE BULHOES	LB12000009	DAIA S2	13/10/2020 07:18	13/10/2020 10:03	13/10/2020 07:18	13/10/2020 10:03	2,74	2	5,49	CHI
20201064704	ANICUNS	AC21021759	ANICUNS	13/10/2020 07:19	13/10/2020 18:49	13/10/2020 07:19	13/10/2020 18:49	11,49	1	11,49	CHI
20201064729	CAIAPONIA	CP12223010	PALESTINA	13/10/2020 07:19	14/10/2020 02:35	13/10/2020 07:19	14/10/2020 02:35	19,26	9	173,33	CHI
20201064706	IACIARA	IA12194773	IACIARA S2	13/10/2020 07:19	13/10/2020 08:52	13/10/2020 07:19	13/10/2020 08:52	1,54	2	3,07	CHI
20201064710	SILVANIA	SV21288450	VIANOPOLIS	13/10/2020 07:20	13/10/2020 14:01	13/10/2020 07:20	13/10/2020 14:01	6,68	1	6,68	CHI
20201064716	NEROPOLIS	10014252412	NEROPOLIS S2	13/10/2020 07:20	13/10/2020 13:41	13/10/2020 07:20	13/10/2020 13:41	6,34	1	6,34	CHI
20201065086	ANAPOLIS	AN12351048	ANAPOLIS UNIVERSITARIO S2	13/10/2020 07:20	13/10/2020 12:09	13/10/2020 07:20	13/10/2020 12:09	4,81	17	81,69	CHI
20201064728	ITAPIRAPUA	IU12341188	JUSSARA	13/10/2020 07:21	13/10/2020 10:45	13/10/2020 07:21	13/10/2020 10:45	3,40	6	20,39	CHI
20201066083	JARAGUA	JA12000134	JARAGUA	13/10/2020 07:21	13/10/2020 20:10	13/10/2020 07:21	13/10/2020 20:10	12,81	151	1934,44	CHI
20201067638	PIRES DO RIO	PR12337219	PIRES DO RIO S1	13/10/2020 07:22	13/10/2020 19:28	13/10/2020 07:22	13/10/2020 19:28	12,10	4	48,38	CHI
20201064748	RIO VERDE	MV12214244	MONTIVIDIU T	13/10/2020 07:22	13/10/2020 15:35	13/10/2020 07:22	13/10/2020 15:35	8,21	1	8,21	CHI
20201064748	MONTIVIDIU	MV12214244	MONTIVIDIU T	13/10/2020 07:22	13/10/2020 15:35	13/10/2020 07:22	13/10/2020 15:35	8,21	7	57,47	CHI
20201064749	GOIANIA	GN11003166	CAMPINAS S2	13/10/2020 07:22	13/10/2020 10:21	13/10/2020 07:22	13/10/2020 10:21	2,98	102	303,56	CHI
20201065762	CRISTALINA	IP12165527	CRISTALINA S1	13/10/2020 07:22	13/10/2020 09:44	13/10/2020 07:22	13/10/2020 09:44	2,35	15	35,28	CHI
20201064759	PIRACANJUBA	60069582	PIRACANJUBA	13/10/2020 07:22	13/10/2020 11:28	13/10/2020 07:22	13/10/2020 11:28	4,09	1	4,09	CHI
20201064760	MINEROS	MY12322128RE	PARQUE DAS EMAS	13/10/2020 07:23	13/10/2020 15:30	13/10/2020 07:23	13/10/2020 15:30	8,12	4	32,47	CHI
20201065231	CAMPO ALEGRE DE GOIAS	CM12127532	CAMPO ALEGRE DE GOIAS	13/10/2020 07:23	13/10/2020 12:15	13/10/2020 07:23	13/10/2020 12:15	4,86	59	286,77	CHI
20201064768	CATALAO	CT12288394	CAMPO ALEGRE DE GOIAS	13/10/2020 07:23	13/10/2020 09:58	13/10/2020 07:23	13/10/2020 09:58	2,57	3	7,72	CHI
20201064772	TRINDADE	TR21323751	TRINDADE	13/10/2020 07:23	13/10/2020 13:03	13/10/2020 07:23	13/10/2020 13:03	5,66	1	5,66	CHI
20201064776	GOIANIRA	GR12311184	GOIANIRA	13/10/2020 07:24	13/10/2020 15:24	13/10/2020 07:24	13/10/2020 15:24	8,00	1	8,00	CHI
20201064783	URUACU	640081411	URUACU	13/10/2020 07:24	13/10/2020 11:18	13/10/2020 07:24	13/10/2020 11:18	3,89	1	3,89	CHI
20201064786	AMORINOPOLIS	AM21000011	IPORA	13/10/2020 07:24	14/10/2020 04:44	13/10/2020 07:24	14/10/2020 04:20	20,92	1	20,92	CHI
20201064786	AMORINOPOLIS	AM12253722	IPORA	13/10/2020 07:24	14/10/2020 04:44	14/10/2020 02:51	14/10/2020 04:44	1,88	2	3,77	CHI
20201065024	SENADOR CANEDO	SW12099164	GOIANIA LESTE S2	13/10/2020 07:24	13/10/2020 09:42	13/10/2020 07:24	13/10/2020 09:42	2,29	446	1019,23	CHI
20201065024	GOIANIA	SW12099164	GOIANIA LESTE S2	13/10/2020 07:24	13/10/2020 09:42	13/10/2020 07:24	13/10/2020 09:42	2,29	15	34,28	CHI
20201065144	GOIANIA	GN11001651	CAMPINAS S3	13/10/2020 07:25	13/10/2020 08:53	13/10/2020 07:25	13/10/2020 08:53	1,47	108	158,31	CHI
20201064794	CABECEIRAS	GW21257619	ITUIQUIRA	13/10/2020 07:25	13/10/2020 11:26	13/10/2020 07:25	13/10/2020 11:26	4,01	1	4,01	CHI
20201064796	LEOPOLDO DE BULHOES	LB12270649	DAIA S2	13/10/2020 07:25	13/10/2020 17:39	13/10/2020 07:25	13/10/2020 17:39	10,24	54	553,10	CHI
20201064800	CACHOEIRA ALTA	CA21360675	CACHOEIRA ALTA	13/10/2020 07:25	13/10/2020 14:31	13/10/2020 07:25	13/10/2020 14:31	7,09	3	21,28	CHI
20201064803	JATAI	JT21093816	CACHOEIRA ALTA	13/10/2020 07:25	13/10/2020 13:05	13/10/2020 07:25	13/10/2020 13:05	5,65	1	5,65	CHI
20201064819	VICENTINOPOLIS	VI21028475	VICENTINOPOLIS	13/10/2020 07:27	13/10/2020 17:17	13/10/2020 07:27	13/10/2020 17:17	9,82	1	9,82	CHI
20201064825	PALMELO	PZ11000146	PIRES DO RIO S2	13/10/2020 07:28	13/10/2020 10:36	13/10/2020 07:28	13/10/2020 10:36	3,12	100	312,14	CHI
20201065445	PILAR DE GOIAS	GG12171805RE	SANTA TEREZINHA	13/10/2020 07:29	13/10/2020 12:01	13/10/2020 07:29	13/10/2020 12:01	4,53	60	271,87	CHI
20201065445	SANTA TEREZINHA DE GOIAS	GG12171805RE	SANTA TEREZINHA	13/10/2020 07:29	13/10/2020 12:01	13/10/2020 07:29	13/10/2020 12:01	4,53	46	208,43	CHI
20201064845	APARECIDA DE GOIANIA	10017970626	INDEPENDENCIA S2	13/10/2020 07:30	13/10/2020 11:52	13/10/2020 07:30	13/10/2020 11:52	4,36	1	4,36	CHI
20201065220	PIRACANJUBA	PJ12418894	PIRACANJUBA	13/10/2020 07:30	13/10/2020 10:01	13/10/2020 07:30	13/10/2020 10:01	2,51	3	7,52	CHI
20201065327	GOIANIA	GN11340702	ATLANTICO S1	13/10/2020 07:30	13/10/2020 11:12	13/10/2020 07:30	13/10/2020 11:12	3,69	25	92,24	CHI
20201064852	GAMELEIRA DE GOIAS	SV21227721	DAIA S2	13/10/2020 07:30	13/10/2020 11:31	13/10/2020 07:30	13/10/2020 11:31	4,00	1	4,00	CHI
20201064853	GUAPO	GA11356695	GUAPO S1	13/10/2020 07:30	13/10/2020 13:53	13/10/2020 07:30	13/10/2020 13:53	6,37	84	534,92	CHI
20201065173	NOVA VENEZA	NV12272399	INHUMAS S1	13/10/2020 07:31	13/10/2020 10:43	13/10/2020 07:31	13/10/2020 10:43	3,20	8	25,60	CHI
20201064855	GOIANIA	10494431	GOIANIA LESTE S3	13/10/2020 07:31	13/10/2020 10:26	13/10/2020 07:31	13/10/2020 10:26	2,92	1	2,92	CHI
20201065499	SILVANIA	SV12229372	VIANOPOLIS	13/10/2020 07:31	13/10/2020 10:42	13/10/2020 07:31	13/10/2020 10:42	3,18	4	12,70	CHI
20201064865	LUZIANIA	LZ21387884	VIANOPOLIS	13/10/2020 07:32	13/10/2020 12:41	13/10/2020 07:32	13/10/2020 12:41	5,14	1	5,14	CHI
20201067760	LUZIANIA	LZ12390028	VIANOPOLIS	13/10/2020 07:32	14/10/2020 09:13	13/10/2020 07:32	14/10/2020 09:13	25,68	7	179,73	CHI
20201065197	ANAPOLIS	AN12270373	ANAPOLIS UNIVERSITARIO S2	13/10/2020 07:32	13/10/2020 09:37	13/10/2020 07:32	13/10/2020 09:37	2,07	16	33,20	CHI
20201064868	GOIANIRA	GR21089368	GOIANIRA	13/10/2020 07:32	13/10/2020 09:34	13/10/2020 07:32	13/10/2020 09:34	2,02	1	2,02	CHI
20201064870	GOIANIA	14451050	FERROVIARIO S2	13/10/2020 07:32	13/10/2020 09:55	13/10/2020 07:32	13/10/2020 09:55	2,37	1	2,37	CHI
20201068205	GOIANIA	GN11402891	ATLANTICO S3	13/10/2020 07:32	13/10/2020 15:35	13/10/2020 07:32	13/10/2020 15:35	8,03	111	891,76	CHI
20201064887	GOIANIRA	GR21313315	GOIANIRA	13/10/2020 07:34	13/10/2020 12:04	13/10/2020 07:34	13/10/2020 12:04	4,50	1	4,50	CHI
20201065111	CAMPO ALEGRE DE GOIAS	CM12420390	CAMPO ALEGRE DE GOIAS	13/10/2020 07:34	13/10/2020 13:41	13/10/2020 07:34	13/10/2020 13:41	6,10	24	146,47	CHI
20201064902	CRISTALINA	7504355	PAMPLONA	13/10/2020 07:35	13/10/2020 11:02	13/10/2020 07:35	13/10/2020 11:02	3,45	2	6,89	CHI
20201066224	URUACU	UR12202045	URUACU	13/10/2020 07:35	13/10/2020 11:02	13/10/2020 07:35	13/10/2020 11:02	3,45	197	679,65	CHI
20201064911	MARA ROSA	MQ21251031	SANTA TEREZINHA	13/10/2020 07:35	13/10/2020 16:53	13/10/2020 07:35	13/10/2020 16:53	9,29	1	9,29	CHI
20201065410	JANDAIA	JD12260012	PALMEIRAS	13/10/2020 07:35	13/10/2020 12:00	13/10/2020 07:35	13/10/2020 12:00	4,41	11	48,46	CHI
20201065410	JANDAIA	JD12260012	PALMEIRAS	13/10/2020 07:35	13/10/2020 12:00	13/10/2020 09:55	13/10/2020 12:00	2,08	3	6,25	CHI
20201065506	PIRES DO RIO	PR11186583	PIRES DO RIO S1	13/10/2020 07:35	13/10/2020 13:50	13/10/2020 07:35	13/10/2020 13:50	6,24	88	549,29	CHI
20201065655	MOSSAMEDES	MD12304614	ANICUNS	13/10/2020 07:36	13/10/2020 14:11	13/10/2020 07:36	13/10/2020 14:11	6,57	7	46,01	CHI
20201065655	ADELANDIA	MD12304614	ANICUNS	13/10/2020 07:36	13/10/2020 14:11	13/10/2020 07:36	13/10/2020 14:11	6,57	2	13,15	CHI

20201064925	ANAPOLIS	10013401910	JUNDIAI S2	13/10/2020 07:36	13/10/2020 09:14	13/10/2020 07:36	13/10/2020 09:14	1,62	1	1,62	CHI
20201064986	GOIANIA	GN11383133	GOYA S1	13/10/2020 07:36	13/10/2020 09:02	13/10/2020 07:36	13/10/2020 09:02	1,42	14	19,88	CHI
20201067634	PARAUNA	JD12308479	PALMEIRAS	13/10/2020 07:37	14/10/2020 07:46	13/10/2020 07:37	14/10/2020 07:46	24,15	6	144,90	CHI
20201067634	JANDAIA	JD12308479	PALMEIRAS	13/10/2020 07:37	14/10/2020 07:46	13/10/2020 07:37	14/10/2020 07:46	24,15	150	3622,42	CHI
20201064930	IPAMERI	580027533	IPAMERI	13/10/2020 07:37	13/10/2020 12:15	13/10/2020 07:37	13/10/2020 12:15	4,63	1	4,63	CHI
20201064941	GOIANIA	12186077	GOIANIA LESTE S2	13/10/2020 07:37	13/10/2020 12:16	13/10/2020 07:37	13/10/2020 12:16	4,64	1	4,64	CHI
20201068349	TAQUARAL DE GOIAS	7551534	ITABERAI S1	13/10/2020 07:38	13/10/2020 15:55	13/10/2020 07:38	13/10/2020 15:55	8,28	3	24,83	CHI
20201064963	SANTA HELENA DE GOIAS	SH21214113	ACREUNA	13/10/2020 07:38	13/10/2020 10:22	13/10/2020 07:38	13/10/2020 10:22	2,72	1	2,72	CHI
20201066101	ANAPOLIS	AN12258810	JUNDIAI S2	13/10/2020 07:38	13/10/2020 12:23	13/10/2020 07:38	13/10/2020 12:23	4,73	20	94,68	CHI
20201064967	ANAPOLIS	10010386996	JUNDIAI S1	13/10/2020 07:39	13/10/2020 09:33	13/10/2020 07:39	13/10/2020 09:33	1,90	1	1,90	CHI
20201064968	ESTRELA DO NORTE	ET11329972	MARA ROSA	13/10/2020 07:39	13/10/2020 11:51	13/10/2020 07:39	13/10/2020 11:51	4,21	47	198,03	CHI
20201064970	ANAPOLIS	AN21382438	DAIA S1	13/10/2020 07:39	13/10/2020 14:25	13/10/2020 07:39	13/10/2020 14:25	6,76	1	6,76	CHI
20201064974	BELA VISTA DE GOIAS	BV21167934	BELA VISTA S1	13/10/2020 07:39	13/10/2020 09:45	13/10/2020 07:39	13/10/2020 09:45	2,09	1	2,09	CHI
20201064979	EDEIA	EA12028603	VICENTINOPOLIS	13/10/2020 07:39	13/10/2020 17:49	13/10/2020 07:39	13/10/2020 17:49	10,15	3	30,45	CHI
20201064980	APARECIDA DE GOIANIA	10009837050	INDEPENDENCIA S2	13/10/2020 07:39	13/10/2020 14:35	13/10/2020 07:39	13/10/2020 14:35	6,92	1	6,92	CHI
20201065425	CALDAS NOVAS	CN11122150	SERRA DE CALDAS	13/10/2020 07:40	13/10/2020 11:15	13/10/2020 07:40	13/10/2020 11:15	3,58	139	497,31	CHI
20201062870	SAO FRANCISCO DE GOIAS	SF12055351	SAO FRANCISCO DE GOIAS	13/10/2020 07:40	13/10/2020 12:09	13/10/2020 07:40	13/10/2020 12:09	4,48	163	729,70	CHI
20201064990	IACIARA	IA12218688	IACIARA S2	13/10/2020 07:40	13/10/2020 09:34	13/10/2020 07:40	13/10/2020 09:34	1,89	3	5,66	CHI
20201068600	PALMINOPOLIS	PP11040342	FIRMINOPOLIS S2	13/10/2020 07:40	13/10/2020 18:30	13/10/2020 07:40	13/10/2020 18:30	10,82	38	411,16	CHI
20201064995	ESTRELA DO NORTE	ET12291111	MARA ROSA	13/10/2020 07:41	13/10/2020 11:29	13/10/2020 07:41	13/10/2020 11:29	3,80	1	3,80	CHI
20201064997	TRINDADE	10018337935	MEIA PONTE	13/10/2020 07:41	13/10/2020 09:15	13/10/2020 07:41	13/10/2020 09:15	1,56	1	1,56	CHI
20201064999	MAMBAI	MB12239972	IACIARA S2	13/10/2020 07:41	13/10/2020 10:14	13/10/2020 07:41	13/10/2020 10:14	2,54	40	101,68	CHI
20201065102	BELA VISTA DE GOIAS	SV12384976	DAIA S2	13/10/2020 07:41	13/10/2020 12:47	13/10/2020 07:41	13/10/2020 12:47	5,10	1	5,10	CHI
20201065102	SILVANIA	SV12384976	DAIA S2	13/10/2020 07:41	13/10/2020 12:47	13/10/2020 07:41	13/10/2020 12:47	5,10	16	81,62	CHI
20201065102	SILVANIA	SV12384976	DAIA S2	13/10/2020 07:41	13/10/2020 12:47	13/10/2020 11:10	13/10/2020 12:47	1,62	1	1,62	CHI
20201065004	SANCLERLANDIA	SC21357327	FIRMINOPOLIS S2	13/10/2020 07:41	14/10/2020 14:06	13/10/2020 07:41	14/10/2020 14:06	30,40	1	30,40	CHI
20201065564	PIRENOPOLIS	PV12384891	CORUMBA	13/10/2020 07:42	13/10/2020 12:30	13/10/2020 07:42	13/10/2020 12:30	4,79	15	71,86	CHI
20201067770	GOIANIRA	GR12016121	GOIANIRA	13/10/2020 07:42	13/10/2020 13:22	13/10/2020 07:42	13/10/2020 13:22	5,66	4	22,62	CHI
20201065014	GOIAS	GS12362353	MATRINCHA	13/10/2020 07:42	13/10/2020 17:33	13/10/2020 07:42	13/10/2020 17:33	9,84	1	9,84	CHI
20201065017	MINEIROS	MY12377570	PARQUE DAS EMAS	13/10/2020 07:43	13/10/2020 13:42	13/10/2020 07:43	13/10/2020 13:42	5,98	168	1005,20	CHI
20201065018	VIANOPOLIS	VN12009490	VIANOPOLIS	13/10/2020 07:43	13/10/2020 11:07	13/10/2020 07:43	13/10/2020 11:07	3,40	2	6,80	CHI
20201066455	FORMOSO	ET12143705	MARA ROSA	13/10/2020 07:43	13/10/2020 12:21	13/10/2020 07:43	13/10/2020 12:21	4,62	7	32,36	CHI
20201066455	ESTRELA DO NORTE	ET12143705	MARA ROSA	13/10/2020 07:43	13/10/2020 12:21	13/10/2020 07:43	13/10/2020 12:21	4,62	9	41,60	CHI
20201065034	GOIANIA	14205154	AEROPORTO S1	13/10/2020 07:44	13/10/2020 13:15	13/10/2020 07:44	13/10/2020 13:15	5,51	1	5,51	CHI
20201066119	NEROPOLIS	NR12000048	NEROPOLIS S2	13/10/2020 07:44	13/10/2020 09:51	13/10/2020 07:44	13/10/2020 09:51	2,11	17	35,79	CHI
20201065040	IPAMERI	580085764	IPAMERI	13/10/2020 07:44	13/10/2020 13:24	13/10/2020 07:44	13/10/2020 13:24	5,65	1	5,65	CHI
20201065041	NIQUELANDIA	NQ11252066	NIQUELANDIA SUBTRANSMISSAO	13/10/2020 07:44	13/10/2020 11:45	13/10/2020 07:44	13/10/2020 11:45	4,00	35	140,10	CHI
20201065047	COCALZINHO DE GOIAS	ZN21297573	COCALZINHO	13/10/2020 07:45	13/10/2020 15:57	13/10/2020 07:45	13/10/2020 15:57	8,20	1	8,20	CHI
20201065048	PEROLANDIA	MY12301837	PARQUE DAS EMAS	13/10/2020 07:45	13/10/2020 11:11	13/10/2020 07:45	13/10/2020 11:11	3,43	3	10,28	CHI
20201065048	MINEIROS	MY12301837	PARQUE DAS EMAS	13/10/2020 07:45	13/10/2020 11:11	13/10/2020 07:45	13/10/2020 11:11	3,43	2	6,85	CHI
20201065054	NEROPOLIS	160073741	NEROPOLIS S2	13/10/2020 07:45	14/10/2020 03:29	13/10/2020 07:45	14/10/2020 03:29	19,72	1	19,72	CHI
20201065062	VALPARAISO DE GOIAS	VA11192830	MARAJOARA	13/10/2020 07:45	13/10/2020 09:51	13/10/2020 07:45	13/10/2020 09:51	2,08	50	104,22	CHI
20201065472	GOIANIA	GN11000471	CAMPINAS S3	13/10/2020 07:46	13/10/2020 09:30	13/10/2020 07:46	13/10/2020 09:30	1,73	97	168,13	CHI
20201065070	SANTA RITA DO ARAGUAIA	SU21142729	SANTA RITA DO ARAGUAIA	13/10/2020 07:46	13/10/2020 22:12	13/10/2020 07:46	13/10/2020 22:12	14,43	2	28,85	CHI
20201065074	TAQUARAL DE GOIAS	340012602	ITABERAI S1	13/10/2020 07:46	13/10/2020 19:08	13/10/2020 07:46	13/10/2020 19:08	11,35	1	11,35	CHI
20201065082	ESTRELA DO NORTE	MQ12150566	MARA ROSA	13/10/2020 07:46	13/10/2020 09:48	13/10/2020 07:46	13/10/2020 09:48	2,02	7	14,14	CHI
20201065082	MARA ROSA	MQ12150566	MARA ROSA	13/10/2020 07:46	13/10/2020 09:48	13/10/2020 07:46	13/10/2020 09:48	2,02	7	14,14	CHI
20201067529	PETROLINA DE GOIAS	PG12298074	PETROLINA	13/10/2020 07:46	13/10/2020 16:50	13/10/2020 07:46	13/10/2020 16:50	9,05	9	81,47	CHI
20201065079	CHAPADAO DO CEU	DJ21196209	CHAPADAO DO CEU	13/10/2020 07:47	13/10/2020 17:23	13/10/2020 07:47	13/10/2020 17:23	9,60	1	9,60	CHI
20201065081	SANTA FE DE GOIAS	RN12078427	BRITANIA	13/10/2020 07:47	13/10/2020 20:59	13/10/2020 07:47	13/10/2020 20:59	13,21	2	26,42	CHI
20201065081	JUSSARA	RN12078427	BRITANIA	13/10/2020 07:47	13/10/2020 20:59	13/10/2020 20:01	13/10/2020 20:59	0,97	3	2,92	CHI
20201068206	GOIANIA	GN11144798	ATLANTICO S3	13/10/2020 07:47	13/10/2020 13:50	13/10/2020 07:47	13/10/2020 13:50	6,05	126	761,84	CHI
20201065084	AMARALINA	MU11268743	MARA ROSA	13/10/2020 07:47	13/10/2020 11:46	13/10/2020 07:47	13/10/2020 11:46	3,98	2	7,96	CHI
20201065085	NOVA VENEZA	NV21029550	INHUMAS S1	13/10/2020 07:47	13/10/2020 15:23	13/10/2020 07:47	13/10/2020 15:23	7,60	1	7,60	CHI
20201065092	PALMEIRAS DE GOIAS	10018631396	PALMEIRAS	13/10/2020 07:48	13/10/2020 10:17	13/10/2020 07:48	13/10/2020 10:17	2,48	1	2,48	CHI
20201067097	ITAGUARI	IC12390107	ITABERAI S1	13/10/2020 07:48	13/10/2020 12:18	13/10/2020 07:48	13/10/2020 12:18	4,50	41	184,45	CHI
20201065107	GOIANIA	11153490	REAL S2	13/10/2020 07:49	13/10/2020 12:44	13/10/2020 07:49	13/10/2020 12:44	4,91	1	4,91	CHI
20201065108	VIANOPOLIS	2060055848	PIRES DO RIO S2	13/10/2020 07:49	13/10/2020 16:19	13/10/2020 07:49	13/10/2020 16:19	8,50	1	8,50	CHI

20201065117	BELA VISTA DE GOIAS	SQ10423941	CRISTIANOPOLIS	13/10/2020 07:50	13/10/2020 23:51	13/10/2020 07:50	13/10/2020 22:47	14,95	31	463,57	CHI
20201065117	SAO MIGUEL DO PASSA QUATRO	SQ10423941	CRISTIANOPOLIS	13/10/2020 07:50	13/10/2020 23:51	13/10/2020 07:50	13/10/2020 22:47	14,95	9	134,58	CHI
20201065117	SAO MIGUEL DO PASSA QUATRO	SQ13343462	CRISTIANOPOLIS	13/10/2020 07:50	13/10/2020 23:51	13/10/2020 07:50	13/10/2020 23:51	16,02	1	16,02	CHI
20201065117	BELA VISTA DE GOIAS	SQ13343462	CRISTIANOPOLIS	13/10/2020 07:50	13/10/2020 23:51	13/10/2020 07:50	13/10/2020 23:51	16,02	33	528,82	CHI
20201065117	SAO MIGUEL DO PASSA QUATRO	SQ13343461	CRISTIANOPOLIS	13/10/2020 07:50	13/10/2020 23:51	13/10/2020 23:20	13/10/2020 23:51	0,52	9	4,70	CHI
20201065117	BELA VISTA DE GOIAS	SQ13343461	CRISTIANOPOLIS	13/10/2020 07:50	13/10/2020 23:51	13/10/2020 23:20	13/10/2020 23:51	0,52	31	16,20	CHI
20201065124	ANICUNS	AC21289746	ANICUNS	13/10/2020 07:50	13/10/2020 14:09	13/10/2020 07:50	13/10/2020 14:09	6,31	1	6,31	CHI
20201065126	AGUA FRIA DE GOIAS	TL12316356	SAO JOAO D ALIANCA	13/10/2020 07:50	13/10/2020 11:01	13/10/2020 07:50	13/10/2020 11:01	3,17	1	3,17	CHI
20201065128	APARECIDA DE GOIANIA	AP11067631	REAL S1	13/10/2020 07:51	13/10/2020 13:04	13/10/2020 07:51	13/10/2020 13:04	5,21	6	31,29	CHI
20201065131	EDEALINA	VI12381142	VICENTINOPOLIS	13/10/2020 07:51	13/10/2020 16:06	13/10/2020 07:51	13/10/2020 16:06	8,24	12	98,91	CHI
20201065141	APARECIDA DE GOIANIA	10002019823	INDEPENDENCIA S1	13/10/2020 07:52	13/10/2020 13:20	13/10/2020 07:52	13/10/2020 13:20	5,47	1	5,47	CHI
20201061699	SERRANOPOLIS	SX11129744	JATAI S1	13/10/2020 07:52	13/10/2020 11:25	13/10/2020 07:52	13/10/2020 11:25	3,55	59	209,27	CHI
20201065147	LEOPOLDO DE BULHOES	LB21349372	DAIA S1	13/10/2020 07:52	13/10/2020 09:32	13/10/2020 07:52	13/10/2020 09:32	1,66	1	1,66	CHI
20201065160	PIRENOPOLIS	PV21171449	CORUMBA	13/10/2020 07:53	13/10/2020 16:20	13/10/2020 07:53	13/10/2020 16:20	8,44	3	25,33	CHI
20201065167	CATURAI	CK12015388	INHUMAS S1	13/10/2020 07:53	13/10/2020 08:57	13/10/2020 07:53	13/10/2020 08:57	1,05	22	23,15	CHI
20201065174	CRISTALINA	IP21168495	CRISTALINA S2	13/10/2020 07:54	13/10/2020 11:12	13/10/2020 07:54	13/10/2020 11:12	3,29	1	3,29	CHI
20201065179	SANTA TEREZINHA DE GOIAS	10001148867	SANTA TEREZINHA	13/10/2020 07:55	14/10/2020 13:16	13/10/2020 07:55	14/10/2020 13:16	29,35	1	29,35	CHI
20201068423	PALMEIRAS DE GOIAS	PL12085277	PALMEIRAS	13/10/2020 07:55	13/10/2020 14:07	13/10/2020 07:55	13/10/2020 14:07	6,19	13	80,50	CHI
20201069430	NOVO BRASIL	NB12378823	JUSSARA	13/10/2020 07:55	13/10/2020 16:48	13/10/2020 07:55	13/10/2020 16:48	8,87	1	8,87	CHI
202010189300	COCALZINHO DE GOIAS	ZN12297582	COCALZINHO	13/10/2020 07:55	13/10/2020 16:31	13/10/2020 07:55	13/10/2020 16:31	8,59	2	17,18	CHI
20201065382	LUZIANIA	LZ12013828	VIANOPOLIS	13/10/2020 07:55	13/10/2020 10:15	13/10/2020 07:55	13/10/2020 10:15	2,32	8	18,58	CHI
20201065190	GOIANIA	GN11133905	ATLANTICO S3	13/10/2020 07:55	13/10/2020 13:25	13/10/2020 07:55	13/10/2020 13:25	5,49	85	466,44	CHI
20201065199	GOIANIA	TR21001620	TRINDADE	13/10/2020 07:56	13/10/2020 11:40	13/10/2020 07:56	13/10/2020 11:40	3,73	1	3,73	CHI
20201065200	APARECIDA DE GOIANIA	AP12132702	ANHANGUERA	13/10/2020 07:56	13/10/2020 09:24	13/10/2020 07:56	13/10/2020 09:24	1,46	16	23,38	CHI
20201065581	GOIANIRA	GR11365574	GOIANIRA	13/10/2020 07:56	13/10/2020 10:27	13/10/2020 07:56	13/10/2020 10:27	2,51	85	213,18	CHI
20201065397	CATALAO	CPG-TR2	CAMPO ALEGRE DE GOIAS	13/10/2020 07:56	13/10/2020 16:58	13/10/2020 07:56	13/10/2020 10:41	2,75	18	49,48	CHI
20201065397	CAMPO ALEGRE DE GOIAS	CPG-TR2	CAMPO ALEGRE DE GOIAS	13/10/2020 07:56	13/10/2020 16:58	13/10/2020 07:56	13/10/2020 10:41	2,75	2433	6688,72	CHI
20201065397	IPAMERI	CPG-TR2	CAMPO ALEGRE DE GOIAS	13/10/2020 07:56	13/10/2020 16:58	13/10/2020 07:56	13/10/2020 10:41	2,75	16	43,99	CHI
20201065397	CAMPO ALEGRE DE GOIAS	CM12039865	CAMPO ALEGRE DE GOIAS	13/10/2020 07:56	13/10/2020 16:58	13/10/2020 10:19	13/10/2020 16:58	6,64	92	610,60	CHI
20201065208	PLANALTINA	2960058090	PLANALTINA	13/10/2020 07:56	13/10/2020 09:03	13/10/2020 07:56	13/10/2020 09:03	1,10	1	1,10	CHI
20201064298	ITAGUARI	II12274243	ITABERAI S1	13/10/2020 07:57	13/10/2020 10:48	13/10/2020 07:57	13/10/2020 10:48	2,85	5	14,25	CHI
20201064298	JARAGUA	II12274243	ITABERAI S1	13/10/2020 07:57	13/10/2020 10:48	13/10/2020 07:57	13/10/2020 10:48	2,85	1	2,85	CHI
20201065211	JARAGUA	JA12284970	JARAGUA	13/10/2020 07:57	13/10/2020 19:29	13/10/2020 07:57	13/10/2020 19:29	11,53	143	1648,91	CHI
20201065726	APARECIDA DE GOIANIA	AP11130647	REAL S1	13/10/2020 07:57	13/10/2020 10:45	13/10/2020 07:57	13/10/2020 10:45	2,80	95	265,79	CHI
20201066374	BELA VISTA DE GOIAS	BV12031626	BELA VISTA S1	13/10/2020 07:57	13/10/2020 10:51	13/10/2020 07:57	13/10/2020 10:51	2,90	3	8,69	CHI
20201065214	CRIXAS	20164505	RUBIATABA	13/10/2020 07:57	14/10/2020 18:52	13/10/2020 07:57	14/10/2020 18:52	34,91	2	69,83	CHI
20201065218	BURITI ALEGRE	BG21190929	ALTO BURITI	13/10/2020 07:57	13/10/2020 10:35	13/10/2020 07:57	13/10/2020 10:35	2,64	1	2,64	CHI
20201065222	TRINDADE	40020939	TRINDADE	13/10/2020 07:57	13/10/2020 12:27	13/10/2020 07:57	13/10/2020 12:27	4,49	1	4,49	CHI
20201067665	CAMPINORTE	MQ12082973	MARA ROSA	13/10/2020 07:57	13/10/2020 11:53	13/10/2020 07:57	13/10/2020 11:53	3,92	1	3,92	CHI
20201067665	MARA ROSA	MQ12082973	MARA ROSA	13/10/2020 07:57	13/10/2020 11:53	13/10/2020 07:57	13/10/2020 11:53	3,92	2	7,84	CHI
20201070576	CATURAI	CK12211426	INHUMAS S1	13/10/2020 07:58	13/10/2020 19:29	13/10/2020 07:58	13/10/2020 19:29	11,51	173	1990,51	CHI
20201065230	NOVA CRIXAS	NA21091700	NOVA CRIXAS	13/10/2020 07:58	13/10/2020 12:26	13/10/2020 07:58	13/10/2020 12:26	4,45	1	4,45	CHI
20201065248	DAMOLANDIA	DL11132783	INHUMAS S1	13/10/2020 08:00	13/10/2020 10:51	13/10/2020 08:00	13/10/2020 10:51	2,84	36	102,19	CHI
20201065258	MINACU	IH21187826	MINACU	13/10/2020 08:01	13/10/2020 13:01	13/10/2020 08:01	13/10/2020 13:01	5,00	1	5,00	CHI
20201066020	IPAMERI	IP12272801	IPAMERI	13/10/2020 08:01	13/10/2020 10:50	13/10/2020 08:01	13/10/2020 10:50	2,81	12	33,70	CHI
20201065267	CAMPO LIMPO	AN21267801	NEROPOLIS S1	13/10/2020 08:01	13/10/2020 15:45	13/10/2020 08:01	13/10/2020 15:45	7,72	1	7,72	CHI
20201065368	SILVANIA	SV12151524	VIANOPOLIS	13/10/2020 08:02	13/10/2020 13:45	13/10/2020 08:02	13/10/2020 13:45	5,71	9	51,39	CHI
20201065274	APARECIDA DE GOIANIA	AP12350200	INDEPENDENCIA S2	13/10/2020 08:02	13/10/2020 10:10	13/10/2020 08:02	13/10/2020 10:10	2,12	35	74,35	CHI
20201065276	GOIANIA	14382957	GOYA S2	13/10/2020 08:02	13/10/2020 11:11	13/10/2020 08:02	13/10/2020 11:11	3,14	1	3,14	CHI
20201065277	NOVA CRIXAS	NA21060635	NOVA CRIXAS	13/10/2020 08:03	13/10/2020 09:40	13/10/2020 08:03	13/10/2020 09:40	1,61	1	1,61	CHI
20201065279	SAO LUIS DE MONTES BELOS	10012968518	SAO LUIZ DOS MONTES BELOS	13/10/2020 08:03	13/10/2020 15:27	13/10/2020 08:03	13/10/2020 15:27	7,40	1	7,40	CHI
20201065290	CHAPADAO DO CEU	DJ12241801LD	CHAPADAO DO CEU	13/10/2020 08:03	13/10/2020 18:47	13/10/2020 08:03	13/10/2020 17:42	9,64	2	19,28	CHI
20201065290	CHAPADAO DO CEU	DJ12248365	CHAPADAO DO CEU	13/10/2020 08:03	13/10/2020 18:47	13/10/2020 18:34	13/10/2020 18:47	0,21	4	0,83	CHI
20201065292	MARA ROSA	MQ21285218	MARA ROSA	13/10/2020 08:03	13/10/2020 12:04	13/10/2020 08:03	13/10/2020 12:04	4,00	1	4,00	CHI
20201065299	ITUMBIARA	IT12293317	CACHOEIRA DOURADA	13/10/2020 08:04	13/10/2020 10:49	13/10/2020 08:04	13/10/2020 10:49	2,74	1	2,74	CHI
20201067591	GOIAS	GS12124703	GOIAS	13/10/2020 08:04	13/10/2020 12:54	13/10/2020 08:04	13/10/2020 12:54	4,82	175	843,79	CHI
20201065307	SANTA CRUZ DE GOIAS	BC21027034	PIRES DO RIO S2	13/10/2020 08:04	13/10/2020 09:36	13/10/2020 08:04	13/10/2020 09:36	1,52	1	1,52	CHI
20201065308	QUIRINOPOLIS	QI21100930	QUIRINOPOLIS	13/10/2020 08:04	13/10/2020 10:08	13/10/2020 08:04	13/10/2020 10:08	2,05	1	2,05	CHI

20201065309	TRINDADE	40049553	TRINDADE	13/10/2020 08:04	13/10/2020 10:12	13/10/2020 08:04	13/10/2020 10:12	2,12	1	2,12	CHI
20201065328	SILVANIA	660038201	VIANOPOLIS	13/10/2020 08:06	13/10/2020 19:26	13/10/2020 08:06	13/10/2020 19:26	11,33	1	11,33	CHI
20201065613	APARECIDA DE GOIANIA	AP12391639	INDEPENDENCIA S2	13/10/2020 08:06	13/10/2020 10:26	13/10/2020 08:06	13/10/2020 10:26	2,33	157	365,85	CHI
20201065332	SANTA RITA DO ARAGUAIA	SU21184229	SANTA RITA DO ARAGUAIA	13/10/2020 08:06	14/10/2020 09:20	13/10/2020 08:06	14/10/2020 09:20	25,23	1	25,23	CHI
20201065333	IPAMERI	IP21344669	CAMPO ALEGRE DE GOIAS	13/10/2020 08:06	13/10/2020 20:55	13/10/2020 08:06	13/10/2020 20:55	12,81	1	12,81	CHI
20201065361	IPAMERI	7929223	CRISTALINA S1	13/10/2020 08:06	13/10/2020 09:18	13/10/2020 08:06	13/10/2020 09:18	1,19	1	1,19	CHI
20201065361	LUZIANIA	7929223	CRISTALINA S1	13/10/2020 08:06	13/10/2020 09:18	13/10/2020 08:06	13/10/2020 09:18	1,19	8	9,53	CHI
20201065361	CRISTALINA	7929223	CRISTALINA S1	13/10/2020 08:06	13/10/2020 09:18	13/10/2020 08:06	13/10/2020 09:18	1,19	32	38,12	CHI
20201065826	FIRMINOPOLIS	FR11024058	FIRMINOPOLIS S1	13/10/2020 08:06	13/10/2020 10:32	13/10/2020 08:06	13/10/2020 10:32	2,43	78	189,65	CHI
20201070644	PARAUNA	PU12213315	MONTIVIDIU T	13/10/2020 08:07	13/10/2020 23:12	13/10/2020 08:07	13/10/2020 23:12	15,08	6	90,45	CHI
20201070644	IVOLANDIA	PU12213315	MONTIVIDIU T	13/10/2020 08:07	13/10/2020 23:12	13/10/2020 08:07	13/10/2020 23:12	15,08	2	30,15	CHI
20201065358	NIQUELANDIA	2750080211	NIQUELANDIA SUBTRANSMISSAO	13/10/2020 08:08	13/10/2020 11:19	13/10/2020 08:08	13/10/2020 11:19	3,18	1	3,18	CHI
20201066030	CRISTALINA	1060054970	CRISTALINA S1	13/10/2020 08:08	13/10/2020 09:49	13/10/2020 08:08	13/10/2020 09:49	1,68	1	1,68	CHI
20201065362	COCALZINHO DE GOIAS	ZN21135818	COCALZINHO	13/10/2020 08:08	13/10/2020 12:21	13/10/2020 08:08	13/10/2020 12:21	4,21	2	8,42	CHI
20201065365	PALMEIRAS DE GOIAS	PL21194153	PALMEIRAS	13/10/2020 08:08	13/10/2020 16:12	13/10/2020 08:08	13/10/2020 16:12	8,06	2	16,12	CHI
20201065367	GOIANIA	12069838	GOIANIA LESTE S2	13/10/2020 08:08	13/10/2020 11:37	13/10/2020 08:08	13/10/2020 11:37	3,47	1	3,47	CHI
20201065370	APARECIDA DE GOIANIA	AP21321284	CEPAIGO S1	13/10/2020 08:09	13/10/2020 16:39	13/10/2020 08:09	13/10/2020 16:39	8,50	1	8,50	CHI
20201065371	GOIANIA	14665839	GOIANIA LESTE S2	13/10/2020 08:09	13/10/2020 10:58	13/10/2020 08:09	13/10/2020 10:58	2,82	1	2,82	CHI
20201065373	URUACU	UR12181211	URUACU	13/10/2020 08:09	13/10/2020 11:44	13/10/2020 08:09	13/10/2020 11:44	3,58	3	10,74	CHI
20201065378	SANTO ANTONIO DO DESCOBERTO	AX21311914	MARAJOARA	13/10/2020 08:09	13/10/2020 09:55	13/10/2020 08:09	13/10/2020 09:55	1,76	1	1,76	CHI
20201065394	PIRES DO RIO	460094403	PIRES DO RIO S1	13/10/2020 08:10	13/10/2020 11:10	13/10/2020 08:10	13/10/2020 11:10	2,99	1	2,99	CHI
20201065406	PALESTINA DE GOIAS	IV12108126	IPORA	13/10/2020 08:11	14/10/2020 11:48	13/10/2020 08:11	14/10/2020 11:48	27,61	33	911,28	CHI
20201065406	IVOLANDIA	IV12108126	IPORA	13/10/2020 08:11	14/10/2020 11:48	13/10/2020 08:11	14/10/2020 11:48	27,61	16	441,83	CHI
20201065420	RIO VERDE	RV12022474	RIO VERDE S1	13/10/2020 08:13	13/10/2020 10:31	13/10/2020 08:13	13/10/2020 10:31	2,29	7	16,05	CHI
20201065684	TRES RANCHOS	2170014336	CATALAO S1	13/10/2020 08:13	13/10/2020 11:47	13/10/2020 08:13	13/10/2020 11:47	3,56	1	3,56	CHI
20201067420	RUBIATABA	RB12244416	RUBIATABA	13/10/2020 08:13	14/10/2020 08:28	13/10/2020 08:13	14/10/2020 08:28	24,24	4	96,96	CHI
20201065427	INACIOLANDIA	ID12128107	QUIRINOPOLIS	13/10/2020 08:13	13/10/2020 16:52	13/10/2020 08:13	13/10/2020 16:52	8,65	16	138,46	CHI
20201065858	FLORES DE GOIAS	FB12329779	FLORES DE GOIAS	13/10/2020 08:13	13/10/2020 11:02	13/10/2020 08:13	13/10/2020 11:02	2,80	7	19,63	CHI
20201066230	BRAZABRANTES	DL12026638	INHUMAS S1	13/10/2020 08:14	13/10/2020 19:21	13/10/2020 08:14	13/10/2020 19:21	11,11	28	311,20	CHI
20201066230	DAMOLANDIA	DL12026638	INHUMAS S1	13/10/2020 08:14	13/10/2020 19:21	13/10/2020 08:14	13/10/2020 19:21	11,11	9	100,03	CHI
20201065594	CATALAO	CT12229926	CATALAO S1	13/10/2020 08:14	13/10/2020 09:43	13/10/2020 08:14	13/10/2020 09:43	1,47	4	5,89	CHI
20201065440	SAO JOAO D ALIANCA	JL12383338	SAO JOAO D ALIANCA	13/10/2020 08:14	13/10/2020 10:30	13/10/2020 08:14	13/10/2020 10:30	2,25	31	69,79	CHI
20201065442	MARA ROSA	MQ21238491	MARA ROSA	13/10/2020 08:14	13/10/2020 11:02	13/10/2020 08:14	13/10/2020 11:02	2,78	1	2,78	CHI
20201065449	ABADIA DE GOIAS	LG11373824	INDEPENDENCIA S2	13/10/2020 08:15	13/10/2020 16:51	13/10/2020 08:15	13/10/2020 16:51	8,59	12	103,12	CHI
20201065454	NEROPOLIS	160079743	NEROPOLIS S2	13/10/2020 08:15	13/10/2020 18:27	13/10/2020 08:15	13/10/2020 18:27	10,19	1	10,19	CHI
20201065456	IPAMERI	IP12057877RE	PIRES DO RIO S2	13/10/2020 08:15	13/10/2020 21:03	13/10/2020 08:15	13/10/2020 21:03	12,79	18	230,15	CHI
20201065460	CATALAO	1990188725	CATALAO S2	13/10/2020 08:16	13/10/2020 09:44	13/10/2020 08:16	13/10/2020 09:44	1,46	1	1,46	CHI
20201068867	GOIANIA	AP11004639	ATLANTICO S1	13/10/2020 08:16	13/10/2020 16:15	13/10/2020 08:16	13/10/2020 16:15	7,98	113	901,49	CHI
20201065470	GOIAS	10024450616	ITABERAI S1	13/10/2020 08:17	13/10/2020 14:29	13/10/2020 08:17	13/10/2020 14:29	6,21	1	6,21	CHI
20201065474	UIRAPURU	UP21281044	SANTA TEREZINHA	13/10/2020 08:17	13/10/2020 20:46	13/10/2020 08:17	13/10/2020 20:46	12,48	1	12,48	CHI
20201065487	ALEXANIA	480005000	ALEXANIA	13/10/2020 08:18	13/10/2020 10:07	13/10/2020 08:18	13/10/2020 10:07	1,81	1	1,81	CHI
20201068009	JARAGUA	JA12044169	JARAGUA	13/10/2020 08:18	13/10/2020 18:07	13/10/2020 08:18	13/10/2020 18:07	9,80	230	2254,38	CHI
20201065492	GOIANAPOLIS	10008921464	DAIA S2	13/10/2020 08:19	13/10/2020 10:54	13/10/2020 08:19	13/10/2020 10:54	2,58	1	2,58	CHI
20201065498	CORUMBA DE GOIAS	260032670	CORUMBA	13/10/2020 08:20	13/10/2020 11:57	13/10/2020 08:20	13/10/2020 11:57	3,62	1	3,62	CHI
20201065516	ITABERAI	IB10404109	ITABERAI S2	13/10/2020 08:20	14/10/2020 11:39	13/10/2020 08:20	13/10/2020 10:41	2,36	26	61,25	CHI
20201065516	ITABERAI	IB10404109	ITABERAI S2	13/10/2020 08:20	14/10/2020 11:39	13/10/2020 08:20	13/10/2020 16:50	8,51	17	144,70	CHI
20201065516	ITABERAI	IB10404109	ITABERAI S2	13/10/2020 08:20	14/10/2020 11:39	13/10/2020 08:20	13/10/2020 17:36	9,28	80	742,16	CHI
20201065516	ITABERAI	IB12000056	ITABERAI S2	13/10/2020 08:20	14/10/2020 11:39	13/10/2020 08:20	14/10/2020 11:39	27,33	11	300,61	CHI
20201065505	APARECIDA DE GOIANIA	10014813180	REAL S2	13/10/2020 08:20	13/10/2020 11:31	13/10/2020 08:20	13/10/2020 11:31	3,17	1	3,17	CHI
20201065512	ARAGUAPAZ	1780017781	MOZARLANDIA	13/10/2020 08:21	13/10/2020 09:20	13/10/2020 08:21	13/10/2020 09:20	0,98	1	0,98	CHI
20201065514	JUSSARA	BT12292746	BRITANIA	13/10/2020 08:21	13/10/2020 10:05	13/10/2020 08:21	13/10/2020 10:05	1,73	1	1,73	CHI
20201066755	MARA ROSA	MQ11051090	MARA ROSA	13/10/2020 08:22	13/10/2020 14:12	13/10/2020 08:22	13/10/2020 14:12	5,83	171	997,17	CHI
20201065522	SANTA HELENA DE GOIAS	SH12247775	SANTA HELENA S1	13/10/2020 08:22	13/10/2020 09:12	13/10/2020 08:22	13/10/2020 09:12	0,83	2	1,66	CHI
20201065558	RIO VERDE	RV12049063	RIO VERDE S1	13/10/2020 08:22	13/10/2020 10:08	13/10/2020 08:22	13/10/2020 10:08	1,76	16	28,17	CHI
20201065527	SAO JOAO D ALIANCA	JL11130018	SAO JOAO D ALIANCA	13/10/2020 08:22	13/10/2020 11:03	13/10/2020 08:22	13/10/2020 11:03	2,67	6	16,03	CHI
20201065533	GOIAS	90049664	GOIAS	13/10/2020 08:23	13/10/2020 13:42	13/10/2020 08:23	13/10/2020 13:42	5,31	1	5,31	CHI
20201065539	MINACU	IH21207709	MINACU	13/10/2020 08:23	13/10/2020 11:13	13/10/2020 08:23	13/10/2020 11:13	2,82	1	2,82	CHI
20201065542	PLANALTINA	PI12375541	PLANALTINA	13/10/2020 08:24	13/10/2020 10:48	13/10/2020 08:24	13/10/2020 10:48	2,40	188	450,89	CHI

20201066527	JUSSARA	JR12396252	JUSSARA	13/10/2020 08:24	13/10/2020 15:59	13/10/2020 08:24	13/10/2020 15:59	7,58	14	106,12	CHI
20201066560	LUZIANIA	LZ12013824	VIANOPOLIS	13/10/2020 08:24	13/10/2020 15:40	13/10/2020 08:24	13/10/2020 15:40	7,26	17	123,49	CHI
20201065551	GOIANIA	17212390	GOYA S1	13/10/2020 08:24	13/10/2020 12:19	13/10/2020 08:24	13/10/2020 12:19	3,91	1	3,91	CHI
20201066814	NOVA VENEZA	NV12382719	INHUMAS S1	13/10/2020 08:25	13/10/2020 12:37	13/10/2020 08:25	13/10/2020 12:37	4,20	90	377,75	CHI
20201066814	SANTO ANTONIO DE GOIAS	NV12382719	INHUMAS S1	13/10/2020 08:25	13/10/2020 12:37	13/10/2020 08:25	13/10/2020 12:37	4,20	1	4,20	CHI
20201066814	OURO VERDE DE GOIAS	NV12382719	INHUMAS S1	13/10/2020 08:25	13/10/2020 12:37	13/10/2020 08:25	13/10/2020 12:37	4,20	31	130,11	CHI
20201065563	ITUMBIARA	IT12088613	PARANAIBA	13/10/2020 08:25	13/10/2020 09:59	13/10/2020 08:25	13/10/2020 09:59	1,56	7	10,92	CHI
20201065565	CAMPINORTE	CR21320944	MARA ROSA	13/10/2020 08:25	13/10/2020 09:50	13/10/2020 08:25	13/10/2020 09:50	1,41	2	2,82	CHI
20201065566	ANAPOLIS	21311572	JUNDIAI S2	13/10/2020 08:25	13/10/2020 12:12	13/10/2020 08:25	13/10/2020 12:12	3,77	1	3,77	CHI
20201065649	IPAMERI	IP12079464	CAMPO ALEGRE DE GOIAS	13/10/2020 08:25	13/10/2020 22:03	13/10/2020 08:25	13/10/2020 22:03	13,63	4	54,52	CHI
20201065579	PALMEIRAS DE GOIAS	PL12000270	PALMEIRAS	13/10/2020 08:25	13/10/2020 09:08	13/10/2020 08:25	13/10/2020 09:08	0,71	49	35,02	CHI
20201065577	BELA VISTA DE GOIAS	BV21349059	BELA VISTA S1	13/10/2020 08:26	13/10/2020 13:48	13/10/2020 08:26	13/10/2020 13:48	5,37	1	5,37	CHI
20201065578	PALESTINA DE GOIAS	PY21087110	ARENOPOLIS	13/10/2020 08:26	14/10/2020 12:05	13/10/2020 08:26	14/10/2020 12:05	27,66	1	27,66	CHI
20201067136	BRITANIA	BT12171780	BRITANIA	13/10/2020 08:26	13/10/2020 15:23	13/10/2020 08:26	13/10/2020 15:23	6,94	233	1617,93	CHI
20201065582	MORRINHOS	150117590	MORRINHOS	13/10/2020 08:26	13/10/2020 10:05	13/10/2020 08:26	13/10/2020 10:05	1,64	1	1,64	CHI
20201066537	GOIANIA	GN11287870	CARAJAS S2	13/10/2020 08:26	13/10/2020 12:05	13/10/2020 08:26	13/10/2020 12:05	3,64	36	130,91	CHI
20201065595	LUZIANIA	LZ21109869	CRISTALINA S2	13/10/2020 08:27	13/10/2020 11:35	13/10/2020 08:27	13/10/2020 11:35	3,13	1	3,13	CHI
20201065596	GOIANIA	GN12049002	ATLANTICO S1	13/10/2020 08:27	13/10/2020 12:38	13/10/2020 08:27	13/10/2020 12:38	4,18	144	601,68	CHI
20201069110	MINACU	IH12252305	MINACU	13/10/2020 08:27	13/10/2020 18:32	13/10/2020 08:27	13/10/2020 18:32	10,07	4	40,30	CHI
20201065605	TRES RANCHOS	TH21316091	CATALAO S1	13/10/2020 08:27	13/10/2020 11:21	13/10/2020 08:27	13/10/2020 11:21	2,89	20	57,74	CHI
20201065607	NOVA CRIXAS	NA21158720	NOVA CRIXAS	13/10/2020 08:27	13/10/2020 11:37	13/10/2020 08:27	13/10/2020 11:37	3,15	1	3,15	CHI
20201065615	SAO LUIS DE MONTES BELOS	500110232	SAO LUIZ DOS MONTES BELOS	13/10/2020 08:28	13/10/2020 17:32	13/10/2020 08:28	13/10/2020 17:32	9,08	1	9,08	CHI
20201065617	GOIANIA	12325340	GOIANIA LESTE S2	13/10/2020 08:28	13/10/2020 10:57	13/10/2020 08:28	13/10/2020 10:57	2,48	1	2,48	CHI
20201066772	GOIANIA	GN11000518	CAMPINAS S3	13/10/2020 08:28	13/10/2020 12:14	13/10/2020 08:28	13/10/2020 12:14	3,76	87	327,07	CHI
20201070292	JUSSARA	JR12220055	JUSSARA	13/10/2020 08:28	14/10/2020 07:30	13/10/2020 08:28	14/10/2020 07:30	23,03	4	92,10	CHI
20201065637	ORIZONA	OZ11140712	PIRES DO RIO S2	13/10/2020 08:29	13/10/2020 10:45	13/10/2020 08:29	13/10/2020 10:45	2,26	150	338,75	CHI
20201065653	MAMBAI	MB21373597	IACIARA S2	13/10/2020 08:30	13/10/2020 10:09	13/10/2020 08:30	13/10/2020 10:09	1,64	2	3,27	CHI
20201067565	ITAPIRAPUA	IU12362955	JUSSARA	13/10/2020 08:31	13/10/2020 15:57	13/10/2020 08:31	13/10/2020 15:57	7,43	3	22,29	CHI
20201065660	CATALAO	CT12333612	CATALAO S1	13/10/2020 08:31	13/10/2020 10:01	13/10/2020 08:31	13/10/2020 10:01	1,49	1	1,49	CHI
20201065661	APARECIDA DE GOIANIA	AP11200592	INDEPENDENCIA S2	13/10/2020 08:31	13/10/2020 17:52	13/10/2020 08:31	13/10/2020 17:52	9,36	49	458,60	CHI
20201066603	PIRES DO RIO	PR11272852	PIRES DO RIO S1	13/10/2020 08:31	13/10/2020 12:39	13/10/2020 08:31	13/10/2020 12:39	4,13	113	466,28	CHI
20201065664	ANAPOLIS	20077142	ANAPOLIS UNIVERSITARIO S2	13/10/2020 08:31	13/10/2020 10:14	13/10/2020 08:31	13/10/2020 10:14	1,71	1	1,71	CHI
20201065668	TRINDADE	40101186	TRINDADE	13/10/2020 08:31	13/10/2020 13:11	13/10/2020 08:31	13/10/2020 13:11	4,65	1	4,65	CHI
20201065685	APARECIDA DE GOIANIA	13996666	REAL S2	13/10/2020 08:33	13/10/2020 11:08	13/10/2020 08:33	13/10/2020 11:08	2,58	1	2,58	CHI
20201068297	NEROPOLIS	NR12010422	NEROPOLIS S2	13/10/2020 08:33	13/10/2020 14:40	13/10/2020 08:33	13/10/2020 14:40	6,11	4	24,43	CHI
20201065693	CALDAS NOVAS	CN11142421	CALDAS NOVAS S2	13/10/2020 08:33	13/10/2020 10:00	13/10/2020 08:33	13/10/2020 10:00	1,43	63	90,37	CHI
20201065699	ORIZONA	OZ21143748	PIRES DO RIO S2	13/10/2020 08:34	14/10/2020 11:23	13/10/2020 08:34	14/10/2020 11:23	26,81	1	26,81	CHI
20201068412	PARAUNA	PU12205943	PARAUNA	13/10/2020 08:34	13/10/2020 21:14	13/10/2020 08:34	13/10/2020 21:14	12,67	28	354,74	CHI
20201068412	JANDAIA	PU12205943	PARAUNA	13/10/2020 08:34	13/10/2020 21:14	13/10/2020 08:34	13/10/2020 21:14	12,67	4	50,68	CHI
20201065707	PIRENOPOLIS	PV21297613	CORUMBA	13/10/2020 08:35	13/10/2020 23:49	13/10/2020 08:35	13/10/2020 23:49	15,23	1	15,23	CHI
20201065708	PALMEIRAS DE GOIAS	PL21403729	PALMEIRAS	13/10/2020 08:35	13/10/2020 16:59	13/10/2020 08:35	13/10/2020 16:59	8,40	1	8,40	CHI
20201065710	LUZIANIA	LZ21057553	VIANOPOLIS	13/10/2020 08:35	13/10/2020 13:02	13/10/2020 08:35	13/10/2020 13:02	4,45	1	4,45	CHI
20201067751	ISRAELANDIA	FN12223049	IPORA	13/10/2020 08:35	14/10/2020 12:20	13/10/2020 08:35	14/10/2020 12:20	27,74	2	55,48	CHI
20201067751	FAZENDA NOVA	FN12223049	IPORA	13/10/2020 08:35	14/10/2020 12:20	13/10/2020 08:35	14/10/2020 12:20	27,74	8	221,91	CHI
20201065724	VILA PROPICIO	NP12235927	GOIANESIA S1	13/10/2020 08:36	13/10/2020 12:29	13/10/2020 08:36	13/10/2020 12:29	3,88	1	3,88	CHI
20201065725	PIRENOPOLIS	PV12381259	CORUMBA	13/10/2020 08:36	13/10/2020 13:31	13/10/2020 08:36	13/10/2020 13:31	4,91	3	14,74	CHI
20201069232	VILA PROPICIO	NP12228397	GOIANESIA S1	13/10/2020 08:36	13/10/2020 21:04	13/10/2020 08:36	13/10/2020 21:04	12,46	3	37,39	CHI
20201065740	FORMOSA	10007857169	ITUIQUIRA	13/10/2020 08:37	13/10/2020 10:02	13/10/2020 08:37	13/10/2020 10:02	1,42	1	1,42	CHI
20201066249	CALDAS NOVAS	CN11000006	SERRA DE CALDAS	13/10/2020 08:37	13/10/2020 10:08	13/10/2020 08:37	13/10/2020 10:08	1,51	52	78,29	CHI
20201065755	GOIANIA	10016348662	GOYA S2	13/10/2020 08:38	13/10/2020 14:29	13/10/2020 08:38	13/10/2020 14:29	5,84	1	5,84	CHI
20201065757	ESTRELA DO NORTE	ET12050729	MARA ROSA	13/10/2020 08:38	13/10/2020 10:59	13/10/2020 08:38	13/10/2020 10:59	2,34	2	4,67	CHI
20201065759	AMORINOPOLIS	AM12000032	IPORA	13/10/2020 08:39	13/10/2020 11:51	13/10/2020 08:39	13/10/2020 11:51	3,20	5	15,99	CHI
20201065759	IVOLANDIA	AM12000032	IPORA	13/10/2020 08:39	13/10/2020 11:51	13/10/2020 08:39	13/10/2020 11:51	3,20	12	38,38	CHI
20201065760	HIDROLANDIA	HD21017181	INDEPENDENCIA S1	13/10/2020 08:39	13/10/2020 12:16	13/10/2020 08:39	13/10/2020 12:16	3,61	1	3,61	CHI
20201065770	LEOPOLDO DE BULHOES	LB12011166	DAIA S2	13/10/2020 08:39	13/10/2020 11:37	13/10/2020 08:39	13/10/2020 11:37	2,95	1	2,95	CHI
20201065770	SILVANIA	LB12011166	DAIA S2	13/10/2020 08:39	13/10/2020 11:37	13/10/2020 08:39	13/10/2020 11:37	2,95	2	5,91	CHI
20201065772	ARAGUAPAZ	AZ21329927	MOZARLANDIA	13/10/2020 08:39	13/10/2020 10:00	13/10/2020 08:39	13/10/2020 10:00	1,34	1	1,34	CHI
20201065776	CAMPINORTE	UR12231322	MARA ROSA	13/10/2020 08:40	13/10/2020 16:09	13/10/2020 08:40	13/10/2020 16:09	7,48	4	29,93	CHI

20201065778	MONTIVIDIU DO NORTE	MX12365604	PORANGATU	13/10/2020 08:40	13/10/2020 11:06	13/10/2020 08:40	13/10/2020 11:06	2,43	1	2,43	CHI
20201065780	PIRES DO RIO	460090252	PIRES DO RIO S1	13/10/2020 08:40	13/10/2020 19:46	13/10/2020 08:40	13/10/2020 19:46	11,09	1	11,09	CHI
20201065782	APARECIDA DE GOIANIA	200023070	INDEPENDENCIA S1	13/10/2020 08:40	13/10/2020 12:53	13/10/2020 08:40	13/10/2020 12:53	4,21	1	4,21	CHI
20201066752	JARAGUA	JA11000029	JARAGUA	13/10/2020 08:40	13/10/2020 14:47	13/10/2020 08:40	13/10/2020 14:47	6,11	94	574,00	CHI
20201065784	ARAGUAPAZ	1780009152	MOZARLANDIA	13/10/2020 08:40	13/10/2020 14:01	13/10/2020 08:40	13/10/2020 14:01	5,34	1	5,34	CHI
20201065786	IPORA	IR12380956	IPORA	13/10/2020 08:41	13/10/2020 11:50	13/10/2020 08:41	13/10/2020 11:50	3,15	107	336,87	CHI
20201065790	CALDAS NOVAS	760184938	SERRA DE CALDAS	13/10/2020 08:41	13/10/2020 12:57	13/10/2020 08:41	13/10/2020 12:57	4,26	1	4,26	CHI
20201065794	CRIXAS	2490004846	SERRA DO OURO	13/10/2020 08:41	13/10/2020 22:24	13/10/2020 08:41	13/10/2020 22:24	13,71	1	13,71	CHI
20201065801	PORANGATU	PO12079746	PORANGATU	13/10/2020 08:41	13/10/2020 11:24	13/10/2020 08:41	13/10/2020 11:24	2,70	3	8,11	CHI
20201065802	NOVO GAMA	NJ11165078	MARAJOARA	13/10/2020 08:41	13/10/2020 09:50	13/10/2020 08:41	13/10/2020 09:50	1,13	18	20,43	CHI
20201065807	CAIAPONIA	930021198	CAIAPONIA	13/10/2020 08:42	13/10/2020 15:21	13/10/2020 08:42	13/10/2020 15:21	6,65	1	6,65	CHI
202010176790	CAMPINACU	UC21244553	PORANGATU	13/10/2020 08:42	14/10/2020 08:57	13/10/2020 08:42	14/10/2020 08:57	24,26	1	24,26	CHI
20201065812	BELA VISTA DE GOIAS	240006306	BELA VISTA S1	13/10/2020 08:42	13/10/2020 11:03	13/10/2020 08:42	13/10/2020 11:03	2,34	1	2,34	CHI
20201069808	SANCLERLANDIA	SC12376377	FIRMINOPOLIS S2	13/10/2020 08:43	13/10/2020 22:16	13/10/2020 08:43	13/10/2020 22:16	13,55	2	27,09	CHI
20201065822	PORANGATU	PO12020945	PORANGATU	13/10/2020 08:43	13/10/2020 10:25	13/10/2020 08:43	13/10/2020 10:25	1,69	6	10,15	CHI
20201065823	INHUMAS	30176748	INHUMAS S2	13/10/2020 08:43	13/10/2020 15:57	13/10/2020 08:43	13/10/2020 15:57	7,22	1	7,22	CHI
20201065830	BARRO ALTO	BA21140657	BARRO ALTO	13/10/2020 08:44	14/10/2020 16:52	13/10/2020 08:44	14/10/2020 16:52	32,13	1	32,13	CHI
20201065833	APARECIDA DE GOIANIA	13489653	REAL S2	13/10/2020 08:44	13/10/2020 16:14	13/10/2020 08:44	13/10/2020 16:14	7,49	1	7,49	CHI
20201065962	MINACU	IH12245137	MINACU	13/10/2020 08:44	13/10/2020 14:35	13/10/2020 08:44	13/10/2020 14:35	5,84	2	11,68	CHI
20201065835	AMARALINA	LC12291118	MARA ROSA	13/10/2020 08:44	13/10/2020 14:22	13/10/2020 08:44	13/10/2020 14:22	5,62	1	5,62	CHI
20201068515	MORRO AGUDO DE GOIAS	MS11376388	ITAPURANGA	13/10/2020 08:44	13/10/2020 15:20	13/10/2020 08:44	13/10/2020 15:20	6,59	87	573,16	CHI
20201066735	SILVANIA	SV12011218	DAIA S2	13/10/2020 08:44	13/10/2020 12:40	13/10/2020 08:44	13/10/2020 12:40	3,92	19	74,42	CHI
20201065851	RUBIATABA	RB12358938	RUBIATABA	13/10/2020 08:45	13/10/2020 15:14	13/10/2020 08:45	13/10/2020 15:14	6,48	2	12,96	CHI
20201065856	APARECIDA DE GOIANIA	15596783	REAL S2	13/10/2020 08:46	13/10/2020 16:36	13/10/2020 08:46	13/10/2020 16:36	7,83	1	7,83	CHI
20201065862	TRINDADE	40155638	TRINDADE	13/10/2020 08:46	13/10/2020 10:26	13/10/2020 08:46	13/10/2020 10:26	1,66	1	1,66	CHI
20201065871	FORMOSA	FA21146232	ITUIQUIRA	13/10/2020 08:46	13/10/2020 09:26	13/10/2020 08:46	13/10/2020 09:26	0,66	1	0,66	CHI
20201069568	NOVA VENEZA	DL12014187	INHUMAS S1	13/10/2020 08:46	13/10/2020 19:21	13/10/2020 08:46	13/10/2020 19:21	10,57	1	10,57	CHI
20201069568	BRAZABRANTES	DL12014187	INHUMAS S1	13/10/2020 08:46	13/10/2020 19:21	13/10/2020 08:46	13/10/2020 19:21	10,57	12	126,85	CHI
20201069568	DAMOLANDIA	DL12014187	INHUMAS S1	13/10/2020 08:46	13/10/2020 19:21	13/10/2020 08:46	13/10/2020 19:21	10,57	2	21,14	CHI
202010161914	SILVANIA	SV21157830	VIANOPOLIS	13/10/2020 08:46	14/10/2020 14:30	13/10/2020 08:46	14/10/2020 14:30	29,72	1	29,72	CHI
20201065869	GOIANIA	GN21251885	CAMPINAS S1	13/10/2020 08:46	13/10/2020 11:35	13/10/2020 08:46	13/10/2020 11:35	2,80	1	2,80	CHI
20201065872	URUACU	CR12405404	MARA ROSA	13/10/2020 08:47	13/10/2020 12:53	13/10/2020 08:47	13/10/2020 12:53	4,09	13	53,20	CHI
20201067273	PIRENOPOLIS	PV12352327	CORUMBA	13/10/2020 08:47	13/10/2020 22:06	13/10/2020 08:47	13/10/2020 22:06	13,30	18	239,46	CHI
20201065887	APARECIDA DE GOIANIA	13776423	REAL S2	13/10/2020 08:48	13/10/2020 11:56	13/10/2020 08:48	13/10/2020 11:56	3,12	1	3,12	CHI
20201067047	PIRACANJUBA	PI12000011	PIRACANJUBA	13/10/2020 08:49	13/10/2020 13:26	13/10/2020 08:49	13/10/2020 13:26	4,61	166	765,31	CHI
20201063879	GOIANIA	GN11048071	GOIANIA LESTE S3	13/10/2020 08:50	13/10/2020 10:37	13/10/2020 08:50	13/10/2020 10:37	1,78	81	144,45	CHI
20201065143	VIANOPOLIS	OZ12036983	PIRES DO RIO S2	13/10/2020 08:50	13/10/2020 16:54	13/10/2020 08:50	13/10/2020 16:54	8,07	10	80,71	CHI
20201065143	ORIZONA	OZ12036983	PIRES DO RIO S2	13/10/2020 08:50	13/10/2020 16:54	13/10/2020 08:50	13/10/2020 16:54	8,07	1	8,07	CHI
20201065916	SERRANOPOLIS	SX12314281	JATAI S1	13/10/2020 08:50	14/10/2020 14:54	13/10/2020 08:50	14/10/2020 14:54	30,06	2	60,12	CHI
20201065928	APARECIDA DE GOIANIA	10026834101	INDEPENDENCIA S1	13/10/2020 08:51	13/10/2020 11:24	13/10/2020 08:51	13/10/2020 11:24	2,54	1	2,54	CHI
20201067499	RIO VERDE	RV11018070	SANTA HELENA S1	13/10/2020 08:52	13/10/2020 22:13	13/10/2020 08:52	13/10/2020 22:13	13,34	83	1107,52	CHI
20201065937	ARAGUAPAZ	1780004671	MOZARLANDIA	13/10/2020 08:52	13/10/2020 12:02	13/10/2020 08:52	13/10/2020 12:02	3,15	1	3,15	CHI
20201065939	RIO VERDE	630082790	RIO VERDE S2	13/10/2020 08:52	13/10/2020 23:07	13/10/2020 08:52	13/10/2020 23:07	14,23	1	14,23	CHI
20201065942	SANTO ANTONIO DE GOIAS	NR12246208	NEROPOLIS S2	13/10/2020 08:53	13/10/2020 15:35	13/10/2020 08:53	13/10/2020 15:35	6,69	21	140,50	CHI
20201065943	SENADOR CANEDO	190138348	SENADOR CANEDO	13/10/2020 08:53	13/10/2020 11:06	13/10/2020 08:53	13/10/2020 11:06	2,20	1	2,20	CHI
20201067107	BURITI DE GOIAS	SC12052751	FIRMINOPOLIS S2	13/10/2020 08:54	13/10/2020 21:00	13/10/2020 08:54	13/10/2020 21:00	12,09	3	36,28	CHI
20201067107	SANCLERLANDIA	SC12052751	FIRMINOPOLIS S2	13/10/2020 08:54	13/10/2020 21:00	13/10/2020 08:54	13/10/2020 21:00	12,09	19	229,79	CHI
20201065950	GOIANIA	10374668	CAMPINAS S1	13/10/2020 08:54	13/10/2020 15:11	13/10/2020 08:54	13/10/2020 15:11	6,28	1	6,28	CHI
20201065952	IPAMERI	IP21100331	IPAMERI	13/10/2020 08:54	13/10/2020 17:30	13/10/2020 08:54	13/10/2020 17:30	8,59	1	8,59	CHI
20201065967	PIRES DO RIO	PR12000037RE	PIRES DO RIO S1	13/10/2020 08:55	14/10/2020 01:35	13/10/2020 08:55	14/10/2020 01:35	16,65	27	449,64	CHI
20201065973	PIRACANJUBA	PI21263068	PIRACANJUBA	13/10/2020 08:56	13/10/2020 11:45	13/10/2020 08:56	13/10/2020 11:45	2,81	2	5,63	CHI
20201072261	PARAUNA	PU21212397	MONTIVIDIU T	13/10/2020 08:56	14/10/2020 12:25	13/10/2020 08:56	14/10/2020 12:25	27,47	1	27,47	CHI
20201065980	BARRO ALTO	1150000550	BARRO ALTO	13/10/2020 08:56	14/10/2020 16:05	13/10/2020 08:56	14/10/2020 16:05	31,14	1	31,14	CHI
20201065981	ITAPACI	100041218	ITAPACI	13/10/2020 08:57	13/10/2020 14:08	13/10/2020 08:57	13/10/2020 14:08	5,18	1	5,18	CHI
20201065984	HIDROLANDIA	HD21200304	CEPAIGO S2	13/10/2020 08:57	13/10/2020 11:33	13/10/2020 08:57	13/10/2020 11:33	2,59	1	2,59	CHI
20201065988	GOIANIA	12461581	CAMPINAS S1	13/10/2020 08:58	14/10/2020 02:10	13/10/2020 08:58	14/10/2020 02:10	17,20	1	17,20	CHI
20201065991	TAQUARAL DE GOIAS	TQ21040983	ITABERAI S1	13/10/2020 08:58	13/10/2020 16:59	13/10/2020 08:58	13/10/2020 16:59	8,01	1	8,01	CHI
20201066203	PORANGATU	PO12230401	MARA ROSA	13/10/2020 08:58	13/10/2020 11:20	13/10/2020 08:58	13/10/2020 11:20	2,36	5	11,78	CHI

20201066004	APARECIDA DE GOIANIA	AP12193733	INDEPENDENCIA S1	13/10/2020 08:59	13/10/2020 09:58	13/10/2020 08:59	13/10/2020 09:58	0,98	155	151,99	CHI
20201066009	OURO VERDE DE GOIAS	OV12384175	NEROPOLIS S1	13/10/2020 08:59	13/10/2020 19:33	13/10/2020 08:59	13/10/2020 19:33	10,56	6	63,34	CHI
20201066079	SITIO D ABADIA	SI12329755	IACIARA S2	13/10/2020 09:02	13/10/2020 11:07	13/10/2020 09:02	13/10/2020 11:07	2,08	11	22,84	CHI
20201066102	CAIAPONIA	CP10400723	CAIAPONIA	13/10/2020 09:02	13/10/2020 18:15	13/10/2020 11:44	13/10/2020 11:52	0,14	152	21,07	CHI
20201066102	DOVERLANDIA	CP10400723	CAIAPONIA	13/10/2020 09:02	13/10/2020 18:15	13/10/2020 11:44	13/10/2020 11:52	0,14	10	1,39	CHI
20201066102	CAIAPONIA	CP10400723	CAIAPONIA	13/10/2020 09:02	13/10/2020 18:15	13/10/2020 13:28	13/10/2020 13:49	0,34	152	52,14	CHI
20201066102	DOVERLANDIA	CP10400723	CAIAPONIA	13/10/2020 09:02	13/10/2020 18:15	13/10/2020 13:28	13/10/2020 13:49	0,34	10	3,43	CHI
20201066102	DOVERLANDIA	CP10400723	CAIAPONIA	13/10/2020 09:02	13/10/2020 18:15	13/10/2020 09:02	13/10/2020 15:00	5,96	5	29,80	CHI
20201066102	DOVERLANDIA	CP10400723	CAIAPONIA	13/10/2020 09:02	13/10/2020 18:15	13/10/2020 09:02	13/10/2020 15:26	6,39	3136	20039,04	CHI
20201066102	DOVERLANDIA	CP10400723	CAIAPONIA	13/10/2020 09:02	13/10/2020 18:15	13/10/2020 09:02	13/10/2020 15:26	6,39	36	230,04	CHI
20201066102	BALIZA	DV13349709	CAIAPONIA	13/10/2020 09:02	13/10/2020 18:15	13/10/2020 09:02	13/10/2020 15:26	6,39	620	3961,80	CHI
20201066102	CAIAPONIA	CP10400723	CAIAPONIA	13/10/2020 09:02	13/10/2020 18:15	13/10/2020 09:02	13/10/2020 15:26	6,39	22	140,58	CHI
20201066102	DOVERLANDIA	DV13349709	CAIAPONIA	13/10/2020 09:02	13/10/2020 18:15	13/10/2020 09:02	13/10/2020 15:26	6,39	451	2881,89	CHI
20201066102	DOVERLANDIA	DV10407328	CAIAPONIA	13/10/2020 09:02	13/10/2020 18:15	13/10/2020 09:03	13/10/2020 15:26	6,37	2	12,74	CHI
20201066102	DOVERLANDIA	CP10400723	CAIAPONIA	13/10/2020 09:02	13/10/2020 18:15	13/10/2020 09:03	13/10/2020 15:26	6,37	3	19,12	CHI
20201066102	DOVERLANDIA	CP10400723	CAIAPONIA	13/10/2020 09:02	13/10/2020 18:15	13/10/2020 13:28	13/10/2020 15:26	1,96	1	1,96	CHI
20201066102	DOVERLANDIA	CP10411318	CAIAPONIA	13/10/2020 09:02	13/10/2020 18:15	13/10/2020 13:28	13/10/2020 18:15	4,77	9	42,97	CHI
20201066102	DOVERLANDIA	CP10411318	CAIAPONIA	13/10/2020 09:02	13/10/2020 18:15	13/10/2020 16:52	13/10/2020 18:15	1,37	510	700,97	CHI
20201066102	DOVERLANDIA	CP10411318	CAIAPONIA	13/10/2020 09:02	13/10/2020 18:15	13/10/2020 16:52	13/10/2020 18:15	1,37	3140	4315,76	CHI
20201066102	PIRANHAS	CP10411318	CAIAPONIA	13/10/2020 09:02	13/10/2020 18:15	13/10/2020 16:52	13/10/2020 18:15	1,37	13	17,87	CHI
20201066102	BALIZA	CP10411318	CAIAPONIA	13/10/2020 09:02	13/10/2020 18:15	13/10/2020 16:52	13/10/2020 18:15	1,37	621	853,53	CHI
20201066102	CAIAPONIA	CP10411318	CAIAPONIA	13/10/2020 09:02	13/10/2020 18:15	13/10/2020 16:52	13/10/2020 18:15	1,37	439	603,38	CHI
20201066102	CAIAPONIA	CP10411318	CAIAPONIA	13/10/2020 09:02	13/10/2020 18:15	13/10/2020 16:52	13/10/2020 18:15	1,37	22	30,24	CHI
20201066607	GOIANIA	GN11058684	GOIANIA LESTE S3	13/10/2020 09:02	13/10/2020 11:31	13/10/2020 09:02	13/10/2020 11:31	2,47	36	88,94	CHI
20201066852	SANTA CRUZ DE GOIAS	PR12337190	PIRES DO RIO S1	13/10/2020 09:03	13/10/2020 11:44	13/10/2020 09:03	13/10/2020 11:44	2,67	1	2,67	CHI
20201066852	PIRES DO RIO	PR12337190	PIRES DO RIO S1	13/10/2020 09:03	13/10/2020 11:44	13/10/2020 09:03	13/10/2020 11:44	2,67	7	18,72	CHI
20201066061	MINEIROS	PW21301982	PARQUE DAS EMAS	13/10/2020 09:03	13/10/2020 12:09	13/10/2020 09:03	13/10/2020 12:09	3,09	1	3,09	CHI
20201066062	SANTA HELENA DE GOIAS	SH21280585	IPEGUARI	13/10/2020 09:03	13/10/2020 12:57	13/10/2020 09:03	13/10/2020 12:57	3,89	1	3,89	CHI
20201066064	CATALAO	CT11316048	CATALAO S2	13/10/2020 09:03	13/10/2020 17:29	13/10/2020 09:03	13/10/2020 17:29	8,42	2	16,84	CHI
20201066068	GOIANIA	11544168	FERROVIARIO S1	13/10/2020 09:04	13/10/2020 15:10	13/10/2020 09:04	13/10/2020 15:10	6,11	1	6,11	CHI
20201066069	TRINDADE	40074936	TRINDADE	13/10/2020 09:04	13/10/2020 11:54	13/10/2020 09:04	13/10/2020 11:54	2,83	1	2,83	CHI
20201066070	NOVA AMERICA	NM12291589	RUBIATABA	13/10/2020 09:04	13/10/2020 21:06	13/10/2020 09:04	13/10/2020 21:06	12,04	1	12,04	CHI
20201066077	CATALAO	CT12318674	CATALAO S1	13/10/2020 09:04	13/10/2020 12:43	13/10/2020 09:04	13/10/2020 12:43	3,64	2	7,27	CHI
20201066077	DAVINOPOLIS	CT12318674	CATALAO S1	13/10/2020 09:04	13/10/2020 12:43	13/10/2020 09:04	13/10/2020 12:43	3,64	3	10,91	CHI
20201066080	ANAPOLIS	AN12370432	JUNDIAI S2	13/10/2020 09:05	13/10/2020 13:05	13/10/2020 09:05	13/10/2020 13:05	4,00	112	447,75	CHI
202010189383	RIO VERDE	RV21226271	MONTIVIDIU T	13/10/2020 09:05	13/10/2020 17:53	13/10/2020 09:05	13/10/2020 17:53	8,81	1	8,81	CHI
202010189383	RIO VERDE	RV12207146	MONTIVIDIU T	13/10/2020 09:05	13/10/2020 17:53	13/10/2020 13:41	13/10/2020 17:53	4,20	21	88,18	CHI
20201066084	GOIANIA	12239501	REAL S1	13/10/2020 09:05	13/10/2020 12:29	13/10/2020 09:05	13/10/2020 12:29	3,39	1	3,39	CHI
20201066091	IPAMERI	IP12079435	PIRES DO RIO S2	13/10/2020 09:06	14/10/2020 01:37	13/10/2020 09:06	14/10/2020 01:37	16,51	1	16,51	CHI
20201066099	SANTA RITA DO ARAGUAIA	SU21184143	SANTA RITA DO ARAGUAIA	13/10/2020 09:06	13/10/2020 11:38	13/10/2020 09:06	13/10/2020 11:38	2,52	1	2,52	CHI
20201066103	NAZARIO	440016125	ANICUNS	13/10/2020 09:07	13/10/2020 11:19	13/10/2020 09:07	13/10/2020 11:19	2,20	1	2,20	CHI
20201066110	ARAGOIANIA	10004950800	GUAPU S2	13/10/2020 09:08	13/10/2020 17:07	13/10/2020 09:08	13/10/2020 17:07	7,98	1	7,98	CHI
20201066111	CALDAS NOVAS	CN12214002	SERRA DE CALDAS	13/10/2020 09:08	13/10/2020 11:01	13/10/2020 09:08	13/10/2020 11:01	1,88	248	465,76	CHI
20201066112	FORMOSA	FA21341489	ITUIQUIRA	13/10/2020 09:08	13/10/2020 12:12	13/10/2020 09:08	13/10/2020 12:12	3,06	1	3,06	CHI
20201066135	GOIANIA	10011459571	GOYA S1	13/10/2020 09:10	13/10/2020 14:21	13/10/2020 09:10	13/10/2020 14:21	5,19	1	5,19	CHI
20201066137	GOIANIA	10641932	AEROPORTO S2	13/10/2020 09:10	13/10/2020 15:32	13/10/2020 09:10	13/10/2020 15:32	6,36	1	6,36	CHI
20201066140	CHAPADAO DO CEU	DJ12131923	CHAPADAO DO CEU	13/10/2020 09:10	14/10/2020 08:58	13/10/2020 09:10	14/10/2020 08:58	23,79	10	237,93	CHI
20201066142	APARECIDA DE GOIANIA	10001803920	INDEPENDENCIA S2	13/10/2020 09:11	13/10/2020 12:38	13/10/2020 09:11	13/10/2020 12:38	3,45	1	3,45	CHI
20201066683	IPORA	IR11014386	IPORA	13/10/2020 09:11	13/10/2020 12:50	13/10/2020 09:11	13/10/2020 12:50	3,65	66	240,70	CHI
20201066144	ORIZONA	PR21090301	PIRES DO RIO S2	13/10/2020 09:11	13/10/2020 20:54	13/10/2020 09:11	13/10/2020 20:54	11,71	1	11,71	CHI
20201066157	GOIANIA	16770420	ATLANTICO S1	13/10/2020 09:12	13/10/2020 17:14	13/10/2020 09:12	13/10/2020 17:14	8,03	1	8,03	CHI
20201066161	MOZARLANDIA	10000394961	MOZARLANDIA	13/10/2020 09:12	13/10/2020 11:50	13/10/2020 09:12	13/10/2020 11:50	2,64	1	2,64	CHI
20201066165	VALPARAISO DE GOIAS	10029549688	MARAJOARA	13/10/2020 09:13	13/10/2020 10:56	13/10/2020 09:13	13/10/2020 10:56	1,72	1	1,72	CHI
20201066172	PIRANHAS	1930013544	PIRANHAS	13/10/2020 09:13	13/10/2020 17:46	13/10/2020 09:13	13/10/2020 17:46	8,54	1	8,54	CHI
20201066173	JOVIANIA	JV11025369	GOIATUBA S1	13/10/2020 09:13	13/10/2020 13:33	13/10/2020 09:13	13/10/2020 13:33	4,34	34	147,39	CHI
20201066174	CORUMBA DE GOIAS	10016250395	CORUMBA	13/10/2020 09:13	13/10/2020 14:43	13/10/2020 09:13	13/10/2020 14:43	5,49	1	5,49	CHI
20201066175	GOIANIA	GN21052683	REAL S2	13/10/2020 09:13	13/10/2020 17:33	13/10/2020 09:13	13/10/2020 17:33	8,32	1	8,32	CHI
20201066176	PALMEIRAS DE GOIAS	PL21000057	PALMEIRAS	13/10/2020 09:13	13/10/2020 16:04	13/10/2020 09:13	13/10/2020 16:04	6,83	5	34,17	CHI

20201066177	PLANALTINA	PI11355783	PLANALTINA	13/10/2020 09:14	13/10/2020 10:41	13/10/2020 09:14	13/10/2020 10:41	1,45	1	1,45	CHI
20201066178	CRISTALINA	1060118455	CRISTALINA S1	13/10/2020 09:14	13/10/2020 11:44	13/10/2020 09:14	13/10/2020 11:44	2,50	1	2,50	CHI
20201067065	NEROPOLIS	NR11271870	NEROPOLIS S2	13/10/2020 09:14	13/10/2020 11:41	13/10/2020 09:14	13/10/2020 11:41	2,44	35	85,45	CHI
20201066190	MARA ROSA	2260016632	MARA ROSA	13/10/2020 09:15	13/10/2020 23:08	13/10/2020 09:15	13/10/2020 23:08	13,87	1	13,87	CHI
20201068544	JESUPOLIS	SF12007222	SAO FRANCISCO DE GOIAS	13/10/2020 09:15	13/10/2020 14:51	13/10/2020 09:15	13/10/2020 14:51	5,59	20	111,74	CHI
20201068544	JARAGUA	SF12007222	SAO FRANCISCO DE GOIAS	13/10/2020 09:15	13/10/2020 14:51	13/10/2020 09:15	13/10/2020 14:51	5,59	2	11,17	CHI
20201066192	URUACU	640045110	URUACU	13/10/2020 09:15	13/10/2020 16:16	13/10/2020 09:15	13/10/2020 16:16	7,00	1	7,00	CHI
20201066649	INHUMAS	IN12343069	INHUMAS S2	13/10/2020 09:17	13/10/2020 16:38	13/10/2020 09:17	13/10/2020 16:38	7,35	20	146,96	CHI
20201067756	CATALAO	CT12149164RE	CATALAO S1	13/10/2020 09:17	13/10/2020 16:39	13/10/2020 09:17	13/10/2020 16:39	7,36	146	1075,25	CHI
20201066215	GOIANDIRA	GD12078352	CATALAO S1	13/10/2020 09:17	13/10/2020 11:37	13/10/2020 09:17	13/10/2020 11:37	2,33	21	48,85	CHI
20201071949	ITAPACI	GF12147945	ITAPACI	13/10/2020 09:17	14/10/2020 02:45	13/10/2020 09:17	14/10/2020 02:45	17,45	2	34,91	CHI
20201071949	GUARINOS	GF12147945	ITAPACI	13/10/2020 09:17	14/10/2020 02:45	13/10/2020 09:17	14/10/2020 02:45	17,45	17	296,73	CHI
20201066221	GOIANIA	10728533	ATLANTICO S3	13/10/2020 09:17	13/10/2020 12:31	13/10/2020 09:17	13/10/2020 12:31	3,22	1	3,22	CHI
20201066225	SAO DOMINGOS	SD12254354	SAO DOMINGOS	13/10/2020 09:18	13/10/2020 11:20	13/10/2020 09:18	13/10/2020 11:20	2,03	5	10,13	CHI
20201066238	MIMOSO DE GOIAS	MJ21294997	PADRE BERNARDO	13/10/2020 09:19	13/10/2020 12:07	13/10/2020 09:19	13/10/2020 12:07	2,79	1	2,79	CHI
20201066244	CATALAO	CT21230569	CATALAO S1	13/10/2020 09:20	13/10/2020 11:03	13/10/2020 09:20	13/10/2020 11:03	1,71	1	1,71	CHI
20201067577	NIQUELANDIA	NQ12245209	BARRO ALTO	13/10/2020 09:20	14/10/2020 17:12	13/10/2020 09:20	14/10/2020 17:12	31,86	10	318,63	CHI
20201066248	CAIAPONIA	MV21261012	MONTIVIDIU T	13/10/2020 09:20	14/10/2020 18:07	13/10/2020 09:20	14/10/2020 18:07	32,77	1	32,77	CHI
20201066254	MINEIROS	1390030523	PARQUE DAS EMAS	13/10/2020 09:20	14/10/2020 07:58	13/10/2020 09:20	14/10/2020 07:58	22,62	1	22,62	CHI
20201066258	POSSE	PS21304345	IACIARA S2	13/10/2020 09:21	13/10/2020 11:27	13/10/2020 09:21	13/10/2020 11:27	2,10	1	2,10	CHI
20201066260	GOIANIA	13280430	CAMPINAS S3	13/10/2020 09:21	13/10/2020 15:59	13/10/2020 09:21	13/10/2020 15:59	6,63	1	6,63	CHI
20201066270	CAMPINORTE	CR12374719	MARA ROSA	13/10/2020 09:22	13/10/2020 17:27	13/10/2020 09:22	13/10/2020 17:27	8,07	3	24,20	CHI
20201066273	BOM JARDIM DE GOIAS	1880031039	BOM JARDIM	13/10/2020 09:23	13/10/2020 12:24	13/10/2020 09:23	13/10/2020 12:24	3,01	1	3,01	CHI
20201066284	GOIANIA	10500819	GOIANIA LESTE S1	13/10/2020 09:24	13/10/2020 10:45	13/10/2020 09:24	13/10/2020 10:45	1,34	1	1,34	CHI
20201066872	IPAMERI	GD12161081	CATALAO S1	13/10/2020 09:24	13/10/2020 12:36	13/10/2020 09:24	13/10/2020 12:36	3,19	6	19,13	CHI
20201066291	AMARALINA	MU21143699	MARA ROSA	13/10/2020 09:25	13/10/2020 13:11	13/10/2020 09:25	13/10/2020 13:11	3,76	1	3,76	CHI
20201066292	GOIANIA	16723612	FERROVIARIO S2	13/10/2020 09:25	13/10/2020 11:48	13/10/2020 09:25	13/10/2020 11:48	2,38	1	2,38	CHI
20201066296	JATAI	JT12260447LD	JATAI S1	13/10/2020 09:25	13/10/2020 15:11	13/10/2020 09:25	13/10/2020 15:11	5,76	34	195,74	CHI
20201066300	SANTA HELENA DE GOIAS	SH21246777	IPEGUARI	13/10/2020 09:25	14/10/2020 17:11	13/10/2020 09:25	13/10/2020 16:02	6,61	1	6,61	CHI
20201066300	SANTA HELENA DE GOIAS	SH13047113	IPEGUARI	13/10/2020 09:25	14/10/2020 17:11	13/10/2020 15:21	14/10/2020 17:11	25,84	15	387,53	CHI
20201066308	HIDROLANDIA	AO31089418	GUAPO S2	13/10/2020 09:26	13/10/2020 16:11	13/10/2020 09:26	13/10/2020 16:11	6,74	4	26,95	CHI
20201066309	TROMBAS	TB12185402	PORANGATU	13/10/2020 09:26	13/10/2020 19:02	13/10/2020 09:26	13/10/2020 19:02	9,59	3	28,76	CHI
20201069500	JARAGUA	JA12258144	JARAGUA	13/10/2020 09:26	13/10/2020 16:55	13/10/2020 09:26	13/10/2020 16:55	7,47	42	313,61	CHI
20201066322	GOIANIA	10744540	CAMPINAS S1	13/10/2020 09:27	13/10/2020 19:31	13/10/2020 09:27	13/10/2020 19:31	10,06	1	10,06	CHI
20201066323	RIO VERDE	630430354	RIO VERDE S2	13/10/2020 09:27	13/10/2020 11:44	13/10/2020 09:27	13/10/2020 11:44	2,27	1	2,27	CHI
20201066325	PLANALTINA	PI12302908	PLANALTINA	13/10/2020 09:27	13/10/2020 18:21	13/10/2020 09:27	13/10/2020 18:21	8,89	39	346,63	CHI
20201066326	ORIZONA	IP12217837	PIRES DO RIO S2	13/10/2020 09:27	14/10/2020 10:13	13/10/2020 09:27	14/10/2020 10:13	24,75	1	24,75	CHI
20201066328	CATALAO	CT12278148	CATALAO S1	13/10/2020 09:27	13/10/2020 19:06	13/10/2020 09:27	13/10/2020 19:06	9,64	5	48,18	CHI
20201066329	CALDAS NOVAS	CN21038863	RIO QUENTE	13/10/2020 09:27	13/10/2020 11:23	13/10/2020 09:27	13/10/2020 11:23	1,92	2	3,84	CHI
20201066333	GOIANESIA	550130706	GOIANESIA S2	13/10/2020 09:28	13/10/2020 16:04	13/10/2020 09:28	13/10/2020 16:04	6,60	1	6,60	CHI
20201066337	CALDAS NOVAS	760380375	SERRA DE CALDAS	13/10/2020 09:28	13/10/2020 15:10	13/10/2020 09:28	13/10/2020 15:10	5,69	1	5,69	CHI
20201067607	CAMPINORTE	CR12202139RE	MARA ROSA	13/10/2020 09:28	13/10/2020 14:32	13/10/2020 09:28	13/10/2020 14:32	5,05	32	161,70	CHI
20201067607	URUACU	CR12202139RE	MARA ROSA	13/10/2020 09:28	13/10/2020 14:32	13/10/2020 09:28	13/10/2020 14:32	5,05	106	535,62	CHI
20201066340	ARAGARCAS	1820000178	ARAGARCAS	13/10/2020 09:28	13/10/2020 15:42	13/10/2020 09:28	13/10/2020 15:42	6,22	1	6,22	CHI
20201066343	GOIANIA	10703548	ATLANTICO S2	13/10/2020 09:29	13/10/2020 17:12	13/10/2020 09:29	13/10/2020 17:12	7,72	1	7,72	CHI
20201066349	GOIANIA	10016717781	GOIANIA LESTE S1	13/10/2020 09:29	13/10/2020 18:17	13/10/2020 09:29	13/10/2020 18:17	8,80	1	8,80	CHI
20201066515	PORANGATU	PO12384305	PORANGATU	13/10/2020 09:29	13/10/2020 11:47	13/10/2020 09:29	13/10/2020 11:47	2,29	5	11,43	CHI
20201066550	GOIANIA	AP11168051	ATLANTICO S1	13/10/2020 09:30	13/10/2020 13:04	13/10/2020 09:30	13/10/2020 13:04	3,56	87	310,06	CHI
20201066359	ARAGARCAS	1820036379	ARAGARCAS	13/10/2020 09:30	13/10/2020 15:20	13/10/2020 09:30	13/10/2020 15:20	5,83	1	5,83	CHI
20201066366	APARECIDA DE GOIANIA	10030428120	REAL S1	13/10/2020 09:31	13/10/2020 14:41	13/10/2020 09:31	13/10/2020 14:41	5,16	1	5,16	CHI
20201066695	GOIANIA	GN11281516	INDEPENDENCIA S2	13/10/2020 09:31	13/10/2020 12:59	13/10/2020 09:31	13/10/2020 12:59	3,46	94	325,32	CHI
20201068127	ORIZONA	OZ12326482	PIRES DO RIO S2	13/10/2020 09:31	13/10/2020 22:54	13/10/2020 09:31	13/10/2020 22:54	13,38	2	26,75	CHI
20201070935	BARRO ALTO	BA18000051FS	BARRO ALTO	13/10/2020 09:32	14/10/2020 14:58	13/10/2020 09:32	13/10/2020 22:00	12,47	130	1620,85	CHI
20201070935	NIQUELANDIA	BA18000051FS	BARRO ALTO	13/10/2020 09:32	14/10/2020 14:58	13/10/2020 09:32	13/10/2020 22:00	12,47	122	1521,10	CHI
20201070935	BARRO ALTO	BA18000051FS	BARRO ALTO	13/10/2020 09:32	14/10/2020 14:58	13/10/2020 22:01	13/10/2020 23:33	1,53	58	88,63	CHI
20201070935	BARRO ALTO	BA18000051FS	BARRO ALTO	13/10/2020 09:32	14/10/2020 14:58	13/10/2020 23:36	14/10/2020 00:59	1,38	24	33,08	CHI
20201070935	BARRO ALTO	BA13282029	BARRO ALTO	13/10/2020 09:32	14/10/2020 14:58	13/10/2020 23:36	14/10/2020 11:38	12,03	17	204,56	CHI
20201070935	NIQUELANDIA	BA12401983LD	BARRO ALTO	13/10/2020 09:32	14/10/2020 14:58	13/10/2020 22:01	14/10/2020 12:37	14,59	122	1780,39	CHI

20201070935	BARRO ALTO	BA12401983LD	BARRO ALTO	13/10/2020 09:32	14/10/2020 14:58	13/10/2020 22:01	14/10/2020 12:37	14,59	72	1050,72	CHI
20201070935	BARRO ALTO	BA12382484	BARRO ALTO	13/10/2020 09:32	14/10/2020 14:58	13/10/2020 23:36	14/10/2020 14:58	15,36	17	261,10	CHI
20201066518	GOIANIA	GN11000471	CAMPINAS S3	13/10/2020 09:33	13/10/2020 14:07	13/10/2020 09:33	13/10/2020 14:07	4,57	97	442,94	CHI
20201066388	VARJAO	VJ31099612	GUAPO S2	13/10/2020 09:33	13/10/2020 12:56	13/10/2020 09:33	13/10/2020 12:56	3,38	1	3,38	CHI
20201066390	PONTALINA	PK12000100	PONTALINA	13/10/2020 09:33	13/10/2020 15:26	13/10/2020 09:33	13/10/2020 15:26	5,88	11	64,67	CHI
20201066393	TRINDADE	TR12052787	TRINDADE	13/10/2020 09:33	13/10/2020 12:08	13/10/2020 09:33	13/10/2020 12:08	2,57	68	175,04	CHI
20201066397	TRINDADE	40196460	TRINDADE	13/10/2020 09:33	14/10/2020 10:45	13/10/2020 09:33	14/10/2020 10:45	25,19	1	25,19	CHI
20201068526	SANCLERLANDIA	SC12072237	FIRMINOPOLIS S2	13/10/2020 09:33	13/10/2020 17:55	13/10/2020 09:33	13/10/2020 17:55	8,35	4	33,42	CHI
20201065691	BOM JARDIM DE GOIAS	BM11053416	BOM JARDIM	13/10/2020 09:33	13/10/2020 10:34	13/10/2020 09:33	13/10/2020 10:34	1,00	89	89,35	CHI
20201066403	ARAGOIANIA	AO21031749	GUAPO S2	13/10/2020 09:33	13/10/2020 18:14	13/10/2020 09:33	13/10/2020 18:14	8,67	2	17,34	CHI
20201066406	ITAPURANGA	10030795484	ITAPURANGA	13/10/2020 09:33	13/10/2020 16:44	13/10/2020 09:33	13/10/2020 16:44	7,17	1	7,17	CHI
20201066417	SANTA HELENA DE GOIAS	400023234	IPEGUARI	13/10/2020 09:34	14/10/2020 02:56	13/10/2020 09:34	14/10/2020 02:56	17,36	1	17,36	CHI
20201066420	ALEXANIA	AX21315393	ALEXANIA	13/10/2020 09:34	13/10/2020 11:27	13/10/2020 09:34	13/10/2020 11:27	1,87	1	1,87	CHI
20201066421	GOIAS	HE21158835	ITABERAI S1	13/10/2020 09:35	13/10/2020 13:01	13/10/2020 09:35	13/10/2020 13:01	3,43	2	6,86	CHI
20201066431	MAMBAI	1570008878	IACIARA S2	13/10/2020 09:35	13/10/2020 10:52	13/10/2020 09:35	13/10/2020 10:52	1,27	1	1,27	CHI
20201066429	TRINDADE	40169303	TRINDADE	13/10/2020 09:35	13/10/2020 14:17	13/10/2020 09:35	13/10/2020 14:17	4,69	1	4,69	CHI
20201066450	GOIANIA	10487396	GOIANIA LESTE S1	13/10/2020 09:36	13/10/2020 12:08	13/10/2020 09:36	13/10/2020 12:08	2,52	1	2,52	CHI
20201066451	INHUMAS	IN21130202	INHUMAS S2	13/10/2020 09:36	13/10/2020 23:50	13/10/2020 09:36	13/10/2020 23:50	14,22	1	14,22	CHI
20201066452	SENADOR CANEDO	10004437592	SENADOR CANEDO	13/10/2020 09:37	13/10/2020 12:10	13/10/2020 09:37	13/10/2020 12:10	2,55	1	2,55	CHI
20201066457	GOIANIA	16929986	XAVANTES	13/10/2020 09:37	13/10/2020 15:19	13/10/2020 09:37	13/10/2020 15:19	5,69	1	5,69	CHI
20201066465	JATAI	290268059	JATAI S2	13/10/2020 09:37	13/10/2020 17:13	13/10/2020 09:37	13/10/2020 17:13	7,58	1	7,58	CHI
20201066466	GOIATUBA	GT21419705	GOIATUBA S2	13/10/2020 09:38	13/10/2020 13:03	13/10/2020 09:38	13/10/2020 13:03	3,42	1	3,42	CHI
20201066469	SENADOR CANEDO	190019931	SENADOR CANEDO	13/10/2020 09:38	13/10/2020 12:54	13/10/2020 09:38	13/10/2020 12:54	3,26	1	3,26	CHI
20201066473	GOIANDIRA	GD12127537	CATALAO S1	13/10/2020 09:38	13/10/2020 13:04	13/10/2020 09:38	13/10/2020 13:04	3,42	8	27,39	CHI
20201066479	ANAPOLIS	AN21258326	JUNDIAI S2	13/10/2020 09:39	13/10/2020 17:27	13/10/2020 09:39	13/10/2020 17:27	7,79	1	7,79	CHI
20201066492	ITAUCU	IX11000012	INHUMAS S1	13/10/2020 09:39	13/10/2020 13:35	13/10/2020 09:39	13/10/2020 13:35	3,92	20	78,35	CHI
20201066733	GOIANIA	AP12265057LD	INDEPENDENCIA S2	13/10/2020 09:40	13/10/2020 13:29	13/10/2020 09:40	13/10/2020 13:29	3,81	1163	4434,26	CHI
20201066503	ITABERAI	IB12220541	ITABERAI S1	13/10/2020 09:40	13/10/2020 17:28	13/10/2020 09:40	13/10/2020 17:28	7,79	2	15,57	CHI
20201066509	CAMPOS BELOS	CH11164562	SAO DOMINGOS	13/10/2020 09:41	13/10/2020 10:27	13/10/2020 09:41	13/10/2020 10:27	0,77	24	18,38	CHI
20201067410	GOIANIA	GN11001738	REAL S1	13/10/2020 09:41	13/10/2020 11:47	13/10/2020 09:41	13/10/2020 11:47	2,10	69	144,61	CHI
20201066514	APARECIDA DE GOIANIA	200126751	ANHANGUERA	13/10/2020 09:41	13/10/2020 19:04	13/10/2020 09:41	13/10/2020 19:04	9,38	1	9,38	CHI
20201066516	VALPARAISO DE GOIAS	10014341598	MARAJOARA	13/10/2020 09:41	13/10/2020 13:32	13/10/2020 09:41	13/10/2020 13:32	3,84	1	3,84	CHI
20201066519	FIRMINOPOLIS	900034452	FIRMINOPOLIS S1	13/10/2020 09:41	15/10/2020 01:07	13/10/2020 09:41	15/10/2020 01:07	39,43	1	39,43	CHI
202010189301	CORREGO DO OURO	CO12299161	FIRMINOPOLIS S2	13/10/2020 09:41	13/10/2020 19:28	13/10/2020 09:41	13/10/2020 19:28	9,77	3	29,32	CHI
20201066528	APARECIDA DE GOIANIA	200017718	INDEPENDENCIA S1	13/10/2020 09:42	13/10/2020 16:02	13/10/2020 09:42	13/10/2020 16:02	6,33	1	6,33	CHI
20201066539	GOIANIA	14400972	FERROVIARIO S3	13/10/2020 09:43	13/10/2020 13:44	13/10/2020 09:43	13/10/2020 13:44	4,01	1	4,01	CHI
20201066549	APARECIDA DE GOIANIA	200200197	ANHANGUERA	13/10/2020 09:44	13/10/2020 12:52	13/10/2020 09:44	13/10/2020 12:52	3,12	1	3,12	CHI
20201066575	GOIANIA	GN21313079	GOIANIA LESTE S3	13/10/2020 09:46	13/10/2020 12:02	13/10/2020 09:46	13/10/2020 12:02	2,25	1	2,25	CHI
20201064465	GOIANIA	GN11000181	AEROPORTO S2	13/10/2020 09:48	13/10/2020 12:49	13/10/2020 09:48	13/10/2020 12:49	3,02	13	39,22	CHI
20201066599	JAUPACI	JP21334905	IPORA	13/10/2020 09:48	13/10/2020 16:32	13/10/2020 09:48	13/10/2020 16:32	6,74	1	6,74	CHI
20201066609	GUAPO	710025956	GUAPO S1	13/10/2020 09:49	13/10/2020 12:59	13/10/2020 09:49	13/10/2020 12:59	3,16	1	3,16	CHI
20201066614	PIRACANJUBA	60025475	PIRACANJUBA	13/10/2020 09:50	13/10/2020 14:45	13/10/2020 09:50	13/10/2020 14:45	4,91	1	4,91	CHI
20201066620	GOIANIA	10004032614	MEIA PONTE	13/10/2020 09:50	13/10/2020 16:01	13/10/2020 09:50	13/10/2020 16:01	6,17	1	6,17	CHI
20201066626	GOIANIRA	10002889747	GOIANIRA	13/10/2020 09:50	13/10/2020 13:59	13/10/2020 09:50	13/10/2020 13:59	4,13	1	4,13	CHI
20201066630	CALDAZINHA	LB12270648	DAIA S2	13/10/2020 09:51	13/10/2020 11:00	13/10/2020 09:51	13/10/2020 11:00	1,15	1	1,15	CHI
20201066630	LEOPOLDO DE BULHOES	LB12270648	DAIA S2	13/10/2020 09:51	13/10/2020 11:00	13/10/2020 09:51	13/10/2020 11:00	1,15	20	22,98	CHI
20201066636	SANTA CRUZ DE GOIAS	BC21300720	CRISTIANOPOLIS	13/10/2020 09:51	13/10/2020 13:59	13/10/2020 09:51	13/10/2020 13:59	4,13	1	4,13	CHI
20201066640	TRINDADE	40096476	TRINDADE	13/10/2020 09:51	13/10/2020 18:32	13/10/2020 09:51	13/10/2020 18:32	8,67	1	8,67	CHI
20201066734	MORRINHOS	MR11000019	MORRINHOS	13/10/2020 09:51	13/10/2020 20:50	13/10/2020 09:51	13/10/2020 20:50	10,97	156	1711,67	CHI
20201066652	GOIANIA	10234214	CAMPINAS S3	13/10/2020 09:52	13/10/2020 16:38	13/10/2020 09:52	13/10/2020 16:38	6,75	1	6,75	CHI
20201066653	ALOANDIA	AD12000007	GOIATUBA S1	13/10/2020 09:52	13/10/2020 15:35	13/10/2020 09:52	13/10/2020 15:35	5,70	1	5,70	CHI
20201066658	AGUA FRIA DE GOIAS	TL21321706	SAO JOAO D ALIANCA	13/10/2020 09:53	13/10/2020 12:25	13/10/2020 09:53	13/10/2020 12:25	2,52	1	2,52	CHI
20201066660	BELA VISTA DE GOIAS	10022655121	BELA VISTA S1	13/10/2020 09:53	13/10/2020 14:27	13/10/2020 09:53	13/10/2020 14:27	4,55	1	4,55	CHI
20201066661	ESTRELA DO NORTE	ET11203484	MARA ROSA	13/10/2020 09:53	13/10/2020 13:11	13/10/2020 09:53	13/10/2020 13:11	3,29	15	49,30	CHI
20201066684	CRIXAS	CX12253967	SANTA TEREZINHA	13/10/2020 09:54	13/10/2020 19:15	13/10/2020 09:54	13/10/2020 19:15	9,35	2	18,69	CHI
20201066670	GOIANIA	GN12227549	CEPAIGO S1	13/10/2020 09:54	13/10/2020 12:01	13/10/2020 09:54	13/10/2020 12:01	2,10	4	8,42	CHI
20201066692	ANAPOLIS	10017160594	ANAPOLIS UNIVERSITARIO S2	13/10/2020 09:56	13/10/2020 12:08	13/10/2020 09:56	13/10/2020 12:08	2,19	1	2,19	CHI
20201066693	GOIANIA	16349660	GOIANIA LESTE S2	13/10/2020 09:56	13/10/2020 16:33	13/10/2020 09:56	13/10/2020 16:33	6,61	1	6,61	CHI

20201066698	CRISTALINA	IP21165536	CRISTALINA S1	13/10/2020 09:56	13/10/2020 16:23	13/10/2020 09:56	13/10/2020 16:23	6,43	1	6,43	CHI
20201066701	PIRENOPOLIS	PV21119802	CORUMBA	13/10/2020 09:57	13/10/2020 17:40	13/10/2020 09:57	13/10/2020 17:40	7,71	1	7,71	CHI
20201066738	GOUVELANDIA	GB12261016	QUIRINOPOLIS	13/10/2020 09:58	13/10/2020 17:31	13/10/2020 09:58	13/10/2020 17:31	7,54	5	37,71	CHI
20201066721	CAMPO LIMPO	960020962	NEROPOLIS S1	13/10/2020 09:59	13/10/2020 15:33	13/10/2020 09:59	13/10/2020 15:33	5,56	1	5,56	CHI
20201066737	SANTA CRUZ DE GOIAS	BC12027042	PIRES DO RIO S2	13/10/2020 10:00	13/10/2020 15:45	13/10/2020 10:00	13/10/2020 15:45	5,74	10	57,43	CHI
20201066741	SAO JOAO D ALIANCA	6915031	SAO JOAO D ALIANCA	13/10/2020 10:00	13/10/2020 14:07	13/10/2020 10:00	13/10/2020 14:07	4,11	2	8,21	CHI
20201066745	SANTA HELENA DE GOIAS	SH21000203	IPEGUARI	13/10/2020 10:01	13/10/2020 15:31	13/10/2020 10:01	13/10/2020 13:21	3,33	1	3,33	CHI
20201066745	SANTA HELENA DE GOIAS	SH12295822LD	IPEGUARI	13/10/2020 10:01	13/10/2020 15:31	13/10/2020 12:59	13/10/2020 15:31	2,53	78	197,06	CHI
20201066748	GOIANIA	12758310	ATLANTICO S2	13/10/2020 10:01	14/10/2020 00:03	13/10/2020 10:01	14/10/2020 00:03	14,03	1	14,03	CHI
20201066750	DAMOLANDIA	10003985715	INHUMAS S1	13/10/2020 10:01	13/10/2020 22:41	13/10/2020 10:01	13/10/2020 22:41	12,66	1	12,66	CHI
20201066758	CALDAS NOVAS	CN12142352	CALDAS NOVAS S1	13/10/2020 10:02	13/10/2020 12:12	13/10/2020 10:02	13/10/2020 12:12	2,16	21	45,41	CHI
20201066759	GOIANIA	GN21226686	GOIANIA LESTE S3	13/10/2020 10:02	14/10/2020 00:27	13/10/2020 10:02	14/10/2020 00:27	14,42	1	14,42	CHI
20201066782	PALMEIRAS DE GOIAS	PL21124544	PALMEIRAS	13/10/2020 10:04	13/10/2020 16:11	13/10/2020 10:04	13/10/2020 16:11	6,11	1	6,11	CHI
20201066785	GOIANIA	14718900	CAMPINAS S1	13/10/2020 10:04	13/10/2020 15:58	13/10/2020 10:04	13/10/2020 15:58	5,89	1	5,89	CHI
20201067151	APARECIDA DE GOIANIA	AP11127135	INDEPENDENCIA S1	13/10/2020 10:05	13/10/2020 11:34	13/10/2020 10:05	13/10/2020 11:34	1,48	241	357,01	CHI
20201066806	CALDAS NOVAS	760141253	CALDAS NOVAS S2	13/10/2020 10:06	13/10/2020 11:30	13/10/2020 10:06	13/10/2020 11:30	1,39	1	1,39	CHI
20201066817	LUZIANIA	LZ21261348	MARAJOARA	13/10/2020 10:07	13/10/2020 13:11	13/10/2020 10:07	13/10/2020 13:11	3,06	2	6,13	CHI
20201066829	ORIZONA	2060043846	PIRES DO RIO S2	13/10/2020 10:07	13/10/2020 19:04	13/10/2020 10:07	13/10/2020 19:04	8,94	1	8,94	CHI
20201067596	PALESTINA DE GOIAS	PY12358571	PALESTINA	13/10/2020 10:07	14/10/2020 12:45	13/10/2020 10:07	14/10/2020 12:45	26,62	2	53,24	CHI
20201066831	ANAPOLIS	AN31054489	ANAPOLIS UNIVERSITARIO S2	13/10/2020 10:08	13/10/2020 12:50	13/10/2020 10:08	13/10/2020 12:50	2,70	1	2,70	CHI
20201066842	VILA PROPICIO	GE12255985	GOIANESIA S1	13/10/2020 10:08	13/10/2020 14:31	13/10/2020 10:08	13/10/2020 14:31	4,37	8	34,98	CHI
20201066877	MINEIROS	MY12043894RE	PARQUE DAS EMAS	13/10/2020 10:10	15/10/2020 16:27	13/10/2020 10:10	13/10/2020 14:27	4,29	48	206,09	CHI
20201066877	MINEIROS	MY12043894RE	PARQUE DAS EMAS	13/10/2020 10:10	15/10/2020 16:27	13/10/2020 10:10	13/10/2020 17:15	7,09	5	35,45	CHI
20201066877	MINEIROS	MY12043894RE	PARQUE DAS EMAS	13/10/2020 10:10	15/10/2020 16:27	13/10/2020 14:28	13/10/2020 17:15	2,79	9	25,13	CHI
20201066877	MINEIROS	MY13196005	PARQUE DAS EMAS	13/10/2020 10:10	15/10/2020 16:27	13/10/2020 14:28	14/10/2020 10:46	20,31	1	20,31	CHI
20201066877	MINEIROS	MY12043894RE	PARQUE DAS EMAS	13/10/2020 10:10	15/10/2020 16:27	13/10/2020 10:10	14/10/2020 12:35	26,42	2	52,84	CHI
20201066877	MINEIROS	MY12043894RE	PARQUE DAS EMAS	13/10/2020 10:10	15/10/2020 16:27	14/10/2020 12:46	14/10/2020 17:14	4,48	18	80,57	CHI
20201066877	MINEIROS	MY13196005	PARQUE DAS EMAS	13/10/2020 10:10	15/10/2020 16:27	14/10/2020 12:46	14/10/2020 21:43	8,95	4	35,80	CHI
20201066877	MINEIROS	MY12219457RE	PARQUE DAS EMAS	13/10/2020 10:10	15/10/2020 16:27	14/10/2020 12:45	15/10/2020 01:01	12,27	22	269,92	CHI
20201066877	MINEIROS	MY12043894RE	PARQUE DAS EMAS	13/10/2020 10:10	15/10/2020 16:27	13/10/2020 10:10	15/10/2020 01:01	38,86	1	38,86	CHI
20201066877	MINEIROS	MY12043894RE	PARQUE DAS EMAS	13/10/2020 10:10	15/10/2020 16:27	15/10/2020 01:03	15/10/2020 03:15	2,20	20	43,98	CHI
20201066877	MINEIROS	MY13196005	PARQUE DAS EMAS	13/10/2020 10:10	15/10/2020 16:27	15/10/2020 01:03	15/10/2020 16:27	15,40	40	615,98	CHI
20201066880	INHUMAS	IN12098790	INHUMAS S1	13/10/2020 10:10	13/10/2020 18:16	13/10/2020 10:10	13/10/2020 18:16	8,09	1	8,09	CHI
20201066884	GOIANAPOLIS	TJ12402042	DAIA S2	13/10/2020 10:10	13/10/2020 12:06	13/10/2020 10:10	13/10/2020 12:06	1,92	1	1,92	CHI
20201066888	TRINDADE	40073142	TRINDADE	13/10/2020 10:11	13/10/2020 18:36	13/10/2020 10:11	13/10/2020 18:36	8,41	1	8,41	CHI
20201066889	ANICUNS	AC12308589	ANICUNS	13/10/2020 10:11	13/10/2020 17:46	13/10/2020 10:11	13/10/2020 17:46	7,58	1	7,58	CHI
20201066964	CRISTALINA	KR10406652	CRISTALINA S1	13/10/2020 10:11	13/10/2020 17:15	13/10/2020 10:11	13/10/2020 16:54	6,71	108	725,10	CHI
20201066964	CRISTALINA	KR12370868LD	CRISTALINA S1	13/10/2020 10:11	13/10/2020 17:15	13/10/2020 10:11	13/10/2020 17:15	7,07	5	35,34	CHI
20201066944	TURVANIA	TV12259071	FIRMINOPOLIS S2	13/10/2020 10:12	13/10/2020 20:30	13/10/2020 10:12	13/10/2020 20:30	10,29	7	72,05	CHI
20201066904	ANAPOLIS	20418670	JUNDIAI S1	13/10/2020 10:12	13/10/2020 13:26	13/10/2020 10:12	13/10/2020 13:26	3,22	1	3,22	CHI
20201066905	RIO VERDE	630492864	RIO VERDE S2	13/10/2020 10:12	13/10/2020 21:10	13/10/2020 10:12	13/10/2020 21:10	10,95	1	10,95	CHI
20201066910	PIRACANJUBA	MR21120875	MORRINHOS	13/10/2020 10:13	13/10/2020 16:41	13/10/2020 10:13	13/10/2020 16:41	6,47	1	6,47	CHI
20201066945	FIRMINOPOLIS	FR21061399	FIRMINOPOLIS S1	13/10/2020 10:14	14/10/2020 15:22	13/10/2020 10:14	14/10/2020 15:22	29,13	1	29,13	CHI
20201066957	APARECIDA DE GOIANIA	AP12246439	CEPAIGO S1	13/10/2020 10:14	13/10/2020 12:45	13/10/2020 10:14	13/10/2020 12:45	2,50	1	2,50	CHI
20201066967	GOIANIA	GN21163927	XAVANTES	13/10/2020 10:15	13/10/2020 11:52	13/10/2020 10:15	13/10/2020 11:52	1,60	1	1,60	CHI
20201066985	CORUMBA DE GOIAS	CB21292239	CORUMBA	13/10/2020 10:17	13/10/2020 19:23	13/10/2020 10:17	13/10/2020 19:23	9,09	1	9,09	CHI
20201068493	APARECIDA DE GOIANIA	AP11000051	INDEPENDENCIA S2	13/10/2020 10:18	13/10/2020 14:54	13/10/2020 10:18	13/10/2020 14:54	4,60	69	317,40	CHI
20201067019	APARECIDA DE GOIANIA	AP11383875	INDEPENDENCIA S2	13/10/2020 10:18	13/10/2020 10:27	13/10/2020 10:18	13/10/2020 10:27	0,13	34	4,56	CHI
20201067031	ALTO PARAISO DE GOIAS	BF11129977	FLORES DE GOIAS	13/10/2020 10:20	13/10/2020 10:59	13/10/2020 10:20	13/10/2020 10:59	0,65	151	97,44	CHI
20201067032	APARECIDA DE GOIANIA	200168836	INDEPENDENCIA S1	13/10/2020 10:20	13/10/2020 13:20	13/10/2020 10:20	13/10/2020 13:20	3,00	1	3,00	CHI
20201067050	SANTO ANTONIO DO DESCOBERTO	SN12330532	MARAJOARA	13/10/2020 10:21	13/10/2020 14:27	13/10/2020 10:21	13/10/2020 14:27	4,10	23	94,28	CHI
20201067050	ALEXANIA	SN12330532	MARAJOARA	13/10/2020 10:21	13/10/2020 14:27	13/10/2020 10:21	13/10/2020 14:27	4,10	4	16,40	CHI
20201067055	ITUMBIARA	IT11000132	PARANAIBA	13/10/2020 10:21	13/10/2020 21:37	13/10/2020 10:21	13/10/2020 21:37	11,26	30	337,74	CHI
20201067058	ANAPOLIS	SV21192046	ANAPOLIS UNIVERSITARIO S2	13/10/2020 10:21	13/10/2020 15:33	13/10/2020 10:21	13/10/2020 15:33	5,19	1	5,19	CHI
20201067085	LEOPOLDO DE BULHOES	LB12000009	DAIA S2	13/10/2020 10:23	13/10/2020 11:31	13/10/2020 10:23	13/10/2020 11:31	1,13	2	2,25	CHI
20201067087	JANDAIA	JD12233370	PALMEIRAS	13/10/2020 10:23	13/10/2020 16:28	13/10/2020 10:23	13/10/2020 16:28	6,07	10	60,71	CHI
20201067091	IPORA	730111921	IPORA	13/10/2020 10:24	13/10/2020 16:43	13/10/2020 10:24	13/10/2020 16:43	6,31	1	6,31	CHI
20201067100	URUACU	640008884	URUACU	13/10/2020 10:24	13/10/2020 17:31	13/10/2020 10:24	13/10/2020 17:31	7,10	1	7,10	CHI

20201067137	CATALAO	CT12266758	CATALAO S1	13/10/2020 10:27	13/10/2020 14:19	13/10/2020 10:27	13/10/2020 14:19	3,85	47	181,13	CHI
20201067146	NOVA CRIXAS	10017201339	NOVA CRIXAS	13/10/2020 10:28	13/10/2020 15:49	13/10/2020 10:28	13/10/2020 15:49	5,35	1	5,35	CHI
20201067149	PARAUNA	PU21136886	PARAUNA	13/10/2020 10:28	13/10/2020 16:54	13/10/2020 10:28	13/10/2020 16:54	6,44	1	6,44	CHI
20201067179	GOIANIA	10031289280	CAMPINAS S2	13/10/2020 10:30	13/10/2020 22:12	13/10/2020 10:30	13/10/2020 22:12	11,69	1	11,69	CHI
20201067201	TRINDADE	40210480	TRINDADE	13/10/2020 10:32	13/10/2020 15:46	13/10/2020 10:32	13/10/2020 15:46	5,22	1	5,22	CHI
20201067202	TRINDADE	10011770358	GOYA S2	13/10/2020 10:32	13/10/2020 13:17	13/10/2020 10:32	13/10/2020 13:17	2,74	1	2,74	CHI
20201067225	TURVANIA	TV21005781	FIRMINOPOLIS S2	13/10/2020 10:33	13/10/2020 19:58	13/10/2020 10:33	13/10/2020 19:58	9,40	1	9,40	CHI
20201067226	PIRENOPOLIS	PV21056022	CORUMBA	13/10/2020 10:34	13/10/2020 20:47	13/10/2020 10:34	13/10/2020 20:47	10,22	1	10,22	CHI
20201067233	CATALAO	CT21266714	CATALAO S1	13/10/2020 10:34	13/10/2020 19:13	13/10/2020 10:34	13/10/2020 19:13	8,64	1	8,64	CHI
20201067234	INHUMAS	30174028	INHUMAS S2	13/10/2020 10:34	13/10/2020 15:23	13/10/2020 10:34	13/10/2020 15:23	4,81	1	4,81	CHI
20201068743	PIRES DO RIO	PR12064874	PIRES DO RIO S1	13/10/2020 10:34	13/10/2020 15:04	13/10/2020 10:34	13/10/2020 15:04	4,49	126	565,56	CHI
20201067657	JARAGUA	70032968	SAO FRANCISCO DE GOIAS	13/10/2020 10:35	13/10/2020 20:21	13/10/2020 10:35	13/10/2020 20:21	9,76	1	9,76	CHI
20201067245	PARAUNA	PU21295874	ACREUNA	13/10/2020 10:35	13/10/2020 18:01	13/10/2020 10:35	13/10/2020 18:01	7,43	1	7,43	CHI
20201067246	GOIANIA	11285138	ATLANTICO S2	13/10/2020 10:35	13/10/2020 15:22	13/10/2020 10:35	13/10/2020 15:22	4,78	1	4,78	CHI
20201067247	JANDAIA	10017597933	PALMEIRAS	13/10/2020 10:35	14/10/2020 22:36	13/10/2020 10:35	14/10/2020 22:36	36,02	1	36,02	CHI
20201069014	CAMPINACU	UC12285921	PORANGATU	13/10/2020 10:35	13/10/2020 19:27	13/10/2020 10:35	13/10/2020 19:27	8,86	42	372,00	CHI
20201067276	ITABERAI	IB12088050	ITABERAI S1	13/10/2020 10:36	13/10/2020 13:05	13/10/2020 10:36	13/10/2020 13:05	2,47	4	9,89	CHI
20201067280	CRISTALINA	KR21041576	CRISTALINA S2	13/10/2020 10:36	13/10/2020 16:22	13/10/2020 10:36	13/10/2020 16:22	5,75	1	5,75	CHI
20201067282	QUIRINOPOLIS	QI21091033	QUIRINOPOLIS	13/10/2020 10:36	13/10/2020 12:16	13/10/2020 10:36	13/10/2020 12:16	1,65	1	1,65	CHI
20201067287	SANTA RITA DO ARAGUAIA	10000361656	SANTA RITA DO ARAGUAIA	13/10/2020 10:37	14/10/2020 08:18	13/10/2020 10:37	14/10/2020 08:18	21,68	1	21,68	CHI
20201067293	PIRACANJUBA	PI12352525	PIRACANJUBA	13/10/2020 10:38	13/10/2020 12:59	13/10/2020 10:38	13/10/2020 12:59	2,35	16	37,52	CHI
20201067294	SIMOLANDIA	AQ12131772	IACIARA S2	13/10/2020 10:38	13/10/2020 15:11	13/10/2020 10:38	13/10/2020 15:11	4,55	1	4,55	CHI
20201067294	ALVORADA DO NORTE	AQ12131772	IACIARA S2	13/10/2020 10:38	13/10/2020 15:11	13/10/2020 10:38	13/10/2020 15:11	4,55	119	540,86	CHI
20201067409	SANTA RITA DO ARAGUAIA	SU12188574	SANTA RITA DO ARAGUAIA	13/10/2020 10:38	13/10/2020 13:41	13/10/2020 10:38	13/10/2020 13:41	3,04	3	9,12	CHI
20201068314	DAMOLANDIA	DL11054609	INHUMAS S1	13/10/2020 10:38	13/10/2020 21:59	13/10/2020 10:38	13/10/2020 21:59	11,34	71	805,02	CHI
20201067319	LUZIANIA	LZ12394914	MARAJOARA	13/10/2020 10:40	13/10/2020 12:31	13/10/2020 10:40	13/10/2020 12:31	1,84	8	14,76	CHI
20201067320	GOIAS	IU12198548	MATRINCHA	13/10/2020 10:40	13/10/2020 23:43	13/10/2020 10:40	13/10/2020 23:43	13,04	1	13,04	CHI
20201067320	ITAPIRAPUA	IU12198548	MATRINCHA	13/10/2020 10:40	13/10/2020 23:43	13/10/2020 10:40	13/10/2020 23:43	13,04	2	26,08	CHI
20201067322	MOSSAMEDES	MD11378319	FIRMINOPOLIS S2	13/10/2020 10:40	14/10/2020 00:20	13/10/2020 10:40	14/10/2020 00:20	13,65	37	505,16	CHI
20201067327	CRISTALINA	KR21237928	CRISTALINA S2	13/10/2020 10:41	13/10/2020 18:36	13/10/2020 10:41	13/10/2020 18:36	7,91	1	7,91	CHI
20201067328	APARECIDA DE GOIANIA	200258126	INDEPENDENCIA S1	13/10/2020 10:41	13/10/2020 15:21	13/10/2020 10:41	13/10/2020 15:21	4,66	1	4,66	CHI
20201067333	VILA PROPICIO	GE21258457	GOIANESIA S1	13/10/2020 10:41	14/10/2020 00:02	13/10/2020 10:41	14/10/2020 00:02	13,34	1	13,34	CHI
20201067336	GOIANIA	15584689	MEIA PONTE	13/10/2020 10:41	13/10/2020 14:57	13/10/2020 10:41	13/10/2020 14:57	4,25	1	4,25	CHI
20201067341	GOIANIA	11293470	ATLANTICO S2	13/10/2020 10:42	13/10/2020 14:43	13/10/2020 10:42	13/10/2020 14:43	4,01	1	4,01	CHI
20201067344	GOIANIA	10008568349	AEROPORTO S2	13/10/2020 10:42	13/10/2020 17:54	13/10/2020 10:42	13/10/2020 17:54	7,19	1	7,19	CHI
20201067349	APARECIDA DE GOIANIA	AP21350520	INDEPENDENCIA S2	13/10/2020 10:43	13/10/2020 10:52	13/10/2020 10:43	13/10/2020 10:52	0,15	1	0,15	CHI
20201067451	HIDROLANDIA	HD11376824	ANHANGUERA	13/10/2020 10:43	13/10/2020 13:01	13/10/2020 10:43	13/10/2020 13:01	2,30	104	238,80	CHI
20201067375	CALDAS NOVAS	CN11263383	SERRA DE CALDAS	13/10/2020 10:44	13/10/2020 11:19	13/10/2020 10:44	13/10/2020 11:19	0,58	131	76,23	CHI
20201067864	JESUPOLIS	JE11159200	SAO FRANCISCO DE GOIAS	13/10/2020 10:44	13/10/2020 18:19	13/10/2020 10:44	13/10/2020 18:19	7,58	103	780,45	CHI
20201067376	MINEIROS	PW21045403	PARQUE DAS EMAS	13/10/2020 10:44	14/10/2020 09:20	13/10/2020 10:44	14/10/2020 09:20	22,59	1	22,59	CHI
20201067518	APARECIDA DE GOIANIA	AP11101601	ANHANGUERA	13/10/2020 10:44	13/10/2020 11:43	13/10/2020 10:44	13/10/2020 11:43	0,97	587	568,74	CHI
20201067381	GOIANIA	15026267	CARAJAS S1	13/10/2020 10:45	13/10/2020 12:16	13/10/2020 10:45	13/10/2020 12:16	1,51	1	1,51	CHI
20201067392	CAMPRESTRE DE GOIAS	1230004182	TRINDADE	13/10/2020 10:46	13/10/2020 19:02	13/10/2020 10:46	13/10/2020 19:02	8,26	1	8,26	CHI
20201067398	TRINDADE	10000732859	TRINDADE	13/10/2020 10:46	13/10/2020 14:23	13/10/2020 10:46	13/10/2020 14:23	3,61	1	3,61	CHI
20201067396	PIRACANJUBA	PJ12058038	PIRACANJUBA	13/10/2020 10:46	13/10/2020 15:26	13/10/2020 10:46	13/10/2020 15:26	4,65	2	9,31	CHI
20201067403	JATAI	10012307317	JATAI S3	13/10/2020 10:47	13/10/2020 13:47	13/10/2020 10:47	13/10/2020 13:47	3,00	1	3,00	CHI
20201067408	ANICUNS	AC21216442	ANICUNS	13/10/2020 10:48	13/10/2020 17:19	13/10/2020 10:48	13/10/2020 17:19	6,51	1	6,51	CHI
20201067415	ARAGARCAS	1820055751	ARAGARCAS	13/10/2020 10:48	13/10/2020 16:54	13/10/2020 10:48	13/10/2020 16:54	6,09	1	6,09	CHI
20201067417	GOIANIA	13036993	AEROPORTO S2	13/10/2020 10:48	13/10/2020 15:32	13/10/2020 10:48	13/10/2020 15:32	4,72	1	4,72	CHI
20201067424	SENADOR CANEDO	SW11065499	SENADOR CANEDO	13/10/2020 10:49	13/10/2020 12:04	13/10/2020 10:49	13/10/2020 12:04	1,24	91	113,09	CHI
20201067434	ANAPOLIS	10003540756	ANAPOLIS UNIVERSITARIO S2	13/10/2020 10:50	13/10/2020 18:42	13/10/2020 10:50	13/10/2020 18:42	7,86	1	7,86	CHI
20201070267	CAMPO LIMPO	AN12390325	NEROPOLIS S1	13/10/2020 10:51	13/10/2020 17:56	13/10/2020 10:51	13/10/2020 17:56	7,07	8	56,59	CHI
20201067449	APARECIDA DE GOIANIA	16488404	INDEPENDENCIA S2	13/10/2020 10:52	13/10/2020 19:06	13/10/2020 10:52	13/10/2020 19:06	8,23	1	8,23	CHI
20201067463	PALMEIRAS DE GOIAS	PL21125159	PALMEIRAS	13/10/2020 10:53	13/10/2020 14:02	13/10/2020 10:53	13/10/2020 14:02	3,14	2	6,28	CHI
20201067473	CRISTALINA	KR21263087	PAMPLONA	13/10/2020 10:55	13/10/2020 15:01	13/10/2020 10:55	13/10/2020 15:01	4,09	1	4,09	CHI
20201067474	ANAPOLIS	AN21059679	ANAPOLIS UNIVERSITARIO S2	13/10/2020 10:55	13/10/2020 12:52	13/10/2020 10:55	13/10/2020 12:52	1,93	1	1,93	CHI
20201065109	ALEXANIA	AX11349392	ALEXANIA	13/10/2020 10:56	13/10/2020 18:51	13/10/2020 10:56	13/10/2020 18:51	7,92	14	110,83	CHI
20201067477	MARA ROSA	MQ21246889	MARA ROSA	13/10/2020 10:56	13/10/2020 14:52	13/10/2020 10:56	13/10/2020 14:52	3,93	1	3,93	CHI

20201067480	PORTELANDIA	PW21374310	PARQUE DAS EMAS	13/10/2020 10:56	13/10/2020 17:04	13/10/2020 10:56	13/10/2020 17:04	6,13	1	6,13	CHI
20201067483	ITAPACI	IW21294800	ITAPACI	13/10/2020 10:56	13/10/2020 20:59	13/10/2020 10:56	13/10/2020 20:59	10,04	1	10,04	CHI
20201067486	CRISTALINA	KR21343833	CRISTALINA S1	13/10/2020 10:56	13/10/2020 13:40	13/10/2020 10:56	13/10/2020 13:40	2,72	2	5,43	CHI
20201068660	SERRANOPOLIS	SX12361089	JATAI S1	13/10/2020 10:57	14/10/2020 00:51	13/10/2020 10:57	14/10/2020 00:51	13,89	5	69,46	CHI
20201067494	JATAI	JT12303380RE	JATAI S1	13/10/2020 10:57	13/10/2020 16:03	13/10/2020 10:57	13/10/2020 16:03	5,09	25	127,16	CHI
20201067495	FLORES DE GOIAS	FB21143273	IACIARA S2	13/10/2020 10:58	13/10/2020 12:37	13/10/2020 10:58	13/10/2020 12:37	1,65	1	1,65	CHI
20201067497	CAIAPONIA	930014297	CAIAPONIA	13/10/2020 10:58	13/10/2020 17:32	13/10/2020 10:58	13/10/2020 17:32	6,56	1	6,56	CHI
202010189410	NIQUELANDIA	2750077303	NIQUELANDIA SUBTRANSMISSAO	13/10/2020 10:59	13/10/2020 11:07	13/10/2020 10:59	13/10/2020 11:07	0,14	1	0,14	CHI
20201067502	GOIANIA	13483730	ATLANTICO S1	13/10/2020 10:59	13/10/2020 12:59	13/10/2020 10:59	13/10/2020 12:59	2,00	1	2,00	CHI
20201068022	ARENOPOLIS	AY12000021	ARENOPOLIS	13/10/2020 10:59	13/10/2020 18:53	13/10/2020 10:59	13/10/2020 18:53	7,89	19	149,92	CHI
20201067507	JUSSARA	JR12020137	JUSSARA	13/10/2020 10:59	13/10/2020 13:30	13/10/2020 10:59	13/10/2020 13:30	2,52	1	2,52	CHI
20201067515	LUZIANIA	LZ12059685	RIO VERMELHO	13/10/2020 11:00	13/10/2020 12:42	13/10/2020 11:00	13/10/2020 12:42	1,69	2	3,39	CHI
20201068238	CAMPO ALEGRE DE GOIAS	CM12338725	CAMPO ALEGRE DE GOIAS	13/10/2020 11:01	13/10/2020 17:26	13/10/2020 11:01	13/10/2020 17:26	6,40	3	19,21	CHI
20201068818	FORMOSO	FO12170963	MARA ROSA	13/10/2020 11:01	13/10/2020 15:21	13/10/2020 11:01	13/10/2020 15:21	4,32	11	47,50	CHI
20201067543	APARECIDA DE GOIANIA	200084756	INDEPENDENCIA S1	13/10/2020 11:02	13/10/2020 18:02	13/10/2020 11:02	13/10/2020 18:02	6,99	1	6,99	CHI
20201067547	CATALAO	CT21042361	CATALAO S1	13/10/2020 11:02	13/10/2020 19:24	13/10/2020 11:02	13/10/2020 19:24	8,35	2	16,70	CHI
20201067549	JANDAIA	JD21301634	ACREUNA	13/10/2020 11:03	15/10/2020 08:27	13/10/2020 11:03	15/10/2020 08:27	45,40	1	45,40	CHI
20201067555	APARECIDA DE GOIANIA	200140528	INDEPENDENCIA S1	13/10/2020 11:04	13/10/2020 15:28	13/10/2020 11:04	13/10/2020 15:28	4,40	1	4,40	CHI
20201067558	JATAI	JT21331351	JATAI S1	13/10/2020 11:04	13/10/2020 14:59	13/10/2020 11:04	13/10/2020 14:59	3,91	1	3,91	CHI
20201067559	ABADIANIA	AA12401019	ANAPOLIS UNIVERSITARIO S1	13/10/2020 11:04	13/10/2020 16:58	13/10/2020 11:04	13/10/2020 16:58	5,89	2	11,79	CHI
20201068174	FORMOSA	FA11102399	ITUIQUIRA	13/10/2020 11:05	13/10/2020 13:30	13/10/2020 11:05	13/10/2020 13:30	2,43	191	463,49	CHI
20201067574	CALDASINHA	SW21192129	SENADOR CANEDO	13/10/2020 11:05	13/10/2020 15:10	13/10/2020 11:05	13/10/2020 15:10	4,07	2	8,14	CHI
20201067578	GOIANIA	10574748	GOIANIA LESTE S2	13/10/2020 11:06	13/10/2020 18:13	13/10/2020 11:06	13/10/2020 18:13	7,12	1	7,12	CHI
20201067583	QUIRINOPOLIS	10012844495	QUIRINOPOLIS	13/10/2020 11:07	13/10/2020 12:21	13/10/2020 11:07	13/10/2020 12:21	1,23	1	1,23	CHI
20201067585	GOIANIA	10500170	GOIANIA LESTE S1	13/10/2020 11:07	13/10/2020 13:57	13/10/2020 11:07	13/10/2020 13:57	2,83	1	2,83	CHI
20201067593	EDEIA	EA21086962	EDEIA	13/10/2020 11:08	13/10/2020 12:40	13/10/2020 11:08	13/10/2020 12:40	1,53	1	1,53	CHI
20201067595	CALDAS NOVAS	CN12363719	SERRA DE CALDAS	13/10/2020 11:08	13/10/2020 14:06	13/10/2020 11:08	13/10/2020 14:06	2,96	109	322,28	CHI
20201067625	NIQUELANDIA	NQ10400422	URUACU	13/10/2020 11:09	15/10/2020 01:04	13/10/2020 11:09	13/10/2020 11:18	0,16	770	123,63	CHI
20201067625	NIQUELANDIA	NQ10400419	URUACU	13/10/2020 11:09	15/10/2020 01:04	13/10/2020 11:11	13/10/2020 11:18	0,13	1	0,13	CHI
20201067625	NIQUELANDIA	01290414	NIQUELANDIA SUBTRANSMISSAO	13/10/2020 11:09	15/10/2020 01:04	13/10/2020 11:17	13/10/2020 11:45	0,46	840	383,37	CHI
20201067625	NIQUELANDIA	01290414	NIQUELANDIA SUBTRANSMISSAO	13/10/2020 11:09	15/10/2020 01:04	13/10/2020 11:17	13/10/2020 11:45	0,46	4560	2081,13	CHI
20201067625	URUACU	01290414	NIQUELANDIA SUBTRANSMISSAO	13/10/2020 11:09	15/10/2020 01:04	13/10/2020 11:17	13/10/2020 11:45	0,46	3	1,37	CHI
20201067625	NIQUELANDIA	01290424	NIQUELANDIA SUBTRANSMISSAO	13/10/2020 11:09	15/10/2020 01:04	13/10/2020 11:17	13/10/2020 11:45	0,46	6113	2827,26	CHI
20201067625	NIQUELANDIA	NQ13416321	NIQUELANDIA SUBTRANSMISSAO	13/10/2020 11:09	15/10/2020 01:04	13/10/2020 11:09	13/10/2020 14:59	3,83	3	11,48	CHI
20201067625	NIQUELANDIA	NQ13197569	URUACU	13/10/2020 11:09	15/10/2020 01:04	13/10/2020 12:17	13/10/2020 20:27	8,18	964	7882,84	CHI
20201067625	NIQUELANDIA	NQ13197569	URUACU	13/10/2020 11:09	15/10/2020 01:04	13/10/2020 12:59	13/10/2020 20:27	7,48	53	396,29	CHI
20201067625	SAO JOAO D ALIANCA	01290434	NIQUELANDIA SUBTRANSMISSAO	13/10/2020 11:09	15/10/2020 01:04	13/10/2020 11:09	14/10/2020 11:59	24,82	1	24,82	CHI
20201067625	COLINAS DO SUL	01290434	NIQUELANDIA SUBTRANSMISSAO	13/10/2020 11:09	15/10/2020 01:04	13/10/2020 11:09	14/10/2020 11:59	24,82	1164	28888,54	CHI
20201067625	NIQUELANDIA	01290434	NIQUELANDIA SUBTRANSMISSAO	13/10/2020 11:09	15/10/2020 01:04	13/10/2020 11:09	14/10/2020 11:59	24,82	1746	43332,81	CHI
20201067625	ALTO PARAISO DE GOIAS	01290434	NIQUELANDIA SUBTRANSMISSAO	13/10/2020 11:09	15/10/2020 01:04	13/10/2020 11:09	14/10/2020 11:59	24,82	12	297,82	CHI
20201067625	NIQUELANDIA	NQ10400422	NIQUELANDIA SUBTRANSMISSAO	13/10/2020 11:09	15/10/2020 01:04	14/10/2020 11:59	14/10/2020 12:14	0,25	6350	1589,26	CHI
20201067625	NIQUELANDIA	NQ10400422	URUACU	13/10/2020 11:09	15/10/2020 01:04	14/10/2020 11:59	14/10/2020 12:14	0,25	53	13,26	CHI
20201067625	URUACU	NQ10400422	NIQUELANDIA SUBTRANSMISSAO	13/10/2020 11:09	15/10/2020 01:04	14/10/2020 11:59	14/10/2020 12:14	0,25	3	0,75	CHI
20201067625	NIQUELANDIA	NQ10400422	NIQUELANDIA SUBTRANSMISSAO	13/10/2020 11:09	15/10/2020 01:04	14/10/2020 11:59	14/10/2020 12:14	0,25	881	220,49	CHI
20201067625	NIQUELANDIA	NQ10400422	NIQUELANDIA SUBTRANSMISSAO	13/10/2020 11:09	15/10/2020 01:04	14/10/2020 11:59	14/10/2020 12:14	0,25	4629	1158,54	CHI
20201067625	NIQUELANDIA	NQ13235630	URUACU	13/10/2020 11:09	15/10/2020 01:04	13/10/2020 12:17	14/10/2020 22:08	33,86	166	5621,31	CHI
20201067625	NIQUELANDIA	NQ12221654LD	URUACU	13/10/2020 11:09	15/10/2020 01:04	13/10/2020 22:13	14/10/2020 22:08	23,93	181	4331,33	CHI
20201067625	NIQUELANDIA	NQ12221654LD	URUACU	13/10/2020 11:09	15/10/2020 01:04	14/10/2020 10:07	14/10/2020 22:08	12,03	12	144,36	CHI
20201067625	NIQUELANDIA	NQ13361693	URUACU	13/10/2020 11:09	15/10/2020 01:04	13/10/2020 22:13	15/10/2020 00:06	25,90	771	19965,26	CHI
20201067625	NIQUELANDIA	NQ12086253RE	NIQUELANDIA SUBTRANSMISSAO	13/10/2020 11:09	15/10/2020 01:04	13/10/2020 11:09	15/10/2020 01:04	37,90	1	37,90	CHI
20201067625	NIQUELANDIA	NQ12086253RE	URUACU	13/10/2020 11:09	15/10/2020 01:04	13/10/2020 12:17	15/10/2020 01:04	36,78	47	1728,82	CHI
20201067598	CAMPO LIMPO	960009553	NEROPOLIS S1	13/10/2020 11:09	13/10/2020 13:28	13/10/2020 11:09	13/10/2020 13:28	2,32	1	2,32	CHI
20201067600	FORMOSA	FA12204777	ITUIQUIRA	13/10/2020 11:09	13/10/2020 16:41	13/10/2020 11:09	13/10/2020 16:41	5,53	2	11,05	CHI
20201067602	GOIANIA	10012839068	AEROPORTO S1	13/10/2020 11:09	13/10/2020 15:26	13/10/2020 11:09	13/10/2020 15:26	4,27	1	4,27	CHI
20201073744	NIQUELANDIA	NQ12235313	NIQUELANDIA SUBTRANSMISSAO	13/10/2020 11:09	15/10/2020 14:45	13/10/2020 11:09	15/10/2020 14:45	51,58	1	51,58	CHI
20201073744	NIQUELANDIA	NQ12235313	NIQUELANDIA SUBTRANSMISSAO	13/10/2020 11:09	15/10/2020 14:45	14/10/2020 09:57	15/10/2020 14:45	28,79	1	28,79	CHI
20201067603	TRINDADE	40112573	TRINDADE	13/10/2020 11:09	13/10/2020 16:30	13/10/2020 11:09	13/10/2020 16:30	5,34	1	5,34	CHI
20201067604	FORMOSA	610309365	ITUIQUIRA	13/10/2020 11:10	14/10/2020 00:08	13/10/2020 11:10	14/10/2020 00:08	12,97	1	12,97	CHI

20201070885	GOIAS	GS11183211	GOIAS	13/10/2020 11:10	13/10/2020 22:18	13/10/2020 11:10	13/10/2020 22:18	11,12	2	22,24	CHI
20201067640	GOIAS	GS21219930	GOIAS	13/10/2020 11:13	13/10/2020 16:59	13/10/2020 11:13	13/10/2020 16:59	5,75	1	5,75	CHI
20201068255	RIO VERDE	RV21305877	CABRIUVA S2	13/10/2020 11:13	13/10/2020 17:07	13/10/2020 11:13	13/10/2020 17:07	5,88	2	11,77	CHI
20201067645	RUBIATABA	780010190	RUBIATABA	13/10/2020 11:14	14/10/2020 12:11	13/10/2020 11:14	14/10/2020 12:11	24,95	1	24,95	CHI
20201067646	SAO JOAO D ALIANCA	JL11218458	SAO JOAO D ALIANCA	13/10/2020 11:14	13/10/2020 12:47	13/10/2020 11:14	13/10/2020 12:47	1,55	3	4,64	CHI
20201067658	MORRINHOS	MR21000069	MORRINHOS	13/10/2020 11:15	13/10/2020 15:46	13/10/2020 11:15	13/10/2020 15:46	4,52	1	4,52	CHI
20201067669	ANAPOLIS	AN21185637	JUNDIAI S2	13/10/2020 11:17	13/10/2020 12:37	13/10/2020 11:17	13/10/2020 12:37	1,32	1	1,32	CHI
20201067670	ITAPIRAPUA	1420031251	MATRINCHA	13/10/2020 11:17	14/10/2020 08:26	13/10/2020 11:17	14/10/2020 08:26	21,14	1	21,14	CHI
20201067672	CALDAS NOVAS	CN11392078	SERRA DE CALDAS	13/10/2020 11:18	13/10/2020 23:53	13/10/2020 11:18	13/10/2020 23:53	12,58	60	754,58	CHI
20201068481	GOIANIA	GN11138764	CARAJAS S1	13/10/2020 11:18	13/10/2020 14:59	13/10/2020 11:18	13/10/2020 14:59	3,67	162	594,32	CHI
20201067681	SANTO ANTONIO DO DESCOBERTO	10013377025	ALEXANIA	13/10/2020 11:19	13/10/2020 14:15	13/10/2020 11:19	13/10/2020 14:15	2,92	1	2,92	CHI
20201067691	PLANALTINA	PI21110953	PLANALTINA	13/10/2020 11:20	13/10/2020 12:28	13/10/2020 11:20	13/10/2020 12:28	1,13	1	1,13	CHI
20201070791	MOIPORA	MO12193367	IPORA	13/10/2020 11:20	13/10/2020 21:52	13/10/2020 11:20	13/10/2020 21:52	10,52	3	31,57	CHI
20201068246	PALMEIRAS DE GOIAS	PL12000032	PALMEIRAS	13/10/2020 11:20	13/10/2020 15:45	13/10/2020 11:20	13/10/2020 15:45	4,41	6	26,43	CHI
20201067701	APARECIDA DE GOIANIA	15159413	INDEPENDENCIA S2	13/10/2020 11:21	13/10/2020 17:00	13/10/2020 11:21	13/10/2020 17:00	5,65	1	5,65	CHI
20201067702	VILA PROPICIO	NP11229040	GOIANESIA S1	13/10/2020 11:21	14/10/2020 10:15	13/10/2020 11:21	14/10/2020 10:15	22,90	1	22,90	CHI
20201067716	MARA ROSA	MQ12120038	MARA ROSA	13/10/2020 11:21	13/10/2020 13:41	13/10/2020 11:21	13/10/2020 13:41	2,33	2	4,66	CHI
20201067926	SAO JOAO D ALIANCA	JL12146125	SAO JOAO D ALIANCA	13/10/2020 11:21	13/10/2020 13:38	13/10/2020 11:21	13/10/2020 13:38	2,27	3	6,82	CHI
20201067711	APARECIDA DE GOIANIA	14320060	ATLANTICO S3	13/10/2020 11:21	13/10/2020 16:47	13/10/2020 11:21	13/10/2020 16:47	5,42	1	5,42	CHI
20201067718	IPAMERI	IP21157433	IPAMERI	13/10/2020 11:22	13/10/2020 18:15	13/10/2020 11:22	13/10/2020 18:15	6,87	1	6,87	CHI
20201067719	GOIANIA	10028154680	INDEPENDENCIA S1	13/10/2020 11:22	13/10/2020 12:45	13/10/2020 11:22	13/10/2020 12:45	1,38	1	1,38	CHI
20201067723	GOIANIA	10822082	GOIANIA LESTE S2	13/10/2020 11:23	13/10/2020 15:41	13/10/2020 11:23	13/10/2020 15:41	4,29	1	4,29	CHI
20201067725	INHUMAS	IN21234834	INHUMAS S2	13/10/2020 11:23	13/10/2020 17:05	13/10/2020 11:23	13/10/2020 17:05	5,68	1	5,68	CHI
20201067726	MOZARLANDIA	MZ12065014	MOZARLANDIA	13/10/2020 11:23	13/10/2020 16:50	13/10/2020 11:23	13/10/2020 16:50	5,43	1	5,43	CHI
20201067731	GUAPO	AO21277407	GUAPO S2	13/10/2020 11:24	13/10/2020 13:38	13/10/2020 11:24	13/10/2020 13:38	2,23	1	2,23	CHI
20201067734	GOIANIA	GN11417740	ATLANTICO S2	13/10/2020 11:24	13/10/2020 15:54	13/10/2020 11:24	13/10/2020 15:54	4,48	3	13,45	CHI
20201067738	ORIZONA	OZ21186243	PIRES DO RIO S2	13/10/2020 11:25	14/10/2020 10:28	13/10/2020 11:25	14/10/2020 10:28	23,05	1	23,05	CHI
20201071025	CRISTALINA	KR12230241	CRISTALINA S2	13/10/2020 11:25	13/10/2020 21:07	13/10/2020 11:25	13/10/2020 21:07	9,69	5	48,46	CHI
20201067741	INHUMAS	IN21025204	INHUMAS S2	13/10/2020 11:25	14/10/2020 07:59	13/10/2020 11:25	14/10/2020 07:59	20,56	1	20,56	CHI
20201067743	CALDAS NOVAS	760169226	SERRA DE CALDAS	13/10/2020 11:25	13/10/2020 12:33	13/10/2020 11:25	13/10/2020 12:33	1,12	1	1,12	CHI
20201067745	TRINDADE	40178845	TRINDADE	13/10/2020 11:26	13/10/2020 18:32	13/10/2020 11:26	13/10/2020 18:32	7,10	1	7,10	CHI
20201067750	FORMOSA	10012538661	ITUIQUIRA	13/10/2020 11:26	13/10/2020 15:51	13/10/2020 11:26	13/10/2020 15:51	4,40	1	4,40	CHI
202010161065	NIQUELANDIA	NQ21252224	BARRO ALTO	13/10/2020 11:27	14/10/2020 13:07	13/10/2020 11:27	14/10/2020 13:07	25,66	1	25,66	CHI
20201067753	CACU	CC11327074	CACHOEIRA ALTA	13/10/2020 11:27	13/10/2020 13:42	13/10/2020 11:27	13/10/2020 13:42	2,24	1	2,24	CHI
20201067754	CRISTALINA	KR21132664	CRISTALINA S1	13/10/2020 11:27	13/10/2020 14:34	13/10/2020 11:27	13/10/2020 14:34	3,10	1	3,10	CHI
20201067816	GOIANIA	GN16404363	FERROVIARIO S1	13/10/2020 11:28	13/10/2020 11:56	13/10/2020 11:28	13/10/2020 11:31	0,06	2404	141,57	CHI
20201067816	GOIANIA	GN16425900	FERROVIARIO S1	13/10/2020 11:28	13/10/2020 11:56	13/10/2020 11:28	13/10/2020 11:49	0,36	2930	1057,24	CHI
20201067816	GOIANIA	GN16415967	FERROVIARIO S1	13/10/2020 11:28	13/10/2020 11:56	13/10/2020 11:28	13/10/2020 11:52	0,41	1887	775,77	CHI
20201067816	GOIANIA	GN16415967	FERROVIARIO S1	13/10/2020 11:28	13/10/2020 11:56	13/10/2020 11:28	13/10/2020 11:56	0,47	954	449,71	CHI
20201068137	DAMOLANDIA	DL12014191	INHUMAS S1	13/10/2020 11:28	13/10/2020 15:20	13/10/2020 11:28	13/10/2020 15:20	3,85	18	69,31	CHI
20201067764	CATALAO	CT21127671	CATALAO S1	13/10/2020 11:29	13/10/2020 17:13	13/10/2020 11:29	13/10/2020 17:13	5,73	1	5,73	CHI
20201067781	GOIAS	GS21145455	GOIAS	13/10/2020 11:31	13/10/2020 12:54	13/10/2020 11:31	13/10/2020 12:54	1,38	1	1,38	CHI
20201067784	FAINA	FC12274421	GOIAS	13/10/2020 11:32	13/10/2020 13:35	13/10/2020 11:32	13/10/2020 13:35	2,05	18	36,86	CHI
20201067789	SANTA TEREZINHA DE GOIAS	GG21243711	SANTA TEREZINHA	13/10/2020 11:32	14/10/2020 15:28	13/10/2020 11:32	14/10/2020 15:28	27,92	1	27,92	CHI
20201067801	ITABERAI	50041230	ITABERAI S2	13/10/2020 11:33	13/10/2020 17:49	13/10/2020 11:33	13/10/2020 17:49	6,25	1	6,25	CHI
20201067806	FORMOSA	10010263215	ITUIQUIRA	13/10/2020 11:34	13/10/2020 14:37	13/10/2020 11:34	13/10/2020 14:37	3,04	1	3,04	CHI
20201067814	ITABERAI	IB12000038	ITABERAI S2	13/10/2020 11:35	13/10/2020 13:59	13/10/2020 11:35	13/10/2020 13:59	2,40	35	83,97	CHI
20201067824	CABECEIRAS	CW21150220	ITUIQUIRA	13/10/2020 11:37	13/10/2020 17:49	13/10/2020 11:37	13/10/2020 17:49	6,20	1	6,20	CHI
20201067831	BOM JARDIM DE GOIAS	BM11231062	BOM JARDIM	13/10/2020 11:37	13/10/2020 14:04	13/10/2020 11:37	13/10/2020 14:04	2,44	136	331,50	CHI
20201067833	LUZIANIA	LZ11369981	RIO VERMELHO	13/10/2020 11:37	13/10/2020 15:06	13/10/2020 11:37	13/10/2020 15:06	3,47	22	76,27	CHI
20201067836	GOIANIA	13314919	REAL S1	13/10/2020 11:38	13/10/2020 15:41	13/10/2020 11:38	13/10/2020 15:41	4,05	1	4,05	CHI
20201067839	ANAPOLIS	20904990	ANAPOLIS UNIVERSITARIO S2	13/10/2020 11:38	13/10/2020 13:35	13/10/2020 11:38	13/10/2020 13:35	1,95	1	1,95	CHI
20201067851	APARECIDA DE GOIANIA	14427667	INDEPENDENCIA S2	13/10/2020 11:39	13/10/2020 18:40	13/10/2020 11:39	13/10/2020 18:40	7,00	1	7,00	CHI
20201067860	FORMOSO	TB12051886	PORANGATU	13/10/2020 11:41	13/10/2020 19:02	13/10/2020 11:41	13/10/2020 19:02	7,35	2	14,69	CHI
20201067860	TROMBAS	TB12051886	PORANGATU	13/10/2020 11:41	13/10/2020 19:02	13/10/2020 11:41	13/10/2020 19:02	7,35	22	161,60	CHI
20201067865	RUBIATABA	780052584	RUBIATABA	13/10/2020 11:42	13/10/2020 19:43	13/10/2020 11:42	13/10/2020 19:43	8,01	1	8,01	CHI
20201067874	GOIANIA	11213255	GOIANIA LESTE S3	13/10/2020 11:43	13/10/2020 16:54	13/10/2020 11:43	13/10/2020 16:54	5,17	1	5,17	CHI
20201067885	NOVA VENEZA	300021150	INHUMAS S1	13/10/2020 11:44	13/10/2020 16:29	13/10/2020 11:44	13/10/2020 16:29	4,73	1	4,73	CHI

20201067903	GOIANIA	GN10394599	XAVANTES	13/10/2020 11:46	13/10/2020 16:57	13/10/2020 11:46	13/10/2020 16:01	4,26	398	1696,92	CHI
20201067903	GOIANIA	GN10394599	XAVANTES	13/10/2020 11:46	13/10/2020 16:57	13/10/2020 11:46	13/10/2020 16:57	5,20	1	5,20	CHI
20201067894	GOIAS	GS21341898	GOIAS	13/10/2020 11:46	13/10/2020 15:26	13/10/2020 11:46	13/10/2020 15:26	3,66	1	3,66	CHI
20201067935	CALDAZINHA	SV12129389	DAIA S2	13/10/2020 11:46	13/10/2020 14:10	13/10/2020 11:46	13/10/2020 14:10	2,39	2	4,78	CHI
20201067935	SILVANIA	SV12129389	DAIA S2	13/10/2020 11:46	13/10/2020 14:10	13/10/2020 11:46	13/10/2020 14:10	2,39	15	35,87	CHI
20201067901	SANTO ANTONIO DO DESCOBERTO	SN21305155	MARAJÓARA	13/10/2020 11:46	13/10/2020 14:02	13/10/2020 11:46	13/10/2020 14:02	2,25	1	2,25	CHI
20201069062	PIRENÓPOLIS	SF12211811	CORUMBA	13/10/2020 11:47	13/10/2020 23:02	13/10/2020 11:47	13/10/2020 23:02	11,24	27	303,53	CHI
20201069062	SAO FRANCISCO DE GOIAS	SF12211811	CORUMBA	13/10/2020 11:47	13/10/2020 23:02	13/10/2020 11:47	13/10/2020 23:02	11,24	2	22,48	CHI
20201067912	URUACU	UR12270613	URUACU	13/10/2020 11:48	13/10/2020 13:24	13/10/2020 11:48	13/10/2020 13:24	1,60	5	7,98	CHI
20201067912	ALEXANIA	AX21308912	CORUMBA	13/10/2020 11:48	13/10/2020 18:05	13/10/2020 11:48	13/10/2020 18:05	6,28	1	6,28	CHI
20201067916	CRIXAS	IW12032522	RUBIATABA	13/10/2020 11:48	14/10/2020 09:37	13/10/2020 11:48	14/10/2020 09:37	21,80	13	283,42	CHI
20201067916	ITAPACI	IW12032522	RUBIATABA	13/10/2020 11:48	14/10/2020 09:37	13/10/2020 11:48	14/10/2020 09:37	21,80	33	719,45	CHI
20201067916	GUARINOS	IW12032522	RUBIATABA	13/10/2020 11:48	14/10/2020 09:37	13/10/2020 11:48	14/10/2020 09:37	21,80	11	239,82	CHI
20201067917	SERRANÓPOLIS	SX11129744	JATAI S1	13/10/2020 11:49	13/10/2020 23:26	13/10/2020 11:49	13/10/2020 23:26	11,62	59	685,37	CHI
20201067920	CAMPINORTE	CR21262822	MARA ROSA	13/10/2020 11:49	13/10/2020 17:42	13/10/2020 11:49	13/10/2020 17:42	5,87	1	5,87	CHI
20201067877	GOIAS	20334392	MATRINCHA	13/10/2020 11:49	13/10/2020 12:33	13/10/2020 11:49	13/10/2020 12:33	0,72	2	1,44	CHI
20201067922	APARECIDA DE GOIANIA	10560968	REAL S2	13/10/2020 11:49	13/10/2020 20:45	13/10/2020 11:49	13/10/2020 20:45	8,92	1	8,92	CHI
20201067927	AMARALINA	LC21200460	SAO MIGUEL DO ARAGUAIA	13/10/2020 11:50	13/10/2020 14:09	13/10/2020 11:50	13/10/2020 14:09	2,30	2	4,60	CHI
20201067929	FORMOSA	610295391	ITUIQUIRA	13/10/2020 11:51	13/10/2020 14:10	13/10/2020 11:51	13/10/2020 14:10	2,32	1	2,32	CHI
20201067936	SITIO D ABADIA	SI12329755	IACIARA S2	13/10/2020 11:52	13/10/2020 19:08	13/10/2020 11:52	13/10/2020 16:56	5,08	3	15,24	CHI
20201067936	SITIO D ABADIA	SI12238732LD	IACIARA S2	13/10/2020 11:52	13/10/2020 19:08	13/10/2020 11:52	13/10/2020 19:08	7,26	8	58,12	CHI
20201067937	BONFINÓPOLIS	920009852	CEPAIGO S2	13/10/2020 11:52	13/10/2020 12:46	13/10/2020 11:52	13/10/2020 12:46	0,89	1	0,89	CHI
20201067944	ALEXANIA	AX21085998	ALEXANIA	13/10/2020 11:53	13/10/2020 17:25	13/10/2020 11:53	13/10/2020 17:25	5,52	1	5,52	CHI
20201067940	SANTA HELENA DE GOIAS	10032591274	IPEGUARI	13/10/2020 11:53	13/10/2020 16:02	13/10/2020 11:53	13/10/2020 16:02	4,14	1	4,14	CHI
20201067941	INHUMAS	30097204	INHUMAS S2	13/10/2020 11:53	13/10/2020 19:20	13/10/2020 11:53	13/10/2020 19:20	7,44	1	7,44	CHI
20201067943	MINACU	4020049416	MINACU	13/10/2020 11:53	14/10/2020 11:02	13/10/2020 11:53	14/10/2020 11:02	23,14	1	23,14	CHI
20201068163	ARUANA	AK11253726	ARUANA	13/10/2020 11:54	13/10/2020 16:21	13/10/2020 11:54	13/10/2020 16:21	4,45	79	351,53	CHI
20201067948	UIRAPURU	MH12391944	NOVA CRIXAS	13/10/2020 11:54	13/10/2020 15:44	13/10/2020 11:54	13/10/2020 15:44	3,82	6	22,94	CHI
20201067954	SANTA FE DE GOIAS	RN21292784	BRITANIA	13/10/2020 11:55	14/10/2020 10:56	13/10/2020 11:55	14/10/2020 10:56	23,03	1	23,03	CHI
20201067956	CALDAS NOVAS	760230717	SERRA DE CALDAS	13/10/2020 11:55	13/10/2020 15:39	13/10/2020 11:55	13/10/2020 15:39	3,72	1	3,72	CHI
20201067957	GOIANIA	11352152	FERROVIARIO S1	13/10/2020 11:56	13/10/2020 21:47	13/10/2020 11:56	13/10/2020 21:47	9,85	1	9,85	CHI
20201067959	FORMOSO	FO21320743	PORANGATU	13/10/2020 11:56	13/10/2020 17:38	13/10/2020 11:56	13/10/2020 17:38	5,69	1	5,69	CHI
20201068451	CACHOEIRA DOURADA	CD12222296	CACHOEIRA DOURADA	13/10/2020 11:57	13/10/2020 17:43	13/10/2020 11:57	13/10/2020 17:43	5,77	16	92,27	CHI
20201067967	PONTALINA	210049947	PONTALINA	13/10/2020 11:57	13/10/2020 17:20	13/10/2020 11:57	13/10/2020 17:20	5,38	1	5,38	CHI
20201067970	FORMOSA	FA21085471	ITUIQUIRA	13/10/2020 11:57	13/10/2020 13:58	13/10/2020 11:57	13/10/2020 13:58	2,00	7	14,03	CHI
20201067973	SAO MIGUEL DO ARAGUAIA	10000191246	SAO MIGUEL DO ARAGUAIA	13/10/2020 11:58	13/10/2020 23:15	13/10/2020 11:58	13/10/2020 23:15	11,28	1	11,28	CHI
20201071148	SERRANÓPOLIS	SX12391185	JATAI S1	13/10/2020 11:58	14/10/2020 10:00	13/10/2020 11:58	14/10/2020 10:00	22,03	3	66,08	CHI
20201070636	CATALAO	CT12209404	CATALAO S1	13/10/2020 11:59	13/10/2020 18:36	13/10/2020 11:59	13/10/2020 18:36	6,61	3	19,83	CHI
20201067993	MONTIVIDIU	MV12106537	MONTIVIDIU T	13/10/2020 11:59	13/10/2020 23:07	13/10/2020 11:59	13/10/2020 23:07	11,12	3	33,36	CHI
20201067995	OURO VERDE DE GOIAS	DL21272361	INHUMAS S1	13/10/2020 11:59	13/10/2020 15:19	13/10/2020 11:59	13/10/2020 15:19	3,32	4	13,27	CHI
20201068361	PARAUNA	RP18304543TS	FIRMINÓPOLIS S2	13/10/2020 12:00	13/10/2020 15:02	13/10/2020 12:00	13/10/2020 15:02	3,02	35	105,73	CHI
20201068361	AURILANDIA	RP18304543TS	FIRMINÓPOLIS S2	13/10/2020 12:00	13/10/2020 15:02	13/10/2020 12:00	13/10/2020 15:02	3,02	3	9,06	CHI
20201068013	MUNDO NOVO DE GOIAS	4240015286	NOVA CRIXAS	13/10/2020 12:01	13/10/2020 14:11	13/10/2020 12:01	13/10/2020 14:11	2,15	1	2,15	CHI
20201068024	AMARALINA	LC21220621	SAO MIGUEL DO ARAGUAIA	13/10/2020 12:05	13/10/2020 15:03	13/10/2020 12:05	13/10/2020 15:03	2,96	1	2,96	CHI
20201068025	RIO VERDE	RV12303875	ACREUNA	13/10/2020 12:05	13/10/2020 20:06	13/10/2020 12:05	13/10/2020 20:06	8,01	41	328,41	CHI
20201068026	GUAPO	710010084	GUAPO S1	13/10/2020 12:05	13/10/2020 14:08	13/10/2020 12:05	13/10/2020 14:08	2,03	1	2,03	CHI
20201068082	CAMPOS VERDES	3790027908	SANTA TEREZINHA	13/10/2020 12:06	14/10/2020 01:15	13/10/2020 12:06	14/10/2020 01:15	13,15	1	13,15	CHI
20201068089	CAMPINORTE	UR21231325	MARA ROSA	13/10/2020 12:06	13/10/2020 19:34	13/10/2020 12:06	13/10/2020 19:34	7,45	1	7,45	CHI
20201068091	SAO LUIS DE MONTES BELOS	500114870	SAO LUIZ DOS MONTES BELOS	13/10/2020 12:07	14/10/2020 09:43	13/10/2020 12:07	14/10/2020 09:43	21,60	1	21,60	CHI
20201068098	MINEIROS	MY21197146	PARQUE DAS EMAS	13/10/2020 12:08	13/10/2020 18:34	13/10/2020 12:08	13/10/2020 18:34	6,43	1	6,43	CHI
20201068105	PEROLANDIA	MY12241784	PARQUE DAS EMAS	13/10/2020 12:09	14/10/2020 14:03	13/10/2020 12:09	14/10/2020 14:03	25,89	1	25,89	CHI
20201068107	CATALAO	CT21131361	CATALAO S1	13/10/2020 12:09	13/10/2020 21:02	13/10/2020 12:09	13/10/2020 21:02	8,87	1	8,87	CHI
20201068109	GOIANAPOLIS	GP21321283	DAIA S2	13/10/2020 12:09	13/10/2020 12:45	13/10/2020 12:09	13/10/2020 12:45	0,58	1	0,58	CHI
20201070727	JATAI	SX12205192RE	JATAI S1	13/10/2020 12:10	14/10/2020 00:19	13/10/2020 12:10	14/10/2020 00:19	12,15	3	36,45	CHI
20201070727	SERRANÓPOLIS	SX12205192RE	JATAI S1	13/10/2020 12:10	14/10/2020 00:19	13/10/2020 12:10	14/10/2020 00:19	12,15	16	194,40	CHI
20201071605	NIQUELANDIA	NQ10404181	BARRO ALTO	13/10/2020 12:12	14/10/2020 16:37	13/10/2020 12:12	14/10/2020 13:07	24,91	616	15342,85	CHI
20201071605	NIQUELANDIA	NQ13031021	BARRO ALTO	13/10/2020 12:12	14/10/2020 16:37	14/10/2020 11:40	14/10/2020 16:07	4,47	3	13,40	CHI
20201071605	NIQUELANDIA	8001240	BARRO ALTO	13/10/2020 12:12	14/10/2020 16:37	13/10/2020 12:12	14/10/2020 16:33	28,35	1	28,35	CHI

20201071605	NIQUELANDIA	NQ13031022	BARRO ALTO	13/10/2020 12:12	14/10/2020 16:37	14/10/2020 13:10	14/10/2020 16:35	3,42	10	34,20	CHI
20201071605	NIQUELANDIA	NQ13212750	BARRO ALTO	13/10/2020 12:12	14/10/2020 16:37	13/10/2020 12:12	14/10/2020 16:37	28,42	124	3524,46	CHI
20201068131	URUACU	UR21350229	URUACU	13/10/2020 12:12	13/10/2020 17:53	13/10/2020 12:12	13/10/2020 17:53	5,67	2	11,34	CHI
20201068132	MARA ROSA	2260003169	MARA ROSA	13/10/2020 12:12	13/10/2020 16:19	13/10/2020 12:12	13/10/2020 16:19	4,10	1	4,10	CHI
20201068135	VIANOPOLIS	VN21159684	VIANOPOLIS	13/10/2020 12:13	13/10/2020 15:32	13/10/2020 12:13	13/10/2020 15:32	3,32	1	3,32	CHI
20201068141	SAO MIGUEL DO ARAGUAIA	SM12394085	SAO MIGUEL DO ARAGUAIA	13/10/2020 12:13	13/10/2020 19:15	13/10/2020 12:13	13/10/2020 19:15	7,04	1	7,04	CHI
20201068139	ABADIANIA	AA12025498	DAIA S2	13/10/2020 12:13	13/10/2020 14:48	13/10/2020 12:13	13/10/2020 14:48	2,57	41	105,52	CHI
20201068993	SAO FRANCISCO DE GOIAS	PG12298071	PETROLINA	13/10/2020 12:13	13/10/2020 16:24	13/10/2020 12:13	13/10/2020 16:24	4,17	1	4,17	CHI
20201068993	PETROLINA DE GOIAS	PG12298071	PETROLINA	13/10/2020 12:13	13/10/2020 16:24	13/10/2020 12:13	13/10/2020 16:24	4,17	44	183,55	CHI
20201068146	ITAPIRAPUA	IU12087963	MATRINCHA	13/10/2020 12:14	13/10/2020 15:54	13/10/2020 12:14	13/10/2020 15:54	3,66	44	161,08	CHI
20201068153	OURO VERDE DE GOIAS	OV21241586	NEROPOLIS S1	13/10/2020 12:15	13/10/2020 14:11	13/10/2020 12:15	13/10/2020 14:11	1,92	2	3,85	CHI
20201068187	UIRAPURU	UP12067411	SANTA TEREZINHA	13/10/2020 12:19	13/10/2020 15:56	13/10/2020 12:19	13/10/2020 15:56	3,60	93	335,01	CHI
20201068192	ESTRELA DO NORTE	ET11100731	MARA ROSA	13/10/2020 12:20	14/10/2020 16:36	13/10/2020 12:20	14/10/2020 16:36	28,26	131	3702,42	CHI
20201068201	FAZENDA NOVA	FN21250946	IPORA	13/10/2020 12:21	14/10/2020 10:40	13/10/2020 12:21	14/10/2020 10:40	22,32	1	22,32	CHI
20201071523	TRINDADE	TR11053485	TRINDADE	13/10/2020 12:22	13/10/2020 20:47	13/10/2020 12:22	13/10/2020 20:47	8,41	166	1396,24	CHI
20201070055	JARAGUA	7273627	INHUMAS S1	13/10/2020 12:25	14/10/2020 10:38	13/10/2020 12:25	14/10/2020 10:38	22,21	2	44,42	CHI
20201070055	TAQUARAL DE GOIAS	7273627	INHUMAS S1	13/10/2020 12:25	14/10/2020 10:38	13/10/2020 12:25	14/10/2020 10:38	22,21	19	421,97	CHI
20201070055	SANTA ROSA DE GOIAS	7273627	INHUMAS S1	13/10/2020 12:25	14/10/2020 10:38	13/10/2020 12:25	14/10/2020 10:38	22,21	19	421,97	CHI
20201068231	AGUAS LINDAS DE GOIAS	LA12345961	AGUAS LINDAS DE GOIAS S2	13/10/2020 12:25	13/10/2020 14:05	13/10/2020 12:25	13/10/2020 14:05	1,66	1	1,66	CHI
20201068240	GOIANESIA	GE21000256	GOIANESIA S2	13/10/2020 12:26	13/10/2020 17:08	13/10/2020 12:26	13/10/2020 17:08	4,69	1	4,69	CHI
20201068241	TRINDADE	40196148	TRINDADE	13/10/2020 12:27	13/10/2020 18:58	13/10/2020 12:27	13/10/2020 18:58	6,52	1	6,52	CHI
20201068242	IPAMERI	IP21150037	IPAMERI	13/10/2020 12:27	13/10/2020 15:39	13/10/2020 12:27	13/10/2020 15:39	3,19	1	3,19	CHI
20201068257	NOVA CRIXAS	NA12057201	MOZARLANDIA	13/10/2020 12:30	13/10/2020 15:49	13/10/2020 12:30	13/10/2020 15:49	3,31	11	36,46	CHI
20201069353	IPAMERI	IP12107659	CAMPO ALEGRE DE GOIAS	13/10/2020 12:30	13/10/2020 16:58	13/10/2020 12:30	13/10/2020 16:58	4,46	5	22,28	CHI
20201068268	APARECIDA DE GOIANIA	AP11166223	REAL S1	13/10/2020 12:31	13/10/2020 16:25	13/10/2020 12:31	13/10/2020 16:25	3,89	149	580,02	CHI
20201068280	APARECIDA DE GOIANIA	10007901834	REAL S1	13/10/2020 12:33	13/10/2020 16:36	13/10/2020 12:33	13/10/2020 16:36	4,05	1	4,05	CHI
20201068291	BELA VISTA DE GOIAS	BV21000070	CEPAIGO S2	13/10/2020 12:34	13/10/2020 16:57	13/10/2020 12:34	13/10/2020 16:57	4,38	1	4,38	CHI
20201068293	GOIANIA	12049050	REAL S1	13/10/2020 12:34	13/10/2020 16:52	13/10/2020 12:34	13/10/2020 16:52	4,29	1	4,29	CHI
20201068300	JUSSARA	JR21259692	JUSSARA	13/10/2020 12:34	13/10/2020 14:09	13/10/2020 12:34	13/10/2020 14:09	1,57	1	1,57	CHI
20201068302	ITARUMA	IM21058061	CACHOEIRA ALTA	13/10/2020 12:35	13/10/2020 16:34	13/10/2020 12:35	13/10/2020 16:34	3,98	1	3,98	CHI
20201068311	GOIANIA	13693104	CARAJAS S1	13/10/2020 12:36	13/10/2020 17:54	13/10/2020 12:36	13/10/2020 17:54	5,29	1	5,29	CHI
20201068312	NOVA VENEZA	NV21111316	INHUMAS S1	13/10/2020 12:36	13/10/2020 17:33	13/10/2020 12:36	13/10/2020 17:33	4,93	3	14,80	CHI
20201068319	SANTA CRUZ DE GOIAS	BC12023183	CRISTIANOPOLIS	13/10/2020 12:37	13/10/2020 17:51	13/10/2020 12:37	13/10/2020 17:51	5,22	42	219,30	CHI
20201068322	APARECIDA DE GOIANIA	200186176	INDEPENDENCIA S2	13/10/2020 12:38	13/10/2020 22:05	13/10/2020 12:38	13/10/2020 22:05	9,44	1	9,44	CHI
20201068323	ABADIANIA	AA12374481	ANAPOLIS UNIVERSITARIO S1	13/10/2020 12:38	13/10/2020 13:46	13/10/2020 12:38	13/10/2020 13:46	1,12	1	1,12	CHI
20201068324	ANAPOLIS	AN11194872	ANAPOLIS UNIVERSITARIO S2	13/10/2020 12:38	13/10/2020 13:47	13/10/2020 12:38	13/10/2020 13:47	1,14	53	60,38	CHI
20201068328	SANTA CRUZ DE GOIAS	3570002972	PIRES DO RIO S2	13/10/2020 12:39	13/10/2020 22:59	13/10/2020 12:39	13/10/2020 22:59	10,33	1	10,33	CHI
20201068344	SAO JOAO D ALIANCA	JL11238303	ITUIQUIRA	13/10/2020 12:42	13/10/2020 17:33	13/10/2020 12:42	13/10/2020 17:33	4,85	1	4,85	CHI
20201068354	GOIANDIRA	2010013585	CATALAO S1	13/10/2020 12:43	13/10/2020 19:57	13/10/2020 12:43	13/10/2020 19:57	7,23	1	7,23	CHI
20201068467	NOVO BRASIL	NB12087607	JUSSARA	13/10/2020 12:44	14/10/2020 10:45	13/10/2020 12:44	14/10/2020 10:45	22,01	10	220,14	CHI
20201068374	SAO MIGUEL DO ARAGUAIA	SM11315125	SAO MIGUEL DO ARAGUAIA	13/10/2020 12:44	13/10/2020 19:08	13/10/2020 12:44	13/10/2020 19:08	6,39	45	287,70	CHI
20201068892	RIO VERDE	SH12000198	IPEGUARI	13/10/2020 12:44	13/10/2020 17:06	13/10/2020 12:44	13/10/2020 17:06	4,36	4	17,44	CHI
20201068892	SANTA HELENA DE GOIAS	SH12000198	IPEGUARI	13/10/2020 12:44	13/10/2020 17:06	13/10/2020 12:44	13/10/2020 17:06	4,36	7	30,52	CHI
20201068360	RIO VERDE	630003798	RIO VERDE S2	13/10/2020 12:44	13/10/2020 23:02	13/10/2020 12:44	13/10/2020 23:02	10,29	1	10,29	CHI
20201068363	ANAPOLIS	21328912	ANAPOLIS UNIVERSITARIO S2	13/10/2020 12:44	13/10/2020 15:29	13/10/2020 12:44	13/10/2020 15:29	2,74	1	2,74	CHI
20201068367	BALIZA	BH12210020	BOM JARDIM	13/10/2020 12:45	13/10/2020 17:11	13/10/2020 12:45	13/10/2020 17:11	4,43	93	412,12	CHI
20201068371	APARECIDA DE GOIANIA	200293096	INDEPENDENCIA S1	13/10/2020 12:45	13/10/2020 14:57	13/10/2020 12:45	13/10/2020 14:57	2,19	1	2,19	CHI
202010189401	IPORA	IR12259495	ARENOPOLIS	13/10/2020 12:46	14/10/2020 08:40	13/10/2020 12:46	14/10/2020 08:40	19,89	1	19,89	CHI
20201068384	INHUMAS	IN21000172	INHUMAS S1	13/10/2020 12:47	14/10/2020 09:44	13/10/2020 12:47	14/10/2020 09:44	20,94	1	20,94	CHI
20201068387	NOVO BRASIL	NB12396208	JUSSARA	13/10/2020 12:48	13/10/2020 20:16	13/10/2020 12:48	13/10/2020 20:16	7,47	1	7,47	CHI
20201068391	IPAMERI	IP12068500	CRISTALINA S2	13/10/2020 12:48	13/10/2020 19:19	13/10/2020 12:48	13/10/2020 19:19	6,52	72	469,18	CHI
20201068393	CALDAZINHA	DE21312913	CEPAIGO S2	13/10/2020 12:48	13/10/2020 14:50	13/10/2020 12:48	13/10/2020 14:50	2,02	2	4,04	CHI
20201068394	IPORA	IR21014088	IPORA	13/10/2020 12:48	13/10/2020 14:14	13/10/2020 12:48	13/10/2020 14:14	1,42	2	2,84	CHI
20201068395	VALPARAISO DE GOIAS	VA11192850	PACAEMBU S1	13/10/2020 12:48	13/10/2020 13:59	13/10/2020 12:48	13/10/2020 13:59	1,17	214	250,38	CHI
20201068396	APARECIDA DE GOIANIA	13363086	ATLANTICO S2	13/10/2020 12:48	13/10/2020 18:31	13/10/2020 12:48	13/10/2020 18:31	5,71	1	5,71	CHI
20201068435	LUZIANIA	LZ12305065LD	CRISTALINA S2	13/10/2020 12:50	14/10/2020 01:25	13/10/2020 12:50	13/10/2020 16:27	3,62	49	177,20	CHI
20201068435	LUZIANIA	LZ12390041	CRISTALINA S2	13/10/2020 12:50	14/10/2020 01:25	13/10/2020 12:50	14/10/2020 01:25	12,58	7	88,05	CHI
20201070779	GOIAS	GS12325839	GOIAS	13/10/2020 12:50	14/10/2020 09:48	13/10/2020 12:50	14/10/2020 09:48	20,96	5	104,81	CHI

20201068450	MARA ROSA	MQ12237778	MARA ROSA	13/10/2020 12:53	13/10/2020 13:19	13/10/2020 12:53	13/10/2020 13:19	0,43	1	0,43	CHI
20201068546	PIRES DO RIO	PR12272817	PIRES DO RIO S1	13/10/2020 12:54	13/10/2020 20:08	13/10/2020 12:54	13/10/2020 20:08	7,23	4	28,93	CHI
20201069266	PIRACANJUBA	PJ12000214	PIRACANJUBA	13/10/2020 12:54	13/10/2020 16:10	13/10/2020 12:54	13/10/2020 16:10	3,26	6	19,58	CHI
20201068431	MINEIROS	10012878756	PARQUE DAS EMAS	13/10/2020 12:55	13/10/2020 15:35	13/10/2020 12:55	13/10/2020 15:35	2,66	1	2,66	CHI
20201068989	GOIÁS	GS12162482	GOIÁS	13/10/2020 12:56	13/10/2020 15:52	13/10/2020 12:56	13/10/2020 15:52	2,92	7	20,44	CHI
20201069296	FLORES DE GOIÁS	FB12312620	FLORES DE GOIÁS	13/10/2020 12:59	13/10/2020 16:47	13/10/2020 12:59	13/10/2020 16:47	3,80	4	15,19	CHI
202010189219	MINACU	IH11262531	MINACU	13/10/2020 13:00	13/10/2020 18:27	13/10/2020 13:00	13/10/2020 18:27	5,46	69	376,41	CHI
20201068462	PARAUNA	PU21217022	PARAUNA	13/10/2020 13:00	13/10/2020 16:46	13/10/2020 13:00	13/10/2020 16:46	3,76	1	3,76	CHI
20201068464	ANAPOLIS	20153430	JUNDIAI S2	13/10/2020 13:01	13/10/2020 23:14	13/10/2020 13:01	13/10/2020 23:14	10,21	1	10,21	CHI
20201071499	PORTELANDIA	PW12248465RE	PARQUE DAS EMAS	13/10/2020 13:02	14/10/2020 01:40	13/10/2020 13:02	14/10/2020 01:40	12,62	10	126,25	CHI
20201068640	NOVA IGUAÇU DE GOIÁS	NH12317131	CAMPINORTE	13/10/2020 13:02	13/10/2020 15:02	13/10/2020 13:02	13/10/2020 15:02	1,99	44	87,54	CHI
20201068474	APARECIDA DE GOIANIA	10007890417	REAL S1	13/10/2020 13:02	13/10/2020 17:02	13/10/2020 13:02	13/10/2020 17:02	3,99	1	3,99	CHI
20201068495	IPAMERI	IP21073339	CAMPO ALEGRE DE GOIÁS	13/10/2020 13:05	13/10/2020 19:46	13/10/2020 13:05	13/10/2020 19:46	6,67	1	6,67	CHI
20201068500	GOIANIA	10874495	GOIANIA LESTE S2	13/10/2020 13:06	13/10/2020 20:36	13/10/2020 13:06	13/10/2020 20:36	7,50	1	7,50	CHI
20201068503	IVOLANDIA	IV21371862	IPORA	13/10/2020 13:06	14/10/2020 21:11	13/10/2020 13:06	14/10/2020 21:11	32,07	1	32,07	CHI
20201068510	FIRMINOPOLIS	FR21081380	FIRMINOPOLIS S2	13/10/2020 13:07	14/10/2020 10:35	13/10/2020 13:07	14/10/2020 10:35	21,46	1	21,46	CHI
20201068518	VARJAO	940002292	GUAPU S2	13/10/2020 13:08	13/10/2020 19:06	13/10/2020 13:08	13/10/2020 19:06	5,95	1	5,95	CHI
20201068519	HEITORAI	HE12099418	ITAPURANGA	13/10/2020 13:08	13/10/2020 19:13	13/10/2020 13:08	13/10/2020 19:13	6,07	38	230,57	CHI
20201068520	CABECEIRAS	CW21257768	ITUIQUIRA	13/10/2020 13:08	13/10/2020 14:14	13/10/2020 13:08	13/10/2020 14:14	1,08	1	1,08	CHI
20201068870	GOIANIA	11410413	ATLANTICO S1	13/10/2020 13:09	13/10/2020 16:53	13/10/2020 13:09	13/10/2020 16:53	3,74	1	3,74	CHI
20201068522	JARAGUA	JA12205814	JARAGUA	13/10/2020 13:09	13/10/2020 15:55	13/10/2020 13:09	13/10/2020 15:55	2,76	285	785,97	CHI
20201069936	FAINA	IK12300247	ITAPURANGA	13/10/2020 13:09	13/10/2020 18:06	13/10/2020 13:09	13/10/2020 18:06	4,93	25	123,36	CHI
20201069936	ITAPURANGA	IK12300247	ITAPURANGA	13/10/2020 13:09	13/10/2020 18:06	13/10/2020 13:09	13/10/2020 18:06	4,93	6	29,61	CHI
20201073524	IPORA	IR12223115	IPORA	13/10/2020 13:10	14/10/2020 10:17	13/10/2020 13:10	14/10/2020 10:17	21,13	1	21,13	CHI
20201073524	IVOLANDIA	IR12223115	IPORA	13/10/2020 13:10	14/10/2020 10:17	13/10/2020 13:10	14/10/2020 10:17	21,13	10	211,28	CHI
20201068527	APARECIDA DE GOIANIA	16436740	REAL S1	13/10/2020 13:10	13/10/2020 14:24	13/10/2020 13:10	13/10/2020 14:24	1,23	1	1,23	CHI
20201068535	TURVELANDIA	TD21326928	RIO DOS BOIS	13/10/2020 13:11	13/10/2020 20:05	13/10/2020 13:11	13/10/2020 20:05	6,90	4	27,59	CHI
20201068538	SAO SIMAO	2240001337	CACHOEIRA ALTA	13/10/2020 13:11	13/10/2020 16:10	13/10/2020 13:11	13/10/2020 16:10	2,98	1	2,98	CHI
20201068545	PADRE BERNARDO	LA11428389	AGUAS LINDAS DE GOIÁS S1	13/10/2020 13:12	13/10/2020 14:27	13/10/2020 13:12	13/10/2020 14:27	1,24	84	104,14	CHI
20201068552	APARECIDA DE GOIANIA	10001953450	INDEPENDENCIA S1	13/10/2020 13:13	13/10/2020 16:08	13/10/2020 13:13	13/10/2020 16:08	2,90	1	2,90	CHI
20201068554	AMARALINA	MU11335280	MARA ROSA	13/10/2020 13:14	13/10/2020 15:04	13/10/2020 13:14	13/10/2020 15:04	1,83	1	1,83	CHI
20201068565	CALDAS NOVAS	CN11114778	SERRA DE CALDAS	13/10/2020 13:15	13/10/2020 18:21	13/10/2020 13:15	13/10/2020 18:21	5,09	33	168,12	CHI
20201068758	ANICUNS	AC11032074	ANICUNS	13/10/2020 13:15	13/10/2020 16:36	13/10/2020 13:15	13/10/2020 16:36	3,34	160	533,78	CHI
20201068567	ESTRELA DO NORTE	MQ21265835	MARA ROSA	13/10/2020 13:15	13/10/2020 19:18	13/10/2020 13:15	13/10/2020 19:18	6,04	1	6,04	CHI
20201068570	ABADIA DE GOIÁS	10028946985	CARAJAS S2	13/10/2020 13:16	13/10/2020 16:21	13/10/2020 13:16	13/10/2020 16:21	3,08	1	3,08	CHI
20201068572	IPAMERI	IP12071493	PIRES DO RIO S2	13/10/2020 13:17	13/10/2020 22:16	13/10/2020 13:17	13/10/2020 22:16	8,98	6	53,89	CHI
20201068938	GOIANIA	AP12164475	ATLANTICO S1	13/10/2020 13:18	13/10/2020 15:43	13/10/2020 13:18	13/10/2020 15:43	2,41	87	209,24	CHI
20201069752	PLANALTINA	PI12100878	PLANALTINA	13/10/2020 13:19	13/10/2020 17:09	13/10/2020 13:19	13/10/2020 17:09	3,82	23	87,96	CHI
20201068586	CACHOEIRA DOURADA	CD21000146	CACHOEIRA DOURADA	13/10/2020 13:19	13/10/2020 18:35	13/10/2020 13:19	13/10/2020 18:35	5,25	2	10,51	CHI
20201068590	GOIANIA	GN11373724	MEIA PONTE	13/10/2020 13:20	13/10/2020 17:29	13/10/2020 13:20	13/10/2020 17:13	3,88	79	306,48	CHI
20201068590	GOIANIA	GN12373725	MEIA PONTE	13/10/2020 13:20	13/10/2020 17:29	13/10/2020 17:00	13/10/2020 17:29	0,48	47	22,38	CHI
20201068594	JANDAIA	JD12102347	ACREUNA	13/10/2020 13:21	14/10/2020 23:00	13/10/2020 13:21	14/10/2020 23:00	33,65	1	33,65	CHI
20201068606	FORMOSA	610049021	ITUIQUIRA	13/10/2020 13:21	13/10/2020 15:20	13/10/2020 13:21	13/10/2020 15:20	1,97	1	1,97	CHI
20201068597	CATALAO	1990176991	CATALAO S2	13/10/2020 13:22	13/10/2020 16:56	13/10/2020 13:22	13/10/2020 16:56	3,56	1	3,56	CHI
20201068603	GOIANIA	15455324	INDEPENDENCIA S2	13/10/2020 13:22	13/10/2020 16:35	13/10/2020 13:22	13/10/2020 16:35	3,21	1	3,21	CHI
20201068621	APARECIDA DE GOIANIA	14649160	ATLANTICO S2	13/10/2020 13:26	13/10/2020 20:50	13/10/2020 13:26	13/10/2020 20:50	7,40	1	7,40	CHI
20201068631	SILVANIA	SV21107836	VIANOPOLIS	13/10/2020 13:28	13/10/2020 15:36	13/10/2020 13:28	13/10/2020 15:36	2,13	1	2,13	CHI
20201068657	ANAPOLIS	AN12258954	NEROPOLIS S1	13/10/2020 13:28	14/10/2020 17:20	13/10/2020 13:28	14/10/2020 17:20	27,86	1	27,86	CHI
20201068657	CAMPO LIMPO	AN12258954	NEROPOLIS S1	13/10/2020 13:28	14/10/2020 17:20	13/10/2020 13:28	14/10/2020 17:20	27,86	3	83,59	CHI
20201069036	CRISTALINA	KR12305009	PAMPLONA	13/10/2020 13:28	13/10/2020 16:17	13/10/2020 13:28	13/10/2020 16:17	2,81	6	16,85	CHI
20201068864	CUMARI	CT12266235	CATALAO S2	13/10/2020 13:29	13/10/2020 16:15	13/10/2020 13:29	13/10/2020 16:15	2,76	2	5,51	CHI
20201071683	PIRENOPOLIS	PV11210838	CORUMBA	13/10/2020 13:31	13/10/2020 22:13	13/10/2020 13:31	13/10/2020 22:13	8,69	12	104,30	CHI
20201068672	FLORES DE GOIÁS	FA12042061	ITUIQUIRA	13/10/2020 13:33	14/10/2020 23:50	13/10/2020 13:33	14/10/2020 23:50	34,28	1	34,28	CHI
20201068672	VILA BOA	FA12042061	ITUIQUIRA	13/10/2020 13:33	14/10/2020 23:50	13/10/2020 13:33	14/10/2020 23:50	34,28	1	34,28	CHI
20201068674	GOIANIA	13287590	FERROVIARIO S1	13/10/2020 13:33	13/10/2020 15:40	13/10/2020 13:33	13/10/2020 15:40	2,12	1	2,12	CHI
20201068676	GOIANIA	16862375	CARAJAS S2	13/10/2020 13:33	13/10/2020 18:22	13/10/2020 13:33	13/10/2020 18:22	4,80	1	4,80	CHI
20201069963	OURO VERDE DE GOIÁS	OV12272462	INHUMAS S1	13/10/2020 13:34	15/10/2020 17:53	13/10/2020 13:34	14/10/2020 13:32	23,97	10	239,67	CHI
20201069963	DAMOLANDIA	OV12272462	INHUMAS S1	13/10/2020 13:34	15/10/2020 17:53	13/10/2020 13:34	15/10/2020 17:53	52,32	3	156,95	CHI

20201069963	NEROPOLIS	OV12272462	INHUMAS S1	13/10/2020 13:34	15/10/2020 17:53	13/10/2020 13:34	15/10/2020 17:53	52,32	2	104,63	CHI
20201069963	NOVA VENEZA	OV12272462	INHUMAS S1	13/10/2020 13:34	15/10/2020 17:53	13/10/2020 13:34	15/10/2020 17:53	52,32	21	1098,66	CHI
20201069963	OURO VERDE DE GOIAS	OV12272462	INHUMAS S1	13/10/2020 13:34	15/10/2020 17:53	13/10/2020 13:34	15/10/2020 17:53	52,32	9	470,85	CHI
20201069963	OURO VERDE DE GOIAS	OV12272462	INHUMAS S1	13/10/2020 13:34	15/10/2020 17:53	15/10/2020 17:31	15/10/2020 17:53	0,36	10	3,64	CHI
20201068678	IPAMERI	IP21009393	IPAMERI	13/10/2020 13:34	13/10/2020 16:28	13/10/2020 13:34	13/10/2020 16:28	2,90	1	2,90	CHI
20201068685	IPORA	IR11014460	IPORA	13/10/2020 13:35	13/10/2020 20:00	13/10/2020 13:35	13/10/2020 20:00	6,41	20	128,22	CHI
20201068695	PALMEIRAS DE GOIAS	TV21005398	FIRMINOPOLIS S2	13/10/2020 13:37	13/10/2020 19:38	13/10/2020 13:37	13/10/2020 19:38	6,01	2	12,02	CHI
20201069957	MIMOSO DE GOIAS	MJ18071960FS	PADRE BERNARDO	13/10/2020 13:37	13/10/2020 16:59	13/10/2020 13:37	13/10/2020 16:59	3,35	161	539,93	CHI
20201069957	NIQUELANDIA	MJ18071960FS	PADRE BERNARDO	13/10/2020 13:37	13/10/2020 16:59	13/10/2020 13:37	13/10/2020 16:59	3,35	1	3,35	CHI
20201070708	GOIANIA	GN11213713	XAVANTES	13/10/2020 13:38	13/10/2020 22:10	13/10/2020 13:38	13/10/2020 22:10	8,53	112	954,83	CHI
20201068715	BARRO ALTO	BA21045686	BARRO ALTO	13/10/2020 13:39	14/10/2020 16:14	13/10/2020 13:39	14/10/2020 16:14	26,58	1	26,58	CHI
20201069123	GOIANIA	GN11323670	INDEPENDENCIA S2	13/10/2020 13:40	13/10/2020 15:02	13/10/2020 13:40	13/10/2020 15:02	1,37	94	128,47	CHI
20201068850	JARAGUA	JA12205819	JARAGUA	13/10/2020 13:40	13/10/2020 16:34	13/10/2020 13:40	13/10/2020 16:34	2,90	5	14,50	CHI
20201068726	MORRINHOS	MR21254809	MORRINHOS	13/10/2020 13:40	13/10/2020 15:00	13/10/2020 13:40	13/10/2020 15:00	1,32	1	1,32	CHI
20201069351	GOIAS	GS11037804	GOIAS	13/10/2020 13:41	13/10/2020 19:30	13/10/2020 13:41	13/10/2020 19:30	5,82	44	256,04	CHI
20201068736	GOIANIA	11617469	ATLANTICO S3	13/10/2020 13:42	13/10/2020 19:27	13/10/2020 13:42	13/10/2020 19:27	5,75	1	5,75	CHI
20201068740	MINACU	IH12396733LD	MINACU	13/10/2020 13:42	13/10/2020 18:46	13/10/2020 13:42	13/10/2020 18:46	5,07	65	329,51	CHI
20201068740	MINACU	IH12396733LD	MINACU	13/10/2020 13:42	13/10/2020 18:46	13/10/2020 17:12	13/10/2020 18:46	1,56	86	134,49	CHI
20201068739	ALEXANIA	480075359	ALEXANIA	13/10/2020 13:42	13/10/2020 16:41	13/10/2020 13:42	13/10/2020 16:41	2,98	1	2,98	CHI
20201068741	APARECIDA DE GOIANIA	10023234855	ANHANGUERA	13/10/2020 13:42	13/10/2020 15:19	13/10/2020 13:42	13/10/2020 15:19	1,61	1	1,61	CHI
20201068751	GOIAS	GS21316812	GOIAS	13/10/2020 13:44	13/10/2020 15:19	13/10/2020 13:44	13/10/2020 15:19	1,58	1	1,58	CHI
20201068767	ITABERAI	50068714	ITABERAI S2	13/10/2020 13:45	13/10/2020 17:43	13/10/2020 13:45	13/10/2020 17:43	3,95	1	3,95	CHI
20201071824	SERRANOPOLIS	JT12260431RE	JATAI S1	13/10/2020 13:45	13/10/2020 21:29	13/10/2020 13:45	13/10/2020 21:29	7,73	19	146,82	CHI
20201071824	JATAI	JT12260431RE	JATAI S1	13/10/2020 13:45	13/10/2020 21:29	13/10/2020 13:45	13/10/2020 21:29	7,73	22	170,01	CHI
20201068773	FORMOSA	FA11102399	ITQUIRA	13/10/2020 13:46	13/10/2020 14:35	13/10/2020 13:46	13/10/2020 14:35	0,81	191	154,44	CHI
20201068784	NOVO PLANALTO	TA12391901	NOVO PLANALTO	13/10/2020 13:47	13/10/2020 15:18	13/10/2020 13:47	13/10/2020 15:18	1,50	1	1,50	CHI
20201068799	MORRINHOS	10016656154	MORRINHOS	13/10/2020 13:50	13/10/2020 15:37	13/10/2020 13:50	13/10/2020 15:37	1,77	1	1,77	CHI
20201068800	NOVA VENEZA	NV31188752	INHUMAS S1	13/10/2020 13:50	14/10/2020 04:55	13/10/2020 13:50	14/10/2020 04:55	15,07	2	30,14	CHI
20201068809	GOIANIA	14873771	CARAJAS S2	13/10/2020 13:52	13/10/2020 17:25	13/10/2020 13:52	13/10/2020 17:25	3,55	1	3,55	CHI
20201068813	GOIANIA	12780029	CARAJAS S1	13/10/2020 13:53	13/10/2020 22:14	13/10/2020 13:53	13/10/2020 22:14	8,35	1	8,35	CHI
20201068816	PETROLINA DE GOIAS	PG11156817	PETROLINA	13/10/2020 13:53	13/10/2020 15:28	13/10/2020 13:53	13/10/2020 15:28	1,58	134	211,20	CHI
20201068819	GOIANIA	15012189	REAL S2	13/10/2020 13:53	13/10/2020 20:27	13/10/2020 13:53	13/10/2020 20:27	6,56	1	6,56	CHI
20201068820	SENADOR CANEDO	SW11240504	SENADOR CANEDO	13/10/2020 13:53	13/10/2020 16:00	13/10/2020 13:53	13/10/2020 16:00	2,11	23	48,43	CHI
20201068833	GOIANIA	11734620	GOIANIA LESTE S3	13/10/2020 13:53	13/10/2020 17:38	13/10/2020 13:53	13/10/2020 17:38	3,75	1	3,75	CHI
20201068840	ITABERAI	IB12379732	ITABERAI S1	13/10/2020 13:54	13/10/2020 15:25	13/10/2020 13:54	13/10/2020 15:25	1,51	2	3,01	CHI
20201068845	BELA VISTA DE GOIAS	BV21088022	BELA VISTA S1	13/10/2020 13:55	13/10/2020 14:45	13/10/2020 13:55	13/10/2020 14:45	0,82	1	0,82	CHI
20201068852	GOIANIA	13729834	XAVANTES	13/10/2020 13:57	13/10/2020 18:57	13/10/2020 13:57	13/10/2020 18:57	5,00	1	5,00	CHI
20201068854	GOIANIA	15809742	GOIANIA LESTE S1	13/10/2020 13:57	13/10/2020 19:56	13/10/2020 13:57	13/10/2020 19:56	5,98	1	5,98	CHI
20201068858	PIRANHAS	1930047165	PIRANHAS	13/10/2020 13:57	13/10/2020 17:30	13/10/2020 13:57	13/10/2020 17:30	3,53	1	3,53	CHI
20201068860	CALDAZINHA	DE21227973	CEPAIGO S2	13/10/2020 13:58	13/10/2020 15:50	13/10/2020 13:58	13/10/2020 15:50	1,87	1	1,87	CHI
20201068874	SANTA HELENA DE GOIAS	SH12296223	IPEGUARI	13/10/2020 13:59	13/10/2020 18:02	13/10/2020 13:59	13/10/2020 18:02	4,04	6	24,27	CHI
20201068887	UIRAPURU	10007262734	SANTA TEREZINHA	13/10/2020 14:01	13/10/2020 16:37	13/10/2020 14:01	13/10/2020 16:37	2,59	1	2,59	CHI
20201069131	GOIANIA	GN10380028	ATLANTICO S1	13/10/2020 14:02	13/10/2020 14:51	13/10/2020 14:02	13/10/2020 14:51	0,81	951	771,63	CHI
20201068905	MINACU	IH12252329	MINACU	13/10/2020 14:03	14/10/2020 09:26	13/10/2020 14:03	14/10/2020 09:26	19,38	1	19,38	CHI
20201068907	PILAR DE GOIAS	3050006892	URUCU	13/10/2020 14:03	14/10/2020 09:17	13/10/2020 14:03	14/10/2020 09:17	19,22	1	19,22	CHI
20201068912	CATALAO	CT12318674	CATALAO S1	13/10/2020 14:04	13/10/2020 21:25	13/10/2020 14:04	13/10/2020 21:25	7,34	2	14,68	CHI
20201068912	DAVINOPOLIS	CT12318674	CATALAO S1	13/10/2020 14:04	13/10/2020 21:25	13/10/2020 14:04	13/10/2020 21:25	7,34	3	22,03	CHI
20201068915	RIO VERDE	RV21031839	RIO VERDE S1	13/10/2020 14:05	13/10/2020 17:14	13/10/2020 14:05	13/10/2020 17:14	3,15	1	3,15	CHI
20201068927	IPIRANGA DE GOIAS	01630414	RUBIATABA	13/10/2020 14:06	13/10/2020 17:46	13/10/2020 14:06	13/10/2020 17:46	3,65	36	131,44	CHI
20201068927	CERES	01630414	RUBIATABA	13/10/2020 14:06	13/10/2020 17:46	13/10/2020 14:06	13/10/2020 17:46	3,65	21	76,67	CHI
20201068927	ITAPACI	01630414	RUBIATABA	13/10/2020 14:06	13/10/2020 17:46	13/10/2020 14:06	13/10/2020 17:46	3,65	10	36,51	CHI
20201068927	RUBIATABA	01630414	RUBIATABA	13/10/2020 14:06	13/10/2020 17:46	13/10/2020 14:06	13/10/2020 17:46	3,65	139	507,50	CHI
20201068927	NOVA GLORIA	01630414	RUBIATABA	13/10/2020 14:06	13/10/2020 17:46	13/10/2020 14:06	13/10/2020 17:46	3,65	76	277,48	CHI
20201068929	SANCLERLANDIA	SC12005464	FIRMINOPOLIS S2	13/10/2020 14:07	13/10/2020 17:06	13/10/2020 14:07	13/10/2020 17:06	2,97	1	2,97	CHI
20201068930	CRISTALINA	KR21212026	PAMPLONA	13/10/2020 14:07	13/10/2020 16:50	13/10/2020 14:07	13/10/2020 16:50	2,71	2	5,41	CHI
20201067514	GOIANIA	GN11133504	CAMPINAS S2	13/10/2020 14:08	13/10/2020 16:17	13/10/2020 14:08	13/10/2020 16:17	2,15	94	202,07	CHI
20201068936	CALDAS NOVAS	10030545720	CALDAS NOVAS S2	13/10/2020 14:09	13/10/2020 17:19	13/10/2020 14:09	13/10/2020 17:19	3,16	1	3,16	CHI
20201068948	GOIANIA	10852633	GOIANIA LESTE S1	13/10/2020 14:12	14/10/2020 02:57	13/10/2020 14:12	14/10/2020 02:57	12,75	1	12,75	CHI

20201069007	CRISTALINA	KR12389576	CRISTALINA S2	13/10/2020 14:12	13/10/2020 16:10	13/10/2020 14:12	13/10/2020 16:10	1,96	38	74,41	CHI
20201071111	JANDAIA	JD12260012	PALMEIRAS	13/10/2020 14:12	14/10/2020 14:07	13/10/2020 14:12	14/10/2020 10:37	20,41	2	40,82	CHI
20201071111	JANDAIA	JD12289828LD	PALMEIRAS	13/10/2020 14:12	14/10/2020 14:07	13/10/2020 14:12	14/10/2020 14:07	23,91	9	215,23	CHI
20201070231	PIRENOPOLIS	PV12056014	CORUMBA	13/10/2020 14:13	13/10/2020 18:26	13/10/2020 14:13	13/10/2020 18:26	4,21	48	202,19	CHI
20201068958	NEROPOLIS	NR11271870	NEROPOLIS S2	13/10/2020 14:13	13/10/2020 19:40	13/10/2020 14:13	13/10/2020 19:40	5,44	35	190,40	CHI
20201069078	GOIANIA	GN16426131	CAMPINAS S1	13/10/2020 14:15	13/10/2020 14:26	13/10/2020 14:15	13/10/2020 14:19	0,07	6331	466,03	CHI
20201069078	GOIANIA	GN16427482	CAMPINAS S1	13/10/2020 14:15	13/10/2020 14:26	13/10/2020 14:15	13/10/2020 14:26	0,19	4225	791,01	CHI
20201059921	GOIAS	6650000937	MATRINCHA	13/10/2020 14:15	13/10/2020 18:29	13/10/2020 14:15	13/10/2020 18:29	4,23	1	4,23	CHI
20201069013	GOIAS	GS21316814	GOIAS	13/10/2020 14:19	13/10/2020 17:58	13/10/2020 14:19	13/10/2020 17:58	3,64	2	7,28	CHI
20201069021	MONTIVIDIU	MV21370228	MONTIVIDIU T	13/10/2020 14:20	13/10/2020 19:42	13/10/2020 14:20	13/10/2020 19:42	5,36	1	5,36	CHI
20201069024	MARA ROSA	ET12391905	MARA ROSA	13/10/2020 14:20	15/10/2020 14:37	13/10/2020 14:20	15/10/2020 14:37	48,29	2	96,58	CHI
20201069032	SENADOR CANEDO	10010894908	SENADOR CANEDO	13/10/2020 14:21	13/10/2020 17:31	13/10/2020 14:21	13/10/2020 17:31	3,17	1	3,17	CHI
20201069047	SAO SIMAO	6388351	CACHOEIRA ALTA	13/10/2020 14:21	13/10/2020 17:08	13/10/2020 17:04	13/10/2020 17:07	0,06	7	0,42	CHI
20201069047	PARANAIGUARA	6388351	CACHOEIRA ALTA	13/10/2020 14:21	13/10/2020 17:08	13/10/2020 17:04	13/10/2020 17:07	0,06	2	0,12	CHI
20201069047	PARANAIGUARA	PC11380653	CACHOEIRA ALTA	13/10/2020 14:21	13/10/2020 17:08	13/10/2020 14:21	13/10/2020 17:08	2,77	2	5,54	CHI
20201069086	ANAPOLIS	20781787	JUNDAI S1	13/10/2020 14:24	13/10/2020 15:31	13/10/2020 14:24	13/10/2020 15:31	1,11	1	1,11	CHI
20201070287	VIANOPOLIS	SQ12231379	CRISTIANOPOLIS	13/10/2020 14:26	14/10/2020 05:43	13/10/2020 14:26	14/10/2020 05:43	15,28	7	106,96	CHI
20201070287	SAO MIGUEL DO PASSA QUATRO	SQ12231379	CRISTIANOPOLIS	13/10/2020 14:26	14/10/2020 05:43	13/10/2020 14:26	14/10/2020 05:43	15,28	14	213,92	CHI
20201069330	INDIAIRA	IY12010814	EDEIA	13/10/2020 14:26	13/10/2020 23:24	13/10/2020 14:26	13/10/2020 23:24	8,96	10	89,61	CHI
20201069109	ANAPOLIS	10008872870	ANAPOLIS UNIVERSITARIO S2	13/10/2020 14:26	13/10/2020 16:39	13/10/2020 14:26	13/10/2020 16:39	2,22	1	2,22	CHI
20201069593	PIRENOPOLIS	PV12362268	CORUMBA	13/10/2020 14:28	14/10/2020 03:33	13/10/2020 14:28	14/10/2020 03:33	13,08	6	78,47	CHI
20201069137	ITABERAI	IB21310586	ITABERAI S2	13/10/2020 14:29	13/10/2020 15:31	13/10/2020 14:29	13/10/2020 15:31	1,03	1	1,03	CHI
20201069148	GOIANIA	15221192	CARAJAS S1	13/10/2020 14:30	13/10/2020 19:06	13/10/2020 14:30	13/10/2020 19:06	4,60	1	4,60	CHI
20201069157	RIO VERDE	RV21000056	CABRIUVA S1	13/10/2020 14:31	14/10/2020 04:57	13/10/2020 14:31	14/10/2020 04:57	14,43	1	14,43	CHI
20201069161	APARECIDA DE GOIANIA	200072808	INDEPENDENCIA S1	13/10/2020 14:31	13/10/2020 19:40	13/10/2020 14:31	13/10/2020 19:40	5,14	1	5,14	CHI
20201069163	PIRENOPOLIS	PV21040450	CORUMBA	13/10/2020 14:32	14/10/2020 10:50	13/10/2020 14:32	14/10/2020 10:50	20,30	1	20,30	CHI
20201069176	NOVA CRIXAS	NA12391603	NOVA CRIXAS	13/10/2020 14:33	13/10/2020 18:04	13/10/2020 14:33	13/10/2020 18:04	3,52	41	144,15	CHI
20201069177	NOVA CRIXAS	NA21235856	NOVA CRIXAS	13/10/2020 14:33	13/10/2020 16:16	13/10/2020 14:33	13/10/2020 16:16	1,72	1	1,72	CHI
20201069199	GOIANIA	15897965	GOIANIA LESTE S1	13/10/2020 14:35	13/10/2020 18:28	13/10/2020 14:35	13/10/2020 18:28	3,87	1	3,87	CHI
20201069739	PIRENOPOLIS	PV12381260	CORUMBA	13/10/2020 14:35	14/10/2020 04:13	13/10/2020 14:35	14/10/2020 04:13	13,62	77	1048,74	CHI
20201069229	SENADOR CANEDO	190083657	SENADOR CANEDO	13/10/2020 14:37	13/10/2020 17:27	13/10/2020 14:37	13/10/2020 17:27	2,83	1	2,83	CHI
20201069581	APARECIDA DE GOIANIA	AP11140140	INDEPENDENCIA S2	13/10/2020 14:38	13/10/2020 16:46	13/10/2020 14:38	13/10/2020 16:46	2,12	138	292,94	CHI
20201069246	MAURILANDIA	ML21303333	RIO DOS BOIS	13/10/2020 14:38	13/10/2020 18:21	13/10/2020 14:38	13/10/2020 18:21	3,72	2	7,44	CHI
20201071825	JARAGUA	JA12026047	JARAGUA	13/10/2020 14:39	14/10/2020 09:00	13/10/2020 14:39	13/10/2020 22:31	7,86	6	47,19	CHI
20201071825	JARAGUA	JA12026047	JARAGUA	13/10/2020 14:39	14/10/2020 09:00	13/10/2020 14:39	14/10/2020 09:00	10,28	6	61,69	CHI
20201069265	CALDAS NOVAS	CN21182795	SERRA DE CALDAS	13/10/2020 14:41	13/10/2020 17:04	13/10/2020 14:41	13/10/2020 17:04	2,38	1	2,38	CHI
20201069270	INHUMAS	IN21381644	INHUMAS S2	13/10/2020 14:41	14/10/2020 04:15	13/10/2020 14:41	14/10/2020 04:15	13,56	2	27,11	CHI
20201069273	FORMOSA	FA12320531	ITUIQUIRA	13/10/2020 14:41	13/10/2020 23:52	13/10/2020 14:41	13/10/2020 23:52	9,17	1	9,17	CHI
20201069285	ALEXANIA	AX21315393	ALEXANIA	13/10/2020 14:43	13/10/2020 18:55	13/10/2020 14:43	13/10/2020 18:55	4,19	1	4,19	CHI
20201069298	MARA ROSA	MQ21050764	MARA ROSA	13/10/2020 14:44	14/10/2020 10:37	13/10/2020 14:44	14/10/2020 10:37	19,87	2	39,73	CHI
20201069300	SANTA TEREZA DE GOIAS	SE21312289	MARA ROSA	13/10/2020 14:45	13/10/2020 17:00	13/10/2020 14:45	13/10/2020 17:00	2,25	1	2,25	CHI
20201069302	GOIANIRA	10018173479	GOIANIRA	13/10/2020 14:45	13/10/2020 19:21	13/10/2020 14:45	13/10/2020 19:21	4,60	1	4,60	CHI
20201069315	AGUAS LINDAS DE GOIAS	4830177112	AGUAS LINDAS DE GOIAS S1	13/10/2020 14:46	13/10/2020 15:53	13/10/2020 14:46	13/10/2020 15:53	1,10	1	1,10	CHI
20201069316	GOIANIA	11484731	ATLANTICO S1	13/10/2020 14:46	14/10/2020 04:24	13/10/2020 14:46	14/10/2020 04:24	13,62	1	13,62	CHI
20201069325	SAO LUIZ DO NORTE	SZ12312661LD	ITAPACI	13/10/2020 14:47	14/10/2020 13:13	13/10/2020 14:47	14/10/2020 13:13	22,43	1	22,43	CHI
20201069326	CAMPOS BELOS	10010593568	SAO DOMINGOS	13/10/2020 14:47	13/10/2020 16:31	13/10/2020 14:47	13/10/2020 16:31	1,73	1	1,73	CHI
20201069419	APARECIDA DE GOIANIA	AP11055783	INDEPENDENCIA S1	13/10/2020 14:47	13/10/2020 18:12	13/10/2020 14:47	13/10/2020 18:12	3,40	209	710,77	CHI
20201070370	GOIANIA	GN11274972	CARAJAS S2	13/10/2020 14:49	13/10/2020 19:40	13/10/2020 14:49	13/10/2020 19:40	4,83	57	275,55	CHI
20201069358	RIO VERDE	10003207704	RIO VERDE S2	13/10/2020 14:50	14/10/2020 08:25	13/10/2020 14:50	14/10/2020 08:25	17,58	1	17,58	CHI
20201069362	GOIANIA	10004719113	GOIANIA LESTE S3	13/10/2020 14:50	14/10/2020 01:32	13/10/2020 14:50	14/10/2020 01:32	10,69	1	10,69	CHI
20201069393	CAMPO ALEGRE DE GOIAS	CM12358429	CAMPO ALEGRE DE GOIAS	13/10/2020 14:52	14/10/2020 09:53	13/10/2020 14:52	14/10/2020 09:53	19,00	9	171,03	CHI
20201069394	GOIAS	GS21183005	ITABERAI S1	13/10/2020 14:52	13/10/2020 20:13	13/10/2020 14:52	13/10/2020 19:05	4,21	1	4,21	CHI
20201069394	GOIAS	GS12206917	ITABERAI S1	13/10/2020 14:52	13/10/2020 20:13	13/10/2020 17:56	13/10/2020 20:13	2,28	12	27,35	CHI
20201069397	RIO VERDE	RV21271388	CABRIUVA S2	13/10/2020 14:53	13/10/2020 21:35	13/10/2020 14:53	13/10/2020 21:35	6,70	1	6,70	CHI
20201069401	APARECIDA DE GOIANIA	200264590	INDEPENDENCIA S1	13/10/2020 14:53	14/10/2020 03:36	13/10/2020 14:53	14/10/2020 03:36	12,71	1	12,71	CHI
20201069403	GOIANIA	16323907	CARAJAS S1	13/10/2020 14:53	13/10/2020 22:59	13/10/2020 14:53	13/10/2020 22:59	8,09	1	8,09	CHI
20201069408	GOIANESIA	GE12000233	GOIANESIA S2	13/10/2020 14:54	13/10/2020 16:02	13/10/2020 14:54	13/10/2020 16:02	1,13	23	26,01	CHI
20201069415	CIDADE OCIDENTAL	DH12261759	MARAJOARA	13/10/2020 14:54	13/10/2020 19:25	13/10/2020 14:54	13/10/2020 19:25	4,50	338	1521,28	CHI

20201069420	CATALAO	1990069505	CATALAO S2	13/10/2020 14:55	13/10/2020 16:25	13/10/2020 14:55	13/10/2020 16:25	1,50	1	1,50	CHI
20201069444	PETROLINA DE GOIAS	PG12090320	PETROLINA	13/10/2020 14:57	13/10/2020 18:36	13/10/2020 14:57	13/10/2020 18:36	3,64	6	21,84	CHI
20201069447	MONTIVIDIU	MV21147823	MONTIVIDIU T	13/10/2020 14:57	14/10/2020 11:20	13/10/2020 14:57	14/10/2020 11:20	20,37	1	20,37	CHI
20201069551	PALMINOPOLIS	PP12007041	PALMEIRAS	13/10/2020 14:58	13/10/2020 18:04	13/10/2020 14:58	13/10/2020 18:04	3,09	5	15,44	CHI
20201069456	CACU	CC12053029	CACHOEIRA ALTA	13/10/2020 14:59	13/10/2020 18:38	13/10/2020 14:59	13/10/2020 18:38	3,65	2	7,30	CHI
20201067710	JATAI	SX12080854RE	JATAI S1	13/10/2020 14:59	14/10/2020 05:30	13/10/2020 14:59	14/10/2020 05:30	14,52	8	116,18	CHI
20201067710	SERRANOPOLIS	SX12080854RE	JATAI S1	13/10/2020 14:59	14/10/2020 05:30	13/10/2020 14:59	14/10/2020 05:30	14,52	3	43,57	CHI
20201069469	SAO FRANCISCO DE GOIAS	SF11254541	SAO FRANCISCO DE GOIAS	13/10/2020 15:00	13/10/2020 18:59	13/10/2020 15:00	13/10/2020 18:59	3,98	90	358,23	CHI
20201069480	GOIANIA	GN21047133	CARAJAS S1	13/10/2020 15:01	13/10/2020 16:21	13/10/2020 15:01	13/10/2020 16:21	1,33	3	4,00	CHI
20201069483	CALDAS NOVAS	760401147	SERRA DE CALDAS	13/10/2020 15:01	13/10/2020 16:55	13/10/2020 15:01	13/10/2020 16:55	1,90	1	1,90	CHI
20201069490	URUACU	640057536	URUACU	13/10/2020 15:01	14/10/2020 09:37	13/10/2020 15:01	14/10/2020 09:37	18,59	1	18,59	CHI
20201069504	ANAPOLIS	20546671	JUNDIAI S1	13/10/2020 15:03	13/10/2020 16:29	13/10/2020 15:03	13/10/2020 16:29	1,43	1	1,43	CHI
20201069515	MINEIROS	MY21234376	PARQUE DAS EMAS	13/10/2020 15:04	13/10/2020 19:31	13/10/2020 15:04	13/10/2020 19:31	4,45	1	4,45	CHI
20201069521	JOVIANIA	PK21296834	GOIATUBA S1	13/10/2020 15:04	13/10/2020 16:44	13/10/2020 15:04	13/10/2020 16:44	1,66	1	1,66	CHI
20201069797	RIO VERDE	RV11000043	RIO VERDE S1	13/10/2020 15:04	13/10/2020 15:58	13/10/2020 15:04	13/10/2020 15:58	0,89	78	69,29	CHI
20201069525	SAO MIGUEL DO PASSA QUATRO	SQ21300644	CRISTIANOPOLIS	13/10/2020 15:05	14/10/2020 10:47	13/10/2020 15:05	14/10/2020 10:47	19,70	1	19,70	CHI
20201069538	ANAPOLIS	20176880	ANAPOLIS UNIVERSITARIO S2	13/10/2020 15:06	13/10/2020 17:27	13/10/2020 15:06	13/10/2020 17:27	2,34	1	2,34	CHI
20201069549	PETROLINA DE GOIAS	PG12070562	PETROLINA	13/10/2020 15:08	13/10/2020 16:15	13/10/2020 15:08	13/10/2020 16:15	1,12	11	12,27	CHI
20201069554	RIO VERDE	630067480	RIO VERDE S1	13/10/2020 15:09	13/10/2020 20:10	13/10/2020 15:09	13/10/2020 20:10	5,02	1	5,02	CHI
20201069558	GOIANIA	10069781	CAMPINAS S3	13/10/2020 15:09	13/10/2020 20:47	13/10/2020 15:09	13/10/2020 20:47	5,62	1	5,62	CHI
20201069579	AGUA FRIA DE GOIAS	TL21337506	SAO JOAO D ALIANCA	13/10/2020 15:12	13/10/2020 20:19	13/10/2020 15:12	13/10/2020 20:19	5,12	2	10,23	CHI
20201069588	ARAGOANIA	680019595	GUAPU S2	13/10/2020 15:13	13/10/2020 23:07	13/10/2020 15:13	13/10/2020 23:07	7,90	1	7,90	CHI
20201069591	GOIANIA	10280790	CAMPINAS S2	13/10/2020 15:13	13/10/2020 21:46	13/10/2020 15:13	13/10/2020 21:46	6,55	1	6,55	CHI
20201069592	SAO FRANCISCO DE GOIAS	SF21377751	SAO FRANCISCO DE GOIAS	13/10/2020 15:13	13/10/2020 22:32	13/10/2020 15:13	13/10/2020 22:32	7,31	2	14,63	CHI
20201070958	GOIANIA	GN12000541	CAMPINAS S3	13/10/2020 15:13	13/10/2020 19:21	13/10/2020 15:13	13/10/2020 19:21	4,12	98	403,90	CHI
20201069607	INHUMAS	IN21083416	INHUMAS S1	13/10/2020 15:15	14/10/2020 10:14	13/10/2020 15:15	14/10/2020 10:14	18,98	1	18,98	CHI
20201069610	PADRE BERNARDO	PB12313952	PADRE BERNARDO	13/10/2020 15:15	13/10/2020 19:41	13/10/2020 15:15	13/10/2020 19:41	4,42	2	8,84	CHI
20201069914	JARAGUA	JA11054616	JARAGUA	13/10/2020 15:15	13/10/2020 23:12	13/10/2020 15:15	13/10/2020 23:12	7,94	128	1016,50	CHI
20201069622	JATAI	JT11357725	JATAI S1	13/10/2020 15:17	14/10/2020 08:24	13/10/2020 15:17	14/10/2020 08:24	17,11	1	17,11	CHI
20201069624	TRINDADE	TR31043434	TRINDADE	13/10/2020 15:17	14/10/2020 07:53	13/10/2020 15:17	14/10/2020 07:53	16,59	1	16,59	CHI
20201069636	INHUMAS	IX12013297	INHUMAS S2	13/10/2020 15:18	14/10/2020 03:51	13/10/2020 15:18	14/10/2020 03:51	12,54	13	162,96	CHI
20201069637	SANTO ANTONIO DO DESCOBERTO	2210119929	ALEXANIA	13/10/2020 15:18	13/10/2020 18:03	13/10/2020 15:18	13/10/2020 18:03	2,74	1	2,74	CHI
20201069638	GOIANIA	16671727	GOIANIA LESTE S2	13/10/2020 15:18	13/10/2020 22:22	13/10/2020 15:18	13/10/2020 22:22	7,05	1	7,05	CHI
20201069650	PIRENOPOLIS	PV12285272	CORUMBA	13/10/2020 15:20	14/10/2020 02:08	13/10/2020 15:20	14/10/2020 02:08	10,80	10	108,00	CHI
20201069643	PIRACANJUBA	PJ12142469	PIRACANJUBA	13/10/2020 15:20	13/10/2020 20:38	13/10/2020 15:20	13/10/2020 20:38	5,06	1	5,06	CHI
20201069643	PIRACANJUBA	PJ12249884	PIRACANJUBA	13/10/2020 15:20	13/10/2020 20:38	13/10/2020 17:50	13/10/2020 20:38	2,81	3	8,42	CHI
20201069646	CABECEIRAS	CW21325665	ITUIQUIRA	13/10/2020 15:20	14/10/2020 00:55	13/10/2020 15:20	14/10/2020 00:55	9,59	1	9,59	CHI
20201069648	PLANALTINA	2960186492	PLANALTINA	13/10/2020 15:20	13/10/2020 17:23	13/10/2020 15:20	13/10/2020 17:23	2,04	1	2,04	CHI
20201069651	LUZIANIA	LZ21112998	RIO VERMELHO	13/10/2020 15:20	13/10/2020 16:45	13/10/2020 15:20	13/10/2020 16:45	1,40	1	1,40	CHI
20201069666	PIRACANJUBA	60045292	PIRACANJUBA	13/10/2020 15:23	13/10/2020 17:17	13/10/2020 15:23	13/10/2020 17:17	1,90	1	1,90	CHI
20201070198	NIQUELANDIA	NQ11000007	NIQUELANDIA SUBTRANSMISSAO	13/10/2020 15:23	14/10/2020 13:34	13/10/2020 15:23	14/10/2020 13:34	22,18	107	2372,99	CHI
20201070189	CAMPO ALEGRE DE GOIAS	CM12266823	CAMPO ALEGRE DE GOIAS	13/10/2020 15:24	13/10/2020 18:53	13/10/2020 15:24	13/10/2020 18:53	3,47	42	145,76	CHI
2020101300116	AGUAS LINDAS DE GOIAS	03730214	AGUAS LINDAS DE GOIAS S1	13/10/2020 15:25	13/10/2020 15:28	13/10/2020 15:25	13/10/2020 15:28	0,05	9000	450,00	CHI
20201069684	GOIANIA	16576792	REAL S2	13/10/2020 15:25	13/10/2020 22:12	13/10/2020 15:25	13/10/2020 22:12	6,78	1	6,78	CHI
20201069688	ANAPOLIS	AN12381938	ANAPOLIS UNIVERSITARIO S2	13/10/2020 15:25	13/10/2020 20:31	13/10/2020 15:25	13/10/2020 20:31	5,09	220	1119,98	CHI
20201069693	AURILANDIA	PU21063152	FIRMINOPOLIS S2	13/10/2020 15:26	14/10/2020 18:50	13/10/2020 15:26	14/10/2020 18:50	27,39	1	27,39	CHI
20201069932	IPORA	IR12380956	IPORA	13/10/2020 15:26	13/10/2020 16:44	13/10/2020 15:26	13/10/2020 16:44	1,29	107	137,52	CHI
20201069707	FLORES DE GOIAS	20818944	FLORES DE GOIAS	13/10/2020 15:27	13/10/2020 18:29	13/10/2020 15:27	13/10/2020 18:29	3,03	11	33,31	CHI
20201069722	CEZARINA	CZ21085425	CEZARINA	13/10/2020 15:29	14/10/2020 10:39	13/10/2020 15:29	14/10/2020 10:39	19,16	1	19,16	CHI
20201069731	INHUMAS	30050650	INHUMAS S2	13/10/2020 15:31	13/10/2020 21:07	13/10/2020 15:31	13/10/2020 21:07	5,60	1	5,60	CHI
20201070262	SANTO ANTONIO DO DESCOBERTO	AX12402045	ALEXANIA	13/10/2020 15:32	13/10/2020 20:52	13/10/2020 15:32	13/10/2020 20:52	5,33	1	5,33	CHI
20201070262	ALEXANIA	AX12402045	ALEXANIA	13/10/2020 15:32	13/10/2020 20:52	13/10/2020 15:32	13/10/2020 20:52	5,33	205	1091,97	CHI
20201069742	VIANOPOLIS	2060031546	PIRES DO RIO S2	13/10/2020 15:32	13/10/2020 23:19	13/10/2020 15:32	13/10/2020 23:19	7,77	1	7,77	CHI
20201069743	GOIANIA	11725588	REAL S1	13/10/2020 15:32	13/10/2020 18:30	13/10/2020 15:32	13/10/2020 18:30	2,95	1	2,95	CHI
20201069745	CABECEIRAS	CW21184611	ITUIQUIRA	13/10/2020 15:32	13/10/2020 22:40	13/10/2020 15:32	13/10/2020 22:40	7,12	1	7,12	CHI
20201069759	ANAPOLIS	10007923226	ANAPOLIS UNIVERSITARIO S2	13/10/2020 15:34	13/10/2020 16:47	13/10/2020 15:34	13/10/2020 16:47	1,21	1	1,21	CHI
20201069769	URUACU	640052782	URUACU	13/10/2020 15:36	13/10/2020 19:08	13/10/2020 15:36	13/10/2020 19:08	3,53	1	3,53	CHI
20201069770	GOIANIA	11088930	REAL S1	13/10/2020 15:36	13/10/2020 23:19	13/10/2020 15:36	13/10/2020 23:19	7,71	1	7,71	CHI

20201069772	FORMOSA	610143591	ITUIQUIRA	13/10/2020 15:36	13/10/2020 17:06	13/10/2020 15:36	13/10/2020 17:06	1,50	1	1,50	CHI
20201069792	SILVANIA	LB21164021	DAIA S2	13/10/2020 15:38	13/10/2020 17:19	13/10/2020 15:38	13/10/2020 17:19	1,67	1	1,67	CHI
20201069795	ITABERAI	IB12132416	ITABERAI S1	13/10/2020 15:39	13/10/2020 17:59	13/10/2020 15:39	13/10/2020 17:59	2,33	12	27,97	CHI
20201069801	JUSSARA	JR12120986	BRITANIA	13/10/2020 15:39	14/10/2020 00:49	13/10/2020 15:39	14/10/2020 00:49	9,16	3	27,48	CHI
20201071805	PADRE BERNARDO	ZN12330505	AGUAS LINDAS DE GOIAS S2	13/10/2020 15:39	14/10/2020 01:06	13/10/2020 15:39	14/10/2020 01:06	9,44	4	37,74	CHI
20201071805	COCALZINHO DE GOIAS	ZN12330505	AGUAS LINDAS DE GOIAS S2	13/10/2020 15:39	14/10/2020 01:06	13/10/2020 15:39	14/10/2020 01:06	9,44	27	254,77	CHI
20201070337	BRITANIA	BT12171780	BRITANIA	13/10/2020 15:42	13/10/2020 17:53	13/10/2020 15:42	13/10/2020 17:53	2,17	233	506,00	CHI
20201069829	RIO VERDE	10003219273	RIO VERDE S1	13/10/2020 15:42	13/10/2020 21:00	13/10/2020 15:42	13/10/2020 21:00	5,29	1	5,29	CHI
20201069834	CHAPADAO DO CEU	DJ21160240	CHAPADAO DO CEU	13/10/2020 15:43	13/10/2020 21:43	13/10/2020 15:43	13/10/2020 21:43	5,99	1	5,99	CHI
20201069836	MARA ROSA	MQ21246534	MARA ROSA	13/10/2020 15:43	14/10/2020 14:47	13/10/2020 15:43	14/10/2020 14:47	23,06	2	46,12	CHI
20201070804	FLORES DE GOIAS	FB12045259	IACIARA S2	13/10/2020 15:43	14/10/2020 01:54	13/10/2020 15:43	14/10/2020 01:54	10,17	346	3519,01	CHI
20201070804	SITIO D ABADIA	FB12045259	IACIARA S2	13/10/2020 15:43	14/10/2020 01:54	13/10/2020 15:43	14/10/2020 01:54	10,17	3	30,51	CHI
20201069910	ABADIANIA	AA21385097	ANAPOLIS UNIVERSITARIO S1	13/10/2020 15:44	13/10/2020 17:56	13/10/2020 15:44	13/10/2020 17:56	2,20	1	2,20	CHI
20201069865	ANAPOLIS	OV21223921	NEROPOLIS S1	13/10/2020 15:46	13/10/2020 17:05	13/10/2020 15:46	13/10/2020 17:05	1,30	1	1,30	CHI
20201069876	CALDAZINHA	920026758	DAIA S2	13/10/2020 15:47	13/10/2020 20:02	13/10/2020 15:47	13/10/2020 20:02	4,25	1	4,25	CHI
20201069878	ALOANDIA	AD21320267	GOIATUBA S1	13/10/2020 15:47	13/10/2020 17:57	13/10/2020 15:47	13/10/2020 17:57	2,15	1	2,15	CHI
20201069895	ITUMBIARA	690367752	PARANAIBA	13/10/2020 15:49	13/10/2020 17:31	13/10/2020 15:49	13/10/2020 17:31	1,70	1	1,70	CHI
20201069899	GOIANIA	15703307	CARAJAS S2	13/10/2020 15:49	13/10/2020 18:14	13/10/2020 15:49	13/10/2020 18:14	2,41	1	2,41	CHI
20201070162	COLINAS DO SUL	TI10401551	MINACU	13/10/2020 15:50	14/10/2020 19:00	13/10/2020 15:50	14/10/2020 14:32	22,69	2	45,39	CHI
20201070162	COLINAS DO SUL	TI10401551	MINACU	13/10/2020 15:50	14/10/2020 19:00	13/10/2020 15:52	14/10/2020 14:32	22,67	2	45,34	CHI
20201070162	COLINAS DO SUL	TI10401551	MINACU	13/10/2020 15:50	14/10/2020 19:00	13/10/2020 15:50	14/10/2020 18:42	26,87	13	349,31	CHI
20201070162	CAVALCANTE	TI10401551	MINACU	13/10/2020 15:50	14/10/2020 19:00	13/10/2020 15:50	14/10/2020 18:42	26,87	12	322,44	CHI
20201070162	COLINAS DO SUL	TI10401551	MINACU	13/10/2020 15:50	14/10/2020 19:00	13/10/2020 15:52	14/10/2020 18:42	26,85	3	80,54	CHI
20201070162	CAVALCANTE	TI10401551	MINACU	13/10/2020 15:50	14/10/2020 19:00	13/10/2020 15:52	14/10/2020 18:42	26,85	3	80,54	CHI
20201070162	COLINAS DO SUL	TI12304945LD	MINACU	13/10/2020 15:50	14/10/2020 19:00	13/10/2020 15:50	14/10/2020 19:00	27,16	7	190,12	CHI
20201070162	CAVALCANTE	TI12304945LD	MINACU	13/10/2020 15:50	14/10/2020 19:00	13/10/2020 15:50	14/10/2020 19:00	27,16	284	7713,60	CHI
20201070162	COLINAS DO SUL	TI12304945LD	MINACU	13/10/2020 15:50	14/10/2020 19:00	13/10/2020 15:52	14/10/2020 19:00	27,14	1	27,14	CHI
20201070162	CAVALCANTE	TI12304945LD	MINACU	13/10/2020 15:50	14/10/2020 19:00	13/10/2020 15:52	14/10/2020 19:00	27,14	4	108,55	CHI
20201070162	CAVALCANTE	TI12304945LD	MINACU	13/10/2020 15:50	14/10/2020 19:00	13/10/2020 20:18	14/10/2020 19:00	22,70	8	181,59	CHI
20201069954	APARECIDA DE GOIANIA	AP11000072	ANHANGUERA	13/10/2020 15:50	13/10/2020 18:20	13/10/2020 15:50	13/10/2020 18:20	2,49	137	340,67	CHI
20201069922	QUIRINOPOLIS	QI11113291	QUIRINOPOLIS	13/10/2020 15:51	13/10/2020 18:41	13/10/2020 15:51	13/10/2020 18:41	2,83	91	257,68	CHI
20201069937	CAMPINACU	UC21239734	PORANGATU	13/10/2020 15:52	14/10/2020 10:02	13/10/2020 15:52	14/10/2020 10:02	18,17	1	18,17	CHI
20201069950	PIRENOPOLIS	PV11273082	CORUMBA	13/10/2020 15:52	13/10/2020 21:33	13/10/2020 15:52	13/10/2020 21:33	5,67	26	147,38	CHI
20201069967	HEITORAI	HE12023239	ITAPURANGA	13/10/2020 15:53	13/10/2020 20:50	13/10/2020 15:53	13/10/2020 20:50	4,94	3	14,82	CHI
20201069975	ITUMBIARA	IT12000091	PARANAIBA	13/10/2020 15:54	13/10/2020 18:13	13/10/2020 15:54	13/10/2020 18:13	2,31	12	27,75	CHI
20201069997	CHAPADAO DO CEU	DJ12152864	CHAPADAO DO CEU	13/10/2020 15:56	13/10/2020 20:41	13/10/2020 15:56	13/10/2020 20:41	4,74	4	18,98	CHI
20201070049	MORRINHOS	MR12269061	MORRINHOS	13/10/2020 15:56	13/10/2020 18:20	13/10/2020 15:56	13/10/2020 18:20	2,40	1	2,40	CHI
20201070049	PIRACANJUBA	MR12269061	MORRINHOS	13/10/2020 15:56	13/10/2020 18:20	13/10/2020 15:56	13/10/2020 18:20	2,40	3	7,21	CHI
20201070009	MIMOSO DE GOIAS	MJ12165657	PADRE BERNARDO	13/10/2020 15:57	13/10/2020 18:34	13/10/2020 15:57	13/10/2020 18:34	2,61	13	33,99	CHI
20201070021	SANTA HELENA DE GOIAS	SH12024975	IPEGUARI	13/10/2020 15:57	14/10/2020 04:31	13/10/2020 15:57	14/10/2020 04:31	12,56	8	100,46	CHI
20201070025	GOIANIA	12020072	REAL S1	13/10/2020 15:58	14/10/2020 00:44	13/10/2020 15:58	14/10/2020 00:44	8,76	1	8,76	CHI
20201070567	PIRES DO RIO	PR11186583	PIRES DO RIO S1	13/10/2020 15:58	13/10/2020 18:04	13/10/2020 15:58	13/10/2020 18:04	2,09	88	183,97	CHI
20201070065	CRIXAS	CX21145542	RUBIATABA	13/10/2020 16:00	15/10/2020 00:18	13/10/2020 16:00	15/10/2020 00:18	32,30	1	32,30	CHI
20201070072	PALMINOPOLIS	PP21312521	PALMEIRAS	13/10/2020 16:00	13/10/2020 17:42	13/10/2020 16:00	13/10/2020 17:42	1,69	1	1,69	CHI
20201070089	AGUAS LINDAS DE GOIAS	LA12370875	AGUAS LINDAS DE GOIAS S1	13/10/2020 16:01	14/10/2020 00:15	13/10/2020 16:01	14/10/2020 00:15	8,22	54	443,71	CHI
20201070095	ITAPIRAPUA	IU11362937	JUSSARA	13/10/2020 16:02	13/10/2020 16:31	13/10/2020 16:02	13/10/2020 16:31	0,47	1	0,47	CHI
20201070139	VALPARAISO DE GOIAS	2860305677	MARAJOARA	13/10/2020 16:05	13/10/2020 19:23	13/10/2020 16:05	13/10/2020 19:23	3,29	1	3,29	CHI
20201070143	CORUMBAIBA	CI12000486	VILA CORUMBA	13/10/2020 16:05	13/10/2020 18:57	13/10/2020 16:05	13/10/2020 18:57	2,85	5	14,27	CHI
20201070151	FORMOSO	CR12172326	MARA ROSA	13/10/2020 16:06	15/10/2020 13:07	13/10/2020 16:06	15/10/2020 13:07	45,01	3	135,04	CHI
20201070151	CAMPINORTE	CR12172326	MARA ROSA	13/10/2020 16:06	15/10/2020 13:07	13/10/2020 16:06	15/10/2020 13:07	45,01	3	135,04	CHI
20201070242	FORMOSA	FA11100258	ITUIQUIRA	13/10/2020 16:06	13/10/2020 19:09	13/10/2020 16:06	13/10/2020 19:09	3,05	120	366,33	CHI
20201070158	FORMOSA	610112259	ITUIQUIRA	13/10/2020 16:07	13/10/2020 17:21	13/10/2020 16:07	13/10/2020 17:21	1,24	1	1,24	CHI
20201070161	JANDAIA	JD21226931	PALMEIRAS	13/10/2020 16:07	14/10/2020 17:20	13/10/2020 16:07	14/10/2020 17:20	25,21	1	25,21	CHI
20201070166	PALMELO	450006049	PIRES DO RIO S2	13/10/2020 16:08	14/10/2020 00:03	13/10/2020 16:08	14/10/2020 00:03	7,91	1	7,91	CHI
20201070167	APARECIDA DE GOIANIA	10015185930	INDEPENDENCIA S1	13/10/2020 16:08	14/10/2020 02:39	13/10/2020 16:08	14/10/2020 02:39	10,51	1	10,51	CHI
20201070176	RIO VERDE	10003217777	RIO VERDE S1	13/10/2020 16:09	13/10/2020 23:10	13/10/2020 16:09	13/10/2020 23:10	7,01	1	7,01	CHI
20201070185	CACHOEIRA ALTA	CA12132269	CACHOEIRA ALTA	13/10/2020 16:10	13/10/2020 19:24	13/10/2020 16:10	13/10/2020 19:24	3,22	2	6,44	CHI
20201070190	AGUAS LINDAS DE GOIAS	4830117449	AGUAS LINDAS DE GOIAS S1	13/10/2020 16:11	13/10/2020 18:16	13/10/2020 16:11	13/10/2020 18:16	2,08	1	2,08	CHI

20201070193	JATAI	290232259	JATAI S3	13/10/2020 16:11	14/10/2020 04:53	13/10/2020 16:11	14/10/2020 04:53	12,69	1	12,69	CHI
20201070206	GOIAS	GS11082064	GOIAS	13/10/2020 16:13	14/10/2020 01:16	13/10/2020 16:13	14/10/2020 01:16	9,04	2	18,08	CHI
20201070207	NOVA CRIXAS	8570020705	NOVA CRIXAS	13/10/2020 16:13	13/10/2020 23:11	13/10/2020 16:13	13/10/2020 23:11	6,95	1	6,95	CHI
20201067178	PIRENOPOLIS	PV21241187	CORUMBA	13/10/2020 16:15	13/10/2020 16:45	13/10/2020 16:15	13/10/2020 16:45	0,50	8	4,00	CHI
20201070212	TRINDADE	TR12036568	TRINDADE	13/10/2020 16:15	13/10/2020 20:50	13/10/2020 16:15	13/10/2020 20:18	4,05	4	16,21	CHI
20201070212	TRINDADE	TR21365666	TRINDADE	13/10/2020 16:15	13/10/2020 20:50	13/10/2020 16:15	13/10/2020 20:50	4,58	3	13,75	CHI
20201070217	TRINDADE	40080730	TRINDADE	13/10/2020 16:15	13/10/2020 17:24	13/10/2020 16:15	13/10/2020 17:24	1,14	1	1,14	CHI
20201070511	MINACU	IH11202467	MINACU	13/10/2020 16:16	14/10/2020 02:32	13/10/2020 16:16	14/10/2020 02:32	10,27	39	400,36	CHI
20201070220	APARECIDA DE GOIANIA	200051179	INDEPENDENCIA S2	13/10/2020 16:16	13/10/2020 19:15	13/10/2020 16:16	13/10/2020 19:15	2,98	1	2,98	CHI
20201071018	ARENOPOLIS	AY11380896	ARENOPOLIS	13/10/2020 16:16	14/10/2020 10:39	13/10/2020 16:16	14/10/2020 10:39	18,39	23	422,86	CHI
20201071018	ARENOPOLIS	AY12374937	ARENOPOLIS	13/10/2020 16:16	14/10/2020 10:39	13/10/2020 21:19	14/10/2020 10:39	13,33	84	1119,84	CHI
20201070227	GOUVELANDIA	2250016441	QUIRINOPOLIS	13/10/2020 16:16	13/10/2020 18:10	13/10/2020 16:16	13/10/2020 18:10	1,89	1	1,89	CHI
20201070229	ALVORADA DO NORTE	AQ12000004LD	IACIARA S2	13/10/2020 16:16	13/10/2020 23:42	13/10/2020 18:41	13/10/2020 21:54	3,23	225	725,94	CHI
20201070229	ALVORADA DO NORTE	00010224	IACIARA S2	13/10/2020 16:16	13/10/2020 23:42	13/10/2020 21:47	13/10/2020 21:54	0,11	241	27,25	CHI
20201070229	ALVORADA DO NORTE	AQ12000004LD	IACIARA S2	13/10/2020 16:16	13/10/2020 23:42	13/10/2020 16:16	13/10/2020 22:18	6,03	139	837,51	CHI
20201070229	SIMOLANDIA	AQ12000004LD	IACIARA S2	13/10/2020 16:16	13/10/2020 23:42	13/10/2020 16:16	13/10/2020 22:18	6,03	3	18,08	CHI
20201070229	ALVORADA DO NORTE	AQ12000004LD	IACIARA S2	13/10/2020 16:16	13/10/2020 23:42	13/10/2020 16:16	13/10/2020 22:40	6,40	235	1504,07	CHI
20201070229	SIMOLANDIA	00010224	IACIARA S2	13/10/2020 16:16	13/10/2020 23:42	13/10/2020 22:32	13/10/2020 22:40	0,15	3	0,45	CHI
20201070229	ALVORADA DO NORTE	00010224	IACIARA S2	13/10/2020 16:16	13/10/2020 23:42	13/10/2020 22:32	13/10/2020 22:40	0,15	605	90,08	CHI
20201070229	ALVORADA DO NORTE	AQ12000004LD	IACIARA S2	13/10/2020 16:16	13/10/2020 23:42	13/10/2020 16:16	13/10/2020 23:42	7,43	360	2676,00	CHI
20201070232	TRINDADE	TR21006369	GUAPO S1	13/10/2020 16:17	13/10/2020 21:10	13/10/2020 16:17	13/10/2020 21:10	4,88	1	4,88	CHI
20201070240	GOIANIA	15262121	ATLANTICO S2	13/10/2020 16:18	14/10/2020 02:06	13/10/2020 16:18	14/10/2020 02:06	9,79	1	9,79	CHI
20201070252	MINACU	IH12088797	MINACU	13/10/2020 16:19	13/10/2020 22:05	13/10/2020 16:19	13/10/2020 22:05	5,75	163	937,66	CHI
20201070255	INHUMAS	IN12012145	INHUMAS S2	13/10/2020 16:20	14/10/2020 12:56	13/10/2020 16:20	14/10/2020 12:56	20,59	6	123,57	CHI
20201070258	CAMPO ALEGRE DE GOIAS	CM12077694	CAMPO ALEGRE DE GOIAS	13/10/2020 16:21	13/10/2020 20:57	13/10/2020 16:21	13/10/2020 20:57	4,60	1	4,60	CHI
20201070953	PADRE BERNARDO	PB12039344	PADRE BERNARDO	13/10/2020 16:21	13/10/2020 21:09	13/10/2020 16:21	13/10/2020 21:09	4,79	33	157,93	CHI
20201070269	PETROLINA DE GOIAS	PG12015839	PETROLINA	13/10/2020 16:22	14/10/2020 20:35	13/10/2020 16:22	14/10/2020 17:20	24,95	3	74,86	CHI
20201070269	PETROLINA DE GOIAS	6414648	PETROLINA	13/10/2020 16:22	14/10/2020 20:35	13/10/2020 16:22	14/10/2020 20:35	28,22	2	56,44	CHI
20201070276	ANICUNS	910039471	ANICUNS	13/10/2020 16:23	13/10/2020 19:51	13/10/2020 16:23	13/10/2020 19:51	3,46	1	3,46	CHI
20201070279	ANAPOLIS	20782949	ANAPOLIS UNIVERSITARIO S2	13/10/2020 16:23	13/10/2020 18:16	13/10/2020 16:23	13/10/2020 18:16	1,88	1	1,88	CHI
20201070282	AGUAS LINDAS DE GOIAS	LA11200521	AGUAS LINDAS DE GOIAS S1	13/10/2020 16:24	13/10/2020 22:23	13/10/2020 16:24	13/10/2020 22:23	5,98	150	897,54	CHI
20201070283	IPAMERI	IP12404738	IPAMERI	13/10/2020 16:24	13/10/2020 17:01	13/10/2020 16:24	13/10/2020 17:01	0,62	4	2,46	CHI
20201070288	PADRE BERNARDO	PB12305257	PADRE BERNARDO	13/10/2020 16:25	13/10/2020 19:48	13/10/2020 16:25	13/10/2020 19:48	3,38	5	16,91	CHI
20201070288	PLANALTIMA	PB12305257	PADRE BERNARDO	13/10/2020 16:25	13/10/2020 19:48	13/10/2020 16:25	13/10/2020 19:48	3,38	65	219,77	CHI
20201070290	GOIANIA	10841246	GOIANIA LESTE S2	13/10/2020 16:25	14/10/2020 01:50	13/10/2020 16:25	14/10/2020 01:50	9,41	1	9,41	CHI
20201069702	GOIANIA	GN21282803	GOIANIA LESTE S2	13/10/2020 16:26	13/10/2020 16:54	13/10/2020 16:26	13/10/2020 16:54	0,47	1	0,47	CHI
202010189385	NIQUELANDIA	NQ12378040	NIQUELANDIA SUBTRANSMISSAO	13/10/2020 16:26	15/10/2020 02:28	13/10/2020 16:26	15/10/2020 02:28	34,03	24	816,60	CHI
20201070300	PETROLINA DE GOIAS	PG12118242LD	PETROLINA	13/10/2020 16:28	15/10/2020 09:18	13/10/2020 16:28	15/10/2020 09:18	40,84	5	204,18	CHI
20201070309	MARA ROSA	MQ21210277	MARA ROSA	13/10/2020 16:30	13/10/2020 22:42	13/10/2020 16:30	13/10/2020 22:42	6,20	1	6,20	CHI
20201070311	GOIANIA	14353878	CARAJAS S1	13/10/2020 16:30	13/10/2020 18:45	13/10/2020 16:30	13/10/2020 18:45	2,24	1	2,24	CHI
20201070317	GOIANIA	16032070	REAL S2	13/10/2020 16:31	13/10/2020 23:36	13/10/2020 16:31	13/10/2020 23:36	7,07	1	7,07	CHI
20201070319	MORRINHOS	MR21249891	MORRINHOS	13/10/2020 16:32	13/10/2020 19:28	13/10/2020 16:32	13/10/2020 19:28	2,93	2	5,86	CHI
20201070322	JANDAIA	EU12255747	ACREUNA	13/10/2020 16:33	14/10/2020 22:52	13/10/2020 16:33	14/10/2020 22:52	30,33	1	30,33	CHI
20201070322	PARAUNA	EU12255747	ACREUNA	13/10/2020 16:33	14/10/2020 22:52	13/10/2020 16:33	14/10/2020 22:52	30,33	1	30,33	CHI
20201070324	SITIO D ABADIA	SI12236912	IACIARA S2	13/10/2020 16:34	13/10/2020 19:12	13/10/2020 16:34	13/10/2020 19:12	2,62	2	5,25	CHI
20201070330	POSSE	PS21267774	IACIARA S2	13/10/2020 16:35	13/10/2020 17:58	13/10/2020 16:35	13/10/2020 17:58	1,38	1	1,38	CHI
20201070333	GOIANIA	GN11323132	AEROPORTO S2	13/10/2020 16:35	13/10/2020 23:49	13/10/2020 16:35	13/10/2020 23:49	7,22	35	252,83	CHI
20201070932	MINACU	IH11202453	MINACU	13/10/2020 16:35	14/10/2020 01:35	13/10/2020 16:35	14/10/2020 01:35	8,99	35	314,66	CHI
20201071478	COCALZINHO DE GOIAS	ZN12320107	AGUAS LINDAS DE GOIAS S1	13/10/2020 16:36	14/10/2020 02:09	13/10/2020 16:36	14/10/2020 02:09	9,55	14	133,69	CHI
20201071784	SANCLERLANDIA	SC12395118	FIRMINOPOLIS S2	13/10/2020 16:37	14/10/2020 11:35	13/10/2020 16:37	14/10/2020 11:35	18,95	3	56,86	CHI
20201071784	MOSSAMEDES	SC12395118	FIRMINOPOLIS S2	13/10/2020 16:37	14/10/2020 11:35	13/10/2020 16:37	14/10/2020 11:35	18,95	28	530,71	CHI
20201070347	SAO FRANCISCO DE GOIAS	SF12010602	SAO FRANCISCO DE GOIAS	13/10/2020 16:37	13/10/2020 20:14	13/10/2020 16:37	13/10/2020 20:14	3,60	2	7,21	CHI
20201070348	CEZARINA	1650001712	CEZARINA	13/10/2020 16:38	14/10/2020 10:09	13/10/2020 16:38	14/10/2020 10:09	17,51	1	17,51	CHI
20201070431	LUZIANIA	LZ11348212	MARAJOARA	13/10/2020 16:39	13/10/2020 18:10	13/10/2020 16:39	13/10/2020 18:10	1,50	89	133,60	CHI
20201070360	GOIANIA	13331681	REAL S2	13/10/2020 16:40	13/10/2020 19:49	13/10/2020 16:40	13/10/2020 19:49	3,15	1	3,15	CHI
20201070361	RIO VERDE	CP12123360	MONTIVIDIU T	13/10/2020 16:40	14/10/2020 00:19	13/10/2020 16:40	14/10/2020 00:19	7,66	6	45,95	CHI
20201070368	BONFINOPOLIS	920006541	CEPAIGO S2	13/10/2020 16:43	13/10/2020 17:24	13/10/2020 16:43	13/10/2020 17:24	0,67	1	0,67	CHI
20201070376	CRISTALINA	KR21248325	CRISTALINA S1	13/10/2020 16:45	13/10/2020 19:26	13/10/2020 16:45	13/10/2020 19:26	2,68	1	2,68	CHI

20201070377	PADRE BERNARDO	PB12333235	PADRE BERNARDO	13/10/2020 16:45	13/10/2020 19:46	13/10/2020 16:45	13/10/2020 19:46	3,00	24	72,05	CHI
20201070379	LUZIANIA	LZ21172154	PAMPLONA	13/10/2020 16:46	13/10/2020 19:58	13/10/2020 16:46	13/10/2020 19:58	3,19	1	3,19	CHI
20201070403	SAO SIMAO	2240035890	CACHOEIRA ALTA	13/10/2020 16:47	13/10/2020 18:36	13/10/2020 16:47	13/10/2020 18:36	1,81	1	1,81	CHI
20201070931	NIQUELANDIA	NQ12035683RE	URUACU	13/10/2020 16:49	14/10/2020 17:00	13/10/2020 16:49	14/10/2020 17:00	24,18	4	96,72	CHI
20201070434	PILAR DE GOIAS	HL21365140	URUACU	13/10/2020 16:49	14/10/2020 20:27	13/10/2020 16:49	14/10/2020 20:27	27,62	2	55,24	CHI
20201070439	CALDAS NOVAS	760024182	SERRA DE CALDAS	13/10/2020 16:50	13/10/2020 18:11	13/10/2020 16:50	13/10/2020 18:11	1,35	1	1,35	CHI
20201070444	APARECIDA DE GOIANIA	12266395	ATLANTICO S1	13/10/2020 16:50	14/10/2020 05:01	13/10/2020 16:50	14/10/2020 05:01	12,17	1	12,17	CHI
20201070446	MONTIVIDIU	MV21267639	MONTIVIDIU T	13/10/2020 16:51	14/10/2020 10:05	13/10/2020 16:51	14/10/2020 10:05	17,23	1	17,23	CHI
20201071770	SILVANIA	SV12211132	VIANOPOLIS	13/10/2020 16:51	14/10/2020 01:20	13/10/2020 16:51	14/10/2020 01:20	8,48	44	373,01	CHI
20201070439	GAMELEIRA DE GOIAS	SV12211132	VIANOPOLIS	13/10/2020 16:51	14/10/2020 01:20	13/10/2020 16:51	14/10/2020 01:20	8,48	14	118,68	CHI
20201070772	NIQUELANDIA	NQ12181068RE	URUACU	13/10/2020 16:51	13/10/2020 22:22	13/10/2020 16:51	13/10/2020 22:22	5,50	107	588,53	CHI
20201070457	URUACU	UR21181205	URUACU	13/10/2020 16:52	14/10/2020 08:54	13/10/2020 16:52	14/10/2020 08:54	16,02	1	16,02	CHI
20201070459	SILVANIA	660015626	VIANOPOLIS	13/10/2020 16:53	13/10/2020 17:52	13/10/2020 16:53	13/10/2020 17:52	0,99	1	0,99	CHI
20201071330	GOIANIA	GN11001998	CAMPINAS S2	13/10/2020 16:53	13/10/2020 20:11	13/10/2020 16:53	13/10/2020 20:11	3,29	67	220,76	CHI
20201070464	ABADIANIA	AA12050405	ANAPOLIS UNIVERSITARIO S1	13/10/2020 16:53	13/10/2020 19:25	13/10/2020 16:53	13/10/2020 19:25	2,52	15	37,84	CHI
20201070472	CALDAZINHA	SV12171341RE	DAIA S2	13/10/2020 16:55	13/10/2020 19:18	13/10/2020 16:55	13/10/2020 19:18	2,38	21	49,88	CHI
20201070472	BELA VISTA DE GOIAS	SV12171341RE	DAIA S2	13/10/2020 16:55	13/10/2020 19:18	13/10/2020 16:55	13/10/2020 19:18	2,38	1	2,38	CHI
20201070472	SILVANIA	SV12171341RE	DAIA S2	13/10/2020 16:55	13/10/2020 19:18	13/10/2020 16:55	13/10/2020 19:18	2,38	25	59,38	CHI
20201070670	CRISTALINA	KR12163676RE	PAMPLONA	13/10/2020 16:56	14/10/2020 10:36	13/10/2020 16:56	14/10/2020 10:36	17,67	21	370,99	CHI
20201070479	ABADIA DE GOIAS	10028417141	CARAJAS S1	13/10/2020 16:56	13/10/2020 20:39	13/10/2020 16:56	13/10/2020 20:39	3,71	1	3,71	CHI
20201070553	URUACU	UR11243604	URUACU	13/10/2020 16:56	13/10/2020 20:36	13/10/2020 16:56	13/10/2020 20:36	3,66	49	179,33	CHI
20201070725	CRISTALINA	KR12248700	CRISTALINA S2	13/10/2020 16:56	13/10/2020 19:55	13/10/2020 16:56	13/10/2020 19:55	2,97	20	59,44	CHI
20201070486	FORMOSA	FA21153685	ITUIQUIRA	13/10/2020 16:57	13/10/2020 18:40	13/10/2020 16:57	13/10/2020 18:40	1,72	1	1,72	CHI
20201071006	ALVORADA DO NORTE	AQ12161124	IACIARA S2	13/10/2020 16:57	14/10/2020 10:15	13/10/2020 16:57	14/10/2020 10:15	17,31	262	4535,37	CHI
20201070488	SENADOR CANEDO	190097413	SENADOR CANEDO	13/10/2020 16:57	13/10/2020 18:16	13/10/2020 16:57	13/10/2020 18:16	1,31	1	1,31	CHI
20201070642	CAMPOS VERDES	3790014069	SANTA TEREZINHA	13/10/2020 16:57	13/10/2020 23:05	13/10/2020 16:57	13/10/2020 23:05	6,12	1	6,12	CHI
20201070491	OURO VERDE DE GOIAS	OV12060189	NEROPOLIS S1	13/10/2020 16:57	14/10/2020 02:17	13/10/2020 16:57	14/10/2020 02:17	9,32	5	46,59	CHI
20201070493	AGUAS LINDAS DE GOIAS	4830298845	AGUAS LINDAS DE GOIAS S1	13/10/2020 16:58	13/10/2020 19:57	13/10/2020 16:58	13/10/2020 19:57	2,98	1	2,98	CHI
20201070496	BELA VISTA DE GOIAS	240007475	BELA VISTA S1	13/10/2020 16:58	13/10/2020 19:08	13/10/2020 16:58	13/10/2020 19:08	2,15	1	2,15	CHI
20201070736	ANAPOLIS	AN12390204	ANAPOLIS UNIVERSITARIO S1	13/10/2020 16:59	13/10/2020 19:15	13/10/2020 16:59	13/10/2020 19:15	2,27	2	4,53	CHI
20201070501	SERRANOPOLIS	SX21365441	CACHOEIRA ALTA	13/10/2020 17:00	15/10/2020 12:07	13/10/2020 17:00	15/10/2020 12:07	43,13	1	43,13	CHI
20201070506	ANAPOLIS	20183100	JUNDIAI S1	13/10/2020 17:00	13/10/2020 18:22	13/10/2020 17:00	13/10/2020 18:22	1,36	1	1,36	CHI
20201070509	POSSE	PS21265365	IACIARA S2	13/10/2020 17:01	13/10/2020 21:06	13/10/2020 17:01	13/10/2020 21:06	4,08	1	4,08	CHI
20201070514	JATAI	290193746	JATAI S3	13/10/2020 17:02	14/10/2020 09:44	13/10/2020 17:02	14/10/2020 09:44	16,69	1	16,69	CHI
20201070515	PLANALTINA	PI21107029	PLANALTINA	13/10/2020 17:02	14/10/2020 02:29	13/10/2020 17:02	14/10/2020 02:29	9,44	1	9,44	CHI
20201070520	GOIANIA	14926210	MEIA PONTE	13/10/2020 17:03	14/10/2020 02:59	13/10/2020 17:03	14/10/2020 02:59	9,92	1	9,92	CHI
20201070521	SANTA RITA DO ARAGUAIA	SU21129165	SANTA RITA DO ARAGUAIA	13/10/2020 17:03	14/10/2020 09:43	13/10/2020 17:03	14/10/2020 09:43	16,65	1	16,65	CHI
20201070522	MUTUNOPOLIS	MU12405206	MARA ROSA	13/10/2020 17:03	14/10/2020 01:08	13/10/2020 17:03	14/10/2020 01:08	8,07	10	80,67	CHI
20201070523	ANAPOLIS	20997024	ANAPOLIS UNIVERSITARIO S2	13/10/2020 17:04	13/10/2020 21:13	13/10/2020 17:04	13/10/2020 21:13	4,15	1	4,15	CHI
20201070524	BONOPOLIS	BX21333257	SAO MIGUEL DO ARAGUAIA	13/10/2020 17:04	13/10/2020 19:47	13/10/2020 17:04	13/10/2020 19:47	2,71	1	2,71	CHI
20201070718	DIORAMA	DI12060554	IPORA	13/10/2020 17:04	15/10/2020 01:08	13/10/2020 17:04	15/10/2020 01:08	32,05	7	224,38	CHI
202010176889	CAIAPONIA	CP21215415	MONTIVIDIU T	13/10/2020 17:05	14/10/2020 21:50	13/10/2020 17:05	14/10/2020 21:50	28,74	1	28,74	CHI
20201070537	PLANALTINA	PI21141035	PLANALTINA	13/10/2020 17:06	14/10/2020 02:03	13/10/2020 17:06	14/10/2020 02:03	8,95	1	8,95	CHI
20201070622	BURITINOPOLIS	MB12314303	IACIARA S2	13/10/2020 17:06	13/10/2020 20:29	13/10/2020 17:06	13/10/2020 20:29	3,37	2	6,75	CHI
20201070622	MAMBAI	MB12314303	IACIARA S2	13/10/2020 17:06	13/10/2020 20:29	13/10/2020 17:06	13/10/2020 20:29	3,37	4	13,49	CHI
20201065809	CAMPINACU	UC12197189	PORANGATU	13/10/2020 17:07	14/10/2020 11:06	13/10/2020 17:07	14/10/2020 08:57	15,84	62	982,17	CHI
20201065809	CAMPINACU	UC12239723	PORANGATU	13/10/2020 17:07	14/10/2020 11:06	13/10/2020 17:07	14/10/2020 11:06	17,98	4	71,93	CHI
20201065809	CAMPINACU	UC12239716	PORANGATU	13/10/2020 17:07	14/10/2020 11:06	14/10/2020 10:07	14/10/2020 11:06	0,97	31	30,22	CHI
20201071010	PEROLANDIA	DP12249731	JATAI S1	13/10/2020 17:08	14/10/2020 01:27	13/10/2020 17:08	13/10/2020 22:43	5,59	2	11,17	CHI
20201071010	PEROLANDIA	DP12249731	JATAI S1	13/10/2020 17:08	14/10/2020 01:27	13/10/2020 22:44	14/10/2020 00:43	1,98	2	3,95	CHI
20201071010	PEROLANDIA	DP12285778	JATAI S1	13/10/2020 17:08	14/10/2020 01:27	13/10/2020 17:08	14/10/2020 01:10	8,05	5	40,23	CHI
20201071010	MINEIROS	DP12272501LD	JATAI S1	13/10/2020 17:08	14/10/2020 01:27	13/10/2020 17:08	14/10/2020 01:27	8,32	3	24,97	CHI
20201071010	PEROLANDIA	DP12272501LD	JATAI S1	13/10/2020 17:08	14/10/2020 01:27	13/10/2020 17:08	14/10/2020 01:27	8,32	50	416,17	CHI
20201070754	POSSE	PS12232231	IACIARA S2	13/10/2020 17:10	13/10/2020 23:34	13/10/2020 17:10	13/10/2020 23:34	6,40	16	102,38	CHI
20201071510	NIQUELANDIA	NQ12353777	URUACU	13/10/2020 17:11	14/10/2020 09:40	13/10/2020 17:11	14/10/2020 09:40	16,47	21	345,81	CHI
20201070573	ANAPOLIS	10023151550	ANAPOLIS UNIVERSITARIO S2	13/10/2020 17:12	14/10/2020 00:12	13/10/2020 17:12	14/10/2020 00:12	6,99	1	6,99	CHI
20201070574	CRISTALINA	KR21344638	CRISTALINA S2	13/10/2020 17:13	13/10/2020 21:19	13/10/2020 17:13	13/10/2020 21:19	4,10	1	4,10	CHI
20201070731	CRIXAS	CX12380748	SERRA DO OURO	13/10/2020 17:13	13/10/2020 19:23	13/10/2020 17:13	13/10/2020 19:23	2,15	26	55,99	CHI

20201070645	FORMOSA	FA10395393	ITIQUEIRA	13/10/2020 17:14	14/10/2020 01:43	13/10/2020 17:14	13/10/2020 17:17	0,05	119	6,54	CHI
20201070645	VILA BOA	FB10408313	IACIARA S2	13/10/2020 17:14	14/10/2020 01:43	13/10/2020 17:23	13/10/2020 17:29	0,09	1382	123,61	CHI
20201070645	FLORES DE GOIAS	FB10408313	IACIARA S2	13/10/2020 17:14	14/10/2020 01:43	13/10/2020 17:23	13/10/2020 17:29	0,09	72	6,44	CHI
20201070645	VILA BOA	FB10408313	IACIARA S2	13/10/2020 17:14	14/10/2020 01:43	13/10/2020 17:23	13/10/2020 17:29	0,09	63	5,64	CHI
20201070645	FORMOSA	FA10410992	ITIQUEIRA	13/10/2020 17:14	14/10/2020 01:43	13/10/2020 17:14	13/10/2020 18:59	1,76	813	1433,59	CHI
20201070645	FORMOSA	FA10401450	ITIQUEIRA	13/10/2020 17:14	14/10/2020 01:43	13/10/2020 17:14	13/10/2020 18:59	1,76	507	894,01	CHI
20201070645	VILA BOA	FA10410992	ITIQUEIRA	13/10/2020 17:14	14/10/2020 01:43	13/10/2020 17:14	13/10/2020 18:59	1,76	4	7,05	CHI
20201070645	VILA BOA	FA10410992	ITIQUEIRA	13/10/2020 17:14	14/10/2020 01:43	13/10/2020 17:14	13/10/2020 20:58	3,73	5	18,67	CHI
20201070645	FLORES DE GOIAS	FA10410992	ITIQUEIRA	13/10/2020 17:14	14/10/2020 01:43	13/10/2020 17:14	13/10/2020 20:58	3,73	2	7,47	CHI
20201070645	SAO JOAO D ALIANCA	FA10410992	ITIQUEIRA	13/10/2020 17:14	14/10/2020 01:43	13/10/2020 17:14	13/10/2020 20:58	3,73	224	836,20	CHI
20201070645	VILA BOA	FA10401450	ITIQUEIRA	13/10/2020 17:14	14/10/2020 01:43	13/10/2020 17:14	13/10/2020 20:58	3,73	22	82,13	CHI
20201070645	FORMOSA	FA10410992	ITIQUEIRA	13/10/2020 17:14	14/10/2020 01:43	13/10/2020 17:14	13/10/2020 20:58	3,73	584	2180,10	CHI
20201070645	FORMOSA	FA10401450	ITIQUEIRA	13/10/2020 17:14	14/10/2020 01:43	13/10/2020 17:14	13/10/2020 20:58	3,73	12	44,80	CHI
20201070645	FORMOSA	FA10410992	ITIQUEIRA	13/10/2020 17:14	14/10/2020 01:43	13/10/2020 20:58	13/10/2020 21:32	0,57	813	462,51	CHI
20201070645	FORMOSA	FA10410992	ITIQUEIRA	13/10/2020 17:14	14/10/2020 01:43	13/10/2020 20:58	13/10/2020 21:32	0,57	957	544,43	CHI
20201070645	VILA BOA	FA10410992	ITIQUEIRA	13/10/2020 17:14	14/10/2020 01:43	13/10/2020 20:58	13/10/2020 21:32	0,57	4	2,28	CHI
20201070645	VILA BOA	FA10410992	ITIQUEIRA	13/10/2020 17:14	14/10/2020 01:43	13/10/2020 20:58	13/10/2020 21:32	0,57	7	3,98	CHI
20201070645	VILA BOA	FA13067874	ITIQUEIRA	13/10/2020 17:14	14/10/2020 01:43	13/10/2020 21:24	13/10/2020 23:51	2,45	2	4,91	CHI
20201070645	FORMOSA	FA13067874	ITIQUEIRA	13/10/2020 17:14	14/10/2020 01:43	13/10/2020 21:24	13/10/2020 23:51	2,45	12	29,44	CHI
20201070645	VILA BOA	FA10401450	ITIQUEIRA	13/10/2020 17:14	14/10/2020 01:43	13/10/2020 17:14	14/10/2020 00:20	7,11	180	1279,55	CHI
20201070645	FORMOSA	FA10401450	ITIQUEIRA	13/10/2020 17:14	14/10/2020 01:43	13/10/2020 17:14	14/10/2020 00:20	7,11	70	497,60	CHI
20201070645	FORMOSA	FA10410992	ITIQUEIRA	13/10/2020 17:14	14/10/2020 01:43	14/10/2020 00:26	14/10/2020 00:35	0,15	813	122,18	CHI
20201070645	VILA BOA	FA10410992	ITIQUEIRA	13/10/2020 17:14	14/10/2020 01:43	14/10/2020 00:26	14/10/2020 00:35	0,15	9	1,35	CHI
20201070645	FORMOSA	FA10410992	ITIQUEIRA	13/10/2020 17:14	14/10/2020 01:43	14/10/2020 00:26	14/10/2020 00:35	0,15	969	145,62	CHI
20201070645	VILA BOA	FA10410992	ITIQUEIRA	13/10/2020 17:14	14/10/2020 01:43	14/10/2020 00:26	14/10/2020 00:35	0,15	4	0,60	CHI
20201070645	VILA BOA	FA13344344	ITIQUEIRA	13/10/2020 17:14	14/10/2020 01:43	14/10/2020 00:26	14/10/2020 01:24	0,97	2	1,94	CHI
20201070645	FORMOSA	FA13344344	ITIQUEIRA	13/10/2020 17:14	14/10/2020 01:43	14/10/2020 00:26	14/10/2020 01:24	0,97	8	7,74	CHI
20201070645	FORMOSA	FA13067874	ITIQUEIRA	13/10/2020 17:14	14/10/2020 01:43	13/10/2020 21:24	14/10/2020 01:43	4,32	584	2524,18	CHI
20201070645	VILA BOA	FA13067874	ITIQUEIRA	13/10/2020 17:14	14/10/2020 01:43	13/10/2020 21:24	14/10/2020 01:43	4,32	5	21,61	CHI
20201070645	FLORES DE GOIAS	FA13067874	ITIQUEIRA	13/10/2020 17:14	14/10/2020 01:43	13/10/2020 21:24	14/10/2020 01:43	4,32	2	8,64	CHI
20201070645	VILA BOA	FA13401451B	ITIQUEIRA	13/10/2020 17:14	14/10/2020 01:43	13/10/2020 21:24	14/10/2020 01:43	4,32	20	86,44	CHI
20201070645	SAO JOAO D ALIANCA	FA13067874	ITIQUEIRA	13/10/2020 17:14	14/10/2020 01:43	13/10/2020 21:24	14/10/2020 01:43	4,32	226	976,82	CHI
20201070645	VILA BOA	VB12204775RE	ITIQUEIRA	13/10/2020 17:14	14/10/2020 01:43	14/10/2020 00:26	14/10/2020 01:43	1,29	178	228,93	CHI
20201070645	FORMOSA	VB12204775RE	ITIQUEIRA	13/10/2020 17:14	14/10/2020 01:43	14/10/2020 00:26	14/10/2020 01:43	1,29	62	79,74	CHI
20201070810	AGUAS LINDAS DE GOIAS	LA11168617	AGUAS LINDAS DE GOIAS S1	13/10/2020 17:14	13/10/2020 19:26	13/10/2020 17:14	13/10/2020 19:26	2,19	40	87,76	CHI
20201072294	CAIAPONIA	CP12223099	PALESTINA	13/10/2020 17:14	14/10/2020 10:08	13/10/2020 17:14	14/10/2020 10:08	16,89	21	354,64	CHI
20201070659	CABECEIRAS	03740424	ITIQUEIRA	13/10/2020 17:17	13/10/2020 22:00	13/10/2020 17:17	13/10/2020 20:11	2,90	15	43,53	CHI
20201070659	FORMOSA	03740424	ITIQUEIRA	13/10/2020 17:17	13/10/2020 22:00	13/10/2020 17:17	13/10/2020 20:11	2,90	6	17,41	CHI
20201070659	CABECEIRAS	03740424	ITIQUEIRA	13/10/2020 17:17	13/10/2020 22:00	13/10/2020 17:17	13/10/2020 21:13	3,94	13	51,26	CHI
20201070659	CABECEIRAS	03740424	ITIQUEIRA	13/10/2020 17:17	13/10/2020 22:00	13/10/2020 17:17	13/10/2020 21:45	4,46	4	17,86	CHI
20201070659	CABECEIRAS	03740424	ITIQUEIRA	13/10/2020 17:17	13/10/2020 22:00	13/10/2020 17:17	13/10/2020 22:00	4,72	20	94,44	CHI
20201070590	INHUMAS	30086784	INHUMAS S2	13/10/2020 17:17	14/10/2020 09:11	13/10/2020 17:17	14/10/2020 09:11	15,90	1	15,90	CHI
20201070604	NIQUELANDIA	NQ21243456	URUACU	13/10/2020 17:17	14/10/2020 17:56	13/10/2020 17:17	14/10/2020 17:56	24,64	1	24,64	CHI
20201070593	CACU	1140042716	CACHOEIRA ALTA	13/10/2020 17:17	13/10/2020 18:05	13/10/2020 17:17	13/10/2020 18:05	0,79	1	0,79	CHI
20201070594	SILVANIA	10001034063	VIANOPOLIS	13/10/2020 17:17	13/10/2020 18:16	13/10/2020 17:17	13/10/2020 18:16	0,98	1	0,98	CHI
20201070596	MORRINHOS	MR12093208	MORRINHOS	13/10/2020 17:17	13/10/2020 21:00	13/10/2020 17:17	13/10/2020 21:00	3,70	5	18,51	CHI
20201070602	BELA VISTA DE GOIAS	240070586	BELA VISTA S1	13/10/2020 17:18	14/10/2020 01:55	13/10/2020 17:18	14/10/2020 01:55	8,61	1	8,61	CHI
20201070616	JARAGUA	JA11191327	JARAGUA	13/10/2020 17:20	14/10/2020 01:40	13/10/2020 17:20	14/10/2020 01:40	8,32	104	865,22	CHI
20201070617	NIQUELANDIA	NQ12243364RE	URUACU	13/10/2020 17:21	16/10/2020 00:25	13/10/2020 17:21	14/10/2020 19:12	25,85	3	77,54	CHI
20201070617	MARA ROSA	NQ13375603	URUACU	13/10/2020 17:21	16/10/2020 00:25	13/10/2020 17:21	15/10/2020 14:40	45,31	1	45,31	CHI
20201070617	NIQUELANDIA	NQ13375603	URUACU	13/10/2020 17:21	16/10/2020 00:25	13/10/2020 17:21	15/10/2020 14:40	45,31	11	498,44	CHI
20201070617	NIQUELANDIA	NQ13375603	URUACU	13/10/2020 17:21	16/10/2020 00:25	15/10/2020 02:20	15/10/2020 14:40	12,33	1	12,33	CHI
20201070617	NIQUELANDIA	NQ13375603	URUACU	13/10/2020 17:21	16/10/2020 00:25	13/10/2020 17:21	16/10/2020 00:25	55,08	1	55,08	CHI
20201070617	NIQUELANDIA	6736103	URUACU	13/10/2020 17:21	16/10/2020 00:25	15/10/2020 02:20	16/10/2020 00:25	22,10	1	22,10	CHI
20201070620	PETROLINA DE GOIAS	PG21222686	PETROLINA	13/10/2020 17:21	14/10/2020 12:30	13/10/2020 17:21	14/10/2020 12:30	19,14	2	38,28	CHI
20201070621	RIO VERDE	630051872	RIO VERDE S1	13/10/2020 17:21	14/10/2020 10:14	13/10/2020 17:21	14/10/2020 10:14	16,87	1	16,87	CHI
20201070941	GUARINOS	GF12202065	SANTA TEREZINHA	13/10/2020 17:22	14/10/2020 10:07	13/10/2020 17:22	14/10/2020 10:07	16,75	8	133,99	CHI
20201070710	AGUAS LINDAS DE GOIAS	LA11148967	AGUAS LINDAS DE GOIAS S1	13/10/2020 17:22	13/10/2020 19:00	13/10/2020 17:22	13/10/2020 19:00	1,62	171	277,73	CHI

20201070633	SANTA HELENA DE GOIAS	SH12000198	IPEGUARI	13/10/2020 17:22	14/10/2020 09:11	13/10/2020 17:22	14/10/2020 09:11	15,80	7	110,62	CHI
20201070633	RIO VERDE	SH12000198	IPEGUARI	13/10/2020 17:22	14/10/2020 09:11	13/10/2020 17:22	14/10/2020 09:11	15,80	4	63,21	CHI
20201070643	CALDAS NOVAS	CN11163513	CALDAS NOVAS S2	13/10/2020 17:24	13/10/2020 22:19	13/10/2020 17:24	13/10/2020 22:19	4,90	65	318,72	CHI
20201070647	CAMPOS VERDES	VD21237352	SANTA TEREZINHA	13/10/2020 17:25	14/10/2020 11:21	13/10/2020 17:25	14/10/2020 11:21	17,92	1	17,92	CHI
20201070651	ITUMBIARA	IT21305367	ITUMBIARA NOVA	13/10/2020 17:26	13/10/2020 18:52	13/10/2020 17:26	13/10/2020 18:52	1,43	1	1,43	CHI
20201070655	GOIANIA	10991955	FERROVIARIO S1	13/10/2020 17:26	13/10/2020 21:34	13/10/2020 17:26	13/10/2020 21:34	4,14	1	4,14	CHI
20201071513	CAMPINORTE	CR10404187	MARA ROSA	13/10/2020 17:28	13/10/2020 22:31	13/10/2020 17:28	13/10/2020 19:23	1,92	17	32,71	CHI
20201071513	CAMPINORTE	UR13025408	MARA ROSA	13/10/2020 17:28	13/10/2020 22:31	13/10/2020 22:10	13/10/2020 22:31	0,34	17	5,79	CHI
20201070663	NIQUELANDIA	NQ12146984	URUACU	13/10/2020 17:28	14/10/2020 10:50	13/10/2020 17:28	14/10/2020 10:50	17,36	89	1545,29	CHI
20201070808	PADRE BERNARDO	PB12261645	PADRE BERNARDO	13/10/2020 17:28	14/10/2020 01:50	13/10/2020 17:28	14/10/2020 01:50	8,36	9	75,21	CHI
20201070808	PADRE BERNARDO	PB12261645	PADRE BERNARDO	13/10/2020 17:28	14/10/2020 01:50	13/10/2020 23:32	14/10/2020 01:50	2,30	68	156,57	CHI
20201071073	ABADIANIA	AA11000008	ANAPOLIS UNIVERSITARIO S1	13/10/2020 17:28	13/10/2020 19:27	13/10/2020 17:28	13/10/2020 19:27	1,97	120	236,40	CHI
20201070676	APARECIDA DE GOIANIA	10000821789	INDEPENDENCIA S1	13/10/2020 17:29	14/10/2020 02:04	13/10/2020 17:29	14/10/2020 02:04	8,57	1	8,57	CHI
20201071568	SAO LUIZ DO NORTE	SZ12375610	ITAPACI	13/10/2020 17:30	14/10/2020 15:47	13/10/2020 17:30	14/10/2020 15:47	22,28	1	22,28	CHI
20201070679	UIRAPURU	UP12190106	SANTA TEREZINHA	13/10/2020 17:30	14/10/2020 01:21	13/10/2020 17:30	14/10/2020 01:21	7,85	12	94,18	CHI
20201070682	CORUMBA DE GOIAS	CB21295518	CORUMBA	13/10/2020 17:30	14/10/2020 09:03	13/10/2020 17:30	14/10/2020 09:03	15,54	1	15,54	CHI
20201070695	PETROLINA DE GOIAS	PG12070564	PETROLINA	13/10/2020 17:33	14/10/2020 13:23	13/10/2020 17:33	14/10/2020 13:23	19,83	4	79,31	CHI
20201070697	OUVIDOR	OU21131019	CATALAO S1	13/10/2020 17:33	13/10/2020 21:30	13/10/2020 17:33	13/10/2020 21:30	3,94	2	7,88	CHI
20201071247	FORMOSA	FA12322759	ITUIQUIRA	13/10/2020 17:34	13/10/2020 23:52	13/10/2020 17:34	13/10/2020 23:52	6,30	36	226,67	CHI
20201071247	DISTRITO FEDERAL	FA12322759	ITUIQUIRA	13/10/2020 17:34	13/10/2020 23:52	13/10/2020 17:34	13/10/2020 23:52	6,30	1	6,30	CHI
20201070701	MINEIROS	MY12324528	PARQUE DAS EMAS	13/10/2020 17:34	14/10/2020 11:18	13/10/2020 17:34	14/10/2020 11:18	17,72	4	70,90	CHI
20201070703	CALDAS NOVAS	CN12186195	SERRA DE CALDAS	13/10/2020 17:34	13/10/2020 20:23	13/10/2020 17:34	13/10/2020 20:23	2,81	7	19,65	CHI
20201070706	SERRANOPOLIS	SX21189496	CHAPADAO DO CEU	13/10/2020 17:35	14/10/2020 01:02	13/10/2020 17:35	14/10/2020 01:02	7,45	1	7,45	CHI
20201070711	PORANGATU	PO21300996	PORANGATU	13/10/2020 17:35	13/10/2020 22:17	13/10/2020 17:35	13/10/2020 22:17	4,69	1	4,69	CHI
20201062008	NIQUELANDIA	NQ12095753LD	NIQUELANDIA SUBTRANSMISSAO	13/10/2020 17:36	14/10/2020 00:13	13/10/2020 17:36	14/10/2020 00:13	6,61	107	707,45	CHI
20201070719	SERRANOPOLIS	DJ12135998	CHAPADAO DO CEU	13/10/2020 17:37	14/10/2020 00:12	13/10/2020 17:37	14/10/2020 00:12	6,58	3	19,75	CHI
20201070735	VIANOPOLIS	VN21060809	VIANOPOLIS	13/10/2020 17:39	13/10/2020 19:14	13/10/2020 17:39	13/10/2020 19:14	1,57	1	1,57	CHI
20201070840	IPAMERI	IP12107641	IPAMERI	13/10/2020 17:40	13/10/2020 22:52	13/10/2020 17:40	13/10/2020 22:52	5,20	21	109,11	CHI
20201070741	CALDAS NOVAS	760269907	SERRA DE CALDAS	13/10/2020 17:40	13/10/2020 22:03	13/10/2020 17:40	13/10/2020 22:03	4,38	1	4,38	CHI
20201070974	GOIANIA	GN12000660	CAMPINAS S2	13/10/2020 17:42	13/10/2020 21:10	13/10/2020 17:42	13/10/2020 21:10	3,47	149	517,44	CHI
20201070749	INHUMAS	30140250	INHUMAS S2	13/10/2020 17:42	14/10/2020 10:04	13/10/2020 17:42	14/10/2020 10:04	16,36	1	16,36	CHI
20201070750	APARECIDA DE GOIANIA	AP12193733	INDEPENDENCIA S1	13/10/2020 17:42	13/10/2020 18:42	13/10/2020 17:42	13/10/2020 18:42	0,98	155	152,63	CHI
20201071705	NIQUELANDIA	NQ12148151RE	NIQUELANDIA SUBTRANSMISSAO	13/10/2020 17:43	14/10/2020 00:13	13/10/2020 17:43	14/10/2020 00:13	6,50	6	39,00	CHI
20201070753	INHUMAS	8598291	INHUMAS S2	13/10/2020 17:43	14/10/2020 10:52	13/10/2020 17:43	14/10/2020 10:52	17,16	1	17,16	CHI
20201071123	IACIARA	IA12394108	IACIARA S1	13/10/2020 17:44	13/10/2020 20:29	13/10/2020 17:44	13/10/2020 20:29	2,74	7	19,20	CHI
20201070771	CRIXAS	2490015777	SERRA DO OURO	13/10/2020 17:46	15/10/2020 00:20	13/10/2020 17:46	15/10/2020 00:20	30,56	1	30,56	CHI
20201070773	NOVA VENEZA	NV21010330	INHUMAS S1	13/10/2020 17:46	13/10/2020 19:53	13/10/2020 17:46	13/10/2020 19:53	2,11	4	8,43	CHI
20201070774	TURVANIA	TV21005594	FIRMINOPOLIS S1	13/10/2020 17:47	14/10/2020 09:32	13/10/2020 17:47	14/10/2020 09:32	15,75	1	15,75	CHI
20201070778	CRISTALINA	1060038484	CRISTALINA S1	13/10/2020 17:47	13/10/2020 20:49	13/10/2020 17:47	13/10/2020 20:49	3,03	1	3,03	CHI
20201070781	ANICUNS	910027420	ANICUNS	13/10/2020 17:47	13/10/2020 20:26	13/10/2020 17:47	13/10/2020 20:26	2,64	1	2,64	CHI
20201070782	CRISTALINA	KR21133664	CRISTALINA S2	13/10/2020 17:47	13/10/2020 20:53	13/10/2020 17:47	13/10/2020 20:53	3,08	2	6,17	CHI
20201070783	ANAPOLIS	AN11285396	ANAPOLIS UNIVERSITARIO S2	13/10/2020 17:48	13/10/2020 18:57	13/10/2020 17:48	13/10/2020 18:57	1,15	161	185,78	CHI
20201071777	NIQUELANDIA	NQ12243394RE	NIQUELANDIA SUBTRANSMISSAO	13/10/2020 17:48	14/10/2020 16:22	13/10/2020 17:48	14/10/2020 16:22	22,56	36	812,01	CHI
20201070794	POSSE	PS11389693	IACIARA S2	13/10/2020 17:49	13/10/2020 22:37	13/10/2020 17:49	13/10/2020 22:37	4,79	9	43,12	CHI
20201070795	AMORINOPOLIS	AM21193757	IPORA	13/10/2020 17:49	14/10/2020 11:50	13/10/2020 17:49	14/10/2020 11:50	18,01	1	18,01	CHI
20201070797	MINEIROS	MY21326735	PARQUE DAS EMAS	13/10/2020 17:49	13/10/2020 18:50	13/10/2020 17:49	13/10/2020 18:50	1,00	1	1,00	CHI
20201070866	PIRENOPOLIS	PV12000067	CORUMBA	13/10/2020 17:49	14/10/2020 00:15	13/10/2020 17:49	14/10/2020 00:15	6,42	19	121,95	CHI
20201070826	PIRENOPOLIS	PV10397556	CORUMBA	13/10/2020 17:52	13/10/2020 22:36	13/10/2020 17:52	13/10/2020 20:43	2,85	624	1777,01	CHI
20201070826	PIRENOPOLIS	PV13275575	CORUMBA	13/10/2020 17:52	13/10/2020 22:36	13/10/2020 17:52	13/10/2020 21:45	3,89	261	1016,52	CHI
20201070826	GOIANESIA	PV13275575	CORUMBA	13/10/2020 17:52	13/10/2020 22:36	13/10/2020 17:52	13/10/2020 21:45	3,89	11	42,84	CHI
20201070826	JARAGUA	PV13275575	CORUMBA	13/10/2020 17:52	13/10/2020 22:36	13/10/2020 17:52	13/10/2020 21:45	3,89	4	15,58	CHI
20201070826	ANAPOLIS	PV13275575	CORUMBA	13/10/2020 17:52	13/10/2020 22:36	13/10/2020 17:52	13/10/2020 21:45	3,89	1	3,89	CHI
20201070826	VILA PROPICIO	PV13275575	CORUMBA	13/10/2020 17:52	13/10/2020 22:36	13/10/2020 17:52	13/10/2020 21:45	3,89	16	62,32	CHI
20201070826	PIRENOPOLIS	PV13384830	CORUMBA	13/10/2020 17:52	13/10/2020 22:36	13/10/2020 17:52	13/10/2020 22:28	4,60	126	579,81	CHI
20201070826	PIRENOPOLIS	PV12221408	CORUMBA	13/10/2020 17:52	13/10/2020 22:36	13/10/2020 17:52	13/10/2020 22:36	4,74	13	61,57	CHI
20201070824	INDIARA	IY12206402	CEZARINA	13/10/2020 17:53	15/10/2020 06:04	13/10/2020 17:53	15/10/2020 06:04	36,19	4	144,77	CHI
20201070849	JATAI	JT12134421	JATAI S1	13/10/2020 17:54	14/10/2020 12:07	13/10/2020 17:54	14/10/2020 12:07	18,21	1	18,21	CHI
20201070833	APARECIDA DE GOIANIA	10012936233	INDEPENDENCIA S1	13/10/2020 17:54	13/10/2020 19:39	13/10/2020 17:54	13/10/2020 19:39	1,73	1	1,73	CHI

20201070834	HIDROLANDIA	HD21007389	CEPAIGO S2	13/10/2020 17:55	14/10/2020 02:18	13/10/2020 17:55	14/10/2020 02:18	8,38	1	8,38	CHI
20201070839	OURO VERDE DE GOIAS	PG12014304	PETROLINA	13/10/2020 17:55	14/10/2020 09:40	13/10/2020 17:55	14/10/2020 09:40	15,74	1	15,74	CHI
20201070839	PETROLINA DE GOIAS	PG12014304	PETROLINA	13/10/2020 17:55	14/10/2020 09:40	13/10/2020 17:55	14/10/2020 09:40	15,74	3	47,22	CHI
20201070843	PEROLANDIA	DP21169578	PARQUE DAS EMAS	13/10/2020 17:55	14/10/2020 10:59	13/10/2020 17:55	14/10/2020 10:59	17,05	1	17,05	CHI
20201071026	ANAPOLIS	AN12000037	ANAPOLIS UNIVERSITARIO S2	13/10/2020 17:56	13/10/2020 20:59	13/10/2020 17:56	13/10/2020 20:59	3,04	455	1384,72	CHI
20201071752	FORMOSA	FA12146108	ITUIQUIRA	13/10/2020 17:57	13/10/2020 23:17	13/10/2020 17:57	13/10/2020 23:17	5,33	33	175,92	CHI
20201070858	SAO JOAO D ALIANCA	FB12106993	FLORES DE GOIAS	13/10/2020 17:57	13/10/2020 18:54	13/10/2020 17:57	13/10/2020 18:54	0,93	5	4,67	CHI
20201070858	FORMOSA	FB12106993	FLORES DE GOIAS	13/10/2020 17:57	13/10/2020 18:54	13/10/2020 17:57	13/10/2020 18:54	0,93	9	8,40	CHI
20201070858	FLORES DE GOIAS	FB12106993	FLORES DE GOIAS	13/10/2020 17:57	13/10/2020 18:54	13/10/2020 17:57	13/10/2020 18:54	0,93	14	13,07	CHI
20201070864	PARANAIGUARA	PC11380653	CACHOEIRA ALTA	13/10/2020 17:58	13/10/2020 19:38	13/10/2020 17:58	13/10/2020 19:38	1,66	2	3,32	CHI
20201070863	PETROLINA DE GOIAS	PG21337653	PETROLINA	13/10/2020 17:58	14/10/2020 14:10	13/10/2020 17:58	14/10/2020 14:10	20,19	3	60,57	CHI
20201070868	ANAPOLIS	20957774	JUNDIAI S1	13/10/2020 17:59	13/10/2020 19:16	13/10/2020 17:59	13/10/2020 19:16	1,29	1	1,29	CHI
20201071410	SAO LUIZ DO NORTE	SZ11371681	ITAPACI	13/10/2020 18:01	14/10/2020 07:47	13/10/2020 18:01	14/10/2020 07:47	13,77	55	757,09	CHI
20201070884	CORREGO DO OURO	CO12054671	FIRMINOPOLIS S2	13/10/2020 18:01	14/10/2020 10:56	13/10/2020 18:01	14/10/2020 10:56	16,91	3	50,72	CHI
20201070887	URUACU	640077304	URUACU	13/10/2020 18:02	14/10/2020 10:30	13/10/2020 18:02	14/10/2020 10:30	16,46	1	16,46	CHI
20201071931	JANDAIA	JD11244804	PALMEIRAS	13/10/2020 18:02	14/10/2020 02:57	13/10/2020 18:02	14/10/2020 02:57	8,91	46	409,82	CHI
20201071241	URUACU	UR11135596	URUACU	13/10/2020 18:03	13/10/2020 22:22	13/10/2020 18:03	13/10/2020 22:22	4,31	189	814,33	CHI
20201070913	RUBIATABA	RB21126613	RUBIATABA	13/10/2020 18:04	14/10/2020 08:20	13/10/2020 18:04	14/10/2020 08:20	14,26	1	14,26	CHI
2020101300031	PORTEIRAO	11301	RIO DOS BOIS	13/10/2020 18:05	13/10/2020 18:12	13/10/2020 18:05	13/10/2020 18:12	0,12	4	0,47	CHI
20201071569	SAO LUIZ DO NORTE	SZ11090339	ITAPACI	13/10/2020 18:05	14/10/2020 08:19	13/10/2020 18:05	14/10/2020 08:19	14,22	177	2516,50	CHI
20201070919	ANAPOLIS	AN21135399	ANAPOLIS UNIVERSITARIO S2	13/10/2020 18:06	13/10/2020 19:28	13/10/2020 18:06	13/10/2020 19:28	1,37	1	1,37	CHI
20201070927	PADRE BERNARDO	PB12255470	PADRE BERNARDO	13/10/2020 18:07	13/10/2020 20:14	13/10/2020 18:07	13/10/2020 20:14	2,12	6	12,69	CHI
20201070934	PORANGATU	PO12262621	PORANGATU	13/10/2020 18:07	13/10/2020 19:39	13/10/2020 18:07	13/10/2020 19:39	1,52	362	550,64	CHI
20201070938	ITAPACI	100026333	ITAPACI	13/10/2020 18:08	13/10/2020 22:48	13/10/2020 18:08	13/10/2020 22:48	4,66	1	4,66	CHI
20201070939	MINEIROS	1390007562	PARQUE DAS EMAS	13/10/2020 18:08	14/10/2020 09:55	13/10/2020 18:08	14/10/2020 09:55	15,77	1	15,77	CHI
20201070945	NIQUELANDIA	NQ11349211	NIQUELANDIA SUBTRANSMISSAO	13/10/2020 18:09	14/10/2020 22:14	13/10/2020 18:09	14/10/2020 22:14	28,08	16	449,26	CHI
20201071356	COCALZINHO DE GOIAS	ZN11075875	COCALZINHO	13/10/2020 18:09	13/10/2020 20:25	13/10/2020 18:09	13/10/2020 20:25	2,26	30	67,77	CHI
20201070948	VALPARAISO DE GOIAS	10004413553	PACAEMBU S2	13/10/2020 18:09	14/10/2020 00:03	13/10/2020 18:09	14/10/2020 00:03	5,89	1	5,89	CHI
20201070951	AGUAS LINDAS DE GOIAS	4830452627	AGUAS LINDAS DE GOIAS S1	13/10/2020 18:10	13/10/2020 21:42	13/10/2020 18:10	13/10/2020 21:42	3,53	1	3,53	CHI
20201070957	VIANOPOLIS	510046101	VIANOPOLIS	13/10/2020 18:10	13/10/2020 19:22	13/10/2020 18:10	13/10/2020 19:22	1,19	1	1,19	CHI
20201071099	PORANGATU	PO11252131	PORANGATU	13/10/2020 18:11	13/10/2020 23:08	13/10/2020 18:11	13/10/2020 23:08	4,95	59	292,00	CHI
20201070961	HIDROLANDIA	VJ21235143	GUAPO S2	13/10/2020 18:11	14/10/2020 00:05	13/10/2020 18:11	14/10/2020 00:05	5,90	1	5,90	CHI
20201071204	FORMOSA	03740414	ITUIQUIRA	13/10/2020 18:11	13/10/2020 23:32	13/10/2020 18:11	13/10/2020 18:15	0,07	16	1,13	CHI
20201071204	DISTRITO FEDERAL	03740414	ITUIQUIRA	13/10/2020 18:11	13/10/2020 23:32	13/10/2020 18:11	13/10/2020 18:28	0,27	2	0,55	CHI
20201071204	FORMOSA	03740414	ITUIQUIRA	13/10/2020 18:11	13/10/2020 23:32	13/10/2020 18:11	13/10/2020 18:28	0,27	16	4,39	CHI
20201071204	FORMOSA	FA10389092	ITUIQUIRA	13/10/2020 18:11	13/10/2020 23:32	13/10/2020 18:18	13/10/2020 18:31	0,21	16	3,43	CHI
20201071204	DISTRITO FEDERAL	03740414	ITUIQUIRA	13/10/2020 18:11	13/10/2020 23:32	13/10/2020 18:29	13/10/2020 23:32	5,06	2	10,11	CHI
20201071204	FORMOSA	03740414	ITUIQUIRA	13/10/2020 18:11	13/10/2020 23:32	13/10/2020 18:29	13/10/2020 23:32	5,06	16	80,89	CHI
20201070966	JATAI	JT11354983	JATAI S1	13/10/2020 18:11	14/10/2020 00:33	13/10/2020 18:11	14/10/2020 00:33	6,35	1	6,35	CHI
20201070976	GOIANIA	14431658	CAMPINAS S2	13/10/2020 18:13	13/10/2020 21:04	13/10/2020 18:13	13/10/2020 21:04	2,84	1	2,84	CHI
20201071496	VALPARAISO DE GOIAS	VA11192850	PACAEMBU S2	13/10/2020 18:13	13/10/2020 20:26	13/10/2020 18:13	13/10/2020 20:26	2,20	214	471,75	CHI
20201070984	MINACU	IH12220694	MINACU	13/10/2020 18:14	14/10/2020 05:04	13/10/2020 18:14	14/10/2020 05:04	10,83	5	54,14	CHI
20201071180	PORANGATU	PO11218984	PORANGATU	13/10/2020 18:14	13/10/2020 20:37	13/10/2020 18:14	13/10/2020 20:37	2,37	24	56,95	CHI
20201070987	MINEIROS	MY21308760	PARQUE DAS EMAS	13/10/2020 18:14	14/10/2020 10:18	13/10/2020 18:14	14/10/2020 10:18	16,06	1	16,06	CHI
20201070988	SAO MIGUEL DO ARAGUAIA	SM12192361	SAO MIGUEL DO ARAGUAIA	13/10/2020 18:14	13/10/2020 21:11	13/10/2020 18:14	13/10/2020 21:11	2,94	165	484,78	CHI
20201070989	GOUVELANDIA	GB21303173	QUIRINOPOLIS	13/10/2020 18:14	13/10/2020 19:40	13/10/2020 18:14	13/10/2020 19:40	1,42	1	1,42	CHI
20201070998	GOIAS	90066686	GOIAS	13/10/2020 18:16	14/10/2020 05:56	13/10/2020 18:16	14/10/2020 05:56	11,66	1	11,66	CHI
20201071003	FORMOSA	FA21320612	ITUIQUIRA	13/10/2020 18:16	13/10/2020 19:08	13/10/2020 18:16	13/10/2020 19:08	0,85	1	0,85	CHI
20201071238	CRISTALINA	KR10413343	PAMPLONA	13/10/2020 18:17	14/10/2020 11:45	13/10/2020 18:17	13/10/2020 18:21	0,06	46	2,84	CHI
20201071238	LUZIANIA	03460414	PAMPLONA	13/10/2020 18:17	14/10/2020 11:45	13/10/2020 18:17	14/10/2020 11:19	17,03	71	1208,87	CHI
20201071238	CRISTALINA	03460414	PAMPLONA	13/10/2020 18:17	14/10/2020 11:45	13/10/2020 18:17	14/10/2020 11:19	17,03	16	272,42	CHI
20201071238	CRISTALINA	KR13118895	PAMPLONA	13/10/2020 18:17	14/10/2020 11:45	13/10/2020 18:17	14/10/2020 11:45	17,47	25	436,74	CHI
20201071238	LUZIANIA	KR13118895	PAMPLONA	13/10/2020 18:17	14/10/2020 11:45	13/10/2020 18:17	14/10/2020 11:45	17,47	1	17,47	CHI
20201071238	CRISTALINA	KR13118895	PAMPLONA	13/10/2020 18:17	14/10/2020 11:45	13/10/2020 18:21	14/10/2020 11:45	17,41	7	121,86	CHI
20201071013	NEROPOLIS	NR11199321	NEROPOLIS S2	13/10/2020 18:17	13/10/2020 21:30	13/10/2020 18:17	13/10/2020 21:30	3,20	53	169,61	CHI
20201071566	PALMINOPOLIS	PP11000037	PALMEIRAS	13/10/2020 18:18	13/10/2020 23:41	13/10/2020 18:18	13/10/2020 23:41	5,38	191	1027,21	CHI
20201071100	BOM JARDIM DE GOIAS	BM11187496	BOM JARDIM	13/10/2020 18:19	14/10/2020 01:19	13/10/2020 18:19	14/10/2020 01:19	7,00	77	538,64	CHI
20201071158	SILVANIA	SV21161526	VIANOPOLIS	13/10/2020 18:19	14/10/2020 09:45	13/10/2020 18:19	14/10/2020 09:45	15,43	2	30,85	CHI

20201071024	FORMOSA	10010553698	ITUIQUIRA	13/10/2020 18:20	13/10/2020 20:08	13/10/2020 18:20	13/10/2020 20:08	1,81	1	1,81	CHI
20201071535	TROMBAS	TB11189825	PORANGATU	13/10/2020 18:22	13/10/2020 21:30	13/10/2020 18:22	13/10/2020 21:30	3,12	105	327,69	CHI
20201071570	SAO LUIZ DO NORTE	SZ11201722	ITAPACI	13/10/2020 18:22	14/10/2020 09:50	13/10/2020 18:22	14/10/2020 09:50	15,45	58	896,16	CHI
20201071150	FORMOSO	TB12372648	PORANGATU	13/10/2020 18:23	13/10/2020 19:53	13/10/2020 18:23	13/10/2020 19:53	1,50	1	1,50	CHI
20201071150	TROMBAS	TB12372648	PORANGATU	13/10/2020 18:23	13/10/2020 19:53	13/10/2020 18:23	13/10/2020 19:53	1,50	68	101,66	CHI
20201072634	SAO LUIZ DO NORTE	SZ12348617	ITAPACI	13/10/2020 18:23	14/10/2020 09:10	13/10/2020 18:23	14/10/2020 09:10	14,77	8	118,18	CHI
20201071055	ARAGOIANIA	10019954784	GUAPO S2	13/10/2020 18:24	14/10/2020 02:03	13/10/2020 18:24	14/10/2020 02:03	7,64	1	7,64	CHI
20201071057	NIQUELANDIA	10011171373	URUACU	13/10/2020 18:25	14/10/2020 17:01	13/10/2020 18:25	14/10/2020 17:01	22,59	1	22,59	CHI
20201071414	MINEIROS	MY11171859	PARQUE DAS EMAS	13/10/2020 18:25	13/10/2020 23:23	13/10/2020 18:25	13/10/2020 23:23	4,95	125	619,34	CHI
20201071332	SILVANIA	SV12084550	VIANOPOLIS	13/10/2020 18:25	13/10/2020 22:58	13/10/2020 18:25	13/10/2020 22:58	4,54	49	222,31	CHI
20201071072	SAO LUIS DE MONTES BELOS	SL12304423	SAO LUIZ DOS MONTES BELOS	13/10/2020 18:26	14/10/2020 11:55	13/10/2020 18:26	14/10/2020 11:55	17,48	1	17,48	CHI
20201068461	SAO LUIZ DO NORTE	SZ12054579	ITAPACI	13/10/2020 18:27	14/10/2020 00:40	13/10/2020 18:27	14/10/2020 00:40	6,21	465	2885,71	CHI
20201071080	ADELANDIA	DN11160989	FIRMINOPOLIS S2	13/10/2020 18:27	14/10/2020 02:00	13/10/2020 18:27	14/10/2020 02:00	7,54	46	346,70	CHI
20201071092	ANAPOLIS	20348400	JUNDAI S2	13/10/2020 18:29	13/10/2020 22:52	13/10/2020 18:29	13/10/2020 22:52	4,38	1	4,38	CHI
20201071323	CRISTALINA	KR12287396	CRISTALINA S1	13/10/2020 18:29	14/10/2020 01:43	13/10/2020 18:29	14/10/2020 01:43	7,22	23	166,12	CHI
20201071105	CAIAPONIA	CP21167948	CAIAPONIA	13/10/2020 18:30	13/10/2020 23:12	13/10/2020 18:30	13/10/2020 23:12	4,69	1	4,69	CHI
20201071108	SAO FRANCISCO DE GOIAS	SF21284997	SAO FRANCISCO DE GOIAS	13/10/2020 18:30	14/10/2020 13:37	13/10/2020 18:30	14/10/2020 13:37	19,10	1	19,10	CHI
20201071117	ANAPOLIS	20763761	JUNDAI S2	13/10/2020 18:32	14/10/2020 00:38	13/10/2020 18:32	14/10/2020 00:38	6,10	1	6,10	CHI
20201071717	VILA BOA	VB11042055	IACIARA S2	13/10/2020 18:32	14/10/2020 11:49	13/10/2020 18:32	14/10/2020 11:49	17,28	153	2644,35	CHI
20201071393	CAMPOS VERDES	VD11049792	SANTA TEREZINHA	13/10/2020 18:33	13/10/2020 21:59	13/10/2020 18:33	13/10/2020 21:59	3,43	137	470,40	CHI
20201071532	GOIANIA	GN11410458	GOYA S2	13/10/2020 18:33	14/10/2020 08:26	13/10/2020 18:33	14/10/2020 08:26	13,88	56	777,14	CHI
20201071132	LUZIANIA	LZ11000226	MARAJOARA	13/10/2020 18:33	13/10/2020 19:21	13/10/2020 18:33	13/10/2020 19:21	0,79	187	147,21	CHI
20201071134	MINACU	CR12234940	PORANGATU	13/10/2020 18:33	14/10/2020 11:35	13/10/2020 18:33	14/10/2020 11:35	17,02	9	153,17	CHI
20201071152	CRISTALINA	KR12249242	CRISTALINA S2	13/10/2020 18:35	13/10/2020 22:56	13/10/2020 18:35	13/10/2020 22:56	4,35	3	13,04	CHI
20201071156	SANTA TEREZA DE GOIAS	SE11061004	MARA ROSA	13/10/2020 18:35	13/10/2020 20:21	13/10/2020 18:35	13/10/2020 20:21	1,76	107	188,26	CHI
20201071160	FORMOSO	FO11000010	PORANGATU	13/10/2020 18:35	13/10/2020 21:33	13/10/2020 18:35	13/10/2020 21:33	2,95	78	230,14	CHI
20201071165	FORMOSA	10015532257	ITUIQUIRA	13/10/2020 18:36	13/10/2020 20:50	13/10/2020 18:36	13/10/2020 20:50	2,23	1	2,23	CHI
20201071169	AGUAS LINDAS DE GOIAS	4830289856	AGUAS LINDAS DE GOIAS S1	13/10/2020 18:37	14/10/2020 03:35	13/10/2020 18:37	14/10/2020 03:35	8,96	1	8,96	CHI
20201071170	FORMOSO	2410006390	PORANGATU	13/10/2020 18:37	13/10/2020 23:38	13/10/2020 18:37	13/10/2020 23:38	5,01	1	5,01	CHI
20201071173	ABADIA DE GOIAS	GN32050563	TRINIDADE	13/10/2020 18:37	13/10/2020 21:49	13/10/2020 18:37	13/10/2020 21:49	3,19	1	3,19	CHI
20201071178	MINEIROS	1390113489	PARQUE DAS EMAS	13/10/2020 18:37	13/10/2020 23:56	13/10/2020 18:37	13/10/2020 23:56	5,30	1	5,30	CHI
20201071182	SANTO ANTONIO DE GOIAS	BW21266509	NEROPOLIS S1	13/10/2020 18:37	14/10/2020 00:33	13/10/2020 18:37	14/10/2020 00:33	5,92	1	5,92	CHI
20201071557	NOVA CRIXAS	NA12334349	NOVA CRIXAS	13/10/2020 18:38	14/10/2020 11:55	13/10/2020 18:38	13/10/2020 23:23	4,75	25	118,87	CHI
20201071557	NOVA CRIXAS	NA12202054LD	NOVA CRIXAS	13/10/2020 18:38	14/10/2020 11:55	13/10/2020 18:38	14/10/2020 02:18	7,67	10	76,73	CHI
20201071557	NOVA CRIXAS	NA12334349	NOVA CRIXAS	13/10/2020 18:38	14/10/2020 11:55	14/10/2020 02:25	14/10/2020 04:15	1,85	23	42,52	CHI
20201071557	NOVA CRIXAS	NA12202054LD	NOVA CRIXAS	13/10/2020 18:38	14/10/2020 11:55	13/10/2020 18:38	14/10/2020 10:09	15,52	51	791,34	CHI
20201071557	NOVA CRIXAS	NA12202054LD	NOVA CRIXAS	13/10/2020 18:38	14/10/2020 11:55	14/10/2020 02:25	14/10/2020 10:09	7,73	9	69,61	CHI
20201071557	NOVA CRIXAS	NA21132317	NOVA CRIXAS	13/10/2020 18:38	14/10/2020 11:55	14/10/2020 02:25	14/10/2020 11:55	9,50	1	9,50	CHI
20201071190	MATRINCHA	MP21274455	MATRINCHA	13/10/2020 18:39	14/10/2020 09:28	13/10/2020 18:39	14/10/2020 09:28	14,81	1	14,81	CHI
20201071194	GOIAS	GS21148731	ITABERAI S2	13/10/2020 18:39	14/10/2020 10:33	13/10/2020 18:39	14/10/2020 10:33	15,88	1	15,88	CHI
20201071341	CABECEIRAS	CW11262324	ITUIQUIRA	13/10/2020 18:39	13/10/2020 23:36	13/10/2020 18:39	13/10/2020 23:36	4,95	24	118,70	CHI
20201071198	RIO VERDE	RV21139857	RIO DOS BOIS	13/10/2020 18:40	14/10/2020 07:57	13/10/2020 18:40	14/10/2020 07:57	13,28	1	13,28	CHI
20201071199	MINEIROS	MY21265885	CHAPADAO DO CEU	13/10/2020 18:40	13/10/2020 22:23	13/10/2020 18:40	13/10/2020 22:23	3,71	1	3,71	CHI
20201071205	APARECIDA DE GOIANIA	11479292	REAL S1	13/10/2020 18:40	14/10/2020 00:41	13/10/2020 18:40	14/10/2020 00:41	6,00	1	6,00	CHI
20201071211	ESTRELA DO NORTE	ET12088710	MARA ROSA	13/10/2020 18:41	14/10/2020 02:14	13/10/2020 18:41	14/10/2020 02:14	7,54	3	22,63	CHI
20201071219	MUTUNOPOLIS	MU21132172	MARA ROSA	13/10/2020 18:41	14/10/2020 10:20	13/10/2020 18:41	14/10/2020 10:20	15,63	1	15,63	CHI
20201071227	CORUMBA DE GOIAS	CB21089840	CORUMBA	13/10/2020 18:43	14/10/2020 13:38	13/10/2020 18:43	14/10/2020 13:38	18,92	1	18,92	CHI
20201071258	AGUA FRIA DE GOIAS	PI10400578	SAO JOAO D ALIANCA	13/10/2020 18:44	14/10/2020 20:01	13/10/2020 18:44	13/10/2020 22:46	4,03	58	233,71	CHI
20201071258	AGUA FRIA DE GOIAS	PI10400578	SAO JOAO D ALIANCA	13/10/2020 18:44	14/10/2020 20:01	13/10/2020 18:44	13/10/2020 23:14	4,49	12	53,93	CHI
20201071258	MIMOSO DE GOIAS	PI10400578	SAO JOAO D ALIANCA	13/10/2020 18:44	14/10/2020 20:01	13/10/2020 18:44	13/10/2020 23:14	4,50	29	130,48	CHI
20201071258	AGUA FRIA DE GOIAS	PI10400578	SAO JOAO D ALIANCA	13/10/2020 18:44	14/10/2020 20:01	13/10/2020 18:44	13/10/2020 23:14	4,50	1686	7585,59	CHI
20201071258	PLANALTINA	PI10400578	SAO JOAO D ALIANCA	13/10/2020 18:44	14/10/2020 20:01	13/10/2020 18:44	13/10/2020 23:14	4,50	284	1277,76	CHI
20201071258	AGUA FRIA DE GOIAS	TL10394719	SAO JOAO D ALIANCA	13/10/2020 18:44	14/10/2020 20:01	13/10/2020 19:13	13/10/2020 23:14	4,02	6	24,11	CHI
20201071258	AGUA FRIA DE GOIAS	PI10400578	SAO JOAO D ALIANCA	13/10/2020 18:44	14/10/2020 20:01	13/10/2020 18:44	13/10/2020 23:14	4,50	132	594,62	CHI
20201071258	PLANALTINA	PI10400578	SAO JOAO D ALIANCA	13/10/2020 18:44	14/10/2020 20:01	14/10/2020 02:08	14/10/2020 02:14	0,11	284	31,71	CHI
20201071258	MIMOSO DE GOIAS	PI10400578	SAO JOAO D ALIANCA	13/10/2020 18:44	14/10/2020 20:01	14/10/2020 02:08	14/10/2020 02:14	0,11	29	3,24	CHI
20201071258	AGUA FRIA DE GOIAS	PI10400578	SAO JOAO D ALIANCA	13/10/2020 18:44	14/10/2020 20:01	14/10/2020 02:08	14/10/2020 02:14	0,11	1894	211,50	CHI
20201071258	AGUA FRIA DE GOIAS	PI10400578	SAO JOAO D ALIANCA	13/10/2020 18:44	14/10/2020 20:01	13/10/2020 18:44	14/10/2020 20:01	25,28	7	176,96	CHI

20201071542	TROMBAS	TB11055137	PORANGATU	13/10/2020 18:44	14/10/2020 00:02	13/10/2020 18:44	14/10/2020 00:02	5,29	92	486,78	CHI
20201071547	GOIANESIA	GE10394587	GOIANESIA S2	13/10/2020 18:44	15/10/2020 00:06	13/10/2020 18:44	13/10/2020 19:18	0,57	85	48,73	CHI
20201071547	PIRENOPOLIS	GE16413709	GOIANESIA S2	13/10/2020 18:44	15/10/2020 00:06	13/10/2020 18:44	13/10/2020 20:22	1,63	1	1,63	CHI
20201071547	JARAGUA	GE16413709	GOIANESIA S2	13/10/2020 18:44	15/10/2020 00:06	13/10/2020 18:44	13/10/2020 20:22	1,63	75	121,90	CHI
20201071547	GOIANESIA	GE16413709	GOIANESIA S2	13/10/2020 18:44	15/10/2020 00:06	13/10/2020 18:44	13/10/2020 20:22	1,63	175	284,42	CHI
20201071547	GOIANESIA	GE10394587	GOIANESIA S2	13/10/2020 18:44	15/10/2020 00:06	13/10/2020 20:23	13/10/2020 20:26	0,05	85	4,42	CHI
20201071547	GOIANESIA	GE16413709	GOIANESIA S2	13/10/2020 18:44	15/10/2020 00:06	13/10/2020 18:44	13/10/2020 21:17	2,55	4	10,21	CHI
20201071547	JARAGUA	GE16413709	GOIANESIA S2	13/10/2020 18:44	15/10/2020 00:06	13/10/2020 18:44	13/10/2020 21:17	2,55	410	1046,52	CHI
20201071547	JARAGUA	GE16413709	GOIANESIA S2	13/10/2020 18:44	15/10/2020 00:06	13/10/2020 20:23	13/10/2020 21:17	0,90	25	22,60	CHI
20201071547	GOIANESIA	GE16413709	GOIANESIA S2	13/10/2020 18:44	15/10/2020 00:06	13/10/2020 20:23	13/10/2020 21:17	0,90	55	49,73	CHI
20201071547	JARAGUA	GE12339475LD	GOIANESIA S2	13/10/2020 18:44	15/10/2020 00:06	13/10/2020 20:23	13/10/2020 22:41	2,30	25	57,49	CHI
20201071547	GOIANESIA	GE12339475LD	GOIANESIA S2	13/10/2020 18:44	15/10/2020 00:06	13/10/2020 20:23	13/10/2020 22:41	2,30	39	89,69	CHI
20201071547	JARAGUA	GE10394587	GOIANESIA S2	13/10/2020 18:44	15/10/2020 00:06	13/10/2020 20:23	14/10/2020 03:00	6,62	11	72,80	CHI
20201071547	JARAGUA	GE10394587	GOIANESIA S2	13/10/2020 18:44	15/10/2020 00:06	14/10/2020 02:40	14/10/2020 03:00	0,34	462	155,41	CHI
20201071547	GOIANESIA	GE10394587	GOIANESIA S2	13/10/2020 18:44	15/10/2020 00:06	14/10/2020 02:40	14/10/2020 03:00	0,34	184	61,90	CHI
20201071547	JARAGUA	GE16413709	GOIANESIA S2	13/10/2020 18:44	15/10/2020 00:06	14/10/2020 08:06	14/10/2020 09:47	1,68	437	733,67	CHI
20201071547	GOIANESIA	GE16413709	GOIANESIA S2	13/10/2020 18:44	15/10/2020 00:06	14/10/2020 08:06	14/10/2020 09:47	1,68	60	100,73	CHI
20201071547	GOIANESIA	GE10394587	GOIANESIA S2	13/10/2020 18:44	15/10/2020 00:06	14/10/2020 10:10	14/10/2020 10:14	0,08	85	6,56	CHI
20201071547	GOIANESIA	GE12339475LD	GOIANESIA S2	13/10/2020 18:44	15/10/2020 00:06	14/10/2020 08:06	14/10/2020 11:09	3,06	39	119,24	CHI
20201071547	JARAGUA	GE12339475LD	GOIANESIA S2	13/10/2020 18:44	15/10/2020 00:06	14/10/2020 08:06	14/10/2020 11:09	3,06	25	76,44	CHI
20201071547	GOIANESIA	GE16413709	GOIANESIA S2	13/10/2020 18:44	15/10/2020 00:06	14/10/2020 10:10	14/10/2020 11:09	1,00	60	59,72	CHI
20201071547	JARAGUA	GE16413709	GOIANESIA S2	13/10/2020 18:44	15/10/2020 00:06	14/10/2020 10:10	14/10/2020 11:09	1,00	437	434,94	CHI
20201071547	JARAGUA	GE13382316	GOIANESIA S2	13/10/2020 18:44	15/10/2020 00:06	13/10/2020 20:23	14/10/2020 20:56	24,54	20	490,84	CHI
20201071547	GOIANESIA	GE13382316	GOIANESIA S2	13/10/2020 18:44	15/10/2020 00:06	13/10/2020 20:23	14/10/2020 20:56	24,54	24	589,01	CHI
20201071547	GOIANESIA	GE12093160	GOIANESIA S2	13/10/2020 18:44	15/10/2020 00:06	13/10/2020 20:23	14/10/2020 23:40	27,28	48	1309,39	CHI
20201071547	GOIANESIA	GE12006564	GOIANESIA S2	13/10/2020 18:44	15/10/2020 00:06	13/10/2020 20:23	15/10/2020 00:06	27,71	9	249,41	CHI
20201071547	JARAGUA	GE12006564	GOIANESIA S2	13/10/2020 18:44	15/10/2020 00:06	13/10/2020 20:23	15/10/2020 00:06	27,71	2	55,42	CHI
20201071547	PIRENOPOLIS	GE12006564	GOIANESIA S2	13/10/2020 18:44	15/10/2020 00:06	13/10/2020 20:23	15/10/2020 00:06	27,71	1	27,71	CHI
20201071237	ANAPOLIS	10000117640	JUNDIAI S1	13/10/2020 18:44	13/10/2020 22:46	13/10/2020 18:44	13/10/2020 22:46	4,02	1	4,02	CHI
20201071256	SENADOR CANEDO	190079241	SENADOR CANEDO	13/10/2020 18:46	13/10/2020 20:14	13/10/2020 18:46	13/10/2020 20:14	1,45	1	1,45	CHI
20201071307	AGUAS LINDAS DE GOIAS	LA11148968	AGUAS LINDAS DE GOIAS S1	13/10/2020 18:46	13/10/2020 20:35	13/10/2020 18:46	13/10/2020 20:35	1,80	144	259,76	CHI
20201071261	ESTRELA DO NORTE	ET11151070	MARA ROSA	13/10/2020 18:47	14/10/2020 10:11	13/10/2020 18:47	14/10/2020 10:11	15,40	99	1524,35	CHI
20201071264	LUZIANIA	LZ11192903	RIO VERMELHO	13/10/2020 18:47	13/10/2020 21:19	13/10/2020 18:47	13/10/2020 21:19	2,52	125	315,24	CHI
20201071267	MINACU	IH21182347	MINACU	13/10/2020 18:48	14/10/2020 01:10	13/10/2020 18:48	14/10/2020 01:10	6,37	15	95,48	CHI
20201071318	PALMEIRAS DE GOIAS	PL12380964	ANICUNS	13/10/2020 18:48	13/10/2020 21:51	13/10/2020 18:48	13/10/2020 21:51	3,04	7	21,31	CHI
20201071917	DOVERLANDIA	DV12138335	CAIAPONIA	13/10/2020 18:49	13/10/2020 22:42	13/10/2020 18:49	13/10/2020 22:42	3,87	37	143,36	CHI
20201071285	CAMPINORTE	CR12003468	CAMPINORTE	13/10/2020 18:50	14/10/2020 00:01	13/10/2020 18:50	14/10/2020 00:01	5,18	90	466,05	CHI
20201071692	PORANGATU	PO12390255	PORANGATU	13/10/2020 18:50	14/10/2020 00:00	13/10/2020 18:50	14/10/2020 00:00	5,15	4	20,61	CHI
20201071296	TRINDADE	40029177	TRINDADE	13/10/2020 18:51	13/10/2020 23:40	13/10/2020 18:51	13/10/2020 23:40	4,81	1	4,81	CHI
20201071298	AGUAS LINDAS DE GOIAS	10027849412	AGUAS LINDAS DE GOIAS S1	13/10/2020 18:51	14/10/2020 07:39	13/10/2020 18:51	14/10/2020 07:39	12,79	1	12,79	CHI
20201071300	APARECIDA DE GOIANIA	12651692	REAL S2	13/10/2020 18:51	14/10/2020 05:09	13/10/2020 18:51	14/10/2020 05:09	10,29	1	10,29	CHI
20201071302	PIRENOPOLIS	PV21278532	CORUMBA	13/10/2020 18:51	13/10/2020 21:55	13/10/2020 18:51	13/10/2020 21:55	3,05	2	6,11	CHI
20201071312	ACREUNA	3330004081	ACREUNA	13/10/2020 18:53	13/10/2020 22:56	13/10/2020 18:53	13/10/2020 22:56	4,05	1	4,05	CHI
20201071315	PORANGATU	840148239	PORANGATU	13/10/2020 18:53	13/10/2020 23:28	13/10/2020 18:53	13/10/2020 23:28	4,58	1	4,58	CHI
20201071317	PLANALTINA	2960006507	PLANALTINA	13/10/2020 18:53	13/10/2020 22:13	13/10/2020 18:53	13/10/2020 22:13	3,33	1	3,33	CHI
20201072135	PALMEIRAS DE GOIAS	440008438	ANICUNS	13/10/2020 18:53	14/10/2020 02:04	13/10/2020 18:53	14/10/2020 02:04	7,17	1	7,17	CHI
20201072278	AMORINOPOLIS	AM12133499	IPORA	13/10/2020 18:53	14/10/2020 08:23	13/10/2020 18:53	14/10/2020 08:23	13,49	69	930,87	CHI
20201071324	ANICUNS	910035817	ANICUNS	13/10/2020 18:54	13/10/2020 23:09	13/10/2020 18:54	13/10/2020 23:09	4,25	1	4,25	CHI
20201071590	SANTA TEREZA DE GOIAS	FO12392284	PORANGATU	13/10/2020 18:54	14/10/2020 07:51	13/10/2020 18:54	14/10/2020 07:51	12,94	17	220,06	CHI
20201071590	FORMOSO	FO12392284	PORANGATU	13/10/2020 18:54	14/10/2020 07:51	13/10/2020 18:54	14/10/2020 07:51	12,94	14	181,22	CHI
20201071578	SAO LUIZ DO NORTE	3090018601	ITAPACI	13/10/2020 18:54	14/10/2020 11:39	13/10/2020 18:54	14/10/2020 11:39	16,74	1	16,74	CHI
20201071338	SERRANOPOLIS	SX21153242	ITAJA S1	13/10/2020 18:55	14/10/2020 12:21	13/10/2020 18:55	14/10/2020 12:21	17,43	1	17,43	CHI
20201071401	GOIANIA	GN11189663	ATLANTICO S1	13/10/2020 18:55	13/10/2020 19:54	13/10/2020 18:55	13/10/2020 19:54	0,97	111	107,42	CHI
20201071389	SANCLERLANDIA	SC12163921	FIRMINOPOLIS S2	13/10/2020 18:56	13/10/2020 22:36	13/10/2020 18:56	13/10/2020 22:36	3,66	12	43,89	CHI
20201071350	NEROPOLIS	GN12324570	NEROPOLIS S2	13/10/2020 18:56	13/10/2020 22:58	13/10/2020 18:56	13/10/2020 22:58	4,02	1	4,02	CHI
20201071350	GOIANIA	GN12324570	NEROPOLIS S2	13/10/2020 18:56	13/10/2020 22:58	13/10/2020 18:56	13/10/2020 22:58	4,02	1	4,02	CHI
20201071359	RUBIATABA	RB21070024	RUBIATABA	13/10/2020 18:57	14/10/2020 02:42	13/10/2020 18:57	14/10/2020 02:42	7,74	2	15,47	CHI
20201071360	FORMOSO	FO12391929	PORANGATU	13/10/2020 18:57	13/10/2020 23:58	13/10/2020 18:57	13/10/2020 23:58	5,00	11	55,04	CHI

20201071361	FLORES DE GOIAS	FB21062293	FLORES DE GOIAS	13/10/2020 18:58	13/10/2020 19:52	13/10/2020 18:58	13/10/2020 19:52	0,90	1	0,90	CHI
20201071363	LUZIANIA	LZ12230287	MARAJOARA	13/10/2020 18:58	13/10/2020 20:45	13/10/2020 18:58	13/10/2020 20:45	1,78	10	17,82	CHI
20201071038	AGUAS LINDAS DE GOIAS	SN21096324	AGUAS LINDAS DE GOIAS S1	13/10/2020 18:58	13/10/2020 20:05	13/10/2020 18:58	13/10/2020 20:05	1,11	1	1,11	CHI
20201071369	CAVALCANTE	TI12162624	NIQUELANDIA SUBTRANSMISSAO	13/10/2020 18:58	14/10/2020 17:35	13/10/2020 18:58	14/10/2020 17:35	22,60	1	22,60	CHI
20201071369	COLINAS DO SUL	TI12162624	NIQUELANDIA SUBTRANSMISSAO	13/10/2020 18:58	14/10/2020 17:35	13/10/2020 18:58	14/10/2020 17:35	22,60	6	135,63	CHI
20201071378	APARECIDA DE GOIANIA	10007852370	REAL S1	13/10/2020 18:58	13/10/2020 21:51	13/10/2020 18:58	13/10/2020 21:51	2,87	1	2,87	CHI
20201071370	SANTA RITA DO NOVO DESTINO	BA12211709	BARRO ALTO	13/10/2020 18:59	13/10/2020 20:57	13/10/2020 18:59	13/10/2020 20:57	1,97	99	194,62	CHI
2020101300120	BONOPOLIS	35201	MARA ROSA	13/10/2020 19:00	13/10/2020 19:03	13/10/2020 19:00	13/10/2020 19:03	0,05	2	0,10	CHI
2020101300120	FORMOSO	20701	MARA ROSA	13/10/2020 19:00	13/10/2020 19:03	13/10/2020 19:00	13/10/2020 19:03	0,05	105	5,25	CHI
2020101300120	AMARALINA	04732	MARA ROSA	13/10/2020 19:00	13/10/2020 19:03	13/10/2020 19:00	13/10/2020 19:03	0,05	47	2,35	CHI
2020101300120	ESTRELA DO NORTE	01120414	MARA ROSA	13/10/2020 19:00	13/10/2020 19:03	13/10/2020 19:00	13/10/2020 19:03	0,05	19	0,95	CHI
2020101300120	ESTRELA DO NORTE	20701	MARA ROSA	13/10/2020 19:00	13/10/2020 19:03	13/10/2020 19:00	13/10/2020 19:03	0,05	3	0,15	CHI
2020101300120	MARA ROSA	04732	MARA ROSA	13/10/2020 19:00	13/10/2020 19:03	13/10/2020 19:00	13/10/2020 19:03	0,05	31	1,55	CHI
2020101300120	ESTRELA DO NORTE	04731	MARA ROSA	13/10/2020 19:00	13/10/2020 19:03	13/10/2020 19:00	13/10/2020 19:03	0,05	52	2,60	CHI
2020101300120	MARA ROSA	04701	MARA ROSA	13/10/2020 19:00	13/10/2020 19:03	13/10/2020 19:00	13/10/2020 19:03	0,05	102	5,10	CHI
2020101300120	MUTUNOPOLIS	04732	MARA ROSA	13/10/2020 19:00	13/10/2020 19:03	13/10/2020 19:00	13/10/2020 19:03	0,05	99	4,95	CHI
2020101300120	ESTRELA DO NORTE	04701	MARA ROSA	13/10/2020 19:00	13/10/2020 19:03	13/10/2020 19:00	13/10/2020 19:03	0,05	1158	57,90	CHI
2020101300120	FORMOSO	04701	MARA ROSA	13/10/2020 19:00	13/10/2020 19:03	13/10/2020 19:00	13/10/2020 19:03	0,05	74	3,70	CHI
2020101300120	PORANGATU	35201	MARA ROSA	13/10/2020 19:00	13/10/2020 19:03	13/10/2020 19:00	13/10/2020 19:03	0,05	235	11,75	CHI
2020101300120	SANTA TEREZA DE GOIAS	20701	MARA ROSA	13/10/2020 19:00	13/10/2020 19:03	13/10/2020 19:00	13/10/2020 19:03	0,05	1577	78,85	CHI
2020101300120	MUTUNOPOLIS	35201	MARA ROSA	13/10/2020 19:00	13/10/2020 19:03	13/10/2020 19:00	13/10/2020 19:03	0,05	224	11,20	CHI
2020101300120	ESTRELA DO NORTE	04732	MARA ROSA	13/10/2020 19:00	13/10/2020 19:03	13/10/2020 19:00	13/10/2020 19:03	0,05	44	2,20	CHI
2020101300120	PORANGATU	20701	MARA ROSA	13/10/2020 19:00	13/10/2020 19:03	13/10/2020 19:00	13/10/2020 19:03	0,05	3	0,15	CHI
2020101300120	ESTRELA DO NORTE	35202	MARA ROSA	13/10/2020 19:00	13/10/2020 19:03	13/10/2020 19:00	13/10/2020 19:03	0,05	1	0,05	CHI
2020101300120	MUTUNOPOLIS	35202	MARA ROSA	13/10/2020 19:00	13/10/2020 19:03	13/10/2020 19:00	13/10/2020 19:03	0,05	1455	72,75	CHI
2020101300120	AMARALINA	35201	MARA ROSA	13/10/2020 19:00	13/10/2020 19:03	13/10/2020 19:00	13/10/2020 19:03	0,05	6	0,30	CHI
2020101300120	MARA ROSA	01120414	MARA ROSA	13/10/2020 19:00	13/10/2020 19:03	13/10/2020 19:00	13/10/2020 19:03	0,05	79	3,95	CHI
2020101300120	MUTUNOPOLIS	20701	MARA ROSA	13/10/2020 19:00	13/10/2020 19:03	13/10/2020 19:00	13/10/2020 19:03	0,05	6	0,30	CHI
2020101300120	AMARALINA	35202	MARA ROSA	13/10/2020 19:00	13/10/2020 19:03	13/10/2020 19:00	13/10/2020 19:03	0,05	144	7,20	CHI
2020101300120	FORMOSO	04731	MARA ROSA	13/10/2020 19:00	13/10/2020 19:03	13/10/2020 19:00	13/10/2020 19:03	0,05	21	1,05	CHI
2020101300120	SANTA TEREZA DE GOIAS	04731	MARA ROSA	13/10/2020 19:00	13/10/2020 19:03	13/10/2020 19:00	13/10/2020 19:03	0,05	26	1,30	CHI
20201071382	GOIANIA	16721317	ATLANTICO S3	13/10/2020 19:00	13/10/2020 20:28	13/10/2020 19:00	13/10/2020 20:28	1,46	1	1,46	CHI
20201071383	GOIANIA	14223053	CARAJAS S1	13/10/2020 19:00	13/10/2020 22:12	13/10/2020 19:00	13/10/2020 22:12	3,19	1	3,19	CHI
20201071390	AGUAS LINDAS DE GOIAS	LA12370835	AGUAS LINDAS DE GOIAS S1	13/10/2020 19:01	13/10/2020 20:58	13/10/2020 19:01	13/10/2020 20:58	1,94	2	3,89	CHI
20201071391	GOIANIA	14502380	CARAJAS S1	13/10/2020 19:01	14/10/2020 05:39	13/10/2020 19:01	14/10/2020 05:39	10,62	1	10,62	CHI
20201071398	RIO VERDE	RV21207024	MONTIVIDIU T	13/10/2020 19:02	13/10/2020 20:16	13/10/2020 19:02	13/10/2020 20:16	1,23	1	1,23	CHI
20201071400	GOIANIA	14422529	CAMPINAS S1	13/10/2020 19:02	13/10/2020 23:29	13/10/2020 19:02	13/10/2020 23:29	4,45	1	4,45	CHI
20201071406	FORMOSA	10002979886	ITIQUEIRA	13/10/2020 19:03	13/10/2020 22:00	13/10/2020 19:03	13/10/2020 22:00	2,94	1	2,94	CHI
20201071407	FORMOSA	610184118	ITIQUEIRA	13/10/2020 19:03	13/10/2020 20:58	13/10/2020 19:03	13/10/2020 20:58	1,90	1	1,90	CHI
20201071409	INHUMAS	30118591	INHUMAS S2	13/10/2020 19:03	14/10/2020 11:10	13/10/2020 19:03	14/10/2020 11:10	16,10	1	16,10	CHI
20201071458	CAMPINORTE	UR12243278	MARA ROSA	13/10/2020 19:04	13/10/2020 21:36	13/10/2020 19:04	13/10/2020 21:36	2,53	7	17,73	CHI
20201071458	URUACU	UR12243278	MARA ROSA	13/10/2020 19:04	13/10/2020 21:36	13/10/2020 19:04	13/10/2020 21:36	2,53	14	35,45	CHI
20201071419	GOIANESIA	GE21240126	GOIANESIA S2	13/10/2020 19:05	14/10/2020 21:45	13/10/2020 19:05	14/10/2020 21:45	26,66	1	26,66	CHI
20201071425	PETROLINA DE GOIAS	PG21060609	PETROLINA	13/10/2020 19:05	14/10/2020 10:32	13/10/2020 19:05	14/10/2020 10:32	15,44	1	15,44	CHI
20201071431	AURILANDIA	AI21361571	FIRMINOPOLIS S2	13/10/2020 19:06	13/10/2020 20:34	13/10/2020 19:06	13/10/2020 20:34	1,46	1	1,46	CHI
20201071436	NIQUELANDIA	NQ12088704	URUACU	13/10/2020 19:07	14/10/2020 17:45	13/10/2020 19:07	14/10/2020 17:45	22,63	22	497,77	CHI
20201071437	INHUMAS	IN12027780	INHUMAS S2	13/10/2020 19:07	14/10/2020 10:32	13/10/2020 19:07	14/10/2020 10:32	15,41	2	30,82	CHI
20201071438	AMORINOPOLIS	1540000993	IPORA	13/10/2020 19:07	14/10/2020 10:23	13/10/2020 19:07	14/10/2020 10:23	15,25	1	15,25	CHI
20201071441	APARECIDA DE GOIANIA	200283194	INDEPENDENCIA S1	13/10/2020 19:08	13/10/2020 19:29	13/10/2020 19:08	13/10/2020 19:29	0,34	1	0,34	CHI
20201072134	GOIANIA	AP11004639	ATLANTICO S1	13/10/2020 19:09	14/10/2020 01:55	13/10/2020 19:09	14/10/2020 01:55	6,76	113	764,01	CHI
20201072323	PORANGATU	PO11345568	PORANGATU	13/10/2020 19:09	14/10/2020 01:09	13/10/2020 19:09	14/10/2020 01:09	5,99	78	467,03	CHI
20201072225	GOIANIA	GN11410459	GOYA S2	13/10/2020 19:09	14/10/2020 00:48	13/10/2020 19:09	14/10/2020 00:48	5,63	49	276,06	CHI
20201071452	NIQUELANDIA	NQ21345134	NIQUELANDIA SUBTRANSMISSAO	13/10/2020 19:11	15/10/2020 11:59	13/10/2020 19:11	15/10/2020 04:03	32,87	2	65,74	CHI
20201071452	NIQUELANDIA	NQ12398051LD	NIQUELANDIA SUBTRANSMISSAO	13/10/2020 19:11	15/10/2020 11:59	14/10/2020 17:23	15/10/2020 11:59	18,60	74	1376,63	CHI
20201071452	NIQUELANDIA	NQ12398051LD	NIQUELANDIA SUBTRANSMISSAO	13/10/2020 19:11	15/10/2020 11:59	15/10/2020 08:05	15/10/2020 11:59	3,90	2	7,81	CHI
20201071455	AMARALINA	MQ12252155	MARA ROSA	13/10/2020 19:11	13/10/2020 21:12	13/10/2020 19:11	13/10/2020 21:12	2,01	8	16,04	CHI
20201071467	GOIANIA	10028503838	GOYA S2	13/10/2020 19:13	14/10/2020 08:47	13/10/2020 19:13	14/10/2020 08:47	13,56	1	13,56	CHI
20201071472	SAO MIGUEL DO ARAGUAIA	830045740	SAO MIGUEL DO ARAGUAIA	13/10/2020 19:14	13/10/2020 22:33	13/10/2020 19:14	13/10/2020 22:33	3,31	1	3,31	CHI

20201071477	SILVANIA	SV21131996	VIANOPOLIS	13/10/2020 19:14	14/10/2020 00:15	13/10/2020 19:14	14/10/2020 00:15	5,00	1	5,00	CHI
20201072511	NIQUELANDIA	NQ12398045	URUACU	13/10/2020 19:15	14/10/2020 15:01	13/10/2020 19:15	14/10/2020 11:46	16,53	4	66,11	CHI
20201072511	NIQUELANDIA	NQ12228247LD	URUACU	13/10/2020 19:15	14/10/2020 15:01	13/10/2020 19:15	14/10/2020 15:01	19,78	8	158,21	CHI
20201071481	ITAJA	2300003412	ITAJA S2	13/10/2020 19:15	13/10/2020 19:58	13/10/2020 19:15	13/10/2020 19:58	0,71	1	0,71	CHI
20201071487	ALEXANIA	AX21090406	ALEXANIA	13/10/2020 19:16	13/10/2020 22:01	13/10/2020 19:16	13/10/2020 22:01	2,74	1	2,74	CHI
20201071488	ANAPOLIS	20651533	ANAPOLIS UNIVERSITARIO S2	13/10/2020 19:16	13/10/2020 20:14	13/10/2020 19:16	13/10/2020 20:14	0,96	1	0,96	CHI
20201071490	PORANGATU	PO12241996	PORANGATU	13/10/2020 19:17	13/10/2020 21:11	13/10/2020 19:17	13/10/2020 21:11	1,90	83	157,40	CHI
20201071529	TRINDADE	GR11242160	GOIANIRA	13/10/2020 19:17	13/10/2020 21:47	13/10/2020 19:17	13/10/2020 21:47	2,49	142	353,86	CHI
20201071871	FORMOSA	FA11268093	ITUIQUIRA	13/10/2020 19:17	13/10/2020 21:25	13/10/2020 19:17	13/10/2020 21:25	2,12	134	284,19	CHI
20201071592	CRIXAS	GF12243493	SANTA TEREZINHA	13/10/2020 19:17	14/10/2020 20:58	13/10/2020 19:17	14/10/2020 20:58	25,67	3	77,00	CHI
20201071592	GUARINOS	GF12243493	SANTA TEREZINHA	13/10/2020 19:17	14/10/2020 20:58	13/10/2020 19:17	14/10/2020 20:58	25,67	14	359,34	CHI
20201071505	PORANGATU	PO12297141	PORANGATU	13/10/2020 19:18	13/10/2020 23:30	13/10/2020 19:18	13/10/2020 23:30	4,19	14	58,70	CHI
20201071634	MINEIROS	MY12034227RE	PARQUE DAS EMAS	13/10/2020 19:18	14/10/2020 09:58	13/10/2020 19:18	14/10/2020 09:58	14,66	30	439,77	CHI
20201071634	SANTA RITA DO ARAGUAIA	MY12034227RE	PARQUE DAS EMAS	13/10/2020 19:18	14/10/2020 09:58	13/10/2020 19:18	14/10/2020 09:58	14,66	2	29,32	CHI
20201071516	CAIAPONIA	930025179	CAIAPONIA	13/10/2020 19:20	14/10/2020 14:42	13/10/2020 19:20	14/10/2020 14:42	19,36	1	19,36	CHI
20201071517	CRISTALINA	1060033516	CRISTALINA S1	13/10/2020 19:20	13/10/2020 23:06	13/10/2020 19:20	13/10/2020 23:06	3,76	1	3,76	CHI
20201071522	PARANAIGUARA	6391789	CACHOEIRA ALTA	13/10/2020 19:21	14/10/2020 15:12	13/10/2020 19:21	14/10/2020 15:12	19,84	2	39,69	CHI
20201071524	GOIANIA	10011510160	AEROPORTO S3	13/10/2020 19:21	13/10/2020 21:37	13/10/2020 19:21	13/10/2020 21:37	2,25	1	2,25	CHI
20201071526	COLINAS DO SUL	TL12355533	NIQUELANDIA SUBTRANSMISSAO	13/10/2020 19:22	14/10/2020 18:23	13/10/2020 19:22	14/10/2020 18:23	23,02	9	207,14	CHI
20201071530	CORUMBA DE GOIAS	10022456684	CORUMBA	13/10/2020 19:22	13/10/2020 22:34	13/10/2020 19:22	13/10/2020 22:34	3,19	1	3,19	CHI
20201071554	TRINDADE	40071698	TRINDADE	13/10/2020 19:24	14/10/2020 08:29	13/10/2020 19:24	14/10/2020 08:29	13,07	1	13,07	CHI
20201071558	ANAPOLIS	AN11000100	ANAPOLIS UNIVERSITARIO S2	13/10/2020 19:25	13/10/2020 22:05	13/10/2020 19:25	13/10/2020 22:05	2,66	26	69,04	CHI
20201066991	GOIANIA	GN11000928	CAMPINAS S2	13/10/2020 19:26	13/10/2020 22:43	13/10/2020 19:26	13/10/2020 22:43	3,27	87	284,66	CHI
20201071587	CRIXAS	CX12250107	SANTA TEREZINHA	13/10/2020 19:29	14/10/2020 05:53	13/10/2020 19:29	14/10/2020 05:53	10,40	9	93,59	CHI
20201071595	SILVANIA	SV21107934	VIANOPOLIS	13/10/2020 19:29	13/10/2020 23:12	13/10/2020 19:29	13/10/2020 23:12	3,70	1	3,70	CHI
20201071599	GUARINOS	SG21049816	SANTA TEREZINHA	13/10/2020 19:30	14/10/2020 09:33	13/10/2020 19:30	14/10/2020 09:33	14,04	1	14,04	CHI
20201071600	JARAGUA	JA12278888	JARAGUA	13/10/2020 19:30	13/10/2020 21:35	13/10/2020 19:30	13/10/2020 21:35	2,07	2	4,14	CHI
20201071602	PORANGATU	840027473	PORANGATU	13/10/2020 19:31	14/10/2020 09:40	13/10/2020 19:31	14/10/2020 09:40	14,14	1	14,14	CHI
20201071603	SANTA TEREZINHA DE GOIAS	SG21210151	SANTA TEREZINHA	13/10/2020 19:31	14/10/2020 04:55	13/10/2020 19:31	14/10/2020 04:55	9,39	1	9,39	CHI
20201071747	GUARINOS	GF11099026	SANTA TEREZINHA	13/10/2020 19:32	13/10/2020 22:33	13/10/2020 19:32	13/10/2020 22:33	3,01	136	409,28	CHI
20201071624	JARAGUA	JA11000029	JARAGUA	13/10/2020 19:32	13/10/2020 22:03	13/10/2020 19:32	13/10/2020 22:03	2,50	94	235,42	CHI
20201071632	PILAR DE GOIAS	GF12213049	SANTA TEREZINHA	13/10/2020 19:34	14/10/2020 15:14	13/10/2020 19:34	14/10/2020 15:14	19,66	5	98,30	CHI
20201071632	GUARINOS	GF12213049	SANTA TEREZINHA	13/10/2020 19:34	14/10/2020 15:14	13/10/2020 19:34	14/10/2020 15:14	19,66	7	137,62	CHI
20201071635	FORMOSA	10001841724	ITUIQUIRA	13/10/2020 19:34	13/10/2020 23:24	13/10/2020 19:34	13/10/2020 23:24	3,82	1	3,82	CHI
20201071637	SAO LUIZ DO NORTE	3090017750	ITAPACI	13/10/2020 19:35	14/10/2020 14:00	13/10/2020 19:35	14/10/2020 14:00	18,41	1	18,41	CHI
20201071639	GOIANIA	13494351	MEIA PONTE	13/10/2020 19:35	14/10/2020 08:01	13/10/2020 19:35	14/10/2020 08:01	12,42	1	12,42	CHI
20201071648	MINACU	IH12314767	MINACU	13/10/2020 19:38	14/10/2020 06:18	13/10/2020 19:38	14/10/2020 06:18	10,66	33	351,90	CHI
20201071650	FORMOSA	610188744	ITUIQUIRA	13/10/2020 19:38	13/10/2020 22:49	13/10/2020 19:38	13/10/2020 22:49	3,17	1	3,17	CHI
20201071652	GOIANIA	14346930	CARAJAS S2	13/10/2020 19:39	14/10/2020 02:06	13/10/2020 19:39	14/10/2020 02:06	6,45	1	6,45	CHI
20201071658	LUZIANIA	LZ21139702	MARAJOARA	13/10/2020 19:40	14/10/2020 03:27	13/10/2020 19:40	14/10/2020 03:27	7,78	1	7,78	CHI
20201072175	AGUAS LINDAS DE GOIAS	LA11351435	AGUAS LINDAS DE GOIAS S1	13/10/2020 19:41	13/10/2020 22:49	13/10/2020 19:41	13/10/2020 22:49	3,13	145	453,69	CHI
20201071672	LUZIANIA	KR12290773	CRISTALINA S2	13/10/2020 19:42	13/10/2020 21:50	13/10/2020 19:42	13/10/2020 21:50	2,13	3	6,39	CHI
20201071672	CRISTALINA	KR12290773	CRISTALINA S2	13/10/2020 19:42	13/10/2020 21:50	13/10/2020 19:42	13/10/2020 21:50	2,13	5	10,66	CHI
20201071677	MAURILANDIA	ML21393516	SANTA HELENA S1	13/10/2020 19:42	13/10/2020 22:08	13/10/2020 19:42	13/10/2020 22:08	2,42	1	2,42	CHI
20201071679	CACU	CC21027357	CACHOEIRA ALTA	13/10/2020 19:43	13/10/2020 23:35	13/10/2020 19:43	13/10/2020 23:35	3,86	1	3,86	CHI
20201071680	PORTEIRAO	CL21166499	RIO DOS BOIS	13/10/2020 19:43	13/10/2020 23:16	13/10/2020 19:43	13/10/2020 23:16	3,54	1	3,54	CHI
20201072152	ANAPOLIS	AN11238151	DAIA S1	13/10/2020 19:44	14/10/2020 00:04	13/10/2020 19:44	14/10/2020 00:04	4,33	155	671,54	CHI
20201071693	CRIXAS	2490025552	SERRA DO OURO	13/10/2020 19:44	15/10/2020 00:33	13/10/2020 19:44	15/10/2020 00:33	28,81	1	28,81	CHI
20201071894	CAIAPONIA	CP12415062	MONTIVIDIU T	13/10/2020 19:45	14/10/2020 14:54	13/10/2020 19:45	14/10/2020 14:54	19,16	6	114,96	CHI
20201071699	VALPARAISO DE GOIAS	2860036083	MARAJOARA	13/10/2020 19:45	13/10/2020 20:51	13/10/2020 19:45	13/10/2020 20:51	1,09	1	1,09	CHI
20201071711	TROMBAS	TB11391674	PORANGATU	13/10/2020 19:48	13/10/2020 22:50	13/10/2020 19:48	13/10/2020 22:50	3,02	59	178,21	CHI
20201071716	FORMOSA	FA11180558	ITUIQUIRA	13/10/2020 19:50	13/10/2020 22:33	13/10/2020 19:50	13/10/2020 22:33	2,72	24	65,19	CHI
20201071802	FORMOSA	FA12364319	SAO JOAO D ALIANCA	13/10/2020 19:54	14/10/2020 11:03	13/10/2020 19:54	14/10/2020 11:03	15,14	12	181,72	CHI
20201071745	APARECIDA DE GOIANIA	AP11007353	INDEPENDENCIA S1	13/10/2020 19:55	13/10/2020 21:37	13/10/2020 19:55	13/10/2020 21:37	1,70	216	367,20	CHI
20201071738	FLORES DE GOIAS	FB12257743	FLORES DE GOIAS	13/10/2020 19:56	15/10/2020 15:46	13/10/2020 19:56	14/10/2020 11:24	15,47	6	92,80	CHI
20201071738	FLORES DE GOIAS	FB12257743	FLORES DE GOIAS	13/10/2020 19:56	15/10/2020 15:46	13/10/2020 19:56	14/10/2020 11:24	14,32	1	14,32	CHI
20201071738	FLORES DE GOIAS	FB12257743	FLORES DE GOIAS	13/10/2020 19:56	15/10/2020 15:46	14/10/2020 11:34	14/10/2020 13:14	1,67	2	3,34	CHI
20201071738	FLORES DE GOIAS	FB12257743	FLORES DE GOIAS	13/10/2020 19:56	15/10/2020 15:46	13/10/2020 19:56	15/10/2020 08:27	36,53	1	36,53	CHI

20201071738	FLORES DE GOIAS	FB12257743	FLORES DE GOIAS	13/10/2020 19:56	15/10/2020 15:46	14/10/2020 11:34	15/10/2020 15:46	28,20	5	141,00	CHI
20201071738	FLORES DE GOIAS	FB12257743	FLORES DE GOIAS	13/10/2020 19:56	15/10/2020 15:46	15/10/2020 13:47	15/10/2020 15:46	2,00	3	5,99	CHI
20201071746	CRIXAS	2490020311	SERRA DO OURO	13/10/2020 19:58	15/10/2020 00:22	13/10/2020 19:58	15/10/2020 00:22	28,40	1	28,40	CHI
20201071750	CRISTALINA	KR21103517	CRISTALINA S1	13/10/2020 19:58	13/10/2020 21:59	13/10/2020 19:58	13/10/2020 21:59	2,00	4	8,02	CHI
20201071760	AGUA FRIA DE GOIAS	TL21337467	SAO JOAO D ALIANCA	13/10/2020 19:59	14/10/2020 08:08	13/10/2020 19:59	14/10/2020 08:08	12,14	1	12,14	CHI
20201071764	GUARINOS	GF11037310	SANTA TEREZINHA	13/10/2020 20:00	14/10/2020 02:59	13/10/2020 20:00	14/10/2020 02:59	6,98	133	928,12	CHI
20201071766	NEROPOLIS	10012917905	NEROPOLIS S2	13/10/2020 20:00	14/10/2020 09:04	13/10/2020 20:00	14/10/2020 09:04	13,06	1	13,06	CHI
20201071774	GOIANIA	15769690	REAL S1	13/10/2020 20:03	13/10/2020 23:03	13/10/2020 20:03	13/10/2020 23:03	3,00	1	3,00	CHI
20201071897	GOIANIA	GN11191229	CARAJAS S2	13/10/2020 20:03	13/10/2020 21:36	13/10/2020 20:03	13/10/2020 21:36	1,54	80	123,38	CHI
20201071779	DIORAMA	1530005994	IPORA	13/10/2020 20:04	13/10/2020 22:13	13/10/2020 20:04	13/10/2020 22:13	2,14	1	2,14	CHI
20201071788	SANTO ANTONIO DE GOIAS	BW12406479	NEROPOLIS S1	13/10/2020 20:05	14/10/2020 11:46	13/10/2020 20:05	14/10/2020 11:46	15,67	21	329,12	CHI
20201071791	GOIANIA	10703159	ATLANTICO S2	13/10/2020 20:05	14/10/2020 09:19	13/10/2020 20:05	14/10/2020 09:19	13,22	1	13,22	CHI
20201072536	SANTA TEREZINHA DE GOIAS	GG12166527	SANTA TEREZINHA	13/10/2020 20:06	14/10/2020 08:52	13/10/2020 20:06	14/10/2020 08:52	12,77	7	89,36	CHI
20201072536	PILAR DE GOIAS	GG12166527	SANTA TEREZINHA	13/10/2020 20:06	14/10/2020 08:52	13/10/2020 20:06	14/10/2020 08:52	12,77	13	165,95	CHI
20201071796	CAIAPONIA	CP11268533	CAIAPONIA	13/10/2020 20:06	14/10/2020 01:00	13/10/2020 20:06	14/10/2020 01:00	4,89	6	29,35	CHI
20201071801	NOVA CRIXAS	NA12328070	NOVA CRIXAS	13/10/2020 20:06	15/10/2020 19:10	13/10/2020 20:06	14/10/2020 10:25	14,31	113	1616,50	CHI
20201071801	NOVA CRIXAS	NA12077123LD	NOVA CRIXAS	13/10/2020 20:06	15/10/2020 19:10	13/10/2020 20:06	15/10/2020 19:10	47,05	1	47,05	CHI
20201071804	SANTA FE DE GOIAS	RN11055348	BRITANIA	13/10/2020 20:07	14/10/2020 01:50	13/10/2020 20:07	14/10/2020 01:50	5,72	140	800,22	CHI
20201071806	JUSSARA	JR21089655	JUSSARA	13/10/2020 20:08	14/10/2020 08:18	13/10/2020 20:08	14/10/2020 08:18	12,16	1	12,16	CHI
20201071808	AGUA FRIA DE GOIAS	PI12048039	SAO JOAO D ALIANCA	13/10/2020 20:08	14/10/2020 07:16	13/10/2020 20:08	14/10/2020 07:16	11,12	44	489,45	CHI
20201071835	CRISTALINA	03460424	PAMPLONA	13/10/2020 20:09	13/10/2020 22:33	13/10/2020 20:09	13/10/2020 21:46	1,62	69	111,74	CHI
20201071835	CRISTALINA	03460424	PAMPLONA	13/10/2020 20:09	13/10/2020 22:33	13/10/2020 20:09	13/10/2020 22:33	2,40	70	168,14	CHI
20201071828	NOVA CRIXAS	NA10407765	NOVA CRIXAS	13/10/2020 20:11	14/10/2020 13:08	13/10/2020 20:11	14/10/2020 13:08	16,93	1216	20592,96	CHI
20201071828	ARUANA	NA10407765	NOVA CRIXAS	13/10/2020 20:11	14/10/2020 13:08	13/10/2020 20:11	14/10/2020 13:08	16,93	25	423,37	CHI
20201071828	NOVA CRIXAS	NA10407765	NOVA CRIXAS	13/10/2020 20:11	14/10/2020 13:08	13/10/2020 20:11	14/10/2020 13:08	16,93	3	50,80	CHI
20201071828	NOVA CRIXAS	NA10407765	NOVA CRIXAS	13/10/2020 20:11	14/10/2020 13:08	13/10/2020 20:11	14/10/2020 13:08	16,93	46	779,01	CHI
20201071833	NIQUELANDIA	NQ12253182	URUACU	13/10/2020 20:12	14/10/2020 10:23	13/10/2020 20:12	14/10/2020 10:23	14,17	8	113,35	CHI
20201071834	BOM JARDIM DE GOIAS	BM21118187	BOM JARDIM	13/10/2020 20:13	14/10/2020 08:15	13/10/2020 20:13	14/10/2020 08:15	12,03	1	12,03	CHI
20201071837	RIO VERDE	RV21303564	SANTA HELENA S1	13/10/2020 20:13	14/10/2020 09:37	13/10/2020 20:13	14/10/2020 09:37	13,39	1	13,39	CHI
20201071838	GOIAS	GS21148716	GOIAS	13/10/2020 20:13	14/10/2020 09:55	13/10/2020 20:13	14/10/2020 09:55	13,69	1	13,69	CHI
20201071839	MORRO AGUDO DE GOIAS	FC12299810LD	GOIAS	13/10/2020 20:14	13/10/2020 22:21	13/10/2020 20:14	13/10/2020 22:21	2,12	2	4,23	CHI
20201071839	ITAPURANGA	FC12299810LD	GOIAS	13/10/2020 20:14	13/10/2020 22:21	13/10/2020 20:14	13/10/2020 22:21	2,12	2	4,23	CHI
20201071839	FAINA	FC12299810LD	GOIAS	13/10/2020 20:14	13/10/2020 22:21	13/10/2020 20:14	13/10/2020 22:21	2,12	240	507,67	CHI
20201071884	NOVO PLANALTO	TA12391932	NOVO PLANALTO	13/10/2020 20:14	14/10/2020 00:34	13/10/2020 20:14	14/10/2020 00:34	4,32	6	25,91	CHI
20201071845	LUZIANIA	LZ21064511	VIANOPOLIS	13/10/2020 20:15	14/10/2020 01:59	13/10/2020 20:15	14/10/2020 01:59	5,73	1	5,73	CHI
20201071846	MINEIROS	10006745235	PARQUE DAS EMAS	13/10/2020 20:15	14/10/2020 00:17	13/10/2020 20:15	14/10/2020 00:17	4,03	1	4,03	CHI
20201071999	TRINDADE	TR11157607	GOYA S2	13/10/2020 20:15	13/10/2020 22:07	13/10/2020 20:15	13/10/2020 22:07	1,86	127	236,29	CHI
20201071855	CATURAI	CK11210361	INHUMAS S1	13/10/2020 20:17	14/10/2020 09:07	13/10/2020 20:17	14/10/2020 09:07	12,82	79	1012,96	CHI
20201071863	FORMOSA	FA32042677	SAO JOAO D ALIANCA	13/10/2020 20:20	14/10/2020 07:42	13/10/2020 20:20	14/10/2020 07:42	11,36	14	159,00	CHI
20201071889	PALMEIRAS DE GOIAS	PL12063336	PALMEIRAS	13/10/2020 20:21	15/10/2020 08:43	13/10/2020 20:21	15/10/2020 08:43	36,36	10	363,64	CHI
20201071889	PALMINOPOLIS	PL12063336	PALMEIRAS	13/10/2020 20:21	15/10/2020 08:43	13/10/2020 20:21	15/10/2020 08:43	36,36	1	36,36	CHI
20201071869	PLANALTINA	PI11129906	PLANALTINA	13/10/2020 20:21	13/10/2020 22:42	13/10/2020 20:21	13/10/2020 22:42	2,34	125	292,47	CHI
20201071983	MUNDO NOVO DE GOIAS	MH11255520	NOVA CRIXAS	13/10/2020 20:21	14/10/2020 02:48	13/10/2020 20:21	14/10/2020 02:48	6,44	101	649,99	CHI
20201071875	CABECEIRAS	CW21157340	ITUIQUIRA	13/10/2020 20:23	14/10/2020 07:46	13/10/2020 20:23	14/10/2020 07:46	11,38	1	11,38	CHI
20201072229	SANTO ANTONIO DA BARRA	BZ12214190	ACREUNA	13/10/2020 20:26	14/10/2020 09:05	13/10/2020 20:26	14/10/2020 09:05	12,64	8	101,14	CHI
20201071887	RIO VERDE	630319200	RIO VERDE S2	13/10/2020 20:26	13/10/2020 23:11	13/10/2020 20:26	13/10/2020 23:11	2,74	1	2,74	CHI
20201071895	GOIANIA	10689965	ATLANTICO S2	13/10/2020 20:28	14/10/2020 03:08	13/10/2020 20:28	14/10/2020 03:08	6,65	1	6,65	CHI
20201071932	APARECIDA DE GOIANIA	AP11075382	ANHANGUERA	13/10/2020 20:32	13/10/2020 21:31	13/10/2020 20:32	13/10/2020 21:31	0,97	200	194,50	CHI
20201071915	GOIANIA	12652210	ATLANTICO S2	13/10/2020 20:34	14/10/2020 04:26	13/10/2020 20:34	14/10/2020 04:26	7,85	1	7,85	CHI
20201071916	MINEIROS	MY12254104	PARQUE DAS EMAS	13/10/2020 20:35	14/10/2020 18:35	13/10/2020 20:35	14/10/2020 18:35	22,00	1	22,00	CHI
20201071921	SAO LUIS DE MONTES BELOS	500034849	SAO LUIZ DOS MONTES BELOS	13/10/2020 20:35	14/10/2020 10:08	13/10/2020 20:35	14/10/2020 10:08	13,54	1	13,54	CHI
20201071928	SAO MIGUEL DO ARAGUAIA	830067358	SAO MIGUEL DO ARAGUAIA	13/10/2020 20:37	14/10/2020 05:01	13/10/2020 20:37	14/10/2020 05:01	8,40	1	8,40	CHI
20201071930	FORMOSA	FA12257630	ITUIQUIRA	13/10/2020 20:37	13/10/2020 23:32	13/10/2020 20:37	13/10/2020 23:32	2,91	6	17,46	CHI
20201072027	GOIANIA	GN11002154	GOYA S2	13/10/2020 20:37	13/10/2020 22:50	13/10/2020 20:37	13/10/2020 22:50	2,20	208	457,95	CHI
20201072010	FORMOSA	FA11129972	ITUIQUIRA	13/10/2020 20:38	13/10/2020 21:35	13/10/2020 20:38	13/10/2020 21:35	0,96	116	111,07	CHI
20201071939	JARAGUA	70015650	JARAGUA	13/10/2020 20:39	14/10/2020 00:10	13/10/2020 20:39	14/10/2020 00:10	3,51	1	3,51	CHI
20201072427	PORANGATU	10006514616	PORANGATU	13/10/2020 20:39	14/10/2020 10:12	13/10/2020 20:39	14/10/2020 10:12	13,55	1	13,55	CHI
20201071942	MOSSAMEDES	MD21204357	ITABERAII S2	13/10/2020 20:39	14/10/2020 16:49	13/10/2020 20:39	14/10/2020 16:49	20,16	2	40,32	CHI

20201071966	AMORINOPOLIS	AM12402915	IPORA	13/10/2020 20:43	14/10/2020 09:42	13/10/2020 20:43	14/10/2020 09:42	12,97	3	38,92	CHI
20201072056	LUZIANIA	LZ12092802	RIO VERMELHO	13/10/2020 20:45	13/10/2020 22:00	13/10/2020 20:45	13/10/2020 22:00	1,24	292	362,24	CHI
20201072093	SANTO ANTONIO DO DESCOBERTO	SN12108808	ALEXANIA	13/10/2020 20:46	14/10/2020 00:00	13/10/2020 20:46	14/10/2020 00:00	3,22	271	872,92	CHI
20201071886	DOVERLANDIA	DV11193288	CAIAPONIA	13/10/2020 20:46	13/10/2020 21:14	13/10/2020 20:46	13/10/2020 21:14	0,45	87	39,44	CHI
20201071979	GUARINOS	CX12097448RE	SANTA TEREZINHA	13/10/2020 20:47	14/10/2020 20:30	13/10/2020 20:47	14/10/2020 20:30	23,71	46	1090,72	CHI
20201071979	CRIXAS	CX12097448RE	SANTA TEREZINHA	13/10/2020 20:47	14/10/2020 20:30	13/10/2020 20:47	14/10/2020 20:30	23,71	25	592,78	CHI
20201072003	MARA ROSA	MQ21146948	MARA ROSA	13/10/2020 20:53	14/10/2020 01:37	13/10/2020 20:53	14/10/2020 01:37	4,72	2	9,44	CHI
20201072004	GOIANIA	14002553	CARAJAS S1	13/10/2020 20:53	14/10/2020 09:04	13/10/2020 20:53	14/10/2020 09:04	12,17	1	12,17	CHI
20201072043	GOIANIA	GN11048929	REAL S1	13/10/2020 20:57	14/10/2020 04:17	13/10/2020 20:57	14/10/2020 04:17	7,34	220	1614,62	CHI
20201072021	GOIANIA	10538630	GOIANIA LESTE S2	13/10/2020 20:59	14/10/2020 00:44	13/10/2020 20:59	14/10/2020 00:44	3,74	1	3,74	CHI
20201072083	JATAI	JT12063437	JATAI S3	13/10/2020 21:01	13/10/2020 22:14	13/10/2020 21:01	13/10/2020 22:14	1,23	434	532,37	CHI
20201072039	BRAZABRANTES	DL21016701	INHUMAS S1	13/10/2020 21:03	14/10/2020 12:18	13/10/2020 21:03	14/10/2020 12:18	15,24	2	30,49	CHI
20201072054	APARECIDA DE GOIANIA	10238438	REAL S1	13/10/2020 21:06	13/10/2020 23:10	13/10/2020 21:06	13/10/2020 23:10	2,07	1	2,07	CHI
20201072126	LUZIANIA	LZ12000175	RIO VERMELHO	13/10/2020 21:07	13/10/2020 22:43	13/10/2020 21:07	13/10/2020 22:43	1,58	197	312,03	CHI
20201072063	TRINDADE	40137892	TRINDADE	13/10/2020 21:08	13/10/2020 23:41	13/10/2020 21:08	13/10/2020 23:41	2,54	1	2,54	CHI
20201072070	JESUPOLIS	SF21000150	SAO FRANCISCO DE GOIAS	13/10/2020 21:11	14/10/2020 19:30	13/10/2020 21:11	14/10/2020 19:30	22,31	1	22,31	CHI
20201072071	ANAPOLIS	AN12386259	ANAPOLIS UNIVERSITARIO S2	13/10/2020 21:12	14/10/2020 09:29	13/10/2020 21:12	14/10/2020 09:29	12,27	13	159,55	CHI
20201072089	LUZIANIA	LZ12128849	RIO VERMELHO	13/10/2020 21:22	14/10/2020 05:25	13/10/2020 21:22	14/10/2020 04:47	7,40	10	74,01	CHI
20201072089	LUZIANIA	LZ12128849	RIO VERMELHO	13/10/2020 21:22	14/10/2020 05:25	13/10/2020 21:22	14/10/2020 05:25	8,03	35	281,20	CHI
20201072100	UIRAPURU	MH21239913	NOVA CRIXAS	13/10/2020 21:26	14/10/2020 10:04	13/10/2020 21:26	14/10/2020 10:04	12,63	1	12,63	CHI
20201072119	LUZIANIA	LZ21128880	MARAJOARA	13/10/2020 21:30	14/10/2020 02:02	13/10/2020 21:30	14/10/2020 02:02	4,53	1	4,53	CHI
20201072137	NEROPOLIS	NR21317365	NEROPOLIS S2	13/10/2020 21:37	14/10/2020 14:19	13/10/2020 21:37	14/10/2020 14:19	16,69	1	16,69	CHI
20201072158	QUIRINOPOLIS	QI11189167	QUIRINOPOLIS	13/10/2020 21:48	13/10/2020 23:05	13/10/2020 21:48	13/10/2020 23:05	1,29	111	142,91	CHI
20201072150	PORANGATU	PO21187878	PORANGATU	13/10/2020 21:49	14/10/2020 02:33	13/10/2020 21:49	14/10/2020 02:33	4,72	1	4,72	CHI
20201072157	GOIANIA	10569364	GOIANIA LESTE S2	13/10/2020 21:51	14/10/2020 00:13	13/10/2020 21:51	14/10/2020 00:13	2,36	1	2,36	CHI
20201072161	QUIRINOPOLIS	10020093312	QUIRINOPOLIS	13/10/2020 21:52	14/10/2020 01:01	13/10/2020 21:52	14/10/2020 01:01	3,14	1	3,14	CHI
20201072162	GOIANIA	10015235279	GOIANIA LESTE S2	13/10/2020 21:54	14/10/2020 07:16	13/10/2020 21:54	14/10/2020 07:16	9,37	1	9,37	CHI
20201072163	TROMBAS	2560013946	PORANGATU	13/10/2020 21:54	14/10/2020 08:52	13/10/2020 21:54	14/10/2020 08:52	10,97	1	10,97	CHI
20201072164	GOIANIA	11300784	AEROPORTO S2	13/10/2020 21:54	14/10/2020 01:25	13/10/2020 21:54	14/10/2020 01:25	3,51	1	3,51	CHI
20201072168	APARECIDA DE GOIANIA	13894043	INDEPENDENCIA S1	13/10/2020 21:55	14/10/2020 00:38	13/10/2020 21:55	14/10/2020 00:38	2,70	1	2,70	CHI
20201072180	GOIANIA	GN11001641	FERROVIARIO S1	13/10/2020 21:56	14/10/2020 01:08	13/10/2020 21:56	14/10/2020 01:08	3,20	152	486,36	CHI
20201072207	LUZIANIA	LZ12000240	RIO VERMELHO	13/10/2020 21:56	13/10/2020 23:35	13/10/2020 21:56	13/10/2020 23:35	1,64	888	1457,80	CHI
20201072500	COCALZINHO DE GOIAS	ZN12068045	AGUAS LINDAS DE GOIAS S1	13/10/2020 21:56	14/10/2020 08:57	13/10/2020 21:56	14/10/2020 08:57	11,01	13	143,10	CHI
20201072184	CIDADE OCIDENTAL	2680101759	MARAJOARA	13/10/2020 22:00	14/10/2020 03:40	13/10/2020 22:00	14/10/2020 03:40	5,66	1	5,66	CHI
20201072192	GOIANIA	13774529	CARAJAS S1	13/10/2020 22:01	14/10/2020 00:38	13/10/2020 22:01	14/10/2020 00:38	2,61	1	2,61	CHI
20201072486	LUZIANIA	LZ12070127RE	MARAJOARA	13/10/2020 22:03	14/10/2020 07:18	13/10/2020 22:03	14/10/2020 07:18	9,24	17	157,01	CHI
20201072498	ALTO HORIZONTE	AU12320992RE	SANTA TEREZINHA	13/10/2020 22:10	14/10/2020 09:01	13/10/2020 22:10	14/10/2020 09:01	10,85	47	509,75	CHI
20201072220	LUZIANIA	120182592	RIO VERMELHO	13/10/2020 22:11	13/10/2020 23:35	13/10/2020 22:11	13/10/2020 23:35	1,40	1	1,40	CHI
20201072228	SANTA RITA DO ARAGUAIA	SU11360691	SANTA RITA DO ARAGUAIA	13/10/2020 22:15	14/10/2020 07:53	13/10/2020 22:15	14/10/2020 07:53	9,63	1	9,63	CHI
20201072259	GOIANIA	GN11199197	ATLANTICO S1	13/10/2020 22:22	14/10/2020 03:15	13/10/2020 22:22	14/10/2020 03:15	4,88	93	454,12	CHI
20201072243	URUACU	UR21050054	URUACU	13/10/2020 22:23	15/10/2020 01:25	13/10/2020 22:23	15/10/2020 01:25	27,04	1	27,04	CHI
20201072250	ITAJA	IJ21000077	CACHOEIRA ALTA	13/10/2020 22:26	13/10/2020 23:43	13/10/2020 22:26	13/10/2020 23:43	1,28	1	1,28	CHI
20201072253	GOIANIA	11828663	ATLANTICO S1	13/10/2020 22:28	14/10/2020 08:58	13/10/2020 22:28	14/10/2020 08:58	10,49	1	10,49	CHI
20201072283	AGUAS LINDAS DE GOIAS	4830066429	AGUAS LINDAS DE GOIAS S1	13/10/2020 22:43	14/10/2020 01:56	13/10/2020 22:43	14/10/2020 01:56	3,21	1	3,21	CHI
20201072290	CIDADE OCIDENTAL	DH12170612	MARAJOARA	13/10/2020 22:46	14/10/2020 20:06	13/10/2020 22:46	14/10/2020 20:06	21,33	15	319,92	CHI
20201072291	RIO VERDE	RV21021187	RIO VERDE S1	13/10/2020 22:46	14/10/2020 08:44	13/10/2020 22:46	14/10/2020 08:44	9,96	1	9,96	CHI
20201072303	LUZIANIA	LZ11169061	MARAJOARA	13/10/2020 22:50	14/10/2020 03:29	13/10/2020 22:50	14/10/2020 03:29	4,64	64	296,69	CHI
20201072314	TRINDADE	40201170	TRINDADE	13/10/2020 22:58	14/10/2020 00:57	13/10/2020 22:58	14/10/2020 00:57	1,97	1	1,97	CHI
20201072320	LUZIANIA	LZ11348212	MARAJOARA	13/10/2020 23:01	14/10/2020 03:03	13/10/2020 23:01	14/10/2020 03:03	4,02	89	358,13	CHI
20201072324	NOVO GAMA	10009703371	PACAEMBU S1	13/10/2020 23:06	13/10/2020 23:52	13/10/2020 23:06	13/10/2020 23:52	0,76	1	0,76	CHI
20201072331	CAMPINACU	UC21316361	MARA ROSA	13/10/2020 23:12	14/10/2020 16:09	13/10/2020 23:12	14/10/2020 16:09	16,95	2	33,89	CHI
20201072336	GOIANIA	15572936	CARAJAS S1	13/10/2020 23:14	14/10/2020 09:45	13/10/2020 23:14	14/10/2020 09:45	10,51	1	10,51	CHI
20201072337	GOIANIA	GN11281237	GOYA S2	13/10/2020 23:16	14/10/2020 02:16	13/10/2020 23:16	14/10/2020 02:16	2,99	45	134,65	CHI
20201072342	CACU	CC11095408	CACHOEIRA ALTA	13/10/2020 23:20	14/10/2020 01:10	13/10/2020 23:20	14/10/2020 01:10	1,82	116	211,41	CHI
20201072344	SENADOR CANEDO	SW11064925	SENADOR CANEDO	13/10/2020 23:21	14/10/2020 00:27	13/10/2020 23:21	14/10/2020 00:27	1,09	160	174,44	CHI
20201072345	ANAPOLIS	AN12000105	ANAPOLIS UNIVERSITARIO S2	13/10/2020 23:21	14/10/2020 02:12	13/10/2020 23:21	14/10/2020 02:12	2,84	53	150,53	CHI
20201072358	CRIXAS	2490022095	SERRA DO OURO	13/10/2020 23:36	14/10/2020 23:19	13/10/2020 23:36	14/10/2020 23:19	23,71	1	23,71	CHI
20201072359	MONTE ALEGRE DE GOIAS	MA12233169	SAO DOMINGOS	13/10/2020 23:41	14/10/2020 01:57	13/10/2020 23:41	14/10/2020 01:57	2,25	18	40,52	CHI

20201072361	SAO MIGUEL DO ARAGUAIA	SM12334369LD	SAO MIGUEL DO ARAGUAIA	13/10/2020 23:47	14/10/2020 10:29	13/10/2020 23:47	14/10/2020 10:29	10,71	105	1124,17	CHI
20201072364	GOIANIA	10000020239	GOIANIA LESTE S1	13/10/2020 23:49	14/10/2020 10:03	13/10/2020 23:49	14/10/2020 10:03	10,23	1	10,23	CHI
20201072375	LUZIANIA	LZ11201488	RIO VERMELHO	14/10/2020 00:05	14/10/2020 01:33	14/10/2020 00:05	14/10/2020 01:33	1,45	69	100,39	CHI
20201072522	APARECIDA DE GOIANIA	AP11162125	INDEPENDENCIA S1	14/10/2020 00:34	14/10/2020 07:36	14/10/2020 00:34	14/10/2020 07:36	7,02	64	449,46	CHI
20201072388	ALEXANIA	AX21381458	ALEXANIA	14/10/2020 00:37	14/10/2020 06:34	14/10/2020 00:37	14/10/2020 06:34	5,94	1	5,94	CHI
20201072396	LUZIANIA	LZ12209616	MARAOARA	14/10/2020 01:02	14/10/2020 02:02	14/10/2020 01:02	14/10/2020 02:02	0,99	128	126,15	CHI
20201072400	ANAPOLIS	AN21167602	ANAPOLIS UNIVERSITARIO S2	14/10/2020 01:14	14/10/2020 09:24	14/10/2020 01:14	14/10/2020 09:24	8,16	2	16,32	CHI
20201072496	ANAPOLIS	AN11000256	JUNDIAI S2	14/10/2020 01:20	14/10/2020 08:45	14/10/2020 01:20	14/10/2020 08:45	7,41	112	829,80	CHI
20201072407	GOIANIA	10014742444	REAL S1	14/10/2020 01:35	14/10/2020 07:17	14/10/2020 01:35	14/10/2020 07:17	5,69	1	5,69	CHI
20201072412	LUZIANIA	LZ11162866	RIO VERMELHO	14/10/2020 01:57	14/10/2020 02:37	14/10/2020 01:57	14/10/2020 02:37	0,67	111	74,00	CHI
20201072490	PORANGATU	PO12391912	PORANGATU	14/10/2020 02:21	14/10/2020 08:21	14/10/2020 02:21	14/10/2020 08:21	6,00	52	311,83	CHI
20201072490	MUTUNOPOLIS	PO12391912	PORANGATU	14/10/2020 02:21	14/10/2020 08:21	14/10/2020 02:21	14/10/2020 08:21	6,00	4	23,99	CHI
20201072421	ALTO PARAISO DE GOIAS	BF21365294	NIQUELANDIA SUBTRANSMISSAO	14/10/2020 02:29	14/10/2020 07:29	14/10/2020 02:29	14/10/2020 07:29	4,99	1	4,99	CHI
20201072422	FORMOSA	VB12204775RE	ITIQUEIRA	14/10/2020 02:33	14/10/2020 22:15	14/10/2020 02:33	14/10/2020 14:04	11,52	3	34,57	CHI
20201072422	VILA BOA	FA10410992	ITIQUEIRA	14/10/2020 02:33	14/10/2020 22:15	14/10/2020 14:04	14/10/2020 14:07	0,05	7	0,37	CHI
20201072422	FORMOSA	FA10410992	ITIQUEIRA	14/10/2020 02:33	14/10/2020 22:15	14/10/2020 14:04	14/10/2020 14:07	0,05	446	23,66	CHI
20201072422	FORMOSA	FA10410992	ITIQUEIRA	14/10/2020 02:33	14/10/2020 22:15	14/10/2020 14:04	14/10/2020 14:12	0,13	810	105,75	CHI
20201072422	VILA BOA	FA10401450	ITIQUEIRA	14/10/2020 02:33	14/10/2020 22:15	14/10/2020 14:04	14/10/2020 14:12	0,13	24	3,13	CHI
20201072422	VILA BOA	FA10410992	ITIQUEIRA	14/10/2020 02:33	14/10/2020 22:15	14/10/2020 14:04	14/10/2020 14:12	0,13	5	0,65	CHI
20201072422	FORMOSA	FA10410992	ITIQUEIRA	14/10/2020 02:33	14/10/2020 22:15	14/10/2020 14:04	14/10/2020 14:12	0,13	581	75,85	CHI
20201072422	FORMOSA	FA10401450	ITIQUEIRA	14/10/2020 02:33	14/10/2020 22:15	14/10/2020 14:04	14/10/2020 14:12	0,13	527	68,80	CHI
20201072422	VILA BOA	FA10410992	ITIQUEIRA	14/10/2020 02:33	14/10/2020 22:15	14/10/2020 14:04	14/10/2020 14:12	0,13	4	0,52	CHI
20201072422	SAO JOAO D ALIANCA	FA10410992	ITIQUEIRA	14/10/2020 02:33	14/10/2020 22:15	14/10/2020 14:04	14/10/2020 14:12	0,13	205	26,76	CHI
20201072422	FLORES DE GOIAS	FA10410992	ITIQUEIRA	14/10/2020 02:33	14/10/2020 22:15	14/10/2020 14:04	14/10/2020 14:12	0,13	2	0,26	CHI
20201072422	VILA BOA	VB12204775RE	ITIQUEIRA	14/10/2020 02:33	14/10/2020 22:15	14/10/2020 02:33	14/10/2020 15:08	12,58	48	604,07	CHI
20201072422	VILA BOA	VB12204775RE	ITIQUEIRA	14/10/2020 02:33	14/10/2020 22:15	14/10/2020 02:33	14/10/2020 15:23	12,84	11	141,21	CHI
20201072422	FORMOSA	VB12204775RE	ITIQUEIRA	14/10/2020 02:33	14/10/2020 22:15	14/10/2020 02:33	14/10/2020 15:23	12,84	45	577,69	CHI
20201072422	FORMOSA	VB13361377	ITIQUEIRA	14/10/2020 02:33	14/10/2020 22:15	14/10/2020 02:35	14/10/2020 15:23	12,80	1	12,80	CHI
20201072422	VILA BOA	VB12204775RE	ITIQUEIRA	14/10/2020 02:33	14/10/2020 22:15	14/10/2020 02:33	14/10/2020 15:54	13,35	115	1535,35	CHI
20201072422	VILA BOA	VB12270084LD	ITIQUEIRA	14/10/2020 02:33	14/10/2020 22:15	14/10/2020 02:35	14/10/2020 15:54	13,31	4	53,24	CHI
20201072422	FORMOSA	FA10395393	ITIQUEIRA	14/10/2020 02:33	14/10/2020 22:15	14/10/2020 16:18	14/10/2020 16:23	0,08	119	9,45	CHI
20201072422	VILA BOA	FA10401450	ITIQUEIRA	14/10/2020 02:33	14/10/2020 22:15	14/10/2020 16:13	14/10/2020 16:40	0,44	202	88,60	CHI
20201072422	FORMOSA	FA10401450	ITIQUEIRA	14/10/2020 02:33	14/10/2020 22:15	14/10/2020 16:13	14/10/2020 16:40	0,44	573	251,32	CHI
20201072422	VILA BOA	FA10410992	ITIQUEIRA	14/10/2020 02:33	14/10/2020 22:15	14/10/2020 16:13	14/10/2020 16:40	0,44	4	1,75	CHI
20201072422	FLORES DE GOIAS	FA10410992	ITIQUEIRA	14/10/2020 02:33	14/10/2020 22:15	14/10/2020 16:13	14/10/2020 16:40	0,44	2	0,88	CHI
20201072422	VILA BOA	FA10410992	ITIQUEIRA	14/10/2020 02:33	14/10/2020 22:15	14/10/2020 16:13	14/10/2020 16:40	0,44	4	1,75	CHI
20201072422	SAO JOAO D ALIANCA	FA10410992	ITIQUEIRA	14/10/2020 02:33	14/10/2020 22:15	14/10/2020 16:13	14/10/2020 16:40	0,44	203	89,04	CHI
20201072422	FORMOSA	FA10410992	ITIQUEIRA	14/10/2020 02:33	14/10/2020 22:15	14/10/2020 16:13	14/10/2020 16:40	0,44	811	355,71	CHI
20201072422	FORMOSA	FA10410992	ITIQUEIRA	14/10/2020 02:33	14/10/2020 22:15	14/10/2020 16:13	14/10/2020 16:40	0,44	579	253,96	CHI
20201072422	FORMOSA	FA10410992	ITIQUEIRA	14/10/2020 02:33	14/10/2020 22:15	14/10/2020 17:30	14/10/2020 17:39	0,15	1023	151,46	CHI
20201072422	VILA BOA	FA10410992	ITIQUEIRA	14/10/2020 02:33	14/10/2020 22:15	14/10/2020 17:30	14/10/2020 17:39	0,15	4	0,59	CHI
20201072422	SAO JOAO D ALIANCA	FA10410992	ITIQUEIRA	14/10/2020 02:33	14/10/2020 22:15	14/10/2020 17:30	14/10/2020 17:39	0,15	203	30,06	CHI
20201072422	FLORES DE GOIAS	FA10410992	ITIQUEIRA	14/10/2020 02:33	14/10/2020 22:15	14/10/2020 17:30	14/10/2020 17:39	0,15	2	0,30	CHI
20201072422	VILA BOA	FA10410992	ITIQUEIRA	14/10/2020 02:33	14/10/2020 22:15	14/10/2020 17:30	14/10/2020 17:39	0,15	4	0,59	CHI
20201072422	FORMOSA	FA10410992	ITIQUEIRA	14/10/2020 02:33	14/10/2020 22:15	14/10/2020 17:30	14/10/2020 17:39	0,15	579	85,72	CHI
20201072422	FORMOSA	FA10410992	ITIQUEIRA	14/10/2020 02:33	14/10/2020 22:15	14/10/2020 17:30	14/10/2020 17:39	0,15	811	120,07	CHI
20201072422	VILA BOA	FA10410992	ITIQUEIRA	14/10/2020 02:33	14/10/2020 22:15	14/10/2020 17:30	14/10/2020 17:39	0,15	209	30,94	CHI
20201072422	FORMOSA	03740454	ITIQUEIRA	14/10/2020 02:33	14/10/2020 22:15	14/10/2020 17:48	14/10/2020 17:51	0,05	579	29,75	CHI
20201072422	VILA BOA	03740454	ITIQUEIRA	14/10/2020 02:33	14/10/2020 22:15	14/10/2020 17:48	14/10/2020 17:51	0,05	4	0,21	CHI
20201072422	SAO JOAO D ALIANCA	03740454	ITIQUEIRA	14/10/2020 02:33	14/10/2020 22:15	14/10/2020 17:48	14/10/2020 17:51	0,05	203	10,43	CHI
20201072422	VILA BOA	03740454	ITIQUEIRA	14/10/2020 02:33	14/10/2020 22:15	14/10/2020 17:48	14/10/2020 17:51	0,05	4	0,21	CHI
20201072422	FORMOSA	03740454	ITIQUEIRA	14/10/2020 02:33	14/10/2020 22:15	14/10/2020 17:48	14/10/2020 17:51	0,05	2215	113,83	CHI
20201072422	VILA BOA	03740454	ITIQUEIRA	14/10/2020 02:33	14/10/2020 22:15	14/10/2020 17:48	14/10/2020 17:51	0,05	209	10,74	CHI
20201072422	FLORES DE GOIAS	03740454	ITIQUEIRA	14/10/2020 02:33	14/10/2020 22:15	14/10/2020 17:48	14/10/2020 17:51	0,05	2	0,10	CHI
20201072422	FORMOSA	03740454	ITIQUEIRA	14/10/2020 02:33	14/10/2020 22:15	14/10/2020 17:48	14/10/2020 17:51	0,05	811	41,68	CHI
20201072422	DISTRITO FEDERAL	FA10396080	ITIQUEIRA	14/10/2020 02:33	14/10/2020 22:15	14/10/2020 17:48	14/10/2020 17:52	0,07	1	0,07	CHI
20201072422	CABECEIRAS	FA10396080	ITIQUEIRA	14/10/2020 02:33	14/10/2020 22:15	14/10/2020 17:48	14/10/2020 17:52	0,07	21	1,48	CHI
20201072422	FORMOSA	FA10396080	ITIQUEIRA	14/10/2020 02:33	14/10/2020 22:15	14/10/2020 17:48	14/10/2020 17:52	0,07	98	6,89	CHI

20201072422	FORMOSA	FA10396080	ITUIQUIRA	14/10/2020 02:33	14/10/2020 22:15	14/10/2020 17:48	14/10/2020 17:52	0,07	95	6,68	CHI
20201072422	CABECEIRAS	FA10396080	ITUIQUIRA	14/10/2020 02:33	14/10/2020 22:15	14/10/2020 17:48	14/10/2020 17:52	0,07	19	1,34	CHI
20201072422	FORMOSA	VB12204775RE	ITUIQUIRA	14/10/2020 02:33	14/10/2020 22:15	14/10/2020 02:33	14/10/2020 22:15	19,70	13	256,10	CHI
20201072426	VARJAO	GA12008565	GUAPO S2	14/10/2020 02:56	14/10/2020 09:19	14/10/2020 02:56	14/10/2020 09:19	6,38	4	25,53	CHI
20201072426	GUAPO	GA12008565	GUAPO S2	14/10/2020 02:56	14/10/2020 09:19	14/10/2020 02:56	14/10/2020 09:19	6,38	3	19,15	CHI
20201072435	GOIANAPOLIS	00030424	DAIA S2	14/10/2020 03:13	14/10/2020 03:39	14/10/2020 03:13	14/10/2020 03:39	0,43	344	147,63	CHI
20201072435	NEROPOLIS	00030424	DAIA S2	14/10/2020 03:13	14/10/2020 03:39	14/10/2020 03:13	14/10/2020 03:39	0,43	49	21,03	CHI
20201072435	GOIANAPOLIS	00030424	DAIA S2	14/10/2020 03:13	14/10/2020 03:39	14/10/2020 03:13	14/10/2020 03:39	0,43	2	0,86	CHI
20201072435	NEROPOLIS	00030424	DAIA S2	14/10/2020 03:13	14/10/2020 03:39	14/10/2020 03:13	14/10/2020 03:39	0,43	3	1,29	CHI
20201072435	BONFINOPOLIS	00030424	DAIA S2	14/10/2020 03:13	14/10/2020 03:39	14/10/2020 03:13	14/10/2020 03:39	0,43	1	0,43	CHI
20201072435	TEREZOPOLIS DE GOIAS	00030424	DAIA S2	14/10/2020 03:13	14/10/2020 03:39	14/10/2020 03:13	14/10/2020 03:39	0,43	2300	987,08	CHI
20201072435	LEOPOLDO DE BULHOES	AN10413925	DAIA S2	14/10/2020 03:13	14/10/2020 03:39	14/10/2020 03:13	14/10/2020 03:39	0,43	1	0,43	CHI
20201072435	LEOPOLDO DE BULHOES	00030424	DAIA S2	14/10/2020 03:13	14/10/2020 03:39	14/10/2020 03:13	14/10/2020 03:39	0,43	537	230,46	CHI
20201072435	GOIANAPOLIS	00030424	DAIA S2	14/10/2020 03:13	14/10/2020 03:39	14/10/2020 03:13	14/10/2020 03:39	0,43	3	1,29	CHI
20201072435	ANAPOLIS	00030424	DAIA S2	14/10/2020 03:13	14/10/2020 03:39	14/10/2020 03:13	14/10/2020 03:39	0,43	9	3,86	CHI
20201072435	GOIANAPOLIS	AN10413925	DAIA S2	14/10/2020 03:13	14/10/2020 03:39	14/10/2020 03:13	14/10/2020 03:39	0,43	2	0,86	CHI
20201072435	TEREZOPOLIS DE GOIAS	00030424	DAIA S2	14/10/2020 03:13	14/10/2020 03:39	14/10/2020 03:13	14/10/2020 03:39	0,43	48	20,60	CHI
20201072435	ANAPOLIS	AN10413925	DAIA S2	14/10/2020 03:13	14/10/2020 03:39	14/10/2020 03:13	14/10/2020 03:39	0,43	1	0,43	CHI
20201072435	LEOPOLDO DE BULHOES	00030424	DAIA S2	14/10/2020 03:13	14/10/2020 03:39	14/10/2020 03:13	14/10/2020 03:39	0,43	618	265,23	CHI
20201072435	GAMELEIRA DE GOIAS	00030424	DAIA S2	14/10/2020 03:13	14/10/2020 03:39	14/10/2020 03:13	14/10/2020 03:39	0,43	2	0,86	CHI
20201072435	ANAPOLIS	00030424	DAIA S2	14/10/2020 03:13	14/10/2020 03:39	14/10/2020 03:13	14/10/2020 03:39	0,43	1	0,43	CHI
20201072435	TEREZOPOLIS DE GOIAS	00030424	DAIA S2	14/10/2020 03:13	14/10/2020 03:39	14/10/2020 03:13	14/10/2020 03:39	0,43	719	308,57	CHI
20201072435	TEREZOPOLIS DE GOIAS	00030424	DAIA S2	14/10/2020 03:13	14/10/2020 03:39	14/10/2020 03:13	14/10/2020 03:39	0,43	2	0,86	CHI
20201072435	BONFINOPOLIS	00030424	DAIA S2	14/10/2020 03:13	14/10/2020 03:39	14/10/2020 03:13	14/10/2020 03:39	0,43	53	22,75	CHI
20201072435	GOIANAPOLIS	00030424	DAIA S2	14/10/2020 03:13	14/10/2020 03:39	14/10/2020 03:13	14/10/2020 03:39	0,43	3615	1551,44	CHI
20201072435	GOIANAPOLIS	00030424	DAIA S2	14/10/2020 03:13	14/10/2020 03:39	14/10/2020 03:13	14/10/2020 03:39	0,43	1098	471,23	CHI
20201072435	GOIANIA	00030424	DAIA S2	14/10/2020 03:13	14/10/2020 03:39	14/10/2020 03:13	14/10/2020 03:39	0,43	1	0,43	CHI
20201072437	SANTA TEREZA DE GOIAS	SE21187888	MARA ROSA	14/10/2020 03:46	14/10/2020 08:56	14/10/2020 03:46	14/10/2020 08:56	5,17	1	5,17	CHI
20201072226	GOIANIA	GN11323132	AEROPORTO S2	14/10/2020 04:23	14/10/2020 04:38	14/10/2020 04:23	14/10/2020 04:38	0,25	35	8,71	CHI
20201072454	MUTUNOPOLIS	MU12246496	MARA ROSA	14/10/2020 04:31	14/10/2020 10:58	14/10/2020 04:31	14/10/2020 10:58	6,44	2	12,88	CHI
20201072457	QUIRINOPOLIS	QI21116468	QUIRINOPOLIS	14/10/2020 04:49	14/10/2020 09:06	14/10/2020 04:49	14/10/2020 09:06	4,27	1	4,27	CHI
20201072458	RIO VERDE	630034631	RIO VERDE S2	14/10/2020 04:50	14/10/2020 12:38	14/10/2020 04:50	14/10/2020 12:38	7,80	1	7,80	CHI
20201072462	CRISTALINA	KR21206514	PAMPLONA	14/10/2020 05:02	14/10/2020 09:18	14/10/2020 05:02	14/10/2020 09:18	4,25	1	4,25	CHI
20201072466	TROMBAS	TB12288306	PORANGATU	14/10/2020 05:14	14/10/2020 07:17	14/10/2020 05:14	14/10/2020 07:17	2,05	24	49,13	CHI
20201072487	RUBIATABA	RB12392305	RUBIATABA	14/10/2020 05:25	14/10/2020 09:43	14/10/2020 05:25	14/10/2020 09:43	4,30	15	64,47	CHI
20201072477	ALVORADA DO NORTE	AQ11161122	IACIARA S2	14/10/2020 05:43	14/10/2020 08:47	14/10/2020 05:43	14/10/2020 08:47	3,06	135	413,02	CHI
20201072480	APORE	AE21136299	ITAJA S1	14/10/2020 05:45	14/10/2020 07:16	14/10/2020 05:45	14/10/2020 07:16	1,52	1	1,52	CHI
20201073986	SAO FRANCISCO DE GOIAS	PG12216919	PETROLINA	14/10/2020 05:49	14/10/2020 14:45	14/10/2020 05:49	14/10/2020 14:45	8,92	1	8,92	CHI
20201073986	PETROLINA DE GOIAS	PG12216919	PETROLINA	14/10/2020 05:49	14/10/2020 14:45	14/10/2020 05:49	14/10/2020 14:45	8,92	8	71,38	CHI
20201072488	PIRENOPOLIS	PV11327853	CORUMBA	14/10/2020 05:54	14/10/2020 13:17	14/10/2020 05:54	14/10/2020 13:17	7,38	114	841,04	CHI
20201072491	CABECEIRAS	CW12042593LD	ITUIQUIRA	14/10/2020 05:59	14/10/2020 12:20	14/10/2020 05:59	14/10/2020 09:27	3,48	104	361,46	CHI
20201072491	CABECEIRAS	CW12042593LD	ITUIQUIRA	14/10/2020 05:59	14/10/2020 12:20	14/10/2020 08:46	14/10/2020 09:27	0,69	1	0,69	CHI
20201072491	CABECEIRAS	CW12042593LD	ITUIQUIRA	14/10/2020 05:59	14/10/2020 12:20	14/10/2020 09:30	14/10/2020 10:05	0,57	99	56,73	CHI
20201072491	CABECEIRAS	CW12049387LD	ITUIQUIRA	14/10/2020 05:59	14/10/2020 12:20	14/10/2020 09:30	14/10/2020 12:07	2,61	6	15,65	CHI
20201072491	CABECEIRAS	CW12042593LD	ITUIQUIRA	14/10/2020 05:59	14/10/2020 12:20	14/10/2020 05:59	14/10/2020 12:20	6,35	128	813,05	CHI
20201072510	SANTA RITA DO NOVO DESTINO	DF12382140	BARRO ALTO	14/10/2020 06:00	14/10/2020 10:15	14/10/2020 06:00	14/10/2020 10:15	4,25	15	63,70	CHI
20201072652	MUTUNOPOLIS	MU12395764	MARA ROSA	14/10/2020 06:00	14/10/2020 09:44	14/10/2020 06:00	14/10/2020 09:44	3,72	9	33,49	CHI
20201072499	SERRANOPOLIS	DJ21136045	CHAPADAO DO CEU	14/10/2020 06:04	14/10/2020 14:46	14/10/2020 06:04	14/10/2020 14:46	8,69	1	8,69	CHI
20201072714	PADRE BERNARDO	PB12330893	PADRE BERNARDO	14/10/2020 06:05	14/10/2020 10:07	14/10/2020 06:05	14/10/2020 10:07	4,02	4	16,10	CHI
20201073148	ANAPOLIS	AN11217372	ANAPOLIS UNIVERSITARIO S2	14/10/2020 06:13	14/10/2020 10:24	14/10/2020 06:13	14/10/2020 10:24	4,18	116	485,01	CHI
20201072515	HIDROLINA	HL21372467	SANTA TEREZINHA	14/10/2020 06:13	14/10/2020 17:30	14/10/2020 06:13	14/10/2020 17:30	11,28	1	11,28	CHI
20201072520	GOIANIA	10002327	REAL S2	14/10/2020 06:17	14/10/2020 09:03	14/10/2020 06:17	14/10/2020 09:03	2,76	1	2,76	CHI
20201072524	GUARINOS	O1950214	ITAPACI	14/10/2020 06:18	14/10/2020 14:21	14/10/2020 06:18	14/10/2020 14:21	8,04	20	160,78	CHI
20201072524	ITAPACI	O1950214	ITAPACI	14/10/2020 06:18	14/10/2020 14:21	14/10/2020 06:18	14/10/2020 14:21	8,04	177	1422,93	CHI
20201072524	NOVA GLORIA	O1950214	ITAPACI	14/10/2020 06:18	14/10/2020 14:21	14/10/2020 06:18	14/10/2020 14:21	8,04	1	8,04	CHI
20201072525	POSSE	PS12235222	IACIARA S2	14/10/2020 06:19	14/10/2020 08:18	14/10/2020 06:19	14/10/2020 08:18	1,98	164	324,95	CHI
20201072525	IACIARA	PS12235222	IACIARA S2	14/10/2020 06:19	14/10/2020 08:18	14/10/2020 06:19	14/10/2020 08:18	1,98	1	1,98	CHI
20201075495	PILAR DE GOIAS	GG12243730	SANTA TEREZINHA	14/10/2020 06:21	14/10/2020 18:46	14/10/2020 06:21	14/10/2020 18:46	12,41	28	347,50	CHI

20201072534	CIDADE OCIDENTAL	DH21305306	MARAJOARA	14/10/2020 06:23	14/10/2020 16:07	14/10/2020 06:23	14/10/2020 16:07	9,72	1	9,72	CHI
20201072540	PORTEIRAO	CL21190859	RIO DOS BOIS	14/10/2020 06:26	14/10/2020 09:26	14/10/2020 06:26	14/10/2020 09:26	3,00	3	8,99	CHI
20201072543	LUZIANIA	LZ12290851	MARAJOARA	14/10/2020 06:27	14/10/2020 10:22	14/10/2020 06:27	14/10/2020 10:22	3,91	24	93,90	CHI
20201072639	NIQUELANDIA	NQ12221620	URUACU	14/10/2020 06:32	14/10/2020 15:56	14/10/2020 06:32	14/10/2020 15:56	9,40	148	1390,46	CHI
20201073964	ITAUCU	IX31066022	INHUMAS S2	14/10/2020 06:33	14/10/2020 14:02	14/10/2020 06:33	14/10/2020 14:02	7,48	1	7,48	CHI
20201072559	LEOPOLDO DE BULHOES	870000196	DAIA S2	14/10/2020 06:34	14/10/2020 09:28	14/10/2020 06:34	14/10/2020 09:28	2,89	1	2,89	CHI
20201072560	GOIANIA	GN12040003	GOIANIA LESTE S1	14/10/2020 06:35	14/10/2020 08:37	14/10/2020 06:35	14/10/2020 08:37	2,03	1	2,03	CHI
20201072561	FORMOSO	FO21202575	MARA ROSA	14/10/2020 06:36	14/10/2020 12:13	14/10/2020 06:36	14/10/2020 12:13	5,61	1	5,61	CHI
20201072727	MINEIROS	MY12197173	PARQUE DAS EMAS	14/10/2020 06:36	14/10/2020 13:25	14/10/2020 06:36	14/10/2020 13:25	6,81	7	47,65	CHI
20201072563	DISTRITO FEDERAL	FA13146118	ITUIQUIRA	14/10/2020 06:36	14/10/2020 10:48	14/10/2020 06:36	14/10/2020 10:48	4,19	1	4,19	CHI
20201072563	FORMOSA	FA13146118	ITUIQUIRA	14/10/2020 06:36	14/10/2020 10:48	14/10/2020 06:36	14/10/2020 10:48	4,19	16	67,04	CHI
20201072767	ALVORADA DO NORTE	FB12143258	IACIARA S2	14/10/2020 06:38	14/10/2020 11:06	14/10/2020 06:38	14/10/2020 11:06	4,46	30	133,77	CHI
20201072767	FLORES DE GOIAS	FB12143258	IACIARA S2	14/10/2020 06:38	14/10/2020 11:06	14/10/2020 06:38	14/10/2020 11:06	4,46	27	120,39	CHI
20201072574	HIDROLINA	HL12000023	SANTA TEREZINHA	14/10/2020 06:42	14/10/2020 13:49	14/10/2020 06:42	14/10/2020 13:49	7,12	2	14,23	CHI
20201072581	EDEIA	EA12305964	RIO DOS BOIS	14/10/2020 06:46	14/10/2020 10:03	14/10/2020 06:46	14/10/2020 10:03	3,27	2	6,55	CHI
20201072583	ANAPOLIS	AN12089153	ANAPOLIS UNIVERSITARIO S2	14/10/2020 06:46	14/10/2020 12:43	14/10/2020 06:46	14/10/2020 12:43	5,94	1	5,94	CHI
20201072583	PIRENOPOLIS	AN12089153	ANAPOLIS UNIVERSITARIO S2	14/10/2020 06:46	14/10/2020 12:43	14/10/2020 06:46	14/10/2020 12:43	5,94	13	77,17	CHI
20201072584	GUARINOS	GF21147974	SANTA TEREZINHA	14/10/2020 06:47	14/10/2020 10:53	14/10/2020 06:47	14/10/2020 10:53	4,10	1	4,10	CHI
20201072585	ESTRELA DO NORTE	ET12012488	MARA ROSA	14/10/2020 06:47	14/10/2020 09:16	14/10/2020 06:47	14/10/2020 09:16	2,48	19	47,16	CHI
20201072586	LUZIANIA	LZ11092801	RIO VERMELHO	14/10/2020 06:47	14/10/2020 08:12	14/10/2020 06:47	14/10/2020 08:12	1,42	118	167,00	CHI
20201072589	CRISTALINA	KR21248718	CRISTALINA S2	14/10/2020 06:48	14/10/2020 10:07	14/10/2020 06:48	14/10/2020 10:07	3,32	3	9,95	CHI
20201072592	LUZIANIA	3200006983	MARAJOARA	14/10/2020 06:49	14/10/2020 10:37	14/10/2020 06:49	14/10/2020 10:37	3,80	1	3,80	CHI
20201072595	MIMOSO DE GOIAS	MJ12305277	PADRE BERNARDO	14/10/2020 06:49	14/10/2020 10:01	14/10/2020 06:49	14/10/2020 10:01	3,19	16	51,00	CHI
20201072602	CHAPADAO DO CEU	DJ12152864	CHAPADAO DO CEU	14/10/2020 06:53	14/10/2020 11:28	14/10/2020 06:53	14/10/2020 11:28	4,58	4	18,34	CHI
20201072603	SANTA TEREZINHA DE GOIAS	SG12000032	SANTA TEREZINHA	14/10/2020 06:53	14/10/2020 10:37	14/10/2020 06:53	14/10/2020 10:37	3,73	1	3,73	CHI
20201072604	SAO JOAO D ALIANCA	JL11279191	SAO JOAO D ALIANCA	14/10/2020 06:54	14/10/2020 12:01	14/10/2020 06:54	14/10/2020 12:01	5,11	1	5,11	CHI
20201073283	FORMOSO	FO12298166	MARA ROSA	14/10/2020 06:54	14/10/2020 10:27	14/10/2020 06:54	14/10/2020 10:27	3,54	7	24,77	CHI
20201072606	JATAI	JT21365074	MONTIVIDIU T	14/10/2020 06:54	14/10/2020 23:45	14/10/2020 06:54	14/10/2020 23:45	16,84	1	16,84	CHI
20201072607	GOIANIA	15087098	CARAJAS S2	14/10/2020 06:55	14/10/2020 11:39	14/10/2020 06:55	14/10/2020 11:39	4,72	1	4,72	CHI
20201072608	PARANAIGUARA	PC21000060	CACHOEIRA ALTA	14/10/2020 06:56	14/10/2020 09:33	14/10/2020 06:56	14/10/2020 09:33	2,62	1	2,62	CHI
20201072613	SAO MIGUEL DO ARAGUAIA	SM12235205	SAO MIGUEL DO ARAGUAIA	14/10/2020 06:57	14/10/2020 10:46	14/10/2020 06:57	14/10/2020 10:46	3,81	9	34,31	CHI
20201072615	CACU	CC12193929	CACHOEIRA ALTA	14/10/2020 06:58	14/10/2020 11:00	14/10/2020 06:58	14/10/2020 11:00	4,03	1	4,03	CHI
20201072625	MARA ROSA	MQ12422919	MARA ROSA	14/10/2020 07:01	14/10/2020 09:34	14/10/2020 07:01	14/10/2020 09:34	2,53	9	22,81	CHI
20201072630	APARECIDA DO RIO DOCE	JT21081465	JATAI S1	14/10/2020 07:02	14/10/2020 15:32	14/10/2020 07:02	14/10/2020 15:32	8,49	1	8,49	CHI
20201072633	SANTA TEREZA DE GOIAS	SE21063614	MARA ROSA	14/10/2020 07:04	14/10/2020 10:45	14/10/2020 07:04	14/10/2020 10:45	3,67	1	3,67	CHI
20201072635	PIRENOPOLIS	PV12382175	CORUMBA	14/10/2020 07:05	14/10/2020 10:32	14/10/2020 07:05	14/10/2020 10:32	3,44	11	37,85	CHI
20201072640	PLANALTINA	PI12257785	PLANALTINA	14/10/2020 07:07	14/10/2020 10:43	14/10/2020 07:07	14/10/2020 10:43	3,59	4	14,36	CHI
20201072644	GOIANIA	10392610	FERROVIARIO S2	14/10/2020 07:08	14/10/2020 08:51	14/10/2020 07:08	14/10/2020 08:51	1,71	1	1,71	CHI
20201072648	PORANGATU	PO12348288	PORANGATU	14/10/2020 07:09	14/10/2020 09:26	14/10/2020 07:09	14/10/2020 09:26	2,27	8	18,20	CHI
20201072649	NOVO GAMA	NJ12344854	PACAEMBU S1	14/10/2020 07:09	14/10/2020 08:49	14/10/2020 07:09	14/10/2020 08:49	1,66	234	387,92	CHI
20201072650	NOVO GAMA	NJ12261344	PACAEMBU S1	14/10/2020 07:09	14/10/2020 09:47	14/10/2020 07:09	14/10/2020 09:47	2,62	50	131,04	CHI
20201072651	ACREUNA	EU21350869	ACREUNA	14/10/2020 07:10	14/10/2020 09:03	14/10/2020 07:10	14/10/2020 09:03	1,88	1	1,88	CHI
20201072654	SAO MIGUEL DO PASSA QUATRO	SQ21328163	BELA VISTA S2	14/10/2020 07:11	14/10/2020 10:28	14/10/2020 07:11	14/10/2020 10:28	3,27	1	3,27	CHI
20201072656	APARECIDA DE GOIANIA	200478473	INDEPENDENCIA S1	14/10/2020 07:12	14/10/2020 09:28	14/10/2020 07:12	14/10/2020 09:28	2,26	1	2,26	CHI
20201072657	PIRENOPOLIS	PV21185604	COCALZINHO	14/10/2020 07:13	15/10/2020 13:40	14/10/2020 07:13	15/10/2020 13:27	30,24	2	60,48	CHI
20201072657	COCALZINHO DE GOIAS	PV12227808	COCALZINHO	14/10/2020 07:13	15/10/2020 13:40	15/10/2020 12:44	15/10/2020 13:40	0,94	1	0,94	CHI
20201072657	PIRENOPOLIS	PV12227808	COCALZINHO	14/10/2020 07:13	15/10/2020 13:40	15/10/2020 12:44	15/10/2020 13:40	0,94	6	5,62	CHI
20201072760	FORMOSA	FA12243166	SAO JOAO D ALIANCA	14/10/2020 07:15	14/10/2020 09:17	14/10/2020 07:15	14/10/2020 09:17	2,02	3	6,05	CHI
20201073386	VIANOPOLIS	VN12017544RE	VIANOPOLIS	14/10/2020 07:16	14/10/2020 23:00	14/10/2020 07:16	14/10/2020 21:40	14,40	48	691,13	CHI
20201073386	SILVANIA	VN12017544RE	VIANOPOLIS	14/10/2020 07:16	14/10/2020 23:00	14/10/2020 07:16	14/10/2020 21:40	14,40	21	302,37	CHI
20201073386	SILVANIA	VN12017544RE	VIANOPOLIS	14/10/2020 07:16	14/10/2020 23:00	14/10/2020 07:16	14/10/2020 23:00	15,75	98	1543,04	CHI
20201073386	SILVANIA	SV12400029	VIANOPOLIS	14/10/2020 07:16	14/10/2020 23:00	14/10/2020 21:40	14/10/2020 23:00	1,35	1	1,35	CHI
20201072667	SILVANIA	SV12205353	VIANOPOLIS	14/10/2020 07:16	14/10/2020 12:39	14/10/2020 07:16	14/10/2020 12:39	5,37	7	37,62	CHI
20201072902	ANAPOLIS	AN11238151	DAIA S1	14/10/2020 07:16	14/10/2020 10:03	14/10/2020 07:16	14/10/2020 10:03	2,77	155	429,48	CHI
20201072673	SILVANIA	SV12310162	VIANOPOLIS	14/10/2020 07:17	14/10/2020 10:32	14/10/2020 07:17	14/10/2020 10:32	3,24	1	3,24	CHI
20201072678	GOIANIA	13692306	XAVANTES	14/10/2020 07:20	14/10/2020 10:00	14/10/2020 07:20	14/10/2020 10:00	2,66	1	2,66	CHI
20201072682	SANTA RITA DO ARAGUAIA	SU21369790	SANTA RITA DO ARAGUAIA	14/10/2020 07:21	14/10/2020 11:31	14/10/2020 07:21	14/10/2020 11:31	4,17	1	4,17	CHI
20201072683	CRIXAS	CX12062048	SANTA TEREZINHA	14/10/2020 07:21	14/10/2020 10:21	14/10/2020 07:21	14/10/2020 10:21	3,00	2	5,99	CHI

20201072691	NIQUELANDIA	NQ12181068RE	URUACU	14/10/2020 07:23	14/10/2020 12:46	14/10/2020 07:23	14/10/2020 12:46	5,38	107	575,75	CHI
20201072758	FORMOSO	TB12185306	PORANGATU	14/10/2020 07:23	14/10/2020 08:49	14/10/2020 07:23	14/10/2020 08:49	1,42	1	1,42	CHI
20201072758	TROMBAS	TB12185306	PORANGATU	14/10/2020 07:23	14/10/2020 08:49	14/10/2020 07:23	14/10/2020 08:49	1,42	10	14,21	CHI
20201072694	GOIANIA	GN21000417	FERROVIARIO S3	14/10/2020 07:23	14/10/2020 09:35	14/10/2020 07:23	14/10/2020 09:35	2,19	1	2,19	CHI
20201072698	FLORES DE GOIAS	FB21180698	FLORES DE GOIAS	14/10/2020 07:24	15/10/2020 17:26	14/10/2020 07:24	15/10/2020 17:26	34,03	1	34,03	CHI
20201072699	CAMPINORTE	MQ21240671	MARA ROSA	14/10/2020 07:24	14/10/2020 11:10	14/10/2020 07:24	14/10/2020 11:10	3,76	1	3,76	CHI
20201072707	VIANOPOLIS	VN21102968	VIANOPOLIS	14/10/2020 07:26	14/10/2020 21:35	14/10/2020 07:26	14/10/2020 21:35	14,14	2	28,29	CHI
20201072708	BONOPOLIS	BX21083866	SAO MIGUEL DO ARAGUAIA	14/10/2020 07:26	14/10/2020 08:43	14/10/2020 07:26	14/10/2020 08:43	1,28	1	1,28	CHI
20201072711	APARECIDA DE GOIANIA	200037353	INDEPENDENCIA S1	14/10/2020 07:28	14/10/2020 08:33	14/10/2020 07:28	14/10/2020 08:33	1,08	1	1,08	CHI
20201072712	PADRE BERNARDO	PB21199742	PADRE BERNARDO	14/10/2020 07:28	14/10/2020 15:48	14/10/2020 07:28	14/10/2020 15:48	8,33	1	8,33	CHI
20201072716	MINACU	IH21230434	MINACU	14/10/2020 07:29	14/10/2020 11:46	14/10/2020 07:29	14/10/2020 11:46	4,28	1	4,28	CHI
20201074350	PIRENOPOLIS	PV12289876	SAO FRANCISCO DE GOIAS	14/10/2020 07:29	14/10/2020 14:53	14/10/2020 07:29	14/10/2020 14:53	7,39	14	103,39	CHI
20201072720	MONTE ALEGRE DE GOIAS	MA12130281	SAO DOMINGOS	14/10/2020 07:30	14/10/2020 09:51	14/10/2020 07:30	14/10/2020 09:51	2,35	12	28,15	CHI
20201072721	IVOLANDIA	PU12213315	MONTIVIDIU T	14/10/2020 07:30	14/10/2020 22:00	14/10/2020 07:30	14/10/2020 15:29	7,99	2	15,98	CHI
20201072721	PARAUNA	PU12213315	MONTIVIDIU T	14/10/2020 07:30	14/10/2020 22:00	14/10/2020 07:30	14/10/2020 15:29	7,99	3	23,97	CHI
20201072721	PARAUNA	PU12336654	MONTIVIDIU T	14/10/2020 07:30	14/10/2020 22:00	14/10/2020 07:30	14/10/2020 22:00	14,50	5	72,51	CHI
20201072728	ANAPOLIS	AN11135827	ANAPOLIS UNIVERSITARIO S1	14/10/2020 07:31	14/10/2020 10:52	14/10/2020 07:31	14/10/2020 10:52	3,35	104	348,28	CHI
20201072729	ANAPOLIS	10024522846	ANAPOLIS UNIVERSITARIO S2	14/10/2020 07:31	14/10/2020 11:35	14/10/2020 07:31	14/10/2020 11:35	4,06	1	4,06	CHI
20201072731	PADRE BERNARDO	PB12342151	PADRE BERNARDO	14/10/2020 07:31	14/10/2020 13:00	14/10/2020 07:31	14/10/2020 13:00	5,47	2	10,95	CHI
20201072872	PADRE BERNARDO	PB12377293	PADRE BERNARDO	14/10/2020 07:31	14/10/2020 10:52	14/10/2020 07:31	14/10/2020 10:52	3,34	12	40,07	CHI
20201072733	PORANGATU	MU12266664	MARA ROSA	14/10/2020 07:32	14/10/2020 12:10	14/10/2020 07:32	14/10/2020 12:10	4,63	48	222,40	CHI
20201072740	ALTO PARAISO DE GOIAS	BF21144666	NIQUELANDIA SUBTRANSMISSAO	14/10/2020 07:33	14/10/2020 20:53	14/10/2020 07:33	14/10/2020 20:53	13,33	2	26,66	CHI
20201072743	SENADOR CANEDO	SW11210400	SENADOR CANEDO	14/10/2020 07:33	14/10/2020 10:48	14/10/2020 07:33	14/10/2020 10:48	3,25	131	425,79	CHI
20201072748	URUACU	CR12181484RE	MARA ROSA	14/10/2020 07:34	14/10/2020 10:57	14/10/2020 07:34	14/10/2020 10:57	3,38	9	30,39	CHI
20201072761	FORMOSA	FA21091068	ITUIQUIRA	14/10/2020 07:37	14/10/2020 16:01	14/10/2020 07:37	14/10/2020 16:01	8,39	2	16,78	CHI
20201072768	CAVALCANTE	CJ12047981	FLORES DE GOIAS	14/10/2020 07:37	14/10/2020 08:32	14/10/2020 07:37	14/10/2020 08:32	0,91	1168	1058,34	CHI
20201072769	GOIANIA	10728533	ATLANTICO S3	14/10/2020 07:38	14/10/2020 10:21	14/10/2020 07:38	14/10/2020 10:21	2,71	1	2,71	CHI
20201074463	CABECEIRAS	CW12398925	ITUIQUIRA	14/10/2020 07:38	14/10/2020 16:28	14/10/2020 07:38	14/10/2020 16:28	8,82	28	246,87	CHI
20201072778	LUZIANIA	LZ12390018	MARAJOARA	14/10/2020 07:39	14/10/2020 13:35	14/10/2020 07:39	14/10/2020 13:35	5,92	2	11,84	CHI
20201072791	PEROLANDIA	MY12348932	PARQUE DAS EMAS	14/10/2020 07:41	14/10/2020 13:26	14/10/2020 07:41	14/10/2020 13:26	5,73	3	17,20	CHI
20201072801	CRISTALINA	KR12290455LD	PAMPLONA	14/10/2020 07:44	14/10/2020 11:39	14/10/2020 07:44	14/10/2020 11:39	3,92	8	31,32	CHI
20201073731	NIQUELANDIA	NQ12243364RE	URUACU	14/10/2020 07:45	14/10/2020 13:43	14/10/2020 07:45	14/10/2020 13:43	5,96	12	71,57	CHI
20201072810	NOVO GAMA	2460043473	PACAEMBU S1	14/10/2020 07:47	14/10/2020 09:16	14/10/2020 07:47	14/10/2020 09:16	1,47	1	1,47	CHI
20201072827	ANAPOLIS	AN11000288	JUNDIAI S2	14/10/2020 07:53	14/10/2020 09:48	14/10/2020 07:53	14/10/2020 09:48	1,92	118	226,10	CHI
20201072828	PIRENOPOLIS	PV11090371	SAO FRANCISCO DE GOIAS	14/10/2020 07:53	14/10/2020 14:16	14/10/2020 07:53	14/10/2020 14:16	6,39	76	485,37	CHI
20201072833	AGUAS LINDAS DE GOIAS	LA12191175	AGUAS LINDAS DE GOIAS S1	14/10/2020 07:53	14/10/2020 11:00	14/10/2020 07:53	14/10/2020 10:16	2,39	567	1354,81	CHI
20201072833	AGUAS LINDAS DE GOIAS	LA11313899	AGUAS LINDAS DE GOIAS S1	14/10/2020 07:53	14/10/2020 11:00	14/10/2020 07:53	14/10/2020 11:00	3,12	8	24,96	CHI
20201072840	LUZIANIA	LZ120184539	RIO VERMELHO	14/10/2020 07:54	14/10/2020 08:58	14/10/2020 07:54	14/10/2020 08:58	1,05	1	1,05	CHI
20201072846	SANTO ANTONIO DO DESCOBERTO	SN12330527	MARAJOARA	14/10/2020 07:55	14/10/2020 10:39	14/10/2020 07:55	14/10/2020 10:39	2,72	16	43,60	CHI
20201076541	SANTA TEREZINHA DE GOIAS	GG12171180	SANTA TEREZINHA	14/10/2020 07:55	14/10/2020 19:23	14/10/2020 07:55	14/10/2020 19:23	11,46	34	389,50	CHI
20201072853	CRISTALINA	KR12230276	CRISTALINA S2	14/10/2020 07:55	14/10/2020 10:57	14/10/2020 07:55	14/10/2020 10:57	3,02	13	39,23	CHI
20201072890	GOIANIA	04530274	CARAJAS S2	14/10/2020 07:56	14/10/2020 16:31	14/10/2020 07:56	14/10/2020 07:59	0,06	6326	409,43	CHI
20201072890	GOIANIA	GN10413216	CARAJAS S2	14/10/2020 07:56	14/10/2020 16:31	14/10/2020 07:56	14/10/2020 07:59	0,06	2750	177,99	CHI
20201072890	GOIANIA	04530274	CARAJAS S2	14/10/2020 07:56	14/10/2020 16:31	14/10/2020 10:45	14/10/2020 16:12	5,45	3	16,35	CHI
20201072890	GOIANIA	GN21055854	CARAJAS S2	14/10/2020 07:56	14/10/2020 16:31	14/10/2020 09:14	14/10/2020 16:31	7,28	1	7,28	CHI
20201072859	AGUA FRIA DE GOIAS	TL21204667	SAO JOAO D ALIANCA	14/10/2020 07:56	14/10/2020 09:44	14/10/2020 07:56	14/10/2020 09:44	1,79	1	1,79	CHI
202010189310	RIO VERDE	MV12303520	MONTIVIDIU T	14/10/2020 07:57	14/10/2020 12:25	14/10/2020 07:57	14/10/2020 12:25	4,46	1	4,46	CHI
202010189310	MONTIVIDIU	MV12303520	MONTIVIDIU T	14/10/2020 07:57	14/10/2020 12:25	14/10/2020 07:57	14/10/2020 12:25	4,46	3	13,39	CHI
20201072866	SAO DOMINGOS	SD21138955	SAO DOMINGOS	14/10/2020 07:57	14/10/2020 11:46	14/10/2020 07:57	14/10/2020 11:46	3,81	1	3,81	CHI
20201072867	CALDAZINHA	DE21312913	CEPAIGO S2	14/10/2020 07:57	14/10/2020 09:39	14/10/2020 07:57	14/10/2020 09:39	1,69	2	3,38	CHI
20201072868	TRINDADE	TR12005149	TRINDADE	14/10/2020 07:57	14/10/2020 12:36	14/10/2020 07:57	14/10/2020 12:36	4,64	3	13,92	CHI
20201072870	VIANOPOLIS	VN21105502	VIANOPOLIS	14/10/2020 07:57	14/10/2020 14:04	14/10/2020 07:57	14/10/2020 14:04	6,11	1	6,11	CHI
20201073155	LUZIANIA	LZ12164807	CRISTALINA S2	14/10/2020 07:57	14/10/2020 11:32	14/10/2020 07:57	14/10/2020 11:32	3,57	4	14,28	CHI
20201072876	LUZIANIA	LZ12290786	RIO VERMELHO	14/10/2020 07:58	14/10/2020 10:01	14/10/2020 07:58	14/10/2020 10:01	2,04	87	177,60	CHI
20201072885	VIANOPOLIS	VN21014631	VIANOPOLIS	14/10/2020 08:00	14/10/2020 20:47	14/10/2020 08:00	14/10/2020 20:47	12,77	1	12,77	CHI
20201072888	GUAPO	GA11000010	GUAPO S1	14/10/2020 08:01	14/10/2020 12:12	14/10/2020 08:01	14/10/2020 12:12	4,18	78	325,93	CHI
20201072891	LUZIANIA	LZ120058881	RIO VERMELHO	14/10/2020 08:01	14/10/2020 09:53	14/10/2020 08:01	14/10/2020 09:53	1,86	1	1,86	CHI
20201072893	PEROLANDIA	DP12249731	JATAI S1	14/10/2020 08:01	14/10/2020 17:03	14/10/2020 08:01	14/10/2020 17:03	9,02	57	514,06	CHI

20201072893	MINEIROS	DP12249731	JATAI S1	14/10/2020 08:01	14/10/2020 17:03	14/10/2020 08:01	14/10/2020 17:03	9,02	3	27,06	CHI
20201073640	DISTRITO FEDERAL	CW12383384	ITUIQUIRA	14/10/2020 08:02	14/10/2020 14:19	14/10/2020 08:02	14/10/2020 14:19	6,28	1	6,28	CHI
20201073640	CABECEIRAS	CW12383384	ITUIQUIRA	14/10/2020 08:02	14/10/2020 14:19	14/10/2020 08:02	14/10/2020 14:19	6,28	61	383,00	CHI
20201072901	JARAGUA	JA12000134	JARAGUA	14/10/2020 08:02	14/10/2020 11:17	14/10/2020 08:02	14/10/2020 11:17	3,24	151	489,37	CHI
20201072905	GOIANIA	10828047	GOIANIA LESTE S2	14/10/2020 08:03	14/10/2020 12:34	14/10/2020 08:03	14/10/2020 12:34	4,52	1	4,52	CHI
20201072903	LUZIANIA	LZ21261761	RIO VERMELHO	14/10/2020 08:03	14/10/2020 11:44	14/10/2020 08:03	14/10/2020 11:44	3,68	2	7,36	CHI
20201073021	ITARUMA	IM12058060	CACHOEIRA ALTA	14/10/2020 08:03	14/10/2020 10:23	14/10/2020 08:03	14/10/2020 10:23	2,33	18	41,93	CHI
20201072910	URUACU	UR21003383	URUACU	14/10/2020 08:03	14/10/2020 09:16	14/10/2020 08:03	14/10/2020 09:16	1,20	2	2,40	CHI
20201072911	CRIXAS	2490011437	SERRA DO OURO	14/10/2020 08:04	15/10/2020 05:40	14/10/2020 08:04	15/10/2020 05:40	21,60	1	21,60	CHI
20201072917	CRIXAS	CX12321023	SANTA TEREZINHA	14/10/2020 08:04	14/10/2020 11:39	14/10/2020 08:04	14/10/2020 11:39	3,57	11	39,30	CHI
20201072919	GOIANIA	15240447	ATLANTICO S2	14/10/2020 08:05	14/10/2020 12:48	14/10/2020 08:05	14/10/2020 12:48	4,72	1	4,72	CHI
20201072920	PIRENOPOLIS	PV12362268	CORUMBA	14/10/2020 08:05	14/10/2020 13:17	14/10/2020 08:05	14/10/2020 13:17	5,20	6	31,19	CHI
20201072921	JARAGUA	70088135	JARAGUA	14/10/2020 08:05	14/10/2020 11:36	14/10/2020 08:05	14/10/2020 11:36	3,51	1	3,51	CHI
20201072924	MINACU	IH12341446	MINACU	14/10/2020 08:05	14/10/2020 09:56	14/10/2020 08:05	14/10/2020 09:56	1,85	34	62,73	CHI
20201072928	SILVANIA	SV12285478	VIANOPOLIS	14/10/2020 08:05	14/10/2020 14:22	14/10/2020 08:05	14/10/2020 14:22	6,27	76	476,52	CHI
20201072929	JARAGUA	JA21129669	JARAGUA	14/10/2020 08:05	14/10/2020 13:36	14/10/2020 08:05	14/10/2020 13:36	5,50	2	11,01	CHI
20201072932	NOVO GAMA	2900009735	MARAJOARA	14/10/2020 08:06	14/10/2020 11:59	14/10/2020 08:06	14/10/2020 11:59	3,88	1	3,88	CHI
20201072937	NIQUELANDIA	NQ11349209	NIQUELANDIA SUBTRANSMISSAO	14/10/2020 08:06	14/10/2020 23:20	14/10/2020 08:06	14/10/2020 23:20	15,22	5	76,10	CHI
20201072943	GUAPO	710025956	GUAPO S1	14/10/2020 08:07	14/10/2020 13:38	14/10/2020 08:07	14/10/2020 13:38	5,50	1	5,50	CHI
20201072944	BRAZABRANTES	BR21016172	NEROPOLIS S1	14/10/2020 08:07	14/10/2020 17:53	14/10/2020 08:07	14/10/2020 17:53	9,75	1	9,75	CHI
20201072946	NEROPOLIS	160024730	NEROPOLIS S2	14/10/2020 08:08	15/10/2020 10:44	14/10/2020 08:08	15/10/2020 10:44	26,60	1	26,60	CHI
20201072951	NOVA CRIXAS	NA12096364	NOVA CRIXAS	14/10/2020 08:08	14/10/2020 11:38	14/10/2020 08:08	14/10/2020 11:38	3,50	5	17,49	CHI
20201072953	MARA ROSA	FO21115555	MARA ROSA	14/10/2020 08:08	14/10/2020 11:42	14/10/2020 08:08	14/10/2020 11:42	3,56	1	3,56	CHI
20201071734	CAMPINORTE	CR12202139RE	MARA ROSA	14/10/2020 08:08	14/10/2020 10:35	14/10/2020 08:08	14/10/2020 10:35	2,43	32	77,92	CHI
20201071734	URUACU	CR12202139RE	MARA ROSA	14/10/2020 08:08	14/10/2020 10:35	14/10/2020 08:08	14/10/2020 10:35	2,43	106	258,11	CHI
20201072968	URUACU	UR12003408	URUACU	14/10/2020 08:10	14/10/2020 16:29	14/10/2020 08:10	14/10/2020 16:29	8,30	4	33,21	CHI
20201072970	GOUVELANDIA	GB21193909	QUIRINOPOLIS	14/10/2020 08:11	14/10/2020 13:51	14/10/2020 08:11	14/10/2020 13:51	5,66	1	5,66	CHI
20201073452	MARA ROSA	MQ12168877	MARA ROSA	14/10/2020 08:11	14/10/2020 15:26	14/10/2020 08:11	14/10/2020 15:26	7,25	4	28,98	CHI
20201072975	CACU	1140012748	CACHOEIRA ALTA	14/10/2020 08:11	14/10/2020 11:15	14/10/2020 08:11	14/10/2020 11:15	3,05	1	3,05	CHI
20201072985	GOIANIA	14154006	INDEPENDENCIA S2	14/10/2020 08:13	14/10/2020 10:50	14/10/2020 08:13	14/10/2020 10:50	2,60	1	2,60	CHI
20201073306	PILAR DE GOIAS	HL12380749	SANTA TEREZINHA	14/10/2020 08:14	14/10/2020 10:48	14/10/2020 08:14	14/10/2020 10:48	2,55	1	2,55	CHI
20201073306	HIDROLINA	HL12380749	SANTA TEREZINHA	14/10/2020 08:14	14/10/2020 10:48	14/10/2020 08:14	14/10/2020 10:48	2,55	8	20,41	CHI
20201072997	NEROPOLIS	TI12417616	DAIA S2	14/10/2020 08:15	14/10/2020 18:49	14/10/2020 08:15	14/10/2020 18:49	10,57	1	10,57	CHI
20201073002	MAIRIPOTABA	VJ12019862	GUAPO S2	14/10/2020 08:16	14/10/2020 11:11	14/10/2020 08:16	14/10/2020 11:11	2,92	2	5,83	CHI
20201073002	HIDROLANDIA	VJ12019862	GUAPO S2	14/10/2020 08:16	14/10/2020 11:11	14/10/2020 08:16	14/10/2020 11:11	2,92	1	2,92	CHI
20201073002	VARJAO	VJ12019862	GUAPO S2	14/10/2020 08:16	14/10/2020 11:11	14/10/2020 08:16	14/10/2020 11:11	2,92	6	17,49	CHI
20201073015	JATAI	JT21062173	JATAI S1	14/10/2020 08:19	14/10/2020 17:42	14/10/2020 08:19	14/10/2020 17:42	9,38	1	9,38	CHI
20201073022	LUZIANIA	LZ11405491	RIO VERMELHO	14/10/2020 08:19	14/10/2020 09:41	14/10/2020 08:19	14/10/2020 09:41	1,35	9	12,15	CHI
20201073044	GOIANIA	11969155	CARAJAS S2	14/10/2020 08:23	14/10/2020 10:20	14/10/2020 08:23	14/10/2020 10:20	1,95	1	1,95	CHI
20201073046	CAVALCANTE	CI11071301	FLORES DE GOIAS	14/10/2020 08:24	14/10/2020 09:34	14/10/2020 08:24	14/10/2020 09:34	1,17	53	61,79	CHI
20201073056	MINEIROS	SU12184127	SANTA RITA DO ARAGUAIA	14/10/2020 08:25	14/10/2020 10:52	14/10/2020 08:25	14/10/2020 10:52	2,44	14	34,17	CHI
20201077442	RIO VERDE	RV12296585	QUIRINOPOLIS	14/10/2020 08:27	15/10/2020 18:53	14/10/2020 08:27	15/10/2020 18:53	34,44	14	482,17	CHI
20201073074	RIO VERDE	RV21159497	MONTIVIDIU T	14/10/2020 08:27	14/10/2020 09:52	14/10/2020 08:27	14/10/2020 09:52	1,41	1	1,41	CHI
20201073075	CRIXAS	2490032994	SERRA DO OURO	14/10/2020 08:27	15/10/2020 02:10	14/10/2020 08:27	15/10/2020 02:10	17,72	1	17,72	CHI
20201073630	CRISTALINA	KR12245975	CRISTALINA S1	14/10/2020 08:28	14/10/2020 13:49	14/10/2020 08:28	14/10/2020 13:49	5,35	5	26,74	CHI
20201073080	FORMOSA	FA32042708	SAO JOAO D ALIANCA	14/10/2020 08:28	14/10/2020 11:21	14/10/2020 08:28	14/10/2020 11:21	2,88	8	23,04	CHI
20201073083	BARRO ALTO	BA21237503	BARRO ALTO	14/10/2020 08:28	14/10/2020 16:58	14/10/2020 08:28	14/10/2020 16:58	8,49	2	16,98	CHI
20201073085	FORMOSA	FA11046850	ITUIQUIRA	14/10/2020 08:28	14/10/2020 09:31	14/10/2020 08:28	14/10/2020 09:31	1,04	201	209,26	CHI
20201073086	POSSE	1480024779	IACIARA S2	14/10/2020 08:28	14/10/2020 10:56	14/10/2020 08:28	14/10/2020 10:56	2,45	1	2,45	CHI
20201073096	MARA ROSA	CR11349197	MARA ROSA	14/10/2020 08:30	14/10/2020 10:41	14/10/2020 08:30	14/10/2020 10:41	2,18	21	45,76	CHI
20201073185	NIQUELANDIA	NQ12265691	URUACU	14/10/2020 08:30	14/10/2020 17:27	14/10/2020 08:30	14/10/2020 17:27	8,94	17	152,06	CHI
20201073100	APARECIDA DE GOIANIA	16727629	INDEPENDENCIA S2	14/10/2020 08:30	14/10/2020 10:05	14/10/2020 08:30	14/10/2020 10:05	1,57	1	1,57	CHI
20201073109	SILVANIA	LB21270679	DAIA S2	14/10/2020 08:31	14/10/2020 11:08	14/10/2020 08:31	14/10/2020 11:08	2,61	1	2,61	CHI
20201073113	LUZIANIA	LZ11201490	RIO VERMELHO	14/10/2020 08:31	14/10/2020 14:48	14/10/2020 08:31	14/10/2020 14:48	6,27	68	426,68	CHI
20201073115	MINACU	IH12129795	MINACU	14/10/2020 08:31	14/10/2020 15:18	14/10/2020 08:31	14/10/2020 15:18	6,77	31	209,86	CHI
20201073159	ANAPOLIS	AN11319637	JUNDIAI S2	14/10/2020 08:31	14/10/2020 11:04	14/10/2020 08:31	14/10/2020 11:04	2,53	125	316,81	CHI
20201073119	RIO VERDE	RV21060854	RIO VERDE S1	14/10/2020 08:32	14/10/2020 20:51	14/10/2020 08:32	14/10/2020 20:51	12,32	1	12,32	CHI
20201073136	TRINDADE	TR21119034	TRINDADE	14/10/2020 08:34	14/10/2020 14:23	14/10/2020 08:34	14/10/2020 14:23	5,81	1	5,81	CHI

20201073143	GOIANIA	GN21002189	FERROVIARIO S1	14/10/2020 08:35	14/10/2020 10:04	14/10/2020 08:35	14/10/2020 10:04	1,48	4	5,92	CHI
20201073161	URUACU	UR12221690	URUACU	14/10/2020 08:36	14/10/2020 11:35	14/10/2020 08:36	14/10/2020 11:35	2,97	1	2,97	CHI
20201073163	LUZIANIA	LZ11168719	RIO VERMELHO	14/10/2020 08:37	14/10/2020 16:52	14/10/2020 08:37	14/10/2020 16:39	8,04	161	1294,40	CHI
20201073163	LUZIANIA	LZ12165080	RIO VERMELHO	14/10/2020 08:37	14/10/2020 16:52	14/10/2020 15:25	14/10/2020 16:52	1,45	143	206,87	CHI
20201073166	PORANGATU	PO12189555	PORANGATU	14/10/2020 08:37	14/10/2020 10:35	14/10/2020 08:37	14/10/2020 10:35	1,96	8	15,65	CHI
20201073169	CRISTALINA	KR12408889LD	CRISTALINA S2	14/10/2020 08:38	14/10/2020 12:05	14/10/2020 08:38	14/10/2020 12:05	3,45	8	27,58	CHI
20201073171	APARECIDA DE GOIANIA	10238438	REAL S1	14/10/2020 08:38	14/10/2020 10:58	14/10/2020 08:38	14/10/2020 10:58	2,33	1	2,33	CHI
20201075046	VILA PROPICIO	GE12258501	GOIANESIA S1	14/10/2020 08:38	14/10/2020 15:25	14/10/2020 08:38	14/10/2020 15:25	6,77	3	20,32	CHI
20201073180	NEROPOLIS	10009814980	NEROPOLIS S2	14/10/2020 08:38	14/10/2020 16:22	14/10/2020 08:38	14/10/2020 16:22	7,72	1	7,72	CHI
20201073182	PLANALTINA	PI12361252	PLANALTINA	14/10/2020 08:39	14/10/2020 11:18	14/10/2020 08:39	14/10/2020 11:18	2,64	34	89,79	CHI
20201073190	NEROPOLIS	NR21010671	NEROPOLIS S2	14/10/2020 08:40	14/10/2020 17:03	14/10/2020 08:40	14/10/2020 17:03	8,38	1	8,38	CHI
20201073193	CRISTALINA	KR12343802	CRISTALINA S1	14/10/2020 08:40	14/10/2020 12:18	14/10/2020 08:40	14/10/2020 12:18	3,63	3	10,88	CHI
20201074655	CRIXAS	NA12229644	NOVA CRIXAS	14/10/2020 08:40	14/10/2020 15:33	14/10/2020 08:40	14/10/2020 15:33	6,87	2	13,75	CHI
20201074655	NOVA CRIXAS	NA12229644	NOVA CRIXAS	14/10/2020 08:40	14/10/2020 15:33	14/10/2020 08:40	14/10/2020 15:33	6,87	1	6,87	CHI
20201073202	VALPARAISO DE GOIAS	2860175873	PACAEMBU S2	14/10/2020 08:41	14/10/2020 11:35	14/10/2020 08:41	14/10/2020 11:35	2,90	1	2,90	CHI
20201073208	FLORES DE GOIAS	SI12375586	IACIARA S2	14/10/2020 08:42	14/10/2020 13:18	14/10/2020 08:42	14/10/2020 13:18	4,60	4	18,40	CHI
20201073208	SITIO D ABADIA	SI12375586	IACIARA S2	14/10/2020 08:42	14/10/2020 13:18	14/10/2020 08:42	14/10/2020 13:18	4,60	4	18,40	CHI
20201073214	FORMOSA	FA11278191	ITUIQUIRA	14/10/2020 08:43	14/10/2020 18:04	14/10/2020 08:43	14/10/2020 18:04	9,35	1	9,35	CHI
20201073215	GOIANIA	13907943	CARAJAS S1	14/10/2020 08:43	14/10/2020 10:49	14/10/2020 08:43	14/10/2020 10:49	2,10	1	2,10	CHI
20201073218	PLANALTINA	PI11218355	PLANALTINA	14/10/2020 08:43	14/10/2020 13:30	14/10/2020 08:43	14/10/2020 13:30	4,77	25	119,24	CHI
20201073224	PIRENOPOLIS	ZN21295692	COCALZINHO	14/10/2020 08:44	14/10/2020 12:02	14/10/2020 08:44	14/10/2020 12:02	3,29	1	3,29	CHI
20201073236	GOIANIA	GN21042145	GOIANIA LESTE S1	14/10/2020 08:45	14/10/2020 08:50	14/10/2020 08:45	14/10/2020 08:50	0,07	1	0,07	CHI
20201073231	POSSE	IA12034649	IACIARA S2	14/10/2020 08:45	14/10/2020 09:56	14/10/2020 08:45	14/10/2020 09:56	1,17	99	116,05	CHI
20201073237	MINEIROS	1390008074	PARQUE DAS EMAS	14/10/2020 08:46	14/10/2020 10:57	14/10/2020 08:46	14/10/2020 10:57	2,17	1	2,17	CHI
20201073245	MONTE ALEGRE DE GOIAS	1620007827	SAO DOMINGOS	14/10/2020 08:46	14/10/2020 11:32	14/10/2020 08:46	14/10/2020 11:32	2,75	1	2,75	CHI
20201073532	NEROPOLIS	NR11022753	NEROPOLIS S2	14/10/2020 08:47	14/10/2020 13:52	14/10/2020 08:47	14/10/2020 13:52	5,08	97	493,08	CHI
20201073259	INHUMAS	30063012	INHUMAS S2	14/10/2020 08:48	14/10/2020 12:05	14/10/2020 08:48	14/10/2020 12:05	3,28	1	3,28	CHI
20201073261	CAMPINACU	UC12269887	MARA ROSA	14/10/2020 08:48	14/10/2020 14:16	14/10/2020 08:48	14/10/2020 14:16	5,46	7	38,20	CHI
20201073895	SAO JOAO D ALIANCA	JL12383338	SAO JOAO D ALIANCA	14/10/2020 08:49	14/10/2020 12:04	14/10/2020 08:49	14/10/2020 12:04	3,24	39	126,47	CHI
20201073314	PIRENOPOLIS	PV12278592	CORUMBA	14/10/2020 08:50	14/10/2020 17:34	14/10/2020 08:50	14/10/2020 15:56	7,11	19	135,16	CHI
20201073314	PIRENOPOLIS	PV12278592	CORUMBA	14/10/2020 08:50	14/10/2020 17:34	14/10/2020 08:50	14/10/2020 17:34	8,74	1	8,74	CHI
20201073278	NIQUELANDIA	10007794949	NIQUELANDIA SUBTRANSMISSAO	14/10/2020 08:50	14/10/2020 15:57	14/10/2020 08:50	14/10/2020 15:57	7,11	1	7,11	CHI
20201069715	JATAI	JT12209712RE	JATAI S1	14/10/2020 08:50	14/10/2020 14:24	14/10/2020 08:50	14/10/2020 09:54	1,06	2	2,13	CHI
20201069715	PEROLANDIA	JT12209712RE	JATAI S1	14/10/2020 08:50	14/10/2020 14:24	14/10/2020 09:58	14/10/2020 14:24	4,44	9	39,99	CHI
20201069715	JATAI	JT12209712RE	JATAI S1	14/10/2020 08:50	14/10/2020 14:24	14/10/2020 09:58	14/10/2020 14:24	4,44	110	488,74	CHI
20201073285	FORMOSA	FA31218279	SAO JOAO D ALIANCA	14/10/2020 08:51	14/10/2020 13:08	14/10/2020 08:51	14/10/2020 13:08	4,27	1	4,27	CHI
20201073291	SANTA RITA DO ARAGUAIA	SU12302007	SANTA RITA DO ARAGUAIA	14/10/2020 08:51	14/10/2020 13:16	14/10/2020 08:51	14/10/2020 13:16	4,40	2	8,80	CHI
20201073311	APARECIDA DE GOIANIA	16976186	REAL S1	14/10/2020 08:55	14/10/2020 12:02	14/10/2020 08:55	14/10/2020 12:02	3,11	1	3,11	CHI
20201073315	SENADOR CANEDO	SW11189574	SENADOR CANEDO	14/10/2020 08:55	14/10/2020 11:20	14/10/2020 08:55	14/10/2020 11:20	2,41	178	428,29	CHI
20201073317	JATAI	JT12193921	JATAI S1	14/10/2020 08:55	14/10/2020 12:42	14/10/2020 08:55	14/10/2020 12:42	3,77	1	3,77	CHI
20201073321	GOIANIA	10276907	CAMPINAS S2	14/10/2020 08:56	14/10/2020 09:51	14/10/2020 08:56	14/10/2020 09:51	0,91	1	0,91	CHI
20201073328	POSSE	PS11391001	IACIARA S2	14/10/2020 08:57	14/10/2020 11:46	14/10/2020 08:57	14/10/2020 11:46	2,81	4	11,26	CHI
20201073641	ITAUCU	IX12000021	INHUMAS S1	14/10/2020 08:57	14/10/2020 12:25	14/10/2020 08:57	14/10/2020 12:25	3,45	15	51,81	CHI
20201073641	TAQUARAL DE GOIAS	IX12000021	INHUMAS S1	14/10/2020 08:57	14/10/2020 12:25	14/10/2020 08:57	14/10/2020 12:25	3,45	6	20,72	CHI
20201073340	PADRE BERNARDO	PB12234573	PADRE BERNARDO	14/10/2020 08:59	14/10/2020 13:48	14/10/2020 08:59	14/10/2020 13:48	4,81	7	33,67	CHI
20201073367	SILVANIA	SV12400022	VIANOPOLIS	14/10/2020 09:00	14/10/2020 13:07	14/10/2020 09:00	14/10/2020 13:07	4,12	29	119,36	CHI
20201073346	GOIANIA	14523036	GOIANIA LESTE S1	14/10/2020 09:00	14/10/2020 10:28	14/10/2020 09:00	14/10/2020 10:28	1,46	1	1,46	CHI
20201073351	PETROLINA DE GOIAS	PG12297811	PETROLINA	14/10/2020 09:01	15/10/2020 14:10	14/10/2020 09:01	15/10/2020 14:10	29,15	2	58,30	CHI
20201073477	SANTA BARBARA DE GOIAS	SB11215434	TRINDADE	14/10/2020 09:02	14/10/2020 10:42	14/10/2020 09:02	14/10/2020 10:42	1,67	116	193,33	CHI
20201073364	APARECIDA DE GOIANIA	200066640	INDEPENDENCIA S1	14/10/2020 09:03	14/10/2020 09:48	14/10/2020 09:03	14/10/2020 09:48	0,73	1	0,73	CHI
20201072705	GOIANIA	GN11167634	AEROPORTO S3	14/10/2020 09:04	14/10/2020 10:48	14/10/2020 09:04	14/10/2020 10:48	1,73	11	19,07	CHI
20201073369	SILVANIA	CL21361819	DAIA S2	14/10/2020 09:04	15/10/2020 07:48	14/10/2020 09:04	15/10/2020 07:48	22,73	2	45,46	CHI
20201073370	NOVA AMERICA	NM21188977	RUBIATABA	14/10/2020 09:04	15/10/2020 04:09	14/10/2020 09:04	15/10/2020 04:09	19,08	1	19,08	CHI
20201073372	GOIANIA	15362012	MEIA PONTE	14/10/2020 09:04	14/10/2020 09:49	14/10/2020 09:04	14/10/2020 09:49	0,74	1	0,74	CHI
20201073381	TROMBAS	TB12257858	PORANGATU	14/10/2020 09:06	14/10/2020 13:06	14/10/2020 09:06	14/10/2020 13:06	4,00	5	19,98	CHI
20201073383	GOIANIA	10277900	GOYA S2	14/10/2020 09:06	14/10/2020 10:26	14/10/2020 09:06	14/10/2020 10:26	1,33	0	0,00	CHI
20201073387	GOIANIA	GN11034730	ATLANTICO S3	14/10/2020 09:06	14/10/2020 11:49	14/10/2020 09:06	14/10/2020 11:49	2,71	97	262,60	CHI
20201073388	TROMBAS	2560004659	PORANGATU	14/10/2020 09:06	14/10/2020 22:40	14/10/2020 09:06	14/10/2020 22:40	13,56	1	13,56	CHI

20201073426	ALEXANIA	AX10394596	ALEXANIA	14/10/2020 09:07	14/10/2020 15:29	14/10/2020 09:07	14/10/2020 13:49	6,68	8	37,47	CHI
20201073426	SANTO ANTONIO DO DESCOBERTO	AX10394596	ALEXANIA	14/10/2020 09:07	14/10/2020 15:29	14/10/2020 09:07	14/10/2020 15:29	6,35	1	6,35	CHI
20201073426	ALEXANIA	AX10394596	ALEXANIA	14/10/2020 09:07	14/10/2020 15:29	14/10/2020 09:07	14/10/2020 15:29	6,35	140	889,66	CHI
20201073426	CORUMBA DE GOIAS	AX10394596	ALEXANIA	14/10/2020 09:07	14/10/2020 15:29	14/10/2020 09:07	14/10/2020 15:29	6,35	7	44,48	CHI
20201073426	ALEXANIA	AX13000095	ALEXANIA	14/10/2020 09:07	14/10/2020 15:29	14/10/2020 10:19	14/10/2020 15:29	5,17	4	20,68	CHI
20201073426	SANTO ANTONIO DO DESCOBERTO	AX13000095	ALEXANIA	14/10/2020 09:07	14/10/2020 15:29	14/10/2020 10:19	14/10/2020 15:29	5,17	3	15,51	CHI
20201073403	MARA ROSA	7940000122	MARA ROSA	14/10/2020 09:09	14/10/2020 14:03	14/10/2020 09:09	14/10/2020 14:03	4,89	1	4,89	CHI
20201073405	APARECIDA DE GOIANIA	200002480	ANHANGUERA	14/10/2020 09:09	14/10/2020 12:47	14/10/2020 09:09	14/10/2020 12:47	3,62	1	3,62	CHI
20201073414	URUACU	UR21372464	URUACU	14/10/2020 09:10	14/10/2020 10:11	14/10/2020 09:10	14/10/2020 10:11	1,00	1	1,00	CHI
20201073416	IPAMERI	IP12376252	CRISTALINA S2	14/10/2020 09:11	14/10/2020 14:10	14/10/2020 09:11	14/10/2020 14:10	4,98	20	99,64	CHI
20201073928	INHUMAS	IN11092699	INHUMAS S2	14/10/2020 09:11	14/10/2020 11:05	14/10/2020 09:11	14/10/2020 11:05	1,89	58	109,33	CHI
20201073429	SANTA ROSA DE GOIAS	540013316	INHUMAS S1	14/10/2020 09:12	14/10/2020 13:25	14/10/2020 09:12	14/10/2020 13:25	4,21	1	4,21	CHI
20201074136	SANTO ANTONIO DE GOIAS	NR11246207	NEROPOLIS S2	14/10/2020 09:13	15/10/2020 03:44	14/10/2020 09:13	15/10/2020 03:44	18,51	21	388,67	CHI
20201073444	ABADIA DE GOIAS	10025043950	CARAJAS S1	14/10/2020 09:16	14/10/2020 14:19	14/10/2020 09:16	14/10/2020 14:19	5,05	1	5,05	CHI
20201073445	ITAUUCU	IX12324563	INHUMAS S1	14/10/2020 09:16	14/10/2020 14:18	14/10/2020 09:16	14/10/2020 14:18	5,03	4	20,13	CHI
20201073445	INHUMAS	IX12324563	INHUMAS S1	14/10/2020 09:16	14/10/2020 14:18	14/10/2020 09:16	14/10/2020 14:18	5,03	12	60,38	CHI
20201073449	JARAGUA	70124127	JARAGUA	14/10/2020 09:16	14/10/2020 15:40	14/10/2020 09:16	14/10/2020 15:40	6,39	1	6,39	CHI
20201073451	AGUAS LINDAS DE GOIAS	LA12261324	AGUAS LINDAS DE GOIAS S1	14/10/2020 09:17	14/10/2020 11:20	14/10/2020 09:17	14/10/2020 11:20	2,05	13	26,62	CHI
20201073461	JARAGUA	JA12300549	JARAGUA	14/10/2020 09:18	14/10/2020 12:54	14/10/2020 09:18	14/10/2020 12:54	3,60	16	57,59	CHI
20201073499	ORIZONA	LZ10400597	VIANOPOLIS	14/10/2020 09:19	14/10/2020 14:03	14/10/2020 09:19	14/10/2020 11:07	1,81	72	130,50	CHI
20201073499	SILVANIA	LZ10400597	VIANOPOLIS	14/10/2020 09:19	14/10/2020 14:03	14/10/2020 09:19	14/10/2020 11:07	1,81	15	27,19	CHI
20201073499	LUZIANIA	LZ10400597	VIANOPOLIS	14/10/2020 09:19	14/10/2020 14:03	14/10/2020 09:19	14/10/2020 11:07	1,81	72	130,50	CHI
20201073499	SILVANIA	SV12390030LD	VIANOPOLIS	14/10/2020 09:19	14/10/2020 14:03	14/10/2020 09:19	14/10/2020 13:24	4,08	54	220,55	CHI
20201073499	SILVANIA	LZ12168079LD	VIANOPOLIS	14/10/2020 09:19	14/10/2020 14:03	14/10/2020 09:19	14/10/2020 14:03	4,75	46	218,37	CHI
20201073469	VILA PROPICIO	10025666604	GOIANESIA S1	14/10/2020 09:19	14/10/2020 16:06	14/10/2020 09:19	14/10/2020 16:06	6,78	1	6,78	CHI
20201073484	PADRE BERNARDO	PB21162838	PADRE BERNARDO	14/10/2020 09:21	14/10/2020 12:11	14/10/2020 09:21	14/10/2020 12:11	2,83	1	2,83	CHI
20201073486	GOIANIA	14741477	CAMPINAS S2	14/10/2020 09:21	14/10/2020 10:39	14/10/2020 09:21	14/10/2020 10:39	1,30	1	1,30	CHI
20201073496	BELA VISTA DE GOIAS	240036451	BELA VISTA S1	14/10/2020 09:22	14/10/2020 11:26	14/10/2020 09:22	14/10/2020 11:26	2,06	1	2,06	CHI
20201073507	CAMPESTRE DE GOIAS	GC12389820	TRINDADE	14/10/2020 09:23	14/10/2020 11:51	14/10/2020 09:23	14/10/2020 11:51	2,46	40	98,29	CHI
20201073511	FORMOSO	FO11393892	PORANGATU	14/10/2020 09:24	14/10/2020 15:41	14/10/2020 09:24	14/10/2020 15:41	6,28	1	6,28	CHI
20201073515	GOIANIA	11410413	ATLANTICO S1	14/10/2020 09:25	14/10/2020 12:14	14/10/2020 09:25	14/10/2020 12:14	2,81	1	2,81	CHI
20201073516	BONFINOPOLIS	920031924	CEPAIGO S2	14/10/2020 09:25	14/10/2020 12:03	14/10/2020 09:25	14/10/2020 12:03	2,63	1	2,63	CHI
20201073517	NIQUELANDIA	NQ12262804	URUACU	14/10/2020 09:25	14/10/2020 21:33	14/10/2020 09:25	14/10/2020 21:33	12,14	2	24,28	CHI
20201073528	GOIANIA	GN21356280	ATLANTICO S1	14/10/2020 09:26	14/10/2020 10:47	14/10/2020 09:26	14/10/2020 10:47	1,35	1	1,35	CHI
20201073535	CAMPINORTE	UR21231329	MARA ROSA	14/10/2020 09:27	14/10/2020 13:53	14/10/2020 09:27	14/10/2020 13:53	4,43	1	4,43	CHI
20201073541	ABADIANIA	AA12382488	ANAPOLIS UNIVERSITARIO S1	14/10/2020 09:27	14/10/2020 13:20	14/10/2020 09:27	14/10/2020 13:20	3,87	3	11,62	CHI
20201072478	NIQUELANDIA	NQ12293886	URUACU	14/10/2020 09:30	15/10/2020 17:07	14/10/2020 09:30	14/10/2020 11:20	1,82	10	18,25	CHI
20201072478	NIQUELANDIA	NQ12375602	URUACU	14/10/2020 09:30	15/10/2020 17:07	14/10/2020 11:22	15/10/2020 17:07	29,74	34	1011,31	CHI
20201072786	LUZIANIA	LZ11128810	RIO VERMELHO	14/10/2020 09:30	14/10/2020 12:30	14/10/2020 09:30	14/10/2020 12:30	2,99	35	104,49	CHI
20201073579	GOIANIA	14014336	CARAJAS S2	14/10/2020 09:32	14/10/2020 11:48	14/10/2020 09:32	14/10/2020 11:48	2,26	1	2,26	CHI
20201073585	CRIXAS	CX11371045	RUBIATABA	14/10/2020 09:32	14/10/2020 13:23	14/10/2020 09:32	14/10/2020 13:23	3,84	1	3,84	CHI
20201073593	LUZIANIA	3200076936	MARAJOARA	14/10/2020 09:34	14/10/2020 11:46	14/10/2020 09:34	14/10/2020 11:46	2,19	1	2,19	CHI
202010161237	SILVANIA	SV12319545LD	BELA VISTA S2	14/10/2020 09:34	14/10/2020 20:28	14/10/2020 09:34	14/10/2020 20:27	10,88	44	478,78	CHI
202010161237	CALDAZINHA	SV12319545LD	BELA VISTA S2	14/10/2020 09:34	14/10/2020 20:28	14/10/2020 09:34	14/10/2020 20:27	10,88	6	65,29	CHI
202010161237	BELA VISTA DE GOIAS	SV12319545LD	BELA VISTA S2	14/10/2020 09:34	14/10/2020 20:28	14/10/2020 09:34	14/10/2020 20:27	10,88	76	826,99	CHI
202010161237	SAO MIGUEL DO PASSA QUATRO	SV12319545LD	BELA VISTA S2	14/10/2020 09:34	14/10/2020 20:28	14/10/2020 16:47	14/10/2020 20:27	3,67	2	7,33	CHI
202010161237	SILVANIA	SV12340450	BELA VISTA S2	14/10/2020 09:34	14/10/2020 20:28	14/10/2020 09:34	14/10/2020 20:28	10,89	34	370,35	CHI
20201073600	AGUAS LINDAS DE GOIAS	4830343267	AGUAS LINDAS DE GOIAS S1	14/10/2020 09:36	14/10/2020 11:57	14/10/2020 09:36	14/10/2020 11:57	2,35	1	2,35	CHI
20201073617	DAMOLANDIA	DL21269365	INHUMAS S1	14/10/2020 09:38	14/10/2020 16:28	14/10/2020 09:38	14/10/2020 16:28	6,82	1	6,82	CHI
20201073628	GUARINOS	GF11099026	SANTA TEREZINHA	14/10/2020 09:40	14/10/2020 18:28	14/10/2020 09:40	14/10/2020 18:28	8,79	136	1195,97	CHI
20201073633	MARA ROSA	2260020945	MARA ROSA	14/10/2020 09:41	14/10/2020 11:58	14/10/2020 09:41	14/10/2020 11:58	2,29	1	2,29	CHI
20201073646	ITABERAI	IB21337292	INHUMAS S1	14/10/2020 09:43	14/10/2020 11:46	14/10/2020 09:43	14/10/2020 11:46	2,04	1	2,04	CHI
20201073651	HIDROLANDIA	HD21058877	CEPAIGO S2	14/10/2020 09:44	14/10/2020 13:02	14/10/2020 09:44	14/10/2020 13:02	3,30	1	3,30	CHI
20201073654	URUACU	UR21118005	URUACU	14/10/2020 09:44	14/10/2020 10:50	14/10/2020 09:44	14/10/2020 10:50	1,09	1	1,09	CHI
20201073665	LUZIANIA	10022847411	RIO VERMELHO	14/10/2020 09:46	14/10/2020 12:22	14/10/2020 09:46	14/10/2020 12:22	2,59	1	2,59	CHI
20201073674	CRISTALINA	KR12376230	PAMPLONA	14/10/2020 09:47	14/10/2020 14:31	14/10/2020 09:47	14/10/2020 14:31	4,72	2	9,45	CHI
20201074024	LUZIANIA	LZ12351406RE	MARAJOARA	14/10/2020 09:47	14/10/2020 13:39	14/10/2020 09:47	14/10/2020 13:39	3,86	100	385,56	CHI
20201073678	APARECIDA DE GOIANIA	200271763	INDEPENDENCIA S1	14/10/2020 09:48	14/10/2020 11:48	14/10/2020 09:48	14/10/2020 11:48	1,99	1	1,99	CHI

20201073680	SAO MIGUEL DO ARAGUAIA	830056877	SAO MIGUEL DO ARAGUAIA	14/10/2020 09:49	14/10/2020 15:33	14/10/2020 09:49	14/10/2020 15:33	5,73	1	5,73	CHI
20201073682	GOIANIA	GN21271031	XAVANTES	14/10/2020 09:49	14/10/2020 10:41	14/10/2020 09:49	14/10/2020 10:41	0,86	1	0,86	CHI
20201073695	AGUAS LINDAS DE GOIAS	LA12096325	AGUAS LINDAS DE GOIAS S1	14/10/2020 09:50	14/10/2020 13:15	14/10/2020 09:50	14/10/2020 13:15	3,40	20	68,07	CHI
20201073700	BONOPOLIS	BX12262762	SAO MIGUEL DO ARAGUAIA	14/10/2020 09:50	14/10/2020 11:53	14/10/2020 09:50	14/10/2020 11:53	2,03	5	10,17	CHI
20201073720	ARUANA	410041830	NOVA CRIXAS	14/10/2020 09:53	14/10/2020 16:46	14/10/2020 09:53	14/10/2020 16:46	6,89	1	6,89	CHI
20201074687	ALTO HORIZONTE	AJ12204148	SANTA TEREZINHA	14/10/2020 09:54	14/10/2020 15:26	14/10/2020 09:54	14/10/2020 15:26	5,53	14	77,47	CHI
20201073728	APARECIDA DE GOIANIA	10042260	REAL S1	14/10/2020 09:54	14/10/2020 12:35	14/10/2020 09:54	14/10/2020 12:35	2,67	1	2,67	CHI
20201073792	SANTA TEREZINHA DE GOIAS	GG12166527	SANTA TEREZINHA	14/10/2020 09:56	14/10/2020 12:04	14/10/2020 09:56	14/10/2020 12:04	2,12	7	14,85	CHI
20201073792	PILAR DE GOIAS	GG12166527	SANTA TEREZINHA	14/10/2020 09:56	14/10/2020 12:04	14/10/2020 09:56	14/10/2020 12:04	2,12	13	27,57	CHI
20201073754	APARECIDA DE GOIANIA	10008975572	ANHANGUERA	14/10/2020 09:59	14/10/2020 12:02	14/10/2020 09:59	14/10/2020 12:02	2,05	1	2,05	CHI
20201073767	MARA ROSA	MQ12208528	MARA ROSA	14/10/2020 10:01	14/10/2020 12:07	14/10/2020 10:01	14/10/2020 12:07	2,10	1	2,10	CHI
20201074762	SAO MIGUEL DO ARAGUAIA	SM12350501	SAO MIGUEL DO ARAGUAIA	14/10/2020 10:11	15/10/2020 08:45	14/10/2020 10:11	15/10/2020 08:45	22,56	6	135,38	CHI
20201073829	SAO LUIZ DO NORTE	10018608491	ITAPACI	14/10/2020 10:12	14/10/2020 16:20	14/10/2020 10:12	14/10/2020 16:20	6,13	1	6,13	CHI
20201073854	NIQUELANDIA	NQ21095793	NIQUELANDIA SUBTRANSMISSAO	14/10/2020 10:16	15/10/2020 13:16	14/10/2020 10:16	15/10/2020 13:16	26,99	1	26,99	CHI
20201073899	SAO MIGUEL DO ARAGUAIA	SM21151398	SAO MIGUEL DO ARAGUAIA	14/10/2020 10:25	14/10/2020 16:10	14/10/2020 10:25	14/10/2020 16:10	5,76	6	34,55	CHI
20201073912	PORANGATU	PO21019931	PORANGATU	14/10/2020 10:27	14/10/2020 12:07	14/10/2020 10:27	14/10/2020 12:07	1,67	1	1,67	CHI
20201073946	PORANGATU	PO11227217	PORANGATU	14/10/2020 10:33	14/10/2020 17:04	14/10/2020 10:33	14/10/2020 17:04	6,53	1	6,53	CHI
20201074054	FORMOSO	2410015238	PORANGATU	14/10/2020 10:51	14/10/2020 13:09	14/10/2020 10:51	14/10/2020 13:09	2,29	1	2,29	CHI
20201074316	NOVA GLORIA	IW12181408	RUBIATABA	14/10/2020 10:55	14/10/2020 14:35	14/10/2020 10:55	14/10/2020 14:35	3,65	10	36,52	CHI
20201074310	PORANGATU	PO12378346	PORANGATU	14/10/2020 10:59	14/10/2020 16:49	14/10/2020 10:59	14/10/2020 16:49	5,82	23	133,83	CHI
20201074158	NIQUELANDIA	6307242	NIQUELANDIA SUBTRANSMISSAO	14/10/2020 10:59	15/10/2020 18:45	14/10/2020 10:59	15/10/2020 18:45	31,75	3	95,25	CHI
20201074190	NIQUELANDIA	NQ12413966	URUACU	14/10/2020 11:05	14/10/2020 11:40	14/10/2020 11:05	14/10/2020 11:40	0,58	1	0,58	CHI
20201074202	MINACU	IH21150731	MINACU	14/10/2020 11:07	14/10/2020 14:45	14/10/2020 11:07	14/10/2020 14:45	3,63	3	10,88	CHI
20201074242	PORANGATU	PO12208396	PORANGATU	14/10/2020 11:14	14/10/2020 11:31	14/10/2020 11:14	14/10/2020 11:31	0,27	1	0,27	CHI
20201074263	MARA ROSA	MQ12051070	MARA ROSA	14/10/2020 11:19	14/10/2020 12:13	14/10/2020 11:19	14/10/2020 12:13	0,89	197	174,51	CHI
202010162148	SAO MIGUEL DO ARAGUAIA	SM10404183	SAO MIGUEL DO ARAGUAIA	14/10/2020 11:33	15/10/2020 17:19	14/10/2020 11:33	14/10/2020 15:14	3,70	25	92,41	CHI
202010162148	SAO MIGUEL DO ARAGUAIA	SM10404183	SAO MIGUEL DO ARAGUAIA	14/10/2020 11:33	15/10/2020 17:19	14/10/2020 11:33	14/10/2020 23:52	12,32	6	73,95	CHI
202010162148	SAO MIGUEL DO ARAGUAIA	SM12349178	SAO MIGUEL DO ARAGUAIA	14/10/2020 11:33	15/10/2020 17:19	14/10/2020 11:33	15/10/2020 00:52	13,32	87	1158,74	CHI
202010162148	SAO MIGUEL DO ARAGUAIA	SM12235205	SAO MIGUEL DO ARAGUAIA	14/10/2020 11:33	15/10/2020 17:19	14/10/2020 11:33	15/10/2020 16:23	28,84	9	259,52	CHI
202010162148	SAO MIGUEL DO ARAGUAIA	SM10404183	SAO MIGUEL DO ARAGUAIA	14/10/2020 11:33	15/10/2020 17:19	15/10/2020 16:59	15/10/2020 17:19	0,34	127	42,93	CHI
20201074379	FORMOSO	FO21052582	PORANGATU	14/10/2020 11:45	14/10/2020 15:34	14/10/2020 11:45	14/10/2020 15:34	3,81	1	3,81	CHI
20201074396	URUACU	UR21138164	URUACU	14/10/2020 11:52	14/10/2020 13:22	14/10/2020 11:52	14/10/2020 13:22	1,49	1	1,49	CHI

5. Plotagem das Ocorrências conforme a Espacialização das Chuvas

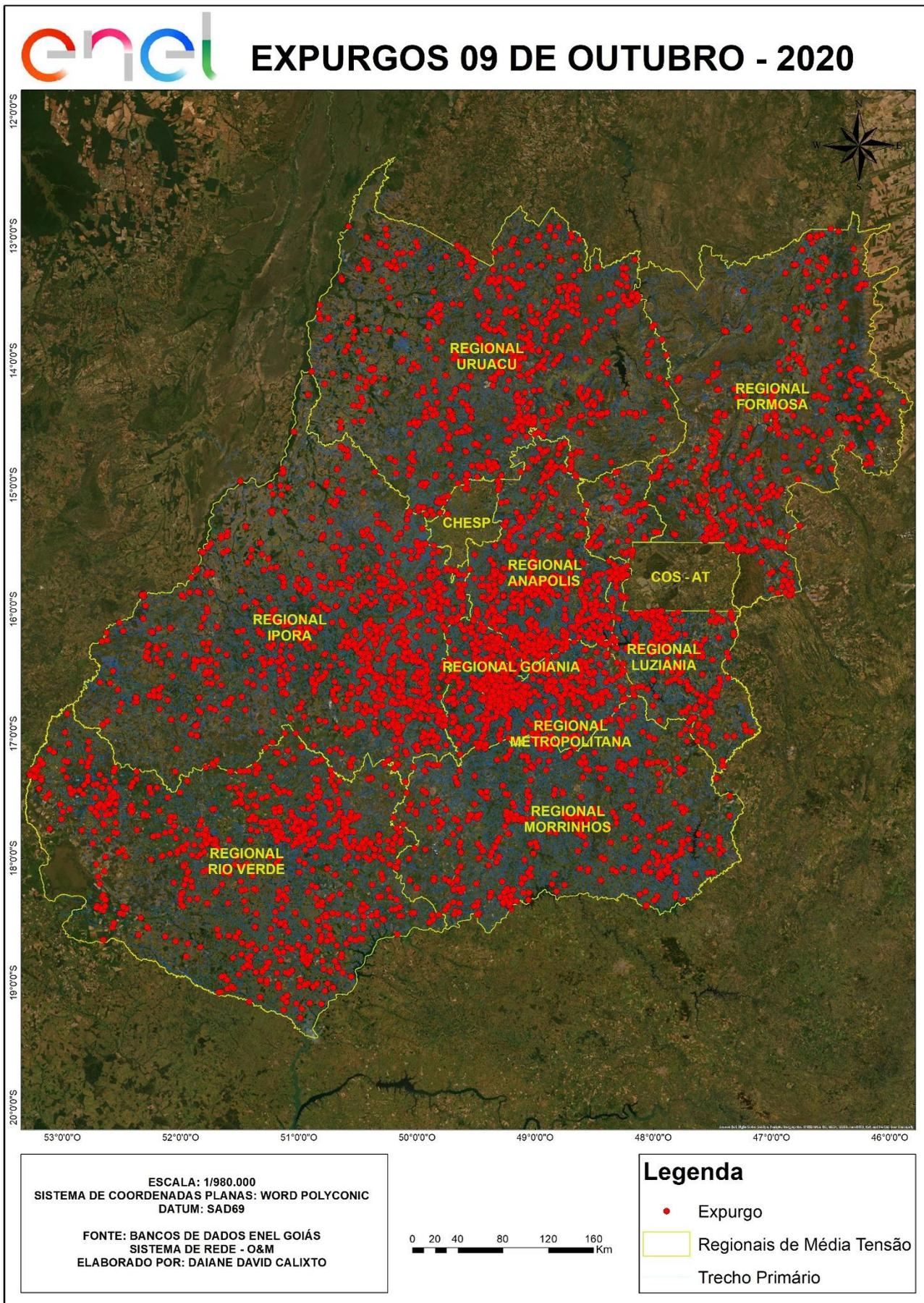

6. Clientes Afetados e Impactos Globais

Em análise ao número de clientes interrompidos (CI) na área de concessão da ENEL GO, a figura abaixo apresenta a atipicidade vivenciada no dia 09 a 16 de outubro de 2020, data esta que, conforme laudo meteorológico emitido por empresa especializada, a referida concessão passou por um período de condições climáticas de extrema severidade.

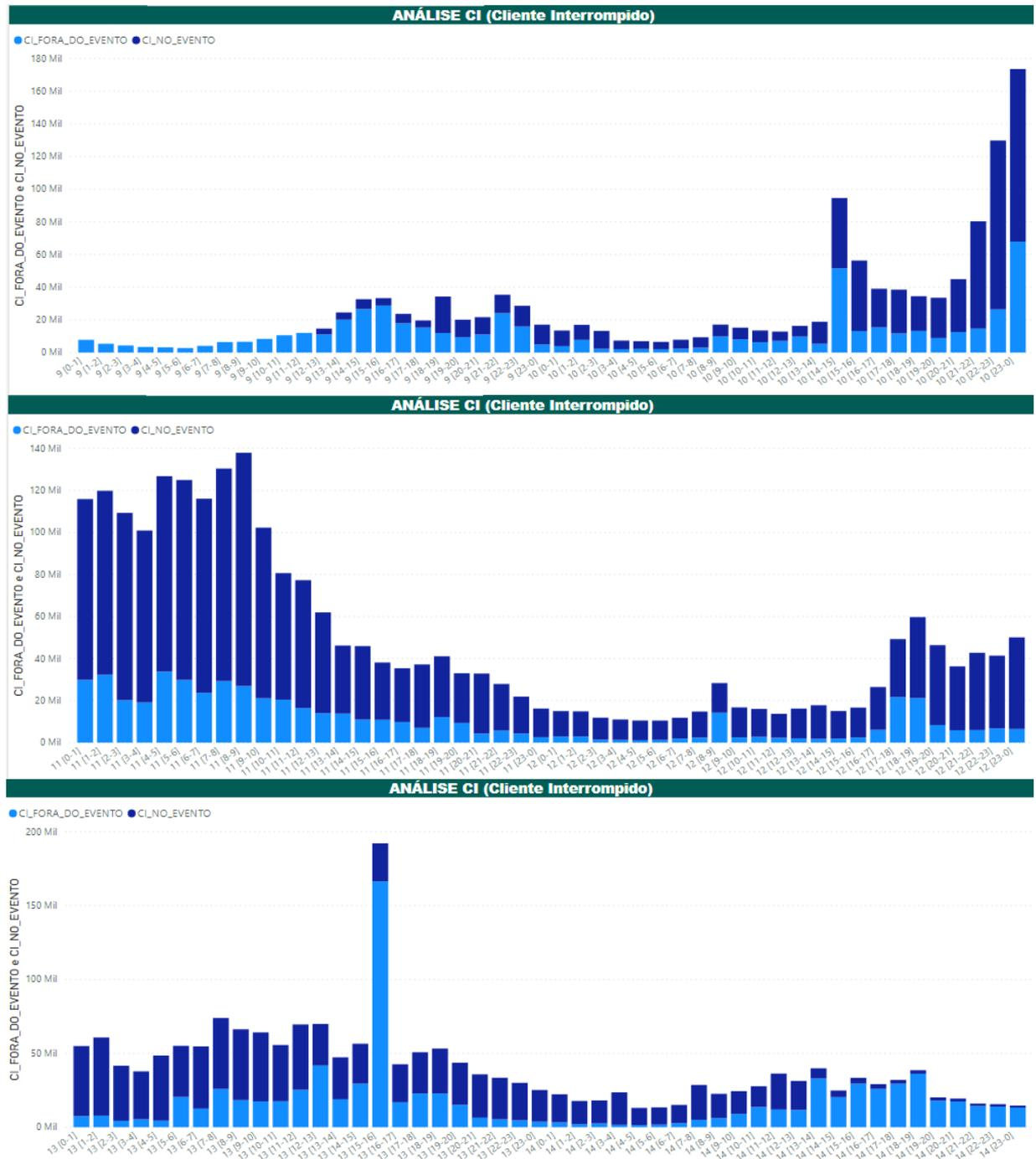

Figuras – Clientes Interrompidos em intervalos de horas

Na figura acima, as barras em azul claro representam a quantidade de clientes interrompidos simultaneamente em condições normais de operação, e as barras azul escuro os clientes interrompidos simultaneamente no período do evento.

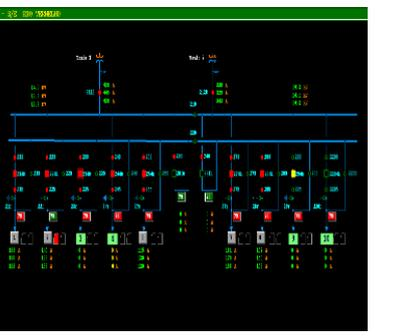
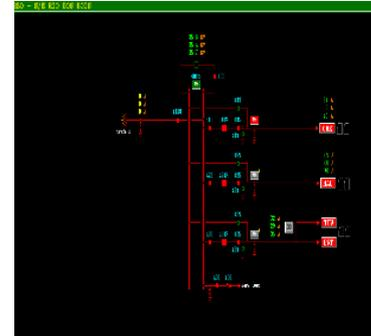
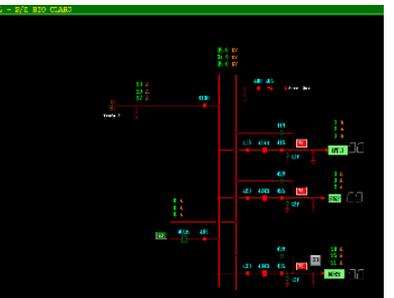
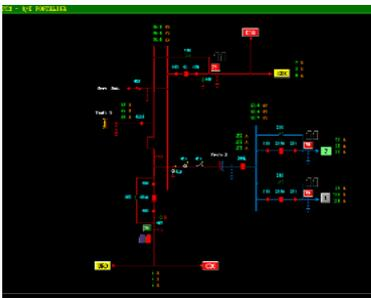
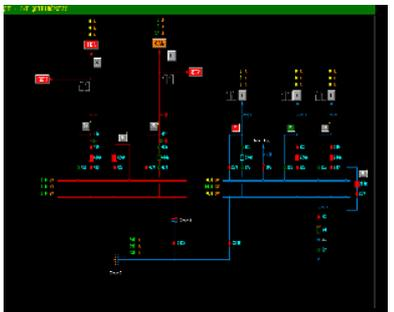
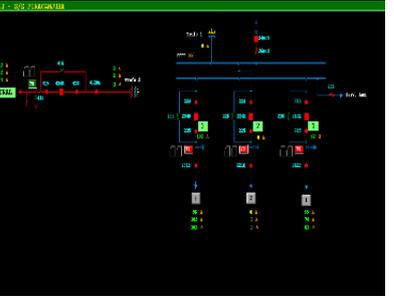
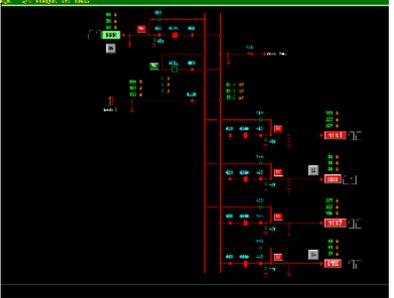
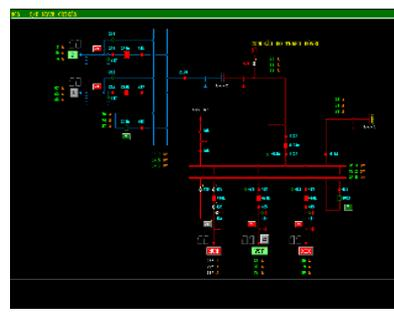

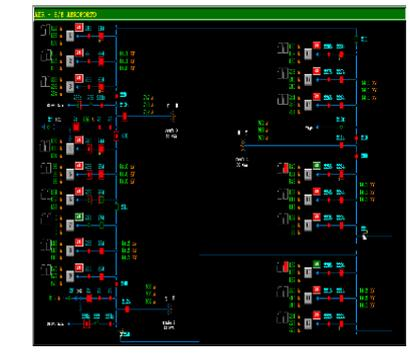
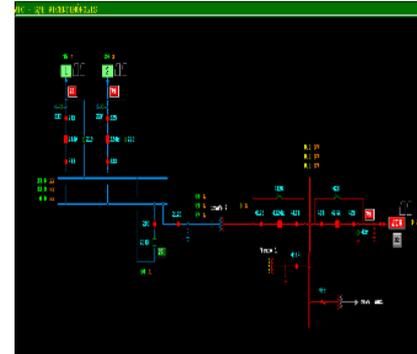
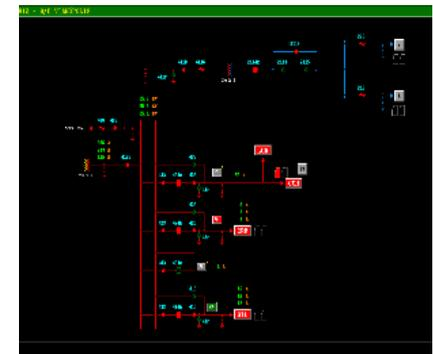
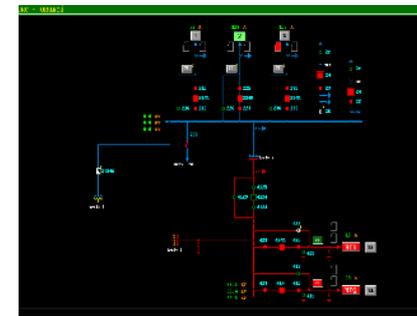
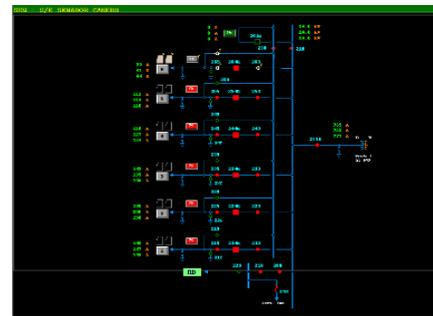
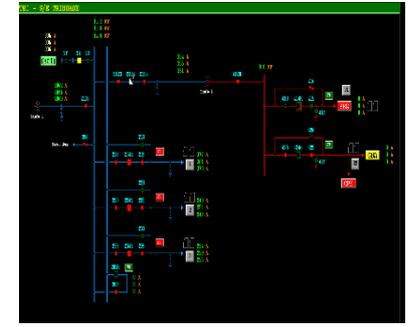
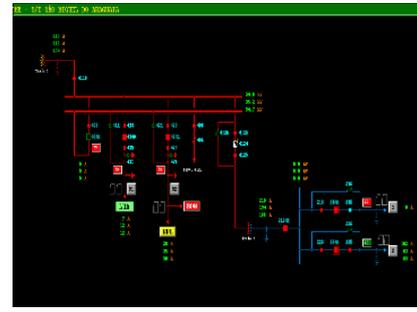
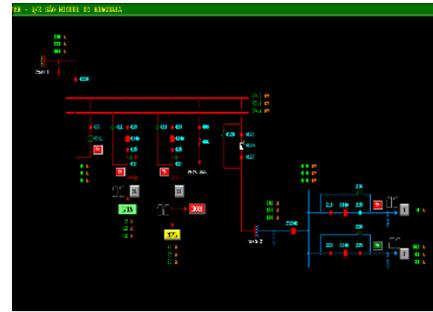
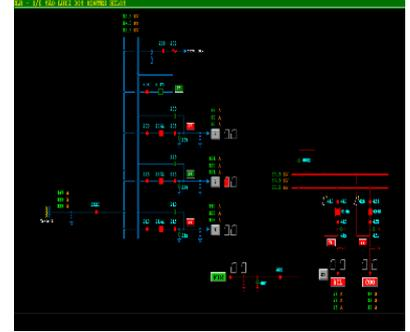
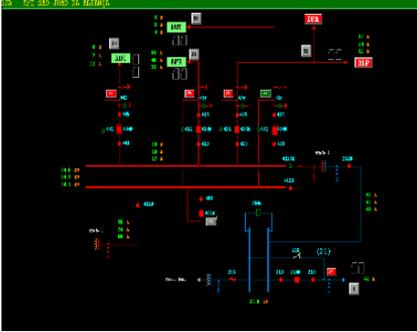
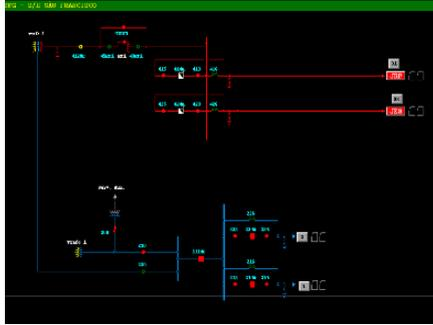
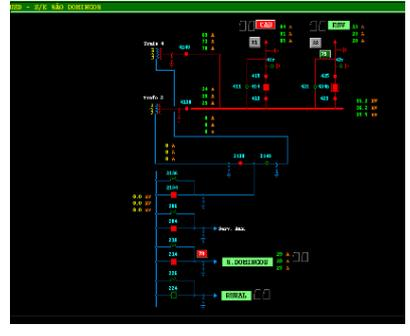
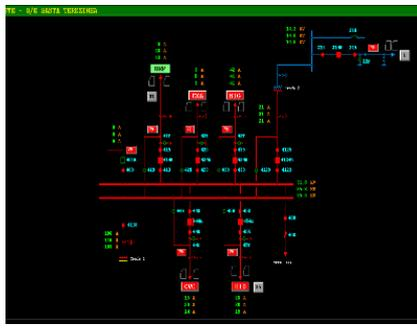
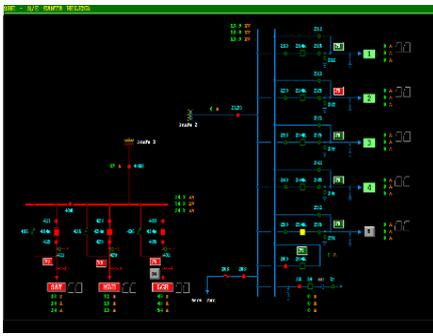

INTERNAL

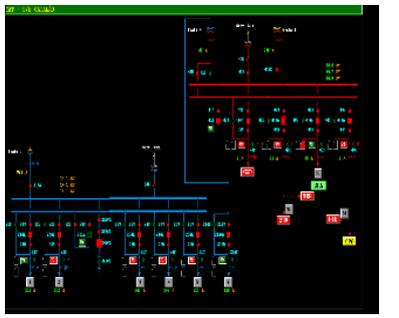
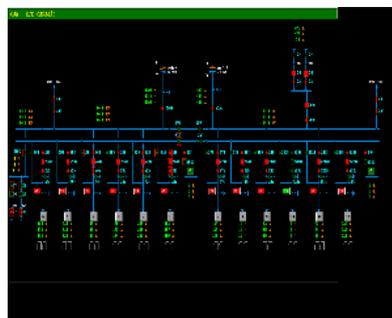
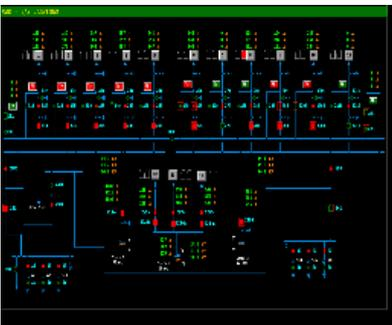
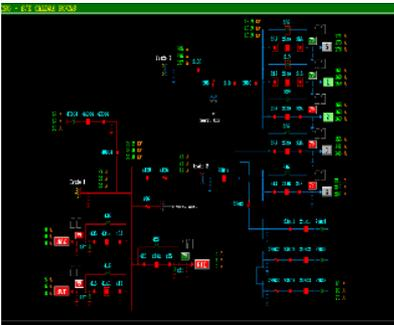
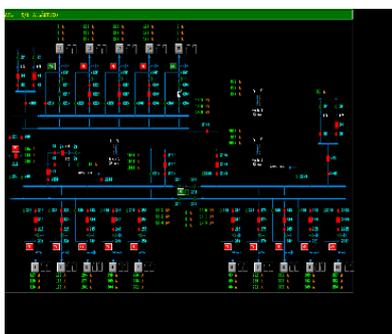
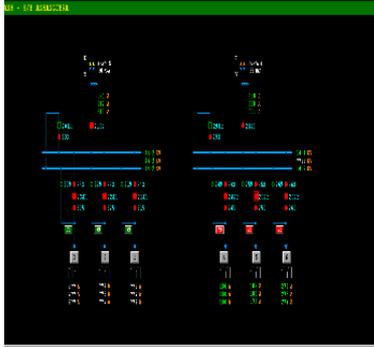
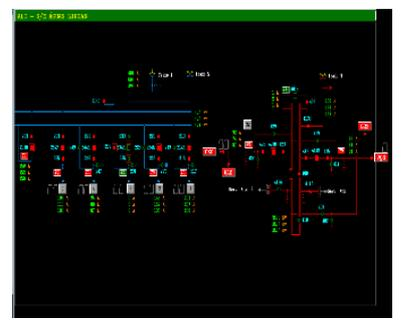
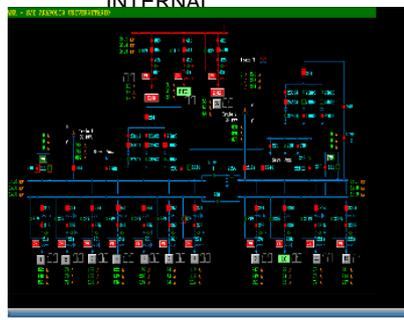

INTERNAL

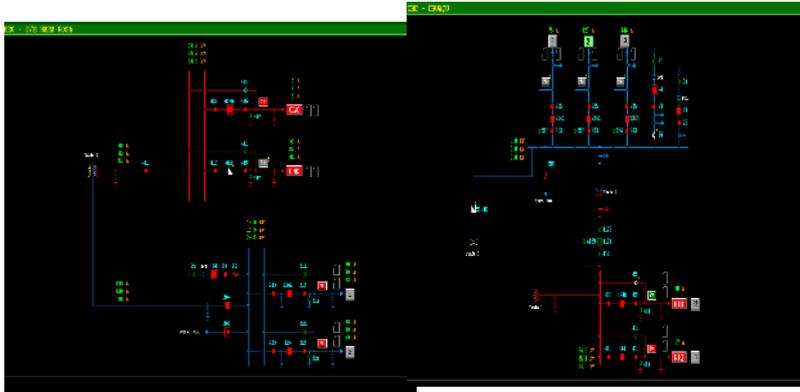
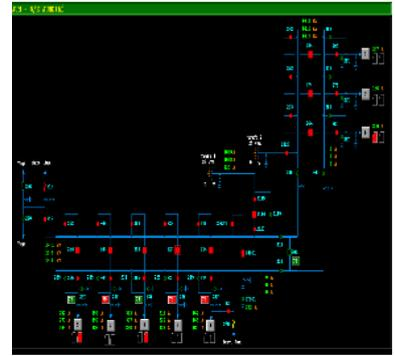
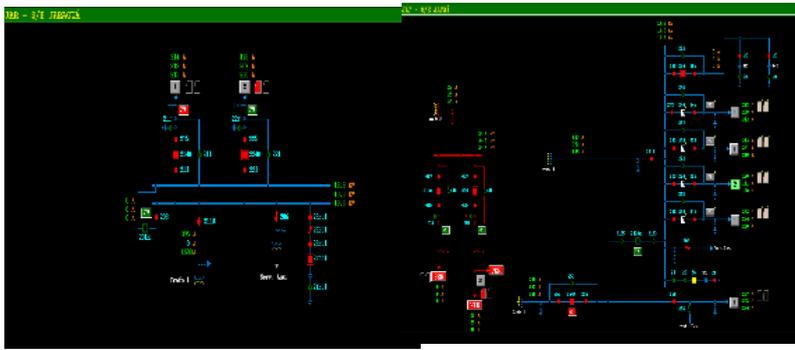

8. DEMAIS EVIDÊNCIAS

8.1. DADOS TÉCNICO - OPERACIONAIS ENEL GO

Enel - GO

TMAE e OE por Dia - Outubro 2020



Regional Anápolis – GO

TMAE e OE por Dia - Outubro 2020

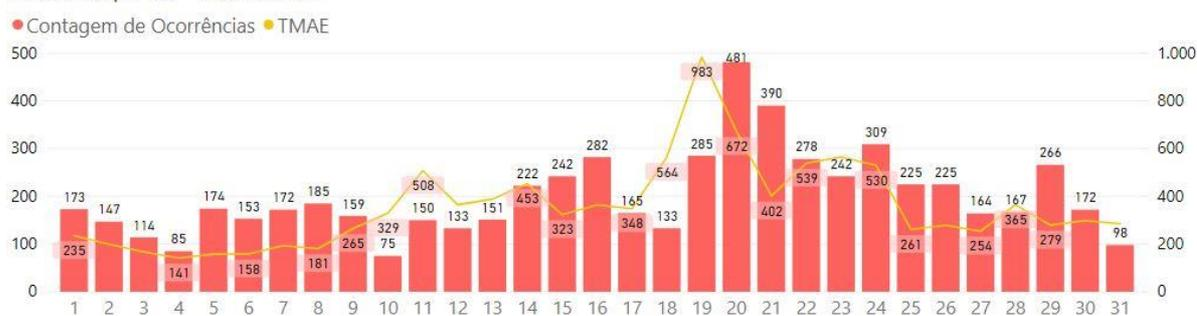

Regional Formosa – GO

TMAE e OE por Dia - Outubro 2020

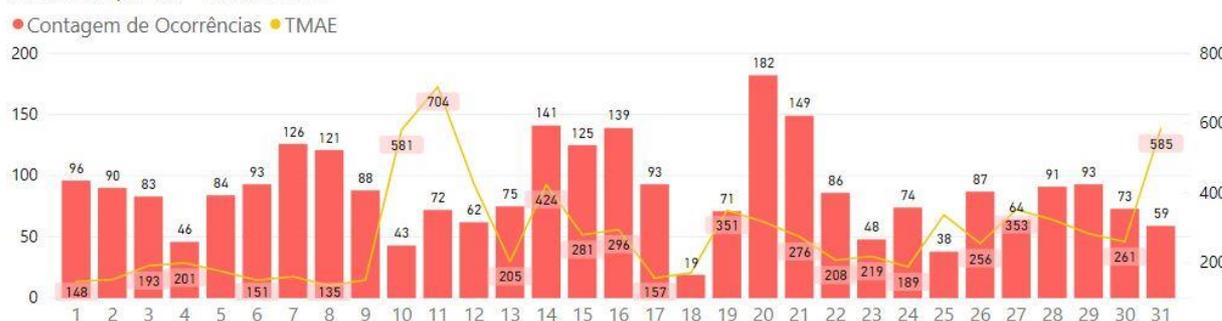

Regional Goiânia – GO

TMAE e OE por Dia - Outubro 2020

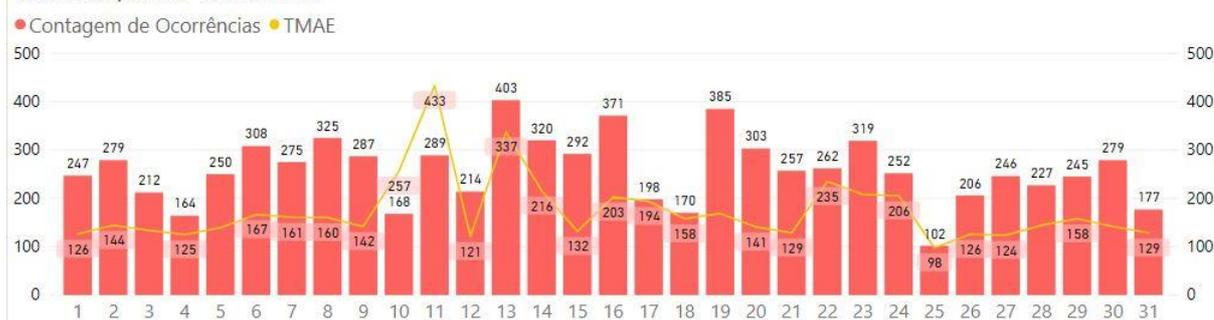

Regional Iporá – GO



Regional Luziânia – GO



Regional Metropolitana – GO



Regional Morrinhos – GO



Regional Rio Verde – GO

TMAE e OE por Dia - Outubro 2020



Regional Uruaçu - GO

TMAE e OE por Dia - Outubro 2020



8.2. Dados climatológicos pelo INMET

Instituto Nacional de Meteorologia – INMET

Chuva Acumulada em 24h || Estação: ARAGARCAS (83368) – 10/2020

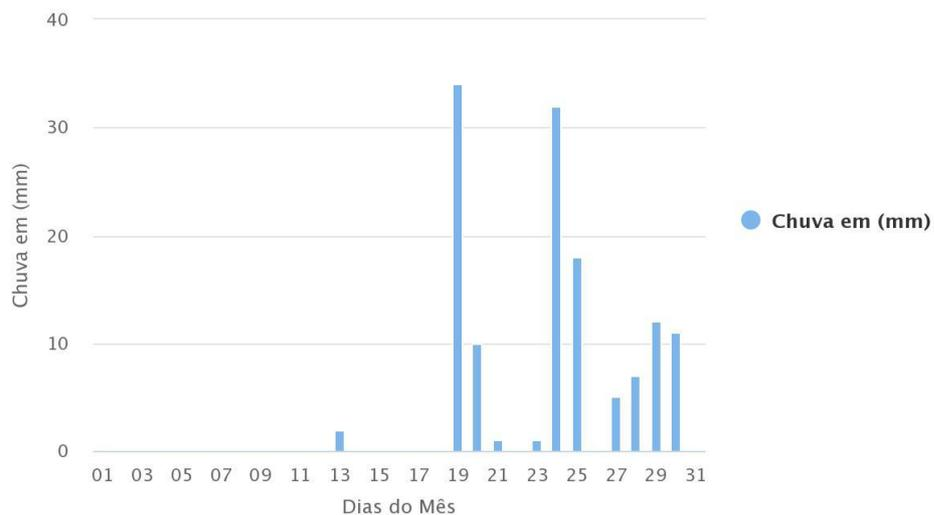

Instituto Nacional de Meteorologia – INMET

Chuva Acumulada em 24h || Estação: CATALAO (83526) – 10/2020

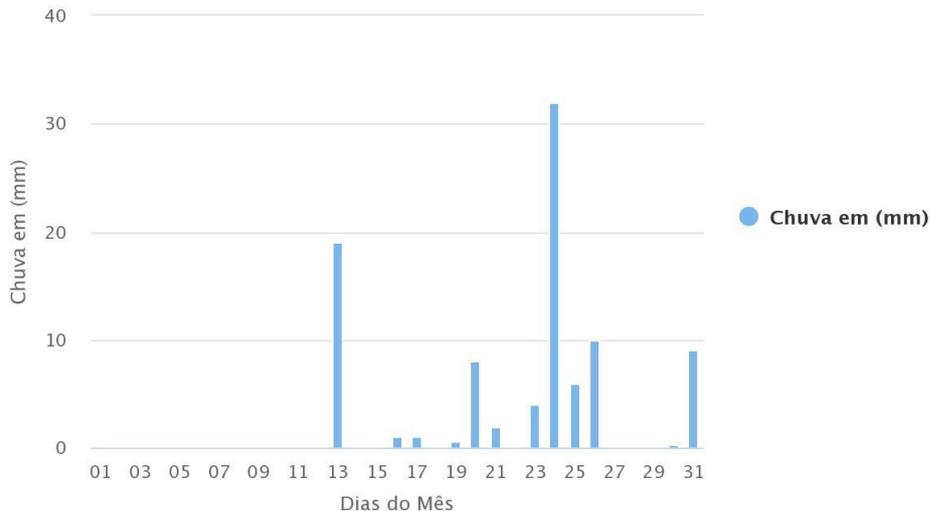

Highcharts.com

Instituto Nacional de Meteorologia – INMET

Chuva Acumulada em 24h || Estação: FORMOSA (83379) – 10/2020

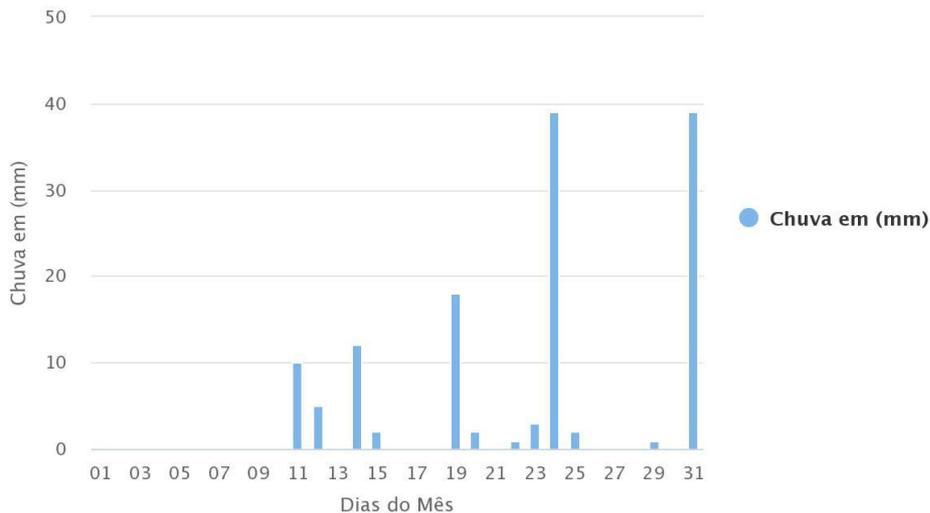

Highcharts.com

Instituto Nacional de Meteorologia – INMET

Chuva Acumulada em 24h || Estação: GOIANIA (83423) – 10/2020

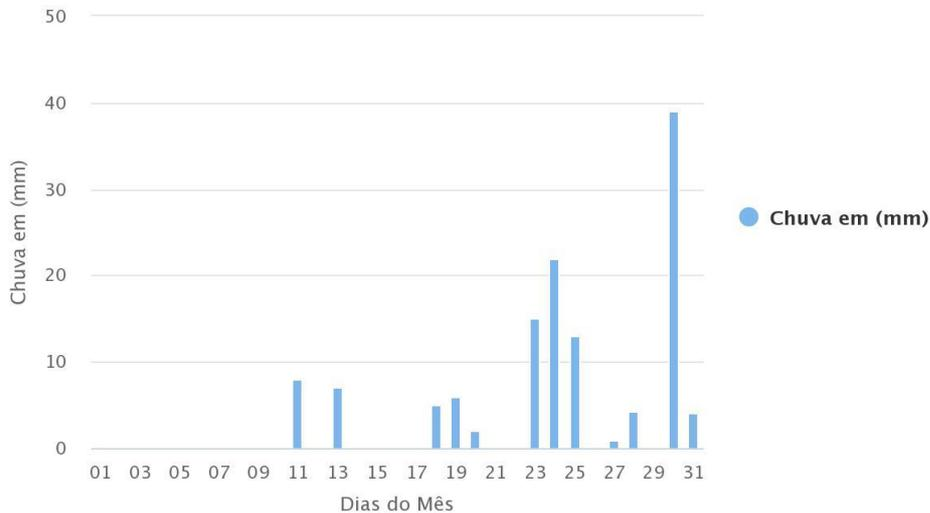

Highcharts.com

Instituto Nacional de Meteorologia – INMET

Chuva Acumulada em 24h || Estação: IPAMERI (83522) – 10/2020

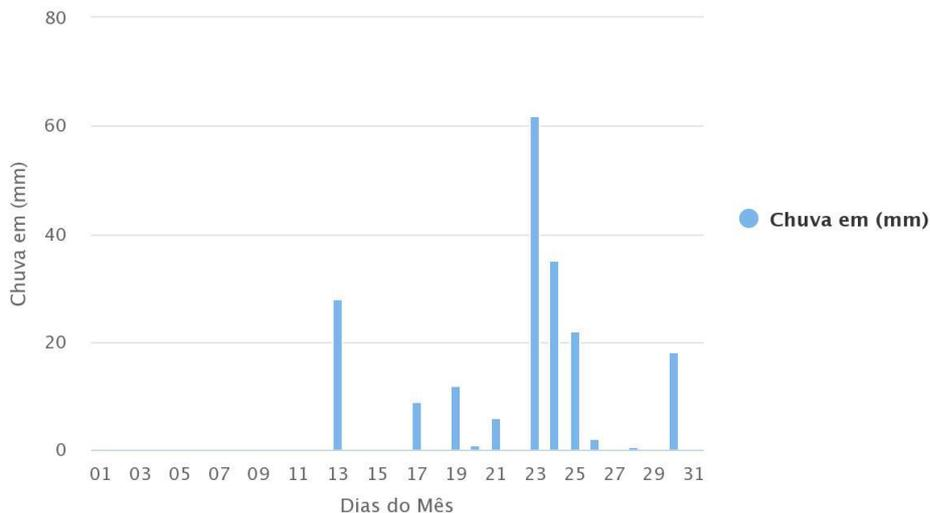

Highcharts.com

Instituto Nacional de Meteorologia – INMET

Chuva Acumulada em 24h || Estação: PIRENOPOLIS (83376) – 10/2020

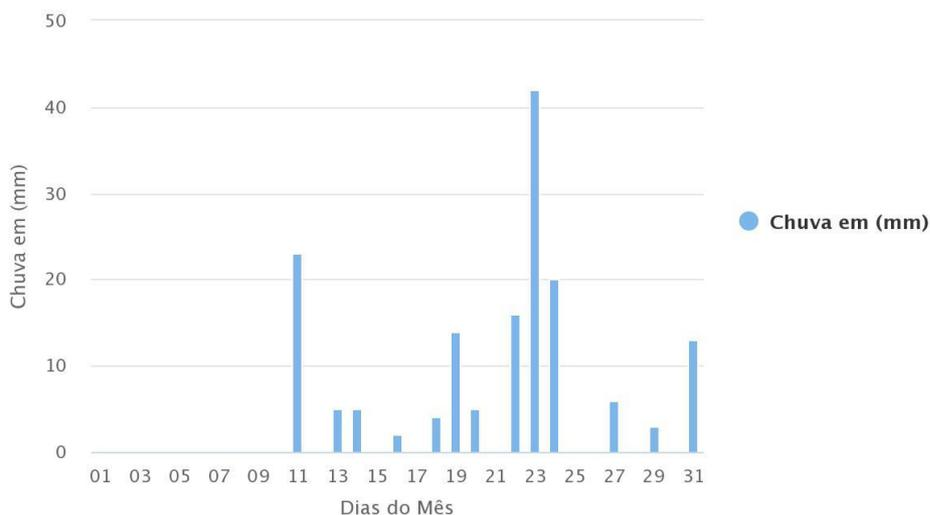

Highcharts.com

Instituto Nacional de Meteorologia – INMET

Chuva Acumulada em 24h || Estação: POSSE (83332) – 10/2020

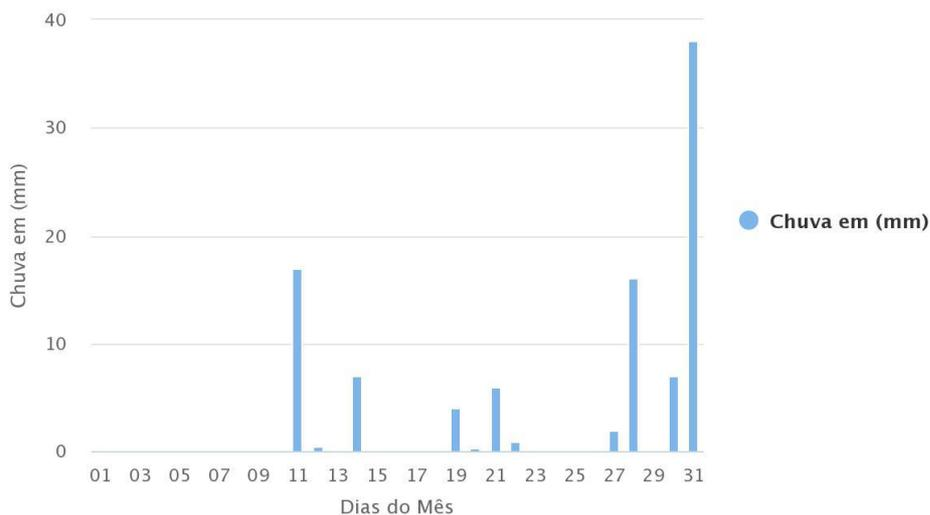

Highcharts.com

Instituto Nacional de Meteorologia – INMET

Chuva Acumulada em 24h || Estação: RIO VERDE (83470) – 10/2020

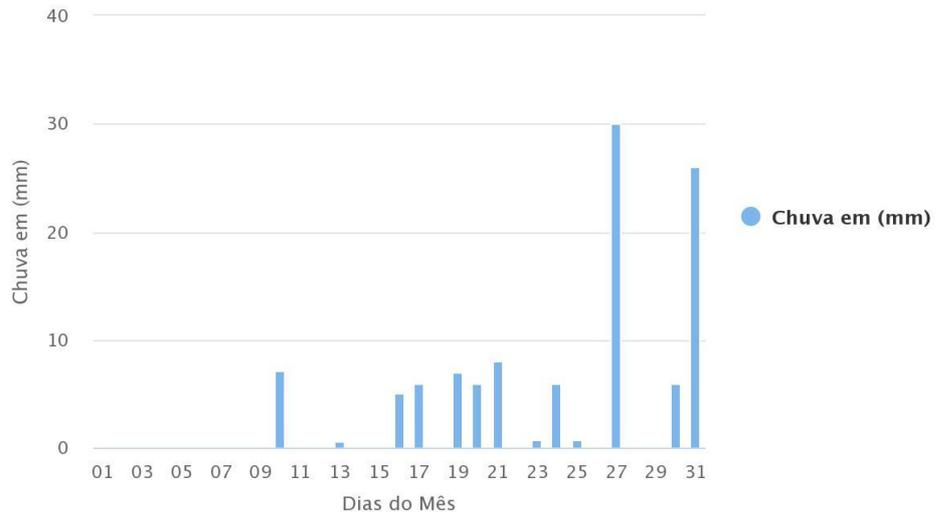

9. NOTÍCIAS RELACIONADAS

<https://altairtavares.com.br/em-goiania-chuvas-deixam-bairros-sem-energia-eletrica/>

Em Goiânia, chuvas deixam bairros sem energia elétrica



Por Redação do Blog — 11/10/2020 em Destaques, Notícias



Chuvas são bem vindas mas trazem transtornos em Goiânia e outras cidades

A tão esperada chuva para Goiás veio e aliviou a população goiana, que era castigada havia meses por uma estiagem prolongada. As temperaturas bateram recordes em todo o estado.

Ao longo da noite e madrugada do sábado (10/11) para o domingo (11/10), finalmente choveu em Goiânia. Após um longo período de estiagem com temperaturas batendo recordes em todo o estado, finalmente um frescor para os goianienses no final de semana prolongado. Porém, com as chuvas, também algumas dores de cabeça.

É que alguns bairros de Goiânia e Aparecida de Goiânia ficaram sem energia por conta da chuva forte, Setores de Goiânia (Parque Tremendão, Vila dos Alpes, Conjunto Vera Cruz e setor Sudoeste) e Aparecida de Goiânia (Jardim Maria Inês e Jardim Belo Horizonte) sofreram com a queda da energia na noite deste sábado (10).

Em nota, a Enel Distribuição Goiás informou que “fortes chuvas e ventos causaram a queda da energia e que a empresa aumentou o número de funcionários nestas cidades para atender à população o mais rápido possível”.

Uma das promessas da empresa era solucionar este problema, conhecido de longa data dos goianos desde os tempos da estatal Celg.

Há relatos de moradores que a falta de energia também aconteceu em cidades do interior do estado.

Por meio de nota, a Enel Distribuição Goiás informou que em menos de 24 horas conseguiu restabelecer a energia em 72% das casas que “tiveram interrupção no serviço em decorrência das chuvas com fortes ventos”.

: preg_match() expects parameter 2 to be string, array given in on line

Posto de Combustível

Seu posto precisa de automação de bombas?
Unio Tecnologia

Notícias de hoje

Superprêmio da Mega da Virada perto de R\$300 milhões 21/12/2020

<https://www.comprerural.com/alerta-temporais-com-ventos-de-mais-de-70-km-h/>

ALERTA: TEMPORAIS COM VENTOS DE MAIS DE 70 KM/H

14 de outubro de 2020

PARTILHAR



Facebook



Twitter



Curtir 0



Tweet



Foto: Pixabay

A expectativa é de aumento da umidade do solo em parte de MG, norte de SP, sudoeste de GO e nordeste e norte de MS; Temporais devem atingir interior do Brasil.

A chuva vai enfraquecer sobre o Matopiba, mas aumenta sobre Mato Grosso do Sul, Paraná e São Paulo e prossegue sobre Goiás, Minas Gerais e Espírito Santo nos próximos dias. Para esta semana, as pancadas de chuva serão mais intensas sobre Minas Gerais, sudoeste de Goiás, São Paulo, Paraná e Mato Grosso do Sul. Há, inclusive, previsão de tempestades mais intensas na quinta-feira, 15, em todos os estados citados.



Anúncios Google

Enviar comentários

Anúncio? Por quê? ⓘ

<https://www.instagram.com/p/CGOK-KHISif/?hl=pt-br>



maisgoias • Seguindo
Original Audio

maisgoias Tempo: e choveu granizo no final da tarde deste domingo na cidade de Serranópolis (GO)
10 sem

annecassiarocha Gezuiz
10 sem Responder

alessandrogsales Só faltou água nessa chuva né 😂😂😂
10 sem Responder

Curtido por xandexleite e outras 7.774 pessoas
11 DE OUTUBRO

Adicione um comentário... **Publicar**

<https://www.instagram.com/p/CGLcn5FIZ66/?hl=pt-br>



maisgoias • Seguindo
Original Audio

maisgoias Tempo: e a chuva está se aproximando de Goiânia! 🌧️🌧️ imagem registrada em São Francisco de Goiás, nas proximidades do entroncamento da GO-080 com a BR 153. Vídeo @hokenbarck
10 sem

sonia_bmendonca 🙏🙏🙏
10 sem Responder

betaniacaldeiraosdeid Oh, Senhor! Permita que caia
10 sem Responder

Curtido por xandexleite e outras 15.673 pessoas
10 DE OUTUBRO

Adicione um comentário... **Publicar**

<https://www.instagram.com/p/CGNajdTl6Vz/?hl=pt-br>



maisgoiás • Seguindo

maisgoiás A chuva de ontem causou enxurrada nas ruas da cidade de Goiás
10 sem

jessica.dosanjos @alvesgladyston 10 sem Responder

terezinha.castro.go Que coisa boa em, se tem enxurrada é pq foi uma chuva boa não é mesmo.
10 sem Responder

mariciridianaru @adudulimameoira

82.923 visualizações
11 DE OUTUBRO

Adicione um comentário... **Publicar**

https://www.instagram.com/p/CGPedSUIO_t/?hl=pt-br



maisgoiás • Seguindo

maisgoiás De acordo com a previsão do Instituto Nacional de Meteorologia (Inmet), nesta segunda-feira (12), feriado de Nossa Senhora Aparecida, Goiânia vai continuar com tempo nublado e chuvas isoladas.

Pela tarde e a noite é observado a maior possibilidade de pancadas de chuva e trovoadas, com o clima nublado a maior parte do tempo. A temperatura máxima na capital chegará a 32°C e a mínima 19°C. A umidade máxima chega a 90%.

Já na próxima terça-feira (13), a chuva não vai dar as caras e o tempo permanecerá apenas encoberto.

Feriado será de chuva em Goiânia; confira a previsão do tempo

Curtido por **xandexleite** e outras 18.381 pessoas
12 DE OUTUBRO

Adicione um comentário... **Publicar**

https://www.instagram.com/p/CGQokA9IK_E/?hl=pt-br



maisgoias • Seguindo
Original Audio

maisgoias Tempo: e o final da tarde foi de muita chuva de granizo na zona rural de Caiapônia. Vídeo @j.gabriel_hp
10 sem

mary_souza75 Coitados dos animais 🤔😞😞
9 sem Responder

sarodrigs @milenacriis bem próximo da onde nois tava
9 sem 1 curtida Responder

Curtido por **adryan_jerry** e outras 19.602 pessoas
12 DE OUTUBRO

Adicione um comentário... **Publicar**

Contingência Operacional

Jussara



Contingência Operacional

Montes Claros



#JornalBahia

Morador registra chuva, em Rio Verde
31 seg - Exibição em 10 out 2020

Chuva aconteceu na última sexta-feira (9) e teve também relâmpagos.

<https://globoplay.globo.com/v/8929788/>

#BahiaOnline

CHUVA CHEGOU PRA DAR UM ALIVIO
Chuva gelada em Serranópolis

Chuva de granizo atinge Serranópolis
35 seg - Exibição em 12 out 2020

Depois de muitos dias de calor, chuva trouxe alívio.

<https://globoplay.globo.com/v/8932079/>

Contingência Operacional

Notícias

10. Laudo Técnico

CLIMATEMPO

**Laudo Meteorológico de Evento Climático
- ENEL Goiás - 09 de outubro de 2020**

São Paulo, SP, Brasil

Novembro de 2020

Sumário

1	ANÁLISE DE EVENTO METEOROLÓGICO	2
1.1	DESCRIÇÃO DO EVENTO	2
1.2	ABRANGÊNCIA DO EVENTO	5
2	CLASSIFICAÇÃO COBRADE	19
3	RESUMO DO EVENTO	20
4	REFERÊNCIAS.....	23
	ANEXOS.....	24

1. Análise de Evento Meteorológico

1.1. Descrição do Evento

Na figura a seguir é apresentada a área de concessão da ENEL DISTRIBUIÇÃO GOIÁS, dividida em regiões, a serem analisadas neste relatório.



Figura 1 – Regiões atendidas pela ENEL Goiás.

A presença de uma frente fria na costa do Brasil favoreceu a organização de um canal de umidade sobre o estado de Goiás. Áreas de instabilidade associadas a esse padrão atuaram sobre a área de concessão da ENEL DISTRIBUIÇÃO GOIÁS entre a tarde do dia 09 e a manhã do dia 14 de outubro de 2020.

Nas Figuras 2 e 3 são apresentadas as descargas atmosféricas nuvem-solo (raios) e nuvem-nuvem detectadas pelo sistema Earth Networks. Entre as 12h30 do dia 09 e 11h40 do dia 14 de outubro de 2020 foram registrados 34105 raios nuvem-solo e 89949 descargas nuvem-nuvem sobre a área da ENEL DISTRIBUIÇÃO GOIÁS.

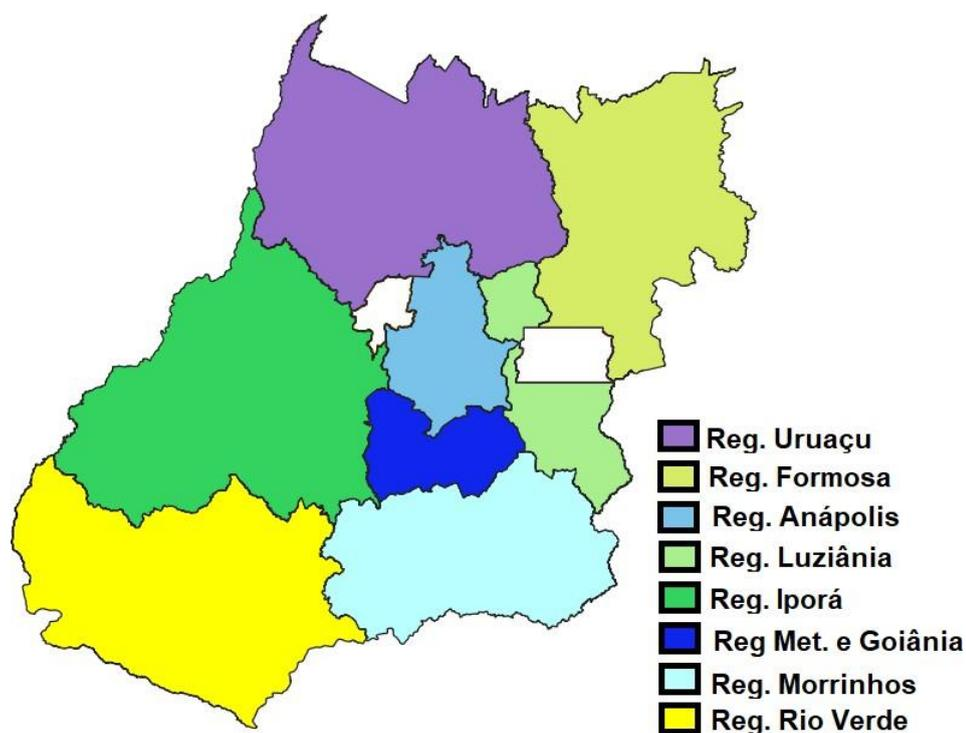

Figura 2 – Descargas atmosféricas nuvem-solo (em preto) detectadas pelo sistema Earth Networks entre 12h30 do dia 09 e 11h40 do dia 14 de outubro de 2020 sobre a área de concessão da ENEL DISTRIBUIÇÃO GOIÁS.



Figura 3 – Descargas atmosféricas nuvem-nuvem (em vermelho) detectadas pelo sistema Earth Networks entre 12h30 do dia 09 e 11h40 do dia 14 de outubro de 2020 sobre a área de concessão da ENEL DISTRIBUIÇÃO GOIÁS.

Estações do Instituto Nacional de Meteorologia (INMET), representativas da área de concessão da ENEL DISTRIBUIÇÃO GOIÁS, registraram chuva forte (segundo a American Meteorological Society - Sociedade Meteorológica Americana -, chuvas com taxa entre 2,5mm a 7,6 mm por hora são consideradas moderadas e aquelas com taxa superior a 7,6 mm por hora são consideradas chuva forte). Na tabela 1 são apresentados os registros de acumulados horários superiores a 7,6 mm.

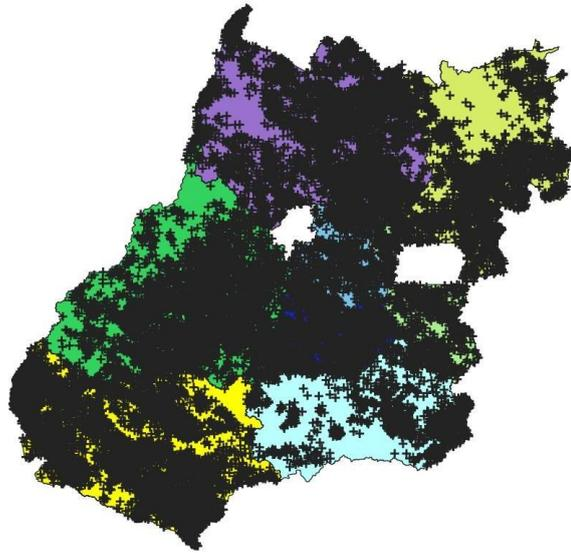
A estação de Alto Araguaia do INMET acumulou 73,0 mm em um intervalo de apenas uma hora, entre as 17h e 18h do dia 11 de outubro de 2020, valor que corresponde a aproximadamente 58% da média climatológica de chuva para a região.

Tabela 1 – Acumulado horário de chuva registrada pelo INMET.

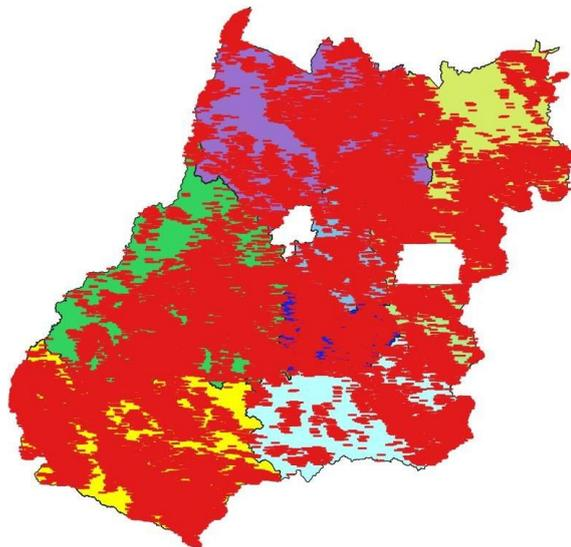
Estação	Horário	Precipitação (mm)
Alto Araguaia	Entre 17h e 18h do dia 11/10/2020	73.0
Alto Araguaia	Entre 18h e 19h do dia 11/10/2020	10.6
Alto Paraíso de Goiás	Entre 22h e 23h do dia 10/10/2020	8.0
Catalão	Entre 21h e 22h do dia 12/10/2020	11.2
Cristalina	Entre 2h e 3h do dia 13/10/2020	17.0
Goiânia	Entre 23h e 0h do dia 11/10/2020	19.8
Goiás	Entre 23h e 0h do dia 11/10/2020	81.6
Goiás	Entre 2h e 3h do dia 11/10/2020	8.2
Goiás	Entre 18h e 19h do dia 12/10/2020	10.2
Itapaci	Entre 20h e 21h do dia 12/10/2020	12.2
Mineiros	Entre 18h e 19h do dia 11/10/2020	8.8
Mineiros	Entre 19h e 20h do dia 11/10/2020	11.0
Pires do Rio	Entre 0h e 1h do dia 13/10/2020	28.2
Pires do Rio	Entre 1h e 2h do dia 13/10/2020	8.2
Posse	Entre 5h e 6h do dia 11/10/2020	8.4
Silvânia	Entre 1h e 2h do dia 11/10/2020	13.2

Na tabela 2 são apresentadas as rajadas de vento iguais ou superiores a 50 km/h registradas por estações do Instituto Nacional de Meteorologia (INMET) representativas da área de concessão da ENEL Distribuição Goiás. Como é possível observar, o maior valor registrado foi de 79,9 km/h na estação de Goiás entre as 18h e 19h do dia 12 de outubro, vento classificado como ventania forte pela escala Beaufort.

Tabela 2 – Rajadas de vento maiores ou iguais a 50 km/h registradas pelo INMET. Segundo a escala Beaufort, ventos entre 50 e 61 km/h são classificados como vento forte, entre 62 e 74 km/h como ventania, entre 75 e 88 km/h como ventania forte.

Estação	Horário	Rajada (km/h)
Alto Araguaia	Entre 17h e 18h do dia 11/10/2020	70.9
Alto Araguaia	Entre 18h e 19h do dia 11/10/2020	69.5
Goiás	Entre 18h e 19h do dia 12/10/2020	79.9
Goiás	Entre 19h e 20h do dia 12/10/2020	65.2
Itumbiara	Entre 17h e 18h do dia 9/10/2020	66.6
Jataí	Entre 17h e 18h do dia 11/10/2020	51.1
Monte Alegre de Goiás	Entre 3h e 4h do dia 10/10/2020	50.8
São Simão	Entre 14h e 15h do dia 9/10/2020	57.2
São Simão	Entre 15h e 16h do dia 9/10/2020	54.4
Silvânia	Entre 2h e 3h do dia 11/10/2020	56.9

1.2. Abrangência do Evento

A seguir são apresentadas as imagens realçadas do satélite GOES-16 entre as 12h00 do dia 09 e 09h00 do dia 14 de outubro de 2020. Os tons em vermelho e preto indicam a presença de nuvens de grande desenvolvimento vertical, geralmente associadas à ocorrência de tempo severo.

12h00 - 09 de Outubro de 2020 - BRT



Figura 4 – Imagens realçadas do satélite GOES-16 das 12h00 do dia 09 de Outubro de 2020. FONTE: Cptec/INPE.

15h00 - 09 de Outubro de 2020 - BRT

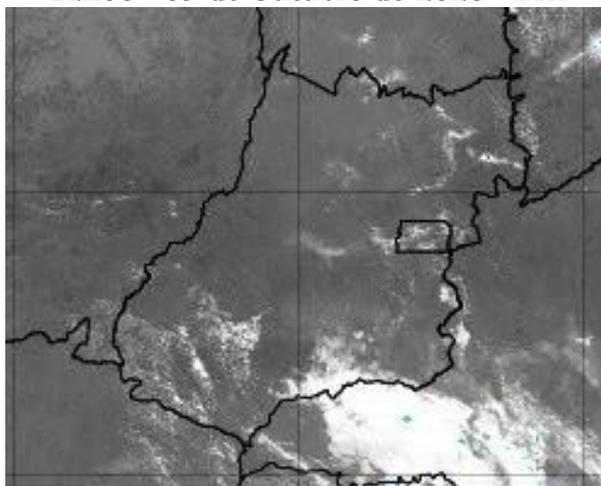

Figura 5 – Imagens realçadas do satélite GOES-16 das 15h00 do dia 09 de Outubro de 2020. FONTE: Cptec/INPE.

18h00 - 09 de Outubro de 2020 - BRT

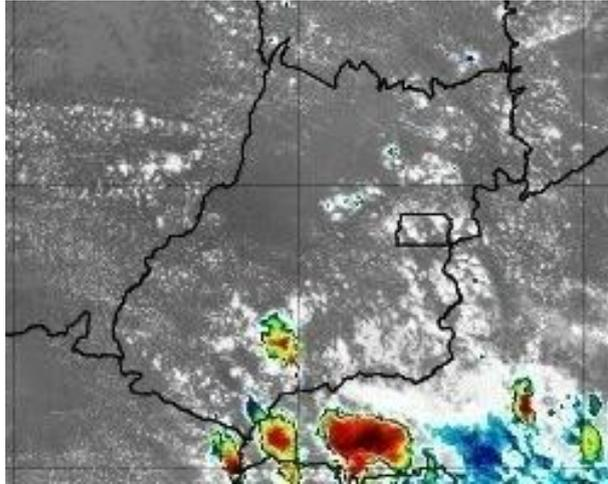

Figura 6 – Imagens realçadas do satélite GOES-16 das 18h00 do dia 09 de Outubro de 2020. FONTE: Cptec/INPE.

21h00 - 9 de Outubro de 2020 - BRT

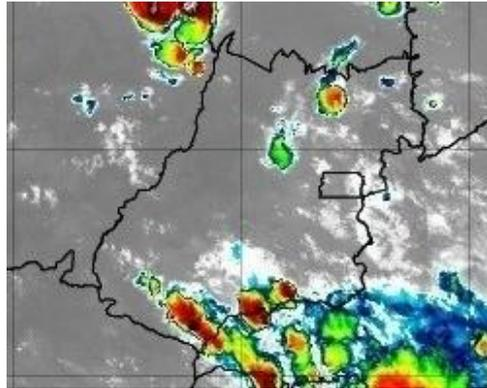

Figura 7 – Imagens realçadas do satélite GOES-16 das 21h00 do dia 9 de Outubro de 2020. FONTE: Cptec/INPE.

0h00 - 10 de Outubro de 2020 - BRT

Figura 8 – Imagens realçadas do satélite GOES-16 das 0h00 do dia 10 de Outubro de 2020. FONTE: Cptec/INPE.

3h00 - 10 de Outubro de 2020 - BRT

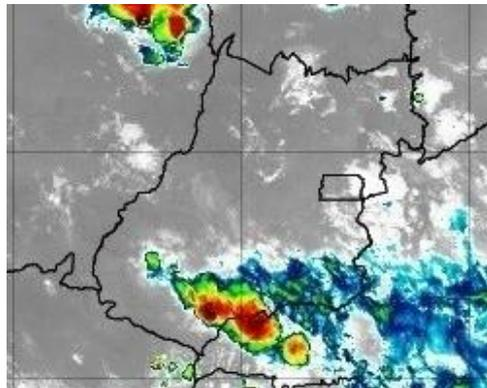
Figura 9 – Imagens realçadas do satélite GOES-16 das 3h00 do dia 10 de Outubro de 2020. FONTE: Cptec/INPE.

6h00 - 10 de Outubro de 2020 - BRT

Figura 10 – Imagens realçadas do satélite GOES-16 das 6h00 do dia 10 de Outubro de 2020. FONTE: Cptec/INPE.

9h00 - 10 de Outubro de 2020 - BRT

Figura 11 – Imagens realçadas do satélite GOES-16 das 9h00 do dia 10 de Outubro de 2020. FONTE: Cptec/INPE.

12h00 - 10 de Outubro de 2020 - BRT

Figura 12 – Imagens realçadas do satélite GOES-16 das 12h00 do dia 10 de Outubro de 2020. FONTE: Cptec/INPE.

15h00 - 10 de Outubro de 2020 - BRT

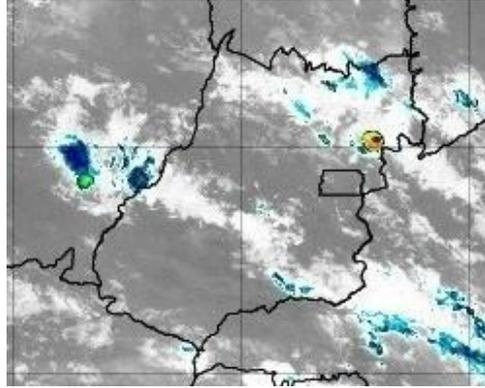
Figura 13 – Imagens realçadas do satélite GOES-16 das 15h00 do dia 10 de Outubro de 2020. FONTE: Cptec/INPE.

18h00 - 10 de Outubro de 2020 - BRT

Figura 14 – Imagens realçadas do satélite GOES-16 das 18h00 do dia 10 de Outubro de 2020. FONTE: Cptec/INPE.

21h00 - 10 de Outubro de 2020 - BRT

Figura 15 – Imagens realçadas do satélite GOES-16 das 21h00 do dia 10 de Outubro de 2020. FONTE: Cptec/INPE.

0h00 - 11 de Outubro de 2020 - BRT

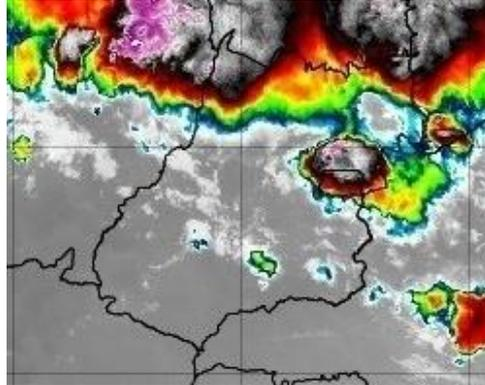
Figura 16 – Imagens realçadas do satélite GOES-16 das 0h00 do dia 11 de Outubro de 2020. FONTE: Cptec/INPE.

3h00 - 11 de Outubro de 2020 - BRT

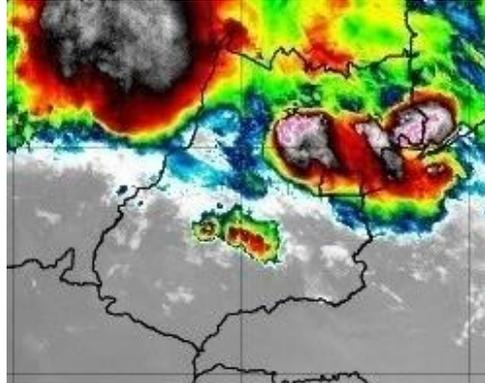
Figura 17 – Imagens realçadas do satélite GOES-16 das 3h00 do dia 11 de Outubro de 2020. FONTE: Cptec/INPE.

6h00 - 11 de Outubro de 2020 - BRT

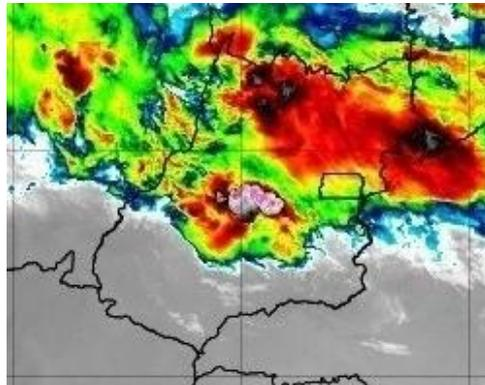
Figura 18 – Imagens realçadas do satélite GOES-16 das 6h00 do dia 11 de Outubro de 2020. FONTE: Cptec/INPE.

9h00 - 11 de Outubro de 2020 - BRT

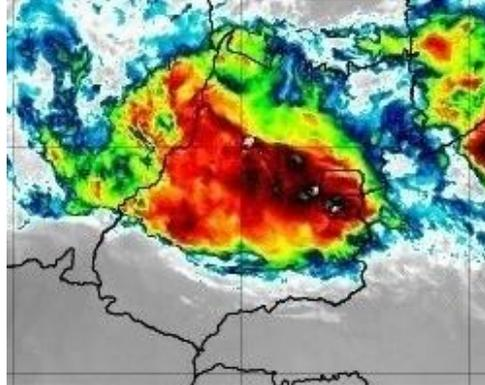
Figura 19 – Imagens realçadas do satélite GOES-16 das 9h00 do dia 11 de Outubro de 2020. FONTE: Cptec/INPE.

12h00 - 11 de Outubro de 2020 - BRT

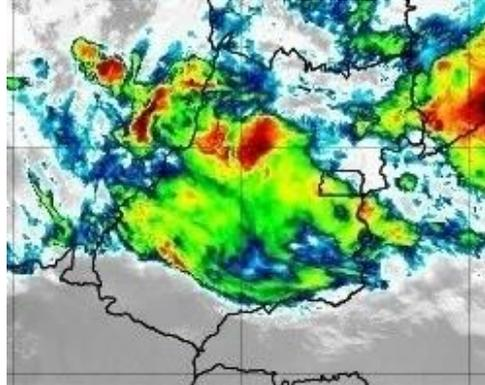
Figura 20 – Imagens realçadas do satélite GOES-16 das 12h00 do dia 11 de Outubro de 2020.
FONTE: Cptec/INPE.

15h00 - 11 de Outubro de 2020 - BRT

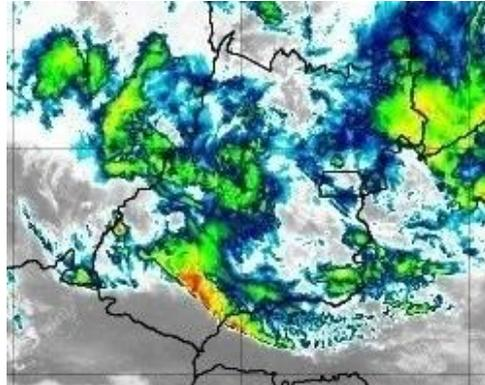
Figura 21 – Imagens realçadas do satélite GOES-16 das 15h00 do dia 11 de Outubro de 2020.
FONTE: Cptec/INPE.

18h00 - 11 de Outubro de 2020 - BRT

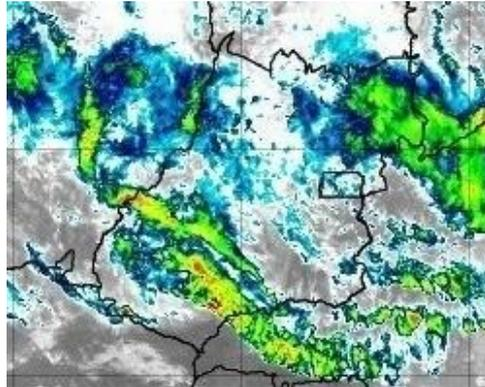
Figura 22 – Imagens realçadas do satélite GOES-16 das 18h00 do dia 11 de Outubro de 2020.
FONTE: Cptec/INPE.

21h00 - 11 de Outubro de 2020 - BRT

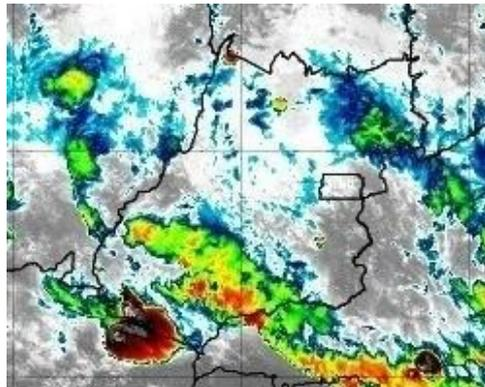
Figura 23 – Imagens realçadas do satélite GOES-16 das 21h00 do dia 11 de Outubro de 2020.
FONTE: Cptec/INPE.

0h00 - 12 de Outubro de 2020 - BRT

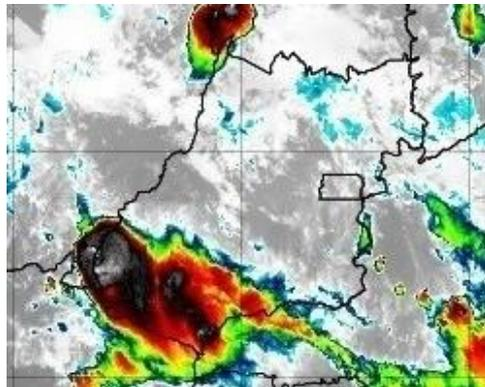
Figura 24 – Imagens realçadas do satélite GOES-16 das 0h00 do dia 12 de Outubro de 2020. FONTE:
Cptec/INPE.

3h00 - 12 de Outubro de 2020 - BRT

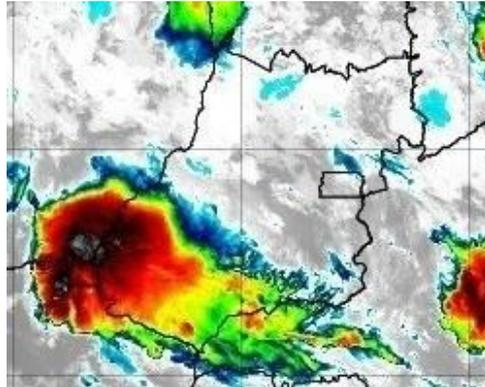
Figura 25 – Imagens realçadas do satélite GOES-16 das 3h00 do dia 12 de Outubro de 2020.
FONTE: Cptec/INPE.

6h00 - 12 de Outubro de 2020 - BRT

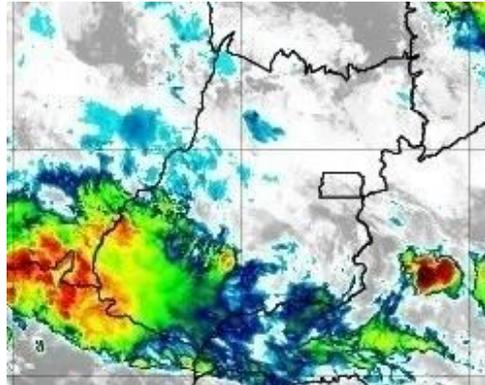
Figura 26 – Imagens realçadas do satélite GOES-16 das 6h00 do dia 12 de Outubro de 2020. FONTE: Cptec/INPE.

9h00 - 12 de Outubro de 2020 - BRT

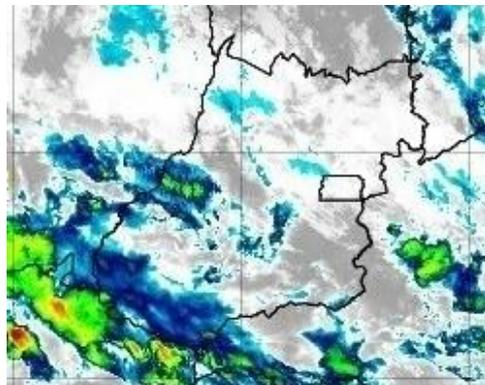
Figura 27 – Imagens realçadas do satélite GOES-16 das 9h00 do dia 12 de Outubro de 2020. FONTE: Cptec/INPE.

12h00 - 12 de Outubro de 2020 - BRT

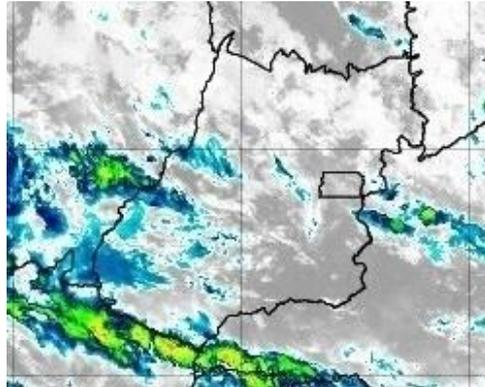
Figura 28 – Imagens realçadas do satélite GOES-16 das 12h00 do dia 12 de Outubro de 2020. FONTE: Cptec/INPE.

15h00 - 12 de Outubro de 2020 - BRT

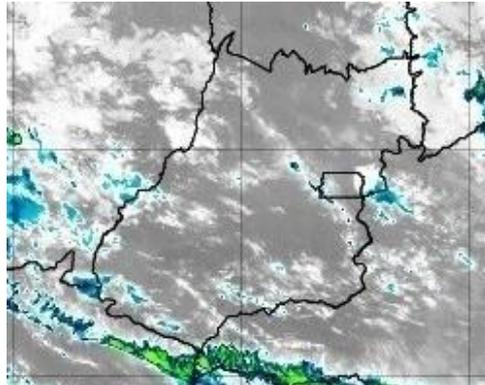
Figura 29 – Imagens realçadas do satélite GOES-16 das 15h00 do dia 12 de Outubro de 2020. FONTE: Cptec/INPE.

18h00 - 12 de Outubro de 2020 - BRT

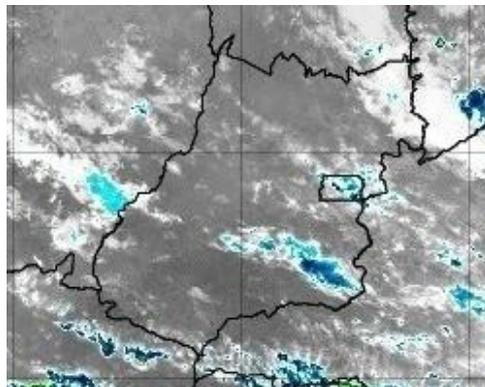
Figura 30 – Imagens realçadas do satélite GOES-16 das 18h00 do dia 12 de Outubro de 2020. FONTE: Cptec/INPE.

21h00 - 12 de Outubro de 2020 - BRT

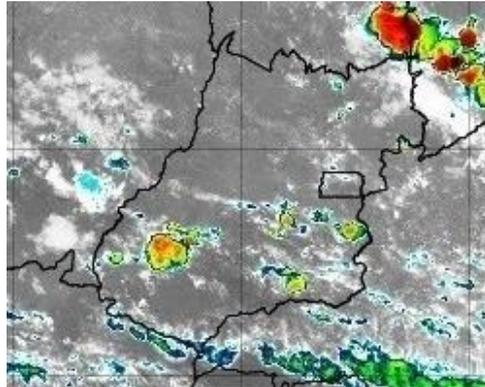
Figura 31 – Imagens realçadas do satélite GOES-16 das 21h00 do dia 12 de Outubro de 2020. FONTE: Cptec/INPE.

0h00 - 13 de Outubro de 2020 - BRT

Figura 32 – Imagens realçadas do satélite GOES-16 das 0h00 do dia 13 de Outubro de 2020. FONTE: Cptec/INPE.

3h00 - 13 de Outubro de 2020 - BRT

Figura 33 – Imagens realçadas do satélite GOES-16 das 3h00 do dia 13 de Outubro de 2020. FONTE: Cptec/INPE.

6h00 - 13 de Outubro de 2020 - BRT

Figura 34 – Imagens realçadas do satélite GOES-16 das 6h00 do dia 13 de Outubro de 2020. FONTE: Cptec/INPE.

9h00 - 13 de Outubro de 2020 - BRT

Figura 35 – Imagens realçadas do satélite GOES-16 das 9h00 do dia 13 de Outubro de 2020.
FONTE: Cptec/INPE.

12h00 - 13 de Outubro de 2020 - BRT

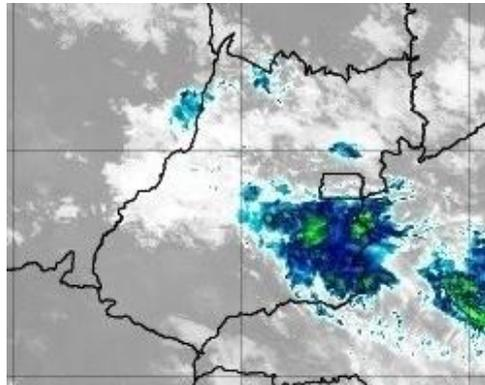
Figura 36 – Imagens realçadas do satélite GOES-16 das 12h00 do dia 13 de Outubro de 2020. FONTE:
Cptec/INPE.

15h00 - 13 de Outubro de 2020 - BRT

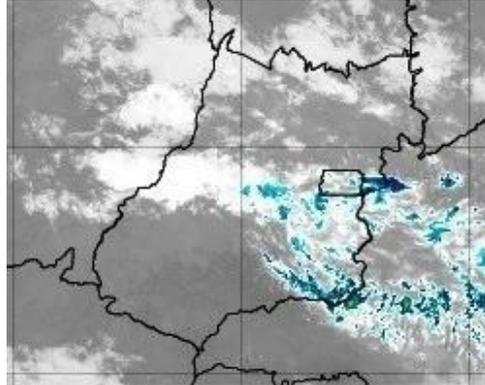
Figura 37 – Imagens realçadas do satélite GOES-16 das 15h00 do dia 13 de Outubro de 2020.
FONTE: Cptec/INPE.

18h00 - 13 de Outubro de 2020 - BRT

Figura 38 – Imagens realçadas do satélite GOES-16 das 18h00 do dia 13 de Outubro de 2020. FONTE: Cptec/INPE.

21h00 - 13 de Outubro de 2020 - BRT

Figura 39 – Imagens realçadas do satélite GOES-16 das 21h00 do dia 13 de Outubro de 2020. FONTE: Cptec/INPE.

0h00 - 14 de Outubro de 2020 - BRT

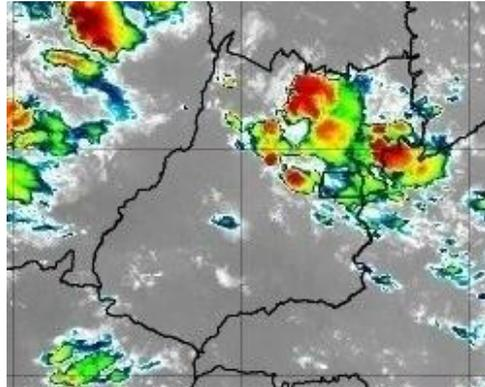
Figura 40 – Imagens realçadas do satélite GOES-16 das 0h00 do dia 14 de Outubro de 2020. FONTE: Cptec/INPE.

3h00 - 14 de Outubro de 2020 - BRT

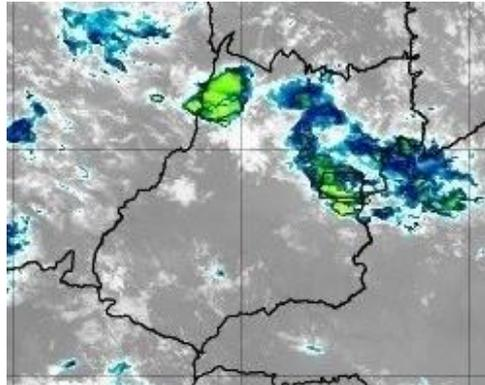
Figura 41 – Imagens realçadas do satélite GOES-16 das 3h00 do dia 14 de Outubro de 2020. FONTE: Cptec/INPE.

6h00 - 14 de Outubro de 2020 - BRT

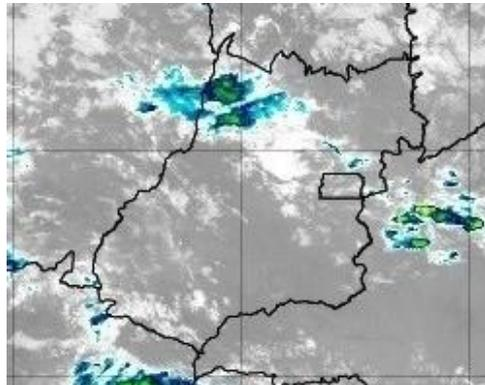
Figura 42 – Imagens realçadas do satélite GOES-16 das 6h00 do dia 14 de Outubro de 2020. FONTE: Cptec/INPE.

9h00 - 14 de Outubro de 2020 - BRT

Figura 43 – Imagens realçadas do satélite GOES-16 das 9h00 do dia 14 de Outubro de 2020. FONTE: Cptec/INPE.

2. Classificação COBRADE

O COBRADE (Classificação e Codificação Brasileira de Desastres) foi criado com o intuito de adequar a classificação brasileira à classificação utilizada pela ONU na classificação de desastres e nivelar o país aos demais organismos de gestão de desastres do mundo.

Baseados nos dados analisados nos itens anteriores, podemos classificar o evento ocorrido sobre a área de concessão da ENEL DISTRIBUIÇÃO GOIÁS como Zona de Convergência (Código 1.3.1.2.0).

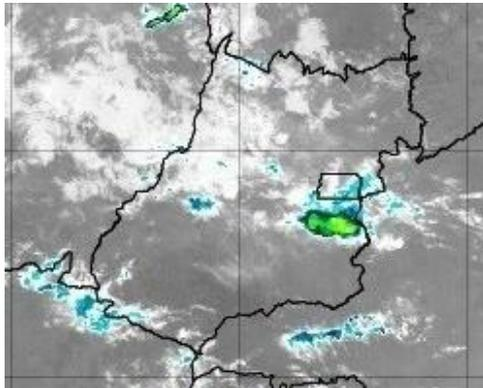
3. Resumo do Evento

O sistema de detecção da Earth Networks registrou 124054 descargas atmosféricas sobre a área de concessão da ENEL em Goiás entre as 12h30 do dia 09 e 11h40 do dia 14 de outubro de 2020.

A estação de Alto Araguaia do INMET registrou em apenas uma hora o acumulado de chuva de 73,0 mm, volume que corresponde a aproximadamente 58% da média de chuva para o mês de outubro na região.

Rajadas de vento classificadas como vento forte, ventania e ventania forte pela escala Beaufort foram registrados em estações do INMET representativas da região durante o período. Na cidade de Goiás rajadas de até 79,9 km/h foram registradas no início da noite do dia 12 de outubro. Vento com tal intensidade é capaz de provocar danos em árvores e em pequenas construções.

Tabela 3 – Resumo do evento Regional Rio Verde

Número/Código do Evento	
Número/Código do Relatório	
Descrição	Zona de convergência é uma região que está ligada à tempestade causada por uma zona de baixa pressão atmosférica, provocando forte deslocamento de massas de ar, vendavais, chuvas intensas e até queda de granizo.
Código COBRADE	1.3.1.2.0 - Zona de Convergência
Hora início do evento	12h00 do dia 09 de outubro de 2020
Hora de fim do evento	01h00 do dia 14 de outubro de 2020
Abrangência	Regional Rio Verde

Tabela 4 – Resumo do evento Regional Morrinhos

Número/Código do Evento	
Número/Código do Relatório	
Descrição	Zona de convergência é uma região que está ligada à tempestade causada por uma zona de baixa pressão atmosférica, provocando forte deslocamento de massas de ar, vendavais, chuvas intensas e até queda de granizo.
Código COBRADE	1.3.1.2.0 - Zona de Convergência
Hora início do evento	14h30 do dia 09 de outubro de 2020
Hora de fim do evento	18h00 do dia 13 de outubro de 2020
Abrangência	Regional Morrinhos

Tabela 5 – Resumo do evento Regional Metropolitana e Goiânia

Número/Código do Evento	
Número/Código do Relatório	
Descrição	Zona de convergência é uma região que está ligada à tempestade causada por uma zona de baixa pressão atmosférica, provocando forte deslocamento de massas de ar, vendavais, chuvas intensas e até queda de granizo.
Código COBRADE	1.3.1.2.0 - Zona de Convergência
Hora início do evento	13h00 do dia 10 de outubro de 2020
Hora de fim do evento	10h00 do dia 14 de outubro de 2020
Abrangência	Regional Metropolitana e Goiânia

Tabela 6 – Resumo do evento Regional Iporá

Número/Código do Evento	
Número/Código do Relatório	
Descrição	Zona de convergência é uma região que está ligada à tempestade causada por uma zona de baixa pressão atmosférica, provocando forte deslocamento de massas de ar, vendavais, chuvas intensas e até queda de granizo.
Código COBRADE	1.3.1.2.0 - Zona de Convergência
Hora início do evento	20h00 do dia 09 de outubro de 2020
Hora de fim do evento	22h30 do dia 13 de outubro de 2020
Abrangência	Regional Iporá

Tabela 7 – Resumo do evento Regional Luziânia

Número/Código do Evento	
Número/Código do Relatório	
Descrição	Zona de convergência é uma região que está ligada à tempestade causada por uma zona de baixa pressão atmosférica, provocando forte deslocamento de massas de ar, vendavais, chuvas intensas e até queda de granizo.
Código COBRADE	1.3.1.2.0 - Zona de Convergência
Hora início do evento	16h30 do dia 09 de outubro de 2020
Hora de fim do evento	10h00 do dia 14 de outubro de 2020
Abrangência	Regional Luziânia

Tabela 8 – Resumo do evento Regional Anápolis

Número/Código do Evento	
Número/Código do Relatório	
Descrição	Zona de convergência é uma região que está ligada à tempestade causada por uma zona de baixa pressão atmosférica, provocando forte deslocamento de massas de ar, vendavais, chuvas intensas e até queda de granizo.
Código COBRADE	1.3.1.2.0 - Zona de Convergência
Hora início do evento	14h30 do dia 09 de outubro de 2020
Hora de fim do evento	09h30 do dia 14 de outubro de 2020
Abrangência	Regional Anápolis

Tabela 9 – Resumo do evento Regional Uruaçu

Número/Código do Evento	
Número/Código do Relatório	
Descrição	Zona de convergência é uma região que está ligada à tempestade causada por uma zona de baixa pressão atmosférica, provocando forte deslocamento de massas de ar, vendavais, chuvas intensas e até queda de granizo.
Código COBRADE	1.3.1.2.0 - Zona de Convergência
Hora início do evento	14h30 do dia 09 de outubro de 2020
Hora de fim do evento	12h00 do dia 14 de outubro de 2020
Abrangência	Regional Uruaçu

Tabela 10 – Resumo do evento Regional Formosa

Número/Código do Evento	
Número/Código do Relatório	
Descrição	Zona de convergência é uma região que está ligada à tempestade causada por uma zona de baixa pressão atmosférica, provocando forte deslocamento de massas de ar, vendavais, chuvas intensas e até queda de granizo.
Código COBRADE	1.3.1.2.0 - Zona de Convergência
Hora início do evento	13h00 do dia 09 de outubro de 2020
Hora de fim do evento	07h30 do dia 14 de outubro de 2020
Abrangência	Regional Formosa

4. Referências

- RMetS Royal Meteorological Society – Beaufort Scale - <https://www.rmets.org/weather-and-climate/observing/beaufort-scale>
- Instituto Nacional de Meteorologia (INMET) - <http://www.inmet.gov.br>
- Cptec/INPE- <https://www.cptec.inpe.br/>
- Centro de Hidrografia da Marinha do Brasil - <https://www.marinha.mil.br/chm/>
- Meteorology Glossary - American Meteorological Society - <http://glossary.ametsoc.org/>

Anexos

A.1. Carta Sinótica



Figura A1 - Carta sinótica da Marinha do Brasil para as 1200Z do dia 09 de outubro de 2020 (09h00 do dia 09 de outubro de 2020, hora local).



LEGENDA			
	Frente Fria	A	Alta Pressão
	Frente Quente	B	Baixa Pressão
	Instabilidade		Zona de Convergência

Figura A2 - Carta sinótica da Marinha do Brasil para as 1200Z do dia 10 de outubro de 2020 (09h00 do dia 10 de outubro de 2020, hora local).

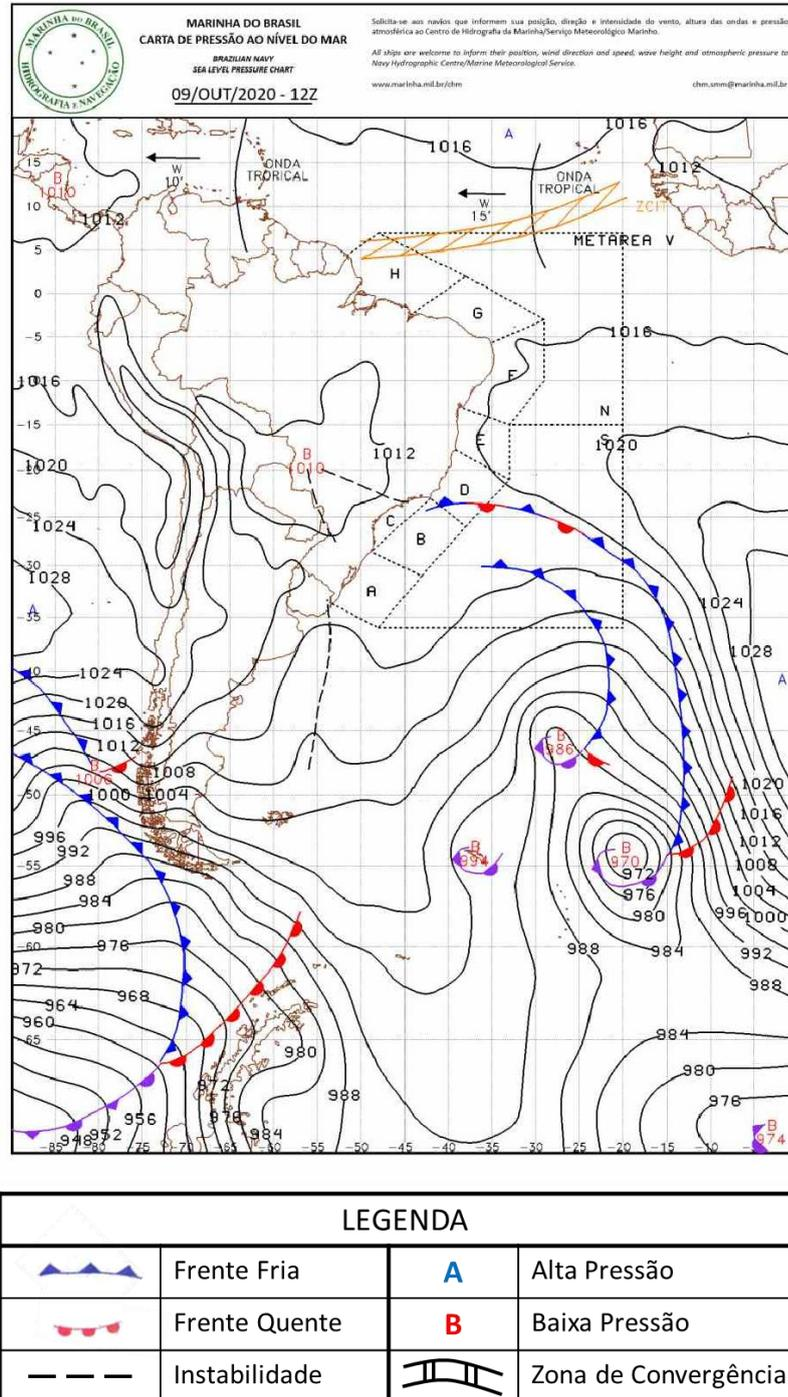
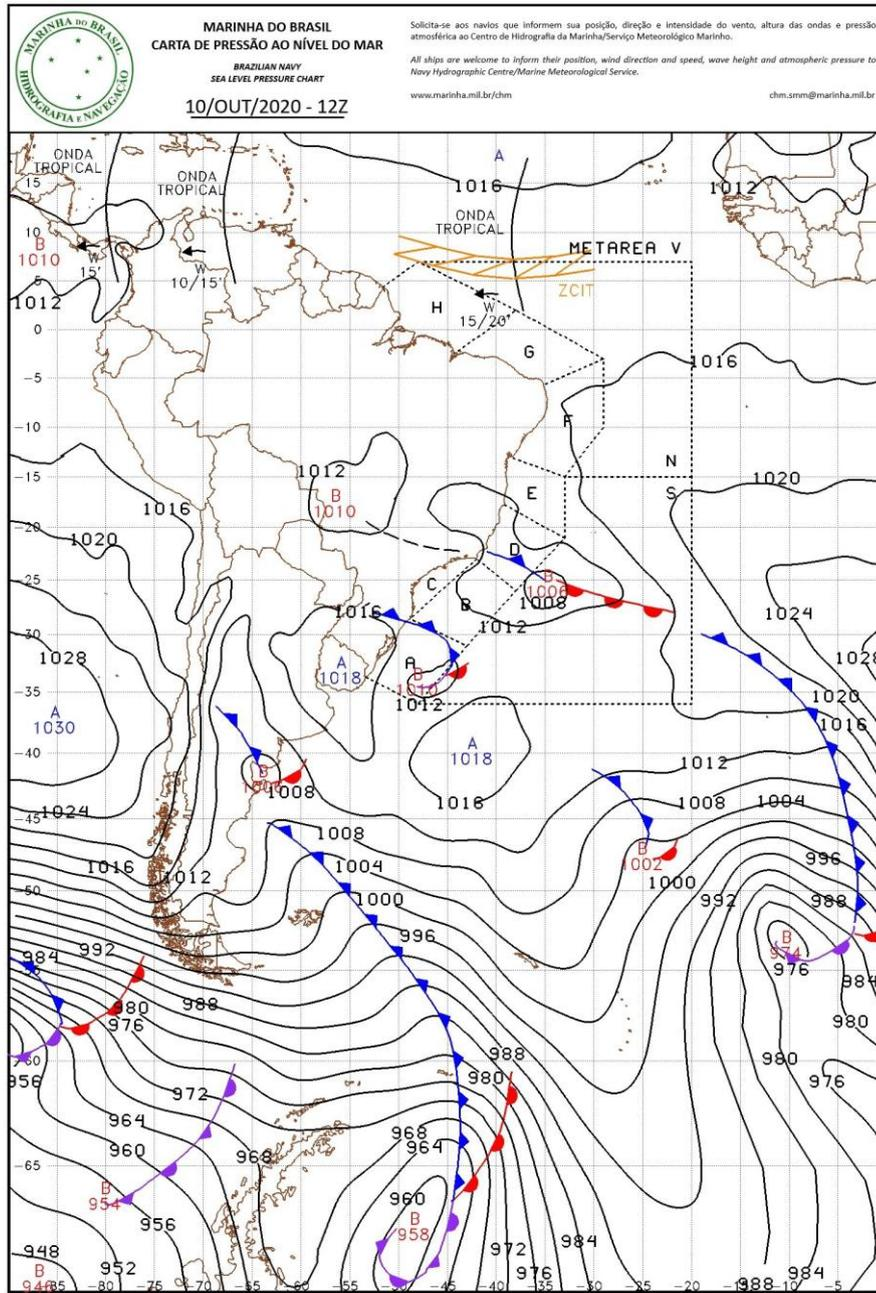

Figura A3 - Carta sinótica da Marinha do Brasil para as 1200Z do dia 11 de outubro de 2020 (09h00 do dia 11 de outubro de 2020, hora local).



Figura A4 - Carta sinótica da Marinha do Brasil para as 1200Z do dia 12 de outubro de 2020 (09h00 do dia 12 de outubro de 2020, hora local).

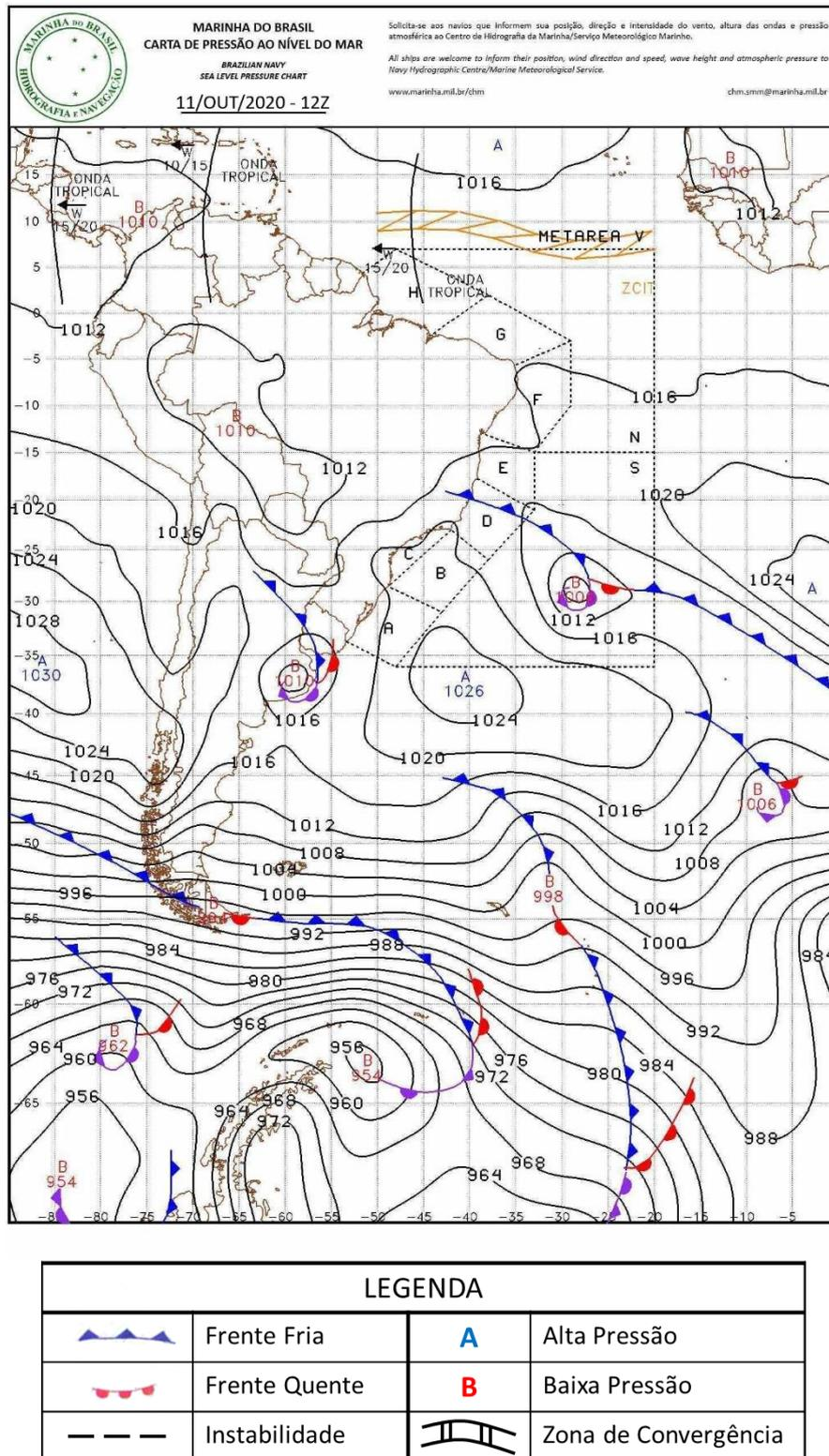

LEGENDA			
	Frente Fria	A	Alta Pressão
	Frente Quente	B	Baixa Pressão
	Instabilidade		Zona de Convergência

Figura A5 - Carta sinótica da Marinha do Brasil para as 1200Z do dia 13 de outubro de 2020 (09h00 do dia 13 de outubro de 2020, hora local).

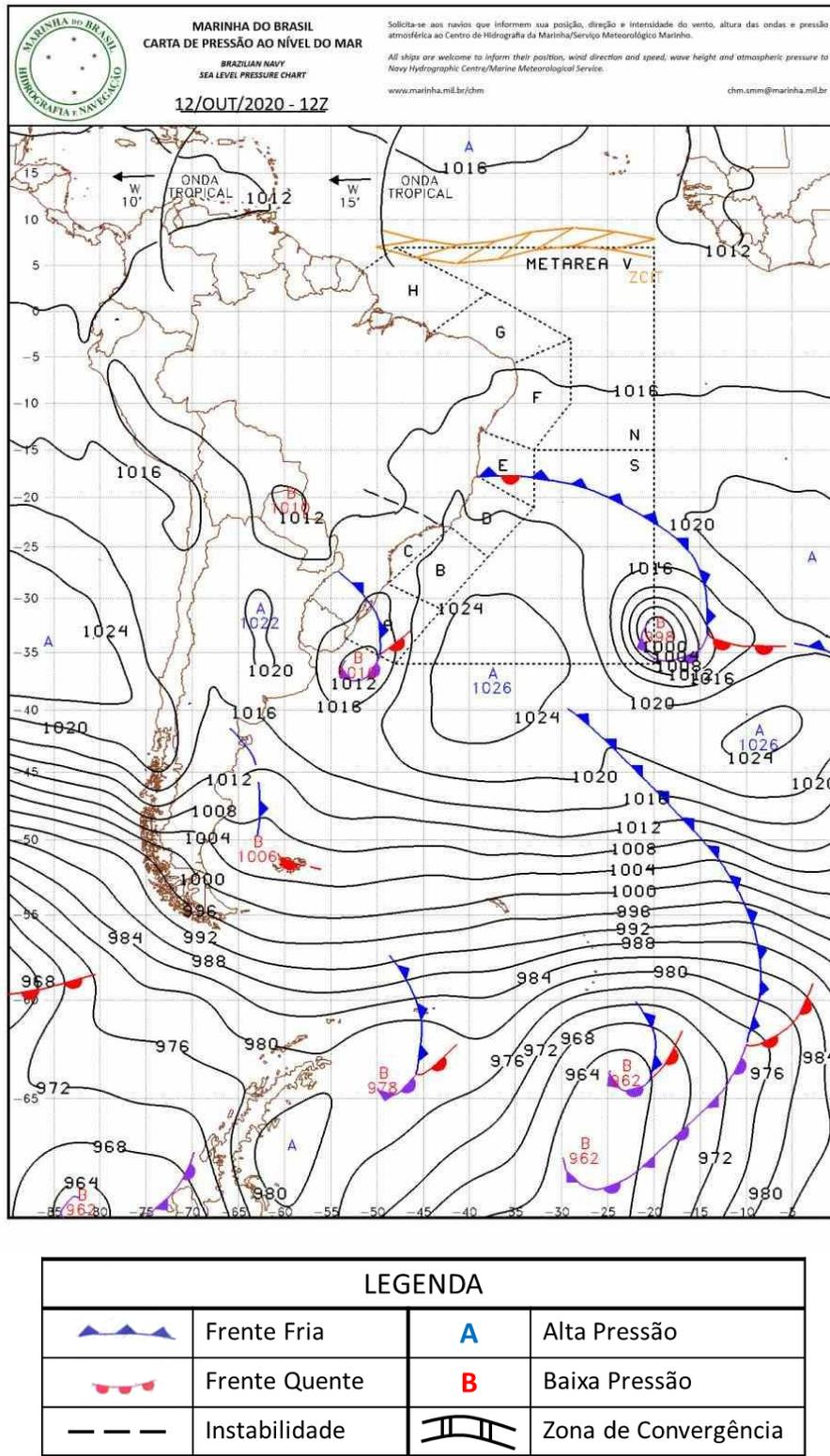
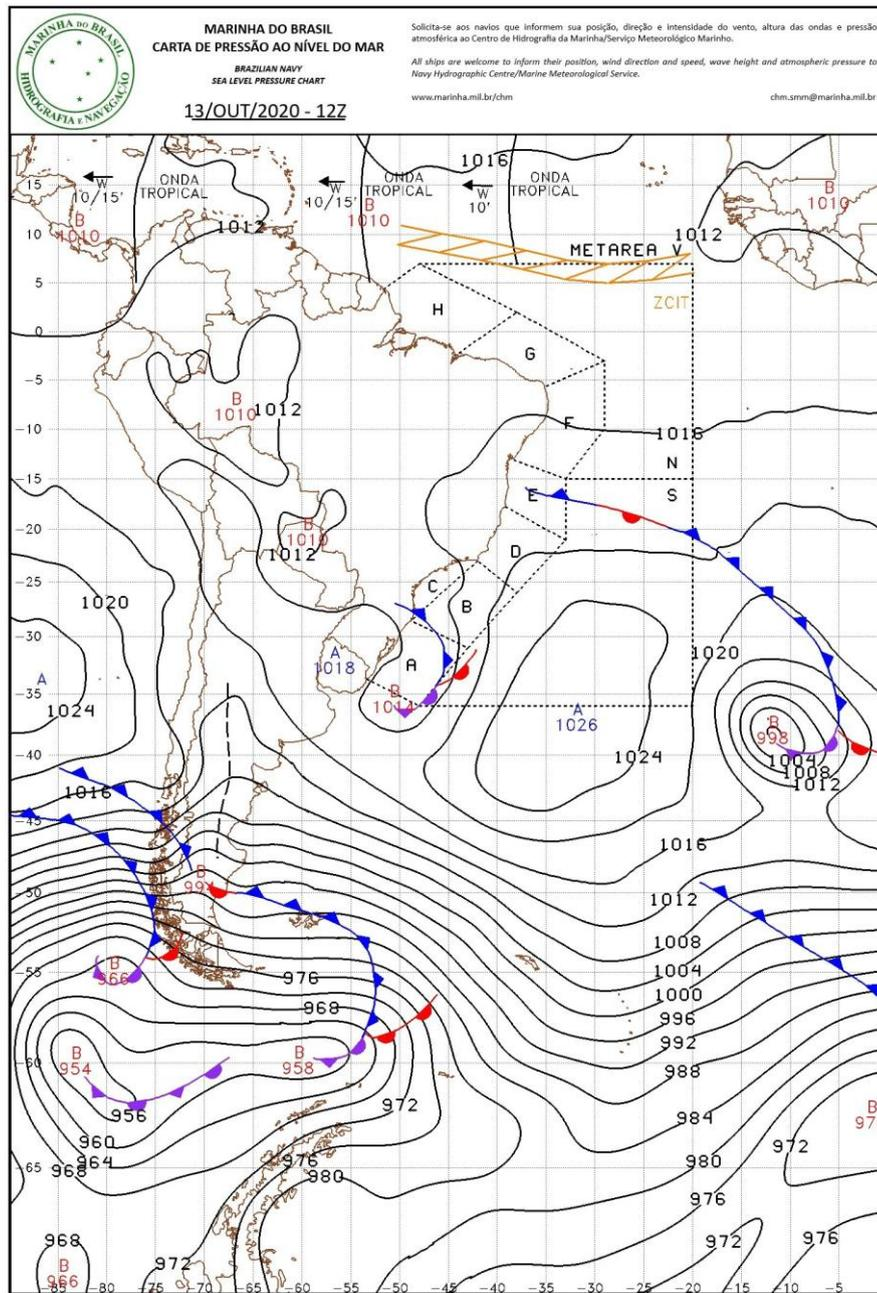
A.2. Notícias associadas

- Em Goiânia, chuvas deixam bairros sem energia elétrica

<https://altairtavares.com.br/em-goiania-chuvas-deixam-bairros-sem-energia-eletrica/>

- ALERTA: TEMPORAIS COM VENTOS DE MAIS DE 70 KM/H

<https://www.comprerural.com/alerta-temporais-com-ventos-de-mais-de-70-km-h/>

Bianca Lobo Silva Meteorologista

CREA 5063840

