

ENEL DISTRIBUIÇÃO GOLÁS



Relatório de Evento em Situação de Emergência

Nº CHI-050

1.	INTRODUÇÃO.....	3
2.	DEFINIÇÃO	3
3.	RESUMO EXECUTIVO.....	5
3.1.	RELATÓRIO DE OCORRÊNCIAS DO PERÍODO.....	5
4.	LISTA DE OCORRÊNCIAS	9
5.	PLOTAGEM DAS OCORRÊNCIAS CONFORME A ESPACIALIZAÇÃO DAS CHUVAS.....	100
6.	CLIENTES AFETADOS E IMPACTOS GLOBAIS	101
7.	DIAGRAMAS UNIFILARES	102
8.	DEMAIS EVIDÊNCIAS	108
8.1.	DADOS TÉCNICO - OPERACIONAIS ENEL GO.....	108
8.2.	DADOS CLIMATOLÓGICOS PELO INMET	110
9.	NOTÍCIAS RELACIONADAS.....	1144
10.	LAUDO TÉCNICO	11919

1. Introdução

As concessionárias do serviço público de distribuição de energia elétrica devem prover o serviço de forma adequada, buscando sempre a eficiência, conforme disposto na legislação e nos respectivos contratos de concessão.

Dentre a legislação vigente, destacam-se os Procedimentos de Distribuição de Energia Elétrica no Sistema Elétrico Nacional – PRODIST, que consistem em documentos elaborados pela Agência Nacional de Energia Elétrica – ANEEL, com a participação dos agentes de distribuição e de outras entidades e associações do setor elétrico nacional, que normatizam e padronizam as atividades técnicas relacionadas ao funcionamento e desempenho dos sistemas de distribuição de energia elétrica.

O Módulo 8 do PRODIST – Revisão 11, mais especificamente em sua Seção 8.2, regulamenta a qualidade do serviço prestado pelas distribuidoras de energia elétrica, estabelecendo a metodologia para apuração dos indicadores de continuidade e dos tempos de atendimento a ocorrências emergenciais.

O referido regulamento prevê que, na apuração dos indicadores coletivos e individuais deverão ser consideradas todas as interrupções de longa duração que atingirem as unidades consumidoras, admitidas algumas exceções (denominadas expurgos), que podem ser encontradas no Item 5.6.2.2 da seção 8.2 do Módulo 8 do PRODIST, transcrito abaixo:

5.6.2.2 Na apuração dos indicadores DEC e FEC devem ser consideradas todas as interrupções, admitidas apenas as seguintes exceções:

i. falha nas instalações da unidade consumidora que não provoque interrupção em instalações de terceiros;

ii. interrupção decorrente de obras de interesse exclusivo do consumidor e que afete somente a unidade consumidora do mesmo;

iii. Interrupção em Situação de Emergência;

iv. suspensão por inadimplemento do consumidor ou por deficiência técnica e/ou de segurança das instalações da unidade consumidora que não provoque interrupção em instalações de terceiros, previstas em regulamentação;

v. vinculadas a programas de racionamento instituídos pela União;

vi. ocorridas em Dia Crítico;

vii. oriundas de atuação de Esquema Regional de Alívio de Carga estabelecido pelo ONS. [grifos nossos]

Para os casos de expurgo por Interrupção em Situação de Emergência (ISE), a alínea “h” do Item 5.12.1 da seção 8.2 do Módulo 8 do PRODIST estabelece a obrigatoriedade das distribuidoras em disponibilizar, em seu sítio eletrônico, relatórios digitais com as evidências do evento que tenha gerado tais interrupções enquadradas no inciso iii do Item 5.6.2.2 do mesmo.

Nesta seara, o presente documento, visa apresentar as evidências de um evento ocorrido na área de concessão da Eletropaulo, bem como informações relevantes a respeito das interrupções em Situação de Emergência decorrentes do mesmo.

Destaca-se que, para o entendimento completo das regras de apuração dos indicadores de continuidade e expurgos, faz-se necessário também a observação das regras contidas nos Módulos 1 e 6 do PRODIST. Todos os módulos destes procedimentos encontram-se disponíveis para consulta no site da ANEEL (www.aneel.gov.br) e as principais definições relacionadas ao tema estão contidas no item 2 deste documento.

2. Definição

Seção 1.2 do Módulo 1 do PRODIST – Revisão 10

2.198 Evento

Acontecimento que afete as condições normais de funcionamento de uma rede elétrica, podendo gerar uma ou mais interrupções no fornecimento de energia.

2.131 e 2.158 DIC

Duração de interrupção individual por unidade consumidora, ou seja, intervalo de tempo que, no período de apuração, em cada unidade consumidora ou ponto de conexão ocorreu descontinuidade da distribuição de energia elétrica.

2.216 e 2.220 FIC

Frequência de interrupção individual por unidade consumidora, ou seja, Número de interrupções ocorridas, no período de apuração, em cada unidade consumidora ou ponto de conexão.

2.87 Consumidor Hora Interrompido (CHI):

Somatório dos DICs dos consumidores atingidos por interrupção no fornecimento de energia, expresso em horas e centésimos de horas.

2.251 Interrupção em Situação de Emergência:

Interrupção originada no sistema de distribuição, resultante de Evento que comprovadamente impossibilite a atuação imediata da distribuidora e que não tenha sido provocada ou agravada por esta e que seja:

- Decorrentes de evento associado a Decreto de Declaração de Situação de Emergência ou Estado de Calamidade Pública emitido por órgão competente; ou
- Decorrentes de Evento cuja soma do CHI das interrupções ocorridas no sistema de distribuição seja superior ao calculado conforme equação a seguir:

$$2.612 \times N^{0,35}$$

N – número de unidades consumidoras faturadas e atendidas em BT ou MT, com 2 (duas) casas decimais, do mês de outubro do ano anterior ao período de apuração

3. Resumo Executivo

O Presente Relatório tem como objetivo a incorporação de informações que sejam relevantes para que se possa fazer a devida associação aos dados contidos no documento objeto da classificação de Situação de Emergência caracterizada pelo Módulo 8 do Prodist. Este enquadramento se apresenta na maioria das vezes em condições climáticas adversas com severidade dos fatores inerentes a situação, caracterizado na maioria dos casos por fortes ventos e chuvas de grande intensidade e continuidade.

A partir do início da tarde do dia 17/10/2020 – sábado – Áreas de instabilidade associadas a presença de uma frente fria na costa do Brasil favoreceram a formação de chuva forte, rajadas de vento e raios sobre o estado de Goiás.

Conforme informações do Climatempo Meteorologia, o Instituto Nacional de Meteorologia (INMET) detectou rajadas de vento acima de 50km/h registradas por estações representativas da área de concessão da ENEL Distribuição Goiás. Na estação de Jataí, o maior valor registrado foi de 62,6 km/h entre as 15h e 17h do dia 18 de outubro de 2020, classificada como ventania, segundo a escala Beaufort.

O sistema de detecção da EarthNetworks registrou 78.457 descargas atmosféricas (16.582 nuvem-solo e 61.875 nuvem-nuvem) sobre a área de concessão da ENEL em Goiás entre as 13h50 do dia 17 de outubro de 2020 e 00h00 do dia 20 de outubro de 2020, causando grande instabilidade na rede.

Chuva forte foi registrada pelo INMET em estações representativas da área de concessão da ENEL Distribuição Goiás. Na estação de Cristalina foram acumulados 41,4 mm de chuva entre as 09h do dia 18 e as 09h do dia 19 de outubro de 2020, valor que corresponde 27,0% da média de chuva para o mês na região.

3.1. Relatório de Ocorrências do período

Em todo o Estado de Goiás verificou-se também que a intensidade da chuva e dos ventos danificaram a rede de distribuição de energia elétrica em diversos pontos, registrando aproximadamente 593 mil clientes com interrupção no fornecimento de energia elétrica devido a eventos relacionados ao temporal, afetando 238 municípios e 311 Subestações.

Para otimizar o volume de atendimentos e reduzir os tempos de interrupção foram mobilizados os recursos extras da empresa que aumentou o contingente em relação a situação normal de operação. O acompanhamento da quantidade de equipes e o Tempo Médio de Atendimento podem ser consultados na Pág.05 do Relatório em anexo.

O impacto e severidade do evento estão relatados em artigos de mídia, como fotos e reportagens que demonstram os danos na Rede de Distribuição, oriundos dos eventos climáticos no período. Eventos estes que afetaram 593.051 consumidores com CHI de 1.611.943,60 superior ao de 482.597,74 estabelecido como limite para definição de Situação de Emergência, conforme resumo das informações obrigatórias.

Empresa		ENEL DISTRIBUIÇÃO GOIÁS			
Código do Relatório		CHI-050 - ENEL DISTRIBUIÇÃO GOIÁS			
Evento:		TEMPORAL NA AREA DE CONCESSÃO DA ENEL DISTRIBUIÇÃO GOIAS			
Código COBRADE:	1.3.1.2.0	Data Início	17/10/2020	Hora início	13h30
Código do Evento:	CHI-050-ENEL GO	Data Término	20/10/2020	Hora Término	08h59
Valor CHI (Limite e Real)	482.597,74	1.611.943,60			
Código do Decreto (Se Houver):					
Quantidade de Interrupções (Evento)	4.632				
Início 1ª Incidência (Data e Hora)	17/10/2020 13:34		Subestações Atingidas	ABADIANIA / ABC / ACREUNA / ADELANDIA / AEROPORTO / AGUA LIMPA (MARZAGAO) / AGUAS LINDAS / ALEXANIA / ALEXANIA TRANSMISSAO / ALOANDIA / ALPHAVILLE / ALTO HORIZONTE / ALTO PARAISO DE GOIAS / ALVORADA DO NORTE / AMERICANO (RIO VERDE) / AMERICANO DO BRASIL / AMORINOPOLIS / ANAPOLIS UNIVERSITARIA / ANHANGUERA / ANICUNS / ANTONIO DO VITTO / APARECIDA DO RIO DOCE / APORE / ARACU / ARAGARCAS / ARAGOIANIA / ARAGUAPAZ / ARARAS / AREIAS / ARENOPOLIS / ARUANA / ARUANA (TRANSMISSAO) / ATLANTICO / AURILANDIA / AVELINOPOLIS / BACURI (RIO VERDE) / BARBOSELANDIA / BARCELONA / BARREIRO (PORANGATU) / BARRO ALTO / BELA VISTA (TRANSMISSAO) / BOA VISTA / BOM JARDIM / BOM JESUS DE GOIAS / BONFINOPOLIS / BONITO / BONOPOLIS / BRAZABRANTES / BRITANIA / BRITANIA (TRANSMISSAO) / BURITI ALEGRE / BURITI DE GOIAS / CABECEIRAS / CABRIUVA (RIO VERDE) / CACHOEIRA ALTA / CACHOEIRA DOURADA / CACHOEIRA NOVA / CACHOEIRINHA (ITARUMA) / CACU / CAIAPONIA / CALCILANDIA / CALDAS NOVAS / CALDAZINHA / CAMPESTRE / CAMPINAS / CAMPINORTE / CAMPO ALEGRE DE GOIAS / CAMPO LIMPO DE GOIAS / CAMPO NOVO / CAMPOS BELOS / CAMPOS VERDES / CARAIBAS / CARAJAS / CASTELANDIA / CATALAO / CATURAI / CEBRASA FABRICA DA AMBEV / CEPALGO / CEZARINA / CHAPADAO DO CEU / CIDADE ECLETICA / CIDADE OCIDENTAL / COCALZINHO / COLINACU / CORUMBA / CORUMBAIBA / CRISTALINA TRANSMISSAO / CRISTIANOPOLIS / CRIXAS / CROMINIA / CUMARI / DAIA - ANAPOLIS / DAMOLANDIA / DAVINOPOLIS / DESFECHO / DESTILARIA BRASIL CENTRAL / DIMIC / DIORAMA / DORCELINO PEIXOTO DE MORAES / DOVERLANDIA / EDEALINA / EDEIA / ENERSUL / ESTANIFERA / ESTRELA DO NORTE / FAINA / FAZENDA CANADA / FAZENDA NOVA / FERROVIARIO / FIRMINOPOLIS / FLORES DE GOIAS / FORMIGA / FORMOSO / FRONTEIRA / GAMELEIRA / GIRASSOL / GOIANDIRA / GOIANESIA / GOIANIA LESTE / GOIANIRA / GOIAS / GOIATUBA / GOUVERLANDIA / GOYA / GUAPO / HEITORAI / HIDROLANDIA / IACIARA / INACIOLANDIA / INDEPENDENCIA / INDIARA / INHUMAS / IPAMERI / IPEGUARI / IPORA / ISRAELANDIA / ITABERAI / ITAGUARI / ITAGUARU / ITAJA / ITAPACI / ITAPACI (TRANSMISSAO) / ITAPIRAPUA / ITAPURANGA / ITAPURANGA (TRANSMISSAO) / ITARUMA / ITAUCU / ITIQUIRA (FORMOSA) / ITUMBIARA NOVA / ITUMBIARA VELHA / JACILANDIA / JANDAIA / JARAGUA / JARANAPOLIS / JATAI / JAUPACI / JESUPOLIS / JOVIANIA / JUNDIAI / JURUMIRIM / JUSCELANDIA / JUSSARA / LAGES / LAGOA DA SERRA / LAGOA DO BAUZINHO (RIO VERDE) / LEOPOLDO DE BULHOES / LUZANIA / MAIRIPOTABA / MARA ROSA / MARAJOARA / MARIAPOLIS (PADRE BERNARDO) / MARZAGAO / MATO GRANDE / MATRINCHA / MAURILANDIA / MEIA PONTE / MINACU / MINEIROS / MINEIROS TRANSMISSAO / MOIPORA / MONTES CLAROS DE GOIAS / MONTIVIDIU T / MORRINHOS / MORRO AGUDO / MOSSAMEDES / MOZARLANDIA / MOZARLANDIA (TRANSMISSAO) / MUNDO NOVO DE GOIAS / MUTUNOPOLIS / NAZARIO / NEROPOLIS / NIQUELANDIA / NOVA AMERICA / NOVA AURORA / NOVA CRIXAS (TRANSMISSAO) / NOVA IGUACU / NOVA PONTE / NOVA VENEZA / NOVO BRASIL / NOVO GAMA / NOVO PLANALTO / OLHOS DAGUA / ORIZONA / OURO VERDE DE GOIAS / OUVIDOR / PACAEMBU (NOVO GAMA) / PADRE BERNARDO / PALESTINA / PALMEIRAS / PALMEIRAS DE GOIAS / PALMELO / PALMINOPOLIS / PAMPLONA / PANAMA / PARANA / PARANAIBA / PARANAIGUARA / PARAUNA SE ALTA TENSAO / PARQUE DAS EMAS (MINEIROS) / PARQUE DAS NACOES / PEROLANDIA / PETROLINA / PILAR / PILOANDIA / PIRACANJUBA / PIRANHAS T / PIRENOPOLIS / PIRES BELO / PIRES DO RIO / PLANALTINA / PLANALTINA (TRANSMISSAO) / PLANALTO / PONTALINA / PORANGATU / PORTEIRAO / PORTELANDIA / POSSE / POSSELANDIA / PROFESSOR JAMIL / QUEBRA LINHA / QUIRINOPOLIS / REAL / RETIRO / GOIAS / RIO CLARO / JATAI MONTIVIDIU / RIO DO PEIXE / RIO DOS BOIS (MAURILANDIA) / RIO PRETO / RIO QUENTE / RIO VERDE / RIO VERMELHO / RIVERLANDIA (RIO VERDE) / ROCHEDO (UEH) / RUBIATABA / SANCLERLANDIA / SANTA FE DE GOIAS / SANTA HELENA / SANTA RITA DO ARAGUAIA / SANTA ROSA / SANTA ROSA DE GOIAS / SANTA ROSA DO MEIA PONTE / SANTA TEREZA DE GOIAS / SANTA TEREZINHA / SANTANA / SANTO ANTONIO DA BARRA / SANTO ANTONIO DE GOIAS / SANTO ANTONIO DO DESCOBERTO / SAO BARTOLOMEU / SAO DOMINGOS / SAO FRANCISCO DE GOIAS / SAO JOAO D ALIANCA / SAO JOAO DA PARAUNA / SAO JUDAS TADEU / SAO LUIZ DOS MONTES BELOS / SAO MIGUEL DO ARAGUAIA / SAO MIGUEL DO PASSA QUATRO / SAO SIMAO / SENADOR CANEDO TRANSMISSAO / SERRA AZUL (JATAI) / SERRA DE CALDAS / SERRANOPOLIS /	

			SITIO DABADIA / SOUZALANDIA / SUCURI / TAIOBA / TAQUARI / TEREZOPOLIS / TERRA VERMELHA / TRES BARRAS / TRES RANCHOS / TRINDADE / TUCUNARE / TURVANIA / TURVELANDIA / URU / URUACU / URUTAI / USINA DE ACUCAR DE GOIANESIA / USINA MAMBAI / VALPARAISO / VARJAO / VENDA SECA / VIANOPOLIS / VICENTINOPOLIS / VILA CORUMBA / VILA PROPICIO / XAVANTES / XIXA / ZELANDIA / NIQUELANDIA 69KV / VILA BOA
Início Última Incidência (Data e Hora)	20/10/2020 08:50		
Média de Duração das Incidências (h)	7,81		
Duração da Incidência mais longa (h)	86,12		
Total de Clientes afetados	593.051	Municípios Atingidos	ABADIA DE GOIAS / ABADIANIA / ACREUNA / ADELANDIA / AGUA FRIA DE GOIAS / AGUA LIMPA / AGUAS LINDAS DE GOIAS / ALEXANIA / ALOANDIA / ALTO HORIZONTE / ALTO PARAISO DE GOIAS / ALVORADA DO NORTE / AMARALINA / AMERICANO DO BRASIL / AMORINOPOLIS / ANAPOLIS / ANHANGUERA / ANICUNS / APARECIDA DE GOIANIA / APARECIDA DO RIO DOCE / APORE / ARACU / ARAGARCAS / ARAGOIANIA / ARAGUAPAZ / ARENOPOLIS / ARUANA / AURILANDIA / AVELINOPOLIS / BALIZA / BARRO ALTO / BELA VISTA DE GOIAS / BOM JARDIM DE GOIAS / BOM JESUS DE GOIAS / BONFINOPOLIS / BONOPOLIS / BRAZABRANTES / BRITANIA / BURITI ALEGRE / BURITI DE GOIAS / BURITINOPOLIS / CABECEIRAS / CACHOEIRA ALTA / CACHOEIRA DE GOIAS / CACHOEIRA DOURADA / CACU / CAIAPONIA / CALDAS NOVAS / CALDAZINHA / CAMPESTRE DE GOIAS / CAMPINACU / CAMPINORTE / CAMPO ALEGRE DE GOIAS / CAMPO LIMPO / CAMPOS BELOS / CAMPOS VERDES / CARMO DO RIO VERDE / CASTELANDIA / CATALAO / CATURAI / CAVALCANTE / CERES / CEZARINA / CHAPADAO DO CEU / CIDADE OCIDENTAL / COCALZINHO DE GOIAS / COLINAS DO SUL / CORREGO DO OURO / CORUMBA DE GOIAS / CORUMBAIBA / CRISTALINA / CRISTIANOPOLIS / CRIXAS / CROMINIA / CUMARI / DAMOLANDIA / DIORAMA / DISTRITO FEDERAL / DIVINOPOLIS DE GOIAS / DOVERLANDIA / EDEALINA / EDEIA / ESTRELA DO NORTE / FAINA / FAZENDA NOVA / FIRMINOPOLIS / FLORES DE GOIAS / FORMOSA / FORMOSO / GAMELEIRA DE GOIAS / GOIANAPOLIS / GOIANDIRA / GOIANESIA / GOIANIA / GOIANIRA / GOIAS / GOIATUBA / GOUVELANDIA / GUAPO / GUARAITA / GUARANI DE GOIAS / GUARINOS / HEITORAI / HIDROLANDIA / HIDROLINA / IACIARA / INACIOLANDIA / INDIARA / INHUMAS / IPAMERI / IPORA / ISRAELANDIA / ITABERAI / ITAGUARI / ITAGUARU / ITAJA / ITAPACI / ITAPIRAPUA / ITAPURANGA / ITARUMA / ITAUCU / ITUMBIARA / IVOLANDIA / JANDAIA / JARAGUA / JATAI / JAUPACI / JESUPOLIS / JOVIANIA / JUSSARA / LAGOA SANTA / LEOPOLDO DE BULHOES / LUZIANIA / MAIRIPOTABA / MAMBAI / MARA ROSA / MATRINCHA / MAURILANDIA / MIMOSO DE GOIAS / MINACU / MINEIROS / MOIPORA / MONTES CLAROS DE GOIAS / MONTIVIDIU / MONTIVIDIU DO NORTE / MORRINHOS / MORRO AGUDO DE GOIAS / MOSSAMEDES / MOZARLANDIA / MUNDO NOVO DE GOIAS / MUTUNOPOLIS / NAZARIO / NEROPOLIS / NIQUELANDIA / NOVA AMERICA / NOVA AURORA / NOVA CRIXAS / NOVA GLORIA / NOVA IGUACU DE GOIAS / NOVA ROMA / NOVA VENEZA / NOVO BRASIL / NOVO GAMA / NOVO PLANALTO / ORIZONA / OURO VERDE DE GOIAS / OUVIDOR / PADRE BERNARDO / PALESTINA DE GOIAS / PALMEIRAS DE GOIAS / PALMELO / PALMINOPOLIS / PANAMA / PARANAIGUARA / PARAUNA / PEROLANDIA / PETROLINA DE GOIAS / PILAR DE GOIAS / PIRACANJUBA / PIRANHAS / PIRENOPOLIS / PIRES DO RIO / PLANALTINA / PONTALINA / PORANGATU / PORTEIRAO / PORTELANDIA / POSSE / PROFESSOR JAMIL SAFADY / QUIRINOPOLIS / RIO QUENTE / RIO VERDE / RUBIATABA / SANCLERLANDIA / SANTA BARBARA DE GOIAS / SANTA CRUZ DE GOIAS / SANTA FE DE GOIAS / SANTA HELENA DE GOIAS / SANTA RITA DO ARAGUAIA / SANTA RITA DO NOVO DESTINO / SANTA ROSA DE GOIAS / SANTA TEREZA DE GOIAS / SANTA TEREZINHA DE GOIAS / SANTO ANTONIO DA BARRA / SANTO ANTONIO DE GOIAS / SANTO ANTONIO DO DESCOBERTO / SAO DOMINGOS / SAO FRANCISCO DE GOIAS / SAO JOAO D ALIANCA / SAO JOAO DA PARAUNA / SAO LUIS DE MONTES BELOS / SAO LUIZ DO NORTE / SAO MIGUEL DO ARAGUAIA / SAO MIGUEL DO PASSA QUATRO / SAO PATRICIO / SAO SIMAO / SENADOR CANEDO / SERRANOPOLIS / SILVANIA / SIMOLANDIA / SITIO D ABADIA / TAQUARAL DE GOIAS / TERESINA DE GOIAS / TEREZOPOLIS DE GOIAS / TRES RANCHOS / TRINDADE / TROMBAS / TURVANIA / TURVELANDIA / UIRAPURU / URUACU / URUTAI / VALPARAISO DE GOIAS / VARJAO / VIANOPOLIS / VICENTINOPOLIS / VILA BOA / VILA PROPICIO

DANOS CAUSADOS			
Equipamentos Danificado	Importância para o Sistema	Local	Quantidade
Disjuntor/Religador Operado	Proteção do Alimentador	Área de Concessão	139
Chaves Fusíveis Operada	Proteção de Ramais de Alimentadores	Área de Concessão	1.164
Transformador Operado	Proteção do Transformador	Área de Concessão	1.099

Relato técnico sobre a Intervenção realizada em Goiânia e Região Metropolitana					
Informações sobre Equipas	17/10	18/10	19/10	20/10	
Quantidade Usual	845	719	1.046	1.046	turmas
Quantidade Adicional	45	15	60	104	turmas
Quantidade Total	890	734	1.106	1.150	turmas
Tempos Médios					
Preparação	2,79	4,01	5,78	5,18	Horas
Deslocamento	0,93	0,75	0,72	0,95	Horas
Execução	0,80	1,07	1,00	1,20	Horas
TMAE	4,52	5,82	7,50	7,33	Horas

Principais Dificuldades Encontradas:

Chuvas com ventos fortes provocaram muitos pontos de alagamento e enxurrada, trânsito impedido por vários semáforos desligados dificultando a chegada ao atendimento das ocorrências emergenciais. Em determinadas regiões, decorrente dos fortes ventos, houve o tombamento de árvores nas estruturas de alimentação de média tensão. danos em ramais de ligação dos clientes. impedimentos

Empresa	ENEL DISTRIBUIÇÃO GOIAS		
Valor CHI (Limite e Real)	482.597,74		1.611.943,60

4. Lista de Ocorrências

DOC ORIGEM	MIUNICIPIO	EQP_ORIGEM	CONJUNTO	INI_OCORRENC	FIM_OCORRENC	DT_INI_EVENTO	DT_FIM_EVENTO	DURAÇ	UC INT	CHI	EXPURGO
20201090800	CACHOEIRA ALTA	00270214	CACHOEIRA ALTA	17/10/2020 13:34	18/10/2020 17:28	17/10/2020 13:34	18/10/2020 17:28	27,90	1	27,90	CHI
20201090800	CACHOEIRA ALTA	CA13219249	CACHOEIRA ALTA	17/10/2020 13:34	18/10/2020 17:28	18/10/2020 12:10	18/10/2020 15:08	2,96	64	189,21	CHI
20201090800	CACHOEIRA ALTA	00270214	CACHOEIRA ALTA	17/10/2020 13:34	18/10/2020 17:28	17/10/2020 13:34	18/10/2020 01:11	11,61	51	591,91	CHI
20201090800	CACHOEIRA ALTA	00270214	CACHOEIRA ALTA	17/10/2020 13:34	18/10/2020 17:28	17/10/2020 13:34	18/10/2020 00:46	11,19	13	145,42	CHI
20201090800	CACHOEIRA ALTA	00270214	CACHOEIRA ALTA	17/10/2020 13:34	18/10/2020 17:28	17/10/2020 21:17	17/10/2020 21:27	0,17	27	4,68	CHI
20201090800	CACU	00270214	CACHOEIRA ALTA	17/10/2020 13:34	18/10/2020 17:28	17/10/2020 21:17	17/10/2020 21:27	0,17	6	1,04	CHI
20201090800	CACHOEIRA ALTA	00270214	CACHOEIRA ALTA	17/10/2020 13:34	18/10/2020 17:28	17/10/2020 19:43	17/10/2020 20:09	0,42	27	11,32	CHI
20201090800	CACU	00270214	CACHOEIRA ALTA	17/10/2020 13:34	18/10/2020 17:28	17/10/2020 19:43	17/10/2020 20:09	0,42	6	2,52	CHI
20201090800	CACHOEIRA ALTA	00270214	CACHOEIRA ALTA	17/10/2020 13:34	18/10/2020 17:28	17/10/2020 13:34	17/10/2020 18:19	4,74	9	42,65	CHI
20201090800	CACU	00270214	CACHOEIRA ALTA	17/10/2020 13:34	18/10/2020 17:28	17/10/2020 13:34	17/10/2020 16:38	3,06	6	18,34	CHI
20201090800	CACHOEIRA ALTA	00270214	CACHOEIRA ALTA	17/10/2020 13:34	18/10/2020 17:28	17/10/2020 13:34	17/10/2020 16:38	3,06	18	55,02	CHI
20201090837	RIO VERDE	RV1271295	CABRIUVA S2	17/10/2020 13:46	17/10/2020 20:29	17/10/2020 13:46	17/10/2020 20:29	6,71	1	6,71	CHI
20201090866	SANTA HELENA DE GOIAS	400073663	IPEGUARI	17/10/2020 13:53	17/10/2020 21:11	17/10/2020 13:53	17/10/2020 21:11	7,30	1	7,30	CHI
20201090871	JATAI	290126472	JATAI S2	17/10/2020 13:54	17/10/2020 23:56	17/10/2020 13:54	17/10/2020 23:56	10,02	1	10,02	CHI
20201090887	CAIAPONIA	MV12054336	MONTIVIDIU T	17/10/2020 13:58	18/10/2020 11:58	17/10/2020 13:58	18/10/2020 11:58	22,01	37	814,27	CHI
20201090887	MONTIVIDIU	MV12054336	MONTIVIDIU T	17/10/2020 13:58	18/10/2020 11:58	17/10/2020 13:58	18/10/2020 11:58	22,01	2	44,01	CHI
20201090782	SERRANOPOLIS	SX12267586	JATAI S1	17/10/2020 14:02	17/10/2020 19:20	17/10/2020 18:47	17/10/2020 19:20	0,55	7	3,84	CHI
20201090782	JATAI	SX12013892RE	JATAI S1	17/10/2020 14:02	17/10/2020 19:20	17/10/2020 14:02	17/10/2020 18:30	4,46	13	58,00	CHI
20201090782	SERRANOPOLIS	SX12013892RE	JATAI S1	17/10/2020 14:02	17/10/2020 19:20	17/10/2020 14:02	17/10/2020 18:30	4,46	143	637,98	CHI
20201091466	RIO VERDE	RV12360702	MONTIVIDIU T	17/10/2020 14:03	17/10/2020 17:48	17/10/2020 14:03	17/10/2020 17:48	3,74	12	44,85	CHI
20201090911	JATAI	10013332722	JATAI S2	17/10/2020 14:08	17/10/2020 20:14	17/10/2020 14:08	17/10/2020 20:14	6,10	1	6,10	CHI
20201091163	GOIANESIA	GE12115122	GOIANESIA S2	17/10/2020 14:08	17/10/2020 17:10	17/10/2020 14:08	17/10/2020 17:10	3,03	23	69,68	CHI
20201090924	GOIANESIA	GE21115096	GOIANESIA S2	17/10/2020 14:13	17/10/2020 16:09	17/10/2020 14:13	17/10/2020 16:09	1,93	1	1,93	CHI
20201090927	CHAPADAO DO CEU	DJ21137843	CHAPADAO DO CEU	17/10/2020 14:14	17/10/2020 21:40	17/10/2020 14:14	17/10/2020 21:40	7,42	1	7,42	CHI
20201090928	CORREGO DO OURO	SC21005409	SAO LUIZ DOS MONTES BELOS	17/10/2020 14:14	17/10/2020 17:24	17/10/2020 14:14	17/10/2020 17:24	3,15	1	3,15	CHI
20201091311	RIO VERDE	RV11113540	RIO VERDE S2	17/10/2020 14:17	17/10/2020 18:16	17/10/2020 14:17	17/10/2020 18:16	3,98	128	509,19	CHI
20201090944	QUIRINOPOLIS	QI21191862	QUIRINOPOLIS	17/10/2020 14:18	17/10/2020 17:38	17/10/2020 14:18	17/10/2020 17:38	3,33	1	3,33	CHI
20201090947	CAMPINORTE	2040010756	CAMPINORTE	17/10/2020 14:19	17/10/2020 15:57	17/10/2020 14:19	17/10/2020 15:57	1,63	1	1,63	CHI
20201090955	GOIAS	90059621	GOIAS	17/10/2020 14:22	17/10/2020 16:03	17/10/2020 14:22	17/10/2020 16:03	1,67	1	1,67	CHI
20201090956	PORTELANDIA	PW12318144	PARQUE DAS EMAS	17/10/2020 14:22	17/10/2020 23:50	17/10/2020 14:22	17/10/2020 23:50	9,45	2	18,91	CHI
20201090964	ITABERAI	IB12300330	ITABERAI S2	17/10/2020 14:24	17/10/2020 16:47	17/10/2020 14:24	17/10/2020 16:47	2,38	14	33,34	CHI
20201090968	QUIRINOPOLIS	QI31050220	QUIRINOPOLIS	17/10/2020 14:25	17/10/2020 19:49	17/10/2020 14:25	17/10/2020 19:49	5,39	1	5,39	CHI
20201090973	JARAGUA	JA21297469	JARAGUA	17/10/2020 14:27	17/10/2020 16:30	17/10/2020 14:27	17/10/2020 16:30	2,04	1	2,04	CHI
20201090977	NIQUELANDIA	NQ211232352	NIQUELANDIA SUBTRANSMISSAO	17/10/2020 14:27	17/10/2020 16:20	17/10/2020 14:27	17/10/2020 16:20	1,87	1	1,87	CHI
20201090981	APARECIDA DE GOIANIA	11852380	REAL S2	17/10/2020 14:30	17/10/2020 17:18	17/10/2020 14:30	17/10/2020 17:18	2,80	1	2,80	CHI
20201090982	GAMELEIRA DE GOIAS	SV21095363	DAIA S2	17/10/2020 14:30	17/10/2020 15:56	17/10/2020 14:30	17/10/2020 15:56	1,43	1	1,43	CHI
20201090984	APORE	IJ12194905	ITAJA S2	17/10/2020 14:30	17/10/2020 16:41	17/10/2020 14:30	17/10/2020 16:41	2,17	1	2,17	CHI
20201090984	ITAJA	IJ12194905	ITAJA S2	17/10/2020 14:30	17/10/2020 16:41	17/10/2020 14:30	17/10/2020 16:41	2,17	34	73,75	CHI
20201090985	BONFINOPOLIS	920016637	CEPAIGO S2	17/10/2020 14:31	17/10/2020 14:54	17/10/2020 14:31	17/10/2020 14:54	0,38	1	0,38	CHI
20201088930	SANTA FE DE GOIAS	IU13259756	MATRINCHA	17/10/2020 14:31	17/10/2020 14:42	17/10/2020 14:31	17/10/2020 14:42	0,17	12	2,02	CHI
20201088930	JUSSARA	IU13259756	MATRINCHA	17/10/2020 14:31	17/10/2020 14:42	17/10/2020 14:31	17/10/2020 14:42	0,17	4	0,67	CHI
20201088930	ITAPIRAPUA	IU13259756	MATRINCHA	17/10/2020 14:31	17/10/2020 14:42	17/10/2020 14:31	17/10/2020 14:42	0,17	321	54,04	CHI
20201090988	MONTIVIDIU	2840023897	MONTIVIDIU T	17/10/2020 14:31	17/10/2020 20:38	17/10/2020 14:31	17/10/2020 20:38	6,10	1	6,10	CHI
20201091000	ITARUMA	IM21338682	CACHOEIRA ALTA	17/10/2020 14:34	18/10/2020 04:47	17/10/2020 14:34	18/10/2020 04:47	14,21	1	14,21	CHI
20201091020	BOM JARDIM DE GOIAS	BM12390150	BOM JARDIM	17/10/2020 14:36	17/10/2020 17:20	17/10/2020 14:36	17/10/2020 17:20	2,73	9	24,59	CHI
20201091020	BALIZA	BM12390150	BOM JARDIM	17/10/2020 14:36	17/10/2020 17:20	17/10/2020 14:36	17/10/2020 17:20	2,73	50	136,60	CHI
20201091032	ANAPOLIS	AN11071526	ANAPOLIS UNIVERSITARIO S2	17/10/2020 14:36	17/10/2020 22:27	17/10/2020 14:36	17/10/2020 22:27	7,85	193	1514,35	CHI
20201091010	CACU	CC12226533	CACHOEIRA ALTA	17/10/2020 14:37	17/10/2020 21:37	17/10/2020 14:37	17/10/2020 21:37	7,01	21	147,24	CHI

20201091010	CACHOEIRA ALTA	CC12226533	CACHOEIRA ALTA	17/10/2020 14:37	17/10/2020 21:37	17/10/2020 14:37	17/10/2020 21:37	7,01	6	42,07	CHI
20201090465	GOIANIA	20748423	XAVANTES	17/10/2020 14:38	17/10/2020 14:54	17/10/2020 14:38	17/10/2020 14:54	0,27	3	0,80	CHI
20201091014	ABADIANIA	AA21146473	ANAPOLIS UNIVERSITARIO S1	17/10/2020 14:39	17/10/2020 17:35	17/10/2020 14:39	17/10/2020 17:35	2,92	2	5,85	CHI
20201091016	ABADIA DE GOIAS	GN32050558LD	TRINDADE	17/10/2020 14:39	17/10/2020 20:01	17/10/2020 14:39	17/10/2020 20:01	5,36	1	5,36	CHI
20201091019	FAZENDA NOVA	FN12073782	IPORA	17/10/2020 14:40	17/10/2020 20:54	17/10/2020 14:40	17/10/2020 20:54	6,23	21	130,80	CHI
20201091019	ISRAELANDIA	FN12073782	IPORA	17/10/2020 14:40	17/10/2020 20:54	17/10/2020 14:40	17/10/2020 20:54	6,23	2	12,46	CHI
20201091028	PETROLINA DE GOIAS	PG12073197	PETROLINA	17/10/2020 14:43	17/10/2020 19:09	17/10/2020 14:43	17/10/2020 19:09	4,42	3	13,26	CHI
2020101700049	CORUMBA DE GOIAS	02001	ANAPOLIS UNIVERSITARIO S1	17/10/2020 14:47	17/10/2020 14:50	17/10/2020 14:47	17/10/2020 14:50	0,05	62	3,10	CHI
2020101700049	ABADIANIA	00050424	ANAPOLIS UNIVERSITARIO S1	17/10/2020 14:47	17/10/2020 14:50	17/10/2020 14:47	17/10/2020 14:50	0,05	17	0,85	CHI
2020101700049	ANAPOLIS	00050424	ANAPOLIS UNIVERSITARIO S1	17/10/2020 14:47	17/10/2020 14:50	17/10/2020 14:47	17/10/2020 14:50	0,05	112	5,60	CHI
2020101700049	ABADIANIA	02001	ANAPOLIS UNIVERSITARIO S1	17/10/2020 14:47	17/10/2020 14:50	17/10/2020 14:47	17/10/2020 14:50	0,05	1517	75,85	CHI
2020101700049	ABADIANIA	02002	ANAPOLIS UNIVERSITARIO S1	17/10/2020 14:47	17/10/2020 14:50	17/10/2020 14:47	17/10/2020 14:50	0,05	3630	181,50	CHI
2020101700049	CORUMBA DE GOIAS	02002	ANAPOLIS UNIVERSITARIO S1	17/10/2020 14:47	17/10/2020 14:50	17/10/2020 14:47	17/10/2020 14:50	0,05	4	0,20	CHI
2020101700049	GAMELEIRA DE GOIAS	02002	ANAPOLIS UNIVERSITARIO S1	17/10/2020 14:47	17/10/2020 14:50	17/10/2020 14:47	17/10/2020 14:50	0,05	11	0,55	CHI
2020101700049	ABADIA DE GOIAS	02002	ANAPOLIS UNIVERSITARIO S1	17/10/2020 14:47	17/10/2020 14:50	17/10/2020 14:47	17/10/2020 14:50	0,05	1	0,05	CHI
202010189304	MINEIROS	05690214	SANTA RITA DO ARAGUAIA	17/10/2020 14:51	17/10/2020 15:29	17/10/2020 14:51	17/10/2020 15:29	0,63	33	20,95	CHI
202010189304	SANTA RITA DO ARAGUAIA	05690214	SANTA RITA DO ARAGUAIA	17/10/2020 14:51	17/10/2020 15:29	17/10/2020 14:51	17/10/2020 15:29	0,63	387	245,64	CHI
202010189304	SANTA RITA DO ARAGUAIA	SU16418241	SANTA RITA DO ARAGUAIA	17/10/2020 14:51	17/10/2020 15:29	17/10/2020 14:51	17/10/2020 15:15	0,41	1651	680,12	CHI
20201091057	ANAPOLIS	AN12135843	ANAPOLIS UNIVERSITARIO S2	17/10/2020 14:52	17/10/2020 15:46	17/10/2020 14:52	17/10/2020 15:46	0,89	645	576,02	CHI
20201091248	ANAPOLIS	AN12000105	ANAPOLIS UNIVERSITARIO S2	17/10/2020 14:53	17/10/2020 19:01	17/10/2020 14:53	17/10/2020 19:01	4,13	53	218,85	CHI
20201091071	ITAPURANGA	3860000194	ITAPURANGA	17/10/2020 14:54	17/10/2020 16:48	17/10/2020 14:54	17/10/2020 16:48	1,90	1	1,90	CHI
20201091085	GOIANIA	10005001984	ATLANTICO S1	17/10/2020 14:56	17/10/2020 15:49	17/10/2020 14:56	17/10/2020 15:49	0,88	1	0,88	CHI
20201091086	SENADOR CANEDO	10018015890	SENADOR CANEDO	17/10/2020 14:56	17/10/2020 22:34	17/10/2020 14:56	17/10/2020 22:34	7,62	1	7,62	CHI
20201091105	ABADIANIA	350038156	ANAPOLIS UNIVERSITARIO S1	17/10/2020 14:58	17/10/2020 23:18	17/10/2020 14:58	17/10/2020 23:18	8,33	1	8,33	CHI
20201091400	GOIANAPOLIS	GP12000043	DAIA S2	17/10/2020 14:59	18/10/2020 00:07	17/10/2020 14:59	18/10/2020 00:07	9,15	6	54,89	CHI
20201091400	GOIANAPOLIS	GP12000043	DAIA S2	17/10/2020 14:59	18/10/2020 00:07	17/10/2020 22:40	18/10/2020 00:07	1,45	3	4,36	CHI
20201092137	LEOPOLDO DE BULHOES	AN12382480LD	ANAPOLIS UNIVERSITARIO S2	17/10/2020 14:59	17/10/2020 18:54	17/10/2020 14:59	17/10/2020 18:54	3,90	1	3,90	CHI
20201092137	GAMELEIRA DE GOIAS	AN12382480LD	ANAPOLIS UNIVERSITARIO S2	17/10/2020 14:59	17/10/2020 18:54	17/10/2020 14:59	17/10/2020 18:54	3,90	40	156,06	CHI
20201092137	SILVANIA	AN12382480LD	ANAPOLIS UNIVERSITARIO S2	17/10/2020 14:59	17/10/2020 18:54	17/10/2020 14:59	17/10/2020 18:54	3,90	40	156,06	CHI
20201092137	ANAPOLIS	AN12382480LD	ANAPOLIS UNIVERSITARIO S2	17/10/2020 14:59	17/10/2020 18:54	17/10/2020 14:59	17/10/2020 18:54	3,90	23	89,73	CHI
20201091103	BELA VISTA DE GOIAS	240050496	BELA VISTA S1	17/10/2020 15:00	17/10/2020 16:07	17/10/2020 15:00	17/10/2020 16:07	1,11	1	1,11	CHI
20201091110	ITAJA	IM21202749	ITAJA S2	17/10/2020 15:01	17/10/2020 17:13	17/10/2020 15:01	17/10/2020 17:13	2,19	1	2,19	CHI
20201091117	GOIANIA	15601432	REAL S1	17/10/2020 15:03	17/10/2020 19:12	17/10/2020 15:03	17/10/2020 19:12	4,15	1	4,15	CHI
20201090601	RIO VERDE	RV11214211	CABRIUVA S1	17/10/2020 15:05	17/10/2020 15:45	17/10/2020 15:05	17/10/2020 15:45	0,65	117	76,41	CHI
20201091133	ABADIANIA	AA21050461	ANAPOLIS UNIVERSITARIO S1	17/10/2020 15:06	17/10/2020 20:12	17/10/2020 15:06	17/10/2020 20:12	5,10	1	5,10	CHI
20201091137	RIO VERDE	RV21160758	CABRIUVA S1	17/10/2020 15:06	17/10/2020 20:46	17/10/2020 15:06	17/10/2020 20:46	5,66	1	5,66	CHI
20201091156	CORUMBAIBA	CI11263867	VILA CORUMBA	17/10/2020 15:11	17/10/2020 18:56	17/10/2020 15:11	17/10/2020 18:56	3,74	22	82,34	CHI
20201091160	CAMPESTRE DE GOIAS	GC21185462	TRINDADE	17/10/2020 15:12	17/10/2020 19:33	17/10/2020 15:12	17/10/2020 19:33	4,35	1	4,35	CHI
20201091161	RIO VERDE	RV21271581	CABRIUVA S2	17/10/2020 15:12	17/10/2020 20:06	17/10/2020 15:12	17/10/2020 20:06	4,90	1	4,90	CHI
20201091536	PORANGATU	PO12192281	PORANGATU	17/10/2020 15:13	17/10/2020 20:27	17/10/2020 15:13	17/10/2020 20:27	5,23	2	10,46	CHI
20201091169	PORTELANDIA	PW21318136	PARQUE DAS EMAS	17/10/2020 15:13	18/10/2020 00:17	17/10/2020 15:13	18/10/2020 00:17	9,06	1	9,06	CHI
20201091226	ANAPOLIS	AN16407060	JUNDIAI S1	17/10/2020 15:14	17/10/2020 21:22	17/10/2020 15:14	17/10/2020 21:22	6,13	32	196,20	CHI
20201091226	ANAPOLIS	AN16407060	JUNDIAI S1	17/10/2020 15:14	17/10/2020 21:22	17/10/2020 15:14	17/10/2020 17:06	1,86	456	849,43	CHI
20201091226	ANAPOLIS	AN16407060	JUNDIAI S1	17/10/2020 15:14	17/10/2020 21:22	17/10/2020 15:14	17/10/2020 16:43	1,48	277	409,65	CHI
20201091226	ANAPOLIS	AN16413997	JUNDIAI S1	17/10/2020 15:14	17/10/2020 21:22	17/10/2020 15:14	17/10/2020 15:25	0,18	688	123,08	CHI
20201091226	ANAPOLIS	AN16401598	JUNDIAI S1	17/10/2020 15:14	17/10/2020 21:22	17/10/2020 15:14	17/10/2020 15:25	0,17	721	121,57	CHI
20201091226	ANAPOLIS	AN16411389	JUNDIAI S1	17/10/2020 15:14	17/10/2020 21:22	17/10/2020 15:14	17/10/2020 15:22	0,12	1586	192,08	CHI
20201091226	ANAPOLIS	02370254	JUNDIAI S1	17/10/2020 15:14	17/10/2020 21:22	17/10/2020 15:14	17/10/2020 15:18	0,06	2055	121,59	CHI
20201091174	PIRACANJUBA	PJ12070277	BELA VISTA S1	17/10/2020 15:15	17/10/2020 17:49	17/10/2020 15:15	17/10/2020 17:49	2,55	9	22,98	CHI
20201092070	RIO VERDE	MV12260996	MONTIVIDIU T	17/10/2020 15:17	18/10/2020 09:22	17/10/2020 15:17	18/10/2020 09:22	18,08	7	126,54	CHI
20201091183	ABADIANIA	AN12267886	ANAPOLIS UNIVERSITARIO S2	17/10/2020 15:17	18/10/2020 00:56	17/10/2020 15:17	18/10/2020 00:56	9,64	4	38,57	CHI

20201091188	FIRMINOPOLIS	900028166	FIRMINOPOLIS S1	17/10/2020 15:18	17/10/2020 22:42	17/10/2020 15:18	17/10/2020 22:42	7,39	1	7,39	CHI
20201091191	RIO VERDE	630204469	RIO VERDE S1	17/10/2020 15:19	17/10/2020 20:49	17/10/2020 15:19	17/10/2020 20:49	5,49	1	5,49	CHI
20201091197	GOIANIA	16809490	ATLANTICO S3	17/10/2020 15:21	17/10/2020 16:27	17/10/2020 15:21	17/10/2020 16:27	1,10	1	1,10	CHI
20201091394	ANAPOLIS	AN11135802	ANAPOLIS UNIVERSITARIO S2	17/10/2020 15:21	17/10/2020 21:06	17/10/2020 15:21	17/10/2020 21:06	5,75	120	689,53	CHI
20201091201	ANAPOLIS	10020873342	ANAPOLIS UNIVERSITARIO S2	17/10/2020 15:21	18/10/2020 00:12	17/10/2020 15:21	18/10/2020 00:12	8,84	1	8,84	CHI
20201091379	ANAPOLIS	AN11000277	JUNDIAI S2	17/10/2020 15:22	17/10/2020 19:23	17/10/2020 15:22	17/10/2020 19:23	4,01	177	710,11	CHI
20201091379	ANAPOLIS	AN12096798	JUNDIAI S2	17/10/2020 15:22	17/10/2020 19:23	17/10/2020 15:22	17/10/2020 17:22	1,99	941	1871,54	CHI
20201092409	ANAPOLIS	AN11107993	JUNDIAI S2	17/10/2020 15:23	17/10/2020 23:29	17/10/2020 15:23	17/10/2020 23:29	8,10	144	1166,44	CHI
20201091609	ANAPOLIS	AN12000071	JUNDIAI S2	17/10/2020 15:23	17/10/2020 18:26	17/10/2020 15:23	17/10/2020 18:26	3,05	142	433,10	CHI
20201088997	APARECIDA DE GOIANIA	AP11379523	INDEPENDENCIA S2	17/10/2020 15:23	17/10/2020 16:30	17/10/2020 15:23	17/10/2020 16:30	1,12	50	56,00	CHI
20201091208	ITABERAÍ	10014503342	ITABERAÍ S2	17/10/2020 15:23	17/10/2020 18:03	17/10/2020 15:23	17/10/2020 18:03	2,66	1	2,66	CHI
20201091287	MINEIROS	MY12303919RE	PARQUE DAS EMAS	17/10/2020 15:24	19/10/2020 18:13	17/10/2020 15:24	19/10/2020 18:13	50,81	13	660,52	CHI
20201091287	MINEIROS	MY12303919RE	PARQUE DAS EMAS	17/10/2020 15:24	19/10/2020 18:13	17/10/2020 15:24	19/10/2020 15:12	47,81	6	286,83	CHI
20201091287	MINEIROS	MY12303919RE	PARQUE DAS EMAS	17/10/2020 15:24	19/10/2020 18:13	18/10/2020 11:26	18/10/2020 14:24	2,97	1	2,97	CHI
20201091287	MINEIROS	MY12303919RE	PARQUE DAS EMAS	17/10/2020 15:24	19/10/2020 18:13	17/10/2020 15:24	17/10/2020 21:07	5,72	1	5,72	CHI
20201091218	BELA VISTA DE GOIAS	240016415	BELA VISTA S1	17/10/2020 15:24	17/10/2020 18:33	17/10/2020 15:24	17/10/2020 18:33	3,14	1	3,14	CHI
20201091231	GOIATUBA	GT1263295	VELICENTINOPOLIS	17/10/2020 15:27	17/10/2020 17:05	17/10/2020 15:27	17/10/2020 17:05	1,62	1	1,62	CHI
20201091369	ANAPOLIS	AN11003267	ANAPOLIS UNIVERSITARIO S2	17/10/2020 15:29	17/10/2020 16:38	17/10/2020 15:29	17/10/2020 16:38	1,15	196	224,64	CHI
20201091485	ORIZONA	OZ12048939LD	PIRES DO RIO S1	17/10/2020 15:29	17/10/2020 19:13	17/10/2020 15:29	17/10/2020 19:13	3,72	7	26,03	CHI
20201091242	MONTIVIDIU DO NORTE	MX12168971	PORANGATU	17/10/2020 15:29	17/10/2020 20:15	17/10/2020 15:29	17/10/2020 20:15	4,75	281	1334,98	CHI
20201091246	ANAPOLIS	21269440	JUNDIAI S1	17/10/2020 15:30	17/10/2020 20:24	17/10/2020 15:30	17/10/2020 20:24	4,89	1	4,89	CHI
20201091252	BELA VISTA DE GOIAS	BV31085440	BELA VISTA S1	17/10/2020 15:32	17/10/2020 17:13	17/10/2020 15:32	17/10/2020 17:13	1,68	1	1,68	CHI
20201091339	ARAGUAPAZ	AZ12290380	MOZARLANDIA	17/10/2020 15:32	17/10/2020 18:30	17/10/2020 15:32	17/10/2020 18:30	2,95	7	20,67	CHI
20201091339	MOZARLANDIA	AZ12290380	MOZARLANDIA	17/10/2020 15:32	17/10/2020 18:30	17/10/2020 15:32	17/10/2020 18:30	2,95	2	5,91	CHI
20201091262	NOVO GAMA	2900103909	MARAJOARA	17/10/2020 15:34	17/10/2020 19:25	17/10/2020 15:34	17/10/2020 19:25	3,84	1	3,84	CHI
20201091265	ITABERAÍ	50104974	ITABERAÍ S2	17/10/2020 15:35	17/10/2020 16:47	17/10/2020 15:35	17/10/2020 16:47	1,20	1	1,20	CHI
20201091266	ANAPOLIS	20807387	ANAPOLIS UNIVERSITARIO S2	17/10/2020 15:35	18/10/2020 01:45	17/10/2020 15:35	18/10/2020 01:45	10,16	1	10,16	CHI
20201091331	ANAPOLIS	AN11198708	ANAPOLIS UNIVERSITARIO S2	17/10/2020 15:36	17/10/2020 21:56	17/10/2020 15:36	17/10/2020 21:56	6,33	81	513,00	CHI
20201091278	GOIAS	GS21183457	GOIAS	17/10/2020 15:36	17/10/2020 18:29	17/10/2020 15:36	17/10/2020 18:29	2,87	1	2,87	CHI
20201091271	CATALAO	1990118772	CATALAO S2	17/10/2020 15:36	17/10/2020 17:25	17/10/2020 15:36	17/10/2020 17:25	1,80	1	1,80	CHI
20201091589	ANAPOLIS	AN12096740	JUNDIAI S2	17/10/2020 15:36	17/10/2020 17:52	17/10/2020 15:36	17/10/2020 17:52	2,25	21	47,31	CHI
20201091273	RIO VERDE	630040436	RIO VERDE S1	17/10/2020 15:36	17/10/2020 21:11	17/10/2020 15:36	17/10/2020 21:11	5,57	1	5,57	CHI
20201091274	RIO VERDE	630240670	RIO VERDE S1	17/10/2020 15:36	17/10/2020 17:32	17/10/2020 15:36	17/10/2020 17:32	1,92	1	1,92	CHI
20201091280	SANTA TEREZINHA DE GOIAS	SG12337132	SANTA TEREZINHA	17/10/2020 15:37	17/10/2020 20:40	17/10/2020 15:37	17/10/2020 20:40	5,04	7	35,25	CHI
20201091281	URUACU	640142126	URUACU	17/10/2020 15:38	17/10/2020 17:25	17/10/2020 15:38	17/10/2020 17:25	1,78	1	1,78	CHI
20201091987	ANAPOLIS	AN11107749	ANAPOLIS UNIVERSITARIO S2	17/10/2020 15:39	17/10/2020 19:13	17/10/2020 15:39	17/10/2020 19:13	3,57	102	363,80	CHI
20201091499	ANAPOLIS	AN11000628	JUNDIAI S1	17/10/2020 15:39	17/10/2020 19:51	17/10/2020 15:39	17/10/2020 19:51	4,20	123	516,05	CHI
20201091366	ANAPOLIS	AN11258091	ANAPOLIS UNIVERSITARIO S2	17/10/2020 15:41	17/10/2020 16:45	17/10/2020 15:41	17/10/2020 16:45	1,06	114	120,81	CHI
20201092358	RIO VERDE	RV12016822	CABRIUVA S1	17/10/2020 15:42	17/10/2020 21:53	17/10/2020 15:42	17/10/2020 21:53	6,18	3	18,53	CHI
20201091819	PETROLINA DE GOIAS	PG12297931	PETROLINA	17/10/2020 15:43	17/10/2020 23:37	17/10/2020 15:43	17/10/2020 23:37	7,91	117	925,15	CHI
20201091819	SAO FRANCISCO DE GOIAS	PG12297931	PETROLINA	17/10/2020 15:43	17/10/2020 23:37	17/10/2020 15:43	17/10/2020 23:37	7,91	1	7,91	CHI
20201091307	GOIANIA	11267756	CAMPINAS S2	17/10/2020 15:43	17/10/2020 17:18	17/10/2020 15:43	17/10/2020 17:18	1,57	1	1,57	CHI
20201091470	ANAPOLIS	AN11166254	JUNDIAI S1	17/10/2020 15:43	17/10/2020 17:05	17/10/2020 15:43	17/10/2020 17:05	1,37	132	180,62	CHI
20201091310	ALEXANIA	AX21073857	ALEXANIA	17/10/2020 15:44	18/10/2020 12:09	17/10/2020 15:44	18/10/2020 12:09	20,42	3	61,25	CHI
20201091313	FAINA	FC11061649	MATRINCHA	17/10/2020 15:45	17/10/2020 23:26	17/10/2020 15:45	17/10/2020 23:26	7,67	30	230,21	CHI
20201091316	PIRENOPOLIS	PV11210828	SAO FRANCISCO DE GOIAS	17/10/2020 15:47	17/10/2020 18:05	17/10/2020 15:47	17/10/2020 18:05	2,30	121	277,76	CHI
20201091325	ANAPOLIS	AN12000076	JUNDIAI S2	17/10/2020 15:52	17/10/2020 19:38	17/10/2020 15:52	17/10/2020 19:38	3,76	1	3,76	CHI
20201092146	BOM JARDIM DE GOIAS	BM12201516	BOM JARDIM	17/10/2020 15:52	17/10/2020 19:53	17/10/2020 15:52	17/10/2020 19:53	4,00	40	160,19	CHI
20201091330	CHAPADAO DO CEU	DJ21132278	CHAPADAO DO CEU	17/10/2020 15:53	17/10/2020 22:07	17/10/2020 15:53	17/10/2020 22:07	6,23	1	6,23	CHI
20201091460	ITAPIRAPUA	IU12087963	MATRINCHA	17/10/2020 15:53	17/10/2020 21:30	17/10/2020 15:53	17/10/2020 21:30	5,61	44	246,89	CHI
20201091716	ANAPOLIS	AN11194876	ANAPOLIS UNIVERSITARIO S2	17/10/2020 15:53	17/10/2020 19:30	17/10/2020 15:53	17/10/2020 19:30	3,62	119	430,35	CHI

20201091504	ANAPOLIS	AN11130729	JUNDIAI S1	17/10/2020 15:53	17/10/2020 17:50	17/10/2020 15:53	17/10/2020 17:50	1,94	157	304,58	CHI
20201091337	JATAI	290218860	JATAI S2	17/10/2020 15:54	17/10/2020 19:47	17/10/2020 15:54	17/10/2020 19:47	3,88	1	3,88	CHI
20201091341	BELA VISTA DE GOIAS	BV21110798	BELA VISTA S1	17/10/2020 15:55	17/10/2020 17:55	17/10/2020 15:55	17/10/2020 17:55	1,99	1	1,99	CHI
20201091342	AMERICANO DO BRASIL	KB11000004	ANICUNS	17/10/2020 15:55	17/10/2020 22:18	17/10/2020 15:55	17/10/2020 22:18	6,37	65	413,91	CHI
20201091451	ANAPOLIS	AN11101548	JUNDIAI S2	17/10/2020 15:56	17/10/2020 21:03	17/10/2020 15:56	17/10/2020 21:03	5,11	114	582,76	CHI
20201091344	GOIANIA	GN11378785	MEIA PONTE	17/10/2020 15:56	17/10/2020 17:12	17/10/2020 15:56	17/10/2020 17:12	1,25	42	52,61	CHI
20201091511	ANAPOLIS	AN11107754	ANAPOLIS UNIVERSITARIO S2	17/10/2020 15:58	18/10/2020 00:48	17/10/2020 15:58	18/10/2020 00:48	8,83	138	1218,69	CHI
20201091350	SAO FRANCISCO DE GOIAS	SF21066074	SAO FRANCISCO DE GOIAS	17/10/2020 15:58	17/10/2020 19:23	17/10/2020 15:58	17/10/2020 19:23	3,41	2	6,81	CHI
20201091351	ACREUNA	EU12045541LD	ACREUNA	17/10/2020 15:58	17/10/2020 22:22	17/10/2020 15:58	17/10/2020 22:22	6,39	1	6,39	CHI
20201091353	GOIAS	GS12217051	GOIAS	17/10/2020 15:58	17/10/2020 17:13	17/10/2020 15:58	17/10/2020 17:13	1,23	236	291,13	CHI
20201091356	RIO VERDE	RV21400993	MONTIVIDIU T	17/10/2020 16:01	17/10/2020 19:50	17/10/2020 16:01	17/10/2020 19:50	3,81	1	3,81	CHI
20201091357	ANAPOLIS	10019063987	ANAPOLIS UNIVERSITARIO S2	17/10/2020 16:01	17/10/2020 22:27	17/10/2020 16:01	17/10/2020 22:27	6,44	1	6,44	CHI
20201091359	CALDAS NOVAS	760003117	CALDAS NOVAS S2	17/10/2020 16:01	17/10/2020 17:25	17/10/2020 16:01	17/10/2020 17:25	1,39	1	1,39	CHI
20201091360	ARAGOIANIA	AO21197002	GUAPO S2	17/10/2020 16:01	17/10/2020 23:01	17/10/2020 16:01	17/10/2020 23:01	6,99	1	6,99	CHI
20201091370	IPAMERI	CM12281443LD	CAMPO ALEGRE DE GOIAS	17/10/2020 16:02	18/10/2020 18:59	17/10/2020 16:02	18/10/2020 18:59	26,95	1	26,95	CHI
20201091370	CAMPO ALEGRE DE GOIAS	CM12281443LD	CAMPO ALEGRE DE GOIAS	17/10/2020 16:02	18/10/2020 18:59	17/10/2020 16:02	18/10/2020 18:59	26,95	14	377,35	CHI
20201091370	CATALAO	CM10397305	CAMPO ALEGRE DE GOIAS	17/10/2020 16:02	18/10/2020 18:59	17/10/2020 16:02	17/10/2020 21:13	5,18	3	15,54	CHI
20201091370	IPAMERI	CM10397305	CAMPO ALEGRE DE GOIAS	17/10/2020 16:02	18/10/2020 18:59	17/10/2020 16:02	17/10/2020 21:13	5,18	10	51,81	CHI
20201091370	CAMPO ALEGRE DE GOIAS	CM10397305	CAMPO ALEGRE DE GOIAS	17/10/2020 16:02	18/10/2020 18:59	17/10/2020 16:02	17/10/2020 21:13	5,18	36	186,51	CHI
20201091370	CATALAO	CM10397305	CAMPO ALEGRE DE GOIAS	17/10/2020 16:02	18/10/2020 18:59	17/10/2020 16:02	17/10/2020 19:08	3,10	17	52,66	CHI
20201091370	DISTRITO FEDERAL	CM10397305	CAMPO ALEGRE DE GOIAS	17/10/2020 16:02	18/10/2020 18:59	17/10/2020 16:02	17/10/2020 19:08	3,10	1	3,10	CHI
20201091370	CAMPO ALEGRE DE GOIAS	CM10397305	CAMPO ALEGRE DE GOIAS	17/10/2020 16:02	18/10/2020 18:59	17/10/2020 16:02	17/10/2020 19:08	3,10	43	133,20	CHI
20201091370	CAMPO ALEGRE DE GOIAS	CM13266056	CAMPO ALEGRE DE GOIAS	17/10/2020 16:02	18/10/2020 18:59	17/10/2020 16:03	17/10/2020 19:08	3,08	2	6,17	CHI
20201091370	CAMPO ALEGRE DE GOIAS	CM10397305	CAMPO ALEGRE DE GOIAS	17/10/2020 16:02	18/10/2020 18:59	17/10/2020 16:02	17/10/2020 17:23	1,36	29	39,42	CHI
20201091365	GOIAS	GS21183063	GOIAS	17/10/2020 16:02	17/10/2020 19:19	17/10/2020 16:02	17/10/2020 19:19	3,27	1	3,27	CHI
20201091367	NOVA AMERICA	NM21188996	RUBIATABA	17/10/2020 16:03	17/10/2020 19:05	17/10/2020 16:03	17/10/2020 19:05	3,03	1	3,03	CHI
20201091749	ANAPOLIS	AN11319625	JUNDIAI S2	17/10/2020 16:04	17/10/2020 17:40	17/10/2020 16:04	17/10/2020 17:40	1,60	46	73,52	CHI
20201091374	CATALAO	CT11000002	CATALAO S2	17/10/2020 16:04	17/10/2020 18:27	17/10/2020 16:04	17/10/2020 18:27	2,37	106	251,25	CHI
20201091380	GAMELEIRA DE GOIAS	SV31068087	DAIA S2	17/10/2020 16:06	17/10/2020 17:13	17/10/2020 16:06	17/10/2020 17:13	1,10	1	1,10	CHI
20201091473	APARECIDA DE GOIANIA	AP11000058	INDEPENDENCIA S1	17/10/2020 16:07	17/10/2020 18:13	17/10/2020 16:07	17/10/2020 18:13	2,10	201	421,10	CHI
20201091391	ABADIA DE GOIAS	5582278131	CARAJAS S1	17/10/2020 16:08	18/10/2020 01:55	17/10/2020 16:08	18/10/2020 01:55	9,78	1	9,78	CHI
20201091393	APARECIDA DE GOIANIA	12361100	REAL S1	17/10/2020 16:08	17/10/2020 19:03	17/10/2020 16:08	17/10/2020 19:03	2,91	1	2,91	CHI
20201091407	AGUAS LINDAS DE GOIAS	10014201273	AGUAS LINDAS DE GOIAS S1	17/10/2020 16:11	17/10/2020 18:15	17/10/2020 16:11	17/10/2020 18:15	2,06	1	2,06	CHI
20201091412	HEITORAI	360010003	ITAPURANGA	17/10/2020 16:12	17/10/2020 18:47	17/10/2020 16:12	17/10/2020 18:47	2,58	1	2,58	CHI
20201091415	ABADIANIA	AA31084786	ANAPOLIS UNIVERSITARIO S1	17/10/2020 16:13	17/10/2020 22:31	17/10/2020 16:13	17/10/2020 22:31	6,29	2	12,59	CHI
20201091418	CRIXAS	CX21243406	SANTA TEREZINHA	17/10/2020 16:15	17/10/2020 18:32	17/10/2020 16:15	17/10/2020 18:32	2,28	1	2,28	CHI
20201091480	DAMOLANDIA	PG12255953	PETROLINA	17/10/2020 16:15	17/10/2020 18:37	17/10/2020 16:15	17/10/2020 18:37	2,36	1	2,36	CHI
20201091480	OURO VERDE DE GOIAS	PG12255953	PETROLINA	17/10/2020 16:15	17/10/2020 18:37	17/10/2020 16:15	17/10/2020 18:37	2,36	27	63,67	CHI
20201091480	PETROLINA DE GOIAS	PG12255953	PETROLINA	17/10/2020 16:15	17/10/2020 18:37	17/10/2020 16:15	17/10/2020 18:37	2,36	119	280,61	CHI
20201091472	ANAPOLIS	AN11107755	ANAPOLIS UNIVERSITARIO S2	17/10/2020 16:15	17/10/2020 17:48	17/10/2020 16:15	17/10/2020 17:48	1,54	151	232,67	CHI
20201091449	JUSSARA	JR12120986	BRITANIA	17/10/2020 16:17	18/10/2020 01:28	17/10/2020 16:17	18/10/2020 01:28	9,17	3	27,52	CHI
20201091434	CACU	1140013480	CACHOEIRA ALTA	17/10/2020 16:17	17/10/2020 18:35	17/10/2020 16:17	17/10/2020 18:35	2,29	1	2,29	CHI
20201091441	NEROPOLIS	NR21199958	NEROPOLIS S2	17/10/2020 16:18	17/10/2020 19:53	17/10/2020 16:18	17/10/2020 19:53	3,58	2	7,16	CHI
20201091873	MINEIROS	MY11036534	PARQUE DAS EMAS	17/10/2020 16:18	17/10/2020 21:06	17/10/2020 16:18	17/10/2020 21:06	4,79	144	689,64	CHI
20201091464	APARECIDA DE GOIANIA	AP21002045	ANHANGUERA	17/10/2020 16:21	17/10/2020 20:05	17/10/2020 16:21	17/10/2020 20:05	3,73	2	7,45	CHI
20201091468	ANAPOLIS	AN21370499	ANAPOLIS UNIVERSITARIO S2	17/10/2020 16:23	18/10/2020 13:39	17/10/2020 16:23	18/10/2020 13:39	21,28	1	21,28	CHI
20201091469	GOIANIA	GN11245618	XAVANTES	17/10/2020 16:23	18/10/2020 00:03	17/10/2020 16:23	18/10/2020 00:03	7,66	108	827,19	CHI
20201091471	GOIANIA	10181611	AEROPORTO S3	17/10/2020 16:23	17/10/2020 17:42	17/10/2020 16:23	17/10/2020 17:42	1,30	1	1,30	CHI
20201092116	ANAPOLIS	AN12382307	ANAPOLIS UNIVERSITARIO S2	17/10/2020 16:25	17/10/2020 22:25	17/10/2020 16:25	17/10/2020 22:25	6,00	41	245,85	CHI
20201092116	GAMELEIRA DE GOIAS	AN12382307	ANAPOLIS UNIVERSITARIO S2	17/10/2020 16:25	17/10/2020 22:25	17/10/2020 16:25	17/10/2020 22:25	6,00	30	179,89	CHI
20201091493	GOIANIA	GN11247739	XAVANTES	17/10/2020 16:25	17/10/2020 18:07	17/10/2020 16:25	17/10/2020 18:07	1,69	71	120,05	CHI

20201091482	BELA VISTA DE GOIAS	BV12035058	BELA VISTA S1	17/10/2020 16:27	17/10/2020 17:55	17/10/2020 16:27	17/10/2020 17:55	1,47	5	7,33	CHI
20201092119	ANAPOLIS	AN12258563	ANAPOLIS UNIVERSITARIO S2	17/10/2020 16:27	17/10/2020 19:46	17/10/2020 16:27	17/10/2020 19:46	3,31	19	62,90	CHI
20201091487	SAO JOAO DA PARAUNA	PU12361883	PARAUNA	17/10/2020 16:27	17/10/2020 17:54	17/10/2020 16:27	17/10/2020 17:54	1,44	4	5,75	CHI
20201091491	ITABERAÍ	IB11000015	ITABERAÍ S2	17/10/2020 16:28	17/10/2020 21:15	17/10/2020 16:28	17/10/2020 21:15	4,78	94	449,48	CHI
20201091492	ANAPOLIS	21102041	JUNDIAÍ S1	17/10/2020 16:28	18/10/2020 08:27	17/10/2020 16:28	18/10/2020 08:27	15,98	1	15,98	CHI
20201091514	ANAPOLIS	AN11003265	ANAPOLIS UNIVERSITARIO S2	17/10/2020 16:28	17/10/2020 17:02	17/10/2020 16:28	17/10/2020 17:02	0,56	121	67,59	CHI
20201092120	ANAPOLIS	AN12289096	ANAPOLIS UNIVERSITARIO S2	17/10/2020 16:30	18/10/2020 07:36	17/10/2020 16:30	18/10/2020 07:36	15,09	4	60,36	CHI
20201091508	CATALAO	CT21192676	CATALAO S1	17/10/2020 16:30	17/10/2020 18:38	17/10/2020 16:30	17/10/2020 18:38	2,12	1	2,12	CHI
20201091512	ITARUMA	10006589870	CACHOEIRA ALTA	17/10/2020 16:31	18/10/2020 02:46	17/10/2020 16:31	18/10/2020 02:46	10,25	1	10,25	CHI
20201091560	ABADIANIA	AA12335610	ANAPOLIS UNIVERSITARIO S1	17/10/2020 16:31	17/10/2020 18:26	17/10/2020 16:31	17/10/2020 18:26	1,91	9	17,19	CHI
202010189328	JATAÍ	JT12306843	JATAÍ S1	17/10/2020 16:31	18/10/2020 00:28	17/10/2020 16:31	18/10/2020 00:28	7,94	2	15,88	CHI
20201091520	TURVELANDIA	10008242320	RIO DOS BOIS	17/10/2020 16:33	17/10/2020 18:27	17/10/2020 16:33	17/10/2020 18:27	1,88	1	1,88	CHI
20201091673	SAO FRANCISCO DE GOIAS	SF12000177	SAO FRANCISCO DE GOIAS	17/10/2020 16:37	17/10/2020 18:56	17/10/2020 16:37	17/10/2020 18:56	2,32	4	9,27	CHI
20201092000	ANAPOLIS	AN11258093	ANAPOLIS UNIVERSITARIO S2	17/10/2020 16:37	17/10/2020 21:57	17/10/2020 16:37	17/10/2020 21:57	5,32	79	420,39	CHI
20201091808	ANAPOLIS	AN11004087	ANAPOLIS UNIVERSITARIO S2	17/10/2020 16:38	17/10/2020 20:18	17/10/2020 16:38	17/10/2020 20:18	3,66	134	490,92	CHI
20201091550	APARECIDA DO RIO DOCE	JT21074688	CACHOEIRA ALTA	17/10/2020 16:39	18/10/2020 09:12	17/10/2020 16:39	18/10/2020 09:12	16,54	1	16,54	CHI
20201091557	OURO VERDE DE GOIAS	OV21332160	NEROPOLIS S1	17/10/2020 16:40	18/10/2020 10:57	17/10/2020 16:40	18/10/2020 10:57	18,27	2	36,55	CHI
20201091558	ANAPOLIS	AN21258360	DAIA S1	17/10/2020 16:40	18/10/2020 08:49	17/10/2020 16:40	18/10/2020 08:49	16,14	1	16,14	CHI
20201091624	MONTES CLAROS DE GOIAS	ME12085895	IPORA	17/10/2020 16:41	17/10/2020 23:24	17/10/2020 16:41	17/10/2020 23:24	6,72	20	134,33	CHI
20201091577	IPAMERI	580016274	IPAMERI	17/10/2020 16:42	17/10/2020 18:15	17/10/2020 16:42	17/10/2020 18:15	1,55	1	1,55	CHI
20201091578	JARAGUA	JA12374469	JARAGUA	17/10/2020 16:42	17/10/2020 19:56	17/10/2020 16:42	17/10/2020 19:56	3,22	11	35,47	CHI
20201091649	MINEIROS	MY12332634RE	PARQUE DAS EMAS	17/10/2020 16:43	18/10/2020 15:07	17/10/2020 16:43	18/10/2020 15:07	22,40	7	156,79	CHI
20201091649	MINEIROS	MY12332634RE	PARQUE DAS EMAS	17/10/2020 16:43	18/10/2020 15:07	17/10/2020 16:43	18/10/2020 02:37	9,89	2	19,79	CHI
20201091585	ABADIA DE GOIAS	LG21295238	TRINDADE	17/10/2020 16:44	17/10/2020 21:20	17/10/2020 16:44	17/10/2020 21:20	4,60	2	9,19	CHI
20201091629	JANDAIA	JD12308479	PALMEIRAS	17/10/2020 16:44	17/10/2020 18:15	17/10/2020 16:44	17/10/2020 18:15	1,51	151	227,63	CHI
20201091629	PARAUNA	JD12308479	PALMEIRAS	17/10/2020 16:44	17/10/2020 18:15	17/10/2020 16:44	17/10/2020 18:15	1,51	6	9,05	CHI
20201091596	GOIANESIA	GE21191345	GOIANESIA S2	17/10/2020 16:45	17/10/2020 22:31	17/10/2020 16:45	17/10/2020 22:31	5,75	1	5,75	CHI
20201091598	COLINAS DO SUL	TI21357764	NIQUELANDIA SUBTRANSMISSAO	17/10/2020 16:46	17/10/2020 23:48	17/10/2020 16:46	17/10/2020 23:48	7,03	1	7,03	CHI
20201091601	GOIANIA	12078773	CAMPINAS S3	17/10/2020 16:46	17/10/2020 18:43	17/10/2020 16:46	17/10/2020 18:43	1,94	1	1,94	CHI
20201091602	COCALZINHO DE GOIAS	ZN21101925	COCALZINHO	17/10/2020 16:46	17/10/2020 18:22	17/10/2020 16:46	17/10/2020 18:22	1,59	1	1,59	CHI
20201091704	ANAPOLIS	AN12259031	ANAPOLIS UNIVERSITARIO S2	17/10/2020 16:49	17/10/2020 20:45	17/10/2020 16:49	17/10/2020 20:45	3,93	12	47,11	CHI
20201091619	LUZIANIA	LZ12164807	CRISTALINA S2	17/10/2020 16:52	17/10/2020 20:26	17/10/2020 16:52	17/10/2020 20:26	3,55	2	7,11	CHI
20201091628	APORE	AE21358914	ITAJA S1	17/10/2020 16:55	18/10/2020 14:22	17/10/2020 16:55	18/10/2020 14:22	21,45	1	21,45	CHI
20201091631	CAMPESTRE DE GOIAS	GC11276783	TRINDADE	17/10/2020 16:56	18/10/2020 00:53	17/10/2020 16:56	18/10/2020 00:53	7,95	1	7,95	CHI
20201092559	MONTIVIDIU	RV12060217	MONTIVIDIU T	17/10/2020 16:57	17/10/2020 21:44	17/10/2020 16:57	17/10/2020 21:44	4,77	9	42,97	CHI
20201092559	RIO VERDE	RV12060217	MONTIVIDIU T	17/10/2020 16:57	17/10/2020 21:44	17/10/2020 16:57	17/10/2020 21:44	4,77	1	4,77	CHI
20201091640	PIRENOPOLIS	PV21345655	CORUMBA	17/10/2020 16:57	17/10/2020 22:32	17/10/2020 16:57	17/10/2020 22:32	5,57	1	5,57	CHI
20201091644	PETROLINA DE GOIAS	PG21353355	PETROLINA	17/10/2020 16:58	17/10/2020 19:32	17/10/2020 16:58	17/10/2020 19:32	2,56	1	2,56	CHI
20201091848	PALMEIRAS DE GOIAS	JD12005438	PALMEIRAS	17/10/2020 16:58	17/10/2020 19:27	17/10/2020 16:58	17/10/2020 19:27	2,48	8	19,88	CHI
20201091848	JANDAIA	JD12005438	PALMEIRAS	17/10/2020 16:58	17/10/2020 19:27	17/10/2020 16:58	17/10/2020 19:27	2,48	54	134,18	CHI
20201091848	PALMINOPOLIS	JD12005438	PALMEIRAS	17/10/2020 16:58	17/10/2020 19:27	17/10/2020 16:58	17/10/2020 19:27	2,48	15	37,27	CHI
20201091646	CAMPINORTE	MQ21359545	MARA ROSA	17/10/2020 16:58	17/10/2020 18:40	17/10/2020 16:58	17/10/2020 18:40	1,69	1	1,69	CHI
20201091685	ANAPOLIS	AN12258395	JUNDIAÍ S2	17/10/2020 16:58	17/10/2020 19:24	17/10/2020 16:58	17/10/2020 19:24	2,42	13	31,47	CHI
20201091651	ANAPOLIS	AN12272994	ANAPOLIS UNIVERSITARIO S2	17/10/2020 16:59	17/10/2020 17:18	17/10/2020 16:59	17/10/2020 17:18	0,31	340	105,68	CHI
20201091653	PONTALINA	210049625	PONTALINA	17/10/2020 16:59	17/10/2020 17:55	17/10/2020 16:59	17/10/2020 17:55	0,92	1	0,92	CHI
20201091655	ANAPOLIS	AN11130869	ANAPOLIS UNIVERSITARIO S2	17/10/2020 17:00	17/10/2020 20:00	17/10/2020 17:00	17/10/2020 20:00	3,00	95	284,58	CHI
20201091668	PIRENOPOLIS	SF21210275	CORUMBA	17/10/2020 17:02	18/10/2020 02:25	17/10/2020 17:02	18/10/2020 02:25	9,38	2	18,75	CHI
20201091669	GOIANIA	GN11169524	GOYA S2	17/10/2020 17:02	18/10/2020 09:19	17/10/2020 17:02	18/10/2020 09:19	16,27	7	113,92	CHI
20201091670	ORIZONA	2060023677	PIRES DO RIO S2	17/10/2020 17:02	17/10/2020 22:41	17/10/2020 17:02	17/10/2020 22:41	5,64	1	5,64	CHI
20201091693	PARAUNA	PU12163951	PARAUNA	17/10/2020 17:03	18/10/2020 08:59	17/10/2020 17:03	18/10/2020 08:59	15,93	3	47,78	CHI
20201091738	SANTO ANTONIO DE GOIAS	O1320424	NEROPOLIS S1	17/10/2020 17:08	18/10/2020 03:20	17/10/2020 17:08	18/10/2020 03:20	10,19	605	6167,64	CHI

20201091738	GOIANIA	01320424	NEROPOLIS S1	17/10/2020 17:08	18/10/2020 03:20	17/10/2020 17:08	18/10/2020 03:20	10,19	74	754,39	CHI
20201091738	NEROPOLIS	01320424	NEROPOLIS S1	17/10/2020 17:08	18/10/2020 03:20	17/10/2020 17:08	18/10/2020 03:20	10,19	5	50,97	CHI
20201091738	GOIANIA	01320424	NEROPOLIS S1	17/10/2020 17:08	18/10/2020 03:20	17/10/2020 17:15	18/10/2020 03:20	10,08	64	645,42	CHI
20201091738	NOVA VENEZA	01320424	NEROPOLIS S1	17/10/2020 17:08	18/10/2020 03:20	17/10/2020 17:15	18/10/2020 03:20	10,08	1	10,08	CHI
20201091738	SANTO ANTONIO DE GOIAS	01320424	NEROPOLIS S1	17/10/2020 17:08	18/10/2020 03:20	17/10/2020 17:15	18/10/2020 03:20	10,08	7	70,59	CHI
20201091738	NEROPOLIS	01320424	NEROPOLIS S1	17/10/2020 17:08	18/10/2020 03:20	17/10/2020 17:15	18/10/2020 03:20	10,08	12	121,02	CHI
20201091738	SANTO ANTONIO DE GOIAS	NR13402788	NEROPOLIS S1	17/10/2020 17:08	18/10/2020 03:20	17/10/2020 18:11	18/10/2020 03:20	9,14	25	228,44	CHI
20201091738	SANTO ANTONIO DE GOIAS	01320424	NEROPOLIS S1	17/10/2020 17:08	18/10/2020 03:20	17/10/2020 17:08	18/10/2020 03:20	10,19	2254	22977,65	CHI
20201091738	SANTO ANTONIO DE GOIAS	01320424	NEROPOLIS S1	17/10/2020 17:08	18/10/2020 03:20	17/10/2020 17:08	18/10/2020 03:20	10,19	52	530,04	CHI
20201091738	SANTO ANTONIO DE GOIAS	NV13162418	NEROPOLIS S1	17/10/2020 17:08	18/10/2020 03:20	18/10/2020 01:36	18/10/2020 03:20	1,73	121	209,50	CHI
20201091738	NOVA VENEZA	01320424	NEROPOLIS S1	17/10/2020 17:08	18/10/2020 03:20	18/10/2020 02:07	18/10/2020 02:28	0,35	91	31,67	CHI
20201091738	BRAZABRANTES	01320424	NEROPOLIS S1	17/10/2020 17:08	18/10/2020 03:20	18/10/2020 02:07	18/10/2020 02:28	0,35	9	3,13	CHI
20201091738	GOIANIRA	01320424	NEROPOLIS S1	17/10/2020 17:08	18/10/2020 03:20	18/10/2020 02:07	18/10/2020 02:28	0,35	29	10,09	CHI
20201091738	BRAZABRANTES	01320424	NEROPOLIS S1	17/10/2020 17:08	18/10/2020 03:20	18/10/2020 02:07	18/10/2020 02:28	0,35	1223	425,67	CHI
20201091738	SANTO ANTONIO DE GOIAS	01320424	INHUMAS S1	17/10/2020 17:08	18/10/2020 03:20	18/10/2020 02:07	18/10/2020 02:28	0,35	1	0,35	CHI
20201091738	NOVA VENEZA	01320424	INHUMAS S1	17/10/2020 17:08	18/10/2020 03:20	18/10/2020 02:07	18/10/2020 02:28	0,35	1955	680,45	CHI
20201091738	BRAZABRANTES	01320424	INHUMAS S1	17/10/2020 17:08	18/10/2020 03:20	18/10/2020 02:07	18/10/2020 02:28	0,35	61	21,23	CHI
20201091738	GOIANIRA	01320424	NEROPOLIS S1	17/10/2020 17:08	18/10/2020 03:20	18/10/2020 02:07	18/10/2020 02:28	0,35	22	7,66	CHI
20201091738	SANTO ANTONIO DE GOIAS	01320424	NEROPOLIS S1	17/10/2020 17:08	18/10/2020 03:20	18/10/2020 02:07	18/10/2020 02:28	0,35	5	1,74	CHI
20201091738	NEROPOLIS	01320424	NEROPOLIS S1	17/10/2020 17:08	18/10/2020 03:20	18/10/2020 02:07	18/10/2020 02:28	0,35	117	40,72	CHI
20201091738	DAMOLANDIA	01320424	INHUMAS S1	17/10/2020 17:08	18/10/2020 03:20	18/10/2020 02:07	18/10/2020 02:28	0,35	3	1,04	CHI
20201091738	INHUMAS	01320424	INHUMAS S1	17/10/2020 17:08	18/10/2020 03:20	18/10/2020 02:07	18/10/2020 02:28	0,35	19	6,61	CHI
20201091738	NOVA VENEZA	01320424	NEROPOLIS S1	17/10/2020 17:08	18/10/2020 03:20	18/10/2020 02:07	18/10/2020 02:28	0,35	3	1,04	CHI
20201091738	OURO VERDE DE GOIAS	01320424	INHUMAS S1	17/10/2020 17:08	18/10/2020 03:20	18/10/2020 02:07	18/10/2020 02:28	0,35	50	17,40	CHI
20201091738	BRAZABRANTES	01320424	NEROPOLIS S1	17/10/2020 17:08	18/10/2020 03:20	18/10/2020 02:07	18/10/2020 02:28	0,35	378	131,56	CHI
20201091738	NOVA VENEZA	01320424	INHUMAS S1	17/10/2020 17:08	18/10/2020 03:20	18/10/2020 02:07	18/10/2020 02:28	0,35	2063	718,04	CHI
20201091738	NEROPOLIS	01320424	INHUMAS S1	17/10/2020 17:08	18/10/2020 03:20	18/10/2020 02:07	18/10/2020 02:28	0,35	10	3,48	CHI
20201091738	SANTO ANTONIO DE GOIAS	01320424	NEROPOLIS S1	17/10/2020 17:08	18/10/2020 03:20	17/10/2020 17:08	17/10/2020 20:53	3,74	121	452,98	CHI
20201091738	BRAZABRANTES	01320424	NEROPOLIS S1	17/10/2020 17:08	18/10/2020 03:20	17/10/2020 17:08	17/10/2020 19:18	2,17	9	19,53	CHI
20201091738	NOVA VENEZA	01320424	NEROPOLIS S1	17/10/2020 17:08	18/10/2020 03:20	17/10/2020 17:08	17/10/2020 19:18	2,17	84	182,33	CHI
20201091738	BRAZABRANTES	01320424	INHUMAS S1	17/10/2020 17:08	18/10/2020 03:20	17/10/2020 17:08	17/10/2020 18:36	1,47	58	85,02	CHI
20201091738	NOVA VENEZA	01320424	INHUMAS S1	17/10/2020 17:08	18/10/2020 03:20	17/10/2020 17:08	17/10/2020 18:36	1,47	1955	2865,70	CHI
20201091738	INHUMAS	01320424	INHUMAS S1	17/10/2020 17:08	18/10/2020 03:20	17/10/2020 17:08	17/10/2020 18:36	1,47	19	27,85	CHI
20201091738	OURO VERDE DE GOIAS	01320424	INHUMAS S1	17/10/2020 17:08	18/10/2020 03:20	17/10/2020 17:08	17/10/2020 18:36	1,47	50	73,29	CHI
20201091738	NOVA VENEZA	01320424	NEROPOLIS S1	17/10/2020 17:08	18/10/2020 03:20	17/10/2020 17:08	17/10/2020 18:36	1,47	7	10,26	CHI
20201091738	NOVA VENEZA	01320424	INHUMAS S1	17/10/2020 17:08	18/10/2020 03:20	17/10/2020 17:08	17/10/2020 18:36	1,47	2061	3021,08	CHI
20201091738	DAMOLANDIA	01320424	INHUMAS S1	17/10/2020 17:08	18/10/2020 03:20	17/10/2020 17:08	17/10/2020 18:36	1,47	3	4,40	CHI
20201091738	SANTO ANTONIO DE GOIAS	01320424	INHUMAS S1	17/10/2020 17:08	18/10/2020 03:20	17/10/2020 17:08	17/10/2020 18:36	1,47	1	1,47	CHI
20201091738	NEROPOLIS	01320424	INHUMAS S1	17/10/2020 17:08	18/10/2020 03:20	17/10/2020 17:08	17/10/2020 18:36	1,47	10	14,66	CHI
20201091738	BRAZABRANTES	01320424	INHUMAS S1	17/10/2020 17:08	18/10/2020 03:20	17/10/2020 17:15	17/10/2020 18:36	1,36	3	4,07	CHI
20201091738	NOVA VENEZA	01320424	INHUMAS S1	17/10/2020 17:08	18/10/2020 03:20	17/10/2020 17:15	17/10/2020 18:36	1,36	2	2,71	CHI
20201091738	BRAZABRANTES	01320424	NEROPOLIS S1	17/10/2020 17:08	18/10/2020 03:20	17/10/2020 17:08	17/10/2020 18:14	1,09	1223	1339,18	CHI
20201091738	GOIANIRA	01320424	NEROPOLIS S1	17/10/2020 17:08	18/10/2020 03:20	17/10/2020 17:08	17/10/2020 18:14	1,09	22	24,09	CHI
20201091738	SANTO ANTONIO DE GOIAS	01320424	NEROPOLIS S1	17/10/2020 17:08	18/10/2020 03:20	17/10/2020 17:08	17/10/2020 18:14	1,09	5	5,47	CHI
20201091738	SANTO ANTONIO DE GOIAS	01320424	NEROPOLIS S1	17/10/2020 17:08	18/10/2020 03:20	17/10/2020 17:08	17/10/2020 18:11	1,05	1	1,05	CHI
20201091738	NEROPOLIS	01320424	NEROPOLIS S1	17/10/2020 17:08	18/10/2020 03:20	17/10/2020 17:08	17/10/2020 18:11	1,05	117	122,56	CHI
20201091738	GOIANIRA	IN16407240	NEROPOLIS S1	17/10/2020 17:08	18/10/2020 03:20	17/10/2020 17:08	17/10/2020 17:15	0,12	29	3,58	CHI
20201091738	BRAZABRANTES	IN16407240	NEROPOLIS S1	17/10/2020 17:08	18/10/2020 03:20	17/10/2020 17:08	17/10/2020 17:15	0,12	378	46,72	CHI
20201091738	NOVA VENEZA	IN16407240	NEROPOLIS S1	17/10/2020 17:08	18/10/2020 03:20	17/10/2020 17:08	17/10/2020 17:15	0,12	3	0,37	CHI
20201091738	SANTO ANTONIO DE GOIAS	01320424	NEROPOLIS S1	17/10/2020 17:08	18/10/2020 03:20	17/10/2020 17:08	17/10/2020 17:14	0,10	25	2,44	CHI
20201091763	PIRENOPOLIS	PV12302141	SAO FRANCISCO DE GOIAS	17/10/2020 17:08	18/10/2020 00:27	17/10/2020 17:08	18/10/2020 00:27	7,30	94	686,44	CHI

20201091744	GOIANIA	10002444303	MEIA PONTE	17/10/2020 17:15	17/10/2020 23:41	17/10/2020 17:15	17/10/2020 23:41	6,43	1	6,43	CHI
20201092491	GOIANIA	GN11001774	FERROVIARIO S3	17/10/2020 17:16	18/10/2020 12:00	17/10/2020 17:16	18/10/2020 12:00	18,73	92	1723,19	CHI
20201091755	GOIANESIA	SZ21346787	ITAPACI	17/10/2020 17:16	17/10/2020 19:18	17/10/2020 17:16	17/10/2020 19:18	2,03	1	2,03	CHI
20201091762	QUIRINOPOLIS	80018452	QUIRINOPOLIS	17/10/2020 17:18	17/10/2020 19:41	17/10/2020 17:18	17/10/2020 19:41	2,38	1	2,38	CHI
20201091773	URUACU	UR21292555	CAMPINORTE	17/10/2020 17:20	17/10/2020 19:31	17/10/2020 17:20	17/10/2020 19:31	2,18	1	2,18	CHI
20201091775	ANAPOLIS	AN12414610	ANAPOLIS UNIVERSITARIO S2	17/10/2020 17:20	17/10/2020 22:34	17/10/2020 17:20	17/10/2020 22:34	5,23	11	57,51	CHI
20201091775	CAMPO LIMPO	AN12414610	ANAPOLIS UNIVERSITARIO S2	17/10/2020 17:20	17/10/2020 22:34	17/10/2020 17:20	17/10/2020 22:34	5,23	5	26,14	CHI
20201091782	PARAUNA	PU21326807	ACREUNA	17/10/2020 17:21	18/10/2020 16:43	17/10/2020 17:21	18/10/2020 16:43	23,36	1	23,36	CHI
20201091785	TEREZOPOLIS DE GOIAS	TJ21377699	JUNDIAI S2	17/10/2020 17:21	17/10/2020 19:38	17/10/2020 17:21	17/10/2020 19:38	2,27	4	9,07	CHI
20201091788	LUZIANIA	LZ21200520	MARAJOARA	17/10/2020 17:22	17/10/2020 20:45	17/10/2020 17:22	17/10/2020 20:45	3,38	1	3,38	CHI
20201091790	GOIANIA	GN12383188	GOYA S2	17/10/2020 17:22	18/10/2020 06:29	18/10/2020 04:29	18/10/2020 06:29	2,01	4	8,03	CHI
20201091790	GOIANIA	GN21045318	GOYA S2	17/10/2020 17:22	18/10/2020 06:29	17/10/2020 17:22	18/10/2020 06:25	13,05	1	13,05	CHI
20201091791	CAMPINORTE	CR11257439	PORANGATU	17/10/2020 17:22	17/10/2020 22:11	17/10/2020 17:22	17/10/2020 22:11	4,80	1	4,80	CHI
20201091672	TRINDADE	TR11129535	GOYA S2	17/10/2020 17:23	18/10/2020 05:15	17/10/2020 17:23	18/10/2020 05:15	11,86	119	1411,77	CHI
20201091923	RUBIATABA	RB12070858RE	RUBIATABA	17/10/2020 17:26	17/10/2020 20:07	17/10/2020 17:26	17/10/2020 20:07	2,67	37	98,79	CHI
20201091822	GOIATUBA	GT21190909	GOIATUBA S2	17/10/2020 17:26	17/10/2020 18:12	17/10/2020 17:26	17/10/2020 18:12	0,75	1	0,75	CHI
20201092313	PARAUNA	CG12391407	FIRMINOPOLIS S2	17/10/2020 17:28	17/10/2020 20:10	17/10/2020 17:28	17/10/2020 20:10	2,69	32	86,21	CHI
20201092313	CACHOEIRA DE GOIAS	CG12391407	FIRMINOPOLIS S2	17/10/2020 17:28	17/10/2020 20:10	17/10/2020 17:28	17/10/2020 20:10	2,69	58	156,26	CHI
20201092313	AURILANDIA	CG12391407	FIRMINOPOLIS S2	17/10/2020 17:28	17/10/2020 20:10	17/10/2020 17:28	17/10/2020 20:10	2,69	2	5,39	CHI
20201092021	ANICUNS	AC12304663	FIRMINOPOLIS S2	17/10/2020 17:28	18/10/2020 08:02	17/10/2020 17:28	18/10/2020 08:02	14,55	11	160,10	CHI
20201091834	ANAPOLIS	10020397460	ANAPOLIS UNIVERSITARIO S2	17/10/2020 17:29	18/10/2020 10:11	17/10/2020 17:29	18/10/2020 10:11	16,69	1	16,69	CHI
20201091847	GOIANIA	GN21001393	AEROPORTO S1	17/10/2020 17:31	18/10/2020 11:00	17/10/2020 17:31	18/10/2020 11:00	17,47	11	192,14	CHI
20201091849	QUIRINOPOLIS	QI21303275	CACHOEIRA ALTA	17/10/2020 17:33	17/10/2020 21:03	17/10/2020 17:33	17/10/2020 21:03	3,50	1	3,50	CHI
20201091864	GOIANDIRA	GD12127529	CATALAO S1	17/10/2020 17:35	17/10/2020 18:40	17/10/2020 17:35	17/10/2020 18:40	1,07	10	10,74	CHI
20201092067	GOIANIA	GN10424461	CAMPINAS S2	17/10/2020 17:36	17/10/2020 18:54	17/10/2020 17:36	17/10/2020 18:54	1,31	87	113,87	CHI
20201092067	GOIANIA	GN10424461	CAMPINAS S2	17/10/2020 17:36	17/10/2020 18:54	17/10/2020 17:36	17/10/2020 18:53	1,28	362	463,46	CHI
20201092013	ABADIANIA	AN12258800	ANAPOLIS UNIVERSITARIO S2	17/10/2020 17:36	17/10/2020 19:27	17/10/2020 17:36	17/10/2020 19:27	1,84	10	18,40	CHI
20201091886	GOIANIA	GN12398018	XAVANTES	17/10/2020 17:36	18/10/2020 17:19	17/10/2020 17:44	18/10/2020 17:19	23,58	27	636,78	CHI
20201091886	GOIANIA	GN13395297	XAVANTES	17/10/2020 17:36	18/10/2020 17:19	17/10/2020 17:44	18/10/2020 16:54	23,17	3	69,50	CHI
20201091886	GOIANIA	GN10394641	XAVANTES	17/10/2020 17:36	18/10/2020 17:19	18/10/2020 03:47	18/10/2020 03:57	0,17	2416	400,65	CHI
20201091886	GOIANIA	GN16421055	XAVANTES	17/10/2020 17:36	18/10/2020 17:19	18/10/2020 02:50	18/10/2020 03:48	0,97	1393	1348,11	CHI
20201091886	GOIANIA	GN16422741	XAVANTES	17/10/2020 17:36	18/10/2020 17:19	17/10/2020 18:13	18/10/2020 02:56	8,73	149	1300,60	CHI
20201091886	GOIANIA	GN16422741	XAVANTES	17/10/2020 17:36	18/10/2020 17:19	17/10/2020 18:18	18/10/2020 01:29	7,18	1294	9297,03	CHI
20201091886	GOIANIA	GN16421055	XAVANTES	17/10/2020 17:36	18/10/2020 17:19	17/10/2020 18:20	18/10/2020 01:29	7,16	99	709,01	CHI
20201091886	GOIANIA	GN16403892	XAVANTES	17/10/2020 17:36	18/10/2020 17:19	17/10/2020 21:29	17/10/2020 21:39	0,15	1937	299,70	CHI
20201091886	GOIANIA	GN16403892	XAVANTES	17/10/2020 17:36	18/10/2020 17:19	17/10/2020 17:44	17/10/2020 19:34	1,82	1937	3532,33	CHI
20201091886	GOIANIA	GN10394641	XAVANTES	17/10/2020 17:36	18/10/2020 17:19	17/10/2020 18:13	17/10/2020 18:21	0,14	479	66,93	CHI
20201091886	GOIANIA	GN16420374	XAVANTES	17/10/2020 17:36	18/10/2020 17:19	17/10/2020 18:13	17/10/2020 18:21	0,13	419	56,10	CHI
20201091886	GOIANIA	GN10394641	XAVANTES	17/10/2020 17:36	18/10/2020 17:19	17/10/2020 17:36	17/10/2020 17:40	0,05	1967	107,09	CHI
20201091874	CAMPESTRE DE GOIAS	1230007973	TRINDADE	17/10/2020 17:37	17/10/2020 20:03	17/10/2020 17:37	17/10/2020 20:03	2,43	1	2,43	CHI
20201091875	NOVA CRIXAS	NA21091712	NOVA CRIXAS	17/10/2020 17:37	17/10/2020 21:39	17/10/2020 17:37	17/10/2020 21:39	4,03	1	4,03	CHI
20201092433	SANTA TEREZA DE GOIAS	SE13262656	MARA ROSA	17/10/2020 17:37	18/10/2020 17:56	17/10/2020 17:37	18/10/2020 17:56	24,33	7	170,28	CHI
20201092433	SANTA TEREZA DE GOIAS	SE13066559	MARA ROSA	17/10/2020 17:37	18/10/2020 17:56	17/10/2020 21:38	18/10/2020 17:56	20,31	9	182,83	CHI
20201092433	SANTA TEREZA DE GOIAS	SE21143625	MARA ROSA	17/10/2020 17:37	18/10/2020 17:56	17/10/2020 21:38	18/10/2020 17:47	20,15	1	20,15	CHI
20201092433	SANTA TEREZA DE GOIAS	FO12060936RE	MARA ROSA	17/10/2020 17:37	18/10/2020 17:56	17/10/2020 21:38	18/10/2020 12:19	14,68	1	14,68	CHI
20201092433	SANTA TEREZA DE GOIAS	FO12060936RE	MARA ROSA	17/10/2020 17:37	18/10/2020 17:56	18/10/2020 10:26	18/10/2020 12:19	1,87	6	11,24	CHI
20201092433	FORMOSO	FO12060936RE	MARA ROSA	17/10/2020 17:37	18/10/2020 17:56	18/10/2020 10:26	18/10/2020 12:19	1,87	4	7,49	CHI
20201092433	SANTA TEREZA DE GOIAS	SE12143626	MARA ROSA	17/10/2020 17:37	18/10/2020 17:56	17/10/2020 17:37	17/10/2020 23:23	5,77	1	5,77	CHI
20201092433	SANTA TEREZA DE GOIAS	SE12143626	MARA ROSA	17/10/2020 17:37	18/10/2020 17:56	17/10/2020 21:38	17/10/2020 23:23	1,76	1	1,76	CHI
20201092433	SANTA TEREZA DE GOIAS	SE13262656	MARA ROSA	17/10/2020 17:37	18/10/2020 17:56	17/10/2020 17:37	17/10/2020 22:57	5,34	2	10,68	CHI
20201092433	SANTA TEREZA DE GOIAS	SE13262656	MARA ROSA	17/10/2020 17:37	18/10/2020 17:56	17/10/2020 21:38	17/10/2020 22:57	1,33	1	1,33	CHI

20201092433	FORMOSO	FO12060936RE	MARA ROSA	17/10/2020 17:37	18/10/2020 17:56	17/10/2020 21:38	17/10/2020 22:07	0,50	5	2,48	CHI
20201092433	SANTA TEREZA DE GOIAS	FO12060936RE	MARA ROSA	17/10/2020 17:37	18/10/2020 17:56	17/10/2020 21:38	17/10/2020 22:07	0,50	10	4,95	CHI
20201092433	SANTA TEREZA DE GOIAS	SE13262656	MARA ROSA	17/10/2020 17:37	18/10/2020 17:56	17/10/2020 17:37	17/10/2020 21:38	4,01	2	8,02	CHI
20201092433	SANTA TEREZA DE GOIAS	FO12060936RE	MARA ROSA	17/10/2020 17:37	18/10/2020 17:56	17/10/2020 17:37	17/10/2020 21:11	3,56	6	21,36	CHI
20201092433	FORMOSO	FO12060936RE	MARA ROSA	17/10/2020 17:37	18/10/2020 17:56	17/10/2020 17:37	17/10/2020 21:11	3,56	1	3,56	CHI
20201091879	ITUMBIARA	IT21198608	ITUMBIARA NOVA	17/10/2020 17:37	17/10/2020 18:37	17/10/2020 17:37	17/10/2020 18:37	0,98	1	0,98	CHI
20201091880	CRISTALINA	KR12248743	CRISTALINA S2	17/10/2020 17:38	17/10/2020 19:51	17/10/2020 17:38	17/10/2020 19:51	2,21	5	11,07	CHI
20201091880	CRISTALINA	KR12248743	CRISTALINA S2	17/10/2020 17:38	17/10/2020 19:51	17/10/2020 17:38	17/10/2020 19:51	2,21	3	6,64	CHI
202010189360	CACHOEIRA DE GOIAS	CG12377182	FIRMINOPOLIS S2	17/10/2020 17:38	17/10/2020 20:10	17/10/2020 17:38	17/10/2020 20:10	2,53	11	27,82	CHI
20201091975	ANAPOLIS	AN11135803	DAIA S1	17/10/2020 17:38	17/10/2020 19:56	17/10/2020 17:38	17/10/2020 19:56	2,29	84	192,27	CHI
20201091907	GOIANIA	GN10394640	XAVANTES	17/10/2020 17:40	18/10/2020 04:07	17/10/2020 17:40	18/10/2020 04:07	10,45	34	355,47	CHI
20201091907	GOIANIA	GN10394640	XAVANTES	17/10/2020 17:40	18/10/2020 04:07	17/10/2020 17:40	18/10/2020 04:04	10,39	24	249,43	CHI
20201091907	GOIANIA	GN10394640	XAVANTES	17/10/2020 17:40	18/10/2020 04:07	17/10/2020 17:40	18/10/2020 01:05	7,42	696	5162,00	CHI
20201091907	SANTO ANTONIO DE GOIAS	GN10394640	XAVANTES	17/10/2020 17:40	18/10/2020 04:07	17/10/2020 17:40	18/10/2020 00:40	7,00	15	105,01	CHI
20201091907	GOIANIA	GN10394640	XAVANTES	17/10/2020 17:40	18/10/2020 04:07	17/10/2020 17:40	18/10/2020 00:40	7,00	553	3871,31	CHI
20201091907	GOIANIA	GN10394640	XAVANTES	17/10/2020 17:40	18/10/2020 04:07	17/10/2020 17:40	17/10/2020 22:22	4,70	108	507,63	CHI
20201091894	MUNDO NOVO DE GOIAS	MH11269172	NOVA CRIXAS	17/10/2020 17:41	17/10/2020 19:05	17/10/2020 17:41	17/10/2020 19:05	1,40	1	1,40	CHI
20201091899	ARAGOIANIA	AO21238603	INDEPENDENCIA S2	17/10/2020 17:42	17/10/2020 22:11	17/10/2020 17:42	17/10/2020 22:11	4,48	2	8,96	CHI
20201091905	SENADOR CANEDO	GN12060626	GOIANIA LESTE S2	17/10/2020 17:43	17/10/2020 21:09	17/10/2020 17:43	17/10/2020 21:09	3,44	99	340,56	CHI
20201091910	PIRENOPOLIS	PV21017590	CORUMBA	17/10/2020 17:44	17/10/2020 20:55	17/10/2020 17:44	17/10/2020 20:55	3,20	2	6,39	CHI
20201091912	BONOPOLIS	BX21128366	SAO MIGUEL DO ARAGUAIA	17/10/2020 17:44	17/10/2020 20:57	17/10/2020 17:44	17/10/2020 20:57	3,21	1	3,21	CHI
20201091969	GOIANIA	GN11130434	MEIA PONTE	17/10/2020 17:46	18/10/2020 10:35	17/10/2020 17:46	18/10/2020 10:35	16,80	207	3477,71	CHI
20201093114	GOIANIA	GN11002148	GOYA S1	17/10/2020 17:47	17/10/2020 23:51	17/10/2020 17:47	17/10/2020 23:51	6,07	67	406,39	CHI
20201092164	GOIANIA	GN12001784	GOYA S1	17/10/2020 17:47	17/10/2020 20:26	17/10/2020 17:47	17/10/2020 20:26	2,65	79	209,64	CHI
20201091931	SAO LUIS DE MONTES BELOS	SL21145854	FIRMINOPOLIS S2	17/10/2020 17:47	17/10/2020 23:36	17/10/2020 17:47	17/10/2020 23:36	5,81	1	5,81	CHI
20201091933	BELA VISTA DE GOIAS	BV21102775	CEPAIGO S2	17/10/2020 17:47	17/10/2020 20:21	17/10/2020 17:47	17/10/2020 20:21	2,56	1	2,56	CHI
20201091985	SENADOR CANEDO	SW11251960	GOIANIA LESTE S1	17/10/2020 17:48	17/10/2020 19:23	17/10/2020 17:48	17/10/2020 19:23	1,58	103	162,94	CHI
20201092230	TRINDADE	TR12390005	GOYA S2	17/10/2020 17:49	17/10/2020 19:57	17/10/2020 17:49	17/10/2020 19:57	2,15	637	1366,54	CHI
20201092303	GOIANIA	GN11161023	CAMPINAS S2	17/10/2020 17:49	17/10/2020 20:52	17/10/2020 17:49	17/10/2020 20:52	3,05	111	338,49	CHI
20201091964	CRISTALINA	KR21219672	CRISTALINA S1	17/10/2020 17:49	17/10/2020 20:44	17/10/2020 17:49	17/10/2020 20:44	2,91	1	2,91	CHI
20201091951	GOIANIA	GN11040689	CAMPINAS S2	17/10/2020 17:49	17/10/2020 19:31	17/10/2020 17:49	17/10/2020 19:31	1,69	120	202,70	CHI
20201092097	GOIANIA	GN11147729	MEIA PONTE	17/10/2020 17:50	17/10/2020 22:00	17/10/2020 17:50	17/10/2020 22:00	4,16	134	558,00	CHI
20201091958	GOIANESIA	GE21406189	GOIANESIA S2	17/10/2020 17:50	18/10/2020 00:32	17/10/2020 17:50	18/10/2020 00:32	6,69	1	6,69	CHI
20201091974	SANTO ANTONIO DO DESCOBERTO	SN21314252	MARAJOARA	17/10/2020 17:52	17/10/2020 21:27	17/10/2020 17:52	17/10/2020 21:27	3,58	2	7,15	CHI
202010180081	ANICUNS	AC13323623	ANICUNS	17/10/2020 17:53	17/10/2020 18:43	17/10/2020 17:53	17/10/2020 18:43	0,83	1	0,83	CHI
20201091996	GOIATUBA	140061046	GOIATUBA S2	17/10/2020 17:56	17/10/2020 18:40	17/10/2020 17:56	17/10/2020 18:40	0,72	1	0,72	CHI
20201093458	NOVA CRIXAS	NA12262740	NOVA CRIXAS	17/10/2020 17:58	18/10/2020 03:51	17/10/2020 17:58	18/10/2020 03:51	9,87	107	1056,45	CHI
20201092016	FIRMINOPOLIS	FR12362920	FIRMINOPOLIS S2	17/10/2020 17:59	17/10/2020 20:52	17/10/2020 17:59	17/10/2020 20:52	2,87	1	2,87	CHI
20201092020	ANAPOLIS	10010706141	ANAPOLIS UNIVERSITARIO S2	17/10/2020 18:00	18/10/2020 07:52	17/10/2020 18:00	18/10/2020 07:52	13,86	1	13,86	CHI
20201091040	ARACU	00090424	ANICUNS	17/10/2020 18:01	17/10/2020 18:11	17/10/2020 18:01	17/10/2020 18:11	0,17	17	2,95	CHI
20201091040	AVELINOPOLIS	00090424	ANICUNS	17/10/2020 18:01	17/10/2020 18:11	17/10/2020 18:01	17/10/2020 18:11	0,17	224	38,83	CHI
20201091040	SANTA BARBARA DE GOIAS	00090424	ANICUNS	17/10/2020 18:01	17/10/2020 18:11	17/10/2020 18:01	17/10/2020 18:11	0,17	8	1,39	CHI
20201091040	NAZARIO	00090424	ANICUNS	17/10/2020 18:01	17/10/2020 18:11	17/10/2020 18:01	17/10/2020 18:11	0,17	10	1,73	CHI
20201091040	CATURAI	00090424	ANICUNS	17/10/2020 18:01	17/10/2020 18:11	17/10/2020 18:01	17/10/2020 18:11	0,17	9	1,56	CHI
20201091040	ARACU	00090424	ANICUNS	17/10/2020 18:01	17/10/2020 18:11	17/10/2020 18:01	17/10/2020 18:11	0,17	2	0,35	CHI
20201091040	TURVANIA	00090424	ANICUNS	17/10/2020 18:01	17/10/2020 18:11	17/10/2020 18:01	17/10/2020 18:11	0,17	6	1,04	CHI
20201091040	ANICUNS	00090424	ANICUNS	17/10/2020 18:01	17/10/2020 18:11	17/10/2020 18:01	17/10/2020 18:11	0,17	14	2,43	CHI
20201091040	AVELINOPOLIS	00090424	ANICUNS	17/10/2020 18:01	17/10/2020 18:11	17/10/2020 18:01	17/10/2020 18:11	0,17	2	0,35	CHI
20201091040	AVELINOPOLIS	00090424	ANICUNS	17/10/2020 18:01	17/10/2020 18:11	17/10/2020 18:01	17/10/2020 18:11	0,17	1093	189,45	CHI
20201091040	ITABERAÍ	00090424	ANICUNS	17/10/2020 18:01	17/10/2020 18:11	17/10/2020 18:01	17/10/2020 18:11	0,17	42	7,28	CHI
20201091040	ITABERAÍ	00090424	ANICUNS	17/10/2020 18:01	17/10/2020 18:11	17/10/2020 18:01	17/10/2020 18:11	0,17	18	3,12	CHI

20201091040	ANICUNS	00090424	ANICUNS	17/10/2020 18:01	17/10/2020 18:11	17/10/2020 18:01	17/10/2020 18:11	0,17	255	44,20	CHI
20201092453	GOIANIA	GN11166218	MEIA PONTE	17/10/2020 18:02	18/10/2020 09:14	17/10/2020 18:02	18/10/2020 09:14	15,20	145	2203,60	CHI
20201092028	COCALZINHO DE GOIAS	ZN12320107	AGUAS LINDAS DE GOIAS S1	17/10/2020 18:02	17/10/2020 20:05	17/10/2020 18:02	17/10/2020 20:05	2,04	14	28,61	CHI
20201092455	SAO FRANCISCO DE GOIAS	SF12319829	SAO FRANCISCO DE GOIAS	17/10/2020 18:02	17/10/2020 19:54	17/10/2020 18:02	17/10/2020 19:54	1,85	20	37,01	CHI
20201092035	GOIAS	GS21248145	ITABERAI S1	17/10/2020 18:04	17/10/2020 23:15	17/10/2020 18:04	17/10/2020 23:15	5,18	1	5,18	CHI
20201092683	PORANGATU	PO12208614	PORANGATU	17/10/2020 18:04	17/10/2020 20:15	17/10/2020 18:04	17/10/2020 20:15	2,17	10	21,70	CHI
20201092044	JARAGUA	JA21170569	JARAGUA	17/10/2020 18:05	17/10/2020 21:53	17/10/2020 18:05	17/10/2020 21:53	3,78	1	3,78	CHI
20201092598	SAO MIGUEL DO ARAGUAIA	SM12351119LD	SAO MIGUEL DO ARAGUAIA	17/10/2020 18:07	18/10/2020 04:24	17/10/2020 18:07	18/10/2020 04:24	10,28	212	2179,01	CHI
20201092598	SAO MIGUEL DO ARAGUAIA	SM12086469	SAO MIGUEL DO ARAGUAIA	17/10/2020 18:07	18/10/2020 04:24	17/10/2020 18:07	17/10/2020 23:41	5,57	277	1542,12	CHI
20201092598	SAO MIGUEL DO ARAGUAIA	SM10406657	SAO MIGUEL DO ARAGUAIA	17/10/2020 18:07	18/10/2020 04:24	17/10/2020 23:34	17/10/2020 23:38	0,07	567	39,06	CHI
20201092598	NOVA CRIXAS	SM10406657	SAO MIGUEL DO ARAGUAIA	17/10/2020 18:07	18/10/2020 04:24	17/10/2020 23:34	17/10/2020 23:38	0,07	1	0,07	CHI
20201092598	SAO MIGUEL DO ARAGUAIA	SM10406657	SAO MIGUEL DO ARAGUAIA	17/10/2020 18:07	18/10/2020 04:24	17/10/2020 22:59	17/10/2020 23:17	0,29	567	165,53	CHI
20201092598	NOVA CRIXAS	SM10406657	SAO MIGUEL DO ARAGUAIA	17/10/2020 18:07	18/10/2020 04:24	17/10/2020 22:59	17/10/2020 23:17	0,29	1	0,29	CHI
20201092052	SAO MIGUEL DO ARAGUAIA	SM12113573	SAO MIGUEL DO ARAGUAIA	17/10/2020 18:07	17/10/2020 22:53	17/10/2020 18:07	17/10/2020 22:53	4,75	4	19,01	CHI
20201092068	GOIANIA	GN10413219	XAVANTES	17/10/2020 18:08	17/10/2020 23:03	17/10/2020 18:08	17/10/2020 23:03	4,92	752	3696,50	CHI
20201092060	ITAPACI	IW21277369	ITAPACI	17/10/2020 18:09	17/10/2020 23:11	17/10/2020 18:09	17/10/2020 23:11	5,03	1	5,03	CHI
20201092061	SILVANIA	SV12390025	VIANOPOLIS	17/10/2020 18:09	17/10/2020 21:09	17/10/2020 18:09	17/10/2020 21:09	2,99	1	2,99	CHI
20201092503	GOIANIA	GN11002045	CAMPINAS S2	17/10/2020 18:09	17/10/2020 21:51	17/10/2020 18:09	17/10/2020 21:51	3,69	71	262,13	CHI
20201092063	VILA PROPICIO	NP11224244	GOIANESIA S1	17/10/2020 18:09	17/10/2020 19:22	17/10/2020 18:09	17/10/2020 19:22	1,21	2	2,41	CHI
20201093067	JATAI	JT12355226	JATAI S1	17/10/2020 18:10	18/10/2020 01:30	17/10/2020 18:10	18/10/2020 01:30	7,32	5	36,62	CHI
20201092072	ABADIANIA	AA21399222	ANAPOLIS UNIVERSITARIO S1	17/10/2020 18:10	18/10/2020 08:55	17/10/2020 18:10	18/10/2020 08:55	14,74	1	14,74	CHI
20201092076	PARAUNA	PU12295900LD	ACREUNA	17/10/2020 18:11	18/10/2020 02:55	17/10/2020 18:11	18/10/2020 02:55	8,72	7	61,06	CHI
20201092580	GOIANIA	GN11002153	GOYA S2	17/10/2020 18:11	18/10/2020 01:26	17/10/2020 18:11	18/10/2020 01:26	7,24	136	984,49	CHI
20201092100	COLINAS DO SUL	TI12396760	MINACU	17/10/2020 18:12	18/10/2020 00:26	17/10/2020 18:12	18/10/2020 00:26	6,23	11	68,48	CHI
20201092100	NIQUELANDIA	TI12396760	MINACU	17/10/2020 18:12	18/10/2020 00:26	17/10/2020 18:12	18/10/2020 00:26	6,23	1	6,23	CHI
20201092428	GOIANIA	GN12383183	XAVANTES	17/10/2020 18:12	18/10/2020 08:00	17/10/2020 18:12	18/10/2020 08:00	13,79	240	3308,53	CHI
20201092102	ABADIANIA	1400000900	CORUMBA	17/10/2020 18:12	18/10/2020 03:32	17/10/2020 18:12	18/10/2020 03:32	9,33	1	9,33	CHI
2020101700067	GOIANIA	00630214	XAVANTES	17/10/2020 18:13	17/10/2020 18:19	17/10/2020 18:13	17/10/2020 18:19	0,10	8593	859,30	CHI
20201092156	RIO VERDE	10002104766	CABRIUVA S1	17/10/2020 18:15	17/10/2020 21:47	17/10/2020 18:15	17/10/2020 21:47	3,52	1	3,52	CHI
20201092174	ITABERAI	IB11188029	ITABERAI S2	17/10/2020 18:16	17/10/2020 19:28	17/10/2020 18:16	17/10/2020 19:28	1,19	49	58,54	CHI
20201092509	GOIANIA	GN11002368	AEROPORTO S1	17/10/2020 18:16	18/10/2020 11:20	17/10/2020 18:16	18/10/2020 11:20	17,06	30	511,66	CHI
20201092197	OURO VERDE DE GOIAS	OV11332114	NEROPOLIS S2	17/10/2020 18:16	17/10/2020 22:02	17/10/2020 18:16	17/10/2020 22:02	3,75	4	15,01	CHI
20201092715	GOIANIA	GN11001923	FERROVIARIO S3	17/10/2020 18:17	17/10/2020 20:18	17/10/2020 18:17	17/10/2020 20:18	2,01	116	233,03	CHI
20201092352	MOSSAMEDES	MD12050971	FIRMINOPOLIS S2	17/10/2020 18:17	18/10/2020 04:47	17/10/2020 18:17	18/10/2020 04:47	10,49	1	10,49	CHI
20201092352	ADELANDIA	MD12050971	FIRMINOPOLIS S2	17/10/2020 18:17	18/10/2020 04:47	17/10/2020 18:17	18/10/2020 04:47	10,49	15	157,28	CHI
20201092354	GOIANIA	GN11185428	XAVANTES	17/10/2020 18:17	18/10/2020 10:45	17/10/2020 18:17	18/10/2020 10:45	16,45	210	3454,68	CHI
20201093249	GOIANIA	GN11043359	XAVANTES	17/10/2020 18:18	17/10/2020 23:16	17/10/2020 18:18	17/10/2020 23:16	4,96	95	471,44	CHI
20201092484	GOIANIA	GN12043355	XAVANTES	17/10/2020 18:18	17/10/2020 21:14	17/10/2020 18:18	17/10/2020 21:14	2,93	101	295,85	CHI
20201092858	ANAPOLIS	AN12084838	NEROPOLIS S1	17/10/2020 18:19	17/10/2020 21:37	17/10/2020 18:19	17/10/2020 21:37	3,29	13	42,81	CHI
20201092858	PIRENOPOLIS	AN12084838	NEROPOLIS S1	17/10/2020 18:19	17/10/2020 21:37	17/10/2020 18:19	17/10/2020 21:37	3,29	1	3,29	CHI
20201092261	JAUPACI	JP12349650	IPORA	17/10/2020 18:20	17/10/2020 20:05	17/10/2020 18:20	17/10/2020 20:05	1,75	13	22,70	CHI
20201092320	GOIANIA	GN11164386	XAVANTES	17/10/2020 18:21	18/10/2020 01:44	17/10/2020 18:21	18/10/2020 01:44	7,37	141	1038,93	CHI
20201092366	GOIANIA	GN12000703	REAL S2	17/10/2020 18:22	17/10/2020 20:14	17/10/2020 18:22	17/10/2020 20:14	1,86	70	130,24	CHI
20201092291	JATAI	JT12346054	JATAI S1	17/10/2020 18:22	17/10/2020 21:35	17/10/2020 18:22	17/10/2020 21:35	3,21	1	3,21	CHI
202010189329	DOVERLANDIA	DV12395475	CAIAPONIA	17/10/2020 18:22	17/10/2020 20:14	17/10/2020 18:22	17/10/2020 20:14	1,85	11	20,38	CHI
20201092301	AGUAS LINDAS DE GOIAS	10000365201	AGUAS LINDAS DE GOIAS S2	17/10/2020 18:24	17/10/2020 19:35	17/10/2020 18:24	17/10/2020 19:35	1,18	1	1,18	CHI
20201092648	GOIANIA	GN11347467	GOYA S1	17/10/2020 18:24	17/10/2020 20:20	17/10/2020 18:24	17/10/2020 20:20	1,92	59	113,57	CHI
20201092309	GOIANIA	GN12001527	GOYA S1	17/10/2020 18:24	17/10/2020 21:19	17/10/2020 18:24	17/10/2020 21:19	2,90	62	180,06	CHI
20201092490	MORRO AGUDO DE GOIAS	MS12136795	ITAPURANGA	17/10/2020 18:25	17/10/2020 21:44	17/10/2020 18:25	17/10/2020 21:44	3,31	37	122,50	CHI
20201092487	BURITI ALEGRE	BG12257085	ITUMBIARA VELHA S2	17/10/2020 18:26	17/10/2020 20:31	17/10/2020 18:26	17/10/2020 20:31	2,08	5	10,38	CHI
20201092487	ITUMBIARA	BG12257085	ITUMBIARA VELHA S2	17/10/2020 18:26	17/10/2020 20:31	17/10/2020 18:26	17/10/2020 20:31	2,08	4	8,30	CHI

20201092329	GOIANIA	GN11001267	CARAJAS S2	17/10/2020 18:26	18/10/2020 10:17	17/10/2020 18:26	18/10/2020 10:17	15,84	173	2740,22	CHI
20201092333	NAZARIO	NZ21233490	ANICUNS	17/10/2020 18:27	17/10/2020 20:59	17/10/2020 18:27	17/10/2020 20:59	2,53	1	2,53	CHI
20201092346	VIANOPOLIS	VN122229564	VIANOPOLIS	17/10/2020 18:28	17/10/2020 19:46	17/10/2020 18:28	17/10/2020 19:46	1,29	5	6,47	CHI
20201092348	LUZIANIA	120365080	VIANOPOLIS	17/10/2020 18:28	17/10/2020 20:55	17/10/2020 18:28	17/10/2020 20:55	2,45	1	2,45	CHI
20201092357	GOIANIA	10011283490	GOYA S2	17/10/2020 18:29	17/10/2020 20:12	17/10/2020 18:29	17/10/2020 20:12	1,71	1	1,71	CHI
20201092379	PIRACANJUBA	PJ21033271	MORRINHOS	17/10/2020 18:31	17/10/2020 19:48	17/10/2020 18:31	17/10/2020 19:48	1,27	1	1,27	CHI
20201092388	GOIANIA	GN11002154	GOYA S2	17/10/2020 18:32	18/10/2020 00:40	17/10/2020 18:32	18/10/2020 00:40	6,12	208	1273,25	CHI
20201092394	GOIANIA	11272582	GOYA S2	17/10/2020 18:34	18/10/2020 11:14	17/10/2020 18:34	18/10/2020 11:14	16,66	1	16,66	CHI
20201092422	ANAPOLIS	10007755668	JUNDIAI S2	17/10/2020 18:37	17/10/2020 22:28	17/10/2020 18:37	17/10/2020 22:28	3,84	1	3,84	CHI
20201092423	MARA ROSA	10001170625	MARA ROSA	17/10/2020 18:37	17/10/2020 21:41	17/10/2020 18:37	17/10/2020 21:41	3,05	1	3,05	CHI
20201092430	MORRO AGUDO DE GOIAS	MS21232707	RUBIATABA	17/10/2020 18:39	17/10/2020 23:53	17/10/2020 18:39	17/10/2020 23:53	5,23	1	5,23	CHI
20201092436	PILAR DE GOIAS	GG21253514	SANTA TEREZINHA	17/10/2020 18:40	17/10/2020 20:29	17/10/2020 18:40	17/10/2020 20:29	1,81	1	1,81	CHI
20201092441	PONTALINA	PK12064649	PONTALINA	17/10/2020 18:40	17/10/2020 19:06	17/10/2020 18:40	17/10/2020 19:06	0,42	125	52,60	CHI
20201092454	NOVA VENEZA	NV21098752	INHUMAS S1	17/10/2020 18:42	18/10/2020 00:51	17/10/2020 18:42	18/10/2020 00:51	6,13	1	6,13	CHI
20201092456	SANTO ANTONIO DO DESCOBERTO	2210136277	ALEXANIA	17/10/2020 18:43	17/10/2020 19:45	17/10/2020 18:43	17/10/2020 19:45	1,03	1	1,03	CHI
20201092677	GOIANIA	GN11187205	XAVANTES	17/10/2020 18:43	17/10/2020 23:43	17/10/2020 18:43	17/10/2020 23:43	4,99	59	294,62	CHI
20201092463	ANICUNS	AC12291513B	ANICUNS	17/10/2020 18:43	17/10/2020 23:49	17/10/2020 18:43	17/10/2020 23:49	5,09	1	5,09	CHI
20201092463	ANICUNS	AC12291513B	ANICUNS	17/10/2020 18:43	17/10/2020 23:49	17/10/2020 21:40	17/10/2020 22:43	1,05	1	1,05	CHI
20201092463	AMERICANO DO BRASIL	AC12291513B	ANICUNS	17/10/2020 18:43	17/10/2020 23:49	17/10/2020 18:43	17/10/2020 21:40	2,95	1	2,95	CHI
20201092463	ANICUNS	AC12291513B	ANICUNS	17/10/2020 18:43	17/10/2020 23:49	17/10/2020 18:43	17/10/2020 21:40	2,95	17	50,09	CHI
20201092465	ANAPOLIS	AN11209020	JUNDIAI S1	17/10/2020 18:44	17/10/2020 21:50	17/10/2020 18:44	17/10/2020 21:50	3,10	106	328,78	CHI
20201092469	BURITI DE GOIAS	10019256106	FIRMINOPOLIS S2	17/10/2020 18:44	17/10/2020 20:12	17/10/2020 18:44	17/10/2020 20:12	1,46	1	1,46	CHI
20201091952	APARECIDA DE GOIANIA	AP11166663	ATLANTICO S2	17/10/2020 18:44	17/10/2020 20:34	17/10/2020 18:44	17/10/2020 20:34	1,82	78	142,07	CHI
20201092793	GOIANIA	GN11132333	GOYA S1	17/10/2020 18:46	17/10/2020 20:49	17/10/2020 18:46	17/10/2020 20:49	2,05	203	416,04	CHI
20201092727	CORUMBAIBA	CI12000463RE	VILA CORUMBA	17/10/2020 18:46	17/10/2020 21:00	17/10/2020 18:46	17/10/2020 21:00	2,23	133	296,37	CHI
20201092481	GUAPO	710006263	GUAPO S1	17/10/2020 18:46	18/10/2020 01:05	17/10/2020 18:46	18/10/2020 01:05	6,30	1	6,30	CHI
20201092493	JATAI	SX12086163LD	JATAI S1	17/10/2020 18:47	17/10/2020 21:05	17/10/2020 18:47	17/10/2020 21:05	2,29	13	29,75	CHI
20201092493	SERRANOPOLIS	SX12086163LD	JATAI S1	17/10/2020 18:47	17/10/2020 21:05	17/10/2020 18:47	17/10/2020 21:05	2,29	84	192,24	CHI
20201092494	GOIANIRA	GR11365525	GOIANIRA	17/10/2020 18:47	17/10/2020 20:01	17/10/2020 18:47	17/10/2020 20:01	1,22	89	108,38	CHI
20201092630	IPAMERI	IP12000013	IPAMERI	17/10/2020 18:49	17/10/2020 23:06	17/10/2020 18:49	17/10/2020 23:06	4,29	329	1412,05	CHI
20201092510	ANAPOLIS	10007329219	JUNDIAI S2	17/10/2020 18:49	18/10/2020 04:18	17/10/2020 18:49	18/10/2020 04:18	9,48	1	9,48	CHI
20201092511	AGUAS LINDAS DE GOIAS	4830081005	AGUAS LINDAS DE GOIAS S1	17/10/2020 18:49	17/10/2020 19:55	17/10/2020 18:49	17/10/2020 19:55	1,09	1	1,09	CHI
20201092640	GOIANIA	GN11213715	XAVANTES	17/10/2020 18:50	17/10/2020 20:53	17/10/2020 18:50	17/10/2020 20:53	2,04	166	339,24	CHI
20201092522	ANAPOLIS	20909536	JUNDIAI S1	17/10/2020 18:50	18/10/2020 09:52	17/10/2020 18:50	18/10/2020 09:52	15,02	1	15,02	CHI
20201092524	ANAPOLIS	20859296	JUNDIAI S2	17/10/2020 18:51	17/10/2020 23:39	17/10/2020 18:51	17/10/2020 23:39	4,80	1	4,80	CHI
20201092561	COLINAS DO SUL	TI12196546RE	MINACU	17/10/2020 18:51	17/10/2020 21:57	17/10/2020 18:51	17/10/2020 21:57	3,09	28	86,47	CHI
20201092529	BELA VISTA DE GOIAS	10010848914	BELA VISTA S1	17/10/2020 18:51	17/10/2020 20:28	17/10/2020 18:51	17/10/2020 20:28	1,60	1	1,60	CHI
20201092538	MAURILANDIA	1040035600	RIO DOS BOIS	17/10/2020 18:53	17/10/2020 20:23	17/10/2020 18:53	17/10/2020 20:23	1,50	1	1,50	CHI
20201092673	JUSSARA	JR12022269RE	BRITANIA	17/10/2020 18:53	17/10/2020 23:53	17/10/2020 18:53	17/10/2020 23:53	5,00	30	149,98	CHI
20201092673	MONTES CLAROS DE GOIAS	JR12022269RE	BRITANIA	17/10/2020 18:53	17/10/2020 23:53	17/10/2020 18:53	17/10/2020 23:53	5,00	267	1334,85	CHI
20201092546	GOIANIA	12918945	AEROPORTO S3	17/10/2020 18:53	18/10/2020 03:05	17/10/2020 18:53	18/10/2020 03:05	8,20	1	8,20	CHI
20201093011	GOIATUBA	GT12000148RE	GOIATUBA S1	17/10/2020 18:53	17/10/2020 22:20	17/10/2020 18:53	17/10/2020 22:20	3,44	13	44,67	CHI
20201093011	PANAMA	GT12000148RE	GOIATUBA S1	17/10/2020 18:53	17/10/2020 22:20	17/10/2020 18:53	17/10/2020 22:20	3,44	78	268,00	CHI
20201092557	CAIAPONIA	CP12342197	CAIAPONIA	17/10/2020 18:55	17/10/2020 21:49	17/10/2020 18:55	17/10/2020 21:49	2,90	2	5,79	CHI
20201092562	MUTUNOPOLIS	2400000366	MARA ROSA	17/10/2020 18:55	18/10/2020 01:38	17/10/2020 18:55	18/10/2020 01:38	6,71	1	6,71	CHI
20201093091	GOIANIA	GN11001635	XAVANTES	17/10/2020 18:57	17/10/2020 22:09	17/10/2020 18:57	17/10/2020 22:09	3,19	106	337,64	CHI
20201092589	MINACU	IH12192447	MINACU	17/10/2020 18:59	17/10/2020 22:27	17/10/2020 18:59	17/10/2020 22:27	3,46	23	79,65	CHI
20201092589	CAMPINACU	IH12192447	MINACU	17/10/2020 18:59	17/10/2020 22:27	17/10/2020 18:59	17/10/2020 22:27	3,46	5	17,32	CHI
20201092595	ARENOPOLIS	AY11056272	IPORA	17/10/2020 18:59	17/10/2020 21:37	17/10/2020 18:59	17/10/2020 21:37	2,62	111	290,79	CHI
20201092779	ABADIANIA	AA12258355	ANAPOLIS UNIVERSITARIO S1	17/10/2020 19:00	17/10/2020 21:15	17/10/2020 19:00	17/10/2020 21:15	2,25	4	8,98	CHI
20201092637	RUBIATABA	RB12156088	RUBIATABA	17/10/2020 19:01	17/10/2020 22:23	17/10/2020 19:01	17/10/2020 22:23	3,36	12	40,37	CHI

20201092614	NOVA VENEZA	NV21272457	INHUMAS S1	17/10/2020 19:02	18/10/2020 01:49	17/10/2020 19:02	18/10/2020 01:49	6,78	2	13,56	CHI
20201092617	GOIANIA	11458630	ATLANTICO S1	17/10/2020 19:02	18/10/2020 02:25	17/10/2020 19:02	18/10/2020 02:25	7,37	1	7,37	CHI
20201092618	GOIANIRA	10004310126	MEIA PONTE	17/10/2020 19:03	18/10/2020 04:14	17/10/2020 19:03	18/10/2020 04:14	9,17	1	9,17	CHI
20201092716	JOVIANIA	GT12052893RE	GOIATUBA S1	17/10/2020 19:04	17/10/2020 22:08	17/10/2020 19:04	17/10/2020 22:08	3,05	10	30,52	CHI
20201092716	GOIATUBA	GT12052893RE	GOIATUBA S1	17/10/2020 19:04	17/10/2020 22:08	17/10/2020 19:04	17/10/2020 22:08	3,05	7	21,37	CHI
20201092633	CRISTALINA	3490002750	PAMPLONA	17/10/2020 19:05	17/10/2020 20:55	17/10/2020 19:05	17/10/2020 20:55	1,83	1	1,83	CHI
20201092658	CRISTALINA	KR12261531	CRISTALINA S1	17/10/2020 19:09	17/10/2020 21:30	17/10/2020 19:09	17/10/2020 21:30	2,35	4	9,40	CHI
20201092661	ANAPOLIS	AN21258670	ANAPOLIS UNIVERSITARIO S2	17/10/2020 19:10	17/10/2020 23:49	17/10/2020 19:10	17/10/2020 23:49	4,65	1	4,65	CHI
20201092669	LUZIANIA	120277062	RIO VERMELHO	17/10/2020 19:11	17/10/2020 21:32	17/10/2020 19:11	17/10/2020 21:32	2,35	1	2,35	CHI
20201092675	ARAGOIANIA	680007880	GUAPO S2	17/10/2020 19:12	17/10/2020 22:02	17/10/2020 19:12	17/10/2020 22:02	2,83	1	2,83	CHI
20201092678	SERRANOPOLIS	3000021794	JATAI S1	17/10/2020 19:12	17/10/2020 20:51	17/10/2020 19:12	17/10/2020 20:51	1,64	1	1,64	CHI
20201092697	INDIARA	IY21186459	PALMEIRAS	17/10/2020 19:16	17/10/2020 22:14	17/10/2020 19:16	17/10/2020 22:14	2,97	1	2,97	CHI
20201092701	GOIANIA	13041149	GOYA S2	17/10/2020 19:16	17/10/2020 23:45	17/10/2020 19:16	17/10/2020 23:45	4,47	1	4,47	CHI
20201092704	CALDAS NOVAS	760194506	SERRA DE CALDAS	17/10/2020 19:17	17/10/2020 22:48	17/10/2020 19:17	17/10/2020 22:48	3,51	1	3,51	CHI
20201092774	GOIANIA	GN11001971	FERROVIARIO S2	17/10/2020 19:19	17/10/2020 22:25	17/10/2020 19:19	17/10/2020 22:25	3,09	103	318,16	CHI
20201092711	ARAGOIANIA	680019595	GUAPO S2	17/10/2020 19:19	17/10/2020 23:58	17/10/2020 19:19	17/10/2020 23:58	4,64	1	4,64	CHI
20201092874	GOIANIA	GN12045310	GOYA S2	17/10/2020 19:21	17/10/2020 21:52	17/10/2020 19:21	17/10/2020 21:52	2,51	42	105,31	CHI
20201092720	GOIANIA	GN11189321	XAVANTES	17/10/2020 19:21	18/10/2020 00:50	17/10/2020 19:21	18/10/2020 00:50	5,47	75	410,42	CHI
20201092744	GOIANIA	GN11192118	ATLANTICO S2	17/10/2020 19:25	17/10/2020 21:41	17/10/2020 19:25	17/10/2020 21:41	2,26	139	314,49	CHI
20201092747	ANAPOLIS	AN11130744	ANAPOLIS UNIVERSITARIO S2	17/10/2020 19:25	17/10/2020 21:37	17/10/2020 19:25	17/10/2020 21:37	2,19	208	456,50	CHI
20201092459	PIRACANJUBA	470007138	BELA VISTA S1	17/10/2020 19:25	17/10/2020 20:35	17/10/2020 19:25	17/10/2020 20:35	1,16	1	1,16	CHI
20201092735	PIRES DO RIO	460035514	PIRES DO RIO S1	17/10/2020 19:26	18/10/2020 02:41	17/10/2020 19:26	18/10/2020 02:41	7,23	1	7,23	CHI
20201092736	GOIANIA	15284311	ATLANTICO S3	17/10/2020 19:27	18/10/2020 03:46	17/10/2020 19:27	18/10/2020 03:46	8,32	1	8,32	CHI
20201092743	CAMPO LIMPO	AN21191346	NEROPOLIS S1	17/10/2020 19:28	17/10/2020 20:42	17/10/2020 19:28	17/10/2020 20:42	1,22	1	1,22	CHI
20201092750	LAGOA SANTA	IJ21191715	ITAJA S2	17/10/2020 19:30	17/10/2020 22:18	17/10/2020 19:30	17/10/2020 22:18	2,80	1	2,80	CHI
20201092752	GOIATUBA	140085452	GOIATUBA S2	17/10/2020 19:30	17/10/2020 22:33	17/10/2020 19:30	17/10/2020 22:33	3,05	1	3,05	CHI
20201093039	CAIAPONIA	CP12193478	CAIAPONIA	17/10/2020 19:30	18/10/2020 00:35	17/10/2020 19:30	18/10/2020 00:35	5,08	100	507,72	CHI
20201092865	ABADIA DE GOIAS	GN11127729	INDEPENDENCIA S2	17/10/2020 19:30	17/10/2020 21:55	17/10/2020 19:30	17/10/2020 21:55	2,41	20	48,12	CHI
20201093363	TROMBAS	TB12185317	PORANGATU	17/10/2020 19:31	18/10/2020 00:35	17/10/2020 19:31	18/10/2020 00:35	5,06	1	5,06	CHI
20201093363	FORMOSO	TB12185317	PORANGATU	17/10/2020 19:31	18/10/2020 00:35	17/10/2020 19:31	18/10/2020 00:35	5,06	5	25,29	CHI
20201093023	GOIANIA	GN11002471	AEROPORTO S2	17/10/2020 19:33	18/10/2020 00:39	17/10/2020 19:33	18/10/2020 00:39	5,10	63	321,21	CHI
20201092769	PETROLINA DE GOIAS	PG21070541	PETROLINA	17/10/2020 19:33	17/10/2020 20:14	17/10/2020 19:33	17/10/2020 20:14	0,68	1	0,68	CHI
20201092770	SERRANOPOLIS	SX21391222	JATAI S1	17/10/2020 19:33	18/10/2020 07:50	17/10/2020 19:33	18/10/2020 07:50	12,28	1	12,28	CHI
20201092772	CRIXAS	CX21253124	SANTA TEREZINHA	17/10/2020 19:33	17/10/2020 23:56	17/10/2020 19:33	17/10/2020 23:56	4,37	1	4,37	CHI
20201092946	GOIANIA	GN12405636	CAMPINAS S2	17/10/2020 19:34	17/10/2020 21:58	17/10/2020 19:34	17/10/2020 21:58	2,39	518	1239,75	CHI
20201093045	GOIANIA	GN12130337	AEROPORTO S3	17/10/2020 19:35	17/10/2020 23:53	17/10/2020 19:35	17/10/2020 23:53	4,29	134	574,60	CHI
20201092963	GOIANIA	GN11082036	XAVANTES	17/10/2020 19:39	17/10/2020 23:12	17/10/2020 19:39	17/10/2020 23:12	3,55	148	525,07	CHI
20201093020	GOIANIA	GN11167479	FERROVIARIO S2	17/10/2020 19:40	18/10/2020 00:49	17/10/2020 19:40	18/10/2020 00:49	5,14	19	97,74	CHI
20201093027	GOIANIA	GN11002519	CAMPINAS S2	17/10/2020 19:41	17/10/2020 22:08	17/10/2020 19:41	17/10/2020 22:08	2,44	92	224,22	CHI
20201093269	GOIANIA	GN11001998	CAMPINAS S2	17/10/2020 19:43	18/10/2020 01:35	17/10/2020 19:43	18/10/2020 01:35	5,85	67	391,99	CHI
20201092872	NOVA AURORA	00830204	IPAMERI	17/10/2020 19:45	17/10/2020 21:15	17/10/2020 19:45	17/10/2020 21:15	1,49	2	2,98	CHI
20201092872	IPAMERI	00830204	IPAMERI	17/10/2020 19:45	17/10/2020 21:15	17/10/2020 19:45	17/10/2020 21:15	1,49	9746	14513,42	CHI
20201092872	URUTAI	00830204	IPAMERI	17/10/2020 19:45	17/10/2020 21:15	17/10/2020 19:45	17/10/2020 21:15	1,49	3	4,47	CHI
20201092872	GOIANDIRA	00830204	IPAMERI	17/10/2020 19:45	17/10/2020 21:15	17/10/2020 19:45	17/10/2020 21:15	1,49	15	22,34	CHI
20201092872	CORUMBAIBA	00830204	IPAMERI	17/10/2020 19:45	17/10/2020 21:15	17/10/2020 19:45	17/10/2020 21:15	1,49	19	28,29	CHI
20201092872	CATALAO	00830204	IPAMERI	17/10/2020 19:45	17/10/2020 21:15	17/10/2020 19:45	17/10/2020 21:15	1,49	7	10,42	CHI
20201092872	CALDAS NOVAS	00830204	IPAMERI	17/10/2020 19:45	17/10/2020 21:15	17/10/2020 19:45	17/10/2020 21:15	1,49	11	16,38	CHI
20201092872	IPAMERI	00830404	IPAMERI	17/10/2020 19:45	17/10/2020 21:15	17/10/2020 19:46	17/10/2020 21:13	1,45	39	56,53	CHI
20201092872	CATALAO	00830404	IPAMERI	17/10/2020 19:45	17/10/2020 21:15	17/10/2020 19:46	17/10/2020 21:13	1,45	2	2,90	CHI
20201092872	IPAMERI	00830404	IPAMERI	17/10/2020 19:45	17/10/2020 21:15	17/10/2020 19:46	17/10/2020 21:13	1,45	255	369,61	CHI
20201093034	SANTO ANTONIO DA BARRA	BZ21207395	ACREUNA	17/10/2020 19:46	19/10/2020 09:28	18/10/2020 22:26	19/10/2020 09:28	11,03	1	11,03	CHI

20201093034	SANTO ANTONIO DA BARRA	EU12207513	ACREUNA	17/10/2020 19:46	19/10/2020 09:28	17/10/2020 19:46	19/10/2020 08:37	36,87	4	147,46	CHI
20201093034	ACREUNA	EU12207513	ACREUNA	17/10/2020 19:46	19/10/2020 09:28	17/10/2020 19:46	19/10/2020 08:37	36,87	3	110,60	CHI
20201093034	SANTO ANTONIO DA BARRA	BZ21207395	ACREUNA	17/10/2020 19:46	19/10/2020 09:28	17/10/2020 19:46	18/10/2020 21:48	26,04	1	26,04	CHI
20201092931	GOIANIA	GN11002572	XAVANTES	17/10/2020 19:46	18/10/2020 10:59	17/10/2020 19:46	18/10/2020 10:59	15,21	139	2114,77	CHI
20201092949	GOIANIA	GN11002589	CAMPINAS S2	17/10/2020 19:46	18/10/2020 13:38	17/10/2020 19:46	18/10/2020 13:38	17,86	151	2697,15	CHI
20201092868	MINEIROS	MY21127102	PARQUE DAS EMAS	17/10/2020 19:46	18/10/2020 05:04	17/10/2020 19:46	18/10/2020 05:04	9,29	1	9,29	CHI
20201092867	GOIANIA	11536457	CAMPINAS S2	17/10/2020 19:47	18/10/2020 02:44	17/10/2020 19:47	18/10/2020 02:44	6,94	1	6,94	CHI
20201092875	AGUAS LINDAS DE GOIAS	LA11149040	AGUAS LINDAS DE GOIAS S1	17/10/2020 19:47	17/10/2020 20:39	17/10/2020 19:47	17/10/2020 20:39	0,85	234	199,09	CHI
20201092877	URUACU	UR21292592	URUACU	17/10/2020 19:48	17/10/2020 22:21	17/10/2020 19:48	17/10/2020 22:21	2,54	2	5,07	CHI
20201093265	GOIANIA	GN12025473	AEROPORTO S3	17/10/2020 19:49	18/10/2020 00:39	17/10/2020 19:49	18/10/2020 00:39	4,83	172	830,95	CHI
20201092881	VIANOPOLIS	510029796	VIANOPOLIS	17/10/2020 19:49	17/10/2020 22:29	17/10/2020 19:49	17/10/2020 22:29	2,66	1	2,66	CHI
20201092961	SANTO ANTONIO DA BARRA	BZ12048954	ACREUNA	17/10/2020 19:49	18/10/2020 00:13	17/10/2020 19:49	18/10/2020 00:13	4,38	5	21,92	CHI
20201092959	GOIANIA	GN11162131	CAMPINAS S2	17/10/2020 19:51	18/10/2020 04:38	17/10/2020 19:51	18/10/2020 04:38	8,78	117	1027,00	CHI
20201092897	PIRENOPOLIS	PV21245646	CORUMBA	17/10/2020 19:52	17/10/2020 23:35	17/10/2020 19:52	17/10/2020 23:35	3,73	1	3,73	CHI
20201092950	GOIANIA	GN11171198	CAMPINAS S3	17/10/2020 19:53	17/10/2020 22:20	17/10/2020 19:53	17/10/2020 22:20	2,44	74	180,89	CHI
20201092904	INHUMAS	IN21336703	ARACU	17/10/2020 19:53	17/10/2020 23:00	17/10/2020 19:53	17/10/2020 23:00	3,11	1	3,11	CHI
20201093324	GOIANIA	GN11205319	CAMPINAS S2	17/10/2020 19:53	18/10/2020 00:08	17/10/2020 19:53	18/10/2020 00:08	4,24	159	673,41	CHI
20201093006	GOIANIA	GN11328207	CAMPINAS S2	17/10/2020 19:54	17/10/2020 23:46	17/10/2020 19:54	17/10/2020 23:46	3,85	67	258,14	CHI
20201092921	CACHOEIRA ALTA	CA21350893	CACHOEIRA ALTA	17/10/2020 19:55	18/10/2020 02:24	17/10/2020 19:55	18/10/2020 02:24	6,47	2	12,94	CHI
20201092923	GOIANIA	16231594	MEIA PONTE	17/10/2020 19:55	18/10/2020 02:34	17/10/2020 19:55	18/10/2020 02:34	6,64	1	6,64	CHI
20201093195	GOIANIA	GN11210958	XAVANTES	17/10/2020 19:57	18/10/2020 02:18	17/10/2020 19:57	18/10/2020 02:18	6,35	121	768,22	CHI
20201092940	ANAPOLIS	AN12026160	ANAPOLIS UNIVERSITARIO S2	17/10/2020 19:58	18/10/2020 08:51	17/10/2020 19:58	18/10/2020 08:51	12,89	7	90,21	CHI
20201092976	GOIANIA	GN11002081	CAMPINAS S2	17/10/2020 19:59	17/10/2020 21:36	17/10/2020 19:59	17/10/2020 21:36	1,61	123	198,44	CHI
20201092964	ITUMBIARA	690261720	ITUMBIARA VELHA S1	17/10/2020 20:01	17/10/2020 20:30	17/10/2020 20:01	17/10/2020 20:30	0,47	1	0,47	CHI
20201093109	TURVELANDIA	TD12025737	RIO DOS BOIS	17/10/2020 20:04	17/10/2020 22:14	17/10/2020 20:04	17/10/2020 22:14	2,17	65	140,83	CHI
20201093109	ACREUNA	TD12025737	RIO DOS BOIS	17/10/2020 20:04	17/10/2020 22:14	17/10/2020 20:04	17/10/2020 22:14	2,17	26	56,33	CHI
20201093109	SANTA HELENA DE GOIAS	TD12025737	RIO DOS BOIS	17/10/2020 20:04	17/10/2020 22:14	17/10/2020 20:04	17/10/2020 22:14	2,17	18	39,00	CHI
20201092981	GOIANIA	GN12222884	XAVANTES	17/10/2020 20:05	17/10/2020 22:11	17/10/2020 20:05	17/10/2020 22:11	2,11	42	88,45	CHI
20201092993	GOIANIA	GN21188610	XAVANTES	17/10/2020 20:08	18/10/2020 02:13	17/10/2020 20:08	18/10/2020 02:13	6,07	1	6,07	CHI
20201092995	ANAPOLIS	20623197	ANAPOLIS UNIVERSITARIO S2	17/10/2020 20:08	18/10/2020 09:33	17/10/2020 20:08	18/10/2020 09:33	13,40	1	13,40	CHI
20201093212	GOIANIA	GN11162026	CAMPINAS S2	17/10/2020 20:11	18/10/2020 03:20	17/10/2020 20:11	18/10/2020 03:20	7,15	80	571,91	CHI
20201093033	CAIAPONIA	CP12020896	PIRANHAS	17/10/2020 20:16	18/10/2020 14:50	17/10/2020 20:16	18/10/2020 14:50	18,56	2	37,13	CHI
20201093033	CAIAPONIA	CP12020896	PIRANHAS	17/10/2020 20:16	18/10/2020 14:50	17/10/2020 20:16	18/10/2020 10:56	14,66	4	58,65	CHI
20201093033	CAIAPONIA	CP12020896	PIRANHAS	17/10/2020 20:16	18/10/2020 14:50	17/10/2020 20:16	18/10/2020 05:00	8,73	2	17,46	CHI
20201093037	INHUMAS	IN21066359	INHUMAS S2	17/10/2020 20:16	18/10/2020 03:00	17/10/2020 20:16	18/10/2020 03:00	6,72	1	6,72	CHI
20201093054	ANAPOLIS	AN11008938	JUNDIAI S1	17/10/2020 20:19	18/10/2020 05:50	17/10/2020 20:19	18/10/2020 05:50	9,51	134	1274,86	CHI
20201093054	ANAPOLIS	AN12072839	JUNDIAI S1	17/10/2020 20:19	18/10/2020 05:50	18/10/2020 03:40	18/10/2020 04:07	0,45	144	65,04	CHI
20201093051	BELA VISTA DE GOIAS	BV21347515	CEPAIGO S2	17/10/2020 20:20	17/10/2020 21:30	17/10/2020 20:20	17/10/2020 21:30	1,16	1	1,16	CHI
20201093060	JATAI	JT21357706	JATAI S1	17/10/2020 20:23	18/10/2020 04:34	17/10/2020 20:23	18/10/2020 04:34	8,18	1	8,18	CHI
20201093064	ANAPOLIS	10004049363	ANAPOLIS UNIVERSITARIO S2	17/10/2020 20:24	18/10/2020 01:58	17/10/2020 20:24	18/10/2020 01:58	5,56	1	5,56	CHI
20201093087	APARECIDA DE GOIANIA	AP11140757	ATLANTICO S3	17/10/2020 20:24	17/10/2020 22:01	17/10/2020 20:24	17/10/2020 22:01	1,61	120	192,67	CHI
20201093076	AGUAS LINDAS DE GOIAS	10003793891	AGUAS LINDAS DE GOIAS S1	17/10/2020 20:27	17/10/2020 21:34	17/10/2020 20:27	17/10/2020 21:34	1,11	1	1,11	CHI
20201093077	SANTO ANTONIO DA BARRA	BZ212123238	ACREUNA	17/10/2020 20:27	18/10/2020 10:04	17/10/2020 20:27	18/10/2020 10:04	13,62	7	95,35	CHI
20201093084	ANICUNS	AC21304687	FIRMINOPOLIS S2	17/10/2020 20:28	18/10/2020 09:12	17/10/2020 20:28	18/10/2020 09:12	12,72	1	12,72	CHI
20201093086	PORANGATU	PO11350121	PORANGATU	17/10/2020 20:29	18/10/2020 03:08	17/10/2020 20:29	18/10/2020 03:08	6,65	1	6,65	CHI
20201093090	EDEALINA	ED11280905	PONTALINA	17/10/2020 20:29	17/10/2020 22:00	17/10/2020 20:29	17/10/2020 22:00	1,50	69	103,84	CHI
20201093093	CAMPESTRE DE GOIAS	GC21282753	TRINDADE	17/10/2020 20:30	17/10/2020 23:54	17/10/2020 20:30	17/10/2020 23:54	3,39	1	3,39	CHI
20201093100	GOIANIA	11104090	CAMPINAS S2	17/10/2020 20:33	18/10/2020 04:27	17/10/2020 20:33	18/10/2020 04:27	7,90	1	7,90	CHI
20201093102	ANAPOLIS	10027743622	JUNDIAI S2	17/10/2020 20:33	17/10/2020 22:13	17/10/2020 20:33	17/10/2020 22:13	1,66	1	1,66	CHI
20201093105	BELA VISTA DE GOIAS	240002260	BELA VISTA S1	17/10/2020 20:33	17/10/2020 21:39	17/10/2020 20:33	17/10/2020 21:39	1,09	1	1,09	CHI
20201093182	AMERICANO DO BRASIL	KB13000001	ANICUNS	17/10/2020 20:34	18/10/2020 15:35	18/10/2020 09:31	18/10/2020 15:35	6,06	9	54,53	CHI

20201093182	ADELANDIA	KB13000001	ANICUNS	17/10/2020 20:34	18/10/2020 15:35	18/10/2020 15:30	18/10/2020 15:35	0,08	31	2,52	CHI
20201093182	AMERICANO DO BRASIL	KB13000001	ANICUNS	17/10/2020 20:34	18/10/2020 15:35	18/10/2020 15:30	18/10/2020 15:35	0,08	25	2,03	CHI
20201093182	MOSSAMEDES	KB13000001	ANICUNS	17/10/2020 20:34	18/10/2020 15:35	18/10/2020 15:30	18/10/2020 15:35	0,08	32	2,60	CHI
20201093182	ANICUNS	KB13000001	ANICUNS	17/10/2020 20:34	18/10/2020 15:35	18/10/2020 15:30	18/10/2020 15:35	0,08	38	3,09	CHI
20201093182	ANICUNS	AC12259094LD	ANICUNS	17/10/2020 20:34	18/10/2020 15:35	17/10/2020 20:34	18/10/2020 11:04	14,49	12	173,82	CHI
20201093182	ADELANDIA	AC12259094LD	ANICUNS	17/10/2020 20:34	18/10/2020 15:35	17/10/2020 20:34	18/10/2020 11:04	14,49	31	449,04	CHI
20201093182	AMERICANO DO BRASIL	AC12259094LD	ANICUNS	17/10/2020 20:34	18/10/2020 15:35	17/10/2020 20:34	18/10/2020 11:04	14,49	18	260,73	CHI
20201093182	MOSSAMEDES	AC12259094LD	ANICUNS	17/10/2020 20:34	18/10/2020 15:35	17/10/2020 20:34	18/10/2020 11:04	14,49	30	434,56	CHI
20201093182	ANICUNS	AC16409753	ANICUNS	17/10/2020 20:34	18/10/2020 15:35	18/10/2020 08:38	18/10/2020 08:49	0,18	26	4,58	CHI
20201093182	AMERICANO DO BRASIL	AC16409753	ANICUNS	17/10/2020 20:34	18/10/2020 15:35	18/10/2020 08:38	18/10/2020 08:49	0,18	7	1,23	CHI
20201093182	MOSSAMEDES	AC12259094LD	ANICUNS	17/10/2020 20:34	18/10/2020 15:35	17/10/2020 20:34	18/10/2020 05:54	9,32	2	18,65	CHI
20201093115	ITAPACI	10024531462	ITAPACI	17/10/2020 20:36	18/10/2020 02:00	17/10/2020 20:36	18/10/2020 02:00	5,39	1	5,39	CHI
20201093119	ABADIANIA	AA21297633	ANAPOLIS UNIVERSITARIO S1	17/10/2020 20:37	18/10/2020 00:05	17/10/2020 20:37	18/10/2020 00:05	3,45	1	3,45	CHI
20201093125	URUACU	10029286911	URUACU	17/10/2020 20:40	18/10/2020 02:03	17/10/2020 20:40	18/10/2020 02:03	5,37	1	5,37	CHI
20201093130	ANAPOLIS	10012544793	ANAPOLIS UNIVERSITARIO S2	17/10/2020 20:43	18/10/2020 12:28	17/10/2020 20:43	18/10/2020 12:28	15,75	1	15,75	CHI
20201093131	LAGOA SANTA	IJ21095808	ITAJA S2	17/10/2020 20:43	17/10/2020 23:27	17/10/2020 20:43	17/10/2020 23:27	2,72	1	2,72	CHI
20201093140	NEROPOLIS	10029510579	NEROPOLIS S2	17/10/2020 20:46	17/10/2020 22:48	17/10/2020 20:46	17/10/2020 22:48	2,03	1	2,03	CHI
20201093161	JATAI	JT12324906	JATAI S1	17/10/2020 20:50	18/10/2020 11:38	17/10/2020 20:50	18/10/2020 11:38	14,79	2	29,59	CHI
20201093161	JATAI	JT12226593LD	JATAI S1	17/10/2020 20:50	18/10/2020 11:38	18/10/2020 10:50	18/10/2020 11:38	0,80	2	1,60	CHI
20201093161	JATAI	JT12324906	JATAI S1	17/10/2020 20:50	18/10/2020 11:38	17/10/2020 20:50	18/10/2020 08:34	11,73	2	23,45	CHI
20201093161	JATAI	JT12324906	JATAI S1	17/10/2020 20:50	18/10/2020 11:38	17/10/2020 20:50	18/10/2020 06:52	10,04	3	30,11	CHI
20201093162	URUACU	UR12000054RE	CAMPINORTE	17/10/2020 20:52	17/10/2020 23:43	17/10/2020 20:52	17/10/2020 23:43	2,84	93	263,91	CHI
20201093162	NOVA IGUACU DE GOIAS	UR12000054RE	CAMPINORTE	17/10/2020 20:52	17/10/2020 23:43	17/10/2020 20:52	17/10/2020 23:43	2,84	19	53,92	CHI
20201093163	VIANOPOLIS	VN12033292	CAMPINORTE	17/10/2020 20:52	17/10/2020 23:41	17/10/2020 20:52	17/10/2020 23:41	2,80	21	58,81	CHI
20201093166	PARAUNA	CG12391526	FIRMINOPOLIS S2	17/10/2020 20:53	18/10/2020 11:47	17/10/2020 20:53	18/10/2020 11:47	14,90	17	253,33	CHI
20201093166	CACHOEIRA DE GOIAS	CG12391526	FIRMINOPOLIS S2	17/10/2020 20:53	18/10/2020 11:47	17/10/2020 20:53	18/10/2020 11:47	14,90	6	89,41	CHI
20201093166	PARAUNA	CG12391526	FIRMINOPOLIS S2	17/10/2020 20:53	18/10/2020 11:47	17/10/2020 20:53	18/10/2020 08:59	12,10	15	181,48	CHI
20201093166	CACHOEIRA DE GOIAS	CG12391526	FIRMINOPOLIS S2	17/10/2020 20:53	18/10/2020 11:47	17/10/2020 20:53	18/10/2020 08:59	12,10	5	60,49	CHI
20201093166	AURILANDIA	CG12391526	FIRMINOPOLIS S2	17/10/2020 20:53	18/10/2020 11:47	17/10/2020 20:53	18/10/2020 08:59	12,10	2	24,20	CHI
20201093179	RIO VERDE	RV12092821	MONTIVIDIU T	17/10/2020 21:01	18/10/2020 12:08	17/10/2020 21:01	18/10/2020 12:08	15,12	11	166,37	CHI
20201093185	CHAPADAO DO CEU	9880017589	CHAPADAO DO CEU	17/10/2020 21:02	17/10/2020 23:11	17/10/2020 21:02	17/10/2020 23:11	2,14	1	2,14	CHI
20201093551	GOIAS	GS21165315	MATRINCHA	17/10/2020 21:07	18/10/2020 07:50	17/10/2020 21:07	18/10/2020 07:50	10,71	1	10,71	CHI
20201093193	MATRINCHA	GS12362364	MATRINCHA	17/10/2020 21:07	18/10/2020 02:26	17/10/2020 21:07	18/10/2020 02:26	5,32	1	5,32	CHI
20201093193	FAINA	GS12362364	MATRINCHA	17/10/2020 21:07	18/10/2020 02:26	17/10/2020 21:07	18/10/2020 02:26	5,32	11	58,47	CHI
20201093193	GOIAS	GS12362364	MATRINCHA	17/10/2020 21:07	18/10/2020 02:26	17/10/2020 21:07	18/10/2020 02:26	5,32	7	37,21	CHI
20201093197	UIRAPURU	UP12181466	SANTA TEREZINHA	17/10/2020 21:10	18/10/2020 00:57	17/10/2020 21:10	18/10/2020 00:57	3,78	13	49,10	CHI
20201093297	ANAPOLIS	AN12329882	JUNDIAI S1	17/10/2020 21:14	17/10/2020 23:45	17/10/2020 21:14	17/10/2020 23:45	2,51	406	1019,17	CHI
20201093201	ANAPOLIS	10022625494	JUNDIAI S2	17/10/2020 21:15	18/10/2020 01:31	17/10/2020 21:15	18/10/2020 01:31	4,26	1	4,26	CHI
20201093204	CRISTALINA	1750000365	CRISTALINA S2	17/10/2020 21:17	17/10/2020 23:07	17/10/2020 21:17	17/10/2020 23:07	1,82	1	1,82	CHI
20201093205	ANAPOLIS	10024938449	JUNDIAI S1	17/10/2020 21:19	17/10/2020 22:59	17/10/2020 21:19	17/10/2020 22:59	1,65	1	1,65	CHI
20201093207	ANAPOLIS	AN11129497	JUNDIAI S1	17/10/2020 21:20	18/10/2020 00:34	17/10/2020 21:20	18/10/2020 00:34	3,23	93	300,39	CHI
20201093224	CALDAS NOVAS	760063862	SERRA DE CALDAS	17/10/2020 21:29	18/10/2020 01:02	17/10/2020 21:29	18/10/2020 01:02	3,55	1	3,55	CHI
20201093226	ITAJA	2300007065	ITAJA S2	17/10/2020 21:29	18/10/2020 01:02	17/10/2020 21:29	18/10/2020 01:02	3,54	1	3,54	CHI
20201093228	CALDAS NOVAS	CN12000057	CALDAS NOVAS S2	17/10/2020 21:30	17/10/2020 23:04	17/10/2020 21:30	17/10/2020 23:04	1,56	23	35,93	CHI
20201093236	ANAPOLIS	10007793020	ANAPOLIS UNIVERSITARIO S2	17/10/2020 21:34	17/10/2020 23:21	17/10/2020 21:34	17/10/2020 23:21	1,78	1	1,78	CHI
20201093247	GOIANIA	10005100680	CARAIAS S1	17/10/2020 21:37	18/10/2020 12:18	17/10/2020 21:37	18/10/2020 12:18	14,67	1	14,67	CHI
20201093285	ANAPOLIS	AN11015854	JUNDIAI S1	17/10/2020 21:40	17/10/2020 23:47	17/10/2020 21:40	17/10/2020 23:47	2,11	171	361,62	CHI
20201093256	APARECIDA DE GOIANIA	15991714	REAL S1	17/10/2020 21:41	17/10/2020 23:34	17/10/2020 21:41	17/10/2020 23:34	1,87	1	1,87	CHI
20201093259	GOIANIRA	GR12016222	GOIANIRA	17/10/2020 21:43	18/10/2020 07:12	17/10/2020 21:43	18/10/2020 07:12	9,47	1	9,47	CHI
20201093262	GOIANIA	GN11051585	FERROVIARIO S2	17/10/2020 21:45	17/10/2020 23:10	17/10/2020 21:45	17/10/2020 23:10	1,42	45	63,72	CHI
20201093263	CRISTALINA	10009256510	PAMPLONA	17/10/2020 21:45	17/10/2020 23:49	17/10/2020 21:45	17/10/2020 23:49	2,05	1	2,05	CHI

20201093268	ANAPOLIS	20510937	JUNDIAI S1	17/10/2020 21:51	17/10/2020 23:44	17/10/2020 21:51	17/10/2020 23:44	1,88	1	1,88	CHI
20201093300	CALDAS NOVAS	CN12392080	CALDAS NOVAS S2	17/10/2020 21:58	18/10/2020 00:05	17/10/2020 21:58	18/10/2020 00:05	2,12	17	35,96	CHI
20201093288	ITAPIRAPUA	IU12087963	MATRINCHA	17/10/2020 21:59	18/10/2020 00:00	17/10/2020 21:59	18/10/2020 00:00	2,01	44	88,27	CHI
20201093309	ANAPOLIS	AN11334273	JUNDIAI S1	17/10/2020 21:59	17/10/2020 23:14	17/10/2020 21:59	17/10/2020 23:14	1,24	113	139,81	CHI
20201093301	PIRENOPOLIS	220014619	CORUMBA	17/10/2020 22:07	18/10/2020 05:13	17/10/2020 22:07	18/10/2020 05:13	7,09	1	7,09	CHI
20201093305	GOIANIA	GN12001789	CAMPINAS S2	17/10/2020 22:10	17/10/2020 22:42	17/10/2020 22:10	17/10/2020 22:42	0,52	71	36,76	CHI
20201093307	ANAPOLIS	AN11221412	JUNDIAI S2	17/10/2020 22:13	17/10/2020 22:34	17/10/2020 22:13	17/10/2020 22:34	0,35	22	7,61	CHI
20201093315	CRISTALINA	KR12248743	CRISTALINA S2	17/10/2020 22:20	17/10/2020 23:56	17/10/2020 22:20	17/10/2020 23:56	1,59	3	4,78	CHI
20201093315	CRISTALINA	KR12248743	CRISTALINA S2	17/10/2020 22:20	17/10/2020 23:56	17/10/2020 22:20	17/10/2020 23:56	1,59	5	7,96	CHI
20201093325	ANAPOLIS	AN11209019	JUNDIAI S1	17/10/2020 22:24	17/10/2020 22:47	17/10/2020 22:24	17/10/2020 22:47	0,38	124	46,50	CHI
20201093335	ANAPOLIS	21152329	JUNDIAI S1	17/10/2020 22:28	18/10/2020 10:43	17/10/2020 22:28	18/10/2020 10:43	12,25	1	12,25	CHI
20201093344	APARECIDA DE GOIANIA	AP11140757	ATLANTICO S3	17/10/2020 22:28	18/10/2020 00:12	17/10/2020 22:28	18/10/2020 00:12	1,72	120	206,70	CHI
20201093357	GOIANIA	10004052151	CAMPINAS S2	17/10/2020 22:40	18/10/2020 07:59	17/10/2020 22:40	18/10/2020 07:59	9,30	1	9,30	CHI
20201093364	RIO VERDE	RV12248973	CABRIUVA S2	17/10/2020 22:42	18/10/2020 05:24	17/10/2020 22:42	18/10/2020 05:24	6,69	12	80,33	CHI
20201093364	JATAI	RV12248973	CABRIUVA S2	17/10/2020 22:42	18/10/2020 05:24	17/10/2020 22:42	18/10/2020 05:24	6,69	9	60,25	CHI
20201093367	CALDAS NOVAS	CN11123656	SERRA DE CALDAS	17/10/2020 22:45	17/10/2020 23:29	17/10/2020 22:45	17/10/2020 23:29	0,72	101	73,11	CHI
20201093381	PONTALINA	PK11000019	PONTALINA	17/10/2020 22:55	17/10/2020 23:23	17/10/2020 22:55	17/10/2020 23:23	0,45	163	74,03	CHI
20201093384	ANAPOLIS	AN12072839	JUNDIAI S1	17/10/2020 22:58	18/10/2020 02:34	17/10/2020 22:58	18/10/2020 02:34	3,59	144	517,00	CHI
20201093389	ANAPOLIS	AN11006569	JUNDIAI S1	17/10/2020 23:02	18/10/2020 04:02	17/10/2020 23:02	18/10/2020 04:02	4,99	87	434,15	CHI
20201093415	ALTO HORIZONTE	AJ11162622	SANTA TEREZINHA	17/10/2020 23:22	18/10/2020 03:01	17/10/2020 23:22	18/10/2020 03:01	3,65	91	331,72	CHI
20201094001	ALEXANIA	AX12211852	ALEXANIA	17/10/2020 23:28	18/10/2020 08:31	17/10/2020 23:28	18/10/2020 08:31	9,04	17	153,62	CHI
20201093514	PORANGATU	PO11151039	PORANGATU	17/10/2020 23:45	18/10/2020 09:25	17/10/2020 23:45	18/10/2020 09:25	9,67	122	1179,23	CHI
20201093435	SAO MIGUEL DO ARAGUAIA	SM11352926	SAO MIGUEL DO ARAGUAIA	17/10/2020 23:50	18/10/2020 10:24	17/10/2020 23:50	18/10/2020 10:24	10,55	107	1129,06	CHI
20201093429	ANAPOLIS	10030019255	JUNDIAI S1	17/10/2020 23:51	18/10/2020 09:37	17/10/2020 23:51	18/10/2020 09:37	9,76	1	9,76	CHI
20201092624	TRINDADE	TR11107252	TRINDADE	18/10/2020 00:00	18/10/2020 01:10	18/10/2020 00:00	18/10/2020 01:10	1,17	208	242,72	CHI
20201093630	ALEXANIA	AX12000080LD	ALEXANIA	18/10/2020 00:03	18/10/2020 08:14	18/10/2020 00:03	18/10/2020 08:14	8,17	121	988,57	CHI
20201093443	GOIAS	GS21203874	GOIAS	18/10/2020 00:04	18/10/2020 01:52	18/10/2020 00:04	18/10/2020 01:52	1,80	1	1,80	CHI
20201093445	VIANOPOLIS	510019699	VIANOPOLIS	18/10/2020 00:07	18/10/2020 00:25	18/10/2020 00:07	18/10/2020 00:25	0,30	1	0,30	CHI
20201093372	JOVIANIA	JV12050338	GOIATUBA S1	18/10/2020 00:07	18/10/2020 10:20	18/10/2020 00:07	18/10/2020 10:20	10,21	8	81,72	CHI
20201093372	PONTALINA	JV12050338	GOIATUBA S1	18/10/2020 00:07	18/10/2020 10:20	18/10/2020 00:07	18/10/2020 10:20	10,21	16	163,43	CHI
20201093447	ANAPOLIS	AN11209020	JUNDIAI S1	18/10/2020 00:08	18/10/2020 02:10	18/10/2020 00:08	18/10/2020 02:10	2,03	106	215,53	CHI
202010189330	PIRACANJUBA	PJ12000022	PIRACANJUBA	18/10/2020 00:12	18/10/2020 07:21	18/10/2020 00:12	18/10/2020 07:21	7,14	20	142,85	CHI
20201093465	PONTALINA	03130214	VICENTINOPOLIS	18/10/2020 00:18	18/10/2020 11:27	18/10/2020 00:18	18/10/2020 11:27	11,15	5	55,76	CHI
20201093465	PONTALINA	03130214	VICENTINOPOLIS	18/10/2020 00:18	18/10/2020 11:27	18/10/2020 00:18	18/10/2020 11:06	10,81	15	162,17	CHI
20201093465	PONTALINA	03130214	VICENTINOPOLIS	18/10/2020 00:18	18/10/2020 11:27	18/10/2020 00:18	18/10/2020 10:01	9,72	6	58,31	CHI
20201093465	PONTALINA	03130214	VICENTINOPOLIS	18/10/2020 00:18	18/10/2020 11:27	18/10/2020 00:18	18/10/2020 09:33	9,26	7	64,84	CHI
20201093465	PONTALINA	03130214	VICENTINOPOLIS	18/10/2020 00:18	18/10/2020 11:27	18/10/2020 00:18	18/10/2020 02:06	1,81	78	141,25	CHI
20201093465	VICENTINOPOLIS	03130214	VICENTINOPOLIS	18/10/2020 00:18	18/10/2020 11:27	18/10/2020 00:18	18/10/2020 02:06	1,81	13	23,54	CHI
20201093465	PONTALINA	03130214	VICENTINOPOLIS	18/10/2020 00:18	18/10/2020 11:27	18/10/2020 00:18	18/10/2020 00:23	0,09	66	5,89	CHI
20201093466	ANAPOLIS	21292589	ANAPOLIS UNIVERSITARIO S2	18/10/2020 00:28	18/10/2020 02:54	18/10/2020 00:28	18/10/2020 02:54	2,42	1	2,42	CHI
20201093473	ORIZONA	OZ11202891	PIRES DO RIO S2	18/10/2020 00:41	18/10/2020 07:39	18/10/2020 00:41	18/10/2020 07:39	6,96	9	62,62	CHI
20201093496	ESTRELA DO NORTE	ET11100731	MARA ROSA	18/10/2020 00:45	18/10/2020 08:07	18/10/2020 00:45	18/10/2020 08:07	7,36	131	963,98	CHI
20201093511	GOIANIA	GN12002214	CAMPINAS S3	18/10/2020 00:47	18/10/2020 04:21	18/10/2020 00:47	18/10/2020 04:21	3,57	344	1226,93	CHI
20201093481	VIANOPOLIS	510035814	VIANOPOLIS	18/10/2020 01:01	18/10/2020 02:48	18/10/2020 01:01	18/10/2020 02:48	1,78	1	1,78	CHI
20201093497	MORRINHOS	MR12060782	MORRINHOS	18/10/2020 01:14	18/10/2020 08:06	18/10/2020 01:14	18/10/2020 08:06	6,85	5	34,27	CHI
20201093515	GOIANIA	GN11002231	CAMPINAS S3	18/10/2020 01:21	18/10/2020 04:30	18/10/2020 01:21	18/10/2020 04:30	3,14	39	122,41	CHI
20201093519	ALOANDIA	03950214	GOIATUBA S1	18/10/2020 01:28	18/10/2020 18:46	18/10/2020 01:28	18/10/2020 18:46	17,30	3	51,89	CHI
20201093519	PONTALINA	03950214	GOIATUBA S1	18/10/2020 01:28	18/10/2020 18:46	18/10/2020 01:28	18/10/2020 18:46	17,30	2	34,59	CHI
20201093519	PONTALINA	03950214	GOIATUBA S1	18/10/2020 01:28	18/10/2020 18:46	18/10/2020 01:28	18/10/2020 08:27	6,98	32	223,40	CHI
20201093519	JOVIANIA	03950214	GOIATUBA S1	18/10/2020 01:28	18/10/2020 18:46	18/10/2020 01:28	18/10/2020 08:27	6,98	8	55,85	CHI
20201093519	JOVIANIA	03950214	GOIATUBA S1	18/10/2020 01:28	18/10/2020 18:46	18/10/2020 01:28	18/10/2020 05:24	3,93	2	7,87	CHI

20201093519	ALOANDIA	03950214	GOIATUBA S1	18/10/2020 01:28	18/10/2020 18:46	18/10/2020 01:28	18/10/2020 05:24	3,93	12	47,19	CHI
20201093519	PONTALINA	03950214	GOIATUBA S1	18/10/2020 01:28	18/10/2020 18:46	18/10/2020 01:28	18/10/2020 05:24	3,93	3	11,80	CHI
20201093519	ALOANDIA	03950214	GOIATUBA S1	18/10/2020 01:28	18/10/2020 18:46	18/10/2020 01:28	18/10/2020 04:44	3,27	70	228,76	CHI
20201093519	PONTALINA	03950214	GOIATUBA S1	18/10/2020 01:28	18/10/2020 18:46	18/10/2020 01:28	18/10/2020 03:58	2,49	74	184,63	CHI
20201093519	ALOANDIA	03950214	GOIATUBA S1	18/10/2020 01:28	18/10/2020 18:46	18/10/2020 01:28	18/10/2020 03:58	2,49	28	69,86	CHI
20201093519	MORRINHOS	03950214	GOIATUBA S1	18/10/2020 01:28	18/10/2020 18:46	18/10/2020 01:28	18/10/2020 03:58	2,49	23	57,28	CHI
20201093519	ALOANDIA	03950214	GOIATUBA S1	18/10/2020 01:28	18/10/2020 18:46	18/10/2020 01:28	18/10/2020 03:58	2,49	131	326,26	CHI
20201093519	PONTALINA	03950214	GOIATUBA S1	18/10/2020 01:28	18/10/2020 18:46	18/10/2020 01:28	18/10/2020 03:58	2,49	9	22,42	CHI
20201093518	VALPARAISO DE GOIAS	VA11192786	PACAEMBU S1	18/10/2020 01:29	18/10/2020 02:41	18/10/2020 01:29	18/10/2020 02:41	1,19	184	219,78	CHI
20201093635	GOIANIA	GN11280924	CARAJAS S2	18/10/2020 01:35	18/10/2020 07:28	18/10/2020 01:35	18/10/2020 07:28	5,87	156	915,46	CHI
20201093524	ITABERAI	IB12220379	ITABERAI S1	18/10/2020 01:47	18/10/2020 11:36	18/10/2020 01:47	18/10/2020 11:36	9,82	47	461,34	CHI
20201093524	ITABERAI	IB12198809	ITABERAI S1	18/10/2020 01:47	18/10/2020 11:36	18/10/2020 02:43	18/10/2020 11:36	8,89	1	8,89	CHI
20201093524	ITABERAI	IB12220379	ITABERAI S1	18/10/2020 01:47	18/10/2020 11:36	18/10/2020 01:47	18/10/2020 08:26	6,65	44	292,71	CHI
20201093524	ITABERAI	IB12220379	ITABERAI S1	18/10/2020 01:47	18/10/2020 11:36	18/10/2020 02:43	18/10/2020 08:26	5,73	20	114,59	CHI
20201093524	ITABERAI	IB12220379	ITABERAI S1	18/10/2020 01:47	18/10/2020 11:36	18/10/2020 01:47	18/10/2020 02:43	0,92	8	7,38	CHI
20201093526	MONTIVIDIU DO NORTE	MX21088652	PORANGATU	18/10/2020 01:50	18/10/2020 08:34	18/10/2020 01:50	18/10/2020 08:34	6,73	1	6,73	CHI
20201093527	ANAPOLIS	AN11000205	JUNDIAI S1	18/10/2020 01:52	18/10/2020 05:45	18/10/2020 01:52	18/10/2020 05:45	3,88	214	829,73	CHI
20201093528	ANAPOLIS	20496503	ANAPOLIS UNIVERSITARIO S2	18/10/2020 01:53	18/10/2020 09:47	18/10/2020 01:53	18/10/2020 09:47	7,90	1	7,90	CHI
20201093529	ANAPOLIS	AN11273290	JUNDIAI S1	18/10/2020 02:02	18/10/2020 05:35	18/10/2020 02:02	18/10/2020 05:35	3,55	107	379,49	CHI
20201093530	GOIANESIA	GE11090257	GOIANESIA S1	18/10/2020 02:03	18/10/2020 03:05	18/10/2020 02:03	18/10/2020 03:05	1,02	84	86,08	CHI
20201093535	PONTALINA	PK21156125	PONTALINA	18/10/2020 02:13	18/10/2020 10:26	18/10/2020 02:13	18/10/2020 10:26	8,20	1	8,20	CHI
20201093706	ANAPOLIS	AN12353433	JUNDIAI S1	18/10/2020 02:20	18/10/2020 07:20	18/10/2020 02:20	18/10/2020 07:20	5,00	5	24,99	CHI
20201093543	GOIANIA	13546491	CAMPINAS S2	18/10/2020 02:36	18/10/2020 09:47	18/10/2020 02:36	18/10/2020 09:47	7,18	1	7,18	CHI
20201093552	GOIANIA	GN12000607	CAMPINAS S3	18/10/2020 02:39	18/10/2020 11:28	18/10/2020 02:39	18/10/2020 11:28	8,80	330	2905,10	CHI
20201093548	CRIXAS	UP12391834	SANTA TEREZINHA	18/10/2020 02:56	18/10/2020 10:39	18/10/2020 02:56	18/10/2020 10:39	7,71	10	77,07	CHI
20201093548	UIRAPURU	UP12391834	SANTA TEREZINHA	18/10/2020 02:56	18/10/2020 10:39	18/10/2020 02:56	18/10/2020 10:39	7,71	1	7,71	CHI
20201093550	VIANOPOLIS	510020367	VIANOPOLIS	18/10/2020 03:00	18/10/2020 04:12	18/10/2020 03:00	18/10/2020 04:12	1,19	1	1,19	CHI
20201093545	VALPARAISO DE GOIAS	VA11345939	MARAJOARA	18/10/2020 03:13	18/10/2020 11:04	18/10/2020 03:13	18/10/2020 11:04	7,83	238	1864,66	CHI
20201093369	GAMELEIRA DE GOIAS	AA12285384	ANAPOLIS UNIVERSITARIO S1	18/10/2020 03:21	18/10/2020 07:41	18/10/2020 03:21	18/10/2020 07:41	4,33	1	4,33	CHI
20201093369	ABADIANIA	AA12285384	ANAPOLIS UNIVERSITARIO S1	18/10/2020 03:21	18/10/2020 07:41	18/10/2020 03:21	18/10/2020 07:41	4,33	104	450,18	CHI
20201093560	GOIANIA	GN12070258	ATLANTICO S3	18/10/2020 03:27	18/10/2020 04:26	18/10/2020 03:27	18/10/2020 04:26	0,97	262	255,30	CHI
20201093562	GOIANIA	GN11187205	XAVANTES	18/10/2020 03:31	18/10/2020 04:49	18/10/2020 03:31	18/10/2020 04:49	1,29	59	76,19	CHI
20201093567	IPAMERI	IP21359965	PIRES DO RIO S2	18/10/2020 03:37	18/10/2020 09:35	18/10/2020 03:37	18/10/2020 09:35	5,97	1	5,97	CHI
20201093659	FIRMINOPOLIS	FR12096839RE	FIRMINOPOLIS S1	18/10/2020 03:43	18/10/2020 07:34	18/10/2020 03:43	18/10/2020 07:34	3,84	70	268,51	CHI
20201093659	PALMINOPOLIS	FR12096839RE	FIRMINOPOLIS S1	18/10/2020 03:43	18/10/2020 07:34	18/10/2020 03:43	18/10/2020 07:34	3,84	1	3,84	CHI
20201093659	SAO JOAO DA PARAUNA	FR12096839RE	FIRMINOPOLIS S1	18/10/2020 03:43	18/10/2020 07:34	18/10/2020 03:43	18/10/2020 07:34	3,84	19	72,88	CHI
20201093657	GOIANIA	GN11021067	XAVANTES	18/10/2020 03:51	18/10/2020 14:10	18/10/2020 03:51	18/10/2020 14:10	10,32	28	288,84	CHI
20201093689	PIRACANJUBA	04220214	CALDAS NOVAS S1	18/10/2020 04:04	18/10/2020 09:38	18/10/2020 04:04	18/10/2020 09:38	5,56	169	939,50	CHI
20201093689	CALDAS NOVAS	04220214	CALDAS NOVAS S1	18/10/2020 04:04	18/10/2020 09:38	18/10/2020 04:04	18/10/2020 09:38	5,56	1	5,56	CHI
20201093582	PIRENOPOLIS	ZN12273073	COCALZINHO	18/10/2020 04:06	18/10/2020 09:30	18/10/2020 04:06	18/10/2020 09:30	5,40	14	75,59	CHI
20201093582	CORUMBA DE GOIAS	ZN12273073	COCALZINHO	18/10/2020 04:06	18/10/2020 09:30	18/10/2020 04:06	18/10/2020 09:30	5,40	2	10,80	CHI
20201093591	GOIANIA	GN12000875LD	XAVANTES	18/10/2020 04:21	18/10/2020 09:00	18/10/2020 04:21	18/10/2020 09:00	4,64	1	4,64	CHI
20201093595	JAUPACI	DI12023266RE	IPORA	18/10/2020 04:24	18/10/2020 08:14	18/10/2020 04:24	18/10/2020 08:14	3,82	9	34,37	CHI
20201093595	DIORAMA	DI12023266RE	IPORA	18/10/2020 04:24	18/10/2020 08:14	18/10/2020 04:24	18/10/2020 08:14	3,82	61	232,95	CHI
20201093594	GOIANIA	GN11159197	XAVANTES	18/10/2020 04:27	18/10/2020 06:37	18/10/2020 04:27	18/10/2020 06:37	2,16	24	51,84	CHI
20201093598	GOIANIA	GN11002836	XAVANTES	18/10/2020 04:36	18/10/2020 08:53	18/10/2020 04:36	18/10/2020 08:53	4,28	34	145,63	CHI
20201093601	ORIZONA	OZ21159625	PIRES DO RIO S1	18/10/2020 04:50	18/10/2020 07:31	18/10/2020 04:50	18/10/2020 07:31	2,67	1	2,67	CHI
20201093782	GOIAS	GS12259614	GOIAS	18/10/2020 05:04	18/10/2020 08:25	18/10/2020 05:04	18/10/2020 08:25	3,34	14	46,80	CHI
20201093604	ITABERAI	GS12310594	ITABERAI S1	18/10/2020 05:05	18/10/2020 09:58	18/10/2020 05:05	18/10/2020 09:58	4,88	25	122,07	CHI
20201093604	GOIAS	GS12310594	ITABERAI S1	18/10/2020 05:05	18/10/2020 09:58	18/10/2020 05:05	18/10/2020 09:58	4,88	5	24,41	CHI
20201093605	NOVA CRIXAS	10031642401	NOVA CRIXAS	18/10/2020 05:07	18/10/2020 08:34	18/10/2020 05:07	18/10/2020 08:34	3,44	1	3,44	CHI

20201093619	BURITI ALEGRE	BG12000103	ITUMBIARA VELHA S2	18/10/2020 05:09	18/10/2020 08:35	18/10/2020 05:09	18/10/2020 08:35	3,44	42	144,35	CHI
20201093607	ANAPOLIS	AN12096740	JUNDIAI S2	18/10/2020 05:11	18/10/2020 14:11	18/10/2020 05:11	18/10/2020 14:11	9,00	16	144,06	CHI
20201093607	ANAPOLIS	AN12096740	JUNDIAI S2	18/10/2020 05:11	18/10/2020 14:11	18/10/2020 05:11	18/10/2020 12:05	6,90	5	34,48	CHI
20201093609	ANICUNS	AC12391412	ANICUNS	18/10/2020 05:13	18/10/2020 07:16	18/10/2020 05:13	18/10/2020 07:16	2,03	27	54,91	CHI
20201093609	AVELINOPOLIS	AC12391412	ANICUNS	18/10/2020 05:13	18/10/2020 07:16	18/10/2020 05:13	18/10/2020 07:16	2,03	1	2,03	CHI
20201093610	CORUMBAIBA	CI21025297	VILA CORUMBA	18/10/2020 05:14	18/10/2020 08:55	18/10/2020 05:14	18/10/2020 08:55	3,68	2	7,35	CHI
20201093613	GOIANIA	GN12002214	CAMPINAS S3	18/10/2020 05:18	18/10/2020 08:40	18/10/2020 05:18	18/10/2020 08:40	3,36	270	907,05	CHI
20201093614	CRIXAS	CX12297040	SERRA DO OURO	18/10/2020 05:26	18/10/2020 09:32	18/10/2020 05:26	18/10/2020 09:32	4,10	1	4,10	CHI
20201093615	ARACU	AR12019237	ARACU	18/10/2020 05:27	18/10/2020 14:03	18/10/2020 05:27	18/10/2020 14:03	8,59	3	25,76	CHI
20201093615	ARACU	AR12029885LD	ARACU	18/10/2020 05:27	18/10/2020 14:03	18/10/2020 08:18	18/10/2020 14:03	5,73	1	5,73	CHI
20201093615	ARACU	AR12019237	ARACU	18/10/2020 05:27	18/10/2020 14:03	18/10/2020 05:27	18/10/2020 11:36	6,15	9	55,34	CHI
20201094107	ALOANDIA	AD12150204	GOIATUBA S1	18/10/2020 05:29	18/10/2020 09:42	18/10/2020 05:29	18/10/2020 09:42	4,20	21	88,26	CHI
20201093617	ALOANDIA	AD12349784	GOIATUBA S1	18/10/2020 05:30	18/10/2020 10:36	18/10/2020 05:30	18/10/2020 10:36	5,08	1	5,08	CHI
20201093620	FAINA	FC12234276	GOIAS	18/10/2020 05:35	18/10/2020 07:14	18/10/2020 05:35	18/10/2020 07:14	1,65	3	4,95	CHI
20201093622	VILA BOA	VB12202206	IACIARA S2	18/10/2020 05:37	18/10/2020 08:27	18/10/2020 05:37	18/10/2020 08:27	2,83	3	8,49	CHI
20201093622	FLORES DE GOIAS	VB12202206	IACIARA S2	18/10/2020 05:37	18/10/2020 08:27	18/10/2020 05:37	18/10/2020 08:27	2,83	1	2,83	CHI
20201093624	QUIRINOPOLIS	QI21094260	QUIRINOPOLIS	18/10/2020 05:39	18/10/2020 07:48	18/10/2020 05:39	18/10/2020 07:48	2,14	1	2,14	CHI
20201093631	ARENOPOLIS	AY12000051	ARENOPOLIS	18/10/2020 05:49	18/10/2020 07:24	18/10/2020 05:49	18/10/2020 07:24	1,57	4	6,28	CHI
20201093631	DIORAMA	AY12000051	ARENOPOLIS	18/10/2020 05:49	18/10/2020 07:24	18/10/2020 05:49	18/10/2020 07:24	1,57	2	3,14	CHI
20201093633	SANTO ANTONIO DE GOIAS	BW11343452	NEROPOLIS S1	18/10/2020 05:52	18/10/2020 08:08	18/10/2020 05:52	18/10/2020 08:08	2,25	16	36,01	CHI
20201093634	CACHOEIRA DE GOIAS	AI12126017	FIRMINOPOLIS S2	18/10/2020 05:54	18/10/2020 12:34	18/10/2020 05:54	18/10/2020 12:34	6,67	4	26,66	CHI
20201093634	AURILANDIA	AI12126017	FIRMINOPOLIS S2	18/10/2020 05:54	18/10/2020 12:34	18/10/2020 05:54	18/10/2020 12:34	6,67	5	33,33	CHI
20201093637	PIRES DO RIO	460031557	PIRES DO RIO S1	18/10/2020 05:55	18/10/2020 09:07	18/10/2020 05:55	18/10/2020 09:07	3,19	1	3,19	CHI
20201093698	ANAPOLIS	AN11209026	JUNDIAI S1	18/10/2020 06:01	18/10/2020 07:42	18/10/2020 06:01	18/10/2020 07:42	1,68	133	222,96	CHI
20201093642	GOIAS	GS12203880	GOIAS	18/10/2020 06:01	18/10/2020 09:00	18/10/2020 06:01	18/10/2020 09:00	2,98	26	77,36	CHI
20201093645	GOIANIA	14610000	XAVANTES	18/10/2020 06:02	18/10/2020 09:30	18/10/2020 06:02	18/10/2020 09:30	3,46	1	3,46	CHI
20201093646	PLANALTINA	PI21325554	PLANALTINA	18/10/2020 06:03	18/10/2020 07:21	18/10/2020 06:03	18/10/2020 07:21	1,29	1	1,29	CHI
20201093647	PALMELO	7547721	PIRES DO RIO S2	18/10/2020 06:03	18/10/2020 13:25	18/10/2020 06:03	18/10/2020 13:25	7,36	9	66,25	CHI
20201093647	SANTA CRUZ DE GOIAS	7547721	PIRES DO RIO S2	18/10/2020 06:03	18/10/2020 13:25	18/10/2020 06:03	18/10/2020 13:25	7,36	9	66,25	CHI
20201093647	PIRES DO RIO	7547721	PIRES DO RIO S2	18/10/2020 06:03	18/10/2020 13:25	18/10/2020 06:03	18/10/2020 13:25	7,36	5	36,81	CHI
20201093654	ITUMBIARA	IT12033049	BOM JESUS DE GOIAS	18/10/2020 06:08	18/10/2020 09:44	18/10/2020 06:08	18/10/2020 09:44	3,60	7	25,20	CHI
20201093658	MARA ROSA	MQ12263046	MARA ROSA	18/10/2020 06:09	18/10/2020 08:10	18/10/2020 06:09	18/10/2020 08:10	2,01	8	16,07	CHI
20201093660	ARAGARCAS	AG11000012	ARAGARCAS	18/10/2020 06:10	18/10/2020 08:59	18/10/2020 06:10	18/10/2020 08:59	2,80	124	347,61	CHI
20201093665	CORUMBAIBA	560006901	VILA CORUMBA	18/10/2020 06:12	18/10/2020 10:03	18/10/2020 06:12	18/10/2020 10:03	3,84	1	3,84	CHI
20201093667	GOIATUBA	GT12000127	GOIATUBA S2	18/10/2020 06:13	18/10/2020 09:32	18/10/2020 06:13	18/10/2020 09:32	3,31	28	92,70	CHI
20201093669	ANAPOLIS	21280976	JUNDIAI S1	18/10/2020 06:15	18/10/2020 10:45	18/10/2020 06:15	18/10/2020 10:45	4,49	1	4,49	CHI
20201093800	GAMELEIRA DE GOIAS	SV12382483	ANAPOLIS UNIVERSITARIO S1	18/10/2020 06:16	18/10/2020 09:37	18/10/2020 06:16	18/10/2020 09:37	3,34	18	60,05	CHI
20201093672	ANAPOLIS	21282420	ANAPOLIS UNIVERSITARIO S2	18/10/2020 06:17	18/10/2020 10:53	18/10/2020 06:17	18/10/2020 10:53	4,60	1	4,60	CHI
20201093676	ITAPACI	IW21361713	ITAPACI	18/10/2020 06:19	18/10/2020 09:05	18/10/2020 06:19	18/10/2020 09:05	2,75	1	2,75	CHI
20201094121	ITARUMA	IM11306249	CACHOEIRA ALTA	18/10/2020 06:19	18/10/2020 09:47	18/10/2020 06:19	18/10/2020 09:47	3,45	189	652,42	CHI
20201093678	ITAPURANGA	IK12311324	ITAPURANGA	18/10/2020 06:19	18/10/2020 07:22	18/10/2020 06:19	18/10/2020 07:22	1,03	6	6,20	CHI
20201094221	GAMELEIRA DE GOIAS	SV21089489	ANAPOLIS UNIVERSITARIO S2	18/10/2020 06:22	18/10/2020 11:35	18/10/2020 06:22	18/10/2020 11:35	5,20	1	5,20	CHI
20201093748	URUACU	UR12210930	URUACU	18/10/2020 06:22	18/10/2020 09:21	18/10/2020 06:22	18/10/2020 09:21	2,97	11	32,64	CHI
20201093684	LEOPOLDO DE BULHOES	AN21258530	DAIA S1	18/10/2020 06:24	18/10/2020 12:44	18/10/2020 06:24	18/10/2020 12:44	6,33	1	6,33	CHI
20201094382	GOIAS	GS12162480LD	GOIAS	18/10/2020 06:27	18/10/2020 11:35	18/10/2020 06:27	18/10/2020 11:35	5,13	43	220,73	CHI
20201093692	ANAPOLIS	21236483	JUNDIAI S2	18/10/2020 06:27	18/10/2020 09:36	18/10/2020 06:27	18/10/2020 09:36	3,15	1	3,15	CHI
20201093693	GOIANIA	11898471	GOYA S2	18/10/2020 06:27	18/10/2020 11:22	18/10/2020 06:27	18/10/2020 11:22	4,91	1	4,91	CHI
20201093694	LUZIANIA	LZ12000547	MARAJOARA	18/10/2020 06:28	18/10/2020 07:40	18/10/2020 06:28	18/10/2020 07:40	1,20	5	6,00	CHI
20201093695	TRINDADE	TR12015759	INHUMAS S1	18/10/2020 06:28	18/10/2020 08:15	18/10/2020 06:28	18/10/2020 08:15	1,78	51	90,92	CHI
20201093695	GOIANIRA	TR12015759	INHUMAS S1	18/10/2020 06:28	18/10/2020 08:15	18/10/2020 06:28	18/10/2020 08:15	1,78	1	1,78	CHI
20201093697	EDELINA	ED12307998	PONTALINA	18/10/2020 06:28	18/10/2020 08:54	18/10/2020 06:28	18/10/2020 08:54	2,43	4	9,71	CHI

20201093703	GOIANIA	GN12000805	XAVANTES	18/10/2020 06:30	18/10/2020 12:17	18/10/2020 06:30	18/10/2020 12:17	5,77	15	86,56	CHI
20201093704	MONTES CLAROS DE GOIAS	ME12334949	IPORA	18/10/2020 06:30	18/10/2020 11:05	18/10/2020 06:30	18/10/2020 11:05	4,57	8	36,54	CHI
20201094002	GOIANIA	GN11197024	MEIA PONTE	18/10/2020 06:32	18/10/2020 08:51	18/10/2020 06:32	18/10/2020 08:51	2,31	50	115,39	CHI
20201093821	MINEIROS	MY12020040	PARQUE DAS EMAS	18/10/2020 06:32	18/10/2020 09:24	18/10/2020 06:32	18/10/2020 09:24	2,85	86	245,36	CHI
20201093770	ITAPIRAPUA	IU12121382	MATRINCHA	18/10/2020 06:33	18/10/2020 08:31	18/10/2020 06:33	18/10/2020 08:31	1,96	14	27,43	CHI
20201093968	JATAI	JT21324824	JATAI S1	18/10/2020 06:35	18/10/2020 09:43	18/10/2020 06:35	18/10/2020 09:43	3,13	1	3,13	CHI
20201093746	PETROLINA DE GOIAS	IN12014368	INHUMAS S1	18/10/2020 06:36	18/10/2020 08:03	18/10/2020 06:36	18/10/2020 08:03	1,43	6	8,61	CHI
20201093746	DAMOLANDIA	IN12014368	INHUMAS S1	18/10/2020 06:36	18/10/2020 08:03	18/10/2020 06:36	18/10/2020 08:03	1,43	62	88,94	CHI
20201093746	INHUMAS	IN12014368	INHUMAS S1	18/10/2020 06:36	18/10/2020 08:03	18/10/2020 06:36	18/10/2020 08:03	1,43	53	76,03	CHI
20201093721	ALEXANIA	AX11000032	ALEXANIA	18/10/2020 06:39	18/10/2020 08:21	18/10/2020 06:39	18/10/2020 08:21	1,69	31	52,46	CHI
20201094222	ANAPOLIS	AN12351048	ANAPOLIS UNIVERSITARIO S2	18/10/2020 06:42	18/10/2020 10:22	18/10/2020 06:42	18/10/2020 10:22	3,66	17	62,25	CHI
20201093727	GOIANIA	10015623201	GOYA S1	18/10/2020 06:42	18/10/2020 09:16	18/10/2020 06:42	18/10/2020 09:16	2,56	1	2,56	CHI
20201093899	RUBIATABA	RB12392290	RUBIATABA	18/10/2020 06:42	18/10/2020 13:15	18/10/2020 06:42	18/10/2020 13:15	6,53	3	19,60	CHI
20201093899	SAO PATRICIO	RB12392290	RUBIATABA	18/10/2020 06:42	18/10/2020 13:15	18/10/2020 06:42	18/10/2020 13:15	6,53	10	65,34	CHI
20201093730	PADRE BERNARDO	PB12163212	PADRE BERNARDO	18/10/2020 06:43	18/10/2020 07:45	18/10/2020 06:43	18/10/2020 07:45	1,03	22	22,70	CHI
20201093733	CALDAZINHA	BV21072782	CEPAIGO S2	18/10/2020 06:45	18/10/2020 09:15	18/10/2020 06:45	18/10/2020 09:15	2,50	2	5,00	CHI
20201093736	GOIANIA	GN11391583	GOYA S2	18/10/2020 06:46	18/10/2020 11:00	18/10/2020 06:46	18/10/2020 11:00	4,23	2	8,46	CHI
20201093737	GOIANDIRA	GD21401639	CATALAO S1	18/10/2020 06:47	18/10/2020 08:40	18/10/2020 06:47	18/10/2020 08:40	1,88	1	1,88	CHI
20201093743	SANTO ANTONIO DE GOIAS	BW11161022	NEROPOLIS S1	18/10/2020 06:48	18/10/2020 10:03	18/10/2020 06:48	18/10/2020 10:03	3,25	105	340,96	CHI
20201093765	TRINDADE	TR11129533	GOYA S2	18/10/2020 06:58	18/10/2020 08:06	18/10/2020 06:58	18/10/2020 08:06	1,13	168	190,03	CHI
20201093767	AMERICANO DO BRASIL	KB21277515	ANICUNS	18/10/2020 06:59	18/10/2020 14:17	18/10/2020 06:59	18/10/2020 14:17	7,30	1	7,30	CHI
20201093843	URUTAI	UT12083186	URUTAI	18/10/2020 07:04	18/10/2020 09:00	18/10/2020 07:04	18/10/2020 09:00	1,93	3	5,78	CHI
20201093777	GOIANIA	13677299	MEIA PONTE	18/10/2020 07:04	18/10/2020 10:42	18/10/2020 07:04	18/10/2020 10:42	3,63	1	3,63	CHI
20201093833	GAMELEIRA DE GOIAS	GL12265246	DAIA S2	18/10/2020 07:05	18/10/2020 11:03	18/10/2020 07:05	18/10/2020 11:03	3,96	7	27,75	CHI
20201093780	MONTES CLAROS DE GOIAS	ME21038973	IPORA	18/10/2020 07:05	18/10/2020 12:41	18/10/2020 07:05	18/10/2020 12:41	5,60	1	5,60	CHI
20201093784	NOVA CRIXAS	NA21193686	MOZARLANDIA	18/10/2020 07:06	18/10/2020 12:13	18/10/2020 07:06	18/10/2020 12:13	5,10	1	5,10	CHI
20201093785	CAIAPONIA	CP21357558	PALESTINA	18/10/2020 07:07	18/10/2020 14:25	18/10/2020 07:07	18/10/2020 14:25	7,30	1	7,30	CHI
20201093786	EDEALINA	EA12039620RE	VICENTINOPOLIS	18/10/2020 07:08	18/10/2020 10:15	18/10/2020 07:08	18/10/2020 10:15	3,11	6	18,69	CHI
20201093787	ANAPOLIS	20468349	JUNDIAI S2	18/10/2020 07:08	18/10/2020 11:27	18/10/2020 07:08	18/10/2020 11:27	4,30	1	4,30	CHI
20201093794	APARECIDA DE GOIANIA	16700843	REAL S1	18/10/2020 07:11	18/10/2020 08:40	18/10/2020 07:11	18/10/2020 08:40	1,47	1	1,47	CHI
20201093795	APORE	AE12234187	ITAJA S2	18/10/2020 07:11	18/10/2020 09:24	18/10/2020 07:11	18/10/2020 09:24	2,20	2	4,41	CHI
20201093802	GOIANIA	11818001	ATLANTICO S1	18/10/2020 07:13	18/10/2020 08:13	18/10/2020 07:13	18/10/2020 08:13	0,98	1	0,98	CHI
20201093803	ANAPOLIS	20564934	ANAPOLIS UNIVERSITARIO S2	18/10/2020 07:14	18/10/2020 11:52	18/10/2020 07:14	18/10/2020 11:52	4,63	1	4,63	CHI
20201095153	TRINDADE	TR11180160	TRINDADE	18/10/2020 07:15	18/10/2020 15:52	18/10/2020 07:15	18/10/2020 15:52	8,62	69	594,55	CHI
20201094849	TRINDADE	TR12047845	TRINDADE	18/10/2020 07:15	18/10/2020 13:30	18/10/2020 07:15	18/10/2020 13:30	6,25	619	3868,75	CHI
20201093810	GOIAS	GS12249339	MATRINCHA	18/10/2020 07:16	18/10/2020 10:40	18/10/2020 07:16	18/10/2020 10:40	3,39	10	33,88	CHI
20201093814	GOIANIA	11587180	CAMPINAS S2	18/10/2020 07:17	18/10/2020 09:16	18/10/2020 07:17	18/10/2020 09:16	1,97	1	1,97	CHI
20201093897	ANAPOLIS	AN12353412	JUNDIAI S1	18/10/2020 07:19	18/10/2020 08:25	18/10/2020 07:19	18/10/2020 08:25	1,09	90	98,40	CHI
20201093824	AGUA LIMPA	AL12172361	VILA CORUMBA	18/10/2020 07:20	18/10/2020 08:46	18/10/2020 07:20	18/10/2020 08:46	1,42	6	8,53	CHI
20201093943	PARAUNA	EU12044261	ACREUNA	18/10/2020 07:20	18/10/2020 10:51	18/10/2020 07:20	18/10/2020 10:51	3,50	10	35,04	CHI
20201093826	APARECIDA DE GOIANIA	AP11016120	INDEPENDENCIA S1	18/10/2020 07:21	18/10/2020 09:09	18/10/2020 07:21	18/10/2020 09:09	1,80	177	318,16	CHI
20201093827	LAGOA SANTA	IJ12321777	CACHOEIRA ALTA	18/10/2020 07:22	18/10/2020 12:27	18/10/2020 07:22	18/10/2020 12:27	5,08	12	60,97	CHI
20201093827	ITAJA	IJ12321777	CACHOEIRA ALTA	18/10/2020 07:22	18/10/2020 12:27	18/10/2020 07:22	18/10/2020 12:27	5,08	20	101,62	CHI
20201093828	JATAI	290184198	JATAI S3	18/10/2020 07:22	18/10/2020 09:02	18/10/2020 07:22	18/10/2020 09:02	1,66	1	1,66	CHI
20201093839	GOIANESIA	550129509	GOIANESIA S2	18/10/2020 07:25	18/10/2020 08:47	18/10/2020 07:25	18/10/2020 08:47	1,36	1	1,36	CHI
20201093838	SAO JOAO DA PARAUNA	RP21147975	FIRMINOPOLIS S2	18/10/2020 07:26	18/10/2020 15:27	18/10/2020 07:26	18/10/2020 15:27	8,02	1	8,02	CHI
20201093840	GOIANIA	11213255	GOIANIA LESTE S3	18/10/2020 07:26	18/10/2020 09:14	18/10/2020 07:26	18/10/2020 09:14	1,79	1	1,79	CHI
20201093846	JOVIANIA	GT12050672	GOIATUBA S1	18/10/2020 07:29	18/10/2020 12:38	18/10/2020 07:29	18/10/2020 12:38	5,15	1	5,15	CHI
20201093846	VICENTINOPOLIS	GT12050672	GOIATUBA S1	18/10/2020 07:29	18/10/2020 12:38	18/10/2020 07:29	18/10/2020 12:38	5,15	3	15,45	CHI
20201093846	GOIATUBA	GT12050672	GOIATUBA S1	18/10/2020 07:29	18/10/2020 12:38	18/10/2020 07:29	18/10/2020 12:38	5,15	1	5,15	CHI
20201093847	CORUMBA DE GOIAS	CB21148333	CORUMBA	18/10/2020 07:29	18/10/2020 08:58	18/10/2020 07:29	18/10/2020 08:58	1,47	1	1,47	CHI

20201093851	DOVERLANDIA	DV12395478	CAIAPONIA	18/10/2020 07:30	18/10/2020 09:21	18/10/2020 07:30	18/10/2020 09:21	1,84	29	53,34	CHI
20201093853	COLINAS DO SUL	TI12236621	MINACU	18/10/2020 07:30	18/10/2020 09:35	18/10/2020 07:30	18/10/2020 09:35	2,07	9	18,61	CHI
20201093856	GOIANIA	10199809	AEROPORTO S1	18/10/2020 07:32	18/10/2020 12:04	18/10/2020 07:32	18/10/2020 12:04	4,53	1	4,53	CHI
20201093857	GOIANIA	10015018286	XAVANTES	18/10/2020 07:32	18/10/2020 10:51	18/10/2020 07:32	18/10/2020 10:51	3,31	1	3,31	CHI
20201093862	ITABERAI	IB21000029	ITABERAI S2	18/10/2020 07:33	18/10/2020 14:40	18/10/2020 07:33	18/10/2020 14:40	7,11	1	7,11	CHI
20201093863	AGUA LIMPA	AL12024213	VILA CORUMBA	18/10/2020 07:33	18/10/2020 09:50	18/10/2020 07:33	18/10/2020 09:50	2,27	2	4,54	CHI
20201093864	RUBIATABA	RB12000038	RUBIATABA	18/10/2020 07:33	18/10/2020 11:26	18/10/2020 07:33	18/10/2020 11:26	3,88	4	15,51	CHI
20201093972	JATAI	JT12244770	JATAI S1	18/10/2020 07:34	18/10/2020 10:28	18/10/2020 07:34	18/10/2020 10:28	2,89	13	37,56	CHI
20201093870	HEITORAI	360005962	ITAPURANGA	18/10/2020 07:35	18/10/2020 08:57	18/10/2020 07:35	18/10/2020 08:57	1,36	1	1,36	CHI
20201093873	GUARANI DE GOIAS	GY12211248	SAO DOMINGOS	18/10/2020 07:36	18/10/2020 09:46	18/10/2020 07:36	18/10/2020 09:46	2,18	120	261,10	CHI
20201093873	SAO DOMINGOS	GY12211248	SAO DOMINGOS	18/10/2020 07:36	18/10/2020 09:46	18/10/2020 07:36	18/10/2020 09:46	2,18	13	28,29	CHI
20201093877	ITAPIRAPUA	IU21089796	MATRINCHA	18/10/2020 07:38	18/10/2020 10:48	18/10/2020 07:38	18/10/2020 10:48	3,16	1	3,16	CHI
20201093879	ALEXANIA	AX21144103	ALEXANIA	18/10/2020 07:38	18/10/2020 09:53	18/10/2020 07:38	18/10/2020 09:53	2,24	1	2,24	CHI
20201093930	PORTELANDIA	PW12072215	PARQUE DAS EMAS	18/10/2020 07:38	18/10/2020 13:19	18/10/2020 07:38	18/10/2020 13:19	5,67	4	22,67	CHI
20201093881	CRISTALINA	KR12404434	CRISTALINA S1	18/10/2020 07:39	18/10/2020 08:25	18/10/2020 07:39	18/10/2020 08:25	0,76	6	4,57	CHI
20201093885	ANAPOLIS	20671908	JUNDIAI S1	18/10/2020 07:39	18/10/2020 08:31	18/10/2020 07:39	18/10/2020 08:31	0,86	1	0,86	CHI
20201093888	NIQUELANDIA	2750077467	NIQUELANDIA SUBTRANSMISSAO	18/10/2020 07:39	18/10/2020 11:28	18/10/2020 07:39	18/10/2020 11:28	3,81	1	3,81	CHI
20201093889	SAO DOMINGOS	SD21261968	SAO DOMINGOS	18/10/2020 07:40	18/10/2020 12:20	18/10/2020 07:40	18/10/2020 12:20	4,66	1	4,66	CHI
20201093891	ANAPOLIS	AN31221422	JUNDIAI S2	18/10/2020 07:40	18/10/2020 09:10	18/10/2020 07:40	18/10/2020 09:10	1,49	3	4,47	CHI
20201093894	CRISTIANOPOLIS	CF21102408	CRISTIANOPOLIS	18/10/2020 07:41	18/10/2020 14:40	18/10/2020 07:41	18/10/2020 14:40	6,98	1	6,98	CHI
20201093901	MARA ROSA	MQ21238491	MARA ROSA	18/10/2020 07:44	18/10/2020 10:13	18/10/2020 07:44	18/10/2020 10:13	2,48	1	2,48	CHI
20201093904	MORRO AGUDO DE GOIAS	MS12136795	ITAPURANGA	18/10/2020 07:45	18/10/2020 11:04	18/10/2020 07:45	18/10/2020 11:04	3,32	37	122,72	CHI
20201093912	APARECIDA DE GOIANIA	10000749905	INTERDEPENDENCIA S2	18/10/2020 07:47	18/10/2020 08:36	18/10/2020 07:47	18/10/2020 08:36	0,81	1	0,81	CHI
20201093914	RIO VERDE	RV21260223	CABRIUVA S1	18/10/2020 07:48	18/10/2020 09:38	18/10/2020 07:48	18/10/2020 09:38	1,83	1	1,83	CHI
20201093915	MONTES CLAROS DE GOIAS	ME21370282	IPORA	18/10/2020 07:48	18/10/2020 18:41	18/10/2020 07:48	18/10/2020 18:41	10,88	1	10,88	CHI
20201094424	GOIANIA	GN11001923	FERROVIARIO S3	18/10/2020 07:49	18/10/2020 11:21	18/10/2020 07:49	18/10/2020 11:21	3,53	116	409,19	CHI
20201094102	ANAPOLIS	AN12013254	ANAPOLIS UNIVERSITARIO S2	18/10/2020 07:49	18/10/2020 09:41	18/10/2020 07:49	18/10/2020 09:41	1,86	14	26,02	CHI
20201093917	GOIATUBA	GT12008236	BOM JESUS DE GOIAS	18/10/2020 07:49	18/10/2020 10:01	18/10/2020 07:49	18/10/2020 10:01	2,19	17	37,21	CHI
20201093924	MARA ROSA	MQ21244255	MARA ROSA	18/10/2020 07:52	18/10/2020 10:52	18/10/2020 07:52	18/10/2020 10:52	3,00	1	3,00	CHI
20201094057	QUIRINOPOLIS	QI32058080	QUIRINOPOLIS	18/10/2020 07:52	18/10/2020 09:59	18/10/2020 07:52	18/10/2020 09:59	2,11	10	21,13	CHI
20201093926	PEROLANDIA	10017642424	PARQUE DAS EMAS	18/10/2020 07:52	18/10/2020 11:40	18/10/2020 07:52	18/10/2020 11:40	3,81	1	3,81	CHI
20201093928	NIQUELANDIA	NQ21374780	BARRO ALTO	18/10/2020 07:53	18/10/2020 14:09	18/10/2020 07:53	18/10/2020 14:09	6,27	3	18,80	CHI
20201093933	LUZIANIA	SV12159750	VIANOPOLIS	18/10/2020 07:53	18/10/2020 08:56	18/10/2020 07:53	18/10/2020 08:56	1,05	4	4,18	CHI
20201093935	PIRES DO RIO	460025892	PIRES DO RIO S1	18/10/2020 07:54	18/10/2020 10:15	18/10/2020 07:54	18/10/2020 10:15	2,35	1	2,35	CHI
20201093937	ARENOPOLIS	AY21103478	ARENOPOLIS	18/10/2020 07:55	18/10/2020 10:05	18/10/2020 07:55	18/10/2020 10:05	2,16	1	2,16	CHI
20201093940	CAIAPONIA	CP11193461	CAIAPONIA	18/10/2020 07:55	18/10/2020 10:40	18/10/2020 07:55	18/10/2020 10:40	2,75	60	164,72	CHI
20201093942	LUZIANIA	10012672210	RIO VERMELHO	18/10/2020 07:55	18/10/2020 08:47	18/10/2020 07:55	18/10/2020 08:47	0,86	1	0,86	CHI
20201093949	SENADOR CANEDO	SW11414002	SENADOR CANEDO	18/10/2020 07:57	18/10/2020 09:30	18/10/2020 07:57	18/10/2020 09:30	1,54	80	122,87	CHI
20201093957	GOIANIA	14318490	CAMPINAS S2	18/10/2020 07:59	18/10/2020 10:34	18/10/2020 07:59	18/10/2020 10:34	2,58	1	2,58	CHI
20201094087	PORANGATU	PO12391912	PORANGATU	18/10/2020 08:01	18/10/2020 09:21	18/10/2020 08:01	18/10/2020 09:21	1,33	51	67,82	CHI
20201094087	MUTUNOPOLIS	PO12391912	PORANGATU	18/10/2020 08:01	18/10/2020 09:21	18/10/2020 08:01	18/10/2020 09:21	1,33	4	5,32	CHI
20201093965	BRAZABRANTES	GR21021093	NEROPOLIS S1	18/10/2020 08:01	18/10/2020 09:51	18/10/2020 08:01	18/10/2020 09:51	1,82	1	1,82	CHI
20201093977	FIRMINOPOLIS	FR21206036	FIRMINOPOLIS S1	18/10/2020 08:02	18/10/2020 09:23	18/10/2020 08:02	18/10/2020 09:23	1,34	1	1,34	CHI
20201093981	FORMOSA	FB12242937LD	FLORES DE GOIAS	18/10/2020 08:03	18/10/2020 12:19	18/10/2020 12:16	18/10/2020 12:19	0,06	134	7,89	CHI
20201093981	FLORES DE GOIAS	FB12242937LD	FLORES DE GOIAS	18/10/2020 08:03	18/10/2020 12:19	18/10/2020 12:16	18/10/2020 12:19	0,06	3	0,18	CHI
20201093981	FORMOSO	FB12242937LD	FLORES DE GOIAS	18/10/2020 08:03	18/10/2020 12:19	18/10/2020 12:16	18/10/2020 12:19	0,06	1	0,06	CHI
20201093981	SAO JOAO D ALIANCA	FB12242937LD	FLORES DE GOIAS	18/10/2020 08:03	18/10/2020 12:19	18/10/2020 12:16	18/10/2020 12:19	0,06	5	0,29	CHI
20201093981	FORMOSA	FB12242937LD	FLORES DE GOIAS	18/10/2020 08:03	18/10/2020 12:19	18/10/2020 08:03	18/10/2020 12:14	4,18	134	560,42	CHI
20201093981	FORMOSO	FB12242937LD	FLORES DE GOIAS	18/10/2020 08:03	18/10/2020 12:19	18/10/2020 08:03	18/10/2020 12:14	4,18	1	4,18	CHI
20201093981	FLORES DE GOIAS	FB12242937LD	FLORES DE GOIAS	18/10/2020 08:03	18/10/2020 12:19	18/10/2020 08:03	18/10/2020 12:14	4,18	3	12,55	CHI
20201093981	SAO JOAO D ALIANCA	FB12242937LD	FLORES DE GOIAS	18/10/2020 08:03	18/10/2020 12:19	18/10/2020 08:03	18/10/2020 12:14	4,18	5	20,91	CHI

20201093988	FIRMINOPOLIS	FR21159040	FIRMINOPOLIS S1	18/10/2020 08:04	18/10/2020 09:54	18/10/2020 08:04	18/10/2020 09:54	1,82	1	1,82	CHI
20201093991	ORIZONA	OZ12023002	PIRES DO RIO S2	18/10/2020 08:05	18/10/2020 09:49	18/10/2020 08:05	18/10/2020 09:49	1,73	4	6,92	CHI
20201093992	ARAGUAPAZ	AZ11327545	MOZARLANDIA	18/10/2020 08:05	18/10/2020 09:32	18/10/2020 08:05	18/10/2020 09:32	1,45	1	1,45	CHI
20201093993	ANAPOLIS	10003337551	JUNDIAI S1	18/10/2020 08:05	18/10/2020 10:51	18/10/2020 08:05	18/10/2020 10:51	2,76	1	2,76	CHI
20201093995	ABADIANIA	AA21122897	ANAPOLIS UNIVERSITARIO S1	18/10/2020 08:05	18/10/2020 11:29	18/10/2020 08:05	18/10/2020 11:29	3,39	1	3,39	CHI
20201093752	GAMELEIRA DE GOIAS	GL21287742	ANAPOLIS UNIVERSITARIO S2	18/10/2020 08:05	18/10/2020 08:36	18/10/2020 08:05	18/10/2020 08:36	0,51	1	0,51	CHI
20201094345	GOIANIA	GN11166685	CAMPINAS S2	18/10/2020 08:06	18/10/2020 10:33	18/10/2020 08:06	18/10/2020 10:33	2,44	78	190,64	CHI
20201093998	ANAPOLIS	AN12258561	ANAPOLIS UNIVERSITARIO S2	18/10/2020 08:06	18/10/2020 13:15	18/10/2020 08:06	18/10/2020 13:15	5,13	1	5,13	CHI
20201093998	ANAPOLIS	AN12258561	ANAPOLIS UNIVERSITARIO S2	18/10/2020 08:06	18/10/2020 13:15	18/10/2020 08:06	18/10/2020 11:30	3,40	53	180,10	CHI
20201094003	AGUA FRIA DE GOIAS	NQ12140182	SAO JOAO D ALIANCA	18/10/2020 08:08	18/10/2020 10:08	18/10/2020 08:08	18/10/2020 10:08	2,00	72	144,22	CHI
20201094003	NIQUELANDIA	NQ12140182	SAO JOAO D ALIANCA	18/10/2020 08:08	18/10/2020 10:08	18/10/2020 08:08	18/10/2020 10:08	2,00	5	10,02	CHI
20201094004	ACREUNA	EU12260954	ACREUNA	18/10/2020 08:08	18/10/2020 14:04	18/10/2020 08:08	18/10/2020 14:04	5,93	1	5,93	CHI
20201094018	ANAPOLIS	10003125171	ANAPOLIS UNIVERSITARIO S2	18/10/2020 08:11	18/10/2020 12:22	18/10/2020 08:11	18/10/2020 12:22	4,17	1	4,17	CHI
20201094020	MORRINHOS	MR12000136	MORRINHOS	18/10/2020 08:12	18/10/2020 10:05	18/10/2020 08:12	18/10/2020 10:05	1,88	1	1,88	CHI
20201094021	RIO VERDE	RV21271626	CABRIUVA S2	18/10/2020 08:12	18/10/2020 10:08	18/10/2020 08:12	18/10/2020 10:08	1,93	1	1,93	CHI
20201094025	SERRANOPOLIS	SX21264464	JATAI S1	18/10/2020 08:13	18/10/2020 12:05	18/10/2020 08:13	18/10/2020 12:05	3,87	1	3,87	CHI
20201094026	BELA VISTA DE GOIAS	BV11251828	BELA VISTA S1	18/10/2020 08:13	18/10/2020 10:14	18/10/2020 08:13	18/10/2020 10:14	2,02	92	185,41	CHI
20201094029	ANAPOLIS	10007409476	JUNDIAI S1	18/10/2020 08:14	18/10/2020 12:49	18/10/2020 08:14	18/10/2020 12:49	4,57	1	4,57	CHI
202010189398	NIQUELANDIA	NQ12072538	NIQUELANDIA SUBTRANSMISSAO	18/10/2020 08:15	19/10/2020 12:00	18/10/2020 08:15	19/10/2020 12:00	27,75	3	83,25	CHI
20201094040	OURO VERDE DE GOIAS	NR21221921	NEROPOLIS S2	18/10/2020 08:15	18/10/2020 11:56	18/10/2020 08:15	18/10/2020 11:56	3,67	1	3,67	CHI
20201094041	PADRE BERNARDO	2760007840	PADRE BERNARDO	18/10/2020 08:15	18/10/2020 09:55	18/10/2020 08:15	18/10/2020 09:55	1,65	1	1,65	CHI
20201094042	CIDADE OCIDENTAL	19782163	MARAJOARA	18/10/2020 08:16	18/10/2020 10:27	18/10/2020 08:16	18/10/2020 10:27	2,18	6	13,06	CHI
20201094043	POSSE	PS11279937	IACIARA S2	18/10/2020 08:16	18/10/2020 13:28	18/10/2020 08:16	18/10/2020 13:28	5,19	110	570,93	CHI
20201094044	PLANALTINA	PI21324277	SAO JOAO D ALIANCA	18/10/2020 08:16	18/10/2020 11:06	18/10/2020 08:16	18/10/2020 11:06	2,82	1	2,82	CHI
20201094050	ANAPOLIS	20810040	JUNDIAI S1	18/10/2020 08:18	18/10/2020 09:28	18/10/2020 08:18	18/10/2020 09:28	1,16	1	1,16	CHI
20201094203	SERRANOPOLIS	SX12165995	CHAPADAO DO CEU	18/10/2020 08:18	18/10/2020 11:50	18/10/2020 08:18	18/10/2020 11:50	3,52	2	7,05	CHI
20201094053	ANAPOLIS	10013662862	JUNDIAI S2	18/10/2020 08:18	18/10/2020 10:54	18/10/2020 08:18	18/10/2020 10:54	2,59	1	2,59	CHI
20201094056	ITABERAI	GS12310430	ITABERAI S1	18/10/2020 08:19	18/10/2020 14:47	18/10/2020 08:19	18/10/2020 14:47	6,46	2	12,93	CHI
20201094056	GOIAS	GS12310430	ITABERAI S1	18/10/2020 08:19	18/10/2020 14:47	18/10/2020 08:19	18/10/2020 14:47	6,46	1	6,46	CHI
20201094060	ITUMBIARA	IT11088631	CACHOEIRA DOURADA	18/10/2020 08:19	18/10/2020 12:03	18/10/2020 08:19	18/10/2020 12:03	3,73	97	361,65	CHI
20201094061	ABADIA DE GOIAS	5582278131	CARAJAS S1	18/10/2020 08:19	18/10/2020 09:47	18/10/2020 08:19	18/10/2020 09:47	1,46	1	1,46	CHI
20201094065	GOIANIA	GN11107078	CAMPINAS S2	18/10/2020 08:20	18/10/2020 13:03	18/10/2020 08:20	18/10/2020 13:03	4,71	158	744,58	CHI
20201094066	ANAPOLIS	21333166	ANAPOLIS UNIVERSITARIO S2	18/10/2020 08:20	18/10/2020 09:29	18/10/2020 08:20	18/10/2020 09:29	1,14	1	1,14	CHI
20201094075	EDEALINA	ED12223334	VICENTINOPOLIS	18/10/2020 08:21	18/10/2020 10:48	18/10/2020 08:21	18/10/2020 10:48	2,45	1	2,45	CHI
20201094077	PIRES DO RIO	UT21300790	PIRES DO RIO S1	18/10/2020 08:21	18/10/2020 10:10	18/10/2020 08:21	18/10/2020 10:10	1,81	3	5,42	CHI
20201094078	APARECIDA DE GOIANIA	12015325	REAL S1	18/10/2020 08:21	18/10/2020 10:26	18/10/2020 08:21	18/10/2020 10:26	2,07	1	2,07	CHI
20201094082	JANDIAIA	JD21138755	PALMEIRAS	18/10/2020 08:22	18/10/2020 12:30	18/10/2020 08:22	18/10/2020 12:30	4,13	1	4,13	CHI
20201094085	GOIANIA	10006103209	XAVANTES	18/10/2020 08:23	18/10/2020 12:18	18/10/2020 08:23	18/10/2020 12:18	3,91	1	3,91	CHI
20201094089	ITAUCU	IX31066022	INHUMAS S2	18/10/2020 08:23	18/10/2020 09:47	18/10/2020 08:23	18/10/2020 09:47	1,39	1	1,39	CHI
20201094090	ITAPURANGA	IK21298524	ITAPURANGA	18/10/2020 08:24	18/10/2020 10:58	18/10/2020 08:24	18/10/2020 10:58	2,57	1	2,57	CHI
20201094097	CRISTALINA	KR12209473LD	CRISTALINA S2	18/10/2020 08:25	18/10/2020 10:37	18/10/2020 08:25	18/10/2020 10:37	2,19	10	21,91	CHI
20201094101	ANAPOLIS	20068840	JUNDIAI S1	18/10/2020 08:26	18/10/2020 11:54	18/10/2020 08:26	18/10/2020 11:54	3,47	1	3,47	CHI
20201094104	CALDAS NOVAS	CN12246666	SERRA DE CALDAS	18/10/2020 08:28	18/10/2020 09:50	18/10/2020 08:28	18/10/2020 09:50	1,36	29	39,54	CHI
20201094113	GOIANIA	11529118	XAVANTES	18/10/2020 08:31	18/10/2020 09:42	18/10/2020 08:31	18/10/2020 09:42	1,18	1	1,18	CHI
20201094115	GOIANIA	10999139	XAVANTES	18/10/2020 08:31	18/10/2020 09:49	18/10/2020 08:31	18/10/2020 09:49	1,29	1	1,29	CHI
20201094368	GOIANIA	GN11162081	CAMPINAS S2	18/10/2020 08:31	18/10/2020 16:16	18/10/2020 08:31	18/10/2020 16:16	7,75	52	402,88	CHI
20201094313	ALEXANIA	AX12295610	ALEXANIA	18/10/2020 08:32	18/10/2020 18:03	18/10/2020 08:32	18/10/2020 18:03	9,51	13	123,67	CHI
20201094313	ALEXANIA	AX12295610	ALEXANIA	18/10/2020 08:32	18/10/2020 18:03	18/10/2020 15:15	18/10/2020 18:03	2,80	9	25,20	CHI
20201094120	SAO FRANCISCO DE GOIAS	SF12032711	SAO FRANCISCO DE GOIAS	18/10/2020 08:32	18/10/2020 09:35	18/10/2020 08:32	18/10/2020 09:35	1,06	277	294,08	CHI
20201094125	JOVIANIA	PK21296834	GOIATUBA S1	18/10/2020 08:33	18/10/2020 12:47	18/10/2020 08:33	18/10/2020 12:47	4,22	1	4,22	CHI
202010189512	MORRINHOS	650009400	GOIATUBA S1	18/10/2020 08:34	18/10/2020 21:04	18/10/2020 08:34	18/10/2020 21:04	12,50	1	12,50	CHI

20201094128	MUNDO NOVO DE GOIAS	NA21058010	NOVA CRIXAS	18/10/2020 08:34	18/10/2020 10:29	18/10/2020 08:34	18/10/2020 10:29	1,91	1	1,91	CHI
20201094130	NOVA CRIXAS	NA11213031	NOVA CRIXAS	18/10/2020 08:35	18/10/2020 11:36	18/10/2020 08:35	18/10/2020 11:36	3,01	14	42,17	CHI
20201094132	GOIANIA	10004719113	GOIANIA LESTE S3	18/10/2020 08:35	18/10/2020 10:17	18/10/2020 08:35	18/10/2020 10:17	1,69	1	1,69	CHI
20201094133	VALPARAISO DE GOIAS	VA11149817	MARAJOARA	18/10/2020 08:36	18/10/2020 09:12	18/10/2020 08:36	18/10/2020 09:12	0,60	36	21,52	CHI
20201094137	POSSE	PS21237079	IACIARA S2	18/10/2020 08:37	18/10/2020 12:54	18/10/2020 08:37	18/10/2020 12:54	4,28	3	12,83	CHI
20201094140	ANICUNS	AC21186917	ANICUNS	18/10/2020 08:38	18/10/2020 13:56	18/10/2020 08:38	18/10/2020 13:56	5,30	1	5,30	CHI
20201094142	CALDAZINHA	SV21302145	CEPAIGO S2	18/10/2020 08:38	18/10/2020 10:42	18/10/2020 08:38	18/10/2020 10:42	2,06	2	4,12	CHI
20201094143	COLINAS DO SUL	TI12162624	NIQUELANDIA SUBTRANSMISSAO	18/10/2020 08:38	18/10/2020 10:55	18/10/2020 08:38	18/10/2020 10:55	2,27	1	2,27	CHI
20201094148	SANTA TEREZINHA DE GOIAS	SG21341384	SANTA TEREZINHA	18/10/2020 08:39	18/10/2020 10:53	18/10/2020 08:39	18/10/2020 10:53	2,23	1	2,23	CHI
20201093953	GOIANIA	GN11170373	XAVANTES	18/10/2020 08:42	18/10/2020 08:52	18/10/2020 08:42	18/10/2020 08:52	0,17	70	11,67	CHI
20201094201	ITAPIRAPUA	IU12025065	MATRINCHA	18/10/2020 08:42	18/10/2020 11:50	18/10/2020 08:42	18/10/2020 11:50	3,13	15	46,91	CHI
20201094201	BRITANIA	IU12025065	MATRINCHA	18/10/2020 08:42	18/10/2020 11:50	18/10/2020 08:42	18/10/2020 11:50	3,13	6	18,76	CHI
20201094162	ITUMBIARA	IT11122244	ITUMBIARA VELHA S1	18/10/2020 08:44	18/10/2020 16:31	18/10/2020 08:44	18/10/2020 16:31	7,78	18	140,10	CHI
20201094163	CRISTALINA	KR21171017	CRISTALINA S1	18/10/2020 08:44	18/10/2020 10:31	18/10/2020 08:44	18/10/2020 10:31	1,78	1	1,78	CHI
20201094167	MUTUNOPOLIS	MU12354548	MARA ROSA	18/10/2020 08:44	18/10/2020 14:46	18/10/2020 08:44	18/10/2020 14:46	6,02	2	12,05	CHI
20201094170	SANTO ANTONIO DA BARRA	BZ21279439	ACREUNA	18/10/2020 08:45	18/10/2020 11:14	18/10/2020 08:45	18/10/2020 11:14	2,48	3	7,44	CHI
20201094180	ISRAELANDIA	IS12223059	IPORA	18/10/2020 08:45	18/10/2020 11:21	18/10/2020 08:45	18/10/2020 11:21	2,59	3	7,76	CHI
20201094173	CAIAPONIA	CP21415081	PALESTINA	18/10/2020 08:45	18/10/2020 14:30	18/10/2020 08:45	18/10/2020 14:30	5,75	1	5,75	CHI
20201094179	VARJAO	VJ21221676	GUAPO S2	18/10/2020 08:46	18/10/2020 10:45	18/10/2020 08:46	18/10/2020 10:45	1,97	2	3,95	CHI
20201094191	GOIANIA	GN12001850	CAMPINAS S2	18/10/2020 08:48	18/10/2020 18:59	18/10/2020 08:48	18/10/2020 18:59	10,20	1	10,20	CHI
20201094192	JATAI	JT12202741	JATAI S1	18/10/2020 08:48	18/10/2020 13:07	18/10/2020 08:48	18/10/2020 13:07	4,31	3	12,93	CHI
20201094197	CALDAS NOVAS	CN11213987	SERRA DE CALDAS	18/10/2020 08:50	18/10/2020 12:03	18/10/2020 08:50	18/10/2020 12:03	3,21	70	224,97	CHI
20201094205	APARECIDA DE GOIANIA	13246045	ATLANTICO S2	18/10/2020 08:51	18/10/2020 11:56	18/10/2020 08:51	18/10/2020 11:56	3,08	1	3,08	CHI
20201094211	MOSSAMEDES	MD12311080	ITABERAI S2	18/10/2020 08:53	18/10/2020 12:21	18/10/2020 08:53	18/10/2020 12:21	3,46	15	51,84	CHI
20201091517	RIO VERDE	RV21240368	CABRIUVA S2	18/10/2020 08:54	18/10/2020 15:16	18/10/2020 08:54	18/10/2020 15:16	6,36	1	6,36	CHI
20201093590	UIRAPURU	UP12181466	SANTA TEREZINHA	18/10/2020 08:55	18/10/2020 12:33	18/10/2020 08:55	18/10/2020 12:33	3,64	13	47,36	CHI
20201094229	CUMARI	CY12000309	CATALAO S1	18/10/2020 08:55	18/10/2020 10:43	18/10/2020 08:55	18/10/2020 10:43	1,80	12	21,54	CHI
20201094231	CAMPO LIMPO	AN21258262	NEROPOLIS S1	18/10/2020 08:55	18/10/2020 11:14	18/10/2020 08:55	18/10/2020 11:14	2,30	7	16,13	CHI
20201094404	ALOANDIA	AD12293110	GOIATUBA S1	18/10/2020 08:56	18/10/2020 11:09	18/10/2020 08:56	18/10/2020 11:09	2,20	12	26,44	CHI
20201094234	APARECIDA DE GOIANIA	AP21012585	INDEPENDENCIA S1	18/10/2020 08:56	18/10/2020 10:36	18/10/2020 08:56	18/10/2020 10:36	1,65	1	1,65	CHI
20201094237	DIORAMA	DI12380801	IPORA	18/10/2020 08:57	18/10/2020 11:45	18/10/2020 08:57	18/10/2020 11:45	2,79	8	22,36	CHI
20201094241	TEREZOPOLIS DE GOIAS	GP31029283	JUNDIAI S1	18/10/2020 08:58	18/10/2020 12:33	18/10/2020 08:58	18/10/2020 12:33	3,57	1	3,57	CHI
20201093886	GOIANIA	GN11001644	FERROVIARIO S3	18/10/2020 09:00	18/10/2020 09:57	18/10/2020 09:00	18/10/2020 09:57	0,95	211	200,45	CHI
20201094244	SANTA RITA DO ARAGUAIA	SU12027942	SANTA RITA DO ARAGUAIA	18/10/2020 09:00	18/10/2020 10:30	18/10/2020 09:00	18/10/2020 10:30	1,49	1	1,49	CHI
20201094246	GOIANIA	10019027778	XAVANTES	18/10/2020 09:01	18/10/2020 11:27	18/10/2020 09:01	18/10/2020 11:27	2,43	1	2,43	CHI
20201094247	AVELINOPOLIS	AV21193582	ANICUNS	18/10/2020 09:01	18/10/2020 10:37	18/10/2020 09:01	18/10/2020 10:37	1,59	1	1,59	CHI
20201094249	ANAPOLIS	21033092	JUNDIAI S1	18/10/2020 09:02	18/10/2020 11:58	18/10/2020 09:02	18/10/2020 11:58	2,94	1	2,94	CHI
20201094250	APARECIDA DE GOIANIA	14188326	ANHANGUERA	18/10/2020 09:02	18/10/2020 12:24	18/10/2020 09:02	18/10/2020 12:24	3,36	1	3,36	CHI
20201094263	MUNDO NOVO DE GOIAS	MH12208599	NOVA CRIXAS	18/10/2020 09:03	18/10/2020 12:34	18/10/2020 09:03	18/10/2020 12:34	3,51	2	7,02	CHI
20201094390	PALMEIRAS DE GOIAS	PL21312516	PALMEIRAS	18/10/2020 09:04	18/10/2020 11:28	18/10/2020 09:04	18/10/2020 11:28	2,41	0	0,00	CHI
20201094258	ANAPOLIS	AN21215124	ANAPOLIS UNIVERSITARIO S2	18/10/2020 09:05	18/10/2020 12:15	18/10/2020 09:05	18/10/2020 12:15	3,16	1	3,16	CHI
20201094259	ANICUNS	AC21304640	ANICUNS	18/10/2020 09:06	18/10/2020 09:57	18/10/2020 09:06	18/10/2020 09:57	0,85	2	1,70	CHI
20201094260	CAMPINORTE	MQ12380774	MARA ROSA	18/10/2020 09:06	18/10/2020 10:50	18/10/2020 09:06	18/10/2020 10:50	1,73	1	1,73	CHI
20201094260	MARA ROSA	MQ12380774	MARA ROSA	18/10/2020 09:06	18/10/2020 10:50	18/10/2020 09:06	18/10/2020 10:50	1,73	5	8,66	CHI
20201094261	PORANGATU	PO21192262	PORANGATU	18/10/2020 09:06	18/10/2020 15:01	18/10/2020 09:06	18/10/2020 15:01	5,91	1	5,91	CHI
20201094283	JUSSARA	JR12396094	JUSSARA	18/10/2020 09:07	18/10/2020 11:24	18/10/2020 09:07	18/10/2020 11:24	2,28	26	59,36	CHI
20201094264	RIO VERDE	630108250	RIO VERDE S1	18/10/2020 09:07	18/10/2020 12:19	18/10/2020 09:07	18/10/2020 12:19	3,19	1	3,19	CHI
20201094266	NIQUELANDIA	NQ21366186	SAO JOAO D ALIANCA	18/10/2020 09:07	18/10/2020 12:12	18/10/2020 09:07	18/10/2020 12:12	3,07	1	3,07	CHI
20201094267	TURVELANDIA	1760001172	RIO DOS BOIS	18/10/2020 09:07	18/10/2020 13:00	18/10/2020 09:07	18/10/2020 13:00	3,87	1	3,87	CHI
20201094270	BRITANIA	BT21114052	BRITANIA	18/10/2020 09:08	18/10/2020 10:20	18/10/2020 09:08	18/10/2020 10:20	1,20	1	1,20	CHI
20201094288	GOIANIA	GN11170373	XAVANTES	18/10/2020 09:08	18/10/2020 14:20	18/10/2020 09:08	18/10/2020 14:20	5,21	70	364,60	CHI

20201094281	POSSE	PS21143799	IACIARA S2	18/10/2020 09:11	18/10/2020 11:12	18/10/2020 09:11	18/10/2020 11:12	2,02	1	2,02	CHI
20201094287	RIO VERDE	RV21033593	SANTA HELENA S1	18/10/2020 09:12	18/10/2020 11:35	18/10/2020 09:12	18/10/2020 11:35	2,38	1	2,38	CHI
20201094289	GOIANIA	13001954	CAMPINAS S2	18/10/2020 09:12	18/10/2020 10:39	18/10/2020 09:12	18/10/2020 10:39	1,44	1	1,44	CHI
20201094544	CUMARI	CT12266868	CATALAO S2	18/10/2020 09:12	18/10/2020 11:08	18/10/2020 09:12	18/10/2020 11:08	1,92	4	7,69	CHI
20201094292	DIORAMA	DI12231110	IPORA	18/10/2020 09:12	18/10/2020 16:43	18/10/2020 09:12	18/10/2020 16:43	7,50	4	30,01	CHI
20201094293	POSSE	PS21373722	IACIARA S2	18/10/2020 09:12	18/10/2020 11:28	18/10/2020 09:12	18/10/2020 11:28	2,25	1	2,25	CHI
20201094295	GOIANIA	10331487	CAMPINAS S1	18/10/2020 09:13	18/10/2020 10:20	18/10/2020 09:13	18/10/2020 10:20	1,10	1	1,10	CHI
20201094298	PIRES DO RIO	10014513887	PIRES DO RIO S1	18/10/2020 09:14	18/10/2020 11:23	18/10/2020 09:14	18/10/2020 11:23	2,14	1	2,14	CHI
20201094466	PARAUNA	EU12054056	ACREUNA	18/10/2020 09:15	20/10/2020 02:08	18/10/2020 09:15	20/10/2020 02:08	40,87	4	163,50	CHI
20201094303	SAO DOMINGOS	SD21108992	SAO DOMINGOS	18/10/2020 09:15	18/10/2020 11:58	18/10/2020 09:15	18/10/2020 11:58	2,70	1	2,70	CHI
20201094306	MONTIVIDIU	MV21373903	MONTIVIDIU T	18/10/2020 09:16	19/10/2020 11:18	18/10/2020 09:16	19/10/2020 11:18	26,03	1	26,03	CHI
20201094309	GOIANIA	GN21052683	REAL S2	18/10/2020 09:17	18/10/2020 10:10	18/10/2020 09:17	18/10/2020 10:10	0,87	1	0,87	CHI
20201094514	EDEALINA	CZ32013590	PONTALINA	18/10/2020 09:17	18/10/2020 11:31	18/10/2020 09:17	18/10/2020 11:31	2,22	21	46,68	CHI
20201094514	CEZARINA	CZ32013590	PONTALINA	18/10/2020 09:17	18/10/2020 11:31	18/10/2020 09:17	18/10/2020 11:31	2,22	2	4,45	CHI
20201094316	CATALAO	IP12222966	IPAMERI	18/10/2020 09:19	18/10/2020 17:55	18/10/2020 09:19	18/10/2020 17:55	8,60	2	17,20	CHI
20201094316	IPAMERI	IP12222966	IPAMERI	18/10/2020 09:19	18/10/2020 17:55	18/10/2020 09:19	18/10/2020 17:55	8,60	2	17,20	CHI
20201094829	IPAMERI	IP12222966	IPAMERI	18/10/2020 09:19	18/10/2020 17:55	18/10/2020 09:19	18/10/2020 17:55	8,60	3	25,80	CHI
20201094317	GOIANIA	10003917248	GOYA S1	18/10/2020 09:19	18/10/2020 10:26	18/10/2020 09:19	18/10/2020 10:26	1,11	1	1,11	CHI
20201094319	ABADIANIA	AA21379424	ANAPOLIS UNIVERSITARIO S1	18/10/2020 09:20	18/10/2020 13:33	18/10/2020 09:20	18/10/2020 13:33	4,22	1	4,22	CHI
20201094322	FIRMINOPOLIS	FR21398926	FIRMINOPOLIS S1	18/10/2020 09:20	18/10/2020 15:58	18/10/2020 09:20	18/10/2020 15:58	6,62	1	6,62	CHI
20201095889	JANDAIA	JD12255748	ACREUNA	18/10/2020 09:20	19/10/2020 16:53	18/10/2020 09:20	19/10/2020 16:53	31,54	1	31,54	CHI
20201095889	ACREUNA	JD12255748	ACREUNA	18/10/2020 09:20	19/10/2020 16:53	18/10/2020 09:20	19/10/2020 16:53	31,54	5	157,68	CHI
20201094327	TRINDADE	40283513	GOYA S1	18/10/2020 09:20	18/10/2020 11:09	18/10/2020 09:20	18/10/2020 11:09	1,80	1	1,80	CHI
20201091539	ANAPOLIS	AN11209287	ANAPOLIS UNIVERSITARIO S2	18/10/2020 09:21	18/10/2020 12:11	18/10/2020 09:21	18/10/2020 12:11	2,85	19	54,10	CHI
20201094331	APARECIDA DE GOIANIA	14268036	ATLANTICO S2	18/10/2020 09:22	18/10/2020 10:45	18/10/2020 09:22	18/10/2020 10:45	1,38	1	1,38	CHI
20201094820	ACREUNA	EU12026757	RIO DOS BOIS	18/10/2020 09:22	18/10/2020 15:16	18/10/2020 09:22	18/10/2020 15:16	5,89	5	29,46	CHI
20201094820	TURVELANDIA	EU12026757	RIO DOS BOIS	18/10/2020 09:22	18/10/2020 15:16	18/10/2020 09:22	18/10/2020 15:16	5,89	5	29,46	CHI
20201094347	PIRENOPOLIS	PV12017274	SAO FRANCISCO DE GOIAS	18/10/2020 09:22	18/10/2020 10:54	18/10/2020 09:22	18/10/2020 10:54	1,52	3	4,55	CHI
20201094339	RIO VERDE	630367024	RIO VERDE S2	18/10/2020 09:24	18/10/2020 11:49	18/10/2020 09:24	18/10/2020 11:49	2,41	1	2,41	CHI
20201094575	GOIANIA	GN11048931	REAL S1	18/10/2020 09:28	18/10/2020 12:46	18/10/2020 09:28	18/10/2020 12:46	3,29	148	486,88	CHI
20201094139	GOIANIA	GN11240459	XAVANTES	18/10/2020 09:29	18/10/2020 10:06	18/10/2020 09:29	18/10/2020 10:06	0,62	27	16,65	CHI
20201094355	GOIANIA	11563552	CAMPINAS S2	18/10/2020 09:30	18/10/2020 11:24	18/10/2020 09:30	18/10/2020 11:24	1,89	1	1,89	CHI
20201094357	CALDAS NOVAS	10001104045	SERRA DE CALDAS	18/10/2020 09:30	18/10/2020 11:31	18/10/2020 09:30	18/10/2020 11:31	2,01	1	2,01	CHI
20201094358	RIO VERDE	RV12025889	RIO VERDE S2	18/10/2020 09:31	18/10/2020 12:11	18/10/2020 09:31	18/10/2020 12:11	2,66	29	77,25	CHI
20201094362	MORRINHOS	MR11269731	MORRINHOS	18/10/2020 09:33	18/10/2020 11:13	18/10/2020 09:33	18/10/2020 11:13	1,66	1	1,66	CHI
20201094371	GOIANIA	11620559	GOIANIA LESTE S2	18/10/2020 09:37	18/10/2020 11:43	18/10/2020 09:37	18/10/2020 11:43	2,10	1	2,10	CHI
20201094372	JARAGUA	JA21129669	JARAGUA	18/10/2020 09:38	18/10/2020 13:24	18/10/2020 09:38	18/10/2020 13:24	3,76	2	7,52	CHI
20201094377	ANAPOLIS	21183752	JUNDIAI S1	18/10/2020 09:40	18/10/2020 11:14	18/10/2020 09:40	18/10/2020 11:14	1,57	1	1,57	CHI
20201094378	ANAPOLIS	20370830	JUNDIAI S2	18/10/2020 09:40	18/10/2020 14:22	18/10/2020 09:40	18/10/2020 14:22	4,69	1	4,69	CHI
20201094379	GOIANIRA	GR12016121	GOIANIRA	18/10/2020 09:40	18/10/2020 10:30	18/10/2020 09:40	18/10/2020 10:30	0,82	7	5,75	CHI
20201094386	MARA ROSA	MQ21135507	MARA ROSA	18/10/2020 09:41	18/10/2020 12:22	18/10/2020 09:41	18/10/2020 12:22	2,67	1	2,67	CHI
20201094385	ARAGOIANIA	AO11198357	GUAPO S2	18/10/2020 09:42	18/10/2020 11:17	18/10/2020 09:42	18/10/2020 11:17	1,58	18	28,42	CHI
20201094387	CALDAZINHA	DE21217261	CEPAIGO S2	18/10/2020 09:42	18/10/2020 11:01	18/10/2020 09:42	18/10/2020 11:01	1,31	2	2,62	CHI
20201094388	GOIANIA	11487422	CAMPINAS S2	18/10/2020 09:42	18/10/2020 11:41	18/10/2020 09:42	18/10/2020 11:41	1,97	1	1,97	CHI
20201094392	AMARALINA	LC21265993	MARA ROSA	18/10/2020 09:43	18/10/2020 13:22	18/10/2020 09:43	18/10/2020 13:22	3,64	1	3,64	CHI
20201094394	CALDAS NOVAS	760293557	VILA CORUMBA	18/10/2020 09:43	18/10/2020 12:00	18/10/2020 09:43	18/10/2020 12:00	2,27	1	2,27	CHI
20201094469	INHUMAS	IN12021337	INHUMAS S2	18/10/2020 09:46	18/10/2020 15:11	18/10/2020 09:46	18/10/2020 15:11	5,41	6	32,45	CHI
20201094400	GOUVELANDIA	2250006617	QUIRINOPOLIS	18/10/2020 09:47	18/10/2020 13:22	18/10/2020 09:47	18/10/2020 13:22	3,58	1	3,58	CHI
20201094406	URUACU	CR12282384	MARA ROSA	18/10/2020 09:48	18/10/2020 14:07	18/10/2020 09:48	18/10/2020 14:07	4,30	3	12,90	CHI
20201094410	IACIARA	IA21373149	IACIARA S1	18/10/2020 09:51	18/10/2020 10:24	18/10/2020 09:51	18/10/2020 10:24	0,55	1	0,55	CHI
20201094411	PARANAIGUARA	PC12209794	QUIRINOPOLIS	18/10/2020 09:51	18/10/2020 14:40	18/10/2020 09:51	18/10/2020 14:40	4,81	7	33,69	CHI

20201094553	PIRACANJUBA	PJ12263070	PIRACANJUBA	18/10/2020 09:54	18/10/2020 11:08	18/10/2020 09:54	18/10/2020 11:08	1,23	5	6,16	CHI
20201094420	ITAUCU	110022336	INHUMAS S1	18/10/2020 09:54	18/10/2020 11:30	18/10/2020 09:54	18/10/2020 11:30	1,59	1	1,59	CHI
20201094421	ANAPOLIS	20764698	JUNDIAI S1	18/10/2020 09:55	18/10/2020 12:04	18/10/2020 09:55	18/10/2020 12:04	2,15	1	2,15	CHI
20201094425	FORMOSA	FA12000030	ITUIQUIRA	18/10/2020 09:56	18/10/2020 10:55	18/10/2020 09:56	18/10/2020 10:55	0,98	618	605,30	CHI
20201094439	CALDAS NOVAS	10017559675	SERRA DE CALDAS	18/10/2020 09:57	18/10/2020 11:25	18/10/2020 09:57	18/10/2020 11:25	1,47	1	1,47	CHI
20201094436	GOIANIA	13621270	MEIA PONTE	18/10/2020 09:58	18/10/2020 11:17	18/10/2020 09:58	18/10/2020 11:17	1,31	1	1,31	CHI
20201094440	MONTIVIDIU DO NORTE	MX11241197	PORANGATU	18/10/2020 09:59	18/10/2020 11:34	18/10/2020 09:59	18/10/2020 11:34	1,58	1	1,58	CHI
20201094442	SAO DOMINGOS	10023429818	SAO DOMINGOS	18/10/2020 09:59	18/10/2020 11:10	18/10/2020 09:59	18/10/2020 11:10	1,17	1	1,17	CHI
20201094453	LUZIANIA	3200030912	RIO VERMELHO	18/10/2020 10:01	18/10/2020 11:26	18/10/2020 10:01	18/10/2020 11:26	1,42	1	1,42	CHI
20201094457	PILAR DE GOIAS	GG12214544	URUACU	18/10/2020 10:02	18/10/2020 13:06	18/10/2020 10:02	18/10/2020 13:06	3,05	1	3,05	CHI
20201094463	HIDROLANDIA	PJ12006617	ROCHEDO	18/10/2020 10:03	18/10/2020 11:50	18/10/2020 10:03	18/10/2020 11:50	1,77	2	3,55	CHI
20201094463	PIRACANJUBA	PJ12006617	ROCHEDO	18/10/2020 10:03	18/10/2020 11:50	18/10/2020 10:03	18/10/2020 11:50	1,77	2	3,55	CHI
20201094236	GOIANIA	GN11001054	XAVANTES	18/10/2020 10:04	18/10/2020 12:59	18/10/2020 10:04	18/10/2020 12:59	2,92	28	81,67	CHI
20201094467	LUZIANIA	LZ12376188	RIO VERMELHO	18/10/2020 10:04	18/10/2020 13:40	18/10/2020 10:04	18/10/2020 13:40	3,60	3	10,79	CHI
20201094470	ANAPOLIS	AN21258371	JUNDIAI S1	18/10/2020 10:05	18/10/2020 10:46	18/10/2020 10:05	18/10/2020 10:46	0,67	1	0,67	CHI
20201094475	SERRANOPOLIS	SX21371618	JATAI S1	18/10/2020 10:07	18/10/2020 15:16	18/10/2020 10:07	18/10/2020 15:16	5,15	1	5,15	CHI
20201094476	NOVA VENEZA	10016117024	INHUMAS S1	18/10/2020 10:07	18/10/2020 13:27	18/10/2020 10:07	18/10/2020 13:27	3,32	1	3,32	CHI
20201094477	GOIANIA	10869165	GOIANIA LESTE S3	18/10/2020 10:08	18/10/2020 13:09	18/10/2020 10:08	18/10/2020 13:09	3,02	1	3,02	CHI
20201094478	SAO LUIS DE MONTES BELOS	SL31095921	SAO LUIZ DOS MONTES BELOS	18/10/2020 10:08	18/10/2020 11:26	18/10/2020 10:08	18/10/2020 11:26	1,30	1	1,30	CHI
20201094479	SANTA HELENA DE GOIAS	SH11207103	IPEGUARI	18/10/2020 10:08	18/10/2020 13:06	18/10/2020 10:08	18/10/2020 13:06	2,96	22	65,13	CHI
20201094481	GOIANIA	15022079	CARAJAS S1	18/10/2020 10:08	18/10/2020 16:54	18/10/2020 10:08	18/10/2020 16:54	6,75	1	6,75	CHI
20201094483	VILA BOA	2880002315	IACIARA S2	18/10/2020 10:09	18/10/2020 12:20	18/10/2020 10:09	18/10/2020 12:20	2,18	1	2,18	CHI
20201094490	ANICUNS	AC21000078	ANICUNS	18/10/2020 10:11	18/10/2020 13:35	18/10/2020 10:11	18/10/2020 13:35	3,39	1	3,39	CHI
20201094491	CATALAO	CT21246499	CATALAO S1	18/10/2020 10:12	18/10/2020 18:53	18/10/2020 10:12	18/10/2020 18:53	8,68	1	8,68	CHI
20201094495	PANAMA	PX11166415	GOIATUBA S1	18/10/2020 10:13	18/10/2020 12:03	18/10/2020 10:13	18/10/2020 12:03	1,83	37	67,57	CHI
20201094497	GOIANIA	17051277	XAVANTES	18/10/2020 10:13	18/10/2020 10:54	18/10/2020 10:13	18/10/2020 10:54	0,68	1	0,68	CHI
20201094498	SANTO ANTONIO DA BARRA	BZ21247412	ACREUNA	18/10/2020 10:14	18/10/2020 12:56	18/10/2020 10:14	18/10/2020 12:56	2,70	1	2,70	CHI
20201094501	AGUA LIMPA	AL21024214	VILA CORUMBA	18/10/2020 10:14	18/10/2020 12:27	18/10/2020 10:14	18/10/2020 12:27	2,21	1	2,21	CHI
20201094654	ANICUNS	AC11158910	ANICUNS	18/10/2020 10:14	18/10/2020 11:54	18/10/2020 10:14	18/10/2020 11:54	1,65	57	94,22	CHI
20201094503	SIMOLANDIA	SA21234139	IACIARA S2	18/10/2020 10:15	18/10/2020 12:18	18/10/2020 10:15	18/10/2020 12:18	2,04	1	2,04	CHI
20201094507	BELA VISTA DE GOIAS	BV31117080	BELA VISTA S1	18/10/2020 10:17	18/10/2020 11:54	18/10/2020 10:17	18/10/2020 11:54	1,61	1	1,61	CHI
20201094508	SANTA TEREZINHA DE GOIAS	SG12337610	SANTA TEREZINHA	18/10/2020 10:17	18/10/2020 15:23	18/10/2020 10:17	18/10/2020 15:23	5,09	6	30,56	CHI
20201094517	ESTRELA DO NORTE	ET21181733	MARA ROSA	18/10/2020 10:20	18/10/2020 11:39	18/10/2020 10:20	18/10/2020 11:39	1,32	1	1,32	CHI
20201094518	CATALAO	CT21166712	CATALAO S1	18/10/2020 10:20	18/10/2020 13:30	18/10/2020 10:20	18/10/2020 13:30	3,16	1	3,16	CHI
20201094519	ITAPURANGA	IK21206798	ITAPURANGA	18/10/2020 10:20	18/10/2020 12:34	18/10/2020 10:20	18/10/2020 12:34	2,22	1	2,22	CHI
20201094522	NEROPOLIS	160061570	NEROPOLIS S2	18/10/2020 10:22	18/10/2020 11:36	18/10/2020 10:22	18/10/2020 11:36	1,22	1	1,22	CHI
20201094526	SILVANIA	SV21078656	VIANOPOLIS	18/10/2020 10:25	18/10/2020 11:32	18/10/2020 10:25	18/10/2020 11:32	1,12	1	1,12	CHI
20201094527	BELA VISTA DE GOIAS	240027826	BELA VISTA S1	18/10/2020 10:25	18/10/2020 12:09	18/10/2020 10:25	18/10/2020 12:09	1,72	1	1,72	CHI
20201094528	ANAPOLIS	20612862	ANAPOLIS UNIVERSITARIO S2	18/10/2020 10:25	18/10/2020 12:38	18/10/2020 10:25	18/10/2020 12:38	2,20	1	2,20	CHI
20201094628	ANICUNS	AC11105825	ANICUNS	18/10/2020 10:26	18/10/2020 11:55	18/10/2020 10:26	18/10/2020 11:55	1,47	161	236,94	CHI
20201094534	MONTES CLAROS DE GOIAS	ME21139340	IPORA	18/10/2020 10:28	18/10/2020 19:18	18/10/2020 10:28	18/10/2020 19:18	8,83	2	17,66	CHI
20201094535	GOIANIA	GN13395874	CAMPINAS S3	18/10/2020 10:28	18/10/2020 15:21	18/10/2020 10:28	18/10/2020 15:21	4,88	48	234,27	CHI
20201094535	GOIANIA	GN13395874	CAMPINAS S3	18/10/2020 10:28	18/10/2020 15:21	18/10/2020 14:10	18/10/2020 15:21	1,18	475	560,24	CHI
20201094541	FAZENDA NOVA	FN12073782	IPORA	18/10/2020 10:30	18/10/2020 16:36	18/10/2020 10:30	18/10/2020 16:36	6,10	21	128,20	CHI
20201094541	ISRAELANDIA	FN12073782	IPORA	18/10/2020 10:30	18/10/2020 16:36	18/10/2020 10:30	18/10/2020 16:36	6,10	2	12,21	CHI
20201094545	GOIANIA	11131883	ATLANTICO S1	18/10/2020 10:31	18/10/2020 11:46	18/10/2020 10:31	18/10/2020 11:46	1,24	1	1,24	CHI
20201094549	GOIANIA	14082408	GOYA S2	18/10/2020 10:33	18/10/2020 12:25	18/10/2020 10:33	18/10/2020 12:25	1,86	1	1,86	CHI
20201094621	INDIARA	JD12272364	PALMEIRAS	18/10/2020 10:33	18/10/2020 12:38	18/10/2020 10:33	18/10/2020 12:38	2,07	5	10,34	CHI
20201094621	PALMEIRAS DE GOIAS	JD12272364	PALMEIRAS	18/10/2020 10:33	18/10/2020 12:38	18/10/2020 10:33	18/10/2020 12:38	2,07	21	43,45	CHI
20201094559	SENADOR CANEDO	190055546	SENADOR CANEDO	18/10/2020 10:37	18/10/2020 12:55	18/10/2020 10:37	18/10/2020 12:55	2,29	1	2,29	CHI
20201094562	ORIZONA	OZ12115295	PIRES DO RIO S2	18/10/2020 10:38	19/10/2020 18:38	18/10/2020 10:38	19/10/2020 18:38	32,01	1	32,01	CHI

20201094562	ORIZONA	OZ12115295	PIRES DO RIO S2	18/10/2020 10:38	19/10/2020 18:38	18/10/2020 10:38	19/10/2020 17:59	31,35	21	658,30	CHI
20201094563	ARENOPOLIS	AY21359610	ARENOPOLIS	18/10/2020 10:38	18/10/2020 12:13	18/10/2020 10:38	18/10/2020 12:13	1,57	1	1,57	CHI
20201094564	FORMOSA	610264709	ITUIQUIRA	18/10/2020 10:38	18/10/2020 11:21	18/10/2020 10:38	18/10/2020 11:21	0,70	1	0,70	CHI
20201094565	PIRES DO RIO	460028546	PIRES DO RIO S1	18/10/2020 10:38	18/10/2020 12:18	18/10/2020 10:38	18/10/2020 12:18	1,65	1	1,65	CHI
20201094567	JOVIANIA	JV21388303	VICENTINOPOLIS	18/10/2020 10:39	18/10/2020 12:21	18/10/2020 10:39	18/10/2020 12:21	1,69	1	1,69	CHI
20201094568	GOIANIA	14056033	CAMPINAS S3	18/10/2020 10:39	18/10/2020 11:50	18/10/2020 10:39	18/10/2020 11:50	1,18	1	1,18	CHI
20201094571	SANTA TEREZINHA DE GOIAS	2480005544	SANTA TEREZINHA	18/10/2020 10:40	18/10/2020 12:53	18/10/2020 10:40	18/10/2020 12:53	2,21	1	2,21	CHI
20201094583	APARECIDA DE GOIANIA	200523429	ANHANGUERA	18/10/2020 10:44	18/10/2020 12:37	18/10/2020 10:44	18/10/2020 12:37	1,88	1	1,88	CHI
20201094586	ABADIANIA	AA12385392	DAIA S2	18/10/2020 10:44	18/10/2020 15:54	18/10/2020 10:44	18/10/2020 15:54	5,16	22	113,42	CHI
20201094589	PIRENOPOLIS	PV12370317	CORUMBA	18/10/2020 10:46	18/10/2020 12:32	18/10/2020 10:46	18/10/2020 12:32	1,76	23	40,57	CHI
20201094590	NEROPOLIS	NR11022753	NEROPOLIS S2	18/10/2020 10:46	18/10/2020 12:39	18/10/2020 10:46	18/10/2020 12:39	1,87	97	181,55	CHI
20201094668	CORUMBAIBA	CI12035404	VILA CORUMBA	18/10/2020 10:47	18/10/2020 13:21	18/10/2020 10:47	18/10/2020 13:21	2,56	85	218,00	CHI
20201094607	PIRACANJUBA	PJ21263068	PIRACANJUBA	18/10/2020 10:49	18/10/2020 12:18	18/10/2020 10:49	18/10/2020 12:18	1,47	2	2,94	CHI
20201094615	MONTES CLAROS DE GOIAS	ME21086436	IPORA	18/10/2020 10:52	18/10/2020 18:00	18/10/2020 10:52	18/10/2020 18:00	7,12	1	7,12	CHI
20201094616	GOIANIA	10023959230	MEIA PONTE	18/10/2020 10:53	18/10/2020 12:06	18/10/2020 10:53	18/10/2020 12:06	1,22	1	1,22	CHI
20201094851	PALMEIRAS DE GOIAS	PL12376414	PALMEIRAS	18/10/2020 10:53	18/10/2020 14:15	18/10/2020 10:53	18/10/2020 14:15	3,36	50	168,25	CHI
20201094851	INDIARA	PL12376414	PALMEIRAS	18/10/2020 10:53	18/10/2020 14:15	18/10/2020 10:53	18/10/2020 14:15	3,36	3	10,09	CHI
20201094619	ITABERAI	IB12021852	ITABERAI S2	18/10/2020 10:53	18/10/2020 12:08	18/10/2020 10:53	18/10/2020 12:08	1,24	80	99,09	CHI
20201094626	VARJAO	940015778	GUAPO S2	18/10/2020 10:57	18/10/2020 13:26	18/10/2020 10:57	18/10/2020 13:26	2,48	1	2,48	CHI
20201094627	CRISTALINA	KR12249242	CRISTALINA S2	18/10/2020 10:57	18/10/2020 12:00	18/10/2020 10:57	18/10/2020 12:00	1,04	3	3,12	CHI
20201094630	GOIANIA	14670513	CAMPINAS S2	18/10/2020 10:58	18/10/2020 14:10	18/10/2020 10:58	18/10/2020 14:10	3,19	1	3,19	CHI
20201094636	GOIANIA	14513845	MEIA PONTE	18/10/2020 11:00	18/10/2020 12:33	18/10/2020 11:00	18/10/2020 12:33	1,56	1	1,56	CHI
20201094638	BRITANIA	BT12206760	BRITANIA	18/10/2020 11:00	18/10/2020 12:02	18/10/2020 11:00	18/10/2020 12:02	1,02	2	2,05	CHI
20201094641	MONTES CLAROS DE GOIAS	ME12088922	IPORA	18/10/2020 11:01	18/10/2020 15:25	18/10/2020 11:01	18/10/2020 15:25	4,39	17	74,71	CHI
20201094827	JARAGUA	JA12297444	JARAGUA	18/10/2020 11:02	18/10/2020 14:24	18/10/2020 11:02	18/10/2020 14:24	3,37	8	26,93	CHI
20201094644	FORMOSA	FA11000011	ITUIQUIRA	18/10/2020 11:02	18/10/2020 11:46	18/10/2020 11:02	18/10/2020 11:46	0,73	93	67,58	CHI
20201094648	BOM JESUS DE GOIAS	BJ21222335	BOM JESUS DE GOIAS	18/10/2020 11:02	18/10/2020 16:21	18/10/2020 11:02	18/10/2020 16:21	5,31	1	5,31	CHI
20201094649	GOIANIA	12888011	XAVANTES	18/10/2020 11:02	18/10/2020 13:17	18/10/2020 11:02	18/10/2020 13:17	2,24	1	2,24	CHI
20201093681	GOIANIA	GN21188610	XAVANTES	18/10/2020 11:03	18/10/2020 11:48	18/10/2020 11:03	18/10/2020 11:48	0,75	1	0,75	CHI
20201094651	GUARANI DE GOIAS	GY12213591	SAO DOMINGOS	18/10/2020 11:03	18/10/2020 12:48	18/10/2020 11:03	18/10/2020 12:48	1,74	18	31,38	CHI
20201094655	TRINDADE	TR12393570	GOIANIRA	18/10/2020 11:04	18/10/2020 12:47	18/10/2020 11:04	18/10/2020 12:47	1,71	13	22,20	CHI
20201094656	GOIANIA	13965190	MEIA PONTE	18/10/2020 11:05	18/10/2020 12:44	18/10/2020 11:05	18/10/2020 12:44	1,65	1	1,65	CHI
20201094659	GOIANIA	14994963	CAMPINAS S2	18/10/2020 11:06	18/10/2020 11:47	18/10/2020 11:06	18/10/2020 11:47	0,68	1	0,68	CHI
20201094742	ANAPOLIS	AN11129384	JUNDIAI S1	18/10/2020 11:06	18/10/2020 15:28	18/10/2020 11:06	18/10/2020 15:28	4,36	88	383,66	CHI
20201094663	ANAPOLIS	10024772516	JUNDIAI S1	18/10/2020 11:06	18/10/2020 13:34	18/10/2020 11:06	18/10/2020 13:34	2,47	1	2,47	CHI
20201094666	CACHOEIRA ALTA	CA21127285	CACHOEIRA ALTA	18/10/2020 11:07	18/10/2020 14:16	18/10/2020 11:07	18/10/2020 14:16	3,14	1	3,14	CHI
20201094672	CRIXAS	CX12145539	RUBIATABA	18/10/2020 11:08	18/10/2020 15:30	18/10/2020 11:08	18/10/2020 15:30	4,35	19	82,72	CHI
20201094670	MARA ROSA	MQ21028233	MARA ROSA	18/10/2020 11:09	18/10/2020 12:09	18/10/2020 11:09	18/10/2020 12:09	1,00	1	1,00	CHI
20201094761	SANTO ANTONIO DE GOIAS	BW12325111	NEROPOLIS S1	18/10/2020 11:09	18/10/2020 14:57	18/10/2020 11:09	18/10/2020 14:57	3,79	6	22,75	CHI
20201094673	CAMPINORTE	UR21314210	URUACU	18/10/2020 11:11	18/10/2020 13:36	18/10/2020 11:11	18/10/2020 13:36	2,42	2	4,83	CHI
20201094846	FIRMINOPOLIS	TV12105311	FIRMINOPOLIS S1	18/10/2020 11:11	18/10/2020 14:09	18/10/2020 11:11	18/10/2020 14:09	2,95	6	17,72	CHI
20201094679	GOIANIA	10016338748	MEIA PONTE	18/10/2020 11:13	18/10/2020 12:05	18/10/2020 11:13	18/10/2020 12:05	0,86	1	0,86	CHI
20201094681	ORIZONA	OZ21185968	PIRES DO RIO S2	18/10/2020 11:13	18/10/2020 14:18	18/10/2020 11:13	18/10/2020 14:18	3,07	2	6,14	CHI
20201094683	CEZARINA	CZ21237558	GUAPO S2	18/10/2020 11:13	18/10/2020 13:05	18/10/2020 11:13	18/10/2020 13:05	1,85	2	3,70	CHI
20201094697	DISTRITO FEDERAL	2900052422	MARAJOARA	18/10/2020 11:16	18/10/2020 13:39	18/10/2020 11:16	18/10/2020 13:39	2,38	1	2,38	CHI
20201094702	PALMEIRAS DE GOIAS	PL12085277	PALMEIRAS	18/10/2020 11:17	18/10/2020 13:12	18/10/2020 11:17	18/10/2020 13:12	1,91	13	24,77	CHI
20201094704	ITABERAI	IB21105414	ITABERAI S1	18/10/2020 11:18	18/10/2020 15:01	18/10/2020 11:18	18/10/2020 15:01	3,71	1	3,71	CHI
20201094706	LUZIANIA	LZ12060273	MARAJOARA	18/10/2020 11:19	18/10/2020 12:42	18/10/2020 11:19	18/10/2020 12:42	1,38	1	1,38	CHI
20201095273	PILAR DE GOIAS	GG12181337	SANTA TEREZINHA	18/10/2020 11:20	18/10/2020 20:33	18/10/2020 11:20	18/10/2020 20:33	9,21	10	92,13	CHI
20201094716	CATURAI	CK21152049	INHUMAS S1	18/10/2020 11:23	18/10/2020 16:57	18/10/2020 11:23	18/10/2020 16:57	5,56	1	5,56	CHI
20201094722	APORE	AE21155312	ITAJA S2	18/10/2020 11:26	19/10/2020 19:28	18/10/2020 11:26	19/10/2020 19:28	32,03	1	32,03	CHI

20201094059	JATAI	SX12264387RE	JATAI S1	18/10/2020 11:26	18/10/2020 13:11	18/10/2020 11:26	18/10/2020 13:11	1,75	3	5,24	CHI
20201094883	ALEXANIA	AX11284987	ALEXANIA	18/10/2020 11:27	18/10/2020 19:28	18/10/2020 11:27	18/10/2020 19:28	8,01	200	1602,06	CHI
20201094730	LEOPOLDO DE BULHOES	AN21258412	JUNDIAI S1	18/10/2020 11:29	18/10/2020 14:49	18/10/2020 11:29	18/10/2020 14:49	3,32	1	3,32	CHI
20201094731	LUZIANIA	120029730	RIO VERMELHO	18/10/2020 11:29	18/10/2020 12:32	18/10/2020 11:29	18/10/2020 12:32	1,04	1	1,04	CHI
20201094745	PARAUNA	PU12163951	PARAUNA	18/10/2020 11:30	18/10/2020 20:55	18/10/2020 11:30	18/10/2020 20:55	9,41	3	28,23	CHI
20201094735	APARECIDA DE GOIANIA	11321246	REAL S2	18/10/2020 11:30	18/10/2020 13:52	18/10/2020 11:30	18/10/2020 13:52	2,35	1	2,35	CHI
20201094838	ANICUNS	AC12259103	FIRMINOPOLIS S2	18/10/2020 11:30	18/10/2020 15:56	18/10/2020 11:30	18/10/2020 15:56	4,42	19	83,94	CHI
20201094740	SENADOR CANEDO	16963829	SENADOR CANEDO	18/10/2020 11:32	18/10/2020 15:11	18/10/2020 11:32	18/10/2020 15:11	3,64	1	3,64	CHI
20201094741	ANAPOLIS	21282420	ANAPOLIS UNIVERSITARIO S2	18/10/2020 11:32	18/10/2020 12:32	18/10/2020 11:32	18/10/2020 12:32	1,00	1	1,00	CHI
20201094857	GOIANIA	00592234	FERROVIARIO S3	18/10/2020 11:33	18/10/2020 11:37	18/10/2020 11:33	18/10/2020 11:37	0,06	9569	616,67	CHI
202010100703	ANICUNS	AC11186436	ANICUNS	18/10/2020 11:34	18/10/2020 22:59	18/10/2020 11:34	18/10/2020 22:59	11,40	46	524,55	CHI
20201098859	ANICUNS	AC11186440	ANICUNS	18/10/2020 11:34	18/10/2020 19:47	18/10/2020 11:34	18/10/2020 19:47	8,21	82	673,27	CHI
20201098859	ANICUNS	AC12391416	ANICUNS	18/10/2020 11:34	18/10/2020 19:47	18/10/2020 19:33	18/10/2020 19:39	0,10	163	16,80	CHI
20201098859	ANICUNS	AC12391416	ANICUNS	18/10/2020 11:34	18/10/2020 19:47	18/10/2020 11:34	18/10/2020 19:27	7,88	163	1283,99	CHI
20201094750	BONOPOLIS	PO12315103	NOVO PLANALTO	18/10/2020 11:35	18/10/2020 14:05	18/10/2020 11:35	18/10/2020 14:05	2,49	1	2,49	CHI
20201094750	PORANGATU	PO12315103	NOVO PLANALTO	18/10/2020 11:35	18/10/2020 14:05	18/10/2020 11:35	18/10/2020 14:05	2,49	2	4,99	CHI
20201094750	NOFINOPOLIS	PO12315103	NOVO PLANALTO	18/10/2020 11:35	18/10/2020 14:05	18/10/2020 11:35	18/10/2020 14:05	2,49	1	2,49	CHI
20201094753	SILVANIA	SV21107835	VIANOPOLIS	18/10/2020 11:35	18/10/2020 13:28	18/10/2020 11:35	18/10/2020 13:28	1,87	1	1,87	CHI
20201094757	APARECIDA DE GOIANIA	10000723701	INDEPENDENCIA S1	18/10/2020 11:36	18/10/2020 13:11	18/10/2020 11:36	18/10/2020 13:11	1,57	1	1,57	CHI
20201094768	ITAPACI	IW12335647	RUBIATABA	18/10/2020 11:39	18/10/2020 17:43	18/10/2020 11:39	18/10/2020 17:43	6,06	2	12,13	CHI
20201094768	GUARINOS	IW12335647	RUBIATABA	18/10/2020 11:39	18/10/2020 17:43	18/10/2020 11:39	18/10/2020 17:43	6,06	2	12,13	CHI
20201094780	SERRANOPOLIS	SX12314281	JATAI S1	18/10/2020 11:43	18/10/2020 13:15	18/10/2020 11:43	18/10/2020 13:15	1,52	2	3,05	CHI
20201094834	QUIRINOPOLIS	QI12000225	QUIRINOPOLIS	18/10/2020 11:44	18/10/2020 13:06	18/10/2020 11:44	18/10/2020 13:06	1,36	46	62,75	CHI
20201094782	FORMOSA	610229904	ITUIQUIRA	18/10/2020 11:44	18/10/2020 14:50	18/10/2020 11:44	18/10/2020 14:50	3,10	1	3,10	CHI
20201094784	APARECIDA DE GOIANIA	11282265	REAL S2	18/10/2020 11:44	18/10/2020 13:28	18/10/2020 11:44	18/10/2020 13:28	1,72	1	1,72	CHI
20201094786	BELA VISTA DE GOIAS	240004577	BELA VISTA S1	18/10/2020 11:44	18/10/2020 14:10	18/10/2020 11:44	18/10/2020 14:10	2,42	1	2,42	CHI
20201094794	ITAPURANGA	IK11000009	ITAPURANGA	18/10/2020 11:45	18/10/2020 16:50	18/10/2020 11:45	18/10/2020 16:50	5,07	173	877,83	CHI
20201094797	EDEALINA	ED21037913	PONTALINA	18/10/2020 11:46	18/10/2020 13:54	18/10/2020 11:46	18/10/2020 13:54	2,13	1	2,13	CHI
20201094799	GOIANIA	12874176	GOIANIA LESTE S2	18/10/2020 11:46	18/10/2020 14:47	18/10/2020 11:46	18/10/2020 14:47	3,01	1	3,01	CHI
20201094804	BELA VISTA DE GOIAS	10005798360	BELA VISTA S1	18/10/2020 11:48	18/10/2020 13:16	18/10/2020 11:48	18/10/2020 13:16	1,46	1	1,46	CHI
20201094806	UIRAPURU	4200001951	SANTA TEREZINHA	18/10/2020 11:48	18/10/2020 14:25	18/10/2020 11:48	18/10/2020 14:25	2,61	1	2,61	CHI
20201094810	JESUPOLIS	JE12377405	SAO FRANCISCO DE GOIAS	18/10/2020 11:49	18/10/2020 13:54	18/10/2020 11:49	18/10/2020 13:54	2,07	2	4,14	CHI
20201094815	ANAPOLIS	AN31000791	ANAPOLIS UNIVERSITARIO S2	18/10/2020 11:53	18/10/2020 13:05	18/10/2020 11:53	18/10/2020 13:05	1,20	1	1,20	CHI
20201094923	ANICUNS	AC11159074	ANICUNS	18/10/2020 11:57	18/10/2020 17:05	18/10/2020 11:57	18/10/2020 17:05	5,12	33	169,00	CHI
20201095679	GOIANESIA	GE21026066	GOIANESIA S1	18/10/2020 12:05	18/10/2020 19:53	18/10/2020 12:05	18/10/2020 19:53	7,79	2	15,59	CHI
20201094843	GOIANESIA	BA12258276	GOIANESIA S1	18/10/2020 12:05	18/10/2020 15:26	18/10/2020 12:05	18/10/2020 15:26	3,34	82	274,09	CHI
20201094843	VILA PROPICIO	BA12258276	GOIANESIA S1	18/10/2020 12:05	18/10/2020 15:26	18/10/2020 12:05	18/10/2020 15:26	3,34	1	3,34	CHI
20201094843	BARRO ALTO	BA12258276	GOIANESIA S1	18/10/2020 12:05	18/10/2020 15:26	18/10/2020 12:05	18/10/2020 15:26	3,34	1	3,34	CHI
20201094843	GOIANESIA	BA12258276	GOIANESIA S1	18/10/2020 12:05	18/10/2020 15:26	18/10/2020 14:03	18/10/2020 15:26	1,38	7	9,68	CHI
20201094844	LUZIANIA	LZ12389577	VIANOPOLIS	18/10/2020 12:06	18/10/2020 13:52	18/10/2020 12:06	18/10/2020 13:52	1,75	3	5,26	CHI
20201094852	PROFESSOR JAMIL SAFADY	JS11142397	ROCHEDO	18/10/2020 12:08	18/10/2020 14:32	18/10/2020 12:08	18/10/2020 14:32	2,39	81	193,19	CHI
20201094853	GOIANIA	11192227	CAMPINAS S2	18/10/2020 12:09	18/10/2020 13:42	18/10/2020 12:09	18/10/2020 13:42	1,55	1	1,55	CHI
20201094854	ALEXANIA	AX11390613	ALEXANIA	18/10/2020 12:09	18/10/2020 16:53	18/10/2020 12:09	18/10/2020 16:53	4,73	136	642,60	CHI
20201094856	GOIANIA	15684325	CARAJAS S1	18/10/2020 12:09	18/10/2020 12:56	18/10/2020 12:09	18/10/2020 12:56	0,77	1	0,77	CHI
20201094862	ANICUNS	AC21186918	ANICUNS	18/10/2020 12:12	19/10/2020 11:09	18/10/2020 12:12	19/10/2020 11:09	22,95	2	45,90	CHI
20201094863	QUIRINOPOLIS	80018452	QUIRINOPOLIS	18/10/2020 12:12	18/10/2020 15:57	18/10/2020 12:12	18/10/2020 15:57	3,75	1	3,75	CHI
202010189331	MORRINHOS	MR12276678	MORRINHOS	18/10/2020 12:14	18/10/2020 14:05	18/10/2020 12:14	18/10/2020 14:05	1,83	2	3,67	CHI
20201094872	CRISTALINA	KR21249265	CRISTALINA S2	18/10/2020 12:15	18/10/2020 12:24	18/10/2020 12:15	18/10/2020 12:24	0,14	1	0,14	CHI
20201095277	PILAR DE GOIAS	GG21181225	SANTA TEREZINHA	18/10/2020 12:21	19/10/2020 00:55	18/10/2020 12:21	19/10/2020 00:55	12,56	1	12,56	CHI
20201095068	NOVO PLANALTO	TA12139136	SAO MIGUEL DO ARAGUAIA	18/10/2020 12:21	18/10/2020 16:39	18/10/2020 12:21	18/10/2020 16:39	4,29	17	72,90	CHI
20201095068	BONOPOLIS	TA12139136	SAO MIGUEL DO ARAGUAIA	18/10/2020 12:21	18/10/2020 16:39	18/10/2020 12:21	18/10/2020 16:39	4,29	3	12,86	CHI

20201094890	ANAPOLIS	AN21412947	ANAPOLIS UNIVERSITARIO S1	18/10/2020 12:22	18/10/2020 13:47	18/10/2020 12:22	18/10/2020 13:47	1,41	1	1,41	CHI
20201094891	VILA PROPICIO	GE21196943	GOIANESIA S1	18/10/2020 12:22	18/10/2020 17:32	18/10/2020 12:22	18/10/2020 17:32	5,16	1	5,16	CHI
20201094894	FORMOSA	610251569	ITUIQUIRA	18/10/2020 12:23	18/10/2020 13:06	18/10/2020 12:23	18/10/2020 13:06	0,71	1	0,71	CHI
20201094895	APARECIDA DE GOIANIA	200284241	ANHANGUERA	18/10/2020 12:23	18/10/2020 14:16	18/10/2020 12:23	18/10/2020 14:16	1,87	1	1,87	CHI
20201094896	ITAUCU	IX11000013	INHUMAS S1	18/10/2020 12:23	18/10/2020 16:54	18/10/2020 12:23	18/10/2020 16:54	4,50	69	310,67	CHI
20201094906	GOIANIA	10707499	ATLANTICO S3	18/10/2020 12:24	18/10/2020 14:24	18/10/2020 12:24	18/10/2020 14:24	1,99	1	1,99	CHI
20201094907	POSSE	PS12255422	IACIARA S2	18/10/2020 12:24	18/10/2020 14:05	18/10/2020 12:24	18/10/2020 14:05	1,67	4	6,68	CHI
20201094908	GOIANIA	12887109	XAVANTES	18/10/2020 12:24	18/10/2020 16:35	18/10/2020 12:24	18/10/2020 16:35	4,17	1	4,17	CHI
20201094909	JATAI	JT21244789	JATAI S1	18/10/2020 12:25	18/10/2020 15:34	18/10/2020 12:25	18/10/2020 15:34	3,15	1	3,15	CHI
20201094910	ITAPURANGA	170029438	ITAPURANGA	18/10/2020 12:25	18/10/2020 19:09	18/10/2020 12:25	18/10/2020 19:09	6,73	1	6,73	CHI
20201094916	SILVANIA	SV21010236	DAIA S2	18/10/2020 12:27	18/10/2020 14:49	18/10/2020 12:27	18/10/2020 14:49	2,36	1	2,36	CHI
20201094918	PIRENOPOLIS	PV21017858	CORUMBA	18/10/2020 12:27	18/10/2020 14:31	18/10/2020 12:27	18/10/2020 14:31	2,06	1	2,06	CHI
20201094925	ITAJA	IJ11252065	ITAJA S2	18/10/2020 12:29	18/10/2020 15:33	18/10/2020 12:29	18/10/2020 15:33	3,06	128	392,00	CHI
20201094926	CATALAO	1990208736	CATALAO S2	18/10/2020 12:29	18/10/2020 14:55	18/10/2020 12:29	18/10/2020 14:55	2,42	1	2,42	CHI
20201094929	TRINDADE	10014568681	MEIA PONTE	18/10/2020 12:30	18/10/2020 15:02	18/10/2020 12:30	18/10/2020 15:02	2,53	1	2,53	CHI
20201094931	HIDROLANDIA	HD31190422	CEPAIGO S2	18/10/2020 12:31	18/10/2020 15:54	18/10/2020 12:31	18/10/2020 15:54	3,38	12	40,51	CHI
20201094932	ANAPOLIS	AN11163705	JUNDAI S2	18/10/2020 12:31	18/10/2020 14:58	18/10/2020 12:31	18/10/2020 14:58	2,44	98	238,66	CHI
20201094939	GOIANIA	11775312	CAMPINAS S2	18/10/2020 12:34	18/10/2020 16:48	18/10/2020 12:34	18/10/2020 16:48	4,23	1	4,23	CHI
20201094946	CAMPOS BELOS	CH11320567	SAO DOMINGOS	18/10/2020 12:36	18/10/2020 13:51	18/10/2020 12:36	18/10/2020 13:51	1,24	55	68,43	CHI
20201094950	AMORINOPOLIS	AM21287188	IPORA	18/10/2020 12:38	18/10/2020 14:23	18/10/2020 12:38	18/10/2020 14:23	1,74	1	1,74	CHI
20201094954	BRAZABRANTES	BR11193250	NEROPOLIS S1	18/10/2020 12:41	18/10/2020 15:59	18/10/2020 12:41	18/10/2020 15:59	3,30	153	504,43	CHI
20201094956	BRITANIA	BT21317231	BRITANIA	18/10/2020 12:41	18/10/2020 15:20	18/10/2020 12:41	18/10/2020 15:20	2,64	2	5,29	CHI
20201094957	RIO VERDE	RV21303310	ACREUNA	18/10/2020 12:41	18/10/2020 16:53	18/10/2020 12:41	18/10/2020 16:53	4,19	1	4,19	CHI
20201095010	MARA ROSA	SG12318449	SANTA TEREZINHA	18/10/2020 12:41	19/10/2020 17:40	18/10/2020 12:41	19/10/2020 17:40	28,99	15	434,84	CHI
20201095010	SANTA TEREZINHA DE GOIAS	SG12318449	SANTA TEREZINHA	18/10/2020 12:41	19/10/2020 17:40	19/10/2020 16:35	19/10/2020 17:40	1,08	3	3,25	CHI
20201095010	CAMPOS VERDES	SG12318449	SANTA TEREZINHA	18/10/2020 12:41	19/10/2020 17:40	19/10/2020 16:35	19/10/2020 17:40	1,08	1	1,08	CHI
20201095010	SANTA TEREZINHA DE GOIAS	SG12318449	SANTA TEREZINHA	18/10/2020 12:41	19/10/2020 17:40	18/10/2020 12:41	19/10/2020 10:23	21,70	3	65,10	CHI
20201095010	CAMPOS VERDES	SG12318449	SANTA TEREZINHA	18/10/2020 12:41	19/10/2020 17:40	18/10/2020 12:41	19/10/2020 10:23	21,70	1	21,70	CHI
20201094960	OURO VERDE DE GOIAS	PG12255953	PETROLINA	18/10/2020 12:42	18/10/2020 17:14	18/10/2020 12:42	18/10/2020 17:14	4,53	25	113,15	CHI
20201094960	PETROLINA DE GOIAS	PG12255953	PETROLINA	18/10/2020 12:42	18/10/2020 17:14	18/10/2020 12:42	18/10/2020 17:14	4,53	118	534,08	CHI
20201094960	DAMOLANDIA	PG12255953	PETROLINA	18/10/2020 12:42	18/10/2020 17:14	18/10/2020 12:42	18/10/2020 17:14	4,53	1	4,53	CHI
20201094960	OURO VERDE DE GOIAS	PG12255953	PETROLINA	18/10/2020 12:42	18/10/2020 17:14	18/10/2020 12:42	18/10/2020 16:25	3,71	2	7,42	CHI
20201094960	PETROLINA DE GOIAS	PG12255953	PETROLINA	18/10/2020 12:42	18/10/2020 17:14	18/10/2020 12:42	18/10/2020 16:25	3,71	1	3,71	CHI
20201094969	SAO DOMINGOS	SD21160071	IACIARA S1	18/10/2020 12:44	18/10/2020 14:14	18/10/2020 12:44	18/10/2020 14:14	1,48	1	1,48	CHI
20201095089	CAMPOS VERDES	VD11049793	SANTA TEREZINHA	18/10/2020 12:48	18/10/2020 15:28	18/10/2020 12:48	18/10/2020 15:28	2,66	79	210,32	CHI
20201095380	OUVIDOR	OU12061242RE	CATALAO S1	18/10/2020 12:48	18/10/2020 16:01	18/10/2020 12:48	18/10/2020 16:01	3,21	13	41,68	CHI
202010180674	BALIZA	BH12331486	CAIAPONIA	18/10/2020 12:53	19/10/2020 11:40	18/10/2020 12:58	19/10/2020 11:40	22,70	8	181,63	CHI
202010180674	BALIZA	BH12331367	CAIAPONIA	18/10/2020 12:53	19/10/2020 11:40	18/10/2020 12:58	19/10/2020 09:40	20,70	20	413,99	CHI
202010180674	BALIZA	BH12331510	CAIAPONIA	18/10/2020 12:53	19/10/2020 11:40	18/10/2020 12:58	19/10/2020 09:37	20,65	28	578,24	CHI
202010180674	BALIZA	BH10407181	CAIAPONIA	18/10/2020 12:53	19/10/2020 11:40	19/10/2020 02:04	19/10/2020 09:15	7,17	141	1010,89	CHI
202010180674	BALIZA	BH10400432	CAIAPONIA	18/10/2020 12:53	19/10/2020 11:40	18/10/2020 12:58	19/10/2020 01:48	12,84	141	1810,91	CHI
202010180674	BALIZA	BH10400432	CAIAPONIA	18/10/2020 12:53	19/10/2020 11:40	18/10/2020 12:58	18/10/2020 19:00	6,04	163	984,61	CHI
202010180674	BALIZA	BH10400432	CAIAPONIA	18/10/2020 12:53	19/10/2020 11:40	18/10/2020 15:57	18/10/2020 16:20	0,38	29	11,14	CHI
202010180674	BALIZA	BH10400432	CAIAPONIA	18/10/2020 12:53	19/10/2020 11:40	18/10/2020 12:58	18/10/2020 15:43	2,75	29	79,73	CHI
202010180674	BALIZA	BH10400432	CAIAPONIA	18/10/2020 12:53	19/10/2020 11:40	18/10/2020 12:53	18/10/2020 12:57	0,06	389	24,53	CHI
20201094987	SILVANIA	SV21078656	VIANOPOLIS	18/10/2020 12:56	19/10/2020 13:29	18/10/2020 12:56	19/10/2020 13:29	24,55	1	24,55	CHI
20201095028	JATAI	JT11353619	JATAI S1	18/10/2020 12:57	18/10/2020 15:03	18/10/2020 12:57	18/10/2020 15:03	2,09	1	2,09	CHI
20201095001	GOIATUBA	GT11000034	GOIATUBA S2	18/10/2020 13:00	18/10/2020 20:40	18/10/2020 13:00	18/10/2020 20:40	7,66	132	1011,01	CHI
20201094999	GOIANIA	16350455	MEIA PONTE	18/10/2020 13:00	18/10/2020 14:27	18/10/2020 13:00	18/10/2020 14:27	1,44	1	1,44	CHI
20201095002	NIQUELANDIA	NQ12293886	URUACU	18/10/2020 13:00	18/10/2020 15:52	18/10/2020 13:00	18/10/2020 15:52	2,85	14	39,92	CHI
20201095005	IPAMERI	580114776	IPAMERI	18/10/2020 13:01	18/10/2020 14:12	18/10/2020 13:01	18/10/2020 14:12	1,17	1	1,17	CHI

20201095006	ANAPOLIS	AN21258365	JUNDIAI S2	18/10/2020 13:02	18/10/2020 13:58	18/10/2020 13:02	18/10/2020 13:58	0,92	1	0,92	CHI
20201095447	JATAI	JT12219320LD	JATAI S3	18/10/2020 13:03	19/10/2020 17:35	18/10/2020 13:03	19/10/2020 17:35	28,53	13	370,89	CHI
20201095447	RIO VERDE	JT12125794RE	JATAI S3	18/10/2020 13:03	19/10/2020 17:35	18/10/2020 13:03	19/10/2020 16:51	27,80	3	83,39	CHI
20201095447	JATAI	JT12125794RE	JATAI S3	18/10/2020 13:03	19/10/2020 17:35	18/10/2020 13:03	19/10/2020 16:51	27,80	12	333,57	CHI
20201095447	JATAI	JT12125794RE	JATAI S3	18/10/2020 13:03	19/10/2020 17:35	18/10/2020 13:03	19/10/2020 15:58	26,91	2	53,82	CHI
20201095447	RIO VERDE	JT12125794RE	JATAI S3	18/10/2020 13:03	19/10/2020 17:35	18/10/2020 13:03	19/10/2020 15:58	26,91	2	53,82	CHI
20201095447	JATAI	JT12125794RE	JATAI S3	18/10/2020 13:03	19/10/2020 17:35	18/10/2020 13:03	19/10/2020 12:54	23,85	2	47,70	CHI
20201095447	RIO VERDE	JT10394711	JATAI S3	18/10/2020 13:03	19/10/2020 17:35	18/10/2020 23:44	19/10/2020 00:03	0,33	3	0,99	CHI
20201095447	JATAI	JT10394711	JATAI S3	18/10/2020 13:03	19/10/2020 17:35	18/10/2020 23:44	19/10/2020 00:03	0,33	144	47,40	CHI
20201095447	JATAI	JT10394711	JATAI S3	18/10/2020 13:03	19/10/2020 17:35	18/10/2020 19:41	18/10/2020 20:23	0,70	144	100,28	CHI
20201095447	RIO VERDE	JT10394711	JATAI S3	18/10/2020 13:03	19/10/2020 17:35	18/10/2020 19:41	18/10/2020 20:23	0,70	3	2,09	CHI
20201095008	PLANALTINA	2960192480	PLANALTINA	18/10/2020 13:05	18/10/2020 14:04	18/10/2020 13:05	18/10/2020 14:04	0,98	1	0,98	CHI
20201095022	GOIANIA	GN11001257	GOIANIA LESTE S2	18/10/2020 13:07	18/10/2020 14:37	18/10/2020 13:07	18/10/2020 14:37	1,50	93	139,45	CHI
20201095017	NIQUELANDIA	NQ21344614	SAO JOAO D ALIANCA	18/10/2020 13:07	18/10/2020 19:57	18/10/2020 13:07	18/10/2020 19:57	6,83	1	6,83	CHI
20201095107	JOVIANIA	GT12052893RE	GOIATUBA S1	18/10/2020 13:09	18/10/2020 16:28	18/10/2020 13:09	18/10/2020 16:28	3,31	18	59,65	CHI
20201095107	GOIATUBA	GT12052893RE	GOIATUBA S1	18/10/2020 13:09	18/10/2020 16:28	18/10/2020 13:09	18/10/2020 16:28	3,31	1	3,31	CHI
20201095036	MONTIVIDIU	MV12260778LD	MONTIVIDIU T	18/10/2020 13:10	19/10/2020 12:10	18/10/2020 13:10	19/10/2020 12:10	23,00	14	321,98	CHI
20201095036	RIO VERDE	MV10409385	MONTIVIDIU T	18/10/2020 13:10	19/10/2020 12:10	19/10/2020 07:37	19/10/2020 07:48	0,17	20	3,44	CHI
20201095036	MONTIVIDIU	MV10409385	MONTIVIDIU T	18/10/2020 13:10	19/10/2020 12:10	19/10/2020 07:37	19/10/2020 07:48	0,17	12	2,07	CHI
20201095036	RIO VERDE	RV12260652	MONTIVIDIU T	18/10/2020 13:10	19/10/2020 12:10	18/10/2020 13:10	18/10/2020 20:04	6,91	2	13,82	CHI
20201095036	RIO VERDE	RV12260650LD	MONTIVIDIU T	18/10/2020 13:10	19/10/2020 12:10	18/10/2020 19:30	18/10/2020 19:41	0,19	3	0,58	CHI
20201095036	RIO VERDE	RV12260651	MONTIVIDIU T	18/10/2020 13:10	19/10/2020 12:10	18/10/2020 13:10	18/10/2020 19:21	6,18	7	43,27	CHI
20201095036	MONTIVIDIU	RV12260651	MONTIVIDIU T	18/10/2020 13:10	19/10/2020 12:10	18/10/2020 13:10	18/10/2020 19:21	6,18	1	6,18	CHI
20201095036	MONTIVIDIU	MV10409385	MONTIVIDIU T	18/10/2020 13:10	19/10/2020 12:10	18/10/2020 18:51	18/10/2020 19:01	0,16	11	1,74	CHI
20201095036	RIO VERDE	MV10409385	MONTIVIDIU T	18/10/2020 13:10	19/10/2020 12:10	18/10/2020 18:51	18/10/2020 19:01	0,16	4	0,63	CHI
20201095036	RIO VERDE	MV13106478	MONTIVIDIU T	18/10/2020 13:10	19/10/2020 12:10	18/10/2020 13:10	18/10/2020 15:27	2,29	4	9,15	CHI
20201095036	MONTIVIDIU	MV13106478	MONTIVIDIU T	18/10/2020 13:10	19/10/2020 12:10	18/10/2020 13:10	18/10/2020 15:27	2,29	1	2,29	CHI
20201095036	RIO VERDE	MV10409385	MONTIVIDIU T	18/10/2020 13:10	19/10/2020 12:10	18/10/2020 13:10	18/10/2020 13:58	0,81	7	5,69	CHI
20201095036	MONTIVIDIU	MV10409385	MONTIVIDIU T	18/10/2020 13:10	19/10/2020 12:10	18/10/2020 13:10	18/10/2020 13:58	0,81	10	8,12	CHI
20201095045	CAIAPONIA	00300214	CAIAPONIA	18/10/2020 13:11	18/10/2020 18:49	18/10/2020 13:11	18/10/2020 18:49	5,63	9	50,70	CHI
20201095045	CAIAPONIA	00300214	CAIAPONIA	18/10/2020 13:11	18/10/2020 18:49	18/10/2020 13:11	18/10/2020 16:43	3,53	4	14,10	CHI
20201095045	CAIAPONIA	00300214	CAIAPONIA	18/10/2020 13:11	18/10/2020 18:49	18/10/2020 13:11	18/10/2020 16:07	2,93	5	14,64	CHI
20201095045	CAIAPONIA	00300214	CAIAPONIA	18/10/2020 13:11	18/10/2020 18:49	18/10/2020 13:11	18/10/2020 15:33	2,36	272	641,24	CHI
20201095045	CAIAPONIA	CP16410131	CAIAPONIA	18/10/2020 13:11	18/10/2020 18:49	18/10/2020 13:11	18/10/2020 15:30	2,32	528	1224,23	CHI
20201095133	MINEIROS	MY12303402	PARQUE DAS EMAS	18/10/2020 13:12	18/10/2020 20:11	18/10/2020 13:12	18/10/2020 20:11	6,98	2	13,96	CHI
20201095034	FORMOSO	FO21320744	MARA ROSA	18/10/2020 13:12	18/10/2020 14:41	18/10/2020 13:12	18/10/2020 14:41	1,48	1	1,48	CHI
20201095035	COLINAS DO SUL	TI21355497	MINACU	18/10/2020 13:12	18/10/2020 15:00	18/10/2020 13:12	18/10/2020 15:00	1,79	1	1,79	CHI
20201095039	GOIANIA	11595474	CAMPINAS S2	18/10/2020 13:13	18/10/2020 14:20	18/10/2020 13:13	18/10/2020 14:20	1,10	1	1,10	CHI
20201095040	GOIANIA	15092926	MEIA PONTE	18/10/2020 13:13	18/10/2020 15:40	18/10/2020 13:13	18/10/2020 15:40	2,43	1	2,43	CHI
20201095052	GOIANIA	GN21273463	XAVANTES	18/10/2020 13:15	18/10/2020 13:45	18/10/2020 13:15	18/10/2020 13:45	0,49	1	0,49	CHI
20201095112	RIO VERDE	RV12303492	MONTIVIDIU T	18/10/2020 13:16	19/10/2020 01:31	18/10/2020 13:16	19/10/2020 01:31	12,26	19	232,85	CHI
20201095048	JANDAIA	00190214	PALMEIRAS	18/10/2020 13:16	19/10/2020 13:19	18/10/2020 16:20	19/10/2020 13:19	20,99	2	41,98	CHI
20201095048	JANDAIA	JD13215318	PALMEIRAS	18/10/2020 13:16	19/10/2020 13:19	18/10/2020 21:56	19/10/2020 13:19	15,38	4	61,50	CHI
20201095048	JANDAIA	00190214	PARAUNA	18/10/2020 13:16	19/10/2020 13:19	18/10/2020 21:56	18/10/2020 23:04	1,13	3	3,38	CHI
20201095048	PALMEIRAS DE GOIAS	00190214	PALMEIRAS	18/10/2020 13:16	19/10/2020 13:19	18/10/2020 21:56	18/10/2020 23:04	1,13	38	42,81	CHI
20201095048	PARAUNA	00190214	PARAUNA	18/10/2020 13:16	19/10/2020 13:19	18/10/2020 21:56	18/10/2020 23:04	1,13	17	19,15	CHI
20201095048	INDIARA	00190214	PALMEIRAS	18/10/2020 13:16	19/10/2020 13:19	18/10/2020 21:56	18/10/2020 23:04	1,13	180	202,80	CHI
20201095048	PARAUNA	00190214	PALMEIRAS	18/10/2020 13:16	19/10/2020 13:19	18/10/2020 21:56	18/10/2020 23:04	1,13	53	59,71	CHI
20201095048	JANDAIA	00190214	PALMEIRAS	18/10/2020 13:16	19/10/2020 13:19	18/10/2020 21:56	18/10/2020 23:04	1,13	2117	2385,15	CHI
20201095048	JANDAIA	00190214	PALMEIRAS	18/10/2020 13:16	19/10/2020 13:19	18/10/2020 16:20	18/10/2020 21:55	5,59	4	22,37	CHI
20201095048	INDIARA	00190214	PALMEIRAS	18/10/2020 13:16	19/10/2020 13:19	18/10/2020 16:20	18/10/2020 20:25	4,10	49	200,67	CHI

20201095048	JANDAIA	00190214	PALMEIRAS	18/10/2020 13:16	19/10/2020 13:19	18/10/2020 16:20	18/10/2020 20:25	4,10	3	12,29	CHI
20201095048	JANDAIA	00190214	PALMEIRAS	18/10/2020 13:16	19/10/2020 13:19	18/10/2020 16:20	18/10/2020 20:11	3,86	7	27,01	CHI
20201095048	PARAUNA	JD10394978	PALMEIRAS	18/10/2020 13:16	19/10/2020 13:19	18/10/2020 19:31	18/10/2020 19:39	0,13	6	0,75	CHI
20201095048	JANDAIA	JD10394978	PALMEIRAS	18/10/2020 13:16	19/10/2020 13:19	18/10/2020 19:31	18/10/2020 19:39	0,13	207	25,88	CHI
20201095048	PALMEIRAS DE GOIAS	JD10394978	PALMEIRAS	18/10/2020 13:16	19/10/2020 13:19	18/10/2020 19:31	18/10/2020 19:39	0,13	38	4,75	CHI
20201095048	INDIARA	JD10394978	PALMEIRAS	18/10/2020 13:16	19/10/2020 13:19	18/10/2020 19:31	18/10/2020 19:39	0,13	133	16,63	CHI
20201095048	JANDAIA	00190214	PALMEIRAS	18/10/2020 13:16	19/10/2020 13:19	18/10/2020 16:20	18/10/2020 17:54	1,57	31	48,82	CHI
20201095048	INDIARA	00190214	PALMEIRAS	18/10/2020 13:16	19/10/2020 13:19	18/10/2020 16:20	18/10/2020 17:54	1,57	133	209,44	CHI
20201095048	PALMEIRAS DE GOIAS	00190214	PALMEIRAS	18/10/2020 13:16	19/10/2020 13:19	18/10/2020 16:20	18/10/2020 17:54	1,57	38	59,84	CHI
20201095048	JANDAIA	00190214	PALMEIRAS	18/10/2020 13:16	19/10/2020 13:19	18/10/2020 16:20	18/10/2020 17:32	1,22	176	213,84	CHI
20201095048	PARAUNA	00190214	PALMEIRAS	18/10/2020 13:16	19/10/2020 13:19	18/10/2020 16:20	18/10/2020 17:32	1,22	6	7,29	CHI
20201095048	PARAUNA	00190214	PARAUNA	18/10/2020 13:16	19/10/2020 13:19	18/10/2020 16:20	18/10/2020 16:27	0,12	18	2,21	CHI
20201095048	PARAUNA	00190214	PALMEIRAS	18/10/2020 13:16	19/10/2020 13:19	18/10/2020 16:20	18/10/2020 16:27	0,12	47	5,78	CHI
20201095048	JANDAIA	00190214	PARAUNA	18/10/2020 13:16	19/10/2020 13:19	18/10/2020 16:20	18/10/2020 16:27	0,12	3	0,37	CHI
20201095048	JANDAIA	00190214	PALMEIRAS	18/10/2020 13:16	19/10/2020 13:19	18/10/2020 16:20	18/10/2020 16:27	0,12	1901	233,93	CHI
20201095048	PALMEIRAS DE GOIAS	00190214	PALMEIRAS	18/10/2020 13:16	19/10/2020 13:19	18/10/2020 13:16	18/10/2020 15:37	2,34	38	88,87	CHI
20201095048	PARAUNA	00190214	PALMEIRAS	18/10/2020 13:16	19/10/2020 13:19	18/10/2020 13:16	18/10/2020 15:37	2,34	53	123,95	CHI
20201095048	JANDAIA	00190214	PALMEIRAS	18/10/2020 13:16	19/10/2020 13:19	18/10/2020 13:16	18/10/2020 15:37	2,34	2100	4911,08	CHI
20201095048	PARAUNA	00190214	PARAUNA	18/10/2020 13:16	19/10/2020 13:19	18/10/2020 13:16	18/10/2020 15:37	2,34	18	42,09	CHI
20201095048	INDIARA	00190214	PALMEIRAS	18/10/2020 13:16	19/10/2020 13:19	18/10/2020 13:16	18/10/2020 15:37	2,34	182	425,63	CHI
20201095048	JANDAIA	00190214	PARAUNA	18/10/2020 13:16	19/10/2020 13:19	18/10/2020 13:16	18/10/2020 15:37	2,34	3	7,02	CHI
20201095060	POSSE	PS11272119	IACIARA S2	18/10/2020 13:20	18/10/2020 14:07	18/10/2020 13:20	18/10/2020 14:07	0,77	93	71,33	CHI
20201095239	RIO VERDE	MV12301707LD	MONTIVIDIU T	18/10/2020 13:25	19/10/2020 03:18	18/10/2020 18:25	19/10/2020 03:18	8,88	7	62,15	CHI
20201095239	MONTIVIDIU	MV12260781	MONTIVIDIU T	18/10/2020 13:25	19/10/2020 03:18	18/10/2020 21:10	19/10/2020 02:34	5,40	3	16,19	CHI
20201095239	RIO VERDE	RV13076246	MONTIVIDIU T	18/10/2020 13:25	19/10/2020 03:18	18/10/2020 13:25	18/10/2020 18:21	4,95	36	178,08	CHI
20201095239	RIO VERDE	RV13076246	MONTIVIDIU T	18/10/2020 13:25	19/10/2020 03:18	18/10/2020 13:25	18/10/2020 18:21	4,95	31	153,35	CHI
20201095239	MONTIVIDIU	05700414	MONTIVIDIU T	18/10/2020 13:25	19/10/2020 03:18	18/10/2020 13:25	18/10/2020 16:34	3,16	3	9,48	CHI
20201095071	ITABERAI	IB21148038	ITABERAI S1	18/10/2020 13:25	18/10/2020 15:35	18/10/2020 13:25	18/10/2020 15:35	2,15	1	2,15	CHI
20201095074	NOVA AURORA	NE21311815	CATALAO S1	18/10/2020 13:26	18/10/2020 14:25	18/10/2020 13:26	18/10/2020 14:25	0,97	1	0,97	CHI
20201094560	CACU	IM13355061	CACHOEIRA ALTA	18/10/2020 13:28	18/10/2020 15:50	18/10/2020 13:28	18/10/2020 15:50	2,37	4	9,47	CHI
20201094560	ITARUMA	IM13355061	CACHOEIRA ALTA	18/10/2020 13:28	18/10/2020 15:50	18/10/2020 13:28	18/10/2020 15:50	2,37	100	236,69	CHI
20201095829	NIQUELANDIA	NQ12243457	URUACU	18/10/2020 13:31	18/10/2020 23:21	18/10/2020 13:31	18/10/2020 23:21	9,82	2	19,65	CHI
20201095829	BARRO ALTO	NQ12243457	URUACU	18/10/2020 13:31	18/10/2020 23:21	18/10/2020 13:31	18/10/2020 23:21	9,82	1	9,82	CHI
20201095082	RIO VERDE	RV12030057	MONTIVIDIU T	18/10/2020 13:32	18/10/2020 17:07	18/10/2020 13:32	18/10/2020 17:07	3,57	12	42,81	CHI
20201095084	GUAPO	GA21000056	GUAPO S1	18/10/2020 13:33	19/10/2020 00:58	18/10/2020 13:33	19/10/2020 00:58	11,42	1	11,42	CHI
20201095085	FORMOSA	610004426	ITUIQUIRA	18/10/2020 13:33	18/10/2020 16:36	18/10/2020 13:33	18/10/2020 16:36	3,04	1	3,04	CHI
20201095088	CAVALCANTE	CJ11063107	FLORES DE GOIAS	18/10/2020 13:34	18/10/2020 16:18	18/10/2020 13:34	18/10/2020 16:18	2,72	77	209,72	CHI
20201095090	MONTIVIDIU	MV12301552	MONTIVIDIU T	18/10/2020 13:34	19/10/2020 00:45	18/10/2020 13:34	19/10/2020 00:45	11,17	9	100,55	CHI
20201095094	PORANGATU	PO12208614	PORANGATU	18/10/2020 13:35	18/10/2020 16:25	18/10/2020 13:35	18/10/2020 16:25	2,83	10	28,28	CHI
20201095135	PALMEIRAS DE GOIAS	PL12364761	PALMEIRAS	18/10/2020 13:35	18/10/2020 20:56	18/10/2020 13:35	18/10/2020 20:56	7,35	6	44,12	CHI
20201095135	PALMEIRAS DE GOIAS	PL12364761	PALMEIRAS	18/10/2020 13:35	18/10/2020 20:56	18/10/2020 15:05	18/10/2020 20:56	5,86	4	23,43	CHI
20201095095	MUNDO NOVO DE GOIAS	MH11253834	NOVA CRIXAS	18/10/2020 13:35	18/10/2020 16:35	18/10/2020 13:35	18/10/2020 16:35	2,99	112	334,51	CHI
20201095183	GUAPO	GA12000002	GUAPO S1	18/10/2020 13:39	18/10/2020 16:37	18/10/2020 13:39	18/10/2020 16:37	2,97	210	622,94	CHI
20201095110	GOIAS	GS21087817	ITABERAI S1	18/10/2020 13:41	18/10/2020 17:25	18/10/2020 13:41	18/10/2020 17:25	3,73	1	3,73	CHI
20201095111	MINACU	IH12338798LD	MINACU	18/10/2020 13:41	18/10/2020 15:49	18/10/2020 13:41	18/10/2020 15:49	2,12	11	23,35	CHI
20201095131	RIO VERDE	O2450424	CABRIUVA S2	18/10/2020 13:42	18/10/2020 14:29	18/10/2020 13:42	18/10/2020 14:29	0,78	149	116,47	CHI
20201095131	JATAI	O2450424	CABRIUVA S2	18/10/2020 13:42	18/10/2020 14:29	18/10/2020 13:42	18/10/2020 14:29	0,78	28	21,89	CHI
20201095115	APARECIDA DE GOIANIA	14602593	INDEPENDENCIA S1	18/10/2020 13:43	18/10/2020 16:01	18/10/2020 13:43	18/10/2020 16:01	2,29	1	2,29	CHI
20201095117	GOIANIA	GN11169549	AEROPORTO S2	18/10/2020 13:44	18/10/2020 15:22	18/10/2020 13:44	18/10/2020 15:22	1,63	52	84,86	CHI
20201095130	BONFINOPOLIS	BV21029119	GOIANIA LESTE S2	18/10/2020 13:49	18/10/2020 16:21	18/10/2020 13:49	18/10/2020 16:21	2,52	1	2,52	CHI
20201095132	CAMPO ALEGRE DE GOIAS	CM12077548	CAMPO ALEGRE DE GOIAS	18/10/2020 13:49	18/10/2020 16:19	18/10/2020 13:49	18/10/2020 16:19	2,49	6	14,93	CHI

20201095136	CUMARI	CY12144249RE	CATALAO S2	18/10/2020 13:51	18/10/2020 18:02	18/10/2020 13:51	18/10/2020 18:02	4,18	53	221,61	CHI
20201095136	CATALAO	CY12144249RE	CATALAO S2	18/10/2020 13:51	18/10/2020 18:02	18/10/2020 13:51	18/10/2020 18:02	4,18	7	29,27	CHI
20201095207	SANTA TEREZINHA DE GOIAS	GG12171805RE	SANTA TEREZINHA	18/10/2020 13:51	18/10/2020 16:48	18/10/2020 13:51	18/10/2020 16:48	2,95	46	135,58	CHI
20201095207	PILAR DE GOIAS	GG12171805RE	SANTA TEREZINHA	18/10/2020 13:51	18/10/2020 16:48	18/10/2020 13:51	18/10/2020 16:48	2,95	60	176,85	CHI
2020101800114	GUAPO	00755114	GUAPO S2	18/10/2020 13:52	18/10/2020 23:47	18/10/2020 13:52	18/10/2020 23:47	9,93	5	49,64	CHI
2020101800114	VARJAO	00755114	GUAPO S2	18/10/2020 13:52	18/10/2020 23:47	18/10/2020 13:52	18/10/2020 22:57	9,09	25	227,24	CHI
2020101800114	GUAPO	00755114	GUAPO S2	18/10/2020 13:52	18/10/2020 23:47	18/10/2020 13:52	18/10/2020 22:57	9,09	513	4663,03	CHI
2020101800114	GUAPO	00755114	GUAPO S2	18/10/2020 13:52	18/10/2020 23:47	18/10/2020 13:52	18/10/2020 22:57	9,09	123	1118,04	CHI
2020101800114	GUAPO	00755114	GUAPO S2	18/10/2020 13:52	18/10/2020 23:47	18/10/2020 13:52	18/10/2020 22:57	9,09	2	18,18	CHI
2020101800114	VARJAO	00755114	GUAPO S2	18/10/2020 13:52	18/10/2020 23:47	18/10/2020 13:52	18/10/2020 19:12	5,34	1	5,34	CHI
2020101800114	GUAPO	00755114	GUAPO S2	18/10/2020 13:52	18/10/2020 23:47	18/10/2020 13:52	18/10/2020 19:12	5,34	159	848,27	CHI
2020101800114	CAMPESTRE DE GOIAS	00755114	GUAPO S2	18/10/2020 13:52	18/10/2020 23:47	18/10/2020 13:52	18/10/2020 19:12	5,34	13	69,36	CHI
2020101800114	GUAPO	00750434	GUAPO S2	18/10/2020 13:52	18/10/2020 23:47	18/10/2020 17:23	18/10/2020 18:01	0,63	13	8,22	CHI
2020101800114	VARJAO	00750434	GUAPO S2	18/10/2020 13:52	18/10/2020 23:47	18/10/2020 17:23	18/10/2020 18:01	0,63	1705	1077,47	CHI
2020101800114	GUAPO	00750434	GUAPO S2	18/10/2020 13:52	18/10/2020 23:47	18/10/2020 17:23	18/10/2020 18:01	0,63	133	84,05	CHI
2020101800114	ARAGOIANIA	00750434	GUAPO S2	18/10/2020 13:52	18/10/2020 23:47	18/10/2020 17:23	18/10/2020 18:01	0,63	1	0,63	CHI
2020101800114	INDIARA	00750434	GUAPO S2	18/10/2020 13:52	18/10/2020 23:47	18/10/2020 17:23	18/10/2020 18:01	0,63	1	0,63	CHI
2020101800114	VARJAO	00750434	GUAPO S2	18/10/2020 13:52	18/10/2020 23:47	18/10/2020 17:23	18/10/2020 18:01	0,63	204	128,92	CHI
2020101800114	CEZARINA	00750434	GUAPO S2	18/10/2020 13:52	18/10/2020 23:47	18/10/2020 17:23	18/10/2020 18:01	0,63	244	154,19	CHI
2020101800114	ARAGOIANIA	00755114	GUAPO S2	18/10/2020 13:52	18/10/2020 23:47	18/10/2020 13:52	18/10/2020 16:01	2,15	1	2,15	CHI
2020101800114	VARJAO	00755114	GUAPO S2	18/10/2020 13:52	18/10/2020 23:47	18/10/2020 13:52	18/10/2020 16:01	2,15	204	438,03	CHI
2020101800114	GUAPO	00755114	GUAPO S2	18/10/2020 13:52	18/10/2020 23:47	18/10/2020 13:52	18/10/2020 16:01	2,15	133	285,58	CHI
2020101800114	GUAPO	00755114	GUAPO S2	18/10/2020 13:52	18/10/2020 23:47	18/10/2020 13:52	18/10/2020 15:56	2,07	13	26,87	CHI
2020101800114	CEZARINA	00755114	GUAPO S2	18/10/2020 13:52	18/10/2020 23:47	18/10/2020 13:52	18/10/2020 15:56	2,07	244	504,33	CHI
2020101800114	VARJAO	00755114	GUAPO S2	18/10/2020 13:52	18/10/2020 23:47	18/10/2020 13:52	18/10/2020 15:56	2,07	1705	3524,14	CHI
2020101800114	INDIARA	00755114	GUAPO S2	18/10/2020 13:52	18/10/2020 23:47	18/10/2020 13:52	18/10/2020 15:56	2,07	1	2,07	CHI
20201095830	NIQUELANDIA	10011048270	URUACU	18/10/2020 13:52	18/10/2020 20:29	18/10/2020 13:52	18/10/2020 20:29	6,62	1	6,62	CHI
20201095144	RIO VERDE	RV11230869	RIO VERDE S2	18/10/2020 13:52	19/10/2020 01:31	18/10/2020 13:52	19/10/2020 01:31	11,64	35	407,50	CHI
20201095146	MORRINHOS	MR31090564	MORRINHOS	18/10/2020 13:52	18/10/2020 14:59	18/10/2020 13:52	18/10/2020 14:59	1,11	1	1,11	CHI
20201095151	GOIANIA	11050068	ATLANTICO S1	18/10/2020 13:53	18/10/2020 15:29	18/10/2020 13:53	18/10/2020 15:29	1,59	1	1,59	CHI
20201095152	CRIXAS	10024623650	SERRA DO OURO	18/10/2020 13:53	18/10/2020 15:26	18/10/2020 13:53	18/10/2020 15:26	1,54	1	1,54	CHI
20201095208	PALMEIRAS DE GOIAS	PL12205904	PALMEIRAS	18/10/2020 13:54	18/10/2020 16:23	18/10/2020 13:54	18/10/2020 16:23	2,47	54	133,34	CHI
20201095208	JANDAIA	PL12205904	PALMEIRAS	18/10/2020 13:54	18/10/2020 16:23	18/10/2020 13:54	18/10/2020 16:23	2,47	1	2,47	CHI
20201095155	GOIANIA	11113054	FERROVIARIO S3	18/10/2020 13:54	18/10/2020 14:38	18/10/2020 13:54	18/10/2020 14:38	0,72	1	0,72	CHI
20201095158	CACHOEIRA ALTA	CA21226909	CACHOEIRA ALTA	18/10/2020 13:55	18/10/2020 16:13	18/10/2020 13:55	18/10/2020 16:13	2,29	1	2,29	CHI
20201095171	SAO JOAO DA PARAUNA	FR12040685	FIRMINOPOLIS S2	18/10/2020 13:56	18/10/2020 16:46	18/10/2020 13:56	18/10/2020 16:46	2,82	6	16,91	CHI
20201095169	MINEIROS	10004716041	PARQUE DAS EMAS	18/10/2020 13:58	18/10/2020 18:08	18/10/2020 13:58	18/10/2020 18:08	4,15	1	4,15	CHI
20201095173	LUZIANIA	LZ12376188	RIO VERMELHO	18/10/2020 14:00	18/10/2020 22:09	18/10/2020 14:00	18/10/2020 22:09	8,16	10	81,60	CHI
20201099815	SANTA TEREZINHA DE GOIAS	SG12156648	SANTA TEREZINHA	18/10/2020 14:00	18/10/2020 23:09	18/10/2020 14:00	18/10/2020 23:09	9,15	2	18,29	CHI
20201095177	APARECIDA DE GOIANIA	200374357	INDEPENDENCIA S1	18/10/2020 14:00	18/10/2020 16:48	18/10/2020 14:00	18/10/2020 16:48	2,79	1	2,79	CHI
20201095259	ARAGUAPAZ	MZ10291679	MOZARLANDIA	18/10/2020 14:02	18/10/2020 20:16	18/10/2020 14:02	18/10/2020 20:16	6,24	2862	17858,88	CHI
20201095259	MATRINCHA	MZ10291679	MOZARLANDIA	18/10/2020 14:02	18/10/2020 20:16	18/10/2020 14:02	18/10/2020 20:16	6,24	42	262,08	CHI
20201095259	ARAGUAPAZ	MZ10291679	MOZARLANDIA	18/10/2020 14:02	18/10/2020 20:16	18/10/2020 14:02	18/10/2020 20:16	6,24	36	224,64	CHI
20201095259	MOZARLANDIA	MZ10291679	MOZARLANDIA	18/10/2020 14:02	18/10/2020 20:16	18/10/2020 14:02	18/10/2020 20:16	6,24	3	18,72	CHI
20201095259	MOZARLANDIA	MZ10291679	MOZARLANDIA	18/10/2020 14:02	18/10/2020 20:16	18/10/2020 14:02	18/10/2020 20:16	6,24	10	62,40	CHI
20201095259	ARUANA	MZ10291679	MOZARLANDIA	18/10/2020 14:02	18/10/2020 20:16	18/10/2020 14:02	18/10/2020 20:16	6,24	73	455,52	CHI
20201095259	MOZARLANDIA	MZ10291679	MOZARLANDIA	18/10/2020 14:02	18/10/2020 20:16	18/10/2020 14:02	18/10/2020 18:05	4,06	93	377,74	CHI
20201095259	MOZARLANDIA	MZ10291679	MOZARLANDIA	18/10/2020 14:02	18/10/2020 20:16	18/10/2020 15:51	18/10/2020 18:05	2,23	15	33,45	CHI
20201095184	APARECIDA DE GOIANIA	10018813710	INDEPENDENCIA S2	18/10/2020 14:03	18/10/2020 15:34	18/10/2020 14:03	18/10/2020 15:34	1,51	1	1,51	CHI
20201095187	FLORES DE GOIAS	FB21419115	FLORES DE GOIAS	18/10/2020 14:04	18/10/2020 15:44	18/10/2020 14:04	18/10/2020 15:44	1,65	1	1,65	CHI
20201095188	SANTA TEREZINHA DE GOIAS	SG12243403	SANTA TEREZINHA	18/10/2020 14:04	19/10/2020 00:31	18/10/2020 14:04	19/10/2020 00:31	10,43	1	10,43	CHI

20201095191	SENADOR CANEDO	10001805590	SENADOR CANEDO	18/10/2020 14:05	18/10/2020 16:11	18/10/2020 14:05	18/10/2020 16:11	2,10	1	2,10	CHI
20201096157	CORUMBAIBA	CI12110154	VILA CORUMBA	18/10/2020 14:05	18/10/2020 20:26	18/10/2020 14:05	18/10/2020 20:26	6,34	67	424,67	CHI
20201095781	RUBIATABA	RB12187176	RUBIATABA	18/10/2020 14:07	19/10/2020 22:56	18/10/2020 14:07	19/10/2020 22:56	32,81	1	32,81	CHI
20201095781	SÃO PATRÍCIO	RB12187176	RUBIATABA	18/10/2020 14:07	19/10/2020 22:56	18/10/2020 14:07	19/10/2020 22:56	32,81	6	196,85	CHI
20201095209	GOIANIA	13862285	XAVANTES	18/10/2020 14:09	18/10/2020 15:56	18/10/2020 14:09	18/10/2020 15:56	1,77	1	1,77	CHI
20201091075	NOVO PLANALTO	TA11143668	NOVO PLANALTO	18/10/2020 14:10	18/10/2020 14:15	18/10/2020 14:10	18/10/2020 14:15	0,08	132	10,96	CHI
20201095234	SÃO MIGUEL DO ARAGUAIA	SM12262763	SÃO MIGUEL DO ARAGUAIA	18/10/2020 14:10	19/10/2020 01:15	18/10/2020 14:10	19/10/2020 01:15	11,08	2	22,16	CHI
20201095234	SÃO MIGUEL DO ARAGUAIA	SM12013036	SÃO MIGUEL DO ARAGUAIA	18/10/2020 14:10	19/10/2020 01:15	18/10/2020 14:10	18/10/2020 22:55	8,75	22	192,52	CHI
20201095234	BONOPOLIS	SM10396890	SÃO MIGUEL DO ARAGUAIA	18/10/2020 14:10	19/10/2020 01:15	18/10/2020 14:10	18/10/2020 22:09	7,98	105	838,07	CHI
20201095234	SÃO MIGUEL DO ARAGUAIA	SM10396890	SÃO MIGUEL DO ARAGUAIA	18/10/2020 14:10	19/10/2020 01:15	18/10/2020 14:10	18/10/2020 22:09	7,98	10	79,82	CHI
20201095234	SÃO MIGUEL DO ARAGUAIA	SM10396890	SÃO MIGUEL DO ARAGUAIA	18/10/2020 14:10	19/10/2020 01:15	18/10/2020 14:10	18/10/2020 22:04	7,91	4	31,63	CHI
20201095234	SÃO MIGUEL DO ARAGUAIA	SM10396890	SÃO MIGUEL DO ARAGUAIA	18/10/2020 14:10	19/10/2020 01:15	18/10/2020 14:10	18/10/2020 16:34	2,40	5	12,02	CHI
20201095234	SÃO MIGUEL DO ARAGUAIA	SM10396890	SÃO MIGUEL DO ARAGUAIA	18/10/2020 14:10	19/10/2020 01:15	18/10/2020 14:10	18/10/2020 14:20	0,18	69	12,09	CHI
20201095211	CAIAPONIA	CP11184362	CAIAPONIA	18/10/2020 14:10	18/10/2020 18:19	18/10/2020 14:10	18/10/2020 18:19	4,15	69	286,01	CHI
20201095229	PEROLANDIA	02610444	PARQUE DAS EMAS	18/10/2020 14:10	19/10/2020 14:23	18/10/2020 16:24	19/10/2020 14:23	21,98	18	395,68	CHI
20201095229	MINEIROS	02610444	PARQUE DAS EMAS	18/10/2020 14:10	19/10/2020 14:23	18/10/2020 16:24	19/10/2020 14:23	21,98	14	307,75	CHI
20201095229	MINEIROS	MY10396069	PARQUE DAS EMAS	18/10/2020 14:10	19/10/2020 14:23	18/10/2020 18:36	19/10/2020 14:23	19,79	7	138,51	CHI
20201095229	PEROLANDIA	MY10396069	PARQUE DAS EMAS	18/10/2020 14:10	19/10/2020 14:23	18/10/2020 18:36	19/10/2020 14:23	19,79	3	59,36	CHI
20201095229	PORTELANDIA	MY10396069	PARQUE DAS EMAS	18/10/2020 14:10	19/10/2020 14:23	18/10/2020 18:36	19/10/2020 14:23	19,79	1	19,79	CHI
20201095229	MINEIROS	02610444	PARQUE DAS EMAS	18/10/2020 14:10	19/10/2020 14:23	18/10/2020 16:24	18/10/2020 18:35	2,18	4	8,72	CHI
20201095229	PORTELANDIA	02610444	PARQUE DAS EMAS	18/10/2020 14:10	19/10/2020 14:23	18/10/2020 14:10	18/10/2020 17:01	2,85	120	341,47	CHI
20201095229	PORTELANDIA	PW13209698	PARQUE DAS EMAS	18/10/2020 14:10	19/10/2020 14:23	18/10/2020 14:10	18/10/2020 17:01	2,84	60	170,38	CHI
20201095229	PORTELANDIA	02610444	PARQUE DAS EMAS	18/10/2020 14:10	19/10/2020 14:23	18/10/2020 14:10	18/10/2020 17:01	2,84	4	11,36	CHI
20201095229	PEROLANDIA	02610444	PARQUE DAS EMAS	18/10/2020 14:10	19/10/2020 14:23	18/10/2020 14:10	18/10/2020 16:45	2,58	2	5,16	CHI
20201095229	MINEIROS	02610444	PARQUE DAS EMAS	18/10/2020 14:10	19/10/2020 14:23	18/10/2020 14:10	18/10/2020 16:45	2,58	14	36,09	CHI
20201095229	DOVERLANDIA	02610444	PARQUE DAS EMAS	18/10/2020 14:10	19/10/2020 14:23	18/10/2020 14:10	18/10/2020 16:45	2,58	3	7,73	CHI
20201095229	PORTELANDIA	02610444	PARQUE DAS EMAS	18/10/2020 14:10	19/10/2020 14:23	18/10/2020 14:10	18/10/2020 16:45	2,58	4	10,31	CHI
20201095229	PORTELANDIA	02610444	PARQUE DAS EMAS	18/10/2020 14:10	19/10/2020 14:23	18/10/2020 14:10	18/10/2020 16:45	2,57	2	5,14	CHI
20201095229	MINEIROS	02610444	PARQUE DAS EMAS	18/10/2020 14:10	19/10/2020 14:23	18/10/2020 14:10	18/10/2020 16:45	2,57	2	5,14	CHI
20201095229	CAIAPONIA	02610444	PARQUE DAS EMAS	18/10/2020 14:10	19/10/2020 14:23	18/10/2020 14:10	18/10/2020 16:45	2,57	1	2,57	CHI
20201095229	DOVERLANDIA	02610444	PARQUE DAS EMAS	18/10/2020 14:10	19/10/2020 14:23	18/10/2020 14:10	18/10/2020 16:45	2,57	1	2,57	CHI
20201095229	PEROLANDIA	02610444	PARQUE DAS EMAS	18/10/2020 14:10	19/10/2020 14:23	18/10/2020 14:10	18/10/2020 16:45	2,57	1	2,57	CHI
20201095229	MINEIROS	02610444	PARQUE DAS EMAS	18/10/2020 14:10	19/10/2020 14:23	18/10/2020 14:10	18/10/2020 16:20	2,17	4	8,69	CHI
20201095215	CORUMBAIBA	560011738	VILA CORUMBA	18/10/2020 14:11	18/10/2020 17:12	18/10/2020 14:11	18/10/2020 17:12	3,02	1	3,02	CHI
20201095272	PROFESSOR JAMIL SAFADY	JS11115432	ROCHEDO	18/10/2020 14:12	18/10/2020 23:51	18/10/2020 14:12	18/10/2020 23:51	9,65	80	771,96	CHI
20201095272	PROFESSOR JAMIL SAFADY	URO-TR2	ROCHEDO	18/10/2020 14:12	18/10/2020 23:51	18/10/2020 14:12	18/10/2020 22:42	8,49	570	4841,99	CHI
20201095272	PIRACANJUBA	URO-TR2	ROCHEDO	18/10/2020 14:12	18/10/2020 23:51	18/10/2020 14:12	18/10/2020 22:42	8,49	230	1953,79	CHI
20201095272	HIDROLANDIA	URO-TR2	ROCHEDO	18/10/2020 14:12	18/10/2020 23:51	18/10/2020 14:12	18/10/2020 22:42	8,49	9	76,45	CHI
20201095272	CROMINIA	URO-TR2	ROCHEDO	18/10/2020 14:12	18/10/2020 23:51	18/10/2020 14:12	18/10/2020 22:42	8,49	4	33,98	CHI
20201095272	PROFESSOR JAMIL SAFADY	URO-TR2	ROCHEDO	18/10/2020 14:12	18/10/2020 23:51	18/10/2020 14:12	18/10/2020 22:42	8,49	1	8,49	CHI
20201095272	PROFESSOR JAMIL SAFADY	01620424	ROCHEDO	18/10/2020 14:12	18/10/2020 23:51	18/10/2020 19:11	18/10/2020 22:42	3,53	1	3,53	CHI
20201095272	PIRACANJUBA	01620424	ROCHEDO	18/10/2020 14:12	18/10/2020 23:51	18/10/2020 19:11	18/10/2020 22:42	3,53	65	229,18	CHI
20201095272	PROFESSOR JAMIL SAFADY	URO-TR2	ROCHEDO	18/10/2020 14:12	18/10/2020 23:51	18/10/2020 14:12	18/10/2020 22:12	7,99	4	31,97	CHI
20201095272	PIRACANJUBA	URO-TR2	ROCHEDO	18/10/2020 14:12	18/10/2020 23:51	18/10/2020 14:12	18/10/2020 21:14	7,03	1	7,03	CHI
20201095272	PROFESSOR JAMIL SAFADY	URO-TR2	ROCHEDO	18/10/2020 14:12	18/10/2020 23:51	18/10/2020 14:12	18/10/2020 21:14	7,03	2	14,07	CHI
20201095272	CROMINIA	JS16432472	ROCHEDO	18/10/2020 14:12	18/10/2020 23:51	18/10/2020 14:12	18/10/2020 19:33	5,34	42	224,26	CHI
20201095272	PROFESSOR JAMIL SAFADY	JS16432472	ROCHEDO	18/10/2020 14:12	18/10/2020 23:51	18/10/2020 14:12	18/10/2020 19:33	5,34	597	3187,65	CHI
20201095272	PROFESSOR JAMIL SAFADY	JS16432472	ROCHEDO	18/10/2020 14:12	18/10/2020 23:51	18/10/2020 19:10	18/10/2020 19:33	0,39	25	9,66	CHI
20201095272	PROFESSOR JAMIL SAFADY	JS11000008	ROCHEDO	18/10/2020 14:12	18/10/2020 23:51	18/10/2020 14:12	18/10/2020 19:23	5,18	99	513,18	CHI
20201095272	PIRACANJUBA	URO-TR2	ROCHEDO	18/10/2020 14:12	18/10/2020 23:51	18/10/2020 14:12	18/10/2020 15:54	1,71	323	552,87	CHI
20201095272	PROFESSOR JAMIL SAFADY	URO-TR2	ROCHEDO	18/10/2020 14:12	18/10/2020 23:51	18/10/2020 14:12	18/10/2020 15:54	1,70	28	47,51	CHI

20201095272	PIRACANJUBA	URO-TR2	ROCHEDO	18/10/2020 14:12	18/10/2020 23:51	18/10/2020 14:12	18/10/2020 15:54	1,70	50	84,85	CHI
202010101040	PROFESSOR JAMIL SAFADY	JS11109606	ROCHEDO	18/10/2020 14:12	19/10/2020 14:11	18/10/2020 14:12	19/10/2020 14:11	23,97	74	1773,70	CHI
20201095231	APARECIDA DE GOIANIA	16718616	REAL S1	18/10/2020 14:14	18/10/2020 15:16	18/10/2020 14:14	18/10/2020 15:16	1,03	0	0,00	CHI
20201095233	MONTIVIDU DO NORTE	MX12192265	PORANGATU	18/10/2020 14:14	18/10/2020 19:32	18/10/2020 14:14	18/10/2020 19:32	5,28	65	343,52	CHI
20201095236	ANAPOLIS	21304660	JUNDIAI S1	18/10/2020 14:15	18/10/2020 15:50	18/10/2020 14:15	18/10/2020 15:50	1,57	1	1,57	CHI
20201095901	CROMINIA	CQ12000217	PONTALINA	18/10/2020 14:16	18/10/2020 22:00	18/10/2020 14:16	18/10/2020 22:00	7,72	13	100,32	CHI
20201095244	MUNDO NOVO DE GOIAS	MH12220610	NOVA CRIXAS	18/10/2020 14:17	18/10/2020 22:30	18/10/2020 14:17	18/10/2020 22:30	8,21	56	459,64	CHI
20201095246	QUIRINOPOLIS	QI21140932	QUIRINOPOLIS	18/10/2020 14:18	18/10/2020 15:23	18/10/2020 14:18	18/10/2020 15:23	1,08	1	1,08	CHI
20201095249	MUNDO NOVO DE GOIAS	MH12255527	NOVA CRIXAS	18/10/2020 14:19	18/10/2020 16:02	18/10/2020 14:19	18/10/2020 16:02	1,71	83	142,25	CHI
202010189358	MORRINHOS	MR12389875	MORRINHOS	18/10/2020 14:19	18/10/2020 17:02	18/10/2020 14:19	18/10/2020 17:02	2,71	7	18,97	CHI
20201095260	ARUANA	AK12307529	ARUANA	18/10/2020 14:21	18/10/2020 15:39	18/10/2020 14:21	18/10/2020 15:39	1,29	1	1,29	CHI
20201095269	PIRENOPOLIS	220014619	CORUMBA	18/10/2020 14:23	18/10/2020 17:11	18/10/2020 14:23	18/10/2020 17:11	2,79	1	2,79	CHI
20201095274	APARECIDA DE GOIANIA	13289834	REAL S1	18/10/2020 14:24	18/10/2020 17:53	18/10/2020 14:24	18/10/2020 17:53	3,48	1	3,48	CHI
20201095281	BELA VISTA DE GOIAS	BV21340068	CEPAIGO S2	18/10/2020 14:24	18/10/2020 19:26	18/10/2020 14:24	18/10/2020 19:26	5,02	2	10,05	CHI
20201095635	FIRMINOPOLIS	TV12105311	FIRMINOPOLIS S1	18/10/2020 14:24	18/10/2020 16:45	18/10/2020 14:24	18/10/2020 16:45	2,34	6	14,02	CHI
20201095285	APARECIDA DE GOIANIA	200150169	ANHANGUERA	18/10/2020 14:24	18/10/2020 16:52	18/10/2020 14:24	18/10/2020 16:52	2,45	1	2,45	CHI
20201095517	SANTA TEREZINHA DE GOIAS	SG11034165	SANTA TEREZINHA	18/10/2020 14:24	18/10/2020 18:10	18/10/2020 14:24	18/10/2020 18:10	3,75	200	750,17	CHI
20201095291	JUSSARA	JR21120662	JUSSARA	18/10/2020 14:26	18/10/2020 20:28	18/10/2020 14:26	18/10/2020 20:28	6,02	1	6,02	CHI
20201095367	HIDROLANDIA	HD12365522	CEPAIGO S2	18/10/2020 14:27	18/10/2020 17:40	18/10/2020 14:27	18/10/2020 17:40	3,21	31	99,42	CHI
20201095295	GOIANIA	GN21000294	XAVANTES	18/10/2020 14:27	18/10/2020 17:27	18/10/2020 14:27	18/10/2020 17:27	2,99	1	2,99	CHI
20201095302	ANAPOLIS	AN11129498	JUNDIAI S1	18/10/2020 14:30	18/10/2020 16:39	18/10/2020 14:30	18/10/2020 16:39	2,14	126	269,43	CHI
20201095307	CORUMBA DE GOIAS	CB11090246	CORUMBA	18/10/2020 14:31	18/10/2020 18:18	18/10/2020 14:31	18/10/2020 18:18	3,77	112	422,36	CHI
20201095309	SANTA HELENA DE GOIAS	SH11159473	IPEGUARI	18/10/2020 14:32	18/10/2020 16:20	18/10/2020 14:32	18/10/2020 16:20	1,80	49	88,15	CHI
20201095313	PROFESSOR JAMIL SAFADY	PJ12000052RE	PIRACANJUBA	18/10/2020 14:34	18/10/2020 16:21	18/10/2020 14:34	18/10/2020 16:21	1,78	3	5,34	CHI
20201095313	PIRACANJUBA	PJ12000052RE	PIRACANJUBA	18/10/2020 14:34	18/10/2020 16:21	18/10/2020 14:34	18/10/2020 16:21	1,78	53	94,25	CHI
20201095351	RIO VERDE	O1600224	RIO VERDE S2	18/10/2020 14:35	18/10/2020 14:39	18/10/2020 14:35	18/10/2020 14:39	0,06	1427	80,86	CHI
20201095351	RIO VERDE	O1600224	RIO VERDE S2	18/10/2020 14:35	18/10/2020 14:39	18/10/2020 14:35	18/10/2020 14:39	0,05	3583	187,11	CHI
202010100673	MINEIROS	MY12060151LD	PARQUE DAS EMAS	18/10/2020 14:37	19/10/2020 01:10	18/10/2020 14:37	19/10/2020 01:10	10,54	413	4354,74	CHI
202010100673	MINEIROS	MY12060151LD	PARQUE DAS EMAS	18/10/2020 14:37	19/10/2020 01:10	18/10/2020 20:59	19/10/2020 01:10	4,17	1	4,17	CHI
20201095369	MINEIROS	MY16401260	PARQUE DAS EMAS	18/10/2020 14:37	18/10/2020 22:55	18/10/2020 14:37	18/10/2020 22:55	8,30	533	4423,31	CHI
202010100673	MINEIROS	MY16401260	PARQUE DAS EMAS	18/10/2020 14:37	19/10/2020 01:10	18/10/2020 20:59	18/10/2020 22:55	1,92	208	400,34	CHI
202010100673	MINEIROS	MY10404141	PARQUE DAS EMAS	18/10/2020 14:37	19/10/2020 01:10	18/10/2020 20:59	18/10/2020 21:04	0,08	3026	257,21	CHI
202010100673	MINEIROS	MY10404141	PARQUE DAS EMAS	18/10/2020 14:37	19/10/2020 01:10	18/10/2020 20:59	18/10/2020 21:04	0,08	306	24,56	CHI
20201095369	MINEIROS	MY10348882	PARQUE DAS EMAS	18/10/2020 14:37	18/10/2020 22:55	18/10/2020 14:37	18/10/2020 14:42	0,08	220	18,46	CHI
20201095369	MINEIROS	MY10404141	PARQUE DAS EMAS	18/10/2020 14:37	18/10/2020 22:55	18/10/2020 14:37	18/10/2020 14:42	0,08	3589	280,14	CHI
20201095327	MINEIROS	SU16418241	SANTA RITA DO ARAGUAIA	18/10/2020 14:37	18/10/2020 14:56	18/10/2020 14:37	18/10/2020 14:56	0,31	33	10,25	CHI
20201095327	SANTA RITA DO ARAGUAIA	SU16418241	SANTA RITA DO ARAGUAIA	18/10/2020 14:37	18/10/2020 14:56	18/10/2020 14:37	18/10/2020 14:56	0,31	1965	610,24	CHI
20201099422	CAIAPONIA	CP12248981	CAIAPONIA	18/10/2020 14:39	18/10/2020 22:11	18/10/2020 14:39	18/10/2020 22:11	7,52	8	60,16	CHI
20201095350	GOIANIA	16860275	CAMPINAS S1	18/10/2020 14:40	18/10/2020 16:07	18/10/2020 14:40	18/10/2020 16:07	1,44	1	1,44	CHI
20201095648	NIQUELANDIA	NQ12235112	URUACU	18/10/2020 14:41	18/10/2020 18:06	18/10/2020 14:41	18/10/2020 18:06	3,41	11	37,51	CHI
20201095363	NOVA CRIXAS	NA12380421	NOVA CRIXAS	18/10/2020 14:43	18/10/2020 22:23	18/10/2020 14:43	18/10/2020 22:23	7,67	49	375,60	CHI
20201095530	CEZARINA	CZ12314870	CEZARINA	18/10/2020 14:43	18/10/2020 21:38	18/10/2020 14:43	18/10/2020 21:38	6,90	3	20,71	CHI
20201095530	CEZARINA	CZ12314870	CEZARINA	18/10/2020 14:43	18/10/2020 21:38	18/10/2020 14:43	18/10/2020 17:30	2,77	20	55,40	CHI
20201095392	MATRINCHA	MP12122362	MATRINCHA	18/10/2020 14:47	18/10/2020 16:44	18/10/2020 14:47	18/10/2020 16:44	1,94	69	133,75	CHI
20201095395	POSSE	PS21237082	IACIARA S2	18/10/2020 14:48	18/10/2020 17:33	18/10/2020 14:48	18/10/2020 17:33	2,75	1	2,75	CHI
20201095398	PIRES DO RIO	6433761	PIRES DO RIO S1	18/10/2020 14:48	19/10/2020 13:56	18/10/2020 14:48	19/10/2020 13:56	23,13	5	115,63	CHI
20201095402	CALDAS NOVAS	10024585996	CALDAS NOVAS S1	18/10/2020 14:48	19/10/2020 08:12	18/10/2020 14:48	19/10/2020 08:12	17,39	1	17,39	CHI
20201095403	CAIAPONIA	MY12402481RE	PARQUE DAS EMAS	18/10/2020 14:48	18/10/2020 22:23	18/10/2020 14:48	18/10/2020 22:23	7,57	5	37,84	CHI
20201095403	PEROLANDIA	MY12402481RE	PARQUE DAS EMAS	18/10/2020 14:48	18/10/2020 22:23	18/10/2020 14:48	18/10/2020 22:23	7,57	9	68,12	CHI
20201095403	MINEIROS	MY12402481RE	PARQUE DAS EMAS	18/10/2020 14:48	18/10/2020 22:23	18/10/2020 14:48	18/10/2020 22:23	7,57	11	83,25	CHI
20201095464	ITAPACI	IW11056081	ITAPACI	18/10/2020 14:49	18/10/2020 17:41	18/10/2020 14:49	18/10/2020 17:41	2,86	210	601,13	CHI

20201095909	SANTA TEREZINHA DE GOIAS	SG12181363	SANTA TEREZINHA	18/10/2020 14:49	18/10/2020 19:29	18/10/2020 14:49	18/10/2020 19:29	4,66	147	685,06	CHI
20201095446	CAMPOS VERDES	VD12049791	SANTA TEREZINHA	18/10/2020 14:49	18/10/2020 16:45	18/10/2020 14:49	18/10/2020 16:45	1,92	18	34,58	CHI
20201095418	ORIZONA	OZ11140712	PIRES DO RIO S2	18/10/2020 14:51	18/10/2020 16:45	18/10/2020 14:51	18/10/2020 16:45	1,88	150	282,58	CHI
20201095425	PILAR DE GOIAS	GG12318452	URUACU	18/10/2020 14:53	18/10/2020 21:24	18/10/2020 14:53	18/10/2020 21:24	6,51	87	566,23	CHI
20201095425	GUARINOS	GG12318452	URUACU	18/10/2020 14:53	18/10/2020 21:24	18/10/2020 14:53	18/10/2020 21:24	6,51	1	6,51	CHI
20201095425	SANTA TEREZINHA DE GOIAS	GG12318452	URUACU	18/10/2020 14:53	18/10/2020 21:24	18/10/2020 14:53	18/10/2020 21:24	6,51	4	26,03	CHI
20201095427	GOIANIA	13733448	REAL S1	18/10/2020 14:53	18/10/2020 17:14	18/10/2020 14:53	18/10/2020 17:14	2,33	1	2,33	CHI
20201096830	MINEIROS	MY11065323	PARQUE DAS EMAS	18/10/2020 14:54	18/10/2020 21:01	18/10/2020 14:54	18/10/2020 21:01	6,11	45	275,05	CHI
20201095438	AGUA FRIA DE GOIAS	TL21236292	SAO JOAO D ALIANCA	18/10/2020 14:55	18/10/2020 17:39	18/10/2020 14:55	18/10/2020 17:39	2,73	1	2,73	CHI
20201095440	TRINDADE	TR11005104	TRINDADE	18/10/2020 14:55	18/10/2020 16:58	18/10/2020 14:55	18/10/2020 16:58	2,04	62	126,65	CHI
20201095442	ANAPOLIS	20525308	ANAPOLIS UNIVERSITARIO S2	18/10/2020 14:55	18/10/2020 16:30	18/10/2020 14:55	18/10/2020 16:30	1,57	1	1,57	CHI
20201095445	GOIANIA	12324085	MEIA PONTE	18/10/2020 14:56	18/10/2020 17:23	18/10/2020 14:56	18/10/2020 17:23	2,44	1	2,44	CHI
20201097774	RIO VERDE	RV12026529	RIO VERDE S1	18/10/2020 14:57	19/10/2020 22:15	18/10/2020 14:57	19/10/2020 22:15	31,30	10	313,04	CHI
20201095715	MUNDO NOVO DE GOIAS	MH12274903	NOVA CRIXAS	18/10/2020 14:57	19/10/2020 09:49	18/10/2020 14:57	19/10/2020 09:49	18,86	11	207,43	CHI
20201095454	SAO MIGUEL DO ARAGUAIA	SM21235534	SAO MIGUEL DO ARAGUAIA	18/10/2020 14:58	19/10/2020 04:14	18/10/2020 14:58	19/10/2020 04:14	13,26	1	13,26	CHI
20201095457	PIRACANJUBA	PJ12359676	MORRINHOS	18/10/2020 14:59	18/10/2020 18:45	18/10/2020 14:59	18/10/2020 18:45	3,78	7	26,43	CHI
20201096696	CRIXAS	CX12201610	SANTA TEREZINHA	18/10/2020 15:03	18/10/2020 19:24	18/10/2020 15:03	18/10/2020 19:24	4,34	163	707,92	CHI
20201095477	ARAGOIANIA	AO32095549	GUAPO S2	18/10/2020 15:05	19/10/2020 08:45	18/10/2020 15:05	19/10/2020 08:45	17,66	4	70,63	CHI
20201095510	MINEIROS	MY11217019	PARQUE DAS EMAS	18/10/2020 15:07	18/10/2020 20:17	18/10/2020 15:07	18/10/2020 20:17	5,16	106	546,55	CHI
20201095488	MINACU	IH12236222	MINACU	18/10/2020 15:08	18/10/2020 16:38	18/10/2020 15:08	18/10/2020 16:38	1,49	19	28,31	CHI
20201095489	SILVANIA	SV21141919	DAIA S2	18/10/2020 15:08	18/10/2020 16:41	18/10/2020 15:08	18/10/2020 16:41	1,54	1	1,54	CHI
20201098189	RIO VERDE	RV12172877	CABRIUVA S2	18/10/2020 15:09	18/10/2020 22:00	18/10/2020 15:09	18/10/2020 22:00	6,84	12	82,10	CHI
20201095499	GOIANIA	GP21124502	GOIANIA LESTE S3	18/10/2020 15:10	18/10/2020 19:06	18/10/2020 15:10	18/10/2020 19:06	3,93	1	3,93	CHI
20201095501	MUNDO NOVO DE GOIAS	MH21181641	NOVA CRIXAS	18/10/2020 15:10	19/10/2020 18:59	18/10/2020 15:10	19/10/2020 18:59	27,81	1	27,81	CHI
20201095502	MINEIROS	MY12303914	PARQUE DAS EMAS	18/10/2020 15:10	19/10/2020 10:00	18/10/2020 15:10	19/10/2020 10:00	18,82	2	37,63	CHI
20201095512	RIO VERDE	RV11271372	RIO VERDE S1	18/10/2020 15:11	18/10/2020 22:35	18/10/2020 15:11	18/10/2020 22:35	7,40	121	895,37	CHI
20201095516	PADRE BERNARDO	PB12382938	PADRE BERNARDO	18/10/2020 15:12	18/10/2020 16:01	18/10/2020 15:12	18/10/2020 16:01	0,81	6	4,85	CHI
20201095567	CATURAI	TR32045881LD	TRINDADE	18/10/2020 15:13	19/10/2020 20:03	19/10/2020 15:05	19/10/2020 20:03	4,97	5	24,85	CHI
20201095567	GOIANIRA	TR32045881LD	TRINDADE	18/10/2020 15:13	19/10/2020 20:03	19/10/2020 15:05	19/10/2020 20:03	4,97	25	124,26	CHI
20201095567	TRINDADE	TR32045881LD	TRINDADE	18/10/2020 15:13	19/10/2020 20:03	19/10/2020 15:05	19/10/2020 20:03	4,97	5	24,85	CHI
20201095567	TRINDADE	TR10394746	TRINDADE	18/10/2020 15:13	19/10/2020 20:03	18/10/2020 15:59	19/10/2020 14:58	22,99	5	114,95	CHI
20201095567	GOIANIRA	TR10394746	TRINDADE	18/10/2020 15:13	19/10/2020 20:03	18/10/2020 15:59	19/10/2020 14:58	22,99	25	574,77	CHI
20201095567	CATURAI	TR10394746	TRINDADE	18/10/2020 15:13	19/10/2020 20:03	18/10/2020 15:59	19/10/2020 14:58	22,99	5	114,95	CHI
20201095567	GOIANIRA	TR13229174	TRINDADE	18/10/2020 15:13	19/10/2020 20:03	19/10/2020 01:45	19/10/2020 12:10	10,41	1	10,41	CHI
20201095567	TRINDADE	TR13229174	TRINDADE	18/10/2020 15:13	19/10/2020 20:03	19/10/2020 01:45	19/10/2020 12:10	10,41	41	426,94	CHI
20201095567	TRINDADE	TR10394746	TRINDADE	18/10/2020 15:13	19/10/2020 20:03	19/10/2020 05:28	19/10/2020 05:43	0,25	41	10,42	CHI
20201095567	GOIANIRA	TR10394746	TRINDADE	18/10/2020 15:13	19/10/2020 20:03	18/10/2020 15:59	18/10/2020 21:57	5,97	1	5,97	CHI
20201095567	TRINDADE	TR10394746	TRINDADE	18/10/2020 15:13	19/10/2020 20:03	18/10/2020 15:59	18/10/2020 21:57	5,97	82	489,15	CHI
20201095567	TRINDADE	TR10406874	TRINDADE	18/10/2020 15:13	19/10/2020 20:03	18/10/2020 18:20	18/10/2020 19:27	1,11	121	134,68	CHI
20201095567	SANTA BARBARA DE GOIAS	TR10406874	TRINDADE	18/10/2020 15:13	19/10/2020 20:03	18/10/2020 18:20	18/10/2020 19:27	1,11	23	25,60	CHI
20201095567	TRINDADE	TR16413212	TRINDADE	18/10/2020 15:13	19/10/2020 20:03	18/10/2020 18:20	18/10/2020 19:26	1,10	1395	1528,30	CHI
20201095567	TRINDADE	TR16423877	TRINDADE	18/10/2020 15:13	19/10/2020 20:03	18/10/2020 15:13	18/10/2020 19:18	4,10	121	495,70	CHI
20201095567	TRINDADE	TR12402790LD	TRINDADE	18/10/2020 15:13	19/10/2020 20:03	18/10/2020 15:13	18/10/2020 19:00	3,79	397	1504,08	CHI
20201095567	TRINDADE	TR16423873	TRINDADE	18/10/2020 15:13	19/10/2020 20:03	18/10/2020 15:13	18/10/2020 17:44	2,52	3455	8699,88	CHI
20201095567	GOIANIA	TR16423873	TRINDADE	18/10/2020 15:13	19/10/2020 20:03	18/10/2020 15:13	18/10/2020 17:44	2,52	53	133,46	CHI
20201095567	TRINDADE	TR10395417	TRINDADE	18/10/2020 15:13	19/10/2020 20:03	18/10/2020 15:13	18/10/2020 17:41	2,47	2932	7234,71	CHI
20201095567	TRINDADE	TR16423877	TRINDADE	18/10/2020 15:13	19/10/2020 20:03	18/10/2020 15:14	18/10/2020 17:34	2,33	121	281,69	CHI
20201095567	SANTA BARBARA DE GOIAS	TR16423877	TRINDADE	18/10/2020 15:13	19/10/2020 20:03	18/10/2020 15:14	18/10/2020 17:34	2,33	23	53,55	CHI
20201095567	TRINDADE	TR16423877	TRINDADE	18/10/2020 15:13	19/10/2020 20:03	18/10/2020 15:14	18/10/2020 17:28	2,23	5047	11232,38	CHI
20201095567	TRINDADE	TR16423877	TRINDADE	18/10/2020 15:13	19/10/2020 20:03	18/10/2020 15:13	18/10/2020 17:25	2,21	173	382,33	CHI
20201095567	SANTA BARBARA DE GOIAS	TR13131440	TRINDADE	18/10/2020 15:13	19/10/2020 20:03	18/10/2020 15:14	18/10/2020 16:37	1,38	150	207,54	CHI

20201095567	TRINDADE	TR13131440	TRINDADE	18/10/2020 15:13	19/10/2020 20:03	18/10/2020 15:14	18/10/2020 16:37	1,38	122	168,80	CHI
20201095843	RIO VERDE	04150224	QUIRINOPOLIS	18/10/2020 15:13	18/10/2020 18:36	18/10/2020 15:13	18/10/2020 18:36	3,37	1	3,37	CHI
20201095843	RIO VERDE	04150224	RIO VERDE S1	18/10/2020 15:13	18/10/2020 18:36	18/10/2020 15:13	18/10/2020 18:36	3,37	31	104,46	CHI
20201095843	QUIRINOPOLIS	04150224	CABRIUVA S2	18/10/2020 15:13	18/10/2020 18:36	18/10/2020 15:13	18/10/2020 18:36	3,37	4	13,48	CHI
20201095843	RIO VERDE	04150224	CABRIUVA S2	18/10/2020 15:13	18/10/2020 18:36	18/10/2020 15:13	18/10/2020 18:36	3,37	168	566,11	CHI
20201095521	PIRACANJUBA	60010150	PIRACANJUBA	18/10/2020 15:14	18/10/2020 19:13	18/10/2020 15:14	18/10/2020 19:13	3,98	1	3,98	CHI
20201095522	CAMPO ALEGRE DE GOIAS	CM21231586	CAMPO ALEGRE DE GOIAS	18/10/2020 15:14	18/10/2020 16:49	18/10/2020 15:14	18/10/2020 16:49	1,57	1	1,57	CHI
20201095572	PIRACANJUBA	PJ12000096	PIRACANJUBA	18/10/2020 15:14	18/10/2020 17:24	18/10/2020 15:14	18/10/2020 17:24	2,15	34	73,22	CHI
20201095534	MINEIROS	MY12036176	PARQUE DAS EMAS	18/10/2020 15:15	18/10/2020 17:16	18/10/2020 15:15	18/10/2020 17:16	2,01	196	393,80	CHI
20201095066	GUAPO	GA11048122	GUAPO S1	18/10/2020 15:18	18/10/2020 16:55	18/10/2020 15:18	18/10/2020 16:55	1,62	73	118,02	CHI
20201095584	ITAJA	IJ12017218	ITAJA S2	18/10/2020 15:18	18/10/2020 16:13	18/10/2020 15:18	18/10/2020 16:13	0,91	23	20,97	CHI
20201095584	LAGOA SANTA	IJ12017218	ITAJA S2	18/10/2020 15:18	18/10/2020 16:13	18/10/2020 15:18	18/10/2020 16:13	0,91	4	3,65	CHI
20201095548	ITARUMA	IM21296652	CACHOEIRA ALTA	18/10/2020 15:18	18/10/2020 18:46	18/10/2020 15:18	18/10/2020 18:46	3,46	1	3,46	CHI
20201095563	GOIAS	GS21139663	ITABERAI S1	18/10/2020 15:20	18/10/2020 17:25	18/10/2020 15:20	18/10/2020 17:25	2,08	1	2,08	CHI
20201095568	CIDADE OCIDENTAL	DH11199647	MARAJOARA	18/10/2020 15:21	18/10/2020 16:36	18/10/2020 15:21	18/10/2020 16:36	1,25	77	95,97	CHI
20201095825	NOVA CRIXAS	NA11035561	NOVA CRIXAS	18/10/2020 15:23	18/10/2020 17:20	18/10/2020 15:23	18/10/2020 17:20	1,94	122	236,61	CHI
20201095583	SANTA TEREZINHA DE GOIAS	SG12405201	SANTA TEREZINHA	18/10/2020 15:23	18/10/2020 19:00	18/10/2020 15:23	18/10/2020 19:00	3,60	2	7,20	CHI
20201095588	MINACU	IH12307129	MINACU	18/10/2020 15:24	18/10/2020 18:21	18/10/2020 15:24	18/10/2020 18:21	2,94	13	38,23	CHI
20201095590	MORRINHOS	MR12412117	MORRINHOS	18/10/2020 15:24	18/10/2020 17:36	18/10/2020 15:24	18/10/2020 17:36	2,20	7	15,37	CHI
20201095593	BRAZABRANTES	BR21209159	NEROPOLIS S1	18/10/2020 15:25	18/10/2020 16:47	18/10/2020 15:25	18/10/2020 16:47	1,36	3	4,07	CHI
20201095643	MONTIVIDIU	CP12076264	MONTIVIDIU T	18/10/2020 15:26	19/10/2020 03:54	18/10/2020 15:26	19/10/2020 03:54	12,47	2	24,93	CHI
20201095643	RIO VERDE	CP12076264	MONTIVIDIU T	18/10/2020 15:26	19/10/2020 03:54	18/10/2020 15:26	19/10/2020 03:54	12,47	12	149,59	CHI
20201095643	JATAI	CP12076264	MONTIVIDIU T	18/10/2020 15:26	19/10/2020 03:54	18/10/2020 15:26	19/10/2020 03:54	12,47	7	87,26	CHI
20201095643	CAIAPONIA	CP12076264	MONTIVIDIU T	18/10/2020 15:26	19/10/2020 03:54	18/10/2020 15:26	19/10/2020 03:54	12,47	78	972,34	CHI
20201097991	ITAPACI	IW12405295	ITAPACI	18/10/2020 15:26	18/10/2020 21:11	18/10/2020 15:26	18/10/2020 21:11	5,74	42	240,97	CHI
20201097991	NOVA GLORIA	IW12405295	ITAPACI	18/10/2020 15:26	18/10/2020 21:11	18/10/2020 15:26	18/10/2020 21:11	5,74	1	5,74	CHI
20201095925	NOVA CRIXAS	NA12091638	NOVA CRIXAS	18/10/2020 15:26	19/10/2020 01:05	18/10/2020 15:26	19/10/2020 01:05	9,63	9	86,71	CHI
20201095619	PONTALINA	O1510224	PONTALINA	18/10/2020 15:27	18/10/2020 20:27	18/10/2020 15:27	18/10/2020 20:27	4,99	531	2649,69	CHI
20201095619	PONTALINA	PK11000014	PONTALINA	18/10/2020 15:27	18/10/2020 20:27	18/10/2020 16:43	18/10/2020 20:21	3,63	89	323,34	CHI
20201095619	PONTALINA	PK16418739	PONTALINA	18/10/2020 15:27	18/10/2020 20:27	18/10/2020 15:27	18/10/2020 16:29	1,03	3056	3139,19	CHI
20201095619	PONTALINA	O1510224	PONTALINA	18/10/2020 15:27	18/10/2020 20:27	18/10/2020 15:27	18/10/2020 16:22	0,91	315	286,91	CHI
20201095769	GOIATUBA	JV16411560	GOIATUBA S1	18/10/2020 15:28	19/10/2020 04:07	18/10/2020 15:28	19/10/2020 04:07	12,65	2	25,30	CHI
20201095769	JOVIANIA	JV16411560	GOIATUBA S1	18/10/2020 15:28	19/10/2020 04:07	18/10/2020 15:28	19/10/2020 04:07	12,65	13	164,44	CHI
20201095769	JOVIANIA	JV16411560	GOIATUBA S1	18/10/2020 15:28	19/10/2020 04:07	18/10/2020 15:28	18/10/2020 17:15	1,79	251	448,10	CHI
20201095769	PONTALINA	AD16430902	GOIATUBA S1	18/10/2020 15:28	19/10/2020 04:07	18/10/2020 15:28	18/10/2020 15:32	0,07	35	2,42	CHI
20201095769	PONTALINA	AD16430902	GOIATUBA S1	18/10/2020 15:28	19/10/2020 04:07	18/10/2020 15:28	18/10/2020 15:32	0,07	32	2,21	CHI
20201095769	JOVIANIA	AD16430902	GOIATUBA S1	18/10/2020 15:28	19/10/2020 04:07	18/10/2020 15:28	18/10/2020 15:32	0,07	8	0,55	CHI
20201095769	JOVIANIA	AD16430902	GOIATUBA S1	18/10/2020 15:28	19/10/2020 04:07	18/10/2020 15:28	18/10/2020 15:32	0,07	59	4,08	CHI
20201095608	JAUPACI	JP12074458	IPORA	18/10/2020 15:28	18/10/2020 23:10	18/10/2020 15:28	18/10/2020 23:10	7,71	1	7,71	CHI
20201095930	ITAPACI	IW12181402	ITAPACI	18/10/2020 15:28	18/10/2020 19:13	18/10/2020 15:28	18/10/2020 19:13	3,73	52	194,16	CHI
20201095930	NOVA GLORIA	IW12181402	ITAPACI	18/10/2020 15:28	18/10/2020 19:13	18/10/2020 15:28	18/10/2020 19:13	3,73	26	97,08	CHI
20201095612	AGUAS LINDAS DE GOIAS	4830171973	AGUAS LINDAS DE GOIAS S1	18/10/2020 15:29	18/10/2020 16:26	18/10/2020 15:29	18/10/2020 16:26	0,95	1	0,95	CHI
20201095614	RIO VERDE	MV12154022	MONTIVIDIU T	18/10/2020 15:29	19/10/2020 09:08	18/10/2020 15:29	19/10/2020 09:08	17,66	90	1589,30	CHI
20201095614	MONTIVIDIU	MV12154022	MONTIVIDIU T	18/10/2020 15:29	19/10/2020 09:08	18/10/2020 15:29	19/10/2020 09:08	17,66	10	176,59	CHI
20201095974	RIO VERDE	RV13301109	CABRIUVA S2	18/10/2020 15:29	19/10/2020 11:10	18/10/2020 15:29	19/10/2020 11:10	19,68	5	98,40	CHI
20201095974	RIO VERDE	RV12200774	CABRIUVA S2	18/10/2020 15:29	19/10/2020 11:10	18/10/2020 15:29	19/10/2020 00:59	9,51	6	57,03	CHI
20201095617	CATALAO	CT12127882	CATALAO S1	18/10/2020 15:29	18/10/2020 17:24	18/10/2020 15:29	18/10/2020 17:24	1,90	30	57,05	CHI
20201095618	GOIANIA	GN11160169	MEIA PONTE	18/10/2020 15:30	18/10/2020 20:23	18/10/2020 15:30	18/10/2020 20:23	4,88	96	468,64	CHI
20201095780	TRINDADE	TR11000022	TRINDADE	18/10/2020 15:31	18/10/2020 20:34	18/10/2020 15:31	18/10/2020 20:34	5,04	104	524,36	CHI
20201096334	PONTALINA	PK12182928	PONTALINA	18/10/2020 15:31	18/10/2020 20:00	18/10/2020 15:31	18/10/2020 20:00	4,47	15	67,04	CHI
20201095637	CAMPO LIMPO	AN21185589	NEROPOLIS S1	18/10/2020 15:35	19/10/2020 13:40	18/10/2020 15:35	19/10/2020 13:40	22,08	1	22,08	CHI

20201095641	ANAPOLIS	20544900	JUNDIAI S2	18/10/2020 15:36	18/10/2020 18:31	18/10/2020 15:36	18/10/2020 18:31	2,91	1	2,91	CHI
20201096659	NOVA CRIXAS	NA12334349	NOVA CRIXAS	18/10/2020 15:36	18/10/2020 20:43	18/10/2020 15:36	18/10/2020 20:43	5,11	86	439,63	CHI
20201095644	GOIANIA	10876182	GOIANIA LESTE S3	18/10/2020 15:36	18/10/2020 16:46	18/10/2020 15:36	18/10/2020 16:46	1,16	1	1,16	CHI
20201097623	TRINDADE	TR11193148	GOYA S1	18/10/2020 15:36	18/10/2020 22:02	18/10/2020 15:36	18/10/2020 22:02	6,42	33	211,88	CHI
20201095676	JANDAIA	00080424	ACREUNA	18/10/2020 15:36	19/10/2020 01:04	18/10/2020 15:36	19/10/2020 01:04	9,47	1	9,47	CHI
20201095676	JANDAIA	00080424	ACREUNA	18/10/2020 15:36	19/10/2020 01:04	18/10/2020 15:36	18/10/2020 21:38	6,02	30	180,73	CHI
20201095676	ACREUNA	00080424	ACREUNA	18/10/2020 15:36	19/10/2020 01:04	18/10/2020 15:36	18/10/2020 21:38	6,02	7	42,17	CHI
20201095676	INDIARA	00080424	ACREUNA	18/10/2020 15:36	19/10/2020 01:04	18/10/2020 15:36	18/10/2020 21:38	6,02	25	150,61	CHI
20201095676	PARAUNA	00080424	ACREUNA	18/10/2020 15:36	19/10/2020 01:04	18/10/2020 15:36	18/10/2020 19:53	4,28	1	4,28	CHI
20201095676	JANDAIA	00080424	ACREUNA	18/10/2020 15:36	19/10/2020 01:04	18/10/2020 15:36	18/10/2020 19:53	4,28	2	8,56	CHI
20201095676	ACREUNA	00080424	ACREUNA	18/10/2020 15:36	19/10/2020 01:04	18/10/2020 15:36	18/10/2020 19:53	4,28	1	4,28	CHI
20201095676	ACREUNA	00080424	ACREUNA	18/10/2020 15:36	19/10/2020 01:04	18/10/2020 15:36	18/10/2020 18:36	3,00	28	83,95	CHI
20201095649	RIO VERDE	630061830	RIO VERDE S2	18/10/2020 15:37	18/10/2020 22:49	18/10/2020 15:37	18/10/2020 22:49	7,20	1	7,20	CHI
20201095675	PARAUNA	PU21136886	PARAUNA	18/10/2020 15:38	18/10/2020 17:44	18/10/2020 15:38	18/10/2020 17:44	2,09	1	2,09	CHI
20201096091	PLANALTINA	TL12381390	SAO JOAO D ALIANCA	18/10/2020 15:39	18/10/2020 18:32	18/10/2020 15:39	18/10/2020 18:32	2,88	21	60,51	CHI
20201096091	AGUA FRIA DE GOIAS	TL12381390	SAO JOAO D ALIANCA	18/10/2020 15:39	18/10/2020 18:32	18/10/2020 15:39	18/10/2020 18:32	2,88	3	8,64	CHI
20201095680	FORMOSA	FA11397678	ITIQUEIRA	18/10/2020 15:39	18/10/2020 18:27	18/10/2020 15:39	18/10/2020 18:27	2,80	1	2,80	CHI
20201096278	TRINDADE	TR12200194	TRINDADE	18/10/2020 15:39	18/10/2020 20:14	18/10/2020 15:39	18/10/2020 20:14	4,57	22	100,50	CHI
20201095684	CAIAPONIA	MV12260782	MONTIVIDIU T	18/10/2020 15:39	19/10/2020 09:55	18/10/2020 15:39	19/10/2020 09:55	18,25	1	18,25	CHI
20201095684	MONTIVIDIU	MV12260782	MONTIVIDIU T	18/10/2020 15:39	19/10/2020 09:55	18/10/2020 15:39	19/10/2020 09:55	18,25	6	109,51	CHI
20201095700	GOIANIA	10480912	GOIANIA LESTE S1	18/10/2020 15:41	18/10/2020 17:42	18/10/2020 15:41	18/10/2020 17:42	2,01	1	2,01	CHI
202010163844	RIO VERDE	01600224	RIO VERDE S2	18/10/2020 15:41	19/10/2020 02:40	18/10/2020 15:41	19/10/2020 02:40	10,97	158	1733,17	CHI
202010163844	RIO VERDE	01600224	RIO VERDE S2	18/10/2020 15:41	19/10/2020 02:40	18/10/2020 15:41	19/10/2020 02:22	10,68	334	3567,21	CHI
202010163844	RIO VERDE	RV11000007	RIO VERDE S2	18/10/2020 15:41	19/10/2020 02:40	18/10/2020 15:41	19/10/2020 02:10	10,48	125	1309,86	CHI
202010163844	RIO VERDE	01600224	RIO VERDE S2	18/10/2020 15:41	19/10/2020 02:40	18/10/2020 15:41	19/10/2020 02:01	10,33	27	278,90	CHI
202010163844	RIO VERDE	01600224	RIO VERDE S2	18/10/2020 15:41	19/10/2020 02:40	18/10/2020 18:11	19/10/2020 02:01	7,84	112	878,11	CHI
202010163844	RIO VERDE	01600224	RIO VERDE S2	18/10/2020 15:41	19/10/2020 02:40	18/10/2020 15:41	18/10/2020 18:04	2,38	112	266,90	CHI
202010163844	RIO VERDE	RV16407150	RIO VERDE S2	18/10/2020 15:41	19/10/2020 02:40	18/10/2020 15:41	18/10/2020 15:48	0,12	210	24,21	CHI
202010163844	RIO VERDE	RV16408210	RIO VERDE S2	18/10/2020 15:41	19/10/2020 02:40	18/10/2020 15:41	18/10/2020 15:46	0,07	4961	358,29	CHI
20201095848	PALESTINA DE GOIAS	PY12126840	PALESTINA	18/10/2020 15:43	18/10/2020 19:11	18/10/2020 15:43	18/10/2020 19:11	3,46	7	24,22	CHI
20201095848	CAIAPONIA	PY12126840	PALESTINA	18/10/2020 15:43	18/10/2020 19:11	18/10/2020 15:43	18/10/2020 19:11	3,46	5	17,30	CHI
20201095750	PONTALINA	PK12080063	PONTALINA	18/10/2020 15:44	18/10/2020 17:47	18/10/2020 15:44	18/10/2020 17:47	2,05	38	77,85	CHI
20201095727	FORMOSA	FA11269916	ITIQUEIRA	18/10/2020 15:44	18/10/2020 17:37	18/10/2020 15:44	18/10/2020 17:37	1,87	1	1,87	CHI
20201095759	GOIANESIA	GE12353391	GOIANESIA S2	18/10/2020 15:44	18/10/2020 17:33	18/10/2020 15:44	18/10/2020 17:33	1,80	1	1,80	CHI
20201095759	JARAGUA	GE12353391	GOIANESIA S2	18/10/2020 15:44	18/10/2020 17:33	18/10/2020 15:44	18/10/2020 17:33	1,80	8	14,43	CHI
20201095940	SANTA TEREZINHA DE GOIAS	SG12337137	SANTA TEREZINHA	18/10/2020 15:45	19/10/2020 13:12	18/10/2020 15:45	19/10/2020 13:12	21,44	1	21,44	CHI
20201095940	GUARINOS	SG12337137	SANTA TEREZINHA	18/10/2020 15:45	19/10/2020 13:12	18/10/2020 15:45	19/10/2020 12:02	20,28	1	20,28	CHI
20201095940	SANTA TEREZINHA DE GOIAS	SG12337137	SANTA TEREZINHA	18/10/2020 15:45	19/10/2020 13:12	18/10/2020 15:45	19/10/2020 12:02	20,28	1	20,28	CHI
20201095743	DIVINOPOLIS DE GOIAS	GH21180653	SAO DOMINGOS	18/10/2020 15:46	18/10/2020 17:36	18/10/2020 15:46	18/10/2020 17:36	1,83	1	1,83	CHI
20201095744	CAIAPONIA	CP12052996	MONTIVIDIU T	18/10/2020 15:46	19/10/2020 12:21	18/10/2020 15:46	19/10/2020 12:21	20,59	211	4344,14	CHI
20201095744	RIO VERDE	RV12030683	MONTIVIDIU T	18/10/2020 15:46	19/10/2020 12:21	18/10/2020 15:46	19/10/2020 11:30	19,73	4	78,93	CHI
20201095746	APARECIDA DE GOIANIA	200263640	INDEPENDENCIA S1	18/10/2020 15:46	18/10/2020 19:07	18/10/2020 15:46	18/10/2020 19:07	3,34	1	3,34	CHI
20201095755	JANDAIA	JD12373324	PALMEIRAS	18/10/2020 15:47	18/10/2020 23:48	18/10/2020 15:47	18/10/2020 23:48	8,03	46	369,27	CHI
20201095755	JANDAIA	JD12373324	PALMEIRAS	18/10/2020 15:47	18/10/2020 23:48	18/10/2020 15:47	18/10/2020 23:48	8,02	102	817,87	CHI
20201095762	RIO VERDE	630040930	RIO VERDE S1	18/10/2020 15:48	19/10/2020 04:54	18/10/2020 15:48	19/10/2020 04:54	13,10	1	13,10	CHI
20201095763	CALDAS NOVAS	PJ12263075	CALDAS NOVAS S1	18/10/2020 15:48	18/10/2020 18:53	18/10/2020 15:48	18/10/2020 18:53	3,08	5	15,40	CHI
20201095767	RIO VERDE	RV11000043	RIO VERDE S1	18/10/2020 15:48	18/10/2020 18:23	18/10/2020 15:48	18/10/2020 18:23	2,58	78	201,17	CHI
20201095772	RIO VERDE	RV11341030	CABRIUVA S1	18/10/2020 15:48	18/10/2020 18:10	18/10/2020 15:48	18/10/2020 18:10	2,36	98	231,12	CHI
20201095773	MARA ROSA	MQ12263046	MARA ROSA	18/10/2020 15:48	18/10/2020 19:37	18/10/2020 15:48	18/10/2020 19:37	3,81	8	30,46	CHI
20201095777	RIO VERDE	RV21000135	RIO VERDE S1	18/10/2020 15:48	18/10/2020 18:40	18/10/2020 15:48	18/10/2020 18:40	2,85	1	2,85	CHI
20201095790	GOIANESIA	GE21036607	GOIANESIA S2	18/10/2020 15:52	18/10/2020 21:03	18/10/2020 15:52	18/10/2020 21:03	5,18	1	5,18	CHI

20201095796	GOIANIA	GN12001825LD	GOYA S2	18/10/2020 15:53	19/10/2020 10:25	18/10/2020 15:53	19/10/2020 10:25	18,54	3	55,63	CHI
20201095796	GOIANIA	GN12001790	GOYA S2	18/10/2020 15:53	19/10/2020 10:25	18/10/2020 15:53	19/10/2020 05:49	13,94	11	153,31	CHI
20201095798	GOIATUBA	04580214	BOM JESUS DE GOIAS	18/10/2020 15:53	21/10/2020 01:30	19/10/2020 17:04	21/10/2020 01:30	32,43	8	259,45	CHI
20201095798	GOIATUBA	GT13332549	BOM JESUS DE GOIAS	18/10/2020 15:53	21/10/2020 01:30	19/10/2020 18:16	21/10/2020 01:30	31,24	1	31,24	CHI
20201095798	GOIATUBA	04580214	BOM JESUS DE GOIAS	18/10/2020 15:53	21/10/2020 01:30	19/10/2020 17:04	19/10/2020 19:46	2,69	5	13,47	CHI
20201095798	GOIATUBA	04580214	BOM JESUS DE GOIAS	18/10/2020 15:53	21/10/2020 01:30	18/10/2020 18:42	19/10/2020 18:45	24,05	21	505,08	CHI
20201095798	GOIATUBA	04580214	BOM JESUS DE GOIAS	18/10/2020 15:53	21/10/2020 01:30	19/10/2020 17:04	19/10/2020 18:35	1,50	93	139,86	CHI
20201095798	GOIATUBA	04580214	BOM JESUS DE GOIAS	18/10/2020 15:53	21/10/2020 01:30	19/10/2020 18:16	19/10/2020 18:35	0,31	3	0,93	CHI
20201095798	GOIATUBA	04580214	BOM JESUS DE GOIAS	18/10/2020 15:53	21/10/2020 01:30	18/10/2020 15:53	19/10/2020 13:45	21,87	6	131,24	CHI
20201095798	GOIATUBA	04580214	BOM JESUS DE GOIAS	18/10/2020 15:53	21/10/2020 01:30	18/10/2020 18:42	19/10/2020 13:45	19,06	3	57,19	CHI
20201095798	GOIATUBA	04580214	BOM JESUS DE GOIAS	18/10/2020 15:53	21/10/2020 01:30	18/10/2020 15:53	19/10/2020 12:49	20,94	5	104,68	CHI
20201095798	GOIATUBA	04580214	BOM JESUS DE GOIAS	18/10/2020 15:53	21/10/2020 01:30	18/10/2020 18:42	19/10/2020 12:06	17,40	1	17,40	CHI
20201095798	GOIATUBA	GT12352741RE	BOM JESUS DE GOIAS	18/10/2020 15:53	21/10/2020 01:30	19/10/2020 10:37	19/10/2020 12:06	1,48	38	56,37	CHI
20201095798	GOIATUBA	04580214	BOM JESUS DE GOIAS	18/10/2020 15:53	21/10/2020 01:30	18/10/2020 18:42	18/10/2020 23:42	5,01	38	190,28	CHI
20201095798	GOIATUBA	04580214	BOM JESUS DE GOIAS	18/10/2020 15:53	21/10/2020 01:30	18/10/2020 15:53	18/10/2020 23:23	7,50	58	434,89	CHI
20201095804	DOVERLANDIA	DV11204217	CAIAPONIA	18/10/2020 15:54	18/10/2020 18:24	18/10/2020 15:54	18/10/2020 18:24	2,48	3	7,45	CHI
20201095805	CACHOEIRA DE GOIAS	1260002680	FIRMINOPOLIS S2	18/10/2020 15:55	18/10/2020 19:47	18/10/2020 15:55	18/10/2020 19:47	3,87	1	3,87	CHI
20201095806	OUVIDOR	OU21061214	CATALAO S1	18/10/2020 15:55	18/10/2020 17:57	18/10/2020 15:55	18/10/2020 17:57	2,03	1	2,03	CHI
20201095808	SANTA CRUZ DE GOIAS	BC12012000	PIRES DO RIO S2	18/10/2020 15:55	18/10/2020 19:30	18/10/2020 15:55	18/10/2020 19:30	3,57	39	139,27	CHI
20201095919	MOZARLANDIA	MZ12147383	MOZARLANDIA	18/10/2020 15:57	18/10/2020 21:46	18/10/2020 15:57	18/10/2020 21:46	5,81	7	40,68	CHI
20201097833	RIO VERDE	RV12271370	RIO VERDE S1	18/10/2020 15:57	18/10/2020 22:35	18/10/2020 15:57	18/10/2020 22:35	6,62	115	761,78	CHI
20201095832	GOIANIA	GN12169506	GOYA S2	18/10/2020 15:59	18/10/2020 20:02	18/10/2020 15:59	18/10/2020 20:02	4,05	7	28,34	CHI
202010109180	SANTA BARBARA DE GOIAS	TR12277048	TRINDADE	18/10/2020 15:59	20/10/2020 12:53	18/10/2020 15:59	20/10/2020 12:53	44,89	24	1077,41	CHI
202010109180	TRINDADE	TR12277048	TRINDADE	18/10/2020 15:59	20/10/2020 12:53	18/10/2020 15:59	20/10/2020 12:53	44,89	17	763,16	CHI
202010109180	GOIANIRA	TR12277048	TRINDADE	18/10/2020 15:59	20/10/2020 12:53	18/10/2020 15:59	20/10/2020 12:53	44,89	27	1212,08	CHI
202010109180	CATURAI	TR12277048	TRINDADE	18/10/2020 15:59	20/10/2020 12:53	18/10/2020 15:59	20/10/2020 12:53	44,89	9	404,03	CHI
20201095856	GOIANAPOLIS	TJ12353408	DAIA S2	18/10/2020 16:00	18/10/2020 17:59	18/10/2020 16:00	18/10/2020 17:59	1,98	3	5,94	CHI
20201095856	TEREZOPOLIS DE GOIAS	TJ12353408	DAIA S2	18/10/2020 16:00	18/10/2020 17:59	18/10/2020 16:00	18/10/2020 17:59	1,98	1	1,98	CHI
20201095840	ANAPOLIS	20667747	ANAPOLIS UNIVERSITARIO S2	18/10/2020 16:00	18/10/2020 18:06	18/10/2020 16:00	18/10/2020 18:06	2,09	1	2,09	CHI
20201095849	MUTUNOPOLIS	MU21208359	MARA ROSA	18/10/2020 16:02	18/10/2020 19:26	18/10/2020 16:02	18/10/2020 19:26	3,40	1	3,40	CHI
20201095879	GOIANIA	GN11209261	MEIA PONTE	18/10/2020 16:03	19/10/2020 07:42	18/10/2020 16:03	19/10/2020 07:42	15,64	81	1266,95	CHI
20201096081	GOIANIA	GN12151313	MEIA PONTE	18/10/2020 16:03	18/10/2020 17:38	18/10/2020 16:03	18/10/2020 17:38	1,59	463	736,30	CHI
20201096440	RIO VERDE	RV11280386	RIO VERDE S1	18/10/2020 16:04	18/10/2020 18:35	18/10/2020 16:04	18/10/2020 18:35	2,51	81	203,11	CHI
20201095979	ITAPACI	IW12210177	ITAPACI	18/10/2020 16:04	19/10/2020 19:07	18/10/2020 16:04	19/10/2020 19:07	27,04	1	27,04	CHI
20201095979	ITAPACI	IW12210177	ITAPACI	18/10/2020 16:04	19/10/2020 19:07	18/10/2020 16:04	19/10/2020 16:28	24,40	1	24,40	CHI
20201095979	PILAR DE GOIAS	IW12210177	ITAPACI	18/10/2020 16:04	19/10/2020 19:07	18/10/2020 16:04	19/10/2020 16:28	24,40	2	48,80	CHI
20201095979	ITAPACI	IW12210177	ITAPACI	18/10/2020 16:04	19/10/2020 19:07	18/10/2020 16:04	19/10/2020 15:46	23,69	4	94,77	CHI
20201095979	PILAR DE GOIAS	IW12210177	ITAPACI	18/10/2020 16:04	19/10/2020 19:07	18/10/2020 16:04	19/10/2020 15:46	23,69	1	23,69	CHI
20201095979	ITAPACI	IW12210177	ITAPACI	18/10/2020 16:04	19/10/2020 19:07	18/10/2020 16:04	19/10/2020 15:31	23,45	1	23,45	CHI
20201095935	MINEIROS	DJ10418274	CHAPADAO DO CEU	18/10/2020 16:05	19/10/2020 16:44	19/10/2020 16:36	19/10/2020 16:44	0,14	20	2,84	CHI
20201095935	SERRANOPOLIS	DJ10418274	CHAPADAO DO CEU	18/10/2020 16:05	19/10/2020 16:44	19/10/2020 16:36	19/10/2020 16:44	0,14	48	6,81	CHI
20201095935	SERRANOPOLIS	JT13324840	JATAI S1	18/10/2020 16:05	19/10/2020 16:44	18/10/2020 21:25	19/10/2020 14:40	17,24	1	17,24	CHI
20201095935	JATAI	JT13214519	JATAI S1	18/10/2020 16:05	19/10/2020 16:44	18/10/2020 21:25	19/10/2020 14:35	17,17	1	17,17	CHI
20201095935	CHAPADAO DO CEU	DJ12378153LD	CHAPADAO DO CEU	18/10/2020 16:05	19/10/2020 16:44	18/10/2020 19:59	19/10/2020 13:47	17,80	2	35,59	CHI
20201095935	MINEIROS	DJ12303887RE	CHAPADAO DO CEU	18/10/2020 16:05	19/10/2020 16:44	18/10/2020 16:06	19/10/2020 13:21	21,24	9	191,19	CHI
20201095935	CHAPADAO DO CEU	DJ12303887RE	CHAPADAO DO CEU	18/10/2020 16:05	19/10/2020 16:44	18/10/2020 16:06	19/10/2020 13:21	21,24	81	1720,71	CHI
20201095935	CHAPADAO DO CEU	CHC-TR1	CHAPADAO DO CEU	18/10/2020 16:05	19/10/2020 16:44	18/10/2020 16:06	19/10/2020 12:41	20,58	79	1625,97	CHI
20201095935	CHAPADAO DO CEU	02430429	CHAPADAO DO CEU	18/10/2020 16:05	19/10/2020 16:44	18/10/2020 18:51	19/10/2020 12:41	17,84	4	71,34	CHI
20201095935	JATAI	JT13184074	JATAI S1	18/10/2020 16:05	19/10/2020 16:44	18/10/2020 21:25	19/10/2020 10:07	12,70	12	152,35	CHI
20201095935	CHAPADAO DO CEU	DJ16416710	CHAPADAO DO CEU	18/10/2020 16:05	19/10/2020 16:44	18/10/2020 16:06	19/10/2020 09:14	17,13	698	11959,26	CHI
20201095935	CHAPADAO DO CEU	CHC-TR2	CHAPADAO DO CEU	18/10/2020 16:05	19/10/2020 16:44	18/10/2020 20:50	19/10/2020 09:08	12,30	1326	16305,38	CHI

20201095935	CHAPADAO DO CEU	CHC-TR2	CHAPADAO DO CEU	18/10/2020 16:05	19/10/2020 16:44	18/10/2020 20:50	19/10/2020 08:35	11,75	2471	29028,07	CHI
20201095935	CHAPADAO DO CEU	DJ12136065	CHAPADAO DO CEU	18/10/2020 16:05	19/10/2020 16:44	19/10/2020 08:18	19/10/2020 08:27	0,15	11	1,68	CHI
20201095935	MINEIROS	DJ12136065	CHAPADAO DO CEU	18/10/2020 16:05	19/10/2020 16:44	19/10/2020 08:18	19/10/2020 08:27	0,15	26	3,96	CHI
20201095935	SERRANOPOLIS	DJ12136065	CHAPADAO DO CEU	18/10/2020 16:05	19/10/2020 16:44	19/10/2020 08:18	19/10/2020 08:27	0,15	81	12,35	CHI
20201095935	SERRANOPOLIS	MY13324363	CHAPADAO DO CEU	18/10/2020 16:05	19/10/2020 16:44	18/10/2020 21:27	19/10/2020 05:40	8,22	67	550,63	CHI
20201095935	MINEIROS	MY13324363	CHAPADAO DO CEU	18/10/2020 16:05	19/10/2020 16:44	18/10/2020 21:27	19/10/2020 05:40	8,22	20	164,37	CHI
20201095935	CHAPADAO DO CEU	MY13324363	CHAPADAO DO CEU	18/10/2020 16:05	19/10/2020 16:44	18/10/2020 21:27	19/10/2020 05:40	8,22	11	90,40	CHI
20201095935	CHAPADAO DO CEU	CHC-TR2	CHAPADAO DO CEU	18/10/2020 16:05	19/10/2020 16:44	18/10/2020 16:06	18/10/2020 20:49	4,71	1326	6245,83	CHI
20201095935	CHAPADAO DO CEU	DJ10414981	CHAPADAO DO CEU	18/10/2020 16:05	19/10/2020 16:44	18/10/2020 16:05	18/10/2020 20:02	3,95	1031	4075,89	CHI
20201095935	CHAPADAO DO CEU	DJ16416711	CHAPADAO DO CEU	18/10/2020 16:05	19/10/2020 16:44	18/10/2020 16:05	18/10/2020 19:35	3,50	437	1531,20	CHI
20201095935	CHAPADAO DO CEU	CHC-TR2	CHAPADAO DO CEU	18/10/2020 16:05	19/10/2020 16:44	18/10/2020 16:05	18/10/2020 18:50	2,77	1004	2777,45	CHI
20201095935	SERRANOPOLIS	SX10400642	CHAPADAO DO CEU	18/10/2020 16:05	19/10/2020 16:44	18/10/2020 18:45	18/10/2020 18:50	0,08	28	2,22	CHI
20201095935	CHAPADAO DO CEU	SX10400642	CHAPADAO DO CEU	18/10/2020 16:05	19/10/2020 16:44	18/10/2020 18:45	18/10/2020 18:50	0,08	11	0,87	CHI
20201095935	CHAPADAO DO CEU	JT10400238	CHAPADAO DO CEU	18/10/2020 16:05	19/10/2020 16:44	18/10/2020 18:18	18/10/2020 18:22	0,06	11	0,64	CHI
20201095935	JATAI	JT10400238	JATAI S1	18/10/2020 16:05	19/10/2020 16:44	18/10/2020 18:18	18/10/2020 18:22	0,06	25	1,44	CHI
20201095935	SERRANOPOLIS	JT10400238	JATAI S1	18/10/2020 16:05	19/10/2020 16:44	18/10/2020 18:18	18/10/2020 18:22	0,06	3	0,17	CHI
20201095935	SERRANOPOLIS	JT10400238	CHAPADAO DO CEU	18/10/2020 16:05	19/10/2020 16:44	18/10/2020 18:18	18/10/2020 18:22	0,06	26	1,50	CHI
2020101800037	CHAPADAO DO CEU	O2430224	CHAPADAO DO CEU	18/10/2020 16:05	18/10/2020 18:15	18/10/2020 16:05	18/10/2020 18:15	2,17	3	6,50	CHI
20201095935	CHAPADAO DO CEU	DJ13164074	CHAPADAO DO CEU	18/10/2020 16:05	19/10/2020 16:44	18/10/2020 16:06	18/10/2020 18:06	1,99	9	17,89	CHI
20201095869	FIRMINOPOLIS	900033952	FIRMINOPOLIS S1	18/10/2020 16:06	18/10/2020 17:50	18/10/2020 16:06	18/10/2020 17:50	1,73	1	1,73	CHI
20201095872	GOIANIA	15035920	MEIA PONTE	18/10/2020 16:07	18/10/2020 18:10	18/10/2020 16:07	18/10/2020 18:10	2,05	1	2,05	CHI
20201095256	RIO VERDE	RV11000097	RIO VERDE S1	18/10/2020 16:08	18/10/2020 19:40	18/10/2020 16:08	18/10/2020 19:40	3,53	75	265,00	CHI
20201095876	ACREUNA DE GOIANIA	AP11166220	REAL S1	18/10/2020 16:08	18/10/2020 19:50	18/10/2020 16:08	18/10/2020 19:50	3,69	77	284,04	CHI
20201096692	ACREUNA	EU12271565	ACREUNA	18/10/2020 16:08	18/10/2020 18:55	18/10/2020 16:08	18/10/2020 18:55	2,77	161	445,93	CHI
20201095891	CAIAPONIA	CP12151179	CAIAPONIA	18/10/2020 16:09	18/10/2020 19:24	18/10/2020 16:09	18/10/2020 19:24	3,24	89	288,41	CHI
20201095884	CAIAPONIA	CP21188386	PIRANHAS	18/10/2020 16:09	18/10/2020 17:36	18/10/2020 16:09	18/10/2020 17:36	1,44	2	2,88	CHI
20201095892	MINEIROS	MY11036188	PARQUE DAS EMAS	18/10/2020 16:10	18/10/2020 22:02	18/10/2020 16:10	18/10/2020 22:02	5,86	37	216,81	CHI
20201095977	ITABERAI	IB12300044	ITABERAI S1	18/10/2020 16:11	18/10/2020 19:53	18/10/2020 16:11	18/10/2020 19:53	3,69	9	33,23	CHI
20201095905	ARUANA	AK12310748	ARUANA	18/10/2020 16:14	18/10/2020 16:55	18/10/2020 16:14	18/10/2020 16:55	0,68	2	1,36	CHI
20201095908	GOIANIRA	GR11275325	MEIA PONTE	18/10/2020 16:14	18/10/2020 17:46	18/10/2020 16:14	18/10/2020 17:46	1,52	108	164,43	CHI
20201095912	VIANOPOLIS	VN21037575	VIANOPOLIS	18/10/2020 16:15	19/10/2020 00:41	18/10/2020 16:15	19/10/2020 00:41	8,43	1	8,43	CHI
20201095913	MORRINHOS	150009860	MORRINHOS	18/10/2020 16:15	18/10/2020 19:22	18/10/2020 16:15	18/10/2020 19:22	3,11	1	3,11	CHI
20201095915	TRINDADE	TR11180197	GOYA S2	18/10/2020 16:15	18/10/2020 19:05	18/10/2020 16:15	18/10/2020 19:05	2,82	71	200,00	CHI
20201095918	NOVA CRIXAS	NA21263045	NOVA CRIXAS	18/10/2020 16:16	18/10/2020 21:01	18/10/2020 16:16	18/10/2020 21:01	4,74	1	4,74	CHI
20201095931	GOIANIRA	GR11291674	MEIA PONTE	18/10/2020 16:18	18/10/2020 20:59	18/10/2020 16:18	18/10/2020 20:59	4,68	68	318,15	CHI
20201096578	TRINDADE	TR11158289	GOYA S2	18/10/2020 16:18	18/10/2020 18:55	18/10/2020 16:18	18/10/2020 18:55	2,60	69	179,48	CHI
20201096017	GOIANIA	GN11203373	MEIA PONTE	18/10/2020 16:19	18/10/2020 20:08	18/10/2020 16:19	18/10/2020 20:08	3,81	192	732,43	CHI
20201095950	GOIANIA	14962391	XAVANTES	18/10/2020 16:21	18/10/2020 20:29	18/10/2020 16:21	18/10/2020 20:29	4,13	1	4,13	CHI
20201095987	CAVALCANTE	TI12162624	NIQUELANDIA SUBTRANSMISSAO	18/10/2020 16:21	18/10/2020 18:43	18/10/2020 16:21	18/10/2020 18:43	2,35	22	51,80	CHI
20201097278	GOIANIA	GN12045310	GOYA S2	18/10/2020 16:22	18/10/2020 21:30	18/10/2020 16:22	18/10/2020 21:30	5,12	42	215,02	CHI
20201095964	MINEIROS	MY12360754	PARQUE DAS EMAS	18/10/2020 16:22	19/10/2020 12:39	18/10/2020 16:22	19/10/2020 12:39	20,27	1	20,27	CHI
20201095966	NOVA CRIXAS	NA21053312	NOVA CRIXAS	18/10/2020 16:22	19/10/2020 05:09	18/10/2020 16:22	19/10/2020 05:09	12,77	1	12,77	CHI
20201096579	ANICUNS	AC11139876	ANICUNS	18/10/2020 16:23	18/10/2020 22:31	18/10/2020 16:23	18/10/2020 22:31	6,13	171	1048,04	CHI
20201095969	ANAPOLIS	AN12401978	JUNDIAI S2	18/10/2020 16:23	18/10/2020 18:37	18/10/2020 16:23	18/10/2020 18:37	2,23	4	8,91	CHI
202010100578	ORIZONA	OZ12113013	PIRES DO RIO S2	18/10/2020 16:23	18/10/2020 23:58	18/10/2020 16:23	18/10/2020 23:58	7,58	11	83,33	CHI
20201095984	MORRO AGUDO DE GOIAS	MS21133290	ITAPURANGA	18/10/2020 16:25	18/10/2020 19:40	18/10/2020 16:25	18/10/2020 19:40	3,24	2	6,49	CHI
20201095988	ITABERAI	IB21022020	ITABERAI S2	18/10/2020 16:26	18/10/2020 18:06	18/10/2020 16:26	18/10/2020 18:06	1,67	2	3,33	CHI
20201095992	RIO VERDE	10030268760	RIO VERDE S2	18/10/2020 16:26	18/10/2020 23:58	18/10/2020 16:26	18/10/2020 23:58	7,52	1	7,52	CHI
202010100863	ANICUNS	AC11098894	ANICUNS	18/10/2020 16:28	19/10/2020 02:38	18/10/2020 16:28	19/10/2020 02:38	10,16	147	1494,09	CHI
20201099294	ANICUNS	AC12391419	ANICUNS	18/10/2020 16:28	18/10/2020 21:50	18/10/2020 16:28	18/10/2020 21:50	5,36	164	879,68	CHI
20201096004	MINEIROS	MY12324379	PARQUE DAS EMAS	18/10/2020 16:29	18/10/2020 23:30	18/10/2020 16:29	18/10/2020 23:30	7,00	2	14,00	CHI

20201096782	VIANOPOLIS	OZ12094835	VIANOPOLIS	18/10/2020 16:30	19/10/2020 03:14	18/10/2020 16:30	19/10/2020 03:14	10,72	26	278,80	CHI
20201096782	ORIZONA	OZ12094835	VIANOPOLIS	18/10/2020 16:30	19/10/2020 03:14	18/10/2020 16:30	19/10/2020 03:14	10,72	2	21,45	CHI
20201096305	SENADOR CANEDO	SEN-TR1	SENADOR CANEDO	18/10/2020 16:30	18/10/2020 23:28	18/10/2020 16:30	18/10/2020 23:28	6,96	2175	15142,83	CHI
20201096305	SENADOR CANEDO	SEN-TR1	SENADOR CANEDO	18/10/2020 16:30	18/10/2020 23:28	18/10/2020 16:30	18/10/2020 23:27	6,94	3812	26456,34	CHI
20201096305	SENADOR CANEDO	SEN-TR1	SENADOR CANEDO	18/10/2020 16:30	18/10/2020 23:28	18/10/2020 16:30	18/10/2020 23:27	6,94	10446	72498,14	CHI
20201096305	GOIANIA	SEN-TR1	SENADOR CANEDO	18/10/2020 16:30	18/10/2020 23:28	18/10/2020 16:30	18/10/2020 23:27	6,94	9	62,46	CHI
20201096305	SENADOR CANEDO	SEN-TR1	SENADOR CANEDO	18/10/2020 16:30	18/10/2020 23:28	18/10/2020 16:30	18/10/2020 23:27	6,94	8642	59977,88	CHI
20201096305	SENADOR CANEDO	SEN-TR1	SENADOR CANEDO	18/10/2020 16:30	18/10/2020 23:28	18/10/2020 16:30	18/10/2020 23:27	6,94	4780	33174,53	CHI
20201096305	CALDAZINHA	04180214	SENADOR CANEDO	18/10/2020 16:30	18/10/2020 23:28	18/10/2020 16:44	18/10/2020 23:27	6,71	119	797,99	CHI
20201096305	SENADOR CANEDO	04180214	SENADOR CANEDO	18/10/2020 16:30	18/10/2020 23:28	18/10/2020 16:44	18/10/2020 23:27	6,71	2809	18836,69	CHI
20201096305	GOIANIA	GN10380016	GOIANIA LESTE S3	18/10/2020 16:30	18/10/2020 23:28	18/10/2020 19:54	18/10/2020 21:03	1,14	325	371,22	CHI
20201096305	GOIANIA	GN16409436	GOIANIA LESTE S3	18/10/2020 16:30	18/10/2020 23:28	18/10/2020 19:56	18/10/2020 20:44	0,80	2885	2308,00	CHI
20201096305	GOIANIA	GN16409431	GOIANIA LESTE S3	18/10/2020 16:30	18/10/2020 23:28	18/10/2020 19:56	18/10/2020 20:43	0,79	2203	1730,58	CHI
20201096305	GOIANIA	GN16410428	GOIANIA LESTE S3	18/10/2020 16:30	18/10/2020 23:28	18/10/2020 19:56	18/10/2020 20:42	0,76	709	537,66	CHI
20201096305	GOIANIA	GN16407242	SENADOR CANEDO	18/10/2020 16:30	18/10/2020 23:28	18/10/2020 18:37	18/10/2020 20:35	1,97	1139	2242,88	CHI
20201096305	GOIANIA	GN16407378	GOIANIA LESTE S3	18/10/2020 16:30	18/10/2020 23:28	18/10/2020 19:56	18/10/2020 20:32	0,59	2040	1209,83	CHI
20201096305	SENADOR CANEDO	SW16426749	SENADOR CANEDO	18/10/2020 16:30	18/10/2020 23:28	18/10/2020 16:30	18/10/2020 16:43	0,21	527	112,87	CHI
20201096305	SENADOR CANEDO	SW16426749	SENADOR CANEDO	18/10/2020 16:30	18/10/2020 23:28	18/10/2020 16:30	18/10/2020 16:42	0,20	260	51,13	CHI
20201096305	SENADOR CANEDO	SW16426749	SENADOR CANEDO	18/10/2020 16:30	18/10/2020 23:28	18/10/2020 16:30	18/10/2020 16:41	0,18	1459	261,81	CHI
20201096305	SENADOR CANEDO	SW16426749	SENADOR CANEDO	18/10/2020 16:30	18/10/2020 23:28	18/10/2020 16:30	18/10/2020 16:41	0,17	3858	664,43	CHI
20201096305	GOIANIA	SW16426749	SENADOR CANEDO	18/10/2020 16:30	18/10/2020 23:28	18/10/2020 16:30	18/10/2020 16:39	0,14	2385	335,23	CHI
20201096305	SENADOR CANEDO	SW16426749	SENADOR CANEDO	18/10/2020 16:30	18/10/2020 23:28	18/10/2020 16:30	18/10/2020 16:39	0,14	2272	319,34	CHI
20201096305	GOIANIA	SW16426749	SENADOR CANEDO	18/10/2020 16:30	18/10/2020 23:28	18/10/2020 16:35	18/10/2020 16:39	0,07	1554	110,51	CHI
20201096305	SENADOR CANEDO	SW16426749	SENADOR CANEDO	18/10/2020 16:30	18/10/2020 23:28	18/10/2020 16:35	18/10/2020 16:39	0,07	2219	157,80	CHI
20201096305	SENADOR CANEDO	SW16407657	SENADOR CANEDO	18/10/2020 16:30	18/10/2020 23:28	18/10/2020 16:30	18/10/2020 16:38	0,12	23	2,86	CHI
20201096305	SENADOR CANEDO	SW16426749	SENADOR CANEDO	18/10/2020 16:30	18/10/2020 23:28	18/10/2020 16:30	18/10/2020 16:38	0,12	1527	185,79	CHI
20201096305	SENADOR CANEDO	SW16426749	SENADOR CANEDO	18/10/2020 16:30	18/10/2020 23:28	18/10/2020 16:35	18/10/2020 16:38	0,05	230	12,01	CHI
20201096305	SENADOR CANEDO	DE16415194	SENADOR CANEDO	18/10/2020 16:30	18/10/2020 23:28	18/10/2020 16:30	18/10/2020 16:38	0,12	2809	337,86	CHI
20201096305	CALDAZINHA	DE16415194	SENADOR CANEDO	18/10/2020 16:30	18/10/2020 23:28	18/10/2020 16:30	18/10/2020 16:38	0,12	119	14,31	CHI
20201096305	BELA VISTA DE GOIAS	SW16414811	SENADOR CANEDO	18/10/2020 16:30	18/10/2020 23:28	18/10/2020 16:30	18/10/2020 16:36	0,10	24	2,29	CHI
20201096305	SENADOR CANEDO	SW16414811	SENADOR CANEDO	18/10/2020 16:30	18/10/2020 23:28	18/10/2020 16:30	18/10/2020 16:36	0,10	28	2,68	CHI
20201096305	CALDAZINHA	SW16414811	SENADOR CANEDO	18/10/2020 16:30	18/10/2020 23:28	18/10/2020 16:30	18/10/2020 16:36	0,10	58	5,54	CHI
20201096305	SENADOR CANEDO	SW16401514	SENADOR CANEDO	18/10/2020 16:30	18/10/2020 23:28	18/10/2020 16:30	18/10/2020 16:35	0,07	396	28,60	CHI
20201096305	ANAPOLIS	00036138	DAIA S1	18/10/2020 16:30	18/10/2020 23:28	18/10/2020 16:30	18/10/2020 16:35	0,07	81	5,69	CHI
20201096305	SILVANIA	00036138	DAIA S1	18/10/2020 16:30	18/10/2020 23:28	18/10/2020 16:30	18/10/2020 16:35	0,07	24	1,69	CHI
20201096305	LEOPOLDO DE BULHOES	00036138	DAIA S1	18/10/2020 16:30	18/10/2020 23:28	18/10/2020 16:30	18/10/2020 16:35	0,07	80	5,62	CHI
20201096008	MATRINCHA	MP12231985	MATRINCHA	18/10/2020 16:30	18/10/2020 18:51	18/10/2020 16:30	18/10/2020 18:51	2,33	2	4,67	CHI
20201096012	PARAUNA	PU21103328	PARAUNA	18/10/2020 16:31	18/10/2020 18:40	18/10/2020 16:31	18/10/2020 18:40	2,14	1	2,14	CHI
20201096014	RIO VERDE	RV11214211	CABRIUVA S1	18/10/2020 16:31	18/10/2020 20:46	18/10/2020 16:31	18/10/2020 20:46	4,24	117	495,56	CHI
20201096016	SANTA TEREZINHA DE GOIAS	SG12237497	SANTA TEREZINHA	18/10/2020 16:32	18/10/2020 21:55	18/10/2020 16:32	18/10/2020 21:55	5,38	4	21,53	CHI
20201096022	TRINDADE	CK12015717	INHUMAS S1	18/10/2020 16:32	19/10/2020 08:49	18/10/2020 16:32	19/10/2020 08:49	16,27	69	1122,55	CHI
20201096022	GOIANIRA	CK12015717	INHUMAS S1	18/10/2020 16:32	19/10/2020 08:49	18/10/2020 16:32	19/10/2020 08:49	16,27	42	683,29	CHI
20201096024	CAMPO ALEGRE DE GOIAS	CM12377078	CAMPO ALEGRE DE GOIAS	18/10/2020 16:33	19/10/2020 21:37	18/10/2020 16:33	19/10/2020 21:37	29,07	2	58,15	CHI
20201096312	JATAI	JT11036246	JATAI S3	18/10/2020 16:33	19/10/2020 02:46	18/10/2020 16:33	19/10/2020 02:46	10,21	141	1439,61	CHI
20201096335	TRINDADE	TR11159251	GOYA S2	18/10/2020 16:33	19/10/2020 06:16	18/10/2020 16:33	19/10/2020 06:16	13,71	85	1165,26	CHI
20201096031	CACU	CC12416665LD	CACHOEIRA ALTA	18/10/2020 16:33	18/10/2020 17:37	18/10/2020 16:33	18/10/2020 17:37	1,06	8	8,46	CHI
20201096031	QUIRINOPOLIS	CC12416665LD	CACHOEIRA ALTA	18/10/2020 16:33	18/10/2020 17:37	18/10/2020 16:33	18/10/2020 17:37	1,06	1	1,06	CHI
20201096033	CATALAO	1990238911	CATALAO S2	18/10/2020 16:33	18/10/2020 18:20	18/10/2020 16:33	18/10/2020 18:20	1,77	1	1,77	CHI
20201096037	CIDADE OCIDENTAL	2680084440	MARAJOARA	18/10/2020 16:34	18/10/2020 17:21	18/10/2020 16:34	18/10/2020 17:21	0,78	1	0,78	CHI
20201096880	ITAPACI	IW11044775	ITAPACI	18/10/2020 16:34	19/10/2020 00:45	18/10/2020 16:34	19/10/2020 00:45	8,18	184	1504,76	CHI
20201096044	NOVO GAMA	LZ12290720	PACAEMBU S1	18/10/2020 16:34	18/10/2020 18:20	18/10/2020 16:34	18/10/2020 18:20	1,76	466	818,48	CHI

20201098680	JATAI	JT11296461	JATAI S3	18/10/2020 16:35	19/10/2020 11:05	18/10/2020 16:35	19/10/2020 11:05	18,51	65	1203,08	CHI
20201096382	JATAI	JT12264371	JATAI S3	18/10/2020 16:35	18/10/2020 18:05	18/10/2020 16:35	18/10/2020 18:05	1,50	264	395,19	CHI
20201096063	GOIANIA	15106391	CARAJAS S1	18/10/2020 16:36	18/10/2020 18:34	18/10/2020 16:36	18/10/2020 18:34	1,96	1	1,96	CHI
20201096300	JATAI	JT11136097	JATAI S3	18/10/2020 16:36	19/10/2020 10:36	18/10/2020 16:36	19/10/2020 10:36	18,00	160	2879,47	CHI
20201096281	JATAI	JT12248447	JATAI S3	18/10/2020 16:36	19/10/2020 01:04	18/10/2020 16:36	19/10/2020 01:04	8,45	5	42,25	CHI
20201096080	RIO VERDE	RV21279710	RIO VERDE S1	18/10/2020 16:37	18/10/2020 20:31	18/10/2020 16:37	18/10/2020 20:31	3,90	1	3,90	CHI
202010100095	MINEIROS	MY11377338	PARQUE DAS EMAS	18/10/2020 16:37	18/10/2020 21:27	18/10/2020 16:37	18/10/2020 21:27	4,83	58	280,24	CHI
20201097279	JATAI	JT12211164	JATAI S2	18/10/2020 16:37	19/10/2020 10:00	18/10/2020 16:37	19/10/2020 10:00	17,38	10	173,81	CHI
20201097603	SANTA CRUZ DE GOIAS	BC12027042	PIRES DO RIO S2	18/10/2020 16:37	18/10/2020 20:45	18/10/2020 16:37	18/10/2020 20:45	4,12	11	45,30	CHI
20201096532	ANAPOLIS	AN12261182	JUNDIAI S1	18/10/2020 16:37	20/10/2020 08:34	18/10/2020 16:37	20/10/2020 08:34	39,93	32	1277,89	CHI
20201096532	ANAPOLIS	AN12261182	JUNDIAI S1	18/10/2020 16:37	20/10/2020 08:34	18/10/2020 16:37	19/10/2020 17:03	24,42	15	366,26	CHI
20201096532	ANAPOLIS	AN12261182	JUNDIAI S1	18/10/2020 16:37	20/10/2020 08:34	18/10/2020 16:37	19/10/2020 08:26	15,80	90	1422,35	CHI
20201096532	LEOPOLDO DE BULHOES	AN12261182	JUNDIAI S1	18/10/2020 16:37	20/10/2020 08:34	18/10/2020 16:37	18/10/2020 19:11	2,55	5	12,75	CHI
20201096532	GOIANAPOLIS	AN12261182	JUNDIAI S1	18/10/2020 16:37	20/10/2020 08:34	18/10/2020 16:37	18/10/2020 19:11	2,55	9	22,96	CHI
20201096532	ANAPOLIS	AN12261182	JUNDIAI S1	18/10/2020 16:37	20/10/2020 08:34	18/10/2020 16:37	18/10/2020 19:11	2,55	14	35,71	CHI
20201096107	ORIZONA	OZ11073418	PIRES DO RIO S2	18/10/2020 16:38	18/10/2020 20:19	18/10/2020 16:38	18/10/2020 20:19	3,68	8	29,42	CHI
20201096109	CATALAO	1990298592	CATALAO S1	18/10/2020 16:38	18/10/2020 17:30	18/10/2020 16:38	18/10/2020 17:30	0,86	1	0,86	CHI
20201096448	APARECIDA DE GOIANIA	AP11043153	ANHANGUERA	18/10/2020 16:39	18/10/2020 23:28	18/10/2020 16:39	18/10/2020 23:28	6,81	77	524,48	CHI
20201096118	CAMPO LIMPO	10016044248	NEROPOLIS S1	18/10/2020 16:39	19/10/2020 15:23	18/10/2020 16:39	19/10/2020 15:23	22,74	1	22,74	CHI
20201096474	APARECIDA DE GOIANIA	AP11376806	ANHANGUERA	18/10/2020 16:39	18/10/2020 18:27	18/10/2020 16:39	18/10/2020 18:27	1,79	202	362,09	CHI
20201096126	APARECIDA DE GOIANIA	205773308	INDEPENDENCIA S1	18/10/2020 16:39	18/10/2020 17:27	18/10/2020 16:39	18/10/2020 17:27	0,79	1	0,79	CHI
20201096272	ANAPOLIS	AN16404673	ANAPOLIS UNIVERSITARIO S2	18/10/2020 16:40	19/10/2020 16:33	19/10/2020 16:27	19/10/2020 16:33	0,10	1482	147,79	CHI
20201096272	ANAPOLIS	05800254	ANAPOLIS UNIVERSITARIO S2	18/10/2020 16:40	19/10/2020 16:33	18/10/2020 16:40	19/10/2020 15:55	23,26	525	12211,65	CHI
20201096272	ANAPOLIS	AN13351076	ANAPOLIS UNIVERSITARIO S2	18/10/2020 16:40	19/10/2020 16:33	18/10/2020 16:42	19/10/2020 15:55	23,22	365	8475,20	CHI
20201096272	ANAPOLIS	05800254	ANAPOLIS UNIVERSITARIO S2	18/10/2020 16:40	19/10/2020 16:33	18/10/2020 16:40	18/10/2020 16:45	0,09	317	27,12	CHI
20201096272	ANAPOLIS	05800254	ANAPOLIS UNIVERSITARIO S2	18/10/2020 16:40	19/10/2020 16:33	18/10/2020 16:40	18/10/2020 16:45	0,08	3	0,25	CHI
20201096166	GOIANIA	16225326	XAVANTES	18/10/2020 16:42	18/10/2020 18:07	18/10/2020 16:42	18/10/2020 18:07	1,42	1	1,42	CHI
20201096175	FLORES DE GOIAS	FB11286819	FLORES DE GOIAS	18/10/2020 16:42	18/10/2020 17:54	18/10/2020 16:42	18/10/2020 17:54	1,20	1	1,20	CHI
20201098578	NOVO GAMA	NJ11383816	PACAEMBU S1	18/10/2020 16:42	18/10/2020 22:31	18/10/2020 16:42	18/10/2020 22:31	5,80	1	5,80	CHI
20201096204	UIRAPURU	UP21190109	NOVA CRIXAS	18/10/2020 16:43	18/10/2020 21:20	18/10/2020 16:43	18/10/2020 21:20	4,60	1	4,60	CHI
20201096208	APARECIDA DE GOIANIA	16561454	REAL S1	18/10/2020 16:44	19/10/2020 04:48	18/10/2020 16:44	19/10/2020 04:48	12,07	1	12,07	CHI
20201096221	MORRINHOS	MR32097324	MORRINHOS	18/10/2020 16:44	18/10/2020 19:16	18/10/2020 16:44	18/10/2020 19:16	2,52	2	5,05	CHI
20201096497	JATAI	JT11036334	JATAI S3	18/10/2020 16:45	19/10/2020 10:12	18/10/2020 16:45	19/10/2020 10:12	17,45	152	2652,19	CHI
20201096233	ANAPOLIS	AN16407061	JUNDIAI S2	18/10/2020 16:45	19/10/2020 04:21	18/10/2020 19:32	19/10/2020 04:21	8,82	623	5494,51	CHI
20201096233	ANAPOLIS	AN16407061	JUNDIAI S2	18/10/2020 16:45	19/10/2020 04:21	18/10/2020 20:40	19/10/2020 04:21	7,68	73	560,76	CHI
20201096233	ANAPOLIS	AN16401596	JUNDIAI S2	18/10/2020 16:45	19/10/2020 04:21	18/10/2020 17:20	18/10/2020 17:32	0,20	112	21,90	CHI
20201096233	TEREZOPOLIS DE GOIAS	AN16401596	JUNDIAI S2	18/10/2020 16:45	19/10/2020 04:21	18/10/2020 17:20	18/10/2020 17:32	0,20	46	9,00	CHI
20201096233	CAMPO LIMPO	AN16401596	JUNDIAI S2	18/10/2020 16:45	19/10/2020 04:21	18/10/2020 17:20	18/10/2020 17:32	0,20	2	0,39	CHI
20201096233	ANAPOLIS	AN16401596	JUNDIAI S2	18/10/2020 16:45	19/10/2020 04:21	18/10/2020 17:21	18/10/2020 17:32	0,18	3003	534,70	CHI
20201096233	ANAPOLIS	AN16414746	JUNDIAI S2	18/10/2020 16:45	19/10/2020 04:21	18/10/2020 16:45	18/10/2020 17:21	0,60	1361	822,27	CHI
20201096233	TEREZOPOLIS DE GOIAS	AN16408376	JUNDIAI S2	18/10/2020 16:45	19/10/2020 04:21	18/10/2020 16:45	18/10/2020 17:19	0,58	46	26,48	CHI
20201096233	CAMPO LIMPO	AN16408376	JUNDIAI S2	18/10/2020 16:45	19/10/2020 04:21	18/10/2020 16:45	18/10/2020 17:19	0,58	2	1,15	CHI
20201096233	ANAPOLIS	AN16408376	JUNDIAI S2	18/10/2020 16:45	19/10/2020 04:21	18/10/2020 16:45	18/10/2020 17:19	0,58	6584	3789,46	CHI
20201096233	ANAPOLIS	AN16415807	JUNDIAI S2	18/10/2020 16:45	19/10/2020 04:21	18/10/2020 16:45	18/10/2020 17:19	0,57	3001	1700,57	CHI
20201096253	NOVO GAMA	NJ11372277	PACAEMBU S1	18/10/2020 16:46	18/10/2020 21:25	18/10/2020 16:46	18/10/2020 21:25	4,65	58	269,67	CHI
20201096460	GOIANIA	GN11150302	MEIA PONTE	18/10/2020 16:46	18/10/2020 23:48	18/10/2020 16:46	18/10/2020 23:48	7,03	88	618,84	CHI
20201096624	TEREZOPOLIS DE GOIAS	GP12382872LD	NEROPOLIS S1	18/10/2020 16:46	20/10/2020 11:48	19/10/2020 09:25	20/10/2020 11:48	26,38	9	237,44	CHI
20201096624	ANAPOLIS	GP12382872LD	NEROPOLIS S1	18/10/2020 16:46	20/10/2020 11:48	19/10/2020 09:25	20/10/2020 11:48	26,38	8	211,06	CHI
20201096624	TEREZOPOLIS DE GOIAS	AN12262521	NEROPOLIS S1	18/10/2020 16:46	20/10/2020 11:48	19/10/2020 10:14	20/10/2020 10:50	24,59	1	24,59	CHI
20201096624	ANAPOLIS	AN12262521	NEROPOLIS S1	18/10/2020 16:46	20/10/2020 11:48	19/10/2020 10:14	20/10/2020 10:50	24,59	9	221,31	CHI
20201096624	ANAPOLIS	AN12258159	NEROPOLIS S1	18/10/2020 16:46	20/10/2020 11:48	18/10/2020 16:46	19/10/2020 12:31	19,76	2	39,51	CHI

20201096624	NEROPOLIS	AN12258159	NEROPOLIS S1	18/10/2020 16:46	20/10/2020 11:48	18/10/2020 16:46	19/10/2020 12:31	19,76	1	19,76	CHI
20201096624	ANAPOLIS	AN12258159	NEROPOLIS S1	18/10/2020 16:46	20/10/2020 11:48	19/10/2020 10:14	19/10/2020 11:42	1,47	4	5,88	CHI
20201096624	ANAPOLIS	AN12258159	NEROPOLIS S1	18/10/2020 16:46	20/10/2020 11:48	19/10/2020 09:25	19/10/2020 10:13	0,80	13	10,40	CHI
20201096624	TEREZOPOLIS DE GOIAS	AN12258159	NEROPOLIS S1	18/10/2020 16:46	20/10/2020 11:48	19/10/2020 09:25	19/10/2020 10:13	0,80	1	0,80	CHI
20201096624	TEREZOPOLIS DE GOIAS	AN12258159	NEROPOLIS S1	18/10/2020 16:46	20/10/2020 11:48	18/10/2020 16:46	19/10/2020 09:24	16,63	10	166,31	CHI
20201096624	ANAPOLIS	AN12258159	NEROPOLIS S1	18/10/2020 16:46	20/10/2020 11:48	18/10/2020 16:46	19/10/2020 09:24	16,63	21	349,24	CHI
20201096263	UIRAPURU	UP21087321	NOVA CRIXAS	18/10/2020 16:46	18/10/2020 22:40	18/10/2020 16:46	18/10/2020 22:40	5,90	1	5,90	CHI
20201096293	NOVA CRIXAS	NA21057381	NOVA CRIXAS	18/10/2020 16:47	19/10/2020 03:33	18/10/2020 16:47	19/10/2020 03:33	10,75	1	10,75	CHI
20201098070	VIANOPOLIS	OZ12079953	VIANOPOLIS	18/10/2020 16:48	19/10/2020 00:00	18/10/2020 16:48	19/10/2020 00:00	7,20	12	86,40	CHI
20201098070	ORIZONA	OZ12079953	VIANOPOLIS	18/10/2020 16:48	19/10/2020 00:00	18/10/2020 16:48	19/10/2020 00:00	7,20	4	28,80	CHI
20201096314	IPAMERI	IP12112780	IPAMERI	18/10/2020 16:48	18/10/2020 20:22	18/10/2020 16:48	18/10/2020 20:22	3,55	11	39,09	CHI
20201099637	ANICUNS	AC11013965	ANICUNS	18/10/2020 16:50	18/10/2020 23:22	18/10/2020 16:50	18/10/2020 23:22	6,52	125	815,24	CHI
20201096722	ANICUNS	AC12233495	ANICUNS	18/10/2020 16:51	19/10/2020 17:52	18/10/2020 16:51	19/10/2020 17:52	25,00	53	1325,22	CHI
20201096722	ANICUNS	AC12233495	ANICUNS	18/10/2020 16:51	19/10/2020 17:52	18/10/2020 16:51	19/10/2020 07:19	14,45	103	1488,81	CHI
202010101056	ORIZONA	OZ12094962	VIANOPOLIS	18/10/2020 16:51	19/10/2020 08:45	18/10/2020 16:51	19/10/2020 08:45	15,89	1	15,89	CHI
202010101056	VIANOPOLIS	OZ12094962	VIANOPOLIS	18/10/2020 16:51	19/10/2020 08:45	18/10/2020 16:51	19/10/2020 08:45	15,89	20	317,74	CHI
20201096766	BRAZABRANTES	BR10413404	NEROPOLIS S1	18/10/2020 16:52	18/10/2020 16:56	18/10/2020 16:52	18/10/2020 16:56	0,07	6	0,39	CHI
20201096766	GOIANIRA	BR10413404	NEROPOLIS S1	18/10/2020 16:52	18/10/2020 16:56	18/10/2020 16:52	18/10/2020 16:56	0,07	29	1,89	CHI
20201096766	NOVA VENEZA	03920414	NEROPOLIS S1	18/10/2020 16:52	18/10/2020 16:56	18/10/2020 16:52	18/10/2020 16:55	0,06	3	0,18	CHI
20201096766	BRAZABRANTES	03920414	NEROPOLIS S1	18/10/2020 16:52	18/10/2020 16:56	18/10/2020 16:52	18/10/2020 16:55	0,06	372	22,53	CHI
202010100838	ANAPOLIS	AN11350986	JUNDIAI S1	18/10/2020 16:52	18/10/2020 23:55	18/10/2020 16:52	18/10/2020 23:55	7,04	57	401,15	CHI
20201097469	ANAPOLIS	AN12000676	JUNDIAI S1	18/10/2020 16:52	18/10/2020 21:23	18/10/2020 16:52	18/10/2020 21:23	4,50	270	1216,13	CHI
20201096412	CROMINIA	CQ12245186	PONTALINA	18/10/2020 16:52	19/10/2020 00:10	18/10/2020 16:52	19/10/2020 00:10	7,28	2	14,57	CHI
20201097551	SANTA CRUZ DE GOIAS	CF12337210	CRISTIANOPOLIS	18/10/2020 16:54	18/10/2020 19:53	18/10/2020 16:54	18/10/2020 19:53	2,98	23	68,43	CHI
20201097551	CRISTIANOPOLIS	CF12337210	CRISTIANOPOLIS	18/10/2020 16:54	18/10/2020 19:53	18/10/2020 16:54	18/10/2020 19:53	2,98	28	83,31	CHI
20201096437	RIO QUENTE	RQ12316156	VILA CORUMBA	18/10/2020 16:55	18/10/2020 19:21	18/10/2020 16:55	18/10/2020 19:21	2,42	2	4,85	CHI
20201096446	PIRANHAS	1930029771	PIRANHAS	18/10/2020 16:55	18/10/2020 20:29	18/10/2020 16:55	18/10/2020 20:29	3,55	1	3,55	CHI
20201096368	INDIARA	6284175	EDEIA	18/10/2020 16:57	19/10/2020 14:27	18/10/2020 16:57	19/10/2020 14:27	21,50	15	322,52	CHI
20201096368	PALMEIRAS DE GOIAS	6284175	EDEIA	18/10/2020 16:57	19/10/2020 14:27	18/10/2020 16:57	19/10/2020 14:27	21,50	5	107,51	CHI
20201096467	RIO VERDE	QI21306090	QUIRINOPOLIS	18/10/2020 16:57	19/10/2020 09:04	18/10/2020 16:57	19/10/2020 09:04	16,10	3	48,31	CHI
20201096470	JATAI	JT11083494	JATAI S2	18/10/2020 16:58	19/10/2020 14:44	18/10/2020 16:58	19/10/2020 14:44	21,76	1	21,76	CHI
20201098781	ANAPOLIS	AN11008938	JUNDIAI S1	18/10/2020 16:58	19/10/2020 18:02	18/10/2020 16:58	19/10/2020 18:02	25,06	134	3358,08	CHI
20201096471	ANAPOLIS	AN12072839	JUNDIAI S1	18/10/2020 16:58	18/10/2020 17:54	18/10/2020 16:58	18/10/2020 17:54	0,93	144	133,48	CHI
20201096481	SANTA CRUZ DE GOIAS	BC12300721	CRISTIANOPOLIS	18/10/2020 16:59	18/10/2020 18:55	18/10/2020 16:59	18/10/2020 18:55	1,93	4	7,70	CHI
20201096486	RIO VERDE	RV21049144	MONTIVIDIU T	18/10/2020 16:59	19/10/2020 13:55	18/10/2020 16:59	19/10/2020 13:55	20,92	1	20,92	CHI
20201095076	RIO VERDE	RV10400628	MONTIVIDIU T	18/10/2020 17:00	20/10/2020 19:52	18/10/2020 17:00	20/10/2020 19:52	50,87	4	203,47	CHI
20201095076	MONTIVIDIU	RV10400628	MONTIVIDIU T	18/10/2020 17:00	20/10/2020 19:52	20/10/2020 00:46	20/10/2020 19:52	19,09	31	591,88	CHI
20201095076	RIO VERDE	RV10400628	MONTIVIDIU T	18/10/2020 17:00	20/10/2020 19:52	20/10/2020 00:46	20/10/2020 19:52	19,09	12	229,12	CHI
20201096616	ANAPOLIS	AN10383652	ANAPOLIS UNIVERSITARIO S2	18/10/2020 17:00	18/10/2020 17:05	18/10/2020 17:00	18/10/2020 17:05	0,08	181	14,88	CHI
20201096616	ANAPOLIS	AN10383652	ANAPOLIS UNIVERSITARIO S2	18/10/2020 17:00	18/10/2020 17:05	18/10/2020 17:00	18/10/2020 17:05	0,07	388	28,56	CHI
20201096616	ANAPOLIS	00052214	ANAPOLIS UNIVERSITARIO S2	18/10/2020 17:00	18/10/2020 17:05	18/10/2020 17:00	18/10/2020 17:04	0,07	598	39,53	CHI
20201096616	ANAPOLIS	00052214	ANAPOLIS UNIVERSITARIO S2	18/10/2020 17:00	18/10/2020 17:05	18/10/2020 17:00	18/10/2020 17:04	0,05	410	21,87	CHI
20201096533	DISTRITO FEDERAL	CD12222463	CACHOEIRA DOURADA	18/10/2020 17:02	18/10/2020 18:54	18/10/2020 17:02	18/10/2020 18:54	1,86	1	1,86	CHI
20201096533	CACHOEIRA DOURADA	CD12222463	CACHOEIRA DOURADA	18/10/2020 17:02	18/10/2020 18:54	18/10/2020 17:02	18/10/2020 18:54	1,86	30	55,92	CHI
202010100914	ANAPOLIS	AN11000183	JUNDIAI S1	18/10/2020 17:02	19/10/2020 21:46	18/10/2020 17:02	19/10/2020 21:46	28,72	145	4164,84	CHI
202010100911	ANAPOLIS	AN11130729	JUNDIAI S1	18/10/2020 17:02	19/10/2020 09:20	18/10/2020 17:02	19/10/2020 09:20	16,29	157	2557,44	CHI
20201097201	ANAPOLIS	AN12000675	JUNDIAI S1	18/10/2020 17:02	18/10/2020 23:19	18/10/2020 17:02	18/10/2020 23:19	6,27	435	2728,78	CHI
20201096567	VIANOPOLIS	OZ12288381	PIRES DO RIO S2	18/10/2020 17:04	19/10/2020 02:58	18/10/2020 17:04	19/10/2020 02:58	9,89	68	672,46	CHI
20201096567	ORIZONA	OZ12288381	PIRES DO RIO S2	18/10/2020 17:04	19/10/2020 02:58	18/10/2020 17:04	19/10/2020 02:58	9,89	47	464,79	CHI
20201096584	JATAI	JT12000156	JATAI S2	18/10/2020 17:06	19/10/2020 11:47	18/10/2020 17:06	19/10/2020 11:47	18,68	4	74,72	CHI
20201096673	PONTALINA	PK12074320	VICENTINOPOLIS	18/10/2020 17:06	18/10/2020 23:03	18/10/2020 17:06	18/10/2020 23:03	5,96	18	107,21	CHI

20201096601	CALDAS NOVAS	10026826192	VILA CORUMBA	18/10/2020 17:07	18/10/2020 22:18	18/10/2020 17:07	18/10/2020 22:18	5,18	1	5,18	CHI
20201096631	SANTO ANTONIO DO DESCOBERTO	NJ16410040	MARAJÓARA	18/10/2020 17:07	19/10/2020 01:12	18/10/2020 17:07	19/10/2020 01:12	8,07	165	1332,15	CHI
20201096631	DISTRITO FEDERAL	NJ16410040	MARAJÓARA	18/10/2020 17:07	19/10/2020 01:12	18/10/2020 17:07	19/10/2020 01:12	8,07	14	113,03	CHI
20201096631	NOVO GAMA	NJ16410040	MARAJÓARA	18/10/2020 17:07	19/10/2020 01:12	18/10/2020 17:07	19/10/2020 01:12	8,07	545	4400,12	CHI
20201096631	NOVO GAMA	NJ16410040	MARAJÓARA	18/10/2020 17:07	19/10/2020 01:12	18/10/2020 22:28	19/10/2020 01:12	2,73	2008	5489,65	CHI
20201096608	ANAPOLIS	AN11000440	JUNDIAI S1	18/10/2020 17:08	19/10/2020 19:04	18/10/2020 17:08	19/10/2020 19:04	25,93	85	2204,05	CHI
20201096611	INHUMAS	IN11086978	INHUMAS S2	18/10/2020 17:08	18/10/2020 19:28	18/10/2020 17:08	18/10/2020 19:28	2,33	133	309,56	CHI
20201097527	NOVO GAMA	NJ11183623	PACAEMBU S1	18/10/2020 17:08	18/10/2020 19:06	18/10/2020 17:08	18/10/2020 19:06	1,96	133	260,13	CHI
20201096621	CATURAI	CK21018906	ARACU	18/10/2020 17:09	19/10/2020 12:13	18/10/2020 17:09	19/10/2020 12:13	19,07	1	19,07	CHI
20201096679	BOM JESUS DE GOIAS	BJ12352647LD	BOM JESUS DE GOIAS	18/10/2020 17:09	19/10/2020 09:16	18/10/2020 17:09	19/10/2020 09:16	16,10	3	48,30	CHI
20201097874	NOVO GAMA	NJ21245997	PACAEMBU S2	18/10/2020 17:11	19/10/2020 10:25	18/10/2020 17:11	19/10/2020 10:25	17,23	2	34,46	CHI
20201096643	NOVO GAMA	LZ12085964	PACAEMBU S2	18/10/2020 17:11	18/10/2020 18:49	18/10/2020 17:11	18/10/2020 18:49	1,63	17	27,69	CHI
20201096643	LUZIANIA	LZ12085964	PACAEMBU S2	18/10/2020 17:11	18/10/2020 18:49	18/10/2020 17:11	18/10/2020 18:49	1,63	30	48,87	CHI
20201096648	ABADIANIA	AA11043940	ANAPOLIS UNIVERSITARIO S1	18/10/2020 17:11	18/10/2020 19:58	18/10/2020 17:11	18/10/2020 19:58	2,77	122	338,52	CHI
20201097700	GOIANIRA	GR11209014	GOIANIRA	18/10/2020 17:11	18/10/2020 20:57	18/10/2020 17:11	18/10/2020 20:57	3,76	98	368,02	CHI
20201096657	SENADOR CANEDO	SW11366016	SENADOR CANEDO	18/10/2020 17:12	19/10/2020 00:03	18/10/2020 17:12	19/10/2020 00:03	6,84	62	424,36	CHI
20201096944	ITUMBIARA	IT11208052	PARANAIBA	18/10/2020 17:13	19/10/2020 21:21	18/10/2020 17:13	18/10/2020 21:21	4,13	58	239,46	CHI
20201097162	ANAPOLIS	AN11129479	JUNDIAI S1	18/10/2020 17:13	18/10/2020 22:51	18/10/2020 17:13	18/10/2020 22:51	5,63	95	534,59	CHI
20201096676	CALDAS NOVAS	760047819	CALDAS NOVAS S1	18/10/2020 17:13	18/10/2020 19:30	18/10/2020 17:13	18/10/2020 19:30	2,27	1	2,27	CHI
20201096678	ALOANDIA	AD21384517	GOIATUBA S1	18/10/2020 17:14	19/10/2020 10:00	18/10/2020 17:14	19/10/2020 10:00	16,77	1	16,77	CHI
20201096681	PIRENÓPOLIS	OV21077954	NERÓPOLIS S1	18/10/2020 17:14	19/10/2020 13:59	18/10/2020 17:14	19/10/2020 13:59	20,75	1	20,75	CHI
20201096757	GOIANIA	GN11076705	MEIA PONTE	18/10/2020 17:14	18/10/2020 20:05	18/10/2020 17:14	18/10/2020 20:05	2,85	236	671,81	CHI
20201096805	GOIANIRA	BR12166574	NERÓPOLIS S1	18/10/2020 17:15	18/10/2020 20:29	18/10/2020 17:15	18/10/2020 20:29	3,22	22	70,86	CHI
20201096805	SANTO ANTONIO DE GOIAS	BR12166574	NERÓPOLIS S1	18/10/2020 17:15	18/10/2020 20:29	18/10/2020 17:15	18/10/2020 20:29	3,22	5	16,11	CHI
20201096805	BRAZABRANTES	BR12166574	NERÓPOLIS S1	18/10/2020 17:15	18/10/2020 20:29	18/10/2020 17:15	18/10/2020 20:29	3,22	2	6,44	CHI
20201096807	BRAZABRANTES	03920414	NERÓPOLIS S1	18/10/2020 17:15	18/10/2020 19:39	18/10/2020 17:15	18/10/2020 19:39	2,40	313	752,50	CHI
20201096807	BRAZABRANTES	03920414	NERÓPOLIS S1	18/10/2020 17:15	18/10/2020 19:39	18/10/2020 17:15	18/10/2020 19:06	1,84	908	1670,47	CHI
20201096807	GOIANIRA	BR10413404	NERÓPOLIS S1	18/10/2020 17:15	18/10/2020 19:39	18/10/2020 18:48	18/10/2020 18:56	0,13	29	3,87	CHI
20201096807	BRAZABRANTES	BR10413404	NERÓPOLIS S1	18/10/2020 17:15	18/10/2020 19:39	18/10/2020 18:48	18/10/2020 18:56	0,13	6	0,80	CHI
20201096807	BRAZABRANTES	03920224	NERÓPOLIS S1	18/10/2020 17:15	18/10/2020 19:39	18/10/2020 18:48	18/10/2020 18:56	0,13	370	47,79	CHI
20201096807	NOVA VENEZA	03920224	NERÓPOLIS S1	18/10/2020 17:15	18/10/2020 19:39	18/10/2020 18:48	18/10/2020 18:56	0,13	3	0,39	CHI
20201096807	BRAZABRANTES	03920414	NERÓPOLIS S1	18/10/2020 17:15	18/10/2020 19:39	18/10/2020 17:15	18/10/2020 17:19	0,07	378	26,25	CHI
20201096807	GOIANIRA	03920414	NERÓPOLIS S1	18/10/2020 17:15	18/10/2020 19:39	18/10/2020 17:15	18/10/2020 17:19	0,07	29	2,01	CHI
20201096807	NOVA VENEZA	03920414	NERÓPOLIS S1	18/10/2020 17:15	18/10/2020 19:39	18/10/2020 17:15	18/10/2020 17:19	0,07	3	0,21	CHI
20201096715	RIO VERDE	RV21322156	CABRIUVA S2	18/10/2020 17:16	19/10/2020 07:29	18/10/2020 17:16	19/10/2020 07:29	14,20	1	14,20	CHI
20201096717	PONTALINA	PK12083350	PONTALINA	18/10/2020 17:16	18/10/2020 19:04	18/10/2020 17:16	18/10/2020 19:04	1,78	7	12,49	CHI
20201096908	JATAI	JT11083555	JATAI S3	18/10/2020 17:17	19/10/2020 01:09	18/10/2020 17:17	19/10/2020 01:09	7,87	158	1242,93	CHI
202010189157	DOVERLANDIA	DV12332038	CAIAPONIA	18/10/2020 17:17	20/10/2020 13:01	18/10/2020 17:17	20/10/2020 13:01	43,74	3	131,21	CHI
202010189157	CAIAPONIA	DV12332038	CAIAPONIA	18/10/2020 17:17	20/10/2020 13:01	18/10/2020 17:17	20/10/2020 12:30	43,22	22	950,74	CHI
202010189157	DOVERLANDIA	DV12332038	CAIAPONIA	18/10/2020 17:17	20/10/2020 13:01	18/10/2020 17:17	20/10/2020 12:30	43,22	9	388,94	CHI
202010189157	DOVERLANDIA	DV12332038	CAIAPONIA	18/10/2020 17:17	20/10/2020 13:01	18/10/2020 17:17	20/10/2020 07:27	38,16	16	610,57	CHI
20201097767	DOVERLANDIA	DV12217564	CAIAPONIA	18/10/2020 17:17	19/10/2020 01:04	18/10/2020 17:17	19/10/2020 01:04	7,78	7	54,44	CHI
202010100603	ANAPOLIS	AN11075818	JUNDIAI S2	18/10/2020 17:18	19/10/2020 14:28	18/10/2020 17:18	19/10/2020 14:28	21,17	96	2032,45	CHI
20201098555	PALMEIRAS DE GOIAS	NZ12147519LD	ANICUNS	18/10/2020 17:18	18/10/2020 20:30	18/10/2020 17:18	18/10/2020 20:30	3,19	3	9,57	CHI
20201098555	NAZARIO	NZ12147519LD	ANICUNS	18/10/2020 17:18	18/10/2020 20:30	18/10/2020 17:18	18/10/2020 20:30	3,19	101	322,36	CHI
20201098555	ANICUNS	NZ12147519LD	ANICUNS	18/10/2020 17:18	18/10/2020 20:30	18/10/2020 17:18	18/10/2020 20:30	3,19	110	351,08	CHI
20201098555	TURVANIA	NZ12147519LD	ANICUNS	18/10/2020 17:18	18/10/2020 20:30	18/10/2020 17:18	18/10/2020 20:30	3,19	47	150,01	CHI
20201096742	ANAPOLIS	21389056	JUNDIAI S1	18/10/2020 17:18	20/10/2020 13:33	18/10/2020 17:18	20/10/2020 13:33	44,24	1	44,24	CHI
20201096743	APORE	AE12219493	ITAJA S1	18/10/2020 17:18	19/10/2020 17:44	18/10/2020 17:18	19/10/2020 17:44	24,42	3	73,26	CHI
202010100847	ANAPOLIS	AN11000430	JUNDIAI S1	18/10/2020 17:20	19/10/2020 04:44	18/10/2020 17:20	19/10/2020 04:44	11,39	79	899,77	CHI
20201097761	ANAPOLIS	AN12072304	JUNDIAI S1	18/10/2020 17:20	18/10/2020 21:36	18/10/2020 17:20	18/10/2020 21:36	4,26	364	1549,33	CHI

20201096769	SANTO ANTONIO DE GOIAS	GR12002132	NEROPOLIS S1	18/10/2020 17:22	18/10/2020 19:51	18/10/2020 17:22	18/10/2020 19:51	2,47	6	14,84	CHI
20201096774	MORRINHOS	150126530	MORRINHOS	18/10/2020 17:23	18/10/2020 19:09	18/10/2020 17:23	18/10/2020 19:09	1,77	1	1,77	CHI
20201096775	BELA VISTA DE GOIAS	BV11187585	CEPAIGO S2	18/10/2020 17:23	18/10/2020 21:07	18/10/2020 17:23	18/10/2020 21:07	3,73	16	59,68	CHI
20201096778	JATAI	JT21234350	JATAI S2	18/10/2020 17:23	19/10/2020 12:29	18/10/2020 17:23	19/10/2020 12:29	19,09	1	19,09	CHI
20201099524	JATAI	JT11036924	JATAI S2	18/10/2020 17:23	19/10/2020 04:05	18/10/2020 17:23	19/10/2020 04:05	10,69	59	630,68	CHI
20201096785	ITAPACI	10027794375	ITAPACI	18/10/2020 17:23	19/10/2020 04:46	18/10/2020 17:23	19/10/2020 04:46	11,37	1	11,37	CHI
20201096786	GOIATUBA	GT12000127	GOIATUBA S2	18/10/2020 17:23	18/10/2020 23:38	18/10/2020 17:23	18/10/2020 23:38	6,23	39	243,12	CHI
202010100912	ANAPOLIS	AN11205794	ANAPOLIS UNIVERSITARIO S2	18/10/2020 17:24	19/10/2020 02:00	18/10/2020 17:24	19/10/2020 02:00	8,59	102	875,87	CHI
202010100792	ANAPOLIS	AN12050424	ANAPOLIS UNIVERSITARIO S2	18/10/2020 17:24	19/10/2020 00:39	18/10/2020 17:24	19/10/2020 00:39	7,24	138	998,70	CHI
20201098056	TRINDADE	TR11095982	MEIA PONTE	18/10/2020 17:25	18/10/2020 21:49	18/10/2020 17:25	18/10/2020 21:49	4,40	169	743,22	CHI
20201097653	ANAPOLIS	AN11003275	JUNDIAI S1	18/10/2020 17:25	19/10/2020 16:42	18/10/2020 17:25	19/10/2020 16:42	23,28	154	3584,91	CHI
20201096802	PIRES DO RIO	PR11352216	PIRES DO RIO S1	18/10/2020 17:25	18/10/2020 18:59	18/10/2020 17:25	18/10/2020 18:59	1,55	72	111,88	CHI
20201097068	ALEXANIA	AX12258528	ALEXANIA	18/10/2020 17:26	18/10/2020 19:34	18/10/2020 17:26	18/10/2020 19:34	2,13	37	78,93	CHI
20201097450	PIRENOPOLIS	PV21052324	CORUMBA	18/10/2020 17:26	18/10/2020 19:26	18/10/2020 17:26	18/10/2020 19:26	2,00	1	2,00	CHI
20201096803	GOIANIA	17353312	CAMPINAS S2	18/10/2020 17:26	18/10/2020 19:27	18/10/2020 17:26	18/10/2020 19:27	2,02	1	2,02	CHI
20201096806	CROMINIA	CQ12344595	PONTALINA	18/10/2020 17:26	18/10/2020 23:48	18/10/2020 17:26	18/10/2020 23:48	6,36	2	12,73	CHI
20201098142	ANAPOLIS	AN11198363	ANAPOLIS UNIVERSITARIO S2	18/10/2020 17:26	18/10/2020 20:29	18/10/2020 17:26	18/10/2020 20:29	3,04	142	431,96	CHI
20201098173	ANAPOLIS	AN11130744	ANAPOLIS UNIVERSITARIO S2	18/10/2020 17:26	18/10/2020 23:41	18/10/2020 17:26	18/10/2020 23:41	6,24	208	1298,27	CHI
20201098481	ANAPOLIS	AN11166250	ANAPOLIS UNIVERSITARIO S2	18/10/2020 17:26	18/10/2020 20:18	18/10/2020 17:26	18/10/2020 20:18	2,86	140	400,09	CHI
20201098397	ABADIANIA	AA12295520	ANAPOLIS UNIVERSITARIO S1	18/10/2020 17:26	19/10/2020 07:30	18/10/2020 17:26	19/10/2020 07:30	14,07	6	84,44	CHI
20201096811	PALMEIRAS DE GOIAS	PL12391390	PALMEIRAS	18/10/2020 17:26	19/10/2020 11:55	18/10/2020 17:26	19/10/2020 11:55	18,47	2	36,94	CHI
20201096980	GOIANIRA	GR11094599	GOIANIRA	18/10/2020 17:27	19/10/2020 04:25	18/10/2020 17:27	19/10/2020 04:25	10,97	104	1140,56	CHI
202010100066	NOVO GAMA	NJ11201418	PACAEMBU S1	18/10/2020 17:27	18/10/2020 21:45	18/10/2020 17:27	18/10/2020 21:45	4,29	112	480,17	CHI
20201099736	SANTO ANTONIO DE GOIAS	NR12246208	NEROPOLIS S2	18/10/2020 17:27	18/10/2020 21:31	18/10/2020 17:27	18/10/2020 21:31	4,05	48	194,56	CHI
20201096820	PALMEIRAS DE GOIAS	PL12000008	ANICUNS	18/10/2020 17:27	19/10/2020 05:58	18/10/2020 17:27	19/10/2020 05:58	12,50	58	725,15	CHI
20201096820	NAZARIO	PL12000008	ANICUNS	18/10/2020 17:27	19/10/2020 05:58	18/10/2020 17:27	19/10/2020 05:58	12,50	3	37,51	CHI
202010100564	NOVO GAMA	NJ11183908	PACAEMBU S1	18/10/2020 17:28	19/10/2020 12:05	18/10/2020 17:28	19/10/2020 12:05	18,61	68	1265,57	CHI
20201098761	NOVO GAMA	LZ12000114LD	PACAEMBU S2	18/10/2020 17:28	20/10/2020 10:44	18/10/2020 17:28	20/10/2020 10:44	41,26	75	3094,58	CHI
202010103726	AVELINOPOLIS	AC21323605	ANICUNS	18/10/2020 17:28	19/10/2020 18:36	18/10/2020 17:28	19/10/2020 18:36	25,12	1	25,12	CHI
20201097076	ANICUNS	AV12282415	ANICUNS	18/10/2020 17:28	19/10/2020 10:19	18/10/2020 17:28	19/10/2020 10:19	16,83	48	808,07	CHI
20201097076	AVELINOPOLIS	AV12282415	ANICUNS	18/10/2020 17:28	19/10/2020 10:19	18/10/2020 17:28	19/10/2020 10:19	16,83	3	50,50	CHI
20201096846	DOVERLANDIA	DV11138403	CAIAPONIA	18/10/2020 17:28	19/10/2020 00:00	18/10/2020 17:28	19/10/2020 00:00	6,52	2	13,03	CHI
20201097662	JATAI	JT11400161	JATAI S2	18/10/2020 17:29	19/10/2020 12:00	18/10/2020 17:29	19/10/2020 12:00	18,51	18	333,20	CHI
20201096935	ABADIA DE GOIAS	AO11007316	INDEPENDENCIA S2	18/10/2020 17:29	18/10/2020 21:59	18/10/2020 17:29	18/10/2020 21:59	4,48	78	349,83	CHI
20201096898	NEROPOLIS	NR12356423	NEROPOLIS S2	18/10/2020 17:31	18/10/2020 19:33	18/10/2020 17:31	18/10/2020 19:33	2,02	8	16,18	CHI
20201096900	JATAI	10013839860	JATAI S2	18/10/2020 17:31	19/10/2020 11:02	18/10/2020 17:31	19/10/2020 11:02	17,50	1	17,50	CHI
20201096914	SANTO ANTONIO DO DESCOBERTO	10025670687	ALEXANIA	18/10/2020 17:32	18/10/2020 18:50	18/10/2020 17:32	18/10/2020 18:50	1,29	1	1,29	CHI
20201096959	MINEIROS	MY11360212	PARQUE DAS EMAS	18/10/2020 17:34	19/10/2020 09:39	18/10/2020 17:34	19/10/2020 09:39	16,07	22	353,53	CHI
20201097870	NOVO GAMA	NJ11199539	PACAEMBU S1	18/10/2020 17:35	18/10/2020 20:02	18/10/2020 17:35	18/10/2020 20:02	2,45	115	281,75	CHI
20201097444	VALPARAISO DE GOIAS	VA12345917	PACAEMBU S2	18/10/2020 17:35	18/10/2020 21:26	18/10/2020 17:35	18/10/2020 21:26	3,85	281	1081,15	CHI
20201096977	ANAPOLIS	AN11048221	JUNDIAI S1	18/10/2020 17:35	19/10/2020 13:50	18/10/2020 17:35	19/10/2020 13:50	20,24	137	2772,88	CHI
20201097010	COCALZINHO DE GOIAS	ZN12389401	AGUAS LINDAS DE GOIAS S2	18/10/2020 17:36	18/10/2020 19:18	18/10/2020 17:36	18/10/2020 19:18	1,69	1	1,69	CHI
20201097012	IPAMERI	IP12376252	CRISTALINA S2	18/10/2020 17:36	18/10/2020 19:58	18/10/2020 17:36	18/10/2020 19:58	2,35	20	47,03	CHI
20201097984	ANAPOLIS	AN12000160	JUNDIAI S1	18/10/2020 17:37	18/10/2020 19:24	18/10/2020 17:37	18/10/2020 19:24	1,78	132	234,78	CHI
20201097020	ARUANA	AK11051861	ARUANA	18/10/2020 17:37	18/10/2020 20:43	18/10/2020 17:37	18/10/2020 20:43	3,09	52	160,93	CHI
20201097028	NOVA CRIXAS	NA12057206	MOZARLANDIA	18/10/2020 17:37	19/10/2020 03:21	18/10/2020 17:37	19/10/2020 03:21	9,72	1	9,72	CHI
20201097032	GOIANIA	11390451	ATLANTICO S1	18/10/2020 17:37	18/10/2020 18:48	18/10/2020 17:37	18/10/2020 18:48	1,17	1	1,17	CHI
20201097057	FAZENDA NOVA	FN12390152	IPORA	18/10/2020 17:39	18/10/2020 20:00	18/10/2020 17:39	18/10/2020 20:00	2,35	12	28,20	CHI
20201097057	ISRAELANDIA	FN12390152	IPORA	18/10/2020 17:39	18/10/2020 20:00	18/10/2020 17:39	18/10/2020 20:00	2,35	2	4,70	CHI
20201097067	RIO VERDE	MV12214244	MONTIVIDIU T	18/10/2020 17:39	19/10/2020 09:04	18/10/2020 17:39	19/10/2020 09:04	15,41	2	30,82	CHI
20201097067	MONTIVIDIU	MV12214244	MONTIVIDIU T	18/10/2020 17:39	19/10/2020 09:04	18/10/2020 17:39	19/10/2020 09:04	15,41	16	246,58	CHI

20201097707	ITABERAÍ	IB12021852	ITABERAÍ S2	18/10/2020 17:41	18/10/2020 20:01	18/10/2020 17:41	18/10/2020 20:01	2,32	80	185,87	CHI
20201097151	NOVA CRIXAS	NA21077146	NOVA CRIXAS	18/10/2020 17:42	19/10/2020 04:37	18/10/2020 17:42	19/10/2020 04:37	10,91	1	10,91	CHI
20201097187	ANAPOLIS	20178700	JUNDIAÍ S1	18/10/2020 17:43	20/10/2020 00:10	18/10/2020 17:43	20/10/2020 00:10	30,44	1	30,44	CHI
20201097343	GOIANDIRA	CT12399850	CATALAO S1	18/10/2020 17:44	18/10/2020 20:47	18/10/2020 17:44	18/10/2020 20:47	3,05	39	118,93	CHI
20201097343	CATALAO	CT12399850	CATALAO S1	18/10/2020 17:44	18/10/2020 20:47	18/10/2020 17:44	18/10/2020 20:47	3,05	54	164,67	CHI
20201097234	ANAPOLIS	10000411521	JUNDIAÍ S2	18/10/2020 17:45	19/10/2020 14:33	18/10/2020 17:45	19/10/2020 14:33	20,80	1	20,80	CHI
202010100311	JATAÍ	JT11058495	JATAÍ S3	18/10/2020 17:45	19/10/2020 01:55	18/10/2020 17:45	19/10/2020 01:55	8,16	82	669,01	CHI
20201097248	NOVO PLANALTO	2500002890	NOVO PLANALTO	18/10/2020 17:45	18/10/2020 22:36	18/10/2020 17:45	18/10/2020 22:36	4,84	1	4,84	CHI
20201097365	ITARUMA	JT12260447LD	JATAÍ S1	18/10/2020 17:46	19/10/2020 13:04	19/10/2020 13:00	19/10/2020 13:04	0,07	1	0,07	CHI
20201097365	SERRANOPOLIS	JT12260447LD	JATAÍ S1	18/10/2020 17:46	19/10/2020 13:04	19/10/2020 13:00	19/10/2020 13:04	0,07	87	6,45	CHI
20201097365	JATAÍ	JT12260447LD	JATAÍ S1	18/10/2020 17:46	19/10/2020 13:04	19/10/2020 13:00	19/10/2020 13:04	0,07	13	0,96	CHI
20201097365	JATAÍ	JT10274087	JATAÍ S1	18/10/2020 17:46	19/10/2020 13:04	19/10/2020 13:00	19/10/2020 13:04	0,07	237	17,58	CHI
20201097365	SERRANOPOLIS	JT10274087	JATAÍ S1	18/10/2020 17:46	19/10/2020 13:04	19/10/2020 13:00	19/10/2020 13:04	0,07	115	8,53	CHI
20201097365	SERRANOPOLIS	JT12260447LD	JATAÍ S1	18/10/2020 17:46	19/10/2020 13:04	19/10/2020 13:00	19/10/2020 13:04	0,07	3280	243,27	CHI
20201097365	APORE	JT12260447LD	JATAÍ S1	18/10/2020 17:46	19/10/2020 13:04	19/10/2020 13:00	19/10/2020 13:04	0,07	7	0,52	CHI
20201097365	JATAÍ	JT13306455	JATAÍ S1	18/10/2020 17:46	19/10/2020 13:04	19/10/2020 11:22	19/10/2020 11:44	0,38	11	4,16	CHI
20201097365	JATAÍ	O4800424	JATAÍ S1	18/10/2020 17:46	19/10/2020 13:04	18/10/2020 17:46	19/10/2020 11:40	17,90	2	35,79	CHI
20201097365	APORE	JT12260447LD	JATAÍ S1	18/10/2020 17:46	19/10/2020 13:04	19/10/2020 06:17	19/10/2020 07:52	1,58	6	9,46	CHI
20201097365	JATAÍ	JT12260447LD	JATAÍ S1	18/10/2020 17:46	19/10/2020 13:04	19/10/2020 06:17	19/10/2020 07:52	1,58	248	391,15	CHI
20201097365	SERRANOPOLIS	JT12260447LD	JATAÍ S1	18/10/2020 17:46	19/10/2020 13:04	19/10/2020 06:17	19/10/2020 07:52	1,58	87	137,22	CHI
20201097365	SERRANOPOLIS	JT12260447LD	JATAÍ S1	18/10/2020 17:46	19/10/2020 13:04	19/10/2020 06:17	19/10/2020 07:52	1,58	115	181,38	CHI
20201097365	SERRANOPOLIS	JT12260447LD	JATAÍ S1	18/10/2020 17:46	19/10/2020 13:04	19/10/2020 06:17	19/10/2020 07:52	1,58	3291	5190,64	CHI
20201097365	JATAÍ	JT12260447LD	JATAÍ S1	18/10/2020 17:46	19/10/2020 13:04	19/10/2020 06:17	19/10/2020 07:52	1,58	13	20,50	CHI
20201097365	ITARUMA	JT12260447LD	JATAÍ S1	18/10/2020 17:46	19/10/2020 13:04	19/10/2020 06:17	19/10/2020 07:52	1,58	1	1,58	CHI
20201097365	JATAÍ	O4800424	JATAÍ S1	18/10/2020 17:46	19/10/2020 13:04	18/10/2020 17:46	18/10/2020 22:26	4,66	11	51,30	CHI
20201097365	JATAÍ	O4800424	JATAÍ S1	18/10/2020 17:46	19/10/2020 13:04	18/10/2020 21:26	18/10/2020 21:45	0,33	11	3,65	CHI
20201097365	JATAÍ	O4800424	JATAÍ S1	18/10/2020 17:46	19/10/2020 13:04	18/10/2020 17:46	18/10/2020 19:50	2,07	11	22,81	CHI
20201097365	APORE	O4800424	JATAÍ S1	18/10/2020 17:46	19/10/2020 13:04	18/10/2020 17:46	18/10/2020 19:21	1,59	7	11,12	CHI
20201097365	SERRANOPOLIS	O4800424	JATAÍ S1	18/10/2020 17:46	19/10/2020 13:04	18/10/2020 17:46	18/10/2020 19:21	1,59	3257	5172,30	CHI
20201097365	ITARUMA	O4800424	JATAÍ S1	18/10/2020 17:46	19/10/2020 13:04	18/10/2020 17:46	18/10/2020 19:21	1,59	1	1,59	CHI
20201097365	SERRANOPOLIS	JT13306513	JATAÍ S1	18/10/2020 17:46	19/10/2020 13:04	18/10/2020 17:46	18/10/2020 19:21	1,59	115	182,63	CHI
20201097365	JATAÍ	JT13306513	JATAÍ S1	18/10/2020 17:46	19/10/2020 13:04	18/10/2020 17:46	18/10/2020 19:21	1,59	279	443,07	CHI
20201097365	SERRANOPOLIS	JT13306513	JATAÍ S1	18/10/2020 17:46	19/10/2020 13:04	18/10/2020 17:46	18/10/2020 19:21	1,59	33	52,41	CHI
20201097365	SERRANOPOLIS	O4800424	JATAÍ S1	18/10/2020 17:46	19/10/2020 13:04	18/10/2020 17:46	18/10/2020 19:21	1,59	87	138,16	CHI
20201097365	JATAÍ	JT13306513	JATAÍ S1	18/10/2020 17:46	19/10/2020 13:04	18/10/2020 17:46	18/10/2020 19:21	1,59	51	80,99	CHI
20201097365	JATAÍ	O4800424	JATAÍ S1	18/10/2020 17:46	19/10/2020 13:04	18/10/2020 17:46	18/10/2020 19:21	1,59	13	20,64	CHI
20201097365	JATAÍ	JT13306513	JATAÍ S1	18/10/2020 17:46	19/10/2020 13:04	18/10/2020 17:47	18/10/2020 19:21	1,56	10	15,64	CHI
20201097590	SERRANOPOLIS	O0100414	ITAJA S1	18/10/2020 17:46	19/10/2020 13:32	18/10/2020 17:46	19/10/2020 13:32	19,76	46	909,08	CHI
20201097590	APORE	O0100414	ITAJA S1	18/10/2020 17:46	19/10/2020 13:32	18/10/2020 17:46	19/10/2020 13:32	19,76	48	948,60	CHI
20201097590	APORE	AE13311586	ITAJA S1	18/10/2020 17:46	19/10/2020 13:32	18/10/2020 17:46	19/10/2020 13:32	19,76	1	19,76	CHI
20201097590	APORE	O0100414	ITAJA S1	18/10/2020 17:46	19/10/2020 13:32	18/10/2020 17:46	19/10/2020 13:32	19,76	97	1916,96	CHI
20201097590	APORE	AE13311577	ITAJA S1	18/10/2020 17:46	19/10/2020 13:32	18/10/2020 17:46	19/10/2020 11:55	18,16	4	72,63	CHI
20201097590	APORE	AE13311577	ITAJA S1	18/10/2020 17:46	19/10/2020 13:32	18/10/2020 17:46	19/10/2020 08:15	14,48	3	43,43	CHI
20201097271	PONTALINA	PK21181926	PONTALINA	18/10/2020 17:46	18/10/2020 18:55	18/10/2020 17:46	18/10/2020 18:55	1,14	1	1,14	CHI
20201097272	MINEIROS	MY12360240	PARQUE DAS EMAS	18/10/2020 17:46	19/10/2020 09:39	18/10/2020 17:46	19/10/2020 09:39	15,87	19	301,61	CHI
2020101800164	PIRENOPOLIS	31201	NEROPOLIS S1	18/10/2020 17:47	18/10/2020 17:50	18/10/2020 17:47	18/10/2020 17:50	0,05	47	2,35	CHI
2020101800164	ANAPOLIS	31201	NEROPOLIS S1	18/10/2020 17:47	18/10/2020 17:50	18/10/2020 17:47	18/10/2020 17:50	0,05	190	9,50	CHI
2020101800164	CAMPO LIMPO	39302	NEROPOLIS S1	18/10/2020 17:47	18/10/2020 17:50	18/10/2020 17:47	18/10/2020 17:50	0,05	1776	88,80	CHI
2020101800164	PETROLINA DE GOIAS	31201	NEROPOLIS S1	18/10/2020 17:47	18/10/2020 17:50	18/10/2020 17:47	18/10/2020 17:50	0,05	13	0,65	CHI
2020101800164	ANAPOLIS	39301	NEROPOLIS S1	18/10/2020 17:47	18/10/2020 17:50	18/10/2020 17:47	18/10/2020 17:50	0,05	3	0,15	CHI
2020101800164	OURO VERDE DE GOIAS	O1320444	NEROPOLIS S1	18/10/2020 17:47	18/10/2020 17:50	18/10/2020 17:47	18/10/2020 17:50	0,05	12	0,60	CHI

2020101800164	OURO VERDE DE GOIAS	39301	NEROPOLIS S1	18/10/2020 17:47	18/10/2020 17:50	18/10/2020 17:47	18/10/2020 17:50	0,05	1	0,05	CHI
2020101800164	ANAPOLIS	39302	NEROPOLIS S1	18/10/2020 17:47	18/10/2020 17:50	18/10/2020 17:47	18/10/2020 17:50	0,05	425	21,25	CHI
2020101800164	CAMPO LIMPO	31201	NEROPOLIS S1	18/10/2020 17:47	18/10/2020 17:50	18/10/2020 17:47	18/10/2020 17:50	0,05	18	0,90	CHI
2020101800164	CAMPO LIMPO	39301	NEROPOLIS S1	18/10/2020 17:47	18/10/2020 17:50	18/10/2020 17:47	18/10/2020 17:50	0,05	1130	56,50	CHI
2020101800164	OURO VERDE DE GOIAS	31201	NEROPOLIS S1	18/10/2020 17:47	18/10/2020 17:50	18/10/2020 17:47	18/10/2020 17:50	0,05	1449	72,45	CHI
20201097476	APARECIDA DE GOIANIA	AP12166247	REAL S1	18/10/2020 17:47	18/10/2020 18:49	18/10/2020 17:47	18/10/2020 18:49	1,03	452	466,82	CHI
20201097304	MINACU	IH12328091	MINACU	18/10/2020 17:47	18/10/2020 21:01	18/10/2020 17:47	18/10/2020 21:01	3,22	8	25,75	CHI
20201097311	TURVANIA	TV11005730	FIRMINOPOLIS S2	18/10/2020 17:48	19/10/2020 12:35	18/10/2020 17:48	19/10/2020 12:35	18,79	100	1878,83	CHI
20201097322	AGUAS LINDAS DE GOIAS	10014345321	AGUAS LINDAS DE GOIAS S1	18/10/2020 17:48	18/10/2020 18:40	18/10/2020 17:48	18/10/2020 18:40	0,86	1	0,86	CHI
202010100902	JATAI	JT11182134	JATAI S2	18/10/2020 17:48	19/10/2020 02:50	18/10/2020 17:48	19/10/2020 02:50	9,02	96	865,73	CHI
20201098196	ITUMBIARA	IT11000130	ITUMBIARA VELHA S1	18/10/2020 17:49	19/10/2020 06:38	18/10/2020 17:49	19/10/2020 06:38	12,81	94	1204,22	CHI
20201097386	GAMELEIRA DE GOIAS	GL10395380	ANAPOLIS UNIVERSITARIO S1	18/10/2020 17:49	20/10/2020 09:09	18/10/2020 17:49	20/10/2020 09:09	39,34	1	39,34	CHI
20201097386	ANAPOLIS	GL10395380	DAIA S2	18/10/2020 17:49	20/10/2020 09:09	18/10/2020 17:49	20/10/2020 09:09	39,34	4	157,36	CHI
20201097386	GAMELEIRA DE GOIAS	GL10395380	DAIA S2	18/10/2020 17:49	20/10/2020 09:09	18/10/2020 17:49	20/10/2020 09:09	39,34	74	2911,24	CHI
20201097386	GAMELEIRA DE GOIAS	SV12013378	DAIA S2	18/10/2020 17:49	20/10/2020 09:09	18/10/2020 17:49	20/10/2020 00:31	30,70	6	184,21	CHI
20201097386	GAMELEIRA DE GOIAS	GL13265250	DAIA S2	18/10/2020 17:49	20/10/2020 09:09	19/10/2020 09:47	20/10/2020 00:30	14,71	41	603,08	CHI
20201097386	GAMELEIRA DE GOIAS	GL10395380	DAIA S2	18/10/2020 17:49	20/10/2020 09:09	19/10/2020 11:46	19/10/2020 12:02	0,27	135	36,75	CHI
20201097386	SILVANIA	GL10395380	DAIA S2	18/10/2020 17:49	20/10/2020 09:09	19/10/2020 11:46	19/10/2020 12:02	0,27	1	0,27	CHI
20201097386	GAMELEIRA DE GOIAS	GL10395380	DAIA S2	18/10/2020 17:49	20/10/2020 09:09	19/10/2020 10:35	19/10/2020 11:03	0,45	135	61,35	CHI
20201097386	SILVANIA	GL10395380	DAIA S2	18/10/2020 17:49	20/10/2020 09:09	19/10/2020 10:35	19/10/2020 11:03	0,45	1	0,45	CHI
20201097386	GAMELEIRA DE GOIAS	GL10395380	DAIA S2	18/10/2020 17:49	20/10/2020 09:09	18/10/2020 17:49	19/10/2020 09:46	15,95	41	653,90	CHI
20201097386	SILVANIA	GL10395380	DAIA S2	18/10/2020 17:49	20/10/2020 09:09	19/10/2020 02:03	19/10/2020 02:22	0,32	1	0,32	CHI
20201097386	GAMELEIRA DE GOIAS	GL10395380	DAIA S2	18/10/2020 17:49	20/10/2020 09:09	19/10/2020 02:03	19/10/2020 02:22	0,32	135	42,98	CHI
20201097386	GAMELEIRA DE GOIAS	GL10395380	DAIA S2	18/10/2020 17:49	20/10/2020 09:09	19/10/2020 00:05	19/10/2020 00:09	0,08	135	10,27	CHI
20201097386	SILVANIA	GL10395380	DAIA S2	18/10/2020 17:49	20/10/2020 09:09	19/10/2020 00:05	19/10/2020 00:09	0,08	1	0,08	CHI
20201097386	SILVANIA	GL10395380	DAIA S2	18/10/2020 17:49	20/10/2020 09:09	18/10/2020 23:06	18/10/2020 23:12	0,10	1	0,10	CHI
20201097386	GAMELEIRA DE GOIAS	GL10395380	DAIA S2	18/10/2020 17:49	20/10/2020 09:09	18/10/2020 23:06	18/10/2020 23:12	0,10	135	14,10	CHI
20201097386	SILVANIA	GL10395380	DAIA S2	18/10/2020 17:49	20/10/2020 09:09	18/10/2020 17:49	18/10/2020 21:40	3,85	1	3,85	CHI
20201097386	GAMELEIRA DE GOIAS	GL10395380	DAIA S2	18/10/2020 17:49	20/10/2020 09:09	18/10/2020 17:49	18/10/2020 21:40	3,85	135	519,60	CHI
20201097353	MORRINHOS	MR21404840	MORRINHOS	18/10/2020 17:49	18/10/2020 20:14	18/10/2020 17:49	18/10/2020 20:14	2,41	1	2,41	CHI
20201097369	ANAPOLIS	AN11217365	JUNDIAI S1	18/10/2020 17:50	20/10/2020 16:36	18/10/2020 17:50	20/10/2020 16:36	46,76	57	2665,53	CHI
20201097368	VALPARAISO DE GOIAS	VA11405466	MARAJOARA	18/10/2020 17:50	18/10/2020 19:08	18/10/2020 17:50	18/10/2020 19:08	1,30	87	112,83	CHI
20201099567	GOIANESIA	GE11273339	GOIANESIA S2	18/10/2020 17:51	18/10/2020 21:50	18/10/2020 17:51	18/10/2020 21:50	3,97	109	432,97	CHI
20201097415	GOIANIA	GN11162001	FERROVIARIO S3	18/10/2020 17:51	18/10/2020 18:39	18/10/2020 17:51	18/10/2020 18:39	0,78	26	20,40	CHI
20201097989	ITUMBIARA	IT11000159	ITUMBIARA NOVA	18/10/2020 17:52	19/10/2020 11:10	18/10/2020 17:52	19/10/2020 11:10	17,30	102	1764,37	CHI
20201099688	NOVA CRIXAS	MH12125309	NOVA CRIXAS	18/10/2020 17:52	20/10/2020 09:30	18/10/2020 17:52	20/10/2020 09:30	39,63	3	118,89	CHI
20201099688	MUNDO NOVO DE GOIAS	MH12125309	NOVA CRIXAS	18/10/2020 17:52	20/10/2020 09:30	18/10/2020 17:52	20/10/2020 09:30	39,63	1	39,63	CHI
20201097484	NOVO GAMA	2460070968	PACAEMBU S1	18/10/2020 17:55	18/10/2020 22:34	18/10/2020 17:55	18/10/2020 22:34	4,65	1	4,65	CHI
20201097845	ANAPOLIS	AN11000319	JUNDIAI S2	18/10/2020 17:56	18/10/2020 21:00	18/10/2020 17:56	18/10/2020 21:00	3,05	92	280,93	CHI
20201098197	CALDAS NOVAS	CN12025381	SERRA DE CALDAS	18/10/2020 17:57	19/10/2020 00:16	18/10/2020 17:57	19/10/2020 00:16	6,31	10	63,14	CHI
20201097536	ALOANDIA	AD12011372RE	GOIATUBA S1	18/10/2020 17:57	18/10/2020 21:04	18/10/2020 17:57	18/10/2020 21:04	3,11	24	74,70	CHI
20201097536	MORRINHOS	AD12011372RE	GOIATUBA S1	18/10/2020 17:57	18/10/2020 21:04	18/10/2020 17:57	18/10/2020 21:04	3,11	21	65,36	CHI
20201097536	PONTALINA	AD12011372RE	GOIATUBA S1	18/10/2020 17:57	18/10/2020 21:04	18/10/2020 17:57	18/10/2020 21:04	3,11	6	18,67	CHI
20201097541	CAMPO LIMPO	AN21035296	NEROPOLIS S1	18/10/2020 17:57	19/10/2020 10:20	18/10/2020 17:57	19/10/2020 10:20	16,37	1	16,37	CHI
202010100989	ANAPOLIS	AN11129354	JUNDIAI S1	18/10/2020 17:58	19/10/2020 20:46	18/10/2020 17:58	19/10/2020 20:46	26,80	151	4047,09	CHI
20201097568	GOIANIA	GN11131445	GOIANIA LESTE S3	18/10/2020 17:58	18/10/2020 23:12	18/10/2020 17:58	18/10/2020 23:12	5,22	111	579,24	CHI
20201099196	RIO VERDE	6538173	RIO VERDE S2	18/10/2020 17:59	19/10/2020 10:05	18/10/2020 17:59	19/10/2020 10:05	16,10	238	3831,07	CHI
20201097577	LUZIANIA	120287810	RIO VERMELHO	18/10/2020 17:59	18/10/2020 19:48	18/10/2020 17:59	18/10/2020 19:48	1,81	1	1,81	CHI
20201099153	SAO LUIS DE MONTES BELOS	SL12000031	SAO LUIZ DOS MONTES BELOS	18/10/2020 18:00	18/10/2020 21:26	18/10/2020 18:00	18/10/2020 21:26	3,43	123	421,31	CHI
20201097607	ANICUNS	AC21289747	ANICUNS	18/10/2020 18:01	19/10/2020 15:57	18/10/2020 18:01	19/10/2020 15:57	21,93	2	43,87	CHI
20201097613	ALOANDIA	AD12108925	GOIATUBA S1	18/10/2020 18:01	19/10/2020 08:59	18/10/2020 18:01	19/10/2020 08:59	14,96	5	74,81	CHI

20201097613	MORRINHOS	AD12108925	GOIATUBA S1	18/10/2020 18:01	19/10/2020 08:59	18/10/2020 18:01	19/10/2020 08:59	14,96	2	29,92	CHI
20201098997	APARECIDA DE GOIANIA	AP11205337	ANHANGUERA	18/10/2020 18:01	18/10/2020 21:10	18/10/2020 18:01	18/10/2020 21:10	3,14	151	473,55	CHI
20201097625	APARECIDA DE GOIANIA	AP12205339	ANHANGUERA	18/10/2020 18:01	18/10/2020 20:19	18/10/2020 18:01	18/10/2020 20:19	2,30	809	1856,88	CHI
20201097863	ANAPOLIS	AN11377552	ANAPOLIS UNIVERSITARIO S2	18/10/2020 18:02	18/10/2020 19:32	18/10/2020 18:02	18/10/2020 19:32	1,50	91	136,10	CHI
20201098164	ANAPOLIS	AN11000312	JUNDIAI S1	18/10/2020 18:02	19/10/2020 10:36	18/10/2020 18:02	19/10/2020 10:36	16,55	153	2532,28	CHI
20201097753	PONTALINA	JV12025428	GOIATUBA S1	18/10/2020 18:04	18/10/2020 21:57	18/10/2020 18:04	18/10/2020 21:57	3,88	18	69,84	CHI
20201097753	PONTALINA	JV12025428	GOIATUBA S1	18/10/2020 18:04	18/10/2020 21:57	18/10/2020 18:04	18/10/2020 21:57	3,88	22	85,37	CHI
20201097753	JOVIANIA	JV12025428	GOIATUBA S1	18/10/2020 18:04	18/10/2020 21:57	18/10/2020 18:04	18/10/2020 21:57	3,88	8	31,04	CHI
20201097753	JOVIANIA	JV12025428	GOIATUBA S1	18/10/2020 18:04	18/10/2020 21:57	18/10/2020 18:04	18/10/2020 21:57	3,88	4	15,52	CHI
20201098270	NOVO GAMA	NJ11201118	MARAJOARA	18/10/2020 18:05	18/10/2020 21:24	18/10/2020 18:05	18/10/2020 21:24	3,31	73	241,79	CHI
20201097677	NOVO PLANALTO	2500004930	NOVO PLANALTO	18/10/2020 18:05	18/10/2020 21:59	18/10/2020 18:05	18/10/2020 21:59	3,89	1	3,89	CHI
20201097679	ANAPOLIS	20227309	JUNDIAI S1	18/10/2020 18:05	19/10/2020 14:28	18/10/2020 18:05	19/10/2020 14:28	20,37	1	20,37	CHI
20201097682	VIANOPOLIS	VN21159784	VIANOPOLIS	18/10/2020 18:06	19/10/2020 09:15	18/10/2020 18:06	19/10/2020 09:15	15,15	1	15,15	CHI
20201097684	CACHOEIRA DOURADA	CD12057901	CACHOEIRA DOURADA	18/10/2020 18:06	19/10/2020 11:53	18/10/2020 20:58	19/10/2020 11:53	14,93	1	14,93	CHI
20201097684	CACHOEIRA DOURADA	CD12000044	CACHOEIRA DOURADA	18/10/2020 18:06	19/10/2020 11:53	18/10/2020 20:58	19/10/2020 04:16	7,30	9	65,69	CHI
20201097684	CACHOEIRA DOURADA	CD21305478	CACHOEIRA DOURADA	18/10/2020 18:06	19/10/2020 11:53	18/10/2020 18:06	19/10/2020 03:22	9,27	1	9,27	CHI
20201097691	NIQUELANDIA	NQ12086219	URUACU	18/10/2020 18:06	18/10/2020 20:18	18/10/2020 18:06	18/10/2020 20:18	2,18	10	21,84	CHI
20201098917	ANAPOLIS	AN12270460	ANAPOLIS UNIVERSITARIO S2	18/10/2020 18:11	19/10/2020 16:34	18/10/2020 18:11	19/10/2020 16:34	22,37	74	1655,61	CHI
20201097736	ANAPOLIS	AN11107979	JUNDIAI S2	18/10/2020 18:11	18/10/2020 19:12	18/10/2020 18:11	18/10/2020 19:12	1,00	143	143,28	CHI
20201097749	ITAPACI	IW21181334	ITAPACI	18/10/2020 18:13	19/10/2020 05:58	18/10/2020 18:13	19/10/2020 05:58	11,75	1	11,75	CHI
20201097752	PIRES DO RIO	460039830	PIRES DO RIO S1	18/10/2020 18:13	19/10/2020 08:04	18/10/2020 18:13	19/10/2020 08:04	13,84	1	13,84	CHI
20201097914	DOVERLANDIA	DV12212770	CAIAPONIA	18/10/2020 18:13	18/10/2020 20:29	18/10/2020 18:13	18/10/2020 20:29	2,26	5	11,28	CHI
20201097763	LUZANIA	LZ11313608	MARAJOARA	18/10/2020 18:14	19/10/2020 08:23	18/10/2020 18:14	19/10/2020 08:23	14,15	179	2532,10	CHI
20201097797	NOVO GAMA	NJ11172228	PACAEMBU S1	18/10/2020 18:16	19/10/2020 10:02	18/10/2020 18:16	19/10/2020 10:02	15,76	55	866,56	CHI
20201097812	ANAPOLIS	21323690	JUNDIAI S1	18/10/2020 18:17	19/10/2020 17:56	18/10/2020 18:17	19/10/2020 17:56	23,65	1	23,65	CHI
202010100626	ANICUNS	AC12382504	ANICUNS	18/10/2020 18:17	19/10/2020 10:04	18/10/2020 18:17	19/10/2020 10:04	15,78	28	441,79	CHI
20201098277	MONTES CLAROS DE GOIAS	ME12244013	IPORA	18/10/2020 18:17	19/10/2020 01:37	18/10/2020 18:17	19/10/2020 01:37	7,33	8	58,60	CHI
202010100939	ANAPOLIS	AN11135737	JUNDIAI S1	18/10/2020 18:17	19/10/2020 10:19	18/10/2020 18:17	19/10/2020 10:19	16,02	93	1490,04	CHI
20201097824	ITARUMA	IM21158382	ITAJA S2	18/10/2020 18:17	18/10/2020 21:33	18/10/2020 18:17	18/10/2020 21:33	3,26	1	3,26	CHI
202010100940	ANAPOLIS	AN11022652	JUNDIAI S1	18/10/2020 18:17	19/10/2020 06:10	18/10/2020 18:17	19/10/2020 06:10	11,87	123	1459,87	CHI
20201098138	GOIANIA	GN12324570	NEROPOLIS S2	18/10/2020 18:18	19/10/2020 09:51	18/10/2020 18:18	19/10/2020 09:51	15,54	5	77,68	CHI
20201098138	NEROPOLIS	GN12324570	NEROPOLIS S2	18/10/2020 18:18	19/10/2020 09:51	18/10/2020 18:18	19/10/2020 09:51	15,54	1	15,54	CHI
20201097886	GOIAS	90093951	GOIAS	18/10/2020 18:19	18/10/2020 21:38	18/10/2020 18:19	18/10/2020 21:38	3,30	1	3,30	CHI
20201097905	NEROPOLIS	NR12319547	NEROPOLIS S2	18/10/2020 18:20	19/10/2020 18:30	18/10/2020 18:20	19/10/2020 18:30	24,16	4	96,64	CHI
20201097907	CATALAO	CT12288065LD	CATALAO S1	18/10/2020 18:20	19/10/2020 17:05	19/10/2020 16:52	19/10/2020 17:05	0,22	5	1,08	CHI
20201097907	CATALAO	CT12306674RE	CATALAO S1	18/10/2020 18:20	19/10/2020 17:05	18/10/2020 18:20	19/10/2020 01:29	7,15	129	922,78	CHI
20201097907	CATALAO	CT12306674RE	CATALAO S1	18/10/2020 18:20	19/10/2020 17:05	18/10/2020 20:28	19/10/2020 01:29	5,02	11	55,20	CHI
20201097972	ANAPOLIS	AN11374658	ANAPOLIS UNIVERSITARIO S2	18/10/2020 18:20	18/10/2020 22:56	18/10/2020 18:20	18/10/2020 22:56	4,58	123	563,85	CHI
20201097922	CAMPO LIMPO	AN21001073	NEROPOLIS S1	18/10/2020 18:21	19/10/2020 20:22	18/10/2020 18:21	19/10/2020 20:22	26,01	2	52,02	CHI
20201098648	ANAPOLIS	AN11129383	JUNDIAI S1	18/10/2020 18:21	19/10/2020 17:17	18/10/2020 18:21	19/10/2020 17:17	22,92	158	3621,67	CHI
20201099206	ANAPOLIS	AN12370439	JUNDIAI S2	18/10/2020 18:21	18/10/2020 20:53	18/10/2020 18:21	18/10/2020 20:53	2,52	161	405,81	CHI
20201097949	DISTRITO FEDERAL	SN12237830	MARAJOARA	18/10/2020 18:22	19/10/2020 08:35	18/10/2020 18:22	19/10/2020 08:35	14,22	3	42,67	CHI
20201097949	SANTO ANTONIO DO DESCOBERTO	SN12237830	MARAJOARA	18/10/2020 18:22	19/10/2020 08:35	18/10/2020 18:22	19/10/2020 08:35	14,22	25	355,58	CHI
20201098180	ANAPOLIS	AN11121965	JUNDIAI S1	18/10/2020 18:22	19/10/2020 06:06	18/10/2020 18:22	19/10/2020 06:06	11,72	120	1406,67	CHI
20201097965	MOIPORA	MO12073398	IPORA	18/10/2020 18:23	18/10/2020 20:58	18/10/2020 18:23	18/10/2020 20:58	2,58	2	5,16	CHI
20201097987	ALOANDIA	AD12349784	GOIATUBA S1	18/10/2020 18:23	18/10/2020 23:25	18/10/2020 18:23	18/10/2020 23:25	5,02	1	5,02	CHI
202010100442	ANAPOLIS	AN11107980	ANAPOLIS UNIVERSITARIO S2	18/10/2020 18:24	19/10/2020 11:13	18/10/2020 18:24	19/10/2020 11:13	16,81	127	2135,08	CHI
20201098033	APARECIDA DE GOIANIA	AP12193733	INDEPENDENCIA S1	18/10/2020 18:25	18/10/2020 21:19	18/10/2020 18:25	18/10/2020 21:19	2,90	155	448,85	CHI
20201098035	BOM JESUS DE GOIAS	BJ21293326	BOM JESUS DE GOIAS	18/10/2020 18:25	19/10/2020 10:06	18/10/2020 18:25	19/10/2020 10:06	15,68	1	15,68	CHI
20201098467	ANAPOLIS	AN11000301	JUNDIAI S2	18/10/2020 18:25	19/10/2020 11:20	18/10/2020 18:25	19/10/2020 11:20	16,91	88	1488,13	CHI
20201098040	GOIANIA	17420118	FERROVIARIO S3	18/10/2020 18:25	18/10/2020 19:22	18/10/2020 18:25	18/10/2020 19:22	0,94	1	0,94	CHI

20201098058	PIRES DO RIO	PR12404780	PIRES DO RIO S1	18/10/2020 18:26	19/10/2020 08:57	18/10/2020 18:26	19/10/2020 08:57	14,53	3	43,58	CHI
20201099420	JATAI	JT11172861	JATAI S3	18/10/2020 18:26	19/10/2020 00:18	18/10/2020 18:26	19/10/2020 00:18	5,86	79	463,01	CHI
20201098075	CIDADE OCIDENTAL	DH11156970	MARAJOARA	18/10/2020 18:27	18/10/2020 22:50	18/10/2020 18:27	18/10/2020 22:50	4,39	8	35,09	CHI
20201098089	AMORINOPOLIS	IV12165613	IPORA	18/10/2020 18:27	18/10/2020 22:11	18/10/2020 18:27	18/10/2020 22:11	3,72	6	22,33	CHI
20201098089	IVOLANDIA	IV12165613	IPORA	18/10/2020 18:27	18/10/2020 22:11	18/10/2020 18:27	18/10/2020 22:11	3,72	6	22,33	CHI
20201098800	BELA VISTA DE GOIAS	HD16424179	CEPAIGO S2	18/10/2020 18:30	19/10/2020 13:22	18/10/2020 18:37	19/10/2020 13:22	18,74	9	168,63	CHI
20201098800	HIDROLANDIA	HD16424179	CEPAIGO S2	18/10/2020 18:30	19/10/2020 13:22	18/10/2020 18:37	19/10/2020 13:22	18,74	220	4121,94	CHI
20201098800	HIDROLANDIA	HD16424174	CEPAIGO S2	18/10/2020 18:30	19/10/2020 13:22	19/10/2020 13:18	19/10/2020 13:21	0,05	315	15,92	CHI
20201098800	HIDROLANDIA	HD10403998	CEPAIGO S2	18/10/2020 18:30	19/10/2020 13:22	18/10/2020 18:37	19/10/2020 11:59	17,36	9	156,23	CHI
20201098800	HIDROLANDIA	HD12313035LD	CEPAIGO S2	18/10/2020 18:30	19/10/2020 13:22	18/10/2020 18:37	19/10/2020 11:55	17,30	4	69,19	CHI
20201098800	HIDROLANDIA	HD10383712	CEPAIGO S2	18/10/2020 18:30	19/10/2020 13:22	18/10/2020 18:30	19/10/2020 10:26	15,95	12	191,34	CHI
20201098800	HIDROLANDIA	00360434	CEPAIGO S2	18/10/2020 18:30	19/10/2020 13:22	18/10/2020 18:37	19/10/2020 10:26	15,81	567	8966,00	CHI
20201098800	HIDROLANDIA	HD12341895LD	CEPAIGO S2	18/10/2020 18:30	19/10/2020 13:22	19/10/2020 05:41	19/10/2020 10:16	4,59	22	101,05	CHI
20201098800	ARAGOIANIA	HD12341895LD	CEPAIGO S2	18/10/2020 18:30	19/10/2020 13:22	19/10/2020 05:41	19/10/2020 10:16	4,59	2	9,19	CHI
20201098800	HIDROLANDIA	HD13072710	CEPAIGO S2	18/10/2020 18:30	19/10/2020 13:22	18/10/2020 18:37	19/10/2020 09:56	15,31	107	1638,47	CHI
20201098800	HIDROLANDIA	PJ13200328	CEPAIGO S2	18/10/2020 18:30	19/10/2020 13:22	18/10/2020 18:37	18/10/2020 23:36	4,98	64	318,60	CHI
20201098800	PROFESSOR JAMIL SAFADY	PJ13200328	CEPAIGO S2	18/10/2020 18:30	19/10/2020 13:22	18/10/2020 18:37	18/10/2020 23:36	4,98	1	4,98	CHI
20201098800	PIRACANJUBA	PJ13200328	CEPAIGO S2	18/10/2020 18:30	19/10/2020 13:22	18/10/2020 18:37	18/10/2020 23:36	4,98	4	19,91	CHI
20201098800	HIDROLANDIA	HD10221925	CEPAIGO S2	18/10/2020 18:30	19/10/2020 13:22	18/10/2020 18:37	18/10/2020 22:49	4,19	488	2044,18	CHI
20201098800	HIDROLANDIA	HD10216316	CEPAIGO S2	18/10/2020 18:30	19/10/2020 13:22	18/10/2020 18:37	18/10/2020 21:59	3,35	299	1002,73	CHI
20201098800	HIDROLANDIA	HD16415918	CEPAIGO S2	18/10/2020 18:30	19/10/2020 13:22	18/10/2020 18:37	18/10/2020 21:57	3,33	109	363,06	CHI
20201098800	HIDROLANDIA	HD10396915	CEPAIGO S2	18/10/2020 18:30	19/10/2020 13:22	18/10/2020 18:37	18/10/2020 21:17	2,65	1124	2981,72	CHI
20201098800	HIDROLANDIA	HD10413635	CEPAIGO S2	18/10/2020 18:30	19/10/2020 13:22	18/10/2020 18:46	18/10/2020 20:25	1,66	541	898,06	CHI
20201098800	HIDROLANDIA	HD10402775	CEPAIGO S2	18/10/2020 18:30	19/10/2020 13:22	18/10/2020 18:37	18/10/2020 20:21	1,72	524	903,03	CHI
20201098800	APARECIDA DE GOIANIA	HD10383712	CEPAIGO S2	18/10/2020 18:30	19/10/2020 13:22	18/10/2020 18:30	18/10/2020 20:16	1,78	4	7,13	CHI
20201098800	HIDROLANDIA	HD10383712	CEPAIGO S2	18/10/2020 18:30	19/10/2020 13:22	18/10/2020 18:30	18/10/2020 20:16	1,78	2	3,56	CHI
20201098800	HIDROLANDIA	HD16409682	CEPAIGO S2	18/10/2020 18:30	19/10/2020 13:22	18/10/2020 18:37	18/10/2020 18:41	0,07	1934	127,86	CHI
20201098800	APARECIDA DE GOIANIA	00360434	CEPAIGO S2	18/10/2020 18:30	19/10/2020 13:22	18/10/2020 18:30	18/10/2020 18:34	0,07	1	0,07	CHI
20201099018	GOIANIRA	GR11133810	GOIANIRA	18/10/2020 18:30	18/10/2020 21:54	18/10/2020 18:30	18/10/2020 21:54	3,40	164	557,60	CHI
20201098858	ANAPOLIS	AN11375933	JUNDIAI S1	18/10/2020 18:30	19/10/2020 03:37	18/10/2020 18:30	19/10/2020 03:37	9,11	59	537,67	CHI
20201098156	NOVA GLORIA	NG21130115	ITAPACI	18/10/2020 18:30	19/10/2020 10:15	18/10/2020 18:30	19/10/2020 10:15	15,74	1	15,74	CHI
20201098174	SAO FRANCISCO DE GOIAS	SF12297998	SAO FRANCISCO DE GOIAS	18/10/2020 18:31	19/10/2020 08:04	18/10/2020 18:31	19/10/2020 08:04	13,54	88	1191,89	CHI
20201098212	PADRE BERNARDO	PB12320095	PADRE BERNARDO	18/10/2020 18:32	18/10/2020 19:47	18/10/2020 18:32	18/10/2020 19:47	1,24	1	1,24	CHI
20201098225	OUVIDOR	OU12195351	CATALAO S1	18/10/2020 18:33	18/10/2020 20:13	18/10/2020 18:33	18/10/2020 20:13	1,67	2	3,33	CHI
20201098343	CRISTALINA	KR10395376	CRISTALINA S1	18/10/2020 18:33	18/10/2020 18:36	18/10/2020 18:33	18/10/2020 18:36	0,05	269	13,67	CHI
20201098343	IPAMERI	KR10395376	CRISTALINA S1	18/10/2020 18:33	18/10/2020 18:36	18/10/2020 18:33	18/10/2020 18:36	0,05	6	0,31	CHI
202010100768	SANTO ANTONIO DE GOIAS	NV12382719	INHUMAS S1	18/10/2020 18:33	19/10/2020 09:48	18/10/2020 18:33	19/10/2020 09:48	15,24	1	15,24	CHI
202010100768	OURO VERDE DE GOIAS	NV12382719	INHUMAS S1	18/10/2020 18:33	19/10/2020 09:48	18/10/2020 18:33	19/10/2020 09:48	15,24	50	762,24	CHI
202010100768	NOVA VENEZA	NV12382719	INHUMAS S1	18/10/2020 18:33	19/10/2020 09:48	18/10/2020 18:33	19/10/2020 09:48	15,24	115	1753,14	CHI
202010100768	NEROPOLIS	NV12382719	INHUMAS S1	18/10/2020 18:33	19/10/2020 09:48	18/10/2020 18:33	19/10/2020 09:48	15,24	2	30,49	CHI
202010100768	DAMOLANDIA	NV12382719	INHUMAS S1	18/10/2020 18:33	19/10/2020 09:48	18/10/2020 18:33	19/10/2020 09:48	15,24	3	45,73	CHI
20201098243	NOVO GAMA	NJ11097405	PACAEMBU S1	18/10/2020 18:33	18/10/2020 21:58	18/10/2020 18:33	18/10/2020 21:58	3,41	140	476,82	CHI
20201099758	NEROPOLIS	NR11169182	NEROPOLIS S2	18/10/2020 18:33	18/10/2020 22:53	18/10/2020 18:33	18/10/2020 22:53	4,32	124	535,96	CHI
20201099892	NOVO GAMA	NJ11059648	PACAEMBU S1	18/10/2020 18:34	18/10/2020 21:04	18/10/2020 18:34	18/10/2020 21:04	2,49	144	359,28	CHI
20201099073	PETROLINA DE GOIAS	PG11156817	PETROLINA	18/10/2020 18:34	18/10/2020 21:14	18/10/2020 18:34	18/10/2020 21:14	2,66	134	356,51	CHI
20201098273	LUZIANIA	LZ12383010	MARAJOARA	18/10/2020 18:34	18/10/2020 22:31	18/10/2020 18:34	18/10/2020 22:31	3,94	9	35,42	CHI
20201098293	PLANALTINA	10003400440	PLANALTINA	18/10/2020 18:35	18/10/2020 19:44	18/10/2020 18:35	18/10/2020 19:44	1,14	1	1,14	CHI
20201098324	CAMPO LIMPO	AN21357369	NEROPOLIS S1	18/10/2020 18:37	19/10/2020 21:21	18/10/2020 18:37	19/10/2020 21:21	26,73	3	80,18	CHI
20201098332	MARA ROSA	MQ21220764	SANTA TEREZINHA	18/10/2020 18:37	18/10/2020 23:49	18/10/2020 18:37	18/10/2020 23:49	5,19	1	5,19	CHI
20201098335	ANAPOLIS	AN21370324	JUNDIAI S1	18/10/2020 18:38	18/10/2020 21:26	18/10/2020 18:38	18/10/2020 21:26	2,80	1	2,80	CHI
20201098338	PONTALINA	PK12099534	VICENTINOPOLIS	18/10/2020 18:38	19/10/2020 06:03	18/10/2020 18:38	19/10/2020 06:03	11,42	2	22,84	CHI

202010100874	PONTALINA	PK32047343RE	VICENTINOPOLIS	18/10/2020 18:38	19/10/2020 06:03	18/10/2020 18:38	19/10/2020 06:03	11,42	29	331,12	CHI
20201098353	MARA ROSA	MQ21125487	MARA ROSA	18/10/2020 18:38	18/10/2020 19:49	18/10/2020 18:38	18/10/2020 19:49	1,17	1	1,17	CHI
20201098371	RIO VERDE	10008697904	RIO VERDE S1	18/10/2020 18:39	18/10/2020 19:55	18/10/2020 18:39	18/10/2020 19:55	1,27	1	1,27	CHI
20201098391	ANAPOLIS	20950652	JUNDIAI S1	18/10/2020 18:40	19/10/2020 18:20	18/10/2020 18:40	19/10/2020 18:20	23,66	1	23,66	CHI
20201098398	PALMINOPOLIS	PP21053893	PALMEIRAS	18/10/2020 18:41	18/10/2020 23:26	18/10/2020 18:41	18/10/2020 23:26	4,75	3	14,25	CHI
20201099019	ANAPOLIS	AN11185054	ANAPOLIS UNIVERSITARIO S2	18/10/2020 18:41	19/10/2020 22:58	18/10/2020 18:41	19/10/2020 22:58	28,27	115	3251,37	CHI
20201098412	GOIATUBA	GT21197901	BOM JESUS DE GOIAS	18/10/2020 18:41	18/10/2020 21:12	18/10/2020 18:41	18/10/2020 21:12	2,50	2	5,01	CHI
20201099536	ITUMBIARA	IT11000036	ITUMBIARA VELHA S1	18/10/2020 18:42	18/10/2020 23:46	18/10/2020 18:42	18/10/2020 23:46	5,06	92	465,55	CHI
202010100589	CALDAS NOVAS	CN21216501	VILA CORUMBA	18/10/2020 18:42	18/10/2020 21:46	18/10/2020 18:42	18/10/2020 21:46	3,05	42	128,31	CHI
20201098463	VARJAO	VJ21198538	GUAPO S2	18/10/2020 18:43	19/10/2020 05:26	18/10/2020 18:43	19/10/2020 05:26	10,72	1	10,72	CHI
20201098464	PIRACANJUBA	PJ11182881	PIRACANJUBA	18/10/2020 18:43	18/10/2020 21:08	18/10/2020 18:43	18/10/2020 21:08	2,41	74	178,34	CHI
20201098473	DAMOLANDIA	DL12014118	INHUMAS S1	18/10/2020 18:43	19/10/2020 12:26	18/10/2020 18:43	19/10/2020 12:26	17,70	7	123,92	CHI
20201098484	SANTO ANTONIO DA BARRA	BZ21381446	ACREUNA	18/10/2020 18:44	18/10/2020 20:43	18/10/2020 18:44	18/10/2020 20:43	1,98	1	1,98	CHI
20201098493	ANAPOLIS	20591585	JUNDIAI S1	18/10/2020 18:44	19/10/2020 10:08	18/10/2020 18:44	19/10/2020 10:08	15,39	1	15,39	CHI
20201098503	GUAPO	GA21220924	GUAPO S1	18/10/2020 18:45	19/10/2020 00:09	18/10/2020 18:45	19/10/2020 00:09	5,39	1	5,39	CHI
20201099302	SAO JOAO DA PARAUNA	RP12076382RE	FIRMINOPOLIS S2	18/10/2020 18:46	19/10/2020 00:40	18/10/2020 18:46	19/10/2020 00:40	5,90	61	359,63	CHI
20201098531	ABADIANIA	AA12384735	DAIA S2	18/10/2020 18:46	18/10/2020 22:50	18/10/2020 18:46	18/10/2020 22:50	4,06	69	280,43	CHI
20201098532	NEROPOLIS	NR21009260	NEROPOLIS S2	18/10/2020 18:46	19/10/2020 02:38	18/10/2020 18:46	19/10/2020 02:38	7,86	1	7,86	CHI
20201099703	CORUMBAIBA	CI12110198	VILA CORUMBA	18/10/2020 18:47	18/10/2020 21:22	18/10/2020 18:47	18/10/2020 21:22	2,58	8	20,64	CHI
20201098551	SAO JOAO D ALIANCA	JL11287959	SAO JOAO D ALIANCA	18/10/2020 18:47	18/10/2020 20:32	18/10/2020 18:47	18/10/2020 20:32	1,74	16	27,91	CHI
202010100789	ANAPOLIS	AN12000688	JUNDIAI S1	18/10/2020 18:47	19/10/2020 00:24	18/10/2020 18:47	19/10/2020 00:24	5,61	423	2372,56	CHI
20201099278	ANAPOLIS	AN11000499	ANAPOLIS UNIVERSITARIO S2	18/10/2020 18:47	19/10/2020 13:23	18/10/2020 18:47	19/10/2020 13:23	18,59	153	2844,53	CHI
20201098599	GOIANIRA	10010116786	MEIA PONTE	18/10/2020 18:49	19/10/2020 04:27	18/10/2020 18:49	19/10/2020 04:27	9,63	1	9,63	CHI
20201099739	CAMPO LIMPO	AN12258905	JUNDIAI S1	18/10/2020 18:49	18/10/2020 22:27	18/10/2020 18:49	18/10/2020 22:27	3,63	1	3,63	CHI
20201099739	ANAPOLIS	AN12258905	JUNDIAI S1	18/10/2020 18:49	18/10/2020 22:27	18/10/2020 18:49	18/10/2020 22:27	3,63	6	21,77	CHI
20201099601	JESUPOLIS	SF12066036	SAO FRANCISCO DE GOIAS	18/10/2020 18:50	18/10/2020 21:03	18/10/2020 18:50	18/10/2020 21:03	2,20	16	35,21	CHI
202010100096	SAO MIGUEL DO ARAGUAIA	SM12074411	SAO MIGUEL DO ARAGUAIA	18/10/2020 18:50	18/10/2020 22:23	18/10/2020 18:50	18/10/2020 22:23	3,54	13	45,98	CHI
20201098693	BRITANIA	BT11165325	BRITANIA	18/10/2020 18:52	18/10/2020 23:01	18/10/2020 18:52	18/10/2020 23:01	4,14	42	173,98	CHI
20201098703	SANTO ANTONIO DO DESCOBERTO	SN12330527	MARAJOARA	18/10/2020 18:53	18/10/2020 23:07	18/10/2020 18:53	18/10/2020 23:07	4,23	16	67,68	CHI
20201098709	SILVANIA	SV21120471	DAIA S2	18/10/2020 18:53	18/10/2020 22:40	18/10/2020 18:53	18/10/2020 22:40	3,78	1	3,78	CHI
20201098739	ANAPOLIS	AN11000404	JUNDIAI S1	18/10/2020 18:55	19/10/2020 13:21	18/10/2020 18:55	19/10/2020 13:21	18,43	69	1271,78	CHI
20201099968	ANAPOLIS	AN11034168	ANAPOLIS UNIVERSITARIO S2	18/10/2020 18:56	19/10/2020 08:49	18/10/2020 18:56	19/10/2020 08:49	13,87	64	887,73	CHI
20201098808	MOZARLANDIA	10012604559	MOZARLANDIA	18/10/2020 18:57	19/10/2020 03:55	18/10/2020 18:57	19/10/2020 03:55	8,95	1	8,95	CHI
20201098813	ANAPOLIS	21384800	JUNDIAI S1	18/10/2020 18:58	19/10/2020 08:49	18/10/2020 18:58	19/10/2020 08:49	13,85	1	13,85	CHI
20201098818	ANAPOLIS	20759630	JUNDIAI S2	18/10/2020 18:58	19/10/2020 09:58	18/10/2020 18:58	19/10/2020 09:58	14,99	1	14,99	CHI
202010101281	PETROLINA DE GOIAS	PG12015839	PETROLINA	18/10/2020 19:00	19/10/2020 08:09	18/10/2020 19:00	19/10/2020 08:09	13,14	5	65,68	CHI
20201099505	ITAUUCU	IX12000065	INHUMAS S1	18/10/2020 19:01	19/10/2020 10:08	18/10/2020 19:01	19/10/2020 10:08	15,11	39	589,25	CHI
20201099505	ITABERAI	IX12000065	INHUMAS S1	18/10/2020 19:01	19/10/2020 10:08	18/10/2020 19:01	19/10/2020 10:08	15,11	40	604,36	CHI
20201099076	GOIANIA	GN11059989	ATLANTICO S3	18/10/2020 19:09	19/10/2020 00:48	18/10/2020 19:09	19/10/2020 00:48	5,64	99	558,36	CHI
20201099856	ANAPOLIS	AN11000405	JUNDIAI S1	18/10/2020 19:10	18/10/2020 22:32	18/10/2020 19:10	18/10/2020 22:32	3,37	136	457,72	CHI
20201099133	CAIAPONIA	CP12223010	PALESTINA	18/10/2020 19:12	19/10/2020 09:15	18/10/2020 19:12	19/10/2020 09:15	14,04	9	126,38	CHI
20201099146	CAMPO ALEGRE DE GOIAS	CM12192737	CAMPO ALEGRE DE GOIAS	18/10/2020 19:13	18/10/2020 21:28	18/10/2020 19:13	18/10/2020 21:28	2,25	17	38,22	CHI
20201099182	NOVO GAMA	NJ11248693	MARAJOARA	18/10/2020 19:14	18/10/2020 21:55	18/10/2020 19:14	18/10/2020 21:55	2,67	123	328,38	CHI
20201099850	ANAPOLIS	AN11129406	ANAPOLIS UNIVERSITARIO S2	18/10/2020 19:16	19/10/2020 15:53	18/10/2020 19:16	19/10/2020 15:53	20,62	128	2638,90	CHI
20201099216	GOIANIA	14660751	XAVANTES	18/10/2020 19:16	18/10/2020 20:01	18/10/2020 19:16	18/10/2020 20:01	0,75	1	0,75	CHI
20201099511	ITAUUCU	IX12015031	INHUMAS S1	18/10/2020 19:16	19/10/2020 23:05	18/10/2020 19:16	19/10/2020 23:05	27,80	16	444,87	CHI
20201099254	ANAPOLIS	10020753142	JUNDIAI S1	18/10/2020 19:18	19/10/2020 10:56	18/10/2020 19:18	19/10/2020 10:56	15,63	1	15,63	CHI
20201099272	NIQUELANDIA	NQ12371855RE	BARRO ALTO	18/10/2020 19:19	18/10/2020 23:50	18/10/2020 19:19	18/10/2020 23:50	4,51	245	1105,97	CHI
20201099272	MIMOSO DE GOIAS	NQ12371855RE	BARRO ALTO	18/10/2020 19:19	18/10/2020 23:50	18/10/2020 19:19	18/10/2020 23:50	4,51	4	18,06	CHI
20201099795	GOIANIA	GN12042244	ATLANTICO S3	18/10/2020 19:19	18/10/2020 20:47	18/10/2020 19:19	18/10/2020 20:47	1,46	131	191,51	CHI
20201099290	GOIANIA	12471252	GOIANIA LESTE S2	18/10/2020 19:19	18/10/2020 22:01	18/10/2020 19:19	18/10/2020 22:01	2,69	1	2,69	CHI

20201099305	ANAPOLIS	20831810	JUNDIAI S1	18/10/2020 19:20	20/10/2020 08:46	18/10/2020 19:20	20/10/2020 08:46	37,42	1	37,42	CHI
20201099411	SANTO ANTONIO DE GOIAS	GR21012965	NEROPOLIS S1	18/10/2020 19:23	19/10/2020 10:24	18/10/2020 19:23	19/10/2020 10:24	15,01	1	15,01	CHI
20201099455	MORRINHOS	MR21000141	MORRINHOS	18/10/2020 19:25	18/10/2020 21:12	18/10/2020 19:25	18/10/2020 21:12	1,78	1	1,78	CHI
20201099485	CALDAS NOVAS	CN21090589	RIO QUENTE	18/10/2020 19:26	18/10/2020 21:22	18/10/2020 19:26	18/10/2020 21:22	1,93	1	1,93	CHI
202010100570	APARECIDA DE GOIANIA	AP12004656	INDEPENDENCIA S1	18/10/2020 19:26	18/10/2020 21:35	18/10/2020 19:26	18/10/2020 21:35	2,15	353	757,68	CHI
20201099492	GAMELEIRA DE GOIAS	SV21090547	DAIA S2	18/10/2020 19:26	19/10/2020 04:50	18/10/2020 19:26	19/10/2020 04:50	9,39	1	9,39	CHI
20201099518	CORUMBAIBA	CI12000093RE	VILA CORUMBA	18/10/2020 19:27	18/10/2020 23:45	18/10/2020 19:27	18/10/2020 23:45	4,29	55	235,68	CHI
20201099533	MOSSAMEDES	AC12308555	ANICUNS	18/10/2020 19:29	19/10/2020 17:44	18/10/2020 19:29	19/10/2020 17:44	22,25	18	400,50	CHI
20201099533	AMERICANO DO BRASIL	AC12308555	ANICUNS	18/10/2020 19:29	19/10/2020 17:44	18/10/2020 19:29	19/10/2020 17:44	22,25	18	400,50	CHI
20201099533	ANICUNS	AC12308555	ANICUNS	18/10/2020 19:29	19/10/2020 17:44	18/10/2020 19:29	19/10/2020 17:44	22,25	4	89,00	CHI
20201099535	APARECIDA DE GOIANIA	10024786991	INDEPENDENCIA S1	18/10/2020 19:29	18/10/2020 22:27	18/10/2020 19:29	18/10/2020 22:27	2,96	1	2,96	CHI
20201099542	CRIXAS	CX12254975	SERRA DO OURO	18/10/2020 19:29	19/10/2020 01:27	18/10/2020 19:29	19/10/2020 01:27	5,95	61	363,24	CHI
20201099556	RIO VERDE	RV12219435LD	ACREUNA	18/10/2020 19:31	19/10/2020 10:11	18/10/2020 19:31	19/10/2020 10:11	14,67	3	44,02	CHI
20201099556	PARAUNA	RV12219435LD	ACREUNA	18/10/2020 19:31	19/10/2020 10:11	19/10/2020 09:04	19/10/2020 10:11	1,12	147	165,25	CHI
20201099556	RIO VERDE	RV12219435LD	ACREUNA	18/10/2020 19:31	19/10/2020 10:11	19/10/2020 09:04	19/10/2020 10:11	1,12	33	37,10	CHI
20201099754	JARAGUA	JA11211755	JARAGUA	18/10/2020 19:31	18/10/2020 22:32	18/10/2020 19:31	18/10/2020 22:32	3,01	70	210,72	CHI
20201099561	LUZIANIA	120118993	PACAEMBU S2	18/10/2020 19:31	19/10/2020 22:24	18/10/2020 19:31	18/10/2020 22:24	2,89	1	2,89	CHI
20201099572	MORRINHOS	150138787	MORRINHOS	18/10/2020 19:32	18/10/2020 20:22	18/10/2020 19:32	18/10/2020 20:22	0,82	1	0,82	CHI
202010100352	ISRAELANDIA	IS11043228	IPORA	18/10/2020 19:32	19/10/2020 12:15	18/10/2020 19:32	19/10/2020 12:15	16,70	159	2655,83	CHI
20201099589	PALMINOPOLIS	PP21006720	PALMEIRAS	18/10/2020 19:34	19/10/2020 01:28	18/10/2020 19:34	19/10/2020 01:28	5,89	1	5,89	CHI
20201099593	NOVO GAMA	2900059131	MARAJOARA	18/10/2020 19:34	19/10/2020 09:53	18/10/2020 19:34	19/10/2020 09:53	14,31	1	14,31	CHI
20201099596	ANICUNS	AC21204355	FIRMINOPOLIS S2	18/10/2020 19:35	19/10/2020 08:58	18/10/2020 19:35	19/10/2020 08:58	13,38	1	13,38	CHI
202010100574	DAMOLANDIA	PG12335038	PETROLINA	18/10/2020 19:35	18/10/2020 21:52	18/10/2020 19:35	18/10/2020 21:52	2,27	1	2,27	CHI
202010100574	PETROLINA DE GOIAS	PG12335038	PETROLINA	18/10/2020 19:35	18/10/2020 21:52	18/10/2020 19:35	18/10/2020 21:52	2,27	24	54,55	CHI
202010100115	ITAUCU	IX12324563	INHUMAS S1	18/10/2020 19:36	19/10/2020 14:01	18/10/2020 19:36	19/10/2020 14:01	18,41	4	73,64	CHI
202010100115	INHUMAS	IX12324563	INHUMAS S1	18/10/2020 19:36	19/10/2020 14:01	18/10/2020 19:36	19/10/2020 14:01	18,41	12	220,92	CHI
20201099618	CAMPO ALEGRE DE GOIAS	CM12166728	CAMPO ALEGRE DE GOIAS	18/10/2020 19:37	19/10/2020 00:12	18/10/2020 19:37	19/10/2020 00:12	4,58	35	160,39	CHI
20201099622	JATAI	JT21334210	JATAI S3	18/10/2020 19:37	19/10/2020 06:04	18/10/2020 19:37	19/10/2020 06:04	10,43	1	10,43	CHI
20201099624	LUZIANIA	LZ21261348	MARAJOARA	18/10/2020 19:37	19/10/2020 03:48	18/10/2020 19:37	19/10/2020 03:48	8,17	2	16,33	CHI
20201099957	NEROPOLIS	NR11199326	NEROPOLIS S2	18/10/2020 19:38	18/10/2020 22:15	18/10/2020 19:38	18/10/2020 22:15	2,61	88	230,12	CHI
20201099679	CRISTALINA	KR12074919RE	CRISTALINA S2	18/10/2020 19:39	20/10/2020 17:22	19/10/2020 17:15	20/10/2020 17:22	24,12	88	2122,76	CHI
20201099679	CRISTALINA	KR13407439	CRISTALINA S2	18/10/2020 19:39	20/10/2020 17:22	19/10/2020 17:15	20/10/2020 16:34	23,32	14	326,50	CHI
20201099679	CRISTALINA	KR10414277	CRISTALINA S2	18/10/2020 19:39	20/10/2020 17:22	19/10/2020 17:15	19/10/2020 17:41	0,44	4	1,75	CHI
20201099679	CRISTALINA	KR10414277	CRISTALINA S2	18/10/2020 19:39	20/10/2020 17:22	18/10/2020 19:39	19/10/2020 17:14	21,58	102	2201,33	CHI
20201099679	CRISTALINA	KR10414277	CRISTALINA S2	18/10/2020 19:39	20/10/2020 17:22	19/10/2020 00:10	19/10/2020 00:40	0,51	4	2,04	CHI
20201099679	CRISTALINA	KR10414277	CRISTALINA S2	18/10/2020 19:39	20/10/2020 17:22	18/10/2020 19:39	18/10/2020 22:34	2,92	4	11,69	CHI
20201099679	LUZIANIA	LZ10410943	CRISTALINA S2	18/10/2020 19:39	20/10/2020 17:22	18/10/2020 20:15	18/10/2020 21:50	1,59	68	108,27	CHI
20201099679	CRISTALINA	KR10414277	CRISTALINA S2	18/10/2020 19:39	20/10/2020 17:22	18/10/2020 19:39	18/10/2020 21:45	2,11	449	948,76	CHI
20201099679	CRISTALINA	KR10414277	CRISTALINA S2	18/10/2020 19:39	20/10/2020 17:22	18/10/2020 19:39	18/10/2020 21:45	2,11	29	61,28	CHI
20201099679	LUZIANIA	KR10414277	CRISTALINA S2	18/10/2020 19:39	20/10/2020 17:22	18/10/2020 19:39	18/10/2020 21:45	2,11	265	559,96	CHI
20201099643	ANAPOLIS	21202278	JUNDIAI S1	18/10/2020 19:39	19/10/2020 17:56	18/10/2020 19:39	19/10/2020 17:56	22,27	1	22,27	CHI
20201099645	PARANAIGUARA	2230045204	CACHOEIRA ALTA	18/10/2020 19:39	18/10/2020 21:34	18/10/2020 19:39	18/10/2020 21:34	1,90	1	1,90	CHI
20201099659	GOIANIA	10007567039	XAVANTES	18/10/2020 19:40	18/10/2020 22:30	18/10/2020 19:40	18/10/2020 22:30	2,82	1	2,82	CHI
20201099673	INHUMAS	IN12000105	INHUMAS S2	18/10/2020 19:42	19/10/2020 16:09	18/10/2020 19:42	19/10/2020 16:09	20,45	1	20,45	CHI
20201099696	PIRENOPOLIS	PV21000026	CORUMBA	18/10/2020 19:43	18/10/2020 21:35	18/10/2020 19:43	18/10/2020 21:35	1,85	1	1,85	CHI
20201099710	ANAPOLIS	AN21045694	JUNDIAI S1	18/10/2020 19:45	19/10/2020 17:28	18/10/2020 19:45	19/10/2020 17:28	21,72	6	130,30	CHI
20201099817	JARAGUA	GE12353391	GOIANESIA S2	18/10/2020 19:45	18/10/2020 23:09	18/10/2020 19:45	18/10/2020 23:09	3,39	8	27,12	CHI
20201099817	GOIANESIA	GE12353391	GOIANESIA S2	18/10/2020 19:45	18/10/2020 23:09	18/10/2020 19:45	18/10/2020 23:09	3,39	1	3,39	CHI
202010100213	ANICUNS	AC11000016	ANICUNS	18/10/2020 19:46	19/10/2020 06:33	18/10/2020 19:46	19/10/2020 06:33	10,78	187	2015,91	CHI
20201099730	ANAPOLIS	20239993	JUNDIAI S1	18/10/2020 19:47	19/10/2020 12:43	18/10/2020 19:47	19/10/2020 12:43	16,93	1	16,93	CHI
20201099826	CATALAO	CT11246490	CATALAO S2	18/10/2020 19:47	19/10/2020 00:10	18/10/2020 19:47	19/10/2020 00:10	4,39	219	962,20	CHI

202010100198	GOIANIRA	03920224	NEROPOLIS S1	18/10/2020 19:47	18/10/2020 20:54	18/10/2020 19:47	18/10/2020 20:54	1,11	7	7,77	CHI
202010100198	BRAZABRANTES	03920224	NEROPOLIS S1	18/10/2020 19:47	18/10/2020 20:54	18/10/2020 19:47	18/10/2020 20:54	1,11	2	2,22	CHI
202010100198	BRAZABRANTES	03920224	NEROPOLIS S1	18/10/2020 19:47	18/10/2020 20:54	18/10/2020 19:47	18/10/2020 20:34	0,78	4	3,13	CHI
202010100198	GOIANIRA	03920224	NEROPOLIS S1	18/10/2020 19:47	18/10/2020 20:54	18/10/2020 19:47	18/10/2020 20:34	0,78	22	17,22	CHI
202010100198	BRAZABRANTES	03920224	NEROPOLIS S1	18/10/2020 19:47	18/10/2020 20:54	18/10/2020 19:47	18/10/2020 20:08	0,35	310	108,50	CHI
202010100198	NOVA VENEZA	03920224	NEROPOLIS S1	18/10/2020 19:47	18/10/2020 20:54	18/10/2020 19:47	18/10/2020 20:08	0,35	3	1,05	CHI
202010100198	BRAZABRANTES	03920224	NEROPOLIS S1	18/10/2020 19:47	18/10/2020 20:54	18/10/2020 19:47	18/10/2020 20:05	0,30	3	0,90	CHI
202010100198	BRAZABRANTES	03920224	NEROPOLIS S1	18/10/2020 19:47	18/10/2020 20:54	18/10/2020 19:58	18/10/2020 20:05	0,13	59	7,39	CHI
20201099746	LUZIANIA	LZ21087397	MARAJOARA	18/10/2020 19:47	19/10/2020 00:49	18/10/2020 19:47	19/10/2020 00:49	5,02	1	5,02	CHI
202010100420	GOIANIRA	GR12102868	INHUMAS S2	18/10/2020 19:48	19/10/2020 02:17	18/10/2020 19:48	19/10/2020 02:17	6,48	3	19,44	CHI
20201099767	CRIXAS	10032375164	SERRA DO OURO	18/10/2020 19:49	19/10/2020 10:35	18/10/2020 19:49	19/10/2020 10:35	14,77	1	14,77	CHI
20201099770	SILVANIA	SV12087511	DAIA S2	18/10/2020 19:49	19/10/2020 09:05	18/10/2020 19:49	19/10/2020 09:05	13,27	2	26,53	CHI
20201099776	ITUMBIARA	10017896744	ITUMBIARA VELHA S1	18/10/2020 19:50	19/10/2020 09:37	18/10/2020 19:50	19/10/2020 09:37	13,78	1	13,78	CHI
20201099785	AGUA FRIA DE GOIAS	TL21321706	SAO JOAO D ALIANCA	18/10/2020 19:51	18/10/2020 21:52	18/10/2020 19:51	18/10/2020 21:52	2,01	1	2,01	CHI
20201099807	LEOPOLDO DE BULHOES	LB11105043	CEPAIGO S2	18/10/2020 19:52	18/10/2020 20:51	18/10/2020 19:52	18/10/2020 20:51	0,97	25	24,22	CHI
20201099808	ITAUCU	XX0869168X	INHUMAS S1	18/10/2020 19:52	19/10/2020 17:34	18/10/2020 19:52	19/10/2020 17:34	21,68	2	43,37	CHI
20201099829	GOIANIA	GN12130337	AEROPORTO S3	18/10/2020 19:55	19/10/2020 21:04	18/10/2020 19:55	18/10/2020 21:04	1,15	134	153,99	CHI
20201099819	ANICUNS	AC11186440	ANICUNS	18/10/2020 19:55	18/10/2020 22:37	18/10/2020 19:55	18/10/2020 22:37	2,70	82	221,06	CHI
202010100439	NOVA VENEZA	NV11075905	INHUMAS S1	18/10/2020 19:55	19/10/2020 00:48	18/10/2020 19:55	19/10/2020 00:48	4,88	145	707,40	CHI
20201099839	SAO JOAO D ALIANCA	3840014679	SAO JOAO D ALIANCA	18/10/2020 19:55	18/10/2020 21:07	18/10/2020 19:55	18/10/2020 21:07	1,19	1	1,19	CHI
20201099841	CRIXAS	CX12380727	SANTA TEREZINHA	18/10/2020 19:56	19/10/2020 06:21	18/10/2020 19:56	19/10/2020 06:21	10,42	6	62,50	CHI
20201099842	ANAPOLIS	20499188	DAIA S1	18/10/2020 19:56	19/10/2020 16:49	18/10/2020 19:56	19/10/2020 16:49	20,89	1	20,89	CHI
20201099849	TRINDADE	TR12144364	TRINDADE	18/10/2020 19:56	19/10/2020 08:04	18/10/2020 19:56	19/10/2020 08:04	12,12	134	1624,27	CHI
20201099858	TRINDADE	10031357219	GOYA S2	18/10/2020 19:57	18/10/2020 23:29	18/10/2020 19:57	18/10/2020 23:29	3,53	1	3,53	CHI
202010100232	CUMARI	CY12266858	CATALAO S1	18/10/2020 19:57	18/10/2020 22:02	18/10/2020 19:57	18/10/2020 22:02	2,07	78	161,53	CHI
202010100232	GOIANDIRA	CY12266858	CATALAO S1	18/10/2020 19:57	18/10/2020 22:02	18/10/2020 19:57	18/10/2020 22:02	2,07	13	26,92	CHI
202010100232	CORUMBAIBA	CY12266858	CATALAO S1	18/10/2020 19:57	18/10/2020 22:02	18/10/2020 19:57	18/10/2020 22:02	2,07	4	8,28	CHI
202010100232	NOVA AURORA	CY12266858	CATALAO S1	18/10/2020 19:57	18/10/2020 22:02	18/10/2020 19:57	18/10/2020 22:02	2,07	1	2,07	CHI
202010100232	ANHANGUERA	CY12266858	CATALAO S1	18/10/2020 19:57	18/10/2020 22:02	18/10/2020 19:57	18/10/2020 22:02	2,07	7	14,50	CHI
20201099876	MATRINCHA	MP12299725	MATRINCHA	18/10/2020 19:58	19/10/2020 07:18	18/10/2020 19:58	19/10/2020 07:18	11,33	6	68,00	CHI
20201099879	NOVO GAMA	10001136168	PACAEMBU S1	18/10/2020 19:58	19/10/2020 08:48	18/10/2020 19:58	19/10/2020 08:48	12,83	1	12,83	CHI
20201099881	CATALAO	CT12010458	CATALAO S2	18/10/2020 19:58	18/10/2020 21:57	18/10/2020 19:58	18/10/2020 21:57	1,98	7	13,85	CHI
20201099881	CUMARI	CT12010458	CATALAO S2	18/10/2020 19:58	18/10/2020 21:57	18/10/2020 19:58	18/10/2020 21:57	1,98	10	19,78	CHI
20201099895	GOIANIA	16893414	GOIANIA LESTE S3	18/10/2020 19:59	18/10/2020 22:41	18/10/2020 19:59	18/10/2020 22:41	2,70	1	2,70	CHI
20201099906	DOVERLANDIA	DV21241643	CAIAPONIA	18/10/2020 19:59	19/10/2020 16:28	18/10/2020 19:59	19/10/2020 16:28	20,47	1	20,47	CHI
20201099992	IPAMERI	IP12056133	IPAMERI	18/10/2020 20:00	18/10/2020 21:28	18/10/2020 20:00	18/10/2020 21:28	1,45	523	760,67	CHI
20201099936	MORRINHOS	150061626	MORRINHOS	18/10/2020 20:01	18/10/2020 21:28	18/10/2020 20:01	18/10/2020 21:28	1,44	1	1,44	CHI
20201099964	CABECEIRAS	CW12257769	ITIQUIRA	18/10/2020 20:03	18/10/2020 21:07	18/10/2020 20:03	18/10/2020 21:07	1,07	47	50,12	CHI
20201099980	ANAPOLIS	21012120	ANAPOLIS UNIVERSITARIO S2	18/10/2020 20:03	20/10/2020 09:39	18/10/2020 20:03	20/10/2020 09:39	37,59	1	37,59	CHI
20201099979	MORRINHOS	VN12060828	VIANOPOLIS	18/10/2020 20:03	19/10/2020 01:24	18/10/2020 20:03	19/10/2020 01:24	5,33	1	5,33	CHI
20201099979	SILVANIA	VN12060828	VIANOPOLIS	18/10/2020 20:03	19/10/2020 01:24	18/10/2020 20:03	19/10/2020 01:24	5,33	7	37,34	CHI
20201099979	VIANOPOLIS	VN12060828	VIANOPOLIS	18/10/2020 20:03	19/10/2020 01:24	18/10/2020 20:03	19/10/2020 01:24	5,33	21	112,02	CHI
20201099979	ORIZONA	VN12060828	VIANOPOLIS	18/10/2020 20:03	19/10/2020 01:24	18/10/2020 20:03	19/10/2020 01:24	5,33	50	266,72	CHI
202010100033	SILVANIA	SV12390030LD	VIANOPOLIS	18/10/2020 20:04	19/10/2020 11:12	18/10/2020 20:04	19/10/2020 11:12	15,14	92	1392,45	CHI
202010100033	ORIZONA	LZ10400597	VIANOPOLIS	18/10/2020 20:04	19/10/2020 11:12	18/10/2020 20:04	19/10/2020 09:09	13,09	72	942,70	CHI
202010100033	LUZIANIA	LZ10400597	VIANOPOLIS	18/10/2020 20:04	19/10/2020 11:12	18/10/2020 20:04	19/10/2020 09:09	13,09	71	929,61	CHI
202010100033	SILVANIA	LZ10400597	VIANOPOLIS	18/10/2020 20:04	19/10/2020 11:12	18/10/2020 20:04	19/10/2020 09:09	13,09	15	196,40	CHI
202010100033	LUZIANIA	LZ10400597	VIANOPOLIS	18/10/2020 20:04	19/10/2020 11:12	18/10/2020 22:37	19/10/2020 09:09	10,54	1	10,54	CHI
20201099981	JATAI	JT11083491	JATAI S2	18/10/2020 20:04	19/10/2020 14:58	18/10/2020 20:04	19/10/2020 14:58	18,89	1	18,89	CHI
20201099986	ARENOPOLIS	AY12390169	ARENOPOLIS	18/10/2020 20:04	18/10/2020 23:52	18/10/2020 20:04	18/10/2020 23:52	3,79	23	87,09	CHI
20201099986	DIORAMA	AY12390169	ARENOPOLIS	18/10/2020 20:04	18/10/2020 23:52	18/10/2020 20:04	18/10/2020 23:52	3,79	3	11,36	CHI

202010100026	GOIANIA	GN12073228	GOYA S1	18/10/2020 20:07	18/10/2020 22:28	18/10/2020 20:07	18/10/2020 22:28	2,34	21	49,22	CHI
202010100036	GOIANIA	GN12082433	GOYA S2	18/10/2020 20:07	18/10/2020 21:27	18/10/2020 20:07	18/10/2020 21:27	1,32	2	2,64	CHI
202010100038	SANTO ANTONIO DO DESCOBERTO	SN12389385	MARAJOARA	18/10/2020 20:07	19/10/2020 08:35	18/10/2020 20:07	19/10/2020 08:35	12,47	57	710,62	CHI
202010100038	ALEXANIA	SN12389385	MARAJOARA	18/10/2020 20:07	19/10/2020 08:35	18/10/2020 20:07	19/10/2020 08:35	12,47	4	49,87	CHI
2020101800177	PIRENOPOLIS	CCZ-TR1	COCALZINHO	18/10/2020 20:08	18/10/2020 23:10	18/10/2020 20:08	18/10/2020 23:10	3,04	49	148,92	CHI
2020101800177	PADRE BERNARDO	CCZ-TR1	COCALZINHO	18/10/2020 20:08	18/10/2020 23:10	18/10/2020 20:08	18/10/2020 23:10	3,04	1	3,04	CHI
2020101800177	COCALZINHO DE GOIAS	CCZ-TR1	COCALZINHO	18/10/2020 20:08	18/10/2020 23:10	18/10/2020 20:08	18/10/2020 23:10	3,04	1679	5102,76	CHI
2020101800177	CORUMBA DE GOIAS	CCZ-TR1	COCALZINHO	18/10/2020 20:08	18/10/2020 23:10	18/10/2020 20:08	18/10/2020 23:10	3,04	20	60,78	CHI
2020101800177	PIRENOPOLIS	CCZ-TR1	COCALZINHO	18/10/2020 20:08	18/10/2020 23:10	18/10/2020 20:08	18/10/2020 23:10	3,04	34	103,33	CHI
2020101800177	COCALZINHO DE GOIAS	CCZ-TR1	COCALZINHO	18/10/2020 20:08	18/10/2020 23:10	18/10/2020 20:08	18/10/2020 23:10	3,04	3432	10430,42	CHI
2020101800177	VILA PROPICIO	CCZ-TR1	COCALZINHO	18/10/2020 20:08	18/10/2020 23:10	18/10/2020 20:08	18/10/2020 23:10	3,04	1	3,04	CHI
2020101800177	CORUMBA DE GOIAS	CCZ-TR1	COCALZINHO	18/10/2020 20:08	18/10/2020 23:10	18/10/2020 20:08	18/10/2020 23:10	3,04	318	966,45	CHI
202010100048	GOIANIA	GN12049398	ATLANTICO S3	18/10/2020 20:08	18/10/2020 23:23	18/10/2020 20:08	18/10/2020 23:23	3,24	127	411,44	CHI
202010100064	GOIANIA	10483068	GOIANIA LESTE S2	18/10/2020 20:09	19/10/2020 00:45	18/10/2020 20:09	19/10/2020 00:45	4,59	1	4,59	CHI
202010100071	PIRACANJUBA	PJ12263070	PIRACANJUBA	18/10/2020 20:09	18/10/2020 23:47	18/10/2020 20:09	18/10/2020 23:47	3,62	5	18,12	CHI
202010100079	PIRENOPOLIS	PV21353252	CORUMBA	18/10/2020 20:10	19/10/2020 00:31	18/10/2020 20:10	19/10/2020 00:31	4,35	18	78,22	CHI
202010101201	IPAMERI	KR12330533	CRISTALINA S1	18/10/2020 20:10	19/10/2020 08:02	18/10/2020 20:10	19/10/2020 08:02	11,86	1	11,86	CHI
202010101201	CRISTALINA	KR12330533	CRISTALINA S1	18/10/2020 20:10	19/10/2020 08:02	18/10/2020 20:10	19/10/2020 08:02	11,86	35	415,00	CHI
202010101201	LUZIANIA	KR12330533	CRISTALINA S1	18/10/2020 20:10	19/10/2020 08:02	18/10/2020 20:10	19/10/2020 08:02	11,86	8	94,86	CHI
202010100094	PETROLINA DE GOIAS	PG12010184	PETROLINA	18/10/2020 20:11	19/10/2020 07:17	18/10/2020 20:11	19/10/2020 07:17	11,11	19	211,01	CHI
202010100127	ITUMBIARA	690003997	ITUMBIARA VELHA S1	18/10/2020 20:13	19/10/2020 07:32	18/10/2020 20:13	19/10/2020 07:32	11,31	1	11,31	CHI
202010100132	ALEXANIA	AX21319859	ALEXANIA	18/10/2020 20:13	19/10/2020 07:23	18/10/2020 20:13	19/10/2020 07:23	11,16	1	11,16	CHI
202010100135	ALTO PARAISO DE GOIAS	10024204240	FLORES DE GOIAS	18/10/2020 20:13	18/10/2020 21:08	18/10/2020 20:13	18/10/2020 21:08	0,91	1	0,91	CHI
202010100142	GOUVELANDIA	GB21199317	QUIRINOPOLIS	18/10/2020 20:14	18/10/2020 21:16	18/10/2020 20:14	18/10/2020 21:16	1,03	1	1,03	CHI
202010100121	CRISTALINA	KR10395376	CRISTALINA S1	18/10/2020 20:15	18/10/2020 23:24	18/10/2020 22:23	18/10/2020 23:24	1,02	269	275,20	CHI
202010100121	IPAMERI	KR10395376	CRISTALINA S1	18/10/2020 20:15	18/10/2020 23:24	18/10/2020 22:23	18/10/2020 23:24	1,02	6	6,14	CHI
202010100121	CRISTALINA	KR10414276	CRISTALINA S1	18/10/2020 20:15	18/10/2020 23:24	18/10/2020 22:23	18/10/2020 22:33	0,18	28	5,04	CHI
202010100121	CRISTALINA	KR10414276	CRISTALINA S1	18/10/2020 20:15	18/10/2020 23:24	18/10/2020 22:23	18/10/2020 22:27	0,07	13	0,88	CHI
202010100121	IPAMERI	KR10395376	CRISTALINA S1	18/10/2020 20:15	18/10/2020 23:24	18/10/2020 21:58	18/10/2020 22:04	0,09	6	0,56	CHI
202010100121	CRISTALINA	KR10395376	CRISTALINA S1	18/10/2020 20:15	18/10/2020 23:24	18/10/2020 21:58	18/10/2020 22:04	0,09	269	25,11	CHI
202010100121	CRISTALINA	KR10395376	CRISTALINA S1	18/10/2020 20:15	18/10/2020 23:24	18/10/2020 20:15	18/10/2020 20:56	0,69	269	186,06	CHI
202010100121	IPAMERI	KR10395376	CRISTALINA S1	18/10/2020 20:15	18/10/2020 23:24	18/10/2020 20:15	18/10/2020 20:56	0,69	6	4,15	CHI
202010100121	CRISTALINA	KR10414276	CRISTALINA S1	18/10/2020 20:15	18/10/2020 23:24	18/10/2020 20:15	18/10/2020 20:48	0,55	28	15,46	CHI
202010100121	CRISTALINA	KR10414276	CRISTALINA S1	18/10/2020 20:15	18/10/2020 23:24	18/10/2020 20:15	18/10/2020 20:45	0,50	13	6,54	CHI
202010100153	GOIANIA	GN11000119	GOIANIA LESTE S2	18/10/2020 20:15	19/10/2020 00:19	18/10/2020 20:15	19/10/2020 00:19	4,06	45	182,85	CHI
202010100158	GOIANIA	16477583	MEIA PONTE	18/10/2020 20:15	18/10/2020 22:40	18/10/2020 20:15	18/10/2020 22:40	2,41	1	2,41	CHI
202010100170	NOVO GAMA	4990103118	PACAEMBU S1	18/10/2020 20:15	19/10/2020 00:19	18/10/2020 20:15	19/10/2020 00:19	4,05	1	4,05	CHI
202010100180	GOIANIA	TR12001804	GOYA S1	18/10/2020 20:16	19/10/2020 14:44	19/10/2020 13:16	19/10/2020 14:44	1,45	1	1,45	CHI
202010100180	GOIANIA	TR21001307	GOYA S1	18/10/2020 20:16	19/10/2020 14:44	18/10/2020 20:16	19/10/2020 14:30	18,23	1	18,23	CHI
202010100219	SANCLERLANDIA	SC12008814	FIRMINOPOLIS S2	18/10/2020 20:16	18/10/2020 23:18	18/10/2020 20:16	18/10/2020 23:18	3,03	19	57,48	CHI
202010100214	SAO MIGUEL DO ARAGUAIA	SM12000065	SAO MIGUEL DO ARAGUAIA	18/10/2020 20:17	19/10/2020 15:40	18/10/2020 20:17	19/10/2020 15:40	19,38	5	96,89	CHI
202010100214	SAO MIGUEL DO ARAGUAIA	SM13253733	SAO MIGUEL DO ARAGUAIA	18/10/2020 20:17	19/10/2020 15:40	19/10/2020 15:09	19/10/2020 15:40	0,51	3	1,54	CHI
202010100214	SAO MIGUEL DO ARAGUAIA	SM12000065	SAO MIGUEL DO ARAGUAIA	18/10/2020 20:17	19/10/2020 15:40	18/10/2020 20:17	19/10/2020 13:31	17,23	3	51,69	CHI
202010100214	SAO MIGUEL DO ARAGUAIA	SM12000065	SAO MIGUEL DO ARAGUAIA	18/10/2020 20:17	19/10/2020 15:40	18/10/2020 20:17	19/10/2020 11:04	14,77	3	44,32	CHI
202010100214	SAO MIGUEL DO ARAGUAIA	SM12000065	SAO MIGUEL DO ARAGUAIA	18/10/2020 20:17	19/10/2020 15:40	18/10/2020 20:17	19/10/2020 09:34	13,28	12	159,31	CHI
202010101178	DISTRITO FEDERAL	CT10212768	CATALAO S1	18/10/2020 20:18	19/10/2020 09:15	18/10/2020 20:18	19/10/2020 09:15	12,94	1	12,94	CHI
202010101178	CAMPO ALEGRE DE GOIAS	CT10212768	CATALAO S1	18/10/2020 20:18	19/10/2020 09:15	18/10/2020 20:18	19/10/2020 09:15	12,94	2	25,88	CHI
202010101178	CATALAO	CT10212768	CATALAO S1	18/10/2020 20:18	19/10/2020 09:15	18/10/2020 20:18	19/10/2020 09:15	12,94	437	5655,27	CHI
202010100229	RIO VERDE	RV12371510	RIO VERDE S1	18/10/2020 20:18	19/10/2020 00:11	18/10/2020 20:18	19/10/2020 00:11	3,87	24	92,93	CHI
202010100240	CAIAPONIA	930019349	CAIAPONIA	18/10/2020 20:19	19/10/2020 08:35	18/10/2020 20:19	19/10/2020 08:35	12,27	1	12,27	CHI
202010100269	ACREUNA	10008689260	ACREUNA	18/10/2020 20:21	18/10/2020 22:25	18/10/2020 20:21	18/10/2020 22:25	2,06	1	2,06	CHI

202010100281	SAO MIGUEL DO ARAGUAIA	830074168	SAO MIGUEL DO ARAGUAIA	18/10/2020 20:22	19/10/2020 05:00	18/10/2020 20:22	19/10/2020 05:00	8,63	1	8,63	CHI
202010100284	CATALAO	CT12266101	CATALAO S1	18/10/2020 20:22	18/10/2020 21:50	18/10/2020 20:22	18/10/2020 21:50	1,46	5	7,28	CHI
202010100307	ANAPOLIS	20240211	JUNDIAI S1	18/10/2020 20:24	19/10/2020 12:30	18/10/2020 20:24	19/10/2020 12:30	16,09	1	16,09	CHI
202010100308	ORIZONA	OZ21027134	PIRES DO RIO S2	18/10/2020 20:24	18/10/2020 22:07	18/10/2020 20:24	18/10/2020 22:07	1,70	1	1,70	CHI
202010100746	JAUPACI	JP12349752	IPORA	18/10/2020 20:25	19/10/2020 00:33	18/10/2020 20:25	19/10/2020 00:33	4,13	41	169,41	CHI
202010100329	ITABERAI	IB12040389	ITABERAI S2	18/10/2020 20:25	19/10/2020 00:49	18/10/2020 20:25	19/10/2020 00:49	4,38	31	135,89	CHI
202010101475	ABADIANIA	AA12085971	ANAPOLIS UNIVERSITARIO S1	18/10/2020 20:28	19/10/2020 07:57	18/10/2020 20:28	19/10/2020 07:57	11,48	13	149,25	CHI
202010100467	ABADIANIA	AA12377766	ANAPOLIS UNIVERSITARIO S1	18/10/2020 20:29	19/10/2020 07:58	18/10/2020 20:29	19/10/2020 07:58	11,48	10	114,84	CHI
202010100488	VALPARAISO DE GOIAS	VA11163844	MARAJOARA	18/10/2020 20:29	19/10/2020 01:16	18/10/2020 20:29	19/10/2020 01:16	4,78	137	655,05	CHI
202010100562	GOIANIA	AP11169536	INDEPENDENCIA S1	18/10/2020 20:31	19/10/2020 11:09	18/10/2020 20:31	19/10/2020 11:09	14,62	62	906,53	CHI
202010100608	TRINDADE	TR12000037	TRINDADE	18/10/2020 20:32	19/10/2020 02:02	18/10/2020 20:32	19/10/2020 02:02	5,50	459	2523,10	CHI
202010100419	ITAUCU	IX12016021	INHUMAS S1	18/10/2020 20:32	19/10/2020 08:03	18/10/2020 20:32	19/10/2020 08:03	11,50	50	575,19	CHI
202010100419	TAQUARAL DE GOIAS	IX12016021	INHUMAS S1	18/10/2020 20:32	19/10/2020 08:03	18/10/2020 20:32	19/10/2020 08:03	11,50	48	552,19	CHI
202010100471	LUZIANIA	LZ21120208	MARAJOARA	18/10/2020 20:36	19/10/2020 00:01	18/10/2020 20:36	19/10/2020 00:01	3,41	2	6,83	CHI
202010100482	JAUPACI	JP12008688	IPORA	18/10/2020 20:37	19/10/2020 03:01	18/10/2020 20:37	19/10/2020 03:01	6,39	2	12,78	CHI
202010100487	SILVANIA	SV12403479	VIANOPOLIS	18/10/2020 20:38	19/10/2020 13:17	18/10/2020 20:38	19/10/2020 13:17	16,65	3	49,94	CHI
202010102264	ITUMBIARA	IT12000052	ITUMBIARA VELHA S1	18/10/2020 20:39	19/10/2020 18:43	18/10/2020 20:39	19/10/2020 18:43	22,06	20	441,25	CHI
202010102264	ITUMBIARA	IT12000052	ITUMBIARA VELHA S1	18/10/2020 20:39	19/10/2020 18:43	18/10/2020 20:39	19/10/2020 11:00	14,35	23	330,02	CHI
202010100523	IACIARA	IA21373149	IACIARA S1	18/10/2020 20:41	18/10/2020 21:11	18/10/2020 20:41	18/10/2020 21:11	0,49	1	0,49	CHI
202010100536	ANAPOLIS	20462682	JUNDIAI S1	18/10/2020 20:43	19/10/2020 13:34	18/10/2020 20:43	19/10/2020 13:34	16,85	1	16,85	CHI
202010100538	JATAI	290144073	JATAI S3	18/10/2020 20:43	19/10/2020 17:36	18/10/2020 20:43	19/10/2020 17:36	20,88	1	20,88	CHI
202010100539	ORIZONA	OZ21085087	PIRES DO RIO S2	18/10/2020 20:43	18/10/2020 22:44	18/10/2020 20:43	18/10/2020 22:44	2,01	1	2,01	CHI
202010101931	SILVANIA	SV12389456	VIANOPOLIS	18/10/2020 20:43	20/10/2020 03:25	18/10/2020 20:43	20/10/2020 03:25	30,69	16	491,04	CHI
202010100556	LUZIANIA	10008338432	MARAJOARA	18/10/2020 20:45	19/10/2020 10:02	18/10/2020 20:45	19/10/2020 10:02	13,27	1	13,27	CHI
202010100557	SANTA TEREZA DE GOIAS	SE12352924	MARA ROSA	18/10/2020 20:46	18/10/2020 22:07	18/10/2020 20:46	18/10/2020 22:07	1,35	1	1,35	CHI
202010100557	MUTUNOPOLIS	SE12352924	MARA ROSA	18/10/2020 20:46	18/10/2020 22:07	18/10/2020 20:46	18/10/2020 22:07	1,35	6	8,09	CHI
202010100565	CATALAO	CT21309519	CATALAO S1	18/10/2020 20:47	19/10/2020 22:36	18/10/2020 20:47	19/10/2020 22:36	25,82	1	25,82	CHI
202010100572	JANDIAIA	JD21328166	PALMEIRAS	18/10/2020 20:47	19/10/2020 13:46	18/10/2020 20:47	19/10/2020 13:46	16,98	1	16,98	CHI
202010100575	PORTEIRAO	CL21306021	RIO DOS BOIS	18/10/2020 20:47	18/10/2020 22:08	18/10/2020 20:47	18/10/2020 22:08	1,34	1	1,34	CHI
202010100579	JAUPACI	IS12207765	IPORA	18/10/2020 20:48	19/10/2020 09:01	18/10/2020 20:48	19/10/2020 09:01	12,22	3	36,65	CHI
202010100588	CRIXAS	CX11394269	SERRA DO OURO	18/10/2020 20:51	19/10/2020 09:39	18/10/2020 20:51	19/10/2020 09:39	12,80	1	12,80	CHI
202010100601	ANICUNS	AC12034105	ANICUNS	18/10/2020 20:53	19/10/2020 05:03	18/10/2020 20:53	19/10/2020 05:03	8,16	1	8,16	CHI
202010100601	NAZARIO	AC12034105	ANICUNS	18/10/2020 20:53	19/10/2020 05:03	18/10/2020 20:53	19/10/2020 05:03	8,16	9	73,41	CHI
202010100612	SANTO ANTONIO DO DESCOBERTO	10030416025	ALEXANIA	18/10/2020 20:55	19/10/2020 11:01	18/10/2020 20:55	19/10/2020 11:01	14,09	1	14,09	CHI
202010100618	POSSE	1480075945	IACIARA S2	18/10/2020 20:57	18/10/2020 22:24	18/10/2020 20:57	18/10/2020 22:24	1,45	1	1,45	CHI
202010101853	ABADIANIA	AA12261204	ANAPOLIS UNIVERSITARIO S1	18/10/2020 20:57	19/10/2020 09:34	18/10/2020 20:57	19/10/2020 09:34	12,61	24	302,73	CHI
202010100621	GOIANIA	10212632	FERROVIARIO S3	18/10/2020 20:57	18/10/2020 22:12	18/10/2020 20:57	18/10/2020 22:12	1,25	1	1,25	CHI
202010100627	ABADIA DE GOIAS	LG21310201	GUAPO S1	18/10/2020 20:57	18/10/2020 22:32	18/10/2020 20:57	18/10/2020 22:32	1,57	2	3,14	CHI
202010100636	CATALAO	CT11166858	CATALAO S1	18/10/2020 21:00	19/10/2020 09:48	18/10/2020 21:00	19/10/2020 09:48	12,79	173	2213,29	CHI
202010100641	ABADIANIA	AA21221560	ANAPOLIS UNIVERSITARIO S1	18/10/2020 21:00	19/10/2020 08:29	18/10/2020 21:00	19/10/2020 08:29	11,47	2	22,94	CHI
202010100644	POSSE	PS12124656	IACIARA S2	18/10/2020 21:01	19/10/2020 10:23	18/10/2020 21:01	19/10/2020 10:23	13,38	95	1270,84	CHI
202010100655	TRINDADE	TR12095985	MEIA PONTE	18/10/2020 21:02	19/10/2020 04:14	18/10/2020 21:02	19/10/2020 04:14	7,19	354	2545,56	CHI
202010100698	JATAI	290095360	JATAI S3	18/10/2020 21:03	19/10/2020 06:47	18/10/2020 21:03	19/10/2020 06:47	9,73	1	9,73	CHI
202010100674	ALEXANIA	AX21295585	ALEXANIA	18/10/2020 21:05	19/10/2020 06:41	18/10/2020 21:05	19/10/2020 06:41	9,60	1	9,60	CHI
202010100675	APARECIDA DE GOIANIA	10007283316	INDEPENDENCIA S1	18/10/2020 21:05	18/10/2020 23:22	18/10/2020 21:05	18/10/2020 23:22	2,27	1	2,27	CHI
202010100680	MONTES CLAROS DE GOIAS	DI12063493RE	IPORA	18/10/2020 21:06	19/10/2020 08:11	18/10/2020 21:06	19/10/2020 08:11	11,08	7	77,55	CHI
202010100680	IPORA	DI12063493RE	IPORA	18/10/2020 21:06	19/10/2020 08:11	18/10/2020 21:06	19/10/2020 08:11	11,08	3	33,24	CHI
202010100680	DIORAMA	DI12063493RE	IPORA	18/10/2020 21:06	19/10/2020 08:11	18/10/2020 21:06	19/10/2020 08:11	11,08	38	420,98	CHI
202010101208	MOSSAMEDES	SC12068211	FIRMINOPOLIS S2	18/10/2020 21:06	19/10/2020 09:11	18/10/2020 21:06	19/10/2020 09:11	12,07	1	12,07	CHI
202010101208	SANCLERLANDIA	SC12068211	FIRMINOPOLIS S2	18/10/2020 21:06	19/10/2020 09:11	18/10/2020 21:06	19/10/2020 09:11	12,07	15	181,10	CHI
202010100684	GOIANIA	14972281	GOIANIA LESTE S2	18/10/2020 21:07	18/10/2020 23:03	18/10/2020 21:07	18/10/2020 23:03	1,93	1	1,93	CHI

202010100685	CRISTALINA	KR21133660	CRISTALINA S1	18/10/2020 21:07	19/10/2020 08:45	18/10/2020 21:07	19/10/2020 08:45	11,63	1	11,63	CHI
202010100691	FAZENDA NOVA	FN12113974	IPORA	18/10/2020 21:08	19/10/2020 08:04	18/10/2020 21:08	19/10/2020 08:04	10,93	17	185,79	CHI
202010100691	ISRAELANDIA	FN12113974	IPORA	18/10/2020 21:08	19/10/2020 08:04	18/10/2020 21:08	19/10/2020 08:04	10,93	11	120,22	CHI
202010100695	VILA BOA	2880000033	IACIARA S2	18/10/2020 21:08	18/10/2020 21:53	18/10/2020 21:08	18/10/2020 21:53	0,74	1	0,74	CHI
202010100700	JAUPACI	JP21341766	IPORA	18/10/2020 21:09	19/10/2020 00:56	18/10/2020 21:09	19/10/2020 00:56	3,78	1	3,78	CHI
202010101033	ANICUNS	SL12019453	FIRMINOPOLIS S2	18/10/2020 21:10	19/10/2020 17:41	18/10/2020 21:10	19/10/2020 17:41	20,53	1	20,53	CHI
202010101033	ADELANDIA	SL12019453	FIRMINOPOLIS S2	18/10/2020 21:10	19/10/2020 17:41	18/10/2020 21:10	19/10/2020 17:41	20,53	37	759,57	CHI
202010101033	SANCLERLANDIA	SL12019453	FIRMINOPOLIS S2	18/10/2020 21:10	19/10/2020 17:41	18/10/2020 21:10	19/10/2020 17:41	20,53	22	451,64	CHI
202010101033	MOSSAMEDES	SL12019453	FIRMINOPOLIS S2	18/10/2020 21:10	19/10/2020 17:41	18/10/2020 21:10	19/10/2020 17:41	20,53	5	102,64	CHI
202010101033	SAO LUIS DE MONTES BELOS	SL12019453	FIRMINOPOLIS S2	18/10/2020 21:10	19/10/2020 17:41	18/10/2020 21:10	19/10/2020 16:47	19,62	12	235,39	CHI
202010101033	ADELANDIA	SL12019453	FIRMINOPOLIS S2	18/10/2020 21:10	19/10/2020 17:41	18/10/2020 21:10	19/10/2020 16:47	19,62	8	156,92	CHI
202010101033	SANCLERLANDIA	SL12019453	FIRMINOPOLIS S2	18/10/2020 21:10	19/10/2020 17:41	18/10/2020 21:10	19/10/2020 16:47	19,62	8	156,92	CHI
202010101033	SAO LUIS DE MONTES BELOS	SL12019453	FIRMINOPOLIS S2	18/10/2020 21:10	19/10/2020 17:41	18/10/2020 21:10	19/10/2020 13:01	15,86	2	31,72	CHI
202010100719	TURVELANDIA	TD12305981	RIO DOS BOIS	18/10/2020 21:12	18/10/2020 23:26	18/10/2020 21:12	18/10/2020 23:26	2,22	1	2,22	CHI
202010100722	APARECIDA DO RIO DOCE	AW21089911	CACHOEIRA ALTA	18/10/2020 21:13	19/10/2020 11:50	18/10/2020 21:13	19/10/2020 11:50	14,61	1	14,61	CHI
202010100739	MORRINHOS	MR21097323	MORRINHOS	18/10/2020 21:15	18/10/2020 23:13	18/10/2020 21:15	18/10/2020 23:13	1,98	1	1,98	CHI
202010100761	FORMOSA	610092730	ITUIQUIRA	18/10/2020 21:19	18/10/2020 22:41	18/10/2020 21:19	18/10/2020 22:41	1,37	1	1,37	CHI
202010189393	IPORA	10030070781	IPORA	18/10/2020 21:19	18/10/2020 23:46	18/10/2020 21:19	18/10/2020 23:46	2,45	1	2,45	CHI
202010100770	ALEXANIA	AX11273229	ALEXANIA	18/10/2020 21:19	19/10/2020 12:49	18/10/2020 21:19	19/10/2020 12:49	15,49	15	232,28	CHI
202010100774	IPAMERI	IP21112287	IPAMERI	18/10/2020 21:20	19/10/2020 14:33	18/10/2020 21:20	19/10/2020 14:33	17,21	1	17,21	CHI
202010100778	GOIANIA	14178291	ATLANTICO S1	18/10/2020 21:21	19/10/2020 00:44	18/10/2020 21:21	19/10/2020 00:44	3,37	1	3,37	CHI
202010100782	ANAPOLIS	20198565	JUNDIAI S1	18/10/2020 21:22	19/10/2020 16:12	18/10/2020 21:22	19/10/2020 16:12	18,83	1	18,83	CHI
202010100783	LUZANIA	LZ21214910	PAMPLONA	18/10/2020 21:22	19/10/2020 10:39	18/10/2020 21:22	19/10/2020 10:39	13,28	2	26,56	CHI
202010100786	ANAPOLIS	AN21258697	JUNDIAI S1	18/10/2020 21:22	20/10/2020 10:34	18/10/2020 21:22	20/10/2020 10:34	37,19	1	37,19	CHI
202010100799	PLANALTINA	PI12043459	PLANALTINA	18/10/2020 21:23	18/10/2020 22:22	18/10/2020 21:23	18/10/2020 22:22	0,98	6	5,90	CHI
2020101800068	SERRANOPOLIS	04800424	JATAI S1	18/10/2020 21:26	18/10/2020 21:44	18/10/2020 21:26	18/10/2020 21:44	0,30	115	34,50	CHI
2020101800068	JATAI	04800424	JATAI S1	18/10/2020 21:26	18/10/2020 21:44	18/10/2020 21:26	18/10/2020 21:44	0,30	289	86,70	CHI
2020101800068	ITARUMA	16701	JATAI S1	18/10/2020 21:26	18/10/2020 21:44	18/10/2020 21:26	18/10/2020 21:44	0,30	1	0,30	CHI
2020101800068	SERRANOPOLIS	16702	JATAI S1	18/10/2020 21:26	18/10/2020 21:44	18/10/2020 21:26	18/10/2020 21:44	0,30	16	4,80	CHI
2020101800068	SERRANOPOLIS	16701	JATAI S1	18/10/2020 21:26	18/10/2020 21:44	18/10/2020 21:26	18/10/2020 21:44	0,30	1265	379,50	CHI
2020101800068	JATAI	16701	JATAI S1	18/10/2020 21:26	18/10/2020 21:44	18/10/2020 21:26	18/10/2020 21:44	0,30	7	2,10	CHI
2020101800068	APORE	16701	JATAI S1	18/10/2020 21:26	18/10/2020 21:44	18/10/2020 21:26	18/10/2020 21:44	0,30	5	1,50	CHI
2020101800068	SERRANOPOLIS	01670404	JATAI S1	18/10/2020 21:26	18/10/2020 21:44	18/10/2020 21:26	18/10/2020 21:44	0,30	2033	609,90	CHI
2020101800068	SERRANOPOLIS	01670404	JATAI S1	18/10/2020 21:26	18/10/2020 21:44	18/10/2020 21:26	18/10/2020 21:44	0,30	71	21,30	CHI
2020101800068	JATAI	01670404	JATAI S1	18/10/2020 21:26	18/10/2020 21:44	18/10/2020 21:26	18/10/2020 21:44	0,30	6	1,80	CHI
2020101800068	APORE	01670404	JATAI S1	18/10/2020 21:26	18/10/2020 21:44	18/10/2020 21:26	18/10/2020 21:44	0,30	2	0,60	CHI
202010100827	ANAPOLIS	AN11000329	JUNDIAI S1	18/10/2020 21:26	19/10/2020 08:23	18/10/2020 21:26	19/10/2020 08:23	10,94	105	1148,18	CHI
202010100858	CACU	CC13322236	CACHOEIRA ALTA	18/10/2020 22:25	19/10/2020 00:41	18/10/2020 22:25	19/10/2020 00:41	2,26	1	2,26	CHI
202010100862	SAO MIGUEL DO PASSA QUATRO	SQ12077213RE	CRISTIANOPOLIS	18/10/2020 22:31	19/10/2020 15:26	18/10/2020 22:31	19/10/2020 15:26	16,92	41	693,59	CHI
202010100862	SAO MIGUEL DO PASSA QUATRO	SQ12074838RE	CRISTIANOPOLIS	18/10/2020 22:31	19/10/2020 15:26	18/10/2020 22:31	19/10/2020 03:50	5,31	32	169,98	CHI
202010100862	SAO MIGUEL DO PASSA QUATRO	SQ10401460	CRISTIANOPOLIS	18/10/2020 22:31	19/10/2020 15:26	19/10/2020 02:07	19/10/2020 02:20	0,20	55	11,12	CHI
202010100862	VIANOPOLIS	SQ10401460	CRISTIANOPOLIS	18/10/2020 22:31	19/10/2020 15:26	19/10/2020 02:07	19/10/2020 02:20	0,20	2	0,40	CHI
202010100862	SAO MIGUEL DO PASSA QUATRO	SQ10401460	CRISTIANOPOLIS	18/10/2020 22:31	19/10/2020 15:26	18/10/2020 22:31	19/10/2020 01:55	3,40	55	186,74	CHI
202010100862	VIANOPOLIS	SQ10401460	CRISTIANOPOLIS	18/10/2020 22:31	19/10/2020 15:26	18/10/2020 22:31	19/10/2020 01:55	3,40	2	6,79	CHI
202010100876	TAQUARAL DE GOIAS	IB12198803	ITABERAI S2	18/10/2020 23:03	19/10/2020 02:57	18/10/2020 23:03	19/10/2020 02:57	3,89	2	7,78	CHI
202010100876	ITABERAI	IB12198803	ITABERAI S2	18/10/2020 23:03	19/10/2020 02:57	18/10/2020 23:03	19/10/2020 02:57	3,89	68	264,67	CHI
202010100887	CRISTALINA	03460424	PAMPLONA	18/10/2020 23:14	20/10/2020 02:55	18/10/2020 23:14	20/10/2020 02:55	27,67	61	1687,89	CHI
202010100887	CRISTALINA	03460424	PAMPLONA	18/10/2020 23:14	20/10/2020 02:55	18/10/2020 23:14	20/10/2020 02:55	27,67	6	166,00	CHI
202010100887	CRISTALINA	KR13313636	PAMPLONA	18/10/2020 23:14	20/10/2020 02:55	19/10/2020 16:44	20/10/2020 02:54	10,16	3	30,49	CHI
202010100887	CRISTALINA	03460424	PAMPLONA	18/10/2020 23:14	20/10/2020 02:55	19/10/2020 16:44	19/10/2020 17:05	0,36	5	1,78	CHI
202010100887	CRISTALINA	03460424	PAMPLONA	18/10/2020 23:14	20/10/2020 02:55	18/10/2020 23:14	19/10/2020 16:43	17,47	3	52,41	CHI

202010100887	CRISTALINA	03460424	PAMPLONA	18/10/2020 23:14	20/10/2020 02:55	18/10/2020 23:14	19/10/2020 15:33	16,31	2	32,62	CHI
202010100887	CRISTALINA	03460424	PAMPLONA	18/10/2020 23:14	20/10/2020 02:55	18/10/2020 23:14	19/10/2020 14:58	15,73	3	47,20	CHI
202010100887	CRISTALINA	03460424	PAMPLONA	18/10/2020 23:14	20/10/2020 02:55	18/10/2020 23:14	18/10/2020 23:39	0,41	63	25,74	CHI
202010100887	CRISTALINA	KR10409768	PAMPLONA	18/10/2020 23:14	20/10/2020 02:55	18/10/2020 23:14	18/10/2020 23:39	0,41	1	0,41	CHI
202010100888	ITAPIRAPUA	IU11183397	MATRINCHA	18/10/2020 23:21	19/10/2020 10:23	18/10/2020 23:21	19/10/2020 10:23	11,03	89	981,87	CHI
202010100889	APARECIDA DE GOIANIA	200367778	ANHANGUERA	18/10/2020 23:21	19/10/2020 01:15	18/10/2020 23:21	19/10/2020 01:15	1,89	1	1,89	CHI
202010100900	ANAPOLIS	AN11000115	JUNDIAI S2	18/10/2020 23:25	19/10/2020 01:16	18/10/2020 23:25	19/10/2020 01:16	1,84	87	160,42	CHI
202010189394	IPORA	730038348	IPORA	18/10/2020 23:34	18/10/2020 23:46	18/10/2020 23:34	18/10/2020 23:46	0,20	1	0,20	CHI
2020101800196	IVOLANDIA	00850434	IPORA	18/10/2020 23:46	19/10/2020 00:21	18/10/2020 23:46	19/10/2020 00:21	0,60	14	8,34	CHI
2020101800196	IPORA	00850434	IPORA	18/10/2020 23:46	19/10/2020 00:21	18/10/2020 23:46	19/10/2020 00:21	0,60	9314	5549,59	CHI
2020101800196	IPORA	00850434	IPORA	18/10/2020 23:46	19/10/2020 00:21	18/10/2020 23:46	19/10/2020 00:21	0,59	7466	4440,20	CHI
2020101800196	IVOLANDIA	00850434	IPORA	18/10/2020 23:46	19/10/2020 00:21	18/10/2020 23:46	19/10/2020 00:21	0,58	63	36,80	CHI
2020101800196	MOIPORA	00850434	IPORA	18/10/2020 23:46	19/10/2020 00:21	18/10/2020 23:46	19/10/2020 00:21	0,58	94	54,91	CHI
2020101800196	AMORINOPOLIS	00850434	IPORA	18/10/2020 23:46	19/10/2020 00:21	18/10/2020 23:46	19/10/2020 00:21	0,58	12	7,01	CHI
2020101800196	ISRAELANDIA	00850434	IPORA	18/10/2020 23:46	19/10/2020 00:21	18/10/2020 23:46	19/10/2020 00:21	0,58	25	14,60	CHI
2020101800196	IPORA	00850434	IPORA	18/10/2020 23:46	19/10/2020 00:21	18/10/2020 23:46	19/10/2020 00:21	0,58	340	198,62	CHI
202010100918	JUSSARA	JR12406350	JUSSARA	18/10/2020 23:47	19/10/2020 05:43	18/10/2020 23:47	19/10/2020 05:43	5,93	302	1790,10	CHI
202010100923	ITAPURANGA	IK11124726	ITAPURANGA	18/10/2020 23:49	19/10/2020 01:37	18/10/2020 23:49	19/10/2020 01:37	1,79	34	60,95	CHI
202010100926	JANDAIA	JD11198352	PALMEIRAS	18/10/2020 23:50	19/10/2020 12:59	18/10/2020 23:50	19/10/2020 12:59	13,14	102	1340,22	CHI
202010100941	VILA BOA	VB12328750LD	ITIQUIRA	18/10/2020 23:52	19/10/2020 14:04	18/10/2020 23:52	19/10/2020 14:04	14,20	1	14,20	CHI
202010100941	FLORES DE GOIAS	FA13361342	ITIQUIRA	18/10/2020 23:52	19/10/2020 14:04	19/10/2020 06:52	19/10/2020 10:30	3,63	3	10,89	CHI
202010100941	SAO JOAO D ALIANCA	FA13361342	ITIQUIRA	18/10/2020 23:52	19/10/2020 14:04	19/10/2020 06:52	19/10/2020 10:30	3,63	225	816,94	CHI
202010100941	VILA BOA	FA13361342	ITIQUIRA	18/10/2020 23:52	19/10/2020 14:04	19/10/2020 06:52	19/10/2020 10:30	3,63	6	21,79	CHI
202010100941	FORMOSA	FA13361342	ITIQUIRA	18/10/2020 23:52	19/10/2020 14:04	19/10/2020 06:52	19/10/2020 10:30	3,63	582	2113,15	CHI
202010100941	VILA BOA	FA10401450	ITIQUIRA	18/10/2020 23:52	19/10/2020 14:04	18/10/2020 23:52	19/10/2020 10:13	10,35	9	93,15	CHI
202010100941	VILA BOA	FA10401450	ITIQUIRA	18/10/2020 23:52	19/10/2020 14:04	18/10/2020 23:52	19/10/2020 09:05	9,21	10	92,14	CHI
202010100941	FORMOSA	FA10401450	ITIQUIRA	18/10/2020 23:52	19/10/2020 14:04	18/10/2020 23:52	19/10/2020 07:49	7,95	67	532,35	CHI
202010100941	VILA BOA	FA10401450	ITIQUIRA	18/10/2020 23:52	19/10/2020 14:04	18/10/2020 23:52	19/10/2020 07:49	7,95	180	1430,20	CHI
202010100941	FORMOSA	FA10401450	ITIQUIRA	18/10/2020 23:52	19/10/2020 14:04	18/10/2020 23:52	19/10/2020 07:27	7,58	519	3935,03	CHI
202010100941	VILA BOA	FA10401450	ITIQUIRA	18/10/2020 23:52	19/10/2020 14:04	18/10/2020 23:52	19/10/2020 07:27	7,58	2	15,16	CHI
202010100941	VILA BOA	FA10410992	ITIQUIRA	18/10/2020 23:52	19/10/2020 14:04	19/10/2020 06:52	19/10/2020 07:27	0,59	4	2,35	CHI
202010100941	FORMOSA	FA10410992	ITIQUIRA	18/10/2020 23:52	19/10/2020 14:04	19/10/2020 06:52	19/10/2020 07:27	0,59	813	477,64	CHI
202010100945	BRITANIA	AK10400388	BRITANIA	18/10/2020 23:58	19/10/2020 07:41	18/10/2020 23:58	19/10/2020 07:41	7,72	12	92,69	CHI
202010100945	ARUANA	AK10400388	BRITANIA	18/10/2020 23:58	19/10/2020 07:41	18/10/2020 23:58	19/10/2020 07:41	7,72	14	108,13	CHI
202010100945	BRITANIA	03210424	BRITANIA	18/10/2020 23:58	19/10/2020 07:41	19/10/2020 01:20	19/10/2020 07:41	6,36	12	76,37	CHI
202010100945	ARUANA	03210424	BRITANIA	18/10/2020 23:58	19/10/2020 07:41	19/10/2020 01:20	19/10/2020 07:38	6,30	25	157,60	CHI
202010100945	BRITANIA	03210424	BRITANIA	18/10/2020 23:58	19/10/2020 07:41	19/10/2020 01:20	19/10/2020 07:38	6,30	7	44,13	CHI
202010100945	JUSSARA	03210424	BRITANIA	18/10/2020 23:58	19/10/2020 07:41	19/10/2020 01:20	19/10/2020 02:52	1,55	49	75,73	CHI
202010100945	BRITANIA	03210424	BRITANIA	18/10/2020 23:58	19/10/2020 07:41	19/10/2020 01:20	19/10/2020 02:52	1,55	1420	2194,69	CHI
202010100945	ARUANA	03210424	BRITANIA	18/10/2020 23:58	19/10/2020 07:41	19/10/2020 01:20	19/10/2020 02:52	1,55	25	38,64	CHI
202010100945	JUSSARA	03210424	BRITANIA	18/10/2020 23:58	19/10/2020 07:41	19/10/2020 01:20	19/10/2020 02:52	1,55	24	37,09	CHI
202010100945	ITAPIRAPUA	03210424	BRITANIA	18/10/2020 23:58	19/10/2020 07:41	19/10/2020 01:20	19/10/2020 02:52	1,55	2	3,09	CHI
202010100945	BRITANIA	03210424	BRITANIA	18/10/2020 23:58	19/10/2020 07:41	19/10/2020 01:20	19/10/2020 02:52	1,55	1939	2996,83	CHI
202010100945	BRITANIA	03210424	BRITANIA	18/10/2020 23:58	19/10/2020 07:41	18/10/2020 23:58	19/10/2020 01:17	1,32	7	9,24	CHI
202010100945	ARUANA	03210424	BRITANIA	18/10/2020 23:58	19/10/2020 07:41	18/10/2020 23:58	19/10/2020 01:17	1,32	25	33,00	CHI
202010100945	BRITANIA	03210424	BRITANIA	18/10/2020 23:58	19/10/2020 07:41	18/10/2020 23:58	19/10/2020 00:55	0,95	1420	1350,97	CHI
202010100945	JUSSARA	03210424	BRITANIA	18/10/2020 23:58	19/10/2020 07:41	18/10/2020 23:58	19/10/2020 00:55	0,95	49	46,62	CHI
202010100945	ARUANA	03210424	BRITANIA	18/10/2020 23:58	19/10/2020 07:41	18/10/2020 23:58	19/10/2020 00:55	0,95	25	23,78	CHI
202010100945	BRITANIA	03210424	BRITANIA	18/10/2020 23:58	19/10/2020 07:41	18/10/2020 23:58	19/10/2020 00:55	0,95	1939	1844,74	CHI
202010100945	ITAPIRAPUA	03210424	BRITANIA	18/10/2020 23:58	19/10/2020 07:41	18/10/2020 23:58	19/10/2020 00:55	0,95	2	1,90	CHI
202010100945	JUSSARA	03210424	BRITANIA	18/10/2020 23:58	19/10/2020 07:41	18/10/2020 23:58	19/10/2020 00:55	0,95	24	22,83	CHI

202010100946	APARECIDA DE GOIANIA	AP11065236	INDEPENDENCIA S1	19/10/2020 00:03	19/10/2020 02:20	19/10/2020 00:03	19/10/2020 02:20	2,27	11	24,99	CHI
202010100951	GOIANIA	11836192	AEROPORTO S3	19/10/2020 00:10	19/10/2020 10:08	19/10/2020 00:10	19/10/2020 10:08	9,96	1	9,96	CHI
202010102059	ANAPOLIS	AN11129433	JUNDIAI S1	19/10/2020 00:14	19/10/2020 11:46	19/10/2020 00:14	19/10/2020 11:46	11,53	66	760,80	CHI
202010101420	FAZENDA NOVA	JP12089836	IPORA	19/10/2020 00:16	19/10/2020 11:33	19/10/2020 00:16	19/10/2020 11:33	11,27	46	518,36	CHI
202010100959	ALEXANIA	AX12196986	ALEXANIA	19/10/2020 00:22	19/10/2020 17:09	19/10/2020 00:22	19/10/2020 17:09	16,78	3	50,34	CHI
202010100961	ARAGARCAS	AG11000004	ARAGARCAS	19/10/2020 00:24	19/10/2020 02:23	19/10/2020 00:24	19/10/2020 02:23	1,97	112	220,45	CHI
202010100968	ITABERAI	IB12284866	ITABERAI S1	19/10/2020 00:28	19/10/2020 06:15	19/10/2020 00:28	19/10/2020 06:15	5,78	3	17,35	CHI
202010100988	SANTA FE DE GOIAS	RN12346779LD	BRITANIA	19/10/2020 00:33	19/10/2020 12:50	19/10/2020 00:33	19/10/2020 12:50	12,29	5	61,43	CHI
202010100988	ITAPIRAPUA	RN12298934LD	BRITANIA	19/10/2020 00:33	19/10/2020 12:50	19/10/2020 00:33	19/10/2020 12:15	11,70	2	23,40	CHI
202010100988	SANTA FE DE GOIAS	RN12398934LD	BRITANIA	19/10/2020 00:33	19/10/2020 12:50	19/10/2020 00:33	19/10/2020 12:15	11,70	6	70,19	CHI
202010100988	SANTA FE DE GOIAS	RN10396175	BRITANIA	19/10/2020 00:33	19/10/2020 12:50	19/10/2020 00:33	19/10/2020 10:08	9,58	23	220,38	CHI
202010101222	CORUMBA DE GOIAS	CB12056813	CORUMBA	19/10/2020 00:33	19/10/2020 08:03	19/10/2020 00:33	19/10/2020 08:03	7,49	24	179,68	CHI
202010100974	GOIANIA	GN12025473	AEROPORTO S3	19/10/2020 00:34	19/10/2020 03:35	19/10/2020 00:34	19/10/2020 03:35	3,01	172	517,62	CHI
202010100982	MINACU	IH11202455	MINACU	19/10/2020 00:34	19/10/2020 02:23	19/10/2020 00:34	19/10/2020 02:23	1,81	77	139,18	CHI
202010102262	ANAPOLIS	AN11226668	ANAPOLIS UNIVERSITARIO S2	19/10/2020 00:36	19/10/2020 17:08	19/10/2020 00:36	19/10/2020 17:08	16,52	80	1321,40	CHI
202010100980	AGUAS LINDAS DE GOIAS	LA12148512	AGUAS LINDAS DE GOIAS S1	19/10/2020 00:38	19/10/2020 02:33	19/10/2020 00:38	19/10/2020 02:33	1,92	361	691,42	CHI
202010100984	ITABERAI	IB12300330	ITABERAI S2	19/10/2020 00:41	19/10/2020 03:39	19/10/2020 00:41	19/10/2020 03:39	2,96	14	41,44	CHI
202010100995	GOIANIA	10016232850	CARAJAS S1	19/10/2020 00:59	19/10/2020 03:58	19/10/2020 00:59	19/10/2020 03:58	2,97	1	2,97	CHI
202010101386	CRISTALINA	KR12290816	PAMPLONA	19/10/2020 01:08	19/10/2020 10:15	19/10/2020 01:08	19/10/2020 10:15	9,11	33	300,64	CHI
202010101427	MONTES CLAROS DE GOIAS	ME12029537	BRITANIA	19/10/2020 01:11	21/10/2020 16:30	19/10/2020 01:11	21/10/2020 16:30	63,33	1	63,33	CHI
202010101427	MONTES CLAROS DE GOIAS	ME12029537	BRITANIA	19/10/2020 01:11	21/10/2020 16:30	19/10/2020 01:11	20/10/2020 14:37	37,45	12	449,35	CHI
202010101007	GOIANIA	10011090918	GOYA S2	19/10/2020 01:19	19/10/2020 02:06	19/10/2020 01:19	19/10/2020 02:06	0,77	1	0,77	CHI
202010101008	ANAPOLIS	AN11000274	JUNDIAI S2	19/10/2020 01:21	19/10/2020 09:30	19/10/2020 01:21	19/10/2020 09:30	8,14	88	716,52	CHI
202010101013	NOVA IGUACU DE GOIAS	NH12317131	CAMPINORTE	19/10/2020 01:29	19/10/2020 05:33	19/10/2020 01:29	19/10/2020 05:33	4,06	46	186,87	CHI
202010101022	EDEIA	EA21198066	EDEIA	19/10/2020 01:43	19/10/2020 08:30	19/10/2020 01:43	19/10/2020 08:30	6,77	1	6,77	CHI
202010101024	AGUA FRIA DE GOIAS	TL13342347	SAO JOAO D ALIANCA	19/10/2020 01:46	19/10/2020 08:59	19/10/2020 01:46	19/10/2020 08:59	7,21	8	57,69	CHI
202010101024	AGUA FRIA DE GOIAS	TL10402672	SAO JOAO D ALIANCA	19/10/2020 01:46	19/10/2020 08:59	19/10/2020 01:46	19/10/2020 07:46	6,00	30	180,07	CHI
202010102550	CRISTALINA	KR12376280	PAMPLONA	19/10/2020 01:50	19/10/2020 11:20	19/10/2020 01:50	19/10/2020 11:20	9,48	33	312,97	CHI
202010104006	BURITI DE GOIAS	BS12079946	FIRMINOPOLIS S2	19/10/2020 01:53	19/10/2020 15:48	19/10/2020 01:53	19/10/2020 15:48	13,92	3	41,75	CHI
202010101030	PIRENOPOLIS	PV12062894	SAO FRANCISCO DE GOIAS	19/10/2020 01:56	19/10/2020 06:25	19/10/2020 01:56	19/10/2020 06:25	4,47	22	98,43	CHI
202010101030	PETROLINA DE GOIAS	PV12062894	SAO FRANCISCO DE GOIAS	19/10/2020 01:56	19/10/2020 06:25	19/10/2020 01:56	19/10/2020 06:25	4,47	3	13,42	CHI
202010101034	IPAMERI	IP21359965	PIRES DO RIO S2	19/10/2020 02:01	19/10/2020 09:59	19/10/2020 02:01	19/10/2020 09:59	7,96	1	7,96	CHI
202010103018	MINEIROS	MY11036551	PARQUE DAS EMAS	19/10/2020 02:01	19/10/2020 16:00	19/10/2020 02:01	19/10/2020 16:00	13,97	119	1662,76	CHI
202010101084	ANAPOLIS	AN13413936	ANAPOLIS UNIVERSITARIO S2	19/10/2020 02:12	19/10/2020 15:04	19/10/2020 08:54	19/10/2020 15:04	6,17	1	6,17	CHI
202010101084	ANAPOLIS	00052204	ANAPOLIS UNIVERSITARIO S2	19/10/2020 02:12	19/10/2020 15:04	19/10/2020 02:12	19/10/2020 08:50	6,63	1064	7050,18	CHI
202010101084	ANAPOLIS	AN16407976	ANAPOLIS UNIVERSITARIO S2	19/10/2020 02:12	19/10/2020 15:04	19/10/2020 08:30	19/10/2020 08:49	0,32	800	256,67	CHI
202010101084	ANAPOLIS	00052204	ANAPOLIS UNIVERSITARIO S2	19/10/2020 02:12	19/10/2020 15:04	19/10/2020 02:12	19/10/2020 08:21	6,15	800	4920,00	CHI
202010101084	ANAPOLIS	00052204	ANAPOLIS UNIVERSITARIO S2	19/10/2020 02:12	19/10/2020 15:04	19/10/2020 02:12	19/10/2020 02:28	0,26	3708	955,84	CHI
202010101358	PALESTINA DE GOIAS	PY18223011TS	PALESTINA	19/10/2020 02:12	19/10/2020 10:39	19/10/2020 02:12	19/10/2020 10:39	8,43	115	969,96	CHI
202010102061	ANAPOLIS	AN11205838	JUNDIAI S1	19/10/2020 02:22	19/10/2020 11:08	19/10/2020 02:22	19/10/2020 11:08	8,76	104	910,64	CHI
202010101048	ITABERAI	00120214	ARACU	19/10/2020 02:30	19/10/2020 08:00	19/10/2020 02:30	19/10/2020 08:00	5,49	63	345,73	CHI
202010101048	ANICUNS	00120214	ARACU	19/10/2020 02:30	19/10/2020 08:00	19/10/2020 02:30	19/10/2020 08:00	5,49	69	378,66	CHI
202010101048	ITAUCU	00120214	ARACU	19/10/2020 02:30	19/10/2020 08:00	19/10/2020 02:30	19/10/2020 08:00	5,49	16	87,80	CHI
202010101048	CATURAI	00120214	ARACU	19/10/2020 02:30	19/10/2020 08:00	19/10/2020 02:30	19/10/2020 08:00	5,49	55	301,83	CHI
202010101048	INHUMAS	00120214	ARACU	19/10/2020 02:30	19/10/2020 08:00	19/10/2020 02:30	19/10/2020 08:00	5,49	138	757,31	CHI
202010101048	ARACU	00120214	ARACU	19/10/2020 02:30	19/10/2020 08:00	19/10/2020 02:30	19/10/2020 08:00	5,49	1878	10306,05	CHI
202010101052	SANCLERLANDIA	SL12019284	SAO LUIZ DOS MONTES BELOS	19/10/2020 02:34	19/10/2020 07:41	19/10/2020 02:34	19/10/2020 07:41	5,10	28	142,81	CHI
202010101052	SAO LUIS DE MONTES BELOS	SL12019284	SAO LUIZ DOS MONTES BELOS	19/10/2020 02:34	19/10/2020 07:41	19/10/2020 02:34	19/10/2020 07:41	5,10	59	300,92	CHI
202010101059	JARAGUA	JA11211755	JARAGUA	19/10/2020 02:55	19/10/2020 04:00	19/10/2020 02:55	19/10/2020 04:00	1,08	70	75,29	CHI
202010101085	PLANALTINA	PI12322780	SAO JOAO D ALIANCA	19/10/2020 03:45	19/10/2020 14:09	19/10/2020 08:30	19/10/2020 14:09	5,65	7	39,54	CHI
202010101085	PLANALTINA	PI13325392	SAO JOAO D ALIANCA	19/10/2020 03:45	19/10/2020 14:09	19/10/2020 08:30	19/10/2020 11:54	3,41	134	457,01	CHI

202010101085	PLANALTINA	TL13383207	SAO JOAO D ALIANCA	19/10/2020 03:45	19/10/2020 14:09	19/10/2020 03:45	19/10/2020 09:58	6,21	74	459,83	CHI
202010101085	PLANALTINA	TL13383207	SAO JOAO D ALIANCA	19/10/2020 03:45	19/10/2020 14:09	19/10/2020 08:30	19/10/2020 09:58	1,47	43	63,00	CHI
202010101085	AGUA FRIA DE GOIAS	TL13383207	SAO JOAO D ALIANCA	19/10/2020 03:45	19/10/2020 14:09	19/10/2020 08:30	19/10/2020 09:58	1,47	2	2,93	CHI
202010101085	PLANALTINA	TL10404985	SAO JOAO D ALIANCA	19/10/2020 03:45	19/10/2020 14:09	19/10/2020 08:30	19/10/2020 09:16	0,77	5	3,85	CHI
202010101085	AGUA FRIA DE GOIAS	TL10404985	SAO JOAO D ALIANCA	19/10/2020 03:45	19/10/2020 14:09	19/10/2020 08:30	19/10/2020 09:16	0,77	35	26,96	CHI
202010101085	PLANALTINA	TL10404985	SAO JOAO D ALIANCA	19/10/2020 03:45	19/10/2020 14:09	19/10/2020 03:45	19/10/2020 08:28	4,72	189	892,61	CHI
202010101085	AGUA FRIA DE GOIAS	TL10404985	SAO JOAO D ALIANCA	19/10/2020 03:45	19/10/2020 14:09	19/10/2020 03:45	19/10/2020 08:28	4,72	37	174,74	CHI
202010101086	SANTA RITA DO NOVO DESTINO	BA12208877	BARRO ALTO	19/10/2020 04:41	20/10/2020 14:57	19/10/2020 04:41	20/10/2020 14:57	34,27	29	993,80	CHI
202010101086	SANTA RITA DO NOVO DESTINO	DF12229507	BARRO ALTO	19/10/2020 04:41	20/10/2020 14:57	19/10/2020 04:41	19/10/2020 20:31	15,84	32	506,91	CHI
202010101086	SANTA RITA DO NOVO DESTINO	DF13140557	BARRO ALTO	19/10/2020 04:41	20/10/2020 14:57	19/10/2020 04:41	19/10/2020 19:26	14,75	6	88,50	CHI
202010101086	SANTA RITA DO NOVO DESTINO	DF12382136LD	BARRO ALTO	19/10/2020 04:41	20/10/2020 14:57	19/10/2020 04:41	19/10/2020 11:36	6,91	22	151,98	CHI
202010101086	BARRO ALTO	DF10394591	BARRO ALTO	19/10/2020 04:41	20/10/2020 14:57	19/10/2020 04:41	19/10/2020 09:00	4,31	67	288,97	CHI
202010101086	SANTA RITA DO NOVO DESTINO	DF10394591	BARRO ALTO	19/10/2020 04:41	20/10/2020 14:57	19/10/2020 04:41	19/10/2020 09:00	4,31	166	715,97	CHI
202010101830	JATAI	JT12060140LD	JATAI S2	19/10/2020 05:10	19/10/2020 09:56	19/10/2020 05:10	19/10/2020 09:56	4,76	706	3358,60	CHI
202010102254	ANAPOLIS	AN12000673	JUNDIAI S1	19/10/2020 05:11	19/10/2020 10:52	19/10/2020 05:11	19/10/2020 10:52	5,67	350	1986,25	CHI
202010101095	PROFESSOR JAMIL SAFADY	JS12163826	ROCHEDO	19/10/2020 05:12	19/10/2020 09:06	19/10/2020 05:12	19/10/2020 09:06	3,90	4	15,60	CHI
202010101097	GOIAS	GS12206865	MATRINCHA	19/10/2020 05:13	20/10/2020 04:54	19/10/2020 05:13	20/10/2020 04:54	23,67	67	1586,13	CHI
202010101101	AMORINOPOLIS	AM21312069	IPORA	19/10/2020 05:16	19/10/2020 10:05	19/10/2020 05:16	19/10/2020 10:05	4,81	1	4,81	CHI
202010101977	ANAPOLIS	AN12135843	ANAPOLIS UNIVERSITARIO S2	19/10/2020 05:17	19/10/2020 12:46	19/10/2020 09:20	19/10/2020 12:46	3,42	645	2206,44	CHI
202010101977	ANAPOLIS	AN12135843	ANAPOLIS UNIVERSITARIO S2	19/10/2020 05:17	19/10/2020 12:46	19/10/2020 05:17	19/10/2020 09:19	4,03	645	2596,84	CHI
202010101104	MINEIROS	1390069051	PARQUE DAS EMAS	19/10/2020 05:17	19/10/2020 11:53	19/10/2020 05:17	19/10/2020 11:53	6,59	1	6,59	CHI
202010102279	ANAPOLIS	AN11107984	ANAPOLIS UNIVERSITARIO S2	19/10/2020 05:19	19/10/2020 10:40	19/10/2020 05:19	19/10/2020 10:40	5,35	92	492,17	CHI
202010101108	PIRACANJUBA	PJ21082712	PIRACANJUBA	19/10/2020 05:19	19/10/2020 07:07	19/10/2020 05:19	19/10/2020 07:07	1,79	1	1,79	CHI
202010101109	FAZENDA NOVA	NB12099390	JUSSARA	19/10/2020 05:20	19/10/2020 09:08	19/10/2020 05:20	19/10/2020 09:08	3,79	15	56,85	CHI
202010101109	NOVO BRASIL	NB12099390	JUSSARA	19/10/2020 05:20	19/10/2020 09:08	19/10/2020 05:20	19/10/2020 09:08	3,79	26	98,55	CHI
202010102204	ORIZONA	OZ12375421	VIANOPOLIS	19/10/2020 05:22	20/10/2020 11:06	19/10/2020 05:22	20/10/2020 11:06	29,73	13	386,55	CHI
202010103037	LUZIANIA	LZ12383059	CRISTALINA S2	19/10/2020 05:22	19/10/2020 11:56	19/10/2020 05:22	19/10/2020 11:56	6,56	54	354,09	CHI
202010101369	ANAPOLIS	AN12077949	ANAPOLIS UNIVERSITARIO S2	19/10/2020 05:22	19/10/2020 10:06	19/10/2020 05:22	19/10/2020 10:06	4,72	404	1907,55	CHI
202010101115	APARECIDA DE GOIANIA	AP12193733	INDEPENDENCIA S1	19/10/2020 05:22	19/10/2020 16:57	19/10/2020 05:22	19/10/2020 16:57	11,58	154	1783,23	CHI
202010101115	APARECIDA DE GOIANIA	AP21211339	INDEPENDENCIA S1	19/10/2020 05:22	19/10/2020 16:57	19/10/2020 05:22	19/10/2020 15:47	10,41	1	10,41	CHI
202010103105	NAZARIO	PL10404075	PALMEIRAS	19/10/2020 05:24	19/10/2020 10:30	19/10/2020 05:24	19/10/2020 10:30	5,09	4	20,37	CHI
202010103105	PALMEIRAS DE GOIAS	PL10404075	PALMEIRAS	19/10/2020 05:24	19/10/2020 10:30	19/10/2020 05:24	19/10/2020 10:30	5,09	137	697,75	CHI
202010101118	MOSSAMEDES	MD12307488LD	ITABERAI S2	19/10/2020 05:25	19/10/2020 11:15	19/10/2020 05:25	19/10/2020 11:15	5,82	114	663,77	CHI
202010102076	IPAMERI	IP12068500	CRISTALINA S2	19/10/2020 05:27	19/10/2020 11:11	19/10/2020 05:27	19/10/2020 11:11	5,73	66	378,20	CHI
202010101122	DISTRITO FEDERAL	IJ12200617	ITAJA S2	19/10/2020 05:27	19/10/2020 07:13	19/10/2020 05:27	19/10/2020 07:13	1,76	2	3,52	CHI
202010101122	ITAJA	IJ12200617	ITAJA S2	19/10/2020 05:27	19/10/2020 07:13	19/10/2020 05:27	19/10/2020 07:13	1,76	5	8,81	CHI
202010101123	GOIANIA	GN12155252	CAMPINAS S2	19/10/2020 05:28	19/10/2020 07:05	19/10/2020 05:28	19/10/2020 07:05	1,61	130	209,73	CHI
202010101134	FAINA	FC12299792	GOIAS	19/10/2020 05:34	19/10/2020 11:01	19/10/2020 05:34	19/10/2020 11:01	5,45	54	294,30	CHI
202010101135	SANCLERLANDIA	SC12052751	FIRMINOPOLIS S2	19/10/2020 05:34	19/10/2020 07:54	19/10/2020 05:34	19/10/2020 07:54	2,32	19	44,16	CHI
202010101135	BURITI DE GOIAS	SC12052751	FIRMINOPOLIS S2	19/10/2020 05:34	19/10/2020 07:54	19/10/2020 05:34	19/10/2020 07:54	2,32	3	6,97	CHI
202010101136	GUAPO	GA21319473	GUAPO S2	19/10/2020 05:35	19/10/2020 07:09	19/10/2020 05:35	19/10/2020 07:09	1,56	2	3,12	CHI
202010101829	JUSSARA	20016682	BRITANIA	19/10/2020 05:36	19/10/2020 13:09	19/10/2020 05:36	19/10/2020 13:09	7,54	5	37,70	CHI
202010101138	ABADIANIA	AA12258349LD	DAIA S2	19/10/2020 05:37	19/10/2020 12:42	19/10/2020 05:37	19/10/2020 12:42	7,08	8	56,66	CHI
202010101140	FORMOSA	FA11322742	ITUIQUIRA	19/10/2020 05:37	19/10/2020 11:52	19/10/2020 05:37	19/10/2020 11:52	6,24	61	380,59	CHI
202010102202	MONTES CLAROS DE GOIAS	ME21088292	IPORA	19/10/2020 05:38	19/10/2020 23:00	19/10/2020 05:38	19/10/2020 23:00	17,36	1	17,36	CHI
202010101147	URUACU	01970414	MINACU	19/10/2020 05:40	19/10/2020 18:01	19/10/2020 05:40	19/10/2020 18:01	12,34	1	12,34	CHI
202010101147	CAVALCANTE	01970414	MINACU	19/10/2020 05:40	19/10/2020 18:01	19/10/2020 05:40	19/10/2020 18:01	12,34	378	4664,10	CHI
202010101147	COLINAS DO SUL	01970414	MINACU	19/10/2020 05:40	19/10/2020 18:01	19/10/2020 05:40	19/10/2020 18:01	12,34	443	5466,13	CHI
202010101147	NIQUELANDIA	01970414	MINACU	19/10/2020 05:40	19/10/2020 18:01	19/10/2020 05:40	19/10/2020 18:01	12,34	1	12,34	CHI
202010101147	COLINAS DO SUL	TI10401551	MINACU	19/10/2020 05:40	19/10/2020 18:01	19/10/2020 05:41	19/10/2020 18:01	12,33	2	24,65	CHI
202010101147	CAVALCANTE	TI10401551	MINACU	19/10/2020 05:40	19/10/2020 18:01	19/10/2020 05:41	19/10/2020 18:01	12,33	1	12,33	CHI

202010101147	COLINAS DO SUL	01970414	MINACU	19/10/2020 05:40	19/10/2020 18:01	19/10/2020 05:40	19/10/2020 17:21	11,68	1	11,68	CHI
202010101147	COLINAS DO SUL	01970414	MINACU	19/10/2020 05:40	19/10/2020 18:01	19/10/2020 05:40	19/10/2020 13:22	7,69	2	15,39	CHI
202010101147	MINACU	01970414	MINACU	19/10/2020 05:40	19/10/2020 18:01	19/10/2020 05:40	19/10/2020 13:22	7,69	5	38,47	CHI
202010101147	MINACU	01970414	MINACU	19/10/2020 05:40	19/10/2020 18:01	19/10/2020 05:41	19/10/2020 11:50	6,15	1	6,15	CHI
202010101147	MINACU	01970414	MINACU	19/10/2020 05:40	19/10/2020 18:01	19/10/2020 05:40	19/10/2020 09:28	3,79	2	7,58	CHI
202010101148	AGUA LIMPA	AL12391494RE	VILA CORUMBA	19/10/2020 05:47	19/10/2020 09:10	19/10/2020 05:47	19/10/2020 09:10	3,38	16	54,00	CHI
202010101150	DOVERLANDIA	DV12212770	CAIAPONIA	19/10/2020 05:50	19/10/2020 10:04	19/10/2020 05:50	19/10/2020 10:04	4,23	5	21,14	CHI
202010101151	CRISTALINA	03940216	CRISTALINA S2	19/10/2020 05:50	19/10/2020 10:30	19/10/2020 05:50	19/10/2020 10:30	4,66	256	1192,82	CHI
202010101348	ITUMBIARA	BJ18392097TS	BOM JESUS DE GOIAS	19/10/2020 05:52	19/10/2020 08:48	19/10/2020 05:52	19/10/2020 08:48	2,92	66	192,85	CHI
202010101348	BOM JESUS DE GOIAS	BJ18392097TS	BOM JESUS DE GOIAS	19/10/2020 05:52	19/10/2020 08:48	19/10/2020 05:52	19/10/2020 08:48	2,92	2	5,84	CHI
202010101154	ITAPIRAPUA	IU12206870	MATRINCHA	19/10/2020 05:52	19/10/2020 11:23	19/10/2020 05:52	19/10/2020 11:23	5,50	8	44,02	CHI
202010101156	PROFESSOR JAMIL SAFADY	PJ21088310	ROCHEDO	19/10/2020 05:57	19/10/2020 10:59	19/10/2020 05:57	19/10/2020 10:59	5,03	2	10,07	CHI
202010101159	JARAGUA	JA12297837	JARAGUA	19/10/2020 06:00	19/10/2020 07:08	19/10/2020 06:00	19/10/2020 07:08	1,13	9	10,17	CHI
202010101162	SANTA ROSA DE GOIAS	SR12107586	INHUMAS S1	19/10/2020 06:01	19/10/2020 15:10	19/10/2020 06:01	19/10/2020 15:10	9,14	62	566,61	CHI
202010101163	PONTALINA	PK12074323	VICENTINOPOLIS	19/10/2020 06:02	19/10/2020 10:29	19/10/2020 06:02	19/10/2020 10:29	4,44	6	26,67	CHI
202010101165	MINACU	IH12397473	MINACU	19/10/2020 06:02	19/10/2020 10:26	19/10/2020 06:02	19/10/2020 10:26	4,39	8	35,12	CHI
202010102562	JAUPACI	JP12349752	IPORA	19/10/2020 06:04	19/10/2020 12:41	19/10/2020 06:04	19/10/2020 12:41	6,62	41	271,27	CHI
202010100344	CAMPO ALEGRE DE GOIAS	CM12077633RE	CAMPO ALEGRE DE GOIAS	19/10/2020 06:04	19/10/2020 13:10	19/10/2020 06:04	19/10/2020 13:10	7,09	39	276,64	CHI
202010101170	ITUMBIARA	CD12097345RE	BOM JESUS DE GOIAS	19/10/2020 06:04	19/10/2020 07:50	19/10/2020 06:04	19/10/2020 07:50	1,76	6	10,57	CHI
202010101282	GAMELEIRA DE GOIAS	LB12267953	DAIA S2	19/10/2020 06:04	20/10/2020 16:40	19/10/2020 06:04	20/10/2020 16:40	34,59	11	380,44	CHI
202010101282	SILVANIA	LB12267953	DAIA S2	19/10/2020 06:04	20/10/2020 16:40	19/10/2020 06:04	20/10/2020 16:40	34,59	9	311,27	CHI
202010101282	SILVANIA	LB12267953	DAIA S2	19/10/2020 06:04	20/10/2020 16:40	19/10/2020 16:01	20/10/2020 16:40	24,65	13	320,39	CHI
202010101282	SILVANIA	LB12267953	DAIA S2	19/10/2020 06:04	20/10/2020 16:40	19/10/2020 06:04	19/10/2020 15:33	9,48	13	123,27	CHI
202010101175	AGUA FRIA DE GOIAS	TL12048061	SAO JOAO D ALIANCA	19/10/2020 06:06	19/10/2020 13:02	19/10/2020 06:06	19/10/2020 13:02	6,93	56	388,27	CHI
202010101542	PONTALINA	PK12047371RE	VICENTINOPOLIS	19/10/2020 06:06	19/10/2020 08:56	19/10/2020 06:06	19/10/2020 08:56	2,82	48	135,49	CHI
202010101177	TURVANIA	TV12005220	FIRMINOPOLIS S2	19/10/2020 06:06	19/10/2020 10:19	19/10/2020 06:06	19/10/2020 10:19	4,21	9	37,85	CHI
202010101177	PALMEIRAS DE GOIAS	TV12005220	FIRMINOPOLIS S2	19/10/2020 06:06	19/10/2020 10:19	19/10/2020 06:06	19/10/2020 10:19	4,21	5	21,03	CHI
202010105808	BURITI DE GOIAS	BS12304457	FIRMINOPOLIS S2	19/10/2020 06:08	20/10/2020 00:00	19/10/2020 06:08	20/10/2020 00:00	17,86	9	160,76	CHI
202010102352	ITAPIRAPUA	IU12014779	MATRINCHA	19/10/2020 06:08	20/10/2020 08:16	19/10/2020 06:08	20/10/2020 08:16	26,12	12	313,41	CHI
202010101432	MONTES CLAROS DE GOIAS	ME12088922	IPORA	19/10/2020 06:09	19/10/2020 12:06	19/10/2020 06:09	19/10/2020 12:06	5,95	17	101,08	CHI
202010101398	GOIANESIA	GE12360247	GOIANESIA S2	19/10/2020 06:09	19/10/2020 08:15	19/10/2020 06:09	19/10/2020 08:15	2,09	9	18,81	CHI
202010103712	NOVO GAMA	NJ12149816	PACAEMBU S1	19/10/2020 06:10	19/10/2020 13:15	19/10/2020 06:10	19/10/2020 13:15	7,08	232	1643,33	CHI
202010101185	NOVA ROMA	TE12237605RE	FLORES DE GOIAS	19/10/2020 06:10	19/10/2020 10:16	19/10/2020 06:10	19/10/2020 10:16	4,10	32	131,15	CHI
202010101185	TERESINA DE GOIAS	TE12237605RE	FLORES DE GOIAS	19/10/2020 06:10	19/10/2020 10:16	19/10/2020 06:10	19/10/2020 10:16	4,10	217	889,34	CHI
202010101739	ANAPOLIS	AN11000405	JUNDIAI S1	19/10/2020 06:10	19/10/2020 17:50	19/10/2020 06:10	19/10/2020 17:50	11,68	136	1588,37	CHI
202010101568	ITAPIRAPUA	GS12217234	MATRINCHA	19/10/2020 06:11	19/10/2020 09:02	19/10/2020 06:11	19/10/2020 09:02	2,85	1	2,85	CHI
202010101568	NOVO BRASIL	GS12217234	MATRINCHA	19/10/2020 06:11	19/10/2020 09:02	19/10/2020 06:11	19/10/2020 09:02	2,85	36	102,55	CHI
202010101568	GOIAS	GS12217234	MATRINCHA	19/10/2020 06:11	19/10/2020 09:02	19/10/2020 06:11	19/10/2020 09:02	2,85	83	236,43	CHI
202010101757	MATRINCHA	MP12299732	MATRINCHA	19/10/2020 06:11	20/10/2020 11:49	19/10/2020 06:11	20/10/2020 11:49	29,64	42	1244,77	CHI
202010101757	FAINA	MP12299732	MATRINCHA	19/10/2020 06:11	20/10/2020 11:49	19/10/2020 06:11	20/10/2020 11:49	29,64	67	1985,71	CHI
202010101757	ARAGUAPAZ	MP12299732	MATRINCHA	19/10/2020 06:11	20/10/2020 11:49	19/10/2020 06:11	20/10/2020 11:49	29,64	1	29,64	CHI
202010101757	MATRINCHA	MP12299732	MATRINCHA	19/10/2020 06:11	20/10/2020 11:49	19/10/2020 06:11	20/10/2020 10:22	28,19	20	563,79	CHI
202010101751	ANAPOLIS	AN12382500	ANAPOLIS UNIVERSITARIO S2	19/10/2020 06:12	19/10/2020 09:54	19/10/2020 06:12	19/10/2020 09:54	3,70	707	2613,54	CHI
202010104035	URUACU	UR12232449RE	URUACU	19/10/2020 06:13	19/10/2020 12:39	19/10/2020 06:13	19/10/2020 12:39	6,43	55	353,68	CHI
202010101200	BOM JARDIM DE GOIAS	BM12395433	BOM JARDIM	19/10/2020 06:13	19/10/2020 10:33	19/10/2020 06:13	19/10/2020 10:33	4,33	7	30,31	CHI
202010101202	ARAGUAPAZ	AZ12061016	GOIAS	19/10/2020 06:13	19/10/2020 08:40	19/10/2020 06:13	19/10/2020 08:40	2,45	22	53,81	CHI
202010101202	FAINA	AZ12061016	GOIAS	19/10/2020 06:13	19/10/2020 08:40	19/10/2020 06:13	19/10/2020 08:40	2,45	20	48,92	CHI
202010102203	NOVO BRASIL	NB12020253	JUSSARA	19/10/2020 06:15	19/10/2020 12:02	19/10/2020 06:15	19/10/2020 12:02	5,77	7	40,38	CHI
202010102400	ANAPOLIS	AN11377410	JUNDIAI S1	19/10/2020 06:16	19/10/2020 15:36	19/10/2020 06:16	19/10/2020 15:36	9,33	61	568,84	CHI
20201097716	PALMEIRAS DE GOIAS	PL12000093	PALMEIRAS	19/10/2020 06:16	19/10/2020 10:32	19/10/2020 06:16	19/10/2020 10:32	4,27	45	192,00	CHI
202010101217	NIQUELANDIA	NQ12201753LD	URUACU	19/10/2020 06:16	19/10/2020 13:10	19/10/2020 06:16	19/10/2020 13:10	6,88	72	495,68	CHI

202010101219	IPAMERI	IP11056134	IPAMERI	19/10/2020 06:17	19/10/2020 09:45	19/10/2020 06:17	19/10/2020 09:45	3,47	76	263,47	CHI
202010101220	BALIZA	BH12380942	BOM JARDIM	19/10/2020 06:17	20/10/2020 21:10	19/10/2020 06:17	20/10/2020 21:10	38,89	7	272,23	CHI
202010104676	PIRENOPOLIS	PV12297602	CORUMBA	19/10/2020 06:17	19/10/2020 23:25	19/10/2020 06:17	19/10/2020 23:25	17,12	14	239,64	CHI
202010101227	PIRENOPOLIS	PV12381262	CORUMBA	19/10/2020 06:19	19/10/2020 13:51	19/10/2020 06:19	19/10/2020 13:51	7,52	5	37,62	CHI
202010101230	RIO VERDE	04160224	MONTIVIDIU T	19/10/2020 06:19	19/10/2020 08:28	19/10/2020 06:19	19/10/2020 08:28	2,14	98	209,39	CHI
202010101360	ARAGUAPAZ	AZ12404560	GOIAS	19/10/2020 06:20	19/10/2020 08:15	19/10/2020 06:20	19/10/2020 08:15	1,92	4	7,66	CHI
202010101234	ANICUNS	AC21222011	FIRMINOPOLIS S2	19/10/2020 06:20	20/10/2020 09:22	19/10/2020 06:20	20/10/2020 09:22	27,02	1	27,02	CHI
202010101236	BONOPOLIS	BX12391936	SAO MIGUEL DO ARAGUAIA	19/10/2020 06:20	19/10/2020 12:10	19/10/2020 06:20	19/10/2020 12:10	5,82	29	168,81	CHI
202010101239	GOIANIRA	390097561	GOIANIRA	19/10/2020 06:21	19/10/2020 09:46	19/10/2020 06:21	19/10/2020 09:46	3,41	1	3,41	CHI
202010102034	ANAPOLIS	AN21278849	NEROPOLIS S1	19/10/2020 06:22	19/10/2020 12:57	19/10/2020 06:22	19/10/2020 12:57	6,58	1	6,58	CHI
202010101246	PIRENOPOLIS	OV18416809TS	NEROPOLIS S1	19/10/2020 06:22	19/10/2020 10:16	19/10/2020 06:22	19/10/2020 10:16	3,90	29	113,00	CHI
202010101246	ANAPOLIS	OV18416809TS	NEROPOLIS S1	19/10/2020 06:22	19/10/2020 10:16	19/10/2020 06:22	19/10/2020 10:16	3,90	56	218,20	CHI
202010101246	PETROLINA DE GOIAS	OV18416809TS	NEROPOLIS S1	19/10/2020 06:22	19/10/2020 10:16	19/10/2020 06:22	19/10/2020 10:16	3,90	10	38,96	CHI
202010101246	OURO VERDE DE GOIAS	OV18416809TS	NEROPOLIS S1	19/10/2020 06:22	19/10/2020 10:16	19/10/2020 06:22	19/10/2020 10:16	3,90	9	35,07	CHI
202010101247	PIRENOPOLIS	PV12016354	CORUMBA	19/10/2020 06:22	20/10/2020 16:35	19/10/2020 09:56	20/10/2020 16:35	30,66	35	1073,22	CHI
202010101247	PIRENOPOLIS	PV12016354	CORUMBA	19/10/2020 06:22	20/10/2020 16:35	19/10/2020 06:22	19/10/2020 09:55	3,54	35	123,97	CHI
202010101248	RIO VERDE	JT12340898	CABRIUVA S2	19/10/2020 06:22	19/10/2020 16:46	19/10/2020 06:22	19/10/2020 16:46	10,40	1	10,40	CHI
202010101248	RIO VERDE	JT12340898	CABRIUVA S2	19/10/2020 06:22	19/10/2020 16:46	19/10/2020 06:22	19/10/2020 12:58	6,60	5	33,02	CHI
202010101248	RIO VERDE	JT12340898	CABRIUVA S2	19/10/2020 06:22	19/10/2020 16:46	19/10/2020 09:40	19/10/2020 12:58	3,31	1	3,31	CHI
202010101921	ANAPOLIS	AN11022652	JUNDIAI S1	19/10/2020 06:22	20/10/2020 12:02	19/10/2020 06:22	20/10/2020 12:02	29,65	123	3647,09	CHI
202010102684	MOSSAMEDES	MD12006197	FIRMINOPOLIS S2	19/10/2020 06:23	19/10/2020 21:18	19/10/2020 06:23	19/10/2020 21:18	14,91	24	357,95	CHI
202010101258	PORANGATU	PO12384305	PORANGATU	19/10/2020 06:24	19/10/2020 09:02	19/10/2020 06:24	19/10/2020 09:02	2,63	5	13,15	CHI
202010101265	GUAPO	GA11047590	GUAPO S2	19/10/2020 06:25	19/10/2020 11:03	19/10/2020 06:25	19/10/2020 11:03	4,63	123	569,01	CHI
20201099857	JAUPACI	DI12023266RE	IPORA	19/10/2020 06:25	19/10/2020 07:32	19/10/2020 06:25	19/10/2020 07:32	1,11	9	9,97	CHI
20201099857	DIORAMA	DI12023266RE	IPORA	19/10/2020 06:25	19/10/2020 07:32	19/10/2020 06:25	19/10/2020 07:32	1,11	61	67,59	CHI
202010102150	FAZENDA NOVA	JP12207789	IPORA	19/10/2020 06:25	19/10/2020 11:50	19/10/2020 06:25	19/10/2020 11:50	5,41	19	102,75	CHI
202010102150	JAUPACI	JP12207789	IPORA	19/10/2020 06:25	19/10/2020 11:50	19/10/2020 06:25	19/10/2020 11:50	5,41	15	81,12	CHI
202010101269	SANTA CRUZ DE GOIAS	PZ12114941	PIRES DO RIO S2	19/10/2020 06:25	19/10/2020 12:55	19/10/2020 06:25	19/10/2020 12:55	6,49	31	201,08	CHI
202010101269	PIRES DO RIO	PZ12114941	PIRES DO RIO S2	19/10/2020 06:25	19/10/2020 12:55	19/10/2020 06:25	19/10/2020 12:55	6,49	3	19,46	CHI
202010101410	PARAUNA	PU12110555	PARAUNA	19/10/2020 06:25	19/10/2020 08:39	19/10/2020 06:25	19/10/2020 08:39	2,22	16	35,52	CHI
202010101271	MINEIROS	MY21303401	PARQUE DAS EMAS	19/10/2020 06:25	19/10/2020 11:19	19/10/2020 06:25	19/10/2020 11:19	4,88	1	4,88	CHI
202010103642	CORUMBA DE GOIAS	CB12062146	CORUMBA	19/10/2020 06:26	19/10/2020 16:11	19/10/2020 06:26	19/10/2020 16:11	9,74	9	87,65	CHI
202010102171	ANAPOLIS	AN11068145	ANAPOLIS UNIVERSITARIO S2	19/10/2020 06:26	19/10/2020 09:40	19/10/2020 06:26	19/10/2020 09:40	3,22	202	650,83	CHI
202010101276	NOVA CRIXAS	NA21057209	MOZARLANDIA	19/10/2020 06:27	19/10/2020 11:03	19/10/2020 06:27	19/10/2020 11:03	4,60	1	4,60	CHI
202010101382	MINEIROS	MY21221992	PARQUE DAS EMAS	19/10/2020 06:27	19/10/2020 10:08	19/10/2020 06:27	19/10/2020 10:08	3,68	1	3,68	CHI
202010101278	FIRMINOPOLIS	FR12096839RE	FIRMINOPOLIS S1	19/10/2020 06:27	19/10/2020 09:42	19/10/2020 06:27	19/10/2020 09:42	3,24	70	227,15	CHI
202010101278	SAO JOAO DA PARAUNA	FR12096839RE	FIRMINOPOLIS S1	19/10/2020 06:27	19/10/2020 09:42	19/10/2020 06:27	19/10/2020 09:42	3,24	19	61,65	CHI
202010101278	PALMINOPOLIS	FR12096839RE	FIRMINOPOLIS S1	19/10/2020 06:27	19/10/2020 09:42	19/10/2020 06:27	19/10/2020 09:42	3,24	1	3,24	CHI
202010101283	EDEIA	EA12257919RE	EDEIA	19/10/2020 06:28	19/10/2020 08:27	19/10/2020 06:28	19/10/2020 08:27	1,98	45	89,02	CHI
202010101283	EDEALINA	EA12257919RE	EDEIA	19/10/2020 06:28	19/10/2020 08:27	19/10/2020 06:28	19/10/2020 08:27	1,98	1	1,98	CHI
202010102090	NOVA CRIXAS	NA12091692	NOVA CRIXAS	19/10/2020 06:28	19/10/2020 19:36	19/10/2020 06:28	19/10/2020 19:36	13,13	22	288,79	CHI
202010101287	MOSSAMEDES	MD21151459	ITABERAI S2	19/10/2020 06:28	19/10/2020 19:10	19/10/2020 06:28	19/10/2020 19:10	12,69	1	12,69	CHI
202010101897	ARAGUAPAZ	AZ12042908	MOZARLANDIA	19/10/2020 06:28	19/10/2020 09:07	19/10/2020 06:28	19/10/2020 09:07	2,64	46	121,38	CHI
202010101288	JATAI	JT12248478	JATAI S1	19/10/2020 06:28	19/10/2020 12:24	19/10/2020 06:28	19/10/2020 12:24	5,93	3	17,78	CHI
202010101298	MARA ROSA	MQ12051065	MARA ROSA	19/10/2020 06:29	19/10/2020 08:32	19/10/2020 06:29	19/10/2020 08:32	2,05	21	42,99	CHI
202010101292	CACU	CC12322236LD	CACHOEIRA ALTA	19/10/2020 06:29	19/10/2020 21:17	19/10/2020 06:29	19/10/2020 21:17	14,79	1	14,79	CHI
202010101297	NOVA VENEZA	NV12402749	INHUMAS S1	19/10/2020 06:31	19/10/2020 11:38	19/10/2020 06:31	19/10/2020 11:38	5,11	2	10,21	CHI
202010102106	ITAPIRAPUA	IU12396098	JUSSARA	19/10/2020 06:31	20/10/2020 18:40	19/10/2020 06:31	20/10/2020 18:40	36,14	8	289,10	CHI
202010102106	ITAPIRAPUA	IU12020177	JUSSARA	19/10/2020 06:31	20/10/2020 18:40	20/10/2020 06:11	20/10/2020 07:17	1,09	84	91,75	CHI
202010101303	BARRO ALTO	BA12000051LD	BARRO ALTO	19/10/2020 06:32	19/10/2020 12:42	19/10/2020 06:32	19/10/2020 12:42	6,16	129	794,53	CHI
202010101303	NIQUELANDIA	BA12000051LD	BARRO ALTO	19/10/2020 06:32	19/10/2020 12:42	19/10/2020 06:32	19/10/2020 12:42	6,16	111	683,67	CHI

202010102436	ABADIANIA	AA12180462	DAIA S2	19/10/2020 06:32	19/10/2020 10:18	19/10/2020 06:32	19/10/2020 10:18	3,76	3	11,27	CHI
202010101306	URUACU	UR12331932	URUACU	19/10/2020 06:33	19/10/2020 11:36	19/10/2020 06:33	19/10/2020 11:36	5,05	2	10,10	CHI
202010101344	OURO VERDE DE GOIAS	OV12014233	INHUMAS S1	19/10/2020 06:34	19/10/2020 12:05	19/10/2020 06:34	19/10/2020 12:05	5,51	31	170,78	CHI
202010101315	CAMPOS VERDES	3790034032	SANTA TEREZINHA	19/10/2020 06:35	19/10/2020 16:20	19/10/2020 06:35	19/10/2020 16:20	9,76	1	9,76	CHI
202010102650	ANAPOLIS	AN12000149	JUNDIAI S2	19/10/2020 06:35	19/10/2020 10:09	19/10/2020 06:35	19/10/2020 10:09	3,55	378	1343,37	CHI
202010101323	PIRANHAS	PH12024566	ARENOPOLIS	19/10/2020 06:36	19/10/2020 08:42	19/10/2020 06:36	19/10/2020 08:42	2,09	23	48,04	CHI
202010101324	GOIANIA	10517728	GOIANIA LESTE S1	19/10/2020 06:36	19/10/2020 08:38	19/10/2020 06:36	19/10/2020 08:38	2,02	1	2,02	CHI
202010101325	FORMOSA	FA11392331	ITIQUEIRA	19/10/2020 06:37	19/10/2020 09:04	19/10/2020 06:37	19/10/2020 09:04	2,45	1	2,45	CHI
202010101492	FAZENDA NOVA	FN12250532	JUSSARA	19/10/2020 06:37	19/10/2020 09:42	19/10/2020 06:37	19/10/2020 09:42	3,07	11	33,76	CHI
202010102744	CROMINIA	CQ12000217	PONTALINA	19/10/2020 06:38	19/10/2020 14:30	19/10/2020 06:38	19/10/2020 14:30	7,87	13	102,35	CHI
202010101332	ARAGARCAS	AG12334918	ARAGARCAS	19/10/2020 06:38	20/10/2020 20:50	19/10/2020 06:38	20/10/2020 20:50	38,20	3	114,61	CHI
202010102756	PADRE BERNARDO	PB12152732	PADRE BERNARDO	19/10/2020 06:39	19/10/2020 12:35	19/10/2020 06:39	19/10/2020 12:35	5,92	14	82,95	CHI
202010101339	ITAPURANGA	IK12299313	ITAPURANGA	19/10/2020 06:39	19/10/2020 17:39	19/10/2020 06:39	19/10/2020 17:39	10,99	33	362,76	CHI
202010101339	ITAPURANGA	IK12300244	ITAPURANGA	19/10/2020 06:39	19/10/2020 17:39	19/10/2020 06:39	19/10/2020 13:52	7,21	37	266,75	CHI
202010101339	GUARAITA	IK12300356	ITAPURANGA	19/10/2020 06:39	19/10/2020 17:39	19/10/2020 06:39	19/10/2020 11:57	5,29	33	174,57	CHI
202010101339	ITAPURANGA	IK12300356	ITAPURANGA	19/10/2020 06:39	19/10/2020 17:39	19/10/2020 06:39	19/10/2020 11:57	5,29	13	68,77	CHI
202010103393	PIRENOPOLIS	PV11210827	SAO FRANCISCO DE GOIAS	19/10/2020 06:40	19/10/2020 12:14	19/10/2020 06:40	19/10/2020 12:14	5,56	101	561,48	CHI
202010102770	JUSSARA	JR12074365	BRITANIA	19/10/2020 06:42	20/10/2020 10:40	19/10/2020 06:42	20/10/2020 10:40	27,97	37	1034,82	CHI
202010102770	SANTA FE DE GOIAS	JR12074365	BRITANIA	19/10/2020 06:42	20/10/2020 10:40	19/10/2020 06:42	20/10/2020 10:40	27,97	21	587,33	CHI
202010101350	ARENOPOLIS	AY12105959	ARENOPOLIS	19/10/2020 06:43	19/10/2020 10:15	19/10/2020 06:43	19/10/2020 10:15	3,53	2	7,06	CHI
202010101350	PIRANHAS	AY12105959	ARENOPOLIS	19/10/2020 06:43	19/10/2020 10:15	19/10/2020 06:43	19/10/2020 10:15	3,53	1	3,53	CHI
202010101353	GOIANIA	10928649	FERROVIARIO S2	19/10/2020 06:44	19/10/2020 08:13	19/10/2020 06:44	19/10/2020 08:13	1,47	1	1,47	CHI
202010101361	RUBIATABA	780058690	RUBIATABA	19/10/2020 06:46	19/10/2020 08:31	19/10/2020 06:46	19/10/2020 08:31	1,74	1	1,74	CHI
202010101362	ANAPOLIS	20634341	JUNDIAI S1	19/10/2020 06:46	20/10/2020 07:53	19/10/2020 06:46	20/10/2020 07:53	25,10	1	25,10	CHI
202010101366	JARAGUA	JA12297448	JARAGUA	19/10/2020 06:47	19/10/2020 07:48	19/10/2020 06:47	19/10/2020 07:48	1,01	169	170,64	CHI
202010101366	PIRENOPOLIS	JA12297448	JARAGUA	19/10/2020 06:47	19/10/2020 07:48	19/10/2020 06:47	19/10/2020 07:48	1,01	55	55,53	CHI
202010101368	ABADIA DE GOIAS	LG12099099	GUAPO S1	19/10/2020 06:47	19/10/2020 08:49	19/10/2020 06:47	19/10/2020 08:49	2,02	12	24,28	CHI
202010101370	PROFESSOR JAMIL SAFADY	JS21129278	ROCHEDO	19/10/2020 06:48	19/10/2020 10:15	19/10/2020 06:48	19/10/2020 10:15	3,45	2	6,90	CHI
202010101372	RIO VERDE	10009940276	CABRIUVA S1	19/10/2020 06:48	19/10/2020 11:30	19/10/2020 06:48	19/10/2020 11:30	4,70	1	4,70	CHI
202010102404	ABADIANIA	AA12388803	DAIA S2	19/10/2020 06:48	19/10/2020 10:59	19/10/2020 06:48	19/10/2020 10:59	4,17	36	150,13	CHI
202010103932	PIRENOPOLIS	PV12362263	CORUMBA	19/10/2020 06:49	20/10/2020 09:32	19/10/2020 06:49	20/10/2020 09:32	26,71	13	347,27	CHI
202010101377	JARAGUA	JA12070670	JARAGUA	19/10/2020 06:49	19/10/2020 09:10	19/10/2020 06:49	19/10/2020 09:10	2,34	10	23,41	CHI
202010100322	CAMPO ALEGRE DE GOIAS	CM12266823	CAMPO ALEGRE DE GOIAS	19/10/2020 06:50	19/10/2020 09:56	19/10/2020 06:50	19/10/2020 09:56	3,10	42	130,11	CHI
202010101383	ANAPOLIS	10006052787	JUNDIAI S1	19/10/2020 06:51	20/10/2020 11:51	19/10/2020 06:51	20/10/2020 11:51	28,99	1	28,99	CHI
202010101385	APARECIDA DE GOIANIA	200328505	INDEPENDENCIA S1	19/10/2020 06:51	19/10/2020 09:03	19/10/2020 06:51	19/10/2020 09:03	2,18	1	2,18	CHI
202010103137	JUSSARA	JR12406350	JUSSARA	19/10/2020 06:52	19/10/2020 14:06	19/10/2020 06:52	19/10/2020 14:06	7,22	302	2181,45	CHI
202010101388	VIANOPOLIS	VN12093853	VIANOPOLIS	19/10/2020 06:53	19/10/2020 11:55	19/10/2020 06:53	19/10/2020 11:55	5,03	8	40,24	CHI
202010102627	PADRE BERNARDO	PB12290560	PADRE BERNARDO	19/10/2020 06:53	19/10/2020 11:26	19/10/2020 06:53	19/10/2020 11:26	4,55	29	131,83	CHI
202010101391	FAZENDA NOVA	FN12060710	IPORA	19/10/2020 06:53	19/10/2020 15:02	19/10/2020 06:53	19/10/2020 15:02	8,13	49	398,59	CHI
202010101706	CRISTALINA	KR12304869	CRISTALINA S2	19/10/2020 06:54	19/10/2020 11:57	19/10/2020 06:54	19/10/2020 11:57	5,04	16	80,67	CHI
202010101400	SAO MIGUEL DO ARAGUAIA	SM12074386RE	SAO MIGUEL DO ARAGUAIA	19/10/2020 06:55	19/10/2020 20:30	19/10/2020 06:55	19/10/2020 20:30	13,57	134	1818,42	CHI
202010101400	NOVO PLANALTO	SM12074386RE	SAO MIGUEL DO ARAGUAIA	19/10/2020 06:55	19/10/2020 20:30	19/10/2020 06:55	19/10/2020 20:30	13,57	6	81,42	CHI
202010108840	ITAPIRAPUA	IU12060539	MATRINCHA	19/10/2020 06:56	20/10/2020 11:55	19/10/2020 06:56	20/10/2020 11:55	28,98	4	115,91	CHI
202010101405	GAMELEIRA DE GOIAS	05720214	DAIA S2	19/10/2020 06:56	19/10/2020 23:32	19/10/2020 06:56	19/10/2020 23:32	16,59	12	199,10	CHI
202010101406	SANTO ANTONIO DO DESCOBERTO	SN12241549	MARAJOARA	19/10/2020 06:56	19/10/2020 14:06	19/10/2020 06:56	19/10/2020 14:06	7,15	2	14,30	CHI
202010103935	NOVO GAMA	NU12313972	MARAJOARA	19/10/2020 06:57	19/10/2020 12:09	19/10/2020 06:57	19/10/2020 12:09	5,19	301	1563,44	CHI
202010100662	MONTES CLAROS DE GOIAS	JR10408237	BRITANIA	19/10/2020 06:57	19/10/2020 14:20	19/10/2020 06:57	19/10/2020 14:20	7,37	164	1209,41	CHI
202010100662	JUSSARA	JR10408237	BRITANIA	19/10/2020 06:57	19/10/2020 14:20	19/10/2020 06:57	19/10/2020 14:20	7,37	78	575,21	CHI
202010101507	BARRO ALTO	BA12382467	BARRO ALTO	19/10/2020 06:58	19/10/2020 13:50	19/10/2020 09:49	19/10/2020 13:50	4,03	3	12,09	CHI
202010101507	BARRO ALTO	BA12382467	BARRO ALTO	19/10/2020 06:58	19/10/2020 13:50	19/10/2020 13:26	19/10/2020 13:50	0,41	12	4,93	CHI
202010101507	HIDROLINA	00180434	BARRO ALTO	19/10/2020 06:58	19/10/2020 13:50	19/10/2020 06:58	19/10/2020 12:34	5,60	1	5,60	CHI

202010101507	SAO LUIZ DO NORTE	00180434	BARRO ALTO	19/10/2020 06:58	19/10/2020 13:50	19/10/2020 06:58	19/10/2020 12:34	5,60	89	498,72	CHI
202010101507	BARRO ALTO	BA10401412	BARRO ALTO	19/10/2020 06:58	19/10/2020 13:50	19/10/2020 06:58	19/10/2020 12:22	5,41	2	10,83	CHI
202010101507	SAO LUIZ DO NORTE	BA10401412	BARRO ALTO	19/10/2020 06:58	19/10/2020 13:50	19/10/2020 06:58	19/10/2020 12:22	5,41	2	10,83	CHI
202010101507	SANTA RITA DO NOVO DESTINO	BA10401412	BARRO ALTO	19/10/2020 06:58	19/10/2020 13:50	19/10/2020 06:58	19/10/2020 12:22	5,41	8	43,32	CHI
202010101507	BARRO ALTO	BA12382467	BARRO ALTO	19/10/2020 06:58	19/10/2020 13:50	19/10/2020 09:49	19/10/2020 11:34	1,76	12	21,10	CHI
202010101507	SAO LUIZ DO NORTE	00180434	BARRO ALTO	19/10/2020 06:58	19/10/2020 13:50	19/10/2020 06:58	19/10/2020 09:48	2,84	8	22,75	CHI
202010101507	GOIANESIA	00180434	BARRO ALTO	19/10/2020 06:58	19/10/2020 13:50	19/10/2020 06:58	19/10/2020 09:02	2,07	4	8,27	CHI
202010101507	BARRO ALTO	00180434	BARRO ALTO	19/10/2020 06:58	19/10/2020 13:50	19/10/2020 06:58	19/10/2020 09:02	2,07	24	49,62	CHI
202010101507	SAO LUIZ DO NORTE	00180434	BARRO ALTO	19/10/2020 06:58	19/10/2020 13:50	19/10/2020 06:58	19/10/2020 09:02	2,07	14	28,94	CHI
202010101507	SANTA RITA DO NOVO DESTINO	00180434	BARRO ALTO	19/10/2020 06:58	19/10/2020 13:50	19/10/2020 06:58	19/10/2020 09:02	2,07	218	450,71	CHI
202010101507	MIMOSO DE GOIAS	00180434	BARRO ALTO	19/10/2020 06:58	19/10/2020 13:50	19/10/2020 06:58	19/10/2020 07:03	0,09	4	0,38	CHI
202010101507	NIQUELANDIA	00180434	BARRO ALTO	19/10/2020 06:58	19/10/2020 13:50	19/10/2020 06:58	19/10/2020 07:03	0,09	1051	98,97	CHI
202010101507	VILA PROPICIO	00180434	BARRO ALTO	19/10/2020 06:58	19/10/2020 13:50	19/10/2020 06:58	19/10/2020 07:03	0,09	31	2,92	CHI
202010101507	NIQUELANDIA	00180434	BARRO ALTO	19/10/2020 06:58	19/10/2020 13:50	19/10/2020 06:58	19/10/2020 07:03	0,09	183	17,23	CHI
202010101507	MIMOSO DE GOIAS	00180434	BARRO ALTO	19/10/2020 06:58	19/10/2020 13:50	19/10/2020 06:58	19/10/2020 07:03	0,09	9	0,85	CHI
202010101507	VILA PROPICIO	BA10400442	BARRO ALTO	19/10/2020 06:58	19/10/2020 13:50	19/10/2020 06:58	19/10/2020 07:03	0,09	1	0,09	CHI
202010101507	VILA PROPICIO	00180434	BARRO ALTO	19/10/2020 06:58	19/10/2020 13:50	19/10/2020 06:58	19/10/2020 07:03	0,09	49	4,61	CHI
202010101408	NOVO GAMA	LZ12000279	PACAEMBU S2	19/10/2020 06:58	19/10/2020 11:55	19/10/2020 06:58	19/10/2020 11:55	4,95	18	89,03	CHI
202010101868	SAO MIGUEL DO PASSA QUATRO	BV12211127	CRISTIANOPOLIS	19/10/2020 06:58	19/10/2020 10:53	19/10/2020 06:58	19/10/2020 10:53	3,91	13	50,78	CHI
202010101868	BELA VISTA DE GOIAS	BV12211127	CRISTIANOPOLIS	19/10/2020 06:58	19/10/2020 10:53	19/10/2020 06:58	19/10/2020 10:53	3,91	1	3,91	CHI
202010104504	TRINDADE	TR12000037	TRINDADE	19/10/2020 06:59	19/10/2020 13:24	19/10/2020 06:59	19/10/2020 13:24	6,41	459	2944,36	CHI
202010101424	SANTA RITA DO ARAGUAIA	SU12248425	SANTA RITA DO ARAGUAIA	19/10/2020 06:59	19/10/2020 19:32	19/10/2020 06:59	19/10/2020 19:32	12,55	136	1706,76	CHI
202010101424	BURITINOPOLIS	SU12248425	SANTA RITA DO ARAGUAIA	19/10/2020 06:59	19/10/2020 19:32	19/10/2020 06:59	19/10/2020 19:32	12,55	1	12,55	CHI
202010101424	MINEIROS	SU12248425	SANTA RITA DO ARAGUAIA	19/10/2020 06:59	19/10/2020 19:32	19/10/2020 06:59	19/10/2020 19:32	12,55	11	138,05	CHI
202010101424	SANTA RITA DO ARAGUAIA	SU10402666	SANTA RITA DO ARAGUAIA	19/10/2020 06:59	19/10/2020 19:32	19/10/2020 06:59	19/10/2020 13:57	6,98	18	125,62	CHI
202010101424	SANTA RITA DO ARAGUAIA	SU10402666	SANTA RITA DO ARAGUAIA	19/10/2020 06:59	19/10/2020 19:32	19/10/2020 12:58	19/10/2020 13:02	0,07	39	2,87	CHI
202010101424	SANTA RITA DO ARAGUAIA	SU10402666	SANTA RITA DO ARAGUAIA	19/10/2020 06:59	19/10/2020 19:32	19/10/2020 10:26	19/10/2020 10:40	0,23	39	8,89	CHI
202010101424	SANTA RITA DO ARAGUAIA	SU10402666	SANTA RITA DO ARAGUAIA	19/10/2020 06:59	19/10/2020 19:32	19/10/2020 06:59	19/10/2020 10:16	3,29	39	128,20	CHI
202010109511	CAMPOS VERDES	VD21054417	SANTA TEREZINHA	19/10/2020 06:59	20/10/2020 04:29	19/10/2020 06:59	20/10/2020 04:29	21,49	1	21,49	CHI
202010101417	ITABERAI	1810002440	ITABERAI S1	19/10/2020 06:59	19/10/2020 08:06	19/10/2020 06:59	19/10/2020 08:06	1,10	1	1,10	CHI
202010101418	ITABERAI	IB12108138	ITABERAI S2	19/10/2020 06:59	19/10/2020 09:16	19/10/2020 06:59	19/10/2020 09:16	2,27	28	63,50	CHI
202010102768	GOIAS	GS12250872	GOIAS	19/10/2020 07:00	19/10/2020 11:10	19/10/2020 07:00	19/10/2020 11:10	4,17	33	137,45	CHI
202010101422	CRISTALINA	KR11170148	CRISTALINA S1	19/10/2020 07:01	19/10/2020 14:04	19/10/2020 07:01	19/10/2020 14:04	7,05	145	1022,21	CHI
202010101425	ITABERAI	IB12379742	ITABERAI S2	19/10/2020 07:01	19/10/2020 09:47	19/10/2020 07:01	19/10/2020 09:47	2,75	225	619,19	CHI
202010101426	GOIANIA	10301872	CAMPINAS S2	19/10/2020 07:01	19/10/2020 08:36	19/10/2020 07:01	19/10/2020 08:36	1,57	1	1,57	CHI
202010101428	SANTO ANTONIO DO DESCOBERTO	SN21135451	MARAJOARA	19/10/2020 07:02	19/10/2020 12:42	19/10/2020 07:02	19/10/2020 12:42	5,66	1	5,66	CHI
202010101496	ITAPIRAPUA	IU12014785	MATRINCHA	19/10/2020 07:02	20/10/2020 07:16	19/10/2020 07:02	20/10/2020 07:16	24,22	8	193,75	CHI
202010101438	HIDROLINA	HL12068284RE	URUACU	19/10/2020 07:04	19/10/2020 15:59	19/10/2020 07:04	19/10/2020 15:59	8,90	22	195,90	CHI
202010103004	GAMELEIRA DE GOIAS	AA12295623	ANAPOLIS UNIVERSITARIO S1	19/10/2020 07:07	20/10/2020 11:15	19/10/2020 07:07	20/10/2020 11:15	28,13	28	787,69	CHI
202010103004	ABADIANIA	AA12295623	ANAPOLIS UNIVERSITARIO S1	19/10/2020 07:07	20/10/2020 11:15	19/10/2020 07:07	20/10/2020 11:15	28,13	7	196,92	CHI
202010101452	QUIRINOPOLIS	QI12000225	QUIRINOPOLIS	19/10/2020 07:07	19/10/2020 10:01	19/10/2020 07:07	19/10/2020 10:01	2,89	46	132,94	CHI
202010102518	APARECIDA DE GOIANIA	AP11205332	ANHANGUERA	19/10/2020 07:07	19/10/2020 10:18	19/10/2020 07:07	19/10/2020 10:18	3,17	109	345,62	CHI
202010101455	GOIAS	GS12220163	GOIAS	19/10/2020 07:07	19/10/2020 08:40	19/10/2020 07:07	19/10/2020 08:40	1,54	143	219,78	CHI
202010102924	ABADIANIA	AA12382337	CORUMBA	19/10/2020 07:08	19/10/2020 10:57	19/10/2020 07:08	19/10/2020 10:57	3,81	43	163,90	CHI
202010101460	ORIZONA	OZ21326690	PIRES DO RIO S2	19/10/2020 07:08	19/10/2020 09:13	19/10/2020 07:08	19/10/2020 09:13	2,08	1	2,08	CHI
202010101525	ANAPOLIS	AN11000180	JUNDIAI S1	19/10/2020 07:08	19/10/2020 10:22	19/10/2020 07:08	19/10/2020 10:22	3,22	58	186,99	CHI
202010101661	ANICUNS	AC11105825	ANICUNS	19/10/2020 07:08	19/10/2020 13:00	19/10/2020 07:08	19/10/2020 13:00	5,85	161	941,98	CHI
202010101464	CORUMBA DE GOIAS	CB12382397	CORUMBA	19/10/2020 07:09	19/10/2020 09:47	19/10/2020 07:09	19/10/2020 09:47	2,63	33	86,90	CHI
202010101467	ANAPOLIS	AN21302285	JUNDIAI S1	19/10/2020 07:09	19/10/2020 08:26	19/10/2020 07:09	19/10/2020 08:26	1,27	2	2,54	CHI
202010101468	IPORA	730073750	IPORA	19/10/2020 07:09	19/10/2020 10:04	19/10/2020 07:09	19/10/2020 10:04	2,90	1	2,90	CHI
202010101474	NIQUELANDIA	NQ12094112	NIQUELANDIA SUBTRANSMISSAO	19/10/2020 07:11	19/10/2020 09:49	19/10/2020 07:11	19/10/2020 09:49	2,63	258	678,90	CHI

202010101574	ALEXANIA	AX12311915	ALEXANIA	19/10/2020 07:11	19/10/2020 09:05	19/10/2020 07:11	19/10/2020 09:05	1,89	107	202,62	CHI
202010102569	SANTA FE DE GOIAS	RN12232821	BRITANIA	19/10/2020 07:11	19/10/2020 18:41	19/10/2020 07:11	19/10/2020 18:41	11,49	3	34,47	CHI
202010101481	HIDROLANDIA	HD21243310	CEPAIGO S2	19/10/2020 07:12	19/10/2020 08:37	19/10/2020 07:12	19/10/2020 08:37	1,41	1	1,41	CHI
202010105917	SAO MIGUEL DO ARAGUAIA	SM12104528	SAO MIGUEL DO ARAGUAIA	19/10/2020 07:13	20/10/2020 11:39	19/10/2020 07:13	20/10/2020 11:39	28,42	2	56,84	CHI
202010101490	ALTO PARAISO DE GOIAS	BF21268373	IACIARA S2	19/10/2020 07:14	19/10/2020 10:22	19/10/2020 07:14	19/10/2020 10:22	3,12	1	3,12	CHI
202010101491	GOIANDIRA	GD12081394LD	CATALAO S1	19/10/2020 07:15	19/10/2020 11:29	19/10/2020 07:15	19/10/2020 11:29	4,24	1	4,24	CHI
202010102715	ESTRELA DO NORTE	ET12136395	MARA ROSA	19/10/2020 07:15	19/10/2020 10:53	19/10/2020 07:15	19/10/2020 10:53	3,63	11	39,92	CHI
202010102715	MARA ROSA	ET12136395	MARA ROSA	19/10/2020 07:15	19/10/2020 10:53	19/10/2020 07:15	19/10/2020 10:53	3,63	9	32,66	CHI
202010101495	MORRINHOS	MR12060782	MORRINHOS	19/10/2020 07:15	19/10/2020 08:47	19/10/2020 07:15	19/10/2020 08:47	1,53	6	9,16	CHI
202010101497	PROFESSOR JAMIL SAFADY	JS21181919	ROCHEDO	19/10/2020 07:15	19/10/2020 09:27	19/10/2020 07:15	19/10/2020 09:27	2,18	1	2,18	CHI
202010101501	BELA VISTA DE GOIAS	BV21324924	BELA VISTA S1	19/10/2020 07:16	19/10/2020 14:07	19/10/2020 07:16	19/10/2020 14:07	6,84	2	13,69	CHI
202010101504	ANAPOLIS	AN21258783	JUNDIAI S1	19/10/2020 07:17	19/10/2020 23:05	19/10/2020 07:17	19/10/2020 23:05	15,80	1	15,80	CHI
202010101506	TURVELANDIA	TD11170324	RIO DOS BOIS	19/10/2020 07:17	19/10/2020 09:48	19/10/2020 07:17	19/10/2020 09:48	2,51	108	270,93	CHI
202010104008	ANAPOLIS	AN11375933	JUNDIAI S1	19/10/2020 07:18	19/10/2020 13:38	19/10/2020 07:18	19/10/2020 13:38	6,33	59	373,58	CHI
202010101514	APARECIDA DE GOIANIA	AP21168922	CEPAIGO S1	19/10/2020 07:18	19/10/2020 10:12	19/10/2020 07:18	19/10/2020 10:12	2,89	1	2,89	CHI
202010101516	RIO VERDE	7112986	CABRIUVA S2	19/10/2020 07:18	19/10/2020 19:40	19/10/2020 07:18	19/10/2020 19:40	12,37	3	37,10	CHI
202010101519	GUAPO	GA21000056	GUAPO S1	19/10/2020 07:18	19/10/2020 09:07	19/10/2020 07:18	19/10/2020 09:07	1,80	1	1,80	CHI
202010101521	JARAGUA	JA11121790	SAO FRANCISCO DE GOIAS	19/10/2020 07:19	19/10/2020 09:24	19/10/2020 07:19	19/10/2020 09:24	2,08	14	29,06	CHI
202010101522	EDEIA	1120015318	EDEIA	19/10/2020 07:19	19/10/2020 08:54	19/10/2020 07:19	19/10/2020 08:54	1,57	1	1,57	CHI
202010103467	RIO VERDE	RV12260256	RIO VERDE S1	19/10/2020 07:20	19/10/2020 14:50	19/10/2020 07:20	19/10/2020 14:50	7,50	19	142,49	CHI
202010101530	NIQUELANDIA	NQ12392028	URUACU	19/10/2020 07:20	19/10/2020 11:51	19/10/2020 07:20	19/10/2020 11:51	4,51	8	36,10	CHI
202010101531	GOIANIA	13760142	CAMPINAS S2	19/10/2020 07:20	19/10/2020 09:47	19/10/2020 07:20	19/10/2020 09:47	2,44	1	2,44	CHI
202010101639	SANTO ANTONIO DO DESCOBERTO	SN12382252	ALEXANIA	19/10/2020 07:20	19/10/2020 10:20	19/10/2020 07:20	19/10/2020 10:20	2,99	10	29,91	CHI
202010101946	SAO MIGUEL DO ARAGUAIA	SM12096089RE	SAO MIGUEL DO ARAGUAIA	19/10/2020 07:20	20/10/2020 11:25	19/10/2020 07:20	20/10/2020 11:25	28,08	14	393,07	CHI
202010101535	FORMOSA	FA12146108	ITUIQUIRA	19/10/2020 07:21	19/10/2020 09:44	19/10/2020 07:21	19/10/2020 09:44	2,38	33	78,57	CHI
202010102946	ALEXANIA	AX12114206	ALEXANIA	19/10/2020 07:21	19/10/2020 12:34	19/10/2020 07:21	19/10/2020 12:34	5,21	96	499,84	CHI
202010102222	SANTA FE DE GOIAS	RN12250752	BRITANIA	19/10/2020 07:24	19/10/2020 10:07	19/10/2020 07:24	19/10/2020 10:07	2,72	43	116,78	CHI
202010102222	JUSSARA	RN12250752	BRITANIA	19/10/2020 07:24	19/10/2020 10:07	19/10/2020 07:24	19/10/2020 10:07	2,72	19	51,60	CHI
202010102952	MONTES CLAROS DE GOIAS	ME12210017	IPORA	19/10/2020 07:24	19/10/2020 13:30	19/10/2020 07:24	19/10/2020 13:30	6,09	24	146,18	CHI
202010101557	BOM JARDIM DE GOIAS	BM12064233	BOM JARDIM	19/10/2020 07:25	19/10/2020 11:55	19/10/2020 07:25	19/10/2020 11:55	4,50	6	27,00	CHI
202010104982	ITAPACI	IW12282269	ITAPACI	19/10/2020 07:25	19/10/2020 14:00	19/10/2020 07:25	19/10/2020 14:00	6,58	7	46,07	CHI
202010101567	TRINDADE	TR11005124	TRINDADE	19/10/2020 07:26	19/10/2020 10:09	19/10/2020 07:26	19/10/2020 10:09	2,72	89	241,78	CHI
202010101569	GOIAS	GS12310670	GOIAS	19/10/2020 07:26	20/10/2020 19:12	19/10/2020 07:26	20/10/2020 19:12	35,76	2	71,53	CHI
202010101569	GOIAS	GS12310670	GOIAS	19/10/2020 07:26	20/10/2020 19:12	19/10/2020 07:26	20/10/2020 18:20	34,90	2	69,79	CHI
202010101569	GOIAS	GS12310670	GOIAS	19/10/2020 07:26	20/10/2020 19:12	19/10/2020 22:43	19/10/2020 23:51	1,12	2	2,25	CHI
202010101569	GOIAS	GS12310670	GOIAS	19/10/2020 07:26	20/10/2020 19:12	19/10/2020 07:26	19/10/2020 14:15	6,81	2	13,63	CHI
202010102675	ALEXANIA	AX12401984	ALEXANIA	19/10/2020 07:27	19/10/2020 15:08	19/10/2020 07:27	19/10/2020 15:08	7,68	12	92,13	CHI
202010101576	PIRENOPOLIS	PV12381260	CORUMBA	19/10/2020 07:28	19/10/2020 12:33	19/10/2020 07:28	19/10/2020 12:33	5,07	77	390,52	CHI
202010102214	CAMPO ALEGRE DE GOIAS	CM12192738RE	CAMPO ALEGRE DE GOIAS	19/10/2020 07:28	19/10/2020 21:37	19/10/2020 07:28	19/10/2020 21:37	14,15	43	608,31	CHI
202010102253	HIDROLINA	SZ12190057	ITAPACI	19/10/2020 07:29	21/10/2020 01:30	19/10/2020 07:29	21/10/2020 01:30	42,01	2	84,03	CHI
202010102253	HIDROLINA	SZ12190057	ITAPACI	19/10/2020 07:29	21/10/2020 01:30	19/10/2020 07:29	21/10/2020 00:42	41,21	10	412,13	CHI
202010102253	HIDROLINA	SZ12190057	ITAPACI	19/10/2020 07:29	21/10/2020 01:30	20/10/2020 22:42	21/10/2020 00:42	2,00	21	42,09	CHI
202010102253	SAO LUIZ DO NORTE	SZ12190057	ITAPACI	19/10/2020 07:29	21/10/2020 01:30	20/10/2020 22:42	21/10/2020 00:42	2,00	2	4,01	CHI
202010102253	HIDROLINA	SZ12190057	ITAPACI	19/10/2020 07:29	21/10/2020 01:30	19/10/2020 07:29	20/10/2020 21:04	37,59	1	37,59	CHI
202010102253	HIDROLINA	SZ12190057	ITAPACI	19/10/2020 07:29	21/10/2020 01:30	19/10/2020 07:29	20/10/2020 20:40	37,18	14	520,49	CHI
202010102253	SAO LUIZ DO NORTE	SZ12190057	ITAPACI	19/10/2020 07:29	21/10/2020 01:30	19/10/2020 07:29	20/10/2020 02:03	18,57	2	37,14	CHI
202010102253	HIDROLINA	SZ12190057	ITAPACI	19/10/2020 07:29	21/10/2020 01:30	19/10/2020 07:29	20/10/2020 02:03	18,57	6	111,41	CHI
202010101584	PILAR DE GOIAS	GG21318422	URUACU	19/10/2020 07:29	20/10/2020 03:53	19/10/2020 07:29	20/10/2020 03:53	20,39	1	20,39	CHI
202010101585	CABECEIRAS	CW21042065	ITUIQUIRA	19/10/2020 07:29	19/10/2020 08:36	19/10/2020 07:29	19/10/2020 08:36	1,10	1	1,10	CHI
202010101589	APARECIDA DE GOIANIA	13499774	INDEPENDENCIA S1	19/10/2020 07:30	19/10/2020 09:08	19/10/2020 07:30	19/10/2020 09:08	1,62	1	1,62	CHI
202010101592	SENADOR CANEDO	SW12092691	CEPAIGO S1	19/10/2020 07:31	19/10/2020 10:56	19/10/2020 07:31	19/10/2020 10:56	3,41	38	129,57	CHI

202010102054	NOVA AMERICA	NM12075610	RUBIATABA	19/10/2020 07:31	19/10/2020 11:19	19/10/2020 07:31	19/10/2020 11:19	3,78	13	49,19	CHI
202010101600	ARUANA	AK12183185	BRITANIA	19/10/2020 07:32	19/10/2020 19:36	19/10/2020 07:32	19/10/2020 19:36	12,06	5	60,32	CHI
202010101606	CRISTALINA	KR12389576	CRISTALINA S2	19/10/2020 07:33	19/10/2020 11:19	19/10/2020 07:33	19/10/2020 11:19	3,76	42	158,06	CHI
202010102623	MONTES CLAROS DE GOIAS	ME12244013	IPORA	19/10/2020 07:33	19/10/2020 15:05	19/10/2020 07:33	19/10/2020 15:05	7,52	9	67,68	CHI
202010101617	ITAPACI	IW12243655	ITAPACI	19/10/2020 07:34	19/10/2020 10:03	19/10/2020 07:34	19/10/2020 10:03	2,48	3	7,45	CHI
202010101619	ARENOPOLIS	AY21323301	ARENOPOLIS	19/10/2020 07:34	19/10/2020 10:32	19/10/2020 07:34	19/10/2020 10:32	2,98	1	2,98	CHI
202010101624	NOVA VENEZA	GR12002131	NEROPOLIS S1	19/10/2020 07:34	19/10/2020 09:05	19/10/2020 07:34	19/10/2020 09:05	1,51	1	1,51	CHI
202010101624	SANTO ANTONIO DE GOIAS	GR12002131	NEROPOLIS S1	19/10/2020 07:34	19/10/2020 09:05	19/10/2020 07:34	19/10/2020 09:05	1,51	6	9,04	CHI
202010102964	CORUMBA DE GOIAS	AA12258346	ANAPOLIS UNIVERSITARIO S1	19/10/2020 07:34	19/10/2020 19:45	19/10/2020 07:34	19/10/2020 19:45	12,17	2	24,34	CHI
202010102964	ABADIANIA	AA12258346	ANAPOLIS UNIVERSITARIO S1	19/10/2020 07:34	19/10/2020 19:45	19/10/2020 07:34	19/10/2020 19:45	12,17	20	243,39	CHI
202010101633	GOIATUBA	GT12052919	GOIATUBA S1	19/10/2020 07:35	19/10/2020 13:46	19/10/2020 07:35	19/10/2020 13:46	6,17	3	18,52	CHI
202010103080	ALEXANIA	AX12403337	ALEXANIA	19/10/2020 07:35	20/10/2020 09:38	19/10/2020 07:35	20/10/2020 09:38	26,04	7	182,25	CHI
202010101641	GOIAS	GS12364746	ITABERAI S1	19/10/2020 07:36	19/10/2020 09:41	19/10/2020 07:36	19/10/2020 09:41	2,07	2	4,14	CHI
202010101722	NOVA AMERICA	NM12191293	RUBIATABA	19/10/2020 07:37	19/10/2020 10:27	19/10/2020 07:37	19/10/2020 10:27	2,83	14	39,63	CHI
202010101646	ANAPOLIS	20724950	JUNDIAI S1	19/10/2020 07:37	20/10/2020 10:18	19/10/2020 07:37	20/10/2020 10:18	26,68	1	26,68	CHI
202010101647	FORMOSA	CW12154467	ITIQUEIRA	19/10/2020 07:37	20/10/2020 18:08	19/10/2020 07:37	20/10/2020 18:08	34,52	3	103,56	CHI
202010101647	CABECEIRAS	CW12154467	ITIQUEIRA	19/10/2020 07:37	20/10/2020 18:08	19/10/2020 07:37	20/10/2020 18:08	34,52	3	103,56	CHI
202010101647	CABECEIRAS	CW12154467	ITIQUEIRA	19/10/2020 07:37	20/10/2020 18:08	19/10/2020 07:37	19/10/2020 18:07	10,49	19	199,36	CHI
202010101647	CABECEIRAS	CW12154467	ITIQUEIRA	19/10/2020 07:37	20/10/2020 18:08	19/10/2020 07:37	19/10/2020 17:37	9,99	9	89,95	CHI
202010101647	CABECEIRAS	CW12154467	ITIQUEIRA	19/10/2020 07:37	20/10/2020 18:08	19/10/2020 07:37	19/10/2020 14:28	6,84	4	27,36	CHI
202010101647	CABECEIRAS	CW12154467	ITIQUEIRA	19/10/2020 07:37	20/10/2020 18:08	19/10/2020 07:37	19/10/2020 12:59	5,36	1	5,36	CHI
202010106127	RIO VERDE	RV12303493	MONTIVIDIU T	19/10/2020 07:37	22/10/2020 02:07	19/10/2020 07:37	22/10/2020 02:07	66,49	3	199,47	CHI
202010106127	RIO VERDE	RV12303493	MONTIVIDIU T	19/10/2020 07:37	22/10/2020 02:07	21/10/2020 01:54	22/10/2020 02:07	24,22	1	24,22	CHI
202010101658	BRITANIA	BT12060643	BRITANIA	19/10/2020 07:38	19/10/2020 08:37	19/10/2020 07:38	19/10/2020 08:37	0,97	11	10,70	CHI
202010101660	NOVO BRASIL	NB12378823	JUSSARA	19/10/2020 07:39	19/10/2020 11:00	19/10/2020 07:39	19/10/2020 11:00	3,34	1	3,34	CHI
202010102846	PIRENOPOLIS	PV12295641	SAO FRANCISCO DE GOIAS	19/10/2020 07:39	19/10/2020 11:17	19/10/2020 07:39	19/10/2020 11:17	3,62	183	662,15	CHI
202010101670	VILA PROPICIO	PV21115146	GOIANESIA S1	19/10/2020 07:40	20/10/2020 12:42	19/10/2020 07:40	20/10/2020 12:42	29,02	1	29,02	CHI
202010101673	ITAJA	IJ12370148	ITAJA S2	19/10/2020 07:41	19/10/2020 10:07	19/10/2020 07:41	19/10/2020 10:07	2,42	2	4,84	CHI
202010101681	JATAI	290101384	JATAI S3	19/10/2020 07:43	19/10/2020 21:21	19/10/2020 07:43	19/10/2020 21:21	13,63	1	13,63	CHI
202010101692	COLINAS DO SUL	TI12162624	NIQUELANDIA SUBTRANSMISSAO	19/10/2020 07:44	20/10/2020 13:10	19/10/2020 07:44	20/10/2020 13:10	29,42	1	29,42	CHI
202010101692	CAVALCANTE	TI12162624	NIQUELANDIA SUBTRANSMISSAO	19/10/2020 07:44	20/10/2020 13:10	19/10/2020 07:44	19/10/2020 13:40	5,92	20	118,46	CHI
202010101692	COLINAS DO SUL	TI12162624	NIQUELANDIA SUBTRANSMISSAO	19/10/2020 07:44	20/10/2020 13:10	19/10/2020 07:44	19/10/2020 13:40	5,92	1	5,92	CHI
202010101697	ABADIANIA	AA12388767	ANAPOLIS UNIVERSITARIO S1	19/10/2020 07:45	20/10/2020 11:27	19/10/2020 07:45	20/10/2020 11:27	27,69	2	55,39	CHI
202010101932	PARAUNA	PU12205943	PARAUNA	19/10/2020 07:46	19/10/2020 09:30	19/10/2020 07:46	19/10/2020 09:30	1,73	29	50,18	CHI
202010101932	JANDAIA	PU12205943	PARAUNA	19/10/2020 07:46	19/10/2020 09:30	19/10/2020 07:46	19/10/2020 09:30	1,73	4	6,92	CHI
202010101703	APARECIDA DE GOIANIA	17226181	INDEPENDENCIA S2	19/10/2020 07:46	19/10/2020 08:49	19/10/2020 07:46	19/10/2020 08:49	1,05	1	1,05	CHI
202010101711	BRITANIA	BT21009722	BRITANIA	19/10/2020 07:47	19/10/2020 14:58	19/10/2020 07:47	19/10/2020 14:58	7,17	1	7,17	CHI
202010103850	ANAPOLIS	AN11352357	JUNDIAI S2	19/10/2020 07:48	19/10/2020 13:53	19/10/2020 07:48	19/10/2020 13:53	6,08	177	1075,72	CHI
202010103347	PIRENOPOLIS	PV12000461	SAO FRANCISCO DE GOIAS	19/10/2020 07:48	19/10/2020 12:14	19/10/2020 07:48	19/10/2020 12:14	4,42	68	300,54	CHI
202010102667	NOVO GAMA	NJ12214850	MARAJOARA	19/10/2020 07:49	19/10/2020 11:48	19/10/2020 07:49	19/10/2020 11:48	3,97	150	595,87	CHI
202010101728	GOIANIA	12428577	GOIANIA LESTE S1	19/10/2020 07:49	19/10/2020 10:01	19/10/2020 07:49	19/10/2020 10:01	2,19	1	2,19	CHI
202010101732	MORRINHOS	MR21120872	MORRINHOS	19/10/2020 07:50	19/10/2020 11:45	19/10/2020 07:50	19/10/2020 11:45	3,92	1	3,92	CHI
202010101740	BELA VISTA DE GOIAS	BV12402769	BELA VISTA S1	19/10/2020 07:51	19/10/2020 15:20	19/10/2020 07:51	19/10/2020 15:20	7,47	11	82,17	CHI
202010101746	EDEIA	ED21031763	PONTALINA	19/10/2020 07:52	19/10/2020 10:20	19/10/2020 07:52	19/10/2020 10:20	2,46	1	2,46	CHI
202010103703	ITAPACI	IW12405204	ITAPACI	19/10/2020 07:52	19/10/2020 13:26	19/10/2020 07:52	19/10/2020 13:26	5,56	17	94,48	CHI
202010101753	ITABERAI	IB12300311	ITABERAI S2	19/10/2020 07:52	19/10/2020 11:04	19/10/2020 07:52	19/10/2020 11:04	3,19	5	15,94	CHI
202010101756	ANHANGUERA	AH12082017	CATALAO S1	19/10/2020 07:52	19/10/2020 09:22	19/10/2020 07:52	19/10/2020 09:22	1,48	3	4,45	CHI
202010101760	BRAZABRANTES	10010394930	NEROPOLIS S1	19/10/2020 07:53	19/10/2020 10:21	19/10/2020 07:53	19/10/2020 10:21	2,46	1	2,46	CHI
202010101762	ALVORADA DO NORTE	AQ12168089	IACIARA S2	19/10/2020 07:54	19/10/2020 08:58	19/10/2020 07:54	19/10/2020 08:58	1,06	8	8,50	CHI
2020101900099	AGUAS LINDAS DE GOIAS	03735114	AGUAS LINDAS DE GOIAS S2	19/10/2020 07:55	19/10/2020 08:01	19/10/2020 07:55	19/10/2020 08:01	0,11	12	1,33	CHI
2020101900099	SANTO ANTONIO DO DESCOBERTO	03735114	AGUAS LINDAS DE GOIAS S2	19/10/2020 07:55	19/10/2020 08:01	19/10/2020 07:55	19/10/2020 08:01	0,11	291	32,33	CHI

2020101900099	SANTO ANTONIO DO DESCOBERTO	03735114	AGUAS LINDAS DE GOIAS S2	19/10/2020 07:55	19/10/2020 08:01	19/10/2020 07:55	19/10/2020 08:01	0,11	9787	1087,44	CHI
2020101900099	DISTRITO FEDERAL	03735114	AGUAS LINDAS DE GOIAS S2	19/10/2020 07:55	19/10/2020 08:01	19/10/2020 07:55	19/10/2020 08:01	0,11	1	0,11	CHI
2020101900099	SANTO ANTONIO DO DESCOBERTO	03735114	AGUAS LINDAS DE GOIAS S2	19/10/2020 07:55	19/10/2020 08:01	19/10/2020 07:55	19/10/2020 08:01	0,11	52	5,78	CHI
2020101900099	COCALZINHO DE GOIAS	03735114	AGUAS LINDAS DE GOIAS S1	19/10/2020 07:55	19/10/2020 08:01	19/10/2020 07:55	19/10/2020 07:59	0,08	345	26,07	CHI
2020101900099	AGUAS LINDAS DE GOIAS	03735114	AGUAS LINDAS DE GOIAS S1	19/10/2020 07:55	19/10/2020 08:01	19/10/2020 07:55	19/10/2020 07:59	0,08	9000	680,00	CHI
2020101900099	AGUAS LINDAS DE GOIAS	03735114	AGUAS LINDAS DE GOIAS S1	19/10/2020 07:55	19/10/2020 08:01	19/10/2020 07:55	19/10/2020 07:59	0,08	4022	303,88	CHI
2020101900099	SANTO ANTONIO DO DESCOBERTO	03735114	AGUAS LINDAS DE GOIAS S1	19/10/2020 07:55	19/10/2020 08:01	19/10/2020 07:55	19/10/2020 07:59	0,08	18	1,36	CHI
2020101900099	AGUAS LINDAS DE GOIAS	03735114	AGUAS LINDAS DE GOIAS S1	19/10/2020 07:55	19/10/2020 08:01	19/10/2020 07:55	19/10/2020 07:59	0,08	13866	1047,65	CHI
2020101900099	AGUAS LINDAS DE GOIAS	03735114	AGUAS LINDAS DE GOIAS S1	19/10/2020 07:55	19/10/2020 08:01	19/10/2020 07:55	19/10/2020 07:59	0,08	211	15,94	CHI
2020101900099	COCALZINHO DE GOIAS	03735114	AGUAS LINDAS DE GOIAS S1	19/10/2020 07:55	19/10/2020 08:01	19/10/2020 07:55	19/10/2020 07:59	0,08	1	0,08	CHI
2020101900099	AGUAS LINDAS DE GOIAS	03735114	AGUAS LINDAS DE GOIAS S1	19/10/2020 07:55	19/10/2020 08:01	19/10/2020 07:55	19/10/2020 07:59	0,07	10126	756,64	CHI
2020101900099	PADRE BERNARDO	03735114	AGUAS LINDAS DE GOIAS S1	19/10/2020 07:55	19/10/2020 08:01	19/10/2020 07:55	19/10/2020 07:59	0,07	84	6,28	CHI
2020101900099	AGUAS LINDAS DE GOIAS	03735114	AGUAS LINDAS DE GOIAS S1	19/10/2020 07:55	19/10/2020 08:01	19/10/2020 07:55	19/10/2020 07:59	0,07	10041	750,29	CHI
2020101900099	COCALZINHO DE GOIAS	03735114	AGUAS LINDAS DE GOIAS S1	19/10/2020 07:55	19/10/2020 08:01	19/10/2020 07:55	19/10/2020 07:59	0,07	3	0,22	CHI
2020101900099	AGUAS LINDAS DE GOIAS	03735114	AGUAS LINDAS DE GOIAS S1	19/10/2020 07:55	19/10/2020 08:01	19/10/2020 07:55	19/10/2020 07:59	0,07	13275	991,94	CHI
2020101900099	AGUAS LINDAS DE GOIAS	03735114	AGUAS LINDAS DE GOIAS S1	19/10/2020 07:55	19/10/2020 08:01	19/10/2020 07:55	19/10/2020 07:59	0,07	4545	339,61	CHI
2020101900099	AGUAS LINDAS DE GOIAS	03735114	AGUAS LINDAS DE GOIAS S2	19/10/2020 07:55	19/10/2020 08:01	19/10/2020 07:55	19/10/2020 07:59	0,07	7230	538,23	CHI
2020101900099	COCALZINHO DE GOIAS	03735114	AGUAS LINDAS DE GOIAS S2	19/10/2020 07:55	19/10/2020 08:01	19/10/2020 07:55	19/10/2020 07:59	0,07	3	0,22	CHI
2020101900099	PADRE BERNARDO	03735114	AGUAS LINDAS DE GOIAS S2	19/10/2020 07:55	19/10/2020 08:01	19/10/2020 07:55	19/10/2020 07:59	0,07	3	0,22	CHI
2020101900099	AGUAS LINDAS DE GOIAS	03735114	AGUAS LINDAS DE GOIAS S2	19/10/2020 07:55	19/10/2020 08:01	19/10/2020 07:55	19/10/2020 07:59	0,07	4569	340,14	CHI
2020101900099	COCALZINHO DE GOIAS	03735114	AGUAS LINDAS DE GOIAS S2	19/10/2020 07:55	19/10/2020 08:01	19/10/2020 07:55	19/10/2020 07:59	0,07	67	4,99	CHI
2020101900099	PADRE BERNARDO	03735114	AGUAS LINDAS DE GOIAS S2	19/10/2020 07:55	19/10/2020 08:01	19/10/2020 07:55	19/10/2020 07:59	0,07	2	0,15	CHI
2020101900099	AGUAS LINDAS DE GOIAS	03735114	AGUAS LINDAS DE GOIAS S2	19/10/2020 07:55	19/10/2020 08:01	19/10/2020 07:55	19/10/2020 07:59	0,07	1	0,07	CHI
202010101772	ANAPOLIS	AN21267813	NEROPOLIS S1	19/10/2020 07:55	19/10/2020 13:37	19/10/2020 07:55	19/10/2020 13:37	5,69	1	5,69	CHI
202010101775	ARUANA	AK12292820	BRITANIA	19/10/2020 07:56	19/10/2020 10:44	19/10/2020 07:56	19/10/2020 10:44	2,80	4	11,20	CHI
202010101778	BOM JARDIM DE GOIAS	BM12395482	BOM JARDIM	19/10/2020 07:56	19/10/2020 11:27	19/10/2020 07:56	19/10/2020 11:27	3,51	8	28,12	CHI
202010106728	ANAPOLIS	AN11056411	JUNDIAI S1	19/10/2020 07:56	19/10/2020 21:45	19/10/2020 07:56	19/10/2020 21:45	13,81	110	1519,34	CHI
202010101782	FLORES DE GOIAS	FB12409870	FLORES DE GOIAS	19/10/2020 07:56	19/10/2020 15:17	19/10/2020 07:56	19/10/2020 15:17	7,34	122	895,17	CHI
202010101785	MONTES CLAROS DE GOIAS	ME12334949	IPORA	19/10/2020 07:57	20/10/2020 13:24	19/10/2020 07:57	20/10/2020 13:24	29,45	8	235,58	CHI
202010101793	TURVELANDIA	EU12026747	RIO DOS BOIS	19/10/2020 07:58	19/10/2020 10:25	19/10/2020 07:58	19/10/2020 10:25	2,44	16	39,01	CHI
202010101793	ACREUNA	EU12026747	RIO DOS BOIS	19/10/2020 07:58	19/10/2020 10:25	19/10/2020 07:58	19/10/2020 10:25	2,44	11	26,82	CHI
202010101802	ITUMBIARA	690058627	ITUMBIARA VELHA S1	19/10/2020 07:59	19/10/2020 17:22	19/10/2020 07:59	19/10/2020 17:22	9,38	1	9,38	CHI
202010101804	ALEXANIA	AX21350069	ALEXANIA	19/10/2020 08:00	19/10/2020 19:31	19/10/2020 08:00	19/10/2020 19:31	11,50	3	34,51	CHI
202010101964	ITAUCU	IX11072158	INHUMAS S1	19/10/2020 08:01	19/10/2020 13:52	19/10/2020 08:01	19/10/2020 13:52	5,85	84	491,10	CHI
202010101813	TURVANIA	TV12394814	FIRMINOPOLIS S2	19/10/2020 08:01	19/10/2020 13:02	19/10/2020 08:01	19/10/2020 13:02	5,01	1	5,01	CHI
202010101816	ANAPOLIS	AN21071890	ANAPOLIS UNIVERSITARIO S2	19/10/2020 08:01	19/10/2020 21:30	19/10/2020 08:01	19/10/2020 21:30	13,47	2	26,94	CHI
202010105936	NIQUELANDIA	NQ21369947	NIQUELANDIA SUBTRANSMISSAO	19/10/2020 08:02	19/10/2020 22:57	19/10/2020 08:02	19/10/2020 22:57	14,91	2	29,82	CHI
202010101820	ANAPOLIS	AN12054439	ANAPOLIS UNIVERSITARIO S2	19/10/2020 08:02	20/10/2020 11:55	19/10/2020 08:02	20/10/2020 11:55	27,87	1	27,87	CHI
202010111842	CORUMBA DE GOIAS	AX21387533	CORUMBA	19/10/2020 08:02	20/10/2020 12:18	19/10/2020 08:02	20/10/2020 12:18	28,26	1	28,26	CHI
202010101262	GOIANIA	GN11350735	GOIANIA LESTE S2	19/10/2020 08:03	19/10/2020 08:30	19/10/2020 08:03	19/10/2020 08:30	0,45	98	44,10	CHI
202010103149	CRISTALINA	IP12100702	CRISTALINA S2	19/10/2020 08:03	19/10/2020 11:47	19/10/2020 08:03	19/10/2020 11:47	3,72	17	63,24	CHI
202010103149	IPAMERI	IP12100702	CRISTALINA S2	19/10/2020 08:03	19/10/2020 11:47	19/10/2020 08:03	19/10/2020 11:47	3,72	8	29,76	CHI
202010102641	EDEALINA	ED12044056	PONTALINA	19/10/2020 08:04	19/10/2020 11:45	19/10/2020 08:04	19/10/2020 11:45	3,67	154	565,61	CHI
202010102175	AGUAS LINDAS DE GOIAS	LA11347936	AGUAS LINDAS DE GOIAS S2	19/10/2020 08:05	19/10/2020 13:25	19/10/2020 08:05	19/10/2020 13:25	5,33	149	793,43	CHI
202010101839	MORRINHOS	MR21265931	MORRINHOS	19/10/2020 08:05	19/10/2020 10:07	19/10/2020 08:05	19/10/2020 10:07	2,02	1	2,02	CHI
20201098965	ANAPOLIS	AN12091362	JUNDIAI S1	19/10/2020 08:06	19/10/2020 11:21	19/10/2020 08:06	19/10/2020 11:21	3,25	183	594,29	CHI
202010101847	SERRANOPOLIS	SX21328786	JATAI S1	19/10/2020 08:07	19/10/2020 09:31	19/10/2020 08:07	19/10/2020 09:31	1,40	1	1,40	CHI
202010102095	SAO JOAO D ALIANCA	JL12268110	FLORES DE GOIAS	19/10/2020 08:07	19/10/2020 12:14	19/10/2020 08:07	19/10/2020 12:14	4,12	9	37,04	CHI
202010101857	BELA VISTA DE GOIAS	BV21299256	BELA VISTA S2	19/10/2020 08:08	19/10/2020 14:04	19/10/2020 08:08	19/10/2020 14:04	5,93	1	5,93	CHI
202010101859	PETROLINA DE GOIAS	PG12010184	PETROLINA	19/10/2020 08:08	19/10/2020 10:06	19/10/2020 08:08	19/10/2020 10:06	1,96	19	37,28	CHI
202010101861	PADRE BERNARDO	PB12382938	PADRE BERNARDO	19/10/2020 08:08	20/10/2020 14:21	19/10/2020 08:08	20/10/2020 14:21	30,21	1	30,21	CHI

202010101861	PADRE BERNARDO	PB12382938	PADRE BERNARDO	19/10/2020 08:08	20/10/2020 14:21	19/10/2020 08:08	20/10/2020 14:10	30,02	2	60,05	CHI
202010101861	PADRE BERNARDO	PB12382938	PADRE BERNARDO	19/10/2020 08:08	20/10/2020 14:21	19/10/2020 08:08	20/10/2020 14:04	29,93	1	29,93	CHI
202010101861	PADRE BERNARDO	PB12382938	PADRE BERNARDO	19/10/2020 08:08	20/10/2020 14:21	20/10/2020 10:46	20/10/2020 13:13	2,45	2	4,90	CHI
202010101861	PADRE BERNARDO	PB12382938	PADRE BERNARDO	19/10/2020 08:08	20/10/2020 14:21	20/10/2020 09:05	20/10/2020 10:45	1,66	2	3,32	CHI
202010101861	PADRE BERNARDO	PB12382938	PADRE BERNARDO	19/10/2020 08:08	20/10/2020 14:21	19/10/2020 18:38	19/10/2020 20:11	1,55	2	3,10	CHI
202010101861	PADRE BERNARDO	PB12382938	PADRE BERNARDO	19/10/2020 08:08	20/10/2020 14:21	19/10/2020 09:46	19/10/2020 13:50	4,05	2	8,10	CHI
202010101862	SANTA RITA DO NOVO DESTINO	BA21156227	BARRO ALTO	19/10/2020 08:08	19/10/2020 23:56	19/10/2020 08:08	19/10/2020 23:56	15,79	2	31,57	CHI
202010101863	INDIARA	IY21315317	EDEIA	19/10/2020 08:08	19/10/2020 13:41	19/10/2020 08:08	19/10/2020 13:41	5,54	1	5,54	CHI
202010101871	ARENOPOLIS	1920007249	ARENOPOLIS	19/10/2020 08:10	19/10/2020 12:17	19/10/2020 08:10	19/10/2020 12:17	4,11	1	4,11	CHI
202010101874	GOIANIRA	10015070245	GOIANIRA	19/10/2020 08:10	19/10/2020 13:18	19/10/2020 08:10	19/10/2020 13:18	5,13	1	5,13	CHI
202010102038	PARAUNA	PU12079038	PARAUNA	19/10/2020 08:10	19/10/2020 10:23	19/10/2020 08:10	19/10/2020 10:23	2,21	2	4,42	CHI
202010102691	FAINA	FC12071269	GOIAS	19/10/2020 08:10	19/10/2020 12:08	19/10/2020 08:10	19/10/2020 12:08	3,96	7	27,72	CHI
202010101882	PONTALINA	PK21047381	VICENTINOPOLIS	19/10/2020 08:11	19/10/2020 10:24	19/10/2020 08:11	19/10/2020 10:24	2,21	1	2,21	CHI
202010101883	GOIANIA	GN12326197	GOYA S1	19/10/2020 08:11	19/10/2020 09:22	19/10/2020 08:11	19/10/2020 09:22	1,17	386	453,55	CHI
202010101887	BRITANIA	BT18073348TS	BRITANIA	19/10/2020 08:11	21/10/2020 16:33	19/10/2020 08:11	21/10/2020 16:33	56,36	5	281,80	CHI
202010101887	BRITANIA	BT12130431	BRITANIA	19/10/2020 08:11	21/10/2020 16:33	21/10/2020 15:34	21/10/2020 16:12	0,63	2	1,27	CHI
202010101887	BRITANIA	BT18073348TS	BRITANIA	19/10/2020 08:11	21/10/2020 16:33	19/10/2020 08:11	21/10/2020 15:19	55,13	4	220,50	CHI
202010101887	BRITANIA	BT18073348TS	BRITANIA	19/10/2020 08:11	21/10/2020 16:33	21/10/2020 10:54	21/10/2020 15:19	4,42	41	181,05	CHI
202010101887	BRITANIA	BT18073348TS	BRITANIA	19/10/2020 08:11	21/10/2020 16:33	19/10/2020 08:11	21/10/2020 01:46	41,57	1	41,57	CHI
202010101887	BRITANIA	BT18073348TS	BRITANIA	19/10/2020 08:11	21/10/2020 16:33	19/10/2020 08:11	20/10/2020 22:49	38,63	12	463,58	CHI
202010101887	BRITANIA	BT18073348TS	BRITANIA	19/10/2020 08:11	21/10/2020 16:33	20/10/2020 14:13	20/10/2020 16:29	2,27	8	18,13	CHI
202010101887	BRITANIA	BT18073348TS	BRITANIA	19/10/2020 08:11	21/10/2020 16:33	20/10/2020 14:13	20/10/2020 16:29	2,26	20	45,13	CHI
202010101887	BRITANIA	BT18073348TS	BRITANIA	19/10/2020 08:11	21/10/2020 16:33	19/10/2020 08:11	20/10/2020 12:38	28,45	6	170,67	CHI
202010101887	BRITANIA	BT18073348TS	BRITANIA	19/10/2020 08:11	21/10/2020 16:33	19/10/2020 08:11	20/10/2020 09:50	25,65	14	359,09	CHI
202010101887	BRITANIA	BT18073348TS	BRITANIA	19/10/2020 08:11	21/10/2020 16:33	19/10/2020 08:11	19/10/2020 16:52	8,68	8	69,42	CHI
202010101889	JARAGUA	JA11191291	JARAGUA	19/10/2020 08:13	19/10/2020 15:02	19/10/2020 08:13	19/10/2020 15:02	6,82	152	1035,88	CHI
202010101891	ITUMBIARA	IT21352568	BOM JESUS DE GOIAS	19/10/2020 08:13	19/10/2020 09:05	19/10/2020 08:13	19/10/2020 09:05	0,86	1	0,86	CHI
202010102800	SAO LUIZ DO NORTE	SZ12090338	ITAPACI	19/10/2020 08:15	19/10/2020 11:42	19/10/2020 08:15	19/10/2020 11:42	3,44	291	1001,04	CHI
202010102847	CORUMBA DE GOIAS	CB12161727	CORUMBA	19/10/2020 08:15	19/10/2020 10:12	19/10/2020 08:15	19/10/2020 10:12	1,94	310	601,31	CHI
202010101905	CAMPO LIMPO	AN12267847	NEROPOLIS S1	19/10/2020 08:15	19/10/2020 13:31	19/10/2020 08:15	19/10/2020 13:31	5,25	62	325,59	CHI
202010101906	GOIANIA	GN12071938	XAVANTES	19/10/2020 08:16	20/10/2020 00:37	19/10/2020 23:47	20/10/2020 00:37	0,83	59	49,17	CHI
202010101906	GOIANIA	GN21163927	XAVANTES	19/10/2020 08:16	20/10/2020 00:37	19/10/2020 08:16	20/10/2020 00:22	16,10	1	16,10	CHI
202010101910	PLANALTINA	PI12325516	PLANALTINA	19/10/2020 08:16	19/10/2020 10:26	19/10/2020 08:16	19/10/2020 10:26	2,15	9	19,36	CHI
202010101914	CATALAO	CM13411848	CAMPO ALEGRE DE GOIAS	19/10/2020 08:17	20/10/2020 17:27	20/10/2020 17:22	20/10/2020 17:27	0,08	21	1,61	CHI
202010101914	DISTRITO FEDERAL	CM13411848	CAMPO ALEGRE DE GOIAS	19/10/2020 08:17	20/10/2020 17:27	20/10/2020 17:22	20/10/2020 17:27	0,08	1	0,08	CHI
202010101914	CAMPO ALEGRE DE GOIAS	CM13411848	CAMPO ALEGRE DE GOIAS	19/10/2020 08:17	20/10/2020 17:27	20/10/2020 17:22	20/10/2020 17:27	0,08	247	18,94	CHI
202010101914	IPAMERI	CM13411848	CAMPO ALEGRE DE GOIAS	19/10/2020 08:17	20/10/2020 17:27	20/10/2020 17:22	20/10/2020 17:27	0,08	92	7,05	CHI
202010101914	CAMPO ALEGRE DE GOIAS	CM13411846	CAMPO ALEGRE DE GOIAS	19/10/2020 08:17	20/10/2020 17:27	20/10/2020 12:03	20/10/2020 16:29	4,44	7	31,05	CHI
202010101914	CAMPO ALEGRE DE GOIAS	CM21166762	CAMPO ALEGRE DE GOIAS	19/10/2020 08:17	20/10/2020 17:27	19/10/2020 08:17	20/10/2020 15:41	31,41	1	31,41	CHI
202010101918	GOIANESIA	550150316	GOIANESIA S2	19/10/2020 08:17	19/10/2020 16:27	19/10/2020 08:17	19/10/2020 16:27	8,17	1	8,17	CHI
202010101917	FAINA	FC12072193	GOIAS	19/10/2020 08:17	19/10/2020 10:32	19/10/2020 08:17	19/10/2020 10:32	2,24	12	26,93	CHI
202010103323	CRISTALINA	IP12219725	CRISTALINA S2	19/10/2020 08:17	19/10/2020 11:56	19/10/2020 08:17	19/10/2020 11:56	3,64	2	7,28	CHI
202010103323	IPAMERI	IP12219725	CRISTALINA S2	19/10/2020 08:17	19/10/2020 11:56	19/10/2020 08:17	19/10/2020 11:56	3,64	3	10,93	CHI
202010102915	OURO VERDE DE GOIAS	OV12115017	NEROPOLIS S1	19/10/2020 08:18	19/10/2020 10:36	19/10/2020 08:18	19/10/2020 10:36	2,30	9	20,70	CHI
202010101933	GOIAS	GS21210648	GOIAS	19/10/2020 08:19	19/10/2020 11:33	19/10/2020 08:19	19/10/2020 11:33	3,22	1	3,22	CHI
202010101936	GOIANIA	GN21150410	CAMPINAS S3	19/10/2020 08:20	19/10/2020 09:59	19/10/2020 08:20	19/10/2020 09:59	1,65	1	1,65	CHI
202010101937	MOSSAMEDES	KB12079150	ANICUNS	19/10/2020 08:20	19/10/2020 14:20	19/10/2020 08:20	19/10/2020 14:20	6,00	7	41,98	CHI
202010102706	SANCLERLANDIA	SC12299153	FIRMINOPOLIS S2	19/10/2020 08:20	19/10/2020 14:18	19/10/2020 08:20	19/10/2020 14:18	5,96	4	23,84	CHI
202010103333	ALEXANIA	AX21319868	ALEXANIA	19/10/2020 08:20	19/10/2020 10:59	19/10/2020 08:20	19/10/2020 10:59	2,64	2	5,28	CHI
202010103074	SAO LUIS DE MONTES BELOS	SL12145835	FIRMINOPOLIS S2	19/10/2020 08:20	19/10/2020 11:44	19/10/2020 08:20	19/10/2020 11:44	3,39	15	50,85	CHI
202010101943	ITUMBIARA	IT11122314	CACHOEIRA DOURADA	19/10/2020 08:20	19/10/2020 10:38	19/10/2020 08:20	19/10/2020 10:38	2,29	183	419,02	CHI

202010103298	CORUMBA DE GOIAS	ZN12273000RE	COCALZINHO	19/10/2020 08:20	19/10/2020 11:45	19/10/2020 08:20	19/10/2020 11:45	3,40	20	68,02	CHI
202010103298	COCALZINHO DE GOIAS	ZN12273000RE	COCALZINHO	19/10/2020 08:20	19/10/2020 11:45	19/10/2020 08:20	19/10/2020 11:45	3,40	20	68,02	CHI
202010103298	PIRENOPOLIS	ZN12273000RE	COCALZINHO	19/10/2020 08:20	19/10/2020 11:45	19/10/2020 08:20	19/10/2020 11:45	3,40	14	47,61	CHI
202010101949	LUZIANIA	LZ12261750	CRISTALINA S2	19/10/2020 08:21	19/10/2020 15:04	19/10/2020 08:21	19/10/2020 15:04	6,71	6	40,29	CHI
202010103775	GOIAS	GS12234131	GOIAS	19/10/2020 08:21	20/10/2020 09:42	19/10/2020 08:21	20/10/2020 09:42	25,34	11	278,75	CHI
202010101963	ALEXANIA	AX21157936	ALEXANIA	19/10/2020 08:22	19/10/2020 10:42	19/10/2020 08:22	19/10/2020 10:42	2,33	1	2,33	CHI
202010101968	CAMPINACU	UC12316380	MARA ROSA	19/10/2020 08:22	19/10/2020 10:53	19/10/2020 08:22	19/10/2020 10:53	2,50	56	140,03	CHI
202010101972	DISTRITO FEDERAL	FA21131708	ITIQUEIRA	19/10/2020 08:23	20/10/2020 21:23	19/10/2020 08:23	20/10/2020 21:23	36,99	1	36,99	CHI
202010101976	VIANOPOLIS	OZ11073390	PIRES DO RIO S2	19/10/2020 08:23	19/10/2020 11:23	19/10/2020 08:23	19/10/2020 11:23	2,99	36	107,63	CHI
202010101989	URUACU	CR12398061	CAMPINORTE	19/10/2020 08:25	19/10/2020 12:11	19/10/2020 08:25	19/10/2020 12:11	3,76	5	18,79	CHI
202010101989	CAMPINORTE	CR12398061	CAMPINORTE	19/10/2020 08:25	19/10/2020 12:11	19/10/2020 08:25	19/10/2020 12:11	3,76	1	3,76	CHI
202010189497	NIQUELANDIA	NQ12375652	URUACU	19/10/2020 08:26	19/10/2020 15:00	19/10/2020 08:26	19/10/2020 15:00	6,56	215	1411,24	CHI
202010106012	COLINAS DO SUL	9700005233	NIQUELANDIA SUBTRANSMISSAO	19/10/2020 08:26	20/10/2020 11:16	19/10/2020 08:26	20/10/2020 11:16	26,83	1	26,83	CHI
202010102000	ANAPOLIS	10029035935	ANAPOLIS UNIVERSITARIO S1	19/10/2020 08:26	20/10/2020 11:36	19/10/2020 08:26	20/10/2020 11:36	27,16	1	27,16	CHI
202010102001	SAO MIGUEL DO PASSA QUATRO	SQ12104016	BELA VISTA S2	19/10/2020 08:26	19/10/2020 15:07	19/10/2020 08:26	19/10/2020 15:07	6,67	12	80,03	CHI
202010102001	SILVANIA	SQ12104016	BELA VISTA S2	19/10/2020 08:26	19/10/2020 15:07	19/10/2020 08:26	19/10/2020 15:07	6,67	1	6,67	CHI
202010102003	INHUMAS	IN21282899	INHUMAS S2	19/10/2020 08:26	20/10/2020 02:46	19/10/2020 08:26	20/10/2020 02:46	18,32	1	18,32	CHI
202010102008	ITAPURANGA	IK12311318	ITAPURANGA	19/10/2020 08:27	19/10/2020 13:14	19/10/2020 08:27	19/10/2020 13:14	4,77	13	62,01	CHI
202010102010	ORIZONA	OZ21023000	PIRES DO RIO S2	19/10/2020 08:27	19/10/2020 10:03	19/10/2020 08:27	19/10/2020 10:03	1,58	2	3,17	CHI
202010102013	FLORES DE GOIAS	FB21330323	IACIARA S2	19/10/2020 08:28	19/10/2020 10:12	19/10/2020 08:28	19/10/2020 10:12	1,73	1	1,73	CHI
202010102015	AGUA FRIA DE GOIAS	TL11279960	SAO JOAO D ALIANCA	19/10/2020 08:28	19/10/2020 10:44	19/10/2020 08:28	19/10/2020 10:44	2,26	4	9,03	CHI
20201099591	ANAPOLIS	AN12353412	JUNDIAI S1	19/10/2020 08:29	20/10/2020 17:44	19/10/2020 08:29	20/10/2020 17:44	33,26	1	33,26	CHI
20201099591	ANAPOLIS	AN12353412	JUNDIAI S1	19/10/2020 08:29	20/10/2020 17:44	19/10/2020 08:29	20/10/2020 16:56	32,45	4	129,82	CHI
20201099591	ANAPOLIS	AN12353412	JUNDIAI S1	19/10/2020 08:29	20/10/2020 17:44	20/10/2020 12:43	20/10/2020 16:56	4,22	85	358,84	CHI
20201099591	ANAPOLIS	AN12353412	JUNDIAI S1	19/10/2020 08:29	20/10/2020 17:44	19/10/2020 08:29	19/10/2020 16:03	7,57	85	643,40	CHI
202010102021	IPAMERI	IP21122383	IPAMERI	19/10/2020 08:29	19/10/2020 19:58	19/10/2020 08:29	19/10/2020 19:58	11,47	1	11,47	CHI
202010102022	GOIANIA	10000320682	MEIA PONTE	19/10/2020 08:29	19/10/2020 13:08	19/10/2020 08:29	19/10/2020 13:08	4,64	1	4,64	CHI
202010102025	URUACU	640102967	URUACU	19/10/2020 08:30	19/10/2020 11:25	19/10/2020 08:30	19/10/2020 11:25	2,91	1	2,91	CHI
202010102028	GOIANIA	15103687	GOYA S2	19/10/2020 08:30	19/10/2020 11:06	19/10/2020 08:30	19/10/2020 11:06	2,59	1	2,59	CHI
202010102031	MUNDO NOVO DE GOIAS	4240002917	NOVA CRIXAS	19/10/2020 08:31	19/10/2020 14:03	19/10/2020 08:31	19/10/2020 14:03	5,52	1	5,52	CHI
202010102036	SAO MIGUEL DO ARAGUAIA	SM12074411	SAO MIGUEL DO ARAGUAIA	19/10/2020 08:32	20/10/2020 11:43	19/10/2020 08:32	20/10/2020 11:43	27,18	8	217,41	CHI
202010104469	ITAUCU	IX12018278	INHUMAS S1	19/10/2020 08:32	19/10/2020 23:05	19/10/2020 08:32	19/10/2020 23:05	14,54	60	872,52	CHI
202010102039	GOIAS	GS21334003	GOIAS	19/10/2020 08:32	19/10/2020 16:56	19/10/2020 08:32	19/10/2020 16:56	8,38	1	8,38	CHI
202010102040	GOIANIA	10021887	AEROPORTO S1	19/10/2020 08:33	19/10/2020 09:46	19/10/2020 08:33	19/10/2020 09:46	1,22	1	1,22	CHI
202010103960	MAMBAI	MB12314303	IACIARA S2	19/10/2020 08:33	19/10/2020 11:47	19/10/2020 08:33	19/10/2020 11:47	3,23	4	12,91	CHI
202010103960	BURITINOPOLIS	MB12314303	IACIARA S2	19/10/2020 08:33	19/10/2020 11:47	19/10/2020 08:33	19/10/2020 11:47	3,23	2	6,46	CHI
202010104100	ANAPOLIS	AN12211783	ANAPOLIS UNIVERSITARIO S2	19/10/2020 08:34	19/10/2020 13:08	19/10/2020 08:34	19/10/2020 13:08	4,57	234	1068,53	CHI
202010103590	LUZIANIA	LZ12330544	MARAJOARA	19/10/2020 08:34	19/10/2020 22:32	19/10/2020 08:34	19/10/2020 22:32	13,97	8	111,74	CHI
202010102057	NOVA CRIXAS	NA21349195	NOVA CRIXAS	19/10/2020 08:35	20/10/2020 15:25	19/10/2020 08:35	20/10/2020 15:25	30,82	1	30,82	CHI
202010102060	CRISTALINA	KR21031673	CRISTALINA S1	19/10/2020 08:35	19/10/2020 17:43	19/10/2020 08:35	19/10/2020 17:43	9,12	1	9,12	CHI
202010102066	ANAPOLIS	20646707	JUNDIAI S1	19/10/2020 08:35	20/10/2020 09:17	19/10/2020 08:35	20/10/2020 09:17	24,69	1	24,69	CHI
202010102069	MINEIROS	1390055763	PARQUE DAS EMAS	19/10/2020 08:36	19/10/2020 13:08	19/10/2020 08:36	19/10/2020 13:08	4,53	1	4,53	CHI
202010102072	GOIANIA	13578881	INDEPENDENCIA S1	19/10/2020 08:36	19/10/2020 12:00	19/10/2020 08:36	19/10/2020 12:00	3,40	1	3,40	CHI
202010102073	JATAI	JT11182135	JATAI S2	19/10/2020 08:36	20/10/2020 08:21	19/10/2020 08:36	20/10/2020 08:21	23,75	52	1234,83	CHI
202010104112	SANTA FE DE GOIAS	RN12080831	JUSSARA	19/10/2020 08:36	19/10/2020 17:33	19/10/2020 08:36	19/10/2020 17:33	8,96	17	152,24	CHI
202010105112	ITAPURANGA	IK12311324	ITAPURANGA	19/10/2020 08:36	19/10/2020 18:46	19/10/2020 08:36	19/10/2020 18:46	10,16	6	60,94	CHI
202010103261	APORE	AE12038902	ITAJA S1	19/10/2020 08:37	19/10/2020 14:18	19/10/2020 08:37	19/10/2020 14:18	5,67	2	11,34	CHI
202010102094	CABECEIRAS	CW21280653	ITIQUEIRA	19/10/2020 08:37	19/10/2020 19:53	19/10/2020 08:37	19/10/2020 19:53	11,25	2	22,50	CHI
202010102101	PIRACANJUBA	60047537	PIRACANJUBA	19/10/2020 08:38	19/10/2020 19:16	19/10/2020 08:38	19/10/2020 19:16	10,62	1	10,62	CHI
202010102109	CABECEIRAS	CW21325504	ITIQUEIRA	19/10/2020 08:39	19/10/2020 21:15	19/10/2020 08:39	19/10/2020 21:15	12,59	2	25,19	CHI
202010103437	ANAPOLIS	AN11000306	JUNDIAI S1	19/10/2020 08:39	19/10/2020 12:51	19/10/2020 08:39	19/10/2020 12:51	4,19	150	628,63	CHI

202010102120	CRISTALINA	KR12087954	CRISTALINA S2	19/10/2020 08:40	19/10/2020 22:39	19/10/2020 08:40	19/10/2020 22:39	13,98	3	41,95	CHI
202010102133	ITUMBIARA	690121611	ITUMBIARA NOVA	19/10/2020 08:40	19/10/2020 17:01	19/10/2020 08:40	19/10/2020 17:01	8,34	1	8,34	CHI
202010102146	CRISTALINA	1060011028	CRISTALINA S1	19/10/2020 08:41	19/10/2020 15:09	19/10/2020 08:41	19/10/2020 15:09	6,46	1	6,46	CHI
202010101843	FAINA	MP12064995LD	MATRINCHA	19/10/2020 08:42	20/10/2020 14:46	19/10/2020 08:42	20/10/2020 14:46	30,06	1	30,06	CHI
202010101843	MATRINCHA	MP12064995LD	MATRINCHA	19/10/2020 08:42	20/10/2020 14:46	19/10/2020 08:42	20/10/2020 14:46	30,06	2	60,12	CHI
202010101843	FAINA	MP12064995LD	MATRINCHA	19/10/2020 08:42	20/10/2020 14:46	20/10/2020 11:57	20/10/2020 14:46	2,81	13	36,47	CHI
202010101843	MATRINCHA	MP12064995LD	MATRINCHA	19/10/2020 08:42	20/10/2020 14:46	20/10/2020 11:57	20/10/2020 14:46	2,81	47	131,86	CHI
202010104841	SANTA FE DE GOIAS	RN12009764	BRITANIA	19/10/2020 08:42	20/10/2020 09:33	19/10/2020 08:42	20/10/2020 09:33	24,84	6	149,04	CHI
202010104023	SITIO D ABADIA	SI12247434	IACIARA S2	19/10/2020 08:42	19/10/2020 12:42	19/10/2020 08:42	19/10/2020 12:42	3,99	6	23,94	CHI
202010102156	VILA PROPICIO	2850005200	GOIANESIA S1	19/10/2020 08:42	20/10/2020 11:42	19/10/2020 08:42	20/10/2020 11:42	26,99	1	26,99	CHI
202010102159	ARUANA	AK11183289	ARUANA	19/10/2020 08:42	20/10/2020 16:31	19/10/2020 08:42	20/10/2020 16:31	31,80	58	1844,48	CHI
202010103586	ANAPOLIS	AN12370436LD	ANAPOLIS UNIVERSITARIO S2	19/10/2020 08:43	19/10/2020 14:32	19/10/2020 08:43	19/10/2020 14:32	5,82	267	1553,12	CHI
202010102162	NOVO GAMA	2460049578	PACAEMBU S1	19/10/2020 08:43	19/10/2020 12:28	19/10/2020 08:43	19/10/2020 12:28	3,75	1	3,75	CHI
202010102169	JUSSARA	JR12073378	BRITANIA	19/10/2020 08:43	19/10/2020 13:20	19/10/2020 08:43	19/10/2020 13:20	4,60	5	23,02	CHI
202010102172	ANAPOLIS	10029531720	DAIA S1	19/10/2020 08:43	20/10/2020 14:42	19/10/2020 08:43	20/10/2020 14:42	29,97	1	29,97	CHI
202010102181	ITAGUARI	10002768486	ITABERAÍ S1	19/10/2020 08:44	19/10/2020 10:54	19/10/2020 08:44	19/10/2020 10:54	2,15	1	2,15	CHI
202010102182	ANAPOLIS	20877341	JUNDIAI S2	19/10/2020 08:44	20/10/2020 15:49	19/10/2020 08:44	20/10/2020 15:49	31,07	1	31,07	CHI
202010102874	BOM JESUS DE GOIAS	BJ12000040	BOM JESUS DE GOIAS	19/10/2020 08:45	19/10/2020 11:53	19/10/2020 08:45	19/10/2020 11:53	3,13	4	12,51	CHI
202010102190	MORRINHOS	MR12323915LD	MORRINHOS	19/10/2020 08:45	21/10/2020 15:34	20/10/2020 13:33	21/10/2020 15:34	26,03	1	26,03	CHI
202010102190	MORRINHOS	MR32097324	MORRINHOS	19/10/2020 08:45	21/10/2020 15:34	19/10/2020 08:45	20/10/2020 13:08	28,38	2	56,76	CHI
202010102193	SAO JOAO DA PARAUNA	RP12076381RE	FIRMINOPOLIS S2	19/10/2020 08:46	19/10/2020 11:37	19/10/2020 08:46	19/10/2020 11:37	2,85	33	94,21	CHI
202010102193	AURILANDIA	RP12076381RE	FIRMINOPOLIS S2	19/10/2020 08:46	19/10/2020 11:37	19/10/2020 08:46	19/10/2020 11:37	2,85	4	11,42	CHI
202010103152	ITAPACI	IW11181451	ITAPACI	19/10/2020 08:46	19/10/2020 12:19	19/10/2020 08:46	19/10/2020 12:19	3,54	107	378,93	CHI
202010102196	GUAPAO	710031014	GUAPAO S1	19/10/2020 08:46	19/10/2020 12:00	19/10/2020 08:46	19/10/2020 12:00	3,22	1	3,22	CHI
202010102197	HIDROLANDIA	HD21291462	CEPAIGO S2	19/10/2020 08:46	19/10/2020 09:26	19/10/2020 08:46	19/10/2020 09:26	0,65	1	0,65	CHI
202010104799	ANICUNS	AC12304639	ANICUNS	19/10/2020 08:47	20/10/2020 00:16	19/10/2020 08:47	20/10/2020 00:16	15,48	7	108,38	CHI
202010104799	AMERICANO DO BRASIL	AC12304639	ANICUNS	19/10/2020 08:47	20/10/2020 00:16	19/10/2020 08:47	19/10/2020 16:40	7,88	1	7,88	CHI
202010104799	ANICUNS	AC12304639	ANICUNS	19/10/2020 08:47	20/10/2020 00:16	19/10/2020 08:47	19/10/2020 16:40	7,88	11	86,71	CHI
202010102201	PETROLINA DE GOIAS	PG21191308	PETROLINA	19/10/2020 08:47	19/10/2020 23:39	19/10/2020 08:47	19/10/2020 23:39	14,87	2	29,73	CHI
202010102206	ITUMBIARA	IT121273960	ITUMBIARA VELHA S1	19/10/2020 08:47	19/10/2020 10:19	19/10/2020 08:47	19/10/2020 10:19	1,53	1	1,53	CHI
202010106517	SAO MIGUEL DO ARAGUAIA	SM12240639	SAO MIGUEL DO ARAGUAIA	19/10/2020 08:47	19/10/2020 21:30	19/10/2020 08:47	19/10/2020 21:30	12,71	2	25,43	CHI
202010103751	CABECEIRAS	CW12403588	ITUIQUIRA	19/10/2020 08:47	19/10/2020 12:16	19/10/2020 08:47	19/10/2020 12:16	3,48	19	66,12	CHI
202010104602	ANICUNS	AC12021696	FIRMINOPOLIS S2	19/10/2020 08:47	19/10/2020 20:04	19/10/2020 08:47	19/10/2020 20:04	11,28	140	1579,16	CHI
202010102216	GOIAS	90036062	GOIAS	19/10/2020 08:47	19/10/2020 11:05	19/10/2020 08:47	19/10/2020 11:05	2,30	1	2,30	CHI
202010102221	ORIZONA	OZ31052405	PIRES DO RIO S2	19/10/2020 08:47	19/10/2020 11:17	19/10/2020 08:47	19/10/2020 11:17	2,50	2	4,99	CHI
202010102383	ANAPOLIS	AN11000319	JUNDIAI S2	19/10/2020 08:47	19/10/2020 14:42	19/10/2020 08:47	19/10/2020 14:42	5,92	92	544,21	CHI
202010102231	MUNDO NOVO DE GOIAS	MH12269054	NOVA CRIXAS	19/10/2020 08:47	19/10/2020 11:14	19/10/2020 08:47	19/10/2020 11:14	2,44	9	21,97	CHI
202010102237	CIDADE OCIDENTAL	2680014760	MARAJOARA	19/10/2020 08:47	19/10/2020 11:07	19/10/2020 08:47	19/10/2020 11:07	2,32	1	2,32	CHI
202010102239	SAO LUIS DE MONTES BELOS	500008760	SAO LUIZ DOS MONTES BELOS	19/10/2020 08:47	19/10/2020 17:31	19/10/2020 08:47	19/10/2020 17:31	8,74	1	8,74	CHI
202010102271	SITIO D ABADIA	SI12143367	IACIARA S2	19/10/2020 08:47	19/10/2020 12:15	19/10/2020 08:47	19/10/2020 12:15	3,46	23	79,47	CHI
202010106629	ANAPOLIS	AN11000432	JUNDIAI S1	19/10/2020 08:47	20/10/2020 09:38	19/10/2020 08:47	20/10/2020 09:38	24,84	91	2260,01	CHI
202010107038	GOIANESIA	GE11090257	GOIANESIA S1	19/10/2020 08:48	19/10/2020 20:10	19/10/2020 08:48	19/10/2020 20:10	11,37	84	954,80	CHI
202010103264	ANAPOLIS	AN11315977	ANAPOLIS UNIVERSITARIO S2	19/10/2020 08:48	20/10/2020 00:02	19/10/2020 08:48	20/10/2020 00:02	15,23	101	1538,17	CHI
202010102255	IPORA	730095812	IPORA	19/10/2020 08:48	19/10/2020 09:50	19/10/2020 08:48	19/10/2020 09:50	1,03	1	1,03	CHI
202010102258	CRISTALINA	KR12345955	CRISTALINA S2	19/10/2020 08:48	19/10/2020 17:10	19/10/2020 08:48	19/10/2020 17:10	8,36	1	8,36	CHI
202010102633	CRISTALINA	KR12389569	PAMPLONA	19/10/2020 08:48	19/10/2020 14:50	19/10/2020 08:48	19/10/2020 14:50	6,02	4	24,09	CHI
202010102266	RIO VERDE	630442540	RIO VERDE S2	19/10/2020 08:49	19/10/2020 13:22	19/10/2020 08:49	19/10/2020 13:22	4,55	1	4,55	CHI
202010102273	FAZENDA NOVA	FN21073618	BRITANIA	19/10/2020 08:49	20/10/2020 12:26	19/10/2020 08:49	20/10/2020 12:26	27,61	33	911,20	CHI
202010102783	ANAPOLIS	AN11205795	ANAPOLIS UNIVERSITARIO S2	19/10/2020 08:49	19/10/2020 16:25	19/10/2020 08:49	19/10/2020 16:25	7,59	21	159,31	CHI
202010103060	CAMPO ALEGRE DE GOIAS	CM12077272	CAMPO ALEGRE DE GOIAS	19/10/2020 08:49	19/10/2020 13:52	19/10/2020 08:49	19/10/2020 13:52	5,03	8	40,28	CHI
202010102292	PIRENOPOLIS	PV21033505	CORUMBA	19/10/2020 08:50	20/10/2020 00:05	19/10/2020 08:50	20/10/2020 00:05	15,25	1	15,25	CHI

202010102297	SANTO ANTONIO DO DESCOBERTO	SN21393766	MARAJOARA	19/10/2020 08:50	19/10/2020 15:36	19/10/2020 08:50	19/10/2020 15:36	6,76	1	6,76	CHI
202010102300	GOIANIRA	GR21244947	GOIANIRA	19/10/2020 08:50	20/10/2020 00:30	19/10/2020 08:50	20/10/2020 00:30	15,66	1	15,66	CHI
202010102886	SAO MIGUEL DO ARAGUAIA	SM12208936	SAO MIGUEL DO ARAGUAIA	19/10/2020 08:50	21/10/2020 15:20	19/10/2020 08:50	21/10/2020 15:20	54,49	5	272,46	CHI
202010102886	SAO MIGUEL DO ARAGUAIA	SM12208936	SAO MIGUEL DO ARAGUAIA	19/10/2020 08:50	21/10/2020 15:20	21/10/2020 14:50	21/10/2020 15:20	0,50	5	2,50	CHI
202010102886	SAO MIGUEL DO ARAGUAIA	SM12208936	SAO MIGUEL DO ARAGUAIA	19/10/2020 08:50	21/10/2020 15:20	21/10/2020 10:30	21/10/2020 11:22	0,87	5	4,36	CHI
202010102886	SAO MIGUEL DO ARAGUAIA	SM12208936	SAO MIGUEL DO ARAGUAIA	19/10/2020 08:50	21/10/2020 15:20	19/10/2020 08:50	20/10/2020 16:43	31,88	5	159,41	CHI
202010102311	VIANOPOLIS	VN21159672	VIANOPOLIS	19/10/2020 08:50	19/10/2020 11:49	19/10/2020 08:50	19/10/2020 11:49	2,97	2	5,94	CHI
202010102314	CORUMBA DE GOIAS	CB21141563	CORUMBA	19/10/2020 08:50	20/10/2020 12:32	19/10/2020 08:50	20/10/2020 12:32	27,69	1	27,69	CHI
202010102321	ITABERAI	IB21040778	ITABERAI S2	19/10/2020 08:51	19/10/2020 12:41	19/10/2020 08:51	19/10/2020 12:41	3,83	1	3,83	CHI
202010102322	SENADOR CANEDO	10002663633	SENADOR CANEDO	19/10/2020 08:51	19/10/2020 10:23	19/10/2020 08:51	19/10/2020 10:23	1,53	1	1,53	CHI
202010104038	ANAPOLIS	AN11000308	JUNDIAI S2	19/10/2020 08:51	19/10/2020 14:39	19/10/2020 08:51	19/10/2020 14:39	5,80	100	579,56	CHI
202010102900	ANAPOLIS	AN11107979	JUNDIAI S2	19/10/2020 08:51	19/10/2020 11:04	19/10/2020 08:51	19/10/2020 11:04	2,21	143	315,63	CHI
202010102337	SANCLERLANDIA	SC21186308	FIRMINOPOLIS S2	19/10/2020 08:51	19/10/2020 16:30	19/10/2020 08:51	19/10/2020 16:30	7,65	3	22,95	CHI
202010102345	ITUMBIARA	690286867	ITUMBIARA VELHA S1	19/10/2020 08:52	19/10/2020 16:09	19/10/2020 08:52	19/10/2020 16:09	7,28	1	7,28	CHI
202010102346	ALOANDIA	AD21238418	GOIATUBA S1	19/10/2020 08:52	19/10/2020 10:27	19/10/2020 08:52	19/10/2020 10:27	1,58	1	1,58	CHI
202010102348	SANTA CRUZ DE GOIAS	BC12012519	PIRES DO RIO S2	19/10/2020 08:52	19/10/2020 10:29	19/10/2020 08:52	19/10/2020 10:29	1,61	2	3,22	CHI
202010102349	CARMO DO RIO VERDE	IK12220547	ITAPURANGA	19/10/2020 08:52	19/10/2020 12:02	19/10/2020 08:52	19/10/2020 12:02	3,16	12	37,93	CHI
202010102350	PALESTINA DE GOIAS	PL12000049	PALMEIRAS	19/10/2020 08:52	19/10/2020 20:14	19/10/2020 08:52	19/10/2020 20:14	11,37	1	11,37	CHI
202010102350	PALMEIRAS DE GOIAS	PL12000049	PALMEIRAS	19/10/2020 08:52	19/10/2020 20:14	19/10/2020 08:52	19/10/2020 20:14	11,37	26	295,73	CHI
202010102350	JANDAIA	PL12000049	PALMEIRAS	19/10/2020 08:52	19/10/2020 20:14	19/10/2020 08:52	19/10/2020 20:14	11,37	8	90,99	CHI
202010103848	INHUMAS	IX12000030	INHUMAS S1	19/10/2020 08:52	20/10/2020 04:31	19/10/2020 08:52	20/10/2020 04:31	19,64	12	235,71	CHI
202010103848	ITAUCU	IX12000030	INHUMAS S1	19/10/2020 08:52	20/10/2020 04:31	19/10/2020 08:52	20/10/2020 04:31	19,64	4	78,57	CHI
202010102877	ANAPOLIS	AN11000427	JUNDIAI S1	19/10/2020 08:52	19/10/2020 15:33	19/10/2020 08:52	19/10/2020 15:33	6,69	96	642,32	CHI
202010102358	PALMINOPOLIS	PP21308384	PALMEIRAS	19/10/2020 08:52	19/10/2020 10:57	19/10/2020 08:52	19/10/2020 10:57	2,07	2	4,15	CHI
202010102702	MINEIROS	MY11182129	PARQUE DAS EMAS	19/10/2020 08:52	19/10/2020 11:45	19/10/2020 08:52	19/10/2020 11:45	2,87	67	192,42	CHI
202010102360	ANICUNS	AC12065201	ANICUNS	19/10/2020 08:52	20/10/2020 07:41	19/10/2020 08:52	20/10/2020 07:41	22,80	6	136,83	CHI
202010102361	CAMPO ALEGRE DE GOIAS	1160005282	CAMPO ALEGRE DE GOIAS	19/10/2020 08:52	19/10/2020 10:05	19/10/2020 08:52	19/10/2020 10:05	1,20	1	1,20	CHI
202010102852	ANAPOLIS	AN11370433	JUNDIAI S2	19/10/2020 08:52	19/10/2020 23:10	19/10/2020 08:52	19/10/2020 23:10	14,28	89	1271,27	CHI
202010102363	HIDROLANDIA	HD21323402	CEPAIGO S2	19/10/2020 08:52	19/10/2020 10:49	19/10/2020 08:52	19/10/2020 10:49	1,93	1	1,93	CHI
202010102369	BELA VISTA DE GOIAS	240028120	BELA VISTA S1	19/10/2020 08:53	19/10/2020 12:35	19/10/2020 08:53	19/10/2020 12:35	3,69	1	3,69	CHI
202010103948	BOM JARDIM DE GOIAS	BM12193386	BOM JARDIM	19/10/2020 08:53	20/10/2020 08:32	19/10/2020 08:53	20/10/2020 08:32	23,65	2	47,30	CHI
202010103948	BOM JARDIM DE GOIAS	BM12193386	BOM JARDIM	19/10/2020 08:53	20/10/2020 08:32	19/10/2020 08:53	20/10/2020 07:34	22,68	14	317,51	CHI
202010102375	NEROPOLIS	NR12067990	NEROPOLIS S2	19/10/2020 08:53	19/10/2020 09:59	19/10/2020 08:53	19/10/2020 09:59	1,10	2	2,20	CHI
202010103065	CAMPO LIMPO	AN12011924	NEROPOLIS S1	19/10/2020 08:53	19/10/2020 15:56	19/10/2020 08:53	19/10/2020 15:56	7,04	47	330,76	CHI
202010102791	ANAPOLIS	AN12414610	ANAPOLIS UNIVERSITARIO S2	19/10/2020 08:54	19/10/2020 12:55	19/10/2020 08:54	19/10/2020 12:55	4,02	61	244,97	CHI
202010102791	CAMPO LIMPO	AN12414610	ANAPOLIS UNIVERSITARIO S2	19/10/2020 08:54	19/10/2020 12:55	19/10/2020 08:54	19/10/2020 12:55	4,02	9	36,14	CHI
202010102379	APARECIDA DE GOIANIA	10013197698	ANHANGUERA	19/10/2020 08:54	19/10/2020 10:09	19/10/2020 08:54	19/10/2020 10:09	1,25	1	1,25	CHI
202010102381	SANTA TEREZINHA DE GOIAS	SG21242357	SANTA TEREZINHA	19/10/2020 08:54	20/10/2020 12:32	19/10/2020 08:54	20/10/2020 12:32	27,63	1	27,63	CHI
202010102764	JUSSARA	JR12069070LD	JUSSARA	19/10/2020 08:54	20/10/2020 12:22	19/10/2020 08:54	20/10/2020 12:22	27,47	27	741,81	CHI
202010102764	JUSSARA	JR12101204	JUSSARA	19/10/2020 08:54	20/10/2020 12:22	19/10/2020 08:54	19/10/2020 11:40	2,76	3	8,28	CHI
202010102385	MINACU	IH21230408	MINACU	19/10/2020 08:54	19/10/2020 12:28	19/10/2020 08:54	19/10/2020 12:28	3,56	1	3,56	CHI
202010102507	QUIRINOPOLIS	QI12296643	QUIRINOPOLIS	19/10/2020 08:55	19/10/2020 10:34	19/10/2020 08:55	19/10/2020 10:34	1,65	5	8,25	CHI
202010102395	SAO MIGUEL DO ARAGUAIA	SM12029795	SAO MIGUEL DO ARAGUAIA	19/10/2020 08:55	19/10/2020 16:45	19/10/2020 08:55	19/10/2020 16:45	7,83	12	93,98	CHI
202010102401	GOIANIA	13554736	FERROVIARIO S3	19/10/2020 08:55	19/10/2020 13:02	19/10/2020 08:55	19/10/2020 13:02	4,11	1	4,11	CHI
202010103806	ANAPOLIS	AN11196998	JUNDIAI S1	19/10/2020 08:55	19/10/2020 12:11	19/10/2020 08:55	19/10/2020 12:11	3,26	70	227,99	CHI
202010104631	FAINA	FC12147790	GOIAS	19/10/2020 08:55	19/10/2020 15:46	19/10/2020 08:55	19/10/2020 15:46	6,83	6	41,00	CHI
202010104978	SANTA CRUZ DE GOIAS	BC12023177	CRISTIANOPOLIS	19/10/2020 08:56	19/10/2020 16:33	19/10/2020 08:56	19/10/2020 16:33	7,62	3	22,85	CHI
202010102927	ANAPOLIS	AN11346751	ANAPOLIS UNIVERSITARIO S2	19/10/2020 08:56	19/10/2020 16:38	19/10/2020 08:56	19/10/2020 16:38	7,70	84	646,57	CHI
202010102417	GOIANIA	10026976054	GOYA S1	19/10/2020 08:56	19/10/2020 11:56	19/10/2020 08:56	19/10/2020 11:56	3,00	1	3,00	CHI
202010102513	ABADIANIA	AA12075882	CORUMBA	19/10/2020 08:56	19/10/2020 11:20	19/10/2020 08:56	19/10/2020 11:20	2,39	10	23,92	CHI
202010106981	AGUA FRIA DE GOIAS	4440001374	SAO JOAO D ALIANCA	19/10/2020 08:56	19/10/2020 21:18	19/10/2020 08:56	19/10/2020 21:18	12,36	1	12,36	CHI

202010102424	ALTO PARAISO DE GOIAS	BF21256412	NIQUELANDIA SUBTRANSMISSAO	19/10/2020 08:56	19/10/2020 14:26	19/10/2020 08:56	19/10/2020 14:26	5,48	2	10,97	CHI
202010102425	CABECEIRAS	CW21157340	ITIQUEIRA	19/10/2020 08:57	19/10/2020 20:34	19/10/2020 08:57	19/10/2020 20:34	11,62	1	11,62	CHI
202010102854	SILVANIA	SV12103764	VIANOPOLIS	19/10/2020 08:57	20/10/2020 12:12	19/10/2020 08:57	20/10/2020 12:12	27,24	13	354,17	CHI
202010102429	SANTA TEREZA DE GOIAS	SE12060934	MARA ROSA	19/10/2020 08:57	19/10/2020 11:10	19/10/2020 08:57	19/10/2020 11:10	2,21	6	13,26	CHI
202010102430	COCALZINHO DE GOIAS	ZN21302503	COCALZINHO	19/10/2020 08:57	19/10/2020 20:30	19/10/2020 08:57	19/10/2020 20:30	11,54	2	23,09	CHI
202010102433	POSSE	PS11067854	IACIARA S2	19/10/2020 08:57	19/10/2020 09:15	19/10/2020 08:57	19/10/2020 09:15	0,29	42	12,02	CHI
202010102439	ABADIA DE GOIAS	GN32050563	TRINDADE	19/10/2020 08:58	19/10/2020 10:05	19/10/2020 08:58	19/10/2020 10:05	1,12	1	1,12	CHI
202010102446	ANAPOLIS	AN12000236	ANAPOLIS UNIVERSITARIO S2	19/10/2020 08:59	19/10/2020 14:04	19/10/2020 08:59	19/10/2020 14:04	5,08	113	574,42	CHI
202010102473	NIQUELANDIA	10002807813	NIQUELANDIA SUBTRANSMISSAO	19/10/2020 09:01	20/10/2020 03:15	19/10/2020 09:01	20/10/2020 03:15	18,23	1	18,23	CHI
202010103277	ABADIANIA	AA11043940	ANAPOLIS UNIVERSITARIO S1	19/10/2020 09:02	19/10/2020 20:59	19/10/2020 09:02	19/10/2020 20:59	11,94	122	1456,65	CHI
202010101232	MATRINCHA	MP12235811LD	MATRINCHA	19/10/2020 09:02	19/10/2020 18:03	19/10/2020 09:02	19/10/2020 18:03	9,00	58	522,03	CHI
202010102498	AGUA LIMPA	AL12097209	VILA CORUMBA	19/10/2020 09:03	19/10/2020 10:00	19/10/2020 09:03	19/10/2020 10:00	0,95	6	5,68	CHI
202010102499	ALVORADA DO NORTE	AQ12160975	IACIARA S2	19/10/2020 09:03	19/10/2020 10:25	19/10/2020 09:03	19/10/2020 10:25	1,36	17	23,18	CHI
202010102501	MINEIROS	1390068204	PARQUE DAS EMAS	19/10/2020 09:03	19/10/2020 15:04	19/10/2020 09:03	19/10/2020 15:04	6,01	1	6,01	CHI
202010102502	PIRENOPOLIS	220046517	CORUMBA	19/10/2020 09:03	19/10/2020 22:01	19/10/2020 09:03	19/10/2020 22:01	12,96	1	12,96	CHI
202010102505	ITAPURANGA	IK11299480	ITAPURANGA	19/10/2020 09:03	19/10/2020 14:42	19/10/2020 09:03	19/10/2020 14:42	5,64	108	609,48	CHI
202010104821	JATAI	JT12264399	JATAI S1	19/10/2020 09:03	19/10/2020 19:02	19/10/2020 09:03	19/10/2020 19:02	9,99	5	49,95	CHI
202010104357	SAO MIGUEL DO ARAGUAIA	SM12384276	SAO MIGUEL DO ARAGUAIA	19/10/2020 09:03	20/10/2020 13:30	19/10/2020 09:03	20/10/2020 13:30	28,44	4	113,75	CHI
202010103805	IPAMERI	IP12275811	IPAMERI	19/10/2020 09:03	19/10/2020 17:03	19/10/2020 09:03	19/10/2020 17:03	7,99	87	694,82	CHI
202010103714	PLANALTINA	PI12257785	PLANALTINA	19/10/2020 09:03	19/10/2020 12:02	19/10/2020 09:03	19/10/2020 12:02	2,97	4	11,87	CHI
202010102532	EDEIA	EA12257964	EDEIA	19/10/2020 09:04	19/10/2020 12:37	19/10/2020 09:04	19/10/2020 12:37	3,54	1	3,54	CHI
202010102538	ITAJA	IJ21184032	CACHOEIRA ALTA	19/10/2020 09:04	19/10/2020 12:49	19/10/2020 09:04	19/10/2020 12:49	3,73	1	3,73	CHI
202010102537	CATALAO	CT21150913	CATALAO S1	19/10/2020 09:04	19/10/2020 11:22	19/10/2020 09:04	19/10/2020 11:22	2,28	1	2,28	CHI
202010102541	PALMEIRAS DE GOIAS	10020637746	PALMEIRAS	19/10/2020 09:05	19/10/2020 14:55	19/10/2020 09:05	19/10/2020 14:55	5,83	1	5,83	CHI
202010102951	ANAPOLIS	AN11272984	ANAPOLIS UNIVERSITARIO S2	19/10/2020 09:05	19/10/2020 22:07	19/10/2020 09:05	19/10/2020 22:07	13,03	91	1185,55	CHI
202010102554	NOVA CRIXAS	NA11213034	NOVA CRIXAS	19/10/2020 09:05	20/10/2020 20:03	19/10/2020 09:05	20/10/2020 20:03	34,95	13	454,39	CHI
202010102559	PORANGATU	PO12189555	PORANGATU	19/10/2020 09:06	20/10/2020 17:30	19/10/2020 09:06	20/10/2020 17:30	32,41	8	259,26	CHI
202010102564	ABADIANIA	AN12390620	ANAPOLIS UNIVERSITARIO S1	19/10/2020 09:06	19/10/2020 18:33	19/10/2020 09:06	19/10/2020 18:33	9,45	1	9,45	CHI
202010102570	ANAPOLIS	AN21222250	ANAPOLIS UNIVERSITARIO S2	19/10/2020 09:06	19/10/2020 12:22	19/10/2020 09:06	19/10/2020 12:22	3,26	1	3,26	CHI
202010102573	MONTIVIDIU	MV12207748	MONTIVIDIU T	19/10/2020 09:06	19/10/2020 12:01	19/10/2020 09:06	19/10/2020 12:01	2,90	7	20,32	CHI
202010102581	MONTIVIDIU	MV21326934	MONTIVIDIU T	19/10/2020 09:07	19/10/2020 11:51	19/10/2020 09:07	19/10/2020 11:51	2,73	1	2,73	CHI
202010102583	CRIXAS	2490005723	SERRA DO OURO	19/10/2020 09:07	19/10/2020 20:01	19/10/2020 09:07	19/10/2020 20:01	10,89	1	10,89	CHI
202010104424	AMERICANO DO BRASIL	KB11314794	ANICUNS	19/10/2020 09:07	19/10/2020 13:41	19/10/2020 09:07	19/10/2020 13:41	4,56	94	428,20	CHI
202010102601	MORRINHOS	MR12058489LD	MORRINHOS	19/10/2020 09:08	19/10/2020 11:49	19/10/2020 09:08	19/10/2020 11:49	2,68	16	42,89	CHI
202010103160	ANAPOLIS	AN11072062	ANAPOLIS UNIVERSITARIO S2	19/10/2020 09:09	19/10/2020 13:15	19/10/2020 09:09	19/10/2020 13:15	4,10	45	184,29	CHI
202010102621	DOVERLANDIA	4220026497	CAIAPONIA	19/10/2020 09:09	19/10/2020 13:04	19/10/2020 09:09	19/10/2020 13:04	3,91	1	3,91	CHI
202010102626	AGUA FRIA DE GOIAS	TL12356260	SAO JOAO D ALIANCA	19/10/2020 09:09	19/10/2020 12:20	19/10/2020 09:09	19/10/2020 12:20	3,17	19	60,17	CHI
202010104979	NOVO BRASIL	GS12073672	MATRINCHA	19/10/2020 09:10	19/10/2020 17:28	19/10/2020 09:10	19/10/2020 17:28	8,28	36	298,26	CHI
202010104979	GOIAS	GS12073672	MATRINCHA	19/10/2020 09:10	19/10/2020 17:28	19/10/2020 09:10	19/10/2020 17:28	8,28	38	314,83	CHI
202010104979	ITAPIRAPUA	GS12073672	MATRINCHA	19/10/2020 09:10	19/10/2020 17:28	19/10/2020 09:10	19/10/2020 17:28	8,28	1	8,28	CHI
202010102653	SANTA CRUZ DE GOIAS	BC12087092	PIRES DO RIO S2	19/10/2020 09:11	20/10/2020 19:12	19/10/2020 09:11	20/10/2020 19:12	34,01	5	170,06	CHI
202010102653	SANTA CRUZ DE GOIAS	BC12087092	PIRES DO RIO S2	19/10/2020 09:11	20/10/2020 19:12	20/10/2020 18:05	20/10/2020 19:12	1,11	6	6,67	CHI
202010102653	SANTA CRUZ DE GOIAS	BC12087092	PIRES DO RIO S2	19/10/2020 09:11	20/10/2020 19:12	19/10/2020 09:11	20/10/2020 16:42	31,51	1	31,51	CHI
202010102653	SANTA CRUZ DE GOIAS	BC12087092	PIRES DO RIO S2	19/10/2020 09:11	20/10/2020 19:12	19/10/2020 09:11	19/10/2020 20:35	11,39	6	68,32	CHI
202010102660	MARA ROSA	MQ12051070	MARA ROSA	19/10/2020 09:12	19/10/2020 10:00	19/10/2020 09:12	19/10/2020 10:00	0,80	197	157,11	CHI
202010104306	ANAPOLIS	AN11195696	JUNDIAI S1	19/10/2020 09:12	19/10/2020 13:55	19/10/2020 09:12	19/10/2020 13:55	4,71	66	311,13	CHI
202010102817	FORMOSA	FA21115713	ITIQUEIRA	19/10/2020 09:12	19/10/2020 11:30	19/10/2020 09:12	19/10/2020 11:30	2,30	1	2,30	CHI
202010104813	GOIAS	GS12250574	GOIAS	19/10/2020 09:12	19/10/2020 15:45	19/10/2020 09:12	19/10/2020 15:45	6,54	8	52,30	CHI
202010105051	ANAPOLIS	AN11205858	ANAPOLIS UNIVERSITARIO S2	19/10/2020 09:12	19/10/2020 14:57	19/10/2020 09:12	19/10/2020 14:57	5,74	13	74,59	CHI
202010104792	ANAPOLIS	AN21382879	ANAPOLIS UNIVERSITARIO S2	19/10/2020 09:12	19/10/2020 14:36	19/10/2020 09:12	19/10/2020 14:36	5,39	1	5,39	CHI
202010103182	CATALAO	CT12134367	CATALAO S1	19/10/2020 09:12	19/10/2020 17:08	19/10/2020 09:12	19/10/2020 17:08	7,92	11	87,10	CHI

202010102700	ALVORADA DO NORTE	AQ21238726	IACIARA S2	19/10/2020 09:13	19/10/2020 11:04	19/10/2020 09:13	19/10/2020 11:04	1,84	1	1,84	CHI
202010102696	NOVA ROMA	ND12392238	IACIARA S2	19/10/2020 09:14	19/10/2020 12:55	19/10/2020 09:14	19/10/2020 12:55	3,68	243	893,77	CHI
202010102701	PIRENOPOLIS	PV12413943	CORUMBA	19/10/2020 09:14	20/10/2020 16:12	19/10/2020 09:14	20/10/2020 16:12	30,96	1	30,96	CHI
202010102710	MINEIROS	MY21166000	PARQUE DAS EMAS	19/10/2020 09:14	19/10/2020 12:47	19/10/2020 09:14	19/10/2020 12:47	3,53	1	3,53	CHI
202010104259	DOVERLANDIA	DV12139919	CAIAPONIA	19/10/2020 09:15	19/10/2020 14:57	19/10/2020 09:15	19/10/2020 14:57	5,70	49	279,27	CHI
202010103469	JANDAIA	JD12010996LD	PALMEIRAS	19/10/2020 09:15	19/10/2020 19:58	19/10/2020 09:15	19/10/2020 19:58	10,71	21	224,94	CHI
202010102728	IPORA	IR11325040	IPORA	19/10/2020 09:15	19/10/2020 10:36	19/10/2020 09:15	19/10/2020 10:36	1,33	73	97,37	CHI
202010103053	ANAPOLIS	10008725436	JUNDIAI S2	19/10/2020 09:16	20/10/2020 10:45	19/10/2020 09:16	20/10/2020 10:45	25,50	1	25,50	CHI
202010106582	MOSSAMEDES	ND12299618	ITABERAI S2	19/10/2020 09:16	19/10/2020 20:23	19/10/2020 09:16	19/10/2020 20:23	11,11	18	200,02	CHI
202010102735	ARAGARCAS	7048790	BOM JARDIM	19/10/2020 09:16	20/10/2020 21:10	19/10/2020 09:16	20/10/2020 21:10	35,91	24	861,77	CHI
202010102735	BALIZA	7048790	BOM JARDIM	19/10/2020 09:16	20/10/2020 21:10	19/10/2020 09:16	20/10/2020 21:10	35,91	262	9407,69	CHI
202010102735	BALIZA	BM13334980	BOM JARDIM	19/10/2020 09:16	20/10/2020 21:10	20/10/2020 16:39	20/10/2020 20:44	4,08	7	28,53	CHI
202010102735	BOM JARDIM DE GOIAS	BM13334980	BOM JARDIM	19/10/2020 09:16	20/10/2020 21:10	20/10/2020 16:39	20/10/2020 20:44	4,08	7	28,53	CHI
202010102737	SAO FRANCISCO DE GOIAS	SF21066079	SAO FRANCISCO DE GOIAS	19/10/2020 09:16	19/10/2020 13:42	19/10/2020 09:16	19/10/2020 13:42	4,42	1	4,42	CHI
202010102743	MINEIROS	MY21033145	PARQUE DAS EMAS	19/10/2020 09:16	19/10/2020 13:31	19/10/2020 09:16	19/10/2020 13:31	4,23	1	4,23	CHI
202010102746	ITUMBIARA	10031042200	ITUMBIARA VELHA S1	19/10/2020 09:17	19/10/2020 12:38	19/10/2020 09:17	19/10/2020 12:38	3,35	1	3,35	CHI
202010102751	EDEIA	1120029330	EDEIA	19/10/2020 09:17	19/10/2020 11:19	19/10/2020 09:17	19/10/2020 11:19	2,03	1	2,03	CHI
202010102752	APORE	AE21303835	ITAJA S1	19/10/2020 09:17	19/10/2020 23:53	19/10/2020 09:17	19/10/2020 23:53	14,59	1	14,59	CHI
202010102754	URUACU	10003801738	URUACU	19/10/2020 09:17	19/10/2020 11:35	19/10/2020 09:17	19/10/2020 11:35	2,29	1	2,29	CHI
202010103563	ANAPOLIS	AN11264485	ANAPOLIS UNIVERSITARIO S2	19/10/2020 09:17	19/10/2020 16:28	19/10/2020 09:17	19/10/2020 16:28	7,17	53	380,16	CHI
202010102453	ARAGARCAS	BM12372345	BOM JARDIM	19/10/2020 09:17	19/10/2020 13:45	19/10/2020 09:17	19/10/2020 13:45	4,46	23	102,47	CHI
202010102953	ABADIANIA	AA12349442	ANAPOLIS UNIVERSITARIO S1	19/10/2020 09:17	19/10/2020 18:56	19/10/2020 09:17	19/10/2020 18:56	9,64	17	163,84	CHI
202010103275	PIRACANJUBA	PJ12212207	PIRACANJUBA	19/10/2020 09:18	19/10/2020 11:53	19/10/2020 09:18	19/10/2020 11:53	2,58	10	25,76	CHI
202010102777	ACREUNA	EU12219448	ACREUNA	19/10/2020 09:18	19/10/2020 11:34	19/10/2020 09:18	19/10/2020 11:34	2,25	5	11,26	CHI
202010102777	PARAUNA	EU12219448	ACREUNA	19/10/2020 09:18	19/10/2020 11:34	19/10/2020 09:18	19/10/2020 11:34	2,25	3	6,76	CHI
202010103181	CORUMBA DE GOIAS	CB12382386	CORUMBA	19/10/2020 09:19	20/10/2020 13:45	19/10/2020 09:19	20/10/2020 13:45	28,43	2	56,87	CHI
202010104234	VILA PROPICIO	BA12258276	GOIANESIA S1	19/10/2020 09:19	19/10/2020 13:37	19/10/2020 09:19	19/10/2020 13:37	4,29	1	4,29	CHI
202010104234	BARRO ALTO	BA12258276	GOIANESIA S1	19/10/2020 09:19	19/10/2020 13:37	19/10/2020 09:19	19/10/2020 13:37	4,29	4	17,16	CHI
202010104234	GOIANESIA	BA12258276	GOIANESIA S1	19/10/2020 09:19	19/10/2020 13:37	19/10/2020 09:19	19/10/2020 13:37	4,29	89	381,83	CHI
202010102820	NOVO BRASIL	NB12246495	JUSSARA	19/10/2020 09:21	19/10/2020 14:35	19/10/2020 09:21	19/10/2020 14:35	5,22	5	26,10	CHI
202010102822	POSSE	PS21164583	IACIARA S2	19/10/2020 09:21	19/10/2020 12:03	19/10/2020 09:21	19/10/2020 12:03	2,69	1	2,69	CHI
202010103782	ITAPIRAPUA	IU12206880	MATRINCHA	19/10/2020 09:21	19/10/2020 13:22	19/10/2020 09:21	19/10/2020 13:22	4,00	11	44,02	CHI
202010102830	GOIAS	GS21319425	ITABERAI S2	19/10/2020 09:22	19/10/2020 17:12	19/10/2020 09:22	19/10/2020 17:12	7,83	2	15,65	CHI
202010102832	FORMOSA	FA12302845	ITUIQUIRA	19/10/2020 09:22	19/10/2020 13:10	19/10/2020 09:22	19/10/2020 13:10	3,79	19	72,04	CHI
202010102832	CABECEIRAS	FA12302845	ITUIQUIRA	19/10/2020 09:22	19/10/2020 13:10	19/10/2020 09:22	19/10/2020 13:10	3,79	17	64,45	CHI
202010107862	ABADIANIA	AA12384735	DAIA S2	19/10/2020 09:22	21/10/2020 11:36	19/10/2020 09:22	21/10/2020 11:36	50,22	59	2962,83	CHI
202010102863	VILA PROPICIO	GE21129079	GOIANESIA S2	19/10/2020 09:24	20/10/2020 16:35	19/10/2020 09:24	20/10/2020 16:35	31,17	1	31,17	CHI
202010102865	URUACU	10009959414	URUACU	19/10/2020 09:24	19/10/2020 16:32	19/10/2020 09:24	19/10/2020 16:32	7,12	1	7,12	CHI
202010102881	JUSSARA	JR12011813	BRITANIA	19/10/2020 09:26	19/10/2020 15:27	19/10/2020 09:26	19/10/2020 15:27	6,01	13	78,16	CHI
202010102882	ARUANA	AK12312496	ARUANA	19/10/2020 09:26	19/10/2020 16:52	19/10/2020 09:26	19/10/2020 16:52	7,42	24	178,19	CHI
202010104746	ALEXANIA	AX12319851	ALEXANIA	19/10/2020 09:26	19/10/2020 16:41	19/10/2020 09:26	19/10/2020 16:41	7,24	21	151,97	CHI
202010104374	CATALAO	CT12166899	CATALAO S1	19/10/2020 09:26	19/10/2020 17:11	19/10/2020 09:26	19/10/2020 17:11	7,74	5	38,68	CHI
202010102890	MOIPORA	1430001050	IPORA	19/10/2020 09:27	19/10/2020 18:13	19/10/2020 09:27	19/10/2020 18:13	8,77	1	8,77	CHI
202010106014	NIQUELANDIA	NQ12398036	NIQUELANDIA SUBTRANSMISSAO	19/10/2020 09:27	20/10/2020 17:45	19/10/2020 09:27	20/10/2020 17:45	32,31	1	32,31	CHI
202010106014	NIQUELANDIA	NQ12265777LD	NIQUELANDIA SUBTRANSMISSAO	19/10/2020 09:27	20/10/2020 17:45	19/10/2020 20:40	20/10/2020 17:45	21,09	1	21,09	CHI
202010106014	NIQUELANDIA	NQ12398036	NIQUELANDIA SUBTRANSMISSAO	19/10/2020 09:27	20/10/2020 17:45	19/10/2020 09:27	19/10/2020 20:40	11,21	1	11,21	CHI
202010104054	SITIO D ABADIA	SI12211588	IACIARA S2	19/10/2020 09:27	19/10/2020 12:02	19/10/2020 09:27	19/10/2020 12:02	2,58	12	30,92	CHI
202010102906	JATAI	290069830	JATAI S3	19/10/2020 09:27	20/10/2020 11:43	19/10/2020 09:27	20/10/2020 11:43	26,25	1	26,25	CHI
202010102908	GAMELEIRA DE GOIAS	SV21227744	DAIA S2	19/10/2020 09:28	20/10/2020 11:26	19/10/2020 09:28	20/10/2020 11:26	25,96	1	25,96	CHI
202010108461	ANAPOLIS	AN11374658	ANAPOLIS UNIVERSITARIO S2	19/10/2020 09:28	20/10/2020 02:42	19/10/2020 09:28	20/10/2020 02:42	17,23	123	2119,12	CHI
202010103349	DOVERLANDIA	DV12380883	CAIAPONIA	19/10/2020 09:28	19/10/2020 11:59	19/10/2020 09:28	19/10/2020 11:59	2,51	8	20,09	CHI

202010102917	ITAPACI	IW21294797	RUBIATABA	19/10/2020 09:28	19/10/2020 22:14	19/10/2020 09:28	19/10/2020 22:14	12,75	1	12,75	CHI
202010102981	ALEXANIA	AX12313240	ALEXANIA	19/10/2020 09:28	19/10/2020 11:44	19/10/2020 09:28	19/10/2020 11:44	2,25	18	40,56	CHI
202010102921	ITUMBIARA	BJ12392125	BOM JESUS DE GOIAS	19/10/2020 09:28	19/10/2020 14:22	19/10/2020 09:28	19/10/2020 14:22	4,89	4	19,54	CHI
202010102931	PIRENOPOLIS	PV12360338RE	CORUMBA	19/10/2020 09:29	19/10/2020 13:43	19/10/2020 09:29	19/10/2020 13:43	4,23	95	401,53	CHI
202010102933	ARAGARCAS	AG21140027	ARAGARCAS	19/10/2020 09:29	19/10/2020 14:07	19/10/2020 09:29	19/10/2020 14:07	4,63	1	4,63	CHI
202010102940	ITABERAI	IB12250717	ITABERAI S1	19/10/2020 09:29	19/10/2020 11:44	19/10/2020 09:29	19/10/2020 11:44	2,24	5	11,19	CHI
202010102959	NOVA CRIXAS	NA21349235	NOVA CRIXAS	19/10/2020 09:31	20/10/2020 15:25	19/10/2020 09:31	20/10/2020 15:25	29,89	1	29,89	CHI
202010102965	NOVA CRIXAS	NA12321769	MOZARLANDIA	19/10/2020 09:32	19/10/2020 12:57	19/10/2020 09:32	19/10/2020 12:57	3,42	11	37,58	CHI
202010104570	GOIAS	GS12071261	GOIAS	19/10/2020 09:33	19/10/2020 13:17	19/10/2020 09:33	19/10/2020 13:17	3,73	7	26,13	CHI
202010102991	ALEXANIA	480059020	ALEXANIA	19/10/2020 09:33	19/10/2020 20:33	19/10/2020 09:33	19/10/2020 20:33	10,99	1	10,99	CHI
202010102998	SANTA HELENA DE GOIAS	SH21296190	IPEGUARI	19/10/2020 09:33	19/10/2020 13:00	19/10/2020 09:33	19/10/2020 13:00	3,44	1	3,44	CHI
202010103008	ITUMBIARA	IT12263732	CACHOEIRA DOURADA	19/10/2020 09:34	19/10/2020 12:19	19/10/2020 09:34	19/10/2020 12:19	2,74	4	10,98	CHI
202010104146	VILA PROPICIO	NP12327883	GOIANESIA S1	19/10/2020 09:34	20/10/2020 08:09	19/10/2020 09:34	20/10/2020 08:09	22,57	14	316,02	CHI
202010103027	MORRINHOS	MR21157208	MORRINHOS	19/10/2020 09:35	19/10/2020 15:44	19/10/2020 09:35	19/10/2020 15:44	6,14	1	6,14	CHI
202010101827	CACU	CC12196047LD	CACHOEIRA ALTA	19/10/2020 09:35	19/10/2020 15:28	19/10/2020 09:35	19/10/2020 15:28	5,88	12	70,62	CHI
202010103032	ITABERAI	IB21148867	ANICUNS	19/10/2020 09:35	19/10/2020 15:38	19/10/2020 09:35	19/10/2020 15:38	6,04	1	6,04	CHI
202010103035	RIO VERDE	630557007	RIO VERDE S1	19/10/2020 09:36	20/10/2020 09:29	19/10/2020 09:36	20/10/2020 09:29	23,88	1	23,88	CHI
202010103854	ANAPOLIS	AN12000235	ANAPOLIS UNIVERSITARIO S2	19/10/2020 09:36	19/10/2020 18:15	19/10/2020 09:36	19/10/2020 18:15	8,64	74	639,30	CHI
202010103061	CATALAO	CT12042334	CATALAO S1	19/10/2020 09:37	19/10/2020 13:49	19/10/2020 09:37	19/10/2020 13:49	4,19	6	25,16	CHI
202010103054	CATALAO	CT11000052	CATALAO S2	19/10/2020 09:37	19/10/2020 10:58	19/10/2020 09:37	19/10/2020 10:58	1,34	161	215,25	CHI
202010103067	SITIO D ABADIA	SI12236807	IACIARA S2	19/10/2020 09:38	19/10/2020 12:29	19/10/2020 09:38	19/10/2020 12:29	2,84	3	8,52	CHI
202010103077	GOIANESIA	550084150	GOIANESIA S2	19/10/2020 09:39	19/10/2020 16:20	19/10/2020 09:39	19/10/2020 16:20	6,68	1	6,68	CHI
202010106982	AGUA FRIA DE GOIAS	TL12067446	SAO JOAO D ALIANCA	19/10/2020 09:39	20/10/2020 13:01	19/10/2020 09:39	20/10/2020 13:01	27,36	2	54,71	CHI
202010106982	MIMOSO DE GOIAS	TL12067446	SAO JOAO D ALIANCA	19/10/2020 09:39	20/10/2020 13:01	19/10/2020 09:39	20/10/2020 13:01	27,36	3	82,07	CHI
202010103094	PIRENOPOLIS	PV21227802	CORUMBA	19/10/2020 09:39	20/10/2020 21:50	19/10/2020 09:39	20/10/2020 21:50	36,18	1	36,18	CHI
202010103115	EDEIA	ED21000028	PONTALINA	19/10/2020 09:40	20/10/2020 01:09	19/10/2020 09:40	20/10/2020 01:09	4,46	1	4,46	CHI
202010103115	EDEIA	EA21000027	PONTALINA	19/10/2020 09:40	20/10/2020 01:09	19/10/2020 09:40	20/10/2020 01:04	15,40	2	30,80	CHI
202010103115	EDEIA	EA12000030	PONTALINA	19/10/2020 09:40	20/10/2020 01:09	19/10/2020 20:04	20/10/2020 00:56	4,86	9	43,74	CHI
202010103119	GOIAS	GS12073673	MATRINCHA	19/10/2020 09:40	20/10/2020 18:45	19/10/2020 09:40	20/10/2020 18:45	33,08	1	33,08	CHI
202010103119	GOIAS	GS12073673	MATRINCHA	19/10/2020 09:40	20/10/2020 18:45	19/10/2020 09:40	20/10/2020 18:40	32,99	1	32,99	CHI
202010103119	GOIAS	GS12073673	MATRINCHA	19/10/2020 09:40	20/10/2020 18:45	19/10/2020 09:40	20/10/2020 18:35	32,90	1	32,90	CHI
202010103119	GOIAS	GS12073673	MATRINCHA	19/10/2020 09:40	20/10/2020 18:45	19/10/2020 09:40	20/10/2020 12:55	27,24	7	190,68	CHI
202010189350	MORRINHOS	MR21000152	MORRINHOS	19/10/2020 09:41	21/10/2020 00:15	19/10/2020 09:41	21/10/2020 00:15	38,55	1	38,55	CHI
202010103134	AGUA LIMPA	AL21307803	VILA CORUMBA	19/10/2020 09:42	19/10/2020 10:46	19/10/2020 09:42	19/10/2020 10:46	1,06	1	1,06	CHI
202010103146	OUVIDOR	OU21042455	CATALAO S1	19/10/2020 09:43	19/10/2020 13:43	19/10/2020 09:43	19/10/2020 13:43	3,99	1	3,99	CHI
202010105057	NOVO PLANALTO	TA12369993	NOVO PLANALTO	19/10/2020 09:43	21/10/2020 03:16	19/10/2020 09:43	21/10/2020 03:16	41,55	42	1745,00	CHI
202010105057	NOVO PLANALTO	TA12369993	NOVO PLANALTO	19/10/2020 09:43	21/10/2020 03:16	19/10/2020 09:43	21/10/2020 02:27	40,73	7	285,14	CHI
202010105057	NOVO PLANALTO	TA12369993	NOVO PLANALTO	19/10/2020 09:43	21/10/2020 03:16	19/10/2020 09:43	20/10/2020 17:43	32,00	3	96,00	CHI
202010104180	ANAPOLIS	AN11135852	JUNDIAI S2	19/10/2020 09:44	19/10/2020 22:07	19/10/2020 09:44	19/10/2020 22:07	12,38	97	1200,94	CHI
202010103156	MINEIROS	1390090350	PARQUE DAS EMAS	19/10/2020 09:44	19/10/2020 11:47	19/10/2020 09:44	19/10/2020 11:47	2,04	1	2,04	CHI
202010103178	EDEALINA	ED21151646	PONTALINA	19/10/2020 09:46	19/10/2020 19:40	19/10/2020 09:46	19/10/2020 19:40	9,89	1	9,89	CHI
202010103179	ORIZONA	OZ21159585	PIRES DO RIO S2	19/10/2020 09:46	19/10/2020 12:36	19/10/2020 09:46	19/10/2020 12:36	2,83	1	2,83	CHI
202010103186	SILVANIA	SV21137437	DAIA S2	19/10/2020 09:47	20/10/2020 11:31	19/10/2020 09:47	20/10/2020 11:31	25,73	1	25,73	CHI
202010103190	JATAI	JT12234420	JATAI S1	19/10/2020 09:47	21/10/2020 15:30	19/10/2020 09:47	21/10/2020 15:30	53,71	1	53,71	CHI
202010103193	PIRACANJUBA	60036746	PIRACANJUBA	19/10/2020 09:48	19/10/2020 17:47	19/10/2020 09:48	19/10/2020 17:47	7,98	1	7,98	CHI
202010103823	ANAPOLIS	AN11000008	ANAPOLIS UNIVERSITARIO S2	19/10/2020 09:48	19/10/2020 13:31	19/10/2020 09:48	19/10/2020 13:31	3,71	77	285,97	CHI
202010103198	FAINA	FC12057965	GOIAS	19/10/2020 09:48	19/10/2020 13:12	19/10/2020 09:48	19/10/2020 13:12	3,39	6	20,35	CHI
202010104725	ANAPOLIS	AN11324101	ANAPOLIS UNIVERSITARIO S2	19/10/2020 09:49	19/10/2020 19:57	19/10/2020 09:49	19/10/2020 19:57	10,13	54	546,87	CHI
202010103221	ANAPOLIS	AN12412945	ANAPOLIS UNIVERSITARIO S1	19/10/2020 09:50	19/10/2020 15:06	19/10/2020 09:50	19/10/2020 15:06	5,26	4	21,05	CHI
202010103491	PLANALTINA	TL12206256	SAO JOAO D ALIANCA	19/10/2020 09:50	19/10/2020 14:45	19/10/2020 09:50	19/10/2020 14:45	4,90	4	19,60	CHI
202010103252	PIRENOPOLIS	220010195	CORUMBA	19/10/2020 09:52	20/10/2020 22:28	19/10/2020 09:52	20/10/2020 22:28	36,59	1	36,59	CHI

202010103256	ANAPOLIS	21064143	JUNDIAI S2	19/10/2020 09:52	19/10/2020 11:35	19/10/2020 09:52	19/10/2020 11:35	1,70	1	1,70	CHI
202010103269	SAO MIGUEL DO ARAGUAIA	SM21291090	SAO MIGUEL DO ARAGUAIA	19/10/2020 09:53	19/10/2020 12:34	19/10/2020 09:53	19/10/2020 12:34	2,67	1	2,67	CHI
202010103274	ITABERAÍ	IB21105423	ITABERAÍ S2	19/10/2020 09:54	19/10/2020 12:46	19/10/2020 09:54	19/10/2020 12:46	2,86	1	2,86	CHI
202010103279	URUACU	UR21271951	MARA ROSA	19/10/2020 09:55	20/10/2020 14:32	19/10/2020 09:55	20/10/2020 14:32	28,61	2	57,22	CHI
202010103293	PLANALTINA	PI12131795	PLANALTINA	19/10/2020 09:56	19/10/2020 11:15	19/10/2020 09:56	19/10/2020 11:15	1,32	7	9,21	CHI
202010103300	FAZENDA NOVA	FN12073774	JUSSARA	19/10/2020 09:56	19/10/2020 16:36	19/10/2020 09:56	19/10/2020 16:36	6,65	2	13,31	CHI
202010103309	IPAMERI	IP21000046	IPAMERI	19/10/2020 09:57	19/10/2020 20:33	19/10/2020 09:57	19/10/2020 20:33	10,60	1	10,60	CHI
202010103536	AVELINOPOLIS	AV12020309	ANICUNS	19/10/2020 09:57	19/10/2020 11:39	19/10/2020 09:57	19/10/2020 11:39	1,69	22	37,27	CHI
202010103314	ANAPOLIS	AN11000205	JUNDIAI S1	19/10/2020 09:57	19/10/2020 18:58	19/10/2020 09:57	19/10/2020 18:58	9,01	214	1927,72	CHI
202010103321	PANAMA	310007070	GOIATUBA S1	19/10/2020 09:57	19/10/2020 11:59	19/10/2020 09:57	19/10/2020 11:59	2,02	1	2,02	CHI
202010103325	SANTA CRUZ DE GOIAS	BC21072313	CRISTIANOPOLIS	19/10/2020 09:57	19/10/2020 18:08	19/10/2020 09:57	19/10/2020 18:08	8,17	1	8,17	CHI
202010103329	NOVA IGUAÇU DE GOIAS	NH21164027	MARA ROSA	19/10/2020 09:58	19/10/2020 12:36	19/10/2020 09:58	19/10/2020 12:36	2,62	1	2,62	CHI
202010104558	ANAPOLIS	AN12319737	JUNDIAI S1	19/10/2020 09:58	20/10/2020 10:09	19/10/2020 09:58	20/10/2020 10:09	24,17	7	169,19	CHI
202010103335	SITIO D ABADIA	1500003053	IACIARA S2	19/10/2020 09:59	19/10/2020 11:44	19/10/2020 09:59	19/10/2020 11:44	1,75	1	1,75	CHI
202010103336	SANCLERLANDIA	SC21352459	FIRMINOPOLIS S2	19/10/2020 09:59	20/10/2020 03:11	19/10/2020 09:59	20/10/2020 03:11	17,19	3	51,58	CHI
202010103346	NOVA AURORA	NE21311815	CATALAO S1	19/10/2020 10:01	19/10/2020 12:27	19/10/2020 10:01	19/10/2020 12:27	2,43	1	2,43	CHI
202010103354	DIORAMA	DI21135463	IPORA	19/10/2020 10:01	19/10/2020 11:40	19/10/2020 10:01	19/10/2020 11:40	1,64	1	1,64	CHI
202010103356	ITABERAÍ	IB21198958	ITABERAÍ S2	19/10/2020 10:01	19/10/2020 11:15	19/10/2020 10:01	19/10/2020 11:15	1,22	2	2,44	CHI
202010103916	NIQUELANDIA	NQ12245206	NIQUELANDIA SUBTRANSMISSAO	19/10/2020 10:01	19/10/2020 15:07	19/10/2020 10:01	19/10/2020 15:07	5,09	8	40,69	CHI
202010103406	ALTO PARAISO DE GOIAS	BF12170287	NIQUELANDIA SUBTRANSMISSAO	19/10/2020 10:03	19/10/2020 12:23	19/10/2020 10:03	19/10/2020 12:23	2,33	11	25,65	CHI
202010103380	LEOPOLDO DE BULHOES	LB12270649	DAIA S2	19/10/2020 10:04	19/10/2020 18:10	19/10/2020 10:04	19/10/2020 18:10	8,10	74	599,22	CHI
202010106109	ANAPOLIS	AN11077851	JUNDIAI S2	19/10/2020 10:04	20/10/2020 01:08	19/10/2020 10:04	20/10/2020 01:08	15,05	46	692,49	CHI
202010103390	IPORA	730018489	IPORA	19/10/2020 10:04	19/10/2020 17:37	19/10/2020 10:04	19/10/2020 17:37	7,53	1	7,53	CHI
202010103396	ANAPOLIS	20209319	ANAPOLIS UNIVERSITARIO S2	19/10/2020 10:05	20/10/2020 07:35	19/10/2020 10:05	20/10/2020 07:35	21,51	1	21,51	CHI
202010103397	SAO LUIS DE MONTES BELOS	500123160	SAO LUIZ DOS MONTES BELOS	19/10/2020 10:05	19/10/2020 12:10	19/10/2020 10:05	19/10/2020 12:10	2,08	1	2,08	CHI
202010105884	ANICUNS	AC12259103	FIRMINOPOLIS S2	19/10/2020 10:07	19/10/2020 20:39	19/10/2020 10:07	19/10/2020 20:39	10,53	19	200,08	CHI
202010103417	ITUMBIARA	690374835	ITUMBIARA NOVA	19/10/2020 10:07	19/10/2020 17:44	19/10/2020 10:07	19/10/2020 17:44	7,60	1	7,60	CHI
202010103428	ITABERAÍ	IB21105979	ITABERAÍ S2	19/10/2020 10:08	19/10/2020 14:23	19/10/2020 10:08	19/10/2020 14:23	4,23	1	4,23	CHI
202010103429	IPORA	730038762	IPORA	19/10/2020 10:08	19/10/2020 12:46	19/10/2020 10:08	19/10/2020 12:46	2,62	1	2,62	CHI
202010103432	ANAPOLIS	21214190	ANAPOLIS UNIVERSITARIO S2	19/10/2020 10:09	20/10/2020 21:13	19/10/2020 10:09	20/10/2020 21:13	35,06	1	35,06	CHI
202010103441	MINEIROS	10018343757	PARQUE DAS EMAS	19/10/2020 10:10	19/10/2020 16:25	19/10/2020 10:10	19/10/2020 16:25	6,24	1	6,24	CHI
202010104650	CERES	JA12273206RE	RUBIATABA	19/10/2020 10:10	20/10/2020 09:39	19/10/2020 10:10	20/10/2020 09:39	23,47	13	305,14	CHI
202010103914	ANAPOLIS	AN11003266	ANAPOLIS UNIVERSITARIO S2	19/10/2020 10:11	19/10/2020 14:31	19/10/2020 10:11	19/10/2020 14:31	4,33	212	918,20	CHI
202010104043	SIMOLANDIA	SA12397619	IACIARA S2	19/10/2020 10:11	19/10/2020 12:30	19/10/2020 10:11	19/10/2020 12:30	2,31	18	41,58	CHI
202010103454	ANAPOLIS	20894363	JUNDIAI S2	19/10/2020 10:11	19/10/2020 14:27	19/10/2020 10:11	19/10/2020 14:27	4,27	1	4,27	CHI
202010103455	PONTALINA	JV12223261	GOIATUBA S1	19/10/2020 10:11	19/10/2020 12:27	19/10/2020 10:11	19/10/2020 12:27	2,26	3	6,77	CHI
202010103459	RIO VERDE	RV21123246	MONTIVIDIU T	19/10/2020 10:12	19/10/2020 12:50	19/10/2020 10:12	19/10/2020 12:50	2,63	1	2,63	CHI
202010103509	SAO MIGUEL DO ARAGUAIA	SM12013044	SAO MIGUEL DO ARAGUAIA	19/10/2020 10:12	21/10/2020 01:41	19/10/2020 10:12	21/10/2020 01:41	39,48	2	78,97	CHI
202010103509	SAO MIGUEL DO ARAGUAIA	SM12262763	SAO MIGUEL DO ARAGUAIA	19/10/2020 10:12	21/10/2020 01:41	19/10/2020 10:12	20/10/2020 23:25	37,21	2	74,43	CHI
202010103509	SAO MIGUEL DO ARAGUAIA	SM12013036	SAO MIGUEL DO ARAGUAIA	19/10/2020 10:12	21/10/2020 01:41	19/10/2020 10:12	20/10/2020 18:19	32,12	22	706,62	CHI
202010103509	BONOPOLIS	SM13182482	SAO MIGUEL DO ARAGUAIA	19/10/2020 10:12	21/10/2020 01:41	20/10/2020 01:05	20/10/2020 15:37	14,54	105	1527,17	CHI
202010103509	SAO MIGUEL DO ARAGUAIA	SM13182482	SAO MIGUEL DO ARAGUAIA	19/10/2020 10:12	21/10/2020 01:41	20/10/2020 01:05	20/10/2020 15:37	14,54	12	174,53	CHI
202010103509	SAO MIGUEL DO ARAGUAIA	SM10396890	SAO MIGUEL DO ARAGUAIA	19/10/2020 10:12	21/10/2020 01:41	20/10/2020 01:05	20/10/2020 01:21	0,27	74	20,27	CHI
202010103509	SAO MIGUEL DO ARAGUAIA	SM10396890	SAO MIGUEL DO ARAGUAIA	19/10/2020 10:12	21/10/2020 01:41	19/10/2020 10:12	20/10/2020 01:04	14,86	12	178,33	CHI
202010103509	BONOPOLIS	SM10396890	SAO MIGUEL DO ARAGUAIA	19/10/2020 10:12	21/10/2020 01:41	19/10/2020 10:12	20/10/2020 01:04	14,86	104	1545,53	CHI
202010103509	BONOPOLIS	SM13182482	SAO MIGUEL DO ARAGUAIA	19/10/2020 10:12	21/10/2020 01:41	19/10/2020 18:08	20/10/2020 01:04	6,93	1	6,93	CHI
202010103509	SAO MIGUEL DO ARAGUAIA	SM16404040	SAO MIGUEL DO ARAGUAIA	19/10/2020 10:12	21/10/2020 01:41	19/10/2020 18:08	19/10/2020 18:36	0,47	5	2,36	CHI
202010103509	SAO MIGUEL DO ARAGUAIA	SM10396890	SAO MIGUEL DO ARAGUAIA	19/10/2020 10:12	21/10/2020 01:41	19/10/2020 10:12	19/10/2020 16:06	5,90	5	29,51	CHI
202010103509	SAO MIGUEL DO ARAGUAIA	SM10396890	SAO MIGUEL DO ARAGUAIA	19/10/2020 10:12	21/10/2020 01:41	19/10/2020 10:12	19/10/2020 10:16	0,07	69	5,16	CHI
202010103489	ANAPOLIS	AN12007253	JUNDIAI S2	19/10/2020 10:13	19/10/2020 13:12	19/10/2020 10:13	19/10/2020 13:12	2,98	135	401,70	CHI
202010103478	RIO VERDE	630153255	RIO VERDE S1	19/10/2020 10:14	19/10/2020 15:09	19/10/2020 10:14	19/10/2020 15:09	4,91	1	4,91	CHI

202010103482	PARAUNA	PU21109610	PARAUNA	19/10/2020 10:15	19/10/2020 13:37	19/10/2020 10:15	19/10/2020 13:37	3,37	1	3,37	CHI
202010103483	ANAPOLIS	20645650	JUNDIAI S1	19/10/2020 10:15	19/10/2020 14:05	19/10/2020 10:15	19/10/2020 14:05	3,83	1	3,83	CHI
202010103488	GOIATUBA	140071635	GOIATUBA S2	19/10/2020 10:15	19/10/2020 18:58	19/10/2020 10:15	19/10/2020 18:58	8,71	1	8,71	CHI
202010103490	ANAPOLIS	10004293221	ANAPOLIS UNIVERSITARIO S2	19/10/2020 10:15	20/10/2020 14:09	19/10/2020 10:15	20/10/2020 14:09	27,89	1	27,89	CHI
202010103494	FAINA	FC11220264	GOIAS	19/10/2020 10:16	19/10/2020 13:29	19/10/2020 10:16	19/10/2020 13:29	3,21	106	340,73	CHI
202010103573	FLORES DE GOIAS	FB12285966	FLORES DE GOIAS	19/10/2020 10:16	19/10/2020 13:38	19/10/2020 10:16	19/10/2020 13:38	3,36	63	211,84	CHI
202010106983	AGUA FRIA DE GOIAS	PI12265884	SAO JOAO D ALIANCA	19/10/2020 10:16	19/10/2020 18:35	19/10/2020 10:16	19/10/2020 18:35	8,31	20	166,13	CHI
202010103568	URUACU	UR12278486	URUACU	19/10/2020 10:17	19/10/2020 14:26	19/10/2020 10:17	19/10/2020 14:26	4,15	9	37,34	CHI
202010103507	ANAPOLIS	AN11377776	ANAPOLIS UNIVERSITARIO S2	19/10/2020 10:17	20/10/2020 13:40	19/10/2020 10:17	20/10/2020 13:40	27,38	45	1232,05	CHI
202010103514	ITUMBIARA	IT21305367	ITUMBIARA NOVA	19/10/2020 10:17	19/10/2020 12:41	19/10/2020 10:17	19/10/2020 12:41	2,39	1	2,39	CHI
202010103569	SAO MIGUEL DO ARAGUAIA	SM10371101	SAO MIGUEL DO ARAGUAIA	19/10/2020 10:17	21/10/2020 00:05	19/10/2020 10:17	21/10/2020 00:05	37,79	105	3967,48	CHI
202010103569	SAO MIGUEL DO ARAGUAIA	SM10371101	SAO MIGUEL DO ARAGUAIA	19/10/2020 10:17	21/10/2020 00:05	19/10/2020 10:17	20/10/2020 19:09	32,86	24	788,63	CHI
202010103569	SAO MIGUEL DO ARAGUAIA	SM10371101	SAO MIGUEL DO ARAGUAIA	19/10/2020 10:17	21/10/2020 00:05	19/10/2020 10:17	20/10/2020 11:31	25,23	6	151,41	CHI
202010103569	SAO MIGUEL DO ARAGUAIA	SM10371101	SAO MIGUEL DO ARAGUAIA	19/10/2020 10:17	21/10/2020 00:05	19/10/2020 10:17	19/10/2020 23:34	13,28	120	1593,60	CHI
202010106408	MORRINHOS	MR12024156	MORRINHOS	19/10/2020 10:18	19/10/2020 20:53	19/10/2020 10:18	19/10/2020 20:53	10,58	6	63,49	CHI
202010103527	ANAPOLIS	20633014	ANAPOLIS UNIVERSITARIO S2	19/10/2020 10:18	20/10/2020 09:36	19/10/2020 10:18	20/10/2020 09:36	23,29	1	23,29	CHI
202010103528	ITABERAI	50057250	ITABERAI S2	19/10/2020 10:18	19/10/2020 14:32	19/10/2020 10:18	19/10/2020 14:32	4,22	1	4,22	CHI
202010103531	ALTO PARAISO DE GOIAS	BF21385528	NIQUELANDIA SUBTRANSMISSAO	19/10/2020 10:18	19/10/2020 12:51	19/10/2020 10:18	19/10/2020 12:51	2,54	1	2,54	CHI
202010104060	GOIANESIA	GE12379106	GOIANESIA S2	19/10/2020 10:19	19/10/2020 12:02	19/10/2020 10:19	19/10/2020 12:02	1,71	199	341,01	CHI
202010103537	EDEALINA	ED12047062	PONTALINA	19/10/2020 10:19	19/10/2020 20:16	19/10/2020 17:16	19/10/2020 20:16	2,99	4	11,97	CHI
202010103537	EDEALINA	ED21108505	PONTALINA	19/10/2020 10:19	19/10/2020 20:16	19/10/2020 10:19	19/10/2020 19:50	9,53	1	9,53	CHI
202010103538	NOVO BRASIL	NB12396244	JUSSARA	19/10/2020 10:19	19/10/2020 15:35	19/10/2020 10:19	19/10/2020 15:35	5,26	4	21,04	CHI
202010103543	PLANALTINA	PI11402619	PLANALTINA	19/10/2020 10:19	19/10/2020 11:36	19/10/2020 10:19	19/10/2020 11:36	1,28	116	147,93	CHI
202010103547	ITUMBIARA	IT21033044	BOM JESUS DE GOIAS	19/10/2020 10:19	19/10/2020 11:48	19/10/2020 10:19	19/10/2020 11:48	1,47	1	1,47	CHI
202010103551	PLANALTINA	10019094696	PLANALTINA	19/10/2020 10:20	19/10/2020 13:36	19/10/2020 10:20	19/10/2020 13:36	3,26	1	3,26	CHI
202010103790	CRIXAS	CX12213587	SANTA TEREZINHA	19/10/2020 10:20	19/10/2020 12:12	19/10/2020 10:20	19/10/2020 12:12	1,86	2	3,72	CHI
202010103790	UIRAPURU	CX12213587	SANTA TEREZINHA	19/10/2020 10:20	19/10/2020 12:12	19/10/2020 10:20	19/10/2020 12:12	1,86	9	16,75	CHI
202010103557	ANAPOLIS	10016847278	JUNDIAI S2	19/10/2020 10:20	20/10/2020 11:16	19/10/2020 10:20	20/10/2020 11:16	24,93	1	24,93	CHI
202010103560	CAIAPONIA	CP12091543	CAIAPONIA	19/10/2020 10:20	19/10/2020 14:46	19/10/2020 10:20	19/10/2020 14:46	4,42	15	66,30	CHI
202010103584	ALEXANIA	AX11221364	ALEXANIA	19/10/2020 10:22	19/10/2020 22:05	19/10/2020 10:22	19/10/2020 22:05	11,71	36	421,69	CHI
202010103597	SERRANOPOLIS	SX12353677	JATAI S1	19/10/2020 10:23	19/10/2020 17:27	19/10/2020 10:23	19/10/2020 17:27	7,06	16	112,95	CHI
202010103599	GUARINOS	GF12314385	SANTA TEREZINHA	19/10/2020 10:23	19/10/2020 17:10	19/10/2020 10:23	19/10/2020 17:10	6,77	2	13,55	CHI
202010103600	MAIRIPOTABA	MI12120719	PONTALINA	19/10/2020 10:23	19/10/2020 12:31	19/10/2020 10:23	19/10/2020 12:31	2,12	1	2,12	CHI
202010103600	CROMINIA	MI12120719	PONTALINA	19/10/2020 10:23	19/10/2020 12:31	19/10/2020 10:23	19/10/2020 12:31	2,12	5	10,62	CHI
202010103606	PLANALTINA	PI12324338	SAO JOAO D ALIANCA	19/10/2020 10:24	19/10/2020 20:59	19/10/2020 10:24	19/10/2020 20:59	10,58	6	63,47	CHI
202010104328	MOSSAMEDES	MD12006031	FIRMINOPOLIS S2	19/10/2020 10:24	19/10/2020 23:08	19/10/2020 10:24	19/10/2020 23:08	12,72	5	63,60	CHI
202010103617	CATALAO	CT21160931	CATALAO S1	19/10/2020 10:25	19/10/2020 12:33	19/10/2020 10:25	19/10/2020 12:33	2,12	2	4,24	CHI
202010103618	NAZARIO	440016654	ANICUNS	19/10/2020 10:25	19/10/2020 16:52	19/10/2020 10:25	19/10/2020 16:52	6,43	1	6,43	CHI
202010103620	SANTA TEREZINHA DE GOIAS	SG12237497	SANTA TEREZINHA	19/10/2020 10:25	19/10/2020 18:20	19/10/2020 10:25	19/10/2020 18:20	7,90	4	31,60	CHI
202010105230	ANICUNS	AC12020336	ANICUNS	19/10/2020 10:26	19/10/2020 17:07	19/10/2020 10:26	19/10/2020 17:07	6,67	23	153,39	CHI
202010103635	QUIRINOPOLIS	QI12384049	BOM JESUS DE GOIAS	19/10/2020 10:27	19/10/2020 13:29	19/10/2020 10:27	19/10/2020 13:29	3,03	3	9,09	CHI
202010103655	FLORES DE GOIAS	FB21062293	FLORES DE GOIAS	19/10/2020 10:28	19/10/2020 18:25	19/10/2020 10:28	19/10/2020 18:25	7,94	1	7,94	CHI
202010104874	CAMPO ALEGRE DE GOIAS	CM12166728	CAMPO ALEGRE DE GOIAS	19/10/2020 10:29	19/10/2020 15:43	19/10/2020 10:29	19/10/2020 15:43	5,22	34	177,63	CHI
202010105756	EDEIA	EA11263330	EDEIA	19/10/2020 10:30	19/10/2020 15:50	19/10/2020 10:30	19/10/2020 15:50	5,33	92	490,56	CHI
202010103670	PALMEIRAS DE GOIAS	590030220	PALMEIRAS	19/10/2020 10:30	19/10/2020 14:48	19/10/2020 10:30	19/10/2020 14:48	4,29	1	4,29	CHI
202010105725	PONTALINA	PK12109412	PONTALINA	19/10/2020 10:30	19/10/2020 18:08	19/10/2020 10:30	19/10/2020 18:08	7,62	14	106,65	CHI
202010103676	CEZARINA	CZ21277765	CEZARINA	19/10/2020 10:30	19/10/2020 16:40	19/10/2020 10:30	19/10/2020 16:40	6,16	1	6,16	CHI
202010103679	MINEIROS	10014051760	PARQUE DAS EMAS	19/10/2020 10:31	19/10/2020 17:45	19/10/2020 10:31	19/10/2020 17:45	7,22	1	7,22	CHI
202010104595	ANAPOLIS	AN11171987	ANAPOLIS UNIVERSITARIO S2	19/10/2020 10:33	19/10/2020 14:11	19/10/2020 10:33	19/10/2020 14:11	3,63	22	79,93	CHI
202010103864	ANAPOLIS	AN11000296	ANAPOLIS UNIVERSITARIO S2	19/10/2020 10:33	20/10/2020 03:27	19/10/2020 10:33	20/10/2020 03:27	16,90	133	2247,52	CHI
202010106442	ANICUNS	AC12030992	ANICUNS	19/10/2020 10:33	20/10/2020 16:55	19/10/2020 10:33	20/10/2020 16:55	30,36	18	546,50	CHI

202010103719	GOIANESIA	GE11000055	GOIANESIA S2	19/10/2020 10:35	19/10/2020 17:15	19/10/2020 10:35	19/10/2020 17:15	6,67	83	553,31	CHI
202010103721	CATALAO	CT12093871	CATALAO S1	19/10/2020 10:35	19/10/2020 21:54	19/10/2020 10:35	19/10/2020 21:54	11,31	40	452,54	CHI
202010104522	NIQUELANDIA	NQ11320929	NIQUELANDIA SUBTRANSMISSAO	19/10/2020 10:35	19/10/2020 16:06	19/10/2020 10:35	19/10/2020 16:06	5,50	47	258,67	CHI
202010103733	NIQUELANDIA	NQ12148151RE	NIQUELANDIA SUBTRANSMISSAO	19/10/2020 10:35	19/10/2020 14:18	19/10/2020 10:35	19/10/2020 14:18	3,70	12	44,45	CHI
202010107491	NOVO BRASIL	NB12396250	JUSSARA	19/10/2020 10:36	20/10/2020 03:58	19/10/2020 10:36	20/10/2020 03:58	17,37	4	69,47	CHI
202010103748	MOSSAMEDES	MD21157132	FIRMINOPOLIS S2	19/10/2020 10:36	20/10/2020 02:24	19/10/2020 10:36	20/10/2020 02:24	15,79	1	15,79	CHI
202010103754	ANAPOLIS	20197603	JUNDIAI S1	19/10/2020 10:37	19/10/2020 17:10	19/10/2020 10:37	19/10/2020 17:10	6,55	1	6,55	CHI
202010104182	GOIANESIA	GE11139640	GOIANESIA S2	19/10/2020 10:37	19/10/2020 16:08	19/10/2020 10:37	19/10/2020 16:08	5,51	187	1031,30	CHI
202010103757	EDEIA	EA21070746	EDEIA	19/10/2020 10:37	19/10/2020 20:42	19/10/2020 10:37	19/10/2020 20:42	10,08	1	10,08	CHI
202010106297	ANAPOLIS	AN11135718	ANAPOLIS UNIVERSITARIO S2	19/10/2020 10:37	19/10/2020 19:41	19/10/2020 10:37	19/10/2020 19:41	9,05	94	851,12	CHI
202010103767	FORMOSA	610092789	ITUIQUIRA	19/10/2020 10:38	19/10/2020 11:43	19/10/2020 10:38	19/10/2020 11:43	1,08	1	1,08	CHI
202010103770	PARAUNA	PU21207868	PARAUNA	19/10/2020 10:38	19/10/2020 17:07	19/10/2020 10:38	19/10/2020 17:07	6,48	1	6,48	CHI
202010103777	IPORA	730017709	IPORA	19/10/2020 10:38	19/10/2020 16:35	19/10/2020 10:38	19/10/2020 16:35	5,95	1	5,95	CHI
202010103797	DOVERLANDIA	DV21342699	CAIAPONIA	19/10/2020 10:39	19/10/2020 15:48	19/10/2020 10:39	19/10/2020 15:48	5,13	2	10,27	CHI
202010107752	ANAPOLIS	AN11000364	ANAPOLIS UNIVERSITARIO S2	19/10/2020 10:40	20/10/2020 03:10	19/10/2020 10:40	20/10/2020 03:10	16,50	45	742,29	CHI
202010104263	ANICUNS	AC11159074	ANICUNS	19/10/2020 10:40	19/10/2020 20:40	19/10/2020 10:40	19/10/2020 20:40	10,00	33	329,97	CHI
202010105878	IPAMERI	IP12000095	IPAMERI	19/10/2020 10:41	19/10/2020 18:39	19/10/2020 10:41	19/10/2020 18:39	7,96	15	119,42	CHI
202010103812	MINEIROS	10025015239	PARQUE DAS EMAS	19/10/2020 10:41	19/10/2020 13:28	19/10/2020 10:41	19/10/2020 13:28	2,78	1	2,78	CHI
202010106045	SAO MIGUEL DO ARAGUAIA	SM12143671	SAO MIGUEL DO ARAGUAIA	19/10/2020 10:41	19/10/2020 18:20	19/10/2020 10:41	19/10/2020 18:20	7,64	275	2100,69	CHI
202010103819	CORUMBAIBA	CI21028985	VILA CORUMBA	19/10/2020 10:41	19/10/2020 12:24	19/10/2020 10:41	19/10/2020 12:24	1,70	1	1,70	CHI
202010105492	MUTUNOPOLIS	MU12060988RE	MARA ROSA	19/10/2020 10:42	19/10/2020 21:21	19/10/2020 10:42	19/10/2020 21:21	10,65	24	255,70	CHI
202010105492	AMARALINA	MU12060988RE	MARA ROSA	19/10/2020 10:42	19/10/2020 21:21	19/10/2020 10:42	19/10/2020 21:21	10,65	144	1534,20	CHI
202010105492	MUTUNOPOLIS	MU12060988RE	MARA ROSA	19/10/2020 10:42	19/10/2020 21:21	19/10/2020 10:42	19/10/2020 19:10	8,47	6	50,81	CHI
202010105730	MARA ROSA	MQ12051070	MARA ROSA	19/10/2020 10:42	19/10/2020 18:41	19/10/2020 10:42	19/10/2020 18:41	7,98	197	1571,68	CHI
202010103826	PALMEIRAS DE GOIAS	PL12000104	PALMEIRAS	19/10/2020 10:42	19/10/2020 13:25	19/10/2020 10:42	19/10/2020 13:25	2,71	11	29,81	CHI
202010109276	ALEXANIA	AX12402044	ALEXANIA	19/10/2020 10:42	20/10/2020 19:51	19/10/2020 10:42	20/10/2020 19:51	33,14	142	4705,80	CHI
202010103834	URUACU	UR12232450	URUACU	19/10/2020 10:43	19/10/2020 13:35	19/10/2020 10:43	19/10/2020 13:35	2,87	8	22,93	CHI
202010103857	AGUA FRIA DE GOIAS	TL12096482	SAO JOAO D ALIANCA	19/10/2020 10:45	19/10/2020 16:19	19/10/2020 10:45	19/10/2020 16:19	5,56	31	172,50	CHI
202010103852	MORRINHOS	MR12212184	MORRINHOS	19/10/2020 10:45	19/10/2020 22:13	19/10/2020 10:45	19/10/2020 22:13	11,46	2	22,92	CHI
202010104353	ANAPOLIS	AN11000245	JUNDIAI S2	19/10/2020 10:46	19/10/2020 12:40	19/10/2020 10:46	19/10/2020 12:40	1,90	116	220,24	CHI
202010103866	PLANALTINA	2960023967	PLANALTINA	19/10/2020 10:46	19/10/2020 12:04	19/10/2020 10:46	19/10/2020 12:04	1,29	1	1,29	CHI
202010103867	GOIANESIA	550047669	GOIANESIA S2	19/10/2020 10:46	20/10/2020 16:20	19/10/2020 10:46	20/10/2020 16:20	29,55	1	29,55	CHI
202010103886	MORRINHOS	150031634	MORRINHOS	19/10/2020 10:48	19/10/2020 19:12	19/10/2020 10:48	19/10/2020 19:12	8,39	1	8,39	CHI
202010103887	TROMBAS	TB12288232	PORANGATU	19/10/2020 10:48	19/10/2020 11:59	19/10/2020 10:48	19/10/2020 11:59	1,17	22	25,76	CHI
202010104590	FAINA	FC12072196	GOIAS	19/10/2020 10:49	19/10/2020 17:48	19/10/2020 10:49	19/10/2020 17:48	6,97	6	41,81	CHI
202010103902	BURITINOPOLIS	3610001407	IACIARA S2	19/10/2020 10:50	19/10/2020 16:02	19/10/2020 10:50	19/10/2020 16:02	5,20	1	5,20	CHI
202010105669	JANDAIA	JD12026382	PALMEIRAS	19/10/2020 10:51	19/10/2020 17:40	19/10/2020 10:51	19/10/2020 17:40	6,80	12	81,62	CHI
202010103924	QUIRINOPOLIS	QI21370172	QUIRINOPOLIS	19/10/2020 10:52	19/10/2020 12:07	19/10/2020 10:52	19/10/2020 12:07	1,24	1	1,24	CHI
202010106067	GOIAS	GS12076722	GOIAS	19/10/2020 10:53	19/10/2020 17:12	19/10/2020 10:53	19/10/2020 17:12	6,31	14	88,40	CHI
202010103931	NOVA ROMA	ND21229388	IACIARA S2	19/10/2020 10:53	19/10/2020 11:45	19/10/2020 10:53	19/10/2020 11:45	0,86	2	1,73	CHI
202010103941	RIO VERDE	RV11000019	RIO VERDE S2	19/10/2020 10:55	19/10/2020 22:20	19/10/2020 10:55	19/10/2020 22:20	11,41	88	1003,98	CHI
202010106416	ANAPOLIS	AN11043575	ANAPOLIS UNIVERSITARIO S2	19/10/2020 10:55	19/10/2020 17:15	19/10/2020 10:55	19/10/2020 17:15	6,32	130	822,21	CHI
202010103942	SAO LUIS DE MONTES BELOS	10028064710	SAO LUIZ DOS MONTES BELOS	19/10/2020 10:55	19/10/2020 14:30	19/10/2020 10:55	19/10/2020 14:30	3,57	1	3,57	CHI
202010103946	ANAPOLIS	21232258	JUNDIAI S2	19/10/2020 10:56	20/10/2020 14:19	19/10/2020 10:56	20/10/2020 14:19	27,38	1	27,38	CHI
202010103951	PARAUNA	PU12233300	PARAUNA	19/10/2020 10:56	19/10/2020 16:10	19/10/2020 10:56	19/10/2020 16:10	1,02	1	1,02	CHI
202010103951	PARAUNA	PU12233300	PARAUNA	19/10/2020 10:56	19/10/2020 16:10	19/10/2020 15:10	19/10/2020 16:10	1,00	3	3,00	CHI
202010103951	PARAUNA	PU12233300	PARAUNA	19/10/2020 10:56	19/10/2020 16:10	19/10/2020 10:56	19/10/2020 12:51	1,90	4	7,62	CHI
202010103952	PIRENOPOLIS	PV21056047	CORUMBA	19/10/2020 10:56	19/10/2020 20:54	19/10/2020 10:56	19/10/2020 20:54	9,95	1	9,95	CHI
202010103965	MUNDO NOVO DE GOIAS	4240000740	NOVA CRIXAS	19/10/2020 10:58	19/10/2020 16:13	19/10/2020 10:58	19/10/2020 16:13	5,24	1	5,24	CHI
202010103967	PALMEIRAS DE GOIAS	PL12000111	PALMEIRAS	19/10/2020 10:59	19/10/2020 17:01	19/10/2020 10:59	19/10/2020 17:01	6,03	4	24,13	CHI
202010104940	JARAGUA	JA11073289	JARAGUA	19/10/2020 11:00	19/10/2020 18:10	19/10/2020 11:00	19/10/2020 18:10	7,18	21	150,68	CHI

202010103986	JUSSARA	JR21183243	JUSSARA	19/10/2020 11:01	20/10/2020 10:54	19/10/2020 11:01	20/10/2020 10:54	23,88	1	23,88	CHI
202010106782	NOVO BRASIL	FN12250941	JUSSARA	19/10/2020 11:01	19/10/2020 23:15	19/10/2020 11:01	19/10/2020 23:15	12,22	2	24,45	CHI
202010106782	FAZENDA NOVA	FN12250941	JUSSARA	19/10/2020 11:01	19/10/2020 23:15	19/10/2020 11:01	19/10/2020 23:15	12,22	71	867,88	CHI
202010103999	ANAPOLIS	20319332	JUNDIAI S1	19/10/2020 11:02	19/10/2020 15:15	19/10/2020 11:02	19/10/2020 15:15	4,20	1	4,20	CHI
202010104002	MINACU	IH12320901	MINACU	19/10/2020 11:03	20/10/2020 12:09	19/10/2020 11:03	20/10/2020 12:09	25,10	5	125,49	CHI
202010104162	LEOPOLDO DE BULHOES	LB12270648	DAIA S2	19/10/2020 11:04	19/10/2020 18:54	19/10/2020 11:04	19/10/2020 18:54	7,83	20	156,63	CHI
202010104162	CALDAZINHA	LB12270648	DAIA S2	19/10/2020 11:04	19/10/2020 18:54	19/10/2020 11:04	19/10/2020 18:54	7,83	1	7,83	CHI
202010104027	MINEIROS	MY12020040	PARQUE DAS EMAS	19/10/2020 11:04	19/10/2020 15:20	19/10/2020 11:04	19/10/2020 15:20	4,25	86	365,76	CHI
202010104136	ANAPOLIS	10013538070	JUNDIAI S1	19/10/2020 11:04	20/10/2020 16:52	19/10/2020 11:04	20/10/2020 16:52	29,79	1	29,79	CHI
202010104031	PIRANHAS	PH21201829	PIRANHAS	19/10/2020 11:05	19/10/2020 13:34	19/10/2020 11:05	19/10/2020 13:34	2,48	1	2,48	CHI
202010104037	FORMOSA	FA21404582	SAO JOAO D ALIANCA	19/10/2020 11:06	19/10/2020 15:35	19/10/2020 11:06	19/10/2020 15:35	4,48	1	4,48	CHI
202010104042	ANAPOLIS	AN21267892	ANAPOLIS UNIVERSITARIO S2	19/10/2020 11:06	19/10/2020 12:45	19/10/2020 11:06	19/10/2020 12:45	1,64	1	1,64	CHI
202010104734	ANAPOLIS	AN11107984	ANAPOLIS UNIVERSITARIO S2	19/10/2020 11:06	19/10/2020 14:24	19/10/2020 11:06	19/10/2020 14:24	3,29	92	302,30	CHI
202010104055	ANAPOLIS	AN21261169	ANAPOLIS UNIVERSITARIO S2	19/10/2020 11:08	19/10/2020 13:07	19/10/2020 11:08	19/10/2020 13:07	1,98	1	1,98	CHI
202010104065	ANAPOLIS	20448697	ANAPOLIS UNIVERSITARIO S2	19/10/2020 11:08	19/10/2020 12:33	19/10/2020 11:08	19/10/2020 12:33	1,41	1	1,41	CHI
202010104467	SAO MIGUEL DO ARAGUAIA	SM10406657	SAO MIGUEL DO ARAGUAIA	19/10/2020 11:08	20/10/2020 19:09	20/10/2020 16:26	20/10/2020 19:09	2,72	126	343,28	CHI
202010104467	SAO MIGUEL DO ARAGUAIA	SM12086469	SAO MIGUEL DO ARAGUAIA	19/10/2020 11:08	20/10/2020 19:09	19/10/2020 11:08	20/10/2020 18:05	30,95	489	15134,14	CHI
202010104467	NOVA CRIXAS	SM10406657	SAO MIGUEL DO ARAGUAIA	19/10/2020 11:08	20/10/2020 19:09	20/10/2020 17:07	20/10/2020 17:14	0,11	1	0,11	CHI
202010104467	SAO MIGUEL DO ARAGUAIA	SM10406657	SAO MIGUEL DO ARAGUAIA	19/10/2020 11:08	20/10/2020 19:09	20/10/2020 17:07	20/10/2020 17:14	0,11	311	33,17	CHI
202010104467	SAO MIGUEL DO ARAGUAIA	SM10406657	SAO MIGUEL DO ARAGUAIA	19/10/2020 11:08	20/10/2020 19:09	20/10/2020 16:26	20/10/2020 17:05	0,66	311	204,57	CHI
202010104467	NOVA CRIXAS	SM10406657	SAO MIGUEL DO ARAGUAIA	19/10/2020 11:08	20/10/2020 19:09	20/10/2020 16:26	20/10/2020 17:05	0,66	1	0,66	CHI
202010107304	ANAPOLIS	AN11221396	ANAPOLIS UNIVERSITARIO S2	19/10/2020 11:12	19/10/2020 21:13	19/10/2020 11:12	19/10/2020 21:13	10,00	36	360,09	CHI
202010104096	MORRINHOS	MR21404235	MORRINHOS	19/10/2020 11:13	19/10/2020 15:31	19/10/2020 11:13	19/10/2020 15:31	4,28	1	4,28	CHI
202010104104	SANTO ANTONIO DO DESCOBERTO	2210104860	ALEXANIA	19/10/2020 11:14	19/10/2020 11:57	19/10/2020 11:14	19/10/2020 11:57	0,71	1	0,71	CHI
202010104106	MINEIROS	MY21264447	PARQUE DAS EMAS	19/10/2020 11:14	19/10/2020 13:54	19/10/2020 11:14	19/10/2020 13:54	2,65	2	5,31	CHI
202010104110	ANAPOLIS	AN12007248	ANAPOLIS UNIVERSITARIO S2	19/10/2020 11:15	20/10/2020 12:34	19/10/2020 11:15	20/10/2020 12:34	25,31	1	25,31	CHI
202010104164	SAO MIGUEL DO ARAGUAIA	SM12235205	SAO MIGUEL DO ARAGUAIA	19/10/2020 11:15	20/10/2020 13:50	19/10/2020 11:15	20/10/2020 13:50	26,58	9	239,20	CHI
202010104115	TRES RANCHOS	OU21244422	CATALAO S1	19/10/2020 11:15	19/10/2020 18:21	19/10/2020 11:15	19/10/2020 18:21	7,09	1	7,09	CHI
202010104142	ANAPOLIS	10012928370	ANAPOLIS UNIVERSITARIO S2	19/10/2020 11:15	19/10/2020 18:04	19/10/2020 11:15	19/10/2020 18:04	6,81	1	6,81	CHI
202010104118	ANAPOLIS	10018057215	ANAPOLIS UNIVERSITARIO S2	19/10/2020 11:15	19/10/2020 13:16	19/10/2020 11:15	19/10/2020 13:16	2,02	1	2,02	CHI
202010104122	CAVALCANTE	BF21063196	FLORES DE GOIAS	19/10/2020 11:15	19/10/2020 16:03	19/10/2020 11:15	19/10/2020 16:03	4,78	1	4,78	CHI
202010104129	PROFESSOR JAMIL SAFADY	JS12120785	ROCHEDO	19/10/2020 11:16	19/10/2020 18:13	19/10/2020 11:16	19/10/2020 18:13	6,94	50	346,93	CHI
202010104133	SAO LUIS DE MONTES BELOS	500065135	SAO LUIZ DOS MONTES BELOS	19/10/2020 11:16	19/10/2020 16:16	19/10/2020 11:16	19/10/2020 16:16	4,98	1	4,98	CHI
202010104955	SANTO ANTONIO DO DESCOBERTO	AX12376529	ALEXANIA	19/10/2020 11:19	19/10/2020 22:05	19/10/2020 11:19	19/10/2020 22:05	10,77	1	10,77	CHI
202010104955	ALEXANIA	AX12376529	ALEXANIA	19/10/2020 11:19	19/10/2020 22:05	19/10/2020 11:19	19/10/2020 22:05	10,77	12	129,24	CHI
202010104986	ITABERAI	IB12079203	ITABERAI S1	19/10/2020 11:19	19/10/2020 15:28	19/10/2020 11:19	19/10/2020 15:28	4,14	24	99,47	CHI
202010104156	ANAPOLIS	21219655	JUNDIAI S2	19/10/2020 11:19	20/10/2020 20:52	19/10/2020 11:19	20/10/2020 20:52	33,55	1	33,55	CHI
202010104157	CATALAO	CT12266118	CATALAO S1	19/10/2020 11:19	19/10/2020 14:00	19/10/2020 11:19	19/10/2020 14:00	2,67	4	10,69	CHI
202010104165	SAO MIGUEL DO ARAGUAIA	830074521	SAO MIGUEL DO ARAGUAIA	19/10/2020 11:20	20/10/2020 14:56	19/10/2020 11:20	20/10/2020 14:56	27,59	1	27,59	CHI
202010104166	CATALAO	10021104636	CATALAO S1	19/10/2020 11:20	19/10/2020 18:52	19/10/2020 11:20	19/10/2020 18:52	7,53	1	7,53	CHI
202010105918	SAO MIGUEL DO ARAGUAIA	SM12208945	SAO MIGUEL DO ARAGUAIA	19/10/2020 11:20	20/10/2020 14:40	19/10/2020 11:20	20/10/2020 14:40	27,32	9	245,90	CHI
202010104171	SANTA HELENA DE GOIAS	400036370	IPEGUARI	19/10/2020 11:20	19/10/2020 14:42	19/10/2020 11:20	19/10/2020 14:42	3,35	1	3,35	CHI
202010104173	PETROLINA DE GOIAS	320021520	PETROLINA	19/10/2020 11:20	19/10/2020 18:55	19/10/2020 11:20	19/10/2020 18:55	7,57	1	7,57	CHI
202010104179	ITUMBIARA	IT12208080	ITUMBIARA VELHA S1	19/10/2020 11:21	19/10/2020 18:00	19/10/2020 11:21	19/10/2020 18:00	6,64	2	13,28	CHI
202010104757	DOVERLANDIA	CP12119577	CAIAPONIA	19/10/2020 11:22	19/10/2020 15:55	19/10/2020 11:22	19/10/2020 15:55	4,56	7	31,91	CHI
202010104757	CAIAPONIA	CP12119577	CAIAPONIA	19/10/2020 11:22	19/10/2020 15:55	19/10/2020 11:22	19/10/2020 15:55	4,56	67	305,41	CHI
202010101347	PIRANHAS	PH11374802	PIRANHAS	19/10/2020 11:23	19/10/2020 12:19	19/10/2020 11:23	19/10/2020 12:19	0,93	55	50,94	CHI
202010104205	CAIAPONIA	CP12020902	PIRANHAS	19/10/2020 11:24	20/10/2020 07:21	19/10/2020 11:24	20/10/2020 07:21	19,95	4	79,81	CHI
202010105378	NIQUELANDIA	NQ12262929	URUACU	19/10/2020 11:24	20/10/2020 09:36	19/10/2020 11:24	20/10/2020 09:36	22,19	4	88,77	CHI
202010104232	ITUMBIARA	IT12000052	ITUMBIARA VELHA S1	19/10/2020 11:25	19/10/2020 18:43	19/10/2020 11:25	19/10/2020 18:43	7,29	23	167,63	CHI
202010104228	IPORA	IR11392560	IPORA	19/10/2020 11:27	20/10/2020 01:00	19/10/2020 11:27	20/10/2020 01:00	13,54	11	148,92	CHI

202010104276	ANAPOLIS	AN21050414	ANAPOLIS UNIVERSITARIO S2	19/10/2020 11:32	19/10/2020 14:42	19/10/2020 11:32	19/10/2020 14:42	3,16	2	6,31	CHI
202010104279	URUACU	CR12282384	MARA ROSA	19/10/2020 11:32	20/10/2020 14:32	19/10/2020 11:32	20/10/2020 14:32	26,98	3	80,95	CHI
202010104279	CAMPINORTE	CR12282384	MARA ROSA	19/10/2020 11:32	20/10/2020 14:32	19/10/2020 11:32	20/10/2020 14:32	26,98	1	26,98	CHI
202010104282	SAO SIMAO	2240027284	CACHOEIRA ALTA	19/10/2020 11:33	19/10/2020 14:02	19/10/2020 11:33	19/10/2020 14:02	2,48	1	2,48	CHI
202010104295	PETROLINA DE GOIAS	PG21015836	PETROLINA	19/10/2020 11:34	19/10/2020 14:14	19/10/2020 11:34	19/10/2020 14:14	2,66	2	5,31	CHI
202010104311	MUNDO NOVO DE GOIAS	MH12291217LD	NOVA CRIXAS	19/10/2020 11:36	20/10/2020 17:19	19/10/2020 11:36	20/10/2020 17:19	29,72	12	356,62	CHI
202010104311	MUNDO NOVO DE GOIAS	MH12291217LD	NOVA CRIXAS	19/10/2020 11:36	20/10/2020 17:19	19/10/2020 11:36	20/10/2020 17:05	29,49	15	442,28	CHI
202010104315	MINEIROS	10014627939	PARQUE DAS EMAS	19/10/2020 11:36	20/10/2020 07:43	19/10/2020 11:36	20/10/2020 07:43	20,10	1	20,10	CHI
202010104324	OUVIDOR	IO21108293	CATALAO S1	19/10/2020 11:38	19/10/2020 15:35	19/10/2020 11:38	19/10/2020 15:35	3,94	1	3,94	CHI
202010106639	GAMELEIRA DE GOIAS	AA12285384	ANAPOLIS UNIVERSITARIO S1	19/10/2020 11:39	19/10/2020 18:56	19/10/2020 11:39	19/10/2020 18:56	7,28	1	7,28	CHI
202010106639	ABADIANIA	AA12285384	ANAPOLIS UNIVERSITARIO S1	19/10/2020 11:39	19/10/2020 18:56	19/10/2020 11:39	19/10/2020 18:56	7,28	122	887,79	CHI
202010105763	AGUA FRIA DE GOIAS	TL11361259	SAO JOAO D ALIANCA	19/10/2020 11:39	19/10/2020 16:59	19/10/2020 11:39	19/10/2020 16:59	5,32	74	393,97	CHI
202010104334	NAZARIO	NZ21000032	ANICUNS	19/10/2020 11:39	19/10/2020 17:29	19/10/2020 11:39	19/10/2020 17:29	5,82	1	5,82	CHI
202010104336	ITAPURANGA	IK12300232	ITAPURANGA	19/10/2020 11:39	20/10/2020 00:37	19/10/2020 11:39	20/10/2020 00:37	12,96	13	168,44	CHI
202010104338	CALDAS NOVAS	760132460	SERRA DE CALDAS	19/10/2020 11:40	19/10/2020 18:51	19/10/2020 11:40	19/10/2020 18:51	7,17	1	7,17	CHI
202010104359	ITUMBIARA	690317440	ITUMBIARA VELHA S1	19/10/2020 11:42	19/10/2020 14:06	19/10/2020 11:42	19/10/2020 14:06	2,39	1	2,39	CHI
202010104361	ANAPOLIS	10018102342	JUNDIAI S1	19/10/2020 11:43	20/10/2020 12:25	19/10/2020 11:43	20/10/2020 12:25	24,70	1	24,70	CHI
202010101484	SAO MIGUEL DO ARAGUAIA	SM12371095	SAO MIGUEL DO ARAGUAIA	19/10/2020 11:43	19/10/2020 13:08	19/10/2020 11:43	19/10/2020 13:08	1,41	1	1,41	CHI
202010107136	SERRANOPOLIS	SX12234203	JATAI S1	19/10/2020 11:43	19/10/2020 23:12	19/10/2020 11:43	19/10/2020 23:12	11,47	1	11,47	CHI
202010104366	PIRENOPOLIS	PV21059778	SAO FRANCISCO DE GOIAS	19/10/2020 11:43	20/10/2020 22:27	19/10/2020 11:43	20/10/2020 22:27	34,72	3	104,17	CHI
202010104567	CAMPINORTE	CR12202139RE	MARA ROSA	19/10/2020 11:44	20/10/2020 23:00	19/10/2020 11:44	20/10/2020 23:00	35,27	16	564,32	CHI
202010104567	URUACU	CR12202139RE	MARA ROSA	19/10/2020 11:44	20/10/2020 23:00	19/10/2020 11:44	20/10/2020 23:00	35,27	77	2715,77	CHI
202010104567	CAMPINORTE	CR12202139RE	MARA ROSA	19/10/2020 11:44	20/10/2020 23:00	19/10/2020 11:44	19/10/2020 22:22	10,64	10	106,38	CHI
202010104567	URUACU	CR12202139RE	MARA ROSA	19/10/2020 11:44	20/10/2020 23:00	19/10/2020 11:44	19/10/2020 22:22	10,64	3	31,91	CHI
202010104567	URUACU	CR12202139RE	MARA ROSA	19/10/2020 11:44	20/10/2020 23:00	19/10/2020 11:44	19/10/2020 19:38	7,91	26	205,54	CHI
202010104567	CAMPINORTE	CR12202139RE	MARA ROSA	19/10/2020 11:44	20/10/2020 23:00	19/10/2020 11:44	19/10/2020 19:38	7,91	7	55,34	CHI
202010106984	AGUA FRIA DE GOIAS	TL12067436	SAO JOAO D ALIANCA	19/10/2020 11:44	19/10/2020 19:56	19/10/2020 11:44	19/10/2020 19:56	8,19	14	114,72	CHI
202010106184	ANAPOLIS	AN21000034	JUNDIAI S2	19/10/2020 11:45	20/10/2020 05:01	19/10/2020 11:45	20/10/2020 05:01	17,26	31	535,14	CHI
202010105931	ANAPOLIS	AN11166254	JUNDIAI S1	19/10/2020 11:45	19/10/2020 16:05	19/10/2020 11:45	19/10/2020 16:05	4,33	132	571,01	CHI
202010104396	FAZEIRAS	860015865	ITUIQUIRA	19/10/2020 11:45	19/10/2020 14:46	19/10/2020 11:45	19/10/2020 14:46	3,00	1	3,00	CHI
202010104845	FAZENDA NOVA	FN12292871	IPORA	19/10/2020 11:45	19/10/2020 16:24	19/10/2020 11:45	19/10/2020 16:24	4,64	34	157,65	CHI
202010104398	MINEIROS	1390123501	PARQUE DAS EMAS	19/10/2020 11:45	20/10/2020 10:01	19/10/2020 11:45	20/10/2020 10:01	22,25	1	22,25	CHI
202010104571	SAO MIGUEL DO ARAGUAIA	SM12291166	SAO MIGUEL DO ARAGUAIA	19/10/2020 11:48	19/10/2020 16:21	19/10/2020 11:48	19/10/2020 16:21	4,54	8	36,35	CHI
202010104417	JATAI	290184757	JATAI S3	19/10/2020 11:48	20/10/2020 08:34	19/10/2020 11:48	20/10/2020 08:34	20,76	1	20,76	CHI
202010104420	CALDAS NOVAS	CN12186153	VILA CORUMBA	19/10/2020 11:48	19/10/2020 15:20	19/10/2020 11:48	19/10/2020 15:20	3,52	2	7,04	CHI
202010104736	ANAPOLIS	AN11050440	ANAPOLIS UNIVERSITARIO S2	19/10/2020 11:50	19/10/2020 19:28	19/10/2020 11:50	19/10/2020 19:28	7,63	95	724,96	CHI
202010107868	ANAPOLIS	AN11129479	JUNDIAI S1	19/10/2020 11:51	20/10/2020 07:14	19/10/2020 11:51	20/10/2020 07:14	19,38	95	1841,18	CHI
202010104444	JATAI	290327477	JATAI S3	19/10/2020 11:51	21/10/2020 08:26	19/10/2020 11:51	21/10/2020 08:26	44,58	1	44,58	CHI
202010104452	RIO VERDE	10027288372	RIO VERDE S1	19/10/2020 11:52	19/10/2020 14:09	19/10/2020 11:52	19/10/2020 14:09	2,28	1	2,28	CHI
202010104454	ANAPOLIS	20802286	JUNDIAI S1	19/10/2020 11:52	20/10/2020 11:51	19/10/2020 11:52	20/10/2020 11:51	23,97	1	23,97	CHI
202010104466	JARAGUA	JA21159871	JARAGUA	19/10/2020 11:54	19/10/2020 19:00	19/10/2020 11:54	19/10/2020 19:00	7,10	2	14,19	CHI
20201097299	PALMINOPOLIS	JD12003211	PALMEIRAS	19/10/2020 11:54	19/10/2020 15:43	19/10/2020 11:54	19/10/2020 15:43	3,80	15	57,05	CHI
20201097299	PALMEIRAS DE GOIAS	JD12003211	PALMEIRAS	19/10/2020 11:54	19/10/2020 15:43	19/10/2020 11:54	19/10/2020 15:43	3,80	4	15,21	CHI
20201097299	JANDAIA	JD12003211	PALMEIRAS	19/10/2020 11:54	19/10/2020 15:43	19/10/2020 11:54	19/10/2020 15:43	3,80	10	38,03	CHI
202010104471	PLANALTINA	2960114997	PLANALTINA	19/10/2020 11:55	19/10/2020 14:16	19/10/2020 11:55	19/10/2020 14:16	2,35	1	2,35	CHI
202010104474	FAZENDA NOVA	FN21237252	IPORA	19/10/2020 11:55	20/10/2020 13:02	19/10/2020 11:55	20/10/2020 13:02	25,11	1	25,11	CHI
202010104476	CEZARINA	1650009243	CEZARINA	19/10/2020 11:55	19/10/2020 19:47	19/10/2020 11:55	19/10/2020 19:47	7,86	1	7,86	CHI
202010104482	JATAI	10029136588	JATAI S3	19/10/2020 11:56	19/10/2020 22:46	19/10/2020 11:56	19/10/2020 22:46	10,82	1	10,82	CHI
202010104496	CAMPO ALEGRE DE GOIAS	CM12347169	CAMPO ALEGRE DE GOIAS	19/10/2020 11:58	21/10/2020 05:48	19/10/2020 11:58	21/10/2020 05:48	41,83	13	543,82	CHI
202010104498	MUNDO NOVO DE GOIAS	4240020555	NOVA CRIXAS	19/10/2020 11:58	21/10/2020 00:22	19/10/2020 11:58	21/10/2020 00:22	36,40	1	36,40	CHI
202010104503	MINEIROS	MY21195603	PARQUE DAS EMAS	19/10/2020 11:58	19/10/2020 13:55	19/10/2020 11:58	19/10/2020 13:55	1,94	1	1,94	CHI

202010104518	SANTO ANTONIO DA BARRA	EU12000181	ACREUNA	19/10/2020 11:59	19/10/2020 13:33	19/10/2020 11:59	19/10/2020 13:33	1,56	1	1,56	CHI
202010104518	ACREUNA	EU12000181	ACREUNA	19/10/2020 11:59	19/10/2020 13:33	19/10/2020 11:59	19/10/2020 13:33	1,56	26	40,50	CHI
202010189356	ITAPIRAPUA	IU12341264	MATRINCHA	19/10/2020 12:02	19/10/2020 21:38	19/10/2020 12:02	19/10/2020 21:38	9,61	4	38,45	CHI
202010108277	DOVERLANDIA	DV12212770	CAIAPONIA	19/10/2020 12:02	20/10/2020 09:15	19/10/2020 12:02	20/10/2020 09:15	21,23	5	106,14	CHI
202010105453	SAO MIGUEL DO ARAGUAIA	SM12239670	SAO MIGUEL DO ARAGUAIA	19/10/2020 12:04	20/10/2020 11:08	19/10/2020 12:04	20/10/2020 11:08	23,06	11	253,68	CHI
202010105631	ANAPOLIS	AN11191382	ANAPOLIS UNIVERSITARIO S2	19/10/2020 12:05	19/10/2020 16:50	19/10/2020 12:05	19/10/2020 16:50	4,75	57	270,62	CHI
202010104560	MORRINHOS	MR21308022	MORRINHOS	19/10/2020 12:05	19/10/2020 14:55	19/10/2020 12:05	19/10/2020 14:55	2,82	1	2,82	CHI
202010107425	MONTES CLAROS DE GOIAS	ME12124938	IPORA	19/10/2020 12:10	20/10/2020 06:19	19/10/2020 12:10	20/10/2020 06:19	18,16	47	853,62	CHI
202010107425	DIORAMA	ME12124938	IPORA	19/10/2020 12:10	20/10/2020 06:19	19/10/2020 12:10	20/10/2020 06:19	18,16	1	18,16	CHI
202010106445	ANICUNS	AC12126246	ANICUNS	19/10/2020 12:10	19/10/2020 19:35	19/10/2020 12:10	19/10/2020 19:35	7,41	8	59,29	CHI
202010104596	CACHOEIRA ALTA	CA21000012	CACHOEIRA ALTA	19/10/2020 12:11	19/10/2020 16:18	19/10/2020 12:11	19/10/2020 16:18	4,11	1	4,11	CHI
202010104798	MARA ROSA	LC12050751	MARA ROSA	19/10/2020 12:12	19/10/2020 15:39	19/10/2020 12:12	19/10/2020 15:39	3,45	5	17,25	CHI
202010104798	AMARALINA	LC12050751	MARA ROSA	19/10/2020 12:12	19/10/2020 15:39	19/10/2020 12:12	19/10/2020 15:39	3,45	12	41,40	CHI
202010106539	CATALAO	CT11000052	CATALAO S2	19/10/2020 12:14	19/10/2020 18:37	19/10/2020 12:14	19/10/2020 18:37	6,38	161	1027,45	CHI
202010104618	CABECEIRAS	CW21344315	ITIQUEIRA	19/10/2020 12:14	19/10/2020 16:48	19/10/2020 12:14	19/10/2020 16:48	4,56	1	4,56	CHI
202010104629	JATAI	290156348	JATAI S3	19/10/2020 12:15	19/10/2020 22:51	19/10/2020 12:15	19/10/2020 22:51	10,58	1	10,58	CHI
202010104635	ANAPOLIS	21158617	JUNDIAI S1	19/10/2020 12:16	20/10/2020 15:21	19/10/2020 12:16	20/10/2020 15:21	27,07	1	27,07	CHI
202010104638	CALDAS NOVAS	CN11040987	SERRA DE CALDAS	19/10/2020 12:17	19/10/2020 14:20	19/10/2020 12:17	19/10/2020 14:20	2,04	64	130,61	CHI
202010108499	ACREUNA	TD12303600	RIO DOS BOIS	19/10/2020 12:18	19/10/2020 22:11	19/10/2020 12:18	19/10/2020 22:11	9,87	6	59,24	CHI
202010104645	PIRANHAS	1930007258	PIRANHAS	19/10/2020 12:19	19/10/2020 14:51	19/10/2020 12:19	19/10/2020 14:51	2,53	1	2,53	CHI
202010107846	ANAPOLIS	AN11000252	ANAPOLIS UNIVERSITARIO S2	19/10/2020 12:21	20/10/2020 02:11	19/10/2020 12:21	20/10/2020 02:11	13,82	51	704,98	CHI
202010104866	GOIANESIA	GE12360247	GOIANESIA S2	19/10/2020 12:21	19/10/2020 18:05	19/10/2020 12:21	19/10/2020 18:05	5,72	9	51,50	CHI
202010104682	MINEIROS	MY12202613RE	PARQUE DAS EMAS	19/10/2020 12:24	20/10/2020 14:00	19/10/2020 12:24	20/10/2020 14:00	25,59	10	255,90	CHI
202010104685	ARAGUAPAZ	AZ12061016	GOIAS	19/10/2020 12:25	19/10/2020 16:42	19/10/2020 12:25	19/10/2020 16:42	4,28	22	94,06	CHI
202010104685	FAINA	AZ12061016	GOIAS	19/10/2020 12:25	19/10/2020 16:42	19/10/2020 12:25	19/10/2020 16:42	4,28	20	85,51	CHI
202010104688	JARAGUA	JA21016749	GOIANESIA S2	19/10/2020 12:25	19/10/2020 22:36	19/10/2020 12:25	19/10/2020 22:36	10,17	2	20,34	CHI
202010104714	JAUPACI	JP12074459	IPORA	19/10/2020 12:29	19/10/2020 14:54	19/10/2020 12:29	19/10/2020 14:54	2,41	5	12,06	CHI
202010104714	DIORAMA	JP12074459	IPORA	19/10/2020 12:29	19/10/2020 14:54	19/10/2020 12:29	19/10/2020 14:54	2,41	3	7,24	CHI
202010104717	JATAI	290126873	JATAI S3	19/10/2020 12:29	20/10/2020 01:39	19/10/2020 12:29	20/10/2020 01:39	13,17	1	13,17	CHI
202010104730	MINACU	IH12230454	MINACU	19/10/2020 12:30	19/10/2020 14:30	19/10/2020 12:30	19/10/2020 14:30	1,98	1	1,98	CHI
202010104737	SAO LUIS DE MONTES BELOS	SL21304514	FIRMINOPOLIS S2	19/10/2020 12:32	19/10/2020 15:37	19/10/2020 12:32	19/10/2020 15:37	3,08	1	3,08	CHI
202010104738	MORRINHOS	MR12182584	MORRINHOS	19/10/2020 12:32	19/10/2020 17:28	19/10/2020 12:32	19/10/2020 17:28	4,92	4	19,70	CHI
202010104742	AGUA FRIA DE GOIAS	TL12255433	SAO JOAO D ALIANCA	19/10/2020 12:33	20/10/2020 13:02	19/10/2020 12:33	20/10/2020 13:02	24,48	1	24,48	CHI
202010104745	PALMEIRAS DE GOIAS	PL21125159	PALMEIRAS	19/10/2020 12:33	19/10/2020 15:48	19/10/2020 12:33	19/10/2020 15:48	3,24	2	6,48	CHI
202010104748	SAO JOAO D ALIANCA	FB12248238	FLORES DE GOIAS	19/10/2020 12:34	19/10/2020 22:34	19/10/2020 12:34	19/10/2020 22:34	10,00	9	89,99	CHI
202010104748	SAO JOAO D ALIANCA	FB12248238	FLORES DE GOIAS	19/10/2020 12:34	19/10/2020 22:34	19/10/2020 12:34	19/10/2020 18:23	5,82	30	174,47	CHI
202010104748	FLORES DE GOIAS	FB12248238	FLORES DE GOIAS	19/10/2020 12:34	19/10/2020 22:34	19/10/2020 12:34	19/10/2020 18:23	5,82	108	628,08	CHI
202010104753	ANAPOLIS	10004256334	ANAPOLIS UNIVERSITARIO S2	19/10/2020 12:34	20/10/2020 11:20	19/10/2020 12:34	20/10/2020 11:20	22,75	1	22,75	CHI
202010104755	MARA ROSA	MQ21359152	MARA ROSA	19/10/2020 12:35	19/10/2020 20:19	19/10/2020 12:35	19/10/2020 20:19	7,73	2	15,46	CHI
202010107129	TURVELANDIA	TD12306032	RIO DOS BOIS	19/10/2020 12:36	19/10/2020 20:41	19/10/2020 12:36	19/10/2020 20:41	8,07	5	40,35	CHI
202010104769	FORMOSA	610201554	ITIQUEIRA	19/10/2020 12:37	19/10/2020 15:44	19/10/2020 12:37	19/10/2020 15:44	3,10	1	3,10	CHI
202010105156	APORE	AE12205145RE	ITAJA S2	19/10/2020 12:38	19/10/2020 18:32	19/10/2020 12:38	19/10/2020 18:32	5,90	33	194,54	CHI
202010104773	CAMPOS VERDES	VD12049788	SANTA TEREZINHA	19/10/2020 12:38	20/10/2020 01:48	19/10/2020 12:38	20/10/2020 01:48	13,15	1	13,15	CHI
202010105261	AGUA LIMPA	AL12242538	VILA CORUMBA	19/10/2020 12:40	19/10/2020 23:52	19/10/2020 12:40	19/10/2020 23:52	11,18	4	44,74	CHI
202010104806	RIO VERDE	630089255	RIO VERDE S2	19/10/2020 12:43	19/10/2020 20:39	19/10/2020 12:43	19/10/2020 20:39	7,93	1	7,93	CHI
202010104809	BONOPOLIS	BX12292423	SAO MIGUEL DO ARAGUAIA	19/10/2020 12:43	19/10/2020 15:25	19/10/2020 12:43	19/10/2020 15:25	2,69	2	5,38	CHI
202010104810	ITAPACI	IW12123121	ITAPACI	19/10/2020 12:43	19/10/2020 18:30	19/10/2020 12:43	19/10/2020 18:30	5,77	1	5,77	CHI
202010105053	CORUMBA DE GOIAS	CB12377445	CORUMBA	19/10/2020 12:44	20/10/2020 08:18	19/10/2020 12:44	20/10/2020 08:18	19,57	21	410,87	CHI
202010104817	PIRENOPOLIS	PV31090227	SAO FRANCISCO DE GOIAS	19/10/2020 12:45	20/10/2020 01:05	19/10/2020 12:45	20/10/2020 01:05	12,33	3	36,99	CHI
202010104837	AMARALINA	3590011747	MARA ROSA	19/10/2020 12:47	19/10/2020 22:36	19/10/2020 12:47	19/10/2020 22:36	9,82	1	9,82	CHI
202010108265	ANAPOLIS	AN11000242	ANAPOLIS UNIVERSITARIO S2	19/10/2020 12:47	19/10/2020 21:48	19/10/2020 12:47	19/10/2020 21:48	9,00	107	963,53	CHI

202010104846	ITAUCU	IB12078567	ITABERAI S1	19/10/2020 12:48	19/10/2020 15:56	19/10/2020 12:48	19/10/2020 15:56	3,12	1	3,12	CHI
202010104846	ITABERAI	IB12078567	ITABERAI S1	19/10/2020 12:48	19/10/2020 15:56	19/10/2020 12:48	19/10/2020 15:56	3,12	6	18,72	CHI
202010104863	CACU	CC12202722	CACHOEIRA ALTA	19/10/2020 12:51	19/10/2020 14:39	19/10/2020 12:51	19/10/2020 14:39	1,80	1	1,80	CHI
202010104864	PIRES DO RIO	460038369	PIRES DO RIO S1	19/10/2020 12:51	19/10/2020 16:37	19/10/2020 12:51	19/10/2020 16:37	3,76	1	3,76	CHI
202010104887	MORRINHOS	MR21121327	MORRINHOS	19/10/2020 12:57	19/10/2020 16:22	19/10/2020 12:57	19/10/2020 16:22	3,40	1	3,40	CHI
202010104491	CRIXAS	CX12254975	SERRA DO OURO	19/10/2020 12:59	19/10/2020 20:44	19/10/2020 12:59	19/10/2020 20:44	7,75	61	472,58	CHI
202010104893	SAO DOMINGOS	SD12090135	SAO DOMINGOS	19/10/2020 12:59	19/10/2020 18:00	19/10/2020 12:59	19/10/2020 18:00	5,00	82	410,30	CHI
202010104893	DIVINOPOLIS DE GOIAS	SD12090135	SAO DOMINGOS	19/10/2020 12:59	19/10/2020 18:00	19/10/2020 12:59	19/10/2020 18:00	5,00	24	120,09	CHI
202010104894	RIO VERDE	RV21147882	MONTIVIDIU T	19/10/2020 12:59	19/10/2020 14:42	19/10/2020 12:59	19/10/2020 14:42	1,70	1	1,70	CHI
202010104980	ITABERAI	IB16432534B	ITABERAI S2	19/10/2020 13:01	19/10/2020 16:23	19/10/2020 13:17	19/10/2020 16:23	3,10	64	198,13	CHI
202010104980	ITABERAI	IB16407964	ITABERAI S2	19/10/2020 13:01	19/10/2020 16:23	19/10/2020 13:01	19/10/2020 13:04	0,05	4606	246,93	CHI
202010106016	ALTO PARAISO DE GOIAS	BF12264794	NIQUELANDIA SUBTRANSMISSAO	19/10/2020 13:01	19/10/2020 17:54	19/10/2020 13:01	19/10/2020 17:54	4,87	2	9,74	CHI
202010104914	GOIANESIA	550130287	GOIANESIA S2	19/10/2020 13:03	21/10/2020 12:36	19/10/2020 13:03	21/10/2020 12:36	47,54	1	47,54	CHI
202010104919	FLORES DE GOIAS	FB12233549	FLORES DE GOIAS	19/10/2020 13:03	19/10/2020 17:33	19/10/2020 13:03	19/10/2020 17:33	4,48	1	4,48	CHI
202010104923	IPORA	730068808	IPORA	19/10/2020 13:04	19/10/2020 16:06	19/10/2020 13:04	19/10/2020 16:06	3,02	1	3,02	CHI
202010104924	PLANALTIMA	3890009886	PLANALTIMA	19/10/2020 13:04	19/10/2020 17:48	19/10/2020 13:04	19/10/2020 17:48	4,72	1	4,72	CHI
202010102353	MONTIVIDIU	MV12249172	MONTIVIDIU T	19/10/2020 13:05	19/10/2020 17:13	19/10/2020 13:05	19/10/2020 17:13	4,13	4	16,51	CHI
202010104934	GAMELEIRA DE GOIAS	AN11273366	DAIA S1	19/10/2020 13:05	19/10/2020 16:13	19/10/2020 13:05	19/10/2020 16:13	3,12	25	78,12	CHI
202010104943	ANAPOLIS	20581385	JUNDIAI S1	19/10/2020 13:06	20/10/2020 17:48	19/10/2020 13:06	20/10/2020 17:48	28,69	1	28,69	CHI
202010106021	COLINAS DO SUL	TI12162624	NIQUELANDIA SUBTRANSMISSAO	19/10/2020 13:06	20/10/2020 13:10	19/10/2020 13:06	20/10/2020 13:10	24,05	1	24,05	CHI
202010104953	ANAPOLIS	AN12351005	ANAPOLIS UNIVERSITARIO S2	19/10/2020 13:08	19/10/2020 17:03	19/10/2020 13:08	19/10/2020 17:03	3,92	279	1092,59	CHI
202010104958	PORTEIRAO	GT12140377	RIO DOS BOIS	19/10/2020 13:09	20/10/2020 00:44	19/10/2020 13:09	20/10/2020 00:44	11,59	3	34,78	CHI
202010104959	ANAPOLIS	10004007423	ANAPOLIS UNIVERSITARIO S2	19/10/2020 13:09	20/10/2020 12:10	19/10/2020 13:09	20/10/2020 12:10	23,01	1	23,01	CHI
202010107200	MARA ROSA	AJ12384910RE	MARA ROSA	19/10/2020 13:09	19/10/2020 21:58	19/10/2020 13:09	19/10/2020 21:58	8,80	5	44,01	CHI
202010107200	ALTO HORIZONTE	AJ12384910RE	MARA ROSA	19/10/2020 13:09	19/10/2020 21:58	19/10/2020 13:09	19/10/2020 21:58	8,80	36	316,90	CHI
202010104963	CROMINIA	CQ21245187	PONTALINA	19/10/2020 13:09	19/10/2020 20:30	19/10/2020 13:09	19/10/2020 20:30	7,34	2	14,67	CHI
202010106077	GOIAS	GS12188167	MATRINCHA	19/10/2020 13:12	19/10/2020 18:20	19/10/2020 13:12	19/10/2020 18:20	5,13	31	158,89	CHI
202010105002	JUSSARA	1290021720	JUSSARA	19/10/2020 13:15	19/10/2020 16:22	19/10/2020 13:15	19/10/2020 16:22	3,10	1	3,10	CHI
202010105006	ITUMBIARA	690140988	ITUMBIARA VELHA S1	19/10/2020 13:16	19/10/2020 18:19	19/10/2020 13:16	19/10/2020 18:19	5,04	1	5,04	CHI
202010105012	MINEIROS	1390098877	PARQUE DAS EMAS	19/10/2020 13:17	19/10/2020 16:57	19/10/2020 13:17	19/10/2020 16:57	3,66	1	3,66	CHI
202010105014	IPORA	IR21316349	IPORA	19/10/2020 13:18	19/10/2020 16:51	19/10/2020 13:18	19/10/2020 16:51	3,55	2	7,09	CHI
202010107737	ANAPOLIS	AN11000232	ANAPOLIS UNIVERSITARIO S1	19/10/2020 13:20	19/10/2020 23:19	19/10/2020 13:20	19/10/2020 23:19	9,97	136	1356,37	CHI
202010105028	SAO MIGUEL DO ARAGUAIA	SM21131504	SAO MIGUEL DO ARAGUAIA	19/10/2020 13:22	21/10/2020 07:29	19/10/2020 13:22	21/10/2020 07:29	42,12	1	42,12	CHI
202010105033	URUACU	UR21000030	CAMPINORTE	19/10/2020 13:23	19/10/2020 14:01	19/10/2020 13:23	19/10/2020 14:01	0,63	1	0,63	CHI
202010105105	ANAPOLIS	AN11135792	ANAPOLIS UNIVERSITARIO S1	19/10/2020 13:23	19/10/2020 23:08	19/10/2020 13:23	19/10/2020 23:08	9,74	133	1295,35	CHI
202010105039	JUSSARA	JR21159293	BRITANIA	19/10/2020 13:24	20/10/2020 10:15	19/10/2020 13:24	20/10/2020 10:15	20,85	2	41,70	CHI
202010106470	FAZENDA NOVA	FN12242283	IPORA	19/10/2020 13:24	19/10/2020 20:51	19/10/2020 13:24	19/10/2020 20:51	7,45	25	186,13	CHI
202010105056	CALDAS NOVAS	CN11363712	CALDAS NOVAS S2	19/10/2020 13:27	19/10/2020 17:42	19/10/2020 13:27	19/10/2020 17:42	4,25	11	46,79	CHI
202010105061	ANAPOLIS	AN21000571	JUNDIAI S1	19/10/2020 13:28	20/10/2020 17:16	19/10/2020 13:28	20/10/2020 17:16	27,80	1	27,80	CHI
202010105553	ANAPOLIS	AN12000092	ANAPOLIS UNIVERSITARIO S2	19/10/2020 13:28	19/10/2020 17:19	19/10/2020 13:28	19/10/2020 17:19	3,84	100	384,03	CHI
202010105078	URUACU	10006613908	URUACU	19/10/2020 13:30	19/10/2020 18:44	19/10/2020 13:30	19/10/2020 18:44	5,23	1	5,23	CHI
202010105598	CAMPO ALEGRE DE GOIAS	CM12156359	CAMPO ALEGRE DE GOIAS	19/10/2020 13:31	19/10/2020 19:46	19/10/2020 13:31	19/10/2020 19:46	6,25	31	193,66	CHI
202010189505	JOVIANIA	JV12101884LD	GOIATUBA S1	19/10/2020 13:31	19/10/2020 19:13	19/10/2020 18:58	19/10/2020 19:13	0,25	13	3,31	CHI
202010189505	GOIATUBA	JV12101884LD	GOIATUBA S1	19/10/2020 13:31	19/10/2020 19:13	19/10/2020 18:58	19/10/2020 19:13	0,25	2	0,51	CHI
202010189505	JOVIANIA	JV16411611	GOIATUBA S1	19/10/2020 13:31	19/10/2020 19:13	19/10/2020 13:31	19/10/2020 18:56	5,41	13	70,33	CHI
202010189505	GOIATUBA	JV16411611	GOIATUBA S1	19/10/2020 13:31	19/10/2020 19:13	19/10/2020 13:31	19/10/2020 18:56	5,41	2	10,82	CHI
202010189505	JOVIANIA	JV16411611	GOIATUBA S1	19/10/2020 13:31	19/10/2020 19:13	19/10/2020 13:31	19/10/2020 16:31	2,98	251	749,23	CHI
202010189505	PONTALINA	JV16411611	GOIATUBA S1	19/10/2020 13:31	19/10/2020 19:13	19/10/2020 13:31	19/10/2020 13:37	0,09	35	3,23	CHI
202010189505	JOVIANIA	JV16411611	GOIATUBA S1	19/10/2020 13:31	19/10/2020 19:13	19/10/2020 13:31	19/10/2020 13:37	0,09	59	5,44	CHI
202010189505	JOVIANIA	JV16411611	GOIATUBA S1	19/10/2020 13:31	19/10/2020 19:13	19/10/2020 13:31	19/10/2020 13:36	0,07	998	74,30	CHI
202010189505	JOVIANIA	JV16411611	GOIATUBA S1	19/10/2020 13:31	19/10/2020 19:13	19/10/2020 13:31	19/10/2020 13:34	0,06	657	36,32	CHI

202010105960	PIRES DO RIO	PR12000002	PIRES DO RIO S1	19/10/2020 13:32	19/10/2020 16:16	19/10/2020 13:32	19/10/2020 16:16	2,73	209	569,99	CHI
202010105103	PLANALTINA	2960167783	PLANALTINA	19/10/2020 13:32	19/10/2020 18:34	19/10/2020 13:32	19/10/2020 18:34	5,02	1	5,02	CHI
202010106191	PIRENOPOLIS	CB12215044	CORUMBA	19/10/2020 13:33	19/10/2020 17:25	19/10/2020 13:33	19/10/2020 17:25	3,86	2	7,73	CHI
202010106191	CORUMBA DE GOIAS	CB12215044	CORUMBA	19/10/2020 13:33	19/10/2020 17:25	19/10/2020 13:33	19/10/2020 17:25	3,86	23	88,85	CHI
202010105194	URUACU	UR12390452	URUACU	19/10/2020 13:35	19/10/2020 15:39	19/10/2020 13:35	19/10/2020 15:39	2,07	13	26,87	CHI
202010106505	SANTA RITA DO NOVO DESTINO	GE12006474	BARRO ALTO	19/10/2020 13:35	19/10/2020 19:09	19/10/2020 13:35	19/10/2020 19:09	5,57	6	33,40	CHI
202010106505	SAO LUIZ DO NORTE	GE12006474	BARRO ALTO	19/10/2020 13:35	19/10/2020 19:09	19/10/2020 13:35	19/10/2020 19:09	5,57	1	5,57	CHI
202010106505	GOIANESIA	GE12006474	BARRO ALTO	19/10/2020 13:35	19/10/2020 19:09	19/10/2020 13:35	19/10/2020 19:09	5,57	2	11,13	CHI
202010105135	CABECEIRAS	CW21151417	ITIQUIRA	19/10/2020 13:37	19/10/2020 17:34	19/10/2020 13:37	19/10/2020 17:34	3,95	1	3,95	CHI
202010105141	JATAI	JT11036760	JATAI S2	19/10/2020 13:37	20/10/2020 08:01	19/10/2020 13:37	20/10/2020 08:01	18,39	3	55,17	CHI
202010105642	FAINA	FC12234276	GOIAS	19/10/2020 13:38	19/10/2020 17:11	19/10/2020 13:38	19/10/2020 17:11	3,54	3	10,63	CHI
202010105157	ITAGUARI	II21034759	ITABERAI S1	19/10/2020 13:40	19/10/2020 15:54	19/10/2020 13:40	19/10/2020 15:54	2,23	1	2,23	CHI
202010105159	ITAGUARU	IC21155379	ITABERAI S1	19/10/2020 13:40	19/10/2020 17:35	19/10/2020 13:40	19/10/2020 17:35	3,91	1	3,91	CHI
202010105163	JATAI	290024432	JATAI S2	19/10/2020 13:40	20/10/2020 00:58	19/10/2020 13:40	20/10/2020 00:58	11,29	1	11,29	CHI
202010105170	SAO LUIZ DO NORTE	SZ12090338	ITAPACI	19/10/2020 13:41	19/10/2020 17:43	19/10/2020 13:41	19/10/2020 17:43	4,02	291	1169,42	CHI
202010106794	PARAUNA	JD12377478	PALMEIRAS	19/10/2020 13:42	19/10/2020 19:00	19/10/2020 13:42	19/10/2020 19:00	5,29	8	42,29	CHI
202010105186	PIRANHAS	PH21038106	PIRANHAS	19/10/2020 13:43	20/10/2020 12:00	19/10/2020 13:43	20/10/2020 12:00	22,27	1	22,27	CHI
202010105191	SANTA HELENA DE GOIAS	SH21000190	IPEGUARI	19/10/2020 13:44	19/10/2020 20:59	19/10/2020 13:44	19/10/2020 20:59	7,24	1	7,24	CHI
202010105197	CALDAS NOVAS	760110116	SERRA DE CALDAS	19/10/2020 13:44	19/10/2020 17:29	19/10/2020 13:44	19/10/2020 17:29	3,73	1	3,73	CHI
202010105198	ABADIANIA	10009753689	ANAPOLIS UNIVERSITARIO S1	19/10/2020 13:44	20/10/2020 14:07	19/10/2020 13:44	20/10/2020 14:07	24,37	1	24,37	CHI
202010105209	COCALZINHO DE GOIAS	ZN11387197	COCALZINHO	19/10/2020 13:46	20/10/2020 11:54	19/10/2020 13:46	20/10/2020 11:54	22,13	10	221,33	CHI
202010105212	ANAPOLIS	20996100	ANAPOLIS UNIVERSITARIO S2	19/10/2020 13:46	20/10/2020 15:09	19/10/2020 13:46	20/10/2020 15:09	25,38	1	25,38	CHI
202010105215	ANAPOLIS	AN11375933	JUNDIAI S1	19/10/2020 13:47	19/10/2020 17:20	19/10/2020 13:47	19/10/2020 17:20	3,55	59	209,66	CHI
202010109421	ANAPOLIS	AN11264483	JUNDIAI S1	19/10/2020 13:47	20/10/2020 03:09	19/10/2020 13:47	20/10/2020 03:09	13,36	115	1536,05	CHI
202010105220	GAMELEIRA DE GOIAS	GL21338856	DAIA S2	19/10/2020 13:48	19/10/2020 17:42	19/10/2020 13:48	19/10/2020 17:42	3,89	1	3,89	CHI
202010105221	MINACU	9950000202	MINACU	19/10/2020 13:49	19/10/2020 17:17	19/10/2020 13:49	19/10/2020 17:17	3,47	1	3,47	CHI
202010105240	ITABERAI	IB12000001	ITABERAI S2	19/10/2020 13:53	19/10/2020 16:24	19/10/2020 13:53	19/10/2020 16:24	2,51	145	364,27	CHI
202010106349	ARUANA	AK12274236LD	MOZARLANDIA	19/10/2020 13:54	20/10/2020 17:08	19/10/2020 13:54	20/10/2020 17:08	27,24	10	272,43	CHI
202010105246	FORMOSA	610316394	ITIQUIRA	19/10/2020 13:54	19/10/2020 17:48	19/10/2020 13:54	19/10/2020 17:48	3,90	1	3,90	CHI
202010105247	PIRANHAS	1930033658	PIRANHAS	19/10/2020 13:54	19/10/2020 17:56	19/10/2020 13:54	19/10/2020 17:56	4,03	1	4,03	CHI
202010105760	JATAI	JT11136028	JATAI S3	19/10/2020 13:54	19/10/2020 17:51	19/10/2020 13:54	19/10/2020 17:51	3,95	34	134,18	CHI
202010105250	UIRAPURU	4200007266	SANTA TEREZINHA	19/10/2020 13:54	19/10/2020 14:59	19/10/2020 13:54	19/10/2020 14:59	1,08	1	1,08	CHI
202010105252	JUSSARA	1290088503	JUSSARA	19/10/2020 13:54	20/10/2020 12:10	19/10/2020 13:54	20/10/2020 12:10	22,26	1	22,26	CHI
202010105257	SAO MIGUEL DO ARAGUAIA	SM11332463	SAO MIGUEL DO ARAGUAIA	19/10/2020 13:55	20/10/2020 15:06	19/10/2020 13:55	20/10/2020 15:06	25,18	1	25,18	CHI
202010105339	ANAPOLIS	AN11000227	JUNDIAI S2	19/10/2020 13:55	19/10/2020 15:45	19/10/2020 13:55	19/10/2020 15:45	1,82	67	122,07	CHI
202010107426	DIORAMA	DI12023266RE	IPORA	19/10/2020 13:56	20/10/2020 07:28	19/10/2020 13:56	20/10/2020 07:28	17,53	61	1069,33	CHI
202010107426	JAUPACI	DI12023266RE	IPORA	19/10/2020 13:56	20/10/2020 07:28	19/10/2020 13:56	20/10/2020 07:28	17,53	9	157,77	CHI
202010106417	MUNDO NOVO DE GOIAS	MH12362454	NOVA CRIXAS	19/10/2020 13:57	19/10/2020 20:59	19/10/2020 13:57	19/10/2020 20:59	7,03	118	828,95	CHI
202010109515	JUSSARA	RN12250752	BRITANIA	19/10/2020 13:57	20/10/2020 08:10	19/10/2020 13:57	20/10/2020 08:10	18,20	19	345,83	CHI
202010109515	SANTA FE DE GOIAS	RN12250752	BRITANIA	19/10/2020 13:57	20/10/2020 08:10	19/10/2020 13:57	20/10/2020 08:10	18,20	43	782,67	CHI
202010108045	ANAPOLIS	AN11035287	ANAPOLIS UNIVERSITARIO S2	19/10/2020 13:58	19/10/2020 22:32	19/10/2020 13:58	19/10/2020 22:32	8,56	77	659,50	CHI
202010105284	ANAPOLIS	10018940372	JUNDIAI S1	19/10/2020 13:58	19/10/2020 19:27	19/10/2020 13:58	19/10/2020 19:27	5,47	1	5,47	CHI
202010105855	BARRO ALTO	BA12382484	BARRO ALTO	19/10/2020 13:59	23/10/2020 13:19	19/10/2020 23:12	23/10/2020 13:19	86,12	3	258,35	CHI
202010105855	BARRO ALTO	BA12382484	BARRO ALTO	19/10/2020 13:59	23/10/2020 13:19	23/10/2020 11:00	23/10/2020 13:19	2,31	14	32,41	CHI
202010105855	BARRO ALTO	BA12382484	BARRO ALTO	19/10/2020 13:59	23/10/2020 13:19	19/10/2020 23:12	23/10/2020 08:45	81,56	1	81,56	CHI
202010105855	BARRO ALTO	BA12382484	BARRO ALTO	19/10/2020 13:59	23/10/2020 13:19	19/10/2020 23:12	22/10/2020 23:47	72,58	1	72,58	CHI
202010105855	BARRO ALTO	BA12382484	BARRO ALTO	19/10/2020 13:59	23/10/2020 13:19	19/10/2020 23:12	22/10/2020 23:35	72,38	2	144,77	CHI
202010105855	BARRO ALTO	BA12382484	BARRO ALTO	19/10/2020 13:59	23/10/2020 13:19	22/10/2020 22:07	22/10/2020 23:35	1,47	10	14,69	CHI
202010105855	BARRO ALTO	BA21163359	BARRO ALTO	19/10/2020 13:59	23/10/2020 13:19	22/10/2020 18:10	22/10/2020 21:58	3,81	1	3,81	CHI
202010105855	BARRO ALTO	BA12382484	BARRO ALTO	19/10/2020 13:59	23/10/2020 13:19	19/10/2020 23:12	22/10/2020 21:20	70,14	1	70,14	CHI
202010105855	BARRO ALTO	BA12382484	BARRO ALTO	19/10/2020 13:59	23/10/2020 13:19	22/10/2020 21:04	22/10/2020 21:20	0,28	8	2,20	CHI

202010105855	BARRO ALTO	BA12382484	BARRO ALTO	19/10/2020 13:59	23/10/2020 13:19	19/10/2020 23:12	22/10/2020 20:57	69,75	2	139,51	CHI
202010105855	BARRO ALTO	BA12382484	BARRO ALTO	19/10/2020 13:59	23/10/2020 13:19	22/10/2020 20:47	22/10/2020 20:57	0,17	6	1,01	CHI
202010105855	BARRO ALTO	BA12382484	BARRO ALTO	19/10/2020 13:59	23/10/2020 13:19	19/10/2020 23:12	22/10/2020 20:38	69,44	3	208,33	CHI
202010105855	BARRO ALTO	BA12382484	BARRO ALTO	19/10/2020 13:59	23/10/2020 13:19	22/10/2020 20:07	22/10/2020 20:38	0,51	3	1,54	CHI
202010105855	BARRO ALTO	BA12382484	BARRO ALTO	19/10/2020 13:59	23/10/2020 13:19	19/10/2020 23:12	22/10/2020 19:50	68,64	1	68,64	CHI
202010105855	BARRO ALTO	BA12382484	BARRO ALTO	19/10/2020 13:59	23/10/2020 13:19	19/10/2020 23:12	22/10/2020 19:45	68,55	1	68,55	CHI
202010105855	BARRO ALTO	BA12382484	BARRO ALTO	19/10/2020 13:59	23/10/2020 13:19	19/10/2020 23:12	22/10/2020 19:32	68,34	1	68,34	CHI
202010105855	BARRO ALTO	BA12382484	BARRO ALTO	19/10/2020 13:59	23/10/2020 13:19	19/10/2020 23:12	22/10/2020 17:50	66,63	1	66,63	CHI
202010105855	NIQUELANDIA	BA18000051FS	BARRO ALTO	19/10/2020 13:59	23/10/2020 13:19	19/10/2020 13:59	21/10/2020 13:42	47,71	122	5821,06	CHI
202010105855	BARRO ALTO	BA18000051FS	BARRO ALTO	19/10/2020 13:59	23/10/2020 13:19	19/10/2020 13:59	21/10/2020 13:42	47,71	15	715,70	CHI
202010105855	BARRO ALTO	BA12401983LD	BARRO ALTO	19/10/2020 13:59	23/10/2020 13:19	19/10/2020 23:12	20/10/2020 13:23	14,18	57	808,39	CHI
202010105855	BARRO ALTO	BA13282029	BARRO ALTO	19/10/2020 13:59	23/10/2020 13:19	19/10/2020 23:12	20/10/2020 13:05	13,89	17	236,12	CHI
202010105855	BARRO ALTO	BA18000051FS	BARRO ALTO	19/10/2020 13:59	23/10/2020 13:19	20/10/2020 10:22	20/10/2020 11:41	1,31	24	31,51	CHI
202010105855	BARRO ALTO	BA18000051FS	BARRO ALTO	19/10/2020 13:59	23/10/2020 13:19	19/10/2020 23:12	20/10/2020 08:47	9,59	24	230,22	CHI
202010105855	BARRO ALTO	BA18000051FS	BARRO ALTO	19/10/2020 13:59	23/10/2020 13:19	19/10/2020 13:59	19/10/2020 23:10	9,18	115	1055,64	CHI
202010105404	ANAPOLIS	AN12258718	JUNDIAI S2	19/10/2020 14:00	19/10/2020 15:28	19/10/2020 14:00	19/10/2020 15:28	1,47	21	30,77	CHI
202010105298	ANAPOLIS	AN11288615	JUNDIAI S2	19/10/2020 14:00	19/10/2020 15:03	19/10/2020 14:00	19/10/2020 15:03	1,04	40	41,73	CHI
202010105301	AMARALINA	LC12170975	MARA ROSA	19/10/2020 14:00	19/10/2020 16:26	19/10/2020 14:00	19/10/2020 16:26	2,42	11	26,63	CHI
202010105311	CATALAO	CT12246501	CATALAO S1	19/10/2020 14:01	19/10/2020 21:15	19/10/2020 14:01	19/10/2020 21:15	7,22	4	28,89	CHI
202010105963	JANDAIA	JD12308457	PALMEIRAS	19/10/2020 14:03	20/10/2020 13:33	19/10/2020 14:03	20/10/2020 13:33	23,50	15	352,44	CHI
202010105963	JANDAIA	JD12308457	PALMEIRAS	19/10/2020 14:03	20/10/2020 13:33	20/10/2020 12:32	20/10/2020 13:33	1,01	2	2,03	CHI
202010105963	JANDAIA	JD12308457	PALMEIRAS	19/10/2020 14:03	20/10/2020 13:33	19/10/2020 14:03	19/10/2020 20:12	6,14	2	12,28	CHI
202010105337	GOIATUBA	140047049	GOIATUBA S2	19/10/2020 14:06	19/10/2020 20:54	19/10/2020 14:06	19/10/2020 20:54	6,80	1	6,80	CHI
202010105338	ANAPOLIS	AN11000179	JUNDIAI S1	19/10/2020 14:06	19/10/2020 17:16	19/10/2020 14:06	19/10/2020 17:16	3,16	39	123,16	CHI
202010108804	ALEXANIA	AX12402045	ALEXANIA	19/10/2020 14:07	19/10/2020 22:05	19/10/2020 14:07	19/10/2020 22:05	7,96	157	1249,59	CHI
202010105352	JARAGUA	JA12025642	ITABERAI S1	19/10/2020 14:08	19/10/2020 22:42	19/10/2020 14:08	19/10/2020 22:42	8,56	59	504,79	CHI
202010105356	PLANALTINA	PI21139651	PLANALTINA	19/10/2020 14:08	19/10/2020 23:09	19/10/2020 14:08	19/10/2020 23:09	9,00	1	9,00	CHI
202010105362	ITUMBIARA	IT11309811	ITUMBIARA VELHA S1	19/10/2020 14:09	19/10/2020 18:12	19/10/2020 14:09	19/10/2020 18:12	4,04	104	419,76	CHI
202010105366	NIQUELANDIA	2750077819	URUACU	19/10/2020 14:10	19/10/2020 18:52	19/10/2020 14:10	19/10/2020 18:52	4,71	1	4,71	CHI
202010105375	ORIZONA	OZ21375409	PIRES DO RIO S2	19/10/2020 14:10	19/10/2020 18:42	19/10/2020 14:10	19/10/2020 18:42	4,54	1	4,54	CHI
202010105375	ORIZONA	OZ12113013	PIRES DO RIO S2	19/10/2020 14:10	19/10/2020 18:42	19/10/2020 14:10	19/10/2020 17:37	3,44	10	34,41	CHI
202010106839	PORANGATU	PO12020945	PORANGATU	19/10/2020 14:11	19/10/2020 20:38	19/10/2020 14:11	19/10/2020 20:38	6,45	6	38,68	CHI
202010110584	FAZENDA NOVA	FN12229876	JUSSARA	19/10/2020 14:11	21/10/2020 00:38	19/10/2020 14:11	21/10/2020 00:38	34,43	5	172,17	CHI
202010105390	FORMOSA	FA21071391	ITIQUIRA	19/10/2020 14:12	19/10/2020 17:30	19/10/2020 14:12	19/10/2020 17:30	3,30	1	3,30	CHI
202010105978	JATAI	JT12209819	JATAI S1	19/10/2020 14:12	19/10/2020 16:44	19/10/2020 14:12	19/10/2020 16:44	2,53	10	25,27	CHI
202010105398	NOVO BRASIL	1460000617	JUSSARA	19/10/2020 14:12	20/10/2020 16:40	19/10/2020 14:12	20/10/2020 16:40	26,45	1	26,45	CHI
202010105419	SAO JOAO DA PARAUNA	RP21008155	FIRMINOPOLIS S2	19/10/2020 14:14	19/10/2020 19:35	19/10/2020 14:14	19/10/2020 19:35	5,33	2	10,67	CHI
202010109195	JATAI	JT12286459	CABRIUVA S2	19/10/2020 14:15	20/10/2020 14:26	19/10/2020 14:15	20/10/2020 14:26	24,18	9	217,64	CHI
202010105421	ALVORADA DO NORTE	AQ21053598	IACIARA S2	19/10/2020 14:15	19/10/2020 17:14	19/10/2020 14:15	19/10/2020 17:14	2,98	1	2,98	CHI
202010105447	GAMELEIRA DE GOIAS	SV21008398	DAIA S2	19/10/2020 14:17	20/10/2020 12:13	19/10/2020 14:17	20/10/2020 12:13	21,93	3	65,80	CHI
202010105996	MOSSAMEDES	MD12020722LD	ITABERAI S2	19/10/2020 14:17	20/10/2020 22:55	19/10/2020 14:17	20/10/2020 22:55	32,62	27	880,76	CHI
202010105996	MOSSAMEDES	MD12020758	ITABERAI S2	19/10/2020 14:17	20/10/2020 22:55	19/10/2020 14:17	20/10/2020 22:40	32,37	27	874,01	CHI
202010105996	MOSSAMEDES	MD12020758	ITABERAI S2	19/10/2020 14:17	20/10/2020 22:55	19/10/2020 14:17	20/10/2020 22:20	32,04	8	256,30	CHI
202010107606	NIQUELANDIA	NQ12235663	URUACU	19/10/2020 14:19	20/10/2020 02:38	19/10/2020 14:19	20/10/2020 02:38	12,31	7	86,19	CHI
202010105472	ITAPIRAPUA	1420012116	MATRINCHA	19/10/2020 14:19	20/10/2020 15:32	19/10/2020 14:19	20/10/2020 15:32	25,20	1	25,20	CHI
202010105708	JUSSARA	JR11380862	JUSSARA	19/10/2020 14:20	19/10/2020 15:57	19/10/2020 14:20	19/10/2020 15:57	1,61	14	22,53	CHI
202010106756	PIRENOPOLIS	PV12381262	CORUMBA	19/10/2020 14:22	20/10/2020 11:17	19/10/2020 14:22	20/10/2020 11:17	20,91	5	104,54	CHI
202010107715	CATALAO	CT12399870	CATALAO S1	19/10/2020 14:23	19/10/2020 19:33	19/10/2020 14:23	19/10/2020 19:33	5,17	11	56,83	CHI
202010105650	TRES RANCHOS	TH12281446	CATALAO S1	19/10/2020 14:23	19/10/2020 15:48	19/10/2020 14:23	19/10/2020 15:48	1,41	10	14,07	CHI
202010105522	PORANGATU	10030581069	PORANGATU	19/10/2020 14:24	19/10/2020 15:45	19/10/2020 14:24	19/10/2020 15:45	1,34	1	1,34	CHI
202010105531	COCALZINHO DE GOIAS	ZN12144220	COCALZINHO	19/10/2020 14:25	20/10/2020 09:45	19/10/2020 14:25	20/10/2020 09:45	19,32	1	19,32	CHI

202010107696	SANTA TEREZINHA DE GOIAS	SG12320672	SANTA TEREZINHA	19/10/2020 14:26	20/10/2020 11:09	19/10/2020 14:26	20/10/2020 11:09	20,72	6	124,33	CHI
202010105556	SAO FRANCISCO DE GOIAS	SF21050984	SAO FRANCISCO DE GOIAS	19/10/2020 14:27	20/10/2020 11:29	19/10/2020 14:27	20/10/2020 11:29	21,03	2	42,06	CHI
202010105681	BONOPOLIS	TA12139136	SAO MIGUEL DO ARAGUAIA	19/10/2020 14:28	19/10/2020 20:50	19/10/2020 14:28	19/10/2020 20:50	6,36	3	19,09	CHI
202010105681	NOVO PLANALTO	TA12139136	SAO MIGUEL DO ARAGUAIA	19/10/2020 14:28	19/10/2020 20:50	19/10/2020 14:28	19/10/2020 20:50	6,36	17	108,20	CHI
202010105573	CAMPINORTE	2040007137	CAMPINORTE	19/10/2020 14:29	20/10/2020 11:37	19/10/2020 14:29	20/10/2020 11:37	21,13	1	21,13	CHI
202010105592	ITABERAI	IB21311055	ITABERAI S2	19/10/2020 14:30	19/10/2020 16:15	19/10/2020 14:30	19/10/2020 16:15	1,74	1	1,74	CHI
202010106457	RIO VERDE	RV12034596	CABRIUVA S2	19/10/2020 14:31	22/10/2020 16:45	20/10/2020 13:07	22/10/2020 16:45	51,64	1	51,64	CHI
202010106457	JATAI	RV10402217	CABRIUVA S2	19/10/2020 14:31	22/10/2020 16:45	21/10/2020 13:55	21/10/2020 14:03	0,13	12	1,59	CHI
202010106457	RIO VERDE	RV10402217	CABRIUVA S2	19/10/2020 14:31	22/10/2020 16:45	21/10/2020 13:55	21/10/2020 14:03	0,13	53	7,02	CHI
202010106457	JATAI	RV10402217	CABRIUVA S2	19/10/2020 14:31	22/10/2020 16:45	19/10/2020 14:31	20/10/2020 14:35	24,07	12	288,80	CHI
202010106457	RIO VERDE	RV10402217	CABRIUVA S2	19/10/2020 14:31	22/10/2020 16:45	19/10/2020 14:31	20/10/2020 14:35	24,07	53	1275,55	CHI
202010106457	RIO VERDE	RV12034596	CABRIUVA S2	19/10/2020 14:31	22/10/2020 16:45	20/10/2020 08:15	20/10/2020 10:49	2,57	8	20,52	CHI
202010106457	RIO VERDE	RV12034596	CABRIUVA S2	19/10/2020 14:31	22/10/2020 16:45	19/10/2020 23:50	20/10/2020 07:59	8,15	8	65,23	CHI
202010105603	URUACU	640081587	URUACU	19/10/2020 14:32	19/10/2020 21:36	19/10/2020 14:32	19/10/2020 21:36	7,06	1	7,06	CHI
202010105613	INDIARA	JD12272364	PALMEIRAS	19/10/2020 14:33	19/10/2020 16:07	19/10/2020 14:33	19/10/2020 16:07	1,56	5	7,82	CHI
202010105613	PALMEIRAS DE GOIAS	JD12272364	PALMEIRAS	19/10/2020 14:33	19/10/2020 16:07	19/10/2020 14:33	19/10/2020 16:07	1,56	21	32,82	CHI
202010105619	CRIXAS	2490038546	SERRA DO OURO	19/10/2020 14:33	20/10/2020 07:38	19/10/2020 14:33	20/10/2020 07:38	17,07	1	17,07	CHI
202010105701	CABECEIRAS	CW12184604	ITIQUEIRA	19/10/2020 14:34	19/10/2020 15:22	19/10/2020 14:34	19/10/2020 15:22	0,80	6	4,78	CHI
202010105629	JUSSARA	JR11259688	JUSSARA	19/10/2020 14:34	19/10/2020 15:44	19/10/2020 14:34	19/10/2020 15:44	1,16	83	96,14	CHI
202010105633	FORMOSA	610185536	ITIQUEIRA	19/10/2020 14:35	19/10/2020 15:53	19/10/2020 14:35	19/10/2020 15:53	1,30	1	1,30	CHI
202010105634	CATALAO	10010499731	CATALAO S2	19/10/2020 14:35	19/10/2020 16:50	19/10/2020 14:35	19/10/2020 16:50	2,25	1	2,25	CHI
202010105363	MINEIROS	PW10408096	PARQUE DAS EMAS	19/10/2020 14:35	19/10/2020 17:57	19/10/2020 14:35	19/10/2020 17:57	3,36	172	578,64	CHI
202010105363	SANTA RITA DO ARAGUAIA	PW10408096	PARQUE DAS EMAS	19/10/2020 14:35	19/10/2020 17:57	19/10/2020 14:35	19/10/2020 17:57	3,36	4	13,46	CHI
202010105967	MOZARLANDIA	MZ12055628	MOZARLANDIA	19/10/2020 14:35	21/10/2020 15:09	19/10/2020 14:35	21/10/2020 15:09	48,57	3	145,71	CHI
202010105967	MOZARLANDIA	MZ12055628	MOZARLANDIA	19/10/2020 14:35	21/10/2020 15:09	19/10/2020 14:35	20/10/2020 21:25	30,83	11	339,11	CHI
202010105967	CRIXAS	MZ12055628	MOZARLANDIA	19/10/2020 14:35	21/10/2020 15:09	19/10/2020 14:35	20/10/2020 10:11	19,60	26	509,64	CHI
202010105967	MOZARLANDIA	MZ12055628	MOZARLANDIA	19/10/2020 14:35	21/10/2020 15:09	19/10/2020 14:35	20/10/2020 10:11	19,60	5	98,01	CHI
202010105967	MOZARLANDIA	MZ12055628	MOZARLANDIA	19/10/2020 14:35	21/10/2020 15:09	19/10/2020 14:35	20/10/2020 00:10	9,58	21	201,22	CHI
202010105639	PLANALTINA	2960006740	PLANALTINA	19/10/2020 14:35	19/10/2020 17:13	19/10/2020 14:35	19/10/2020 17:13	2,62	1	2,62	CHI
202010105645	NOVO BRASIL	NB12099378	JUSSARA	19/10/2020 14:36	20/10/2020 15:10	19/10/2020 14:36	20/10/2020 15:10	24,57	1	24,57	CHI
202010105645	FAZENDA NOVA	NB12099378	JUSSARA	19/10/2020 14:36	20/10/2020 15:10	19/10/2020 14:36	20/10/2020 15:10	24,57	3	73,72	CHI
202010105648	CACHOEIRA ALTA	1090004040	CACHOEIRA ALTA	19/10/2020 14:36	19/10/2020 16:57	19/10/2020 14:36	19/10/2020 16:57	2,35	1	2,35	CHI
202010106273	PLANALTINA	PI11325432	PLANALTINA	19/10/2020 14:36	19/10/2020 17:31	19/10/2020 14:36	19/10/2020 17:31	2,90	82	238,07	CHI
202010105984	AGUA FRIA DE GOIAS	TL12095889	SAO JOAO D ALIANCA	19/10/2020 14:36	19/10/2020 17:51	19/10/2020 14:36	19/10/2020 17:51	3,24	7	22,65	CHI
202010105696	GOIANESIA	GE21256008	GOIANESIA S2	19/10/2020 14:39	19/10/2020 23:01	19/10/2020 14:39	19/10/2020 23:01	8,36	1	8,36	CHI
202010105697	UIRAPURU	UP21171786	SANTA TEREZINHA	19/10/2020 14:40	19/10/2020 18:40	19/10/2020 14:40	19/10/2020 18:40	4,00	1	4,00	CHI
202010105703	SAO MIGUEL DO ARAGUAIA	830061009	SAO MIGUEL DO ARAGUAIA	19/10/2020 14:41	19/10/2020 18:57	19/10/2020 14:41	19/10/2020 18:57	4,26	1	4,26	CHI
202010105704	SAO MIGUEL DO ARAGUAIA	SM21016663	SAO MIGUEL DO ARAGUAIA	19/10/2020 14:41	20/10/2020 15:55	19/10/2020 14:41	20/10/2020 15:55	25,23	1	25,23	CHI
202010105710	JATAI	290129631	JATAI S3	19/10/2020 14:41	19/10/2020 21:21	19/10/2020 14:41	19/10/2020 21:21	6,66	1	6,66	CHI
202010106732	ANAPOLIS	AN11129433	JUNDIAI S1	19/10/2020 14:42	20/10/2020 14:25	19/10/2020 14:42	20/10/2020 14:25	23,70	66	1564,47	CHI
202010105741	PIRACANJUBA	PJ21139505	PIRACANJUBA	19/10/2020 14:44	19/10/2020 22:36	19/10/2020 14:44	19/10/2020 22:36	7,86	2	15,72	CHI
202010105747	MARA ROSA	2260020088	MARA ROSA	19/10/2020 14:45	20/10/2020 02:32	19/10/2020 14:45	20/10/2020 02:32	11,78	1	11,78	CHI
202010105751	PIRENOPOLIS	220037383	CORUMBA	19/10/2020 14:45	20/10/2020 22:42	19/10/2020 14:45	20/10/2020 22:42	31,95	1	31,95	CHI
202010105770	JATAI	JT12337053	JATAI S1	19/10/2020 14:46	19/10/2020 16:10	19/10/2020 14:46	19/10/2020 16:10	1,39	12	16,65	CHI
202010105768	IPORA	IR21069079	IPORA	19/10/2020 14:46	20/10/2020 11:57	19/10/2020 14:46	20/10/2020 11:57	21,17	1	21,17	CHI
202010105775	QUIRINOPOLIS	80103315	QUIRINOPOLIS	19/10/2020 14:48	19/10/2020 16:10	19/10/2020 14:48	19/10/2020 16:10	1,36	1	1,36	CHI
202010105784	SAO LUIS DE MONTES BELOS	500116118	SAO LUIZ DOS MONTES BELOS	19/10/2020 14:49	19/10/2020 17:00	19/10/2020 14:49	19/10/2020 17:00	2,18	1	2,18	CHI
202010105790	ANAPOLIS	20024757	JUNDIAI S1	19/10/2020 14:50	20/10/2020 12:09	19/10/2020 14:50	20/10/2020 12:09	21,31	1	21,31	CHI
202010109221	ANAPOLIS	AN11121966	JUNDIAI S1	19/10/2020 14:51	20/10/2020 01:51	19/10/2020 14:51	20/10/2020 01:51	10,98	122	1340,00	CHI
202010105802	NIQUELANDIA	NQ12270128RE	SAO JOAO D ALIANCA	19/10/2020 14:52	20/10/2020 10:19	19/10/2020 14:52	20/10/2020 10:19	19,44	17	330,54	CHI
202010105802	AGUA FRIA DE GOIAS	NQ12270128RE	SAO JOAO D ALIANCA	19/10/2020 14:52	20/10/2020 10:19	19/10/2020 14:52	20/10/2020 10:19	19,44	72	1399,94	CHI

202010105804	PLANALTINA	2960102995	PLANALTINA	19/10/2020 14:52	19/10/2020 20:56	19/10/2020 14:52	19/10/2020 20:56	6,06	1	6,06	CHI
202010189229	BRITANIA	IU12020119	MATRINCHA	19/10/2020 14:53	19/10/2020 22:59	19/10/2020 14:53	19/10/2020 22:59	8,09	6	48,55	CHI
202010189229	ITAPIRAPUA	IU12020119	MATRINCHA	19/10/2020 14:53	19/10/2020 22:59	19/10/2020 14:53	19/10/2020 22:59	8,09	42	339,87	CHI
202010105817	JUSSARA	JR11390156	JUSSARA	19/10/2020 14:56	19/10/2020 15:51	19/10/2020 14:56	19/10/2020 15:51	0,92	6	5,49	CHI
202010105823	JATAI	JT12260440	JATAI S1	19/10/2020 14:56	20/10/2020 09:59	19/10/2020 14:56	20/10/2020 09:59	19,04	2	38,07	CHI
202010105824	RIO VERDE	RV12271281	ACREUNA	19/10/2020 14:56	20/10/2020 12:05	20/10/2020 09:31	20/10/2020 12:05	2,56	8	20,52	CHI
202010105824	RIO VERDE	RV21301722	ACREUNA	19/10/2020 14:56	20/10/2020 12:05	19/10/2020 14:56	20/10/2020 11:45	20,80	1	20,80	CHI
202010106562	JAUPACI	JP12349648	IPORA	19/10/2020 14:58	20/10/2020 07:55	19/10/2020 14:58	20/10/2020 07:55	16,94	9	152,48	CHI
202010105844	JATAI	JT1334253	JATAI S2	19/10/2020 14:59	20/10/2020 10:53	19/10/2020 14:59	20/10/2020 10:53	19,90	1	19,90	CHI
202010105923	CATALAO	CT12042366	CATALAO S1	19/10/2020 14:59	19/10/2020 17:49	19/10/2020 14:59	19/10/2020 17:49	2,82	19	53,67	CHI
202010105854	ANAPOLIS	20549647	JUNDIAI S2	19/10/2020 14:59	20/10/2020 17:45	19/10/2020 14:59	20/10/2020 17:45	26,76	1	26,76	CHI
202010105862	ANICUNS	AC21031310	ANICUNS	19/10/2020 15:00	20/10/2020 14:50	19/10/2020 15:00	20/10/2020 14:50	23,82	1	23,82	CHI
202010108279	DOVERLANDIA	DV12139935	CAIAPONIA	19/10/2020 15:02	20/10/2020 10:15	19/10/2020 15:02	20/10/2020 10:15	19,21	6	115,28	CHI
202010108279	BALIZA	DV12139935	CAIAPONIA	19/10/2020 15:02	20/10/2020 10:15	19/10/2020 15:02	20/10/2020 10:15	19,21	1	19,21	CHI
202010106136	SANTA CRUZ DE GOIAS	BC12027042	PIRES DO RIO S2	19/10/2020 15:02	19/10/2020 19:40	19/10/2020 15:02	19/10/2020 19:40	4,63	11	50,94	CHI
202010105880	ANAPOLIS	21143195	JUNDIAI S1	19/10/2020 15:03	20/10/2020 13:36	19/10/2020 15:03	20/10/2020 13:36	22,54	1	22,54	CHI
202010105882	SANTA TEREZINHA DE GOIAS	SG11090414	SANTA TEREZINHA	19/10/2020 15:03	19/10/2020 23:24	19/10/2020 15:03	19/10/2020 23:24	8,34	103	858,99	CHI
202010105891	RIO VERDE	630521827	RIO VERDE S2	19/10/2020 15:04	20/10/2020 02:59	19/10/2020 15:04	20/10/2020 02:59	11,91	1	11,91	CHI
202010102228	ITAPIRAPUA	7385934	MATRINCHA	19/10/2020 15:04	19/10/2020 21:08	19/10/2020 15:04	19/10/2020 21:08	6,06	44	266,80	CHI
202010105928	RIO VERDE	RV11340955	CABRIUVA S1	19/10/2020 15:08	20/10/2020 02:23	19/10/2020 15:08	20/10/2020 02:23	11,25	12	134,99	CHI
202010105937	SANTA HELENA DE GOIAS	400135413	IPEGUARI	19/10/2020 15:09	19/10/2020 17:55	19/10/2020 15:09	19/10/2020 17:55	2,77	1	2,77	CHI
202010105953	SAO LUIZ DO NORTE	SZ21353876	ITAPACI	19/10/2020 15:11	20/10/2020 17:33	19/10/2020 15:11	20/10/2020 17:33	26,37	1	26,37	CHI
202010105956	SANCLERLANDIA	SC11377197	FIRMINOPOLIS S2	19/10/2020 15:11	19/10/2020 17:10	19/10/2020 15:11	19/10/2020 17:10	1,99	9	17,87	CHI
202010105958	CHAPADAO DO CEU	DJ1205133	CHAPADAO DO CEU	19/10/2020 15:11	20/10/2020 08:40	19/10/2020 15:11	20/10/2020 08:40	17,47	1	17,47	CHI
202010106599	ANAPOLIS	AN12000221	ANAPOLIS UNIVERSITARIO S2	19/10/2020 15:11	19/10/2020 18:20	19/10/2020 15:11	19/10/2020 18:20	3,14	243	763,09	CHI
202010108568	ANAPOLIS	AN11000143	ANAPOLIS UNIVERSITARIO S2	19/10/2020 15:17	20/10/2020 00:31	19/10/2020 15:17	20/10/2020 00:31	9,23	125	1153,89	CHI
202010106034	SANTO ANTONIO DO DESCOBERTO	10005275588	ALEXANIA	19/10/2020 15:17	19/10/2020 15:31	19/10/2020 15:17	19/10/2020 15:31	0,22	1	0,22	CHI
202010109008	RIO VERDE	RV12200774	CABRIUVA S2	19/10/2020 15:18	20/10/2020 00:56	19/10/2020 15:18	20/10/2020 00:56	9,63	7	67,38	CHI
202010106041	GOIATUBA	GT12052920	GOIATUBA S1	19/10/2020 15:18	20/10/2020 04:47	19/10/2020 15:18	20/10/2020 04:47	13,47	2	26,94	CHI
202010106047	FLORES DE GOIAS	FB12204157	FLORES DE GOIAS	19/10/2020 15:19	19/10/2020 17:06	19/10/2020 15:19	19/10/2020 17:06	1,77	13	23,04	CHI
202010106056	FORMOSO	2410005531	PORANGATU	19/10/2020 15:20	19/10/2020 21:22	19/10/2020 15:20	19/10/2020 21:22	6,02	1	6,02	CHI
202010103150	CORUMBA DE GOIAS	CB12144031	CORUMBA	19/10/2020 15:20	20/10/2020 11:25	19/10/2020 15:20	20/10/2020 11:25	20,07	7	140,49	CHI
202010106058	ANICUNS	AC21123432	ANICUNS	19/10/2020 15:21	20/10/2020 11:06	19/10/2020 15:21	20/10/2020 11:06	19,75	1	19,75	CHI
202010106120	FAINA	FC10395387	GOIAS	19/10/2020 15:23	19/10/2020 15:26	19/10/2020 15:23	19/10/2020 15:26	0,05	46	2,31	CHI
202010106120	ARAGUAPAZ	FC10395387	GOIAS	19/10/2020 15:23	19/10/2020 15:26	19/10/2020 15:23	19/10/2020 15:26	0,05	99	4,98	CHI
202010106082	URUACU	UR12232461	URUACU	19/10/2020 15:23	19/10/2020 17:32	19/10/2020 15:23	19/10/2020 17:32	2,14	7	14,97	CHI
202010106083	FORMOSA	610173390	ITIQUEIRA	19/10/2020 15:23	19/10/2020 17:29	19/10/2020 15:23	19/10/2020 17:29	2,09	1	2,09	CHI
202010106087	CATALAO	CT11127668	CATALAO S1	19/10/2020 15:24	19/10/2020 22:25	19/10/2020 15:24	19/10/2020 22:25	7,02	1	7,02	CHI
202010107163	PORANGATU	PO12354489	NOVO PLANALTO	19/10/2020 15:25	19/10/2020 22:21	19/10/2020 15:25	19/10/2020 22:21	6,93	10	69,27	CHI
202010106099	PALMINOPOLIS	PP21307041	PALMEIRAS	19/10/2020 15:25	19/10/2020 19:10	19/10/2020 15:25	19/10/2020 19:10	3,74	1	3,74	CHI
202010106104	ITAPACI	IW12071383	ITAPACI	19/10/2020 15:26	19/10/2020 19:59	19/10/2020 15:26	19/10/2020 19:59	4,54	47	213,42	CHI
202010106112	ACREUNA	EU21301593	ACREUNA	19/10/2020 15:27	19/10/2020 21:09	19/10/2020 15:27	19/10/2020 21:09	5,69	1	5,69	CHI
202010106125	RIO VERDE	RV21194433	RIO VERDE S1	19/10/2020 15:29	19/10/2020 17:47	19/10/2020 15:29	19/10/2020 17:47	2,29	1	2,29	CHI
202010106526	DOVERLANDIA	DV12395475	CAIAPONIA	19/10/2020 15:30	20/10/2020 14:25	19/10/2020 15:30	20/10/2020 14:25	22,92	11	252,07	CHI
202010106590	NOVA AMERICA	NM11099834	RUBIATABA	19/10/2020 15:30	19/10/2020 20:21	19/10/2020 15:30	19/10/2020 20:21	4,84	151	730,59	CHI
202010106135	SAO LUIZ DO NORTE	SZ21143590	ITAPACI	19/10/2020 15:31	20/10/2020 11:38	19/10/2020 15:31	20/10/2020 11:38	20,12	1	20,12	CHI
202010107638	ABADIANIA	AA12382362	CORUMBA	19/10/2020 15:31	20/10/2020 09:35	19/10/2020 15:31	20/10/2020 09:35	18,07	12	216,80	CHI
202010106143	FIRMINOPOLIS	900018793	FIRMINOPOLIS S1	19/10/2020 15:32	19/10/2020 17:17	19/10/2020 15:32	19/10/2020 17:17	1,74	1	1,74	CHI
202010109173	RIO VERDE	RV12380646	RIO VERDE S2	19/10/2020 15:34	20/10/2020 00:20	19/10/2020 15:34	20/10/2020 00:20	8,75	2	17,51	CHI
202010106164	NOVA IGUACU DE GOIAS	NH21271727	CAMPINORTE	19/10/2020 15:36	20/10/2020 16:56	19/10/2020 15:36	20/10/2020 16:56	25,32	2	50,64	CHI
202010106165	ARUANA	AK11183265	ARUANA	19/10/2020 15:36	19/10/2020 18:45	19/10/2020 15:36	19/10/2020 18:45	3,14	38	119,25	CHI

202010106172	JAUPACI	1280008663	IPORA	19/10/2020 15:37	20/10/2020 20:41	19/10/2020 15:37	20/10/2020 20:41	29,06	1	29,06	CHI
202010106176	BARRO ALTO	BA21163333	BARRO ALTO	19/10/2020 15:37	20/10/2020 11:45	19/10/2020 15:37	20/10/2020 11:45	20,12	1	20,12	CHI
202010106177	PLANALTINA	PI12262322	PLANALTINA	19/10/2020 15:37	19/10/2020 20:39	19/10/2020 15:37	19/10/2020 20:39	5,02	11	55,22	CHI
202010106179	MINEIROS	1390000208	PARQUE DAS EMAS	19/10/2020 15:37	20/10/2020 10:30	19/10/2020 15:37	20/10/2020 10:30	18,88	1	18,88	CHI
202010106188	SANTA HELENA DE GOIAS	SH21370215	SANTA HELENA S1	19/10/2020 15:39	19/10/2020 18:14	19/10/2020 15:39	19/10/2020 18:14	2,57	1	2,57	CHI
202010106234	ARUANA	AK13395244	BRITANIA	19/10/2020 15:40	20/10/2020 20:02	19/10/2020 15:40	20/10/2020 20:02	28,36	12	340,38	CHI
202010106234	ARUANA	AK10400388	BRITANIA	19/10/2020 15:40	20/10/2020 20:02	19/10/2020 23:27	19/10/2020 23:51	0,41	2	0,81	CHI
202010106234	BRITANIA	AK10400388	BRITANIA	19/10/2020 15:40	20/10/2020 20:02	19/10/2020 23:27	19/10/2020 23:51	0,41	12	4,86	CHI
202010106234	BRITANIA	03210424	BRITANIA	19/10/2020 15:40	20/10/2020 20:02	19/10/2020 23:27	19/10/2020 23:51	0,41	12	4,86	CHI
202010106234	ARUANA	03210424	BRITANIA	19/10/2020 15:40	20/10/2020 20:02	19/10/2020 23:27	19/10/2020 23:50	0,40	25	9,91	CHI
202010106234	BRITANIA	03210424	BRITANIA	19/10/2020 15:40	20/10/2020 20:02	19/10/2020 23:27	19/10/2020 23:50	0,40	7	2,77	CHI
202010106234	JUSSARA	03210424	BRITANIA	19/10/2020 15:40	20/10/2020 20:02	19/10/2020 23:27	19/10/2020 23:35	0,14	49	6,75	CHI
202010106234	ITAPIRAPUA	03210424	BRITANIA	19/10/2020 15:40	20/10/2020 20:02	19/10/2020 23:27	19/10/2020 23:35	0,14	2	0,28	CHI
202010106234	BRITANIA	03210424	BRITANIA	19/10/2020 15:40	20/10/2020 20:02	19/10/2020 23:27	19/10/2020 23:35	0,14	1939	267,15	CHI
202010106234	ARUANA	03210424	BRITANIA	19/10/2020 15:40	20/10/2020 20:02	19/10/2020 23:27	19/10/2020 23:35	0,14	25	3,44	CHI
202010106234	BRITANIA	03210424	BRITANIA	19/10/2020 15:40	20/10/2020 20:02	19/10/2020 23:27	19/10/2020 23:35	0,14	1378	189,86	CHI
202010106234	JUSSARA	03210424	BRITANIA	19/10/2020 15:40	20/10/2020 20:02	19/10/2020 23:27	19/10/2020 23:35	0,14	24	3,31	CHI
202010106234	BRITANIA	00250414	BRITANIA	19/10/2020 15:40	20/10/2020 20:02	19/10/2020 15:40	19/10/2020 17:44	2,06	12	24,74	CHI
202010106234	BRITANIA	AK10400388	BRITANIA	19/10/2020 15:40	20/10/2020 20:02	19/10/2020 15:40	19/10/2020 17:44	2,06	12	24,74	CHI
202010106234	ARUANA	AK10400388	BRITANIA	19/10/2020 15:40	20/10/2020 20:02	19/10/2020 15:40	19/10/2020 17:44	2,06	1	2,06	CHI
202010106234	ARUANA	00250414	BRITANIA	19/10/2020 15:40	20/10/2020 20:02	19/10/2020 15:40	19/10/2020 17:20	1,68	25	41,88	CHI
202010106234	BRITANIA	00250414	BRITANIA	19/10/2020 15:40	20/10/2020 20:02	19/10/2020 15:40	19/10/2020 17:20	1,68	7	11,73	CHI
202010106401	FORMOSA	FA12376671	ITIQUEIRA	19/10/2020 15:41	20/10/2020 15:00	19/10/2020 15:41	20/10/2020 15:00	23,30	21	489,40	CHI
202010106397	RIO VERDE	RV12327004	RIO VERDE S2	19/10/2020 15:42	19/10/2020 21:47	19/10/2020 15:42	19/10/2020 21:47	6,08	3	18,25	CHI
202010108787	ANAPOLIS	AN11329898	ANAPOLIS UNIVERSITARIO S2	19/10/2020 15:43	20/10/2020 01:46	19/10/2020 15:43	20/10/2020 01:46	10,05	33	331,60	CHI
202010106212	FORMOSA	610300726	ITIQUEIRA	19/10/2020 15:43	19/10/2020 16:57	19/10/2020 15:43	19/10/2020 16:57	1,23	1	1,23	CHI
202010107098	JATAI	JT11164164	JATAI S2	19/10/2020 15:43	19/10/2020 19:15	19/10/2020 15:43	19/10/2020 19:15	3,53	116	409,42	CHI
202010106216	CAMPINORTE	CR21252004	MARA ROSA	19/10/2020 15:43	20/10/2020 17:42	19/10/2020 15:43	20/10/2020 17:42	25,97	1	25,97	CHI
202010106220	MUNDO NOVO DE GOIAS	4240002917	NOVA CRIXAS	19/10/2020 15:44	19/10/2020 20:59	19/10/2020 15:44	19/10/2020 20:59	5,25	1	5,25	CHI
202010106246	JARAGUA	JA11054616	JARAGUA	19/10/2020 15:51	20/10/2020 02:13	19/10/2020 15:51	20/10/2020 02:13	10,37	128	1326,76	CHI
202010106249	PONTALINA	JV12230561	VICENTINOPOLIS	19/10/2020 15:51	19/10/2020 18:33	19/10/2020 15:51	19/10/2020 18:33	2,70	1	2,70	CHI
202010106250	IPAMERI	IP12266896	IPAMERI	19/10/2020 15:51	19/10/2020 21:40	19/10/2020 15:51	19/10/2020 21:40	5,80	3	17,41	CHI
202010107666	QUIRINOPOLIS	QI12000104	QUIRINOPOLIS	19/10/2020 15:52	19/10/2020 20:17	19/10/2020 15:52	19/10/2020 20:17	4,41	14	61,69	CHI
202010106266	ABADIANIA	AA21184584	DAIA S2	19/10/2020 15:54	21/10/2020 10:33	19/10/2020 15:54	21/10/2020 10:33	42,65	1	42,65	CHI
202010106285	FAZENDA NOVA	FN12292109	IPORA	19/10/2020 15:54	20/10/2020 11:02	19/10/2020 15:54	20/10/2020 11:02	19,13	15	286,88	CHI
202010106269	PIRES DO RIO	460093976	PIRES DO RIO S1	19/10/2020 15:54	19/10/2020 17:30	19/10/2020 15:54	19/10/2020 17:30	1,59	1	1,59	CHI
202010110176	NIQUELANDIA	NQ12264207	NIQUELANDIA SUBTRANSMISSAO	19/10/2020 15:56	21/10/2020 20:22	21/10/2020 11:11	21/10/2020 20:22	9,18	13	119,31	CHI
202010110176	NIQUELANDIA	NQ12234274	NIQUELANDIA SUBTRANSMISSAO	19/10/2020 15:56	21/10/2020 20:22	19/10/2020 15:56	21/10/2020 20:22	52,43	2	104,87	CHI
202010110176	NIQUELANDIA	NQ12234274	NIQUELANDIA SUBTRANSMISSAO	19/10/2020 15:56	21/10/2020 20:22	21/10/2020 11:11	21/10/2020 20:22	9,18	6	55,06	CHI
202010110176	NIQUELANDIA	NQ12213117	NIQUELANDIA SUBTRANSMISSAO	19/10/2020 15:56	21/10/2020 20:22	19/10/2020 15:56	21/10/2020 18:25	50,48	3	151,45	CHI
202010110176	NIQUELANDIA	NQ12234731	NIQUELANDIA SUBTRANSMISSAO	19/10/2020 15:56	21/10/2020 20:22	19/10/2020 15:56	21/10/2020 17:49	49,89	1	49,89	CHI
202010110176	ALTO PARAISO DE GOIAS	NQ12234731	NIQUELANDIA SUBTRANSMISSAO	19/10/2020 15:56	21/10/2020 20:22	19/10/2020 15:56	21/10/2020 17:49	49,89	1	49,89	CHI
202010110176	NIQUELANDIA	NQ13148152	NIQUELANDIA SUBTRANSMISSAO	19/10/2020 15:56	21/10/2020 20:22	21/10/2020 11:11	21/10/2020 17:09	5,97	26	155,30	CHI
202010110176	NIQUELANDIA	NQ12148151RE	NIQUELANDIA SUBTRANSMISSAO	19/10/2020 15:56	21/10/2020 20:22	21/10/2020 11:11	21/10/2020 12:18	1,11	7	7,78	CHI
202010110176	NIQUELANDIA	NQ12148151RE	NIQUELANDIA SUBTRANSMISSAO	19/10/2020 15:56	21/10/2020 20:22	19/10/2020 15:56	20/10/2020 15:58	24,05	5	120,23	CHI
202010106276	IACIARA	IA12211563	IACIARA S1	19/10/2020 15:56	20/10/2020 00:20	19/10/2020 15:56	20/10/2020 00:20	8,40	5	41,98	CHI
202010106276	IACIARA	IA12211563	IACIARA S1	19/10/2020 15:56	20/10/2020 00:20	19/10/2020 15:56	19/10/2020 22:46	6,83	4	27,33	CHI
202010108266	IVOLANDIA	IV12011808	IPORA	19/10/2020 15:56	20/10/2020 00:44	19/10/2020 15:56	20/10/2020 00:44	8,79	23	202,21	CHI
202010109374	QUIRINOPOLIS	QI11189167	QUIRINOPOLIS	19/10/2020 15:57	20/10/2020 01:25	19/10/2020 15:57	20/10/2020 01:25	9,46	111	1049,78	CHI
202010106291	CATALAO	1990062298	CATALAO S2	19/10/2020 15:57	19/10/2020 17:17	19/10/2020 15:57	19/10/2020 17:17	1,32	1	1,32	CHI
202010106850	NOVO PLANALTO	TA12293695	SAO MIGUEL DO ARAGUAIA	19/10/2020 15:57	19/10/2020 21:31	19/10/2020 15:57	19/10/2020 21:31	5,55	7	38,88	CHI

202010106302	PIRACANJUBA	60068450	PIRACANJUBA	19/10/2020 15:58	20/10/2020 11:20	19/10/2020 15:58	20/10/2020 11:20	19,37	1	19,37	CHI
202010106305	ARAGUAPAZ	AZ12042965	MOZARLANDIA	19/10/2020 15:58	19/10/2020 18:58	19/10/2020 15:58	19/10/2020 18:58	3,00	64	191,77	CHI
202010106305	MATRINCHA	AZ12042965	MOZARLANDIA	19/10/2020 15:58	19/10/2020 18:58	19/10/2020 15:58	19/10/2020 18:58	3,00	40	119,86	CHI
202010106305	ARUANA	AZ12042965	MOZARLANDIA	19/10/2020 15:58	19/10/2020 18:58	19/10/2020 15:58	19/10/2020 18:58	3,00	69	206,75	CHI
202010106310	CAIAPONIA	JT12334266	JATAI S1	19/10/2020 15:59	20/10/2020 12:27	19/10/2020 15:59	20/10/2020 12:27	20,47	1	20,47	CHI
202010106320	CHAPADAO DO CEU	10022162478	CHAPADAO DO CEU	19/10/2020 16:01	19/10/2020 21:45	19/10/2020 16:01	19/10/2020 21:45	5,73	1	5,73	CHI
202010106319	SAO LUIS DE MONTES BELOS	10019762486	SAO LUIZ DOS MONTES BELOS	19/10/2020 16:01	19/10/2020 20:38	19/10/2020 16:01	19/10/2020 20:38	4,62	1	4,62	CHI
202010189160	SANTA RITA DO NOVO DESTINO	GE12006485	BARRO ALTO	19/10/2020 16:01	19/10/2020 20:28	19/10/2020 16:01	19/10/2020 20:28	4,45	7	31,13	CHI
202010106331	QUIRINOPOLIS	QI21091033	QUIRINOPOLIS	19/10/2020 16:02	19/10/2020 18:52	19/10/2020 16:02	19/10/2020 18:52	2,82	1	2,82	CHI
202010106356	ANAPOLIS	20445246	JUNDIAI S1	19/10/2020 16:06	20/10/2020 11:45	19/10/2020 16:06	20/10/2020 11:45	19,64	1	19,64	CHI
202010106357	JATAI	JT12234318	JATAI S1	19/10/2020 16:06	19/10/2020 21:26	19/10/2020 16:06	19/10/2020 21:26	5,33	1	5,33	CHI
202010106359	MINEIROS	1390106011	PARQUE DAS EMAS	19/10/2020 16:06	20/10/2020 00:04	19/10/2020 16:06	20/10/2020 00:04	7,95	1	7,95	CHI
202010106361	GAMELEIRA DE GOIAS	SV21155181	DAIA S2	19/10/2020 16:07	20/10/2020 11:34	19/10/2020 16:07	20/10/2020 11:34	19,44	1	19,44	CHI
202010106390	BURITINOPOLIS	MB12314303	IACIARA S2	19/10/2020 16:09	20/10/2020 09:40	19/10/2020 16:09	20/10/2020 09:40	17,53	2	35,06	CHI
202010106390	MAMBAI	MB12314303	IACIARA S2	19/10/2020 16:09	20/10/2020 09:40	19/10/2020 16:09	20/10/2020 09:40	17,53	4	70,11	CHI
202010106405	ALEXANIA	480062651	ALEXANIA	19/10/2020 16:11	20/10/2020 13:27	19/10/2020 16:11	20/10/2020 13:27	21,26	1	21,26	CHI
202010106406	SANTO ANTONIO DO DESCOBERTO	2210143312	ALEXANIA	19/10/2020 16:11	19/10/2020 18:59	19/10/2020 16:11	19/10/2020 18:59	2,79	1	2,79	CHI
202010106410	IVOLANDIA	IV21014466	IPORA	19/10/2020 16:12	20/10/2020 12:47	19/10/2020 16:12	20/10/2020 12:47	20,57	1	20,57	CHI
202010106412	JATAI	JT12172276	JATAI S1	19/10/2020 16:12	21/10/2020 10:00	19/10/2020 16:12	21/10/2020 10:00	41,79	1	41,79	CHI
202010108619	RIO VERDE	RV12327049	CABRIUVA S2	19/10/2020 16:14	20/10/2020 00:03	19/10/2020 16:14	20/10/2020 00:03	7,81	3	23,44	CHI
202010106427	AGUA FRIA DE GOIAS	PI12048065	SAO JOAO D ALIANCA	19/10/2020 16:16	19/10/2020 20:16	19/10/2020 16:16	19/10/2020 20:16	3,99	1	3,99	CHI
202010106429	JATAI	290086905	JATAI S3	19/10/2020 16:16	20/10/2020 00:19	19/10/2020 16:16	20/10/2020 00:19	8,04	1	8,04	CHI
202010106477	MORRINHOS	MR32076974	MORRINHOS	19/10/2020 16:20	19/10/2020 17:51	19/10/2020 16:20	19/10/2020 17:51	1,51	10	15,08	CHI
202010106480	SITIO D ABADIA	SI12234157	IACIARA S2	19/10/2020 16:20	19/10/2020 17:10	19/10/2020 16:20	19/10/2020 17:10	0,82	12	9,82	CHI
202010106481	ALVORADA DO NORTE	AQ12062306	IACIARA S2	19/10/2020 16:20	19/10/2020 21:24	19/10/2020 16:20	19/10/2020 21:24	5,05	6	30,30	CHI
202010106483	JOVIANIA	JV11315850	GOIATUBA S1	19/10/2020 16:21	19/10/2020 18:46	19/10/2020 16:21	19/10/2020 18:46	2,41	15	36,22	CHI
202010108250	ANAPOLIS	AN11107984	ANAPOLIS UNIVERSITARIO S2	19/10/2020 16:22	19/10/2020 22:08	19/10/2020 16:22	19/10/2020 22:08	5,76	92	530,02	CHI
202010106506	GOUVELANDIA	GB21199317	QUIRINOPOLIS	19/10/2020 16:23	19/10/2020 23:05	19/10/2020 16:23	19/10/2020 23:05	6,69	1	6,69	CHI
202010106515	GOIATUBA	GT12305352LD	GOIATUBA S2	19/10/2020 16:24	21/10/2020 15:55	19/10/2020 16:24	21/10/2020 15:55	47,51	6	285,03	CHI
202010106515	GOIATUBA	GT12390091	GOIATUBA S2	19/10/2020 16:24	21/10/2020 15:55	19/10/2020 16:24	21/10/2020 15:55	47,51	3	142,52	CHI
202010106515	GOIATUBA	GT12390091	GOIATUBA S2	19/10/2020 16:24	21/10/2020 15:55	19/10/2020 16:24	21/10/2020 15:55	41,39	1	41,39	CHI
202010106515	GOIATUBA	GT12390091	GOIATUBA S2	19/10/2020 16:24	21/10/2020 15:55	19/10/2020 16:24	19/10/2020 21:16	4,87	1	4,87	CHI
202010107096	ARAGARCAS	AG11000007	ARAGARCAS	19/10/2020 16:25	19/10/2020 21:16	19/10/2020 16:25	19/10/2020 21:16	4,85	52	252,34	CHI
202010107096	ARAGARCAS	AG12140067	ARAGARCAS	19/10/2020 16:25	19/10/2020 21:16	19/10/2020 18:11	19/10/2020 20:51	2,68	14	37,53	CHI
202010106573	CAMPO ALEGRE DE GOIAS	CM12266823	CAMPO ALEGRE DE GOIAS	19/10/2020 16:26	20/10/2020 22:21	20/10/2020 22:11	20/10/2020 22:21	0,18	42	7,35	CHI
202010106573	CAMPO ALEGRE DE GOIAS	CM12266823	CAMPO ALEGRE DE GOIAS	19/10/2020 16:26	20/10/2020 22:21	19/10/2020 16:26	20/10/2020 21:04	28,63	1	28,63	CHI
202010106573	CAMPO ALEGRE DE GOIAS	CM12266823	CAMPO ALEGRE DE GOIAS	19/10/2020 16:26	20/10/2020 22:21	20/10/2020 12:56	20/10/2020 15:36	2,67	41	109,27	CHI
202010106573	CAMPO ALEGRE DE GOIAS	CM12266823	CAMPO ALEGRE DE GOIAS	19/10/2020 16:26	20/10/2020 22:21	19/10/2020 16:26	20/10/2020 11:49	19,38	1	19,38	CHI
202010106573	CAMPO ALEGRE DE GOIAS	CM12266823	CAMPO ALEGRE DE GOIAS	19/10/2020 16:26	20/10/2020 22:21	19/10/2020 16:26	20/10/2020 02:37	10,18	32	325,88	CHI
202010106573	CAMPO ALEGRE DE GOIAS	CM12266823	CAMPO ALEGRE DE GOIAS	19/10/2020 16:26	20/10/2020 22:21	19/10/2020 16:26	19/10/2020 23:47	7,36	8	58,87	CHI
202010106529	QUIRINOPOLIS	80099506	QUIRINOPOLIS	19/10/2020 16:26	20/10/2020 01:55	19/10/2020 16:26	20/10/2020 01:55	9,47	1	9,47	CHI
202010106538	JATAI	JT12380680	JATAI S1	19/10/2020 16:28	20/10/2020 08:54	19/10/2020 16:28	20/10/2020 08:54	16,43	1	16,43	CHI
202010106563	IPORA	IR21222973	IPORA	19/10/2020 16:32	19/10/2020 19:25	19/10/2020 16:32	19/10/2020 19:25	2,87	2	5,75	CHI
202010106575	SAO MIGUEL DO ARAGUAIA	SM21012638	SAO MIGUEL DO ARAGUAIA	19/10/2020 16:33	21/10/2020 04:41	19/10/2020 16:33	21/10/2020 04:41	36,12	1	36,12	CHI
202010106588	JUSSARA	1002776385	JUSSARA	19/10/2020 16:35	20/10/2020 13:10	19/10/2020 16:35	20/10/2020 13:10	20,57	1	20,57	CHI
202010106788	JUSSARA	JR11380862	JUSSARA	19/10/2020 16:36	20/10/2020 00:59	19/10/2020 16:36	20/10/2020 00:59	8,38	14	117,30	CHI
202010106595	SANTA CRUZ DE GOIAS	BC21186549	PIRES DO RIO S2	19/10/2020 16:36	19/10/2020 17:58	19/10/2020 16:36	19/10/2020 17:58	1,36	1	1,36	CHI
202010106596	FIRMINOPOLIS	900026121	FIRMINOPOLIS S1	19/10/2020 16:36	19/10/2020 18:08	19/10/2020 16:36	19/10/2020 18:08	1,53	1	1,53	CHI
202010106601	ARAGARCAS	AG21188252	ARAGARCAS	19/10/2020 16:37	20/10/2020 14:52	19/10/2020 16:37	20/10/2020 14:52	22,25	1	22,25	CHI
202010106606	ANAPOLIS	AN11059036	ANAPOLIS UNIVERSITARIO S2	19/10/2020 16:37	20/10/2020 22:25	19/10/2020 16:37	20/10/2020 22:25	29,79	21	625,63	CHI
202010109540	IPORA	730038762	IPORA	19/10/2020 16:38	20/10/2020 09:47	19/10/2020 16:38	20/10/2020 09:47	17,13	1	17,13	CHI

202010106624	ITABERAÍ	IB12079205	ITABERAÍ S1	19/10/2020 16:40	19/10/2020 17:57	19/10/2020 16:40	19/10/2020 17:57	1,28	4	5,11	CHI
202010106824	ANAPOLIS	AN11189932	ANAPOLIS UNIVERSITARIO S2	19/10/2020 16:41	20/10/2020 00:11	19/10/2020 16:41	20/10/2020 00:11	7,50	139	1042,23	CHI
202010106652	ANAPOLIS	20656087	DAIA S1	19/10/2020 16:45	20/10/2020 12:32	19/10/2020 16:45	20/10/2020 12:32	19,78	1	19,78	CHI
202010106896	ANAPOLIS	AN11000140	JUNDIAI S2	19/10/2020 16:45	19/10/2020 23:07	19/10/2020 16:45	19/10/2020 23:07	6,36	152	966,55	CHI
202010106657	RIO VERDE	RV21228699	CABRIUVA S2	19/10/2020 16:45	20/10/2020 10:20	19/10/2020 16:45	20/10/2020 10:20	17,59	1	17,59	CHI
202010106659	JANDAIA	JD21328166	PALMEIRAS	19/10/2020 16:46	19/10/2020 19:11	19/10/2020 16:46	19/10/2020 19:11	2,40	1	2,40	CHI
202010106676	CAIAPONIA	PY13316484	PALESTINA	19/10/2020 16:49	19/10/2020 20:09	19/10/2020 16:49	19/10/2020 20:09	3,34	252	841,89	CHI
202010106676	PALESTINA DE GOIAS	PY13316484	PALESTINA	19/10/2020 16:49	19/10/2020 20:09	19/10/2020 16:49	19/10/2020 20:09	3,34	254	848,57	CHI
202010106676	PALESTINA DE GOIAS	CP16410129	PALESTINA	19/10/2020 16:49	19/10/2020 20:09	19/10/2020 16:49	19/10/2020 17:09	0,34	85	28,99	CHI
202010106676	CAIAPONIA	CP16410129	PALESTINA	19/10/2020 16:49	19/10/2020 20:09	19/10/2020 16:49	19/10/2020 17:09	0,34	227	77,43	CHI
202010106678	ALVORADA DO NORTE	AQ12160975	IACIARA S2	19/10/2020 16:49	19/10/2020 22:24	19/10/2020 16:49	19/10/2020 22:24	5,57	17	94,74	CHI
202010106682	JANDAIA	10017597933	PALMEIRAS	19/10/2020 16:49	19/10/2020 18:23	19/10/2020 16:49	19/10/2020 18:23	1,56	1	1,56	CHI
202010106777	SANTA TEREZINHA DE GOIAS	GG12181600	SANTA TEREZINHA	19/10/2020 16:50	19/10/2020 21:49	19/10/2020 16:50	19/10/2020 21:49	4,97	7	34,78	CHI
202010106710	ANAPOLIS	21093167	JUNDIAI S1	19/10/2020 16:53	20/10/2020 10:51	19/10/2020 16:53	20/10/2020 10:51	17,96	1	17,96	CHI
202010106716	JATAI	290205165	JATAI S2	19/10/2020 16:53	20/10/2020 11:11	19/10/2020 16:53	20/10/2020 11:11	18,29	1	18,29	CHI
202010107446	ARAGARCAS	AG12000006	ARAGARCAS	19/10/2020 16:54	20/10/2020 06:55	19/10/2020 16:54	20/10/2020 06:55	14,01	42	588,46	CHI
202010107774	MINACU	IH12339952	MINACU	19/10/2020 16:54	19/10/2020 22:02	19/10/2020 16:54	19/10/2020 22:02	5,12	16	81,92	CHI
202010107020	PORTELANDIA	PW12072215	PARQUE DAS EMAS	19/10/2020 16:56	21/10/2020 18:53	19/10/2020 16:56	21/10/2020 18:53	49,94	4	199,78	CHI
202010106743	MINEIROS	MY12303407	PARQUE DAS EMAS	19/10/2020 16:57	19/10/2020 18:55	19/10/2020 16:57	19/10/2020 18:55	1,96	2	3,92	CHI
202010106826	ARAGARCAS	AG12000012	ARAGARCAS	19/10/2020 16:59	19/10/2020 21:51	19/10/2020 16:59	19/10/2020 21:51	4,85	42	203,73	CHI
202010107237	INDIARA	JD12391452	PALMEIRAS	19/10/2020 17:02	19/10/2020 22:04	19/10/2020 17:02	19/10/2020 22:04	5,03	5	25,14	CHI
202010107237	JANDAIA	JD12391452	PALMEIRAS	19/10/2020 17:02	19/10/2020 22:04	19/10/2020 17:02	19/10/2020 22:04	5,03	4	20,11	CHI
202010108395	AGUA FRIA DE GOIAS	TL12320501	SAO JOAO D ALIANCA	19/10/2020 17:02	20/10/2020 00:35	19/10/2020 17:02	20/10/2020 00:35	7,54	36	271,37	CHI
202010104572	ANAPOLIS	AN12000688	JUNDIAI S1	19/10/2020 17:04	19/10/2020 18:39	19/10/2020 17:04	19/10/2020 18:39	1,58	424	668,62	CHI
202010106801	PALMEIRAS DE GOIAS	PL12016686	PALMEIRAS	19/10/2020 17:05	19/10/2020 23:18	19/10/2020 17:05	19/10/2020 23:18	6,22	12	74,59	CHI
202010106823	SAO JOAO D ALIANCA	JL11287959	SAO JOAO D ALIANCA	19/10/2020 17:06	20/10/2020 15:44	19/10/2020 17:06	20/10/2020 15:44	22,63	16	362,01	CHI
202010114070	ANAPOLIS	AN11000263	JUNDIAI S1	19/10/2020 17:06	20/10/2020 20:24	19/10/2020 17:06	20/10/2020 20:24	27,29	69	1882,80	CHI
202010106837	FORMOSA	10009143775	ITIQUEIRA	19/10/2020 17:08	19/10/2020 18:03	19/10/2020 17:08	19/10/2020 18:03	0,91	1	0,91	CHI
202010106843	GOIANESIA	SY21207375	GOIANESIA S2	19/10/2020 17:09	21/10/2020 11:06	19/10/2020 17:09	21/10/2020 11:06	41,93	1	41,93	CHI
202010107768	MOSSAMEDES	KB12391521	ANICUNS	19/10/2020 17:10	20/10/2020 09:20	19/10/2020 17:10	20/10/2020 09:20	16,16	11	177,73	CHI
202010107768	AMERICANO DO BRASIL	KB12391521	ANICUNS	19/10/2020 17:10	20/10/2020 09:20	19/10/2020 17:10	20/10/2020 09:20	16,16	11	177,73	CHI
202010107314	AURILANDIA	CG12382596	FIRMINOPOLIS S2	19/10/2020 17:10	20/10/2020 00:38	19/10/2020 17:10	20/10/2020 00:38	7,46	24	178,94	CHI
202010107314	CACHOEIRA DE GOIAS	CG12382596	FIRMINOPOLIS S2	19/10/2020 17:10	20/10/2020 00:38	19/10/2020 17:10	20/10/2020 00:38	7,46	2	14,91	CHI
202010107314	MOIPORA	CG12382596	FIRMINOPOLIS S2	19/10/2020 17:10	20/10/2020 00:38	19/10/2020 17:10	20/10/2020 00:38	7,46	1	7,46	CHI
202010107151	FORMOSA	FA10410992	ITIQUEIRA	19/10/2020 17:11	19/10/2020 17:16	19/10/2020 17:11	19/10/2020 17:16	0,09	585	54,44	CHI
202010107151	VILA BOA	FA10410992	ITIQUEIRA	19/10/2020 17:11	19/10/2020 17:16	19/10/2020 17:11	19/10/2020 17:16	0,09	202	18,80	CHI
202010107151	FORMOSA	FA10410992	ITIQUEIRA	19/10/2020 17:11	19/10/2020 17:16	19/10/2020 17:11	19/10/2020 17:16	0,08	119	9,32	CHI
202010107151	FORMOSA	FA10410992	ITIQUEIRA	19/10/2020 17:11	19/10/2020 17:16	19/10/2020 17:11	19/10/2020 17:15	0,07	307	20,89	CHI
202010107151	VILA BOA	FA10410992	ITIQUEIRA	19/10/2020 17:11	19/10/2020 17:16	19/10/2020 17:11	19/10/2020 17:15	0,07	7	0,48	CHI
202010106852	ANAPOLIS	20035457	ANAPOLIS UNIVERSITARIO S1	19/10/2020 17:11	20/10/2020 23:27	19/10/2020 17:11	20/10/2020 23:27	30,26	1	30,26	CHI
202010107779	ARAGUAPAZ	AZ12248246	GOIAS	19/10/2020 17:11	20/10/2020 08:03	19/10/2020 17:11	20/10/2020 08:03	14,85	9	133,67	CHI
202010106866	SAO DOMINGOS	GY21333108	SAO DOMINGOS	19/10/2020 17:13	19/10/2020 21:37	19/10/2020 17:13	19/10/2020 21:37	4,39	1	4,39	CHI
202010106871	ANAPOLIS	20189916	JUNDIAI S2	19/10/2020 17:13	20/10/2020 14:18	19/10/2020 17:13	20/10/2020 14:18	21,07	1	21,07	CHI
202010106880	SAO JOAO D ALIANCA	JL21325411	FLORES DE GOIAS	19/10/2020 17:15	20/10/2020 06:40	19/10/2020 17:15	20/10/2020 06:40	13,40	1	13,40	CHI
202010106886	MORRINHOS	MR21048481	GOIATUBA S2	19/10/2020 17:16	19/10/2020 23:22	19/10/2020 17:16	19/10/2020 23:22	6,09	1	6,09	CHI
202010107000	MOIPORA	IR18222977TS	IPORA	19/10/2020 17:17	19/10/2020 19:25	19/10/2020 17:17	19/10/2020 19:25	2,13	60	127,72	CHI
202010107000	ISRAELANDIA	IR18222977TS	IPORA	19/10/2020 17:17	19/10/2020 19:25	19/10/2020 17:17	19/10/2020 19:25	2,13	25	53,22	CHI
202010107000	IPORA	IR18222977TS	IPORA	19/10/2020 17:17	19/10/2020 19:25	19/10/2020 17:17	19/10/2020 19:25	2,13	14	29,80	CHI
202010106891	ITABERAÍ	IB12336867	ITABERAÍ S1	19/10/2020 17:17	19/10/2020 20:55	19/10/2020 17:17	19/10/2020 20:55	3,62	4	14,48	CHI
202010106951	RIO VERDE	RV12271417	CABRIUVA S2	19/10/2020 17:18	19/10/2020 22:38	19/10/2020 17:18	19/10/2020 22:38	5,33	6	32,00	CHI
202010106895	ANAPOLIS	10003548587	ANAPOLIS UNIVERSITARIO S2	19/10/2020 17:18	20/10/2020 11:15	19/10/2020 17:18	20/10/2020 11:15	17,95	1	17,95	CHI

202010106980	SANTA RITA DO ARAGUAIA	SU13000002	SANTA RITA DO ARAGUAIA	19/10/2020 17:18	20/10/2020 01:12	19/10/2020 17:18	20/10/2020 01:12	7,90	285	2251,34	CHI
202010106980	MINEIROS	05690214	SANTA RITA DO ARAGUAIA	19/10/2020 17:18	20/10/2020 01:12	19/10/2020 17:18	19/10/2020 20:58	3,66	25	91,39	CHI
202010106980	SANTA RITA DO ARAGUAIA	05690214	SANTA RITA DO ARAGUAIA	19/10/2020 17:18	20/10/2020 01:12	19/10/2020 17:18	19/10/2020 20:58	3,66	375	1370,83	CHI
202010106980	SANTA RITA DO ARAGUAIA	SU16415900	SANTA RITA DO ARAGUAIA	19/10/2020 17:18	20/10/2020 01:12	19/10/2020 17:18	19/10/2020 20:42	3,39	844	2864,91	CHI
202010106980	SANTA RITA DO ARAGUAIA	SU16415900	SANTA RITA DO ARAGUAIA	19/10/2020 17:18	20/10/2020 01:12	19/10/2020 19:07	19/10/2020 20:42	1,57	191	300,61	CHI
202010107350	QUIRINOPOLIS	QI12000241	QUIRINOPOLIS	19/10/2020 17:18	19/10/2020 21:25	19/10/2020 17:18	19/10/2020 21:25	4,10	9	36,94	CHI
202010106903	ALTO PARAISO DE GOIAS	BF12048002	SAO JOAO D ALIANCA	19/10/2020 17:18	19/10/2020 19:00	19/10/2020 17:18	19/10/2020 19:00	1,68	1	1,68	CHI
202010106946	QUIRINOPOLIS	QI10394707	QUIRINOPOLIS	19/10/2020 17:19	20/10/2020 12:41	19/10/2020 17:19	20/10/2020 12:41	19,36	64	1238,86	CHI
202010106946	QUIRINOPOLIS	QI10394707	QUIRINOPOLIS	19/10/2020 17:19	20/10/2020 12:41	19/10/2020 17:19	19/10/2020 19:28	2,15	10	21,46	CHI
202010106946	QUIRINOPOLIS	QI10394707	QUIRINOPOLIS	19/10/2020 17:19	20/10/2020 12:41	19/10/2020 17:19	19/10/2020 18:30	1,18	68	80,56	CHI
202010107183	FORMOSA	FA11000014	ITUIQUIRA	19/10/2020 17:20	19/10/2020 18:46	19/10/2020 17:20	19/10/2020 18:46	1,42	188	267,74	CHI
202010107003	SITIO D ABADIA	FB10407015	IACIARA S2	19/10/2020 17:21	19/10/2020 23:31	19/10/2020 17:21	19/10/2020 23:31	6,18	120	741,37	CHI
202010107003	FLORES DE GOIAS	FB10407015	IACIARA S2	19/10/2020 17:21	19/10/2020 23:31	19/10/2020 17:21	19/10/2020 23:31	6,18	423	2613,32	CHI
202010107003	VILA BOA	FB10407015	IACIARA S2	19/10/2020 17:21	19/10/2020 23:31	19/10/2020 17:21	19/10/2020 19:09	1,81	1382	2498,35	CHI
202010107003	FLORES DE GOIAS	FB10407015	IACIARA S2	19/10/2020 17:21	19/10/2020 23:31	19/10/2020 17:21	19/10/2020 18:46	1,42	618	878,25	CHI
202010107003	VILA BOA	FB10407015	IACIARA S2	19/10/2020 17:21	19/10/2020 23:31	19/10/2020 17:21	19/10/2020 18:46	1,42	4	5,68	CHI
202010107003	FORMOSA	FB10407015	IACIARA S2	19/10/2020 17:21	19/10/2020 23:31	19/10/2020 17:21	19/10/2020 18:46	1,42	1	1,42	CHI
202010107003	FLORES DE GOIAS	FB10407015	IACIARA S2	19/10/2020 17:21	19/10/2020 23:31	19/10/2020 17:21	19/10/2020 17:28	0,12	71	8,44	CHI
202010107003	VILA BOA	FB10407015	IACIARA S2	19/10/2020 17:21	19/10/2020 23:31	19/10/2020 17:21	19/10/2020 17:28	0,12	63	7,49	CHI
202010107003	FLORES DE GOIAS	FB10407015	IACIARA S2	19/10/2020 17:21	19/10/2020 23:31	19/10/2020 17:21	19/10/2020 17:26	0,09	195	17,22	CHI
202010106933	BOM JARDIM DE GOIAS	BM21136797	BOM JARDIM	19/10/2020 17:21	19/10/2020 18:38	19/10/2020 17:21	19/10/2020 18:38	1,27	1	1,27	CHI
202010106942	ALVORADA DO NORTE	SI12243039	IACIARA S2	19/10/2020 17:22	20/10/2020 01:35	19/10/2020 17:22	20/10/2020 01:35	8,21	5	41,06	CHI
202010106958	PALMEIRAS DE GOIAS	PL21132236	PALMEIRAS	19/10/2020 17:24	20/10/2020 08:37	19/10/2020 17:24	20/10/2020 08:37	15,21	1	15,21	CHI
202010107337	ARAGARCAS	AG11212886	ARAGARCAS	19/10/2020 17:24	19/10/2020 23:31	19/10/2020 17:24	19/10/2020 23:31	6,10	75	457,79	CHI
202010107646	SANTA FE DE GOIAS	IU13259756	MATRINCHA	19/10/2020 17:26	20/10/2020 03:45	19/10/2020 17:26	20/10/2020 03:45	10,33	12	123,94	CHI
202010107646	ITAPIRAPUA	IU13259756	MATRINCHA	19/10/2020 17:26	20/10/2020 03:45	19/10/2020 17:26	20/10/2020 03:45	10,33	392	4048,60	CHI
202010107646	ITAPIRAPUA	IU13259756	MATRINCHA	19/10/2020 17:26	20/10/2020 03:45	19/10/2020 17:26	20/10/2020 03:45	10,33	43	444,11	CHI
202010108124	DOVERLANDIA	DV12138342	CAIAPONIA	19/10/2020 17:26	21/10/2020 02:28	19/10/2020 17:26	21/10/2020 02:28	33,03	9	297,29	CHI
202010107419	CORREGO DO OURO	CO12040569	SAO LUIZ DOS MONTES BELOS	19/10/2020 17:28	20/10/2020 10:46	19/10/2020 17:28	20/10/2020 10:46	17,29	3	51,88	CHI
202010108285	CAIAPONIA	CP12243821	CAIAPONIA	19/10/2020 17:29	20/10/2020 20:30	19/10/2020 17:29	20/10/2020 20:30	27,00	15	405,03	CHI
202010107018	QUIRINOPOLIS	10009308375	QUIRINOPOLIS	19/10/2020 17:31	20/10/2020 03:54	19/10/2020 17:31	20/10/2020 03:54	10,37	1	10,37	CHI
202010107019	JARAGUA	10029149574	JARAGUA	19/10/2020 17:31	20/10/2020 13:49	19/10/2020 17:31	20/10/2020 13:49	20,28	1	20,28	CHI
202010107042	PLANALTINA	PI12324319	SAO JOAO D ALIANCA	19/10/2020 17:32	19/10/2020 20:06	19/10/2020 17:32	19/10/2020 20:06	2,56	6	15,35	CHI
202010107078	QUIRINOPOLIS	QI12198335	QUIRINOPOLIS	19/10/2020 17:33	19/10/2020 19:39	19/10/2020 17:33	19/10/2020 19:39	2,09	3	6,28	CHI
202010107031	SAO JOAO D ALIANCA	JL21373613	FLORES DE GOIAS	19/10/2020 17:33	20/10/2020 16:20	19/10/2020 17:33	20/10/2020 16:20	22,77	1	22,77	CHI
202010107256	ALTO PARAISO DE GOIAS	BF12129915	FLORES DE GOIAS	19/10/2020 17:35	19/10/2020 19:46	19/10/2020 17:35	19/10/2020 19:46	2,18	24	52,34	CHI
202010107067	RIO VERDE	630377893	RIO VERDE S2	19/10/2020 17:36	19/10/2020 20:40	19/10/2020 17:36	19/10/2020 20:40	3,07	1	3,07	CHI
202010107071	ANAPOLIS	10007238647	JUNDIAI S1	19/10/2020 17:37	20/10/2020 14:31	19/10/2020 17:37	20/10/2020 14:31	20,90	1	20,90	CHI
202010114283	DOVERLANDIA	MY12219553	PARQUE DAS EMAS	19/10/2020 17:38	20/10/2020 23:07	19/10/2020 17:38	20/10/2020 23:07	29,48	47	1385,42	CHI
202010107781	ABADIANIA	00050294	ANAPOLIS UNIVERSITARIO S2	19/10/2020 17:38	20/10/2020 16:26	20/10/2020 16:21	20/10/2020 16:26	0,09	365	32,24	CHI
202010107781	CORUMBA DE GOIAS	00050294	ANAPOLIS UNIVERSITARIO S2	19/10/2020 17:38	20/10/2020 16:26	20/10/2020 16:21	20/10/2020 16:26	0,09	1	0,09	CHI
202010107781	ANAPOLIS	00050294	ANAPOLIS UNIVERSITARIO S2	19/10/2020 17:38	20/10/2020 16:26	20/10/2020 16:21	20/10/2020 16:26	0,09	2171	191,77	CHI
202010107781	ANAPOLIS	00050294	ANAPOLIS UNIVERSITARIO S2	19/10/2020 17:38	20/10/2020 16:26	20/10/2020 16:21	20/10/2020 16:26	0,09	3113	274,98	CHI
202010107781	ANAPOLIS	00050294	ANAPOLIS UNIVERSITARIO S2	19/10/2020 17:38	20/10/2020 16:26	20/10/2020 16:21	20/10/2020 16:26	0,09	10313	910,98	CHI
202010107781	ANAPOLIS	00050294	ANAPOLIS UNIVERSITARIO S2	19/10/2020 17:38	20/10/2020 16:26	20/10/2020 16:21	20/10/2020 16:26	0,09	959	84,71	CHI
202010107781	CAMPO LIMPO	AN16401571	ANAPOLIS UNIVERSITARIO S2	19/10/2020 17:38	20/10/2020 16:26	19/10/2020 17:53	20/10/2020 11:41	17,80	1	17,80	CHI
202010107781	ANAPOLIS	AN16401571	ANAPOLIS UNIVERSITARIO S2	19/10/2020 17:38	20/10/2020 16:26	19/10/2020 17:53	20/10/2020 11:41	17,80	132	2348,98	CHI
202010107781	ANAPOLIS	AN16404672	ANAPOLIS UNIVERSITARIO S2	19/10/2020 17:38	20/10/2020 16:26	20/10/2020 02:19	20/10/2020 02:27	0,13	797	106,27	CHI
202010107781	PIRENOPOLIS	AN16404672	ANAPOLIS UNIVERSITARIO S2	19/10/2020 17:38	20/10/2020 16:26	20/10/2020 02:19	20/10/2020 02:27	0,13	30	4,00	CHI
202010107781	ABADIANIA	AN16404672	ANAPOLIS UNIVERSITARIO S2	19/10/2020 17:38	20/10/2020 16:26	20/10/2020 02:19	20/10/2020 02:27	0,13	18	2,40	CHI
202010107781	ANAPOLIS	AN13384950B	ANAPOLIS UNIVERSITARIO S2	19/10/2020 17:38	20/10/2020 16:26	20/10/2020 02:19	20/10/2020 02:27	0,13	197	26,10	CHI

202010107781	CAMPO LIMPO	AN13384950B	ANAPOLIS UNIVERSITARIO S2	19/10/2020 17:38	20/10/2020 16:26	20/10/2020 02:19	20/10/2020 02:27	0,13	9	1,19	CHI
202010107781	ABADIANIA	AN16401592	ANAPOLIS UNIVERSITARIO S2	19/10/2020 17:38	20/10/2020 16:26	20/10/2020 01:34	20/10/2020 01:38	0,06	18	1,15	CHI
202010107781	PIRENOPOLIS	AN16401592	ANAPOLIS UNIVERSITARIO S2	19/10/2020 17:38	20/10/2020 16:26	20/10/2020 01:34	20/10/2020 01:38	0,06	30	1,92	CHI
202010107781	CAMPO LIMPO	AN16401592	ANAPOLIS UNIVERSITARIO S2	19/10/2020 17:38	20/10/2020 16:26	20/10/2020 01:34	20/10/2020 01:38	0,06	9	0,58	CHI
202010107781	ANAPOLIS	AN16401592	ANAPOLIS UNIVERSITARIO S2	19/10/2020 17:38	20/10/2020 16:26	20/10/2020 01:34	20/10/2020 01:38	0,06	994	63,78	CHI
202010107781	ANAPOLIS	AN16407972	ANAPOLIS UNIVERSITARIO S2	19/10/2020 17:38	20/10/2020 16:26	19/10/2020 17:53	19/10/2020 21:39	3,77	24	90,45	CHI
202010107781	CAMPO LIMPO	AN16407972	ANAPOLIS UNIVERSITARIO S2	19/10/2020 17:38	20/10/2020 16:26	19/10/2020 17:53	19/10/2020 21:39	3,77	1	3,77	CHI
202010107781	ANAPOLIS	AN10408191	ANAPOLIS UNIVERSITARIO S2	19/10/2020 17:38	20/10/2020 16:26	19/10/2020 17:53	19/10/2020 21:06	3,23	1195	3856,53	CHI
202010107781	ANAPOLIS	AN16407973	ANAPOLIS UNIVERSITARIO S2	19/10/2020 17:38	20/10/2020 16:26	19/10/2020 18:23	19/10/2020 21:01	2,64	452	1193,41	CHI
202010107781	ABADIANIA	AN16401592	ANAPOLIS UNIVERSITARIO S2	19/10/2020 17:38	20/10/2020 16:26	19/10/2020 17:53	19/10/2020 20:29	2,60	18	46,88	CHI
202010107781	ANAPOLIS	AN16401592	ANAPOLIS UNIVERSITARIO S2	19/10/2020 17:38	20/10/2020 16:26	19/10/2020 17:53	19/10/2020 20:29	2,60	994	2588,82	CHI
202010107781	PIRENOPOLIS	AN16401592	ANAPOLIS UNIVERSITARIO S2	19/10/2020 17:38	20/10/2020 16:26	19/10/2020 17:53	19/10/2020 20:29	2,60	30	78,13	CHI
202010107781	CAMPO LIMPO	AN16401592	ANAPOLIS UNIVERSITARIO S2	19/10/2020 17:38	20/10/2020 16:26	19/10/2020 17:53	19/10/2020 20:29	2,60	9	23,44	CHI
202010107781	CAMPO LIMPO	AN16414798	ANAPOLIS UNIVERSITARIO S2	19/10/2020 17:38	20/10/2020 16:26	19/10/2020 18:23	19/10/2020 20:28	2,09	7	14,62	CHI
202010107781	ANAPOLIS	AN16414798	ANAPOLIS UNIVERSITARIO S2	19/10/2020 17:38	20/10/2020 16:26	19/10/2020 18:23	19/10/2020 20:28	2,09	1241	2591,62	CHI
202010107781	ANAPOLIS	AN16411431	ANAPOLIS UNIVERSITARIO S2	19/10/2020 17:38	20/10/2020 16:26	19/10/2020 19:17	19/10/2020 19:54	0,61	1477	904,25	CHI
202010107781	ANAPOLIS	AN10384950	ANAPOLIS UNIVERSITARIO S2	19/10/2020 17:38	20/10/2020 16:26	19/10/2020 18:35	19/10/2020 19:00	0,41	1477	608,44	CHI
202010107781	ANAPOLIS	AN16414798	ANAPOLIS UNIVERSITARIO S2	19/10/2020 17:38	20/10/2020 16:26	19/10/2020 17:53	19/10/2020 18:18	0,41	1693	697,89	CHI
202010107781	CAMPO LIMPO	AN16414798	ANAPOLIS UNIVERSITARIO S2	19/10/2020 17:38	20/10/2020 16:26	19/10/2020 17:53	19/10/2020 18:18	0,41	7	2,89	CHI
202010107781	ANAPOLIS	AN16414798	ANAPOLIS UNIVERSITARIO S2	19/10/2020 17:38	20/10/2020 16:26	19/10/2020 17:38	19/10/2020 17:44	0,10	10	0,99	CHI
202010107781	ANAPOLIS	AN16401593	ANAPOLIS UNIVERSITARIO S2	19/10/2020 17:38	20/10/2020 16:26	19/10/2020 17:38	19/10/2020 17:42	0,06	279	16,97	CHI
202010107781	ANAPOLIS	AN16407075	ANAPOLIS UNIVERSITARIO S2	19/10/2020 17:38	20/10/2020 16:26	19/10/2020 17:38	19/10/2020 17:42	0,06	10429	625,74	CHI
202010107094	RIO VERDE	RV11213463	RIO VERDE S2	19/10/2020 17:39	19/10/2020 22:16	19/10/2020 17:39	19/10/2020 22:16	4,62	135	623,21	CHI
202010107111	ANAPOLIS	21268885	ANAPOLIS UNIVERSITARIO S1	19/10/2020 17:40	20/10/2020 16:10	19/10/2020 17:40	20/10/2020 16:10	22,49	1	22,49	CHI
202010107164	FORMOSA	FA11000021	ITUIQUIRA	19/10/2020 17:42	19/10/2020 19:36	19/10/2020 17:42	19/10/2020 19:36	1,89	49	92,62	CHI
202010107915	ANAPOLIS	AN11051291	ANAPOLIS UNIVERSITARIO S1	19/10/2020 17:44	19/10/2020 23:02	19/10/2020 17:44	19/10/2020 23:02	5,29	125	660,87	CHI
202010108039	JARAGUA	JA12273265	JARAGUA	19/10/2020 17:46	20/10/2020 08:30	19/10/2020 17:46	20/10/2020 08:30	14,73	17	250,33	CHI
202010107172	ANAPOLIS	20938755	JUNDIAI S1	19/10/2020 17:47	20/10/2020 12:30	19/10/2020 17:47	20/10/2020 12:30	18,71	1	18,71	CHI
202010107190	JARAGUA	JA21034847	JARAGUA	19/10/2020 17:50	20/10/2020 19:16	19/10/2020 17:50	20/10/2020 19:16	25,43	1	25,43	CHI
202010107195	ITABERAÍ	IB11274215	ITABERAÍ S2	19/10/2020 17:50	19/10/2020 19:16	19/10/2020 17:50	19/10/2020 19:16	1,42	89	126,80	CHI
202010108472	GAMELEIRA DE GOIAS	SV12278872	DAIA S2	19/10/2020 17:52	20/10/2020 11:15	19/10/2020 17:52	20/10/2020 11:15	17,37	36	625,35	CHI
202010107214	CACHEOEIRA ALTA	Q113251539	QUIRINOPOLIS	19/10/2020 17:52	20/10/2020 00:37	19/10/2020 17:52	20/10/2020 00:37	6,74	33	222,45	CHI
202010107214	RIO VERDE	Q113251539	QUIRINOPOLIS	19/10/2020 17:52	20/10/2020 00:37	19/10/2020 17:52	20/10/2020 00:37	6,74	91	613,42	CHI
202010107214	QUIRINOPOLIS	Q113251539	QUIRINOPOLIS	19/10/2020 17:52	20/10/2020 00:37	19/10/2020 17:52	20/10/2020 00:37	6,74	83	559,49	CHI
202010107214	QUIRINOPOLIS	Q113301521	QUIRINOPOLIS	19/10/2020 17:52	20/10/2020 00:37	19/10/2020 17:52	20/10/2020 00:19	6,45	277	1785,34	CHI
202010107214	RIO VERDE	Q113301521	QUIRINOPOLIS	19/10/2020 17:52	20/10/2020 00:37	19/10/2020 17:52	20/10/2020 00:19	6,45	43	277,15	CHI
202010107231	QUIRINOPOLIS	Q121279790	QUIRINOPOLIS	19/10/2020 17:54	20/10/2020 21:45	19/10/2020 17:54	20/10/2020 21:45	27,84	2	55,69	CHI
202010107593	QUIRINOPOLIS	Q112240357	QUIRINOPOLIS	19/10/2020 17:54	19/10/2020 19:33	19/10/2020 17:54	19/10/2020 19:33	1,65	630	1037,58	CHI
202010107246	SAO JOAO DA PARAUNA	PU112361883	PARAUNA	19/10/2020 17:55	19/10/2020 20:08	19/10/2020 17:55	19/10/2020 20:08	2,21	4	8,84	CHI
202010107270	IPORA	730085960	IPORA	19/10/2020 17:57	20/10/2020 12:20	19/10/2020 17:57	20/10/2020 12:20	18,38	1	18,38	CHI
202010108392	CASTELANDIA	Q112370150	QUIRINOPOLIS	19/10/2020 17:58	19/10/2020 20:49	19/10/2020 17:58	19/10/2020 20:49	2,84	2	5,67	CHI
202010108392	QUIRINOPOLIS	Q112370150	QUIRINOPOLIS	19/10/2020 17:58	19/10/2020 20:49	19/10/2020 17:58	19/10/2020 20:49	2,84	47	133,35	CHI
202010108392	RIO VERDE	Q112370150	QUIRINOPOLIS	19/10/2020 17:58	19/10/2020 20:49	19/10/2020 17:58	19/10/2020 20:49	2,84	1	2,84	CHI
202010108037	BOM JARDIM DE GOIAS	BM12349615	BOM JARDIM	19/10/2020 17:58	20/10/2020 19:45	19/10/2020 17:58	20/10/2020 19:45	25,77	16	412,28	CHI
202010107317	GOIANESIA	GE12384191	GOIANESIA S2	19/10/2020 18:00	21/10/2020 09:57	19/10/2020 18:00	21/10/2020 09:57	39,94	4	159,74	CHI
202010107497	ACREUNA	EU12403890	ACREUNA	19/10/2020 18:01	19/10/2020 21:38	19/10/2020 18:01	19/10/2020 21:38	3,62	15	54,25	CHI
202010107335	SAO LUIS DE MONTES BELOS	10019946170	SAO LUIZ DOS MONTES BELOS	19/10/2020 18:02	19/10/2020 19:45	19/10/2020 18:02	19/10/2020 19:45	1,72	1	1,72	CHI
202010107341	BOM JESUS DE GOIAS	BJ21305407	BOM JESUS DE GOIAS	19/10/2020 18:02	19/10/2020 20:58	19/10/2020 18:02	19/10/2020 20:58	2,92	1	2,92	CHI
202010108673	CHAPADAO DO CEU	DJ112160236	CHAPADAO DO CEU	19/10/2020 18:03	20/10/2020 12:56	19/10/2020 18:03	20/10/2020 12:56	18,89	11	207,78	CHI
202010107516	SAO JOAO D ALIANCA	JL12383338	SAO JOAO D ALIANCA	19/10/2020 18:04	19/10/2020 23:43	19/10/2020 18:04	19/10/2020 23:43	5,64	39	219,80	CHI
202010107398	FLORES DE GOIAS	FB21410001	FLORES DE GOIAS	19/10/2020 18:08	20/10/2020 07:40	19/10/2020 18:08	20/10/2020 07:40	13,53	1	13,53	CHI

202010107410	ANAPOLIS	20389723	JUNDIAI S2	19/10/2020 18:09	20/10/2020 16:28	19/10/2020 18:09	20/10/2020 16:28	22,31	1	22,31	CHI
202010107442	ANAPOLIS	AN21210807	ANAPOLIS UNIVERSITARIO S2	19/10/2020 18:11	20/10/2020 09:34	19/10/2020 18:11	20/10/2020 09:34	15,37	1	15,37	CHI
202010107461	CALDAS NOVAS	CN11037876	SERRA DE CALDAS	19/10/2020 18:14	20/10/2020 00:27	19/10/2020 18:14	20/10/2020 00:27	6,21	217	1347,45	CHI
202010107852	PIRENOPOLIS	PV12000004	CORUMBA	19/10/2020 18:15	20/10/2020 11:17	19/10/2020 18:15	20/10/2020 11:17	17,03	15	255,45	CHI
202010107485	CACHOEIRA DOURADA	CD21240028	CACHOEIRA DOURADA	19/10/2020 18:15	19/10/2020 19:01	19/10/2020 18:15	19/10/2020 19:01	0,75	2	1,51	CHI
202010107487	CAMPO ALEGRE DE GOIAS	CM11039867	CAMPO ALEGRE DE GOIAS	19/10/2020 18:16	20/10/2020 02:14	19/10/2020 18:16	20/10/2020 02:14	7,96	92	732,63	CHI
202010108699	QUIRINOPOLIS	QI11018008	QUIRINOPOLIS	19/10/2020 18:16	20/10/2020 00:57	19/10/2020 18:16	20/10/2020 00:57	6,67	95	634,10	CHI
202010108623	GUARAITA	IK12299436	ITAPURANGA	19/10/2020 18:17	19/10/2020 23:29	19/10/2020 18:17	19/10/2020 23:29	5,20	15	77,98	CHI
202010107506	SAO LUIS DE MONTES BELOS	500123380	SAO LUIZ DOS MONTES BELOS	19/10/2020 18:18	19/10/2020 20:32	19/10/2020 18:18	19/10/2020 20:32	2,23	1	2,23	CHI
202010107611	ANAPOLIS	AN11198704	JUNDIAI S2	19/10/2020 18:18	19/10/2020 22:19	19/10/2020 18:18	19/10/2020 22:19	4,01	131	525,75	CHI
202010108921	ANAPOLIS	AN11000274	JUNDIAI S2	19/10/2020 18:19	19/10/2020 21:39	19/10/2020 18:19	19/10/2020 21:39	3,33	88	293,02	CHI
202010107987	RIO VERDE	RV12303552LD	SANTA HELENA S1	19/10/2020 18:23	21/10/2020 19:07	19/10/2020 18:23	21/10/2020 19:07	48,74	4	194,96	CHI
202010107987	RIO VERDE	RV18301218TS	SANTA HELENA S1	19/10/2020 18:23	21/10/2020 19:07	19/10/2020 18:23	21/10/2020 18:43	48,34	1	48,34	CHI
202010107987	SANTA HELENA DE GOIAS	RV10407548	SANTA HELENA S1	19/10/2020 18:23	21/10/2020 19:07	21/10/2020 18:14	21/10/2020 18:43	0,48	1	0,48	CHI
202010107987	RIO VERDE	RV10407548	SANTA HELENA S1	19/10/2020 18:23	21/10/2020 19:07	21/10/2020 18:14	21/10/2020 18:43	0,48	614	296,94	CHI
202010107987	QUIRINOPOLIS	RV10407548	SANTA HELENA S1	19/10/2020 18:23	21/10/2020 19:07	21/10/2020 18:14	21/10/2020 18:43	0,48	44	21,28	CHI
202010107987	QUIRINOPOLIS	RV18301218TS	SANTA HELENA S1	19/10/2020 18:23	21/10/2020 19:07	19/10/2020 18:23	20/10/2020 14:49	20,43	39	796,89	CHI
202010107987	RIO VERDE	RV18301218TS	SANTA HELENA S1	19/10/2020 18:23	21/10/2020 19:07	19/10/2020 18:23	20/10/2020 14:49	20,43	14	286,06	CHI
202010108286	DOVERLANDIA	DV21144444	CAIAPONIA	19/10/2020 18:25	20/10/2020 23:20	19/10/2020 18:25	20/10/2020 23:20	28,92	1	28,92	CHI
202010109003	PIRENOPOLIS	PV12062894	SAO FRANCISCO DE GOIAS	19/10/2020 18:25	20/10/2020 08:13	19/10/2020 18:25	20/10/2020 08:13	13,80	22	303,50	CHI
202010109003	PETROLINA DE GOIAS	PV12062894	SAO FRANCISCO DE GOIAS	19/10/2020 18:25	20/10/2020 08:13	19/10/2020 18:25	20/10/2020 08:13	13,80	3	41,39	CHI
202010107576	ITABERAI	IB12210464	ITABERAI S1	19/10/2020 18:26	19/10/2020 22:37	19/10/2020 18:26	19/10/2020 22:37	4,18	4	16,71	CHI
202010108048	ANAPOLIS	AN11135749	ANAPOLIS UNIVERSITARIO S1	19/10/2020 18:27	19/10/2020 20:19	19/10/2020 18:27	19/10/2020 20:19	1,86	124	231,23	CHI
202010107742	ANAPOLIS	AN11000190	ANAPOLIS UNIVERSITARIO S1	19/10/2020 18:28	19/10/2020 22:35	19/10/2020 18:28	19/10/2020 22:35	4,11	153	628,15	CHI
202010107751	MINEIROS	MY11341152	PARQUE DAS EMAS	19/10/2020 18:30	19/10/2020 21:41	19/10/2020 18:30	19/10/2020 21:41	3,18	86	273,67	CHI
202010109422	ANAPOLIS	20557802	JUNDIAI S1	19/10/2020 18:30	20/10/2020 11:38	19/10/2020 18:30	20/10/2020 11:38	17,13	1	17,13	CHI
202010107654	ISRAELANDIA	IS21074016	IPORA	19/10/2020 18:30	20/10/2020 02:24	19/10/2020 18:30	20/10/2020 02:24	7,90	1	7,90	CHI
202010107653	RIO VERDE	630470698	RIO VERDE S1	19/10/2020 18:30	19/10/2020 20:16	19/10/2020 18:30	19/10/2020 20:16	1,76	1	1,76	CHI
202010107665	GOIAS	10009316505	GOIAS	19/10/2020 18:31	20/10/2020 16:14	19/10/2020 18:31	20/10/2020 16:14	21,71	1	21,71	CHI
202010107899	ANAPOLIS	AN11000145	ANAPOLIS UNIVERSITARIO S2	19/10/2020 18:31	20/10/2020 11:18	19/10/2020 18:31	20/10/2020 11:18	16,78	137	2298,40	CHI
202010107305	ANAPOLIS	AN11166254	JUNDIAI S1	19/10/2020 18:32	19/10/2020 19:33	19/10/2020 18:32	19/10/2020 19:33	1,00	132	132,29	CHI
202010107700	ANAPOLIS	21103963	JUNDIAI S1	19/10/2020 18:33	20/10/2020 10:26	19/10/2020 18:33	20/10/2020 10:26	15,87	1	15,87	CHI
202010107709	QUIRINOPOLIS	QI21072109	QUIRINOPOLIS	19/10/2020 18:34	20/10/2020 00:00	19/10/2020 18:34	20/10/2020 00:00	5,43	1	5,43	CHI
202010107716	ACREUNA	2440068567	ACREUNA	19/10/2020 18:34	20/10/2020 00:03	19/10/2020 18:34	20/10/2020 00:03	5,49	1	5,49	CHI
202010107722	ANAPOLIS	21350840	ANAPOLIS UNIVERSITARIO S2	19/10/2020 18:34	20/10/2020 20:56	19/10/2020 18:34	20/10/2020 20:56	26,35	1	26,35	CHI
202010107730	CALDAS NOVAS	CN21182865	VILA CORUMBA	19/10/2020 18:35	19/10/2020 20:07	19/10/2020 18:35	19/10/2020 20:07	1,53	1	1,53	CHI
202010107741	LEOPOLDO DE BULHOES	LB21242347	DAIA S2	19/10/2020 18:35	19/10/2020 19:46	19/10/2020 18:35	19/10/2020 19:46	1,17	1	1,17	CHI
202010107756	ANAPOLIS	10004615628	ANAPOLIS UNIVERSITARIO S2	19/10/2020 18:36	20/10/2020 15:07	19/10/2020 18:36	20/10/2020 15:07	20,51	1	20,51	CHI
202010107776	ANAPOLIS	10029003820	ANAPOLIS UNIVERSITARIO S2	19/10/2020 18:37	20/10/2020 15:21	19/10/2020 18:37	20/10/2020 15:21	20,74	1	20,74	CHI
202010107804	GOIANESIA	550092470	GOIANESIA S2	19/10/2020 18:39	20/10/2020 23:17	19/10/2020 18:39	20/10/2020 23:17	28,62	1	28,62	CHI
202010107817	ANAPOLIS	21295827	ANAPOLIS UNIVERSITARIO S2	19/10/2020 18:40	20/10/2020 19:49	19/10/2020 18:40	20/10/2020 19:49	25,16	1	25,16	CHI
202010107839	LEOPOLDO DE BULHOES	LB21279316	DAIA S2	19/10/2020 18:41	19/10/2020 20:19	19/10/2020 18:41	19/10/2020 20:19	1,63	1	1,63	CHI
202010107859	MONTES CLAROS DE GOIAS	ME21210018	IPORA	19/10/2020 18:42	20/10/2020 13:58	19/10/2020 18:42	20/10/2020 13:58	19,26	2	38,52	CHI
202010108365	MINEIROS	MY11337056	PARQUE DAS EMAS	19/10/2020 18:42	20/10/2020 01:49	19/10/2020 18:42	20/10/2020 01:49	7,10	65	461,64	CHI
202010163665	ANAPOLIS	AN16416865	ANAPOLIS UNIVERSITARIO S2	19/10/2020 18:43	19/10/2020 20:52	19/10/2020 18:43	19/10/2020 20:52	2,16	425	919,18	CHI
202010163665	ANAPOLIS	AN16411666	ANAPOLIS UNIVERSITARIO S2	19/10/2020 18:43	19/10/2020 20:52	19/10/2020 18:43	19/10/2020 19:38	0,92	752	691,63	CHI
202010163665	ANAPOLIS	AN10411434	ANAPOLIS UNIVERSITARIO S2	19/10/2020 18:43	19/10/2020 20:52	19/10/2020 18:43	19/10/2020 19:36	0,89	730	651,52	CHI
202010163665	ANAPOLIS	AN16413911	ANAPOLIS UNIVERSITARIO S2	19/10/2020 18:43	19/10/2020 20:52	19/10/2020 18:43	19/10/2020 19:34	0,86	803	691,92	CHI
202010163665	ANAPOLIS	AN10383720	ANAPOLIS UNIVERSITARIO S2	19/10/2020 18:43	19/10/2020 20:52	19/10/2020 18:43	19/10/2020 18:53	0,17	960	164,27	CHI
202010163665	ANAPOLIS	AN10394592	ANAPOLIS UNIVERSITARIO S1	19/10/2020 18:43	19/10/2020 20:52	19/10/2020 18:43	19/10/2020 18:52	0,15	939	143,20	CHI
202010107883	GOIATUBA	GT21335328	GOIATUBA S2	19/10/2020 18:44	19/10/2020 23:19	19/10/2020 18:44	19/10/2020 23:19	4,58	1	4,58	CHI

202010108397	MOSSAMEDES	SC12003889	FIRMINOPOLIS S2	19/10/2020 18:44	20/10/2020 13:52	19/10/2020 18:44	20/10/2020 13:52	19,12	5	95,59	CHI
202010108397	ADELANDIA	SC12003889	FIRMINOPOLIS S2	19/10/2020 18:44	20/10/2020 13:52	19/10/2020 18:44	20/10/2020 13:52	19,12	24	458,83	CHI
202010108397	SANCLERLANDIA	SC12003889	FIRMINOPOLIS S2	19/10/2020 18:44	20/10/2020 13:52	19/10/2020 18:44	20/10/2020 13:52	19,12	17	325,00	CHI
202010108299	SANTO ANTONIO DO DESCOBERTO	SN12382252	ALEXANIA	19/10/2020 18:45	19/10/2020 20:19	19/10/2020 18:45	19/10/2020 20:19	1,55	10	15,54	CHI
202010107903	ANAPOLIS	SV21211764	DAIA S2	19/10/2020 18:46	20/10/2020 23:18	19/10/2020 18:46	20/10/2020 23:18	28,52	1	28,52	CHI
202010107933	PIRACANJUBA	60020994	PIRACANJUBA	19/10/2020 18:48	19/10/2020 21:07	19/10/2020 18:48	19/10/2020 21:07	2,31	1	2,31	CHI
202010107938	IPAMERI	IP21234078	IPAMERI	19/10/2020 18:48	19/10/2020 22:05	19/10/2020 18:48	19/10/2020 22:05	3,28	1	3,28	CHI
202010108517	ANAPOLIS	AN11319625	JUNDIAI S2	19/10/2020 18:48	20/10/2020 02:21	19/10/2020 18:48	20/10/2020 02:21	7,53	46	346,61	CHI
202010107946	RIO VERDE	630153255	RIO VERDE S1	19/10/2020 18:48	20/10/2020 00:32	19/10/2020 18:48	20/10/2020 00:32	5,72	1	5,72	CHI
202010107949	ALTO PARAISO DE GOIAS	BF12096495	SAO JOAO D ALIANCA	19/10/2020 18:49	20/10/2020 08:20	19/10/2020 18:49	20/10/2020 08:20	13,52	7	94,61	CHI
202010109069	ARAGARCAS	1820068150	ARAGARCAS	19/10/2020 18:49	20/10/2020 09:40	19/10/2020 18:49	20/10/2020 09:40	14,84	1	14,84	CHI
202010107959	ARAGARCAS	AG11000003	ARAGARCAS	19/10/2020 18:49	20/10/2020 05:45	19/10/2020 18:49	20/10/2020 05:45	10,93	29	316,89	CHI
202010107959	ARAGARCAS	AG12000003	ARAGARCAS	19/10/2020 18:49	20/10/2020 05:45	19/10/2020 20:56	19/10/2020 21:36	0,66	68	44,97	CHI
202010107972	QUIRINOPOLIS	QI12101212	QUIRINOPOLIS	19/10/2020 18:49	19/10/2020 23:04	19/10/2020 18:49	19/10/2020 23:04	4,24	1	4,24	CHI
202010107974	ALTO PARAISO DE GOIAS	BF21072308	SAO JOAO D ALIANCA	19/10/2020 18:49	19/10/2020 22:49	19/10/2020 18:49	19/10/2020 22:49	3,98	1	3,98	CHI
202010108172	FAZENDA NOVA	FN12066285	JUSSARA	19/10/2020 18:50	20/10/2020 02:24	19/10/2020 18:50	20/10/2020 02:24	7,56	13	98,29	CHI
202010108003	FAINA	FC21278242	GOIAS	19/10/2020 18:51	20/10/2020 07:30	19/10/2020 18:51	20/10/2020 07:30	12,65	1	12,65	CHI
202010108005	PIRENOPOLIS	PV21353238	CORUMBA	19/10/2020 18:51	20/10/2020 15:52	19/10/2020 18:51	20/10/2020 15:52	21,01	1	21,01	CHI
202010108007	PIRENOPOLIS	PV12062557	ANAPOLIS UNIVERSITARIO S2	19/10/2020 18:51	20/10/2020 20:04	19/10/2020 18:51	20/10/2020 20:04	25,21	6	151,23	CHI
202010108024	AGUA FRIA DE GOIAS	TL21322494	SAO JOAO D ALIANCA	19/10/2020 18:52	20/10/2020 21:43	19/10/2020 18:52	20/10/2020 21:43	26,83	3	80,50	CHI
202010108323	ANAPOLIS	AN11008938	JUNDIAI S1	19/10/2020 18:53	19/10/2020 21:11	19/10/2020 18:53	19/10/2020 21:11	2,30	134	307,98	CHI
202010108043	CATALAO	CT21333613	CATALAO S1	19/10/2020 18:53	19/10/2020 20:30	19/10/2020 18:53	19/10/2020 20:30	1,60	1	1,60	CHI
202010108056	PLANALTINA	PI11000003	PLANALTINA	19/10/2020 18:55	19/10/2020 20:19	19/10/2020 18:55	19/10/2020 20:19	1,40	122	170,33	CHI
202010108379	GOUVELANDIA	QI12000140	QUIRINOPOLIS	19/10/2020 18:55	19/10/2020 21:32	19/10/2020 18:55	19/10/2020 21:32	2,62	12	31,41	CHI
202010108061	FORMOSA	610292870	ITIQUEIRA	19/10/2020 18:55	20/10/2020 03:30	19/10/2020 18:55	20/10/2020 03:30	8,58	1	8,58	CHI
202010108396	ARENOPOLIS	AY11193266	ARENOPOLIS	19/10/2020 18:55	20/10/2020 00:16	19/10/2020 18:55	20/10/2020 00:16	5,34	90	480,67	CHI
202010108066	CHAPADAO DO CEU	9880014163	CHAPADAO DO CEU	19/10/2020 18:55	19/10/2020 22:59	19/10/2020 18:55	19/10/2020 22:59	4,06	1	4,06	CHI
202010109327	ANAPOLIS	AN11003275	JUNDIAI S1	19/10/2020 18:55	20/10/2020 00:18	19/10/2020 18:55	20/10/2020 00:18	5,37	154	826,89	CHI
202010108535	VILA BOA	FA12067449	ITIQUEIRA	19/10/2020 18:55	20/10/2020 19:23	19/10/2020 18:55	20/10/2020 19:23	24,45	2	48,90	CHI
202010108535	VILA BOA	FA12164524LD	ITIQUEIRA	19/10/2020 18:55	20/10/2020 19:23	19/10/2020 18:55	20/10/2020 16:45	21,83	1	21,83	CHI
202010108535	FLORES DE GOIAS	FA13361342	ITIQUEIRA	19/10/2020 18:55	20/10/2020 19:23	19/10/2020 23:47	20/10/2020 16:35	16,80	3	50,40	CHI
202010108535	SAO JOAO D ALIANCA	FA13361342	ITIQUEIRA	19/10/2020 18:55	20/10/2020 19:23	19/10/2020 23:47	20/10/2020 16:35	16,80	225	3779,63	CHI
202010108535	VILA BOA	FA13361342	ITIQUEIRA	19/10/2020 18:55	20/10/2020 19:23	19/10/2020 23:47	20/10/2020 16:35	16,80	6	100,79	CHI
202010108535	FORMOSA	FA13361342	ITIQUEIRA	19/10/2020 18:55	20/10/2020 19:23	19/10/2020 23:47	20/10/2020 16:35	16,80	584	9810,23	CHI
202010108535	VILA BOA	FA12146215	ITIQUEIRA	19/10/2020 18:55	20/10/2020 19:23	19/10/2020 18:55	20/10/2020 16:10	21,24	2	42,47	CHI
202010108535	VILA BOA	FA12065577	ITIQUEIRA	19/10/2020 18:55	20/10/2020 19:23	19/10/2020 18:55	20/10/2020 15:59	21,06	2	42,12	CHI
202010108535	VILA BOA	VB13383253	ITIQUEIRA	19/10/2020 18:55	20/10/2020 19:23	20/10/2020 05:38	20/10/2020 15:28	9,83	3	29,49	CHI
202010108535	VILA BOA	FA10410992	ITIQUEIRA	19/10/2020 18:55	20/10/2020 19:23	20/10/2020 08:08	20/10/2020 08:41	0,55	199	110,00	CHI
202010108535	FORMOSA	FA10410992	ITIQUEIRA	19/10/2020 18:55	20/10/2020 19:23	20/10/2020 08:08	20/10/2020 08:41	0,55	1003	554,44	CHI
202010108535	VILA BOA	FA10401450	ITIQUEIRA	19/10/2020 18:55	20/10/2020 19:23	20/10/2020 05:38	20/10/2020 05:44	0,10	192	18,72	CHI
202010108535	FORMOSA	FA10401450	ITIQUEIRA	19/10/2020 18:55	20/10/2020 19:23	20/10/2020 05:38	20/10/2020 05:44	0,10	586	57,13	CHI
202010108535	FORMOSA	FA10401450	ITIQUEIRA	19/10/2020 18:55	20/10/2020 19:23	20/10/2020 00:56	20/10/2020 01:15	0,32	586	186,54	CHI
202010108535	VILA BOA	FA10401450	ITIQUEIRA	19/10/2020 18:55	20/10/2020 19:23	20/10/2020 00:56	20/10/2020 01:15	0,32	192	61,12	CHI
202010108535	FORMOSA	FA10401450	ITIQUEIRA	19/10/2020 18:55	20/10/2020 19:23	20/10/2020 00:04	20/10/2020 00:19	0,24	586	141,45	CHI
202010108535	VILA BOA	FA10401450	ITIQUEIRA	19/10/2020 18:55	20/10/2020 19:23	20/10/2020 00:04	20/10/2020 00:19	0,24	192	46,35	CHI
202010108535	FORMOSA	FA10401450	ITIQUEIRA	19/10/2020 18:55	20/10/2020 19:23	19/10/2020 22:03	19/10/2020 22:12	0,16	507	78,59	CHI
202010108535	FORMOSA	FA10410992	ITIQUEIRA	19/10/2020 18:55	20/10/2020 19:23	19/10/2020 18:59	19/10/2020 19:03	0,07	1	0,07	CHI
202010108083	ANAPOLIS	10015234833	ANAPOLIS UNIVERSITARIO S2	19/10/2020 18:56	19/10/2020 23:43	19/10/2020 18:56	19/10/2020 23:43	4,77	1	4,77	CHI
202010108655	PIRENOPOLIS	PV11210827	SAO FRANCISCO DE GOIAS	19/10/2020 18:56	20/10/2020 00:40	19/10/2020 18:56	20/10/2020 00:40	5,72	101	577,61	CHI
202010108521	ANAPOLIS	AN11000157	ANAPOLIS UNIVERSITARIO S2	19/10/2020 18:57	20/10/2020 04:48	19/10/2020 18:57	20/10/2020 04:48	9,85	155	1526,23	CHI
202010108094	ACREUNA	EU21068271	ACREUNA	19/10/2020 18:57	19/10/2020 21:53	19/10/2020 18:57	19/10/2020 21:53	2,92	1	2,92	CHI

202010108102	ARUANA	10013262368	ARUANA	19/10/2020 18:58	20/10/2020 17:48	19/10/2020 18:58	20/10/2020 17:48	22,83	1	22,83	CHI
202010108288	CAIAPONIA	CP12226867	CAIAPONIA	19/10/2020 18:59	19/10/2020 21:19	19/10/2020 18:59	19/10/2020 21:19	2,33	11	25,58	CHI
202010108501	GOIANESIA	GE12360247	GOIANESIA S2	19/10/2020 18:59	19/10/2020 22:17	19/10/2020 18:59	19/10/2020 22:17	3,29	9	29,63	CHI
202010108135	ANAPOLIS	10004161538	ANAPOLIS UNIVERSITARIO S2	19/10/2020 19:00	20/10/2020 00:41	19/10/2020 19:00	20/10/2020 00:41	5,68	1	5,68	CHI
202010108587	AGUA FRIA DE GOIAS	JL12117446	SAO JOAO D ALIANCA	19/10/2020 19:00	19/10/2020 22:31	19/10/2020 19:00	19/10/2020 22:31	3,51	20	70,17	CHI
202010108587	SAO JOAO D ALIANCA	JL12117446	SAO JOAO D ALIANCA	19/10/2020 19:00	19/10/2020 22:31	19/10/2020 19:00	19/10/2020 22:31	3,51	26	91,22	CHI
202010108187	MAIRIPOTABA	MI31060561	PONTALINA	19/10/2020 19:02	19/10/2020 21:58	19/10/2020 19:02	19/10/2020 21:58	2,92	2	5,84	CHI
202010108195	CABECEIRAS	CW21181814	ITIQUEIRA	19/10/2020 19:03	19/10/2020 22:21	19/10/2020 19:03	19/10/2020 22:21	3,30	1	3,30	CHI
202010108401	GOIANESIA	GE11139640	GOIANESIA S2	19/10/2020 19:03	19/10/2020 20:03	19/10/2020 19:03	19/10/2020 20:03	1,00	187	186,12	CHI
202010108226	BOM JARDIM DE GOIAS	BM12065611	BOM JARDIM	19/10/2020 19:04	20/10/2020 01:10	19/10/2020 19:04	20/10/2020 01:10	6,09	4	24,36	CHI
202010108230	PORTELANDIA	PW21196593	PARQUE DAS EMAS	19/10/2020 19:05	21/10/2020 14:22	19/10/2020 19:05	21/10/2020 14:22	43,28	1	43,28	CHI
202010108823	PARAUNA	PU12031500LD	ACREUNA	19/10/2020 19:05	20/10/2020 10:20	19/10/2020 19:05	20/10/2020 10:20	15,24	2	30,48	CHI
202010108823	PARAUNA	PU12301142LD	ACREUNA	19/10/2020 19:05	20/10/2020 10:20	19/10/2020 19:05	20/10/2020 08:19	13,23	3	39,70	CHI
202010108823	PARAUNA	PU12206469	ACREUNA	19/10/2020 19:05	20/10/2020 10:20	20/10/2020 03:36	20/10/2020 05:25	1,82	16	29,13	CHI
202010108823	PARAUNA	PU12206469	ACREUNA	19/10/2020 19:05	20/10/2020 10:20	19/10/2020 19:05	20/10/2020 02:08	7,04	12	84,52	CHI
202010108259	ANAPOLIS	10009739490	ANAPOLIS UNIVERSITARIO S2	19/10/2020 19:06	20/10/2020 02:14	19/10/2020 19:06	20/10/2020 02:14	7,13	1	7,13	CHI
202010108832	JATAI	JT12248447	JATAI S3	19/10/2020 19:06	19/10/2020 21:53	19/10/2020 19:06	19/10/2020 21:53	2,77	2	5,54	CHI
202010108267	SAO JOAO D ALIANCA	JL21314654	SAO JOAO D ALIANCA	19/10/2020 19:07	20/10/2020 09:46	19/10/2020 19:07	20/10/2020 09:46	14,65	1	14,65	CHI
202010108330	ANAPOLIS	AN11130707	JUNDIAI S1	19/10/2020 19:12	20/10/2020 15:47	19/10/2020 19:12	20/10/2020 15:47	20,57	183	3764,16	CHI
202010108364	ANAPOLIS	10016185003	ANAPOLIS UNIVERSITARIO S2	19/10/2020 19:15	20/10/2020 21:34	19/10/2020 19:15	20/10/2020 21:34	26,31	1	26,31	CHI
202010108370	FORMOSA	FA21120062	ITIQUEIRA	19/10/2020 19:15	20/10/2020 10:01	19/10/2020 19:15	20/10/2020 10:01	14,75	1	14,75	CHI
202010108922	FAZENDA NOVA	FN12060710	IPORA	19/10/2020 19:17	20/10/2020 08:55	19/10/2020 19:17	20/10/2020 08:55	13,63	49	667,73	CHI
202010108627	ANAPOLIS	AN12370432	JUNDIAI S2	19/10/2020 19:18	20/10/2020 07:09	19/10/2020 19:18	20/10/2020 07:09	11,85	23	272,46	CHI
202010108422	SAO DOMINGOS	8680004860	SAO DOMINGOS	19/10/2020 19:19	19/10/2020 20:31	19/10/2020 19:19	19/10/2020 20:31	1,19	1	1,19	CHI
202010108559	NIQUELANDIA	NQ11035682	BARRO ALTO	19/10/2020 19:21	20/10/2020 00:00	19/10/2020 19:21	20/10/2020 00:00	4,64	124	575,84	CHI
202010108448	PEROLANDIA	DP11254664	JATAI S1	19/10/2020 19:21	20/10/2020 10:16	19/10/2020 19:21	20/10/2020 10:16	14,91	1	14,91	CHI
202010108473	PIRENOPOLIS	1640001430	SAO FRANCISCO DE GOIAS	19/10/2020 19:22	21/10/2020 00:13	19/10/2020 19:22	21/10/2020 00:13	28,84	1	28,84	CHI
202010108480	FAINA	FC12072196	GOIAS	19/10/2020 19:23	20/10/2020 10:49	19/10/2020 19:23	20/10/2020 10:49	15,43	6	92,58	CHI
202010108496	CATALAO	1990249040	CATALAO S2	19/10/2020 19:24	19/10/2020 20:36	19/10/2020 19:24	19/10/2020 20:36	1,19	1	1,19	CHI
202010108495	PONTALINA	JV12208116	VICENTINOPOLIS	19/10/2020 19:26	20/10/2020 08:40	19/10/2020 19:26	20/10/2020 08:40	13,23	2	26,45	CHI
202010108543	JOVIANIA	570004615	GOIATUBA S1	19/10/2020 19:26	20/10/2020 13:57	19/10/2020 19:26	20/10/2020 13:57	18,51	1	18,51	CHI
202010108968	SERRANOPOLIS	SX12353677	JATAI S1	19/10/2020 19:26	20/10/2020 07:28	19/10/2020 19:26	20/10/2020 07:28	12,02	16	192,28	CHI
202010108640	ANAPOLIS	AN12258749	JUNDIAI S1	19/10/2020 19:28	20/10/2020 08:34	19/10/2020 19:28	20/10/2020 08:34	13,09	15	196,40	CHI
202010108752	JATAI	JT11182134	JATAI S2	19/10/2020 19:28	19/10/2020 20:46	19/10/2020 19:28	19/10/2020 20:46	1,29	96	124,13	CHI
202010108563	CAMPO ALEGRE DE GOIAS	CM12077272	CAMPO ALEGRE DE GOIAS	19/10/2020 19:28	20/10/2020 09:42	19/10/2020 19:28	20/10/2020 09:42	14,23	8	113,80	CHI
202010108569	SANCLERLANDIA	SC12299153	FIRMINOPOLIS S2	19/10/2020 19:29	20/10/2020 12:57	19/10/2020 19:29	20/10/2020 12:57	17,46	4	69,84	CHI
202010108572	CATALAO	CT21250221	CATALAO S2	19/10/2020 19:29	19/10/2020 21:35	19/10/2020 19:29	19/10/2020 21:35	2,09	1	2,09	CHI
202010108595	SANTA RITA DO NOVO DESTINO	BA21339381	BARRO ALTO	19/10/2020 19:31	20/10/2020 13:50	19/10/2020 19:31	20/10/2020 13:50	18,31	1	18,31	CHI
202010108605	FORMOSA	FA21393546	ITIQUEIRA	19/10/2020 19:32	20/10/2020 18:32	19/10/2020 19:32	20/10/2020 18:32	22,99	4	91,95	CHI
202010108607	QUIRINOPOLIS	QI12000316	QUIRINOPOLIS	19/10/2020 19:32	20/10/2020 01:03	19/10/2020 19:32	20/10/2020 01:03	5,50	3	16,51	CHI
202010108613	SAO LUIS DE MONTES BELOS	SL31145761	SAO LUIZ DOS MONTES BELOS	19/10/2020 19:33	20/10/2020 04:33	19/10/2020 19:33	20/10/2020 04:33	9,00	1	9,00	CHI
202010108634	IVOLANDIA	AM12000041	IPORA	19/10/2020 19:36	20/10/2020 17:44	19/10/2020 19:36	20/10/2020 17:44	22,12	2	44,24	CHI
202010108636	ANAPOLIS	10010534278	ANAPOLIS UNIVERSITARIO S2	19/10/2020 19:36	20/10/2020 12:24	19/10/2020 19:36	20/10/2020 12:24	16,79	1	16,79	CHI
202010109066	RIO VERDE	RV12402229	CABRIUVA S2	19/10/2020 19:40	20/10/2020 21:07	19/10/2020 19:40	20/10/2020 21:07	25,44	7	178,08	CHI
202010109066	APARECIDA DO RIO DOCE	RV12402229	CABRIUVA S2	19/10/2020 19:40	20/10/2020 21:07	19/10/2020 19:40	20/10/2020 21:07	25,44	6	152,64	CHI
202010108785	SAO LUIZ DO NORTE	00180434	BARRO ALTO	19/10/2020 19:41	20/10/2020 12:23	19/10/2020 19:41	20/10/2020 12:23	16,71	2	33,42	CHI
202010108785	SANTA RITA DO NOVO DESTINO	00180434	BARRO ALTO	19/10/2020 19:41	20/10/2020 12:23	19/10/2020 19:41	20/10/2020 12:23	16,71	8	133,67	CHI
202010108785	BARRO ALTO	00180434	BARRO ALTO	19/10/2020 19:41	20/10/2020 12:23	19/10/2020 19:41	20/10/2020 12:23	16,71	2	33,42	CHI
202010108785	SANTA RITA DO NOVO DESTINO	00180434	BARRO ALTO	19/10/2020 19:41	20/10/2020 12:23	19/10/2020 19:49	20/10/2020 12:23	16,57	211	3496,56	CHI
202010108785	HIDROLINA	00180434	BARRO ALTO	19/10/2020 19:41	20/10/2020 12:23	19/10/2020 19:49	20/10/2020 12:23	16,57	1	16,57	CHI
202010108785	SAO LUIZ DO NORTE	00180434	BARRO ALTO	19/10/2020 19:41	20/10/2020 12:23	19/10/2020 19:49	20/10/2020 12:23	16,57	13	215,43	CHI

202010108785	SAO LUIZ DO NORTE	00180434	BARRO ALTO	19/10/2020 19:41	20/10/2020 12:23	19/10/2020 19:49	20/10/2020 12:23	16,57	95	1574,28	CHI
202010108785	GOIANESIA	00180434	BARRO ALTO	19/10/2020 19:41	20/10/2020 12:23	19/10/2020 19:49	20/10/2020 12:23	16,57	4	66,29	CHI
202010108785	BARRO ALTO	00180434	BARRO ALTO	19/10/2020 19:41	20/10/2020 12:23	19/10/2020 19:49	20/10/2020 12:23	16,57	22	364,57	CHI
202010108785	NIQUELANDIA	00180434	BARRO ALTO	19/10/2020 19:41	20/10/2020 12:23	20/10/2020 00:07	20/10/2020 00:11	0,07	183	13,22	CHI
202010108785	VILA PROPICIO	00180434	BARRO ALTO	19/10/2020 19:41	20/10/2020 12:23	20/10/2020 00:07	20/10/2020 00:11	0,07	1	0,07	CHI
202010108785	MIMOSO DE GOIAS	00180434	BARRO ALTO	19/10/2020 19:41	20/10/2020 12:23	20/10/2020 00:07	20/10/2020 00:11	0,07	9	0,65	CHI
202010108785	VILA PROPICIO	00180434	BARRO ALTO	19/10/2020 19:41	20/10/2020 12:23	20/10/2020 00:07	20/10/2020 00:11	0,07	51	3,68	CHI
202010108785	VILA PROPICIO	00180434	BARRO ALTO	19/10/2020 19:41	20/10/2020 12:23	20/10/2020 00:07	20/10/2020 00:11	0,07	31	2,24	CHI
202010108785	MIMOSO DE GOIAS	00180434	BARRO ALTO	19/10/2020 19:41	20/10/2020 12:23	20/10/2020 00:07	20/10/2020 00:11	0,07	4	0,29	CHI
202010108785	JANTALANDIA	00180434	BARRO ALTO	19/10/2020 19:41	20/10/2020 12:23	20/10/2020 00:07	20/10/2020 00:11	0,07	1051	75,91	CHI
202010108785	VILA PROPICIO	00180434	BARRO ALTO	19/10/2020 19:41	20/10/2020 12:23	19/10/2020 19:41	19/10/2020 19:52	0,19	1	0,19	CHI
202010108679	DOVERLANDIA	DV11138402	CAIAPONIA	19/10/2020 19:41	21/10/2020 01:34	19/10/2020 19:41	21/10/2020 01:34	29,88	2	59,75	CHI
202010108694	SAO LUIS DE MONTES BELOS	10031816027	SAO LUIZ DOS MONTES BELOS	19/10/2020 19:43	19/10/2020 20:43	19/10/2020 19:43	19/10/2020 20:43	1,00	1	1,00	CHI
202010109260	RIO VERDE	RV12024714	RIO VERDE S1	19/10/2020 19:43	19/10/2020 22:40	19/10/2020 19:43	19/10/2020 22:40	2,94	15	44,17	CHI
202010108720	ANAPOLIS	AN12346439	ANAPOLIS UNIVERSITARIO S2	19/10/2020 19:49	20/10/2020 12:18	19/10/2020 19:49	20/10/2020 12:18	16,48	631	10396,08	CHI
202010110082	MINEIROS	MY12248466	PARQUE DAS EMAS	19/10/2020 19:51	22/10/2020 00:55	19/10/2020 19:51	22/10/2020 00:55	53,05	3	159,16	CHI
202010108736	JANDAIA	JD21328166	PALMEIRAS	19/10/2020 19:52	20/10/2020 17:03	19/10/2020 19:52	20/10/2020 17:03	21,19	1	21,19	CHI
202010109308	PONTALINA	210076860	PONTALINA	19/10/2020 19:53	20/10/2020 00:11	19/10/2020 19:53	20/10/2020 00:11	4,29	1	4,29	CHI
202010110041	JAUPACI	JP12251548	IPORA	19/10/2020 19:55	20/10/2020 15:47	19/10/2020 19:55	20/10/2020 15:47	19,86	3	59,59	CHI
202010109425	ANAPOLIS	AN11166254	JUNDIAI S1	19/10/2020 19:55	20/10/2020 01:11	19/10/2020 19:55	20/10/2020 01:11	5,26	132	693,99	CHI
202010108767	JATAI	290311366	JATAI S2	19/10/2020 19:56	20/10/2020 14:56	19/10/2020 19:56	20/10/2020 14:56	18,99	1	18,99	CHI
202010108958	CASTELANDIA	DM12295950	RIO DOS BOIS	19/10/2020 20:01	19/10/2020 23:56	19/10/2020 20:01	19/10/2020 23:56	3,91	24	93,87	CHI
202010108958	MAURILANDIA	DM12295950	RIO DOS BOIS	19/10/2020 20:01	19/10/2020 23:56	19/10/2020 20:01	19/10/2020 23:56	3,91	1	3,91	CHI
202010108805	PONTALINA	PK21161687	PONTALINA	19/10/2020 20:01	19/10/2020 22:54	19/10/2020 20:01	19/10/2020 22:54	2,87	2	5,74	CHI
202010108810	GOIAS	90061627	GOIAS	19/10/2020 20:03	20/10/2020 11:38	19/10/2020 20:03	20/10/2020 11:38	15,58	0	0,00	CHI
202010108812	GOUVELANDIA	GB21303044	QUIRINOPOLIS	19/10/2020 20:03	19/10/2020 23:37	19/10/2020 20:03	19/10/2020 23:37	3,56	1	3,56	CHI
202010108881	AGUA FRIA DE GOIAS	TL21152808	SAO JOAO D ALIANCA	19/10/2020 20:14	20/10/2020 10:30	19/10/2020 20:14	20/10/2020 10:30	14,25	1	14,25	CHI
202010108889	PALMEIRAS DE GOIAS	PL11323548	PALMEIRAS	19/10/2020 20:16	19/10/2020 21:27	19/10/2020 20:16	19/10/2020 21:27	1,18	89	104,60	CHI
202010110160	CAIAPONIA	PY18040163TS	PALESTINA	19/10/2020 20:17	20/10/2020 09:51	19/10/2020 20:17	20/10/2020 09:51	13,58	46	624,59	CHI
202010110160	PALESTINA DE GOIAS	PY18040163TS	PALESTINA	19/10/2020 20:17	20/10/2020 09:51	19/10/2020 20:17	20/10/2020 09:51	13,58	102	1384,96	CHI
202010108907	PLANALTINA	2960234656	PLANALTINA	19/10/2020 20:19	19/10/2020 22:10	19/10/2020 20:19	19/10/2020 22:10	1,84	1	1,84	CHI
202010109296	PALESTINA DE GOIAS	PY18223011TS	PALESTINA	19/10/2020 20:19	20/10/2020 02:46	19/10/2020 20:19	20/10/2020 02:46	6,45	115	741,97	CHI
202010108911	ANAPOLIS	20648110	ANAPOLIS UNIVERSITARIO S1	19/10/2020 20:20	20/10/2020 10:18	19/10/2020 20:20	20/10/2020 10:18	13,97	1	13,97	CHI
202010109765	FORMOSA	FA12051040	ITUIQUIRA	19/10/2020 20:20	20/10/2020 10:14	19/10/2020 20:20	20/10/2020 10:14	13,88	11	152,73	CHI
202010109423	ANAPOLIS	20690393	JUNDIAI S1	19/10/2020 20:21	20/10/2020 20:52	19/10/2020 20:21	20/10/2020 20:52	24,51	1	24,51	CHI
202010108918	SAO JOAO D ALIANCA	JL21322708	SAO JOAO D ALIANCA	19/10/2020 20:21	20/10/2020 12:20	19/10/2020 20:21	20/10/2020 12:20	15,97	1	15,97	CHI
202010108923	ANAPOLIS	AN21302385	DAIA S1	19/10/2020 20:22	20/10/2020 18:55	19/10/2020 20:22	20/10/2020 18:55	22,54	2	45,08	CHI
202010108934	ANAPOLIS	10029135395	ANAPOLIS UNIVERSITARIO S2	19/10/2020 20:25	20/10/2020 14:27	19/10/2020 20:25	20/10/2020 14:27	18,02	1	18,02	CHI
202010108947	NAZARIO	440032489	ANICUNS	19/10/2020 20:27	20/10/2020 02:38	19/10/2020 20:27	20/10/2020 02:38	6,17	1	6,17	CHI
202010108997	GOIANESIA	GE11139640	GOIANESIA S2	19/10/2020 20:29	20/10/2020 09:03	19/10/2020 20:29	20/10/2020 09:03	12,56	187	2348,93	CHI
202010108995	ITUMBIARA	BJ12392124LD	BOM JESUS DE GOIAS	19/10/2020 20:31	20/10/2020 14:20	19/10/2020 20:31	20/10/2020 14:20	17,81	40	712,23	CHI
202010108995	ITUMBIARA	BJ18392097TS	BOM JESUS DE GOIAS	19/10/2020 20:31	20/10/2020 14:20	19/10/2020 20:31	20/10/2020 10:13	13,70	27	369,77	CHI
202010108995	BOM JESUS DE GOIAS	BJ18392097TS	BOM JESUS DE GOIAS	19/10/2020 20:31	20/10/2020 14:20	19/10/2020 20:31	20/10/2020 10:13	13,70	2	27,39	CHI
202010108986	CAIAPONIA	CP12354549	CAIAPONIA	19/10/2020 20:35	19/10/2020 22:13	19/10/2020 20:35	19/10/2020 22:13	1,62	13	21,10	CHI
202010108988	ARAGARCAS	1820023567	ARAGARCAS	19/10/2020 20:36	20/10/2020 10:51	19/10/2020 20:36	20/10/2020 10:51	14,26	1	14,26	CHI
202010109014	CACHOEIRA DOURADA	CD21000046	CACHOEIRA DOURADA	19/10/2020 20:41	19/10/2020 22:41	19/10/2020 20:41	19/10/2020 22:41	2,00	1	2,00	CHI
202010109021	ANAPOLIS	10007618741	ANAPOLIS UNIVERSITARIO S2	19/10/2020 20:43	20/10/2020 22:45	19/10/2020 20:43	20/10/2020 22:45	26,03	1	26,03	CHI
202010109161	ANAPOLIS	AN11205795	ANAPOLIS UNIVERSITARIO S2	19/10/2020 20:49	20/10/2020 02:21	19/10/2020 20:49	20/10/2020 02:21	5,52	21	115,88	CHI
202010109108	ANAPOLIS	AN12321219	ANAPOLIS UNIVERSITARIO S2	19/10/2020 20:52	19/10/2020 22:37	19/10/2020 20:52	19/10/2020 22:37	1,74	327	568,25	CHI
202010109061	GOIATUBA	GT12296905	GOIATUBA S2	19/10/2020 20:53	20/10/2020 02:32	19/10/2020 20:53	20/10/2020 02:32	5,63	7	39,44	CHI
202010109117	BARRO ALTO	01960224	GOIANESIA S1	19/10/2020 20:58	20/10/2020 05:11	20/10/2020 00:43	20/10/2020 05:11	4,47	12	53,62	CHI

202010109117	GOIANESIA	01960224	GOIANESIA S1	19/10/2020 20:58	20/10/2020 05:11	20/10/2020 00:43	20/10/2020 05:11	4,47	48	214,47	CHI
202010109117	SANTA RITA DO NOVO DESTINO	01960224	GOIANESIA S1	19/10/2020 20:58	20/10/2020 05:11	20/10/2020 00:43	20/10/2020 05:11	4,47	459	2050,84	CHI
202010109117	BARRO ALTO	01960224	GOIANESIA S1	19/10/2020 20:58	20/10/2020 05:11	19/10/2020 20:58	20/10/2020 00:40	3,71	12	44,47	CHI
202010109117	SANTA RITA DO NOVO DESTINO	01960224	GOIANESIA S1	19/10/2020 20:58	20/10/2020 05:11	19/10/2020 20:58	20/10/2020 00:40	3,71	459	1701,10	CHI
202010109117	GOIANESIA	01960224	GOIANESIA S1	19/10/2020 20:58	20/10/2020 05:11	19/10/2020 20:58	20/10/2020 00:40	3,71	48	177,89	CHI
202010109087	ORIZONA	OZ11047553	PIRES DO RIO S2	19/10/2020 20:59	19/10/2020 22:03	19/10/2020 20:59	19/10/2020 22:03	1,06	154	163,80	CHI
202010109090	FORMOSA	FA12058455	SAO JOAO D ALIANCA	19/10/2020 21:01	20/10/2020 05:00	19/10/2020 21:01	20/10/2020 05:00	7,98	8	63,85	CHI
202010109160	ANAPOLIS	AN11319696	ANAPOLIS UNIVERSITARIO S2	19/10/2020 21:03	19/10/2020 23:00	19/10/2020 21:03	19/10/2020 23:00	1,95	117	227,60	CHI
202010109361	ANAPOLIS	20588239	ANAPOLIS UNIVERSITARIO S2	19/10/2020 21:04	20/10/2020 09:52	19/10/2020 21:04	20/10/2020 09:52	12,80	1	12,80	CHI
202010109136	IPORA	IR11014386	IPORA	19/10/2020 21:10	20/10/2020 12:53	19/10/2020 21:10	20/10/2020 12:53	15,72	66	1037,23	CHI
2020101900081	ABADIANIA	00050414	ANAPOLIS UNIVERSITARIO S1	19/10/2020 21:11	19/10/2020 21:14	19/10/2020 21:11	19/10/2020 21:14	0,05	22	1,10	CHI
2020101900081	CORUMBA DE GOIAS	02001	ANAPOLIS UNIVERSITARIO S1	19/10/2020 21:11	19/10/2020 21:14	19/10/2020 21:11	19/10/2020 21:14	0,05	62	3,10	CHI
2020101900081	GAMELEIRA DE GOIAS	02002	ANAPOLIS UNIVERSITARIO S1	19/10/2020 21:11	19/10/2020 21:14	19/10/2020 21:11	19/10/2020 21:14	0,05	11	0,55	CHI
2020101900081	ABADIA DE GOIAS	02002	ANAPOLIS UNIVERSITARIO S1	19/10/2020 21:11	19/10/2020 21:14	19/10/2020 21:11	19/10/2020 21:14	0,05	1	0,05	CHI
2020101900081	ANAPOLIS	00201	ANAPOLIS UNIVERSITARIO S1	19/10/2020 21:11	19/10/2020 21:14	19/10/2020 21:11	19/10/2020 21:14	0,05	440	22,00	CHI
2020101900081	ANAPOLIS	00050424	ANAPOLIS UNIVERSITARIO S1	19/10/2020 21:11	19/10/2020 21:14	19/10/2020 21:11	19/10/2020 21:14	0,05	112	5,60	CHI
2020101900081	ABADIANIA	00201	ANAPOLIS UNIVERSITARIO S1	19/10/2020 21:11	19/10/2020 21:14	19/10/2020 21:11	19/10/2020 21:14	0,05	67	3,35	CHI
2020101900081	ANAPOLIS	00050404	ANAPOLIS UNIVERSITARIO S1	19/10/2020 21:11	19/10/2020 21:14	19/10/2020 21:11	19/10/2020 21:14	0,05	1	0,05	CHI
2020101900081	CORUMBA DE GOIAS	02002	ANAPOLIS UNIVERSITARIO S1	19/10/2020 21:11	19/10/2020 21:14	19/10/2020 21:11	19/10/2020 21:14	0,05	4	0,20	CHI
2020101900081	ANAPOLIS	00050414	ANAPOLIS UNIVERSITARIO S1	19/10/2020 21:11	19/10/2020 21:14	19/10/2020 21:11	19/10/2020 21:14	0,05	65	3,25	CHI
2020101900081	ANAPOLIS	00202	ANAPOLIS UNIVERSITARIO S1	19/10/2020 21:11	19/10/2020 21:14	19/10/2020 21:11	19/10/2020 21:14	0,05	377	18,85	CHI
2020101900081	ABADIANIA	00232	ANAPOLIS UNIVERSITARIO S1	19/10/2020 21:11	19/10/2020 21:14	19/10/2020 21:11	19/10/2020 21:14	0,05	29	1,45	CHI
2020101900081	ABADIANIA	00050424	ANAPOLIS UNIVERSITARIO S1	19/10/2020 21:11	19/10/2020 21:14	19/10/2020 21:11	19/10/2020 21:14	0,05	17	0,85	CHI
2020101900081	ABADIANIA	00202	ANAPOLIS UNIVERSITARIO S1	19/10/2020 21:11	19/10/2020 21:14	19/10/2020 21:11	19/10/2020 21:14	0,05	129	6,45	CHI
2020101900081	ABADIANIA	02001	ANAPOLIS UNIVERSITARIO S1	19/10/2020 21:11	19/10/2020 21:14	19/10/2020 21:11	19/10/2020 21:14	0,05	1517	75,85	CHI
2020101900081	GAMELEIRA DE GOIAS	00202	ANAPOLIS UNIVERSITARIO S1	19/10/2020 21:11	19/10/2020 21:14	19/10/2020 21:11	19/10/2020 21:14	0,05	5	0,25	CHI
2020101900081	ABADIANIA	02002	ANAPOLIS UNIVERSITARIO S1	19/10/2020 21:11	19/10/2020 21:14	19/10/2020 21:11	19/10/2020 21:14	0,05	3632	181,60	CHI
202010109143	ITAJA	IJ12200624LD	CACHOEIRA ALTA	19/10/2020 21:12	21/10/2020 19:01	19/10/2020 21:12	21/10/2020 19:01	45,81	12	549,76	CHI
202010109143	LAGOA SANTA	IJ12200624LD	CACHOEIRA ALTA	19/10/2020 21:12	21/10/2020 19:01	19/10/2020 21:12	21/10/2020 19:01	45,81	13	595,57	CHI
202010109143	ITARUMA	IJ12200624LD	CACHOEIRA ALTA	19/10/2020 21:12	21/10/2020 19:01	20/10/2020 02:46	21/10/2020 19:01	40,24	1	40,24	CHI
202010109143	ITAJA	IJ12200624LD	CACHOEIRA ALTA	19/10/2020 21:12	21/10/2020 19:01	20/10/2020 02:46	21/10/2020 19:01	40,24	5	201,22	CHI
202010109186	ANICUNS	AC12000068	ANICUNS	19/10/2020 21:14	20/10/2020 13:28	19/10/2020 21:14	20/10/2020 13:28	16,24	23	373,49	CHI
202010109186	ANICUNS	AC12116668	ANICUNS	19/10/2020 21:14	20/10/2020 13:28	20/10/2020 00:33	20/10/2020 13:28	12,92	1	12,92	CHI
202010109186	ANICUNS	AC12000068	ANICUNS	19/10/2020 21:14	20/10/2020 13:28	19/10/2020 21:14	20/10/2020 11:10	13,94	11	153,31	CHI
202010109149	ANAPOLIS	20237881	ANAPOLIS UNIVERSITARIO S2	19/10/2020 21:14	20/10/2020 18:13	19/10/2020 21:14	20/10/2020 18:13	20,98	1	20,98	CHI
202010109151	ALEXANIA	AX21247692	ALEXANIA	19/10/2020 21:15	20/10/2020 14:29	19/10/2020 21:15	20/10/2020 14:29	17,24	1	17,24	CHI
202010109159	ARAGARCAS	10022742903	ARAGARCAS	19/10/2020 21:17	20/10/2020 15:10	19/10/2020 21:17	20/10/2020 15:10	17,89	1	17,89	CHI
202010109170	ITAPURANGA	IK12311324	ITAPURANGA	19/10/2020 21:22	20/10/2020 03:55	19/10/2020 21:22	20/10/2020 03:55	6,54	6	39,27	CHI
202010109183	MONTIVIDIU	MV12214244	MONTIVIDIU T	19/10/2020 21:27	21/10/2020 14:45	19/10/2020 21:27	21/10/2020 14:45	41,30	1	41,30	CHI
202010109183	RIO VERDE	MV12214244	MONTIVIDIU T	19/10/2020 21:27	21/10/2020 14:45	19/10/2020 21:27	21/10/2020 14:04	40,61	1	40,61	CHI
202010109183	MONTIVIDIU	MV12214244	MONTIVIDIU T	19/10/2020 21:27	21/10/2020 14:45	19/10/2020 21:27	21/10/2020 14:04	40,61	1	40,61	CHI
202010109183	MONTIVIDIU	MV12214244	MONTIVIDIU T	19/10/2020 21:27	21/10/2020 14:45	21/10/2020 10:00	21/10/2020 12:35	2,58	13	33,59	CHI
202010109183	MONTIVIDIU	MV12214244	MONTIVIDIU T	19/10/2020 21:27	21/10/2020 14:45	19/10/2020 21:27	20/10/2020 15:46	18,32	6	109,90	CHI
202010109183	MONTIVIDIU	MV12214244	MONTIVIDIU T	19/10/2020 21:27	21/10/2020 14:45	20/10/2020 12:00	20/10/2020 15:46	3,77	1	3,77	CHI
202010109183	MONTIVIDIU	MV12214244	MONTIVIDIU T	19/10/2020 21:27	21/10/2020 14:45	19/10/2020 21:27	20/10/2020 12:00	14,55	4	58,19	CHI
202010109183	RIO VERDE	MV12214244	MONTIVIDIU T	19/10/2020 21:27	21/10/2020 14:45	19/10/2020 21:27	20/10/2020 12:00	14,55	1	14,55	CHI
202010109190	RIO VERDE	10031977632	RIO VERDE S1	19/10/2020 21:29	20/10/2020 01:24	19/10/2020 21:29	20/10/2020 01:24	3,91	1	3,91	CHI
202010109192	ITAGUARI	II11000033	ITABERAI S1	19/10/2020 21:29	19/10/2020 23:39	19/10/2020 21:29	19/10/2020 23:39	2,15	120	258,07	CHI
202010110775	CORUMBA DE GOIAS	CB12302395	CORUMBA	19/10/2020 21:33	20/10/2020 10:15	19/10/2020 21:33	20/10/2020 10:15	12,69	17	215,68	CHI
202010109804	PIRENOPOLIS	JA12382495RE	JARAGUA	19/10/2020 21:34	20/10/2020 07:13	19/10/2020 21:34	20/10/2020 07:13	9,65	99	954,91	CHI
202010109804	JARAGUA	JA12382495RE	JARAGUA	19/10/2020 21:34	20/10/2020 07:13	19/10/2020 21:34	20/10/2020 07:13	9,65	128	1234,63	CHI

202010189235	JARAGUA	JA12059975	JARAGUA	19/10/2020 21:38	20/10/2020 07:14	19/10/2020 21:38	20/10/2020 07:14	9,59	8	76,71	CHI
202010109219	ANAPOLIS	20729698	JUNDIAI S1	19/10/2020 21:40	20/10/2020 15:53	19/10/2020 21:40	20/10/2020 15:53	18,21	1	18,21	CHI
202010109220	GOIANESIA	10000079055	GOIANESIA S2	19/10/2020 21:40	21/10/2020 10:50	19/10/2020 21:40	21/10/2020 10:50	37,16	1	37,16	CHI
202010109412	ANAPOLIS	AN11008938	JUNDIAI S1	19/10/2020 21:49	20/10/2020 04:32	19/10/2020 21:49	20/10/2020 04:32	6,71	134	898,92	CHI
202010109335	ACREUNA	00080424	ACREUNA	19/10/2020 22:31	20/10/2020 12:37	19/10/2020 22:31	20/10/2020 12:37	14,09	7	98,64	CHI
202010109335	INDIARA	00080424	ACREUNA	19/10/2020 22:31	20/10/2020 12:37	19/10/2020 22:31	20/10/2020 12:37	14,09	25	352,27	CHI
202010109335	JANDAIA	00080424	ACREUNA	19/10/2020 22:31	20/10/2020 12:37	19/10/2020 22:31	20/10/2020 12:37	14,09	17	239,54	CHI
202010109335	JANDAIA	EU13074471	ACREUNA	19/10/2020 22:31	20/10/2020 12:37	20/10/2020 01:46	20/10/2020 12:37	10,85	12	130,19	CHI
202010109335	ACREUNA	00080424	ACREUNA	19/10/2020 22:31	20/10/2020 12:37	20/10/2020 01:46	20/10/2020 02:00	0,24	29	6,94	CHI
202010109335	JANDAIA	00080424	ACREUNA	19/10/2020 22:31	20/10/2020 12:37	20/10/2020 01:46	20/10/2020 02:00	0,24	2	0,48	CHI
202010109335	PARAUNA	00080424	ACREUNA	19/10/2020 22:31	20/10/2020 12:37	20/10/2020 01:46	20/10/2020 02:00	0,24	1	0,24	CHI
202010109335	JANDAIA	00080424	ACREUNA	19/10/2020 22:31	20/10/2020 12:37	19/10/2020 22:31	20/10/2020 01:25	2,89	12	34,72	CHI
202010109335	PARAUNA	00080424	ACREUNA	19/10/2020 22:31	20/10/2020 12:37	19/10/2020 22:31	20/10/2020 00:26	1,92	1	1,92	CHI
202010109335	ACREUNA	00080424	ACREUNA	19/10/2020 22:31	20/10/2020 12:37	19/10/2020 22:31	20/10/2020 00:26	1,92	29	55,71	CHI
202010109335	JANDAIA	00080424	ACREUNA	19/10/2020 22:31	20/10/2020 12:37	19/10/2020 22:31	20/10/2020 00:26	1,92	2	3,84	CHI
202010112264	PORTELANDIA	PW21103061	PARQUE DAS EMAS	19/10/2020 22:35	22/10/2020 00:12	19/10/2020 22:35	22/10/2020 00:12	49,61	1	49,61	CHI
202010109372	JATAI	JT21205167	JATAI S3	19/10/2020 22:56	20/10/2020 00:42	19/10/2020 22:56	20/10/2020 00:42	1,76	1	1,76	CHI
202010109385	SERRANOPOLIS	00100414	ITAJA S1	19/10/2020 22:57	19/10/2020 23:15	19/10/2020 22:57	19/10/2020 23:15	0,29	46	13,51	CHI
202010109385	APORE	00100414	ITAJA S1	19/10/2020 22:57	19/10/2020 23:15	19/10/2020 22:57	19/10/2020 23:15	0,29	8	2,35	CHI
202010109385	APORE	00100414	ITAJA S1	19/10/2020 22:57	19/10/2020 23:15	19/10/2020 22:57	19/10/2020 23:15	0,29	96	28,19	CHI
202010109385	APORE	00100414	ITAJA S1	19/10/2020 22:57	19/10/2020 23:15	19/10/2020 22:57	19/10/2020 23:15	0,29	53	15,56	CHI
202010109404	RIO VERDE	RV21345380	RIO VERDE S2	19/10/2020 23:16	20/10/2020 00:28	19/10/2020 23:16	20/10/2020 00:28	1,19	1	1,19	CHI
202010109417	RIO VERDE	RV12040471LD	MONTIVIDIU T	19/10/2020 23:25	20/10/2020 13:34	19/10/2020 23:25	20/10/2020 13:34	14,15	2	28,31	CHI
202010109417	RIO VERDE	7819179	MONTIVIDIU T	19/10/2020 23:25	20/10/2020 13:34	19/10/2020 23:25	20/10/2020 13:25	14,00	11	154,05	CHI
202010109417	RIO VERDE	RV12355049LD	MONTIVIDIU T	19/10/2020 23:25	20/10/2020 13:34	20/10/2020 02:57	20/10/2020 12:16	9,31	1	9,31	CHI
202010109504	LAGOA SANTA	LS16419936	ITAJA S2	20/10/2020 00:49	20/10/2020 11:06	20/10/2020 00:49	20/10/2020 11:06	10,29	612	6300,54	CHI
202010109503	RIO VERDE	RV11000072	CABRIUVA S1	20/10/2020 00:51	20/10/2020 11:22	20/10/2020 00:51	20/10/2020 11:22	10,51	82	861,55	CHI
202010109608	APORE	IJ12194905	ITAJA S2	20/10/2020 00:56	20/10/2020 06:46	20/10/2020 00:56	20/10/2020 06:46	5,83	1	5,83	CHI
202010109608	ITAJA	IJ12194905	ITAJA S2	20/10/2020 00:56	20/10/2020 06:46	20/10/2020 00:56	20/10/2020 06:46	5,83	36	209,77	CHI
202010109532	JATAI	10029240377	JATAI S2	20/10/2020 02:19	20/10/2020 04:40	20/10/2020 02:19	20/10/2020 04:40	2,34	1	2,34	CHI
202010109538	MINEIROS	MY21324395	PARQUE DAS EMAS	20/10/2020 02:36	20/10/2020 05:00	20/10/2020 02:36	20/10/2020 05:00	2,41	1	2,41	CHI
202010109554	ITARUMA	CC12202744	CACHOEIRA ALTA	20/10/2020 03:01	20/10/2020 13:28	20/10/2020 03:01	20/10/2020 13:28	10,45	4	41,82	CHI
202010109554	ITARUMA	CC13082113	CACHOEIRA ALTA	20/10/2020 03:01	20/10/2020 13:28	20/10/2020 03:01	20/10/2020 08:41	5,67	8	45,33	CHI
202010109554	CACU	CC13082113	CACHOEIRA ALTA	20/10/2020 03:01	20/10/2020 13:28	20/10/2020 03:01	20/10/2020 08:41	5,67	106	600,58	CHI
202010109554	CACU	00270444	CACHOEIRA ALTA	20/10/2020 03:01	20/10/2020 13:28	20/10/2020 03:01	20/10/2020 07:59	4,97	29	144,10	CHI
202010109554	CACHOEIRA ALTA	00270444	CACHOEIRA ALTA	20/10/2020 03:01	20/10/2020 13:28	20/10/2020 03:01	20/10/2020 07:59	4,97	9	44,72	CHI
202010109548	CASTELANDIA	QI12370150	QUIRINOPOLIS	20/10/2020 03:24	20/10/2020 19:30	20/10/2020 03:24	20/10/2020 19:30	16,10	19	305,89	CHI
202010109548	RIO VERDE	QI12370150	QUIRINOPOLIS	20/10/2020 03:24	20/10/2020 19:30	20/10/2020 03:24	20/10/2020 19:30	16,10	1	16,10	CHI
202010109548	QUIRINOPOLIS	QI12370150	QUIRINOPOLIS	20/10/2020 03:24	20/10/2020 19:30	20/10/2020 03:24	20/10/2020 19:30	16,10	34	547,38	CHI
202010109548	QUIRINOPOLIS	QI12370150	QUIRINOPOLIS	20/10/2020 03:24	20/10/2020 19:30	20/10/2020 03:24	20/10/2020 18:19	14,92	30	447,72	CHI
202010109536	RIO VERDE	RV13301759	RIO VERDE S2	20/10/2020 03:27	20/10/2020 14:30	20/10/2020 03:27	20/10/2020 14:30	11,04	15	165,67	CHI
202010109536	RIO VERDE	RV13301759	RIO VERDE S2	20/10/2020 03:27	20/10/2020 14:30	20/10/2020 10:07	20/10/2020 14:30	4,38	11	48,13	CHI
202010109575	JATAI	JT21234462	JATAI S1	20/10/2020 04:05	20/10/2020 05:22	20/10/2020 04:05	20/10/2020 05:22	1,28	1	1,28	CHI
202010110292	LAGOA SANTA	IJ13131616	CACHOEIRA ALTA	20/10/2020 05:12	20/10/2020 17:04	20/10/2020 09:55	20/10/2020 17:04	7,14	4	28,55	CHI
202010110292	ITARUMA	IJ13131616	CACHOEIRA ALTA	20/10/2020 05:12	20/10/2020 17:04	20/10/2020 09:55	20/10/2020 17:04	7,14	2	14,27	CHI
202010110292	ITAJA	IJ13131616	CACHOEIRA ALTA	20/10/2020 05:12	20/10/2020 17:04	20/10/2020 09:55	20/10/2020 17:04	7,14	24	171,27	CHI
202010110292	LAGOA SANTA	IJ13110423	CACHOEIRA ALTA	20/10/2020 05:12	20/10/2020 17:04	20/10/2020 09:55	20/10/2020 16:13	6,29	24	150,87	CHI
202010110292	LAGOA SANTA	IJ13112762	CACHOEIRA ALTA	20/10/2020 05:12	20/10/2020 17:04	20/10/2020 09:55	20/10/2020 15:27	5,52	48	264,95	CHI
202010110292	ITAJA	IJ13112763	CACHOEIRA ALTA	20/10/2020 05:12	20/10/2020 17:04	20/10/2020 09:55	20/10/2020 13:32	3,62	7	25,32	CHI
202010110292	LAGOA SANTA	IJ13112763	CACHOEIRA ALTA	20/10/2020 05:12	20/10/2020 17:04	20/10/2020 09:55	20/10/2020 13:32	3,62	2	7,23	CHI
202010110292	LAGOA SANTA	04400224	CACHOEIRA ALTA	20/10/2020 05:12	20/10/2020 17:04	20/10/2020 09:55	20/10/2020 12:01	2,09	12	25,05	CHI

202010110292	ITAJA	04400224	CACHOEIRA ALTA	20/10/2020 05:12	20/10/2020 17:04	20/10/2020 09:55	20/10/2020 12:01	2,09	66	137,77	CHI
202010110292	ITAJA	04400214	CACHOEIRA ALTA	20/10/2020 05:12	20/10/2020 17:04	20/10/2020 11:05	20/10/2020 11:41	0,60	31	18,66	CHI
202010110292	ITARUMA	04400214	CACHOEIRA ALTA	20/10/2020 05:12	20/10/2020 17:04	20/10/2020 11:05	20/10/2020 11:41	0,60	130	78,25	CHI
202010110292	CACU	04400214	CACHOEIRA ALTA	20/10/2020 05:12	20/10/2020 17:04	20/10/2020 11:05	20/10/2020 11:41	0,60	4	2,41	CHI
202010110292	ITAJA	04400214	CACHOEIRA ALTA	20/10/2020 05:12	20/10/2020 17:04	20/10/2020 09:37	20/10/2020 09:43	0,10	31	3,06	CHI
202010110292	CACU	04400214	CACHOEIRA ALTA	20/10/2020 05:12	20/10/2020 17:04	20/10/2020 09:37	20/10/2020 09:43	0,10	4	0,39	CHI
202010110292	ITARUMA	04400214	CACHOEIRA ALTA	20/10/2020 05:12	20/10/2020 17:04	20/10/2020 09:37	20/10/2020 09:43	0,10	130	12,82	CHI
202010110292	ITAJA	04400224	CACHOEIRA ALTA	20/10/2020 05:12	20/10/2020 17:04	20/10/2020 09:15	20/10/2020 09:37	0,37	73	26,85	CHI
202010110292	LAGOA SANTA	04400224	CACHOEIRA ALTA	20/10/2020 05:12	20/10/2020 17:04	20/10/2020 09:15	20/10/2020 09:37	0,37	86	31,63	CHI
202010110292	ITAJA	04400224	CACHOEIRA ALTA	20/10/2020 05:12	20/10/2020 17:04	20/10/2020 09:15	20/10/2020 09:37	0,37	24	8,83	CHI
202010110292	ITARUMA	04400224	CACHOEIRA ALTA	20/10/2020 05:12	20/10/2020 17:04	20/10/2020 09:15	20/10/2020 09:37	0,37	1	0,37	CHI
202010110292	LAGOA SANTA	04400224	CACHOEIRA ALTA	20/10/2020 05:12	20/10/2020 17:04	20/10/2020 09:15	20/10/2020 09:37	0,37	4	1,47	CHI
202010110292	ITARUMA	04400416	CACHOEIRA ALTA	20/10/2020 05:12	20/10/2020 17:04	20/10/2020 05:12	20/10/2020 09:15	4,06	124	503,47	CHI
202010110292	CACU	04400416	CACHOEIRA ALTA	20/10/2020 05:12	20/10/2020 17:04	20/10/2020 05:12	20/10/2020 09:15	4,06	2	8,12	CHI
202010110292	ITAJA	04400416	CACHOEIRA ALTA	20/10/2020 05:12	20/10/2020 17:04	20/10/2020 05:12	20/10/2020 09:15	4,06	25	101,51	CHI
202010110292	ITAJA	04400416	CACHOEIRA ALTA	20/10/2020 05:12	20/10/2020 17:04	20/10/2020 05:12	20/10/2020 09:14	4,04	21	84,80	CHI
202010110292	ITARUMA	04400416	CACHOEIRA ALTA	20/10/2020 05:12	20/10/2020 17:04	20/10/2020 05:12	20/10/2020 09:14	4,04	1	4,04	CHI
202010110292	ITAJA	04400416	CACHOEIRA ALTA	20/10/2020 05:12	20/10/2020 17:04	20/10/2020 05:12	20/10/2020 09:14	4,04	53	214,03	CHI
202010110292	LAGOA SANTA	04400416	CACHOEIRA ALTA	20/10/2020 05:12	20/10/2020 17:04	20/10/2020 05:12	20/10/2020 09:14	4,04	72	290,76	CHI
202010110292	LAGOA SANTA	04400416	CACHOEIRA ALTA	20/10/2020 05:12	20/10/2020 17:04	20/10/2020 05:12	20/10/2020 09:14	4,04	3	12,11	CHI
202010109620	QUIRINOPOLIS	QI12000060	QUIRINOPOLIS	20/10/2020 05:12	20/10/2020 10:10	20/10/2020 05:12	20/10/2020 10:10	4,95	7	34,66	CHI
202010109631	MINEIROS	MY12324396RE	PARQUE DAS EMAS	20/10/2020 05:28	20/10/2020 08:38	20/10/2020 05:28	20/10/2020 08:38	3,16	21	66,27	CHI
202010109653	QUIRINOPOLIS	GB12116585	QUIRINOPOLIS	20/10/2020 05:43	20/10/2020 08:32	20/10/2020 05:43	20/10/2020 08:32	2,83	14	39,60	CHI
202010110336	PEROLANDIA	DP12210131RE	PARQUE DAS EMAS	20/10/2020 05:47	21/10/2020 12:41	20/10/2020 05:47	21/10/2020 12:41	30,89	4	123,57	CHI
202010110336	PORTELANDIA	DP12210131RE	PARQUE DAS EMAS	20/10/2020 05:47	21/10/2020 12:41	20/10/2020 05:47	21/10/2020 12:41	30,89	1	30,89	CHI
202010110336	MINEIROS	DP12210131RE	PARQUE DAS EMAS	20/10/2020 05:47	21/10/2020 12:41	20/10/2020 05:47	21/10/2020 12:41	30,89	7	216,25	CHI
202010109697	JATAI	JT21165969	JATAI S2	20/10/2020 05:50	21/10/2020 19:30	20/10/2020 05:50	21/10/2020 19:30	37,67	1	37,67	CHI
202010109712	JATAI	290108998	JATAI S3	20/10/2020 06:00	20/10/2020 13:33	20/10/2020 06:00	20/10/2020 13:33	7,55	1	7,55	CHI
202010109704	JATAI	290190964	JATAI S2	20/10/2020 06:00	20/10/2020 09:10	20/10/2020 06:00	20/10/2020 09:10	3,17	1	3,17	CHI
202010112090	MAURILANDIA	DM12295950	RIO DOS BOIS	20/10/2020 06:14	20/10/2020 21:43	20/10/2020 06:14	20/10/2020 21:43	15,47	1	15,47	CHI
202010112090	CASTELANDIA	DM12295950	RIO DOS BOIS	20/10/2020 06:14	20/10/2020 21:43	20/10/2020 06:14	20/10/2020 21:43	15,47	24	371,24	CHI
202010109906	CACHOEIRA ALTA	CA12384081	CACHOEIRA ALTA	20/10/2020 06:19	20/10/2020 09:53	20/10/2020 06:19	20/10/2020 09:53	3,56	16	56,95	CHI
202010109812	QUIRINOPOLIS	QI12000224RE	QUIRINOPOLIS	20/10/2020 06:25	20/10/2020 17:09	20/10/2020 06:25	20/10/2020 17:09	10,74	93	999,00	CHI
202010109817	MONTIVIDIU	MV12075216	MONTIVIDIU T	20/10/2020 06:26	20/10/2020 12:16	20/10/2020 06:26	20/10/2020 12:16	5,83	6	34,99	CHI
202010109817	CAIAPONIA	MV12075216	MONTIVIDIU T	20/10/2020 06:26	20/10/2020 12:16	20/10/2020 06:26	20/10/2020 12:16	5,83	7	40,82	CHI
202010113241	JATAI	JT11321166	JATAI S3	20/10/2020 06:29	20/10/2020 18:45	20/10/2020 06:29	20/10/2020 18:45	12,26	83	1017,49	CHI
202010110631	JATAI	JT12313252	JATAI S3	20/10/2020 06:29	20/10/2020 14:27	20/10/2020 06:29	20/10/2020 14:27	7,96	1	7,96	CHI
202010109841	RIO VERDE	RV12338619	CABRIUVA S2	20/10/2020 06:30	21/10/2020 10:44	20/10/2020 06:30	21/10/2020 10:44	28,22	1	28,22	CHI
202010109848	RIO VERDE	RV21306622	CABRIUVA S2	20/10/2020 06:33	20/10/2020 09:12	20/10/2020 06:33	20/10/2020 09:12	2,64	1	2,64	CHI
202010109884	CAIAPONIA	MV21144611	MONTIVIDIU T	20/10/2020 06:39	22/10/2020 08:08	20/10/2020 06:39	22/10/2020 08:08	49,47	1	49,47	CHI
202010107962	MINEIROS	MY12156850RE	PARQUE DAS EMAS	20/10/2020 06:42	21/10/2020 15:25	20/10/2020 06:42	21/10/2020 15:25	32,72	30	981,60	CHI
202010107962	MINEIROS	PW10408096	PARQUE DAS EMAS	20/10/2020 06:42	21/10/2020 15:25	20/10/2020 12:51	20/10/2020 13:19	0,46	84	38,59	CHI
202010107962	SANTA RITA DO ARAGUAIA	PW10408096	PARQUE DAS EMAS	20/10/2020 06:42	21/10/2020 15:25	20/10/2020 12:51	20/10/2020 13:19	0,46	2	0,92	CHI
202010110207	MINEIROS	MY12020040	PARQUE DAS EMAS	20/10/2020 06:43	20/10/2020 11:33	20/10/2020 06:43	20/10/2020 11:33	4,83	86	415,19	CHI
202010112597	APORE	AE12216751	ITAJA S2	20/10/2020 06:46	20/10/2020 13:56	20/10/2020 06:46	20/10/2020 13:56	7,16	4	28,66	CHI
202010109938	RIO VERDE	RV21305811	MONTIVIDIU T	20/10/2020 06:52	20/10/2020 13:33	20/10/2020 06:52	20/10/2020 13:33	6,68	1	6,68	CHI
202010189250	RIO VERDE	RV12104444	RIO VERDE S1	20/10/2020 06:52	20/10/2020 15:20	20/10/2020 06:52	20/10/2020 15:20	8,47	77	652,17	CHI
202010109968	ACREUNA	2440068567	ACREUNA	20/10/2020 06:59	20/10/2020 14:01	20/10/2020 06:59	20/10/2020 14:01	7,03	1	7,03	CHI
202010109998	MINEIROS	MY12303919RE	PARQUE DAS EMAS	20/10/2020 07:03	21/10/2020 22:53	20/10/2020 07:03	21/10/2020 22:53	39,84	7	278,90	CHI
202010109998	MINEIROS	MY12303919RE	PARQUE DAS EMAS	20/10/2020 07:03	21/10/2020 22:53	20/10/2020 07:03	20/10/2020 18:42	11,65	13	151,44	CHI
202010109774	ACREUNA	EU12045046LD	ACREUNA	20/10/2020 07:07	20/10/2020 13:21	20/10/2020 07:07	20/10/2020 13:21	6,22	391	2430,83	CHI

202010109774	TURVELANDIA	EU12045046LD	ACREUNA	20/10/2020 07:07	20/10/2020 13:21	20/10/2020 07:07	20/10/2020 13:21	6,22	2	12,43	CHI
202010110126	SANTO ANTONIO DA BARRA	BZ12213347	SANTA HELENA S1	20/10/2020 07:21	21/10/2020 16:13	20/10/2020 07:21	21/10/2020 16:13	32,86	2	65,72	CHI
202010110126	SANTO ANTONIO DA BARRA	BZ21207222	SANTA HELENA S1	20/10/2020 07:21	21/10/2020 16:13	20/10/2020 07:21	21/10/2020 16:13	32,86	1	32,86	CHI
202010110126	RIO VERDE	BZ12212620	SANTA HELENA S1	20/10/2020 07:21	21/10/2020 16:13	20/10/2020 07:21	21/10/2020 15:32	32,18	4	128,74	CHI
202010110126	SANTO ANTONIO DA BARRA	BZ12212620	SANTA HELENA S1	20/10/2020 07:21	21/10/2020 16:13	20/10/2020 07:21	21/10/2020 15:32	32,18	12	386,21	CHI
202010110126	SANTO ANTONIO DA BARRA	BZ12211442	SANTA HELENA S1	20/10/2020 07:21	21/10/2020 16:13	20/10/2020 07:21	20/10/2020 23:00	15,64	5	78,21	CHI
202010110126	SANTO ANTONIO DA BARRA	BZ13159365	SANTA HELENA S1	20/10/2020 07:21	21/10/2020 16:13	20/10/2020 07:21	20/10/2020 14:06	6,75	2	13,50	CHI
202010110126	SANTA HELENA DE GOIAS	SH13326792	SANTA HELENA S1	20/10/2020 07:21	21/10/2020 16:13	20/10/2020 07:21	20/10/2020 11:23	4,03	39	157,27	CHI
202010110126	ACREUNA	SH13326792	SANTA HELENA S1	20/10/2020 07:21	21/10/2020 16:13	20/10/2020 07:21	20/10/2020 11:23	4,03	3	12,10	CHI
202010110126	SANTO ANTONIO DA BARRA	SH13326792	SANTA HELENA S1	20/10/2020 07:21	21/10/2020 16:13	20/10/2020 07:21	20/10/2020 11:23	4,03	1	4,03	CHI
202010110126	RIO VERDE	01660414	SANTA HELENA S1	20/10/2020 07:21	21/10/2020 16:13	20/10/2020 07:21	20/10/2020 08:13	0,85	3	2,56	CHI
202010110126	SANTA HELENA DE GOIAS	01660414	SANTA HELENA S1	20/10/2020 07:21	21/10/2020 16:13	20/10/2020 07:21	20/10/2020 08:13	0,85	18	15,38	CHI
202010110228	RIO VERDE	RV13371493	RIO VERDE S1	20/10/2020 07:25	20/10/2020 15:20	20/10/2020 07:25	20/10/2020 15:20	7,92	253	2003,62	CHI
202010110228	SANTA HELENA DE GOIAS	RV13371493	RIO VERDE S1	20/10/2020 07:25	20/10/2020 15:20	20/10/2020 07:25	20/10/2020 15:20	7,92	57	451,41	CHI
202010110228	RIO VERDE	RV13371493	RIO VERDE S1	20/10/2020 07:25	20/10/2020 15:20	20/10/2020 13:40	20/10/2020 15:20	1,68	19	31,90	CHI
202010110191	MINEIROS	MY21322106	PARQUE DAS EMAS	20/10/2020 07:30	20/10/2020 14:32	20/10/2020 07:30	20/10/2020 14:32	7,02	1	7,02	CHI
202010110439	QUIRINOPOLIS	QI12198335	QUIRINOPOLIS	20/10/2020 07:32	21/10/2020 16:59	20/10/2020 07:32	20/10/2020 16:59	9,45	3	28,34	CHI
202010112928	ACREUNA	TD12303600	RIO DOS BOIS	20/10/2020 07:40	21/10/2020 12:25	20/10/2020 07:40	21/10/2020 12:25	28,74	6	172,44	CHI
202010110268	JATAI	290320070	JATAI S3	20/10/2020 07:41	20/10/2020 16:29	20/10/2020 07:41	20/10/2020 16:29	8,79	1	8,79	CHI
202010110269	ACREUNA	EU21045191	ACREUNA	20/10/2020 07:41	20/10/2020 09:38	20/10/2020 07:41	20/10/2020 09:38	1,94	1	1,94	CHI
202010110298	QUIRINOPOLIS	QI21319946	QUIRINOPOLIS	20/10/2020 07:48	20/10/2020 23:52	20/10/2020 07:48	20/10/2020 23:52	16,06	1	16,06	CHI
202010110381	SANTA HELENA DE GOIAS	SH11228528	RIO VERDE S2	20/10/2020 07:58	20/10/2020 17:58	20/10/2020 07:58	20/10/2020 17:58	10,00	1	10,00	CHI
202010110990	SANTA HELENA DE GOIAS	TD12213488	RIO DOS BOIS	20/10/2020 08:03	21/10/2020 04:53	20/10/2020 08:03	21/10/2020 04:53	20,83	3	62,49	CHI
202010110990	TURVELANDIA	TD12213488	RIO DOS BOIS	20/10/2020 08:03	21/10/2020 04:53	20/10/2020 08:03	21/10/2020 04:53	20,83	6	124,97	CHI
202010110426	MINEIROS	10010956474	PARQUE DAS EMAS	20/10/2020 08:03	20/10/2020 15:20	20/10/2020 08:03	20/10/2020 15:20	7,28	1	7,28	CHI
202010110470	RIO VERDE	630471733	RIO VERDE S1	20/10/2020 08:06	20/10/2020 11:42	20/10/2020 08:06	20/10/2020 11:42	3,59	1	3,59	CHI
202010110475	PORTEIRAO	CL13326936	RIO DOS BOIS	20/10/2020 08:07	20/10/2020 20:19	20/10/2020 08:07	20/10/2020 20:19	12,20	2	24,39	CHI
202010110475	PORTEIRAO	CL12230803	RIO DOS BOIS	20/10/2020 08:07	20/10/2020 20:19	20/10/2020 08:07	20/10/2020 15:00	6,88	4	27,53	CHI
202010110544	TURVELANDIA	TD12305981	RIO DOS BOIS	20/10/2020 08:16	21/10/2020 00:30	20/10/2020 08:16	21/10/2020 00:30	16,23	1	16,23	CHI
202010110570	RIO VERDE	RV11113541	RIO VERDE S1	20/10/2020 08:20	20/10/2020 13:30	20/10/2020 08:20	20/10/2020 13:30	5,16	221	1141,16	CHI
202010110663	MINEIROS	MY12197100LD	PARQUE DAS EMAS	20/10/2020 08:26	20/10/2020 20:58	20/10/2020 08:26	20/10/2020 20:58	12,53	6	75,16	CHI
202010110663	MINEIROS	MY12234339	PARQUE DAS EMAS	20/10/2020 08:26	20/10/2020 20:58	20/10/2020 08:26	20/10/2020 14:51	6,41	5	32,07	CHI
202010110637	SANTA HELENA DE GOIAS	SH12038397	IPEGUARI	20/10/2020 08:27	20/10/2020 15:32	20/10/2020 08:27	20/10/2020 15:32	7,09	172	1219,96	CHI
202010110644	RIO VERDE	630449727	RIO VERDE S2	20/10/2020 08:27	21/10/2020 12:31	20/10/2020 08:27	21/10/2020 12:31	28,06	1	28,06	CHI
202010110687	JATAI	JT12360224	JATAI S1	20/10/2020 08:33	21/10/2020 09:55	20/10/2020 08:33	21/10/2020 09:55	25,36	3	76,08	CHI
202010110715	SERRANOPOLIS	SX12353677	JATAI S1	20/10/2020 08:35	20/10/2020 11:14	20/10/2020 08:35	20/10/2020 11:14	2,64	16	42,17	CHI
202010110718	ITAJA	IJ21000004	ITAJA S2	20/10/2020 08:36	20/10/2020 14:00	20/10/2020 08:36	20/10/2020 14:00	5,40	1	5,40	CHI
202010112429	CAIAPONIA	MV12260782	MONTIVIDIU T	20/10/2020 08:38	20/10/2020 14:40	20/10/2020 08:38	20/10/2020 14:40	6,02	1	6,02	CHI
202010112429	MONTIVIDIU	MV12260782	MONTIVIDIU T	20/10/2020 08:38	20/10/2020 14:40	20/10/2020 08:38	20/10/2020 14:40	6,02	6	36,15	CHI
202010110792	MINEIROS	MY21287498	PARQUE DAS EMAS	20/10/2020 08:42	21/10/2020 18:09	20/10/2020 08:42	21/10/2020 18:09	33,46	1	33,46	CHI
202010113547	ITARUMA	IM21058483	CACHOEIRA ALTA	20/10/2020 08:46	20/10/2020 16:24	20/10/2020 08:46	20/10/2020 16:24	7,62	1	7,62	CHI
202010110849	QUIRINOPOLIS	80090047	QUIRINOPOLIS	20/10/2020 08:47	20/10/2020 11:28	20/10/2020 08:47	20/10/2020 11:28	2,68	1	2,68	CHI
202010110850	SAO SIMAO	SO11350050	CACHOEIRA ALTA	20/10/2020 08:47	21/10/2020 12:57	20/10/2020 08:47	21/10/2020 12:57	28,16	10	281,60	CHI
202010110861	INACIOLANDIA	2810009242	QUIRINOPOLIS	20/10/2020 08:48	20/10/2020 13:48	20/10/2020 08:48	20/10/2020 13:48	4,99	1	4,99	CHI
202010110877	JATAI	JT12359177	JATAI S1	20/10/2020 08:50	20/10/2020 11:06	20/10/2020 08:50	20/10/2020 11:06	2,25	2	4,51	CHI

5. Plotagem das Ocorrências conforme a Especialização das Chuvas

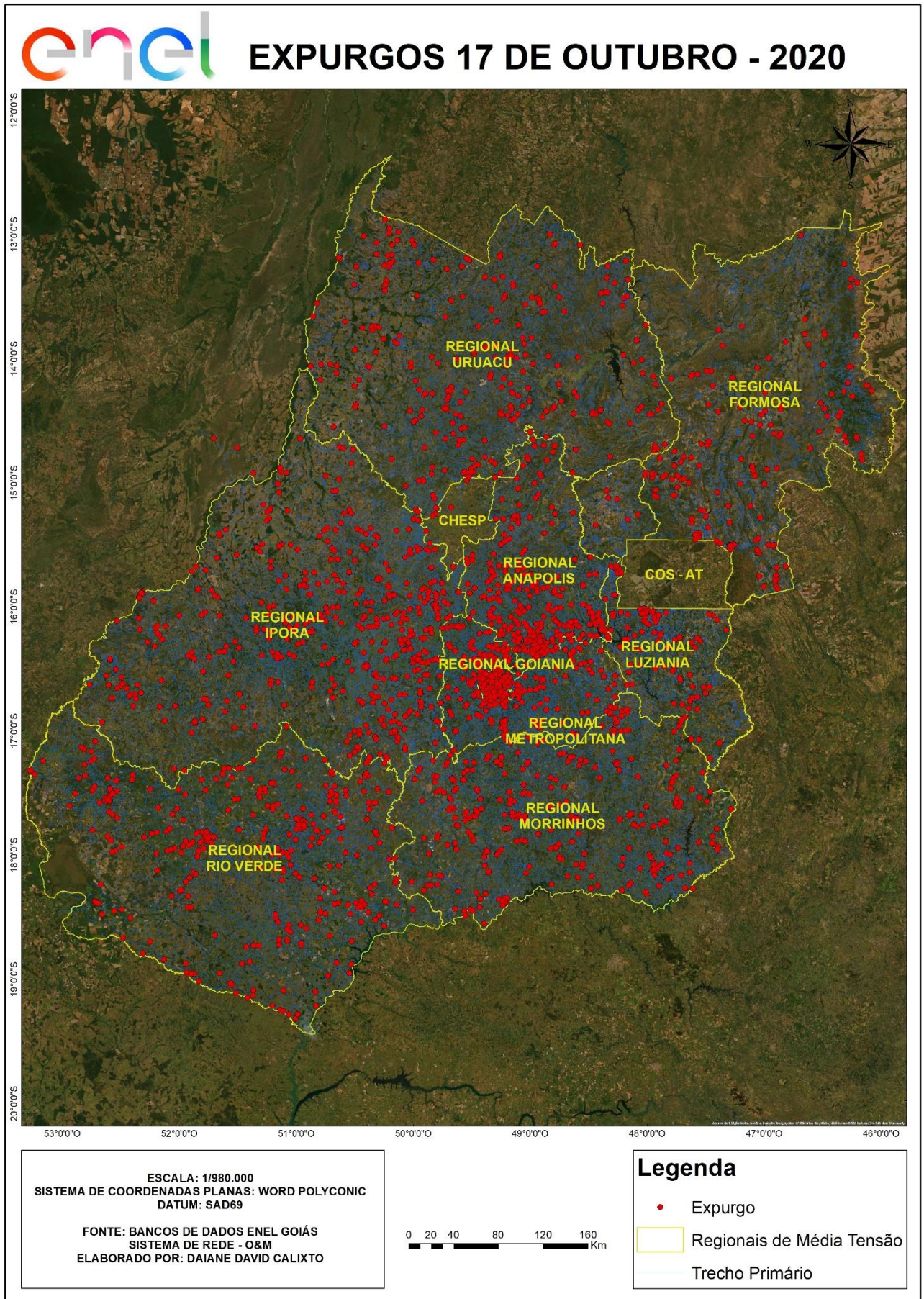

6. Clientes Afetados e Impactos Globais

Em análise ao número de clientes interrompidos (CI) na área de concessão da ENEL GO, a figura abaixo apresenta a atipicidade vivenciada no dia 17 a 20 de outubro de 2020, data esta que, conforme laudo meteorológico emitido por empresa especializada, a referida concessão passou por um período de condições climáticas de extrema severidade.

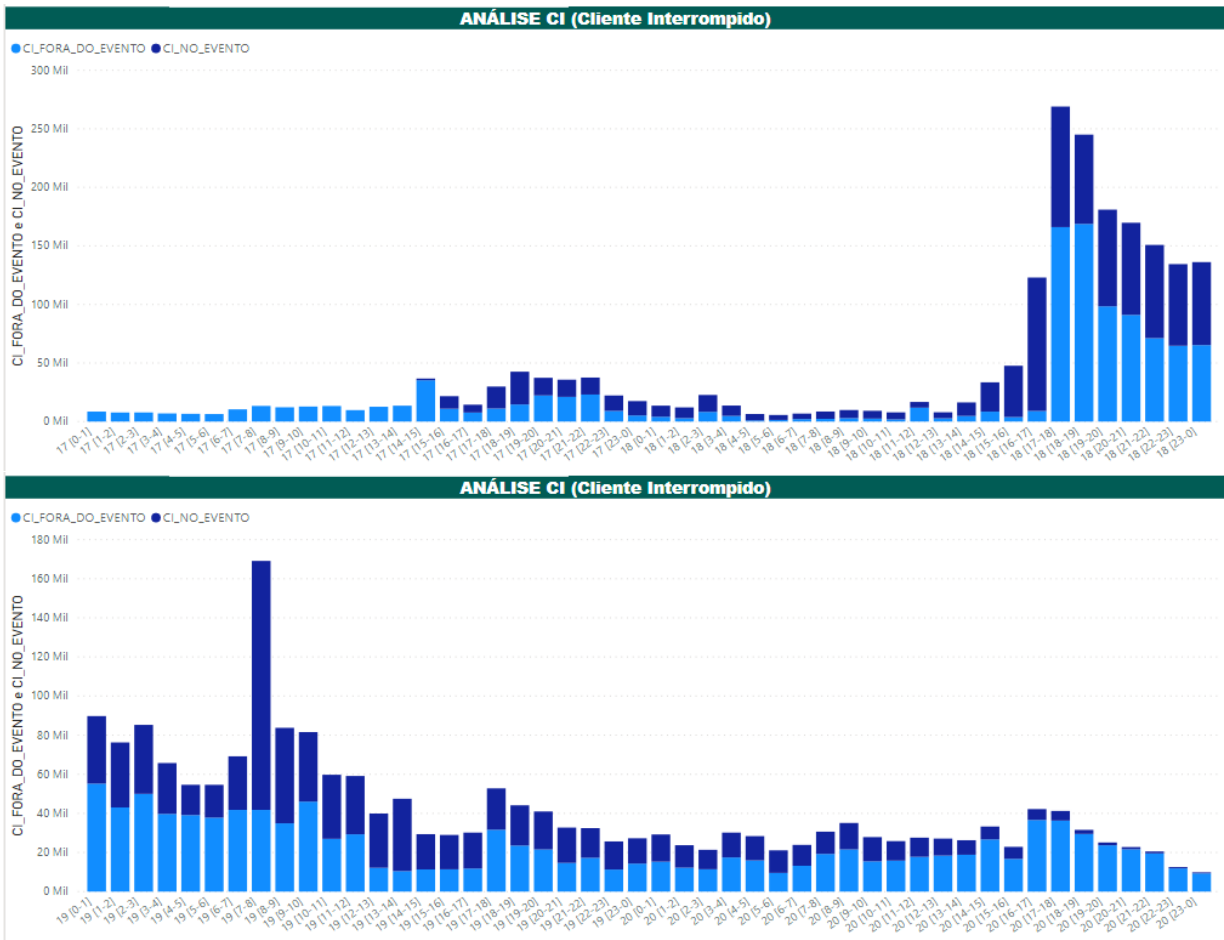

Figuras – Clientes Interrompidos em intervalos de horas

Na figura acima, as barras em azul claro representam a quantidade de clientes interrompidos simultaneamente em condições normais de operação, e as barras azul escuro os clientes interrompidos simultaneamente no período do evento.

7. Diagramas Unifilares



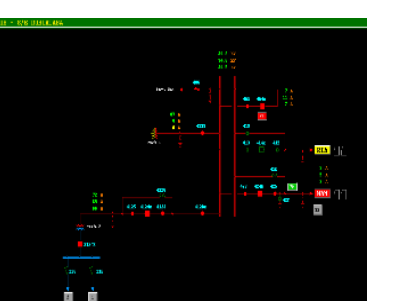
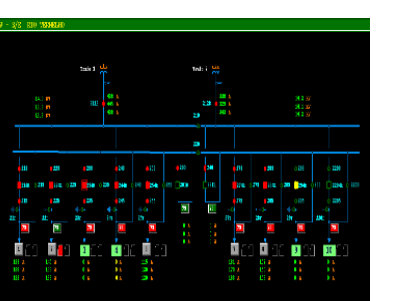
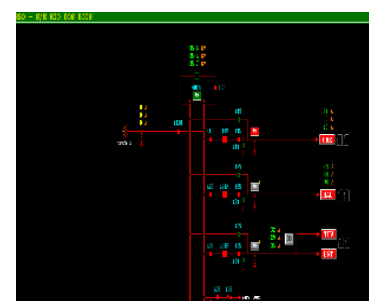
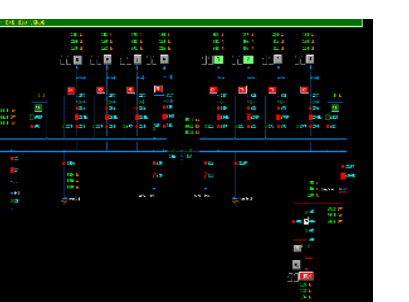
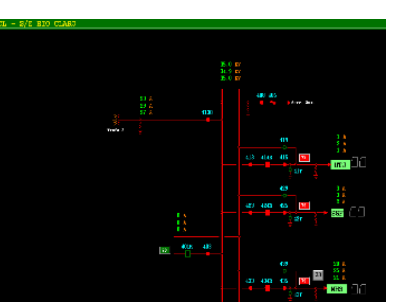
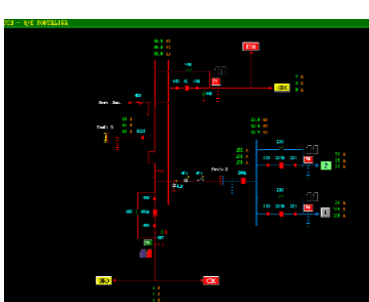
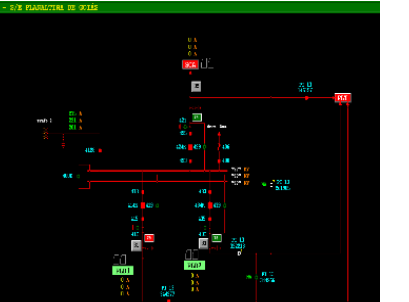
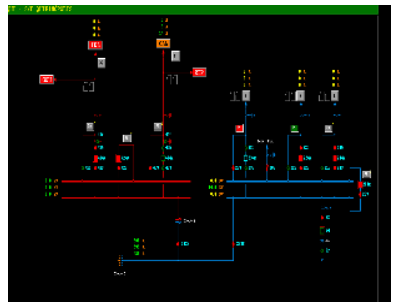
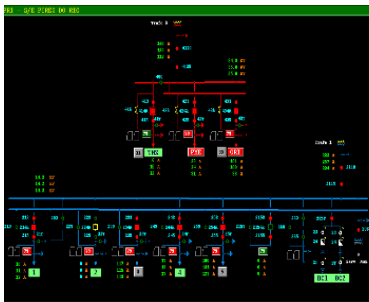
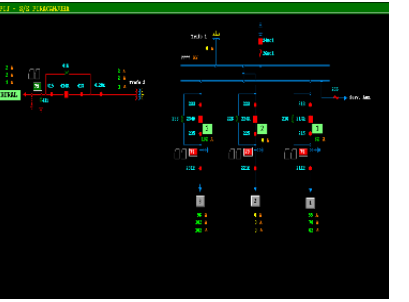
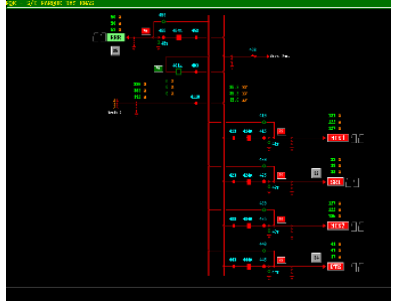
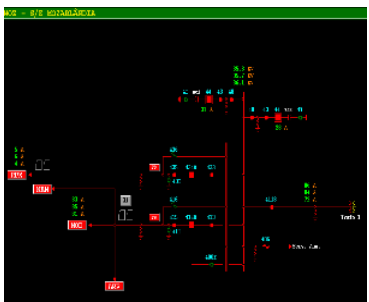
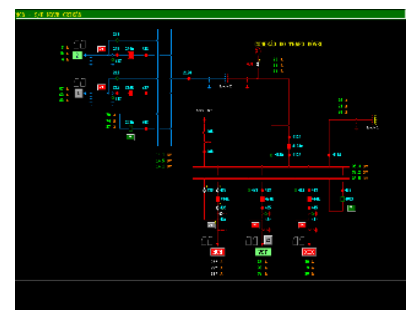

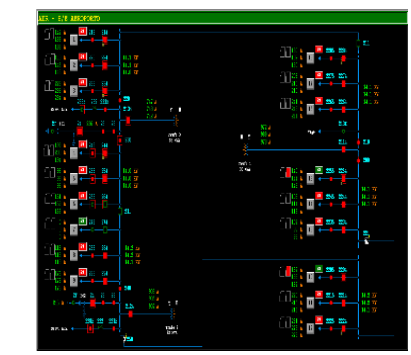
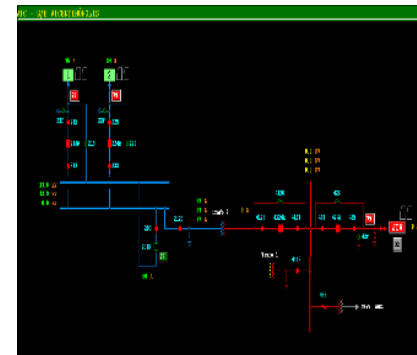
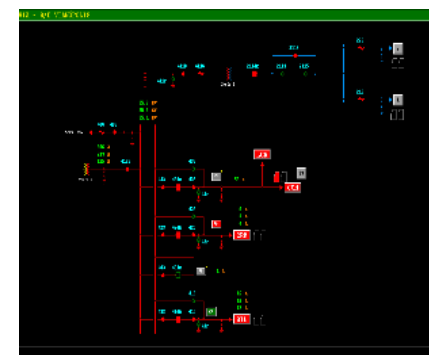
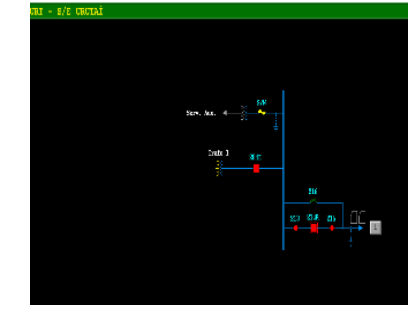
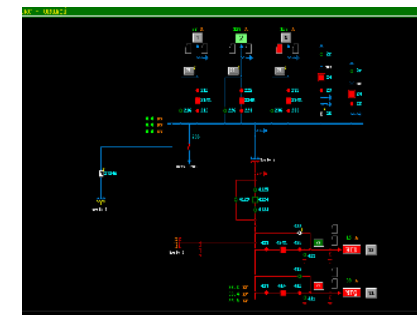
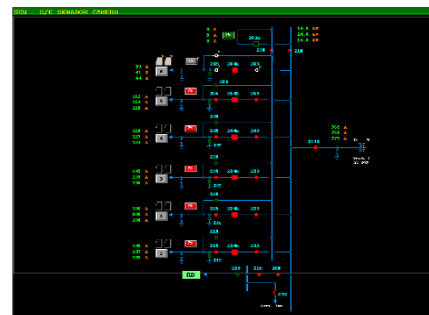
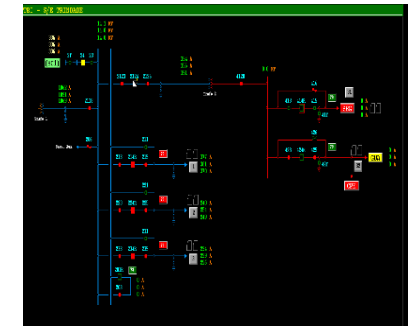
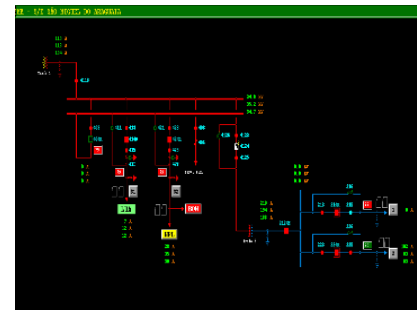
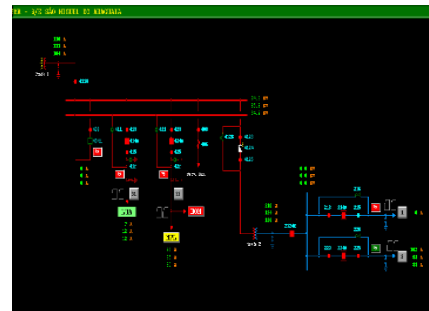
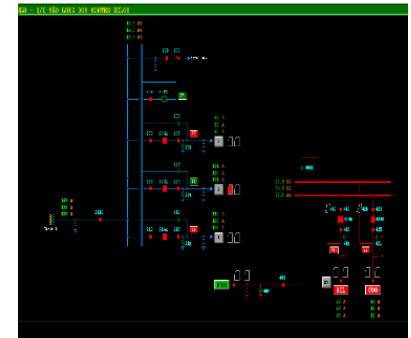
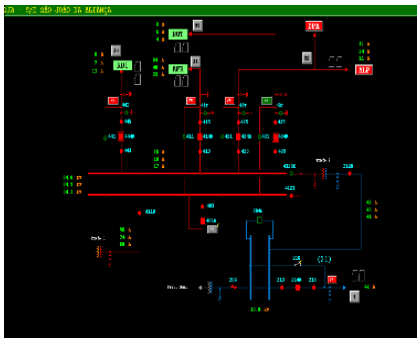
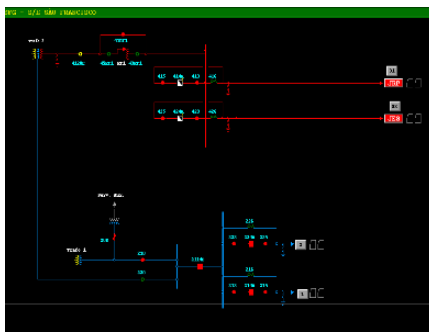
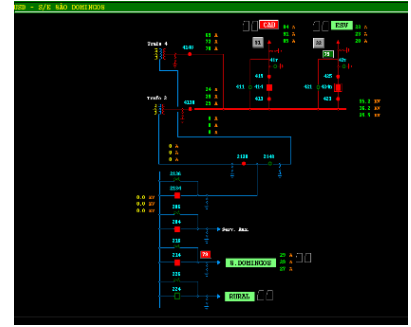
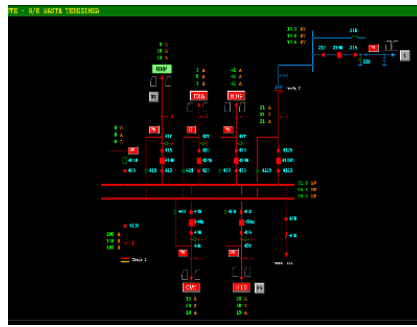
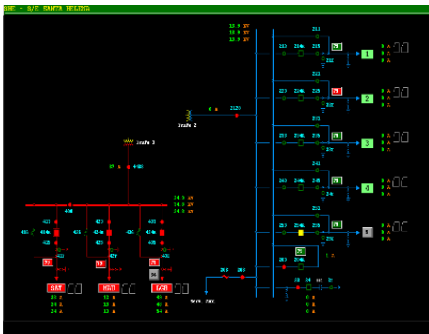

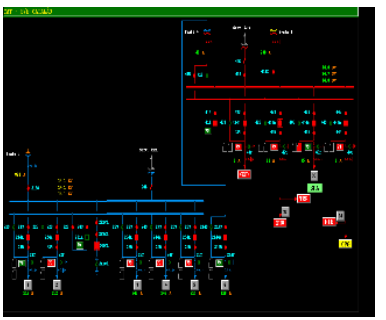
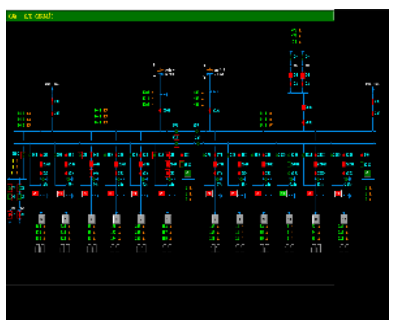
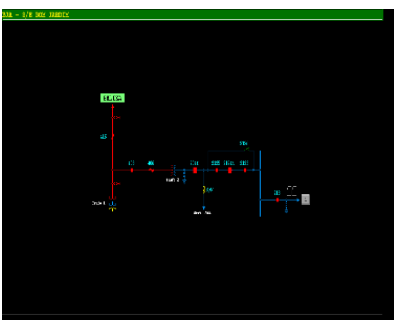
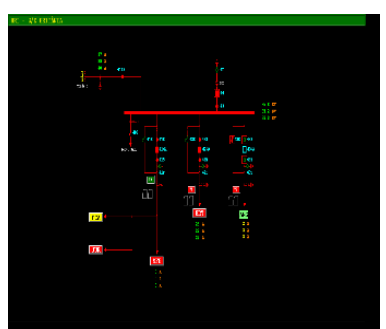
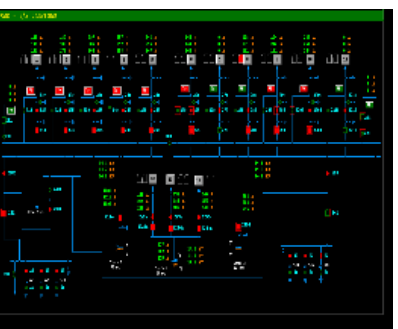
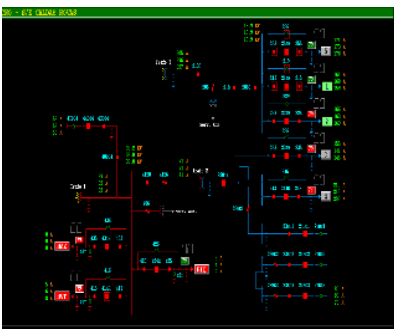
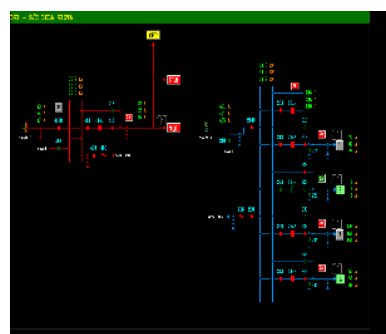
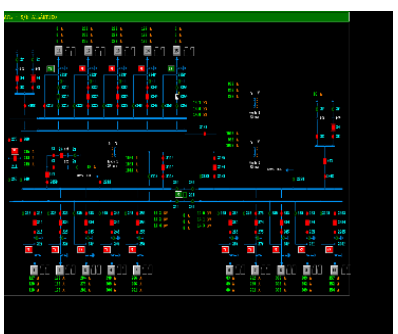
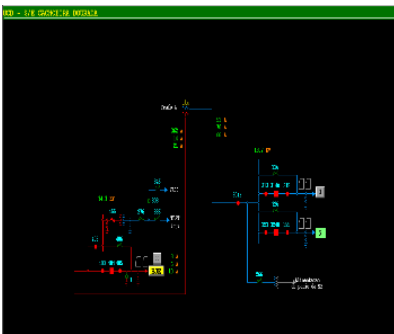
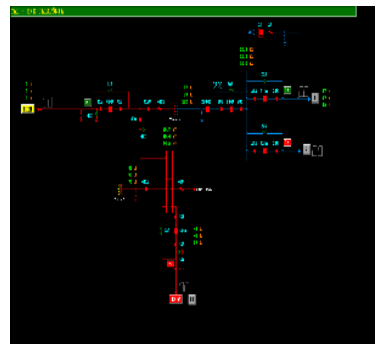
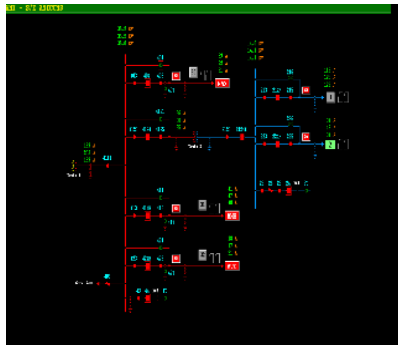
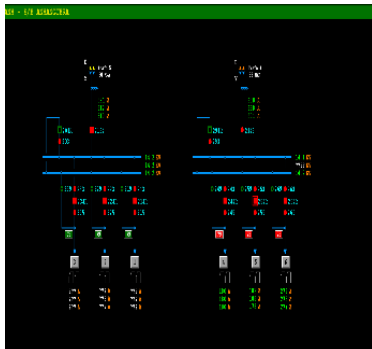
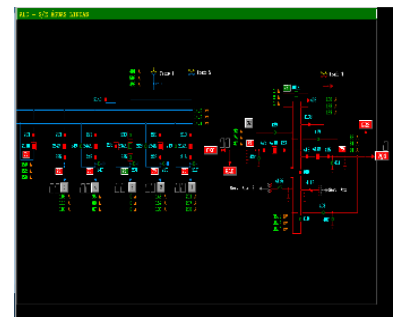
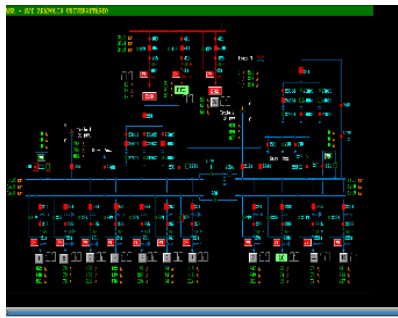
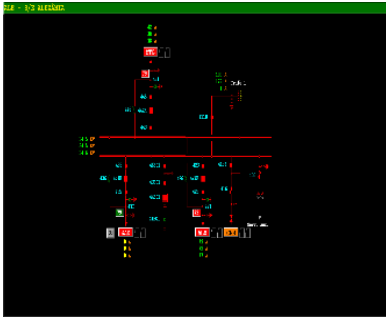

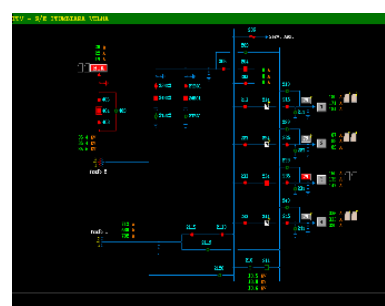
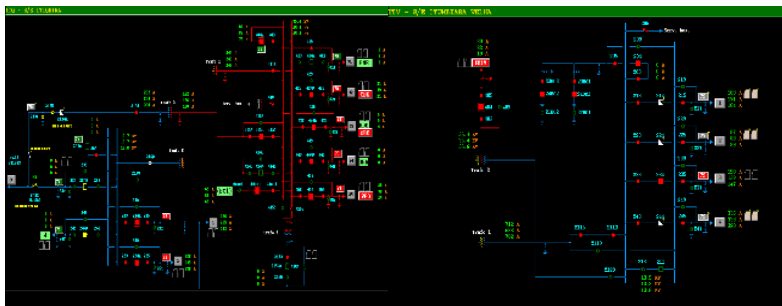
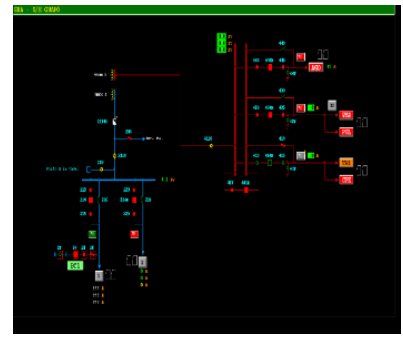
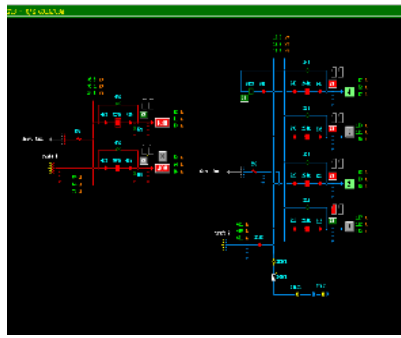
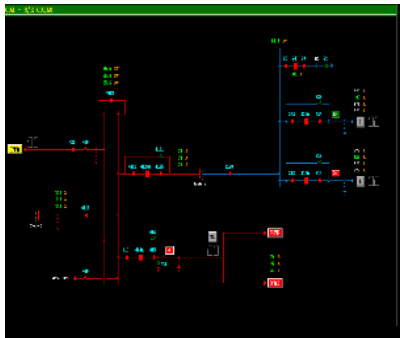
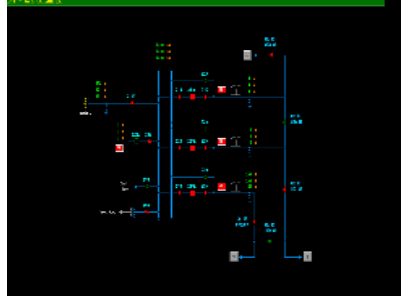
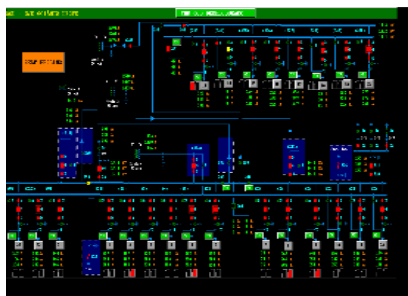
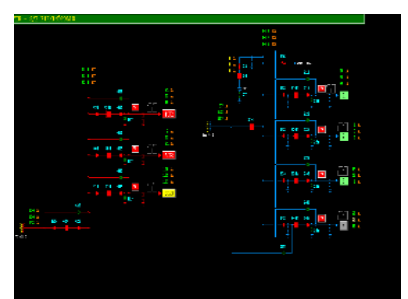
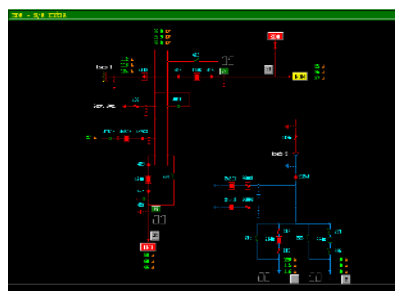
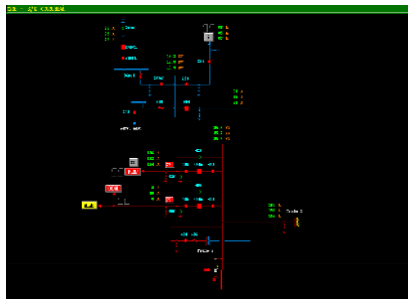
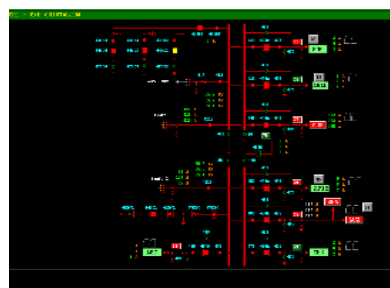
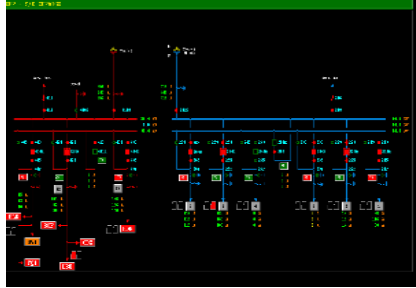
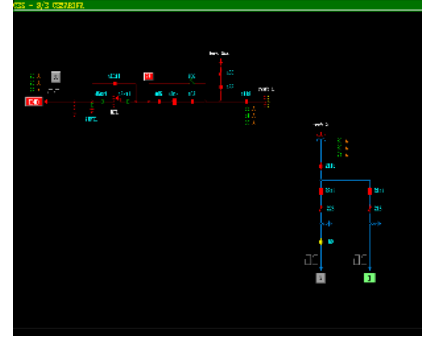
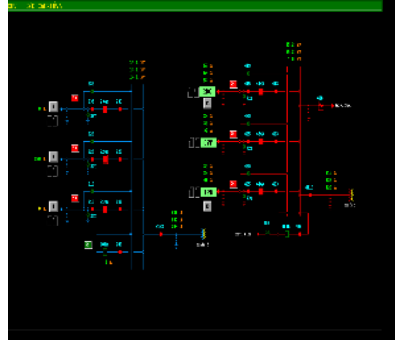
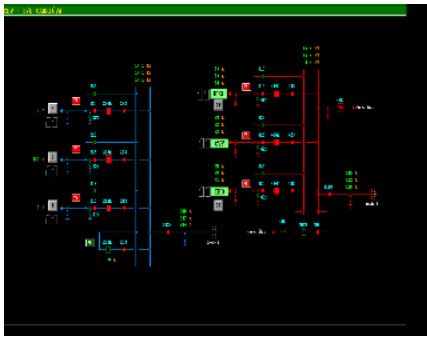

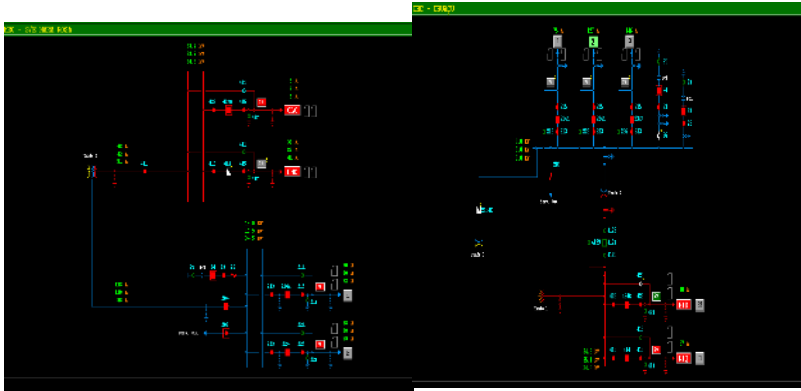
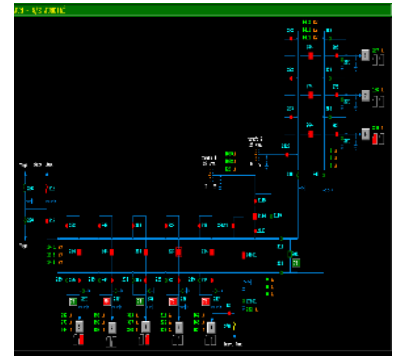
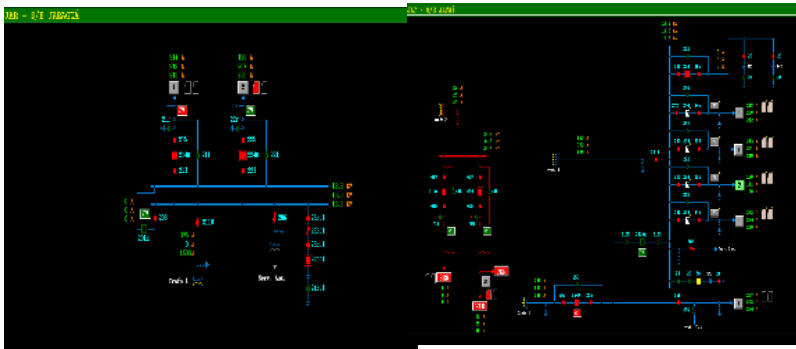

8. DEMAIS EVIDÊNCIAS

8.1. DADOS TÉCNICO - OPERACIONAIS ENEL GO

Enel - GO

TMAE e OE por Dia - Outubro 2020

● Contagem de Ocorrências ● TMAE



Regional Anápolis – GO

TMAE e OE por Dia - Outubro 2020

● Contagem de Ocorrências ● TMAE

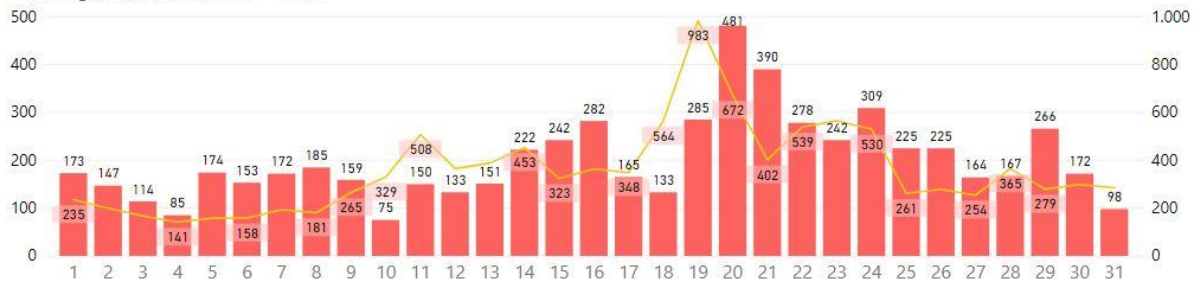

Regional Formosa – GO

TMAE e OE por Dia - Outubro 2020

● Contagem de Ocorrências ● TMAE

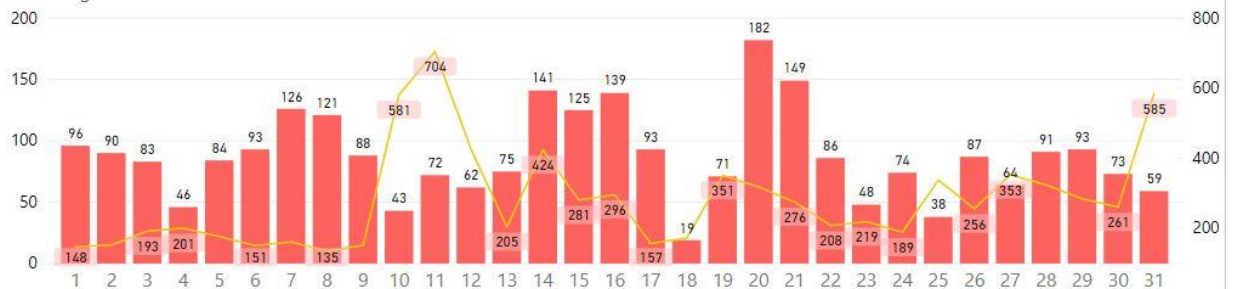

Regional Goiânia – GO

TMAE e OE por Dia - Outubro 2020

● Contagem de Ocorrências ● TMAE



Regional Iporá – GO

TMAE e OE por Dia - Outubro 2020

Regional Luziânia – GO

TMAE e OE por Dia - Outubro 2020

Regional Metropolitana – GO

TMAE e OE por Dia - Outubro 2020

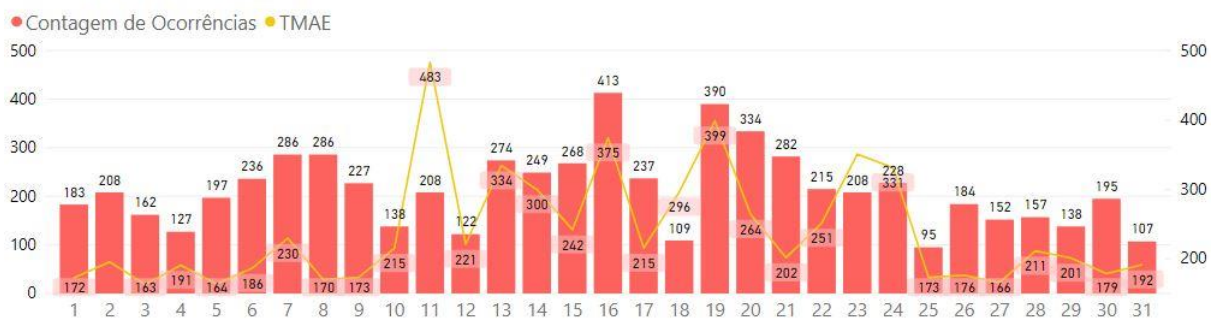
Regional Morrinhos – GO

TMAE e OE por Dia - Outubro 2020



Regional Rio Verde – GO

TMAE e OE por Dia - Outubro 2020

● Contagem de Ocorrências ● TMAE



Regional Uruaçu - GO

TMAE e OE por Dia - Outubro 2020

● Contagem de Ocorrências ● TMAE

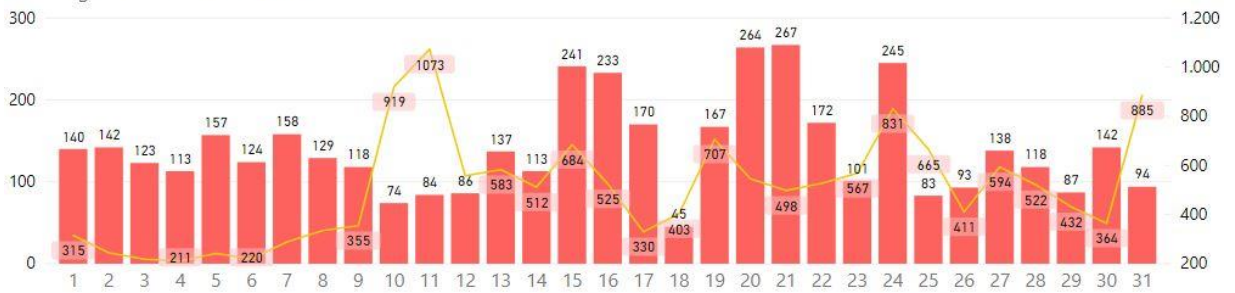

8.2. Dados climatológicos pelo INMET

Instituto Nacional de Meteorologia – INMET

Chuva Acumulada em 24h || Estação: ARAGARCAS (83368) – 10/2020

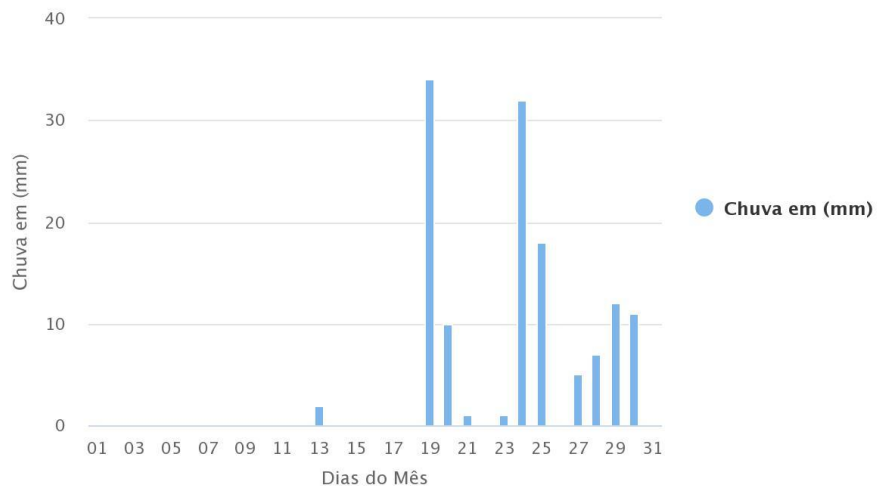

Instituto Nacional de Meteorologia – INMET

Chuva Acumulada em 24h || Estação: CATALAO (83526) – 10/2020

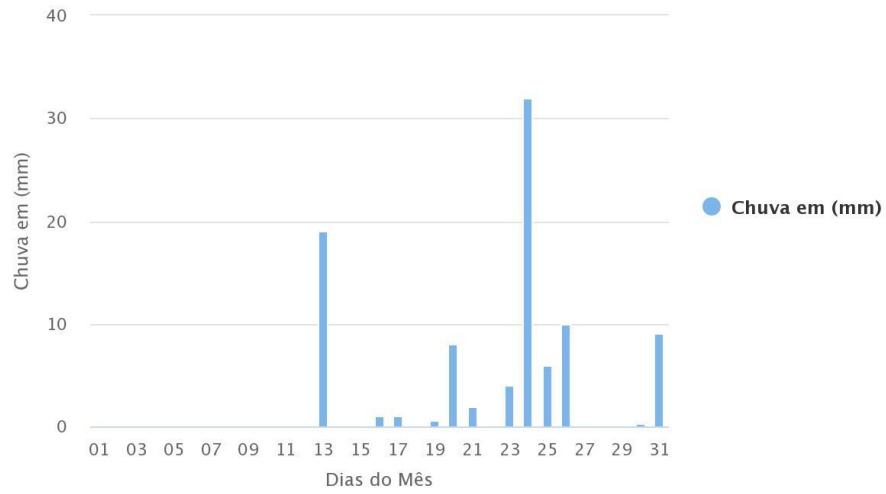

Highcharts.com

Instituto Nacional de Meteorologia – INMET

Chuva Acumulada em 24h || Estação: FORMOSA (83379) – 10/2020

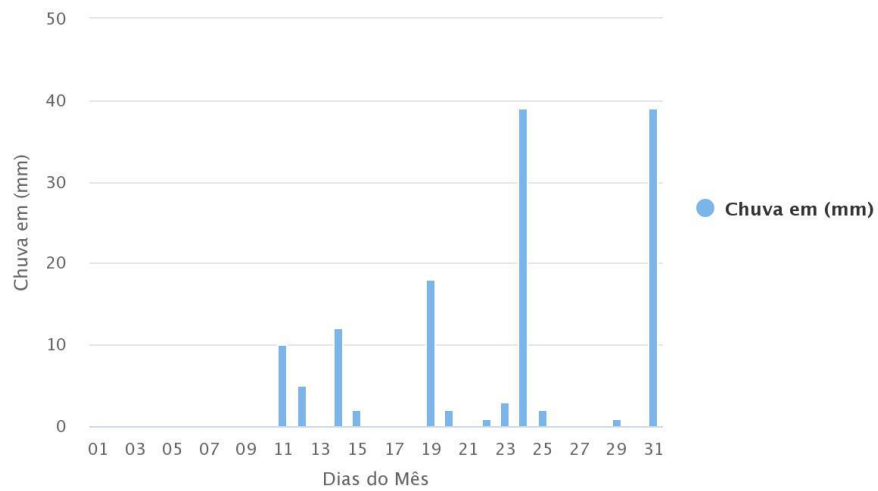

Highcharts.com

Instituto Nacional de Meteorologia – INMET

Chuva Acumulada em 24h || Estação: GOIANIA (83423) – 10/2020

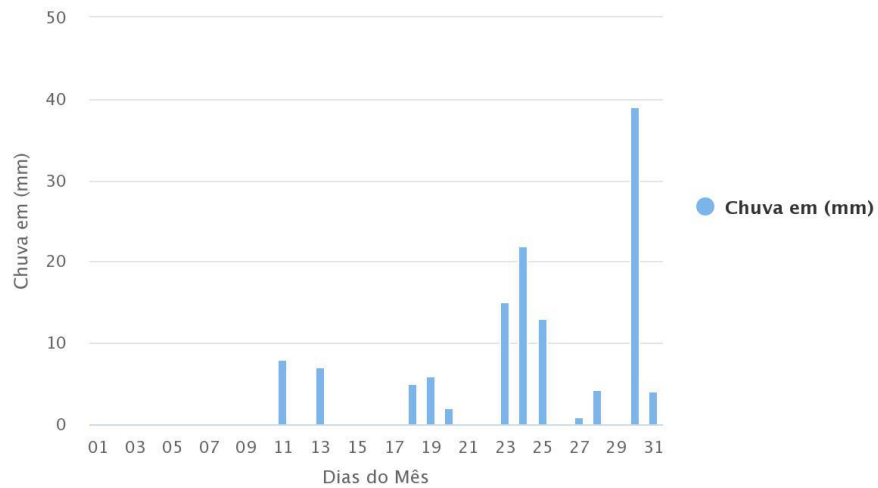

Highcharts.com

Instituto Nacional de Meteorologia – INMET

Chuva Acumulada em 24h || Estação: IPAMERI (83522) – 10/2020

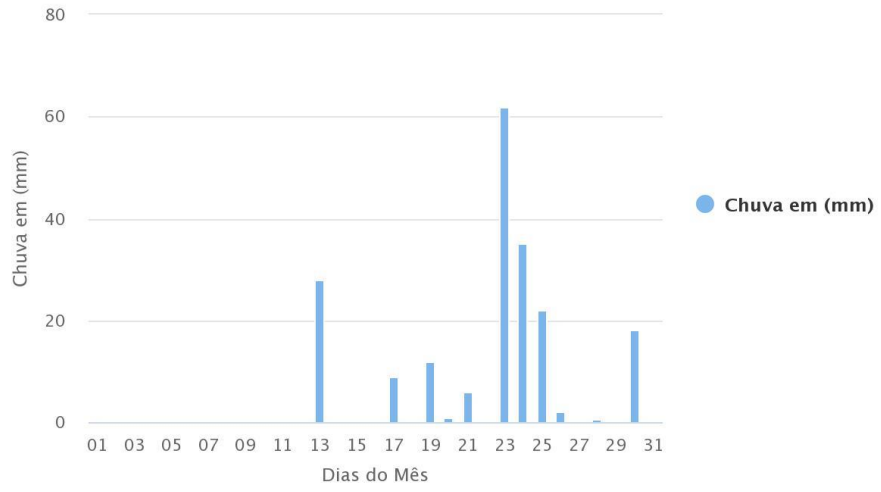

Highcharts.com

Instituto Nacional de Meteorologia – INMET

Chuva Acumulada em 24h || Estação: JATAI (83464) – 10/2020

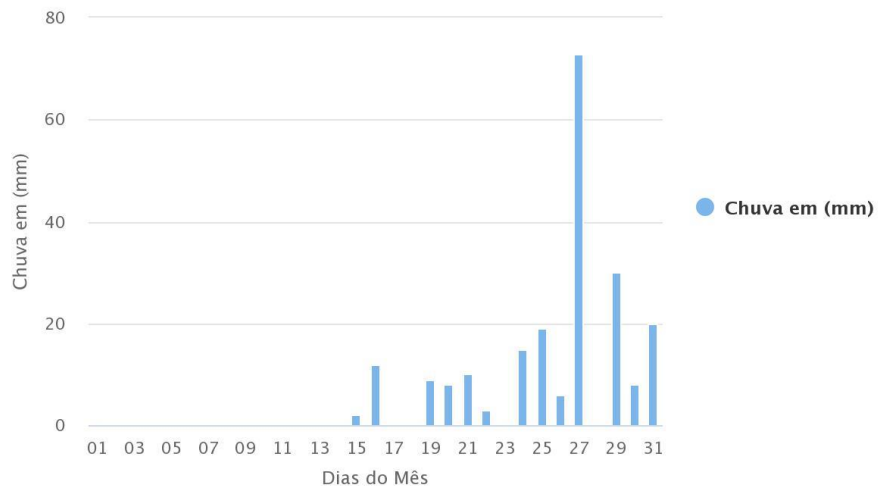

Highcharts.com

Instituto Nacional de Meteorologia – INMET

Chuva Acumulada em 24h || Estação: PIRENOPOLIS (83376) – 10/2020

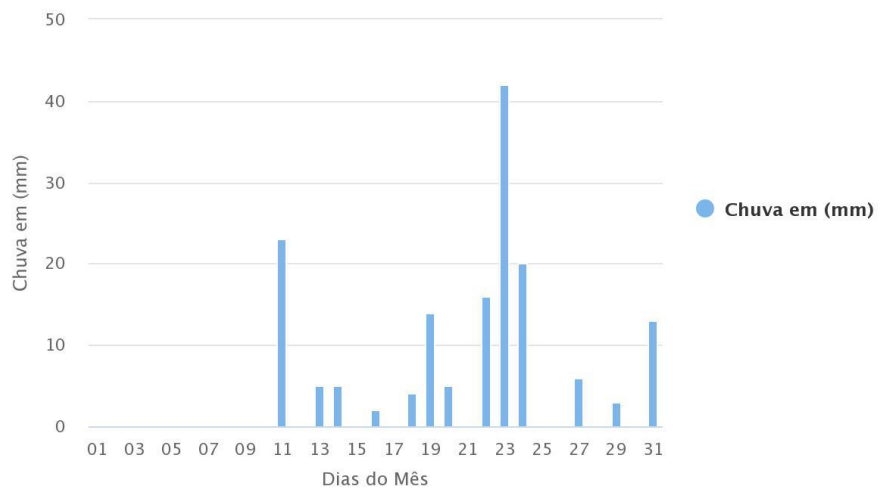

Highcharts.com

Instituto Nacional de Meteorologia – INMET

Chuva Acumulada em 24h || Estação: POSSE (83332) – 10/2020

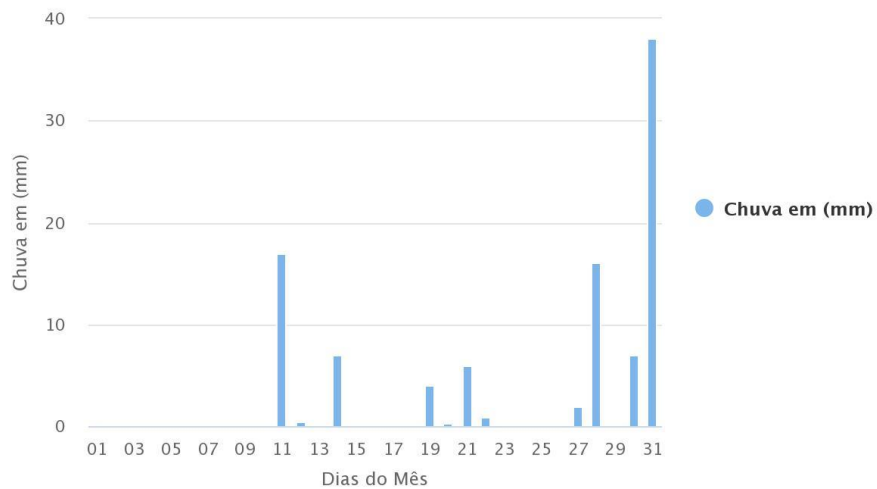

Highcharts.com

Instituto Nacional de Meteorologia – INMET

Chuva Acumulada em 24h || Estação: RIO VERDE (83470) – 10/2020

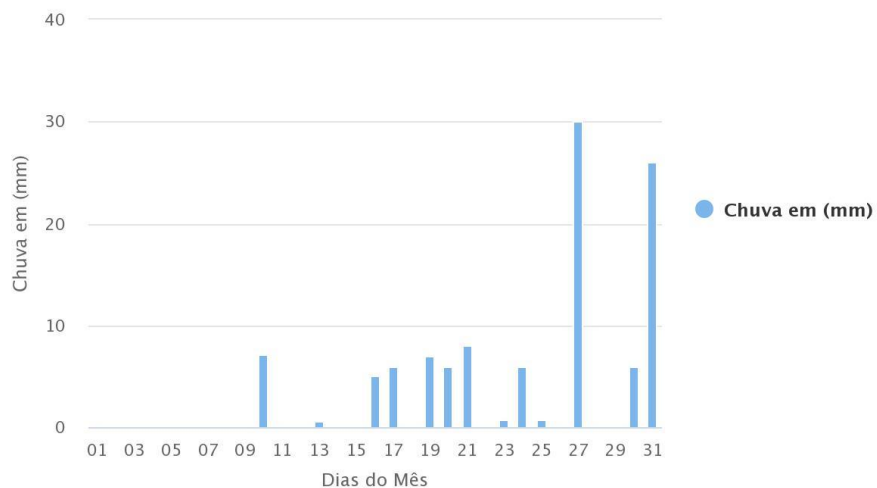

Highcharts.com

9. NOTÍCIAS RELACIONADAS

<https://www.emaisgoias.com.br/chuva-forte-derruba-teto-da-santa-casa-de-anapolis/>

Chuva forte derruba teto da Santa Casa de Anápolis

Unidade informou que os danos foram pequenos e garantiu que o atendimento não foi comprometido

Ton Paulo
Do Meu Goias | Em: 19/10/2020 às 17:48:12



Foto: Reprodução



Finalmente o controle da diabetes é simplificado com isso. [VEJA AGORA]

Parte do teto da **Santa casa de Anápolis** acabou cedendo, no último domingo (18), após a forte **chuva** com vendaval que caiu na cidade. Várias partes do **hospital** foram afetadas pela tempestade e os pacientes desses locais tiveram que ser remanejados. Apesar do grande susto, **ninguém ficou ferido**.

De acordo com a **assessoria da Santa Casa de Anápolis**, a chuva afetou o Centro Médico, a Ala Isolamento Covid, a administração e outros, mas somente o teto de um dos corredores da unidade chegou a cair. “Com a tempestade de ontem [domingo], a forte chuva e ventos, que acometeram toda a cidade de Anápolis, infelizmente a Santa Casa está entre as instituições que prestam serviço relevante pra comunidade que foram comprometidas”, lamentou a assessoria do hospital.

No entanto, ainda conforme a unidade, os danos materiais foram pequenos e, felizmente, **não houve nenhum ferido**. Quanto à parte do teto que caiu e às outras áreas do hospital, a assessoria informou que “os locais danificados já estão isolados” e a correção já foi iniciada.

<https://portal6.com.br/2020/10/19/anapolis-acordou-assim-apos-14h-de-forte-chuva-e-sem-energia/>

Anápolis ‘acordou’ assim após 14h de forte chuva e sem energia

São vários os prejuízos e previsão é que um grande volume de água volte a cair na cidade



Rafaella Soares — 20 de outubro de 2020



(Foto: Reprodução)

Uma Pergunta Rápida

Qual das seguintes marcas você mais associa com Conta Positiva?

Banco BMG

Banco Inter

Banco Original

Banco Pan

Nubank

VOTE PARA VER OS RESULTADOS

A segunda-feira (19) começou do jeito que muitos anapolinos gostam: com chuvinha leve, temperatura baixa e umidade acima dos 90%. As notícias boas, no entanto, param

Além dos prejuízos, são vários os bairros do município que ainda estão sem energia elétrica e água. O último comunicado enviado pela Enel à imprensa afirmava que ainda não havia previsão de normalização do serviço na cidade. Logo depois, a Saneago anunciou que o abastecimento na cidade ficou comprometido.

por aí.

É que para quem precisou sair de casa nesta manhã, não foi difícil encontrar pontos de destruição deixados pela forte chuva que caiu no final da tarde e noite deste domingo (18).

Imagens enviadas por internautas ao Portal 6 mostram parte dos estragos. São casas que perderam o telhado, estabelecimentos que ficaram sem fachadas, parques inundados e árvores que não suportaram a força dos ventos e caíram

<https://www.instagram.com/p/CGdZxTBFpry/?hl=pt-br>



<https://www.instagram.com/p/CGaguCcFiCa/?hl=pt-br>



maisgoias • Seguindo

maisgoias Tempo: chove nesse momento em alguns bairros de Goiânia. Vídeo @rogerseabra

9 sem

+

arieldobarros como eu amo essa cidade...

9 sem Responder

veronicabatista7098 Aqui em Bela vista de Goiás choveu muito forte hj, mas foi muito bom 🙏

9 sem Responder

118.237 visualizações

16 DE OUTUBRO

Adicione um comentário... **Publicar**

<https://www.instagram.com/p/CGhbHy-FYQY/?hl=pt-br>



maisgoias • Seguindo

maisgoias O dia amanheceu com muita chuva na região norte de Goiás. Imagem registrada em Barro Alto pelo leitor @ramons_menezes

9 sem

+

mendamorais Graças a Deus choveu em Minaçu tava muito quente

9 sem Responder

daviblack645 Amém que venha

9 sem Responder

Curtido por gleisonsousa e outras 10.348 pessoas

19 DE OUTUBRO

Adicione um comentário... **Publicar**

Contingência Operacional

OE 97311 – 18/10



Descrição	Atividade	Observações
010101	010101	010101
010102	010102	010102
010103	010103	010103
010104	010104	010104
010105	010105	010105
010106	010106	010106
010107	010107	010107
010108	010108	010108
010109	010109	010109
010110	010110	010110
010111	010111	010111
010112	010112	010112
010113	010113	010113
010114	010114	010114
010115	010115	010115
010116	010116	010116
010117	010117	010117
010118	010118	010118
010119	010119	010119
010120	010120	010120
010121	010121	010121
010122	010122	010122
010123	010123	010123
010124	010124	010124
010125	010125	010125
010126	010126	010126
010127	010127	010127
010128	010128	010128
010129	010129	010129
010130	010130	010130
010131	010131	010131
010132	010132	010132
010133	010133	010133
010134	010134	010134
010135	010135	010135
010136	010136	010136
010137	010137	010137
010138	010138	010138
010139	010139	010139
010140	010140	010140
010141	010141	010141
010142	010142	010142
010143	010143	010143
010144	010144	010144
010145	010145	010145
010146	010146	010146
010147	010147	010147
010148	010148	010148
010149	010149	010149
010150	010150	010150
010151	010151	010151
010152	010152	010152
010153	010153	010153
010154	010154	010154
010155	010155	010155
010156	010156	010156
010157	010157	010157
010158	010158	010158
010159	010159	010159
010160	010160	010160
010161	010161	010161
010162	010162	010162
010163	010163	010163
010164	010164	010164
010165	010165	010165
010166	010166	010166
010167	010167	010167
010168	010168	010168
010169	010169	010169
010170	010170	010170
010171	010171	010171
010172	010172	010172
010173	010173	010173
010174	010174	010174
010175	010175	010175
010176	010176	010176
010177	010177	010177
010178	010178	010178
010179	010179	010179
010180	010180	010180
010181	010181	010181
010182	010182	010182
010183	010183	010183
010184	010184	010184
010185	010185	010185
010186	010186	010186
010187	010187	010187
010188	010188	010188
010189	010189	010189
010190	010190	010190
010191	010191	010191
010192	010192	010192
010193	010193	010193
010194	010194	010194
010195	010195	010195
010196	010196	010196
010197	010197	010197
010198	010198	010198
010199	010199	010199
010200	010200	010200

Contingência Operacional

Nos dias 17 e 19 de outubro, tivemos contingencia na regional Morrinhos ocasionados por ventos e chuvas



OE-88833 – POSTE ABALROADO - PONTALINA



OE- 105164 – CABO PARTIDO – JOVIANIA



OE- 95272 – ÁRVORE NA REDE - ROCHEDO

<https://globoplay.globo.com/v/8952857/>



<https://globoplay.globo.com/v/8952857/>



<https://globoplay.globo.com/v/8952857/>



<https://globoplay.globo.com/v/8951433/>

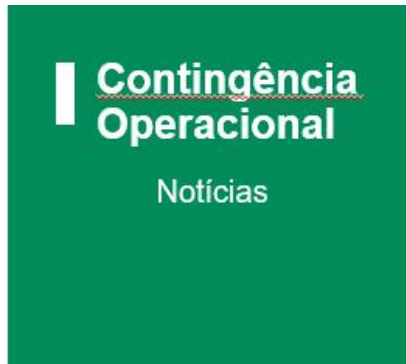
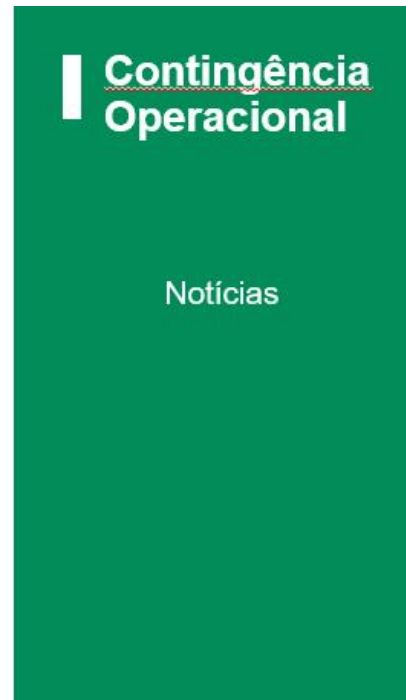

10. Laudo Técnico

CLIMATEMPO

**Laudo Meteorológico de Evento Climático
- ENEL Goiás - 17 de outubro de 2020**

São Paulo, SP, Brasil

Novembro de 2020

Sumário

1	ANÁLISE DE EVENTO METEOROLÓGICO.....	2
1.1	Descrição do Evento.....	2
1.2	Abrangência do Evento.....	5
2	CLASSIFICAÇÃO COBRADE.....	13
3	RESUMO DO EVENTO.....	14
4	REFERÊNCIAS.....	17
	ANEXOS.....	18

1. Análise de Evento Meteorológico

1.1. Descrição do Evento

Na figura a seguir é apresentada a área de concessão da ENEL DISTRIBUIÇÃO GOIÁS, dividida em regiões, a serem analisadas neste relatório.



Figura 1 – Regiões atendidas pela ENEL Goiás.

Áreas de instabilidade organizadas pela presença de uma frente fria na costa do Brasil atuaram sobre o estado de Goiás a partir do dia 17 de outubro de 2020.

Nas Figuras 2 e 3 são apresentadas as descargas atmosféricas nuvem-solo (raios) e nuvem-nuvem detectadas pelo sistema Earth Networks. Entre as 13h50 do dia 17 e 00h00 do dia 20 de outubro de 2020 foram registrados 16582 raios nuvem-solo e 61875 descargas nuvem-nuvem sobre a área da ENEL DISTRIBUIÇÃO GOIÁS.

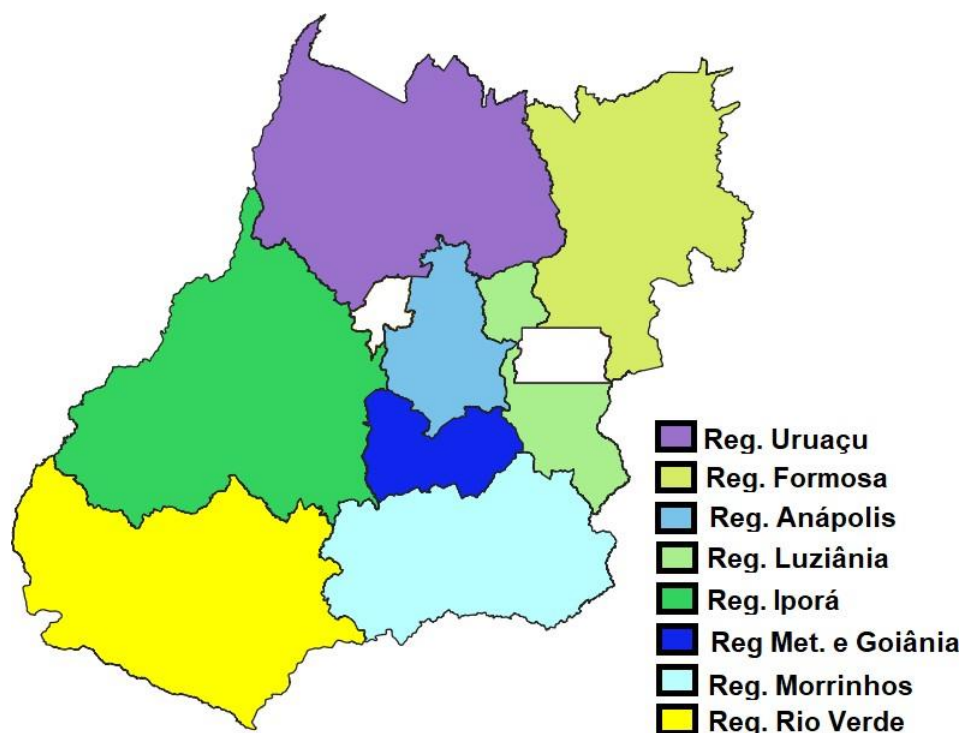

Figura 2 – Descargas atmosféricas nuvem-solo (em preto) detectadas pelo sistema Earth Networks entre 13h50 do dia 17 e 00h00 do dia 20 de outubro de 2020 sobre a área de concessão da ENEL DISTRIBUIÇÃO GOIÁS.



Figura 3 – Descargas atmosféricas nuvem-nuvem (em vermelho) detectadas pelo sistema Earth Networks entre 13h50 do dia 17 e 00h00 do dia 20 de outubro de 2020 sobre a área de concessão da ENEL DISTRIBUIÇÃO GOIÁS.

Estações do Instituto Nacional de Meteorologia (INMET), representativas da área de concessão da ENEL DISTRIBUIÇÃO GOIÁS, registraram chuva forte (segundo a American Meteorological Society - Sociedade Meteorológica Americana -, chuvas com taxa entre 2,5mm a 7,6 mm por hora são consideradas moderadas e aquelas com taxa superior a 7,6 mm por hora são consideradas chuva forte). Na tabela 1 são apresentados os registros de acumulados horários superiores a 7,6 mm.

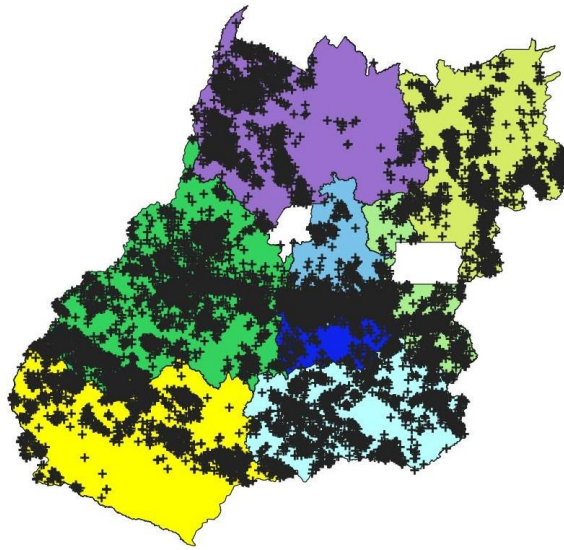
Segundo dados do INMET, entre as 09h00 do dia 18 e as 09h00 do dia 19 de outubro (horário de Brasília) foram acumulados 41,4 mm na estação de Cristalina, valor que corresponde a aproximadamente 27% da média climatológica de chuva para um mês de outubro na região.

Tabela 1 – Acumulado horário de chuva registrada pelo INMET.

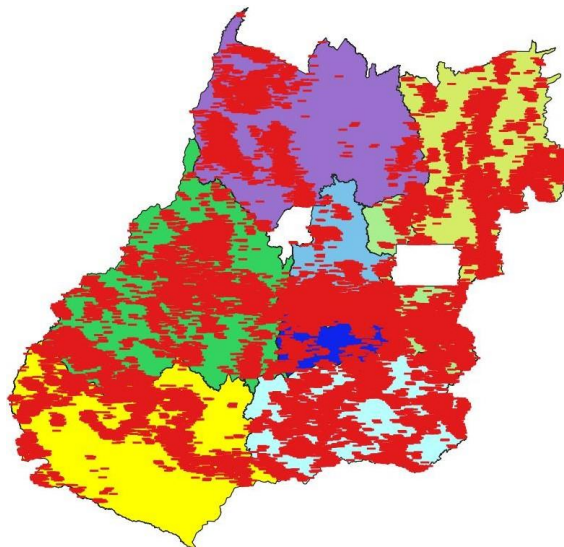
Estação	Horário	Precipitação (mm)
Alto Paraíso de Goiás	Entre 16h e 17h do dia 19/10/2020	8.8
Alto Paraíso de Goiás	Entre 17h e 18h do dia 19/10/2020	9.0
Aragarças	Entre 23h e 0h do dia 19/10/2020	23.8
Cristalina	Entre 21h e 22h do dia 18/10/2020	20.6
Itumbiara	Entre 17h e 18h do dia 18/10/2020	10.0
Itumbiara	Entre 14h e 15h do dia 20/10/2020	8.4
Mineiros	Entre 16h e 17h do dia 20/10/2020	14.6
Morrinhos	Entre 15h e 16h do dia 18/10/2020	22.0

Na tabela 2 são apresentadas as rajadas de vento iguais ou superiores a 50 km/h registradas por estações do Instituto Nacional de Meteorologia (INMET) representativas da área de concessão da ENEL Distribuição Goiás. Como é possível observar, o maior valor registrado foi de 62,6 km/h na estação de Jataí entre as 15h e 17h do dia 18 de outubro, vento classificado como ventania pela escala Beaufort.

Tabela 2 – Rajadas de vento maiores ou iguais a 50 km/h registradas pelo INMET. Segundo a escala Beaufort, ventos entre 50 e 61 km/h são classificados como vento forte e entre 62 e 74 km/h como ventania.

Estação	Horário	Rajada (km/h)
Aragarças	Entre 15h e 16h do dia 19/10/2020	51.5
Aragarças	Entre 16h e 17h do dia 19/10/2020	51.5
Itumbiara	Entre 17h e 18h do dia 18/10/2020	53.3
Jataí	Entre 15h e 16h do dia 18/10/2020	62.6
Jataí	Entre 16h e 17h do dia 18/10/2020	62.6
Jataí	Entre 17h e 18h do dia 18/10/2020	55.8
Jataí	Entre 17h e 18h do dia 20/10/2020	58.0
Paraúna	Entre 22h e 23h do dia 18/10/2020	50.8
Paraúna	Entre 23h e 0h do dia 19/10/2020	50.8
Posse	Entre 12h e 13h do dia 18/10/2020	51.8

1.2. Abrangência do Evento

A seguir são apresentadas as imagens realçadas do satélite GOES-16 entre as 12h00 do dia 09 e 09h00 do dia 14 de outubro de 2020. Os tons em vermelho e preto indicam a presença de nuvens de grande desenvolvimento vertical, geralmente associadas à ocorrência de tempo severo.

12h00 - 17 de Outubro de 2020 - BRT



Figura 4 – Imagens realçadas do satélite GOES-16 das 12h00 do dia 17 de Outubro de 2020.
FONTE: Cptec/INPE.

15h00 - 17 de Outubro de 2020 - BRT

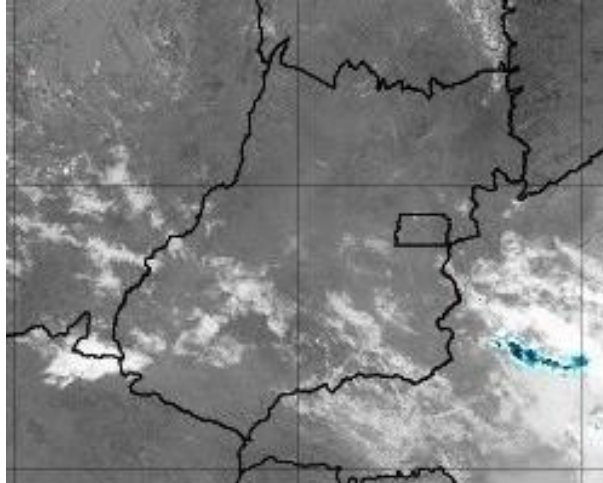

Figura 5 – Imagens realçadas do satélite GOES-16 das 15h00 do dia 17 de Outubro de 2020.
FONTE: Cptec/INPE.

18h00 - 17 de Outubro de 2020 - BRT

Figura 6 – Imagens realçadas do satélite GOES-16 das 18h00 do dia 17 de Outubro de 2020.
FONTE: Cptec/INPE.

21h00 - 17 de Outubro de 2020 - BRT

Figura 7 – Imagens realçadas do satélite GOES-16 das 21h00 do dia 17 de Outubro de 2020.
FONTE: Cptec/INPE.

0h00 - 18 de Outubro de 2020 - BRT

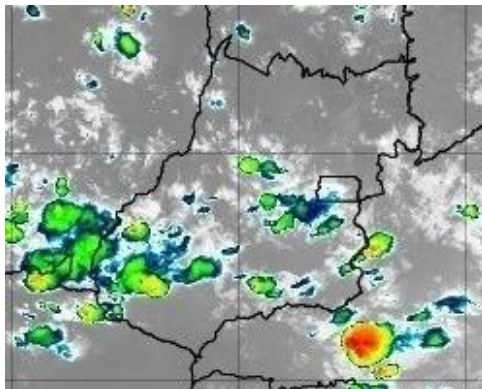
Figura 8 – Imagens realçadas do satélite GOES-16 das 0h00 do dia 18 de Outubro de 2020. FONTE:
Cptec/INPE.

3h00 - 18 de Outubro de 2020 - BRT

Figura 9 – Imagens realçadas do satélite GOES-16 das 3h00 do dia 18 de Outubro de 2020. FONTE: Cptec/INPE.

6h00 - 18 de Outubro de 2020 - BRT

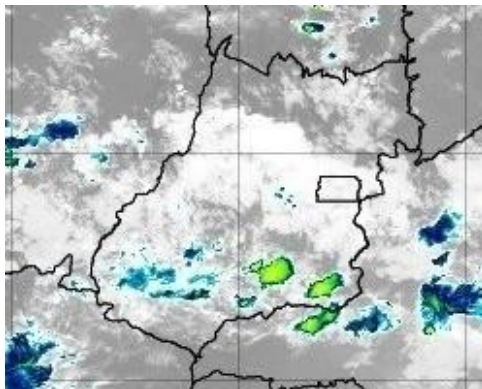
Figura 10 – Imagens realçadas do satélite GOES-16 das 6h00 do dia 18 de Outubro de 2020. FONTE: Cptec/INPE.

9h00 - 18 de Outubro de 2020 - BRT

Figura 11 – Imagens realçadas do satélite GOES-16 das 9h00 do dia 18 de Outubro de 2020. FONTE: Cptec/INPE.

12h00 - 18 de Outubro de 2020 - BRT

Figura 12 – Imagens realçadas do satélite GOES-16 das 12h00 do dia 18 de Outubro de 2020.
FONTE: Cptec/INPE.

15h00 - 18 de Outubro de 2020 - BRT

Figura 13 – Imagens realçadas do satélite GOES-16 das 15h00 do dia 18 de Outubro de 2020.
FONTE: Cptec/INPE.

18h00 - 18 de Outubro de 2020 - BRT

Figura 14 – Imagens realçadas do satélite GOES-16 das 18h00 do dia 18 de Outubro de 2020.
FONTE: Cptec/INPE.

21h00 - 18 de Outubro de 2020 - BRT

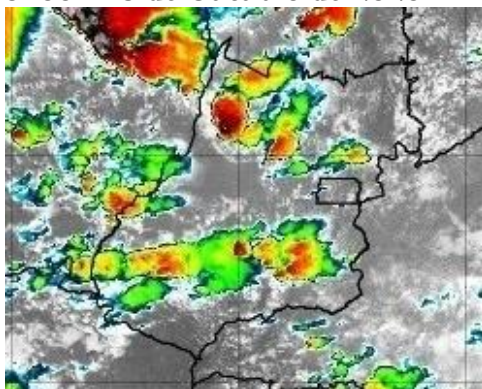
Figura 15 – Imagens realçadas do satélite GOES-16 das 21h00 do dia 18 de Outubro de 2020.
FONTE: Cptec/INPE.

0h00 - 19 de Outubro de 2020 - BRT

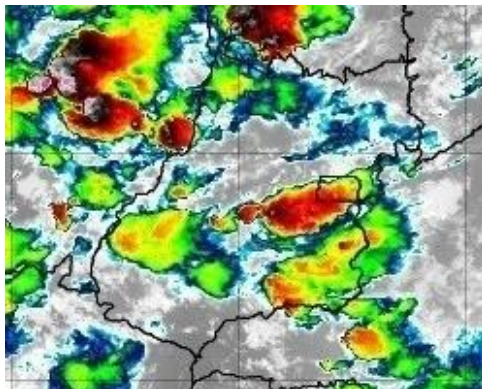
Figura 16 – Imagens realçadas do satélite GOES-16 das 0h00 do dia 19 de Outubro de 2020.
FONTE: Cptec/INPE.

3h00 - 19 de Outubro de 2020 - BRT

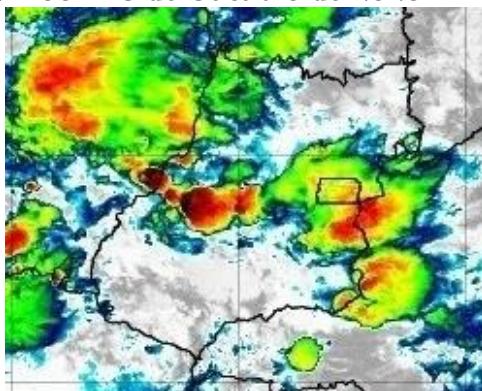
Figura 17 – Imagens realçadas do satélite GOES-16 das 3h00 do dia 19 de Outubro de 2020.
FONTE: Cptec/INPE.

6h00 - 19 de Outubro de 2020 - BRT

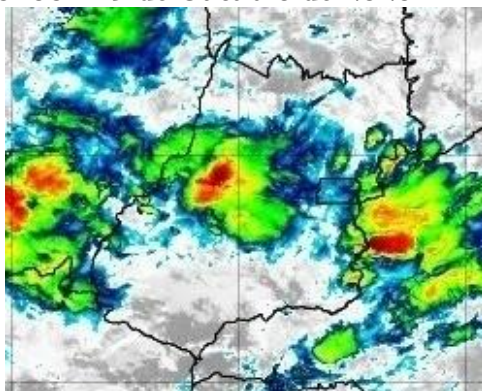
Figura 18 – Imagens realçadas do satélite GOES-16 das 6h00 do dia 19 de Outubro de 2020.
FONTE: Cptec/INPE.

9h00 - 19 de Outubro de 2020 - BRT

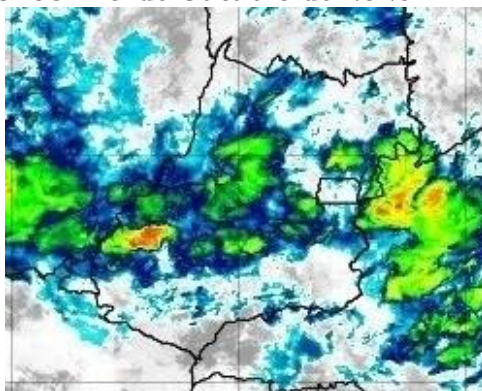
Figura 19 – Imagens realçadas do satélite GOES-16 das 9h00 do dia 19 de Outubro de 2020.
FONTE: Cptec/INPE.

12h00 - 19 de Outubro de 2020 - BRT

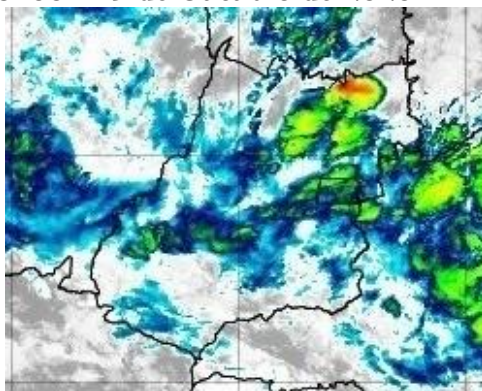
Figura 20 – Imagens realçadas do satélite GOES-16 das 12h00 do dia 19 de Outubro de 2020. FONTE:
Cptec/INPE.

15h00 - 19 de Outubro de 2020 - BRT

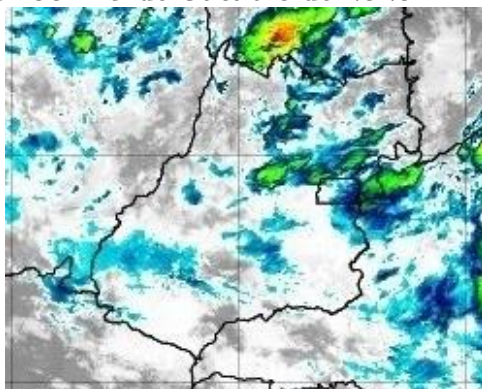
Figura 21 – Imagens realçadas do satélite GOES-16 das 15h00 do dia 19 de Outubro de 2020.
FONTE: Cptec/INPE.

18h00 - 19 de Outubro de 2020 - BRT

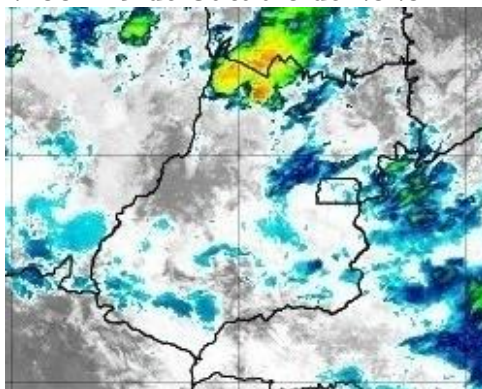
Figura 22 – Imagens realçadas do satélite GOES-16 das 18h00 do dia 19 de Outubro de 2020. FONTE:
Cptec/INPE.

21h00 - 19 de Outubro de 2020 - BRT

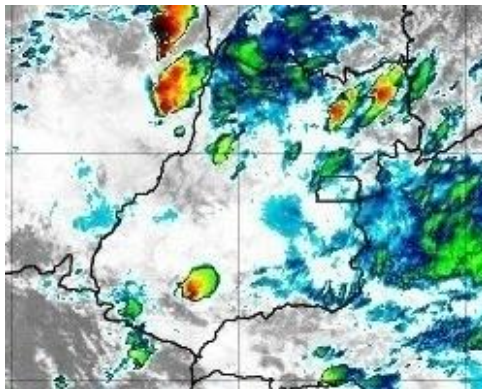
Figura 23 – Imagens realçadas do satélite GOES-16 das 21h00 do dia 19 de Outubro de 2020.
FONTE: Cptec/INPE.

0h00 - 20 de Outubro de 2020 - BRT

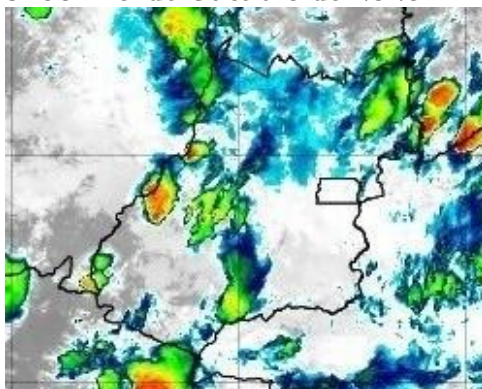
Figura 24 – Imagens realçadas do satélite GOES-16 das 0h00 do dia 20 de Outubro de 2020. FONTE: Cptec/INPE.

2. Classificação COBRADE

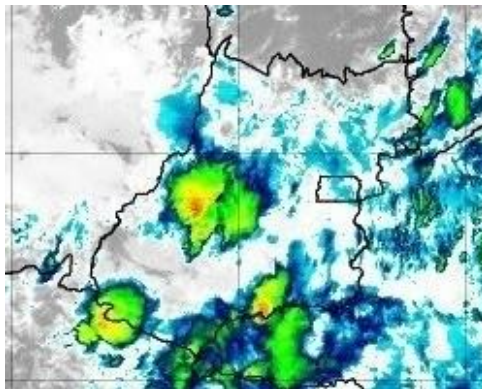
O COBRADE (Classificação e Codificação Brasileira de Desastres) foi criado com o intuito de adequar a classificação brasileira à classificação utilizada pela ONU na classificação de desastres e nivelar o país aos demais organismos de gestão de desastres do mundo.

Baseados nos dados analisados nos itens anteriores, podemos classificar o evento ocorrido sobre a área de concessão da ENEL DISTRIBUIÇÃO GOIÁS como Zona de Convergência (Código 1.3.1.2.0).

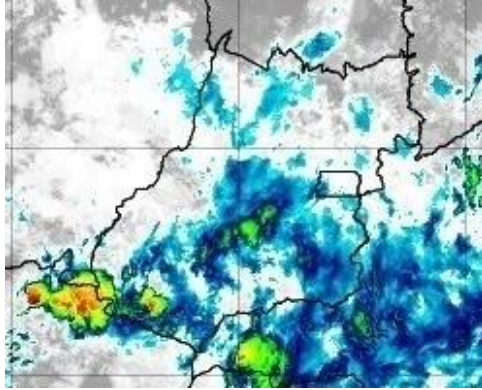
3. Resumo do Evento

Áreas de instabilidades associadas a presença de uma frente fria na costa do Brasil favoreceram a ocorrência de chuva forte, rajadas de vento e raios sobre o estado de Goiás entre a tarde do dia 17 e a noite do dia 19 de outubro de 2020.

O sistema de detecção da Earth Networks registrou 78457 descargas atmosféricas sobre a área de concessão da ENEL em Goiás entre as 13h50 do dia 17 e 00h00 do dia 20 de outubro de 2020.

Rajadas de vento classificadas como vento forte e ventania pela escala Beaufort foram registrados em estações do INMET representativas da região durante o período. Na cidade de Jataí rajadas de até 62,6 km/h foram registradas na tarde do dia 18 de outubro.

Tabela 3 – Resumo do evento Regional Rio Verde

Número/Código do Evento	
Número/Código do Relatório	
Descrição	Zona de convergência é uma região que está ligada à tempestade causada por uma zona de baixa pressão atmosférica, provocando forte deslocamento de massas de ar, vendavais, chuvas intensas e até queda de granizo.
Código COBRADE	1.3.1.2.0 - Zona de Convergência
Hora início do evento	13h30 do dia 17 de outubro de 2020
Hora de fim do evento	00h00 do dia 20 de outubro de 2020
Abrangência	Regional Rio Verde

Tabela 4 – Resumo do evento Regional Morrinhos

Número/Código do Evento	
Número/Código do Relatório	
Descrição	Zona de convergência é uma região que está ligada à tempestade causada por uma zona de baixa pressão atmosférica, provocando forte deslocamento de massas de ar, vendavais, chuvas intensas e até queda de granizo.
Código COBRADE	1.3.1.2.0 - Zona de Convergência
Hora início do evento	15h00 do dia 17 de outubro de 2020
Hora de fim do evento	22h00 do dia 19 de outubro de 2020
Abrangência	Regional Morrinhos

Tabela 5 – Resumo do evento Regional Metropolitana e Goiânia

Número/Código do Evento	
Número/Código do Relatório	
Descrição	Zona de convergência é uma região que está ligada à tempestade causada por uma zona de baixa pressão atmosférica, provocando forte deslocamento de massas de ar, vendavais, chuvas intensas e até queda de granizo.
Código COBRADE	1.3.1.2.0 - Zona de Convergência
Hora início do evento	14h30 do dia 17 de outubro de 2020
Hora de fim do evento	03h30 do dia 19 de outubro de 2020
Abrangência	Regional Metropolitana e Goiânia

Tabela 6 – Resumo do evento Regional Iporá

Número/Código do Evento	
Número/Código do Relatório	
Descrição	Zona de convergência é uma região que está ligada à tempestade causada por uma zona de baixa pressão atmosférica, provocando forte deslocamento de massas de ar, vendavais, chuvas intensas e até queda de granizo.
Código COBRADE	1.3.1.2.0 - Zona de Convergência
Hora início do evento	14h00 do dia 17 de outubro de 2020
Hora de fim do evento	21h30 do dia 19 de outubro de 2020
Abrangência	Regional Iporá

Tabela 7 – Resumo do evento Regional Luziânia

Número/Código do Evento	
Número/Código do Relatório	
Descrição	Zona de convergência é uma região que está ligada à tempestade causada por uma zona de baixa pressão atmosférica, provocando forte deslocamento de massas de ar, vendavais, chuvas intensas e até queda de granizo.
Código COBRADE	1.3.1.2.0 - Zona de Convergência
Hora início do evento	15h00 do dia 17 de outubro de 2020
Hora de fim do evento	04h00 do dia 19 de outubro de 2020
Abrangência	Regional Luziânia

Tabela 8 – Resumo do evento Regional Anápolis

Número/Código do Evento	
Número/Código do Relatório	
Descrição	Zona de convergência é uma região que está ligada à tempestade causada por uma zona de baixa pressão atmosférica, provocando forte deslocamento de massas de ar, vendavais, chuvas intensas e até queda de granizo.
Código COBRADE	1.3.1.2.0 - Zona de Convergência
Hora início do evento	14h00 do dia 17 de outubro de 2020
Hora de fim do evento	22h00 do dia 19 de outubro de 2020
Abrangência	Regional Anápolis

Tabela 9 – Resumo do evento Regional Uruaçu

Número/Código do Evento	
Número/Código do Relatório	
Descrição	Zona de convergência é uma região que está ligada à tempestade causada por uma zona de baixa pressão atmosférica, provocando forte deslocamento de massas de ar, vendavais, chuvas intensas e até queda de granizo.
Código COBRADE	1.3.1.2.0 - Zona de Convergência
Hora início do evento	14h00 do dia 17 de outubro de 2020
Hora de fim do evento	17h00 do dia 19 de outubro de 2020
Abrangência	Regional Uruaçu

Tabela 10 – Resumo do evento Regional Formosa

Número/Código do Evento	
Número/Código do Relatório	
Descrição	Zona de convergência é uma região que está ligada à tempestade causada por uma zona de baixa pressão atmosférica, provocando forte deslocamento de massas de ar, vendavais, chuvas intensas e até queda de granizo.
Código COBRADE	1.3.1.2.0 - Zona de Convergência
Hora início do evento	00h00 do dia 18 de outubro de 2020
Hora de fim do evento	23h00 do dia 19 de outubro de 2020
Abrangência	Regional Formosa

4. Referências

- RMets Royal Meteorological Society – Beaufort Scale -

<https://www.rmets.org/weather-and-climate/observing/beaufort-scale>

- Instituto Nacional de Meteorologia (INMET) - <http://www.inmet.gov.br>

- Cptec/INPE

<https://www.cptec.inpe.br/>

- Centro de Hidrografia da Marinha do Brasil -

<https://www.marinha.mil.br/chm/>

- Meteorology Glossary - American Meteorological Society -

<http://glossary.ametsoc.org/>

Anexos

A.1. Carta Sinótica



Figura A1 - Carta sinótica da Marinha do Brasil para as 1200Z do dia 17 de outubro de 2020 (09h00 do dia 17 de outubro de 2020, hora local).



LEGENDA			
	Frente Fria	A	Alta Pressão
	Frente Quente	B	Baixa Pressão
	Instabilidade		Zona de Convergência

Figura A2 - Carta sinótica da Marinha do Brasil para as 1200Z do dia 18 de outubro de 2020 (09h00 do dia 18 de outubro de 2020, hora local).

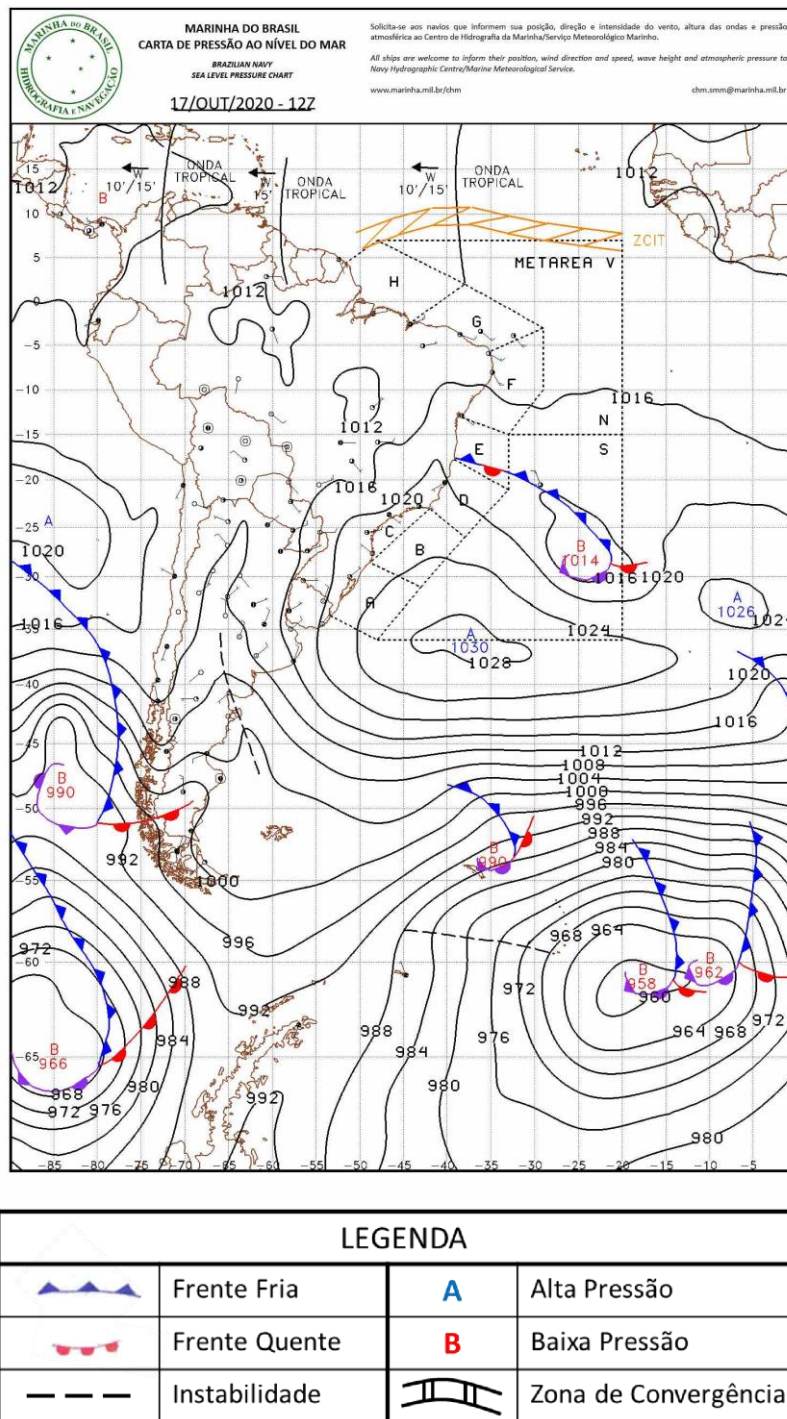
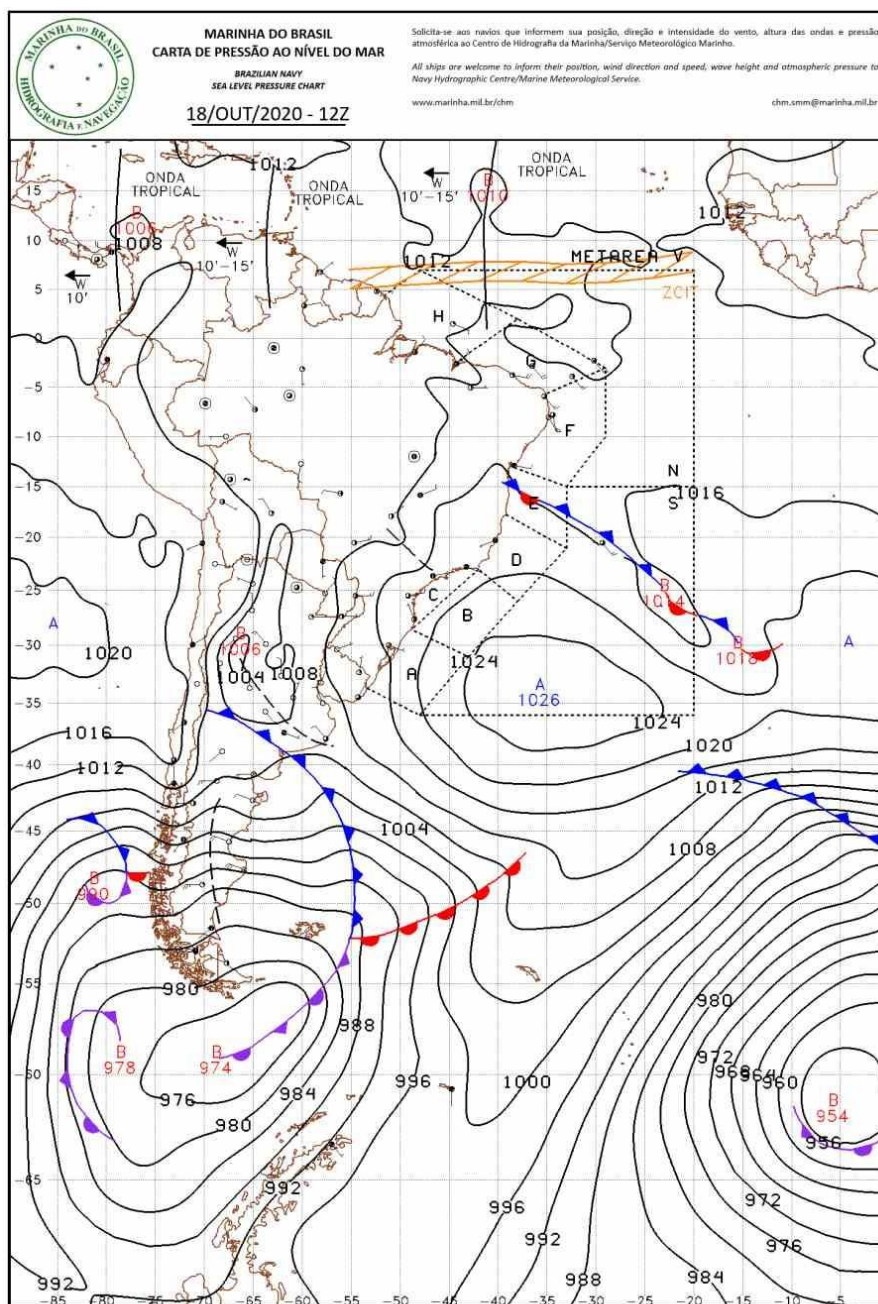
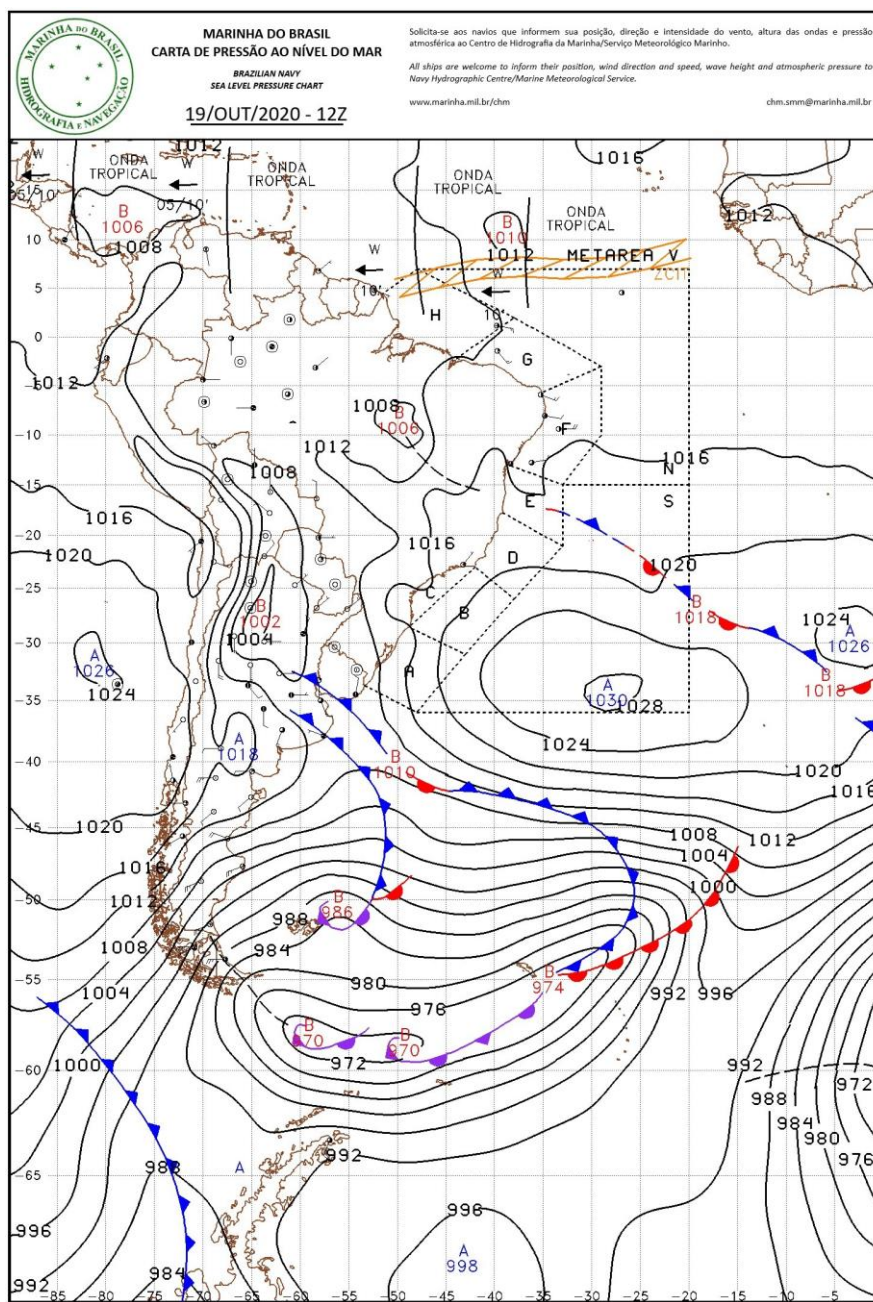

LEGENDA			
	Frente Fria	A	Alta Pressão
	Frente Quente	B	Baixa Pressão
	Instabilidade		Zona de Convergência

Figura A3 - Carta sinótica da Marinha do Brasil para as 1200Z do dia 19 de outubro de 2020 (09h00 do dia 19 de outubro de 2020, hora local).

A.2. Notícias associadas

- Chuva forte derruba teto da Santa Casa de Anápolis

<https://www.emaisgoias.com.br/chuva-forte-derruba-teto-da-santa-casa-de-anapolis/>

- Anápolis 'acordou' assim após 14h de forte chuva e sem energia

<https://portal6.com.br/2020/10/19/anapolis-acordou-assim-apos-14h-de-forte-chuva-e-sem-energia/>

Bianca Lobo Silva
Meteorologista CREA
5063840461

