

## **ENEL DISTRIBUIÇÃO GOLÁS**



**Relatório de Evento em Situação de Emergência**

**Nº CHI-051**

1.	INTRODUÇÃO.....	3
2.	DEFINIÇÃO .....	3
3.	RESUMO EXECUTIVO.....	5
3.1.	RELATÓRIO DE OCORRÊNCIAS DO PERÍODO.....	5
4.	LISTA DE OCORRÊNCIAS .....	9
5.	PLOTAGEM DAS OCORRÊNCIAS CONFORME A ESPACIALIZAÇÃO DAS CHUVAS.....	78
6.	CLIENTES AFETADOS E IMPACTOS GLOBAIS .....	79
7.	DIAGRAMAS UNIFILARES .....	80
8.	DEMAIS EVIDÊNCIAS .....	8686
8.1.	DADOS TÉCNICO - OPERACIONAIS ENEL GO.....	8686
8.2.	DADOS CLIMATOLÓGICOS PELO INMET .....	88
9.	NOTÍCIAS RELACIONADAS.....	92
10.	LAUDO TÉCNICO .....	94

## 1. Introdução

As concessionárias do serviço público de distribuição de energia elétrica devem prover o serviço de forma adequada, buscando sempre a eficiência, conforme disposto na legislação e nos respectivos contratos de concessão.

Dentre a legislação vigente, destacam-se os Procedimentos de Distribuição de Energia Elétrica no Sistema Elétrico Nacional – PRODIST, que consistem em documentos elaborados pela Agência Nacional de Energia Elétrica – ANEEL, com a participação dos agentes de distribuição e de outras entidades e associações do setor elétrico nacional, que normatizam e padronizam as atividades técnicas relacionadas ao funcionamento e desempenho dos sistemas de distribuição de energia elétrica.

O Módulo 8 do PRODIST – Revisão 11, mais especificamente em sua Seção 8.2, regulamenta a qualidade do serviço prestado pelas distribuidoras de energia elétrica, estabelecendo a metodologia para apuração dos indicadores de continuidade e dos tempos de atendimento a ocorrências emergenciais.

O referido regulamento prevê que, na apuração dos indicadores coletivos e individuais deverão ser consideradas todas as interrupções de longa duração que atingirem as unidades consumidoras, admitidas algumas exceções (denominadas expurgos), que podem ser encontradas no Item 5.6.2.2 da seção 8.2 do Módulo 8 do PRODIST, transcrito abaixo:

*5.6.2.2 Na apuração dos indicadores DEC e FEC devem ser consideradas todas as interrupções, admitidas apenas as seguintes exceções:*

*i. falha nas instalações da unidade consumidora que não provoque interrupção em instalações de terceiros;*

*ii. interrupção decorrente de obras de interesse exclusivo do consumidor e que afete somente a unidade consumidora do mesmo;*

***iii. Interrupção em Situação de Emergência;***

*iv. suspensão por inadimplemento do consumidor ou por deficiência técnica e/ou de segurança das instalações da unidade consumidora que não provoque interrupção em instalações de terceiros, previstas em regulamentação;*

*v. vinculadas a programas de racionamento instituídos pela União;*

*vi. ocorridas em Dia Crítico;*

*vii. oriundas de atuação de Esquema Regional de Alívio de Carga estabelecido pelo ONS. [grifos nossos]*

Para os casos de expurgo por Interrupção em Situação de Emergência (ISE), a alínea “h” do Item 5.12.1 da seção 8.2 do Módulo 8 do PRODIST estabelece a obrigatoriedade das distribuidoras em disponibilizar, em seu sítio eletrônico, relatórios digitais com as evidências do evento que tenha gerado tais interrupções enquadradas no inciso iii do Item 5.6.2.2 do mesmo.

Nesta seara, o presente documento, visa apresentar as evidências de um evento ocorrido na área de concessão da Eletropaulo, bem como informações relevantes a respeito das interrupções em Situação de Emergência decorrentes do mesmo.

Destaca-se que, para o entendimento completo das regras de apuração dos indicadores de continuidade e expurgos, faz-se necessário também a observação das regras contidas nos Módulos 1 e 6 do PRODIST. Todos os módulos destes procedimentos encontram-se disponíveis para consulta no site da ANEEL ([www.aneel.gov.br](http://www.aneel.gov.br)) e as principais definições relacionadas ao tema estão contidas no item 2 deste documento.

## 2. Definição

Seção 1.2 do Módulo 1 do PRODIST – Revisão 10

### **2.198 Evento**

Acontecimento que afete as condições normais de funcionamento de uma rede elétrica, podendo gerar uma ou mais interrupções no fornecimento de energia.

**2.131 e 2.158 DIC**

Duração de interrupção individual por unidade consumidora, ou seja, intervalo de tempo que, no período de apuração, em cada unidade consumidora ou ponto de conexão ocorreu descontinuidade da distribuição de energia elétrica.

**2.216 e 2.220 FIC**

Frequência de interrupção individual por unidade consumidora, ou seja, Número de interrupções ocorridas, no período de apuração, em cada unidade consumidora ou ponto de conexão.

**2.87 Consumidor Hora Interrompido (CHI):**

Somatório dos DICs dos consumidores atingidos por interrupção no fornecimento de energia, expresso em horas e centésimos de horas.

**2.251 Interrupção em Situação de Emergência:**

Interrupção originada no sistema de distribuição, resultante de Evento que comprovadamente impossibilite a atuação imediata da distribuidora e que não tenha sido provocada ou agravada por esta e que seja:

- Decorrentes de evento associado a Decreto de Declaração de Situação de Emergência ou Estado de Calamidade Pública emitido por órgão competente; ou
- Decorrentes de Evento cuja soma do CHI das interrupções ocorridas no sistema de distribuição seja superior ao calculado conforme equação a seguir:

$$2.612 \times N^{0,35}$$

N – número de unidades consumidoras faturadas e atendidas em BT ou MT, com 2 (duas) casas decimais, do mês de outubro do ano anterior ao período de apuração



### 3. Resumo Executivo

O Presente Relatório tem como objetivo a incorporação de informações que sejam relevantes para que se possa fazer a devida associação aos dados contidos no documento objeto da classificação de Situação de Emergência caracterizada pelo Módulo 8 do Prodist. Este enquadramento se apresenta na maioria das vezes em condições climáticas adversas com severidade dos fatores inerentes a situação, caracterizado na maioria dos casos por fortes ventos e chuvas de grande intensidade e continuidade.

A partir do final da manhã do dia 22/10/2020 – quinta-feira – Áreas de instabilidade organizadas pela passagem de uma frente fria na costa brasileira, favoreceram a formação de chuva forte, raio e rajadas de vento sobre o estado de Goiás.

Conforme informações do Climatempo Meteorologia, o Instituto Nacional de Meteorologia (INMET) detectou rajadas de vento acima de 50km/h registradas por estações representativas da área de concessão da ENEL Distribuição Goiás. Na estação de Jataí, o maior valor registrado foi de 54,7 km/h entre as 14h e 15h do dia 23 de outubro de 2020, classificada como vento forte, segundo a escala Beaufort.

O sistema de detecção da EarthNetworks registrou 110.541 descargas atmosféricas (27.089 nuvem-solo e 83.452 nuvem-nuvem) sobre a área de concessão da ENEL em Goiás entre as 11h00 do dia 22 de outubro de 2020 e 09h40 do dia 24 de outubro de 2020, causando grande instabilidade na rede.

Chuva forte foi registrada pelo INMET em estações representativas da área de concessão da ENEL Distribuição Goiás. Na estação de Cristalina foram acumulados 71,6 mm de chuva entre as 22h do dia 22 e as 01h do dia 23 de outubro de 2020, valor que corresponde 57,0% da média de chuva para o mês na região.

#### 3.1. Relatório de Ocorrências do período

Em todo o Estado de Goiás verificou-se também que a intensidade da chuva e dos ventos danificaram a rede de distribuição de energia elétrica em diversos pontos, registrando aproximadamente 433 mil clientes com interrupção no fornecimento de energia elétrica devido a eventos relacionados ao temporal, afetando 233 municípios e 306 Subestações.

Para otimizar o volume de atendimentos e reduzir os tempos de interrupção foram mobilizados os recursos extras da empresa que aumentou o contingente em relação a situação normal de operação. O acompanhamento da quantidade de equipes e o Tempo Médio de Atendimento podem ser consultados na Pág.05 do Relatório em anexo.

O impacto e severidade do evento estão relatados em artigos de mídia, como fotos e reportagens que demonstram os danos na Rede de Distribuição, oriundos dos eventos climáticos no período. Eventos estes que afetaram 432.758 consumidores com CHI de 993.286,75 superior ao de 482.597,74 estabelecido como limite para definição de Situação de Emergência, conforme resumo das informações obrigatórias.

<b>Empresa</b>		ENEL DISTRIBUIÇÃO GOIÁS			
<b>Código do Relatório</b>		CHI-051 - ENEL DISTRIBUIÇÃO GOIÁS			
<b>Evento:</b>		TEMPORAL NA AREA DE CONCESSÃO DA ENEL DISTRIBUIÇÃO GOIAS			
<b>Código COBRADE:</b>	1.3.1.2.0	<b>Data Inicio</b>	22/10/2020	<b>Hora início</b>	10h30
<b>Código do Evento:</b>	CHI-051-ENEL GO	<b>Data Término</b>	24/10/2020	<b>Hora Término</b>	09h40
<b>Valor CHI (Limite e Real)</b>	482.597,74	993.286,75			
<b>Código do Decreto (Se Houver):</b>					
<b>Quantidade de Interrupções (Evento)</b>	3.508				
<b>Início 1ª Incidência (Data e Hora)</b>	22/10/2020 10:38		<b>Subestações Atingidas</b>	ABC / ACREUNA / ADELANDIA / AEROPORTO / AGUA LIMPA (MARZAGAO) / AGUAS LINDAS / ALEXANIA / ALEXANIA TRANSMISSAO / ALMERINDONOPOLIS / ALOANDIA / ALTO BURITI / ALTO HORIZONTE / ALTO PARAISO DE GOIAS / ALVORADA DO NORTE / AMERICANO DO BRASIL / AMORINOPOLIS / ANHANGUERA / ANICUNS / APARECIDA DO RIO DOCE / ARACU / ARAGARCAS / ARAGOIANIA / ARAGUAPAZ / ARARAS / AREIAS / ARENOPSIS / ARUANA / ARUANA (TRANSMISSAO) / ASA BRANCA / ATLANTICO / AURILANDIA / AVELINOPOLIS / BACURI (RIO VERDE) / BARBOSELANDIA / BARCELONA / BARREIRO (PORANGATU) / BARRO ALTO / BELA VISTA (TRANSMISSAO) / BOA VISTA / BOM JARDIM / BOM JESUS DE GOIAS / BONITO / BONOPOLIS / BRAZABRANTES / BRITANIA / BURITI ALEGRE / BURITI DE GOIAS / BURITIZINHO / CABECEIRAS / CABRIUVA (RIO VERDE) / CACHOEIRA ALTA / CACHOEIRA DOURADA / CACHOEIRA NOVA / CACHOEIRINHA (ITARUMA) / CACU / CAIAPONIA / CALCILANDIA / CALDAS NOVAS / CALDAZINHA / CAMPESTRE / CAMPINAS / CAMPINORTE / CAMPO ALEGRE DE GOIAS / CAMPO LIMPO DE GOIAS / CAMPO NOVO / CAMPOS BELOS / CAMPOS VERDES / CARAIBAS / CARAJAS / CASTELANDIA / CATALAO / CATURAI / CEPALGO / CEZARINA / CHAPADAO DO CEU / CIDADE ECLETICA / CIDADE OCIDENTAL / COCALZINHO / COLINACU / CORREGO DO OURO / CORUMBAIBA / CRISTALINA / CRISTALINA TRANSMISSAO / CRISTIANOPOLIS / CRIXAS / CROMINIA / CUMARI / DAIA - ANAPOLIS / DAMOLANDIA / DAVINOPOLIS / DESFECHO / DESTILARIA BRASIL CENTRAL / DIMIC / DIORAMA / DORCELINO PEIXOTO DE MORAES / DOVERLANDIA / EDEALINA / EDEIA / ENERSUL / ESTRELA DO NORTE / FAINA / FAZENDA CANADA / FAZENDA NOVA / FERROVIARIO / FIRMINOPOLIS / FLORES DE GOIAS / FORMIGA / FORMOSO / FRONTEIRA / GAMELEIRA / GIRASSOL / GOIANDIRA / GOIANESIA / GOIANIA LESTE / GOIANIRA / GOIAS / GOIATUBA / GOUVERLANDIA / GOYA / GUAPO / HEITORAI / HIDROLANDIA / HIDROLINA / IACIARA / INACIOLANDIA / INDEPENDENCIA / INDIARA / INHUMAS / IPAMERI / IPEGUARI / IPORA / ISRAELANDIA / ITABERAI / ITAGUARI / ITAJA / ITAPIRAPUA / ITAPURANGA / ITAPURANGA (TRANSMISSAO) / ITARUMA / ITAUCU / ITIQUIRA (FORMOSA) / ITUMBIARA NOVA / ITUMBIARA VELHA / JACILANDIA / JANDAIA / JARAGUA / JARANAPOLIS / JATAI / JAUPACI / JESUPOLIS / JOVIANIA / JUNDIAI / JURUMIRIM / JUSCELANDIA / JUSSARA / LAGES / LAGOA DA SERRA / LAGOA DO BAUZINHO (RIO VERDE) / LEOPOLDO DE BULHOES / LUZIANIA / LUZIANIA INDUSTRIAL / MAIRIPOTABA / MAMBAI / MARA ROSA / MARAJOARA / MARCIANOPOLIS / MARIAPOLIS (PADRE BERNARDO) / MARZAGAO / MATO GRANDE / MATRINCHA / MAURILANDIA / MEIA PONTE / MINACU / MINEIROS / MINEIROS TRANSMISSAO / MOIPORA / MONTE ALEGRE / MONTES CLAROS DE GOIAS / MONTIVIDIU T / MORRINHOS / MORRO AGUDO / MOSSAMEDES / MOZARLANDIA / MOZARLANDIA (TRANSMISSAO) / MUNDO NOVO DE GOIAS / MUTUNOPOLIS / NAVESLANDIA ( JATAI ) / NAZARIO / NEROPOLIS / NIQUELANDIA / NOVA AMERICA / NOVA AURORA / NOVA CRIXAS (TRANSMISSAO) / NOVA IGUAQU / NOVA VENEZA / NOVO BRASIL / NOVO GAMA / NOVO PLANALTO / OLOANA / ORIZONA / OUVIDOR / PACAEMBU (NOVO GAMA) / PADRE BERNARDO / PALESTINA / PALMEIRAS / PALMEIRAS DE GOIAS / PALMELO / PALMINOPOLIS / PAMPLONA / PANAMA / PARANA / PARANAIBA / PARANAIGUARA / PARAUNA SE ALTA TENSAO / PARQUE DAS EMAS (MINEIROS) / PARQUE DAS NACOES / PEROLANDIA / PETROLINA / PILAR / PILOANDIA / PIRACANJUBA / PIRANHAS T / PIRES BELO / PIRES DO RIO / PLANALTINA / PLANALTINA (TRANSMISSAO) / PLANALTO / PONTALINA / PORANGATU / PORTEIRAO / PORTELANDIA / POSSE / POSSELANDIA / PROFESSOR JAMIL / QUEBRA LINHA / QUIRINOPOLIS / REAL / RETIRO / GOIAS / RIO CLARO JATAI MONTIVIDIU / RIO DO PEIXE / RIO PRETO / RIO QUENTE / RIO VERDE / RIO VERMELHO / RIVERLANDIA (RIO VERDE) / ROCHEDO (UEH) / RUBIATABA / SANCLERLANDIA / SANTA BARBARA / SANTA FE DE GOIAS / SANTA HELENA / SANTA RITA DO ARAGUAIA / SANTA ROSA / SANTA ROSA DE GOIAS / SANTA ROSA DO MEIA PONTE / SANTA TEREZA DE GOIAS / SANTA TEREZINHA / SANTO ANTONIO DA BARRA / SANTO ANTONIO DE GOIAS / SANTO ANTONIO DO DESCOBERTO / SAO BARTOLOMEU / SAO DOMINGOS / SAO FRANCISCO DE GOIAS / SAO GABRIEL DE GOIAS / SAO JOAO D ALIANCA / SAO JOAO DA PARAUNA / SAO LUIZ DOS MONTES BELOS / SAO MIGUEL DO ARAGUAIA / SAO MIGUEL DO PASSA QUATRO / SAO SIMAO / SENADOR CANEDO TRANSMISSAO / SERRA AZUL (JATAI) / SERRA DE CALDAS / SERRA DO OURO / SERRANOPOLIS / SILVANIA / SITIO DABADIA / SOUZALANDIA / SUCURI / TAIOPA / TAQUARAL / TAQUARI / TEREZOPOLIS / TERRA VERMELHA / TRES	

			RANCHOS / TRINDADE / TUCUNARE / TURVANIA / TURVELANDIA / URU / URUACU / URUTAI / USINA DE ACUCAR DE GOIANESIA / USINA MAMBAI / VALPARAISO / VARJAO / VENDA SECA / VIANOPOLIS / VICENTINOPOLIS / VILA CORUMBA / VILA PROPICIO / XAVANTES / XIXA / ZELANDIA / NIQUELANDIA 69KV / VILA BOA
<b>Início Última Incidência (Data e Hora)</b>	24/10/2020 09:39		<p><b>Municípios Atingidos</b></p> <p>ABADIA DE GOIAS / ABADIANIA / ACREUNA / ADELANDIA / AGUA FRIA DE GOIAS / AGUA LIMPA / AGUAS LINDAS DE GOIAS / ALEXANIA / ALOANDIA / ALTO HORIZONTE / ALTO PARAISO DE GOIAS / ALVORADA DO NORTE / AMARALINA / AMERICANO DO BRASIL / AMORINOPOLIS / ANAPOLIS / ANICUNS / APARECIDA DE GOIANIA / APARECIDA DO RIO DOCE / APORE / ARACU / ARAGARCAS / ARAGOIANIA / ARAGUAPAZ / ARENOPOLIS / ARUANA / AURILANDIA / AVELINOPOLIS / BALIZA / BARRO ALTO / BELA VISTA DE GOIAS / BOM JARDIM DE GOIAS / BOM JESUS DE GOIAS / BONFINOPOLIS / BONOPOLIS / BRAZABRANTES / BRITANIA / BURITI ALEGRE / BURITI DE GOIAS / BURITINOPOLIS / CABECEIRAS / CACHOEIRA ALTA / CACHOEIRA DE GOIAS / CACHOEIRA DOURADA / CACU / CAIAPONIA / CALDAS NOVAS / CALDAZINHA / CAMPESTRE DE GOIAS / CAMPINACU / CAMPINORTE / CAMPO ALEGRE DE GOIAS / CAMPO LIMPO / CAMPOS BELOS / CAMPOS VERDES / CARMO DO RIO VERDE / CASTELANDIA / CATALAO / CATURAI / CAVALCANTE / CEZARINA / CHAPADAO DO CEU / CIDADE OCIDENTAL / COCALZINHO DE GOIAS / COLINAS DO SUL / CORREGO DO OURO / CORUMBA DE GOIAS / CORUMBAIBA / CRISTALINA / CRISTIANOPOLIS / CRIXAS / CROMINIA / CUMARI / DAMIANOPOLIS / DAMOLANDIA / DAVINOPOLIS / DIORAMA / DISTRITO FEDERAL / DIVINOPOLIS DE GOIAS / DOVERLANDIA / EDEALINA / EDEIA / ESTRELA DO NORTE / FAINA / FAZENDA NOVA / FIRMINOPOLIS / FLORES DE GOIAS / FORMOSA / FORMOSO / GAMELEIRA DE GOIAS / GOIANDIRA / GOIANESIA / GOIANIA / GOIANIRA / GOIAS / GOIATUBA / GOUVELANDIA / GUAPO / GUARAITA / GUARANI DE GOIAS / GUARINOS / HEITORAI / HIDROLANDIA / HIDROLINA / IACIARA / INACIOLANDIA / INDIARA / INHUMAS / IPAMERI / IPIRANGA DE GOIAS / IPORA / ISRAELANDIA / ITABERAI / ITAGUARI / ITAJA / ITAPIRAPUA / ITAPURANGA / ITARUMA / ITAUCU / ITUMBIARA / IVOLANDIA / JANDAIA / JARAGUA / JATAI / JESUPOLIS / JOVIANIA / JUSSARA / LAGOA SANTA / LEOPOLDO DE BULHOES / LUZIANIA / MAIRIPOTABA / MAMBAI / MARA ROSA / MARZAGAO / MATRINCHA / MAURILANDIA / MIMOSO DE GOIAS / MINACU / MINEIROS / MOIPORA / MONTE ALEGRE DE GOIAS / MONTES CLAROS DE GOIAS / MONTIVIDIU / MONTIVIDIU DO NORTE / MORRINHOS / MORRO AGUDO DE GOIAS / MOSSAMEDES / MOZARLANDIA / MUNDO NOVO DE GOIAS / MUTUNOPOLIS / NAZARIO / NEROPOLIS / NIQUELANDIA / NOVA AURORA / NOVA CRIXAS / NOVA IGUACU DE GOIAS / NOVA ROMA / NOVA VENEZA / NOVO BRASIL / NOVO GAMA / NOVO PLANALTO / ORIZONA / OURO VERDE DE GOIAS / OUVIDOR / PADRE BERNARDO / PALESTINA DE GOIAS / PALMEIRAS DE GOIAS / PALMINOPOLIS / PANAMA / PARANAIGUARA / PARAUNA / PEROLANDIA / PETROLINA DE GOIAS / PILAR DE GOIAS / PIRACANJUBA / PIRANHAS / PIRENOPOLIS / PIRES DO RIO / PLANALTINA / PONTALINA / PORANGATU / PORTEIRAO / PORTELANDIA / POSSE / PROFESSOR JAMIL SAFADY / QUIRINOPOLIS / RIO QUENTE / RIO VERDE / RUBIATABA / SANCLERLANDIA / SANTA BARBARA DE GOIAS / SANTA CRUZ DE GOIAS / SANTA FE DE GOIAS / SANTA HELENA DE GOIAS / SANTA RITA DO ARAGUAIA / SANTA RITA DO NOVO DESTINO / SANTA ROSA DE GOIAS / SANTA TEREZA DE GOIAS / SANTA TEREZINHA DE GOIAS / SANTO ANTONIO DA BARRA / SANTO ANTONIO DE GOIAS / SANTO ANTONIO DO DESCOBERTO / SAO DOMINGOS / SAO FRANCISCO DE GOIAS / SAO JOAO D ALIANCA / SAO JOAO DA PARAUNA / SAO LUIS DE MONTES BELOS / SAO LUIZ DO NORTE / SAO MIGUEL DO ARAGUAIA / SAO MIGUEL DO PASSA QUATRO / SAO SIMAO / SENADOR CANEDO / SERRANOPOLIS / SILVANIA / SIMOLANDIA / SITIO D ABADIA / TAQUARAL DE GOIAS / TERESINA DE GOIAS / TEREZOPOLIS DE GOIAS / TRES RANCHOS / TRINDADE / TROMBAS / TURVANIA / TURVELANDIA / UIRAPURU / URUACU / URUTAI / VALPARAISO DE GOIAS / VARJAO / VIANOPOLIS / VICENTINOPOLIS / VILA BOA / VILA PROPICIO</p>
<b>Média de Duração das Incidências (h)</b>	7,66		
<b>Duração da Incidência mais longa (h)</b>	94,47		
<b>Total de Clientes afetados</b>	432.758		

<b>DANOS CAUSADOS</b>			
<b>Equipamentos Danificado</b>	<b>Importância para o Sistema</b>	<b>Local</b>	<b>Quantidade</b>
Disjuntor/Religador Operado	Proteção do Alimentador	Área de Concessão	101
Chaves Fusíveis Operada	Proteção de Ramais de Alimentadores	Área de Concessão	907
Transformador Operado	Proteção do Transformador	Área de Concessão	771

Relato técnico sobre a Intervenção realizada em Goiânia e Região Metropolitana				
Informações sobre Equipes	22/10	23/10	24/10	
Quantidade Usual	1.046	1.046	845	turmas
Quantidade Adicional	59	90	90	turmas
Quantidade Total	1.105	1.136	935	turmas
Tempos Médios				
Preparação	4,13	4,64	6,12	Horas
Deslocamento	0,81	0,66	0,87	Horas
Execução	0,99	0,87	0,98	Horas
TMAE	5,93	6,18	7,97	Horas

**Principais Dificuldades Encontradas:**

Chuvas com ventos fortes provocaram muitos pontos de alagamento e enxurrada, trânsito impedido por vários semáforos desligados dificultando a chegada ao atendimento das ocorrências emergenciais. Em determinadas regiões, decorrente dos fortes ventos, houve o tombamento de árvores nas estruturas de alimentação de média tensão, danos em ramais de ligação dos clientes, impedimentos

Empresa	ENEL DISTRIBUIÇÃO GOIAS		
Valor CHI (Limite e Real)	<b>482.597,74</b>		<b>993.286,75</b>

#### 4. Lista de Ocorrências

DOC ORIGEM	MIUNICIPIO	EQP_ORIGEM	CONJUNTO	INI_OCORRENC	FIM_OCORRENC	DT_INI_EVENTO	DT_FIM_EVENTO	DURAÇ	UC INT	CHI	EXPURGO
202010123511	AGUAS LINDAS DE GOIAS	10005031131	AGUAS LINDAS DE GOIAS S1	22/10/2020 10:38	22/10/2020 11:04	22/10/2020 10:38	22/10/2020 11:04	0,42	1	0,42	CHI
202010123675	NOVO GAMA	NJ21246079	PACAEMBU S1	22/10/2020 11:08	22/10/2020 11:47	22/10/2020 11:08	22/10/2020 11:47	0,65	1	0,65	CHI
202010123680	LUZIANIA	10024522684	MARAJOARA	22/10/2020 11:11	22/10/2020 13:40	22/10/2020 11:11	22/10/2020 13:40	2,48	1	2,48	CHI
202010123691	VALPARAISO DE GOIAS	2860315270	MARAJOARA	22/10/2020 11:13	22/10/2020 12:18	22/10/2020 11:13	22/10/2020 12:18	1,07	1	1,07	CHI
202010123779	LUZIANIA	3200252131	MARAJOARA	22/10/2020 11:36	22/10/2020 13:36	22/10/2020 11:36	22/10/2020 13:36	1,99	1	1,99	CHI
202010125294	CRISTALINA	KR12133541	CRISTALINA S1	22/10/2020 11:46	22/10/2020 17:12	22/10/2020 11:46	22/10/2020 17:12	5,43	13	70,55	CHI
202010123867	CATALAO	1990120821	CATALAO S2	22/10/2020 12:00	22/10/2020 13:34	22/10/2020 12:00	22/10/2020 13:34	1,56	1	1,56	CHI
202010123868	EDEIA	EA21321441	EDEIA	22/10/2020 12:00	22/10/2020 13:59	22/10/2020 12:00	22/10/2020 13:59	1,97	2	3,95	CHI
202010123879	ITAPIRAPUA	GS12003616	MATRINCHA	22/10/2020 12:04	23/10/2020 18:27	23/10/2020 17:11	23/10/2020 18:27	1,26	1	1,26	CHI
202010123879	ITAPIRAPUA	GS12003616	MATRINCHA	22/10/2020 12:04	23/10/2020 18:27	22/10/2020 12:04	23/10/2020 16:53	28,81	1	28,81	CHI
202010124069	MUTUNOPOLIS	MU12208388	MARA ROSA	22/10/2020 12:04	22/10/2020 16:43	22/10/2020 12:04	22/10/2020 16:43	4,64	2	9,28	CHI
202010123914	DISTRITO FEDERAL	CM12077348LD	CAMPO ALEGRE DE GOIAS	22/10/2020 12:12	22/10/2020 17:38	22/10/2020 12:12	22/10/2020 17:38	5,42	1	5,42	CHI
202010123914	CAMPO ALEGRE DE GOIAS	CM12077348LD	CAMPO ALEGRE DE GOIAS	22/10/2020 12:12	22/10/2020 17:38	22/10/2020 12:12	22/10/2020 17:38	5,42	136	737,42	CHI
202010123914	CATALAO	CM12077348LD	CAMPO ALEGRE DE GOIAS	22/10/2020 12:12	22/10/2020 17:38	22/10/2020 12:12	22/10/2020 17:38	5,42	21	113,87	CHI
202010123914	IPAMERI	CM12077348LD	CAMPO ALEGRE DE GOIAS	22/10/2020 12:12	22/10/2020 17:38	22/10/2020 12:12	22/10/2020 17:38	5,42	11	59,64	CHI
202010123915	FAINA	FC21063194	GOIAS	22/10/2020 12:12	22/10/2020 16:29	22/10/2020 12:12	22/10/2020 16:29	4,27	1	4,27	CHI
202010123938	ARUANA	03200434	ARUANA	22/10/2020 12:13	22/10/2020 12:29	22/10/2020 12:13	22/10/2020 12:29	0,27	8	2,16	CHI
202010123922	AGUAS LINDAS DE GOIAS	4830374999	AGUAS LINDAS DE GOIAS S1	22/10/2020 12:13	22/10/2020 16:57	22/10/2020 12:13	22/10/2020 16:57	4,72	1	4,72	CHI
202010123927	NOVO PLANALTO	TA21150791	SAO MIGUEL DO ARAGUAIA	22/10/2020 12:15	22/10/2020 14:22	22/10/2020 12:15	22/10/2020 14:22	2,11	1	2,11	CHI
202010124146	CAMPINACU	UC12197189	PORANGATU	22/10/2020 12:16	22/10/2020 16:58	22/10/2020 12:16	22/10/2020 16:58	4,68	67	313,86	CHI
202010123937	GOIAS	GS12172051	GOIAS	22/10/2020 12:17	22/10/2020 15:16	22/10/2020 12:17	22/10/2020 15:16	2,98	6	17,88	CHI
202010123959	EDEIA	EA21086952	EDEIA	22/10/2020 12:21	22/10/2020 13:01	22/10/2020 12:21	22/10/2020 13:01	0,66	1	0,66	CHI
202010123973	MATRINCHA	MP21374868	MATRINCHA	22/10/2020 12:23	22/10/2020 18:26	22/10/2020 12:23	22/10/2020 18:26	6,04	1	6,04	CHI
202010123977	ALEXANIA	AX21302166	ALEXANIA	22/10/2020 12:24	22/10/2020 15:47	22/10/2020 12:24	22/10/2020 15:47	3,38	1	3,38	CHI
202010123980	JUSSARA	JR21142862	BRITANIA	22/10/2020 12:25	22/10/2020 16:20	22/10/2020 12:25	22/10/2020 16:20	3,91	1	3,91	CHI
202010124024	CRIXAS	CX12405291	SANTA TEREZINHA	22/10/2020 12:37	22/10/2020 18:17	22/10/2020 12:37	22/10/2020 18:17	5,67	94	532,61	CHI
202010124031	RUBIATABA	RB12194289	RUBIATABA	22/10/2020 12:39	22/10/2020 14:19	22/10/2020 12:39	22/10/2020 14:19	1,65	1	1,65	CHI
202010124059	MONTES CLAROS DE GOIAS	ME12066160	IPORA	22/10/2020 12:41	22/10/2020 17:03	22/10/2020 12:41	22/10/2020 17:03	4,36	82	357,54	CHI
202010124041	MOSSAMEDES	GS12379734	ITABERAI S1	22/10/2020 12:41	22/10/2020 17:35	22/10/2020 12:41	22/10/2020 17:35	4,88	1	4,88	CHI
202010124041	ITABERAI	GS12379734	ITABERAI S1	22/10/2020 12:41	22/10/2020 17:35	22/10/2020 12:41	22/10/2020 17:35	4,88	4	19,54	CHI
202010189419	AGUAS LINDAS DE GOIAS	4830342032	AGUAS LINDAS DE GOIAS S1	22/10/2020 12:42	22/10/2020 13:28	22/10/2020 12:42	22/10/2020 13:28	0,77	1	0,77	CHI
202010126436	SAO JOAO D ALIANCA	JL121256947	FLORES DE GOIAS	22/10/2020 12:42	22/10/2020 20:56	22/10/2020 12:42	22/10/2020 20:56	8,22	1	8,22	CHI
202010124048	SAO JOAO D ALIANCA	JL12268110	FLORES DE GOIAS	22/10/2020 12:42	22/10/2020 17:23	22/10/2020 12:42	22/10/2020 17:23	4,67	8	37,35	CHI
202010124052	CEZARINA	1650003691	CEZARINA	22/10/2020 12:43	22/10/2020 16:47	22/10/2020 12:43	22/10/2020 16:47	4,05	1	4,05	CHI
202010124677	SANTO ANTONIO DO DESCOBERTO	SN12133153	AGUAS LINDAS DE GOIAS S2	22/10/2020 12:45	22/10/2020 16:00	22/10/2020 12:45	22/10/2020 16:00	3,25	1	3,25	CHI
202010124064	MINEIROS	10013459200	PARQUE DAS EMAS	22/10/2020 12:46	23/10/2020 08:19	22/10/2020 12:46	23/10/2020 08:19	19,54	1	19,54	CHI
202010124066	AVELINOPOLIS	AV21039026	ANICUNS	22/10/2020 12:47	22/10/2020 17:18	22/10/2020 12:47	22/10/2020 17:18	4,51	2	9,02	CHI
202010124068	LUZIANIA	10005082305	MARAJOARA	22/10/2020 12:47	22/10/2020 17:45	22/10/2020 12:47	22/10/2020 17:45	4,95	1	4,95	CHI
202010124070	NIQUELANDIA	NQ12262927	URUACU	22/10/2020 12:48	22/10/2020 16:02	22/10/2020 12:48	22/10/2020 16:02	3,22	3	9,65	CHI
202010124077	OUIDOR	OU12131025	CATALAO S1	22/10/2020 12:50	22/10/2020 17:47	22/10/2020 12:50	22/10/2020 17:47	4,94	5	24,72	CHI
202010124079	JATAI	JT12260431RE	JATAI S1	22/10/2020 12:50	22/10/2020 19:53	22/10/2020 12:50	22/10/2020 19:53	7,04	23	161,93	CHI
202010124079	SERRANOPOLIS	JT12260431RE	JATAI S1	22/10/2020 12:50	22/10/2020 19:53	22/10/2020 12:50	22/10/2020 19:53	7,04	19	133,77	CHI
202010124087	CALDAS NOVAS	CN21352220	CALDAS NOVAS S2	22/10/2020 12:54	22/10/2020 14:40	22/10/2020 12:54	22/10/2020 14:40	1,77	1	1,77	CHI
202010124088	ORIZONA	OZ21185905	PIRES DO RIO S2	22/10/2020 12:54	22/10/2020 16:28	22/10/2020 12:54	22/10/2020 16:28	3,57	1	3,57	CHI
202010124090	FAINA	FC21388548	GOIAS	22/10/2020 12:55	22/10/2020 19:53	22/10/2020 12:55	22/10/2020 19:53	6,96	1	6,96	CHI
202010124092	CALDAS NOVAS	CN21000085	CALDAS NOVAS S2	22/10/2020 12:55	22/10/2020 15:26	22/10/2020 12:55	22/10/2020 15:26	2,50	2	5,00	CHI
202010124107	MINEIROS	MY11171856	PARQUE DAS EMAS	22/10/2020 12:56	22/10/2020 14:53	22/10/2020 12:56	22/10/2020 14:53	1,93	96	185,68	CHI

202010124121	ALTO PARAISO DE GOIAS	BF12206289LD	SAO JOAO D ALIANCA	22/10/2020 12:57	22/10/2020 21:06	22/10/2020 12:57	22/10/2020 21:06	8,17	48	391,93	CHI
202010124121	ALTO PARAISO DE GOIAS	BF10409732	SAO JOAO D ALIANCA	22/10/2020 12:57	22/10/2020 21:06	22/10/2020 12:57	22/10/2020 21:03	8,10	183	1483,01	CHI
202010124108	JATAI	JT21127223	JATAI S1	22/10/2020 12:57	23/10/2020 00:19	22/10/2020 12:57	23/10/2020 00:19	11,36	1	11,36	CHI
202010124113	SAO LUIS DE MONTES BELOS	10028596151	SAO LUIZ DOS MONTES BELOS	22/10/2020 12:57	22/10/2020 15:10	22/10/2020 12:57	22/10/2020 15:10	2,20	1	2,20	CHI
202010124116	CAMPINACU	UC21280044	MARA ROSA	22/10/2020 12:58	22/10/2020 23:41	22/10/2020 12:58	22/10/2020 23:41	10,71	2	21,43	CHI
202010124122	CRISTALINA	10004715010	CRISTALINA S1	22/10/2020 12:58	22/10/2020 15:49	22/10/2020 12:58	22/10/2020 15:49	2,84	1	2,84	CHI
202010135026	JARAGUA	JA21339792	GOIANESIA S2	22/10/2020 12:59	23/10/2020 19:21	22/10/2020 12:59	23/10/2020 19:21	30,36	4	121,42	CHI
202010124173	GOIANESIA	GE12000241	GOIANESIA S2	22/10/2020 12:59	22/10/2020 18:26	22/10/2020 12:59	22/10/2020 18:26	5,44	2	10,88	CHI
202010124173	JARAGUA	GE12000241	GOIANESIA S2	22/10/2020 12:59	22/10/2020 18:26	22/10/2020 12:59	22/10/2020 18:26	5,44	19	103,33	CHI
202010124130	ANICUNS	910044685	ANICUNS	22/10/2020 13:00	22/10/2020 21:42	22/10/2020 13:00	22/10/2020 21:42	8,69	1	8,69	CHI
202010124133	NIQUELANDIA	NQ21221622	URUACU	22/10/2020 13:01	22/10/2020 16:20	22/10/2020 13:01	22/10/2020 16:20	3,32	20	66,32	CHI
202010124177	MONTIVIDIU	RV12219433LD	MONTIVIDIU T	22/10/2020 13:01	23/10/2020 20:25	22/10/2020 22:01	23/10/2020 20:25	22,41	6	134,46	CHI
202010124177	RIO VERDE	RV12219433LD	MONTIVIDIU T	22/10/2020 13:01	23/10/2020 20:25	22/10/2020 22:01	23/10/2020 20:25	22,41	7	156,86	CHI
202010124177	RIO VERDE	RV10400628	MONTIVIDIU T	22/10/2020 13:01	23/10/2020 20:25	22/10/2020 22:01	22/10/2020 22:25	0,41	4	1,65	CHI
202010124177	RIO VERDE	05700414	MONTIVIDIU T	22/10/2020 13:01	23/10/2020 20:25	22/10/2020 13:01	22/10/2020 19:12	6,19	16	98,98	CHI
202010124177	MONTIVIDIU	05700414	MONTIVIDIU T	22/10/2020 13:01	23/10/2020 20:25	22/10/2020 13:01	22/10/2020 18:02	5,02	4	20,09	CHI
202010124177	RIO VERDE	05700414	MONTIVIDIU T	22/10/2020 13:01	23/10/2020 20:25	22/10/2020 13:01	22/10/2020 18:02	5,02	21	105,48	CHI
202010124136	ANAPOLIS	21343822	JUNDIAI S1	22/10/2020 13:01	22/10/2020 15:20	22/10/2020 13:01	22/10/2020 15:20	2,31	1	2,31	CHI
202010124138	CATALAO	CT21267076	CATALAO S1	22/10/2020 13:01	22/10/2020 15:45	22/10/2020 13:01	22/10/2020 15:45	2,72	1	2,72	CHI
202010125083	QUIRINOPOLIS	GB32116534	QUIRINOPOLIS	22/10/2020 13:01	22/10/2020 20:49	22/10/2020 13:01	22/10/2020 20:49	7,79	6	46,74	CHI
202010124149	NOVO GAMA	4990015126	PACAEMBU S1	22/10/2020 13:03	22/10/2020 14:49	22/10/2020 13:03	22/10/2020 14:49	1,76	1	1,76	CHI
202010124151	SANTO ANTONIO DO DESCOBERTO	03560406	AGUAS LINDAS DE GOIAS S2	22/10/2020 13:03	22/10/2020 14:48	22/10/2020 13:03	22/10/2020 14:48	1,75	262	459,59	CHI
202010124153	JANDAIA	JD21248935	PALMEIRAS	22/10/2020 13:04	22/10/2020 17:00	22/10/2020 13:04	22/10/2020 17:00	3,93	1	3,93	CHI
202010124154	PALMEIRAS DE GOIAS	590043420	PALMEIRAS	22/10/2020 13:04	22/10/2020 14:23	22/10/2020 13:04	22/10/2020 14:23	1,31	1	1,31	CHI
202010124329	CEZARINA	CZ11035082	CEZARINA	22/10/2020 13:05	22/10/2020 15:30	22/10/2020 13:05	22/10/2020 15:30	2,40	103	247,34	CHI
202010124339	RIO VERDE	RV12371440	MONTIVIDIU T	22/10/2020 13:07	22/10/2020 17:00	22/10/2020 13:07	22/10/2020 17:00	3,87	16	61,89	CHI
202010124180	BARRO ALTO	GE21000079	GOIANESIA S1	22/10/2020 13:08	22/10/2020 17:15	22/10/2020 13:08	22/10/2020 17:15	4,11	1	4,11	CHI
202010124181	SANTO ANTONIO DO DESCOBERTO	SN21198695	AGUAS LINDAS DE GOIAS S2	22/10/2020 13:09	22/10/2020 14:40	22/10/2020 13:09	22/10/2020 14:40	1,52	1	1,52	CHI
202010124182	CIDADE OCIDENTAL	2680034709	MARAJOARA	22/10/2020 13:09	22/10/2020 16:54	22/10/2020 13:09	22/10/2020 16:54	3,75	1	3,75	CHI
202010124183	ACREUNA	EU12026741	RIO DOS BOIS	22/10/2020 13:09	22/10/2020 23:09	22/10/2020 13:09	22/10/2020 23:09	10,00	2	19,99	CHI
202010124190	AGUAS LINDAS DE GOIAS	4830102938	AGUAS LINDAS DE GOIAS S2	22/10/2020 13:10	22/10/2020 15:00	22/10/2020 13:10	22/10/2020 15:00	1,83	1	1,83	CHI
202010189418	AGUAS LINDAS DE GOIAS	4830117814	AGUAS LINDAS DE GOIAS S1	22/10/2020 13:12	22/10/2020 13:28	22/10/2020 13:12	22/10/2020 13:28	0,26	1	0,26	CHI
202010124360	ARUANA	AK12307445	MOZARLANDIA	22/10/2020 13:13	22/10/2020 19:43	22/10/2020 13:13	22/10/2020 19:43	6,48	12	77,80	CHI
202010124210	SAO MIGUEL DO ARAGUAIA	SM12095569	SAO MIGUEL DO ARAGUAIA	22/10/2020 13:17	22/10/2020 17:35	22/10/2020 13:17	22/10/2020 17:35	4,30	5	21,48	CHI
202010124212	MUNDO NOVO DE GOIAS	MH11220801	NOVA CRIXAS	22/10/2020 13:17	23/10/2020 13:05	22/10/2020 13:17	23/10/2020 13:05	23,79	1	23,79	CHI
202010124223	JARAGUA	JA21270395	JARAGUA	22/10/2020 13:19	23/10/2020 14:01	22/10/2020 13:19	23/10/2020 14:01	24,69	1	24,69	CHI
202010124468	GOIATUBA	GT11026948	GOIATUBA S2	22/10/2020 13:20	22/10/2020 23:52	22/10/2020 13:20	22/10/2020 23:52	10,53	33	347,61	CHI
202010124231	PIRACANJUBA	60099343	PIRACANJUBA	22/10/2020 13:20	22/10/2020 19:43	22/10/2020 13:20	22/10/2020 19:43	6,37	1	6,37	CHI
202010124237	RIO VERDE	RV21060223	MONTIVIDIU T	22/10/2020 13:22	22/10/2020 23:45	22/10/2020 13:22	22/10/2020 23:45	10,38	1	10,38	CHI
202010124252	PLANALTINA	PI11344205	PLANALTINA	22/10/2020 13:23	22/10/2020 14:16	22/10/2020 13:23	22/10/2020 14:16	0,88	117	102,57	CHI
202010124245	JATAI	JT21358085	JATAI S1	22/10/2020 13:24	22/10/2020 15:41	22/10/2020 13:24	22/10/2020 15:41	2,28	1	2,28	CHI
202010124248	VILA PROPICIO	NP11327884	GOIANESIA S1	22/10/2020 13:24	23/10/2020 17:47	22/10/2020 13:24	23/10/2020 17:47	28,37	1	28,37	CHI
202010124257	ITARUMA	2310007116	CACHOEIRA ALTA	22/10/2020 13:26	22/10/2020 15:24	22/10/2020 13:26	22/10/2020 15:24	1,95	1	1,95	CHI
202010124260	GOIATUBA	GT12273961	GOIATUBA S2	22/10/2020 13:27	22/10/2020 18:57	22/10/2020 13:27	22/10/2020 18:57	5,48	2	10,97	CHI
202010124273	COCALZINHO DE GOIAS	LA12261328LD	AGUAS LINDAS DE GOIAS S1	22/10/2020 13:28	23/10/2020 16:39	22/10/2020 13:28	23/10/2020 16:39	27,18	1	27,18	CHI
202010124273	AGUAS LINDAS DE GOIAS	LA12261328LD	AGUAS LINDAS DE GOIAS S1	22/10/2020 13:28	23/10/2020 16:39	22/10/2020 13:28	23/10/2020 16:39	27,18	33	897,07	CHI
202010124273	SANTO ANTONIO DO DESCOBERTO	LA12261328LD	AGUAS LINDAS DE GOIAS S1	22/10/2020 13:28	23/10/2020 16:39	22/10/2020 17:14	23/10/2020 16:39	23,40	18	421,28	CHI
202010124273	AGUAS LINDAS DE GOIAS	LA12261328LD	AGUAS LINDAS DE GOIAS S1	22/10/2020 13:28	23/10/2020 16:39	22/10/2020 17:14	23/10/2020 16:39	23,40	83	1942,55	CHI
202010124273	AGUAS LINDAS DE GOIAS	LA10400755	AGUAS LINDAS DE GOIAS S1	22/10/2020 13:28	23/10/2020 16:39	22/10/2020 19:47	22/10/2020 20:20	0,54	220	118,43	CHI
202010124273	AGUAS LINDAS DE GOIAS	LA10400755	AGUAS LINDAS DE GOIAS S1	22/10/2020 13:28	23/10/2020 16:39	22/10/2020 17:14	22/10/2020 17:30	0,25	220	55,98	CHI
202010124273	SANTO ANTONIO DO DESCOBERTO	LA12261328LD	AGUAS LINDAS DE GOIAS S1	22/10/2020 13:28	23/10/2020 16:39	22/10/2020 13:28	22/10/2020 17:13	3,75	17	63,72	CHI



202010124273	AGUAS LINDAS DE GOIAS	LA12261328LD	AGUAS LINDAS DE GOIAS S1	22/10/2020 13:28	23/10/2020 16:39	22/10/2020 13:28	22/10/2020 17:13	3,75	55	206,14	CHI
202010124273	AGUAS LINDAS DE GOIAS	LA12261328LD	AGUAS LINDAS DE GOIAS S1	22/10/2020 13:28	23/10/2020 16:39	22/10/2020 13:29	22/10/2020 17:13	3,73	28	104,30	CHI
202010124273	SANTO ANTONIO DO DESCOBERTO	LA12261328LD	AGUAS LINDAS DE GOIAS S1	22/10/2020 13:28	23/10/2020 16:39	22/10/2020 13:29	22/10/2020 17:13	3,73	1	3,73	CHI
202010124273	AGUAS LINDAS DE GOIAS	LA10400755	AGUAS LINDAS DE GOIAS S1	22/10/2020 13:28	23/10/2020 16:39	22/10/2020 13:28	22/10/2020 15:50	2,37	220	520,73	CHI
202010124261	CRIXAS	UP12391834	SANTA TEREZINHA	22/10/2020 13:28	22/10/2020 21:23	22/10/2020 13:28	22/10/2020 21:23	7,91	10	79,14	CHI
202010124261	UIRAPURU	UP12391834	SANTA TEREZINHA	22/10/2020 13:28	22/10/2020 21:23	22/10/2020 13:28	22/10/2020 21:23	7,91	1	7,91	CHI
202010123330	NOVO GAMA	NJ11136618	PACAEMBU S1	22/10/2020 13:30	22/10/2020 15:53	22/10/2020 13:30	22/10/2020 15:53	2,38	244	581,60	CHI
202010124275	MONTIVIDIU	2840019810	MONTIVIDIU T	22/10/2020 13:30	22/10/2020 16:24	22/10/2020 13:30	22/10/2020 16:24	2,88	1	2,88	CHI
202010124278	SANTA TEREZA DE GOIAS	SE21000019	MARA ROSA	22/10/2020 13:32	22/10/2020 18:49	22/10/2020 13:32	22/10/2020 18:49	5,29	1	5,29	CHI
202010124278	SANTA TEREZA DE GOIAS	SE10396893	MARA ROSA	22/10/2020 13:32	22/10/2020 18:49	22/10/2020 17:46	22/10/2020 18:47	1,02	137	139,97	CHI
202010124278	PORANGATU	SE10396893	MARA ROSA	22/10/2020 13:32	22/10/2020 18:49	22/10/2020 17:46	22/10/2020 18:47	1,02	3	3,06	CHI
202010125439	CAIAPONIA	CP12065845LD	CAIAPONIA	22/10/2020 13:32	23/10/2020 13:32	22/10/2020 13:32	23/10/2020 13:32	24,00	8	192,02	CHI
202010124282	ITABERAI	IB12388375	ITABERAI S2	22/10/2020 13:33	22/10/2020 15:58	22/10/2020 13:33	22/10/2020 15:58	2,41	1	2,41	CHI
202010124283	URUACU	UR11056775	URUACU	22/10/2020 13:33	22/10/2020 18:38	22/10/2020 13:33	22/10/2020 18:38	5,08	179	909,92	CHI
202010124283	URUACU	UR12056774	URUACU	22/10/2020 13:33	22/10/2020 18:38	22/10/2020 13:33	22/10/2020 16:29	2,93	112	327,91	CHI
202010124286	CAMPO ALEGRE DE GOIAS	CM12216147	CAMPO ALEGRE DE GOIAS	22/10/2020 13:34	22/10/2020 14:22	22/10/2020 13:34	22/10/2020 14:22	0,80	3	2,39	CHI
202010124292	PONTALINA	PK11307877	PONTALINA	22/10/2020 13:34	22/10/2020 19:22	22/10/2020 13:34	22/10/2020 19:22	5,79	31	179,58	CHI
202010124285	PLANALTINA	2960258302	PLANALTINA	22/10/2020 13:34	22/10/2020 14:26	22/10/2020 13:34	22/10/2020 14:26	0,86	1	0,86	CHI
202010124296	CATALAO	1990193356	CATALAO S2	22/10/2020 13:37	22/10/2020 15:08	22/10/2020 13:37	22/10/2020 15:08	1,51	1	1,51	CHI
202010125111	BRITANIA	BT12274251	BRITANIA	22/10/2020 13:38	25/10/2020 14:35	22/10/2020 13:38	25/10/2020 14:35	72,95	10	729,50	CHI
202010125111	BRITANIA	BT18073348TS	BRITANIA	22/10/2020 13:38	25/10/2020 14:35	22/10/2020 13:38	25/10/2020 14:17	72,66	12	871,91	CHI
202010125111	BRITANIA	BT18073348TS	BRITANIA	22/10/2020 13:38	25/10/2020 14:35	25/10/2020 11:18	25/10/2020 12:29	1,19	28	33,27	CHI
202010125111	BRITANIA	BT12131110	BRITANIA	22/10/2020 13:38	25/10/2020 14:35	25/10/2020 10:11	25/10/2020 10:30	0,33	8	2,65	CHI
202010125111	BRITANIA	BT18073348TS	BRITANIA	22/10/2020 13:38	25/10/2020 14:35	24/10/2020 20:10	24/10/2020 21:12	1,04	28	29,24	CHI
202010125111	BRITANIA	BT18073348TS	BRITANIA	22/10/2020 13:38	25/10/2020 14:35	23/10/2020 17:37	23/10/2020 18:42	1,08	28	30,29	CHI
202010125111	BRITANIA	BT12131110	BRITANIA	22/10/2020 13:38	25/10/2020 14:35	22/10/2020 13:38	23/10/2020 13:42	24,08	8	192,63	CHI
202010125111	BRITANIA	BT18073348TS	BRITANIA	22/10/2020 13:38	25/10/2020 14:35	22/10/2020 13:38	23/10/2020 11:29	21,85	12	262,18	CHI
202010125111	BRITANIA	BT12101446	BRITANIA	22/10/2020 13:38	25/10/2020 14:35	22/10/2020 13:38	23/10/2020 10:11	20,55	5	102,77	CHI
202010125111	BRITANIA	BT18073348TS	BRITANIA	22/10/2020 13:38	25/10/2020 14:35	22/10/2020 13:38	23/10/2020 08:56	19,31	3	57,94	CHI
202010122397	SAO MIGUEL DO PASSA QUATRO	SQ12112026	CRISTIANOPOLIS	22/10/2020 13:40	22/10/2020 17:03	22/10/2020 13:40	22/10/2020 17:03	3,39	18	60,95	CHI
202010124314	PIRES DO RIO	460003951	PIRES DO RIO S1	22/10/2020 13:41	22/10/2020 15:34	22/10/2020 13:41	22/10/2020 15:34	1,87	1	1,87	CHI
202010124317	ORIZONA	4550000832	PIRES DO RIO S2	22/10/2020 13:42	22/10/2020 18:02	22/10/2020 13:42	22/10/2020 18:02	4,33	1	4,33	CHI
202010124321	SANTO ANTONIO DO DESCOBERTO	SN21246080	AGUAS LINDAS DE GOIAS S2	22/10/2020 13:42	24/10/2020 18:32	22/10/2020 13:42	24/10/2020 18:32	52,82	1	52,82	CHI
202010124332	NOVO GAMA	10004978062	PACAEMBU S1	22/10/2020 13:44	22/10/2020 21:59	22/10/2020 13:44	22/10/2020 21:59	8,25	1	8,25	CHI
202010124334	BELA VISTA DE GOIAS	BV31095582	BELA VISTA S1	22/10/2020 13:44	22/10/2020 16:09	22/10/2020 13:44	22/10/2020 16:09	2,41	1	2,41	CHI
202010128094	SANTO ANTONIO DO DESCOBERTO	SN12345960	AGUAS LINDAS DE GOIAS S2	22/10/2020 13:44	23/10/2020 11:39	22/10/2020 13:44	23/10/2020 11:39	21,90	11	240,92	CHI
202010124342	ITUMBIARA	BG21000045	ITUMBIARA VELHA S2	22/10/2020 13:45	22/10/2020 15:50	22/10/2020 13:45	22/10/2020 15:50	2,07	1	2,07	CHI
202010124343	CAMPINACU	UC11269607	MARA ROSA	22/10/2020 13:45	22/10/2020 23:15	22/10/2020 13:45	22/10/2020 23:15	9,49	1	9,49	CHI
202010124348	MOZARLANDIA	MZ11158815	MOZARLANDIA	22/10/2020 13:46	22/10/2020 18:00	22/10/2020 13:46	22/10/2020 18:00	4,22	14	59,10	CHI
202010124453	GOIATUBA	00730404	GOIATUBA S1	22/10/2020 13:48	22/10/2020 15:33	22/10/2020 13:48	22/10/2020 15:33	1,76	2	3,52	CHI
202010124453	GOIATUBA	GT10401441	GOIATUBA S1	22/10/2020 13:48	22/10/2020 15:33	22/10/2020 13:50	22/10/2020 15:33	1,72	2	3,44	CHI
202010124453	MORRINHOS	00730404	GOIATUBA S1	22/10/2020 13:48	22/10/2020 15:33	22/10/2020 13:48	22/10/2020 14:10	0,38	25	9,55	CHI
202010124453	GOIATUBA	00730404	GOIATUBA S1	22/10/2020 13:48	22/10/2020 15:33	22/10/2020 13:48	22/10/2020 14:10	0,38	47	17,95	CHI
202010124453	MORRINHOS	00730404	GOIATUBA S1	22/10/2020 13:48	22/10/2020 15:33	22/10/2020 13:50	22/10/2020 14:10	0,34	1	0,34	CHI
202010124453	GOIATUBA	00730404	GOIATUBA S1	22/10/2020 13:48	22/10/2020 15:33	22/10/2020 13:50	22/10/2020 14:10	0,34	10	3,38	CHI
202010124453	GOIATUBA	00730404	GOIATUBA S1	22/10/2020 13:48	22/10/2020 15:33	22/10/2020 13:48	22/10/2020 13:59	0,19	4	0,76	CHI
202010124453	JOVIANIA	GT10401441	GOIATUBA S1	22/10/2020 13:48	22/10/2020 15:33	22/10/2020 13:50	22/10/2020 13:59	0,15	20	2,98	CHI
202010124453	GOIATUBA	GT10401441	GOIATUBA S1	22/10/2020 13:48	22/10/2020 15:33	22/10/2020 13:50	22/10/2020 13:59	0,15	28	4,17	CHI
202010124453	PONTALINA	AD16430902	GOIATUBA S1	22/10/2020 13:48	22/10/2020 15:33	22/10/2020 13:53	22/10/2020 13:56	0,06	2	0,11	CHI
202010124453	JOVIANIA	AD16430902	GOIATUBA S1	22/10/2020 13:48	22/10/2020 15:33	22/10/2020 13:53	22/10/2020 13:56	0,06	86	4,87	CHI
202010124453	PONTALINA	AD16430902	GOIATUBA S1	22/10/2020 13:48	22/10/2020 15:33	22/10/2020 13:53	22/10/2020 13:56	0,06	1	0,06	CHI

202010124356	BELA VISTA DE GOIAS	BV21340072	CEPAIGO S2	22/10/2020 13:48	22/10/2020 17:23	22/10/2020 13:48	22/10/2020 17:23	3,58	28	100,18	CHI
202010125331	SANTO ANTONIO DO DESCOBERTO	SN12345962	AGUAS LINDAS DE GOIAS S2	22/10/2020 13:51	23/10/2020 07:21	22/10/2020 13:51	23/10/2020 07:21	17,50	5	87,48	CHI
202010125514	NOVO GAMA	NU11376146	PACAEMBU S1	22/10/2020 13:52	22/10/2020 20:45	22/10/2020 13:52	22/10/2020 20:45	6,88	96	660,53	CHI
202010124375	CAIAPONIA	03800226	PALESTINA	22/10/2020 13:52	22/10/2020 16:01	22/10/2020 13:52	22/10/2020 16:01	2,15	476	1025,38	CHI
202010124375	PALESTINA DE GOIAS	03800226	PALESTINA	22/10/2020 13:52	22/10/2020 16:01	22/10/2020 13:52	22/10/2020 16:01	2,15	315	678,56	CHI
202010124376	SAO JOAO D ALIANCA	JL11279203	SAO JOAO D ALIANCA	22/10/2020 13:52	22/10/2020 17:51	22/10/2020 13:52	22/10/2020 17:51	3,98	2	7,96	CHI
202010124378	MINACU	IH12208567	MINACU	22/10/2020 13:52	22/10/2020 19:11	22/10/2020 13:52	22/10/2020 19:11	5,30	6	31,81	CHI
202010124385	LUZIANIA	LZ12169077	MARAJOARA	22/10/2020 13:55	22/10/2020 16:32	22/10/2020 13:55	22/10/2020 16:32	2,61	336	878,64	CHI
202010124391	ACREUNA	EU21340834	ACREUNA	22/10/2020 13:55	22/10/2020 16:04	22/10/2020 13:55	22/10/2020 16:04	2,14	1	2,14	CHI
202010124402	CRIXAS	CX11394918	RUBIATABA	22/10/2020 13:56	23/10/2020 10:54	22/10/2020 13:56	23/10/2020 10:54	20,96	1	20,96	CHI
202010124410	MINEIROS	MY21070318	PARQUE DAS EMAS	22/10/2020 13:57	22/10/2020 19:18	22/10/2020 13:57	22/10/2020 19:18	5,34	1	5,34	CHI
202010124412	MINEIROS	MY12324392	PARQUE DAS EMAS	22/10/2020 13:57	22/10/2020 21:49	22/10/2020 13:57	22/10/2020 21:49	7,85	3	23,56	CHI
202010124414	GOIANESIA	GE11372671	GOIANESIA S1	22/10/2020 13:58	22/10/2020 16:24	22/10/2020 13:58	22/10/2020 16:24	2,43	1	2,43	CHI
202010124416	CRIXAS	2490010068	SERRA DO OURO	22/10/2020 13:58	23/10/2020 15:15	22/10/2020 13:58	23/10/2020 15:15	25,28	1	25,28	CHI
202010124392	MORRINHOS	MR12000143	GOIATUBA S1	22/10/2020 13:59	22/10/2020 15:50	22/10/2020 13:59	22/10/2020 15:50	1,84	3	5,52	CHI
202010124436	JATAI	JT21141713	JATAI S1	22/10/2020 14:01	22/10/2020 16:22	22/10/2020 14:01	22/10/2020 16:22	2,35	1	2,35	CHI
202010124439	TURVELANDIA	TD21383918	RIO DOS BOIS	22/10/2020 14:01	22/10/2020 19:09	22/10/2020 14:01	22/10/2020 19:09	5,12	1	5,12	CHI
202010124443	PORANGATU	PO11217315	PORANGATU	22/10/2020 14:01	23/10/2020 10:53	22/10/2020 14:01	23/10/2020 10:53	20,85	1	20,85	CHI
202010124530	ANICUNS	AC12259088	ANICUNS	22/10/2020 14:02	22/10/2020 16:09	22/10/2020 14:02	22/10/2020 16:09	2,11	55	115,96	CHI
202010124454	RIO VERDE	630010237	RIO VERDE S1	22/10/2020 14:03	22/10/2020 16:36	22/10/2020 14:03	22/10/2020 16:36	2,56	1	2,56	CHI
202010124757	PORANGATU	MU12391982	MARA ROSA	22/10/2020 14:04	23/10/2020 11:48	22/10/2020 14:04	23/10/2020 11:48	21,73	17	369,33	CHI
202010124465	ITAPURANGA	IK21298453	ITAPURANGA	22/10/2020 14:04	22/10/2020 16:09	22/10/2020 14:04	22/10/2020 16:09	2,07	1	2,07	CHI
202010112947	JUSSARA	JR12362412	BRITANIA	22/10/2020 14:06	22/10/2020 20:13	22/10/2020 14:06	22/10/2020 20:13	6,12	3	18,35	CHI
202010124475	GAUPO	GA21063162	GAUPO S2	22/10/2020 14:06	22/10/2020 16:06	22/10/2020 14:06	22/10/2020 16:06	2,00	1	2,00	CHI
202010124476	BOM JESUS DE GOIAS	BJ12305432	BOM JESUS DE GOIAS	22/10/2020 14:06	22/10/2020 22:02	22/10/2020 14:06	22/10/2020 22:02	7,93	2	15,86	CHI
202010124481	PETROLINA DE GOIAS	270005729	INHUMAS S1	22/10/2020 14:07	23/10/2020 21:28	22/10/2020 14:07	23/10/2020 21:28	31,35	1	31,35	CHI
202010124485	SANTA TEREZINHA DE GOIAS	SG12243403	SANTA TEREZINHA	22/10/2020 14:08	22/10/2020 15:51	22/10/2020 14:08	22/10/2020 15:51	1,71	1	1,71	CHI
202010124687	GOUVELANDIA	QI12035777LD	QUIRINOPOLIS	22/10/2020 14:09	22/10/2020 18:26	22/10/2020 14:09	22/10/2020 18:26	4,28	8	34,24	CHI
202010125432	SAO MIGUEL DO ARAGUAIA	SM12143671	SAO MIGUEL DO ARAGUAIA	22/10/2020 14:12	22/10/2020 17:27	22/10/2020 14:12	22/10/2020 17:27	3,25	275	894,67	CHI
202010124505	IPORA	10023061381	IPORA	22/10/2020 14:12	22/10/2020 17:16	22/10/2020 14:12	22/10/2020 17:16	3,06	0	0,00	CHI
202010124529	QUIRINOPOLIS	10025073964	QUIRINOPOLIS	22/10/2020 14:17	22/10/2020 15:53	22/10/2020 14:17	22/10/2020 15:53	1,59	1	1,59	CHI
202010124532	POSSE	PS12298947	FLORES DE GOIAS	22/10/2020 14:18	22/10/2020 18:29	22/10/2020 14:18	22/10/2020 18:29	4,18	1	4,18	CHI
202010126207	GOIANIRA	TR12015734	INHUMAS S1	22/10/2020 14:20	23/10/2020 18:07	23/10/2020 13:53	23/10/2020 18:07	4,24	16	67,82	CHI
202010126207	TRINDADE	TR12015734	INHUMAS S1	22/10/2020 14:20	23/10/2020 18:07	23/10/2020 13:53	23/10/2020 18:07	4,24	2	8,48	CHI
202010124664	TRINDADE	CK12015717	INHUMAS S1	22/10/2020 14:20	23/10/2020 15:55	22/10/2020 14:20	23/10/2020 15:55	25,59	40	1023,71	CHI
202010126207	TRINDADE	CK12015717	INHUMAS S1	22/10/2020 14:20	23/10/2020 18:07	22/10/2020 14:20	23/10/2020 15:55	25,59	21	537,45	CHI
202010126207	GOIANIRA	CK12015717	INHUMAS S1	22/10/2020 14:20	23/10/2020 18:07	22/10/2020 14:20	23/10/2020 15:55	25,59	1	25,59	CHI
202010126207	TRINDADE	GR12282901	INHUMAS S1	22/10/2020 14:20	23/10/2020 18:07	22/10/2020 18:56	23/10/2020 15:55	20,98	1	20,98	CHI
202010126207	GOIANIRA	GR12282901	INHUMAS S1	22/10/2020 14:20	23/10/2020 18:07	23/10/2020 13:53	23/10/2020 15:55	2,04	5	10,21	CHI
202010126207	TRINDADE	GR12282901	INHUMAS S1	22/10/2020 14:20	23/10/2020 18:07	23/10/2020 13:53	23/10/2020 15:55	2,04	4	8,17	CHI
202010126207	GOIANIRA	CK12015717	INHUMAS S1	22/10/2020 14:20	23/10/2020 18:07	23/10/2020 13:53	23/10/2020 15:07	1,24	20	24,84	CHI
202010126207	TRINDADE	CK12015717	INHUMAS S1	22/10/2020 14:20	23/10/2020 18:07	23/10/2020 13:53	23/10/2020 15:07	1,24	1	1,24	CHI
202010126207	TRINDADE	CK12015717	INHUMAS S1	22/10/2020 14:20	23/10/2020 18:07	23/10/2020 12:00	23/10/2020 13:01	1,02	7	7,17	CHI
202010126207	GOIANIRA	CK12015717	INHUMAS S1	22/10/2020 14:20	23/10/2020 18:07	23/10/2020 12:00	23/10/2020 13:01	1,02	41	42,01	CHI
202010124664	TRINDADE	CK12015717	INHUMAS S1	22/10/2020 14:20	23/10/2020 15:55	22/10/2020 14:20	23/10/2020 11:18	20,97	2	41,94	CHI
202010124664	GOIANIRA	CK12015717	INHUMAS S1	22/10/2020 14:20	23/10/2020 15:55	22/10/2020 14:20	23/10/2020 11:18	20,97	22	461,30	CHI
202010126207	TRINDADE	CK12015717	INHUMAS S1	22/10/2020 14:20	23/10/2020 18:07	22/10/2020 14:20	23/10/2020 11:18	20,97	5	104,84	CHI
202010126207	GOIANIRA	CK12015717	INHUMAS S1	22/10/2020 14:20	23/10/2020 18:07	22/10/2020 14:20	23/10/2020 11:18	20,97	19	398,40	CHI
202010124664	TRINDADE	CK12015717	INHUMAS S1	22/10/2020 14:20	23/10/2020 15:55	22/10/2020 14:20	22/10/2020 16:19	1,99	1	1,99	CHI
202010124653	PIRACANJUBA	PJ12352525	PIRACANJUBA	22/10/2020 14:20	22/10/2020 17:03	22/10/2020 14:20	22/10/2020 17:03	2,70	16	43,25	CHI
202010124549	GOIANIA	13204233	GOIANIA LESTE S3	22/10/2020 14:20	22/10/2020 16:36	22/10/2020 14:20	22/10/2020 16:36	2,25	1	2,25	CHI



202010189280	RIO VERDE	RV12326944	MONTIVIDIU T	22/10/2020 14:21	22/10/2020 20:24	22/10/2020 14:21	22/10/2020 20:24	6,04	23	138,86	CHI
202010127666	NIQUELANDIA	NQ13083002	BARRO ALTO	22/10/2020 14:21	23/10/2020 18:20	23/10/2020 02:11	23/10/2020 18:20	16,15	171	2761,51	CHI
202010127666	NIQUELANDIA	NQ12371855RE	BARRO ALTO	22/10/2020 14:21	23/10/2020 18:20	23/10/2020 02:11	23/10/2020 05:14	3,05	72	219,78	CHI
202010127666	MIMOSO DE GOIAS	NQ12371855RE	BARRO ALTO	22/10/2020 14:21	23/10/2020 18:20	23/10/2020 02:11	23/10/2020 05:14	3,05	4	12,21	CHI
202010127666	MIMOSO DE GOIAS	NQ12371855RE	BARRO ALTO	22/10/2020 14:21	23/10/2020 18:20	22/10/2020 14:21	23/10/2020 02:10	11,80	4	47,21	CHI
202010127666	NIQUELANDIA	NQ12371855RE	BARRO ALTO	22/10/2020 14:21	23/10/2020 18:20	22/10/2020 14:21	23/10/2020 02:10	11,80	243	2868,07	CHI
202010124572	MINEIROS	10030356693	PARQUE DAS EMAS	22/10/2020 14:23	22/10/2020 23:00	22/10/2020 14:23	22/10/2020 23:00	8,61	1	8,61	CHI
202010124575	BURITI ALEGRE	BG12263630	ITUMBIARA VELHA S2	22/10/2020 14:23	23/10/2020 00:52	22/10/2020 14:23	23/10/2020 00:52	10,47	1	10,47	CHI
202010124619	LUZIANIA	03890214	MARAJOARA	22/10/2020 14:24	23/10/2020 14:51	22/10/2020 14:24	23/10/2020 14:51	24,45	32	782,31	CHI
202010124619	LUZIANIA	03890214	MARAJOARA	22/10/2020 14:24	23/10/2020 14:51	22/10/2020 14:24	23/10/2020 00:09	9,74	44	428,38	CHI
202010124619	LUZIANIA	03890214	MARAJOARA	22/10/2020 14:24	23/10/2020 14:51	22/10/2020 14:24	22/10/2020 22:24	7,99	48	383,36	CHI
202010124619	CIDADE OCIDENTAL	03890214	MARAJOARA	22/10/2020 14:24	23/10/2020 14:51	22/10/2020 14:24	22/10/2020 22:24	7,99	1	7,99	CHI
202010124619	LUZIANIA	03890214	MARAJOARA	22/10/2020 14:24	23/10/2020 14:51	22/10/2020 14:24	22/10/2020 20:24	5,99	41	245,76	CHI
202010124619	CIDADE OCIDENTAL	03890214	MARAJOARA	22/10/2020 14:24	23/10/2020 14:51	22/10/2020 14:24	22/10/2020 18:02	3,63	117	424,52	CHI
202010124619	LUZIANIA	03890214	MARAJOARA	22/10/2020 14:24	23/10/2020 14:51	22/10/2020 14:24	22/10/2020 18:02	3,63	6	21,77	CHI
202010124619	CRISTALINA	03890214	MARAJOARA	22/10/2020 14:24	23/10/2020 14:51	22/10/2020 14:24	22/10/2020 18:02	3,63	33	119,74	CHI
202010124619	CRISTALINA	03890214	MARAJOARA	22/10/2020 14:24	23/10/2020 14:51	22/10/2020 14:25	22/10/2020 18:02	3,62	1	3,62	CHI
202010124734	BONOPOLIS	BX10403948	SAO MIGUEL DO ARAGUAIA	22/10/2020 14:25	23/10/2020 20:46	23/10/2020 09:54	23/10/2020 20:46	10,88	18	195,84	CHI
202010124734	BONOPOLIS	BX10403944	SAO MIGUEL DO ARAGUAIA	22/10/2020 14:25	23/10/2020 20:46	23/10/2020 09:54	23/10/2020 15:56	6,03	259	1562,49	CHI
202010124734	PORANGATU	TA12391675	NOVO PLANALTO	22/10/2020 14:25	23/10/2020 20:46	23/10/2020 02:29	23/10/2020 10:27	7,97	2	15,95	CHI
202010124734	BONOPOLIS	TA10400556	NOVO PLANALTO	22/10/2020 14:25	23/10/2020 20:46	23/10/2020 02:29	23/10/2020 09:49	7,34	53	388,86	CHI
202010124734	PORANGATU	TA10400556	NOVO PLANALTO	22/10/2020 14:25	23/10/2020 20:46	23/10/2020 02:29	23/10/2020 09:49	7,34	166	1217,93	CHI
202010124734	BONOPOLIS	TA10400556	SAO MIGUEL DO ARAGUAIA	22/10/2020 14:25	23/10/2020 20:46	23/10/2020 02:29	23/10/2020 09:49	7,34	277	2032,33	CHI
202010124734	BONFINOPOLIS	TA10400556	NOVO PLANALTO	22/10/2020 14:25	23/10/2020 20:46	23/10/2020 02:29	23/10/2020 09:49	7,34	1	7,34	CHI
202010124734	NOVO PLANALTO	SM10400363	SAO MIGUEL DO ARAGUAIA	22/10/2020 14:25	23/10/2020 20:46	22/10/2020 14:25	22/10/2020 20:52	6,45	293	1890,91	CHI
202010124734	BONOPOLIS	SM10400363	SAO MIGUEL DO ARAGUAIA	22/10/2020 14:25	23/10/2020 20:46	22/10/2020 14:25	22/10/2020 20:52	6,45	3	19,36	CHI
202010124734	NOVO PLANALTO	SM13182457	SAO MIGUEL DO ARAGUAIA	22/10/2020 14:25	23/10/2020 20:46	22/10/2020 14:26	22/10/2020 20:52	6,44	3	19,33	CHI
202010124734	NOVO PLANALTO	SM10400363	SAO MIGUEL DO ARAGUAIA	22/10/2020 14:25	23/10/2020 20:46	22/10/2020 18:43	22/10/2020 18:58	0,25	33	8,40	CHI
202010124734	SAO MIGUEL DO ARAGUAIA	SM10400363	SAO MIGUEL DO ARAGUAIA	22/10/2020 14:25	23/10/2020 20:46	22/10/2020 18:43	22/10/2020 18:58	0,25	174	44,27	CHI
202010124734	SAO MIGUEL DO ARAGUAIA	SM10400363	SAO MIGUEL DO ARAGUAIA	22/10/2020 14:25	23/10/2020 20:46	22/10/2020 14:25	22/10/2020 17:01	2,59	199	515,80	CHI
202010124734	NOVO PLANALTO	SM10400363	SAO MIGUEL DO ARAGUAIA	22/10/2020 14:25	23/10/2020 20:46	22/10/2020 14:25	22/10/2020 17:01	2,59	47	121,82	CHI
202010124734	BONOPOLIS	SM10400363	SAO MIGUEL DO ARAGUAIA	22/10/2020 14:25	23/10/2020 20:46	22/10/2020 14:25	22/10/2020 17:01	2,59	14	36,29	CHI
202010124734	NOVO PLANALTO	SM10400363	SAO MIGUEL DO ARAGUAIA	22/10/2020 14:25	23/10/2020 20:46	22/10/2020 14:26	22/10/2020 17:01	2,58	1	2,58	CHI
202010124734	SAO MIGUEL DO ARAGUAIA	SM10400363	SAO MIGUEL DO ARAGUAIA	22/10/2020 14:25	23/10/2020 20:46	22/10/2020 14:26	22/10/2020 17:01	2,58	1	2,58	CHI
202010124734	BONOPOLIS	SM10400363	SAO MIGUEL DO ARAGUAIA	22/10/2020 14:25	23/10/2020 20:46	22/10/2020 14:26	22/10/2020 17:01	2,58	6	15,50	CHI
202010124734	BONOPOLIS	SM10400363	SAO MIGUEL DO ARAGUAIA	22/10/2020 14:25	23/10/2020 20:46	22/10/2020 14:26	22/10/2020 16:59	2,55	13	33,18	CHI
202010124734	BONOPOLIS	BX10403948	SAO MIGUEL DO ARAGUAIA	22/10/2020 14:25	23/10/2020 20:46	22/10/2020 16:23	22/10/2020 16:59	0,59	205	121,18	CHI
202010124734	PORANGATU	BX10403948	SAO MIGUEL DO ARAGUAIA	22/10/2020 14:25	23/10/2020 20:46	22/10/2020 16:23	22/10/2020 16:59	0,59	1	0,59	CHI
202010124734	BONOPOLIS	SM10400363	SAO MIGUEL DO ARAGUAIA	22/10/2020 14:25	23/10/2020 20:46	22/10/2020 14:26	22/10/2020 16:23	1,96	6	11,76	CHI
202010124734	AMARALINA	SM10400363	SAO MIGUEL DO ARAGUAIA	22/10/2020 14:25	23/10/2020 20:46	22/10/2020 14:26	22/10/2020 16:23	1,96	3	5,88	CHI
202010124734	BONOPOLIS	BX10403944	SAO MIGUEL DO ARAGUAIA	22/10/2020 14:25	23/10/2020 20:46	22/10/2020 14:26	22/10/2020 14:30	0,07	14	0,94	CHI
202010124614	RIO VERDE	01660414	SANTA HELENA S1	22/10/2020 14:27	22/10/2020 23:19	22/10/2020 14:27	22/10/2020 23:19	8,87	7	62,09	CHI
202010124614	SANTA HELENA DE GOIAS	01660414	SANTA HELENA S1	22/10/2020 14:27	22/10/2020 23:19	22/10/2020 14:27	22/10/2020 23:19	8,87	58	514,43	CHI
202010124614	SANTO ANTONIO DA BARRA	01660414	SANTA HELENA S1	22/10/2020 14:27	22/10/2020 23:19	22/10/2020 14:27	22/10/2020 23:19	8,87	23	204,00	CHI
202010124614	ACREUNA	01660414	SANTA HELENA S1	22/10/2020 14:27	22/10/2020 23:19	22/10/2020 14:27	22/10/2020 23:19	8,87	3	26,61	CHI
202010124592	LUZIANIA	LZ11219787	MARAJOARA	22/10/2020 14:27	22/10/2020 18:19	22/10/2020 14:27	22/10/2020 18:19	3,86	188	726,05	CHI
202010125410	UIRAPURU	UP12352423	SANTA TEREZINHA	22/10/2020 14:28	22/10/2020 19:23	22/10/2020 14:28	22/10/2020 19:23	4,91	4	19,63	CHI
202010124601	CATURAI	CK21066153	ARACU	22/10/2020 14:28	23/10/2020 05:04	22/10/2020 14:28	23/10/2020 05:04	14,59	1	14,59	CHI
2020102200059	ARUANA	03200434	ARUANA	22/10/2020 14:33	22/10/2020 14:40	22/10/2020 14:33	22/10/2020 14:40	0,12	8	0,93	CHI
202010124632	BOM JESUS DE GOIAS	BJ12226866	RIO DOS BOIS	22/10/2020 14:34	22/10/2020 23:57	22/10/2020 14:34	22/10/2020 23:57	9,38	5	46,90	CHI
202010124632	GOIATUBA	BJ12226866	RIO DOS BOIS	22/10/2020 14:34	22/10/2020 23:57	22/10/2020 14:34	22/10/2020 23:57	9,38	1	9,38	CHI

202010125763	CAMPINORTE	CR12101036	CAMPINORTE	22/10/2020 14:34	22/10/2020 18:51	22/10/2020 14:34	22/10/2020 18:51	4,28	7	29,96	CHI
202010125763	NOVA IGUACU DE GOIAS	CR12101036	CAMPINORTE	22/10/2020 14:34	22/10/2020 18:51	22/10/2020 14:34	22/10/2020 18:51	4,28	5	21,40	CHI
202010124635	MINEIROS	MY21337102	SANTA RITA DO ARAGUAIA	22/10/2020 14:34	23/10/2020 09:20	22/10/2020 14:34	23/10/2020 09:20	18,75	1	18,75	CHI
202010124945	ALEXANIA	AX13196774	ALEXANIA	22/10/2020 14:36	22/10/2020 21:19	22/10/2020 14:36	22/10/2020 21:19	6,72	478	3213,09	CHI
202010124945	SANTO ANTONIO DO DESCOBERTO	AX13196774	ALEXANIA	22/10/2020 14:36	22/10/2020 21:19	22/10/2020 14:36	22/10/2020 21:19	6,72	1	6,72	CHI
202010124945	BARRO ALTO	AX13196774	ALEXANIA	22/10/2020 14:36	22/10/2020 21:19	22/10/2020 14:36	22/10/2020 21:19	6,72	3	20,17	CHI
202010125747	SAO MIGUEL DO ARAGUAIA	SM11341467	SAO MIGUEL DO ARAGUAIA	22/10/2020 14:36	22/10/2020 21:06	22/10/2020 14:36	22/10/2020 21:06	6,50	125	812,22	CHI
202010124655	BELA VISTA DE GOIAS	10001131395	CEPAIGO S2	22/10/2020 14:37	22/10/2020 16:33	22/10/2020 14:37	22/10/2020 16:33	1,93	1	1,93	CHI
202010126522	PARAUNA	PU21288601	MONTIVIDIU T	22/10/2020 14:37	23/10/2020 10:02	22/10/2020 14:37	23/10/2020 10:02	19,41	2	38,82	CHI
202010124919	MONTIVIDIU	MV12305995	MONTIVIDIU T	22/10/2020 14:37	23/10/2020 03:15	22/10/2020 14:37	23/10/2020 03:15	12,62	28	353,48	CHI
202010124919	IVOLANDIA	MV12305995	MONTIVIDIU T	22/10/2020 14:37	23/10/2020 03:15	22/10/2020 14:37	23/10/2020 03:15	12,62	29	366,10	CHI
202010124919	CAIAPONIA	MV12305995	MONTIVIDIU T	22/10/2020 14:37	23/10/2020 03:15	22/10/2020 14:37	23/10/2020 03:15	12,62	38	479,72	CHI
202010124919	PARAUNA	MV12305995	MONTIVIDIU T	22/10/2020 14:37	23/10/2020 03:15	22/10/2020 14:37	23/10/2020 03:15	12,62	59	744,83	CHI
202010124684	RIO VERDE	630157340	RIO VERDE S1	22/10/2020 14:41	22/10/2020 16:31	22/10/2020 14:41	22/10/2020 16:31	1,83	1	1,83	CHI
202010124747	SERRANOPOLIS	SX10400642	CHAPADAO DO CEU	22/10/2020 14:42	22/10/2020 14:47	22/10/2020 14:42	22/10/2020 14:47	0,08	47	3,85	CHI
202010124747	MINEIROS	SX10400642	CHAPADAO DO CEU	22/10/2020 14:42	22/10/2020 14:47	22/10/2020 14:42	22/10/2020 14:47	0,08	20	1,64	CHI
202010125536	MIMOSO DE GOIAS	MJ12376736	PADRE BERNARDO	22/10/2020 14:43	22/10/2020 18:57	22/10/2020 14:43	22/10/2020 18:57	4,22	26	109,81	CHI
202010125440	QUIRINOPOLIS	QI11000030	QUIRINOPOLIS	22/10/2020 14:44	22/10/2020 16:51	22/10/2020 14:44	22/10/2020 16:51	2,11	66	139,48	CHI
202010124701	FORMOSA	610161570	ITIQUEIRA	22/10/2020 14:44	22/10/2020 16:55	22/10/2020 14:44	22/10/2020 16:55	2,18	1	2,18	CHI
202010124742	MORRINHOS	MR21349835	MORRINHOS	22/10/2020 14:49	22/10/2020 16:13	22/10/2020 14:49	22/10/2020 16:13	1,40	1	1,40	CHI
202010124746	ANAPOLIS	10004966536	JUNDIAI S2	22/10/2020 14:49	22/10/2020 17:17	22/10/2020 14:49	22/10/2020 17:17	2,45	1	2,45	CHI
202010124783	AGUA LIMPA	AL12049885LD	VILA CORUMBA	22/10/2020 14:50	22/10/2020 20:21	22/10/2020 14:50	22/10/2020 20:21	5,51	19	104,72	CHI
202010124783	AGUA LIMPA	AL13263215	VILA CORUMBA	22/10/2020 14:50	22/10/2020 20:21	22/10/2020 14:50	22/10/2020 19:30	4,66	54	251,77	CHI
202010124783	MORRINHOS	AL13263215	VILA CORUMBA	22/10/2020 14:50	22/10/2020 20:21	22/10/2020 14:50	22/10/2020 19:30	4,66	9	41,96	CHI
202010124783	MORRINHOS	AL13263214	VILA CORUMBA	22/10/2020 14:50	22/10/2020 20:21	22/10/2020 14:50	22/10/2020 18:04	3,24	46	148,90	CHI
202010124783	AGUA LIMPA	AL13263214	VILA CORUMBA	22/10/2020 14:50	22/10/2020 20:21	22/10/2020 14:50	22/10/2020 18:04	3,24	16	51,79	CHI
202010124783	AGUA LIMPA	03750224	VILA CORUMBA	22/10/2020 14:50	22/10/2020 20:21	22/10/2020 14:50	22/10/2020 16:52	2,04	47	95,83	CHI
202010124783	MARZAGAO	03750224	VILA CORUMBA	22/10/2020 14:50	22/10/2020 20:21	22/10/2020 14:50	22/10/2020 16:52	2,04	3	6,12	CHI
202010124723	MIMOSO DE GOIAS	MJ12126284	PADRE BERNARDO	22/10/2020 14:51	22/10/2020 17:51	22/10/2020 14:51	22/10/2020 17:51	2,98	4	11,94	CHI
202010126018	MAURILANDIA	ML11000004	RIO DOS BOIS	22/10/2020 14:56	22/10/2020 18:44	22/10/2020 14:56	22/10/2020 18:44	3,80	84	318,85	CHI
202010125263	MIMOSO DE GOIAS	MJ12183873	PADRE BERNARDO	22/10/2020 14:56	22/10/2020 18:36	22/10/2020 14:56	22/10/2020 18:36	3,66	28	102,49	CHI
202010125263	AGUA FRIA DE GOIAS	MJ12183873	PADRE BERNARDO	22/10/2020 14:56	22/10/2020 18:36	22/10/2020 14:56	22/10/2020 18:36	3,66	11	40,26	CHI
202010124795	FORMOSA	FA11278158	ITIQUEIRA	22/10/2020 14:57	22/10/2020 15:55	22/10/2020 14:57	22/10/2020 15:55	0,96	1	0,96	CHI
202010124814	URUTAI	UT12352273	URUTAI	22/10/2020 14:58	22/10/2020 16:40	22/10/2020 14:58	22/10/2020 16:40	1,69	2	3,39	CHI
202010124816	GOIAS	10030998245	GOIAS	22/10/2020 14:59	22/10/2020 18:44	22/10/2020 14:59	22/10/2020 18:44	3,74	1	3,74	CHI
202010124871	CRISTIANOPOLIS	CF10409097	CRISTIANOPOLIS	22/10/2020 14:59	22/10/2020 18:31	22/10/2020 14:59	22/10/2020 18:31	3,53	102	359,98	CHI
202010124871	PIRACANJUBA	CF10409097	CRISTIANOPOLIS	22/10/2020 14:59	22/10/2020 18:31	22/10/2020 14:59	22/10/2020 18:31	3,53	160	564,67	CHI
202010124871	CRISTIANOPOLIS	CF16429520	CRISTIANOPOLIS	22/10/2020 14:59	22/10/2020 18:31	22/10/2020 14:59	22/10/2020 15:03	0,06	139	8,57	CHI
202010124871	CRISTIANOPOLIS	CF16414886	CRISTIANOPOLIS	22/10/2020 14:59	22/10/2020 18:31	22/10/2020 14:59	22/10/2020 15:03	0,06	434	26,76	CHI
202010124826	PILAR DE GOIAS	GG12212320	SANTA TEREZINHA	22/10/2020 15:01	23/10/2020 02:47	22/10/2020 15:01	23/10/2020 02:47	11,75	3	35,25	CHI
202010125014	CACU	CC12202700	CACHOEIRA ALTA	22/10/2020 15:02	22/10/2020 16:47	22/10/2020 15:02	22/10/2020 16:47	1,74	17	29,50	CHI
202010124835	AGUA FRIA DE GOIAS	TL21314282	SAO JOAO D ALIANCA	22/10/2020 15:03	22/10/2020 22:10	22/10/2020 15:03	22/10/2020 22:10	7,10	1	7,10	CHI
202010124892	MORRINHOS	MR12033194	MORRINHOS	22/10/2020 15:04	22/10/2020 16:22	22/10/2020 15:04	22/10/2020 16:22	1,30	15	19,50	CHI
202010125076	FIRMINOPOLIS	TV12105311	FIRMINOPOLIS S1	22/10/2020 15:04	23/10/2020 00:40	22/10/2020 15:04	23/10/2020 00:40	9,60	6	57,59	CHI
202010126173	MOIPORA	IV12201972	IPORA	22/10/2020 15:04	23/10/2020 02:27	22/10/2020 15:04	23/10/2020 02:27	11,38	7	79,66	CHI
202010126173	IVOLANDIA	IV12201972	IPORA	22/10/2020 15:04	23/10/2020 02:27	22/10/2020 15:04	23/10/2020 02:27	11,38	2	22,76	CHI
202010124912	CAIAPONIA	CP12207860	CAIAPONIA	22/10/2020 15:04	22/10/2020 17:29	22/10/2020 15:04	22/10/2020 17:29	2,40	3	7,21	CHI
202010124847	CATALAO	10009165515	CATALAO S2	22/10/2020 15:05	22/10/2020 18:29	22/10/2020 15:05	22/10/2020 18:29	3,40	1	3,40	CHI
202010124862	GOUVELANDIA	GB21296636	QUIRINOPOLIS	22/10/2020 15:05	22/10/2020 18:44	22/10/2020 15:05	22/10/2020 18:44	3,64	1	3,64	CHI
202010124955	SAO JOAO D ALIANCA	JL12106845	SAO JOAO D ALIANCA	22/10/2020 15:07	22/10/2020 16:02	22/10/2020 15:07	22/10/2020 16:02	0,91	15	13,70	CHI
202010124879	JARAGUA	70046694	JARAGUA	22/10/2020 15:07	23/10/2020 10:39	22/10/2020 15:07	23/10/2020 10:39	19,53	1	19,53	CHI

202010125423	AURILANDIA	RP18304543TS	FIRMINOPOLIS S2	22/10/2020 15:09	22/10/2020 22:38	22/10/2020 15:09	22/10/2020 22:38	7,48	3	22,43	CHI
202010125423	PARAUNA	RP18304543TS	FIRMINOPOLIS S2	22/10/2020 15:09	22/10/2020 22:38	22/10/2020 15:09	22/10/2020 22:38	7,48	35	261,67	CHI
202010128934	MIMOSO DE GOIAS	MJ12304747	PADRE BERNARDO	22/10/2020 15:09	23/10/2020 00:42	22/10/2020 15:09	23/10/2020 00:42	9,54	9	85,89	CHI
202010124896	SAO JOAO DA PARAUNA	PU12361883	PARAUNA	22/10/2020 15:09	22/10/2020 18:50	22/10/2020 15:09	22/10/2020 18:50	3,67	4	14,70	CHI
202010124899	SILVANIA	SV12056199	DAIA S2	22/10/2020 15:10	22/10/2020 16:49	22/10/2020 15:10	22/10/2020 16:49	1,65	9	14,81	CHI
202010125035	CACHOEIRA DE GOIAS	CG12382596	FIRMINOPOLIS S2	22/10/2020 15:11	23/10/2020 14:17	22/10/2020 15:11	23/10/2020 14:17	23,10	2	46,20	CHI
202010125035	AURILANDIA	CG12382596	FIRMINOPOLIS S2	22/10/2020 15:11	23/10/2020 14:17	22/10/2020 15:11	23/10/2020 14:17	23,10	24	554,41	CHI
202010125035	MOIPORA	CG12382596	FIRMINOPOLIS S2	22/10/2020 15:11	23/10/2020 14:17	22/10/2020 15:11	23/10/2020 14:17	23,10	1	23,10	CHI
202010124921	GOIANIA	11673928	GOIANIA LESTE S3	22/10/2020 15:11	22/10/2020 16:28	22/10/2020 15:11	22/10/2020 16:28	1,27	1	1,27	CHI
202010124922	GOIANIA	14635574	MEIA PONTE	22/10/2020 15:11	22/10/2020 16:35	22/10/2020 15:11	22/10/2020 16:35	1,39	1	1,39	CHI
2020102200063	ARUANA	03200434	ARUANA	22/10/2020 15:12	22/10/2020 15:18	22/10/2020 15:12	22/10/2020 15:18	0,10	8	0,80	CHI
202010124927	GOIANIA	14565780	AEROPORTO S2	22/10/2020 15:12	22/10/2020 16:34	22/10/2020 15:12	22/10/2020 16:34	1,36	1	1,36	CHI
202010126032	ARUANA	AK12066603	ARUANA	22/10/2020 15:12	23/10/2020 13:11	22/10/2020 15:12	23/10/2020 13:11	22,00	4	87,98	CHI
202010124934	GOIANIA	11487290	CAMPINAS S1	22/10/2020 15:13	22/10/2020 16:45	22/10/2020 15:13	22/10/2020 16:45	1,53	1	1,53	CHI
202010124940	LUZIANIA	LZ12370631	MARAJOARA	22/10/2020 15:13	22/10/2020 22:35	22/10/2020 15:13	22/10/2020 22:35	7,36	28	206,20	CHI
202010124940	LUZIANIA	LZ21139690	MARAJOARA	22/10/2020 15:13	22/10/2020 22:35	22/10/2020 15:13	22/10/2020 22:10	6,94	4	27,74	CHI
202010124943	MINEIROS	MY21234502	PARQUE DAS EMAS	22/10/2020 15:14	23/10/2020 10:00	22/10/2020 15:14	23/10/2020 10:00	18,75	1	18,75	CHI
202010124952	JATAI	290343719	JATAI S2	22/10/2020 15:16	23/10/2020 01:04	22/10/2020 15:16	23/10/2020 01:04	9,80	1	9,80	CHI
202010125004	RUBIATABA	RB12201235	RUBIATABA	22/10/2020 15:17	22/10/2020 17:25	22/10/2020 15:17	22/10/2020 17:25	2,12	10	21,23	CHI
202010126345	GOUVELANDIA	GB12402360RE	QUIRINOPOLIS	22/10/2020 15:17	22/10/2020 19:52	22/10/2020 15:17	22/10/2020 19:52	4,57	8	36,57	CHI
202010126345	QUIRINOPOLIS	GB12402360RE	QUIRINOPOLIS	22/10/2020 15:17	22/10/2020 19:52	22/10/2020 15:17	22/10/2020 19:52	4,57	4	18,29	CHI
202010124965	EDEIA	1120010163	EDEIA	22/10/2020 15:18	22/10/2020 23:51	22/10/2020 15:18	22/10/2020 23:51	8,54	1	8,54	CHI
202010124993	ITABERAI	10019047027	ITABERAI S2	22/10/2020 15:19	22/10/2020 16:48	22/10/2020 15:19	22/10/2020 16:48	1,48	1	1,48	CHI
202010125009	GOIANIA	GN11336796	GOYA S2	22/10/2020 15:21	22/10/2020 19:42	22/10/2020 15:21	22/10/2020 19:42	4,35	105	456,60	CHI
202010124983	PIRACANJUBA	PJ21098666	PIRACANJUBA	22/10/2020 15:21	22/10/2020 18:34	22/10/2020 15:21	22/10/2020 18:34	3,21	1	3,21	CHI
202010124988	GOIANIA	12102878	GOYA S1	22/10/2020 15:21	22/10/2020 16:36	22/10/2020 15:21	22/10/2020 16:36	1,24	1	1,24	CHI
202010124995	MARA ROSA	MQ21192408	MARA ROSA	22/10/2020 15:23	22/10/2020 19:24	22/10/2020 15:23	22/10/2020 19:24	4,02	1	4,02	CHI
202010125000	PIRACANJUBA	PJ12249878	PIRACANJUBA	22/10/2020 15:23	22/10/2020 17:56	22/10/2020 15:23	22/10/2020 17:56	2,53	7	17,74	CHI
202010125001	SAO SIMAO	2240033922	CACHOEIRA ALTA	22/10/2020 15:24	22/10/2020 16:39	22/10/2020 15:24	22/10/2020 16:39	1,25	1	1,25	CHI
202010125011	MOIPORA	MO11102480	IPORA	22/10/2020 15:25	22/10/2020 20:28	22/10/2020 15:25	22/10/2020 20:28	5,05	109	550,00	CHI
202010128097	SANTO ANTONIO DO DESCOBERTO	SN12355964	AGUAS LINDAS DE GOIAS S2	22/10/2020 15:25	23/10/2020 10:31	22/10/2020 15:25	23/10/2020 10:31	19,09	3	57,27	CHI
202010126987	LUZIANIA	LZ11383814	MARAJOARA	22/10/2020 15:25	23/10/2020 01:40	22/10/2020 15:25	23/10/2020 01:40	10,24	70	716,51	CHI
202010125396	MIMOSO DE GOIAS	MJ12313854	PADRE BERNARDO	22/10/2020 15:26	22/10/2020 21:15	22/10/2020 15:26	22/10/2020 21:15	5,82	21	122,14	CHI
202010125027	MORRINHOS	MR12064832	GOIATUBA S1	22/10/2020 15:26	23/10/2020 16:07	22/10/2020 15:26	23/10/2020 16:07	24,67	1	24,67	CHI
202010125029	NEROPOLIS	NR11271870	NEROPOLIS S2	22/10/2020 15:27	22/10/2020 17:24	22/10/2020 15:27	22/10/2020 17:24	1,95	35	68,21	CHI
202010125030	PARAUNA	EU12044261	ACREUNA	22/10/2020 15:27	22/10/2020 20:47	22/10/2020 15:27	22/10/2020 20:47	5,34	10	53,39	CHI
202010125036	SAO LUIS DE MONTES BELOS	SL31206306	FIRMINOPOLIS S1	22/10/2020 15:28	23/10/2020 07:09	22/10/2020 15:28	23/10/2020 07:09	15,68	1	15,68	CHI
202010125042	APORE	AE21154108	ITAJA S1	22/10/2020 15:29	22/10/2020 22:47	22/10/2020 15:29	22/10/2020 22:47	7,29	1	7,29	CHI
202010125050	CRISTALINA	KR12090200	CRISTALINA S1	22/10/2020 15:31	22/10/2020 21:06	22/10/2020 15:31	22/10/2020 21:06	5,58	5	27,89	CHI
202010125055	NOVA CRIXAS	NA21291259	NOVA CRIXAS	22/10/2020 15:32	22/10/2020 17:43	22/10/2020 15:32	22/10/2020 17:43	2,17	1	2,17	CHI
202010125064	FORMOSA	FA11254294	ITUIQUIRA	22/10/2020 15:33	22/10/2020 20:59	22/10/2020 15:33	22/10/2020 20:59	5,42	1	5,42	CHI
202010125066	PLANALTINA	10001390471	PLANALTINA	22/10/2020 15:34	22/10/2020 16:55	22/10/2020 15:34	22/10/2020 16:55	1,35	1	1,35	CHI
202010125080	LUZIANIA	LZ21412425	VIANOPOLIS	22/10/2020 15:35	23/10/2020 13:18	22/10/2020 15:35	23/10/2020 13:18	21,71	1	21,71	CHI
202010125084	RUBIATABA	RB21187184	RUBIATABA	22/10/2020 15:36	22/10/2020 18:07	22/10/2020 15:36	22/10/2020 18:07	2,52	1	2,52	CHI
202010125090	RIO VERDE	RV21305778	CABRIUVA S2	22/10/2020 15:37	22/10/2020 18:15	22/10/2020 15:37	22/10/2020 18:15	2,63	2	5,27	CHI
202010125092	APARECIDA DE GOIANIA	200659686	ANHANGUERA	22/10/2020 15:37	22/10/2020 17:15	22/10/2020 15:37	22/10/2020 17:15	1,63	1	1,63	CHI
202010125096	DIVINOPOLIS DE GOIAS	GH11272557	SAO DOMINGOS	22/10/2020 15:37	22/10/2020 22:53	22/10/2020 15:37	22/10/2020 22:53	7,25	1	7,25	CHI
202010125102	BURITI ALEGRE	BG21134586	ITUMBIARA VELHA S2	22/10/2020 15:39	22/10/2020 18:04	22/10/2020 15:39	22/10/2020 18:04	2,42	1	2,42	CHI
202010125620	CHAPADAO DO CEU	DJ12160236	CHAPADAO DO CEU	22/10/2020 15:41	22/10/2020 18:28	22/10/2020 15:41	22/10/2020 18:28	2,77	11	30,45	CHI
202010125115	LUZIANIA	LZ21156962	CRISTALINA S2	22/10/2020 15:42	23/10/2020 00:30	22/10/2020 15:42	23/10/2020 00:30	8,80	1	8,80	CHI
202010125466	IPAMERI	KR12330533	CRISTALINA S1	22/10/2020 15:42	22/10/2020 17:59	22/10/2020 15:42	22/10/2020 17:59	2,27	1	2,27	CHI

202010125466	LUZIANIA	KR12330533	CRISTALINA S1	22/10/2020 15:42	22/10/2020 17:59	22/10/2020 15:42	22/10/2020 17:59	2,27	8	18,15	CHI
202010125466	CRISTALINA	KR12330533	CRISTALINA S1	22/10/2020 15:42	22/10/2020 17:59	22/10/2020 15:42	22/10/2020 17:59	2,27	35	79,40	CHI
202010125129	PALMEIRAS DE GOIAS	PL21239700	PALMEIRAS	22/10/2020 15:45	22/10/2020 18:00	22/10/2020 15:45	22/10/2020 18:00	2,24	1	2,24	CHI
202010125143	PADRE BERNARDO	PB21305141	PADRE BERNARDO	22/10/2020 15:49	22/10/2020 19:52	22/10/2020 15:49	22/10/2020 19:52	4,05	1	4,05	CHI
202010125155	IACIARA	1550010983	IACIARA S1	22/10/2020 15:50	22/10/2020 20:21	22/10/2020 15:50	22/10/2020 20:21	4,52	1	4,52	CHI
202010125154	PARAUNA	PU11158980	PARAUNA	22/10/2020 15:50	22/10/2020 17:28	22/10/2020 15:50	22/10/2020 17:28	1,63	156	254,71	CHI
202010125157	RIO VERDE	630518737	RIO VERDE S1	22/10/2020 15:50	22/10/2020 20:32	22/10/2020 15:50	22/10/2020 20:32	4,69	1	4,69	CHI
202010125225	VALPARAISO DE GOIAS	VA11192965	PACAEMBU S2	22/10/2020 15:50	22/10/2020 18:28	22/10/2020 15:50	22/10/2020 18:28	2,62	98	256,87	CHI
202010125161	GOIAS	MP21118266	MATRINCHA	22/10/2020 15:51	23/10/2020 13:22	22/10/2020 15:51	23/10/2020 13:22	21,51	1	21,51	CHI
202010125165	SANTA HELENA DE GOIAS	SH12246719	ACREUNA	22/10/2020 15:52	23/10/2020 00:50	22/10/2020 15:52	23/10/2020 00:50	8,96	32	286,76	CHI
202010125165	SANTA HELENA DE GOIAS	SH12246719	ACREUNA	22/10/2020 15:52	23/10/2020 00:50	22/10/2020 22:11	23/10/2020 00:50	2,65	7	18,54	CHI
202010125203	NIQUELANDIA	NQ12268729	BARRO ALTO	22/10/2020 15:52	22/10/2020 18:02	22/10/2020 15:52	22/10/2020 18:02	2,16	63	136,04	CHI
202010127830	APARECIDA DO RIO DOCE	7418901	CACHOEIRA ALTA	22/10/2020 15:53	24/10/2020 08:29	22/10/2020 15:53	24/10/2020 08:29	40,60	17	690,28	CHI
202010127830	JATAI	7418901	CACHOEIRA ALTA	22/10/2020 15:53	24/10/2020 08:29	22/10/2020 15:53	24/10/2020 08:29	40,60	32	1299,35	CHI
202010127830	APARECIDA DO RIO DOCE	7418901	CACHOEIRA ALTA	22/10/2020 15:53	24/10/2020 08:29	22/10/2020 15:53	23/10/2020 14:34	22,69	23	521,93	CHI
202010125672	GOIANESIA	GE12358979	GOIANESIA S2	22/10/2020 15:53	22/10/2020 23:16	22/10/2020 15:53	22/10/2020 23:16	7,38	4	29,51	CHI
202010125672	VILA PROPICIO	GE12358979	GOIANESIA S1	22/10/2020 15:53	22/10/2020 23:16	22/10/2020 15:53	22/10/2020 23:16	7,38	11	81,15	CHI
202010125672	VILA PROPICIO	GE12358979	GOIANESIA S2	22/10/2020 15:53	22/10/2020 23:16	22/10/2020 15:53	22/10/2020 23:16	7,38	9	66,39	CHI
202010125206	FORMOSA	610217537	ITIQUEIRA	22/10/2020 15:55	22/10/2020 16:55	22/10/2020 15:55	22/10/2020 16:55	1,00	1	1,00	CHI
202010125198	GOIANIA	13253803	CAMPINAS S3	22/10/2020 15:56	22/10/2020 18:57	22/10/2020 15:56	22/10/2020 18:57	3,02	1	3,02	CHI
202010125199	SAO JOAO DA PARAUNA	RP12076381RE	FIRMINOPOLIS S2	22/10/2020 15:56	22/10/2020 18:02	22/10/2020 15:56	22/10/2020 18:02	2,10	33	69,26	CHI
202010125199	AURILANDIA	RP12076381RE	FIRMINOPOLIS S2	22/10/2020 15:56	22/10/2020 18:02	22/10/2020 15:56	22/10/2020 18:02	2,10	4	8,40	CHI
202010126232	PALMINOPOLIS	PP12233526	PALMEIRAS	22/10/2020 15:56	22/10/2020 19:32	22/10/2020 15:56	22/10/2020 19:32	3,60	30	107,93	CHI
202010125202	CHAPADAO DO CEU	AE21054556	CHAPADAO DO CEU	22/10/2020 15:56	22/10/2020 19:26	22/10/2020 15:56	22/10/2020 19:26	3,50	1	3,50	CHI
202010125211	PARAUNA	PU12060471	PARAUNA	22/10/2020 15:57	22/10/2020 17:28	22/10/2020 15:57	22/10/2020 17:28	1,51	808	1223,67	CHI
202010125221	MIMOSO DE GOIAS	MJ12097505	PADRE BERNARDO	22/10/2020 15:58	22/10/2020 17:49	22/10/2020 15:58	22/10/2020 17:49	1,84	67	123,56	CHI
202010125522	NIQUELANDIA	NQ11035208	NIQUELANDIA SUBTRANSMISSAO	22/10/2020 15:59	22/10/2020 21:18	22/10/2020 15:59	22/10/2020 21:18	5,30	226	1198,18	CHI
202010125229	ACREUNA	EU12085790	ACREUNA	22/10/2020 15:59	23/10/2020 03:51	22/10/2020 15:59	23/10/2020 03:51	11,85	21	248,87	CHI
202010125231	AGUA FRIA DE GOIAS	TL12096488	SAO JOAO D ALIANCA	22/10/2020 16:00	22/10/2020 17:25	22/10/2020 16:00	22/10/2020 17:25	1,41	1	1,41	CHI
202010125238	CABECEIRAS	CW21257768	ITIQUEIRA	22/10/2020 16:00	22/10/2020 18:45	22/10/2020 16:00	22/10/2020 18:45	2,73	1	2,73	CHI
202010125240	MONTE ALEGRE DE GOIAS	7970000781	SAO DOMINGOS	22/10/2020 16:01	22/10/2020 19:53	22/10/2020 16:01	22/10/2020 19:53	3,87	1	3,87	CHI
202010125344	RUBIATABA	RB12194366	RUBIATABA	22/10/2020 16:01	22/10/2020 17:26	22/10/2020 16:01	22/10/2020 17:26	1,41	8	11,29	CHI
202010125248	SANTA HELENA DE GOIAS	10023301005	IPEGUARI	22/10/2020 16:01	23/10/2020 07:47	22/10/2020 16:01	23/10/2020 07:47	15,75	1	15,75	CHI
202010125261	PIRACANJUBA	PJ12223405RE	PIRACANJUBA	22/10/2020 16:02	22/10/2020 20:36	22/10/2020 16:02	22/10/2020 20:36	4,57	6	27,42	CHI
202010125261	SANTA CRUZ DE GOIAS	PJ12223405RE	PIRACANJUBA	22/10/2020 16:02	22/10/2020 20:36	22/10/2020 16:02	22/10/2020 20:36	4,57	33	150,80	CHI
202010125255	GOIATUBA	GT12048509	GOIATUBA S2	22/10/2020 16:02	23/10/2020 03:21	22/10/2020 16:02	23/10/2020 03:21	11,31	2	22,61	CHI
202010125258	CAMPO ALEGRE DE GOIAS	1160007254	CAMPO ALEGRE DE GOIAS	22/10/2020 16:02	22/10/2020 20:40	22/10/2020 16:02	22/10/2020 20:40	4,62	1	4,62	CHI
202010176426	MINEIROS	MY12234375	PARQUE DAS EMAS	22/10/2020 16:04	23/10/2020 13:46	22/10/2020 16:04	23/10/2020 13:46	21,70	8	173,60	CHI
202010176426	DOVERLANDIA	MY12234375	PARQUE DAS EMAS	22/10/2020 16:04	23/10/2020 13:46	22/10/2020 16:04	23/10/2020 13:46	21,70	4	86,80	CHI
202010176426	CAIAPONIA	MY12234375	PARQUE DAS EMAS	22/10/2020 16:04	23/10/2020 13:46	22/10/2020 16:04	23/10/2020 13:46	21,70	1	21,70	CHI
202010125265	DOVERLANDIA	DV11253258	CAIAPONIA	22/10/2020 16:04	22/10/2020 18:18	22/10/2020 16:04	22/10/2020 18:18	2,23	1	2,23	CHI
202010189338	PORTELANDIA	PW12248465RE	PARQUE DAS EMAS	22/10/2020 16:05	23/10/2020 13:12	22/10/2020 16:05	23/10/2020 13:12	21,10	11	232,15	CHI
202010125770	ACREUNA	EU11271566	ACREUNA	22/10/2020 16:07	22/10/2020 19:29	22/10/2020 16:07	22/10/2020 19:29	3,36	161	541,18	CHI
202010125303	SERRANOPOLIS	DJ12164269	CHAPADAO DO CEU	22/10/2020 16:07	23/10/2020 13:08	22/10/2020 16:07	23/10/2020 13:08	21,00	5	105,02	CHI
202010125292	APARECIDA DE GOIANIA	10005839929	INDEPENDENCIA S2	22/10/2020 16:07	22/10/2020 16:36	22/10/2020 16:07	22/10/2020 16:36	0,47	1	0,47	CHI
202010123394	JESUPOLIS	SR16416490	INHUMAS S1	22/10/2020 16:08	23/10/2020 11:44	22/10/2020 16:08	23/10/2020 11:44	19,61	24	470,53	CHI
202010123394	JARAGUA	SR16416490	INHUMAS S1	22/10/2020 16:08	23/10/2020 11:44	22/10/2020 16:08	23/10/2020 11:44	19,61	38	745,00	CHI
202010123394	SANTA ROSA DE GOIAS	SR16416490	INHUMAS S1	22/10/2020 16:08	23/10/2020 11:44	22/10/2020 16:08	23/10/2020 11:44	19,61	78	1529,21	CHI
202010123394	JARAGUA	SR16416490	INHUMAS S1	22/10/2020 16:08	23/10/2020 11:44	23/10/2020 11:38	23/10/2020 11:44	0,10	2	0,19	CHI
202010123394	TAQUARAL DE GOIAS	SR16416490	INHUMAS S1	22/10/2020 16:08	23/10/2020 11:44	23/10/2020 11:38	23/10/2020 11:44	0,10	45	4,28	CHI
202010123394	SANTA ROSA DE GOIAS	SR16416490	INHUMAS S1	22/10/2020 16:08	23/10/2020 11:44	23/10/2020 11:38	23/10/2020 11:44	0,10	112	10,64	CHI

202010125295	PIRACANJUBA	PJ12024136	PIRACANJUBA	22/10/2020 16:08	22/10/2020 20:53	22/10/2020 16:08	22/10/2020 20:53	4,74	3	14,23	CHI
202010125298	PARAUNA	AI12008084	FIRMINOPOLIS S2	22/10/2020 16:08	22/10/2020 21:43	22/10/2020 16:08	22/10/2020 21:43	5,57	6	33,44	CHI
202010125340	MINEIROS	MY12274100RE	PARQUE DAS EMAS	22/10/2020 16:08	22/10/2020 19:41	22/10/2020 16:08	22/10/2020 19:41	3,54	15	53,09	CHI
202010125653	NIQUELANDIA	NQ12140184	SAO JOAO D ALIANCA	22/10/2020 16:10	23/10/2020 10:59	22/10/2020 16:10	23/10/2020 10:59	18,81	60	1128,37	CHI
202010125526	RIO VERDE	RV13058188	CABRIUVA S2	22/10/2020 16:10	23/10/2020 21:00	22/10/2020 23:03	23/10/2020 21:00	21,95	1	21,95	CHI
202010125526	RIO VERDE	RV12034596	CABRIUVA S2	22/10/2020 16:10	23/10/2020 21:00	22/10/2020 16:10	22/10/2020 16:45	0,58	7	4,06	CHI
202010125326	ITAPIRAPUA	IU21143110	MATRINCHA	22/10/2020 16:13	23/10/2020 08:37	22/10/2020 16:13	23/10/2020 08:37	16,40	1	16,40	CHI
202010126399	HIDROLINA	UR12048650RE	URUACU	22/10/2020 16:13	22/10/2020 19:42	22/10/2020 16:13	22/10/2020 19:42	3,48	15	52,23	CHI
202010126399	URUACU	UR12048650RE	URUACU	22/10/2020 16:13	22/10/2020 19:42	22/10/2020 16:13	22/10/2020 19:42	3,48	34	118,40	CHI
202010125329	GOIANIA	14907410	ATLANTICO S2	22/10/2020 16:13	22/10/2020 18:10	22/10/2020 16:13	22/10/2020 18:10	1,95	1	1,95	CHI
202010125337	MORRINHOS	MR12000105	MORRINHOS	22/10/2020 16:14	23/10/2020 13:37	22/10/2020 16:14	23/10/2020 13:37	21,39	2	42,78	CHI
202010125337	MORRINHOS	MR12000105	MORRINHOS	22/10/2020 16:14	23/10/2020 13:37	22/10/2020 19:00	23/10/2020 13:37	18,62	1	18,62	CHI
202010125337	MORRINHOS	MR12000105	MORRINHOS	22/10/2020 16:14	23/10/2020 13:37	23/10/2020 12:44	23/10/2020 13:37	0,88	3	2,65	CHI
202010125337	MORRINHOS	MR12000105	MORRINHOS	22/10/2020 16:14	23/10/2020 13:37	22/10/2020 16:14	22/10/2020 20:13	3,98	3	11,95	CHI
202010125342	CRIXAS	CX21151899	SANTA TEREZINHA	22/10/2020 16:15	22/10/2020 21:06	22/10/2020 16:15	22/10/2020 21:06	4,84	1	4,84	CHI
202010125347	MINEIROS	MY12194493	PARQUE DAS EMAS	22/10/2020 16:16	24/10/2020 10:03	22/10/2020 16:16	24/10/2020 10:03	41,78	5	208,89	CHI
202010125775	FIRMINOPOLIS	FR12096839RE	FIRMINOPOLIS S1	22/10/2020 16:16	22/10/2020 19:05	22/10/2020 16:16	22/10/2020 19:05	2,81	59	165,90	CHI
202010125351	EDEIA	EA21114703	EDEIA	22/10/2020 16:16	22/10/2020 22:38	22/10/2020 16:16	22/10/2020 22:38	6,35	1	6,35	CHI
202010126084	NIQUELANDIA	NQ12113859	URUACU	22/10/2020 16:17	22/10/2020 19:45	22/10/2020 16:17	22/10/2020 19:45	3,46	17	58,82	CHI
202010125367	ACREUNA	00080424	ACREUNA	22/10/2020 16:17	24/10/2020 14:15	22/10/2020 16:17	24/10/2020 14:15	45,96	7	321,72	CHI
202010125367	INDIARA	00080424	ACREUNA	22/10/2020 16:17	24/10/2020 14:15	22/10/2020 16:17	24/10/2020 14:15	45,96	4	183,84	CHI
202010125367	PARAUNA	00080424	ACREUNA	22/10/2020 16:17	24/10/2020 14:15	23/10/2020 18:25	23/10/2020 19:12	0,79	1	0,79	CHI
202010125367	INDIARA	00080424	ACREUNA	22/10/2020 16:17	24/10/2020 14:15	23/10/2020 18:25	23/10/2020 19:12	0,79	21	16,62	CHI
202010125367	JANDAIA	00080424	ACREUNA	22/10/2020 16:17	24/10/2020 14:15	23/10/2020 18:25	23/10/2020 19:12	0,79	33	26,12	CHI
202010125367	ACREUNA	00080424	ACREUNA	22/10/2020 16:17	24/10/2020 14:15	23/10/2020 18:25	23/10/2020 19:12	0,79	29	22,96	CHI
202010125367	INDIARA	00080424	ACREUNA	22/10/2020 16:17	24/10/2020 14:15	22/10/2020 16:17	23/10/2020 12:51	20,56	12	246,69	CHI
202010125367	INDIARA	00080424	ACREUNA	22/10/2020 16:17	24/10/2020 14:15	22/10/2020 16:17	23/10/2020 11:23	19,10	6	114,57	CHI
202010125367	JANDAIA	00080424	ACREUNA	22/10/2020 16:17	24/10/2020 14:15	22/10/2020 16:17	23/10/2020 00:19	8,02	1	8,02	CHI
202010125367	PARAUNA	00080424	ACREUNA	22/10/2020 16:17	24/10/2020 14:15	22/10/2020 23:00	22/10/2020 23:06	0,10	1	0,10	CHI
202010125367	JANDAIA	00080424	ACREUNA	22/10/2020 16:17	24/10/2020 14:15	22/10/2020 23:00	22/10/2020 23:06	0,10	32	3,31	CHI
202010125367	INDIARA	00080424	ACREUNA	22/10/2020 16:17	24/10/2020 14:15	22/10/2020 23:00	22/10/2020 23:06	0,10	3	0,31	CHI
202010125367	ACREUNA	00080424	ACREUNA	22/10/2020 16:17	24/10/2020 14:15	22/10/2020 23:00	22/10/2020 23:06	0,10	29	3,00	CHI
202010125367	JANDAIA	00080424	ACREUNA	22/10/2020 16:17	24/10/2020 14:15	22/10/2020 16:17	22/10/2020 22:36	6,32	16	101,11	CHI
202010125367	INDIARA	00080424	ACREUNA	22/10/2020 16:17	24/10/2020 14:15	22/10/2020 16:17	22/10/2020 22:36	6,32	3	18,96	CHI
202010125367	PARAUNA	00080424	ACREUNA	22/10/2020 16:17	24/10/2020 14:15	22/10/2020 16:17	22/10/2020 18:27	2,15	1	2,15	CHI
202010125367	ACREUNA	00080424	ACREUNA	22/10/2020 16:17	24/10/2020 14:15	22/10/2020 16:17	22/10/2020 18:27	2,15	29	62,46	CHI
202010125367	JANDAIA	00080424	ACREUNA	22/10/2020 16:17	24/10/2020 14:15	22/10/2020 16:17	22/10/2020 18:27	2,15	16	34,46	CHI
202010125368	NIQUELANDIA	NQ21197544	NIQUELANDIA SUBTRANSMISSAO	22/10/2020 16:18	23/10/2020 09:00	22/10/2020 16:18	23/10/2020 09:00	16,69	2	33,37	CHI
202010126145	MOIPORA	MO12073400	IPORA	22/10/2020 16:19	23/10/2020 03:14	22/10/2020 16:19	23/10/2020 03:14	10,91	29	316,25	CHI
202010126145	ISRAELANDIA	MO12073400	IPORA	22/10/2020 16:19	23/10/2020 03:14	22/10/2020 16:19	23/10/2020 03:14	10,91	15	163,58	CHI
202010125373	ITUMBIARA	IT12033787	CACHOEIRA DOURADA	22/10/2020 16:20	22/10/2020 19:41	22/10/2020 16:20	22/10/2020 19:41	3,35	3	10,04	CHI
202010125374	NIQUELANDIA	NQ12262920	BARRO ALTO	22/10/2020 16:20	22/10/2020 22:03	22/10/2020 16:20	22/10/2020 22:03	5,71	3	17,14	CHI
202010125376	RIO VERDE	RV21260716	RIO VERDE S2	22/10/2020 16:20	23/10/2020 04:31	22/10/2020 16:20	23/10/2020 04:31	12,18	1	12,18	CHI
202010124705	QUIRINOPOLIS	QI11107391	QUIRINOPOLIS	22/10/2020 16:20	22/10/2020 18:30	22/10/2020 16:20	22/10/2020 18:30	2,15	58	124,96	CHI
202010125393	SILVANIA	SV21142577	VIANOPOLIS	22/10/2020 16:22	22/10/2020 18:03	22/10/2020 16:22	22/10/2020 18:03	1,67	1	1,67	CHI
202010125761	GOIANIA	GN11343046	ATLANTICO S1	22/10/2020 16:23	22/10/2020 23:00	22/10/2020 16:23	22/10/2020 23:00	6,61	104	686,98	CHI
202010125397	GOIANIA	GN11333048	ATLANTICO S1	22/10/2020 16:23	22/10/2020 18:18	22/10/2020 16:23	22/10/2020 18:18	1,92	84	161,23	CHI
202010125400	PARAUNA	980015868	PARAUNA	22/10/2020 16:24	22/10/2020 17:02	22/10/2020 16:24	22/10/2020 17:02	0,63	1	0,63	CHI
202010125411	ANAPOLIS	10007281429	JUNDIAI S2	22/10/2020 16:26	23/10/2020 09:20	22/10/2020 16:26	23/10/2020 09:20	16,89	1	16,89	CHI
202010125742	CUMARI	CT12266948RE	CATALAO S2	22/10/2020 16:26	22/10/2020 18:34	22/10/2020 16:26	22/10/2020 18:34	2,12	18	38,23	CHI
202010125742	CATALAO	CT12266948RE	CATALAO S2	22/10/2020 16:26	22/10/2020 18:34	22/10/2020 16:26	22/10/2020 18:34	2,12	15	31,86	CHI



202010125413	SANTA HELENA DE GOIAS	10027328307	IPEGUARI	22/10/2020 16:27	22/10/2020 19:27	22/10/2020 16:27	22/10/2020 19:27	3,00	1	3,00	CHI
202010125415	ALOANDIA	AD12000007	GOIATUBA S1	22/10/2020 16:27	22/10/2020 18:28	22/10/2020 16:27	22/10/2020 18:28	2,02	1	2,02	CHI
202010125431	APARECIDA DE GOIANIA	10005297107	INDEPENDENCIA S2	22/10/2020 16:29	22/10/2020 17:18	22/10/2020 16:29	22/10/2020 17:18	0,80	1	0,80	CHI
202010126055	MINEIROS	MY18149310TS	PARQUE DAS EMAS	22/10/2020 16:31	23/10/2020 12:34	22/10/2020 16:31	23/10/2020 12:34	20,05	76	1523,57	CHI
202010125444	ALEXANIA	10029991305	ALEXANIA	22/10/2020 16:32	23/10/2020 08:42	22/10/2020 16:32	23/10/2020 08:42	16,16	1	16,16	CHI
202010125648	LUZIANIA	LZ11000055	MARAJOARA	22/10/2020 16:32	22/10/2020 22:42	22/10/2020 16:32	22/10/2020 22:42	6,15	116	713,79	CHI
202010127785	MINEIROS	MY12202613RE	PARQUE DAS EMAS	22/10/2020 16:33	23/10/2020 01:00	22/10/2020 16:33	23/10/2020 01:00	8,44	10	84,38	CHI
202010126517	CAIAPONIA	CP12060848	CAIAPONIA	22/10/2020 16:34	23/10/2020 04:58	22/10/2020 16:34	23/10/2020 04:58	12,40	12	148,78	CHI
202010125460	PALMEIRAS DE GOIAS	PL12011094	PALMEIRAS	22/10/2020 16:35	22/10/2020 18:47	22/10/2020 16:35	22/10/2020 18:47	2,20	3	6,59	CHI
202010125473	CAVALCANTE	TI12162624	NIQUELANDIA SUBTRANSMISSAO	22/10/2020 16:36	22/10/2020 21:46	22/10/2020 16:36	22/10/2020 21:46	5,16	1	5,16	CHI
202010128275	LUZIANIA	LZ11128875	MARAJOARA	22/10/2020 16:37	23/10/2020 02:06	22/10/2020 16:37	23/10/2020 02:06	9,48	100	948,31	CHI
202010125477	GOIANIA	10018851280	CAMPINAS S2	22/10/2020 16:37	22/10/2020 17:42	22/10/2020 16:37	22/10/2020 17:42	1,08	1	1,08	CHI
202010125478	GOIANIA	12427160	GOIANIA LESTE S1	22/10/2020 16:37	22/10/2020 17:26	22/10/2020 16:37	22/10/2020 17:26	0,81	1	0,81	CHI
202010125525	JANDAIA	PP12307065	PALMEIRAS	22/10/2020 16:37	22/10/2020 18:30	22/10/2020 16:37	22/10/2020 18:30	1,87	15	28,10	CHI
202010125525	PALMINOPOLIS	PP12307065	PALMEIRAS	22/10/2020 16:37	22/10/2020 18:30	22/10/2020 16:37	22/10/2020 18:30	1,87	7	13,12	CHI
202010125491	SILVANIA	SV12103759	VIANOPOLIS	22/10/2020 16:38	22/10/2020 22:29	22/10/2020 16:38	22/10/2020 22:29	5,83	4	23,34	CHI
202010125492	SANTA CRUZ DE GOIAS	BC12311644	PIRES DO RIO S2	22/10/2020 16:39	22/10/2020 19:13	22/10/2020 16:39	22/10/2020 19:13	2,56	3	7,69	CHI
202010125496	RIO VERDE	630010237	RIO VERDE S1	22/10/2020 16:39	22/10/2020 20:03	22/10/2020 16:39	22/10/2020 20:03	3,39	1	3,39	CHI
202010125508	APARECIDA DE GOIANIA	AP12212351	ANHANGUERA	22/10/2020 16:39	22/10/2020 20:00	22/10/2020 16:39	22/10/2020 20:00	3,33	13	43,34	CHI
202010125498	BELA VISTA DE GOIAS	BV11269852	CEPAIGO S2	22/10/2020 16:40	22/10/2020 20:44	22/10/2020 16:40	22/10/2020 20:44	4,06	8	32,52	CHI
202010125509	PIRACANJUBA	PJ21051395	PIRACANJUBA	22/10/2020 16:41	23/10/2020 17:41	22/10/2020 16:41	23/10/2020 17:41	24,99	1	24,99	CHI
202010125985	NOVA CRIXAS	NA12057201	MOZARLANDIA	22/10/2020 16:42	23/10/2020 17:50	23/10/2020 17:30	23/10/2020 17:50	0,33	11	3,66	CHI
202010125985	CRIXAS	NA12156613	MOZARLANDIA	22/10/2020 16:42	23/10/2020 17:50	22/10/2020 16:42	23/10/2020 17:35	24,87	2	49,74	CHI
202010125985	NOVA CRIXAS	NA12156613	MOZARLANDIA	22/10/2020 16:42	23/10/2020 17:50	22/10/2020 16:42	23/10/2020 17:35	24,87	34	845,53	CHI
202010125618	ARUANA	AK11183289	ARUANA	22/10/2020 16:43	23/10/2020 00:01	22/10/2020 16:43	23/10/2020 00:01	7,29	58	422,87	CHI
202010125711	CATALAO	CT12010458	CATALAO S2	22/10/2020 16:45	22/10/2020 18:43	22/10/2020 16:45	22/10/2020 18:43	1,96	7	13,75	CHI
202010125711	CUMARI	CT12010458	CATALAO S2	22/10/2020 16:45	22/10/2020 18:43	22/10/2020 16:45	22/10/2020 18:43	1,96	10	19,64	CHI
202010125543	HIDROLANDIA	HD12372943	CEPAIGO S2	22/10/2020 16:45	22/10/2020 19:36	22/10/2020 16:45	22/10/2020 19:36	2,84	24	68,19	CHI
202010127060	VILA BOA	FA12278155	ITUIQUIRA	22/10/2020 16:46	22/10/2020 20:18	22/10/2020 16:46	22/10/2020 20:18	3,53	4	14,13	CHI
202010127060	FORMOSA	FA12278155	ITUIQUIRA	22/10/2020 16:46	22/10/2020 20:18	22/10/2020 16:46	22/10/2020 20:18	3,53	32	113,06	CHI
202010125614	MUNDO NOVO DE GOIAS	MH12269058	NOVA CRIXAS	22/10/2020 16:46	23/10/2020 12:47	22/10/2020 16:46	23/10/2020 12:47	20,01	59	1180,85	CHI
202010125550	MOSSAMEDES	MD211339968	ITABERAI S1	22/10/2020 16:46	22/10/2020 18:23	22/10/2020 16:46	22/10/2020 18:23	1,61	1	1,61	CHI
202010125552	SAO MIGUEL DO PASSA QUATRO	BV21346186	CRISTIANOPOLIS	22/10/2020 16:47	22/10/2020 19:35	22/10/2020 16:47	22/10/2020 19:35	2,80	1	2,80	CHI
202010125557	NOVA CRIXAS	NA11330150	NOVA CRIXAS	22/10/2020 16:47	22/10/2020 18:33	22/10/2020 16:47	22/10/2020 18:33	1,76	10	17,60	CHI
202010125560	GOIANIA	11819248	REAL S1	22/10/2020 16:48	22/10/2020 19:15	22/10/2020 16:48	22/10/2020 19:15	2,43	1	2,43	CHI
202010125563	JATAI	290288850	JATAI S2	22/10/2020 16:49	22/10/2020 22:44	22/10/2020 16:49	22/10/2020 22:44	5,91	1	5,91	CHI
202010125568	TURVELANDIA	TD21193725	RIO DOS BOIS	22/10/2020 16:49	22/10/2020 18:14	22/10/2020 16:49	22/10/2020 18:14	1,41	1	1,41	CHI
202010125663	GOIANIA	GN12001644	REAL S2	22/10/2020 16:49	22/10/2020 18:45	22/10/2020 16:49	22/10/2020 18:45	1,92	593	1138,72	CHI
202010127625	SAO MIGUEL DO ARAGUAIA	SM21138156	SAO MIGUEL DO ARAGUAIA	22/10/2020 16:49	22/10/2020 22:48	22/10/2020 16:49	22/10/2020 22:48	5,97	1	5,97	CHI
202010127378	NOVO PLANALTO	SM12099146RE	SAO MIGUEL DO ARAGUAIA	22/10/2020 16:49	22/10/2020 20:31	22/10/2020 16:49	22/10/2020 20:31	3,68	0	0,00	CHI
202010127378	SAO MIGUEL DO ARAGUAIA	SM12099146RE	SAO MIGUEL DO ARAGUAIA	22/10/2020 16:49	22/10/2020 20:31	22/10/2020 16:49	22/10/2020 20:31	3,68	51	187,92	CHI
202010125961	INDIARA	IY12010846	EDEIA	22/10/2020 16:50	23/10/2020 09:18	22/10/2020 16:50	23/10/2020 09:18	16,46	16	263,37	CHI
202010126400	URUACU	UR12342129RE	URUACU	22/10/2020 16:50	23/10/2020 03:23	22/10/2020 16:50	23/10/2020 03:23	10,54	189	1992,32	CHI
202010129001	NIQUELANDIA	NQ12359802	NIQUELANDIA SUBTRANSMISSAO	22/10/2020 16:50	23/10/2020 16:23	22/10/2020 16:50	23/10/2020 16:23	23,54	1	23,54	CHI
202010125587	SANTA FE DE GOIAS	RN21275851	BRITANIA	22/10/2020 16:51	22/10/2020 18:47	22/10/2020 16:51	22/10/2020 18:47	1,92	1	1,92	CHI
202010125592	GOIANIA	GN11191229	CARAJAS S2	22/10/2020 16:52	22/10/2020 20:00	22/10/2020 16:52	22/10/2020 20:00	3,12	80	249,62	CHI
202010126338	GOIANIA	GN11071523	REAL S1	22/10/2020 16:53	23/10/2020 00:22	22/10/2020 16:53	23/10/2020 00:22	7,48	130	972,26	CHI
202010125595	GOIANIA	GN12071584	REAL S1	22/10/2020 16:53	22/10/2020 18:50	22/10/2020 16:53	22/10/2020 18:50	1,96	128	251,02	CHI
202010125606	GOIANIA	AP12077035	INDEPENDENCIA S2	22/10/2020 16:54	22/10/2020 19:49	22/10/2020 16:54	22/10/2020 19:49	2,92	278	810,76	CHI
202010125966	SANTA RITA DO NOVO DESTINO	BA12208877	BARRO ALTO	22/10/2020 16:54	23/10/2020 09:50	22/10/2020 16:54	23/10/2020 09:50	16,92	29	490,69	CHI
202010125910	JANDAIA	PL12205904	PALMEIRAS	22/10/2020 16:54	22/10/2020 19:31	22/10/2020 16:54	22/10/2020 19:31	2,60	1	2,60	CHI

202010125910	PALMEIRAS DE GOIAS	PL12205904	PALMEIRAS	22/10/2020 16:54	22/10/2020 19:31	22/10/2020 16:54	22/10/2020 19:31	2,60	54	140,43	CHI
202010125616	MINEIROS	MY12390605RE	PARQUE DAS EMAS	22/10/2020 16:55	24/10/2020 12:47	22/10/2020 16:55	24/10/2020 12:47	43,86	1	43,86	CHI
202010125616	MINEIROS	MY12390605RE	PARQUE DAS EMAS	22/10/2020 16:55	24/10/2020 12:47	23/10/2020 15:00	24/10/2020 12:47	21,78	8	174,27	CHI
202010125616	MINEIROS	MY12390605RE	PARQUE DAS EMAS	22/10/2020 16:55	24/10/2020 12:47	23/10/2020 15:00	24/10/2020 11:42	20,71	7	144,97	CHI
202010125889	GOIANIA	GN12042254	REAL S2	22/10/2020 16:55	22/10/2020 20:40	22/10/2020 16:55	22/10/2020 20:40	3,76	399	1498,47	CHI
202010125621	SAO MIGUEL DO ARAGUAIA	SM12208945	SAO MIGUEL DO ARAGUAIA	22/10/2020 16:56	23/10/2020 13:10	22/10/2020 16:56	23/10/2020 13:10	20,23	9	182,08	CHI
202010125623	SANTA TEREZA DE GOIAS	SE21372091	MARA ROSA	22/10/2020 16:56	22/10/2020 18:50	22/10/2020 16:56	22/10/2020 18:50	1,89	3	5,67	CHI
202010125626	TRINDADE	TR12071591	TRINDADE	22/10/2020 16:56	22/10/2020 22:20	22/10/2020 16:56	22/10/2020 22:20	5,39	10	53,88	CHI
202010125631	FORMOSA	10019648594	ITUIQUIRA	22/10/2020 16:57	22/10/2020 17:45	22/10/2020 16:57	22/10/2020 17:45	0,79	1	0,79	CHI
202010125634	GOIANIA	13578807	GOYA S1	22/10/2020 16:57	22/10/2020 20:11	22/10/2020 16:57	22/10/2020 20:11	3,22	1	3,22	CHI
202010128250	MINEIROS	MY11171859	PARQUE DAS EMAS	22/10/2020 16:58	22/10/2020 21:53	22/10/2020 16:58	22/10/2020 21:53	4,91	125	613,44	CHI
202010125637	CALDAS NOVAS	760183983	SERRA DE CALDAS	22/10/2020 16:58	22/10/2020 18:15	22/10/2020 16:58	22/10/2020 18:15	1,27	1	1,27	CHI
202010125642	APARECIDA DE GOIANIA	15237400	REAL S1	22/10/2020 16:58	22/10/2020 18:31	22/10/2020 16:58	22/10/2020 18:31	1,54	1	1,54	CHI
202010125644	RIO VERDE	630116143	RIO VERDE S2	22/10/2020 16:58	22/10/2020 23:53	22/10/2020 16:58	22/10/2020 23:53	6,90	1	6,90	CHI
202010125779	BELA VISTA DE GOIAS	BV12011059	BELA VISTA S1	22/10/2020 16:59	22/10/2020 21:06	22/10/2020 16:59	22/10/2020 21:06	4,11	31	127,40	CHI
202010125655	COCALZINHO DE GOIAS	1200004854	COCALZINHO	22/10/2020 17:00	24/10/2020 00:59	22/10/2020 17:00	24/10/2020 00:59	31,99	1	31,99	CHI
202010125657	NOVO GAMA	10025719694	MARAJOARA	22/10/2020 17:00	23/10/2020 10:20	22/10/2020 17:00	23/10/2020 10:20	17,33	1	17,33	CHI
202010127040	SANCLERLANDIA	SC12102362	FIRMINOPOLIS S2	22/10/2020 17:00	22/10/2020 22:39	22/10/2020 17:00	22/10/2020 22:39	5,64	211	1190,68	CHI
202010125662	QUIRINOPOLIS	QI21301487	QUIRINOPOLIS	22/10/2020 17:01	22/10/2020 19:19	22/10/2020 17:01	22/10/2020 19:19	2,30	4	9,20	CHI
202010126447	GOIANIA	GN11374075	GOIANIA LESTE S2	22/10/2020 17:01	23/10/2020 14:02	22/10/2020 17:01	23/10/2020 14:02	21,01	46	966,42	CHI
202010125670	MONTES CLAROS DE GOIAS	ME12204933	IPORA	22/10/2020 17:01	22/10/2020 20:50	22/10/2020 17:01	22/10/2020 20:50	3,81	1	3,81	CHI
202010126612	GOIANIA	GN11167808	ATLANTICO S2	22/10/2020 17:02	22/10/2020 20:01	22/10/2020 17:02	22/10/2020 20:01	2,98	133	396,52	CHI
202010125692	SERRANOPOLIS	SX12234203	JATAI S1	22/10/2020 17:02	23/10/2020 15:42	22/10/2020 17:02	23/10/2020 15:42	22,66	2	45,32	CHI
202010125684	MAMBAI	MB11109324	IACIARA S2	22/10/2020 17:03	22/10/2020 18:01	22/10/2020 17:03	22/10/2020 18:01	0,96	94	90,68	CHI
202010125853	GOIANIA	GN12000142	GOIANIA LESTE S2	22/10/2020 17:03	22/10/2020 20:14	22/10/2020 17:03	22/10/2020 20:14	3,19	194	619,08	CHI
202010125687	BALIZA	BH21356613	BOM JARDIM	22/10/2020 17:03	22/10/2020 20:59	22/10/2020 17:03	22/10/2020 20:59	3,93	1	3,93	CHI
202010125688	GOIANIA	15970309	FERROVIARIO S1	22/10/2020 17:03	22/10/2020 19:41	22/10/2020 17:03	22/10/2020 19:41	2,63	1	2,63	CHI
202010126129	URUACU	UR12341322	URUACU	22/10/2020 17:04	22/10/2020 21:14	22/10/2020 17:04	22/10/2020 21:14	4,16	7	29,15	CHI
202010125696	SENADOR CANEDO	10023506626	CEPAIGO S2	22/10/2020 17:04	22/10/2020 18:16	22/10/2020 17:04	22/10/2020 18:16	1,20	1	1,20	CHI
202010126140	GOIANIA	GN11323670	INDEPENDENCIA S2	22/10/2020 17:04	22/10/2020 20:14	22/10/2020 17:04	22/10/2020 20:14	3,16	94	296,67	CHI
202010125703	CABECEIRAS	CW21157368	ITUIQUIRA	22/10/2020 17:04	22/10/2020 20:08	22/10/2020 17:04	22/10/2020 20:08	3,06	1	3,06	CHI
202010125843	GOIANIA	GN11193241	ATLANTICO S1	22/10/2020 17:05	22/10/2020 18:24	22/10/2020 17:05	22/10/2020 18:24	1,30	100	130,31	CHI
202010128684	SANTA RITA DO NOVO DESTINO	BA12152769	BARRO ALTO	22/10/2020 17:06	23/10/2020 18:12	22/10/2020 17:06	23/10/2020 18:12	25,10	62	1556,10	CHI
202010125719	SENADOR CANEDO	SW11209176	CEPAIGO S2	22/10/2020 17:06	22/10/2020 19:07	22/10/2020 17:06	22/10/2020 19:07	2,01	15	30,15	CHI
202010125732	CAMPINACU	UC21244550	PORANGATU	22/10/2020 17:07	23/10/2020 00:19	22/10/2020 17:07	23/10/2020 00:19	7,19	1	7,19	CHI
202010128744	ALTO HORIZONTE	NH12396799	SANTA TEREZINHA	22/10/2020 17:07	23/10/2020 09:28	22/10/2020 17:07	23/10/2020 09:28	16,34	50	816,75	CHI
202010128744	CAMPOS VERDES	NH12396799	SANTA TEREZINHA	22/10/2020 17:07	23/10/2020 09:28	22/10/2020 17:07	23/10/2020 09:28	16,34	4	65,34	CHI
202010128744	PILAR DE GOIAS	NH12396799	SANTA TEREZINHA	22/10/2020 17:07	23/10/2020 09:28	22/10/2020 17:07	23/10/2020 09:28	16,34	1	16,34	CHI
202010125848	GOIANIA	AP11005064	REAL S2	22/10/2020 17:09	23/10/2020 10:13	22/10/2020 17:09	23/10/2020 10:13	17,06	88	1501,57	CHI
202010125746	IPIRANGA DE GOIAS	CE12063327	RUBIATABA	22/10/2020 17:09	22/10/2020 22:40	22/10/2020 17:09	22/10/2020 22:40	5,51	4	22,04	CHI
202010125750	RUBIATABA	RB21273707	RUBIATABA	22/10/2020 17:10	22/10/2020 20:11	22/10/2020 17:10	22/10/2020 20:11	3,01	1	3,01	CHI
202010125753	CAMPESTRE DE GOIAS	1230015416	TRINDADE	22/10/2020 17:10	22/10/2020 19:38	22/10/2020 17:10	22/10/2020 19:38	2,46	1	2,46	CHI
202010125764	GOIANIA	GN11000730	GOIANIA LESTE S1	22/10/2020 17:11	22/10/2020 21:04	22/10/2020 17:11	22/10/2020 21:04	3,88	145	562,36	CHI
202010126565	NIQUELANDIA	NQ12182461	NIQUELANDIA SUBTRANSMISSAO	22/10/2020 17:12	23/10/2020 05:49	22/10/2020 17:12	23/10/2020 05:49	12,61	4	50,45	CHI
202010125774	CAIAPONIA	CP11054764	CAIAPONIA	22/10/2020 17:12	22/10/2020 22:00	22/10/2020 17:12	22/10/2020 22:00	4,79	64	306,63	CHI
202010125777	GOIANIA	GN12000610	CAMPINAS S3	22/10/2020 17:12	22/10/2020 18:57	22/10/2020 17:12	22/10/2020 18:57	1,74	259	450,30	CHI
202010125791	PALMEIRAS DE GOIAS	PL13414975B	PALMEIRAS	22/10/2020 17:13	22/10/2020 22:05	22/10/2020 17:13	22/10/2020 22:05	4,87	19	92,46	CHI
202010125782	BELA VISTA DE GOIAS	BV11278411	CEPAIGO S2	22/10/2020 17:13	22/10/2020 19:46	22/10/2020 17:13	22/10/2020 19:46	2,55	8	20,39	CHI
202010125787	GOIANIA	GN11030563	CAMPINAS S1	22/10/2020 17:13	22/10/2020 19:48	22/10/2020 17:13	22/10/2020 19:48	2,58	68	175,18	CHI
202010125792	RIO VERDE	RV21248974	RIO VERDE S1	22/10/2020 17:13	23/10/2020 09:00	22/10/2020 17:13	23/10/2020 09:00	15,77	1	15,77	CHI
202010125800	VICENTINOPOLIS	VI12352541	VICENTINOPOLIS	22/10/2020 17:14	22/10/2020 19:27	22/10/2020 17:14	22/10/2020 19:27	2,21	4	8,86	CHI

202010125802	SANTA FE DE GOIAS	RN21155727	BRITANIA	22/10/2020 17:14	22/10/2020 21:28	22/10/2020 17:14	22/10/2020 21:28	4,23	1	4,23	CHI
202010125807	ALEXANIA	AX21321207	ALEXANIA	22/10/2020 17:14	23/10/2020 13:11	22/10/2020 17:14	23/10/2020 13:11	19,94	1	19,94	CHI
202010128728	INDIARA	IY11309605	EDEIA	22/10/2020 17:16	22/10/2020 21:34	22/10/2020 17:16	22/10/2020 21:34	4,30	68	292,38	CHI
202010125821	AGUA FRIA DE GOIAS	TL12330870	SAO JOAO D ALIANCA	22/10/2020 17:16	22/10/2020 18:50	22/10/2020 17:16	22/10/2020 18:50	1,58	1	1,58	CHI
202010125823	AGUAS LINDAS DE GOIAS	10019619632	AGUAS LINDAS DE GOIAS S2	22/10/2020 17:16	22/10/2020 19:38	22/10/2020 17:16	22/10/2020 19:38	2,36	1	2,36	CHI
202010126655	MINEIROS	MY12042996RE	PARQUE DAS EMAS	22/10/2020 17:16	22/10/2020 20:17	22/10/2020 17:16	22/10/2020 20:17	3,01	3	9,03	CHI
202010126405	GOIANIA	GN11180163	CAMPINAS S3	22/10/2020 17:16	22/10/2020 19:44	22/10/2020 17:16	22/10/2020 19:44	2,46	60	147,70	CHI
202010126444	GOIANIA	GN11062657	CAMPINAS S3	22/10/2020 17:16	22/10/2020 19:47	22/10/2020 17:16	22/10/2020 19:47	2,51	36	90,29	CHI
202010125831	MINEIROS	MY12234332	PARQUE DAS EMAS	22/10/2020 17:17	22/10/2020 20:46	22/10/2020 17:17	22/10/2020 20:46	3,48	8	27,87	CHI
202010127653	ALTO HORIZONTE	AJ11325232	SANTA TEREZINHA	22/10/2020 17:17	23/10/2020 04:53	22/10/2020 17:17	23/10/2020 04:53	11,59	137	1587,56	CHI
202010125842	AMORINOPOLIS	AM21312069	IPORA	22/10/2020 17:17	22/10/2020 18:23	22/10/2020 17:17	22/10/2020 18:23	1,08	1	1,08	CHI
202010126041	MINEIROS	MY12360762	PARQUE DAS EMAS	22/10/2020 17:18	22/10/2020 18:31	22/10/2020 17:18	22/10/2020 18:31	1,21	32	38,78	CHI
202010126474	MOSSAMEDES	BS12304459	FIRMINOPOLIS S2	22/10/2020 17:18	22/10/2020 19:47	22/10/2020 17:18	22/10/2020 19:47	2,47	4	9,88	CHI
202010126474	BURITI DE GOIAS	BS12304459	FIRMINOPOLIS S2	22/10/2020 17:18	22/10/2020 19:47	22/10/2020 17:18	22/10/2020 19:47	2,47	10	24,69	CHI
202010126474	SANCLERLANDIA	BS12304459	FIRMINOPOLIS S2	22/10/2020 17:18	22/10/2020 19:47	22/10/2020 17:18	22/10/2020 19:47	2,47	1	2,47	CHI
202010126086	EDEIA	EA11263330	EDEIA	22/10/2020 17:19	22/10/2020 19:55	22/10/2020 17:19	22/10/2020 19:55	2,59	92	238,41	CHI
202010125864	CIDADE OCIDENTAL	DH21313687	MARAJOARA	22/10/2020 17:19	23/10/2020 10:45	22/10/2020 17:19	23/10/2020 10:45	17,42	1	17,42	CHI
202010125876	GOIANIA	GN11161933	CAMPINAS S1	22/10/2020 17:20	22/10/2020 18:51	22/10/2020 17:20	22/10/2020 18:51	1,51	129	195,11	CHI
202010125915	GOIANIA	GN11002604	CARAJAS S2	22/10/2020 17:21	22/10/2020 19:01	22/10/2020 17:21	22/10/2020 19:01	1,67	122	203,16	CHI
202010125881	APARECIDA DE GOIANIA	14455651	ATLANTICO S2	22/10/2020 17:21	23/10/2020 10:30	22/10/2020 17:21	23/10/2020 10:30	17,14	1	17,14	CHI
202010125882	APARECIDA DE GOIANIA	10011755740	INDEPENDENCIA S2	22/10/2020 17:21	22/10/2020 17:33	22/10/2020 17:21	22/10/2020 17:33	0,19	1	0,19	CHI
202010125893	ARAGOIANIA	680016375	GUAPO S2	22/10/2020 17:21	23/10/2020 07:49	22/10/2020 17:21	23/10/2020 07:49	14,45	1	14,45	CHI
202010125900	SANTA TEREZINHA DE GOIAS	2480034842	SANTA TEREZINHA	22/10/2020 17:22	22/10/2020 19:18	22/10/2020 17:22	22/10/2020 19:18	1,92	1	1,92	CHI
202010125904	APARECIDA DE GOIANIA	17331985	ATLANTICO S2	22/10/2020 17:22	22/10/2020 18:49	22/10/2020 17:22	22/10/2020 18:49	1,44	1	1,44	CHI
202010125907	GOIANIA	GN11001840	CAMPINAS S3	22/10/2020 17:22	23/10/2020 04:36	22/10/2020 17:22	23/10/2020 04:36	11,22	140	1570,37	CHI
202010125913	JUSSARA	JR12022269RE	BRITANIA	22/10/2020 17:23	23/10/2020 10:46	22/10/2020 17:23	23/10/2020 10:46	17,39	30	521,60	CHI
202010125913	MONTES CLAROS DE GOIAS	JR12022269RE	BRITANIA	22/10/2020 17:23	23/10/2020 10:46	22/10/2020 17:23	23/10/2020 10:46	17,39	267	4642,24	CHI
202010125928	SANTA RITA DO ARAGUAIA	SU11256818	SANTA RITA DO ARAGUAIA	22/10/2020 17:24	23/10/2020 14:21	22/10/2020 17:24	23/10/2020 14:21	20,94	1	20,94	CHI
202010125978	GOIANIA	GN11343397	GOIANIA LESTE S2	22/10/2020 17:25	22/10/2020 18:34	22/10/2020 17:25	22/10/2020 18:34	1,15	97	111,31	CHI
202010125937	OUIDOR	OU12127615	CATALAO S1	22/10/2020 17:25	22/10/2020 18:38	22/10/2020 17:25	22/10/2020 18:38	1,21	11	13,29	CHI
202010125937	CATALAO	OU12127615	CATALAO S1	22/10/2020 17:25	22/10/2020 18:38	22/10/2020 17:25	22/10/2020 18:38	1,21	2	2,42	CHI
202010128171	BRITANIA	BT11060642	BRITANIA	22/10/2020 17:27	23/10/2020 08:25	22/10/2020 17:27	23/10/2020 08:25	14,96	7	104,70	CHI
202010125954	BOM JESUS DE GOIAS	10004445978	BOM JESUS DE GOIAS	22/10/2020 17:27	23/10/2020 09:37	22/10/2020 17:27	23/10/2020 09:37	16,15	1	16,15	CHI
202010126050	GOIANIA	GN11167644	XAVANTES	22/10/2020 17:28	22/10/2020 18:33	22/10/2020 17:28	22/10/2020 18:33	1,08	125	134,44	CHI
202010125968	CRISTALINA	KR21097543	CRISTALINA S1	22/10/2020 17:29	22/10/2020 21:53	22/10/2020 17:29	22/10/2020 21:53	4,39	1	4,39	CHI
202010129044	TRINDADE	TR11378268	TRINDADE	22/10/2020 17:29	23/10/2020 00:14	22/10/2020 17:29	23/10/2020 00:14	6,74	87	586,74	CHI
202010126062	TRINDADE	TR12077759	TRINDADE	22/10/2020 17:29	22/10/2020 21:21	22/10/2020 17:29	22/10/2020 21:21	3,86	261	1007,68	CHI
202010125971	RIO VERDE	RV11230633	MONTIVIDIU T	22/10/2020 17:29	23/10/2020 01:12	22/10/2020 17:29	23/10/2020 01:12	7,71	1	7,71	CHI
202010125972	CORUMBAIBA	CI21060014	CATALAO S1	22/10/2020 17:29	22/10/2020 20:53	22/10/2020 17:29	22/10/2020 20:53	3,39	2	6,79	CHI
202010125973	QUIRINOPOLIS	QI12303193	RIO DOS BOIS	22/10/2020 17:29	22/10/2020 22:54	22/10/2020 17:29	22/10/2020 22:54	5,41	4	21,64	CHI
202010126441	ALTO HORIZONTE	AJ11298180	SANTA TEREZINHA	22/10/2020 17:30	22/10/2020 22:09	22/10/2020 17:30	22/10/2020 22:09	4,64	113	523,85	CHI
202010125987	GOIAS	90107986	GOIAS	22/10/2020 17:31	22/10/2020 20:10	22/10/2020 17:31	22/10/2020 20:10	2,65	1	2,65	CHI
202010126014	TRES RANCHOS	TH12394003	CATALAO S1	22/10/2020 17:31	22/10/2020 19:03	22/10/2020 17:31	22/10/2020 19:03	1,53	32	48,98	CHI
202010125990	CEZARINA	PL12349283	PALMEIRAS	22/10/2020 17:31	22/10/2020 18:31	22/10/2020 17:31	22/10/2020 18:31	1,00	1	1,00	CHI
202010125994	GUAPO	GA21157809	GUAPO S2	22/10/2020 17:31	23/10/2020 08:33	22/10/2020 17:31	23/10/2020 08:33	15,03	3	45,10	CHI
202010126279	ALTO HORIZONTE	AJ11232404	SANTA TEREZINHA	22/10/2020 17:32	23/10/2020 00:21	22/10/2020 17:32	23/10/2020 00:21	6,81	99	673,72	CHI
202010126008	CIDADE OCIDENTAL	LZ12261266	MARAJOARA	22/10/2020 17:33	23/10/2020 13:07	22/10/2020 17:33	23/10/2020 13:07	19,55	8	156,41	CHI
202010126015	ITABERAI	IB11227357	ITABERAI S1	22/10/2020 17:34	22/10/2020 19:24	22/10/2020 17:34	22/10/2020 19:24	1,82	1	1,82	CHI
202010126045	GOIANIA	GN12042847	FERROVIARIO S2	22/10/2020 17:36	22/10/2020 20:12	22/10/2020 17:36	22/10/2020 20:12	2,61	508	1324,47	CHI
202010126360	PALMEIRAS DE GOIAS	PL12000118	PALMEIRAS	22/10/2020 17:37	23/10/2020 06:58	22/10/2020 17:37	23/10/2020 06:58	13,35	23	307,05	CHI
202010126360	NAZARIO	PL12000118	PALMEIRAS	22/10/2020 17:37	23/10/2020 06:58	22/10/2020 17:37	23/10/2020 06:58	13,35	4	53,40	CHI



202010126043	DOVERLANDIA	DV21187343	CAIAPONIA	22/10/2020 17:37	22/10/2020 20:58	22/10/2020 17:37	22/10/2020 20:58	3,36	1	3,36	CHI
202010126256	INDIARA	IY11186437	EDEIA	22/10/2020 17:37	22/10/2020 21:02	22/10/2020 17:37	22/10/2020 21:02	3,41	156	531,22	CHI
202010126350	ALTO HORIZONTE	AJ11023820	SANTA TEREZINHA	22/10/2020 17:37	22/10/2020 23:12	22/10/2020 17:37	22/10/2020 23:12	5,57	129	718,74	CHI
202010126061	ARAGUAPAZ	AZ21063165	MOZARLANDIA	22/10/2020 17:38	22/10/2020 20:43	22/10/2020 17:38	22/10/2020 20:43	3,07	1	3,07	CHI
202010126063	SAO JOAO DA PARAUNA	FR12040685	FIRMINOPOLIS S2	22/10/2020 17:38	23/10/2020 09:17	22/10/2020 17:38	23/10/2020 09:17	15,63	6	93,80	CHI
202010126200	NIQUELANDIA	NQ12219200	NIQUELANDIA SUBTRANSMISSAO	22/10/2020 17:39	22/10/2020 22:15	22/10/2020 17:39	22/10/2020 22:15	4,60	48	220,59	CHI
202010126082	SERRANOPOLIS	SX21209930	JATAI S1	22/10/2020 17:40	23/10/2020 09:07	22/10/2020 17:40	23/10/2020 09:07	15,44	1	15,44	CHI
202010126085	GOIANIA	14243787	SENADOR CANEDO	22/10/2020 17:41	23/10/2020 17:00	22/10/2020 17:41	23/10/2020 17:00	23,32	1	23,32	CHI
202010126089	HIDROLANDIA	180026392	CEPAIGO S2	22/10/2020 17:41	23/10/2020 07:59	22/10/2020 17:41	23/10/2020 07:59	14,31	1	14,31	CHI
202010126918	ARACU	AR11132827	ARACU	22/10/2020 17:42	23/10/2020 02:52	22/10/2020 17:42	23/10/2020 02:52	9,16	100	916,42	CHI
202010126102	SAO JOAO D ALIANCA	JL12383342	SAO JOAO D ALIANCA	22/10/2020 17:42	22/10/2020 21:24	22/10/2020 17:42	22/10/2020 21:24	3,70	2	7,39	CHI
202010126577	GOIANIA	GN11000568	CAMPINAS S3	22/10/2020 17:42	22/10/2020 20:34	22/10/2020 17:42	22/10/2020 20:34	2,85	84	239,47	CHI
202010126343	GOIANESIA	GE12360291	GOIANESIA S2	22/10/2020 17:43	22/10/2020 19:58	22/10/2020 17:43	22/10/2020 19:58	2,25	8	18,00	CHI
202010126419	GOIANIA	GN12000574	AEROPORTO S2	22/10/2020 17:43	23/10/2020 17:23	22/10/2020 17:43	23/10/2020 17:23	23,66	224	5300,77	CHI
202010126331	APARECIDA DE GOIANIA	AP11036396	REAL S2	22/10/2020 17:43	23/10/2020 02:22	22/10/2020 17:43	23/10/2020 02:22	8,65	154	1331,50	CHI
202010126125	PLANALTINA	PI12375541	PLANALTINA	22/10/2020 17:43	22/10/2020 19:01	22/10/2020 17:43	22/10/2020 19:01	1,29	188	242,73	CHI
202010126190	PLANALTINA	PI12107018LD	PLANALTINA	22/10/2020 17:44	23/10/2020 20:46	22/10/2020 17:44	23/10/2020 20:46	27,04	12	324,47	CHI
202010126190	PLANALTINA	PI12262322	PLANALTINA	22/10/2020 17:44	23/10/2020 20:46	22/10/2020 17:44	22/10/2020 22:18	4,56	1	4,56	CHI
202010126141	PLANALTINA	10001390471	PLANALTINA	22/10/2020 17:45	22/10/2020 20:23	22/10/2020 17:45	22/10/2020 20:23	2,63	1	2,63	CHI
202010127899	PARAUNA	PU12361897	PARAUNA	22/10/2020 17:45	23/10/2020 07:06	22/10/2020 17:45	23/10/2020 07:06	13,35	4	53,40	CHI
202010127899	JANDAIA	PU12361897	PARAUNA	22/10/2020 17:45	23/10/2020 07:06	22/10/2020 17:45	23/10/2020 07:06	13,35	3	40,05	CHI
202010126152	APARECIDA DE GOIANIA	10013039030	INDEPENDENCIA S1	22/10/2020 17:46	22/10/2020 18:53	22/10/2020 17:46	22/10/2020 18:53	1,12	1	1,12	CHI
202010126162	ORIZONA	OZ11140712	PIRES DO RIO S2	22/10/2020 17:47	22/10/2020 19:45	22/10/2020 17:47	22/10/2020 19:45	1,96	150	294,42	CHI
202010126166	GOIANDIRA	GD12340044	CATALAO S1	22/10/2020 17:47	22/10/2020 21:27	22/10/2020 17:47	22/10/2020 21:27	3,66	2	7,32	CHI
202010126337	GOIANIRA	GN12001206	MEIA PONTE	22/10/2020 17:47	23/10/2020 10:00	22/10/2020 17:47	23/10/2020 10:00	16,21	10	162,08	CHI
202010126337	GOIANIA	GN12001206	MEIA PONTE	22/10/2020 17:47	23/10/2020 10:00	22/10/2020 17:47	23/10/2020 09:49	16,02	18	288,42	CHI
202010126176	URUACU	640063068	URUACU	22/10/2020 17:47	23/10/2020 03:45	22/10/2020 17:47	23/10/2020 03:45	9,95	1	9,95	CHI
202010128797	PLANALTINA	PI12139508	PLANALTINA	22/10/2020 17:47	23/10/2020 02:23	22/10/2020 17:47	23/10/2020 02:23	8,59	32	274,74	CHI
202010126192	CATURAI	CK11093363	GOIANIRA	22/10/2020 17:49	23/10/2020 01:15	22/10/2020 17:49	23/10/2020 01:15	7,44	59	438,70	CHI
202010126194	RIO VERDE	RV21260632	RIO VERDE S1	22/10/2020 17:49	22/10/2020 19:31	22/10/2020 17:49	22/10/2020 19:31	1,69	1	1,69	CHI
202010126196	CACHEOIRA DE GOIAS	CG21165615	FIRMINOPOLIS S2	22/10/2020 17:49	23/10/2020 14:20	22/10/2020 17:49	23/10/2020 14:20	20,50	1	20,50	CHI
202010126203	ACREUNA	EU11271434	ACREUNA	22/10/2020 17:50	23/10/2020 11:11	22/10/2020 17:50	23/10/2020 11:11	17,35	93	1613,14	CHI
202010126205	SAO JOAO D ALIANCA	JL21106843	SAO JOAO D ALIANCA	22/10/2020 17:50	22/10/2020 20:04	22/10/2020 17:50	22/10/2020 20:04	2,23	1	2,23	CHI
202010128023	BELA VISTA DE GOIAS	BV12052642	CEPAIGO S2	22/10/2020 17:51	22/10/2020 23:44	22/10/2020 17:51	22/10/2020 23:44	5,88	95	558,36	CHI
202010126867	GOIANIA	GN11000961	CAMPINAS S1	22/10/2020 17:51	22/10/2020 20:07	22/10/2020 17:51	22/10/2020 20:07	2,26	158	356,86	CHI
202010126217	GOIANIA	10322863	CAMPINAS S1	22/10/2020 17:51	22/10/2020 20:34	22/10/2020 17:51	22/10/2020 20:34	2,70	1	2,70	CHI
202010126235	CATURAI	CK11148603	GOIANIRA	22/10/2020 17:53	23/10/2020 10:55	22/10/2020 17:53	23/10/2020 10:55	17,03	85	1447,38	CHI
202010126752	GOIANIA	GN12000515	FERROVIARIO S3	22/10/2020 17:53	22/10/2020 20:36	22/10/2020 17:53	22/10/2020 20:36	2,71	396	1071,29	CHI
202010129286	GOIANIA	GN11000702	REAL S2	22/10/2020 17:53	23/10/2020 08:17	22/10/2020 17:53	23/10/2020 08:17	14,39	121	1740,89	CHI
202010126239	TRINDADE	TR21278707	TRINDADE	22/10/2020 17:53	22/10/2020 19:38	22/10/2020 17:53	22/10/2020 19:38	1,74	2	3,47	CHI
202010126241	INDIARA	IY21289793	EDEIA	22/10/2020 17:53	23/10/2020 09:13	22/10/2020 17:53	23/10/2020 09:13	15,32	1	15,32	CHI
202010126353	MINEIROS	MY12248460RE	PARQUE DAS EMAS	22/10/2020 17:53	23/10/2020 00:58	22/10/2020 17:53	23/10/2020 00:58	7,07	8	56,55	CHI
202010126252	JANDAIA	PU12205943	PARAUNA	22/10/2020 17:54	22/10/2020 21:41	22/10/2020 17:54	22/10/2020 21:41	3,77	4	15,09	CHI
202010126252	PARAUNA	PU12205943	PARAUNA	22/10/2020 17:54	22/10/2020 21:41	22/10/2020 17:54	22/10/2020 21:41	3,77	29	109,40	CHI
202010126519	GUAPO	GA16399995	GUAPO S1	22/10/2020 17:55	23/10/2020 01:23	22/10/2020 17:55	23/10/2020 01:23	7,46	323	2411,11	CHI
202010126519	ABADIA DE GOIAS	GA16399995	GUAPO S1	22/10/2020 17:55	23/10/2020 01:23	22/10/2020 17:55	23/10/2020 01:23	7,46	164	1224,21	CHI
202010126519	TRINDADE	GA16399995	GUAPO S1	22/10/2020 17:55	23/10/2020 01:23	22/10/2020 17:55	23/10/2020 01:23	7,46	5	37,32	CHI
202010126519	GUAPO	GA16399995	GUAPO S1	22/10/2020 17:55	23/10/2020 01:23	22/10/2020 22:27	23/10/2020 01:23	2,94	450	1323,37	CHI
202010126262	CROMINIA	CQ12079894	PONTALINA	22/10/2020 17:55	23/10/2020 13:18	22/10/2020 17:55	23/10/2020 13:18	19,38	2	38,77	CHI
202010126274	MINEIROS	MY21336967	PARQUE DAS EMAS	22/10/2020 17:56	22/10/2020 22:02	22/10/2020 17:56	22/10/2020 22:02	4,09	1	4,09	CHI
202010128253	AMARALINA	LC21230356	NOVA CRIXAS	22/10/2020 17:57	22/10/2020 22:34	22/10/2020 17:57	22/10/2020 22:34	4,61	1	4,61	CHI

202010126285	GOIANIA	GN12000598	CAMPINAS S3	22/10/2020 17:57	22/10/2020 20:02	22/10/2020 17:57	22/10/2020 20:02	2,07	129	267,67	CHI
202010127722	NIQUELANDIA	NQ12375605	URUACU	22/10/2020 17:57	23/10/2020 10:55	22/10/2020 17:57	23/10/2020 10:55	16,96	44	746,14	CHI
202010126288	PIRES DO RIO	BC21012016	PIRES DO RIO S2	22/10/2020 17:57	22/10/2020 20:40	22/10/2020 17:57	22/10/2020 20:40	2,71	1	2,71	CHI
202010126291	PARAUNA	PU12191978	MONTIVIDIU T	22/10/2020 17:57	23/10/2020 13:38	22/10/2020 17:57	23/10/2020 13:38	19,67	3	59,01	CHI
202010126293	TAQUARAL DE GOIAS	340000636	ITABERAI S1	22/10/2020 17:58	22/10/2020 20:33	22/10/2020 17:58	22/10/2020 20:33	2,58	1	2,58	CHI
202010126296	JARAGUA	JA21112438	GOIANESIA S2	22/10/2020 17:58	23/10/2020 19:10	22/10/2020 17:58	23/10/2020 19:10	25,19	1	25,19	CHI
202010126303	CALDAZINHA	BV12070808	CEPAIGO S2	22/10/2020 17:59	22/10/2020 20:45	22/10/2020 17:59	22/10/2020 20:45	2,78	11	30,53	CHI
202010126313	LEOPOLDO DE BULHOES	LB21084064	DAIA S2	22/10/2020 18:00	22/10/2020 18:55	22/10/2020 18:00	22/10/2020 18:55	0,91	2	1,82	CHI
202010126314	PALESTINA DE GOIAS	PY12396112	PALESTINA	22/10/2020 18:00	22/10/2020 22:17	22/10/2020 18:00	22/10/2020 22:17	4,28	5	21,39	CHI
202010126328	NIQUELANDIA	10010405028	NIQUELANDIA SUBTRANSMISSAO	22/10/2020 18:01	23/10/2020 16:48	22/10/2020 18:01	23/10/2020 16:48	22,77	1	22,77	CHI
202010126609	PORANGATU	PO13374525	PORANGATU	22/10/2020 18:02	23/10/2020 18:38	23/10/2020 18:25	23/10/2020 18:38	0,22	144	31,28	CHI
202010126609	PORANGATU	PO12049340	PORANGATU	22/10/2020 18:02	23/10/2020 18:38	22/10/2020 18:02	23/10/2020 18:17	24,27	7	169,86	CHI
202010126609	PORANGATU	PO13320884	PORANGATU	22/10/2020 18:02	23/10/2020 18:38	22/10/2020 18:02	23/10/2020 17:47	23,76	87	2067,10	CHI
202010126609	PORANGATU	PO10400350	PORANGATU	22/10/2020 18:02	23/10/2020 18:38	22/10/2020 22:25	22/10/2020 23:03	0,64	80	51,31	CHI
202010126609	PORANGATU	PO13083033	PORANGATU	22/10/2020 18:02	23/10/2020 18:38	22/10/2020 18:02	22/10/2020 20:35	2,56	75	191,73	CHI
202010126609	PORANGATU	PO10400350	PORANGATU	22/10/2020 18:02	23/10/2020 18:38	22/10/2020 18:02	22/10/2020 19:59	1,97	5	9,83	CHI
202010126370	IPAMERI	IP12107641	IPAMERI	22/10/2020 18:03	23/10/2020 20:40	22/10/2020 18:03	22/10/2020 20:40	2,62	21	54,94	CHI
202010127264	GOIANIRA	GR11094599	GOIANIRA	22/10/2020 18:03	22/10/2020 19:57	22/10/2020 18:03	22/10/2020 19:57	1,90	104	197,54	CHI
202010126551	MAURILANDIA	ML11000005	RIO DOS BOIS	22/10/2020 18:03	22/10/2020 19:15	22/10/2020 18:03	22/10/2020 19:15	1,20	61	73,08	CHI
202010126549	APARECIDA DE GOIANIA	AP11003038	REAL S2	22/10/2020 18:03	22/10/2020 19:49	22/10/2020 18:03	22/10/2020 19:49	1,76	222	391,28	CHI
202010128619	PLANALTINA	PI12043463	PLANALTINA	22/10/2020 18:04	22/10/2020 21:06	22/10/2020 18:04	22/10/2020 21:06	3,02	104	314,40	CHI
202010126699	NIQUELANDIA	NQ12213022	NIQUELANDIA SUBTRANSMISSAO	22/10/2020 18:05	23/10/2020 17:56	22/10/2020 18:05	23/10/2020 17:56	23,84	5	119,22	CHI
202010126368	CRIXAS	CX21070612	SERRA DO OURO	22/10/2020 18:06	23/10/2020 08:47	22/10/2020 18:06	23/10/2020 08:47	14,68	2	29,36	CHI
202010126380	TRINDADE	40221970	TRINDADE	22/10/2020 18:07	23/10/2020 19:56	22/10/2020 18:07	23/10/2020 19:56	1,81	1	1,81	CHI
202010127652	ALTO HORIZONTE	AJ11162623	SANTA TEREZINHA	22/10/2020 18:07	23/10/2020 05:26	22/10/2020 18:07	23/10/2020 05:26	11,31	130	1469,94	CHI
202010126389	ORIZONA	OZ12326482	PIRES DO RIO S2	22/10/2020 18:08	22/10/2020 21:04	22/10/2020 18:08	22/10/2020 21:04	2,93	2	5,87	CHI
202010126392	ITUMBIARA	690114308	ITUMBIARA VELHA S1	22/10/2020 18:08	22/10/2020 22:19	22/10/2020 18:08	22/10/2020 22:19	4,18	1	4,18	CHI
202010126397	CATALAO	CT12267023	CATALAO S1	22/10/2020 18:08	22/10/2020 21:28	22/10/2020 18:08	22/10/2020 21:28	3,32	1	3,32	CHI
202010127549	NOVO PLANALTO	TA12099914	NOVO PLANALTO	22/10/2020 18:08	23/10/2020 17:38	22/10/2020 18:08	23/10/2020 17:38	23,50	2	46,99	CHI
202010127554	RIO VERDE	RV12159300	CABRIUVA S2	22/10/2020 18:08	22/10/2020 23:43	22/10/2020 18:08	22/10/2020 23:43	5,58	12	66,95	CHI
202010127132	GOIANIA	GN11203578	REAL S1	22/10/2020 18:09	22/10/2020 20:30	22/10/2020 18:09	22/10/2020 20:30	2,34	138	322,54	CHI
202010126529	BELA VISTA DE GOIAS	BV12337806	BELA VISTA S2	22/10/2020 18:09	22/10/2020 20:23	22/10/2020 18:09	22/10/2020 20:23	2,22	16	35,51	CHI
202010126413	GOIANIA	10275071	CAMPINAS S2	22/10/2020 18:10	23/10/2020 11:38	22/10/2020 18:10	23/10/2020 11:38	17,46	1	17,46	CHI
202010126414	URUTAI	UT12016932RE	URUTAI	22/10/2020 18:10	22/10/2020 20:32	22/10/2020 18:10	22/10/2020 20:32	2,36	5	11,81	CHI
202010126414	IPAMERI	UT12016932RE	URUTAI	22/10/2020 18:10	22/10/2020 20:32	22/10/2020 18:10	22/10/2020 20:32	2,36	3	7,09	CHI
202010127217	CAMPINORTE	CR12000060RE	CAMPINORTE	22/10/2020 18:12	22/10/2020 20:44	22/10/2020 18:12	22/10/2020 20:44	2,52	9	22,70	CHI
202010127217	NOVA IGUAÇU DE GOIAS	CR12000060RE	CAMPINORTE	22/10/2020 18:12	22/10/2020 20:44	22/10/2020 18:12	22/10/2020 20:44	2,52	102	257,24	CHI
202010126443	ITAUCU	110018400	INHUMAS S1	22/10/2020 18:14	23/10/2020 14:49	22/10/2020 18:14	23/10/2020 14:49	20,58	1	20,58	CHI
202010126445	SERRANOPOLIS	SX21216573	JATAI S1	22/10/2020 18:14	23/10/2020 07:06	22/10/2020 18:14	23/10/2020 07:06	12,86	1	12,86	CHI
202010126451	CAMPINORTE	2040028062	CAMPINORTE	22/10/2020 18:14	22/10/2020 23:31	22/10/2020 18:14	22/10/2020 23:31	5,27	1	5,27	CHI
202010126560	SANTO ANTONIO DE GOIAS	BW13162442	NEROPOLIS S1	22/10/2020 18:15	22/10/2020 22:56	22/10/2020 22:50	22/10/2020 22:56	0,10	2255	225,50	CHI
202010126560	SANTO ANTONIO DE GOIAS	BW10401401	NEROPOLIS S1	22/10/2020 18:15	22/10/2020 22:56	22/10/2020 18:15	22/10/2020 22:41	4,44	1	4,44	CHI
202010126560	SANTO ANTONIO DE GOIAS	NV13162418	NEROPOLIS S1	22/10/2020 18:15	22/10/2020 22:56	22/10/2020 18:15	22/10/2020 22:22	4,12	172	709,02	CHI
202010126560	BRAZABRANTES	01320424	NEROPOLIS S1	22/10/2020 18:15	22/10/2020 22:56	22/10/2020 21:38	22/10/2020 21:42	0,06	9	0,55	CHI
202010126560	NEROPOLIS	01320424	NEROPOLIS S1	22/10/2020 18:15	22/10/2020 22:56	22/10/2020 21:38	22/10/2020 21:42	0,06	117	7,15	CHI
202010126560	NOVA VENEZA	01320424	NEROPOLIS S1	22/10/2020 18:15	22/10/2020 22:56	22/10/2020 21:38	22/10/2020 21:42	0,06	91	5,56	CHI
202010126560	SANTO ANTONIO DE GOIAS	BW13146003	NEROPOLIS S1	22/10/2020 18:15	22/10/2020 22:56	22/10/2020 20:55	22/10/2020 21:08	0,21	2255	483,57	CHI
202010126560	SANTO ANTONIO DE GOIAS	BW13162442	NEROPOLIS S1	22/10/2020 18:15	22/10/2020 22:56	22/10/2020 19:31	22/10/2020 20:38	1,11	2255	2513,70	CHI
202010126560	SANTO ANTONIO DE GOIAS	BR13203585	NEROPOLIS S1	22/10/2020 18:15	22/10/2020 22:56	22/10/2020 18:59	22/10/2020 20:16	1,27	5	6,34	CHI
202010126560	BRAZABRANTES	BR13203586	NEROPOLIS S1	22/10/2020 18:15	22/10/2020 22:56	22/10/2020 18:59	22/10/2020 20:16	1,27	372	471,82	CHI
202010126560	GOIANIRA	BR13203585	NEROPOLIS S1	22/10/2020 18:15	22/10/2020 22:56	22/10/2020 18:59	22/10/2020 20:16	1,27	22	27,90	CHI

202010126560	NOVA VENEZA	BR13203586	NEROPOLIS S1	22/10/2020 18:15	22/10/2020 22:56	22/10/2020 18:59	22/10/2020 20:16	1,27	3	3,80	CHI
202010126560	BRAZABRANTES	BR13203585	NEROPOLIS S1	22/10/2020 18:15	22/10/2020 22:56	22/10/2020 18:59	22/10/2020 20:16	1,27	1223	1551,17	CHI
202010126560	BRAZABRANTES	NV13250026	NEROPOLIS S1	22/10/2020 18:15	22/10/2020 22:56	22/10/2020 18:15	22/10/2020 20:16	2,01	9	18,06	CHI
202010126560	NOVA VENEZA	NV13250026	NEROPOLIS S1	22/10/2020 18:15	22/10/2020 22:56	22/10/2020 18:15	22/10/2020 20:16	2,01	84	168,56	CHI
202010126560	GOIANIRA	IN16407240	NEROPOLIS S1	22/10/2020 18:15	22/10/2020 22:56	22/10/2020 19:55	22/10/2020 20:05	0,17	7	1,21	CHI
202010126560	BRAZABRANTES	IN16407240	NEROPOLIS S1	22/10/2020 18:15	22/10/2020 22:56	22/10/2020 19:55	22/10/2020 20:05	0,17	2	0,35	CHI
202010126560	INHUMAS	IN10400762	INHUMAS S2	22/10/2020 18:15	22/10/2020 22:56	22/10/2020 19:55	22/10/2020 20:01	0,10	32	3,18	CHI
202010126560	CATURAI	IN10400762	INHUMAS S2	22/10/2020 18:15	22/10/2020 22:56	22/10/2020 19:55	22/10/2020 20:01	0,10	1	0,10	CHI
202010126560	GOIANIRA	IN10400762	INHUMAS S2	22/10/2020 18:15	22/10/2020 22:56	22/10/2020 19:55	22/10/2020 20:01	0,10	11	1,09	CHI
202010126560	BRAZABRANTES	IN10400762	INHUMAS S2	22/10/2020 18:15	22/10/2020 22:56	22/10/2020 19:55	22/10/2020 20:01	0,10	40	3,98	CHI
202010126560	BRAZABRANTES	NV13000001	INHUMAS S1	22/10/2020 18:15	22/10/2020 22:56	22/10/2020 18:59	22/10/2020 19:29	0,50	61	30,47	CHI
202010126560	NOVA VENEZA	NV13000001	INHUMAS S1	22/10/2020 18:15	22/10/2020 22:56	22/10/2020 18:59	22/10/2020 19:29	0,50	1955	976,41	CHI
202010126560	INHUMAS	NV13000001	INHUMAS S1	22/10/2020 18:15	22/10/2020 22:56	22/10/2020 18:59	22/10/2020 19:29	0,50	19	9,49	CHI
202010126560	NEROPOLIS	NV13319338	INHUMAS S1	22/10/2020 18:15	22/10/2020 22:56	22/10/2020 18:59	22/10/2020 19:29	0,50	10	5,00	CHI
202010126560	OURO VERDE DE GOIAS	NV13319338	INHUMAS S1	22/10/2020 18:15	22/10/2020 22:56	22/10/2020 18:59	22/10/2020 19:29	0,50	50	24,99	CHI
202010126560	NOVA VENEZA	NV13319338	INHUMAS S1	22/10/2020 18:15	22/10/2020 22:56	22/10/2020 18:59	22/10/2020 19:29	0,50	2063	1030,93	CHI
202010126560	DAMOLANDIA	NV13319338	INHUMAS S1	22/10/2020 18:15	22/10/2020 22:56	22/10/2020 18:59	22/10/2020 19:29	0,50	3	1,50	CHI
202010126560	SANTO ANTONIO DE GOIAS	NV13319338	INHUMAS S1	22/10/2020 18:15	22/10/2020 22:56	22/10/2020 18:59	22/10/2020 19:29	0,50	1	0,50	CHI
202010126560	NEROPOLIS	01320424	NEROPOLIS S1	22/10/2020 18:15	22/10/2020 22:56	22/10/2020 18:15	22/10/2020 19:29	1,24	117	144,85	CHI
202010126560	NOVA VENEZA	01320424	NEROPOLIS S1	22/10/2020 18:15	22/10/2020 22:56	22/10/2020 18:15	22/10/2020 19:29	1,24	7	8,67	CHI
202010126466	SENADOR CANEDO	SW21125212	SENADOR CANEDO	22/10/2020 18:16	22/10/2020 19:36	22/10/2020 18:16	22/10/2020 19:36	1,33	3	3,99	CHI
202010126584	IPAMERI	IP12197355	IPAMERI	22/10/2020 18:16	23/10/2020 16:56	22/10/2020 18:16	23/10/2020 16:56	22,66	7	158,63	CHI
202010126327	INDIARA	IY12010954	EDEIA	22/10/2020 18:17	23/10/2020 14:22	22/10/2020 18:17	23/10/2020 14:22	20,08	13	261,09	CHI
202010126327	EDEIA	IY12010954	EDEIA	22/10/2020 18:17	23/10/2020 14:22	23/10/2020 04:45	23/10/2020 14:22	9,61	5	48,04	CHI
202010126327	INDIARA	IY12010954	EDEIA	22/10/2020 18:17	23/10/2020 14:22	23/10/2020 04:45	23/10/2020 14:22	9,61	33	317,06	CHI
202010126526	APARECIDA DE GOIANIA	03440234	ANHANGUERA	22/10/2020 18:17	22/10/2020 18:21	22/10/2020 18:17	22/10/2020 18:21	0,06	1268	77,14	CHI
202010126490	MAIRIPOTABA	MI21091071	PONTALINA	22/10/2020 18:18	22/10/2020 22:11	22/10/2020 18:18	22/10/2020 22:11	3,88	1	3,88	CHI
202010126492	PIRACANJUBA	MR21000173	MORRINHOS	22/10/2020 18:18	22/10/2020 19:58	22/10/2020 18:18	22/10/2020 19:58	1,66	2	3,32	CHI
202010126497	INDIARA	IY21206040	EDEIA	22/10/2020 18:19	23/10/2020 09:33	22/10/2020 18:19	23/10/2020 09:33	15,23	1	15,23	CHI
202010128754	NOVA IGUACU DE GOIAS	NH12202113	SANTA TEREZINHA	22/10/2020 18:20	23/10/2020 10:06	22/10/2020 18:20	23/10/2020 10:06	15,77	64	1009,07	CHI
202010126511	PIRACANJUBA	PJ21120728	PIRACANJUBA	22/10/2020 18:20	22/10/2020 22:31	22/10/2020 18:20	22/10/2020 22:31	4,18	1	4,18	CHI
202010126512	PIRACANJUBA	PJ12000109	PIRACANJUBA	22/10/2020 18:20	23/10/2020 08:24	22/10/2020 18:20	23/10/2020 08:24	14,06	2	28,13	CHI
202010126530	AGUA FRIA DE GOIAS	TL21180552	SAO JOAO D ALIANCA	22/10/2020 18:22	22/10/2020 22:26	22/10/2020 18:22	22/10/2020 22:26	4,07	1	4,07	CHI
202010128076	GOIANIA	GN12026282	REAL S1	22/10/2020 18:22	22/10/2020 22:17	22/10/2020 18:22	22/10/2020 22:17	3,91	169	660,41	CHI
202010126540	GOIAS	GS12065878	MATRINCHA	22/10/2020 18:22	23/10/2020 10:22	22/10/2020 18:22	23/10/2020 10:22	15,99	0	0,00	CHI
202010126710	APARECIDA DE GOIANIA	10028131612	INDEPENDENCIA S2	22/10/2020 18:23	22/10/2020 19:57	22/10/2020 18:23	22/10/2020 19:57	1,57	1	1,57	CHI
202010126587	PLANALTINA	PI21300685	PLANALTINA	22/10/2020 18:25	22/10/2020 21:23	22/10/2020 18:25	22/10/2020 21:23	2,96	1	2,96	CHI
202010126666	APARECIDA DE GOIANIA	AP11167082	CARAJAS S1	22/10/2020 18:25	22/10/2020 21:30	22/10/2020 18:25	22/10/2020 21:30	3,08	46	141,63	CHI
202010127423	GOIANIA	GN11226810	ATLANTICO S1	22/10/2020 18:26	22/10/2020 19:28	22/10/2020 18:26	22/10/2020 19:28	1,02	47	48,12	CHI
202010126607	QUIRINOPOLIS	80055588	QUIRINOPOLIS	22/10/2020 18:26	22/10/2020 21:16	22/10/2020 18:26	22/10/2020 21:16	2,82	1	2,82	CHI
202010127003	TRINDADE	TR12381313	TRINDADE	22/10/2020 18:26	23/10/2020 03:21	22/10/2020 18:26	23/10/2020 03:21	8,90	143	1273,38	CHI
202010126984	GOIANIA	GN11056164	GOYA S2	22/10/2020 18:27	22/10/2020 20:15	22/10/2020 18:27	22/10/2020 20:15	1,79	97	174,09	CHI
202010127445	URUACU	UR12384347	URUACU	22/10/2020 18:27	22/10/2020 21:27	22/10/2020 18:27	22/10/2020 21:27	2,99	25	74,68	CHI
202010126622	CRISTALINA	KR12330533	CRISTALINA S1	22/10/2020 18:28	22/10/2020 21:14	22/10/2020 18:28	22/10/2020 21:14	2,76	34	93,99	CHI
202010126622	IPAMERI	KR12330533	CRISTALINA S1	22/10/2020 18:28	22/10/2020 21:14	22/10/2020 18:28	22/10/2020 21:14	2,76	1	2,76	CHI
202010126622	LUZIANIA	KR12330533	CRISTALINA S1	22/10/2020 18:28	22/10/2020 21:14	22/10/2020 18:28	22/10/2020 21:14	2,76	8	22,12	CHI
202010126642	VALPARAISO DE GOIAS	2860103280	MARAJOARA	22/10/2020 18:29	23/10/2020 10:48	22/10/2020 18:29	23/10/2020 10:48	16,30	1	16,30	CHI
202010126657	TRINDADE	40243941	TRINDADE	22/10/2020 18:30	23/10/2020 00:19	22/10/2020 18:30	23/10/2020 00:19	5,80	1	5,80	CHI
202010128505	PLANALTINA	PI11136679	PLANALTINA	22/10/2020 18:31	22/10/2020 22:08	22/10/2020 18:31	22/10/2020 22:08	3,62	88	318,27	CHI
202010127098	PIRACANJUBA	CN13092049	CALDAS NOVAS S1	22/10/2020 18:31	23/10/2020 16:23	22/10/2020 18:31	23/10/2020 16:23	21,86	2	43,72	CHI
202010127098	CALDAS NOVAS	CN13092049	CALDAS NOVAS S1	22/10/2020 18:31	23/10/2020 16:23	22/10/2020 18:31	23/10/2020 16:23	21,86	5	109,31	CHI

202010127098	CALDAS NOVAS	CN13092049	CALDAS NOVAS S1	22/10/2020 18:31	23/10/2020 16:23	22/10/2020 21:20	23/10/2020 16:23	19,03	3	57,10	CHI
202010127098	CALDAS NOVAS	00320414	CALDAS NOVAS S1	22/10/2020 18:31	23/10/2020 16:23	22/10/2020 21:20	22/10/2020 21:32	0,19	288	55,04	CHI
202010127098	PIRACANJUBA	00320414	CALDAS NOVAS S1	22/10/2020 18:31	23/10/2020 16:23	22/10/2020 21:20	22/10/2020 21:32	0,19	7	1,34	CHI
202010127098	SANTA CRUZ DE GOIAS	00320414	CALDAS NOVAS S1	22/10/2020 18:31	23/10/2020 16:23	22/10/2020 21:20	22/10/2020 21:32	0,19	8	1,53	CHI
202010127098	CALDAS NOVAS	CN13059926	CALDAS NOVAS S1	22/10/2020 18:31	23/10/2020 16:23	22/10/2020 18:31	22/10/2020 20:06	1,58	245	387,85	CHI
202010127098	SANTA CRUZ DE GOIAS	00320414	CALDAS NOVAS S1	22/10/2020 18:31	23/10/2020 16:23	22/10/2020 18:31	22/10/2020 19:54	1,39	8	11,14	CHI
202010127098	CALDAS NOVAS	00320414	CALDAS NOVAS S1	22/10/2020 18:31	23/10/2020 16:23	22/10/2020 18:31	22/10/2020 19:54	1,39	42	58,46	CHI
202010127098	PIRACANJUBA	00320414	CALDAS NOVAS S1	22/10/2020 18:31	23/10/2020 16:23	22/10/2020 18:31	22/10/2020 19:54	1,39	6	8,35	CHI
202010126668	ANAPOLIS	10030176873	JUNDIAI S2	22/10/2020 18:31	23/10/2020 10:51	22/10/2020 18:31	23/10/2020 10:51	16,32	1	16,32	CHI
202010129259	IPAMERI	IP21195072	IPAMERI	22/10/2020 18:32	23/10/2020 09:32	22/10/2020 18:32	23/10/2020 09:32	15,00	1	15,00	CHI
202010128673	IPAMERI	IP12300882	IPAMERI	22/10/2020 18:32	22/10/2020 23:48	22/10/2020 18:32	22/10/2020 23:48	5,26	2	10,52	CHI
202010127889	CAMPESTRE DE GOIAS	GC11252069	TRINDADE	22/10/2020 18:32	22/10/2020 20:16	22/10/2020 18:32	22/10/2020 20:16	1,72	115	198,18	CHI
202010127026	INDIARA	IY11169763	EDEIA	22/10/2020 18:32	22/10/2020 22:44	22/10/2020 18:32	22/10/2020 22:44	4,19	80	334,91	CHI
202010127749	GOIANIA	GN11129236	CARAJAS S2	22/10/2020 18:32	22/10/2020 20:29	22/10/2020 18:32	22/10/2020 20:29	1,93	178	344,28	CHI
202010127090	APARECIDA DE GOIANIA	AP11162028	INDEPENDENCIA S2	22/10/2020 18:34	22/10/2020 21:14	22/10/2020 18:34	22/10/2020 21:14	2,66	76	202,03	CHI
202010126864	GOIANIA	GN11408801	CARAJAS S1	22/10/2020 18:35	22/10/2020 21:22	22/10/2020 18:35	22/10/2020 21:22	2,79	46	128,51	CHI
202010126739	CATALAO	1990144345	CATALAO S2	22/10/2020 18:35	22/10/2020 19:55	22/10/2020 18:35	23/10/2020 19:55	1,33	1	1,33	CHI
202010126741	GOIANIA	GN12000311	GOIANIA LESTE S3	22/10/2020 18:35	22/10/2020 20:52	22/10/2020 18:35	22/10/2020 20:52	2,28	72	164,04	CHI
202010126742	GOIANIA	13079815	AEROPORTO S2	22/10/2020 18:35	22/10/2020 21:22	22/10/2020 18:35	22/10/2020 21:22	2,78	1	2,78	CHI
202010126750	GOIANIA	14048644	GOYA S2	22/10/2020 18:35	23/10/2020 09:44	22/10/2020 18:35	23/10/2020 09:44	15,14	1	15,14	CHI
202010128960	GOIANIA	12208334	ATLANTICO S2	22/10/2020 18:36	22/10/2020 23:20	22/10/2020 18:36	22/10/2020 23:20	4,73	1	4,73	CHI
202010129156	ANAPOLIS	AN12254173	JUNDIAI S1	22/10/2020 18:36	23/10/2020 07:54	22/10/2020 18:36	23/10/2020 07:54	13,29	274	3640,55	CHI
202010126778	SANTA RITA DO ARAGUAIA	2130021524	SANTA RITA DO ARAGUAIA	22/10/2020 18:37	23/10/2020 16:03	22/10/2020 18:37	23/10/2020 16:03	21,43	1	21,43	CHI
202010126782	GOIANIA	15661982	REAL S1	22/10/2020 18:37	23/10/2020 08:36	22/10/2020 18:37	23/10/2020 08:36	13,98	1	13,98	CHI
202010126797	GOIANIA	GN11282002	GOIANIA LESTE S1	22/10/2020 18:38	22/10/2020 21:25	22/10/2020 18:38	22/10/2020 21:25	2,78	40	111,36	CHI
202010126804	GOIANIA	GN12395829	XAVANTES	22/10/2020 18:38	22/10/2020 21:21	22/10/2020 18:38	22/10/2020 21:21	2,71	146	395,34	CHI
202010127263	QUIRINOPOLIS	QI11171910	QUIRINOPOLIS	22/10/2020 18:39	22/10/2020 20:35	22/10/2020 18:39	22/10/2020 20:35	1,93	83	160,42	CHI
202010127452	BRAZABRANTES	BR12016135LD	INHUMAS S2	22/10/2020 18:39	23/10/2020 09:50	22/10/2020 18:39	23/10/2020 09:50	15,18	3	45,53	CHI
202010127452	INHUMAS	IN12013940	INHUMAS S2	22/10/2020 18:39	23/10/2020 09:50	22/10/2020 18:39	23/10/2020 08:23	13,73	9	123,58	CHI
202010127452	BRAZABRANTES	IN12013940	INHUMAS S2	22/10/2020 18:39	23/10/2020 09:50	22/10/2020 18:39	23/10/2020 08:23	13,73	9	123,58	CHI
202010127475	APARECIDA DE GOIANIA	AP11043153	ANHANGUERA	22/10/2020 18:39	22/10/2020 22:03	22/10/2020 18:39	23/10/2020 22:03	3,39	77	261,01	CHI
202010126830	NOVO GAMA	10010202046	PACAEMBU S1	22/10/2020 18:39	23/10/2020 10:56	22/10/2020 18:39	23/10/2020 10:56	16,27	1	16,27	CHI
202010126833	CAIAPONIA	CP12244449	CAIAPONIA	22/10/2020 18:39	23/10/2020 10:12	22/10/2020 18:39	23/10/2020 10:12	15,54	4	62,14	CHI
202010126849	TURVANIA	TV12215375	FIRMINOPOLIS S1	22/10/2020 18:40	23/10/2020 02:59	22/10/2020 18:40	23/10/2020 02:59	8,31	1	8,31	CHI
202010127124	AMARALINA	LC12215796	MARA ROSA	22/10/2020 18:40	22/10/2020 21:08	22/10/2020 18:40	22/10/2020 21:08	2,46	13	31,95	CHI
202010126870	CALDAS NOVAS	CN11386274	SERRA DE CALDAS	22/10/2020 18:41	22/10/2020 20:51	22/10/2020 18:41	22/10/2020 20:51	2,16	21	45,41	CHI
202010126871	CUMARI	2000002359	CATALAO S1	22/10/2020 18:41	22/10/2020 23:03	22/10/2020 18:41	22/10/2020 23:03	4,36	1	4,36	CHI
202010129279	JARAGUA	JA11000044	JARAGUA	22/10/2020 18:41	23/10/2020 04:09	22/10/2020 18:41	23/10/2020 04:09	9,45	100	945,14	CHI
202010127057	JARAGUA	JA12000204	JARAGUA	22/10/2020 18:41	22/10/2020 21:43	22/10/2020 18:41	22/10/2020 21:43	3,02	265	799,71	CHI
202010126890	AGUA LIMPA	430001605	VILA CORUMBA	22/10/2020 18:42	22/10/2020 22:03	22/10/2020 18:42	22/10/2020 22:03	3,35	1	3,35	CHI
202010126895	ABADIANIA	AN10383406	DAIA S2	22/10/2020 18:42	23/10/2020 11:10	22/10/2020 18:42	23/10/2020 11:10	16,48	60	988,63	CHI
202010126895	SILVANIA	AN10383406	DAIA S2	22/10/2020 18:42	23/10/2020 11:10	22/10/2020 18:42	23/10/2020 11:10	16,48	1	16,48	CHI
202010126895	GAMELEIRA DE GOIAS	AN10383406	DAIA S2	22/10/2020 18:42	23/10/2020 11:10	22/10/2020 18:42	23/10/2020 11:10	16,48	159	2619,88	CHI
202010126895	GAMELEIRA DE GOIAS	AN10383406	DAIA S2	22/10/2020 18:42	23/10/2020 11:10	22/10/2020 18:42	23/10/2020 11:10	16,48	1	16,48	CHI
202010126895	ANAPOLIS	AN10383406	DAIA S2	22/10/2020 18:42	23/10/2020 11:10	22/10/2020 18:42	23/10/2020 11:10	16,48	15	247,16	CHI
202010126895	GAMELEIRA DE GOIAS	AN10383406	DAIA S2	22/10/2020 18:42	23/10/2020 11:10	22/10/2020 18:42	23/10/2020 11:10	16,48	1016	16740,86	CHI
202010126895	ABADIANIA	AN10383406	DAIA S2	22/10/2020 18:42	23/10/2020 11:10	22/10/2020 18:42	23/10/2020 11:10	16,48	568	9359,06	CHI
202010126895	ABADIANIA	AN10383406	DAIA S2	22/10/2020 18:42	23/10/2020 11:10	22/10/2020 18:42	23/10/2020 11:10	16,48	2	32,95	CHI
202010126895	ANAPOLIS	AN10383406	DAIA S2	22/10/2020 18:42	23/10/2020 11:10	22/10/2020 18:42	23/10/2020 11:10	16,48	4	65,91	CHI
202010126895	SILVANIA	AN10383406	DAIA S2	22/10/2020 18:42	23/10/2020 11:10	22/10/2020 18:42	23/10/2020 11:10	16,48	372	6129,53	CHI
202010126895	ABADIANIA	AN10383406	DAIA S2	22/10/2020 18:42	23/10/2020 11:10	22/10/2020 18:42	23/10/2020 11:10	16,48	4	65,91	CHI

202010126895	GAMELEIRA DE GOIAS	AN10383406	DAIA S2	22/10/2020 18:42	23/10/2020 11:10	22/10/2020 18:42	23/10/2020 11:10	16,48	235	3872,15	CHI
202010126895	ABADIANIA	AN10383406	DAIA S2	22/10/2020 18:42	23/10/2020 11:10	22/10/2020 18:42	23/10/2020 11:10	16,48	1	16,48	CHI
202010126895	BELA VISTA DE GOIAS	AN10383406	DAIA S2	22/10/2020 18:42	23/10/2020 11:10	22/10/2020 18:42	23/10/2020 11:10	16,48	1	16,48	CHI
202010126895	SILVANIA	AN10383406	DAIA S2	22/10/2020 18:42	23/10/2020 11:10	22/10/2020 20:41	23/10/2020 11:10	14,49	8	115,89	CHI
202010126895	ABADIANIA	AN10383406	DAIA S2	22/10/2020 18:42	23/10/2020 11:10	22/10/2020 20:41	23/10/2020 11:10	14,49	99	1434,10	CHI
202010126895	ABADIANIA	AN10383406	DAIA S2	22/10/2020 18:42	23/10/2020 11:10	22/10/2020 20:41	23/10/2020 11:10	14,49	9	130,37	CHI
202010126902	APARECIDA DE GOIANIA	AP11162127	ANHANGUERA	22/10/2020 18:42	22/10/2020 21:01	22/10/2020 18:42	22/10/2020 21:01	2,31	41	94,77	CHI
202010126910	ARAGUAPAZ	1780021796	MOZARLANDIA	22/10/2020 18:42	23/10/2020 10:57	22/10/2020 18:42	23/10/2020 10:57	16,24	1	16,24	CHI
202010126994	APARECIDA DE GOIANIA	AP11030731	REAL S2	22/10/2020 18:42	22/10/2020 22:24	22/10/2020 18:42	22/10/2020 22:24	3,70	160	591,96	CHI
202010127045	GOIANIA	GN11001436	FERROVIARIO S2	22/10/2020 18:43	23/10/2020 12:06	22/10/2020 18:43	23/10/2020 12:06	17,38	146	2537,20	CHI
202010126928	CRIXAS	CX12391661	SANTA TEREZINHA	22/10/2020 18:43	22/10/2020 22:31	22/10/2020 18:43	22/10/2020 22:31	3,79	32	121,27	CHI
202010128115	GOIANIA	GN11073423	ATLANTICO S1	22/10/2020 18:43	23/10/2020 10:35	22/10/2020 18:43	23/10/2020 10:35	15,85	50	792,53	CHI
202010127921	BOM JESUS DE GOIAS	6955126	BOM JESUS DE GOIAS	22/10/2020 18:45	22/10/2020 23:58	22/10/2020 18:45	22/10/2020 23:58	5,21	2	10,41	CHI
202010127921	GOIATUBA	6955126	BOM JESUS DE GOIAS	22/10/2020 18:45	22/10/2020 23:58	22/10/2020 18:45	22/10/2020 23:58	5,21	3	15,62	CHI
202010126989	MUTUNOPOLIS	MU21208387	MARA ROSA	22/10/2020 18:45	23/10/2020 16:47	22/10/2020 18:45	23/10/2020 16:47	22,02	1	22,02	CHI
202010126997	CATALAO	1990147700	CATALAO S2	22/10/2020 18:46	22/10/2020 21:28	22/10/2020 18:46	22/10/2020 21:28	2,70	1	2,70	CHI
202010127696	CACHOEIRA ALTA	CA12013266	CACHOEIRA ALTA	22/10/2020 18:46	22/10/2020 21:42	22/10/2020 18:46	22/10/2020 21:42	2,93	16	46,85	CHI
202010127641	GOIANIRA	GR11209014	GOIANIRA	22/10/2020 18:46	22/10/2020 21:09	22/10/2020 18:46	22/10/2020 21:09	2,37	98	232,67	CHI
202010127015	SANTA TEREZINHA DE GOIAS	SG12321954	SANTA TEREZINHA	22/10/2020 18:47	22/10/2020 22:13	22/10/2020 18:47	22/10/2020 22:13	3,43	15	51,48	CHI
202010127015	CAMPOS VERDES	SG12321954	SANTA TEREZINHA	22/10/2020 18:47	22/10/2020 22:13	22/10/2020 18:47	22/10/2020 22:13	3,43	1	3,43	CHI
202010127015	MARA ROSA	SG12321954	SANTA TEREZINHA	22/10/2020 18:47	22/10/2020 22:13	22/10/2020 18:47	22/10/2020 22:13	3,43	15	51,48	CHI
202010127097	APARECIDA DE GOIANIA	10019631373	INDEPENDENCIA S2	22/10/2020 18:50	23/10/2020 08:53	22/10/2020 18:50	23/10/2020 08:53	14,03	1	14,03	CHI
202010127114	PARAUNA	980020591	PARAUNA	22/10/2020 18:51	22/10/2020 22:59	22/10/2020 18:51	22/10/2020 22:59	4,12	1	4,12	CHI
202010127119	GOIANESIA	BA12163310	GOIANESIA S1	22/10/2020 18:52	23/10/2020 12:41	22/10/2020 18:52	23/10/2020 12:41	17,82	2	35,63	CHI
202010127136	QUIRINOPOLIS	QI21054926	QUIRINOPOLIS	22/10/2020 18:52	22/10/2020 22:16	22/10/2020 18:52	22/10/2020 22:16	3,39	1	3,39	CHI
202010127144	SAO MIGUEL DO ARAGUAIA	10005637536	SAO MIGUEL DO ARAGUAIA	22/10/2020 18:52	23/10/2020 00:56	22/10/2020 18:52	23/10/2020 00:56	6,05	1	6,05	CHI
202010127996	ANICUNS	AC12091322	ANICUNS	22/10/2020 18:54	23/10/2020 00:14	22/10/2020 18:54	23/10/2020 00:14	5,33	8	42,65	CHI
202010127183	APARECIDA DE GOIANIA	16670401	INDEPENDENCIA S2	22/10/2020 18:54	22/10/2020 20:41	22/10/2020 18:54	22/10/2020 20:41	1,77	1	1,77	CHI
202010127205	FORMOSA	FA12195774	ITQUIRA	22/10/2020 18:55	22/10/2020 19:41	22/10/2020 18:55	22/10/2020 19:41	0,75	676	509,25	CHI
202010127387	SANTO ANTONIO DO DESCOBERTO	SN12379433	ALEXANIA	22/10/2020 18:56	22/10/2020 22:06	22/10/2020 18:56	22/10/2020 22:06	3,16	23	72,72	CHI
202010127213	PLANALTINA	PI11149012	PLANALTINA	22/10/2020 18:56	22/10/2020 20:57	22/10/2020 18:56	22/10/2020 20:57	2,01	37	74,40	CHI
202010127364	SENADOR CANEDO	SW11239213	SENADOR CANEDO	22/10/2020 18:56	22/10/2020 21:32	22/10/2020 18:56	22/10/2020 21:32	2,58	96	248,13	CHI
202010127232	GOIANIA	10346107	CAMPINAS S1	22/10/2020 18:57	22/10/2020 21:30	22/10/2020 18:57	22/10/2020 21:30	2,54	1	2,54	CHI
202010127243	ITAPURANGA	IK11023659	ITAPURANGA	22/10/2020 18:57	22/10/2020 21:49	22/10/2020 18:57	22/10/2020 21:49	2,85	142	404,86	CHI
202010129130	GUAPO	GA21000040	GUAPO S1	22/10/2020 18:59	23/10/2020 07:35	22/10/2020 18:59	23/10/2020 07:35	12,59	1	12,59	CHI
202010128009	GUAPO	GA12000023	GUAPO S1	22/10/2020 18:59	22/10/2020 22:11	22/10/2020 18:59	22/10/2020 22:11	3,19	4	12,77	CHI
202010127273	SAO MIGUEL DO PASSA QUATRO	SQ21216207	CRISTIANOPOLIS	22/10/2020 18:59	22/10/2020 22:22	22/10/2020 18:59	22/10/2020 22:22	3,38	1	3,38	CHI
202010127279	BOM JESUS DE GOIAS	BJ12352647LD	BOM JESUS DE GOIAS	22/10/2020 18:59	23/10/2020 01:58	22/10/2020 18:59	23/10/2020 01:58	6,97	1	6,97	CHI
202010127297	FAINA	FC11101085	GOIAS	22/10/2020 19:00	23/10/2020 10:54	22/10/2020 19:00	23/10/2020 10:54	15,89	2	31,78	CHI
202010127313	RIO VERDE	630076765	RIO VERDE S2	22/10/2020 19:01	22/10/2020 22:52	22/10/2020 19:01	22/10/2020 22:52	3,84	1	3,84	CHI
202010127321	UIRAPURU	UP21248230	SANTA TEREZINHA	22/10/2020 19:01	22/10/2020 23:28	22/10/2020 19:01	22/10/2020 23:28	4,44	1	4,44	CHI
202010127322	MARA ROSA	MQ12208423	MARA ROSA	22/10/2020 19:01	23/10/2020 01:58	22/10/2020 19:01	23/10/2020 01:58	6,94	13	90,20	CHI
202010127336	FORMOSA	FA12013352	ITQUIRA	22/10/2020 19:02	22/10/2020 21:18	22/10/2020 19:02	22/10/2020 21:18	2,26	3	6,77	CHI
202010127566	ABADIA DE GOIAS	LG12158044	CARAJAS S1	22/10/2020 19:02	22/10/2020 22:03	22/10/2020 19:02	22/10/2020 22:03	3,01	403	1214,71	CHI
202010128418	GUAPO	GA12381335	GUAPO S2	22/10/2020 19:05	23/10/2020 04:06	22/10/2020 19:05	23/10/2020 04:06	9,00	19	171,07	CHI
202010128336	ANAPOLIS	AN11130813	JUNDIAI S1	22/10/2020 19:05	23/10/2020 14:20	22/10/2020 19:05	23/10/2020 14:20	19,24	132	2539,13	CHI
202010127426	QUIRINOPOLIS	QI31191863	QUIRINOPOLIS	22/10/2020 19:06	23/10/2020 00:05	22/10/2020 19:06	23/10/2020 00:05	4,98	2	9,96	CHI
202010127437	SERRANOPOLIS	3000003901	JATAI S1	22/10/2020 19:06	23/10/2020 13:22	22/10/2020 19:06	23/10/2020 13:22	18,25	1	18,25	CHI
202010127451	BELA VISTA DE GOIAS	BV32063026	BELA VISTA S1	22/10/2020 19:07	23/10/2020 00:35	22/10/2020 19:07	23/10/2020 00:35	5,46	70	382,20	CHI
202010127456	GOIANIA	10806570	GOIANIA LESTE S2	22/10/2020 19:07	23/10/2020 06:44	22/10/2020 19:07	23/10/2020 06:44	11,61	1	11,61	CHI
202010127508	SILVANIA	SV12317629	DAIA S2	22/10/2020 19:08	22/10/2020 23:13	22/10/2020 19:08	22/10/2020 23:13	4,07	14	57,03	CHI



202010127508	BELA VISTA DE GOIAS	SV12317629	DAIA S2	22/10/2020 19:08	22/10/2020 23:13	22/10/2020 19:08	22/10/2020 23:13	4,07	7	28,52	CHI
202010128044	APARECIDA DE GOIANIA	AP11063486	INDEPENDENCIA S1	22/10/2020 19:09	23/10/2020 08:23	22/10/2020 19:09	23/10/2020 08:23	13,23	194	2566,14	CHI
202010130861	PIRENOPOLIS	PV21273400	SAO FRANCISCO DE GOIAS	22/10/2020 19:09	23/10/2020 11:55	22/10/2020 19:09	23/10/2020 11:55	16,75	2	33,51	CHI
202010128904	PETROLINA DE GOIAS	PV12062894	SAO FRANCISCO DE GOIAS	22/10/2020 19:09	23/10/2020 08:26	22/10/2020 19:09	23/10/2020 08:26	13,27	3	39,81	CHI
202010128904	PIRENOPOLIS	PV12062894	SAO FRANCISCO DE GOIAS	22/10/2020 19:09	23/10/2020 08:26	22/10/2020 19:09	23/10/2020 08:26	13,27	20	265,41	CHI
202010127495	JUSSARA	JR12160972	BRITANIA	22/10/2020 19:10	23/10/2020 18:25	22/10/2020 19:10	23/10/2020 18:25	23,26	4	93,05	CHI
202010127504	TRINDADE	10031916978	MEIA PONTE	22/10/2020 19:10	22/10/2020 23:14	22/10/2020 19:10	22/10/2020 23:14	4,06	1	4,06	CHI
202010127515	JATAI	JT12104620	JATAI S1	22/10/2020 19:10	22/10/2020 22:16	22/10/2020 19:10	22/10/2020 22:16	3,09	7	21,60	CHI
202010127528	URUACU	UR21201762	URUACU	22/10/2020 19:11	22/10/2020 21:02	22/10/2020 19:11	22/10/2020 21:02	1,84	1	1,84	CHI
202010127534	TRINDADE	40198054	GOYA S1	22/10/2020 19:12	22/10/2020 23:51	22/10/2020 19:12	22/10/2020 23:51	4,65	1	4,65	CHI
202010127543	RIO VERDE	RV12023947	RIO VERDE S2	22/10/2020 19:12	22/10/2020 23:02	22/10/2020 19:12	22/10/2020 23:02	3,83	10	38,29	CHI
202010128280	TRINDADE	TR12386712	TRINDADE	22/10/2020 19:13	22/10/2020 22:32	22/10/2020 19:13	22/10/2020 22:32	3,31	14	46,38	CHI
202010128460	SENADOR CANEDO	SW11141241	SENADOR CANEDO	22/10/2020 19:13	22/10/2020 21:29	22/10/2020 19:13	22/10/2020 21:29	2,26	172	388,77	CHI
202010127634	TRINDADE	TR11132186	TRINDADE	22/10/2020 19:14	22/10/2020 21:36	22/10/2020 19:14	22/10/2020 21:36	2,36	99	233,89	CHI
202010127573	CATALAO	1990129691	CATALAO S2	22/10/2020 19:14	22/10/2020 20:57	22/10/2020 19:14	22/10/2020 20:57	1,71	1	1,71	CHI
202010127592	ITABERAÍ	IB12227143	ITABERAÍ S1	22/10/2020 19:15	22/10/2020 21:14	22/10/2020 19:15	22/10/2020 21:14	1,98	38	75,15	CHI
202010127593	ANAPOLIS	20058573	JUNDIAI S2	22/10/2020 19:15	23/10/2020 10:28	22/10/2020 19:15	23/10/2020 10:28	15,21	1	15,21	CHI
202010127610	NEROPOLIS	NR21010664	NEROPOLIS S2	22/10/2020 19:16	23/10/2020 06:50	22/10/2020 19:16	23/10/2020 06:50	11,57	1	11,57	CHI
202010127715	BOM JESUS DE GOIAS	DM12153969	RIO DOS BOIS	22/10/2020 19:16	22/10/2020 22:08	22/10/2020 19:16	22/10/2020 22:08	2,86	1	2,86	CHI
202010127715	QUIRINOPOLIS	DM12153969	RIO DOS BOIS	22/10/2020 19:16	22/10/2020 22:08	22/10/2020 19:16	22/10/2020 22:08	2,86	9	25,76	CHI
202010127715	CASTELANDIA	DM12153969	RIO DOS BOIS	22/10/2020 19:16	22/10/2020 22:08	22/10/2020 19:16	22/10/2020 22:08	2,86	5	14,31	CHI
202010127615	APARECIDA DE GOIANIA	200409037	INDEPENDENCIA S2	22/10/2020 19:16	22/10/2020 22:14	22/10/2020 19:16	22/10/2020 22:14	2,96	1	2,96	CHI
202010127628	GOIAS	90061690	GOIAS	22/10/2020 19:17	22/10/2020 22:07	22/10/2020 19:17	22/10/2020 22:07	2,83	1	2,83	CHI
202010127638	LUZIANIA	120392549	MARAJOARA	22/10/2020 19:17	23/10/2020 09:17	22/10/2020 19:17	23/10/2020 09:17	13,98	1	13,98	CHI
202010127643	PLANALTINA	PI21406439	PLANALTINA	22/10/2020 19:18	22/10/2020 21:26	22/10/2020 19:18	22/10/2020 21:26	2,13	3	6,39	CHI
202010127660	COCALZINHO DE GOIAS	ZN12302874	AGUAS LINDAS DE GOIAS S2	22/10/2020 19:19	23/10/2020 07:46	22/10/2020 19:19	23/10/2020 07:46	12,45	2	24,90	CHI
202010127663	GOIANIA	GN11169111	CAMPINAS S3	22/10/2020 19:19	23/10/2020 15:43	22/10/2020 19:19	23/10/2020 15:43	20,39	20	407,83	CHI
202010127664	GOIANIA	GR31018500	MEIA PONTE	22/10/2020 19:19	23/10/2020 07:28	22/10/2020 19:19	23/10/2020 07:28	12,14	1	12,14	CHI
202010128019	GOIANIA	GN11333048	ATLANTICO S1	22/10/2020 19:21	23/10/2020 11:36	22/10/2020 19:21	23/10/2020 11:36	16,25	84	1364,70	CHI
202010127716	FORMOSA	610107021	ITIQUEIRA	22/10/2020 19:22	22/10/2020 22:53	22/10/2020 19:22	22/10/2020 22:53	3,51	1	3,51	CHI
202010127766	LUZIANIA	LZ21120160	MARAJOARA	22/10/2020 19:24	23/10/2020 14:26	22/10/2020 19:24	23/10/2020 14:26	19,03	1	19,03	CHI
202010127798	NEROPOLIS	GN13144258LD	XAVANTES	22/10/2020 19:25	23/10/2020 15:51	22/10/2020 19:25	23/10/2020 15:51	20,44	26	531,56	CHI
202010127798	GOIANIA	GN13144258LD	XAVANTES	22/10/2020 19:25	23/10/2020 15:51	22/10/2020 19:25	23/10/2020 15:51	20,44	27	552,01	CHI
202010127798	GOIANIA	GN12090095LD	XAVANTES	22/10/2020 19:25	23/10/2020 15:51	22/10/2020 19:25	23/10/2020 13:49	18,40	1	18,40	CHI
202010127798	GOIANIA	GN12373691LD	XAVANTES	22/10/2020 19:25	23/10/2020 15:51	22/10/2020 19:25	23/10/2020 10:34	15,16	34	515,33	CHI
202010127798	GOIANIA	GN13066497	XAVANTES	22/10/2020 19:25	23/10/2020 15:51	22/10/2020 19:25	22/10/2020 22:44	3,33	1	3,33	CHI
202010127798	GOIANIA	GN10394643	XAVANTES	22/10/2020 19:25	23/10/2020 15:51	22/10/2020 19:25	22/10/2020 22:11	2,78	534	1482,59	CHI
202010127794	AGUAS LINDAS DE GOIAS	4830194043	AGUAS LINDAS DE GOIAS S1	22/10/2020 19:25	23/10/2020 08:42	22/10/2020 19:25	23/10/2020 08:42	13,27	1	13,27	CHI
202010127815	TERESINA DE GOIAS	TE11047977	FLORES DE GOIAS	22/10/2020 19:27	22/10/2020 22:27	22/10/2020 19:27	22/10/2020 22:27	3,00	142	425,41	CHI
202010127829	FORMOSA	610018279	ITIQUEIRA	22/10/2020 19:27	22/10/2020 21:34	22/10/2020 19:27	22/10/2020 21:34	2,11	1	2,11	CHI
202010128180	LEOPOLDO DE BULHOES	LB12172114	DAIA S2	22/10/2020 19:27	22/10/2020 22:24	22/10/2020 19:27	22/10/2020 22:24	2,94	6	17,63	CHI
202010128180	SILVANIA	LB12172114	DAIA S2	22/10/2020 19:27	22/10/2020 22:24	22/10/2020 19:27	22/10/2020 22:24	2,94	10	29,38	CHI
202010128538	ANAPOLIS	AN11090380	JUNDIAI S2	22/10/2020 19:28	22/10/2020 23:19	22/10/2020 19:28	22/10/2020 23:19	3,85	139	534,49	CHI
202010127844	FORMOSA	FA21042020	ITIQUEIRA	22/10/2020 19:28	22/10/2020 22:38	22/10/2020 19:28	22/10/2020 22:38	3,16	1	3,16	CHI
202010127849	NEROPOLIS	NR21284793	NEROPOLIS S2	22/10/2020 19:28	23/10/2020 09:47	22/10/2020 19:28	23/10/2020 09:47	14,30	1	14,30	CHI
202010127863	INHUMAS	30105092	INHUMAS S2	22/10/2020 19:30	23/10/2020 08:30	22/10/2020 19:30	23/10/2020 08:30	13,00	1	13,00	CHI
202010127868	NEROPOLIS	NR21360959	NEROPOLIS S2	22/10/2020 19:30	23/10/2020 10:45	22/10/2020 19:30	23/10/2020 10:45	15,24	1	15,24	CHI
202010128033	NIQUELANDIA	NQ12253797	URUACU	22/10/2020 19:31	23/10/2020 11:08	22/10/2020 19:31	23/10/2020 11:08	15,60	21	327,62	CHI
202010127904	PALMINOPOLIS	1340007050	PALMEIRAS	22/10/2020 19:32	23/10/2020 10:37	22/10/2020 19:32	23/10/2020 10:37	15,08	1	15,08	CHI
202010127887	GOIANIA	GN12001644	REAL S2	22/10/2020 19:33	22/10/2020 23:41	22/10/2020 19:33	22/10/2020 23:41	4,13	593	2447,61	CHI
202010127891	SAO MIGUEL DO ARAGUAIA	SM12358772	SAO MIGUEL DO ARAGUAIA	22/10/2020 19:33	23/10/2020 05:44	22/10/2020 19:33	23/10/2020 05:44	10,17	5	50,85	CHI

202010127898	ALTO PARAISO DE GOIAS	BF21392822	NIQUELANDIA SUBTRANSMISSAO	22/10/2020 19:34	23/10/2020 00:58	22/10/2020 19:34	23/10/2020 00:58	5,39	2	10,79	CHI
202010129430	SILVANIA	SV12382750	DAIA S2	22/10/2020 19:34	23/10/2020 11:16	22/10/2020 19:34	23/10/2020 11:16	15,69	2	31,37	CHI
202010128090	ITABERAI	IB11000004	ITABERAI S2	22/10/2020 19:34	23/10/2020 00:30	22/10/2020 19:34	23/10/2020 00:30	4,92	167	821,55	CHI
202010127928	SILVANIA	3X100A	VIANOPOLIS	22/10/2020 19:37	22/10/2020 22:59	22/10/2020 19:37	22/10/2020 22:59	3,35	1	3,35	CHI
202010127935	GOIANIA	GN11134851	GOIANIA LESTE S1	22/10/2020 19:38	22/10/2020 22:36	22/10/2020 19:38	22/10/2020 22:36	2,96	136	402,48	CHI
202010127938	APARECIDA DE GOIANIA	15136188	INDEPENDENCIA S1	22/10/2020 19:38	23/10/2020 08:09	22/10/2020 19:38	23/10/2020 08:09	12,52	1	12,52	CHI
202010127945	PETROLINA DE GOIAS	PG12297811	PETROLINA	22/10/2020 19:39	22/10/2020 23:51	22/10/2020 19:39	22/10/2020 23:51	4,19	2	8,39	CHI
202010128213	GOIANIA	GN12000343	GOIANIA LESTE S2	22/10/2020 19:39	22/10/2020 21:41	22/10/2020 19:39	22/10/2020 21:41	2,02	565	1140,99	CHI
202010127973	APARECIDA DE GOIANIA	12953325	INDEPENDENCIA S1	22/10/2020 19:41	23/10/2020 14:30	22/10/2020 19:41	23/10/2020 14:30	18,81	1	18,81	CHI
202010128267	BELA VISTA DE GOIAS	BV12242070	BELA VISTA S1	22/10/2020 19:41	23/10/2020 23:27	22/10/2020 19:41	23/10/2020 23:27	3,75	11	41,27	CHI
202010128066	IPAMERI	IP12404730	IPAMERI	22/10/2020 19:42	23/10/2020 00:58	22/10/2020 19:42	23/10/2020 00:58	5,25	14	73,51	CHI
202010128066	CATALAO	IP12404730	IPAMERI	22/10/2020 19:42	23/10/2020 00:58	22/10/2020 19:42	23/10/2020 00:58	5,25	2	10,50	CHI
202010128066	GOIANDIRA	IP12404730	IPAMERI	22/10/2020 19:42	23/10/2020 00:58	22/10/2020 19:42	23/10/2020 00:58	5,25	4	21,00	CHI
202010127997	CAMPO ALEGRE DE GOIAS	CM12266823	CAMPO ALEGRE DE GOIAS	22/10/2020 19:43	22/10/2020 23:52	22/10/2020 19:43	22/10/2020 23:52	4,14	43	178,12	CHI
202010128429	BOM JARDIM DE GOIAS	BM12201516	BOM JARDIM	22/10/2020 19:43	23/10/2020 14:03	22/10/2020 19:43	23/10/2020 14:03	18,32	40	732,97	CHI
202010128006	IPAMERI	1060132592	CRISTALINA S2	22/10/2020 19:44	22/10/2020 22:20	22/10/2020 19:44	22/10/2020 22:20	2,60	1	2,60	CHI
202010128068	INHUMAS	NV12000113LD	INHUMAS S1	22/10/2020 19:44	23/10/2020 05:45	22/10/2020 19:44	23/10/2020 05:45	10,00	19	190,06	CHI
202010128068	BRAZABRANTES	NV12000113LD	INHUMAS S1	22/10/2020 19:44	23/10/2020 05:45	22/10/2020 19:44	23/10/2020 05:45	10,00	60	600,18	CHI
202010128068	NOVA VENEZA	NV12000113LD	INHUMAS S1	22/10/2020 19:44	23/10/2020 05:45	22/10/2020 19:44	23/10/2020 05:45	10,00	447	4471,37	CHI
202010128027	GOIAS	GS12310400	ITABERAI S1	22/10/2020 19:45	23/10/2020 14:58	22/10/2020 19:45	23/10/2020 14:58	19,22	5	96,08	CHI
202010128027	ITABERAI	GS12310400	ITABERAI S1	22/10/2020 19:45	23/10/2020 14:58	22/10/2020 19:45	23/10/2020 14:58	19,22	25	480,41	CHI
202010128027	GOIAS	GS12310400	ITABERAI S1	22/10/2020 19:45	23/10/2020 14:58	23/10/2020 11:26	23/10/2020 14:58	3,53	38	134,21	CHI
202010128028	GOIANIA	GN12001010	GOYA S2	22/10/2020 19:45	23/10/2020 02:39	22/10/2020 19:45	23/10/2020 02:39	6,89	23	158,39	CHI
202010128131	GOIANIA	GN11000736	GOIANIA LESTE S2	22/10/2020 19:45	22/10/2020 22:05	22/10/2020 19:45	22/10/2020 22:05	2,32	96	222,45	CHI
202010128780	COCALZINHO DE GOIAS	ZN12320107	AGUAS LINDAS DE GOIAS S1	22/10/2020 19:46	23/10/2020 10:26	22/10/2020 19:46	23/10/2020 10:26	14,66	14	205,22	CHI
202010128092	ITAGUARI	II12307467	ITABERAI S1	22/10/2020 19:51	23/10/2020 06:53	22/10/2020 19:51	23/10/2020 06:53	11,02	4	44,07	CHI
202010128110	TEREZOPOLIS DE GOIAS	TJ12273371	DAIA S2	22/10/2020 19:53	22/10/2020 21:05	22/10/2020 19:53	22/10/2020 21:05	1,20	33	39,61	CHI
202010128112	AGUA FRIA DE GOIAS	TL121337506	SAO JOAO D ALIANCA	22/10/2020 19:53	22/10/2020 23:39	22/10/2020 19:53	22/10/2020 23:39	3,76	2	7,53	CHI
202010128150	IPORA	IR21102654	IPORA	22/10/2020 19:55	23/10/2020 07:01	22/10/2020 19:55	23/10/2020 07:01	11,09	1	11,09	CHI
202010128296	ITABERAI	IB18310600TS	ITABERAI S2	22/10/2020 19:56	22/10/2020 23:30	22/10/2020 19:56	22/10/2020 23:30	3,56	78	277,48	CHI
202010128226	CAMPO LIMPO	AN16408189	NEROPOLIS S1	22/10/2020 19:57	23/10/2020 06:07	22/10/2020 19:57	23/10/2020 06:07	10,17	1684	17118,33	CHI
202010128183	TEREZOPOLIS DE GOIAS	TJ11254542	DAIA S2	22/10/2020 19:58	22/10/2020 21:23	22/10/2020 19:58	22/10/2020 21:23	1,41	9	12,66	CHI
202010128186	ANAPOLIS	10007234609	JUNDIAI S2	22/10/2020 19:59	23/10/2020 08:57	22/10/2020 19:59	23/10/2020 08:57	12,96	1	12,96	CHI
202010125969	APARECIDA DE GOIANIA	10473798	REAL S1	22/10/2020 19:59	23/10/2020 02:27	22/10/2020 19:59	23/10/2020 02:27	6,47	1	6,47	CHI
202010128188	PIRENOPOLIS	PV21196914	SAO FRANCISCO DE GOIAS	22/10/2020 19:59	23/10/2020 17:30	22/10/2020 19:59	23/10/2020 17:30	21,51	1	21,51	CHI
202010128193	ITABERAI	IB21337297	ITABERAI S2	22/10/2020 20:00	23/10/2020 03:54	22/10/2020 20:00	23/10/2020 03:54	7,89	1	7,89	CHI
202010128247	BALIZA	BH21142109	BOM JARDIM	22/10/2020 20:04	22/10/2020 22:19	22/10/2020 20:04	22/10/2020 22:19	2,24	1	2,24	CHI
202010128255	SANTA CRUZ DE GOIAS	CN12180278	CALDAS NOVAS S1	22/10/2020 20:05	22/10/2020 23:02	22/10/2020 20:05	22/10/2020 23:02	2,95	4	11,78	CHI
202010128255	CALDAS NOVAS	CN12180278	CALDAS NOVAS S1	22/10/2020 20:05	22/10/2020 23:02	22/10/2020 20:05	22/10/2020 23:02	2,95	6	17,67	CHI
202010128257	GOIANIA	16542861	GOIANIA LESTE S1	22/10/2020 20:05	23/10/2020 11:37	22/10/2020 20:05	23/10/2020 11:37	15,52	1	15,52	CHI
202010128266	RUBIATABA	10032223267	RUBIATABA	22/10/2020 20:06	23/10/2020 06:54	22/10/2020 20:06	23/10/2020 06:54	10,81	1	10,81	CHI
202010128273	TURVELANDIA	1760003533	RIO DOS BOIS	22/10/2020 20:07	22/10/2020 23:40	22/10/2020 20:07	22/10/2020 23:40	3,55	1	3,55	CHI
202010128694	ITABERAI	IB21310576	ITABERAI S2	22/10/2020 20:07	23/10/2020 07:59	22/10/2020 20:07	23/10/2020 07:59	11,86	2	23,72	CHI
202010128283	SANTA CRUZ DE GOIAS	BC12311644	PIRES DO RIO S2	22/10/2020 20:07	23/10/2020 02:20	22/10/2020 20:07	23/10/2020 02:20	6,20	3	18,60	CHI
202010189334	BALIZA	BH12402901	CAIAPONIA	22/10/2020 20:08	23/10/2020 17:15	22/10/2020 20:08	23/10/2020 17:15	21,10	27	569,80	CHI
202010128289	PALMEIRAS DE GOIAS	PL12000219	PALMEIRAS	22/10/2020 20:08	23/10/2020 21:46	22/10/2020 20:08	23/10/2020 21:46	1,62	6	9,72	CHI
202010128442	CALDAS NOVAS	CN11386832	SERRA DE CALDAS	22/10/2020 20:09	22/10/2020 21:06	22/10/2020 20:09	22/10/2020 21:06	0,94	11	10,39	CHI
202010128293	GOIANIA	GN12387059	CARAJAS S1	22/10/2020 20:09	22/10/2020 21:22	22/10/2020 20:09	22/10/2020 21:22	1,22	13	15,86	CHI
202010128295	URUACU	UR21132627	MARA ROSA	22/10/2020 20:09	23/10/2020 00:07	22/10/2020 20:09	23/10/2020 00:07	3,96	1	3,96	CHI
202010128304	GOIANIA	GN21349601	CAMPINAS S2	22/10/2020 20:10	23/10/2020 04:39	22/10/2020 20:10	23/10/2020 04:39	8,47	1	8,47	CHI
202010128304	GOIANIA	GN12232724	CAMPINAS S2	22/10/2020 20:10	23/10/2020 04:39	22/10/2020 20:10	23/10/2020 04:23	8,21	2	16,42	CHI

202010128308	IPAMERI	580065145	IPAMERI	22/10/2020 20:11	22/10/2020 22:29	22/10/2020 20:11	22/10/2020 22:29	2,29	1	2,29	CHI
202010128326	HEITORAI	HE21307645	ITABERAI S1	22/10/2020 20:12	23/10/2020 01:00	22/10/2020 20:12	23/10/2020 01:00	4,79	1	4,79	CHI
202010128328	ANAPOLIS	20101417	JUNDIAI S2	22/10/2020 20:13	23/10/2020 11:36	22/10/2020 20:13	23/10/2020 11:36	15,38	1	15,38	CHI
202010128333	PONTALINA	PK12074058	VICENTINOPOLIS	22/10/2020 20:14	22/10/2020 21:16	22/10/2020 20:14	22/10/2020 21:16	1,03	20	20,58	CHI
202010128340	GOUVELANDIA	GB31214140	QUIRINOPOLIS	22/10/2020 20:15	22/10/2020 20:44	22/10/2020 20:15	22/10/2020 20:44	0,48	1	0,48	CHI
202010128346	ALTO HORIZONTE	05780224	SANTA TEREZINHA	22/10/2020 20:16	23/10/2020 04:00	22/10/2020 20:16	23/10/2020 04:00	7,73	873	6750,23	CHI
202010129586	MUNDO NOVO DE GOIAS	MH12386622	NOVA CRIXAS	22/10/2020 20:16	23/10/2020 10:21	22/10/2020 20:16	23/10/2020 10:21	14,07	27	379,96	CHI
202010128362	ITABERAI	IB21013361	ITABERAI S2	22/10/2020 20:17	23/10/2020 03:41	22/10/2020 20:17	23/10/2020 03:41	7,39	1	7,39	CHI
202010129047	GOIANIA	GN11085951	REAL S1	22/10/2020 20:17	23/10/2020 00:14	22/10/2020 20:17	23/10/2020 00:14	3,93	68	267,52	CHI
202010128438	GOIANIA	GN16407222	REAL S1	22/10/2020 20:17	23/10/2020 21:53	22/10/2020 20:17	23/10/2020 21:53	1,60	229	366,53	CHI
202010128382	ITABERAI	IB21300287	ITABERAI S2	22/10/2020 20:18	23/10/2020 04:28	22/10/2020 20:18	23/10/2020 04:28	8,15	2	16,31	CHI
202010129036	ALEXANIA	AX11101793	ALEXANIA	22/10/2020 20:19	22/10/2020 22:53	22/10/2020 20:19	22/10/2020 22:53	2,56	47	120,54	CHI
202010129030	GOIANIA	GN11001829	CAMPINAS S3	22/10/2020 20:19	23/10/2020 04:32	22/10/2020 20:19	23/10/2020 04:32	8,21	119	977,55	CHI
202010128397	ANAPOLIS	20558636	JUNDIAI S1	22/10/2020 20:19	23/10/2020 10:51	22/10/2020 20:19	23/10/2020 10:51	14,52	1	14,52	CHI
202010129605	AMARALINA	MH12362454	NOVA CRIXAS	22/10/2020 20:20	23/10/2020 10:16	22/10/2020 20:20	23/10/2020 10:16	13,93	1	13,93	CHI
202010129605	MUNDO NOVO DE GOIAS	MH12362454	NOVA CRIXAS	22/10/2020 20:20	23/10/2020 10:16	22/10/2020 20:20	23/10/2020 10:16	13,93	235	3274,59	CHI
202010128409	RIO VERDE	RV21026918	RIO DOS BOIS	22/10/2020 20:20	23/10/2020 14:12	22/10/2020 20:20	23/10/2020 14:12	17,86	1	17,86	CHI
202010128423	COCALZINHO DE GOIAS	ZN12205828	AGUAS LINDAS DE GOIAS S2	22/10/2020 20:21	23/10/2020 08:24	22/10/2020 20:21	23/10/2020 08:24	12,04	16	192,56	CHI
202010128432	GOIAS	GS21319445	GOIAS	22/10/2020 20:22	23/10/2020 11:35	22/10/2020 20:22	23/10/2020 11:35	15,21	1	15,21	CHI
202010128439	ANAPOLIS	10016254927	JUNDIAI S1	22/10/2020 20:23	23/10/2020 11:43	22/10/2020 20:23	23/10/2020 11:43	15,33	1	15,33	CHI
202010128478	IPAMERI	KR21249267	CRISTALINA S2	22/10/2020 20:27	23/10/2020 05:16	22/10/2020 20:27	23/10/2020 05:16	8,80	1	8,80	CHI
202010128486	CRISTALINA	KR21219771	CRISTALINA S2	22/10/2020 20:28	23/10/2020 07:30	22/10/2020 20:28	23/10/2020 07:30	11,02	1	11,02	CHI
202010128500	APARECIDA DE GOIANIA	16157102	REAL S1	22/10/2020 20:30	22/10/2020 23:34	22/10/2020 20:30	22/10/2020 23:34	3,06	1	3,06	CHI
202010128508	ALEXANIA	10029977922	ALEXANIA	22/10/2020 20:31	23/10/2020 11:50	22/10/2020 20:31	23/10/2020 11:50	15,31	1	15,31	CHI
202010129116	INDIARA	IY12009123	EDEIA	22/10/2020 20:32	23/10/2020 08:47	22/10/2020 20:32	23/10/2020 08:47	12,25	64	783,88	CHI
202010128516	MINEIROS	1390017804	PARQUE DAS EMAS	22/10/2020 20:32	23/10/2020 09:37	22/10/2020 20:32	23/10/2020 09:37	13,07	1	13,07	CHI
202010129417	URUACU	UR12374713	URUACU	22/10/2020 20:33	23/10/2020 07:40	22/10/2020 20:33	23/10/2020 07:40	11,11	3	33,33	CHI
202010129417	HIDROLINA	UR12374713	URUACU	22/10/2020 20:33	23/10/2020 07:40	22/10/2020 20:33	23/10/2020 07:40	11,11	4	44,44	CHI
202010128546	APARECIDA DE GOIANIA	200354838	ANHANGUERA	22/10/2020 20:36	23/10/2020 07:54	22/10/2020 20:36	23/10/2020 07:54	11,30	1	11,30	CHI
202010128652	GOIANIA	17348869	INDEPENDENCIA S2	22/10/2020 20:36	22/10/2020 22:27	22/10/2020 20:36	22/10/2020 22:27	1,85	1	1,85	CHI
202010128919	JARAGUA	JA11382426	JARAGUA	22/10/2020 20:36	23/10/2020 00:36	22/10/2020 20:36	23/10/2020 00:36	3,99	58	231,69	CHI
202010189370	PORANGATU	PO12027986	PORANGATU	22/10/2020 20:38	23/10/2020 04:34	22/10/2020 20:38	23/10/2020 04:34	7,93	17	134,85	CHI
202010189370	PORANGATU	PO12027986	PORANGATU	22/10/2020 20:38	23/10/2020 04:34	22/10/2020 20:38	22/10/2020 23:39	3,02	7	21,12	CHI
202010128575	DAMOLANDIA	NV12382719	INHUMAS S1	22/10/2020 20:39	24/10/2020 04:29	22/10/2020 20:39	24/10/2020 04:29	31,83	3	95,50	CHI
202010128575	NOVA VENEZA	7405511	INHUMAS S1	22/10/2020 20:39	24/10/2020 04:29	22/10/2020 20:39	24/10/2020 04:29	31,83	1	31,83	CHI
202010128575	OURO VERDE DE GOIAS	NV12382719	INHUMAS S1	22/10/2020 20:39	24/10/2020 04:29	22/10/2020 20:39	24/10/2020 04:29	31,83	41	1305,20	CHI
202010128575	NEROPOLIS	NV12382719	INHUMAS S1	22/10/2020 20:39	24/10/2020 04:29	22/10/2020 20:39	24/10/2020 04:29	31,83	2	63,67	CHI
202010128575	NOVA VENEZA	NV12382719	INHUMAS S1	22/10/2020 20:39	24/10/2020 04:29	22/10/2020 20:39	24/10/2020 04:29	31,83	25	795,85	CHI
202010128575	OURO VERDE DE GOIAS	7405511	INHUMAS S1	22/10/2020 20:39	24/10/2020 04:29	23/10/2020 05:18	24/10/2020 04:29	23,20	9	208,77	CHI
202010128575	NOVA VENEZA	7405511	INHUMAS S1	22/10/2020 20:39	24/10/2020 04:29	23/10/2020 05:18	24/10/2020 04:29	23,20	15	347,95	CHI
202010128575	NOVA VENEZA	7405511	INHUMAS S1	22/10/2020 20:39	24/10/2020 04:29	23/10/2020 13:59	24/10/2020 04:29	14,51	33	478,79	CHI
202010128575	NOVA VENEZA	NV12382719	INHUMAS S1	22/10/2020 20:39	24/10/2020 04:29	23/10/2020 13:59	24/10/2020 04:29	14,51	21	304,69	CHI
202010128575	SANTO ANTONIO DE GOIAS	NV12382719	INHUMAS S1	22/10/2020 20:39	24/10/2020 04:29	24/10/2020 02:50	24/10/2020 03:49	0,98	1	0,98	CHI
202010128575	NOVA VENEZA	NV12382719	INHUMAS S1	22/10/2020 20:39	24/10/2020 04:29	24/10/2020 02:50	24/10/2020 03:49	0,98	20	19,65	CHI
202010128575	NOVA VENEZA	NV12382719	INHUMAS S1	22/10/2020 20:39	24/10/2020 04:29	23/10/2020 13:59	23/10/2020 15:52	1,88	20	37,66	CHI
202010128575	SANTO ANTONIO DE GOIAS	NV12382719	INHUMAS S1	22/10/2020 20:39	24/10/2020 04:29	23/10/2020 13:59	23/10/2020 15:52	1,88	1	1,88	CHI
202010128575	NOVA VENEZA	NV12382719	INHUMAS S1	22/10/2020 20:39	24/10/2020 04:29	22/10/2020 20:39	23/10/2020 13:58	17,31	18	311,53	CHI
202010128575	NOVA VENEZA	NV13376801	INHUMAS S1	22/10/2020 20:39	24/10/2020 04:29	23/10/2020 05:18	23/10/2020 13:58	8,67	15	130,05	CHI
202010128575	SANTO ANTONIO DE GOIAS	NV12382719	INHUMAS S1	22/10/2020 20:39	24/10/2020 04:29	22/10/2020 20:39	23/10/2020 12:09	15,50	1	15,50	CHI
202010128575	NOVA VENEZA	NV12382719	INHUMAS S1	22/10/2020 20:39	24/10/2020 04:29	22/10/2020 20:39	23/10/2020 12:09	15,50	36	557,88	CHI
202010128575	NOVA VENEZA	NV12382719	INHUMAS S1	22/10/2020 20:39	24/10/2020 04:29	23/10/2020 05:18	23/10/2020 12:09	6,86	5	34,30	CHI



202010128603	BOM JARDIM DE GOIAS	BM12245130	BOM JARDIM	22/10/2020 20:40	23/10/2020 01:31	22/10/2020 20:40	23/10/2020 01:31	4,84	6	29,04	CHI
202010128603	PIRANHAS	BM12245130	BOM JARDIM	22/10/2020 20:40	23/10/2020 01:31	22/10/2020 20:40	23/10/2020 01:31	4,84	4	19,36	CHI
202010128587	SILVANIA	SV12011755	DAIA S2	22/10/2020 20:40	23/10/2020 02:19	22/10/2020 20:40	23/10/2020 02:19	5,64	6	33,83	CHI
202010128605	APARECIDA DE GOIANIA	AP12002083	INDEPENDENCIA S2	22/10/2020 20:43	22/10/2020 23:55	22/10/2020 20:43	22/10/2020 23:55	3,21	273	874,97	CHI
202010128613	APORE	AE21122786	ITAJA S2	22/10/2020 20:44	22/10/2020 23:58	22/10/2020 20:44	22/10/2020 23:58	3,22	1	3,22	CHI
202010128625	JARAGUA	JA11000029	JARAGUA	22/10/2020 20:45	23/10/2020 07:12	22/10/2020 20:45	23/10/2020 07:12	10,44	94	981,31	CHI
202010128900	SANTO ANTONIO DO DESCOBERTO	SN12192799	AGUAS LINDAS DE GOIAS S2	22/10/2020 20:48	23/10/2020 01:47	22/10/2020 20:48	23/10/2020 01:47	4,97	227	1127,81	CHI
202010128668	LUZIANIA	120195008	MARAJOARA	22/10/2020 20:50	23/10/2020 10:30	22/10/2020 20:50	23/10/2020 10:30	13,66	1	13,66	CHI
202010128682	ALEXANIA	AX21318552	ALEXANIA	22/10/2020 20:52	23/10/2020 14:40	22/10/2020 20:52	23/10/2020 14:40	17,79	1	17,79	CHI
202010128698	PIRENOPOLIS	PV12000464	SAO FRANCISCO DE GOIAS	22/10/2020 20:54	23/10/2020 14:59	22/10/2020 20:54	23/10/2020 14:59	18,08	42	759,56	CHI
202010128706	TRINDADE	TR21119039	TRINDADE	22/10/2020 20:55	23/10/2020 07:38	22/10/2020 20:55	23/10/2020 07:38	10,70	2	21,40	CHI
202010128707	SANTA ROSA DE GOIAS	SR12107586	INHUMAS S1	22/10/2020 20:56	22/10/2020 22:59	22/10/2020 20:56	22/10/2020 22:59	2,04	62	126,58	CHI
202010128708	GOIANIA	17479472	CARAJAS S2	22/10/2020 20:56	23/10/2020 10:24	22/10/2020 20:56	23/10/2020 10:24	13,46	1	13,46	CHI
202010128764	ITABERAI	IB21000141	ITABERAI S2	22/10/2020 21:01	23/10/2020 03:32	22/10/2020 21:01	23/10/2020 03:32	6,51	3	19,53	CHI
202010128816	ORIZONA	OZ11047553	PIRES DO RIO S2	22/10/2020 21:03	22/10/2020 22:54	22/10/2020 21:03	22/10/2020 22:54	1,84	154	283,49	CHI
202010128782	SAO MIGUEL DO ARAGUAIA	SM21138138	SAO MIGUEL DO ARAGUAIA	22/10/2020 21:04	23/10/2020 00:20	22/10/2020 21:04	23/10/2020 00:20	3,25	1	3,25	CHI
202010128920	COCALZINHO DE GOIAS	ZN11000003	COCALZINHO	22/10/2020 21:07	23/10/2020 14:44	22/10/2020 21:07	23/10/2020 14:44	17,62	91	1602,97	CHI
202010129550	CAMPINACU	UC12316380	MARA ROSA	22/10/2020 21:07	23/10/2020 13:12	22/10/2020 21:07	23/10/2020 13:12	16,08	56	900,29	CHI
202010128800	CRISTALINA	IP12100702	CRISTALINA S2	22/10/2020 21:07	23/10/2020 05:16	22/10/2020 21:07	23/10/2020 05:16	8,14	18	146,55	CHI
202010128800	IPAMERI	IP12100702	CRISTALINA S2	22/10/2020 21:07	23/10/2020 05:16	22/10/2020 21:07	23/10/2020 05:16	8,14	8	65,14	CHI
202010128811	ITAJA	Z300000642	ITAJA S2	22/10/2020 21:08	23/10/2020 00:05	22/10/2020 21:08	23/10/2020 00:05	2,94	1	2,94	CHI
202010128819	CUMARI	CT21011275	CATALAO S2	22/10/2020 21:09	23/10/2020 00:58	22/10/2020 21:09	23/10/2020 00:58	3,81	1	3,81	CHI
202010128821	ITABERAI	IB21307434	ITABERAI S2	22/10/2020 21:09	23/10/2020 04:13	22/10/2020 21:09	23/10/2020 04:13	7,05	1	7,05	CHI
202010128825	RIO VERDE	RV12024714	RIO VERDE S1	22/10/2020 21:11	23/10/2020 00:09	22/10/2020 21:11	23/10/2020 00:09	2,97	25	74,13	CHI
202010128835	JATAI	JT12324801	JATAI S1	22/10/2020 21:13	23/10/2020 02:52	22/10/2020 21:13	23/10/2020 02:52	5,64	1	5,64	CHI
202010128836	MONTE ALEGRE DE GOIAS	MA12233169	SAO DOMINGOS	22/10/2020 21:13	23/10/2020 02:54	22/10/2020 21:13	23/10/2020 02:54	5,67	18	102,09	CHI
202010125678	JATAI	JT13248376	JATAI S1	22/10/2020 21:14	24/10/2020 17:26	24/10/2020 11:32	24/10/2020 17:26	5,91	41	242,46	CHI
202010125678	SERRANOPOLIS	JT13306513	JATAI S1	22/10/2020 21:14	24/10/2020 17:26	22/10/2020 22:39	24/10/2020 15:05	40,44	3	121,33	CHI
202010125678	JATAI	JT13306513	JATAI S1	22/10/2020 21:14	24/10/2020 17:26	22/10/2020 22:39	24/10/2020 15:05	40,44	15	606,65	CHI
202010125678	JATAI	JT13306513	JATAI S1	22/10/2020 21:14	24/10/2020 17:26	22/10/2020 23:37	24/10/2020 15:05	39,47	3	118,41	CHI
202010125678	SERRANOPOLIS	JT13306513	JATAI S1	22/10/2020 21:14	24/10/2020 17:26	24/10/2020 00:52	24/10/2020 15:05	14,22	7	99,51	CHI
202010125678	JATAI	JT13306513	JATAI S1	22/10/2020 21:14	24/10/2020 17:26	24/10/2020 00:52	24/10/2020 15:05	14,22	29	412,28	CHI
202010125678	JATAI	JT10400620	JATAI S1	22/10/2020 21:14	24/10/2020 17:26	24/10/2020 08:38	24/10/2020 09:02	0,39	70	27,49	CHI
202010125678	PEROLANDIA	MY10409364	JATAI S1	22/10/2020 21:14	24/10/2020 17:26	24/10/2020 08:38	24/10/2020 08:42	0,06	46	2,72	CHI
202010125678	JATAI	MY10409364	JATAI S1	22/10/2020 21:14	24/10/2020 17:26	24/10/2020 08:38	24/10/2020 08:42	0,06	161	9,53	CHI
202010125678	JATAI	MY10409364	JATAI S1	22/10/2020 21:14	24/10/2020 17:26	24/10/2020 08:38	24/10/2020 08:42	0,06	303	17,93	CHI
202010125678	DOVERLANDIA	MY10409364	CAIAPONIA	22/10/2020 21:14	24/10/2020 17:26	24/10/2020 08:38	24/10/2020 08:42	0,06	3	0,18	CHI
202010125678	JATAI	MY10409364	PARQUE DAS EMAS	22/10/2020 21:14	24/10/2020 17:26	24/10/2020 08:38	24/10/2020 08:42	0,06	29	1,72	CHI
202010125678	PEROLANDIA	MY10409364	JATAI S1	22/10/2020 21:14	24/10/2020 17:26	24/10/2020 08:38	24/10/2020 08:42	0,06	948	56,09	CHI
202010125678	MINEIROS	MY10409364	PARQUE DAS EMAS	22/10/2020 21:14	24/10/2020 17:26	24/10/2020 08:38	24/10/2020 08:42	0,06	26	1,54	CHI
202010125678	CAIAPONIA	MY10409364	JATAI S1	22/10/2020 21:14	24/10/2020 17:26	24/10/2020 08:38	24/10/2020 08:42	0,06	38	2,25	CHI
202010125678	CAIAPONIA	MY10409364	CAIAPONIA	22/10/2020 21:14	24/10/2020 17:26	24/10/2020 08:38	24/10/2020 08:42	0,06	61	3,61	CHI
202010125678	PEROLANDIA	MY10409364	PARQUE DAS EMAS	22/10/2020 21:14	24/10/2020 17:26	24/10/2020 08:38	24/10/2020 08:42	0,06	19	1,12	CHI
202010125678	MINEIROS	MY10409364	JATAI S1	22/10/2020 21:14	24/10/2020 17:26	24/10/2020 08:38	24/10/2020 08:42	0,06	3	0,18	CHI
202010125678	CAIAPONIA	MY10409364	JATAI S1	22/10/2020 21:14	24/10/2020 17:26	24/10/2020 08:38	24/10/2020 08:42	0,06	20	1,18	CHI
202010125678	PEROLANDIA	MY10409364	JATAI S1	22/10/2020 21:14	24/10/2020 17:26	24/10/2020 08:38	24/10/2020 08:42	0,06	136	8,05	CHI
202010125678	PEROLANDIA	MY10409364	JATAI S1	22/10/2020 21:14	24/10/2020 17:26	24/10/2020 08:38	24/10/2020 08:42	0,06	41	2,43	CHI
202010125678	MINEIROS	MY10409364	JATAI S1	22/10/2020 21:14	24/10/2020 17:26	24/10/2020 08:38	24/10/2020 08:42	0,06	2	0,12	CHI
202010125678	JATAI	JT10400620	JATAI S1	22/10/2020 21:14	24/10/2020 17:26	24/10/2020 00:52	24/10/2020 01:34	0,69	70	48,18	CHI
202010125678	PEROLANDIA	JT10400565	JATAI S1	22/10/2020 21:14	24/10/2020 17:26	24/10/2020 00:52	24/10/2020 00:59	0,11	9	0,97	CHI
202010125678	JATAI	JT10400565	JATAI S1	22/10/2020 21:14	24/10/2020 17:26	24/10/2020 00:52	24/10/2020 00:59	0,11	149	16,06	CHI

202010125678	JATAI	JT10400621	JATAI S1	22/10/2020 21:14	24/10/2020 17:26	24/10/2020 00:52	24/10/2020 00:57	0,08	303	25,25	CHI
202010125678	PEROLANDIA	JT10400621	JATAI S1	22/10/2020 21:14	24/10/2020 17:26	24/10/2020 00:52	24/10/2020 00:57	0,08	41	3,42	CHI
202010125678	CAIAPONIA	JT10400621	JATAI S1	22/10/2020 21:14	24/10/2020 17:26	24/10/2020 00:52	24/10/2020 00:57	0,08	38	3,17	CHI
202010125678	MINEIROS	JT10400621	JATAI S1	22/10/2020 21:14	24/10/2020 17:26	24/10/2020 00:52	24/10/2020 00:57	0,08	2	0,17	CHI
202010125678	PEROLANDIA	JT10400621	JATAI S1	22/10/2020 21:14	24/10/2020 17:26	24/10/2020 00:52	24/10/2020 00:57	0,08	136	11,33	CHI
202010125678	PEROLANDIA	JT10400621	JATAI S1	22/10/2020 21:14	24/10/2020 17:26	24/10/2020 00:52	24/10/2020 00:57	0,08	37	3,08	CHI
202010125678	CAIAPONIA	JT10400621	CAIAPONIA	22/10/2020 21:14	24/10/2020 17:26	24/10/2020 00:52	24/10/2020 00:57	0,08	53	4,42	CHI
202010125678	CAIAPONIA	JT10400621	JATAI S1	22/10/2020 21:14	24/10/2020 17:26	24/10/2020 00:52	24/10/2020 00:57	0,08	20	1,67	CHI
202010125678	JATAI	JT10400621	JATAI S1	22/10/2020 21:14	24/10/2020 17:26	24/10/2020 00:52	24/10/2020 00:57	0,08	12	1,00	CHI
202010125678	PEROLANDIA	JT10400621	JATAI S1	22/10/2020 21:14	24/10/2020 17:26	24/10/2020 00:52	24/10/2020 00:57	0,08	948	79,00	CHI
202010125678	DOVERLANDIA	JT10400621	CAIAPONIA	22/10/2020 21:14	24/10/2020 17:26	24/10/2020 00:52	24/10/2020 00:57	0,08	3	0,25	CHI
202010125678	MINEIROS	JT10400621	JATAI S1	22/10/2020 21:14	24/10/2020 17:26	24/10/2020 00:52	24/10/2020 00:57	0,08	3	0,25	CHI
202010125678	JATAI	JT12260447LD	JATAI S1	22/10/2020 21:14	24/10/2020 17:26	22/10/2020 23:21	22/10/2020 23:56	0,59	52	30,48	CHI
202010125678	JATAI	JT10400620	JATAI S1	22/10/2020 21:14	24/10/2020 17:26	22/10/2020 23:37	22/10/2020 23:52	0,24	70	17,11	CHI
202010125678	JATAI	JT13337013	JATAI S1	22/10/2020 21:14	24/10/2020 17:26	22/10/2020 21:14	22/10/2020 21:45	0,52	59	30,45	CHI
202010128844	GOIANIA	10027330786	CARAJAS S2	22/10/2020 21:15	23/10/2020 00:16	22/10/2020 21:15	23/10/2020 00:16	3,02	1	3,02	CHI
202010128851	JATAI	JT21086123	JATAI S1	22/10/2020 21:15	23/10/2020 11:04	22/10/2020 21:15	23/10/2020 11:04	13,80	1	13,80	CHI
202010128852	GOIATUBA	GT11000016	GOIATUBA S2	22/10/2020 21:16	23/10/2020 12:56	22/10/2020 21:16	23/10/2020 12:56	15,66	97	1519,42	CHI
202010128885	GOIANIA	GN11000836	GOIANIA LESTE S1	22/10/2020 21:17	23/10/2020 05:55	22/10/2020 23:27	23/10/2020 05:55	6,47	60	388,07	CHI
202010128885	GOIANIA	00590284	FERROVIARIO S2	22/10/2020 21:17	23/10/2020 05:55	22/10/2020 21:17	23/10/2020 05:35	8,30	193	1602,86	CHI
202010128885	GOIANIA	GN10410484	GOIANIA LESTE S1	22/10/2020 21:17	23/10/2020 05:55	22/10/2020 23:27	23/10/2020 05:12	5,75	1197	6883,08	CHI
202010128885	GOIANIA	00590284	FERROVIARIO S2	22/10/2020 21:17	23/10/2020 05:55	22/10/2020 21:17	22/10/2020 22:52	1,59	605	961,95	CHI
202010128885	GOIANIA	00590284	FERROVIARIO S2	22/10/2020 21:17	23/10/2020 05:55	22/10/2020 21:17	22/10/2020 21:20	0,07	855	55,58	CHI
202010128863	CACHOEIRA ALTA	CA21229345	CACHOEIRA ALTA	22/10/2020 21:18	22/10/2020 23:09	22/10/2020 21:18	22/10/2020 23:09	1,84	1	1,84	CHI
202010128872	FORMOSA	10015725519	ITUIQUIRA	22/10/2020 21:20	22/10/2020 23:45	22/10/2020 21:20	22/10/2020 23:45	2,41	1	2,41	CHI
202010128880	SANTO ANTONIO DO DESCOBERTO	SN21212141	AGUAS LINDAS DE GOIAS S2	22/10/2020 21:21	23/10/2020 12:08	22/10/2020 21:21	23/10/2020 12:08	14,79	1	14,79	CHI
202010128976	FAINA	FC12275448	GOIAS	22/10/2020 21:25	23/10/2020 07:05	22/10/2020 21:25	23/10/2020 07:05	9,66	8	77,32	CHI
202010129063	SANTO ANTONIO DO DESCOBERTO	SN12214872	ALEXANIA	22/10/2020 21:27	23/10/2020 02:35	22/10/2020 21:27	23/10/2020 02:35	5,12	298	1526,67	CHI
202010128917	PORTELANDIA	PW21043920	PARQUE DAS EMAS	22/10/2020 21:28	23/10/2020 10:29	22/10/2020 21:28	23/10/2020 10:29	13,01	1	13,01	CHI
202010128921	ITUMBIARA	IT21034370	CACHOEIRA DOURADA	22/10/2020 21:30	23/10/2020 00:45	22/10/2020 21:30	23/10/2020 00:45	3,25	1	3,25	CHI
202010128923	IPAMERI	IP21071414	IPAMERI	22/10/2020 21:30	23/10/2020 03:11	22/10/2020 21:30	23/10/2020 03:11	5,68	1	5,68	CHI
202010129981	CORUMBA DE GOIAS	AX12377762RE	ALEXANIA	22/10/2020 21:32	23/10/2020 10:19	22/10/2020 21:32	23/10/2020 10:19	12,77	3	38,32	CHI
202010129981	ALEXANIA	AX12377762RE	ALEXANIA	22/10/2020 21:32	23/10/2020 10:19	22/10/2020 21:32	23/10/2020 10:19	12,77	37	472,55	CHI
202010128956	ANAPOLIS	21316363	JUNDIAI S1	22/10/2020 21:37	23/10/2020 11:46	22/10/2020 21:37	23/10/2020 11:46	14,14	1	14,14	CHI
202010128965	APARECIDA DE GOIANIA	16716190	INDEPENDENCIA S1	22/10/2020 21:40	23/10/2020 11:27	22/10/2020 21:40	23/10/2020 11:27	13,77	1	13,77	CHI
202010128971	IPAMERI	IP12359101	IPAMERI	22/10/2020 21:42	23/10/2020 06:12	22/10/2020 21:42	23/10/2020 06:12	8,50	6	50,98	CHI
202010128983	GOIANIA	14179350	ATLANTICO S2	22/10/2020 21:45	23/10/2020 13:50	22/10/2020 21:45	23/10/2020 13:50	16,07	1	16,07	CHI
202010130725	FORMOSA	2970000654	ITUIQUIRA	22/10/2020 21:57	23/10/2020 10:22	22/10/2020 21:57	23/10/2020 10:22	12,40	1	12,40	CHI
202010129013	CAMPO LIMPO	AN21077962	NEROPOLIS S1	22/10/2020 21:58	23/10/2020 11:22	22/10/2020 21:58	23/10/2020 11:22	13,40	2	26,80	CHI
202010129015	ALEXANIA	AX21000099	ALEXANIA	22/10/2020 21:59	23/10/2020 12:00	22/10/2020 21:59	23/10/2020 12:00	14,01	1	14,01	CHI
202010129016	FAZENDA NOVA	FN21119481	IPORA	22/10/2020 21:59	23/10/2020 09:28	22/10/2020 21:59	23/10/2020 09:28	11,47	1	11,47	CHI
202010129019	GOIANIA	10021236192	GOYA S1	22/10/2020 22:01	23/10/2020 02:33	22/10/2020 22:01	23/10/2020 02:33	4,53	1	4,53	CHI
202010129493	NOVA IGUACU DE GOIAS	NH12317131	CAMPINORTE	22/10/2020 22:02	23/10/2020 12:05	22/10/2020 22:02	23/10/2020 12:05	14,04	46	645,81	CHI
202010129041	JARAGUA	JA21039348	GOIANESIA S2	22/10/2020 22:06	23/10/2020 14:47	22/10/2020 22:06	23/10/2020 14:47	16,68	1	16,68	CHI
2020102200101	SAO FRANCISCO DE GOIAS	03160414	SAO FRANCISCO DE GOIAS	22/10/2020 22:07	22/10/2020 22:51	22/10/2020 22:07	22/10/2020 22:51	0,73	25	18,33	CHI
2020102200101	PIRENOPOLIS	53901	SAO FRANCISCO DE GOIAS	22/10/2020 22:07	22/10/2020 22:51	22/10/2020 22:07	22/10/2020 22:51	0,73	1142	837,47	CHI
2020102200101	PETROLINA DE GOIAS	53901	SAO FRANCISCO DE GOIAS	22/10/2020 22:07	22/10/2020 22:51	22/10/2020 22:07	22/10/2020 22:51	0,73	10	7,33	CHI
2020102200101	PETROLINA DE GOIAS	03160414	SAO FRANCISCO DE GOIAS	22/10/2020 22:07	22/10/2020 22:51	22/10/2020 22:07	22/10/2020 22:51	0,73	3	2,20	CHI
2020102200101	PETROLINA DE GOIAS	53902	SAO FRANCISCO DE GOIAS	22/10/2020 22:07	22/10/2020 22:51	22/10/2020 22:07	22/10/2020 22:51	0,73	3	2,20	CHI
2020102200101	PIRENOPOLIS	53902	SAO FRANCISCO DE GOIAS	22/10/2020 22:07	22/10/2020 22:51	22/10/2020 22:07	22/10/2020 22:51	0,73	336	246,40	CHI
2020102200101	PIRENOPOLIS	03160414	SAO FRANCISCO DE GOIAS	22/10/2020 22:07	22/10/2020 22:51	22/10/2020 22:07	22/10/2020 22:51	0,73	1	0,73	CHI

2020102200101	SAO FRANCISCO DE GOIAS	53901	SAO FRANCISCO DE GOIAS	22/10/2020 22:07	22/10/2020 22:51	22/10/2020 22:07	22/10/2020 22:51	0,73	21	15,40	CHI
2020102200102	JARAGUA	47401	SAO FRANCISCO DE GOIAS	22/10/2020 22:07	22/10/2020 22:49	22/10/2020 22:07	22/10/2020 22:49	0,70	22	15,40	CHI
2020102200102	SAO FRANCISCO DE GOIAS	03160424	SAO FRANCISCO DE GOIAS	22/10/2020 22:07	22/10/2020 22:49	22/10/2020 22:07	22/10/2020 22:49	0,70	1	0,70	CHI
2020102200102	JESUPOLIS	47401	SAO FRANCISCO DE GOIAS	22/10/2020 22:07	22/10/2020 22:49	22/10/2020 22:07	22/10/2020 22:49	0,70	980	686,00	CHI
2020102200102	PETROLINA DE GOIAS	47401	SAO FRANCISCO DE GOIAS	22/10/2020 22:07	22/10/2020 22:49	22/10/2020 22:07	22/10/2020 22:49	0,70	1	0,70	CHI
2020102200102	JESUPOLIS	47402	SAO FRANCISCO DE GOIAS	22/10/2020 22:07	22/10/2020 22:49	22/10/2020 22:07	22/10/2020 22:49	0,70	156	109,20	CHI
2020102200102	SAO FRANCISCO DE GOIAS	47402	SAO FRANCISCO DE GOIAS	22/10/2020 22:07	22/10/2020 22:49	22/10/2020 22:07	22/10/2020 22:49	0,70	87	60,90	CHI
202010129249	RIO VERDE	RV11189197	SANTA HELENA S1	22/10/2020 22:07	23/10/2020 11:02	22/10/2020 22:07	23/10/2020 11:02	12,91	87	1123,34	CHI
202010129629	SERRANOPOLIS	SX12390596	JATAI S1	22/10/2020 22:07	23/10/2020 08:31	22/10/2020 22:07	23/10/2020 08:31	10,38	30	311,52	CHI
202010129048	CIDADE OCIDENTAL	DH11199613	MARAJOARA	22/10/2020 22:09	23/10/2020 03:18	22/10/2020 22:09	23/10/2020 03:18	5,14	81	416,63	CHI
202010129054	DISTRITO FEDERAL	2900098343	MARAJOARA	22/10/2020 22:13	23/10/2020 15:16	22/10/2020 22:13	23/10/2020 15:16	17,05	1	17,05	CHI
202010129061	PILAR DE GOIAS	GG11350217	URUACU	22/10/2020 22:16	23/10/2020 07:40	22/10/2020 22:16	23/10/2020 07:40	9,39	30	281,81	CHI
202010129070	SENADOR CANEDO	10024202990	SENADOR CANEDO	22/10/2020 22:18	22/10/2020 23:39	22/10/2020 22:18	22/10/2020 23:39	1,34	1	1,34	CHI
202010129079	NIQUELANDIA	10010006450	NIQUELANDIA SUBTRANSMISSAO	22/10/2020 22:23	23/10/2020 14:48	22/10/2020 22:23	23/10/2020 14:48	16,41	1	16,41	CHI
202010129084	COLINAS DO SUL	5300000405	MINACU	22/10/2020 22:25	23/10/2020 05:57	22/10/2020 22:25	23/10/2020 05:57	7,53	1	7,53	CHI
202010129088	GOIANIA	GN11066001	GOIANIA LESTE S1	22/10/2020 22:27	23/10/2020 00:26	22/10/2020 22:27	23/10/2020 00:26	1,98	21	41,55	CHI
202010129089	MONTIVIDIU DO NORTE	MX12088676	PORANGATU	22/10/2020 22:27	23/10/2020 03:14	22/10/2020 22:27	23/10/2020 03:14	4,77	2	9,54	CHI
202010129100	MINACU	IH12236146	MINACU	22/10/2020 22:31	23/10/2020 10:53	22/10/2020 22:31	23/10/2020 10:53	12,36	2	24,72	CHI
202010129145	AGUA FRIA DE GOIAS	MJ21151982	PADRE BERNARDO	22/10/2020 22:44	23/10/2020 12:37	22/10/2020 22:44	23/10/2020 12:37	13,87	1	13,87	CHI
202010129151	TRINDADE	TR21239685	TRINDADE	22/10/2020 22:47	23/10/2020 01:23	22/10/2020 22:47	23/10/2020 01:23	2,59	2	5,18	CHI
202010129152	CACHOEIRA ALTA	CA12013266	CACHOEIRA ALTA	22/10/2020 22:48	23/10/2020 12:21	22/10/2020 22:48	23/10/2020 12:21	13,57	16	217,05	CHI
202010129165	PIRACANJUBA	PJ21084957	CALDAS NOVAS S1	22/10/2020 22:53	23/10/2020 11:37	22/10/2020 22:53	23/10/2020 11:37	12,72	1	12,72	CHI
202010129168	APORE	AE12324797	ITAJA S1	22/10/2020 22:56	23/10/2020 12:10	22/10/2020 22:56	23/10/2020 12:10	13,23	11	145,56	CHI
202010129168	SERRANOPOLIS	AE12324797	ITAJA S1	22/10/2020 22:56	23/10/2020 12:10	22/10/2020 22:56	23/10/2020 12:10	13,23	8	105,86	CHI
202010129174	FORMOSA	FA21326275	ITUIQUIRA	22/10/2020 22:59	23/10/2020 01:53	22/10/2020 22:59	23/10/2020 01:53	2,90	1	2,90	CHI
202010129188	BARRO ALTO	BA21342222	GOIANESIA S1	22/10/2020 23:09	23/10/2020 16:46	22/10/2020 23:09	23/10/2020 16:46	17,62	1	17,62	CHI
202010129195	APARECIDA DE GOIANIA	200505816	ANHANGUERA	22/10/2020 23:14	23/10/2020 10:02	22/10/2020 23:14	23/10/2020 10:02	10,80	1	10,80	CHI
202010129244	MONTES CLAROS DE GOIAS	ME11023313	IPORA	22/10/2020 23:20	23/10/2020 05:18	22/10/2020 23:20	23/10/2020 05:18	5,95	117	696,51	CHI
202010129207	MINEIROS	MY12296343	PARQUE DAS EMAS	22/10/2020 23:25	23/10/2020 10:26	22/10/2020 23:25	23/10/2020 10:26	11,01	8	88,08	CHI
202010129213	ARAGARCAS	10002241330	ARAGARCAS	22/10/2020 23:31	23/10/2020 07:26	22/10/2020 23:31	23/10/2020 07:26	7,93	1	7,93	CHI
202010130319	BALIZA	BH12331370	CAIAPONIA	22/10/2020 23:34	23/10/2020 13:54	22/10/2020 23:34	23/10/2020 13:54	14,33	13	186,29	CHI
202010129243	SANTA TEREZA DE GOIAS	2430001051	MARA ROSA	22/10/2020 23:53	23/10/2020 02:46	22/10/2020 23:53	23/10/2020 02:46	2,88	1	2,88	CHI
202010129245	CATALAO	CT21267023	CATALAO S1	22/10/2020 23:55	23/10/2020 01:35	22/10/2020 23:55	23/10/2020 01:35	1,66	1	1,66	CHI
202010129246	HIDROLANDIA	HD11251854	CEPAIGO S2	22/10/2020 23:56	23/10/2020 09:04	22/10/2020 23:56	23/10/2020 09:04	9,12	81	738,90	CHI
202010129254	SAO MIGUEL DO ARAGUAIA	SM12000065	SAO MIGUEL DO ARAGUAIA	23/10/2020 00:06	23/10/2020 02:27	23/10/2020 00:06	23/10/2020 02:27	2,34	25	58,51	CHI
202010129389	BALIZA	BH12210020	BOM JARDIM	23/10/2020 00:10	23/10/2020 07:16	23/10/2020 00:10	23/10/2020 07:16	7,09	93	659,68	CHI
202010129264	GOIANIA	GN12100381	XAVANTES	23/10/2020 00:19	23/10/2020 02:42	23/10/2020 00:19	23/10/2020 02:42	2,37	1	2,37	CHI
202010130106	PADRE BERNARDO	PB12377293	PADRE BERNARDO	23/10/2020 00:52	23/10/2020 09:45	23/10/2020 00:52	23/10/2020 09:45	8,87	12	106,43	CHI
202010129292	PARANAIGUARA	PC12000076	CACHOEIRA ALTA	23/10/2020 01:05	23/10/2020 07:47	23/10/2020 01:05	23/10/2020 07:47	6,69	5	33,43	CHI
202010129292	CACHOEIRA ALTA	PC12000076	CACHOEIRA ALTA	23/10/2020 01:05	23/10/2020 07:47	23/10/2020 01:05	23/10/2020 07:47	6,69	8	53,48	CHI
202010129355	APARECIDA DE GOIANIA	AP11081166	INDEPENDENCIA S2	23/10/2020 01:35	23/10/2020 08:21	23/10/2020 01:35	23/10/2020 08:21	6,76	192	1297,81	CHI
202010129311	SANTA FE DE GOIAS	RN12346779LD	BRITANIA	23/10/2020 01:54	23/10/2020 17:31	23/10/2020 01:54	23/10/2020 17:31	15,62	5	78,08	CHI
202010129311	ITAPIRAPUA	RN10396175	BRITANIA	23/10/2020 01:54	23/10/2020 17:31	23/10/2020 16:00	23/10/2020 16:57	0,97	2	1,93	CHI
202010129311	SANTA FE DE GOIAS	RN10396175	BRITANIA	23/10/2020 01:54	23/10/2020 17:31	23/10/2020 16:00	23/10/2020 16:57	0,97	29	27,99	CHI
202010129311	SANTA FE DE GOIAS	02700414	BRITANIA	23/10/2020 01:54	23/10/2020 17:31	23/10/2020 16:24	23/10/2020 16:57	0,55	38	20,86	CHI
202010129311	JUSSARA	02700414	BRITANIA	23/10/2020 01:54	23/10/2020 17:31	23/10/2020 16:24	23/10/2020 16:57	0,55	10	5,49	CHI
202010129311	ITAPIRAPUA	RN10396175	BRITANIA	23/10/2020 01:54	23/10/2020 17:31	23/10/2020 01:54	23/10/2020 15:27	13,55	2	27,10	CHI
202010129311	SANTA FE DE GOIAS	RN10396175	BRITANIA	23/10/2020 01:54	23/10/2020 17:31	23/10/2020 01:54	23/10/2020 15:27	13,55	6	81,30	CHI
202010129311	SANTA FE DE GOIAS	RN10396175	BRITANIA	23/10/2020 01:54	23/10/2020 17:31	23/10/2020 14:57	23/10/2020 15:27	0,51	23	11,70	CHI
202010129311	SANTA FE DE GOIAS	RN12159290LD	BRITANIA	23/10/2020 01:54	23/10/2020 17:31	23/10/2020 01:54	23/10/2020 13:43	11,80	8	94,44	CHI
202010129311	SANTA FE DE GOIAS	RN10396175	BRITANIA	23/10/2020 01:54	23/10/2020 17:31	23/10/2020 01:54	23/10/2020 12:04	10,16	15	152,41	CHI

202010129310	CHAPADAO DO CEU	DJ13216639	CHAPADAO DO CEU	23/10/2020 02:02	23/10/2020 05:27	23/10/2020 02:02	23/10/2020 05:27	3,43	1	3,43	CHI
202010129366	FAINA	FC11083684	GOIAS	23/10/2020 02:12	23/10/2020 08:43	23/10/2020 02:12	23/10/2020 08:43	6,51	142	923,95	CHI
202010129315	ACREUNA	EU21361036	ACREUNA	23/10/2020 02:15	23/10/2020 13:12	23/10/2020 02:15	23/10/2020 13:12	10,94	1	10,94	CHI
202010129318	GOIAS	GS11103771	GOIAS	23/10/2020 02:32	23/10/2020 08:05	23/10/2020 02:32	23/10/2020 08:05	5,54	107	592,51	CHI
202010129744	BELA VISTA DE GOIAS	BV32037980	BELA VISTA S1	23/10/2020 02:45	23/10/2020 10:20	23/10/2020 02:45	23/10/2020 10:20	7,58	4	30,31	CHI
202010129334	MARA ROSA	ET12256314	MARA ROSA	23/10/2020 03:02	23/10/2020 13:39	23/10/2020 03:02	23/10/2020 13:39	10,61	8	84,86	CHI
202010129337	BARRO ALTO	SJ12006466	GOIANESIA S1	23/10/2020 03:19	23/10/2020 08:08	23/10/2020 03:19	23/10/2020 08:08	4,81	1	4,81	CHI
202010129337	GOIANESIA	SJ12006466	GOIANESIA S1	23/10/2020 03:19	23/10/2020 08:08	23/10/2020 03:19	23/10/2020 08:08	4,81	8	38,51	CHI
202010129337	VILA PROPICIO	SJ12006466	GOIANESIA S1	23/10/2020 03:19	23/10/2020 08:08	23/10/2020 03:19	23/10/2020 08:08	4,81	1	4,81	CHI
202010129343	ITAPIRAPUA	GS12217234	MATRINCHA	23/10/2020 03:43	23/10/2020 15:20	23/10/2020 03:43	23/10/2020 15:20	11,61	1	11,61	CHI
202010129343	NOVO BRASIL	GS12217234	MATRINCHA	23/10/2020 03:43	23/10/2020 15:20	23/10/2020 03:43	23/10/2020 15:20	11,61	36	417,81	CHI
202010129343	GOIAS	GS12217234	MATRINCHA	23/10/2020 03:43	23/10/2020 15:20	23/10/2020 03:43	23/10/2020 15:20	11,61	37	429,42	CHI
202010129343	GOIAS	GS12217234	MATRINCHA	23/10/2020 03:43	23/10/2020 15:20	23/10/2020 03:43	23/10/2020 10:35	6,86	47	322,22	CHI
202010129435	GOIANDIRA	CT12399850	CATALAO S1	23/10/2020 03:53	23/10/2020 07:44	23/10/2020 03:53	23/10/2020 07:44	3,85	40	154,00	CHI
202010129435	CATALAO	CT12399850	CATALAO S1	23/10/2020 03:53	23/10/2020 07:44	23/10/2020 03:53	23/10/2020 07:44	3,85	54	207,90	CHI
202010129577	GOIANIA	GN12383183	XAVANTES	23/10/2020 03:58	23/10/2020 09:51	23/10/2020 03:58	23/10/2020 09:51	5,88	240	1411,07	CHI
202010129352	IPORA	IR12038307	IPORA	23/10/2020 04:04	23/10/2020 14:25	23/10/2020 04:04	23/10/2020 14:25	10,35	21	217,30	CHI
202010129352	IPORA	IR12038307	IPORA	23/10/2020 04:04	23/10/2020 14:25	23/10/2020 14:00	23/10/2020 14:25	0,42	34	14,22	CHI
202010129352	IPORA	IR12038307	IPORA	23/10/2020 04:04	23/10/2020 14:25	23/10/2020 04:04	23/10/2020 13:40	9,60	11	105,57	CHI
202010129352	IPORA	IR12038307	IPORA	23/10/2020 04:04	23/10/2020 14:25	23/10/2020 04:04	23/10/2020 11:00	6,93	23	159,40	CHI
202010129361	NOVO BRASIL	NB12099383	JUSSARA	23/10/2020 04:19	23/10/2020 08:13	23/10/2020 04:19	23/10/2020 08:13	3,89	8	31,11	CHI
202010129367	BALIZA	BH12358780	BOM JARDIM	23/10/2020 04:28	23/10/2020 10:08	23/10/2020 04:28	23/10/2020 10:08	5,66	19	107,48	CHI
202010129370	URUTAI	UT12115680	PIRES DO RIO S2	23/10/2020 04:33	23/10/2020 08:02	23/10/2020 04:33	23/10/2020 08:02	3,47	34	118,02	CHI
202010129424	ARENOPOLIS	AY12040870	ARENOPOLIS	23/10/2020 04:34	23/10/2020 10:45	23/10/2020 04:34	23/10/2020 10:45	6,19	23	142,42	CHI
202010129372	RIO QUENTE	RQ11092084	RIO QUENTE	23/10/2020 04:36	23/10/2020 11:47	23/10/2020 04:36	23/10/2020 11:47	7,18	14	100,47	CHI
202010130168	URUACU	MQ12181177	MARA ROSA	23/10/2020 04:58	23/10/2020 10:13	23/10/2020 04:58	23/10/2020 10:13	5,25	1	5,25	CHI
202010130168	MARA ROSA	MQ12181177	MARA ROSA	23/10/2020 04:58	23/10/2020 10:13	23/10/2020 04:58	23/10/2020 10:13	5,25	28	146,89	CHI
202010130168	ALTO HORIZONTE	MQ12181177	MARA ROSA	23/10/2020 04:58	23/10/2020 10:13	23/10/2020 04:58	23/10/2020 10:13	5,25	3	15,74	CHI
202010129501	CORUMBAIBA	CI12000459RE	VILA CORUMBA	23/10/2020 05:10	23/10/2020 07:21	23/10/2020 05:10	23/10/2020 07:21	2,17	33	71,55	CHI
202010131302	PILAR DE GOIAS	GG12100377	SANTA TEREZINHA	23/10/2020 05:11	23/10/2020 11:33	23/10/2020 05:11	23/10/2020 11:33	6,36	2	12,71	CHI
202010130509	NOVA VENEZA	NV12200061	INHUMAS S1	23/10/2020 05:12	23/10/2020 11:17	23/10/2020 05:12	23/10/2020 11:17	6,07	279	1693,53	CHI
202010129452	GOIAS	GS12206884	GOIAS	23/10/2020 05:15	23/10/2020 10:11	23/10/2020 05:15	23/10/2020 10:11	4,92	16	78,78	CHI
202010129412	ANICUNS	AC21304676	FIRMINOPOLIS S2	23/10/2020 05:18	23/10/2020 07:30	23/10/2020 05:18	23/10/2020 07:30	2,20	2	4,39	CHI
202010129413	SILVANIA	SV12205367	VIANOPOLIS	23/10/2020 05:18	23/10/2020 07:57	23/10/2020 05:18	23/10/2020 07:57	2,65	14	37,03	CHI
202010129448	RIO QUENTE	RQ12263111	VILA CORUMBA	23/10/2020 05:19	23/10/2020 09:21	23/10/2020 05:19	23/10/2020 09:21	4,03	15	60,41	CHI
202010129448	MORRINHOS	RQ12263111	VILA CORUMBA	23/10/2020 05:19	23/10/2020 09:21	23/10/2020 05:19	23/10/2020 09:21	4,03	5	20,14	CHI
202010129448	AGUA LIMPA	RQ12263111	VILA CORUMBA	23/10/2020 05:19	23/10/2020 09:21	23/10/2020 05:19	23/10/2020 09:21	4,03	9	36,25	CHI
202010129928	ALTO HORIZONTE	AJ12384910RE	MARA ROSA	23/10/2020 05:19	23/10/2020 15:43	23/10/2020 05:19	23/10/2020 15:43	10,39	36	374,12	CHI
202010129928	MARA ROSA	AJ12384910RE	MARA ROSA	23/10/2020 05:19	23/10/2020 15:43	23/10/2020 05:19	23/10/2020 15:43	10,39	5	51,96	CHI
202010130617	JUSSARA	NB12020225	JUSSARA	23/10/2020 05:22	23/10/2020 11:30	23/10/2020 05:22	23/10/2020 11:30	6,12	1	6,12	CHI
202010130617	NOVO BRASIL	NB12020225	JUSSARA	23/10/2020 05:22	23/10/2020 11:30	23/10/2020 05:22	23/10/2020 11:30	6,12	40	244,77	CHI
202010130617	FAZENDA NOVA	NB12020225	JUSSARA	23/10/2020 05:22	23/10/2020 11:30	23/10/2020 05:22	23/10/2020 11:30	6,12	38	232,53	CHI
202010130617	HEITORAI	NB12020225	JUSSARA	23/10/2020 05:22	23/10/2020 11:30	23/10/2020 05:22	23/10/2020 11:30	6,12	1	6,12	CHI
202010130021	ALTO HORIZONTE	AJ11295204	SANTA TEREZINHA	23/10/2020 05:22	23/10/2020 15:23	23/10/2020 14:55	23/10/2020 15:23	0,46	93	42,57	CHI
202010130021	ALTO HORIZONTE	05780224	SANTA TEREZINHA	23/10/2020 05:22	23/10/2020 15:23	23/10/2020 05:22	23/10/2020 14:50	9,46	874	8266,34	CHI
202010129422	PLANALTINA	PI12131795	PLANALTINA	23/10/2020 05:23	23/10/2020 07:59	23/10/2020 05:23	23/10/2020 07:59	2,59	7	18,10	CHI
202010129425	QUIRINOPOLIS	QI12303193	RIO DOS BOIS	23/10/2020 05:24	23/10/2020 08:37	23/10/2020 05:24	23/10/2020 08:37	3,20	4	12,81	CHI
202010129975	NOVA IGUACU DE GOIAS	MQ12146959	MARA ROSA	23/10/2020 05:26	23/10/2020 12:19	23/10/2020 05:26	23/10/2020 12:19	6,88	12	82,57	CHI
202010129975	MARA ROSA	MQ12146959	MARA ROSA	23/10/2020 05:26	23/10/2020 12:19	23/10/2020 05:26	23/10/2020 12:19	6,88	11	75,69	CHI
202010129434	GOIATUBA	3320001939	RIO DOS BOIS	23/10/2020 05:29	23/10/2020 08:56	23/10/2020 05:29	23/10/2020 08:56	3,45	1	3,45	CHI
202010129442	MUTUNOPOLIS	PO21240661	PORANGATU	23/10/2020 05:33	23/10/2020 09:28	23/10/2020 05:33	23/10/2020 09:28	3,91	1	3,91	CHI

202010129447	CHAPADAO DO CEU	DJ13066107	CHAPADAO DO CEU	23/10/2020 05:33	23/10/2020 13:30	23/10/2020 05:33	23/10/2020 13:30	7,95	1	7,95	CHI
202010129447	CHAPADAO DO CEU	DJ13066107	CHAPADAO DO CEU	23/10/2020 05:33	23/10/2020 13:30	23/10/2020 10:24	23/10/2020 13:30	3,09	13	40,14	CHI
202010129453	PALMEIRAS DE GOIAS	PL12000219	PALMEIRAS	23/10/2020 05:37	23/10/2020 13:00	23/10/2020 05:37	23/10/2020 13:00	7,38	12	88,62	CHI
202010130251	MINEIROS	MY12042996RE	PARQUE DAS EMAS	23/10/2020 05:44	24/10/2020 15:30	24/10/2020 11:43	24/10/2020 15:30	3,78	17	64,25	CHI
202010130251	MINEIROS	MY12278425LD	PARQUE DAS EMAS	23/10/2020 05:44	24/10/2020 15:30	23/10/2020 05:44	24/10/2020 15:10	33,43	5	167,14	CHI
202010130251	MINEIROS	MY12303454RE	PARQUE DAS EMAS	23/10/2020 05:44	24/10/2020 15:30	23/10/2020 05:44	23/10/2020 13:40	7,93	7	55,53	CHI
202010129477	GOIANIA	GN11297210	INDEPENDENCIA S2	23/10/2020 05:44	23/10/2020 11:37	23/10/2020 05:44	23/10/2020 11:37	5,87	71	416,79	CHI
202010129480	JATAI	JT12182190	JATAI S1	23/10/2020 05:47	24/10/2020 13:46	23/10/2020 05:47	24/10/2020 13:46	31,97	1	31,97	CHI
202010129480	JATAI	JT12182190	JATAI S1	23/10/2020 05:47	24/10/2020 13:46	23/10/2020 05:47	23/10/2020 09:52	4,08	24	97,93	CHI
202010130073	ADELANDIA	DN12039706	FIRMINOPOLIS S2	23/10/2020 05:49	23/10/2020 15:15	23/10/2020 05:49	23/10/2020 15:15	9,44	1	9,44	CHI
202010130073	SAO LUIS DE MONTES BELOS	DN12039706	FIRMINOPOLIS S2	23/10/2020 05:49	23/10/2020 15:15	23/10/2020 05:49	23/10/2020 15:15	9,44	5	47,18	CHI
202010130073	TURVANIA	DN12039706	FIRMINOPOLIS S2	23/10/2020 05:49	23/10/2020 15:15	23/10/2020 11:02	23/10/2020 15:15	4,22	2	8,43	CHI
202010130073	ADELANDIA	DN12039706	FIRMINOPOLIS S2	23/10/2020 05:49	23/10/2020 15:15	23/10/2020 11:02	23/10/2020 15:15	4,22	3	12,65	CHI
202010130073	SAO LUIS DE MONTES BELOS	DN12039706	FIRMINOPOLIS S2	23/10/2020 05:49	23/10/2020 15:15	23/10/2020 11:02	23/10/2020 15:15	4,22	33	139,15	CHI
202010130073	SAO LUIS DE MONTES BELOS	DN12039706	FIRMINOPOLIS S2	23/10/2020 05:49	23/10/2020 15:15	23/10/2020 05:49	23/10/2020 10:58	5,16	33	170,29	CHI
202010130073	ADELANDIA	DN12039706	FIRMINOPOLIS S2	23/10/2020 05:49	23/10/2020 15:15	23/10/2020 05:49	23/10/2020 10:58	5,16	3	15,48	CHI
202010130073	TURVANIA	DN12039706	FIRMINOPOLIS S2	23/10/2020 05:49	23/10/2020 15:15	23/10/2020 05:49	23/10/2020 10:58	5,16	2	10,32	CHI
202010130073	SAO LUIS DE MONTES BELOS	DN12039706	FIRMINOPOLIS S2	23/10/2020 05:49	23/10/2020 15:15	23/10/2020 05:49	23/10/2020 09:40	3,85	1	3,85	CHI
202010129486	PARANAIGUARA	PC21312293	QUIRINOPOLIS	23/10/2020 05:49	23/10/2020 08:53	23/10/2020 05:49	23/10/2020 08:53	3,05	1	3,05	CHI
202010129496	CROMINIA	CQ21161574	PONTALINA	23/10/2020 05:54	23/10/2020 13:35	23/10/2020 05:54	23/10/2020 13:35	7,67	1	7,67	CHI
202010130036	MARA ROSA	MQ12135696	MARA ROSA	23/10/2020 05:56	23/10/2020 09:05	23/10/2020 05:56	23/10/2020 09:05	3,14	10	31,40	CHI
202010129056	PONTALINA	PK12074320	VICENTINOPOLIS	23/10/2020 05:57	23/10/2020 09:31	23/10/2020 05:57	23/10/2020 09:31	3,56	18	64,10	CHI
202010129992	SANTA CRUZ DE GOIAS	BC12110028RE	PIRES DO RIO S2	23/10/2020 05:57	23/10/2020 09:29	23/10/2020 05:57	23/10/2020 09:29	3,52	20	70,37	CHI
202010129516	ALTO PARAISO DE GOIAS	BF21144685	SAO JOAO D ALIANCA	23/10/2020 06:01	23/10/2020 09:01	23/10/2020 06:01	23/10/2020 09:01	2,99	1	2,99	CHI
202010129949	PIRENOPOLIS	JA12059976	JARAGUA	23/10/2020 06:01	24/10/2020 14:30	23/10/2020 06:01	24/10/2020 14:30	32,48	36	1169,13	CHI
202010129949	JARAGUA	JA12059976	JARAGUA	23/10/2020 06:01	24/10/2020 14:30	23/10/2020 06:01	23/10/2020 13:03	7,03	2	14,06	CHI
202010129949	PIRENOPOLIS	JA12059976	JARAGUA	23/10/2020 06:01	24/10/2020 14:30	23/10/2020 06:01	23/10/2020 13:03	7,03	61	428,97	CHI
202010129524	GOIANIA	11581219	GOIANIA LESTE S1	23/10/2020 06:03	23/10/2020 10:22	23/10/2020 06:03	23/10/2020 10:22	4,32	1	4,32	CHI
202010129525	CALDAS NOVAS	CN12363792	SERRA DE CALDAS	23/10/2020 06:03	23/10/2020 07:51	23/10/2020 06:03	23/10/2020 07:51	1,80	130	233,46	CHI
202010129529	SAO LUIZ DO NORTE	SZ21317074	GOIANESIA S1	23/10/2020 06:03	23/10/2020 11:01	23/10/2020 06:03	23/10/2020 11:01	4,96	1	4,96	CHI
202010129537	GOIANIA	GS12299699	GOIAS	23/10/2020 06:05	23/10/2020 10:30	23/10/2020 06:05	23/10/2020 10:30	4,41	32	141,16	CHI
202010129539	GOIANIA	10005818280	GOYA S2	23/10/2020 06:06	23/10/2020 11:16	23/10/2020 06:06	23/10/2020 11:16	5,16	1	5,16	CHI
202010129544	GOIANIA	10489289	GOIANIA LESTE S3	23/10/2020 06:06	23/10/2020 09:42	23/10/2020 06:06	23/10/2020 09:42	3,58	1	3,58	CHI
202010129606	ALVORADA DO NORTE	AQ12085499	IACIARA S2	23/10/2020 06:09	23/10/2020 09:22	23/10/2020 06:09	23/10/2020 09:22	3,22	2	6,43	CHI
202010129606	FLORES DE GOIAS	AQ12085499	IACIARA S2	23/10/2020 06:09	23/10/2020 09:22	23/10/2020 06:09	23/10/2020 09:22	3,22	2	6,43	CHI
202010129565	NOVA CRIXAS	NA21120948	NOVA CRIXAS	23/10/2020 06:11	23/10/2020 10:24	23/10/2020 06:11	23/10/2020 10:24	4,21	1	4,21	CHI
202010129585	ITAPIRAPUA	IU12206870	MATRINCHA	23/10/2020 06:11	23/10/2020 12:35	23/10/2020 06:11	23/10/2020 12:35	6,39	8	51,15	CHI
202010129572	MAMBAI	MB12314303	IACIARA S2	23/10/2020 06:11	23/10/2020 09:36	23/10/2020 06:11	23/10/2020 09:36	3,41	4	13,64	CHI
202010129572	BURITINOPOLIS	MB12314303	IACIARA S2	23/10/2020 06:11	23/10/2020 09:36	23/10/2020 06:11	23/10/2020 09:36	3,41	2	6,82	CHI
202010129581	JARAGUA	70094822	JARAGUA	23/10/2020 06:13	23/10/2020 10:27	23/10/2020 06:13	23/10/2020 10:27	4,23	1	4,23	CHI
202010129822	GOIAS	GS12310670	GOIAS	23/10/2020 06:13	23/10/2020 09:16	23/10/2020 06:13	23/10/2020 09:16	3,03	6	18,21	CHI
202010129592	APARECIDA DE GOIANIA	13716967	INDEPENDENCIA S1	23/10/2020 06:16	23/10/2020 09:46	23/10/2020 06:16	23/10/2020 09:46	3,50	1	3,50	CHI
202010130874	ALTO PARAISO DE GOIAS	BF12244579	SAO JOAO D ALIANCA	23/10/2020 06:16	23/10/2020 18:33	23/10/2020 06:16	23/10/2020 18:33	12,27	34	417,23	CHI
202010129602	LUZIANIA	LZ21320178	MARAJOARA	23/10/2020 06:16	23/10/2020 19:46	23/10/2020 06:16	23/10/2020 19:46	13,48	3	40,45	CHI
202010129619	MONTA ALEGRE DE GOIAS	MA11332998	SAO DOMINGOS	23/10/2020 06:19	23/10/2020 11:03	23/10/2020 06:19	23/10/2020 11:03	4,73	2	9,47	CHI
202010129610	AGUA FRIA DE GOIAS	PI21206207	SAO JOAO D ALIANCA	23/10/2020 06:19	23/10/2020 08:47	23/10/2020 06:19	23/10/2020 08:47	2,47	1	2,47	CHI
202010129963	VILA PROPICIO	GE12000016	GOIANESIA S2	23/10/2020 06:19	23/10/2020 08:52	23/10/2020 06:19	23/10/2020 08:52	2,55	5	12,74	CHI
202010129963	GOIANESIA	GE12000016	GOIANESIA S2	23/10/2020 06:19	23/10/2020 08:52	23/10/2020 06:19	23/10/2020 08:52	2,55	8	20,39	CHI
202010129615	MINEIROS	MY12332634RE	PARQUE DAS EMAS	23/10/2020 06:19	26/10/2020 12:13	23/10/2020 06:19	26/10/2020 12:13	77,90	8	623,18	CHI
202010129616	PIRANHAS	PH12187444	PIRANHAS	23/10/2020 06:19	23/10/2020 09:21	23/10/2020 06:19	23/10/2020 09:21	3,02	1	3,02	CHI
202010131621	EDEIA	EA12378410	EDEIA	23/10/2020 06:20	23/10/2020 12:34	23/10/2020 06:20	23/10/2020 12:34	6,22	5	31,09	CHI



202010129630	BELA VISTA DE GOIAS	BV12410357	SENADOR CANEDO	23/10/2020 06:21	23/10/2020 13:52	23/10/2020 06:21	23/10/2020 13:52	7,50	11	82,50	CHI
202010129964	NIQUELANDIA	04564114	BARRO ALTO	23/10/2020 06:23	23/10/2020 10:50	23/10/2020 06:23	23/10/2020 10:50	4,45	454	2019,67	CHI
202010129964	NIQUELANDIA	04564114	BARRO ALTO	23/10/2020 06:23	23/10/2020 10:50	23/10/2020 06:23	23/10/2020 10:50	4,45	183	814,10	CHI
202010129964	MIMOSO DE GOIAS	04564114	BARRO ALTO	23/10/2020 06:23	23/10/2020 10:50	23/10/2020 06:23	23/10/2020 10:50	4,45	9	40,04	CHI
202010129964	MIMOSO DE GOIAS	04564114	BARRO ALTO	23/10/2020 06:23	23/10/2020 10:50	23/10/2020 06:23	23/10/2020 10:50	4,45	4	17,79	CHI
202010129964	VILA PROPICIO	04564114	BARRO ALTO	23/10/2020 06:23	23/10/2020 10:50	23/10/2020 06:23	23/10/2020 10:50	4,45	31	137,91	CHI
202010129964	VILA PROPICIO	04564114	BARRO ALTO	23/10/2020 06:23	23/10/2020 10:50	23/10/2020 06:23	23/10/2020 10:50	4,45	51	226,88	CHI
202010129635	SANTO ANTONIO DA BARRA	BZ21302020	ACREUNA	23/10/2020 06:23	23/10/2020 09:35	23/10/2020 06:23	23/10/2020 09:35	3,20	1	3,20	CHI
202010132242	SERRANOPOLIS	SX12165995	CHAPADAO DO CEU	23/10/2020 06:23	24/10/2020 11:06	23/10/2020 06:23	24/10/2020 11:06	28,71	4	114,83	CHI
202010129641	CRIXAS	CX12248286	SERRA DO OURO	23/10/2020 06:24	23/10/2020 12:39	23/10/2020 06:24	23/10/2020 12:39	6,25	17	106,30	CHI
202010130170	VILA PROPICIO	GE12196931	GOIANESIA S1	23/10/2020 06:26	23/10/2020 13:10	23/10/2020 06:26	23/10/2020 13:10	6,72	9	60,51	CHI
202010130204	CRIXAS	CX12252911	SANTA TEREZINHA	23/10/2020 06:27	23/10/2020 16:58	23/10/2020 06:27	23/10/2020 16:58	10,51	13	136,58	CHI
202010129671	CIDADE OCIDENTAL	DH11370713	MARAJOARA	23/10/2020 06:28	23/10/2020 11:27	23/10/2020 06:28	23/10/2020 11:27	4,97	122	606,37	CHI
202010129686	SANTA RITA DO ARAGUAIA	SU21090643	SANTA RITA DO ARAGUAIA	23/10/2020 06:30	23/10/2020 13:41	23/10/2020 06:30	23/10/2020 13:41	7,18	1	7,18	CHI
202010129692	CATURAI	CK12131260	ARACU	23/10/2020 06:31	23/10/2020 10:15	23/10/2020 06:31	23/10/2020 10:15	3,73	3	11,18	CHI
202010189179	NIQUELANDIA	NQ21378331	NIQUELANDIA SUBTRANSMISSAO	23/10/2020 06:34	23/10/2020 23:16	23/10/2020 06:34	23/10/2020 23:16	16,71	1	16,71	CHI
202010129714	SANTO ANTONIO DA BARRA	BZ21287981	ACREUNA	23/10/2020 06:34	23/10/2020 08:52	23/10/2020 06:34	23/10/2020 08:52	2,29	2	4,58	CHI
202010129731	ORIZONA	LZ12304995	VIANOPOLIS	23/10/2020 06:36	23/10/2020 10:51	23/10/2020 06:36	23/10/2020 10:51	4,24	91	385,92	CHI
202010129731	LUZIANIA	LZ12304995	VIANOPOLIS	23/10/2020 06:36	23/10/2020 10:51	23/10/2020 06:36	23/10/2020 10:51	4,24	8	33,93	CHI
202010129885	MATRINCHA	MP12299732	MATRINCHA	23/10/2020 06:38	24/10/2020 08:19	23/10/2020 06:38	24/10/2020 08:19	25,68	62	1591,92	CHI
202010129885	FAINA	MP12299732	MATRINCHA	23/10/2020 06:38	24/10/2020 08:19	23/10/2020 06:38	24/10/2020 08:19	25,68	67	1720,30	CHI
202010129885	ARAGUAPAZ	MP12299732	MATRINCHA	23/10/2020 06:38	24/10/2020 08:19	23/10/2020 06:38	24/10/2020 08:19	25,68	1	25,68	CHI
202010130499	IPAMERI	IP12404710	IPAMERI	23/10/2020 06:39	23/10/2020 11:34	23/10/2020 06:39	23/10/2020 11:34	4,91	4	19,66	CHI
202010129750	URUACU	UR12314206	URUACU	23/10/2020 06:39	23/10/2020 10:21	23/10/2020 06:39	23/10/2020 10:21	3,70	2	7,39	CHI
202010129756	PALMEIRAS DE GOIAS	PL12125675	PALMEIRAS	23/10/2020 06:39	23/10/2020 09:09	23/10/2020 06:39	23/10/2020 09:09	2,49	2	4,97	CHI
202010130162	MINEIROS	MY12202613RE	PARQUE DAS EMAS	23/10/2020 06:40	24/10/2020 16:09	23/10/2020 06:40	24/10/2020 16:09	33,49	10	334,86	CHI
202010129775	CATALAO	CT12267054	CATALAO S1	23/10/2020 06:43	23/10/2020 09:02	23/10/2020 06:43	23/10/2020 09:02	2,31	17	39,30	CHI
202010129778	PADRE BERNARDO	PB12250116	PADRE BERNARDO	23/10/2020 06:43	23/10/2020 12:44	23/10/2020 06:43	23/10/2020 12:44	6,01	2	12,01	CHI
202010129796	GOIANIA	13243500	AEROPORTO S1	23/10/2020 06:46	23/10/2020 09:20	23/10/2020 06:46	23/10/2020 09:20	2,57	1	2,57	CHI
202010129798	VALPARAISO DE GOIAS	10032321749	PACAEMBU S1	23/10/2020 06:46	23/10/2020 09:36	23/10/2020 06:46	23/10/2020 09:36	2,82	1	2,82	CHI
202010129799	PALESTINA DE GOIAS	PY12342606	PALESTINA	23/10/2020 06:46	23/10/2020 10:37	23/10/2020 06:46	23/10/2020 10:37	3,84	6	23,04	CHI
202010129985	AGUA FRIA DE GOIAS	TL12151992	SAO JOAO D ALIANCA	23/10/2020 06:46	23/10/2020 10:49	23/10/2020 06:46	23/10/2020 10:49	4,04	5	20,19	CHI
202010128529	JUSSARA	JR12027532	BRITANIA	23/10/2020 06:48	23/10/2020 12:22	23/10/2020 06:48	23/10/2020 12:22	5,57	40	222,66	CHI
202010129829	VILA PROPICIO	NP21216972	GOIANESIA S1	23/10/2020 06:50	23/10/2020 12:28	23/10/2020 06:50	23/10/2020 12:28	5,63	2	11,26	CHI
202010129831	PLANALTINA	PI12139508	PLANALTINA	23/10/2020 06:50	23/10/2020 11:16	23/10/2020 06:50	23/10/2020 11:16	4,42	32	141,56	CHI
202010129833	AMARALINA	LC21182430	MARA ROSA	23/10/2020 06:50	23/10/2020 10:32	23/10/2020 06:50	23/10/2020 10:32	3,69	1	3,69	CHI
202010189290	ALTO PARAISO DE GOIAS	BF12365282	SAO JOAO D ALIANCA	23/10/2020 06:51	23/10/2020 11:33	23/10/2020 06:51	23/10/2020 11:33	4,70	47	220,93	CHI
202010129742	GOIATUBA	JV13282681S	GOIATUBA S1	23/10/2020 06:52	23/10/2020 10:34	23/10/2020 06:52	23/10/2020 10:34	3,70	2	7,41	CHI
202010129844	ITARUMA	IM12015479	CACHOEIRA ALTA	23/10/2020 06:52	23/10/2020 09:26	23/10/2020 06:52	23/10/2020 09:26	2,55	23	58,75	CHI
202010130691	PORANGATU	PO12265802	PORANGATU	23/10/2020 06:53	23/10/2020 16:52	23/10/2020 06:53	23/10/2020 16:52	9,97	1	9,97	CHI
202010130691	PORANGATU	PO12265802	PORANGATU	23/10/2020 06:53	23/10/2020 16:52	23/10/2020 06:53	23/10/2020 10:18	3,40	116	394,43	CHI
202010129862	CAIAPONIA	CP12135376	CAIAPONIA	23/10/2020 06:54	23/10/2020 23:22	23/10/2020 06:54	23/10/2020 23:22	16,46	8	131,70	CHI
202010129864	GOIAS	GS12070358	GOIAS	23/10/2020 06:54	23/10/2020 12:22	23/10/2020 06:54	23/10/2020 12:22	5,45	11	60,00	CHI
202010130271	ORIZONA	OZ12094835	VIANOPOLIS	23/10/2020 06:55	23/10/2020 10:59	23/10/2020 06:55	23/10/2020 10:59	4,05	2	8,11	CHI
202010130271	VIANOPOLIS	OZ12094835	VIANOPOLIS	23/10/2020 06:55	23/10/2020 10:59	23/10/2020 06:55	23/10/2020 10:59	4,05	26	105,42	CHI
202010129877	PORTELANDIA	1470011168	PARQUE DAS EMAS	23/10/2020 06:56	23/10/2020 09:00	23/10/2020 06:56	23/10/2020 09:00	2,06	1	2,06	CHI
202010129882	LUZIANIA	LZ11136536	PACAEMBU S2	23/10/2020 06:57	23/10/2020 10:18	23/10/2020 06:57	23/10/2020 10:18	3,36	36	120,99	CHI
202010130479	SANTO ANTONIO DO DESCOBERTO	SN12401863	MARAJOARA	23/10/2020 06:59	23/10/2020 12:10	23/10/2020 06:59	23/10/2020 12:10	5,18	2	10,37	CHI
202010129894	CRIXAS	CX12319088	SERRA DO OURO	23/10/2020 06:59	23/10/2020 10:42	23/10/2020 06:59	23/10/2020 10:42	3,72	8	29,72	CHI
202010129896	QUIRINOPOLIS	QI21298273	QUIRINOPOLIS	23/10/2020 06:59	23/10/2020 11:19	23/10/2020 06:59	23/10/2020 11:19	4,32	1	4,32	CHI
202010129900	CRISTALINA	1060011673	CRISTALINA S1	23/10/2020 07:00	23/10/2020 09:18	23/10/2020 07:00	23/10/2020 09:18	2,28	1	2,28	CHI

202010129906	MONTES CLAROS DE GOIAS	3060000140	IPORA	23/10/2020 07:01	23/10/2020 14:30	23/10/2020 07:01	23/10/2020 14:30	7,47	1	7,47	CHI
202010130085	GOIANESIA	GE12248150	GOIANESIA S2	23/10/2020 07:02	23/10/2020 10:06	23/10/2020 07:02	23/10/2020 10:06	3,06	14	42,86	CHI
202010129912	QUIRINOPOLIS	QI31052461	QUIRINOPOLIS	23/10/2020 07:02	23/10/2020 09:49	23/10/2020 07:02	23/10/2020 09:49	2,77	1	2,77	CHI
202010130854	CATALAO	CT12338757	CATALAO S1	23/10/2020 07:04	23/10/2020 10:24	23/10/2020 07:04	23/10/2020 10:24	3,33	11	36,65	CHI
202010130854	CAMPO ALEGRE DE GOIAS	CT12338757	CATALAO S1	23/10/2020 07:04	23/10/2020 10:24	23/10/2020 07:04	23/10/2020 10:24	3,33	2	6,66	CHI
202010189340	PIRACANJUBA	PJ12233807	ROCHEDO	23/10/2020 07:04	23/10/2020 17:00	23/10/2020 07:04	23/10/2020 17:00	9,92	8	79,36	CHI
202010129933	BOM JARDIM DE GOIAS	BM12358756	BOM JARDIM	23/10/2020 07:07	23/10/2020 10:24	23/10/2020 07:07	23/10/2020 10:24	3,28	2	6,55	CHI
202010130261	SANTA RITA DO NOVO DESTINO	BA12163300	BARRO ALTO	23/10/2020 07:07	23/10/2020 10:53	23/10/2020 07:07	23/10/2020 10:53	3,75	6	22,51	CHI
202010130105	BURITI ALEGRE	BG12000162	ALTO BURITI	23/10/2020 07:08	23/10/2020 08:19	23/10/2020 07:08	23/10/2020 08:19	1,18	13	15,34	CHI
202010130105	ITUMBIARA	BG12000162	ALTO BURITI	23/10/2020 07:08	23/10/2020 08:19	23/10/2020 07:08	23/10/2020 08:19	1,18	10	11,80	CHI
202010129945	PEROLANDIA	DP12285778	JATAI S1	23/10/2020 07:08	23/10/2020 09:54	23/10/2020 07:08	23/10/2020 09:54	2,76	5	13,80	CHI
202010129957	PADRE BERNARDO	PB12163248	PADRE BERNARDO	23/10/2020 07:08	23/10/2020 09:58	23/10/2020 07:08	23/10/2020 09:58	2,82	7	19,77	CHI
202010129951	NOVO GAMA	2460062923	PACAEMBU S2	23/10/2020 07:08	23/10/2020 09:51	23/10/2020 07:08	23/10/2020 09:51	2,71	1	2,71	CHI
202010130510	GUAPO	GA12381335	GUAPO S2	23/10/2020 07:09	23/10/2020 10:29	23/10/2020 07:09	23/10/2020 10:29	3,32	9	29,85	CHI
202010129976	MIMOSO DE GOIAS	MJ12305235	PADRE BERNARDO	23/10/2020 07:12	23/10/2020 16:33	23/10/2020 07:12	23/10/2020 16:33	9,34	1	9,34	CHI
202010130177	MUTUNOPOLIS	SE12352924	MARA ROSA	23/10/2020 07:14	23/10/2020 09:23	23/10/2020 07:14	23/10/2020 09:23	2,15	6	12,90	CHI
202010130177	SANTA TEREZA DE GOIAS	SE12352924	MARA ROSA	23/10/2020 07:14	23/10/2020 09:23	23/10/2020 07:14	23/10/2020 09:23	2,15	1	2,15	CHI
202010129986	PIRANHAS	8226300	PIRANHAS	23/10/2020 07:14	23/10/2020 15:41	23/10/2020 07:14	23/10/2020 15:41	8,45	1	8,45	CHI
202010130207	PADRE BERNARDO	PB21330808	PADRE BERNARDO	23/10/2020 07:14	23/10/2020 15:13	23/10/2020 07:14	23/10/2020 15:13	7,97	1	7,97	CHI
202010130912	DISTRITO FEDERAL	PB12377290	PADRE BERNARDO	23/10/2020 07:14	23/10/2020 15:13	23/10/2020 07:14	23/10/2020 15:13	7,97	2	15,94	CHI
202010130912	ITARUMA	PB12377290	PADRE BERNARDO	23/10/2020 07:14	23/10/2020 15:13	23/10/2020 07:14	23/10/2020 15:13	7,97	1	7,97	CHI
202010130912	PLANALTINA	PB12377290	PADRE BERNARDO	23/10/2020 07:14	23/10/2020 15:13	23/10/2020 07:14	23/10/2020 15:13	7,97	9	71,73	CHI
202010130912	PADRE BERNARDO	PB12377290	PADRE BERNARDO	23/10/2020 07:14	23/10/2020 15:13	23/10/2020 07:14	23/10/2020 15:13	7,97	9	71,73	CHI
202010132168	DISTRITO FEDERAL	PB12377290	PADRE BERNARDO	23/10/2020 07:14	23/10/2020 15:13	23/10/2020 07:14	23/10/2020 15:13	7,97	4	31,88	CHI
202010132168	PLANALTINA	PB12377290	PADRE BERNARDO	23/10/2020 07:14	23/10/2020 15:13	23/10/2020 07:14	23/10/2020 15:13	7,97	5	39,85	CHI
202010132168	PADRE BERNARDO	PB12377290	PADRE BERNARDO	23/10/2020 07:14	23/10/2020 15:13	23/10/2020 07:14	23/10/2020 15:13	7,97	11	87,67	CHI
202010129990	INDIARA	IY12233475	EDEIA	23/10/2020 07:14	23/10/2020 11:24	23/10/2020 07:14	23/10/2020 11:24	4,15	4	16,62	CHI
202010130007	BELA VISTA DE GOIAS	BV21032025	BELA VISTA S1	23/10/2020 07:17	23/10/2020 11:14	23/10/2020 07:17	23/10/2020 11:14	3,94	1	3,94	CHI
202010130009	ALTO PARAISO DE GOIAS	BF12244573	SAO JOAO D ALIANCA	23/10/2020 07:17	23/10/2020 15:13	23/10/2020 07:17	23/10/2020 15:13	7,93	1	7,93	CHI
202010130042	UIRAPURU	UP12321028	SANTA TEREZINHA	23/10/2020 07:18	23/10/2020 16:30	23/10/2020 07:18	23/10/2020 16:30	9,19	7	64,36	CHI
202010131508	INDIARA	IY12010924	PALMEIRAS	23/10/2020 07:18	23/10/2020 17:12	23/10/2020 07:18	23/10/2020 17:12	9,89	16	158,21	CHI
202010131508	JANDAIA	IY12010924	PALMEIRAS	23/10/2020 07:18	23/10/2020 17:12	23/10/2020 07:18	23/10/2020 17:12	9,89	1	9,89	CHI
202010130269	PALMEIRAS DE GOIAS	PL12000121	PALMEIRAS	23/10/2020 07:23	24/10/2020 01:11	23/10/2020 07:23	24/10/2020 01:11	17,79	9	160,07	CHI
202010130045	SERRANOPOLIS	SX21324743	CHAPADAO DO CEU	23/10/2020 07:25	24/10/2020 12:28	23/10/2020 07:25	24/10/2020 12:28	29,05	1	29,05	CHI
202010130051	PROFESSOR JAMIL SAFADY	JS12074215	ROCHEDO	23/10/2020 07:26	23/10/2020 10:56	23/10/2020 07:26	23/10/2020 10:56	3,50	2	7,00	CHI
202010130052	CATALAO	IP12404730	IPAMERI	23/10/2020 07:26	23/10/2020 11:05	23/10/2020 07:26	23/10/2020 11:05	3,65	2	7,29	CHI
202010130052	IPAMERI	IP12404730	IPAMERI	23/10/2020 07:26	23/10/2020 11:05	23/10/2020 07:26	23/10/2020 11:05	3,65	14	51,03	CHI
202010130052	GOIANDIRA	IP12404730	IPAMERI	23/10/2020 07:26	23/10/2020 11:05	23/10/2020 07:26	23/10/2020 11:05	3,65	4	14,58	CHI
202010130054	BOM JESUS DE GOIAS	BJ12222335	BOM JESUS DE GOIAS	23/10/2020 07:27	23/10/2020 11:42	23/10/2020 07:27	23/10/2020 11:42	4,25	1	4,25	CHI
202010130889	HIDROLINA	HL12068284RE	URUACU	23/10/2020 07:27	23/10/2020 11:33	23/10/2020 07:27	23/10/2020 11:33	4,09	22	90,05	CHI
202010130059	ITUMBIARA	CD21222294	BOM JESUS DE GOIAS	23/10/2020 07:27	23/10/2020 09:45	23/10/2020 07:27	23/10/2020 09:45	2,28	1	2,28	CHI
202010130395	DIVINOPOLIS DE GOIAS	GH11164679	SAO DOMINGOS	23/10/2020 07:28	23/10/2020 10:41	23/10/2020 07:28	23/10/2020 10:41	3,21	82	262,92	CHI
202010130067	IPAMERI	OZ12137542RE	PIRES DO RIO S2	23/10/2020 07:29	23/10/2020 11:10	23/10/2020 07:29	23/10/2020 11:10	3,67	10	36,74	CHI
202010130070	CATALAO	CT21286327	CATALAO S1	23/10/2020 07:29	23/10/2020 08:32	23/10/2020 07:29	23/10/2020 08:32	1,04	1	1,04	CHI
202010130072	NOVO PLANALTO	TA21146563	SAO MIGUEL DO ARAGUAIA	23/10/2020 07:29	23/10/2020 11:36	23/10/2020 07:29	23/10/2020 11:36	4,10	1	4,10	CHI
202010130075	MINEIROS	MY12360240	PARQUE DAS EMAS	23/10/2020 07:30	23/10/2020 09:04	23/10/2020 07:30	23/10/2020 09:04	1,57	41	64,20	CHI
202010130076	VILA BOA	FA12071040LD	ITIQUEIRA	23/10/2020 07:30	23/10/2020 19:12	23/10/2020 07:30	23/10/2020 19:12	11,71	7	81,94	CHI
202010130076	FORMOSA	FA12071040LD	ITIQUEIRA	23/10/2020 07:30	23/10/2020 19:12	23/10/2020 07:30	23/10/2020 19:12	11,71	219	2563,52	CHI
202010130076	FORMOSA	FA12071040LD	ITIQUEIRA	23/10/2020 07:30	23/10/2020 19:12	23/10/2020 17:36	23/10/2020 19:12	1,60	13	20,81	CHI
202010130089	UIRAPURU	UP12036688	NOVA CRIXAS	23/10/2020 07:31	23/10/2020 15:40	23/10/2020 07:31	23/10/2020 15:40	8,14	6	48,85	CHI
202010130095	GOIANIA	11200005	XAVANTES	23/10/2020 07:32	23/10/2020 10:22	23/10/2020 07:32	23/10/2020 10:22	2,82	1	2,82	CHI

202010131080	RIO VERDE	RV12159300	CABRIUVA S2	23/10/2020 07:33	23/10/2020 15:42	23/10/2020 07:33	23/10/2020 15:42	8,15	12	97,76	CHI
202010130101	LUZIANIA	LZ12314021	MARAJOARA	23/10/2020 07:33	23/10/2020 15:33	23/10/2020 12:51	23/10/2020 15:33	2,70	10	27,02	CHI
202010130101	LUZIANIA	LZ21314022	MARAJOARA	23/10/2020 07:33	23/10/2020 15:33	23/10/2020 07:33	23/10/2020 14:57	7,40	1	7,40	CHI
202010130856	FAZENDA NOVA	FN12183337	IPORA	23/10/2020 07:33	23/10/2020 12:51	23/10/2020 07:33	23/10/2020 12:51	5,29	4	21,17	CHI
202010130109	MORRINHOS	MR12092964	MORRINHOS	23/10/2020 07:34	23/10/2020 09:05	23/10/2020 07:34	23/10/2020 09:05	1,52	3	4,55	CHI
202010130121	INHUMAS	30039125	INHUMAS S2	23/10/2020 07:36	23/10/2020 23:39	23/10/2020 07:36	23/10/2020 23:39	16,04	1	16,04	CHI
202010130123	UIRAPURU	MH21037815	NOVA CRIXAS	23/10/2020 07:36	23/10/2020 15:40	23/10/2020 07:36	23/10/2020 15:40	8,05	1	8,05	CHI
202010130129	CABECEIRAS	CW12184519	ITUIQUIRA	23/10/2020 07:37	23/10/2020 08:42	23/10/2020 07:37	23/10/2020 08:42	1,07	2	2,15	CHI
202010131211	INHUMAS	IN12000127	INHUMAS S1	23/10/2020 07:37	23/10/2020 15:23	23/10/2020 07:37	23/10/2020 15:23	7,76	7	54,30	CHI
202010130139	GOUVELANDIA	GB21301530	QUIRINOPOLIS	23/10/2020 07:38	23/10/2020 09:14	23/10/2020 07:38	23/10/2020 09:14	1,60	1	1,60	CHI
202010130157	PILAR DE GOIAS	NH21213056	SANTA TEREZINHA	23/10/2020 07:41	23/10/2020 14:30	23/10/2020 07:41	23/10/2020 14:30	6,81	1	6,81	CHI
202010130164	JARAGUA	JA12070670	JARAGUA	23/10/2020 07:42	23/10/2020 12:37	23/10/2020 07:42	23/10/2020 12:37	4,91	9	44,16	CHI
202010131250	MONTES CLAROS DE GOIAS	ME12097812RE	IPORA	23/10/2020 07:42	23/10/2020 14:13	23/10/2020 07:42	23/10/2020 14:13	6,51	101	657,03	CHI
202010130172	MONTIVIDIU DO NORTE	9670001024	PORANGATU	23/10/2020 07:43	23/10/2020 09:29	23/10/2020 07:43	23/10/2020 09:29	1,76	1	1,76	CHI
202010130173	MONTES CLAROS DE GOIAS	ME21138678	IPORA	23/10/2020 07:43	23/10/2020 14:14	23/10/2020 07:43	23/10/2020 14:14	6,51	1	6,51	CHI
202010130192	JARAGUA	70026932	JARAGUA	23/10/2020 07:47	23/10/2020 08:46	23/10/2020 07:47	23/10/2020 08:46	0,98	1	0,98	CHI
202010130193	RIO VERDE	RV11400195	CABRIUVA S1	23/10/2020 07:47	23/10/2020 14:08	23/10/2020 07:47	23/10/2020 14:08	6,34	23	145,88	CHI
202010130198	COLINAS DO SUL	TI11116081	MINACU	23/10/2020 07:47	23/10/2020 11:40	23/10/2020 07:47	23/10/2020 11:40	3,87	61	236,17	CHI
202010130199	PIRANHAS	1930008536	PIRANHAS	23/10/2020 07:48	23/10/2020 16:50	23/10/2020 07:48	23/10/2020 16:50	9,03	1	9,03	CHI
202010130206	SILVANIA	SV21334099	VIANOPOLIS	23/10/2020 07:49	23/10/2020 11:57	23/10/2020 07:49	23/10/2020 11:57	4,13	3	12,40	CHI
202010130210	DOVERLANDIA	MY12036563RE	PARQUE DAS EMAS	23/10/2020 07:49	24/10/2020 01:40	23/10/2020 07:49	24/10/2020 01:40	17,84	70	1249,05	CHI
202010130212	APARECIDA DE GOIANIA	11965587	REAL S1	23/10/2020 07:49	23/10/2020 10:22	23/10/2020 07:49	23/10/2020 10:22	2,54	1	2,54	CHI
202010130368	APARECIDA DE GOIANIA	AP11167082	CARAJAS S1	23/10/2020 07:50	23/10/2020 13:21	23/10/2020 07:50	23/10/2020 13:21	5,51	46	253,46	CHI
202010130220	ITUMBIAARA	IT12296859	CACHOEIRA DOURADA	23/10/2020 07:50	24/10/2020 16:05	23/10/2020 07:50	24/10/2020 16:05	32,24	9	290,17	CHI
202010130224	PIRACANJUBA	PJ21223588	CALDAS NOVAS S1	23/10/2020 07:51	23/10/2020 12:07	23/10/2020 07:51	23/10/2020 12:07	4,27	2	8,53	CHI
202010130383	CRISTALINA	IP12165527	CRISTALINA S1	23/10/2020 07:54	23/10/2020 09:14	23/10/2020 07:54	23/10/2020 09:14	1,33	15	19,99	CHI
202010130245	SANTA HELENA DE GOIAS	SH12295844	IPEGUARI	23/10/2020 07:54	23/10/2020 10:36	23/10/2020 07:54	23/10/2020 10:36	2,70	18	48,56	CHI
202010130247	FORMOSA	FA31042727	SAO JOAO D ALIANCA	23/10/2020 07:54	23/10/2020 09:48	23/10/2020 07:54	23/10/2020 09:48	1,90	1	1,90	CHI
202010130252	CRISTIANOPOLIS	CF12086343	CRISTIANOPOLIS	23/10/2020 07:54	23/10/2020 09:54	23/10/2020 07:54	23/10/2020 09:54	1,99	4	7,96	CHI
202010130253	ARAGARCAS	1820018717	ARAGARCAS	23/10/2020 07:54	23/10/2020 09:00	23/10/2020 07:54	23/10/2020 09:00	1,10	1	1,10	CHI
202010130257	PLANALTINA	PI21146242	PLANALTINA	23/10/2020 07:55	23/10/2020 09:28	23/10/2020 07:55	23/10/2020 09:28	1,54	1	1,54	CHI
202010130906	ITARUMA	IM12205220LD	ITAJA S2	23/10/2020 07:56	23/10/2020 09:48	23/10/2020 07:56	23/10/2020 09:48	1,87	9	16,79	CHI
202010130276	GOIANIRA	GR21016221	GOIANIRA	23/10/2020 07:57	23/10/2020 13:08	23/10/2020 07:57	23/10/2020 13:08	5,17	1	5,17	CHI
202010130280	ANICUNS	AC12259933	FIRMINOPOLIS S2	23/10/2020 07:57	23/10/2020 17:51	23/10/2020 07:57	23/10/2020 17:51	9,88	8	79,08	CHI
202010130292	SANTA HELENA DE GOIAS	SH12301271	ACREUNA	23/10/2020 07:59	23/10/2020 10:05	23/10/2020 07:59	23/10/2020 10:05	2,09	5	10,43	CHI
202010130295	QUIRINOPOLIS	10011409027	QUIRINOPOLIS	23/10/2020 08:00	23/10/2020 10:14	23/10/2020 08:00	23/10/2020 10:14	2,23	1	2,23	CHI
202010130310	HIDROLANDIA	AO31097679	GUAPO S2	23/10/2020 08:02	23/10/2020 10:29	23/10/2020 08:02	23/10/2020 10:29	2,45	1	2,45	CHI
202010130313	LUZIANIA	LZ21086756	VIANOPOLIS	23/10/2020 08:02	23/10/2020 14:13	23/10/2020 08:02	23/10/2020 14:13	6,18	1	6,18	CHI
202010130323	MINEIROS	MY21296359	PARQUE DAS EMAS	23/10/2020 08:03	23/10/2020 11:30	23/10/2020 08:03	23/10/2020 11:30	3,44	1	3,44	CHI
202010130334	IPORA	730002020	IPORA	23/10/2020 08:04	23/10/2020 09:17	23/10/2020 08:04	23/10/2020 09:17	1,21	1	1,21	CHI
202010130336	PIRES DO RIO	PR12000083	PIRES DO RIO S1	23/10/2020 08:04	23/10/2020 10:21	23/10/2020 08:04	23/10/2020 10:21	2,28	3	6,83	CHI
202010130338	ORIZONA	4690000130	PIRES DO RIO S2	23/10/2020 08:04	23/10/2020 13:19	23/10/2020 08:04	23/10/2020 13:19	5,24	1	5,24	CHI
202010189345	PORTELANDIA	PW12302970	PARQUE DAS EMAS	23/10/2020 08:05	23/10/2020 14:18	23/10/2020 08:05	23/10/2020 14:18	6,22	4	24,86	CHI
202010131084	MONTES CLAROS DE GOIAS	ME12204903	IPORA	23/10/2020 08:05	23/10/2020 13:30	23/10/2020 08:05	23/10/2020 13:30	5,41	3	16,24	CHI
202010130359	CRISTALINA	10021742209	CRISTALINA S1	23/10/2020 08:07	23/10/2020 10:32	23/10/2020 08:07	23/10/2020 10:32	2,41	1	2,41	CHI
202010130361	SAO MIGUEL DO ARAGUAIA	SM12013036	SAO MIGUEL DO ARAGUAIA	23/10/2020 08:07	23/10/2020 13:59	23/10/2020 08:07	23/10/2020 13:59	5,85	22	128,79	CHI
202010130377	BELA VISTA DE GOIAS	SQ21016180	CRISTIANOPOLIS	23/10/2020 08:09	23/10/2020 10:26	23/10/2020 08:09	23/10/2020 10:26	2,27	1	2,27	CHI
202010131000	PORTELANDIA	DP12210131RE	PARQUE DAS EMAS	23/10/2020 08:10	23/10/2020 11:22	23/10/2020 08:10	23/10/2020 11:22	3,20	1	3,20	CHI
202010131000	PEROLANDIA	DP12210131RE	PARQUE DAS EMAS	23/10/2020 08:10	23/10/2020 11:22	23/10/2020 08:10	23/10/2020 11:22	3,20	4	12,80	CHI
202010131000	MINEIROS	DP12210131RE	PARQUE DAS EMAS	23/10/2020 08:10	23/10/2020 11:22	23/10/2020 08:10	23/10/2020 11:22	3,20	5	16,00	CHI
202010130388	CUMARI	CT12103432	CATALAO S2	23/10/2020 08:11	23/10/2020 14:20	23/10/2020 08:11	23/10/2020 14:20	6,14	1	6,14	CHI



202010130388	CATALAO	CT12103432	CATALAO S2	23/10/2020 08:11	23/10/2020 14:20	23/10/2020 08:11	23/10/2020 14:20	6,14	3	18,42	CHI
202010130390	CATALAO	CT21272527	CATALAO S1	23/10/2020 08:12	23/10/2020 13:14	23/10/2020 08:12	23/10/2020 13:14	5,03	1	5,03	CHI
202010130393	GUAPO	710048749	GUAPO S1	23/10/2020 08:12	23/10/2020 12:04	23/10/2020 08:12	23/10/2020 12:04	3,86	1	3,86	CHI
202010130394	MUNDO NOVO DE GOIAS	MH11221667	NOVA CRIXAS	23/10/2020 08:12	23/10/2020 14:03	23/10/2020 08:12	23/10/2020 14:03	5,84	1	5,84	CHI
202010130409	TERESINA DE GOIAS	TE12281553	FLORES DE GOIAS	23/10/2020 08:15	23/10/2020 09:12	23/10/2020 08:15	23/10/2020 09:12	0,94	112	105,72	CHI
202010130414	NOVA VENEZA	NV21188791	INHUMAS S1	23/10/2020 08:16	23/10/2020 10:45	23/10/2020 08:16	23/10/2020 10:45	2,48	1	2,48	CHI
202010130417	SANTA HELENA DE GOIAS	SH31074858	IPEGUARI	23/10/2020 08:16	23/10/2020 11:37	23/10/2020 08:16	23/10/2020 11:37	3,34	1	3,34	CHI
202010131249	PIRANHAS	PH12390163	PIRANHAS	23/10/2020 08:16	23/10/2020 14:33	23/10/2020 08:16	23/10/2020 14:33	6,27	11	68,99	CHI
202010130424	PALMEIRAS DE GOIAS	PL11276897	PALMEIRAS	23/10/2020 08:17	23/10/2020 14:28	23/10/2020 08:17	23/10/2020 14:28	6,17	1	6,17	CHI
202010130425	INHUMAS	10004224670	INHUMAS S2	23/10/2020 08:17	23/10/2020 14:40	23/10/2020 08:17	23/10/2020 14:40	6,38	1	6,38	CHI
202010130429	PIRES DO RIO	PR21275739	PIRES DO RIO S1	23/10/2020 08:18	23/10/2020 12:14	23/10/2020 08:18	23/10/2020 12:14	3,94	1	3,94	CHI
202010130490	IPORA	10011891724	IPORA	23/10/2020 08:24	23/10/2020 10:19	23/10/2020 08:24	23/10/2020 10:19	1,90	1	1,90	CHI
202010130994	IPAMERI	IP21000035	IPAMERI	23/10/2020 08:25	23/10/2020 10:55	23/10/2020 08:25	23/10/2020 10:55	2,49	1	2,49	CHI
202010130501	GOIATUBA	GT21013257	GOIATUBA S1	23/10/2020 08:26	23/10/2020 10:56	23/10/2020 08:26	23/10/2020 10:56	2,50	1	2,50	CHI
202010130511	GOIANIA	11006134	FERROVIARIO S2	23/10/2020 08:26	23/10/2020 10:02	23/10/2020 08:26	23/10/2020 10:02	1,58	1	1,58	CHI
202010130514	CRISTALINA	KR21184844	CRISTALINA S1	23/10/2020 08:27	23/10/2020 14:41	23/10/2020 08:27	23/10/2020 14:41	6,23	1	6,23	CHI
202010130515	LUZIANIA	LZ21290525	VIANOPOLIS	23/10/2020 08:27	23/10/2020 14:56	23/10/2020 08:27	23/10/2020 14:56	6,47	1	6,47	CHI
202010130516	FAZENDA NOVA	FN12250947	JUSSARA	23/10/2020 08:27	23/10/2020 11:21	23/10/2020 08:27	23/10/2020 11:21	2,89	8	23,13	CHI
202010130530	MORRINHOS	10012566894	MORRINHOS	23/10/2020 08:28	23/10/2020 10:24	23/10/2020 08:28	23/10/2020 10:24	1,93	1	1,93	CHI
202010130540	AGUAS LINDAS DE GOIAS	4830284433	AGUAS LINDAS DE GOIAS S1	23/10/2020 08:29	23/10/2020 10:13	23/10/2020 08:29	23/10/2020 10:13	1,73	1	1,73	CHI
202010130556	GOIANIA	16620914	CAMPINAS S3	23/10/2020 08:30	23/10/2020 11:50	23/10/2020 08:30	23/10/2020 11:50	3,32	1	3,32	CHI
202010130561	AGUA FRIA DE GOIAS	TL12067535	SAO JOAO D ALIANCA	23/10/2020 08:31	23/10/2020 11:30	23/10/2020 08:31	23/10/2020 11:30	2,99	5	14,95	CHI
202010130562	JATAI	290185208	JATAI S2	23/10/2020 08:31	23/10/2020 09:57	23/10/2020 08:31	23/10/2020 09:57	1,42	1	1,42	CHI
202010130571	GOIANIA	15446608	GOIANIA LESTE S1	23/10/2020 08:33	23/10/2020 11:18	23/10/2020 08:33	23/10/2020 11:18	2,75	1	2,75	CHI
202010130573	CIDADE OCIDENTAL	10009621367	MARAJOARA	23/10/2020 08:33	23/10/2020 13:37	23/10/2020 08:33	23/10/2020 13:37	5,06	1	5,06	CHI
202010130575	BOM JARDIM DE GOIAS	BM21155710	BOM JARDIM	23/10/2020 08:33	23/10/2020 16:00	23/10/2020 08:33	23/10/2020 16:00	7,44	1	7,44	CHI
202010130600	CAMPINORTE	CR12086295	CAMPINORTE	23/10/2020 08:35	23/10/2020 14:42	23/10/2020 08:35	23/10/2020 14:42	6,10	2	12,21	CHI
202010130600	URUACU	CR12086295	CAMPINORTE	23/10/2020 08:35	23/10/2020 14:42	23/10/2020 08:35	23/10/2020 14:42	6,10	4	24,41	CHI
202010129725	GOIANIA	GN11262068	GOIANIA LESTE S2	23/10/2020 08:36	23/10/2020 11:36	23/10/2020 08:36	23/10/2020 11:36	3,00	76	228,02	CHI
202010130605	PORTEIRAO	2470003319	RIO DOS BOIS	23/10/2020 08:36	23/10/2020 11:32	23/10/2020 08:36	23/10/2020 11:32	2,93	1	2,93	CHI
202010130615	IPAMERI	580115999	IPAMERI	23/10/2020 08:37	23/10/2020 13:26	23/10/2020 08:37	23/10/2020 13:26	4,82	1	4,82	CHI
202010130993	NEROPOLIS	NR12319547	NEROPOLIS S2	23/10/2020 08:39	23/10/2020 12:44	23/10/2020 08:39	23/10/2020 12:44	4,08	4	16,33	CHI
202010130647	AMARALINA	LC21303946	MARA ROSA	23/10/2020 08:39	23/10/2020 11:37	23/10/2020 08:39	23/10/2020 11:37	2,96	1	2,96	CHI
202010130648	CARMO DO RIO VERDE	IK21310975	ITAPURANGA	23/10/2020 08:39	23/10/2020 13:22	23/10/2020 08:39	23/10/2020 13:22	4,71	1	4,71	CHI
202010130654	IVOLANDIA	IV12223012	IPORA	23/10/2020 08:40	23/10/2020 14:06	23/10/2020 08:40	23/10/2020 14:06	5,43	11	59,78	CHI
202010130660	CRIXAS	10013908861	MOZARLANDIA	23/10/2020 08:41	24/10/2020 16:56	23/10/2020 08:41	24/10/2020 16:56	32,25	1	32,25	CHI
202010130673	HIDROLINA	UR21358183	URUACU	23/10/2020 08:42	23/10/2020 16:47	23/10/2020 08:42	23/10/2020 16:47	8,08	1	8,08	CHI
202010130684	PIRACANJUBA	6424919	PIRACANJUBA	23/10/2020 08:43	23/10/2020 21:58	23/10/2020 18:05	23/10/2020 21:58	3,90	7	27,28	CHI
202010130684	PIRACANJUBA	PJ11171385	PIRACANJUBA	23/10/2020 08:43	23/10/2020 21:58	23/10/2020 08:43	23/10/2020 20:40	11,94	1	11,94	CHI
202010130686	VICENTINOPOLIS	VI12352542	VICENTINOPOLIS	23/10/2020 08:44	23/10/2020 13:23	23/10/2020 08:44	23/10/2020 13:23	4,65	14	65,10	CHI
202010130686	EDEIA	VI12352542	VICENTINOPOLIS	23/10/2020 08:44	23/10/2020 13:23	23/10/2020 08:44	23/10/2020 13:23	4,65	8	37,20	CHI
202010130848	SANTA RITA DO NOVO DESTINO	BA12156230	BARRO ALTO	23/10/2020 08:44	23/10/2020 11:51	23/10/2020 08:44	23/10/2020 11:51	3,11	5	15,57	CHI
202010130690	ANICUNS	AC21021759	ANICUNS	23/10/2020 08:44	23/10/2020 19:45	23/10/2020 08:44	23/10/2020 19:45	11,01	1	11,01	CHI
202010130693	VALPARAISO DE GOIAS	10008044714	PACAEMBU S2	23/10/2020 08:45	23/10/2020 11:41	23/10/2020 08:45	23/10/2020 11:41	2,93	1	2,93	CHI
202010130699	JUSSARA	JR21142862	BRITANIA	23/10/2020 08:45	23/10/2020 12:49	23/10/2020 08:45	23/10/2020 12:49	4,05	1	4,05	CHI
202010130701	LUZIANIA	LZ11313688	MARAJOARA	23/10/2020 08:46	23/10/2020 11:50	23/10/2020 08:46	23/10/2020 11:50	3,07	10	30,66	CHI
202010130710	RIO VERDE	RV12076181	RIO VERDE S1	23/10/2020 08:46	23/10/2020 11:00	23/10/2020 08:46	23/10/2020 11:00	2,22	3	6,66	CHI
202010130711	PROFESSOR JAMIL SAFADY	JS21256727	ROCHEDO	23/10/2020 08:46	23/10/2020 10:32	23/10/2020 08:46	23/10/2020 10:32	1,75	2	3,50	CHI
202010130713	IPAMERI	UT21165222	URUTAI	23/10/2020 08:47	23/10/2020 11:34	23/10/2020 08:47	23/10/2020 11:34	2,78	1	2,78	CHI
202010131046	CAMPOS VERDES	SG12318449	SANTA TEREZINHA	23/10/2020 08:49	23/10/2020 23:20	23/10/2020 08:49	23/10/2020 23:20	14,51	1	14,51	CHI
202010131046	MARA ROSA	SG12318449	SANTA TEREZINHA	23/10/2020 08:49	23/10/2020 23:20	23/10/2020 08:49	23/10/2020 23:20	14,51	15	217,71	CHI

202010131046	SANTA TEREZINHA DE GOIAS	SG12318449	SANTA TEREZINHA	23/10/2020 08:49	23/10/2020 23:20	23/10/2020 08:49	23/10/2020 23:20	14,51	3	43,54	CHI
202010130801	CACHOEIRA ALTA	PC12000076	CACHOEIRA ALTA	23/10/2020 08:50	23/10/2020 10:34	23/10/2020 08:50	23/10/2020 10:34	1,73	8	13,80	CHI
202010130801	PARANAIGUARA	PC12000076	CACHOEIRA ALTA	23/10/2020 08:50	23/10/2020 10:34	23/10/2020 08:50	23/10/2020 10:34	1,73	5	8,63	CHI
202010131156	CRIXAS	CX12266383	SERRA DO OURO	23/10/2020 08:50	23/10/2020 14:50	23/10/2020 08:50	23/10/2020 14:50	5,99	5	29,95	CHI
202010130867	CRISTALINA	KR12237804	CRISTALINA S1	23/10/2020 08:51	23/10/2020 13:46	23/10/2020 08:51	23/10/2020 13:46	4,90	1	4,90	CHI
202010130867	CRISTALINA	KR12237804	CRISTALINA S1	23/10/2020 08:51	23/10/2020 13:46	23/10/2020 08:51	23/10/2020 13:45	4,89	6	29,32	CHI
202010130867	CRISTALINA	KR10395376	CRISTALINA S1	23/10/2020 08:51	23/10/2020 13:46	23/10/2020 08:51	23/10/2020 13:00	4,15	262	1088,10	CHI
202010130867	IPAMERI	KR10395376	CRISTALINA S1	23/10/2020 08:51	23/10/2020 13:46	23/10/2020 08:51	23/10/2020 13:00	4,15	6	24,92	CHI
202010130784	MORRINHOS	150028969	MORRINHOS	23/10/2020 08:54	23/10/2020 11:35	23/10/2020 08:54	23/10/2020 11:35	2,67	1	2,67	CHI
202010130791	SANTO ANTONIO DO DESCOBERTO	SN21338462	MARAJOARA	23/10/2020 08:56	23/10/2020 13:38	23/10/2020 08:56	23/10/2020 13:38	4,70	2	9,39	CHI
202010130798	POSSE	PS21128043	IACIARA S2	23/10/2020 08:57	23/10/2020 11:13	23/10/2020 08:57	23/10/2020 11:13	2,26	3	6,79	CHI
202010130799	MOSSAMEDES	MD21252204	FIRMINOPOLIS S2	23/10/2020 08:57	23/10/2020 11:40	23/10/2020 08:57	23/10/2020 11:40	2,72	1	2,72	CHI
202010130805	DIVINOPOLIS DE GOIAS	2570008844	SAO DOMINGOS	23/10/2020 08:57	23/10/2020 12:36	23/10/2020 08:57	23/10/2020 12:36	3,64	1	3,64	CHI
202010130809	CUMARI	CY12064048	CATALAO S2	23/10/2020 08:58	23/10/2020 18:32	23/10/2020 08:58	23/10/2020 18:32	9,57	3	28,70	CHI
202010130809	CATALAO	CY12064048	CATALAO S2	23/10/2020 08:58	23/10/2020 18:32	23/10/2020 08:58	23/10/2020 18:32	9,57	5	47,83	CHI
202010130823	VILA PROPICIO	NP12370406	GOIANESIA S1	23/10/2020 08:59	23/10/2020 16:08	23/10/2020 08:59	23/10/2020 16:08	7,14	2	14,29	CHI
202010130836	ALTO PARAISO DE GOIAS	BF12396333	SAO JOAO D ALIANCA	23/10/2020 08:59	23/10/2020 10:24	23/10/2020 08:59	23/10/2020 10:24	1,41	2	2,81	CHI
202010130840	RIO VERDE	10009599108	RIO VERDE S1	23/10/2020 08:59	23/10/2020 10:31	23/10/2020 08:59	23/10/2020 10:31	1,52	1	1,52	CHI
202010130843	GOIANIA	12166832	CAMPINAS S3	23/10/2020 09:00	23/10/2020 12:35	23/10/2020 09:00	23/10/2020 12:35	3,58	1	3,58	CHI
202010131125	PARAUNA	PU12314958	PARAUNA	23/10/2020 09:00	23/10/2020 13:45	23/10/2020 09:00	23/10/2020 13:45	4,74	8	37,95	CHI
202010131125	RIO VERDE	PU12314958	PARAUNA	23/10/2020 09:00	23/10/2020 13:45	23/10/2020 09:00	23/10/2020 13:45	4,74	2	9,49	CHI
202010130857	GOIANIA	16803310	XAVANTES	23/10/2020 09:00	24/10/2020 04:47	23/10/2020 09:00	24/10/2020 04:47	19,77	1	19,77	CHI
202010130862	VILA PROPICIO	NP12248211	GOIANESIA S1	23/10/2020 09:01	24/10/2020 21:43	23/10/2020 09:01	24/10/2020 21:43	36,69	2	73,39	CHI
202010130870	ARAGUAPAZ	AZ12274481	GOIAS	23/10/2020 09:02	23/10/2020 11:03	23/10/2020 09:02	23/10/2020 11:03	2,01	1	2,01	CHI
202010130876	SAO SIMAO	10029586516	CACHOEIRA ALTA	23/10/2020 09:03	23/10/2020 11:35	23/10/2020 09:03	23/10/2020 11:35	2,53	1	2,53	CHI
202010130882	MINACU	10029137061	MINACU	23/10/2020 09:04	23/10/2020 11:05	23/10/2020 09:04	23/10/2020 11:05	2,01	1	2,01	CHI
202010130883	SAO LUIS DE MONTES BELOS	1190005107	SAO LUIZ DOS MONTES BELOS	23/10/2020 09:04	23/10/2020 14:13	23/10/2020 09:04	23/10/2020 14:13	5,15	1	5,15	CHI
202010130885	GOIAS	8703062	MATRINCHA	23/10/2020 09:04	23/10/2020 13:28	23/10/2020 09:04	23/10/2020 13:28	4,39	1	4,39	CHI
202010130911	DIVINOPOLIS DE GOIAS	GH12272677	SAO DOMINGOS	23/10/2020 09:05	23/10/2020 11:49	23/10/2020 09:05	23/10/2020 11:49	2,72	17	46,24	CHI
202010132092	SANTA TEREZINHA DE GOIAS	SG12181588	SANTA TEREZINHA	23/10/2020 09:05	23/10/2020 17:50	23/10/2020 09:05	23/10/2020 17:50	8,73	6	52,41	CHI
202010132092	CAMPOS VERDES	SG12181588	SANTA TEREZINHA	23/10/2020 09:05	23/10/2020 17:50	23/10/2020 09:05	23/10/2020 17:50	8,73	8	69,88	CHI
202010131285	MUTUNOPOLIS	ET12000004	MARA ROSA	23/10/2020 09:06	23/10/2020 13:32	23/10/2020 09:06	23/10/2020 13:32	4,43	3	13,30	CHI
202010131285	AMARALINA	ET12000004	MARA ROSA	23/10/2020 09:06	23/10/2020 13:32	23/10/2020 09:06	23/10/2020 13:32	4,43	6	26,59	CHI
202010130913	BELA VISTA DE GOIAS	BV31010043	BELA VISTA S1	23/10/2020 09:08	23/10/2020 10:58	23/10/2020 09:08	23/10/2020 10:58	1,83	1	1,83	CHI
202010130923	JARAGUA	JA21155118	JARAGUA	23/10/2020 09:09	23/10/2020 12:15	23/10/2020 09:09	23/10/2020 12:15	3,10	1	3,10	CHI
202010130924	ITABERAI	50080131	ITABERAI S2	23/10/2020 09:09	23/10/2020 10:29	23/10/2020 09:09	23/10/2020 10:29	1,32	1	1,32	CHI
202010130930	ORIZONA	2060053384	PIRES DO RIO S2	23/10/2020 09:10	23/10/2020 15:12	23/10/2020 09:10	23/10/2020 15:12	6,03	1	6,03	CHI
202010130935	PIRACANJUBA	60096780	PIRACANJUBA	23/10/2020 09:11	23/10/2020 14:53	23/10/2020 09:11	23/10/2020 14:53	5,70	1	5,70	CHI
202010131186	ESTRELA DO NORTE	MQ12208361	MARA ROSA	23/10/2020 09:12	23/10/2020 14:16	23/10/2020 09:12	23/10/2020 14:16	5,06	4	20,25	CHI
202010132575	MARA ROSA	MQ12371856	MARA ROSA	23/10/2020 09:12	23/10/2020 15:35	23/10/2020 09:12	23/10/2020 15:35	6,38	2	12,75	CHI
202010130946	QUIRINOPOLIS	QI21119906	QUIRINOPOLIS	23/10/2020 09:12	23/10/2020 10:36	23/10/2020 09:12	23/10/2020 10:36	1,39	1	1,39	CHI
202010130947	SANTA HELENA DE GOIAS	400053457	IPEGUARI	23/10/2020 09:12	23/10/2020 10:42	23/10/2020 09:12	23/10/2020 10:42	1,49	1	1,49	CHI
202010130969	GOIANIA	11499631	GOYA S1	23/10/2020 09:14	23/10/2020 11:10	23/10/2020 09:14	23/10/2020 11:10	1,92	1	1,92	CHI
202010130973	IPAMERI	IP21041048	IPAMERI	23/10/2020 09:15	23/10/2020 11:49	23/10/2020 09:15	23/10/2020 11:49	2,56	1	2,56	CHI
202010130974	CEZARINA	CZ21312595	CEZARINA	23/10/2020 09:15	23/10/2020 11:00	23/10/2020 09:15	23/10/2020 11:00	1,74	1	1,74	CHI
202010130986	SANTO ANTONIO DE GOIAS	NR21324557	NEROPOLIS S2	23/10/2020 09:16	23/10/2020 12:45	23/10/2020 09:16	23/10/2020 12:45	3,47	1	3,47	CHI
202010130997	UIRAPURU	UP21183058	SANTA TEREZINHA	23/10/2020 09:18	24/10/2020 00:50	23/10/2020 09:18	24/10/2020 00:50	15,53	1	15,53	CHI
202010130998	VILA PROPICIO	NP21370405	GOIANESIA S1	23/10/2020 09:18	23/10/2020 16:45	23/10/2020 09:18	23/10/2020 16:45	7,44	1	7,44	CHI
202010131001	APARECIDA DE GOIANIA	200495318	INDEPENDENCIA S2	23/10/2020 09:19	23/10/2020 12:00	23/10/2020 09:19	23/10/2020 12:00	2,68	1	2,68	CHI
202010131052	GOIANIA	15825942	GOIANIA LESTE S3	23/10/2020 09:19	23/10/2020 12:55	23/10/2020 09:19	23/10/2020 12:55	3,59	1	3,59	CHI
202010131067	NAZARIO	10027214930	ANICUNS	23/10/2020 09:21	23/10/2020 11:45	23/10/2020 09:21	23/10/2020 11:45	2,40	1	2,40	CHI

202010131073	GOIANIA	10401404	GOIANIA LESTE S2	23/10/2020 09:22	23/10/2020 11:18	23/10/2020 09:22	23/10/2020 11:18	1,93	1	1,93	CHI
202010131075	BRITANIA	BT11060642	BRITANIA	23/10/2020 09:22	23/10/2020 15:08	23/10/2020 09:22	23/10/2020 15:08	5,76	7	40,29	CHI
202010131078	GOIATUBA	GT12222392	GOIATUBA S2	23/10/2020 09:23	23/10/2020 20:34	23/10/2020 09:23	23/10/2020 20:34	11,18	2	22,37	CHI
202010131094	RIO VERDE	10029692260	RIO VERDE S2	23/10/2020 09:24	23/10/2020 16:26	23/10/2020 09:24	23/10/2020 16:26	7,02	1	7,02	CHI
202010131099	CORUMBAIBA	CI21076934	VILA CORUMBA	23/10/2020 09:24	23/10/2020 11:57	23/10/2020 09:24	23/10/2020 11:57	2,54	1	2,54	CHI
202010131104	CALDAS NOVAS	760394830	SERRA DE CALDAS	23/10/2020 09:25	23/10/2020 13:15	23/10/2020 09:25	23/10/2020 13:15	3,83	1	3,83	CHI
202010131108	PIRACANJUBA	PJ21120728	PIRACANJUBA	23/10/2020 09:25	23/10/2020 11:48	23/10/2020 09:25	23/10/2020 11:48	2,38	1	2,38	CHI
202010131120	SAO JOAO D ALIANCA	JL21146136	SAO JOAO D ALIANCA	23/10/2020 09:26	23/10/2020 16:05	23/10/2020 09:26	23/10/2020 16:05	6,63	1	6,63	CHI
202010131144	CACHOEIRA ALTA	CA12301755	CACHOEIRA ALTA	23/10/2020 09:27	23/10/2020 12:05	23/10/2020 09:27	23/10/2020 12:05	2,62	14	36,73	CHI
202010131138	GOIANIA	14455225	FERROVIARIO S1	23/10/2020 09:28	23/10/2020 11:58	23/10/2020 09:28	23/10/2020 11:58	2,49	1	2,49	CHI
202010131150	RIO VERDE	4080005120	SANTA HELENA S1	23/10/2020 09:29	23/10/2020 13:26	23/10/2020 09:29	23/10/2020 13:26	3,93	1	3,93	CHI
202010131154	PIRANHAS	PH21343545	PIRANHAS	23/10/2020 09:30	23/10/2020 13:00	23/10/2020 09:30	23/10/2020 13:00	3,49	1	3,49	CHI
202010131155	BOM JESUS DE GOIAS	BJ21208175	RIO DOS BOIS	23/10/2020 09:30	23/10/2020 19:17	23/10/2020 09:30	23/10/2020 19:17	9,77	1	9,77	CHI
202010131573	SERRANOPOLIS	SX12390576	JATAI S1	23/10/2020 09:32	23/10/2020 13:11	23/10/2020 09:32	23/10/2020 13:11	3,64	9	32,79	CHI
202010131174	CAMPOS VERDES	VD21049790	SANTA TEREZINHA	23/10/2020 09:33	24/10/2020 15:58	23/10/2020 09:33	24/10/2020 15:58	30,40	1	30,40	CHI
202010131181	RIO VERDE	RV21260771	CABRIUVA S1	23/10/2020 09:34	23/10/2020 12:36	23/10/2020 09:34	23/10/2020 12:36	3,03	1	3,03	CHI
202010131188	JANDAIA	JD21308424	PALMEIRAS	23/10/2020 09:34	23/10/2020 14:54	23/10/2020 09:34	23/10/2020 14:54	5,32	2	10,64	CHI
202010131201	SANTA HELENA DE GOIAS	SH21024705	RIO VERDE S1	23/10/2020 09:37	23/10/2020 13:40	23/10/2020 09:37	23/10/2020 13:40	4,05	1	4,05	CHI
202010131757	IPAMERI	IP21272799	IPAMERI	23/10/2020 09:38	23/10/2020 11:41	23/10/2020 09:38	23/10/2020 11:41	2,03	1	2,03	CHI
202010130737	GOIANIA	GN21191202	GOIANIA LESTE S1	23/10/2020 09:40	23/10/2020 10:01	23/10/2020 09:40	23/10/2020 10:01	0,35	1	0,35	CHI
202010131235	VIANOPOLIS	VN21327173	VIANOPOLIS	23/10/2020 09:41	23/10/2020 11:49	23/10/2020 09:41	23/10/2020 11:49	2,13	2	4,25	CHI
202010131234	PLANALTINA	10009234339	PLANALTINA	23/10/2020 09:41	23/10/2020 11:08	23/10/2020 09:41	23/10/2020 11:08	1,44	1	1,44	CHI
202010131237	GOIANIA	16586165	MEIA PONTE	23/10/2020 09:41	23/10/2020 12:36	23/10/2020 09:41	23/10/2020 12:36	2,91	1	2,91	CHI
202010189357	SERRANOPOLIS	SX21037682	JATAI S1	23/10/2020 09:42	23/10/2020 20:24	23/10/2020 09:42	23/10/2020 20:24	10,70	1	10,70	CHI
202010131246	GOIANIA	15965946	CAMPINAS S1	23/10/2020 09:42	23/10/2020 11:50	23/10/2020 09:42	23/10/2020 11:50	2,13	1	2,13	CHI
202010131253	UIRAPURU	UP12396274	NOVA CRIXAS	23/10/2020 09:43	23/10/2020 15:40	23/10/2020 09:43	23/10/2020 15:40	5,95	5	29,73	CHI
202010131258	PIRANHAS	PH12343593	PIRANHAS	23/10/2020 09:43	23/10/2020 17:33	23/10/2020 09:43	23/10/2020 17:33	7,82	4	31,29	CHI
202010131259	PILAR DE GOIAS	GG21254850	SANTA TEREZINHA	23/10/2020 09:43	24/10/2020 16:32	23/10/2020 09:43	24/10/2020 16:32	30,80	1	30,80	CHI
202010131260	QUIRINOPOLIS	80076087	QUIRINOPOLIS	23/10/2020 09:43	23/10/2020 11:08	23/10/2020 09:43	23/10/2020 11:08	1,40	1	1,40	CHI
202010135541	DAMOLANDIA	DL12200062	INHUMAS S1	23/10/2020 09:43	23/10/2020 20:30	23/10/2020 09:43	23/10/2020 20:30	10,77	8	86,14	CHI
202010131626	ARENOPOLIS	AY12259346	IPORA	23/10/2020 09:44	23/10/2020 16:44	23/10/2020 09:44	23/10/2020 16:44	7,00	22	153,90	CHI
202010131264	SAO JOAO DA PARAUNA	PU12361883	PARAUNA	23/10/2020 09:44	23/10/2020 12:37	23/10/2020 09:44	23/10/2020 12:37	2,88	4	11,50	CHI
202010131270	PORTELANDIA	MY21073771	PARQUE DAS EMAS	23/10/2020 09:44	24/10/2020 11:23	23/10/2020 09:44	24/10/2020 11:23	25,64	1	25,64	CHI
202010131271	MINEIROS	10024569737	PARQUE DAS EMAS	23/10/2020 09:44	23/10/2020 10:48	23/10/2020 09:44	23/10/2020 10:48	1,05	0	0,00	CHI
202010131273	GOIATUBA	GT12307867LD	GOIATUBA S2	23/10/2020 09:45	23/10/2020 16:29	23/10/2020 09:45	23/10/2020 16:29	6,74	41	276,47	CHI
202010131280	PLANALTINA	PI21302777	SAO JOAO D ALIANCA	23/10/2020 09:45	23/10/2020 13:16	23/10/2020 09:45	23/10/2020 13:16	3,50	1	3,50	CHI
202010131283	GOIANIA	16480624	GOIANIA LESTE S1	23/10/2020 09:45	23/10/2020 13:42	23/10/2020 09:45	23/10/2020 13:42	3,93	1	3,93	CHI
202010131313	AMARALINA	UP12390498	NOVA CRIXAS	23/10/2020 09:46	23/10/2020 15:40	23/10/2020 09:46	23/10/2020 15:40	5,89	24	141,35	CHI
202010131313	MARA ROSA	UP12390498	NOVA CRIXAS	23/10/2020 09:46	23/10/2020 15:40	23/10/2020 09:46	23/10/2020 15:40	5,89	1	5,89	CHI
202010131313	UIRAPURU	UP12390498	NOVA CRIXAS	23/10/2020 09:46	23/10/2020 15:40	23/10/2020 09:46	23/10/2020 15:40	5,89	5	29,45	CHI
202010131294	MARA ROSA	MH12037774	NOVA CRIXAS	23/10/2020 09:46	23/10/2020 15:40	23/10/2020 09:46	23/10/2020 15:40	5,89	47	276,67	CHI
202010131294	AMARALINA	MH12037774	NOVA CRIXAS	23/10/2020 09:46	23/10/2020 15:40	23/10/2020 09:46	23/10/2020 15:40	5,89	54	317,88	CHI
202010131294	UIRAPURU	MH12037774	NOVA CRIXAS	23/10/2020 09:46	23/10/2020 15:40	23/10/2020 09:46	23/10/2020 15:40	5,89	57	335,54	CHI
202010131294	MUNDO NOVO DE GOIAS	MH12037774	NOVA CRIXAS	23/10/2020 09:46	23/10/2020 15:40	23/10/2020 09:46	23/10/2020 15:40	5,89	4	23,55	CHI
202010131294	SANTA TEREZINHA DE GOIAS	MH12037774	NOVA CRIXAS	23/10/2020 09:46	23/10/2020 15:40	23/10/2020 09:46	23/10/2020 15:40	5,89	1	5,89	CHI
202010131297	CATALAO	CT21195490	CATALAO S1	23/10/2020 09:47	23/10/2020 11:29	23/10/2020 09:47	23/10/2020 11:29	1,69	2	3,39	CHI
202010131300	RUBIATABA	RB21200984	RUBIATABA	23/10/2020 09:47	24/10/2020 02:34	23/10/2020 09:47	24/10/2020 02:34	16,77	1	16,77	CHI
202010131322	LUZIANIA	LZ21244862	VIANOPOLIS	23/10/2020 09:50	23/10/2020 13:54	23/10/2020 09:50	23/10/2020 13:54	4,05	1	4,05	CHI
202010131330	CATALAO	GD21053657	CATALAO S1	23/10/2020 09:52	23/10/2020 11:53	23/10/2020 09:52	23/10/2020 11:53	2,02	1	2,02	CHI
202010131336	SANTA TEREZA DE GOIAS	SE12053854	MARA ROSA	23/10/2020 09:53	23/10/2020 14:15	23/10/2020 09:53	23/10/2020 14:15	4,36	1	4,36	CHI
202010131338	MORRINHOS	10023402871	MORRINHOS	23/10/2020 09:53	23/10/2020 11:31	23/10/2020 09:53	23/10/2020 11:31	1,63	1	1,63	CHI

202010131343	CATALAO	1990112794	CATALAO S2	23/10/2020 09:53	23/10/2020 11:06	23/10/2020 09:53	23/10/2020 11:06	1,20	1	1,20	CHI
202010131463	HIDROLINA	UR12374572	URUACU	23/10/2020 09:54	23/10/2020 11:57	23/10/2020 09:54	23/10/2020 11:57	2,05	2	4,09	CHI
202010131463	URUACU	UR12374572	URUACU	23/10/2020 09:54	23/10/2020 11:57	23/10/2020 09:54	23/10/2020 11:57	2,05	6	12,28	CHI
202010131351	DIORAMA	1530002063	IPORA	23/10/2020 09:55	23/10/2020 11:45	23/10/2020 09:55	23/10/2020 11:45	1,83	1	1,83	CHI
202010131350	GOIAS	GS21079309	MATRINCHA	23/10/2020 09:55	23/10/2020 11:10	23/10/2020 09:55	23/10/2020 11:10	1,24	1	1,24	CHI
202010131365	LUZIANIA	3200150218	MARAJOARA	23/10/2020 09:56	23/10/2020 12:04	23/10/2020 09:56	23/10/2020 12:04	2,12	1	2,12	CHI
202010131652	ITAPURANGA	IK12286989	ITAPURANGA	23/10/2020 09:56	23/10/2020 17:02	23/10/2020 09:56	23/10/2020 17:02	7,08	5	35,42	CHI
202010131369	INACIOLANDIA	ID21000338	CACHOEIRA DOURADA	23/10/2020 09:57	23/10/2020 11:35	23/10/2020 09:57	23/10/2020 11:35	1,63	2	3,26	CHI
202010131379	VALPARAISO DE GOIAS	2860326700	MARAJOARA	23/10/2020 09:58	23/10/2020 13:05	23/10/2020 09:58	23/10/2020 13:05	3,11	1	3,11	CHI
202010131381	CATALAO	CT21042350	CATALAO S1	23/10/2020 09:59	23/10/2020 11:18	23/10/2020 09:59	23/10/2020 11:18	1,31	2	2,62	CHI
202010131382	JUSSARA	JR12206951	BRITANIA	23/10/2020 09:59	23/10/2020 16:51	23/10/2020 09:59	23/10/2020 16:51	6,85	4	27,42	CHI
202010131394	MARA ROSA	MQ12370551	MARA ROSA	23/10/2020 10:00	23/10/2020 14:50	23/10/2020 10:00	23/10/2020 14:50	4,82	25	120,42	CHI
202010131394	CAMPINORTE	MQ12370551	MARA ROSA	23/10/2020 10:00	23/10/2020 14:50	23/10/2020 10:00	23/10/2020 14:50	4,82	5	24,08	CHI
202010131395	ACREUNA	EU12317016	ACREUNA	23/10/2020 10:01	23/10/2020 11:28	23/10/2020 10:01	23/10/2020 11:28	1,45	1	1,45	CHI
202010131397	CEZARINA	CZ21028681	GUAPO S2	23/10/2020 10:01	23/10/2020 13:11	23/10/2020 10:01	23/10/2020 13:11	3,16	1	3,16	CHI
202010131399	GOIANESIA	550198179	GOIANESIA S2	23/10/2020 10:01	23/10/2020 18:53	23/10/2020 10:01	23/10/2020 18:53	8,86	1	8,86	CHI
202010131402	AGUAS LINDAS DE GOIAS	10005031131	AGUAS LINDAS DE GOIAS S1	23/10/2020 10:01	23/10/2020 10:32	23/10/2020 10:01	23/10/2020 10:32	0,51	1	0,51	CHI
202010131574	ACREUNA	EU12045542	ACREUNA	23/10/2020 10:05	23/10/2020 12:35	23/10/2020 10:05	23/10/2020 12:35	2,50	5	12,49	CHI
202010131451	PADRE BERNARDO	PB12377279	PADRE BERNARDO	23/10/2020 10:06	23/10/2020 19:34	23/10/2020 10:06	23/10/2020 19:34	9,46	3	28,39	CHI
202010131452	DISTRITO FEDERAL	2900100805	MARAJOARA	23/10/2020 10:06	23/10/2020 12:36	23/10/2020 10:06	23/10/2020 12:36	2,50	1	2,50	CHI
202010131458	GOUVELANDIA	2250019909	QUIRINOPOLIS	23/10/2020 10:07	23/10/2020 14:41	23/10/2020 10:07	23/10/2020 14:41	4,57	1	4,57	CHI
202010131462	QUIRINOPOLIS	10025009603	QUIRINOPOLIS	23/10/2020 10:08	23/10/2020 12:13	23/10/2020 10:08	23/10/2020 12:13	2,07	1	2,07	CHI
202010131470	PLANALTINA	PI21243000	PLANALTINA	23/10/2020 10:09	23/10/2020 13:38	23/10/2020 10:09	23/10/2020 13:38	3,48	1	3,48	CHI
202010131479	COLINAS DO SUL	TI12196546RE	MINACU	23/10/2020 10:10	23/10/2020 16:26	23/10/2020 10:10	23/10/2020 16:26	6,27	30	187,97	CHI
202010131480	ARAGOIANIA	AO21053770	GUAPO S2	23/10/2020 10:10	23/10/2020 21:53	23/10/2020 10:10	23/10/2020 21:53	11,71	1	11,71	CHI
202010131490	COLINAS DO SUL	TI21163505	NIQUELANDIA SUBTRANSMISSAO	23/10/2020 10:10	24/10/2020 01:35	23/10/2020 10:10	24/10/2020 01:35	15,41	1	15,41	CHI
202010131503	RIO VERDE	RV21226254	CABRIUVA S1	23/10/2020 10:11	23/10/2020 12:16	23/10/2020 10:11	23/10/2020 12:16	2,07	1	2,07	CHI
202010131510	SILVANIA	SV21012009	VIANOPOLIS	23/10/2020 10:12	23/10/2020 11:59	23/10/2020 10:12	23/10/2020 11:59	1,78	1	1,78	CHI
202010131578	PORANGATU	TB12262770	PORANGATU	23/10/2020 10:12	23/10/2020 11:20	23/10/2020 10:12	23/10/2020 11:20	1,12	1	1,12	CHI
202010131578	SANTA TEREZA DE GOIAS	TB12262770	PORANGATU	23/10/2020 10:12	23/10/2020 11:20	23/10/2020 10:12	23/10/2020 11:20	1,12	4	4,49	CHI
202010131578	TROMBAS	TB12262770	PORANGATU	23/10/2020 10:12	23/10/2020 11:20	23/10/2020 10:12	23/10/2020 11:20	1,12	13	14,59	CHI
202010131856	SAO LUIZ DO NORTE	SZ12236801LD	BARRO ALTO	23/10/2020 10:13	23/10/2020 14:41	23/10/2020 10:13	23/10/2020 14:41	4,46	22	98,05	CHI
202010131580	MONTES CLAROS DE GOIAS	ME21135310	BRITANIA	23/10/2020 10:16	24/10/2020 00:25	23/10/2020 10:16	24/10/2020 00:25	14,15	2	28,30	CHI
202010131582	NOVA CRIXAS	NA21213191	MOZARLANDIA	23/10/2020 10:16	24/10/2020 00:26	23/10/2020 10:16	24/10/2020 00:26	14,16	1	14,16	CHI
202010131592	APARECIDA DE GOIANIA	10009240509	REAL S1	23/10/2020 10:17	23/10/2020 15:56	23/10/2020 10:17	23/10/2020 15:56	5,64	1	5,64	CHI
202010131236	RIO VERDE	RV11113526	RIO VERDE S1	23/10/2020 10:18	23/10/2020 12:49	23/10/2020 10:18	23/10/2020 12:49	2,50	176	440,34	CHI
202010131613	MINEIROS	MY21126518	PARQUE DAS EMAS	23/10/2020 10:21	23/10/2020 11:47	23/10/2020 10:21	23/10/2020 11:47	1,42	1	1,42	CHI
202010130968	MINEIROS	MY21195606	PARQUE DAS EMAS	23/10/2020 10:24	23/10/2020 13:51	23/10/2020 10:24	23/10/2020 13:51	3,44	1	3,44	CHI
202010131637	GOIANIA	16541662	FERROVIARIO S1	23/10/2020 10:26	23/10/2020 19:37	23/10/2020 10:26	23/10/2020 19:37	9,18	1	9,18	CHI
202010134036	TURVELANDIA	TD12291862	RIO DOS BOIS	23/10/2020 10:28	24/10/2020 17:11	23/10/2020 10:28	24/10/2020 17:11	30,71	5	153,56	CHI
202010134036	TURVELANDIA	TD12291862	RIO DOS BOIS	23/10/2020 10:28	24/10/2020 17:11	24/10/2020 12:43	24/10/2020 17:11	4,46	10	44,59	CHI
202010134036	TURVELANDIA	TD12291862	RIO DOS BOIS	23/10/2020 10:28	24/10/2020 17:11	23/10/2020 10:28	24/10/2020 07:46	21,29	10	212,93	CHI
202010131669	MIMOSO DE GOIAS	MJ21126286	PADRE BERNARDO	23/10/2020 10:29	23/10/2020 17:07	23/10/2020 10:29	23/10/2020 17:07	6,62	1	6,62	CHI
202010131828	RIO VERDE	RV12245478	RIO VERDE S2	23/10/2020 10:33	23/10/2020 12:01	23/10/2020 10:33	23/10/2020 12:01	1,46	172	251,31	CHI
202010131695	FORMOSA	FA12376671	ITIQUEIRA	23/10/2020 10:34	23/10/2020 20:22	23/10/2020 10:34	23/10/2020 20:22	9,80	33	323,32	CHI
202010131696	GOIANIA	10018509825	MEIA PONTE	23/10/2020 10:34	23/10/2020 12:02	23/10/2020 10:34	23/10/2020 12:02	1,46	1	1,46	CHI
202010131698	NOVA AURORA	NE21311815	CATALAO S1	23/10/2020 10:34	23/10/2020 13:00	23/10/2020 10:34	23/10/2020 13:00	2,42	1	2,42	CHI
202010131703	RIO VERDE	630449934	RIO VERDE S1	23/10/2020 10:35	23/10/2020 19:49	23/10/2020 10:35	23/10/2020 19:49	9,23	1	9,23	CHI
202010131704	MINACU	IH21187763	MINACU	23/10/2020 10:35	23/10/2020 14:25	23/10/2020 10:35	23/10/2020 14:25	3,83	1	3,83	CHI
202010131705	QUIRINOPOLIS	80052824	QUIRINOPOLIS	23/10/2020 10:35	23/10/2020 13:46	23/10/2020 10:35	23/10/2020 13:46	3,17	1	3,17	CHI
202010131710	INDIARA	IY21299106	EDEIA	23/10/2020 10:36	23/10/2020 15:33	23/10/2020 10:36	23/10/2020 15:33	4,94	1	4,94	CHI

202010131715	CALDAS NOVAS	760261957	CALDAS NOVAS S2	23/10/2020 10:37	23/10/2020 11:54	23/10/2020 10:37	23/10/2020 11:54	1,28	1	1,28	CHI
202010136087	PIRANHAS	PH12343666	PIRANHAS	23/10/2020 10:40	24/10/2020 10:40	23/10/2020 10:40	24/10/2020 10:40	24,00	2	47,99	CHI
202010133004	BELA VISTA DE GOIAS	BV31060478	BELA VISTA S1	23/10/2020 10:40	23/10/2020 15:30	23/10/2020 10:40	23/10/2020 15:30	4,83	1	4,83	CHI
202010131745	VILA BOA	FA12042061	ITIQUEIRA	23/10/2020 10:40	23/10/2020 14:20	23/10/2020 10:40	23/10/2020 14:20	3,65	1	3,65	CHI
202010131745	FLORES DE GOIAS	FA12042061	ITIQUEIRA	23/10/2020 10:40	23/10/2020 14:20	23/10/2020 10:40	23/10/2020 14:20	3,65	2	7,30	CHI
202010131750	PONTALINA	PK21047381	VICENTINOPOLIS	23/10/2020 10:41	23/10/2020 13:00	23/10/2020 10:41	23/10/2020 13:00	2,31	1	2,31	CHI
202010131764	NIQUELANDIA	2750049939	NIQUELANDIA SUBTRANSMISSAO	23/10/2020 10:42	23/10/2020 15:42	23/10/2020 10:42	23/10/2020 15:42	4,99	1	4,99	CHI
202010131824	PIRENOPOLIS	PV12290060	GOIANESIA S1	23/10/2020 10:43	23/10/2020 20:45	23/10/2020 10:43	23/10/2020 20:45	10,03	7	70,23	CHI
202010131774	GOIANIA	16753800	GOYA S2	23/10/2020 10:43	23/10/2020 12:46	23/10/2020 10:43	23/10/2020 12:46	2,04	1	2,04	CHI
202010131777	PIRES DO RIO	PR21186673	PIRES DO RIO S1	23/10/2020 10:43	23/10/2020 11:51	23/10/2020 10:43	23/10/2020 11:51	1,12	1	1,12	CHI
202010131789	PIRACANJUBA	PI21106693	CALDAS NOVAS S1	23/10/2020 10:46	23/10/2020 12:48	23/10/2020 10:46	23/10/2020 12:48	2,02	1	2,02	CHI
202010132860	MINEIROS	DP12313351	JATAI S1	23/10/2020 10:47	23/10/2020 16:00	23/10/2020 10:47	23/10/2020 16:00	5,21	3	15,64	CHI
202010132860	PEROLANDIA	DP12313351	JATAI S1	23/10/2020 10:47	23/10/2020 16:00	23/10/2020 10:47	23/10/2020 16:00	5,21	2	10,43	CHI
202010131790	FORMOSA	610173406	ITIQUEIRA	23/10/2020 10:47	23/10/2020 12:17	23/10/2020 10:47	23/10/2020 12:17	1,50	1	1,50	CHI
202010131841	GOIANIA	GN12405619LD	GOIANIA LESTE S3	23/10/2020 10:48	23/10/2020 18:00	23/10/2020 11:42	23/10/2020 18:00	6,30	7	44,12	CHI
202010131841	GOIANIA	GN12405619LD	GOIANIA LESTE S3	23/10/2020 10:48	23/10/2020 18:00	23/10/2020 17:55	23/10/2020 18:00	0,08	57	4,64	CHI
202010131841	GOIANIA	GN16420283	GOIANIA LESTE S3	23/10/2020 10:48	23/10/2020 18:00	23/10/2020 11:42	23/10/2020 13:25	1,71	57	97,60	CHI
202010131841	GOIANIA	GN10385820	GOIANIA LESTE S3	23/10/2020 10:48	23/10/2020 18:00	23/10/2020 11:43	23/10/2020 12:45	1,05	2786	2914,47	CHI
202010131841	GOIANIA	GN10385820	REAL S1	23/10/2020 10:48	23/10/2020 18:00	23/10/2020 11:43	23/10/2020 12:45	1,05	1880	1966,69	CHI
202010131841	GOIANIA	GN16407667	GOIANIA LESTE S3	23/10/2020 10:48	23/10/2020 18:00	23/10/2020 11:42	23/10/2020 12:38	0,94	105	98,32	CHI
202010131841	GOIANIA	00582034	GOIANIA LESTE S3	23/10/2020 10:48	23/10/2020 18:00	23/10/2020 10:48	23/10/2020 11:19	0,50	169	84,88	CHI
202010189285	PARAUNA	PU12045172	ACREUNA	23/10/2020 10:52	23/10/2020 17:53	23/10/2020 10:52	23/10/2020 17:53	7,00	5	35,01	CHI
202010131834	GOIATUBA	GT12050351	GOIATUBA S1	23/10/2020 10:53	23/10/2020 14:11	23/10/2020 10:53	23/10/2020 14:11	3,29	1	3,29	CHI
202010131840	GUAPO	GA21359594	GUAPO S1	23/10/2020 10:54	23/10/2020 20:59	23/10/2020 10:54	23/10/2020 20:59	10,08	2	20,16	CHI
202010131845	PIRANHAS	1930017677	PIRANHAS	23/10/2020 10:54	23/10/2020 18:16	23/10/2020 10:54	23/10/2020 18:16	7,36	1	7,36	CHI
202010131846	SAO DOMINGOS	SD21332882	SAO DOMINGOS	23/10/2020 10:54	23/10/2020 13:46	23/10/2020 10:54	23/10/2020 13:46	2,86	1	2,86	CHI
202010131864	CACHOEIRA DOURADA	CD12191000	CACHOEIRA DOURADA	23/10/2020 10:57	23/10/2020 22:24	23/10/2020 10:57	23/10/2020 22:24	11,45	4	45,80	CHI
202010131867	DIVINOPOLIS DE GOIAS	GH11164679	SAO DOMINGOS	23/10/2020 10:57	23/10/2020 16:03	23/10/2020 10:57	23/10/2020 16:03	5,11	82	418,82	CHI
202010131867	DIVINOPOLIS DE GOIAS	GH12208670	SAO DOMINGOS	23/10/2020 10:57	23/10/2020 16:03	23/10/2020 10:57	23/10/2020 14:18	3,35	50	167,61	CHI
202010131869	CAIAPONIA	CP11246401	CAIAPONIA	23/10/2020 10:57	24/10/2020 08:00	23/10/2020 10:57	24/10/2020 08:00	21,04	1	21,04	CHI
202010131877	FIRMINOPOLIS	6628215	FIRMINOPOLIS S2	23/10/2020 10:58	23/10/2020 16:04	23/10/2020 10:58	23/10/2020 16:04	5,09	2	10,17	CHI
202010131880	JATAI	10004522328	JATAI S2	23/10/2020 10:59	24/10/2020 09:36	23/10/2020 10:59	24/10/2020 09:36	22,61	1	22,61	CHI
202010131881	GOIANIA	11205660	REAL S1	23/10/2020 10:59	23/10/2020 14:26	23/10/2020 10:59	23/10/2020 14:26	3,45	1	3,45	CHI
202010131882	ITAUCU	IX21191028	INHUMAS S1	23/10/2020 10:59	24/10/2020 12:45	23/10/2020 10:59	24/10/2020 12:45	25,76	1	25,76	CHI
202010132284	GUARINOS	GF12164881	SANTA TEREZINHA	23/10/2020 10:59	24/10/2020 21:05	23/10/2020 10:59	24/10/2020 21:05	34,10	7	238,69	CHI
202010132284	GUARINOS	GF12164881	SANTA TEREZINHA	23/10/2020 10:59	24/10/2020 21:05	23/10/2020 10:59	24/10/2020 20:15	33,26	2	66,53	CHI
202010132284	GUARINOS	GF12164881	SANTA TEREZINHA	23/10/2020 10:59	24/10/2020 21:05	23/10/2020 10:59	24/10/2020 19:29	32,50	2	65,00	CHI
202010132284	GUARINOS	GF12164881	SANTA TEREZINHA	23/10/2020 10:59	24/10/2020 21:05	23/10/2020 10:59	24/10/2020 16:12	29,21	3	87,63	CHI
202010132284	GUARINOS	GF12164881	SANTA TEREZINHA	23/10/2020 10:59	24/10/2020 21:05	23/10/2020 10:59	24/10/2020 12:14	25,25	7	176,72	CHI
202010132284	GUARINOS	GF12164881	SANTA TEREZINHA	23/10/2020 10:59	24/10/2020 21:05	23/10/2020 10:59	24/10/2020 06:20	19,34	15	290,05	CHI
202010131884	ARAGOIANIA	AO31097675	GUAPO S2	23/10/2020 10:59	23/10/2020 23:02	23/10/2020 10:59	23/10/2020 23:02	12,04	1	12,04	CHI
202010131890	CRISTALINA	1060010759	CRISTALINA S1	23/10/2020 11:00	23/10/2020 12:20	23/10/2020 11:00	23/10/2020 12:20	1,33	1	1,33	CHI
202010131889	NOVO GAMA	4990102308	MARAJOARA	23/10/2020 11:00	23/10/2020 12:46	23/10/2020 11:00	23/10/2020 12:46	1,76	1	1,76	CHI
202010131891	ADELANDIA	DN21186262	FIRMINOPOLIS S2	23/10/2020 11:00	23/10/2020 22:06	23/10/2020 11:00	23/10/2020 22:06	11,09	1	11,09	CHI
202010131904	GOIANIA	14710468	GOIANIA LESTE S1	23/10/2020 11:03	23/10/2020 13:56	23/10/2020 11:03	23/10/2020 13:56	2,88	1	2,88	CHI
202010134717	MINEIROS	MY12324344	PARQUE DAS EMAS	23/10/2020 11:03	24/10/2020 04:50	23/10/2020 11:03	24/10/2020 04:50	17,77	7	124,41	CHI
202010131911	VALPARAISO DE GOIAS	10005170867	PACAEMBU S1	23/10/2020 11:05	23/10/2020 12:54	23/10/2020 11:05	23/10/2020 12:54	1,81	1	1,81	CHI
202010131918	JATAI	290213540	JATAI S2	23/10/2020 11:06	24/10/2020 09:59	23/10/2020 11:06	24/10/2020 09:59	22,88	1	22,88	CHI
202010131920	LUZIANIA	LZ12389556	PACAEMBU S2	23/10/2020 11:06	23/10/2020 13:11	23/10/2020 11:06	23/10/2020 13:11	2,08	38	79,01	CHI
202010131922	GOIANIA	12176424	GOYA S2	23/10/2020 11:06	23/10/2020 16:57	23/10/2020 11:06	23/10/2020 16:57	5,84	1	5,84	CHI
202010131923	BELA VISTA DE GOIAS	BV12018394	BELA VISTA S1	23/10/2020 11:06	23/10/2020 14:04	23/10/2020 11:06	23/10/2020 14:04	2,96	3	8,87	CHI



202010131923	PIRACANJUBA	BV12018394	BELA VISTA S1	23/10/2020 11:06	23/10/2020 14:04	23/10/2020 11:06	23/10/2020 14:04	2,96	33	97,53	CHI
202010131928	NIQUELANDIA	NQ21238689	NIQUELANDIA SUBTRANSMISSAO	23/10/2020 11:07	24/10/2020 06:14	23/10/2020 11:07	24/10/2020 06:14	19,11	1	19,11	CHI
202010189349	BALIZA	BH12331250	CAIAPONIA	23/10/2020 11:08	24/10/2020 01:21	23/10/2020 11:08	24/10/2020 01:21	14,20	99	1406,02	CHI
202010131939	APARECIDA DE GOIANIA	10003137552	INDEPENDENCIA S1	23/10/2020 11:09	23/10/2020 11:35	23/10/2020 11:09	23/10/2020 11:35	0,43	1	0,43	CHI
202010131943	POSSE	1480084302	IACIARA S2	23/10/2020 11:10	23/10/2020 11:48	23/10/2020 11:10	23/10/2020 11:48	0,63	1	0,63	CHI
202010131952	APARECIDA DE GOIANIA	14310673	INDEPENDENCIA S2	23/10/2020 11:10	23/10/2020 12:03	23/10/2020 11:10	23/10/2020 12:03	0,87	1	0,87	CHI
202010131955	PIRACANJUBA	PJ21032499	MORRINHOS	23/10/2020 11:11	23/10/2020 14:46	23/10/2020 11:11	23/10/2020 14:46	3,58	1	3,58	CHI
202010131962	ANAPOLIS	21031447	JUNDIAI S2	23/10/2020 11:12	23/10/2020 12:49	23/10/2020 11:12	23/10/2020 12:49	1,60	1	1,60	CHI
202010131965	PARAUNA	PU12248129	PARAUNA	23/10/2020 11:12	23/10/2020 16:50	23/10/2020 11:12	23/10/2020 16:50	5,62	4	22,48	CHI
202010131966	ITUMBIARA	690057271	ITUMBIARA NOVA	23/10/2020 11:12	23/10/2020 12:36	23/10/2020 11:12	23/10/2020 12:36	1,38	1	1,38	CHI
202010131968	PLANALTINA	2960095700	PLANALTINA	23/10/2020 11:13	23/10/2020 13:32	23/10/2020 11:13	23/10/2020 13:32	2,31	1	2,31	CHI
202010131974	ARAGUAPAZ	1780008548	MOZARLANDIA	23/10/2020 11:14	23/10/2020 13:35	23/10/2020 11:14	23/10/2020 13:35	2,35	1	2,35	CHI
202010131975	ITAPURANGA	IK21250610	ITAPURANGA	23/10/2020 11:14	23/10/2020 13:59	23/10/2020 11:14	23/10/2020 13:59	2,75	1	2,75	CHI
202010131978	ORIZONA	2060032423	VIANOPOLIS	23/10/2020 11:14	23/10/2020 19:03	23/10/2020 11:14	23/10/2020 19:03	7,81	1	7,81	CHI
202010131983	IPORA	10004858210	IPORA	23/10/2020 11:15	23/10/2020 11:58	23/10/2020 11:15	23/10/2020 11:58	0,71	1	0,71	CHI
202010131988	MARA ROSA	MQ21117953	MARA ROSA	23/10/2020 11:15	24/10/2020 00:05	23/10/2020 11:15	24/10/2020 00:05	12,82	1	12,82	CHI
202010131990	VALPARAISO DE GOIAS	VA11136668	PACAEMBU S1	23/10/2020 11:15	23/10/2020 17:51	23/10/2020 11:15	23/10/2020 17:51	6,58	137	901,99	CHI
202010132004	ACREUNA	EU12301173	ACREUNA	23/10/2020 11:17	23/10/2020 14:17	23/10/2020 11:17	23/10/2020 14:17	2,99	10	29,88	CHI
202010132005	SENADOR CANEDO	190037581	SENADOR CANEDO	23/10/2020 11:17	23/10/2020 13:40	23/10/2020 11:17	23/10/2020 13:40	2,37	1	2,37	CHI
202010132010	ITARUMA	IM21057633	CACHOEIRA ALTA	23/10/2020 11:18	23/10/2020 14:01	23/10/2020 11:18	23/10/2020 14:01	2,72	1	2,72	CHI
202010132030	CUMARI	CT13050601	CATALAO S2	23/10/2020 11:20	23/10/2020 18:32	23/10/2020 11:20	23/10/2020 18:32	7,19	203	1460,19	CHI
202010132030	CATALAO	CT13050601	CATALAO S2	23/10/2020 11:20	23/10/2020 18:32	23/10/2020 11:20	23/10/2020 18:32	7,19	94	676,15	CHI
202010132030	GOIANDIRA	CT13050601	CATALAO S2	23/10/2020 11:20	23/10/2020 18:32	23/10/2020 11:20	23/10/2020 18:32	7,19	6	43,16	CHI
202010132030	CATALAO	05060234	CATALAO S2	23/10/2020 11:20	23/10/2020 18:32	23/10/2020 18:22	23/10/2020 18:32	0,17	27	4,63	CHI
202010132036	PADRE BERNARDO	PB21183714	PADRE BERNARDO	23/10/2020 11:21	23/10/2020 13:10	23/10/2020 11:21	23/10/2020 13:10	1,81	1	1,81	CHI
202010132045	NIQUELANDIA	NQ21197663	BARRO ALTO	23/10/2020 11:22	23/10/2020 15:51	23/10/2020 11:22	23/10/2020 15:51	4,47	1	4,47	CHI
202010132048	FAZENDA NOVA	FN21229911	JUSSARA	23/10/2020 11:23	23/10/2020 14:25	23/10/2020 11:23	23/10/2020 14:25	3,03	1	3,03	CHI
202010132657	CAVALCANTE	TI12162624	NIQUELANDIA SUBTRANSMISSAO	23/10/2020 11:27	23/10/2020 19:20	23/10/2020 11:27	23/10/2020 19:20	7,88	20	157,51	CHI
202010132657	COLINAS DO SUL	TI12162624	NIQUELANDIA SUBTRANSMISSAO	23/10/2020 11:27	23/10/2020 19:20	23/10/2020 11:27	23/10/2020 19:20	7,88	1	7,88	CHI
202010132072	APARECIDA DE GOIANIA	15136188	INDEPENDENCIA S1	23/10/2020 11:27	23/10/2020 13:16	23/10/2020 11:27	23/10/2020 13:16	1,81	1	1,81	CHI
202010132074	PROFESSOR JAMIL SAFADY	JS21344803	ROCHEDO	23/10/2020 11:27	23/10/2020 17:29	23/10/2020 11:27	23/10/2020 17:29	6,02	2	12,04	CHI
202010132085	RIO VERDE	630134080	RIO VERDE S2	23/10/2020 11:30	23/10/2020 15:37	23/10/2020 11:30	23/10/2020 15:37	4,11	1	4,11	CHI
202010132088	INHUMAS	30115978	INHUMAS S2	23/10/2020 11:30	24/10/2020 10:05	23/10/2020 11:30	24/10/2020 10:05	22,57	1	22,57	CHI
202010132100	MUTUNOPOLIS	SE12352924	MARA ROSA	23/10/2020 11:32	23/10/2020 19:23	23/10/2020 11:32	23/10/2020 19:23	7,84	6	47,02	CHI
202010132100	SANTA TEREZA DE GOIAS	SE12352924	MARA ROSA	23/10/2020 11:32	23/10/2020 19:23	23/10/2020 11:32	23/10/2020 19:23	7,84	1	7,84	CHI
202010132106	GOIANIRA	10027886083	MEIA PONTE	23/10/2020 11:33	23/10/2020 17:46	23/10/2020 11:33	23/10/2020 17:46	6,21	1	6,21	CHI
202010133184	PLANALTINA	10002484518	PLANALTINA	23/10/2020 11:37	23/10/2020 16:13	23/10/2020 11:37	23/10/2020 16:13	4,60	1	4,60	CHI
202010132136	INDIARA	2710000204	EDEIA	23/10/2020 11:38	23/10/2020 17:21	23/10/2020 11:38	23/10/2020 17:21	5,71	1	5,71	CHI
202010132137	VILA PROPICIO	PV21144561	GOIANESIA S1	23/10/2020 11:38	23/10/2020 18:39	23/10/2020 11:38	23/10/2020 18:39	7,01	1	7,01	CHI
202010132141	INDIARA	2710014057	EDEIA	23/10/2020 11:38	23/10/2020 14:31	23/10/2020 11:38	23/10/2020 14:31	2,89	1	2,89	CHI
202010132144	RIO VERDE	RV21310300	CABRIUVA S2	23/10/2020 11:39	24/10/2020 12:17	23/10/2020 11:39	24/10/2020 12:17	24,63	1	24,63	CHI
202010132149	AMORINOPOLIS	AM21287188	IPORA	23/10/2020 11:39	23/10/2020 14:45	23/10/2020 11:39	23/10/2020 14:45	3,08	1	3,08	CHI
202010132152	AURILANDIA	AI12377179	FIRMINOPOLIS S2	23/10/2020 11:40	23/10/2020 16:28	23/10/2020 11:40	23/10/2020 16:28	4,79	4	19,15	CHI
202010132158	NIQUELANDIA	NQ21344325	SAO JOAO D ALIANCA	23/10/2020 11:41	23/10/2020 14:26	23/10/2020 11:41	23/10/2020 14:26	2,75	1	2,75	CHI
202010132160	BELA VISTA DE GOIAS	BV21011708	BELA VISTA S1	23/10/2020 11:41	23/10/2020 16:33	23/10/2020 11:41	23/10/2020 16:33	4,85	2	9,70	CHI
202010132185	PROFESSOR JAMIL SAFADY	JS21307973	ROCHEDO	23/10/2020 11:44	23/10/2020 18:21	23/10/2020 11:44	23/10/2020 18:21	6,60	2	13,21	CHI
202010132186	QUIRINOPOLIS	QI21154006	RIO DOS BOIS	23/10/2020 11:45	24/10/2020 01:37	23/10/2020 11:45	24/10/2020 01:37	13,86	1	13,86	CHI
202010132221	GOIANIA	GN12000925	GOIANIA LESTE S3	23/10/2020 11:45	23/10/2020 15:32	23/10/2020 11:45	23/10/2020 15:32	3,77	24	90,51	CHI
202010132198	JATAI	JT12000243	JATAI S1	23/10/2020 11:46	23/10/2020 13:14	23/10/2020 11:46	23/10/2020 13:14	1,46	1	1,46	CHI
202010132205	MARA ROSA	MQ12391777	SANTA TEREZINHA	23/10/2020 11:47	24/10/2020 12:27	23/10/2020 11:47	24/10/2020 12:27	24,66	4	98,65	CHI
202010132206	MORRINHOS	MR31092118	MORRINHOS	23/10/2020 11:47	23/10/2020 17:31	23/10/2020 11:47	23/10/2020 17:31	5,73	1	5,73	CHI

202010132208	NIQUELANDIA	NQ21371114	SAO JOAO D ALIANCA	23/10/2020 11:47	25/10/2020 19:59	23/10/2020 11:47	25/10/2020 19:59	56,19	1	56,19	CHI
202010132225	DISTRITO FEDERAL	PI16408137	PLANALTINA	23/10/2020 11:49	23/10/2020 14:07	23/10/2020 11:49	23/10/2020 14:07	2,29	124	284,44	CHI
202010132225	PLANALTINA	PI16408137	PLANALTINA	23/10/2020 11:49	23/10/2020 14:07	23/10/2020 11:49	23/10/2020 14:07	2,29	8547	19605,87	CHI
202010132225	PLANALTINA	01900234	PLANALTINA	23/10/2020 11:49	23/10/2020 14:07	23/10/2020 13:32	23/10/2020 14:07	0,57	1232	704,64	CHI
202010132229	ANAPOLIS	10032426842	JUNDIAI S2	23/10/2020 11:49	23/10/2020 16:40	23/10/2020 11:49	23/10/2020 16:40	4,83	1	4,83	CHI
202010132252	VARJAO	VJ21113922	GUAPO S2	23/10/2020 11:52	23/10/2020 19:29	23/10/2020 11:52	23/10/2020 19:29	7,61	1	7,61	CHI
202010132254	SANTA HELENA DE GOIAS	SH21136190	IPEGUARI	23/10/2020 11:52	23/10/2020 13:42	23/10/2020 11:52	23/10/2020 13:42	1,82	1	1,82	CHI
202010132268	JUSSARA	JR12250828LD	BRITANIA	23/10/2020 11:55	24/10/2020 15:57	23/10/2020 11:55	24/10/2020 15:57	28,03	22	616,75	CHI
202010132268	MONTES CLAROS DE GOIAS	JR12250828LD	BRITANIA	23/10/2020 11:55	24/10/2020 15:57	23/10/2020 11:55	24/10/2020 15:57	28,03	267	7485,05	CHI
202010132285	AGUAS LINDAS DE GOIAS	4830190797	AGUAS LINDAS DE GOIAS S1	23/10/2020 11:58	23/10/2020 16:26	23/10/2020 11:58	23/10/2020 16:26	4,46	1	4,46	CHI
202010132288	FORMOSA	FA11269990	ITUIQUIRA	23/10/2020 11:58	23/10/2020 19:50	23/10/2020 11:58	23/10/2020 19:50	7,85	1	7,85	CHI
202010132579	FIRMINOPOLIS	TV12105311	FIRMINOPOLIS S1	23/10/2020 11:58	23/10/2020 14:32	23/10/2020 11:58	23/10/2020 14:32	2,55	6	15,32	CHI
202010132293	PLANALTINA	2960088871	PLANALTINA	23/10/2020 11:59	23/10/2020 17:07	23/10/2020 11:59	23/10/2020 17:07	5,13	1	5,13	CHI
202010132303	RIO VERDE	RV21191974	RIO VERDE S2	23/10/2020 12:01	23/10/2020 13:43	23/10/2020 12:01	23/10/2020 13:43	1,70	1	1,70	CHI
202010132304	GOIANESIA	GE21229514	GOIANESIA S1	23/10/2020 12:01	23/10/2020 20:53	23/10/2020 12:01	23/10/2020 20:53	8,86	1	8,86	CHI
202010133547	INHUMAS	IN11040751	INHUMAS S2	23/10/2020 12:01	23/10/2020 19:05	23/10/2020 12:01	23/10/2020 19:05	7,06	103	726,78	CHI
202010132314	CATALAO	CT12130963	CATALAO S2	23/10/2020 12:02	23/10/2020 15:31	23/10/2020 12:02	23/10/2020 15:31	3,47	153	531,12	CHI
202010132317	GOIANIA	11277841	SENADOR CANEDO	23/10/2020 12:03	23/10/2020 15:18	23/10/2020 12:03	23/10/2020 15:18	3,25	1	3,25	CHI
202010132611	ARAGUAPAZ	AZ11212769	MOZARLANDIA	23/10/2020 12:04	23/10/2020 15:41	23/10/2020 12:04	23/10/2020 15:41	3,61	82	296,00	CHI
202010139238	GOIANESIA	GE12352313	GOIANESIA S1	23/10/2020 12:08	24/10/2020 15:05	23/10/2020 12:08	24/10/2020 15:05	26,95	24	646,91	CHI
202010139238	SAO LUIZ DO NORTE	GE12352313	GOIANESIA S1	23/10/2020 12:08	24/10/2020 15:05	23/10/2020 12:08	24/10/2020 15:05	26,95	21	566,05	CHI
202010132436	NOVA IGUACU DE GOIAS	NH12317131	CAMPINORTE	23/10/2020 12:08	23/10/2020 16:58	23/10/2020 12:08	23/10/2020 16:58	4,83	46	222,22	CHI
202010132351	AGUA FRIA DE GOIAS	TL12337440	SAO JOAO D ALIANCA	23/10/2020 12:08	23/10/2020 12:34	23/10/2020 12:08	23/10/2020 12:34	0,43	6	2,57	CHI
202010132569	NIQUELANDIA	NQ12148151RE	NIQUELANDIA SUBTRANSMISSAO	23/10/2020 12:12	27/10/2020 00:36	23/10/2020 12:12	27/10/2020 00:36	84,39	3	253,17	CHI
202010132569	NIQUELANDIA	NQ12148151RE	NIQUELANDIA SUBTRANSMISSAO	23/10/2020 12:12	27/10/2020 00:36	23/10/2020 12:12	26/10/2020 02:04	61,87	10	618,73	CHI
202010132569	NIQUELANDIA	NQ12148151RE	NIQUELANDIA SUBTRANSMISSAO	23/10/2020 12:12	27/10/2020 00:36	25/10/2020 17:25	25/10/2020 18:34	1,16	67	77,85	CHI
202010132569	NIQUELANDIA	NQ12148151RE	NIQUELANDIA SUBTRANSMISSAO	23/10/2020 12:12	27/10/2020 00:36	25/10/2020 11:38	25/10/2020 17:25	5,79	80	462,93	CHI
202010132569	SAO JOAO D ALIANCA	NQ12148151RE	NIQUELANDIA SUBTRANSMISSAO	23/10/2020 12:12	27/10/2020 00:36	25/10/2020 11:38	25/10/2020 17:25	5,79	1	5,79	CHI
202010132569	ALTO PARAISO DE GOIAS	NQ12148151RE	NIQUELANDIA SUBTRANSMISSAO	23/10/2020 12:12	27/10/2020 00:36	25/10/2020 11:38	25/10/2020 17:25	5,79	12	69,44	CHI
202010132569	NIQUELANDIA	NQ12148151RE	NIQUELANDIA SUBTRANSMISSAO	23/10/2020 12:12	27/10/2020 00:36	25/10/2020 11:38	25/10/2020 16:20	4,71	67	315,61	CHI
202010132569	ALTO PARAISO DE GOIAS	NQ12148151RE	NIQUELANDIA SUBTRANSMISSAO	23/10/2020 12:12	27/10/2020 00:36	24/10/2020 10:40	24/10/2020 13:13	2,55	12	30,61	CHI
202010132569	SAO JOAO D ALIANCA	NQ12148151RE	NIQUELANDIA SUBTRANSMISSAO	23/10/2020 12:12	27/10/2020 00:36	24/10/2020 10:40	24/10/2020 13:13	2,55	1	2,55	CHI
202010132569	NIQUELANDIA	NQ12148151RE	NIQUELANDIA SUBTRANSMISSAO	23/10/2020 12:12	27/10/2020 00:36	24/10/2020 10:40	24/10/2020 13:13	2,55	147	374,97	CHI
202010132569	ALTO PARAISO DE GOIAS	NQ12148151RE	NIQUELANDIA SUBTRANSMISSAO	23/10/2020 12:12	27/10/2020 00:36	23/10/2020 12:12	23/10/2020 23:16	11,07	12	132,82	CHI
202010132569	NIQUELANDIA	NQ12148151RE	NIQUELANDIA SUBTRANSMISSAO	23/10/2020 12:12	27/10/2020 00:36	23/10/2020 12:12	23/10/2020 23:16	11,07	79	874,42	CHI
202010132569	SAO JOAO D ALIANCA	NQ12148151RE	NIQUELANDIA SUBTRANSMISSAO	23/10/2020 12:12	27/10/2020 00:36	23/10/2020 12:12	23/10/2020 23:16	11,07	1	11,07	CHI
202010132569	NIQUELANDIA	NQ12148151RE	NIQUELANDIA SUBTRANSMISSAO	23/10/2020 12:12	27/10/2020 00:36	23/10/2020 12:12	23/10/2020 18:19	6,12	67	410,26	CHI
202010132374	CATALAO	CT21104200	CATALAO S1	23/10/2020 12:14	23/10/2020 16:08	23/10/2020 12:14	23/10/2020 16:08	3,89	1	3,89	CHI
202010133109	GOIATUBA	GT12000265	GOIATUBA S2	23/10/2020 12:14	23/10/2020 16:04	23/10/2020 12:14	23/10/2020 16:04	3,82	8	30,56	CHI
202010132383	FORMOSA	FA21049292	ITUIQUIRA	23/10/2020 12:15	23/10/2020 16:02	23/10/2020 12:15	23/10/2020 16:02	3,78	1	3,78	CHI
202010132621	BRITANIA	BT11005984	BRITANIA	23/10/2020 12:16	23/10/2020 16:18	23/10/2020 12:16	23/10/2020 16:18	4,02	134	538,79	CHI
202010132401	CRISTALINA	1060094918	CRISTALINA S1	23/10/2020 12:18	23/10/2020 15:30	23/10/2020 12:18	23/10/2020 15:30	3,19	1	3,19	CHI
202010132403	MAMBAI	MB11302678	IACIARA S2	23/10/2020 12:19	23/10/2020 15:16	23/10/2020 12:19	23/10/2020 15:16	2,96	112	331,02	CHI
202010132441	JUSSARA	NB12396253	JUSSARA	23/10/2020 12:19	23/10/2020 14:58	23/10/2020 12:19	23/10/2020 14:58	2,64	1	2,64	CHI
202010132441	FAZENDA NOVA	NB12396253	JUSSARA	23/10/2020 12:19	23/10/2020 14:58	23/10/2020 12:19	23/10/2020 14:58	2,64	13	34,38	CHI
202010132407	GOIANIA	14449304	INDEPENDENCIA S2	23/10/2020 12:19	23/10/2020 16:28	23/10/2020 12:19	23/10/2020 16:28	4,14	1	4,14	CHI
202010132443	CACHOEIRA ALTA	CA21134898	CACHOEIRA ALTA	23/10/2020 12:19	23/10/2020 23:04	23/10/2020 17:44	23/10/2020 23:04	5,35	1	5,35	CHI
202010132443	LAGOA SANTA	00270434	CACHOEIRA ALTA	23/10/2020 12:19	23/10/2020 23:04	23/10/2020 12:19	23/10/2020 23:04	10,75	4	42,99	CHI
202010132443	ITAJA	00270434	CACHOEIRA ALTA	23/10/2020 12:19	23/10/2020 23:04	23/10/2020 12:19	23/10/2020 23:04	10,75	13	139,73	CHI
202010132443	ITAJA	00270434	CACHOEIRA ALTA	23/10/2020 12:19	23/10/2020 23:04	23/10/2020 12:19	23/10/2020 23:04	10,75	73	784,63	CHI
202010132443	LAGOA SANTA	00270434	CACHOEIRA ALTA	23/10/2020 12:19	23/10/2020 23:04	23/10/2020 12:19	23/10/2020 23:04	10,75	86	924,36	CHI



202010132443	ITARUMA	00270434	CACHOEIRA ALTA	23/10/2020 12:19	23/10/2020 23:04	23/10/2020 12:19	23/10/2020 23:04	10,75	130	1397,25	CHI
202010132443	CACU	00270434	CACHOEIRA ALTA	23/10/2020 12:19	23/10/2020 23:04	23/10/2020 12:19	23/10/2020 23:04	10,75	4	42,99	CHI
202010132443	ITAJA	00270434	CACHOEIRA ALTA	23/10/2020 12:19	23/10/2020 23:04	23/10/2020 12:19	23/10/2020 23:04	10,75	31	333,19	CHI
202010132443	LAGOA SANTA	00270434	CACHOEIRA ALTA	23/10/2020 12:19	23/10/2020 23:04	23/10/2020 12:19	23/10/2020 23:04	10,75	13	139,72	CHI
202010132443	ITAJA	00270434	CACHOEIRA ALTA	23/10/2020 12:19	23/10/2020 23:04	23/10/2020 12:19	23/10/2020 23:04	10,75	7	75,23	CHI
202010132443	ITARUMA	00270434	CACHOEIRA ALTA	23/10/2020 12:19	23/10/2020 23:04	23/10/2020 12:19	23/10/2020 23:04	10,75	6	64,48	CHI
202010132443	ITAJA	00270434	CACHOEIRA ALTA	23/10/2020 12:19	23/10/2020 23:04	23/10/2020 12:19	23/10/2020 23:04	10,75	28	300,93	CHI
202010132443	ITAJA	00270434	CACHOEIRA ALTA	23/10/2020 12:19	23/10/2020 23:04	23/10/2020 12:19	23/10/2020 23:04	10,75	3	32,24	CHI
202010132443	CACU	00270434	CACHOEIRA ALTA	23/10/2020 12:19	23/10/2020 23:04	23/10/2020 12:19	23/10/2020 23:04	10,75	1	10,75	CHI
202010132443	ITARUMA	00270434	CACHOEIRA ALTA	23/10/2020 12:19	23/10/2020 23:04	23/10/2020 12:19	23/10/2020 23:04	10,75	45	483,64	CHI
202010132443	ITARUMA	00270434	CACHOEIRA ALTA	23/10/2020 12:19	23/10/2020 23:04	23/10/2020 12:19	23/10/2020 23:04	10,75	81	870,55	CHI
202010132443	CACU	00270434	CACHOEIRA ALTA	23/10/2020 12:19	23/10/2020 23:04	23/10/2020 12:19	23/10/2020 22:23	10,05	2	20,10	CHI
202010132443	CACHOEIRA ALTA	00270434	CACHOEIRA ALTA	23/10/2020 12:19	23/10/2020 23:04	23/10/2020 12:19	23/10/2020 22:23	10,05	2	20,10	CHI
202010132443	CACHOEIRA ALTA	00270434	CACHOEIRA ALTA	23/10/2020 12:19	23/10/2020 23:04	23/10/2020 17:33	23/10/2020 17:43	0,16	6	0,96	CHI
202010132443	CACHOEIRA ALTA	00270434	CACHOEIRA ALTA	23/10/2020 12:19	23/10/2020 23:04	23/10/2020 12:19	23/10/2020 16:46	4,44	6	26,65	CHI
202010132422	PIRACANJUBA	MR12223456	MORRINHOS	23/10/2020 12:21	23/10/2020 15:22	23/10/2020 12:21	23/10/2020 15:22	3,01	7	21,09	CHI
202010132432	GOIANIA	17253822	CAMPINAS S3	23/10/2020 12:23	23/10/2020 13:58	23/10/2020 12:23	23/10/2020 13:58	1,57	1	1,57	CHI
202010132442	NOVA IGUACU DE GOIAS	MQ21050749	MARA ROSA	23/10/2020 12:25	24/10/2020 11:16	23/10/2020 12:25	24/10/2020 11:16	22,85	1	22,85	CHI
202010132460	MINEIROS	MY10396069	PARQUE DAS EMAS	23/10/2020 12:25	24/10/2020 17:12	23/10/2020 12:25	24/10/2020 17:12	28,78	7	201,44	CHI
202010132460	PEROLANDIA	MY10396069	PARQUE DAS EMAS	23/10/2020 12:25	24/10/2020 17:12	23/10/2020 12:25	24/10/2020 17:12	28,78	7	201,44	CHI
202010132460	PEROLANDIA	MY10396069	PARQUE DAS EMAS	23/10/2020 12:25	24/10/2020 17:12	23/10/2020 12:25	23/10/2020 17:21	4,93	15	74,00	CHI
202010132460	PORTELANDIA	MY10396069	PARQUE DAS EMAS	23/10/2020 12:25	24/10/2020 17:12	23/10/2020 12:25	23/10/2020 17:21	4,93	1	4,93	CHI
202010132460	MINEIROS	MY10396069	PARQUE DAS EMAS	23/10/2020 12:25	24/10/2020 17:12	23/10/2020 12:25	23/10/2020 17:21	4,93	14	69,06	CHI
202010132446	URUACU	UR12050099	URUACU	23/10/2020 12:25	23/10/2020 15:24	23/10/2020 12:25	23/10/2020 15:24	2,97	2	5,94	CHI
202010132458	LUZIANIA	3200283530	MARAJOARA	23/10/2020 12:27	23/10/2020 13:56	23/10/2020 12:27	23/10/2020 13:56	1,47	1	1,47	CHI
202010132463	GOIANIA	11747730	REAL S1	23/10/2020 12:28	23/10/2020 15:32	23/10/2020 12:28	23/10/2020 15:32	3,06	1	3,06	CHI
202010132466	GOIANIA	12490490	GOIANIA LESTE S1	23/10/2020 12:29	23/10/2020 13:55	23/10/2020 12:29	23/10/2020 13:55	1,43	1	1,43	CHI
202010132468	TRINDADE	10010424995	GOYA S2	23/10/2020 12:29	23/10/2020 14:53	23/10/2020 12:29	23/10/2020 14:53	2,39	1	2,39	CHI
202010132472	CRISTALINA	10016121218	CRISTALINA S1	23/10/2020 12:30	23/10/2020 14:45	23/10/2020 12:30	23/10/2020 14:45	2,25	1	2,25	CHI
202010134385	URUACU	UR12003425	URUACU	23/10/2020 12:30	23/10/2020 20:57	23/10/2020 12:30	23/10/2020 20:57	8,44	5	42,20	CHI
202010132555	CAIAPONIA	03800226	PALESTINA	23/10/2020 12:31	23/10/2020 15:10	23/10/2020 12:31	23/10/2020 15:10	2,65	475	1257,56	CHI
202010132555	PALESTINA DE GOIAS	03800226	PALESTINA	23/10/2020 12:31	23/10/2020 15:10	23/10/2020 12:31	23/10/2020 15:10	2,65	335	886,91	CHI
202010132481	GOIANIRA	10022579760	MEIA PONTE	23/10/2020 12:31	23/10/2020 18:25	23/10/2020 12:31	23/10/2020 18:25	5,90	1	5,90	CHI
202010132498	FLORES DE GOIAS	FB12344375	FLORES DE GOIAS	23/10/2020 12:33	23/10/2020 18:28	23/10/2020 12:33	23/10/2020 18:28	5,90	2	11,80	CHI
202010132501	QUIRINOPOLIS	10030455357	QUIRINOPOLIS	23/10/2020 12:34	23/10/2020 14:49	23/10/2020 12:34	23/10/2020 14:49	2,24	1	2,24	CHI
202010132957	MINEIROS	MY12042996RE	PARQUE DAS EMAS	23/10/2020 12:35	23/10/2020 15:22	23/10/2020 12:35	23/10/2020 15:22	2,78	17	47,26	CHI
202010132543	CALDAS NOVAS	CN11214036	SERRA DE CALDAS	23/10/2020 12:41	23/10/2020 18:47	23/10/2020 12:41	23/10/2020 18:47	6,09	124	754,71	CHI
202010132117	GOIANIA	GN11207710	GOIANIA LESTE S2	23/10/2020 12:43	23/10/2020 13:07	23/10/2020 12:43	23/10/2020 13:07	0,40	116	46,40	CHI
202010132562	PLANALTINA	PI21139688	PLANALTINA	23/10/2020 12:44	23/10/2020 18:47	23/10/2020 12:44	23/10/2020 18:47	6,03	1	6,03	CHI
202010132564	APARECIDA DE GOIANIA	200161647	INDEPENDENCIA S1	23/10/2020 12:45	23/10/2020 16:23	23/10/2020 12:45	23/10/2020 16:23	3,63	1	3,63	CHI
202010132583	OUVIDOR	OU21266712	CATALAO S1	23/10/2020 12:47	23/10/2020 15:25	23/10/2020 12:47	23/10/2020 15:25	2,63	1	2,63	CHI
202010189478	NOVA IGUACU DE GOIAS	NH21293527	SANTA TEREZINHA	23/10/2020 12:48	24/10/2020 16:41	23/10/2020 12:48	24/10/2020 16:41	27,88	1	27,88	CHI
202010132851	QUIRINOPOLIS	QI12126495	QUIRINOPOLIS	23/10/2020 12:53	23/10/2020 15:14	23/10/2020 12:53	23/10/2020 15:14	2,34	12	28,09	CHI
202010132629	SAO LUIS DE MONTES BELOS	SL12229127	FIRMINOPOLIS S1	23/10/2020 12:57	23/10/2020 15:31	23/10/2020 12:57	23/10/2020 15:31	2,56	6	15,38	CHI
202010132634	CAMPINORTE	CR21101003	CAMPINORTE	23/10/2020 12:57	24/10/2020 16:49	23/10/2020 12:57	24/10/2020 16:49	27,86	1	27,86	CHI
202010132639	FORMOSA	10001086950	ITUIQUIRA	23/10/2020 12:58	23/10/2020 14:16	23/10/2020 12:58	23/10/2020 14:16	1,30	1	1,30	CHI
202010132644	MIMOSO DE GOIAS	PB21320084	PADRE BERNARDO	23/10/2020 12:58	23/10/2020 18:23	23/10/2020 12:58	23/10/2020 18:23	5,40	1	5,40	CHI
202010132649	CRIXAS	CX21097740	SANTA TEREZINHA	23/10/2020 12:59	23/10/2020 21:29	23/10/2020 12:59	23/10/2020 21:29	8,48	1	8,48	CHI
202010132651	MARA ROSA	MQ21146953	MARA ROSA	23/10/2020 13:00	23/10/2020 14:19	23/10/2020 13:00	23/10/2020 14:19	1,31	1	1,31	CHI
202010132661	PARAUNA	EU12109113	ACREUNA	23/10/2020 13:02	24/10/2020 10:37	23/10/2020 13:02	24/10/2020 10:37	21,57	1	21,57	CHI
202010132661	ACREUNA	EU12109113	ACREUNA	23/10/2020 13:02	24/10/2020 10:37	23/10/2020 13:02	24/10/2020 10:37	21,57	2	43,14	CHI

202010132670	ORIZONA	OZ21022887	PIRES DO RIO S2	23/10/2020 13:05	23/10/2020 17:08	23/10/2020 13:05	23/10/2020 17:08	4,04	1	4,04	CHI
202010132679	POSSE	PS12235540	IACIARA S2	23/10/2020 13:08	23/10/2020 14:48	23/10/2020 13:08	23/10/2020 14:48	1,66	6	9,95	CHI
202010132770	PORANGATU	PO12363572	PORANGATU	23/10/2020 13:10	23/10/2020 15:39	23/10/2020 13:10	23/10/2020 15:39	2,48	9	22,29	CHI
202010132693	GOIANIA	GN12227526	XAVANTES	23/10/2020 13:11	23/10/2020 16:46	23/10/2020 13:11	23/10/2020 16:46	3,58	74	265,19	CHI
202010132704	JUSSARA	1290031591	JUSSARA	23/10/2020 13:14	23/10/2020 16:45	23/10/2020 13:14	23/10/2020 16:45	3,50	1	3,50	CHI
202010132705	JARAGUA	JA21264759	JARAGUA	23/10/2020 13:15	23/10/2020 16:01	23/10/2020 13:15	23/10/2020 16:01	2,76	1	2,76	CHI
202010132706	SAO LUIS DE MONTES BELOS	10031684961	SAO LUIZ DOS MONTES BELOS	23/10/2020 13:15	23/10/2020 15:10	23/10/2020 13:15	23/10/2020 15:10	1,91	1	1,91	CHI
202010137107	SANTA RITA DO NOVO DESTINO	BA12208877	BARRO ALTO	23/10/2020 13:19	24/10/2020 13:40	23/10/2020 13:19	24/10/2020 13:40	24,35	29	706,03	CHI
202010132782	MINEIROS	MY13324495	PARQUE DAS EMAS	23/10/2020 13:20	26/10/2020 19:34	23/10/2020 14:06	26/10/2020 19:34	77,47	27	2091,59	CHI
202010132782	MINEIROS	MY13324495	PARQUE DAS EMAS	23/10/2020 13:20	26/10/2020 19:34	23/10/2020 14:06	26/10/2020 16:15	74,15	21	1557,16	CHI
202010132782	MINEIROS	MY13324495	PARQUE DAS EMAS	23/10/2020 13:20	26/10/2020 19:34	23/10/2020 14:06	26/10/2020 14:30	72,41	17	1230,92	CHI
202010132782	SERRANOPOLIS	MY13324495	PARQUE DAS EMAS	23/10/2020 13:20	26/10/2020 19:34	23/10/2020 14:06	26/10/2020 14:30	72,41	7	506,85	CHI
202010132782	MINEIROS	MY13324495	PARQUE DAS EMAS	23/10/2020 13:20	26/10/2020 19:34	23/10/2020 14:06	26/10/2020 12:13	70,12	4	280,48	CHI
202010132782	MINEIROS	MY10409363	PARQUE DAS EMAS	23/10/2020 13:20	26/10/2020 19:34	25/10/2020 17:36	26/10/2020 12:13	18,61	1	18,61	CHI
202010132782	MINEIROS	MY10396070	PARQUE DAS EMAS	23/10/2020 13:20	26/10/2020 19:34	26/10/2020 11:52	26/10/2020 12:10	0,30	54	16,43	CHI
202010132782	SERRANOPOLIS	DJ12136065	CHAPADAO DO CEU	23/10/2020 13:20	26/10/2020 19:34	23/10/2020 13:20	26/10/2020 10:13	68,88	1	68,88	CHI
202010132782	SERRANOPOLIS	DI12136065	CHAPADAO DO CEU	23/10/2020 13:20	26/10/2020 19:34	23/10/2020 13:22	26/10/2020 10:13	68,84	1	68,84	CHI
202010132782	MINEIROS	MY10396070	PARQUE DAS EMAS	23/10/2020 13:20	26/10/2020 19:34	26/10/2020 09:42	26/10/2020 10:08	0,43	54	23,33	CHI
202010132782	MINEIROS	MY10396070	PARQUE DAS EMAS	23/10/2020 13:20	26/10/2020 19:34	25/10/2020 17:36	25/10/2020 18:15	0,64	54	34,56	CHI
202010132782	MINEIROS	MY12341117LD	PARQUE DAS EMAS	23/10/2020 13:20	26/10/2020 19:34	23/10/2020 14:06	23/10/2020 23:24	9,31	16	148,97	CHI
202010132782	MINEIROS	MY10396070	PARQUE DAS EMAS	23/10/2020 13:20	26/10/2020 19:34	23/10/2020 14:06	23/10/2020 21:27	7,35	38	279,48	CHI
202010132782	MINEIROS	MY10396070	PARQUE DAS EMAS	23/10/2020 13:20	26/10/2020 19:34	23/10/2020 13:43	23/10/2020 14:05	0,35	123	43,66	CHI
202010132782	SERRANOPOLIS	MY10396070	PARQUE DAS EMAS	23/10/2020 13:20	26/10/2020 19:34	23/10/2020 13:43	23/10/2020 14:05	0,35	7	2,48	CHI
202010133154	PIRACANJUBA	PJ12263070	PIRACANJUBA	23/10/2020 13:20	24/10/2020 20:11	23/10/2020 13:20	24/10/2020 20:11	30,84	5	154,19	CHI
202010132750	NOVA IGUAÇU DE GOIAS	NH21416352	CAMPINORTE	23/10/2020 13:22	24/10/2020 11:38	23/10/2020 13:22	24/10/2020 11:38	22,26	1	22,26	CHI
202010134691	IPAMERI	IP12057877RE	PIRES DO RIO S2	23/10/2020 13:23	23/10/2020 19:14	23/10/2020 13:23	23/10/2020 19:14	5,84	40	233,78	CHI
202010132805	CHAPADAO DO CEU	O2430214	CHAPADAO DO CEU	23/10/2020 13:24	23/10/2020 18:07	23/10/2020 13:24	23/10/2020 18:07	4,73	3	14,18	CHI
202010132805	MINEIROS	O2430214	CHAPADAO DO CEU	23/10/2020 13:24	23/10/2020 18:07	23/10/2020 13:24	23/10/2020 15:05	1,69	9	15,17	CHI
202010132805	CHAPADAO DO CEU	O2430214	CHAPADAO DO CEU	23/10/2020 13:24	23/10/2020 18:07	23/10/2020 13:24	23/10/2020 15:05	1,69	78	131,49	CHI
202010132805	CHAPADAO DO CEU	DJ16416707	CHAPADAO DO CEU	23/10/2020 13:24	23/10/2020 18:07	23/10/2020 13:25	23/10/2020 15:05	1,67	1	1,67	CHI
202010132805	CHAPADAO DO CEU	O2430214	CHAPADAO DO CEU	23/10/2020 13:24	23/10/2020 18:07	23/10/2020 13:24	23/10/2020 14:25	1,03	1138	1169,93	CHI
202010134578	MINEIROS	MY11348939	PARQUE DAS EMAS	23/10/2020 13:25	23/10/2020 19:33	23/10/2020 13:25	23/10/2020 19:33	6,12	32	195,86	CHI
202010132781	MINEIROS	MY11150298	PARQUE DAS EMAS	23/10/2020 13:28	23/10/2020 18:24	23/10/2020 13:28	23/10/2020 18:24	4,93	264	1301,01	CHI
202010133913	ITAPURANGA	IK12311324	ITAPURANGA	23/10/2020 13:29	23/10/2020 17:47	23/10/2020 13:29	23/10/2020 17:47	4,30	6	25,80	CHI
202010132788	SAO SIMAO	2240023709	CACHOEIRA ALTA	23/10/2020 13:29	23/10/2020 13:51	23/10/2020 13:29	23/10/2020 13:51	0,36	1	0,36	CHI
202010134786	MINEIROS	MY12377570	PARQUE DAS EMAS	23/10/2020 13:30	23/10/2020 20:15	23/10/2020 13:30	23/10/2020 20:15	6,74	168	1132,83	CHI
202010132797	PIRANHAS	PH21062788	PIRANHAS	23/10/2020 13:30	23/10/2020 17:53	23/10/2020 13:30	23/10/2020 17:53	4,37	2	8,74	CHI
202010134248	MINEIROS	MY12234372	PARQUE DAS EMAS	23/10/2020 13:33	24/10/2020 09:42	23/10/2020 13:33	24/10/2020 09:42	20,15	9	181,35	CHI
202010132862	MONTA ALEGRE DE GOIAS	SD12322677	SAO DOMINGOS	23/10/2020 13:33	23/10/2020 16:32	23/10/2020 13:33	23/10/2020 16:32	2,97	1	2,97	CHI
202010132862	NOVA ROMA	SD12322677	SAO DOMINGOS	23/10/2020 13:33	23/10/2020 16:32	23/10/2020 13:33	23/10/2020 16:32	2,97	3	8,92	CHI
202010132862	SAO DOMINGOS	SD12322677	SAO DOMINGOS	23/10/2020 13:33	23/10/2020 16:32	23/10/2020 13:33	23/10/2020 16:32	2,97	36	107,04	CHI
202010132867	INDIARA	IY12010960	EDEIA	23/10/2020 13:33	23/10/2020 18:19	23/10/2020 13:33	23/10/2020 18:19	4,75	19	90,27	CHI
202010132866	BRAZABRANTES	IN12013940	INHUMAS S2	23/10/2020 13:35	24/10/2020 14:05	23/10/2020 13:35	24/10/2020 14:05	24,50	5	122,49	CHI
202010132866	INHUMAS	IN12013940	INHUMAS S2	23/10/2020 13:35	24/10/2020 14:05	23/10/2020 13:35	24/10/2020 14:00	24,42	9	219,74	CHI
202010132866	BRAZABRANTES	IN12013940	INHUMAS S2	23/10/2020 13:35	24/10/2020 14:05	23/10/2020 13:35	24/10/2020 14:00	24,42	7	170,91	CHI
202010132861	GUARINOS	GF21380723	SANTA TEREZINHA	23/10/2020 13:37	23/10/2020 17:46	23/10/2020 13:37	23/10/2020 17:46	4,14	1	4,14	CHI
202010132874	AGUA FRIA DE GOIAS	TL21067536	SAO JOAO D ALIANCA	23/10/2020 13:39	23/10/2020 18:09	23/10/2020 13:39	23/10/2020 18:09	4,50	2	8,99	CHI
202010132927	MOIPORA	IV12201972	IPORA	23/10/2020 13:39	23/10/2020 17:46	23/10/2020 13:39	23/10/2020 17:46	4,11	7	28,75	CHI
202010132927	IVOLANDIA	IV12201972	IPORA	23/10/2020 13:39	23/10/2020 17:46	23/10/2020 13:39	23/10/2020 17:46	4,11	2	8,21	CHI
202010132896	ITAPURANGA	IK12403439	ITAPURANGA	23/10/2020 13:41	23/10/2020 17:52	23/10/2020 13:41	23/10/2020 17:52	4,17	3	12,51	CHI
202010133339	CAIAPONIA	CP12155495	CAIAPONIA	23/10/2020 13:42	24/10/2020 03:29	23/10/2020 13:42	24/10/2020 03:29	13,78	10	137,76	CHI

202010132904	LUZIANIA	10030001437	MARAJOARA	23/10/2020 13:42	23/10/2020 15:24	23/10/2020 13:42	23/10/2020 15:24	1,69	1	1,69	CHI
202010189359	SERRANOPOLIS	SX21254094	JATAI S1	23/10/2020 13:43	23/10/2020 14:23	23/10/2020 13:43	23/10/2020 14:23	0,67	1	0,67	CHI
202010132920	RIO VERDE	630318372	RIO VERDE S1	23/10/2020 13:43	23/10/2020 17:37	23/10/2020 13:43	23/10/2020 17:37	3,88	1	3,88	CHI
202010133157	MINEIROS	MY12149315	PARQUE DAS EMAS	23/10/2020 13:44	23/10/2020 22:42	23/10/2020 13:44	23/10/2020 22:42	8,96	29	259,75	CHI
202010132922	MINEIROS	MY12260468	PARQUE DAS EMAS	23/10/2020 13:44	24/10/2020 12:33	23/10/2020 13:44	24/10/2020 12:33	22,81	5	114,03	CHI
202010131248	PARAUNA	EU13028640	ACREUNA	23/10/2020 13:45	23/10/2020 17:53	23/10/2020 13:45	23/10/2020 17:53	4,13	176	727,37	CHI
202010131248	JANDAIA	EU13028640	ACREUNA	23/10/2020 13:45	23/10/2020 17:53	23/10/2020 13:45	23/10/2020 17:53	4,13	7	28,93	CHI
202010131248	ACREUNA	EU13028640	ACREUNA	23/10/2020 13:45	23/10/2020 17:53	23/10/2020 13:45	23/10/2020 17:53	4,13	103	425,68	CHI
202010132925	CALDAS NOVAS	CN12213869	SERRA DE CALDAS	23/10/2020 13:45	23/10/2020 16:30	23/10/2020 13:45	23/10/2020 16:30	2,74	53	145,10	CHI
202010132932	PIRACANJUBA	PJ21000063	CALDAS NOVAS S1	23/10/2020 13:46	23/10/2020 23:39	23/10/2020 13:46	23/10/2020 23:39	9,87	1	9,87	CHI
202010132937	GOIANIA	GN11323670	INDEPENDENCIA S2	23/10/2020 13:48	23/10/2020 14:45	23/10/2020 13:48	23/10/2020 14:45	0,95	94	89,30	CHI
202010132942	CORREGO DO OURO	CO12003798	SAO LUIZ DOS MONTES BELOS	23/10/2020 13:48	23/10/2020 16:01	23/10/2020 13:48	23/10/2020 16:01	2,21	59	130,28	CHI
202010133585	GOIANIA	GN12001527	GOYA S1	23/10/2020 13:50	23/10/2020 16:04	23/10/2020 13:50	23/10/2020 16:04	2,23	59	131,46	CHI
202010134188	SILVANIA	SV21074433	VIANOPOLIS	23/10/2020 13:51	24/10/2020 03:36	23/10/2020 13:51	24/10/2020 03:36	13,75	1	13,75	CHI
202010133026	MARA ROSA	2260043600	MARA ROSA	23/10/2020 13:52	23/10/2020 21:49	23/10/2020 13:52	23/10/2020 21:49	7,95	1	7,95	CHI
202010132965	PROFESSOR JAMIL SAFADY	PJ21082753	ROCHEDO	23/10/2020 13:52	23/10/2020 18:42	23/10/2020 13:52	23/10/2020 18:42	4,83	1	4,83	CHI
202010132968	ITABERAI	IB12000111	ITABERAI S2	23/10/2020 13:52	23/10/2020 17:35	23/10/2020 13:52	23/10/2020 17:35	3,71	1	3,71	CHI
202010132969	GOIANIA	GN11041232	GOYA S1	23/10/2020 13:52	23/10/2020 15:20	23/10/2020 13:52	23/10/2020 15:20	1,46	2	2,91	CHI
202010132971	CAIAPONIA	CP12151179	CAIAPONIA	23/10/2020 13:53	23/10/2020 16:43	23/10/2020 13:53	23/10/2020 16:43	2,83	89	252,14	CHI
202010132982	TURVANIA	10032356615	FIRMINOPOLIS S2	23/10/2020 13:54	23/10/2020 18:02	23/10/2020 13:54	23/10/2020 18:02	4,12	1	4,12	CHI
202010132984	ITUMBIARA	690025841	ITUMBIARA VELHA S1	23/10/2020 13:55	23/10/2020 18:36	23/10/2020 13:55	23/10/2020 18:36	4,68	1	4,68	CHI
202010132995	RIO VERDE	RV21248974	RIO VERDE S1	23/10/2020 13:57	23/10/2020 16:49	23/10/2020 13:57	23/10/2020 16:49	2,86	1	2,86	CHI
202010133532	PARAUNA	RP18304543TS	FIRMINOPOLIS S2	23/10/2020 13:57	23/10/2020 17:19	23/10/2020 13:57	23/10/2020 17:19	3,36	35	117,53	CHI
202010133532	AURILANDIA	RP18304543TS	FIRMINOPOLIS S2	23/10/2020 13:57	23/10/2020 17:19	23/10/2020 13:57	23/10/2020 17:19	3,36	3	10,07	CHI
202010133000	MINEIROS	MY21296382	PARQUE DAS EMAS	23/10/2020 13:57	23/10/2020 15:23	23/10/2020 13:57	23/10/2020 15:23	1,42	1	1,42	CHI
202010133008	ITUMBIARA	IT21122309	ITUMBIARA NOVA	23/10/2020 13:58	24/10/2020 07:22	23/10/2020 13:58	24/10/2020 07:22	17,39	1	17,39	CHI
202010133306	INDIARA	IY11391522	EDEIA	23/10/2020 13:58	23/10/2020 16:20	23/10/2020 13:58	23/10/2020 16:20	2,35	60	141,02	CHI
202010133016	PORANGATU	PO21136973	PORANGATU	23/10/2020 13:59	23/10/2020 16:34	23/10/2020 13:59	23/10/2020 16:34	2,57	2	5,14	CHI
202010133024	AGUAS LINDAS DE GOIAS	4830374367	AGUAS LINDAS DE GOIAS S1	23/10/2020 14:01	23/10/2020 15:37	23/10/2020 14:01	23/10/2020 15:37	1,60	1	1,60	CHI
202010134102	MINEIROS	MY12036573	PARQUE DAS EMAS	23/10/2020 14:02	23/10/2020 19:54	23/10/2020 14:02	23/10/2020 19:54	5,85	252	1474,76	CHI
202010133050	CRISTALINA	1060111722	CRISTALINA S1	23/10/2020 14:04	23/10/2020 15:46	23/10/2020 14:04	23/10/2020 15:46	1,70	1	1,70	CHI
202010134797	CALDAZINHA	BV12103250	SENADOR CANEDO	23/10/2020 14:06	23/10/2020 19:36	23/10/2020 14:06	23/10/2020 19:36	5,49	1	5,49	CHI
202010134797	BELA VISTA DE GOIAS	BV12103250	SENADOR CANEDO	23/10/2020 14:06	23/10/2020 19:36	23/10/2020 14:06	23/10/2020 19:36	5,49	7	38,44	CHI
202010133079	URUACU	UR21288347	URUACU	23/10/2020 14:08	23/10/2020 16:43	23/10/2020 14:08	23/10/2020 16:43	2,57	1	2,57	CHI
202010133083	PLANALTINA	10017236299	PLANALTINA	23/10/2020 14:09	23/10/2020 17:36	23/10/2020 14:09	23/10/2020 17:36	3,45	1	3,45	CHI
202010135862	GOIANIA	GN11000961	CAMPINAS S1	23/10/2020 14:10	23/10/2020 22:22	23/10/2020 14:10	23/10/2020 22:22	8,20	158	1295,20	CHI
202010134365	ITABERAI	IB12274556	ITABERAI S2	23/10/2020 14:13	23/10/2020 23:03	23/10/2020 14:13	23/10/2020 23:03	8,83	5	44,16	CHI
202010135037	ITABERAI	IB12274556	ITABERAI S2	23/10/2020 14:13	23/10/2020 23:03	23/10/2020 14:13	23/10/2020 23:03	8,83	6	53,00	CHI
202010133128	PLANALTINA	2960244753	PLANALTINA	23/10/2020 14:15	23/10/2020 17:01	23/10/2020 14:15	23/10/2020 17:01	2,77	1	2,77	CHI
202010133132	GOIANIA	GN11275628	GOYA S2	23/10/2020 14:15	23/10/2020 15:41	23/10/2020 14:15	23/10/2020 15:41	1,42	112	158,98	CHI
202010133138	INHUMAS	10009462897	INHUMAS S2	23/10/2020 14:17	24/10/2020 11:00	23/10/2020 14:17	24/10/2020 11:00	20,71	1	20,71	CHI
202010133141	CIDADE OCIDENTAL	DH21304099	MARAJOARA	23/10/2020 14:18	23/10/2020 15:43	23/10/2020 14:18	23/10/2020 15:43	1,41	1	1,41	CHI
202010133682	ITABERAI	IB12040389	ITABERAI S2	23/10/2020 14:18	23/10/2020 16:36	23/10/2020 14:18	23/10/2020 16:36	2,29	33	75,70	CHI
202010133147	AMERICANO DO BRASIL	1410015340	ANICUNS	23/10/2020 14:18	23/10/2020 22:41	23/10/2020 14:18	23/10/2020 22:41	8,37	1	8,37	CHI
202010134412	AMERICANO DO BRASIL	KB11055798	ANICUNS	23/10/2020 14:20	24/10/2020 11:04	23/10/2020 14:20	24/10/2020 11:04	20,73	6	124,36	CHI
202010133174	APARECIDA DE GOIANIA	16192217	INDEPENDENCIA S2	23/10/2020 14:21	23/10/2020 15:26	23/10/2020 14:21	23/10/2020 15:26	1,07	1	1,07	CHI
202010133177	AGUAS LINDAS DE GOIAS	4830402879	AGUAS LINDAS DE GOIAS S1	23/10/2020 14:22	23/10/2020 17:03	23/10/2020 14:22	23/10/2020 17:03	2,70	1	2,70	CHI
202010133227	RIO VERDE	RV12106546	CABRIUVA S2	23/10/2020 14:22	24/10/2020 09:34	23/10/2020 14:22	24/10/2020 09:34	19,19	2	38,38	CHI
202010133186	SAO MIGUEL DO ARAGUAIA	SM21138138	SAO MIGUEL DO ARAGUAIA	23/10/2020 14:22	24/10/2020 15:39	23/10/2020 14:22	24/10/2020 15:39	25,27	1	25,27	CHI
202010133342	IVOLANDIA	IV12037918	IPORA	23/10/2020 14:23	23/10/2020 16:48	23/10/2020 14:23	23/10/2020 16:48	2,41	11	26,50	CHI
202010133393	MINEIROS	MY12034240	PARQUE DAS EMAS	23/10/2020 14:23	24/10/2020 10:41	23/10/2020 14:23	24/10/2020 10:41	20,29	4	81,17	CHI

202010133393	MINEIROS	MY16405756	PARQUE DAS EMAS	23/10/2020 14:23	24/10/2020 10:41	24/10/2020 09:42	24/10/2020 09:46	0,07	234	16,51	CHI
202010133756	MOZARLANDIA	MZ11158815	MOZARLANDIA	23/10/2020 14:24	23/10/2020 19:32	23/10/2020 14:24	23/10/2020 19:32	5,13	14	71,78	CHI
202010134233	SAO DOMINGOS	SD11151653	SAO DOMINGOS	23/10/2020 14:25	23/10/2020 17:44	23/10/2020 14:25	23/10/2020 17:44	3,30	77	254,40	CHI
202010133248	GOIANIA	GN11039978	CAMPINAS S1	23/10/2020 14:26	23/10/2020 22:13	23/10/2020 14:26	23/10/2020 22:13	7,77	151	1173,31	CHI
202010133221	MINEIROS	1390078398	PARQUE DAS EMAS	23/10/2020 14:27	24/10/2020 13:06	23/10/2020 14:27	24/10/2020 13:06	22,64	1	22,64	CHI
202010134325	TRINDADE	TR11356371	GOYA S2	23/10/2020 14:28	23/10/2020 19:16	23/10/2020 14:28	23/10/2020 19:16	4,79	84	402,50	CHI
202010134539	GUAPO	GA12000002	GUAPO S1	23/10/2020 14:29	23/10/2020 18:46	23/10/2020 14:29	23/10/2020 18:46	4,28	210	898,57	CHI
202010133889	SAO DOMINGOS	SD11046278	SAO DOMINGOS	23/10/2020 14:29	23/10/2020 20:08	23/10/2020 14:29	23/10/2020 20:08	5,64	88	496,44	CHI
202010133250	URUACU	UR21340215	MARA ROSA	23/10/2020 14:30	24/10/2020 11:35	23/10/2020 14:30	24/10/2020 11:35	21,07	2	42,15	CHI
202010133494	TRINDADE	TR11193171	GOYA S1	23/10/2020 14:31	23/10/2020 16:24	23/10/2020 14:31	23/10/2020 16:24	1,87	135	253,01	CHI
202010133263	SANTA RITA DO NOVO DESTINO	BA21156227	BARRO ALTO	23/10/2020 14:32	24/10/2020 11:02	23/10/2020 14:32	24/10/2020 11:02	20,49	2	40,98	CHI
202010133273	BONOPOLIS	BX21165449	SAO MIGUEL DO ARAGUAIA	23/10/2020 14:33	23/10/2020 15:37	23/10/2020 14:33	23/10/2020 15:37	1,05	1	1,05	CHI
202010133291	RIO VERDE	10024197643	CABRIUVA S1	23/10/2020 14:36	24/10/2020 00:27	23/10/2020 14:36	24/10/2020 00:27	9,85	1	9,85	CHI
202010133496	URUACU	HL12292170	URUACU	23/10/2020 14:37	23/10/2020 21:37	23/10/2020 14:37	23/10/2020 21:37	7,00	5	35,00	CHI
202010135142	ITABERA	IB12020719	ANICUNS	23/10/2020 14:37	23/10/2020 21:02	23/10/2020 14:37	23/10/2020 21:02	6,41	10	64,08	CHI
202010135142	MOSSAMEDES	IB12020719	ANICUNS	23/10/2020 14:37	23/10/2020 21:02	23/10/2020 14:37	23/10/2020 21:02	6,41	5	32,04	CHI
202010133334	GOIANIA	GN11169428	REAL S1	23/10/2020 14:37	23/10/2020 22:45	23/10/2020 14:37	23/10/2020 22:45	8,12	114	926,03	CHI
202010133358	APARECIDA DE GOIANIA	AP11193735	INDEPENDENCIA S2	23/10/2020 14:38	23/10/2020 17:43	23/10/2020 14:38	23/10/2020 17:43	3,08	164	505,58	CHI
202010133314	ARENOPOLIS	AY12040870	ARENOPOLIS	23/10/2020 14:38	23/10/2020 17:35	23/10/2020 14:38	23/10/2020 17:35	2,94	23	67,63	CHI
202010133321	JATAI	JT12234311RE	JATAI S2	23/10/2020 14:39	25/10/2020 02:03	23/10/2020 14:39	25/10/2020 02:03	35,40	10	354,04	CHI
202010133321	JATAI	JT12234311RE	JATAI S2	23/10/2020 14:39	25/10/2020 02:03	23/10/2020 14:39	24/10/2020 16:54	26,25	26	682,38	CHI
202010133321	JATAI	JT10407795	JATAI S2	23/10/2020 14:39	25/10/2020 02:03	24/10/2020 09:28	24/10/2020 16:54	7,42	33	244,87	CHI
202010133321	JATAI	JT10407795	JATAI S2	23/10/2020 14:39	25/10/2020 02:03	23/10/2020 14:39	23/10/2020 23:36	8,95	33	295,35	CHI
202010133325	ITAPURANGA	IK12063175	ITAPURANGA	23/10/2020 14:40	23/10/2020 18:29	23/10/2020 14:40	23/10/2020 18:29	3,80	11	41,83	CHI
202010133362	SERRANOPOLIS	JT13214392	JATAI S1	23/10/2020 14:41	24/10/2020 03:54	24/10/2020 03:47	24/10/2020 03:54	0,13	66	8,43	CHI
202010133362	JATAI	JT13214392	JATAI S1	23/10/2020 14:41	24/10/2020 03:54	24/10/2020 03:47	24/10/2020 03:54	0,13	521	66,57	CHI
202010133362	APARECIDA DO RIO DOCE	JT13214391	JATAI S1	23/10/2020 14:41	24/10/2020 03:54	24/10/2020 03:25	24/10/2020 03:34	0,16	71	11,10	CHI
202010133362	JATAI	JT13214391	JATAI S1	23/10/2020 14:41	24/10/2020 03:54	24/10/2020 03:25	24/10/2020 03:34	0,16	304	47,54	CHI
202010133362	JATAI	04800434	JATAI S1	23/10/2020 14:41	24/10/2020 03:54	23/10/2020 14:41	24/10/2020 02:44	12,05	48	578,59	CHI
202010133362	JATAI	JT13212560	JATAI S1	23/10/2020 14:41	24/10/2020 03:54	23/10/2020 14:41	24/10/2020 02:44	12,05	23	277,24	CHI
202010133362	JATAI	04800434	JATAI S1	23/10/2020 14:41	24/10/2020 03:54	23/10/2020 14:41	24/10/2020 02:28	11,78	2	23,57	CHI
202010133362	JATAI	JT16418380	JATAI S1	23/10/2020 14:41	24/10/2020 03:54	23/10/2020 14:41	23/10/2020 22:50	8,15	304	2478,61	CHI
202010133362	APARECIDA DO RIO DOCE	JT16418380	JATAI S1	23/10/2020 14:41	24/10/2020 03:54	23/10/2020 14:41	23/10/2020 22:50	8,15	71	578,89	CHI
202010133362	JATAI	JT13210075	JATAI S1	23/10/2020 14:41	24/10/2020 03:54	23/10/2020 14:41	23/10/2020 22:46	8,08	63	509,27	CHI
202010133362	JATAI	JT16416679	JATAI S1	23/10/2020 14:41	24/10/2020 03:54	23/10/2020 19:52	23/10/2020 21:51	1,99	399	795,78	CHI
202010133362	SERRANOPOLIS	JT16416679	JATAI S1	23/10/2020 14:41	24/10/2020 03:54	23/10/2020 19:52	23/10/2020 21:51	1,99	66	131,63	CHI
202010133362	JATAI	JT10394612	JATAI S1	23/10/2020 14:41	24/10/2020 03:54	23/10/2020 21:05	23/10/2020 21:11	0,10	59	5,82	CHI
202010133362	JATAI	JT10394612	JATAI S2	23/10/2020 14:41	24/10/2020 03:54	23/10/2020 21:05	23/10/2020 21:11	0,10	120	11,83	CHI
202010133362	SERRANOPOLIS	JT10394612	JATAI S1	23/10/2020 14:41	24/10/2020 03:54	23/10/2020 19:32	23/10/2020 19:36	0,06	66	4,00	CHI
202010133362	JATAI	JT10394612	JATAI S1	23/10/2020 14:41	24/10/2020 03:54	23/10/2020 19:32	23/10/2020 19:36	0,06	458	27,73	CHI
202010133362	JATAI	JT10394612	JATAI S2	23/10/2020 14:41	24/10/2020 03:54	23/10/2020 19:32	23/10/2020 19:36	0,06	120	7,27	CHI
202010133362	JATAI	JT16418253	JATAI S1	23/10/2020 14:41	24/10/2020 03:54	23/10/2020 14:41	23/10/2020 19:29	4,80	458	2198,91	CHI
202010133362	SERRANOPOLIS	JT16418253	JATAI S1	23/10/2020 14:41	24/10/2020 03:54	23/10/2020 14:41	23/10/2020 19:29	4,80	66	316,87	CHI
202010133333	CRISTALINA	KR12245975	CRISTALINA S1	23/10/2020 14:41	23/10/2020 15:17	23/10/2020 14:41	23/10/2020 15:17	0,59	2	1,18	CHI
202010133338	SENADOR CANEDO	SW21094914	SENADOR CANEDO	23/10/2020 14:42	23/10/2020 18:30	23/10/2020 14:42	23/10/2020 18:30	3,79	3	11,37	CHI
202010133724	NIQUELANDIA	NQ12264564	BARRO ALTO	23/10/2020 14:43	23/10/2020 20:12	23/10/2020 14:43	23/10/2020 20:12	5,48	12	65,79	CHI
202010143576	BARRO ALTO	BA11332398	BARRO ALTO	23/10/2020 14:44	24/10/2020 21:49	23/10/2020 14:44	24/10/2020 21:49	31,09	1	31,09	CHI
202010143576	BARRO ALTO	BA11332399	BARRO ALTO	23/10/2020 14:44	24/10/2020 21:49	23/10/2020 14:44	24/10/2020 21:32	30,81	1	30,81	CHI
202010136746	MINEIROS	MY11066493	PARQUE DAS EMAS	23/10/2020 14:45	24/10/2020 15:06	23/10/2020 14:45	24/10/2020 15:06	24,35	173	4211,97	CHI
202010133374	VILA BOA	FB21220972	IACIARA S2	23/10/2020 14:47	23/10/2020 17:42	23/10/2020 14:47	23/10/2020 17:42	2,91	1	2,91	CHI
202010133380	LUZIANIA	10010862887	MARAJOARA	23/10/2020 14:47	23/10/2020 16:49	23/10/2020 14:47	23/10/2020 16:49	2,02	1	2,02	CHI

202010133385	GOIANIA	12687352	GOIANIA LESTE S3	23/10/2020 14:48	23/10/2020 17:13	23/10/2020 14:48	23/10/2020 17:13	2,41	1	2,41	CHI
202010133387	FAZENDA NOVA	FN21116781	JUSSARA	23/10/2020 14:48	23/10/2020 18:10	23/10/2020 14:48	23/10/2020 18:10	3,35	1	3,35	CHI
202010133389	GOIANIA	13053097	GOYA S2	23/10/2020 14:49	23/10/2020 19:00	23/10/2020 14:49	23/10/2020 19:00	4,18	1	4,18	CHI
202010133391	GOIANIA	GN21216360	CAMPINAS S1	23/10/2020 14:49	23/10/2020 16:42	23/10/2020 14:49	23/10/2020 16:42	1,87	1	1,87	CHI
202010133399	RUBIATABA	780078627	RUBIATABA	23/10/2020 14:50	24/10/2020 01:20	23/10/2020 14:50	24/10/2020 01:20	10,49	1	10,49	CHI
202010133406	GOIANIA	10007147455	MEIA PONTE	23/10/2020 14:51	23/10/2020 20:05	23/10/2020 14:51	23/10/2020 20:05	5,23	1	5,23	CHI
202010133418	GOIANIA	10575169	GOIANIA LESTE S2	23/10/2020 14:53	23/10/2020 15:40	23/10/2020 14:53	23/10/2020 15:40	0,77	1	0,77	CHI
202010133604	ITUMBIARA	IT12304205	PARANAIBA	23/10/2020 14:54	24/10/2020 09:38	23/10/2020 14:54	24/10/2020 09:38	18,74	10	187,41	CHI
202010133432	SANTA RITA DO ARAGUAIA	SU12184133RE	SANTA RITA DO ARAGUAIA	23/10/2020 14:55	23/10/2020 18:55	23/10/2020 14:55	23/10/2020 18:55	4,00	22	87,96	CHI
202010133432	MINEIROS	SU12184133RE	SANTA RITA DO ARAGUAIA	23/10/2020 14:55	23/10/2020 18:55	23/10/2020 14:55	23/10/2020 18:55	4,00	11	43,98	CHI
202010133755	HIDROLANDIA	HD32049410	INDEPENDENCIA S1	23/10/2020 14:55	23/10/2020 21:12	23/10/2020 14:55	23/10/2020 21:12	6,27	51	319,80	CHI
202010135278	ALTO HORIZONTE	20613243	SANTA TEREZINHA	23/10/2020 14:56	23/10/2020 22:55	23/10/2020 14:56	23/10/2020 22:55	7,99	86	686,73	CHI
202010133461	GOIANIA	10825733	GOIANIA LESTE S2	23/10/2020 14:57	23/10/2020 16:46	23/10/2020 14:57	23/10/2020 16:46	1,80	1	1,80	CHI
202010133465	PALMEIRAS DE GOIAS	PL21377161	PALMEIRAS	23/10/2020 14:57	23/10/2020 17:48	23/10/2020 14:57	23/10/2020 17:48	2,83	1	2,83	CHI
202010132694	GOIANIA	GN11001666	REAL S1	23/10/2020 14:58	23/10/2020 17:51	23/10/2020 14:58	23/10/2020 17:51	2,88	114	328,73	CHI
202010133470	APARECIDA DE GOIANIA	10030085304	INDEPENDENCIA S1	23/10/2020 14:58	23/10/2020 17:07	23/10/2020 14:58	23/10/2020 17:07	2,14	1	2,14	CHI
202010133478	ITARUMA	IM12058060	CACHOEIRA ALTA	23/10/2020 14:59	23/10/2020 17:59	23/10/2020 14:59	23/10/2020 17:59	2,99	17	50,81	CHI
202010133603	ARACU	AR12019237	ARACU	23/10/2020 15:00	23/10/2020 22:04	23/10/2020 15:00	23/10/2020 22:04	7,06	13	91,76	CHI
202010133497	ISRAELANDIA	IS21223200	IPORA	23/10/2020 15:01	23/10/2020 17:16	23/10/2020 15:01	23/10/2020 17:16	2,25	1	2,25	CHI
202010133500	MINEIROS	MY21385362	PARQUE DAS EMAS	23/10/2020 15:01	24/10/2020 12:34	23/10/2020 15:01	24/10/2020 12:34	21,53	2	43,07	CHI
202010133516	AMORINOPOLIS	AM211062899	IPORA	23/10/2020 15:02	23/10/2020 16:16	23/10/2020 15:02	23/10/2020 16:16	1,23	1	1,23	CHI
202010133525	ORIZONA	2060057857	PIRES DO RIO S2	23/10/2020 15:03	23/10/2020 19:08	23/10/2020 15:03	23/10/2020 19:08	4,08	1	4,08	CHI
202010133528	IPORA	IR12353550	IPORA	23/10/2020 15:03	23/10/2020 16:38	23/10/2020 15:03	23/10/2020 16:38	1,58	8	12,64	CHI
202010133534	MINEIROS	10013174035	PARQUE DAS EMAS	23/10/2020 15:03	24/10/2020 14:42	23/10/2020 15:03	24/10/2020 14:42	23,64	1	23,64	CHI
202010135590	SANTA HELENA DE GOIAS	SH11048890	IPEGUARI	23/10/2020 15:04	24/10/2020 03:15	23/10/2020 15:04	24/10/2020 03:15	12,17	108	1314,57	CHI
202010135590	SANTA HELENA DE GOIAS	SH11048103	IPEGUARI	23/10/2020 15:04	24/10/2020 03:15	23/10/2020 15:04	24/10/2020 03:00	11,93	149	1778,27	CHI
202010135590	SANTA HELENA DE GOIAS	SH12000020	IPEGUARI	23/10/2020 15:04	24/10/2020 03:15	23/10/2020 15:04	24/10/2020 02:03	10,97	296	3248,19	CHI
202010137530	PARAUNA	PU12412183	PARAUNA	23/10/2020 15:06	24/10/2020 07:15	23/10/2020 15:06	24/10/2020 07:15	16,14	7	113,00	CHI
202010133631	CRISTALINA	KR10395377	CRISTALINA S1	23/10/2020 15:06	24/10/2020 01:58	23/10/2020 15:06	24/10/2020 01:58	10,86	167	1814,41	CHI
202010133631	CRISTALINA	KR13251533	CRISTALINA S1	23/10/2020 15:06	24/10/2020 01:58	23/10/2020 15:06	24/10/2020 01:24	3,76	1	3,76	CHI
202010135113	CAIAPONIA	CP13251334	IPORA	23/10/2020 15:06	27/10/2020 13:34	23/10/2020 15:06	27/10/2020 13:34	94,47	39	3684,40	CHI
202010135113	CAIAPONIA	CP12062930RE	IPORA	23/10/2020 15:06	27/10/2020 13:34	23/10/2020 15:06	27/10/2020 10:52	91,76	4	367,04	CHI
202010135113	CAIAPONIA	CP12062930RE	IPORA	23/10/2020 15:06	27/10/2020 13:34	23/10/2020 15:06	27/10/2020 09:35	90,49	15	1357,32	CHI
202010133831	IPAMERI	IP12071442LD	IPAMERI	23/10/2020 15:07	24/10/2020 01:00	23/10/2020 15:07	24/10/2020 01:00	9,90	14	138,57	CHI
202010133831	CORUMBAIBA	IP12071442LD	IPAMERI	23/10/2020 15:07	24/10/2020 01:00	23/10/2020 15:07	24/10/2020 01:00	9,90	3	29,69	CHI
202010133572	SANTA HELENA DE GOIAS	SH11214108	ACREUNA	23/10/2020 15:07	24/10/2020 12:47	23/10/2020 15:07	24/10/2020 12:47	21,66	1	21,66	CHI
202010133576	RIO VERDE	RV12271417	CABRIUVA S2	23/10/2020 15:07	24/10/2020 01:00	23/10/2020 15:07	24/10/2020 01:00	9,87	6	59,23	CHI
202010134706	TRINDADE	TR11130456	MEIA PONTE	23/10/2020 15:11	23/10/2020 19:14	23/10/2020 15:11	23/10/2020 19:14	4,04	121	488,60	CHI
202010133614	ORIZONA	OZ21085074	PIRES DO RIO S2	23/10/2020 15:11	23/10/2020 17:58	23/10/2020 15:11	23/10/2020 17:58	2,77	1	2,77	CHI
202010133967	APARECIDA DE GOIANIA	AP11016113	REAL S1	23/10/2020 15:12	23/10/2020 17:37	23/10/2020 15:12	23/10/2020 17:37	2,42	281	678,69	CHI
202010133622	SANTA FE DE GOIAS	2070007590	BRITANIA	23/10/2020 15:12	23/10/2020 18:37	23/10/2020 15:12	23/10/2020 18:37	3,41	1	3,41	CHI
202010133627	IVOLANDIA	IV12062833	IPORA	23/10/2020 15:12	23/10/2020 17:53	23/10/2020 15:12	23/10/2020 17:53	2,67	18	48,09	CHI
202010133932	PARAUNA	PU12304549	PARAUNA	23/10/2020 15:12	23/10/2020 17:42	23/10/2020 15:12	23/10/2020 17:42	2,49	14	34,81	CHI
202010133630	GOIANIA	GN11161506	REAL S1	23/10/2020 15:12	23/10/2020 17:05	23/10/2020 15:12	23/10/2020 17:05	1,87	62	115,84	CHI
202010133876	RIO VERDE	RV11345998	RIO VERDE S2	23/10/2020 15:13	23/10/2020 21:07	23/10/2020 15:13	23/10/2020 21:07	5,88	26	153,00	CHI
202010133649	PIRACANJUBA	PJ21106698	CALDAS NOVAS S1	23/10/2020 15:14	23/10/2020 20:51	23/10/2020 15:14	23/10/2020 20:51	5,60	1	5,60	CHI
202010133651	TAQUARAL DE GOIAS	TQ21381636	INHUMAS S1	23/10/2020 15:14	23/10/2020 18:26	23/10/2020 15:14	23/10/2020 18:26	3,19	1	3,19	CHI
202010133656	PIRACANJUBA	60046170	PIRACANJUBA	23/10/2020 15:15	23/10/2020 16:55	23/10/2020 15:15	23/10/2020 16:55	1,66	1	1,66	CHI
202010133660	PLANALTINA	PI21151822	PLANALTINA	23/10/2020 15:15	23/10/2020 19:59	23/10/2020 15:15	23/10/2020 19:59	4,73	3	14,18	CHI
202010133917	BELA VISTA DE GOIAS	BV12018394	BELA VISTA S1	23/10/2020 15:15	24/10/2020 15:06	23/10/2020 15:15	24/10/2020 15:06	23,84	3	71,52	CHI
202010133917	PIRACANJUBA	BV12018394	BELA VISTA S1	23/10/2020 15:15	24/10/2020 15:06	23/10/2020 15:15	24/10/2020 15:06	23,84	33	786,67	CHI



202010133665	MINACU	4020070636	MINACU	23/10/2020 15:15	23/10/2020 18:06	23/10/2020 15:15	23/10/2020 18:06	2,84	1	2,84	CHI
202010134778	INHUMAS	IN21098388	INHUMAS S2	23/10/2020 15:17	23/10/2020 20:53	23/10/2020 15:17	23/10/2020 20:53	5,59	2	11,18	CHI
202010134329	INHUMAS	IN12320360	INHUMAS S2	23/10/2020 15:17	23/10/2020 18:39	23/10/2020 15:17	23/10/2020 18:39	3,36	103	345,91	CHI
202010133689	SENADOR CANEDO	10005809680	SENADOR CANEDO	23/10/2020 15:18	24/10/2020 07:15	23/10/2020 15:18	24/10/2020 07:15	15,94	1	15,94	CHI
202010133787	DIORAMA	AY12390169	ARENOPOLIS	23/10/2020 15:19	24/10/2020 10:53	23/10/2020 15:19	24/10/2020 10:53	19,55	3	58,65	CHI
202010133787	ARENOPOLIS	AY12390169	ARENOPOLIS	23/10/2020 15:19	24/10/2020 10:53	23/10/2020 15:19	24/10/2020 10:53	19,55	23	449,66	CHI
202010133700	MINEIROS	1390018018	PARQUE DAS EMAS	23/10/2020 15:20	24/10/2020 14:49	23/10/2020 15:20	24/10/2020 14:49	23,48	1	23,48	CHI
202010133716	MINEIROS	MY21322132	PARQUE DAS EMAS	23/10/2020 15:21	24/10/2020 19:37	23/10/2020 15:21	24/10/2020 19:37	28,26	1	28,26	CHI
202010133788	FAZENDA NOVA	FN12250857	IPORA	23/10/2020 15:21	23/10/2020 17:10	23/10/2020 15:21	23/10/2020 17:10	1,81	11	19,86	CHI
202010133723	SAO JOAO DA PARAUNA	PU12361883	PARAUNA	23/10/2020 15:21	24/10/2020 10:05	23/10/2020 15:21	24/10/2020 10:05	18,72	4	74,88	CHI
202010133742	GOIANIA	GN11168957	FERROVIARIO S2	23/10/2020 15:24	24/10/2020 16:45	24/10/2020 16:19	24/10/2020 16:45	0,43	51	21,87	CHI
202010133742	GOIANIA	GN11168957	FERROVIARIO S2	23/10/2020 15:24	24/10/2020 16:45	23/10/2020 15:24	24/10/2020 07:19	15,91	51	811,64	CHI
202010133837	RIO VERDE	RV12306377	CABRIUVA S2	23/10/2020 15:24	24/10/2020 01:27	23/10/2020 15:24	24/10/2020 01:27	10,05	23	231,18	CHI
202010133837	RIO VERDE	RV10394844	CABRIUVA S2	23/10/2020 15:24	24/10/2020 01:27	23/10/2020 15:24	23/10/2020 17:58	2,57	54	138,79	CHI
202010133837	RIO VERDE	RV10406663	CABRIUVA S2	23/10/2020 15:24	24/10/2020 01:27	23/10/2020 15:24	23/10/2020 15:29	0,08	46	3,67	CHI
202010133837	RIO VERDE	RV10394866	RIO VERDE S2	23/10/2020 15:24	24/10/2020 01:27	23/10/2020 15:24	23/10/2020 15:28	0,06	36	2,29	CHI
202010133837	RIO VERDE	O1600404	RIO VERDE S2	23/10/2020 15:24	24/10/2020 01:27	23/10/2020 15:24	23/10/2020 15:27	0,05	1	0,05	CHI
202010133916	APARECIDA DE GOIANIA	AP12000049	CEPAIGO S1	23/10/2020 15:24	23/10/2020 20:13	23/10/2020 15:24	23/10/2020 20:13	4,81	40	192,44	CHI
202010133747	PONTALINA	PK12263503	PONTALINA	23/10/2020 15:24	24/10/2020 12:23	23/10/2020 15:24	24/10/2020 12:23	20,98	6	125,85	CHI
202010133747	PONTALINA	PK12263503	PONTALINA	23/10/2020 15:24	24/10/2020 12:23	23/10/2020 15:24	24/10/2020 09:22	17,97	8	143,73	CHI
202010133753	MARA ROSA	10015745188	MARA ROSA	23/10/2020 15:25	24/10/2020 00:02	23/10/2020 15:25	24/10/2020 00:02	8,62	1	8,62	CHI
202010133771	GOIAS	4050000910	MATRINCHA	23/10/2020 15:26	23/10/2020 18:49	23/10/2020 15:26	23/10/2020 18:49	3,37	1	3,37	CHI
202010133777	URUACU	UR21166532	URUACU	23/10/2020 15:27	24/10/2020 12:19	23/10/2020 15:27	24/10/2020 12:19	20,86	1	20,86	CHI
202010133779	QUIRINOPOLIS	QI21191862	QUIRINOPOLIS	23/10/2020 15:27	23/10/2020 17:58	23/10/2020 15:27	23/10/2020 17:58	2,51	1	2,51	CHI
202010134490	ANICUNS	AC12000068	ANICUNS	23/10/2020 15:27	24/10/2020 09:33	23/10/2020 15:27	24/10/2020 09:33	18,09	24	434,17	CHI
202010134490	ANICUNS	AC12000068	ANICUNS	23/10/2020 15:27	24/10/2020 09:33	23/10/2020 15:27	24/10/2020 08:55	17,46	11	192,08	CHI
202010133789	ESTRELA DO NORTE	MQ21265836	MARA ROSA	23/10/2020 15:28	23/10/2020 18:42	23/10/2020 15:28	23/10/2020 18:42	3,23	1	3,23	CHI
202010133790	MINEIROS	10005814080	PARQUE DAS EMAS	23/10/2020 15:28	23/10/2020 23:53	23/10/2020 15:28	23/10/2020 23:53	8,41	1	8,41	CHI
202010133800	INHUMAS	IN21366113	INHUMAS S2	23/10/2020 15:29	24/10/2020 00:48	23/10/2020 15:29	24/10/2020 00:48	9,32	1	9,32	CHI
202010134451	SILVANIA	SV12389456	VIANOPOLIS	23/10/2020 15:30	23/10/2020 20:32	23/10/2020 15:30	23/10/2020 20:32	5,02	35	175,78	CHI
202010133819	GOIANIRA	10002888678	GOIANIRA	23/10/2020 15:30	24/10/2020 12:23	23/10/2020 15:30	24/10/2020 12:23	20,87	1	20,87	CHI
202010135089	SILVANIA	SV12211132	VIANOPOLIS	23/10/2020 15:33	23/10/2020 21:19	23/10/2020 15:33	23/10/2020 21:19	5,76	44	253,33	CHI
202010135089	GAMELEIRA DE GOIAS	SV12211132	VIANOPOLIS	23/10/2020 15:33	23/10/2020 21:19	23/10/2020 15:33	23/10/2020 21:19	5,76	20	115,15	CHI
202010133856	RIO VERDE	RV11047506	RIO VERDE S1	23/10/2020 15:33	23/10/2020 23:15	23/10/2020 15:33	23/10/2020 23:15	7,69	282	2169,75	CHI
202010133880	NOVO BRASIL	NB21165481	JUSSARA	23/10/2020 15:36	23/10/2020 21:08	23/10/2020 15:36	23/10/2020 21:08	5,53	1	5,53	CHI
202010133885	GOIANIA	GN11340575	GOYA S2	23/10/2020 15:36	23/10/2020 19:48	23/10/2020 15:36	23/10/2020 19:48	4,19	18	75,39	CHI
202010133915	PANAMA	PX21254790	GOIATUBA S1	23/10/2020 15:39	23/10/2020 23:09	23/10/2020 15:39	23/10/2020 23:09	7,50	1	7,50	CHI
202010133920	VILA PROPICIO	PV21080661	GOIANESIA S1	23/10/2020 15:41	23/10/2020 17:48	23/10/2020 15:41	23/10/2020 17:48	2,12	3	6,35	CHI
202010133926	ITAPIRAPUA	IU12072448	MATRINCHA	23/10/2020 15:41	23/10/2020 18:40	23/10/2020 15:41	23/10/2020 18:40	2,97	2	5,95	CHI
202010133937	CRISTALINA	10005516151	CRISTALINA S1	23/10/2020 15:43	23/10/2020 21:46	23/10/2020 15:43	23/10/2020 21:46	6,05	1	6,05	CHI
202010133940	GOIANIA	16394150	GOIANIA LESTE S2	23/10/2020 15:43	23/10/2020 16:58	23/10/2020 15:43	23/10/2020 16:58	1,25	1	1,25	CHI
202010133941	IVOLANDIA	IV12390185	IPORA	23/10/2020 15:43	25/10/2020 15:18	23/10/2020 15:43	25/10/2020 15:18	47,59	10	475,87	CHI
202010133941	IVOLANDIA	IV12390185	IPORA	23/10/2020 15:43	25/10/2020 15:18	23/10/2020 15:43	24/10/2020 13:22	21,66	3	64,97	CHI
202010133997	PARAUNA	PU21348595	PARAUNA	23/10/2020 15:44	23/10/2020 21:54	23/10/2020 15:44	23/10/2020 21:54	6,16	1	6,16	CHI
202010133960	NOVA VENEZA	300003950	INHUMAS S1	23/10/2020 15:45	23/10/2020 22:59	23/10/2020 15:45	23/10/2020 22:59	7,23	1	7,23	CHI
202010133963	SAO MIGUEL DO ARAGUAIA	SM21328898	SAO MIGUEL DO ARAGUAIA	23/10/2020 15:45	23/10/2020 21:39	23/10/2020 15:45	23/10/2020 21:39	5,89	1	5,89	CHI
202010133980	ANICUNS	AC10403934	ANICUNS	23/10/2020 15:46	24/10/2020 11:38	23/10/2020 15:46	24/10/2020 11:38	19,86	11	218,51	CHI
202010133980	ANICUNS	AC13399383	ANICUNS	23/10/2020 15:46	24/10/2020 11:38	24/10/2020 10:26	24/10/2020 11:38	1,19	403	478,23	CHI
202010133980	ANICUNS	AC12061366	ANICUNS	23/10/2020 15:46	24/10/2020 11:38	23/10/2020 15:46	23/10/2020 23:20	7,57	14	105,98	CHI
202010133980	ANICUNS	AC10403934	ANICUNS	23/10/2020 15:46	24/10/2020 11:38	23/10/2020 15:46	23/10/2020 23:11	7,41	389	2884,22	CHI
202010133980	ANICUNS	AC10403934	ANICUNS	23/10/2020 15:46	24/10/2020 11:38	23/10/2020 17:36	23/10/2020 17:49	0,22	36	7,82	CHI

202010133980	ANICUNS	AC10403934	ANICUNS	23/10/2020 15:46	24/10/2020 11:38	23/10/2020 15:46	23/10/2020 16:51	1,09	36	39,09	CHI
202010133972	GOIANIA	15849041	GOYA S1	23/10/2020 15:46	23/10/2020 19:44	23/10/2020 15:46	23/10/2020 19:44	3,95	1	3,95	CHI
202010133974	CATALAO	1990255246	CATALAO S2	23/10/2020 15:46	23/10/2020 17:18	23/10/2020 15:46	23/10/2020 17:18	1,52	1	1,52	CHI
202010133994	CACHOEIRA DOURADA	CD21304162	CACHOEIRA DOURADA	23/10/2020 15:49	23/10/2020 18:11	23/10/2020 15:49	23/10/2020 18:11	2,35	1	2,35	CHI
202010134003	ITABERAI	IB21029606	ITABERAI S2	23/10/2020 15:51	23/10/2020 18:04	23/10/2020 15:51	23/10/2020 18:04	2,21	1	2,21	CHI
202010135169	SANTO ANTONIO DO DESCOBERTO	SN12401863	MARAJOARA	23/10/2020 15:51	23/10/2020 19:04	23/10/2020 15:51	23/10/2020 19:04	3,21	4	12,85	CHI
202010134006	SENADOR CANEDO	12276765	SENADOR CANEDO	23/10/2020 15:51	23/10/2020 17:31	23/10/2020 15:51	23/10/2020 17:31	1,66	1	1,66	CHI
202010134247	GOIATUBA	CL12295982RE	RIO DOS BOIS	23/10/2020 15:53	23/10/2020 18:18	23/10/2020 15:53	23/10/2020 18:18	2,41	19	45,86	CHI
202010134247	PORTEIRAO	CL12295982RE	RIO DOS BOIS	23/10/2020 15:53	23/10/2020 18:18	23/10/2020 15:53	23/10/2020 18:18	2,41	13	31,38	CHI
202010134017	SANTA ROSA DE GOIAS	SR12107586	INHUMAS S1	23/10/2020 15:53	24/10/2020 07:50	23/10/2020 15:53	24/10/2020 07:50	15,94	62	988,56	CHI
202010134026	PARAUNA	PU12205943	PARAUNA	23/10/2020 15:54	23/10/2020 18:39	23/10/2020 15:54	23/10/2020 18:39	2,75	23	63,22	CHI
202010134026	JANDAIA	PU12205943	PARAUNA	23/10/2020 15:54	23/10/2020 18:39	23/10/2020 15:54	23/10/2020 18:39	2,75	2	5,50	CHI
202010134037	CABECEIRAS	CW12233584	ITUIQUIRA	23/10/2020 15:55	23/10/2020 17:46	23/10/2020 15:55	23/10/2020 17:46	1,84	3	5,51	CHI
202010134038	APARECIDA DE GOIANIA	16350984	INDEPENDENCIA S1	23/10/2020 15:55	23/10/2020 17:10	23/10/2020 15:55	23/10/2020 17:10	1,24	1	1,24	CHI
202010134924	CHAPADAO DO CEU	DJ12131923	CHAPADAO DO CEU	23/10/2020 15:57	23/10/2020 22:16	23/10/2020 15:57	23/10/2020 22:16	6,30	10	63,05	CHI
202010134055	GOIANIRA	390062443	GOIANIRA	23/10/2020 15:58	24/10/2020 14:08	23/10/2020 15:58	24/10/2020 14:08	22,17	1	22,17	CHI
202010134059	NEROPOLIS	10009002217	NEROPOLIS S2	23/10/2020 15:58	23/10/2020 19:36	23/10/2020 15:58	23/10/2020 19:36	3,63	1	3,63	CHI
202010134978	HIDROLINA	HL11253146	URUACU	23/10/2020 15:58	24/10/2020 12:09	23/10/2020 15:58	24/10/2020 12:09	20,18	37	746,69	CHI
202010134380	ANICUNS	AC12024032	ANICUNS	23/10/2020 15:59	23/10/2020 22:04	23/10/2020 15:59	23/10/2020 22:04	6,08	24	145,91	CHI
202010134380	TURVANIA	AC12024032	ANICUNS	23/10/2020 15:59	23/10/2020 22:04	23/10/2020 15:59	23/10/2020 22:04	6,08	4	24,32	CHI
202010134078	PIRACANJUBA	BV21055786	BELA VISTA S1	23/10/2020 16:00	24/10/2020 13:01	23/10/2020 16:00	24/10/2020 13:01	21,01	1	21,01	CHI
202010134082	ACREUNA	EU12000138	ACREUNA	23/10/2020 16:00	23/10/2020 21:52	23/10/2020 16:00	23/10/2020 21:52	5,86	341	1996,74	CHI
202010136375	ANICUNS	AC12391410	ANICUNS	23/10/2020 16:00	23/10/2020 21:08	23/10/2020 16:00	23/10/2020 21:08	5,12	3	15,36	CHI
202010134086	RIO VERDE	RV12249177LD	CABRIUVA S1	23/10/2020 16:00	24/10/2020 09:21	23/10/2020 16:00	24/10/2020 09:21	17,33	1	17,33	CHI
202010134318	GOUVELANDIA	QI12000166	QUIRINOPOLIS	23/10/2020 16:01	24/10/2020 09:18	23/10/2020 16:01	24/10/2020 09:18	17,28	19	328,26	CHI
202010134111	MINEIROS	MY11105595	PARQUE DAS EMAS	23/10/2020 16:02	24/10/2020 00:35	23/10/2020 23:55	24/10/2020 00:35	0,65	120	78,23	CHI
202010134111	MINEIROS	MY11036534	PARQUE DAS EMAS	23/10/2020 16:02	24/10/2020 00:35	23/10/2020 16:02	24/10/2020 00:34	8,53	144	1228,64	CHI
202010134189	ALTO HORIZONTE	AJ11023820	SANTA TEREZINHA	23/10/2020 16:02	24/10/2020 01:07	23/10/2020 16:02	24/10/2020 01:07	9,08	129	1170,96	CHI
202010133384	GOIANIA	GN11203578	REAL S1	23/10/2020 16:03	23/10/2020 19:38	23/10/2020 16:03	23/10/2020 19:38	3,58	138	494,50	CHI
202010134137	MORRINHOS	MR21239070	MORRINHOS	23/10/2020 16:05	23/10/2020 18:48	23/10/2020 16:05	23/10/2020 18:48	2,71	2	5,42	CHI
202010134150	MONTIVIDIU DO NORTE	MX12088676	PORANGATU	23/10/2020 16:06	23/10/2020 17:19	23/10/2020 16:06	23/10/2020 17:19	1,21	2	2,41	CHI
202010134625	RIO VERDE	RV11191981	RIO VERDE S1	23/10/2020 16:06	23/10/2020 23:19	23/10/2020 16:06	23/10/2020 23:19	7,21	135	972,75	CHI
202010134164	APARECIDA DE GOIANIA	10017605413	INDEPENDENCIA S2	23/10/2020 16:06	23/10/2020 17:46	23/10/2020 16:06	23/10/2020 17:46	1,65	1	1,65	CHI
202010134173	GOIANIA	14246673	CARAJAS S1	23/10/2020 16:07	24/10/2020 09:06	23/10/2020 16:07	24/10/2020 09:06	16,97	1	16,97	CHI
202010134237	ANAPOLIS	AN12258718	JUNDIAI S2	23/10/2020 16:07	23/10/2020 18:06	23/10/2020 16:07	23/10/2020 18:06	1,97	21	41,37	CHI
202010134176	CACHOEIRA ALTA	CA21294603	CACHOEIRA ALTA	23/10/2020 16:07	23/10/2020 19:05	23/10/2020 16:07	23/10/2020 19:05	2,95	1	2,95	CHI
202010134191	GOIANESIA	550053116	GOIANESIA S2	23/10/2020 16:09	23/10/2020 18:27	23/10/2020 16:09	23/10/2020 18:27	2,30	1	2,30	CHI
202010135002	ACREUNA	EU11048342	ACREUNA	23/10/2020 16:10	23/10/2020 23:22	23/10/2020 16:10	23/10/2020 23:22	7,19	174	1251,25	CHI
202010134208	ACREUNA	EU11044321	ACREUNA	23/10/2020 16:11	24/10/2020 01:41	23/10/2020 16:11	24/10/2020 01:41	9,49	118	1119,49	CHI
202010134216	VALPARAISO DE GOIAS	10006377090	PACAEMBU S2	23/10/2020 16:12	23/10/2020 19:56	23/10/2020 16:12	23/10/2020 19:56	3,73	1	3,73	CHI
202010131171	PEROLANDIA	DP11000001	JATAI S1	23/10/2020 16:13	24/10/2020 17:15	23/10/2020 16:13	24/10/2020 17:15	25,05	86	2153,89	CHI
202010134266	VILA BOA	FA21322702	ITUIQUIRA	23/10/2020 16:21	23/10/2020 20:50	23/10/2020 16:21	23/10/2020 20:50	4,48	1	4,48	CHI
202010134273	ACREUNA	EU11031016	ACREUNA	23/10/2020 16:21	24/10/2020 00:40	23/10/2020 16:21	24/10/2020 00:40	8,30	42	348,69	CHI
202010134278	AURILANDIA	AI21032944	FIRMINOPOLIS S2	23/10/2020 16:23	23/10/2020 18:32	23/10/2020 16:23	23/10/2020 18:32	2,15	1	2,15	CHI
202010135358	SAO FRANCISCO DE GOIAS	PG12297931	PETROLINA	23/10/2020 16:24	24/10/2020 09:09	23/10/2020 16:24	24/10/2020 09:09	16,74	1	16,74	CHI
202010135358	PETROLINA DE GOIAS	PG12297931	PETROLINA	23/10/2020 16:24	24/10/2020 09:09	23/10/2020 16:24	24/10/2020 09:09	16,74	117	1958,81	CHI
202010134290	GOIANIA	12979405	CAMPINAS S1	23/10/2020 16:24	23/10/2020 20:09	23/10/2020 16:24	23/10/2020 20:09	3,74	1	3,74	CHI
202010134720	PETROLINA DE GOIAS	PG12090243	PETROLINA	23/10/2020 16:27	23/10/2020 19:36	23/10/2020 16:27	23/10/2020 19:36	3,14	9	28,27	CHI
202010134431	NOVA VENEZA	NV11293785	INHUMAS S1	23/10/2020 16:28	23/10/2020 21:47	23/10/2020 16:28	23/10/2020 21:47	5,31	84	446,23	CHI
202010134332	ITUMBIARA	10006691810	ITUMBIARA VELHA S1	23/10/2020 16:28	23/10/2020 18:05	23/10/2020 16:28	23/10/2020 18:05	1,61	1	1,61	CHI
202010127499	GOIANESIA	JA12297398	GOIANESIA S2	23/10/2020 16:28	23/10/2020 18:16	23/10/2020 16:28	23/10/2020 18:16	1,79	1	1,79	CHI

202010127499	JARAGUA	JA12297398	GOIANESIA S2	23/10/2020 16:28	23/10/2020 18:16	23/10/2020 16:28	23/10/2020 18:16	1,79	9	16,08	CHI
202010134340	INHUMAS	IN21347728	INHUMAS S1	23/10/2020 16:29	23/10/2020 22:20	23/10/2020 16:29	23/10/2020 22:20	5,85	1	5,85	CHI
202010134341	IPORA	IR11353733	IPORA	23/10/2020 16:29	23/10/2020 17:10	23/10/2020 16:29	23/10/2020 17:10	0,68	1	0,68	CHI
202010134343	RIO VERDE	10023597753	RIO VERDE S1	23/10/2020 16:29	23/10/2020 23:54	23/10/2020 16:29	23/10/2020 23:54	7,41	1	7,41	CHI
202010136083	ACREUNA	EU11135962	ACREUNA	23/10/2020 16:29	24/10/2020 09:58	23/10/2020 16:29	24/10/2020 09:58	17,48	167	2918,74	CHI
202010134347	ARENOPOLIS	1920005186	ARENOPOLIS	23/10/2020 16:29	24/10/2020 09:38	23/10/2020 16:29	24/10/2020 09:38	17,16	1	17,16	CHI
202010134348	GOIANIA	14096444	CAMPINAS S3	23/10/2020 16:29	23/10/2020 18:22	23/10/2020 16:29	23/10/2020 18:22	1,87	1	1,87	CHI
202010134452	AGUA FRIA DE GOIAS	TL12404390	SAO JOAO D ALIANCA	23/10/2020 16:30	23/10/2020 19:48	23/10/2020 16:30	23/10/2020 19:48	3,29	8	26,34	CHI
202010134361	ITABERAI	IB21156273	ITABERAI S2	23/10/2020 16:31	23/10/2020 19:14	23/10/2020 16:31	23/10/2020 19:14	2,70	2	5,40	CHI
202010134370	CABEIRAS	CW21129740	ITUIQUIRA	23/10/2020 16:32	23/10/2020 18:54	23/10/2020 16:32	23/10/2020 18:54	2,35	1	2,35	CHI
202010135214	ARENOPOLIS	AY12102607	ARENOPOLIS	23/10/2020 16:33	23/10/2020 19:33	23/10/2020 16:33	23/10/2020 19:33	2,99	9	26,94	CHI
202010134407	MONTES CLAROS DE GOIAS	ME12088922	IPORA	23/10/2020 16:34	23/10/2020 18:32	23/10/2020 16:34	23/10/2020 18:32	1,96	17	33,39	CHI
202010134386	PARAUNA	PU21364931	PARAUNA	23/10/2020 16:34	24/10/2020 10:59	23/10/2020 16:34	24/10/2020 10:59	18,40	1	18,40	CHI
202010134387	AGUA FRIA DE GOIAS	10010557162	SAO JOAO D ALIANCA	23/10/2020 16:34	23/10/2020 18:44	23/10/2020 16:34	23/10/2020 18:44	2,15	1	2,15	CHI
202010134753	SANTA HELENA DE GOIAS	SH11230949	IPEGUARI	23/10/2020 16:35	24/10/2020 08:04	23/10/2020 16:35	24/10/2020 08:04	15,47	101	1562,53	CHI
202010134403	PLANALTINA	PI21072301	PLANALTINA	23/10/2020 16:36	23/10/2020 17:34	23/10/2020 16:36	23/10/2020 17:34	0,96	3	2,88	CHI
202010135050	GOIATUBA	GT11307879	GOIATUBA S2	23/10/2020 16:36	23/10/2020 22:10	23/10/2020 16:36	23/10/2020 22:10	5,56	20	111,15	CHI
202010134192	MORRINHOS	MR11000021	MORRINHOS	23/10/2020 16:39	24/10/2020 01:41	23/10/2020 16:39	24/10/2020 01:41	9,03	89	803,97	CHI
202010134417	ANICUNS	AC21196708	ANICUNS	23/10/2020 16:39	24/10/2020 14:11	23/10/2020 16:39	24/10/2020 14:11	21,53	1	21,53	CHI
202010135852	CAIAPONIA	CP11247153	CAIAPONIA	23/10/2020 16:39	24/10/2020 10:40	23/10/2020 16:39	24/10/2020 10:40	18,01	81	1458,83	CHI
202010135144	CAIAPONIA	CP12334953	CAIAPONIA	23/10/2020 16:39	24/10/2020 15:47	23/10/2020 16:39	24/10/2020 15:47	23,12	12	277,42	CHI
202010134424	RIO VERDE	630541152	RIO VERDE S2	23/10/2020 16:39	23/10/2020 22:05	23/10/2020 16:39	23/10/2020 22:05	5,42	1	5,42	CHI
202010137212	JATAI	JT12324674	JATAI S2	23/10/2020 16:40	24/10/2020 07:42	23/10/2020 16:40	24/10/2020 07:42	15,04	14	210,51	CHI
202010133405	GOIANIA	GN11196668	CAMPINAS S1	23/10/2020 16:41	23/10/2020 21:04	23/10/2020 17:25	23/10/2020 21:04	3,66	18	65,80	CHI
202010133405	GOIANIA	GN11196668	CAMPINAS S1	23/10/2020 16:41	23/10/2020 21:04	23/10/2020 16:41	23/10/2020 17:07	0,43	18	7,65	CHI
202010134447	CRIXAS	CX12276582	SERRA DO OURO	23/10/2020 16:42	24/10/2020 14:06	23/10/2020 16:42	24/10/2020 14:06	21,40	3	64,19	CHI
202010134448	GOUVELANDIA	GB21255633	QUIRINOPOLIS	23/10/2020 16:42	23/10/2020 17:34	23/10/2020 16:42	23/10/2020 17:34	0,86	1	0,86	CHI
202010134455	CORUMBAIBA	CI12025302	VILA CORUMBA	23/10/2020 16:42	23/10/2020 20:33	23/10/2020 16:42	23/10/2020 20:33	3,84	3	11,53	CHI
202010134473	MORRINHOS	MR11000046	MORRINHOS	23/10/2020 16:44	23/10/2020 18:25	23/10/2020 16:44	23/10/2020 18:25	1,68	37	62,07	CHI
202010136329	CAIAPONIA	CP12200873	PALESTINA	23/10/2020 16:44	23/10/2020 23:49	23/10/2020 16:44	23/10/2020 23:49	7,07	99	699,74	CHI
202010134485	SERRANOPOLIS	SX12260520	JATAI S1	23/10/2020 16:45	23/10/2020 08:50	23/10/2020 16:45	24/10/2020 08:50	16,07	3	48,21	CHI
202010135540	INHUMAS	IN12015928	INHUMAS S2	23/10/2020 16:47	23/10/2020 19:56	23/10/2020 16:47	23/10/2020 19:56	3,14	4	12,55	CHI
202010134507	GOIANIA	13972224	MEIA PONTE	23/10/2020 16:47	23/10/2020 19:17	23/10/2020 16:47	23/10/2020 19:17	2,49	1	2,49	CHI
202010135515	MONTES CLAROS DE GOIAS	ME12241291	BRITANIA	23/10/2020 16:48	24/10/2020 01:23	23/10/2020 16:48	24/10/2020 01:23	8,57	37	317,08	CHI
202010134515	SAO MIGUEL DO ARAGUAIA	830034924	SAO MIGUEL DO ARAGUAIA	23/10/2020 16:48	23/10/2020 18:49	23/10/2020 16:48	23/10/2020 18:49	2,00	1	2,00	CHI
202010134528	AMERICANO DO BRASIL	KB21000013	ANICUNS	23/10/2020 16:51	23/10/2020 23:25	23/10/2020 16:51	23/10/2020 23:25	6,57	1	6,57	CHI
202010134527	AGUAS LINDAS DE GOIAS	4830374999	AGUAS LINDAS DE GOIAS S1	23/10/2020 16:51	23/10/2020 18:19	23/10/2020 16:51	23/10/2020 18:19	1,47	1	1,47	CHI
202010135662	PETROLINA DE GOIAS	PG12388840	PETROLINA	23/10/2020 16:51	24/10/2020 09:56	23/10/2020 16:51	24/10/2020 09:56	17,08	13	222,00	CHI
202010134715	PETROLINA DE GOIAS	01450224	PETROLINA	23/10/2020 16:51	24/10/2020 00:30	23/10/2020 16:51	24/10/2020 00:30	7,64	33	252,26	CHI
202010134715	PETROLINA DE GOIAS	01450224	PETROLINA	23/10/2020 16:51	24/10/2020 00:30	23/10/2020 16:51	23/10/2020 22:36	5,74	8	45,95	CHI
202010134715	PETROLINA DE GOIAS	01450224	PETROLINA	23/10/2020 16:51	24/10/2020 00:30	23/10/2020 16:51	23/10/2020 22:16	5,41	11	59,56	CHI
202010134715	PETROLINA DE GOIAS	01450224	PETROLINA	23/10/2020 16:51	24/10/2020 00:30	23/10/2020 16:51	23/10/2020 21:52	5,01	31	155,45	CHI
202010134715	PETROLINA DE GOIAS	01450224	PETROLINA	23/10/2020 16:51	24/10/2020 00:30	23/10/2020 16:51	23/10/2020 19:28	2,62	138	361,18	CHI
202010134715	SAO FRANCISCO DE GOIAS	01450224	PETROLINA	23/10/2020 16:51	24/10/2020 00:30	23/10/2020 16:51	23/10/2020 19:28	2,62	34	88,99	CHI
202010134715	PETROLINA DE GOIAS	01450224	PETROLINA	23/10/2020 16:51	24/10/2020 00:30	23/10/2020 16:51	23/10/2020 19:28	2,62	1	2,62	CHI
202010134715	PETROLINA DE GOIAS	01450224	PETROLINA	23/10/2020 16:51	24/10/2020 00:30	23/10/2020 16:51	23/10/2020 18:16	1,42	275	391,42	CHI
202010134715	PETROLINA DE GOIAS	01450224	PETROLINA	23/10/2020 16:51	24/10/2020 00:30	23/10/2020 16:51	23/10/2020 18:16	1,42	5	7,11	CHI
202010134532	LUZIANIA	LZ11051977	PACAEMBU S2	23/10/2020 16:51	23/10/2020 19:50	23/10/2020 16:51	23/10/2020 19:50	2,97	10	29,72	CHI
202010134535	MUNDO NOVO DE GOIAS	MH11274867	NOVA CRIXAS	23/10/2020 16:52	23/10/2020 20:26	23/10/2020 16:52	23/10/2020 20:26	3,56	2	7,13	CHI
202010134538	IPAMERI	10001946674	PIRES DO RIO S2	23/10/2020 16:52	24/10/2020 01:29	23/10/2020 16:52	24/10/2020 01:29	8,62	1	8,62	CHI
202010134543	CEZARINA	CZ12259274	CEZARINA	23/10/2020 16:53	24/10/2020 13:40	23/10/2020 16:53	24/10/2020 13:40	20,78	1	20,78	CHI

202010134545	GOIATUBA	BJ21030841	RIO DOS BOIS	23/10/2020 16:53	24/10/2020 01:15	23/10/2020 16:53	24/10/2020 01:15	8,36	1	8,36	CHI
202010134546	CRIXAS	2490012200	SERRA DO OURO	23/10/2020 16:53	23/10/2020 20:19	23/10/2020 16:53	23/10/2020 20:19	3,42	1	3,42	CHI
202010134547	INACIOLANDIA	ID31128246	QUIRINOPOLIS	23/10/2020 16:53	23/10/2020 19:35	23/10/2020 16:53	23/10/2020 19:35	2,69	1	2,69	CHI
202010134552	GOIANIA	11297311	FERROVIARIO S2	23/10/2020 16:54	23/10/2020 19:56	23/10/2020 16:54	23/10/2020 19:56	3,03	1	3,03	CHI
202010134664	HIDROLANDIA	HD12400525	CEPAIGO S1	23/10/2020 16:56	23/10/2020 21:39	23/10/2020 16:56	23/10/2020 21:39	4,71	20	94,26	CHI
202010134740	APORE	AE12059186	ITAJA S1	23/10/2020 16:57	23/10/2020 19:46	23/10/2020 16:57	23/10/2020 19:46	2,81	4	11,23	CHI
202010135783	TURVELANDIA	TD11170324	RIO DOS BOIS	23/10/2020 16:57	23/10/2020 23:29	23/10/2020 16:57	23/10/2020 23:29	6,52	108	704,13	CHI
202010134599	BELA VISTA DE GOIAS	10010325962	BELA VISTA S1	23/10/2020 16:58	23/10/2020 19:49	23/10/2020 16:58	23/10/2020 19:49	2,84	1	2,84	CHI
202010143577	BARRO ALTO	BA11332410	BARRO ALTO	23/10/2020 16:59	24/10/2020 20:00	23/10/2020 16:59	24/10/2020 20:00	27,01	1	27,01	CHI
202010134604	LUZIANIA	10013050468	MARAJOARA	23/10/2020 16:59	23/10/2020 20:29	23/10/2020 16:59	23/10/2020 20:29	3,49	1	3,49	CHI
202010134606	CATALAO	1990107129	CATALAO S2	23/10/2020 16:59	23/10/2020 18:53	23/10/2020 16:59	23/10/2020 18:53	1,89	1	1,89	CHI
202010134700	ITABERAI	IB12108138	ITABERAI S2	23/10/2020 16:59	23/10/2020 22:47	23/10/2020 16:59	23/10/2020 22:47	5,79	28	162,10	CHI
202010134953	PETROLINA DE GOIAS	PG12038042	INHUMAS S1	23/10/2020 16:59	24/10/2020 08:30	23/10/2020 16:59	24/10/2020 08:30	15,50	15	232,52	CHI
202010135748	GOIATUBA	GT12000241	GOIATUBA S2	23/10/2020 17:00	23/10/2020 21:09	23/10/2020 17:00	23/10/2020 21:09	4,15	281	1165,45	CHI
202010134626	PORANGATU	PO12104373	PORANGATU	23/10/2020 17:01	23/10/2020 18:10	23/10/2020 17:01	23/10/2020 18:10	1,15	31	35,56	CHI
202010134998	BOM JESUS DE GOIAS	BJ12352647LD	BOM JESUS DE GOIAS	23/10/2020 17:01	24/10/2020 01:53	23/10/2020 17:01	24/10/2020 01:53	8,86	3	26,58	CHI
202010134631	GOIANIA	GN12168414	MARAJAS S1	23/10/2020 17:01	24/10/2020 01:54	23/10/2020 17:01	24/10/2020 01:54	8,88	65	576,88	CHI
202010134637	GOIANIA	11578221	FERROVIARIO S1	23/10/2020 17:02	23/10/2020 21:26	23/10/2020 17:02	23/10/2020 21:26	4,40	1	4,40	CHI
202010134647	TRES RANCHOS	OU21161372	CATALAO S1	23/10/2020 17:02	23/10/2020 19:34	23/10/2020 17:02	23/10/2020 19:34	2,52	1	2,52	CHI
202010134649	ITUMBIARA	IT21293073	CACHOEIRA DOURADA	23/10/2020 17:02	23/10/2020 21:17	23/10/2020 17:02	23/10/2020 21:17	4,24	1	4,24	CHI
202010134652	CACHOEIRA DOURADA	CD12000327	CACHOEIRA DOURADA	23/10/2020 17:02	23/10/2020 20:40	23/10/2020 17:02	23/10/2020 20:40	3,62	3	10,85	CHI
202010134660	PARAUNA	PU12205936	PARAUNA	23/10/2020 17:03	24/10/2020 14:00	23/10/2020 17:03	24/10/2020 14:00	20,94	5	104,69	CHI
202010135238	RIO VERDE	SH12365460	RIO VERDE S1	23/10/2020 17:05	24/10/2020 01:24	23/10/2020 17:05	24/10/2020 01:24	8,31	14	116,41	CHI
202010135238	SANTA HELENA DE GOIAS	SH12365460	RIO VERDE S1	23/10/2020 17:05	24/10/2020 01:24	23/10/2020 17:05	24/10/2020 01:24	8,31	19	157,98	CHI
202010134679	PALESTINA DE GOIAS	PY21023467	PALESTINA	23/10/2020 17:05	24/10/2020 07:47	23/10/2020 17:05	24/10/2020 07:47	14,70	1	14,70	CHI
202010134680	SANTO ANTONIO DA BARRA	BZ21305897	ACREUNA	23/10/2020 17:05	24/10/2020 13:17	23/10/2020 17:05	24/10/2020 13:17	20,19	1	20,19	CHI
202010134734	MOZARLANDIA	FC10395390	GOIAS	23/10/2020 17:05	23/10/2020 17:15	23/10/2020 17:05	23/10/2020 17:15	0,16	3	0,49	CHI
202010134734	ARAGUAPAZ	FC10395390	GOIAS	23/10/2020 17:05	23/10/2020 17:15	23/10/2020 17:05	23/10/2020 17:15	0,16	223	36,24	CHI
202010134734	FAINA	FC10395390	GOIAS	23/10/2020 17:05	23/10/2020 17:15	23/10/2020 17:05	23/10/2020 17:15	0,16	75	12,19	CHI
202010134681	GOIANIA	10488777	GOIANIA LESTE S3	23/10/2020 17:05	23/10/2020 19:16	23/10/2020 17:05	23/10/2020 19:16	2,17	1	2,17	CHI
202010135601	CALDAS NOVAS	CN11103228	SERRA DE CALDAS	23/10/2020 17:06	23/10/2020 19:46	23/10/2020 17:06	23/10/2020 19:46	2,67	121	322,53	CHI
202010135172	SAO LUIS DE MONTES BELOS	SL11006847	SAO LUIZ DOS MONTES BELOS	23/10/2020 17:06	24/10/2020 00:05	23/10/2020 17:06	24/10/2020 00:05	6,98	270	1884,83	CHI
202010134688	TAQUARAL DE GOIAS	TQ12171611	INHUMAS S1	23/10/2020 17:06	24/10/2020 22:57	23/10/2020 17:06	24/10/2020 22:57	29,85	4	119,38	CHI
202010134693	ACREUNA	2440064422	RIO DOS BOIS	23/10/2020 17:06	23/10/2020 20:22	23/10/2020 17:06	23/10/2020 20:22	3,26	1	3,26	CHI
202010134704	GOIANIA	15998903	XAVANTES	23/10/2020 17:07	23/10/2020 21:31	23/10/2020 17:07	23/10/2020 21:31	4,39	1	4,39	CHI
202010134710	SENADOR CANEDO	10021775450	SENADOR CANEDO	23/10/2020 17:08	23/10/2020 23:25	23/10/2020 17:08	23/10/2020 23:25	6,28	1	6,28	CHI
202010134719	SANTA HELENA DE GOIAS	SH12247775	SANTA HELENA S1	23/10/2020 17:08	24/10/2020 10:38	23/10/2020 17:08	24/10/2020 10:38	17,49	2	34,97	CHI
202010133260	GOIANIA	GN12064721LD	MEIA PONTE	23/10/2020 17:09	23/10/2020 21:56	23/10/2020 19:46	23/10/2020 21:56	2,16	1	2,16	CHI
202010133260	GOIANIRA	GN12001206	MEIA PONTE	23/10/2020 17:09	23/10/2020 21:56	23/10/2020 17:09	23/10/2020 21:25	4,27	6	25,63	CHI
202010133260	GOIANIRA	GN12001206	MEIA PONTE	23/10/2020 17:09	23/10/2020 21:56	23/10/2020 17:09	23/10/2020 19:46	2,63	4	10,52	CHI
202010133260	GOIANIA	GN12001206	MEIA PONTE	23/10/2020 17:09	23/10/2020 21:56	23/10/2020 17:09	23/10/2020 19:05	1,95	18	35,04	CHI
202010134726	JANDAIA	10010250750	PALMEIRAS	23/10/2020 17:09	24/10/2020 11:16	23/10/2020 17:09	24/10/2020 11:16	18,11	1	18,11	CHI
202010134729	ARUANA	AK21056909	ARUANA	23/10/2020 17:09	23/10/2020 19:22	23/10/2020 17:09	23/10/2020 19:22	2,21	1	2,21	CHI
202010136330	CALDAZINHA	SW12091934LD	SENADOR CANEDO	23/10/2020 17:09	24/10/2020 12:20	23/10/2020 17:09	24/10/2020 12:20	19,17	7	134,19	CHI
202010136330	SENADOR CANEDO	SW12091934LD	SENADOR CANEDO	23/10/2020 17:09	24/10/2020 12:20	23/10/2020 17:09	24/10/2020 12:20	19,17	5	95,85	CHI
202010134751	BOM JARDIM DE GOIAS	BM12201959	BOM JARDIM	23/10/2020 17:12	23/10/2020 18:49	23/10/2020 17:12	23/10/2020 18:49	1,61	84	135,54	CHI
202010134768	PIRACANJUBA	PJ21221039	PIRACANJUBA	23/10/2020 17:12	24/10/2020 11:44	23/10/2020 17:12	24/10/2020 11:44	18,52	1	18,52	CHI
202010134775	CACHOEIRA ALTA	RV12214217LD	CACHOEIRA ALTA	23/10/2020 17:13	23/10/2020 21:23	23/10/2020 17:13	23/10/2020 21:23	4,16	2	8,32	CHI
202010134775	RIO VERDE	RV12214217LD	CACHOEIRA ALTA	23/10/2020 17:13	23/10/2020 21:23	23/10/2020 17:13	23/10/2020 21:23	4,16	2	8,32	CHI
202010134783	AMORINOPOLIS	AM21333117	IPORA	23/10/2020 17:14	23/10/2020 21:09	23/10/2020 17:14	23/10/2020 21:09	3,91	1	3,91	CHI
202010134785	CRIXAS	CX12391853	RUBIATABA	23/10/2020 17:14	24/10/2020 12:09	23/10/2020 17:14	24/10/2020 12:09	18,91	9	170,19	CHI

202010134852	ANICUNS	AC12000082	ANICUNS	23/10/2020 17:14	24/10/2020 07:35	23/10/2020 17:14	24/10/2020 07:35	14,34	52	745,51	CHI
202010134795	JARAGUA	SR21059785	INHUMAS S1	23/10/2020 17:15	24/10/2020 09:48	23/10/2020 17:15	24/10/2020 09:48	16,55	1	16,55	CHI
202010134807	QUIRINOPOLIS	QI21296544	QUIRINOPOLIS	23/10/2020 17:17	23/10/2020 18:41	23/10/2020 17:17	23/10/2020 18:41	1,40	1	1,40	CHI
202010134812	CIDADE OCIDENTAL	10027248192	MARAJOARA	23/10/2020 17:17	23/10/2020 21:26	23/10/2020 17:17	23/10/2020 21:26	4,14	1	4,14	CHI
202010135056	JARAGUA	JA12000217	JARAGUA	23/10/2020 17:19	24/10/2020 07:41	23/10/2020 17:19	24/10/2020 07:41	14,36	33	473,92	CHI
202010134830	SERRANOPOLIS	SX12234203	JATAI S1	23/10/2020 17:19	24/10/2020 20:16	23/10/2020 17:19	24/10/2020 20:16	26,94	2	53,87	CHI
202010134850	CALDAS NOVAS	CN21163585	SERRA DE CALDAS	23/10/2020 17:22	23/10/2020 18:47	23/10/2020 17:22	23/10/2020 18:47	1,41	1	1,41	CHI
202010134879	RIO VERDE	RV21123389	RIO VERDE S1	23/10/2020 17:26	23/10/2020 20:43	23/10/2020 17:26	23/10/2020 20:43	3,28	1	3,28	CHI
202010134886	PETROLINA DE GOIAS	320016470	PETROLINA	23/10/2020 17:26	24/10/2020 08:55	23/10/2020 17:26	24/10/2020 08:55	15,48	1	15,48	CHI
202010134891	SERRANOPOLIS	SX12390596	JATAI S1	23/10/2020 17:27	23/10/2020 22:49	23/10/2020 17:27	23/10/2020 22:49	5,36	34	182,33	CHI
202010134894	FORMOSO	2410006006	PORANGATU	23/10/2020 17:27	23/10/2020 20:13	23/10/2020 17:27	23/10/2020 20:13	2,75	1	2,75	CHI
202010135006	GOIANIA	GN12054915	XAVANTES	23/10/2020 17:28	23/10/2020 20:27	23/10/2020 17:28	23/10/2020 20:27	2,97	26	77,15	CHI
202010135086	MAURILANDIA	ML11214233	RIO DOS BOIS	23/10/2020 17:29	23/10/2020 22:25	23/10/2020 17:29	23/10/2020 22:25	4,93	78	384,80	CHI
202010134911	MOZARLANDIA	MZ12064155	MOZARLANDIA	23/10/2020 17:29	25/10/2020 22:17	23/10/2020 17:29	25/10/2020 22:17	52,81	4	211,25	CHI
202010134911	MOZARLANDIA	MZ12064155	MOZARLANDIA	23/10/2020 17:29	25/10/2020 22:17	23/10/2020 17:29	25/10/2020 19:31	50,05	4	200,19	CHI
202010134911	MOZARLANDIA	MZ12064155	MOZARLANDIA	23/10/2020 17:29	25/10/2020 22:17	23/10/2020 17:29	24/10/2020 20:05	26,60	6	159,60	CHI
202010136075	GOIATUBA	GT12352741RE	BOM JESUS DE GOIAS	23/10/2020 17:29	24/10/2020 00:03	23/10/2020 17:29	24/10/2020 00:03	6,56	60	393,87	CHI
202010135408	CEZARINA	CZ11252383	CEZARINA	23/10/2020 17:29	23/10/2020 21:01	23/10/2020 17:29	23/10/2020 21:01	3,52	162	570,91	CHI
202010135397	PORTEIRAO	03680224	RIO DOS BOIS	23/10/2020 17:30	24/10/2020 17:15	23/10/2020 17:30	24/10/2020 17:15	23,75	2	47,51	CHI
202010135397	GOIATUBA	03680224	RIO DOS BOIS	23/10/2020 17:30	24/10/2020 17:15	23/10/2020 17:30	24/10/2020 17:15	23,75	7	166,28	CHI
202010135397	GOIATUBA	BJ13230828	RIO DOS BOIS	23/10/2020 17:30	24/10/2020 17:15	24/10/2020 11:41	24/10/2020 17:15	5,56	1	5,56	CHI
202010135397	GOIATUBA	03680224	RIO DOS BOIS	23/10/2020 17:30	24/10/2020 17:15	23/10/2020 17:30	24/10/2020 13:16	19,78	1	19,78	CHI
202010135397	PORTEIRAO	03680224	RIO DOS BOIS	23/10/2020 17:30	24/10/2020 17:15	23/10/2020 17:30	24/10/2020 13:16	19,78	4	79,10	CHI
202010135397	GOIATUBA	03680224	RIO DOS BOIS	23/10/2020 17:30	24/10/2020 17:15	24/10/2020 11:41	24/10/2020 13:16	1,58	1	1,58	CHI
202010136377	ANICUNS	AC12391411	ANICUNS	23/10/2020 17:30	24/10/2020 06:09	23/10/2020 17:30	24/10/2020 06:09	12,64	1	12,64	CHI
202010134932	TURVELANDIA	TD12306008LD	RIO DOS BOIS	23/10/2020 17:30	24/10/2020 20:27	23/10/2020 17:30	24/10/2020 20:27	26,94	1	26,94	CHI
202010135173	JARAGUA	JA11000009	JARAGUA	23/10/2020 17:31	24/10/2020 14:07	23/10/2020 17:31	24/10/2020 14:07	20,60	103	2121,80	CHI
202010134936	HIDROLANDIA	HD21283342	INDEPENDENCIA S1	23/10/2020 17:31	24/10/2020 09:22	23/10/2020 17:31	24/10/2020 09:22	15,85	4	63,39	CHI
202010134958	SANTA RITA DO ARAGUAIA	SU12188579	PARQUE DAS EMAS	23/10/2020 17:33	23/10/2020 21:40	23/10/2020 17:33	23/10/2020 21:40	4,11	5	20,56	CHI
202010134959	RIO VERDE	RV11025887	RIO VERDE S2	23/10/2020 17:33	24/10/2020 00:55	23/10/2020 17:33	24/10/2020 00:55	7,36	130	956,55	CHI
202010134135	ANICUNS	AC12189632	ANICUNS	23/10/2020 17:33	23/10/2020 20:45	23/10/2020 17:33	23/10/2020 20:45	3,19	5	15,93	CHI
202010134962	GOIANIA	GN12365688	XAVANTES	23/10/2020 17:33	23/10/2020 19:12	23/10/2020 17:33	23/10/2020 19:12	1,64	198	324,06	CHI
202010134969	CEZARINA	CZ21013323	CEZARINA	23/10/2020 17:35	24/10/2020 15:25	23/10/2020 17:35	24/10/2020 15:25	21,83	1	21,83	CHI
202010134970	NOVO BRASIL	NB21092959	MATRINCHA	23/10/2020 17:35	24/10/2020 01:59	23/10/2020 17:35	24/10/2020 01:59	8,40	1	8,40	CHI
202010134977	FORMOSA	610080398	ITUIQUIRA	23/10/2020 17:35	23/10/2020 18:50	23/10/2020 17:35	23/10/2020 18:50	1,24	1	1,24	CHI
202010135506	PONTALINA	PK12047209	PONTALINA	23/10/2020 17:36	23/10/2020 20:28	23/10/2020 17:36	23/10/2020 20:28	2,86	13	37,21	CHI
202010134985	PARAUNA	PU12079036	FIRMINOPOLIS S2	23/10/2020 17:36	23/10/2020 20:34	23/10/2020 17:36	23/10/2020 20:34	2,96	7	20,71	CHI
202010136186	MATRINCHA	03290424	MATRINCHA	23/10/2020 17:37	25/10/2020 21:45	23/10/2020 17:37	25/10/2020 21:45	52,14	21	1094,99	CHI
202010136186	ITAPIRAPUA	MP13265600	MATRINCHA	23/10/2020 17:37	25/10/2020 21:45	23/10/2020 17:37	25/10/2020 21:45	52,14	1	52,14	CHI
202010136186	MATRINCHA	03290424	MATRINCHA	23/10/2020 17:37	25/10/2020 21:45	23/10/2020 17:37	25/10/2020 21:27	51,83	1	51,83	CHI
202010136186	ITAPIRAPUA	IU13259756	MATRINCHA	23/10/2020 17:37	25/10/2020 21:45	24/10/2020 01:15	24/10/2020 03:03	1,81	9	16,26	CHI
2020102300104	ITAPIRAPUA	03295114	MATRINCHA	23/10/2020 17:37	23/10/2020 19:43	23/10/2020 17:37	23/10/2020 19:43	2,10	436	913,66	CHI
2020102300104	JUSSARA	03295114	MATRINCHA	23/10/2020 17:37	23/10/2020 19:43	23/10/2020 17:37	23/10/2020 19:43	2,10	4	8,38	CHI
2020102300104	BRITANIA	03295114	MATRINCHA	23/10/2020 17:37	23/10/2020 19:43	23/10/2020 17:37	23/10/2020 19:43	2,10	6	12,57	CHI
2020102300104	SANTA FE DE GOIAS	03295114	MATRINCHA	23/10/2020 17:37	23/10/2020 19:43	23/10/2020 17:37	23/10/2020 19:43	2,10	12	25,15	CHI
2020102300104	ITAPIRAPUA	03295114	MATRINCHA	23/10/2020 17:37	23/10/2020 19:43	23/10/2020 17:37	23/10/2020 19:43	2,10	92	192,79	CHI
2020102300104	ITAPIRAPUA	GS10400738	MATRINCHA	23/10/2020 17:37	23/10/2020 19:43	23/10/2020 17:37	23/10/2020 18:28	0,86	112	95,88	CHI
2020102300104	GOIAS	GS10400738	MATRINCHA	23/10/2020 17:37	23/10/2020 19:43	23/10/2020 17:37	23/10/2020 18:28	0,86	253	216,60	CHI
2020102300104	GOIAS	03295114	MATRINCHA	23/10/2020 17:37	23/10/2020 19:43	23/10/2020 17:37	23/10/2020 18:27	0,83	189	156,66	CHI
2020102300104	MATRINCHA	03295114	MATRINCHA	23/10/2020 17:37	23/10/2020 19:43	23/10/2020 17:37	23/10/2020 18:27	0,83	2214	1835,16	CHI
2020102300104	ARUANA	03295114	MATRINCHA	23/10/2020 17:37	23/10/2020 19:43	23/10/2020 17:37	23/10/2020 18:27	0,83	5	4,14	CHI



2020102300104	FAINA	03295114	MATRINCHA	23/10/2020 17:37	23/10/2020 19:43	23/10/2020 17:37	23/10/2020 18:27	0,83	56	46,42	CHI
2020102300104	ITAPIRAPUA	03295114	MATRINCHA	23/10/2020 17:37	23/10/2020 19:43	23/10/2020 17:37	23/10/2020 18:27	0,83	36	29,84	CHI
202010135035	ARENOPOLIS	AY12381016	IPORA	23/10/2020 17:37	23/10/2020 21:04	23/10/2020 17:37	23/10/2020 21:04	3,44	46	158,27	CHI
202010135035	PIRANHAS	AY12381016	IPORA	23/10/2020 17:37	23/10/2020 21:04	23/10/2020 17:37	23/10/2020 21:04	3,44	1	3,44	CHI
202010135003	UIRAPURU	4200003819	SANTA TEREZINHA	23/10/2020 17:38	23/10/2020 19:07	23/10/2020 17:38	23/10/2020 19:07	1,47	1	1,47	CHI
202010135020	PARAUNA	PU21198717	FIRMINOPOLIS S2	23/10/2020 17:40	24/10/2020 09:45	23/10/2020 17:40	24/10/2020 09:45	16,08	2	32,16	CHI
202010136781	EDEALINA	ED12390279	PONTALINA	23/10/2020 17:40	25/10/2020 14:11	24/10/2020 23:41	25/10/2020 14:11	14,49	21	304,39	CHI
202010136781	EDEALINA	ED12390279	PONTALINA	23/10/2020 17:40	25/10/2020 14:11	23/10/2020 17:40	24/10/2020 23:10	29,50	21	619,41	CHI
202010135444	RIO VERDE	RV11249014	RIO VERDE S2	23/10/2020 17:40	23/10/2020 21:33	23/10/2020 17:40	23/10/2020 21:33	3,87	87	336,71	CHI
202010135043	VIANOPOLIS	VN12083254	VIANOPOLIS	23/10/2020 17:42	23/10/2020 19:06	23/10/2020 17:42	23/10/2020 19:06	1,40	755	1055,53	CHI
202010135047	QUIRINOPOLIS	QI12144242	QUIRINOPOLIS	23/10/2020 17:42	23/10/2020 19:26	23/10/2020 17:42	23/10/2020 19:26	1,72	5	8,62	CHI
202010135054	IPORA	IR11353543	IPORA	23/10/2020 17:43	24/10/2020 04:16	23/10/2020 17:43	24/10/2020 04:16	10,54	1	10,54	CHI
202010135065	SANTA HELENA DE GOIAS	SH12301271	ACREUNA	23/10/2020 17:44	24/10/2020 04:33	23/10/2020 17:44	24/10/2020 04:33	10,80	5	54,02	CHI
202010135483	JARAGUA	JA12221352	JARAGUA	23/10/2020 17:45	23/10/2020 21:58	23/10/2020 17:45	23/10/2020 21:58	4,21	54	227,46	CHI
202010135072	QUIRINOPOLIS	QI121279815	QUIRINOPOLIS	23/10/2020 17:45	24/10/2020 08:14	23/10/2020 17:45	24/10/2020 08:14	14,48	1	14,48	CHI
202010135081	CABECEIRAS	CW12268087	ITUIQUIRA	23/10/2020 17:45	23/10/2020 21:47	23/10/2020 17:45	23/10/2020 21:47	4,02	1	4,02	CHI
202010135088	TURVANIA	TV12413068	FIRMINOPOLIS S2	23/10/2020 17:46	23/10/2020 22:39	23/10/2020 17:46	23/10/2020 22:39	4,88	10	48,77	CHI
202010135091	CRIXAS	CX21266644	SERRA DO OURO	23/10/2020 17:47	23/10/2020 22:49	23/10/2020 17:47	23/10/2020 22:49	5,03	1	5,03	CHI
202010135633	JARAGUA	JA12059971	JARAGUA	23/10/2020 17:49	23/10/2020 23:06	23/10/2020 17:49	23/10/2020 23:06	5,28	10	52,83	CHI
202010135107	CATALAO	CT21077441	CATALAO S1	23/10/2020 17:49	23/10/2020 19:43	23/10/2020 17:49	23/10/2020 19:43	1,89	1	1,89	CHI
202010135108	AGUAS LINDAS DE GOIAS	4830262978	AGUAS LINDAS DE GOIAS S1	23/10/2020 17:49	23/10/2020 21:31	23/10/2020 17:49	23/10/2020 21:31	3,69	1	3,69	CHI
202010135119	GOIANESIA	GE11185211	GOIANESIA S2	23/10/2020 17:51	23/10/2020 19:28	23/10/2020 17:51	23/10/2020 19:28	1,61	62	99,89	CHI
202010135124	SANTA HELENA DE GOIAS	SH21295820	IPEGUARI	23/10/2020 17:51	24/10/2020 00:00	23/10/2020 17:51	24/10/2020 00:00	6,14	2	12,28	CHI
202010135187	CAMPINACU	UC10398402	PORANGATU	23/10/2020 17:52	23/10/2020 18:39	23/10/2020 17:52	23/10/2020 18:39	0,80	1499	1195,04	CHI
202010135187	MINACU	UC10398402	PORANGATU	23/10/2020 17:52	23/10/2020 18:39	23/10/2020 17:52	23/10/2020 18:39	0,80	1	0,80	CHI
202010135187	PORANGATU	UC10398402	PORANGATU	23/10/2020 17:52	23/10/2020 18:39	23/10/2020 17:52	23/10/2020 18:39	0,80	1	0,80	CHI
202010135127	POSSE	PS12320609	IACIARA S2	23/10/2020 17:52	23/10/2020 18:35	23/10/2020 17:52	23/10/2020 18:35	0,71	433	308,87	CHI
202010135129	GOIANIA	GN12000634	CAMPINAS S1	23/10/2020 17:52	23/10/2020 20:09	23/10/2020 17:52	23/10/2020 20:09	2,28	27	61,51	CHI
202010135140	CORUMBAIBA	CI12041817	VILA CORUMBA	23/10/2020 17:54	23/10/2020 19:22	23/10/2020 17:54	23/10/2020 19:22	1,45	2	2,91	CHI
202010135178	LUZIANIA	LZ12330544	MARAJOARA	23/10/2020 17:56	23/10/2020 21:21	23/10/2020 17:56	23/10/2020 21:21	3,40	8	27,22	CHI
202010137251	SANTA CRUZ DE GOIAS	PJ12223405RE	PIRACANJUBA	23/10/2020 17:57	24/10/2020 19:45	23/10/2020 17:57	24/10/2020 19:45	25,79	25	644,78	CHI
202010137251	PIRACANJUBA	PJ12223405RE	PIRACANJUBA	23/10/2020 17:57	24/10/2020 19:45	23/10/2020 17:57	24/10/2020 19:45	25,79	1	25,79	CHI
202010137251	SANTA CRUZ DE GOIAS	PJ12223405RE	PIRACANJUBA	23/10/2020 17:57	24/10/2020 19:45	24/10/2020 09:39	24/10/2020 19:45	10,08	8	80,68	CHI
202010135180	APARECIDA DE GOIANIA	10011565703	CEPAIGO S1	23/10/2020 17:58	23/10/2020 23:53	23/10/2020 17:58	23/10/2020 23:53	5,92	1	5,92	CHI
202010135398	SAO MIGUEL DO ARAGUAIA	SM12089299	SAO MIGUEL DO ARAGUAIA	23/10/2020 17:58	24/10/2020 08:01	23/10/2020 17:58	24/10/2020 08:01	14,05	90	1264,20	CHI
202010135398	NOVA CRIXAS	SM12089299	SAO MIGUEL DO ARAGUAIA	23/10/2020 17:58	24/10/2020 08:01	23/10/2020 17:58	24/10/2020 08:01	14,05	1	14,05	CHI
202010135184	QUIRINOPOLIS	QI21150603	QUIRINOPOLIS	23/10/2020 17:58	24/10/2020 08:21	23/10/2020 17:58	24/10/2020 08:21	14,38	1	14,38	CHI
202010135767	AMARALINA	LC12270125	SAO MIGUEL DO ARAGUAIA	23/10/2020 17:59	23/10/2020 22:56	23/10/2020 17:59	23/10/2020 22:56	4,95	41	203,02	CHI
202010135192	NOVO GAMA	10006544647	PACAEMBU S1	23/10/2020 17:59	23/10/2020 21:45	23/10/2020 17:59	23/10/2020 21:45	3,76	1	3,76	CHI
202010135194	JOVIANIA	JV21123823	GOIATUBA S1	23/10/2020 17:59	24/10/2020 09:59	23/10/2020 17:59	24/10/2020 09:59	15,99	1	15,99	CHI
202010135217	QUIRINOPOLIS	QI21126519	QUIRINOPOLIS	23/10/2020 18:00	24/10/2020 02:35	23/10/2020 18:00	24/10/2020 02:35	8,58	1	8,58	CHI
202010135210	AMARALINA	LC12286013	NOVA CRIXAS	23/10/2020 18:01	24/10/2020 00:31	23/10/2020 18:01	24/10/2020 00:31	6,49	9	58,45	CHI
202010135210	MARA ROSA	LC12286013	NOVA CRIXAS	23/10/2020 18:01	24/10/2020 00:31	23/10/2020 18:01	24/10/2020 00:31	6,49	1	6,49	CHI
202010135947	NOVA CRIXAS	NA12091692	NOVA CRIXAS	23/10/2020 18:01	25/10/2020 01:38	23/10/2020 18:01	25/10/2020 01:38	31,61	22	695,47	CHI
202010135947	NOVA CRIXAS	NA12201789	NOVA CRIXAS	23/10/2020 18:01	25/10/2020 01:38	23/10/2020 18:01	24/10/2020 23:18	29,28	5	146,38	CHI
202010135216	INDIARA	IY12158916	CEZARINA	23/10/2020 18:01	24/10/2020 10:01	23/10/2020 18:01	24/10/2020 10:01	15,99	2	31,98	CHI
202010135222	GOIANIA	12521164	GOIANIA LESTE S3	23/10/2020 18:02	23/10/2020 19:33	23/10/2020 18:02	23/10/2020 19:33	1,51	1	1,51	CHI
202010135223	COLINAS DO SUL	TI21347093	MINACU	23/10/2020 18:02	23/10/2020 20:54	23/10/2020 18:02	23/10/2020 20:54	2,86	1	2,86	CHI
202010135232	JARAGUA	JA21031519	JARAGUA	23/10/2020 18:03	24/10/2020 01:18	23/10/2020 18:03	24/10/2020 01:18	7,25	1	7,25	CHI
202010135244	BONOPOLIS	BX21137689	SAO MIGUEL DO ARAGUAIA	23/10/2020 18:04	23/10/2020 19:49	23/10/2020 18:04	23/10/2020 19:49	1,75	1	1,75	CHI
202010135774	PORANGATU	PO12208558	PORANGATU	23/10/2020 18:04	23/10/2020 20:06	23/10/2020 18:04	23/10/2020 20:06	2,02	15	30,37	CHI

202010135888	VICENTINOPOLIS	VI12329055	VICENTINOPOLIS	23/10/2020 18:05	23/10/2020 21:55	23/10/2020 18:05	23/10/2020 21:55	3,84	21	80,54	CHI
202010135888	GOIATUBA	VI12329055	VICENTINOPOLIS	23/10/2020 18:05	23/10/2020 21:55	23/10/2020 18:05	23/10/2020 21:55	3,84	12	46,02	CHI
202010135257	AGUAS LINDAS DE GOIAS	LA11192906	AGUAS LINDAS DE GOIAS S1	23/10/2020 18:05	23/10/2020 20:54	23/10/2020 18:05	23/10/2020 20:54	2,81	34	95,70	CHI
202010135259	LUZIANIA	LZ21230110	MARAJOARA	23/10/2020 18:05	23/10/2020 22:58	23/10/2020 18:05	23/10/2020 22:58	4,88	2	9,76	CHI
202010135754	NOVA CRIXAS	NA12156613	MOZARLANDIA	23/10/2020 18:05	23/10/2020 22:51	23/10/2020 18:05	23/10/2020 22:51	4,75	34	161,65	CHI
202010135754	CRIXAS	NA12156613	MOZARLANDIA	23/10/2020 18:05	23/10/2020 22:51	23/10/2020 18:05	23/10/2020 22:51	4,75	2	9,51	CHI
202010136971	ANICUNS	AC21123446	ANICUNS	23/10/2020 18:07	24/10/2020 13:48	23/10/2020 18:07	24/10/2020 13:48	19,68	3	59,04	CHI
202010135280	EDEIA	EA12160409	VICENTINOPOLIS	23/10/2020 18:07	26/10/2020 11:44	23/10/2020 18:07	26/10/2020 11:44	65,62	1	65,62	CHI
202010135280	EDEIA	EA12160409	VICENTINOPOLIS	23/10/2020 18:07	26/10/2020 11:44	23/10/2020 18:07	24/10/2020 03:52	9,75	19	185,17	CHI
202010135280	EDEIA	EA12160409	VICENTINOPOLIS	23/10/2020 18:07	26/10/2020 11:44	23/10/2020 23:25	24/10/2020 03:52	4,45	1	4,45	CHI
202010135569	PIRANHAS	BM12065725	BOM JARDIM	23/10/2020 18:07	23/10/2020 20:54	23/10/2020 18:07	23/10/2020 20:54	2,77	8	22,19	CHI
202010135569	BOM JARDIM DE GOIAS	BM12065725	BOM JARDIM	23/10/2020 18:07	23/10/2020 20:54	23/10/2020 18:07	23/10/2020 20:54	2,77	101	280,13	CHI
202010135299	DAMOLANDIA	270014329	INHUMAS S1	23/10/2020 18:10	24/10/2020 11:10	23/10/2020 18:10	24/10/2020 11:10	17,00	1	17,00	CHI
202010135331	EDEIA	EA12257978	EDEIA	23/10/2020 18:11	23/10/2020 21:53	23/10/2020 18:11	23/10/2020 21:53	3,69	92	339,56	CHI
202010135315	GOIANIA	15579645	CARAJAS S1	23/10/2020 18:11	23/10/2020 20:59	23/10/2020 18:11	23/10/2020 20:59	2,79	1	2,79	CHI
202010135319	APARECIDA DE GOIANIA	200593894	INDEPENDENCIA S2	23/10/2020 18:12	23/10/2020 22:13	23/10/2020 18:12	23/10/2020 22:13	4,01	1	4,01	CHI
202010135321	TEREZOPOLIS DE GOIAS	TJ21327828	JUNDIAI S2	23/10/2020 18:12	24/10/2020 10:11	23/10/2020 18:12	24/10/2020 10:11	15,97	1	15,97	CHI
202010135325	GOIANIA	13421025	GOIANIA LESTE S1	23/10/2020 18:12	23/10/2020 20:41	23/10/2020 18:12	23/10/2020 20:41	2,47	1	2,47	CHI
202010135354	IPORA	IR21089257	ARENOPOLIS	23/10/2020 18:15	23/10/2020 22:47	23/10/2020 18:15	23/10/2020 22:47	4,53	1	4,53	CHI
202010135640	GOIATUBA	04580214	BOM JESUS DE GOIAS	23/10/2020 18:17	24/10/2020 00:03	23/10/2020 18:17	24/10/2020 00:03	5,77	72	415,16	CHI
202010135376	CAVALCANTE	CJ12117406	FLORES DE GOIAS	23/10/2020 18:17	23/10/2020 19:32	23/10/2020 18:17	23/10/2020 19:32	1,24	9	11,13	CHI
202010135377	BOM JESUS DE GOIAS	BJ12068972	BOM JESUS DE GOIAS	23/10/2020 18:17	23/10/2020 20:44	23/10/2020 18:17	23/10/2020 20:44	2,44	2	4,87	CHI
202010135390	NOVA IGUACU DE GOIAS	NH21148285	CAMPINORTE	23/10/2020 18:18	26/10/2020 06:00	23/10/2020 18:18	26/10/2020 06:00	59,69	1	59,69	CHI
202010189491	SAO SIMAO	SO10401495	CACHOEIRA ALTA	23/10/2020 18:19	24/10/2020 03:10	23/10/2020 18:19	24/10/2020 03:10	8,85	3	26,54	CHI
202010189491	SAO SIMAO	PC13062685	CACHOEIRA ALTA	23/10/2020 18:19	24/10/2020 03:10	23/10/2020 18:19	24/10/2020 02:26	8,10	2	16,21	CHI
202010189491	SAO SIMAO	SO16414843	CACHOEIRA ALTA	23/10/2020 18:19	24/10/2020 03:10	23/10/2020 19:06	23/10/2020 19:21	0,25	1428	358,98	CHI
202010189491	SAO SIMAO	SO16414843	CACHOEIRA ALTA	23/10/2020 18:19	24/10/2020 03:10	23/10/2020 18:32	23/10/2020 18:42	0,17	1428	249,50	CHI
202010189491	SAO SIMAO	SO16419957	CACHOEIRA ALTA	23/10/2020 18:19	24/10/2020 03:10	23/10/2020 18:19	23/10/2020 18:30	0,18	592	106,56	CHI
202010189491	SAO SIMAO	SO16419948	CACHOEIRA ALTA	23/10/2020 18:19	24/10/2020 03:10	23/10/2020 18:19	23/10/2020 18:26	0,12	821	99,43	CHI
202010189491	SAO SIMAO	SO16419948	CACHOEIRA ALTA	23/10/2020 18:19	24/10/2020 03:10	23/10/2020 18:19	23/10/2020 18:26	0,12	5383	651,94	CHI
202010135777	AGUAS LINDAS DE GOIAS	LA11187175	AGUAS LINDAS DE GOIAS S1	23/10/2020 18:20	23/10/2020 21:35	23/10/2020 18:20	23/10/2020 21:35	3,25	10	32,50	CHI
202010135421	IPAMERI	IP21152015	PIRES DO RIO S2	23/10/2020 18:20	24/10/2020 00:18	23/10/2020 18:20	24/10/2020 00:18	5,96	1	5,96	CHI
202010135517	NOVA CRIXAS	NA12086286	NOVA CRIXAS	23/10/2020 18:20	25/10/2020 11:00	23/10/2020 18:20	25/10/2020 11:00	40,66	9	365,94	CHI
202010135431	JATAI	10015578150	JATAI S2	23/10/2020 18:21	24/10/2020 13:00	23/10/2020 18:21	24/10/2020 13:00	18,66	1	18,66	CHI
202010135432	VALPARAISO DE GOIAS	10004985115	PACAEMBU S2	23/10/2020 18:21	23/10/2020 21:13	23/10/2020 18:21	23/10/2020 21:13	2,86	1	2,86	CHI
202010135456	GOIANIA	GN11366158	CARAJAS S2	23/10/2020 18:23	23/10/2020 20:50	23/10/2020 18:23	23/10/2020 20:50	2,44	51	124,43	CHI
202010135457	GOIANESIA	NP21241243	GOIANESIA S1	23/10/2020 18:23	23/10/2020 21:22	23/10/2020 18:23	23/10/2020 21:22	2,97	2	5,94	CHI
202010135461	APARECIDA DE GOIANIA	14717694	INDEPENDENCIA S1	23/10/2020 18:24	23/10/2020 22:25	23/10/2020 18:24	23/10/2020 22:25	4,02	1	4,02	CHI
202010135494	URUACU	640062611	URUACU	23/10/2020 18:25	24/10/2020 15:46	23/10/2020 18:25	24/10/2020 15:46	21,34	1	21,34	CHI
202010135499	UIRAPURU	UP12234770	NOVA CRIXAS	23/10/2020 18:25	23/10/2020 21:12	23/10/2020 18:25	23/10/2020 21:12	2,77	3	8,30	CHI
202010136349	LUZIANIA	LZ12389556	PACAEMBU S2	23/10/2020 18:26	23/10/2020 22:07	23/10/2020 18:26	23/10/2020 22:07	3,67	38	139,48	CHI
202010135513	MONTES CLAROS DE GOIAS	ME12097812RE	IPORA	23/10/2020 18:27	24/10/2020 00:18	23/10/2020 18:27	24/10/2020 00:18	5,85	102	596,36	CHI
202010135805	GOIATUBA	GT12392084	GOIATUBA S2	23/10/2020 18:27	23/10/2020 22:26	23/10/2020 18:27	23/10/2020 22:26	3,97	17	67,57	CHI
202010135536	QUIRINOPOLIS	QI11347811	QUIRINOPOLIS	23/10/2020 18:28	23/10/2020 20:41	23/10/2020 18:28	23/10/2020 20:41	2,21	11	24,27	CHI
202010135546	AGUA FRIA DE GOIAS	TL21106934	SAO JOAO D ALIANCA	23/10/2020 18:29	23/10/2020 19:40	23/10/2020 18:29	23/10/2020 19:40	1,17	1	1,17	CHI
202010136235	PONTALINA	PK12181909RE	PONTALINA	23/10/2020 18:30	23/10/2020 22:59	23/10/2020 18:30	23/10/2020 22:59	4,50	9	40,47	CHI
202010136235	EDELINA	PK12181909RE	PONTALINA	23/10/2020 18:30	23/10/2020 22:59	23/10/2020 18:30	23/10/2020 22:59	4,50	4	17,99	CHI
202010135552	ALTO HORIZONTE	9640005570	SANTA TEREZINHA	23/10/2020 18:30	24/10/2020 17:32	23/10/2020 18:30	24/10/2020 17:32	23,03	1	23,03	CHI
202010135555	NEROPOLIS	160029053	NEROPOLIS S2	23/10/2020 18:30	24/10/2020 09:20	23/10/2020 18:30	24/10/2020 09:20	14,82	1	14,82	CHI
202010135563	EDEIA	EA21308025	EDEIA	23/10/2020 18:31	24/10/2020 04:16	23/10/2020 18:31	24/10/2020 04:16	9,74	1	9,74	CHI
202010135917	NOVA CRIXAS	NA12297057	NOVA CRIXAS	23/10/2020 18:32	24/10/2020 11:19	23/10/2020 18:32	24/10/2020 11:19	16,78	334	5605,73	CHI

202010135580	ANAPOLIS	AN12000076	JUNDIAI S2	23/10/2020 18:32	24/10/2020 13:26	23/10/2020 18:32	24/10/2020 13:26	18,89	1	18,89	CHI
202010135583	PETROLINA DE GOIAS	PG11350773	PETROLINA	23/10/2020 18:33	24/10/2020 02:00	23/10/2020 18:33	24/10/2020 02:00	7,46	35	261,16	CHI
202010135649	FAZENDA NOVA	FN12250857	IPORA	23/10/2020 18:33	23/10/2020 23:05	23/10/2020 18:33	23/10/2020 23:05	4,52	11	49,71	CHI
202010135599	FORMOSA	10013855423	ITUIQUIRA	23/10/2020 18:35	23/10/2020 23:37	23/10/2020 18:35	23/10/2020 23:37	5,02	1	5,02	CHI
202010135607	ARUANA	AK12264829	MOZARLANDIA	23/10/2020 18:36	23/10/2020 20:46	23/10/2020 18:36	23/10/2020 20:46	2,16	33	71,22	CHI
202010135608	IPORA	IR21097818	IPORA	23/10/2020 18:36	23/10/2020 20:28	23/10/2020 18:36	23/10/2020 20:28	1,86	1	1,86	CHI
202010135611	JUSSARA	JR12093635	BRITANIA	23/10/2020 18:36	23/10/2020 22:03	23/10/2020 18:36	23/10/2020 22:03	3,44	4	13,74	CHI
202010135800	PORANGATU	PO12100795	PORANGATU	23/10/2020 18:37	23/10/2020 20:44	23/10/2020 18:37	23/10/2020 20:44	2,11	4	8,44	CHI
202010135626	AGUAS LINDAS DE GOIAS	4830361312	AGUAS LINDAS DE GOIAS S1	23/10/2020 18:38	23/10/2020 20:27	23/10/2020 18:38	23/10/2020 20:27	1,81	1	1,81	CHI
202010135630	GOIATUBA	GT12273961	GOIATUBA S2	23/10/2020 18:38	24/10/2020 09:59	23/10/2020 18:38	24/10/2020 09:59	15,34	2	30,69	CHI
202010135642	INHUMAS	30124633	INHUMAS S2	23/10/2020 18:39	24/10/2020 14:14	23/10/2020 18:39	24/10/2020 14:14	19,57	1	19,57	CHI
202010137370	QUIRINOPOLIS	QI32255692	QUIRINOPOLIS	23/10/2020 18:39	25/10/2020 12:35	23/10/2020 18:39	25/10/2020 12:35	41,93	4	167,72	CHI
202010137370	QUIRINOPOLIS	6508319	QUIRINOPOLIS	23/10/2020 18:39	25/10/2020 12:35	25/10/2020 03:14	25/10/2020 12:35	9,35	13	121,52	CHI
202010137370	QUIRINOPOLIS	QI32255692	QUIRINOPOLIS	23/10/2020 18:39	25/10/2020 12:35	25/10/2020 03:14	25/10/2020 07:45	4,51	10	45,06	CHI
202010137370	QUIRINOPOLIS	QI32255692	QUIRINOPOLIS	23/10/2020 18:39	25/10/2020 12:35	23/10/2020 18:39	25/10/2020 02:55	32,25	13	419,29	CHI
202010137370	QUIRINOPOLIS	QI32255692	QUIRINOPOLIS	23/10/2020 18:39	25/10/2020 12:35	24/10/2020 23:35	25/10/2020 02:55	3,34	10	33,35	CHI
202010137370	CASTELANDIA	QI12370150	QUIRINOPOLIS	23/10/2020 18:39	25/10/2020 12:35	25/10/2020 01:47	25/10/2020 02:07	0,33	19	6,34	CHI
202010137370	RIO VERDE	QI12370150	QUIRINOPOLIS	23/10/2020 18:39	25/10/2020 12:35	25/10/2020 01:47	25/10/2020 02:07	0,33	1	0,33	CHI
202010137370	QUIRINOPOLIS	QI12370150	QUIRINOPOLIS	23/10/2020 18:39	25/10/2020 12:35	25/10/2020 01:47	25/10/2020 02:07	0,33	37	12,34	CHI
202010137370	QUIRINOPOLIS	QI32255692	QUIRINOPOLIS	23/10/2020 18:39	25/10/2020 12:35	23/10/2020 18:39	24/10/2020 09:00	14,34	10	143,35	CHI
202010135647	FORMOSA	FA11269920	ITUIQUIRA	23/10/2020 18:40	23/10/2020 22:04	23/10/2020 18:40	23/10/2020 22:04	3,39	1	3,39	CHI
202010135655	JUSSARA	NB12117282	JUSSARA	23/10/2020 18:40	24/10/2020 04:10	23/10/2020 18:40	24/10/2020 04:10	9,49	1	9,49	CHI
202010135655	NOVO BRASIL	NB12117282	JUSSARA	23/10/2020 18:40	24/10/2020 04:10	23/10/2020 18:40	24/10/2020 04:10	9,49	12	113,84	CHI
202010135655	FAZENDA NOVA	NB12117282	JUSSARA	23/10/2020 18:40	24/10/2020 04:10	23/10/2020 18:40	24/10/2020 04:10	9,49	1	9,49	CHI
202010135654	JARAGUA	70026932	JARAGUA	23/10/2020 18:41	24/10/2020 00:54	23/10/2020 18:41	24/10/2020 00:54	6,21	1	6,21	CHI
202010135659	QUIRINOPOLIS	QI21314412	QUIRINOPOLIS	23/10/2020 18:41	24/10/2020 09:01	23/10/2020 18:41	24/10/2020 09:01	14,32	1	14,32	CHI
202010135671	CRISTALINA	1060065360	CRISTALINA S1	23/10/2020 18:42	23/10/2020 20:57	23/10/2020 18:42	23/10/2020 20:57	2,24	1	2,24	CHI
202010135677	PLANALTINA	PI11344205	PLANALTINA	23/10/2020 18:43	24/10/2020 00:28	23/10/2020 18:43	24/10/2020 00:28	5,74	117	672,13	CHI
202010135687	EDEIA	1120005702	EDEIA	23/10/2020 18:43	24/10/2020 05:28	23/10/2020 18:43	24/10/2020 05:28	10,73	1	10,73	CHI
202010135700	PALMEIRAS DE GOIAS	10028397221	PALMEIRAS	23/10/2020 18:45	23/10/2020 19:38	23/10/2020 18:45	23/10/2020 19:38	0,88	1	0,88	CHI
202010135714	BOM JESUS DE GOIAS	BJ21205362	RIO DOS BOIS	23/10/2020 18:46	24/10/2020 01:04	23/10/2020 18:46	24/10/2020 01:04	6,29	2	12,58	CHI
202010135727	RIO VERDE	630062171	CABRIUVA S1	23/10/2020 18:47	24/10/2020 08:40	23/10/2020 18:47	24/10/2020 08:40	13,87	1	13,87	CHI
202010136070	GOIATUBA	GT12000018	GOIATUBA S2	23/10/2020 18:48	24/10/2020 11:43	23/10/2020 18:48	24/10/2020 11:43	16,91	139	2350,76	CHI
202010136070	GOIATUBA	GT12000018	GOIATUBA S2	23/10/2020 18:48	24/10/2020 11:43	23/10/2020 18:48	24/10/2020 10:30	15,70	161	2527,39	CHI
202010135738	PIRANHAS	AY12000024	ARENOPOLIS	23/10/2020 18:48	24/10/2020 01:10	23/10/2020 18:48	24/10/2020 01:10	6,35	2	12,70	CHI
202010136140	SAO MIGUEL DO ARAGUAIA	SM12276148	SAO MIGUEL DO ARAGUAIA	23/10/2020 18:48	24/10/2020 10:24	23/10/2020 18:48	24/10/2020 10:24	15,58	11	171,42	CHI
202010135753	LUZIANIA	LZ21230064	MARAJOARA	23/10/2020 18:50	23/10/2020 23:02	23/10/2020 18:50	23/10/2020 23:02	4,18	1	4,18	CHI
202010135760	ORIZONA	OZ21017055	PIRES DO RIO S2	23/10/2020 18:51	23/10/2020 20:07	23/10/2020 18:51	23/10/2020 20:07	1,25	1	1,25	CHI
202010135763	POSSE	SA12255109	IACIARA S2	23/10/2020 18:51	24/10/2020 00:26	23/10/2020 18:51	24/10/2020 00:26	5,57	15	83,51	CHI
202010135768	GOIANIA	10275502	CAMPINAS S2	23/10/2020 18:52	24/10/2020 11:55	23/10/2020 18:52	24/10/2020 11:55	17,04	1	17,04	CHI
202010135776	ARENOPOLIS	1920004418	ARENOPOLIS	23/10/2020 18:53	24/10/2020 10:40	23/10/2020 18:53	24/10/2020 10:40	15,79	1	15,79	CHI
202010136128	PIRACANJUBA	PJ12412508	CRISTIANOPOLIS	23/10/2020 18:53	24/10/2020 09:52	23/10/2020 18:53	24/10/2020 09:52	14,97	14	209,63	CHI
202010136875	NIQUELANDIA	NQ11307764	NIQUELANDIA SUBTRANSMISSAO	23/10/2020 18:53	24/10/2020 00:46	23/10/2020 18:53	24/10/2020 00:46	5,87	126	739,31	CHI
202010135787	ACREUNA	2440051865	ACREUNA	23/10/2020 18:54	24/10/2020 13:12	23/10/2020 18:54	24/10/2020 13:12	18,30	1	18,30	CHI
202010135797	AGUAS LINDAS DE GOIAS	4830042589	AGUAS LINDAS DE GOIAS S1	23/10/2020 18:55	24/10/2020 10:24	23/10/2020 18:55	24/10/2020 10:24	15,47	1	15,47	CHI
202010135799	POSSE	10006242160	IACIARA S2	23/10/2020 18:56	23/10/2020 19:48	23/10/2020 18:56	23/10/2020 19:48	0,86	1	0,86	CHI
202010135802	BOM JARDIM DE GOIAS	BM21365304	BOM JARDIM	23/10/2020 18:56	23/10/2020 19:00	23/10/2020 18:56	23/10/2020 19:00	0,07	1	0,07	CHI
202010135803	IPORA	IR21282387	IPORA	23/10/2020 18:56	23/10/2020 20:06	23/10/2020 18:56	23/10/2020 20:06	1,16	1	1,16	CHI
202010135807	MATRINCHA	10006913910	MATRINCHA	23/10/2020 18:56	24/10/2020 12:26	23/10/2020 18:56	24/10/2020 12:26	17,49	1	17,49	CHI
202010136063	SERRANOPOLIS	SX12205192RE	JATAI S1	23/10/2020 18:56	24/10/2020 07:59	23/10/2020 18:56	24/10/2020 07:59	13,04	18	234,70	CHI
202010136063	JATAI	SX12205192RE	JATAI S1	23/10/2020 18:56	24/10/2020 07:59	23/10/2020 18:56	24/10/2020 07:59	13,04	3	39,12	CHI

202010135887	APARECIDA DE GOIANIA	AP11157736	INDEPENDENCIA S1	23/10/2020 18:56	23/10/2020 21:20	23/10/2020 18:56	23/10/2020 21:20	2,39	62	147,90	CHI
202010135826	ABADIA DE GOIAS	5583664257	CARAJAS S1	23/10/2020 18:58	24/10/2020 01:17	23/10/2020 18:58	24/10/2020 01:17	6,30	1	6,30	CHI
202010135835	PLANALTINA	PI21359008	PLANALTINA	23/10/2020 18:59	23/10/2020 21:55	23/10/2020 18:59	23/10/2020 21:55	2,93	2	5,85	CHI
202010135841	GOIANIA	16486201	CAMPINAS S1	23/10/2020 19:00	23/10/2020 21:47	23/10/2020 19:00	23/10/2020 21:47	2,78	1	2,78	CHI
202010135846	MONTES CLAROS DE GOIAS	ME21184456	IPORA	23/10/2020 19:00	24/10/2020 07:40	23/10/2020 19:00	24/10/2020 07:40	12,65	1	12,65	CHI
202010135849	TRINDADE	40182459	GOYA S1	23/10/2020 19:01	24/10/2020 13:10	23/10/2020 19:01	24/10/2020 13:10	18,15	1	18,15	CHI
202010135851	NOVA IGUACU DE GOIAS	MQ21070577	MARA ROSA	23/10/2020 19:01	25/10/2020 02:21	23/10/2020 19:01	25/10/2020 02:21	31,33	1	31,33	CHI
202010135853	APARECIDA DE GOIANIA	200133561	INDEPENDENCIA S2	23/10/2020 19:01	23/10/2020 22:36	23/10/2020 19:01	23/10/2020 22:36	3,58	1	3,58	CHI
202010135857	CALDAS NOVAS	760221285	CALDAS NOVAS S2	23/10/2020 19:01	23/10/2020 20:08	23/10/2020 19:01	23/10/2020 20:08	1,11	1	1,11	CHI
202010135869	FAZENDA NOVA	FN21278001	IPORA	23/10/2020 19:02	24/10/2020 08:47	23/10/2020 19:02	24/10/2020 08:47	13,74	1	13,74	CHI
202010135872	PANAMA	PX21305594	ITUMBIARA NOVA	23/10/2020 19:03	24/10/2020 11:07	23/10/2020 19:03	24/10/2020 11:07	16,06	1	16,06	CHI
202010135873	PARAUNA	JD12008606	PALMEIRAS	23/10/2020 19:03	24/10/2020 14:49	23/10/2020 19:03	24/10/2020 14:49	19,76	6	118,55	CHI
202010135873	JANDAIA	JD12008606	PALMEIRAS	23/10/2020 19:03	24/10/2020 14:49	23/10/2020 19:03	24/10/2020 14:49	19,76	85	1679,48	CHI
202010135877	PARAUNA	PU21126115	PARAUNA	23/10/2020 19:04	24/10/2020 14:40	23/10/2020 19:04	24/10/2020 14:40	19,59	2	39,18	CHI
202010136060	MINEIROS	MY12037713	PARQUE DAS EMAS	23/10/2020 19:04	24/10/2020 12:11	23/10/2020 19:04	24/10/2020 12:11	17,10	7	119,73	CHI
202010135885	NIQUELANDIA	NQ21117736	BARRO ALTO	23/10/2020 19:05	25/10/2020 05:36	23/10/2020 19:05	25/10/2020 05:36	34,51	1	34,51	CHI
202010135895	CHAPADAO DO CEU	9880009714	CHAPADAO DO CEU	23/10/2020 19:06	24/10/2020 00:12	23/10/2020 19:06	24/10/2020 00:12	5,09	1	5,09	CHI
202010135909	PARAUNA	10028729305	PARAUNA	23/10/2020 19:08	24/10/2020 12:37	23/10/2020 19:08	24/10/2020 12:37	17,49	1	17,49	CHI
202010136153	MONTES CLAROS DE GOIAS	ME12155653	IPORA	23/10/2020 19:08	24/10/2020 11:35	23/10/2020 19:08	24/10/2020 11:35	16,43	38	624,50	CHI
202010135920	CALDAS NOVAS	760033444	SERRA DE CALDAS	23/10/2020 19:10	24/10/2020 00:22	23/10/2020 19:10	24/10/2020 00:22	5,19	1	5,19	CHI
202010135931	APARECIDA DO RIO DOCE	3650011795	CACHOEIRA ALTA	23/10/2020 19:12	24/10/2020 00:41	23/10/2020 19:12	24/10/2020 00:41	5,48	1	5,48	CHI
202010135940	MATRINCHA	MP11300965	MATRINCHA	23/10/2020 19:12	24/10/2020 08:44	23/10/2020 19:12	24/10/2020 08:44	13,52	24	324,46	CHI
202010135942	PALMEIRAS DE GOIAS	590050874	PALMEIRAS	23/10/2020 19:13	23/10/2020 20:37	23/10/2020 19:13	23/10/2020 20:37	1,40	1	1,40	CHI
202010136056	ALVORADA DO NORTE	AQ11195967	IACIARA S2	23/10/2020 19:14	23/10/2020 21:00	23/10/2020 19:14	23/10/2020 21:00	1,76	220	387,75	CHI
202010135969	RIO VERDE	RV12260256	RIO VERDE S1	23/10/2020 19:14	24/10/2020 11:00	23/10/2020 19:14	24/10/2020 11:00	15,76	19	299,48	CHI
202010136532	SANTA HELENA DE GOIAS	SH12296134	IPEGUARI	23/10/2020 19:14	24/10/2020 10:19	23/10/2020 19:14	24/10/2020 10:19	15,07	11	165,76	CHI
202010135968	SAO DOMINGOS	SD21139008	SAO DOMINGOS	23/10/2020 19:14	24/10/2020 00:37	23/10/2020 19:14	24/10/2020 00:37	5,38	1	5,38	CHI
202010135976	CATALAO	1990107129	CATALAO S2	23/10/2020 19:15	23/10/2020 21:52	23/10/2020 19:15	23/10/2020 21:52	2,61	1	2,61	CHI
202010136544	GOIANIA	GN11097868	GOYA S1	23/10/2020 19:15	23/10/2020 22:33	23/10/2020 19:15	23/10/2020 22:33	3,29	47	154,62	CHI
202010136630	SANTA HELENA DE GOIAS	SH12279903	IPEGUARI	23/10/2020 19:16	24/10/2020 02:52	23/10/2020 19:16	24/10/2020 02:52	7,60	6	45,60	CHI
202010136011	NOVA CRIXAS	NA13262735	NOVA CRIXAS	23/10/2020 19:16	24/10/2020 15:41	23/10/2020 19:16	24/10/2020 15:41	20,42	109	2225,30	CHI
202010136011	NOVA CRIXAS	NA12392031LD	NOVA CRIXAS	23/10/2020 19:16	24/10/2020 15:41	23/10/2020 19:16	24/10/2020 12:27	17,19	326	5604,57	CHI
202010136011	NOVA CRIXAS	NA12267248LD	NOVA CRIXAS	23/10/2020 19:16	24/10/2020 15:41	24/10/2020 02:29	24/10/2020 03:57	1,47	621	909,94	CHI
202010136011	NOVA CRIXAS	03960224	NOVA CRIXAS	23/10/2020 19:16	24/10/2020 15:41	24/10/2020 02:29	24/10/2020 03:12	0,73	160	116,49	CHI
202010136011	NOVA CRIXAS	03960224	NOVA CRIXAS	23/10/2020 19:16	24/10/2020 15:41	23/10/2020 19:16	24/10/2020 01:10	5,90	621	3663,56	CHI
202010136011	NOVA CRIXAS	03960224	NOVA CRIXAS	23/10/2020 19:16	24/10/2020 15:41	24/10/2020 00:10	24/10/2020 01:10	1,00	160	160,71	CHI
202010136011	NOVA CRIXAS	NA13251238	NOVA CRIXAS	23/10/2020 19:16	24/10/2020 15:41	23/10/2020 19:16	23/10/2020 23:26	4,17	156	650,04	CHI
202010136011	NOVA CRIXAS	03960224	NOVA CRIXAS	23/10/2020 19:16	24/10/2020 15:41	23/10/2020 19:16	23/10/2020 22:29	3,21	4	12,85	CHI
202010135987	BOM JESUS DE GOIAS	BJ12078005	BOM JESUS DE GOIAS	23/10/2020 19:16	23/10/2020 21:51	23/10/2020 19:16	23/10/2020 21:51	2,57	2	5,15	CHI
202010135991	PONTALINA	6463008	PONTALINA	23/10/2020 19:16	24/10/2020 10:46	23/10/2020 19:16	24/10/2020 10:46	15,48	2	30,97	CHI
202010136007	IPAMERI	580045079	IPAMERI	23/10/2020 19:19	23/10/2020 22:29	23/10/2020 19:19	23/10/2020 22:29	3,16	1	3,16	CHI
202010136013	TRINDADE	15966525	GOYA S2	23/10/2020 19:20	24/10/2020 11:53	23/10/2020 19:20	24/10/2020 11:53	16,54	1	16,54	CHI
202010136019	NOVA CRIXAS	NA12147208	NOVA CRIXAS	23/10/2020 19:21	24/10/2020 09:58	23/10/2020 19:21	24/10/2020 09:58	14,62	82	1199,07	CHI
202010136019	NOVA CRIXAS	NA12147208	NOVA CRIXAS	23/10/2020 19:21	24/10/2020 09:58	23/10/2020 19:21	24/10/2020 09:31	14,18	1	14,18	CHI
202010136018	PLANALTINA	2960012611	PLANALTINA	23/10/2020 19:21	23/10/2020 21:39	23/10/2020 19:21	23/10/2020 21:39	2,30	1	2,30	CHI
202010136084	ORIZONA	OZ12338865	PIRES DO RIO S2	23/10/2020 19:21	23/10/2020 22:44	23/10/2020 19:21	23/10/2020 22:44	3,38	76	256,50	CHI
202010136021	APARECIDA DE GOIANIA	10026303963	CEPAIGO S1	23/10/2020 19:21	24/10/2020 01:45	23/10/2020 19:21	24/10/2020 01:45	6,39	1	6,39	CHI
202010136086	FORMOSA	FA12038926	ITUIQUIRA	23/10/2020 19:23	23/10/2020 20:55	23/10/2020 19:23	23/10/2020 20:55	1,53	358	546,65	CHI
202010136037	AGUAS LINDAS DE GOIAS	4830337360	AGUAS LINDAS DE GOIAS S1	23/10/2020 19:23	23/10/2020 22:09	23/10/2020 19:23	23/10/2020 22:09	2,75	1	2,75	CHI
202010136046	ITABERAI	IB12000046	ITABERAI S2	23/10/2020 19:24	24/10/2020 10:14	23/10/2020 19:24	24/10/2020 10:14	14,82	3	44,46	CHI
202010136469	RIO VERDE	RV12402229	CABRIUVA S2	23/10/2020 19:26	24/10/2020 08:04	23/10/2020 19:26	24/10/2020 08:04	12,63	7	88,39	CHI

202010136469	APARECIDA DO RIO DOCE	RV12402229	CABRIUVA S2	23/10/2020 19:26	24/10/2020 08:04	23/10/2020 19:26	24/10/2020 08:04	12,63	6	75,77	CHI
202010136115	MORRINHOS	MR16409842	MORRINHOS	23/10/2020 19:27	23/10/2020 19:33	23/10/2020 19:27	23/10/2020 19:33	0,11	1281	137,71	CHI
202010136115	MORRINHOS	MR10411556	MORRINHOS	23/10/2020 19:27	23/10/2020 19:33	23/10/2020 19:27	23/10/2020 19:33	0,10	1245	126,92	CHI
202010136115	MORRINHOS	MR16409845	MORRINHOS	23/10/2020 19:27	23/10/2020 19:33	23/10/2020 19:27	23/10/2020 19:33	0,10	2379	231,95	CHI
202010136115	MORRINHOS	MR16406971	MORRINHOS	23/10/2020 19:27	23/10/2020 19:33	23/10/2020 19:27	23/10/2020 19:32	0,09	385	34,22	CHI
202010136115	MORRINHOS	MR16411170	MORRINHOS	23/10/2020 19:27	23/10/2020 19:33	23/10/2020 19:27	23/10/2020 19:31	0,07	1641	119,43	CHI
202010136115	MORRINHOS	01240244	MORRINHOS	23/10/2020 19:27	23/10/2020 19:33	23/10/2020 19:27	23/10/2020 19:31	0,06	5922	371,77	CHI
202010136073	FAINA	MP21285651	MATRINCHA	23/10/2020 19:28	24/10/2020 15:03	23/10/2020 19:28	24/10/2020 15:03	19,58	1	19,58	CHI
202010136673	QUIRINOPOLIS	QI12303070	QUIRINOPOLIS	23/10/2020 19:29	24/10/2020 05:08	23/10/2020 19:29	24/10/2020 05:08	9,65	26	250,82	CHI
202010136080	GOIANIA	13499646	CARAJAS S1	23/10/2020 19:29	24/10/2020 09:16	23/10/2020 19:29	24/10/2020 09:16	13,77	1	13,77	CHI
202010136092	PALESTINA DE GOIAS	CP21128035	PALESTINA	23/10/2020 19:31	24/10/2020 09:04	23/10/2020 19:31	24/10/2020 09:04	13,55	1	13,55	CHI
202010136835	ALTO HORIZONTE	AJ11295204	SANTA TEREZINHA	23/10/2020 19:32	24/10/2020 01:57	23/10/2020 19:32	24/10/2020 01:57	6,41	93	596,18	CHI
202010137119	BOM JARDIM DE GOIAS	BM11212784	BOM JARDIM	23/10/2020 19:33	24/10/2020 10:10	23/10/2020 19:33	24/10/2020 10:10	14,61	84	1227,64	CHI
202010189351	DOVERLANDIA	DV12380977	CAIAPONIA	23/10/2020 19:35	23/10/2020 23:40	23/10/2020 19:35	23/10/2020 23:40	4,08	94	383,76	CHI
202010136211	MORRINHOS	MR11031102	MORRINHOS	23/10/2020 19:35	24/10/2020 01:34	23/10/2020 19:35	24/10/2020 01:34	5,98	248	1483,11	CHI
202010136383	PORANGATU	PO12241996	PORANGATU	23/10/2020 19:37	25/10/2020 15:31	23/10/2020 19:37	25/10/2020 15:31	43,91	25	1097,65	CHI
202010136383	PORANGATU	PO12241996	PORANGATU	23/10/2020 19:37	25/10/2020 15:31	23/10/2020 19:37	24/10/2020 13:38	18,02	38	684,77	CHI
202010136383	PORANGATU	PO12241996	PORANGATU	23/10/2020 19:37	25/10/2020 15:31	23/10/2020 19:37	24/10/2020 12:37	17,01	11	187,15	CHI
202010136383	PORANGATU	PO12241996	PORANGATU	23/10/2020 19:37	25/10/2020 15:31	24/10/2020 09:58	24/10/2020 12:11	2,21	9	19,91	CHI
202010136383	PORANGATU	PO12241996	PORANGATU	23/10/2020 19:37	25/10/2020 15:31	23/10/2020 19:37	24/10/2020 08:24	12,78	9	115,05	CHI
202010136332	GOIANIA	GN11164372	MEIA PONTE	23/10/2020 19:39	23/10/2020 22:28	23/10/2020 19:39	23/10/2020 22:28	2,82	152	427,96	CHI
202010136157	DOVERLANDIA	DV12289219	CAIAPONIA	23/10/2020 19:42	23/10/2020 22:45	23/10/2020 19:42	23/10/2020 22:45	3,05	1	3,05	CHI
202010136159	APARECIDA DE GOIANIA	200442910	INDEPENDENCIA S1	23/10/2020 19:42	24/10/2020 05:45	23/10/2020 19:42	24/10/2020 05:45	10,04	1	10,04	CHI
202010136935	MONTES CLAROS DE GOIAS	ME11076598	IPORA	23/10/2020 19:42	24/10/2020 01:22	23/10/2020 19:42	24/10/2020 01:22	5,65	123	695,39	CHI
202010136164	APARECIDA DE GOIANIA	10015330115	INDEPENDENCIA S1	23/10/2020 19:42	23/10/2020 22:45	23/10/2020 19:42	23/10/2020 22:45	3,03	1	3,03	CHI
202010136322	PADRE BERNARDO	PB11261459	PADRE BERNARDO	23/10/2020 19:43	23/10/2020 22:37	23/10/2020 19:43	23/10/2020 22:37	2,90	124	359,84	CHI
202010136277	GOIANIA	GN11196691	CARAJAS S1	23/10/2020 19:43	24/10/2020 02:14	23/10/2020 19:43	24/10/2020 02:14	6,50	200	1300,28	CHI
202010136207	ITUMBIARA	690266420	ITUMBIARA NOVA	23/10/2020 19:45	24/10/2020 07:29	23/10/2020 19:45	24/10/2020 07:29	11,73	1	11,73	CHI
202010136229	CACU	1140032231	CACHOEIRA ALTA	23/10/2020 19:48	23/10/2020 21:07	23/10/2020 19:48	23/10/2020 21:07	1,30	1	1,30	CHI
202010136232	SAO JOAO DA PARAUNA	1000005012	FIRMINOPOLIS S2	23/10/2020 19:49	24/10/2020 11:24	23/10/2020 19:49	24/10/2020 11:24	15,58	1	15,58	CHI
202010136234	APARECIDA DE GOIANIA	14764520	REAL S1	23/10/2020 19:49	24/10/2020 08:48	23/10/2020 19:49	24/10/2020 08:48	12,98	1	12,98	CHI
202010136548	PIRACANJUBA	PJ12068868	PIRACANJUBA	23/10/2020 19:52	24/10/2020 08:30	23/10/2020 19:52	24/10/2020 08:30	12,63	12	151,52	CHI
202010136370	MORRINHOS	MR11000017	MORRINHOS	23/10/2020 19:52	24/10/2020 14:04	23/10/2020 19:52	24/10/2020 14:04	18,20	136	2474,52	CHI
202010136278	CROMINIA	MI13293024	PONTALINA	23/10/2020 19:53	24/10/2020 20:02	23/10/2020 19:53	24/10/2020 20:02	24,15	4	96,59	CHI
202010136278	CROMINIA	03580224	PONTALINA	23/10/2020 19:53	24/10/2020 20:02	23/10/2020 19:53	24/10/2020 20:02	24,15	9	217,33	CHI
202010136278	PONTALINA	03580224	PONTALINA	23/10/2020 19:53	24/10/2020 20:02	23/10/2020 19:53	24/10/2020 20:02	24,15	61	1473,05	CHI
202010136278	MAIRIPOTABA	MI13293024	PONTALINA	23/10/2020 19:53	24/10/2020 20:02	23/10/2020 19:53	24/10/2020 20:02	24,15	19	458,82	CHI
202010136278	MAIRIPOTABA	03580224	PONTALINA	23/10/2020 19:53	24/10/2020 20:02	23/10/2020 19:53	24/10/2020 20:02	24,15	139	3356,62	CHI
202010136278	CEZARINA	03580224	PONTALINA	23/10/2020 19:53	24/10/2020 20:02	23/10/2020 19:53	24/10/2020 20:02	24,15	40	965,93	CHI
202010136278	MAIRIPOTABA	03580224	PONTALINA	23/10/2020 19:53	24/10/2020 20:02	23/10/2020 19:53	24/10/2020 19:18	23,41	28	655,45	CHI
202010136278	CROMINIA	03580224	PONTALINA	23/10/2020 19:53	24/10/2020 20:02	23/10/2020 19:53	24/10/2020 19:18	23,41	5	117,04	CHI
202010136278	MAIRIPOTABA	03580224	PONTALINA	23/10/2020 19:53	24/10/2020 20:02	24/10/2020 17:49	24/10/2020 18:22	0,55	177	97,89	CHI
202010136278	MAIRIPOTABA	03580224	PONTALINA	23/10/2020 19:53	24/10/2020 20:02	23/10/2020 19:53	24/10/2020 05:03	9,16	177	1620,98	CHI
202010136266	AVELINOPOLIS	AV12383535	ANICUNS	23/10/2020 19:54	24/10/2020 04:24	23/10/2020 19:54	24/10/2020 04:24	8,50	5	42,48	CHI
202010136272	RIO VERDE	RV21191994	ACREUNA	23/10/2020 19:54	24/10/2020 12:34	23/10/2020 19:54	24/10/2020 12:34	16,66	1	16,66	CHI
202010136287	HIDROLANDIA	CQ13162991	PONTALINA	23/10/2020 19:54	24/10/2020 09:52	23/10/2020 19:54	24/10/2020 09:52	13,97	4	55,87	CHI
202010136287	MAIRIPOTABA	CQ13162991	PONTALINA	23/10/2020 19:54	24/10/2020 09:52	23/10/2020 19:54	24/10/2020 09:52	13,97	3	41,90	CHI
202010136287	HIDROLANDIA	03110434	PONTALINA	23/10/2020 19:54	24/10/2020 09:52	23/10/2020 19:54	24/10/2020 09:52	13,97	75	1047,54	CHI
202010136287	CROMINIA	03110434	PONTALINA	23/10/2020 19:54	24/10/2020 09:52	23/10/2020 19:54	24/10/2020 09:52	13,97	2	27,93	CHI
202010136287	HIDROLANDIA	03110434	PONTALINA	23/10/2020 19:54	24/10/2020 09:52	23/10/2020 19:54	24/10/2020 09:52	13,97	189	2639,80	CHI
202010136287	CROMINIA	CQ13162991	PONTALINA	23/10/2020 19:54	24/10/2020 09:52	23/10/2020 19:54	24/10/2020 09:52	13,97	7	97,77	CHI



202010136287	MAIRIPOTABA	03110434	PONTALINA	23/10/2020 19:54	24/10/2020 09:52	23/10/2020 19:54	24/10/2020 09:52	13,97	10	139,67	CHI
202010136287	VARJAO	03110434	PONTALINA	23/10/2020 19:54	24/10/2020 09:52	23/10/2020 19:54	24/10/2020 09:52	13,97	1	13,97	CHI
202010136287	CROMINIA	03110434	PONTALINA	23/10/2020 19:54	24/10/2020 09:52	23/10/2020 19:54	24/10/2020 09:25	13,51	3	40,53	CHI
202010136275	APARECIDA DE GOIANIA	10029248440	INDEPENDENCIA S2	23/10/2020 19:54	24/10/2020 08:22	23/10/2020 19:54	24/10/2020 08:22	12,45	1	12,45	CHI
202010136291	CRISTALINA	KR21248643	CRISTALINA S1	23/10/2020 19:57	23/10/2020 22:05	23/10/2020 19:57	23/10/2020 22:05	2,13	2	4,26	CHI
202010136298	PLANALTINA	PI21202839	PADRE BERNARDO	23/10/2020 19:57	24/10/2020 08:54	23/10/2020 19:57	24/10/2020 08:54	12,94	1	12,94	CHI
202010136620	SAO SIMAO	SO11000019	CACHOEIRA ALTA	23/10/2020 19:57	24/10/2020 02:47	23/10/2020 19:57	24/10/2020 02:47	6,82	133	907,17	CHI
202010136306	IPORA	730139785	IPORA	23/10/2020 19:58	24/10/2020 02:51	23/10/2020 19:58	24/10/2020 02:51	6,87	1	6,87	CHI
202010136318	MORRINHOS	MR21335147	MORRINHOS	23/10/2020 19:59	24/10/2020 08:43	23/10/2020 19:59	24/10/2020 08:43	12,73	1	12,73	CHI
202010136319	MATRINCHA	MP21250959	MATRINCHA	23/10/2020 19:59	24/10/2020 13:51	23/10/2020 19:59	24/10/2020 13:51	17,85	1	17,85	CHI
202010136345	AGUA FRIA DE GOIAS	TL21095903	SAO JOAO D ALIANCA	23/10/2020 20:03	23/10/2020 21:18	23/10/2020 20:03	23/10/2020 21:18	1,24	1	1,24	CHI
202010136361	MORRINHOS	MR12040540RE	MORRINHOS	23/10/2020 20:06	24/10/2020 08:18	23/10/2020 20:06	24/10/2020 08:18	12,19	48	584,99	CHI
202010136363	NOVO GAMA	2460031288	PACAEMBU S1	23/10/2020 20:07	24/10/2020 03:06	23/10/2020 20:07	24/10/2020 03:06	6,97	1	6,97	CHI
202010136364	CAIAPONIA	CP21135386	CAIAPONIA	23/10/2020 20:07	24/10/2020 12:55	23/10/2020 20:07	24/10/2020 12:55	16,79	1	16,79	CHI
202010137355	MATRINCHA	MP12180079	MATRINCHA	23/10/2020 20:08	24/10/2020 06:31	23/10/2020 20:08	24/10/2020 06:31	10,38	230	2386,70	CHI
202010136379	CRIXAS	2490014608	SERRA DO OURO	23/10/2020 20:09	23/10/2020 22:52	23/10/2020 20:09	23/10/2020 22:52	2,71	1	2,71	CHI
202010137483	MORRINHOS	MR12360057LD	MORRINHOS	23/10/2020 20:10	24/10/2020 14:57	23/10/2020 20:10	24/10/2020 14:57	18,78	8	150,24	CHI
202010136385	INHUMAS	IN21066223	INHUMAS S2	23/10/2020 20:10	23/10/2020 23:29	23/10/2020 20:10	23/10/2020 23:29	3,31	1	3,31	CHI
202010136515	PONTALINA	PK12000100	PONTALINA	23/10/2020 20:10	24/10/2020 13:48	23/10/2020 20:10	24/10/2020 13:48	17,62	11	193,84	CHI
202010136393	URUACU	UR21135690	URUACU	23/10/2020 20:11	24/10/2020 12:57	23/10/2020 20:11	24/10/2020 12:57	16,76	2	33,52	CHI
202010136407	MARA ROSA	MQ21283223	MARA ROSA	23/10/2020 20:14	24/10/2020 13:49	23/10/2020 20:14	24/10/2020 13:49	17,58	1	17,58	CHI
202010136408	FORMOSA	610342101	ITUIQUIRA	23/10/2020 20:14	24/10/2020 10:36	23/10/2020 20:14	24/10/2020 10:36	14,37	1	14,37	CHI
202010136991	SAO MIGUEL DO ARAGUAIA	SM11253871	SAO MIGUEL DO ARAGUAIA	23/10/2020 20:14	24/10/2020 06:26	23/10/2020 20:14	24/10/2020 06:26	10,19	103	1049,26	CHI
202010136416	GOIANIA	13626619	CAMPINAS S3	23/10/2020 20:15	23/10/2020 21:27	23/10/2020 20:15	23/10/2020 21:27	1,19	1	1,19	CHI
202010136389	ARAGUAPAZ	FC16418591	GOIAS	23/10/2020 20:17	24/10/2020 22:01	23/10/2020 22:37	24/10/2020 22:01	23,41	121	2832,17	CHI
202010136389	FAINA	FC16418591	GOIAS	23/10/2020 20:17	24/10/2020 22:01	23/10/2020 22:37	24/10/2020 22:01	23,41	21	491,53	CHI
202010136389	ARAGUAPAZ	FC10395387	GOIAS	23/10/2020 20:17	24/10/2020 22:01	24/10/2020 17:59	24/10/2020 18:08	0,15	45	6,66	CHI
202010136389	FAINA	FC10395387	GOIAS	23/10/2020 20:17	24/10/2020 22:01	24/10/2020 17:59	24/10/2020 18:08	0,15	358	53,00	CHI
202010136389	ARAGUAPAZ	FC10395387	GOIAS	23/10/2020 20:17	24/10/2020 22:01	24/10/2020 14:34	24/10/2020 14:49	0,26	45	11,76	CHI
202010136389	FAINA	FC10395387	GOIAS	23/10/2020 20:17	24/10/2020 22:01	24/10/2020 14:34	24/10/2020 14:49	0,26	358	93,58	CHI
202010136389	FAINA	FC16418591	GOIAS	23/10/2020 20:17	24/10/2020 22:01	23/10/2020 22:37	24/10/2020 12:20	13,72	13	178,34	CHI
202010136389	FAINA	FC16418591	GOIAS	23/10/2020 20:17	24/10/2020 22:01	23/10/2020 22:37	24/10/2020 10:10	11,55	32	369,69	CHI
202010136389	ARAGUAPAZ	FC12198789	GOIAS	23/10/2020 20:17	24/10/2020 22:01	23/10/2020 21:28	23/10/2020 22:34	1,09	166	180,11	CHI
202010136389	FAINA	FC12198789	GOIAS	23/10/2020 20:17	24/10/2020 22:01	23/10/2020 21:28	23/10/2020 22:34	1,09	425	461,13	CHI
202010136389	ITABERAI	FC12198789	GOIAS	23/10/2020 20:17	24/10/2020 22:01	23/10/2020 21:28	23/10/2020 22:34	1,09	1	1,09	CHI
202010136389	FAINA	FC12198789	GOIAS	23/10/2020 20:17	24/10/2020 22:01	23/10/2020 21:28	23/10/2020 22:34	1,09	222	240,87	CHI
202010136389	ARAGUAPAZ	01000224	GOIAS	23/10/2020 20:17	24/10/2020 22:01	23/10/2020 22:27	23/10/2020 22:33	0,09	222	20,47	CHI
202010136389	FAINA	01000224	GOIAS	23/10/2020 20:17	24/10/2020 22:01	23/10/2020 22:27	23/10/2020 22:33	0,09	1803	166,28	CHI
202010136389	MORRO AGUDO DE GOIAS	01000224	GOIAS	23/10/2020 20:17	24/10/2020 22:01	23/10/2020 22:27	23/10/2020 22:33	0,09	2	0,18	CHI
202010136389	MOZARLANDIA	01000224	GOIAS	23/10/2020 20:17	24/10/2020 22:01	23/10/2020 22:27	23/10/2020 22:33	0,09	3	0,28	CHI
202010136389	ITAPURANGA	01000224	GOIAS	23/10/2020 20:17	24/10/2020 22:01	23/10/2020 22:27	23/10/2020 22:33	0,09	2	0,18	CHI
202010136389	FAINA	FC16418591	GOIAS	23/10/2020 20:17	24/10/2020 22:01	23/10/2020 20:17	23/10/2020 20:43	0,44	66	29,26	CHI
202010136389	ARAGUAPAZ	FC16418591	GOIAS	23/10/2020 20:17	24/10/2020 22:01	23/10/2020 20:17	23/10/2020 20:43	0,44	121	53,64	CHI
202010136389	FAINA	FC16410222	GOIAS	23/10/2020 20:17	24/10/2020 22:01	23/10/2020 20:17	23/10/2020 20:43	0,44	78	34,00	CHI
202010136389	ARAGUAPAZ	FC16410222	GOIAS	23/10/2020 20:17	24/10/2020 22:01	23/10/2020 20:17	23/10/2020 20:43	0,44	2	0,87	CHI
202010136389	FAINA	FC16410222	GOIAS	23/10/2020 20:17	24/10/2020 22:01	23/10/2020 20:40	23/10/2020 20:43	0,06	43	2,40	CHI
202010140646	INHUMAS	IN12098348	INHUMAS S2	23/10/2020 20:18	24/10/2020 11:30	23/10/2020 20:18	24/10/2020 11:30	15,20	11	167,15	CHI
202010136428	BONOPOLIS	BX12168214	SAO MIGUEL DO ARAGUAIA	23/10/2020 20:18	24/10/2020 01:05	23/10/2020 20:18	24/10/2020 01:05	4,78	123	587,74	CHI
202010134603	BARRO ALTO	BA21016335	BARRO ALTO	23/10/2020 20:18	24/10/2020 18:02	23/10/2020 20:18	24/10/2020 18:02	21,72	1	21,72	CHI
202010136465	MINACU	4020070508	MINACU	23/10/2020 20:21	24/10/2020 04:09	23/10/2020 20:21	24/10/2020 04:09	7,80	1	7,80	CHI
202010136473	PALESTINA DE GOIAS	PY12374894	PALESTINA	23/10/2020 20:22	24/10/2020 01:24	23/10/2020 20:22	24/10/2020 01:24	5,02	2	10,04	CHI

202010136475	CIDADE OCIDENTAL	10003707235	MARAJOARA	23/10/2020 20:23	24/10/2020 01:21	23/10/2020 20:23	24/10/2020 01:21	4,96	1	4,96	CHI
202010136476	JARAGUA	JA21027789	GOIANESIA S2	23/10/2020 20:23	24/10/2020 11:55	23/10/2020 20:23	24/10/2020 11:55	15,52	1	15,52	CHI
202010136480	MORRINHOS	150013851	MORRINHOS	23/10/2020 20:24	24/10/2020 07:36	23/10/2020 20:24	24/10/2020 07:36	11,20	1	11,20	CHI
202010136488	ALOANDIA	MR12249786	GOIATUBA S1	23/10/2020 20:26	24/10/2020 01:32	23/10/2020 20:26	24/10/2020 01:32	5,10	11	56,06	CHI
202010136488	MORRINHOS	MR12249786	GOIATUBA S1	23/10/2020 20:26	24/10/2020 01:32	23/10/2020 20:26	24/10/2020 01:32	5,10	6	30,58	CHI
202010136488	PONTALINA	MR12249786	GOIATUBA S1	23/10/2020 20:26	24/10/2020 01:32	23/10/2020 20:26	24/10/2020 01:32	5,10	3	15,29	CHI
202010137231	EDEALINA	ED12000006	PONTALINA	23/10/2020 20:26	24/10/2020 06:01	23/10/2020 20:26	24/10/2020 06:01	9,57	4	38,28	CHI
202010137231	PONTALINA	ED12000006	PONTALINA	23/10/2020 20:26	24/10/2020 06:01	23/10/2020 20:26	24/10/2020 06:01	9,57	19	181,85	CHI
202010136500	JARAGUA	JA21064339	GOIANESIA S2	23/10/2020 20:29	24/10/2020 10:39	23/10/2020 20:29	24/10/2020 10:39	14,16	2	28,32	CHI
202010136521	NAZARIO	1170004699	ANICUNS	23/10/2020 20:33	24/10/2020 22:14	23/10/2020 20:33	23/10/2020 22:14	1,68	1	1,68	CHI
202010136538	ANICUNS	AC21000086	ANICUNS	23/10/2020 20:36	24/10/2020 09:31	23/10/2020 20:36	24/10/2020 09:31	12,92	1	12,92	CHI
202010136545	APARECIDA DO RIO DOCE	3650001297	CACHOEIRA ALTA	23/10/2020 20:37	24/10/2020 14:17	23/10/2020 20:37	24/10/2020 14:17	17,66	1	17,66	CHI
202010136694	CALDAS NOVAS	CN12392080	CALDAS NOVAS S2	23/10/2020 20:38	23/10/2020 22:18	23/10/2020 20:38	23/10/2020 22:18	1,66	17	28,30	CHI
202010136560	JARAGUA	JA21354151	GOIANESIA S2	23/10/2020 20:39	24/10/2020 11:24	23/10/2020 20:39	24/10/2020 11:24	14,74	1	14,74	CHI
202010136561	SILVANIA	SV21160875	VIANOPOLIS	23/10/2020 20:39	24/10/2020 08:13	23/10/2020 20:39	24/10/2020 08:13	11,55	1	11,55	CHI
202010137155	APARECIDA DE GOIANIA	14884665	REAL S1	23/10/2020 20:40	24/10/2020 00:47	23/10/2020 20:40	24/10/2020 00:47	4,10	1	4,10	CHI
202010136970	ITAPURANGA	IK11246883	ITAPURANGA	23/10/2020 20:40	24/10/2020 15:00	23/10/2020 20:40	24/10/2020 15:00	18,32	108	1978,32	CHI
202010136564	VIANOPOLIS	VN12126803	VIANOPOLIS	23/10/2020 20:40	24/10/2020 02:51	23/10/2020 20:40	24/10/2020 02:51	6,17	1	6,17	CHI
202010136583	ACREUNA	EU12026740	RIO DOS BOIS	23/10/2020 20:41	24/10/2020 12:09	23/10/2020 20:41	24/10/2020 12:09	15,45	3	46,36	CHI
202010136890	PORANGATU	PO12265802	PORANGATU	23/10/2020 20:42	24/10/2020 01:00	23/10/2020 20:42	24/10/2020 01:00	4,29	117	501,57	CHI
202010136601	CATALAO	1990286061	CATALAO S2	23/10/2020 20:44	24/10/2020 00:02	23/10/2020 20:44	24/10/2020 00:02	3,29	1	3,29	CHI
202010136610	RIO VERDE	10011340574	RIO VERDE S1	23/10/2020 20:45	23/10/2020 22:31	23/10/2020 20:45	23/10/2020 22:31	1,75	1	1,75	CHI
202010136614	OUVIDOR	OU12061128	CATALAO S1	23/10/2020 20:47	23/10/2020 22:34	23/10/2020 20:47	23/10/2020 22:34	1,78	6	10,67	CHI
202010136631	GOIANIRA	CK21015716	INHUMAS S1	23/10/2020 20:49	24/10/2020 12:19	23/10/2020 20:49	24/10/2020 12:19	15,49	1	15,49	CHI
202010136656	GOIANIA	14089099	FERROVIARIO S3	23/10/2020 20:53	23/10/2020 23:00	23/10/2020 20:53	23/10/2020 23:00	2,10	1	2,10	CHI
202010137105	NOVO PLANALTO	TA11100823	NOVO PLANALTO	23/10/2020 20:53	24/10/2020 03:45	23/10/2020 20:53	24/10/2020 03:45	6,85	96	657,95	CHI
202010136668	NIQUELANDIA	NQ12375604	URUACU	23/10/2020 20:56	24/10/2020 01:37	23/10/2020 20:56	24/10/2020 01:37	4,68	3	14,05	CHI
202010136699	ITAPURANGA	19638781	ITAPURANGA	23/10/2020 20:57	24/10/2020 21:57	23/10/2020 22:55	24/10/2020 21:57	23,02	1	23,02	CHI
202010136699	ITAPURANGA	IK12300235	ITAPURANGA	23/10/2020 20:57	24/10/2020 21:57	23/10/2020 22:55	24/10/2020 17:17	18,36	7	128,52	CHI
202010136699	GUARAITA	IK13396072B	ITAPURANGA	23/10/2020 20:57	24/10/2020 21:57	23/10/2020 22:55	24/10/2020 12:34	13,64	18	245,44	CHI
202010136699	GOIAS	IK13396072B	ITAPURANGA	23/10/2020 20:57	24/10/2020 21:57	23/10/2020 22:55	24/10/2020 12:34	13,64	2	27,27	CHI
202010136699	ITAPURANGA	IK13396072B	ITAPURANGA	23/10/2020 20:57	24/10/2020 21:57	23/10/2020 22:55	24/10/2020 12:34	13,64	463	6313,39	CHI
202010136699	GUARAITA	IK13000010	ITAPURANGA	23/10/2020 20:57	24/10/2020 21:57	23/10/2020 22:55	24/10/2020 11:32	12,62	1163	14673,18	CHI
202010136699	GOIAS	IK13000010	ITAPURANGA	23/10/2020 20:57	24/10/2020 21:57	23/10/2020 22:55	24/10/2020 11:32	12,62	33	416,35	CHI
202010136699	ITAPURANGA	IK13000010	ITAPURANGA	23/10/2020 20:57	24/10/2020 21:57	23/10/2020 22:55	24/10/2020 11:32	12,62	520	6560,67	CHI
202010136699	FAINA	IK13000010	ITAPURANGA	23/10/2020 20:57	24/10/2020 21:57	23/10/2020 22:55	24/10/2020 11:32	12,62	268	3381,27	CHI
202010136699	ITAPURANGA	IK13000010	ITAPURANGA	23/10/2020 20:57	24/10/2020 21:57	23/10/2020 22:55	24/10/2020 11:20	12,41	172	2133,85	CHI
202010136699	ITAPURANGA	00930224	ITAPURANGA	23/10/2020 20:57	24/10/2020 21:57	23/10/2020 22:55	24/10/2020 04:59	0,57	338	192,94	CHI
202010136699	ITAPURANGA	00930224	ITAPURANGA	23/10/2020 20:57	24/10/2020 21:57	23/10/2020 22:55	23/10/2020 22:59	0,06	338	21,41	CHI
202010136699	GUARAITA	00930224	ITAPURANGA	23/10/2020 20:57	24/10/2020 21:57	23/10/2020 20:57	23/10/2020 22:54	1,94	1181	2292,45	CHI
202010136699	ITAPURANGA	00930224	ITAPURANGA	23/10/2020 20:57	24/10/2020 21:57	23/10/2020 20:57	23/10/2020 22:54	1,94	1156	2243,92	CHI
202010136699	FAINA	00930224	ITAPURANGA	23/10/2020 20:57	24/10/2020 21:57	23/10/2020 20:57	23/10/2020 22:54	1,94	268	520,22	CHI
202010136699	GOIAS	00930224	ITAPURANGA	23/10/2020 20:57	24/10/2020 21:57	23/10/2020 20:57	23/10/2020 22:54	1,94	34	66,00	CHI
202010136699	ITAPURANGA	IK13000010	ITAPURANGA	23/10/2020 20:57	24/10/2020 21:57	23/10/2020 20:57	23/10/2020 22:54	1,94	7	13,57	CHI
202010136699	GOIAS	IK13000010	ITAPURANGA	23/10/2020 20:57	24/10/2020 21:57	23/10/2020 20:57	23/10/2020 22:54	1,94	1	1,94	CHI
202010136699	ITAPURANGA	00930224	ITAPURANGA	23/10/2020 20:57	24/10/2020 21:57	23/10/2020 20:57	23/10/2020 21:58	1,01	338	340,91	CHI
202010136675	FAINA	3600000042	ITAPURANGA	23/10/2020 20:57	25/10/2020 05:50	23/10/2020 20:57	25/10/2020 05:50	32,89	1	32,89	CHI
202010136677	ITUMBIARA	690249792	ITUMBIARA NOVA	23/10/2020 20:58	24/10/2020 08:28	23/10/2020 20:58	24/10/2020 08:28	11,50	1	11,50	CHI
202010136773	NOVA IGUACU DE GOIAS	NH12202113	SANTA TEREZINHA	23/10/2020 21:00	24/10/2020 16:41	23/10/2020 21:00	24/10/2020 16:41	19,68	63	1240,07	CHI
202010136686	ALVORADA DO NORTE	AQ12160975	IACIARA S2	23/10/2020 21:00	23/10/2020 22:18	23/10/2020 21:00	23/10/2020 22:18	1,30	17	22,05	CHI
202010136722	GOIANIA	00580244	GOIANIA LESTE S1	23/10/2020 21:04	24/10/2020 01:52	23/10/2020 21:04	24/10/2020 01:52	4,80	440	2112,98	CHI

202010136722	GOIANIA	00580244	GOIANIA LESTE S1	23/10/2020 21:04	24/10/2020 01:52	23/10/2020 21:04	23/10/2020 21:43	0,66	559	366,77	CHI
202010136708	ALTO HORIZONTE	10005957247	SANTA TEREZINHA	23/10/2020 21:05	24/10/2020 14:47	23/10/2020 21:05	24/10/2020 14:47	17,70	1	17,70	CHI
202010136713	MINEIROS	MY21296382	PARQUE DAS EMAS	23/10/2020 21:06	24/10/2020 13:32	23/10/2020 21:06	24/10/2020 13:32	16,42	1	16,42	CHI
202010136804	RIO VERDE	630469829	RIO VERDE S2	23/10/2020 21:07	23/10/2020 23:43	23/10/2020 21:07	23/10/2020 23:43	2,59	1	2,59	CHI
202010136719	MORRINHOS	MR21129715	MORRINHOS	23/10/2020 21:07	24/10/2020 10:49	23/10/2020 21:07	24/10/2020 10:49	13,68	1	13,68	CHI
202010136721	GOIANIA	10030058994	GOIANIA LESTE S1	23/10/2020 21:08	23/10/2020 23:55	23/10/2020 21:08	23/10/2020 23:55	2,78	1	2,78	CHI
202010136724	CAMPINACU	5700013567	PORANGATU	23/10/2020 21:08	24/10/2020 01:19	23/10/2020 21:08	24/10/2020 01:19	4,18	1	4,18	CHI
202010136750	NIQUELANDIA	NQ12213022	NIQUELANDIA SUBTRANSMISSAO	23/10/2020 21:12	24/10/2020 05:35	23/10/2020 21:12	24/10/2020 05:35	8,37	9	75,32	CHI
202010136758	SANTO ANTONIO DO DESCOBERTO	SN12339988	MARAJOARA	23/10/2020 21:14	24/10/2020 00:32	23/10/2020 21:14	24/10/2020 00:32	3,30	8	26,38	CHI
202010136761	PILAR DE GOIAS	GG12349212	URUACU	23/10/2020 21:14	24/10/2020 05:43	23/10/2020 21:14	24/10/2020 05:43	8,48	1	8,48	CHI
202010136765	ITUMBIARA	IT21309991	ITUMBIARA NOVA	23/10/2020 21:14	24/10/2020 11:00	23/10/2020 21:14	24/10/2020 11:00	13,75	1	13,75	CHI
202010140150	ITAPURANGA	IK11051548	ITAPURANGA	23/10/2020 21:18	24/10/2020 12:32	23/10/2020 21:18	24/10/2020 12:32	15,23	167	2542,99	CHI
202010136846	GUARAITA	00930214	ITAPURANGA	23/10/2020 21:18	24/10/2020 11:35	23/10/2020 21:18	24/10/2020 11:35	14,28	1	14,28	CHI
202010136846	ITAPURANGA	00930214	ITAPURANGA	23/10/2020 21:18	24/10/2020 11:35	23/10/2020 21:18	24/10/2020 11:35	14,28	1136	16216,72	CHI
202010136846	GUARAITA	IK16408461	ITAPURANGA	23/10/2020 21:18	24/10/2020 11:35	23/10/2020 22:11	24/10/2020 11:35	13,40	6	80,40	CHI
202010136846	ITAPURANGA	IK16408461	ITAPURANGA	23/10/2020 21:18	24/10/2020 11:35	23/10/2020 22:11	24/10/2020 11:35	13,40	146	1956,48	CHI
202010136846	ITAPURANGA	00930214	ITAPURANGA	23/10/2020 21:18	24/10/2020 11:35	23/10/2020 21:18	23/10/2020 22:12	0,90	4696	4244,66	CHI
202010136786	URUACU	640058425	URUACU	23/10/2020 21:19	23/10/2020 22:17	23/10/2020 21:19	23/10/2020 22:17	0,96	1	0,96	CHI
202010137104	INHUMAS	IN12323025	INHUMAS S2	23/10/2020 21:19	24/10/2020 11:00	23/10/2020 21:19	24/10/2020 11:00	13,68	6	82,07	CHI
202010136798	SANTA FE DE GOIAS	RN10396175	BRITANIA	23/10/2020 21:21	24/10/2020 20:44	23/10/2020 21:21	24/10/2020 20:44	23,39	1	23,39	CHI
202010136798	ITAPIRAPUA	RN12298934LD	BRITANIA	23/10/2020 21:21	24/10/2020 20:44	23/10/2020 21:21	24/10/2020 13:03	15,71	2	31,42	CHI
202010136798	SANTA FE DE GOIAS	RN12298934LD	BRITANIA	23/10/2020 21:21	24/10/2020 20:44	23/10/2020 21:21	24/10/2020 13:03	15,71	10	157,11	CHI
202010136798	SANTA FE DE GOIAS	RN12159290LD	BRITANIA	23/10/2020 21:21	24/10/2020 20:44	23/10/2020 21:21	24/10/2020 11:13	13,88	8	111,01	CHI
202010136798	SANTA FE DE GOIAS	RN10396175	BRITANIA	23/10/2020 21:21	24/10/2020 20:44	23/10/2020 21:21	24/10/2020 09:26	12,10	15	181,45	CHI
202010136801	GOIANIA	GN12071600LD	GOIANIA LESTE S1	23/10/2020 21:22	24/10/2020 04:00	24/10/2020 03:55	24/10/2020 04:00	0,08	667	55,77	CHI
202010136801	GOIANIA	GN12071600LD	GOIANIA LESTE S1	23/10/2020 21:22	24/10/2020 04:00	23/10/2020 21:22	24/10/2020 03:46	6,39	55	351,48	CHI
202010136801	GOIANIA	GN12071600LD	GOIANIA LESTE S1	23/10/2020 21:22	24/10/2020 04:00	23/10/2020 21:22	24/10/2020 03:45	6,37	49	312,32	CHI
202010136801	GOIANIA	GN12071600LD	GOIANIA LESTE S1	23/10/2020 21:22	24/10/2020 04:00	23/10/2020 21:22	24/10/2020 03:42	6,32	563	3560,35	CHI
202010136806	VICENTINOPOLIS	VI11222496	VICENTINOPOLIS	23/10/2020 21:24	23/10/2020 23:14	23/10/2020 21:24	23/10/2020 23:14	1,83	76	138,93	CHI
202010136815	JARAGUA	70134996	JARAGUA	23/10/2020 21:27	24/10/2020 15:14	23/10/2020 21:27	24/10/2020 15:14	17,78	1	17,78	CHI
202010137496	ITAPURANGA	IK12311324	ITAPURANGA	23/10/2020 21:29	24/10/2020 11:43	23/10/2020 21:29	24/10/2020 11:43	14,23	6	85,37	CHI
202010136836	SENADOR CANEDO	190106943	SENADOR CANEDO	23/10/2020 21:30	24/10/2020 09:12	23/10/2020 21:30	24/10/2020 09:12	11,69	1	11,69	CHI
202010136840	RIO VERDE	RV21322306	CABRIUVA S2	23/10/2020 21:31	23/10/2020 23:32	23/10/2020 21:31	23/10/2020 23:32	2,03	1	2,03	CHI
202010136847	RUBIATABA	780046160	RUBIATABA	23/10/2020 21:32	24/10/2020 08:27	23/10/2020 21:32	24/10/2020 08:27	10,91	1	10,91	CHI
202010136867	GOIANESIA	1100001417	GOIANESIA S1	23/10/2020 21:38	24/10/2020 01:54	23/10/2020 21:38	24/10/2020 01:54	4,26	1	4,26	CHI
202010136869	GOIATUBA	10001701035	RIO DOS BOIS	23/10/2020 21:39	24/10/2020 15:57	23/10/2020 21:39	24/10/2020 15:57	18,30	1	18,30	CHI
202010136887	PIRACANJUBA	60012821	PIRACANJUBA	23/10/2020 21:43	24/10/2020 07:41	23/10/2020 21:43	24/10/2020 07:41	9,96	1	9,96	CHI
202010136901	TAQUARAL DE GOIAS	TQ21278317	INHUMAS S1	23/10/2020 21:45	25/10/2020 03:33	23/10/2020 21:45	25/10/2020 03:33	29,79	1	29,79	CHI
202010137888	ITAPURANGA	IK12310936	ITAPURANGA	23/10/2020 21:53	24/10/2020 14:48	23/10/2020 21:53	24/10/2020 14:48	16,91	33	558,17	CHI
202010137806	ITAPURANGA	IK11000006	ITAPURANGA	23/10/2020 21:55	25/10/2020 06:57	23/10/2020 21:55	25/10/2020 06:57	33,02	131	4325,22	CHI
202010136942	SENADOR CANEDO	SW11169127	CEPAIGO S1	23/10/2020 21:56	24/10/2020 02:03	23/10/2020 21:56	24/10/2020 02:03	4,11	6	24,64	CHI
202010136990	BOM JARDIM DE GOIAS	BM12065725	BOM JARDIM	23/10/2020 21:57	24/10/2020 07:55	23/10/2020 21:57	24/10/2020 07:55	9,97	100	997,31	CHI
202010136990	PIRANHAS	BM12065725	BOM JARDIM	23/10/2020 21:57	24/10/2020 07:55	23/10/2020 21:57	24/10/2020 07:55	9,97	8	79,78	CHI
202010136972	URUACU	UR12398055	URUACU	23/10/2020 22:03	24/10/2020 11:00	23/10/2020 22:03	24/10/2020 11:00	12,95	13	168,36	CHI
202010136972	URUACU	UR12232449RE	URUACU	23/10/2020 22:03	24/10/2020 11:00	23/10/2020 22:03	24/10/2020 10:35	12,54	42	526,59	CHI
202010136972	CAMPINORTE	UR10400423	URUACU	23/10/2020 22:03	24/10/2020 11:00	23/10/2020 22:03	24/10/2020 08:22	10,32	22	227,14	CHI
202010136972	URUACU	UR10400423	URUACU	23/10/2020 22:03	24/10/2020 11:00	23/10/2020 22:03	24/10/2020 08:22	10,32	245	2529,49	CHI
202010136972	URUACU	UR10400423	URUACU	23/10/2020 22:03	24/10/2020 11:00	23/10/2020 22:03	24/10/2020 06:41	8,64	141	1218,44	CHI
202010136966	GOIAS	IB12000044	ITABERAI S2	23/10/2020 22:03	24/10/2020 17:05	23/10/2020 22:03	24/10/2020 17:05	19,02	1	19,02	CHI
202010136966	ITABERAI	IB12000044	ITABERAI S2	23/10/2020 22:03	24/10/2020 17:05	23/10/2020 22:03	24/10/2020 17:05	19,02	7	133,14	CHI
202010136967	FIRMINOPOLIS	FR21092468	SAO LUIZ DOS MONTES BELOS	23/10/2020 22:04	23/10/2020 23:11	23/10/2020 22:04	23/10/2020 23:11	1,12	1	1,12	CHI

202010136989	NIQUELANDIA	NQ12262875	URUACU	23/10/2020 22:15	24/10/2020 18:33	23/10/2020 22:15	24/10/2020 18:33	20,28	1	20,28	CHI
202010138514	NOVA CRIXAS	NA12034763	NOVA CRIXAS	23/10/2020 22:21	24/10/2020 13:28	23/10/2020 22:21	24/10/2020 13:28	15,12	6	90,70	CHI
202010137846	NIQUELANDIA	NQ12280978	URUACU	23/10/2020 22:21	24/10/2020 10:14	23/10/2020 22:21	24/10/2020 10:14	11,87	90	1068,05	CHI
202010137013	ITUMBIARA	CD12097345RE	BOM JESUS DE GOIAS	23/10/2020 22:26	24/10/2020 08:09	23/10/2020 22:26	24/10/2020 08:09	9,71	9	87,42	CHI
202010137019	PIRES DO RIO	PR21250419	PIRES DO RIO S1	23/10/2020 22:26	24/10/2020 01:00	23/10/2020 22:26	24/10/2020 01:00	2,55	2	5,10	CHI
202010137028	URUACU	UR12003452	CAMPINORTE	23/10/2020 22:29	24/10/2020 11:31	23/10/2020 22:29	24/10/2020 11:31	13,03	9	117,24	CHI
202010138536	MORRINHOS	MR12189844	MORRINHOS	23/10/2020 22:34	25/10/2020 07:30	23/10/2020 22:34	25/10/2020 07:30	32,94	22	724,59	CHI
202010138536	CALDAS NOVAS	MR12189844	MORRINHOS	23/10/2020 22:34	25/10/2020 07:30	23/10/2020 22:34	25/10/2020 07:30	32,94	7	230,55	CHI
202010138536	PIRACANJUBA	MR12189844	MORRINHOS	23/10/2020 22:34	25/10/2020 07:30	23/10/2020 22:34	25/10/2020 07:30	32,94	49	1613,86	CHI
202010137053	MORRO AGUDO DE GOIAS	IK10395420	ITAPURANGA	23/10/2020 22:35	24/10/2020 07:02	23/10/2020 22:35	24/10/2020 07:02	8,45	62	523,66	CHI
202010137053	ITAPURANGA	IK10395420	ITAPURANGA	23/10/2020 22:35	24/10/2020 07:02	23/10/2020 22:35	24/10/2020 07:02	8,45	38	320,95	CHI
202010137053	MORRO AGUDO DE GOIAS	IK10395420	ITAPURANGA	23/10/2020 22:35	24/10/2020 07:02	23/10/2020 22:35	24/10/2020 07:01	8,43	9	75,91	CHI
202010137053	ITAPURANGA	IK10395420	ITAPURANGA	23/10/2020 22:35	24/10/2020 07:02	23/10/2020 22:35	24/10/2020 07:01	8,43	6	50,61	CHI
202010137053	ITAPURANGA	IK10395420	ITAPURANGA	23/10/2020 22:35	24/10/2020 07:02	24/10/2020 06:45	24/10/2020 07:01	0,27	1	0,27	CHI
202010137053	ITAPURANGA	IK10395420	ITAPURANGA	23/10/2020 22:35	24/10/2020 07:02	23/10/2020 22:35	24/10/2020 06:01	7,44	1	7,44	CHI
202010137053	ARAGUAPAZ	IK10395420	ITAPURANGA	23/10/2020 22:35	24/10/2020 07:02	23/10/2020 22:35	24/10/2020 00:21	1,76	3	5,29	CHI
202010137053	MORRO AGUDO DE GOIAS	IK10395420	ITAPURANGA	23/10/2020 22:35	24/10/2020 07:02	23/10/2020 22:35	24/10/2020 00:21	1,76	1283	2262,00	CHI
202010137053	RUBIATABA	IK10395420	ITAPURANGA	23/10/2020 22:35	24/10/2020 07:02	23/10/2020 22:35	24/10/2020 00:21	1,76	15	26,45	CHI
202010137053	FAINA	IK10395420	ITAPURANGA	23/10/2020 22:35	24/10/2020 07:02	23/10/2020 22:35	24/10/2020 00:21	1,76	18	31,74	CHI
202010137048	GOIANIA	13080027	GOYA S1	23/10/2020 22:39	24/10/2020 05:13	23/10/2020 22:39	24/10/2020 05:13	6,55	1	6,55	CHI
202010137648	MONTES CLAROS DE GOIAS	ME12135462	IPORA	23/10/2020 22:41	24/10/2020 13:32	23/10/2020 22:41	24/10/2020 13:32	14,84	2	29,69	CHI
202010137068	CAMPOS BELOS	820001934	SAO DOMINGOS	23/10/2020 22:50	24/10/2020 00:16	23/10/2020 22:50	24/10/2020 00:16	1,43	1	1,43	CHI
202010137072	RIO VERDE	630091146	RIO VERDE S2	23/10/2020 22:52	24/10/2020 09:51	23/10/2020 22:52	24/10/2020 09:51	10,97	1	10,97	CHI
202010137733	TURVELANDIA	TD12246829	RIO DOS BOIS	23/10/2020 22:54	24/10/2020 08:37	23/10/2020 22:54	24/10/2020 08:37	9,71	24	233,05	CHI
202010137733	SANTA HELENA DE GOIAS	TD12246829	RIO DOS BOIS	23/10/2020 22:54	24/10/2020 08:37	23/10/2020 22:54	24/10/2020 08:37	9,71	18	174,79	CHI
202010137733	ACREUNA	TD12246829	RIO DOS BOIS	23/10/2020 22:54	24/10/2020 08:37	23/10/2020 22:54	24/10/2020 08:37	9,71	5	48,55	CHI
202010137077	RIO VERDE	RV12058103LD	RIO VERDE S1	23/10/2020 22:56	24/10/2020 17:13	23/10/2020 22:56	24/10/2020 17:13	18,28	1	18,28	CHI
202010137350	CACU	CC12260993	CACHOEIRA ALTA	23/10/2020 22:58	24/10/2020 13:03	23/10/2020 22:58	24/10/2020 13:03	14,08	8	112,63	CHI
202010136405	GOIANIA	GN11125210	XAVANTES	23/10/2020 22:59	23/10/2020 23:28	23/10/2020 22:59	23/10/2020 23:28	0,50	12	5,98	CHI
202010137113	GOIANIA	GN12001206	MEIA PONTE	23/10/2020 22:59	24/10/2020 16:58	23/10/2020 22:59	24/10/2020 16:58	17,97	18	323,52	CHI
202010137113	GOIANIA	GN12001206	MEIA PONTE	23/10/2020 22:59	24/10/2020 16:58	23/10/2020 22:59	24/10/2020 16:58	17,97	10	179,73	CHI
202010137113	GOIANIA	GN11148319	MEIA PONTE	23/10/2020 22:59	24/10/2020 16:58	24/10/2020 14:52	24/10/2020 16:50	1,97	71	139,53	CHI
202010137094	GOIANDIRA	GD12216033	CATALAO S1	23/10/2020 23:03	24/10/2020 08:40	23/10/2020 23:03	24/10/2020 08:40	9,61	50	480,39	CHI
202010137508	PETROLINA DE GOIAS	PG12255953	PETROLINA	23/10/2020 23:05	24/10/2020 06:47	23/10/2020 23:05	24/10/2020 06:47	7,70	119	915,87	CHI
202010137508	OURO VERDE DE GOIAS	PG12255953	PETROLINA	23/10/2020 23:05	24/10/2020 06:47	23/10/2020 23:05	24/10/2020 06:47	7,70	25	192,41	CHI
202010137508	DAMOLANDIA	PG12255953	PETROLINA	23/10/2020 23:05	24/10/2020 06:47	23/10/2020 23:05	24/10/2020 06:47	7,70	1	7,70	CHI
202010137097	IPORA	10008399512	IPORA	23/10/2020 23:06	24/10/2020 00:17	23/10/2020 23:06	24/10/2020 00:17	1,18	1	1,18	CHI
202010137106	TURVANIA	10031854131	FIRMINOPOLIS S2	23/10/2020 23:10	24/10/2020 11:07	23/10/2020 23:10	24/10/2020 11:07	11,94	1	11,94	CHI
202010138501	MORRINHOS	MR12352594	MORRINHOS	23/10/2020 23:14	24/10/2020 18:12	23/10/2020 23:14	24/10/2020 18:12	18,96	6	113,74	CHI
202010138501	PIRACANJUBA	MR12352594	MORRINHOS	23/10/2020 23:14	24/10/2020 18:12	23/10/2020 23:14	24/10/2020 18:12	18,96	3	56,87	CHI
202010137111	CATALAO	CT11149158	CATALAO S2	23/10/2020 23:14	24/10/2020 00:49	23/10/2020 23:14	24/10/2020 00:49	1,57	45	70,62	CHI
202010137138	GOIATUBA	GT11087235	GOIATUBA S2	23/10/2020 23:32	24/10/2020 08:32	23/10/2020 23:32	24/10/2020 08:32	8,99	187	1680,71	CHI
202010137153	PLANALTINA	PI11164571	PLANALTINA	23/10/2020 23:42	25/10/2020 01:34	23/10/2020 23:42	25/10/2020 01:34	25,85	173	4472,63	CHI
202010137156	APARECIDA DE GOIANIA	13152439	INDEPENDENCIA S2	23/10/2020 23:43	24/10/2020 08:10	23/10/2020 23:43	24/10/2020 08:10	8,44	1	8,44	CHI
202010137160	NOVA VENEZA	NV12010101	INHUMAS S1	23/10/2020 23:45	24/10/2020 09:04	23/10/2020 23:45	24/10/2020 09:04	9,30	18	167,46	CHI
202010137904	PALMEIRAS DE GOIAS	PL12063336	PALMEIRAS	23/10/2020 23:53	24/10/2020 08:10	23/10/2020 23:53	24/10/2020 08:10	8,27	10	82,74	CHI
202010137904	PALMINOPOLIS	PL12063336	PALMEIRAS	23/10/2020 23:53	24/10/2020 08:10	23/10/2020 23:53	24/10/2020 08:10	8,27	1	8,27	CHI
202010137195	SAO LUIS DE MONTES BELOS	SL12376360	FIRMINOPOLIS S2	24/10/2020 00:11	24/10/2020 04:30	24/10/2020 00:11	24/10/2020 04:30	4,31	10	43,12	CHI
202010137201	APARECIDA DE GOIANIA	200028066	INDEPENDENCIA S1	24/10/2020 00:18	24/10/2020 01:43	24/10/2020 00:18	24/10/2020 01:43	1,42	1	1,42	CHI
202010137217	APARECIDA DE GOIANIA	GN10385846	ATLANTICO S1	24/10/2020 00:21	24/10/2020 02:57	24/10/2020 00:21	24/10/2020 02:57	2,59	2116	5488,67	CHI
202010137210	CIDADE OCIDENTAL	10021724235	MARAJOARA	24/10/2020 00:27	24/10/2020 01:37	24/10/2020 00:27	24/10/2020 01:37	1,16	1	1,16	CHI

202010138462	SANTA TEREZINHA DE GOIAS	SG12237481	SANTA TEREZINHA	24/10/2020 00:31	24/10/2020 11:26	24/10/2020 00:31	24/10/2020 11:26	10,91	16	174,52	CHI
202010137475	PALMEIRAS DE GOIAS	PP12259174	PALMEIRAS	24/10/2020 00:45	24/10/2020 07:18	24/10/2020 00:45	24/10/2020 07:18	6,54	3	19,63	CHI
202010137475	PALMINOPOLIS	PP12259174	PALMEIRAS	24/10/2020 00:45	24/10/2020 07:18	24/10/2020 00:45	24/10/2020 07:18	6,54	22	143,92	CHI
202010137225	CALDAS NOVAS	CN13263350	CALDAS NOVAS S1	24/10/2020 00:52	24/10/2020 10:27	24/10/2020 00:52	24/10/2020 10:27	9,59	4	38,35	CHI
202010137225	CALDAS NOVAS	00320434	CALDAS NOVAS S1	24/10/2020 00:52	24/10/2020 10:27	24/10/2020 00:52	24/10/2020 02:37	1,76	333	586,82	CHI
202010137226	VICENTINOPOLIS	VI21320270	VICENTINOPOLIS	24/10/2020 00:52	24/10/2020 11:53	24/10/2020 00:52	24/10/2020 11:53	11,01	1	11,01	CHI
202010137228	PALMEIRAS DE GOIAS	PL11361555	PALMEIRAS	24/10/2020 00:54	24/10/2020 04:50	24/10/2020 00:54	24/10/2020 04:50	3,92	46	180,40	CHI
202010137693	NOVO PLANALTO	TA12139137	NOVO PLANALTO	24/10/2020 01:01	24/10/2020 10:49	24/10/2020 01:01	24/10/2020 10:49	9,78	3	29,35	CHI
202010139179	MOSSAMEDES	MD12020758	ITABERAI S2	24/10/2020 01:03	24/10/2020 14:09	24/10/2020 01:03	24/10/2020 14:09	13,10	62	812,06	CHI
202010137367	CORREGO DO OURO	CO12383517	FIRMINOPOLIS S2	24/10/2020 01:03	24/10/2020 07:29	24/10/2020 01:03	24/10/2020 07:29	6,42	8	51,34	CHI
202010137239	CALDAS NOVAS	CN12103224	SERRA DE CALDAS	24/10/2020 01:04	24/10/2020 03:55	24/10/2020 01:04	24/10/2020 03:55	2,86	121	345,89	CHI
202010137246	PALMEIRAS DE GOIAS	PL12051400	PALMEIRAS	24/10/2020 01:20	24/10/2020 13:03	24/10/2020 01:20	24/10/2020 13:03	11,72	79	925,77	CHI
202010137246	PALMEIRAS DE GOIAS	PL12051400	PALMEIRAS	24/10/2020 01:20	24/10/2020 13:03	24/10/2020 01:20	24/10/2020 09:15	7,90	39	308,28	CHI
202010137459	GOIANIA	GN11076701	CARAJAS S1	24/10/2020 01:27	24/10/2020 08:50	24/10/2020 01:27	24/10/2020 08:50	7,38	95	700,94	CHI
202010137264	MONTE ALEGRE DE GOIAS	MA12211597	SAO DOMINGOS	24/10/2020 01:34	24/10/2020 03:17	24/10/2020 01:34	24/10/2020 03:17	1,71	10	17,14	CHI
202010137270	ORIZONA	OZ11140712	PIRES DO RIO S2	24/10/2020 01:40	24/10/2020 07:31	24/10/2020 01:40	24/10/2020 07:31	5,84	150	875,58	CHI
202010137277	JUSSARA	JR12374831	BRITANIA	24/10/2020 01:45	25/10/2020 15:13	24/10/2020 01:56	25/10/2020 15:13	27,29	1	27,29	CHI
202010137277	JUSSARA	JR10401446	BRITANIA	24/10/2020 01:45	25/10/2020 15:13	24/10/2020 01:45	24/10/2020 12:54	11,16	2	22,33	CHI
202010137277	MONTES CLAROS DE GOIAS	JR10401446	BRITANIA	24/10/2020 01:45	25/10/2020 15:13	24/10/2020 01:45	24/10/2020 12:28	10,72	164	1758,44	CHI
202010137277	JUSSARA	JR10401446	BRITANIA	24/10/2020 01:45	25/10/2020 15:13	24/10/2020 01:45	24/10/2020 12:28	10,72	170	1822,78	CHI
202010137277	JUSSARA	JR10401446	BRITANIA	24/10/2020 01:45	25/10/2020 15:13	24/10/2020 01:45	24/10/2020 11:18	9,55	4	38,21	CHI
202010137277	JUSSARA	JR10401446	BRITANIA	24/10/2020 01:45	25/10/2020 15:13	24/10/2020 01:45	24/10/2020 03:18	1,56	19	29,67	CHI
202010137607	PALMEIRAS DE GOIAS	PL12109625	PALMEIRAS	24/10/2020 01:45	24/10/2020 07:43	24/10/2020 01:45	24/10/2020 07:43	5,96	30	178,77	CHI
202010137551	ITABERAI	IB12300330	ITABERAI S2	24/10/2020 01:45	24/10/2020 08:05	24/10/2020 01:45	24/10/2020 08:05	6,32	14	88,52	CHI
202010137322	INHUMAS	DL12098268	INHUMAS S1	24/10/2020 01:54	24/10/2020 07:03	24/10/2020 01:54	24/10/2020 07:03	5,13	53	272,10	CHI
202010137322	DAMOLANDIA	DL12098268	INHUMAS S1	24/10/2020 01:54	24/10/2020 07:03	24/10/2020 01:54	24/10/2020 07:03	5,13	6	30,80	CHI
202010137300	INHUMAS	IN10394555	INHUMAS S2	24/10/2020 02:06	24/10/2020 09:01	24/10/2020 02:06	24/10/2020 09:01	6,91	1246	8614,71	CHI
202010137300	INHUMAS	IN10394555	INHUMAS S2	24/10/2020 02:06	24/10/2020 09:01	24/10/2020 02:06	24/10/2020 02:20	0,24	4461	1091,71	CHI
202010137294	FAINA	FC21194544	GOIAS	24/10/2020 02:09	24/10/2020 13:42	24/10/2020 02:09	24/10/2020 13:42	11,56	1	11,56	CHI
202010137294	MORRO AGUDO DE GOIAS	FC13095688	GOIAS	24/10/2020 02:09	24/10/2020 13:42	24/10/2020 02:09	24/10/2020 13:04	10,93	2	21,85	CHI
202010137294	FAINA	FC13095688	GOIAS	24/10/2020 02:09	24/10/2020 13:42	24/10/2020 02:09	24/10/2020 13:04	10,93	108	1180,14	CHI
202010137294	ITAPURANGA	FC13095688	GOIAS	24/10/2020 02:09	24/10/2020 13:42	24/10/2020 02:09	24/10/2020 13:04	10,93	2	21,85	CHI
202010137294	FAINA	FC13395389B	GOIAS	24/10/2020 02:09	24/10/2020 13:42	24/10/2020 02:09	24/10/2020 12:29	10,34	128	1322,92	CHI
202010138321	AURILANDIA	RP12076381RE	FIRMINOPOLIS S2	24/10/2020 02:23	24/10/2020 09:36	24/10/2020 02:23	24/10/2020 09:36	7,22	4	28,86	CHI
202010138321	SAO JOAO DA PARAUNA	RP12076381RE	FIRMINOPOLIS S2	24/10/2020 02:23	24/10/2020 09:36	24/10/2020 02:23	24/10/2020 09:36	7,22	33	238,11	CHI
202010137306	FORMOSO	FO12145370RE	MARA ROSA	24/10/2020 02:34	24/10/2020 06:21	24/10/2020 02:34	24/10/2020 06:21	3,78	58	219,35	CHI
202010137550	MORRINHOS	GT12273783	GOIATUBA S2	24/10/2020 02:36	24/10/2020 10:16	24/10/2020 02:36	24/10/2020 10:16	7,65	3	22,96	CHI
202010137550	GOIATUBA	GT12273783	GOIATUBA S2	24/10/2020 02:36	24/10/2020 10:16	24/10/2020 02:36	24/10/2020 10:16	7,65	56	428,57	CHI
202010138429	ABADIA DE GOIAS	LG11373513	CARAJAS S1	24/10/2020 02:53	24/10/2020 10:10	24/10/2020 02:53	24/10/2020 10:10	7,27	77	559,62	CHI
202010137315	ARAGARCAS	AG11207758	ARAGARCAS	24/10/2020 02:55	24/10/2020 09:37	24/10/2020 02:55	24/10/2020 09:37	6,70	116	777,04	CHI
202010137316	GOIANIA	16229757	GOIANIA LESTE S1	24/10/2020 02:58	24/10/2020 09:48	24/10/2020 02:58	24/10/2020 09:48	6,83	1	6,83	CHI
202010137624	URUTAI	UT12115680	PIRES DO RIO S2	24/10/2020 03:10	24/10/2020 07:43	24/10/2020 03:10	24/10/2020 07:43	4,54	34	154,36	CHI
202010137941	PALMEIRAS DE GOIAS	IY12170319	EDEIA	24/10/2020 03:23	24/10/2020 17:35	24/10/2020 03:23	24/10/2020 17:35	14,19	4	56,77	CHI
202010137941	INDIARA	IY12170319	EDEIA	24/10/2020 03:23	24/10/2020 17:35	24/10/2020 03:23	24/10/2020 17:35	14,19	5	70,96	CHI
202010137941	PALMEIRAS DE GOIAS	IY12170319	EDEIA	24/10/2020 03:23	24/10/2020 17:35	24/10/2020 11:52	24/10/2020 17:35	5,72	2	11,43	CHI
202010139606	MIMOSO DE GOIAS	04564114	BARRO ALTO	24/10/2020 03:35	24/10/2020 09:50	24/10/2020 03:35	24/10/2020 09:50	6,25	4	24,98	CHI
202010139606	VILA PROPICIO	04564114	BARRO ALTO	24/10/2020 03:35	24/10/2020 09:50	24/10/2020 03:35	24/10/2020 09:50	6,25	29	181,13	CHI
202010139606	VILA PROPICIO	04564114	BARRO ALTO	24/10/2020 03:35	24/10/2020 09:50	24/10/2020 03:35	24/10/2020 09:50	6,25	50	312,29	CHI
202010139606	MIMOSO DE GOIAS	04564114	BARRO ALTO	24/10/2020 03:35	24/10/2020 09:50	24/10/2020 03:35	24/10/2020 09:50	6,25	9	56,21	CHI
202010139606	NIQUELANDIA	04564114	BARRO ALTO	24/10/2020 03:35	24/10/2020 09:50	24/10/2020 03:35	24/10/2020 09:50	6,25	644	4022,32	CHI
202010139606	NIQUELANDIA	04564114	BARRO ALTO	24/10/2020 03:35	24/10/2020 09:50	24/10/2020 03:35	24/10/2020 09:50	6,25	183	1142,99	CHI



202010137338	GOIANIA	13803827	FERROVIARIO S2	24/10/2020 03:49	24/10/2020 07:37	24/10/2020 03:49	24/10/2020 07:37	3,80	1	3,80	CHI
202010137637	BRAZABRANTES	DL12026638	INHUMAS S1	24/10/2020 03:55	24/10/2020 13:21	24/10/2020 03:55	24/10/2020 13:21	9,42	22	207,29	CHI
202010137637	DAMOLANDIA	DL12026638	INHUMAS S1	24/10/2020 03:55	24/10/2020 13:21	24/10/2020 03:55	24/10/2020 13:21	9,42	3	28,27	CHI
202010137637	BRAZABRANTES	DL12026638	INHUMAS S1	24/10/2020 03:55	24/10/2020 13:21	24/10/2020 03:55	24/10/2020 08:01	4,09	6	24,54	CHI
202010137637	DAMOLANDIA	DL12026638	INHUMAS S1	24/10/2020 03:55	24/10/2020 13:21	24/10/2020 03:55	24/10/2020 08:01	4,09	6	24,54	CHI
202010137609	HIDROLANDIA	HD12372943	CEPAIGO S2	24/10/2020 03:59	24/10/2020 08:51	24/10/2020 03:59	24/10/2020 08:51	4,86	24	116,69	CHI
202010137346	SANTO ANTONIO DO DESCOBERTO	10029127775	ALEXANIA	24/10/2020 04:06	24/10/2020 11:40	24/10/2020 04:06	24/10/2020 11:40	7,56	1	7,56	CHI
202010137349	MINACU	IH12282167	MINACU	24/10/2020 04:10	24/10/2020 06:12	24/10/2020 04:10	24/10/2020 06:12	2,02	641	1296,96	CHI
202010137351	NAZARIO	NZ21076353	ANICUNS	24/10/2020 04:13	24/10/2020 09:53	24/10/2020 04:13	24/10/2020 09:53	5,66	4	22,63	CHI
202010137826	BALIZA	BH12331308	CAIAPONIA	24/10/2020 04:17	24/10/2020 12:40	24/10/2020 04:17	24/10/2020 12:40	8,38	28	234,60	CHI
202010137826	BALIZA	BH12331308	CAIAPONIA	24/10/2020 04:17	24/10/2020 12:40	24/10/2020 09:35	24/10/2020 12:40	3,08	1	3,08	CHI
202010137354	PLANALTINA	PI12316968	PLANALTINA	24/10/2020 04:17	24/10/2020 09:00	24/10/2020 04:17	24/10/2020 09:00	4,71	182	856,71	CHI
202010137386	BELA VISTA DE GOIAS	BV12016443LD	BELA VISTA S1	24/10/2020 04:20	25/10/2020 02:06	24/10/2020 04:20	25/10/2020 02:06	21,77	17	370,01	CHI
202010137386	BELA VISTA DE GOIAS	BV12209360LD	BELA VISTA S1	24/10/2020 04:20	25/10/2020 02:06	24/10/2020 18:11	25/10/2020 00:34	6,38	8	51,08	CHI
202010137386	PIRACANJUBA	BV12209360LD	BELA VISTA S1	24/10/2020 04:20	25/10/2020 02:06	24/10/2020 18:11	25/10/2020 00:34	6,38	15	95,77	CHI
202010137386	BELA VISTA DE GOIAS	BV12209360LD	BELA VISTA S1	24/10/2020 04:20	25/10/2020 02:06	24/10/2020 04:20	24/10/2020 17:25	13,08	8	104,63	CHI
202010137386	PIRACANJUBA	BV12209360LD	BELA VISTA S1	24/10/2020 04:20	25/10/2020 02:06	24/10/2020 04:20	24/10/2020 17:25	13,08	15	196,19	CHI
202010137386	PIRACANJUBA	BV10400759	BELA VISTA S1	24/10/2020 04:20	25/10/2020 02:06	24/10/2020 04:20	24/10/2020 15:49	11,48	3	34,43	CHI
202010137386	BELA VISTA DE GOIAS	BV10400759	BELA VISTA S1	24/10/2020 04:20	25/10/2020 02:06	24/10/2020 04:20	24/10/2020 15:49	11,48	17	195,10	CHI
202010137386	BELA VISTA DE GOIAS	BV10400759	BELA VISTA S1	24/10/2020 04:20	25/10/2020 02:06	24/10/2020 04:20	24/10/2020 11:33	7,22	82	592,24	CHI
202010137386	PIRACANJUBA	BV10400759	BELA VISTA S1	24/10/2020 04:20	25/10/2020 02:06	24/10/2020 04:20	24/10/2020 11:33	7,22	97	700,58	CHI
202010137386	PIRACANJUBA	BV10400759	BELA VISTA S1	24/10/2020 04:20	25/10/2020 02:06	24/10/2020 04:20	24/10/2020 08:55	4,59	35	160,63	CHI
202010137386	BELA VISTA DE GOIAS	BV10400759	BELA VISTA S1	24/10/2020 04:20	25/10/2020 02:06	24/10/2020 04:20	24/10/2020 08:55	4,59	120	550,73	CHI
202010137909	BURITI DE GOIAS	BS12215292	FIRMINOPOLIS S2	24/10/2020 04:20	24/10/2020 09:16	24/10/2020 04:20	24/10/2020 09:16	4,92	39	192,03	CHI
202010137909	NOVO BRASIL	BS12215292	FIRMINOPOLIS S2	24/10/2020 04:20	24/10/2020 09:16	24/10/2020 04:20	24/10/2020 09:16	4,92	16	78,78	CHI
202010137359	POSSE	PS12237062	IACIARA S2	24/10/2020 04:21	24/10/2020 09:07	24/10/2020 04:21	24/10/2020 09:07	4,76	18	85,62	CHI
202010137360	GOIANIA	11501170	GOIANIA LESTE S1	24/10/2020 04:22	24/10/2020 09:46	24/10/2020 04:22	24/10/2020 09:46	5,40	1	5,40	CHI
202010137373	GOIANIA	10010927628	GOIANIA LESTE S1	24/10/2020 04:39	24/10/2020 13:45	24/10/2020 04:39	24/10/2020 13:45	9,09	1	9,09	CHI
202010137378	FORMOSO	2410019610	PORANGATU	24/10/2020 04:43	24/10/2020 10:31	24/10/2020 04:43	24/10/2020 10:31	5,79	1	5,79	CHI
202010137379	FORMOSA	FA12282335	ITUIQUIRA	24/10/2020 04:46	24/10/2020 09:35	24/10/2020 04:46	24/10/2020 09:35	4,81	6	28,83	CHI
202010139885	FAINA	FC12220907	GOIAS	24/10/2020 04:48	25/10/2020 09:12	24/10/2020 04:48	25/10/2020 09:12	28,40	11	312,35	CHI
202010137391	NOVA VENEZA	NV21372113	INHUMAS S1	24/10/2020 04:59	24/10/2020 10:06	24/10/2020 04:59	24/10/2020 10:06	5,12	1	5,12	CHI
202010137394	SAO JOAO D ALIANCA	O2160214	SAO JOAO D ALIANCA	24/10/2020 05:02	24/10/2020 08:44	24/10/2020 05:02	24/10/2020 08:44	3,70	3264	12073,17	CHI
202010137396	JOVIANIA	JV21218127	VICENTINOPOLIS	24/10/2020 05:02	24/10/2020 10:42	24/10/2020 05:02	24/10/2020 10:42	5,66	1	5,66	CHI
202010137774	SANTA CRUZ DE GOIAS	BC12309602	CRISTIANOPOLIS	24/10/2020 05:06	24/10/2020 08:27	24/10/2020 05:06	24/10/2020 08:27	3,34	51	170,27	CHI
202010137745	TURVANIA	TV12005542	FIRMINOPOLIS S2	24/10/2020 05:08	24/10/2020 07:46	24/10/2020 05:08	24/10/2020 07:46	2,63	42	110,37	CHI
202010137745	PALMINOPOLIS	TV12005542	FIRMINOPOLIS S2	24/10/2020 05:08	24/10/2020 07:46	24/10/2020 05:08	24/10/2020 07:46	2,63	20	52,56	CHI
202010138261	AGUA LIMPA	AL12391494RE	VILA CORUMBA	24/10/2020 05:09	25/10/2020 05:52	24/10/2020 05:09	25/10/2020 05:52	24,71	16	395,37	CHI
2020102400088	ARUANA	O3200434	ARUANA	24/10/2020 05:10	24/10/2020 05:15	24/10/2020 05:10	24/10/2020 05:15	0,08	8	0,67	CHI
202010137416	MINACU	IH12397473	MINACU	24/10/2020 05:17	25/10/2020 11:44	24/10/2020 05:17	25/10/2020 11:44	30,44	1	30,44	CHI
202010137416	MINACU	IH12397473	MINACU	24/10/2020 05:17	25/10/2020 11:44	24/10/2020 05:17	24/10/2020 15:46	10,47	7	73,31	CHI
202010137980	GOIANIA	GN11002822	GOYA S2	24/10/2020 05:19	24/10/2020 13:44	24/10/2020 05:19	24/10/2020 13:44	8,40	161	1352,71	CHI
202010137827	GOIANIA	GN11275628	GOYA S2	24/10/2020 05:21	24/10/2020 11:08	24/10/2020 05:21	24/10/2020 11:08	5,78	112	647,64	CHI
202010137438	PIRACANJUBA	PJ12226339	PIRACANJUBA	24/10/2020 05:21	24/10/2020 11:00	24/10/2020 05:21	24/10/2020 11:00	5,64	27	152,23	CHI
202010137772	GOIANESIA	GE12000185	GOIANESIA S2	24/10/2020 05:24	24/10/2020 18:14	24/10/2020 05:24	24/10/2020 18:14	12,82	6	76,91	CHI
202010138508	PONTALINA	PH12063349	PONTALINA	24/10/2020 05:26	24/10/2020 12:52	24/10/2020 05:26	24/10/2020 12:52	7,43	7	51,99	CHI
202010137415	BALIZA	BH12380942	BOM JARDIM	24/10/2020 05:27	24/10/2020 12:28	24/10/2020 05:27	24/10/2020 12:28	7,00	7	49,02	CHI
202010137942	CAMPOS VERDES	NH12396799	SANTA TEREZINHA	24/10/2020 05:29	24/10/2020 15:24	24/10/2020 05:29	24/10/2020 15:24	9,91	9	89,15	CHI
202010137942	PILAR DE GOIAS	NH12396799	SANTA TEREZINHA	24/10/2020 05:29	24/10/2020 15:24	24/10/2020 05:29	24/10/2020 15:24	9,91	1	9,91	CHI
202010137942	ALTO HORIZONTE	NH12396799	SANTA TEREZINHA	24/10/2020 05:29	24/10/2020 15:24	24/10/2020 05:29	24/10/2020 15:24	9,91	58	574,52	CHI
202010137712	SANCLERLANDIA	SC12052751	FIRMINOPOLIS S2	24/10/2020 05:30	24/10/2020 08:36	24/10/2020 05:30	24/10/2020 08:36	3,09	19	58,78	CHI

202010137712	BURITI DE GOIAS	SC12052751	FIRMINOPOLIS S2	24/10/2020 05:30	24/10/2020 08:36	24/10/2020 05:30	24/10/2020 08:36	3,09	3	9,28	CHI
202010137420	GOIANIA	10018788260	CARAJAS S1	24/10/2020 05:30	24/10/2020 11:10	24/10/2020 05:30	24/10/2020 11:10	5,66	1	5,66	CHI
202010137928	BOM JARDIM DE GOIAS	BM12212797	BOM JARDIM	24/10/2020 05:38	24/10/2020 09:02	24/10/2020 05:38	24/10/2020 09:02	3,40	87	295,92	CHI
202010137928	PIRANHAS	BM12212797	BOM JARDIM	24/10/2020 05:38	24/10/2020 09:02	24/10/2020 05:38	24/10/2020 09:02	3,40	2	6,80	CHI
202010138353	MUNDO NOVO DE GOIAS	MH12362454	NOVA CRIXAS	24/10/2020 05:39	24/10/2020 11:25	24/10/2020 05:39	24/10/2020 11:25	5,76	123	708,86	CHI
202010137439	CATALAO	10008393247	CATALAO S1	24/10/2020 05:41	24/10/2020 08:21	24/10/2020 05:41	24/10/2020 08:21	2,66	1	2,66	CHI
202010140304	PONTALINA	PK12095164RE	PONTALINA	24/10/2020 05:42	24/10/2020 12:26	24/10/2020 05:42	24/10/2020 12:26	6,73	11	74,02	CHI
202010140304	MORRINHOS	PK12095164RE	PONTALINA	24/10/2020 05:42	24/10/2020 12:26	24/10/2020 05:42	24/10/2020 12:26	6,73	4	26,92	CHI
202010137445	NOVA CRIXAS	NA12228222	MOZARLANDIA	24/10/2020 05:43	26/10/2020 14:55	25/10/2020 23:03	26/10/2020 14:55	15,87	7	111,06	CHI
202010137445	NOVA CRIXAS	NA12220366	MOZARLANDIA	24/10/2020 05:43	26/10/2020 14:55	24/10/2020 05:43	25/10/2020 23:10	41,45	6	248,68	CHI
202010137445	NOVA CRIXAS	NA13117451	MOZARLANDIA	24/10/2020 05:43	26/10/2020 14:55	24/10/2020 05:43	25/10/2020 22:48	41,08	8	328,66	CHI
202010137445	NOVA CRIXAS	NA13117401	MOZARLANDIA	24/10/2020 05:43	26/10/2020 14:55	24/10/2020 05:43	25/10/2020 21:40	39,95	8	319,62	CHI
202010137445	CRIXAS	NA13117401	MOZARLANDIA	24/10/2020 05:43	26/10/2020 14:55	24/10/2020 05:43	25/10/2020 21:40	39,95	2	79,91	CHI
202010137445	NOVA CRIXAS	NA12156613	MOZARLANDIA	24/10/2020 05:43	26/10/2020 14:55	24/10/2020 05:43	25/10/2020 19:55	38,21	12	458,53	CHI
202010138200	CRISTALINA	KR12383034	CRISTALINA S1	24/10/2020 05:44	24/10/2020 14:12	24/10/2020 05:44	24/10/2020 14:12	8,45	3	25,35	CHI
202010137594	ARAGARCAS	AG12000006	ARAGARCAS	24/10/2020 05:47	24/10/2020 12:15	24/10/2020 05:47	24/10/2020 12:15	6,46	41	264,70	CHI
202010137463	ALVORADA DO NORTE	AQ12160975	IACIARA S2	24/10/2020 05:47	24/10/2020 09:27	24/10/2020 05:47	24/10/2020 09:27	3,65	17	62,06	CHI
202010137477	HIDROLANDIA	HD21402808	INDEPENDENCIA S1	24/10/2020 05:53	24/10/2020 08:27	24/10/2020 05:53	24/10/2020 08:27	2,55	1	2,55	CHI
202010137478	ARAGOIANIA	AO12038066	GUAPO S2	24/10/2020 05:54	24/10/2020 14:18	24/10/2020 05:54	24/10/2020 14:18	8,40	1	8,40	CHI
202010138298	PIRACANJUBA	PJ12212156	PIRACANJUBA	24/10/2020 05:54	24/10/2020 11:39	24/10/2020 05:54	24/10/2020 11:39	5,74	35	200,98	CHI
202010137481	INHUMAS	IN12366112	INHUMAS S2	24/10/2020 05:54	24/10/2020 09:00	24/10/2020 05:54	24/10/2020 09:00	3,09	1	3,09	CHI
202010137527	VILA BOA	FA10410992	ITIQUIRA	24/10/2020 05:55	24/10/2020 19:21	24/10/2020 07:11	24/10/2020 19:21	12,17	7	85,17	CHI
202010137527	FORMOSA	FA10410992	ITIQUIRA	24/10/2020 05:55	24/10/2020 19:21	24/10/2020 07:11	24/10/2020 19:21	12,17	29	352,84	CHI
202010137527	SAO JOAO D ALIANCA	FA10410992	ITIQUIRA	24/10/2020 05:55	24/10/2020 19:21	24/10/2020 05:55	24/10/2020 18:41	12,77	226	2886,46	CHI
202010137527	FLORES DE GOIAS	FA10410992	ITIQUIRA	24/10/2020 05:55	24/10/2020 19:21	24/10/2020 05:55	24/10/2020 18:41	12,77	3	38,32	CHI
202010137527	FORMOSA	FA10410992	ITIQUIRA	24/10/2020 05:55	24/10/2020 19:21	24/10/2020 05:55	24/10/2020 18:41	12,77	584	7458,82	CHI
202010137527	VILA BOA	FA10410992	ITIQUIRA	24/10/2020 05:55	24/10/2020 19:21	24/10/2020 05:55	24/10/2020 18:41	12,77	6	76,63	CHI
202010137527	VILA BOA	FA10410992	ITIQUIRA	24/10/2020 05:55	24/10/2020 19:21	24/10/2020 05:55	24/10/2020 18:17	12,37	20	247,47	CHI
202010137527	FORMOSA	FA10410992	ITIQUIRA	24/10/2020 05:55	24/10/2020 19:21	24/10/2020 07:11	24/10/2020 15:05	7,89	19	149,89	CHI
202010137527	VILA BOA	FA10410992	ITIQUIRA	24/10/2020 05:55	24/10/2020 19:21	24/10/2020 13:34	24/10/2020 13:45	0,20	4	0,78	CHI
202010137527	FORMOSA	FA10401450	ITIQUIRA	24/10/2020 05:55	24/10/2020 19:21	24/10/2020 13:34	24/10/2020 13:45	0,20	589	115,18	CHI
202010137527	FORMOSA	FA10410992	ITIQUIRA	24/10/2020 05:55	24/10/2020 19:21	24/10/2020 13:34	24/10/2020 13:45	0,20	813	158,99	CHI
202010137527	VILA BOA	FA10401450	ITIQUIRA	24/10/2020 05:55	24/10/2020 19:21	24/10/2020 13:34	24/10/2020 13:45	0,20	182	35,59	CHI
202010137527	FORMOSA	FA10395393	ITIQUIRA	24/10/2020 05:55	24/10/2020 19:21	24/10/2020 13:34	24/10/2020 13:45	0,19	119	22,58	CHI
202010137527	FORMOSA	FA10410992	ITIQUIRA	24/10/2020 05:55	24/10/2020 19:21	24/10/2020 13:34	24/10/2020 13:45	0,18	283	51,25	CHI
202010137527	FORMOSA	FA12376669LD	ITIQUIRA	24/10/2020 05:55	24/10/2020 19:21	24/10/2020 07:11	24/10/2020 13:03	5,87	9	52,80	CHI
202010137527	FORMOSA	FA10410992	ITIQUIRA	24/10/2020 05:55	24/10/2020 19:21	24/10/2020 05:55	24/10/2020 11:24	5,49	70	384,07	CHI
202010137527	VILA BOA	FA10410992	ITIQUIRA	24/10/2020 05:55	24/10/2020 19:21	24/10/2020 05:55	24/10/2020 11:24	5,49	180	987,60	CHI
202010137527	VILA BOA	FA10410992	ITIQUIRA	24/10/2020 05:55	24/10/2020 19:21	24/10/2020 05:55	24/10/2020 11:08	5,23	2	10,45	CHI
202010137527	FORMOSA	FA10410992	ITIQUIRA	24/10/2020 05:55	24/10/2020 19:21	24/10/2020 05:55	24/10/2020 11:08	5,23	12	62,73	CHI
202010137527	FORMOSA	FA10410992	ITIQUIRA	24/10/2020 05:55	24/10/2020 19:21	24/10/2020 07:11	24/10/2020 11:00	3,82	187	713,66	CHI
202010137527	FORMOSA	FA10410992	ITIQUIRA	24/10/2020 05:55	24/10/2020 19:21	24/10/2020 05:55	24/10/2020 08:35	2,68	813	2176,13	CHI
202010137527	FORMOSA	FA10410992	ITIQUIRA	24/10/2020 05:55	24/10/2020 19:21	24/10/2020 05:55	24/10/2020 08:35	2,68	507	1357,07	CHI
202010137527	VILA BOA	FA10410992	ITIQUIRA	24/10/2020 05:55	24/10/2020 19:21	24/10/2020 05:55	24/10/2020 08:35	2,68	4	10,71	CHI
202010137527	FORMOSA	FA10395393	ITIQUIRA	24/10/2020 05:55	24/10/2020 19:21	24/10/2020 07:20	24/10/2020 07:40	0,32	119	38,58	CHI
202010137527	FORMOSA	FA10410992	ITIQUIRA	24/10/2020 05:55	24/10/2020 19:21	24/10/2020 07:11	24/10/2020 07:16	0,08	119	9,95	CHI
202010137527	FORMOSA	FA10410992	ITIQUIRA	24/10/2020 05:55	24/10/2020 19:21	24/10/2020 07:11	24/10/2020 07:16	0,07	87	6,38	CHI
202010137527	FORMOSA	FA10410992	ITIQUIRA	24/10/2020 05:55	24/10/2020 19:21	24/10/2020 05:55	24/10/2020 06:02	0,12	119	14,08	CHI
202010137486	PLANALTINA	TL10404985	SAO JOAO D ALIANCA	24/10/2020 05:56	25/10/2020 13:19	24/10/2020 05:56	25/10/2020 13:19	31,39	115	3609,75	CHI
202010137486	PLANALTINA	PI13325392	SAO JOAO D ALIANCA	24/10/2020 05:56	25/10/2020 13:19	24/10/2020 07:37	25/10/2020 13:19	29,71	26	772,45	CHI
202010137486	PLANALTINA	TL10404985	SAO JOAO D ALIANCA	24/10/2020 05:56	25/10/2020 13:19	24/10/2020 18:31	24/10/2020 18:50	0,31	122	37,41	CHI

202010137486	AGUA FRIA DE GOIAS	TL10404985	SAO JOAO D ALIANCA	24/10/2020 05:56	25/10/2020 13:19	24/10/2020 18:31	24/10/2020 18:50	0,31	37	11,35	CHI
202010137486	PLANALTINA	TL10404985	SAO JOAO D ALIANCA	24/10/2020 05:56	25/10/2020 13:19	24/10/2020 05:56	24/10/2020 14:24	8,46	109	922,62	CHI
202010137486	AGUA FRIA DE GOIAS	TL10404985	SAO JOAO D ALIANCA	24/10/2020 05:56	25/10/2020 13:19	24/10/2020 05:56	24/10/2020 14:24	8,46	2	16,93	CHI
202010137486	PLANALTINA	TL13383207	SAO JOAO D ALIANCA	24/10/2020 05:56	25/10/2020 13:19	24/10/2020 07:37	24/10/2020 14:24	6,78	8	54,28	CHI
202010137486	PLANALTINA	TL10404985	SAO JOAO D ALIANCA	24/10/2020 05:56	25/10/2020 13:19	24/10/2020 05:56	24/10/2020 14:01	8,09	4	32,35	CHI
202010137486	AGUA FRIA DE GOIAS	TL10404985	SAO JOAO D ALIANCA	24/10/2020 05:56	25/10/2020 13:19	24/10/2020 05:56	24/10/2020 14:01	8,09	30	242,59	CHI
202010137486	AGUA FRIA DE GOIAS	TL10404985	SAO JOAO D ALIANCA	24/10/2020 05:56	25/10/2020 13:19	24/10/2020 07:37	24/10/2020 14:01	6,41	5	32,03	CHI
202010137486	PLANALTINA	TL10404985	SAO JOAO D ALIANCA	24/10/2020 05:56	25/10/2020 13:19	24/10/2020 07:37	24/10/2020 14:01	6,41	1	6,41	CHI
202010141441	SAO LUIS DE MONTES BELOS	SL12383510	SAO LUIZ DOS MONTES BELOS	24/10/2020 05:57	24/10/2020 16:21	24/10/2020 05:57	24/10/2020 16:21	10,39	6	62,36	CHI
202010137761	FORMOSO	TB12185306	PORANGATU	24/10/2020 05:59	24/10/2020 07:54	24/10/2020 05:59	24/10/2020 07:54	1,91	1	1,91	CHI
202010137761	TROMBAS	TB12185306	PORANGATU	24/10/2020 05:59	24/10/2020 07:54	24/10/2020 05:59	24/10/2020 07:54	1,91	10	19,14	CHI
202010137503	PARAUNA	PU12304549	PARAUNA	24/10/2020 06:00	24/10/2020 08:17	24/10/2020 06:00	24/10/2020 08:17	2,27	14	31,74	CHI
202010137975	JANDAIA	JD12308457	PALMEIRAS	24/10/2020 06:01	24/10/2020 15:45	24/10/2020 06:01	24/10/2020 15:45	9,72	17	165,21	CHI
202010137807	CAMPESTRE DE GOIAS	GC12000127	TRINDADE	24/10/2020 06:03	24/10/2020 08:52	24/10/2020 06:03	24/10/2020 08:52	2,81	5	14,05	CHI
202010137848	ARAGARCAS	AG11212886	ARAGARCAS	24/10/2020 06:03	24/10/2020 12:08	24/10/2020 06:03	24/10/2020 12:08	6,07	75	455,38	CHI
202010140480	GOIAS	GS21075465	GOIAS	24/10/2020 06:04	24/10/2020 13:17	24/10/2020 06:04	24/10/2020 13:17	7,21	1	7,21	CHI
202010137899	GOIAS	GS12274373	GOIAS	24/10/2020 06:04	24/10/2020 09:51	24/10/2020 06:04	24/10/2020 09:51	3,78	11	41,56	CHI
202010137516	ITABERAI	IB31198994	ITABERAI S2	24/10/2020 06:04	25/10/2020 09:17	24/10/2020 06:04	25/10/2020 09:17	27,21	1	27,21	CHI
202010137517	NEROPOLIS	160024250	NEROPOLIS S2	24/10/2020 06:04	24/10/2020 13:52	24/10/2020 06:04	24/10/2020 13:52	7,79	1	7,79	CHI
202010137972	CAMPOS VERDES	SG12202098RE	SANTA TEREZINHA	24/10/2020 06:05	24/10/2020 11:34	24/10/2020 06:05	24/10/2020 11:34	5,48	41	224,63	CHI
202010137972	SANTA TEREZINHA DE GOIAS	SG12202098RE	SANTA TEREZINHA	24/10/2020 06:05	24/10/2020 11:34	24/10/2020 06:05	24/10/2020 11:34	5,48	136	745,13	CHI
202010137972	UIRAPURU	SG12202098RE	SANTA TEREZINHA	24/10/2020 06:05	24/10/2020 11:34	24/10/2020 06:05	24/10/2020 11:34	5,48	59	323,25	CHI
202010141578	URUACU	CR21208431	CAMPINORTE	24/10/2020 06:05	24/10/2020 17:57	24/10/2020 06:05	24/10/2020 17:57	11,86	2	23,72	CHI
202010139739	NIQUELANDIA	NQ12140184	SAO JOAO D ALIANCA	24/10/2020 06:06	24/10/2020 11:18	24/10/2020 06:06	24/10/2020 11:18	5,21	59	307,37	CHI
202010140839	MUNDO NOVO DE GOIAS	MH12037774	NOVA CRIXAS	24/10/2020 06:07	24/10/2020 15:52	24/10/2020 06:07	24/10/2020 15:52	9,74	2	19,48	CHI
202010140839	UIRAPURU	MH12037774	NOVA CRIXAS	24/10/2020 06:07	24/10/2020 15:52	24/10/2020 06:07	24/10/2020 15:52	9,74	49	477,33	CHI
202010140839	AMARALINA	MH12037774	NOVA CRIXAS	24/10/2020 06:07	24/10/2020 15:52	24/10/2020 06:07	24/10/2020 15:52	9,74	33	321,47	CHI
202010140839	MARA ROSA	MH12037774	NOVA CRIXAS	24/10/2020 06:07	24/10/2020 15:52	24/10/2020 06:07	24/10/2020 15:52	9,74	7	68,19	CHI
202010137860	GOIANIA	GN12337790	CAMPINAS S2	24/10/2020 06:08	24/10/2020 13:24	24/10/2020 06:08	24/10/2020 13:24	7,27	121	880,27	CHI
202010137536	CIDADE OCIDENTAL	LZ12072636	MARAJOARA	24/10/2020 06:08	24/10/2020 09:44	24/10/2020 06:08	24/10/2020 09:44	3,60	19	68,36	CHI
202010137539	MORRINHOS	MR12000151	MORRINHOS	24/10/2020 06:08	24/10/2020 09:57	24/10/2020 06:08	24/10/2020 09:57	3,81	11	41,90	CHI
202010137542	CALDAS NOVAS	760129423	SERRA DE CALDAS	24/10/2020 06:08	24/10/2020 07:46	24/10/2020 06:08	24/10/2020 07:46	1,62	1	1,62	CHI
202010137601	GOIANIA	GN11126837	AEROPORTO S2	24/10/2020 06:08	24/10/2020 07:20	24/10/2020 06:08	24/10/2020 07:20	1,19	42	49,97	CHI
202010137546	MORRINHOS	150130685	MORRINHOS	24/10/2020 06:08	24/10/2020 18:30	24/10/2020 06:08	24/10/2020 18:30	12,35	1	12,35	CHI
202010138288	MUNDO NOVO DE GOIAS	NA12035650	NOVA CRIXAS	24/10/2020 06:09	24/10/2020 11:33	24/10/2020 06:09	24/10/2020 11:33	5,40	8	43,16	CHI
202010138288	NOVA CRIXAS	NA12035650	NOVA CRIXAS	24/10/2020 06:09	24/10/2020 11:33	24/10/2020 06:09	24/10/2020 11:33	5,40	24	129,49	CHI
202010137552	GOIANIA	14885359	ATLANTICO S1	24/10/2020 06:09	24/10/2020 14:31	24/10/2020 06:09	24/10/2020 14:31	8,35	1	8,35	CHI
202010137670	GOIAS	GS12092203	MATRINCHA	24/10/2020 06:10	24/10/2020 08:54	24/10/2020 06:10	24/10/2020 08:54	2,73	4	10,92	CHI
202010137670	ITAPIRAPUA	GS12092203	MATRINCHA	24/10/2020 06:10	24/10/2020 08:54	24/10/2020 06:10	24/10/2020 08:54	2,73	7	19,11	CHI
202010138355	CAMPO ALEGRE DE GOIAS	CM12266823	CAMPO ALEGRE DE GOIAS	24/10/2020 06:10	24/10/2020 09:35	24/10/2020 06:10	24/10/2020 09:35	3,40	43	146,36	CHI
202010137560	ARAGUAPAZ	AZ12253302	RUBIATABA	24/10/2020 06:10	24/10/2020 10:10	24/10/2020 06:10	24/10/2020 10:10	3,99	21	83,69	CHI
202010137561	HIDROLANDIA	HD12130657	CEPAIGO S2	24/10/2020 06:10	24/10/2020 16:35	24/10/2020 06:10	24/10/2020 16:35	10,40	1	10,40	CHI
202010137561	HIDROLANDIA	HD12275932	CEPAIGO S2	24/10/2020 06:10	24/10/2020 16:35	24/10/2020 06:10	24/10/2020 12:38	6,47	1	6,47	CHI
202010137563	CATALAO	CT21063905	CATALAO S1	24/10/2020 06:11	24/10/2020 08:25	24/10/2020 06:11	24/10/2020 08:25	2,23	2	4,45	CHI
202010137833	MATRINCHA	AZ12042965	MOZARLANDIA	24/10/2020 06:11	25/10/2020 21:00	24/10/2020 06:11	25/10/2020 21:00	38,80	3	116,41	CHI
202010137833	ARUANA	AZ12042965	MOZARLANDIA	24/10/2020 06:11	25/10/2020 21:00	24/10/2020 06:11	25/10/2020 21:00	38,80	3	116,41	CHI
202010137833	ARUANA	AZ12042965	MOZARLANDIA	24/10/2020 06:11	25/10/2020 21:00	24/10/2020 06:11	25/10/2020 20:36	38,42	2	76,84	CHI
202010137833	MATRINCHA	AZ12042965	MOZARLANDIA	24/10/2020 06:11	25/10/2020 21:00	24/10/2020 06:11	25/10/2020 20:36	38,42	6	230,51	CHI
202010137833	MATRINCHA	AZ12042965	MOZARLANDIA	24/10/2020 06:11	25/10/2020 21:00	24/10/2020 06:11	25/10/2020 20:19	38,12	3	114,36	CHI
202010137833	ARUANA	AZ12042965	MOZARLANDIA	24/10/2020 06:11	25/10/2020 21:00	24/10/2020 06:11	25/10/2020 17:30	35,31	1	35,31	CHI
202010137833	MATRINCHA	AZ12042965	MOZARLANDIA	24/10/2020 06:11	25/10/2020 21:00	24/10/2020 06:11	25/10/2020 17:30	35,31	11	388,44	CHI

202010137833	MATRINCHA	AZ12042965	MOZARLANDIA	24/10/2020 06:11	25/10/2020 21:00	24/10/2020 06:11	25/10/2020 12:57	30,76	12	369,09	CHI
202010137833	ARUANA	MP13042875	MOZARLANDIA	24/10/2020 06:11	25/10/2020 21:00	24/10/2020 10:40	25/10/2020 12:57	26,29	4	105,15	CHI
202010137833	MATRINCHA	MP13042875	MOZARLANDIA	24/10/2020 06:11	25/10/2020 21:00	24/10/2020 10:40	25/10/2020 12:57	26,29	2	52,57	CHI
202010137833	MATRINCHA	AZ12042965	MOZARLANDIA	24/10/2020 06:11	25/10/2020 21:00	24/10/2020 06:11	24/10/2020 17:10	10,97	1	10,97	CHI
202010137833	ARUANA	AZ12042965	MOZARLANDIA	24/10/2020 06:11	25/10/2020 21:00	24/10/2020 06:11	24/10/2020 17:10	10,97	60	658,22	CHI
202010137833	ARUANA	MP12010436LD	MOZARLANDIA	24/10/2020 06:11	25/10/2020 21:00	24/10/2020 10:40	24/10/2020 17:10	6,50	1	6,50	CHI
202010137833	MATRINCHA	AZ12042965	MOZARLANDIA	24/10/2020 06:11	25/10/2020 21:00	24/10/2020 06:11	24/10/2020 14:50	8,65	1	8,65	CHI
202010137833	ARAGUAPAZ	AZ12042965	MOZARLANDIA	24/10/2020 06:11	25/10/2020 21:00	24/10/2020 06:11	24/10/2020 14:50	8,65	4	34,58	CHI
202010137833	ARAGUAPAZ	AZ12042965	MOZARLANDIA	24/10/2020 06:11	25/10/2020 21:00	24/10/2020 10:40	24/10/2020 14:50	4,18	14	58,45	CHI
202010138260	CRISTALINA	LZ10407611	MARAJOARA	24/10/2020 06:12	24/10/2020 10:10	24/10/2020 06:12	24/10/2020 10:10	3,96	1	3,96	CHI
202010138260	LUZIANIA	LZ10407611	MARAJOARA	24/10/2020 06:12	24/10/2020 10:10	24/10/2020 06:12	24/10/2020 10:10	3,96	353	1398,37	CHI
202010138054	PALMEIRAS DE GOIAS	PL12205904	PALMEIRAS	24/10/2020 06:12	24/10/2020 08:30	24/10/2020 06:12	24/10/2020 08:30	2,29	54	123,75	CHI
202010138054	JANDAIA	PL12205904	PALMEIRAS	24/10/2020 06:12	24/10/2020 08:30	24/10/2020 06:12	24/10/2020 08:30	2,29	1	2,29	CHI
202010140900	ARUANA	AK11253726	ARUANA	24/10/2020 06:16	24/10/2020 17:59	24/10/2020 06:16	24/10/2020 17:59	11,71	79	925,46	CHI
202010137590	COCALZINHO DE GOIAS	ZN12155159	COCALZINHO	24/10/2020 06:17	24/10/2020 10:52	24/10/2020 06:17	24/10/2020 10:52	4,58	139	635,93	CHI
202010138886	NOVA CRIXAS	NA12090020	NOVA CRIXAS	24/10/2020 06:18	24/10/2020 16:00	24/10/2020 06:18	24/10/2020 16:00	9,70	12	116,43	CHI
202010137704	NAZARIO	AV12299225	TRINDADE	24/10/2020 06:20	24/10/2020 14:40	24/10/2020 06:20	24/10/2020 14:40	8,32	5	41,62	CHI
202010137704	AVELINOPOLIS	AV12299225	TRINDADE	24/10/2020 06:20	24/10/2020 14:40	24/10/2020 06:20	24/10/2020 14:40	8,32	1	8,32	CHI
202010137704	NAZARIO	AV12299225	TRINDADE	24/10/2020 06:20	24/10/2020 14:40	24/10/2020 12:00	24/10/2020 14:40	2,67	2	5,35	CHI
202010137704	AVELINOPOLIS	AV12299225	TRINDADE	24/10/2020 06:20	24/10/2020 14:40	24/10/2020 12:00	24/10/2020 14:40	2,67	2	5,35	CHI
202010139859	ITAPURANGA	IK12426653	ITAPURANGA	24/10/2020 06:21	24/10/2020 19:39	24/10/2020 06:21	24/10/2020 19:39	13,30	11	146,28	CHI
202010139859	ITAPURANGA	IK21289410	ITAPURANGA	24/10/2020 06:21	24/10/2020 19:39	24/10/2020 16:39	24/10/2020 19:18	2,63	1	2,63	CHI
202010139859	ITAPURANGA	IK21167555	ITAPURANGA	24/10/2020 06:21	24/10/2020 19:39	24/10/2020 16:40	24/10/2020 19:00	2,34	3	7,02	CHI
202010140698	ANAPOLIS	AN11000426	JUNDIAI S1	24/10/2020 06:21	24/10/2020 12:01	24/10/2020 06:21	24/10/2020 12:01	5,66	165	934,50	CHI
202010137612	ANAPOLIS	AN12264489	JUNDIAI S1	24/10/2020 06:21	24/10/2020 11:12	24/10/2020 06:21	24/10/2020 11:12	4,85	112	542,86	CHI
202010137616	SANTA CRUZ DE GOIAS	BC12087092	PIRES DO RIO S2	24/10/2020 06:21	24/10/2020 11:46	24/10/2020 06:21	24/10/2020 11:46	5,42	12	64,99	CHI
202010137617	LUZIANIA	3200207174	MARAJOARA	24/10/2020 06:21	24/10/2020 08:34	24/10/2020 06:21	24/10/2020 08:34	2,20	1	2,20	CHI
202010189362	VICENTINOPOLIS	VI12352541	VICENTINOPOLIS	24/10/2020 06:22	24/10/2020 09:25	24/10/2020 06:22	24/10/2020 09:25	3,05	4	12,20	CHI
202010137622	LUZIANIA	LZ11061803	RIO VERMELHO	24/10/2020 06:22	24/10/2020 08:16	24/10/2020 06:22	24/10/2020 08:16	1,90	7	13,27	CHI
202010137625	APARECIDA DE GOIANIA	16624166	INDEPENDENCIA S2	24/10/2020 06:22	24/10/2020 08:43	24/10/2020 06:22	24/10/2020 08:43	2,34	1	2,34	CHI
202010137628	PILAR DE GOIAS	GG21094183	SANTA TEREZINHA	24/10/2020 06:23	24/10/2020 22:43	24/10/2020 06:23	24/10/2020 22:43	16,33	1	16,33	CHI
202010137630	NOVO BRASIL	6343097	JUSSARA	24/10/2020 06:23	24/10/2020 17:24	24/10/2020 06:23	24/10/2020 17:24	11,02	4	44,08	CHI
202010137632	PLANALTINA	PI12131795	PLANALTINA	24/10/2020 06:23	24/10/2020 18:23	24/10/2020 06:23	24/10/2020 18:23	11,99	2	23,99	CHI
202010137632	PLANALTINA	PI12131795	PLANALTINA	24/10/2020 06:23	24/10/2020 18:23	24/10/2020 16:24	24/10/2020 18:23	1,98	5	9,88	CHI
202010137632	PLANALTINA	PI12131795	PLANALTINA	24/10/2020 06:23	24/10/2020 18:23	24/10/2020 06:23	24/10/2020 12:37	6,22	5	31,09	CHI
202010139692	COCALZINHO DE GOIAS	ZN12297780	COCALZINHO	24/10/2020 06:24	24/10/2020 12:48	24/10/2020 06:24	24/10/2020 12:48	6,39	9	57,49	CHI
202010140974	JARAGUA	JA11258146	JARAGUA	24/10/2020 06:25	24/10/2020 15:32	24/10/2020 06:25	24/10/2020 15:32	9,11	14	127,59	CHI
202010138705	JARAGUA	JA12258144	JARAGUA	24/10/2020 06:25	24/10/2020 11:07	24/10/2020 06:25	24/10/2020 11:07	4,70	28	131,52	CHI
202010137638	MARA ROSA	MQ12099868	MARA ROSA	24/10/2020 06:25	24/10/2020 09:15	24/10/2020 06:25	24/10/2020 09:15	2,83	25	70,70	CHI
202010137638	CAMPINORTE	MQ12099868	MARA ROSA	24/10/2020 06:25	24/10/2020 09:15	24/10/2020 06:25	24/10/2020 09:15	2,83	4	11,31	CHI
202010137642	FAZENDA NOVA	FN12250857	IPORA	24/10/2020 06:25	24/10/2020 10:37	24/10/2020 06:25	24/10/2020 10:37	4,19	11	46,08	CHI
202010140496	ITABERAI	IB12000038	ITABERAI S2	24/10/2020 06:26	25/10/2020 07:46	24/10/2020 06:26	25/10/2020 07:46	25,33	35	886,50	CHI
202010137655	ANICUNS	AC21009071	ANICUNS	24/10/2020 06:27	24/10/2020 13:33	24/10/2020 06:27	24/10/2020 13:33	7,10	1	7,10	CHI
202010137659	SANTA FE DE GOIAS	RN12167348	BRITANIA	24/10/2020 06:27	24/10/2020 12:35	24/10/2020 06:27	24/10/2020 12:35	6,13	1	6,13	CHI
202010137661	GOIANIA	10041345	CARAJAS S2	24/10/2020 06:27	24/10/2020 19:26	24/10/2020 06:27	24/10/2020 19:26	12,97	1	12,97	CHI
202010137669	GUAPO	10026221550	GUAPO S1	24/10/2020 06:29	24/10/2020 08:14	24/10/2020 06:29	24/10/2020 08:14	1,74	1	1,74	CHI
202010139317	GOIAS	GS12259614	GOIAS	24/10/2020 06:31	24/10/2020 16:54	24/10/2020 06:31	24/10/2020 16:54	10,38	14	145,28	CHI
202010137679	TRINDADE	10004181407	TRINDADE	24/10/2020 06:31	24/10/2020 11:06	24/10/2020 06:31	24/10/2020 11:06	4,58	1	4,58	CHI
202010137816	MORRINHOS	MR12098644	MORRINHOS	24/10/2020 06:32	24/10/2020 07:50	24/10/2020 06:32	24/10/2020 07:50	1,29	338	436,02	CHI
202010137691	ARAGOIANIA	AO11291512	GUAPO S2	24/10/2020 06:33	24/10/2020 09:34	24/10/2020 06:33	24/10/2020 09:34	3,01	34	102,41	CHI
202010137867	MOSSAMEDES	KB12079150	ANICUNS	24/10/2020 06:33	24/10/2020 08:33	24/10/2020 06:33	24/10/2020 08:33	1,99	7	13,91	CHI

202010137697	ARAGUAPAZ	AZ12041200	GOIAS	24/10/2020 06:34	24/10/2020 13:24	24/10/2020 06:34	24/10/2020 13:24	6,83	3	20,49	CHI
202010137703	PIRACANJUBA	PJ21134778	PIRACANJUBA	24/10/2020 06:34	24/10/2020 11:30	24/10/2020 06:34	24/10/2020 11:30	4,92	2	9,83	CHI
202010137992	PONTALINA	PK12328982	PONTALINA	24/10/2020 06:35	25/10/2020 09:41	24/10/2020 06:35	25/10/2020 09:41	27,09	8	216,76	CHI
202010137713	PLANALTINA	PI12375539	PLANALTINA	24/10/2020 06:36	24/10/2020 10:27	24/10/2020 06:36	24/10/2020 10:27	3,86	42	161,96	CHI
202010137716	NOVO PLANALTO	TA12391932	NOVO PLANALTO	24/10/2020 06:36	24/10/2020 16:50	24/10/2020 06:36	24/10/2020 16:50	10,22	6	61,33	CHI
202010137727	GOIANIA	11682620	CAMPINAS S3	24/10/2020 06:38	24/10/2020 10:29	24/10/2020 06:38	24/10/2020 10:29	3,84	1	3,84	CHI
202010139239	JARAGUA	JA12000236	JARAGUA	24/10/2020 06:38	24/10/2020 15:47	24/10/2020 06:38	24/10/2020 15:47	9,14	26	237,69	CHI
202010138518	GOIANIA	GN11148159	MEIA PONTE	24/10/2020 06:39	24/10/2020 16:19	24/10/2020 06:39	24/10/2020 16:19	9,65	72	694,92	CHI
202010137741	COCALZINHO DE GOIAS	ZN12144220	COCALZINHO	24/10/2020 06:41	24/10/2020 15:51	24/10/2020 06:41	24/10/2020 15:51	9,17	1	9,17	CHI
202010137748	NOVA IGUACU DE GOIAS	NH12166555	SANTA TEREZINHA	24/10/2020 06:42	25/10/2020 08:56	24/10/2020 06:42	25/10/2020 08:56	26,23	2	52,46	CHI
202010137748	PILAR DE GOIAS	NH12166555	SANTA TEREZINHA	24/10/2020 06:42	25/10/2020 08:56	24/10/2020 06:42	25/10/2020 08:56	26,23	2	52,46	CHI
202010189355	CORREGO DO OURO	CO12383519	FIRMINOPOLIS S2	24/10/2020 06:42	24/10/2020 09:24	24/10/2020 06:42	24/10/2020 09:24	2,69	24	64,59	CHI
202010137885	CAIAPONIA	CP12395440	PALESTINA	24/10/2020 06:42	24/10/2020 10:54	24/10/2020 06:42	24/10/2020 10:54	4,19	18	75,42	CHI
202010137755	MINACU	IH12392289	MINACU	24/10/2020 06:42	24/10/2020 09:40	24/10/2020 06:42	24/10/2020 09:40	2,95	10	29,53	CHI
202010138623	AVELINOPOLIS	AV12071782	ANICUNS	24/10/2020 06:43	24/10/2020 10:05	24/10/2020 06:43	24/10/2020 10:05	3,36	10	33,65	CHI
202010138623	SANTA BARBARA DE GOIAS	AV12071782	ANICUNS	24/10/2020 06:43	24/10/2020 10:05	24/10/2020 06:43	24/10/2020 10:05	3,36	8	26,92	CHI
202010137760	GOIANESIA	GE12016189	GOIANESIA S2	24/10/2020 06:43	24/10/2020 23:11	24/10/2020 06:43	24/10/2020 23:11	16,45	5	82,27	CHI
202010137764	GOIANESIA	550071672	GOIANESIA S2	24/10/2020 06:44	25/10/2020 09:09	24/10/2020 06:44	25/10/2020 09:09	26,42	1	26,42	CHI
202010137766	SENADOR CANEDO	190141750	SENADOR CANEDO	24/10/2020 06:44	24/10/2020 08:06	24/10/2020 06:44	24/10/2020 08:06	1,36	1	1,36	CHI
202010137770	ANAPOLIS	20054397	JUNDIAI S1	24/10/2020 06:44	24/10/2020 11:33	24/10/2020 06:44	24/10/2020 11:33	4,81	1	4,81	CHI
202010138986	SILVANIA	SV12202383	CEPAIGO S2	24/10/2020 06:46	24/10/2020 12:55	24/10/2020 06:46	24/10/2020 12:55	6,15	3	18,45	CHI
202010138986	CALDAZINHA	SV12202383	CEPAIGO S2	24/10/2020 06:46	24/10/2020 12:55	24/10/2020 06:46	24/10/2020 12:55	6,15	14	86,10	CHI
202010137779	GOIANIRA	GR32018478	MEIA PONTE	24/10/2020 06:46	24/10/2020 09:40	24/10/2020 06:46	24/10/2020 09:40	2,90	31	89,75	CHI
202010137781	CALDAS NOVAS	CN11163531	CALDAS NOVAS S2	24/10/2020 06:46	24/10/2020 11:27	24/10/2020 06:46	24/10/2020 11:27	4,67	169	789,51	CHI
202010140961	GOIANIA	GN11265421	ATLANTICO S1	24/10/2020 06:49	24/10/2020 13:06	24/10/2020 06:49	24/10/2020 13:06	6,28	86	540,25	CHI
202010137796	CATALAO	1990174532	CATALAO S2	24/10/2020 06:49	24/10/2020 08:39	24/10/2020 06:49	24/10/2020 08:39	1,83	1	1,83	CHI
202010137797	PIRACANJUBA	60082940	PIRACANJUBA	24/10/2020 06:49	25/10/2020 18:39	24/10/2020 06:49	25/10/2020 18:39	35,82	1	35,82	CHI
202010139343	BARRO ALTO	BA12414688	BARRO ALTO	24/10/2020 06:50	24/10/2020 18:35	24/10/2020 06:50	24/10/2020 18:35	11,74	32	375,83	CHI
202010138271	FORMOSO	FO12145370RE	MARA ROSA	24/10/2020 06:50	25/10/2020 14:44	24/10/2020 06:50	25/10/2020 14:44	31,90	1	31,90	CHI
202010138271	FORMOSO	FO12145370RE	MARA ROSA	24/10/2020 06:50	25/10/2020 14:44	24/10/2020 06:50	25/10/2020 13:56	31,09	3	93,28	CHI
202010138271	FORMOSO	FO12145370RE	MARA ROSA	24/10/2020 06:50	25/10/2020 14:44	25/10/2020 10:59	25/10/2020 13:05	2,09	55	114,78	CHI
202010138271	FORMOSO	FO12145370RE	MARA ROSA	24/10/2020 06:50	25/10/2020 14:44	24/10/2020 06:50	24/10/2020 17:39	10,81	39	421,71	CHI
202010138271	FORMOSO	FO12145370RE	MARA ROSA	24/10/2020 06:50	25/10/2020 14:44	24/10/2020 06:50	24/10/2020 11:21	4,51	16	72,13	CHI
202010138482	NOVA CRIXAS	NA12091638	NOVA CRIXAS	24/10/2020 06:51	24/10/2020 16:51	24/10/2020 06:51	24/10/2020 16:51	10,00	9	89,99	CHI
202010137810	GOIANIA	15965946	CAMPINAS S1	24/10/2020 06:51	24/10/2020 19:53	24/10/2020 06:51	24/10/2020 19:53	13,02	1	13,02	CHI
202010138118	CEZARINA	CZ12010861	CEZARINA	24/10/2020 06:52	24/10/2020 09:37	24/10/2020 06:52	24/10/2020 09:37	2,76	24	66,23	CHI
202010138118	PALMEIRAS DE GOIAS	CZ12010861	CEZARINA	24/10/2020 06:52	24/10/2020 09:37	24/10/2020 06:52	24/10/2020 09:37	2,76	12	33,12	CHI
202010138592	TRINDADE	TR12071591	TRINDADE	24/10/2020 06:52	24/10/2020 12:20	24/10/2020 06:52	24/10/2020 12:20	5,46	10	54,60	CHI
202010137981	CAMPOS VERDES	VD12181194	SANTA TEREZINHA	24/10/2020 06:52	24/10/2020 12:22	24/10/2020 06:52	24/10/2020 12:22	5,49	14	76,79	CHI
202010137824	GOIANIA	10330586	CAMPINAS S1	24/10/2020 06:53	24/10/2020 13:03	24/10/2020 06:53	24/10/2020 13:03	6,17	1	6,17	CHI
202010137927	CALDAS NOVAS	CN12363765	CALDAS NOVAS S1	24/10/2020 06:53	25/10/2020 11:05	24/10/2020 06:53	25/10/2020 11:05	28,19	20	563,86	CHI
202010137834	CRISTALINA	KR21248643	CRISTALINA S1	24/10/2020 06:54	24/10/2020 14:44	24/10/2020 06:54	24/10/2020 14:44	7,83	2	15,66	CHI
202010138272	SILVANIA	SV12349987	VIANOPOLIS	24/10/2020 06:54	24/10/2020 08:46	24/10/2020 06:54	24/10/2020 08:46	1,85	101	187,21	CHI
202010137898	IPAMERI	IP12188743	PIRES DO RIO S2	24/10/2020 06:54	24/10/2020 10:16	24/10/2020 06:54	24/10/2020 10:16	3,35	4	13,42	CHI
202010137850	GOIANIA	12413707	GOIANIA LESTE S1	24/10/2020 06:57	24/10/2020 10:31	24/10/2020 06:57	24/10/2020 10:31	3,57	1	3,57	CHI
202010137852	GOIANIA	10020439316	REAL S1	24/10/2020 06:57	24/10/2020 08:47	24/10/2020 06:57	24/10/2020 08:47	1,83	1	1,83	CHI
202010138648	GOIANIA	GN12044463	XAVANTES	24/10/2020 06:57	24/10/2020 09:09	24/10/2020 06:57	24/10/2020 09:09	2,19	843	1842,19	CHI
202010137862	HIDROLANDIA	HD12402110	INDEPENDENCIA S1	24/10/2020 06:58	24/10/2020 09:53	24/10/2020 06:58	24/10/2020 09:53	2,91	2	5,82	CHI
202010143237	PALMEIRAS DE GOIAS	PL12158923	EDEIA	24/10/2020 06:58	24/10/2020 18:14	24/10/2020 06:58	24/10/2020 18:14	11,26	3	33,77	CHI
202010143237	INDIARA	PL12158923	EDEIA	24/10/2020 06:58	24/10/2020 18:14	24/10/2020 06:58	24/10/2020 18:14	11,26	1	11,26	CHI
202010138678	AGUA FRIA DE GOIAS	TL12208773	SAO JOAO D ALIANCA	24/10/2020 07:00	24/10/2020 11:51	24/10/2020 07:00	24/10/2020 11:51	4,85	14	67,84	CHI



202010138678	MIMOSO DE GOIAS	TL12208773	SAO JOAO D ALIANCA	24/10/2020 07:00	24/10/2020 11:51	24/10/2020 07:00	24/10/2020 11:51	4,85	29	140,52	CHI
202010138519	MOSSAMEDES	ND12299618	ITABERAI S2	24/10/2020 07:00	24/10/2020 17:31	24/10/2020 07:00	24/10/2020 17:31	10,51	18	189,14	CHI
202010137876	MUTUNOPOLIS	MU21208359	MARA ROSA	24/10/2020 07:00	24/10/2020 08:56	24/10/2020 07:00	24/10/2020 08:56	1,92	1	1,92	CHI
202010137883	NEROPOLIS	GN12090095LD	XAVANTES	24/10/2020 07:02	24/10/2020 21:16	24/10/2020 07:02	24/10/2020 21:16	14,25	26	370,38	CHI
202010137883	GOIANIA	GN12090095LD	XAVANTES	24/10/2020 07:02	24/10/2020 21:16	24/10/2020 07:02	24/10/2020 21:16	14,25	27	384,62	CHI
202010137883	GOIANIA	GN12090095LD	XAVANTES	24/10/2020 07:02	24/10/2020 21:16	24/10/2020 19:21	24/10/2020 21:16	1,93	1	1,93	CHI
202010138217	MINACU	IH12220633	MINACU	24/10/2020 07:03	25/10/2020 02:50	24/10/2020 07:03	25/10/2020 02:50	19,78	22	435,13	CHI
202010139939	SANTO ANTONIO DO DESCOBERTO	SN12339988	MARAJOARA	24/10/2020 07:05	24/10/2020 14:40	24/10/2020 07:05	24/10/2020 14:40	7,60	8	60,77	CHI
202010140932	ACREUNA	IY12205934	EDEIA	24/10/2020 07:05	24/10/2020 20:59	24/10/2020 07:05	24/10/2020 20:59	13,89	6	83,35	CHI
202010140932	INDIARA	IY12205934	EDEIA	24/10/2020 07:05	24/10/2020 20:59	24/10/2020 07:05	24/10/2020 20:59	13,89	6	83,35	CHI
202010137932	MARA ROSA	MQ13023845	MARA ROSA	24/10/2020 07:06	24/10/2020 21:34	24/10/2020 14:15	24/10/2020 21:34	7,31	5	36,57	CHI
202010137932	ALTO HORIZONTE	MQ13023845	MARA ROSA	24/10/2020 07:06	24/10/2020 21:34	24/10/2020 14:15	24/10/2020 21:34	7,31	37	270,63	CHI
202010137932	NOVA IGUACU DE GOIAS	MQ13023845	MARA ROSA	24/10/2020 07:06	24/10/2020 21:34	24/10/2020 14:15	24/10/2020 21:34	7,31	12	87,77	CHI
202010137932	MARA ROSA	MQ13023845	MARA ROSA	24/10/2020 07:06	24/10/2020 21:34	24/10/2020 20:54	24/10/2020 21:34	0,66	33	21,94	CHI
202010137932	URUACU	MQ13023845	MARA ROSA	24/10/2020 07:06	24/10/2020 21:34	24/10/2020 20:54	24/10/2020 21:34	0,66	1	0,66	CHI
202010137932	ALTO HORIZONTE	MQ13023845	MARA ROSA	24/10/2020 07:06	24/10/2020 21:34	24/10/2020 20:54	24/10/2020 21:34	0,66	12	7,98	CHI
202010137932	MARA ROSA	MQ12031345	MARA ROSA	24/10/2020 07:06	24/10/2020 21:34	24/10/2020 07:06	24/10/2020 19:52	12,76	7	89,34	CHI
202010137932	MARA ROSA	MQ12146959	MARA ROSA	24/10/2020 07:06	24/10/2020 21:34	24/10/2020 07:06	24/10/2020 19:40	12,57	10	125,69	CHI
202010137932	NOVA IGUACU DE GOIAS	MQ12146959	MARA ROSA	24/10/2020 07:06	24/10/2020 21:34	24/10/2020 07:06	24/10/2020 19:40	12,57	12	150,82	CHI
202010137932	MARA ROSA	MQ13023844	MARA ROSA	24/10/2020 07:06	24/10/2020 21:34	24/10/2020 07:06	24/10/2020 18:58	11,87	91	1080,07	CHI
202010137932	MARA ROSA	MQ10400799	MARA ROSA	24/10/2020 07:06	24/10/2020 21:34	24/10/2020 07:06	24/10/2020 10:42	3,60	37	133,32	CHI
202010137932	URUACU	MQ10400799	MARA ROSA	24/10/2020 07:06	24/10/2020 21:34	24/10/2020 07:06	24/10/2020 10:42	3,60	1	3,60	CHI
202010137932	ALTO HORIZONTE	MQ10400799	MARA ROSA	24/10/2020 07:06	24/10/2020 21:34	24/10/2020 07:06	24/10/2020 10:42	3,60	47	169,36	CHI
202010137932	MARA ROSA	MQ10403947	MARA ROSA	24/10/2020 07:06	24/10/2020 21:34	24/10/2020 07:06	24/10/2020 08:31	1,42	64	90,92	CHI
202010138282	SAO MIGUEL DO PASSA QUATRO	SO12070878	CRISTIANOPOLIS	24/10/2020 07:07	24/10/2020 15:18	24/10/2020 07:07	24/10/2020 15:18	8,18	19	155,47	CHI
202010137930	ITABERAI	IB12090330	ANICUNS	24/10/2020 07:07	24/10/2020 14:52	24/10/2020 07:07	24/10/2020 14:52	7,74	8	61,91	CHI
202010137934	ANAPOLIS	AN12258779	JUNDIAI S1	24/10/2020 07:07	24/10/2020 10:26	24/10/2020 07:07	24/10/2020 10:26	3,30	4	13,20	CHI
202010140591	IVOLANDIA	IV12323743	IPORA	24/10/2020 07:09	24/10/2020 20:48	24/10/2020 07:09	24/10/2020 20:48	13,65	6	81,90	CHI
202010137958	CRISTALINA	KR10414222	CRISTALINA S1	24/10/2020 07:09	24/10/2020 09:23	24/10/2020 07:09	24/10/2020 09:23	2,23	244	543,31	CHI
202010137958	CRISTALINA	KR10395376	CRISTALINA S1	24/10/2020 07:09	24/10/2020 09:23	24/10/2020 07:09	24/10/2020 09:21	2,20	24	52,87	CHI
202010137958	IPAMERI	KR10395376	CRISTALINA S1	24/10/2020 07:09	24/10/2020 09:23	24/10/2020 07:09	24/10/2020 09:21	2,20	6	13,22	CHI
202010137950	EDEIA	1120010278	EDEIA	24/10/2020 07:10	24/10/2020 09:05	24/10/2020 07:10	24/10/2020 09:05	1,91	1	1,91	CHI
202010137953	SAO LUIS DE MONTES BELOS	10021341158	SAO LUIZ DOS MONTES BELOS	24/10/2020 07:11	24/10/2020 14:54	24/10/2020 07:11	24/10/2020 14:54	7,72	1	7,72	CHI
202010137956	NOVA VENEZA	NV21364341	INHUMAS S1	24/10/2020 07:12	24/10/2020 15:26	24/10/2020 07:12	24/10/2020 15:26	8,23	1	8,23	CHI
202010137957	MINACU	4020098166	MINACU	24/10/2020 07:12	24/10/2020 20:23	24/10/2020 07:12	24/10/2020 20:23	13,18	1	13,18	CHI
202010142667	CAMPO ALEGRE DE GOIAS	CM12420390	CAMPO ALEGRE DE GOIAS	24/10/2020 07:13	24/10/2020 16:59	24/10/2020 07:13	24/10/2020 16:59	9,76	24	234,32	CHI
202010137963	SENADOR CANEDO	SW21286568	CEPAIGO S2	24/10/2020 07:13	24/10/2020 09:29	24/10/2020 07:13	24/10/2020 09:29	2,25	1	2,25	CHI
202010137983	GOIANIA	GN11042231	AEROPORTO S2	24/10/2020 07:19	24/10/2020 13:02	24/10/2020 07:19	24/10/2020 13:02	5,71	31	177,11	CHI
202010137984	SANTO ANTONIO DO DESCOBERTO	SN12379435LD	ALEXANIA	24/10/2020 07:19	25/10/2020 20:35	25/10/2020 18:24	25/10/2020 20:35	2,18	11	24,02	CHI
202010137984	SANTO ANTONIO DO DESCOBERTO	SN12379435LD	ALEXANIA	24/10/2020 07:19	25/10/2020 20:35	25/10/2020 19:00	25/10/2020 20:35	1,59	1	1,59	CHI
202010137984	SANTO ANTONIO DO DESCOBERTO	SN12379435LD	ALEXANIA	24/10/2020 07:19	25/10/2020 20:35	24/10/2020 07:19	25/10/2020 18:20	35,02	12	420,18	CHI
202010137995	JARAGUA	JA12353232	GOIANESIA S2	24/10/2020 07:19	24/10/2020 10:03	24/10/2020 07:19	24/10/2020 10:03	2,72	30	81,63	CHI
202010137986	SITIO D ABADIA	SI12302925	IACIARA S2	24/10/2020 07:20	24/10/2020 08:16	24/10/2020 07:20	24/10/2020 08:16	0,93	12	11,13	CHI
202010137997	CATALAO	CT11203040	CATALAO S2	24/10/2020 07:21	24/10/2020 09:06	24/10/2020 07:21	24/10/2020 09:06	1,74	145	252,46	CHI
202010142413	SAO LUIS DE MONTES BELOS	SL32145763	SAO LUIZ DOS MONTES BELOS	24/10/2020 07:22	24/10/2020 17:07	24/10/2020 07:22	24/10/2020 17:07	9,74	3	29,23	CHI
202010138500	CRISTALINA	KR12348546RE	PAMPLONA	24/10/2020 07:23	24/10/2020 09:48	24/10/2020 07:23	24/10/2020 09:48	2,40	23	55,31	CHI
202010138013	ITAPURANGA	7543500	ITAPURANGA	24/10/2020 07:24	25/10/2020 12:45	24/10/2020 07:24	25/10/2020 12:45	29,34	6	176,01	CHI
202010138024	TEREZOPOLIS DE GOIAS	AN12012956	JUNDIAI S1	24/10/2020 07:27	24/10/2020 22:42	24/10/2020 07:27	24/10/2020 22:42	15,25	11	167,79	CHI
202010138023	POSSE	PS11071348	IACIARA S2	24/10/2020 07:27	24/10/2020 10:01	24/10/2020 07:27	24/10/2020 10:01	2,57	166	425,97	CHI
202010138210	NOVA CRIXAS	NA12262740	NOVA CRIXAS	24/10/2020 07:27	24/10/2020 10:01	24/10/2020 07:27	24/10/2020 10:01	2,56	107	274,45	CHI
202010138034	BOM JESUS DE GOIAS	BJ12011402	BOM JESUS DE GOIAS	24/10/2020 07:28	24/10/2020 23:36	24/10/2020 07:28	24/10/2020 23:36	16,13	1	16,13	CHI

202010138038	ANAPOLIS	10029510447	JUNDIAI S2	24/10/2020 07:28	24/10/2020 13:38	24/10/2020 07:28	24/10/2020 13:38	6,16	1	6,16	CHI
202010138442	JARAGUA	JA12070670	JARAGUA	24/10/2020 07:28	24/10/2020 14:13	24/10/2020 07:28	24/10/2020 14:13	6,73	10	67,35	CHI
202010138295	SANTA CRUZ DE GOIAS	BC12023183	CRISTIANOPOLIS	24/10/2020 07:29	24/10/2020 15:27	24/10/2020 07:29	24/10/2020 15:27	7,95	42	334,09	CHI
202010136769	PIRANHAS	PH12253708RE	BOM JARDIM	24/10/2020 07:30	24/10/2020 14:40	24/10/2020 07:30	24/10/2020 14:40	7,15	2	14,31	CHI
202010136769	PIRANHAS	PH12253708RE	BOM JARDIM	24/10/2020 07:30	24/10/2020 14:40	24/10/2020 07:30	24/10/2020 09:59	2,47	20	49,42	CHI
202010138059	MONTES CLAROS DE GOIAS	1440016450	IPORA	24/10/2020 07:30	24/10/2020 09:16	24/10/2020 07:30	24/10/2020 09:16	1,75	1	1,75	CHI
202010138060	MUTUNOPOLIS	MU21133916	MARA ROSA	24/10/2020 07:30	24/10/2020 17:47	24/10/2020 07:30	24/10/2020 17:47	10,27	13	133,49	CHI
202010138065	DAVINOPOLIS	IO12333671	CATALAO S1	24/10/2020 07:31	24/10/2020 10:15	24/10/2020 07:31	24/10/2020 10:15	2,72	3	8,17	CHI
202010138080	ITABERAI	IB12018302	ITABERAI S2	24/10/2020 07:32	24/10/2020 11:10	24/10/2020 07:32	24/10/2020 11:10	3,62	2	7,24	CHI
202010138082	SAO DOMINGOS	GH12241928	SAO DOMINGOS	24/10/2020 07:33	24/10/2020 11:51	24/10/2020 07:33	24/10/2020 11:51	4,30	12	51,55	CHI
202010138082	DIVINOPOLIS DE GOIAS	GH12241928	SAO DOMINGOS	24/10/2020 07:33	24/10/2020 11:51	24/10/2020 07:33	24/10/2020 11:51	4,30	41	176,14	CHI
202010138082	MONTE ALEGRE DE GOIAS	GH12241928	SAO DOMINGOS	24/10/2020 07:33	24/10/2020 11:51	24/10/2020 07:33	24/10/2020 11:51	4,30	2	8,59	CHI
202010138249	RIO QUENTE	RQ12050875	VILA CORUMBA	24/10/2020 07:33	24/10/2020 11:52	24/10/2020 07:33	24/10/2020 11:52	4,31	14	60,27	CHI
202010138097	BOM JESUS DE GOIAS	BJ12078005	BOM JESUS DE GOIAS	24/10/2020 07:34	24/10/2020 09:31	24/10/2020 07:34	24/10/2020 09:31	1,95	3	5,85	CHI
202010138120	PORANGATU	PO12064911	NOVO PLANALTO	24/10/2020 07:35	24/10/2020 11:55	24/10/2020 07:35	24/10/2020 11:55	4,32	136	587,56	CHI
202010138124	EDEIA	EA21245590	EDEIA	24/10/2020 07:36	24/10/2020 09:41	24/10/2020 07:36	24/10/2020 09:41	2,08	2	4,16	CHI
202010138125	IPORA	IR12014019	IPORA	24/10/2020 07:36	24/10/2020 09:13	24/10/2020 07:36	24/10/2020 09:13	1,61	4	6,46	CHI
202010138126	INACIOLANDIA	CD21000091	CACHOEIRA DOURADA	24/10/2020 07:36	24/10/2020 11:20	24/10/2020 07:36	24/10/2020 11:20	3,73	1	3,73	CHI
202010138133	ALEXANIA	AX21086556	ALEXANIA	24/10/2020 07:36	24/10/2020 12:40	24/10/2020 07:36	24/10/2020 12:40	5,05	1	5,05	CHI
202010138134	OURO VERDE DE GOIAS	OV21326414	INHUMAS S1	24/10/2020 07:36	24/10/2020 11:23	24/10/2020 07:36	24/10/2020 11:23	3,77	1	3,77	CHI
202010138148	IACIARA	PS12257681	IACIARA S2	24/10/2020 07:36	24/10/2020 08:58	24/10/2020 07:36	24/10/2020 08:58	1,35	5	6,77	CHI
202010138148	POSSE	PS12257681	IACIARA S2	24/10/2020 07:36	24/10/2020 08:58	24/10/2020 07:36	24/10/2020 08:58	1,35	1	1,35	CHI
202010138139	BURITI ALEGRE	420010282	ALTO BURITI	24/10/2020 07:37	24/10/2020 09:22	24/10/2020 07:37	24/10/2020 09:22	1,75	1	1,75	CHI
202010138939	CATALAO	CT12309518LD	CATALAO S1	24/10/2020 07:37	25/10/2020 11:04	24/10/2020 07:37	25/10/2020 11:04	27,45	4	109,79	CHI
202010138939	CATALAO	CT12203060	CATALAO S1	24/10/2020 07:37	25/10/2020 11:04	24/10/2020 07:37	25/10/2020 09:22	25,75	13	334,74	CHI
202010138939	CATALAO	CT12250333	CATALAO S1	24/10/2020 07:37	25/10/2020 11:04	24/10/2020 07:37	24/10/2020 22:13	14,61	24	350,55	CHI
202010138939	CATALAO	CT12215709RE	CATALAO S1	24/10/2020 07:37	25/10/2020 11:04	24/10/2020 07:37	24/10/2020 21:00	13,39	83	1111,00	CHI
202010138939	CATALAO	CT13341893	CATALAO S1	24/10/2020 07:37	25/10/2020 11:04	24/10/2020 07:37	24/10/2020 20:01	12,40	81	1004,67	CHI
202010138939	CAMPO ALEGRE DE GOIAS	CT13341893	CATALAO S1	24/10/2020 07:37	25/10/2020 11:04	24/10/2020 07:37	24/10/2020 20:01	12,40	1	12,40	CHI
202010138939	CATALAO	CT12306674RE	CATALAO S1	24/10/2020 07:37	25/10/2020 11:04	24/10/2020 07:37	24/10/2020 18:38	11,02	139	1531,55	CHI
202010140066	ARACU	AR11132829	ARACU	24/10/2020 07:37	24/10/2020 13:26	24/10/2020 07:37	24/10/2020 13:26	5,80	70	406,25	CHI
202010138150	APARECIDA DE GOIANIA	200346611	ANHANGUERA	24/10/2020 07:38	24/10/2020 10:31	24/10/2020 07:38	24/10/2020 10:31	2,88	1	2,88	CHI
202010138159	APARECIDA DE GOIANIA	12842369	INDEPENDENCIA S1	24/10/2020 07:38	24/10/2020 10:06	24/10/2020 07:38	24/10/2020 10:06	2,45	1	2,45	CHI
202010138163	EDEALINA	VI12381142	VICENTINOPOLIS	24/10/2020 07:39	24/10/2020 09:29	24/10/2020 07:39	24/10/2020 09:29	1,83	28	51,29	CHI
202010138163	EDEIA	VI12381142	VICENTINOPOLIS	24/10/2020 07:39	24/10/2020 09:29	24/10/2020 07:39	24/10/2020 09:29	1,83	1	1,83	CHI
202010138164	CATALAO	CT21270777	CATALAO S1	24/10/2020 07:39	24/10/2020 11:58	24/10/2020 07:39	24/10/2020 11:58	4,31	2	8,62	CHI
202010138169	IACIARA	IA12385169	IACIARA S2	24/10/2020 07:39	24/10/2020 11:36	24/10/2020 07:39	24/10/2020 11:36	3,94	1	3,94	CHI
202010138170	BOM JARDIM DE GOIAS	BM12241374	BOM JARDIM	24/10/2020 07:39	24/10/2020 10:16	24/10/2020 07:39	24/10/2020 10:16	2,60	2	5,21	CHI
202010140344	PARAUNA	PU21314942	PARAUNA	24/10/2020 07:40	24/10/2020 16:04	24/10/2020 07:40	24/10/2020 16:04	8,40	1	8,40	CHI
202010138172	ANAPOLIS	10021601044	JUNDIAI S1	24/10/2020 07:40	24/10/2020 12:39	24/10/2020 07:40	24/10/2020 12:39	4,98	1	4,98	CHI
202010138173	PALMEIRAS DE GOIAS	10020033999	PALMEIRAS	24/10/2020 07:40	24/10/2020 11:24	24/10/2020 07:40	24/10/2020 11:24	3,73	1	3,73	CHI
202010138232	MORRINHOS	MR12015085	MORRINHOS	24/10/2020 07:40	24/10/2020 09:10	24/10/2020 07:40	24/10/2020 09:10	1,49	9	13,37	CHI
202010139464	GOIAS	GS12217156	GOIAS	24/10/2020 07:41	24/10/2020 16:48	24/10/2020 07:41	24/10/2020 16:48	9,11	4	36,46	CHI
202010138299	INHUMAS	IN21310636	INHUMAS S1	24/10/2020 07:41	24/10/2020 12:15	24/10/2020 07:41	24/10/2020 12:15	4,56	1	4,56	CHI
202010137429	GOIANIA	GN11048166	GOIANIA LESTE S3	24/10/2020 07:42	24/10/2020 08:00	24/10/2020 07:42	24/10/2020 08:00	0,30	51	15,30	CHI
202010141262	SANTA ROSA DE GOIAS	IX12049364	INHUMAS S2	24/10/2020 07:42	24/10/2020 18:58	24/10/2020 07:42	24/10/2020 18:58	11,25	10	112,53	CHI
202010141262	ITAUCU	IX12049364	INHUMAS S2	24/10/2020 07:42	24/10/2020 18:58	24/10/2020 07:42	24/10/2020 18:58	11,25	13	146,29	CHI
202010141193	FAINA	AZ12299868	GOIAS	24/10/2020 07:43	25/10/2020 10:04	24/10/2020 07:43	25/10/2020 10:04	26,34	1	26,34	CHI
202010141193	ARAGUAPAZ	AZ12299868	GOIAS	24/10/2020 07:43	25/10/2020 10:04	24/10/2020 07:43	25/10/2020 10:04	26,34	7	184,37	CHI
202010138530	SANTA TEREZINHA DE GOIAS	GG12171805RE	SANTA TEREZINHA	24/10/2020 07:43	24/10/2020 10:34	24/10/2020 07:43	24/10/2020 10:34	2,84	46	130,60	CHI
202010138530	PILAR DE GOIAS	GG12171805RE	SANTA TEREZINHA	24/10/2020 07:43	24/10/2020 10:34	24/10/2020 07:43	24/10/2020 10:34	2,84	60	170,35	CHI

202010139413	AMARALINA	MU12391653	MARA ROSA	24/10/2020 07:44	24/10/2020 15:16	24/10/2020 07:44	24/10/2020 15:16	7,53	21	158,09	CHI
202010138241	ORIZONA	OZ11202892	PIRES DO RIO S2	24/10/2020 07:44	24/10/2020 14:16	24/10/2020 07:44	24/10/2020 14:16	6,53	134	874,35	CHI
202010138228	COCALZINHO DE GOIAS	ZN12320107	AGUAS LINDAS DE GOIAS S1	24/10/2020 07:45	24/10/2020 15:17	24/10/2020 07:45	24/10/2020 15:17	7,53	14	105,47	CHI
202010138233	GOIATUBA	GT21008229	BOM JESUS DE GOIAS	24/10/2020 07:45	24/10/2020 18:09	24/10/2020 07:45	24/10/2020 18:09	10,39	1	10,39	CHI
202010140617	PIRACANJUBA	PJ12082201	ROCHEDO	24/10/2020 07:46	24/10/2020 17:00	24/10/2020 07:46	24/10/2020 17:00	9,23	7	64,62	CHI
202010138550	MATRINCHA	MP12122362	MATRINCHA	24/10/2020 07:46	24/10/2020 10:19	24/10/2020 07:46	24/10/2020 10:19	2,54	69	175,22	CHI
202010138251	MINACU	IH11208430	MINACU	24/10/2020 07:47	24/10/2020 17:58	24/10/2020 07:47	24/10/2020 17:58	10,18	45	458,24	CHI
202010138262	GOIANIA	10565700	REAL S2	24/10/2020 07:48	24/10/2020 08:45	24/10/2020 07:48	24/10/2020 08:45	0,95	1	0,95	CHI
202010189354	SAO JOAO D ALIANCA	JL12049201	SAO JOAO D ALIANCA	24/10/2020 07:48	24/10/2020 10:17	24/10/2020 07:48	24/10/2020 10:17	2,48	95	235,68	CHI
202010138275	MUTUNOPOLIS	MU21137742	MARA ROSA	24/10/2020 07:49	24/10/2020 16:27	24/10/2020 07:49	24/10/2020 16:27	8,63	1	8,63	CHI
202010189483	SANTA TEREZA DE GOIAS	SE21053789	MARA ROSA	24/10/2020 07:49	25/10/2020 17:53	24/10/2020 07:49	25/10/2020 17:53	34,06	1	34,06	CHI
202010138287	GOIANIA	14498390	GOYA S1	24/10/2020 07:50	24/10/2020 09:45	24/10/2020 07:50	24/10/2020 09:45	1,91	1	1,91	CHI
202010138292	PALMINOPOLIS	PP12259150	PALMEIRAS	24/10/2020 07:50	24/10/2020 09:14	24/10/2020 07:50	24/10/2020 09:14	1,39	8	11,11	CHI
202010138315	ARAGOIANIA	680007880	GUAPO S2	24/10/2020 07:53	24/10/2020 18:06	24/10/2020 07:53	24/10/2020 18:06	10,21	1	10,21	CHI
202010138316	GOIAS	GS12172046	GOIAS	24/10/2020 07:53	24/10/2020 14:42	24/10/2020 07:53	24/10/2020 14:42	6,80	2	13,61	CHI
202010138319	AVELINOPOLIS	AV21379790	TRINDADE	24/10/2020 07:54	24/10/2020 16:47	24/10/2020 07:54	24/10/2020 16:47	8,88	1	8,88	CHI
202010138322	EDEALINA	ED21328998	PONTALINA	24/10/2020 07:54	25/10/2020 22:52	24/10/2020 07:54	25/10/2020 22:52	38,96	2	77,92	CHI
202010141449	COCALZINHO DE GOIAS	ZN12319615	COCALZINHO	24/10/2020 07:54	24/10/2020 14:36	24/10/2020 07:54	24/10/2020 14:36	6,69	22	147,17	CHI
202010138329	LUZIANIA	LZ12390016	MARAJOARA	24/10/2020 07:55	24/10/2020 10:07	24/10/2020 07:55	24/10/2020 10:07	2,20	124	272,25	CHI
202010138330	JUSSARA	BT12274297	BRITANIA	24/10/2020 07:55	24/10/2020 09:18	24/10/2020 07:55	24/10/2020 09:18	1,38	36	49,62	CHI
202010138798	URUACU	CR12410914	MARA ROSA	24/10/2020 07:56	24/10/2020 16:29	24/10/2020 07:56	24/10/2020 16:29	8,54	20	170,80	CHI
202010138798	CAMPINACU	CR12410914	MARA ROSA	24/10/2020 07:56	24/10/2020 16:29	24/10/2020 07:56	24/10/2020 16:29	8,54	283	2416,82	CHI
202010138356	SAO LUIS DE MONTES BELOS	SC12299040	FIRMINOPOLIS S2	24/10/2020 07:57	24/10/2020 10:58	24/10/2020 07:57	24/10/2020 10:58	3,01	47	141,56	CHI
202010138356	SANCLERLANDIA	SC12299040	FIRMINOPOLIS S2	24/10/2020 07:57	24/10/2020 10:58	24/10/2020 07:57	24/10/2020 10:58	3,01	1	3,01	CHI
202010138371	SANTO ANTONIO DE GOIAS	NR21324557	NEROPOLIS S2	24/10/2020 07:59	24/10/2020 09:58	24/10/2020 07:59	24/10/2020 09:58	1,97	1	1,97	CHI
202010138381	CAMPO ALEGRE DE GOIAS	CM21275972	CAMPO ALEGRE DE GOIAS	24/10/2020 08:00	24/10/2020 12:24	24/10/2020 08:00	24/10/2020 12:24	4,40	1	4,40	CHI
202010138613	SANCLERLANDIA	SC12299052	FIRMINOPOLIS S2	24/10/2020 08:02	24/10/2020 11:01	24/10/2020 08:02	24/10/2020 11:01	2,98	4	11,92	CHI
202010138409	CALDAS NOVAS	CN11051668	CALDAS NOVAS S2	24/10/2020 08:03	24/10/2020 13:13	24/10/2020 08:03	24/10/2020 13:13	5,16	95	490,28	CHI
202010138857	SANCLERLANDIA	SC12016782	FIRMINOPOLIS S2	24/10/2020 08:04	24/10/2020 12:51	24/10/2020 08:04	24/10/2020 12:51	4,77	14	66,77	CHI
202010138438	BOM JARDIM DE GOIAS	BM11231854	BOM JARDIM	24/10/2020 08:05	24/10/2020 14:34	24/10/2020 08:05	24/10/2020 14:34	6,47	1	6,47	CHI
202010138441	ITUMBIARA	IT12062955	PARANAIBA	24/10/2020 08:06	24/10/2020 09:50	24/10/2020 08:06	24/10/2020 09:50	1,73	3	5,18	CHI
202010141730	DAMOLANDIA	DL12098268	INHUMAS S1	24/10/2020 08:06	24/10/2020 17:35	24/10/2020 08:06	24/10/2020 17:35	9,47	6	56,82	CHI
202010141730	INHUMAS	DL12098268	INHUMAS S1	24/10/2020 08:06	24/10/2020 17:35	24/10/2020 08:06	24/10/2020 17:35	9,47	53	501,91	CHI
202010138761	BOM JARDIM DE GOIAS	BM12395483	BOM JARDIM	24/10/2020 08:07	24/10/2020 11:43	24/10/2020 08:07	24/10/2020 11:43	3,61	10	36,10	CHI
202010138452	INHUMAS	30039228	INHUMAS S2	24/10/2020 08:07	24/10/2020 10:21	24/10/2020 08:07	24/10/2020 10:21	2,23	1	2,23	CHI
202010138464	CALDAS NOVAS	CN21119175	CALDAS NOVAS S2	24/10/2020 08:09	24/10/2020 15:37	24/10/2020 08:09	24/10/2020 15:37	7,47	2	14,93	CHI
202010139019	CRISTALINA	KR12389554	PAMPLONA	24/10/2020 08:10	24/10/2020 11:40	24/10/2020 08:10	24/10/2020 11:40	3,49	9	31,45	CHI
202010139453	CAMPO ALEGRE DE GOIAS	10021295466	CAMPO ALEGRE DE GOIAS	24/10/2020 08:11	24/10/2020 16:10	24/10/2020 08:11	24/10/2020 16:10	7,99	1	7,99	CHI
202010139428	GOIAS	GS12299706	GOIAS	24/10/2020 08:13	24/10/2020 18:45	24/10/2020 08:13	24/10/2020 18:45	10,53	3	31,58	CHI
202010139875	ORIZONA	OZ12052340	PIRES DO RIO S2	24/10/2020 08:13	24/10/2020 12:27	24/10/2020 08:13	24/10/2020 12:27	4,22	12	50,69	CHI
202010138522	PIRACANJUBA	PJ21018387	BELA VISTA S1	24/10/2020 08:14	24/10/2020 15:37	24/10/2020 08:14	24/10/2020 15:37	7,38	2	14,76	CHI
202010138529	AGUAS LINDAS DE GOIAS	4830201722	AGUAS LINDAS DE GOIAS S1	24/10/2020 08:14	24/10/2020 11:03	24/10/2020 08:14	24/10/2020 11:03	2,80	1	2,80	CHI
202010138532	ITUMBIARA	IT12273924	ITUMBIARA VELHA S2	24/10/2020 08:14	24/10/2020 09:45	24/10/2020 08:14	24/10/2020 09:45	1,50	4	6,01	CHI
202010138537	PIRANHAS	PH21371659	ARENOPOLIS	24/10/2020 08:15	24/10/2020 13:39	24/10/2020 08:15	24/10/2020 13:39	5,40	1	5,40	CHI
202010189372	GOIANIA	10753837	CAMPINAS S1	24/10/2020 08:15	24/10/2020 10:45	24/10/2020 08:15	24/10/2020 10:45	2,51	1	2,51	CHI
202010138543	FORMOSA	FA12146108	ITUIQUIRA	24/10/2020 08:15	24/10/2020 11:16	24/10/2020 08:15	24/10/2020 11:16	3,00	33	99,04	CHI
202010140651	ARUANA	AK12158747	ARUANA	24/10/2020 08:16	24/10/2020 14:43	24/10/2020 08:16	24/10/2020 14:43	6,44	140	901,02	CHI
202010139285	SANTO ANTONIO DO DESCOBERTO	SN12211980	ALEXANIA	24/10/2020 08:17	24/10/2020 10:46	24/10/2020 08:17	24/10/2020 10:46	2,48	168	417,20	CHI
202010139523	PONTALINA	PK12060875	PONTALINA	24/10/2020 08:18	25/10/2020 08:54	24/10/2020 08:18	25/10/2020 08:54	24,60	7	172,22	CHI
202010138625	CALDAS NOVAS	03850424	VILA CORUMBA	24/10/2020 08:19	25/10/2020 13:07	24/10/2020 08:19	25/10/2020 13:07	28,80	55	1584,00	CHI
202010140539	CORREGO DO OURO	CO12054671	FIRMINOPOLIS S2	24/10/2020 08:19	24/10/2020 11:24	24/10/2020 08:19	24/10/2020 11:24	3,07	3	9,22	CHI

202010141653	URUACU	CR12375637	CAMPINORTE	24/10/2020 08:19	24/10/2020 20:58	24/10/2020 08:19	24/10/2020 20:58	12,63	120	1516,17	CHI
202010142702	SAO LUIS DE MONTES BELOS	500048502	SAO LUIZ DOS MONTES BELOS	24/10/2020 08:19	24/10/2020 18:24	24/10/2020 08:19	24/10/2020 18:24	10,07	1	10,07	CHI
202010138589	DAMIANOPOLIS	MB12180675	IACIARA S2	24/10/2020 08:20	24/10/2020 09:16	24/10/2020 08:20	24/10/2020 09:16	0,92	8	7,40	CHI
202010138591	CAMPINACU	UC12197189	PORANGATU	24/10/2020 08:20	24/10/2020 12:05	24/10/2020 08:20	24/10/2020 12:05	3,74	32	119,67	CHI
202010138597	MOIPORA	1450004213	IPORA	24/10/2020 08:21	24/10/2020 10:41	24/10/2020 08:21	24/10/2020 10:41	2,32	1	2,32	CHI
202010138602	PALMINOPOLIS	1340010991	PALMEIRAS	24/10/2020 08:21	24/10/2020 15:54	24/10/2020 08:21	24/10/2020 15:54	7,54	1	7,54	CHI
202010141529	PONTALINA	PK12074320	VICENTINOPOLIS	24/10/2020 08:22	24/10/2020 13:56	24/10/2020 08:22	24/10/2020 13:56	5,56	18	100,13	CHI
202010138694	COCALZINHO DE GOIAS	ZN12295682LD	COCALZINHO	24/10/2020 08:22	24/10/2020 20:26	24/10/2020 08:22	24/10/2020 20:26	12,06	27	325,70	CHI
202010138639	TROMBAS	TB21052574	PORANGATU	24/10/2020 08:24	24/10/2020 09:03	24/10/2020 08:24	24/10/2020 09:03	0,64	1	0,64	CHI
202010139074	CATALAO	1990147735	CATALAO S2	24/10/2020 08:24	24/10/2020 11:18	24/10/2020 08:24	24/10/2020 11:18	2,89	1	2,89	CHI
202010138641	MUNDO NOVO DE GOIAS	4240020798	NOVA CRIXAS	24/10/2020 08:24	24/10/2020 13:09	24/10/2020 08:24	24/10/2020 13:09	4,74	1	4,74	CHI
202010138644	MOIPORA	MO21073407	IPORA	24/10/2020 08:25	24/10/2020 10:10	24/10/2020 08:25	24/10/2020 10:10	1,74	1	1,74	CHI
202010144990	NOVA CRIXAS	NA12391603	NOVA CRIXAS	24/10/2020 08:25	25/10/2020 12:02	24/10/2020 08:25	25/10/2020 12:02	27,60	41	1131,79	CHI
202010138646	ARENOPOLIS	AY21140478	ARENOPOLIS	24/10/2020 08:25	24/10/2020 11:54	24/10/2020 08:25	24/10/2020 11:54	3,48	1	3,48	CHI
202010138650	GOIANIA	12708010	GOYA S1	24/10/2020 08:26	24/10/2020 10:58	24/10/2020 08:26	24/10/2020 10:58	2,53	1	2,53	CHI
202010138659	COCALZINHO DE GOIAS	ZN12406111	COCALZINHO	24/10/2020 08:27	24/10/2020 16:11	24/10/2020 08:27	24/10/2020 16:11	7,72	2	15,44	CHI
202010138664	BRITANIA	BT11284764	BRITANIA	24/10/2020 08:28	24/10/2020 11:08	24/10/2020 08:28	24/10/2020 11:08	2,68	31	82,93	CHI
202010138668	PORANGATU	PO21181571	PORANGATU	24/10/2020 08:29	24/10/2020 10:39	24/10/2020 08:29	24/10/2020 10:39	2,16	1	2,16	CHI
202010143430	ITABERAI	IB12217059	ITABERAI S2	24/10/2020 08:29	25/10/2020 11:06	24/10/2020 08:29	25/10/2020 11:06	26,61	8	212,86	CHI
202010138679	ITABERAI	IB21018320	ITABERAI S2	24/10/2020 08:30	25/10/2020 08:13	24/10/2020 08:30	25/10/2020 08:13	23,71	1	23,71	CHI
202010138681	APARECIDA DE GOIANIA	15620955	INDEPENDENCIA S2	24/10/2020 08:30	24/10/2020 10:11	24/10/2020 08:30	24/10/2020 10:11	1,69	1	1,69	CHI
202010138682	MONTES CLAROS DE GOIAS	ME12204928	IPORA	24/10/2020 08:30	24/10/2020 11:26	24/10/2020 08:30	24/10/2020 11:26	2,93	3	8,78	CHI
202010138691	GOIANIA	16803310	XAVANTES	24/10/2020 08:31	24/10/2020 11:38	24/10/2020 08:31	24/10/2020 11:38	3,11	1	3,11	CHI
202010138710	GOIANDIRA	GD13203010	CATALAO S1	24/10/2020 08:32	24/10/2020 16:36	24/10/2020 16:26	24/10/2020 16:36	0,17	1279	215,65	CHI
202010138710	GOIANDIRA	00540214	CATALAO S1	24/10/2020 08:32	24/10/2020 16:36	24/10/2020 08:32	24/10/2020 16:35	8,06	2	16,13	CHI
202010138710	GOIANDIRA	00540214	CATALAO S1	24/10/2020 08:32	24/10/2020 16:36	24/10/2020 08:32	24/10/2020 15:41	7,16	92	658,57	CHI
202010138710	GOIANDIRA	00540214	CATALAO S1	24/10/2020 08:32	24/10/2020 16:36	24/10/2020 08:32	24/10/2020 13:36	5,07	795	4028,66	CHI
202010138710	GOIANDIRA	00540214	CATALAO S1	24/10/2020 08:32	24/10/2020 16:36	24/10/2020 08:32	24/10/2020 09:50	1,30	1279	1665,54	CHI
202010138716	RUBIATABA	RB21230590	RUBIATABA	24/10/2020 08:34	24/10/2020 12:50	24/10/2020 08:34	24/10/2020 12:50	4,26	4	17,05	CHI
202010138726	SILVANIA	SV21103748	VIANOPOLIS	24/10/2020 08:35	24/10/2020 14:19	24/10/2020 08:35	24/10/2020 14:19	5,73	1	5,73	CHI
202010138727	GOIANIA	10005896639	XAVANTES	24/10/2020 08:35	24/10/2020 13:03	24/10/2020 08:35	24/10/2020 13:03	4,46	1	4,46	CHI
202010143991	ALEXANIA	AX21395701	ALEXANIA	24/10/2020 08:36	24/10/2020 19:24	24/10/2020 08:36	24/10/2020 19:24	10,79	1	10,79	CHI
202010140772	GOIAS	GS12217959	GOIAS	24/10/2020 08:37	24/10/2020 16:10	24/10/2020 08:37	24/10/2020 16:10	7,55	6	45,29	CHI
202010138753	GOIANIA	14626019	CAMPINAS S3	24/10/2020 08:37	24/10/2020 10:02	24/10/2020 08:37	24/10/2020 10:02	1,41	1	1,41	CHI
202010138764	ALTO HORIZONTE	9640004126	SANTA TEREZINHA	24/10/2020 08:38	24/10/2020 16:11	24/10/2020 08:38	24/10/2020 16:11	7,54	1	7,54	CHI
202010140844	ARUANA	AK11051861	ARUANA	24/10/2020 08:40	24/10/2020 15:02	24/10/2020 08:40	24/10/2020 15:02	6,37	52	331,08	CHI
202010139382	CAVALCANTE	TI12156216RE	MINACU	24/10/2020 08:42	24/10/2020 13:27	24/10/2020 08:42	24/10/2020 13:27	4,75	67	318,03	CHI
202010139382	COLINAS DO SUL	TI12156216RE	MINACU	24/10/2020 08:42	24/10/2020 13:27	24/10/2020 08:42	24/10/2020 13:27	4,75	34	161,39	CHI
202010142415	SAO LUIS DE MONTES BELOS	SL12145934	SAO LUIZ DOS MONTES BELOS	24/10/2020 08:42	24/10/2020 16:34	24/10/2020 08:42	24/10/2020 16:34	7,86	8	62,89	CHI
202010142415	SANCLERLANDIA	SL12145934	SAO LUIZ DOS MONTES BELOS	24/10/2020 08:42	24/10/2020 16:34	24/10/2020 08:42	24/10/2020 16:34	7,86	2	15,72	CHI
202010139039	MAIRIPOTABA	MI12078688	PONTALINA	24/10/2020 08:43	24/10/2020 11:51	24/10/2020 08:43	24/10/2020 11:51	3,13	9	28,16	CHI
202010138799	GOIANIA	10003668590	XAVANTES	24/10/2020 08:43	24/10/2020 10:01	24/10/2020 08:43	24/10/2020 10:01	1,29	1	1,29	CHI
202010138802	IPAMERI	IP12071029	URUTAI	24/10/2020 08:43	24/10/2020 12:03	24/10/2020 08:43	24/10/2020 12:03	3,32	13	43,15	CHI
202010138803	SAO LUIS DE MONTES BELOS	SL12206347	FIRMINOPOLIS S2	24/10/2020 08:43	24/10/2020 15:51	24/10/2020 08:43	24/10/2020 15:51	7,12	1	7,12	CHI
202010139169	CORUMBAIBA	CI12363786	VILA CORUMBA	24/10/2020 08:44	25/10/2020 16:32	24/10/2020 08:44	25/10/2020 16:32	31,79	18	572,29	CHI
202010143024	MARZAGAO	MG12120778	VILA CORUMBA	24/10/2020 08:44	25/10/2020 08:31	24/10/2020 08:44	25/10/2020 08:31	23,77	2	47,54	CHI
202010143024	AGUA LIMPA	MG12120778	VILA CORUMBA	24/10/2020 08:44	25/10/2020 08:31	24/10/2020 08:44	25/10/2020 08:31	23,77	17	404,11	CHI
202010138811	CRISTALINA	KR12405474LD	CRISTALINA S1	24/10/2020 08:44	24/10/2020 14:33	24/10/2020 08:44	24/10/2020 14:33	5,80	4	23,21	CHI
202010141368	ALEXANIA	AX11200569	ALEXANIA	24/10/2020 08:45	24/10/2020 12:22	24/10/2020 08:45	24/10/2020 12:22	3,62	66	238,68	CHI
202010140462	ALEXANIA	AX12200553	ALEXANIA	24/10/2020 08:45	24/10/2020 11:56	24/10/2020 08:45	24/10/2020 11:56	3,18	136	432,93	CHI
202010138828	PIRACANJUBA	PJ11182875	PIRACANJUBA	24/10/2020 08:45	24/10/2020 13:34	24/10/2020 08:45	24/10/2020 13:34	4,81	89	427,69	CHI

202010142703	SAO LUIS DE MONTES BELOS	500036883	SAO LUIZ DOS MONTES BELOS	24/10/2020 08:46	24/10/2020 18:37	24/10/2020 08:46	24/10/2020 18:37	9,85	1	9,85	CHI
202010141626	CRIXAS	CX12181172	SANTA TEREZINHA	24/10/2020 08:46	25/10/2020 18:17	24/10/2020 08:46	25/10/2020 18:17	33,51	7	234,57	CHI
202010141614	GOIANIA	GN11169133	CARAJAS S1	24/10/2020 08:46	24/10/2020 15:42	24/10/2020 08:46	24/10/2020 15:42	6,92	49	339,22	CHI
202010138836	GOIANIA	GN12076674	CARAJAS S1	24/10/2020 08:46	24/10/2020 11:49	24/10/2020 08:46	24/10/2020 11:49	3,04	879	2671,92	CHI
202010138843	PROFESSOR JAMIL SAFADY	JS21307973	ROCHEDO	24/10/2020 08:47	24/10/2020 12:15	24/10/2020 08:47	24/10/2020 12:15	3,46	2	6,92	CHI
202010140910	PARAUNA	PU12273594	PARAUNA	24/10/2020 08:48	24/10/2020 23:20	24/10/2020 08:48	24/10/2020 23:20	14,53	9	130,78	CHI
202010139305	GOIANIRA	GR12323028	TRINDADE	24/10/2020 08:48	24/10/2020 11:35	24/10/2020 08:48	24/10/2020 11:35	2,77	11	30,51	CHI
202010138860	CALDAS NOVAS	10007601393	SERRA DE CALDAS	24/10/2020 08:48	24/10/2020 19:34	24/10/2020 08:48	24/10/2020 19:34	10,75	1	10,75	CHI
202010138861	BRITANIA	2110018740	BRITANIA	24/10/2020 08:48	24/10/2020 13:30	24/10/2020 08:48	24/10/2020 13:30	4,70	1	4,70	CHI
202010138868	MOIPORA	MO12031774	IPORA	24/10/2020 08:49	24/10/2020 21:30	24/10/2020 08:49	24/10/2020 21:30	12,67	3	38,02	CHI
202010138869	BELA VISTA DE GOIAS	SW21093826	SENADOR CANEDO	24/10/2020 08:49	24/10/2020 10:16	24/10/2020 08:49	24/10/2020 10:16	1,44	1	1,44	CHI
202010138884	CALDAZINHA	DE21334856	SENADOR CANEDO	24/10/2020 08:50	24/10/2020 13:08	24/10/2020 08:50	24/10/2020 13:08	4,29	6	25,75	CHI
202010138892	GOIANIA	13803220	GOIANIA LESTE S3	24/10/2020 08:50	24/10/2020 13:24	24/10/2020 08:50	24/10/2020 13:24	4,55	1	4,55	CHI
202010139228	MATRINCHA	FC12299779	MATRINCHA	24/10/2020 08:51	24/10/2020 17:21	24/10/2020 08:51	24/10/2020 17:21	8,50	13	110,51	CHI
202010139228	FAINA	FC12299779	MATRINCHA	24/10/2020 08:51	24/10/2020 17:21	24/10/2020 08:51	24/10/2020 12:03	3,19	16	51,10	CHI
202010139228	MATRINCHA	FC12299779	MATRINCHA	24/10/2020 08:51	24/10/2020 17:21	24/10/2020 08:51	24/10/2020 12:03	3,19	23	73,45	CHI
202010138898	ALTO PARAISO DE GOIAS	3870000154	FLORES DE GOIAS	24/10/2020 08:51	24/10/2020 18:02	24/10/2020 08:51	24/10/2020 18:02	9,17	1	9,17	CHI
202010138911	GOIANIA	10206243	FERROVIARIO S3	24/10/2020 08:52	24/10/2020 12:13	24/10/2020 08:52	24/10/2020 12:13	3,34	1	3,34	CHI
202010138934	MORRINHOS	MR12133255	MORRINHOS	24/10/2020 08:52	24/10/2020 10:25	24/10/2020 08:52	24/10/2020 10:25	1,54	12	18,47	CHI
202010139827	GOIAS	GS12188167	MATRINCHA	24/10/2020 08:52	24/10/2020 16:38	24/10/2020 08:52	24/10/2020 16:38	7,76	18	139,59	CHI
202010139566	PALMEIRAS DE GOIAS	PL12349352	PALMEIRAS	24/10/2020 08:52	24/10/2020 12:29	24/10/2020 08:52	24/10/2020 12:29	3,60	67	241,52	CHI
202010139566	INDIARA	PL12349352	PALMEIRAS	24/10/2020 08:52	24/10/2020 12:29	24/10/2020 08:52	24/10/2020 12:29	3,60	3	10,81	CHI
202010139299	GOIANIA	GN11265295	AEROPORTO S2	24/10/2020 08:52	24/10/2020 13:04	24/10/2020 08:52	24/10/2020 13:04	4,18	20	83,68	CHI
202010138920	CATALAO	9580008716	CATALAO S1	24/10/2020 08:53	24/10/2020 10:17	24/10/2020 08:53	24/10/2020 10:17	1,40	1	1,40	CHI
202010138922	CABECEIRAS	CW12042593LD	ITUIQUIRA	24/10/2020 08:53	24/10/2020 11:05	24/10/2020 08:53	24/10/2020 11:05	2,20	233	511,44	CHI
202010140815	CAIAPONIA	DV12023480	CAIAPONIA	24/10/2020 08:53	24/10/2020 15:06	24/10/2020 08:53	24/10/2020 15:06	6,21	127	788,85	CHI
202010140815	PIRANHAS	DV12023480	CAIAPONIA	24/10/2020 08:53	24/10/2020 15:06	24/10/2020 08:53	24/10/2020 15:06	6,21	77	478,28	CHI
202010140815	DOVERLANDIA	DV12023480	CAIAPONIA	24/10/2020 08:53	24/10/2020 15:06	24/10/2020 08:53	24/10/2020 15:06	6,21	11	68,33	CHI
202010138924	GOIANIA	10015319014	CAMPINAS S3	24/10/2020 08:53	24/10/2020 14:41	24/10/2020 08:53	24/10/2020 14:41	5,79	1	5,79	CHI
202010138929	PALMEIRAS DE GOIAS	PL21085331	PALMEIRAS	24/10/2020 08:53	24/10/2020 17:00	24/10/2020 08:53	24/10/2020 17:00	8,11	1	8,11	CHI
202010138935	COCALZINHO DE GOIAS	ZN21370431	COCALZINHO	24/10/2020 08:54	24/10/2020 17:34	24/10/2020 08:54	24/10/2020 17:34	8,67	1	8,67	CHI
202010138981	GOIANIA	00610294	CAMPINAS S2	24/10/2020 08:54	24/10/2020 10:28	24/10/2020 08:54	24/10/2020 10:28	1,56	152	237,58	CHI
202010141250	MOZARLANDIA	MZ21057132	MOZARLANDIA	24/10/2020 08:54	25/10/2020 18:50	24/10/2020 08:54	25/10/2020 18:50	33,92	2	67,83	CHI
202010140041	GOIANESIA	GE12354002	GOIANESIA S2	24/10/2020 08:54	25/10/2020 00:31	24/10/2020 08:54	25/10/2020 00:31	15,60	8	124,81	CHI
202010138977	MOZARLANDIA	MZ13317899	MOZARLANDIA	24/10/2020 08:54	24/10/2020 16:15	24/10/2020 08:54	24/10/2020 16:15	7,34	4	29,37	CHI
202010138977	ARUANA	MZ16418618	MOZARLANDIA	24/10/2020 08:54	24/10/2020 16:15	24/10/2020 08:54	24/10/2020 12:46	3,85	127	489,06	CHI
202010138977	NOVA CRIXAS	MZ16418618	MOZARLANDIA	24/10/2020 08:54	24/10/2020 16:15	24/10/2020 08:54	24/10/2020 12:46	3,85	35	134,78	CHI
202010138977	NOVA CRIXAS	MZ16418618	MOZARLANDIA	24/10/2020 08:54	24/10/2020 16:15	24/10/2020 08:54	24/10/2020 12:46	3,85	26	100,12	CHI
202010138977	MOZARLANDIA	MZ16418618	MOZARLANDIA	24/10/2020 08:54	24/10/2020 16:15	24/10/2020 08:54	24/10/2020 12:46	3,85	13	50,06	CHI
202010138977	MOZARLANDIA	MZ16418618	MOZARLANDIA	24/10/2020 08:54	24/10/2020 16:15	24/10/2020 08:54	24/10/2020 12:46	3,85	84	323,47	CHI
202010138977	ARUANA	MZ16418618	MOZARLANDIA	24/10/2020 08:54	24/10/2020 16:15	24/10/2020 08:54	24/10/2020 12:46	3,85	8	30,81	CHI
202010138948	JUSSARA	JR12008751	BRITANIA	24/10/2020 08:55	24/10/2020 11:39	24/10/2020 08:55	24/10/2020 11:39	2,72	2	5,44	CHI
202010138951	ARENOPOLIS	AY21204020	IPORA	24/10/2020 08:56	24/10/2020 14:50	24/10/2020 08:56	24/10/2020 14:50	5,90	3	17,69	CHI
202010138970	NOVA CRIXAS	8570014950	NOVA CRIXAS	24/10/2020 08:58	24/10/2020 12:11	24/10/2020 08:58	24/10/2020 12:11	3,21	1	3,21	CHI
202010138978	MORRINHOS	MR21092120	MORRINHOS	24/10/2020 08:58	24/10/2020 13:20	24/10/2020 08:58	24/10/2020 13:20	4,35	1	4,35	CHI
202010138988	PLANALTINA	2960121930	PLANALTINA	24/10/2020 09:00	24/10/2020 11:34	24/10/2020 09:00	24/10/2020 11:34	2,56	1	2,56	CHI
202010139018	SAO DOMINGOS	GH12398374	SAO DOMINGOS	24/10/2020 09:03	24/10/2020 12:02	24/10/2020 09:03	24/10/2020 12:02	2,97	32	95,14	CHI
202010139018	DIVINOPOLIS DE GOIAS	GH12398374	SAO DOMINGOS	24/10/2020 09:03	24/10/2020 12:02	24/10/2020 09:03	24/10/2020 12:02	2,97	1	2,97	CHI
202010189506	ALTO PARAISO DE GOIAS	BF12365282	SAO JOAO D ALIANCA	24/10/2020 09:16	24/10/2020 15:30	24/10/2020 09:16	24/10/2020 15:30	6,23	47	293,01	CHI
202010189506	ALTO PARAISO DE GOIAS	BF10409732	SAO JOAO D ALIANCA	24/10/2020 09:16	24/10/2020 15:30	24/10/2020 09:16	24/10/2020 10:50	1,56	183	285,79	CHI
202010139134	SAO JOAO D ALIANCA	JL12335672	SAO JOAO D ALIANCA	24/10/2020 09:17	24/10/2020 12:27	24/10/2020 09:17	24/10/2020 12:27	3,16	91	287,99	CHI



2020102400163	SAO JOAO D ALIANCA	SJA-TR2	SAO JOAO D ALIANCA	24/10/2020 09:39	24/10/2020 10:48	24/10/2020 09:41	24/10/2020 10:48	1,10	3265	3603,29	CHI
2020102400163	AGUA FRIA DE GOIAS	SJA-TR1	SAO JOAO D ALIANCA	24/10/2020 09:39	24/10/2020 10:48	24/10/2020 09:41	24/10/2020 10:48	1,10	2113	2326,65	CHI
2020102400163	PLANALTINA	SJA-TR1	SAO JOAO D ALIANCA	24/10/2020 09:39	24/10/2020 10:48	24/10/2020 09:41	24/10/2020 10:48	1,10	18	19,82	CHI
2020102400163	FORMOSA	SJA-TR1	SAO JOAO D ALIANCA	24/10/2020 09:39	24/10/2020 10:48	24/10/2020 09:41	24/10/2020 10:48	1,10	3	3,30	CHI
2020102400163	SAO JOAO D ALIANCA	SJA-TR1	SAO JOAO D ALIANCA	24/10/2020 09:39	24/10/2020 10:48	24/10/2020 09:41	24/10/2020 10:48	1,10	29	31,93	CHI
2020102400163	SAO JOAO D ALIANCA	SJA-TR1	SAO JOAO D ALIANCA	24/10/2020 09:39	24/10/2020 10:48	24/10/2020 09:41	24/10/2020 10:48	1,10	30	33,03	CHI
2020102400163	SAO JOAO D ALIANCA	SJA-TR1	SAO JOAO D ALIANCA	24/10/2020 09:39	24/10/2020 10:48	24/10/2020 09:41	24/10/2020 10:48	1,10	497	547,25	CHI
2020102400163	NIQUELANDIA	SJA-TR1	SAO JOAO D ALIANCA	24/10/2020 09:39	24/10/2020 10:48	24/10/2020 09:41	24/10/2020 10:48	1,10	154	169,57	CHI
2020102400163	AGUA FRIA DE GOIAS	SJA-TR1	SAO JOAO D ALIANCA	24/10/2020 09:39	24/10/2020 10:48	24/10/2020 09:41	24/10/2020 10:48	1,10	91	100,20	CHI
2020102400163	ALTO PARAISO DE GOIAS	SJA-TR1	SAO JOAO D ALIANCA	24/10/2020 09:39	24/10/2020 10:48	24/10/2020 09:41	24/10/2020 10:48	1,10	58	63,86	CHI
2020102400163	AGUA FRIA DE GOIAS	SJA-TR1	SAO JOAO D ALIANCA	24/10/2020 09:39	24/10/2020 10:48	24/10/2020 09:41	24/10/2020 10:48	1,10	69	75,98	CHI
2020102400163	SAO JOAO D ALIANCA	SJA-TR1	SAO JOAO D ALIANCA	24/10/2020 09:39	24/10/2020 10:48	24/10/2020 09:41	24/10/2020 10:48	1,10	3	3,30	CHI
2020102400163	SIMOLANDIA	AVN-TR1	IACIARA S2	24/10/2020 09:39	24/10/2020 10:48	24/10/2020 10:34	24/10/2020 10:48	0,22	2173	481,08	CHI
2020102400163	BURITINOPOLIS	AVN-TR1	IACIARA S2	24/10/2020 09:39	24/10/2020 10:48	24/10/2020 10:34	24/10/2020 10:48	0,22	1058	234,23	CHI
2020102400163	ALVORADA DO NORTE	AVN-TR1	IACIARA S2	24/10/2020 09:39	24/10/2020 10:48	24/10/2020 10:34	24/10/2020 10:48	0,22	1200	265,67	CHI
2020102400163	SIMOLANDIA	AVN-TR1	IACIARA S2	24/10/2020 09:39	24/10/2020 10:48	24/10/2020 10:34	24/10/2020 10:48	0,22	3	0,66	CHI
2020102400163	POSSE	AVN-TR1	IACIARA S2	24/10/2020 09:39	24/10/2020 10:48	24/10/2020 10:34	24/10/2020 10:48	0,22	111	24,57	CHI
2020102400163	ALVORADA DO NORTE	AVN-TR1	IACIARA S2	24/10/2020 09:39	24/10/2020 10:48	24/10/2020 10:34	24/10/2020 10:48	0,22	2056	455,18	CHI
2020102400163	DISTRITO FEDERAL	ITQ-TR1	ITIQUIRA	24/10/2020 09:39	24/10/2020 10:48	24/10/2020 10:34	24/10/2020 10:47	0,22	1	0,22	CHI
2020102400163	CABECEIRAS	ITQ-TR1	ITIQUIRA	24/10/2020 09:39	24/10/2020 10:48	24/10/2020 10:34	24/10/2020 10:47	0,22	52	11,41	CHI
2020102400163	FORMOSA	ITQ-TR1	ITIQUIRA	24/10/2020 09:39	24/10/2020 10:48	24/10/2020 10:34	24/10/2020 10:47	0,22	6	1,32	CHI
2020102400163	CABECEIRAS	ITQ-TR1	ITIQUIRA	24/10/2020 09:39	24/10/2020 10:48	24/10/2020 10:34	24/10/2020 10:47	0,22	40	8,78	CHI
2020102400163	DISTRITO FEDERAL	ITQ-TR1	ITIQUIRA	24/10/2020 09:39	24/10/2020 10:48	24/10/2020 10:34	24/10/2020 10:47	0,22	2	0,44	CHI
2020102400163	FORMOSA	ITQ-TR1	ITIQUIRA	24/10/2020 09:39	24/10/2020 10:48	24/10/2020 10:34	24/10/2020 10:47	0,22	33	7,24	CHI
2020102400163	FORMOSA	ITQ-TR1	ITIQUIRA	24/10/2020 09:39	24/10/2020 10:48	24/10/2020 10:34	24/10/2020 10:47	0,22	2169	475,97	CHI
2020102400163	CABECEIRAS	ITQ-TR1	ITIQUIRA	24/10/2020 09:39	24/10/2020 10:48	24/10/2020 10:34	24/10/2020 10:47	0,22	145	31,82	CHI
2020102400163	CABECEIRAS	ITQ-TR1	ITIQUIRA	24/10/2020 09:39	24/10/2020 10:48	24/10/2020 10:34	24/10/2020 10:47	0,22	199	43,67	CHI
2020102400163	FORMOSA	ITQ-TR1	ITIQUIRA	24/10/2020 09:39	24/10/2020 10:48	24/10/2020 10:34	24/10/2020 10:47	0,22	33	7,24	CHI
2020102400163	FORMOSA	ITQ-TR1	ITIQUIRA	24/10/2020 09:39	24/10/2020 10:48	24/10/2020 10:34	24/10/2020 10:47	0,22	2	0,44	CHI
2020102400163	FORMOSA	ITQ-TR6	ITIQUIRA	24/10/2020 09:39	24/10/2020 10:48	24/10/2020 10:34	24/10/2020 10:47	0,22	15120	3305,40	CHI
2020102400163	FORMOSA	ITQ-TR6	ITIQUIRA	24/10/2020 09:39	24/10/2020 10:48	24/10/2020 10:34	24/10/2020 10:47	0,22	12584	2751,00	CHI
2020102400163	FORMOSA	ITQ-TR6	ITIQUIRA	24/10/2020 09:39	24/10/2020 10:48	24/10/2020 10:34	24/10/2020 10:47	0,22	15080	3296,66	CHI
2020102400163	ITARUMA	ITQ-TR6	ITIQUIRA	24/10/2020 09:39	24/10/2020 10:48	24/10/2020 10:34	24/10/2020 10:47	0,22	3	0,66	CHI
2020102400163	SAO DOMINGOS	USD-TR3	SAO DOMINGOS	24/10/2020 09:39	24/10/2020 10:48	24/10/2020 10:34	24/10/2020 10:46	0,19	2437	468,45	CHI
2020102400163	MONTE ALEGRE DE GOIAS	USD-TR4	SAO DOMINGOS	24/10/2020 09:39	24/10/2020 10:48	24/10/2020 10:34	24/10/2020 10:46	0,19	154	29,43	CHI
2020102400163	DIVINOPOLIS DE GOIAS	USD-TR4	SAO DOMINGOS	24/10/2020 09:39	24/10/2020 10:48	24/10/2020 10:34	24/10/2020 10:46	0,19	3	0,57	CHI
2020102400163	MONTE ALEGRE DE GOIAS	USD-TR4	SAO DOMINGOS	24/10/2020 09:39	24/10/2020 10:48	24/10/2020 10:34	24/10/2020 10:46	0,19	754	144,10	CHI
2020102400163	DIVINOPOLIS DE GOIAS	USD-TR4	SAO DOMINGOS	24/10/2020 09:39	24/10/2020 10:48	24/10/2020 10:34	24/10/2020 10:46	0,19	2238	427,71	CHI
2020102400163	CAMPOS BELOS	USD-TR4	SAO DOMINGOS	24/10/2020 09:39	24/10/2020 10:48	24/10/2020 10:34	24/10/2020 10:46	0,19	102	19,49	CHI
2020102400163	CAMPOS BELOS	USD-TR4	SAO DOMINGOS	24/10/2020 09:39	24/10/2020 10:48	24/10/2020 10:34	24/10/2020 10:46	0,19	2827	540,27	CHI
2020102400163	SAO DOMINGOS	USD-TR4	SAO DOMINGOS	24/10/2020 09:39	24/10/2020 10:48	24/10/2020 10:34	24/10/2020 10:46	0,19	1183	226,08	CHI
2020102400163	SAO DOMINGOS	USD-TR4	SAO DOMINGOS	24/10/2020 09:39	24/10/2020 10:48	24/10/2020 10:34	24/10/2020 10:46	0,19	287	54,85	CHI
2020102400163	MONTE ALEGRE DE GOIAS	USD-TR4	SAO DOMINGOS	24/10/2020 09:39	24/10/2020 10:48	24/10/2020 10:34	24/10/2020 10:46	0,19	58	11,08	CHI
2020102400163	MONTE ALEGRE DE GOIAS	USD-TR4	SAO DOMINGOS	24/10/2020 09:39	24/10/2020 10:48	24/10/2020 10:34	24/10/2020 10:46	0,19	1	0,19	CHI
2020102400163	CAMPOS BELOS	USD-TR4	SAO DOMINGOS	24/10/2020 09:39	24/10/2020 10:48	24/10/2020 10:34	24/10/2020 10:46	0,19	4739	905,68	CHI
2020102400163	NOVA ROMA	USD-TR4	SAO DOMINGOS	24/10/2020 09:39	24/10/2020 10:48	24/10/2020 10:34	24/10/2020 10:46	0,19	3	0,57	CHI
2020102400163	CAMPOS BELOS	USD-TR4	SAO DOMINGOS	24/10/2020 09:39	24/10/2020 10:48	24/10/2020 10:34	24/10/2020 10:46	0,19	156	29,81	CHI
2020102400163	GUARANI DE GOIAS	USD-TR4	SAO DOMINGOS	24/10/2020 09:39	24/10/2020 10:48	24/10/2020 10:34	24/10/2020 10:46	0,19	152	29,05	CHI
2020102400163	SAO DOMINGOS	USD-TR4	SAO DOMINGOS	24/10/2020 09:39	24/10/2020 10:48	24/10/2020 10:34	24/10/2020 10:46	0,19	407	77,78	CHI
2020102400163	CAMPOS BELOS	USD-TR4	SAO DOMINGOS	24/10/2020 09:39	24/10/2020 10:48	24/10/2020 10:34	24/10/2020 10:46	0,19	377	72,05	CHI
2020102400163	POSSE	IAC-TR2	IACIARA S2	24/10/2020 09:39	24/10/2020 10:48	24/10/2020 10:35	24/10/2020 10:45	0,18	88	15,42	CHI

2020102400163	POSSE	IAC-TR2	IACIARA S2	24/10/2020 09:39	24/10/2020 10:48	24/10/2020 10:35	24/10/2020 10:45	0,18	288	50,48	CHI
2020102400163	FLORES DE GOIAS	IAC-TR2	IACIARA S2	24/10/2020 09:39	24/10/2020 10:48	24/10/2020 10:35	24/10/2020 10:45	0,18	1	0,18	CHI
2020102400163	SAO JOAO D ALIANCA	IAC-TR2	IACIARA S2	24/10/2020 09:39	24/10/2020 10:48	24/10/2020 10:35	24/10/2020 10:45	0,18	28	4,91	CHI
2020102400163	POSSE	IAC-TR2	IACIARA S2	24/10/2020 09:39	24/10/2020 10:48	24/10/2020 10:35	24/10/2020 10:45	0,18	1041	182,46	CHI
2020102400163	NOVA ROMA	IAC-TR2	IACIARA S2	24/10/2020 09:39	24/10/2020 10:48	24/10/2020 10:35	24/10/2020 10:45	0,18	1572	275,54	CHI
2020102400163	MAMBAI	IAC-TR2	IACIARA S2	24/10/2020 09:39	24/10/2020 10:48	24/10/2020 10:35	24/10/2020 10:45	0,18	28	4,91	CHI
2020102400163	IACIARA	IAC-TR2	IACIARA S2	24/10/2020 09:39	24/10/2020 10:48	24/10/2020 10:35	24/10/2020 10:45	0,18	1	0,18	CHI
2020102400163	BURITINOPOLIS	IAC-TR2	IACIARA S2	24/10/2020 09:39	24/10/2020 10:48	24/10/2020 10:35	24/10/2020 10:45	0,18	2	0,35	CHI
2020102400163	POSSE	IAC-TR2	IACIARA S2	24/10/2020 09:39	24/10/2020 10:48	24/10/2020 10:35	24/10/2020 10:45	0,18	1	0,18	CHI
2020102400163	IACIARA	IAC-TR2	IACIARA S2	24/10/2020 09:39	24/10/2020 10:48	24/10/2020 10:35	24/10/2020 10:45	0,18	103	18,05	CHI
2020102400163	IACIARA	IAC-TR2	IACIARA S2	24/10/2020 09:39	24/10/2020 10:48	24/10/2020 10:35	24/10/2020 10:45	0,18	12	2,10	CHI
2020102400163	MONTE ALEGRE DE GOIAS	IAC-TR2	IACIARA S2	24/10/2020 09:39	24/10/2020 10:48	24/10/2020 10:35	24/10/2020 10:45	0,18	1	0,18	CHI
2020102400163	POSSE	IAC-TR2	IACIARA S2	24/10/2020 09:39	24/10/2020 10:48	24/10/2020 10:35	24/10/2020 10:45	0,18	1664	291,66	CHI
2020102400163	POSSE	IAC-TR2	IACIARA S2	24/10/2020 09:39	24/10/2020 10:48	24/10/2020 10:35	24/10/2020 10:45	0,18	3501	613,65	CHI
2020102400163	ALTO PARAISO DE GOIAS	IAC-TR2	IACIARA S2	24/10/2020 09:39	24/10/2020 10:48	24/10/2020 10:35	24/10/2020 10:45	0,18	19	3,33	CHI
2020102400163	IACIARA	IAC-TR2	IACIARA S2	24/10/2020 09:39	24/10/2020 10:48	24/10/2020 10:35	24/10/2020 10:45	0,18	154	26,99	CHI
2020102400163	POSSE	IAC-TR2	IACIARA S2	24/10/2020 09:39	24/10/2020 10:48	24/10/2020 10:35	24/10/2020 10:45	0,18	7089	1242,54	CHI
2020102400163	POSSE	IAC-TR2	IACIARA S2	24/10/2020 09:39	24/10/2020 10:48	24/10/2020 10:35	24/10/2020 10:45	0,18	1	0,18	CHI
2020102400163	GUARANI DE GOIAS	IAC-TR2	IACIARA S2	24/10/2020 09:39	24/10/2020 10:48	24/10/2020 10:35	24/10/2020 10:45	0,18	102	17,88	CHI
2020102400163	SAO DOMINGOS	IAC-TR2	IACIARA S2	24/10/2020 09:39	24/10/2020 10:48	24/10/2020 10:35	24/10/2020 10:45	0,18	7	1,23	CHI
2020102400163	POSSE	FLO-TR1	FLORES DE GOIAS	24/10/2020 09:39	24/10/2020 10:48	24/10/2020 10:34	24/10/2020 10:45	0,18	2	0,35	CHI
2020102400163	FLORES DE GOIAS	FLO-TR1	FLORES DE GOIAS	24/10/2020 09:39	24/10/2020 10:48	24/10/2020 10:34	24/10/2020 10:45	0,18	2338	410,45	CHI
2020102400163	SAO JOAO D ALIANCA	FLO-TR1	FLORES DE GOIAS	24/10/2020 09:39	24/10/2020 10:48	24/10/2020 10:34	24/10/2020 10:45	0,18	103	18,08	CHI
2020102400163	SAO JOAO D ALIANCA	FLO-TR1	FLORES DE GOIAS	24/10/2020 09:39	24/10/2020 10:48	24/10/2020 10:34	24/10/2020 10:45	0,18	5	0,88	CHI
2020102400163	NOVA ROMA	FLO-TR1	FLORES DE GOIAS	24/10/2020 09:39	24/10/2020 10:48	24/10/2020 10:34	24/10/2020 10:45	0,18	2	0,35	CHI
2020102400163	IACIARA	FLO-TR1	FLORES DE GOIAS	24/10/2020 09:39	24/10/2020 10:48	24/10/2020 10:34	24/10/2020 10:45	0,18	16	2,81	CHI
2020102400163	NOVA ROMA	FLO-TR1	FLORES DE GOIAS	24/10/2020 09:39	24/10/2020 10:48	24/10/2020 10:34	24/10/2020 10:45	0,18	32	5,62	CHI
2020102400163	CAVALCANTE	FLO-TR1	FLORES DE GOIAS	24/10/2020 09:39	24/10/2020 10:48	24/10/2020 10:34	24/10/2020 10:45	0,18	2797	491,03	CHI
2020102400163	ALVORADA DO NORTE	FLO-TR1	FLORES DE GOIAS	24/10/2020 09:39	24/10/2020 10:48	24/10/2020 10:34	24/10/2020 10:45	0,18	56	9,83	CHI
2020102400163	SAO JOAO D ALIANCA	FLO-TR1	FLORES DE GOIAS	24/10/2020 09:39	24/10/2020 10:48	24/10/2020 10:34	24/10/2020 10:45	0,18	8	1,40	CHI
2020102400163	FLORES DE GOIAS	FLO-TR1	FLORES DE GOIAS	24/10/2020 09:39	24/10/2020 10:48	24/10/2020 10:34	24/10/2020 10:45	0,18	3	0,53	CHI
2020102400163	ALTO PARAISO DE GOIAS	FLO-TR1	FLORES DE GOIAS	24/10/2020 09:39	24/10/2020 10:48	24/10/2020 10:34	24/10/2020 10:45	0,18	39	6,85	CHI
2020102400163	FORMOSA	FLO-TR1	FLORES DE GOIAS	24/10/2020 09:39	24/10/2020 10:48	24/10/2020 10:34	24/10/2020 10:45	0,18	138	24,23	CHI
2020102400163	TERESINA DE GOIAS	FLO-TR1	FLORES DE GOIAS	24/10/2020 09:39	24/10/2020 10:48	24/10/2020 10:34	24/10/2020 10:45	0,18	1118	196,27	CHI
2020102400163	FORMOSO	FLO-TR1	FLORES DE GOIAS	24/10/2020 09:39	24/10/2020 10:48	24/10/2020 10:34	24/10/2020 10:45	0,18	1	0,18	CHI
2020102400163	FLORES DE GOIAS	FLO-TR1	FLORES DE GOIAS	24/10/2020 09:39	24/10/2020 10:48	24/10/2020 10:34	24/10/2020 10:45	0,18	477	83,74	CHI
2020102400163	POSSE	IAC-TR3	IACIARA S1	24/10/2020 09:39	24/10/2020 10:48	24/10/2020 10:35	24/10/2020 10:45	0,16	174	28,61	CHI
2020102400163	GUARANI DE GOIAS	IAC-TR3	IACIARA S1	24/10/2020 09:39	24/10/2020 10:48	24/10/2020 10:35	24/10/2020 10:45	0,16	1322	217,40	CHI
2020102400163	SAO DOMINGOS	IAC-TR3	IACIARA S1	24/10/2020 09:39	24/10/2020 10:48	24/10/2020 10:35	24/10/2020 10:45	0,16	1	0,16	CHI
2020102400163	IACIARA	IAC-TR3	IACIARA S1	24/10/2020 09:39	24/10/2020 10:48	24/10/2020 10:35	24/10/2020 10:45	0,16	4398	723,23	CHI
2020102400163	FORMOSA	ITQ-TR6	ITIQUIRA	24/10/2020 09:39	24/10/2020 10:48	24/10/2020 09:41	24/10/2020 10:31	0,83	14887	12290,05	CHI
2020102400163	FORMOSA	ITQ-TR6	ITIQUIRA	24/10/2020 09:39	24/10/2020 10:48	24/10/2020 09:41	24/10/2020 10:31	0,83	12012	9916,57	CHI
2020102400163	ITARUMA	ITQ-TR6	ITIQUIRA	24/10/2020 09:39	24/10/2020 10:48	24/10/2020 09:41	24/10/2020 10:31	0,83	3	2,48	CHI
2020102400163	FORMOSA	ITQ-TR6	ITIQUIRA	24/10/2020 09:39	24/10/2020 10:48	24/10/2020 09:41	24/10/2020 10:31	0,83	13253	10941,09	CHI
2020102400163	CABECEIRAS	ITQ-TR1	ITIQUIRA	24/10/2020 09:39	24/10/2020 10:48	24/10/2020 09:41	24/10/2020 10:31	0,83	146	121,91	CHI
2020102400163	FORMOSA	ITQ-TR1	ITIQUIRA	24/10/2020 09:39	24/10/2020 10:48	24/10/2020 09:41	24/10/2020 10:31	0,83	33	27,55	CHI
2020102400163	DISTRITO FEDERAL	ITQ-TR1	ITIQUIRA	24/10/2020 09:39	24/10/2020 10:48	24/10/2020 09:41	24/10/2020 10:31	0,83	2	1,67	CHI
2020102400163	CABECEIRAS	ITQ-TR1	ITIQUIRA	24/10/2020 09:39	24/10/2020 10:48	24/10/2020 09:41	24/10/2020 10:31	0,83	40	33,40	CHI
2020102400163	DISTRITO FEDERAL	ITQ-TR1	ITIQUIRA	24/10/2020 09:39	24/10/2020 10:48	24/10/2020 09:41	24/10/2020 10:31	0,83	1	0,83	CHI
2020102400163	CABECEIRAS	ITQ-TR1	ITIQUIRA	24/10/2020 09:39	24/10/2020 10:48	24/10/2020 09:41	24/10/2020 10:31	0,83	196	163,66	CHI
2020102400163	FORMOSA	ITQ-TR1	ITIQUIRA	24/10/2020 09:39	24/10/2020 10:48	24/10/2020 09:41	24/10/2020 10:31	0,83	32	26,72	CHI

2020102400163	CABECEIRAS	ITQ-TR1	ITUIQUIRA	24/10/2020 09:39	24/10/2020 10:48	24/10/2020 09:41	24/10/2020 10:31	0,83	52	43,42	CHI
2020102400163	FORMOSA	ITQ-TR1	ITUIQUIRA	24/10/2020 09:39	24/10/2020 10:48	24/10/2020 09:41	24/10/2020 10:31	0,83	2167	1809,44	CHI
2020102400163	FORMOSA	ITQ-TR1	ITUIQUIRA	24/10/2020 09:39	24/10/2020 10:48	24/10/2020 09:41	24/10/2020 10:31	0,83	2	1,67	CHI
2020102400163	FORMOSA	ITQ-TR1	ITUIQUIRA	24/10/2020 09:39	24/10/2020 10:48	24/10/2020 09:41	24/10/2020 10:31	0,83	6	5,01	CHI
2020102400163	SAO DOMINGOS	USD-TR3	SAO DOMINGOS	24/10/2020 09:39	24/10/2020 10:48	24/10/2020 09:39	24/10/2020 10:29	0,83	2433	2024,80	CHI
2020102400163	MONTE ALEGRE DE GOIAS	USD-TR4	SAO DOMINGOS	24/10/2020 09:39	24/10/2020 10:48	24/10/2020 09:42	24/10/2020 10:29	0,78	154	120,63	CHI
2020102400163	GUARANI DE GOIAS	USD-TR4	SAO DOMINGOS	24/10/2020 09:39	24/10/2020 10:48	24/10/2020 09:42	24/10/2020 10:29	0,78	151	118,28	CHI
2020102400163	SAO DOMINGOS	USD-TR4	SAO DOMINGOS	24/10/2020 09:39	24/10/2020 10:48	24/10/2020 09:42	24/10/2020 10:29	0,78	1183	926,68	CHI
2020102400163	DIVINOPOLIS DE GOIAS	USD-TR4	SAO DOMINGOS	24/10/2020 09:39	24/10/2020 10:48	24/10/2020 09:42	24/10/2020 10:29	0,78	2237	1752,32	CHI
2020102400163	MONTE ALEGRE DE GOIAS	USD-TR4	SAO DOMINGOS	24/10/2020 09:39	24/10/2020 10:48	24/10/2020 09:42	24/10/2020 10:29	0,78	1	0,78	CHI
2020102400163	SAO DOMINGOS	USD-TR4	SAO DOMINGOS	24/10/2020 09:39	24/10/2020 10:48	24/10/2020 09:42	24/10/2020 10:29	0,78	407	318,82	CHI
2020102400163	NOVA ROMA	USD-TR4	SAO DOMINGOS	24/10/2020 09:39	24/10/2020 10:48	24/10/2020 09:42	24/10/2020 10:29	0,78	3	2,35	CHI
2020102400163	CAMPOS BELOS	USD-TR4	SAO DOMINGOS	24/10/2020 09:39	24/10/2020 10:48	24/10/2020 09:42	24/10/2020 10:29	0,78	102	79,90	CHI
2020102400163	SAO JOAO D ALIANCA	IAC-TR2	IACIARA S2	24/10/2020 09:39	24/10/2020 10:48	24/10/2020 09:40	24/10/2020 10:28	0,81	28	22,68	CHI
2020102400163	POSSE	IAC-TR2	IACIARA S2	24/10/2020 09:39	24/10/2020 10:48	24/10/2020 09:40	24/10/2020 10:28	0,81	1663	1347,03	CHI
2020102400163	IACIARA	IAC-TR3	IACIARA S1	24/10/2020 09:39	24/10/2020 10:48	24/10/2020 09:40	24/10/2020 10:28	0,81	4397	3561,57	CHI
2020102400163	IACIARA	IAC-TR2	IACIARA S2	24/10/2020 09:39	24/10/2020 10:48	24/10/2020 09:40	24/10/2020 10:28	0,81	12	9,72	CHI
2020102400163	IACIARA	IAC-TR2	IACIARA S2	24/10/2020 09:39	24/10/2020 10:48	24/10/2020 09:40	24/10/2020 10:28	0,81	1	0,81	CHI
2020102400163	POSSE	IAC-TR2	IACIARA S2	24/10/2020 09:39	24/10/2020 10:48	24/10/2020 09:40	24/10/2020 10:28	0,81	1	0,81	CHI
2020102400163	GUARANI DE GOIAS	IAC-TR2	IACIARA S2	24/10/2020 09:39	24/10/2020 10:48	24/10/2020 09:40	24/10/2020 10:28	0,81	102	82,62	CHI
2020102400163	ALTO PARAISO DE GOIAS	IAC-TR2	IACIARA S2	24/10/2020 09:39	24/10/2020 10:48	24/10/2020 09:40	24/10/2020 10:28	0,81	19	15,39	CHI
2020102400163	FLORES DE GOIAS	IAC-TR2	IACIARA S2	24/10/2020 09:39	24/10/2020 10:48	24/10/2020 09:40	24/10/2020 10:28	0,81	1	0,81	CHI
2020102400163	POSSE	IAC-TR2	IACIARA S2	24/10/2020 09:39	24/10/2020 10:48	24/10/2020 09:40	24/10/2020 10:28	0,81	1037	839,97	CHI
2020102400163	MONTE ALEGRE DE GOIAS	IAC-TR2	IACIARA S2	24/10/2020 09:39	24/10/2020 10:48	24/10/2020 09:40	24/10/2020 10:28	0,81	1	0,81	CHI
2020102400163	POSSE	IAC-TR2	IACIARA S2	24/10/2020 09:39	24/10/2020 10:48	24/10/2020 09:40	24/10/2020 10:28	0,81	7089	5742,09	CHI
2020102400163	MAMBAI	IAC-TR2	IACIARA S2	24/10/2020 09:39	24/10/2020 10:48	24/10/2020 09:40	24/10/2020 10:28	0,81	28	22,68	CHI
2020102400163	POSSE	IAC-TR2	IACIARA S2	24/10/2020 09:39	24/10/2020 10:48	24/10/2020 09:40	24/10/2020 10:28	0,81	87	70,47	CHI
2020102400163	POSSE	IAC-TR2	IACIARA S2	24/10/2020 09:39	24/10/2020 10:48	24/10/2020 09:40	24/10/2020 10:28	0,81	1	0,81	CHI
2020102400163	IACIARA	IAC-TR2	IACIARA S2	24/10/2020 09:39	24/10/2020 10:48	24/10/2020 09:40	24/10/2020 10:28	0,81	153	123,93	CHI
2020102400163	POSSE	IAC-TR2	IACIARA S2	24/10/2020 09:39	24/10/2020 10:48	24/10/2020 09:40	24/10/2020 10:28	0,81	287	232,47	CHI
2020102400163	BURITINOPOLIS	IAC-TR2	IACIARA S2	24/10/2020 09:39	24/10/2020 10:48	24/10/2020 09:40	24/10/2020 10:28	0,81	2	1,62	CHI
2020102400163	POSSE	IAC-TR3	IACIARA S1	24/10/2020 09:39	24/10/2020 10:48	24/10/2020 09:40	24/10/2020 10:28	0,81	174	140,94	CHI
2020102400163	GUARANI DE GOIAS	IAC-TR3	IACIARA S1	24/10/2020 09:39	24/10/2020 10:48	24/10/2020 09:40	24/10/2020 10:28	0,81	1318	1067,58	CHI
2020102400163	NOVA ROMA	IAC-TR2	IACIARA S2	24/10/2020 09:39	24/10/2020 10:48	24/10/2020 09:40	24/10/2020 10:28	0,81	1572	1273,32	CHI
2020102400163	SAO DOMINGOS	IAC-TR2	IACIARA S2	24/10/2020 09:39	24/10/2020 10:48	24/10/2020 09:40	24/10/2020 10:28	0,81	7	5,67	CHI
2020102400163	IACIARA	IAC-TR2	IACIARA S2	24/10/2020 09:39	24/10/2020 10:48	24/10/2020 09:40	24/10/2020 10:28	0,81	103	83,43	CHI
2020102400163	SAO DOMINGOS	IAC-TR3	IACIARA S1	24/10/2020 09:39	24/10/2020 10:48	24/10/2020 09:40	24/10/2020 10:28	0,81	1	0,81	CHI
2020102400163	POSSE	IAC-TR2	IACIARA S2	24/10/2020 09:39	24/10/2020 10:48	24/10/2020 09:40	24/10/2020 10:28	0,81	3334	2700,54	CHI
2020102400163	POSSE	AVN-TR1	IACIARA S2	24/10/2020 09:39	24/10/2020 10:48	24/10/2020 09:39	24/10/2020 10:27	0,81	111	90,00	CHI
2020102400163	BURITINOPOLIS	AVN-TR1	IACIARA S2	24/10/2020 09:39	24/10/2020 10:48	24/10/2020 09:39	24/10/2020 10:27	0,81	1058	857,86	CHI
2020102400163	SIMOLANDIA	AVN-TR1	IACIARA S2	24/10/2020 09:39	24/10/2020 10:48	24/10/2020 09:39	24/10/2020 10:27	0,81	2173	1761,94	CHI
2020102400163	SIMOLANDIA	AVN-TR1	IACIARA S2	24/10/2020 09:39	24/10/2020 10:48	24/10/2020 09:39	24/10/2020 10:27	0,81	3	2,43	CHI
2020102400163	ALVORADA DO NORTE	AVN-TR1	IACIARA S2	24/10/2020 09:39	24/10/2020 10:48	24/10/2020 09:39	24/10/2020 10:27	0,81	2056	1667,07	CHI
2020102400163	ALVORADA DO NORTE	AVN-TR1	IACIARA S2	24/10/2020 09:39	24/10/2020 10:48	24/10/2020 09:39	24/10/2020 10:27	0,81	1200	973,00	CHI
2020102400163	SIMOLANDIA	AVN-TR2	IACIARA S2	24/10/2020 09:39	24/10/2020 10:48	24/10/2020 09:39	24/10/2020 10:27	0,81	249	201,76	CHI
2020102400163	FLORES DE GOIAS	AVN-TR2	IACIARA S2	24/10/2020 09:39	24/10/2020 10:48	24/10/2020 09:39	24/10/2020 10:27	0,81	1344	1089,01	CHI
2020102400163	POSSE	AVN-TR2	IACIARA S2	24/10/2020 09:39	24/10/2020 10:48	24/10/2020 09:39	24/10/2020 10:27	0,81	78	63,20	CHI
2020102400163	SITIO D ABADIA	AVN-TR2	IACIARA S2	24/10/2020 09:39	24/10/2020 10:48	24/10/2020 09:39	24/10/2020 10:27	0,81	1	0,81	CHI
2020102400163	DAMIANOPOLIS	AVN-TR2	IACIARA S2	24/10/2020 09:39	24/10/2020 10:48	24/10/2020 09:39	24/10/2020 10:27	0,81	134	108,58	CHI
2020102400163	SITIO D ABADIA	AVN-TR2	IACIARA S2	24/10/2020 09:39	24/10/2020 10:48	24/10/2020 09:39	24/10/2020 10:27	0,81	37	29,98	CHI
2020102400163	SIMOLANDIA	AVN-TR2	IACIARA S2	24/10/2020 09:39	24/10/2020 10:48	24/10/2020 09:39	24/10/2020 10:27	0,81	1	0,81	CHI

2020102400163	BURITINOPOLIS	AVN-TR2	IACIARA S2	24/10/2020 09:39	24/10/2020 10:48	24/10/2020 09:39	24/10/2020 10:27	0,81	452	366,25	CHI
2020102400163	VILA BOA	AVN-TR2	IACIARA S2	24/10/2020 09:39	24/10/2020 10:48	24/10/2020 09:39	24/10/2020 10:27	0,81	67	54,29	CHI
2020102400163	ALVORADA DO NORTE	AVN-TR2	IACIARA S2	24/10/2020 09:39	24/10/2020 10:48	24/10/2020 09:39	24/10/2020 10:27	0,81	3	2,43	CHI
2020102400163	DAMIANOPOLIS	AVN-TR2	IACIARA S2	24/10/2020 09:39	24/10/2020 10:48	24/10/2020 09:39	24/10/2020 10:27	0,81	1577	1277,81	CHI
2020102400163	VILA BOA	AVN-TR2	IACIARA S2	24/10/2020 09:39	24/10/2020 10:48	24/10/2020 09:39	24/10/2020 10:27	0,81	1382	1119,80	CHI
2020102400163	SITIO D ABADIA	AVN-TR2	IACIARA S2	24/10/2020 09:39	24/10/2020 10:48	24/10/2020 09:39	24/10/2020 10:27	0,81	529	428,64	CHI
2020102400163	DAMIANOPOLIS	AVN-TR2	IACIARA S2	24/10/2020 09:39	24/10/2020 10:48	24/10/2020 09:39	24/10/2020 10:27	0,81	3	2,43	CHI
2020102400163	SITIO D ABADIA	AVN-TR2	IACIARA S2	24/10/2020 09:39	24/10/2020 10:48	24/10/2020 09:39	24/10/2020 10:27	0,81	389	315,20	CHI
2020102400163	BURITINOPOLIS	AVN-TR2	IACIARA S2	24/10/2020 09:39	24/10/2020 10:48	24/10/2020 09:39	24/10/2020 10:27	0,81	8	6,48	CHI
2020102400163	FORMOSA	AVN-TR2	IACIARA S2	24/10/2020 09:39	24/10/2020 10:48	24/10/2020 09:39	24/10/2020 10:27	0,81	1	0,81	CHI
2020102400163	MAMBAI	AVN-TR2	IACIARA S2	24/10/2020 09:39	24/10/2020 10:48	24/10/2020 09:39	24/10/2020 10:27	0,81	85	68,87	CHI
2020102400163	MAMBAI	AVN-TR2	IACIARA S2	24/10/2020 09:39	24/10/2020 10:48	24/10/2020 09:39	24/10/2020 10:27	0,81	17	13,77	CHI
2020102400163	MAMBAI	AVN-TR2	IACIARA S2	24/10/2020 09:39	24/10/2020 10:48	24/10/2020 09:39	24/10/2020 10:27	0,81	2976	2411,39	CHI
2020102400163	SITIO D ABADIA	AVN-TR2	IACIARA S2	24/10/2020 09:39	24/10/2020 10:48	24/10/2020 09:39	24/10/2020 10:27	0,81	147	119,11	CHI
2020102400163	IACIARA	AVN-TR2	IACIARA S2	24/10/2020 09:39	24/10/2020 10:48	24/10/2020 09:39	24/10/2020 10:27	0,81	1	0,81	CHI
2020102400163	ALVORADA DO NORTE	AVN-TR2	IACIARA S2	24/10/2020 09:39	24/10/2020 10:48	24/10/2020 09:39	24/10/2020 10:27	0,81	293	237,41	CHI
2020102400163	SITIO D ABADIA	AVN-TR2	IACIARA S2	24/10/2020 09:39	24/10/2020 10:48	24/10/2020 09:39	24/10/2020 10:27	0,81	91	73,74	CHI
2020102400163	ALVORADA DO NORTE	AVN-TR2	IACIARA S2	24/10/2020 09:39	24/10/2020 10:48	24/10/2020 09:39	24/10/2020 10:27	0,81	182	147,47	CHI
2020102400163	ALVORADA DO NORTE	FLO-TR1	FLORES DE GOIAS	24/10/2020 09:39	24/10/2020 10:48	24/10/2020 09:41	24/10/2020 10:27	0,76	54	41,14	CHI
2020102400163	FLORES DE GOIAS	FLO-TR1	FLORES DE GOIAS	24/10/2020 09:39	24/10/2020 10:48	24/10/2020 09:41	24/10/2020 10:27	0,76	3	2,29	CHI
2020102400163	FORMOSO	FLO-TR1	FLORES DE GOIAS	24/10/2020 09:39	24/10/2020 10:48	24/10/2020 09:41	24/10/2020 10:27	0,76	1	0,76	CHI
2020102400163	ALTO PARAISO DE GOIAS	FLO-TR1	FLORES DE GOIAS	24/10/2020 09:39	24/10/2020 10:48	24/10/2020 09:41	24/10/2020 10:27	0,76	38	28,95	CHI
2020102400163	CAVALCANTE	FLO-TR1	FLORES DE GOIAS	24/10/2020 09:39	24/10/2020 10:48	24/10/2020 09:41	24/10/2020 10:27	0,76	2796	2130,40	CHI
2020102400163	FORMOSA	FLO-TR1	FLORES DE GOIAS	24/10/2020 09:39	24/10/2020 10:48	24/10/2020 09:41	24/10/2020 10:27	0,76	136	103,62	CHI
2020102400163	FLORES DE GOIAS	FLO-TR1	FLORES DE GOIAS	24/10/2020 09:39	24/10/2020 10:48	24/10/2020 09:41	24/10/2020 10:27	0,76	462	352,02	CHI
2020102400163	IACIARA	FLO-TR1	FLORES DE GOIAS	24/10/2020 09:39	24/10/2020 10:48	24/10/2020 09:41	24/10/2020 10:27	0,76	16	12,19	CHI
2020102400163	FLORES DE GOIAS	FLO-TR1	FLORES DE GOIAS	24/10/2020 09:39	24/10/2020 10:48	24/10/2020 09:41	24/10/2020 10:27	0,76	2316	1764,66	CHI
2020102400163	SAO JOAO D ALIANCA	FLO-TR1	FLORES DE GOIAS	24/10/2020 09:39	24/10/2020 10:48	24/10/2020 09:41	24/10/2020 10:27	0,76	5	3,81	CHI
2020102400163	SAO JOAO D ALIANCA	FLO-TR1	FLORES DE GOIAS	24/10/2020 09:39	24/10/2020 10:48	24/10/2020 09:41	24/10/2020 10:27	0,76	94	71,62	CHI
2020102400163	NOVA ROMA	FLO-TR1	FLORES DE GOIAS	24/10/2020 09:39	24/10/2020 10:48	24/10/2020 09:41	24/10/2020 10:27	0,76	2	1,52	CHI
2020102400163	POSSE	FLO-TR1	FLORES DE GOIAS	24/10/2020 09:39	24/10/2020 10:48	24/10/2020 09:41	24/10/2020 10:27	0,76	2	1,52	CHI
2020102400163	TERESINA DE GOIAS	FLO-TR1	FLORES DE GOIAS	24/10/2020 09:39	24/10/2020 10:48	24/10/2020 09:41	24/10/2020 10:27	0,76	974	742,13	CHI
2020102400163	NOVA ROMA	FLO-TR1	FLORES DE GOIAS	24/10/2020 09:39	24/10/2020 10:48	24/10/2020 09:41	24/10/2020 10:27	0,76	17	12,95	CHI
2020102400163	SAO JOAO D ALIANCA	FLO-TR1	FLORES DE GOIAS	24/10/2020 09:39	24/10/2020 10:48	24/10/2020 09:41	24/10/2020 10:27	0,76	8	6,10	CHI
2020102400163	PADRE BERNARDO	PLG-TR2	PLANALTINA	24/10/2020 09:39	24/10/2020 10:48	24/10/2020 09:41	24/10/2020 10:27	0,76	16	12,22	CHI
2020102400163	FORMOSA	PLG-TR2	PLANALTINA	24/10/2020 09:39	24/10/2020 10:48	24/10/2020 09:41	24/10/2020 10:27	0,76	55	42,01	CHI
2020102400163	PLANALTINA	PLG-TR2	PLANALTINA	24/10/2020 09:39	24/10/2020 10:48	24/10/2020 09:41	24/10/2020 10:27	0,76	12916	9866,39	CHI
2020102400163	DISTRITO FEDERAL	PLG-TR2	PLANALTINA	24/10/2020 09:39	24/10/2020 10:48	24/10/2020 09:41	24/10/2020 10:27	0,76	4	3,06	CHI
2020102400163	PLANALTINA	PLG-TR2	PLANALTINA	24/10/2020 09:39	24/10/2020 10:48	24/10/2020 09:41	24/10/2020 10:27	0,76	13	9,93	CHI
2020102400163	PLANALTINA	PLG-TR2	PLANALTINA	24/10/2020 09:39	24/10/2020 10:48	24/10/2020 09:41	24/10/2020 10:27	0,76	1999	1527,01	CHI
2020102400163	DISTRITO FEDERAL	PLG-TR2	PLANALTINA	24/10/2020 09:39	24/10/2020 10:48	24/10/2020 09:41	24/10/2020 10:27	0,76	124	94,72	CHI
2020102400163	PLANALTINA	PLG-TR2	PLANALTINA	24/10/2020 09:39	24/10/2020 10:48	24/10/2020 09:41	24/10/2020 10:27	0,76	9272	7082,78	CHI
2020102400163	PLANALTINA	PLG-TR2	PLANALTINA	24/10/2020 09:39	24/10/2020 10:48	24/10/2020 09:41	24/10/2020 10:27	0,76	557	425,49	CHI
2020102400163	PLANALTINA	PLG-TR2	PLANALTINA	24/10/2020 09:39	24/10/2020 10:48	24/10/2020 09:41	24/10/2020 10:27	0,76	4	3,06	CHI



### 5. Plotagem das Ocorrências conforme a Especialização das Chuvas

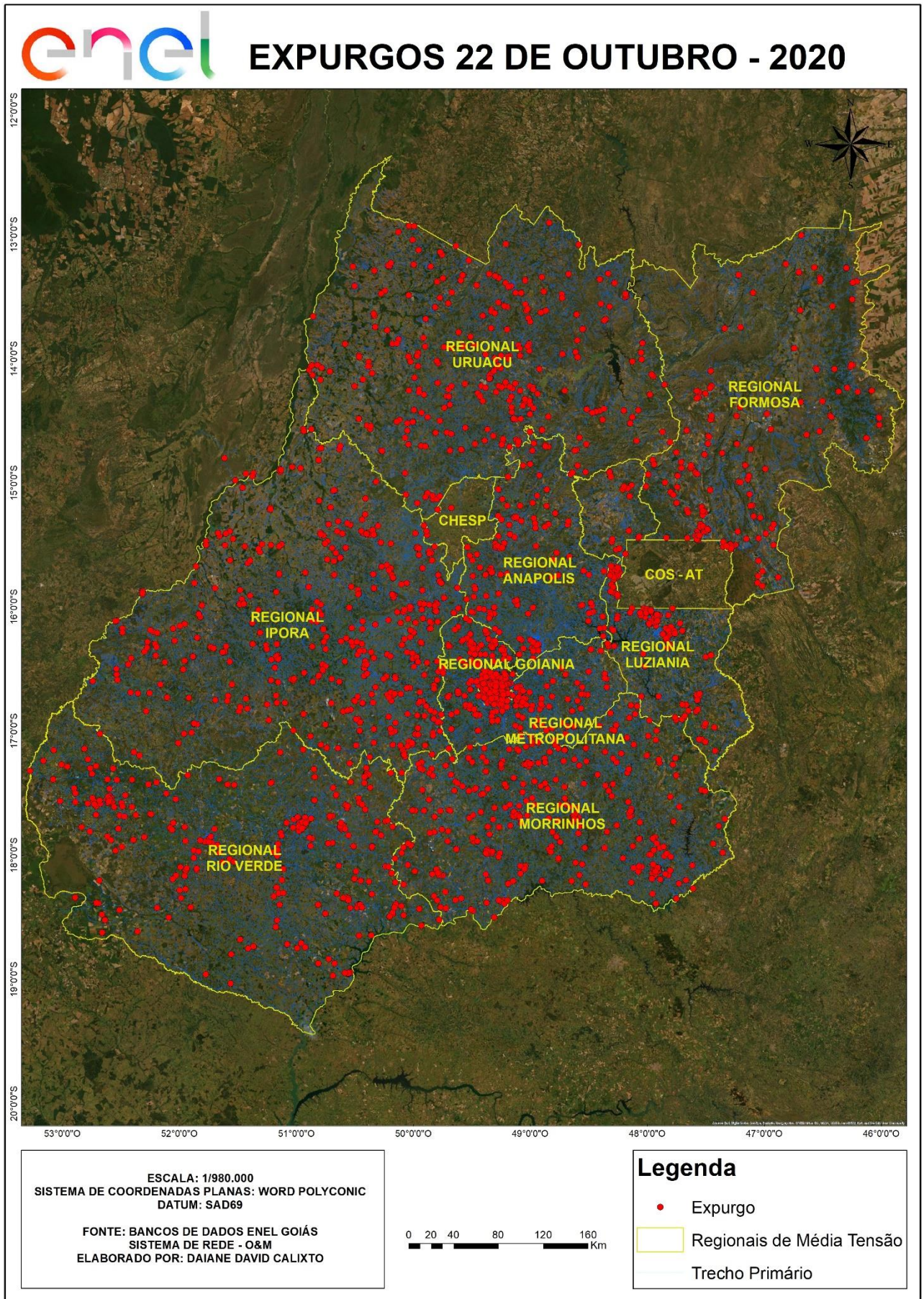



## 6. Clientes Afetados e Impactos Globais

Em análise ao número de clientes interrompidos (CI) na área de concessão da ENEL GO, a figura abaixo apresenta a atipicidade vivenciada no dia 22 a 24 de outubro de 2020, data esta que, conforme laudo meteorológico emitido por empresa especializada, a referida concessão passou por um período de condições climáticas de extrema severidade.

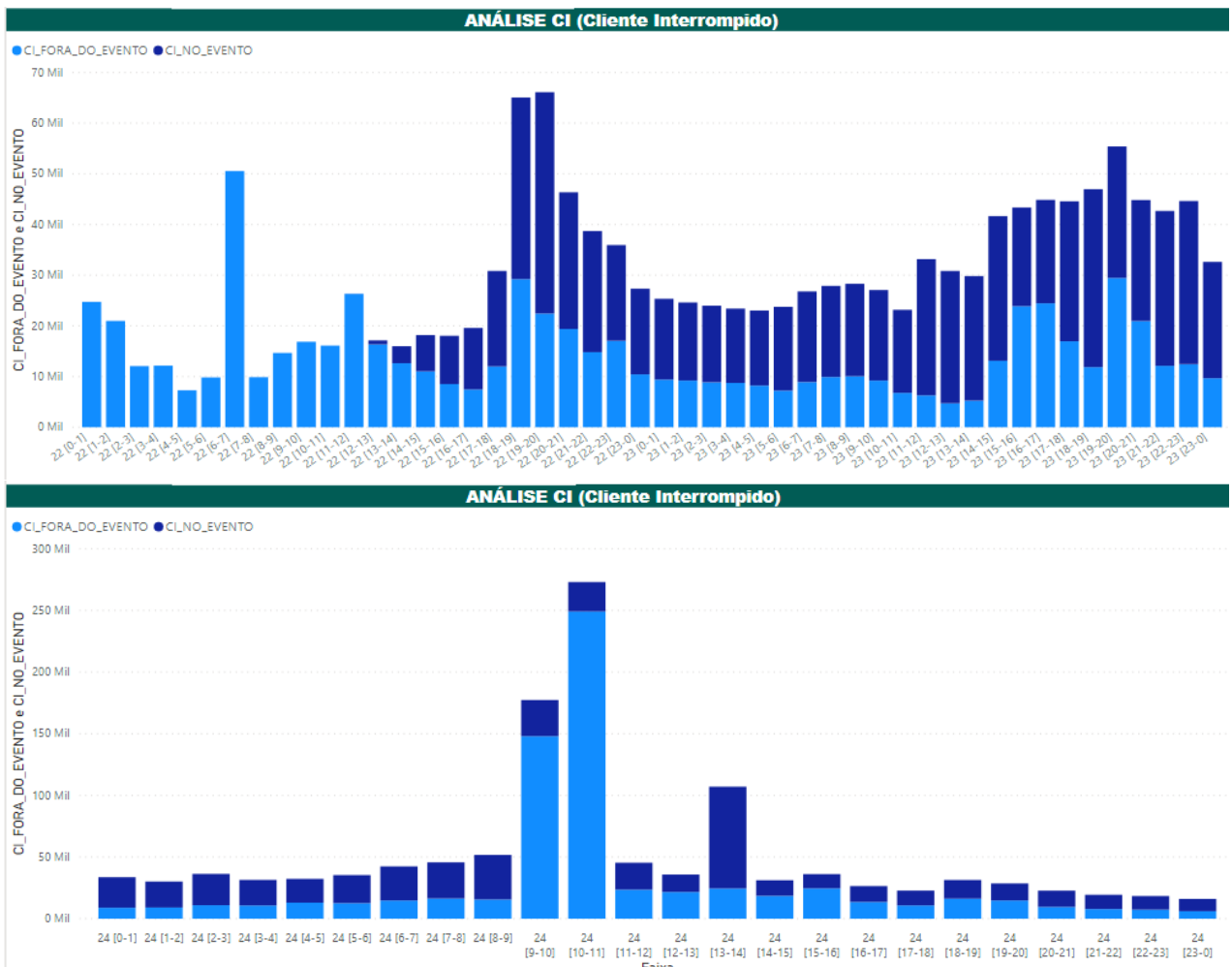

Figuras – Clientes Interrompidos em intervalos de horas

Na figura acima, as barras em azul claro representam a quantidade de clientes interrompidos simultaneamente em condições normais de operação, e as barras azul escuro os clientes interrompidos simultaneamente no período do evento.

### 7. Diagramas Unifilares

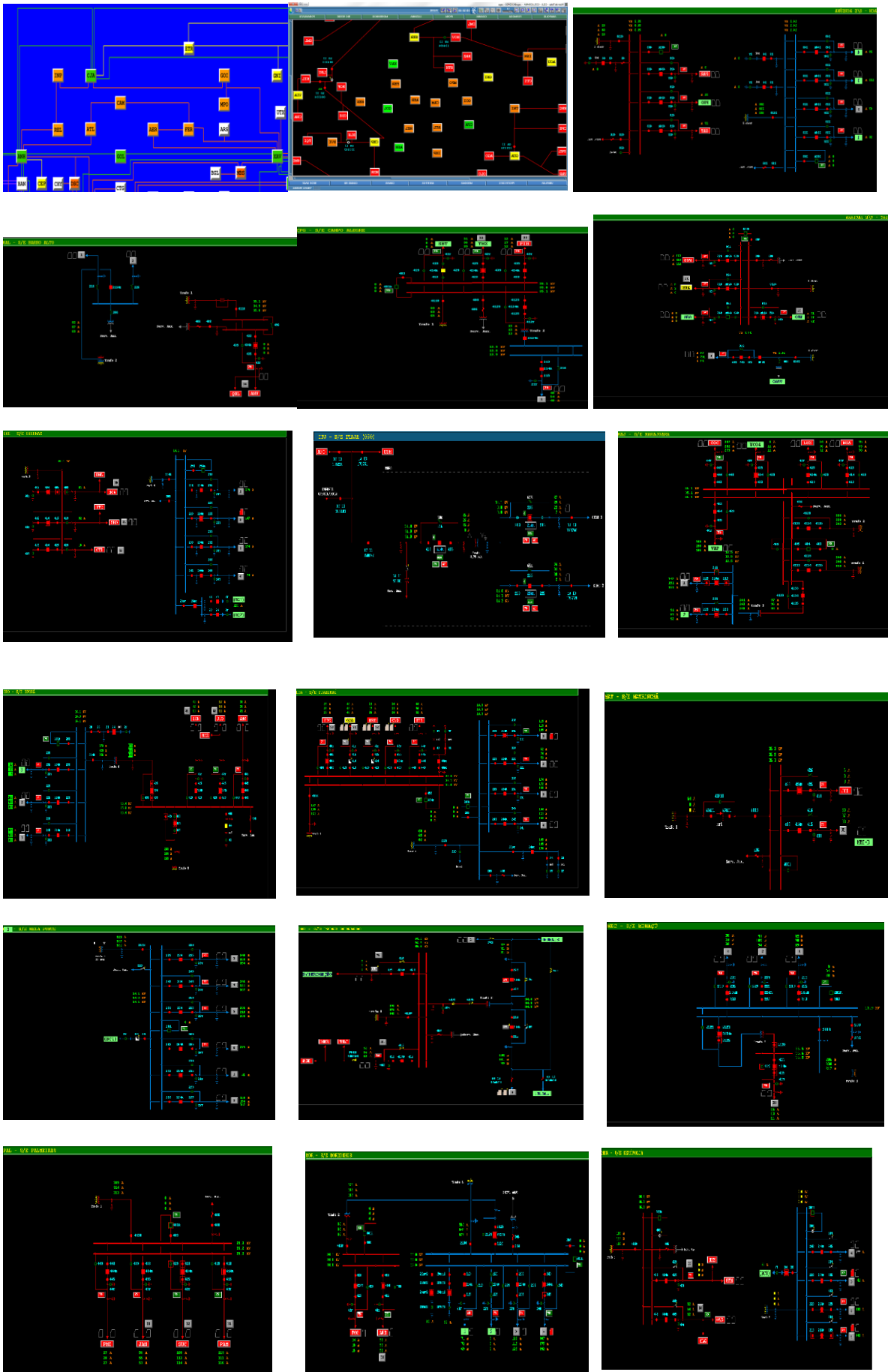

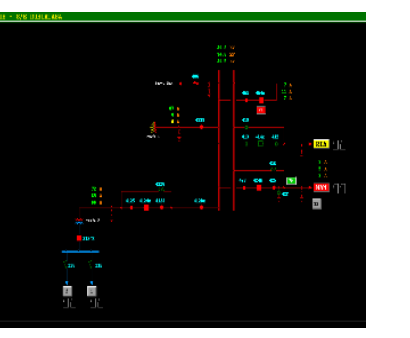
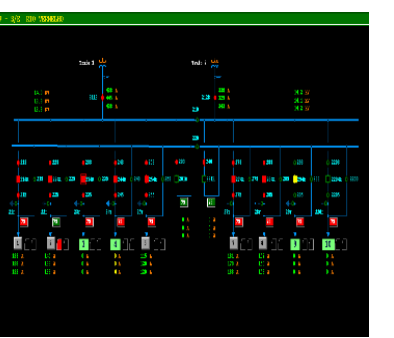
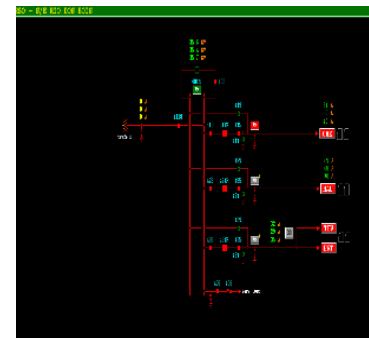
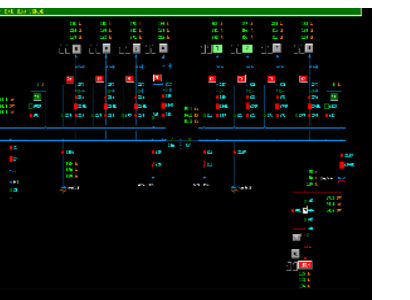
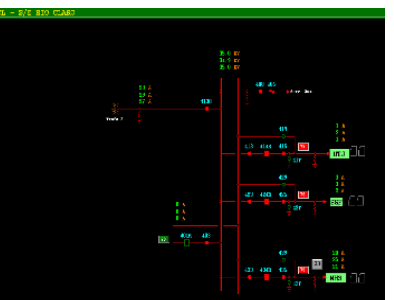
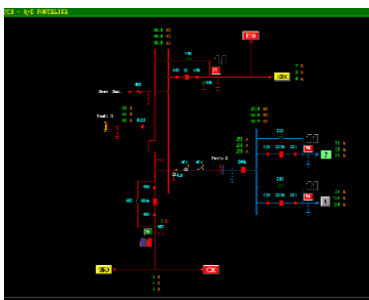
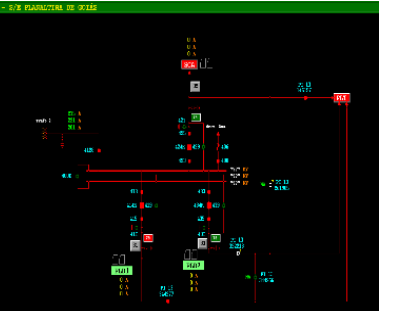
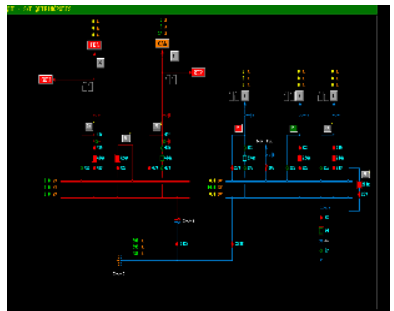
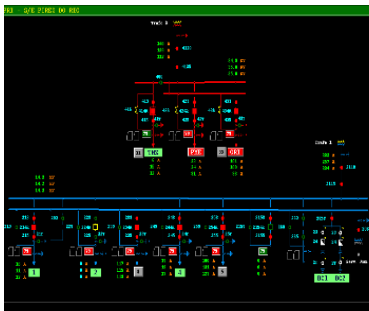
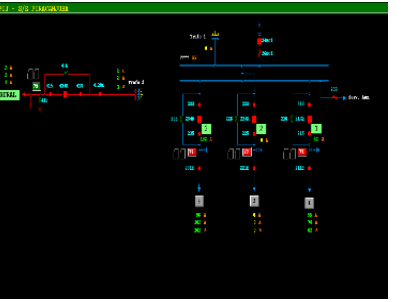
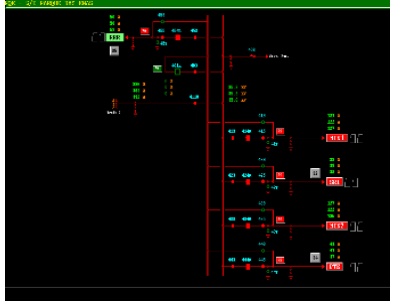
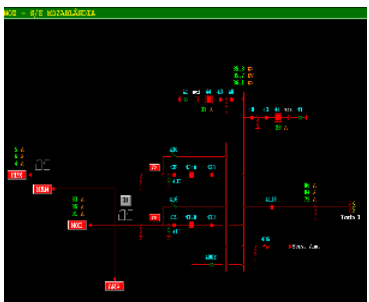
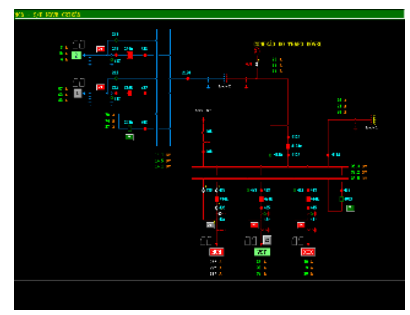
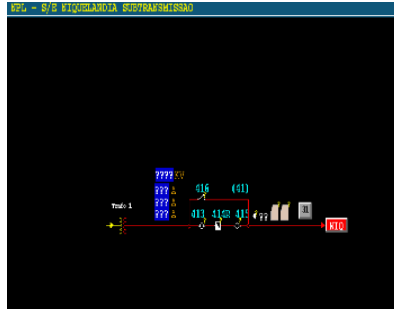

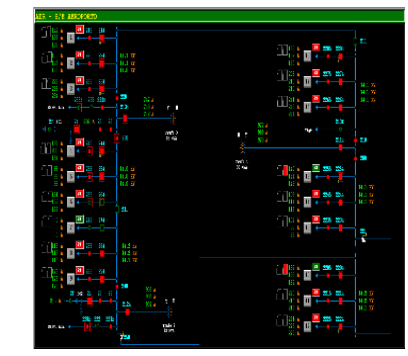
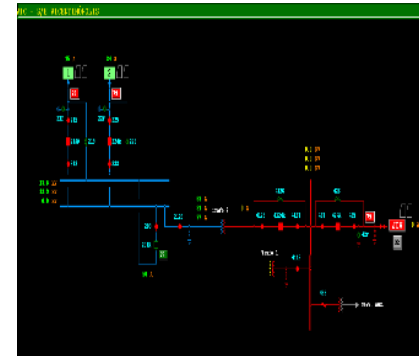
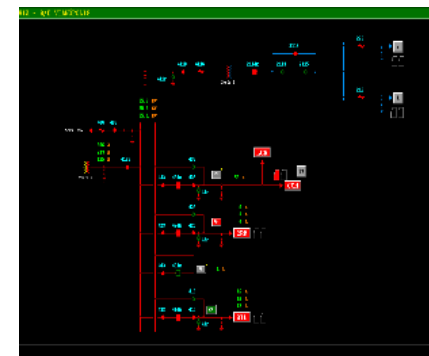
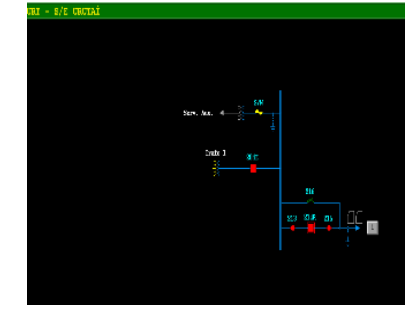
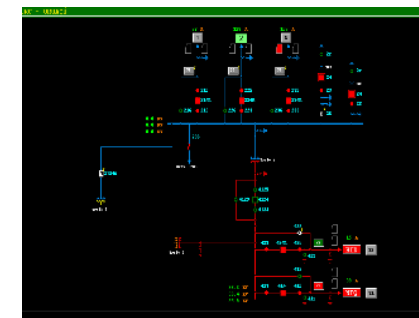
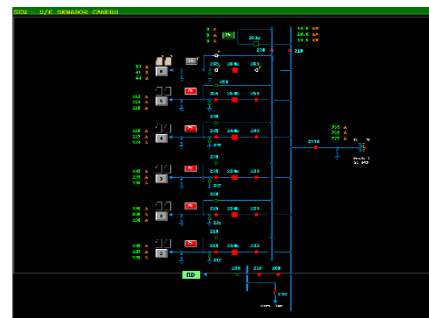
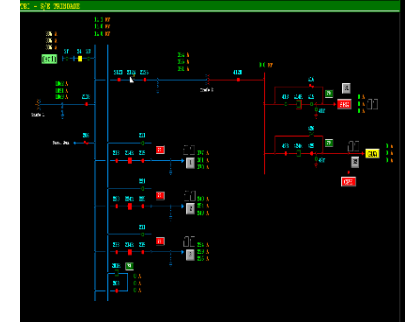
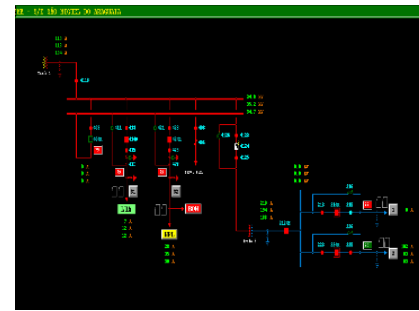
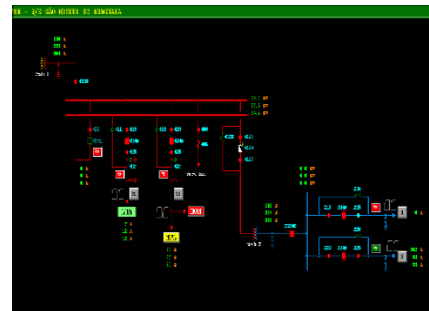
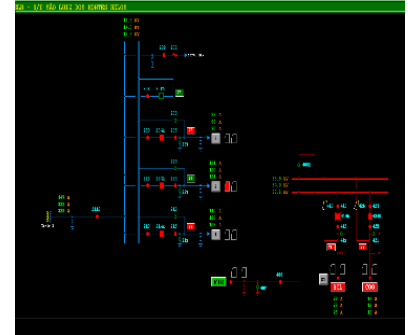
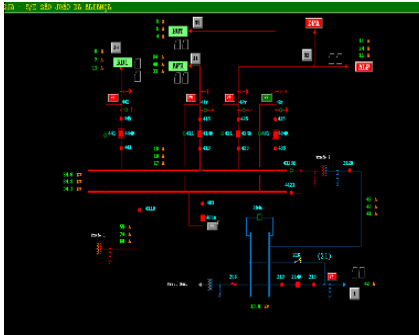
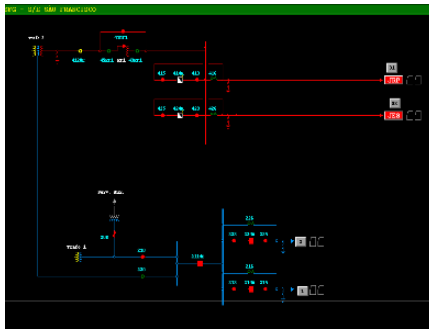
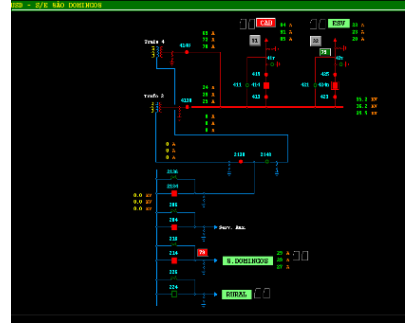
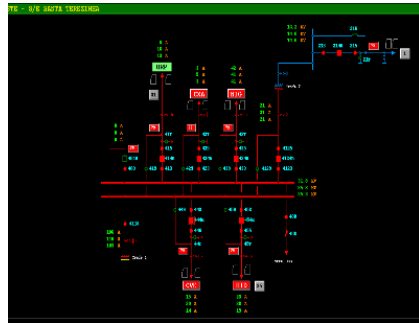
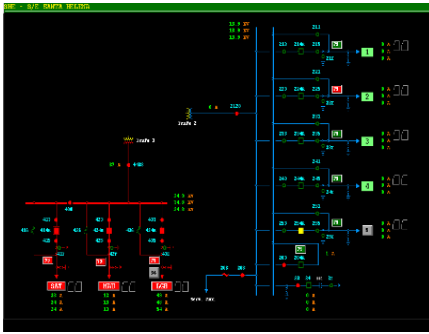

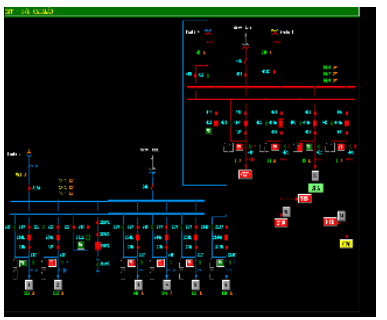
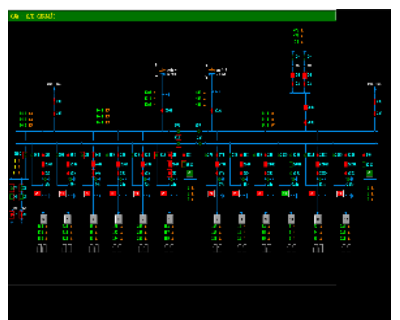
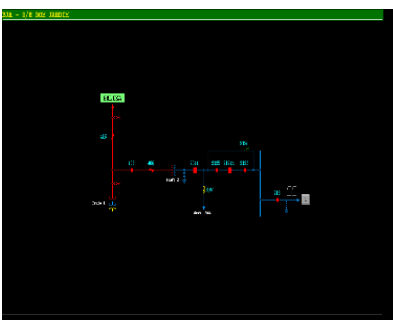
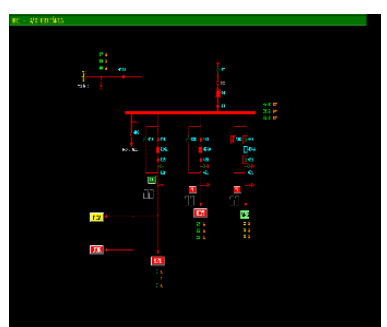
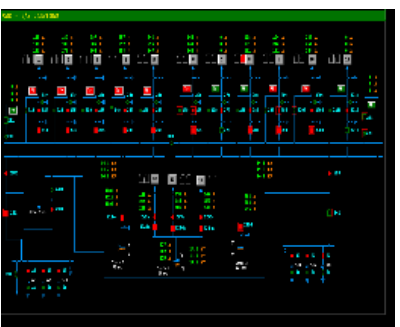
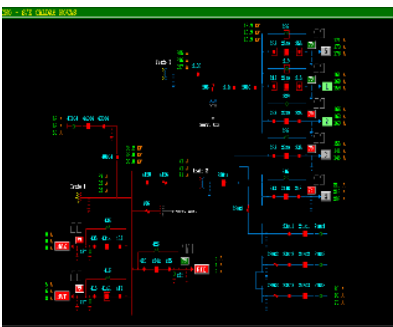
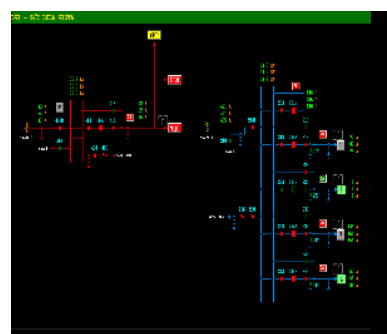
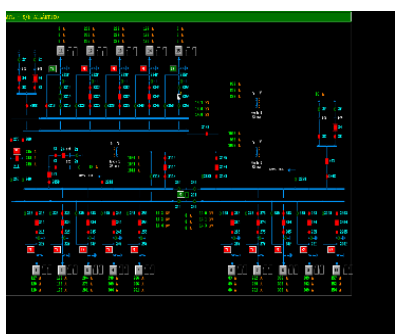
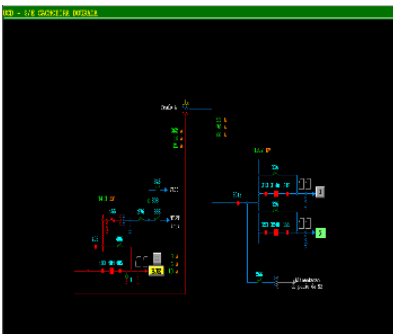
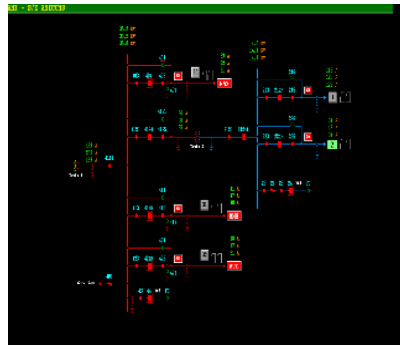
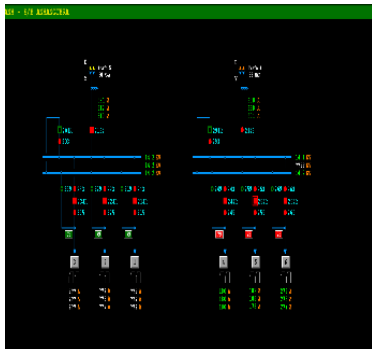
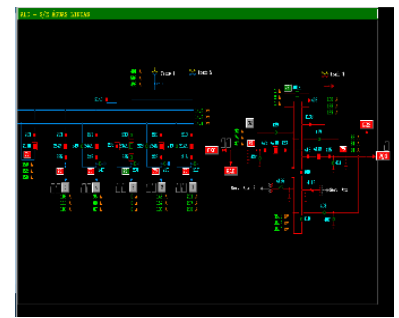
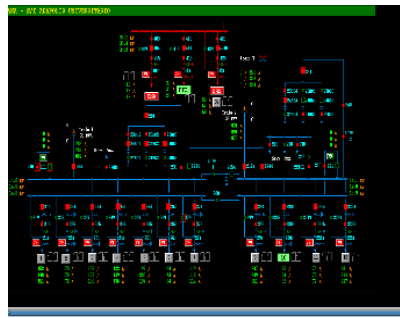
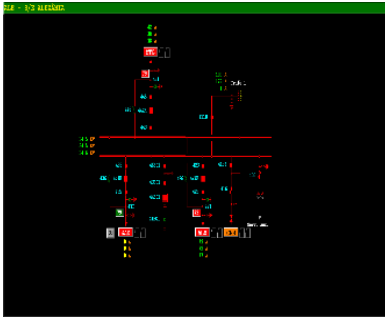



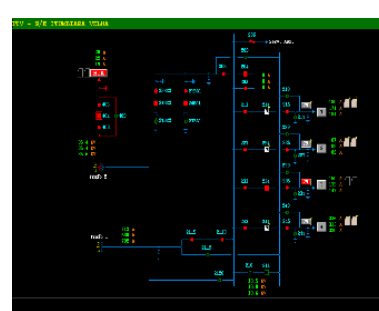
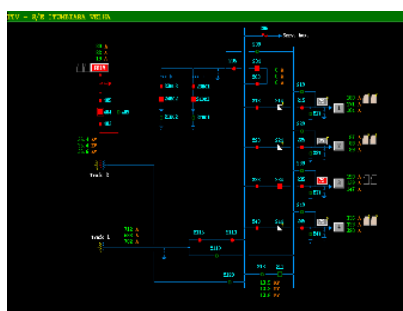
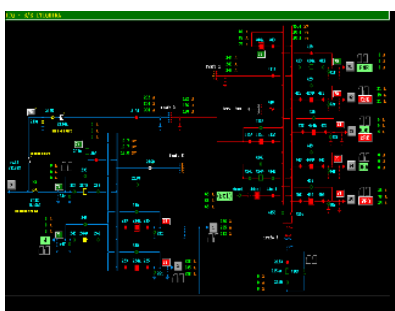
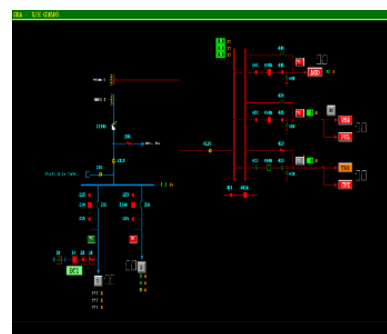
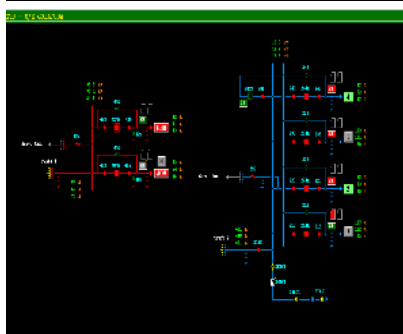
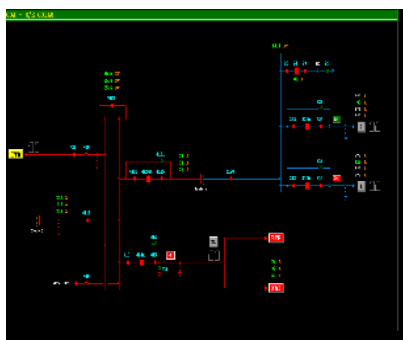
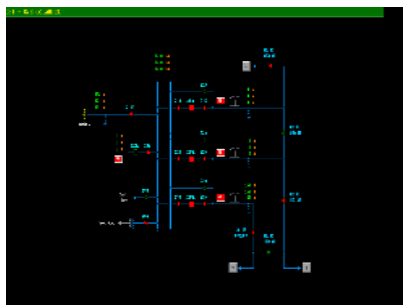
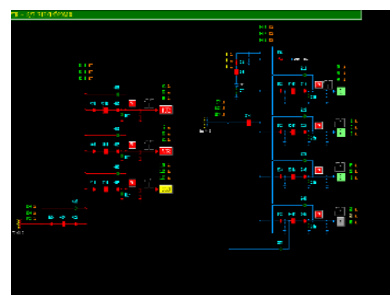
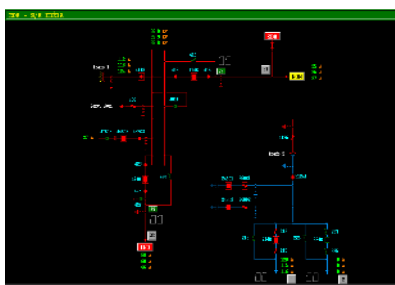
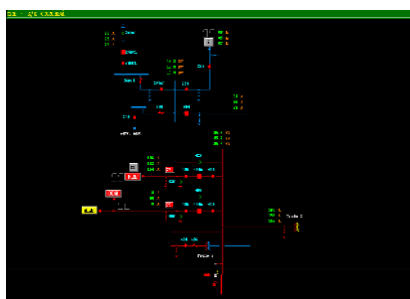
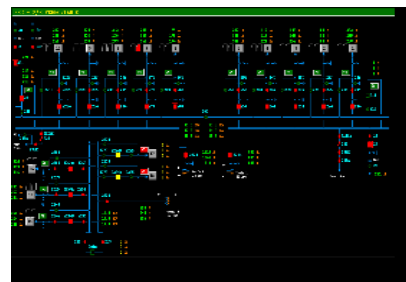
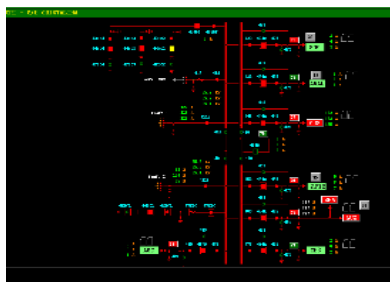
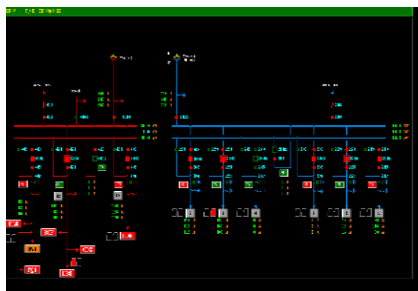
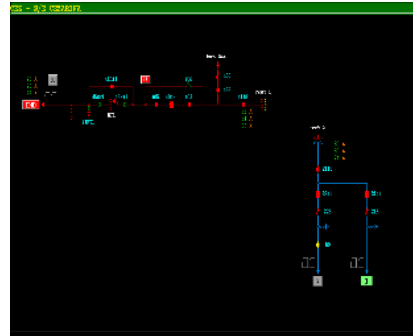
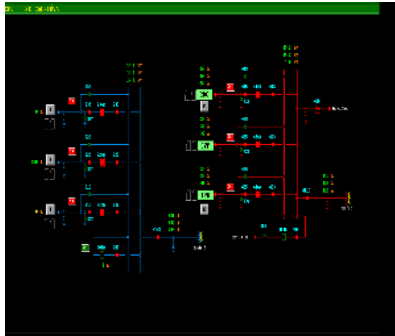
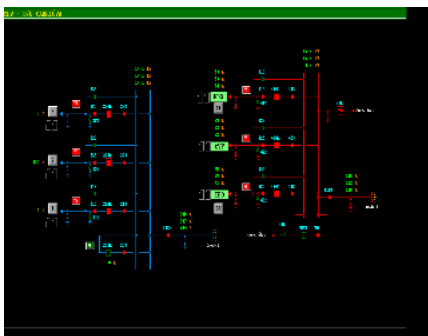

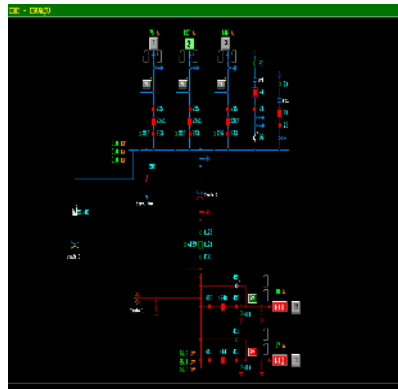
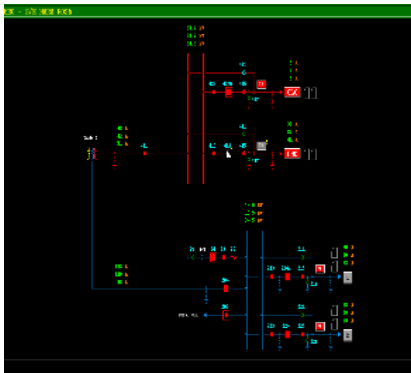
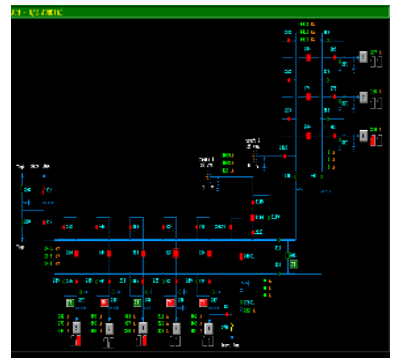
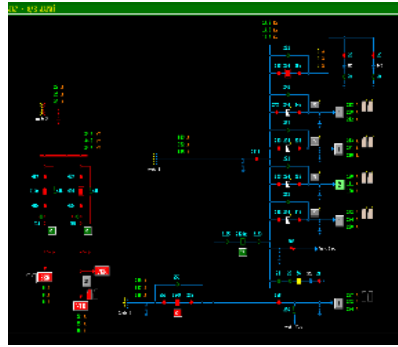
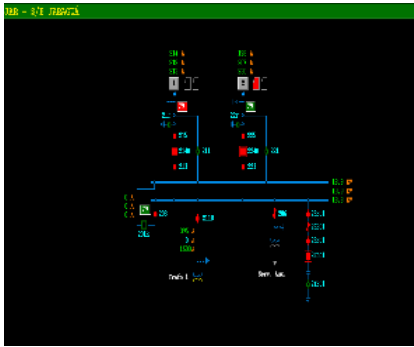

## 8. DEMAIS EVIDÊNCIAS

### 8.1. DADOS TÉCNICO - OPERACIONAIS ENEL GO

Enel - GO

TMAE e OE por Dia - Outubro 2020

● Contagem de Ocorrências ● TMAE



Regional Anápolis – GO

TMAE e OE por Dia - Outubro 2020

● Contagem de Ocorrências ● TMAE

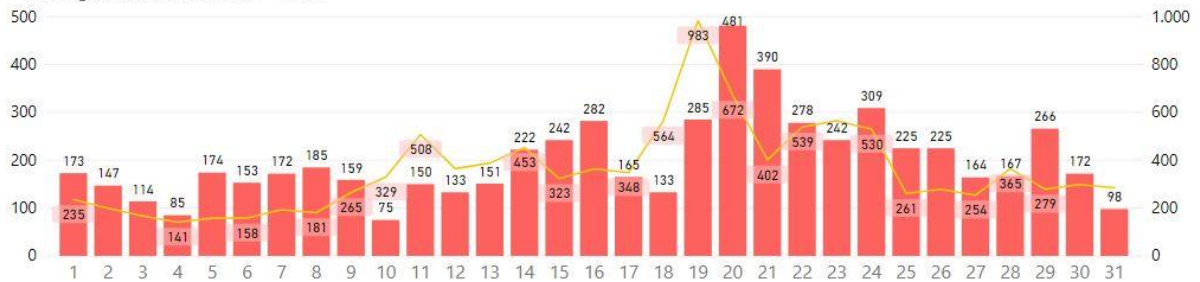

Regional Formosa – GO

TMAE e OE por Dia - Outubro 2020

● Contagem de Ocorrências ● TMAE

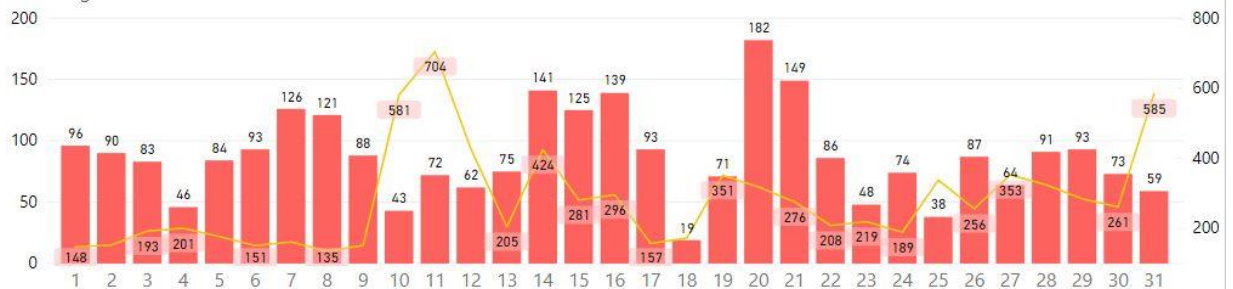

Regional Goiânia – GO

TMAE e OE por Dia - Outubro 2020

● Contagem de Ocorrências ● TMAE



**Regional Iporá – GO**

TMAE e OE por Dia - Outubro 2020

● Contagem de Ocorrências ● TMAE

**Regional Luziânia – GO**

TMAE e OE por Dia - Outubro 2020

● Contagem de Ocorrências ● TMAE

**Regional Metropolitana – GO**

TMAE e OE por Dia - Outubro 2020

● Contagem de Ocorrências ● TMAE

**Regional Morrinhos – GO**

TMAE e OE por Dia - Outubro 2020

● Contagem de Ocorrências ● TMAE

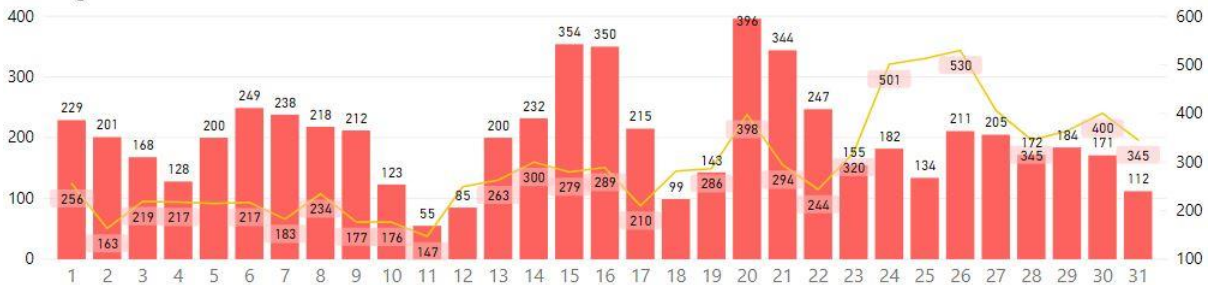

**Regional Rio Verde – GO**

TMAE e OE por Dia - Outubro 2020

● Contagem de Ocorrências ● TMAE



**Regional Uruaçu - GO**

TMAE e OE por Dia - Outubro 2020

● Contagem de Ocorrências ● TMAE

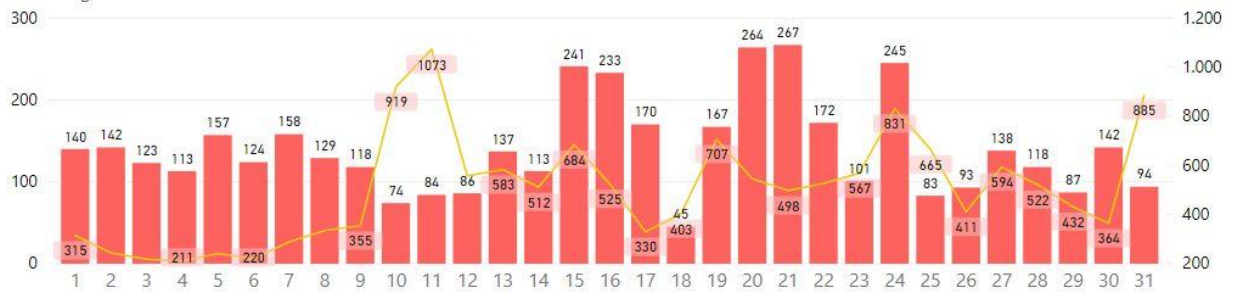

**8.2. Dados climatológicos pelo INMET**

**Instituto Nacional de Meteorologia – INMET**

Chuva Acumulada em 24h || Estação: ARAGARCAS (83368) – 10/2020

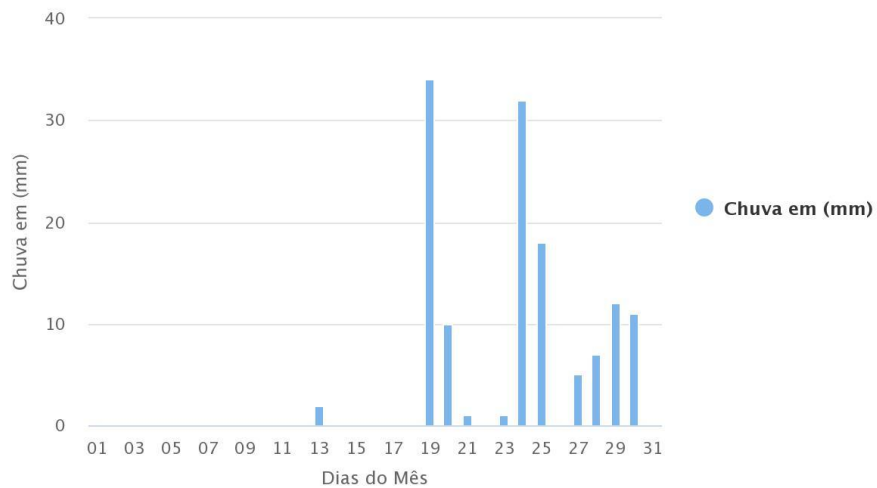



### Instituto Nacional de Meteorologia – INMET

Chuva Acumulada em 24h || Estação: CATALAO (83526) – 10/2020

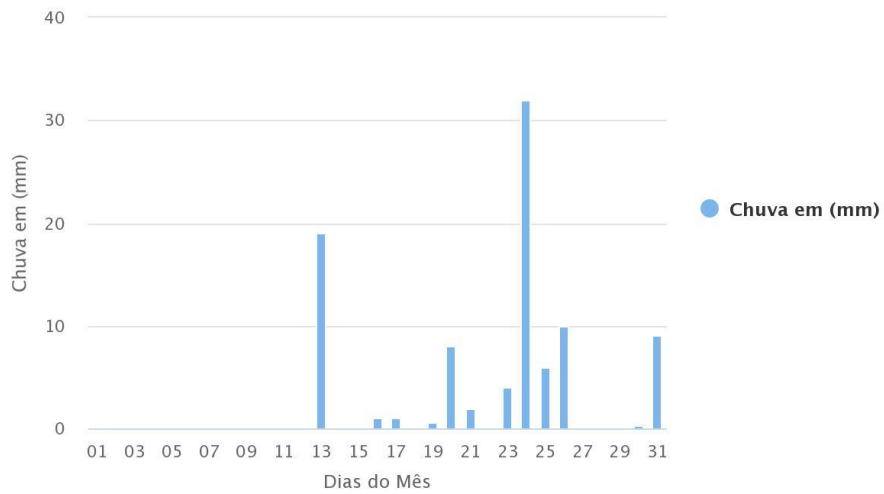

Highcharts.com

### Instituto Nacional de Meteorologia – INMET

Chuva Acumulada em 24h || Estação: FORMOSA (83379) – 10/2020

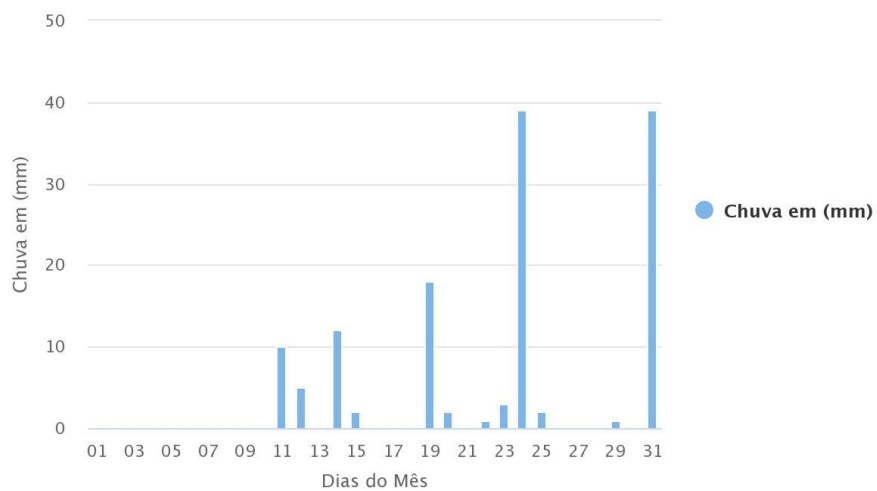

Highcharts.com

### Instituto Nacional de Meteorologia – INMET

Chuva Acumulada em 24h || Estação: GOIANIA (83423) – 10/2020

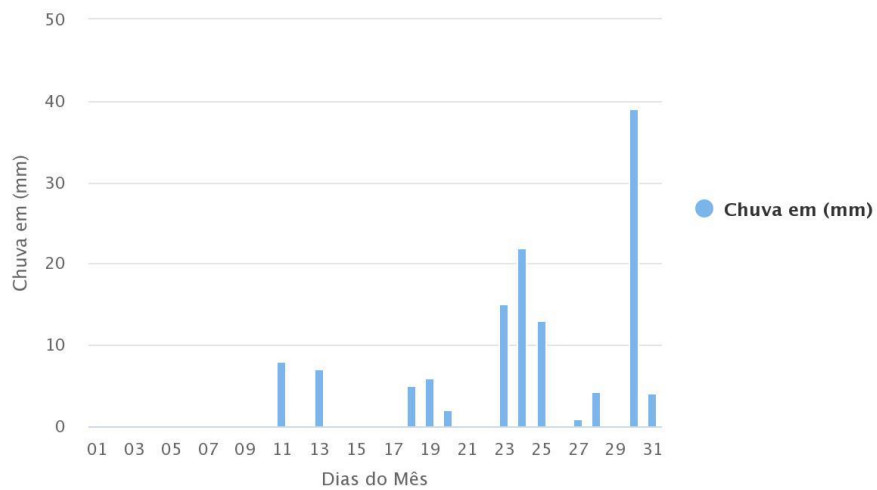

Highcharts.com

### Instituto Nacional de Meteorologia – INMET

Chuva Acumulada em 24h || Estação: IPAMERI (83522) – 10/2020

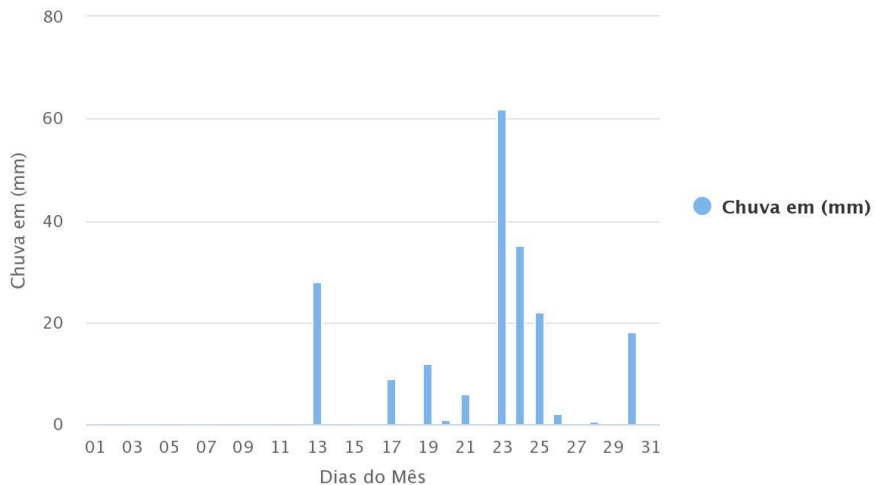

Highcharts.com

### Instituto Nacional de Meteorologia – INMET

Chuva Acumulada em 24h || Estação: JATAI (83464) – 10/2020

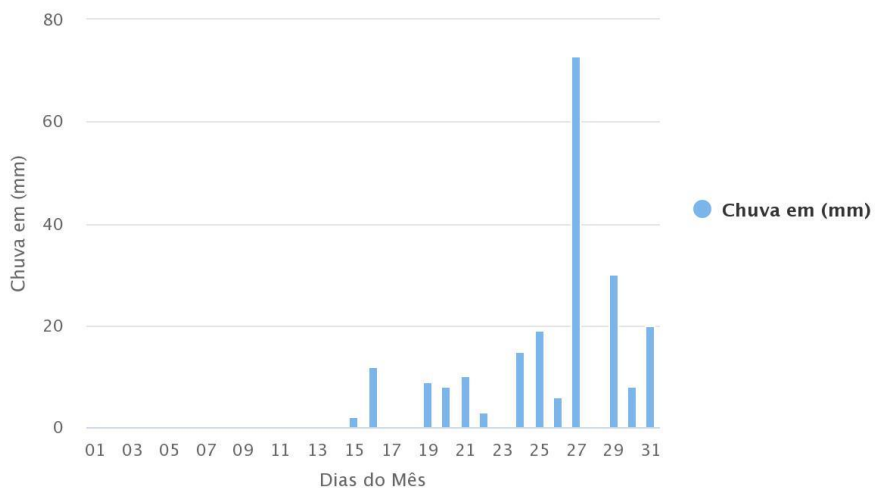

Highcharts.com

### Instituto Nacional de Meteorologia – INMET

Chuva Acumulada em 24h || Estação: PIRENOPOLIS (83376) – 10/2020

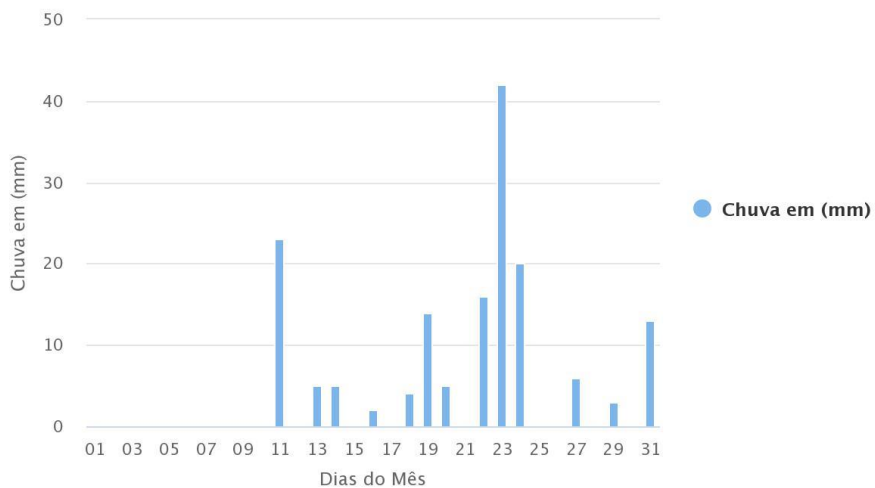

Highcharts.com

### Instituto Nacional de Meteorologia – INMET

Chuva Acumulada em 24h || Estação: RIO VERDE (83470) – 10/2020

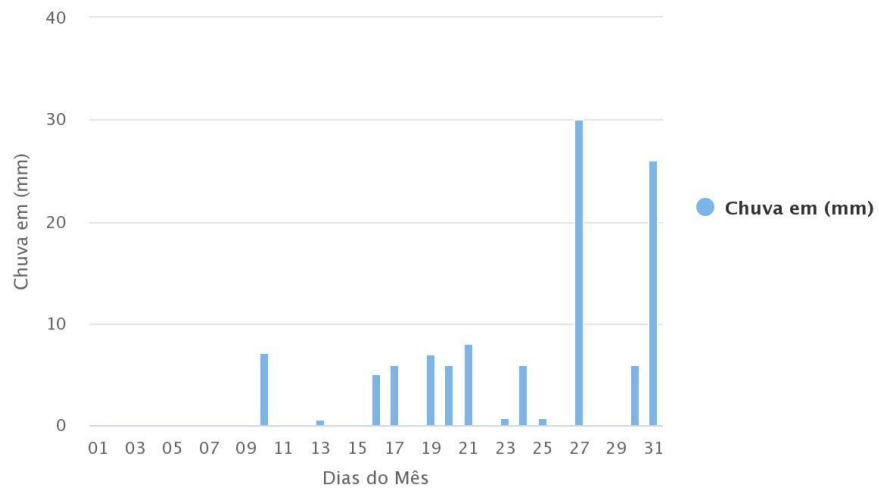

Highcharts.com

## 9. NOTÍCIAS RELACIONADAS

<https://www.zapcatalao.com.br/2020/10/23/chuva-forte-alaga-residencia-e-causa-queda-de-arvore-em-ipameri/>

Home > Ipameri > Chuva Forte Alaga Residência E Causa Queda De Árvore Em Ipameri

### Chuva forte alaga residência e causa queda de árvore em Ipameri

Postado em 23/10/2020 às 09:01

Por Blog Zap Catalão Notícias.

Uma chuva forte alagou uma rua e a enxurrada invadiu uma casa nesta quinta-feira (22) em Ipameri. O ponto crítico foi na Rua 07, no bairro Vera Cruz, onde a água chegou a provocar estragos em uma residência.

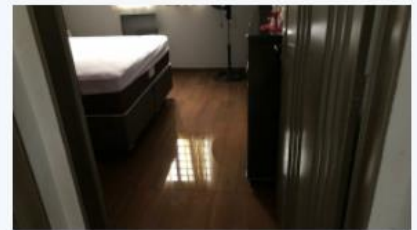

Segundo o Corpo de Bombeiros, quando as equipes chegaram no local o nível da água já havia baixado, mas as marcas ficaram registradas na parede do imóvel, ainda segundo a guarnição, a força da água retirou e danificou o portão da frente da residência.

Em outro ponto da cidade, uma árvore de grande porte caiu sobre um veículo, e obstruindo a rua, os militares fizeram o corte da arvores e providenciaram a retirada dos galhos.



O Corpo de Bombeiros informou que não houve registros de feridos ou desabrigados.

<https://www.instagram.com/p/CGqLGwollsN/?hl=pt-br>

maisgoias • Seguindo

maisgoias Tempo: choveu forte em vários bairros de Goiânia. Vídeo @diego\_fiori

8 sem

elianapintocamargo E muito bom.

14.944 visualizações

22 DE OUTUBRO

Adicione um comentário... Publicar

<https://www.instagram.com/p/CGpJtf-FsA9/?hl=pt-br>



**maisgoias** • Seguindo

**maisgoias** Alô @saneago! Uma adutora estourou nessa manhã na Avenida Caiapó, no Setor Santa Geneveva.

8 sem

**mariotinho** Imaginei que tivesse caído um dilúvio a noite.

8 sem Responder

**mychelle\_alencar** Vai pra conta de quem ?

8 sem Responder

38.151 visualizações

22 DE OUTUBRO

Adicione um comentário... [Publicar](#)

<https://www.instagram.com/p/CGqI3IXIGwt/?hl=pt-br>



**maisgoias** • Seguindo

Original Audio

**maisgoias** Tempo: chove forte em vários bairros de Goiânia.

8 sem

**tia\_olivete** Maravilhosa molha bastante

8 sem Responder

**anarubiaa\_** Chove em tudo quanto é lugar menos onde eu tô. Assim tá difícil viu!

8 sem Responder

Curtido por **eumichaelribeiro** e outras 15.862 pessoas

22 DE OUTUBRO

Adicione um comentário... [Publicar](#)



10. Laudo Técnico

CLIMATEMPO

**Laudo Meteorológico de Evento Climático  
- ENEL Goiás - 22 de outubro de 2020**

São Paulo, SP, Brasil

Novembro de 2020

# Sumário

<b>1</b>	<b>ANÁLISE DE EVENTO METEOROLÓGICO.....</b>	<b>2</b>
1.1	Descrição do Evento.....	2
1.2	Abrangência do Evento.....	6
<b>2</b>	<b>CLASSIFICAÇÃO COBRADE.....</b>	<b>12</b>
<b>3</b>	<b>RESUMO DO EVENTO.....</b>	<b>13</b>
<b>4</b>	<b>REFERÊNCIAS.....</b>	<b>17</b>
	<b>ANEXOS.....</b>	<b>18</b>

# 1. Análise de Evento Meteorológico

## 1.1. Descrição do Evento

Na figura a seguir é apresentada a área de concessão da ENEL DISTRIBUIÇÃO GOIÁS, dividida em regiões, a serem analisadas neste relatório.



Figura 1 – Regiões atendidas pela ENEL Goiás.

Entre os dias 22 e 23 de outubro de 2020 o avanço de uma frente fria pela costa do Brasil favoreceu a organização de áreas de instabilidade sobre o estado de Goiás

Nas Figuras 2 e 3 são apresentadas as descargas atmosféricas nuvem-solo (raios) e nuvem-nuvem detectadas pelo sistema Earth Networks. Entre as 11h00 do dia 22 e as 09h40 do dia 24 de outubro de 2020 foram registrados 27089 raios nuvem-solo e 83452 descargas nuvem-nuvem sobre a área da ENEL DISTRIBUIÇÃO GOIÁS.

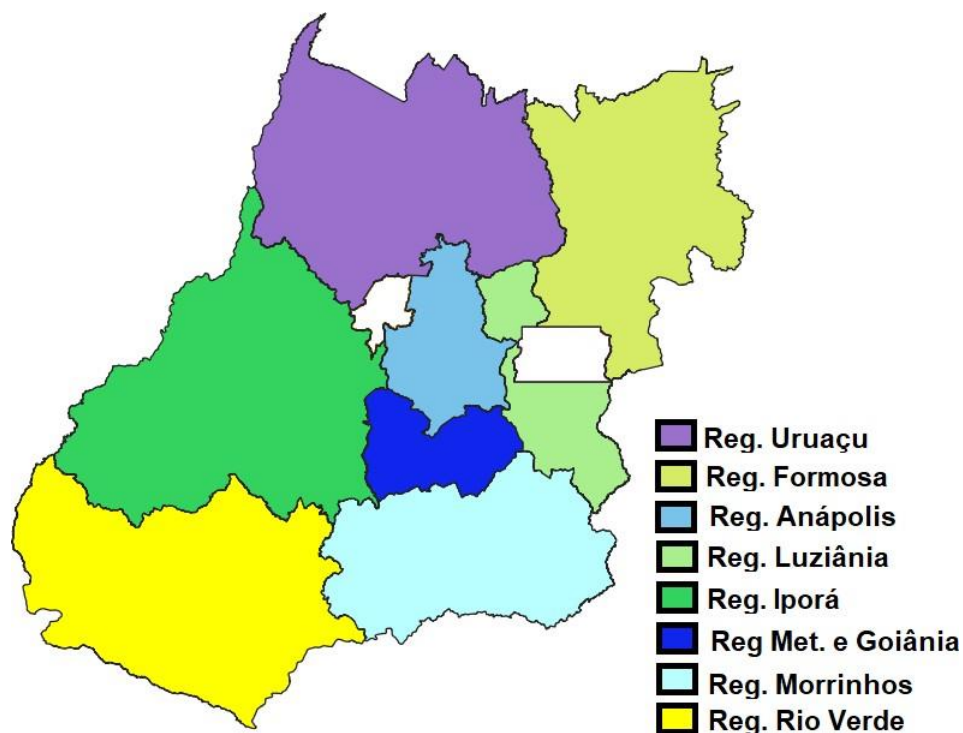

Figura 2 – Descargas atmosféricas nuvem-solo (em preto) detectadas pelo sistema Earth Networks entre 11h00 do dia 22 e as 09h40 do dia 24 de outubro de 2020 sobre a área de concessão da ENEL DISTRIBUIÇÃO GOIÁS.



Figura 3 – Descargas atmosféricas nuvem-nuvem (em vermelho) detectadas pelo sistema Earth Networks entre 11h00 do dia 22 e as 09h40 do dia 24 de outubro de 2020 sobre a área de concessão da ENEL DISTRIBUIÇÃO GOIÁS.

Na tabela 1 são apresentadas as rajadas de vento iguais ou superiores a 50 km/h registradas por estações do Instituto Nacional de Meteorologia (INMET) representativas da área de concessão da ENEL Distribuição Goiás. Como é possível observar, o maior valor registrado foi de 54,7 km/h na estação de Jataí entre as 14h e 15h do dia 23 de outubro, vento classificado como vento forte pela escala Beaufort.

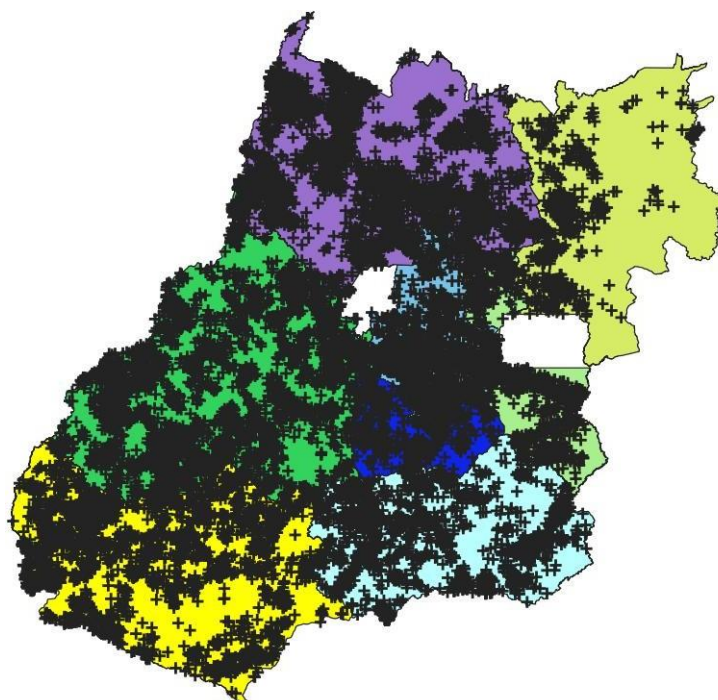
Tabela 1 – Rajadas de vento maiores ou iguais a 50 km/h registradas pelo INMET. Segundo a escala Beaufort, ventos entre 50 e 61 km/h são classificados como vento forte.

Estação	Horário	Rajada (km/h)
Alto Araguaia	Entre 15h e 16h do dia 23/10/2020	53.6
Jataí	Entre 14h e 15h do dia 23/10/2020	54.7

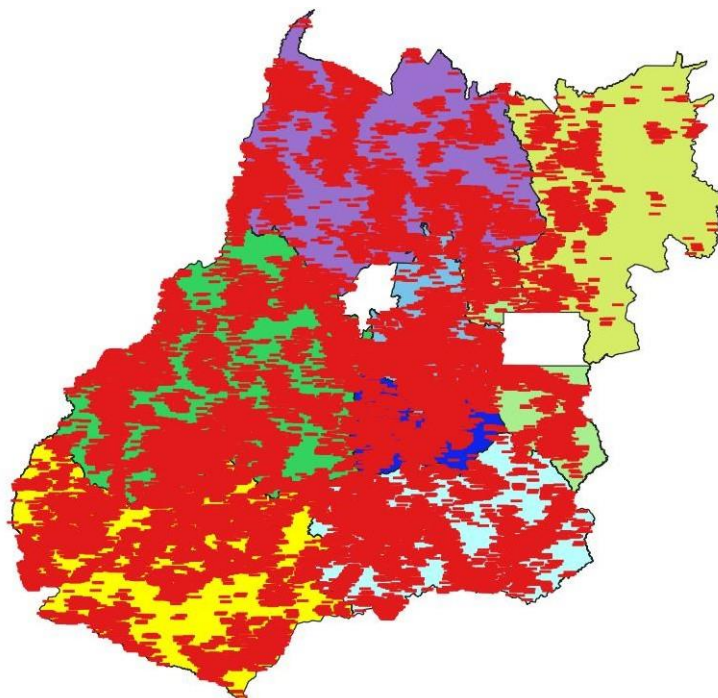
Estações do Instituto Nacional de Meteorologia (INMET), representativas da área de concessão da ENEL DISTRIBUIÇÃO GOIÁS, registraram chuva forte (segundo a American Meteorological Society - Sociedade Meteorológica Americana -, chuvas com taxa entre 2,5mm a 7,6 mm por hora são consideradas moderadas e aquelas com taxa superior a 7,6 mm por hora são consideradas chuva forte). Na tabela 2 são apresentados os registros de acumulados horários superiores a 7,6 mm. Em Cristalina foram acumulados em apenas três horas (entre 22h00 do dia 22 e 01h00 do dia 23 de outubro) 71,6 mm, volume que corresponde a aproximadamente 57% da média climatológica para todo o mês de outubro na região.

Nas tabelas 3 e 4 são apresentados os acumulados diários registrados pelas estações do INMET. Como é possível observar, entre as 09h00 do dia 22 e as 09h00 do dia 23 de outubro (horário de Brasília) foram acumulados 77,4 mm na estação de Cristalina, aproximadamente 62% da média climatológica de chuva para um mês de outubro na região. Entre as 09h00 do dia 23 e as 09h00 do dia 24 foram acumulados 52,4 mm em Itapaci, acumulado que corresponde a quase 42% da média para o mês.

Tabela 2 – Acumulado horário de chuva registrada pelo INMET.

Estação	Horário	Precipitação (mm)
Alto Paraíso de Goiás	Entre 6h e 7h do dia 24/10/2020	8.2
Catalão	Entre 1h e 2h do dia 24/10/2020	18.8
Catalão	Entre 2h e 3h do dia 24/10/2020	9.2
Catalão	Entre 3h e 4h do dia 24/10/2020	19.4
Cristalina	Entre 22h e 23h do dia 22/10/2020	21.0
Cristalina	Entre 23h e 0h do dia 23/10/2020	40.4
Cristalina	Entre 0h e 1h do dia 23/10/2020	10.2
Cristalina	Entre 7h e 8h do dia 24/10/2020	10.4
Goiânia	Entre 17h e 18h do dia 22/10/2020	15.0
Jataí	Entre 19h e 20h do dia 23/10/2020	9.0
Morrinhos	Entre 15h e 16h do dia 23/10/2020	8.0
Morrinhos	Entre 1h e 2h do dia 24/10/2020	8.4
Pires do Rio	Entre 5h e 6h do dia 24/10/2020	16.0
Silvânia	Entre 4h e 5h do dia 24/10/2020	21.6



Tabela 3 – Precipitação acumulada entre 09h do dia 22 e 09h do dia 23 de outubro de 2019. FONTE: INMET

Estação	Precipitação Acumulada(mm)
CRISTALINA	77.4
IPAMERI	62.0
PIRENOPOLIS	42.0

Tabela 4 – Precipitação acumulada entre 09h do dia 23 e 09h do dia 24 de outubro de 2019. FONTE: INMET

Estação	Precipitação Acumulada(mm)
ITAPACI	52.4
CATALÃO	51.8
FORMOSA	39.0
PIRES DO RIO	38.6
SILVANIA	37.6
MORRINHOS	36.2
IPAMERI	35.0
ARAGARCAS	32.0

## 1.2. Abrangência do Evento

A seguir são apresentadas as imagens realçadas do satélite GOES-16 entre as 12h00 do dia 22 e 09h00 do dia 24 de outubro de 2020. Os tons em vermelho e preto indicam a presença de nuvens de grande desenvolvimento vertical, geralmente associadas à ocorrência de tempo severo.

**12h00 - 22 de Outubro de 2020 - BRT**



Figura 4 – Imagens realçadas do satélite GOES-16 das 12h00 do dia 22 de Outubro de 2020. FONTE: Cptec/INPE.

**15h00 - 22 de Outubro de 2020 - BRT**

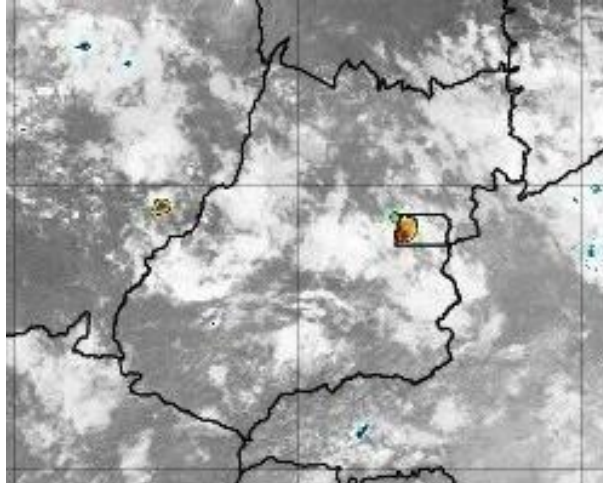

Figura 5 – Imagens realçadas do satélite GOES-16 das 15h00 do dia 22 de Outubro de 2020. FONTE: Cptec/INPE.

**18h00 - 22 de Outubro de 2020 - BRT**

Figura 6 – Imagens realçadas do satélite GOES-16 das 18h00 do dia 22 de Outubro de 2020. FONTE: Cptec/INPE.

**21h00 - 22 de Outubro de 2020 - BRT**

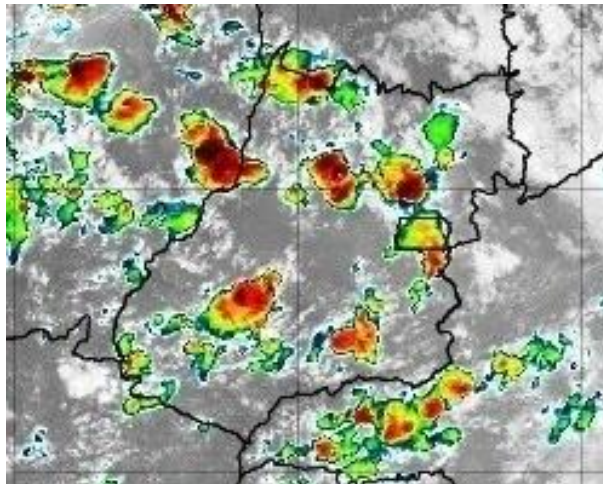
Figura 7 – Imagens realçadas do satélite GOES-16 das 21h00 do dia 22 de Outubro de 2020. FONTE: Cptec/INPE.

**0h00 - 23 de Outubro de 2020 - BRT**

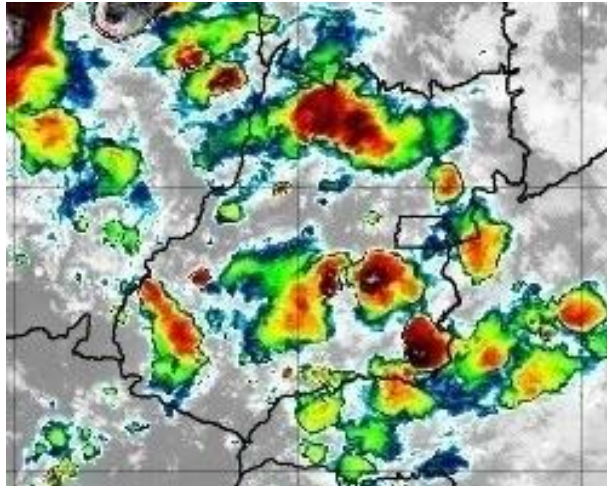
Figura 8 – Imagens realçadas do satélite GOES-16 das 0h00 do dia 23 de Outubro de 2020. FONTE: Cptec/INPE.

**3h00 - 23 de Outubro de 2020 - BRT**

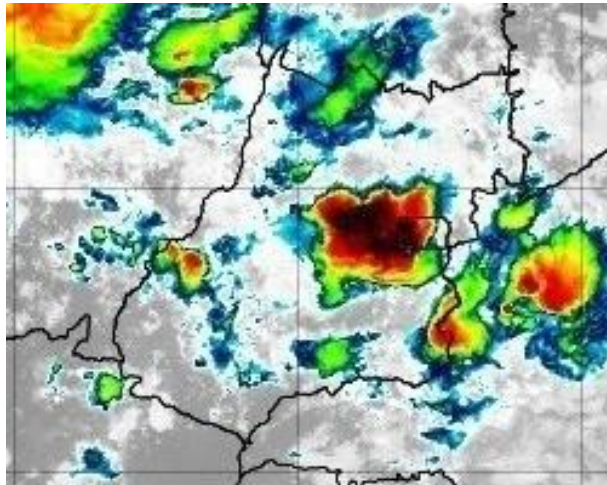
Figura 9 – Imagens realçadas do satélite GOES-16 das 3h00 do dia 23 de Outubro de 2020. FONTE: Cptec/INPE.

**6h00 - 23 de Outubro de 2020 - BRT**

Figura 10 – Imagens realçadas do satélite GOES-16 das 6h00 do dia 23 de Outubro de 2020. FONTE: Cptec/INPE.

**9h00 - 23 de Outubro de 2020 - BRT**

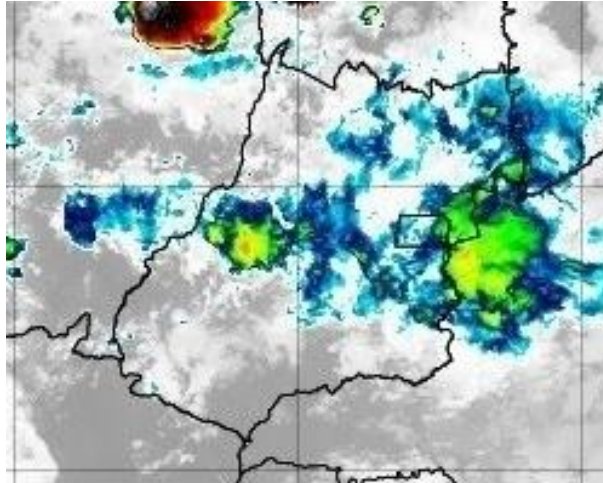
Figura 11 – Imagens realçadas do satélite GOES-16 das 9h00 do dia 23 de Outubro de 2020. FONTE: Cptec/INPE.

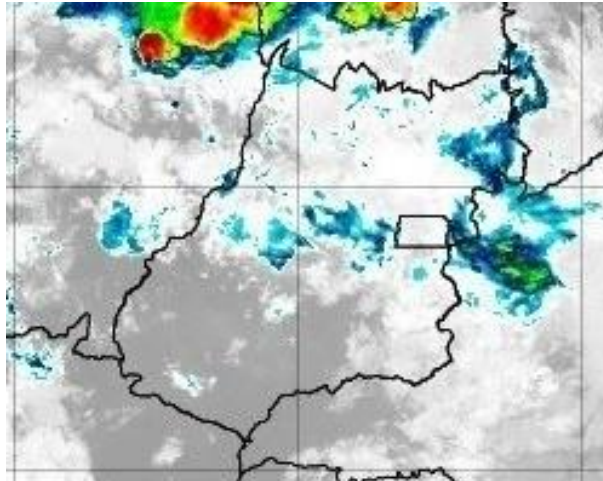

**12h00 - 23 de Outubro de 2020 - BRT**



Figura 12 – Imagens realçadas do satélite GOES-16 das 12h00 do dia 23 de Outubro de 2020.  
FONTE: Cptec/INPE.

**15h00 - 23 de Outubro de 2020 - BRT**



Figura 13 – Imagens realçadas do satélite GOES-16 das 15h00 do dia 23 de Outubro de 2020.  
FONTE: Cptec/INPE.

**18h00 - 23 de Outubro de 2020 - BRT**



Figura 14 – Imagens realçadas do satélite GOES-16 das 18h00 do dia 23 de Outubro de 2020. FONTE:  
Cptec/INPE.



**21h00 - 23 de Outubro de 2020 - BRT**

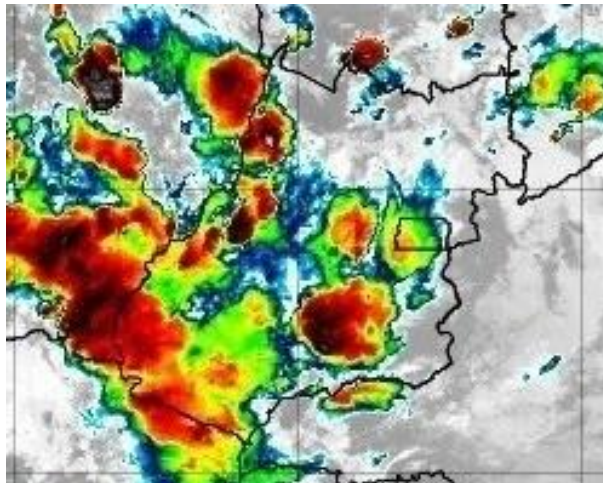

Figura 15 – Imagens realçadas do satélite GOES-16 das 21h00 do dia 23 de Outubro de 2020. FONTE: Cptec/INPE.

**0h00 - 24 de Outubro de 2020 - BRT**

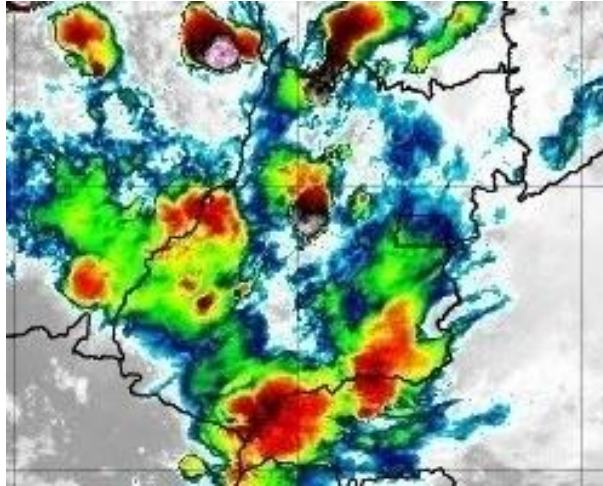

Figura 16 – Imagens realçadas do satélite GOES-16 das 0h00 do dia 24 de Outubro de 2020. FONTE: Cptec/INPE.

**3h00 - 24 de Outubro de 2020 - BRT**

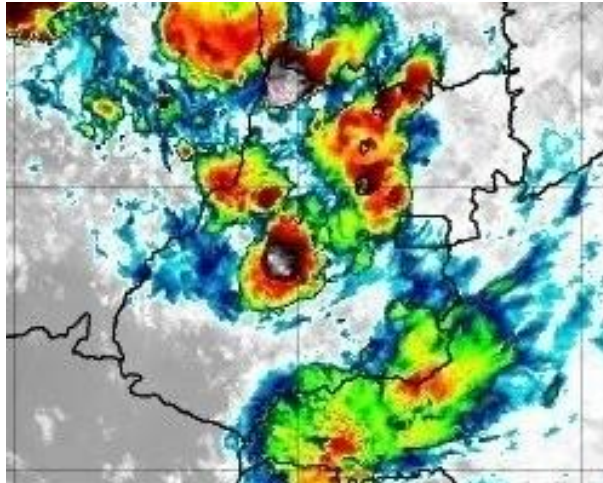

Figura 17 – Imagens realçadas do satélite GOES-16 das 3h00 do dia 24 de Outubro de 2020. FONTE: Cptec/INPE.

**6h00 - 24 de Outubro de 2020 - BRT**

Figura 18 – Imagens realçadas do satélite GOES-16 das 6h00 do dia 24 de Outubro de 2020. FONTE: Cptec/INPE.

**9h00 - 24 de Outubro de 2020 - BRT**

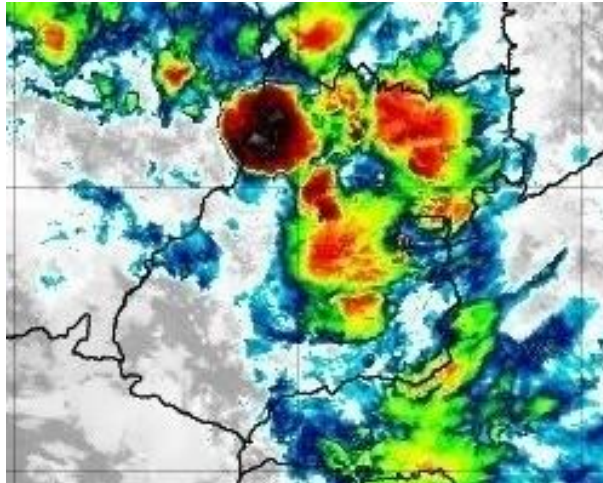
Figura 19 – Imagens realçadas do satélite GOES-16 das 9h00 do dia 24 de Outubro de 2020. FONTE: Cptec/INPE.

## 2. Classificação COBRADE

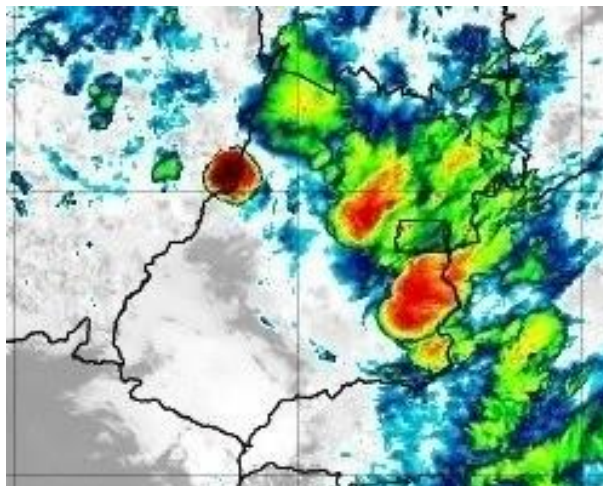
O COBRADE (Classificação e Codificação Brasileira de Desastres) foi criado com o intuito de adequar a classificação brasileira à classificação utilizada pela ONU na classificação de desastres e nivelar o país aos demais organismos de gestão de desastres do mundo.

Baseados nos dados analisados nos itens anteriores, podemos classificar o evento ocorrido sobre a área de concessão da ENEL Distribuição Goiás como Tempestade de Raios (Código 1.3.2.1.2), Chuvas Intensas (Código 1.3.2.1.4) e Vendaval (Código 1.3.2.1.5).

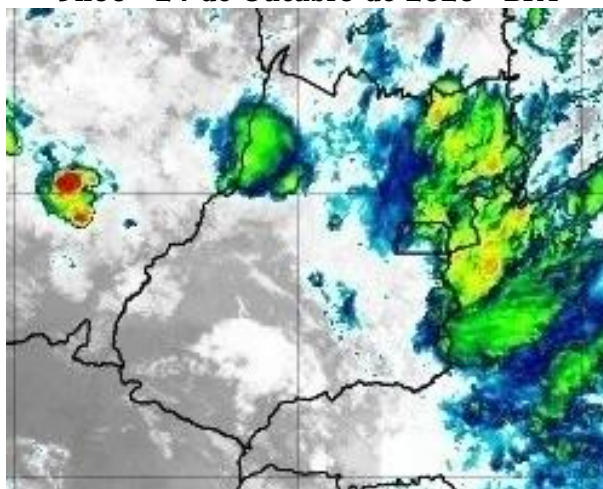
### 3. Resumo do Evento

Áreas de instabilidade organizadas pela passagem de uma frente fria pela costa brasileira favoreceram a ocorrência de chuva forte, raios e rajadas de vento sobre o estado de Goiás entre a manhã do dia 22 e a manhã do dia 24 de outubro de 2020.

O sistema de detecção da Earth Networks registrou 110541 descargas atmosféricas sobre a área de concessão da ENEL em Goiás entre as 11h00 do dia 22 e 09h40 do dia 24 de outubro de 2020.

Rajadas de vento classificadas como vento forte pela escala Beaufort foram registrados em estações do INMET representativas da região durante o período. Na cidade de Jataí rajadas de até 54,7 km/h foram registradas na tarde do dia 23 de outubro.

Chuvas volumosas também foram registradas pelo INMET durante o evento. Em apenas três horas a estação de Cristalina acumulou o equivalente a 57% da média de chuva para o mês. Entre as 22h do dia 22 e 01h00 do dia 23 de outubro acumulou-se 71,6 mm.

Tabela 5 – Resumo do evento Regional Rio Verde

Número/Código do Evento	
Número/Código do Relatório	
Descrição	Tempestade com intensa atividade elétrica no interior das nuvens, com grande desenvolvimento vertical. São chuvas que ocorrem com acumulados significativos. Forte deslocamento de uma massa de ar em uma região.
Código COBRADE	1.2.3.1.2 - Tempestade de raios, 1.3.2.1.4 - Chuvas intensas e 1.3.2.1.5 – Vendaval
Hora início do evento	12h30 do dia 22 de outubro de 2020
Hora fim do evento	23h00 do dia 23 de outubro de 2020
Abrangência	Regional Rio Verde

Tabela 6 – Resumo do evento Regional Morrinhos

Número/Código do Evento	
Número/Código do Relatório	
Descrição	Tempestade com intensa atividade elétrica no interior das nuvens, com grande desenvolvimento vertical. São chuvas que ocorrem com acumulados significativos. Forte deslocamento de uma massa de ar em uma região.
Código COBRADE	1.2.3.1.2 - Tempestade de raios, 1.3.2.1.4 - Chuvas intensas e 1.3.2.1.5 – Vendaval
Hora início do evento	12h00 do dia 22 de outubro de 2020
Hora de fim do evento	07h00 do dia 24 de outubro de 2020
Abrangência	Regional Morrinhos

Tabela 7 – Resumo do evento Regional Metropolitana e Goiânia

Número/Código do Evento	
Número/Código do Relatório	
Descrição	Tempestade com intensa atividade elétrica no interior das nuvens, com grande desenvolvimento vertical. São chuvas que ocorrem com acumulados significativos. Forte deslocamento de uma massa de ar em uma região.
Código COBRADE	1.2.3.1.2 - Tempestade de raios, 1.3.2.1.4 - Chuvas intensas e 1.3.2.1.5 – Vendaval
Hora início do evento	13h30 do dia 22 de outubro de 2020
Hora de fim do evento	06h00 do dia 24 de outubro de 2020
Abrangência	Regional Metropolitana e Goiânia

Tabela 8 – Resumo do evento Regional Iporá

Número/Código do Evento	
Número/Código do Relatório	
Descrição	Tempestade com intensa atividade elétrica no interior das nuvens, com grande desenvolvimento vertical. São chuvas que ocorrem com acumulados significativos. Forte deslocamento de uma massa de ar em uma região.
Código COBRADE	1.2.3.1.2 - Tempestade de raios, 1.3.2.1.4 - Chuvas intensas e 1.3.2.1.5 – Vendaval
Hora início do evento	12h00 do dia 22 de outubro de 2020
Hora de fim do evento	08h00 do dia 24 de outubro de 2020
Abrangência	Regional Iporá



Tabela 9 – Resumo do evento Regional Luziânia

Número/Código do Evento	
Número/Código do Relatório	
Descrição	Tempestade com intensa atividade elétrica no interior das nuvens, com grande desenvolvimento vertical. São chuvas que ocorrem com acumulados significativos. Forte deslocamento de uma massa de ar em uma região.
Código COBRADE	1.2.3.1.2 - Tempestade de raios, 1.3.2.1.4 - Chuvas intensas e 1.3.2.1.5 – Vendaval
Hora início do evento	10h30 do dia 22 de outubro de 2020
Hora de fim do evento	08h00 do dia 24 de outubro de 2020
Abrangência	Regional Luziânia

Tabela 10 – Resumo do evento Regional Anápolis

Número/Código do Evento	
Número/Código do Relatório	
Descrição	Tempestade com intensa atividade elétrica no interior das nuvens, com grande desenvolvimento vertical. São chuvas que ocorrem com acumulados significativos. Forte deslocamento de uma massa de ar em uma região.
Código COBRADE	1.2.3.1.2 - Tempestade de raios, 1.3.2.1.4 - Chuvas intensas e 1.3.2.1.5 – Vendaval
Hora início do evento	12h00 do dia 22 de outubro de 2020
Hora de fim do evento	06h30 do dia 24 de outubro de 2020
Abrangência	Regional Anápolis

Tabela 11 – Resumo do evento Regional Uruaçu

Número/Código do Evento	
Número/Código do Relatório	
Descrição	Tempestade com intensa atividade elétrica no interior das nuvens, com grande desenvolvimento vertical. São chuvas que ocorrem com acumulados significativos. Forte deslocamento de uma massa de ar em uma região.
Código COBRADE	1.2.3.1.2 - Tempestade de raios, 1.3.2.1.4 - Chuvas intensas e 1.3.2.1.5 – Vendaval
Hora início do evento	12h00 do dia 22 de outubro de 2020
Hora de fim do evento	08h00 do dia 24 de outubro de 2020
Abrangência	Regional Uruaçu

Tabela 12 – Resumo do evento Regional Formosa

Número/Código do Evento	
Número/Código do Relatório	
Descrição	Tempestade com intensa atividade elétrica no interior das nuvens, com grande desenvolvimento vertical. São chuvas que ocorrem com acumulados significativos. Forte deslocamento de uma massa de ar em uma região.
Código COBRADE	1.2.3.1.2 - Tempestade de raios, 1.3.2.1.4 - Chuvas intensas e 1.3.2.1.5 – Vendaval
Hora início do evento	12h30 do dia 22 de outubro de 2020
Hora de fim do evento	09h40 do dia 24 de outubro de 2020
Abrangência	Regional Formosa

---

## 4. Referências

- RMets Royal Meteorological Society – Beaufort Scale -

<https://www.rmets.org/weather-and-climate/observing/beaufort-scale>

- Instituto Nacional de Meteorologia (INMET) - <http://www.inmet.gov.br>

- Cptec/INPE

<https://www.cptec.inpe.br/>

- Centro de Hidrografia da Marinha do Brasil -

<https://www.marinha.mil.br/chm/>

- Meteorology Glossary - American Meteorological Society -

<http://glossary.ametsoc.org/>

# Anexos

## A.1. Carta Sinótica



Figura A1 - Carta sinótica da Marinha do Brasil para as 1200Z do dia 22 de outubro de 2020 (09h00 do dia 22 de outubro de 2020, hora local).



Figura A2 - Carta sinótica da Marinha do Brasil para as 1200Z do dia 23 de outubro de 2020 (09h00 do dia 23 de outubro de 2020, hora local).

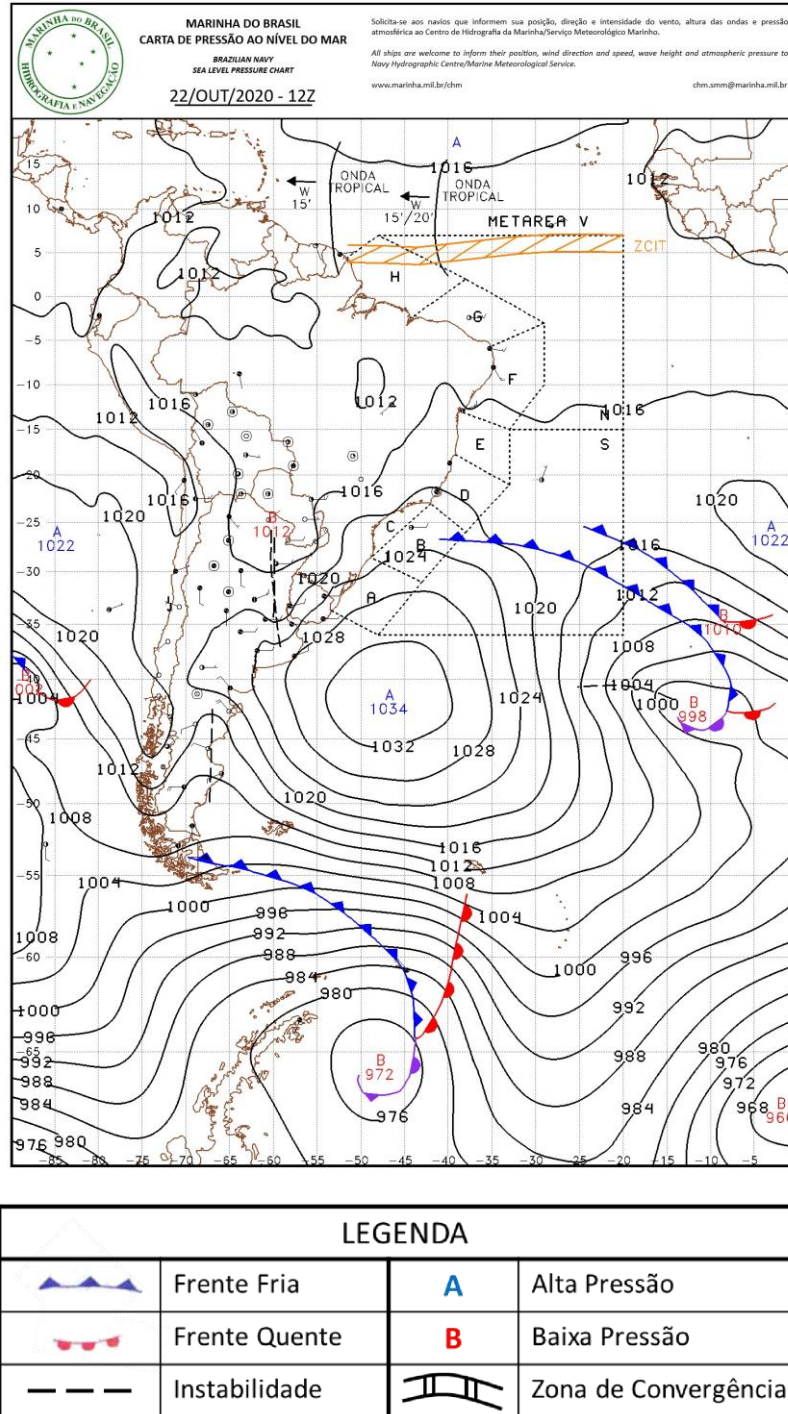

## A.2. Notícias associadas

- Mulher dá à luz dentro de carro em engarrafamento na Avenida T-9; vídeo

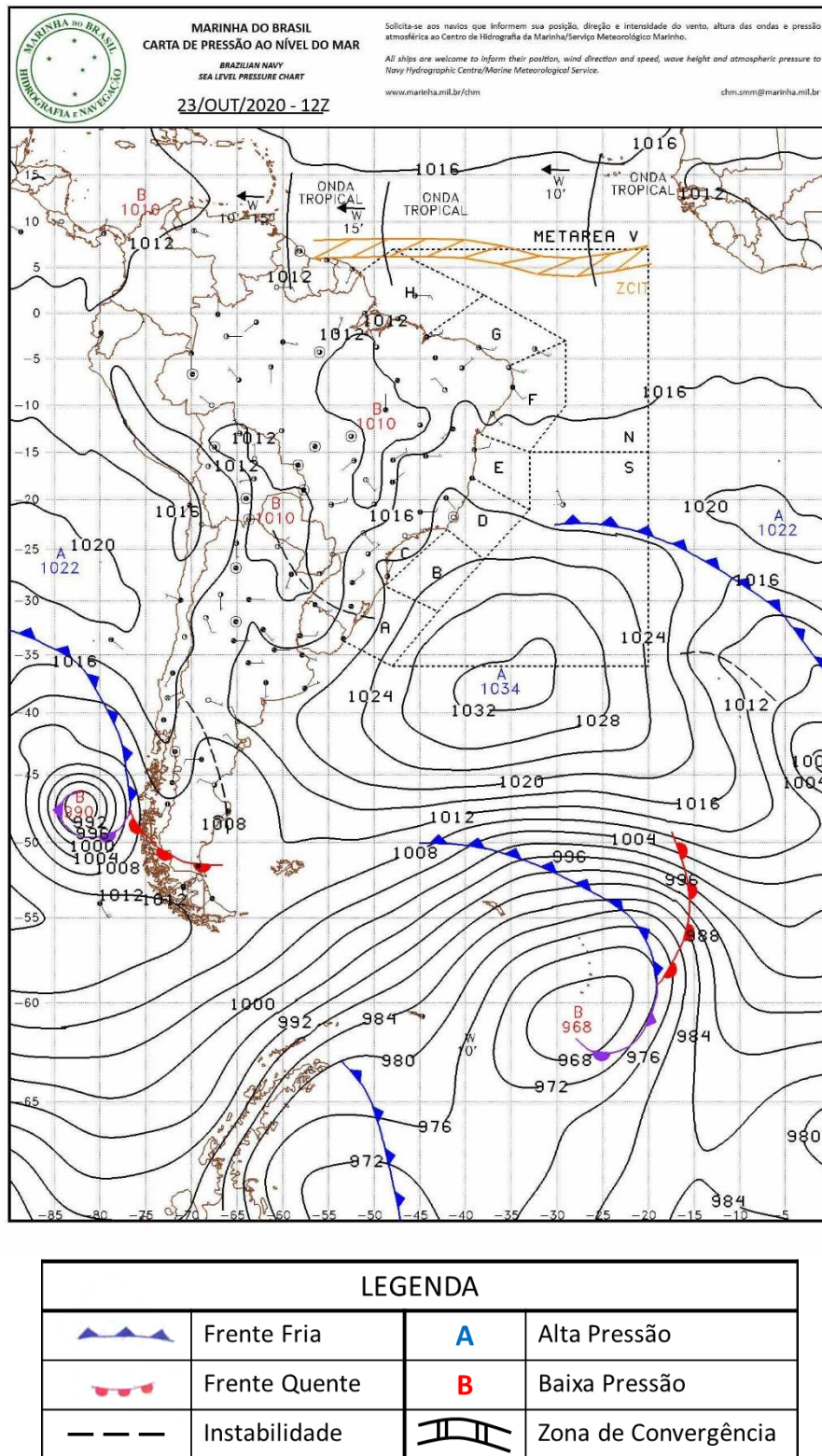
<https://www.emaisgoias.com.br/mulher-da-a-luz-dentro-de-carro-em-engarrafamento-na-avenida-t-9-video/>

- Chuva adia para sábado classificação da Porsche Cup em Goiânia

<https://racemotor.com.br/2020/10/23/chuva-adia-para-sabado-classificacao-da-porsche-cup-em-goiania/>

- Chuva forte alaga residência e causa queda de árvore em Ipameri

<https://www.zapcatalao.com.br/2020/10/23/chuva-forte-alaga-residencia-e-causa-queda-de-arvore-em-ipameri/>

Bianca Lobo Silva  
Meteorologista CREA  
5063840461

