

ENEL DISTRIBUIÇÃO GOLÁS



Relatório de Evento em Situação de Emergência

Nº CHI-053

1.	INTRODUÇÃO.....	3
2.	DEFINIÇÃO	3
3.	RESUMO EXECUTIVO.....	5
3.1.	RELATÓRIO DE OCORRÊNCIAS DO PERÍODO.....	5
4.	LISTA DE OCORRÊNCIAS	9
5.	PLOTAGEM DAS OCORRÊNCIAS CONFORME A ESPACIALIZAÇÃO DAS CHUVAS.....	136
6.	CLIENTES AFETADOS E IMPACTOS GLOBAIS	137
7.	DIAGRAMAS UNIFILARES	139
8.	DEMAIS EVIDÊNCIAS	145
8.1.	DADOS TÉCNICO - OPERACIONAIS ENEL GO.....	145
8.2.	DADOS CLIMATOLÓGICOS PELO INMET	150
9.	NOTÍCIAS RELACIONADAS.....	155
10.	LAUDO TÉCNICO	157

1. Introdução

As concessionárias do serviço público de distribuição de energia elétrica devem prover o serviço de forma adequada, buscando sempre a eficiência, conforme disposto na legislação e nos respectivos contratos de concessão.

Dentre a legislação vigente, destacam-se os Procedimentos de Distribuição de Energia Elétrica no Sistema Elétrico Nacional – PRODIST, que consistem em documentos elaborados pela Agência Nacional de Energia Elétrica – ANEEL, com a participação dos agentes de distribuição e de outras entidades e associações do setor elétrico nacional, que normatizam e padronizam as atividades técnicas relacionadas ao funcionamento e desempenho dos sistemas de distribuição de energia elétrica.

O Módulo 8 do PRODIST – Revisão 11, mais especificamente em sua Seção 8.2, regulamenta a qualidade do serviço prestado pelas distribuidoras de energia elétrica, estabelecendo a metodologia para apuração dos indicadores de continuidade e dos tempos de atendimento a ocorrências emergenciais.

O referido regulamento prevê que, na apuração dos indicadores coletivos e individuais deverão ser consideradas todas as interrupções de longa duração que atingirem as unidades consumidoras, admitidas algumas exceções (denominadas expurgos), que podem ser encontradas no Item 5.6.2.2 da seção 8.2 do Módulo 8 do PRODIST, transcrito abaixo:

5.6.2.2 Na apuração dos indicadores DEC e FEC devem ser consideradas todas as interrupções, admitidas apenas as seguintes exceções:

i. falha nas instalações da unidade consumidora que não provoque interrupção em instalações de terceiros;

ii. interrupção decorrente de obras de interesse exclusivo do consumidor e que afete somente a unidade consumidora do mesmo;

iii. Interrupção em Situação de Emergência;

iv. suspensão por inadimplemento do consumidor ou por deficiência técnica e/ou de segurança das instalações da unidade consumidora que não provoque interrupção em instalações de terceiros, previstas em regulamentação;

v. vinculadas a programas de racionamento instituídos pela União;

vi. ocorridas em Dia Crítico;

vii. oriundas de atuação de Esquema Regional de Alívio de Carga estabelecido pelo ONS. [grifos nossos]

Para os casos de expurgo por Interrupção em Situação de Emergência (ISE), a alínea “h” do Item 5.12.1 da seção 8.2 do Módulo 8 do PRODIST estabelece a obrigatoriedade das distribuidoras em disponibilizar, em seu sítio eletrônico, relatórios digitais com as evidências do evento que tenha gerado tais interrupções enquadradas no inciso iii do Item 5.6.2.2 do mesmo.

Nesta seara, o presente documento, visa apresentar as evidências de um evento ocorrido na área de concessão da Eletropaulo, bem como informações relevantes a respeito das interrupções em Situação de Emergência decorrentes do mesmo.

Destaca-se que, para o entendimento completo das regras de apuração dos indicadores de continuidade e expurgos, faz-se necessário também a observação das regras contidas nos Módulos 1 e 6 do PRODIST. Todos os módulos destes procedimentos encontram-se disponíveis para consulta no site da ANEEL (www.aneel.gov.br) e as principais definições relacionadas ao tema estão contidas no item 2 deste documento.

2. Definição

Seção 1.2 do Módulo 1 do PRODIST – Revisão 10

2.198 Evento

Acontecimento que afete as condições normais de funcionamento de uma rede elétrica, podendo gerar uma ou mais interrupções no fornecimento de energia.

2.131 e 2.158 DIC

Duração de interrupção individual por unidade consumidora, ou seja, intervalo de tempo que, no período de apuração, em cada unidade consumidora ou ponto de conexão ocorreu descontinuidade da distribuição de energia elétrica.

2.216 e 2.220 FIC

Frequência de interrupção individual por unidade consumidora, ou seja, Número de interrupções ocorridas, no período de apuração, em cada unidade consumidora ou ponto de conexão.

2.87 Consumidor Hora Interrompido (CHI):

Somatório dos DICs dos consumidores atingidos por interrupção no fornecimento de energia, expresso em horas e centésimos de horas.

2.251 Interrupção em Situação de Emergência:

Interrupção originada no sistema de distribuição, resultante de Evento que comprovadamente impossibilite a atuação imediata da distribuidora e que não tenha sido provocada ou agravada por esta e que seja:

- Decorrentes de evento associado a Decreto de Declaração de Situação de Emergência ou Estado de Calamidade Pública emitido por órgão competente; ou
- Decorrentes de Evento cuja soma do CHI das interrupções ocorridas no sistema de distribuição seja superior ao calculado conforme equação a seguir:

$$2.612 \times N^{0,35}$$

N – número de unidades consumidoras faturadas e atendidas em BT ou MT, com 2 (duas) casas decimais, do mês de outubro do ano anterior ao período de apuração

3. Resumo Executivo

O Presente Relatório tem como objetivo a incorporação de informações que sejam relevantes para que se possa fazer a devida associação aos dados contidos no documento objeto da classificação de Situação de Emergência caracterizada pelo Módulo 8 do Prodist. Este enquadramento se apresenta na maioria das vezes em condições climáticas adversas com severidade dos fatores inerentes a situação, caracterizado na maioria dos casos por fortes ventos e chuvas de grande intensidade e continuidade.

A partir do final da manhã do dia 30/10/2020 – sexta-feira – Nuvens de tempestade associadas a formação e manutenção de uma zona de convergência do Atlântico Sul atuaram sobre o estado de Goiás.

Conforme informações do Climatempo Meteorologia, o Instituto Nacional de Meteorologia (INMET) detectou rajadas de vento acima de 50km/h registradas por estações representativas da área de concessão da ENEL Distribuição Goiás. Na estação de Monte Alegre, o maior valor registrado foi de 66,6 km/h entre as 12h e 13h do dia 02 de novembro de 2020, classificada como ventania, segundo a escala Beaufort.

O sistema de detecção da EarthNetworks registrou 50.980 descargas atmosféricas (13.230 nuvem-solo e 37.750 nuvem-nuvem) sobre a área de concessão da ENEL em Goiás entre as 09h40 do dia 30 de outubro de 2020 e 19h10 do dia 05 de novembro de 2020, causando grande instabilidade na rede.

Chuva forte foi registrada pelo INMET em estações representativas da área de concessão da ENEL Distribuição Goiás. Na estação de Cristalina foram acumulados 70,8 mm de chuva entre as 06h e as 08h do dia 31 de outubro de 2020, valor que corresponde 48,0% da média de chuva para o mês na região.

3.1. Relatório de Ocorrências do período

Em todo o Estado de Goiás verificou-se também que a intensidade da chuva e dos ventos danificaram a rede de distribuição de energia elétrica em diversos pontos, registrando aproximadamente 423 mil clientes com interrupção no fornecimento de energia elétrica devido a eventos relacionados ao temporal, afetando 243 municípios e 315 Subestações.

Para otimizar o volume de atendimentos e reduzir os tempos de interrupção foram mobilizados os recursos extras da empresa que aumentou o contingente em relação a situação normal de operação. O acompanhamento da quantidade de equipes e o Tempo Médio de Atendimento podem ser consultados na Pág.05 do Relatório em anexo.

O impacto e severidade do evento estão relatados em artigos de mídia, como fotos e reportagens que demonstram os danos na Rede de Distribuição, oriundos dos eventos climáticos no período. Eventos estes que afetaram 423.106 consumidores com CHI de 1.047.442,71 superior ao de 482.597,74 estabelecido como limite para definição de Situação de Emergência, conforme resumo das informações obrigatórias.

Empresa		ENEL DISTRIBUIÇÃO GOIÁS			
Código do Relatório		CHI-053 - ENEL DISTRIBUIÇÃO GOIÁS			
Evento:		TEMPORAL NA AREA DE CONCESSÃO DA ENEL DISTRIBUIÇÃO GOIAS			
Código COBRADE:	1.3.1.2.0	Data Início	30/10/2020	Hora início	09h30
Código do Evento:	CHI-053-ENEL GO	Data Término	05/11/2020	Hora Término	19h30
Valor CHI (Limite e Real)	482.597,74	1.047.442,71			
Código do Decreto (Se Houver):					
Quantidade de Interrupções (Evento)	6.433				
Início 1ª Incidência (Data e Hora)	30/10/2020 09:40		Subestações Atingidas	ABADIANIA / ABC / ACREUNA / ADELANDIA / AEROPORTO / AGUA LIMPA (MARZAGAO) / AGUAS LINDAS / ALEXANIA / ALEXANIA TRANSMISSAO / ALMERINDONOPOLIS / ALOANDIA / ALPHAVILLE / ALTO BURITI / ALTO HORIZONTE / ALTO PARAISO DE GOIAS / ALVORADA DO NORTE / AMERICANO DO BRASIL / AMORINOPOLIS / ANAPOLIS UNIVERSITARIA / ANHANGUERA / ANICUNS / ANTONIO DO VITTO / APARECIDA DO RIO DOCE / APORE / ARACU / ARAGARCAS / ARAGOIANIA / ARAGUAPAZ / ARARAS / AREIAS / ARENOPOLIS / ARUANA / ARUANA (TRANSMISSAO) / ASA BRANCA / ATLANTICO / AURILANDIA / AVELINOPOLIS / BACURI (RIO VERDE) / BARBOSELANDIA / BARCELONA / BARREIRO (PORANGATU) / BARRO ALTO / BELA VISTA (TRANSMISSAO) / BOA VISTA / BOM JARDIM / BOM JESUS DE GOIAS / BONFINOPOLIS / BONOPOLIS / BRITANIA / BRITANIA (TRANSMISSAO) / BURITI ALEGRE / BURITI DE GOIAS / BURITIZINHO / CABECEIRAS / CABRIUVA (RIO VERDE) / CACHOEIRA ALTA / CACHOEIRA DOURADA / CACHOEIRINHA (ITARUMA) / CACU / CAIAPONIA / CALCILANDIA / CALDAS NOVAS / CALDAZINHA / CAMPESTRE / CAMPINAS / CAMPINORTE / CAMPO ALEGRE DE GOIAS / CAMPO LIMPO DE GOIAS / CAMPO NOVO / CAMPOS BELOS / CAMPOS VERDES / CARAIBAS / CARAJAS / CATALAO / CATURAI / CEBRASA FABRICA DA AMBEV / CEMAT/BALIZA / CEPALGO / CEZARINA / CHAPADAO DO CEU / CIDADE ECLETICA / CIDADE OCIDENTAL / COCALZINHO / COLINACU / CORREGO DO OURO / CORUMBA / CORUMBAIBA / CRISTALINA / CRISTALINA TRANSMISSAO / CRISTIANOPOLIS / CRIXAS / CROMINIA / CUMARI / DAIA - ANAPOLIS / DAMOLANDIA / DAVINOPOLIS / DESFECHO / DESTILARIA BRASIL CENTRAL / DIMIC / DIORAMA / DORCELINO PEIXOTO DE MORAES / DOVERLANDIA / EDEALINA / EDEIA / ENERSUL / ESTRELA DO NORTE / FAINA / FAZENDA CANADA / FAZENDA NOVA / FERROVIARIO / FIRMINOPOLIS / FLORES DE GOIAS / FORMIGA / FORMOSO / GAMELEIRA / GIRASSOL / GOIANAPOLIS / GOIANDIRA / GOIANESIA / GOIANIA LESTE / GOIANIRA / GOIAS / GOIATUBA / GOUVERLANDIA / GOYA / GUAPO / HEITORAI / HIDROLANDIA / HIDROLINA / IACIARA / INACIOLANDIA / INDEPENDENCIA / INDIARA / INHUMAS / IPAMERI / IPEGUARI / IPORA / ISRAELANDIA / ITABERAI / ITAGUARI / ITAGUARU / ITAJA / ITAPACI / ITAPACI (TRANSMISSAO) / ITAPIRAPUA / ITAPURANGA / ITAPURANGA (TRANSMISSAO) / ITARUMA / ITAUUCU / ITIQUIRA (FORMOSA) / ITUMBIARA NOVA / ITUMBIARA VELHA / JACILANDIA / JANDAIA / JARAGUA / JARANAPOLIS / JATAI / JAUPACI / JESUPOLIS / JOVIANIA / JUNDIAI / JURUMIRIM / JUSCELANDIA / JUSSARA / LAGES / LAGOA DA SERRA / LEOPOLDO DE BULHOES / LUZIANIA / LUZIANIA INDUSTRIAL / MAIRIPOTABA / MAMBAI / MARA ROSA / MARAJOARA / MARIAPOLIS (PADRE BERNARDO) / MARZAGAO / MATO GRANDE / MATRINCHA / MAURILANDIA / MEIA PONTE / MINACU / MINEIROS / MINEIROS TRANSMISSAO / MOIPORA / MONTE ALEGRE / MONTES CLAROS DE GOIAS / MONTIVIDIU T / MORRINHOS / MORRO AGUDO / MOSSAMEDES / MOZARLANDIA / MOZARLANDIA (TRANSMISSAO) / MUNDO NOVO DE GOIAS / MUTUNOPOLIS / NAVESLANDIA (JATAI) / NAZARIO / NEROPOLIS / NIQUELANDIA / NIQUELANDIA 69KV / NOVA AMERICA / NOVA AURORA / NOVA CRIXAS (TRANSMISSAO) / NOVA IGUACU / NOVA PONTE / NOVA VENEZA / NOVO BRASIL / NOVO GAMA / NOVO PLANALTO / OLHOS DAGUA / OLOANA / ORIZONA / OURO VERDE DE GOIAS / OUVIDOR / PACAEMBU (NOVO GAMA) / PADRE BERNARDO / PALESTINA / PALMEIRAS / PALMEIRAS DE GOIAS / PALMELO / PALMINOPOLIS / PAMPLONA / PANAMA / PARANA / PARANAIBA / PARANAIGUARA / PARAUNA SE ALTA TENSAO / PARQUE DAS EMAS (MINEIROS) / PARQUE DAS NACOES / PEROLANDIA / PETROLINA / PILOANDIA / PIRACANJUBA / PIRANHAS T / PIRENOPOLIS / PIRES BELO / PIRES DO RIO / PLANALTINA / PLANALTINA (TRANSMISSAO) / PLANALTO / PONTALINA / PORANGATU / PORTELANDIA / POSSE / POSSELANDIA / PROFESSOR JAMIL / QUEBRA LINHA / QUIRINOPOLIS / REAL / RETIRO / GOIAS / RIO CLARO JATAI MONTIVIDIU / RIO DO PEIXE / RIO DOS BOIS (MAURILANDIA) / RIO QUENTE / RIO VERDE / RIO VERMELHO / ROCHEDO (UEH) / RUBIATABA / SANCLERLANDIA / SANTA BARBARA / SANTA FE DE GOIAS / SANTA HELENA / SANTA RITA DO ARAGUAIA / SANTA ROSA / SANTA ROSA DE GOIAS / SANTA ROSA DO MEIA PONTE / SANTA TEREZA DE GOIAS / SANTA TEREZINHA / SANTANA / SANTO ANTONIO DA BARRA / SANTO ANTONIO DE GOIAS / SANTO ANTONIO DO DESCOBERTO / SAO BARTOLOMEU / SAO DOMINGOS / SAO FRANCISCO DE GOIAS / SAO GABRIEL DE GOIAS / SAO JOAO D ALIANCA / SAO JOAO DA PARAUNA / SAO LUIZ DOS MONTES BELOS / SAO MIGUEL DO ARAGUAIA / SAO SIMAO / SENADOR CANEDO TRANSMISSAO / SERRA AZUL (JATAI) /	

			SERRA DE CALDAS / SERRANOPOLIS / SILVANIA / SITIO DABADIA / SOUZALANDIA / SUCURI / TAIOBA / TAQUARAL / TAQUARI / TEREZOPOLIS / TERRA VERMELHA / TRAJANOPOLIS (PADRE BERNARDO) / TRES BARRAS / TRES RANCHOS / TRINDADE / TUCUNARE / TURVANIA / TURVELANDIA / URU / URUACU / URUTAI / USINA DE ACUCAR DE GOIANESIA / USINA MAMBAI / VALPARAISO / VARJAO / VENDA SECA / VIANOPOLIS / VICENTINOPOLIS / VILA BOA / VILA CORUMBA / VILA PROPICIO / XAVANTES / XIXA / ZELANDIA
Início Última Incidência (Data e Hora)	05/11/2020 19:23		
Média de Duração das Incidências (h)	5,84		
Duração da Incidência mais longa (h)	52,84		
Total de Clientes afetados	423.106	Municípios Atingidos	ABADIA DE GOIAS / ABADIANIA / ACREUNA / ADELANDIA / AGUA FRIA DE GOIAS / AGUA LIMPA / AGUAS LINDAS DE GOIAS / ALEXANIA / ALOANDIA / ALTO HORIZONTE / ALTO PARAISO DE GOIAS / ALVORADA DO NORTE / AMARALINA / AMERICANO DO BRASIL / AMORINOPOLIS / ANAPOLIS / ANHANGUERA / ANICUNS / APARECIDA DE GOIANIA / APARECIDA DO RIO DOCE / APORE / ARACU / ARAGARCAS / ARAGOIANIA / ARAGUAPAZ / ARENOPOLIS / ARUANA / AURILANDIA / AVELINOPOLIS / BALIZA / BARRO ALTO / BELA VISTA DE GOIAS / BOM JARDIM DE GOIAS / BOM JESUS DE GOIAS / BONFINOPOLIS / BONOPOLIS / BRAZABRANTES / BRITANIA / BURITI ALEGRE / BURITI DE GOIAS / BURITINOPOLIS / CABECEIRAS / CACHOEIRA ALTA / CACHOEIRA DE GOIAS / CACHOEIRA DOURADA / CACU / CAIAPONIA / CALDAS NOVAS / CALDAZINHA / CAMPESTRE DE GOIAS / CAMPINACU / CAMPINORTE / CAMPO ALEGRE DE GOIAS / CAMPO LIMPO / CAMPOS BELOS / CAMPOS VERDES / CARMO DO RIO VERDE / CASTELANDIA / CATALAO / CATURAI / CAVALCANTE / CERES / CEZARINA / CHAPADAO DO CEU / CIDADE OCIDENTAL / COCALZINHO DE GOIAS / COLINAS DO SUL / CORREGO DO OURO / CORUMBA DE GOIAS / CORUMBAIBA / CRISTALINA / CRISTIANOPOLIS / CRIXAS / CROMINIA / CUMARI / DAMIANOPOLIS / DAMOLANDIA / DAVINOPOLIS / DIORAMA / DISTRITO FEDERAL / DIVINOPOLIS DE GOIAS / DOVERLANDIA / EDEALINA / EDEIA / ESTRELA DO NORTE / FAINA / FAZENDA NOVA / FIRMINOPOLIS / FLORES DE GOIAS / FORMOSA / FORMOSO / GAMELEIRA DE GOIAS / GOIANAPOLIS / GOIANDIRA / GOIANESIA / GOIANIA / GOIANIRA / GOIAS / GOIATUBA / GUAPO / GUARAITA / GUARANI DE GOIAS / GUARINOS / HEITORAI / HIDROLANDIA / HIDROLINA / IACIARA / INACIOLANDIA / INDIARA / INHUMAS / IPAMERI / IPORA / ISRAELANDIA / ITABERAI / ITAGUARI / ITAGUARU / ITAJA / ITAPACI / ITAPIRAPUA / ITAPURANGA / ITARUMA / ITAUCU / ITUMBIARA / IVOLANDIA / JANDAIA / JARAGUA / JATAI / JAUPACI / JESUPOLIS / JOVIANIA / JUSSARA / LAGOA SANTA / LEOPOLDO DE BULHOES / LUZIANIA / MAIRIPOTABA / MAMBAI / MARA ROSA / MARZAGAO / MATRINCHA / MAURILANDIA / MIMOSO DE GOIAS / MINACU / MINEIROS / MOIPORA / MONTE ALEGRE DE GOIAS / MONTES CLAROS DE GOIAS / MONTIVIDIU / MONTIVIDIU DO NORTE / MORRINHOS / MORRO AGUDO DE GOIAS / MOSSAMEDES / MOZARLANDIA / MUNDO NOVO DE GOIAS / MUTUNOPOLIS / NAZARIO / NEROPOLIS / NIQUELANDIA / NOVA AMERICA / NOVA AURORA / NOVA CRIXAS / NOVA GLORIA / NOVA IGUACU DE GOIAS / NOVA ROMA / NOVA VENEZA / NOVO BRASIL / NOVO GAMA / NOVO PLANALTO / ORIZONA / OURO VERDE DE GOIAS / OUVIDOR / PADRE BERNARDO / PALESTINA DE GOIAS / PALMEIRAS DE GOIAS / PALMELO / PALMINOPOLIS / PANAMA / PARANAIGUARA / PARAUNA / PEROLANDIA / PETROLINA DE GOIAS / PILAR DE GOIAS / PIRACANJUBA / PIRANHAS / PIRENOPOLIS / PIRES DO RIO / PLANALTINA / PONTALINA / PORANGATU / PORTEIRAO / PORTELANDIA / POSSE / PROFESSOR JAMIL SAFADY / QUIRINOPOLIS / RIO QUENTE / RIO VERDE / RUBIATABA / SANCLERLANDIA / SANTA BARBARA DE GOIAS / SANTA CRUZ DE GOIAS / SANTA FE DE GOIAS / SANTA HELENA DE GOIAS / SANTA ISABEL / SANTA RITA DO ARAGUAIA / SANTA RITA DO NOVO DESTINO / SANTA ROSA DE GOIAS / SANTA TEREZA DE GOIAS / SANTA TEREZINHA DE GOIAS / SANTO ANTONIO DA BARRA / SANTO ANTONIO DE GOIAS / SANTO ANTONIO DO DESCOBERTO / SAO DOMINGOS / SAO FRANCISCO DE GOIAS / SAO JOAO D ALIANCA / SAO JOAO DA PARAUNA / SAO LUIS DE MONTES BELOS / SAO LUIZ DO NORTE / SAO MIGUEL DO ARAGUAIA / SAO MIGUEL DO PASSA QUATRO / SAO PATRICIO / SAO SIMAO / SENADOR CANEDO / SERRANOPOLIS / SILVANIA / SIMOLANDIA / SITIO D ABADIA / TAQUARAL DE GOIAS / TERESINA DE GOIAS / TEREZOPOLIS DE GOIAS / TRES RANCHOS / TRINDADE / TROMBAS / TURVANIA / TURVELANDIA / UIRAPURU / URUACU / URUANA / URUTAI / VALPARAISO DE GOIAS / VARJAO / VIANOPOLIS / VICENTINOPOLIS / VILA BOA / VILA PROPICIO

DANOS CAUSADOS			
Equipamentos Danificado	Importância para o Sistema	Local	Quantidade
Disjuntor/Religador Operado	Proteção do Alimentador	Área de Concessão	106
Chaves Fusíveis Operada	Proteção de Ramais de Alimentadores	Área de Concessão	1.564
Transformador Operado	Proteção do Transformador	Área de Concessão	1.561

Relato técnico sobre a Intervenção realizada em Goiânia e Região Metropolitana								
Informações sobre Equipes	30/10	31/10	01/11	02/11	03/11	04/11	05/11	
Quantidade Usual	1.046	845	758	925	1.116	1.106	1.124	turmas
Quantidade Adicional	92	110	0	0	0	0	14	turmas
Quantidade Total	1.138	955	758	925	1.116	1.106	1.138	turmas
Tempos Médios								
Preparação	2,97	4,25	2,90	2,00	2,20	1,98	1,71	Horas
Deslocamento	0,91	0,76	0,84	0,96	0,76	0,80	0,91	Horas
Execução	0,89	0,79	0,75	1,05	0,84	0,78	0,84	Horas
TMAE	4,77	5,80	4,49	4,01	3,80	3,57	3,46	Horas

Principais Dificuldades Encontradas:

Chuvas com ventos fortes provocaram muitos pontos de alagamento e enxurrada, trânsito impedido por vários semáforos desligados dificultando a chegada ao atendimento das ocorrências emergenciais. Em determinadas regiões, decorrente dos fortes ventos, houve o tombamento de árvores nas estruturas de alimentação de média tensão. danos em ramais de ligação dos clientes. impedimentos

Empresa	ENEL DISTRIBUIÇÃO GOIAS		
Valor CHI (Limite e Real)	482.597,74		1.047.442,71

4. Lista de Ocorrências

DOC ORIGEM	MIUNICIPIO	EQP_ORIGEM	CONJUNTO	INI_OCORRENC	FIM_OCORRENC	DT_INI_EVENTO	DT_FIM_EVENTO	DURAÇ	UC INT	CHI	EXPURGO
202010179953	FORMOSA	FA11254217	ITUIQUIRA	30/10/2020 09:40	30/10/2020 10:07	30/10/2020 09:40	30/10/2020 10:07	0,45	1	0,45	CHI
202010180107	PLANALTINA	TL12206256	SAO JOAO D ALIANCA	30/10/2020 10:07	30/10/2020 12:38	30/10/2020 10:07	30/10/2020 12:38	2,52	4	10,07	CHI
202010180160	NIQUELANDIA	NQ12140182	SAO JOAO D ALIANCA	30/10/2020 10:16	30/10/2020 13:36	30/10/2020 10:16	30/10/2020 13:36	3,33	5	16,63	CHI
202010180160	AGUA FRIA DE GOIAS	NQ12140182	SAO JOAO D ALIANCA	30/10/2020 10:16	30/10/2020 13:36	30/10/2020 10:16	30/10/2020 13:36	3,33	72	239,50	CHI
202010180218	POSSE	10017582790	IACIARA S2	30/10/2020 10:26	30/10/2020 16:42	30/10/2020 10:26	30/10/2020 16:42	6,26	1	6,26	CHI
202010180442	CACHOEIRA DOURADA	CD21000207	CACHOEIRA DOURADA	30/10/2020 11:07	30/10/2020 17:29	30/10/2020 11:07	30/10/2020 17:29	6,36	2	12,72	CHI
202010180498	ITUMBIARA	10000754372	ITUMBIARA NOVA	30/10/2020 11:15	30/10/2020 17:22	30/10/2020 11:15	30/10/2020 17:22	6,11	1	6,11	CHI
202010180522	MINACU	4020036082	MINACU	30/10/2020 11:18	30/10/2020 13:15	30/10/2020 11:18	30/10/2020 13:15	1,94	1	1,94	CHI
202010180527	CAIAPONIA	CP12342197	CAIAPONIA	30/10/2020 11:19	30/10/2020 15:03	30/10/2020 11:19	30/10/2020 15:03	3,73	2	7,47	CHI
202010180529	BURITI ALEGRE	10003512361	ITUMBIARA VELHA S2	30/10/2020 11:19	30/10/2020 13:51	30/10/2020 11:19	30/10/2020 13:51	2,54	1	2,54	CHI
202010179678	ARUANA	MZ16418618	MOZARLANDIA	30/10/2020 11:21	30/10/2020 13:10	30/10/2020 11:21	30/10/2020 11:34	0,21	8	1,66	CHI
202010179678	NOVA CRIXAS	MZ16418618	MOZARLANDIA	30/10/2020 11:21	30/10/2020 13:10	30/10/2020 11:21	30/10/2020 11:34	0,21	33	6,83	CHI
202010179678	NOVA CRIXAS	MZ16418618	MOZARLANDIA	30/10/2020 11:21	30/10/2020 13:10	30/10/2020 11:21	30/10/2020 11:34	0,21	35	7,24	CHI
202010179678	MOZARLANDIA	MZ16418618	MOZARLANDIA	30/10/2020 11:21	30/10/2020 13:10	30/10/2020 11:21	30/10/2020 11:34	0,21	99	20,49	CHI
202010179678	MOZARLANDIA	MZ16418618	MOZARLANDIA	30/10/2020 11:21	30/10/2020 13:10	30/10/2020 11:21	30/10/2020 11:34	0,21	13	2,69	CHI
202010179678	ARUANA	MZ16418618	MOZARLANDIA	30/10/2020 11:21	30/10/2020 13:10	30/10/2020 11:21	30/10/2020 11:34	0,21	127	26,28	CHI
202010179678	MOZARLANDIA	MZ13329944	MOZARLANDIA	30/10/2020 11:21	30/10/2020 13:10	30/10/2020 12:45	30/10/2020 13:10	0,41	13	5,38	CHI
202010179678	NOVA CRIXAS	MZ13329944	MOZARLANDIA	30/10/2020 11:21	30/10/2020 13:10	30/10/2020 12:45	30/10/2020 13:10	0,41	26	10,75	CHI
202010179678	ARUANA	MZ13329944	MOZARLANDIA	30/10/2020 11:21	30/10/2020 13:10	30/10/2020 12:45	30/10/2020 13:10	0,41	127	52,53	CHI
202010180559	JAUPACI	JP21229150	IPORA	30/10/2020 11:25	30/10/2020 14:28	30/10/2020 11:25	30/10/2020 14:28	3,05	1	3,05	CHI
202010180570	SAO JOAO D ALIANCA	JL12117452	SAO JOAO D ALIANCA	30/10/2020 11:26	31/10/2020 01:52	30/10/2020 11:26	31/10/2020 01:52	14,43	5	72,16	CHI
202010181094	CALDAS NOVAS	CN12102170	CALDAS NOVAS S1	30/10/2020 11:31	30/10/2020 19:35	30/10/2020 11:31	30/10/2020 19:35	8,08	159	1284,63	CHI
202010180584	BURITINOPOLIS	3610006302	IACIARA S2	30/10/2020 11:31	30/10/2020 13:52	30/10/2020 11:31	30/10/2020 13:52	2,34	1	2,34	CHI
202010180588	COCALZINHO DE GOIAS	ZN21146712	COCALZINHO	30/10/2020 11:32	30/10/2020 13:53	30/10/2020 11:32	30/10/2020 13:53	2,35	1	2,35	CHI
202010180589	CRIXAS	CX12405291	SANTA TEREZINHA	30/10/2020 11:33	30/10/2020 14:13	30/10/2020 11:33	30/10/2020 14:13	2,66	94	250,04	CHI
202010180590	GOIANIA	11764156	GOIANIA LESTE S3	30/10/2020 11:34	30/10/2020 13:40	30/10/2020 11:34	30/10/2020 13:40	2,09	1	2,09	CHI
202010180593	INHUMAS	IN21098312	INHUMAS S2	30/10/2020 11:34	30/10/2020 15:13	30/10/2020 11:34	30/10/2020 15:13	3,64	1	3,64	CHI
202010180602	GOIANIRA	10023331249	GOIANIRA	30/10/2020 11:36	30/10/2020 15:33	30/10/2020 11:36	30/10/2020 15:33	3,95	1	3,95	CHI
202010180704	HEITORAI	01790226	ITABERAI S1	30/10/2020 11:38	30/10/2020 15:05	30/10/2020 11:38	30/10/2020 15:05	3,45	25	86,19	CHI
202010180704	ITABERAI	01790226	ITABERAI S1	30/10/2020 11:38	30/10/2020 15:05	30/10/2020 11:38	30/10/2020 15:05	3,45	223	768,85	CHI
202010180704	GOIAS	01790226	ITABERAI S1	30/10/2020 11:38	30/10/2020 15:05	30/10/2020 11:38	30/10/2020 15:05	3,45	39	134,46	CHI
202010180611	GOIAS	GS12307383	GOIAS	30/10/2020 11:39	30/10/2020 17:18	30/10/2020 11:39	30/10/2020 17:18	5,65	10	56,47	CHI
202010180612	BALIZA	BH12245902	BOM JARDIM	30/10/2020 11:39	30/10/2020 14:19	30/10/2020 11:39	30/10/2020 14:19	2,66	1	2,66	CHI
202010180615	SENADOR CANEDO	12412417	SENADOR CANEDO	30/10/2020 11:41	30/10/2020 13:33	30/10/2020 11:41	30/10/2020 13:33	1,85	1	1,85	CHI
202010180621	DAVINOPOLIS	CT12318674	CATALAO S1	30/10/2020 11:43	30/10/2020 17:23	30/10/2020 11:43	30/10/2020 17:23	5,65	3	16,95	CHI
202010180621	CATALAO	CT12318674	CATALAO S1	30/10/2020 11:43	30/10/2020 17:23	30/10/2020 11:43	30/10/2020 17:23	5,65	2	11,30	CHI
202010180626	INHUMAS	30102753	INHUMAS S2	30/10/2020 11:44	30/10/2020 15:19	30/10/2020 11:44	30/10/2020 15:19	3,59	0	0,00	CHI
202010180629	RUBIATABA	RB12392304	RUBIATABA	30/10/2020 11:45	30/10/2020 14:10	30/10/2020 11:45	30/10/2020 14:10	2,41	6	14,47	CHI
202010180632	GOIATUBA	GT12052882	GOIATUBA S1	30/10/2020 11:46	30/10/2020 18:12	30/10/2020 11:46	30/10/2020 18:12	6,43	19	122,24	CHI
202010180640	CAMPO ALEGRE DE GOIAS	CM21073555	CAMPO ALEGRE DE GOIAS	30/10/2020 11:48	30/10/2020 16:05	30/10/2020 11:48	30/10/2020 16:05	4,28	1	4,28	CHI
202010180647	APARECIDA DE GOIANIA	10020532316	INDEPENDENCIA S1	30/10/2020 11:50	30/10/2020 14:32	30/10/2020 11:50	30/10/2020 14:32	2,69	1	2,69	CHI
202010180648	MORRINHOS	150104388	MORRINHOS	30/10/2020 11:50	30/10/2020 18:04	30/10/2020 11:50	30/10/2020 18:04	6,23	1	6,23	CHI
202010180693	PIRACANJUBA	BV12018394	BELA VISTA S1	30/10/2020 11:52	30/10/2020 17:10	30/10/2020 11:52	30/10/2020 17:10	5,29	33	174,65	CHI
202010180693	BELA VISTA DE GOIAS	BV12018394	BELA VISTA S1	30/10/2020 11:52	30/10/2020 17:10	30/10/2020 11:52	30/10/2020 17:10	5,29	3	15,88	CHI
202010180656	URUTAI	600004582	URUTAI	30/10/2020 11:52	30/10/2020 18:17	30/10/2020 11:52	30/10/2020 18:17	6,41	1	6,41	CHI
202010180663	ITABERAI	IB12108138	ITABERAI S2	30/10/2020 11:53	30/10/2020 14:44	30/10/2020 11:53	30/10/2020 14:44	2,84	28	79,48	CHI

202010180668	SILVANIA	SV21100438	VIANOPOLIS	30/10/2020 11:55	30/10/2020 14:48	30/10/2020 11:55	30/10/2020 14:48	2,87	2	5,75	CHI
202010180691	NIQUELANDIA	NQ12317176	NIQUELANDIA SUBTRANSMISSAO	30/10/2020 11:55	30/10/2020 21:54	30/10/2020 11:55	30/10/2020 21:54	9,97	77	767,54	CHI
202010180679	ITUMBIARA	10012344867	ITUMBIARA NOVA	30/10/2020 11:58	30/10/2020 18:13	30/10/2020 11:58	30/10/2020 18:13	6,24	1	6,24	CHI
202010180680	COLINAS DO SUL	TI21353813	MINACU	30/10/2020 11:59	30/10/2020 15:49	30/10/2020 11:59	30/10/2020 15:49	3,83	2	7,67	CHI
202010180682	CATALAO	CT21215581	CATALAO S2	30/10/2020 11:59	30/10/2020 18:23	30/10/2020 11:59	30/10/2020 18:23	6,39	1	6,39	CHI
202010180684	TRINDADE	TR21292173	TRINDADE	30/10/2020 11:59	30/10/2020 16:28	30/10/2020 11:59	30/10/2020 16:28	4,48	1	4,48	CHI
202010180685	CEZARINA	1650022132	CEZARINA	30/10/2020 12:00	30/10/2020 14:39	30/10/2020 12:00	30/10/2020 14:39	2,65	1	2,65	CHI
202010180713	CALDAZINHA	SV21157887	CEPAIGO S2	30/10/2020 12:07	30/10/2020 13:56	30/10/2020 12:07	30/10/2020 13:56	1,81	1	1,81	CHI
202010180774	GOIAS	GS12206917	ITABERAI S1	30/10/2020 12:07	30/10/2020 17:10	30/10/2020 12:07	30/10/2020 17:10	5,04	13	65,48	CHI
202010180719	CALDAS NOVAS	760216733	SERRA DE CALDAS	30/10/2020 12:08	30/10/2020 21:17	30/10/2020 12:08	30/10/2020 21:17	9,14	1	9,14	CHI
202010180720	AGUAS LINDAS DE GOIAS	10028735739	AGUAS LINDAS DE GOIAS S1	30/10/2020 12:08	30/10/2020 14:04	30/10/2020 12:08	30/10/2020 14:04	1,92	1	1,92	CHI
202010180724	SAO JOAO D ALIANCA	JL21106841	SAO JOAO D ALIANCA	30/10/2020 12:09	30/10/2020 15:20	30/10/2020 12:09	30/10/2020 15:20	3,17	1	3,17	CHI
202010180725	APARECIDA DE GOIANIA	200041204	ANHANGUERA	30/10/2020 12:09	30/10/2020 15:43	30/10/2020 12:09	30/10/2020 15:43	3,55	1	3,55	CHI
202010180730	SENADOR CANEDO	BO21090123	GOIANIA LESTE S2	30/10/2020 12:10	30/10/2020 13:47	30/10/2020 12:10	30/10/2020 13:47	1,60	1	1,60	CHI
202010180735	SAO LUIS DE MONTES BELOS	500125790	SAO LUIZ DOS MONTES BELOS	30/10/2020 12:11	30/10/2020 14:23	30/10/2020 12:11	30/10/2020 14:23	2,19	1	2,19	CHI
202010180752	TERESINA DE GOIAS	2650003279	FLORES DE GOIAS	30/10/2020 12:15	30/10/2020 14:28	30/10/2020 12:15	30/10/2020 14:28	2,20	1	2,20	CHI
202010180756	INHUMAS	IN21033529	INHUMAS S1	30/10/2020 12:16	30/10/2020 21:46	30/10/2020 12:16	30/10/2020 21:46	9,49	2	18,98	CHI
202010180762	CABECEIRAS	CW12108823	ITUIQUIRA	30/10/2020 12:18	30/10/2020 18:51	30/10/2020 12:18	30/10/2020 18:51	6,55	18	117,89	CHI
202010180765	ITAPACI	IW21268802	ITAPACI	30/10/2020 12:18	30/10/2020 13:42	30/10/2020 12:18	30/10/2020 13:42	1,40	2	2,79	CHI
202010180926	ITAPIRAPUA	IU12259757RE	MATRINCHA	30/10/2020 12:19	30/10/2020 16:28	30/10/2020 12:19	30/10/2020 16:28	4,15	18	74,64	CHI
202010180926	SANTA FE DE GOIAS	IU12259757RE	MATRINCHA	30/10/2020 12:19	30/10/2020 16:28	30/10/2020 12:19	30/10/2020 16:28	4,15	12	49,76	CHI
202010180783	FORMOSA	FA21120293	ITUIQUIRA	30/10/2020 12:25	30/10/2020 21:57	30/10/2020 12:25	30/10/2020 21:57	9,53	2	19,06	CHI
202010180787	CAMPO ALEGRE DE GOIAS	CM12192738RE	CAMPO ALEGRE DE GOIAS	30/10/2020 12:25	30/10/2020 14:58	30/10/2020 12:25	30/10/2020 14:58	2,54	48	121,96	CHI
202010180791	MINACU	IH12192297	MINACU	30/10/2020 12:26	30/10/2020 22:51	30/10/2020 12:26	30/10/2020 22:51	10,41	4	41,66	CHI
202010180791	MINACU	IH12192297	MINACU	30/10/2020 12:26	30/10/2020 22:51	30/10/2020 20:04	30/10/2020 22:51	2,78	3	8,34	CHI
202010180803	ITAPURANGA	IK12023043	ITAPURANGA	30/10/2020 12:26	30/10/2020 15:26	30/10/2020 12:26	30/10/2020 15:26	2,99	86	257,00	CHI
202010180804	BARRO ALTO	BA21360339	BARRO ALTO	30/10/2020 12:28	30/10/2020 22:51	30/10/2020 12:28	30/10/2020 22:51	10,38	1	10,38	CHI
202010181167	TRINDADE	TR12200202	TRINDADE	30/10/2020 12:28	30/10/2020 18:03	30/10/2020 12:28	30/10/2020 17:30	5,03	1	5,03	CHI
202010181167	TRINDADE	TR12200202	TRINDADE	30/10/2020 12:28	30/10/2020 18:03	30/10/2020 12:28	30/10/2020 18:03	5,57	2	11,14	CHI
202010180812	INHUMAS	IN21321549	INHUMAS S1	30/10/2020 12:29	30/10/2020 17:05	30/10/2020 12:29	30/10/2020 17:05	4,60	1	4,60	CHI
202010180818	APARECIDA DE GOIANIA	10022976327	ANHANGUERA	30/10/2020 12:30	30/10/2020 17:56	30/10/2020 12:30	30/10/2020 17:56	5,43	1	5,43	CHI
202010180820	CORUMBAIBA	AL21212161	VILA CORUMBA	30/10/2020 12:30	31/10/2020 09:02	30/10/2020 12:30	31/10/2020 09:02	20,52	1	20,52	CHI
202010180900	NIQUELANDIA	NQ12239432	URUACU	30/10/2020 12:31	30/10/2020 15:31	30/10/2020 12:31	30/10/2020 15:31	2,99	21	62,81	CHI
202010180842	APARECIDA DE GOIANIA	AP12060751	REAL S2	30/10/2020 12:38	30/10/2020 14:46	30/10/2020 12:38	30/10/2020 14:46	2,13	176	374,15	CHI
202010180842	GOIANIA	AP12060751	REAL S2	30/10/2020 12:38	30/10/2020 14:46	30/10/2020 12:38	30/10/2020 14:46	2,13	137	291,24	CHI
202010180846	COCALZINHO DE GOIAS	ZN12377207	PADRE BERNARDO	30/10/2020 12:38	30/10/2020 17:40	30/10/2020 12:38	30/10/2020 17:40	5,02	6	30,11	CHI
202010180865	ITAPURANGA	IK12299951	ITAPURANGA	30/10/2020 12:42	30/10/2020 19:09	30/10/2020 12:42	30/10/2020 19:09	6,44	6	38,65	CHI
202010181419	AVELINOPOLIS	AV12020305	ANICUNS	30/10/2020 12:44	30/10/2020 15:40	30/10/2020 12:44	30/10/2020 15:40	2,93	179	523,67	CHI
202010181419	CATURAI	AV12020305	ANICUNS	30/10/2020 12:44	30/10/2020 15:40	30/10/2020 12:44	30/10/2020 15:40	2,93	9	26,33	CHI
202010181419	ITABERAI	AV12020305	ANICUNS	30/10/2020 12:44	30/10/2020 15:40	30/10/2020 12:44	30/10/2020 15:40	2,93	18	52,66	CHI
202010181419	ARACU	AV12020305	ANICUNS	30/10/2020 12:44	30/10/2020 15:40	30/10/2020 12:44	30/10/2020 15:40	2,93	17	49,73	CHI
202010181419	SANTA BARBARA DE GOIAS	AV12020305	ANICUNS	30/10/2020 12:44	30/10/2020 15:40	30/10/2020 12:44	30/10/2020 15:40	2,93	8	23,40	CHI
202010180873	ITUMBIARA	IT21122275	ITUMBIARA NOVA	30/10/2020 12:44	30/10/2020 18:25	30/10/2020 12:44	30/10/2020 18:25	5,67	1	5,67	CHI
202010180884	SANTA CRUZ DE GOIAS	BC21280073	CRISTIANOPOLIS	30/10/2020 12:46	30/10/2020 14:36	30/10/2020 12:46	30/10/2020 14:36	1,83	1	1,83	CHI
202010180890	APARECIDA DE GOIANIA	10032840487	ATLANTICO S2	30/10/2020 12:46	30/10/2020 17:01	30/10/2020 12:46	30/10/2020 17:01	4,24	0	0,00	CHI
202010181156	ITAPURANGA	GK12299466	ITAPURANGA	30/10/2020 12:47	31/10/2020 00:46	30/10/2020 12:47	31/10/2020 00:46	11,98	19	227,68	CHI
202010181156	GUARAITA	GK12299466	ITAPURANGA	30/10/2020 12:47	31/10/2020 00:46	30/10/2020 12:47	31/10/2020 00:46	11,98	28	335,53	CHI
202010180898	IPAMERI	IP12404706	IPAMERI	30/10/2020 12:47	30/10/2020 17:28	30/10/2020 12:47	30/10/2020 17:28	4,68	29	135,59	CHI
202010180902	MATRINCHA	MP21083977	MATRINCHA	30/10/2020 12:47	30/10/2020 20:39	30/10/2020 12:47	30/10/2020 20:39	7,85	1	7,85	CHI
202010180909	MORRINHOS	MR21385062	MORRINHOS	30/10/2020 12:49	30/10/2020 15:38	30/10/2020 12:49	30/10/2020 15:38	2,81	1	2,81	CHI
202010180919	GOIANIA	10449425	AEROPORTO S1	30/10/2020 12:52	30/10/2020 14:11	30/10/2020 12:52	30/10/2020 14:11	1,31	1	1,31	CHI

202010180952	CRISTALINA	KR10395376	CRISTALINA S1	30/10/2020 12:53	01/11/2020 15:00	01/11/2020 05:28	01/11/2020 05:59	0,51	60	30,43	CHI
202010180952	IPAMERI	KR10395376	CRISTALINA S1	30/10/2020 12:53	01/11/2020 15:00	01/11/2020 05:28	01/11/2020 05:59	0,51	5	2,54	CHI
202010180952	CRISTALINA	KR12251692LD	CRISTALINA S1	30/10/2020 12:53	01/11/2020 15:00	01/11/2020 05:28	01/11/2020 14:19	8,85	30	265,44	CHI
202010180952	CRISTALINA	KR12349104	CRISTALINA S1	30/10/2020 12:53	01/11/2020 15:00	01/11/2020 05:28	01/11/2020 15:00	9,53	8	76,24	CHI
202010180952	CRISTALINA	KR10395376	CRISTALINA S1	30/10/2020 12:53	01/11/2020 15:00	30/10/2020 12:53	30/10/2020 21:38	8,75	29	253,85	CHI
202010180952	IPAMERI	KR10395376	CRISTALINA S1	30/10/2020 12:53	01/11/2020 15:00	31/10/2020 02:33	31/10/2020 02:46	0,22	6	1,32	CHI
202010180952	CRISTALINA	KR10395376	CRISTALINA S1	30/10/2020 12:53	01/11/2020 15:00	31/10/2020 02:33	31/10/2020 02:46	0,22	53	11,66	CHI
202010180952	CRISTALINA	KR10414222	CRISTALINA S1	30/10/2020 12:53	01/11/2020 15:00	31/10/2020 16:10	31/10/2020 16:45	0,58	29	16,95	CHI
202010180952	CRISTALINA	KR10395376	CRISTALINA S1	30/10/2020 12:53	01/11/2020 15:00	30/10/2020 12:53	31/10/2020 20:53	31,99	6	191,96	CHI
202010180952	CRISTALINA	KR10414222	CRISTALINA S1	30/10/2020 12:53	01/11/2020 15:00	31/10/2020 22:08	31/10/2020 22:27	0,33	35	11,54	CHI
202010180952	CRISTALINA	KR12251692LD	CRISTALINA S1	30/10/2020 12:53	01/11/2020 15:00	30/10/2020 12:53	01/11/2020 05:28	40,59	38	1542,40	CHI
202010180952	CRISTALINA	KR12251692LD	CRISTALINA S1	30/10/2020 12:53	01/11/2020 15:00	30/10/2020 12:53	01/11/2020 14:20	49,45	23	1137,28	CHI
202010180952	CRISTALINA	KR10395376	CRISTALINA S1	30/10/2020 12:53	01/11/2020 15:00	30/10/2020 12:53	01/11/2020 14:44	49,85	146	7277,49	CHI
202010180952	CRISTALINA	KR12251692LD	CRISTALINA S1	30/10/2020 12:53	01/11/2020 15:00	30/10/2020 12:53	01/11/2020 14:54	50,01	3	150,04	CHI
202010180924	CRISTALINA	KR21184842	CRISTALINA S2	30/10/2020 12:53	30/10/2020 16:30	30/10/2020 12:53	30/10/2020 16:30	3,61	1	3,61	CHI
202010180927	GOIANIA	13937017	GOIANIA LESTE S2	30/10/2020 12:54	30/10/2020 15:17	30/10/2020 12:54	30/10/2020 15:17	2,38	1	2,38	CHI
202010180931	GOIANIA	12560170	CAMPINAS S2	30/10/2020 12:55	30/10/2020 14:26	30/10/2020 12:55	30/10/2020 14:26	1,52	1	1,52	CHI
202010180936	POSSE	PS12257684	IACIARA S2	30/10/2020 12:56	30/10/2020 14:22	30/10/2020 12:56	30/10/2020 14:22	1,42	5	7,12	CHI
202010182656	ARAGOIANIA	AO32000298	GUAPO S2	30/10/2020 12:56	31/10/2020 00:03	30/10/2020 12:56	31/10/2020 00:03	11,11	7	77,74	CHI
202010180941	EDEIA	EA12352572RE	EDEIA	30/10/2020 12:57	30/10/2020 18:34	30/10/2020 12:57	30/10/2020 18:34	5,61	2	11,22	CHI
202010179891	APARECIDA DE GOIANIA	AP11216350	REAL S1	30/10/2020 13:01	30/10/2020 20:07	30/10/2020 13:01	30/10/2020 20:07	7,10	50	355,00	CHI
202010180956	ANICUNS	AC21318567	ARACU	30/10/2020 13:02	30/10/2020 20:34	30/10/2020 13:02	30/10/2020 20:34	7,53	1	7,53	CHI
202010180958	PONTALINA	PK12189869	PONTALINA	30/10/2020 13:02	30/10/2020 14:49	30/10/2020 13:02	30/10/2020 14:49	1,78	4	7,10	CHI
202010180960	APARECIDA DE GOIANIA	10012959802	ANHANGUERA	30/10/2020 13:03	30/10/2020 14:24	30/10/2020 13:03	30/10/2020 14:24	1,34	1	1,34	CHI
202010181034	PORANGATU	PO12208614	PORANGATU	30/10/2020 13:03	30/10/2020 15:39	30/10/2020 13:03	30/10/2020 15:39	2,59	10	25,89	CHI
202010180969	SANTA TEREZA DE GOIAS	SE21372091	MARA ROSA	30/10/2020 13:04	30/10/2020 15:33	30/10/2020 13:04	30/10/2020 15:33	2,48	3	7,43	CHI
202010180975	VALPARAISO DE GOIAS	VA11136666	PACAEMBU S1	30/10/2020 13:05	30/10/2020 18:44	30/10/2020 13:05	30/10/2020 18:44	5,64	51	287,78	CHI
202010181007	VICENTINOPOLIS	VI11000002	VICENTINOPOLIS	30/10/2020 13:06	30/10/2020 20:19	30/10/2020 13:06	30/10/2020 20:19	7,21	68	490,45	CHI
202010181275	INHUMAS	NV12272408	INHUMAS S1	30/10/2020 13:06	30/10/2020 16:06	30/10/2020 13:06	30/10/2020 16:06	2,99	19	56,77	CHI
202010181275	BRAZABRANTES	NV12272408	INHUMAS S1	30/10/2020 13:06	30/10/2020 16:06	30/10/2020 13:06	30/10/2020 16:06	2,99	60	179,27	CHI
202010181275	NOVA VENEZA	NV12272408	INHUMAS S1	30/10/2020 13:06	30/10/2020 16:06	30/10/2020 13:06	30/10/2020 16:06	2,99	9	26,89	CHI
202010181000	DAVINOPOLIS	IO10400357	CATALAO S1	30/10/2020 13:09	30/10/2020 18:20	30/10/2020 13:09	30/10/2020 17:28	4,32	71	306,60	CHI
202010181000	OUVIDOR	IO10400357	CATALAO S1	30/10/2020 13:09	30/10/2020 18:20	30/10/2020 13:09	30/10/2020 17:28	4,32	18	77,73	CHI
202010181000	DAVINOPOLIS	IO10400357	CATALAO S1	30/10/2020 13:09	30/10/2020 18:20	30/10/2020 13:09	30/10/2020 18:20	5,18	128	663,32	CHI
202010181000	OUVIDOR	IO10400357	CATALAO S1	30/10/2020 13:09	30/10/2020 18:20	30/10/2020 13:09	30/10/2020 18:20	5,18	142	735,88	CHI
202010181000	CATALAO	IO10400357	CATALAO S1	30/10/2020 13:09	30/10/2020 18:20	30/10/2020 13:09	30/10/2020 18:20	5,18	85	440,49	CHI
202010180992	NIQUELANDIA	NQ12371132	SAO JOAO D ALIANCA	30/10/2020 13:09	30/10/2020 23:06	30/10/2020 13:09	30/10/2020 23:06	9,94	8	79,50	CHI
202010180994	SAO JOAO D ALIANCA	JL12129981LD	SAO JOAO D ALIANCA	30/10/2020 13:10	30/10/2020 16:32	30/10/2020 13:10	30/10/2020 16:32	3,37	3	10,10	CHI
202010181002	SAO JOAO D ALIANCA	JL121146133	SAO JOAO D ALIANCA	30/10/2020 13:12	31/10/2020 20:40	30/10/2020 13:12	31/10/2020 20:40	31,46	1	31,46	CHI
202010181278	ARAGOIANIA	AO18399996	INDEPENDENCIA S2	30/10/2020 13:12	30/10/2020 16:13	30/10/2020 13:12	30/10/2020 16:13	3,01	60	180,75	CHI
202010181278	GUAPO	AO18399996	INDEPENDENCIA S2	30/10/2020 13:12	30/10/2020 16:13	30/10/2020 13:12	30/10/2020 16:13	3,01	14	42,17	CHI
202010181278	ABADIA DE GOIAS	AO18399996	INDEPENDENCIA S2	30/10/2020 13:12	30/10/2020 16:13	30/10/2020 13:12	30/10/2020 16:13	3,01	20	60,25	CHI
202010181009	ANAPOLIS	AN21379426	ANAPOLIS UNIVERSITARIO S1	30/10/2020 13:13	30/10/2020 16:26	30/10/2020 13:13	30/10/2020 16:26	3,20	2	6,40	CHI
202010181012	TRINDADE	40143168	GOYA S1	30/10/2020 13:14	30/10/2020 16:32	30/10/2020 13:14	30/10/2020 16:32	3,28	1	3,28	CHI
202010181031	GOIANIA	14817743	REAL S1	30/10/2020 13:19	30/10/2020 14:57	30/10/2020 13:19	30/10/2020 14:57	1,62	1	1,62	CHI
202010181119	ITAPURANGA	IK11000022	ITAPURANGA	30/10/2020 13:19	30/10/2020 20:25	30/10/2020 13:19	30/10/2020 20:25	7,09	136	963,86	CHI
202010181039	SENADOR CANEDO	10019519603	SENADOR CANEDO	30/10/2020 13:20	30/10/2020 16:49	30/10/2020 13:20	30/10/2020 16:49	3,47	1	3,47	CHI
202010181500	TROMBAS	TB12156807	PORANGATU	30/10/2020 13:21	30/10/2020 17:25	30/10/2020 13:21	30/10/2020 17:25	4,06	73	296,66	CHI
202010181051	SAO JOAO D ALIANCA	JL12383340	SAO JOAO D ALIANCA	30/10/2020 13:22	30/10/2020 19:01	30/10/2020 13:22	30/10/2020 19:01	5,64	77	434,30	CHI
202010181085	MOZARLANDIA	MZ12051179	MOZARLANDIA	30/10/2020 13:22	30/10/2020 16:07	30/10/2020 13:22	30/10/2020 16:07	2,73	15	41,01	CHI
202010182908	VICENTINOPOLIS	VI12293191	VICENTINOPOLIS	30/10/2020 13:24	30/10/2020 21:05	30/10/2020 13:24	30/10/2020 21:05	7,67	21	161,09	CHI

202010181063	BURITI ALEGRE	BG21244121	ITUMBIARA VELHA S2	30/10/2020 13:25	31/10/2020 09:03	30/10/2020 13:25	31/10/2020 09:03	19,62	1	19,62	CHI
202010181073	ITAPURANGA	IK12300385	ITAPURANGA	30/10/2020 13:27	30/10/2020 16:05	30/10/2020 13:27	30/10/2020 16:05	2,62	7	18,35	CHI
202010181078	CUMARI	CY12017165	CATALAO S1	30/10/2020 13:28	30/10/2020 21:51	30/10/2020 13:28	30/10/2020 21:51	8,37	1	8,37	CHI
202010181088	ANAPOLIS	20803461	JUNDIAI S2	30/10/2020 13:29	30/10/2020 23:19	30/10/2020 13:29	30/10/2020 23:19	9,82	1	9,82	CHI
202010181097	RIO QUENTE	2530007336	VILA CORUMBA	30/10/2020 13:31	31/10/2020 07:35	30/10/2020 13:31	31/10/2020 07:35	18,06	1	18,06	CHI
202010181104	CALDAZINHA	SV21284528	CEPAIGO S2	30/10/2020 13:32	30/10/2020 16:54	30/10/2020 13:32	30/10/2020 16:54	3,36	1	3,36	CHI
202010181207	PARAUNA	PU12304549	PARAUNA	30/10/2020 13:34	31/10/2020 13:47	30/10/2020 13:34	30/10/2020 18:22	4,79	6	28,77	CHI
202010181207	PARAUNA	PU12304549	PARAUNA	30/10/2020 13:34	31/10/2020 13:47	30/10/2020 18:23	30/10/2020 20:40	2,28	5	11,38	CHI
202010181207	PARAUNA	PU12104533	PARAUNA	30/10/2020 13:34	31/10/2020 13:47	30/10/2020 13:34	30/10/2020 21:20	7,77	8	62,15	CHI
202010181207	PARAUNA	PU12304549	PARAUNA	30/10/2020 13:34	31/10/2020 13:47	30/10/2020 18:23	31/10/2020 13:47	19,39	1	19,39	CHI
202010181207	PARAUNA	PU12304549	PARAUNA	30/10/2020 13:34	31/10/2020 13:47	31/10/2020 13:36	31/10/2020 13:47	0,18	13	2,39	CHI
202010181114	FORMOSA	FA12383233	ITIQUEIRA	30/10/2020 13:34	30/10/2020 16:14	30/10/2020 13:34	30/10/2020 16:14	2,66	71	188,74	CHI
202010181418	ANICUNS	AC12233495	ANICUNS	30/10/2020 13:34	30/10/2020 16:02	30/10/2020 13:34	30/10/2020 16:02	2,45	154	377,51	CHI
202010181118	DOVERLANDIA	DV21151244	CAIAPONIA	30/10/2020 13:35	30/10/2020 17:15	30/10/2020 13:35	30/10/2020 17:15	3,66	1	3,66	CHI
202010181121	APARECIDA DE GOIANIA	13166797	INDEPENDENCIA S2	30/10/2020 13:35	30/10/2020 16:35	30/10/2020 13:35	30/10/2020 16:35	2,98	1	2,98	CHI
202010181123	PIRACANJUBA	PJ21348159	CRISTIANOPOLIS	30/10/2020 13:36	30/10/2020 21:07	30/10/2020 13:36	30/10/2020 21:07	7,52	1	7,52	CHI
202010181126	AGUA FRIA DE GOIAS	TL12381390	SAO JOAO D ALIANCA	30/10/2020 13:37	30/10/2020 17:55	30/10/2020 13:37	30/10/2020 17:55	4,29	3	12,87	CHI
202010181126	PLANALTINA	TL12381390	SAO JOAO D ALIANCA	30/10/2020 13:37	30/10/2020 17:55	30/10/2020 13:37	30/10/2020 17:55	4,29	21	90,10	CHI
202010181129	INHUMAS	IN21347728	INHUMAS S1	30/10/2020 13:38	30/10/2020 15:30	30/10/2020 13:38	30/10/2020 15:30	1,87	1	1,87	CHI
202010181131	ITUMBIARA	690406460	PARANAIBA	30/10/2020 13:38	30/10/2020 18:01	30/10/2020 13:38	30/10/2020 18:01	4,38	1	4,38	CHI
202010181213	TRES RANCHOS	TH12068477	CATALAO S1	30/10/2020 13:38	30/10/2020 18:07	30/10/2020 13:38	30/10/2020 18:07	4,47	19	85,01	CHI
202010181147	SIMOLANDIA	SA11344360	IACIARA S2	30/10/2020 13:40	30/10/2020 16:59	30/10/2020 13:40	30/10/2020 16:59	3,31	6	19,86	CHI
202010181148	CALDAS NOVAS	760053698	CALDAS NOVAS S1	30/10/2020 13:40	30/10/2020 21:28	30/10/2020 13:40	30/10/2020 21:28	7,78	1	7,78	CHI
202010181155	CORUMBAIBA	CI21134629	VILA CORUMBA	30/10/2020 13:42	30/10/2020 18:46	30/10/2020 13:42	30/10/2020 18:46	5,06	1	5,06	CHI
202010181172	OUVIDOR	OU10407540	CATALAO S1	30/10/2020 13:42	30/10/2020 18:18	30/10/2020 13:42	30/10/2020 17:34	3,86	29	112,02	CHI
202010181172	CATALAO	OU10407540	CATALAO S1	30/10/2020 13:42	30/10/2020 18:18	30/10/2020 13:42	30/10/2020 17:34	3,86	8	30,90	CHI
202010181172	CATALAO	OU10407540	CATALAO S1	30/10/2020 13:42	30/10/2020 18:18	30/10/2020 13:42	30/10/2020 17:39	3,94	4	15,78	CHI
202010181172	OUVIDOR	OU10407540	CATALAO S1	30/10/2020 13:42	30/10/2020 18:18	30/10/2020 13:42	30/10/2020 17:39	3,94	56	220,90	CHI
202010181172	TRES RANCHOS	OU10407540	CATALAO S1	30/10/2020 13:42	30/10/2020 18:18	30/10/2020 13:42	30/10/2020 17:39	3,94	24	94,67	CHI
202010181172	CATALAO	OU16433871	CATALAO S1	30/10/2020 13:42	30/10/2020 18:18	30/10/2020 13:42	30/10/2020 17:39	3,94	1	3,94	CHI
202010181172	OUVIDOR	OU16433871	CATALAO S1	30/10/2020 13:42	30/10/2020 18:18	30/10/2020 13:42	30/10/2020 17:39	3,94	2	7,88	CHI
202010181172	TRES RANCHOS	OU13000061	CATALAO S1	30/10/2020 13:42	30/10/2020 18:18	30/10/2020 18:09	30/10/2020 18:18	0,15	24	3,68	CHI
202010181172	CATALAO	OU13000061	CATALAO S1	30/10/2020 13:42	30/10/2020 18:18	30/10/2020 18:09	30/10/2020 18:18	0,15	5	0,77	CHI
202010181172	OUVIDOR	OU13000061	CATALAO S1	30/10/2020 13:42	30/10/2020 18:18	30/10/2020 18:09	30/10/2020 18:18	0,15	58	8,89	CHI
202010181162	BARRO ALTO	BA21353998	BARRO ALTO	30/10/2020 13:43	31/10/2020 04:21	30/10/2020 13:43	31/10/2020 04:21	14,63	2	29,26	CHI
202010181163	GOIANIA	16640184	GOYA S1	30/10/2020 13:43	30/10/2020 16:21	30/10/2020 13:43	30/10/2020 16:21	2,63	1	2,63	CHI
202010181168	GOIANIA	10973837	FERROVIARIO S3	30/10/2020 13:44	30/10/2020 16:33	30/10/2020 13:44	30/10/2020 16:33	2,82	1	2,82	CHI
202010181389	GUARAITA	GS12198785	GOIAS	30/10/2020 13:44	30/10/2020 18:28	30/10/2020 13:44	30/10/2020 18:28	4,73	2	9,46	CHI
202010181389	GOIAS	GS12198785	GOIAS	30/10/2020 13:44	30/10/2020 18:28	30/10/2020 13:44	30/10/2020 18:28	4,73	8	37,82	CHI
202010181389	ITAPURANGA	GS12198785	GOIAS	30/10/2020 13:44	30/10/2020 18:28	30/10/2020 13:44	30/10/2020 18:28	4,73	2	9,46	CHI
202010181175	GOIANIA	17444755	CAMPINAS S1	30/10/2020 13:44	30/10/2020 15:33	30/10/2020 13:44	30/10/2020 15:33	1,80	1	1,80	CHI
202010181187	APARECIDA DE GOIANIA	13767987	REAL S2	30/10/2020 13:46	30/10/2020 15:33	30/10/2020 13:46	30/10/2020 15:33	1,77	1	1,77	CHI
202010181192	GOIAS	GS12021591	GOIAS	30/10/2020 13:47	30/10/2020 15:24	30/10/2020 13:47	30/10/2020 15:24	1,61	6	9,68	CHI
202010181198	SENADOR CANEDO	10025002765	SENADOR CANEDO	30/10/2020 13:48	30/10/2020 16:26	30/10/2020 13:48	30/10/2020 16:26	2,63	1	2,63	CHI
202010181201	FORMOSA	10018122289	ITIQUEIRA	30/10/2020 13:48	30/10/2020 14:46	30/10/2020 13:48	30/10/2020 14:46	0,96	1	0,96	CHI
202010181456	ANICUNS	AC12019279	ANICUNS	30/10/2020 13:50	30/10/2020 19:39	30/10/2020 13:50	30/10/2020 19:39	5,81	23	133,66	CHI
202010181212	PALESTINA DE GOIAS	PY21062869	IPORA	30/10/2020 13:50	30/10/2020 14:58	30/10/2020 13:50	30/10/2020 14:58	1,12	1	1,12	CHI
202010182646	BARRO ALTO	BA12413771	BARRO ALTO	30/10/2020 13:51	31/10/2020 01:22	30/10/2020 13:51	31/10/2020 01:22	11,52	23	264,85	CHI
202010181222	GUAPO	GA21000056	GUAPO S1	30/10/2020 13:53	30/10/2020 19:11	30/10/2020 13:53	30/10/2020 19:11	5,30	1	5,30	CHI
202010181227	APARECIDA DE GOIANIA	15881660	REAL S1	30/10/2020 13:54	30/10/2020 15:12	30/10/2020 13:54	30/10/2020 15:12	1,29	1	1,29	CHI
202010181431	CATALAO	CT12000051RE	CATALAO S1	30/10/2020 13:56	30/10/2020 17:23	30/10/2020 13:56	30/10/2020 17:23	3,45	64	220,59	CHI

202010181237	GOIANIA	10728971	ATLANTICO S3	30/10/2020 13:57	30/10/2020 16:36	30/10/2020 13:57	30/10/2020 16:36	2,65	1	2,65	CHI
202010181239	PALMEIRAS DE GOIAS	PL21011096	PALMEIRAS	30/10/2020 13:57	30/10/2020 16:00	30/10/2020 13:57	30/10/2020 16:00	2,04	1	2,04	CHI
202010181244	PALMEIRAS DE GOIAS	PL12169788	PALMEIRAS	30/10/2020 13:58	30/10/2020 15:59	30/10/2020 13:58	30/10/2020 15:59	2,01	9	18,08	CHI
202010181245	PARAUNA	PU12205943	PARAUNA	30/10/2020 13:58	31/10/2020 13:14	30/10/2020 13:58	31/10/2020 09:04	19,10	8	152,82	CHI
202010181245	PARAUNA	PU13314817	PARAUNA	30/10/2020 13:58	31/10/2020 13:14	30/10/2020 13:58	31/10/2020 11:28	21,49	11	236,37	CHI
202010181245	PARAUNA	PU12172481	PARAUNA	30/10/2020 13:58	31/10/2020 13:14	30/10/2020 13:58	31/10/2020 13:14	23,26	7	162,85	CHI
202010181245	JANDAIA	PU12172481	PARAUNA	30/10/2020 13:58	31/10/2020 13:14	30/10/2020 13:58	31/10/2020 13:14	23,26	3	69,79	CHI
202010181345	VICENTINOPOLIS	VI12263804	VICENTINOPOLIS	30/10/2020 13:58	30/10/2020 19:22	30/10/2020 13:58	30/10/2020 19:22	5,39	15	80,83	CHI
202010181254	JARAGUA	JA11345506	JARAGUA	30/10/2020 14:00	30/10/2020 18:06	30/10/2020 14:00	30/10/2020 18:06	4,09	48	196,44	CHI
202010181555	CATALAO	CT12165146	CATALAO S1	30/10/2020 14:03	30/10/2020 18:45	30/10/2020 14:03	30/10/2020 18:45	4,69	32	150,18	CHI
202010181555	CAMPO ALEGRE DE GOIAS	CT12165146	CATALAO S1	30/10/2020 14:03	30/10/2020 18:45	30/10/2020 14:03	30/10/2020 18:45	4,69	2	9,39	CHI
202010181269	GOIANIA	17295634	CARAJAS S1	30/10/2020 14:03	30/10/2020 15:46	30/10/2020 14:03	30/10/2020 15:46	1,71	1	1,71	CHI
202010181510	PETROLINA DE GOIAS	PG12273266	PETROLINA	30/10/2020 14:03	30/10/2020 17:00	30/10/2020 14:03	30/10/2020 17:00	2,94	16	47,05	CHI
202010182268	MONTIVIDIU DO NORTE	MX12143686RE	PORANGATU	30/10/2020 14:04	30/10/2020 18:18	30/10/2020 14:04	30/10/2020 18:18	4,22	104	439,08	CHI
202010181283	HIDROLANDIA	HD21402817	CEPAIGO S2	30/10/2020 14:04	30/10/2020 15:37	30/10/2020 14:04	30/10/2020 15:37	1,54	1	1,54	CHI
202010181288	MORRINHOS	MR12207453	MORRINHOS	30/10/2020 14:05	30/10/2020 16:12	30/10/2020 14:05	30/10/2020 16:12	2,10	27	56,83	CHI
202010181299	APARECIDA DE GOIANIA	10015755272	ANHANGUERA	30/10/2020 14:06	30/10/2020 15:41	30/10/2020 14:06	30/10/2020 15:41	1,57	1	1,57	CHI
202010181138	GOIANIA	GN11001995	AEROPORTO S2	30/10/2020 14:08	30/10/2020 15:42	30/10/2020 14:08	30/10/2020 15:42	1,57	53	83,05	CHI
202010181304	ITABERAI	10021854937	ITABERAI S2	30/10/2020 14:08	30/10/2020 15:39	30/10/2020 14:08	30/10/2020 15:39	1,50	1	1,50	CHI
202010181305	GOIAS	90077659	GOIAS	30/10/2020 14:08	30/10/2020 18:37	30/10/2020 14:08	30/10/2020 18:37	4,48	1	4,48	CHI
202010182040	JARAGUA	JA12000236	JARAGUA	30/10/2020 14:08	31/10/2020 01:49	30/10/2020 14:08	31/10/2020 01:49	11,67	26	303,40	CHI
202010189166	FAINA	FC12299792	GOIAS	30/10/2020 14:09	30/10/2020 17:45	30/10/2020 14:09	30/10/2020 17:45	3,58	54	193,53	CHI
202010181905	COCALZINHO DE GOIAS	ZN12353427	COCALZINHO	30/10/2020 14:10	30/10/2020 17:52	30/10/2020 14:10	30/10/2020 17:52	3,70	6	22,18	CHI
202010181317	SANCLERLANDIA	SC12376375	FIRMINOPOLIS S2	30/10/2020 14:10	31/10/2020 14:37	30/10/2020 18:18	30/10/2020 18:56	0,63	8	5,04	CHI
202010181317	MOSSAMEDES	SC12395118	FIRMINOPOLIS S2	30/10/2020 14:10	31/10/2020 14:37	30/10/2020 14:10	31/10/2020 14:37	24,46	13	317,92	CHI
202010181430	CATALAO	CT12306674RE	CATALAO S1	30/10/2020 14:11	30/10/2020 17:48	30/10/2020 14:11	30/10/2020 17:48	3,61	129	466,16	CHI
202010181319	HIDROLINA	HL11171827	URUACU	30/10/2020 14:11	30/10/2020 17:58	30/10/2020 14:11	30/10/2020 17:58	3,78	57	215,43	CHI
202010182304	MOSSAMEDES	MD12307488LD	ITABERAI S2	30/10/2020 14:13	01/11/2020 04:51	30/10/2020 14:13	01/11/2020 02:42	36,49	27	985,16	CHI
202010182304	MOSSAMEDES	MD12307488LD	ITABERAI S2	30/10/2020 14:13	01/11/2020 04:51	30/10/2020 14:13	01/11/2020 03:19	37,09	4	148,37	CHI
202010182304	MOSSAMEDES	MD12024495	ITABERAI S2	30/10/2020 14:13	01/11/2020 04:51	30/10/2020 14:13	01/11/2020 03:19	37,10	14	519,43	CHI
202010182304	MOSSAMEDES	MD12307488LD	ITABERAI S2	30/10/2020 14:13	01/11/2020 04:51	30/10/2020 14:13	01/11/2020 04:00	37,78	7	264,49	CHI
202010182304	MOSSAMEDES	MD12020758	ITABERAI S2	30/10/2020 14:13	01/11/2020 04:51	30/10/2020 14:13	01/11/2020 04:23	38,16	35	1335,67	CHI
202010182304	MOSSAMEDES	MD12020722LD	ITABERAI S2	30/10/2020 14:13	01/11/2020 04:51	30/10/2020 14:13	01/11/2020 04:51	38,63	27	1042,97	CHI
202010181330	NEROPOLIS	160045770	NEROPOLIS S2	30/10/2020 14:14	30/10/2020 17:46	30/10/2020 14:14	30/10/2020 17:46	3,53	1	3,53	CHI
202010181334	BALIZA	BH12360382	BOM JARDIM	30/10/2020 14:14	30/10/2020 15:43	30/10/2020 14:14	30/10/2020 15:43	1,47	3	4,41	CHI
202010180977	CRISTALINA	KR11203785	CRISTALINA S1	30/10/2020 14:15	30/10/2020 17:38	30/10/2020 14:15	30/10/2020 17:38	3,39	72	244,44	CHI
202010181346	COCALZINHO DE GOIAS	ZN12384825	COCALZINHO	30/10/2020 14:16	30/10/2020 18:59	30/10/2020 14:16	30/10/2020 18:59	4,71	2	9,42	CHI
202010181350	NEROPOLIS	NR12415166	NEROPOLIS S2	30/10/2020 14:17	30/10/2020 16:00	30/10/2020 14:17	30/10/2020 16:00	1,71	9	15,39	CHI
202010182184	ANICUNS	AC12259103	FIRMINOPOLIS S2	30/10/2020 14:19	30/10/2020 21:50	30/10/2020 14:19	30/10/2020 21:50	7,50	19	142,54	CHI
202010181371	SANTO ANTONIO DE GOIAS	BW12151470	NEROPOLIS S1	30/10/2020 14:19	30/10/2020 18:02	30/10/2020 14:19	30/10/2020 18:02	3,70	2	7,40	CHI
202010181371	GOIANIA	BW12151470	NEROPOLIS S1	30/10/2020 14:19	30/10/2020 18:02	30/10/2020 14:19	30/10/2020 18:02	3,70	137	507,09	CHI
202010181365	NIQUELANDIA	NQ12371122	SAO JOAO D ALIANCA	30/10/2020 14:20	30/10/2020 21:57	30/10/2020 14:20	30/10/2020 21:57	7,61	3	22,84	CHI
202010181368	FAINA	FC12307361	GOIAS	30/10/2020 14:20	30/10/2020 16:43	30/10/2020 14:20	30/10/2020 16:43	2,37	40	94,68	CHI
202010181373	NOVA ROMA	ND11266531	IACIARA S2	30/10/2020 14:21	30/10/2020 18:16	30/10/2020 14:21	30/10/2020 18:16	3,91	6	23,45	CHI
202010181375	MORRINHOS	MR12000097	MORRINHOS	30/10/2020 14:21	30/10/2020 20:11	30/10/2020 14:21	30/10/2020 20:11	5,82	1	5,82	CHI
202010181377	ANAPOLIS	AN11000748	JUNDIAI S2	30/10/2020 14:22	30/10/2020 16:50	30/10/2020 14:22	30/10/2020 16:50	2,46	143	352,06	CHI
202010181379	ANAPOLIS	10030737263	JUNDIAI S1	30/10/2020 14:22	30/10/2020 15:51	30/10/2020 14:22	30/10/2020 15:51	1,47	1	1,47	CHI
202010181382	UIRAPURU	UP21281743	SANTA TEREZINHA	30/10/2020 14:23	30/10/2020 17:00	30/10/2020 14:23	30/10/2020 17:00	2,62	1	2,62	CHI
202010182121	ITABERAI	AC12020513	ANICUNS	30/10/2020 14:23	30/10/2020 21:40	30/10/2020 14:23	30/10/2020 21:40	7,27	11	80,01	CHI
202010182121	AVELINOPOLIS	AC12020513	ANICUNS	30/10/2020 14:23	30/10/2020 21:40	30/10/2020 14:23	30/10/2020 21:40	7,27	3	21,82	CHI
202010182121	ANICUNS	AC12020513	ANICUNS	30/10/2020 14:23	30/10/2020 21:40	30/10/2020 14:23	30/10/2020 21:40	7,27	13	94,55	CHI

202010181386	GOIATUBA	GT21143953	GOIATUBA S2	30/10/2020 14:24	30/10/2020 17:26	30/10/2020 14:24	30/10/2020 17:26	3,03	1	3,03	CHI
202010181387	CABECEIRAS	CW12181818	ITIQUEIRA	30/10/2020 14:24	30/10/2020 18:12	30/10/2020 14:24	30/10/2020 18:12	3,79	3	11,38	CHI
202010181388	APARECIDA DE GOIANIA	12927764	REAL S2	30/10/2020 14:24	30/10/2020 16:33	30/10/2020 14:24	30/10/2020 16:33	2,14	1	2,14	CHI
202010182377	SAO MIGUEL DO ARAGUAIA	SM12083962RE	SAO MIGUEL DO ARAGUAIA	30/10/2020 14:25	30/10/2020 23:39	30/10/2020 14:25	30/10/2020 23:39	9,23	11	101,52	CHI
202010181470	PIRENOPOLIS	PV12355915	CORUMBA	30/10/2020 14:26	30/10/2020 19:56	30/10/2020 14:26	30/10/2020 19:56	5,50	23	126,50	CHI
202010181397	CATALAO	CT21042365	CATALAO S1	30/10/2020 14:26	30/10/2020 21:54	30/10/2020 14:26	30/10/2020 21:54	7,46	2	14,92	CHI
202010181503	ITABERAI	AR12346287	ARACU	30/10/2020 14:27	30/10/2020 21:35	30/10/2020 14:27	30/10/2020 21:35	7,12	5	35,59	CHI
202010181503	ANICUNS	AR12346287	ARACU	30/10/2020 14:27	30/10/2020 21:35	30/10/2020 14:27	30/10/2020 21:35	7,12	7	49,83	CHI
202010181775	ITAPURANGA	IK12300236	ITAPURANGA	30/10/2020 14:28	30/10/2020 16:40	30/10/2020 14:28	30/10/2020 16:40	2,19	11	24,06	CHI
202010181417	SAO JOAO D ALIANCA	JL11242667	SAO JOAO D ALIANCA	30/10/2020 14:29	31/10/2020 11:28	30/10/2020 14:29	31/10/2020 11:28	20,98	1	20,98	CHI
202010181422	DIORAMA	DI21212993	IPORA	30/10/2020 14:30	30/10/2020 17:57	30/10/2020 14:30	30/10/2020 17:57	3,46	1	3,46	CHI
202010181508	ANAPOLIS	AN11217365	JUNDIAI S1	30/10/2020 14:30	30/10/2020 16:50	30/10/2020 14:30	30/10/2020 16:50	2,33	57	132,89	CHI
202010181805	CATALAO	CT12013713	CATALAO S1	30/10/2020 14:31	30/10/2020 18:51	30/10/2020 14:31	30/10/2020 18:51	4,33	13	56,26	CHI
202010181432	PALESTINA DE GOIAS	PY21116728	PALESTINA	30/10/2020 14:32	30/10/2020 17:00	30/10/2020 14:32	30/10/2020 17:00	2,46	1	2,46	CHI
202010181696	JARAGUA	JA12000117	JARAGUA	30/10/2020 14:32	30/10/2020 17:40	30/10/2020 14:32	30/10/2020 17:40	3,12	2	6,24	CHI
202010182299	ARAGOIANIA	AO11159963	GUAPO S2	30/10/2020 14:33	31/10/2020 04:57	30/10/2020 14:33	31/10/2020 04:57	14,39	101	1453,84	CHI
202010181646	HIDROLANDIA	HD12026493	INDEPENDENCIA S1	30/10/2020 14:34	30/10/2020 17:22	30/10/2020 14:34	30/10/2020 17:22	2,79	3	8,38	CHI
202010181452	VALPARAISO DE GOIAS	10019603760	MARAJOARA	30/10/2020 14:36	30/10/2020 15:45	30/10/2020 14:36	30/10/2020 15:45	1,14	1	1,14	CHI
202010181728	CAVALCANTE	TI12162624	NIQUELANDIA SUBTRANSMISSAO	30/10/2020 14:38	31/10/2020 15:26	30/10/2020 14:38	31/10/2020 15:26	24,80	58	1438,13	CHI
202010181728	COLINAS DO SUL	TI12162624	NIQUELANDIA SUBTRANSMISSAO	30/10/2020 14:38	31/10/2020 15:26	30/10/2020 14:38	31/10/2020 15:26	24,80	18	446,32	CHI
202010181507	JARAGUA	JA12009801	JARAGUA	30/10/2020 14:38	30/10/2020 20:32	30/10/2020 14:38	30/10/2020 20:32	5,89	121	713,03	CHI
202010181641	FORMOSA	FA12322759	ITIQUEIRA	30/10/2020 14:38	30/10/2020 19:27	30/10/2020 14:38	30/10/2020 19:27	4,81	37	177,88	CHI
202010181641	DISTRITO FEDERAL	FA12322759	ITIQUEIRA	30/10/2020 14:38	30/10/2020 19:27	30/10/2020 14:38	30/10/2020 19:27	4,81	1	4,81	CHI
202010181465	GOIANIA	10004787593	CAMPINAS S1	30/10/2020 14:39	30/10/2020 16:19	30/10/2020 14:39	30/10/2020 16:19	1,66	1	1,66	CHI
202010181466	PORANGATU	10002450893	PORANGATU	30/10/2020 14:39	30/10/2020 19:46	30/10/2020 14:39	30/10/2020 19:46	5,11	1	5,11	CHI
202010181467	CATURAI	CK21316821	INHUMAS S1	30/10/2020 14:39	30/10/2020 21:29	30/10/2020 14:39	30/10/2020 21:29	6,82	2	13,64	CHI
202010181471	ITAPIRAPUA	1420032190	MATRINCHA	30/10/2020 14:40	30/10/2020 18:06	30/10/2020 14:40	30/10/2020 18:06	3,42	1	3,42	CHI
202010181474	APARECIDA DE GOIANIA	200509986	INDEPENDENCIA S1	30/10/2020 14:41	30/10/2020 17:29	30/10/2020 14:41	30/10/2020 17:29	2,80	1	2,80	CHI
202010181477	INDIARA	2710020240	EDEIA	30/10/2020 14:41	30/10/2020 15:56	30/10/2020 14:41	30/10/2020 15:56	1,24	1	1,24	CHI
202010181518	PIRENOPOLIS	PV12352327	CORUMBA	30/10/2020 14:41	30/10/2020 17:51	30/10/2020 14:41	30/10/2020 17:51	3,15	18	56,71	CHI
202010181754	AGUA FRIA DE GOIAS	TL12206197	SAO JOAO D ALIANCA	30/10/2020 14:42	30/10/2020 19:20	30/10/2020 14:42	30/10/2020 19:20	4,63	9	41,69	CHI
202010181483	CALDAS NOVAS	CN21238424	VILA CORUMBA	30/10/2020 14:42	31/10/2020 15:52	30/10/2020 14:42	31/10/2020 15:52	25,16	1	25,16	CHI
202010182130	HIDROLANDIA	HD12007492	PONTALINA	30/10/2020 14:43	30/10/2020 23:50	30/10/2020 14:43	30/10/2020 23:50	9,11	10	91,11	CHI
202010181491	FORMOSO	2410021172	PORANGATU	30/10/2020 14:44	30/10/2020 18:43	30/10/2020 14:44	30/10/2020 18:43	3,97	1	3,97	CHI
202010181493	FAINA	FC21028553	GOIAS	30/10/2020 14:45	30/10/2020 18:54	30/10/2020 14:45	30/10/2020 18:54	4,15	1	4,15	CHI
202010181501	FORMOSA	610305657	ITIQUEIRA	30/10/2020 14:46	30/10/2020 17:06	30/10/2020 14:46	30/10/2020 17:06	2,33	1	2,33	CHI
202010181509	GOIANIA	10837024	GOIANIA LESTE S1	30/10/2020 14:48	30/10/2020 18:09	30/10/2020 14:48	30/10/2020 18:09	3,34	1	3,34	CHI
202010181513	MINACU	6990000267	MINACU	30/10/2020 14:49	30/10/2020 15:52	30/10/2020 14:49	30/10/2020 15:52	1,04	1	1,04	CHI
202010181516	FAINA	FC21299856	GOIAS	30/10/2020 14:50	30/10/2020 17:59	30/10/2020 14:50	30/10/2020 17:59	3,15	1	3,15	CHI
202010181520	HIDROLANDIA	HD21093306	INDEPENDENCIA S1	30/10/2020 14:50	30/10/2020 23:15	30/10/2020 14:50	30/10/2020 23:15	8,40	1	8,40	CHI
202010181523	SENADOR CANEDO	BO21090123	GOIANIA LESTE S2	30/10/2020 14:51	30/10/2020 15:07	30/10/2020 14:51	30/10/2020 15:07	0,25	1	0,25	CHI
202010181524	ITAPIRAPUA	IU12075401	JUSSARA	30/10/2020 14:52	30/10/2020 19:23	30/10/2020 14:52	30/10/2020 19:23	4,51	2	9,03	CHI
202010181527	CATALAO	8181746	CATALAO S2	30/10/2020 14:52	31/10/2020 12:19	30/10/2020 14:52	31/10/2020 12:19	21,44	1	21,44	CHI
202010181531	CATALAO	CT12215663RE	CATALAO S1	30/10/2020 14:53	31/10/2020 01:21	30/10/2020 14:53	31/10/2020 01:21	10,46	7	73,19	CHI
202010181540	LUZIANIA	120344282	RIO VERMELHO	30/10/2020 14:55	30/10/2020 15:55	30/10/2020 14:55	30/10/2020 15:55	0,99	1	0,99	CHI
202010182254	JARAGUA	JA12044169	JARAGUA	30/10/2020 14:55	30/10/2020 19:35	30/10/2020 14:55	30/10/2020 19:35	4,66	230	1072,37	CHI
202010181545	LEOPOLDO DE BULHOES	10014453370	DAIA S2	30/10/2020 14:56	30/10/2020 17:38	30/10/2020 14:56	30/10/2020 17:38	2,70	1	2,70	CHI
202010181656	SAO JOAO D ALIANCA	JL12268110	FLORES DE GOIAS	30/10/2020 14:56	30/10/2020 18:02	30/10/2020 14:56	30/10/2020 18:02	3,09	9	27,85	CHI
202010181550	GOIANIA	10050700	CAMPINAS S2	30/10/2020 14:56	30/10/2020 15:51	30/10/2020 14:56	30/10/2020 15:51	0,91	1	0,91	CHI
202010181554	LEOPOLDO DE BULHOES	LB21084064	DAIA S2	30/10/2020 14:56	30/10/2020 15:44	30/10/2020 14:56	30/10/2020 15:44	0,79	2	1,57	CHI
202010181556	PONTALINA	PK21120760	PONTALINA	30/10/2020 14:58	30/10/2020 17:06	30/10/2020 14:58	30/10/2020 17:06	2,13	1	2,13	CHI

202010181795	SANTO ANTONIO DE GOIAS	GR12002128	NEROPOLIS S1	30/10/2020 14:58	30/10/2020 19:14	30/10/2020 14:58	30/10/2020 19:14	4,28	6	25,65	CHI
202010181560	PIRENOPOLIS	PV12000464	SAO FRANCISCO DE GOIAS	30/10/2020 14:59	30/10/2020 18:21	30/10/2020 14:59	30/10/2020 18:21	3,37	42	141,38	CHI
202010181643	FAINA	FC12158864	GOIAS	30/10/2020 15:01	30/10/2020 19:18	30/10/2020 15:01	30/10/2020 19:18	4,27	9	38,43	CHI
202010181574	SAO FRANCISCO DE GOIAS	PV21236038	SAO FRANCISCO DE GOIAS	30/10/2020 15:02	30/10/2020 21:24	30/10/2020 15:02	30/10/2020 21:24	6,37	2	12,73	CHI
202010181577	MINACU	4020003143	MINACU	30/10/2020 15:02	30/10/2020 21:46	30/10/2020 15:02	30/10/2020 21:46	6,73	1	6,73	CHI
202010182681	JARAGUA	JA11054445	GOIANESIA S2	30/10/2020 15:02	30/10/2020 20:56	30/10/2020 15:02	30/10/2020 20:56	5,89	88	518,22	CHI
202010181614	ITAPURANGA	IK10396063	ITAPURANGA	30/10/2020 15:03	30/10/2020 21:53	30/10/2020 15:03	30/10/2020 18:54	3,85	221	850,73	CHI
202010181614	ITAPURANGA	IK10396063	ITAPURANGA	30/10/2020 15:03	30/10/2020 21:53	30/10/2020 15:03	30/10/2020 20:24	5,34	193	1031,16	CHI
202010181614	GUARAITA	IK12250511	ITAPURANGA	30/10/2020 15:03	30/10/2020 21:53	30/10/2020 15:03	30/10/2020 21:53	6,84	7	47,87	CHI
202010181614	ITAPURANGA	IK12250511	ITAPURANGA	30/10/2020 15:03	30/10/2020 21:53	30/10/2020 15:03	30/10/2020 21:53	6,84	39	266,70	CHI
202010181583	EDEALINA	ED21108519	EDEIA	30/10/2020 15:03	30/10/2020 17:07	30/10/2020 15:03	30/10/2020 17:07	2,05	1	2,05	CHI
202010181587	ALVORADA DO NORTE	10001010016	IACIARA S2	30/10/2020 15:04	30/10/2020 17:53	30/10/2020 15:04	30/10/2020 17:53	2,82	1	2,82	CHI
202010182527	CAIAPONIA	PH12187421	CAIAPONIA	30/10/2020 15:04	31/10/2020 02:41	30/10/2020 15:04	31/10/2020 02:41	11,61	4	46,45	CHI
202010182527	PIRANHAS	PH12187421	CAIAPONIA	30/10/2020 15:04	31/10/2020 02:41	30/10/2020 15:04	31/10/2020 02:41	11,61	1	11,61	CHI
202010181591	PALESTINA DE GOIAS	PY21251341	IPORA	30/10/2020 15:04	30/10/2020 16:28	30/10/2020 15:04	30/10/2020 16:28	1,39	1	1,39	CHI
202010181684	FORMOSA	FA12096349	ITUIQUIRA	30/10/2020 15:05	30/10/2020 21:11	30/10/2020 15:05	30/10/2020 21:11	6,10	16	97,58	CHI
202010182505	BELA VISTA DE GOIAS	BV12108579	BELA VISTA S1	30/10/2020 15:05	30/10/2020 19:55	30/10/2020 15:05	30/10/2020 19:55	4,82	17	81,94	CHI
202010181609	CORUMBA DE GOIAS	CB21111204	CORUMBA	30/10/2020 15:06	30/10/2020 18:49	30/10/2020 15:06	30/10/2020 18:49	3,71	1	3,71	CHI
202010181613	APARECIDA DE GOIANIA	200050760	INDEPENDENCIA S1	30/10/2020 15:07	30/10/2020 15:59	30/10/2020 15:07	30/10/2020 15:59	0,85	1	0,85	CHI
202010181617	MOZARLANDIA	MZ12055640	MOZARLANDIA	30/10/2020 15:08	30/10/2020 21:00	30/10/2020 15:08	30/10/2020 21:00	5,86	9	52,78	CHI
202010181618	SENADOR CANEDO	SW11375181	SENADOR CANEDO	30/10/2020 15:09	30/10/2020 18:51	30/10/2020 15:09	30/10/2020 18:51	3,70	72	266,38	CHI
202010181621	LEOPOLDO DE BULHOES	LB21011655	DAIA S2	30/10/2020 15:09	30/10/2020 16:31	30/10/2020 15:09	30/10/2020 16:31	1,36	1	1,36	CHI
202010181765	SENADOR CANEDO	SW11141241	SENADOR CANEDO	30/10/2020 15:09	30/10/2020 23:58	30/10/2020 15:09	30/10/2020 23:58	8,80	172	1514,32	CHI
202010181654	GOIANIRA	GR12323028	TRINDADE	30/10/2020 15:10	30/10/2020 17:52	30/10/2020 15:10	30/10/2020 17:52	2,69	12	32,33	CHI
202010181658	TRINDADE	TR12390003	GOYA S2	30/10/2020 15:10	30/10/2020 17:28	30/10/2020 15:10	30/10/2020 17:28	2,29	231	528,93	CHI
202010181629	GOIANIA	10029017481	CAMPINAS S2	30/10/2020 15:10	30/10/2020 17:52	30/10/2020 15:10	30/10/2020 17:52	2,69	0	0,00	CHI
202010181779	FORMOSA	FA12233654	SAO JOAO D ALIANCA	30/10/2020 15:10	30/10/2020 20:17	30/10/2020 15:10	30/10/2020 20:17	5,10	10	51,02	CHI
202010181635	LUZIANIA	10028199454	RIO VERMELHO	30/10/2020 15:11	30/10/2020 18:21	30/10/2020 15:11	30/10/2020 18:21	3,15	1	3,15	CHI
202010181970	ITAPACI	CX12392063	SANTA TEREZINHA	30/10/2020 15:12	30/10/2020 22:58	30/10/2020 15:12	30/10/2020 22:58	7,75	4	31,02	CHI
202010181970	CRIXAS	CX12392063	SANTA TEREZINHA	30/10/2020 15:12	30/10/2020 22:58	30/10/2020 15:12	30/10/2020 22:58	7,75	29	224,89	CHI
202010181638	GOIAS	GS21353052	GOIAS	30/10/2020 15:12	30/10/2020 17:09	30/10/2020 15:12	30/10/2020 17:09	1,93	3	5,80	CHI
202010181647	SAO DOMINGOS	SD12317864	SAO DOMINGOS	30/10/2020 15:14	30/10/2020 18:30	30/10/2020 15:14	30/10/2020 18:30	3,26	34	110,87	CHI
202010181648	PADRE BERNARDO	PB12092844	PADRE BERNARDO	30/10/2020 15:14	30/10/2020 17:34	30/10/2020 15:14	30/10/2020 17:34	2,33	5	11,63	CHI
202010181688	CRISTALINA	KR12304869	CRISTALINA S2	30/10/2020 15:16	30/10/2020 18:31	30/10/2020 15:16	30/10/2020 18:31	3,25	16	51,99	CHI
202010189169	CRIXAS	CX12221633RE	RUBIATABA	30/10/2020 15:18	30/10/2020 22:49	30/10/2020 15:18	30/10/2020 20:15	4,95	97	479,88	CHI
202010189169	NOVA CRIXAS	CX12221633RE	RUBIATABA	30/10/2020 15:18	30/10/2020 22:49	30/10/2020 15:18	30/10/2020 20:15	4,95	1	4,95	CHI
202010189169	CRIXAS	CX12221633RE	RUBIATABA	30/10/2020 15:18	30/10/2020 22:49	30/10/2020 15:18	30/10/2020 22:49	7,51	36	270,51	CHI
202010181676	ARAGOIANIA	AO12221194	INDEPENDENCIA S2	30/10/2020 15:18	30/10/2020 17:30	30/10/2020 15:18	30/10/2020 17:30	2,19	15	32,82	CHI
202010181682	FORMOSA	FA11325635	ITUIQUIRA	30/10/2020 15:19	30/10/2020 21:28	30/10/2020 15:19	30/10/2020 21:28	6,15	2	12,30	CHI
202010181695	JARAGUA	JA12059971	JARAGUA	30/10/2020 15:21	30/10/2020 19:30	30/10/2020 15:21	30/10/2020 19:30	4,15	10	41,46	CHI
202010181705	PLANALTINA	PI12257785	PLANALTINA	30/10/2020 15:22	30/10/2020 18:00	30/10/2020 15:22	30/10/2020 18:00	2,63	1	2,63	CHI
202010183097	JARAGUA	JA12070670	JARAGUA	30/10/2020 15:22	30/10/2020 21:21	30/10/2020 15:22	30/10/2020 21:21	5,97	10	59,75	CHI
202010182197	ANAPOLIS	OV12384197	NEROPOLIS S1	30/10/2020 15:23	30/10/2020 20:28	30/10/2020 15:23	30/10/2020 20:28	5,08	5	25,41	CHI
202010182197	OURO VERDE DE GOIAS	OV12384197	NEROPOLIS S1	30/10/2020 15:23	30/10/2020 20:28	30/10/2020 15:23	30/10/2020 20:28	5,08	2	10,16	CHI
202010181713	NIQUELANDIA	NQ21095773	NIQUELANDIA SUBTRANSMISSAO	30/10/2020 15:23	30/10/2020 17:04	30/10/2020 15:23	30/10/2020 17:04	1,68	1	1,68	CHI
202010181746	PIRACANJUBA	CN16404326	CALDAS NOVAS S2	30/10/2020 15:24	30/10/2020 18:05	30/10/2020 15:24	30/10/2020 17:06	1,69	2	3,39	CHI
202010181746	CALDAS NOVAS	CN16404326	CALDAS NOVAS S2	30/10/2020 15:24	30/10/2020 18:05	30/10/2020 15:24	30/10/2020 17:06	1,69	2447	4143,59	CHI
202010181746	CALDAS NOVAS	CN16404326	CALDAS NOVAS S2	30/10/2020 15:24	30/10/2020 18:05	30/10/2020 15:24	30/10/2020 18:05	2,69	1059	2844,30	CHI
202010181746	CALDAS NOVAS	CN10422068	CALDAS NOVAS S2	30/10/2020 15:24	30/10/2020 18:05	30/10/2020 15:24	30/10/2020 18:05	2,69	1222	3282,09	CHI
202010181720	PONTALINA	PK12000027	PONTALINA	30/10/2020 15:24	30/10/2020 16:35	30/10/2020 15:24	30/10/2020 16:35	1,17	4	4,69	CHI
202010181727	APARECIDA DE GOIANIA	11046170	REAL S2	30/10/2020 15:25	30/10/2020 19:42	30/10/2020 15:25	30/10/2020 19:42	4,27	1	4,27	CHI

202010182371	SAO LUIS DE MONTES BELOS	SL12373573	SAO LUIZ DOS MONTES BELOS	30/10/2020 15:26	30/10/2020 22:07	30/10/2020 15:26	30/10/2020 22:07	6,67	10	66,68	CHI
202010181735	NAZARIO	440023075	ANICUNS	30/10/2020 15:27	30/10/2020 17:11	30/10/2020 15:27	30/10/2020 17:11	1,73	1	1,73	CHI
202010181740	NIQUELANDIA	NQ12236713	NIQUELANDIA SUBTRANSMISSAO	30/10/2020 15:27	30/10/2020 18:27	30/10/2020 15:27	30/10/2020 18:27	2,98	5	14,92	CHI
202010181743	GOIANIA	11645064	CAMPINAS S1	30/10/2020 15:28	30/10/2020 17:09	30/10/2020 15:28	30/10/2020 17:09	1,68	1	1,68	CHI
202010181745	IPAMERI	580078590	IPAMERI	30/10/2020 15:28	30/10/2020 19:31	30/10/2020 15:28	30/10/2020 19:31	4,04	1	4,04	CHI
202010181972	CRIXAS	CX12248286	SERRA DO OURO	30/10/2020 15:29	30/10/2020 20:02	30/10/2020 15:29	30/10/2020 20:02	4,54	17	77,21	CHI
202010181973	CRIXAS	CX12232379	SANTA TEREZINHA	30/10/2020 15:30	02/11/2020 13:14	01/11/2020 00:42	01/11/2020 01:58	1,26	14	17,57	CHI
202010181973	CRIXAS	CX12232379	SANTA TEREZINHA	30/10/2020 15:30	02/11/2020 13:14	01/11/2020 10:37	01/11/2020 13:30	2,89	19	54,86	CHI
202010181973	CRIXAS	CX12232379	SANTA TEREZINHA	30/10/2020 15:30	02/11/2020 13:14	01/11/2020 13:31	01/11/2020 16:45	3,23	19	61,32	CHI
202010181973	CRIXAS	CX12232379	SANTA TEREZINHA	30/10/2020 15:30	02/11/2020 13:14	02/11/2020 03:15	02/11/2020 04:06	0,85	19	16,19	CHI
202010181973	CRIXAS	CX12232379	SANTA TEREZINHA	30/10/2020 15:30	02/11/2020 13:14	02/11/2020 09:35	02/11/2020 12:17	2,70	19	51,26	CHI
202010181973	CRIXAS	CX12232379	SANTA TEREZINHA	30/10/2020 15:30	02/11/2020 13:14	02/11/2020 03:15	02/11/2020 12:59	9,74	1	9,74	CHI
202010181973	CRIXAS	CX21213183	SANTA TEREZINHA	30/10/2020 15:30	02/11/2020 13:14	02/11/2020 02:42	02/11/2020 13:09	10,45	1	10,45	CHI
202010181973	CRIXAS	CX21213128	SANTA TEREZINHA	30/10/2020 15:30	02/11/2020 13:14	02/11/2020 02:11	02/11/2020 13:14	11,05	1	11,05	CHI
202010181973	CRIXAS	CX12232379	SANTA TEREZINHA	30/10/2020 15:30	02/11/2020 13:14	30/10/2020 15:30	31/10/2020 11:24	19,90	1	19,90	CHI
202010181973	CRIXAS	CX12232379	SANTA TEREZINHA	30/10/2020 15:30	02/11/2020 13:14	30/10/2020 15:30	31/10/2020 21:54	30,40	9	273,57	CHI
202010181973	CRIXAS	CX12232379	SANTA TEREZINHA	30/10/2020 15:30	02/11/2020 13:14	31/10/2020 21:06	31/10/2020 21:54	0,80	1	0,80	CHI
202010181973	CRIXAS	CX12190100	SANTA TEREZINHA	30/10/2020 15:30	02/11/2020 13:14	30/10/2020 15:30	31/10/2020 22:34	31,06	4	124,24	CHI
202010181973	CRIXAS	CX12232379	SANTA TEREZINHA	30/10/2020 15:30	02/11/2020 13:14	30/10/2020 15:30	01/11/2020 01:58	34,46	5	172,31	CHI
202010181973	CRIXAS	CX12232379	SANTA TEREZINHA	30/10/2020 15:30	02/11/2020 13:14	30/10/2020 15:30	01/11/2020 14:00	46,50	1	46,50	CHI
202010181973	CRIXAS	CX12232379	SANTA TEREZINHA	30/10/2020 15:30	02/11/2020 13:14	30/10/2020 15:30	01/11/2020 14:05	46,59	1	46,59	CHI
202010181973	CRIXAS	CX12232379	SANTA TEREZINHA	30/10/2020 15:30	02/11/2020 13:14	30/10/2020 15:30	01/11/2020 14:15	46,75	1	46,75	CHI
202010181766	GOIANIA	11800653	XAVANTES	30/10/2020 15:32	30/10/2020 16:59	30/10/2020 15:32	30/10/2020 16:59	1,45	1	1,45	CHI
202010182375	SAO FRANCISCO DE GOIAS	PV12079157	CORUMBA	30/10/2020 15:32	30/10/2020 22:55	30/10/2020 15:32	30/10/2020 22:55	7,38	2	14,75	CHI
202010182375	PIRENOPOLIS	PV12079157	CORUMBA	30/10/2020 15:32	30/10/2020 22:55	30/10/2020 15:32	30/10/2020 22:55	7,38	4	29,51	CHI
202010177424	MORRINHOS	5590000328	MORRINHOS	30/10/2020 15:33	30/10/2020 17:02	30/10/2020 15:33	30/10/2020 17:02	1,49	1	1,49	CHI
202010181829	ITUMBIARA	CD12097345RE	BOM JESUS DE GOIAS	30/10/2020 15:34	30/10/2020 17:44	30/10/2020 15:34	30/10/2020 17:44	2,15	9	19,36	CHI
202010181777	SANTA FE DE GOIAS	RN12045571	BRITANIA	30/10/2020 15:35	30/10/2020 19:16	30/10/2020 15:35	30/10/2020 19:16	3,68	7	25,78	CHI
202010181777	JUSSARA	RN12045571	BRITANIA	30/10/2020 15:35	30/10/2020 19:16	30/10/2020 15:35	30/10/2020 19:16	3,68	4	14,73	CHI
202010181784	NOVO PLANALTO	TA21137619	SAO MIGUEL DO ARAGUAIA	30/10/2020 15:36	30/10/2020 22:07	30/10/2020 15:36	30/10/2020 22:07	6,51	1	6,51	CHI
202010181787	APARECIDA DE GOIANIA	200066201	INDEPENDENCIA S1	30/10/2020 15:36	30/10/2020 16:59	30/10/2020 15:36	30/10/2020 16:59	1,38	1	1,38	CHI
202010181790	JUSSARA	JR12027532	BRITANIA	30/10/2020 15:37	30/10/2020 20:56	30/10/2020 15:37	30/10/2020 20:56	5,31	40	212,50	CHI
202010181793	TRINDADE	10028426370	TRINDADE	30/10/2020 15:37	30/10/2020 20:51	30/10/2020 15:37	30/10/2020 20:51	5,22	1	5,22	CHI
202010181798	QUIRINOPOLIS	10004483110	QUIRINOPOLIS	30/10/2020 15:39	30/10/2020 17:15	30/10/2020 15:39	30/10/2020 17:15	1,59	1	1,59	CHI
202010181898	SILVANIA	AN12165598	DAIA S2	30/10/2020 15:40	31/10/2020 17:02	30/10/2020 15:40	31/10/2020 17:02	25,35	1	25,35	CHI
202010181898	GAMELEIRA DE GOIAS	AN12165598	DAIA S2	30/10/2020 15:40	31/10/2020 17:02	30/10/2020 15:40	31/10/2020 17:02	25,35	3	76,06	CHI
202010181804	ABADIANIA	AA21139888	ANAPOLIS UNIVERSITARIO S1	30/10/2020 15:41	30/10/2020 17:00	30/10/2020 15:41	30/10/2020 17:00	1,32	1	1,32	CHI
202010179075	GOIAS	GS12206751	MATRINCHA	30/10/2020 15:41	30/10/2020 18:17	30/10/2020 15:41	30/10/2020 18:17	2,60	34	88,25	CHI
202010181811	MINEIROS	PW21206292	PARQUE DAS EMAS	30/10/2020 15:41	30/10/2020 19:47	30/10/2020 15:41	30/10/2020 19:47	4,09	1	4,09	CHI
202010181902	COLINAS DO SUL	TI11037454	NIQUELANDIA SUBTRANSMISSAO	30/10/2020 15:41	31/10/2020 12:50	30/10/2020 15:41	31/10/2020 12:50	21,13	124	2620,64	CHI
202010181815	NOVO GAMA	4990073000	PACAEMBU S1	30/10/2020 15:42	30/10/2020 23:14	30/10/2020 15:42	30/10/2020 23:14	7,53	1	7,53	CHI
202010181819	PIRENOPOLIS	GE21134008	CORUMBA	30/10/2020 15:42	31/10/2020 00:31	30/10/2020 15:42	31/10/2020 00:31	8,81	1	8,81	CHI
202010181820	SANTA HELENA DE GOIAS	400135413	IPEGUARI	30/10/2020 15:42	30/10/2020 19:22	30/10/2020 15:42	30/10/2020 19:22	3,67	1	3,67	CHI
202010181822	RIO VERDE	RV12340876	MONTIVIDIU T	30/10/2020 15:43	30/10/2020 23:21	30/10/2020 15:43	30/10/2020 23:21	7,63	5	38,16	CHI
202010181823	ITUMBIARA	690193350	ITUMBIARA VELHA S1	30/10/2020 15:43	30/10/2020 16:50	30/10/2020 15:43	30/10/2020 16:50	1,11	1	1,11	CHI
202010181924	SAO LUIZ DO NORTE	SZ12090338	ITAPACI	30/10/2020 15:43	30/10/2020 20:16	30/10/2020 15:43	30/10/2020 20:16	4,54	291	1321,22	CHI
202010181828	ANAPOLIS	AN11210795	JUNDIAI S1	30/10/2020 15:44	30/10/2020 17:19	30/10/2020 15:44	30/10/2020 17:19	1,57	106	166,33	CHI
202010181830	PIRANHAS	1930048200	PIRANHAS	30/10/2020 15:45	30/10/2020 18:31	30/10/2020 15:45	30/10/2020 18:31	2,77	1	2,77	CHI
202010181835	ITAPURANGA	IK12300342	ITAPURANGA	30/10/2020 15:46	30/10/2020 17:31	30/10/2020 15:46	30/10/2020 17:31	1,74	37	64,31	CHI
202010182340	ITAPIRAPUA	IU12020837	JUSSARA	30/10/2020 15:47	30/10/2020 19:23	30/10/2020 15:47	30/10/2020 19:23	3,60	9	32,36	CHI
202010182019	INDIARA	CZ12000015	CEZARINA	30/10/2020 15:48	30/10/2020 19:37	30/10/2020 15:48	30/10/2020 19:37	3,82	37	141,19	CHI

202010182019	CEZARINA	CZ12000015	CEZARINA	30/10/2020 15:48	30/10/2020 19:37	30/10/2020 15:48	30/10/2020 19:37	3,82	62	236,58	CHI
202010181855	FAINA	FC21120477	GOIAS	30/10/2020 15:51	30/10/2020 19:47	30/10/2020 15:51	30/10/2020 19:47	3,93	1	3,93	CHI
202010182026	ITAPACI	IW12141722	ITAPACI	30/10/2020 15:51	01/11/2020 15:14	30/10/2020 15:51	01/11/2020 15:14	47,38	13	615,99	CHI
202010181864	SILVANIA	SV21045688	DAIA S2	30/10/2020 15:52	30/10/2020 19:34	30/10/2020 15:52	30/10/2020 19:34	3,69	1	3,69	CHI
202010181870	COCALZINHO DE GOIAS	ZN21125022	COCALZINHO	30/10/2020 15:53	30/10/2020 16:57	30/10/2020 15:53	30/10/2020 16:57	1,05	1	1,05	CHI
202010181873	RUBIATABA	RB21114305	RUBIATABA	30/10/2020 15:53	31/10/2020 13:24	30/10/2020 15:53	31/10/2020 13:24	21,50	2	43,01	CHI
202010181879	INHUMAS	10020669389	INHUMAS S2	30/10/2020 15:55	30/10/2020 17:48	30/10/2020 15:55	30/10/2020 17:48	1,87	1	1,87	CHI
202010181884	HIDROLANDIA	AO12394651	GUAPO S2	30/10/2020 15:57	31/10/2020 09:35	30/10/2020 15:57	31/10/2020 09:35	17,64	14	247,01	CHI
202010181887	SAO DOMINGOS	SD21317888	SAO DOMINGOS	30/10/2020 15:57	30/10/2020 18:46	30/10/2020 15:57	30/10/2020 18:46	2,82	1	2,82	CHI
202010181888	ALEXANIA	AX21318552	ALEXANIA	30/10/2020 15:57	31/10/2020 02:34	30/10/2020 15:57	31/10/2020 02:34	10,61	1	10,61	CHI
202010181889	URUTAI	UT12300786	PIRES DO RIO S2	30/10/2020 15:57	31/10/2020 12:17	30/10/2020 15:57	31/10/2020 12:17	20,32	3	60,97	CHI
202010182098	ACREUNA	EU12260931	ACREUNA	30/10/2020 15:59	30/10/2020 19:58	30/10/2020 15:59	30/10/2020 19:58	3,98	3	11,94	CHI
202010181894	PALMEIRAS DE GOIAS	590051120	PALMEIRAS	30/10/2020 15:59	30/10/2020 18:58	30/10/2020 15:59	30/10/2020 18:58	2,98	1	2,98	CHI
202010181899	QUIRINOPOLIS	QI12279618	QUIRINOPOLIS	30/10/2020 16:00	31/10/2020 00:41	30/10/2020 16:00	31/10/2020 00:41	8,68	1	8,68	CHI
202010181908	MORRINHOS	MR21150862	MORRINHOS	30/10/2020 16:01	30/10/2020 16:38	30/10/2020 16:01	30/10/2020 16:38	0,61	1	0,61	CHI
202010181910	JATAI	JT21267543	JATAI S1	30/10/2020 16:01	30/10/2020 19:00	30/10/2020 16:01	30/10/2020 19:00	2,97	1	2,97	CHI
202010181912	JATAI	SX21100843	JATAI S1	30/10/2020 16:02	30/10/2020 18:18	30/10/2020 16:02	30/10/2020 18:18	2,25	1	2,25	CHI
202010182145	JATAI	JT12210073	JATAI S1	30/10/2020 16:03	30/10/2020 21:57	30/10/2020 16:03	30/10/2020 21:57	5,90	23	135,62	CHI
202010181963	MORRINHOS	MR12035913	MORRINHOS	30/10/2020 16:03	30/10/2020 18:21	30/10/2020 16:03	30/10/2020 18:21	2,30	11	25,26	CHI
202010181919	CATALAO	CT12103631	CATALAO S1	30/10/2020 16:03	31/10/2020 11:30	30/10/2020 16:03	31/10/2020 11:30	19,44	8	155,54	CHI
202010181922	QUIRINOPOLIS	QI21101237	QUIRINOPOLIS	30/10/2020 16:04	31/10/2020 08:03	30/10/2020 16:04	31/10/2020 08:03	15,98	1	15,98	CHI
202010182804	PILAR DE GOIAS	GG12171805RE	SANTA TEREZINHA	30/10/2020 16:05	30/10/2020 21:13	30/10/2020 16:05	30/10/2020 21:13	5,12	60	307,43	CHI
202010182804	SANTA TEREZINHA DE GOIAS	GG12171805RE	SANTA TEREZINHA	30/10/2020 16:05	30/10/2020 21:13	30/10/2020 16:05	30/10/2020 21:13	5,12	46	235,70	CHI
202010182162	ITAPURANGA	IK12250571	ITAPURANGA	30/10/2020 16:05	30/10/2020 18:08	30/10/2020 16:05	30/10/2020 18:08	2,03	94	191,19	CHI
202010181942	SENADOR CANEDO	SW11313343	GOIANIA LESTE S2	30/10/2020 16:07	30/10/2020 20:19	30/10/2020 16:07	30/10/2020 20:19	4,19	1	4,19	CHI
202010180213	IPAMERI	IP12112265RE	CAMPO ALEGRE DE GOIAS	30/10/2020 16:08	30/10/2020 18:26	30/10/2020 16:08	30/10/2020 18:26	2,30	32	73,61	CHI
202010181949	ACREUNA	EU21045016	ACREUNA	30/10/2020 16:08	30/10/2020 18:07	30/10/2020 16:08	30/10/2020 18:07	1,98	2	3,95	CHI
202010182506	SENADOR CANEDO	SW11239214	SENADOR CANEDO	30/10/2020 16:09	30/10/2020 18:48	30/10/2020 16:09	30/10/2020 18:48	2,64	166	438,79	CHI
202010181958	FORMOSA	FA11254216	ITUIQUIRA	30/10/2020 16:09	30/10/2020 18:10	30/10/2020 16:09	30/10/2020 18:10	2,00	1	2,00	CHI
202010181959	GOIANIA	10011310152	REAL S1	30/10/2020 16:10	30/10/2020 17:02	30/10/2020 16:10	30/10/2020 17:02	0,87	1	0,87	CHI
202010181962	CATALAO	CT12061149	CATALAO S1	30/10/2020 16:10	31/10/2020 14:45	30/10/2020 16:10	31/10/2020 14:45	22,58	1	22,58	CHI
202010181965	PIRENOPOLIS	PV21056006	CORUMBA	30/10/2020 16:10	31/10/2020 02:29	30/10/2020 16:10	31/10/2020 02:29	10,31	1	10,31	CHI
202010181982	TRINDADE	TR21381823	GOYA S2	30/10/2020 16:11	30/10/2020 22:13	30/10/2020 16:11	30/10/2020 22:13	6,03	1	6,03	CHI
202010181988	CATURAI	CK21297314	INHUMAS S1	30/10/2020 16:12	30/10/2020 20:23	30/10/2020 16:12	30/10/2020 20:23	4,18	1	4,18	CHI
202010182517	RUBIATABA	RB12126565	RUBIATABA	30/10/2020 16:12	31/10/2020 10:10	30/10/2020 16:12	31/10/2020 10:10	17,96	59	1059,85	CHI
202010182517	MORRO AGUDO DE GOIAS	RB12126565	RUBIATABA	30/10/2020 16:12	31/10/2020 10:10	30/10/2020 16:12	31/10/2020 10:10	17,96	5	89,82	CHI
202010181993	NOVA CRIXAS	NA11229673	NOVA CRIXAS	30/10/2020 16:12	30/10/2020 21:16	30/10/2020 16:12	30/10/2020 21:16	5,05	1	5,05	CHI
202010181997	CATALAO	CT1286318	CATALAO S1	30/10/2020 16:13	31/10/2020 09:15	30/10/2020 16:13	31/10/2020 09:15	17,03	1	17,03	CHI
202010182003	BELA VISTA DE GOIAS	CF21257440	CRISTIANOPOLIS	30/10/2020 16:14	31/10/2020 11:38	30/10/2020 16:14	31/10/2020 11:38	19,40	1	19,40	CHI
202010182004	PIRES DO RIO	460031594	PIRES DO RIO S1	30/10/2020 16:14	30/10/2020 17:21	30/10/2020 16:14	30/10/2020 17:21	1,11	1	1,11	CHI
202010182007	RUBIATABA	RB21114304	RUBIATABA	30/10/2020 16:14	30/10/2020 22:59	30/10/2020 16:14	30/10/2020 22:59	6,74	2	13,49	CHI
202010182015	HIDROLINA	1020016179	URUACU	30/10/2020 16:16	30/10/2020 19:18	30/10/2020 16:16	30/10/2020 19:18	3,03	1	3,03	CHI
202010182480	GOIANIRA	CK32015415	INHUMAS S1	30/10/2020 16:18	30/10/2020 19:38	30/10/2020 16:18	30/10/2020 19:38	3,33	3	10,00	CHI
202010182028	SAO DOMINGOS	10032429000	SAO DOMINGOS	30/10/2020 16:18	30/10/2020 18:37	30/10/2020 16:18	30/10/2020 18:37	2,31	1	2,31	CHI
202010182030	MATRINCHA	MP12274498	MOZARLANDIA	30/10/2020 16:18	30/10/2020 21:33	30/10/2020 16:18	30/10/2020 21:33	5,24	3	15,72	CHI
202010182030	ARUANA	MP12274498	MOZARLANDIA	30/10/2020 16:18	30/10/2020 21:33	30/10/2020 16:18	30/10/2020 21:33	5,24	5	26,20	CHI
202010182031	COCALZINHO DE GOIAS	ZN21388589	COCALZINHO	30/10/2020 16:19	30/10/2020 21:22	30/10/2020 16:19	30/10/2020 21:22	5,05	2	10,10	CHI
202010182034	AMARALINA	LC21230330	NOVA CRIXAS	30/10/2020 16:20	30/10/2020 22:36	30/10/2020 16:20	30/10/2020 22:36	6,27	1	6,27	CHI
202010182039	GOIANIA	12192971	ATLANTICO S3	30/10/2020 16:20	30/10/2020 17:52	30/10/2020 16:20	30/10/2020 17:52	1,52	1	1,52	CHI
202010182047	CABECEIRAS	CW21194600	ITUIQUIRA	30/10/2020 16:22	30/10/2020 20:15	30/10/2020 16:22	30/10/2020 20:15	3,88	1	3,88	CHI
202010182049	MORRINHOS	MR21293158	MORRINHOS	30/10/2020 16:22	30/10/2020 18:20	30/10/2020 16:22	30/10/2020 18:20	1,96	1	1,96	CHI

202010182051	CRIXAS	CX21249605	SANTA TEREZINHA	30/10/2020 16:22	30/10/2020 18:16	30/10/2020 16:22	30/10/2020 18:16	1,89	1	1,89	CHI
202010182054	VALPARAISO DE GOIAS	2860315415	PACAEMBU S1	30/10/2020 16:23	31/10/2020 03:59	30/10/2020 16:23	31/10/2020 03:59	11,59	1	11,59	CHI
202010182088	EDEALINA	EA12394174	EDEIA	30/10/2020 16:24	30/10/2020 19:36	30/10/2020 16:24	30/10/2020 19:36	3,19	6	19,15	CHI
202010182059	SAO JOAO D ALIANCA	JL21320608	SAO JOAO D ALIANCA	30/10/2020 16:24	30/10/2020 20:11	30/10/2020 16:24	30/10/2020 20:11	3,77	1	3,77	CHI
202010183163	CAMPOS VERDES	SG12181588	SANTA TEREZINHA	30/10/2020 16:24	31/10/2020 09:36	30/10/2020 16:24	31/10/2020 09:36	17,19	8	137,49	CHI
202010183163	SANTA TEREZINHA DE GOIAS	SG12181588	SANTA TEREZINHA	30/10/2020 16:24	31/10/2020 09:36	30/10/2020 16:24	31/10/2020 09:36	17,19	6	103,12	CHI
202010182061	INHUMAS	30016186	INHUMAS S2	30/10/2020 16:24	30/10/2020 19:05	30/10/2020 16:24	30/10/2020 19:05	2,67	1	2,67	CHI
202010182071	CIDADE OCIDENTAL	DH21290693	MARAJOARA	30/10/2020 16:27	30/10/2020 20:39	30/10/2020 16:27	30/10/2020 20:39	4,19	1	4,19	CHI
202010182169	LUZIANIA	LZ10407611	MARAJOARA	30/10/2020 16:27	31/10/2020 22:12	30/10/2020 16:27	30/10/2020 18:57	2,49	103	256,24	CHI
202010182169	CRISTALINA	LZ10407611	MARAJOARA	30/10/2020 16:27	31/10/2020 22:12	30/10/2020 16:27	30/10/2020 18:57	2,49	1	2,49	CHI
202010182169	LUZIANIA	LZ10407611	MARAJOARA	30/10/2020 16:27	31/10/2020 22:12	30/10/2020 16:27	30/10/2020 20:08	3,67	190	697,09	CHI
202010182169	LUZIANIA	LZ10407611	MARAJOARA	30/10/2020 16:27	31/10/2020 22:12	30/10/2020 16:27	31/10/2020 21:14	28,77	57	1639,92	CHI
202010182169	LUZIANIA	LZ10407611	MARAJOARA	30/10/2020 16:27	31/10/2020 22:12	30/10/2020 16:27	31/10/2020 22:12	29,74	1	29,74	CHI
202010182428	LUZIANIA	LZ21070101	MARAJOARA	30/10/2020 16:27	30/10/2020 22:36	30/10/2020 16:27	30/10/2020 22:36	6,13	2	12,27	CHI
202010182081	CACHOEIRA ALTA	1090014809	CACHOEIRA ALTA	30/10/2020 16:29	31/10/2020 08:16	30/10/2020 16:29	31/10/2020 08:16	15,78	1	15,78	CHI
202010182082	PIRANHAS	PH12204964	PIRANHAS	30/10/2020 16:29	30/10/2020 21:10	30/10/2020 16:29	30/10/2020 21:10	4,68	5	23,42	CHI
202010182083	PIRENOPOLIS	PV21283864	CORUMBA	30/10/2020 16:29	30/10/2020 22:35	30/10/2020 16:29	30/10/2020 22:35	6,09	2	12,18	CHI
202010182085	LUZIANIA	LZ21112948	RIO VERMELHO	30/10/2020 16:29	31/10/2020 07:52	30/10/2020 16:29	31/10/2020 07:52	15,37	1	15,37	CHI
202010182112	ALEXANIA	AX12000099	ALEXANIA	30/10/2020 16:29	30/10/2020 19:26	30/10/2020 16:29	30/10/2020 19:26	2,94	13	38,16	CHI
202010182092	CAIAPONIA	CP21119264	CAIAPONIA	30/10/2020 16:30	31/10/2020 09:15	30/10/2020 16:30	31/10/2020 09:15	16,75	1	16,75	CHI
202010182093	FLORES DE GOIAS	FB12239102	IACIARA S2	30/10/2020 16:30	30/10/2020 19:40	30/10/2020 16:30	30/10/2020 19:40	3,16	19	60,07	CHI
202010182644	RUBIATABA	RB12070009	RUBIATABA	30/10/2020 16:30	31/10/2020 08:59	30/10/2020 16:30	31/10/2020 08:59	16,47	10	164,73	CHI
202010182101	APORE	AE12107467	ITAJA S1	30/10/2020 16:31	30/10/2020 21:44	30/10/2020 16:31	30/10/2020 21:44	5,22	3	15,65	CHI
202010184073	PALMINOPOLIS	PP12233311RE	PALMEIRAS	30/10/2020 16:31	31/10/2020 10:05	30/10/2020 16:31	31/10/2020 10:05	17,56	39	684,89	CHI
202010184073	JANDAIA	PP12233311RE	PALMEIRAS	30/10/2020 16:31	31/10/2020 10:05	30/10/2020 16:31	31/10/2020 10:05	17,56	19	333,67	CHI
202010182103	VIANOPOLIS	VN12286070	VIANOPOLIS	30/10/2020 16:31	30/10/2020 19:04	30/10/2020 16:31	30/10/2020 19:04	2,54	4	10,18	CHI
202010182129	ABADIANIA	AA12335610	ANAPOLIS UNIVERSITARIO S1	30/10/2020 16:31	30/10/2020 18:40	30/10/2020 16:31	30/10/2020 18:40	2,14	9	19,28	CHI
202010182109	JATAI	JT21191689	JATAI S1	30/10/2020 16:33	31/10/2020 12:13	30/10/2020 16:33	31/10/2020 12:13	19,67	1	19,67	CHI
202010182115	TRINDADE	10024953863	TRINDADE	30/10/2020 16:34	30/10/2020 19:46	30/10/2020 16:34	30/10/2020 19:46	3,19	1	3,19	CHI
202010182116	HIDROLANDIA	HD21285820	PONTALINA	30/10/2020 16:34	30/10/2020 23:21	30/10/2020 16:34	30/10/2020 23:21	6,77	1	6,77	CHI
202010182122	JATAI	JT12105211	JATAI S1	30/10/2020 16:35	31/10/2020 08:54	30/10/2020 16:35	31/10/2020 08:54	16,31	26	424,04	CHI
202010183288	BALIZA	BH11137081	CAIAPONIA	30/10/2020 16:35	30/10/2020 21:29	30/10/2020 16:35	30/10/2020 21:29	4,89	10	48,92	CHI
202010182394	FORMOSA	FA12376671	ITUIQUIRA	30/10/2020 16:37	31/10/2020 09:01	30/10/2020 16:37	31/10/2020 09:01	16,40	33	541,07	CHI
202010182193	APARECIDA DE GOIANIA	AP11089717	REAL S1	30/10/2020 16:37	30/10/2020 19:48	30/10/2020 16:37	30/10/2020 19:48	3,17	236	749,30	CHI
202010182351	IPAMERI	IP12112268	PIRES DO RIO S2	30/10/2020 16:37	01/11/2020 13:46	30/10/2020 16:37	31/10/2020 13:10	20,55	11	226,05	CHI
202010182351	IPAMERI	IP12112268	PIRES DO RIO S2	30/10/2020 16:37	01/11/2020 13:46	31/10/2020 13:35	01/11/2020 13:22	23,77	11	261,51	CHI
202010182351	IPAMERI	IP12112268	PIRES DO RIO S2	30/10/2020 16:37	01/11/2020 13:46	30/10/2020 16:37	01/11/2020 13:41	45,06	1	45,06	CHI
202010182351	IPAMERI	IP12112268	PIRES DO RIO S2	30/10/2020 16:37	01/11/2020 13:46	30/10/2020 16:37	01/11/2020 13:46	45,15	8	361,23	CHI
202010179185	DOVERLANDIA	DV21156464	CAIAPONIA	30/10/2020 16:37	30/10/2020 19:28	30/10/2020 16:37	30/10/2020 19:28	2,85	1	2,85	CHI
202010182144	JATAI	JT12205196	JATAI S1	30/10/2020 16:38	31/10/2020 08:34	30/10/2020 16:38	31/10/2020 08:34	15,93	1	15,93	CHI
202010182146	SANTA HELENA DE GOIAS	SH21301723	ACREUNA	30/10/2020 16:38	30/10/2020 22:39	30/10/2020 16:38	30/10/2020 22:39	6,01	1	6,01	CHI
202010182147	LUZIANIA	3200075695	MARAJOARA	30/10/2020 16:38	31/10/2020 00:16	30/10/2020 16:38	31/10/2020 00:16	7,62	1	7,62	CHI
202010182238	EDEIA	EA12393856	EDEIA	30/10/2020 16:38	31/10/2020 00:06	30/10/2020 16:38	31/10/2020 00:06	7,46	7	52,19	CHI
202010182155	JARAGUA	JA12278873	JARAGUA	30/10/2020 16:39	30/10/2020 19:28	30/10/2020 16:39	30/10/2020 19:28	2,80	2	5,60	CHI
202010182159	SANTA CRUZ DE GOIAS	4430000117	PIRES DO RIO S2	30/10/2020 16:40	30/10/2020 19:42	30/10/2020 16:40	30/10/2020 19:42	3,02	1	3,02	CHI
202010182170	GOIANIA	11704068	GOIANIA LESTE S2	30/10/2020 16:42	30/10/2020 19:23	30/10/2020 16:42	30/10/2020 19:23	2,68	1	2,68	CHI
202010182171	ANAPOLIS	20154616	JUNDIAI S2	30/10/2020 16:42	30/10/2020 20:55	30/10/2020 16:42	30/10/2020 20:55	4,21	1	4,21	CHI
202010182202	RUBIATABA	RB12303953	RUBIATABA	30/10/2020 16:43	31/10/2020 11:02	30/10/2020 16:43	31/10/2020 11:02	18,30	3	54,91	CHI
202010182179	ALEXANIA	AX21302166	ALEXANIA	30/10/2020 16:43	30/10/2020 20:11	30/10/2020 16:43	30/10/2020 20:11	3,45	1	3,45	CHI
202010182185	ITABERAI	50075901	ITABERAI S2	30/10/2020 16:44	30/10/2020 18:46	30/10/2020 16:44	30/10/2020 18:46	2,03	1	2,03	CHI
202010182186	CRISTALINA	KR12304869	CRISTALINA S2	30/10/2020 16:44	30/10/2020 18:31	30/10/2020 16:44	30/10/2020 18:31	1,78	1	1,78	CHI

202010182188	MINEIROS	MY12071574	PARQUE DAS EMAS	30/10/2020 16:44	30/10/2020 19:35	30/10/2020 16:44	30/10/2020 19:35	2,83	5	14,17	CHI
202010182191	HIDROLINA	HL21202133	URUACU	30/10/2020 16:45	30/10/2020 20:19	30/10/2020 16:45	30/10/2020 20:19	3,56	1	3,56	CHI
202010182192	RIO VERDE	RV12123331	RIO VERDE S1	30/10/2020 16:45	30/10/2020 22:20	30/10/2020 16:45	30/10/2020 22:20	5,58	48	267,84	CHI
202010182531	CAIAPONIA	CP12207864RE	CAIAPONIA	30/10/2020 16:49	30/10/2020 22:54	30/10/2020 16:49	30/10/2020 22:54	6,08	45	273,75	CHI
202010182206	CATALAO	CT21127893	CATALAO S1	30/10/2020 16:49	31/10/2020 09:56	30/10/2020 16:49	31/10/2020 09:56	17,11	1	17,11	CHI
202010182208	MORRINHOS	MR12196326	MORRINHOS	30/10/2020 16:49	30/10/2020 19:57	30/10/2020 16:49	30/10/2020 19:57	3,13	65	203,34	CHI
202010182210	ABADIANIA	AA21122882	ANAPOLIS UNIVERSITARIO S1	30/10/2020 16:49	30/10/2020 19:52	30/10/2020 16:49	30/10/2020 19:52	3,04	1	3,04	CHI
202010182211	FORMOSA	610191950	ITIQUEIRA	30/10/2020 16:49	30/10/2020 18:49	30/10/2020 16:49	30/10/2020 18:49	2,00	1	2,00	CHI
202010182475	PORTELANDIA	PW12303420	PARQUE DAS EMAS	30/10/2020 16:49	30/10/2020 22:08	30/10/2020 16:49	30/10/2020 22:08	5,31	14	74,30	CHI
202010182544	CAIAPONIA	CP12245299	CAIAPONIA	30/10/2020 16:49	30/10/2020 20:48	30/10/2020 16:49	30/10/2020 20:48	3,97	8	31,76	CHI
202010182218	GOIANIA	SW21322538	SENADOR CANEDO	30/10/2020 16:51	30/10/2020 21:51	30/10/2020 16:51	30/10/2020 21:51	5,00	1	5,00	CHI
202010182408	PARANAIGUARA	PC12306052	QUIRINOPOLIS	30/10/2020 16:51	30/10/2020 21:55	30/10/2020 16:51	30/10/2020 21:55	5,06	6	30,36	CHI
202010182408	QUIRINOPOLIS	PC12306052	QUIRINOPOLIS	30/10/2020 16:51	30/10/2020 21:55	30/10/2020 16:51	30/10/2020 21:55	5,06	3	15,18	CHI
202010182321	RIO VERDE	RV12159300	CABRIUVA S2	30/10/2020 16:53	30/10/2020 19:06	30/10/2020 16:53	30/10/2020 19:06	2,22	12	26,60	CHI
202010182507	NOVA IGUACU DE GOIAS	GG12375656	SANTA TEREZINHA	30/10/2020 16:53	31/10/2020 09:10	30/10/2020 16:53	31/10/2020 09:10	16,27	6	97,60	CHI
202010182507	PILAR DE GOIAS	GG12375656	SANTA TEREZINHA	30/10/2020 16:53	31/10/2020 09:10	30/10/2020 16:53	31/10/2020 09:10	16,27	14	227,74	CHI
202010182235	GOIANIA	11920555	XAVANTES	30/10/2020 16:54	30/10/2020 18:44	30/10/2020 16:54	30/10/2020 18:44	1,83	1	1,83	CHI
202010182237	APORE	AE21112878	ITAJA S1	30/10/2020 16:54	30/10/2020 22:48	30/10/2020 16:54	30/10/2020 22:48	5,89	1	5,89	CHI
202010182245	ARAGUAPAZ	AZ12188220	MOZARLANDIA	30/10/2020 16:57	30/10/2020 19:50	30/10/2020 16:57	30/10/2020 19:50	2,88	34	97,89	CHI
202010182245	MOZARLANDIA	AZ12188220	MOZARLANDIA	30/10/2020 16:57	30/10/2020 19:50	30/10/2020 16:57	30/10/2020 19:50	2,88	8	23,03	CHI
202010182438	ALEXANIA	AX11210820	CORUMBA	30/10/2020 16:57	30/10/2020 21:06	30/10/2020 16:57	30/10/2020 21:06	4,14	47	194,74	CHI
202010182359	JATAI	JT11036765	JATAI S2	30/10/2020 16:59	30/10/2020 19:54	30/10/2020 16:59	30/10/2020 19:54	2,91	93	270,48	CHI
202010182258	GOIATUBA	10027737401	GOIATUBA S2	30/10/2020 17:02	30/10/2020 18:46	30/10/2020 17:02	30/10/2020 18:46	1,73	1	1,73	CHI
202010182261	MINACU	IH12236146	MINACU	30/10/2020 17:02	31/10/2020 02:19	30/10/2020 17:02	31/10/2020 02:19	9,27	2	18,55	CHI
202010182269	CAMPO ALEGRE DE GOIAS	CM12231612	CAMPO ALEGRE DE GOIAS	30/10/2020 17:04	30/10/2020 19:38	30/10/2020 17:04	30/10/2020 19:38	2,55	1	2,55	CHI
202010182271	ALEXANIA	AX11382894	ALEXANIA	30/10/2020 17:05	30/10/2020 21:47	30/10/2020 17:05	30/10/2020 21:47	4,69	7	32,84	CHI
202010182272	APARECIDA DE GOIANIA	10027058946	ANHANGUERA	30/10/2020 17:05	30/10/2020 19:13	30/10/2020 17:05	30/10/2020 19:13	2,12	1	2,12	CHI
202010182397	CRISTALINA	KR12376992	CRISTALINA S2	30/10/2020 17:06	31/10/2020 10:11	30/10/2020 17:06	31/10/2020 09:47	16,69	10	166,89	CHI
202010182397	CRISTALINA	19846221	CRISTALINA S2	30/10/2020 17:06	31/10/2020 10:11	31/10/2020 09:46	31/10/2020 10:11	0,42	69	29,21	CHI
202010182279	CACHOEIRA ALTA	1090036945	CACHOEIRA ALTA	30/10/2020 17:07	31/10/2020 09:47	30/10/2020 17:07	31/10/2020 09:47	16,66	1	16,66	CHI
202010182283	GOIANIA	14853073	REAL S1	30/10/2020 17:08	30/10/2020 20:45	30/10/2020 17:08	30/10/2020 20:45	3,61	1	3,61	CHI
202010182295	LUZIANIA	120057980	RIO VERMELHO	30/10/2020 17:11	30/10/2020 22:39	30/10/2020 17:11	30/10/2020 22:39	5,46	1	5,46	CHI
202010182701	UIRAPURU	MH12391944	NOVA CRIXAS	30/10/2020 17:13	31/10/2020 05:44	30/10/2020 17:13	31/10/2020 05:44	12,52	6	75,09	CHI
202010182310	APARECIDA DE GOIANIA	16489494	REAL S1	30/10/2020 17:14	30/10/2020 21:54	30/10/2020 17:14	30/10/2020 21:54	4,65	1	4,65	CHI
202010182311	URUACU	UR21156474	CAMPINORTE	30/10/2020 17:14	30/10/2020 19:12	30/10/2020 17:14	30/10/2020 19:12	1,95	12	23,44	CHI
202010182357	MAMBAI	MB12314303	IACIARA S2	30/10/2020 17:16	31/10/2020 22:42	30/10/2020 17:16	31/10/2020 22:42	29,45	4	117,79	CHI
202010182357	BURITINOPOLIS	MB12314303	IACIARA S2	30/10/2020 17:16	31/10/2020 22:42	30/10/2020 17:16	31/10/2020 22:42	29,45	2	58,89	CHI
202010182315	MINEIROS	MY21202610	PARQUE DAS EMAS	30/10/2020 17:16	31/10/2020 04:21	30/10/2020 17:16	31/10/2020 04:21	11,08	1	11,08	CHI
202010182601	BELA VISTA DE GOIAS	240097245	BELA VISTA S1	30/10/2020 17:16	30/10/2020 20:51	30/10/2020 17:16	30/10/2020 20:51	3,58	1	3,58	CHI
202010182679	PONTALINA	ED12000010	PONTALINA	30/10/2020 17:16	30/10/2020 23:53	30/10/2020 17:16	30/10/2020 23:53	6,60	5	33,02	CHI
202010182679	EDEALINA	ED12000010	PONTALINA	30/10/2020 17:16	30/10/2020 23:53	30/10/2020 17:16	30/10/2020 23:53	6,60	25	165,08	CHI
202010182679	EDEIA	ED12000010	PONTALINA	30/10/2020 17:16	30/10/2020 23:53	30/10/2020 17:16	30/10/2020 23:53	6,60	1	6,60	CHI
202010182425	CRISTALINA	KR12217277	CRISTALINA S1	30/10/2020 17:17	30/10/2020 20:40	30/10/2020 17:17	30/10/2020 20:40	3,38	12	40,60	CHI
202010182329	MONTE ALEGRE DE GOIAS	MA12236692	SAO DOMINGOS	30/10/2020 17:18	30/10/2020 22:44	30/10/2020 17:18	30/10/2020 22:44	5,42	5	27,11	CHI
202010183312	APARECIDA DO RIO DOCE	RV12402230	CABRIUVA S2	30/10/2020 17:19	30/10/2020 22:48	30/10/2020 17:19	30/10/2020 22:48	5,48	6	32,88	CHI
202010183312	RIO VERDE	RV12402230	CABRIUVA S2	30/10/2020 17:19	30/10/2020 22:48	30/10/2020 17:19	30/10/2020 22:48	5,48	3	16,44	CHI
202010182332	MONTIVIDIU	2840022923	MONTIVIDIU T	30/10/2020 17:19	30/10/2020 21:24	30/10/2020 17:19	30/10/2020 21:24	4,08	1	4,08	CHI
202010182333	GOIANESIA	1380002877	GOIANESIA S1	30/10/2020 17:19	30/10/2020 23:35	30/10/2020 17:19	30/10/2020 23:35	6,26	1	6,26	CHI
202010182335	NOVO PLANALTO	TA11248589	NOVO PLANALTO	30/10/2020 17:20	31/10/2020 02:36	30/10/2020 17:20	31/10/2020 02:36	9,26	264	2445,08	CHI
202010182343	JATAI	JT11234297	JATAI S2	30/10/2020 17:21	30/10/2020 22:27	30/10/2020 17:21	30/10/2020 22:27	5,10	68	346,57	CHI
202010182348	GOIANIA	13531748	FERROVIARIO S3	30/10/2020 17:22	30/10/2020 19:33	30/10/2020 17:22	30/10/2020 19:33	2,19	1	2,19	CHI

202010182553	PIRACANJUBA	PJ12035476	PIRACANJUBA	30/10/2020 17:22	30/10/2020 23:55	30/10/2020 17:22	30/10/2020 23:55	6,55	17	111,27	CHI
202010182354	SAO JOAO DA PARAUNA	PU12361883	PARAUNA	30/10/2020 17:22	30/10/2020 19:38	30/10/2020 17:22	30/10/2020 19:38	2,25	4	9,01	CHI
202010182669	PARAUNA	JD12008614	PALMEIRAS	30/10/2020 17:23	31/10/2020 11:10	30/10/2020 17:23	31/10/2020 11:10	17,78	6	106,69	CHI
202010182669	JANDAIA	JD12008614	PALMEIRAS	30/10/2020 17:23	31/10/2020 11:10	30/10/2020 17:23	31/10/2020 11:10	17,78	20	355,62	CHI
202010182358	NOVA CRIXAS	NA21091712	NOVA CRIXAS	30/10/2020 17:24	30/10/2020 20:07	30/10/2020 17:24	30/10/2020 20:07	2,71	1	2,71	CHI
202010182379	URUACU	UR10400423	URUACU	30/10/2020 17:24	01/11/2020 00:05	30/10/2020 17:24	31/10/2020 23:48	30,38	420	12761,70	CHI
202010182379	CAMPINORTE	UR10400423	URUACU	30/10/2020 17:24	01/11/2020 00:05	30/10/2020 17:24	31/10/2020 23:48	30,38	22	668,47	CHI
202010182379	URUACU	UR10400423	URUACU	30/10/2020 17:24	01/11/2020 00:05	30/10/2020 17:25	31/10/2020 23:48	30,37	20	607,48	CHI
202010182379	URUACU	UR12248311	URUACU	30/10/2020 17:24	01/11/2020 00:05	30/10/2020 17:24	01/11/2020 00:05	30,68	1	30,68	CHI
202010182376	SANTA HELENA DE GOIAS	400044353	IPEGUARI	30/10/2020 17:28	30/10/2020 21:30	30/10/2020 17:28	30/10/2020 21:30	4,03	1	4,03	CHI
202010182629	BELA VISTA DE GOIAS	BV12011697	BELA VISTA S1	30/10/2020 17:28	31/10/2020 00:03	30/10/2020 17:28	31/10/2020 00:03	6,57	12	78,86	CHI
202010182405	URUACU	UR12229447	URUACU	30/10/2020 17:29	30/10/2020 21:45	30/10/2020 17:29	30/10/2020 21:45	4,26	7	29,82	CHI
202010182382	CRISTALINA	KR21165888	CRISTALINA S2	30/10/2020 17:29	30/10/2020 21:48	30/10/2020 17:29	30/10/2020 21:48	4,31	1	4,31	CHI
202010182383	FORMOSA	610136173	ITUIQUIRA	30/10/2020 17:30	30/10/2020 19:30	30/10/2020 17:30	30/10/2020 19:30	2,01	1	2,01	CHI
202010182391	FAZENDA NOVA	FN21217150	FIRMINOPOLIS S2	30/10/2020 17:32	31/10/2020 10:53	30/10/2020 17:32	31/10/2020 10:53	17,35	1	17,35	CHI
202010182395	JATAI	CC21306211	JATAI S1	30/10/2020 17:32	31/10/2020 13:38	30/10/2020 17:32	31/10/2020 13:38	20,09	1	20,09	CHI
202010182846	GOIANIA	GN12001242	ATLANTICO S1	30/10/2020 17:33	30/10/2020 19:31	30/10/2020 17:33	30/10/2020 19:31	1,95	505	986,01	CHI
202010182404	RUBIATABA	780038757	RUBIATABA	30/10/2020 17:34	31/10/2020 09:56	30/10/2020 17:34	31/10/2020 09:56	16,35	1	16,35	CHI
202010183185	ITAPIRAPUA	IU12073717	MATRINCHA	30/10/2020 17:36	30/10/2020 20:07	30/10/2020 17:36	30/10/2020 20:07	2,50	11	27,54	CHI
202010183185	GOIAS	IU12073717	MATRINCHA	30/10/2020 17:36	30/10/2020 20:07	30/10/2020 17:36	30/10/2020 20:07	2,50	9	22,53	CHI
202010182594	IPORA	IR12222975	IPORA	30/10/2020 17:37	30/10/2020 20:17	30/10/2020 17:37	30/10/2020 20:17	2,67	70	186,57	CHI
202010182594	MOIPORA	IR12222975	IPORA	30/10/2020 17:37	30/10/2020 20:17	30/10/2020 17:37	30/10/2020 20:17	2,67	20	53,31	CHI
202010182594	IVOLANDIA	IR12222975	IPORA	30/10/2020 17:37	30/10/2020 20:17	30/10/2020 17:37	30/10/2020 20:17	2,67	6	15,99	CHI
202010182945	CAIAPONIA	4460000028	MONTVIDIU T	30/10/2020 17:37	30/10/2020 21:50	30/10/2020 17:37	30/10/2020 21:50	4,21	1	4,21	CHI
202010182414	PARANAIGUARA	2230001389	CACHOEIRA ALTA	30/10/2020 17:37	30/10/2020 20:55	30/10/2020 17:37	30/10/2020 20:55	3,30	1	3,30	CHI
202010182418	CRISTALINA	KR12394905	CRISTALINA S2	30/10/2020 17:38	30/10/2020 20:05	30/10/2020 17:38	30/10/2020 20:05	2,44	16	39,10	CHI
202010182423	POSSE	PS12257684	IACIARA S2	30/10/2020 17:38	30/10/2020 18:55	30/10/2020 17:38	30/10/2020 18:55	1,27	5	6,34	CHI
202010182427	JATAI	JT13214392	JATAI S1	30/10/2020 17:40	31/10/2020 17:48	30/10/2020 17:40	31/10/2020 04:59	11,33	414	4690,97	CHI
202010182427	SERRANOPOLIS	JT13214392	JATAI S1	30/10/2020 17:40	31/10/2020 17:48	30/10/2020 17:40	31/10/2020 04:59	11,33	45	509,89	CHI
202010182427	SERRANOPOLIS	JT13214392	JATAI S1	30/10/2020 17:40	31/10/2020 17:48	30/10/2020 20:20	31/10/2020 04:59	8,66	2	17,33	CHI
202010182427	JATAI	JT13214392	JATAI S1	30/10/2020 17:40	31/10/2020 17:48	30/10/2020 20:20	31/10/2020 04:59	8,66	4	34,66	CHI
202010182427	SERRANOPOLIS	JT16418253	JATAI S1	30/10/2020 17:40	31/10/2020 17:48	30/10/2020 21:35	31/10/2020 04:59	7,41	19	140,80	CHI
202010182427	JATAI	JT16418253	JATAI S1	30/10/2020 17:40	31/10/2020 17:48	30/10/2020 21:35	31/10/2020 04:59	7,41	20	148,21	CHI
202010182427	SERRANOPOLIS	JT10394612	JATAI S1	30/10/2020 17:40	31/10/2020 17:48	31/10/2020 05:46	31/10/2020 05:55	0,14	66	9,39	CHI
202010182427	JATAI	JT10394612	JATAI S2	30/10/2020 17:40	31/10/2020 17:48	31/10/2020 05:46	31/10/2020 05:55	0,14	120	17,07	CHI
202010182427	JATAI	JT10394612	JATAI S1	30/10/2020 17:40	31/10/2020 17:48	31/10/2020 05:46	31/10/2020 05:55	0,14	438	62,29	CHI
202010182427	JATAI	JT10394612	JATAI S2	30/10/2020 17:40	31/10/2020 17:48	31/10/2020 06:09	31/10/2020 07:04	0,92	120	110,97	CHI
202010182427	SERRANOPOLIS	JT16418253	JATAI S1	30/10/2020 17:40	31/10/2020 17:48	31/10/2020 06:09	31/10/2020 08:32	2,39	66	158,00	CHI
202010182427	JATAI	JT16418253	JATAI S1	30/10/2020 17:40	31/10/2020 17:48	31/10/2020 06:09	31/10/2020 08:32	2,39	438	1048,52	CHI
202010182427	JATAI	JT13214392	JATAI S1	30/10/2020 17:40	31/10/2020 17:48	30/10/2020 17:40	31/10/2020 10:11	16,52	34	561,51	CHI
202010182427	JATAI	04070224	JATAI S1	30/10/2020 17:40	31/10/2020 17:48	30/10/2020 21:35	31/10/2020 10:11	12,59	1	12,59	CHI
202010182427	JATAI	JT13214392	JATAI S1	30/10/2020 17:40	31/10/2020 17:48	30/10/2020 17:40	31/10/2020 11:20	17,67	18	317,97	CHI
202010182427	JATAI	04070224	JATAI S1	30/10/2020 17:40	31/10/2020 17:48	31/10/2020 13:05	31/10/2020 13:40	0,58	53	30,93	CHI
202010182427	JATAI	JT12100852RE	JATAI S1	30/10/2020 17:40	31/10/2020 17:48	30/10/2020 17:40	31/10/2020 16:57	23,30	28	652,34	CHI
202010182427	JATAI	JT13214392	JATAI S1	30/10/2020 17:40	31/10/2020 17:48	30/10/2020 17:40	31/10/2020 17:48	24,14	2	48,29	CHI
202010182431	CAMPOS VERDES	3790047348	SANTA TEREZINHA	30/10/2020 17:41	31/10/2020 08:27	30/10/2020 17:41	31/10/2020 08:27	14,76	1	14,76	CHI
202010182435	LEOPOLDO DE BULHOES	LB12037910	DAIA S1	30/10/2020 17:41	30/10/2020 22:39	30/10/2020 17:41	30/10/2020 22:39	4,96	3	14,87	CHI
202010182439	SANTA TEREZINHA DE GOIAS	2480041147	SANTA TEREZINHA	30/10/2020 17:42	30/10/2020 21:11	30/10/2020 17:42	30/10/2020 21:11	3,49	1	3,49	CHI
202010182441	AGUAS LINDAS DE GOIAS	10014466650	AGUAS LINDAS DE GOIAS S1	30/10/2020 17:43	30/10/2020 19:32	30/10/2020 17:43	30/10/2020 19:32	1,81	1	1,81	CHI
202010182444	BURITINOPOLIS	3610006302	IACIARA S2	30/10/2020 17:44	30/10/2020 18:25	30/10/2020 17:44	30/10/2020 18:25	0,68	1	0,68	CHI
202010182454	VICENTINOPOLIS	VI121263284	VICENTINOPOLIS	30/10/2020 17:46	30/10/2020 23:35	30/10/2020 17:46	30/10/2020 23:35	5,81	1	5,81	CHI

202010182455	AGUA FRIA DE GOIAS	TL12208773	SAO JOAO D ALIANCA	30/10/2020 17:46	30/10/2020 19:38	30/10/2020 17:46	30/10/2020 19:38	1,86	14	25,98	CHI
202010182455	MIMOSO DE GOIAS	TL12208773	SAO JOAO D ALIANCA	30/10/2020 17:46	30/10/2020 19:38	30/10/2020 17:46	30/10/2020 19:38	1,86	29	53,82	CHI
202010183281	SANCLERLANDIA	SL12019284	SAO LUIZ DOS MONTES BELOS	30/10/2020 17:46	30/10/2020 21:40	30/10/2020 17:46	30/10/2020 21:40	3,89	28	108,86	CHI
202010183281	SAO LUIS DE MONTES BELOS	SL12019284	SAO LUIZ DOS MONTES BELOS	30/10/2020 17:46	30/10/2020 21:40	30/10/2020 17:46	30/10/2020 21:40	3,89	59	229,38	CHI
202010182457	GOIANIA	10609787	AEROPORTO S1	30/10/2020 17:46	30/10/2020 20:11	30/10/2020 17:46	30/10/2020 20:11	2,40	1	2,40	CHI
202010182461	PARAUNA	PU12039209	PARAUNA	30/10/2020 17:47	30/10/2020 21:27	30/10/2020 17:47	30/10/2020 21:27	3,65	5	18,25	CHI
202010182462	CAMPINORTE	CR11243390	CAMPINORTE	30/10/2020 17:48	30/10/2020 20:58	30/10/2020 17:48	30/10/2020 20:58	3,17	69	218,50	CHI
202010182464	ANICUNS	AC21418050	ANICUNS	30/10/2020 17:48	31/10/2020 17:04	30/10/2020 17:48	31/10/2020 17:04	23,26	1	23,26	CHI
202010182468	ITABERAI	IB12040786	ITABERAI S2	30/10/2020 17:48	30/10/2020 18:59	30/10/2020 17:48	30/10/2020 18:59	1,17	10	11,73	CHI
202010182469	CRISTALINA	KR11352828	CRISTALINA S2	30/10/2020 17:48	30/10/2020 22:58	30/10/2020 17:48	30/10/2020 22:58	5,15	2	10,30	CHI
202010182473	MONTE ALEGRE DE GOIAS	MA11344192	SAO DOMINGOS	30/10/2020 17:50	30/10/2020 21:11	30/10/2020 17:50	30/10/2020 21:11	3,35	31	103,78	CHI
202010182478	COLINAS DO SUL	TI21243614	MINACU	30/10/2020 17:50	30/10/2020 21:06	30/10/2020 17:50	30/10/2020 21:06	3,26	1	3,26	CHI
202010182554	CAIAPONIA	CP12039210	CAIAPONIA	30/10/2020 17:50	30/10/2020 19:17	30/10/2020 17:50	30/10/2020 19:17	1,44	12	17,26	CHI
202010182809	URUACU	UR12088739	URUACU	30/10/2020 17:51	30/10/2020 20:18	30/10/2020 17:51	30/10/2020 20:18	2,44	6	14,63	CHI
202010182830	CAMPINACU	IH12360453	MINACU	30/10/2020 17:51	31/10/2020 03:27	30/10/2020 17:51	31/10/2020 03:27	9,59	5	47,94	CHI
202010182830	MINACU	IH12360453	MINACU	30/10/2020 17:51	31/10/2020 03:27	30/10/2020 17:51	31/10/2020 03:27	9,59	80	767,00	CHI
202010182498	ARAGOIANIA	AO12094834	GUAPO S2	30/10/2020 17:52	30/10/2020 20:17	30/10/2020 17:52	30/10/2020 20:17	2,41	13	31,39	CHI
202010182778	MINACU	IH12088797	MINACU	30/10/2020 17:52	30/10/2020 19:53	30/10/2020 17:52	30/10/2020 19:53	2,01	172	346,05	CHI
202010182499	RIO VERDE	RV21024713	RIO VERDE S1	30/10/2020 17:52	31/10/2020 00:01	30/10/2020 17:52	31/10/2020 00:01	6,13	1	6,13	CHI
202010182509	QUIRINOPOLIS	QI21279752	QUIRINOPOLIS	30/10/2020 17:54	31/10/2020 01:54	30/10/2020 17:54	31/10/2020 01:54	8,00	1	8,00	CHI
202010182514	IACIARA	IA12164539	IACIARA S2	30/10/2020 17:54	30/10/2020 20:13	30/10/2020 17:54	30/10/2020 20:13	2,30	25	57,57	CHI
202010182586	PIRENOPOLIS	PV12352327	CORUMBA	30/10/2020 17:55	30/10/2020 21:14	30/10/2020 17:55	30/10/2020 21:14	3,31	18	59,55	CHI
202010182522	GOIANIA	14607580	GOYA S1	30/10/2020 17:55	30/10/2020 21:34	30/10/2020 17:55	30/10/2020 21:34	3,63	1	3,63	CHI
202010182534	GOIATUBA	O4580214	BOM JESUS DE GOIAS	30/10/2020 17:56	30/10/2020 21:20	30/10/2020 17:56	30/10/2020 21:20	3,40	129	438,06	CHI
202010182837	RIO VERDE	RV12093125	RIO VERDE S1	30/10/2020 17:56	31/10/2020 09:06	30/10/2020 17:56	31/10/2020 09:06	15,15	5	75,76	CHI
202010182954	LUZIANIA	LZ11261624	RIO VERMELHO	30/10/2020 17:57	30/10/2020 21:57	30/10/2020 17:57	30/10/2020 21:57	3,99	111	442,58	CHI
202010182555	APARECIDA DE GOIANIA	200444130	INDEPENDENCIA S1	30/10/2020 17:58	30/10/2020 19:45	30/10/2020 17:58	30/10/2020 19:45	1,78	1	1,78	CHI
202010182562	SANTA TEREZINHA DE GOIAS	SG12243403	SANTA TEREZINHA	30/10/2020 17:59	30/10/2020 19:38	30/10/2020 17:59	30/10/2020 19:38	1,64	1	1,64	CHI
202010182564	PIRANHAS	PH21058311	PIRANHAS	30/10/2020 17:59	31/10/2020 07:41	30/10/2020 17:59	31/10/2020 07:41	13,68	1	13,68	CHI
202010182572	TRINDADE	10002602308	TRINDADE	30/10/2020 18:01	30/10/2020 21:22	30/10/2020 18:01	30/10/2020 21:22	3,34	1	3,34	CHI
202010182575	MORRINHOS	150074980	MORRINHOS	30/10/2020 18:02	31/10/2020 00:22	30/10/2020 18:02	31/10/2020 00:22	6,34	1	6,34	CHI
202010182577	EDEIA	EA21204480	EDEIA	30/10/2020 18:02	31/10/2020 04:26	30/10/2020 18:02	31/10/2020 04:26	10,39	1	10,39	CHI
202010182579	URUACU	UR12003452	CAMPINORTE	30/10/2020 18:03	31/10/2020 13:11	30/10/2020 18:03	31/10/2020 10:39	16,61	4	66,43	CHI
202010182579	URUACU	UR12213134LD	CAMPINORTE	30/10/2020 18:03	31/10/2020 13:11	30/10/2020 18:03	31/10/2020 11:06	17,05	4	68,21	CHI
202010182579	URUACU	UR12003452	CAMPINORTE	30/10/2020 18:03	31/10/2020 13:11	30/10/2020 18:03	31/10/2020 13:11	19,14	1	19,14	CHI
202010182581	GOIANIA	10044383	GOYA S2	30/10/2020 18:03	30/10/2020 20:21	30/10/2020 18:03	30/10/2020 20:21	2,29	1	2,29	CHI
202010182582	ABADIANIA	AA12382488	ANAPOLIS UNIVERSITARIO S1	30/10/2020 18:03	30/10/2020 22:58	30/10/2020 18:03	30/10/2020 22:58	4,91	5	24,53	CHI
202010182585	MORRO AGUDO DE GOIAS	MS21229565	ITAPURANGA	30/10/2020 18:04	31/10/2020 14:32	30/10/2020 18:04	31/10/2020 14:32	20,45	1	20,45	CHI
202010182587	APARECIDA DE GOIANIA	AP12004993	REAL S2	30/10/2020 18:04	31/10/2020 16:50	31/10/2020 11:00	31/10/2020 13:30	2,51	143	359,05	CHI
202010182587	APARECIDA DE GOIANIA	AP11005000	REAL S2	30/10/2020 18:04	31/10/2020 16:50	30/10/2020 18:04	31/10/2020 16:50	22,76	49	1115,29	CHI
202010183032	APARECIDA DE GOIANIA	10028327967	REAL S1	30/10/2020 18:04	31/10/2020 07:07	30/10/2020 18:04	31/10/2020 07:07	13,04	1	13,04	CHI
202010182591	ABADIA DE GOIAS	LG21085137	INDEPENDENCIA S2	30/10/2020 18:05	30/10/2020 22:30	30/10/2020 18:05	30/10/2020 22:30	4,41	1	4,41	CHI
202010183442	PORTELANDIA	PW12209812	PARQUE DAS EMAS	30/10/2020 18:05	31/10/2020 00:29	30/10/2020 18:05	31/10/2020 00:29	6,39	85	542,89	CHI
202010182595	IPAMERI	IP21162508	CRISTALINA S2	30/10/2020 18:06	31/10/2020 03:25	30/10/2020 18:06	31/10/2020 03:25	9,30	1	9,30	CHI
202010182618	VILA PROPICIO	GE12196931	GOIANESIA S1	30/10/2020 18:07	30/10/2020 23:51	30/10/2020 18:07	30/10/2020 23:51	5,73	9	51,60	CHI
202010182864	VALPARAISO DE GOIAS	VA10414104	PACAEMBU S2	30/10/2020 18:08	30/10/2020 20:59	30/10/2020 18:08	30/10/2020 20:59	2,86	4692	13432,15	CHI
202010182607	PORANGATU	PO21136920	PORANGATU	30/10/2020 18:08	30/10/2020 22:18	30/10/2020 18:08	30/10/2020 22:18	4,16	1	4,16	CHI
202010183169	AGUA FRIA DE GOIAS	JL12262352	SAO JOAO D ALIANCA	30/10/2020 18:08	31/10/2020 19:31	30/10/2020 18:08	31/10/2020 19:31	25,37	6	152,20	CHI
202010183169	SAO JOAO D ALIANCA	JL12262352	SAO JOAO D ALIANCA	30/10/2020 18:08	31/10/2020 19:31	30/10/2020 18:08	31/10/2020 19:31	25,37	108	2739,63	CHI
202010182619	VILA PROPICIO	PV21144561	GOIANESIA S1	30/10/2020 18:09	31/10/2020 08:49	30/10/2020 18:09	31/10/2020 08:49	14,65	1	14,65	CHI
202010182623	APARECIDA DE GOIANIA	11098417	REAL S1	30/10/2020 18:10	30/10/2020 21:46	30/10/2020 18:10	30/10/2020 21:46	3,59	1	3,59	CHI

202010182630	TRINDADE	XX03610032	GOIANIRA	30/10/2020 18:12	30/10/2020 20:11	30/10/2020 18:12	30/10/2020 20:11	1,98	2	3,96	CHI
202010182817	MINACU	IH12052624	MINACU	30/10/2020 18:12	30/10/2020 23:38	30/10/2020 18:12	30/10/2020 23:38	5,42	15	81,30	CHI
202010182693	MUNDO NOVO DE GOIAS	MH12269468	NOVA CRIXAS	30/10/2020 18:14	31/10/2020 22:47	30/10/2020 18:14	31/10/2020 22:47	28,54	6	171,25	CHI
202010182642	CRISTALINA	KR21031886	CRISTALINA S2	30/10/2020 18:15	31/10/2020 01:51	30/10/2020 18:15	31/10/2020 01:51	7,60	1	7,60	CHI
202010182643	SITIO D ABADIA	SI12211621	IACIARA S2	30/10/2020 18:15	30/10/2020 20:09	30/10/2020 18:15	30/10/2020 20:09	1,89	4	7,58	CHI
202010182647	CAMPO ALEGRE DE GOIAS	CM21164123	CAMPO ALEGRE DE GOIAS	30/10/2020 18:15	30/10/2020 20:16	30/10/2020 18:15	30/10/2020 20:16	2,01	1	2,01	CHI
202010182651	APARECIDA DE GOIANIA	200340128	INDEPENDENCIA S2	30/10/2020 18:16	30/10/2020 20:53	30/10/2020 18:16	30/10/2020 20:53	2,61	1	2,61	CHI
202010182840	CALDAS NOVAS	CN12223546	SERRA DE CALDAS	30/10/2020 18:18	30/10/2020 22:11	30/10/2020 18:18	30/10/2020 22:11	3,87	72	278,48	CHI
202010182672	FORMOSA	FA21096337	ITIQUEIRA	30/10/2020 18:21	30/10/2020 22:29	30/10/2020 18:21	30/10/2020 22:29	4,13	1	4,13	CHI
202010182732	MONTEVIDIU DO NORTE	MX12137628	PORANGATU	30/10/2020 18:21	31/10/2020 01:11	30/10/2020 18:21	31/10/2020 01:11	6,82	6	40,93	CHI
202010182684	GOIANIA	10561791	REAL S2	30/10/2020 18:23	30/10/2020 20:05	30/10/2020 18:23	30/10/2020 20:05	1,70	1	1,70	CHI
202010182689	QUIRINOPOLIS	QI21303050	QUIRINOPOLIS	30/10/2020 18:23	31/10/2020 08:31	30/10/2020 18:23	31/10/2020 08:31	14,13	2	28,25	CHI
202010182692	ANAPOLIS	20787558	JUNDIAI S1	30/10/2020 18:23	30/10/2020 20:38	30/10/2020 18:23	30/10/2020 20:38	2,24	1	2,24	CHI
202010182724	GOIANIA	GN11000571	AEROPORTO S2	30/10/2020 18:24	30/10/2020 20:08	30/10/2020 18:24	30/10/2020 20:08	1,72	92	158,04	CHI
202010182703	JATAI	JT21260496	JATAI S1	30/10/2020 18:25	30/10/2020 23:34	30/10/2020 18:25	30/10/2020 23:34	5,13	1	5,13	CHI
202010182704	PARAUNA	PU21228099	PARAUNA	30/10/2020 18:26	30/10/2020 22:37	30/10/2020 18:26	30/10/2020 22:37	4,18	2	8,36	CHI
202010182709	TRINDADE	40314145	TRINDADE	30/10/2020 18:27	30/10/2020 20:17	30/10/2020 18:27	30/10/2020 20:17	1,82	1	1,82	CHI
202010182715	RIO VERDE	10016329528	RIO VERDE S1	30/10/2020 18:28	30/10/2020 22:04	30/10/2020 18:28	30/10/2020 22:04	3,59	1	3,59	CHI
202010182716	EDEIA	EA21383907	EDEIA	30/10/2020 18:29	30/10/2020 22:38	30/10/2020 18:29	30/10/2020 22:38	4,16	1	4,16	CHI
202010182725	ACREUNA	JD12323641LD	ACREUNA	30/10/2020 18:30	30/10/2020 23:18	30/10/2020 18:30	30/10/2020 23:18	4,79	7	33,55	CHI
202010182725	INDIARA	JD12323641LD	ACREUNA	30/10/2020 18:30	30/10/2020 23:18	30/10/2020 18:30	30/10/2020 23:18	4,79	22	105,43	CHI
202010182967	CALDAS NOVAS	MG12120777	VILA CORUMBA	30/10/2020 18:32	30/10/2020 21:34	30/10/2020 18:32	30/10/2020 21:34	3,03	1	3,03	CHI
202010182967	MARZAGAO	MG12120777	VILA CORUMBA	30/10/2020 18:32	30/10/2020 21:34	30/10/2020 18:32	30/10/2020 21:34	3,03	2	6,06	CHI
202010182967	RIO QUENTE	MG12120777	VILA CORUMBA	30/10/2020 18:32	30/10/2020 21:34	30/10/2020 18:32	30/10/2020 21:34	3,03	1	3,03	CHI
202010182741	PIRANHAS	PH12038598	PIRANHAS	30/10/2020 18:33	31/10/2020 00:06	30/10/2020 18:33	31/10/2020 00:06	5,54	33	182,87	CHI
202010183759	CALDAS NOVAS	CN12298765	CALDAS NOVAS S2	30/10/2020 18:34	31/10/2020 00:50	30/10/2020 18:34	31/10/2020 00:50	6,27	4	25,06	CHI
202010182746	CRISTALINA	10001015026	CRISTALINA S1	30/10/2020 18:34	30/10/2020 22:18	30/10/2020 18:34	30/10/2020 22:18	3,73	1	3,73	CHI
202010182748	CRIXAS	CX12390328	SANTA TEREZINHA	30/10/2020 18:34	31/10/2020 11:00	30/10/2020 18:34	31/10/2020 11:00	16,42	31	509,07	CHI
202010182750	ARAGOIANIA	AO32000013	GUAPO S2	30/10/2020 18:35	30/10/2020 20:55	30/10/2020 18:35	30/10/2020 20:55	2,33	3	6,99	CHI
202010183244	LUZIANIA	LZ11093021	RIO VERMELHO	30/10/2020 18:35	30/10/2020 21:28	30/10/2020 18:35	30/10/2020 21:28	2,87	157	450,20	CHI
202010182755	FORMOSA	10021455374	ITIQUEIRA	30/10/2020 18:35	30/10/2020 20:36	30/10/2020 18:35	30/10/2020 20:36	2,00	1	2,00	CHI
202010183093	COCALZINHO DE GOIAS	ZN12084617	AGUAS LINDAS DE GOIAS S2	30/10/2020 18:36	30/10/2020 21:51	30/10/2020 18:36	30/10/2020 21:51	3,25	26	84,49	CHI
202010182766	SANTA TEREZINHA DE GOIAS	VD12251079	SANTA TEREZINHA	30/10/2020 18:37	31/10/2020 22:49	30/10/2020 18:37	31/10/2020 22:49	28,19	3	84,56	CHI
202010182766	CAMPOS VERDES	VD12251079	SANTA TEREZINHA	30/10/2020 18:37	31/10/2020 22:49	30/10/2020 18:37	31/10/2020 22:49	28,19	3	84,56	CHI
202010182767	IACIARA	IA11067863	IACIARA S1	30/10/2020 18:38	31/10/2020 01:08	30/10/2020 18:38	31/10/2020 01:08	6,50	221	1436,50	CHI
202010183266	CALDAS NOVAS	CN12000057	CALDAS NOVAS S2	30/10/2020 18:38	31/10/2020 00:12	30/10/2020 18:38	31/10/2020 00:12	5,56	36	200,34	CHI
202010182769	GOIANDIRA	GD21143391	CATALAO S1	30/10/2020 18:38	30/10/2020 23:31	30/10/2020 18:38	30/10/2020 23:31	4,88	1	4,88	CHI
202010182831	CRISTALINA	KR21171601	CRISTALINA S2	30/10/2020 18:39	31/10/2020 08:04	30/10/2020 18:39	31/10/2020 08:04	13,41	2	26,83	CHI
202010182794	GOIANIA	GN11002656	CARAJAS S1	30/10/2020 18:39	30/10/2020 23:14	30/10/2020 18:39	30/10/2020 23:14	4,58	134	613,42	CHI
202010182787	PILAR DE GOIAS	GG12375625	SANTA TEREZINHA	30/10/2020 18:40	31/10/2020 09:40	30/10/2020 18:40	31/10/2020 09:40	14,99	2	29,97	CHI
202010182791	SILVANIA	SV12399974	VIANOPOLIS	30/10/2020 18:41	31/10/2020 00:08	30/10/2020 18:41	31/10/2020 00:08	5,45	5	27,24	CHI
202010182796	ANICUNS	AC21308538	ANICUNS	30/10/2020 18:42	31/10/2020 10:19	30/10/2020 18:42	31/10/2020 10:19	15,61	2	31,22	CHI
202010182805	GOIANIA	16146475	CAMPINAS S2	30/10/2020 18:43	30/10/2020 20:52	30/10/2020 18:43	30/10/2020 20:52	2,13	1	2,13	CHI
202010182806	CABECEIRAS	CW12342434	ITIQUEIRA	30/10/2020 18:44	30/10/2020 23:36	30/10/2020 18:44	30/10/2020 23:36	4,86	5	24,31	CHI
202010182807	ANAPOLIS	10010113965	JUNDIAI S1	30/10/2020 18:44	30/10/2020 23:06	30/10/2020 18:44	30/10/2020 23:06	4,36	1	4,36	CHI
202010182814	PLANALTINA	2960174362	PLANALTINA	30/10/2020 18:45	30/10/2020 20:14	30/10/2020 18:45	30/10/2020 20:14	1,48	1	1,48	CHI
202010183279	FAINA	FC12072196	GOIAS	30/10/2020 18:45	31/10/2020 10:34	30/10/2020 18:45	31/10/2020 10:34	15,81	6	94,85	CHI
202010182822	CATURAI	IN21228326	ARACU	30/10/2020 18:46	30/10/2020 22:54	30/10/2020 18:46	30/10/2020 22:54	4,13	1	4,13	CHI
202010182824	FAINA	FC12120784	GOIAS	30/10/2020 18:46	31/10/2020 01:58	30/10/2020 18:46	31/10/2020 01:58	7,19	421	3027,22	CHI
202010182829	NIQUELANDIA	NQ21243379	URUACU	30/10/2020 18:47	30/10/2020 21:55	30/10/2020 18:47	30/10/2020 21:55	3,13	10	31,34	CHI
202010181458	CUMARI	CT12266186	CATALAO S2	30/10/2020 18:49	01/11/2020 09:26	30/10/2020 18:49	01/11/2020 09:26	38,61	1	38,61	CHI

202010183379	JATAI	JT12260439	JATAI S1	30/10/2020 18:49	31/10/2020 00:23	30/10/2020 18:49	31/10/2020 00:23	5,56	2	11,12	CHI
202010182845	CRIXAS	CX12000039LD	SERRA DO OURO	30/10/2020 18:49	31/10/2020 16:17	30/10/2020 18:49	31/10/2020 16:17	21,46	3	64,37	CHI
202010183039	DISTRITO FEDERAL	CT12333725	CATALAO S1	30/10/2020 18:50	31/10/2020 13:31	30/10/2020 18:50	31/10/2020 13:31	18,68	1	18,68	CHI
202010183039	CATALAO	CT12333725	CATALAO S1	30/10/2020 18:50	31/10/2020 13:31	30/10/2020 18:50	31/10/2020 13:31	18,68	14	261,55	CHI
202010182858	ANAPOLIS	10027535280	JUNDIAI S1	30/10/2020 18:51	30/10/2020 22:07	30/10/2020 18:51	30/10/2020 22:07	3,26	1	3,26	CHI
202010183172	CRISTALINA	KR12250016	PAMPLONA	30/10/2020 18:51	30/10/2020 22:14	30/10/2020 18:51	30/10/2020 22:14	3,37	26	87,66	CHI
202010182863	PONTALINA	10016001816	PONTALINA	30/10/2020 18:52	30/10/2020 22:36	30/10/2020 18:52	30/10/2020 22:36	3,73	1	3,73	CHI
202010182866	CRISTALINA	KR21163100	CRISTALINA S2	30/10/2020 18:52	31/10/2020 04:33	30/10/2020 18:52	31/10/2020 04:33	9,67	1	9,67	CHI
202010182870	GOIANIA	16122926	GOYA S1	30/10/2020 18:53	30/10/2020 21:01	30/10/2020 18:53	30/10/2020 21:01	2,13	1	2,13	CHI
202010182873	VILA BOA	FA21309088	ITUIQUIRA	30/10/2020 18:53	31/10/2020 12:43	30/10/2020 18:53	31/10/2020 12:43	17,83	2	35,65	CHI
202010182883	SANTA HELENA DE GOIAS	SH12271562LD	IPEGUARI	30/10/2020 18:54	31/10/2020 12:22	30/10/2020 18:54	31/10/2020 04:00	9,10	7	63,67	CHI
202010182883	TURVELANDIA	SH12271562LD	IPEGUARI	30/10/2020 18:54	31/10/2020 12:22	30/10/2020 18:54	31/10/2020 04:00	9,10	3	27,29	CHI
202010182883	SANTA HELENA DE GOIAS	SH12271562LD	IPEGUARI	30/10/2020 18:54	31/10/2020 12:22	30/10/2020 18:54	31/10/2020 12:22	17,48	12	209,71	CHI
202010183084	PIRENOPOLIS	PV12123145	SAO FRANCISCO DE GOIAS	30/10/2020 18:54	31/10/2020 03:17	30/10/2020 18:54	31/10/2020 03:17	8,38	12	100,55	CHI
202010183375	AMORINOPOLIS	IV12390141	IPORA	30/10/2020 18:54	30/10/2020 22:25	30/10/2020 18:54	30/10/2020 22:25	3,51	6	21,03	CHI
202010183375	IVOLANDIA	IV12390141	IPORA	30/10/2020 18:54	30/10/2020 22:25	30/10/2020 18:54	30/10/2020 22:25	3,51	60	210,33	CHI
202010182896	NIQUELANDIA	NQ12236713	NIQUELANDIA SUBTRANSMISSAO	30/10/2020 18:56	01/11/2020 09:24	30/10/2020 18:56	01/11/2020 09:24	38,47	5	192,35	CHI
202010182914	ITABERAI	IB21388376	ITABERAI S2	30/10/2020 18:57	31/10/2020 06:52	30/10/2020 18:57	31/10/2020 06:52	11,90	1	11,90	CHI
202010182915	NOVA CRIXAS	NA12158761	NOVA CRIXAS	30/10/2020 18:57	01/11/2020 03:01	30/10/2020 18:57	01/11/2020 03:01	32,05	6	192,31	CHI
202010182916	ARAGARCAS	1820005267	ARAGARCAS	30/10/2020 18:58	30/10/2020 20:31	30/10/2020 18:58	30/10/2020 20:31	1,55	1	1,55	CHI
202010182948	APARECIDA DE GOIANIA	AP11005005	REAL S2	30/10/2020 18:58	30/10/2020 21:28	30/10/2020 18:58	30/10/2020 21:28	2,50	130	324,53	CHI
202010182920	ITABERAI	IB11227450	ITABERAI S1	30/10/2020 18:58	31/10/2020 00:42	30/10/2020 18:58	31/10/2020 00:42	5,73	1	5,73	CHI
202010182927	NIQUELANDIA	NQ21239428	URUACU	30/10/2020 18:59	31/10/2020 07:53	30/10/2020 18:59	31/10/2020 07:53	12,89	1	12,89	CHI
202010183139	INACIOLANDIA	ID12128107	QUIRINOPOLIS	30/10/2020 18:59	31/10/2020 00:23	30/10/2020 18:59	31/10/2020 00:23	5,39	16	86,18	CHI
202010182932	SENADOR CANEDO	190029651	SENADOR CANEDO	30/10/2020 19:00	30/10/2020 20:17	30/10/2020 19:00	30/10/2020 20:17	1,29	1	1,29	CHI
202010182935	GOIAS	HE21172083	ITAPURANGA	30/10/2020 19:01	31/10/2020 01:38	30/10/2020 19:01	31/10/2020 01:38	6,61	1	6,61	CHI
202010182937	GOIANIA	10023271874	MEIA PONTE	30/10/2020 19:01	30/10/2020 20:29	30/10/2020 19:01	30/10/2020 20:29	1,45	1	1,45	CHI
202010182944	SANTO ANTONIO DO DESCOBERTO	SN21086752	ALEXANIA	30/10/2020 19:03	30/10/2020 21:26	30/10/2020 19:03	30/10/2020 21:26	2,38	1	2,38	CHI
202010182947	GOIANIA	12557602	MEIA PONTE	30/10/2020 19:04	30/10/2020 21:38	30/10/2020 19:04	30/10/2020 21:38	2,56	1	2,56	CHI
202010182952	IACIARA	10025245315	IACIARA S1	30/10/2020 19:04	30/10/2020 20:02	30/10/2020 19:04	30/10/2020 20:02	0,95	1	0,95	CHI
202010183091	ANAPOLIS	AN11130801	JUNDIAI S2	30/10/2020 19:05	30/10/2020 21:31	30/10/2020 19:05	30/10/2020 21:31	2,43	128	311,00	CHI
202010183001	GOIANIA	GN11160525	MEIA PONTE	30/10/2020 19:05	30/10/2020 20:01	30/10/2020 19:05	30/10/2020 20:01	0,93	219	202,88	CHI
202010182960	APARECIDA DE GOIANIA	AP21073531	ANHANGUERA	30/10/2020 19:06	30/10/2020 20:20	30/10/2020 19:06	30/10/2020 20:20	1,22	1	1,22	CHI
202010182965	SENADOR CANEDO	SW11092634	SENADOR CANEDO	30/10/2020 19:07	30/10/2020 23:51	30/10/2020 19:07	30/10/2020 23:51	4,73	196	927,24	CHI
202010182966	ALEXANIA	AX21395701	ALEXANIA	30/10/2020 19:07	30/10/2020 21:45	30/10/2020 19:07	30/10/2020 21:45	2,62	1	2,62	CHI
202010182971	CALDAS NOVAS	CN21110256	RIO QUENTE	30/10/2020 19:07	31/10/2020 10:04	30/10/2020 19:07	31/10/2020 10:04	14,93	2	29,87	CHI
202010182998	EDEIA	EA12070748	EDEIA	30/10/2020 19:09	30/10/2020 21:27	30/10/2020 19:09	30/10/2020 21:27	2,30	3	6,89	CHI
202010182998	INDIARA	EA12070748	EDEIA	30/10/2020 19:09	30/10/2020 21:27	30/10/2020 19:09	30/10/2020 21:27	2,30	1	2,30	CHI
202010182991	CATURAI	CK21244074	TRINDADE	30/10/2020 19:09	30/10/2020 23:46	30/10/2020 19:09	30/10/2020 23:46	4,61	1	4,61	CHI
202010182992	PALMINOPOLIS	PP21077092	PALMEIRAS	30/10/2020 19:09	31/10/2020 11:27	30/10/2020 19:09	31/10/2020 11:27	16,29	1	16,29	CHI
202010182995	EDEALINA	ED21245593	EDEIA	30/10/2020 19:10	31/10/2020 08:41	30/10/2020 19:10	31/10/2020 08:41	13,51	1	13,51	CHI
202010183023	MUNDO NOVO DE GOIAS	MH12291217LD	NOVA CRIXAS	30/10/2020 19:10	31/10/2020 09:52	30/10/2020 19:10	31/10/2020 09:52	14,69	27	396,69	CHI
202010182955	PIRACANJUBA	10024582164	ROCHEDO	30/10/2020 19:11	30/10/2020 22:14	30/10/2020 19:11	30/10/2020 22:14	3,05	1	3,05	CHI
202010183403	SANTO ANTONIO DO DESCOBERTO	AX12000057	ALEXANIA	30/10/2020 19:11	30/10/2020 23:11	30/10/2020 19:11	30/10/2020 23:11	3,99	1	3,99	CHI
202010183403	ALEXANIA	AX12000057	ALEXANIA	30/10/2020 19:11	30/10/2020 23:11	30/10/2020 19:11	30/10/2020 23:11	3,99	10	39,91	CHI
202010183005	JATAI	JT12264347	JATAI S1	30/10/2020 19:12	31/10/2020 11:50	30/10/2020 19:12	31/10/2020 11:50	16,64	3	49,91	CHI
202010183138	JANDAIA	JD11000034	PALMEIRAS	30/10/2020 19:12	30/10/2020 21:15	30/10/2020 19:12	30/10/2020 21:15	2,03	108	219,69	CHI
202010183474	SENADOR CANEDO	SW11101879	SENADOR CANEDO	30/10/2020 19:13	30/10/2020 21:54	30/10/2020 19:13	30/10/2020 21:54	2,68	210	563,21	CHI
202010183014	PONTALINA	PK21181902	PONTALINA	30/10/2020 19:13	30/10/2020 20:37	30/10/2020 19:13	30/10/2020 20:37	1,39	1	1,39	CHI
202010183015	CATALAO	CT21134406	CATALAO S1	30/10/2020 19:13	30/10/2020 22:49	30/10/2020 19:13	30/10/2020 22:49	3,59	1	3,59	CHI
202010183019	LUZIANIA	120177353	RIO VERMELHO	30/10/2020 19:14	30/10/2020 21:16	30/10/2020 19:14	30/10/2020 21:16	2,03	1	2,03	CHI

202010183022	JATAI	290328550	JATAI S2	30/10/2020 19:14	31/10/2020 15:38	30/10/2020 19:14	31/10/2020 15:38	20,39	1	20,39	CHI
202010183026	FORMOSA	FA11254217	ITIQUEIRA	30/10/2020 19:15	31/10/2020 17:24	30/10/2020 19:15	31/10/2020 17:24	22,15	1	22,15	CHI
202010183363	PALMINOPOLIS	TV12005542	FIRMINOPOLIS S2	30/10/2020 19:16	30/10/2020 23:18	30/10/2020 19:16	30/10/2020 23:18	4,03	20	80,66	CHI
202010183363	TURVANIA	TV12005542	FIRMINOPOLIS S2	30/10/2020 19:16	30/10/2020 23:18	30/10/2020 19:16	30/10/2020 23:18	4,03	50	201,65	CHI
202010183067	RIO VERDE	RV12222621	RIO VERDE S2	30/10/2020 19:16	31/10/2020 01:09	30/10/2020 19:16	31/10/2020 01:09	5,88	14	82,35	CHI
202010183067	SANTA HELENA DE GOIAS	RV12222621	RIO VERDE S2	30/10/2020 19:16	31/10/2020 01:09	30/10/2020 19:16	31/10/2020 01:09	5,88	68	399,99	CHI
202010183043	ITABERAI	IB12040786	ITABERAI S2	30/10/2020 19:17	30/10/2020 21:19	30/10/2020 19:17	30/10/2020 21:19	2,02	10	20,21	CHI
202010183047	COLINAS DO SUL	TI11271048	MINACU	30/10/2020 19:17	30/10/2020 21:34	30/10/2020 19:17	30/10/2020 21:34	2,27	1	2,27	CHI
202010182120	GOIANIA	GN11000425	FERROVIARIO S3	30/10/2020 19:18	30/10/2020 21:18	30/10/2020 19:18	30/10/2020 21:18	2,00	90	180,00	CHI
202010183050	RIO VERDE	RV21260628	MONTIVIDIU T	30/10/2020 19:18	30/10/2020 22:49	30/10/2020 19:18	30/10/2020 22:49	3,51	1	3,51	CHI
202010183110	TRES RANCHOS	OU12195337	CATALAO S1	30/10/2020 19:18	30/10/2020 21:31	30/10/2020 19:18	30/10/2020 21:31	2,21	1	2,21	CHI
202010183110	OUVIDOR	OU12195337	CATALAO S1	30/10/2020 19:18	30/10/2020 21:31	30/10/2020 19:18	30/10/2020 21:31	2,21	14	30,95	CHI
202010183110	CATALAO	OU12195337	CATALAO S1	30/10/2020 19:18	30/10/2020 21:31	30/10/2020 19:18	30/10/2020 21:31	2,21	5	11,05	CHI
202010183054	APARECIDA DE GOIANIA	200356537	INDEPENDENCIA S2	30/10/2020 19:18	30/10/2020 23:21	30/10/2020 19:18	30/10/2020 23:21	4,04	1	4,04	CHI
202010183142	SAO LUIS DE MONTES BELOS	SL32145916	SAO LUIZ DOS MONTES BELOS	30/10/2020 19:21	31/10/2020 06:59	30/10/2020 19:21	31/10/2020 06:59	11,63	7	81,38	CHI
202010183069	SANTA CRUZ DE GOIAS	BC21109688	PIRES DO RIO S2	30/10/2020 19:21	30/10/2020 22:01	30/10/2020 19:21	30/10/2020 22:01	2,65	1	2,65	CHI
202010183396	RIO VERDE	RV12260256	RIO VERDE S1	30/10/2020 19:24	31/10/2020 15:09	30/10/2020 19:24	31/10/2020 12:05	16,70	1	16,70	CHI
202010183396	RIO VERDE	RV12260256	RIO VERDE S1	30/10/2020 19:24	31/10/2020 15:09	30/10/2020 19:24	31/10/2020 15:09	19,76	18	355,66	CHI
202010183082	LUZIANIA	LZ21080545	MARAJOARA	30/10/2020 19:24	31/10/2020 02:55	30/10/2020 19:24	31/10/2020 02:55	7,51	3	22,53	CHI
202010183085	NIQUELANDIA	NQ12253182	URUACU	30/10/2020 19:24	30/10/2020 22:47	30/10/2020 19:24	30/10/2020 22:47	3,37	8	26,96	CHI
202010183087	FORMOSA	FA11388143	ITIQUEIRA	30/10/2020 19:25	31/10/2020 11:11	30/10/2020 19:25	31/10/2020 11:11	15,76	1	15,76	CHI
202010183128	LUZIANIA	LZ11376238	RIO VERMELHO	30/10/2020 19:25	30/10/2020 22:02	30/10/2020 19:25	30/10/2020 22:02	2,61	81	211,10	CHI
202010183089	GOIANIA	10468493	AEROPORTO S2	30/10/2020 19:25	30/10/2020 21:47	30/10/2020 19:25	30/10/2020 21:47	2,36	1	2,36	CHI
202010183096	MINEIROS	1390084544	PARQUE DAS EMAS	30/10/2020 19:27	30/10/2020 22:45	30/10/2020 19:27	30/10/2020 22:45	3,29	1	3,29	CHI
202010183102	PADRE BERNARDO	PB11089586	PADRE BERNARDO	30/10/2020 19:28	30/10/2020 22:39	30/10/2020 19:28	30/10/2020 22:39	3,17	249	790,09	CHI
202010183164	GOIANIA	GN11002604	CARAJAS S2	30/10/2020 19:29	30/10/2020 22:27	30/10/2020 19:29	30/10/2020 22:27	2,97	122	361,76	CHI
202010183112	SAO JOAO D ALIANCA	FB12256442	FLORES DE GOIAS	30/10/2020 19:29	30/10/2020 22:27	30/10/2020 19:29	30/10/2020 22:27	2,95	31	91,48	CHI
202010183112	FLORES DE GOIAS	FB12256442	FLORES DE GOIAS	30/10/2020 19:29	30/10/2020 22:27	30/10/2020 19:29	30/10/2020 22:27	2,95	1	2,95	CHI
202010179126	CUMARI	CT21077581	CATALAO S2	30/10/2020 19:30	30/10/2020 21:12	30/10/2020 19:30	30/10/2020 21:12	1,69	1	1,69	CHI
202010183107	AGUAS LINDAS DE GOIAS	4830005908	AGUAS LINDAS DE GOIAS S2	30/10/2020 19:30	30/10/2020 21:10	30/10/2020 19:30	30/10/2020 21:10	1,66	1	1,66	CHI
202010183122	SAO LUIS DE MONTES BELOS	SL31145907	SAO LUIZ DOS MONTES BELOS	30/10/2020 19:32	31/10/2020 09:47	30/10/2020 19:32	31/10/2020 09:47	14,24	3	42,73	CHI
202010183129	RIO VERDE	RV11191084	RIO VERDE S1	30/10/2020 19:34	31/10/2020 04:42	30/10/2020 19:34	31/10/2020 04:42	9,13	184	1680,48	CHI
202010183234	MORRINHOS	MR12035913	MORRINHOS	30/10/2020 19:38	31/10/2020 11:50	30/10/2020 19:38	31/10/2020 11:50	16,19	11	178,14	CHI
202010183147	BELA VISTA DE GOIAS	240060234	BELA VISTA S1	30/10/2020 19:38	31/10/2020 02:56	30/10/2020 19:38	31/10/2020 02:56	7,29	1	7,29	CHI
202010183149	BELA VISTA DE GOIAS	BV21324941	BELA VISTA S2	30/10/2020 19:39	30/10/2020 22:26	30/10/2020 19:39	30/10/2020 22:26	2,78	2	5,56	CHI
202010183150	SANCLERLANDIA	SL12145934	SAO LUIZ DOS MONTES BELOS	30/10/2020 19:39	31/10/2020 08:34	30/10/2020 19:39	31/10/2020 08:34	12,91	2	25,83	CHI
202010183150	SAO LUIS DE MONTES BELOS	SL12145934	SAO LUIZ DOS MONTES BELOS	30/10/2020 19:39	31/10/2020 08:34	30/10/2020 19:39	31/10/2020 08:34	12,91	8	103,32	CHI
202010183154	PARAUNA	PU12344873	PARAUNA	30/10/2020 19:39	31/10/2020 08:37	30/10/2020 19:39	31/10/2020 08:37	12,96	2	25,91	CHI
202010183162	APARECIDA DE GOIANIA	200422315	INDEPENDENCIA S1	30/10/2020 19:41	30/10/2020 21:20	30/10/2020 19:41	30/10/2020 21:20	1,64	1	1,64	CHI
202010183167	CABECEIRAS	CW21157340	ITIQUEIRA	30/10/2020 19:41	30/10/2020 22:13	30/10/2020 19:41	30/10/2020 22:13	2,52	1	2,52	CHI
202010183168	FORMOSO	SE12033994RE	MARA ROSA	30/10/2020 19:42	30/10/2020 22:55	30/10/2020 19:42	30/10/2020 22:55	3,21	74	237,83	CHI
202010183170	APARECIDA DE GOIANIA	200329078	INDEPENDENCIA S2	30/10/2020 19:42	30/10/2020 22:16	30/10/2020 19:42	30/10/2020 22:16	2,55	1	2,55	CHI
202010183177	JARAGUA	JA11009802	JARAGUA	30/10/2020 19:43	30/10/2020 21:42	30/10/2020 19:43	30/10/2020 21:42	1,98	86	170,14	CHI
202010183173	PIRANHAS	PH12316430	PIRANHAS	30/10/2020 19:43	31/10/2020 07:41	30/10/2020 19:43	31/10/2020 07:41	11,96	4	47,83	CHI
202010183239	MINEIROS	MY12244676	PARQUE DAS EMAS	30/10/2020 19:44	31/10/2020 07:02	30/10/2020 19:44	31/10/2020 07:02	11,29	9	101,65	CHI
202010183181	LUZIANIA	120145467	RIO VERMELHO	30/10/2020 19:45	30/10/2020 22:50	30/10/2020 19:45	30/10/2020 22:50	3,07	1	3,07	CHI
202010183182	SANTA TEREZA DE GOIAS	SE12053856	MARA ROSA	30/10/2020 19:45	30/10/2020 21:55	30/10/2020 19:45	30/10/2020 21:55	2,16	3	6,47	CHI
202010183182	FORMOSO	SE12053856	MARA ROSA	30/10/2020 19:45	30/10/2020 21:55	30/10/2020 19:45	30/10/2020 21:55	2,16	6	12,93	CHI
202010183240	OUVIDOR	OU12061245RE	CATALAO S1	30/10/2020 19:46	30/10/2020 21:09	30/10/2020 19:46	30/10/2020 21:09	1,37	62	85,15	CHI
202010183190	SAO MIGUEL DO ARAGUAIA	SM12020666	SAO MIGUEL DO ARAGUAIA	30/10/2020 19:46	31/10/2020 01:39	30/10/2020 19:46	31/10/2020 01:39	5,87	6	35,23	CHI
202010183191	BARRO ALTO	BA21194831	BARRO ALTO	30/10/2020 19:46	31/10/2020 03:42	30/10/2020 19:46	31/10/2020 03:42	7,92	1	7,92	CHI

202010183192	SILVANIA	SV21085398	VIANOPOLIS	30/10/2020 19:47	30/10/2020 21:37	30/10/2020 19:47	30/10/2020 21:37	1,83	1	1,83	CHI
202010183193	TURVANIA	1220002048	FIRMINOPOLIS S2	30/10/2020 19:47	31/10/2020 00:09	30/10/2020 19:47	31/10/2020 00:09	4,35	1	4,35	CHI
202010184477	GOIATUBA	GT12000127	GOIATUBA S2	30/10/2020 19:48	31/10/2020 09:37	30/10/2020 19:48	31/10/2020 09:37	13,82	33	455,95	CHI
202010183200	SIMOLANDIA	SA12268176	IACIARA S2	30/10/2020 19:49	30/10/2020 21:20	30/10/2020 19:49	30/10/2020 21:20	1,51	1	1,51	CHI
202010183206	PADRE BERNARDO	10005142367	PADRE BERNARDO	30/10/2020 19:49	30/10/2020 22:35	30/10/2020 19:49	30/10/2020 22:35	2,75	1	2,75	CHI
202010183208	SAO SIMAO	2240038660	CACHOEIRA ALTA	30/10/2020 19:49	30/10/2020 21:52	30/10/2020 19:49	30/10/2020 21:52	2,03	1	2,03	CHI
202010183209	MATRINCHA	MP12221185	MATRINCHA	30/10/2020 19:50	31/10/2020 11:50	30/10/2020 19:50	31/10/2020 11:50	16,00	58	927,92	CHI
202010183367	LEOPOLDO DE BULHOES	LB11191068	DAIA S2	30/10/2020 19:50	31/10/2020 01:48	30/10/2020 19:50	31/10/2020 01:48	5,96	83	494,43	CHI
202010183219	PONTALINA	PK12392168	PONTALINA	30/10/2020 19:52	30/10/2020 21:08	30/10/2020 19:52	30/10/2020 21:08	1,25	163	203,93	CHI
202010183300	GOIANESIA	GE11091174	GOIANESIA S2	30/10/2020 19:52	31/10/2020 01:55	30/10/2020 19:52	31/10/2020 01:55	6,03	91	549,11	CHI
202010183323	ARENOPOLIS	AY12040870	ARENOPOLIS	30/10/2020 19:53	31/10/2020 03:27	30/10/2020 19:53	31/10/2020 03:27	7,57	23	174,11	CHI
202010183246	ABADIANIA	AA21297633	ANAPOLIS UNIVERSITARIO S1	30/10/2020 19:56	31/10/2020 01:16	30/10/2020 19:56	31/10/2020 01:16	5,33	1	5,33	CHI
202010183247	CATALAO	10021563800	CATALAO S2	30/10/2020 19:56	31/10/2020 00:30	30/10/2020 19:56	31/10/2020 00:30	4,56	1	4,56	CHI
202010183248	GOIANIA	13893294	MEIA PONTE	30/10/2020 19:56	30/10/2020 21:03	30/10/2020 19:56	30/10/2020 21:03	1,11	1	1,11	CHI
202010183252	MORRINHOS	BG21209943	ALTO BURITI	30/10/2020 19:57	31/10/2020 12:06	30/10/2020 19:57	31/10/2020 12:06	16,15	1	16,15	CHI
202010183256	MINEIROS	10026821670	PARQUE DAS EMAS	30/10/2020 19:58	30/10/2020 21:59	30/10/2020 19:58	30/10/2020 21:59	2,00	1	2,00	CHI
202010183270	LUZIANIA	10020503049	RIO VERMELHO	30/10/2020 20:02	30/10/2020 23:04	30/10/2020 20:02	30/10/2020 23:04	3,03	1	3,03	CHI
202010183272	JATAI	JT21166055	JATAI S2	30/10/2020 20:03	31/10/2020 10:19	30/10/2020 20:03	31/10/2020 10:19	14,26	1	14,26	CHI
202010183285	JATAI	10000982065	JATAI S2	30/10/2020 20:04	31/10/2020 10:39	30/10/2020 20:04	31/10/2020 10:39	14,57	1	14,57	CHI
202010183289	PIRACANJUBA	PJ21316601	PIRACANJUBA	30/10/2020 20:06	31/10/2020 07:05	30/10/2020 20:06	31/10/2020 07:05	10,98	1	10,98	CHI
202010183293	DAVINOPOLIS	CT21318675	CATALAO S1	30/10/2020 20:07	30/10/2020 23:50	30/10/2020 20:07	30/10/2020 23:50	3,70	1	3,70	CHI
202010183294	GAMELEIRA DE GOIAS	GL21403503	DAIA S2	30/10/2020 20:08	31/10/2020 00:26	30/10/2020 20:08	31/10/2020 00:26	4,30	1	4,30	CHI
202010183297	CALDAS NOVAS	760102260	SERRA DE CALDAS	30/10/2020 20:08	30/10/2020 23:54	30/10/2020 20:08	30/10/2020 23:54	3,75	1	3,75	CHI
202010183298	PALMEIRAS DE GOIAS	PL21226732	PALMEIRAS	30/10/2020 20:08	30/10/2020 23:19	30/10/2020 20:08	30/10/2020 23:19	3,17	1	3,17	CHI
202010183516	ANICUNS	AC11000022	ANICUNS	30/10/2020 20:13	31/10/2020 03:07	30/10/2020 20:13	31/10/2020 03:07	6,90	48	331,17	CHI
202010183682	TURVANIA	NZ12147519LD	ANICUNS	30/10/2020 20:13	31/10/2020 02:26	30/10/2020 20:13	31/10/2020 02:26	6,22	47	292,16	CHI
202010183682	NAZARIO	NZ12147519LD	ANICUNS	30/10/2020 20:13	31/10/2020 02:26	30/10/2020 20:13	31/10/2020 02:26	6,22	101	627,83	CHI
202010183682	PALMEIRAS DE GOIAS	NZ12147519LD	ANICUNS	30/10/2020 20:13	31/10/2020 02:26	30/10/2020 20:13	31/10/2020 02:26	6,22	3	18,65	CHI
202010183682	ANICUNS	NZ12147519LD	ANICUNS	30/10/2020 20:13	31/10/2020 02:26	30/10/2020 20:13	31/10/2020 02:26	6,22	62	385,40	CHI
202010183332	VALPARAISO DE GOIAS	VA11192788	MARAJOARA	30/10/2020 20:13	30/10/2020 21:01	30/10/2020 20:13	30/10/2020 21:01	0,80	41	32,62	CHI
202010183317	GOIANIA	12189704	AEROPORTO S3	30/10/2020 20:13	30/10/2020 21:57	30/10/2020 20:13	30/10/2020 21:57	1,72	1	1,72	CHI
202010183354	GOIANIA	GN11169568	ATLANTICO S1	30/10/2020 20:15	30/10/2020 22:48	30/10/2020 20:15	30/10/2020 22:48	2,54	63	160,07	CHI
202010183326	GOIANIA	17289178	AEROPORTO S3	30/10/2020 20:15	30/10/2020 22:41	30/10/2020 20:15	30/10/2020 22:41	2,42	1	2,42	CHI
202010183330	SAO DOMINGOS	SD12170576	SAO DOMINGOS	30/10/2020 20:16	30/10/2020 23:18	30/10/2020 20:16	30/10/2020 23:18	3,03	37	111,99	CHI
202010183334	GUARANI DE GOIAS	GY12215935	IACIARA S1	30/10/2020 20:17	30/10/2020 22:42	30/10/2020 20:17	30/10/2020 22:42	2,41	9	21,71	CHI
202010183389	GOIANIA	GN11192024	ATLANTICO S1	30/10/2020 20:23	30/10/2020 21:56	30/10/2020 20:23	30/10/2020 21:56	1,55	68	105,34	CHI
202010183360	GOIANIRA	10008951045	GOIANIRA	30/10/2020 20:25	31/10/2020 00:47	30/10/2020 20:25	31/10/2020 00:47	4,36	1	4,36	CHI
202010183368	GOIANIA	11086543	GOYA S1	30/10/2020 20:26	30/10/2020 22:02	30/10/2020 20:26	30/10/2020 22:02	1,59	1	1,59	CHI
202010183681	OUVIDOR	OU12077295	CATALAO S1	30/10/2020 20:28	30/10/2020 22:50	30/10/2020 20:28	30/10/2020 22:50	2,35	350	824,15	CHI
202010183382	ITARUMA	IM12188975	ITAJA S2	30/10/2020 20:28	31/10/2020 07:49	30/10/2020 20:28	31/10/2020 07:49	11,33	11	124,68	CHI
202010183387	ITAPURANGA	IK10400604	ITAPURANGA	30/10/2020 20:31	31/10/2020 02:19	30/10/2020 20:31	31/10/2020 02:19	5,79	163	944,27	CHI
202010183400	CORUMBAIBA	CI11166792	VILA CORUMBA	30/10/2020 20:34	30/10/2020 22:11	30/10/2020 20:34	30/10/2020 22:11	1,62	87	140,65	CHI
202010184026	ANICUNS	AC12259100	ANICUNS	30/10/2020 20:34	31/10/2020 07:16	30/10/2020 20:34	31/10/2020 07:16	10,69	14	149,72	CHI
202010183395	INHUMAS	10003108226	INHUMAS S2	30/10/2020 20:34	31/10/2020 00:02	30/10/2020 20:34	31/10/2020 00:02	3,45	1	3,45	CHI
202010183406	SAO LUIS DE MONTES BELOS	SL21283618	FIRMINOPOLIS S2	30/10/2020 20:37	31/10/2020 16:25	30/10/2020 20:37	31/10/2020 16:25	19,79	1	19,79	CHI
202010183408	JARAGUA	JA11140645	JARAGUA	30/10/2020 20:37	30/10/2020 22:00	30/10/2020 20:37	30/10/2020 22:00	1,37	121	166,24	CHI
202010183410	APARECIDA DE GOIANIA	15800891	INDEPENDENCIA S2	30/10/2020 20:38	30/10/2020 23:18	30/10/2020 20:38	30/10/2020 23:18	2,66	1	2,66	CHI
202010183426	ITABERAI	IB11000004	ITABERAI S2	30/10/2020 20:40	31/10/2020 04:01	30/10/2020 20:40	31/10/2020 04:01	7,34	167	1226,52	CHI
202010183475	SENADOR CANEDO	SW11199138	SENADOR CANEDO	30/10/2020 20:40	30/10/2020 23:10	30/10/2020 20:40	30/10/2020 22:56	2,26	237	535,09	CHI
202010183475	SENADOR CANEDO	20027826	SENADOR CANEDO	30/10/2020 20:40	30/10/2020 23:10	30/10/2020 22:55	30/10/2020 23:10	0,25	264	65,05	CHI
202010183723	VALPARAISO DE GOIAS	VA11192869	MARAJOARA	30/10/2020 20:40	30/10/2020 23:36	30/10/2020 20:40	30/10/2020 23:36	2,92	131	382,23	CHI

202010183422	ITARUMA	IM12058487	CACHOEIRA ALTA	30/10/2020 20:40	31/10/2020 08:31	30/10/2020 20:40	31/10/2020 08:31	11,83	2	23,67	CHI
202010183425	ITABERAI	IB11336801	ITABERAI S2	30/10/2020 20:41	31/10/2020 00:06	30/10/2020 20:41	31/10/2020 00:06	3,41	72	245,34	CHI
202010183430	ACREUNA	EU21101178	ACREUNA	30/10/2020 20:42	30/10/2020 23:18	30/10/2020 20:42	30/10/2020 23:18	2,59	1	2,59	CHI
202010189164	BOM JESUS DE GOIAS	1250073355	BOM JESUS DE GOIAS	30/10/2020 20:42	31/10/2020 05:35	30/10/2020 20:42	31/10/2020 05:35	8,88	1	8,88	CHI
202010183433	NOVA CRIXAS	NA12091691	NOVA CRIXAS	30/10/2020 20:43	30/10/2020 23:07	30/10/2020 20:43	30/10/2020 23:07	2,39	2	4,78	CHI
202010183435	ARAGOIANIA	AO21290394	GUAPO S2	30/10/2020 20:44	31/10/2020 00:20	30/10/2020 20:44	31/10/2020 00:20	3,59	1	3,59	CHI
202010183437	JATAI	290347294	JATAI S2	30/10/2020 20:45	31/10/2020 13:43	30/10/2020 20:45	31/10/2020 13:43	16,95	1	16,95	CHI
202010183641	ADELANDIA	AC12304639	FIRMINOPOLIS S2	30/10/2020 20:50	31/10/2020 03:20	30/10/2020 20:50	31/10/2020 03:20	6,50	12	78,00	CHI
202010183641	ANICUNS	AC12304639	ANICUNS	30/10/2020 20:50	31/10/2020 03:20	30/10/2020 20:50	31/10/2020 03:20	6,50	18	116,99	CHI
202010183641	AMERICANO DO BRASIL	AC12304639	ANICUNS	30/10/2020 20:50	31/10/2020 03:20	30/10/2020 20:50	31/10/2020 03:20	6,50	1	6,50	CHI
202010183641	ANICUNS	AC12304639	FIRMINOPOLIS S2	30/10/2020 20:50	31/10/2020 03:20	30/10/2020 20:50	31/10/2020 03:20	6,50	241	1566,43	CHI
202010183454	RIO VERDE	630589859	RIO VERDE S2	30/10/2020 20:51	31/10/2020 10:14	30/10/2020 20:51	31/10/2020 10:14	13,38	1	13,38	CHI
202010183459	ANICUNS	AC21021759	ANICUNS	30/10/2020 20:52	31/10/2020 13:47	30/10/2020 20:52	31/10/2020 13:47	16,90	1	16,90	CHI
202010183465	NIQUELANDIA	NQ12239307	NIQUELANDIA SUBTRANSMISSAO	30/10/2020 20:54	31/10/2020 09:54	30/10/2020 20:54	31/10/2020 09:54	12,98	273	3544,68	CHI
202010183470	QUIRINOPOLIS	QI21139091	QUIRINOPOLIS	30/10/2020 20:56	31/10/2020 04:07	30/10/2020 20:56	31/10/2020 04:07	7,18	1	7,18	CHI
202010183490	VILA BOA	FA10401450	ITIQUIRA	30/10/2020 20:57	31/10/2020 15:02	30/10/2020 20:57	30/10/2020 22:48	1,84	4	7,37	CHI
202010183490	FORMOSA	FA10401450	ITIQUIRA	30/10/2020 20:57	31/10/2020 15:02	30/10/2020 20:57	30/10/2020 22:48	1,84	507	933,58	CHI
202010183490	FORMOSA	FA10401450	ITIQUIRA	30/10/2020 20:57	31/10/2020 15:02	30/10/2020 20:57	30/10/2020 22:48	1,84	812	1495,21	CHI
202010183490	FORMOSA	FA13067874	ITIQUIRA	30/10/2020 20:57	31/10/2020 15:02	30/10/2020 20:57	31/10/2020 00:35	3,62	82	297,20	CHI
202010183490	VILA BOA	FA13067874	ITIQUIRA	30/10/2020 20:57	31/10/2020 15:02	30/10/2020 20:57	31/10/2020 00:35	3,62	182	659,65	CHI
202010183490	FORMOSA	FA10401450	ITIQUIRA	30/10/2020 20:57	31/10/2020 15:02	31/10/2020 08:05	31/10/2020 08:35	0,51	812	410,96	CHI
202010183490	VILA BOA	FA10401450	ITIQUIRA	30/10/2020 20:57	31/10/2020 15:02	31/10/2020 08:05	31/10/2020 08:35	0,51	4	2,02	CHI
202010183490	VILA BOA	FA10401450	ITIQUIRA	30/10/2020 20:57	31/10/2020 15:02	31/10/2020 08:05	31/10/2020 08:35	0,51	182	92,11	CHI
202010183490	FORMOSA	FA10401450	ITIQUIRA	30/10/2020 20:57	31/10/2020 15:02	31/10/2020 08:05	31/10/2020 08:35	0,51	589	298,10	CHI
202010183490	VILA BOA	7678680	ITIQUIRA	30/10/2020 20:57	31/10/2020 15:02	30/10/2020 20:57	31/10/2020 11:20	14,38	7	100,64	CHI
202010183490	SAO JOAO D ALIANCA	FA10401450	ITIQUIRA	30/10/2020 20:57	31/10/2020 15:02	30/10/2020 20:57	31/10/2020 11:52	14,91	205	3056,38	CHI
202010183490	FLORES DE GOIAS	FA10401450	ITIQUIRA	30/10/2020 20:57	31/10/2020 15:02	30/10/2020 20:57	31/10/2020 11:52	14,91	3	44,73	CHI
202010183490	FORMOSA	FA10401450	ITIQUIRA	30/10/2020 20:57	31/10/2020 15:02	30/10/2020 20:57	31/10/2020 11:52	14,91	583	8692,04	CHI
202010183490	VILA BOA	FA10401450	ITIQUIRA	30/10/2020 20:57	31/10/2020 15:02	30/10/2020 20:57	31/10/2020 11:52	14,91	6	89,46	CHI
202010183490	VILA BOA	VB13383253	ITIQUIRA	30/10/2020 20:57	31/10/2020 15:02	30/10/2020 20:57	31/10/2020 11:52	14,91	10	149,09	CHI
202010183490	VILA BOA	FA12062387	ITIQUIRA	30/10/2020 20:57	31/10/2020 15:02	30/10/2020 20:57	31/10/2020 14:38	17,68	2	35,37	CHI
202010183490	FORMOSA	FA10401450	ITIQUIRA	30/10/2020 20:57	31/10/2020 15:02	31/10/2020 11:54	31/10/2020 14:40	2,76	582	1608,26	CHI
202010183490	SAO JOAO D ALIANCA	FA10401450	ITIQUIRA	30/10/2020 20:57	31/10/2020 15:02	31/10/2020 11:54	31/10/2020 14:40	2,76	205	566,48	CHI
202010183490	VILA BOA	FA10401450	ITIQUIRA	30/10/2020 20:57	31/10/2020 15:02	31/10/2020 11:54	31/10/2020 14:40	2,76	6	16,58	CHI
202010183490	FLORES DE GOIAS	FA10401450	ITIQUIRA	30/10/2020 20:57	31/10/2020 15:02	31/10/2020 11:54	31/10/2020 14:40	2,76	3	8,29	CHI
202010183490	VILA BOA	FA10401450	ITIQUIRA	30/10/2020 20:57	31/10/2020 15:02	31/10/2020 11:54	31/10/2020 14:40	2,76	10	27,63	CHI
202010183490	VILA BOA	FA12042058	ITIQUIRA	30/10/2020 20:57	31/10/2020 15:02	31/10/2020 14:53	31/10/2020 14:58	0,09	2	0,17	CHI
202010183490	VILA BOA	VB12231831	ITIQUIRA	30/10/2020 20:57	31/10/2020 15:02	30/10/2020 20:57	31/10/2020 15:02	18,07	1	18,07	CHI
202010183484	TRINDADE	TR21000093	TRINDADE	30/10/2020 20:59	30/10/2020 22:13	30/10/2020 20:59	30/10/2020 22:13	1,23	1	1,23	CHI
202010183489	RIO VERDE	RV21000293	RIO VERDE S1	30/10/2020 21:00	30/10/2020 22:26	30/10/2020 21:00	30/10/2020 22:26	1,42	1	1,42	CHI
202010183494	SANTA TEREZA DE GOIAS	SE12000019	MARA ROSA	30/10/2020 21:02	31/10/2020 00:20	30/10/2020 21:02	31/10/2020 00:20	3,29	1	3,29	CHI
202010183509	MINACU	IH12288127	MINACU	30/10/2020 21:09	31/10/2020 01:08	30/10/2020 21:09	31/10/2020 01:08	3,97	7	27,78	CHI
202010183510	CEZARINA	CZ21138557	CEZARINA	30/10/2020 21:10	31/10/2020 15:32	30/10/2020 21:10	31/10/2020 15:32	18,36	1	18,36	CHI
202010184063	MOIPORA	CO12079990	SAO LUIZ DOS MONTES BELOS	30/10/2020 21:11	31/10/2020 10:39	30/10/2020 21:11	31/10/2020 10:39	13,45	2	26,90	CHI
202010184063	CORREGO DO OURO	CO12079990	SAO LUIZ DOS MONTES BELOS	30/10/2020 21:11	31/10/2020 10:39	30/10/2020 21:11	31/10/2020 10:39	13,45	36	484,25	CHI
202010183526	NOVO GAMA	4990062797	PACAEMBU S1	30/10/2020 21:15	30/10/2020 23:55	30/10/2020 21:15	30/10/2020 23:55	2,66	1	2,66	CHI
202010183528	GOIANIA	10009559092	REAL S1	30/10/2020 21:15	30/10/2020 22:08	30/10/2020 21:15	30/10/2020 22:08	0,87	1	0,87	CHI
202010183575	HEITORAI	HE12300074	ITAPURANGA	30/10/2020 21:16	31/10/2020 11:26	30/10/2020 21:16	31/10/2020 11:26	14,16	9	127,47	CHI
202010184217	NOVO PLANALTO	SM12074386RE	SAO MIGUEL DO ARAGUAIA	30/10/2020 21:18	31/10/2020 08:30	30/10/2020 21:18	31/10/2020 08:30	11,18	6	67,10	CHI
202010184217	SAO MIGUEL DO ARAGUAIA	SM12074386RE	SAO MIGUEL DO ARAGUAIA	30/10/2020 21:18	31/10/2020 08:30	30/10/2020 21:18	31/10/2020 08:30	11,18	135	1509,83	CHI
202010183535	INHUMAS	30097939	INHUMAS S2	30/10/2020 21:20	31/10/2020 02:52	30/10/2020 21:20	31/10/2020 02:52	5,53	1	5,53	CHI

202010183539	TRINIDADE	40115598	MEIA PONTE	30/10/2020 21:21	30/10/2020 23:23	30/10/2020 21:21	30/10/2020 23:23	2,03	1	2,03	CHI
202010183540	ABADIA DE GOIAS	LG21147567	CARAJAS S1	30/10/2020 21:21	30/10/2020 23:34	30/10/2020 21:21	30/10/2020 23:34	2,21	2	4,42	CHI
202010183550	MINEIROS	MY21212545	PARQUE DAS EMAS	30/10/2020 21:26	31/10/2020 03:33	30/10/2020 21:26	31/10/2020 03:33	6,11	1	6,11	CHI
202010183573	CALDAS NOVAS	760067880	CALDAS NOVAS S1	30/10/2020 21:32	30/10/2020 23:10	30/10/2020 21:32	30/10/2020 23:10	1,63	1	1,63	CHI
202010183574	ARAGOIANIA	AO11379670	INDEPENDENCIA S2	30/10/2020 21:32	30/10/2020 23:23	30/10/2020 21:32	30/10/2020 23:23	1,84	44	80,89	CHI
202010183580	CEZARINA	CZ21067958	CEZARINA	30/10/2020 21:35	31/10/2020 16:44	30/10/2020 21:35	31/10/2020 16:44	19,15	1	19,15	CHI
202010183851	PORANGATU	01520634	PORANGATU	30/10/2020 21:37	30/10/2020 21:43	30/10/2020 21:39	30/10/2020 21:43	0,05	1	0,05	CHI
202010183851	PORANGATU	NPL-TR1	NOVO PLANALTO	30/10/2020 21:37	30/10/2020 21:43	30/10/2020 21:37	30/10/2020 21:43	0,11	28	3,11	CHI
202010183851	NOVO PLANALTO	NPL-TR1	NOVO PLANALTO	30/10/2020 21:37	30/10/2020 21:43	30/10/2020 21:37	30/10/2020 21:43	0,11	13	1,44	CHI
202010189325	SAO MIGUEL DO ARAGUAIA	SM12089544	SAO MIGUEL DO ARAGUAIA	30/10/2020 21:37	31/10/2020 12:05	30/10/2020 21:37	31/10/2020 12:05	14,47	22	318,27	CHI
2020103000081	NOVO PLANALTO	01360508	NOVO PLANALTO	30/10/2020 21:37	30/10/2020 21:43	30/10/2020 21:37	30/10/2020 21:43	0,10	573	57,30	CHI
2020103000081	NOVO PLANALTO	01715114	SAO MIGUEL DO ARAGUAIA	30/10/2020 21:37	30/10/2020 21:43	30/10/2020 21:37	30/10/2020 21:43	0,10	344	34,40	CHI
2020103000081	NOVO PLANALTO	01360508	NOVO PLANALTO	30/10/2020 21:37	30/10/2020 21:43	30/10/2020 21:37	30/10/2020 21:43	0,10	539	53,90	CHI
2020103000081	SAO MIGUEL DO ARAGUAIA	01715114	SAO MIGUEL DO ARAGUAIA	30/10/2020 21:37	30/10/2020 21:43	30/10/2020 21:37	30/10/2020 21:43	0,10	1252	125,20	CHI
2020103000081	CACU	49501	SAO MIGUEL DO ARAGUAIA	30/10/2020 21:37	30/10/2020 21:43	30/10/2020 21:37	30/10/2020 21:43	0,10	1	0,10	CHI
2020103000081	PORANGATU	01360508	NOVO PLANALTO	30/10/2020 21:37	30/10/2020 21:43	30/10/2020 21:37	30/10/2020 21:43	0,10	246	24,60	CHI
2020103000081	NOVO PLANALTO	01360508	NOVO PLANALTO	30/10/2020 21:37	30/10/2020 21:43	30/10/2020 21:37	30/10/2020 21:43	0,10	97	9,70	CHI
2020103000081	SAO MIGUEL DO ARAGUAIA	01715114	SAO MIGUEL DO ARAGUAIA	30/10/2020 21:37	30/10/2020 21:43	30/10/2020 21:37	30/10/2020 21:43	0,10	5030	503,00	CHI
2020103000081	SAO MIGUEL DO ARAGUAIA	01715114	SAO MIGUEL DO ARAGUAIA	30/10/2020 21:37	30/10/2020 21:43	30/10/2020 21:37	30/10/2020 21:43	0,10	4222	422,20	CHI
2020103000081	BONOPOLIS	01360508	NOVO PLANALTO	30/10/2020 21:37	30/10/2020 21:43	30/10/2020 21:37	30/10/2020 21:43	0,10	53	5,30	CHI
2020103000081	BONOPOLIS	49502	SAO MIGUEL DO ARAGUAIA	30/10/2020 21:37	30/10/2020 21:43	30/10/2020 21:37	30/10/2020 21:43	0,10	562	56,20	CHI
2020103000081	BONOPOLIS	49501	SAO MIGUEL DO ARAGUAIA	30/10/2020 21:37	30/10/2020 21:43	30/10/2020 21:37	30/10/2020 21:43	0,10	794	79,40	CHI
2020103000081	AMARALINA	49501	SAO MIGUEL DO ARAGUAIA	30/10/2020 21:37	30/10/2020 21:43	30/10/2020 21:37	30/10/2020 21:43	0,10	221	22,10	CHI
2020103000081	BONOPOLIS	01715114	SAO MIGUEL DO ARAGUAIA	30/10/2020 21:37	30/10/2020 21:43	30/10/2020 21:37	30/10/2020 21:43	0,10	23	2,30	CHI
2020103000081	BONOPOLIS	01715114	SAO MIGUEL DO ARAGUAIA	30/10/2020 21:37	30/10/2020 21:43	30/10/2020 21:37	30/10/2020 21:43	0,10	105	10,50	CHI
2020103000081	NOVA CRIXAS	01715114	SAO MIGUEL DO ARAGUAIA	30/10/2020 21:37	30/10/2020 21:43	30/10/2020 21:37	30/10/2020 21:43	0,10	1	0,10	CHI
2020103000081	BONFINOPOLIS	01360508	NOVO PLANALTO	30/10/2020 21:37	30/10/2020 21:43	30/10/2020 21:37	30/10/2020 21:43	0,10	1	0,10	CHI
2020103000081	SAO MIGUEL DO ARAGUAIA	01715114	SAO MIGUEL DO ARAGUAIA	30/10/2020 21:37	30/10/2020 21:43	30/10/2020 21:37	30/10/2020 21:43	0,10	502	50,20	CHI
2020103000081	PORANGATU	49502	SAO MIGUEL DO ARAGUAIA	30/10/2020 21:37	30/10/2020 21:43	30/10/2020 21:37	30/10/2020 21:43	0,10	1	0,10	CHI
202010183811	URUACU	MRO-TR1	MARA ROSA	30/10/2020 21:37	30/10/2020 21:43	30/10/2020 21:37	30/10/2020 21:43	0,10	1	0,10	CHI
202010183811	URUACU	MRO-TR1	MARA ROSA	30/10/2020 21:37	30/10/2020 21:43	30/10/2020 21:37	30/10/2020 21:43	0,10	5	0,49	CHI
202010183811	MARA ROSA	MRO-TR1	MARA ROSA	30/10/2020 21:37	30/10/2020 21:43	30/10/2020 21:37	30/10/2020 21:43	0,10	79	7,68	CHI
202010183811	NOVA IGUACU DE GOIAS	MRO-TR1	MARA ROSA	30/10/2020 21:37	30/10/2020 21:43	30/10/2020 21:37	30/10/2020 21:43	0,10	43	4,18	CHI
202010183811	CAMPINORTE	MRO-TR1	MARA ROSA	30/10/2020 21:37	30/10/2020 21:43	30/10/2020 21:37	30/10/2020 21:43	0,10	153	14,88	CHI
202010183811	ALTO HORIZONTE	MRO-TR1	MARA ROSA	30/10/2020 21:37	30/10/2020 21:43	30/10/2020 21:37	30/10/2020 21:43	0,10	88	8,56	CHI
202010183811	ESTRELA DO NORTE	MRO-TR1	MARA ROSA	30/10/2020 21:37	30/10/2020 21:43	30/10/2020 21:37	30/10/2020 21:43	0,10	19	1,85	CHI
202010183811	AMARALINA	MRO-TR1	MARA ROSA	30/10/2020 21:37	30/10/2020 21:43	30/10/2020 21:37	30/10/2020 21:43	0,10	1066	103,64	CHI
202010183811	MUTUNOPOLIS	MRO-TR1	MARA ROSA	30/10/2020 21:37	30/10/2020 21:43	30/10/2020 21:37	30/10/2020 21:43	0,10	2	0,19	CHI
202010183811	MARA ROSA	MRO-TR1	MARA ROSA	30/10/2020 21:37	30/10/2020 21:43	30/10/2020 21:37	30/10/2020 21:43	0,10	2	0,19	CHI
202010183811	CAMPINORTE	MRO-TR1	MARA ROSA	30/10/2020 21:37	30/10/2020 21:43	30/10/2020 21:37	30/10/2020 21:43	0,10	33	3,21	CHI
202010183811	MARA ROSA	MRO-TR1	MARA ROSA	30/10/2020 21:37	30/10/2020 21:43	30/10/2020 21:37	30/10/2020 21:43	0,10	639	62,13	CHI
202010183811	CAMPINORTE	MRO-TR1	MARA ROSA	30/10/2020 21:37	30/10/2020 21:43	30/10/2020 21:37	30/10/2020 21:43	0,10	2	0,19	CHI
202010183811	ESTRELA DO NORTE	MRO-TR1	MARA ROSA	30/10/2020 21:37	30/10/2020 21:43	30/10/2020 21:37	30/10/2020 21:43	0,10	7	0,68	CHI
202010183811	MARA ROSA	MRO-TR1	MARA ROSA	30/10/2020 21:37	30/10/2020 21:43	30/10/2020 21:37	30/10/2020 21:43	0,10	4071	395,79	CHI
202010183811	MUTUNOPOLIS	POR-TR5	PORANGATU	30/10/2020 21:37	30/10/2020 21:43	30/10/2020 21:37	30/10/2020 21:43	0,10	43	4,28	CHI
202010183811	PORANGATU	POR-TR5	PORANGATU	30/10/2020 21:37	30/10/2020 21:43	30/10/2020 21:37	30/10/2020 21:43	0,10	9638	958,45	CHI
202010183811	NIQUELANDIA	POR-TR5	PORANGATU	30/10/2020 21:37	30/10/2020 21:43	30/10/2020 21:37	30/10/2020 21:43	0,10	1	0,10	CHI
202010183811	PORANGATU	POR-TR5	PORANGATU	30/10/2020 21:37	30/10/2020 21:43	30/10/2020 21:37	30/10/2020 21:43	0,10	8038	799,33	CHI
202010183811	FORMOSO	01520634	PORANGATU	30/10/2020 21:37	30/10/2020 21:43	30/10/2020 21:37	30/10/2020 21:43	0,10	157	15,57	CHI
202010183811	CAMPINACU	01520634	PORANGATU	30/10/2020 21:37	30/10/2020 21:43	30/10/2020 21:37	30/10/2020 21:43	0,10	1562	154,90	CHI
202010183811	PORANGATU	01520634	PORANGATU	30/10/2020 21:37	30/10/2020 21:43	30/10/2020 21:37	30/10/2020 21:43	0,10	329	32,63	CHI

202010183811	MONTIVIDIU DO NORTE	01520634	PORANGATU	30/10/2020 21:37	30/10/2020 21:43	30/10/2020 21:37	30/10/2020 21:43	0,10	1686	167,20	CHI
202010183811	PORANGATU	01520634	PORANGATU	30/10/2020 21:37	30/10/2020 21:43	30/10/2020 21:37	30/10/2020 21:43	0,10	184	18,25	CHI
202010183811	TROMBAS	01520634	PORANGATU	30/10/2020 21:37	30/10/2020 21:43	30/10/2020 21:37	30/10/2020 21:43	0,10	171	16,96	CHI
202010183811	PORANGATU	01520634	PORANGATU	30/10/2020 21:37	30/10/2020 21:43	30/10/2020 21:37	30/10/2020 21:43	0,10	1067	105,81	CHI
202010183811	MONTIVIDIU DO NORTE	01520634	PORANGATU	30/10/2020 21:37	30/10/2020 21:43	30/10/2020 21:37	30/10/2020 21:43	0,10	6	0,60	CHI
202010183811	MINACU	01520634	PORANGATU	30/10/2020 21:37	30/10/2020 21:43	30/10/2020 21:37	30/10/2020 21:43	0,10	56	5,55	CHI
202010183811	SANTA TEREZA DE GOIAS	01520634	PORANGATU	30/10/2020 21:37	30/10/2020 21:43	30/10/2020 21:37	30/10/2020 21:43	0,10	17	1,69	CHI
202010183811	SANTA TEREZA DE GOIAS	01520634	PORANGATU	30/10/2020 21:37	30/10/2020 21:43	30/10/2020 21:37	30/10/2020 21:43	0,10	11	1,09	CHI
202010183811	PORANGATU	01520634	PORANGATU	30/10/2020 21:37	30/10/2020 21:43	30/10/2020 21:37	30/10/2020 21:43	0,10	1	0,10	CHI
202010183811	TROMBAS	01520634	PORANGATU	30/10/2020 21:37	30/10/2020 21:43	30/10/2020 21:37	30/10/2020 21:43	0,10	1446	143,40	CHI
202010183811	CAMPINORTE	01520634	PORANGATU	30/10/2020 21:37	30/10/2020 21:43	30/10/2020 21:37	30/10/2020 21:43	0,10	155	15,37	CHI
202010183811	URUACU	CPN-TR1	CAMPINORTE	30/10/2020 21:37	30/10/2020 21:43	30/10/2020 21:37	30/10/2020 21:43	0,11	540	56,85	CHI
202010183811	NOVA IGUACU DE GOIAS	CPN-TR1	CAMPINORTE	30/10/2020 21:37	30/10/2020 21:43	30/10/2020 21:37	30/10/2020 21:43	0,11	23	2,42	CHI
202010183811	CAMPINORTE	CPN-TR1	CAMPINORTE	30/10/2020 21:37	30/10/2020 21:43	30/10/2020 21:37	30/10/2020 21:43	0,11	2377	250,25	CHI
202010183811	CAMPINORTE	CPN-TR1	CAMPINORTE	30/10/2020 21:37	30/10/2020 21:43	30/10/2020 21:37	30/10/2020 21:43	0,11	2245	236,35	CHI
202010183811	MARA ROSA	CPN-TR1	CAMPINORTE	30/10/2020 21:37	30/10/2020 21:43	30/10/2020 21:37	30/10/2020 21:43	0,11	1	0,11	CHI
202010183811	NOVA IGUACU DE GOIAS	CPN-TR1	CAMPINORTE	30/10/2020 21:37	30/10/2020 21:43	30/10/2020 21:37	30/10/2020 21:43	0,11	131	13,79	CHI
202010183674	ANICUNS	AC16417161	ANICUNS	30/10/2020 21:38	31/10/2020 15:16	30/10/2020 21:38	30/10/2020 21:41	0,06	1145	67,75	CHI
202010183674	ANICUNS	00090214	ANICUNS	30/10/2020 21:38	31/10/2020 15:16	30/10/2020 21:38	30/10/2020 21:43	0,09	921	82,63	CHI
202010183674	ANICUNS	AC16410183	ANICUNS	30/10/2020 21:38	31/10/2020 15:16	30/10/2020 21:38	30/10/2020 21:44	0,10	1053	106,47	CHI
202010183674	ANICUNS	AC16410182	ANICUNS	30/10/2020 21:38	31/10/2020 15:16	30/10/2020 21:38	30/10/2020 21:44	0,10	2183	224,36	CHI
202010183674	TURVANIA	AC16410182	ANICUNS	30/10/2020 21:38	31/10/2020 15:16	30/10/2020 21:39	30/10/2020 21:44	0,07	3	0,22	CHI
202010183674	ANICUNS	AC16410182	ANICUNS	30/10/2020 21:38	31/10/2020 15:16	30/10/2020 21:39	30/10/2020 21:44	0,07	7	0,51	CHI
202010183674	AVELINOPOLIS	AC10396902	ANICUNS	30/10/2020 21:38	31/10/2020 15:16	30/10/2020 21:38	30/10/2020 21:47	0,16	1	0,16	CHI
202010183674	ANICUNS	AC10396902	ANICUNS	30/10/2020 21:38	31/10/2020 15:16	30/10/2020 21:38	30/10/2020 21:47	0,16	119	18,54	CHI
202010183674	ANICUNS	AC10396902	ANICUNS	30/10/2020 21:38	31/10/2020 15:16	30/10/2020 21:39	30/10/2020 21:47	0,13	5	0,63	CHI
202010183674	ANICUNS	AC16414972	ANICUNS	30/10/2020 21:38	31/10/2020 15:16	30/10/2020 21:38	31/10/2020 00:23	2,76	495	1364,69	CHI
202010183674	ANICUNS	AC16414972	ANICUNS	30/10/2020 21:38	31/10/2020 15:16	30/10/2020 21:52	31/10/2020 00:23	2,52	798	2009,19	CHI
202010183674	AVELINOPOLIS	AC16414972	ANICUNS	30/10/2020 21:38	31/10/2020 15:16	30/10/2020 21:52	31/10/2020 00:23	2,52	1	2,52	CHI
202010183674	ANICUNS	AC11233415	ANICUNS	30/10/2020 21:38	31/10/2020 15:16	30/10/2020 21:52	31/10/2020 15:16	17,39	152	2643,87	CHI
202010183744	AVELINOPOLIS	AV12019687	ANICUNS	30/10/2020 21:38	31/10/2020 09:14	30/10/2020 21:38	31/10/2020 09:14	11,59	8	92,72	CHI
202010183595	ALEXANIA	AX21000192	ALEXANIA	30/10/2020 21:39	31/10/2020 04:33	30/10/2020 21:39	31/10/2020 04:33	6,89	1	6,89	CHI
202010183614	JUSSARA	JR21092773	JUSSARA	30/10/2020 21:43	31/10/2020 03:05	30/10/2020 21:43	31/10/2020 03:05	5,36	1	5,36	CHI
202010183639	AGUAS LINDAS DE GOIAS	4830027059	AGUAS LINDAS DE GOIAS S1	30/10/2020 21:49	30/10/2020 22:43	30/10/2020 21:49	30/10/2020 22:43	0,90	1	0,90	CHI
202010183662	VALPARAISO DE GOIAS	10004913688	PACAEMBU S1	30/10/2020 21:54	31/10/2020 03:52	30/10/2020 21:54	31/10/2020 03:52	5,97	1	5,97	CHI
202010183701	ANAPOLIS	AN11129383	JUNDIAI S1	30/10/2020 21:55	30/10/2020 23:12	30/10/2020 21:55	30/10/2020 23:12	1,28	158	202,24	CHI
202010183714	ANAPOLIS	AN11319593	JUNDIAI S2	30/10/2020 21:57	31/10/2020 01:11	30/10/2020 21:57	31/10/2020 01:11	3,23	29	93,58	CHI
202010183679	TRINDADE	40143200	GOYA S1	30/10/2020 21:57	30/10/2020 00:18	30/10/2020 21:57	30/10/2020 00:18	2,34	1	2,34	CHI
202010183683	SILVANIA	SV12086404	VIANOPOLIS	30/10/2020 21:58	31/10/2020 02:50	30/10/2020 21:58	31/10/2020 02:50	4,86	1	4,86	CHI
202010183689	CATALAO	CT12250355	CATALAO S1	30/10/2020 22:01	31/10/2020 00:12	30/10/2020 22:01	31/10/2020 00:12	2,18	8	17,44	CHI
202010189165	BOM JESUS DE GOIAS	1250047460	BOM JESUS DE GOIAS	30/10/2020 22:03	30/10/2020 23:15	30/10/2020 22:03	30/10/2020 23:15	1,20	1	1,20	CHI
202010183694	MINEIROS	1390096110	PARQUE DAS EMAS	30/10/2020 22:04	30/10/2020 23:30	30/10/2020 22:04	30/10/2020 23:30	1,43	1	1,43	CHI
202010184425	NOVO PLANALTO	SM12020677	SAO MIGUEL DO ARAGUAIA	30/10/2020 22:05	31/10/2020 09:45	30/10/2020 22:05	31/10/2020 09:45	11,67	7	81,66	CHI
202010184425	SAO MIGUEL DO ARAGUAIA	SM12020677	SAO MIGUEL DO ARAGUAIA	30/10/2020 22:05	31/10/2020 09:45	30/10/2020 22:05	31/10/2020 09:45	11,67	37	431,66	CHI
202010183702	AMERICANO DO BRASIL	KB21119446	ANICUNS	30/10/2020 22:06	31/10/2020 14:39	30/10/2020 22:06	31/10/2020 14:39	16,54	1	16,54	CHI
202010183705	SILVANIA	SV12160613	DAIA S2	30/10/2020 22:09	31/10/2020 08:32	30/10/2020 22:09	31/10/2020 08:32	10,37	1	10,37	CHI
202010183710	ADELANDIA	DN21033993	FIRMINOPOLIS S2	30/10/2020 22:12	31/10/2020 19:46	30/10/2020 22:12	31/10/2020 19:46	21,56	1	21,56	CHI
202010183712	JATAI	JT21153101	JATAI S1	30/10/2020 22:14	31/10/2020 10:44	30/10/2020 22:14	31/10/2020 10:44	12,49	1	12,49	CHI
202010183742	GUARAITA	IK12364707	ITAPURANGA	30/10/2020 22:14	31/10/2020 02:55	30/10/2020 22:14	31/10/2020 02:55	4,67	6	28,01	CHI
202010183742	ITAPURANGA	IK12364707	ITAPURANGA	30/10/2020 22:14	31/10/2020 02:55	30/10/2020 22:14	31/10/2020 02:55	4,67	12	56,02	CHI
202010183720	BELA VISTA DE GOIAS	BV31003239	BELA VISTA S1	30/10/2020 22:16	31/10/2020 02:05	30/10/2020 22:16	31/10/2020 02:05	3,80	1	3,80	CHI

202010183726	ITAPURANGA	IK21310840	ITAPURANGA	30/10/2020 22:19	31/10/2020 18:10	30/10/2020 22:19	31/10/2020 18:10	19,85	1	19,85	CHI
202010183740	BELA VISTA DE GOIAS	BV21364036	BELA VISTA S1	30/10/2020 22:27	31/10/2020 03:02	30/10/2020 22:27	31/10/2020 03:02	4,57	1	4,57	CHI
202010184221	CORUMBA DE GOIAS	CB12065715	CORUMBA	30/10/2020 22:28	31/10/2020 10:26	30/10/2020 22:28	31/10/2020 10:26	11,96	32	382,83	CHI
202010183743	APORE	3110003269	ITAJA S1	30/10/2020 22:29	31/10/2020 10:25	30/10/2020 22:29	31/10/2020 10:25	11,92	1	11,92	CHI
202010183746	NIQUELANDIA	10027487359	NIQUELANDIA SUBTRANSMISSAO	30/10/2020 22:33	31/10/2020 15:24	30/10/2020 22:33	31/10/2020 15:24	16,85	1	16,85	CHI
202010183756	PORANGATU	PO12064911	NOVO PLANALTO	30/10/2020 22:40	31/10/2020 18:44	30/10/2020 22:40	31/10/2020 18:44	20,05	136	2727,03	CHI
202010183757	SAO LUIS DE MONTES BELOS	SL21259964	FIRMINOPOLIS S2	30/10/2020 22:43	31/10/2020 18:09	30/10/2020 22:43	31/10/2020 18:09	19,43	1	19,43	CHI
202010183770	LUZIANIA	10021625750	RIO VERMELHO	30/10/2020 22:48	31/10/2020 00:33	30/10/2020 22:48	31/10/2020 00:33	1,74	1	1,74	CHI
202010183773	IACIARA	IA21000007	IACIARA S1	30/10/2020 22:50	30/10/2020 23:48	30/10/2020 22:50	30/10/2020 23:48	0,96	1	0,96	CHI
202010183775	AGUAS LINDAS DE GOIAS	10008468190	AGUAS LINDAS DE GOIAS S1	30/10/2020 22:50	31/10/2020 00:27	30/10/2020 22:50	31/10/2020 00:27	1,61	1	1,61	CHI
202010183776	GUAPO	GC12000274	GUAPO S1	30/10/2020 22:50	31/10/2020 03:00	30/10/2020 22:50	31/10/2020 03:00	4,17	41	170,86	CHI
202010183776	TRINDADE	GC12000274	GUAPO S1	30/10/2020 22:50	31/10/2020 03:00	30/10/2020 22:50	31/10/2020 03:00	4,17	36	150,02	CHI
202010183779	LUZIANIA	LZ12351406RE	MARAJOARA	30/10/2020 22:53	31/10/2020 00:34	30/10/2020 22:53	31/10/2020 00:34	1,67	100	166,83	CHI
202010183787	BELA VISTA DE GOIAS	240058380	BELA VISTA S2	30/10/2020 22:59	31/10/2020 00:59	30/10/2020 22:59	31/10/2020 00:59	2,00	1	2,00	CHI
202010183790	NIQUELANDIA	NQ11035686	BARRO ALTO	30/10/2020 23:03	31/10/2020 09:33	30/10/2020 23:03	31/10/2020 09:33	10,50	60	630,00	CHI
202010184238	NIQUELANDIA	NQ12208518	NIQUELANDIA SUBTRANSMISSAO	30/10/2020 23:07	31/10/2020 08:40	30/10/2020 23:07	31/10/2020 08:40	9,55	7	66,84	CHI
202010183816	GOIANESIA	GE12089921	GOIANESIA S2	30/10/2020 23:13	31/10/2020 01:55	30/10/2020 23:13	31/10/2020 01:55	2,69	234	628,74	CHI
202010183821	ITUMBIARA	00230424	BOM JESUS DE GOIAS	30/10/2020 23:15	31/10/2020 12:34	30/10/2020 23:15	31/10/2020 04:28	5,21	3	15,64	CHI
202010183821	BOM JESUS DE GOIAS	00230424	BOM JESUS DE GOIAS	30/10/2020 23:15	31/10/2020 12:34	30/10/2020 23:15	31/10/2020 04:28	5,21	13	67,79	CHI
202010183821	BOM JESUS DE GOIAS	BJ13208234	BOM JESUS DE GOIAS	30/10/2020 23:15	31/10/2020 12:34	30/10/2020 23:15	31/10/2020 09:33	10,30	9	92,67	CHI
202010183821	GOIATUBA	BJ13208234	BOM JESUS DE GOIAS	30/10/2020 23:15	31/10/2020 12:34	30/10/2020 23:15	31/10/2020 09:33	10,30	26	267,71	CHI
202010183821	ITUMBIARA	00230424	BOM JESUS DE GOIAS	30/10/2020 23:15	31/10/2020 12:34	31/10/2020 09:37	31/10/2020 10:59	1,36	3	4,07	CHI
202010183821	BOM JESUS DE GOIAS	00230424	BOM JESUS DE GOIAS	30/10/2020 23:15	31/10/2020 12:34	31/10/2020 09:37	31/10/2020 10:59	1,36	13	17,64	CHI
202010183821	BOM JESUS DE GOIAS	BJ13208234	BOM JESUS DE GOIAS	30/10/2020 23:15	31/10/2020 12:34	31/10/2020 09:37	31/10/2020 11:23	1,77	5	8,84	CHI
202010183821	GOIATUBA	BJ13208234	BOM JESUS DE GOIAS	30/10/2020 23:15	31/10/2020 12:34	31/10/2020 09:37	31/10/2020 11:23	1,77	23	40,65	CHI
202010183821	GOIATUBA	GT13254738	BOM JESUS DE GOIAS	30/10/2020 23:15	31/10/2020 12:34	30/10/2020 23:15	31/10/2020 11:30	12,25	102	1249,44	CHI
202010183821	GOIATUBA	GT13254736	BOM JESUS DE GOIAS	30/10/2020 23:15	31/10/2020 12:34	30/10/2020 23:15	31/10/2020 11:41	12,43	132	1640,98	CHI
202010183821	BOM JESUS DE GOIAS	20373562	BOM JESUS DE GOIAS	30/10/2020 23:15	31/10/2020 12:34	31/10/2020 09:37	31/10/2020 12:34	2,95	4	11,78	CHI
202010183821	GOIATUBA	20373562	BOM JESUS DE GOIAS	30/10/2020 23:15	31/10/2020 12:34	31/10/2020 09:37	31/10/2020 12:34	2,95	3	8,84	CHI
202010183820	QUIRINOPOLIS	QI21126431	QUIRINOPOLIS	30/10/2020 23:18	31/10/2020 04:19	30/10/2020 23:18	31/10/2020 04:19	5,00	1	5,00	CHI
202010183827	SILVANIA	AN21214687	DAIA S2	30/10/2020 23:27	31/10/2020 03:24	30/10/2020 23:27	31/10/2020 03:24	3,94	1	3,94	CHI
202010183828	INDIARA	10014025432	EDEIA	30/10/2020 23:28	31/10/2020 17:38	30/10/2020 23:28	31/10/2020 17:38	18,17	1	18,17	CHI
202010183829	CRIXAS	CX12330137	RUBIATABA	30/10/2020 23:29	31/10/2020 00:13	30/10/2020 23:29	31/10/2020 00:13	0,73	36	26,20	CHI
202010183830	ITAPURANGA	IK12310936	ITAPURANGA	30/10/2020 23:31	31/10/2020 11:26	30/10/2020 23:31	31/10/2020 11:26	11,91	33	393,19	CHI
202010183838	SANTA RITA DO ARAGUAIA	2130002876	SANTA RITA DO ARAGUAIA	30/10/2020 23:32	31/10/2020 07:23	30/10/2020 23:32	31/10/2020 07:23	7,83	1	7,83	CHI
202010184162	ITAJA	IM12303219	CACHOEIRA ALTA	30/10/2020 23:39	31/10/2020 09:44	30/10/2020 23:39	31/10/2020 09:44	10,07	5	50,34	CHI
202010184162	ITARUMA	IM12303219	CACHOEIRA ALTA	30/10/2020 23:39	31/10/2020 09:44	30/10/2020 23:39	31/10/2020 09:44	10,07	2	20,13	CHI
202010183860	AGUA FRIA DE GOIAS	TL13344231	SAO JOAO D ALIANCA	30/10/2020 23:43	01/11/2020 01:40	01/11/2020 01:28	01/11/2020 01:40	0,20	55	10,80	CHI
202010183860	SAO JOAO D ALIANCA	TL13344231	SAO JOAO D ALIANCA	30/10/2020 23:43	01/11/2020 01:40	01/11/2020 01:28	01/11/2020 01:40	0,20	11	2,16	CHI
202010183852	GOIANIA	11883390	GOIANIA LESTE S3	30/10/2020 23:44	31/10/2020 00:21	30/10/2020 23:44	31/10/2020 00:21	0,61	1	0,61	CHI
202010183860	SAO JOAO D ALIANCA	02160444	SAO JOAO D ALIANCA	30/10/2020 23:47	01/11/2020 01:40	30/10/2020 23:47	31/10/2020 08:33	8,78	20	175,55	CHI
202010183860	AGUA FRIA DE GOIAS	02160444	SAO JOAO D ALIANCA	30/10/2020 23:47	01/11/2020 01:40	30/10/2020 23:47	31/10/2020 08:33	8,78	17	149,22	CHI
202010183860	SAO JOAO D ALIANCA	02160444	SAO JOAO D ALIANCA	30/10/2020 23:47	01/11/2020 01:40	30/10/2020 23:47	31/10/2020 09:33	9,78	11	107,58	CHI
202010183860	AGUA FRIA DE GOIAS	02160444	SAO JOAO D ALIANCA	30/10/2020 23:47	01/11/2020 01:40	30/10/2020 23:47	31/10/2020 09:33	9,78	11	107,58	CHI
202010183860	AGUA FRIA DE GOIAS	02160444	SAO JOAO D ALIANCA	30/10/2020 23:47	01/11/2020 01:40	30/10/2020 23:47	31/10/2020 14:20	14,55	5	72,77	CHI
202010183860	AGUA FRIA DE GOIAS	TL13400433B	SAO JOAO D ALIANCA	30/10/2020 23:47	01/11/2020 01:40	31/10/2020 11:26	31/10/2020 14:20	2,90	11	31,89	CHI
202010183860	SAO JOAO D ALIANCA	TL13400433B	SAO JOAO D ALIANCA	30/10/2020 23:47	01/11/2020 01:40	31/10/2020 11:26	31/10/2020 14:20	2,90	11	31,89	CHI
202010183860	AGUA FRIA DE GOIAS	TL10402672	SAO JOAO D ALIANCA	30/10/2020 23:47	01/11/2020 01:40	30/10/2020 23:47	31/10/2020 14:31	14,74	38	560,20	CHI
202010183860	AGUA FRIA DE GOIAS	02160444	SAO JOAO D ALIANCA	30/10/2020 23:47	01/11/2020 01:40	31/10/2020 11:26	31/10/2020 23:21	11,92	3	35,75	CHI
202010183860	SAO JOAO D ALIANCA	02160444	SAO JOAO D ALIANCA	30/10/2020 23:47	01/11/2020 01:40	31/10/2020 11:26	31/10/2020 23:21	11,92	1	11,92	CHI
202010183860	SAO JOAO D ALIANCA	02160444	SAO JOAO D ALIANCA	30/10/2020 23:47	01/11/2020 01:40	31/10/2020 11:26	31/10/2020 23:37	12,19	1	12,19	CHI

202010183860	AGUA FRIA DE GOIAS	02160444	SAO JOAO D ALIANCA	30/10/2020 23:47	01/11/2020 01:40	31/10/2020 11:26	01/11/2020 00:09	12,71	9	114,40	CHI
202010183860	SAO JOAO D ALIANCA	02160444	SAO JOAO D ALIANCA	30/10/2020 23:47	01/11/2020 01:40	31/10/2020 11:26	01/11/2020 00:09	12,71	18	228,81	CHI
202010183860	AGUA FRIA DE GOIAS	02160444	SAO JOAO D ALIANCA	30/10/2020 23:47	01/11/2020 01:40	31/10/2020 11:26	01/11/2020 00:21	12,92	1	12,92	CHI
202010183860	AGUA FRIA DE GOIAS	02160444	SAO JOAO D ALIANCA	30/10/2020 23:47	01/11/2020 01:40	31/10/2020 11:26	01/11/2020 01:09	13,73	2	27,45	CHI
202010183860	AGUA FRIA DE GOIAS	02160444	SAO JOAO D ALIANCA	30/10/2020 23:47	01/11/2020 01:40	31/10/2020 11:26	01/11/2020 01:20	13,90	2	27,79	CHI
202010183855	NEROPOLIS	NR11000001	NEROPOLIS S2	30/10/2020 23:48	31/10/2020 03:30	30/10/2020 23:48	31/10/2020 03:30	3,69	179	660,81	CHI
202010183856	CAMPOS VERDES	3790046940	SANTA TEREZINHA	30/10/2020 23:49	01/11/2020 02:14	30/10/2020 23:49	01/11/2020 02:14	26,41	1	26,41	CHI
202010183862	ALTO HORIZONTE	NH12396799	SANTA TEREZINHA	30/10/2020 23:52	01/11/2020 17:25	30/10/2020 23:52	31/10/2020 11:05	11,22	27	302,93	CHI
202010183862	ALTO HORIZONTE	NH12396799	SANTA TEREZINHA	30/10/2020 23:52	01/11/2020 17:25	31/10/2020 13:30	31/10/2020 14:02	0,54	27	14,56	CHI
202010183862	ALTO HORIZONTE	NH12396799	SANTA TEREZINHA	30/10/2020 23:52	01/11/2020 17:25	30/10/2020 23:52	01/11/2020 16:40	40,79	13	530,30	CHI
202010183862	PILAR DE GOIAS	NH12396799	SANTA TEREZINHA	30/10/2020 23:52	01/11/2020 17:25	30/10/2020 23:52	01/11/2020 16:40	40,79	1	40,79	CHI
202010183862	ALTO HORIZONTE	NH12396799	SANTA TEREZINHA	30/10/2020 23:52	01/11/2020 17:25	30/10/2020 23:52	01/11/2020 17:25	41,54	19	789,31	CHI
202010183862	CAMPOS VERDES	NH12396799	SANTA TEREZINHA	30/10/2020 23:52	01/11/2020 17:25	30/10/2020 23:52	01/11/2020 17:25	41,54	9	373,88	CHI
202010183864	NIQUELANDIA	MJ18071960FS	PADRE BERNARDO	30/10/2020 23:52	31/10/2020 02:26	30/10/2020 23:52	31/10/2020 02:26	2,55	1	2,55	CHI
202010183864	MIMOSO DE GOIAS	MJ18071960FS	PADRE BERNARDO	30/10/2020 23:52	31/10/2020 02:26	30/10/2020 23:52	31/10/2020 02:26	2,55	161	410,86	CHI
202010183871	MUNDO NOVO DE GOIAS	MH10364963	NOVA CRIXAS	30/10/2020 23:56	01/11/2020 01:43	01/11/2020 00:37	01/11/2020 01:43	1,09	25	27,37	CHI
202010183871	NOVA CRIXAS	MH10364963	NOVA CRIXAS	30/10/2020 23:56	01/11/2020 01:43	01/11/2020 00:37	01/11/2020 01:43	1,09	3	3,28	CHI
202010183871	MUNDO NOVO DE GOIAS	MH10364963	NOVA CRIXAS	30/10/2020 23:56	01/11/2020 01:43	30/10/2020 23:56	31/10/2020 00:00	0,06	103	6,38	CHI
202010183871	SAO MIGUEL DO ARAGUAIA	MH10364963	NOVA CRIXAS	30/10/2020 23:56	01/11/2020 01:43	30/10/2020 23:56	31/10/2020 00:00	0,06	21	1,30	CHI
202010183871	NOVA CRIXAS	MH10364963	NOVA CRIXAS	30/10/2020 23:56	01/11/2020 01:43	30/10/2020 23:56	31/10/2020 08:36	8,66	3	25,99	CHI
202010183871	MUNDO NOVO DE GOIAS	MH10364963	NOVA CRIXAS	30/10/2020 23:56	01/11/2020 01:43	30/10/2020 23:56	31/10/2020 08:36	8,66	26	225,23	CHI
202010183871	MUNDO NOVO DE GOIAS	MH10364963	NOVA CRIXAS	30/10/2020 23:56	01/11/2020 01:43	31/10/2020 11:40	31/10/2020 12:04	0,39	26	10,16	CHI
202010183871	NOVA CRIXAS	MH10364963	NOVA CRIXAS	30/10/2020 23:56	01/11/2020 01:43	31/10/2020 11:40	31/10/2020 12:04	0,39	3	1,17	CHI
202010183871	MUNDO NOVO DE GOIAS	MH10364963	NOVA CRIXAS	30/10/2020 23:56	01/11/2020 01:43	31/10/2020 12:31	31/10/2020 13:11	0,67	26	17,51	CHI
202010183871	NOVA CRIXAS	MH10364963	NOVA CRIXAS	30/10/2020 23:56	01/11/2020 01:43	31/10/2020 12:31	31/10/2020 13:11	0,67	3	2,02	CHI
202010183871	NOVA CRIXAS	MH10364963	NOVA CRIXAS	30/10/2020 23:56	01/11/2020 01:43	30/10/2020 23:56	01/11/2020 01:43	25,78	1285	33123,02	CHI
202010183871	MUNDO NOVO DE GOIAS	MH10364963	NOVA CRIXAS	30/10/2020 23:56	01/11/2020 01:43	30/10/2020 23:56	01/11/2020 01:43	25,78	3	77,33	CHI
202010183866	GOIANIA	GN11169568	ATLANTICO S1	30/10/2020 23:58	31/10/2020 00:56	30/10/2020 23:58	31/10/2020 00:56	0,96	63	60,62	CHI
202010183881	RIO VERDE	10000418119	RIO VERDE S1	31/10/2020 00:17	31/10/2020 07:43	31/10/2020 00:17	31/10/2020 07:43	7,43	1	7,43	CHI
202010183885	CATALAO	CT11112597	CATALAO S2	31/10/2020 00:23	31/10/2020 10:10	31/10/2020 00:23	31/10/2020 10:10	9,77	95	928,02	CHI
202010183886	CAMPOS VERDES	3790045157	SANTA TEREZINHA	31/10/2020 00:26	31/10/2020 01:54	31/10/2020 00:26	31/10/2020 01:54	1,47	1	1,47	CHI
202010183890	PETROLINA DE GOIAS	10025402798	PETROLINA	31/10/2020 00:34	31/10/2020 02:08	31/10/2020 00:34	31/10/2020 02:08	1,56	1	1,56	CHI
202010183896	RIO VERDE	10004774726	RIO VERDE S1	31/10/2020 00:53	31/10/2020 08:55	31/10/2020 00:53	31/10/2020 08:55	8,03	1	8,03	CHI
202010184276	NIQUELANDIA	10007655043	NIQUELANDIA SUBTRANSMISSAO	31/10/2020 00:56	31/10/2020 18:46	31/10/2020 00:56	31/10/2020 18:46	17,82	1	17,82	CHI
202010183900	GOIANIA	12055293	GOIANIA LESTE S3	31/10/2020 00:57	31/10/2020 01:20	31/10/2020 00:57	31/10/2020 01:20	0,38	1	0,38	CHI
202010183902	GOIANIA	10839197	GOIANIA LESTE S2	31/10/2020 00:58	31/10/2020 02:37	31/10/2020 00:58	31/10/2020 02:37	1,64	1	1,64	CHI
202010184199	CACHOEIRA ALTA	CA12011542	CACHOEIRA ALTA	31/10/2020 01:00	31/10/2020 07:41	31/10/2020 01:00	31/10/2020 07:41	6,68	10	66,75	CHI
202010183907	GOIAS	GS21121462	ITABERAÍ S1	31/10/2020 01:07	31/10/2020 09:56	31/10/2020 01:07	31/10/2020 09:56	8,80	1	8,80	CHI
202010183909	RIO VERDE	RV12222621	RIO VERDE S2	31/10/2020 01:12	31/10/2020 08:57	31/10/2020 01:12	31/10/2020 08:57	7,74	14	108,38	CHI
202010183909	SANTA HELENA DE GOIAS	RV12222621	RIO VERDE S2	31/10/2020 01:12	31/10/2020 08:57	31/10/2020 01:12	31/10/2020 08:57	7,74	64	495,47	CHI
202010183910	MUTUNOPOLIS	MU12076698	MARA ROSA	31/10/2020 01:13	31/10/2020 04:37	31/10/2020 01:13	31/10/2020 04:37	3,40	31	105,25	CHI
202010183910	ESTRELA DO NORTE	MU12076698	MARA ROSA	31/10/2020 01:13	31/10/2020 04:37	31/10/2020 01:13	31/10/2020 04:37	3,40	1	3,40	CHI
202010183911	SAO DOMINGOS	ND12218839	IACIARA S2	31/10/2020 01:20	31/10/2020 07:03	31/10/2020 01:20	31/10/2020 07:03	5,70	3	17,11	CHI
202010183911	IACIARA	ND12218839	IACIARA S2	31/10/2020 01:20	31/10/2020 07:03	31/10/2020 01:20	31/10/2020 07:03	5,70	24	136,87	CHI
202010183919	CAMPINORTE	CR21213179	CAMPINORTE	31/10/2020 01:36	31/10/2020 02:36	31/10/2020 01:36	31/10/2020 02:36	1,00	1	1,00	CHI
202010183921	URUACU	UR21156423	CAMPINORTE	31/10/2020 01:36	31/10/2020 03:19	31/10/2020 01:36	31/10/2020 03:19	1,72	1	1,72	CHI
202010183930	ACREUNA	EU12260931	ACREUNA	31/10/2020 02:02	31/10/2020 03:55	31/10/2020 02:02	31/10/2020 03:55	1,88	3	5,64	CHI
202010183946	SAO MIGUEL DO ARAGUAIA	SM13262598	SAO MIGUEL DO ARAGUAIA	31/10/2020 02:10	01/11/2020 14:50	31/10/2020 02:10	31/10/2020 02:51	0,68	4987	3407,78	CHI
202010183946	SAO MIGUEL DO ARAGUAIA	SM13262598	SAO MIGUEL DO ARAGUAIA	31/10/2020 02:10	01/11/2020 14:50	31/10/2020 02:10	31/10/2020 02:51	0,70	33	23,06	CHI
202010183946	SAO MIGUEL DO ARAGUAIA	SM13262598	SAO MIGUEL DO ARAGUAIA	31/10/2020 02:10	01/11/2020 14:50	31/10/2020 02:10	31/10/2020 02:52	0,71	10	7,13	CHI
202010183946	BONOPOLIS	SM13262598	SAO MIGUEL DO ARAGUAIA	31/10/2020 02:10	01/11/2020 14:50	31/10/2020 02:10	31/10/2020 02:52	0,71	105	74,90	CHI

202010183946	SAO MIGUEL DO ARAGUAIA	SM16404040	SAO MIGUEL DO ARAGUAIA	31/10/2020 02:10	01/11/2020 14:50	31/10/2020 02:58	31/10/2020 11:42	8,73	5	43,65	CHI
202010183946	SAO MIGUEL DO ARAGUAIA	01710224	SAO MIGUEL DO ARAGUAIA	31/10/2020 02:10	01/11/2020 14:50	31/10/2020 19:34	31/10/2020 19:49	0,26	4987	1304,93	CHI
202010183946	SAO MIGUEL DO ARAGUAIA	SM13182482	SAO MIGUEL DO ARAGUAIA	31/10/2020 02:10	01/11/2020 14:50	31/10/2020 02:58	01/11/2020 14:20	35,38	6	212,26	CHI
202010183946	SAO MIGUEL DO ARAGUAIA	SM16404035	SAO MIGUEL DO ARAGUAIA	31/10/2020 02:10	01/11/2020 14:50	31/10/2020 02:57	01/11/2020 14:27	35,50	10	355,02	CHI
202010183946	BONOPOLIS	SM16404035	SAO MIGUEL DO ARAGUAIA	31/10/2020 02:10	01/11/2020 14:50	31/10/2020 02:57	01/11/2020 14:27	35,50	105	3727,73	CHI
202010183946	SAO MIGUEL DO ARAGUAIA	SM12013036	SAO MIGUEL DO ARAGUAIA	31/10/2020 02:10	01/11/2020 14:50	31/10/2020 02:58	01/11/2020 14:50	35,87	22	789,03	CHI
202010183940	CAIAPONIA	PRH-TR1	PIRANHAS	31/10/2020 02:11	31/10/2020 03:27	31/10/2020 02:11	31/10/2020 03:27	1,26	86	108,43	CHI
202010183940	PIRANHAS	PRH-TR1	PIRANHAS	31/10/2020 02:11	31/10/2020 03:27	31/10/2020 02:11	31/10/2020 03:27	1,26	2188	2758,70	CHI
202010183940	BOM JARDIM DE GOIAS	PRH-TR1	PIRANHAS	31/10/2020 02:11	31/10/2020 03:27	31/10/2020 02:11	31/10/2020 03:27	1,26	18	22,69	CHI
202010183940	CAIAPONIA	PRH-TR1	PIRANHAS	31/10/2020 02:11	31/10/2020 03:27	31/10/2020 02:11	31/10/2020 03:27	1,26	1	1,26	CHI
202010183940	ARENOPOLIS	PRH-TR1	PIRANHAS	31/10/2020 02:11	31/10/2020 03:27	31/10/2020 02:11	31/10/2020 03:27	1,26	11	13,87	CHI
202010183940	PIRANHAS	PRH-TR1	PIRANHAS	31/10/2020 02:11	31/10/2020 03:27	31/10/2020 02:11	31/10/2020 03:27	1,26	3172	3999,36	CHI
202010183940	PIRANHAS	PRH-TR1	PIRANHAS	31/10/2020 02:11	31/10/2020 03:27	31/10/2020 02:11	31/10/2020 03:27	1,26	35	44,13	CHI
202010183940	PIRANHAS	PRH-TR1	PIRANHAS	31/10/2020 02:11	31/10/2020 03:27	31/10/2020 02:11	31/10/2020 03:27	1,26	3	3,78	CHI
202010183940	ARENOPOLIS	ARE-TR1	ARENOPOLIS	31/10/2020 02:11	31/10/2020 03:27	31/10/2020 02:11	31/10/2020 03:27	1,26	1339	1689,37	CHI
202010183940	IVOLANDIA	ARE-TR1	ARENOPOLIS	31/10/2020 02:11	31/10/2020 03:27	31/10/2020 02:11	31/10/2020 03:27	1,26	100	126,17	CHI
202010183940	ARENOPOLIS	ARE-TR1	ARENOPOLIS	31/10/2020 02:11	31/10/2020 03:27	31/10/2020 02:11	31/10/2020 03:27	1,26	8	10,09	CHI
202010183940	PALESTINA DE GOIAS	ARE-TR1	ARENOPOLIS	31/10/2020 02:11	31/10/2020 03:27	31/10/2020 02:11	31/10/2020 03:27	1,26	7	8,83	CHI
202010183940	DIORAMA	ARE-TR1	ARENOPOLIS	31/10/2020 02:11	31/10/2020 03:27	31/10/2020 02:11	31/10/2020 03:27	1,26	12	15,14	CHI
202010183940	ARENOPOLIS	ARE-TR1	ARENOPOLIS	31/10/2020 02:11	31/10/2020 03:27	31/10/2020 02:11	31/10/2020 03:27	1,26	223	281,35	CHI
202010183940	PIRANHAS	ARE-TR1	ARENOPOLIS	31/10/2020 02:11	31/10/2020 03:27	31/10/2020 02:11	31/10/2020 03:27	1,26	25	31,54	CHI
202010183940	PALESTINA DE GOIAS	ARE-TR1	ARENOPOLIS	31/10/2020 02:11	31/10/2020 03:27	31/10/2020 02:11	31/10/2020 03:27	1,26	3	3,78	CHI
202010183940	PIRANHAS	ARE-TR1	ARENOPOLIS	31/10/2020 02:11	31/10/2020 03:27	31/10/2020 02:11	31/10/2020 03:27	1,26	7	8,83	CHI
202010183940	PALESTINA DE GOIAS	ARE-TR1	ARENOPOLIS	31/10/2020 02:11	31/10/2020 03:27	31/10/2020 02:11	31/10/2020 03:27	1,26	50	63,08	CHI
202010183940	IPORA	ARE-TR1	ARENOPOLIS	31/10/2020 02:11	31/10/2020 03:27	31/10/2020 02:11	31/10/2020 03:27	1,26	160	201,87	CHI
202010183940	MONTES CLAROS DE GOIAS	ARE-TR1	ARENOPOLIS	31/10/2020 02:11	31/10/2020 03:27	31/10/2020 02:11	31/10/2020 03:27	1,26	25	31,54	CHI
202010183940	DIORAMA	ARE-TR1	ARENOPOLIS	31/10/2020 02:11	31/10/2020 03:27	31/10/2020 02:11	31/10/2020 03:27	1,26	177	223,31	CHI
202010183940	MONTES CLAROS DE GOIAS	ARE-TR1	ARENOPOLIS	31/10/2020 02:11	31/10/2020 03:27	31/10/2020 02:11	31/10/2020 03:27	1,26	41	51,73	CHI
202010183940	ARAGARCAS	BJA-TR1	BOM JARDIM	31/10/2020 02:11	31/10/2020 03:27	31/10/2020 02:11	31/10/2020 03:27	1,26	118	148,84	CHI
202010183940	BOM JARDIM DE GOIAS	BJA-TR1	BOM JARDIM	31/10/2020 02:11	31/10/2020 03:27	31/10/2020 02:11	31/10/2020 03:27	1,26	4000	5045,56	CHI
202010183940	BALIZA	BJA-TR1	BOM JARDIM	31/10/2020 02:11	31/10/2020 03:27	31/10/2020 02:11	31/10/2020 03:27	1,26	330	416,26	CHI
202010183940	BOM JARDIM DE GOIAS	BJA-TR1	BOM JARDIM	31/10/2020 02:11	31/10/2020 03:27	31/10/2020 02:11	31/10/2020 03:27	1,26	4	5,05	CHI
202010183940	PIRANHAS	BJA-TR1	BOM JARDIM	31/10/2020 02:11	31/10/2020 03:27	31/10/2020 02:11	31/10/2020 03:27	1,26	40	50,46	CHI
202010189492	ARAGARCAS	AG10404106	ARAGARCAS	31/10/2020 02:20	31/10/2020 03:31	31/10/2020 02:43	31/10/2020 02:46	0,05	2120	114,24	CHI
202010189492	ARAGARCAS	AG10396202	ARAGARCAS	31/10/2020 02:20	31/10/2020 03:31	31/10/2020 02:42	31/10/2020 03:31	0,81	192	156,16	CHI
202010189492	ARAGARCAS	AG10404076	ARAGARCAS	31/10/2020 02:20	31/10/2020 03:31	31/10/2020 02:20	31/10/2020 03:31	1,19	1490	1771,03	CHI
202010189492	ARAGARCAS	AG10396201	ARAGARCAS	31/10/2020 02:20	31/10/2020 03:31	31/10/2020 02:45	31/10/2020 03:31	0,76	182	138,07	CHI
202010189492	ARAGARCAS	AG10404106	ARAGARCAS	31/10/2020 02:20	31/10/2020 03:31	31/10/2020 02:43	31/10/2020 03:31	0,81	999	805,86	CHI
202010189492	BOM JARDIM DE GOIAS	AG10404106	ARAGARCAS	31/10/2020 02:20	31/10/2020 03:31	31/10/2020 02:43	31/10/2020 03:31	0,81	53	42,75	CHI
202010189492	ARAGARCAS	AG10404106	ARAGARCAS	31/10/2020 02:20	31/10/2020 03:31	31/10/2020 02:50	31/10/2020 03:31	0,68	2120	1449,26	CHI
202010184175	FORMOSA	FA12042563	ITUIQUIRA	31/10/2020 02:42	31/10/2020 08:35	31/10/2020 02:42	31/10/2020 08:35	5,87	54	317,19	CHI
202010184010	GUARAITA	IK10396063	ITAPURANGA	31/10/2020 03:04	31/10/2020 13:24	31/10/2020 03:04	31/10/2020 09:01	5,96	7	41,69	CHI
202010184010	ITAPURANGA	IK10396063	ITAPURANGA	31/10/2020 03:04	31/10/2020 13:24	31/10/2020 03:04	31/10/2020 09:01	5,96	421	2507,64	CHI
202010184010	ITAPURANGA	IK13298539	ITAPURANGA	31/10/2020 03:04	31/10/2020 13:24	31/10/2020 09:05	31/10/2020 09:48	0,73	232	168,26	CHI
202010184010	GUARAITA	IK13298539	ITAPURANGA	31/10/2020 03:04	31/10/2020 13:24	31/10/2020 09:05	31/10/2020 09:48	0,73	7	5,08	CHI
202010184010	ITAPURANGA	IK12300200LD	ITAPURANGA	31/10/2020 03:04	31/10/2020 13:24	31/10/2020 03:04	31/10/2020 13:24	10,33	32	330,62	CHI
202010184032	MOZARLANDIA	01630424	RUBIATABA	31/10/2020 03:19	01/11/2020 22:08	31/10/2020 03:19	31/10/2020 03:29	0,17	4	0,67	CHI
202010184032	ARAGUAPAZ	01630424	RUBIATABA	31/10/2020 03:19	01/11/2020 22:08	31/10/2020 03:19	31/10/2020 03:29	0,17	104	17,42	CHI
202010184032	NOVA AMERICA	01630424	RUBIATABA	31/10/2020 03:19	01/11/2020 22:08	31/10/2020 03:19	31/10/2020 03:29	0,17	210	35,18	CHI
202010184032	NOVA CRIXAS	01630424	RUBIATABA	31/10/2020 03:19	01/11/2020 22:08	31/10/2020 03:19	31/10/2020 03:29	0,17	1	0,17	CHI
202010184032	CRIXAS	01630424	RUBIATABA	31/10/2020 03:19	01/11/2020 22:08	31/10/2020 03:19	31/10/2020 03:29	0,17	294	49,25	CHI

202010184032	RUBIATABA	01630424	RUBIATABA	31/10/2020 03:19	01/11/2020 22:08	31/10/2020 03:19	31/10/2020 03:29	0,17	8	1,34	CHI
202010184032	RUBIATABA	01630424	RUBIATABA	31/10/2020 03:19	01/11/2020 22:08	31/10/2020 03:21	31/10/2020 03:29	0,12	1	0,12	CHI
202010184032	GUARINOS	01630424	RUBIATABA	31/10/2020 03:19	01/11/2020 22:08	31/10/2020 03:21	31/10/2020 03:29	0,12	11	1,31	CHI
202010184032	RUBIATABA	01630424	RUBIATABA	31/10/2020 03:19	01/11/2020 22:08	31/10/2020 03:21	31/10/2020 03:29	0,12	104	12,39	CHI
202010184032	CRIXAS	01630424	RUBIATABA	31/10/2020 03:19	01/11/2020 22:08	31/10/2020 03:21	31/10/2020 03:29	0,12	30	3,58	CHI
202010184032	ITAPACI	01630424	RUBIATABA	31/10/2020 03:19	01/11/2020 22:08	31/10/2020 03:21	31/10/2020 03:29	0,12	163	19,42	CHI
202010184032	NOVA AMERICA	01630424	RUBIATABA	31/10/2020 03:19	01/11/2020 22:08	31/10/2020 03:21	31/10/2020 03:29	0,12	42	5,01	CHI
202010184032	NOVA AMERICA	01630424	RUBIATABA	31/10/2020 03:19	01/11/2020 22:08	31/10/2020 03:21	31/10/2020 03:29	0,12	756	90,09	CHI
202010184032	RUBIATABA	01630424	RUBIATABA	31/10/2020 03:19	01/11/2020 22:08	31/10/2020 03:32	31/10/2020 03:56	0,41	104	42,47	CHI
202010184032	NOVA AMERICA	01630424	RUBIATABA	31/10/2020 03:19	01/11/2020 22:08	31/10/2020 03:32	31/10/2020 03:56	0,41	41	16,74	CHI
202010184032	NOVA AMERICA	01630424	RUBIATABA	31/10/2020 03:19	01/11/2020 22:08	31/10/2020 03:32	31/10/2020 03:57	0,43	1	0,43	CHI
202010184032	ITAPACI	01630424	RUBIATABA	31/10/2020 03:19	01/11/2020 22:08	31/10/2020 03:32	31/10/2020 03:57	0,43	163	69,82	CHI
202010184032	NOVA AMERICA	01630424	RUBIATABA	31/10/2020 03:19	01/11/2020 22:08	31/10/2020 03:32	31/10/2020 03:57	0,43	756	323,82	CHI
202010184032	GUARINOS	01630424	RUBIATABA	31/10/2020 03:19	01/11/2020 22:08	31/10/2020 03:32	31/10/2020 03:57	0,43	11	4,71	CHI
202010184032	CRIXAS	01630424	RUBIATABA	31/10/2020 03:19	01/11/2020 22:08	31/10/2020 03:32	31/10/2020 03:57	0,43	30	12,85	CHI
202010184032	RUBIATABA	01630424	RUBIATABA	31/10/2020 03:19	01/11/2020 22:08	31/10/2020 03:32	31/10/2020 03:57	0,43	1	0,43	CHI
202010184032	NOVA AMERICA	01330434	RUBIATABA	31/10/2020 03:19	01/11/2020 22:08	31/10/2020 03:30	31/10/2020 08:13	4,71	210	989,04	CHI
202010184032	RUBIATABA	01330434	RUBIATABA	31/10/2020 03:19	01/11/2020 22:08	31/10/2020 03:30	31/10/2020 08:13	4,71	8	37,68	CHI
202010184032	CRIXAS	01330434	RUBIATABA	31/10/2020 03:19	01/11/2020 22:08	31/10/2020 03:30	31/10/2020 08:13	4,71	51	240,20	CHI
202010184032	NOVA IGUACU DE GOIAS	01630424	RUBIATABA	31/10/2020 03:19	01/11/2020 22:08	31/10/2020 03:19	31/10/2020 11:54	8,59	1	8,59	CHI
202010184032	CRIXAS	01630424	RUBIATABA	31/10/2020 03:19	01/11/2020 22:08	31/10/2020 03:19	31/10/2020 11:54	8,59	294	2524,40	CHI
202010184032	CRIXAS	01330434	RUBIATABA	31/10/2020 03:19	01/11/2020 22:08	31/10/2020 03:21	31/10/2020 11:54	8,55	1	8,55	CHI
202010184032	CRIXAS	01330434	RUBIATABA	31/10/2020 03:19	01/11/2020 22:08	31/10/2020 03:30	31/10/2020 11:54	8,40	89	747,23	CHI
202010184032	ARAGUAPAZ	01330434	RUBIATABA	31/10/2020 03:19	01/11/2020 22:08	31/10/2020 03:30	31/10/2020 13:36	10,10	6	60,58	CHI
202010184032	CRIXAS	01330434	RUBIATABA	31/10/2020 03:19	01/11/2020 22:08	31/10/2020 03:30	31/10/2020 13:36	10,10	17	171,65	CHI
202010184032	MOZARLANDIA	01330434	RUBIATABA	31/10/2020 03:19	01/11/2020 22:08	31/10/2020 03:30	31/10/2020 16:56	13,44	1	13,44	CHI
202010184032	ARAGUAPAZ	01330434	RUBIATABA	31/10/2020 03:19	01/11/2020 22:08	31/10/2020 18:16	31/10/2020 18:33	0,28	6	1,71	CHI
202010184032	RUBIATABA	01330434	RUBIATABA	31/10/2020 03:19	01/11/2020 22:08	31/10/2020 18:16	31/10/2020 18:33	0,28	8	2,28	CHI
202010184032	CRIXAS	01330434	RUBIATABA	31/10/2020 03:19	01/11/2020 22:08	31/10/2020 18:16	31/10/2020 18:33	0,28	452	128,57	CHI
202010184032	NOVA IGUACU DE GOIAS	01330434	RUBIATABA	31/10/2020 03:19	01/11/2020 22:08	31/10/2020 18:16	31/10/2020 18:33	0,28	1	0,28	CHI
202010184032	NOVA AMERICA	01330434	RUBIATABA	31/10/2020 03:19	01/11/2020 22:08	31/10/2020 18:16	31/10/2020 18:33	0,28	210	59,73	CHI
202010184032	ARAGUAPAZ	01330434	RUBIATABA	31/10/2020 03:19	01/11/2020 22:08	31/10/2020 21:29	31/10/2020 21:49	0,34	6	2,02	CHI
202010184032	RUBIATABA	01330434	RUBIATABA	31/10/2020 03:19	01/11/2020 22:08	31/10/2020 21:29	31/10/2020 21:49	0,34	8	2,69	CHI
202010184032	CRIXAS	01330434	RUBIATABA	31/10/2020 03:19	01/11/2020 22:08	31/10/2020 21:29	31/10/2020 21:49	0,34	452	152,05	CHI
202010184032	NOVA IGUACU DE GOIAS	01330434	RUBIATABA	31/10/2020 03:19	01/11/2020 22:08	31/10/2020 21:29	31/10/2020 21:49	0,34	1	0,34	CHI
202010184032	NOVA AMERICA	01330434	RUBIATABA	31/10/2020 03:19	01/11/2020 22:08	31/10/2020 21:29	31/10/2020 21:49	0,34	210	70,64	CHI
202010184032	CRIXAS	01330434	RUBIATABA	31/10/2020 03:19	01/11/2020 22:08	31/10/2020 03:30	01/11/2020 16:12	36,71	3	110,13	CHI
202010184032	ARAGUAPAZ	01330434	RUBIATABA	31/10/2020 03:19	01/11/2020 22:08	31/10/2020 03:30	01/11/2020 16:12	36,71	1	36,71	CHI
202010184032	ARAGUAPAZ	01330434	RUBIATABA	31/10/2020 03:19	01/11/2020 22:08	31/10/2020 03:30	01/11/2020 16:48	37,30	97	3618,05	CHI
202010184032	CRIXAS	01330434	RUBIATABA	31/10/2020 03:19	01/11/2020 22:08	31/10/2020 03:30	01/11/2020 16:48	37,30	1	37,30	CHI
202010184032	NOVA CRIXAS	01330434	RUBIATABA	31/10/2020 03:19	01/11/2020 22:08	31/10/2020 03:30	01/11/2020 17:08	37,63	1	37,63	CHI
202010184032	CRIXAS	01330434	RUBIATABA	31/10/2020 03:19	01/11/2020 22:08	31/10/2020 03:30	01/11/2020 17:08	37,63	133	5005,38	CHI
202010184032	MOZARLANDIA	01330434	RUBIATABA	31/10/2020 03:19	01/11/2020 22:08	31/10/2020 03:30	01/11/2020 20:51	41,36	3	124,07	CHI
202010184032	MOZARLANDIA	MZ13095557	RUBIATABA	31/10/2020 03:20	01/11/2020 22:08	01/11/2020 22:02	01/11/2020 22:08	0,10	1	0,10	CHI
202010184019	CATALAO	CT12306725	CATALAO S2	31/10/2020 03:33	31/10/2020 14:16	31/10/2020 03:33	31/10/2020 14:16	10,71	1	10,71	CHI
2020103100069	NOVA CRIXAS	05630424	NOVA CRIXAS	31/10/2020 03:38	31/10/2020 03:42	31/10/2020 03:38	31/10/2020 03:42	0,07	50	3,33	CHI
2020103100069	MARA ROSA	05630424	NOVA CRIXAS	31/10/2020 03:38	31/10/2020 03:42	31/10/2020 03:38	31/10/2020 03:42	0,07	48	3,20	CHI
2020103100069	CRIXAS	05630424	NOVA CRIXAS	31/10/2020 03:38	31/10/2020 03:42	31/10/2020 03:38	31/10/2020 03:42	0,07	22	1,47	CHI
2020103100069	AMARALINA	05630424	NOVA CRIXAS	31/10/2020 03:38	31/10/2020 03:42	31/10/2020 03:38	31/10/2020 03:42	0,07	79	5,27	CHI
2020103100069	UIRAPURU	05630424	NOVA CRIXAS	31/10/2020 03:38	31/10/2020 03:42	31/10/2020 03:38	31/10/2020 03:42	0,07	311	20,73	CHI
2020103100069	SANTA TEREZINHA DE GOIAS	05630424	NOVA CRIXAS	31/10/2020 03:38	31/10/2020 03:42	31/10/2020 03:38	31/10/2020 03:42	0,07	1	0,07	CHI

2020103100069	MUNDO NOVO DE GOIAS	15901	NOVA CRIXAS	31/10/2020 03:38	31/10/2020 03:42	31/10/2020 03:38	31/10/2020 03:42	0,07	1905	127,00	CHI
2020103100069	SAO MIGUEL DO ARAGUAIA	05630424	NOVA CRIXAS	31/10/2020 03:38	31/10/2020 03:42	31/10/2020 03:38	31/10/2020 03:42	0,07	21	1,40	CHI
2020103100069	MUNDO NOVO DE GOIAS	05630424	NOVA CRIXAS	31/10/2020 03:38	31/10/2020 03:42	31/10/2020 03:38	31/10/2020 03:42	0,07	789	52,60	CHI
202010183891	NIQUELANDIA	NQ12396795	URUACU	31/10/2020 04:00	01/11/2020 23:36	31/10/2020 04:00	31/10/2020 11:42	7,71	215	1656,75	CHI
202010183891	NIQUELANDIA	NQ13243446	URUACU	31/10/2020 04:00	01/11/2020 23:36	31/10/2020 04:00	31/10/2020 21:40	17,66	19	335,57	CHI
202010183891	NIQUELANDIA	NQ12218976LD	URUACU	31/10/2020 04:00	01/11/2020 23:36	31/10/2020 04:00	01/11/2020 10:46	30,78	26	800,20	CHI
202010183891	NIQUELANDIA	NQ12227348	URUACU	31/10/2020 04:00	01/11/2020 23:36	31/10/2020 04:00	01/11/2020 19:27	39,45	43	1696,53	CHI
202010183891	NIQUELANDIA	NQ21362145	URUACU	31/10/2020 04:00	01/11/2020 23:36	31/10/2020 04:00	01/11/2020 23:36	43,60	2	87,21	CHI
202010184181	ANICUNS	TV12005709	FIRMINOPOLIS S2	31/10/2020 04:18	31/10/2020 08:49	31/10/2020 04:18	31/10/2020 08:49	4,51	18	81,16	CHI
202010184041	NOVA CRIXAS	MZ10400707	MOZARLANDIA	31/10/2020 04:29	31/10/2020 13:51	31/10/2020 04:29	31/10/2020 07:43	3,23	70	226,20	CHI
202010184041	CRIXAS	MZ10400707	MOZARLANDIA	31/10/2020 04:29	31/10/2020 13:51	31/10/2020 04:29	31/10/2020 07:43	3,23	2	6,46	CHI
202010184041	MOZARLANDIA	MZ10400707	MOZARLANDIA	31/10/2020 04:29	31/10/2020 13:51	31/10/2020 04:29	31/10/2020 07:43	3,23	36	116,33	CHI
202010184041	NOVA CRIXAS	NA13259652	NOVA CRIXAS	31/10/2020 04:29	31/10/2020 13:51	31/10/2020 04:29	31/10/2020 13:51	9,36	1	9,36	CHI
202010184041	CRIXAS	NA13259652	MOZARLANDIA	31/10/2020 04:29	31/10/2020 13:51	31/10/2020 04:29	31/10/2020 13:51	9,36	1	9,36	CHI
202010184041	NOVA CRIXAS	NA13259652	MOZARLANDIA	31/10/2020 04:29	31/10/2020 13:51	31/10/2020 04:29	31/10/2020 13:51	9,36	59	552,11	CHI
202010184042	SAO MIGUEL DO ARAGUAIA	SM12143671	SAO MIGUEL DO ARAGUAIA	31/10/2020 04:32	31/10/2020 06:04	31/10/2020 04:32	31/10/2020 06:04	1,53	275	419,76	CHI
202010184084	ARUANA	03200444	ARUANA	31/10/2020 04:40	31/10/2020 12:52	31/10/2020 04:40	31/10/2020 04:46	0,11	61	6,83	CHI
202010184084	ARUANA	03200444	ARUANA	31/10/2020 04:40	31/10/2020 12:52	31/10/2020 04:40	31/10/2020 04:46	0,11	237	26,53	CHI
202010184084	ARUANA	03200444	ARUANA	31/10/2020 04:40	31/10/2020 12:52	31/10/2020 05:26	31/10/2020 07:59	2,56	230	589,57	CHI
202010184084	ARUANA	03200444	ARUANA	31/10/2020 04:40	31/10/2020 12:52	31/10/2020 05:26	31/10/2020 11:32	6,10	1	6,10	CHI
202010184084	ARUANA	03200444	ARUANA	31/10/2020 04:40	31/10/2020 12:52	31/10/2020 05:26	31/10/2020 11:32	6,10	61	372,00	CHI
202010184084	ARUANA	03200444	ARUANA	31/10/2020 04:40	31/10/2020 12:52	31/10/2020 05:26	31/10/2020 12:52	7,45	6	44,67	CHI
202010184046	JATAI	01030414	JATAI S1	31/10/2020 04:41	31/10/2020 15:21	31/10/2020 04:41	31/10/2020 10:38	5,95	2	11,89	CHI
202010184046	JATAI	01030414	JATAI S1	31/10/2020 04:41	31/10/2020 15:21	31/10/2020 09:01	31/10/2020 10:38	1,62	1	1,62	CHI
202010184046	JATAI	JT13336931	JATAI S1	31/10/2020 04:41	31/10/2020 15:21	31/10/2020 04:41	31/10/2020 10:48	6,11	27	164,84	CHI
202010184046	JATAI	01030414	JATAI S1	31/10/2020 04:41	31/10/2020 15:21	31/10/2020 04:41	31/10/2020 15:21	10,67	4	42,67	CHI
202010184049	MONTIVIDIU	05700434	MONTIVIDIU T	31/10/2020 04:52	31/10/2020 14:33	31/10/2020 04:52	31/10/2020 06:46	1,90	43	81,66	CHI
202010184049	RIO VERDE	05700434	MONTIVIDIU T	31/10/2020 04:52	31/10/2020 14:33	31/10/2020 04:52	31/10/2020 06:46	1,90	1	1,90	CHI
202010184049	MONTIVIDIU	05700434	MONTIVIDIU T	31/10/2020 04:52	31/10/2020 14:33	31/10/2020 07:17	31/10/2020 07:42	0,42	43	17,99	CHI
202010184049	RIO VERDE	05700434	MONTIVIDIU T	31/10/2020 04:52	31/10/2020 14:33	31/10/2020 07:17	31/10/2020 07:42	0,42	1	0,42	CHI
202010184049	CAIAPONIA	RV10400629	MONTIVIDIU T	31/10/2020 04:52	31/10/2020 14:33	31/10/2020 04:52	31/10/2020 07:46	2,90	292	846,72	CHI
202010184049	MONTIVIDIU	RV10400629	MONTIVIDIU T	31/10/2020 04:52	31/10/2020 14:33	31/10/2020 04:52	31/10/2020 07:46	2,90	113	327,67	CHI
202010184049	CAIAPONIA	RV10400629	MONTIVIDIU T	31/10/2020 04:52	31/10/2020 14:33	31/10/2020 04:52	31/10/2020 07:46	2,90	41	118,89	CHI
202010184049	JATAI	RV10400629	MONTIVIDIU T	31/10/2020 04:52	31/10/2020 14:33	31/10/2020 04:52	31/10/2020 07:46	2,90	7	20,30	CHI
202010184049	RIO VERDE	RV10400629	MONTIVIDIU T	31/10/2020 04:52	31/10/2020 14:33	31/10/2020 04:52	31/10/2020 07:46	2,90	2	5,80	CHI
202010184049	MONTIVIDIU	RV10400629	MONTIVIDIU T	31/10/2020 04:52	31/10/2020 14:33	31/10/2020 04:52	31/10/2020 07:46	2,90	6	17,40	CHI
202010184049	RIO VERDE	RV10400629	MONTIVIDIU T	31/10/2020 04:52	31/10/2020 14:33	31/10/2020 04:52	31/10/2020 07:46	2,90	82	237,78	CHI
202010184049	MONTIVIDIU	MV13054390	MONTIVIDIU T	31/10/2020 04:52	31/10/2020 14:33	31/10/2020 04:52	31/10/2020 09:35	4,71	31	145,86	CHI
202010184049	MONTIVIDIU	MV13054390	MONTIVIDIU T	31/10/2020 04:52	31/10/2020 14:33	31/10/2020 04:52	31/10/2020 12:08	7,26	1	7,26	CHI
202010184049	MONTIVIDIU	MV13054390	MONTIVIDIU T	31/10/2020 04:52	31/10/2020 14:33	31/10/2020 04:52	31/10/2020 12:41	7,82	33	258,04	CHI
202010184049	CAIAPONIA	RV10400629	MONTIVIDIU T	31/10/2020 04:52	31/10/2020 14:33	31/10/2020 14:12	31/10/2020 14:17	0,08	291	23,85	CHI
202010184049	MONTIVIDIU	RV10400629	MONTIVIDIU T	31/10/2020 04:52	31/10/2020 14:33	31/10/2020 14:12	31/10/2020 14:17	0,08	6	0,49	CHI
202010184049	RIO VERDE	RV10400629	MONTIVIDIU T	31/10/2020 04:52	31/10/2020 14:33	31/10/2020 14:12	31/10/2020 14:17	0,08	82	6,72	CHI
202010184049	JATAI	RV10400629	MONTIVIDIU T	31/10/2020 04:52	31/10/2020 14:33	31/10/2020 14:12	31/10/2020 14:17	0,08	7	0,57	CHI
202010184049	CAIAPONIA	MV13398958E	MONTIVIDIU T	31/10/2020 04:52	31/10/2020 14:33	31/10/2020 14:12	31/10/2020 14:33	0,34	41	13,75	CHI
202010184049	MONTIVIDIU	MV13398958E	MONTIVIDIU T	31/10/2020 04:52	31/10/2020 14:33	31/10/2020 14:12	31/10/2020 14:33	0,34	141	47,27	CHI
202010184047	BRITANIA	2110012219	BRITANIA	31/10/2020 04:53	31/10/2020 08:40	31/10/2020 04:53	31/10/2020 08:40	3,78	1	3,78	CHI
202010184652	SAO MIGUEL DO ARAGUAIA	SM12315128	SAO MIGUEL DO ARAGUAIA	31/10/2020 04:56	31/10/2020 14:50	31/10/2020 04:56	31/10/2020 14:50	9,89	56	553,68	CHI
202010184051	TRINDADE	TR12187566	GOYA S1	31/10/2020 04:57	31/10/2020 08:36	31/10/2020 04:57	31/10/2020 08:36	3,64	101	367,61	CHI
202010184965	SANTA TEREZINHA DE GOIAS	UP12294696	NOVA CRIXAS	31/10/2020 05:00	31/10/2020 19:35	31/10/2020 05:00	31/10/2020 19:35	14,57	1	14,57	CHI
202010184965	AMARALINA	UP12294696	NOVA CRIXAS	31/10/2020 05:00	31/10/2020 19:35	31/10/2020 05:00	31/10/2020 19:35	14,57	54	786,88	CHI

202010184965	UIRAPURU	UP12294696	NOVA CRIXAS	31/10/2020 05:00	31/10/2020 19:35	31/10/2020 05:00	31/10/2020 19:35	14,57	4	58,29	CHI
202010184965	MARA ROSA	UP12294696	NOVA CRIXAS	31/10/2020 05:00	31/10/2020 19:35	31/10/2020 05:00	31/10/2020 19:35	14,57	43	626,59	CHI
202010184061	BRITANIA	BT12183055	BRITANIA	31/10/2020 05:10	31/10/2020 08:13	31/10/2020 05:10	31/10/2020 08:13	3,04	21	63,83	CHI
202010184061	ITAPIRAPUA	BT12183055	BRITANIA	31/10/2020 05:10	31/10/2020 08:13	31/10/2020 05:10	31/10/2020 08:13	3,04	2	6,08	CHI
202010184059	APARECIDA DE GOIANIA	10014088736	INDEPENDENCIA S1	31/10/2020 05:10	31/10/2020 07:08	31/10/2020 05:10	31/10/2020 07:08	1,95	1	1,95	CHI
202010184409	CALDAS NOVAS	10031556793	CALDAS NOVAS S1	31/10/2020 05:17	31/10/2020 11:23	31/10/2020 05:17	31/10/2020 11:23	6,11	1	6,11	CHI
202010184600	SAO LUIS DE MONTES BELOS	SL12019284	SAO LUIZ DOS MONTES BELOS	31/10/2020 05:22	31/10/2020 14:55	31/10/2020 05:22	31/10/2020 14:55	9,55	59	563,34	CHI
202010184600	SANCLERLANDIA	SL12019284	SAO LUIZ DOS MONTES BELOS	31/10/2020 05:22	31/10/2020 14:55	31/10/2020 05:22	31/10/2020 14:55	9,55	28	267,35	CHI
202010184065	SANTA TEREZA DE GOIAS	SE12000019	MARA ROSA	31/10/2020 05:23	31/10/2020 09:50	31/10/2020 05:23	31/10/2020 09:50	4,44	1	4,44	CHI
202010183445	NOVO PLANALTO	TA12192346	SAO MIGUEL DO ARAGUAIA	31/10/2020 05:26	31/10/2020 10:32	31/10/2020 05:26	31/10/2020 09:03	3,61	22	79,50	CHI
202010183445	NOVO PLANALTO	TA12192346	SAO MIGUEL DO ARAGUAIA	31/10/2020 05:26	31/10/2020 10:32	31/10/2020 05:26	31/10/2020 10:32	5,11	4	20,45	CHI
202010184067	MORRINHOS	MR12265945	MORRINHOS	31/10/2020 05:29	31/10/2020 09:20	31/10/2020 05:29	31/10/2020 09:20	3,84	2	7,68	CHI
202010184070	ABADIANIA	AA21090426	ANAPOLIS UNIVERSITARIO S1	31/10/2020 05:31	31/10/2020 06:50	31/10/2020 05:31	31/10/2020 06:50	1,32	1	1,32	CHI
202010184076	CATALAO	CT11166782	CATALAO S2	31/10/2020 05:35	31/10/2020 07:05	31/10/2020 05:35	31/10/2020 07:05	1,50	62	92,88	CHI
202010184078	BOM JESUS DE GOIAS	1250073355	BOM JESUS DE GOIAS	31/10/2020 05:35	31/10/2020 09:02	31/10/2020 05:35	31/10/2020 09:02	3,44	1	3,44	CHI
202010184080	SAO LUIS DE MONTES BELOS	SL21072352	FIRMINOPOLIS S2	31/10/2020 05:38	31/10/2020 20:00	31/10/2020 05:38	31/10/2020 20:00	14,37	2	28,74	CHI
202010184081	BONOPOLIS	TA12263013	NOVO PLANALTO	31/10/2020 05:39	31/10/2020 22:25	31/10/2020 05:39	31/10/2020 22:25	16,76	31	519,48	CHI
202010184083	VALPARAISO DE GOIAS	VA12183503	PACAEMBU S1	31/10/2020 05:40	31/10/2020 08:14	31/10/2020 05:40	31/10/2020 08:14	2,55	202	515,77	CHI
202010184481	SANTA TEREZA DE GOIAS	SE12053856	MARA ROSA	31/10/2020 05:43	31/10/2020 08:51	31/10/2020 05:43	31/10/2020 08:51	3,13	3	9,39	CHI
202010184481	FORMOSO	SE12053856	MARA ROSA	31/10/2020 05:43	31/10/2020 08:51	31/10/2020 05:43	31/10/2020 08:51	3,13	6	18,78	CHI
202010184495	JATAI	JT12000059	JATAI S2	31/10/2020 05:53	31/10/2020 09:47	31/10/2020 05:53	31/10/2020 09:47	3,89	118	459,45	CHI
202010185300	JATAI	JT12264366	JATAI S2	31/10/2020 05:54	31/10/2020 12:16	31/10/2020 05:54	31/10/2020 12:16	6,36	69	439,03	CHI
202010184100	ACREUNA	EU12271615LD	ACREUNA	31/10/2020 05:55	31/10/2020 08:40	31/10/2020 05:55	31/10/2020 08:40	2,74	1	2,74	CHI
202010184101	FORMOSO	FO12088777RE	MARA ROSA	31/10/2020 05:56	31/10/2020 09:58	31/10/2020 05:56	31/10/2020 09:58	4,03	33	133,05	CHI
202010184515	SAO MIGUEL DO ARAGUAIA	SM12000063RE	SAO MIGUEL DO ARAGUAIA	31/10/2020 05:56	01/11/2020 16:52	31/10/2020 05:56	31/10/2020 11:31	5,58	33	184,15	CHI
202010184515	SAO MIGUEL DO ARAGUAIA	SM12000063RE	SAO MIGUEL DO ARAGUAIA	31/10/2020 05:56	01/11/2020 16:52	31/10/2020 05:56	01/11/2020 16:52	34,93	2	69,86	CHI
202010185748	COLINAS DO SUL	TI12271095	MINACU	31/10/2020 05:57	31/10/2020 19:30	31/10/2020 05:57	31/10/2020 19:30	13,54	23	311,50	CHI
202010184212	TRES RANCHOS	TH12068477	CATALAO S1	31/10/2020 05:57	31/10/2020 09:16	31/10/2020 05:57	31/10/2020 09:16	3,31	19	62,84	CHI
202010184112	JUSSARA	JR12027532	BRITANIA	31/10/2020 06:00	31/10/2020 09:33	31/10/2020 06:00	31/10/2020 09:33	3,54	41	145,07	CHI
202010184116	PLANALTINA	PI12359115	SAO JOAO D ALIANCA	31/10/2020 06:03	31/10/2020 09:09	31/10/2020 06:03	31/10/2020 09:09	3,10	6	18,58	CHI
202010184118	APARECIDA DE GOIANIA	AP12000026	INDEPENDENCIA S1	31/10/2020 06:04	31/10/2020 08:43	31/10/2020 06:04	31/10/2020 08:43	2,64	594	1570,80	CHI
202010184122	INHUMAS	IN11000056	INHUMAS S2	31/10/2020 06:06	31/10/2020 07:34	31/10/2020 06:06	31/10/2020 07:34	1,47	104	152,53	CHI
202010184123	IPAMERI	IP12100702	CRISTALINA S2	31/10/2020 06:06	31/10/2020 09:54	31/10/2020 06:06	31/10/2020 09:54	3,81	15	57,16	CHI
202010184123	CRISTALINA	IP12100702	CRISTALINA S2	31/10/2020 06:06	31/10/2020 09:54	31/10/2020 06:06	31/10/2020 09:54	3,81	19	72,40	CHI
202010184572	MUNDO NOVO DE GOIAS	MH12362454	NOVA CRIXAS	31/10/2020 06:06	31/10/2020 19:01	31/10/2020 06:06	31/10/2020 19:01	12,91	295	3809,84	CHI
202010184572	AMARALINA	MH12362454	NOVA CRIXAS	31/10/2020 06:06	31/10/2020 19:01	31/10/2020 06:06	31/10/2020 19:01	12,91	1	12,91	CHI
202010184125	URUACU	UR12339121	MARA ROSA	31/10/2020 06:06	31/10/2020 08:49	31/10/2020 06:06	31/10/2020 08:49	2,70	7	18,92	CHI
202010184126	CORUMBAIBA	CY12071523RE	CATALAO S1	31/10/2020 06:07	31/10/2020 21:30	31/10/2020 06:07	31/10/2020 21:30	15,38	4	61,53	CHI
202010184126	ANHANGUERA	CY12071523RE	CATALAO S1	31/10/2020 06:07	31/10/2020 21:30	31/10/2020 06:07	31/10/2020 21:30	15,38	4	61,53	CHI
202010184126	CUMARI	CY12071523RE	CATALAO S1	31/10/2020 06:07	31/10/2020 21:30	31/10/2020 06:07	31/10/2020 21:30	15,38	20	307,66	CHI
202010184126	NOVA AURORA	CY12071523RE	CATALAO S1	31/10/2020 06:07	31/10/2020 21:30	31/10/2020 06:07	31/10/2020 21:30	15,38	1	15,38	CHI
202010187084	SAO JOAO D ALIANCA	FB12248238	FLORES DE GOIAS	31/10/2020 06:07	31/10/2020 18:48	31/10/2020 06:07	31/10/2020 18:48	12,68	39	494,34	CHI
202010187084	FLORES DE GOIAS	FB12248238	FLORES DE GOIAS	31/10/2020 06:07	31/10/2020 18:48	31/10/2020 06:07	31/10/2020 18:48	12,68	102	1292,88	CHI
202010184129	PONTALINA	PK12293006	PONTALINA	31/10/2020 06:08	31/10/2020 08:12	31/10/2020 06:08	31/10/2020 08:12	2,06	3	6,17	CHI
202010184184	PIRENOPOLIS	PV12352327	CORUMBA	31/10/2020 06:08	31/10/2020 16:47	31/10/2020 06:08	31/10/2020 16:47	10,63	18	191,43	CHI
202010184133	CABECEIRAS	CW12042593LD	ITUIQUIRA	31/10/2020 06:09	31/10/2020 10:43	31/10/2020 06:09	31/10/2020 10:43	4,56	233	1062,22	CHI
202010184139	SANTA TEREZINHA DE GOIAS	SG21087953	SANTA TEREZINHA	31/10/2020 06:13	31/10/2020 08:23	31/10/2020 06:13	31/10/2020 08:23	2,17	1	2,17	CHI
202010184140	SAO FRANCISCO DE GOIAS	PV21236038	SAO FRANCISCO DE GOIAS	31/10/2020 06:13	31/10/2020 07:46	31/10/2020 06:13	31/10/2020 07:46	1,54	2	3,09	CHI
202010184141	SAO LUIS DE MONTES BELOS	SL12308509	SAO LUIZ DOS MONTES BELOS	31/10/2020 06:14	31/10/2020 07:38	31/10/2020 06:14	31/10/2020 07:38	1,40	3	4,20	CHI
202010184142	GOIANIA	10006739936	GOIANIA LESTE S3	31/10/2020 06:14	31/10/2020 07:41	31/10/2020 06:14	31/10/2020 07:41	1,45	1	1,45	CHI
202010184145	PORANGATU	PO21293524	PORANGATU	31/10/2020 06:16	01/11/2020 18:42	01/11/2020 01:05	01/11/2020 18:42	17,62	2	35,24	CHI

202010184536	BALIZA	BH12331302	CAIAPONIA	31/10/2020 06:16	31/10/2020 08:42	31/10/2020 06:16	31/10/2020 08:42	2,43	11	26,76	CHI
202010184147	SAO LUIZ DO NORTE	SZ12090338	ITAPACI	31/10/2020 06:17	31/10/2020 08:54	31/10/2020 06:17	31/10/2020 08:54	2,62	293	766,20	CHI
202010184150	ITAPACI	GF12243492RE	SANTA TEREZINHA	31/10/2020 06:17	31/10/2020 10:58	31/10/2020 06:17	31/10/2020 10:58	4,67	6	28,04	CHI
202010184150	GUARINOS	GF12243492RE	SANTA TEREZINHA	31/10/2020 06:17	31/10/2020 10:58	31/10/2020 06:17	31/10/2020 10:58	4,67	76	355,15	CHI
202010184150	CRIXAS	GF12243492RE	SANTA TEREZINHA	31/10/2020 06:17	31/10/2020 10:58	31/10/2020 06:17	31/10/2020 10:58	4,67	37	172,90	CHI
202010184152	ARAGUAPAZ	MP12299732	MATRINCHA	31/10/2020 06:17	31/10/2020 14:00	31/10/2020 06:17	31/10/2020 14:00	7,70	1	7,70	CHI
202010184152	MATRINCHA	MP12299732	MATRINCHA	31/10/2020 06:17	31/10/2020 14:00	31/10/2020 06:17	31/10/2020 14:00	7,70	62	477,50	CHI
202010184152	FAINA	MP12299732	MATRINCHA	31/10/2020 06:17	31/10/2020 14:00	31/10/2020 06:17	31/10/2020 14:00	7,70	67	516,01	CHI
202010184879	SANTA TEREZINHA DE GOIAS	SG12197521LD	SANTA TEREZINHA	31/10/2020 06:19	01/11/2020 13:18	01/11/2020 09:01	01/11/2020 10:50	1,82	11	19,98	CHI
202010184879	SANTA TEREZINHA DE GOIAS	SG12213220RE	SANTA TEREZINHA	31/10/2020 06:19	01/11/2020 13:18	31/10/2020 06:19	31/10/2020 16:39	10,33	25	258,33	CHI
202010184879	SANTA TEREZINHA DE GOIAS	SG12213220RE	SANTA TEREZINHA	31/10/2020 06:19	01/11/2020 13:18	31/10/2020 06:19	01/11/2020 09:01	26,71	11	293,78	CHI
202010184879	SANTA TEREZINHA DE GOIAS	SG12213220RE	SANTA TEREZINHA	31/10/2020 06:19	01/11/2020 13:18	31/10/2020 06:19	01/11/2020 12:21	30,05	4	120,19	CHI
202010184879	SANTA TEREZINHA DE GOIAS	SG12213220RE	SANTA TEREZINHA	31/10/2020 06:19	01/11/2020 13:18	31/10/2020 06:19	01/11/2020 13:18	30,98	8	247,85	CHI
202010184156	CALDAZINHA	BV21158535	CEPAIGO S2	31/10/2020 06:19	31/10/2020 09:32	31/10/2020 06:19	31/10/2020 09:32	3,21	2	6,42	CHI
202010184158	SANTA TEREZA DE GOIAS	SE21053798	MARA ROSA	31/10/2020 06:20	31/10/2020 08:23	31/10/2020 06:20	31/10/2020 08:23	2,05	1	2,05	CHI
202010184165	SAO LUIS DE MONTES BELOS	SL12373573	SAO LUIZ DOS MONTES BELOS	31/10/2020 06:23	01/11/2020 13:35	01/11/2020 12:55	01/11/2020 13:35	0,65	6	3,91	CHI
202010184165	SAO LUIS DE MONTES BELOS	SL12373573	SAO LUIZ DOS MONTES BELOS	31/10/2020 06:23	01/11/2020 13:35	31/10/2020 06:23	31/10/2020 17:13	10,83	10	108,29	CHI
202010184165	SAO LUIS DE MONTES BELOS	SL12373573	SAO LUIZ DOS MONTES BELOS	31/10/2020 06:23	01/11/2020 13:35	31/10/2020 17:41	31/10/2020 18:08	0,46	6	2,73	CHI
202010184165	SAO LUIS DE MONTES BELOS	SL12373573	SAO LUIZ DOS MONTES BELOS	31/10/2020 06:23	01/11/2020 13:35	31/10/2020 17:41	01/11/2020 13:35	19,89	4	79,58	CHI
202010184803	JATAI	JT12336920	JATAI S1	31/10/2020 06:24	31/10/2020 13:30	31/10/2020 06:24	31/10/2020 13:30	7,09	10	70,89	CHI
202010184169	MORRINHOS	MR12171700	MORRINHOS	31/10/2020 06:24	31/10/2020 08:31	31/10/2020 06:24	31/10/2020 08:31	2,10	5	10,52	CHI
202010184176	JUSSARA	JR12220059	JUSSARA	31/10/2020 06:28	31/10/2020 07:57	31/10/2020 06:28	31/10/2020 07:57	1,48	12	17,78	CHI
202010184219	ACREUNA	JD12255748	ACREUNA	31/10/2020 06:28	31/10/2020 08:52	31/10/2020 06:28	31/10/2020 08:52	2,39	5	11,96	CHI
202010184219	JANDAIA	JD12255748	ACREUNA	31/10/2020 06:28	31/10/2020 08:52	31/10/2020 06:28	31/10/2020 08:52	2,39	1	2,39	CHI
202010189211	CORREGO DO OURO	10030487089	SAO LUIZ DOS MONTES BELOS	31/10/2020 06:28	31/10/2020 15:49	31/10/2020 06:28	31/10/2020 15:49	9,34	1	9,34	CHI
202010184920	SANTA TEREZINHA DE GOIAS	SG12242340	SANTA TEREZINHA	31/10/2020 06:30	31/10/2020 11:46	31/10/2020 06:30	31/10/2020 11:46	5,26	7	36,84	CHI
202010184186	MORRINHOS	MR12196326	MORRINHOS	31/10/2020 06:31	31/10/2020 09:56	31/10/2020 06:31	31/10/2020 09:56	3,41	64	218,31	CHI
202010184277	NIQUELANDIA	NQ21197589	NIQUELANDIA SUBTRANSMISSAO	31/10/2020 06:31	31/10/2020 14:35	31/10/2020 06:31	31/10/2020 14:35	8,05	1	8,05	CHI
202010184247	HIDROLANDIA	HD12007513	PONTALINA	31/10/2020 06:31	31/10/2020 16:05	31/10/2020 06:31	31/10/2020 09:05	2,55	2	5,10	CHI
202010184247	HIDROLANDIA	HD12007513	PONTALINA	31/10/2020 06:31	31/10/2020 16:05	31/10/2020 06:31	31/10/2020 16:05	9,55	50	477,53	CHI
202010184192	APARECIDA DE GOIANIA	10009567990	INDEPENDENCIA S1	31/10/2020 06:34	31/10/2020 07:42	31/10/2020 06:34	31/10/2020 07:42	1,13	1	1,13	CHI
202010184194	BRITANIA	BT18073348TS	BRITANIA	31/10/2020 06:35	01/11/2020 18:06	01/11/2020 10:40	01/11/2020 18:06	7,44	19	141,33	CHI
202010184194	BRITANIA	BT18073348TS	BRITANIA	31/10/2020 06:35	01/11/2020 18:06	01/11/2020 15:13	01/11/2020 18:06	2,88	28	80,54	CHI
202010184194	BRITANIA	BT18073348TS	BRITANIA	31/10/2020 06:35	01/11/2020 18:06	31/10/2020 06:35	31/10/2020 18:40	12,09	28	338,49	CHI
202010184194	BRITANIA	BT18073348TS	BRITANIA	31/10/2020 06:35	01/11/2020 18:06	31/10/2020 06:35	01/11/2020 10:40	28,08	20	561,62	CHI
202010184194	BRITANIA	BT18073348TS	BRITANIA	31/10/2020 06:35	01/11/2020 18:06	31/10/2020 06:35	01/11/2020 18:06	35,52	2	71,04	CHI
202010184195	PIRACANJUBA	PJ12381148	PIRACANJUBA	31/10/2020 06:35	31/10/2020 16:56	31/10/2020 06:35	31/10/2020 16:56	10,35	6	62,11	CHI
202010184197	ACREUNA	EU12260931	ACREUNA	31/10/2020 06:35	31/10/2020 09:47	31/10/2020 06:35	31/10/2020 09:47	3,18	2	6,37	CHI
202010186258	URUACU	UR12243259	MARA ROSA	31/10/2020 06:38	01/11/2020 10:22	31/10/2020 06:38	01/11/2020 10:22	27,73	7	194,08	CHI
202010184937	MUNDO NOVO DE GOIAS	MH11170096	NOVA CRIXAS	31/10/2020 06:39	01/11/2020 19:12	31/10/2020 06:39	01/11/2020 19:12	36,54	76	2777,34	CHI
202010184284	IPAMERI	IP12099279	PIRES DO RIO S2	31/10/2020 06:39	31/10/2020 10:37	31/10/2020 06:39	31/10/2020 10:37	3,96	2	7,91	CHI
202010184664	QUIRINOPOLIS	QI12198335	QUIRINOPOLIS	31/10/2020 06:39	31/10/2020 10:11	31/10/2020 06:39	31/10/2020 10:11	3,52	3	10,57	CHI
202010184215	NOVO PLANALTO	TA12369993	NOVO PLANALTO	31/10/2020 06:41	01/11/2020 09:03	31/10/2020 06:41	01/11/2020 09:03	26,37	52	1371,12	CHI
202010184223	MIMOSO DE GOIAS	MJ12305245	PADRE BERNARDO	31/10/2020 06:42	31/10/2020 08:44	31/10/2020 06:42	31/10/2020 08:44	2,02	14	28,32	CHI
202010184400	NIQUELANDIA	NQ12341309	NIQUELANDIA SUBTRANSMISSAO	31/10/2020 06:43	31/10/2020 14:45	31/10/2020 06:43	31/10/2020 14:45	8,03	14	112,40	CHI
202010184819	NOVO PLANALTO	SM12099146RE	SAO MIGUEL DO ARAGUAIA	31/10/2020 06:44	31/10/2020 11:00	31/10/2020 06:44	31/10/2020 11:00	4,26	0	0,00	CHI
202010184819	SAO MIGUEL DO ARAGUAIA	SM12099146RE	SAO MIGUEL DO ARAGUAIA	31/10/2020 06:44	31/10/2020 11:00	31/10/2020 06:44	31/10/2020 11:00	4,26	53	225,57	CHI
202010185359	MUNDO NOVO DE GOIAS	MH12391964	NOVA CRIXAS	31/10/2020 06:46	01/11/2020 17:08	31/10/2020 06:46	01/11/2020 17:08	34,35	9	309,19	CHI
202010184964	JATAI	JT12182190	JATAI S1	31/10/2020 06:47	31/10/2020 17:51	31/10/2020 06:47	31/10/2020 17:51	11,05	25	276,37	CHI
202010184239	MINACU	IH12247493	MINACU	31/10/2020 06:50	31/10/2020 08:04	31/10/2020 06:50	31/10/2020 08:04	1,23	104	127,63	CHI
202010184242	ALEXANIA	AX11382894	ALEXANIA	31/10/2020 06:51	31/10/2020 08:37	31/10/2020 06:51	31/10/2020 08:37	1,76	7	12,34	CHI

202010184244	ITABERAI	IB11227450	ITABERAI S1	31/10/2020 06:51	31/10/2020 13:05	31/10/2020 06:51	31/10/2020 13:05	6,22	1	6,22	CHI
202010184249	JATAI	JT13303013	JATAI S1	31/10/2020 06:52	01/11/2020 15:35	31/10/2020 06:52	01/11/2020 15:04	32,19	2	64,37	CHI
202010184249	JATAI	JT12306463LD	JATAI S1	31/10/2020 06:52	01/11/2020 15:35	31/10/2020 06:52	01/11/2020 15:35	32,71	1	32,71	CHI
202010184252	PALMEIRAS DE GOIAS	PL12000058	PALMEIRAS	31/10/2020 06:54	31/10/2020 10:18	31/10/2020 06:54	31/10/2020 10:18	3,40	6	20,39	CHI
202010184255	CAMPINORTE	CR12282384	MARA ROSA	31/10/2020 06:54	31/10/2020 13:29	31/10/2020 06:54	31/10/2020 13:29	6,57	1	6,57	CHI
202010184255	URUACU	CR12282384	MARA ROSA	31/10/2020 06:54	31/10/2020 13:29	31/10/2020 06:54	31/10/2020 13:29	6,57	3	19,71	CHI
202010184257	PLANALTINA	PI12324338	SAO JOAO D ALIANCA	31/10/2020 06:55	31/10/2020 11:11	31/10/2020 06:55	31/10/2020 11:11	4,27	6	25,60	CHI
202010184259	FAINA	FC12158800	GOIAS	31/10/2020 06:56	31/10/2020 18:50	31/10/2020 06:56	31/10/2020 18:50	11,90	18	214,21	CHI
202010184817	SAO MIGUEL DO ARAGUAIA	SM12151000	SAO MIGUEL DO ARAGUAIA	31/10/2020 06:56	31/10/2020 10:28	31/10/2020 06:56	31/10/2020 10:28	3,52	19	66,86	CHI
202010184268	ITAPIRAPUA	IU12292875	MATRINCHA	31/10/2020 06:59	31/10/2020 11:15	31/10/2020 06:59	31/10/2020 11:15	4,26	1	4,26	CHI
202010184297	SITIO D ABADIA	AQ10408125	IACIARA S2	31/10/2020 07:02	31/10/2020 23:04	31/10/2020 07:02	31/10/2020 09:39	2,62	390	1020,07	CHI
202010184297	DAMIANOPOLIS	AQ10408125	IACIARA S2	31/10/2020 07:02	31/10/2020 23:04	31/10/2020 07:02	31/10/2020 09:39	2,62	134	350,48	CHI
202010184297	SITIO D ABADIA	AQ10408125	IACIARA S2	31/10/2020 07:02	31/10/2020 23:04	31/10/2020 07:02	31/10/2020 10:44	3,69	93	343,61	CHI
202010184297	SITIO D ABADIA	AQ10408125	IACIARA S2	31/10/2020 07:02	31/10/2020 23:04	31/10/2020 07:02	31/10/2020 11:58	4,93	529	2607,24	CHI
202010184297	ALVORADA DO NORTE	AQ10408125	IACIARA S2	31/10/2020 07:02	31/10/2020 23:04	31/10/2020 07:02	31/10/2020 15:48	8,76	13	113,88	CHI
202010184297	SITIO D ABADIA	AQ10408125	IACIARA S2	31/10/2020 07:02	31/10/2020 23:04	31/10/2020 07:02	31/10/2020 16:15	9,21	2	18,43	CHI
202010184297	ALVORADA DO NORTE	AQ10408125	IACIARA S2	31/10/2020 07:02	31/10/2020 23:04	31/10/2020 07:02	31/10/2020 16:15	9,21	5	46,07	CHI
202010184297	SITIO D ABADIA	AQ10408125	IACIARA S2	31/10/2020 07:02	31/10/2020 23:04	31/10/2020 07:02	31/10/2020 16:48	9,76	29	283,13	CHI
202010184297	SITIO D ABADIA	SI12118076LD	IACIARA S2	31/10/2020 07:02	31/10/2020 23:04	31/10/2020 07:02	31/10/2020 17:00	9,96	2	19,92	CHI
202010184297	ALVORADA DO NORTE	SI12118076LD	IACIARA S2	31/10/2020 07:02	31/10/2020 23:04	31/10/2020 07:02	31/10/2020 17:00	9,96	57	567,61	CHI
202010184297	SITIO D ABADIA	AQ10408125	IACIARA S2	31/10/2020 07:02	31/10/2020 23:04	31/10/2020 07:02	31/10/2020 17:53	10,84	3	32,53	CHI
202010184297	SITIO D ABADIA	AQ10408125	IACIARA S2	31/10/2020 07:02	31/10/2020 23:04	31/10/2020 07:02	31/10/2020 18:04	11,02	1	11,02	CHI
202010184297	ALVORADA DO NORTE	AQ12302809	IACIARA S2	31/10/2020 07:02	31/10/2020 23:04	31/10/2020 07:02	31/10/2020 23:04	16,03	1	16,03	CHI
202010184274	PILAR DE GOIAS	GG21341585	SANTA TEREZINHA	31/10/2020 07:03	31/10/2020 18:03	31/10/2020 07:03	31/10/2020 18:03	11,00	1	11,00	CHI
202010184283	JARAGUA	JA12000236	JARAGUA	31/10/2020 07:04	31/10/2020 10:00	31/10/2020 07:04	31/10/2020 10:00	2,93	26	76,25	CHI
202010184288	CAMPOS VERDES	3790031559	SANTA TEREZINHA	31/10/2020 07:05	01/11/2020 03:45	31/10/2020 07:05	01/11/2020 03:45	20,67	1	20,67	CHI
202010184291	SAO MIGUEL DO ARAGUAIA	SM11358686	SAO MIGUEL DO ARAGUAIA	31/10/2020 07:06	31/10/2020 12:40	31/10/2020 07:06	31/10/2020 12:40	5,55	1	5,55	CHI
202010184292	JUSSARA	JR12009940	JUSSARA	31/10/2020 07:07	31/10/2020 10:09	31/10/2020 07:07	31/10/2020 10:09	3,03	4	12,13	CHI
202010184301	NOVA GLORIA	IW12181387	ITAPACI	31/10/2020 07:09	31/10/2020 09:23	31/10/2020 07:09	31/10/2020 09:23	2,24	4	8,97	CHI
202010184301	ITAPACI	IW12181387	ITAPACI	31/10/2020 07:09	31/10/2020 09:23	31/10/2020 07:09	31/10/2020 09:23	2,24	4	8,97	CHI
202010184323	NOVA CRIXAS	NA12334349	NOVA CRIXAS	31/10/2020 07:09	31/10/2020 12:43	31/10/2020 07:09	31/10/2020 12:43	5,56	86	477,92	CHI
202010184304	GOIANIA	10011031	REAL S1	31/10/2020 07:09	31/10/2020 09:49	31/10/2020 07:09	31/10/2020 09:49	2,65	1	2,65	CHI
202010184367	NOVA ROMA	01230401	IACIARA S2	31/10/2020 07:10	31/10/2020 14:21	31/10/2020 07:10	31/10/2020 07:14	0,08	152	11,57	CHI
202010184367	FLORES DE GOIAS	01230401	IACIARA S2	31/10/2020 07:10	31/10/2020 14:21	31/10/2020 07:10	31/10/2020 07:14	0,08	1	0,08	CHI
202010184367	POSSE	01230401	IACIARA S2	31/10/2020 07:10	31/10/2020 14:21	31/10/2020 07:10	31/10/2020 07:14	0,08	1	0,08	CHI
202010184367	SAO JOAO D ALIANCA	01230401	IACIARA S2	31/10/2020 07:10	31/10/2020 14:21	31/10/2020 07:10	31/10/2020 07:14	0,08	22	1,67	CHI
202010184367	SAO DOMINGOS	01230401	IACIARA S2	31/10/2020 07:10	31/10/2020 14:21	31/10/2020 07:10	31/10/2020 07:14	0,08	3	0,23	CHI
202010184367	IACIARA	01230401	IACIARA S2	31/10/2020 07:10	31/10/2020 14:21	31/10/2020 07:10	31/10/2020 07:14	0,08	155	11,80	CHI
202010184367	ALTO PARAISO DE GOIAS	01230401	IACIARA S2	31/10/2020 07:10	31/10/2020 14:21	31/10/2020 07:10	31/10/2020 07:14	0,08	18	1,37	CHI
202010184367	NOVA ROMA	01230401	IACIARA S2	31/10/2020 07:10	31/10/2020 14:21	31/10/2020 07:10	31/10/2020 09:51	2,70	1177	3172,67	CHI
202010184367	MONTE ALEGRE DE GOIAS	01230401	IACIARA S2	31/10/2020 07:10	31/10/2020 14:21	31/10/2020 07:10	31/10/2020 09:51	2,70	1	2,70	CHI
202010184367	SAO DOMINGOS	01230401	IACIARA S2	31/10/2020 07:10	31/10/2020 14:21	31/10/2020 07:10	31/10/2020 09:51	2,70	4	10,78	CHI
202010184367	NOVA ROMA	01230401	IACIARA S2	31/10/2020 07:10	31/10/2020 14:21	31/10/2020 07:10	31/10/2020 11:49	4,65	12	55,83	CHI
202010184367	NOVA ROMA	01230401	IACIARA S2	31/10/2020 07:10	31/10/2020 14:21	31/10/2020 07:10	31/10/2020 14:21	7,18	231	1659,41	CHI
202010185067	TURVANIA	TV12289724	FIRMINOPOLIS S2	31/10/2020 07:10	31/10/2020 10:56	31/10/2020 07:10	31/10/2020 10:56	3,77	2	7,53	CHI
202010184314	AMORINOPOLIS	AM21312069	IPORA	31/10/2020 07:11	31/10/2020 09:24	31/10/2020 07:11	31/10/2020 09:24	2,21	1	2,21	CHI
202010184422	MUTUNOPOLIS	SE12352924	MARA ROSA	31/10/2020 07:11	31/10/2020 08:56	31/10/2020 07:11	31/10/2020 08:56	1,74	6	10,43	CHI
202010184422	SANTA TEREZA DE GOIAS	SE12352924	MARA ROSA	31/10/2020 07:11	31/10/2020 08:56	31/10/2020 07:11	31/10/2020 08:56	1,74	1	1,74	CHI
202010184319	FORMOSO	FO21289134	MARA ROSA	31/10/2020 07:12	31/10/2020 12:03	31/10/2020 07:12	31/10/2020 12:03	4,84	1	4,84	CHI
202010184321	CALDAS NOVAS	CN21100155	RIO QUENTE	31/10/2020 07:12	31/10/2020 08:43	31/10/2020 07:12	31/10/2020 08:43	1,51	1	1,51	CHI
202010184329	SENADOR CANEDO	190038093	SENADOR CANEDO	31/10/2020 07:15	31/10/2020 10:00	31/10/2020 07:15	31/10/2020 10:00	2,75	1	2,75	CHI

202010184330	JARAGUA	JA21240145	JARAGUA	31/10/2020 07:15	31/10/2020 11:16	31/10/2020 07:15	31/10/2020 11:16	4,01	1	4,01	CHI
202010184962	PIRACANJUBA	PJ12263070	PIRACANJUBA	31/10/2020 07:16	01/11/2020 11:28	31/10/2020 07:16	01/11/2020 11:28	28,21	5	141,04	CHI
202010184337	FORMOSO	FO21313419	MARA ROSA	31/10/2020 07:16	31/10/2020 10:23	31/10/2020 07:16	31/10/2020 10:23	3,10	1	3,10	CHI
202010186268	GUARANI DE GOIAS	PS12218767RE	IACIARA S2	31/10/2020 07:16	31/10/2020 15:07	31/10/2020 07:16	31/10/2020 15:07	7,84	102	799,37	CHI
202010186268	POSSE	PS12218767RE	IACIARA S2	31/10/2020 07:16	31/10/2020 15:07	31/10/2020 07:16	31/10/2020 15:07	7,84	1252	9811,85	CHI
202010184340	NIQUELANDIA	NQ21295501	NIQUELANDIA SUBTRANSMISSAO	31/10/2020 07:16	31/10/2020 16:34	31/10/2020 07:16	31/10/2020 16:34	9,28	1	9,28	CHI
202010185576	LEOPOLDO DE BULHOES	LB12353166	DAIA S2	31/10/2020 07:17	31/10/2020 12:05	31/10/2020 07:17	31/10/2020 12:05	4,79	4	19,18	CHI
202010184344	ORIZONA	OZ21017130	PIRES DO RIO S1	31/10/2020 07:17	31/10/2020 09:33	31/10/2020 07:17	31/10/2020 09:33	2,26	1	2,26	CHI
202010184346	CRISTALINA	KR12217277	CRISTALINA S1	31/10/2020 07:17	31/10/2020 11:49	31/10/2020 07:17	31/10/2020 11:49	4,52	12	54,24	CHI
202010184347	GOIANIA	16638268	MEIA PONTE	31/10/2020 07:18	31/10/2020 08:35	31/10/2020 07:18	31/10/2020 08:35	1,28	1	1,28	CHI
202010184351	SENADOR CANEDO	SW21081161	SENADOR CANEDO	31/10/2020 07:18	31/10/2020 10:04	31/10/2020 07:18	31/10/2020 10:04	2,75	3	8,26	CHI
202010185292	CAMPINORTE	CR12053035	MARA ROSA	31/10/2020 07:20	31/10/2020 23:38	31/10/2020 07:20	31/10/2020 23:38	16,29	4	65,16	CHI
202010184361	PALMEIRAS DE GOIAS	590028546	PALMEIRAS	31/10/2020 07:22	31/10/2020 13:09	31/10/2020 07:22	31/10/2020 13:09	5,79	1	5,79	CHI
202010184957	JARAGUA	JA12070670	JARAGUA	31/10/2020 07:23	31/10/2020 10:25	31/10/2020 07:23	31/10/2020 10:25	3,03	10	30,25	CHI
202010184533	MAURILANDIA	ML12397306	RIO DOS BOIS	31/10/2020 07:23	31/10/2020 15:44	31/10/2020 07:23	31/10/2020 15:44	8,34	21	175,15	CHI
202010184533	CASTELANDIA	ML12397306	RIO DOS BOIS	31/10/2020 07:23	31/10/2020 15:44	31/10/2020 07:23	31/10/2020 15:44	8,34	4	33,36	CHI
202010184366	GUARAITA	IK21129039	ITAPURANGA	31/10/2020 07:23	31/10/2020 19:22	31/10/2020 07:23	31/10/2020 19:22	11,97	1	11,97	CHI
202010184478	SAO JOAO D ALIANCA	JL12383338	SAO JOAO D ALIANCA	31/10/2020 07:25	31/10/2020 10:43	31/10/2020 07:25	31/10/2020 10:43	3,30	39	128,69	CHI
202010184370	MORRINHOS	MR21182916	MORRINHOS	31/10/2020 07:25	31/10/2020 13:44	31/10/2020 07:25	31/10/2020 13:44	6,32	1	6,32	CHI
202010184371	SAO LUIS DE MONTES BELOS	500089425	SAO LUIZ DOS MONTES BELOS	31/10/2020 07:25	31/10/2020 18:19	31/10/2020 07:25	31/10/2020 18:19	10,90	1	10,90	CHI
2020103100089	ALVORADA DO NORTE	00010424	IACIARA S2	31/10/2020 07:26	31/10/2020 07:30	31/10/2020 07:26	31/10/2020 07:30	0,07	3	0,20	CHI
2020103100089	SIMOLANDIA	00010424	IACIARA S2	31/10/2020 07:26	31/10/2020 07:30	31/10/2020 07:26	31/10/2020 07:30	0,07	249	16,60	CHI
2020103100089	POSSE	00010424	IACIARA S2	31/10/2020 07:26	31/10/2020 07:30	31/10/2020 07:26	31/10/2020 07:30	0,07	82	5,47	CHI
202010184375	MINACU	IH11205604	MINACU	31/10/2020 07:27	31/10/2020 10:43	31/10/2020 07:27	31/10/2020 10:43	3,27	2	6,53	CHI
202010184376	URUACU	UR21307770	URUACU	31/10/2020 07:27	31/10/2020 08:19	31/10/2020 07:27	31/10/2020 08:19	0,86	2	1,71	CHI
202010184387	GOIANIA	11277063	GOIANIA LESTE S1	31/10/2020 07:29	31/10/2020 10:10	31/10/2020 07:29	31/10/2020 10:10	2,68	1	2,68	CHI
202010184769	SAO MIGUEL DO ARAGUAIA	SM12100371	SAO MIGUEL DO ARAGUAIA	31/10/2020 07:29	31/10/2020 17:21	31/10/2020 07:29	31/10/2020 17:21	9,86	76	749,21	CHI
202010184386	CORUMBAIBA	560006883	VILA CORUMBA	31/10/2020 07:29	31/10/2020 12:35	31/10/2020 07:29	31/10/2020 12:35	5,09	1	5,09	CHI
202010185106	FLORES DE GOIAS	FB10408311	FLORES DE GOIAS	31/10/2020 07:30	31/10/2020 15:16	31/10/2020 07:30	31/10/2020 13:50	6,33	233	1475,28	CHI
202010185106	FLORES DE GOIAS	FB13255019	FLORES DE GOIAS	31/10/2020 07:30	31/10/2020 15:16	31/10/2020 07:30	31/10/2020 14:47	7,28	179	1303,52	CHI
202010185106	NOVA ROMA	FB12314707	FLORES DE GOIAS	31/10/2020 07:30	31/10/2020 15:16	31/10/2020 07:30	31/10/2020 15:16	7,77	2	15,54	CHI
202010185106	SAO JOAO D ALIANCA	FB12314707	FLORES DE GOIAS	31/10/2020 07:30	31/10/2020 15:16	31/10/2020 07:30	31/10/2020 15:16	7,77	46	357,52	CHI
202010184389	NIQUELANDIA	NQ21316227	NIQUELANDIA SUBTRANSMISSAO	31/10/2020 07:30	31/10/2020 16:42	31/10/2020 07:30	31/10/2020 16:42	9,20	1	9,20	CHI
202010186765	CRIXAS	CX12243193	SANTA TEREZINHA	31/10/2020 07:30	31/10/2020 17:03	31/10/2020 07:30	31/10/2020 17:03	9,54	9	85,85	CHI
202010184399	GOIANIA	14312682	GOIANIA LESTE S2	31/10/2020 07:31	31/10/2020 08:32	31/10/2020 07:31	31/10/2020 08:32	1,01	1	1,01	CHI
202010184401	CATALAO	7156553	CATALAO S1	31/10/2020 07:31	31/10/2020 13:03	31/10/2020 07:31	31/10/2020 13:03	5,52	2	11,04	CHI
202010184988	CATALAO	CT12394015	CATALAO S1	31/10/2020 07:32	01/11/2020 09:59	31/10/2020 07:32	01/11/2020 09:59	26,45	9	238,04	CHI
202010184406	AMARALINA	LC12168855	MARA ROSA	31/10/2020 07:32	01/11/2020 03:28	31/10/2020 07:32	31/10/2020 11:36	4,05	24	97,31	CHI
202010184406	MARA ROSA	LC12168855	MARA ROSA	31/10/2020 07:32	01/11/2020 03:28	31/10/2020 07:32	31/10/2020 11:36	4,05	0	0,00	CHI
202010184406	AMARALINA	LC12168855	MARA ROSA	31/10/2020 07:32	01/11/2020 03:28	31/10/2020 07:32	01/11/2020 03:28	19,93	11	219,20	CHI
202010184406	MARA ROSA	LC12168855	MARA ROSA	31/10/2020 07:32	01/11/2020 03:28	31/10/2020 07:32	01/11/2020 03:28	19,93	8	159,42	CHI
202010184407	COLINAS DO SUL	TI12396760	MINACU	31/10/2020 07:33	31/10/2020 16:56	31/10/2020 07:33	31/10/2020 16:56	9,38	12	112,59	CHI
202010184407	NIQUELANDIA	TI12396760	MINACU	31/10/2020 07:33	31/10/2020 16:56	31/10/2020 07:33	31/10/2020 16:56	9,38	1	9,38	CHI
202010184408	GOIAS	GS12145730	ITABERA I S1	31/10/2020 07:33	31/10/2020 12:33	31/10/2020 07:33	31/10/2020 12:33	5,00	9	44,97	CHI
202010185708	CALDAS NOVAS	10032208861	CALDAS NOVAS S1	31/10/2020 07:33	31/10/2020 11:51	31/10/2020 07:33	31/10/2020 11:51	4,29	1	4,29	CHI
202010184410	MORRINHOS	MR12092130	MORRINHOS	31/10/2020 07:33	31/10/2020 11:40	31/10/2020 07:33	31/10/2020 11:40	4,11	13	53,40	CHI
202010184412	MONTES CLAROS DE GOIAS	ME12204903	IPORA	31/10/2020 07:33	31/10/2020 11:47	31/10/2020 07:33	31/10/2020 11:47	4,22	3	12,67	CHI
202010184482	EDEIA	EA12043985	EDEIA	31/10/2020 07:33	31/10/2020 10:05	31/10/2020 07:33	31/10/2020 10:05	2,52	5	12,61	CHI
202010184842	FLORES DE GOIAS	FB12044974RE	IACIARA S2	31/10/2020 07:34	03/11/2020 15:51	02/11/2020 00:06	03/11/2020 13:03	36,95	73	2697,45	CHI
202010184842	FLORES DE GOIAS	FB12044974RE	IACIARA S2	31/10/2020 07:34	03/11/2020 15:51	02/11/2020 00:06	03/11/2020 15:51	39,75	171	6797,01	CHI
202010184842	FORMOSA	FB12044974RE	IACIARA S2	31/10/2020 07:34	03/11/2020 15:51	02/11/2020 00:06	03/11/2020 15:51	39,75	1	39,75	CHI

202010184842	VILA BOA	FB12044974RE	IACIARA S2	31/10/2020 07:34	03/11/2020 15:51	02/11/2020 00:06	03/11/2020 15:51	39,75	2	79,50	CHI
202010185619	POSSE	PS12195974RE	IACIARA S2	31/10/2020 07:34	31/10/2020 16:55	31/10/2020 07:34	31/10/2020 16:55	9,34	288	2690,40	CHI
202010184842	FLORES DE GOIAS	FB12044974RE	IACIARA S2	31/10/2020 07:34	03/11/2020 15:51	31/10/2020 07:34	01/11/2020 18:53	35,31	5	176,57	CHI
202010184842	FLORES DE GOIAS	FB12238481LD	IACIARA S2	31/10/2020 07:34	03/11/2020 15:51	31/10/2020 07:34	02/11/2020 00:05	40,51	12	486,08	CHI
202010184909	MATRINCHA	MP12299750	MATRINCHA	31/10/2020 07:35	31/10/2020 13:28	31/10/2020 07:35	31/10/2020 13:28	5,88	18	105,87	CHI
202010184427	CABECEIRAS	CW21391153	ITUIQUIRA	31/10/2020 07:35	31/10/2020 12:05	31/10/2020 07:35	31/10/2020 12:05	4,49	1	4,49	CHI
202010184430	FORMOSA	FA31057075	SAO JOAO D ALIANCA	31/10/2020 07:36	31/10/2020 10:32	31/10/2020 07:36	31/10/2020 10:32	2,93	1	2,93	CHI
202010184436	MARA ROSA	MQ21410868	SANTA TEREZINHA	31/10/2020 07:37	31/10/2020 21:14	31/10/2020 07:37	31/10/2020 21:14	13,60	1	13,60	CHI
202010184438	NIQUELANDIA	NQ12125441	NIQUELANDIA SUBTRANSMISSAO	31/10/2020 07:37	31/10/2020 12:32	31/10/2020 07:37	31/10/2020 12:32	4,90	55	269,59	CHI
202010184491	SIMOLANDIA	00010424	IACIARA S2	31/10/2020 07:38	31/10/2020 13:35	31/10/2020 07:38	31/10/2020 10:47	3,16	161	508,18	CHI
202010184491	POSSE	00010424	IACIARA S2	31/10/2020 07:38	31/10/2020 13:35	31/10/2020 07:38	31/10/2020 10:47	3,16	27	85,22	CHI
202010184491	ALVORADA DO NORTE	00010424	IACIARA S2	31/10/2020 07:38	31/10/2020 13:35	31/10/2020 07:38	31/10/2020 10:47	3,16	3	9,47	CHI
202010184491	SIMOLANDIA	00010424	IACIARA S2	31/10/2020 07:38	31/10/2020 13:35	31/10/2020 07:38	31/10/2020 12:58	5,34	8	42,74	CHI
202010184491	POSSE	00010424	IACIARA S2	31/10/2020 07:38	31/10/2020 13:35	31/10/2020 07:38	31/10/2020 12:58	5,34	4	21,37	CHI
202010184491	SIMOLANDIA	00010424	IACIARA S2	31/10/2020 07:38	31/10/2020 13:35	31/10/2020 07:38	31/10/2020 13:21	5,72	10	57,19	CHI
202010184491	POSSE	00010424	IACIARA S2	31/10/2020 07:38	31/10/2020 13:35	31/10/2020 07:38	31/10/2020 13:21	5,72	34	194,43	CHI
202010184491	POSSE	00010424	IACIARA S2	31/10/2020 07:38	31/10/2020 13:35	31/10/2020 07:38	31/10/2020 13:35	5,97	17	101,42	CHI
202010184491	SIMOLANDIA	00010424	IACIARA S2	31/10/2020 07:38	31/10/2020 13:35	31/10/2020 07:38	31/10/2020 13:35	5,97	70	417,63	CHI
202010184440	MINEIROS	MY21212545	PARQUE DAS EMAS	31/10/2020 07:38	31/10/2020 10:50	31/10/2020 07:38	31/10/2020 10:50	3,19	1	3,19	CHI
202010184444	CALDAS NOVAS	CN21245943	RIO QUENTE	31/10/2020 07:38	31/10/2020 11:17	31/10/2020 07:38	31/10/2020 11:17	3,63	1	3,63	CHI
202010184760	SERRANOPOLIS	SX12264387RE	JATAI S1	31/10/2020 07:38	31/10/2020 16:00	31/10/2020 07:38	31/10/2020 16:00	8,36	23	192,20	CHI
202010184760	JATAI	SX12264387RE	JATAI S1	31/10/2020 07:38	31/10/2020 16:00	31/10/2020 07:38	31/10/2020 16:00	8,36	7	58,49	CHI
202010184448	MINACU	6990000012	MINACU	31/10/2020 07:40	31/10/2020 10:47	31/10/2020 07:40	31/10/2020 10:47	3,12	1	3,12	CHI
202010184451	NIQUELANDIA	NQ121221876	NIQUELANDIA SUBTRANSMISSAO	31/10/2020 07:41	31/10/2020 11:38	31/10/2020 07:41	31/10/2020 11:38	3,95	1	3,95	CHI
202010184453	ITAPIRAPUA	IU21077212	JUSSARA	31/10/2020 07:42	31/10/2020 14:19	31/10/2020 07:42	31/10/2020 14:19	6,62	1	6,62	CHI
202010186021	CATALAO	TH12394023RE	CATALAO S2	31/10/2020 07:42	01/11/2020 09:26	31/10/2020 07:42	01/11/2020 09:26	25,73	42	1080,51	CHI
202010186021	GOIANDIRA	TH12394023RE	CATALAO S2	31/10/2020 07:42	01/11/2020 09:26	31/10/2020 07:42	01/11/2020 09:26	25,73	3	77,18	CHI
202010186021	CATALAO	TH12394023RE	CATALAO S1	31/10/2020 07:42	01/11/2020 09:26	31/10/2020 07:42	01/11/2020 09:26	25,73	122	3138,62	CHI
202010186021	TRES RANCHOS	TH12394023RE	CATALAO S1	31/10/2020 07:42	01/11/2020 09:26	31/10/2020 07:42	01/11/2020 09:26	25,73	1	25,73	CHI
202010186021	CUMARI	TH12394023RE	CATALAO S2	31/10/2020 07:42	01/11/2020 09:26	31/10/2020 07:42	01/11/2020 09:26	25,73	35	900,42	CHI
202010184622	NOVA ROMA	TE12284926	FLORES DE GOIAS	31/10/2020 07:42	31/10/2020 11:13	31/10/2020 07:42	31/10/2020 11:13	3,50	23	80,58	CHI
202010184622	TERESINA DE GOIAS	TE12284926	FLORES DE GOIAS	31/10/2020 07:42	31/10/2020 11:13	31/10/2020 07:42	31/10/2020 11:13	3,50	10	35,04	CHI
202010184462	SAO MIGUEL DO ARAGUAIA	SM12298142	SAO MIGUEL DO ARAGUAIA	31/10/2020 07:44	31/10/2020 09:43	31/10/2020 07:44	31/10/2020 09:43	1,98	6	11,87	CHI
202010185685	JATAI	JT12083658	JATAI S2	31/10/2020 07:44	31/10/2020 15:20	31/10/2020 07:44	31/10/2020 15:20	7,59	7	53,16	CHI
202010184466	CATALAO	CT12165146	CATALAO S1	31/10/2020 07:44	01/11/2020 09:59	31/10/2020 07:44	01/11/2020 09:59	26,24	23	603,60	CHI
202010184466	CAMPO ALEGRE DE GOIAS	CT12165146	CATALAO S1	31/10/2020 07:44	01/11/2020 09:59	31/10/2020 07:44	01/11/2020 09:59	26,24	2	52,49	CHI
202010184467	NIQUELANDIA	NQ12374575	NIQUELANDIA SUBTRANSMISSAO	31/10/2020 07:45	31/10/2020 11:51	31/10/2020 07:45	31/10/2020 11:51	4,10	12	49,20	CHI
202010184469	ALEXANIA	AX12082640	ALEXANIA	31/10/2020 07:45	31/10/2020 12:29	31/10/2020 07:45	31/10/2020 12:29	4,72	1	4,72	CHI
202010185127	PIRENOPOLIS	PV12362263	CORUMBA	31/10/2020 07:46	31/10/2020 18:54	31/10/2020 07:46	31/10/2020 18:54	11,13	13	144,70	CHI
202010184648	ALVORADA DO NORTE	AQ12078443	IACIARA S2	31/10/2020 07:46	01/11/2020 00:00	31/10/2020 07:46	01/11/2020 00:00	16,23	5	81,15	CHI
202010184474	JANDAIA	PP12312499RE	PALMEIRAS	31/10/2020 07:46	31/10/2020 11:31	31/10/2020 07:46	31/10/2020 11:31	3,74	29	108,58	CHI
202010184474	PALMINOPOLIS	PP12312499RE	PALMEIRAS	31/10/2020 07:46	31/10/2020 11:31	31/10/2020 07:46	31/10/2020 11:31	3,74	69	258,35	CHI
202010184479	MINEIROS	MY21102157	PARQUE DAS EMAS	31/10/2020 07:47	31/10/2020 10:01	31/10/2020 07:47	31/10/2020 10:01	2,22	1	2,22	CHI
202010184483	TRINDADE	10012426723	GOYA S2	31/10/2020 07:48	31/10/2020 10:00	31/10/2020 07:48	31/10/2020 10:00	2,19	1	2,19	CHI
202010184485	SAO LUIS DE MONTES BELOS	SL32145901	SAO LUIZ DOS MONTES BELOS	31/10/2020 07:48	31/10/2020 07:55	31/10/2020 07:48	31/10/2020 07:55	0,10	5	0,51	CHI
202010184484	COCALZINHO DE GOIAS	ZN21146712	COCALZINHO	31/10/2020 07:49	31/10/2020 23:03	31/10/2020 07:49	31/10/2020 23:03	15,23	1	15,23	CHI
202010184488	EDEIA	EA12383909	EDEIA	31/10/2020 07:49	31/10/2020 13:40	31/10/2020 07:49	31/10/2020 13:40	5,84	1	5,84	CHI
202010184489	OUVIDOR	CT12000069	CATALAO S1	31/10/2020 07:49	31/10/2020 09:38	31/10/2020 07:49	31/10/2020 09:38	1,80	2	3,60	CHI
202010184490	PIRACANJUBA	PJ21082266	PIRACANJUBA	31/10/2020 07:50	31/10/2020 11:59	31/10/2020 07:50	31/10/2020 11:59	4,15	2	8,30	CHI
202010184494	APARECIDA DO RIO DOCE	AW21360962	CABRIUVA S2	31/10/2020 07:50	31/10/2020 14:16	31/10/2020 07:50	31/10/2020 14:16	6,43	1	6,43	CHI
202010184502	PLANALTINA	TL12206256	SAO JOAO D ALIANCA	31/10/2020 07:51	31/10/2020 12:15	31/10/2020 07:51	31/10/2020 12:15	4,38	4	17,54	CHI

202010184697	AGUA FRIA DE GOIAS	PI12048037	SAO JOAO D ALIANCA	31/10/2020 07:52	31/10/2020 11:07	31/10/2020 07:52	31/10/2020 11:07	3,25	7	22,74	CHI
202010184516	HIDROLANDIA	HD21294039	ROCHEDO	31/10/2020 07:54	31/10/2020 10:56	31/10/2020 07:54	31/10/2020 10:56	3,02	1	3,02	CHI
202010185121	COCALZINHO DE GOIAS	ZN12285303	COCALZINHO	31/10/2020 07:54	31/10/2020 17:16	31/10/2020 07:54	31/10/2020 17:16	9,35	12	112,23	CHI
202010185989	NIQUELANDIA	NQ12210926	NIQUELANDIA SUBTRANSMISSAO	31/10/2020 07:55	01/11/2020 11:31	31/10/2020 07:55	01/11/2020 11:31	27,60	7	193,20	CHI
202010184763	JATAI	JT12234396	JATAI S1	31/10/2020 07:55	31/10/2020 16:49	31/10/2020 07:55	31/10/2020 16:49	8,89	9	79,97	CHI
202010185728	JATAI	JT12260493	JATAI S1	31/10/2020 07:56	31/10/2020 14:05	31/10/2020 07:56	31/10/2020 14:05	6,14	18	110,60	CHI
202010184528	NIQUELANDIA	NQ21181065	URUACU	31/10/2020 07:57	31/10/2020 11:04	31/10/2020 07:57	31/10/2020 11:04	3,12	1	3,12	CHI
202010185036	ITAPACI	IW12072411	ITAPACI	31/10/2020 07:57	31/10/2020 10:55	31/10/2020 07:57	31/10/2020 10:55	2,96	60	177,78	CHI
202010185036	GUARINOS	IW12072411	ITAPACI	31/10/2020 07:57	31/10/2020 10:55	31/10/2020 07:57	31/10/2020 10:55	2,96	20	59,26	CHI
202010184530	CRISTALINA	KR21163100	CRISTALINA S2	31/10/2020 07:57	31/10/2020 08:36	31/10/2020 07:57	31/10/2020 08:36	0,65	1	0,65	CHI
202010184537	NIQUELANDIA	NQ12222646	URUACU	31/10/2020 07:58	31/10/2020 10:59	31/10/2020 07:58	31/10/2020 10:59	3,00	8	24,01	CHI
202010184538	RIO VERDE	RV21303473	MONTIVIDIU T	31/10/2020 07:58	31/10/2020 11:38	31/10/2020 07:58	31/10/2020 11:38	3,65	1	3,65	CHI
202010184546	ARAGOIANA	AO11242732	INDEPENDENCIA S2	31/10/2020 08:00	31/10/2020 14:28	31/10/2020 08:00	31/10/2020 14:28	6,45	8	51,61	CHI
202010184556	PIRENOPOLIS	PV21273400	SAO FRANCISCO DE GOIAS	31/10/2020 08:03	31/10/2020 11:19	31/10/2020 08:03	31/10/2020 11:19	3,26	2	6,53	CHI
202010184561	GOIANIA	10006830135	GOIANIA LESTE S1	31/10/2020 08:04	31/10/2020 09:10	31/10/2020 08:04	31/10/2020 09:10	1,10	1	1,10	CHI
202010184610	JUSSARA	JR11009924	JUSSARA	31/10/2020 08:04	31/10/2020 14:50	31/10/2020 08:04	31/10/2020 14:50	6,76	49	331,28	CHI
202010184579	ARUANA	AK21183128	MOZARLANDIA	31/10/2020 08:06	31/10/2020 21:52	31/10/2020 08:06	31/10/2020 21:52	13,75	1	13,75	CHI
202010185069	NOVA CRIXAS	NA12057172	MOZARLANDIA	31/10/2020 08:06	01/11/2020 08:47	31/10/2020 08:06	01/11/2020 08:47	24,67	22	542,75	CHI
202010184882	SANTA TEREZA DE GOIAS	ET12143710	MARA ROSA	31/10/2020 08:07	31/10/2020 10:58	31/10/2020 08:07	31/10/2020 10:58	2,85	1	2,85	CHI
202010184882	ESTRELA DO NORTE	ET12143710	MARA ROSA	31/10/2020 08:07	31/10/2020 10:58	31/10/2020 08:07	31/10/2020 10:58	2,85	1	2,85	CHI
202010184590	PROFESSOR JAMIL SAFADY	JS12000039	PONTALINA	31/10/2020 08:08	01/11/2020 13:22	31/10/2020 08:08	01/11/2020 13:22	29,25	34	994,34	CHI
202010184596	ORIZONA	OZ21309666	PIRES DO RIO S2	31/10/2020 08:08	31/10/2020 11:32	31/10/2020 08:08	31/10/2020 11:32	3,39	1	3,39	CHI
202010184606	SENADOR CANEDO	BO12200299	GOIANIA LESTE S2	31/10/2020 08:09	31/10/2020 19:37	31/10/2020 08:09	31/10/2020 19:37	11,46	1	11,46	CHI
202010184606	SENADOR CANEDO	BO12200299	GOIANIA LESTE S2	31/10/2020 08:09	31/10/2020 19:37	31/10/2020 17:36	31/10/2020 19:37	2,02	3	6,07	CHI
202010184606	BONFINOPOLIS	BO12200299	GOIANIA LESTE S2	31/10/2020 08:09	31/10/2020 19:37	31/10/2020 17:36	31/10/2020 19:37	2,02	12	24,29	CHI
202010186354	FLORES DE GOIAS	FB12285966	FLORES DE GOIAS	31/10/2020 08:11	31/10/2020 18:31	31/10/2020 08:11	31/10/2020 18:31	10,33	63	650,97	CHI
202010184614	SILVANIA	SV21157227	DAIA S2	31/10/2020 08:11	31/10/2020 09:59	31/10/2020 08:11	31/10/2020 09:59	1,79	1	1,79	CHI
202010184615	JATAI	JT21191694	MONTIVIDIU T	31/10/2020 08:11	31/10/2020 13:22	31/10/2020 08:11	31/10/2020 13:22	5,18	1	5,18	CHI
202010184618	SILVANIA	SV12085397	VIANOPOLIS	31/10/2020 08:11	31/10/2020 12:22	31/10/2020 08:11	31/10/2020 12:22	4,17	20	83,34	CHI
202010184621	NIQUELANDIA	NQ21243548	URUACU	31/10/2020 08:12	31/10/2020 19:32	31/10/2020 08:12	31/10/2020 19:32	11,32	1	11,32	CHI
202010184912	SITIO D ABADIA	FB12245566	IACIARA S2	31/10/2020 08:13	31/10/2020 22:17	31/10/2020 08:13	31/10/2020 22:17	14,07	39	548,59	CHI
202010184912	FLORES DE GOIAS	FB12245566	IACIARA S2	31/10/2020 08:13	31/10/2020 22:17	31/10/2020 08:13	31/10/2020 22:17	14,07	73	1026,85	CHI
202010184977	AURILANDIA	RP12076381RE	FIRMINOPOLIS S2	31/10/2020 08:14	31/10/2020 22:47	31/10/2020 08:14	31/10/2020 22:47	14,55	4	58,19	CHI
202010184977	SAO JOAO DA PARAUNA	RP12076381RE	FIRMINOPOLIS S2	31/10/2020 08:14	31/10/2020 22:47	31/10/2020 08:14	31/10/2020 22:47	14,55	33	480,09	CHI
202010184635	URUACU	UR21094161	CAMPINORTE	31/10/2020 08:15	31/10/2020 17:57	31/10/2020 08:15	31/10/2020 17:57	9,69	4	38,76	CHI
202010184636	FORMOSA	10008167956	ITUIQUIRA	31/10/2020 08:15	31/10/2020 11:07	31/10/2020 08:15	31/10/2020 11:07	2,86	1	2,86	CHI
202010184642	AGUAS LINDAS DE GOIAS	10008468190	AGUAS LINDAS DE GOIAS S1	31/10/2020 08:16	31/10/2020 09:38	31/10/2020 08:16	31/10/2020 09:38	1,36	1	1,36	CHI
202010184646	APARECIDA DE GOIANIA	14762080	ATLANTICO S3	31/10/2020 08:17	31/10/2020 11:10	31/10/2020 08:17	31/10/2020 11:10	2,88	1	2,88	CHI
202010184804	MARA ROSA	MQ12051834	MARA ROSA	31/10/2020 08:17	31/10/2020 11:35	31/10/2020 08:17	31/10/2020 11:35	3,28	13	42,70	CHI
202010184791	FAINA	FC12147795	GOIAS	31/10/2020 08:18	31/10/2020 12:00	31/10/2020 08:18	31/10/2020 12:00	3,68	6	22,11	CHI
202010184658	JATAI	JT21234393	MONTIVIDIU T	31/10/2020 08:19	31/10/2020 21:02	31/10/2020 08:19	31/10/2020 21:02	12,71	1	12,71	CHI
202010184787	SANTA TEREZINHA DE GOIAS	SG12380710	SANTA TEREZINHA	31/10/2020 08:19	31/10/2020 14:16	31/10/2020 08:19	31/10/2020 14:16	5,94	8	47,51	CHI
202010184662	EDEIA	EA21171726	EDEIA	31/10/2020 08:19	31/10/2020 11:23	31/10/2020 08:19	31/10/2020 11:23	3,05	1	3,05	CHI
202010184668	SAO JOAO D ALIANCA	10002289960	SAO JOAO D ALIANCA	31/10/2020 08:20	31/10/2020 13:11	31/10/2020 08:20	31/10/2020 13:11	4,84	1	4,84	CHI
202010184670	SENADOR CANEDO	SW12092691	CEPAIGO S1	31/10/2020 08:20	31/10/2020 10:00	31/10/2020 08:20	31/10/2020 10:00	1,65	33	54,61	CHI
202010184673	FORMOSA	FA11264643	ITUIQUIRA	31/10/2020 08:20	31/10/2020 10:55	31/10/2020 08:20	31/10/2020 10:55	2,57	53	136,08	CHI
202010184679	NOVA GLORIA	NG12181400	ITAPACI	31/10/2020 08:21	31/10/2020 12:03	31/10/2020 08:21	31/10/2020 12:03	3,69	12	44,27	CHI
202010184681	FIRMINOPOLIS	900022723	FIRMINOPOLIS S1	31/10/2020 08:22	31/10/2020 18:19	31/10/2020 08:22	31/10/2020 18:19	9,93	1	9,93	CHI
202010184691	PIRENOPOLIS	PV31096556	SAO FRANCISCO DE GOIAS	31/10/2020 08:24	31/10/2020 11:23	31/10/2020 08:24	31/10/2020 11:23	2,98	1	2,98	CHI
202010184947	CRIXAS	CX12276573	SANTA TEREZINHA	31/10/2020 08:24	31/10/2020 23:50	31/10/2020 08:24	31/10/2020 23:50	15,43	10	154,28	CHI
202010184696	MINEIROS	MY21337063	PARQUE DAS EMAS	31/10/2020 08:24	31/10/2020 11:03	31/10/2020 08:24	31/10/2020 11:03	2,64	1	2,64	CHI

202010184702	NIQUELANDIA	NQ21234908	SAO JOAO D ALIANCA	31/10/2020 08:25	01/11/2020 21:25	31/10/2020 08:25	01/11/2020 21:25	36,99	2	73,98	CHI
202010184705	SANTA BARBARA DE GOIAS	6704336	TRINDADE	31/10/2020 08:25	31/10/2020 09:59	31/10/2020 08:25	31/10/2020 09:59	1,56	2	3,11	CHI
202010184709	TROMBAS	10003669171	MINACU	31/10/2020 08:26	02/11/2020 12:47	31/10/2020 08:26	02/11/2020 12:47	52,33	1	52,33	CHI
202010184781	TAQUARAL DE GOIAS	II12217217	ITABERAI S1	31/10/2020 08:27	31/10/2020 10:30	31/10/2020 08:27	31/10/2020 10:30	2,05	47	96,14	CHI
202010184781	ITAGUARI	II12217217	ITABERAI S1	31/10/2020 08:27	31/10/2020 10:30	31/10/2020 08:27	31/10/2020 10:30	2,05	42	85,91	CHI
202010184781	ITABERAI	II12217217	ITABERAI S1	31/10/2020 08:27	31/10/2020 10:30	31/10/2020 08:27	31/10/2020 10:30	2,05	22	45,00	CHI
202010184715	NIQUELANDIA	NQ21345032	NIQUELANDIA SUBTRANSMISSAO	31/10/2020 08:28	01/11/2020 12:30	31/10/2020 08:28	01/11/2020 12:30	28,03	1	28,03	CHI
202010184716	JARAGUA	JA12353260	GOIANESIA S2	31/10/2020 08:28	31/10/2020 11:04	31/10/2020 08:28	31/10/2020 11:04	2,60	95	246,58	CHI
202010184718	RIO VERDE	630528573	RIO VERDE S1	31/10/2020 08:28	31/10/2020 09:58	31/10/2020 08:28	31/10/2020 09:58	1,49	1	1,49	CHI
202010184729	PETROLINA DE GOIAS	PG21255972	SAO FRANCISCO DE GOIAS	31/10/2020 08:29	31/10/2020 10:52	31/10/2020 08:29	31/10/2020 10:52	2,37	2	4,74	CHI
202010184730	GOIANIA	14862530	CAMPINAS S1	31/10/2020 08:30	31/10/2020 11:59	31/10/2020 08:30	31/10/2020 11:59	3,48	1	3,48	CHI
202010185660	ARUANA	AK11183370	ARUANA	31/10/2020 08:31	31/10/2020 22:28	31/10/2020 08:31	31/10/2020 22:28	13,94	13	181,26	CHI
202010184744	PALESTINA DE GOIAS	PY12140029	IPORA	31/10/2020 08:32	31/10/2020 11:07	31/10/2020 08:32	31/10/2020 11:07	2,58	6	15,50	CHI
202010185117	COCALZINHO DE GOIAS	ZN12327436	GOIANESIA S1	31/10/2020 08:32	31/10/2020 13:44	31/10/2020 08:32	31/10/2020 13:44	5,19	14	72,70	CHI
202010185599	ARENOPOLIS	AY21332427	ARENOPOLIS	31/10/2020 08:32	31/10/2020 14:13	31/10/2020 08:32	31/10/2020 14:13	5,68	1	5,68	CHI
202010184749	SENADOR CANEDO	190116845	SENADOR CANEDO	31/10/2020 08:32	31/10/2020 10:48	31/10/2020 08:32	31/10/2020 10:48	2,26	1	2,26	CHI
202010184757	SENADOR CANEDO	SW12240932	CEPAIGO S1	31/10/2020 08:33	31/10/2020 13:37	31/10/2020 08:33	31/10/2020 13:37	5,06	10	50,57	CHI
202010186351	FLORES DE GOIAS	FB12249653	FLORES DE GOIAS	31/10/2020 08:34	31/10/2020 17:47	31/10/2020 08:34	31/10/2020 17:47	9,21	149	1371,92	CHI
202010184828	SAO MIGUEL DO ARAGUAIA	SM12276125	SAO MIGUEL DO ARAGUAIA	31/10/2020 08:34	31/10/2020 09:49	31/10/2020 08:34	31/10/2020 09:49	1,24	45	55,72	CHI
202010184780	INDIARA	EA12070748	EDEIA	31/10/2020 08:35	31/10/2020 13:49	31/10/2020 08:35	31/10/2020 13:49	5,23	1	5,23	CHI
202010184780	EDEIA	EA12070748	EDEIA	31/10/2020 08:35	31/10/2020 13:49	31/10/2020 08:35	31/10/2020 13:49	5,23	3	15,69	CHI
202010185090	RUBIATABA	RB12194289	RUBIATABA	31/10/2020 08:35	31/10/2020 11:28	31/10/2020 08:35	31/10/2020 11:28	2,87	1	2,87	CHI
202010184802	MORRINHOS	MR21242206	MORRINHOS	31/10/2020 08:36	31/10/2020 16:56	31/10/2020 08:36	31/10/2020 16:56	8,33	1	8,33	CHI
202010185184	MORRINHOS	MR12000150	MORRINHOS	31/10/2020 08:36	31/10/2020 11:47	31/10/2020 08:36	31/10/2020 11:47	3,18	27	85,93	CHI
202010184793	MIMOSO DE GOIAS	MJ21333308	PADRE BERNARDO	31/10/2020 08:37	31/10/2020 11:21	31/10/2020 08:37	31/10/2020 11:21	2,73	1	2,73	CHI
202010184798	GOIANIRA	390034265	GOIANIRA	31/10/2020 08:38	31/10/2020 11:15	31/10/2020 08:38	31/10/2020 11:15	2,61	1	2,61	CHI
202010184805	CAIAPONIA	CP21245905	CAIAPONIA	31/10/2020 08:39	31/10/2020 11:42	31/10/2020 08:39	31/10/2020 11:42	3,04	1	3,04	CHI
202010184830	ANAPOLIS	21164344	JUNDIAI S1	31/10/2020 08:41	31/10/2020 10:04	31/10/2020 08:41	31/10/2020 10:04	1,37	1	1,37	CHI
202010184831	ALTO PARAISO DE GOIAS	BF21048003	SAO JOAO D ALIANCA	31/10/2020 08:41	31/10/2020 10:50	31/10/2020 08:41	31/10/2020 10:50	2,13	1	2,13	CHI
202010185641	AMARALINA	MU12390125	MARA ROSA	31/10/2020 08:42	31/10/2020 16:45	31/10/2020 08:42	31/10/2020 16:45	8,05	1	8,05	CHI
202010185641	MUTUNOPOLIS	MU12390125	MARA ROSA	31/10/2020 08:42	31/10/2020 16:45	31/10/2020 08:42	31/10/2020 16:45	8,05	3	24,15	CHI
202010184880	CATALAO	CT12215663RE	CATALAO S1	31/10/2020 08:42	31/10/2020 17:35	31/10/2020 08:42	31/10/2020 17:35	8,88	7	62,17	CHI
202010184843	QUIRINOPOLIS	QI12100493	QUIRINOPOLIS	31/10/2020 08:43	31/10/2020 11:18	31/10/2020 08:43	31/10/2020 11:18	2,58	8	20,65	CHI
202010184843	PARANAIGUARA	QI12100493	QUIRINOPOLIS	31/10/2020 08:43	31/10/2020 11:18	31/10/2020 08:43	31/10/2020 11:18	2,58	3	7,74	CHI
202010184844	SENADOR CANEDO	190047161	SENADOR CANEDO	31/10/2020 08:43	31/10/2020 11:05	31/10/2020 08:43	31/10/2020 11:05	2,36	1	2,36	CHI
202010184851	JATAI	290028759	JATAI S2	31/10/2020 08:44	31/10/2020 11:12	31/10/2020 08:44	31/10/2020 11:12	2,46	1	2,46	CHI
202010184854	SILVANIA	AN12241525	DAIA S2	31/10/2020 08:45	31/10/2020 10:35	31/10/2020 08:45	31/10/2020 10:35	1,83	1	1,83	CHI
202010184855	CATALAO	CT1131358	CATALAO S1	31/10/2020 08:45	31/10/2020 15:05	31/10/2020 08:45	31/10/2020 15:05	6,33	1	6,33	CHI
202010184859	JATAI	290321268	JATAI S2	31/10/2020 08:45	31/10/2020 09:59	31/10/2020 08:45	31/10/2020 09:59	1,22	1	1,22	CHI
202010184860	SANTO ANTONIO DA BARRA	BZ21279456	ACREUNA	31/10/2020 08:45	31/10/2020 11:28	31/10/2020 08:45	31/10/2020 11:28	2,70	1	2,70	CHI
202010185126	COCALZINHO DE GOIAS	ZN11090216	COCALZINHO	31/10/2020 08:45	31/10/2020 12:21	31/10/2020 08:45	31/10/2020 12:21	3,59	96	344,37	CHI
202010186418	ACREUNA	JD12323641LD	ACREUNA	31/10/2020 08:46	01/11/2020 13:46	01/11/2020 09:10	01/11/2020 13:46	4,60	7	32,18	CHI
202010186418	INDIARA	JD12323641LD	ACREUNA	31/10/2020 08:46	01/11/2020 13:46	01/11/2020 09:10	01/11/2020 13:46	4,60	22	101,15	CHI
202010184865	SANTO ANTONIO DO DESCOBERTO	2210136125	AGUAS LINDAS DE GOIAS S2	31/10/2020 08:46	31/10/2020 11:10	31/10/2020 08:46	31/10/2020 11:10	2,39	1	2,39	CHI
202010185495	POSSE	PS12257688	IACIARA S2	31/10/2020 08:46	31/10/2020 18:26	31/10/2020 08:46	31/10/2020 18:26	9,65	23	221,96	CHI
202010186418	ACREUNA	JD12323641LD	ACREUNA	31/10/2020 08:46	01/11/2020 13:46	01/11/2020 08:26	01/11/2020 08:26	23,67	7	165,67	CHI
202010186418	INDIARA	JD12323641LD	ACREUNA	31/10/2020 08:46	01/11/2020 13:46	01/11/2020 08:26	01/11/2020 08:26	23,67	22	520,67	CHI
202010184868	CRISTALINA	KR12219621	PAMPLONA	31/10/2020 08:47	31/10/2020 14:20	31/10/2020 08:47	31/10/2020 14:20	5,55	3	16,65	CHI
202010184870	RIO VERDE	630025460	RIO VERDE S2	31/10/2020 08:47	31/10/2020 10:00	31/10/2020 08:47	31/10/2020 10:00	1,21	1	1,21	CHI
202010184875	RIO VERDE	10010432149	CABRIUVA S1	31/10/2020 08:47	31/10/2020 10:42	31/10/2020 08:47	31/10/2020 10:42	1,91	1	1,91	CHI
202010184877	BOM JESUS DE GOIAS	1250010140	BOM JESUS DE GOIAS	31/10/2020 08:47	31/10/2020 18:45	31/10/2020 08:47	31/10/2020 18:45	9,95	1	9,95	CHI

202010184881	URUTAI	UT21283586	URUTAI	31/10/2020 08:49	31/10/2020 11:17	31/10/2020 08:49	31/10/2020 11:17	2,46	1	2,46	CHI
202010184883	SAO JOAO D ALIANCA	JL11130018	SAO JOAO D ALIANCA	31/10/2020 08:49	01/11/2020 11:10	31/10/2020 08:49	01/11/2020 11:10	26,34	6	158,07	CHI
202010184894	MINEIROS	1390054515	PARQUE DAS EMAS	31/10/2020 08:51	31/10/2020 12:02	31/10/2020 08:51	31/10/2020 12:02	3,18	1	3,18	CHI
202010185413	GOIAS	GS12073686	MATRINCHA	31/10/2020 08:52	01/11/2020 09:12	31/10/2020 08:52	01/11/2020 09:12	24,33	5	121,66	CHI
202010184910	MAURILANDIA	ML32191806	RIO DOS BOIS	31/10/2020 08:52	31/10/2020 14:58	31/10/2020 08:52	31/10/2020 14:58	6,08	32	194,68	CHI
202010184910	RIO VERDE	ML32191806	RIO DOS BOIS	31/10/2020 08:52	31/10/2020 14:58	31/10/2020 08:52	31/10/2020 14:58	6,08	12	73,01	CHI
202010184914	CRISTALINA	KR21147562	CRISTALINA S2	31/10/2020 08:53	31/10/2020 11:28	31/10/2020 08:53	31/10/2020 11:28	2,58	1	2,58	CHI
202010184918	APARECIDA DE GOIANIA	AP21004840	REAL S1	31/10/2020 08:54	31/10/2020 10:02	31/10/2020 08:54	31/10/2020 10:02	1,12	1	1,12	CHI
202010184919	VILA PROPICIO	PV12396662	GOIANESIA S1	31/10/2020 08:54	31/10/2020 17:17	31/10/2020 08:54	31/10/2020 17:17	8,37	5	41,87	CHI
202010184929	MAURILANDIA	10003894094	RIO DOS BOIS	31/10/2020 08:55	31/10/2020 13:35	31/10/2020 08:55	31/10/2020 13:35	4,66	1	4,66	CHI
202010184930	GOIANIA	40117121	MEIA PONTE	31/10/2020 08:55	31/10/2020 10:23	31/10/2020 08:55	31/10/2020 10:23	1,46	1	1,46	CHI
202010184936	FORMOSA	610294830	ITIQUEIRA	31/10/2020 08:55	31/10/2020 13:48	31/10/2020 08:55	31/10/2020 13:48	4,87	1	4,87	CHI
202010184944	BRITANIA	BT12284747	BRITANIA	31/10/2020 08:57	31/10/2020 20:31	31/10/2020 08:57	31/10/2020 20:31	11,56	31	358,33	CHI
202010187778	FLORES DE GOIAS	FB12361373	FLORES DE GOIAS	31/10/2020 08:57	31/10/2020 19:29	31/10/2020 08:57	31/10/2020 19:29	10,52	95	999,37	CHI
202010184949	CABECEIRAS	CW12108823	ITIQUEIRA	31/10/2020 08:58	31/10/2020 13:01	31/10/2020 08:58	31/10/2020 13:01	4,04	8	32,34	CHI
202010186087	ITAPURANGA	FC12160891	GOIAS	31/10/2020 08:58	31/10/2020 20:40	31/10/2020 08:58	31/10/2020 20:40	11,69	2	23,38	CHI
202010186087	FAINA	FC12160891	GOIAS	31/10/2020 08:58	31/10/2020 20:40	31/10/2020 08:58	31/10/2020 20:40	11,69	13	151,99	CHI
202010186087	MORRO AGUDO DE GOIAS	FC12160891	GOIAS	31/10/2020 08:58	31/10/2020 20:40	31/10/2020 08:58	31/10/2020 20:40	11,69	2	23,38	CHI
202010184954	EDEIA	ED12096861	EDEIA	31/10/2020 08:59	31/10/2020 10:52	31/10/2020 08:59	31/10/2020 10:52	1,88	2	3,76	CHI
202010184959	COCALZINHO DE GOIAS	ZN21155091	COCALZINHO	31/10/2020 08:59	31/10/2020 14:06	31/10/2020 08:59	31/10/2020 14:06	5,10	1	5,10	CHI
202010184967	CIDADE OCIDENTAL	DH12304760	MARAJOARA	31/10/2020 09:01	31/10/2020 12:43	31/10/2020 09:01	31/10/2020 12:43	3,69	1	3,69	CHI
202010184970	VALPARAISO DE GOIAS	10010071766	PACAEMBU S2	31/10/2020 09:02	31/10/2020 10:54	31/10/2020 09:02	31/10/2020 10:54	1,86	1	1,86	CHI
202010184973	PLANALTINA	2960023750	PLANALTINA	31/10/2020 09:02	31/10/2020 11:04	31/10/2020 09:02	31/10/2020 11:04	2,02	1	2,02	CHI
202010184983	PADRE BERNARDO	9980002274	PADRE BERNARDO	31/10/2020 09:04	31/10/2020 10:49	31/10/2020 09:04	31/10/2020 10:49	1,73	1	1,73	CHI
202010184989	RIO VERDE	RV21267631	RIO VERDE S1	31/10/2020 09:06	31/10/2020 11:32	31/10/2020 09:06	31/10/2020 11:32	2,43	1	2,43	CHI
202010184990	PIRACANJUBA	60072180	PIRACANJUBA	31/10/2020 09:06	31/10/2020 18:32	31/10/2020 09:06	31/10/2020 18:32	9,43	1	9,43	CHI
202010185372	FORMOSA	FA12096349	ITIQUEIRA	31/10/2020 09:06	31/10/2020 19:53	31/10/2020 09:06	31/10/2020 19:53	10,78	16	172,49	CHI
202010185643	NIQUELANDIA	NQ12295506	NIQUELANDIA SUBTRANSMISSAO	31/10/2020 09:08	01/11/2020 15:14	31/10/2020 09:08	01/11/2020 15:14	30,09	3	90,26	CHI
202010185002	ALEXANIA	AX21273226	ALEXANIA	31/10/2020 09:09	31/10/2020 13:38	31/10/2020 09:09	31/10/2020 13:38	4,48	1	4,48	CHI
202010185003	ACREUNA	EU21026460	ACREUNA	31/10/2020 09:09	31/10/2020 11:10	31/10/2020 09:09	31/10/2020 11:10	2,02	1	2,02	CHI
202010185004	APARECIDA DE GOIANIA	200580504	ANHANGUERA	31/10/2020 09:09	31/10/2020 10:18	31/10/2020 09:09	31/10/2020 10:18	1,15	1	1,15	CHI
202010185010	GOIANIA	13934405	REAL S2	31/10/2020 09:10	31/10/2020 12:34	31/10/2020 09:10	31/10/2020 12:34	3,39	1	3,39	CHI
202010185011	GOIANIA	8519025	XAVANTES	31/10/2020 09:10	31/10/2020 17:23	31/10/2020 09:10	31/10/2020 17:23	8,20	15	123,06	CHI
202010185014	SANTA HELENA DE GOIAS	RV12222621	RIO VERDE S2	31/10/2020 09:10	31/10/2020 12:37	31/10/2020 09:10	31/10/2020 12:37	3,43	68	233,58	CHI
202010185014	RIO VERDE	RV12222621	RIO VERDE S2	31/10/2020 09:10	31/10/2020 12:37	31/10/2020 09:10	31/10/2020 12:37	3,43	14	48,09	CHI
202010185015	VILA PROPICIO	GE21135231	GOIANESIA S1	31/10/2020 09:11	31/10/2020 11:49	31/10/2020 09:11	31/10/2020 11:49	2,63	1	2,63	CHI
202010185021	GOIANIA	10302888	CAMPINAS S2	31/10/2020 09:11	31/10/2020 10:53	31/10/2020 09:11	31/10/2020 10:53	1,69	1	1,69	CHI
202010185277	IACIARA	IA12257569	IACIARA S1	31/10/2020 09:11	31/10/2020 15:16	31/10/2020 09:11	31/10/2020 15:16	6,07	19	115,30	CHI
202010185024	CRISTALINA	KR12305009	PAMPLONA	31/10/2020 09:12	31/10/2020 10:38	31/10/2020 09:12	31/10/2020 10:38	1,43	6	8,59	CHI
202010185029	URUACU	10032716573	URUACU	31/10/2020 09:12	01/11/2020 01:38	31/10/2020 09:12	01/11/2020 01:38	16,42	1	16,42	CHI
202010185030	FAZENDA NOVA	FN12113509	IPORA	31/10/2020 09:12	31/10/2020 16:48	31/10/2020 09:12	31/10/2020 16:48	7,58	36	273,05	CHI
202010185033	AURILANDIA	AI21000016	FIRMINOPOLIS S2	31/10/2020 09:13	01/11/2020 07:32	31/10/2020 09:13	01/11/2020 07:32	22,31	1	22,31	CHI
202010185034	GOIANIA	12157170	GOYA S2	31/10/2020 09:13	31/10/2020 10:56	31/10/2020 09:13	31/10/2020 10:56	1,70	1	1,70	CHI
202010185037	RIO VERDE	RV21200704	CACHOEIRA ALTA	31/10/2020 09:14	31/10/2020 11:42	31/10/2020 09:14	31/10/2020 11:42	2,46	1	2,46	CHI
202010185041	LEOPOLDO DE BULHOES	LB21279271	CEPAIGO S2	31/10/2020 09:15	31/10/2020 10:26	31/10/2020 09:15	31/10/2020 10:26	1,18	1	1,18	CHI
202010185042	INACIOLANDIA	ID12128107	QUIRINOPOLIS	31/10/2020 09:15	31/10/2020 11:16	31/10/2020 09:15	31/10/2020 11:16	2,01	15	30,15	CHI
202010185046	PLANALTINA	10017015357	PLANALTINA	31/10/2020 09:16	31/10/2020 13:39	31/10/2020 09:16	31/10/2020 13:39	4,37	1	4,37	CHI
202010185052	SAO JOAO D ALIANCA	JL12268121	SAO JOAO D ALIANCA	31/10/2020 09:17	01/11/2020 08:39	31/10/2020 09:17	01/11/2020 08:39	23,36	6	140,13	CHI
202010185054	ITUMBIARA	690037077	ITUMBIARA NOVA	31/10/2020 09:17	31/10/2020 11:00	31/10/2020 09:17	31/10/2020 11:00	1,70	1	1,70	CHI
202010185058	MORRINHOS	MR21122171	MORRINHOS	31/10/2020 09:18	31/10/2020 14:56	31/10/2020 09:18	31/10/2020 14:56	5,62	1	5,62	CHI
202010185712	SAO LUIS DE MONTES BELOS	SL12011302	FIRMINOPOLIS S2	31/10/2020 09:19	31/10/2020 20:00	31/10/2020 09:19	31/10/2020 20:00	10,69	9	96,19	CHI

202010185068	NOVA VENEZA	300026109	INHUMAS S1	31/10/2020 09:20	31/10/2020 11:57	31/10/2020 09:20	31/10/2020 11:57	2,62	1	2,62	CHI
202010185073	HIDROLANDIA	HD13376852	CEPAIGO S2	31/10/2020 09:21	31/10/2020 17:30	31/10/2020 09:21	31/10/2020 17:30	8,14	6	48,84	CHI
202010185073	HIDROLANDIA	HD13376852	CEPAIGO S2	31/10/2020 09:21	31/10/2020 17:30	31/10/2020 15:09	31/10/2020 17:30	2,35	2	4,69	CHI
202010185078	SANTA CRUZ DE GOIAS	BC12300692	PIRES DO RIO S2	31/10/2020 09:22	01/11/2020 02:24	31/10/2020 09:22	01/11/2020 02:24	17,03	10	170,34	CHI
202010185083	GOIANIA	15369882	GOIANIA LESTE S1	31/10/2020 09:23	31/10/2020 10:26	31/10/2020 09:23	31/10/2020 10:26	1,04	1	1,04	CHI
202010185415	MINEIROS	MY12360820	PARQUE DAS EMAS	31/10/2020 09:23	31/10/2020 14:51	31/10/2020 09:23	31/10/2020 14:51	5,46	9	49,16	CHI
202010185087	SANTO ANTONIO DE GOIAS	GR21322839	NEROPOLIS S1	31/10/2020 09:23	31/10/2020 18:59	31/10/2020 09:23	31/10/2020 18:59	9,59	1	9,59	CHI
202010185091	SANTO ANTONIO DO DESCOBERTO	2210165770	AGUAS LINDAS DE GOIAS S2	31/10/2020 09:25	31/10/2020 12:43	31/10/2020 09:25	31/10/2020 12:43	3,30	1	3,30	CHI
202010185095	SAO JOAO D ALIANCA	JL21320608	SAO JOAO D ALIANCA	31/10/2020 09:25	01/11/2020 11:20	31/10/2020 09:25	01/11/2020 11:20	25,90	1	25,90	CHI
202010185098	GOIATUBA	140055939	GOIATUBA S2	31/10/2020 09:26	31/10/2020 11:31	31/10/2020 09:26	31/10/2020 11:31	2,08	1	2,08	CHI
202010185101	BARRO ALTO	BA21353566	BARRO ALTO	31/10/2020 09:26	31/10/2020 12:00	31/10/2020 09:26	31/10/2020 12:00	2,56	2	5,13	CHI
202010185392	JATAI	JT12106003	JATAI S2	31/10/2020 09:27	31/10/2020 18:08	31/10/2020 09:27	31/10/2020 18:08	8,67	4	34,68	CHI
202010185111	COCALZINHO DE GOIAS	10007489810	COCALZINHO	31/10/2020 09:28	31/10/2020 18:46	31/10/2020 09:28	31/10/2020 18:46	9,30	1	9,30	CHI
202010185116	RIO VERDE	10009941329	RIO VERDE S1	31/10/2020 09:29	31/10/2020 11:27	31/10/2020 09:29	31/10/2020 11:27	1,95	1	1,95	CHI
202010185353	CATALAO	CT12266758	CATALAO S1	31/10/2020 09:30	31/10/2020 13:53	31/10/2020 09:30	31/10/2020 13:53	4,37	47	205,52	CHI
202010185122	GOIAS	GS12071261	GOIAS	31/10/2020 09:31	31/10/2020 12:04	31/10/2020 09:31	31/10/2020 12:04	2,54	7	17,81	CHI
202010185123	PANAMA	PX12375443	GOIATUBA S1	31/10/2020 09:31	31/10/2020 10:48	31/10/2020 09:31	31/10/2020 10:48	1,28	3	3,83	CHI
202010185124	MORRINHOS	MR21000069	MORRINHOS	31/10/2020 09:31	31/10/2020 11:47	31/10/2020 09:31	31/10/2020 11:47	2,25	1	2,25	CHI
202010185130	SAO JOAO DA PARAUNA	1000006170	FIRMINOPOLIS S2	31/10/2020 09:32	31/10/2020 17:07	31/10/2020 09:32	31/10/2020 17:07	7,57	1	7,57	CHI
202010185133	PADRE BERNARDO	PB12330893	PADRE BERNARDO	31/10/2020 09:33	31/10/2020 11:43	31/10/2020 09:33	31/10/2020 11:43	2,16	4	8,63	CHI
202010185139	SILVANIA	AN21214687	DAIA S2	31/10/2020 09:34	31/10/2020 11:11	31/10/2020 09:34	31/10/2020 11:11	1,61	1	1,61	CHI
202010185142	COCALZINHO DE GOIAS	CB12051786LD	GOIANESIA S1	31/10/2020 09:35	31/10/2020 15:11	31/10/2020 09:35	31/10/2020 15:11	5,60	99	553,91	CHI
202010185143	COLINAS DO SUL	TI12277661	MINACU	31/10/2020 09:35	01/11/2020 03:58	31/10/2020 09:35	01/11/2020 03:58	18,38	10	183,75	CHI
202010185169	ARUANA	AK12310710	ARUANA	31/10/2020 09:35	31/10/2020 12:00	31/10/2020 09:35	31/10/2020 12:00	2,41	21	50,54	CHI
202010185151	SAO JOAO D ALIANCA	JL21106966	SAO JOAO D ALIANCA	31/10/2020 09:36	01/11/2020 13:59	31/10/2020 09:36	01/11/2020 13:59	28,37	1	28,37	CHI
202010186576	FORMOSO	CR12172326	MARA ROSA	31/10/2020 09:37	01/11/2020 13:22	31/10/2020 09:37	01/11/2020 13:22	27,75	3	83,24	CHI
202010186576	CAMPINORTE	CR12172326	MARA ROSA	31/10/2020 09:37	01/11/2020 13:22	31/10/2020 09:37	01/11/2020 13:22	27,75	3	83,24	CHI
202010185156	ANAPOLIS	20694581	JUNDIAI S1	31/10/2020 09:37	31/10/2020 11:38	31/10/2020 09:37	31/10/2020 11:38	2,01	1	2,01	CHI
202010185163	GOIANIA	10005268263	GOYA S1	31/10/2020 09:38	31/10/2020 11:35	31/10/2020 09:38	31/10/2020 11:35	1,94	1	1,94	CHI
202010185164	RIO VERDE	630170368	RIO VERDE S1	31/10/2020 09:38	31/10/2020 11:39	31/10/2020 09:38	31/10/2020 11:39	2,01	1	2,01	CHI
202010185166	VILA PROPICIO	GE21213555	GOIANESIA S1	31/10/2020 09:38	31/10/2020 15:38	31/10/2020 09:38	31/10/2020 15:38	5,99	1	5,99	CHI
202010185171	FLORES DE GOIAS	FB21426821	IACIARA S2	31/10/2020 09:39	31/10/2020 20:40	31/10/2020 09:39	31/10/2020 20:40	11,01	1	11,01	CHI
202010185175	ARUANA	AK21220010	MOZARLANDIA	31/10/2020 09:40	31/10/2020 21:59	31/10/2020 09:40	31/10/2020 21:59	12,32	2	24,63	CHI
202010185177	CAVALCANTE	CJ12396780LD	MINACU	31/10/2020 09:40	01/11/2020 02:54	31/10/2020 09:40	01/11/2020 02:54	17,23	261	4497,61	CHI
202010185177	CAVALCANTE	CJ12396780LD	MINACU	31/10/2020 09:40	01/11/2020 02:54	31/10/2020 23:33	01/11/2020 02:54	3,35	1	3,35	CHI
202010185179	RIO VERDE	RV12230829	MONTIVIDIU T	31/10/2020 09:40	31/10/2020 16:01	31/10/2020 09:40	31/10/2020 16:01	6,34	17	107,76	CHI
202010185190	PONTALINA	PK21223285	VICENTINOPOLIS	31/10/2020 09:42	31/10/2020 13:14	31/10/2020 09:42	31/10/2020 13:14	3,53	1	3,53	CHI
202010185191	PADRE BERNARDO	ZN12216782	PADRE BERNARDO	31/10/2020 09:42	31/10/2020 17:55	31/10/2020 09:42	31/10/2020 17:55	8,22	3	24,66	CHI
202010185191	COCALZINHO DE GOIAS	ZN12216782	PADRE BERNARDO	31/10/2020 09:42	31/10/2020 17:55	31/10/2020 09:42	31/10/2020 17:55	8,22	58	476,78	CHI
202010185752	ITABERA	IB12274556	ITABERAI S2	31/10/2020 09:42	31/10/2020 14:21	31/10/2020 09:42	31/10/2020 14:21	4,64	11	51,04	CHI
202010185194	ITAPIRAPUA	IU12072448	MATRINCHA	31/10/2020 09:42	31/10/2020 20:43	31/10/2020 09:42	31/10/2020 20:43	11,01	2	22,01	CHI
202010185196	ITUMBIARA	IT21034566	ITUMBIARA NOVA	31/10/2020 09:42	31/10/2020 12:58	31/10/2020 09:42	31/10/2020 12:58	3,25	1	3,25	CHI
202010187322	SERRANOPOLIS	SX12037674	JATAI S1	31/10/2020 09:43	01/11/2020 01:13	31/10/2020 09:43	01/11/2020 01:13	15,49	38	588,47	CHI
202010185209	ITAPIRAPUA	IU12018738	MATRINCHA	31/10/2020 09:44	31/10/2020 13:22	31/10/2020 09:44	31/10/2020 13:22	3,62	1	3,62	CHI
202010185212	ARENOPOLIS	1920002057	ARENOPOLIS	31/10/2020 09:45	31/10/2020 15:16	31/10/2020 09:45	31/10/2020 15:16	5,51	1	5,51	CHI
202010185215	APORE	AE21136299	ITAJA S1	31/10/2020 09:45	31/10/2020 13:23	31/10/2020 09:45	31/10/2020 13:23	3,62	1	3,62	CHI
202010185218	APARECIDA DE GOIANIA	200314610	INDEPENDENCIA S1	31/10/2020 09:46	31/10/2020 13:45	31/10/2020 09:46	31/10/2020 13:45	3,98	1	3,98	CHI
202010185220	MARA ROSA	MQ12051065	MARA ROSA	31/10/2020 09:46	31/10/2020 11:07	31/10/2020 09:46	31/10/2020 11:07	1,34	23	30,74	CHI
202010185246	INHUMAS	IN21221097	ARACU	31/10/2020 09:46	31/10/2020 17:33	31/10/2020 09:46	31/10/2020 17:33	7,77	1	7,77	CHI
202010185247	JATAI	JT21135391	JATAI S1	31/10/2020 09:47	31/10/2020 16:24	31/10/2020 09:47	31/10/2020 16:24	6,61	1	6,61	CHI
202010185249	SANTA ROSA DE GOIAS	SR12107586	INHUMAS S1	31/10/2020 09:47	31/10/2020 14:00	31/10/2020 09:47	31/10/2020 14:00	4,21	62	261,19	CHI

202010185251	APARECIDA DE GOIANIA	10014168756	REAL S1	31/10/2020 09:47	31/10/2020 11:23	31/10/2020 09:47	31/10/2020 11:23	1,59	1	1,59	CHI
202010185255	SAO MIGUEL DO ARAGUAIA	SM21170931	SAO MIGUEL DO ARAGUAIA	31/10/2020 09:47	31/10/2020 12:51	31/10/2020 09:47	31/10/2020 12:51	3,05	1	3,05	CHI
202010185258	LUZIANIA	10025235328	RIO VERMELHO	31/10/2020 09:47	31/10/2020 13:33	31/10/2020 09:47	31/10/2020 13:33	3,75	1	3,75	CHI
202010185265	GOIANIA	11162752	CAMPINAS S2	31/10/2020 09:48	31/10/2020 14:22	31/10/2020 09:48	31/10/2020 14:22	4,56	1	4,56	CHI
202010185267	ITAUCU	IX21148254	INHUMAS S1	31/10/2020 09:48	31/10/2020 12:45	31/10/2020 09:48	31/10/2020 12:45	2,94	1	2,94	CHI
202010185271	LEOPOLDO DE BULHOES	LB21249450	DAIA S2	31/10/2020 09:49	31/10/2020 13:25	31/10/2020 09:49	31/10/2020 13:25	3,59	1	3,59	CHI
202010185286	SENADOR CANEDO	SW12402763	SENADOR CANEDO	31/10/2020 09:51	31/10/2020 11:42	31/10/2020 09:51	31/10/2020 11:42	1,83	127	232,97	CHI
202010185290	BELA VISTA DE GOIAS	BV21156519	SENADOR CANEDO	31/10/2020 09:52	31/10/2020 11:05	31/10/2020 09:52	31/10/2020 11:05	1,21	2	2,42	CHI
202010185302	RIO VERDE	RV21260733	RIO VERDE S1	31/10/2020 09:53	31/10/2020 12:09	31/10/2020 09:53	31/10/2020 12:09	2,25	1	2,25	CHI
202010185303	PADRE BERNARDO	PB12095000	PADRE BERNARDO	31/10/2020 09:53	01/11/2020 13:21	31/10/2020 09:53	31/10/2020 13:46	3,87	7	27,12	CHI
202010185303	PADRE BERNARDO	PB12382940LD	PADRE BERNARDO	31/10/2020 09:53	01/11/2020 13:21	31/10/2020 09:53	31/10/2020 16:57	7,06	10	70,59	CHI
202010185303	VILA PROPICIO	PB12382940LD	PADRE BERNARDO	31/10/2020 09:53	01/11/2020 13:21	31/10/2020 09:53	31/10/2020 16:57	7,06	7	49,41	CHI
202010185303	PADRE BERNARDO	PB12346973	PADRE BERNARDO	31/10/2020 09:53	01/11/2020 13:21	31/10/2020 09:53	31/10/2020 20:29	10,60	1	10,60	CHI
202010185303	MIMOSO DE GOIAS	PB12333289	PADRE BERNARDO	31/10/2020 09:53	01/11/2020 13:21	31/10/2020 09:53	01/11/2020 11:51	25,96	5	129,81	CHI
202010185303	PADRE BERNARDO	PB12333289	PADRE BERNARDO	31/10/2020 09:53	01/11/2020 13:21	31/10/2020 09:53	01/11/2020 11:51	25,96	1	25,96	CHI
202010185303	MIMOSO DE GOIAS	MJ12333277	PADRE BERNARDO	31/10/2020 09:53	01/11/2020 13:21	31/10/2020 09:53	01/11/2020 13:21	27,46	5	137,29	CHI
202010185305	GUARAITA	GK21220205	ITAPURANGA	31/10/2020 09:53	31/10/2020 20:41	31/10/2020 09:53	31/10/2020 20:41	10,78	1	10,78	CHI
202010185308	APARECIDA DE GOIANIA	AP12013981	ANHANGUERA	31/10/2020 09:54	31/10/2020 12:19	31/10/2020 09:54	31/10/2020 12:19	2,41	30	72,33	CHI
202010185313	SAO LUIS DE MONTES BELOS	SC12024019	SAO LUIZ DOS MONTES BELOS	31/10/2020 09:55	01/11/2020 10:26	31/10/2020 09:55	01/11/2020 10:26	24,51	3	73,54	CHI
202010185321	MONTES CLAROS DE GOIAS	ME11349045	IPORA	31/10/2020 09:55	31/10/2020 15:24	31/10/2020 09:55	31/10/2020 15:24	5,47	43	235,17	CHI
202010185326	CAIAPONIA	CP11245323	CAIAPONIA	31/10/2020 09:56	31/10/2020 11:38	31/10/2020 09:56	31/10/2020 11:38	1,68	1	1,68	CHI
202010185327	ARENOPOLIS	AY21246894	IPORA	31/10/2020 09:56	31/10/2020 12:06	31/10/2020 09:56	31/10/2020 12:06	2,15	1	2,15	CHI
202010185337	LUZIANIA	OZ21212480	PIRES DO RIO S2	31/10/2020 09:57	31/10/2020 13:14	31/10/2020 09:57	31/10/2020 13:14	3,28	1	3,28	CHI
202010185330	APORE	AE21161262	ITAJA S1	31/10/2020 09:57	31/10/2020 11:17	31/10/2020 09:57	31/10/2020 11:17	1,32	1	1,32	CHI
202010185556	CORUMBA DE GOIAS	AX12000153	CORUMBA	31/10/2020 09:58	31/10/2020 22:40	31/10/2020 09:58	31/10/2020 22:40	12,69	10	126,86	CHI
202010185377	URUACU	UR12210930	URUACU	31/10/2020 09:59	01/11/2020 08:28	31/10/2020 09:59	01/11/2020 08:28	22,48	11	247,31	CHI
202010185340	GOIATUBA	GT21143909	GOIATUBA S2	31/10/2020 09:59	31/10/2020 11:50	31/10/2020 09:59	31/10/2020 11:50	1,85	1	1,85	CHI
202010185342	GAMELEIRA DE GOIAS	SV21127400	DAIA S2	31/10/2020 09:59	31/10/2020 12:30	31/10/2020 09:59	31/10/2020 12:30	2,51	1	2,51	CHI
202010188526	COCALZINHO DE GOIAS	ZN12319615	COCALZINHO	31/10/2020 09:59	01/11/2020 12:46	31/10/2020 09:59	01/11/2020 12:46	26,77	22	588,97	CHI
202010185350	HIDROLINA	1020012125	URUACU	31/10/2020 09:59	31/10/2020 12:33	31/10/2020 09:59	31/10/2020 12:33	2,55	1	2,55	CHI
202010185351	ITAPURANGA	IK21183118	ITAPURANGA	31/10/2020 10:00	01/11/2020 13:49	31/10/2020 10:00	01/11/2020 13:49	27,81	1	27,81	CHI
202010187149	MUNDO NOVO DE GOIAS	MH12035583	NOVA CRIXAS	31/10/2020 10:00	01/11/2020 19:13	31/10/2020 10:00	01/11/2020 19:13	33,20	44	1461,00	CHI
202010187357	MUNDO NOVO DE GOIAS	MH11269734	NOVA CRIXAS	31/10/2020 10:00	02/11/2020 09:55	31/10/2020 10:00	02/11/2020 09:55	47,90	1	47,90	CHI
202010185994	NOVO PLANALTO	SM12074386RE	SAO MIGUEL DO ARAGUAIA	31/10/2020 10:01	02/11/2020 14:56	01/11/2020 07:57	01/11/2020 09:59	2,04	6	12,26	CHI
202010185994	SAO MIGUEL DO ARAGUAIA	SM12074386RE	SAO MIGUEL DO ARAGUAIA	31/10/2020 10:01	02/11/2020 14:56	01/11/2020 07:57	01/11/2020 09:59	2,04	2	4,09	CHI
202010185994	SAO MIGUEL DO ARAGUAIA	SM12074386RE	SAO MIGUEL DO ARAGUAIA	31/10/2020 10:01	02/11/2020 14:56	01/11/2020 07:57	01/11/2020 13:45	5,81	6	34,88	CHI
202010185994	SAO MIGUEL DO ARAGUAIA	SM13315124	SAO MIGUEL DO ARAGUAIA	31/10/2020 10:01	02/11/2020 14:56	01/11/2020 07:57	01/11/2020 14:45	6,80	117	796,15	CHI
202010185994	SAO MIGUEL DO ARAGUAIA	SM12074386RE	SAO MIGUEL DO ARAGUAIA	31/10/2020 10:01	02/11/2020 14:56	01/11/2020 07:57	02/11/2020 14:56	31,00	10	309,96	CHI
202010185994	NOVO PLANALTO	SM12074386RE	SAO MIGUEL DO ARAGUAIA	31/10/2020 10:01	02/11/2020 14:56	31/10/2020 10:01	01/11/2020 07:57	21,92	2	43,83	CHI
202010185994	SAO MIGUEL DO ARAGUAIA	SM12074386RE	SAO MIGUEL DO ARAGUAIA	31/10/2020 10:01	02/11/2020 14:56	31/10/2020 10:01	01/11/2020 07:57	21,92	131	2871,16	CHI
202010185382	ITAPURANGA	IK21289439	ITAPURANGA	31/10/2020 10:04	01/11/2020 14:06	31/10/2020 10:04	01/11/2020 14:06	28,03	1	28,03	CHI
202010185383	JUSSARA	JR12341251	IPORA	31/10/2020 10:04	31/10/2020 13:03	31/10/2020 10:04	31/10/2020 13:03	2,98	190	566,67	CHI
202010185383	MONTES CLAROS DE GOIAS	JR12341251	IPORA	31/10/2020 10:04	31/10/2020 13:03	31/10/2020 10:04	31/10/2020 13:03	2,98	18	53,68	CHI
202010185395	JANDAIA	EU12386350	ACREUNA	31/10/2020 10:06	31/10/2020 18:56	31/10/2020 10:06	31/10/2020 18:56	8,83	1	8,83	CHI
202010185404	FAZENDA NOVA	FN12183426	IPORA	31/10/2020 10:08	31/10/2020 15:34	31/10/2020 10:08	31/10/2020 15:34	5,43	9	48,83	CHI
202010185409	GOIANESIA	550135169	GOIANESIA S2	31/10/2020 10:08	31/10/2020 14:26	31/10/2020 10:08	31/10/2020 14:26	4,29	1	4,29	CHI
202010187341	CAMPOS VERDES	VD12238510	SANTA TEREZINHA	31/10/2020 10:09	31/10/2020 21:00	31/10/2020 10:09	31/10/2020 21:00	10,85	6	65,09	CHI
202010185454	PIRACANJUBA	PJ12000022	PIRACANJUBA	31/10/2020 10:10	01/11/2020 22:35	31/10/2020 10:10	01/11/2020 22:35	36,41	20	728,16	CHI
202010185662	CAMPINACU	CR12410914	MARA ROSA	31/10/2020 10:11	01/11/2020 03:31	31/10/2020 10:11	01/11/2020 03:31	17,33	14	242,65	CHI
202010185426	COCALZINHO DE GOIAS	ZN12327413	GOIANESIA S1	31/10/2020 10:11	31/10/2020 22:05	31/10/2020 10:11	31/10/2020 22:05	11,89	5	59,47	CHI
202010185429	PLANALTINA	2960036123	PLANALTINA	31/10/2020 10:12	31/10/2020 12:00	31/10/2020 10:12	31/10/2020 12:00	1,80	1	1,80	CHI

202010185430	EDEIA	EA21108378	EDEIA	31/10/2020 10:12	31/10/2020 12:31	31/10/2020 10:12	31/10/2020 12:31	2,31	1	2,31	CHI
202010185432	TRINDADE	10012487633	GOYA S2	31/10/2020 10:12	31/10/2020 13:08	31/10/2020 10:12	31/10/2020 13:08	2,92	1	2,92	CHI
202010185434	LUZIANIA	120348615	RIO VERMELHO	31/10/2020 10:12	31/10/2020 11:48	31/10/2020 10:12	31/10/2020 11:48	1,58	1	1,58	CHI
202010185623	MONTES CLAROS DE GOIAS	ME12088922	IPORA	31/10/2020 10:15	31/10/2020 16:26	31/10/2020 10:15	31/10/2020 16:26	6,18	17	105,04	CHI
202010185511	GOIANIA	GN12269050	CARAJAS S2	31/10/2020 10:15	31/10/2020 15:42	31/10/2020 10:15	31/10/2020 15:42	5,44	367	1995,77	CHI
202010186462	ITUMBIARA	IT12047782	CACHOEIRA DOURADA	31/10/2020 10:16	31/10/2020 19:34	31/10/2020 10:16	31/10/2020 19:34	9,30	6	55,79	CHI
202010186667	COCALZINHO DE GOIAS	ZN12188781	GOIANESIA S1	31/10/2020 10:16	31/10/2020 16:18	31/10/2020 10:16	31/10/2020 16:18	6,02	63	379,54	CHI
202010185453	CAVALCANTE	CJ12208768RE	FLORES DE GOIAS	31/10/2020 10:16	31/10/2020 13:13	31/10/2020 10:16	31/10/2020 13:13	2,94	145	426,38	CHI
202010185455	ALTO PARAISO DE GOIAS	BF11376611	NIQUELANDIA SUBTRANSMISSAO	31/10/2020 10:17	31/10/2020 12:34	31/10/2020 10:17	31/10/2020 12:34	2,28	23	52,34	CHI
202010185458	SANTA TEREZA DE GOIAS	SE12053812	MARA ROSA	31/10/2020 10:18	01/11/2020 09:19	31/10/2020 10:18	01/11/2020 09:19	23,02	3	69,07	CHI
202010185466	COCALZINHO DE GOIAS	ZN21146653	COCALZINHO	31/10/2020 10:19	01/11/2020 01:13	31/10/2020 10:19	01/11/2020 01:13	14,89	1	14,89	CHI
202010185467	ANAPOLIS	AN11210795	JUNDIAI S1	31/10/2020 10:19	31/10/2020 14:42	31/10/2020 10:19	31/10/2020 14:42	4,38	106	463,87	CHI
202010188502	MARA ROSA	MQ21137160	SANTA TEREZINHA	31/10/2020 10:20	01/11/2020 10:44	31/10/2020 10:20	01/11/2020 10:44	24,40	1	24,40	CHI
202010185509	GOIANESIA	GE12115090	GOIANESIA S2	31/10/2020 10:20	31/10/2020 11:41	31/10/2020 10:20	31/10/2020 11:41	1,34	295	395,14	CHI
202010185476	ALVORADA DO NORTE	AQ12160975	IACIARA S2	31/10/2020 10:20	31/10/2020 23:32	31/10/2020 10:20	31/10/2020 23:32	13,19	17	224,19	CHI
202010185486	CRISTALINA	KR12168460	CRISTALINA S1	31/10/2020 10:22	31/10/2020 12:16	31/10/2020 10:22	31/10/2020 12:16	1,90	5	9,50	CHI
202010185489	CHAPADAO DO CEU	AE21107456	CHAPADAO DO CEU	31/10/2020 10:22	31/10/2020 12:32	31/10/2020 10:22	31/10/2020 12:32	2,15	1	2,15	CHI
202010185490	URUACU	UR21340215	MARA ROSA	31/10/2020 10:23	01/11/2020 12:16	31/10/2020 10:23	01/11/2020 12:16	25,88	2	51,76	CHI
202010185491	SAO MIGUEL DO ARAGUAIA	SM21081427	SAO MIGUEL DO ARAGUAIA	31/10/2020 10:23	02/11/2020 00:01	31/10/2020 10:23	02/11/2020 00:01	37,63	1	37,63	CHI
202010185493	PADRE BERNARDO	PB12375252	PADRE BERNARDO	31/10/2020 10:23	31/10/2020 12:32	31/10/2020 10:23	31/10/2020 12:32	2,14	2	4,28	CHI
202010185496	ITAPURANGA	HE12023221	ITAPURANGA	31/10/2020 10:24	31/10/2020 12:52	31/10/2020 10:24	31/10/2020 12:52	2,46	1	2,46	CHI
202010185496	HEITORAI	HE12023221	ITAPURANGA	31/10/2020 10:24	31/10/2020 12:52	31/10/2020 10:24	31/10/2020 12:52	2,46	3	7,39	CHI
202010185501	GOIANAPOLIS	950022500	DAIA S2	31/10/2020 10:25	31/10/2020 16:04	31/10/2020 10:25	31/10/2020 16:04	5,64	1	5,64	CHI
202010185504	JOVIANIA	JV21199976	GOIATUBA S1	31/10/2020 10:26	31/10/2020 14:42	31/10/2020 10:26	31/10/2020 14:42	4,27	4	17,07	CHI
202010186659	PIRENOPOLIS	PV12381295	CORUMBA	31/10/2020 10:30	31/10/2020 18:35	31/10/2020 10:30	31/10/2020 18:35	8,08	4	32,33	CHI
202010185523	GOIATUBA	GT21143953	GOIATUBA S2	31/10/2020 10:30	31/10/2020 11:14	31/10/2020 10:30	31/10/2020 11:14	0,72	1	0,72	CHI
202010185527	GOIANIA	GN21154246	CARAJAS S1	31/10/2020 10:30	31/10/2020 11:40	31/10/2020 10:30	31/10/2020 11:40	1,15	3	3,46	CHI
202010185530	ARAGARCAS	1820035181	ARAGARCAS	31/10/2020 10:31	31/10/2020 15:17	31/10/2020 10:31	31/10/2020 15:17	4,76	1	4,76	CHI
202010185537	ITAJA	IJ21191718	CACHOEIRA ALTA	31/10/2020 10:32	31/10/2020 12:01	31/10/2020 10:32	31/10/2020 12:01	1,47	1	1,47	CHI
202010186832	ARUANA	AK12183284	ARUANA	31/10/2020 10:33	01/11/2020 02:48	31/10/2020 10:33	31/10/2020 19:10	8,63	179	1544,67	CHI
202010186832	ARUANA	AK12183284	ARUANA	31/10/2020 10:33	01/11/2020 02:48	31/10/2020 19:22	01/11/2020 02:48	7,43	179	1329,72	CHI
202010185539	ALEXANIA	AX21000066	ALEXANIA	31/10/2020 10:33	31/10/2020 15:09	31/10/2020 10:33	31/10/2020 15:09	4,59	1	4,59	CHI
202010187782	FLORES DE GOIAS	FB12409931	FLORES DE GOIAS	31/10/2020 10:33	31/10/2020 19:47	31/10/2020 10:33	31/10/2020 19:47	9,22	41	378,05	CHI
202010185542	JATAI	290098130	JATAI S3	31/10/2020 10:33	31/10/2020 14:29	31/10/2020 10:33	31/10/2020 14:29	3,92	1	3,92	CHI
202010185544	ABADIANIA	AA12348154	ANAPOLIS UNIVERSITARIO S1	31/10/2020 10:33	31/10/2020 14:31	31/10/2020 10:33	31/10/2020 14:31	3,95	11	43,47	CHI
202010185547	ANAPOLIS	AN12258960	ANAPOLIS UNIVERSITARIO S1	31/10/2020 10:34	31/10/2020 13:48	31/10/2020 10:34	31/10/2020 13:48	3,23	7	22,60	CHI
202010185649	FORMOSA	FA12085474	ITIQUEIRA	31/10/2020 10:34	31/10/2020 11:51	31/10/2020 10:34	31/10/2020 11:51	1,27	29	36,82	CHI
202010185552	GOIAS	GS12206917	ITABERA S1	31/10/2020 10:35	31/10/2020 16:04	31/10/2020 10:35	31/10/2020 16:04	5,47	9	49,24	CHI
202010185562	GOIANIA	AP21000079	CEPAIGO S1	31/10/2020 10:39	31/10/2020 15:24	31/10/2020 10:39	31/10/2020 15:24	4,75	1	4,75	CHI
202010185566	GOIAS	GS21277633	ITAPURANGA	31/10/2020 10:39	31/10/2020 19:39	31/10/2020 10:39	31/10/2020 19:39	8,99	1	8,99	CHI
202010185567	GOIANIA	13988621	GOYA S2	31/10/2020 10:39	31/10/2020 11:44	31/10/2020 10:39	31/10/2020 11:44	1,07	1	1,07	CHI
202010185571	SANTO ANTONIO DO DESCOBERTO	2210087266	ALEXANIA	31/10/2020 10:41	31/10/2020 12:21	31/10/2020 10:41	31/10/2020 12:21	1,66	1	1,66	CHI
202010185613	SANCLERLANDIA	SC12005487	FIRMINOPOLIS S2	31/10/2020 10:43	31/10/2020 15:23	31/10/2020 10:43	31/10/2020 15:23	4,66	22	102,57	CHI
202010185592	JUSSARA	JR12101970RE	BRITANIA	31/10/2020 10:43	31/10/2020 13:32	31/10/2020 10:43	31/10/2020 13:32	2,81	11	30,89	CHI
202010185590	GOIAS	GS21259622	GOIAS	31/10/2020 10:44	31/10/2020 14:23	31/10/2020 10:44	31/10/2020 14:23	3,65	2	7,30	CHI
202010185591	JATAI	290155370	JATAI S3	31/10/2020 10:44	31/10/2020 17:23	31/10/2020 10:44	31/10/2020 17:23	6,64	1	6,64	CHI
202010185689	GAMELEIRA DE GOIAS	AA12285384	ANAPOLIS UNIVERSITARIO S1	31/10/2020 10:45	31/10/2020 13:13	31/10/2020 10:45	31/10/2020 13:13	2,46	1	2,46	CHI
202010185689	ABADIANIA	AA12285384	ANAPOLIS UNIVERSITARIO S1	31/10/2020 10:45	31/10/2020 13:13	31/10/2020 10:45	31/10/2020 13:13	2,46	105	258,77	CHI
202010185595	IPORA	10011526724	IPORA	31/10/2020 10:45	31/10/2020 17:27	31/10/2020 10:45	31/10/2020 17:27	6,69	1	6,69	CHI
202010185596	INHUMAS	IN12098348	INHUMAS S2	31/10/2020 10:45	31/10/2020 13:54	31/10/2020 10:45	31/10/2020 13:54	3,14	76	238,96	CHI
202010185749	NOVA CRIXAS	NA12091638	NOVA CRIXAS	31/10/2020 10:47	31/10/2020 17:29	31/10/2020 10:47	31/10/2020 17:29	6,68	9	60,16	CHI

202010185612	GOIANIA	16200184	GOIANIA LESTE S3	31/10/2020 10:49	31/10/2020 11:42	31/10/2020 10:49	31/10/2020 11:42	0,88	1	0,88	CHI
202010185614	GOIANIA	16200998	MEIA PONTE	31/10/2020 10:49	31/10/2020 13:53	31/10/2020 10:49	31/10/2020 13:53	3,06	1	3,06	CHI
202010185618	GOIANIA	11394870	GOIANIA LESTE S1	31/10/2020 10:50	31/10/2020 16:20	31/10/2020 10:50	31/10/2020 16:20	5,50	0	0,00	CHI
202010185620	BELA VISTA DE GOIAS	10003821755	BELA VISTA S1	31/10/2020 10:50	31/10/2020 11:44	31/10/2020 10:50	31/10/2020 11:44	0,89	1	0,89	CHI
202010185818	GOIANESIA	GE11327808	GOIANESIA S2	31/10/2020 10:52	31/10/2020 13:08	31/10/2020 10:52	31/10/2020 13:08	2,27	77	174,41	CHI
202010186137	ITAUCU	IX12000017	INHUMAS S1	31/10/2020 10:53	31/10/2020 13:42	31/10/2020 10:53	31/10/2020 13:42	2,81	10	28,14	CHI
202010185634	ABADIANIA	350014980	ANAPOLIS UNIVERSITARIO S1	31/10/2020 10:53	31/10/2020 18:28	31/10/2020 10:53	31/10/2020 18:28	7,57	1	7,57	CHI
202010185654	CRIXAS	CX12248286	SERRA DO OURO	31/10/2020 11:00	31/10/2020 14:31	31/10/2020 11:00	31/10/2020 14:31	3,51	17	59,60	CHI
202010185661	AURILANDIA	AI21101623	FIRMINOPOLIS S2	31/10/2020 11:02	01/11/2020 10:00	31/10/2020 11:02	01/11/2020 10:00	22,97	1	22,97	CHI
202010185664	SENADOR CANEDO	190116845	SENADOR CANEDO	31/10/2020 11:03	31/10/2020 11:15	31/10/2020 11:03	31/10/2020 11:15	0,20	1	0,20	CHI
202010185663	RIO VERDE	RV12341013	CABRIUVA S2	31/10/2020 11:03	31/10/2020 13:28	31/10/2020 11:03	31/10/2020 13:28	2,41	1	2,41	CHI
202010188206	MUNDO NOVO DE GOIAS	MH12291217LD	NOVA CRIXAS	31/10/2020 11:03	01/11/2020 23:15	31/10/2020 11:03	01/11/2020 23:15	36,20	27	977,46	CHI
202010185669	NIQUELANDIA	NQ21136457	NIQUELANDIA SUBTRANSMISSAO	31/10/2020 11:03	01/11/2020 18:34	31/10/2020 11:03	01/11/2020 18:34	31,50	1	31,50	CHI
202010185682	JATAI	JT12361791	JATAI S2	31/10/2020 11:04	31/10/2020 16:51	31/10/2020 11:04	31/10/2020 16:51	5,78	28	161,93	CHI
202010185911	NOVO BRASIL	IU12030155	JUSSARA	31/10/2020 11:05	31/10/2020 15:40	31/10/2020 11:05	31/10/2020 15:40	4,58	1	4,58	CHI
202010185911	ITAPIRAPUA	IU12030155	JUSSARA	31/10/2020 11:05	31/10/2020 15:40	31/10/2020 11:05	31/10/2020 15:40	4,58	43	196,94	CHI
202010185679	SANTA TEREZA DE GOIAS	SE12000019	MARA ROSA	31/10/2020 11:05	01/11/2020 15:01	31/10/2020 11:05	01/11/2020 15:01	27,93	1	27,93	CHI
202010185684	PIRANHAS	PH21047479	PIRANHAS	31/10/2020 11:07	31/10/2020 14:08	31/10/2020 11:07	31/10/2020 14:08	3,02	1	3,02	CHI
202010185691	RIO VERDE	RV21260221	CABRIUVA S1	31/10/2020 11:07	31/10/2020 13:39	31/10/2020 11:07	31/10/2020 13:20	2,20	1	2,20	CHI
202010185691	RIO VERDE	RV21260221	CABRIUVA S1	31/10/2020 11:07	31/10/2020 13:39	31/10/2020 13:22	31/10/2020 13:39	0,28	1	0,28	CHI
202010185695	PIRES DO RIO	BC21186551	PIRES DO RIO S1	31/10/2020 11:07	31/10/2020 16:10	31/10/2020 11:07	31/10/2020 16:10	5,03	1	5,03	CHI
202010185710	SAO SIMAO	SO13402201	CACHOEIRA ALTA	31/10/2020 11:09	31/10/2020 18:50	31/10/2020 16:22	31/10/2020 16:37	0,25	18	4,50	CHI
202010185710	CACHOEIRA ALTA	SO13402201	CACHOEIRA ALTA	31/10/2020 11:09	31/10/2020 18:50	31/10/2020 16:22	31/10/2020 16:37	0,25	6	1,50	CHI
202010185710	CACU	SO13402201	CACHOEIRA ALTA	31/10/2020 11:09	31/10/2020 18:50	31/10/2020 16:22	31/10/2020 16:37	0,25	99	24,75	CHI
202010185710	SAO SIMAO	SO13371216	CACHOEIRA ALTA	31/10/2020 11:09	31/10/2020 18:50	31/10/2020 18:31	31/10/2020 18:49	0,30	18	5,40	CHI
202010185710	CACHOEIRA ALTA	SO13371216	CACHOEIRA ALTA	31/10/2020 11:09	31/10/2020 18:50	31/10/2020 18:31	31/10/2020 18:49	0,30	6	1,80	CHI
202010185710	CACU	SO13371216	CACHOEIRA ALTA	31/10/2020 11:09	31/10/2020 18:50	31/10/2020 18:31	31/10/2020 18:49	0,30	99	29,70	CHI
202010185710	SAO SIMAO	SO21214268	CACHOEIRA ALTA	31/10/2020 11:09	31/10/2020 18:50	31/10/2020 11:09	31/10/2020 18:50	7,67	1	7,67	CHI
202010187873	JANDAIA	PP12233311RE	PALMEIRAS	31/10/2020 11:10	01/11/2020 03:10	31/10/2020 11:10	01/11/2020 03:10	16,00	19	303,97	CHI
202010187873	PALMINOPOLIS	PP12233311RE	PALMEIRAS	31/10/2020 11:10	01/11/2020 03:10	31/10/2020 11:10	01/11/2020 03:10	16,00	39	623,94	CHI
202010185714	QUIRINOPOLIS	QI21303051	QUIRINOPOLIS	31/10/2020 11:13	31/10/2020 14:59	31/10/2020 11:13	31/10/2020 14:59	3,76	1	3,76	CHI
202010186124	JATAI	JT12260426RE	JATAI S1	31/10/2020 11:13	31/10/2020 13:55	31/10/2020 11:13	31/10/2020 13:55	2,69	120	322,33	CHI
202010186013	ITAJA	IJ12161267	ITAJA S2	31/10/2020 11:17	31/10/2020 17:39	31/10/2020 11:17	31/10/2020 17:39	6,37	3	19,11	CHI
202010186013	APORE	IJ12161267	ITAJA S2	31/10/2020 11:17	31/10/2020 17:39	31/10/2020 11:17	31/10/2020 17:39	6,37	1	6,37	CHI
202010185733	MINEIROS	MY12156849	PARQUE DAS EMAS	31/10/2020 11:17	31/10/2020 13:27	31/10/2020 11:17	31/10/2020 13:27	2,16	11	23,71	CHI
202010185791	BONFINOPOLIS	TA10400556	NOVO PLANALTO	31/10/2020 11:18	01/11/2020 21:23	01/11/2020 00:01	01/11/2020 00:48	0,78	1	0,78	CHI
202010185791	BONOPOLIS	TA10400556	NOVO PLANALTO	31/10/2020 11:18	01/11/2020 21:23	01/11/2020 00:01	01/11/2020 00:48	0,78	53	41,31	CHI
202010185791	PORANGATU	TA10400556	NOVO PLANALTO	31/10/2020 11:18	01/11/2020 21:23	01/11/2020 00:01	01/11/2020 00:48	0,78	161	125,49	CHI
202010185791	BONOPOLIS	TA10400556	SAO MIGUEL DO ARAGUAIA	31/10/2020 11:18	01/11/2020 21:23	01/11/2020 00:01	01/11/2020 00:48	0,78	277	215,91	CHI
202010185791	NOVO PLANALTO	SM10400363	SAO MIGUEL DO ARAGUAIA	31/10/2020 11:18	01/11/2020 21:23	01/11/2020 00:54	01/11/2020 01:15	0,35	1	0,35	CHI
202010185791	SAO MIGUEL DO ARAGUAIA	SM10400363	SAO MIGUEL DO ARAGUAIA	31/10/2020 11:18	01/11/2020 21:23	01/11/2020 00:54	01/11/2020 01:15	0,35	65	22,93	CHI
202010185791	NOVO PLANALTO	SM10400363	SAO MIGUEL DO ARAGUAIA	31/10/2020 11:18	01/11/2020 21:23	01/11/2020 08:43	01/11/2020 09:09	0,43	1	0,43	CHI
202010185791	SAO MIGUEL DO ARAGUAIA	SM10400363	SAO MIGUEL DO ARAGUAIA	31/10/2020 11:18	01/11/2020 21:23	01/11/2020 08:43	01/11/2020 09:09	0,43	65	27,81	CHI
202010185791	BONFINOPOLIS	TA10400556	NOVO PLANALTO	31/10/2020 11:18	01/11/2020 21:23	01/11/2020 10:15	01/11/2020 10:20	0,08	1	0,08	CHI
202010185791	BONOPOLIS	TA10400556	NOVO PLANALTO	31/10/2020 11:18	01/11/2020 21:23	01/11/2020 10:15	01/11/2020 10:20	0,08	53	4,14	CHI
202010185791	PORANGATU	TA10400556	NOVO PLANALTO	31/10/2020 11:18	01/11/2020 21:23	01/11/2020 10:15	01/11/2020 10:20	0,08	166	12,96	CHI
202010185791	BONOPOLIS	TA10400556	SAO MIGUEL DO ARAGUAIA	31/10/2020 11:18	01/11/2020 21:23	01/11/2020 10:15	01/11/2020 10:20	0,08	277	21,62	CHI
202010185791	BONOPOLIS	TA10400556	SAO MIGUEL DO ARAGUAIA	31/10/2020 11:18	01/11/2020 21:23	01/11/2020 00:01	01/11/2020 14:17	14,26	72	1026,74	CHI
202010185791	PORANGATU	TA10400556	SAO MIGUEL DO ARAGUAIA	31/10/2020 11:18	01/11/2020 21:23	01/11/2020 00:01	01/11/2020 14:17	14,26	1	14,26	CHI
202010185791	BONOPOLIS	TA10400556	SAO MIGUEL DO ARAGUAIA	31/10/2020 11:18	01/11/2020 21:23	01/11/2020 00:01	01/11/2020 15:22	15,34	130	1994,38	CHI
202010185791	BONOPOLIS	TA10400556	SAO MIGUEL DO ARAGUAIA	31/10/2020 11:18	01/11/2020 21:23	01/11/2020 00:01	01/11/2020 16:04	16,05	24	385,16	CHI

202010185791	BONOPOLIS	BX10403948	SAO MIGUEL DO ARAGUAIA	31/10/2020 11:18	01/11/2020 21:23	01/11/2020 16:25	01/11/2020 16:34	0,14	226	32,46	CHI
202010185791	PORANGATU	BX10403948	SAO MIGUEL DO ARAGUAIA	31/10/2020 11:18	01/11/2020 21:23	01/11/2020 16:25	01/11/2020 16:34	0,14	1	0,14	CHI
202010185791	BONOPOLIS	BX13262672	SAO MIGUEL DO ARAGUAIA	31/10/2020 11:18	01/11/2020 21:23	01/11/2020 16:25	01/11/2020 17:12	0,78	783	611,17	CHI
202010185791	CACU	BX13262672	SAO MIGUEL DO ARAGUAIA	31/10/2020 11:18	01/11/2020 21:23	01/11/2020 16:25	01/11/2020 17:12	0,78	1	0,78	CHI
202010185791	BONOPOLIS	BX12079321RE	SAO MIGUEL DO ARAGUAIA	31/10/2020 11:18	01/11/2020 21:23	01/11/2020 00:01	01/11/2020 17:22	17,34	59	1023,21	CHI
202010185791	SAO MIGUEL DO ARAGUAIA	SM13247762	SAO MIGUEL DO ARAGUAIA	31/10/2020 11:18	01/11/2020 21:23	01/11/2020 00:54	01/11/2020 17:26	16,54	8	132,31	CHI
202010185791	SAO MIGUEL DO ARAGUAIA	6656385	SAO MIGUEL DO ARAGUAIA	31/10/2020 11:18	01/11/2020 21:23	01/11/2020 00:54	01/11/2020 17:30	16,59	9	149,30	CHI
202010185791	AMARALINA	BX10403942	SAO MIGUEL DO ARAGUAIA	31/10/2020 11:18	01/11/2020 21:23	01/11/2020 16:25	01/11/2020 18:05	1,67	222	370,37	CHI
202010185791	BONOPOLIS	BX10403942	SAO MIGUEL DO ARAGUAIA	31/10/2020 11:18	01/11/2020 21:23	01/11/2020 16:25	01/11/2020 18:05	1,67	12	20,02	CHI
202010185791	AMARALINA	BX10403948	SAO MIGUEL DO ARAGUAIA	31/10/2020 11:18	01/11/2020 21:23	01/11/2020 21:19	01/11/2020 21:23	0,07	222	14,62	CHI
202010185791	BONOPOLIS	BX10403948	SAO MIGUEL DO ARAGUAIA	31/10/2020 11:18	01/11/2020 21:23	01/11/2020 21:19	01/11/2020 21:23	0,07	795	52,34	CHI
202010185791	BONOPOLIS	BX10403948	SAO MIGUEL DO ARAGUAIA	31/10/2020 11:18	01/11/2020 21:23	01/11/2020 21:19	01/11/2020 21:23	0,07	277	18,24	CHI
202010185791	CACU	BX10403948	SAO MIGUEL DO ARAGUAIA	31/10/2020 11:18	01/11/2020 21:23	01/11/2020 21:19	01/11/2020 21:23	0,07	1	0,07	CHI
202010185791	BONOPOLIS	SM10400363	SAO MIGUEL DO ARAGUAIA	31/10/2020 11:18	01/11/2020 21:23	31/10/2020 11:18	31/10/2020 14:27	3,15	9	28,36	CHI
202010185791	NOVO PLANALTO	SM10400363	SAO MIGUEL DO ARAGUAIA	31/10/2020 11:18	01/11/2020 21:23	31/10/2020 11:18	31/10/2020 14:27	3,15	7	22,05	CHI
202010185791	SAO MIGUEL DO ARAGUAIA	SM10400363	SAO MIGUEL DO ARAGUAIA	31/10/2020 11:18	01/11/2020 21:23	31/10/2020 11:18	31/10/2020 14:27	3,15	48	151,23	CHI
202010185791	NOVO PLANALTO	SM10400363	SAO MIGUEL DO ARAGUAIA	31/10/2020 11:18	01/11/2020 21:23	31/10/2020 11:18	31/10/2020 14:27	3,14	8	25,14	CHI
202010185791	BONOPOLIS	SM10400363	SAO MIGUEL DO ARAGUAIA	31/10/2020 11:18	01/11/2020 21:23	31/10/2020 11:18	31/10/2020 14:27	3,14	11	34,56	CHI
202010185791	SAO MIGUEL DO ARAGUAIA	SM10400363	SAO MIGUEL DO ARAGUAIA	31/10/2020 11:18	01/11/2020 21:23	31/10/2020 11:18	31/10/2020 14:27	3,14	38	119,40	CHI
202010185791	SAO MIGUEL DO ARAGUAIA	SM10400363	SAO MIGUEL DO ARAGUAIA	31/10/2020 11:18	01/11/2020 21:23	31/10/2020 15:25	31/10/2020 15:28	0,07	60	3,93	CHI
202010185791	PORANGATU	TA10400556	NOVO PLANALTO	31/10/2020 11:18	01/11/2020 21:23	31/10/2020 17:42	31/10/2020 17:50	0,14	31	4,31	CHI
202010185791	BONOPOLIS	TA10400556	NOVO PLANALTO	31/10/2020 11:18	01/11/2020 21:23	31/10/2020 17:42	31/10/2020 17:50	0,14	22	3,06	CHI
202010185791	BONOPOLIS	SM13228629	SAO MIGUEL DO ARAGUAIA	31/10/2020 11:18	01/11/2020 21:23	31/10/2020 15:25	31/10/2020 22:07	6,71	20	134,22	CHI
202010185791	NOVO PLANALTO	SM13228629	SAO MIGUEL DO ARAGUAIA	31/10/2020 11:18	01/11/2020 21:23	31/10/2020 15:25	31/10/2020 22:07	6,71	15	100,67	CHI
202010185791	SAO MIGUEL DO ARAGUAIA	SM13228629	SAO MIGUEL DO ARAGUAIA	31/10/2020 11:18	01/11/2020 21:23	31/10/2020 15:25	31/10/2020 22:07	6,71	26	174,49	CHI
202010185791	BONOPOLIS	SM10400363	SAO MIGUEL DO ARAGUAIA	31/10/2020 11:18	01/11/2020 21:23	31/10/2020 11:18	31/10/2020 23:45	12,45	18	224,06	CHI
202010185791	BONOPOLIS	BX10403944	SAO MIGUEL DO ARAGUAIA	31/10/2020 11:18	01/11/2020 21:23	31/10/2020 17:42	31/10/2020 23:45	6,06	259	1569,40	CHI
202010185791	BONOPOLIS	SM10400363	SAO MIGUEL DO ARAGUAIA	31/10/2020 11:18	01/11/2020 21:23	31/10/2020 11:18	01/11/2020 00:01	12,70	246	3125,29	CHI
202010185791	PORANGATU	SM10400363	SAO MIGUEL DO ARAGUAIA	31/10/2020 11:18	01/11/2020 21:23	31/10/2020 11:18	01/11/2020 00:01	12,70	1	12,70	CHI
202010185791	BONOPOLIS	BX13064902	SAO MIGUEL DO ARAGUAIA	31/10/2020 11:18	01/11/2020 21:23	31/10/2020 14:25	01/11/2020 00:01	9,59	4	38,35	CHI
202010185791	BONOPOLIS	BX10403944	SAO MIGUEL DO ARAGUAIA	31/10/2020 11:18	01/11/2020 21:23	31/10/2020 17:42	01/11/2020 00:01	6,32	35	221,06	CHI
202010185791	SAO MIGUEL DO ARAGUAIA	SM13247762	SAO MIGUEL DO ARAGUAIA	31/10/2020 11:18	01/11/2020 21:23	31/10/2020 23:21	01/11/2020 00:54	1,55	17	26,28	CHI
202010185791	CACU	SM10400363	SAO MIGUEL DO ARAGUAIA	31/10/2020 11:18	01/11/2020 21:23	31/10/2020 11:18	01/11/2020 16:24	29,09	1	29,09	CHI
202010185791	AMARALINA	SM10400363	SAO MIGUEL DO ARAGUAIA	31/10/2020 11:18	01/11/2020 21:23	31/10/2020 11:18	01/11/2020 16:24	29,09	220	6400,59	CHI
202010185791	BONOPOLIS	SM10400363	SAO MIGUEL DO ARAGUAIA	31/10/2020 11:18	01/11/2020 21:23	31/10/2020 11:18	01/11/2020 16:24	29,09	29	843,71	CHI
202010185791	AMARALINA	BX13262672	SAO MIGUEL DO ARAGUAIA	31/10/2020 11:18	01/11/2020 21:23	31/10/2020 14:25	01/11/2020 16:24	25,98	1	25,98	CHI
202010185791	BONOPOLIS	BX13262672	SAO MIGUEL DO ARAGUAIA	31/10/2020 11:18	01/11/2020 21:23	31/10/2020 14:25	01/11/2020 16:24	25,98	3	77,93	CHI
202010185742	CRISTALINA	KR21031886	CRISTALINA S2	31/10/2020 11:19	31/10/2020 15:49	31/10/2020 11:19	31/10/2020 15:49	4,50	1	4,50	CHI
202010185746	QUIRINOPOLIS	QI21100545	QUIRINOPOLIS	31/10/2020 11:19	31/10/2020 14:11	31/10/2020 11:19	31/10/2020 14:11	2,85	1	2,85	CHI
202010185750	JATAI	3920000739	JATAI S1	31/10/2020 11:20	31/10/2020 19:07	31/10/2020 11:20	31/10/2020 19:07	7,78	1	7,78	CHI
202010185754	PIRES DO RIO	460090057	PIRES DO RIO S1	31/10/2020 11:21	31/10/2020 12:52	31/10/2020 11:21	31/10/2020 12:52	1,50	1	1,50	CHI
202010185760	SANTO ANTONIO DO DESCOBERTO	LZ21045634	AGUAS LINDAS DE GOIAS S2	31/10/2020 11:22	31/10/2020 12:45	31/10/2020 11:22	31/10/2020 12:45	1,37	1	1,37	CHI
202010185761	NIQUELANDIA	NQ21239327	NIQUELANDIA SUBTRANSMISSAO	31/10/2020 11:23	31/10/2020 15:41	31/10/2020 11:23	31/10/2020 15:41	4,30	1	4,30	CHI
202010187847	NIQUELANDIA	NQ12280469	URUACU	31/10/2020 11:23	01/11/2020 04:42	31/10/2020 11:23	01/11/2020 04:42	17,31	3	51,93	CHI
202010186113	ABADIANA	AA12237717	ANAPOLIS UNIVERSITARIO S1	31/10/2020 11:23	31/10/2020 17:30	31/10/2020 11:23	31/10/2020 17:30	6,10	5	30,51	CHI
202010185780	JUSSARA	JR12093790	JUSSARA	31/10/2020 11:25	31/10/2020 21:07	31/10/2020 11:25	31/10/2020 21:07	9,70	2	19,39	CHI
202010185782	MINEIROS	MY21253194	PARQUE DAS EMAS	31/10/2020 11:25	31/10/2020 18:59	31/10/2020 11:25	31/10/2020 18:59	7,56	1	7,56	CHI
202010185785	GOIANIA	GN12000325	GOIANIA LESTE S3	31/10/2020 11:26	31/10/2020 13:30	31/10/2020 11:26	31/10/2020 13:30	2,06	60	123,53	CHI
202010185786	DOVERLANDIA	DV12086876	CAIAPONIA	31/10/2020 11:26	31/10/2020 13:15	31/10/2020 11:26	31/10/2020 13:15	1,81	9	16,28	CHI
202010185796	QUIRINOPOLIS	80147707	QUIRINOPOLIS	31/10/2020 11:28	31/10/2020 15:53	31/10/2020 11:28	31/10/2020 15:53	4,41	1	4,41	CHI
202010185799	JARAGUA	JA12000236	JARAGUA	31/10/2020 11:29	31/10/2020 13:22	31/10/2020 11:29	31/10/2020 13:22	1,88	26	48,91	CHI

202010185803	FORMOSA	FA12264689	ITUIQUIRA	31/10/2020 11:29	01/11/2020 11:05	31/10/2020 11:29	01/11/2020 11:05	23,59	1	23,59	CHI
202010185807	SANTA HELENA DE GOIAS	SH21384697	IPEGUARI	31/10/2020 11:31	31/10/2020 18:29	31/10/2020 11:31	31/10/2020 18:29	6,97	1	6,97	CHI
202010185813	GOIATUBA	GT21102732	BOM JESUS DE GOIAS	31/10/2020 11:32	31/10/2020 15:13	31/10/2020 11:32	31/10/2020 15:13	3,68	1	3,68	CHI
202010185823	PLANALTINA	PI12359115	SAO JOAO D ALIANCA	31/10/2020 11:33	31/10/2020 13:40	31/10/2020 11:33	31/10/2020 13:40	2,11	6	12,64	CHI
202010185825	GOIANIA	15252036	GOYA S2	31/10/2020 11:33	31/10/2020 12:15	31/10/2020 11:33	31/10/2020 12:15	0,69	1	0,69	CHI
202010186004	FORMOSO	SE12053856	MARA ROSA	31/10/2020 11:34	31/10/2020 14:12	31/10/2020 11:34	31/10/2020 14:12	2,63	6	15,75	CHI
202010186004	SANTA TEREZA DE GOIAS	SE12053856	MARA ROSA	31/10/2020 11:34	31/10/2020 14:12	31/10/2020 11:34	31/10/2020 14:12	2,63	3	7,88	CHI
202010185829	MINEIROS	MY21202610	PARQUE DAS EMAS	31/10/2020 11:34	31/10/2020 20:20	31/10/2020 11:34	31/10/2020 20:20	8,75	1	8,75	CHI
202010185832	TERESINA DE GOIAS	TE21320534	FLORES DE GOIAS	31/10/2020 11:35	31/10/2020 17:24	31/10/2020 11:35	31/10/2020 17:24	5,81	1	5,81	CHI
202010186630	ITABERAI	IK12250721	GOIAS	31/10/2020 11:35	31/10/2020 16:38	31/10/2020 11:35	31/10/2020 16:38	5,04	3	15,11	CHI
202010186630	ITAPURANGA	IK12250721	GOIAS	31/10/2020 11:35	31/10/2020 16:38	31/10/2020 11:35	31/10/2020 16:38	5,04	3	15,11	CHI
202010186630	GOIAS	IK12250721	GOIAS	31/10/2020 11:35	31/10/2020 16:38	31/10/2020 11:35	31/10/2020 16:38	5,04	14	70,51	CHI
202010185835	RIO VERDE	RV21123393	RIO VERDE S1	31/10/2020 11:37	31/10/2020 15:50	31/10/2020 11:37	31/10/2020 15:50	4,21	1	4,21	CHI
202010187250	ALVORADA DO NORTE	AQ12184985	IACIARA S2	31/10/2020 11:37	31/10/2020 18:16	31/10/2020 11:37	31/10/2020 18:16	6,65	34	225,94	CHI
202010186322	SAO LUIS DE MONTES BELOS	SL11006856	SAO LUIZ DOS MONTES BELOS	31/10/2020 11:37	31/10/2020 15:37	31/10/2020 11:37	31/10/2020 15:37	3,99	195	778,65	CHI
202010186579	TURIANIA	TV12005542	FIRMINOPOLIS S2	31/10/2020 11:38	01/11/2020 14:59	31/10/2020 11:38	01/11/2020 14:59	27,34	51	1394,48	CHI
202010186579	PALMINOPOLIS	TV12005542	FIRMINOPOLIS S2	31/10/2020 11:38	01/11/2020 14:59	31/10/2020 11:38	01/11/2020 14:59	27,34	23	628,88	CHI
202010185847	JARAGUA	70077344	JARAGUA	31/10/2020 11:39	31/10/2020 15:25	31/10/2020 11:39	31/10/2020 15:25	3,76	1	3,76	CHI
202010185853	CALDAS NOVAS	760298956	CALDAS NOVAS S1	31/10/2020 11:41	31/10/2020 13:57	31/10/2020 11:41	31/10/2020 13:57	2,25	1	2,25	CHI
202010185854	SANTA RITA DO NOVO DESTINO	BA21254179	BARRO ALTO	31/10/2020 11:42	31/10/2020 13:29	31/10/2020 11:42	31/10/2020 13:29	1,77	1	1,77	CHI
202010185856	QUIRINOPOLIS	QI21101729	QUIRINOPOLIS	31/10/2020 11:43	31/10/2020 14:35	31/10/2020 11:43	31/10/2020 14:35	2,87	1	2,87	CHI
202010185906	MINACU	IH12247493	MINACU	31/10/2020 11:43	31/10/2020 14:48	31/10/2020 11:43	31/10/2020 14:48	3,07	104	319,57	CHI
202010186782	MINACU	IH12360453	MINACU	31/10/2020 11:43	31/10/2020 17:08	31/10/2020 11:43	31/10/2020 17:08	5,41	72	389,18	CHI
202010186782	CAMPINACU	IH12360453	MINACU	31/10/2020 11:43	31/10/2020 17:08	31/10/2020 11:43	31/10/2020 17:08	5,41	5	27,03	CHI
202010185876	JATAI	JT11361762	JATAI S2	31/10/2020 11:46	31/10/2020 14:50	31/10/2020 11:46	31/10/2020 14:50	3,05	1	3,05	CHI
202010186050	GOIANESIA	GE21215141	GOIANESIA S2	31/10/2020 11:47	31/10/2020 15:18	31/10/2020 11:47	31/10/2020 15:18	3,51	5	17,55	CHI
202010185880	NOVO PLANALTO	2500009290	NOVO PLANALTO	31/10/2020 11:48	01/11/2020 12:04	31/10/2020 11:48	01/11/2020 12:04	24,27	1	24,27	CHI
202010185882	GOIATUBA	JV12163934	GOIATUBA S1	31/10/2020 11:48	31/10/2020 16:12	31/10/2020 11:48	31/10/2020 16:12	4,40	1	4,40	CHI
202010185884	DISTRITO FEDERAL	PB12377290	PADRE BERNARDO	31/10/2020 11:48	31/10/2020 13:30	31/10/2020 11:48	31/10/2020 13:30	1,69	6	10,15	CHI
202010185884	PLANALTINA	PB12377290	PADRE BERNARDO	31/10/2020 11:48	31/10/2020 13:30	31/10/2020 11:48	31/10/2020 13:30	1,69	14	23,69	CHI
202010185884	PADRE BERNARDO	PB12377290	PADRE BERNARDO	31/10/2020 11:48	31/10/2020 13:30	31/10/2020 11:48	31/10/2020 13:30	1,69	21	35,54	CHI
202010185884	ITARUMA	PB12377290	PADRE BERNARDO	31/10/2020 11:48	31/10/2020 13:30	31/10/2020 11:48	31/10/2020 13:30	1,69	1	1,69	CHI
202010186215	ITAPURANGA	HE12158782	ITAPURANGA	31/10/2020 11:48	31/10/2020 16:42	31/10/2020 11:48	31/10/2020 16:42	4,89	16	78,28	CHI
202010186215	HEITORAI	HE12158782	ITAPURANGA	31/10/2020 11:48	31/10/2020 16:42	31/10/2020 11:48	31/10/2020 16:42	4,89	5	24,46	CHI
202010185887	NIQUELANDIA	NQ11345556	NIQUELANDIA SUBTRANSMISSAO	31/10/2020 11:49	01/11/2020 16:52	31/10/2020 11:49	01/11/2020 16:52	29,04	8	232,32	CHI
202010187997	NIQUELANDIA	NQ12237523	URUACU	31/10/2020 11:50	31/10/2020 23:00	31/10/2020 11:50	31/10/2020 23:00	11,15	15	167,27	CHI
202010186742	JUSSARA	JR12087418	JUSSARA	31/10/2020 11:51	31/10/2020 16:26	31/10/2020 11:51	31/10/2020 16:26	4,58	11	50,36	CHI
202010186742	ITAPIRAPUA	JR12087418	JUSSARA	31/10/2020 11:51	31/10/2020 16:26	31/10/2020 11:51	31/10/2020 16:26	4,58	1	4,58	CHI
202010186587	ITAPURANGA	IK11051545	ITAPURANGA	31/10/2020 11:51	31/10/2020 16:41	31/10/2020 11:51	31/10/2020 16:41	4,83	42	202,65	CHI
202010185901	GOIANIA	10694092	ATLANTICO S2	31/10/2020 11:52	31/10/2020 14:02	31/10/2020 11:52	31/10/2020 14:02	2,17	1	2,17	CHI
202010185902	TRINDADE	10018860549	GOYA S1	31/10/2020 11:52	31/10/2020 13:54	31/10/2020 11:52	31/10/2020 13:54	2,03	1	2,03	CHI
202010186051	NEROPOLIS	NR12216870LD	NEROPOLIS S2	31/10/2020 11:53	31/10/2020 14:34	31/10/2020 11:53	31/10/2020 14:34	2,68	44	117,90	CHI
202010185922	GOIANIA	10657769	CAMPINAS S3	31/10/2020 11:57	31/10/2020 13:46	31/10/2020 11:57	31/10/2020 13:46	1,81	1	1,81	CHI
202010185926	MUNDO NOVO DE GOIAS	MH21253852	NOVA CRIXAS	31/10/2020 11:58	01/11/2020 19:25	31/10/2020 11:58	01/11/2020 19:25	31,45	1	31,45	CHI
202010185927	GOIANIA	11458021	GOIANIA LESTE S2	31/10/2020 11:58	31/10/2020 17:14	31/10/2020 11:58	31/10/2020 17:14	5,27	1	5,27	CHI
202010185930	NIQUELANDIA	NQ21239326	NIQUELANDIA SUBTRANSMISSAO	31/10/2020 11:58	01/11/2020 16:43	31/10/2020 11:58	01/11/2020 16:43	28,74	1	28,74	CHI
202010185956	IPORA	IR10409819	IPORA	31/10/2020 12:00	31/10/2020 14:04	31/10/2020 12:00	31/10/2020 12:04	0,08	3890	313,36	CHI
202010185956	IPORA	IR10409819	IPORA	31/10/2020 12:00	31/10/2020 14:04	31/10/2020 12:00	31/10/2020 13:22	1,38	23	31,67	CHI
202010185956	IPORA	IR10409819	IPORA	31/10/2020 12:00	31/10/2020 14:04	31/10/2020 12:06	31/10/2020 13:22	1,28	2971	3792,15	CHI
202010185956	IPORA	IR13380967	IPORA	31/10/2020 12:00	31/10/2020 14:04	31/10/2020 12:06	31/10/2020 13:31	1,43	821	1171,29	CHI
202010185956	IPORA	IR11284656	IPORA	31/10/2020 12:00	31/10/2020 14:04	31/10/2020 12:06	31/10/2020 14:04	1,97	98	193,47	CHI

202010185946	ALTO PARAISO DE GOIAS	BF21048003	SAO JOAO D ALIANCA	31/10/2020 12:02	31/10/2020 15:11	31/10/2020 12:02	31/10/2020 15:11	3,14	1	3,14	CHI
202010185947	GOIANIA	17335462	XAVANTES	31/10/2020 12:03	31/10/2020 15:38	31/10/2020 12:03	31/10/2020 15:38	3,58	1	3,58	CHI
202010185674	NIQUELANDIA	NQ12284693	NIQUELANDIA SUBTRANSMISSAO	31/10/2020 12:03	01/11/2020 16:41	31/10/2020 12:03	01/11/2020 16:41	28,63	1	28,63	CHI
202010185952	GOIANIA	GN11313120	CARAJAS S1	31/10/2020 12:04	31/10/2020 16:33	31/10/2020 12:04	31/10/2020 16:33	4,48	71	318,12	CHI
202010186202	ITABERAI	IB12220127	ITABERAI S1	31/10/2020 12:04	31/10/2020 16:12	31/10/2020 12:04	31/10/2020 15:45	3,68	202	742,80	CHI
202010186202	ITABERAI	IB12220146LD	ITABERAI S1	31/10/2020 12:04	31/10/2020 16:12	31/10/2020 12:04	31/10/2020 16:12	4,13	91	375,58	CHI
202010185974	APARECIDA DE GOIANIA	10003310645	ANHANGUERA	31/10/2020 12:07	31/10/2020 15:56	31/10/2020 12:07	31/10/2020 15:56	3,80	1	3,80	CHI
202010185975	SAO LUIS DE MONTES BELOS	SL21237705	SAO LUIZ DOS MONTES BELOS	31/10/2020 12:08	01/11/2020 10:35	31/10/2020 12:08	01/11/2020 10:35	22,44	1	22,44	CHI
202010185977	TERESINA DE GOIAS	TE21218389	FLORES DE GOIAS	31/10/2020 12:09	31/10/2020 18:10	31/10/2020 12:09	31/10/2020 18:10	6,01	1	6,01	CHI
202010185982	AURILANDIA	AI21049632	FIRMINOPOLIS S2	31/10/2020 12:09	01/11/2020 08:36	31/10/2020 12:09	01/11/2020 08:36	20,44	1	20,44	CHI
202010185991	CRIXAS	CX21320663	SANTA TEREZINHA	31/10/2020 12:12	31/10/2020 20:06	31/10/2020 12:12	31/10/2020 20:06	7,90	1	7,90	CHI
202010185993	ESTRELA DO NORTE	ET21181733	MARA ROSA	31/10/2020 12:12	31/10/2020 21:48	31/10/2020 12:12	31/10/2020 21:48	9,59	1	9,59	CHI
202010185995	ORIZONA	OZ21309650	PIRES DO RIO S2	31/10/2020 12:13	31/10/2020 18:24	31/10/2020 12:13	31/10/2020 18:24	6,18	1	6,18	CHI
202010186000	APARECIDA DE GOIANIA	200038485	INDEPENDENCIA S1	31/10/2020 12:14	31/10/2020 14:25	31/10/2020 12:14	31/10/2020 14:25	2,18	1	2,18	CHI
202010186533	JARAGUA	JA12070670	JARAGUA	31/10/2020 12:14	31/10/2020 14:37	31/10/2020 12:14	31/10/2020 14:37	2,38	10	23,77	CHI
202010186007	RIO VERDE	630415377	RIO VERDE S1	31/10/2020 12:15	31/10/2020 14:44	31/10/2020 12:15	31/10/2020 14:44	2,47	1	2,47	CHI
202010186861	PALESTINA DE GOIAS	PY12140029	IPORA	31/10/2020 12:15	31/10/2020 15:53	31/10/2020 12:15	31/10/2020 15:53	3,62	6	21,73	CHI
202010186012	PANAMA	PX21254799	GOIATUBA S1	31/10/2020 12:16	31/10/2020 20:05	31/10/2020 12:16	31/10/2020 20:05	7,81	1	7,81	CHI
202010186015	GOIANIA	13836596	INDEPENDENCIA S2	31/10/2020 12:17	31/10/2020 18:03	31/10/2020 12:17	31/10/2020 18:03	5,77	1	5,77	CHI
202010186019	BELA VISTA DE GOIAS	BV21095872	CEPAIGO S2	31/10/2020 12:17	31/10/2020 13:40	31/10/2020 12:17	31/10/2020 13:40	1,37	2	2,75	CHI
202010186643	GUAPO	GA12000002	GUAPO S1	31/10/2020 12:17	01/11/2020 18:00	31/10/2020 12:17	31/10/2020 17:57	5,66	207	1170,64	CHI
202010186643	GUAPO	GA12395350LD	GUAPO S1	31/10/2020 12:17	01/11/2020 18:00	31/10/2020 12:17	01/11/2020 18:00	29,70	3	89,10	CHI
202010186712	GAMELEIRA DE GOIAS	SV12084559	DAIA S1	31/10/2020 12:18	31/10/2020 21:16	31/10/2020 12:18	31/10/2020 21:16	8,96	3	26,87	CHI
202010186712	SILVANIA	SV12084559	DAIA S1	31/10/2020 12:18	31/10/2020 21:16	31/10/2020 12:18	31/10/2020 21:16	8,96	1	8,96	CHI
202010186029	GOIANIA	GN12193161	MEIA PONTE	31/10/2020 12:18	31/10/2020 14:57	31/10/2020 12:18	31/10/2020 14:57	2,64	245	646,05	CHI
202010186030	JUSSARA	JR11375845	BRITANIA	31/10/2020 12:18	01/11/2020 05:04	31/10/2020 12:18	01/11/2020 05:04	16,75	1	16,75	CHI
202010186032	PIRENOPOLIS	Z20027869	CORUMBA	31/10/2020 12:19	31/10/2020 20:22	31/10/2020 12:19	31/10/2020 20:22	8,05	1	8,05	CHI
202010186045	MORRINHOS	MR21293158	MORRINHOS	31/10/2020 12:19	31/10/2020 16:36	31/10/2020 12:19	31/10/2020 16:36	4,27	1	4,27	CHI
202010186046	ITABERAI	IB21249628	ITABERAI S2	31/10/2020 12:20	31/10/2020 15:29	31/10/2020 12:20	31/10/2020 15:29	3,15	1	3,15	CHI
202010186049	PALESTINA DE GOIAS	PY21142991	PALESTINA	31/10/2020 12:21	31/10/2020 20:55	31/10/2020 12:21	31/10/2020 20:55	8,56	1	8,56	CHI
202010186090	DIORAMA	DI12063513	IPORA	31/10/2020 12:22	31/10/2020 14:53	31/10/2020 12:22	31/10/2020 14:53	2,51	24	60,29	CHI
202010186090	IPORA	DI12063513	IPORA	31/10/2020 12:22	31/10/2020 14:53	31/10/2020 12:22	31/10/2020 14:53	2,51	17	42,70	CHI
202010186057	FAINA	FC12332532	GOIAS	31/10/2020 12:22	01/11/2020 16:24	31/10/2020 12:22	01/11/2020 16:24	28,03	1	28,03	CHI
202010186209	JUSSARA	JR12086356	BRITANIA	31/10/2020 12:22	31/10/2020 14:22	31/10/2020 12:22	31/10/2020 14:22	1,99	1	1,99	CHI
202010186209	FAZENDA NOVA	JR12086356	BRITANIA	31/10/2020 12:22	31/10/2020 14:22	31/10/2020 12:22	31/10/2020 14:22	1,99	8	15,96	CHI
202010186068	CAIAPONIA	CP21214158	MONTIVIDIU T	31/10/2020 12:23	31/10/2020 15:46	31/10/2020 12:23	31/10/2020 15:46	3,37	1	3,37	CHI
202010187995	MINACU	IH12236222	MINACU	31/10/2020 12:24	31/10/2020 20:50	31/10/2020 12:24	31/10/2020 20:50	8,43	20	168,62	CHI
202010186076	SANTA HELENA DE GOIAS	SH11189160	IPEGUARI	31/10/2020 12:25	31/10/2020 15:16	31/10/2020 12:25	31/10/2020 15:16	2,84	56	158,96	CHI
202010186184	APARECIDA DE GOIANIA	AP11140149	INDEPENDENCIA S2	31/10/2020 12:26	31/10/2020 17:24	31/10/2020 12:26	31/10/2020 17:24	4,96	258	1280,54	CHI
202010186114	TRINDADE	TR12015759	INHUMAS S1	31/10/2020 12:27	31/10/2020 15:41	31/10/2020 12:27	31/10/2020 15:41	3,22	51	164,25	CHI
202010186114	GOIANIRA	TR12015759	INHUMAS S1	31/10/2020 12:27	31/10/2020 15:41	31/10/2020 12:27	31/10/2020 15:41	3,22	1	3,22	CHI
202010186132	ALVORADA DO NORTE	AQ12347010	IACIARA S2	31/10/2020 12:28	31/10/2020 16:10	31/10/2020 12:28	31/10/2020 16:10	3,70	15	55,46	CHI
202010186097	SANTO ANTONIO DO DESCOBERTO	SN11162886	AGUAS LINDAS DE GOIAS S2	31/10/2020 12:28	31/10/2020 17:45	31/10/2020 12:28	31/10/2020 17:45	5,28	88	464,57	CHI
202010186099	IPORA	IR21232634	IPORA	31/10/2020 12:28	31/10/2020 15:48	31/10/2020 12:28	31/10/2020 15:48	3,33	1	3,33	CHI
202010186100	SANTO ANTONIO DO DESCOBERTO	SN21381416	ALEXANIA	31/10/2020 12:28	31/10/2020 15:14	31/10/2020 12:28	31/10/2020 15:14	2,76	1	2,76	CHI
202010186102	NIQUELANDIA	NQ21197545	NIQUELANDIA SUBTRANSMISSAO	31/10/2020 12:28	01/11/2020 16:03	31/10/2020 12:28	01/11/2020 16:03	27,57	2	55,14	CHI
202010186105	GOIAS	GS21311156	GOIAS	31/10/2020 12:29	31/10/2020 19:50	31/10/2020 12:29	31/10/2020 19:50	7,34	1	7,34	CHI
202010186291	TRINDADE	TR11074522	GOYA S2	31/10/2020 12:31	31/10/2020 17:00	31/10/2020 12:31	31/10/2020 17:00	4,47	162	724,55	CHI
202010186123	SANTO ANTONIO DO DESCOBERTO	SN21078148	MARAJOARA	31/10/2020 12:32	31/10/2020 21:18	31/10/2020 12:32	31/10/2020 21:18	8,75	1	8,75	CHI
202010186128	GOIANIA	15927726	GOYA S2	31/10/2020 12:34	31/10/2020 16:56	31/10/2020 12:34	31/10/2020 16:56	4,37	1	4,37	CHI
202010189196	POSSE	PS16416740	IACIARA S2	31/10/2020 12:35	31/10/2020 22:42	31/10/2020 12:35	31/10/2020 18:04	5,48	785	4305,72	CHI

202010189196	POSSE	PS10400659	IACIARA S2	31/10/2020 12:35	31/10/2020 22:42	31/10/2020 18:17	31/10/2020 19:02	0,75	318	238,50	CHI
202010189196	POSSE	PS16416740	IACIARA S2	31/10/2020 12:35	31/10/2020 22:42	31/10/2020 18:17	31/10/2020 19:05	0,79	785	623,86	CHI
202010189196	POSSE	PS13288734	IACIARA S2	31/10/2020 12:35	31/10/2020 22:42	31/10/2020 12:35	31/10/2020 22:42	10,13	257	2603,70	CHI
202010189196	MAMBAL	PS13288734	IACIARA S2	31/10/2020 12:35	31/10/2020 22:42	31/10/2020 12:35	31/10/2020 22:42	10,13	24	243,15	CHI
202010189196	POSSE	PS13288734	IACIARA S2	31/10/2020 12:35	31/10/2020 22:42	31/10/2020 12:35	31/10/2020 22:42	10,13	1	10,13	CHI
202010189196	POSSE	PS13288734	IACIARA S2	31/10/2020 12:35	31/10/2020 22:42	31/10/2020 12:35	31/10/2020 22:42	10,13	88	891,54	CHI
202010189196	POSSE	PS10400659	IACIARA S2	31/10/2020 12:35	31/10/2020 22:42	31/10/2020 19:11	31/10/2020 22:42	3,53	785	2768,65	CHI
202010186135	RIO VERDE	RV21340822	RIO VERDE S1	31/10/2020 12:35	31/10/2020 14:00	31/10/2020 12:35	31/10/2020 14:00	1,42	1	1,42	CHI
202010186766	ABADIANIA	SV12158398	ANAPOLIS UNIVERSITARIO S1	31/10/2020 12:35	31/10/2020 22:40	31/10/2020 12:35	31/10/2020 22:40	10,08	5	50,40	CHI
202010186766	GAMELEIRA DE GOIAS	SV12158398	ANAPOLIS UNIVERSITARIO S1	31/10/2020 12:35	31/10/2020 22:40	31/10/2020 12:35	31/10/2020 22:40	10,08	6	60,48	CHI
202010186140	ANAPOLIS	10029705930	DAIA S1	31/10/2020 12:35	31/10/2020 14:47	31/10/2020 12:35	31/10/2020 14:47	2,18	1	2,18	CHI
202010187549	DIORAMA	JP12074459	IPORA	31/10/2020 12:36	31/10/2020 20:34	31/10/2020 12:36	31/10/2020 20:34	7,96	3	23,89	CHI
202010187549	JAUPACI	JP12074459	IPORA	31/10/2020 12:36	31/10/2020 20:34	31/10/2020 12:36	31/10/2020 20:34	7,96	5	39,81	CHI
202010186145	GOIANIA	13746352	CARAJAS S2	31/10/2020 12:36	31/10/2020 15:31	31/10/2020 12:36	31/10/2020 15:31	2,91	1	2,91	CHI
202010186194	APARECIDA DE GOIANIA	03500224	GUAPO S2	31/10/2020 12:37	31/10/2020 16:41	31/10/2020 12:37	31/10/2020 12:41	0,06	2	0,13	CHI
202010186194	ARAGOIANIA	03500224	GUAPO S2	31/10/2020 12:37	31/10/2020 16:41	31/10/2020 12:37	31/10/2020 12:41	0,06	669	42,56	CHI
202010186194	HIDROLANDIA	03500224	GUAPO S2	31/10/2020 12:37	31/10/2020 16:41	31/10/2020 12:37	31/10/2020 12:41	0,06	2	0,13	CHI
202010186194	APARECIDA DE GOIANIA	03500224	GUAPO S2	31/10/2020 12:37	31/10/2020 16:41	31/10/2020 12:37	31/10/2020 12:43	0,09	1	0,09	CHI
202010186194	ARAGOIANIA	03500224	GUAPO S2	31/10/2020 12:37	31/10/2020 16:41	31/10/2020 12:37	31/10/2020 12:43	0,09	932	83,62	CHI
202010186194	GUAPO	03500224	GUAPO S2	31/10/2020 12:37	31/10/2020 16:41	31/10/2020 12:37	31/10/2020 12:43	0,09	29	2,60	CHI
202010186194	GUAPO	03500224	GUAPO S2	31/10/2020 12:37	31/10/2020 16:41	31/10/2020 12:37	31/10/2020 12:43	0,10	45	4,55	CHI
202010186194	ARAGOIANIA	03500224	GUAPO S2	31/10/2020 12:37	31/10/2020 16:41	31/10/2020 12:37	31/10/2020 12:43	0,10	20	2,02	CHI
202010186194	GUAPO	AO10400702	GUAPO S2	31/10/2020 12:37	31/10/2020 16:41	31/10/2020 12:38	31/10/2020 12:43	0,09	1	0,09	CHI
202010186194	ARAGOIANIA	03500224	GUAPO S2	31/10/2020 12:37	31/10/2020 16:41	31/10/2020 12:37	31/10/2020 12:44	0,11	194	20,48	CHI
202010186194	ARAGOIANIA	03500224	GUAPO S2	31/10/2020 12:37	31/10/2020 16:41	31/10/2020 12:37	31/10/2020 12:44	0,11	995	109,45	CHI
202010186194	ARAGOIANIA	03500224	GUAPO S2	31/10/2020 12:37	31/10/2020 16:41	31/10/2020 12:37	31/10/2020 12:50	0,22	660	143,18	CHI
202010186194	ARAGOIANIA	AO16414496	GUAPO S2	31/10/2020 12:37	31/10/2020 16:41	31/10/2020 14:15	31/10/2020 14:24	0,15	1104	160,69	CHI
202010186194	ARAGOIANIA	AO16433128	GUAPO S2	31/10/2020 12:37	31/10/2020 16:41	31/10/2020 12:55	31/10/2020 14:28	1,54	660	1016,77	CHI
202010186194	ARAGOIANIA	AO16423927	GUAPO S2	31/10/2020 12:37	31/10/2020 16:41	31/10/2020 14:15	31/10/2020 16:41	2,42	85	205,72	CHI
202010186194	ARAGOIANIA	AO16423927	GUAPO S2	31/10/2020 12:37	31/10/2020 16:41	31/10/2020 16:37	31/10/2020 16:41	0,05	1104	58,88	CHI
202010186149	ORIZONA	OZ11140712	PIRES DO RIO S2	31/10/2020 12:38	31/10/2020 14:17	31/10/2020 12:38	31/10/2020 14:17	1,64	150	246,62	CHI
202010186152	CALDAS NOVAS	760384551	SERRA DE CALDAS	31/10/2020 12:39	31/10/2020 14:04	31/10/2020 12:39	31/10/2020 14:04	1,41	1	1,41	CHI
202010186799	HEITORAI	HE12390849	ITAPURANGA	31/10/2020 12:40	31/10/2020 21:10	31/10/2020 12:40	31/10/2020 21:10	8,50	30	254,87	CHI
202010186799	ITAPURANGA	HE12390849	ITAPURANGA	31/10/2020 12:40	31/10/2020 21:10	31/10/2020 12:40	31/10/2020 21:10	8,50	1	8,50	CHI
202010186157	ITABERAI	50013609	ITABERAI S2	31/10/2020 12:40	31/10/2020 16:39	31/10/2020 12:40	31/10/2020 16:39	3,98	1	3,98	CHI
202010186161	GOIANIA	11454805	FERROVIARIO S1	31/10/2020 12:41	31/10/2020 16:10	31/10/2020 12:41	31/10/2020 16:10	3,48	1	3,48	CHI
202010187347	RIO QUENTE	RQ12063078	RIO QUENTE	31/10/2020 12:41	31/10/2020 22:22	31/10/2020 12:41	31/10/2020 22:22	9,68	5	48,40	CHI
202010186164	SANTO ANTONIO DO DESCOBERTO	SN11199559	AGUAS LINDAS DE GOIAS S2	31/10/2020 12:41	31/10/2020 18:32	31/10/2020 12:41	31/10/2020 18:32	5,84	101	590,20	CHI
202010186172	PETROLINA DE GOIAS	PG21313367	PETROLINA	31/10/2020 12:42	31/10/2020 15:18	31/10/2020 12:42	31/10/2020 15:18	2,59	1	2,59	CHI
202010186178	VIANOPOLIS	VN21067557	VIANOPOLIS	31/10/2020 12:43	31/10/2020 15:19	31/10/2020 12:43	31/10/2020 15:19	2,60	1	2,60	CHI
202010186175	COCALZINHO DE GOIAS	10011784863	COCALZINHO	31/10/2020 12:43	01/11/2020 01:02	31/10/2020 12:43	01/11/2020 01:02	12,31	1	12,31	CHI
202010186183	ITARUMA	CC12075919	CACHOEIRA ALTA	31/10/2020 12:43	31/10/2020 15:45	31/10/2020 12:43	31/10/2020 15:45	3,02	4	12,07	CHI
202010186183	CACU	CC12075919	CACHOEIRA ALTA	31/10/2020 12:43	31/10/2020 15:45	31/10/2020 12:43	31/10/2020 15:45	3,02	1	3,02	CHI
202010188414	SITIO D ABADIA	AQ12381614	IACIARA S2	31/10/2020 12:44	01/11/2020 00:34	31/10/2020 12:44	01/11/2020 00:34	11,83	6	70,97	CHI
202010186186	ANAPOLIS	OV21223924	NEROPOLIS S1	31/10/2020 12:44	01/11/2020 01:04	31/10/2020 12:44	01/11/2020 01:04	12,32	1	12,32	CHI
202010186188	FORMOSA	2870011060	ITUIQUIRA	31/10/2020 12:44	31/10/2020 19:26	31/10/2020 12:44	31/10/2020 19:26	6,68	0	0,00	CHI
202010186644	CACHOEIRA ALTA	CA12371227	CACHOEIRA ALTA	31/10/2020 12:45	31/10/2020 16:57	31/10/2020 12:45	31/10/2020 16:57	4,19	10	41,89	CHI
202010186201	GOIATUBA	140058126	GOIATUBA S2	31/10/2020 12:47	31/10/2020 15:13	31/10/2020 12:47	31/10/2020 15:13	2,43	1	2,43	CHI
202010186216	CRIXAS	CX12336671	SANTA TEREZINHA	31/10/2020 12:50	01/11/2020 05:01	31/10/2020 12:50	01/11/2020 05:01	16,18	1	16,18	CHI
202010186218	PILAR DE GOIAS	GG21136383	SANTA TEREZINHA	31/10/2020 12:50	31/10/2020 23:33	31/10/2020 12:50	31/10/2020 23:33	10,71	1	10,71	CHI
202010186227	MINEIROS	MY12303919RE	PARQUE DAS EMAS	31/10/2020 12:50	31/10/2020 20:13	31/10/2020 12:50	31/10/2020 20:13	7,37	18	132,64	CHI

202010186221	GOIAS	GS11162381	MATRINCHA	31/10/2020 12:51	01/11/2020 11:50	31/10/2020 12:51	01/11/2020 11:50	22,98	1	22,98	CHI
202010186222	FORMOSA	FA21309101	ITIQUEIRA	31/10/2020 12:51	31/10/2020 14:05	31/10/2020 12:51	31/10/2020 14:05	1,23	1	1,23	CHI
202010186692	FORMOSA	FA12262305	ITIQUEIRA	31/10/2020 12:51	31/10/2020 16:16	31/10/2020 12:51	31/10/2020 16:16	3,40	694	2361,72	CHI
202010186292	FAZENDA NOVA	NB12250852	JUSSARA	31/10/2020 12:52	31/10/2020 17:56	31/10/2020 12:52	31/10/2020 17:56	5,06	4	20,26	CHI
202010186292	NOVO BRASIL	NB12250852	JUSSARA	31/10/2020 12:52	31/10/2020 17:56	31/10/2020 12:52	31/10/2020 17:56	5,06	2	10,13	CHI
202010186292	HEITORAI	NB12250852	JUSSARA	31/10/2020 12:52	31/10/2020 17:56	31/10/2020 12:52	31/10/2020 17:56	5,06	1	5,06	CHI
202010186229	MOZARLANDIA	MZ21224035	MOZARLANDIA	31/10/2020 12:52	31/10/2020 17:24	31/10/2020 12:52	31/10/2020 17:24	4,53	1	4,53	CHI
202010186230	APARECIDA DE GOIANIA	14741003	INDEPENDENCIA S1	31/10/2020 12:52	31/10/2020 14:54	31/10/2020 12:52	31/10/2020 14:54	2,03	1	2,03	CHI
202010186240	LUZIANIA	LZ12051365	CRISTALINA S2	31/10/2020 12:54	31/10/2020 18:40	31/10/2020 12:54	31/10/2020 18:40	5,76	7	40,29	CHI
202010186241	AGUA FRIA DE GOIAS	TL12204677	SAO JOAO D ALIANCA	31/10/2020 12:55	01/11/2020 09:50	31/10/2020 12:55	01/11/2020 09:50	20,92	5	104,58	CHI
202010186247	GOIANIA	10000503582	GOYA S1	31/10/2020 12:55	31/10/2020 19:34	31/10/2020 12:55	31/10/2020 19:34	6,64	1	6,64	CHI
202010185996	GOIANIA	GN11000436	AEROPORTO S1	31/10/2020 12:57	31/10/2020 15:57	31/10/2020 12:57	31/10/2020 15:57	3,00	54	162,00	CHI
202010186255	GOIANIA	12413707	GOIANIA LESTE S1	31/10/2020 12:57	31/10/2020 19:48	31/10/2020 12:57	31/10/2020 19:48	6,84	1	6,84	CHI
202010186264	PALMINOPOLIS	PP21007012	PALMEIRAS	31/10/2020 12:59	31/10/2020 23:54	31/10/2020 12:59	31/10/2020 23:54	10,91	1	10,91	CHI
202010186265	VILA PROPICIO	NP21231821	GOIANESIA S1	31/10/2020 12:59	31/10/2020 17:32	31/10/2020 12:59	31/10/2020 17:32	4,54	1	4,54	CHI
202010186266	SAO MIGUEL DO PASSA QUATRO	SQ21145079	BELA VISTA S2	31/10/2020 12:59	31/10/2020 17:51	31/10/2020 12:59	31/10/2020 17:51	4,86	1	4,86	CHI
202010186410	SAO LUIS DE MONTES BELOS	SL12003914	SAO LUIZ DOS MONTES BELOS	31/10/2020 13:00	31/10/2020 16:18	31/10/2020 13:00	31/10/2020 16:18	3,30	11	36,29	CHI
202010187120	SAO LUIS DE MONTES BELOS	SL21343012	SAO LUIZ DOS MONTES BELOS	31/10/2020 13:00	31/10/2020 19:40	31/10/2020 13:00	31/10/2020 19:40	6,67	2	13,33	CHI
202010186399	GOIANIA	GN13000163	GOIANIA LESTE S1	31/10/2020 13:00	31/10/2020 16:38	31/10/2020 13:00	31/10/2020 16:38	3,63	562	2040,37	CHI
202010186273	FORMOSA	FA11254234	ITIQUEIRA	31/10/2020 13:01	31/10/2020 18:44	31/10/2020 13:01	31/10/2020 18:44	5,71	1	5,71	CHI
202010186284	AGUA FRIA DE GOIAS	TL21205630	SAO JOAO D ALIANCA	31/10/2020 13:03	31/10/2020 17:07	31/10/2020 13:03	31/10/2020 17:07	4,06	1	4,06	CHI
202010186298	JATAI	SX12080854RE	JATAI S1	31/10/2020 13:05	31/10/2020 17:51	31/10/2020 13:05	31/10/2020 17:51	4,75	50	237,74	CHI
202010186298	SERRANOPOLIS	SX12080854RE	JATAI S1	31/10/2020 13:05	31/10/2020 17:51	31/10/2020 13:05	31/10/2020 17:51	4,75	24	114,11	CHI
202010186299	NOVA ROMA	ND12195973	IACIARA S2	31/10/2020 13:06	31/10/2020 19:02	31/10/2020 13:06	31/10/2020 19:02	5,93	11	65,21	CHI
202010186301	GOIANIA	10016374841	SENADOR CANEDO	31/10/2020 13:06	31/10/2020 14:48	31/10/2020 13:06	31/10/2020 14:48	1,69	1	1,69	CHI
202010186318	PADRE BERNARDO	10010785696	PADRE BERNARDO	31/10/2020 13:10	31/10/2020 15:18	31/10/2020 13:10	31/10/2020 15:18	2,13	1	2,13	CHI
202010187021	GOIANIA	GN11169932	CAMPINAS S2	31/10/2020 13:11	31/10/2020 20:08	31/10/2020 13:11	31/10/2020 20:08	6,94	99	687,39	CHI
202010186938	CRISTALINA	KR12261669	CRISTALINA S2	31/10/2020 13:11	31/10/2020 15:45	31/10/2020 13:11	31/10/2020 15:45	2,56	25	63,94	CHI
202010186531	SAO SIMAO	SO11133910	CACHOEIRA ALTA	31/10/2020 13:12	31/10/2020 16:34	31/10/2020 13:12	31/10/2020 16:34	3,35	113	378,96	CHI
202010186389	BELA VISTA DE GOIAS	BV32051409	BELA VISTA S2	31/10/2020 13:14	31/10/2020 15:26	31/10/2020 13:14	31/10/2020 15:26	2,20	306	673,20	CHI
202010186395	CORUMBAIBA	CI21000470	VILA CORUMBA	31/10/2020 13:15	31/10/2020 14:34	31/10/2020 13:15	31/10/2020 14:34	1,31	1	1,31	CHI
202010186412	FORMOSA	610125618	SAO JOAO D ALIANCA	31/10/2020 13:15	31/10/2020 18:36	31/10/2020 13:15	31/10/2020 18:36	5,35	1	5,35	CHI
202010186398	GOIANIA	10287358	CAMPINAS S2	31/10/2020 13:15	31/10/2020 17:41	31/10/2020 13:15	31/10/2020 17:41	4,42	1	4,42	CHI
202010188860	POSSE	IA12034649	IACIARA S2	31/10/2020 13:16	01/11/2020 04:48	31/10/2020 13:16	01/11/2020 04:48	15,53	3	46,59	CHI
202010187760	MINACU	IH12207388	MINACU	31/10/2020 13:16	31/10/2020 20:08	31/10/2020 13:16	31/10/2020 20:08	6,86	79	542,27	CHI
202010186417	CATALAO	1990120730	CATALAO S2	31/10/2020 13:19	01/11/2020 01:51	31/10/2020 13:19	01/11/2020 01:51	12,52	1	12,52	CHI
202010185085	FLORES DE GOIAS	FB12211535	IACIARA S2	31/10/2020 13:20	31/10/2020 20:27	31/10/2020 13:20	31/10/2020 20:27	7,10	363	2578,71	CHI
202010187128	RIO VERDE	10000976871	RIO VERDE S1	31/10/2020 13:21	31/10/2020 16:21	31/10/2020 13:21	31/10/2020 16:21	2,99	1	2,99	CHI
202010186663	GOIAS	GS12087523RE	GOIAS	31/10/2020 13:22	01/11/2020 17:22	31/10/2020 13:22	31/10/2020 18:44	5,36	18	96,55	CHI
202010186663	GOIAS	GS12087523RE	GOIAS	31/10/2020 13:22	01/11/2020 17:22	31/10/2020 19:07	31/10/2020 19:30	0,38	4	1,52	CHI
202010186663	GOIAS	GS13274437	GOIAS	31/10/2020 13:22	01/11/2020 17:22	31/10/2020 19:07	01/11/2020 11:13	16,09	13	209,20	CHI
202010186663	GOIAS	GS12274214LD	GOIAS	31/10/2020 13:22	01/11/2020 17:22	31/10/2020 13:22	01/11/2020 12:31	23,16	50	1157,78	CHI
202010186663	GOIAS	8529446	GOIAS	31/10/2020 13:22	01/11/2020 17:22	31/10/2020 19:07	01/11/2020 17:22	22,24	1	22,24	CHI
202010186431	GOIANIA	16877974	REAL S2	31/10/2020 13:22	31/10/2020 15:14	31/10/2020 13:22	31/10/2020 15:14	1,87	1	1,87	CHI
202010186434	SENADOR CANEDO	10015326690	SENADOR CANEDO	31/10/2020 13:23	31/10/2020 16:45	31/10/2020 13:23	31/10/2020 16:45	3,36	1	3,36	CHI
202010186435	COLINAS DO SUL	9700000077	NIQUELANDIA SUBTRANSMISSAO	31/10/2020 13:23	01/11/2020 20:14	31/10/2020 13:23	01/11/2020 20:14	30,84	1	30,84	CHI
202010186457	JANDAIA	JD12294293	PALMEIRAS	31/10/2020 13:24	31/10/2020 22:17	31/10/2020 13:24	31/10/2020 22:17	8,88	2	17,76	CHI
202010186442	GOIANIA	14282940	CARAJAS S2	31/10/2020 13:24	31/10/2020 16:14	31/10/2020 13:24	31/10/2020 16:14	2,83	1	2,83	CHI
202010186451	FORMOSA	FA21072535	ITIQUEIRA	31/10/2020 13:26	31/10/2020 15:40	31/10/2020 13:26	31/10/2020 15:40	2,23	1	2,23	CHI
202010186454	AGUAS LINDAS DE GOIAS	4830376704	AGUAS LINDAS DE GOIAS S1	31/10/2020 13:27	31/10/2020 14:38	31/10/2020 13:27	31/10/2020 14:38	1,18	1	1,18	CHI
202010186463	PADRE BERNARDO	PB12092844	PADRE BERNARDO	31/10/2020 13:28	31/10/2020 14:59	31/10/2020 13:28	31/10/2020 14:59	1,50	5	7,51	CHI

202010186466	ANAPOLIS	21261532	JUNDIAI S1	31/10/2020 13:29	31/10/2020 14:42	31/10/2020 13:29	31/10/2020 14:42	1,21	1	1,21	CHI
202010186477	ITUMBIARA	IT21290359	ITUMBIARA NOVA	31/10/2020 13:31	31/10/2020 14:58	31/10/2020 13:31	31/10/2020 14:58	1,44	1	1,44	CHI
202010186487	PADRE BERNARDO	PB21330815	PADRE BERNARDO	31/10/2020 13:33	31/10/2020 17:34	31/10/2020 13:33	31/10/2020 16:13	2,65	1	2,65	CHI
202010186487	PADRE BERNARDO	PB12375252	PADRE BERNARDO	31/10/2020 13:33	31/10/2020 17:34	31/10/2020 15:06	31/10/2020 16:51	1,76	1	1,76	CHI
202010186487	PADRE BERNARDO	6367990	PADRE BERNARDO	31/10/2020 13:33	31/10/2020 17:34	31/10/2020 16:51	31/10/2020 17:34	0,72	1	0,72	CHI
202010186494	AGUA FRIA DE GOIAS	TL21204680	SAO JOAO D ALIANCA	31/10/2020 13:34	31/10/2020 18:06	31/10/2020 13:34	31/10/2020 18:06	4,52	1	4,52	CHI
202010186499	CATALAO	CT11032134	CATALAO S2	31/10/2020 13:35	31/10/2020 17:57	31/10/2020 13:35	31/10/2020 17:57	4,36	81	352,91	CHI
202010186500	GOIANIA	10020790692	MEIA PONTE	31/10/2020 13:35	31/10/2020 17:44	31/10/2020 13:35	31/10/2020 17:44	4,14	1	4,14	CHI
202010186714	GUAPO	GA12007340	GUAPO S1	31/10/2020 13:36	31/10/2020 20:35	31/10/2020 13:36	31/10/2020 20:35	6,98	24	167,53	CHI
202010186505	NIQUELANDIA	NQ11171096	BARRO ALTO	31/10/2020 13:36	01/11/2020 11:38	31/10/2020 13:36	01/11/2020 11:38	22,02	2	44,04	CHI
202010186509	SILVANIA	AN21214687	DAIA S2	31/10/2020 13:37	01/11/2020 18:49	31/10/2020 13:37	01/11/2020 18:49	29,19	1	29,19	CHI
202010186511	APARECIDA DE GOIANIA	10013574289	INDEPENDENCIA S2	31/10/2020 13:37	31/10/2020 17:38	31/10/2020 13:37	31/10/2020 17:38	4,01	1	4,01	CHI
202010187545	ITAPACI	IW12197514	ITAPACI	31/10/2020 13:38	31/10/2020 17:50	31/10/2020 13:38	31/10/2020 17:50	4,19	220	921,80	CHI
202010186518	PLANALTINA	PI12291523	PLANALTINA	31/10/2020 13:39	31/10/2020 17:15	31/10/2020 13:39	31/10/2020 17:15	3,59	11	39,54	CHI
202010186911	NIQUELANDIA	NQ12400321	URUACU	31/10/2020 13:40	31/10/2020 20:14	31/10/2020 13:40	31/10/2020 20:14	6,56	191	1252,11	CHI
202010186545	SENADOR CANEDO	SW16414811	CEPAIGO S2	31/10/2020 13:40	31/10/2020 18:04	31/10/2020 13:40	31/10/2020 14:46	1,09	134	145,80	CHI
202010186545	BELA VISTA DE GOIAS	SW16414811	CEPAIGO S2	31/10/2020 13:40	31/10/2020 18:04	31/10/2020 13:40	31/10/2020 14:46	1,09	2	2,18	CHI
202010186545	BELA VISTA DE GOIAS	BV10434739	CEPAIGO S2	31/10/2020 13:40	31/10/2020 18:04	31/10/2020 13:40	31/10/2020 17:42	4,04	82	330,92	CHI
202010186545	SENADOR CANEDO	BV10434739	CEPAIGO S2	31/10/2020 13:40	31/10/2020 18:04	31/10/2020 13:40	31/10/2020 17:42	4,04	297	1198,56	CHI
202010186545	SENADOR CANEDO	SW13234547	CEPAIGO S2	31/10/2020 13:40	31/10/2020 18:04	31/10/2020 17:59	31/10/2020 18:04	0,09	134	11,99	CHI
202010186545	BELA VISTA DE GOIAS	SW13234547	CEPAIGO S2	31/10/2020 13:40	31/10/2020 18:04	31/10/2020 17:59	31/10/2020 18:04	0,09	2	0,18	CHI
202010186538	NOVA GLORIA	NG12181400	ITAPACI	31/10/2020 13:41	31/10/2020 15:10	31/10/2020 13:41	31/10/2020 15:10	1,47	12	17,70	CHI
202010186540	NIQUELANDIA	NQ21156608	BARRO ALTO	31/10/2020 13:41	01/11/2020 15:57	31/10/2020 13:41	01/11/2020 15:57	26,26	1	26,26	CHI
202010186608	CALDAZINHA	BV12043268	CEPAIGO S2	31/10/2020 13:43	31/10/2020 16:02	31/10/2020 13:43	31/10/2020 16:02	2,30	44	101,38	CHI
202010186554	GOIANIA	GN11363200	CARAJAS S1	31/10/2020 13:44	31/10/2020 17:48	31/10/2020 13:44	31/10/2020 17:48	4,05	40	162,19	CHI
202010186791	GOIANIA	GN12168434	GOIANIA LESTE S2	31/10/2020 13:45	31/10/2020 15:40	31/10/2020 13:45	31/10/2020 15:40	1,92	189	362,20	CHI
202010186559	GOIANIA	14817093	CAMPINAS S1	31/10/2020 13:45	31/10/2020 17:45	31/10/2020 13:45	31/10/2020 17:45	4,00	1	4,00	CHI
202010186562	IPAMERI	IP12021532	IPAMERI	31/10/2020 13:45	31/10/2020 17:02	31/10/2020 13:45	31/10/2020 17:02	3,27	3	9,82	CHI
202010186562	CORUMBAIBA	IP12021532	IPAMERI	31/10/2020 13:45	31/10/2020 17:02	31/10/2020 13:45	31/10/2020 17:02	3,27	2	6,54	CHI
202010186992	BELA VISTA DE GOIAS	BV12020406	BELA VISTA S2	31/10/2020 13:46	01/11/2020 18:35	01/11/2020 03:30	01/11/2020 18:35	15,07	2	30,14	CHI
202010186992	BELA VISTA DE GOIAS	BV12020406	BELA VISTA S2	31/10/2020 13:46	01/11/2020 18:35	01/11/2020 14:47	01/11/2020 18:35	3,80	9	34,20	CHI
202010186566	LEOPOLDO DE BULHOES	LB21037888	DAIA S1	31/10/2020 13:46	31/10/2020 23:16	31/10/2020 13:46	31/10/2020 23:16	9,49	2	18,99	CHI
202010186568	MATRINCHA	MP12299734	MATRINCHA	31/10/2020 13:46	31/10/2020 16:20	31/10/2020 13:46	31/10/2020 16:20	2,55	4	10,22	CHI
202010186570	NOVO GAMA	NJ11248693	MARAJOARA	31/10/2020 13:46	31/10/2020 15:11	31/10/2020 13:46	31/10/2020 15:11	1,40	123	172,64	CHI
202010186571	ITABERAI	10032258630	ITABERAI S1	31/10/2020 13:46	31/10/2020 17:29	31/10/2020 13:46	31/10/2020 17:29	3,70	1	3,70	CHI
202010186572	TRINDADE	TR31181988	TRINDADE	31/10/2020 13:46	31/10/2020 16:54	31/10/2020 13:46	31/10/2020 16:54	3,12	1	3,12	CHI
202010186582	CATURAL	CK12211426	INHUMAS S1	31/10/2020 13:48	31/10/2020 16:24	31/10/2020 13:48	31/10/2020 16:24	2,59	173	448,02	CHI
202010186583	CRISTALINA	KR12183807	CRISTALINA S2	31/10/2020 13:48	31/10/2020 18:32	31/10/2020 13:48	31/10/2020 18:32	4,72	2	9,45	CHI
202010186584	INHUMAS	IN21000077	INHUMAS S2	31/10/2020 13:48	31/10/2020 17:39	31/10/2020 13:48	31/10/2020 17:39	3,83	1	3,83	CHI
202010186585	NIQUELANDIA	NQ21294244	URUACU	31/10/2020 13:49	31/10/2020 17:24	31/10/2020 13:49	31/10/2020 17:24	3,58	1	3,58	CHI
202010186588	CACHOEIRA ALTA	CA21078874	CACHOEIRA ALTA	31/10/2020 13:49	31/10/2020 16:36	31/10/2020 13:49	31/10/2020 16:36	2,77	1	2,77	CHI
202010187452	SAO JOAO D ALIANCA	JL12098856	SAO JOAO D ALIANCA	31/10/2020 13:51	31/10/2020 18:55	31/10/2020 13:51	31/10/2020 18:55	5,07	211	1068,83	CHI
202010186598	ANAPOLIS	10002159323	JUNDIAI S1	31/10/2020 13:52	31/10/2020 23:01	31/10/2020 13:52	31/10/2020 23:01	9,15	1	9,15	CHI
202010186602	IPORA	730026668	IPORA	31/10/2020 13:52	31/10/2020 16:06	31/10/2020 13:52	31/10/2020 16:06	2,23	1	2,23	CHI
202010187872	POSSE	SA12211553	IACIARA S2	31/10/2020 13:53	31/10/2020 19:16	31/10/2020 13:53	31/10/2020 19:16	5,38	7	37,68	CHI
202010187872	SIMOLANDIA	SA12211553	IACIARA S2	31/10/2020 13:53	31/10/2020 19:16	31/10/2020 13:53	31/10/2020 19:16	5,38	11	59,21	CHI
202010187020	NIQUELANDIA	NQ11048787	NIQUELANDIA SUBTRANSMISSAO	31/10/2020 13:53	01/11/2020 06:58	31/10/2020 13:53	01/11/2020 06:58	17,08	133	2271,79	CHI
202010186618	BALIZA	BH11259285	CAIAPONIA	31/10/2020 13:55	31/10/2020 17:42	31/10/2020 13:55	31/10/2020 17:42	3,78	1	3,78	CHI
202010187061	GOIATUBA	GT12000178	BOM JESUS DE GOIAS	31/10/2020 13:56	31/10/2020 18:09	31/10/2020 13:56	31/10/2020 18:09	4,21	27	113,76	CHI
202010186627	MAURILANDIA	1040010201	RIO DOS BOIS	31/10/2020 13:56	31/10/2020 19:04	31/10/2020 13:56	31/10/2020 19:04	5,12	1	5,12	CHI
202010187402	PLANALTINA	PI12324293	SAO JOAO D ALIANCA	31/10/2020 13:56	31/10/2020 20:02	31/10/2020 13:56	31/10/2020 20:02	6,09	8	48,69	CHI

202010186629	AGUAS LINDAS DE GOIAS	10015737134	AGUAS LINDAS DE GOIAS S1	31/10/2020 13:56	31/10/2020 15:53	31/10/2020 13:56	31/10/2020 15:53	1,93	1	1,93	CHI
202010186631	CACU	CC21075794	CACHOEIRA ALTA	31/10/2020 13:57	31/10/2020 20:23	31/10/2020 13:57	31/10/2020 20:23	6,43	1	6,43	CHI
202010186632	GOIATUBA	GT21247744	BOM JESUS DE GOIAS	31/10/2020 13:57	31/10/2020 22:24	31/10/2020 13:57	31/10/2020 22:24	8,44	3	25,33	CHI
202010186936	MINACU	IH12088797	MINACU	31/10/2020 13:57	31/10/2020 17:00	31/10/2020 13:57	31/10/2020 17:00	3,04	172	523,64	CHI
202010186642	RUBIATABA	RB12003316	RUBIATABA	31/10/2020 13:59	01/11/2020 12:03	01/11/2020 10:48	01/11/2020 12:03	1,24	5	6,21	CHI
202010186834	APARECIDA DE GOIANIA	AP11123130	INDEPENDENCIA S2	31/10/2020 13:59	31/10/2020 15:25	31/10/2020 13:59	31/10/2020 15:25	1,43	337	481,44	CHI
202010186641	ITAPURANGA	IK12249439	ITAPURANGA	31/10/2020 13:59	31/10/2020 17:22	31/10/2020 13:59	31/10/2020 17:22	3,38	607	2048,79	CHI
202010186642	RUBIATABA	RB12003316	RUBIATABA	31/10/2020 13:59	01/11/2020 12:03	31/10/2020 13:59	01/11/2020 12:03	22,07	39	860,63	CHI
202010186645	ITABERAI	10016994653	ITABERAI S2	31/10/2020 14:00	01/11/2020 09:25	31/10/2020 14:00	01/11/2020 09:25	19,42	1	19,42	CHI
202010186646	MUNDO NOVO DE GOIAS	MH21321055	NOVA CRIXAS	31/10/2020 14:00	02/11/2020 08:26	31/10/2020 14:00	02/11/2020 08:26	42,43	1	42,43	CHI
202010186651	GOIANIA	14143288	GOYA S2	31/10/2020 14:00	31/10/2020 18:40	31/10/2020 14:00	31/10/2020 18:40	4,65	1	4,65	CHI
202010186654	CATALAO	CT12250355	CATALAO S1	31/10/2020 14:01	31/10/2020 17:09	31/10/2020 14:01	31/10/2020 17:09	3,12	8	25,00	CHI
202010186656	MINACU	IH12230531	MINACU	31/10/2020 14:02	01/11/2020 10:31	31/10/2020 14:02	01/11/2020 10:31	20,48	4	81,93	CHI
202010187246	AGUA FRIA DE GOIAS	TL12048061	SAO JOAO D ALIANCA	31/10/2020 14:02	31/10/2020 17:07	31/10/2020 14:02	31/10/2020 17:07	3,08	55	169,51	CHI
202010186991	PARAUNA	PU10377154	PARAUNA	31/10/2020 14:03	01/11/2020 13:55	01/11/2020 01:49	01/11/2020 02:12	0,39	8	3,10	CHI
202010186991	PARAUNA	PU10377154	PARAUNA	31/10/2020 14:03	01/11/2020 13:55	01/11/2020 02:00	01/11/2020 02:12	0,20	37	7,55	CHI
202010186991	SAO JOAO DA PARAUNA	PU10377154	PARAUNA	31/10/2020 14:03	01/11/2020 13:55	01/11/2020 02:00	01/11/2020 02:12	0,20	49	10,00	CHI
202010186991	PARAUNA	PU10404263	PARAUNA	31/10/2020 14:03	01/11/2020 13:55	01/11/2020 10:15	01/11/2020 10:23	0,13	13	1,65	CHI
202010186991	PARAUNA	PU13361632	PARAUNA	31/10/2020 14:03	01/11/2020 13:55	31/10/2020 21:38	01/11/2020 01:32	3,90	1	3,90	CHI
202010186991	PARAUNA	PU10377154	PARAUNA	31/10/2020 14:03	01/11/2020 13:55	31/10/2020 14:03	01/11/2020 01:36	11,55	8	92,40	CHI
202010186991	PARAUNA	PU10377154	PARAUNA	31/10/2020 14:03	01/11/2020 13:55	31/10/2020 14:03	01/11/2020 09:33	19,50	5	97,49	CHI
202010186991	PARAUNA	PU10377154	PARAUNA	31/10/2020 14:03	01/11/2020 13:55	31/10/2020 14:03	01/11/2020 10:23	20,33	53	1077,43	CHI
202010186991	JANDAIA	PU10377154	PARAUNA	31/10/2020 14:03	01/11/2020 13:55	31/10/2020 14:03	01/11/2020 10:23	20,33	3	60,99	CHI
202010186991	PARAUNA	PU12259180	PARAUNA	31/10/2020 14:03	01/11/2020 13:55	31/10/2020 14:03	01/11/2020 13:24	23,34	1	23,34	CHI
202010186991	PARAUNA	PU10377154	PARAUNA	31/10/2020 14:03	01/11/2020 13:55	31/10/2020 14:03	01/11/2020 13:55	23,86	2	47,71	CHI
202010186668	LEOPOLDO DE BULHOES	LB12200132	CEPAIGO S2	31/10/2020 14:03	31/10/2020 15:55	31/10/2020 14:03	31/10/2020 15:55	1,86	5	9,28	CHI
202010186679	JATAI	JT21150172	PARQUE DAS EMAS	31/10/2020 14:05	01/11/2020 01:48	31/10/2020 14:05	01/11/2020 01:48	11,71	1	11,71	CHI
202010186683	ITAGUARU	IC21040543	JARAGUA	31/10/2020 14:05	01/11/2020 16:23	31/10/2020 14:05	01/11/2020 16:23	26,28	1	26,28	CHI
202010186717	GOIANIA	GN10380011	GOIANIA LESTE S2	31/10/2020 14:07	31/10/2020 18:56	31/10/2020 14:07	31/10/2020 14:11	0,07	1	0,07	CHI
202010186717	SENADOR CANEDO	GN10380011	GOIANIA LESTE S2	31/10/2020 14:07	31/10/2020 18:56	31/10/2020 14:07	31/10/2020 14:11	0,07	107	7,94	CHI
202010186717	SENADOR CANEDO	GN10380011	GOIANIA LESTE S2	31/10/2020 14:07	31/10/2020 18:56	31/10/2020 14:07	31/10/2020 14:11	0,08	1547	119,46	CHI
202010186717	GOIANAPOLIS	GN10380011	GOIANIA LESTE S2	31/10/2020 14:07	31/10/2020 18:56	31/10/2020 14:07	31/10/2020 14:11	0,08	30	2,32	CHI
202010186717	BONFINOPOLIS	GN10380011	GOIANIA LESTE S2	31/10/2020 14:07	31/10/2020 18:56	31/10/2020 14:07	31/10/2020 14:11	0,08	89	6,87	CHI
202010186717	GOIANIA	GN10380011	GOIANIA LESTE S2	31/10/2020 14:07	31/10/2020 18:56	31/10/2020 14:07	31/10/2020 14:11	0,08	135	10,43	CHI
202010186717	GOIANIA	GN10380011	GOIANIA LESTE S2	31/10/2020 14:07	31/10/2020 18:56	31/10/2020 14:07	31/10/2020 14:11	0,08	969	76,44	CHI
202010186717	GOIANIA	GN10380011	GOIANIA LESTE S2	31/10/2020 14:07	31/10/2020 18:56	31/10/2020 14:07	31/10/2020 15:16	1,15	455	522,37	CHI
202010186717	GOIANIA	GN16416162	GOIANIA LESTE S2	31/10/2020 14:07	31/10/2020 18:56	31/10/2020 16:33	31/10/2020 16:36	0,05	455	23,00	CHI
202010186717	GOIANIA	GN10380011	GOIANIA LESTE S2	31/10/2020 14:07	31/10/2020 18:56	31/10/2020 14:07	31/10/2020 18:56	4,83	327	1578,41	CHI
202010186689	LUZIANIA	120018998	RIO VERMELHO	31/10/2020 14:07	31/10/2020 14:57	31/10/2020 14:07	31/10/2020 14:57	0,82	1	0,82	CHI
202010187433	SANTA CRUZ DE GOIAS	BC12083249	PIRES DO RIO S2	31/10/2020 14:08	31/10/2020 20:34	31/10/2020 14:08	31/10/2020 20:34	6,43	3	19,29	CHI
202010186694	RIO VERDE	RV11106457	RIO VERDE S2	31/10/2020 14:09	01/11/2020 01:28	31/10/2020 14:09	01/11/2020 01:28	11,32	36	407,40	CHI
202010186699	GOIANIA	16899544	GOIANIA LESTE S2	31/10/2020 14:09	31/10/2020 15:37	31/10/2020 14:09	31/10/2020 15:37	1,45	1	1,45	CHI
202010186722	IPORA	730117893	IPORA	31/10/2020 14:12	31/10/2020 15:12	31/10/2020 14:12	31/10/2020 15:12	0,99	1	0,99	CHI
202010187461	JUSSARA	JR12017178	JUSSARA	31/10/2020 14:17	31/10/2020 17:16	31/10/2020 14:17	31/10/2020 17:16	2,98	15	44,69	CHI
202010186759	GOIANIA	16133092	CARAJAS S1	31/10/2020 14:18	31/10/2020 15:21	31/10/2020 14:18	31/10/2020 15:21	1,04	1	1,04	CHI
202010186823	CRISTIANOPOLIS	PJ12082198	CRISTIANOPOLIS	31/10/2020 14:19	02/11/2020 20:16	01/11/2020 15:41	02/11/2020 08:50	17,14	3	51,42	CHI
202010186823	PIRACANJUBA	PJ12082198	CRISTIANOPOLIS	31/10/2020 14:19	02/11/2020 20:16	01/11/2020 15:41	02/11/2020 08:50	17,14	18	308,55	CHI
202010186823	CRISTIANOPOLIS	PJ12082198	CRISTIANOPOLIS	31/10/2020 14:19	02/11/2020 20:16	02/11/2020 09:36	02/11/2020 12:43	3,11	3	9,34	CHI
202010186823	PIRACANJUBA	PJ12082198	CRISTIANOPOLIS	31/10/2020 14:19	02/11/2020 20:16	02/11/2020 09:36	02/11/2020 12:43	3,11	18	56,07	CHI
202010186823	CRISTIANOPOLIS	PJ12082198	CRISTIANOPOLIS	31/10/2020 14:19	02/11/2020 20:16	01/11/2020 15:41	02/11/2020 12:53	21,20	7	148,42	CHI
202010186823	PIRACANJUBA	PJ12082198	CRISTIANOPOLIS	31/10/2020 14:19	02/11/2020 20:16	01/11/2020 15:41	02/11/2020 12:53	21,20	1	21,20	CHI

202010186823	CRISTIANOPOLIS	PJ12082198	CRISTIANOPOLIS	31/10/2020 14:19	02/11/2020 20:16	01/11/2020 15:41	02/11/2020 20:16	28,57	1	28,57	CHI
202010186762	GOIANIA	13069720	GOYA S1	31/10/2020 14:19	31/10/2020 16:10	31/10/2020 14:19	31/10/2020 16:10	1,85	1	1,85	CHI
202010186823	CRISTIANOPOLIS	PJ12082198	CRISTIANOPOLIS	31/10/2020 14:19	02/11/2020 20:16	31/10/2020 14:19	01/11/2020 14:31	24,19	11	266,10	CHI
202010186823	PIRACANJUBA	PJ12082198	CRISTIANOPOLIS	31/10/2020 14:19	02/11/2020 20:16	31/10/2020 14:19	01/11/2020 14:31	24,19	19	459,63	CHI
202010186773	APARECIDA DE GOIANIA	16545126	INDEPENDENCIA S2	31/10/2020 14:19	31/10/2020 16:53	31/10/2020 14:19	31/10/2020 16:53	2,55	1	2,55	CHI
202010186776	SENADOR CANEDO	16825561	GOIANIA LESTE S2	31/10/2020 14:20	31/10/2020 15:45	31/10/2020 14:20	31/10/2020 15:45	1,41	1	1,41	CHI
202010186779	MINEIROS	MY12212642	PARQUE DAS EMAS	31/10/2020 14:20	31/10/2020 22:06	31/10/2020 14:20	31/10/2020 22:06	7,75	3	23,25	CHI
202010186611	GOIANIA	GN11001464	AEROPORTO S2	31/10/2020 14:21	31/10/2020 17:39	31/10/2020 14:21	31/10/2020 17:39	3,30	60	198,00	CHI
202010183343	CATALAO	CT11333472	CATALAO S2	31/10/2020 14:23	31/10/2020 15:08	31/10/2020 14:23	31/10/2020 15:08	0,75	26	19,50	CHI
202010186792	ANAPOLIS	20509509	JUNDIAI S1	31/10/2020 14:23	31/10/2020 17:40	31/10/2020 14:23	31/10/2020 17:40	3,28	1	3,28	CHI
202010186800	FAINA	FC12307361	GOIAS	31/10/2020 14:23	01/11/2020 01:58	31/10/2020 14:23	01/11/2020 01:58	11,57	40	462,71	CHI
202010186801	MAMBAI	MB11190510	IACIARA S2	31/10/2020 14:24	31/10/2020 17:21	31/10/2020 14:24	31/10/2020 17:21	2,95	12	35,39	CHI
202010186802	LEOPOLDO DE BULHOES	LB21125720	DAIA S2	31/10/2020 14:24	31/10/2020 21:47	31/10/2020 14:24	31/10/2020 21:47	7,38	1	7,38	CHI
202010186803	SILVANIA	VN12028924	VIANOPOLIS	31/10/2020 14:24	31/10/2020 16:38	31/10/2020 14:24	31/10/2020 16:38	2,23	1	2,23	CHI
202010186803	VIANOPOLIS	VN12028924	VIANOPOLIS	31/10/2020 14:24	31/10/2020 16:38	31/10/2020 14:24	31/10/2020 16:38	2,23	13	28,98	CHI
202010186803	SAO MIGUEL DO PASSA QUATRO	VN12028924	VIANOPOLIS	31/10/2020 14:24	31/10/2020 16:38	31/10/2020 14:24	31/10/2020 16:38	2,23	28	62,42	CHI
202010186804	RIO VERDE	630396747	RIO VERDE S1	31/10/2020 14:24	31/10/2020 16:59	31/10/2020 14:24	31/10/2020 16:59	2,58	1	2,58	CHI
202010186806	URUACU	UR21310100	URUACU	31/10/2020 14:24	01/11/2020 02:07	31/10/2020 14:24	01/11/2020 02:07	11,70	1	11,70	CHI
202010186807	APARECIDA DE GOIANIA	11072428	ANHANGUERA	31/10/2020 14:25	31/10/2020 16:45	31/10/2020 14:25	31/10/2020 16:45	2,33	1	2,33	CHI
202010187132	ITABERAI	IB12000035LD	ITABERAI S2	31/10/2020 14:25	31/10/2020 17:18	31/10/2020 14:25	31/10/2020 17:18	2,88	61	175,61	CHI
202010186810	LUZIANIA	120393992	MARAJOARA	31/10/2020 14:25	31/10/2020 16:15	31/10/2020 14:25	31/10/2020 16:15	1,83	1	1,83	CHI
202010186811	GOIANIA	14558282	MEIA PONTE	31/10/2020 14:25	31/10/2020 16:57	31/10/2020 14:25	31/10/2020 16:57	2,53	1	2,53	CHI
202010186837	ITAPURANGA	IK12021644	ITAPURANGA	31/10/2020 14:26	31/10/2020 16:35	31/10/2020 14:26	31/10/2020 16:35	2,15	27	58,02	CHI
202010186824	INHUMAS	IN12366112	INHUMAS S2	31/10/2020 14:27	31/10/2020 21:24	31/10/2020 14:27	31/10/2020 21:24	6,94	1	6,94	CHI
202010186827	GOIAS	GS21217172	GOIAS	31/10/2020 14:28	01/11/2020 12:57	31/10/2020 14:28	01/11/2020 12:57	22,48	1	22,48	CHI
202010186831	RIO QUENTE	CN12404748	CALDAS NOVAS S1	31/10/2020 14:29	31/10/2020 16:07	31/10/2020 14:29	31/10/2020 16:07	1,63	41	66,92	CHI
202010186831	CALDAS NOVAS	CN12404748	CALDAS NOVAS S1	31/10/2020 14:29	31/10/2020 16:07	31/10/2020 14:29	31/10/2020 16:07	1,63	6	9,79	CHI
202010187392	PIRACANJUBA	PJ12212156	PIRACANJUBA	31/10/2020 14:31	02/11/2020 13:29	01/11/2020 14:29	01/11/2020 15:31	1,02	9	9,22	CHI
202010187392	PIRACANJUBA	PJ12212156	PIRACANJUBA	31/10/2020 14:31	02/11/2020 13:29	01/11/2020 17:36	01/11/2020 19:44	2,13	29	61,87	CHI
202010187392	PIRACANJUBA	PJ12212156	PIRACANJUBA	31/10/2020 14:31	02/11/2020 13:29	01/11/2020 17:36	02/11/2020 13:07	19,52	5	97,58	CHI
202010187392	PIRACANJUBA	PJ12212156	PIRACANJUBA	31/10/2020 14:31	02/11/2020 13:29	02/11/2020 04:26	02/11/2020 13:07	8,68	3	26,05	CHI
202010187392	PIRACANJUBA	PJ12212156	PIRACANJUBA	31/10/2020 14:31	02/11/2020 13:29	02/11/2020 11:22	02/11/2020 13:07	1,75	26	45,59	CHI
202010187392	PIRACANJUBA	PJ11171420	PIRACANJUBA	31/10/2020 14:31	02/11/2020 13:29	01/11/2020 17:36	02/11/2020 13:29	19,89	1	19,89	CHI
202010187392	PIRACANJUBA	PJ12212156	PIRACANJUBA	31/10/2020 14:31	02/11/2020 13:29	31/10/2020 14:31	31/10/2020 23:49	9,30	9	83,67	CHI
202010187392	PIRACANJUBA	PJ12212156	PIRACANJUBA	31/10/2020 14:31	02/11/2020 13:29	31/10/2020 14:31	01/11/2020 15:31	25,00	17	424,94	CHI
202010187392	PIRACANJUBA	PJ12212156	PIRACANJUBA	31/10/2020 14:31	02/11/2020 13:29	31/10/2020 14:31	01/11/2020 17:00	26,49	9	238,39	CHI
202010187091	CAIAPONIA	PH12259516	CAIAPONIA	31/10/2020 14:32	31/10/2020 17:43	31/10/2020 14:32	31/10/2020 17:43	3,19	3	9,58	CHI
202010187091	PIRANHAS	PH12259516	CAIAPONIA	31/10/2020 14:32	31/10/2020 17:43	31/10/2020 14:32	31/10/2020 17:43	3,19	70	223,57	CHI
202010186850	MUTUNOPOLIS	MU12384317	MARA ROSA	31/10/2020 14:33	01/11/2020 12:54	31/10/2020 14:33	01/11/2020 12:54	22,34	20	446,86	CHI
202010186850	AMARALINA	MU12384317	MARA ROSA	31/10/2020 14:33	01/11/2020 12:54	31/10/2020 14:33	01/11/2020 12:54	22,34	4	89,37	CHI
202010186855	CAMPO ALEGRE DE GOIAS	CM21161417	CAMPO ALEGRE DE GOIAS	31/10/2020 14:34	31/10/2020 18:26	31/10/2020 14:34	31/10/2020 18:26	3,86	1	3,86	CHI
202010187779	IACIARA	AQ12257608	FLORES DE GOIAS	31/10/2020 14:34	01/11/2020 19:58	31/10/2020 14:34	01/11/2020 19:58	29,39	4	117,56	CHI
202010187779	ALVORADA DO NORTE	AQ12257608	FLORES DE GOIAS	31/10/2020 14:34	01/11/2020 19:58	31/10/2020 14:34	01/11/2020 19:58	29,39	10	293,89	CHI
202010187779	POSSE	AQ12257608	FLORES DE GOIAS	31/10/2020 14:34	01/11/2020 19:58	31/10/2020 14:34	01/11/2020 19:58	29,39	2	58,78	CHI
202010186905	BELA VISTA DE GOIAS	BV10329158	BELA VISTA S1	31/10/2020 14:37	31/10/2020 19:11	31/10/2020 14:37	31/10/2020 14:40	0,05	33	1,78	CHI
202010186905	BELA VISTA DE GOIAS	BV10406911	BELA VISTA S1	31/10/2020 14:37	31/10/2020 19:11	31/10/2020 14:37	31/10/2020 14:40	0,05	36	1,94	CHI
202010186905	PIRACANJUBA	BV10329158	BELA VISTA S1	31/10/2020 14:37	31/10/2020 19:11	31/10/2020 14:37	31/10/2020 19:11	4,58	94	430,36	CHI
202010186905	BELA VISTA DE GOIAS	BV10329158	BELA VISTA S1	31/10/2020 14:37	31/10/2020 19:11	31/10/2020 14:37	31/10/2020 19:11	4,58	38	173,98	CHI
202010186883	CRISTALINA	KR11183784	CRISTALINA S1	31/10/2020 14:38	31/10/2020 22:37	31/10/2020 14:38	31/10/2020 22:37	7,98	1	7,98	CHI
202010186979	ITUMBIARA	BG12000023	ALTO BURITI	31/10/2020 14:38	31/10/2020 17:58	31/10/2020 14:38	31/10/2020 17:58	3,33	10	33,26	CHI
202010186979	BURITI ALEGRE	BG12000023	ALTO BURITI	31/10/2020 14:38	31/10/2020 17:58	31/10/2020 14:38	31/10/2020 17:58	3,33	28	93,12	CHI

202010186887	BELA VISTA DE GOIAS	BV31197962	BELA VISTA S1	31/10/2020 14:39	31/10/2020 17:32	31/10/2020 14:39	31/10/2020 17:32	2,88	2	5,76	CHI
202010187675	ITABERAI	IB12000076	ITABERAI S2	31/10/2020 14:39	31/10/2020 19:02	31/10/2020 14:39	31/10/2020 19:02	4,37	4	17,47	CHI
202010186895	CAMPO ALEGRE DE GOIAS	CM12266823	CAMPO ALEGRE DE GOIAS	31/10/2020 14:40	31/10/2020 16:41	31/10/2020 14:40	31/10/2020 16:41	2,01	7	14,09	CHI
202010186898	NOVO GAMA	2900059040	MARAJOARA	31/10/2020 14:41	31/10/2020 17:39	31/10/2020 14:41	31/10/2020 17:39	2,96	1	2,96	CHI
202010186900	GOIANIA	10005491370	GOYA S1	31/10/2020 14:41	31/10/2020 21:17	31/10/2020 14:41	31/10/2020 21:17	6,59	1	6,59	CHI
202010186906	NEROPOLIS	160015200	NEROPOLIS S2	31/10/2020 14:42	31/10/2020 17:41	31/10/2020 14:42	31/10/2020 17:41	2,98	1	2,98	CHI
202010186909	APARECIDA DE GOIANIA	200163905	INDEPENDENCIA S2	31/10/2020 14:42	31/10/2020 15:52	31/10/2020 14:42	31/10/2020 15:52	1,16	1	1,16	CHI
202010186910	GOIANIA	16200998	MEIA PONTE	31/10/2020 14:42	31/10/2020 15:34	31/10/2020 14:42	31/10/2020 15:34	0,86	1	0,86	CHI
202010186912	NIQUELANDIA	NQ21360524	NIQUELANDIA SUBTRANSMISSAO	31/10/2020 14:42	01/11/2020 19:49	31/10/2020 14:42	01/11/2020 19:49	29,10	1	29,10	CHI
202010186915	ITABERAI	IB21000133	ITABERAI S2	31/10/2020 14:43	31/10/2020 18:28	31/10/2020 14:43	31/10/2020 18:28	3,75	2	7,50	CHI
202010186920	CAIAPONIA	CP21215415	MONTIVIDIU T	31/10/2020 14:44	31/10/2020 17:18	31/10/2020 14:44	31/10/2020 17:18	2,57	1	2,57	CHI
202010187037	ARAGOIANIA	AO11198357	GUAPO S2	31/10/2020 14:44	31/10/2020 17:24	31/10/2020 14:44	31/10/2020 17:24	2,66	18	47,93	CHI
202010186929	RIO VERDE	RV21383901	RIO VERDE S2	31/10/2020 14:45	31/10/2020 15:57	31/10/2020 14:45	31/10/2020 15:57	1,19	1	1,19	CHI
202010186939	GOIAS	GS21135029	ITABERAI S1	31/10/2020 14:48	31/10/2020 22:54	31/10/2020 14:48	31/10/2020 22:54	8,10	1	8,10	CHI
202010186941	SENADOR CANEDO	10012074193	SENADOR CANEDO	31/10/2020 14:48	31/10/2020 16:24	31/10/2020 14:48	31/10/2020 16:24	1,59	1	1,59	CHI
202010187062	NIQUELANDIA	NQ12113859	URUACU	31/10/2020 14:50	31/10/2020 18:40	31/10/2020 14:50	31/10/2020 18:40	3,83	17	65,16	CHI
202010187561	CAMPO ALEGRE DE GOIAS	CM12358429	CAMPO ALEGRE DE GOIAS	31/10/2020 14:51	31/10/2020 20:11	31/10/2020 14:51	31/10/2020 20:11	5,33	9	47,95	CHI
202010186969	MONTES CLAROS DE GOIAS	ME21138678	IPORA	31/10/2020 14:52	31/10/2020 22:28	31/10/2020 14:52	31/10/2020 22:28	7,58	1	7,58	CHI
202010187795	ITAGUARU	IC12219965	ITABERAI S1	31/10/2020 14:53	31/10/2020 19:14	31/10/2020 14:53	31/10/2020 19:14	4,34	8	34,72	CHI
202010186975	CRIXAS	2490005723	SERRA DO OURO	31/10/2020 14:53	01/11/2020 10:29	31/10/2020 14:53	01/11/2020 10:29	19,59	1	19,59	CHI
202010186976	EDEIA	EA21022102	EDEIA	31/10/2020 14:53	31/10/2020 16:29	31/10/2020 14:53	31/10/2020 16:29	1,59	1	1,59	CHI
202010186986	NIQUELANDIA	2750031534	NIQUELANDIA SUBTRANSMISSAO	31/10/2020 14:55	01/11/2020 16:04	31/10/2020 14:55	01/11/2020 16:04	25,15	1	25,15	CHI
202010186987	RIO VERDE	RV21260616	RIO VERDE S2	31/10/2020 14:55	31/10/2020 17:31	31/10/2020 14:55	31/10/2020 17:31	2,60	1	2,60	CHI
202010186988	RIO VERDE	630184422	RIO VERDE S1	31/10/2020 14:55	31/10/2020 16:39	31/10/2020 14:55	31/10/2020 16:39	1,73	0	0,00	CHI
202010186990	FAINA	FC21310653	GOIAS	31/10/2020 14:55	01/11/2020 13:57	31/10/2020 14:55	01/11/2020 13:57	23,02	2	46,04	CHI
202010187004	PALMEIRAS DE GOIAS	PL12109625	PALMEIRAS	31/10/2020 14:58	31/10/2020 16:12	31/10/2020 14:58	31/10/2020 16:12	1,23	31	38,22	CHI
202010187010	CAMPO ALEGRE DE GOIAS	CT21195431	CAMPO ALEGRE DE GOIAS	31/10/2020 14:59	31/10/2020 21:57	31/10/2020 14:59	31/10/2020 21:57	6,95	1	6,95	CHI
202010187011	PADRE BERNARDO	2760031038	PADRE BERNARDO	31/10/2020 14:59	31/10/2020 17:20	31/10/2020 14:59	31/10/2020 17:20	2,34	1	2,34	CHI
202010187018	ANAPOLIS	AN21267927	NEROPOLIS S1	31/10/2020 15:01	01/11/2020 02:46	31/10/2020 15:01	01/11/2020 02:46	11,75	1	11,75	CHI
202010187024	CACHOEIRA ALTA	CA12338614	CACHOEIRA ALTA	31/10/2020 15:02	31/10/2020 21:33	31/10/2020 15:02	31/10/2020 20:56	5,90	5	29,52	CHI
202010187024	CACHOEIRA ALTA	CA12338672	CACHOEIRA ALTA	31/10/2020 15:02	31/10/2020 21:33	31/10/2020 18:50	31/10/2020 21:33	2,71	5	13,54	CHI
202010187030	BELA VISTA DE GOIAS	BV21184796	BELA VISTA S1	31/10/2020 15:03	01/11/2020 05:33	31/10/2020 15:03	01/11/2020 05:33	14,49	3	43,46	CHI
202010187095	SANTA TEREZINHA DE GOIAS	SG12380710	SANTA TEREZINHA	31/10/2020 15:03	01/11/2020 02:10	31/10/2020 15:03	01/11/2020 02:10	11,12	8	88,94	CHI
202010187033	GOIANIA	13796770	XAVANTES	31/10/2020 15:04	31/10/2020 16:48	31/10/2020 15:04	31/10/2020 16:48	1,73	1	1,73	CHI
202010187035	GOIAS	GS21071246	GOIAS	31/10/2020 15:04	01/11/2020 11:41	31/10/2020 15:04	01/11/2020 11:41	20,61	1	20,61	CHI
202010187038	MAURILANDIA	ML21316815	RIO DOS BOIS	31/10/2020 15:05	31/10/2020 19:22	31/10/2020 15:05	31/10/2020 19:22	4,28	2	8,55	CHI
202010187553	MINACU	IH12192460	MINACU	31/10/2020 15:05	31/10/2020 18:06	31/10/2020 15:05	31/10/2020 18:06	3,00	156	468,43	CHI
202010188514	LUZIANIA	LZ12396835	MARAJOARA	31/10/2020 15:06	31/10/2020 21:34	31/10/2020 15:06	31/10/2020 21:34	6,47	27	174,60	CHI
202010188379	CRISTALINA	KR12376992	CRISTALINA S2	31/10/2020 15:06	01/11/2020 02:24	31/10/2020 15:06	01/11/2020 02:24	11,30	10	112,95	CHI
202010187043	JATAI	JT21234419	JATAI S1	31/10/2020 15:07	31/10/2020 22:25	31/10/2020 15:07	31/10/2020 22:25	7,30	1	7,30	CHI
202010187052	COLINAS DO SUL	10013900119	NIQUELANDIA SUBTRANSMISSAO	31/10/2020 15:08	01/11/2020 22:17	31/10/2020 15:08	01/11/2020 22:17	31,14	1	31,14	CHI
202010187056	CALDAS NOVAS	760243839	SERRA DE CALDAS	31/10/2020 15:09	31/10/2020 16:42	31/10/2020 15:09	31/10/2020 16:42	1,54	1	1,54	CHI
202010187059	ORIZONA	OZ12052346	PIRES DO RIO S2	31/10/2020 15:11	31/10/2020 17:53	31/10/2020 15:11	31/10/2020 17:53	2,68	4	10,73	CHI
202010187177	PONTALINA	VI12047314	VICENTINOPOLIS	31/10/2020 15:13	01/11/2020 10:46	01/11/2020 10:30	01/11/2020 10:46	0,27	3	0,80	CHI
202010187177	VICENTINOPOLIS	VI12047314	VICENTINOPOLIS	31/10/2020 15:13	01/11/2020 10:46	01/11/2020 10:30	01/11/2020 10:46	0,27	10	2,66	CHI
202010187177	PONTALINA	O3130214	VICENTINOPOLIS	31/10/2020 15:13	01/11/2020 10:46	31/10/2020 15:13	31/10/2020 17:30	2,30	32	73,54	CHI
202010187177	PONTALINA	PK16430933	VICENTINOPOLIS	31/10/2020 15:13	01/11/2020 10:46	31/10/2020 15:14	31/10/2020 17:30	2,27	1	2,27	CHI
202010187177	PONTALINA	O3130214	VICENTINOPOLIS	31/10/2020 15:13	01/11/2020 10:46	31/10/2020 15:13	31/10/2020 19:15	4,03	71	286,35	CHI
202010187177	PONTALINA	PK13249900	VICENTINOPOLIS	31/10/2020 15:13	01/11/2020 10:46	31/10/2020 15:14	31/10/2020 19:15	4,01	1	4,01	CHI
202010187177	VICENTINOPOLIS	O3130214	VICENTINOPOLIS	31/10/2020 15:13	01/11/2020 10:46	31/10/2020 15:13	31/10/2020 22:08	6,92	10	69,17	CHI
202010187177	PONTALINA	O3130214	VICENTINOPOLIS	31/10/2020 15:13	01/11/2020 10:46	31/10/2020 15:13	31/10/2020 22:08	6,92	2	13,83	CHI

202010187177	PONTALINA	VI12335578	VICENTINOPOLIS	31/10/2020 15:13	01/11/2020 10:46	31/10/2020 15:14	31/10/2020 22:08	6,89	1	6,89	CHI
202010187177	VICENTINOPOLIS	03130214	VICENTINOPOLIS	31/10/2020 15:13	01/11/2020 10:46	31/10/2020 15:13	01/11/2020 10:06	18,89	3	56,67	CHI
202010187177	PONTALINA	03130214	VICENTINOPOLIS	31/10/2020 15:13	01/11/2020 10:46	31/10/2020 15:13	01/11/2020 10:06	18,89	3	56,67	CHI
202010187692	NIQUELANDIA	NQ12265691	URUACU	31/10/2020 15:13	31/10/2020 19:22	31/10/2020 15:13	31/10/2020 19:22	4,15	17	70,49	CHI
202010187069	PARAUNA	01690214	ACREUNA	31/10/2020 15:13	31/10/2020 15:31	31/10/2020 15:13	31/10/2020 15:31	0,29	164	47,65	CHI
202010187069	SANTO ANTONIO DA BARRA	01690214	ACREUNA	31/10/2020 15:13	31/10/2020 15:31	31/10/2020 15:13	31/10/2020 15:31	0,29	1641	476,80	CHI
202010187069	RIO VERDE	01690214	ACREUNA	31/10/2020 15:13	31/10/2020 15:31	31/10/2020 15:13	31/10/2020 15:31	0,29	90	26,15	CHI
202010187391	JUSSARA	JR12341251	IPORA	31/10/2020 15:13	31/10/2020 17:16	31/10/2020 15:13	31/10/2020 17:16	2,04	190	386,91	CHI
202010187391	MONTES CLAROS DE GOIAS	JR12341251	IPORA	31/10/2020 15:13	31/10/2020 17:16	31/10/2020 15:13	31/10/2020 17:16	2,04	18	36,66	CHI
202010187962	CRISTALINA	IP12165527	CRISTALINA S1	31/10/2020 15:14	31/10/2020 21:55	31/10/2020 15:14	31/10/2020 21:55	6,68	15	100,19	CHI
202010187274	NIQUELANDIA	NQ12235621	URUACU	31/10/2020 15:15	31/10/2020 22:07	31/10/2020 15:15	31/10/2020 22:07	6,86	15	102,89	CHI
202010187750	ALTO PARAISO DE GOIAS	ND12302636	IACIARA S2	31/10/2020 15:15	31/10/2020 20:00	31/10/2020 15:15	31/10/2020 20:00	4,74	19	90,07	CHI
202010187750	SAO JOAO D ALIANCA	ND12302636	IACIARA S2	31/10/2020 15:15	31/10/2020 20:00	31/10/2020 15:15	31/10/2020 20:00	4,74	13	61,62	CHI
202010187750	NOVA ROMA	ND12302636	IACIARA S2	31/10/2020 15:15	31/10/2020 20:00	31/10/2020 15:15	31/10/2020 20:00	4,74	101	478,77	CHI
202010187321	CAIAPONIA	CP12119577	CAIAPONIA	31/10/2020 15:15	31/10/2020 16:49	31/10/2020 15:15	31/10/2020 16:49	1,55	67	104,09	CHI
202010187321	DOVERLANDIA	CP12119577	CAIAPONIA	31/10/2020 15:15	31/10/2020 16:49	31/10/2020 15:15	31/10/2020 16:49	1,55	7	10,88	CHI
202010187096	SILVANIA	SV12012125	VIANOPOLIS	31/10/2020 15:17	31/10/2020 20:09	31/10/2020 15:17	31/10/2020 20:09	4,85	4	19,42	CHI
202010187097	JARAGUA	JA12297901	JARAGUA	31/10/2020 15:17	31/10/2020 16:53	31/10/2020 15:17	31/10/2020 16:53	1,59	19	30,13	CHI
202010187859	ANAPOLIS	AN11155224	JUNDIAI S2	31/10/2020 15:19	31/10/2020 19:46	31/10/2020 15:19	31/10/2020 19:46	4,45	108	480,21	CHI
202010187107	JATAI	JT12360972	CABRIUVA S2	31/10/2020 15:19	31/10/2020 18:16	31/10/2020 15:19	31/10/2020 18:16	2,94	5	14,69	CHI
202010187111	TRINDADE	40321022	GOYA S1	31/10/2020 15:20	31/10/2020 17:51	31/10/2020 15:20	31/10/2020 17:51	2,52	1	2,52	CHI
202010187112	SILVANIA	SV21144155	VIANOPOLIS	31/10/2020 15:20	31/10/2020 22:53	31/10/2020 15:20	31/10/2020 22:53	7,55	1	7,55	CHI
202010188432	SAO LUIS DE MONTES BELOS	SC12206494	SAO LUIZ DOS MONTES BELOS	31/10/2020 15:20	31/10/2020 21:07	31/10/2020 15:20	31/10/2020 21:07	5,77	1	5,77	CHI
202010188432	SANCLERLANDIA	SC12206494	SAO LUIZ DOS MONTES BELOS	31/10/2020 15:20	31/10/2020 21:07	31/10/2020 15:20	31/10/2020 21:07	5,77	10	57,71	CHI
202010187121	NEROPOLIS	NR21170353	NEROPOLIS S2	31/10/2020 15:21	31/10/2020 18:21	31/10/2020 15:21	31/10/2020 18:21	2,99	1	2,99	CHI
202010188213	ITAPURANGA	IK12282464	ITAPURANGA	31/10/2020 15:22	31/10/2020 22:54	31/10/2020 15:22	31/10/2020 22:54	7,54	5	37,69	CHI
202010187598	SAO JOAO D ALIANCA	JL12146058	SAO JOAO D ALIANCA	31/10/2020 15:24	01/11/2020 09:23	31/10/2020 15:24	01/11/2020 09:23	17,98	12	215,79	CHI
202010187209	PALMELO	PZ12300710	PIRES DO RIO S2	31/10/2020 15:25	31/10/2020 17:23	31/10/2020 15:25	31/10/2020 17:23	1,95	5	9,77	CHI
202010187205	CACHOEIRA DOURADA	CD12000066	CACHOEIRA DOURADA	31/10/2020 15:26	31/10/2020 16:50	31/10/2020 15:26	31/10/2020 16:50	1,40	11	15,40	CHI
202010187151	PALMINOPOLIS	PP21259847	PALMEIRAS	31/10/2020 15:26	01/11/2020 00:53	31/10/2020 15:26	01/11/2020 00:53	9,44	1	9,44	CHI
202010187152	GOIANESIA	550132260	GOIANESIA S2	31/10/2020 15:26	31/10/2020 20:44	31/10/2020 15:26	31/10/2020 20:44	5,28	1	5,28	CHI
202010187320	CRISTIANOPOLIS	PJ12082248	PIRACANJUBA	31/10/2020 15:26	31/10/2020 19:31	31/10/2020 15:26	31/10/2020 19:31	4,07	5	20,34	CHI
202010187320	PIRACANJUBA	PJ12082248	PIRACANJUBA	31/10/2020 15:26	31/10/2020 19:31	31/10/2020 15:26	31/10/2020 19:31	4,07	17	69,17	CHI
202010187156	JAUPACI	JP21139462	IPORA	31/10/2020 15:27	31/10/2020 21:46	31/10/2020 15:27	31/10/2020 21:46	6,31	1	6,31	CHI
202010187165	BONFINOPOLIS	920007820	CEPAIGO S2	31/10/2020 15:27	31/10/2020 20:16	31/10/2020 15:27	31/10/2020 20:16	4,80	1	4,80	CHI
202010187166	APARECIDA DE GOIANIA	17124748	INDEPENDENCIA S1	31/10/2020 15:28	31/10/2020 16:54	31/10/2020 15:28	31/10/2020 16:54	1,43	1	1,43	CHI
202010187167	OUIDOR	OOU21061242	CATALAO S1	31/10/2020 15:28	01/11/2020 08:50	31/10/2020 15:28	01/11/2020 08:50	17,37	1	17,37	CHI
202010187178	GOIATUBA	140040390	GOIATUBA S2	31/10/2020 15:29	31/10/2020 20:09	31/10/2020 15:29	31/10/2020 20:09	4,66	1	4,66	CHI
202010187216	PALMEIRAS DE GOIAS	PL12000219	PALMEIRAS	31/10/2020 15:29	31/10/2020 16:54	31/10/2020 15:29	31/10/2020 16:54	1,40	11	15,41	CHI
202010187182	NEROPOLIS	NR21000048	NEROPOLIS S2	31/10/2020 15:30	31/10/2020 19:35	31/10/2020 15:30	31/10/2020 19:35	4,08	1	4,08	CHI
202010187184	BELA VISTA DE GOIAS	BV31080362	BELA VISTA S1	31/10/2020 15:30	31/10/2020 18:01	31/10/2020 15:30	31/10/2020 18:01	2,52	1	2,52	CHI
202010187185	GOIANIA	13085244	GOYA S1	31/10/2020 15:30	31/10/2020 17:06	31/10/2020 15:30	31/10/2020 17:06	1,60	1	1,60	CHI
202010187434	CAMPO ALEGRE DE GOIAS	CM12042424	CAMPO ALEGRE DE GOIAS	31/10/2020 15:30	31/10/2020 17:52	31/10/2020 15:30	31/10/2020 17:52	2,36	25	59,01	CHI
202010187213	PONTALINA	PK12263503	PONTALINA	31/10/2020 15:30	31/10/2020 17:40	31/10/2020 15:30	31/10/2020 17:40	2,16	14	30,24	CHI
202010187190	MINACU	IH12230469	MINACU	31/10/2020 15:30	31/10/2020 21:56	31/10/2020 15:30	31/10/2020 21:56	6,42	22	141,25	CHI
202010187192	MINEIROS	MY11324443	PARQUE DAS EMAS	31/10/2020 15:31	31/10/2020 21:47	31/10/2020 15:31	31/10/2020 21:47	6,26	169	1058,69	CHI
202010187202	ITABERAÍ	IB11227408	ITABERAÍ S1	31/10/2020 15:32	01/11/2020 10:45	31/10/2020 15:32	01/11/2020 10:45	19,21	1	19,21	CHI
202010187210	SANTO ANTONIO DO DESCOBERTO	2210162770	AGUAS LINDAS DE GOIAS S2	31/10/2020 15:34	31/10/2020 16:44	31/10/2020 15:34	31/10/2020 16:44	1,17	1	1,17	CHI
202010187211	ARUANA	2380011560	ARUANA	31/10/2020 15:34	01/11/2020 10:14	31/10/2020 15:34	01/11/2020 10:14	18,65	1	18,65	CHI
202010187214	ANAPOLIS	AN12335408	ANAPOLIS UNIVERSITARIO S1	31/10/2020 15:35	31/10/2020 18:59	31/10/2020 15:35	31/10/2020 18:59	3,39	4	13,55	CHI
202010187492	SAO LUIS DE MONTES BELOS	SC12019505	SAO LUIZ DOS MONTES BELOS	31/10/2020 15:36	31/10/2020 20:07	31/10/2020 15:36	31/10/2020 20:07	4,51	12	54,16	CHI

202010187217	ALEXANIA	AX21138024	ALEXANIA	31/10/2020 15:36	31/10/2020 17:50	31/10/2020 15:36	31/10/2020 17:50	2,22	1	2,22	CHI
202010187220	CRISTALINA	1060056395	CRISTALINA S1	31/10/2020 15:37	31/10/2020 20:40	31/10/2020 15:37	31/10/2020 20:40	5,05	1	5,05	CHI
202010187223	PALMEIRAS DE GOIAS	PL21022483	PALMEIRAS	31/10/2020 15:38	31/10/2020 23:24	31/10/2020 15:38	31/10/2020 23:24	7,77	2	15,53	CHI
202010187249	MONTIVIDIU	MV21267606	MONTIVIDIU T	31/10/2020 15:39	31/10/2020 17:06	31/10/2020 15:39	31/10/2020 17:06	1,44	1	1,44	CHI
202010187255	URUACU	UR21307770	URUACU	31/10/2020 15:41	31/10/2020 19:39	31/10/2020 15:41	31/10/2020 19:39	3,96	2	7,93	CHI
202010188117	FORMOSA	FA12249482	ITUIQUIRA	31/10/2020 15:44	01/11/2020 14:36	31/10/2020 15:44	01/11/2020 14:36	22,88	4	91,50	CHI
202010187788	FLORES DE GOIAS	FB12204157	FLORES DE GOIAS	31/10/2020 15:44	31/10/2020 21:36	31/10/2020 15:44	31/10/2020 21:36	5,85	13	76,06	CHI
202010187282	NIQUELANDIA	NQ21239296	NIQUELANDIA SUBTRANSMISSAO	31/10/2020 15:46	01/11/2020 16:19	31/10/2020 15:46	01/11/2020 16:19	24,53	1	24,53	CHI
202010187314	RIO VERDE	630404770	RIO VERDE S1	31/10/2020 15:48	31/10/2020 16:52	31/10/2020 15:48	31/10/2020 16:52	1,07	1	1,07	CHI
202010187316	APARECIDA DE GOIANIA	15167124	REAL S1	31/10/2020 15:48	31/10/2020 19:01	31/10/2020 15:48	31/10/2020 19:01	3,20	1	3,20	CHI
202010187327	CORREGO DO OURO	CO12003798	SAO LUIZ DOS MONTES BELOS	31/10/2020 15:49	01/11/2020 09:46	31/10/2020 15:49	01/11/2020 09:46	17,95	59	1058,87	CHI
202010187330	CALDAS NOVAS	CN11200052	SERRA DE CALDAS	31/10/2020 15:50	31/10/2020 20:45	31/10/2020 15:50	31/10/2020 20:45	4,91	18	88,47	CHI
202010187629	TAQUARAL DE GOIAS	II12217217	ITABERAI S1	31/10/2020 15:50	31/10/2020 18:15	31/10/2020 15:50	31/10/2020 18:15	2,40	47	112,85	CHI
202010187629	ITABERAI	II12217217	ITABERAI S1	31/10/2020 15:50	31/10/2020 18:15	31/10/2020 15:50	31/10/2020 18:15	2,40	22	52,82	CHI
202010187629	ITAGUARI	II12217217	ITABERAI S1	31/10/2020 15:50	31/10/2020 18:15	31/10/2020 15:50	31/10/2020 18:15	2,40	42	100,85	CHI
202010187332	GOIANIA	11458574	GOIANIA LESTE S3	31/10/2020 15:51	31/10/2020 18:39	31/10/2020 15:51	31/10/2020 18:39	2,79	1	2,79	CHI
202010187343	JATAI	290098130	JATAI S3	31/10/2020 15:53	31/10/2020 22:18	31/10/2020 15:53	31/10/2020 22:18	6,42	1	6,42	CHI
202010187345	RIO VERDE	630424378	RIO VERDE S1	31/10/2020 15:53	31/10/2020 18:56	31/10/2020 15:53	31/10/2020 18:56	3,04	1	3,04	CHI
202010187346	GOIANIA	16764134	GOYA S1	31/10/2020 15:53	31/10/2020 19:15	31/10/2020 15:53	31/10/2020 19:15	3,35	1	3,35	CHI
202010187348	COCALZINHO DE GOIAS	ZN11327460	GOIANESIA S1	31/10/2020 15:54	31/10/2020 23:45	31/10/2020 15:54	31/10/2020 23:45	7,84	1	7,84	CHI
202010187351	ACREUNA	EU12301664LD	ACREUNA	31/10/2020 15:54	31/10/2020 18:37	31/10/2020 17:00	31/10/2020 18:01	1,01	54	54,61	CHI
202010187351	ACREUNA	EU11031016	ACREUNA	31/10/2020 15:54	31/10/2020 18:37	31/10/2020 15:54	31/10/2020 18:37	2,71	42	113,82	CHI
202010187359	CRISTALINA	KR12163734	PAMPLONA	31/10/2020 15:57	31/10/2020 23:36	31/10/2020 15:57	31/10/2020 23:36	7,64	1	7,64	CHI
202010187747	IACIARA	ND12218839	IACIARA S2	31/10/2020 15:58	01/11/2020 13:53	01/11/2020 00:03	01/11/2020 04:39	4,60	6	27,60	CHI
202010187747	IACIARA	ND12218839	IACIARA S2	31/10/2020 15:58	01/11/2020 13:53	01/11/2020 05:50	01/11/2020 10:05	4,25	6	25,50	CHI
202010187747	IACIARA	ND12218839	IACIARA S2	31/10/2020 15:58	01/11/2020 13:53	01/11/2020 00:03	01/11/2020 12:40	12,62	3	37,85	CHI
202010187747	IACIARA	IA13218875	IACIARA S2	31/10/2020 15:58	01/11/2020 13:53	01/11/2020 00:03	01/11/2020 13:04	13,03	1	13,03	CHI
202010187747	IACIARA	ND12218839	IACIARA S2	31/10/2020 15:58	01/11/2020 13:53	01/11/2020 00:03	01/11/2020 13:04	13,03	8	104,22	CHI
202010187747	SAO DOMINGOS	ND12218839	IACIARA S2	31/10/2020 15:58	01/11/2020 13:53	01/11/2020 00:03	01/11/2020 13:04	13,03	3	39,08	CHI
202010187747	IACIARA	ND12218839	IACIARA S2	31/10/2020 15:58	01/11/2020 13:53	01/11/2020 00:03	01/11/2020 13:34	13,52	5	67,58	CHI
202010187747	IACIARA	ND12218839	IACIARA S2	31/10/2020 15:58	01/11/2020 13:53	01/11/2020 00:03	01/11/2020 13:53	13,83	1	13,83	CHI
202010187747	SAO DOMINGOS	ND12218839	IACIARA S2	31/10/2020 15:58	01/11/2020 13:53	31/10/2020 15:58	01/11/2020 00:03	8,08	3	24,24	CHI
202010187747	IACIARA	ND12218839	IACIARA S2	31/10/2020 15:58	01/11/2020 13:53	31/10/2020 15:58	01/11/2020 00:03	8,08	23	185,80	CHI
202010187369	GOIANIA	10003701121	FERROVIARIO S1	31/10/2020 15:59	31/10/2020 17:38	31/10/2020 15:59	31/10/2020 17:38	1,65	1	1,65	CHI
202010188552	CRISTALINA	KR12214982	CRISTALINA S2	31/10/2020 16:02	01/11/2020 01:02	31/10/2020 16:02	01/11/2020 01:02	8,99	6	53,97	CHI
202010187387	MONTIVIDIU	MV21340842	MONTIVIDIU T	31/10/2020 16:02	31/10/2020 18:44	31/10/2020 16:02	31/10/2020 18:44	2,69	1	2,69	CHI
202010187389	MARA ROSA	MQ21262615	MARA ROSA	31/10/2020 16:02	01/11/2020 14:26	31/10/2020 16:02	01/11/2020 14:26	22,39	1	22,39	CHI
202010187940	ITABERAI	IB12106151LD	ITABERAI S1	31/10/2020 16:04	31/10/2020 21:57	31/10/2020 16:04	31/10/2020 21:57	5,88	30	176,27	CHI
202010187940	GOIAS	IB12106151LD	ITABERAI S1	31/10/2020 16:04	31/10/2020 21:57	31/10/2020 16:04	31/10/2020 21:57	5,88	3	17,63	CHI
202010187400	MORRINHOS	MR21041269	MORRINHOS	31/10/2020 16:05	31/10/2020 17:18	31/10/2020 16:05	31/10/2020 17:18	1,20	1	1,20	CHI
202010187401	GOIANIA	10007361422	CARAJAS S1	31/10/2020 16:05	31/10/2020 17:12	31/10/2020 16:05	31/10/2020 17:12	1,10	1	1,10	CHI
202010187413	CRISTALINA	KR12304816	CRISTALINA S2	31/10/2020 16:06	31/10/2020 20:45	31/10/2020 16:06	31/10/2020 20:45	4,63	15	69,51	CHI
202010187410	GOIANIA	13886228	CAMPINAS S2	31/10/2020 16:07	31/10/2020 19:10	31/10/2020 16:07	31/10/2020 19:10	3,04	1	3,04	CHI
202010187419	ALOANDIA	PK12046026	GOIATUBA S1	31/10/2020 16:08	31/10/2020 17:34	31/10/2020 16:08	31/10/2020 17:34	1,43	1	1,43	CHI
202010187419	PONTALINA	PK12046026	GOIATUBA S1	31/10/2020 16:08	31/10/2020 17:34	31/10/2020 16:08	31/10/2020 17:34	1,43	28	39,92	CHI
202010187423	VIANOPOLIS	VN12102973	VIANOPOLIS	31/10/2020 16:08	31/10/2020 19:16	31/10/2020 16:08	31/10/2020 19:16	3,12	3	9,36	CHI
202010187430	CHAPADAO DO CEU	AE21260293	CHAPADAO DO CEU	31/10/2020 16:10	31/10/2020 17:45	31/10/2020 16:10	31/10/2020 17:45	1,58	1	1,58	CHI
202010187541	BELA VISTA DE GOIAS	BV32051409	BELA VISTA S2	31/10/2020 16:11	31/10/2020 18:28	31/10/2020 16:11	31/10/2020 18:28	2,29	306	701,25	CHI
202010187447	ITABERAI	AC21234651	ARACU	31/10/2020 16:13	31/10/2020 19:28	31/10/2020 16:13	31/10/2020 19:28	3,25	1	3,25	CHI
202010187451	FORMOSA	FA11257837	ITUIQUIRA	31/10/2020 16:13	31/10/2020 21:41	31/10/2020 16:13	31/10/2020 21:41	5,46	57	311,08	CHI
202010187457	NIQUELANDIA	NQ12358171	NIQUELANDIA SUBTRANSMISSAO	31/10/2020 16:14	01/11/2020 10:42	31/10/2020 16:14	01/11/2020 10:42	18,46	1	18,46	CHI

2020103100107	ALVORADA DO NORTE	00010224	IACIARA S2	31/10/2020 16:15	31/10/2020 16:20	31/10/2020 16:15	31/10/2020 16:20	0,08	1200	100,00	CHI
2020103100107	SIMOLANDIA	00010224	IACIARA S2	31/10/2020 16:15	31/10/2020 16:20	31/10/2020 16:15	31/10/2020 16:20	0,08	3	0,25	CHI
202010187460	LEOPOLDO DE BULHOES	LB12026675	DAIA S2	31/10/2020 16:15	31/10/2020 22:54	31/10/2020 16:15	31/10/2020 22:54	6,64	4	26,57	CHI
202010187464	NIQUELANDIA	NQ21055105	NIQUELANDIA SUBTRANSMISSAO	31/10/2020 16:16	01/11/2020 16:36	31/10/2020 16:16	01/11/2020 16:36	24,33	1	24,33	CHI
202010187466	MORRINHOS	150090973	MORRINHOS	31/10/2020 16:16	31/10/2020 19:07	31/10/2020 16:16	31/10/2020 19:07	2,84	1	2,84	CHI
202010187482	RIO VERDE	630193976	CABRIUVA S1	31/10/2020 16:20	31/10/2020 17:51	31/10/2020 16:20	31/10/2020 17:51	1,50	1	1,50	CHI
202010187523	MORRINHOS	01510404	PONTALINA	31/10/2020 16:21	01/11/2020 20:41	31/10/2020 16:21	31/10/2020 17:51	1,49	4	5,97	CHI
202010187523	MAIRIPOTABA	01510404	PONTALINA	31/10/2020 16:21	01/11/2020 20:41	31/10/2020 16:21	31/10/2020 17:51	1,49	140	208,99	CHI
202010187523	PONTALINA	01510404	PONTALINA	31/10/2020 16:21	01/11/2020 20:41	31/10/2020 16:21	31/10/2020 17:51	1,49	51	76,13	CHI
202010187523	MAIRIPOTABA	01510404	PONTALINA	31/10/2020 16:21	01/11/2020 20:41	31/10/2020 16:21	31/10/2020 18:40	2,31	362	837,93	CHI
202010187523	CROMINIA	01510404	PONTALINA	31/10/2020 16:21	01/11/2020 20:41	31/10/2020 16:21	31/10/2020 18:40	2,31	10	23,15	CHI
202010187523	MAIRIPOTABA	01510404	PONTALINA	31/10/2020 16:21	01/11/2020 20:41	31/10/2020 16:21	31/10/2020 18:40	2,31	8	18,52	CHI
202010187523	PROFESSOR JAMIL SAFADY	01510404	ROCHEDO	31/10/2020 16:21	01/11/2020 20:41	31/10/2020 16:21	31/10/2020 18:40	2,31	7	16,20	CHI
202010187523	PIRACANJUBA	01510404	ROCHEDO	31/10/2020 16:21	01/11/2020 20:41	31/10/2020 16:21	31/10/2020 18:40	2,31	1	2,31	CHI
202010187523	HIDROLANDIA	01510404	ROCHEDO	31/10/2020 16:21	01/11/2020 20:41	31/10/2020 16:21	31/10/2020 18:40	2,31	9	20,83	CHI
202010187523	PIRACANJUBA	01510404	ROCHEDO	31/10/2020 16:21	01/11/2020 20:41	31/10/2020 16:21	31/10/2020 18:40	2,31	295	682,84	CHI
202010187523	PROFESSOR JAMIL SAFADY	01510404	ROCHEDO	31/10/2020 16:21	01/11/2020 20:41	31/10/2020 16:21	31/10/2020 18:40	2,31	28	64,81	CHI
202010187523	CROMINIA	01510404	PONTALINA	31/10/2020 16:21	01/11/2020 20:41	31/10/2020 16:21	31/10/2020 18:40	2,31	1799	4164,19	CHI
202010187523	MAIRIPOTABA	01510404	PONTALINA	31/10/2020 16:21	01/11/2020 20:41	31/10/2020 16:21	31/10/2020 18:40	2,31	788	1824,00	CHI
202010187523	PONTALINA	01510404	PONTALINA	31/10/2020 16:21	01/11/2020 20:41	31/10/2020 16:21	31/10/2020 18:40	2,31	60	138,88	CHI
202010187523	PONTALINA	01510404	PONTALINA	31/10/2020 16:21	01/11/2020 20:41	31/10/2020 16:21	31/10/2020 18:40	2,31	3	6,94	CHI
202010187523	PONTALINA	01510404	PONTALINA	31/10/2020 16:21	01/11/2020 20:41	31/10/2020 16:21	31/10/2020 18:40	2,31	34	78,70	CHI
202010187523	CROMINIA	01510404	ROCHEDO	31/10/2020 16:21	01/11/2020 20:41	31/10/2020 16:21	31/10/2020 18:40	2,31	42	97,22	CHI
202010187523	HIDROLANDIA	01510404	PONTALINA	31/10/2020 16:21	01/11/2020 20:41	31/10/2020 16:21	31/10/2020 18:40	2,31	189	437,48	CHI
202010187523	CEZARINA	01510404	PONTALINA	31/10/2020 16:21	01/11/2020 20:41	31/10/2020 16:21	31/10/2020 18:40	2,31	40	92,59	CHI
202010187523	MAIRIPOTABA	01510404	PONTALINA	31/10/2020 16:21	01/11/2020 20:41	31/10/2020 16:21	31/10/2020 18:40	2,31	10	23,15	CHI
202010187523	CROMINIA	01510404	PONTALINA	31/10/2020 16:21	01/11/2020 20:41	31/10/2020 16:21	31/10/2020 18:40	2,31	20	46,29	CHI
202010187523	CROMINIA	01510404	PONTALINA	31/10/2020 16:21	01/11/2020 20:41	31/10/2020 16:21	31/10/2020 18:40	2,31	18	41,67	CHI
202010187523	CROMINIA	01510404	ROCHEDO	31/10/2020 16:21	01/11/2020 20:41	31/10/2020 16:21	31/10/2020 18:40	2,31	4	9,26	CHI
202010187523	VARJAO	01510404	PONTALINA	31/10/2020 16:21	01/11/2020 20:41	31/10/2020 16:21	31/10/2020 18:40	2,31	1	2,31	CHI
202010187523	PROFESSOR JAMIL SAFADY	01510404	PONTALINA	31/10/2020 16:21	01/11/2020 20:41	31/10/2020 16:21	31/10/2020 18:40	2,31	14	32,41	CHI
202010187523	MAIRIPOTABA	01510404	PONTALINA	31/10/2020 16:21	01/11/2020 20:41	31/10/2020 16:21	31/10/2020 18:40	2,31	2	4,63	CHI
202010187523	PROFESSOR JAMIL SAFADY	01510404	PONTALINA	31/10/2020 16:21	01/11/2020 20:41	31/10/2020 16:21	31/10/2020 18:40	2,31	9	20,83	CHI
202010187523	PROFESSOR JAMIL SAFADY	01510404	ROCHEDO	31/10/2020 16:21	01/11/2020 20:41	31/10/2020 16:21	31/10/2020 18:40	2,31	723	1673,54	CHI
202010187523	HIDROLANDIA	01510404	PONTALINA	31/10/2020 16:21	01/11/2020 20:41	31/10/2020 16:21	31/10/2020 18:40	2,31	4	9,26	CHI
202010187523	MAIRIPOTABA	01510404	PONTALINA	31/10/2020 16:21	01/11/2020 20:41	31/10/2020 16:21	31/10/2020 18:40	2,31	3	6,94	CHI
202010187523	CROMINIA	01510404	PONTALINA	31/10/2020 16:21	01/11/2020 20:41	31/10/2020 16:21	31/10/2020 18:40	2,31	12	27,78	CHI
202010187523	CROMINIA	01510404	PONTALINA	31/10/2020 16:21	01/11/2020 20:41	31/10/2020 16:21	31/10/2020 18:40	2,31	45	104,16	CHI
202010187523	PROFESSOR JAMIL SAFADY	01510404	ROCHEDO	31/10/2020 16:21	01/11/2020 20:41	31/10/2020 16:21	31/10/2020 18:40	2,31	669	1548,55	CHI
202010187523	PIRACANJUBA	01510404	ROCHEDO	31/10/2020 16:21	01/11/2020 20:41	31/10/2020 16:21	31/10/2020 18:40	2,31	50	115,74	CHI
202010187523	MAIRIPOTABA	01510404	PONTALINA	31/10/2020 16:21	01/11/2020 20:41	31/10/2020 16:21	31/10/2020 18:40	2,31	67	155,09	CHI
202010187523	HIDROLANDIA	01510404	PONTALINA	31/10/2020 16:21	01/11/2020 20:41	31/10/2020 16:21	31/10/2020 18:40	2,31	75	173,60	CHI
202010187523	CROMINIA	01510404	PONTALINA	31/10/2020 16:21	01/11/2020 20:41	31/10/2020 16:21	31/10/2020 18:40	2,31	2	4,63	CHI
202010187523	PONTALINA	01510404	PONTALINA	31/10/2020 16:21	01/11/2020 20:41	31/10/2020 16:22	31/10/2020 18:40	2,30	1	2,30	CHI
202010187523	PROFESSOR JAMIL SAFADY	01510404	ROCHEDO	31/10/2020 16:21	01/11/2020 20:41	31/10/2020 16:22	31/10/2020 18:40	2,30	25	57,47	CHI
202010187523	PROFESSOR JAMIL SAFADY	01510404	ROCHEDO	31/10/2020 16:21	01/11/2020 20:41	31/10/2020 16:22	31/10/2020 18:40	2,30	1	2,30	CHI
202010187523	MAIRIPOTABA	01510404	PONTALINA	31/10/2020 16:21	01/11/2020 20:41	31/10/2020 16:22	31/10/2020 18:40	2,30	1	2,30	CHI
202010187523	MAIRIPOTABA	01510404	PONTALINA	31/10/2020 16:21	01/11/2020 20:41	31/10/2020 16:21	31/10/2020 20:54	4,55	8	36,38	CHI
202010187523	MAIRIPOTABA	01510404	PONTALINA	31/10/2020 16:21	01/11/2020 20:41	31/10/2020 16:21	31/10/2020 21:31	5,16	4	20,63	CHI
202010187523	MAIRIPOTABA	MI10408274	PONTALINA	31/10/2020 16:21	01/11/2020 20:41	31/10/2020 22:03	01/11/2020 01:47	3,72	4	14,90	CHI
202010187523	PROFESSOR JAMIL SAFADY	01510404	PONTALINA	31/10/2020 16:21	01/11/2020 20:41	31/10/2020 16:21	01/11/2020 20:41	28,33	8	226,65	CHI

202010187523	PIRACANJUBA	01510404	PONTALINA	31/10/2020 16:21	01/11/2020 20:41	31/10/2020 16:21	01/11/2020 20:41	28,33	1	28,33	CHI
202010187488	ITABERAÍ	HE21307647	ITABERAÍ S1	31/10/2020 16:22	01/11/2020 15:54	31/10/2020 16:22	01/11/2020 15:54	23,52	1	23,52	CHI
202010187496	QUIRINÓPOLIS	Q112370013	CACHOEIRA ALTA	31/10/2020 16:23	31/10/2020 21:07	31/10/2020 16:23	31/10/2020 21:07	4,73	5	23,63	CHI
202010187502	RIO VERDE	630042718	RIO VERDE S2	31/10/2020 16:24	31/10/2020 18:23	31/10/2020 16:24	31/10/2020 18:23	1,98	1	1,98	CHI
202010187751	NOVA ROMA	ND12229410	IACIARA S2	31/10/2020 16:24	31/10/2020 20:20	31/10/2020 16:24	31/10/2020 20:20	3,93	3	11,78	CHI
202010187524	TRES RANCHOS	TH12394003	CATALAO S1	31/10/2020 16:25	01/11/2020 00:32	31/10/2020 16:25	01/11/2020 00:32	8,11	32	259,65	CHI
202010187905	URUACU	CR12202139RE	MARA ROSA	31/10/2020 16:26	31/10/2020 22:35	31/10/2020 16:26	31/10/2020 22:35	6,15	106	651,49	CHI
202010187905	CAMPINORTE	CR12202139RE	MARA ROSA	31/10/2020 16:26	31/10/2020 22:35	31/10/2020 16:26	31/10/2020 22:35	6,15	33	202,82	CHI
202010188567	ALVORADA DO NORTE	AQ12347010	IACIARA S2	31/10/2020 16:26	31/10/2020 23:11	31/10/2020 16:26	31/10/2020 23:11	6,74	15	101,07	CHI
202010187976	COCALZINHO DE GOIAS	ZN12307708	GOIANESIA S1	31/10/2020 16:26	01/11/2020 12:00	31/10/2020 16:26	01/11/2020 12:00	19,57	3	58,70	CHI
202010187271	IACIARA	IA12218797	IACIARA S1	31/10/2020 16:27	01/11/2020 01:16	31/10/2020 16:27	01/11/2020 01:16	8,83	1	8,83	CHI
202010187271	GUARANI DE GOIAS	IA12218797	IACIARA S1	31/10/2020 16:27	01/11/2020 01:16	31/10/2020 16:27	01/11/2020 01:16	8,83	9	79,46	CHI
202010187538	MARA ROSA	MQ21182372	MARA ROSA	31/10/2020 16:29	01/11/2020 17:28	31/10/2020 16:29	01/11/2020 17:28	24,98	1	24,98	CHI
202010187542	COCALZINHO DE GOIAS	ZN21319938	COCALZINHO	31/10/2020 16:29	01/11/2020 04:03	31/10/2020 16:29	01/11/2020 04:03	11,55	1	11,55	CHI
202010187548	PLANALTINA	2960247055	PLANALTINA	31/10/2020 16:31	31/10/2020 18:03	31/10/2020 16:31	31/10/2020 18:03	1,53	1	1,53	CHI
202010187551	GOIANIA	14241808	ATLANTICO S3	31/10/2020 16:32	31/10/2020 19:00	31/10/2020 16:32	31/10/2020 19:00	2,47	1	2,47	CHI
202010187552	LEOPOLDO DE BULHOES	LB21167338	DAIA S2	31/10/2020 16:32	31/10/2020 23:50	31/10/2020 16:32	31/10/2020 23:50	7,30	1	7,30	CHI
202010187554	CRISTALINA	7518339	CRISTALINA S2	31/10/2020 16:32	31/10/2020 19:41	31/10/2020 16:32	31/10/2020 19:41	3,14	3	9,43	CHI
202010187555	JATAI	JT21337008	JATAI S1	31/10/2020 16:32	31/10/2020 20:58	31/10/2020 16:32	31/10/2020 20:58	4,42	1	4,42	CHI
202010187577	OUVIDOR	OU10407540	CATALAO S1	31/10/2020 16:33	31/10/2020 23:41	31/10/2020 16:33	31/10/2020 17:23	0,84	69	57,67	CHI
202010187577	TRES RANCHOS	OU10407540	CATALAO S1	31/10/2020 16:33	31/10/2020 23:41	31/10/2020 16:33	31/10/2020 17:23	0,84	22	18,39	CHI
202010187577	CATALAO	OU10407540	CATALAO S1	31/10/2020 16:33	31/10/2020 23:41	31/10/2020 16:33	31/10/2020 17:23	0,84	12	10,03	CHI
202010187577	CATALAO	OU10407540	CATALAO S1	31/10/2020 16:33	31/10/2020 23:41	31/10/2020 16:34	31/10/2020 17:23	0,81	1	0,81	CHI
202010187577	OUVIDOR	OU10407540	CATALAO S1	31/10/2020 16:33	31/10/2020 23:41	31/10/2020 16:34	31/10/2020 17:23	0,81	12	9,75	CHI
202010187577	TRES RANCHOS	OU10407540	CATALAO S1	31/10/2020 16:33	31/10/2020 23:41	31/10/2020 16:34	31/10/2020 17:23	0,81	2	1,63	CHI
202010187577	OUVIDOR	OU10407540	CATALAO S1	31/10/2020 16:33	31/10/2020 23:41	31/10/2020 16:33	31/10/2020 23:17	6,74	5	33,70	CHI
202010187577	OUVIDOR	OU10407540	CATALAO S1	31/10/2020 16:33	31/10/2020 23:41	31/10/2020 16:34	31/10/2020 23:17	6,72	1	6,72	CHI
202010187577	TRES RANCHOS	OU10407540	CATALAO S1	31/10/2020 16:33	31/10/2020 23:41	31/10/2020 20:25	31/10/2020 23:17	2,86	24	68,66	CHI
202010187577	OUVIDOR	OU10407540	CATALAO S1	31/10/2020 16:33	31/10/2020 23:41	31/10/2020 20:25	31/10/2020 23:17	2,86	57	163,07	CHI
202010187577	CATALAO	OU10407540	CATALAO S1	31/10/2020 16:33	31/10/2020 23:41	31/10/2020 20:25	31/10/2020 23:17	2,86	5	14,30	CHI
202010187577	CATALAO	OU12190458RE	CATALAO S1	31/10/2020 16:33	31/10/2020 23:41	31/10/2020 20:25	31/10/2020 23:41	3,26	8	26,06	CHI
202010187577	OUVIDOR	OU12190458RE	CATALAO S1	31/10/2020 16:33	31/10/2020 23:41	31/10/2020 20:25	31/10/2020 23:41	3,26	24	78,19	CHI
202010187557	PIRANHAS	PH21380945	PIRANHAS	31/10/2020 16:33	31/10/2020 21:18	31/10/2020 16:33	31/10/2020 21:18	4,75	1	4,75	CHI
202010187752	SAO JOAO D ALIANCA	ND12394116	IACIARA S2	31/10/2020 16:33	01/11/2020 15:55	31/10/2020 16:33	01/11/2020 15:55	23,36	15	350,33	CHI
202010187752	NOVA ROMA	ND12394116	IACIARA S2	31/10/2020 16:33	01/11/2020 15:55	31/10/2020 16:33	01/11/2020 15:55	23,36	5	116,78	CHI
202010187571	SIMOLANDIA	SA12221147	IACIARA S2	31/10/2020 16:36	31/10/2020 19:47	31/10/2020 16:36	31/10/2020 19:47	3,17	19	60,29	CHI
202010187888	SAO FRANCISCO DE GOIAS	SF12017628	SAO FRANCISCO DE GOIAS	31/10/2020 16:37	31/10/2020 20:14	31/10/2020 16:37	31/10/2020 20:14	3,61	9	32,48	CHI
202010187888	PIRENÓPOLIS	SF12017628	SAO FRANCISCO DE GOIAS	31/10/2020 16:37	31/10/2020 20:14	31/10/2020 16:37	31/10/2020 20:14	3,61	5	18,05	CHI
202010187580	CALDAS NOVAS	CN12159923	SERRA DE CALDAS	31/10/2020 16:37	01/11/2020 00:29	31/10/2020 16:37	31/10/2020 20:47	4,17	123	512,43	CHI
202010187580	CALDAS NOVAS	CN12159923	SERRA DE CALDAS	31/10/2020 16:37	01/11/2020 00:29	31/10/2020 16:37	31/10/2020 21:16	4,64	256	1187,70	CHI
202010187580	CALDAS NOVAS	CN11159924	SERRA DE CALDAS	31/10/2020 16:37	01/11/2020 00:29	31/10/2020 21:37	01/11/2020 00:29	2,86	122	349,19	CHI
202010187606	SITIO D ABADIA	SI12211588	IACIARA S2	31/10/2020 16:37	31/10/2020 20:17	31/10/2020 16:37	31/10/2020 20:17	3,65	12	43,86	CHI
202010187608	VILA PROPICIO	NP12298233	GOIANESIA S1	31/10/2020 16:37	31/10/2020 18:49	31/10/2020 16:37	31/10/2020 18:49	2,19	7	15,30	CHI
202010187587	NOVA CRIXAS	8570014614	NOVA CRIXAS	31/10/2020 16:38	02/11/2020 17:38	31/10/2020 16:38	02/11/2020 17:38	49,00	1	49,00	CHI
202010187589	IACIARA	IA12194773	IACIARA S2	31/10/2020 16:38	31/10/2020 22:00	31/10/2020 16:38	31/10/2020 22:00	5,36	2	10,71	CHI
202010187591	GOIANIA	15641569	MEIA PONTE	31/10/2020 16:38	31/10/2020 19:28	31/10/2020 16:38	31/10/2020 19:28	2,82	1	2,82	CHI
202010187595	GOIANIA	10015400210	CAMPINAS S2	31/10/2020 16:39	31/10/2020 20:01	31/10/2020 16:39	31/10/2020 20:01	3,36	1	3,36	CHI
202010187600	GOIANIA	GN21001255	GOYA S1	31/10/2020 16:40	31/10/2020 17:50	31/10/2020 16:40	31/10/2020 17:50	1,15	1	1,15	CHI
202010187607	PIRES DO RIO	PR21252415	PIRES DO RIO S2	31/10/2020 16:42	31/10/2020 21:08	31/10/2020 16:42	31/10/2020 21:08	4,43	1	4,43	CHI
202010187617	IPORA	730026668	IPORA	31/10/2020 16:45	31/10/2020 23:15	31/10/2020 16:45	31/10/2020 23:15	6,49	1	6,49	CHI
202010187622	CEZARINA	1650006175	CEZARINA	31/10/2020 16:47	01/11/2020 07:59	31/10/2020 16:47	01/11/2020 07:59	15,21	1	15,21	CHI

202010187626	ANAPOLIS	21260862	JUNDIAI S2	31/10/2020 16:47	31/10/2020 22:37	31/10/2020 16:47	31/10/2020 22:37	5,82	1	5,82	CHI
202010187736	GOIATUBA	GT12000081	GOIATUBA S2	31/10/2020 16:50	31/10/2020 18:58	31/10/2020 16:50	31/10/2020 18:58	2,14	12	25,65	CHI
202010187642	SANTA TEREZINHA DE GOIAS	GG21181147	SANTA TEREZINHA	31/10/2020 16:50	01/11/2020 05:34	31/10/2020 16:50	01/11/2020 05:34	12,73	1	12,73	CHI
202010187644	PIRENOPOLIS	PV21291885	CORUMBA	31/10/2020 16:50	31/10/2020 23:25	31/10/2020 16:50	31/10/2020 23:25	6,58	1	6,58	CHI
202010187652	RIO VERDE	RV21249022	CABRIUVA S2	31/10/2020 16:52	31/10/2020 19:09	31/10/2020 16:52	31/10/2020 19:09	2,27	1	2,27	CHI
202010187658	GOIANIA	14612914	GOIANIA LESTE S3	31/10/2020 16:55	31/10/2020 20:00	31/10/2020 16:55	31/10/2020 20:00	3,08	1	3,08	CHI
202010187659	QUIRINOPOLIS	QI11113291	QUIRINOPOLIS	31/10/2020 16:55	31/10/2020 18:59	31/10/2020 16:55	31/10/2020 18:59	2,06	91	187,11	CHI
202010187661	APORE	AE21359766	ITAJA S1	31/10/2020 16:56	01/11/2020 11:14	31/10/2020 16:56	01/11/2020 11:14	18,30	1	18,30	CHI
202010187672	APORE	3110004791	ITAJA S1	31/10/2020 16:58	01/11/2020 12:30	31/10/2020 16:58	01/11/2020 12:30	19,52	1	19,52	CHI
202010187755	NOVA ROMA	ND12256420	IACIARA S2	31/10/2020 16:59	31/10/2020 21:42	31/10/2020 16:59	31/10/2020 21:42	4,71	30	141,20	CHI
202010187684	CAIAPONIA	CP12207981	CAIAPONIA	31/10/2020 17:01	31/10/2020 17:23	31/10/2020 17:01	31/10/2020 17:23	0,35	23	8,13	CHI
202010187694	PIRENOPOLIS	PV12352327	CORUMBA	31/10/2020 17:04	31/10/2020 19:10	31/10/2020 17:04	31/10/2020 19:10	2,09	18	37,71	CHI
202010187696	AGUA FRIA DE GOIAS	TL21417738	SAO JOAO D ALIANCA	31/10/2020 17:04	31/10/2020 21:33	31/10/2020 17:04	31/10/2020 21:33	4,47	1	4,47	CHI
202010187700	APARECIDA DE GOIANIA	12967063	INDEPENDENCIA S2	31/10/2020 17:07	31/10/2020 19:18	31/10/2020 17:07	31/10/2020 19:18	2,18	1	2,18	CHI
202010187994	CAIAPONIA	CP11184362	CAIAPONIA	31/10/2020 17:07	31/10/2020 19:21	31/10/2020 17:07	31/10/2020 19:21	2,23	69	153,85	CHI
202010187708	URUACU	UR21135700	URUACU	31/10/2020 17:08	31/10/2020 20:30	31/10/2020 17:08	31/10/2020 20:30	3,36	1	3,36	CHI
202010187709	GOIANIA	GN11277526	GOYA S2	31/10/2020 17:09	31/10/2020 22:12	31/10/2020 17:09	31/10/2020 22:12	5,05	1	5,05	CHI
202010187711	ANAPOLIS	20102641	JUNDIAI S2	31/10/2020 17:09	31/10/2020 23:45	31/10/2020 17:09	31/10/2020 23:45	6,59	1	6,59	CHI
202010187980	GOIANIRA	CK12400459	INHUMAS S1	31/10/2020 17:10	01/11/2020 09:21	01/11/2020 09:13	01/11/2020 09:21	0,14	1	0,14	CHI
202010187980	TRINDADE	CK12400459	INHUMAS S1	31/10/2020 17:10	01/11/2020 09:21	01/11/2020 09:13	01/11/2020 09:21	0,14	14	1,91	CHI
202010187980	TRINDADE	TR12015908	INHUMAS S1	31/10/2020 17:10	01/11/2020 09:21	31/10/2020 17:10	01/11/2020 08:56	15,76	8	126,09	CHI
202010188353	DOVERLANDIA	CP12190363	CAIAPONIA	31/10/2020 17:10	31/10/2020 21:38	31/10/2020 17:10	31/10/2020 21:38	4,45	6	26,70	CHI
202010188353	CAIAPONIA	CP12190363	CAIAPONIA	31/10/2020 17:10	31/10/2020 21:38	31/10/2020 17:10	31/10/2020 21:38	4,45	4	17,80	CHI
202010187720	ANAPOLIS	AN21317449	ANAPOLIS UNIVERSITARIO S1	31/10/2020 17:11	31/10/2020 20:48	31/10/2020 17:11	31/10/2020 20:48	3,61	1	3,61	CHI
202010187723	LUZIANIA	10011486315	RIO VERMELHO	31/10/2020 17:12	31/10/2020 21:11	31/10/2020 17:12	31/10/2020 21:11	3,98	1	3,98	CHI
202010187726	GOIANIA	12358459	REAL S2	31/10/2020 17:12	31/10/2020 20:27	31/10/2020 17:12	31/10/2020 20:27	3,24	1	3,24	CHI
202010187729	BALIZA	BH12331338	CAIAPONIA	31/10/2020 17:13	31/10/2020 20:35	31/10/2020 17:13	31/10/2020 20:35	3,36	79	265,09	CHI
202010187767	JATAI	JT21346555	JATAI S1	31/10/2020 17:19	01/11/2020 09:50	31/10/2020 17:19	01/11/2020 09:50	16,51	1	16,51	CHI
202010187791	PORTEIRAO	CL21301098	RIO DOS BOIS	31/10/2020 17:21	31/10/2020 23:19	31/10/2020 17:21	31/10/2020 23:19	5,97	1	5,97	CHI
202010187876	GOIANIA	GN11238206	ATLANTICO S3	31/10/2020 17:23	31/10/2020 23:50	31/10/2020 17:23	31/10/2020 23:50	6,46	126	813,89	CHI
202010187805	ANAPOLIS	20930938	DAIA S1	31/10/2020 17:24	31/10/2020 18:32	31/10/2020 17:24	31/10/2020 18:32	1,13	1	1,13	CHI
202010188004	FORMOSA	FA12248883	ITUIQUIRA	31/10/2020 17:24	01/11/2020 11:24	31/10/2020 17:24	01/11/2020 11:24	18,01	17	306,19	CHI
202010187810	VILA PROPICIO	NP12312760	GOIANESIA S1	31/10/2020 17:25	31/10/2020 18:50	31/10/2020 17:25	31/10/2020 18:50	1,40	1	1,40	CHI
202010187813	PLANALTINA	PI11164582	PLANALTINA	31/10/2020 17:26	31/10/2020 23:08	31/10/2020 17:26	31/10/2020 23:08	5,69	132	751,48	CHI
202010187815	RIO QUENTE	CN21000052	RIO QUENTE	31/10/2020 17:26	31/10/2020 19:44	31/10/2020 17:26	31/10/2020 19:44	2,29	1	2,29	CHI
202010187818	ITAPURANGA	IK21300018	ITAPURANGA	31/10/2020 17:27	01/11/2020 15:16	31/10/2020 17:27	01/11/2020 15:16	21,82	1	21,82	CHI
202010187820	ITABERAI	IB12206910	ITABERAI S1	31/10/2020 17:27	01/11/2020 17:18	31/10/2020 17:27	01/11/2020 17:18	23,84	21	500,56	CHI
202010187822	GOIANIA	11531757	CAMPINAS S1	31/10/2020 17:28	31/10/2020 20:35	31/10/2020 17:28	31/10/2020 20:35	3,11	1	3,11	CHI
202010187824	COCALZINHO DE GOIAS	ZN21302483	COCALZINHO	31/10/2020 17:29	01/11/2020 04:30	31/10/2020 17:29	01/11/2020 04:30	11,01	1	11,01	CHI
202010187825	GOIAS	GS21220307	MATRINCHA	31/10/2020 17:29	31/10/2020 20:50	31/10/2020 17:29	31/10/2020 20:50	3,35	1	3,35	CHI
202010187827	CRISTALINA	KR21165556	CRISTALINA S2	31/10/2020 17:29	31/10/2020 22:00	31/10/2020 17:29	31/10/2020 22:00	4,51	1	4,51	CHI
202010188145	GUARINOS	GF12146937	SANTA TEREZINHA	31/10/2020 17:29	31/10/2020 20:06	31/10/2020 17:29	31/10/2020 20:06	2,61	13	33,89	CHI
202010188145	CRIXAS	GF12146937	SANTA TEREZINHA	31/10/2020 17:29	31/10/2020 20:06	31/10/2020 17:29	31/10/2020 20:06	2,61	242	630,95	CHI
202010187837	TAQUARAL DE GOIAS	TQ21217522	ITABERAI S1	31/10/2020 17:31	01/11/2020 19:49	31/10/2020 17:31	01/11/2020 19:49	26,29	1	26,29	CHI
202010187839	SILVANIA	AN21241547	DAIA S2	31/10/2020 17:32	01/11/2020 01:30	31/10/2020 17:32	01/11/2020 01:30	7,96	1	7,96	CHI
202010187843	FORMOSA	FA12262305	ITUIQUIRA	31/10/2020 17:33	31/10/2020 21:41	31/10/2020 17:33	31/10/2020 21:41	4,13	695	2872,28	CHI
202010187886	INHUMAS	IN11400007	INHUMAS S2	31/10/2020 17:33	31/10/2020 19:14	31/10/2020 17:33	31/10/2020 19:14	1,67	76	126,81	CHI
202010188315	PALMEIRAS DE GOIAS	PL12206430	PALMEIRAS	31/10/2020 17:35	31/10/2020 23:12	31/10/2020 17:35	31/10/2020 23:12	5,61	15	84,20	CHI
202010188893	MONTES CLAROS DE GOIAS	JR12341251	IPORA	31/10/2020 17:35	01/11/2020 09:14	31/10/2020 17:35	01/11/2020 09:14	15,65	18	281,62	CHI
202010188893	JUSSARA	JR12341251	IPORA	31/10/2020 17:35	01/11/2020 09:14	31/10/2020 17:35	01/11/2020 09:14	15,65	190	2972,60	CHI
202010187977	MINACU	IH12230528	MINACU	31/10/2020 17:36	31/10/2020 19:29	31/10/2020 17:36	31/10/2020 19:29	1,88	6	11,28	CHI

202010187867	GOIAS	7382910	MATRINCHA	31/10/2020 17:37	01/11/2020 14:00	01/11/2020 12:30	01/11/2020 13:28	0,97	5	4,85	CHI
202010187862	ALEXANIA	AX12000154	CORUMBA	31/10/2020 17:37	31/10/2020 19:53	31/10/2020 17:37	31/10/2020 19:53	2,25	22	49,58	CHI
202010187862	CORUMBA DE GOIAS	AX12000154	CORUMBA	31/10/2020 17:37	31/10/2020 19:53	31/10/2020 17:37	31/10/2020 19:53	2,25	4	9,01	CHI
202010187865	MINACU	IH21242194	MINACU	31/10/2020 17:37	02/11/2020 03:01	31/10/2020 17:37	02/11/2020 03:01	33,38	1	33,38	CHI
202010187867	GOIAS	GS12408674	MATRINCHA	31/10/2020 17:37	01/11/2020 14:00	31/10/2020 17:37	01/11/2020 14:00	20,38	18	366,81	CHI
202010187871	SAO FRANCISCO DE GOIAS	PG21230686	PETROLINA	31/10/2020 17:39	31/10/2020 19:24	31/10/2020 17:39	31/10/2020 19:24	1,75	1	1,75	CHI
202010188126	ITABERAI	IB12300040	ITABERAI S2	31/10/2020 17:41	31/10/2020 23:42	31/10/2020 17:41	31/10/2020 23:21	5,66	10	56,61	CHI
202010188126	ITAPURANGA	IB12300040	ITABERAI S2	31/10/2020 17:41	31/10/2020 23:42	31/10/2020 17:41	31/10/2020 23:35	5,90	1	5,90	CHI
202010188126	ITABERAI	IB12300040	ITABERAI S2	31/10/2020 17:41	31/10/2020 23:42	31/10/2020 17:41	31/10/2020 23:35	5,90	16	94,46	CHI
202010188126	ITABERAI	IB12300040	ITABERAI S2	31/10/2020 17:41	31/10/2020 23:42	31/10/2020 17:41	31/10/2020 23:42	6,01	16	96,16	CHI
202010188099	NIQUELANDIA	NQ12362142	NIQUELANDIA SUBTRANSMISSAO	31/10/2020 17:43	01/11/2020 22:24	01/11/2020 14:10	01/11/2020 21:39	7,49	7	52,44	CHI
202010188099	NIQUELANDIA	NQ12359240LD	NIQUELANDIA SUBTRANSMISSAO	31/10/2020 17:43	01/11/2020 22:24	01/11/2020 14:10	01/11/2020 22:24	8,24	2	16,48	CHI
202010188099	NIQUELANDIA	NQ12362142	NIQUELANDIA SUBTRANSMISSAO	31/10/2020 17:43	01/11/2020 22:24	31/10/2020 17:43	01/11/2020 14:10	20,45	9	184,05	CHI
202010187892	RIO VERDE	RV21306541	ACREUNA	31/10/2020 17:43	31/10/2020 19:30	31/10/2020 17:43	31/10/2020 19:30	1,78	2	3,56	CHI
202010187897	ARAGOIANA	AO32095549	GUAPO S2	31/10/2020 17:44	31/10/2020 20:34	31/10/2020 17:44	31/10/2020 20:34	2,83	4	11,33	CHI
202010188835	ITAPURANGA	IK11249442	ITAPURANGA	31/10/2020 17:44	01/11/2020 05:56	31/10/2020 17:44	01/11/2020 05:56	12,20	81	987,89	CHI
202010187903	GOIANIA	11843391	CAMPINAS S1	31/10/2020 17:44	31/10/2020 19:33	31/10/2020 17:44	31/10/2020 19:33	1,81	1	1,81	CHI
202010187906	JARAGUA	JA21006444	JARAGUA	31/10/2020 17:44	31/10/2020 20:24	31/10/2020 17:44	31/10/2020 20:24	2,65	1	2,65	CHI
202010187907	APARECIDA DE GOIANIA	200413387	ANHANGUERA	31/10/2020 17:45	31/10/2020 20:09	31/10/2020 17:45	31/10/2020 20:09	2,40	1	2,40	CHI
202010188254	CASTELANDIA	ML12303542	RIO DOS BOIS	31/10/2020 17:45	31/10/2020 19:59	31/10/2020 17:45	31/10/2020 19:59	2,23	4	8,91	CHI
202010188254	MAURILANDIA	ML12303542	RIO DOS BOIS	31/10/2020 17:45	31/10/2020 19:59	31/10/2020 17:45	31/10/2020 19:59	2,23	15	33,43	CHI
202010187912	FIRMINOPOLIS	FR21092468	SAO LUIZ DOS MONTES BELOS	31/10/2020 17:45	01/11/2020 11:41	31/10/2020 17:45	01/11/2020 11:41	17,92	1	17,92	CHI
202010188034	ITARUMA	IM12205220LD	ITAJA S2	31/10/2020 17:46	31/10/2020 22:48	31/10/2020 17:46	31/10/2020 22:48	5,03	9	45,28	CHI
202010187922	CRISTALINA	KR21171351	CRISTALINA S2	31/10/2020 17:48	01/11/2020 03:03	31/10/2020 17:48	01/11/2020 03:03	9,23	1	9,23	CHI
202010187930	ACREUNA	EU12260931	ACREUNA	31/10/2020 17:49	31/10/2020 21:08	31/10/2020 17:49	31/10/2020 21:08	3,31	3	9,94	CHI
202010188588	JARAGUA	JA12000236	JARAGUA	31/10/2020 17:50	31/10/2020 21:40	31/10/2020 17:50	31/10/2020 21:40	3,83	26	99,62	CHI
202010187937	ARAGOIANA	AO31097610	GUAPO S2	31/10/2020 17:52	31/10/2020 21:02	31/10/2020 17:52	31/10/2020 21:02	3,15	1	3,15	CHI
202010187949	ORIZONA	OZ12300550	PIRES DO RIO S2	31/10/2020 17:53	31/10/2020 19:25	31/10/2020 17:53	31/10/2020 19:25	1,53	53	81,21	CHI
202010187957	VICENTINOPOLIS	VI21166493	VICENTINOPOLIS	31/10/2020 17:55	31/10/2020 23:19	31/10/2020 17:55	31/10/2020 23:19	5,39	1	5,39	CHI
202010187964	NOVO GAMA	10020309870	PACAEMBU S1	31/10/2020 17:56	31/10/2020 21:13	31/10/2020 17:56	31/10/2020 21:13	3,27	1	3,27	CHI
202010188111	ARENOPOLIS	AY12316423	ARENOPOLIS	31/10/2020 17:57	31/10/2020 23:38	31/10/2020 17:57	31/10/2020 23:38	5,67	5	28,36	CHI
202010187981	JARAGUA	JA12070670	JARAGUA	31/10/2020 17:58	01/11/2020 12:42	01/11/2020 09:54	01/11/2020 12:42	2,81	10	28,09	CHI
202010187981	JARAGUA	JA12070670	JARAGUA	31/10/2020 17:58	01/11/2020 12:42	31/10/2020 17:58	01/11/2020 09:54	15,93	10	159,28	CHI
202010187973	CAMPO ALEGRE DE GOIAS	CM12166727	CAMPO ALEGRE DE GOIAS	31/10/2020 17:59	31/10/2020 21:11	31/10/2020 17:59	31/10/2020 21:11	3,19	6	19,17	CHI
202010187975	SAO FRANCISCO DE GOIAS	PV21236038	SAO FRANCISCO DE GOIAS	31/10/2020 17:59	31/10/2020 19:26	31/10/2020 17:59	31/10/2020 19:26	1,44	2	2,88	CHI
202010188274	CACHOEIRA DOURADA	CD12000050	CACHOEIRA DOURADA	31/10/2020 18:02	31/10/2020 22:54	31/10/2020 18:02	31/10/2020 22:54	4,85	5	24,26	CHI
202010188274	ITUMBIARA	CD12000050	CACHOEIRA DOURADA	31/10/2020 18:02	31/10/2020 22:54	31/10/2020 18:02	31/10/2020 22:54	4,85	2	9,71	CHI
202010188006	CRISTALINA	KR21219707	CRISTALINA S1	31/10/2020 18:07	31/10/2020 21:05	31/10/2020 18:07	31/10/2020 21:05	2,96	1	2,96	CHI
202010188007	GOIANIA	12579944	ATLANTICO S2	31/10/2020 18:07	01/11/2020 09:28	31/10/2020 18:07	01/11/2020 09:28	15,35	1	15,35	CHI
202010188010	SENADOR CANEDO	SW12055861	CEPAIGO S1	31/10/2020 18:08	31/10/2020 19:30	31/10/2020 18:08	31/10/2020 19:29	1,36	45	61,27	CHI
202010188010	SENADOR CANEDO	SW11291698	CEPAIGO S1	31/10/2020 18:08	31/10/2020 19:30	31/10/2020 18:08	31/10/2020 19:30	1,36	60	81,75	CHI
202010188013	APARECIDA DE GOIANIA	10015608113	INDEPENDENCIA S1	31/10/2020 18:09	31/10/2020 19:53	31/10/2020 18:09	31/10/2020 19:53	1,73	1	1,73	CHI
202010188016	GOIATUBA	GT21190879	GOIATUBA S2	31/10/2020 18:10	31/10/2020 22:03	31/10/2020 18:10	31/10/2020 22:03	3,88	2	7,75	CHI
202010188019	RIO VERDE	630531791	RIO VERDE S2	31/10/2020 18:11	31/10/2020 19:42	31/10/2020 18:11	31/10/2020 19:42	1,51	1	1,51	CHI
202010188366	PLANALTINA	PI12262312	PLANALTINA	31/10/2020 18:12	31/10/2020 22:27	31/10/2020 18:12	31/10/2020 22:27	4,24	10	42,37	CHI
202010188024	PARAUNA	980021674	PARAUNA	31/10/2020 18:13	31/10/2020 20:54	31/10/2020 18:13	31/10/2020 20:54	2,68	1	2,68	CHI
202010188028	NOVO GAMA	2460087269	PACAEMBU S1	31/10/2020 18:13	31/10/2020 21:19	31/10/2020 18:13	31/10/2020 21:19	3,09	1	3,09	CHI
20201155	OUVIDOR	OU12061245RE	CATALAO S1	31/10/2020 18:13	01/11/2020 07:33	31/10/2020 18:13	01/11/2020 07:33	13,32	53	706,17	CHI
202010188037	TRINDADE	TR21000127	TRINDADE	31/10/2020 18:14	31/10/2020 19:35	31/10/2020 18:14	31/10/2020 19:35	1,34	1	1,34	CHI
202010188041	JARAGUA	JA21353389	GOIANESIA S2	31/10/2020 18:15	31/10/2020 22:08	31/10/2020 18:15	31/10/2020 22:08	3,87	1	3,87	CHI
202010188162	AGUA FRIA DE GOIAS	TL12151992	SAO JOAO D ALIANCA	31/10/2020 18:15	31/10/2020 23:12	31/10/2020 18:15	31/10/2020 23:12	4,93	5	24,67	CHI

202010188052	LEOPOLDO DE BULHOES	LB21279271	CEPAIGO S2	31/10/2020 18:16	31/10/2020 23:14	31/10/2020 18:16	31/10/2020 23:14	4,95	1	4,95	CHI
202010188127	IACIARA	IA12392239	IACIARA S2	31/10/2020 18:18	01/11/2020 05:35	31/10/2020 18:18	01/11/2020 05:35	11,27	12	135,28	CHI
202010188064	BURITI ALEGRE	BG12000129	ITUMBIARA VELHA S2	31/10/2020 18:19	31/10/2020 23:50	31/10/2020 18:19	31/10/2020 23:50	5,50	1	5,50	CHI
202010188070	JATAI	JT11083493	JATAI S2	31/10/2020 18:21	31/10/2020 22:57	31/10/2020 18:21	31/10/2020 22:57	4,59	1	4,59	CHI
202010188074	CRISTALINA	1060047473	CRISTALINA S1	31/10/2020 18:22	31/10/2020 20:10	31/10/2020 18:22	31/10/2020 20:10	1,79	1	1,79	CHI
202010188076	MINEIROS	MY12296315	PARQUE DAS EMAS	31/10/2020 18:22	31/10/2020 22:56	31/10/2020 18:22	31/10/2020 22:56	4,56	3	13,69	CHI
202010188078	MINEIROS	MY12156849	PARQUE DAS EMAS	31/10/2020 18:22	01/11/2020 10:01	31/10/2020 18:22	01/11/2020 10:01	15,64	10	156,42	CHI
202010188081	ABADIA DE GOIAS	10024554004	INDEPENDENCIA S2	31/10/2020 18:23	31/10/2020 20:35	31/10/2020 18:23	31/10/2020 20:35	2,20	1	2,20	CHI
202010188082	FORMOSA	FA11397657	ITUIQUIRA	31/10/2020 18:23	01/11/2020 18:23	31/10/2020 18:23	01/11/2020 18:23	26,07	1	26,07	CHI
202010188085	APARECIDA DE GOIANIA	16781910	INDEPENDENCIA S1	31/10/2020 18:23	31/10/2020 21:23	31/10/2020 18:23	31/10/2020 21:23	2,98	1	2,98	CHI
202010188086	JARAGUA	JA21157783	JARAGUA	31/10/2020 18:24	31/10/2020 21:11	31/10/2020 18:24	31/10/2020 21:11	2,78	1	2,78	CHI
202010188088	TURVELANDIA	TD21370033	RIO DOS BOIS	31/10/2020 18:24	31/10/2020 21:09	31/10/2020 18:24	31/10/2020 21:09	2,75	1	2,75	CHI
202010188091	CRIXAS	CX21244071	SANTA TEREZINHA	31/10/2020 18:25	01/11/2020 15:15	31/10/2020 18:25	01/11/2020 15:15	20,83	1	20,83	CHI
202010188098	FORMOSA	FA21146122	ITUIQUIRA	31/10/2020 18:26	01/11/2020 13:25	31/10/2020 18:26	01/11/2020 13:25	18,97	1	18,97	CHI
202010188104	JARAGUA	JA21201270	JARAGUA	31/10/2020 18:27	31/10/2020 20:52	31/10/2020 18:27	31/10/2020 20:52	2,40	2	4,81	CHI
202010188112	APARECIDA DE GOIANIA	11302550	REAL S2	31/10/2020 18:28	31/10/2020 20:33	31/10/2020 18:28	31/10/2020 20:33	2,07	1	2,07	CHI
202010188121	NEROPOLIS	160025618	NEROPOLIS S2	31/10/2020 18:30	31/10/2020 21:00	31/10/2020 18:30	31/10/2020 21:00	2,50	1	2,50	CHI
202010188556	SILVANIA	LZ12241060	VIANOPOLIS	31/10/2020 18:30	01/11/2020 01:22	31/10/2020 18:30	01/11/2020 01:22	6,86	4	27,43	CHI
202010188136	BRITANIA	BT21114052	BRITANIA	31/10/2020 18:32	31/10/2020 23:20	31/10/2020 18:32	31/10/2020 23:20	4,79	1	4,79	CHI
202010188138	PARAUNA	10030426217	PARAUNA	31/10/2020 18:33	31/10/2020 21:51	31/10/2020 18:33	31/10/2020 21:51	3,29	1	3,29	CHI
202010188146	CACHOEIRA ALTA	CA21322218	CACHOEIRA ALTA	31/10/2020 18:34	31/10/2020 22:39	31/10/2020 18:34	31/10/2020 22:39	4,08	1	4,08	CHI
202010189475	NOVA CRIXAS	8570026483	NOVA CRIXAS	31/10/2020 18:35	31/10/2020 22:04	31/10/2020 18:35	31/10/2020 22:04	3,48	1	3,48	CHI
202010188179	IPORA	IR12014552	IPORA	31/10/2020 18:40	01/11/2020 08:07	31/10/2020 18:40	01/11/2020 08:07	13,44	4	53,78	CHI
202010188192	GUAPO	10003162930	GUAPO S1	31/10/2020 18:42	31/10/2020 23:02	31/10/2020 18:42	31/10/2020 23:02	4,33	1	4,33	CHI
202010188194	FORMOSA	FA11325635	ITUIQUIRA	31/10/2020 18:42	01/11/2020 08:25	31/10/2020 18:42	01/11/2020 08:25	13,71	2	27,43	CHI
202010188234	ALTO PARAISO DE GOIAS	BF11325569	NIQUELANDIA SUBTRANSMISSAO	31/10/2020 18:42	01/11/2020 03:11	31/10/2020 18:42	01/11/2020 03:11	8,48	117	992,13	CHI
202010188403	PALMEIRAS DE GOIAS	PL11158606	PALMEIRAS	31/10/2020 18:43	01/11/2020 01:11	31/10/2020 18:43	01/11/2020 01:11	6,45	61	393,57	CHI
202010188204	GOIANIA	14300485	CAMPINAS S2	31/10/2020 18:44	31/10/2020 20:45	31/10/2020 18:44	31/10/2020 20:45	2,00	1	2,00	CHI
202010188478	BELA VISTA DE GOIAS	BV12012780	BELA VISTA S2	31/10/2020 18:45	01/11/2020 13:54	01/11/2020 02:00	01/11/2020 12:25	10,40	21	218,50	CHI
202010188478	BELA VISTA DE GOIAS	BV13323036	BELA VISTA S2	31/10/2020 18:45	01/11/2020 13:54	01/11/2020 02:00	01/11/2020 13:54	11,89	133	1581,59	CHI
202010188478	BELA VISTA DE GOIAS	BV12012780	BELA VISTA S2	31/10/2020 18:45	01/11/2020 13:54	31/10/2020 18:45	31/10/2020 23:56	5,17	22	113,82	CHI
202010188478	BELA VISTA DE GOIAS	BV13323036	BELA VISTA S2	31/10/2020 18:45	01/11/2020 13:54	31/10/2020 18:45	01/11/2020 02:00	7,25	133	963,88	CHI
202010188478	BELA VISTA DE GOIAS	BV13323036	BELA VISTA S2	31/10/2020 18:45	01/11/2020 13:54	31/10/2020 18:45	01/11/2020 13:54	19,14	16	306,30	CHI
202010188212	GOIANIA	12547839	GOIANIA LESTE S1	31/10/2020 18:45	31/10/2020 20:37	31/10/2020 18:45	31/10/2020 20:37	1,85	1	1,85	CHI
202010188222	MINACU	IH12246544	MINACU	31/10/2020 18:47	01/11/2020 08:47	31/10/2020 18:47	01/11/2020 08:47	13,99	1	13,99	CHI
202010188223	GOIANIA	14150785	FERROVIARIO S3	31/10/2020 18:47	31/10/2020 19:46	31/10/2020 18:47	31/10/2020 19:46	0,97	1	0,97	CHI
202010188225	FORMOSA	2970002535	ITUIQUIRA	31/10/2020 18:47	01/11/2020 18:48	31/10/2020 18:47	01/11/2020 18:48	24,00	1	24,00	CHI
202010188226	ITAPIRAPUA	1420001416	MATRINCHA	31/10/2020 18:48	31/10/2020 22:15	31/10/2020 18:48	31/10/2020 22:15	3,45	1	3,45	CHI
202010188230	LUZIANIA	LZ21137691	PIRES DO RIO S2	31/10/2020 18:48	31/10/2020 20:29	31/10/2020 18:48	31/10/2020 20:29	1,67	1	1,67	CHI
202010188232	PLANALTINA	PI21180794	SAO JOAO D ALIANCA	31/10/2020 18:48	31/10/2020 20:49	31/10/2020 18:48	31/10/2020 20:49	2,00	1	2,00	CHI
202010188236	MORRINHOS	150077208	MORRINHOS	31/10/2020 18:49	31/10/2020 19:53	31/10/2020 18:49	31/10/2020 19:53	1,06	1	1,06	CHI
202010188239	SAO JOAO D ALIANCA	JL31198426	SAO JOAO D ALIANCA	31/10/2020 18:50	01/11/2020 19:27	31/10/2020 18:50	01/11/2020 19:27	24,62	1	24,62	CHI
202010188241	ALVORADA DO NORTE	AQ11347068	IACIARA S2	31/10/2020 18:50	01/11/2020 09:50	31/10/2020 18:50	01/11/2020 09:50	15,00	1	15,00	CHI
202010188242	ITUMBIARA	IT21304274	CACHOEIRA DOURADA	31/10/2020 18:50	31/10/2020 20:45	31/10/2020 18:50	31/10/2020 20:45	1,90	1	1,90	CHI
202010188245	GOIANIA	15885460	GOYA S2	31/10/2020 18:51	31/10/2020 20:21	31/10/2020 18:51	31/10/2020 20:21	1,50	1	1,50	CHI
202010188275	HEITORAI	HE12250700	ITAPURANGA	31/10/2020 18:51	01/11/2020 02:05	31/10/2020 18:51	01/11/2020 02:05	7,22	6	43,34	CHI
202010188275	GOIAS	HE12250700	ITAPURANGA	31/10/2020 18:51	01/11/2020 02:05	31/10/2020 18:51	01/11/2020 02:05	7,22	9	65,00	CHI
202010188255	INHUMAS	30105651	INHUMAS S2	31/10/2020 18:53	31/10/2020 23:08	31/10/2020 18:53	31/10/2020 23:08	4,25	1	4,25	CHI
202010188290	NOVO GAMA	NJ11149812	PACAEMBU S1	31/10/2020 18:53	31/10/2020 19:50	31/10/2020 18:53	31/10/2020 19:50	0,94	232	217,63	CHI
202010188262	RUBIATABA	780068981	RUBIATABA	31/10/2020 18:54	01/11/2020 12:02	31/10/2020 18:54	01/11/2020 12:02	17,12	1	17,12	CHI
202010188370	JATAI	JT12303412	JATAI S1	31/10/2020 18:55	01/11/2020 03:54	31/10/2020 18:55	01/11/2020 03:54	8,97	12	107,64	CHI

202010188271	CACHOEIRA DOURADA	CD21000046	CACHOEIRA DOURADA	31/10/2020 18:56	31/10/2020 23:22	31/10/2020 18:56	31/10/2020 23:22	4,42	1	4,42	CHI
202010188272	COCALZINHO DE GOIAS	ZN12335632	GOIANESIA S1	31/10/2020 18:56	31/10/2020 23:18	31/10/2020 18:56	31/10/2020 23:18	4,35	2	8,71	CHI
202010188278	CRISTALINA	1060037285	CRISTALINA S1	31/10/2020 18:58	31/10/2020 21:37	31/10/2020 18:58	31/10/2020 21:37	2,65	1	2,65	CHI
202010188279	GOIANIRA	GR11387069	GOIANIRA	31/10/2020 18:58	31/10/2020 20:39	31/10/2020 18:58	31/10/2020 20:39	1,67	4	6,68	CHI
202010188280	QUIRINOPOLIS	QI21200015	CACHOEIRA ALTA	31/10/2020 18:58	31/10/2020 22:19	31/10/2020 18:58	31/10/2020 22:19	3,33	1	3,33	CHI
202010188284	TRINDADE	TR21015765	INHUMAS S1	31/10/2020 18:59	31/10/2020 21:06	31/10/2020 18:59	31/10/2020 21:06	2,10	4	8,41	CHI
202010188289	MONTIVIDIU	MV21267644	MONTIVIDIU T	31/10/2020 19:00	31/10/2020 20:08	31/10/2020 19:00	31/10/2020 20:08	1,12	1	1,12	CHI
202010188297	LUZIANIA	3200074435	RIO VERMELHO	31/10/2020 19:01	31/10/2020 22:07	31/10/2020 19:01	31/10/2020 22:07	3,09	1	3,09	CHI
202010188300	ALEXANIA	AX21099849	ALEXANIA	31/10/2020 19:02	31/10/2020 21:20	31/10/2020 19:02	31/10/2020 21:20	2,29	2	4,58	CHI
202010188309	FAZENDA NOVA	FN11371937	IPORA	31/10/2020 19:03	01/11/2020 02:43	31/10/2020 19:03	01/11/2020 02:43	7,65	2	15,31	CHI
202010188319	MONTES CLAROS DE GOIAS	ME21139361	IPORA	31/10/2020 19:05	01/11/2020 08:50	31/10/2020 19:05	01/11/2020 08:50	13,75	1	13,75	CHI
202010188320	PIRACANJUBA	PJ21221933	ROCHEDO	31/10/2020 19:05	31/10/2020 23:26	31/10/2020 19:05	31/10/2020 23:26	4,34	1	4,34	CHI
202010188326	ITAJA	IJ12155330	ITAJA S2	31/10/2020 19:06	01/11/2020 02:17	31/10/2020 19:06	01/11/2020 02:17	7,17	5	35,84	CHI
202010188326	LAGOA SANTA	IJ12155330	ITAJA S2	31/10/2020 19:06	01/11/2020 02:17	31/10/2020 19:06	01/11/2020 02:17	7,17	2	14,34	CHI
202010188329	GOIANIA	GN11180059	GOYA S1	31/10/2020 19:07	31/10/2020 20:22	31/10/2020 19:07	31/10/2020 20:22	1,25	73	90,97	CHI
202010188333	RIO VERDE	RV21159351	CABRIUVA S2	31/10/2020 19:07	31/10/2020 21:05	31/10/2020 19:07	31/10/2020 21:05	1,95	1	1,95	CHI
202010188452	HDROLANDIA	HD12007492	PONTALINA	31/10/2020 19:12	01/11/2020 02:25	31/10/2020 19:12	01/11/2020 02:25	7,20	10	72,05	CHI
202010188409	HEITORAI	NB12250852	JUSSARA	31/10/2020 19:12	01/11/2020 03:43	31/10/2020 19:12	01/11/2020 03:43	8,50	1	8,50	CHI
202010188409	NOVO BRASIL	NB12250852	JUSSARA	31/10/2020 19:12	01/11/2020 03:43	31/10/2020 19:12	01/11/2020 03:43	8,50	2	17,00	CHI
202010188409	FAZENDA NOVA	NB12250852	JUSSARA	31/10/2020 19:12	01/11/2020 03:43	31/10/2020 19:12	01/11/2020 03:43	8,50	4	34,00	CHI
202010188356	GOIANIA	10740351	CAMPINAS S1	31/10/2020 19:13	31/10/2020 23:56	31/10/2020 19:13	31/10/2020 23:56	4,71	1	4,71	CHI
202010188374	CATALAO	CT21149203	CATALAO S1	31/10/2020 19:17	01/11/2020 12:39	31/10/2020 19:17	01/11/2020 12:39	17,36	0	0,00	CHI
202010188378	EDEIA	EA12000039	EDEIA	31/10/2020 19:17	31/10/2020 20:30	31/10/2020 19:17	31/10/2020 20:30	1,21	23	27,74	CHI
202010188381	NOVO GAMA	NJ21314118	PACAEMBU S1	31/10/2020 19:20	31/10/2020 21:34	31/10/2020 19:20	31/10/2020 21:34	2,23	2	4,46	CHI
202010188382	SAO JOAO D ALIANCA	FB12256442	FLORES DE GOIAS	31/10/2020 19:20	01/11/2020 00:49	31/10/2020 19:20	01/11/2020 00:49	5,48	31	169,90	CHI
202010188382	FLORES DE GOIAS	FB12256442	FLORES DE GOIAS	31/10/2020 19:20	01/11/2020 00:49	31/10/2020 19:20	01/11/2020 00:49	5,48	1	5,48	CHI
202010188582	URUACU	CR12375637	CAMPINORTE	31/10/2020 19:21	31/10/2020 22:19	31/10/2020 19:21	31/10/2020 22:19	2,96	120	355,67	CHI
202010188471	PORTELANDIA	PW12302930	PARQUE DAS EMAS	31/10/2020 19:21	31/10/2020 22:09	31/10/2020 19:21	31/10/2020 22:09	2,79	13	36,27	CHI
202010188713	CATALAO	CT12250355	CATALAO S1	31/10/2020 19:23	01/11/2020 11:05	31/10/2020 19:23	01/11/2020 11:05	15,70	8	125,58	CHI
202010188407	POSSE	PS21218828	IACIARA S2	31/10/2020 19:24	01/11/2020 12:36	31/10/2020 19:24	01/11/2020 12:36	17,20	1	17,20	CHI
202010188411	ESTRELA DO NORTE	ET12088710	MARA ROSA	31/10/2020 19:24	01/11/2020 08:53	31/10/2020 19:24	01/11/2020 08:53	13,47	3	40,41	CHI
202010188416	COCALZINHO DE GOIAS	ZN12402090	GOIANESIA S1	31/10/2020 19:25	01/11/2020 14:12	31/10/2020 19:25	01/11/2020 14:12	18,77	4	75,08	CHI
202010188418	QUIRINOPOLIS	PC12100483	QUIRINOPOLIS	31/10/2020 19:26	31/10/2020 21:58	31/10/2020 19:26	31/10/2020 21:58	2,53	1	2,53	CHI
202010188418	PARANAIGUARA	PC12100483	QUIRINOPOLIS	31/10/2020 19:26	31/10/2020 21:58	31/10/2020 19:26	31/10/2020 21:58	2,53	10	25,30	CHI
202010188423	VILA BOA	VB12394154	ITUIQUIRA	31/10/2020 19:26	01/11/2020 01:05	31/10/2020 19:26	01/11/2020 01:05	5,63	3	16,90	CHI
202010188428	GOIANIA	15770552	ATLANTICO S1	31/10/2020 19:29	31/10/2020 22:58	31/10/2020 19:29	31/10/2020 22:58	3,48	1	3,48	CHI
202010188429	CAIAPONIA	CP12342197	CAIAPONIA	31/10/2020 19:29	01/11/2020 01:32	31/10/2020 19:29	01/11/2020 01:32	6,04	2	12,08	CHI
202010188431	CATALAO	1990187940	CATALAO S2	31/10/2020 19:30	01/11/2020 06:24	31/10/2020 19:30	01/11/2020 06:24	10,89	1	10,89	CHI
202010188491	CABECEIRAS	CW11106106	ITUIQUIRA	31/10/2020 19:34	31/10/2020 22:31	31/10/2020 19:34	31/10/2020 22:31	2,94	61	179,34	CHI
202010188458	GUARAITA	GK21289014	ITAPURANGA	31/10/2020 19:36	01/11/2020 15:23	31/10/2020 19:36	01/11/2020 15:23	19,78	1	19,78	CHI
202010188465	JAUPACI	1280003094	IPORA	31/10/2020 19:38	01/11/2020 04:05	31/10/2020 19:38	01/11/2020 04:05	8,45	1	8,45	CHI
202010188466	ABADIA DE GOIAS	GN21118353	INDEPENDENCIA S2	31/10/2020 19:38	31/10/2020 21:47	31/10/2020 19:38	31/10/2020 21:47	2,14	1	2,14	CHI
202010188467	MATRINCHA	MP12066028	MATRINCHA	31/10/2020 19:38	01/11/2020 10:07	31/10/2020 19:38	01/11/2020 10:07	14,47	1	14,47	CHI
202010188486	CALDAS NOVAS	10015349851	CALDAS NOVAS S2	31/10/2020 19:43	01/11/2020 00:48	31/10/2020 19:43	01/11/2020 00:48	5,07	1	5,07	CHI
202010188496	NOVO GAMA	LZ21103583	PACAEMBU S1	31/10/2020 19:45	31/10/2020 22:20	31/10/2020 19:45	31/10/2020 22:20	2,58	5	12,88	CHI
202010188497	APARECIDA DE GOIANIA	AP11009632	ATLANTICO S3	31/10/2020 19:45	31/10/2020 21:18	31/10/2020 19:45	31/10/2020 21:18	1,53	247	379,01	CHI
202010188500	UIRAPURU	UP12243590	NOVA CRIXAS	31/10/2020 19:46	01/11/2020 07:51	31/10/2020 19:46	01/11/2020 07:51	12,07	5	60,37	CHI
202010188516	FAZENDA NOVA	FN21040971	JUSSARA	31/10/2020 19:52	01/11/2020 12:10	31/10/2020 19:52	01/11/2020 12:10	16,30	1	16,30	CHI
202010188519	CORUMBAIBA	560001526	VILA CORUMBA	31/10/2020 19:52	01/11/2020 04:59	31/10/2020 19:52	01/11/2020 04:59	9,11	1	9,11	CHI
202010188520	NIQUELANDIA	2750129108	NIQUELANDIA SUBTRANSMISSAO	31/10/2020 19:53	01/11/2020 14:17	31/10/2020 19:53	01/11/2020 14:17	18,40	1	18,40	CHI
202010188521	FLORES DE GOIAS	FB11286824	FLORES DE GOIAS	31/10/2020 19:53	01/11/2020 01:03	31/10/2020 19:53	01/11/2020 01:03	5,17	1	5,17	CHI

202010188523	PIRENOPOLIS	PV11000012	CORUMBA	31/10/2020 19:53	31/10/2020 21:13	31/10/2020 19:53	31/10/2020 21:13	1,32	169	223,64	CHI
202010188550	SENADOR CANEDO	SW11188853	SENADOR CANEDO	31/10/2020 19:53	31/10/2020 22:37	31/10/2020 19:53	31/10/2020 22:37	2,72	147	400,13	CHI
202010188527	APARECIDA DE GOIANIA	200125862	INDEPENDENCIA S2	31/10/2020 19:54	31/10/2020 21:45	31/10/2020 19:54	31/10/2020 21:45	1,84	1	1,84	CHI
202010188536	GOIATUBA	GT12013087	GOIATUBA S2	31/10/2020 19:57	01/11/2020 00:40	31/10/2020 19:57	01/11/2020 00:40	4,71	2	9,43	CHI
202010188573	GOIANIA	GN11048929	REAL S1	31/10/2020 19:57	01/11/2020 01:58	31/10/2020 19:57	01/11/2020 01:58	6,01	220	1322,44	CHI
202010188542	PONTALINA	210013230	PONTALINA	31/10/2020 20:00	31/10/2020 20:56	31/10/2020 20:00	31/10/2020 20:56	0,92	1	0,92	CHI
202010188546	GOIANIA	15067087	CAMPINAS S1	31/10/2020 20:03	31/10/2020 22:38	31/10/2020 20:03	31/10/2020 22:38	2,58	1	2,58	CHI
202010188547	CRISTALINA	1060050230	CRISTALINA S1	31/10/2020 20:04	31/10/2020 22:47	31/10/2020 20:04	31/10/2020 22:47	2,71	1	2,71	CHI
202010188549	GOIANIA	15656676	CAMPINAS S1	31/10/2020 20:04	01/11/2020 01:45	31/10/2020 20:04	01/11/2020 01:45	5,67	1	5,67	CHI
202010188557	GOIANIA	16832309	GOIANIA LESTE S2	31/10/2020 20:06	31/10/2020 21:34	31/10/2020 20:06	31/10/2020 21:34	1,47	1	1,47	CHI
202010188560	MARA ROSA	MQ12170098	NOVA CRIXAS	31/10/2020 20:07	01/11/2020 11:24	31/10/2020 20:07	01/11/2020 11:24	15,27	3	45,82	CHI
202010188560	AMARALINA	MQ12170098	NOVA CRIXAS	31/10/2020 20:07	01/11/2020 11:24	31/10/2020 20:07	01/11/2020 11:24	15,27	10	152,74	CHI
202010188585	PIRANHAS	PH12342187	PIRANHAS	31/10/2020 20:08	01/11/2020 03:48	31/10/2020 20:08	01/11/2020 03:48	7,67	2	15,33	CHI
202010188564	VILA PROPICIO	9290005676	GOIANESIA S1	31/10/2020 20:09	31/10/2020 21:58	31/10/2020 20:09	31/10/2020 21:58	1,81	1	1,81	CHI
202010188565	MORRINHOS	MR12038350	MORRINHOS	31/10/2020 20:10	31/10/2020 21:51	31/10/2020 20:10	31/10/2020 21:51	1,68	2	3,36	CHI
202010188571	ITAPURANGA	10021889153	ITAPURANGA	31/10/2020 20:11	01/11/2020 17:06	31/10/2020 20:11	01/11/2020 17:06	20,91	1	20,91	CHI
202010188681	ANAPOLIS	AN11129383	JUNDIAI S1	31/10/2020 20:16	31/10/2020 22:24	31/10/2020 20:16	31/10/2020 22:24	2,12	158	335,49	CHI
202010188591	IPORA	730019354	IPORA	31/10/2020 20:20	01/11/2020 01:49	31/10/2020 20:20	01/11/2020 01:49	5,48	1	5,48	CHI
202010188593	GOIANIA	13963508	MEIA PONTE	31/10/2020 20:21	31/10/2020 23:42	31/10/2020 20:21	31/10/2020 23:42	3,34	1	3,34	CHI
202010188595	ORIZONA	OZ11047553	PIRES DO RIO S2	31/10/2020 20:22	31/10/2020 21:05	31/10/2020 20:22	31/10/2020 21:05	0,70	154	108,57	CHI
202010188615	BALIZA	BH12360382	BOM JARDIM	31/10/2020 20:28	01/11/2020 08:10	31/10/2020 20:28	01/11/2020 08:10	11,68	3	35,05	CHI
202010188616	FLORES DE GOIAS	FB21409983	FLORES DE GOIAS	31/10/2020 20:29	31/10/2020 21:12	31/10/2020 20:29	31/10/2020 21:12	0,71	1	0,71	CHI
202010188617	APARECIDA DE GOIANIA	10024166764	ANHANGUERA	31/10/2020 20:30	31/10/2020 22:01	31/10/2020 20:30	31/10/2020 22:01	1,51	1	1,51	CHI
202010188621	GOIANIA	12062650	AEROPORTO S1	31/10/2020 20:33	31/10/2020 21:40	31/10/2020 20:33	31/10/2020 21:40	1,11	1	1,11	CHI
202010188626	INHUMAS	30020797	INHUMAS S2	31/10/2020 20:34	31/10/2020 23:43	31/10/2020 20:34	31/10/2020 23:43	3,14	1	3,14	CHI
202010188791	CAMPINACU	IH12360453	MINACU	31/10/2020 20:35	02/11/2020 01:51	01/11/2020 05:20	02/11/2020 01:51	20,52	5	102,62	CHI
202010188791	MINACU	IH12360453	MINACU	31/10/2020 20:35	02/11/2020 01:51	01/11/2020 05:20	02/11/2020 01:51	20,52	72	1477,68	CHI
202010188791	MINACU	IH12360453	MINACU	31/10/2020 20:35	02/11/2020 01:51	31/10/2020 20:35	01/11/2020 05:20	8,74	72	629,24	CHI
202010188791	CAMPINACU	IH12360453	MINACU	31/10/2020 20:35	02/11/2020 01:51	31/10/2020 20:35	01/11/2020 05:20	8,74	5	43,70	CHI
202010188637	GOIANIA	10030555092	GOYA S2	31/10/2020 20:39	31/10/2020 22:06	31/10/2020 20:39	31/10/2020 22:06	1,45	1	1,45	CHI
202010188640	CAMPO ALEGRE DE GOIAS	CM12353531	CAMPO ALEGRE DE GOIAS	31/10/2020 20:40	31/10/2020 23:49	31/10/2020 20:40	31/10/2020 23:49	3,14	1	3,14	CHI
202010188653	CATURAI	CK12211426	INHUMAS S1	31/10/2020 20:42	01/11/2020 03:18	01/11/2020 01:08	01/11/2020 03:18	2,17	176	381,68	CHI
202010188756	ITABERAI	IB11037809	ITABERAI S2	31/10/2020 20:43	01/11/2020 03:11	31/10/2020 20:43	01/11/2020 03:11	6,46	156	1007,50	CHI
202010188662	APARECIDA DE GOIANIA	10031245364	INDEPENDENCIA S2	31/10/2020 20:49	31/10/2020 23:06	31/10/2020 20:49	31/10/2020 23:06	2,28	1	2,28	CHI
202010188670	JARAGUA	JA12259973	JARAGUA	31/10/2020 20:51	31/10/2020 23:15	31/10/2020 20:51	31/10/2020 23:15	2,39	12	28,67	CHI
202010188671	MARA ROSA	VD12201669	SANTA TEREZINHA	31/10/2020 20:52	31/10/2020 21:25	31/10/2020 20:52	31/10/2020 21:25	0,54	1	0,54	CHI
202010188677	GAMELEIRA DE GOIAS	GL21353131	DAIA S2	31/10/2020 20:55	31/10/2020 23:18	31/10/2020 20:55	31/10/2020 23:18	2,37	1	2,37	CHI
202010188686	PIRANHAS	PH12343741	CAIAPONIA	31/10/2020 21:03	01/11/2020 01:24	31/10/2020 21:03	01/11/2020 01:24	4,35	5	21,73	CHI
202010188688	COLINAS DO SUL	TI21309765	MINACU	31/10/2020 21:04	01/11/2020 08:54	31/10/2020 21:04	01/11/2020 08:54	11,83	1	11,83	CHI
202010188691	ANAPOLIS	AN12072304	JUNDIAI S1	31/10/2020 21:06	31/10/2020 22:17	31/10/2020 21:06	31/10/2020 22:17	1,18	443	523,72	CHI
202010188696	FLORES DE GOIAS	FB21416921	IACIARA S2	31/10/2020 21:08	31/10/2020 21:38	31/10/2020 21:08	31/10/2020 21:38	0,50	2	1,00	CHI
202010188697	AGUAS LINDAS DE GOIAS	4830397008	AGUAS LINDAS DE GOIAS S1	31/10/2020 21:08	31/10/2020 22:40	31/10/2020 21:08	31/10/2020 22:40	1,53	1	1,53	CHI
202010188699	FORMOSA	10002046693	ITUIQUIRA	31/10/2020 21:10	31/10/2020 23:31	31/10/2020 21:10	31/10/2020 23:31	2,35	1	2,35	CHI
202011279	NIQUELANDIA	NQ12243514	BARRO ALTO	31/10/2020 21:19	01/11/2020 12:06	31/10/2020 21:19	01/11/2020 12:06	14,77	26	384,06	CHI
202010188715	AGUAS LINDAS DE GOIAS	LA11349021	AGUAS LINDAS DE GOIAS S1	31/10/2020 21:19	31/10/2020 22:53	31/10/2020 21:19	31/10/2020 22:53	1,56	142	220,81	CHI
202010188719	GOIANIA	10843401	GOIANIA LESTE S2	31/10/2020 21:21	31/10/2020 22:46	31/10/2020 21:21	31/10/2020 22:46	1,40	1	1,40	CHI
202010188731	ITAPURANGA	IK12093412	ITAPURANGA	31/10/2020 21:25	31/10/2020 23:44	31/10/2020 21:25	31/10/2020 23:44	2,31	11	25,44	CHI
202010188735	GOIANIA	13533393	CARAJAS S2	31/10/2020 21:31	01/11/2020 02:11	31/10/2020 21:31	01/11/2020 02:11	4,66	1	4,66	CHI
202010188754	FORMOSA	610075640	ITUIQUIRA	31/10/2020 21:43	01/11/2020 08:58	31/10/2020 21:43	01/11/2020 08:58	11,24	1	11,24	CHI
202010188782	MINACU	CR13247090	PORANGATU	31/10/2020 21:54	02/11/2020 14:41	02/11/2020 10:42	02/11/2020 14:41	3,97	27	107,32	CHI
202010188789	GOIAS	GS21223997	GOIAS	31/10/2020 21:57	01/11/2020 14:03	31/10/2020 21:57	01/11/2020 14:03	16,10	1	16,10	CHI

2020114434	NOVA CRIXAS	NA12091692	NOVA CRIXAS	31/10/2020 22:04	02/11/2020 15:18	31/10/2020 22:04	02/11/2020 15:18	41,24	22	907,36	CHI
202010188821	ITAGUARU	IC12219965	ITABERAÍ S1	31/10/2020 22:15	01/11/2020 15:02	31/10/2020 22:15	01/11/2020 15:02	16,78	8	134,25	CHI
202010188823	GOIANIA	10133525	FERROVIARIO S1	31/10/2020 22:16	01/11/2020 01:24	31/10/2020 22:16	01/11/2020 01:24	3,12	1	3,12	CHI
202010188826	LUZIANIA	LZ21245495	MARAJOARA	31/10/2020 22:18	01/11/2020 01:35	31/10/2020 22:18	01/11/2020 01:35	3,27	1	3,27	CHI
202010188834	PIRENOPOLIS	PV11196704	CORUMBA	31/10/2020 22:25	01/11/2020 02:10	01/11/2020 01:53	01/11/2020 02:10	0,30	110	32,97	CHI
202011227	FAINA	MP12096007	MATRINCHA	31/10/2020 22:34	01/11/2020 09:28	01/11/2020 07:45	01/11/2020 09:28	1,71	8	13,66	CHI
202011227	ARAGUAPAZ	MP12299732	MATRINCHA	31/10/2020 22:34	01/11/2020 09:28	01/11/2020 08:39	01/11/2020 09:28	0,81	1	0,81	CHI
202011227	FAINA	MP12299732	MATRINCHA	31/10/2020 22:34	01/11/2020 09:28	01/11/2020 08:39	01/11/2020 09:28	0,81	59	47,63	CHI
202011227	MATRINCHA	MP12299732	MATRINCHA	31/10/2020 22:34	01/11/2020 09:28	01/11/2020 08:39	01/11/2020 09:28	0,81	62	50,05	CHI
202010188840	MATRINCHA	MP12299750	MATRINCHA	31/10/2020 22:34	01/11/2020 13:54	31/10/2020 22:34	01/11/2020 13:54	15,33	18	275,98	CHI
202011227	ARAGUAPAZ	MP12299732	MATRINCHA	31/10/2020 22:34	01/11/2020 09:28	31/10/2020 22:34	01/11/2020 07:49	9,25	1	9,25	CHI
202011227	MATRINCHA	MP12299732	MATRINCHA	31/10/2020 22:34	01/11/2020 09:28	31/10/2020 22:34	01/11/2020 07:49	9,25	62	573,52	CHI
202011227	FAINA	MP12299732	MATRINCHA	31/10/2020 22:34	01/11/2020 09:28	31/10/2020 22:34	01/11/2020 07:49	9,25	59	545,77	CHI
202010188849	ITUMBUIARA	IT12037085	CACHOEIRA DOURADA	31/10/2020 22:41	01/11/2020 07:10	31/10/2020 22:41	01/11/2020 07:10	8,47	12	101,64	CHI
202010188849	PANAMA	IT12037085	CACHOEIRA DOURADA	31/10/2020 22:41	01/11/2020 07:10	31/10/2020 22:41	01/11/2020 07:10	8,47	12	101,64	CHI
20201117	CORUMBAIBA	CI11117136	VILA CORUMBA	31/10/2020 22:44	01/11/2020 09:58	31/10/2020 22:44	01/11/2020 09:58	11,22	19	213,26	CHI
20201187	CORUMBAIBA	CI12110161	VILA CORUMBA	31/10/2020 22:44	01/11/2020 08:27	31/10/2020 22:44	01/11/2020 08:27	9,71	26	252,40	CHI
202010188871	ANAPOLIS	AN12072304	JUNDIAI S1	31/10/2020 23:12	01/11/2020 04:52	01/11/2020 04:20	01/11/2020 04:52	0,54	440	236,87	CHI
202010188871	ANAPOLIS	AN11000512	JUNDIAI S1	31/10/2020 23:12	01/11/2020 04:52	31/10/2020 23:12	01/11/2020 04:20	5,12	111	568,20	CHI
202010188872	URUACU	CR12375637	CAMPINORTE	31/10/2020 23:13	01/11/2020 04:40	31/10/2020 23:13	01/11/2020 04:40	5,46	120	655,73	CHI
202010188876	JARAGUA	JA21081253	JARAGUA	31/10/2020 23:18	01/11/2020 02:18	31/10/2020 23:18	01/11/2020 02:18	3,00	1	3,00	CHI
20201198	PIRACANJUBA	PJ32057770	PIRACANJUBA	31/10/2020 23:21	01/11/2020 08:43	31/10/2020 23:21	01/11/2020 08:43	9,35	15	140,29	CHI
202010188884	PALMEIRAS DE GOIAS	PL11323548	PALMEIRAS	31/10/2020 23:28	01/11/2020 10:20	31/10/2020 23:28	01/11/2020 10:20	10,86	89	966,66	CHI
2020111	MOZARLANDIA	MZ11217248	MOZARLANDIA	01/11/2020 00:00	01/11/2020 05:18	01/11/2020 00:00	01/11/2020 05:18	5,30	53	280,66	CHI
2020114	APARECIDA DE GOIANIA	AP21212345	CEPAIGO S1	01/11/2020 00:05	01/11/2020 03:40	01/11/2020 00:05	01/11/2020 03:40	3,58	4	14,30	CHI
2020116	URUACU	UR12248311	URUACU	01/11/2020 00:07	01/11/2020 10:05	01/11/2020 00:07	01/11/2020 10:05	9,95	1	9,95	CHI
202011937	PORANGATU	TB12262770	PORANGATU	01/11/2020 00:11	01/11/2020 12:43	01/11/2020 00:11	01/11/2020 12:43	12,52	1	12,52	CHI
202011937	SANTA TEREZA DE GOIAS	TB12262770	PORANGATU	01/11/2020 00:11	01/11/2020 12:43	01/11/2020 00:11	01/11/2020 12:43	12,52	5	62,62	CHI
202011937	TROMBAS	TB12262770	PORANGATU	01/11/2020 00:11	01/11/2020 12:43	01/11/2020 00:11	01/11/2020 12:43	12,52	13	162,81	CHI
2020119	ANICUNS	AC21073832	ANICUNS	01/11/2020 00:14	01/11/2020 16:59	01/11/2020 00:14	01/11/2020 16:59	16,74	2	33,47	CHI
20201110	SANTA RITA DO NOVO DESTINO	DF11315628	BARRO ALTO	01/11/2020 00:15	01/11/2020 09:36	01/11/2020 00:15	01/11/2020 09:36	9,34	1	9,34	CHI
20201122	MATRINCHA	MP21083972	MATRINCHA	01/11/2020 01:03	01/11/2020 12:53	01/11/2020 01:03	01/11/2020 12:53	11,82	1	11,82	CHI
20201191	PORANGATU	PO12345569	PORANGATU	01/11/2020 01:05	01/11/2020 08:46	01/11/2020 01:05	01/11/2020 08:46	7,67	15	115,12	CHI
20201124	ANAPOLIS	AN11205798	JUNDIAI S2	01/11/2020 01:08	01/11/2020 02:20	01/11/2020 01:08	01/11/2020 02:20	1,20	37	44,41	CHI
202011622	FLORES DE GOIAS	FB12106993	FLORES DE GOIAS	01/11/2020 03:15	01/11/2020 11:50	01/11/2020 03:15	01/11/2020 11:50	8,57	14	120,01	CHI
202011622	FORMOSA	FB12106993	FLORES DE GOIAS	01/11/2020 03:15	01/11/2020 11:50	01/11/2020 03:15	01/11/2020 11:50	8,57	138	1183,00	CHI
202011622	FORMOSO	FB12106993	FLORES DE GOIAS	01/11/2020 03:15	01/11/2020 11:50	01/11/2020 03:15	01/11/2020 11:50	8,57	1	8,57	CHI
202011622	SAO JOAO D ALIANCA	FB12106993	FLORES DE GOIAS	01/11/2020 03:15	01/11/2020 11:50	01/11/2020 03:15	01/11/2020 11:50	8,57	5	42,86	CHI
202011205	CALDAS NOVAS	10006387606	CALDAS NOVAS S1	01/11/2020 03:25	01/11/2020 08:23	01/11/2020 03:25	01/11/2020 08:23	4,97	1	4,97	CHI
20201152	VIANOPOLIS	OZ12094830LD	VIANOPOLIS	01/11/2020 03:35	01/11/2020 09:21	01/11/2020 03:35	01/11/2020 09:21	5,76	16	92,13	CHI
20201173	AURILANDIA	AI12000010	FIRMINOPOLIS S2	01/11/2020 03:38	01/11/2020 10:51	01/11/2020 03:38	01/11/2020 10:51	7,20	2	14,41	CHI
20201173	FIRMINOPOLIS	AI12000010	FIRMINOPOLIS S2	01/11/2020 03:38	01/11/2020 10:51	01/11/2020 03:38	01/11/2020 10:51	7,20	6	43,22	CHI
20201160	APARECIDA DE GOIANIA	AP11131340	REAL S1	01/11/2020 03:59	01/11/2020 12:50	01/11/2020 03:59	01/11/2020 12:50	8,85	205	1815,27	CHI
20201163	URUACU	UR21237522	URUACU	01/11/2020 04:10	01/11/2020 10:30	01/11/2020 04:10	01/11/2020 10:30	6,33	1	6,33	CHI
202011125	SAO JOAO D ALIANCA	JL12268110	FLORES DE GOIAS	01/11/2020 04:30	01/11/2020 11:46	01/11/2020 04:30	01/11/2020 07:57	3,46	6	20,76	CHI
202011125	SAO JOAO D ALIANCA	JL12300986LD	FLORES DE GOIAS	01/11/2020 04:30	01/11/2020 11:46	01/11/2020 04:30	01/11/2020 11:46	7,27	3	21,82	CHI
202011301	POSSE	PS12132045	IACIARA S2	01/11/2020 04:36	01/11/2020 09:17	01/11/2020 04:36	01/11/2020 09:17	4,68	196	917,82	CHI
20201169	DAMOLANDIA	DL10423890	INHUMAS S1	01/11/2020 04:43	01/11/2020 11:35	01/11/2020 04:43	01/11/2020 11:35	6,85	83	568,78	CHI
20201169	OURO VERDE DE GOIAS	DL10423890	INHUMAS S1	01/11/2020 04:43	01/11/2020 11:35	01/11/2020 04:43	01/11/2020 11:35	6,85	139	952,54	CHI
20201169	PETROLINA DE GOIAS	DL10423890	INHUMAS S1	01/11/2020 04:43	01/11/2020 11:35	01/11/2020 04:43	01/11/2020 11:35	6,85	6	41,12	CHI
202011330	MUNDO NOVO DE GOIAS	MH12362454	NOVA CRIXAS	01/11/2020 04:43	02/11/2020 18:19	01/11/2020 04:43	01/11/2020 11:00	6,28	279	1752,66	CHI

202011330	MUNDO NOVO DE GOIAS	MH12362454	NOVA CRIXAS	01/11/2020 04:43	02/11/2020 18:19	01/11/2020 04:43	02/11/2020 12:31	31,80	10	317,99	CHI
202011330	AMARALINA	MH12362454	NOVA CRIXAS	01/11/2020 04:43	02/11/2020 18:19	01/11/2020 04:43	02/11/2020 18:19	37,59	1	37,59	CHI
202011330	MUNDO NOVO DE GOIAS	MH12362454	NOVA CRIXAS	01/11/2020 04:43	02/11/2020 18:19	01/11/2020 04:43	02/11/2020 18:19	37,59	12	451,07	CHI
20201180	CALDAS NOVAS	CN21271018	CALDAS NOVAS S2	01/11/2020 05:17	01/11/2020 07:27	01/11/2020 05:17	01/11/2020 07:27	2,15	1	2,15	CHI
202011224	VIANOPOLIS	OZ12094957	VIANOPOLIS	01/11/2020 05:17	01/11/2020 09:21	01/11/2020 05:17	01/11/2020 09:21	4,06	17	69,02	CHI
202011209	TRES RANCHOS	TH12068477	CATALAO S1	01/11/2020 05:25	01/11/2020 08:50	01/11/2020 05:25	01/11/2020 08:50	3,41	19	64,82	CHI
202011312	GOIANESIA	PV21097006	GOIANESIA S2	01/11/2020 05:26	01/11/2020 10:43	01/11/2020 05:26	01/11/2020 10:43	5,28	1	5,28	CHI
2020110100030	APARECIDA DE GOIANIA	360234	CEPAIGO S1	01/11/2020 05:30	01/11/2020 05:33	01/11/2020 05:30	01/11/2020 05:33	0,05	1459	72,95	CHI
2020110100030	HIDROLANDIA	360234	CEPAIGO S1	01/11/2020 05:30	01/11/2020 05:33	01/11/2020 05:30	01/11/2020 05:33	0,05	613	30,65	CHI
20201189	GOIAS	GK12220543	ITAPURANGA	01/11/2020 05:35	01/11/2020 09:24	01/11/2020 05:35	01/11/2020 09:24	3,82	12	45,82	CHI
20201189	GUARAITA	GK12220543	ITAPURANGA	01/11/2020 05:35	01/11/2020 09:24	01/11/2020 05:35	01/11/2020 09:24	3,82	22	84,00	CHI
202011165	MUNDO NOVO DE GOIAS	NA12035650	NOVA CRIXAS	01/11/2020 05:43	01/11/2020 09:05	01/11/2020 05:43	01/11/2020 09:05	3,36	8	26,89	CHI
202011165	NOVA CRIXAS	NA12035650	NOVA CRIXAS	01/11/2020 05:43	01/11/2020 09:05	01/11/2020 05:43	01/11/2020 09:05	3,36	24	80,67	CHI
20201199	INHUMAS	IN12031534	INHUMAS S1	01/11/2020 05:48	01/11/2020 09:38	01/11/2020 05:48	01/11/2020 09:38	3,83	7	26,84	CHI
202011101	SAO DOMINGOS	SD21160006	SAO DOMINGOS	01/11/2020 05:48	01/11/2020 11:23	01/11/2020 05:48	01/11/2020 11:23	5,57	2	11,14	CHI
202011106	COLINAS DO SUL	TI12196809	NIQUELANDIA SUBTRANSMISSAO	01/11/2020 05:55	01/11/2020 17:21	01/11/2020 05:55	01/11/2020 17:21	11,42	2	22,85	CHI
202011108	GOIANESIA	GE11372582	GOIANESIA S1	01/11/2020 05:56	01/11/2020 09:18	01/11/2020 05:56	01/11/2020 09:18	3,36	1	3,36	CHI
202011144	PIRENOPOLIS	PV12362263	CORUMBA	01/11/2020 05:56	01/11/2020 12:20	01/11/2020 05:56	01/11/2020 12:20	6,40	13	83,22	CHI
202011111	HIDROLANDIA	HD11006302	CEPAIGO S2	01/11/2020 05:57	01/11/2020 13:27	01/11/2020 05:57	01/11/2020 13:27	7,49	176	1318,92	CHI
202011121	GOIANESIA	GE21297426	GOIANESIA S1	01/11/2020 06:05	01/11/2020 09:08	01/11/2020 06:05	01/11/2020 09:08	3,04	1	3,04	CHI
202011535	ANAPOLIS	AN21295699	ANAPOLIS UNIVERSITARIO S2	01/11/2020 06:05	01/11/2020 11:18	01/11/2020 06:05	01/11/2020 11:18	5,21	1	5,21	CHI
202011252	PORANGATU	PO12104347	PORANGATU	01/11/2020 06:07	02/11/2020 09:51	01/11/2020 06:07	02/11/2020 09:03	26,93	6	161,55	CHI
202011252	PORANGATU	PO12189630	PORANGATU	01/11/2020 06:07	02/11/2020 09:51	01/11/2020 06:07	02/11/2020 09:51	27,73	2	55,46	CHI
202011128	GOIANESIA	GE21215141	GOIANESIA S2	01/11/2020 06:11	01/11/2020 09:24	01/11/2020 06:11	01/11/2020 09:24	3,20	5	16,02	CHI
202011133	SANTA TEREZINHA DE GOIAS	SG12380710	SANTA TEREZINHA	01/11/2020 06:12	01/11/2020 17:52	01/11/2020 06:12	01/11/2020 17:52	11,66	8	93,32	CHI
202011134	BALIZA	BH12381003	BOM JARDIM	01/11/2020 06:14	01/11/2020 07:43	01/11/2020 06:14	01/11/2020 07:43	1,48	23	34,05	CHI
202011136	CAMPESTRE DE GOIAS	GC12312851	TRINDADE	01/11/2020 06:14	01/11/2020 08:22	01/11/2020 06:14	01/11/2020 08:22	2,12	34	72,05	CHI
202011365	PIRACANJUBA	PJ12000054	PIRACANJUBA	01/11/2020 06:14	01/11/2020 11:35	01/11/2020 06:14	01/11/2020 11:35	5,34	21	112,24	CHI
202011184	FORMOSO	SE12053856	MARA ROSA	01/11/2020 06:15	01/11/2020 09:18	01/11/2020 06:15	01/11/2020 09:18	3,05	6	18,30	CHI
202011184	SANTA TEREZA DE GOIAS	SE12053856	MARA ROSA	01/11/2020 06:15	01/11/2020 09:18	01/11/2020 06:15	01/11/2020 09:18	3,05	3	9,15	CHI
202011887	JUSSARA	JR12341254	IPORA	01/11/2020 06:18	01/11/2020 11:57	01/11/2020 06:18	01/11/2020 11:57	5,64	155	874,67	CHI
202011887	MONTES CLAROS DE GOIAS	JR12341254	IPORA	01/11/2020 06:18	01/11/2020 11:57	01/11/2020 06:18	01/11/2020 11:57	5,64	17	95,93	CHI
202011147	FORMOSA	FA21218283	ITUIQUIRA	01/11/2020 06:19	01/11/2020 23:52	01/11/2020 06:19	01/11/2020 23:52	17,55	2	35,10	CHI
202011150	CATALAO	CT12044351	CATALAO S2	01/11/2020 06:19	01/11/2020 08:20	01/11/2020 06:19	01/11/2020 08:20	2,01	21	42,13	CHI
202011255	ARUANA	AK12183369	ARUANA	01/11/2020 06:21	01/11/2020 10:36	01/11/2020 06:21	01/11/2020 10:36	4,24	13	55,13	CHI
202011157	CAMPO ALEGRE DE GOIAS	CM12338725	CAMPO ALEGRE DE GOIAS	01/11/2020 06:23	01/11/2020 11:13	01/11/2020 06:23	01/11/2020 11:13	4,82	3	14,47	CHI
202011168	PIRACANJUBA	PJ12097886	BELA VISTA S1	01/11/2020 06:29	01/11/2020 10:54	01/11/2020 06:29	01/11/2020 10:54	4,41	6	26,49	CHI
202011170	EDEIA	EA12044508	EDEIA	01/11/2020 06:29	01/11/2020 11:14	01/11/2020 06:29	01/11/2020 11:14	4,75	2	9,50	CHI
202011517	INHUMAS	IN12000220	INHUMAS S2	01/11/2020 06:29	01/11/2020 09:52	01/11/2020 06:29	01/11/2020 09:52	3,39	687	2327,59	CHI
202011174	SENADOR CANEDO	10003670285	SENADOR CANEDO	01/11/2020 06:30	01/11/2020 10:33	01/11/2020 06:30	01/11/2020 10:33	4,04	1	4,04	CHI
202011176	PALMEIRAS DE GOIAS	CZ12011076	CEZARINA	01/11/2020 06:31	01/11/2020 12:59	01/11/2020 06:31	01/11/2020 12:59	6,47	5	32,37	CHI
202011177	NOVA VENEZA	300014960	INHUMAS S1	01/11/2020 06:32	01/11/2020 07:58	01/11/2020 06:32	01/11/2020 07:58	1,44	1	1,44	CHI
202011291	SAO MIGUEL DO ARAGUAIA	SM12100371	SAO MIGUEL DO ARAGUAIA	01/11/2020 06:33	01/11/2020 19:25	01/11/2020 06:33	01/11/2020 19:25	12,86	76	977,66	CHI
202011388	SANTA TEREZA DE GOIAS	TB12182394	PORANGATU	01/11/2020 06:33	01/11/2020 11:57	01/11/2020 06:33	01/11/2020 11:57	5,41	3	16,24	CHI
202011388	TROMBAS	TB12182394	PORANGATU	01/11/2020 06:33	01/11/2020 11:57	01/11/2020 06:33	01/11/2020 11:57	5,41	119	644,02	CHI
202011880	PORANGATU	SE12094693	MARA ROSA	01/11/2020 06:34	01/11/2020 18:31	01/11/2020 06:34	01/11/2020 18:31	11,94	3	35,81	CHI
202011880	SANTA TEREZA DE GOIAS	SE12094693	MARA ROSA	01/11/2020 06:34	01/11/2020 18:31	01/11/2020 06:34	01/11/2020 18:31	11,94	18	214,88	CHI
202011186	COCALZINHO DE GOIAS	ZN12402010RE	COCALZINHO	01/11/2020 06:35	01/11/2020 18:16	01/11/2020 06:35	01/11/2020 09:38	3,04	129	392,70	CHI
202011186	VILA PROPICIO	ZN12402010RE	COCALZINHO	01/11/2020 06:35	01/11/2020 18:16	01/11/2020 06:35	01/11/2020 09:38	3,04	1	3,04	CHI
202011186	COCALZINHO DE GOIAS	ZN12402010RE	COCALZINHO	01/11/2020 06:35	01/11/2020 18:16	01/11/2020 06:35	01/11/2020 18:16	11,68	7	81,74	CHI
202011221	TRES RANCHOS	TH12063848	CATALAO S1	01/11/2020 06:35	01/11/2020 10:49	01/11/2020 06:35	01/11/2020 10:49	4,23	1	4,23	CHI

202011368	CALDAS NOVAS	1240424	MORRINHOS	01/11/2020 06:35	01/11/2020 16:25	01/11/2020 13:05	01/11/2020 13:29	0,39	7	2,76	CHI
202011368	MAIRIPOTABA	1240424	MORRINHOS	01/11/2020 06:35	01/11/2020 16:25	01/11/2020 13:05	01/11/2020 13:29	0,39	15	5,92	CHI
202011368	MORRINHOS	1240424	MORRINHOS	01/11/2020 06:35	01/11/2020 16:25	01/11/2020 13:05	01/11/2020 13:29	0,39	201	79,39	CHI
202011368	MORRINHOS	1240424	MORRINHOS	01/11/2020 06:35	01/11/2020 16:25	01/11/2020 13:05	01/11/2020 13:29	0,39	24	9,48	CHI
202011368	MORRINHOS	1240424	MORRINHOS	01/11/2020 06:35	01/11/2020 16:25	01/11/2020 13:05	01/11/2020 13:29	0,39	41	16,19	CHI
202011368	MORRINHOS	1240424	MORRINHOS	01/11/2020 06:35	01/11/2020 16:25	01/11/2020 13:05	01/11/2020 13:29	0,39	13	5,13	CHI
202011368	MORRINHOS	1240424	MORRINHOS	01/11/2020 06:35	01/11/2020 16:25	01/11/2020 13:05	01/11/2020 13:29	0,39	19	7,50	CHI
202011368	PIRACANJUBA	1240424	MORRINHOS	01/11/2020 06:35	01/11/2020 16:25	01/11/2020 13:05	01/11/2020 13:29	0,39	83	32,78	CHI
202011368	PIRACANJUBA	1240424	MORRINHOS	01/11/2020 06:35	01/11/2020 16:25	01/11/2020 13:05	01/11/2020 13:29	0,39	166	65,57	CHI
202011368	PIRACANJUBA	1240424	MORRINHOS	01/11/2020 06:35	01/11/2020 16:25	01/11/2020 13:05	01/11/2020 13:29	0,39	3	1,18	CHI
202011368	PONTALINA	1240424	MORRINHOS	01/11/2020 06:35	01/11/2020 16:25	01/11/2020 13:05	01/11/2020 13:29	0,39	16	6,32	CHI
202011368	MORRINHOS	MR12384522	MORRINHOS	01/11/2020 06:35	01/11/2020 16:25	01/11/2020 07:35	01/11/2020 16:25	8,84	2	17,68	CHI
202011191	CAVALCANTE	CJ12346073	MINACU	01/11/2020 06:36	01/11/2020 14:07	01/11/2020 06:36	01/11/2020 14:07	7,51	144	1080,92	CHI
202011192	TRINDADE	15253478	GOYA S2	01/11/2020 06:37	01/11/2020 10:09	01/11/2020 06:37	01/11/2020 10:09	3,54	1	3,54	CHI
202011194	SAO LUIS DE MONTES BELOS	SL21167247	SAO LUIZ DOS MONTES BELOS	01/11/2020 06:37	01/11/2020 12:08	01/11/2020 06:37	01/11/2020 12:08	5,52	1	5,52	CHI
202011202	ANAPOLIS	AN12166243	ANAPOLIS UNIVERSITARIO S2	01/11/2020 06:39	01/11/2020 10:54	01/11/2020 06:39	01/11/2020 10:54	4,25	195	828,05	CHI
202011401	NOVA CRIXAS	NA12091638	NOVA CRIXAS	01/11/2020 06:39	01/11/2020 14:23	01/11/2020 06:39	01/11/2020 14:23	7,73	9	69,60	CHI
202011206	ANAPOLIS	AN12072304	JUNDIAI S1	01/11/2020 06:41	01/11/2020 10:00	01/11/2020 06:41	01/11/2020 10:00	3,31	440	1456,77	CHI
202011219	SAO JOAO D ALIANCA	JL11218469	SAO JOAO D ALIANCA	01/11/2020 06:41	02/11/2020 19:39	01/11/2020 06:41	02/11/2020 19:39	36,95	3	110,86	CHI
202011382	FLORES DE GOIAS	FB12245566	IACIARA S2	01/11/2020 06:45	01/11/2020 11:31	01/11/2020 06:45	01/11/2020 11:31	4,76	73	347,76	CHI
202011382	SITIO D ABADIA	FB12245566	IACIARA S2	01/11/2020 06:45	01/11/2020 11:31	01/11/2020 06:45	01/11/2020 11:31	4,76	39	185,79	CHI
202011223	IACIARA	GY21379722	IACIARA S1	01/11/2020 06:48	01/11/2020 11:08	01/11/2020 06:48	01/11/2020 11:08	4,33	1	4,33	CHI
202011229	MONTES CLAROS DE GOIAS	1440024501	IPORA	01/11/2020 06:49	01/11/2020 11:49	01/11/2020 06:49	01/11/2020 11:49	4,99	1	4,99	CHI
202011230	CALDAS NOVAS	BC12352288	CALDAS NOVAS S1	01/11/2020 06:50	01/11/2020 15:11	01/11/2020 06:50	01/11/2020 15:11	8,35	1	8,35	CHI
202011369	SAO DOMINGOS	SD12344106	SAO DOMINGOS	01/11/2020 06:50	01/11/2020 12:12	01/11/2020 06:50	01/11/2020 12:12	5,36	6	32,18	CHI
202011237	NOVA CRIXAS	NA21158708	NOVA CRIXAS	01/11/2020 06:52	01/11/2020 17:57	01/11/2020 06:52	01/11/2020 17:57	11,08	1	11,08	CHI
202011239	FORMOSO	FO12377609	MARA ROSA	01/11/2020 06:52	01/11/2020 21:01	01/11/2020 06:52	01/11/2020 21:01	14,14	7	98,98	CHI
202011240	FAZENDA NOVA	FN12060693	IPORA	01/11/2020 06:52	01/11/2020 10:13	01/11/2020 06:52	01/11/2020 10:13	3,35	11	36,85	CHI
202011378	URUACU	UR12385699	URUACU	01/11/2020 06:54	01/11/2020 09:36	01/11/2020 06:54	01/11/2020 09:36	2,69	37	99,65	CHI
202011247	JANDAIA	7307380	PALMEIRAS	01/11/2020 06:56	01/11/2020 13:06	01/11/2020 06:56	01/11/2020 13:06	6,17	14	86,31	CHI
202011259	CRISTALINA	KR10413345	CRISTALINA S2	01/11/2020 06:56	01/11/2020 08:00	01/11/2020 06:56	01/11/2020 07:59	1,04	37	38,46	CHI
202011259	CRISTALINA	KR10414293	CRISTALINA S2	01/11/2020 06:56	01/11/2020 08:00	01/11/2020 06:56	01/11/2020 07:59	1,04	4	4,17	CHI
202011259	CRISTALINA	KR10400736	CRISTALINA S2	01/11/2020 06:56	01/11/2020 08:00	01/11/2020 06:56	01/11/2020 07:59	1,05	64	67,16	CHI
202011259	IPAMERI	KR10400736	CRISTALINA S2	01/11/2020 06:56	01/11/2020 08:00	01/11/2020 06:56	01/11/2020 07:59	1,05	102	107,04	CHI
202011259	CRISTALINA	KR10413321	CRISTALINA S2	01/11/2020 06:56	01/11/2020 08:00	01/11/2020 06:56	01/11/2020 08:00	1,05	12	12,65	CHI
202011259	IPAMERI	KR10413321	CRISTALINA S2	01/11/2020 06:56	01/11/2020 08:00	01/11/2020 06:56	01/11/2020 08:00	1,05	11	11,59	CHI
202011260	PONTALINA	JV12218123	GOIATUBA S1	01/11/2020 07:01	01/11/2020 10:50	01/11/2020 07:01	01/11/2020 10:50	3,81	4	15,25	CHI
202011261	LUZIANIA	LZ12330544	MARAJUARA	01/11/2020 07:01	01/11/2020 09:27	01/11/2020 07:01	01/11/2020 09:27	2,42	8	19,35	CHI
202011262	GOIANIA	15716168	GOIANIA LESTE S1	01/11/2020 07:02	01/11/2020 09:37	01/11/2020 07:02	01/11/2020 09:37	2,58	1	2,58	CHI
202011265	PIRENOPOLIS	PV21144043	CORUMBA	01/11/2020 07:02	01/11/2020 15:30	01/11/2020 07:02	01/11/2020 15:30	8,46	1	8,46	CHI
202011269	APARECIDA DE GOIANIA	13771656	INDEPENDENCIA S1	01/11/2020 07:03	01/11/2020 08:57	01/11/2020 07:03	01/11/2020 08:57	1,90	1	1,90	CHI
202011467	SAO LUIS DE MONTES BELOS	SL11159054	SAO LUIZ DOS MONTES BELOS	01/11/2020 07:03	01/11/2020 09:15	01/11/2020 07:03	01/11/2020 09:15	2,21	163	360,95	CHI
202011274	ANICUNS	AC31083711	ANICUNS	01/11/2020 07:04	01/11/2020 10:50	01/11/2020 07:04	01/11/2020 10:50	3,76	2	7,51	CHI
202011286	NOVA ROMA	ND21318651	IACIARA S2	01/11/2020 07:09	01/11/2020 17:14	01/11/2020 07:09	01/11/2020 17:14	10,08	1	10,08	CHI
202011289	CRISTALINA	KR21165556	CRISTALINA S2	01/11/2020 07:09	01/11/2020 08:40	01/11/2020 07:09	01/11/2020 08:40	1,51	1	1,51	CHI
202011974	ALVORADA DO NORTE	AQ12347002	IACIARA S2	01/11/2020 07:10	01/11/2020 11:34	01/11/2020 11:28	01/11/2020 11:33	0,10	3	0,29	CHI
202011974	ALVORADA DO NORTE	AQ11347004	IACIARA S2	01/11/2020 07:10	01/11/2020 11:34	01/11/2020 07:10	01/11/2020 11:34	4,40	2	8,79	CHI
202011295	PORANGATU	PO12102902	PORANGATU	01/11/2020 07:12	01/11/2020 16:29	01/11/2020 07:12	01/11/2020 16:29	9,28	7	64,93	CHI
202011308	SAO LUIZ DO NORTE	SZ21289333	ITAPACI	01/11/2020 07:12	01/11/2020 11:52	01/11/2020 07:12	01/11/2020 11:52	4,65	3	13,95	CHI
202011302	GOIAS	GS21063242	GOIAS	01/11/2020 07:13	01/11/2020 11:32	01/11/2020 07:13	01/11/2020 11:32	4,30	2	8,60	CHI
202011334	BELA VISTA DE GOIAS	BV12198455	BELA VISTA S2	01/11/2020 07:15	01/11/2020 08:28	01/11/2020 07:15	01/11/2020 08:28	1,22	12	14,58	CHI

202011470	ITAPURANGA	IK12300385	ITAPURANGA	01/11/2020 07:15	01/11/2020 10:00	01/11/2020 07:15	01/11/2020 10:00	2,74	7	19,19	CHI
202011672	VILA PROPICIO	2850005960	GOIANESIA S2	01/11/2020 07:17	01/11/2020 14:38	01/11/2020 07:17	01/11/2020 14:38	7,34	1	7,34	CHI
2020111004	CALDAS NOVAS	10004192158	CALDAS NOVAS S1	01/11/2020 07:18	01/11/2020 10:24	01/11/2020 07:18	01/11/2020 10:24	3,09	1	3,09	CHI
202011574	NOVA CRIXAS	NA12213190	MOZARLANDIA	01/11/2020 07:20	01/11/2020 21:27	01/11/2020 07:20	01/11/2020 12:25	5,07	5	25,34	CHI
202011574	NOVA CRIXAS	NA12213190	MOZARLANDIA	01/11/2020 07:20	01/11/2020 21:27	01/11/2020 07:20	01/11/2020 19:44	12,39	6	74,33	CHI
202011574	NOVA CRIXAS	NA12213190	MOZARLANDIA	01/11/2020 07:20	01/11/2020 21:27	01/11/2020 07:20	01/11/2020 21:27	14,11	14	197,50	CHI
2020111281	SITIO D ABADIA	AQ12344369	IACIARA S2	01/11/2020 07:21	01/11/2020 14:57	01/11/2020 07:21	01/11/2020 14:57	7,58	4	30,34	CHI
2020111714	FLORES DE GOIAS	FB12211535	IACIARA S2	01/11/2020 07:22	01/11/2020 20:45	01/11/2020 07:22	01/11/2020 17:56	10,56	255	2693,23	CHI
2020111714	FLORES DE GOIAS	FB12211535	IACIARA S2	01/11/2020 07:22	01/11/2020 20:45	01/11/2020 07:22	01/11/2020 20:45	13,38	115	1538,48	CHI
202011329	BALIZA	BH12331317	CAIAPONIA	01/11/2020 07:23	01/11/2020 15:16	01/11/2020 07:23	01/11/2020 15:16	7,88	4	31,53	CHI
202011331	FLORES DE GOIAS	FB11255016	FLORES DE GOIAS	01/11/2020 07:23	01/11/2020 13:19	01/11/2020 07:23	01/11/2020 13:19	5,92	11	65,17	CHI
202011337	GUAPO	GA31039403	GUAPO S2	01/11/2020 07:24	01/11/2020 16:52	01/11/2020 07:24	01/11/2020 16:52	9,46	1	9,46	CHI
202011338	APARECIDA DE GOIANIA	14617353	INDEPENDENCIA S1	01/11/2020 07:24	01/11/2020 09:22	01/11/2020 07:24	01/11/2020 09:22	1,97	0	0,00	CHI
202011724	ALEXANIA	AX11289376	ALEXANIA	01/11/2020 07:25	01/11/2020 12:55	01/11/2020 07:25	01/11/2020 12:55	5,50	37	203,53	CHI
202011992	PETROLINA DE GOIAS	SF12017631	SAO FRANCISCO DE GOIAS	01/11/2020 07:25	01/11/2020 11:46	01/11/2020 07:25	01/11/2020 11:46	4,34	6	26,06	CHI
202011992	SAO FRANCISCO DE GOIAS	SF12017631	SAO FRANCISCO DE GOIAS	01/11/2020 07:25	01/11/2020 11:46	01/11/2020 07:25	01/11/2020 11:46	4,34	1	4,34	CHI
202011342	PLANALTINA	PI10400576	PLANALTINA	01/11/2020 07:26	01/11/2020 21:56	01/11/2020 07:26	01/11/2020 10:19	2,88	100	288,42	CHI
202011342	PLANALTINA	PI12099216LD	PLANALTINA	01/11/2020 07:26	01/11/2020 21:56	01/11/2020 07:26	01/11/2020 14:16	6,84	94	643,22	CHI
202011342	PLANALTINA	PI12139508	PLANALTINA	01/11/2020 07:26	01/11/2020 21:56	01/11/2020 07:26	01/11/2020 15:03	7,62	33	251,37	CHI
202011342	PADRE BERNARDO	PI12105580LD	PLANALTINA	01/11/2020 07:26	01/11/2020 21:56	01/11/2020 07:26	01/11/2020 21:56	14,50	15	217,57	CHI
202011342	PLANALTINA	PI12105580LD	PLANALTINA	01/11/2020 07:26	01/11/2020 21:56	01/11/2020 07:26	01/11/2020 21:56	14,50	30	435,14	CHI
202011346	PONTALINA	PK12393853	PONTALINA	01/11/2020 07:28	01/11/2020 09:44	01/11/2020 07:28	01/11/2020 09:44	2,27	3	6,80	CHI
202011350	LUZIANIA	LZ21139690	MARAJOA	01/11/2020 07:29	01/11/2020 08:30	01/11/2020 07:29	01/11/2020 08:30	1,01	4	4,04	CHI
202011392	URUTAI	UT12115680	PIRES DO RIO S2	01/11/2020 07:30	01/11/2020 11:28	01/11/2020 07:30	01/11/2020 11:28	3,95	33	130,37	CHI
202011807	SAO DOMINGOS	SD12348648	SAO DOMINGOS	01/11/2020 07:33	01/11/2020 11:00	01/11/2020 07:33	01/11/2020 11:00	3,46	16	55,28	CHI
202011364	PARAUNA	PU21152650	PARAUNA	01/11/2020 07:34	01/11/2020 17:34	01/11/2020 07:34	01/11/2020 17:34	9,99	1	9,99	CHI
202011373	PADRE BERNARDO	PB12163248	PADRE BERNARDO	01/11/2020 07:37	01/11/2020 09:44	01/11/2020 07:37	01/11/2020 09:44	2,11	8	16,90	CHI
202011383	SAO DOMINGOS	SD21150158	SAO DOMINGOS	01/11/2020 07:40	01/11/2020 12:57	01/11/2020 07:40	01/11/2020 12:57	5,28	1	5,28	CHI
202011384	CALDAZINHA	BV21032847	CEPAIGO S2	01/11/2020 07:40	01/11/2020 10:40	01/11/2020 07:40	01/11/2020 10:40	2,99	4	11,97	CHI
202011389	FORMOSA	FA21120042	ITIQUEIRA	01/11/2020 07:41	01/11/2020 11:28	01/11/2020 07:41	01/11/2020 11:28	3,79	2	7,57	CHI
202011390	ITUMBARA	IT21304274	CACHOEIRA DOURADA	01/11/2020 07:41	01/11/2020 12:22	01/11/2020 07:41	01/11/2020 12:22	4,67	1	4,67	CHI
202011394	MINACU	IH21220734	MINACU	01/11/2020 07:42	01/11/2020 10:39	01/11/2020 07:42	01/11/2020 10:39	2,94	2	5,89	CHI
202011398	JARAGUA	JA21268872	JARAGUA	01/11/2020 07:43	01/11/2020 13:09	01/11/2020 07:43	01/11/2020 13:09	5,44	1	5,44	CHI
202011404	APARECIDA DE GOIANIA	15155651	INDEPENDENCIA S2	01/11/2020 07:44	01/11/2020 09:20	01/11/2020 07:44	01/11/2020 09:20	1,61	1	1,61	CHI
202011410	ITABERAI	10005014822	ITABERAI S2	01/11/2020 07:46	01/11/2020 10:42	01/11/2020 07:46	01/11/2020 10:42	2,93	1	2,93	CHI
202011411	CRIXAS	CX21342232	SERRA DO OURO	01/11/2020 07:46	01/11/2020 12:49	01/11/2020 07:46	01/11/2020 12:49	5,04	1	5,04	CHI
202011413	PALESTINA DE GOIAS	CP21357588	PALESTINA	01/11/2020 07:46	01/11/2020 10:38	01/11/2020 07:46	01/11/2020 10:38	2,85	1	2,85	CHI
202011557	ANICUNS	AC12391422	ANICUNS	01/11/2020 07:47	01/11/2020 11:20	01/11/2020 07:47	01/11/2020 11:20	3,54	5	17,70	CHI
202011426	FAZENDA NOVA	JR12228188	IPORA	01/11/2020 07:48	01/11/2020 09:07	01/11/2020 07:48	01/11/2020 09:07	1,33	6	7,98	CHI
202011426	JUSSARA	JR12228188	IPORA	01/11/2020 07:48	01/11/2020 09:07	01/11/2020 07:48	01/11/2020 09:07	1,33	67	89,09	CHI
202011430	ALTO PARAISO DE GOIAS	10000329680	FLORES DE GOIAS	01/11/2020 07:49	01/11/2020 09:17	01/11/2020 07:49	01/11/2020 09:17	1,46	1	1,46	CHI
202011435	PADRE BERNARDO	PB21330891	PADRE BERNARDO	01/11/2020 07:51	01/11/2020 12:03	01/11/2020 07:51	01/11/2020 12:03	4,20	1	4,20	CHI
202011437	SAO JOAO D ALIANCA	JL11218455	SAO JOAO D ALIANCA	01/11/2020 07:51	01/11/2020 17:39	01/11/2020 07:51	01/11/2020 17:39	9,79	4	39,16	CHI
202011462	GUARAITA	GK11299345	ITAPURANGA	01/11/2020 07:51	01/11/2020 16:50	01/11/2020 07:51	01/11/2020 16:50	8,98	73	655,38	CHI
202011446	INHUMAS	IN12027779	INHUMAS S2	01/11/2020 07:53	01/11/2020 14:41	01/11/2020 07:53	01/11/2020 14:41	6,79	1	6,79	CHI
202011452	CAMPOS BELOS	820038283	SAO DOMINGOS	01/11/2020 07:54	01/11/2020 17:10	01/11/2020 07:54	01/11/2020 17:10	9,25	1	9,25	CHI
202011455	IPORA	IR21102667	IPORA	01/11/2020 07:55	01/11/2020 09:40	01/11/2020 07:55	01/11/2020 09:40	1,75	1	1,75	CHI
202011457	GAMELEIRA DE GOIAS	SV31090740	ANAPOLIS UNIVERSITARIO S2	01/11/2020 07:55	01/11/2020 11:20	01/11/2020 07:55	01/11/2020 11:20	3,41	1	3,41	CHI
202011610	LUZIANIA	LZ11065874	RIO VERMELHO	01/11/2020 07:55	01/11/2020 11:11	01/11/2020 07:55	01/11/2020 11:11	3,27	147	480,04	CHI
202011459	MATRINCHA	MP12299692	MATRINCHA	01/11/2020 07:56	01/11/2020 11:19	01/11/2020 07:56	01/11/2020 11:19	3,38	4	13,53	CHI
202011461	APARECIDA DE GOIANIA	200219583	INDEPENDENCIA S1	01/11/2020 07:56	01/11/2020 09:08	01/11/2020 07:56	01/11/2020 09:08	1,20	1	1,20	CHI

202011486	INHUMAS	IX12016046	INHUMAS S1	01/11/2020 07:57	01/11/2020 09:54	01/11/2020 07:57	01/11/2020 09:54	1,95	8	15,62	CHI
202011486	ITAUCU	IX12016046	INHUMAS S1	01/11/2020 07:57	01/11/2020 09:54	01/11/2020 07:57	01/11/2020 09:54	1,95	3	5,86	CHI
202011469	CALDAS NOVAS	CN21070141	SERRA DE CALDAS	01/11/2020 07:58	01/11/2020 23:24	01/11/2020 07:58	01/11/2020 23:24	15,42	1	15,42	CHI
202011471	GOIANIA	10474882	GOIANIA LESTE S3	01/11/2020 07:58	01/11/2020 09:09	01/11/2020 07:58	01/11/2020 09:09	1,17	1	1,17	CHI
202011647	ANICUNS	AC12308546	ANICUNS	01/11/2020 07:58	01/11/2020 10:55	01/11/2020 07:58	01/11/2020 10:55	2,94	13	38,23	CHI
202011475	ALEXANIA	480022598	ALEXANIA	01/11/2020 07:59	01/11/2020 17:55	01/11/2020 07:59	01/11/2020 17:55	9,92	1	9,92	CHI
202011479	CATALAO	CT12215618	CATALAO S2	01/11/2020 08:02	01/11/2020 10:21	01/11/2020 08:02	01/11/2020 10:21	2,31	107	247,68	CHI
202011480	ALTO HORIZONTE	AJ21100995	SANTA TEREZINHA	01/11/2020 08:02	01/11/2020 14:06	01/11/2020 08:02	01/11/2020 14:06	6,06	1	6,06	CHI
202011482	GOIANDIRA	GD12165160	CATALAO S1	01/11/2020 08:03	01/11/2020 16:12	01/11/2020 08:03	01/11/2020 16:12	8,14	10	81,43	CHI
202011484	AGUA FRIA DE GOIAS	JL21154505	SAO JOAO D ALIANCA	01/11/2020 08:03	01/11/2020 13:23	01/11/2020 08:03	01/11/2020 13:23	5,32	1	5,32	CHI
202011485	CAMPO ALEGRE DE GOIAS	CM21195348	CAMPO ALEGRE DE GOIAS	01/11/2020 08:03	01/11/2020 12:50	01/11/2020 08:03	01/11/2020 12:50	4,77	1	4,77	CHI
202011487	SAO JOAO D ALIANCA	FB11314705	FLORES DE GOIAS	01/11/2020 08:03	01/11/2020 17:02	01/11/2020 08:03	01/11/2020 17:02	8,97	1	8,97	CHI
202011490	BRITANIA	BT12210256	BRITANIA	01/11/2020 08:05	01/11/2020 12:12	01/11/2020 08:05	01/11/2020 12:12	4,11	10	41,11	CHI
202011494	PALMEIRAS DE GOIAS	PL12000059	PALMEIRAS	01/11/2020 08:06	01/11/2020 10:10	01/11/2020 08:06	01/11/2020 10:10	2,06	5	10,29	CHI
202011503	LUZIANIA	LZ21245497	MARAJOARA	01/11/2020 08:08	01/11/2020 09:18	01/11/2020 08:08	01/11/2020 09:18	1,17	3	3,50	CHI
202011581	ARAGOIANIA	AO11068771	GUAPU S2	01/11/2020 08:08	01/11/2020 11:56	01/11/2020 08:08	01/11/2020 11:56	3,79	156	591,76	CHI
202011515	SAO DOMINGOS	SD12268132	SAO DOMINGOS	01/11/2020 08:12	01/11/2020 12:44	01/11/2020 08:12	01/11/2020 12:44	4,52	35	158,15	CHI
202011516	APARECIDA DE GOIANIA	10008610841	ANHANGUERA	01/11/2020 08:12	01/11/2020 11:09	01/11/2020 08:12	01/11/2020 11:09	2,94	1	2,94	CHI
202011520	GOIANIA	10029249900	FERROVIARIO S3	01/11/2020 08:14	01/11/2020 11:31	01/11/2020 08:14	01/11/2020 11:31	3,28	1	3,28	CHI
202011536	CATALAO	CT12318674	CATALAO S1	01/11/2020 08:17	01/11/2020 10:55	01/11/2020 08:17	01/11/2020 10:55	2,62	2	5,23	CHI
202011536	DAVINOPOLIS	CT12318674	CATALAO S1	01/11/2020 08:17	01/11/2020 10:55	01/11/2020 08:17	01/11/2020 10:55	2,62	3	7,85	CHI
202011534	ITAPIRAPUA	IU12018752	MATRINCHA	01/11/2020 08:19	01/11/2020 13:43	01/11/2020 08:19	01/11/2020 13:43	5,39	7	37,76	CHI
2020111037	ANAPOLIS	AN21258665	ANAPOLIS UNIVERSITARIO S2	01/11/2020 08:19	01/11/2020 15:03	01/11/2020 08:19	01/11/2020 15:03	6,73	1	6,73	CHI
202011537	EDEIA	EA12070748	EDEIA	01/11/2020 08:20	01/11/2020 13:53	01/11/2020 08:20	01/11/2020 13:53	5,55	3	16,65	CHI
202011537	INDIARA	EA12070748	EDEIA	01/11/2020 08:20	01/11/2020 13:53	01/11/2020 08:20	01/11/2020 13:53	5,55	1	5,55	CHI
202011582	SAO JOAO D ALIANCA	JL12218487	SAO JOAO D ALIANCA	01/11/2020 08:20	01/11/2020 17:01	01/11/2020 08:20	01/11/2020 17:01	8,67	11	95,38	CHI
202011740	ITAPACI	IW11000007	ITAPACI	01/11/2020 08:21	01/11/2020 13:49	01/11/2020 08:21	01/11/2020 13:49	5,45	80	436,36	CHI
202011549	CABECEIRAS	CW12108823	ITUIQUIRA	01/11/2020 08:22	01/11/2020 10:18	01/11/2020 08:22	01/11/2020 10:18	1,94	20	38,87	CHI
202011560	ITUMBIARA	BJ12068979	BOM JESUS DE GOIAS	01/11/2020 08:23	01/11/2020 14:17	01/11/2020 08:23	01/11/2020 14:17	5,89	3	17,66	CHI
202011819	MINACU	IH12328091	MINACU	01/11/2020 08:23	01/11/2020 11:27	01/11/2020 08:23	01/11/2020 11:27	3,07	8	24,58	CHI
202011565	SAO MIGUEL DO ARAGUAIA	SM21300971	SAO MIGUEL DO ARAGUAIA	01/11/2020 08:24	02/11/2020 05:45	01/11/2020 08:24	02/11/2020 05:45	21,34	1	21,34	CHI
202011569	NOVO GAMA	4990044928	PACAEMBU S1	01/11/2020 08:25	01/11/2020 10:37	01/11/2020 08:25	01/11/2020 10:37	2,20	1	2,20	CHI
202011571	CORUMBAIBA	CI21156398	VILA CORUMBA	01/11/2020 08:26	01/11/2020 12:16	01/11/2020 08:26	01/11/2020 12:16	3,83	1	3,83	CHI
202011572	ALTO PARAISO DE GOIAS	BF12383341	NIQUELANDIA SUBTRANSMISSAO	01/11/2020 08:26	01/11/2020 09:53	01/11/2020 08:26	01/11/2020 09:53	1,45	3	4,35	CHI
202011304	CAMPINACU	UC21318155	MARA ROSA	01/11/2020 08:27	02/11/2020 00:30	01/11/2020 08:27	02/11/2020 00:30	16,04	1	16,04	CHI
2020111203	AMARALINA	UP12294696	NOVA CRIXAS	01/11/2020 08:29	02/11/2020 08:26	01/11/2020 08:29	02/11/2020 08:26	23,94	54	1292,84	CHI
2020111203	MARA ROSA	UP12294696	NOVA CRIXAS	01/11/2020 08:29	02/11/2020 08:26	01/11/2020 08:29	02/11/2020 08:26	23,94	43	1029,48	CHI
2020111203	SANTA TEREZINHA DE GOIAS	UP12294696	NOVA CRIXAS	01/11/2020 08:29	02/11/2020 08:26	01/11/2020 08:29	02/11/2020 08:26	23,94	1	23,94	CHI
2020111203	UIRAPURU	UP12294696	NOVA CRIXAS	01/11/2020 08:29	02/11/2020 08:26	01/11/2020 08:29	02/11/2020 08:26	23,94	4	95,77	CHI
2020112452	CAMPINACU	UC12269887	MARA ROSA	01/11/2020 08:29	02/11/2020 09:34	01/11/2020 08:29	02/11/2020 09:34	25,08	7	175,57	CHI
202011594	APARECIDA DE GOIANIA	12364630	INDEPENDENCIA S2	01/11/2020 08:30	01/11/2020 09:44	01/11/2020 08:30	01/11/2020 09:44	1,25	1	1,25	CHI
202011599	AGUAS LINDAS DE GOIAS	LA11349041	AGUAS LINDAS DE GOIAS S1	01/11/2020 08:30	01/11/2020 20:12	01/11/2020 17:10	01/11/2020 20:12	3,02	84	253,45	CHI
202011981	CAMPO ALEGRE DE GOIAS	CM12358428RE	CAMPO ALEGRE DE GOIAS	01/11/2020 08:31	01/11/2020 13:44	01/11/2020 08:31	01/11/2020 13:44	5,21	5	26,04	CHI
2020111248	JUSSARA	JR13204863	IPORA	01/11/2020 08:31	01/11/2020 19:23	01/11/2020 08:31	01/11/2020 19:23	10,87	6	65,24	CHI
2020111248	JUSSARA	JR13204863	IPORA	01/11/2020 08:31	01/11/2020 19:23	01/11/2020 14:50	01/11/2020 19:23	4,55	162	736,61	CHI
2020111248	MONTES CLAROS DE GOIAS	JR13204863	IPORA	01/11/2020 08:31	01/11/2020 19:23	01/11/2020 14:50	01/11/2020 19:23	4,55	17	77,30	CHI
2020111310	AURILANDIA	RP12008095	FIRMINOPOLIS S2	01/11/2020 08:32	01/11/2020 14:42	01/11/2020 08:32	01/11/2020 14:42	6,15	3	18,46	CHI
2020111310	PARAUNA	RP12008095	FIRMINOPOLIS S2	01/11/2020 08:32	01/11/2020 14:42	01/11/2020 08:32	01/11/2020 14:42	6,15	2	12,31	CHI
2020111310	SAO JOAO DA PARAUNA	RP12008095	FIRMINOPOLIS S2	01/11/2020 08:32	01/11/2020 14:42	01/11/2020 08:32	01/11/2020 14:42	6,15	6	36,92	CHI
202011617	GOIANIA	10017741180	CARAJAS S2	01/11/2020 08:34	01/11/2020 10:47	01/11/2020 08:34	01/11/2020 10:47	2,21	1	2,21	CHI
202011626	MONTES CLAROS DE GOIAS	10006837962	IPORA	01/11/2020 08:35	01/11/2020 11:19	01/11/2020 08:35	01/11/2020 11:19	2,73	1	2,73	CHI

202011925	ITAPURANGA	IK12300186	ITAPURANGA	01/11/2020 08:35	01/11/2020 10:54	01/11/2020 08:35	01/11/2020 10:54	2,32	41	95,07	CHI
202011633	ANAPOLIS	21358606	JUNDIAI S1	01/11/2020 08:36	01/11/2020 11:40	01/11/2020 08:36	01/11/2020 11:40	3,07	1	3,07	CHI
202011642	SAO JOAO D ALIANCA	JL12154439	SAO JOAO D ALIANCA	01/11/2020 08:36	02/11/2020 09:57	01/11/2020 08:36	02/11/2020 09:57	25,33	26	658,67	CHI
202011649	MATRINCHA	MP21165371	MATRINCHA	01/11/2020 08:38	01/11/2020 15:49	01/11/2020 08:38	01/11/2020 15:49	7,18	1	7,18	CHI
202011651	PALMEIRAS DE GOIAS	PL12038678	PALMEIRAS	01/11/2020 08:38	01/11/2020 11:10	01/11/2020 08:38	01/11/2020 11:10	2,52	12	30,24	CHI
202011661	NIQUELANDIA	NQ21393359	NIQUELANDIA SUBTRANSMISSAO	01/11/2020 08:40	03/11/2020 13:07	01/11/2020 08:40	03/11/2020 13:07	52,44	1	52,44	CHI
202011665	SILVANIA	SV11257317	VIANOPOLIS	01/11/2020 08:42	01/11/2020 09:56	01/11/2020 08:42	01/11/2020 09:56	1,23	5	6,16	CHI
202011666	MONTE ALEGRE DE GOIAS	MA21146876	SAO DOMINGOS	01/11/2020 08:42	01/11/2020 14:42	01/11/2020 08:42	01/11/2020 14:42	6,00	1	6,00	CHI
202011669	COCALZINHO DE GOIAS	ZN12327452	GOIANESIA S1	01/11/2020 08:42	01/11/2020 14:32	01/11/2020 08:42	01/11/2020 14:32	5,82	9	52,41	CHI
202011670	DIVINOPOLIS DE GOIAS	GH21269352	SAO DOMINGOS	01/11/2020 08:43	01/11/2020 12:42	01/11/2020 08:43	01/11/2020 12:42	3,98	1	3,98	CHI
202011675	SANTO ANTONIO DO DESCOBERTO	ZN21191323	AGUAS LINDAS DE GOIAS S2	01/11/2020 08:44	01/11/2020 13:12	01/11/2020 08:44	01/11/2020 13:12	4,46	1	4,46	CHI
202011676	TRES RANCHOS	TH21155024	CATALAO S1	01/11/2020 08:44	01/11/2020 13:44	01/11/2020 08:44	01/11/2020 13:44	4,99	1	4,99	CHI
202011677	NOVA IGUACU DE GOIAS	NH21166551	SANTA TEREZINHA	01/11/2020 08:44	02/11/2020 04:22	01/11/2020 08:44	02/11/2020 04:22	19,62	1	19,62	CHI
2020111317	MONTIVIDIU DO NORTE	MX12168971	PORANGATU	01/11/2020 08:44	01/11/2020 15:16	01/11/2020 08:44	01/11/2020 15:16	6,54	283	1849,48	CHI
202011679	PLANALTINA	10013572332	PLANALTINA	01/11/2020 08:45	01/11/2020 11:13	01/11/2020 08:45	01/11/2020 11:13	2,46	1	2,46	CHI
202011681	SAO JOAO D ALIANCA	JL21117434	SAO JOAO D ALIANCA	01/11/2020 08:46	01/11/2020 14:48	01/11/2020 08:46	01/11/2020 14:48	6,03	1	6,03	CHI
202011684	ORIZONA	OZ12300909	PIRES DO RIO S2	01/11/2020 08:46	01/11/2020 12:01	01/11/2020 08:46	01/11/2020 12:01	3,24	13	42,07	CHI
202011688	INDIARA	IY21137887	CEZARINA	01/11/2020 08:48	01/11/2020 20:59	01/11/2020 08:48	01/11/2020 20:59	12,17	1	12,17	CHI
202011694	GOIATUBA	GT12000084	GOIATUBA S2	01/11/2020 08:50	01/11/2020 11:43	01/11/2020 08:50	01/11/2020 11:43	2,87	6	17,25	CHI
202011702	ORIZONA	OZ21085811	PIRES DO RIO S2	01/11/2020 08:52	01/11/2020 13:45	01/11/2020 08:52	01/11/2020 13:45	4,87	1	4,87	CHI
202011703	INHUMAS	IN12063062	INHUMAS S1	01/11/2020 08:52	01/11/2020 16:38	01/11/2020 08:52	01/11/2020 16:38	7,75	1	7,75	CHI
202011709	VIANOPOLIS	SV21128984	VIANOPOLIS	01/11/2020 08:54	01/11/2020 12:54	01/11/2020 08:54	01/11/2020 12:54	3,99	1	3,99	CHI
202011771	NIQUELANDIA	NQ12265691	URUACU	01/11/2020 08:54	01/11/2020 11:38	01/11/2020 08:54	01/11/2020 11:38	2,73	18	49,20	CHI
2020111028	AGUA FRIA DE GOIAS	TL12048061	SAO JOAO D ALIANCA	01/11/2020 08:54	01/11/2020 16:43	01/11/2020 08:54	01/11/2020 16:43	7,81	56	437,58	CHI
202011711	LEOPOLDO DE BULHOES	LB21125720	DAIA S2	01/11/2020 08:55	01/11/2020 10:52	01/11/2020 08:55	01/11/2020 10:52	1,96	1	1,96	CHI
202011716	EDEIA	EA21171726	EDEIA	01/11/2020 08:55	01/11/2020 17:34	01/11/2020 08:55	01/11/2020 17:34	8,64	1	8,64	CHI
202011735	ITAPACI	IW12078035	ITAPACI	01/11/2020 08:56	01/11/2020 15:29	01/11/2020 08:56	01/11/2020 15:29	6,54	21	137,25	CHI
202011735	NOVA GLORIA	IW12078035	ITAPACI	01/11/2020 08:56	01/11/2020 15:29	01/11/2020 08:56	01/11/2020 15:29	6,54	1	6,54	CHI
202011723	OUVIDOR	OU21141010	CATALAO S1	01/11/2020 08:57	01/11/2020 14:23	01/11/2020 08:57	01/11/2020 14:23	5,43	1	5,43	CHI
202011727	ITAPURANGA	IK12065332	ITAPURANGA	01/11/2020 08:57	01/11/2020 17:41	01/11/2020 08:57	01/11/2020 17:41	8,72	3	26,17	CHI
202011729	IVOLANDIA	IV21129873	IPORA	01/11/2020 08:58	01/11/2020 14:20	01/11/2020 08:58	01/11/2020 14:20	5,37	1	5,37	CHI
202011732	COLINAS DO SUL	TI12396760	MINACU	01/11/2020 08:58	02/11/2020 13:10	01/11/2020 08:58	02/11/2020 13:10	28,20	12	338,42	CHI
202011732	NIQUELANDIA	TI12396760	MINACU	01/11/2020 08:58	02/11/2020 13:10	01/11/2020 08:58	02/11/2020 13:10	28,20	1	28,20	CHI
202011879	PIRENOPOLIS	PV12381210	CORUMBA	01/11/2020 08:58	01/11/2020 11:10	01/11/2020 08:58	01/11/2020 11:10	2,20	10	22,02	CHI
202011970	ITAGUARU	IC12353099RE	ITABERAI S1	01/11/2020 08:59	01/11/2020 16:18	01/11/2020 08:59	01/11/2020 16:18	7,30	70	511,08	CHI
202011970	URUANA	IC12353099RE	ITABERAI S1	01/11/2020 08:59	01/11/2020 16:18	01/11/2020 08:59	01/11/2020 16:18	7,30	9	65,71	CHI
202011739	PARAUNA	PU21007974	PARAUNA	01/11/2020 09:00	02/11/2020 00:06	01/11/2020 09:00	02/11/2020 00:06	15,10	1	15,10	CHI
202011741	GOIANIA	15034239	XAVANTES	01/11/2020 09:00	01/11/2020 11:04	01/11/2020 09:00	01/11/2020 11:04	2,07	1	2,07	CHI
202011742	GOIANIA	12069772	CAMPINAS S2	01/11/2020 09:00	01/11/2020 14:51	01/11/2020 09:00	01/11/2020 14:51	5,84	1	5,84	CHI
202011747	ARAGARCAS	AG11138458	ARAGARCAS	01/11/2020 09:01	01/11/2020 11:30	01/11/2020 09:01	01/11/2020 11:30	2,47	34	83,90	CHI
202011752	CRISTALINA	KR12206678	CRISTALINA S1	01/11/2020 09:03	01/11/2020 11:16	01/11/2020 09:03	01/11/2020 11:16	2,21	542	1197,67	CHI
202011754	VALPARAISO DE GOIAS	3350062402	PACAEMBU S2	01/11/2020 09:03	01/11/2020 10:56	01/11/2020 09:03	01/11/2020 10:56	1,87	1	1,87	CHI
202011757	SANCLERLANDIA	SC21259967	SAO LUIZ DOS MONTES BELOS	01/11/2020 09:04	01/11/2020 10:57	01/11/2020 09:04	01/11/2020 10:57	1,89	1	1,89	CHI
202011763	CATALAO	1990089899	CATALAO S2	01/11/2020 09:05	01/11/2020 17:17	01/11/2020 09:05	01/11/2020 17:17	8,19	1	8,19	CHI
202011766	ANICUNS	AC21304697	FIRMINOPOLIS S2	01/11/2020 09:06	01/11/2020 17:43	01/11/2020 09:06	01/11/2020 17:43	8,60	1	8,60	CHI
202011767	PARAUNA	PU12246343	PARAUNA	01/11/2020 09:06	02/11/2020 09:44	01/11/2020 09:06	02/11/2020 09:44	24,62	1	24,62	CHI
202011769	APARECIDA DE GOIANIA	13125795	INDEPENDENCIA S2	01/11/2020 09:07	01/11/2020 10:51	01/11/2020 09:07	01/11/2020 10:51	1,74	1	1,74	CHI
202011775	BALIZA	BH11259285	CAIAPONIA	01/11/2020 09:08	01/11/2020 20:34	01/11/2020 09:08	01/11/2020 20:34	11,43	1	11,43	CHI
202011776	BALIZA	BH11331142	CAIAPONIA	01/11/2020 09:08	01/11/2020 11:19	01/11/2020 09:08	01/11/2020 11:19	2,17	1	2,17	CHI
2020111053	MUNDO NOVO DE GOIAS	MH12391950	NOVA CRIXAS	01/11/2020 09:09	01/11/2020 17:58	01/11/2020 09:09	01/11/2020 17:58	8,81	102	898,42	CHI
202011785	GOIANIA	10029609990	FERROVIARIO S1	01/11/2020 09:10	01/11/2020 10:26	01/11/2020 09:10	01/11/2020 10:26	1,25	1	1,25	CHI

202011790	APARECIDA DE GOIANIA	11959496	INDEPENDENCIA S2	01/11/2020 09:11	01/11/2020 10:32	01/11/2020 09:11	01/11/2020 10:32	1,35	1	1,35	CHI
202011791	CRISTALINA	KR12163734	PAMPLONA	01/11/2020 09:11	01/11/2020 11:09	01/11/2020 09:11	01/11/2020 11:09	1,95	1	1,95	CHI
202011792	PIRACANJUBA	PJ12352525	PIRACANJUBA	01/11/2020 09:12	01/11/2020 13:39	01/11/2020 09:12	01/11/2020 13:39	4,45	16	71,15	CHI
202011800	ANAPOLIS	20010217	JUNDIAI S1	01/11/2020 09:12	01/11/2020 14:07	01/11/2020 09:12	01/11/2020 14:07	4,91	1	4,91	CHI
202011801	CRISTALINA	KR21332515	CRISTALINA S2	01/11/2020 09:12	01/11/2020 16:33	01/11/2020 09:12	01/11/2020 16:33	7,33	1	7,33	CHI
202011804	APARECIDA DE GOIANIA	200547719	ANHANGUERA	01/11/2020 09:13	01/11/2020 11:55	01/11/2020 09:13	01/11/2020 11:55	2,69	1	2,69	CHI
202011805	ANAPOLIS	10025669140	ANAPOLIS UNIVERSITARIO S2	01/11/2020 09:13	01/11/2020 15:35	01/11/2020 09:13	01/11/2020 15:35	6,37	1	6,37	CHI
202011808	MORRINHOS	MR31092141	MORRINHOS	01/11/2020 09:13	01/11/2020 19:30	01/11/2020 09:13	01/11/2020 19:30	10,27	1	10,27	CHI
202011811	CATURAI	CK12037992	ARACU	01/11/2020 09:14	01/11/2020 15:18	01/11/2020 09:14	01/11/2020 15:18	6,06	2	12,11	CHI
202011814	CAIAPONIA	CP21356630	PIRANHAS	01/11/2020 09:15	01/11/2020 12:40	01/11/2020 09:15	01/11/2020 12:40	3,40	1	3,40	CHI
202011816	BELA VISTA DE GOIAS	BV12324972	BELA VISTA S2	01/11/2020 09:15	01/11/2020 15:54	01/11/2020 09:15	01/11/2020 15:54	6,64	2	13,27	CHI
202011820	SANTO ANTONIO DE GOIAS	BW11312966	NEROPOLIS S1	01/11/2020 09:16	01/11/2020 11:11	01/11/2020 09:16	01/11/2020 11:11	1,90	34	64,64	CHI
202011822	NIQUELANDIA	4400000383	URUACU	01/11/2020 09:17	02/11/2020 05:17	01/11/2020 09:17	02/11/2020 05:17	19,99	1	19,99	CHI
202011823	ITABERAI	IB11220369	ITABERAI S2	01/11/2020 09:18	01/11/2020 12:23	01/11/2020 09:18	01/11/2020 12:23	3,08	60	184,98	CHI
202011824	ANAPOLIS	21353438	ANAPOLIS UNIVERSITARIO S2	01/11/2020 09:18	01/11/2020 16:26	01/11/2020 09:18	01/11/2020 16:26	7,13	1	7,13	CHI
202011825	GOIAS	GS12206917	ITABERAI S1	01/11/2020 09:18	01/11/2020 17:49	01/11/2020 09:18	01/11/2020 17:49	8,51	9	76,58	CHI
202011826	PORANGATU	PO11345599	PORANGATU	01/11/2020 09:18	01/11/2020 13:05	01/11/2020 09:18	01/11/2020 13:05	3,77	1	3,77	CHI
202011832	ITABERAI	IB21105200	ANICUNS	01/11/2020 09:19	01/11/2020 20:45	01/11/2020 09:19	01/11/2020 20:45	11,42	1	11,42	CHI
202011833	LUZIANIA	LZ11261574	RIO VERMELHO	01/11/2020 09:20	01/11/2020 13:22	01/11/2020 09:20	01/11/2020 13:22	4,03	88	354,79	CHI
202011840	EDEALINA	ED21000023	PONTALINA	01/11/2020 09:21	01/11/2020 15:35	01/11/2020 09:21	01/11/2020 15:20	5,98	2	11,97	CHI
202011840	EDEALINA	EA12000026LD	PONTALINA	01/11/2020 09:21	01/11/2020 15:35	01/11/2020 13:32	01/11/2020 15:35	2,04	9	18,36	CHI
202011840	EDEIA	EA12000026LD	PONTALINA	01/11/2020 09:21	01/11/2020 15:35	01/11/2020 13:32	01/11/2020 15:35	2,04	2	4,08	CHI
202011149	SAO LUIS DE MONTES BELOS	SL12145942	SAO LUIZ DOS MONTES BELOS	01/11/2020 09:21	01/11/2020 12:43	01/11/2020 09:21	01/11/2020 12:43	3,37	9	30,29	CHI
202011843	ANAPOLIS	20008922	JUNDIAI S1	01/11/2020 09:22	01/11/2020 12:55	01/11/2020 09:22	01/11/2020 12:55	3,56	1	3,56	CHI
202011850	MOSSAMEDES	MD12170893	ITABERAI S1	01/11/2020 09:22	01/11/2020 11:48	01/11/2020 09:22	01/11/2020 11:48	2,42	182	440,24	CHI
202011857	UIRAPURU	UP21297230	NOVA CRIXAS	01/11/2020 09:25	01/11/2020 11:43	01/11/2020 09:25	01/11/2020 11:43	2,30	1	2,30	CHI
202011860	APARECIDA DE GOIANIA	10027769257	ANHANGUERA	01/11/2020 09:26	01/11/2020 12:01	01/11/2020 09:26	01/11/2020 12:01	2,58	1	2,58	CHI
202011861	MINACU	4020086589	MINACU	01/11/2020 09:26	01/11/2020 11:54	01/11/2020 09:26	01/11/2020 11:54	2,46	1	2,46	CHI
202011867	SILVANIA	10009289036	VIANOPOLIS	01/11/2020 09:28	01/11/2020 11:02	01/11/2020 09:28	01/11/2020 11:02	1,58	1	1,58	CHI
2020111523	AGUA FRIA DE GOIAS	PI12325588	SAO JOAO D ALIANCA	01/11/2020 09:28	01/11/2020 18:30	01/11/2020 09:28	01/11/2020 18:30	9,02	1	9,02	CHI
2020111523	PLANALTINA	PI12325588	SAO JOAO D ALIANCA	01/11/2020 09:28	01/11/2020 18:30	01/11/2020 09:28	01/11/2020 18:30	9,02	103	928,92	CHI
202011873	URUACU	640090138	URUACU	01/11/2020 09:29	01/11/2020 15:16	01/11/2020 09:29	01/11/2020 15:16	5,78	1	5,78	CHI
2020111332	CRISTALINA	KR12389576	CRISTALINA S2	01/11/2020 09:31	01/11/2020 13:33	01/11/2020 09:31	01/11/2020 13:33	4,03	38	153,21	CHI
202011961	IPAMERI	IP12332964	IPAMERI	01/11/2020 09:32	01/11/2020 11:13	01/11/2020 09:32	01/11/2020 11:13	1,68	37	62,08	CHI
202011891	GOIANIA	14628776	CARAJAS S1	01/11/2020 09:33	01/11/2020 11:40	01/11/2020 09:33	01/11/2020 11:40	2,12	1	2,12	CHI
202011893	ARUANA	AK12210602	MOZARLANDIA	01/11/2020 09:34	01/11/2020 13:50	01/11/2020 09:34	01/11/2020 13:50	4,27	1	4,27	CHI
202011898	CRISTALINA	KR21184842	CRISTALINA S2	01/11/2020 09:35	01/11/2020 14:38	01/11/2020 09:35	01/11/2020 14:38	5,05	1	5,05	CHI
202011901	ANAPOLIS	AN21084702	ANAPOLIS UNIVERSITARIO S2	01/11/2020 09:35	01/11/2020 15:35	01/11/2020 09:35	01/11/2020 15:35	5,99	1	5,99	CHI
202011912	FORMOSA	FA11254216	ITUIQUIRA	01/11/2020 09:36	01/11/2020 17:00	01/11/2020 09:36	01/11/2020 17:00	7,41	1	7,41	CHI
202011913	PALMEIRAS DE GOIAS	PL12000165	PALMEIRAS	01/11/2020 09:36	01/11/2020 13:49	01/11/2020 09:36	01/11/2020 13:49	4,22	322	1357,77	CHI
202011915	BONFINOPOLIS	LB12258060	DAIA S2	01/11/2020 09:37	01/11/2020 11:49	01/11/2020 09:37	01/11/2020 11:49	2,20	12	26,36	CHI
2020111031	GOIANESIA	GE12000280	GOIANESIA S2	01/11/2020 09:37	01/11/2020 11:24	01/11/2020 09:37	01/11/2020 11:24	1,79	9	16,07	CHI
2020111031	SANTA ISABEL	GE12000280	GOIANESIA S2	01/11/2020 09:37	01/11/2020 11:24	01/11/2020 09:37	01/11/2020 11:24	1,79	1	1,79	CHI
202011960	NIQUELANDIA	NQ11378060	NIQUELANDIA SUBTRANSMISSAO	01/11/2020 09:41	01/11/2020 15:12	01/11/2020 09:41	01/11/2020 15:12	5,52	1	5,52	CHI
202011966	APARECIDA DE GOIANIA	16330961	ATLANTICO S1	01/11/2020 09:42	01/11/2020 12:34	01/11/2020 09:42	01/11/2020 12:34	2,87	1	2,87	CHI
202011967	APARECIDA DE GOIANIA	200205456	INDEPENDENCIA S1	01/11/2020 09:42	01/11/2020 12:12	01/11/2020 09:42	01/11/2020 12:12	2,50	1	2,50	CHI
202011971	HIDROLANDIA	HD21161527	GUAPO S2	01/11/2020 09:43	01/11/2020 12:49	01/11/2020 09:43	01/11/2020 12:49	3,09	1	3,09	CHI
202011973	ANAPOLIS	AN11361004	ANAPOLIS UNIVERSITARIO S2	01/11/2020 09:44	01/11/2020 17:00	01/11/2020 09:44	01/11/2020 17:00	7,26	4	29,06	CHI
202011985	GOIANIA	GN12001191	ATLANTICO S1	01/11/2020 09:44	01/11/2020 10:45	01/11/2020 09:44	01/11/2020 10:45	1,01	318	321,53	CHI
202011979	ESTRELA DO NORTE	ET21022152	MARA ROSA	01/11/2020 09:46	01/11/2020 13:52	01/11/2020 09:46	01/11/2020 13:52	4,10	1	4,10	CHI
202011980	APARECIDA DE GOIANIA	13771656	INDEPENDENCIA S1	01/11/2020 09:46	01/11/2020 12:13	01/11/2020 09:46	01/11/2020 12:13	2,45	1	2,45	CHI

202011983	CIDADE OCIDENTAL	DH11149720	MARAJOARA	01/11/2020 09:48	01/11/2020 14:36	01/11/2020 09:48	01/11/2020 14:36	4,80	92	441,50	CHI
202011987	ITABERAI	IB12105495	ITABERAI S2	01/11/2020 09:48	02/11/2020 11:58	01/11/2020 09:48	02/11/2020 11:58	26,17	4	104,67	CHI
202011988	SAO JOAO D ALIANCA	JL21184907	SAO JOAO D ALIANCA	01/11/2020 09:48	01/11/2020 20:16	01/11/2020 09:48	01/11/2020 20:16	10,46	1	10,46	CHI
202011991	SAO DOMINGOS	SD21343973	SAO DOMINGOS	01/11/2020 09:48	01/11/2020 15:28	01/11/2020 09:48	01/11/2020 15:28	5,65	1	5,65	CHI
2020111230	CATALAO	CT21216930	CATALAO S1	01/11/2020 09:49	01/11/2020 18:22	01/11/2020 09:49	01/11/2020 18:22	8,55	1	8,55	CHI
2020111000	ALEXANIA	AX31061875	ALEXANIA	01/11/2020 09:50	01/11/2020 15:36	01/11/2020 09:50	01/11/2020 15:36	5,75	1	5,75	CHI
2020111002	APARECIDA DE GOIANIA	10013424511	REAL S1	01/11/2020 09:51	01/11/2020 12:11	01/11/2020 09:51	01/11/2020 12:11	2,32	1	2,32	CHI
2020111003	APARECIDA DE GOIANIA	10039983	REAL S2	01/11/2020 09:52	01/11/2020 11:38	01/11/2020 09:52	01/11/2020 11:38	1,78	1	1,78	CHI
2020111011	POSSE	1480084302	IACIARA S2	01/11/2020 09:54	01/11/2020 14:02	01/11/2020 09:54	01/11/2020 14:02	4,12	1	4,12	CHI
2020111117	CAMPINACU	UC21242005	PORANGATU	01/11/2020 09:56	02/11/2020 03:11	01/11/2020 09:56	02/11/2020 03:11	17,25	1	17,25	CHI
2020111024	TRINDADE	XX08382736	INHUMAS S1	01/11/2020 10:00	01/11/2020 12:00	01/11/2020 10:00	01/11/2020 12:00	1,99	1	1,99	CHI
2020111027	CEZARINA	CZ12074810	CEZARINA	01/11/2020 10:00	01/11/2020 14:30	01/11/2020 10:00	01/11/2020 14:30	4,50	977	4399,49	CHI
2020111029	SAO LUIZ DO NORTE	3090003051	ITAPACI	01/11/2020 10:01	01/11/2020 17:00	01/11/2020 10:01	01/11/2020 17:00	6,98	1	6,98	CHI
2020111287	NIQUELANDIA	NQ12213117	NIQUELANDIA SUBTRANSMISSAO	01/11/2020 10:01	01/11/2020 21:10	01/11/2020 10:01	01/11/2020 21:10	11,15	2	22,30	CHI
2020111035	FORMOSA	FA21120041	ITUIQUIRA	01/11/2020 10:02	01/11/2020 17:29	01/11/2020 10:02	01/11/2020 17:29	7,44	1	7,44	CHI
2020111036	GOIANIA	15140386	MEIA PONTE	01/11/2020 10:02	01/11/2020 12:38	01/11/2020 10:02	01/11/2020 12:38	2,59	1	2,59	CHI
2020111043	NAZARIO	NZ21003848	ANICUNS	01/11/2020 10:04	01/11/2020 13:26	01/11/2020 10:04	01/11/2020 13:26	3,36	2	6,73	CHI
2020111044	SAO FRANCISCO DE GOIAS	PV21084690	SAO FRANCISCO DE GOIAS	01/11/2020 10:04	01/11/2020 13:49	01/11/2020 10:04	01/11/2020 13:49	3,74	1	3,74	CHI
2020111045	ITAPURANGA	IK21220992	ITAPURANGA	01/11/2020 10:04	01/11/2020 17:19	01/11/2020 10:04	01/11/2020 17:19	7,24	1	7,24	CHI
2020111047	DOVERLANDIA	DV21342643	CAIAPONIA	01/11/2020 10:05	01/11/2020 13:20	01/11/2020 10:05	01/11/2020 13:20	3,25	2	6,49	CHI
2020111060	NOVO GAMA	4990003239	PACAEMBU S1	01/11/2020 10:08	01/11/2020 11:37	01/11/2020 10:08	01/11/2020 11:37	1,48	1	1,48	CHI
2020111064	LUZIANIA	LZ21245496	MARAJOARA	01/11/2020 10:10	01/11/2020 13:38	01/11/2020 10:10	01/11/2020 13:38	3,47	1	3,47	CHI
2020111067	BELA VISTA DE GOIAS	BV31172781	BELA VISTA S1	01/11/2020 10:10	01/11/2020 14:15	01/11/2020 10:10	01/11/2020 14:15	4,07	1	4,07	CHI
2020111069	GOIANIA	17399774	XAVANTES	01/11/2020 10:11	01/11/2020 12:41	01/11/2020 10:11	01/11/2020 12:41	2,49	1	2,49	CHI
2020111073	VALPARAISO DE GOIAS	2860060243	MARAJOARA	01/11/2020 10:12	01/11/2020 11:43	01/11/2020 10:12	01/11/2020 11:43	1,51	1	1,51	CHI
2020111076	ARAGOIANIA	HD12000186	CEPAIGO S2	01/11/2020 10:12	01/11/2020 12:14	01/11/2020 10:12	01/11/2020 12:14	2,02	16	32,32	CHI
2020111076	HIDROLANDIA	HD12000186	CEPAIGO S2	01/11/2020 10:12	01/11/2020 12:14	01/11/2020 10:12	01/11/2020 12:14	2,02	11	22,22	CHI
2020111077	AVELINOPOLIS	AC12323619	ANICUNS	01/11/2020 10:13	01/11/2020 14:16	01/11/2020 10:13	01/11/2020 14:16	4,04	1	4,04	CHI
2020111077	ITABERAI	AC12323619	ANICUNS	01/11/2020 10:13	01/11/2020 14:16	01/11/2020 10:13	01/11/2020 14:16	4,04	3	12,13	CHI
202011650	GOIANIA	GN11001292	GOIANIA LESTE S1	01/11/2020 10:15	01/11/2020 11:56	01/11/2020 10:15	01/11/2020 11:56	1,68	171	287,85	CHI
2020113277	PORANGATU	PO12189561	PORANGATU	01/11/2020 10:15	02/11/2020 15:10	01/11/2020 10:15	02/11/2020 15:10	28,91	7	202,35	CHI
2020111090	MARA ROSA	ET21256426	MARA ROSA	01/11/2020 10:16	01/11/2020 17:32	01/11/2020 10:16	01/11/2020 17:32	7,27	1	7,27	CHI
2020111098	LUZIANIA	LZ12092820	RIO VERMELHO	01/11/2020 10:16	01/11/2020 11:29	01/11/2020 10:16	01/11/2020 11:29	1,21	3	3,63	CHI
2020111103	GOIANIA	10673714	AEROPORTO S1	01/11/2020 10:18	01/11/2020 11:14	01/11/2020 10:18	01/11/2020 11:14	0,93	1	0,93	CHI
2020111104	SANTA CRUZ DE GOIAS	BC21280074	CRISTIANOPOLIS	01/11/2020 10:19	01/11/2020 11:55	01/11/2020 10:19	01/11/2020 11:55	1,61	1	1,61	CHI
2020111106	MORRINHOS	MR12098617	MORRINHOS	01/11/2020 10:19	02/11/2020 11:26	01/11/2020 10:19	02/11/2020 11:26	25,12	4	100,50	CHI
2020111106	MORRINHOS	MR12098617	MORRINHOS	01/11/2020 10:19	02/11/2020 11:26	02/11/2020 08:07	02/11/2020 11:26	3,32	1	3,32	CHI
2020111107	FORMOSA	610210002	ITUIQUIRA	01/11/2020 10:19	01/11/2020 12:08	01/11/2020 10:19	01/11/2020 12:08	1,83	1	1,83	CHI
2020111109	DIVINOPOLIS DE GOIAS	GH11344133	SAO DOMINGOS	01/11/2020 10:19	01/11/2020 14:38	01/11/2020 10:19	01/11/2020 14:38	4,31	70	301,37	CHI
2020111395	OUVIDOR	OU12063778	CATALAO S1	01/11/2020 10:21	01/11/2020 13:35	01/11/2020 10:21	01/11/2020 13:35	3,22	7	22,54	CHI
2020110100039	AVELINOPOLIS	35101	ANICUNS	01/11/2020 10:21	01/11/2020 10:24	01/11/2020 10:21	01/11/2020 10:24	0,05	1	0,05	CHI
2020110100039	NAZARIO	35101	ANICUNS	01/11/2020 10:21	01/11/2020 10:24	01/11/2020 10:21	01/11/2020 10:24	0,05	100	5,00	CHI
2020110100039	PALMEIRAS DE GOIAS	35101	ANICUNS	01/11/2020 10:21	01/11/2020 10:24	01/11/2020 10:21	01/11/2020 10:24	0,05	18	0,90	CHI
2020110100039	SANTA BARBARA DE GOIAS	35101	ANICUNS	01/11/2020 10:21	01/11/2020 10:24	01/11/2020 10:21	01/11/2020 10:24	0,05	21	1,05	CHI
2020110100039	AVELINOPOLIS	35101	TRINDADE	01/11/2020 10:21	01/11/2020 10:24	01/11/2020 10:21	01/11/2020 10:24	0,05	10	0,50	CHI
2020110100039	NAZARIO	35101	TRINDADE	01/11/2020 10:21	01/11/2020 10:24	01/11/2020 10:21	01/11/2020 10:24	0,05	11	0,55	CHI
2020110100039	SANTA BARBARA DE GOIAS	35101	TRINDADE	01/11/2020 10:21	01/11/2020 10:24	01/11/2020 10:21	01/11/2020 10:24	0,05	1185	59,25	CHI
2020110100039	SANTA BARBARA DE GOIAS	35102	TRINDADE	01/11/2020 10:21	01/11/2020 10:24	01/11/2020 10:21	01/11/2020 10:24	0,05	1363	68,15	CHI
2020110100039	SANTA BARBARA DE GOIAS	1760414	TRINDADE	01/11/2020 10:21	01/11/2020 10:24	01/11/2020 10:21	01/11/2020 10:24	0,05	14	0,70	CHI
2020110100039	TRINDADE	35101	TRINDADE	01/11/2020 10:21	01/11/2020 10:24	01/11/2020 10:21	01/11/2020 10:24	0,05	3	0,15	CHI
2020110100039	TRINDADE	1760414	TRINDADE	01/11/2020 10:21	01/11/2020 10:24	01/11/2020 10:21	01/11/2020 10:24	0,05	13	0,65	CHI

2020111123	GOIANIA	11256072	GOIANIA LESTE S1	01/11/2020 10:22	01/11/2020 12:03	01/11/2020 10:22	01/11/2020 12:03	1,67	1	1,67	CHI
2020111125	CATALAO	CT12130967	CATALAO S1	01/11/2020 10:23	01/11/2020 11:47	01/11/2020 10:23	01/11/2020 11:47	1,40	1	1,40	CHI
2020111320	SANTA CRUZ DE GOIAS	BC12023183	CRISTIANOPOLIS	01/11/2020 10:23	01/11/2020 14:37	01/11/2020 10:23	01/11/2020 14:37	4,23	42	177,74	CHI
2020111134	IPAMERI	IP21385741	CRISTALINA S2	01/11/2020 10:25	01/11/2020 14:45	01/11/2020 10:25	01/11/2020 14:45	4,33	1	4,33	CHI
2020111136	INHUMAS	IN21000093	INHUMAS S2	01/11/2020 10:25	01/11/2020 13:30	01/11/2020 10:25	01/11/2020 13:30	3,07	1	3,07	CHI
2020111145	APARECIDA DE GOIANIA	14447083	INDEPENDENCIA S2	01/11/2020 10:27	01/11/2020 11:15	01/11/2020 10:27	01/11/2020 11:15	0,81	1	0,81	CHI
2020111146	GOIANIA	10293966	CAMPINAS S2	01/11/2020 10:27	01/11/2020 14:21	01/11/2020 10:27	01/11/2020 14:21	3,90	1	3,90	CHI
2020111157	DOVERLANDIA	DV11259467	CAIAPONIA	01/11/2020 10:29	01/11/2020 11:39	01/11/2020 10:29	01/11/2020 11:39	1,17	1	1,17	CHI
2020111160	CRISTALINA	KR21132662	CRISTALINA S1	01/11/2020 10:30	01/11/2020 14:52	01/11/2020 10:30	01/11/2020 14:52	4,35	1	4,35	CHI
2020111166	SAO LUIZ DE MONTES BELOS	500078531	SAO LUIZ DOS MONTES BELOS	01/11/2020 10:31	01/11/2020 13:15	01/11/2020 10:31	01/11/2020 13:15	2,73	1	2,73	CHI
2020111171	BELA VISTA DE GOIAS	BV21170317	BELA VISTA S2	01/11/2020 10:32	01/11/2020 13:48	01/11/2020 10:32	01/11/2020 13:48	3,26	1	3,26	CHI
2020111186	PADRE BERNARDO	PB10400401	PADRE BERNARDO	01/11/2020 10:33	01/11/2020 18:21	01/11/2020 10:33	01/11/2020 12:43	2,15	104	223,92	CHI
2020111186	COCALZINHO DE GOIAS	PB10400401	PADRE BERNARDO	01/11/2020 10:33	01/11/2020 18:21	01/11/2020 10:33	01/11/2020 13:18	2,74	92	251,70	CHI
2020111186	DISTRITO FEDERAL	PB10400401	PADRE BERNARDO	01/11/2020 10:33	01/11/2020 18:21	01/11/2020 10:33	01/11/2020 13:18	2,74	4	10,94	CHI
2020111186	ITARUMA	PB10400401	PADRE BERNARDO	01/11/2020 10:33	01/11/2020 18:21	01/11/2020 10:33	01/11/2020 13:18	2,74	1	2,74	CHI
2020111186	PADRE BERNARDO	PB10400401	PADRE BERNARDO	01/11/2020 10:33	01/11/2020 18:21	01/11/2020 10:33	01/11/2020 13:18	2,74	3712	10155,41	CHI
2020111186	PADRE BERNARDO	PB10400401	PADRE BERNARDO	01/11/2020 10:33	01/11/2020 18:21	01/11/2020 10:33	01/11/2020 13:18	2,74	1052	2878,10	CHI
2020111186	PADRE BERNARDO	PB10400401	PADRE BERNARDO	01/11/2020 10:33	01/11/2020 18:21	01/11/2020 13:19	01/11/2020 13:35	0,27	104	27,94	CHI
2020111186	PADRE BERNARDO	PB13330722	PADRE BERNARDO	01/11/2020 10:33	01/11/2020 18:21	01/11/2020 13:19	01/11/2020 13:58	0,65	99	64,32	CHI
2020111186	DISTRITO FEDERAL	PB10400401	PADRE BERNARDO	01/11/2020 10:33	01/11/2020 18:21	01/11/2020 10:33	01/11/2020 14:49	4,25	6	25,51	CHI
2020111186	ITARUMA	PB10400401	PADRE BERNARDO	01/11/2020 10:33	01/11/2020 18:21	01/11/2020 10:33	01/11/2020 14:49	4,25	1	4,25	CHI
2020111186	PADRE BERNARDO	PB10400401	PADRE BERNARDO	01/11/2020 10:33	01/11/2020 18:21	01/11/2020 10:33	01/11/2020 14:49	4,25	67	284,92	CHI
2020111186	PLANALTINA	PB10400401	PADRE BERNARDO	01/11/2020 10:33	01/11/2020 18:21	01/11/2020 10:33	01/11/2020 14:49	4,25	14	59,53	CHI
2020111186	COCALZINHO DE GOIAS	RT00900418	PADRE BERNARDO	01/11/2020 10:33	01/11/2020 18:21	01/11/2020 13:19	01/11/2020 14:49	1,49	92	137,05	CHI
2020111186	DISTRITO FEDERAL	RT00900418	PADRE BERNARDO	01/11/2020 10:33	01/11/2020 18:21	01/11/2020 13:19	01/11/2020 14:49	1,49	4	5,96	CHI
2020111186	ITARUMA	RT00900418	PADRE BERNARDO	01/11/2020 10:33	01/11/2020 18:21	01/11/2020 13:19	01/11/2020 14:49	1,49	1	1,49	CHI
2020111186	PADRE BERNARDO	PB10400401	PADRE BERNARDO	01/11/2020 10:33	01/11/2020 18:21	01/11/2020 13:19	01/11/2020 14:49	1,49	3712	5529,85	CHI
2020111186	PADRE BERNARDO	RT00900418	PADRE BERNARDO	01/11/2020 10:33	01/11/2020 18:21	01/11/2020 13:19	01/11/2020 14:49	1,49	954	1421,19	CHI
2020111186	COCALZINHO DE GOIAS	PB10400401	PADRE BERNARDO	01/11/2020 10:33	01/11/2020 18:21	01/11/2020 14:50	01/11/2020 18:21	3,52	92	323,99	CHI
2020111186	DISTRITO FEDERAL	PB10400401	PADRE BERNARDO	01/11/2020 10:33	01/11/2020 18:21	01/11/2020 14:50	01/11/2020 18:21	3,52	10	35,22	CHI
2020111186	ITARUMA	PB10400401	PADRE BERNARDO	01/11/2020 10:33	01/11/2020 18:21	01/11/2020 14:50	01/11/2020 18:21	3,52	2	7,04	CHI
2020111186	PADRE BERNARDO	PB10400401	PADRE BERNARDO	01/11/2020 10:33	01/11/2020 18:21	01/11/2020 14:50	01/11/2020 18:21	3,52	3711	13068,91	CHI
2020111186	PADRE BERNARDO	PB10400401	PADRE BERNARDO	01/11/2020 10:33	01/11/2020 18:21	01/11/2020 14:50	01/11/2020 18:21	3,52	1021	3595,62	CHI
2020111186	PLANALTINA	PB10400401	PADRE BERNARDO	01/11/2020 10:33	01/11/2020 18:21	01/11/2020 14:50	01/11/2020 18:21	3,52	14	49,30	CHI
2020111186	PADRE BERNARDO	PB10400401	PADRE BERNARDO	01/11/2020 10:33	01/11/2020 18:21	01/11/2020 18:15	01/11/2020 18:21	0,09	203	19,23	CHI
2020111177	BELA VISTA DE GOIAS	BV21093633	CEPAIGO S2	01/11/2020 10:34	01/11/2020 18:15	01/11/2020 10:34	01/11/2020 18:15	7,68	2	15,35	CHI
2020111178	GOIANIA	12404068	CAMPINAS S2	01/11/2020 10:34	01/11/2020 12:54	01/11/2020 10:34	01/11/2020 12:54	2,33	1	2,33	CHI
2020111179	CORREGO DO OURO	CO21054633	FIRMINOPOLIS S2	01/11/2020 10:34	01/11/2020 12:56	01/11/2020 10:34	01/11/2020 12:56	2,35	1	2,35	CHI
2020111184	NOVA CRIXAS	NA12229641	NOVA CRIXAS	01/11/2020 10:35	02/11/2020 13:11	01/11/2020 10:35	02/11/2020 13:11	26,60	13	345,77	CHI
2020111196	GOIANIA	13595696	REAL S2	01/11/2020 10:39	01/11/2020 11:39	01/11/2020 10:39	01/11/2020 11:39	1,00	1	1,00	CHI
2020111197	PIRENOPOLIS	PV21227845	CORUMBA	01/11/2020 10:39	01/11/2020 16:31	01/11/2020 10:39	01/11/2020 16:31	5,86	1	5,86	CHI
2020111222	GOIANESIA	GE12006474	BARRO ALTO	01/11/2020 10:41	01/11/2020 13:30	01/11/2020 10:41	01/11/2020 13:30	2,81	2	5,62	CHI
2020111222	SANTA RITA DO NOVO DESTINO	GE12006474	BARRO ALTO	01/11/2020 10:41	01/11/2020 13:30	01/11/2020 10:41	01/11/2020 13:30	2,81	6	16,87	CHI
2020111222	SAO LUIZ DO NORTE	GE12006474	BARRO ALTO	01/11/2020 10:41	01/11/2020 13:30	01/11/2020 10:41	01/11/2020 13:30	2,81	1	2,81	CHI
2020111207	CATALAO	CT12389886	CATALAO S1	01/11/2020 10:43	01/11/2020 17:01	01/11/2020 10:43	01/11/2020 17:01	6,30	3	18,89	CHI
2020115019	PORANGATU	PO12170950	PORANGATU	01/11/2020 10:43	02/11/2020 15:42	01/11/2020 10:43	02/11/2020 15:42	28,98	2	57,96	CHI
2020111210	LUZIANIA	LZ21153655	MARAJOARA	01/11/2020 10:44	01/11/2020 13:56	01/11/2020 10:44	01/11/2020 13:56	3,19	1	3,19	CHI
2020111218	ANAPOLIS	AN21248865	ANAPOLIS UNIVERSITARIO S1	01/11/2020 10:45	01/11/2020 14:02	01/11/2020 10:45	01/11/2020 14:02	3,28	3	9,83	CHI
2020111219	SENADOR CANEDO	15816199	GOIANIA LESTE S1	01/11/2020 10:46	01/11/2020 11:48	01/11/2020 10:46	01/11/2020 11:48	1,04	1	1,04	CHI
2020111223	LUZIANIA	LZ12290803	RIO VERMELHO	01/11/2020 10:47	01/11/2020 13:43	01/11/2020 10:47	01/11/2020 13:43	2,93	2	5,86	CHI
2020111700	COCALZINHO DE GOIAS	ZN12327450	GOIANESIA S1	01/11/2020 10:48	01/11/2020 14:50	01/11/2020 10:48	01/11/2020 14:50	4,03	5	20,17	CHI

2020111085	CALDAS NOVAS	CN12246589	SERRA DE CALDAS	01/11/2020 10:50	01/11/2020 13:04	01/11/2020 10:50	01/11/2020 13:04	2,22	58	129,00	CHI
2020111238	NOVA ROMA	ND21117610	IACIARA S2	01/11/2020 10:52	01/11/2020 14:00	01/11/2020 10:52	01/11/2020 14:00	3,12	1	3,12	CHI
2020111246	CAMPINACU	UC12197169	PORANGATU	01/11/2020 10:55	02/11/2020 10:51	01/11/2020 10:55	02/11/2020 10:51	23,92	2	47,85	CHI
2020111249	APARECIDA DE GOIANIA	200071695	INDEPENDENCIA S1	01/11/2020 10:56	01/11/2020 13:43	01/11/2020 10:56	01/11/2020 13:43	2,78	1	2,78	CHI
2020111260	CALDAS NOVAS	CN11200052	SERRA DE CALDAS	01/11/2020 10:59	01/11/2020 18:10	01/11/2020 15:20	01/11/2020 18:10	2,83	17	48,15	CHI
2020111266	GAMELEIRA DE GOIAS	GL21353131	DAIA S2	01/11/2020 11:00	01/11/2020 14:16	01/11/2020 11:00	01/11/2020 14:16	3,25	1	3,25	CHI
2020111270	JARAGUA	JA21328490	JARAGUA	01/11/2020 11:01	01/11/2020 16:05	01/11/2020 11:01	01/11/2020 16:05	5,06	1	5,06	CHI
2020111303	MUNDO NOVO DE GOIAS	MH12242017	NOVA CRIXAS	01/11/2020 11:01	02/11/2020 11:46	01/11/2020 11:01	02/11/2020 11:46	24,75	4	99,00	CHI
2020111282	CRISTALINA	KR11315549	CRISTALINA S1	01/11/2020 11:02	01/11/2020 21:08	01/11/2020 11:02	01/11/2020 21:08	10,09	5	50,47	CHI
2020111294	AGUA LIMPA	AL21292961	VILA CORUMBA	01/11/2020 11:04	01/11/2020 16:33	01/11/2020 11:04	01/11/2020 16:33	5,47	1	5,47	CHI
2020111296	APARECIDA DE GOIANIA	10015513970	REAL S1	01/11/2020 11:05	01/11/2020 14:19	01/11/2020 11:05	01/11/2020 14:19	3,24	1	3,24	CHI
2020111298	VICENTINOPOLIS	VI21218169	VICENTINOPOLIS	01/11/2020 11:05	01/11/2020 13:41	01/11/2020 11:05	01/11/2020 13:41	2,59	1	2,59	CHI
2020111302	PIRACANJUBA	PJ21089900	BELA VISTA S1	01/11/2020 11:05	01/11/2020 16:36	01/11/2020 11:05	01/11/2020 16:36	5,50	1	5,50	CHI
2020111735	ALVORADA DO NORTE	AQ12265971	IACIARA S2	01/11/2020 11:05	01/11/2020 23:25	01/11/2020 11:05	01/11/2020 23:25	12,32	3	36,97	CHI
2020111307	APARECIDA DE GOIANIA	12364630	INDEPENDENCIA S2	01/11/2020 11:07	01/11/2020 13:18	01/11/2020 11:07	01/11/2020 13:18	2,18	1	2,18	CHI
2020111315	ANAPOLIS	10018167673	JUNDIAI S1	01/11/2020 11:11	01/11/2020 15:49	01/11/2020 11:11	01/11/2020 15:49	4,63	1	4,63	CHI
2020111319	BELA VISTA DE GOIAS	240046894	BELA VISTA S1	01/11/2020 11:12	01/11/2020 15:22	01/11/2020 11:12	01/11/2020 15:22	4,16	1	4,16	CHI
2020111321	ALVORADA DO NORTE	AQ12161651LD	IACIARA S2	01/11/2020 11:13	01/11/2020 22:41	01/11/2020 11:13	01/11/2020 22:41	11,45	12	137,43	CHI
2020111321	SIMOLANDIA	AQ12161651LD	IACIARA S2	01/11/2020 11:13	01/11/2020 22:41	01/11/2020 11:13	01/11/2020 22:41	11,45	1	11,45	CHI
2020111334	GOIANIA	10585552	ATLANTICO S3	01/11/2020 11:17	01/11/2020 12:50	01/11/2020 11:17	01/11/2020 12:50	1,54	1	1,54	CHI
2020115020	PORANGATU	PO21136958	PORANGATU	01/11/2020 11:19	02/11/2020 17:30	01/11/2020 11:19	02/11/2020 17:30	30,18	1	30,18	CHI
2020111346	MORRINHOS	MR31060107	MORRINHOS	01/11/2020 11:20	01/11/2020 15:30	01/11/2020 11:20	01/11/2020 15:30	4,17	1	4,17	CHI
2020111356	SANCLERLANDIA	SC12383552	FIRMINOPOLIS S2	01/11/2020 11:22	01/11/2020 14:58	01/11/2020 11:22	01/11/2020 14:58	3,59	11	39,54	CHI
2020111360	GOIANIA	GN11170730	AEROPORTO S2	01/11/2020 11:22	01/11/2020 16:29	01/11/2020 11:22	01/11/2020 16:29	5,10	5	25,52	CHI
2020111361	SAO JOAO D ALIANCA	JL12268111	FLORES DE GOIAS	01/11/2020 11:24	01/11/2020 14:45	01/11/2020 11:24	01/11/2020 14:45	3,34	9	30,04	CHI
2020111636	HIDROLANDIA	HD21285820	PONTALINA	01/11/2020 11:25	01/11/2020 16:19	01/11/2020 11:25	01/11/2020 16:19	4,90	1	4,90	CHI
2020111367	SILVANIA	SV21122398	VIANOPOLIS	01/11/2020 11:27	01/11/2020 16:17	01/11/2020 11:27	01/11/2020 16:17	4,83	1	4,83	CHI
2020111371	AGUAS LINDAS DE GOIAS	LA12093935	AGUAS LINDAS DE GOIAS S1	01/11/2020 11:27	01/11/2020 12:55	01/11/2020 11:27	01/11/2020 12:55	1,45	17	24,70	CHI
2020111379	GOIANIA	13527782	ATLANTICO S3	01/11/2020 11:30	01/11/2020 15:28	01/11/2020 11:30	01/11/2020 15:28	3,96	1	3,96	CHI
2020111386	SANTA TEREZA DE GOIAS	2430004477	MARA ROSA	01/11/2020 11:33	02/11/2020 01:47	01/11/2020 11:33	02/11/2020 01:47	14,23	1	14,23	CHI
2020111394	BURITINOPOLIS	BQ11190593	IACIARA S2	01/11/2020 11:35	01/11/2020 14:07	01/11/2020 11:35	01/11/2020 14:07	2,52	7	17,64	CHI
2020111440	ITABERAI	TQ12000106	ITABERAI S1	01/11/2020 11:37	01/11/2020 16:38	01/11/2020 11:37	01/11/2020 16:38	5,02	3	15,05	CHI
2020111440	ITAGUARI	TQ12000106	ITABERAI S1	01/11/2020 11:37	01/11/2020 16:38	01/11/2020 11:37	01/11/2020 16:38	5,02	1	5,02	CHI
2020111440	TAQUARAL DE GOIAS	TQ12000106	ITABERAI S1	01/11/2020 11:37	01/11/2020 16:38	01/11/2020 11:37	01/11/2020 16:38	5,02	15	75,24	CHI
2020112170	ITAGUARI	II2250783	ITABERAI S1	01/11/2020 11:38	02/11/2020 07:17	01/11/2020 11:38	02/11/2020 07:17	19,64	11	216,08	CHI
2020112170	JARAGUA	II2250783	ITABERAI S1	01/11/2020 11:38	02/11/2020 07:17	01/11/2020 11:38	02/11/2020 07:17	19,64	9	176,79	CHI
2020111411	VALPARAISO DE GOIAS	10012632501	MARAJOARA	01/11/2020 11:39	01/11/2020 13:15	01/11/2020 11:39	01/11/2020 13:15	1,60	1	1,60	CHI
2020111412	MINACU	IH21383491	MINACU	01/11/2020 11:39	01/11/2020 16:10	01/11/2020 11:39	01/11/2020 16:10	4,50	1	4,50	CHI
2020111497	FLORES DE GOIAS	FB11092768	FLORES DE GOIAS	01/11/2020 11:40	01/11/2020 14:25	01/11/2020 11:40	01/11/2020 14:25	2,73	226	617,92	CHI
2020111432	ARUANA	10021562286	ARUANA	01/11/2020 11:45	01/11/2020 16:55	01/11/2020 11:45	01/11/2020 16:55	5,15	1	5,15	CHI
2020111437	SAO FRANCISCO DE GOIAS	PV21236038	SAO FRANCISCO DE GOIAS	01/11/2020 11:46	01/11/2020 16:51	01/11/2020 11:46	01/11/2020 16:51	5,07	2	10,14	CHI
2020111769	APARECIDA DE GOIANIA	AP11345614	CEPAIGO S1	01/11/2020 11:46	01/11/2020 15:46	01/11/2020 11:46	01/11/2020 15:46	4,00	165	660,27	CHI
2020111445	APARECIDA DE GOIANIA	10021065533	ANHANGUERA	01/11/2020 11:48	01/11/2020 12:25	01/11/2020 11:48	01/11/2020 12:25	0,62	1	0,62	CHI
2020111470	FAZENDA NOVA	NB12117282	JUSSARA	01/11/2020 11:48	01/11/2020 15:29	01/11/2020 11:48	01/11/2020 15:29	3,68	1	3,68	CHI
2020111470	JUSSARA	NB12117282	JUSSARA	01/11/2020 11:48	01/11/2020 15:29	01/11/2020 11:48	01/11/2020 15:29	3,68	1	3,68	CHI
2020111470	NOVO BRASIL	NB12117282	JUSSARA	01/11/2020 11:48	01/11/2020 15:29	01/11/2020 11:48	01/11/2020 15:29	3,68	12	44,11	CHI
2020111448	FAZENDA NOVA	1080023632	BRITANIA	01/11/2020 11:49	01/11/2020 18:29	01/11/2020 11:49	01/11/2020 18:29	6,67	1	6,67	CHI
2020111451	LUZIANIA	10031238333	MARAJOARA	01/11/2020 11:50	01/11/2020 13:05	01/11/2020 11:50	01/11/2020 13:05	1,25	1	1,25	CHI
2020111604	POSSE	PS12257684	IACIARA S2	01/11/2020 11:50	01/11/2020 17:13	01/11/2020 11:50	01/11/2020 17:13	5,37	5	26,86	CHI
2020111466	CACHOEIRA DOURADA	CD21000007	CACHOEIRA DOURADA	01/11/2020 11:55	01/11/2020 15:34	01/11/2020 11:55	01/11/2020 15:34	3,64	1	3,64	CHI
2020111467	PALMEIRAS DE GOIAS	PL31132066	PALMEIRAS	01/11/2020 11:56	01/11/2020 17:08	01/11/2020 11:56	01/11/2020 17:08	5,20	1	5,20	CHI

2020111471	APARECIDA DE GOIANIA	10019278193	ANHANGUERA	01/11/2020 11:58	01/11/2020 13:15	01/11/2020 11:58	01/11/2020 13:15	1,29	1	1,29	CHI
2020111483	GUARAITA	IK21129039	ITAPURANGA	01/11/2020 12:03	01/11/2020 18:40	01/11/2020 12:03	01/11/2020 18:40	6,61	1	6,61	CHI
2020111488	GOIANIA	15824688	XAVANTES	01/11/2020 12:04	01/11/2020 14:29	01/11/2020 12:04	01/11/2020 14:29	2,40	1	2,40	CHI
2020111530	JUSSARA	JR12124817	BRITANIA	01/11/2020 12:04	01/11/2020 16:41	01/11/2020 12:04	01/11/2020 16:41	4,62	11	50,82	CHI
2020111491	CAIAPONIA	CP21020887	CAIAPONIA	01/11/2020 12:05	01/11/2020 13:45	01/11/2020 12:05	01/11/2020 13:45	1,65	1	1,65	CHI
2020111493	JANDAIA	PU12172481	PARAUNA	01/11/2020 12:06	01/11/2020 20:31	01/11/2020 12:06	01/11/2020 20:31	8,41	3	25,23	CHI
2020111493	PARAUNA	PU12172481	PARAUNA	01/11/2020 12:06	01/11/2020 20:31	01/11/2020 12:06	01/11/2020 20:31	8,41	6	50,47	CHI
2020111496	ARAGOIANIA	AO31002705	GUAPO S2	01/11/2020 12:07	01/11/2020 17:48	01/11/2020 12:07	01/11/2020 17:48	5,67	4	22,69	CHI
2020111541	SAO LUIS DE MONTES BELOS	SL12053971	SAO LUIZ DOS MONTES BELOS	01/11/2020 12:08	01/11/2020 14:45	01/11/2020 12:08	01/11/2020 14:45	2,61	11	28,69	CHI
2020111696	ANICUNS	AC12030992	ANICUNS	01/11/2020 12:08	01/11/2020 16:49	01/11/2020 12:08	01/11/2020 16:49	4,68	18	84,17	CHI
2020111511	PIRANHAS	PH11273649	PIRANHAS	01/11/2020 12:11	01/11/2020 15:42	01/11/2020 12:11	01/11/2020 15:42	3,51	1	3,51	CHI
2020111512	CALDAS NOVAS	CN12110097	SERRA DE CALDAS	01/11/2020 12:11	01/11/2020 13:30	01/11/2020 12:11	01/11/2020 13:30	1,30	6	7,83	CHI
2020111517	LUZIANIA	10023191692	RIO VERMELHO	01/11/2020 12:12	01/11/2020 15:17	01/11/2020 12:12	01/11/2020 15:17	3,07	1	3,07	CHI
2020112100	COCALZINHO DE GOIAS	ZN12377777	COCALZINHO	01/11/2020 12:12	01/11/2020 16:55	01/11/2020 12:12	01/11/2020 16:55	4,70	2	9,41	CHI
2020112718	SANTA TEREZINHA DE GOIAS	SG12201778	SANTA TEREZINHA	01/11/2020 12:14	02/11/2020 09:30	01/11/2020 12:14	02/11/2020 09:30	21,25	2	42,51	CHI
2020111529	SITIO D ABADIA	150000064	IACIARA S2	01/11/2020 12:16	01/11/2020 16:44	01/11/2020 12:16	01/11/2020 16:44	4,45	1	4,45	CHI
2020111532	GOIANIA	12585555	INDEPENDENCIA S1	01/11/2020 12:17	01/11/2020 15:09	01/11/2020 12:17	01/11/2020 15:09	2,86	1	2,86	CHI
2020111567	ITAPIRAPUA	JR12087418	JUSSARA	01/11/2020 12:17	01/11/2020 14:57	01/11/2020 12:17	01/11/2020 14:57	2,66	1	2,66	CHI
2020111567	JUSSARA	JR12087418	JUSSARA	01/11/2020 12:17	01/11/2020 14:57	01/11/2020 12:17	01/11/2020 14:57	2,66	11	29,26	CHI
2020111536	POSSE	PS12318288	IACIARA S2	01/11/2020 12:18	01/11/2020 22:26	01/11/2020 12:18	01/11/2020 22:26	10,13	1	10,13	CHI
2020111551	SENADOR CANEDO	16430270	GOIANIA LESTE S1	01/11/2020 12:22	01/11/2020 17:03	01/11/2020 12:22	01/11/2020 17:03	4,68	1	4,68	CHI
2020111552	CRISTALINA	KR12400531	CRISTALINA S1	01/11/2020 12:22	01/11/2020 16:05	01/11/2020 12:22	01/11/2020 16:05	3,71	82	303,88	CHI
2020111555	GOIANIA	16778881	CAMPINAS S2	01/11/2020 12:23	01/11/2020 15:47	01/11/2020 12:23	01/11/2020 15:47	3,38	1	3,38	CHI
2020111556	PETROLINA DE GOIAS	PG21015836	PETROLINA	01/11/2020 12:24	01/11/2020 16:15	01/11/2020 12:24	01/11/2020 16:15	3,85	2	7,70	CHI
2020111628	RUBIATABA	RB12201812	RUBIATABA	01/11/2020 12:31	02/11/2020 00:27	01/11/2020 12:31	02/11/2020 00:27	11,93	14	167,01	CHI
2020111643	ANAPOLIS	AN11000231	JUNDIAI S1	01/11/2020 12:32	01/11/2020 20:08	01/11/2020 12:32	01/11/2020 20:08	7,59	131	993,67	CHI
2020111575	BELA VISTA DE GOIAS	BV11278406	CEPAIGO S2	01/11/2020 12:33	01/11/2020 18:38	01/11/2020 12:33	01/11/2020 18:38	6,08	10	60,81	CHI
2020112526	FLORES DE GOIAS	FB12397796	IACIARA S2	01/11/2020 12:36	01/11/2020 19:10	01/11/2020 12:36	01/11/2020 19:10	6,56	2	13,12	CHI
2020111592	TRINDADE	TR31047831	TRINDADE	01/11/2020 12:37	01/11/2020 16:24	01/11/2020 12:37	01/11/2020 16:24	3,78	1	3,78	CHI
2020111594	GOIANIA	16638025	XAVANTES	01/11/2020 12:38	01/11/2020 15:24	01/11/2020 12:38	01/11/2020 15:24	2,77	1	2,77	CHI
2020111607	IPAMERI	580056788	IPAMERI	01/11/2020 12:40	01/11/2020 16:20	01/11/2020 12:40	01/11/2020 16:20	3,66	1	3,66	CHI
2020111608	ALEXANIA	AX11412476	ALEXANIA	01/11/2020 12:40	01/11/2020 17:18	01/11/2020 12:40	01/11/2020 17:18	4,62	12	55,45	CHI
2020111612	LUZIANIA	10006488070	RIO VERMELHO	01/11/2020 12:41	01/11/2020 15:28	01/11/2020 12:41	01/11/2020 15:28	2,78	1	2,78	CHI
2020111617	NOVO GAMA	NJ11165078	MARAJOARA	01/11/2020 12:41	01/11/2020 17:23	01/11/2020 12:41	01/11/2020 17:23	4,68	18	84,32	CHI
2020111618	GOIANIA	GN21118423	CEPAIGO S1	01/11/2020 12:42	01/11/2020 16:53	01/11/2020 12:42	01/11/2020 16:53	4,18	1	4,18	CHI
2020111629	ALVORADA DO NORTE	AQ11180847	IACIARA S2	01/11/2020 12:46	01/11/2020 18:21	01/11/2020 16:07	01/11/2020 18:21	2,24	35	78,46	CHI
2020111630	SAO DOMINGOS	GY21332262	SAO DOMINGOS	01/11/2020 12:46	01/11/2020 17:14	01/11/2020 12:46	01/11/2020 17:14	4,45	1	4,45	CHI
2020111631	GOIANIA	16507850	REAL S1	01/11/2020 12:47	01/11/2020 15:53	01/11/2020 12:47	01/11/2020 15:53	3,09	1	3,09	CHI
2020111632	AGUAS LINDAS DE GOIAS	10013423078	AGUAS LINDAS DE GOIAS S1	01/11/2020 12:49	01/11/2020 14:42	01/11/2020 12:49	01/11/2020 14:42	1,88	1	1,88	CHI
2020111635	ABADIANIA	AA21132814	DAIA S2	01/11/2020 12:49	01/11/2020 17:11	01/11/2020 12:49	01/11/2020 17:11	4,36	1	4,36	CHI
2020111645	NOVO GAMA	4990003252	PACAEMBU S1	01/11/2020 12:53	01/11/2020 16:38	01/11/2020 12:53	01/11/2020 16:38	3,75	1	3,75	CHI
2020111646	APARECIDA DE GOIANIA	10001743170	INDEPENDENCIA S1	01/11/2020 12:53	01/11/2020 13:39	01/11/2020 12:53	01/11/2020 13:39	0,77	1	0,77	CHI
2020111647	CRISTALINA	KR11376948	CRISTALINA S2	01/11/2020 12:53	01/11/2020 20:30	01/11/2020 12:53	01/11/2020 20:30	7,61	1	7,61	CHI
2020111653	RUBIATABA	RB21242392	RUBIATABA	01/11/2020 12:54	01/11/2020 21:48	01/11/2020 12:54	01/11/2020 21:48	8,89	1	8,89	CHI
2020111676	TRINDADE	TR12005149	TRINDADE	01/11/2020 12:59	01/11/2020 17:27	01/11/2020 12:59	01/11/2020 17:27	4,47	3	13,40	CHI
2020111693	FAINA	FC12160891	GOIAS	01/11/2020 13:03	01/11/2020 18:37	01/11/2020 13:03	01/11/2020 18:37	5,55	12	66,62	CHI
2020111693	ITAPURANGA	FC12160891	GOIAS	01/11/2020 13:03	01/11/2020 18:37	01/11/2020 13:03	01/11/2020 18:37	5,55	2	11,10	CHI
2020111693	MORRO AGUDO DE GOIAS	FC12160891	GOIAS	01/11/2020 13:03	01/11/2020 18:37	01/11/2020 13:03	01/11/2020 18:37	5,55	2	11,10	CHI
2020112463	FAINA	FC21299867	GOIAS	01/11/2020 13:03	01/11/2020 20:27	01/11/2020 13:03	01/11/2020 20:27	7,39	1	7,39	CHI
2020111762	PROFESSOR JAMIL SAFADY	JS12091717	ROCHEDO	01/11/2020 13:04	03/11/2020 17:55	01/11/2020 13:04	01/11/2020 19:02	5,95	1	5,95	CHI
2020111762	PROFESSOR JAMIL SAFADY	JS12091717	ROCHEDO	01/11/2020 13:04	03/11/2020 17:55	01/11/2020 13:04	02/11/2020 05:47	16,72	26	434,62	CHI

2020111762	PROFESSOR JAMIL SAFADY	JS12091717	ROCHEDO	01/11/2020 13:04	03/11/2020 17:55	02/11/2020 21:45	02/11/2020 23:35	1,84	26	47,96	CHI
2020111762	CROMINIA	JS12091717	ROCHEDO	01/11/2020 13:04	03/11/2020 17:55	01/11/2020 13:04	03/11/2020 14:49	49,75	1	49,75	CHI
2020111762	CROMINIA	JS13006387	ROCHEDO	01/11/2020 13:04	03/11/2020 17:55	01/11/2020 19:02	03/11/2020 14:49	43,80	1	43,80	CHI
2020111762	PROFESSOR JAMIL SAFADY	JS21109201	ROCHEDO	01/11/2020 13:04	03/11/2020 17:55	01/11/2020 19:02	03/11/2020 15:45	44,72	1	44,72	CHI
2020111762	CROMINIA	JS12091717	ROCHEDO	01/11/2020 13:04	03/11/2020 17:55	01/11/2020 13:04	03/11/2020 17:55	52,84	1	52,84	CHI
2020111677	ANAPOLIS	10007555944	JUNDIAI S2	01/11/2020 13:05	01/11/2020 17:52	01/11/2020 13:05	01/11/2020 17:52	4,77	1	4,77	CHI
2020111720	FLORES DE GOIAS	FB12277935	IACIARA S2	01/11/2020 13:07	02/11/2020 09:58	01/11/2020 13:07	02/11/2020 09:58	20,83	5	104,17	CHI
2020111720	SITIO D ABADIA	FB12277935	IACIARA S2	01/11/2020 13:07	02/11/2020 09:58	01/11/2020 13:07	02/11/2020 09:58	20,83	3	62,50	CHI
2020111743	AGUA FRIA DE GOIAS	JL12117446	SAO JOAO D ALIANCA	01/11/2020 13:07	01/11/2020 15:48	01/11/2020 13:07	01/11/2020 15:48	2,68	20	53,56	CHI
2020111743	SAO JOAO D ALIANCA	JL12117446	SAO JOAO D ALIANCA	01/11/2020 13:07	01/11/2020 15:48	01/11/2020 13:07	01/11/2020 15:48	2,68	26	69,62	CHI
2020111780	AMERICANO DO BRASIL	KB12065194	ANICUNS	01/11/2020 13:07	01/11/2020 17:53	01/11/2020 13:07	01/11/2020 17:53	4,75	29	137,80	CHI
2020111780	MOSSAMEDES	KB12065194	ANICUNS	01/11/2020 13:07	01/11/2020 17:53	01/11/2020 13:07	01/11/2020 17:53	4,75	14	66,52	CHI
2020111683	ANAPOLIS	AN21258721	ANAPOLIS UNIVERSITARIO S2	01/11/2020 13:08	01/11/2020 18:08	01/11/2020 13:08	01/11/2020 18:08	5,00	2	10,00	CHI
2020111684	SANCLERLANDIA	1210031441	FIRMINOPOLIS S2	01/11/2020 13:08	01/11/2020 16:36	01/11/2020 13:08	01/11/2020 16:36	3,46	1	3,46	CHI
2020111945	FLORES DE GOIAS	FB12106993	FLORES DE GOIAS	01/11/2020 13:08	02/11/2020 00:15	01/11/2020 13:08	01/11/2020 16:24	3,26	14	45,60	CHI
2020111945	FORMOSA	FB12106993	FLORES DE GOIAS	01/11/2020 13:08	02/11/2020 00:15	01/11/2020 13:08	01/11/2020 16:24	3,26	39	127,02	CHI
2020111945	FORMOSO	FB12106993	FLORES DE GOIAS	01/11/2020 13:08	02/11/2020 00:15	01/11/2020 13:08	01/11/2020 16:24	3,26	1	3,26	CHI
2020111945	SAO JOAO D ALIANCA	FB12106993	FLORES DE GOIAS	01/11/2020 13:08	02/11/2020 00:15	01/11/2020 13:08	01/11/2020 16:24	3,26	5	16,28	CHI
2020111945	FORMOSA	FB12106993	FLORES DE GOIAS	01/11/2020 13:08	02/11/2020 00:15	01/11/2020 13:08	01/11/2020 21:47	8,64	98	846,77	CHI
2020111945	FORMOSA	FB12106993	FLORES DE GOIAS	01/11/2020 13:08	02/11/2020 00:15	01/11/2020 13:08	02/11/2020 00:15	11,11	1	11,11	CHI
2020111686	PLANALTINA	2960090828	PLANALTINA	01/11/2020 13:09	01/11/2020 15:06	01/11/2020 13:09	01/11/2020 15:06	1,95	1	1,95	CHI
2020111689	FORMOSA	FA21312208	ITUIQUIRA	01/11/2020 13:09	02/11/2020 08:03	01/11/2020 13:09	02/11/2020 08:03	18,89	1	18,89	CHI
2020111703	GOIANIA	10303054	CAMPINAS S2	01/11/2020 13:14	01/11/2020 15:52	01/11/2020 13:14	01/11/2020 15:52	2,63	1	2,63	CHI
2020111704	CRISTALINA	KR21332494	CRISTALINA S2	01/11/2020 13:14	01/11/2020 22:06	01/11/2020 13:14	01/11/2020 22:06	8,86	1	8,86	CHI
2020111710	ITABERAÍ	50079335	ITABERAÍ S2	01/11/2020 13:17	01/11/2020 17:35	01/11/2020 13:17	01/11/2020 17:35	4,29	1	4,29	CHI
2020111729	SAO FRANCISCO DE GOIAS	SF21017618	SAO FRANCISCO DE GOIAS	01/11/2020 13:20	01/11/2020 16:38	01/11/2020 13:20	01/11/2020 16:38	3,29	1	3,29	CHI
2020111730	GOIAS	GS12310766	GOIAS	01/11/2020 13:22	01/11/2020 18:30	01/11/2020 13:22	01/11/2020 18:30	5,13	17	87,27	CHI
2020111733	GOIANESIA	GE11000040	GOIANESIA S2	01/11/2020 13:24	01/11/2020 16:39	01/11/2020 13:24	01/11/2020 16:39	3,24	37	119,87	CHI
2020111736	SAO DOMINGOS	SD12204700	SAO DOMINGOS	01/11/2020 13:26	01/11/2020 16:43	01/11/2020 13:26	01/11/2020 16:43	3,28	12	39,39	CHI
2020111738	GOIANIA	GR12321567	MEIA PONTE	01/11/2020 13:26	01/11/2020 15:25	01/11/2020 13:26	01/11/2020 15:25	1,97	11	21,72	CHI
2020111738	GOIANIRA	GR12321567	MEIA PONTE	01/11/2020 13:26	01/11/2020 15:25	01/11/2020 13:26	01/11/2020 15:25	1,97	56	110,58	CHI
2020111750	ALEXANIA	10029979070	ALEXANIA	01/11/2020 13:32	01/11/2020 19:41	01/11/2020 13:32	01/11/2020 19:41	6,14	1	6,14	CHI
2020111756	LUZIANIA	LZ12061798	RIO VERMELHO	01/11/2020 13:32	01/11/2020 19:07	01/11/2020 13:32	01/11/2020 19:07	5,59	3	16,76	CHI
2020111756	LUZIANIA	LZ12061798	RIO VERMELHO	01/11/2020 13:32	01/11/2020 19:07	01/11/2020 15:57	01/11/2020 19:07	3,18	1	3,18	CHI
2020111758	SANTA TEREZINHA DE GOIAS	VD21245378	SANTA TEREZINHA	01/11/2020 13:34	01/11/2020 19:37	01/11/2020 13:34	01/11/2020 19:37	6,04	1	6,04	CHI
2020111764	NEROPOLIS	NV21043217	NEROPOLIS S2	01/11/2020 13:36	01/11/2020 16:24	01/11/2020 13:36	01/11/2020 16:24	2,80	1	2,80	CHI
2020111765	MARA ROSA	MQ21359556	MARA ROSA	01/11/2020 13:36	01/11/2020 19:50	01/11/2020 13:36	01/11/2020 19:50	6,23	1	6,23	CHI
2020111766	PALMEIRAS DE GOIAS	10006070580	PALMEIRAS	01/11/2020 13:37	01/11/2020 16:29	01/11/2020 13:37	01/11/2020 16:29	2,86	1	2,86	CHI
2020111771	GOIANIA	11425696	ATLANTICO S2	01/11/2020 13:38	01/11/2020 16:21	01/11/2020 13:38	01/11/2020 16:21	2,71	1	2,71	CHI
2020111779	IACIARA	4670004166	IACIARA S1	01/11/2020 13:40	01/11/2020 18:42	01/11/2020 13:40	01/11/2020 18:42	5,02	1	5,02	CHI
2020111781	FIRMINOPOLIS	FR12323491	FIRMINOPOLIS S2	01/11/2020 13:41	01/11/2020 18:29	01/11/2020 13:41	01/11/2020 18:29	4,79	3	14,37	CHI
2020111783	CALDAS NOVAS	MR12059843	MORRINHOS	01/11/2020 13:42	01/11/2020 18:30	01/11/2020 13:42	01/11/2020 18:30	4,79	7	33,56	CHI
2020111783	MORRINHOS	MR12059843	MORRINHOS	01/11/2020 13:42	01/11/2020 18:30	01/11/2020 13:42	01/11/2020 18:30	4,79	12	57,54	CHI
2020111783	PIRACANJUBA	MR12059843	MORRINHOS	01/11/2020 13:42	01/11/2020 18:30	01/11/2020 13:42	01/11/2020 18:30	4,79	4	19,18	CHI
2020111787	ABADIA DE GOIAS	5580010635	INDEPENDENCIA S2	01/11/2020 13:43	01/11/2020 17:43	01/11/2020 13:43	01/11/2020 17:43	3,99	1	3,99	CHI
2020111791	APARECIDA DE GOIANIA	10018521680	CEPAIGO S1	01/11/2020 13:44	01/11/2020 16:51	01/11/2020 13:44	01/11/2020 16:51	3,11	1	3,11	CHI
2020112106	AGUAS LINDAS DE GOIAS	10008536226	AGUAS LINDAS DE GOIAS S1	01/11/2020 13:45	01/11/2020 16:58	01/11/2020 15:45	01/11/2020 16:58	1,21	1	1,21	CHI
2020111799	APARECIDA DE GOIANIA	10002641869	INDEPENDENCIA S2	01/11/2020 13:47	01/11/2020 15:15	01/11/2020 13:47	01/11/2020 15:15	1,47	1	1,47	CHI
2020111809	MONTIVIDIU DO NORTE	MX11254880	PORANGATU	01/11/2020 13:52	02/11/2020 15:10	01/11/2020 13:52	02/11/2020 15:10	25,29	1	25,29	CHI
2020111868	PORANGATU	TB12262770	PORANGATU	01/11/2020 13:53	02/11/2020 09:02	01/11/2020 13:53	02/11/2020 09:02	19,14	1	19,14	CHI
2020111868	SANTA TEREZA DE GOIAS	TB12262770	PORANGATU	01/11/2020 13:53	02/11/2020 09:02	01/11/2020 13:53	02/11/2020 09:02	19,14	5	95,71	CHI

2020111868	TROMBAS	TB12262770	PORANGATU	01/11/2020 13:53	02/11/2020 09:02	01/11/2020 13:53	02/11/2020 09:02	19,14	13	248,83	CHI
2020111819	PADRE BERNARDO	PB12095000	PADRE BERNARDO	01/11/2020 13:56	01/11/2020 15:04	01/11/2020 13:56	01/11/2020 15:04	1,12	13	14,56	CHI
2020112110	MONTIVIDIU DO NORTE	TB12156640	PORANGATU	01/11/2020 13:59	02/11/2020 00:27	01/11/2020 13:59	02/11/2020 00:27	10,46	1	10,46	CHI
2020112110	TROMBAS	TB12156640	PORANGATU	01/11/2020 13:59	02/11/2020 00:27	01/11/2020 13:59	02/11/2020 00:27	10,46	32	334,83	CHI
2020111830	GOIANIA	10796034	CARAJAS S1	01/11/2020 14:00	01/11/2020 16:28	01/11/2020 14:00	01/11/2020 16:28	2,46	1	2,46	CHI
2020111923	CAMPO ALEGRE DE GOIAS	CM12192738RE	CAMPO ALEGRE DE GOIAS	01/11/2020 14:00	01/11/2020 17:11	01/11/2020 14:00	01/11/2020 17:11	3,17	48	152,25	CHI
2020111832	GOIANIA	10155995	FERROVIARIO S3	01/11/2020 14:01	01/11/2020 16:03	01/11/2020 14:01	01/11/2020 16:03	2,02	1	2,02	CHI
2020111834	CRISTALINA	1060038290	CRISTALINA S1	01/11/2020 14:02	01/11/2020 16:51	01/11/2020 14:02	01/11/2020 16:51	2,82	1	2,82	CHI
2020111835	APARECIDA DE GOIANIA	15228230	ATLANTICO S2	01/11/2020 14:02	01/11/2020 16:13	01/11/2020 14:02	01/11/2020 16:13	2,18	1	2,18	CHI
2020111838	VALPARAISO DE GOIAS	3350107010	PACAEMBU S1	01/11/2020 14:03	01/11/2020 16:29	01/11/2020 14:03	01/11/2020 16:29	2,43	1	2,43	CHI
2020111841	SENADOR CANEDO	14902473	GOIANIA LESTE S2	01/11/2020 14:03	01/11/2020 16:38	01/11/2020 14:03	01/11/2020 16:38	2,58	1	2,58	CHI
2020111845	ITAPURANGA	IK21300214	ITAPURANGA	01/11/2020 14:05	01/11/2020 19:09	01/11/2020 14:05	01/11/2020 19:09	5,05	1	5,05	CHI
2020111876	MARZAGAO	2660214	VILA CORUMBA	01/11/2020 14:16	02/11/2020 07:43	01/11/2020 14:16	01/11/2020 16:11	1,92	136	260,55	CHI
2020111876	MARZAGAO	2660214	VILA CORUMBA	01/11/2020 14:16	02/11/2020 07:43	01/11/2020 16:48	01/11/2020 16:53	0,08	136	11,33	CHI
2020111876	MARZAGAO	2660214	VILA CORUMBA	01/11/2020 14:16	02/11/2020 07:43	01/11/2020 17:01	01/11/2020 17:08	0,13	136	17,79	CHI
2020111876	MARZAGAO	2660214	VILA CORUMBA	01/11/2020 14:16	02/11/2020 07:43	01/11/2020 14:16	01/11/2020 17:33	3,27	874	2861,62	CHI
2020111876	AGUA LIMPA	2660214	VILA CORUMBA	01/11/2020 14:16	02/11/2020 07:43	01/11/2020 14:16	01/11/2020 17:46	3,50	17	59,50	CHI
2020111876	CALDAS NOVAS	2660214	VILA CORUMBA	01/11/2020 14:16	02/11/2020 07:43	01/11/2020 14:16	01/11/2020 17:46	3,50	1	3,50	CHI
2020111876	MARZAGAO	2660214	VILA CORUMBA	01/11/2020 14:16	02/11/2020 07:43	01/11/2020 14:16	01/11/2020 17:46	3,50	104	363,97	CHI
2020111876	RIO QUENTE	2660214	VILA CORUMBA	01/11/2020 14:16	02/11/2020 07:43	01/11/2020 14:16	01/11/2020 17:46	3,50	4	14,00	CHI
2020111876	CALDAS NOVAS	2660214	VILA CORUMBA	01/11/2020 14:16	02/11/2020 07:43	01/11/2020 14:16	01/11/2020 18:04	3,80	2	7,60	CHI
2020111876	MARZAGAO	2660214	VILA CORUMBA	01/11/2020 14:16	02/11/2020 07:43	01/11/2020 14:16	01/11/2020 18:04	3,80	13	49,39	CHI
2020111876	MARZAGAO	2660214	VILA CORUMBA	01/11/2020 14:16	02/11/2020 07:43	01/11/2020 14:16	01/11/2020 18:38	4,37	3	13,10	CHI
2020111876	CALDAS NOVAS	2660214	VILA CORUMBA	01/11/2020 14:16	02/11/2020 07:43	01/11/2020 14:16	02/11/2020 07:43	17,46	17	296,75	CHI
2020111876	CORUMBAIBA	2660214	VILA CORUMBA	01/11/2020 14:16	02/11/2020 07:43	01/11/2020 14:16	02/11/2020 07:43	17,46	40	698,23	CHI
2020111876	MARZAGAO	2660214	VILA CORUMBA	01/11/2020 14:16	02/11/2020 07:43	01/11/2020 14:16	02/11/2020 07:43	17,46	5	87,28	CHI
2020111876	AGUA LIMPA	2660214	VILA CORUMBA	01/11/2020 14:16	02/11/2020 07:43	02/11/2020 06:01	02/11/2020 07:43	1,70	17	28,98	CHI
2020111876	CALDAS NOVAS	2660214	VILA CORUMBA	01/11/2020 14:16	02/11/2020 07:43	02/11/2020 06:01	02/11/2020 07:43	1,70	3	5,11	CHI
2020111876	MARZAGAO	2660214	VILA CORUMBA	01/11/2020 14:16	02/11/2020 07:43	02/11/2020 06:01	02/11/2020 07:43	1,70	1130	1926,02	CHI
2020111876	RIO QUENTE	2660214	VILA CORUMBA	01/11/2020 14:16	02/11/2020 07:43	02/11/2020 06:01	02/11/2020 07:43	1,70	4	6,82	CHI
2020111874	JOVIANIA	JV12394181	GOIATUBA S1	01/11/2020 14:17	01/11/2020 15:14	01/11/2020 14:17	01/11/2020 15:14	0,94	2	1,88	CHI
2020111904	JANDAIA	PP12126013	PALMEIRAS	01/11/2020 14:20	01/11/2020 16:55	01/11/2020 14:20	01/11/2020 16:55	2,58	29	74,73	CHI
2020111904	PALMINOPOLIS	PP12126013	PALMEIRAS	01/11/2020 14:20	01/11/2020 16:55	01/11/2020 14:20	01/11/2020 16:55	2,58	15	38,65	CHI
2020111892	CRISTALINA	10025255400	CRISTALINA S1	01/11/2020 14:26	01/11/2020 20:37	01/11/2020 14:26	01/11/2020 20:37	6,17	1	6,17	CHI
2020111893	PALMEIRAS DE GOIAS	PL12000058	PALMEIRAS	01/11/2020 14:26	01/11/2020 16:49	01/11/2020 14:26	01/11/2020 16:49	2,37	6	14,21	CHI
2020111911	MORRINHOS	MR11000043	MORRINHOS	01/11/2020 14:31	01/11/2020 16:49	01/11/2020 14:31	01/11/2020 16:49	2,30	70	160,69	CHI
2020112282	MORRINHOS	MR12000025	MORRINHOS	01/11/2020 14:31	01/11/2020 18:45	01/11/2020 14:31	01/11/2020 18:45	4,23	25	105,80	CHI
202010188690	ITABERAI	IB12304486	ANICUNS	01/11/2020 14:32	01/11/2020 17:06	01/11/2020 14:32	01/11/2020 17:06	2,56	59	151,01	CHI
202010188690	MOSSAMEDES	IB12304486	ANICUNS	01/11/2020 14:32	01/11/2020 17:06	01/11/2020 14:32	01/11/2020 17:06	2,56	5	12,80	CHI
2020111909	APARECIDA DE GOIANIA	14269077	ANHANGUERA	01/11/2020 14:33	01/11/2020 15:51	01/11/2020 14:33	01/11/2020 15:51	1,30	1	1,30	CHI
2020111917	GOIANIA	13978408	GOYA S2	01/11/2020 14:39	01/11/2020 17:04	01/11/2020 14:39	01/11/2020 17:04	2,41	1	2,41	CHI
2020111921	PALMEIRAS DE GOIAS	PL21402942	PALMEIRAS	01/11/2020 14:40	01/11/2020 17:20	01/11/2020 14:40	01/11/2020 17:20	2,67	1	2,67	CHI
2020111922	APARECIDA DE GOIANIA	14794640	INDEPENDENCIA S2	01/11/2020 14:40	01/11/2020 15:28	01/11/2020 14:40	01/11/2020 15:28	0,81	1	0,81	CHI
2020111925	BELA VISTA DE GOIAS	BV21108573	BELA VISTA S1	01/11/2020 14:44	01/11/2020 20:15	01/11/2020 14:44	01/11/2020 20:15	5,51	1	5,51	CHI
2020111929	SAO LUIZ DO NORTE	3090017750	ITAPACI	01/11/2020 14:45	01/11/2020 23:10	01/11/2020 14:45	01/11/2020 23:10	8,40	1	8,40	CHI
2020111933	APARECIDA DE GOIANIA	16792051	INDEPENDENCIA S2	01/11/2020 14:47	01/11/2020 16:49	01/11/2020 14:47	01/11/2020 16:49	2,03	1	2,03	CHI
2020112005	FLORES DE GOIAS	FB12257743	FLORES DE GOIAS	01/11/2020 14:50	01/11/2020 16:54	01/11/2020 14:50	01/11/2020 16:54	2,06	8	16,50	CHI
2020112038	SAO LUIZ DO NORTE	SZ12090338	ITAPACI	01/11/2020 14:51	01/11/2020 16:51	01/11/2020 14:51	01/11/2020 16:51	1,98	292	579,62	CHI
2020111952	ALEXANIA	10029332832	ALEXANIA	01/11/2020 14:52	01/11/2020 20:27	01/11/2020 14:52	01/11/2020 20:27	5,58	1	5,58	CHI
2020111953	GOIANIA	10009346617	XAVANTES	01/11/2020 14:52	01/11/2020 19:53	01/11/2020 14:52	01/11/2020 19:53	5,01	1	5,01	CHI
2020111958	GOIAS	GS12408674	MATRINCHA	01/11/2020 14:53	01/11/2020 16:28	01/11/2020 14:53	01/11/2020 16:28	1,57	18	28,34	CHI

2020111962	LUZIANIA	LZ11163847	RIO VERMELHO	01/11/2020 14:54	01/11/2020 17:01	01/11/2020 14:54	01/11/2020 17:01	2,11	157	330,79	CHI
2020112342	FLORES DE GOIAS	FB12417060	FLORES DE GOIAS	01/11/2020 14:54	01/11/2020 22:50	01/11/2020 14:54	01/11/2020 22:50	7,93	15	118,92	CHI
2020111967	VALPARAISO DE GOIAS	2860155631	PACAEMBU S1	01/11/2020 14:56	01/11/2020 17:23	01/11/2020 14:56	01/11/2020 17:23	2,45	1	2,45	CHI
2020111970	NIQUELANDIA	NQ21232532	BARRO ALTO	01/11/2020 14:56	02/11/2020 03:31	01/11/2020 14:56	02/11/2020 03:31	12,57	1	12,57	CHI
2020111976	CAVALCANTE	CJ21346236	MINACU	01/11/2020 14:58	01/11/2020 17:33	01/11/2020 14:58	01/11/2020 17:33	2,57	1	2,57	CHI
2020111984	SAO LUIS DE MONTES BELOS	SL21020355	SAO LUIZ DOS MONTES BELOS	01/11/2020 15:01	01/11/2020 17:09	01/11/2020 15:01	01/11/2020 17:09	2,12	1	2,12	CHI
2020111987	LUZIANIA	LZ11290804	RIO VERMELHO	01/11/2020 15:02	01/11/2020 17:03	01/11/2020 15:02	01/11/2020 17:03	2,01	2	4,02	CHI
2020111991	GOIANESIA	GE12000280	GOIANESIA S2	01/11/2020 15:05	01/11/2020 16:47	01/11/2020 15:05	01/11/2020 16:47	1,70	9	15,29	CHI
2020111991	SANTA ISABEL	GE12000280	GOIANESIA S2	01/11/2020 15:05	01/11/2020 16:47	01/11/2020 15:05	01/11/2020 16:47	1,70	1	1,70	CHI
2020112001	SAO DOMINGOS	10025849512	SAO DOMINGOS	01/11/2020 15:07	01/11/2020 20:17	01/11/2020 15:07	01/11/2020 20:17	5,17	1	5,17	CHI
2020112379	MINACU	IH12282122	MINACU	01/11/2020 15:08	01/11/2020 21:00	01/11/2020 15:08	01/11/2020 21:00	5,86	13	76,17	CHI
2020112009	PIRES DO RIO	BC12031273	PIRES DO RIO S2	01/11/2020 15:09	01/11/2020 17:54	01/11/2020 15:09	01/11/2020 17:54	2,75	2	5,50	CHI
2020112009	SANTA CRUZ DE GOIAS	BC12031273	PIRES DO RIO S2	01/11/2020 15:09	01/11/2020 17:54	01/11/2020 15:09	01/11/2020 17:54	2,75	1	2,75	CHI
2020112011	FLORES DE GOIAS	FB11277849	IACIARA S2	01/11/2020 15:09	02/11/2020 11:10	01/11/2020 15:09	02/11/2020 11:10	20,00	1	20,00	CHI
2020112013	SANTA RITA DO NOVO DESTINO	BA21254179	BARRO ALTO	01/11/2020 15:10	02/11/2020 11:10	01/11/2020 15:10	02/11/2020 10:54	19,72	1	19,72	CHI
2020112013	SANTA RITA DO NOVO DESTINO	BA12208877	BARRO ALTO	01/11/2020 15:10	02/11/2020 11:10	02/11/2020 08:40	02/11/2020 11:10	2,50	28	69,96	CHI
2020112014	APARECIDA DE GOIANIA	AP11144598	CEPAIGO S1	01/11/2020 15:11	01/11/2020 16:47	01/11/2020 15:11	01/11/2020 16:47	1,60	91	145,70	CHI
2020112015	ANAPOLIS	AN21050441	ANAPOLIS UNIVERSITARIO S2	01/11/2020 15:11	01/11/2020 17:36	01/11/2020 15:11	01/11/2020 17:36	2,41	2	4,82	CHI
2020112019	PARAUNA	980005851	PARAUNA	01/11/2020 15:12	01/11/2020 23:36	01/11/2020 15:12	01/11/2020 23:36	8,40	1	8,40	CHI
2020112026	PLANALTINA	PI12325397	SAO JOAO D ALIANCA	01/11/2020 15:17	02/11/2020 08:52	01/11/2020 15:17	02/11/2020 08:52	17,58	1	17,58	CHI
2020112031	INHUMAS	30179701	INHUMAS S2	01/11/2020 15:18	01/11/2020 17:55	01/11/2020 15:18	01/11/2020 17:55	2,61	1	2,61	CHI
2020112194	CRISTALINA	KR12228851	CRISTALINA S2	01/11/2020 15:18	01/11/2020 18:42	01/11/2020 15:18	01/11/2020 18:42	3,39	6	20,31	CHI
2020112034	AGUAS LINDAS DE GOIAS	4830307410	AGUAS LINDAS DE GOIAS S1	01/11/2020 15:19	01/11/2020 16:45	01/11/2020 15:19	01/11/2020 16:45	1,43	1	1,43	CHI
2020112035	SAO LUIS DE MONTES BELOS	SL21004183	SAO LUIZ DOS MONTES BELOS	01/11/2020 15:19	01/11/2020 16:45	01/11/2020 15:19	01/11/2020 16:45	1,43	2	2,87	CHI
2020112246	CAIAPONIA	CP12345397	CAIAPONIA	01/11/2020 15:19	01/11/2020 20:15	01/11/2020 15:19	01/11/2020 20:15	4,93	7	34,49	CHI
2020112040	IPAMERI	10007362801	IPAMERI	01/11/2020 15:21	01/11/2020 21:47	01/11/2020 15:21	01/11/2020 21:47	6,42	1	6,42	CHI
2020112043	SAO LUIZ DO NORTE	3090004882	ITAPACI	01/11/2020 15:22	01/11/2020 17:25	01/11/2020 15:22	01/11/2020 17:25	2,06	1	2,06	CHI
2020112045	GOIANIA	11100412	CAMPINAS S1	01/11/2020 15:23	01/11/2020 17:31	01/11/2020 15:23	01/11/2020 17:31	2,13	1	2,13	CHI
2020112233	SAO MIGUEL DO ARAGUAIA	SM12096096	SAO MIGUEL DO ARAGUAIA	01/11/2020 15:23	02/11/2020 08:28	01/11/2020 15:23	02/11/2020 08:28	17,08	13	222,00	CHI
2020112049	ANICUNS	AC21060662	ANICUNS	01/11/2020 15:24	01/11/2020 18:42	01/11/2020 15:24	01/11/2020 18:42	3,29	1	3,29	CHI
2020112054	ABADIA DE GOIAS	10011630629	INDEPENDENCIA S2	01/11/2020 15:26	01/11/2020 21:41	01/11/2020 15:26	01/11/2020 21:41	6,24	1	6,24	CHI
2020112055	SANTA RITA DO NOVO DESTINO	BA12021220	BARRO ALTO	01/11/2020 15:27	01/11/2020 17:40	01/11/2020 15:27	01/11/2020 17:40	2,22	7	15,51	CHI
2020112057	ARAGARCAS	1820048310	ARAGARCAS	01/11/2020 15:28	01/11/2020 17:00	01/11/2020 15:28	01/11/2020 17:00	1,53	1	1,53	CHI
2020112072	JUSSARA	JR21183327	JUSSARA	01/11/2020 15:33	01/11/2020 18:43	01/11/2020 15:33	01/11/2020 18:43	3,16	1	3,16	CHI
2020112076	ANAPOLIS	10018682330	ANAPOLIS UNIVERSITARIO S2	01/11/2020 15:34	01/11/2020 19:56	01/11/2020 15:34	01/11/2020 19:56	4,36	1	4,36	CHI
2020112077	BRITANIA	BT21362343	BRITANIA	01/11/2020 15:34	02/11/2020 04:02	01/11/2020 15:34	02/11/2020 04:02	12,45	1	12,45	CHI
2020112126	VIANOPOLIS	OZ12094957	VIANOPOLIS	01/11/2020 15:35	02/11/2020 16:07	01/11/2020 15:35	01/11/2020 18:33	2,98	1	2,98	CHI
2020112126	VIANOPOLIS	OZ12094957	VIANOPOLIS	01/11/2020 15:35	02/11/2020 16:07	01/11/2020 15:35	01/11/2020 20:06	4,51	16	72,21	CHI
2020112126	VIANOPOLIS	OZ12094957	VIANOPOLIS	01/11/2020 15:35	02/11/2020 16:07	01/11/2020 15:35	01/11/2020 21:24	5,81	7	40,69	CHI
2020112126	VIANOPOLIS	OZ12094957	VIANOPOLIS	01/11/2020 15:35	02/11/2020 16:07	01/11/2020 15:35	02/11/2020 16:07	24,54	9	220,82	CHI
2020112126	VIANOPOLIS	OZ12094830LD	VIANOPOLIS	01/11/2020 15:35	02/11/2020 16:07	02/11/2020 15:50	02/11/2020 16:07	0,29	7	2,02	CHI
2020112083	FAINA	MP21096002	MATRINCHA	01/11/2020 15:36	01/11/2020 20:54	01/11/2020 15:36	01/11/2020 20:54	5,29	2	10,59	CHI
2020112093	LUZIANIA	LZ12370631	MARAJOARA	01/11/2020 15:41	01/11/2020 18:03	01/11/2020 15:41	01/11/2020 18:03	2,35	11	25,88	CHI
2020114595	TROMBAS	10003593060	PORANGATU	01/11/2020 15:41	02/11/2020 13:48	01/11/2020 15:41	02/11/2020 13:48	22,12	1	22,12	CHI
2020112096	GOIANIA	13967125	MEIA PONTE	01/11/2020 15:42	01/11/2020 17:09	01/11/2020 15:42	01/11/2020 17:09	1,45	1	1,45	CHI
2020112099	IPAMERI	IP21149989	IPAMERI	01/11/2020 15:43	01/11/2020 18:54	01/11/2020 15:43	01/11/2020 18:54	3,18	1	3,18	CHI
2020112103	CAIAPONIA	CP11287671	PALESTINA	01/11/2020 15:44	01/11/2020 18:10	01/11/2020 15:44	01/11/2020 18:10	2,43	1	2,43	CHI
2020112105	ALEXANIA	480094202	ALEXANIA	01/11/2020 15:45	01/11/2020 18:37	01/11/2020 15:45	01/11/2020 18:37	2,85	1	2,85	CHI
2020112107	CAVALCANTE	TI12162624	NIQUELANDIA SUBTRANSMISSAO	01/11/2020 15:46	01/11/2020 22:06	01/11/2020 15:46	01/11/2020 22:06	6,33	48	303,77	CHI
2020112108	APARECIDA DE GOIANIA	13397266	INDEPENDENCIA S2	01/11/2020 15:46	01/11/2020 18:07	01/11/2020 15:46	01/11/2020 18:07	2,34	1	2,34	CHI
2020112114	AGUA LIMPA	AL21000271	VILA CORUMBA	01/11/2020 15:49	01/11/2020 19:24	01/11/2020 15:49	01/11/2020 19:24	3,58	1	3,58	CHI

2020112115	PIRANHAS	PH21066459	BOM JARDIM	01/11/2020 15:49	01/11/2020 18:03	01/11/2020 15:49	01/11/2020 18:03	2,23	1	2,23	CHI
2020112121	CAMPO ALEGRE DE GOIAS	CM21294385	CAMPO ALEGRE DE GOIAS	01/11/2020 15:51	01/11/2020 20:42	01/11/2020 15:51	01/11/2020 20:42	4,85	3	14,54	CHI
2020112122	SANCLERLANDIA	SL12019284	SAO LUIZ DOS MONTES BELOS	01/11/2020 15:51	01/11/2020 17:53	01/11/2020 15:51	01/11/2020 17:53	2,03	29	58,85	CHI
2020112122	SAO LUIS DE MONTES BELOS	SL12019284	SAO LUIZ DOS MONTES BELOS	01/11/2020 15:51	01/11/2020 17:53	01/11/2020 15:51	01/11/2020 17:53	2,03	58	117,69	CHI
2020112125	ITUMBIARA	CD12097345RE	BOM JESUS DE GOIAS	01/11/2020 15:52	01/11/2020 19:48	01/11/2020 15:52	01/11/2020 19:48	3,93	9	35,35	CHI
2020112141	NEROPOLIS	20044773	NEROPOLIS S2	01/11/2020 15:53	01/11/2020 16:44	01/11/2020 15:53	01/11/2020 16:44	0,86	42	36,31	CHI
2020112164	PALMINOPOLIS	PP12299141	FIRMINOPOLIS S2	01/11/2020 15:53	01/11/2020 16:40	01/11/2020 15:53	01/11/2020 16:40	0,77	15	11,58	CHI
2020112131	CATALAO	CT21156938	CATALAO S2	01/11/2020 15:54	01/11/2020 18:57	01/11/2020 15:54	01/11/2020 18:57	3,05	1	3,05	CHI
2020112132	ANAPOLIS	20868376	JUNDIAI S1	01/11/2020 15:54	01/11/2020 17:24	01/11/2020 15:54	01/11/2020 17:24	1,49	1	1,49	CHI
2020112133	OUVIDOR	OU12390002	CATALAO S1	01/11/2020 15:55	01/11/2020 19:29	01/11/2020 15:55	01/11/2020 19:29	3,56	2	7,13	CHI
2020112193	APARECIDA DE GOIANIA	AP11345614	CEPAIGO S1	01/11/2020 15:57	01/11/2020 19:57	01/11/2020 15:57	01/11/2020 19:57	4,00	165	659,36	CHI
2020112202	CATURAI	TR32045881LD	TRINDADE	01/11/2020 15:58	01/11/2020 22:17	01/11/2020 15:58	01/11/2020 22:17	6,32	9	56,88	CHI
2020112202	GOIANIRA	TR32045881LD	TRINDADE	01/11/2020 15:58	01/11/2020 22:17	01/11/2020 15:58	01/11/2020 22:17	6,32	27	170,63	CHI
2020112202	SANTA BARBARA DE GOIAS	TR32045881LD	TRINDADE	01/11/2020 15:58	01/11/2020 22:17	01/11/2020 15:58	01/11/2020 22:17	6,32	24	151,67	CHI
2020112202	TRINDADE	TR32045881LD	TRINDADE	01/11/2020 15:58	01/11/2020 22:17	01/11/2020 15:58	01/11/2020 22:17	6,32	17	107,44	CHI
2020112202	CATURAI	TR32045881LD	TRINDADE	01/11/2020 15:58	01/11/2020 22:17	01/11/2020 20:30	01/11/2020 22:17	1,79	5	8,94	CHI
2020112202	GOIANIRA	TR32045881LD	TRINDADE	01/11/2020 15:58	01/11/2020 22:17	01/11/2020 20:30	01/11/2020 22:17	1,79	25	44,69	CHI
2020112202	TRINDADE	TR32045881LD	TRINDADE	01/11/2020 15:58	01/11/2020 22:17	01/11/2020 20:30	01/11/2020 22:17	1,79	5	8,94	CHI
2020112146	INHUMAS	IX21325122	INHUMAS S1	01/11/2020 15:59	01/11/2020 17:35	01/11/2020 15:59	01/11/2020 17:35	1,59	1	1,59	CHI
2020112284	BELA VISTA DE GOIAS	BV32041018LD	BELA VISTA S2	01/11/2020 15:59	01/11/2020 23:48	01/11/2020 15:59	01/11/2020 23:48	7,82	10	78,18	CHI
2020112284	SAO MIGUEL DO PASSA QUATRO	BV32041018LD	BELA VISTA S2	01/11/2020 15:59	01/11/2020 23:48	01/11/2020 15:59	01/11/2020 23:48	7,82	14	109,45	CHI
2020112284	BELA VISTA DE GOIAS	BV32041018LD	BELA VISTA S2	01/11/2020 15:59	01/11/2020 23:48	01/11/2020 22:21	01/11/2020 23:48	1,44	21	30,29	CHI
2020112223	BONOPOLIS	SM13391608	SAO MIGUEL DO ARAGUAIA	01/11/2020 16:00	02/11/2020 00:55	01/11/2020 16:00	02/11/2020 00:55	8,90	105	934,94	CHI
2020112223	SAO MIGUEL DO ARAGUAIA	SM13391608	SAO MIGUEL DO ARAGUAIA	01/11/2020 16:00	02/11/2020 00:55	01/11/2020 16:00	02/11/2020 00:55	8,90	3	26,71	CHI
2020112468	PONTALINA	PK12047065	PONTALINA	01/11/2020 16:02	01/11/2020 20:46	01/11/2020 16:02	01/11/2020 20:46	4,72	10	47,24	CHI
2020112158	FORMOSA	2870000565	ITUIQUIRA	01/11/2020 16:05	01/11/2020 18:50	01/11/2020 16:05	01/11/2020 18:50	2,76	1	2,76	CHI
2020112168	INHUMAS	30139879	INHUMAS S2	01/11/2020 16:07	01/11/2020 17:44	01/11/2020 16:07	01/11/2020 17:44	1,61	1	1,61	CHI
2020112184	SENADOR CANEDO	16053928	GOIANIA LESTE S1	01/11/2020 16:14	01/11/2020 17:39	01/11/2020 16:14	01/11/2020 17:39	1,41	1	1,41	CHI
2020112185	BELA VISTA DE GOIAS	BV21078784	BELA VISTA S2	01/11/2020 16:15	01/11/2020 19:58	01/11/2020 16:15	01/11/2020 19:58	3,71	1	3,71	CHI
2020112191	DIVINOPOLIS DE GOIAS	10023618912	SAO DOMINGOS	01/11/2020 16:17	01/11/2020 20:43	01/11/2020 16:17	01/11/2020 20:43	4,43	1	4,43	CHI
2020112208	LEOPOLDO DE BULHOES	LB12012179	DAIA S2	01/11/2020 16:22	02/11/2020 09:58	01/11/2020 16:22	02/11/2020 09:07	16,76	11	184,41	CHI
2020112208	LEOPOLDO DE BULHOES	LB12270649	DAIA S2	01/11/2020 16:22	02/11/2020 09:58	02/11/2020 09:22	02/11/2020 09:58	0,59	73	43,01	CHI
2020112332	LUZIANIA	LZ11348552	MARAJOARA	01/11/2020 16:23	01/11/2020 18:32	01/11/2020 16:23	01/11/2020 18:32	2,14	46	98,41	CHI
2020112213	GUAPO	GA21098788	GUAPO S1	01/11/2020 16:24	01/11/2020 18:45	01/11/2020 16:24	01/11/2020 18:45	2,35	2	4,69	CHI
2020112227	AGUAS LINDAS DE GOIAS	LA11203792	AGUAS LINDAS DE GOIAS S1	01/11/2020 16:28	01/11/2020 18:30	01/11/2020 16:28	01/11/2020 18:30	2,02	12	24,26	CHI
2020112238	VALPARAISO DE GOIAS	2860018676	PACAEMBU S1	01/11/2020 16:32	01/11/2020 18:24	01/11/2020 16:32	01/11/2020 18:24	1,86	1	1,86	CHI
2020112241	HIDROLANDIA	HD21007562	PONTALINA	01/11/2020 16:33	01/11/2020 19:53	01/11/2020 16:33	01/11/2020 19:53	3,32	1	3,32	CHI
2020112250	VILA BOA	FA21065578	ITUIQUIRA	01/11/2020 16:35	01/11/2020 20:50	01/11/2020 16:35	01/11/2020 20:50	4,25	1	4,25	CHI
2020112251	GOIANIA	14788007	INDEPENDENCIA S2	01/11/2020 16:36	01/11/2020 17:57	01/11/2020 16:36	01/11/2020 17:57	1,35	1	1,35	CHI
2020112252	POSSE	PS12302648	IACIARA S2	01/11/2020 16:36	01/11/2020 19:56	01/11/2020 16:36	01/11/2020 19:56	3,32	4	13,29	CHI
2020112253	MINACU	IH21137695	MINACU	01/11/2020 16:36	02/11/2020 04:54	01/11/2020 16:36	02/11/2020 04:54	12,29	1	12,29	CHI
2020112255	BELA VISTA DE GOIAS	BV21282446	BELA VISTA S2	01/11/2020 16:37	01/11/2020 23:40	01/11/2020 16:37	01/11/2020 23:40	7,04	1	7,04	CHI
2020112258	BRITANIA	2110018544	BRITANIA	01/11/2020 16:37	01/11/2020 19:25	01/11/2020 16:37	01/11/2020 19:25	2,79	1	2,79	CHI
2020112259	PETROLINA DE GOIAS	PG12015839	PETROLINA	01/11/2020 16:38	01/11/2020 18:46	01/11/2020 16:38	01/11/2020 18:46	2,13	5	10,65	CHI
2020112261	CRIXAS	CX21346649	SANTA TEREZINHA	01/11/2020 16:38	02/11/2020 01:05	01/11/2020 16:38	02/11/2020 01:05	8,43	1	8,43	CHI
2020112264	GOIANIA	GN12170719	AEROPORTO S2	01/11/2020 16:40	01/11/2020 17:04	01/11/2020 16:40	01/11/2020 17:04	0,39	5	1,94	CHI
2020112569	SANTA TEREZINHA DE GOIAS	SG12048775	SANTA TEREZINHA	01/11/2020 16:41	01/11/2020 19:22	01/11/2020 16:41	01/11/2020 19:22	2,67	11	29,36	CHI
2020112271	ORIZONA	OZ21113141	PIRES DO RIO S2	01/11/2020 16:43	01/11/2020 17:43	01/11/2020 16:43	01/11/2020 17:43	1,00	1	1,00	CHI
2020112302	PIRES DO RIO	PR12051686	PIRES DO RIO S2	01/11/2020 16:43	01/11/2020 19:18	01/11/2020 16:43	01/11/2020 19:18	2,58	1	2,58	CHI
2020112302	SANTA CRUZ DE GOIAS	PR12051686	PIRES DO RIO S2	01/11/2020 16:43	01/11/2020 19:18	01/11/2020 16:43	01/11/2020 19:18	2,58	23	59,40	CHI
2020112281	INHUMAS	30021730	INHUMAS S2	01/11/2020 16:45	01/11/2020 18:03	01/11/2020 16:45	01/11/2020 18:03	1,29	1	1,29	CHI

2020112306	ITAGUARI	II11068201	ITABERAI S1	01/11/2020 16:45	02/11/2020 04:21	01/11/2020 16:45	02/11/2020 04:21	11,59	142	1646,06	CHI
2020112286	APARECIDA DE GOIANIA	200054740	INDEPENDENCIA S2	01/11/2020 16:46	01/11/2020 18:52	01/11/2020 16:46	01/11/2020 18:52	2,09	1	2,09	CHI
2020112290	PORANGATU	PO12363571	PORANGATU	01/11/2020 16:47	02/11/2020 03:42	01/11/2020 16:47	02/11/2020 03:42	10,91	1	10,91	CHI
2020112294	TAQUARAL DE GOIAS	TQ21299576	ITABERAI S1	01/11/2020 16:48	02/11/2020 08:00	01/11/2020 16:48	02/11/2020 08:00	15,19	1	15,19	CHI
2020112309	ITAPACI	100041255	ITAPACI	01/11/2020 16:52	01/11/2020 18:57	01/11/2020 16:52	01/11/2020 18:57	2,08	1	2,08	CHI
2020112310	NIQUELANDIA	NQ12222646	URUACU	01/11/2020 16:52	02/11/2020 03:08	01/11/2020 16:52	02/11/2020 03:08	10,27	8	82,12	CHI
2020112312	JUSSARA	JR21381065	IPORA	01/11/2020 16:52	01/11/2020 22:42	01/11/2020 16:52	01/11/2020 22:42	5,82	1	5,82	CHI
2020112317	COCALZINHO DE GOIAS	ZN11327465	GOIANESIA S1	01/11/2020 16:54	01/11/2020 19:19	01/11/2020 16:54	01/11/2020 19:19	2,42	1	2,42	CHI
2020112363	LUZIANIA	OZ12402562RE	PIRES DO RIO S2	01/11/2020 16:56	01/11/2020 19:52	01/11/2020 16:56	01/11/2020 19:52	2,92	130	379,71	CHI
2020112363	ORIZONA	OZ12402562RE	PIRES DO RIO S2	01/11/2020 16:56	01/11/2020 19:52	01/11/2020 16:56	01/11/2020 19:52	2,92	6	17,53	CHI
2020112338	ITAPURANGA	170022249	ITAPURANGA	01/11/2020 17:00	01/11/2020 19:18	01/11/2020 17:00	01/11/2020 19:18	2,30	1	2,30	CHI
2020112343	LUZIANIA	LZ21192781	MARAJOARA	01/11/2020 17:01	01/11/2020 18:34	01/11/2020 17:01	01/11/2020 18:34	1,55	3	4,64	CHI
2020112345	SAO DOMINGOS	SD12332849	SAO DOMINGOS	01/11/2020 17:01	01/11/2020 18:31	01/11/2020 17:01	01/11/2020 18:31	1,49	8	11,92	CHI
2020112354	FAZENDA NOVA	FN21227622	IPORA	01/11/2020 17:04	02/11/2020 01:41	01/11/2020 17:04	02/11/2020 01:41	8,61	1	8,61	CHI
2020112359	IACIARA	ND12218839	IACIARA S2	01/11/2020 17:05	01/11/2020 19:00	01/11/2020 17:05	01/11/2020 19:00	1,91	24	45,87	CHI
2020112359	SAO DOMINGOS	ND12218839	IACIARA S2	01/11/2020 17:05	01/11/2020 19:00	01/11/2020 17:05	01/11/2020 19:00	1,91	3	5,73	CHI
2020112362	BRITANIA	BT11284764	BRITANIA	01/11/2020 17:07	02/11/2020 02:37	01/11/2020 17:07	02/11/2020 02:37	9,51	31	294,76	CHI
2020112368	VARJAO	VJ21009337	GUAPO S2	01/11/2020 17:09	01/11/2020 20:06	01/11/2020 17:09	01/11/2020 20:06	2,94	5	14,68	CHI
2020112401	MORRINHOS	MR12000160	MORRINHOS	01/11/2020 17:11	01/11/2020 20:01	01/11/2020 17:11	01/11/2020 20:01	2,82	19	53,55	CHI
2020112382	GOIANIA	GN12207446	ATLANTICO S1	01/11/2020 17:17	01/11/2020 19:08	01/11/2020 17:17	01/11/2020 18:55	1,62	63	101,87	CHI
2020112382	GOIANIA	GN11035228	ATLANTICO S1	01/11/2020 17:17	01/11/2020 19:08	01/11/2020 17:17	01/11/2020 19:08	1,84	83	153,07	CHI
2020112384	GOIANIA	16205984	MEIA PONTE	01/11/2020 17:18	01/11/2020 18:49	01/11/2020 17:18	01/11/2020 18:49	1,51	1	1,51	CHI
2020112385	BELA VISTA DE GOIAS	240088773	BELA VISTA S1	01/11/2020 17:19	01/11/2020 19:46	01/11/2020 17:19	01/11/2020 19:46	2,44	1	2,44	CHI
2020112389	ANAPOLIS	AN12390196	ANAPOLIS UNIVERSITARIO S1	01/11/2020 17:20	01/11/2020 20:00	01/11/2020 18:24	01/11/2020 18:33	0,15	9	1,36	CHI
2020112389	ANAPOLIS	AN21258247	ANAPOLIS UNIVERSITARIO S1	01/11/2020 17:20	01/11/2020 20:00	01/11/2020 17:20	01/11/2020 20:00	2,67	1	2,67	CHI
2020112390	EDEIA	EA21084007	EDEIA	01/11/2020 17:21	01/11/2020 18:46	01/11/2020 17:21	01/11/2020 18:46	1,42	1	1,42	CHI
2020112393	PIRENOPOLIS	PV12382357	CORUMBA	01/11/2020 17:22	01/11/2020 22:09	01/11/2020 17:22	01/11/2020 22:09	4,78	3	14,33	CHI
2020112403	CRISTALINA	KR12237804	CRISTALINA S1	01/11/2020 17:26	02/11/2020 08:44	01/11/2020 17:26	02/11/2020 08:44	15,28	6	91,71	CHI
2020112409	AGUAS LINDAS DE GOIAS	10008078350	AGUAS LINDAS DE GOIAS S1	01/11/2020 17:28	01/11/2020 18:34	01/11/2020 17:28	01/11/2020 18:34	1,10	1	1,10	CHI
2020112425	VILA PROPICIO	NP21240127	GOIANESIA S1	01/11/2020 17:32	01/11/2020 19:59	01/11/2020 17:32	01/11/2020 19:59	2,44	1	2,44	CHI
2020112427	EDEIA	IY12044014	EDEIA	01/11/2020 17:34	02/11/2020 20:11	01/11/2020 17:34	02/11/2020 20:11	26,61	1	26,61	CHI
2020112427	INDIARA	IY12044014	EDEIA	01/11/2020 17:34	02/11/2020 20:11	01/11/2020 17:34	02/11/2020 20:11	26,61	1	26,61	CHI
2020112429	PIRENOPOLIS	PV21121851	CORUMBA	01/11/2020 17:35	01/11/2020 21:16	01/11/2020 17:35	01/11/2020 21:16	3,67	1	3,67	CHI
2020112431	JARAGUA	JA12000236	JARAGUA	01/11/2020 17:37	01/11/2020 20:15	01/11/2020 17:37	01/11/2020 20:15	2,63	27	70,95	CHI
2020112432	GOIANIA	12311649	GOYA S2	01/11/2020 17:37	01/11/2020 20:01	01/11/2020 17:37	01/11/2020 20:01	2,39	1	2,39	CHI
2020112435	ITAGUARU	IC12033262	ITABERAI S1	01/11/2020 17:38	02/11/2020 10:31	01/11/2020 17:38	02/11/2020 10:31	16,87	3	50,62	CHI
2020112437	ORIZONA	OZ12375967	PIRES DO RIO S2	01/11/2020 17:38	01/11/2020 19:33	01/11/2020 17:38	01/11/2020 19:33	1,90	4	7,61	CHI
2020112444	GOIANIA	13737089	CAMPINAS S2	01/11/2020 17:40	01/11/2020 18:11	01/11/2020 17:40	01/11/2020 18:11	0,50	1	0,50	CHI
2020112445	JARAGUA	70051094	JARAGUA	01/11/2020 17:40	01/11/2020 19:26	01/11/2020 17:40	01/11/2020 19:26	1,75	1	1,75	CHI
2020112455	JANDAIA	JD12005405	PALMEIRAS	01/11/2020 17:40	02/11/2020 03:33	01/11/2020 17:40	02/11/2020 03:33	9,87	10	98,74	CHI
2020112455	PALMEIRAS DE GOIAS	JD12005405	PALMEIRAS	01/11/2020 17:40	02/11/2020 03:33	01/11/2020 17:40	02/11/2020 03:33	9,87	56	552,97	CHI
2020112449	CATALAO	1990123159	CATALAO S2	01/11/2020 17:42	01/11/2020 18:50	01/11/2020 17:42	01/11/2020 18:50	1,12	1	1,12	CHI
2020112450	EDEIA	1120036334	EDEIA	01/11/2020 17:42	01/11/2020 19:35	01/11/2020 17:42	01/11/2020 19:35	1,87	1	1,87	CHI
2020112451	NOVO PLANALTO	TA12391902	NOVO PLANALTO	01/11/2020 17:42	02/11/2020 15:07	01/11/2020 17:42	02/11/2020 15:07	21,40	2	42,80	CHI
2020112453	GOIANIA	14907136	CAMPINAS S2	01/11/2020 17:44	01/11/2020 19:23	01/11/2020 17:44	01/11/2020 19:23	1,65	1	1,65	CHI
2020112454	ALVORADA DO NORTE	AQ21180861	IACIARA S2	01/11/2020 17:44	01/11/2020 20:42	01/11/2020 17:44	01/11/2020 20:42	2,96	1	2,96	CHI
2020112456	GOIANIA	GN11000594	AEROPORTO S2	01/11/2020 17:44	01/11/2020 19:45	01/11/2020 17:44	01/11/2020 19:45	2,01	93	186,78	CHI
2020112458	SAO DOMINGOS	SD12132214	SAO DOMINGOS	01/11/2020 17:44	01/11/2020 19:36	01/11/2020 17:44	01/11/2020 19:36	1,85	3	5,56	CHI
2020112461	SILVANIA	SV21245106	VIANOPOLIS	01/11/2020 17:45	01/11/2020 19:41	01/11/2020 17:45	01/11/2020 19:41	1,92	1	1,92	CHI
2020112464	APARECIDA DE GOIANIA	12217323	INDEPENDENCIA S1	01/11/2020 17:46	01/11/2020 20:01	01/11/2020 17:46	01/11/2020 20:01	2,25	1	2,25	CHI
2020112465	MONTES CLAROS DE GOIAS	1440025323	BRITANIA	01/11/2020 17:46	01/11/2020 22:33	01/11/2020 17:46	01/11/2020 22:33	4,77	1	4,77	CHI

2020112466	JARAGUA	JA21241140	JARAGUA	01/11/2020 17:46	01/11/2020 21:18	01/11/2020 17:46	01/11/2020 21:18	3,52	1	3,52	CHI
2020112477	SAO MIGUEL DO ARAGUAIA	SM12000040	SAO MIGUEL DO ARAGUAIA	01/11/2020 17:51	02/11/2020 09:42	01/11/2020 17:51	02/11/2020 09:42	15,85	1	15,85	CHI
2020112478	ANAPOLIS	AN21267974	ANAPOLIS UNIVERSITARIO S2	01/11/2020 17:52	01/11/2020 19:33	01/11/2020 17:52	01/11/2020 19:33	1,69	6	10,11	CHI
2020112479	ANAPOLIS	21261799	ANAPOLIS UNIVERSITARIO S2	01/11/2020 17:52	01/11/2020 18:58	01/11/2020 17:52	01/11/2020 18:58	1,09	1	1,09	CHI
2020112494	GOIANESIA	GE11297280	GOIANESIA S1	01/11/2020 17:57	01/11/2020 21:32	01/11/2020 17:57	01/11/2020 21:32	3,58	1	3,58	CHI
2020112498	ORIZONA	OZ21339332	PIRES DO RIO S2	01/11/2020 17:57	01/11/2020 21:25	01/11/2020 17:57	01/11/2020 21:25	3,46	1	3,46	CHI
2020112499	PORANGATU	PO11100752	PORANGATU	01/11/2020 17:57	01/11/2020 21:35	01/11/2020 17:57	01/11/2020 21:35	3,63	10	36,25	CHI
2020112505	GOIANIA	12317860	ATLANTICO S1	01/11/2020 17:59	01/11/2020 19:15	01/11/2020 17:59	01/11/2020 19:15	1,26	1	1,26	CHI
2020112614	MORRINHOS	MR21279126	MORRINHOS	01/11/2020 17:59	01/11/2020 22:59	01/11/2020 17:59	01/11/2020 22:59	4,99	1	4,99	CHI
2020112511	GUAPO	GA21359453	GUAPO S1	01/11/2020 18:02	01/11/2020 20:44	01/11/2020 18:02	01/11/2020 20:44	2,69	1	2,69	CHI
2020112723	ITABERAI	IB12379741	ITABERAI S2	01/11/2020 18:02	01/11/2020 22:56	01/11/2020 18:02	01/11/2020 22:56	4,89	89	435,56	CHI
2020112564	GOIANIA	GN11052662	GOYA S2	01/11/2020 18:03	01/11/2020 20:57	01/11/2020 18:03	01/11/2020 20:57	2,89	152	439,11	CHI
2020112522	ANAPOLIS	10028798617	ANAPOLIS UNIVERSITARIO S1	01/11/2020 18:05	01/11/2020 19:33	01/11/2020 18:05	01/11/2020 19:33	1,45	1	1,45	CHI
2020112532	VALPARAISO DE GOIAS	10024375622	PACAEMBU S2	01/11/2020 18:09	01/11/2020 19:38	01/11/2020 18:09	01/11/2020 19:38	1,48	1	1,48	CHI
2020112539	ITAPACI	IW12405289	ITAPACI	01/11/2020 18:10	01/11/2020 23:04	01/11/2020 18:10	01/11/2020 23:04	4,89	4	19,56	CHI
2020112544	CABECEIRAS	CW12218490	ITUIQUIRA	01/11/2020 18:12	01/11/2020 20:33	01/11/2020 18:12	01/11/2020 20:33	2,34	10	23,42	CHI
2020112545	CALDAS NOVAS	CN12102170	CALDAS NOVAS S1	01/11/2020 18:12	01/11/2020 22:56	01/11/2020 18:12	01/11/2020 22:56	4,72	161	760,46	CHI
2020112548	MONTE ALEGRE DE GOIAS	1620013682	SAO DOMINGOS	01/11/2020 18:12	01/11/2020 20:41	01/11/2020 18:12	01/11/2020 20:41	2,48	1	2,48	CHI
2020112752	CAIAPONIA	CP11030746	CAIAPONIA	01/11/2020 18:17	02/11/2020 07:25	01/11/2020 18:17	02/11/2020 07:25	13,12	70	918,56	CHI
2020112565	CATALAO	CT12266174	CATALAO S1	01/11/2020 18:19	01/11/2020 21:15	01/11/2020 18:19	01/11/2020 21:15	2,93	84	246,05	CHI
2020112566	IACIARA	IA12392240	FLORES DE GOIAS	01/11/2020 18:19	02/11/2020 01:55	01/11/2020 18:19	02/11/2020 01:55	7,59	7	53,16	CHI
2020112568	DIORAMA	DI12023266RE	IPORA	01/11/2020 18:20	01/11/2020 19:41	01/11/2020 18:20	01/11/2020 19:41	1,34	59	78,98	CHI
2020112568	JAUPACI	DI12023266RE	IPORA	01/11/2020 18:20	01/11/2020 19:41	01/11/2020 18:20	01/11/2020 19:41	1,34	1	1,34	CHI
2020112706	COLINAS DO SUL	TI12235546	MINACU	01/11/2020 18:20	02/11/2020 08:42	01/11/2020 18:20	02/11/2020 08:42	14,37	2	28,73	CHI
2020112591	URUACU	CR12375637	CAMPINORTE	01/11/2020 18:21	01/11/2020 22:38	01/11/2020 18:21	01/11/2020 22:38	4,27	120	512,50	CHI
2020112574	CALDAZINHA	BV21094986	CEPAIGO S2	01/11/2020 18:22	01/11/2020 20:41	01/11/2020 18:22	01/11/2020 20:41	2,31	1	2,31	CHI
2020112578	TRINDADE	TR21119026	TRINDADE	01/11/2020 18:23	01/11/2020 19:16	01/11/2020 18:23	01/11/2020 19:16	0,89	2	1,78	CHI
2020112580	CEZARINA	CZ21349307	GUAPO S2	01/11/2020 18:23	01/11/2020 23:58	01/11/2020 18:23	01/11/2020 23:58	5,57	1	5,57	CHI
2020112585	GOIANIA	10082232	AEROPORTO S2	01/11/2020 18:25	01/11/2020 19:47	01/11/2020 18:25	01/11/2020 19:47	1,37	0	0,00	CHI
2020112588	COLINAS DO SUL	TI21278578	MINACU	01/11/2020 18:25	02/11/2020 23:37	01/11/2020 18:25	02/11/2020 23:37	29,19	1	29,19	CHI
2020112679	TRINDADE	TR12199768	GOYA S1	01/11/2020 18:25	01/11/2020 21:07	01/11/2020 18:25	01/11/2020 21:07	2,70	223	601,23	CHI
2020113155	TRINDADE	TR11191032	GOYA S1	01/11/2020 18:25	01/11/2020 22:34	01/11/2020 18:25	01/11/2020 22:34	4,13	117	483,73	CHI
2020112603	GOIAS	HE12250700	ITAPURANGA	01/11/2020 18:26	01/11/2020 23:13	01/11/2020 18:26	01/11/2020 23:13	4,78	9	43,02	CHI
2020112603	HEITORAI	HE12250700	ITAPURANGA	01/11/2020 18:26	01/11/2020 23:13	01/11/2020 18:26	01/11/2020 23:13	4,78	6	28,68	CHI
2020112597	GOIANIA	12131386	ATLANTICO S1	01/11/2020 18:28	01/11/2020 20:43	01/11/2020 18:28	01/11/2020 20:43	2,23	1	2,23	CHI
2020112604	LUZIANIA	LZ21237879	CRISTALINA S2	01/11/2020 18:29	01/11/2020 20:09	01/11/2020 18:29	01/11/2020 20:09	1,65	1	1,65	CHI
2020112606	NOVA ROMA	ND12392238	IACIARA S2	01/11/2020 18:30	01/11/2020 19:58	01/11/2020 18:30	01/11/2020 19:58	1,46	245	357,22	CHI
2020112607	FIRMINOPOLIS	FR21033013	FIRMINOPOLIS S2	01/11/2020 18:30	01/11/2020 22:51	01/11/2020 18:30	01/11/2020 22:51	4,34	2	8,67	CHI
2020112608	HIDROLANDIA	HD31117893	CEPAIGO S2	01/11/2020 18:31	01/11/2020 23:43	01/11/2020 18:31	01/11/2020 23:43	5,20	1	5,20	CHI
2020112609	JARAGUA	JA21000155	JARAGUA	01/11/2020 18:31	01/11/2020 21:32	01/11/2020 18:31	01/11/2020 21:32	3,01	2	6,03	CHI
2020112615	BARRO ALTO	BA21163334	BARRO ALTO	01/11/2020 18:32	01/11/2020 22:44	01/11/2020 18:32	01/11/2020 22:44	4,20	1	4,20	CHI
2020112618	AGUAS LINDAS DE GOIAS	LA11104728	AGUAS LINDAS DE GOIAS S1	01/11/2020 18:33	01/11/2020 19:19	01/11/2020 18:33	01/11/2020 19:19	0,76	200	151,06	CHI
2020112619	CUMARI	2000002980	CATALAO S1	01/11/2020 18:33	01/11/2020 23:21	01/11/2020 18:33	01/11/2020 23:21	4,79	1	4,79	CHI
2020112642	MUNDO NOVO DE GOIAS	NA12035650	NOVA CRIXAS	01/11/2020 18:35	02/11/2020 09:46	01/11/2020 18:35	02/11/2020 09:46	15,19	8	121,48	CHI
2020112642	NOVA CRIXAS	NA12035650	NOVA CRIXAS	01/11/2020 18:35	02/11/2020 09:46	01/11/2020 18:35	02/11/2020 09:46	15,19	24	364,45	CHI
2020112629	FORMOSA	FA11085642	ITUIQUIRA	01/11/2020 18:36	01/11/2020 19:29	01/11/2020 18:36	01/11/2020 19:29	0,88	219	191,69	CHI
2020112709	CATALAO	CT12399870	CATALAO S1	01/11/2020 18:36	02/11/2020 09:00	01/11/2020 18:36	02/11/2020 09:00	14,39	13	187,10	CHI
2020112635	BURITI DE GOIAS	CO12000058RE	FIRMINOPOLIS S2	01/11/2020 18:38	02/11/2020 00:16	01/11/2020 18:38	02/11/2020 00:16	5,63	32	180,27	CHI
2020112635	CORREGO DO OURO	CO12000058RE	FIRMINOPOLIS S2	01/11/2020 18:38	02/11/2020 00:16	01/11/2020 18:38	02/11/2020 00:16	5,63	142	799,93	CHI
2020112635	FAZENDA NOVA	CO12000058RE	FIRMINOPOLIS S2	01/11/2020 18:38	02/11/2020 00:16	01/11/2020 18:38	02/11/2020 00:16	5,63	37	208,43	CHI
2020112636	GOIANIA	10632591	AEROPORTO S3	01/11/2020 18:38	01/11/2020 20:58	01/11/2020 18:38	01/11/2020 20:58	2,33	1	2,33	CHI

2020112639	PIRENOPOLIS	PV21319871	CORUMBA	01/11/2020 18:40	01/11/2020 20:32	01/11/2020 18:40	01/11/2020 20:32	1,85	1	1,85	CHI
2020112720	BALIZA	BH11334950	BOM JARDIM	01/11/2020 18:41	01/11/2020 20:56	01/11/2020 18:41	01/11/2020 20:56	2,25	84	188,67	CHI
2020112646	SANTO ANTONIO DO DESCOBERTO	2210190478	AGUAS LINDAS DE GOIAS S2	01/11/2020 18:42	01/11/2020 19:29	01/11/2020 18:42	01/11/2020 19:29	0,77	1	0,77	CHI
2020112735	ANAPOLIS	AN11072951	JUNDIAI S1	01/11/2020 18:43	01/11/2020 20:15	01/11/2020 18:43	01/11/2020 20:15	1,53	214	327,66	CHI
2020112653	PIRENOPOLIS	PV21273400	SAO FRANCISCO DE GOIAS	01/11/2020 18:44	01/11/2020 21:21	01/11/2020 18:44	01/11/2020 21:21	2,61	2	5,22	CHI
2020112656	ALEXANIA	AX11289376	ALEXANIA	01/11/2020 18:45	01/11/2020 21:44	01/11/2020 18:45	01/11/2020 21:44	2,97	37	110,03	CHI
2020112664	GUAPO	710049584	GUAPO S1	01/11/2020 18:48	01/11/2020 19:54	01/11/2020 18:48	01/11/2020 19:54	1,10	1	1,10	CHI
2020112665	PADRE BERNARDO	PB12261643	PADRE BERNARDO	01/11/2020 18:48	01/11/2020 20:38	01/11/2020 18:48	01/11/2020 20:38	1,83	205	374,24	CHI
2020112666	RUBIATABA	10016599126	RUBIATABA	01/11/2020 18:48	01/11/2020 20:36	01/11/2020 18:48	01/11/2020 20:36	1,79	1	1,79	CHI
2020112669	FLORES DE GOIAS	IA12046295	IACIARA S2	01/11/2020 18:49	01/11/2020 20:43	01/11/2020 18:49	01/11/2020 20:43	1,90	1	1,90	CHI
2020112669	IACIARA	IA12046295	IACIARA S2	01/11/2020 18:49	01/11/2020 20:43	01/11/2020 18:49	01/11/2020 20:43	1,90	91	172,52	CHI
2020112671	FLORES DE GOIAS	FB12106993	FLORES DE GOIAS	01/11/2020 18:49	02/11/2020 00:15	01/11/2020 18:49	02/11/2020 00:15	5,42	9	48,82	CHI
2020112671	FORMOSA	FB12106993	FLORES DE GOIAS	01/11/2020 18:49	02/11/2020 00:15	01/11/2020 18:49	02/11/2020 00:15	5,42	12	65,10	CHI
2020112671	SAO JOAO D ALIANCA	FB12106993	FLORES DE GOIAS	01/11/2020 18:49	02/11/2020 00:15	01/11/2020 18:49	02/11/2020 00:15	5,42	5	27,12	CHI
2020112674	GOIAS	GS21158793	ITABERAI S1	01/11/2020 18:49	02/11/2020 10:13	01/11/2020 18:49	02/11/2020 10:13	15,39	2	30,77	CHI
2020112677	PLANALTINA	2960037220	PLANALTINA	01/11/2020 18:50	01/11/2020 21:34	01/11/2020 18:50	01/11/2020 21:34	2,73	1	2,73	CHI
2020112686	NOVO GAMA	10006694428	PACAEMBU S1	01/11/2020 18:52	01/11/2020 20:46	01/11/2020 18:52	01/11/2020 20:46	1,89	1	1,89	CHI
2020112688	BONOPOLIS	BX12364617	SAO MIGUEL DO ARAGUAIA	01/11/2020 18:55	01/11/2020 23:18	01/11/2020 18:55	01/11/2020 23:18	4,38	7	30,65	CHI
2020112689	GOIANIA	13799022	INDEPENDENCIA S2	01/11/2020 18:55	01/11/2020 22:13	01/11/2020 18:55	01/11/2020 22:13	3,29	1	3,29	CHI
2020112697	LUZIANIA	LZ12336006	VIANOPOLIS	01/11/2020 18:57	01/11/2020 21:31	01/11/2020 18:57	01/11/2020 21:31	2,55	109	278,25	CHI
2020112701	SANTA TEREZA DE GOIAS	SE12361690	MARA ROSA	01/11/2020 18:58	02/11/2020 08:44	01/11/2020 18:58	02/11/2020 08:44	13,76	3	41,29	CHI
2020112702	AGUAS LINDAS DE GOIAS	4830075510	AGUAS LINDAS DE GOIAS S1	01/11/2020 18:58	01/11/2020 22:00	01/11/2020 18:58	01/11/2020 22:00	3,03	1	3,03	CHI
2020112712	LEOPOLDO DE BULHOES	LB21147302	DAIA S2	01/11/2020 19:00	01/11/2020 23:13	01/11/2020 19:00	01/11/2020 23:13	4,22	2	8,43	CHI
2020112786	PIRACANJUBA	PJ12212172	PIRACANJUBA	01/11/2020 19:00	02/11/2020 07:53	01/11/2020 19:00	02/11/2020 07:53	12,88	12	154,54	CHI
2020112930	ABADIANIA	AA12413563	DAIA S2	01/11/2020 19:00	02/11/2020 00:44	01/11/2020 19:00	02/11/2020 00:44	5,73	83	475,96	CHI
2020112726	ESTRELA DO NORTE	ET21254968	MARA ROSA	01/11/2020 19:04	02/11/2020 02:57	01/11/2020 19:04	02/11/2020 02:57	7,87	1	7,87	CHI
2020112742	ORIZONA	OZ12079953	VIANOPOLIS	01/11/2020 19:07	01/11/2020 21:59	01/11/2020 19:07	01/11/2020 21:59	2,85	4	11,41	CHI
2020112742	VIANOPOLIS	OZ12079953	VIANOPOLIS	01/11/2020 19:07	01/11/2020 21:59	01/11/2020 19:07	01/11/2020 21:59	2,85	12	34,22	CHI
2020112744	INHUMAS	10030376775	INHUMAS S2	01/11/2020 19:08	01/11/2020 20:08	01/11/2020 19:08	01/11/2020 20:08	0,99	1	0,99	CHI
2020112750	GOIANIA	10015761469	GOYA S1	01/11/2020 19:11	01/11/2020 20:40	01/11/2020 19:11	01/11/2020 20:40	1,48	1	1,48	CHI
2020112751	GUARAITA	GK11272627	ITAPURANGA	01/11/2020 19:11	01/11/2020 23:00	01/11/2020 19:11	01/11/2020 23:00	3,81	93	354,56	CHI
2020112757	VALPARAISO DE GOIAS	2860314605	MARAJOARA	01/11/2020 19:11	01/11/2020 20:24	01/11/2020 19:11	01/11/2020 20:24	1,20	1	1,20	CHI
2020112890	PORANGATU	PO12059923	PORANGATU	01/11/2020 19:16	01/11/2020 23:20	01/11/2020 19:16	01/11/2020 23:20	4,06	13	52,74	CHI
2020112783	IACIARA	ND12218839	IACIARA S2	01/11/2020 19:18	02/11/2020 22:49	01/11/2020 19:18	02/11/2020 11:43	16,41	1	16,41	CHI
2020112783	IACIARA	IA13218879	IACIARA S2	01/11/2020 19:18	02/11/2020 22:49	02/11/2020 07:18	02/11/2020 12:17	5,00	1	5,00	CHI
2020112783	IACIARA	ND12218839	IACIARA S2	01/11/2020 19:18	02/11/2020 22:49	01/11/2020 19:18	02/11/2020 19:51	24,55	3	73,65	CHI
2020112783	IACIARA	ND12218839	IACIARA S2	01/11/2020 19:18	02/11/2020 22:49	01/11/2020 19:18	02/11/2020 21:15	25,93	3	77,80	CHI
2020112783	IACIARA	ND12218839	IACIARA S2	01/11/2020 19:18	02/11/2020 22:49	01/11/2020 19:18	02/11/2020 22:44	27,43	8	219,47	CHI
2020112783	IACIARA	ND12218839	IACIARA S2	01/11/2020 19:18	02/11/2020 22:49	01/11/2020 19:18	02/11/2020 22:49	27,50	8	220,03	CHI
2020112783	SAO DOMINGOS	ND12218839	IACIARA S2	01/11/2020 19:18	02/11/2020 22:49	01/11/2020 19:18	02/11/2020 22:49	27,50	3	82,51	CHI
2020112796	LUZIANIA	10004701648	RIO VERMELHO	01/11/2020 19:22	01/11/2020 20:32	01/11/2020 19:22	01/11/2020 20:32	1,17	1	1,17	CHI
2020112805	ANAPOLIS	21246749	JUNDIAI S1	01/11/2020 19:26	01/11/2020 20:34	01/11/2020 19:26	01/11/2020 20:34	1,13	1	1,13	CHI
2020112807	ANAPOLIS	21032750	JUNDIAI S1	01/11/2020 19:26	01/11/2020 22:40	01/11/2020 19:26	01/11/2020 22:40	3,22	1	3,22	CHI
2020112809	AGUAS LINDAS DE GOIAS	LA11349021	AGUAS LINDAS DE GOIAS S1	01/11/2020 19:27	01/11/2020 20:15	01/11/2020 19:27	01/11/2020 20:15	0,80	142	112,93	CHI
2020112814	VALPARAISO DE GOIAS	10011515889	MARAJOARA	01/11/2020 19:28	01/11/2020 21:28	01/11/2020 19:28	01/11/2020 21:28	1,99	1	1,99	CHI
2020112843	FORMOSO	SE12053856	MARA ROSA	01/11/2020 19:28	01/11/2020 23:53	01/11/2020 19:28	01/11/2020 23:53	4,40	6	26,41	CHI
2020112843	SANTA TEREZA DE GOIAS	SE12053856	MARA ROSA	01/11/2020 19:28	01/11/2020 23:53	01/11/2020 19:28	01/11/2020 23:53	4,40	3	13,21	CHI
2020112940	CRIXAS	CX12405291	SANTA TEREZINHA	01/11/2020 19:28	01/11/2020 23:56	01/11/2020 19:28	01/11/2020 23:56	4,45	94	418,74	CHI
2020112827	GOIANIA	10763405	ATLANTICO S1	01/11/2020 19:32	01/11/2020 22:11	01/11/2020 19:32	01/11/2020 22:11	2,65	1	2,65	CHI
2020112830	GOIANIA	16557657	GOYA S2	01/11/2020 19:32	01/11/2020 21:05	01/11/2020 19:32	01/11/2020 21:05	1,54	1	1,54	CHI
2020112835	MINACU	IH21255548	MINACU	01/11/2020 19:35	02/11/2020 11:06	01/11/2020 19:35	02/11/2020 11:06	15,50	1	15,50	CHI

2020112873	AURILANDIA	CG12018650	FIRMINOPOLIS S2	01/11/2020 19:38	02/11/2020 00:39	01/11/2020 19:38	02/11/2020 00:39	5,00	24	120,09	CHI
2020112873	CACHOEIRA DE GOIAS	CG12018650	FIRMINOPOLIS S2	01/11/2020 19:38	02/11/2020 00:39	01/11/2020 19:38	02/11/2020 00:39	5,00	31	155,11	CHI
2020112873	MOIPORA	CG12018650	FIRMINOPOLIS S2	01/11/2020 19:38	02/11/2020 00:39	01/11/2020 19:38	02/11/2020 00:39	5,00	1	5,00	CHI
2020112853	FORMOSO	FO12185324	PORANGATU	01/11/2020 19:39	02/11/2020 01:34	01/11/2020 19:39	02/11/2020 01:34	5,90	2	11,81	CHI
2020112857	LUZIANIA	LZ11128855	MARAJOARA	01/11/2020 19:41	01/11/2020 20:58	01/11/2020 19:41	01/11/2020 20:58	1,27	14	17,79	CHI
2020112863	ANAPOLIS	21066735	JUNDIAI S1	01/11/2020 19:44	01/11/2020 21:01	01/11/2020 19:44	01/11/2020 21:01	1,28	1	1,28	CHI
2020112864	CAMPINORTE	10012959055	CAMPINORTE	01/11/2020 19:44	02/11/2020 04:37	01/11/2020 19:44	02/11/2020 04:37	8,88	1	8,88	CHI
2020112866	GAMELEIRA DE GOIAS	GL21287189	DAIA S2	01/11/2020 19:45	01/11/2020 22:55	01/11/2020 19:45	01/11/2020 22:55	3,17	2	6,33	CHI
2020112870	APARECIDA DE GOIANIA	200190891	INDEPENDENCIA S2	01/11/2020 19:45	01/11/2020 20:41	01/11/2020 19:45	01/11/2020 20:41	0,92	1	0,92	CHI
2020112871	JUSSARA	JR21292890	IPORA	01/11/2020 19:45	01/11/2020 23:13	01/11/2020 19:45	01/11/2020 23:13	3,45	2	6,90	CHI
2020112879	ALEXANIA	10019035975	ALEXANIA	01/11/2020 19:49	01/11/2020 22:25	01/11/2020 19:49	01/11/2020 22:25	2,59	1	2,59	CHI
2020112884	GAMELEIRA DE GOIAS	AN11205857	DAIA S1	01/11/2020 19:50	01/11/2020 22:01	01/11/2020 19:50	01/11/2020 22:01	2,17	52	112,84	CHI
2020112887	ALTO HORIZONTE	AJ12384911	MARA ROSA	01/11/2020 19:51	02/11/2020 04:30	01/11/2020 19:51	02/11/2020 04:30	8,64	2	17,29	CHI
2020112891	ARAGARCAS	1820057887	ARAGARCAS	01/11/2020 19:51	01/11/2020 22:25	01/11/2020 19:51	01/11/2020 22:25	2,55	1	2,55	CHI
2020112893	ANAPOLIS	21216850	JUNDIAI S2	01/11/2020 19:51	01/11/2020 21:35	01/11/2020 19:51	01/11/2020 21:35	1,72	1	1,72	CHI
2020113122	FLORES DE GOIAS	FB12423949	IACIARA S2	01/11/2020 19:51	02/11/2020 00:00	01/11/2020 19:51	02/11/2020 00:00	4,14	12	49,72	CHI
2020112897	ARENOPOLIS	AY12235874	IPORA	01/11/2020 19:52	02/11/2020 14:00	01/11/2020 19:52	02/11/2020 03:08	0,55	6	3,29	CHI
2020112897	ARENOPOLIS	AY12235880LD	IPORA	01/11/2020 19:52	02/11/2020 14:00	01/11/2020 19:52	02/11/2020 14:00	18,13	1	18,13	CHI
2020112897	PIRANHAS	AY12235880LD	IPORA	01/11/2020 19:52	02/11/2020 14:00	01/11/2020 19:52	02/11/2020 14:00	18,13	1	18,13	CHI
2020112970	GOIANIA	GN11275002	CARAJAS S1	01/11/2020 19:52	01/11/2020 21:23	01/11/2020 19:52	01/11/2020 21:23	1,51	72	108,74	CHI
2020112909	GOIANIA	11051292	ATLANTICO S1	01/11/2020 19:58	01/11/2020 21:26	01/11/2020 19:58	01/11/2020 21:26	1,46	1	1,46	CHI
2020112912	ALTO HORIZONTE	AJ12100313	SANTA TEREZINHA	01/11/2020 20:00	02/11/2020 01:11	01/11/2020 20:00	02/11/2020 01:11	5,19	10	51,86	CHI
2020112917	SANTO ANTONIO DO DESCOBERTO	2210126685	AGUAS LINDAS DE GOIAS S2	01/11/2020 20:01	01/11/2020 20:49	01/11/2020 20:01	01/11/2020 20:49	0,79	1	0,79	CHI
2020113021	PONTALINA	PK12263503	PONTALINA	01/11/2020 20:04	02/11/2020 09:48	01/11/2020 20:04	02/11/2020 09:48	13,72	15	205,86	CHI
2020112927	ITAUCU	IX21102568	ITABERAI S1	01/11/2020 20:06	01/11/2020 22:33	01/11/2020 20:06	01/11/2020 22:33	2,44	1	2,44	CHI
2020113013	PALMINOPOLIS	PP12022330	FIRMINOPOLIS S2	01/11/2020 20:08	02/11/2020 08:46	01/11/2020 20:08	02/11/2020 08:46	12,63	5	63,16	CHI
2020112935	INHUMAS	10020220055	INHUMAS S2	01/11/2020 20:09	01/11/2020 21:56	01/11/2020 20:09	01/11/2020 21:56	1,78	1	1,78	CHI
2020112943	CIDADE OCIDENTAL	DH11199687	MARAJOARA	01/11/2020 20:11	01/11/2020 21:50	01/11/2020 20:11	01/11/2020 21:50	1,63	28	45,75	CHI
2020112963	APARECIDA DE GOIANIA	AP11345614	CEPAIGO S1	01/11/2020 20:13	02/11/2020 01:06	01/11/2020 20:13	02/11/2020 01:06	4,88	165	804,88	CHI
2020112958	PONTALINA	PK21045997	PONTALINA	01/11/2020 20:15	01/11/2020 23:24	01/11/2020 20:15	01/11/2020 23:24	3,14	4	12,55	CHI
2020112959	CRISTALINA	KR21245993	CRISTALINA S2	01/11/2020 20:16	01/11/2020 21:25	01/11/2020 20:16	01/11/2020 21:25	1,14	1	1,14	CHI
2020113024	SAO FRANCISCO DE GOIAS	SF12000177	SAO FRANCISCO DE GOIAS	01/11/2020 20:20	01/11/2020 21:42	01/11/2020 20:20	01/11/2020 21:42	1,35	3	4,06	CHI
2020112973	AGUAS LINDAS DE GOIAS	4830016657	AGUAS LINDAS DE GOIAS S1	01/11/2020 20:21	01/11/2020 22:05	01/11/2020 20:21	01/11/2020 22:05	1,73	1	1,73	CHI
2020112974	LEOPOLDO DE BULHOES	870017299	DAIA S2	01/11/2020 20:21	01/11/2020 23:26	01/11/2020 20:21	01/11/2020 23:26	3,08	1	3,08	CHI
2020112977	CATALAO	CT12333725	CATALAO S1	01/11/2020 20:22	02/11/2020 21:42	01/11/2020 20:22	02/11/2020 14:13	17,85	8	142,78	CHI
2020112977	CATALAO	CT12333725	CATALAO S1	01/11/2020 20:22	02/11/2020 21:42	01/11/2020 20:22	02/11/2020 21:42	25,32	2	50,64	CHI
2020115001	CATALAO	CT12130955LD	CATALAO S1	01/11/2020 20:22	02/11/2020 21:42	01/11/2020 20:22	02/11/2020 21:42	25,32	3	75,95	CHI
2020115001	DISTRITO FEDERAL	CT12130955LD	CATALAO S1	01/11/2020 20:22	02/11/2020 21:42	01/11/2020 20:22	02/11/2020 21:42	25,32	1	25,32	CHI
2020112985	VALPARAISO DE GOIAS	3350032999	PACAEMBU S2	01/11/2020 20:26	01/11/2020 21:50	01/11/2020 20:26	01/11/2020 21:50	1,40	1	1,40	CHI
2020113010	BOM JESUS DE GOIAS	BJ12330379	BOM JESUS DE GOIAS	01/11/2020 20:34	01/11/2020 22:17	01/11/2020 20:34	01/11/2020 22:17	1,70	1	1,70	CHI
2020113018	TRINDADE	TR12276767	TRINDADE	01/11/2020 20:36	01/11/2020 21:38	01/11/2020 20:36	01/11/2020 21:38	1,03	555	570,26	CHI
2020113210	ITABERAI	IB12227139	ITABERAI S1	01/11/2020 20:39	02/11/2020 07:26	01/11/2020 20:39	02/11/2020 07:26	10,77	9	96,95	CHI
2020113033	PIRACANJUBA	PJ21287336	PIRACANJUBA	01/11/2020 20:41	02/11/2020 06:57	01/11/2020 20:41	02/11/2020 06:57	10,27	1	10,27	CHI
2020113035	IVOLANDIA	IV12158122	IPORA	01/11/2020 20:42	02/11/2020 07:52	01/11/2020 20:42	02/11/2020 07:52	11,17	8	89,33	CHI
2020113050	LUZIANIA	120259618	RIO VERMELHO	01/11/2020 20:48	01/11/2020 21:50	01/11/2020 20:48	01/11/2020 21:50	1,03	1	1,03	CHI
2020113062	GOIANIA	GN11003120	GOYA S1	01/11/2020 20:48	01/11/2020 22:02	01/11/2020 20:48	01/11/2020 22:02	1,22	122	149,15	CHI
2020113066	GOIANIA	GN11180059	GOYA S1	01/11/2020 20:48	01/11/2020 22:17	01/11/2020 20:48	01/11/2020 22:17	1,47	73	107,61	CHI
2020113115	NIQUELANDIA	8001513	BARRO ALTO	01/11/2020 20:49	02/11/2020 10:38	01/11/2020 20:49	02/11/2020 10:38	13,81	30	414,29	CHI
2020113159	SAO MIGUEL DO ARAGUAIA	SM12089544	SAO MIGUEL DO ARAGUAIA	01/11/2020 20:49	02/11/2020 04:54	01/11/2020 20:49	02/11/2020 04:54	8,08	22	177,78	CHI
2020113064	SILVANIA	SV21155105	VIANOPOLIS	01/11/2020 20:50	01/11/2020 22:16	01/11/2020 20:50	01/11/2020 22:16	1,42	1	1,42	CHI
2020113069	GOIANIA	16630117	GOYA S1	01/11/2020 20:52	01/11/2020 22:30	01/11/2020 20:52	01/11/2020 22:30	1,62	1	1,62	CHI

2020113072	SILVANIA	SV12056199	DAIA S2	01/11/2020 20:53	01/11/2020 22:56	01/11/2020 20:53	01/11/2020 22:56	2,04	9	18,33	CHI
2020113080	GOIANESIA	550066159	GOIANESIA S2	01/11/2020 20:58	01/11/2020 21:53	01/11/2020 20:58	01/11/2020 21:53	0,90	1	0,90	CHI
2020113082	CROMINIA	520016762	ROCHEDO	01/11/2020 21:01	02/11/2020 04:42	01/11/2020 21:01	02/11/2020 04:42	7,69	1	7,69	CHI
2020113088	GOIAS	GS21259621	GOIAS	01/11/2020 21:04	02/11/2020 08:55	01/11/2020 21:04	02/11/2020 08:55	11,84	1	11,84	CHI
2020113090	POSSE	10020665073	IACIARA S2	01/11/2020 21:04	01/11/2020 23:21	01/11/2020 21:04	01/11/2020 23:21	2,27	1	2,27	CHI
2020113107	PADRE BERNARDO	PB21219682	PADRE BERNARDO	01/11/2020 21:09	01/11/2020 22:29	01/11/2020 21:09	01/11/2020 22:29	1,32	1	1,32	CHI
2020113110	PADRE BERNARDO	PB12261461	PADRE BERNARDO	01/11/2020 21:09	01/11/2020 22:48	01/11/2020 21:09	01/11/2020 22:48	1,63	286	467,45	CHI
2020113117	GOIANESIA	550109456	GOIANESIA S2	01/11/2020 21:12	01/11/2020 23:36	01/11/2020 21:12	01/11/2020 23:36	2,40	1	2,40	CHI
2020113136	NOVO GAMA	NJ11097524	PACAEMBU S1	01/11/2020 21:21	01/11/2020 22:35	01/11/2020 21:21	01/11/2020 22:35	1,23	160	196,04	CHI
2020113137	ITABERAI	IB21300324	ITABERAI S2	01/11/2020 21:21	02/11/2020 05:19	01/11/2020 21:21	02/11/2020 04:58	7,62	1	7,62	CHI
2020113137	ITABERAI	IB11274238	ITABERAI S2	01/11/2020 21:21	02/11/2020 05:19	02/11/2020 01:41	02/11/2020 05:19	3,63	6	21,81	CHI
2020113151	PIRACANJUBA	PJ21109909	PIRACANJUBA	01/11/2020 21:29	01/11/2020 23:13	01/11/2020 21:29	01/11/2020 23:13	1,72	1	1,72	CHI
2020113164	BURITINOPOLIS	3610006764	IACIARA S2	01/11/2020 21:38	01/11/2020 22:58	01/11/2020 21:38	01/11/2020 22:58	1,32	1	1,32	CHI
2020113165	JARAGUA	SR12321527	INHUMAS S1	01/11/2020 21:38	02/11/2020 00:14	01/11/2020 21:38	02/11/2020 00:14	2,59	10	25,89	CHI
2020113213	ARAGUAPAZ	RB12290996	RUBIATABA	01/11/2020 21:43	02/11/2020 07:55	01/11/2020 21:43	02/11/2020 07:55	10,19	1	10,19	CHI
2020113213	RUBIATABA	RB12290996	RUBIATABA	01/11/2020 21:43	02/11/2020 07:55	01/11/2020 21:43	02/11/2020 07:55	10,19	9	91,72	CHI
2020113173	GOIANIA	10024062039	CARAJAS S2	01/11/2020 21:45	01/11/2020 22:50	01/11/2020 21:45	01/11/2020 22:50	1,08	1	1,08	CHI
2020113180	FAZENDA NOVA	FN12113974	IPORA	01/11/2020 21:49	02/11/2020 02:26	01/11/2020 21:49	02/11/2020 02:26	4,61	17	78,33	CHI
2020113180	ISRAELANDIA	FN12113974	IPORA	01/11/2020 21:49	02/11/2020 02:26	01/11/2020 21:49	02/11/2020 02:26	4,61	11	50,69	CHI
2020113183	ARAGUAPAZ	MP12355886	MATRINCHA	01/11/2020 21:51	02/11/2020 15:15	01/11/2020 21:51	02/11/2020 15:15	17,39	1	17,39	CHI
2020113183	FAINA	MP12355886	MATRINCHA	01/11/2020 21:51	02/11/2020 15:15	01/11/2020 21:51	02/11/2020 15:15	17,39	2	34,78	CHI
2020113185	GOIANIA	10719787	CAMPINAS S3	01/11/2020 21:52	01/11/2020 23:00	01/11/2020 21:52	01/11/2020 23:00	1,12	1	1,12	CHI
2020113193	SANTO ANTONIO DE GOIAS	NR12246208	NEROPOLIS S2	01/11/2020 21:56	02/11/2020 01:06	01/11/2020 21:56	02/11/2020 01:06	3,15	48	151,40	CHI
2020113194	IACIARA	IA12160053	IACIARA S1	01/11/2020 21:57	02/11/2020 03:57	01/11/2020 21:57	02/11/2020 03:57	5,99	2	11,99	CHI
2020113203	MONTES CLAROS DE GOIAS	ME12204933	IPORA	01/11/2020 22:03	01/11/2020 23:12	01/11/2020 22:03	01/11/2020 23:12	1,14	1	1,14	CHI
2020113260	JANDAIA	JD12008606	PALMEIRAS	01/11/2020 22:06	02/11/2020 05:08	01/11/2020 22:06	02/11/2020 05:08	7,03	83	583,72	CHI
2020113260	PARAUNA	JD12008606	PALMEIRAS	01/11/2020 22:06	02/11/2020 05:08	01/11/2020 22:06	02/11/2020 05:08	7,03	6	42,20	CHI
2020113209	NEROPOLIS	10012633850	NEROPOLIS S2	01/11/2020 22:10	02/11/2020 07:13	01/11/2020 22:10	02/11/2020 07:13	9,05	1	9,05	CHI
2020113214	LUZIANIA	120054670	RIO VERMELHO	01/11/2020 22:16	01/11/2020 23:21	01/11/2020 22:16	01/11/2020 23:21	1,08	1	1,08	CHI
2020113217	BALIZA	BH12331302	CAIAPONIA	01/11/2020 22:16	02/11/2020 03:09	01/11/2020 22:16	02/11/2020 03:09	4,87	11	53,55	CHI
2020113222	PONTALINA	210065655	PONTALINA	01/11/2020 22:20	02/11/2020 01:11	01/11/2020 22:20	02/11/2020 01:11	2,84	1	2,84	CHI
2020113224	TRINDADE	10025227740	TRINDADE	01/11/2020 22:22	01/11/2020 23:58	01/11/2020 22:22	01/11/2020 23:58	1,59	1	1,59	CHI
2020113227	CORREGO DO OURO	CO11000049	FIRMINOPOLIS S2	01/11/2020 22:23	02/11/2020 08:07	01/11/2020 22:23	02/11/2020 08:07	9,73	125	1216,53	CHI
2020113245	CRISTALINA	KR12230241	CRISTALINA S2	01/11/2020 22:42	01/11/2020 23:31	01/11/2020 22:42	01/11/2020 23:31	0,80	5	4,02	CHI
2020113247	BOM JESUS DE GOIAS	10001308066	BOM JESUS DE GOIAS	01/11/2020 22:44	02/11/2020 04:34	01/11/2020 22:44	02/11/2020 04:34	5,83	1	5,83	CHI
2020113257	ANAPOLIS	AN11130801	JUNDIAI S2	01/11/2020 22:57	02/11/2020 00:04	01/11/2020 22:57	02/11/2020 00:04	1,11	126	139,86	CHI
2020113270	INHUMAS	IN21394302	INHUMAS S1	01/11/2020 23:11	02/11/2020 05:13	01/11/2020 23:11	02/11/2020 05:13	6,02	1	6,02	CHI
2020113281	SENADOR CANEDO	10002355688	SENADOR CANEDO	01/11/2020 23:25	02/11/2020 00:43	01/11/2020 23:25	02/11/2020 00:43	1,29	1	1,29	CHI
2020113283	TRINDADE	10029628707	TRINDADE	01/11/2020 23:30	02/11/2020 00:53	01/11/2020 23:30	02/11/2020 00:53	1,37	1	1,37	CHI
2020113319	NOVA CRIXAS	NA10396027	NOVA CRIXAS	01/11/2020 23:54	02/11/2020 11:07	01/11/2020 23:54	02/11/2020 09:46	9,87	45	444,07	CHI
2020113319	MUNDO NOVO DE GOIAS	NA10396027	NOVA CRIXAS	01/11/2020 23:54	02/11/2020 11:07	01/11/2020 23:54	02/11/2020 11:07	11,22	37	414,97	CHI
2020113319	NOVA CRIXAS	NA10396027	NOVA CRIXAS	01/11/2020 23:54	02/11/2020 11:07	01/11/2020 23:54	02/11/2020 11:07	11,22	127	1424,34	CHI
2020113328	PADRE BERNARDO	PB12290547	PADRE BERNARDO	02/11/2020 00:42	02/11/2020 07:37	02/11/2020 00:42	02/11/2020 07:37	6,91	18	124,36	CHI
2020113344	GOIANIA	GN12376900	AEROPORTO S2	02/11/2020 01:41	02/11/2020 02:46	02/11/2020 01:41	02/11/2020 02:46	1,08	387	417,53	CHI
2020113349	FLORES DE GOIAS	FB12106993	FLORES DE GOIAS	02/11/2020 02:00	02/11/2020 12:29	02/11/2020 02:00	02/11/2020 09:34	7,56	14	105,87	CHI
2020113349	FORMOSA	FB12106993	FLORES DE GOIAS	02/11/2020 02:00	02/11/2020 12:29	02/11/2020 02:00	02/11/2020 09:34	7,56	136	1028,50	CHI
2020113349	FORMOSO	FB12106993	FLORES DE GOIAS	02/11/2020 02:00	02/11/2020 12:29	02/11/2020 02:00	02/11/2020 09:34	7,56	1	7,56	CHI
2020113349	SAO JOAO D ALIANCA	FB12106993	FLORES DE GOIAS	02/11/2020 02:00	02/11/2020 12:29	02/11/2020 02:00	02/11/2020 09:34	7,56	5	37,81	CHI
2020113349	FORMOSA	FA12395983	FLORES DE GOIAS	02/11/2020 02:00	02/11/2020 12:29	02/11/2020 02:00	02/11/2020 12:29	10,47	2	20,94	CHI
2020113349	FORMOSA	FA12395983	FLORES DE GOIAS	02/11/2020 02:00	02/11/2020 12:29	02/11/2020 11:00	02/11/2020 12:29	1,47	97	142,91	CHI
2020113350	PIRACANJUBA	PJ12263256	CALDAS NOVAS S1	02/11/2020 02:03	02/11/2020 06:25	02/11/2020 02:03	02/11/2020 06:25	4,35	5	21,75	CHI

2020113366	ITAPIRAPUA	IU12030155	JUSSARA	02/11/2020 03:38	02/11/2020 07:34	02/11/2020 03:38	02/11/2020 07:34	3,93	43	169,07	CHI
2020113366	NOVO BRASIL	IU12030155	JUSSARA	02/11/2020 03:38	02/11/2020 07:34	02/11/2020 03:38	02/11/2020 07:34	3,93	1	3,93	CHI
2020113370	VARJAO	GA31095994	CEZARINA	02/11/2020 03:55	02/11/2020 05:08	02/11/2020 03:55	02/11/2020 05:08	1,21	1	1,21	CHI
2020113372	ITUMBIAIRA	IT12033049	BOM JESUS DE GOIAS	02/11/2020 04:30	02/11/2020 10:15	02/11/2020 04:30	02/11/2020 10:15	5,75	7	40,24	CHI
2020113373	ITABERAI	IB12102567	ITABERAI S1	02/11/2020 04:36	02/11/2020 08:55	02/11/2020 04:36	02/11/2020 08:55	4,32	4	17,26	CHI
2020113373	ITAUCU	IB12102567	ITABERAI S1	02/11/2020 04:36	02/11/2020 08:55	02/11/2020 04:36	02/11/2020 08:55	4,32	2	8,63	CHI
2020113447	AMARALINA	LC12215796	MARA ROSA	02/11/2020 04:43	02/11/2020 09:23	02/11/2020 04:43	02/11/2020 09:23	4,67	13	60,66	CHI
2020113376	CORUMBAIBA	560031336	VILA CORUMBA	02/11/2020 04:47	02/11/2020 09:09	02/11/2020 04:47	02/11/2020 09:09	4,35	1	4,35	CHI
2020113665	CAMPINORTE	MQ12370551	MARA ROSA	02/11/2020 04:55	02/11/2020 09:26	02/11/2020 04:55	02/11/2020 09:26	4,51	5	22,54	CHI
2020113665	MARA ROSA	MQ12370551	MARA ROSA	02/11/2020 04:55	02/11/2020 09:26	02/11/2020 04:55	02/11/2020 09:26	4,51	25	112,71	CHI
2020113380	PIRENOPOLIS	PV21227830	CORUMBA	02/11/2020 05:08	02/11/2020 09:01	02/11/2020 05:08	02/11/2020 09:01	3,88	1	3,88	CHI
2020113383	CABECEIRAS	CW12398925	ITUIQUIRA	02/11/2020 05:11	02/11/2020 07:51	02/11/2020 05:11	02/11/2020 07:51	2,66	28	74,62	CHI
2020113385	PIRACANJUBA	PJ12138235	PIRACANJUBA	02/11/2020 05:13	02/11/2020 17:04	02/11/2020 05:13	02/11/2020 17:04	11,85	2	23,69	CHI
2020113596	MUNDO NOVO DE GOIAS	MH12291217LD	NOVA CRIXAS	02/11/2020 05:18	02/11/2020 11:14	02/11/2020 05:18	02/11/2020 11:14	5,92	27	159,95	CHI
2020113390	ITAGUARI	II11068201	ITABERAI S1	02/11/2020 05:22	02/11/2020 15:43	02/11/2020 05:22	02/11/2020 15:43	10,35	142	1469,38	CHI
2020113414	JANDAIA	JD12008607LD	PALMEIRAS	02/11/2020 05:24	02/11/2020 07:24	02/11/2020 05:24	02/11/2020 07:24	2,00	82	163,77	CHI
2020113414	PARAUNA	JD12008607LD	PALMEIRAS	02/11/2020 05:24	02/11/2020 07:24	02/11/2020 05:24	02/11/2020 07:24	2,00	6	11,98	CHI
2020113427	ALTO HORIZONTE	AJ12100313	SANTA TEREZINHA	02/11/2020 05:29	02/11/2020 07:35	02/11/2020 05:29	02/11/2020 07:35	2,09	10	20,91	CHI
2020113399	PORANGATU	4140224	PORANGATU	02/11/2020 05:34	03/11/2020 11:33	02/11/2020 05:34	02/11/2020 08:07	2,55	99	252,61	CHI
2020113399	PORANGATU	4140224	PORANGATU	02/11/2020 05:34	03/11/2020 11:33	02/11/2020 07:55	02/11/2020 08:07	0,20	5	1,00	CHI
2020113399	PORANGATU	4140224	PORANGATU	02/11/2020 05:34	03/11/2020 11:33	02/11/2020 05:34	02/11/2020 08:08	2,57	180	462,35	CHI
2020113399	SANTA TEREZA DE GOIAS	4140224	PORANGATU	02/11/2020 05:34	03/11/2020 11:33	02/11/2020 05:34	02/11/2020 08:08	2,57	4	10,27	CHI
2020113399	TROMBAS	4140224	PORANGATU	02/11/2020 05:34	03/11/2020 11:33	02/11/2020 05:34	02/11/2020 08:08	2,57	149	382,72	CHI
2020113399	PORANGATU	PO10400796	PORANGATU	02/11/2020 05:34	03/11/2020 11:33	02/11/2020 07:55	02/11/2020 08:08	0,22	30	6,52	CHI
2020113399	SANTA TEREZA DE GOIAS	PO10400796	PORANGATU	02/11/2020 05:34	03/11/2020 11:33	02/11/2020 07:55	02/11/2020 08:08	0,22	2	0,43	CHI
2020113399	TROMBAS	PO10400796	PORANGATU	02/11/2020 05:34	03/11/2020 11:33	02/11/2020 07:55	02/11/2020 08:08	0,22	7	1,52	CHI
2020113399	PORANGATU	4140224	PORANGATU	02/11/2020 05:34	03/11/2020 11:33	02/11/2020 05:34	02/11/2020 08:10	2,60	299	777,90	CHI
2020113399	PORANGATU	PO16404034	PORANGATU	02/11/2020 05:34	03/11/2020 11:33	02/11/2020 07:55	02/11/2020 08:10	0,25	10	2,50	CHI
2020113399	PORANGATU	4140224	PORANGATU	02/11/2020 05:34	03/11/2020 11:33	02/11/2020 05:34	02/11/2020 08:12	2,63	49	129,05	CHI
2020113399	PORANGATU	PO10396207	PORANGATU	02/11/2020 05:34	03/11/2020 11:33	02/11/2020 07:55	02/11/2020 08:12	0,28	1	0,28	CHI
2020113399	PORANGATU	4140224	PORANGATU	02/11/2020 05:34	03/11/2020 11:33	02/11/2020 08:14	02/11/2020 08:28	0,23	313	71,99	CHI
2020113399	SANTA TEREZA DE GOIAS	4140224	PORANGATU	02/11/2020 05:34	03/11/2020 11:33	02/11/2020 08:14	02/11/2020 08:28	0,23	6	1,38	CHI
2020113399	TROMBAS	4140224	PORANGATU	02/11/2020 05:34	03/11/2020 11:33	02/11/2020 08:14	02/11/2020 08:28	0,23	156	35,88	CHI
2020113399	PORANGATU	PO16404034	PORANGATU	02/11/2020 05:34	03/11/2020 11:33	02/11/2020 08:14	02/11/2020 09:22	1,12	11	12,37	CHI
2020113399	MONTIVIDIU DO NORTE	4140224	PORANGATU	02/11/2020 05:34	03/11/2020 11:33	02/11/2020 05:34	02/11/2020 11:34	6,01	6	36,06	CHI
2020113399	PORANGATU	4140224	PORANGATU	02/11/2020 05:34	03/11/2020 11:33	02/11/2020 05:34	02/11/2020 11:34	6,01	358	2151,48	CHI
2020113399	PORANGATU	PO16431789	PORANGATU	02/11/2020 05:34	03/11/2020 11:33	02/11/2020 07:55	02/11/2020 11:34	3,66	7	25,61	CHI
2020113399	PORANGATU	PO13020597	PORANGATU	02/11/2020 05:34	03/11/2020 11:33	02/11/2020 08:14	02/11/2020 11:34	3,33	50	166,42	CHI
2020113399	PORANGATU	PO10400797	PORANGATU	02/11/2020 05:34	03/11/2020 11:33	02/11/2020 08:14	02/11/2020 14:54	6,66	11	73,28	CHI
2020113399	PORANGATU	PO10400797	PORANGATU	02/11/2020 05:34	03/11/2020 11:33	02/11/2020 08:14	02/11/2020 16:50	8,58	10	85,84	CHI
2020113399	PORANGATU	PO10400797	PORANGATU	02/11/2020 05:34	03/11/2020 11:33	02/11/2020 16:51	02/11/2020 18:14	1,38	11	15,22	CHI
2020113399	PORANGATU	PO10400797	PORANGATU	02/11/2020 05:34	03/11/2020 11:33	03/11/2020 01:13	03/11/2020 08:22	7,14	11	78,59	CHI
2020113399	PORANGATU	PO10400797	PORANGATU	02/11/2020 05:34	03/11/2020 11:33	02/11/2020 08:14	03/11/2020 10:39	26,42	109	2879,27	CHI
2020113399	PORANGATU	PO13020771	PORANGATU	02/11/2020 05:34	03/11/2020 11:33	02/11/2020 08:14	03/11/2020 10:39	26,42	121	3196,25	CHI
2020113399	PORANGATU	PO13020771	PORANGATU	02/11/2020 05:34	03/11/2020 11:33	02/11/2020 13:25	03/11/2020 10:39	21,25	1	21,25	CHI
2020113399	PORANGATU	PO13020771	PORANGATU	02/11/2020 05:34	03/11/2020 11:33	02/11/2020 16:51	03/11/2020 10:39	17,80	9	160,23	CHI
2020113399	PORANGATU	PO13020771	PORANGATU	02/11/2020 05:34	03/11/2020 11:33	03/11/2020 01:13	03/11/2020 10:39	9,44	1	9,44	CHI
2020113399	PORANGATU	PO10400797	PORANGATU	02/11/2020 05:34	03/11/2020 11:33	02/11/2020 08:14	03/11/2020 11:10	26,93	45	1211,79	CHI
2020113399	PORANGATU	PO12022073	PORANGATU	02/11/2020 05:34	03/11/2020 11:33	02/11/2020 13:25	03/11/2020 11:10	21,76	1	21,76	CHI
2020113399	PORANGATU	PO13020771	PORANGATU	02/11/2020 05:34	03/11/2020 11:33	02/11/2020 16:51	03/11/2020 11:33	18,69	1	18,69	CHI
2020113538	CAMPINACU	UC12354229	MARA ROSA	02/11/2020 05:36	02/11/2020 08:33	02/11/2020 05:36	02/11/2020 08:33	2,94	17	50,03	CHI

2020113410	ORIZONA	OZ12114504	PIRES DO RIO S2	02/11/2020 05:49	02/11/2020 07:24	02/11/2020 05:49	02/11/2020 07:24	1,57	10	15,71	CHI
2020113411	CEZARINA	CZ12066110	CEZARINA	02/11/2020 05:50	02/11/2020 09:57	02/11/2020 05:50	02/11/2020 09:57	4,11	11	45,26	CHI
2020113413	SAO JOAO D ALIANCA	JL11218464	SAO JOAO D ALIANCA	02/11/2020 05:52	02/11/2020 09:28	02/11/2020 05:52	02/11/2020 09:28	3,60	2	7,19	CHI
202011137918	DOVERLANDIA	DV12395475	CAIAPONIA	02/11/2020 05:54	02/11/2020 08:01	02/11/2020 05:54	02/11/2020 08:01	2,11	11	23,18	CHI
2020113421	URUACU	UR12380056	URUACU	02/11/2020 05:58	02/11/2020 08:15	02/11/2020 05:58	02/11/2020 08:15	2,28	83	189,33	CHI
2020114178	CALDAS NOVAS	CN12186176	SERRA DE CALDAS	02/11/2020 05:58	02/11/2020 10:02	02/11/2020 05:58	02/11/2020 10:02	4,06	27	109,55	CHI
2020113432	PONTALINA	PK12085847	PONTALINA	02/11/2020 06:01	02/11/2020 08:00	02/11/2020 06:01	02/11/2020 08:00	1,98	1	1,98	CHI
2020113429	CRIXAS	CX12322601	SANTA TEREZINHA	02/11/2020 06:02	02/11/2020 08:19	02/11/2020 06:02	02/11/2020 08:19	2,28	3	6,83	CHI
2020113730	MOZARLANDIA	MZ12057146	MOZARLANDIA	02/11/2020 06:03	02/11/2020 18:05	02/11/2020 06:03	02/11/2020 10:47	4,74	6	28,47	CHI
2020113730	NOVA CRIXAS	MZ12057146	MOZARLANDIA	02/11/2020 06:03	02/11/2020 18:05	02/11/2020 06:03	02/11/2020 10:47	4,74	2	9,49	CHI
2020113730	NOVA CRIXAS	MZ12057146	MOZARLANDIA	02/11/2020 06:03	02/11/2020 18:05	02/11/2020 06:03	02/11/2020 18:05	12,03	25	300,76	CHI
2020113434	JOVIANIA	JV21232790	GOIATUBA S1	02/11/2020 06:04	02/11/2020 08:50	02/11/2020 06:04	02/11/2020 08:50	2,75	1	2,75	CHI
2020113435	GOIANIA	14450070	FERROVIARIO S3	02/11/2020 06:05	02/11/2020 07:10	02/11/2020 06:05	02/11/2020 07:10	1,08	1	1,08	CHI
2020113733	TRINDADE	TR12169656	TRINDADE	02/11/2020 06:07	02/11/2020 09:39	02/11/2020 06:07	02/11/2020 09:39	3,52	9	31,71	CHI
2020113451	JUSSARA	BT21167547	BRITANIA	02/11/2020 06:12	02/11/2020 09:25	02/11/2020 06:12	02/11/2020 09:25	3,21	1	3,21	CHI
2020113452	GOIATUBA	GT12273783	GOIATUBA S2	02/11/2020 06:12	02/11/2020 14:59	02/11/2020 06:12	02/11/2020 14:59	8,77	56	491,38	CHI
2020113452	MORRINHOS	GT12273783	GOIATUBA S2	02/11/2020 06:12	02/11/2020 14:59	02/11/2020 06:12	02/11/2020 14:59	8,77	2	17,55	CHI
2020114117	JUSSARA	JR21244025	BRITANIA	02/11/2020 06:12	02/11/2020 10:42	02/11/2020 06:12	02/11/2020 10:42	4,50	1	4,50	CHI
2020113457	MORRINHOS	MR21279126	MORRINHOS	02/11/2020 06:16	02/11/2020 09:00	02/11/2020 06:16	02/11/2020 09:00	2,72	1	2,72	CHI
2020113459	LUZIANIA	120224926	RIO VERMELHO	02/11/2020 06:17	02/11/2020 07:03	02/11/2020 06:17	02/11/2020 07:03	0,77	1	0,77	CHI
2020113461	MINACU	4020085240	MINACU	02/11/2020 06:21	02/11/2020 09:42	02/11/2020 06:21	02/11/2020 09:42	3,34	1	3,34	CHI
2020113463	TRINDADE	6682646	TRINDADE	02/11/2020 06:22	02/11/2020 08:20	02/11/2020 06:22	02/11/2020 08:20	1,97	1	1,97	CHI
2020113464	NOVO PLANALTO	TA12139137	NOVO PLANALTO	02/11/2020 06:22	02/11/2020 08:25	02/11/2020 06:22	02/11/2020 08:25	2,04	3	6,13	CHI
2020113348	GOIAS	GS12014714	MATRINCHA	02/11/2020 06:23	02/11/2020 10:06	02/11/2020 06:23	02/11/2020 10:06	3,70	98	363,01	CHI
2020113348	ITAPIRAPUA	GS12014714	MATRINCHA	02/11/2020 06:23	02/11/2020 10:06	02/11/2020 06:23	02/11/2020 10:06	3,70	1	3,70	CHI
2020113348	NOVO BRASIL	GS12014714	MATRINCHA	02/11/2020 06:23	02/11/2020 10:06	02/11/2020 06:23	02/11/2020 10:06	3,70	36	133,35	CHI
2020113521	PONTALINA	PK12109373	PONTALINA	02/11/2020 06:23	02/11/2020 09:33	02/11/2020 06:23	02/11/2020 09:33	3,16	5	15,79	CHI
2020113831	TROMBAS	TB12156807	PORANGATU	02/11/2020 06:23	02/11/2020 11:19	02/11/2020 06:23	02/11/2020 11:19	4,92	72	354,28	CHI
2020113471	ANHANGUERA	CY12266858	CATALAO S1	02/11/2020 06:25	02/11/2020 08:37	02/11/2020 06:25	02/11/2020 08:37	2,20	8	17,56	CHI
2020113471	CORUMBAIBA	CY12266858	CATALAO S1	02/11/2020 06:25	02/11/2020 08:37	02/11/2020 06:25	02/11/2020 08:37	2,20	4	8,78	CHI
2020113471	CUMARI	CY12266858	CATALAO S1	02/11/2020 06:25	02/11/2020 08:37	02/11/2020 06:25	02/11/2020 08:37	2,20	78	171,23	CHI
2020113471	GOIANDIRA	CY12266858	CATALAO S1	02/11/2020 06:25	02/11/2020 08:37	02/11/2020 06:25	02/11/2020 08:37	2,20	13	28,54	CHI
2020113471	NOVA AURORA	CY12266858	CATALAO S1	02/11/2020 06:25	02/11/2020 08:37	02/11/2020 06:25	02/11/2020 08:37	2,20	1	2,20	CHI
2020114132	GOIAS	GS12037486	ITABERAI S1	02/11/2020 06:26	02/11/2020 10:01	02/11/2020 06:26	02/11/2020 10:01	3,58	20	71,66	CHI
2020113539	COLINAS DO SUL	TI12271095	MINACU	02/11/2020 06:28	02/11/2020 16:56	02/11/2020 06:28	02/11/2020 16:56	10,46	23	240,47	CHI
2020113488	BONOPOLIS	SM13391608	SAO MIGUEL DO ARAGUAIA	02/11/2020 06:29	02/11/2020 17:27	02/11/2020 06:29	02/11/2020 17:27	10,97	105	1151,44	CHI
2020113488	SAO MIGUEL DO ARAGUAIA	SM13391608	SAO MIGUEL DO ARAGUAIA	02/11/2020 06:29	02/11/2020 17:27	02/11/2020 06:29	02/11/2020 17:27	10,97	3	32,90	CHI
2020113491	VILA PROPICIO	PV12089909	GOIANESIA S1	02/11/2020 06:29	02/11/2020 18:54	02/11/2020 06:29	02/11/2020 18:54	12,42	3	37,26	CHI
2020113496	FIRMINOPOLIS	2940001577	FIRMINOPOLIS S1	02/11/2020 06:32	02/11/2020 09:07	02/11/2020 06:32	02/11/2020 09:07	2,58	1	2,58	CHI
2020113499	MINACU	IH12247493	MINACU	02/11/2020 06:32	02/11/2020 10:45	02/11/2020 06:32	02/11/2020 10:45	4,20	104	437,23	CHI
2020113500	MORRINHOS	MR12172981	MORRINHOS	02/11/2020 06:34	02/11/2020 08:09	02/11/2020 06:34	02/11/2020 08:09	1,60	4	6,40	CHI
2020113504	BOM JESUS DE GOIAS	BJ21326152	BOM JESUS DE GOIAS	02/11/2020 06:34	02/11/2020 09:24	02/11/2020 06:34	02/11/2020 09:24	2,82	1	2,82	CHI
2020113505	ARAGARCAS	AG12072894	ARAGARCAS	02/11/2020 06:35	02/11/2020 15:24	02/11/2020 06:35	02/11/2020 15:24	8,81	81	713,70	CHI
2020113505	BOM JARDIM DE GOIAS	AG12072894	ARAGARCAS	02/11/2020 06:35	02/11/2020 15:24	02/11/2020 06:35	02/11/2020 15:24	8,81	34	299,58	CHI
2020113505	ARAGARCAS	AG12072894	ARAGARCAS	02/11/2020 06:35	02/11/2020 15:24	02/11/2020 07:56	02/11/2020 15:24	7,47	18	134,47	CHI
2020113505	BOM JARDIM DE GOIAS	AG12072894	ARAGARCAS	02/11/2020 06:35	02/11/2020 15:24	02/11/2020 07:56	02/11/2020 15:24	7,47	6	44,82	CHI
2020113506	FORMOSO	SE12053856	MARA ROSA	02/11/2020 06:36	02/11/2020 08:28	02/11/2020 06:36	02/11/2020 08:28	1,86	6	11,15	CHI
2020113506	SANTA TEREZA DE GOIAS	SE12053856	MARA ROSA	02/11/2020 06:36	02/11/2020 08:28	02/11/2020 06:36	02/11/2020 08:28	1,86	3	5,58	CHI
2020113648	URUACU	UR12232312	URUACU	02/11/2020 06:38	02/11/2020 08:34	02/11/2020 06:38	02/11/2020 08:34	1,92	17	32,65	CHI
2020113519	PLANALTINA	PI12324338	SAO JOAO D ALIANCA	02/11/2020 06:40	02/11/2020 09:54	02/11/2020 06:40	02/11/2020 09:54	3,23	6	19,37	CHI
2020113520	MATRINCHA	MP12198012	MATRINCHA	02/11/2020 06:40	02/11/2020 09:08	02/11/2020 06:40	02/11/2020 09:08	2,46	14	34,47	CHI

2020113522	APARECIDA DE GOIANIA	AP10403991	CEPAIGO S1	02/11/2020 06:41	02/11/2020 09:17	02/11/2020 06:41	02/11/2020 09:17	2,61	35	91,37	CHI
2020113522	GOIANIA	AP10403991	CEPAIGO S1	02/11/2020 06:41	02/11/2020 09:17	02/11/2020 06:41	02/11/2020 09:17	2,61	76	198,40	CHI
2020113522	SENADOR CANEDO	AP10403991	CEPAIGO S1	02/11/2020 06:41	02/11/2020 09:17	02/11/2020 06:41	02/11/2020 09:17	2,61	437	1140,81	CHI
2020113524	MUTUNOPOLIS	MU11395780	MARA ROSA	02/11/2020 06:41	02/11/2020 09:50	02/11/2020 06:41	02/11/2020 09:50	3,14	1	3,14	CHI
2020113753	SAO FRANCISCO DE GOIAS	SF12335087	SAO FRANCISCO DE GOIAS	02/11/2020 06:42	02/11/2020 08:31	02/11/2020 06:42	02/11/2020 08:31	1,81	11	19,96	CHI
2020113530	GOIANESIA	GE12372623	GOIANESIA S1	02/11/2020 06:44	02/11/2020 10:29	02/11/2020 06:44	02/11/2020 10:29	3,74	30	112,30	CHI
2020113540	SAO JOAO D ALIANCA	JL12383338	SAO JOAO D ALIANCA	02/11/2020 06:48	02/11/2020 09:35	02/11/2020 06:48	02/11/2020 09:35	2,77	39	108,21	CHI
2020113541	CATALAO	CT21372766	CAMPO ALEGRE DE GOIAS	02/11/2020 06:48	02/11/2020 08:56	02/11/2020 06:48	02/11/2020 08:56	2,12	1	2,12	CHI
2020113547	NEROPOLIS	NR21215060	NEROPOLIS S2	02/11/2020 06:50	02/11/2020 08:15	02/11/2020 06:50	02/11/2020 08:15	1,40	2	2,80	CHI
2020113636	ITABERAI	II12217217	ITABERAI S1	02/11/2020 06:50	02/11/2020 08:11	02/11/2020 06:50	02/11/2020 08:11	1,34	22	29,55	CHI
2020113636	ITAGUARI	II12217217	ITABERAI S1	02/11/2020 06:50	02/11/2020 08:11	02/11/2020 06:50	02/11/2020 08:11	1,34	42	56,41	CHI
2020113636	TAQUARAL DE GOIAS	II12217217	ITABERAI S1	02/11/2020 06:50	02/11/2020 08:11	02/11/2020 06:50	02/11/2020 08:11	1,34	46	61,78	CHI
2020113554	AMORINOPOLIS	AM12312073	IPORA	02/11/2020 06:53	02/11/2020 09:25	02/11/2020 06:53	02/11/2020 09:25	2,53	3	7,60	CHI
2020113558	MATRINCHA	MP12250740	MATRINCHA	02/11/2020 06:53	02/11/2020 14:55	02/11/2020 06:53	02/11/2020 14:55	8,02	9	72,21	CHI
2020113566	ARAGUAPAZ	AZ12042979	MOZARLANDIA	02/11/2020 06:55	02/11/2020 10:25	02/11/2020 06:55	02/11/2020 08:28	1,54	6	9,25	CHI
2020113566	ARAGUAPAZ	AZ12042979	MOZARLANDIA	02/11/2020 06:55	02/11/2020 10:25	02/11/2020 08:33	02/11/2020 08:40	0,11	3	0,34	CHI
2020113566	ARAGUAPAZ	AZ12042979	MOZARLANDIA	02/11/2020 06:55	02/11/2020 10:25	02/11/2020 06:55	02/11/2020 08:44	1,82	4	7,28	CHI
2020113566	ARAGUAPAZ	AZ12042945LD	MOZARLANDIA	02/11/2020 06:55	02/11/2020 10:25	02/11/2020 08:33	02/11/2020 10:25	1,86	3	5,58	CHI
2020113849	CRIXAS	CX12134501	RUBIATABA	02/11/2020 06:56	02/11/2020 10:48	02/11/2020 06:56	02/11/2020 10:48	3,86	57	220,29	CHI
2020113849	NOVA IGUACU DE GOIAS	CX12134501	RUBIATABA	02/11/2020 06:56	02/11/2020 10:48	02/11/2020 06:56	02/11/2020 10:48	3,86	1	3,86	CHI
2020113579	DIORAMA	DI21212992	IPORA	02/11/2020 06:58	02/11/2020 08:48	02/11/2020 06:58	02/11/2020 08:48	1,83	1	1,83	CHI
2020113583	CRISTALINA	KR12330533	CRISTALINA S1	02/11/2020 06:58	02/11/2020 08:20	02/11/2020 06:58	02/11/2020 08:20	1,35	35	47,26	CHI
2020113583	IPAMERI	KR12330533	CRISTALINA S1	02/11/2020 06:58	02/11/2020 08:20	02/11/2020 06:58	02/11/2020 08:20	1,35	1	1,35	CHI
2020113583	LUZIANIA	KR12330533	CRISTALINA S1	02/11/2020 06:58	02/11/2020 08:20	02/11/2020 06:58	02/11/2020 08:20	1,35	5	6,75	CHI
2020113585	AGUA FRIA DE GOIAS	TL21417738	SAO JOAO D ALIANCA	02/11/2020 06:59	02/11/2020 13:01	02/11/2020 06:59	02/11/2020 13:01	6,02	1	6,02	CHI
2020113599	ORIZONA	OZ12375967	PIRES DO RIO S2	02/11/2020 07:03	02/11/2020 08:17	02/11/2020 07:03	02/11/2020 08:17	1,23	4	4,91	CHI
2020113607	IPAMERI	IP21373679	PIRES DO RIO S2	02/11/2020 07:05	02/11/2020 11:44	02/11/2020 07:05	02/11/2020 11:44	4,64	1	4,64	CHI
2020113609	CRISTALINA	KR12160258	CRISTALINA S2	02/11/2020 07:05	02/11/2020 10:26	02/11/2020 07:05	02/11/2020 10:26	3,34	3	10,01	CHI
2020113698	CACHOEIRA DOURADA	CD12000044	CACHOEIRA DOURADA	02/11/2020 07:05	02/11/2020 10:39	02/11/2020 07:05	02/11/2020 10:39	3,56	8	28,50	CHI
2020113767	CORREGO DO OURO	BS12009575	FIRMINOPOLIS S2	02/11/2020 07:05	02/11/2020 08:38	02/11/2020 07:05	02/11/2020 08:38	1,54	11	16,98	CHI
2020113710	MINACU	IH11257878	MINACU	02/11/2020 07:07	02/11/2020 08:35	02/11/2020 07:07	02/11/2020 08:35	1,46	79	115,12	CHI
2020113619	ARENOPOLIS	AY12380979	ARENOPOLIS	02/11/2020 07:08	02/11/2020 08:44	02/11/2020 07:08	02/11/2020 08:44	1,59	1	1,59	CHI
2020113620	SAO JOAO DA PARAUNA	FR21361864	FIRMINOPOLIS S2	02/11/2020 07:09	02/11/2020 09:41	02/11/2020 07:09	02/11/2020 09:41	2,53	1	2,53	CHI
2020113627	CATALAO	1990053431	CATALAO S2	02/11/2020 07:10	02/11/2020 08:14	02/11/2020 07:10	02/11/2020 08:14	1,06	1	1,06	CHI
2020113632	JARAGUA	JA21339792	GOIANESIA S2	02/11/2020 07:12	02/11/2020 14:49	02/11/2020 07:12	02/11/2020 14:49	7,60	4	30,42	CHI
2020113640	PORANGATU	840116081	PORANGATU	02/11/2020 07:14	02/11/2020 18:33	02/11/2020 07:14	02/11/2020 18:33	11,31	1	11,31	CHI
2020113644	ANAPOLIS	AN12093732	ANAPOLIS UNIVERSITARIO S2	02/11/2020 07:15	02/11/2020 09:19	02/11/2020 07:15	02/11/2020 09:19	2,05	15	30,80	CHI
2020113647	CATALAO	CT21333703	CATALAO S1	02/11/2020 07:17	02/11/2020 09:42	02/11/2020 07:17	02/11/2020 09:42	2,42	1	2,42	CHI
2020113650	GOIANIA	GN11001719	REAL S2	02/11/2020 07:17	02/11/2020 10:49	02/11/2020 08:20	02/11/2020 10:49	2,48	167	414,72	CHI
2020113655	MUNDO NOVO DE GOIAS	MH12417270	NOVA CRIXAS	02/11/2020 07:18	02/11/2020 08:59	02/11/2020 07:18	02/11/2020 08:59	1,67	2	3,35	CHI
2020113662	SANTA FE DE GOIAS	RN12055147	BRITANIA	02/11/2020 07:19	02/11/2020 11:31	02/11/2020 07:19	02/11/2020 11:31	4,19	1	4,19	CHI
2020113663	ALVORADA DO NORTE	AQ12388463	IACIARA S2	02/11/2020 07:19	02/11/2020 10:45	02/11/2020 07:19	02/11/2020 10:45	3,42	3	10,25	CHI
2020113674	MONTIVIDIU DO NORTE	MX12203423	PORANGATU	02/11/2020 07:19	02/11/2020 14:36	02/11/2020 07:19	02/11/2020 14:36	7,28	17	123,79	CHI
2020113667	FLORES DE GOIAS	FB12344172	FLORES DE GOIAS	02/11/2020 07:21	02/11/2020 22:27	02/11/2020 07:21	02/11/2020 22:27	15,10	4	60,40	CHI
2020113670	PADRE BERNARDO	PB12095000	PADRE BERNARDO	02/11/2020 07:22	03/11/2020 11:10	02/11/2020 07:22	02/11/2020 10:47	3,42	17	58,14	CHI
2020113670	VILA PROPICIO	PB12095000	PADRE BERNARDO	02/11/2020 07:22	03/11/2020 11:10	02/11/2020 07:22	02/11/2020 10:47	3,42	7	23,94	CHI
2020113670	PADRE BERNARDO	PB12095000	PADRE BERNARDO	02/11/2020 07:22	03/11/2020 11:10	02/11/2020 09:15	02/11/2020 10:47	1,53	15	23,00	CHI
2020113670	VILA PROPICIO	PB12095000	PADRE BERNARDO	02/11/2020 07:22	03/11/2020 11:10	02/11/2020 09:15	02/11/2020 10:47	1,53	1	1,53	CHI
2020113670	MIMOSO DE GOIAS	PB12095000	PADRE BERNARDO	02/11/2020 07:22	03/11/2020 11:10	02/11/2020 07:22	02/11/2020 12:48	5,44	1	5,44	CHI
2020113670	MIMOSO DE GOIAS	PB12333289	PADRE BERNARDO	02/11/2020 07:22	03/11/2020 11:10	02/11/2020 09:15	02/11/2020 12:48	3,55	31	110,14	CHI
2020113670	PADRE BERNARDO	PB12333289	PADRE BERNARDO	02/11/2020 07:22	03/11/2020 11:10	02/11/2020 09:15	02/11/2020 12:48	3,55	5	17,76	CHI

2020113670	MIMOSO DE GOIAS	PB12095000	PADRE BERNARDO	02/11/2020 07:22	03/11/2020 11:10	02/11/2020 13:54	02/11/2020 14:09	0,25	32	7,96	CHI
2020113670	PADRE BERNARDO	PB12095000	PADRE BERNARDO	02/11/2020 07:22	03/11/2020 11:10	02/11/2020 13:54	02/11/2020 14:09	0,25	37	9,21	CHI
2020113670	VILA PROPICIO	PB12095000	PADRE BERNARDO	02/11/2020 07:22	03/11/2020 11:10	02/11/2020 13:54	02/11/2020 14:09	0,25	8	1,99	CHI
2020113670	MIMOSO DE GOIAS	MJ12333277	PADRE BERNARDO	02/11/2020 07:22	03/11/2020 11:10	02/11/2020 09:15	02/11/2020 16:43	7,46	13	97,03	CHI
2020113670	PADRE BERNARDO	MJ12333277	PADRE BERNARDO	02/11/2020 07:22	03/11/2020 11:10	02/11/2020 09:15	02/11/2020 16:43	7,46	1	7,46	CHI
2020113670	MIMOSO DE GOIAS	PB12095000	PADRE BERNARDO	02/11/2020 07:22	03/11/2020 11:10	03/11/2020 07:04	03/11/2020 08:04	1,00	45	44,87	CHI
2020113670	PADRE BERNARDO	PB12095000	PADRE BERNARDO	02/11/2020 07:22	03/11/2020 11:10	03/11/2020 07:04	03/11/2020 08:04	1,00	38	37,89	CHI
2020113670	VILA PROPICIO	PB12095000	PADRE BERNARDO	02/11/2020 07:22	03/11/2020 11:10	03/11/2020 07:04	03/11/2020 08:04	1,00	8	7,98	CHI
2020113670	MIMOSO DE GOIAS	PB12095000	PADRE BERNARDO	02/11/2020 07:22	03/11/2020 11:10	02/11/2020 07:22	03/11/2020 11:10	27,80	1	27,80	CHI
2020113670	MIMOSO DE GOIAS	MJ12349081	PADRE BERNARDO	02/11/2020 07:22	03/11/2020 11:10	02/11/2020 09:15	03/11/2020 11:10	25,91	2	51,82	CHI
2020113746	SAO MIGUEL DO ARAGUAIA	SM12100371	SAO MIGUEL DO ARAGUAIA	02/11/2020 07:22	02/11/2020 12:22	02/11/2020 07:22	02/11/2020 12:22	5,00	76	379,68	CHI
2020113787	PIRACANJUBA	PJ12263070	PIRACANJUBA	02/11/2020 07:22	02/11/2020 09:50	02/11/2020 07:22	02/11/2020 09:50	2,46	5	12,30	CHI
2020113714	NOVO PLANALTO	TA12391926	SAO MIGUEL DO ARAGUAIA	02/11/2020 07:23	03/11/2020 17:32	02/11/2020 07:23	03/11/2020 10:38	27,25	8	218,04	CHI
2020113714	NOVO PLANALTO	TA12391926	SAO MIGUEL DO ARAGUAIA	02/11/2020 07:23	03/11/2020 17:32	02/11/2020 07:23	03/11/2020 17:32	34,15	10	341,47	CHI
2020115022	PORANGATU	PO12253874	PORANGATU	02/11/2020 07:23	02/11/2020 16:57	02/11/2020 07:23	02/11/2020 16:57	9,55	5	47,76	CHI
2020113681	MONTES CLAROS DE GOIAS	ME21358494	IPORA	02/11/2020 07:26	02/11/2020 09:53	02/11/2020 07:26	02/11/2020 09:53	2,44	1	2,44	CHI
2020113683	HIDROLINA	1020007968	URUACU	02/11/2020 07:27	02/11/2020 09:15	02/11/2020 07:27	02/11/2020 09:15	1,79	1	1,79	CHI
2020113684	PALMEIRAS DE GOIAS	10000887950	PALMEIRAS	02/11/2020 07:27	02/11/2020 09:13	02/11/2020 07:27	02/11/2020 09:13	1,76	1	1,76	CHI
2020113687	TRINDADE	TR32001819	TRINDADE	02/11/2020 07:27	02/11/2020 09:45	02/11/2020 07:27	02/11/2020 09:45	2,29	2	4,58	CHI
2020114334	UIRAPURU	UP12391848	SANTA TEREZINHA	02/11/2020 07:27	02/11/2020 17:19	02/11/2020 07:27	02/11/2020 17:19	9,86	7	69,05	CHI
2020113689	PALMEIRAS DE GOIAS	10021524325	PALMEIRAS	02/11/2020 07:28	02/11/2020 08:35	02/11/2020 07:28	02/11/2020 08:35	1,12	1	1,12	CHI
2020113692	JUSSARA	1290074802	JUSSARA	02/11/2020 07:28	02/11/2020 11:36	02/11/2020 07:28	02/11/2020 11:36	4,12	1	4,12	CHI
2020113699	FLORES DE GOIAS	FB12218564	IACIARA S2	02/11/2020 07:31	02/11/2020 12:00	02/11/2020 07:31	02/11/2020 12:00	4,48	28	125,49	CHI
2020113703	APARECIDA DE GOIANIA	10013986110	INDEPENDENCIA S2	02/11/2020 07:33	02/11/2020 08:35	02/11/2020 07:33	02/11/2020 08:35	1,03	1	1,03	CHI
2020113705	GOIANESIA	GE21394301	GOIANESIA S1	02/11/2020 07:33	02/11/2020 08:33	02/11/2020 07:33	02/11/2020 08:33	0,99	1	0,99	CHI
2020113940	IPAMERI	IP12311626	IPAMERI	02/11/2020 07:34	02/11/2020 10:43	02/11/2020 07:34	02/11/2020 10:43	3,15	42	132,27	CHI
2020113717	ARENOPOLIS	AY21334521	ARENOPOLIS	02/11/2020 07:36	02/11/2020 11:42	02/11/2020 07:36	02/11/2020 11:42	4,09	1	4,09	CHI
2020114031	PORANGATU	PO12363572	PORANGATU	02/11/2020 07:36	02/11/2020 10:57	02/11/2020 07:36	02/11/2020 10:57	3,34	7	23,41	CHI
2020113719	PLANALTINA	PI12211502	PLANALTINA	02/11/2020 07:37	02/11/2020 09:16	02/11/2020 07:37	02/11/2020 09:16	1,64	187	307,30	CHI
2020113724	APARECIDA DE GOIANIA	12925068	REAL S1	02/11/2020 07:38	02/11/2020 09:40	02/11/2020 07:38	02/11/2020 09:40	2,03	1	2,03	CHI
2020113726	SANTA TEREZA DE GOIAS	SE21094141	MARA ROSA	02/11/2020 07:38	02/11/2020 13:05	02/11/2020 07:38	02/11/2020 13:05	5,44	2	10,87	CHI
2020113727	ANAPOLIS	AN11000400	JUNDIAI S1	02/11/2020 07:38	02/11/2020 08:30	02/11/2020 07:38	02/11/2020 08:30	0,85	55	46,92	CHI
2020113731	ALTO PARAISO DE GOIAS	BF12129915	FLORES DE GOIAS	02/11/2020 07:39	03/11/2020 18:14	02/11/2020 07:39	03/11/2020 18:14	34,57	24	829,77	CHI
2020113750	CATALAO	1990114584	CATALAO S2	02/11/2020 07:43	02/11/2020 09:46	02/11/2020 07:43	02/11/2020 09:46	2,04	1	2,04	CHI
2020113754	CEZARINA	CZ21274411	CEZARINA	02/11/2020 07:44	02/11/2020 10:48	02/11/2020 07:44	02/11/2020 10:48	3,05	1	3,05	CHI
2020113755	FLORES DE GOIAS	FB21409851	FLORES DE GOIAS	02/11/2020 07:44	02/11/2020 15:06	02/11/2020 07:44	02/11/2020 15:06	7,35	1	7,35	CHI
2020114406	IPAMERI	8611896	IPAMERI	02/11/2020 07:44	02/11/2020 13:58	02/11/2020 07:44	02/11/2020 13:58	6,23	1	6,23	CHI
2020113757	ARUANA	MP12274498	MOZARLANDIA	02/11/2020 07:45	04/11/2020 00:07	02/11/2020 07:45	02/11/2020 13:23	5,64	4	22,54	CHI
2020113757	MATRINCHA	MP12274498	MOZARLANDIA	02/11/2020 07:45	04/11/2020 00:07	02/11/2020 07:45	02/11/2020 13:23	5,64	2	11,27	CHI
2020113757	ARUANA	MP12274498	MOZARLANDIA	02/11/2020 07:45	04/11/2020 00:07	02/11/2020 07:45	02/11/2020 22:02	14,28	1	14,28	CHI
2020113757	MATRINCHA	MP12274498	MOZARLANDIA	02/11/2020 07:45	04/11/2020 00:07	02/11/2020 07:45	04/11/2020 00:07	40,37	1	40,37	CHI
2020113757	ARUANA	MP12198049LD	MOZARLANDIA	02/11/2020 07:45	04/11/2020 00:07	03/11/2020 22:57	04/11/2020 00:07	1,17	1	1,17	CHI
2020113759	SAO JOAO D ALIANCA	JL12335672	SAO JOAO D ALIANCA	02/11/2020 07:45	02/11/2020 11:17	02/11/2020 07:45	02/11/2020 11:17	3,52	7	24,62	CHI
2020113760	CALDAS NOVAS	CN11393086	CALDAS NOVAS S1	02/11/2020 07:45	02/11/2020 09:45	02/11/2020 07:45	02/11/2020 09:45	2,00	21	41,99	CHI
2020113764	SANTA BARBARA DE GOIAS	SB31058093	TRINDADE	02/11/2020 07:46	02/11/2020 10:39	02/11/2020 07:46	02/11/2020 10:39	2,88	1	2,88	CHI
2020113770	VARJAO	VJ1221704	GAUPO S2	02/11/2020 07:47	02/11/2020 12:06	02/11/2020 07:47	02/11/2020 12:06	4,31	1	4,31	CHI
2020113774	CORUMBAIBA	CI21000534	VILA CORUMBA	02/11/2020 07:47	02/11/2020 10:52	02/11/2020 07:47	02/11/2020 10:52	3,07	1	3,07	CHI
2020113776	TURVANIA	TV12259061	FIRMINOPOLIS S2	02/11/2020 07:48	02/11/2020 10:01	02/11/2020 07:48	02/11/2020 09:04	1,26	5	6,30	CHI
2020113776	TURVANIA	TV12259061	FIRMINOPOLIS S2	02/11/2020 07:48	02/11/2020 10:01	02/11/2020 07:48	02/11/2020 10:01	2,21	4	8,84	CHI
2020114172	TURVANIA	TV12259071	FIRMINOPOLIS S2	02/11/2020 07:48	02/11/2020 10:01	02/11/2020 07:48	02/11/2020 10:01	2,21	1	2,21	CHI
2020113780	COLINAS DO SUL	TI21196542	MINACU	02/11/2020 07:49	03/11/2020 02:59	02/11/2020 07:49	03/11/2020 02:59	19,16	1	19,16	CHI

2020113782	TRINIDADE	TR11044070	GOYA S2	02/11/2020 07:49	02/11/2020 13:00	02/11/2020 07:49	02/11/2020 13:00	5,18	195	1009,29	CHI
2020113785	CAVALCANTE	TE12131896	FLORES DE GOIAS	02/11/2020 07:49	02/11/2020 09:03	02/11/2020 07:49	02/11/2020 09:03	1,22	6	7,34	CHI
2020113785	TERESINA DE GOIAS	TE12131896	FLORES DE GOIAS	02/11/2020 07:49	02/11/2020 09:03	02/11/2020 07:49	02/11/2020 09:03	1,22	21	25,68	CHI
2020113876	PONTALINA	PK12080063	PONTALINA	02/11/2020 07:49	02/11/2020 09:33	02/11/2020 07:49	02/11/2020 09:33	1,72	33	56,89	CHI
2020114045	CAMPOS VERDES	VD12243665	SANTA TEREZINHA	02/11/2020 07:49	02/11/2020 12:54	02/11/2020 07:49	02/11/2020 12:54	5,07	9	45,63	CHI
2020113791	CALDAS NOVAS	PJ12263075	CALDAS NOVAS S1	02/11/2020 07:50	02/11/2020 19:05	02/11/2020 07:50	02/11/2020 19:05	11,24	5	56,19	CHI
2020113793	ANAPOLIS	AN11135827	ANAPOLIS UNIVERSITARIO S1	02/11/2020 07:50	02/11/2020 08:31	02/11/2020 07:50	02/11/2020 08:31	0,67	105	70,50	CHI
2020114188	CEZARINA	CZ12314845	CEZARINA	02/11/2020 07:50	02/11/2020 14:40	02/11/2020 07:50	02/11/2020 14:40	6,82	8	54,58	CHI
2020113794	SILVANIA	SV21151876	DAIA S2	02/11/2020 07:51	02/11/2020 09:46	02/11/2020 07:51	02/11/2020 09:46	1,92	1	1,92	CHI
2020113797	GOIANESIA	550021700	GOIANESIA S2	02/11/2020 07:51	02/11/2020 10:54	02/11/2020 07:51	02/11/2020 10:54	3,05	1	3,05	CHI
20201137919	ALTO PARAISO DE GOIAS	NQ12148151RE	NIQUELANDIA SUBTRANSMISSAO	02/11/2020 07:51	02/11/2020 11:38	02/11/2020 07:51	02/11/2020 11:38	3,78	12	45,36	CHI
20201137919	NIQUELANDIA	NQ12148151RE	NIQUELANDIA SUBTRANSMISSAO	02/11/2020 07:51	02/11/2020 11:38	02/11/2020 07:51	02/11/2020 11:38	3,78	163	616,09	CHI
20201137919	SAO JOAO D ALIANCA	NQ12148151RE	NIQUELANDIA SUBTRANSMISSAO	02/11/2020 07:51	02/11/2020 11:38	02/11/2020 07:51	02/11/2020 11:38	3,78	1	3,78	CHI
2020113799	PIRACANJUBA	PJ21082318	PIRACANJUBA	02/11/2020 07:52	02/11/2020 17:26	02/11/2020 07:52	02/11/2020 17:26	9,55	1	9,55	CHI
2020113802	LUZIANIA	120395095	RIO VERMELHO	02/11/2020 07:54	02/11/2020 09:21	02/11/2020 07:54	02/11/2020 09:21	1,45	1	1,45	CHI
2020113809	BELA VISTA DE GOIAS	SQ12066250	BELA VISTA S1	02/11/2020 07:54	02/11/2020 09:30	02/11/2020 07:54	02/11/2020 09:30	1,59	6	9,55	CHI
2020113813	TRINIDADE	13806920	GOYA S2	02/11/2020 07:55	02/11/2020 11:31	02/11/2020 07:55	02/11/2020 11:31	3,60	1	3,60	CHI
2020113814	BALIZA	BH11331132	CAIAPONIA	02/11/2020 07:55	02/11/2020 10:18	02/11/2020 07:55	02/11/2020 10:18	2,37	1	2,37	CHI
2020113815	CIDADE OCIDENTAL	10012208955	MARAJOARA	02/11/2020 07:56	02/11/2020 09:39	02/11/2020 07:56	02/11/2020 09:39	1,72	1	1,72	CHI
2020113816	LEOPOLDO DE BULHOES	LB12200132	CEPAIGO S2	02/11/2020 07:56	02/11/2020 08:31	02/11/2020 07:56	02/11/2020 08:31	0,58	5	2,91	CHI
2020113818	IPAMERI	IP12272798	IPAMERI	02/11/2020 07:56	02/11/2020 09:38	02/11/2020 07:56	02/11/2020 09:38	1,70	7	11,88	CHI
2020113820	JUSSARA	10028875166	JUSSARA	02/11/2020 07:56	02/11/2020 10:03	02/11/2020 07:56	02/11/2020 10:03	2,11	1	2,11	CHI
2020113825	MONTIVIDIU DO NORTE	MX11203341	PORANGATU	02/11/2020 07:57	02/11/2020 15:35	02/11/2020 07:57	02/11/2020 15:35	7,62	2	15,25	CHI
20201137938	SAO MIGUEL DO ARAGUAIA	SM12372634	SAO MIGUEL DO ARAGUAIA	02/11/2020 07:58	02/11/2020 10:41	02/11/2020 07:58	02/11/2020 10:41	2,71	23	62,41	CHI
2020113833	VIANOPOLIS	VN21151143	VIANOPOLIS	02/11/2020 08:00	02/11/2020 09:11	02/11/2020 08:00	02/11/2020 09:11	1,17	5	5,87	CHI
2020113835	ITUMBIARA	CD12097345RE	BOM JESUS DE GOIAS	02/11/2020 08:01	02/11/2020 12:32	02/11/2020 08:01	02/11/2020 12:32	4,52	5	22,58	CHI
2020113846	SAO JOAO D ALIANCA	JL11130018	SAO JOAO D ALIANCA	02/11/2020 08:04	02/11/2020 10:07	02/11/2020 08:04	02/11/2020 10:07	2,05	6	12,28	CHI
2020113848	GOIANIA	16253607	GOIANIA LESTE S3	02/11/2020 08:04	02/11/2020 09:57	02/11/2020 08:04	02/11/2020 09:57	1,87	1	1,87	CHI
2020113851	CORREGO DO OURO	CO12056069	FIRMINOPOLIS S2	02/11/2020 08:05	02/11/2020 11:22	02/11/2020 08:05	02/11/2020 11:22	3,28	3	9,83	CHI
2020113853	LEOPOLDO DE BULHOES	LB21364947	DAIA S2	02/11/2020 08:06	02/11/2020 09:46	02/11/2020 08:06	02/11/2020 09:46	1,66	2	3,33	CHI
2020113859	BALIZA	BH12331302	CAIAPONIA	02/11/2020 08:08	02/11/2020 11:32	02/11/2020 08:08	02/11/2020 11:32	3,39	11	37,29	CHI
2020113860	GOIANIA	GN21313016	CEPAIGO S1	02/11/2020 08:08	02/11/2020 09:49	02/11/2020 08:08	02/11/2020 09:49	1,67	1	1,67	CHI
2020113861	AMARALINA	LC12050751	MARA ROSA	02/11/2020 08:08	02/11/2020 11:27	02/11/2020 08:08	02/11/2020 11:27	3,30	12	39,62	CHI
2020113861	MARA ROSA	LC12050751	MARA ROSA	02/11/2020 08:08	02/11/2020 11:27	02/11/2020 08:08	02/11/2020 11:27	3,30	5	16,51	CHI
2020113863	EDEIA	EA21025321	EDEIA	02/11/2020 08:09	02/11/2020 09:10	02/11/2020 08:09	02/11/2020 09:10	1,01	2	2,03	CHI
2020113865	INHUMAS	30099640	INHUMAS S2	02/11/2020 08:09	02/11/2020 09:18	02/11/2020 08:09	02/11/2020 09:18	1,14	1	1,14	CHI
2020113866	CAIAPONIA	CP12139786	CAIAPONIA	02/11/2020 08:09	02/11/2020 16:20	02/11/2020 08:09	02/11/2020 16:20	8,17	12	98,05	CHI
2020113866	DOVERLANDIA	CP12139786	CAIAPONIA	02/11/2020 08:09	02/11/2020 16:20	02/11/2020 08:09	02/11/2020 16:20	8,17	3	24,51	CHI
2020113867	JARAGUA	70027985	JARAGUA	02/11/2020 08:09	02/11/2020 10:12	02/11/2020 08:09	02/11/2020 10:12	2,04	1	2,04	CHI
2020113751	IPAMERI	10004657347	IPAMERI	02/11/2020 08:11	02/11/2020 14:35	02/11/2020 08:11	02/11/2020 14:35	6,40	1	6,40	CHI
2020113871	RIO QUENTE	MG21120773	VILA CORUMBA	02/11/2020 08:11	02/11/2020 09:32	02/11/2020 08:11	02/11/2020 09:32	1,35	1	1,35	CHI
2020113872	ANAPOLIS	10011368266	JUNDIAI S2	02/11/2020 08:11	02/11/2020 10:57	02/11/2020 08:11	02/11/2020 10:57	2,77	1	2,77	CHI
2020113875	GAMELEIRA DE GOIAS	GL21241898	DAIA S2	02/11/2020 08:12	02/11/2020 10:16	02/11/2020 08:12	02/11/2020 10:16	2,06	1	2,06	CHI
2020113886	PADRE BERNARDO	PB11314032	PADRE BERNARDO	02/11/2020 08:15	02/11/2020 09:42	02/11/2020 08:15	02/11/2020 09:42	1,45	7	10,13	CHI
2020113888	APARECIDA DE GOIANIA	10002272944	INDEPENDENCIA S2	02/11/2020 08:15	02/11/2020 11:07	02/11/2020 08:15	02/11/2020 11:07	2,86	1	2,86	CHI
2020114106	PLANALTINA	PI12375541	PLANALTINA	02/11/2020 08:18	02/11/2020 10:34	02/11/2020 08:18	02/11/2020 10:34	2,25	185	416,35	CHI
2020113905	ORIZONA	OZ12255426	PIRES DO RIO S2	02/11/2020 08:19	02/11/2020 13:05	02/11/2020 08:19	02/11/2020 10:44	2,40	5	12,01	CHI
2020113905	ORIZONA	OZ12255426	PIRES DO RIO S2	02/11/2020 08:19	02/11/2020 13:05	02/11/2020 10:55	02/11/2020 13:05	2,17	5	10,84	CHI
2020113906	DOVERLANDIA	DV12395475	CAIAPONIA	02/11/2020 08:20	02/11/2020 23:07	02/11/2020 08:20	02/11/2020 23:07	14,79	5	73,93	CHI
2020113906	DOVERLANDIA	DV12395475	CAIAPONIA	02/11/2020 08:20	02/11/2020 23:07	02/11/2020 22:23	02/11/2020 23:07	0,73	6	4,37	CHI
2020113912	FORMOSA	10007434977	ITUIQUIRA	02/11/2020 08:21	02/11/2020 10:04	02/11/2020 08:21	02/11/2020 10:04	1,71	1	1,71	CHI

2020113913	TROMBAS	TB21052574	PORANGATU	02/11/2020 08:21	03/11/2020 03:33	02/11/2020 08:21	03/11/2020 03:33	19,19	1	19,19	CHI
2020113918	SANTA TEREZINHA DE GOIAS	SG12380710	SANTA TEREZINHA	02/11/2020 08:21	02/11/2020 10:50	02/11/2020 08:21	02/11/2020 10:50	2,47	8	19,77	CHI
2020113920	ANICUNS	AC21227266	ANICUNS	02/11/2020 08:22	02/11/2020 10:45	02/11/2020 08:22	02/11/2020 10:45	2,38	1	2,38	CHI
2020113925	TAQUARAL DE GOIAS	II21217073	ITABERAI S1	02/11/2020 08:24	02/11/2020 12:16	02/11/2020 08:24	02/11/2020 12:16	3,86	2	7,72	CHI
2020113928	TURVANIA	TV12005558	FIRMINOPOLIS S1	02/11/2020 08:24	02/11/2020 09:34	02/11/2020 08:24	02/11/2020 09:34	1,16	1	1,16	CHI
2020114118	CRIXAS	CX12400067	RUBIATABA	02/11/2020 08:24	02/11/2020 13:40	02/11/2020 08:24	02/11/2020 13:40	5,26	9	47,35	CHI
2020113932	EDEALINA	ED21044488	PONTALINA	02/11/2020 08:25	02/11/2020 10:08	02/11/2020 08:25	02/11/2020 10:08	1,71	1	1,71	CHI
2020113936	ITABERAI	50001188	ITABERAI S2	02/11/2020 08:26	02/11/2020 11:42	02/11/2020 08:26	02/11/2020 11:42	3,26	1	3,26	CHI
2020113938	PALESTINA DE GOIAS	PY12395436	PALESTINA	02/11/2020 08:27	02/11/2020 14:26	02/11/2020 08:27	02/11/2020 14:26	5,97	5	29,84	CHI
2020113939	FORMOSA	FA21180785	ITUIQUIRA	02/11/2020 08:27	02/11/2020 10:21	02/11/2020 08:27	02/11/2020 10:21	1,88	1	1,88	CHI
2020113941	LUZIANIA	LZ21136620	MARAJOARA	02/11/2020 08:28	02/11/2020 10:46	02/11/2020 08:28	02/11/2020 10:46	2,31	1	2,31	CHI
2020113949	POSSE	PS12318325	IACIARA S2	02/11/2020 08:31	02/11/2020 10:37	02/11/2020 08:31	02/11/2020 10:37	2,09	2	4,18	CHI
2020113950	CAIAPONIA	CP21300483	CAIAPONIA	02/11/2020 08:31	02/11/2020 22:57	02/11/2020 08:31	02/11/2020 22:57	14,42	1	14,42	CHI
2020113953	SAO MIGUEL DO ARAGUAIA	SM12235205	SAO MIGUEL DO ARAGUAIA	02/11/2020 08:33	02/11/2020 12:38	02/11/2020 08:33	02/11/2020 12:38	4,08	8	32,66	CHI
2020113958	TROMBAS	TB21242385	PORANGATU	02/11/2020 08:33	02/11/2020 12:34	02/11/2020 08:33	02/11/2020 12:34	4,01	1	4,01	CHI
2020113959	LUZIANIA	10007080067	RIO VERMELHO	02/11/2020 08:33	02/11/2020 10:33	02/11/2020 08:33	02/11/2020 10:33	1,99	1	1,99	CHI
2020114388	MINACA	IH12207743	MINACA	02/11/2020 08:33	02/11/2020 15:24	02/11/2020 08:33	02/11/2020 15:24	6,85	18	123,26	CHI
2020113969	EDEIA	EA12398648	VICENTINOPOLIS	02/11/2020 08:35	02/11/2020 12:46	02/11/2020 08:35	02/11/2020 12:46	4,17	5	20,87	CHI
2020113972	FAINA	FC21329602	ITAPURANGA	02/11/2020 08:35	02/11/2020 12:32	02/11/2020 08:35	02/11/2020 12:32	3,94	1	3,94	CHI
2020114108	ITABERAI	IB12382593	ANICUNS	02/11/2020 08:35	02/11/2020 21:46	02/11/2020 08:35	02/11/2020 21:46	13,17	8	105,39	CHI
2020113975	SAO JOAO D ALIANCA	6914785	SAO JOAO D ALIANCA	02/11/2020 08:37	02/11/2020 11:37	02/11/2020 08:37	02/11/2020 11:37	2,99	1	2,99	CHI
2020113981	MONTIVIDU DO NORTE	MX11203347	PORANGATU	02/11/2020 08:38	02/11/2020 15:00	02/11/2020 08:38	02/11/2020 15:00	6,36	1	6,36	CHI
2020114004	PALMEIRAS DE GOIAS	PL11181946	PALMEIRAS	02/11/2020 08:38	02/11/2020 09:58	02/11/2020 08:38	02/11/2020 09:58	1,33	107	142,13	CHI
2020114724	IACIARA	ND12218839	IACIARA S2	02/11/2020 08:38	02/11/2020 22:49	02/11/2020 15:38	02/11/2020 22:44	7,12	1	7,12	CHI
2020114724	IACIARA	IA13218875	IACIARA S2	02/11/2020 08:38	02/11/2020 22:49	02/11/2020 15:38	02/11/2020 22:49	7,19	1	7,19	CHI
2020113984	CAVALCANTE	CJ12404450	MINACU	02/11/2020 08:39	02/11/2020 13:21	02/11/2020 08:39	02/11/2020 13:21	4,70	26	122,14	CHI
2020113985	ADELANDIA	2330001107	FIRMINOPOLIS S2	02/11/2020 08:39	02/11/2020 10:27	02/11/2020 08:39	02/11/2020 10:27	1,79	1	1,79	CHI
2020113994	ANAPOLIS	AN21288977	ANAPOLIS UNIVERSITARIO S2	02/11/2020 08:40	02/11/2020 11:55	02/11/2020 08:40	02/11/2020 11:55	3,24	1	3,24	CHI
2020113995	MATRINCHA	MP12311107	MATRINCHA	02/11/2020 08:40	02/11/2020 13:55	02/11/2020 08:40	02/11/2020 13:55	5,23	1	5,23	CHI
2020113996	ITAPURANGA	IK21299527	ITAPURANGA	02/11/2020 08:41	02/11/2020 10:51	02/11/2020 08:41	02/11/2020 10:51	2,16	2	4,31	CHI
2020113999	APARECIDA DE GOIANIA	17372586	INDEPENDENCIA S2	02/11/2020 08:42	02/11/2020 11:07	02/11/2020 08:42	02/11/2020 11:07	2,41	1	2,41	CHI
2020114005	SANCLERLANDIA	SC12154609	FIRMINOPOLIS S2	02/11/2020 08:43	02/11/2020 10:54	02/11/2020 08:43	02/11/2020 10:54	2,18	1	2,18	CHI
2020114006	POSSE	PS21290287	IACIARA S2	02/11/2020 08:43	02/11/2020 10:24	02/11/2020 08:43	02/11/2020 10:24	1,68	1	1,68	CHI
2020114015	GOIANIA	11072908	CAMPINAS S2	02/11/2020 08:44	02/11/2020 11:26	02/11/2020 08:44	02/11/2020 11:26	2,69	1	2,69	CHI
2020114125	JANDAIA	JD12005405	PALMEIRAS	02/11/2020 08:44	02/11/2020 20:54	02/11/2020 08:44	02/11/2020 20:54	12,18	10	121,79	CHI
2020114125	PALMEIRAS DE GOIAS	JD12005405	PALMEIRAS	02/11/2020 08:44	02/11/2020 20:54	02/11/2020 08:44	02/11/2020 20:54	12,18	56	682,03	CHI
2020114018	TURVANIA	TV11194034	FIRMINOPOLIS S2	02/11/2020 08:45	02/11/2020 21:11	02/11/2020 08:45	02/11/2020 21:11	12,43	142	1764,51	CHI
2020114025	ANAPOLIS	AN12258630	ANAPOLIS UNIVERSITARIO S2	02/11/2020 08:47	02/11/2020 10:57	02/11/2020 08:47	02/11/2020 10:57	2,16	5	10,81	CHI
2020114029	AGUAS LINDAS DE GOIAS	4830154021	AGUAS LINDAS DE GOIAS S2	02/11/2020 08:48	02/11/2020 10:54	02/11/2020 08:48	02/11/2020 10:54	2,10	1	2,10	CHI
2020114035	GOIAS	GS21220338	GOIAS	02/11/2020 08:50	02/11/2020 10:17	02/11/2020 08:50	02/11/2020 10:17	1,45	2	2,90	CHI
2020114044	EDEIA	10003750637	EDEIA	02/11/2020 08:53	02/11/2020 10:09	02/11/2020 08:53	02/11/2020 10:09	1,26	1	1,26	CHI
2020114047	SILVANIA	SV21056826	VIANOPOLIS	02/11/2020 08:53	02/11/2020 09:51	02/11/2020 08:53	02/11/2020 09:51	0,96	1	0,96	CHI
2020114252	PANAMA	PX12171365	GOIATUBA S1	02/11/2020 08:53	02/11/2020 14:29	02/11/2020 08:53	02/11/2020 14:29	5,60	6	33,59	CHI
2020114049	APARECIDA DE GOIANIA	15228230	ATLANTICO S2	02/11/2020 08:54	02/11/2020 13:54	02/11/2020 08:54	02/11/2020 13:54	4,99	1	4,99	CHI
2020114051	GOIANIA	14998361	CAMPINAS S1	02/11/2020 08:54	02/11/2020 10:56	02/11/2020 08:54	02/11/2020 10:56	2,02	1	2,02	CHI
2020114053	URUACU	UR11392378	URUACU	02/11/2020 08:55	02/11/2020 10:10	02/11/2020 08:55	02/11/2020 10:10	1,24	13	16,18	CHI
2020114055	CRISTALINA	KR21139063	CRISTALINA S1	02/11/2020 08:55	02/11/2020 12:00	02/11/2020 08:55	02/11/2020 12:00	3,07	1	3,07	CHI
2020114056	APARECIDA DE GOIANIA	17083813	REAL S1	02/11/2020 08:55	02/11/2020 10:26	02/11/2020 08:55	02/11/2020 10:26	1,50	1	1,50	CHI
2020114057	CAVALCANTE	CJ12412226	MINACU	02/11/2020 08:55	02/11/2020 15:56	02/11/2020 08:55	02/11/2020 15:56	7,00	6	42,00	CHI
2020114059	ANICUNS	AC21065202	ANICUNS	02/11/2020 08:57	02/11/2020 11:48	02/11/2020 08:57	02/11/2020 11:48	2,85	1	2,85	CHI
2020114062	AMARALINA	MQ12210288	NOVA CRIXAS	02/11/2020 08:58	02/11/2020 11:53	02/11/2020 08:58	02/11/2020 11:53	2,91	4	11,65	CHI

2020114797	SITIO D ABADIA	AQ12381614	IACIARA S2	02/11/2020 08:58	02/11/2020 14:13	02/11/2020 08:58	02/11/2020 14:13	5,23	6	31,40	CHI
2020114067	CRISTALINA	KR12401767	CRISTALINA S1	02/11/2020 08:59	02/11/2020 10:40	02/11/2020 08:59	02/11/2020 10:40	1,68	8	13,46	CHI
2020114068	INHUMAS	IN21381639	INHUMAS S2	02/11/2020 08:59	02/11/2020 09:59	02/11/2020 08:59	02/11/2020 09:59	1,00	1	1,00	CHI
2020114071	MOIPORA	MO21006812	SAO LUIZ DOS MONTES BELOS	02/11/2020 08:59	02/11/2020 10:36	02/11/2020 08:59	02/11/2020 10:36	1,61	1	1,61	CHI
2020114072	GOIANESIA	GE11386343	GOIANESIA S2	02/11/2020 08:59	02/11/2020 09:34	02/11/2020 08:59	02/11/2020 09:34	0,57	22	12,48	CHI
2020114076	JOVIANIA	570008165	GOIATUBA S1	02/11/2020 09:00	02/11/2020 10:36	02/11/2020 09:00	02/11/2020 10:36	1,59	1	1,59	CHI
2020114082	CATALAO	CT12061149	CATALAO S1	02/11/2020 09:03	02/11/2020 15:46	02/11/2020 09:03	02/11/2020 15:46	6,72	2	13,45	CHI
2020114084	GOIAS	GS11222213	GOIAS	02/11/2020 09:03	02/11/2020 11:26	02/11/2020 09:03	02/11/2020 11:26	2,37	1	2,37	CHI
2020114087	LEOPOLDO DE BULHOES	LB12353165	DAIA S2	02/11/2020 09:04	02/11/2020 11:30	02/11/2020 09:04	02/11/2020 11:30	2,42	18	43,57	CHI
2020114088	CORUMBA DE GOIAS	CB21205852	CORUMBA	02/11/2020 09:05	02/11/2020 10:36	02/11/2020 09:05	02/11/2020 10:36	1,51	1	1,51	CHI
2020114090	URUACU	UR12202170	URUACU	02/11/2020 09:05	02/11/2020 12:40	02/11/2020 09:05	02/11/2020 12:40	3,58	3	10,74	CHI
2020114091	GOIANESIA	GE11297280	GOIANESIA S1	02/11/2020 09:06	02/11/2020 14:06	02/11/2020 09:06	02/11/2020 14:06	5,00	1	5,00	CHI
2020114093	FLORES DE GOIAS	3480008390	FLORES DE GOIAS	02/11/2020 09:06	02/11/2020 20:06	02/11/2020 09:06	02/11/2020 20:06	10,99	1	10,99	CHI
2020114094	GOIAS	GS21124379	ITABERAI S1	02/11/2020 09:06	02/11/2020 12:07	02/11/2020 09:06	02/11/2020 12:07	3,00	1	3,00	CHI
2020114095	GOIANIA	GN11000907	CAMPINAS S2	02/11/2020 09:07	02/11/2020 12:08	02/11/2020 09:07	02/11/2020 12:08	3,02	87	262,31	CHI
2020114100	ALVORADA DO NORTE	10006334057	IACIARA S2	02/11/2020 09:08	02/11/2020 11:30	02/11/2020 09:08	02/11/2020 11:30	2,36	1	2,36	CHI
2020114101	CALDAS NOVAS	CN21363392	CALDAS NOVAS S1	02/11/2020 09:08	02/11/2020 11:33	02/11/2020 09:08	02/11/2020 11:33	2,41	1	2,41	CHI
2020114104	ORIZONA	10010815579	PIRES DO RIO S2	02/11/2020 09:09	02/11/2020 12:31	02/11/2020 09:09	02/11/2020 12:31	3,36	1	3,36	CHI
2020114109	PALMEIRAS DE GOIAS	590000159	PALMEIRAS	02/11/2020 09:10	02/11/2020 10:49	02/11/2020 09:10	02/11/2020 10:49	1,64	1	1,64	CHI
2020114110	GOIANIRA	GR11016216	GOIANIRA	02/11/2020 09:10	02/11/2020 11:45	02/11/2020 09:10	02/11/2020 11:45	2,57	94	241,32	CHI
2020114112	FORMOSA	610199134	ITUIQUIRA	02/11/2020 09:12	02/11/2020 12:07	02/11/2020 09:12	02/11/2020 12:07	2,92	1	2,92	CHI
2020114113	COLINAS DO SUL	TI12235546	MINACU	02/11/2020 09:12	03/11/2020 09:15	02/11/2020 09:12	03/11/2020 09:15	24,05	2	48,10	CHI
202011137972	BONOPOLIS	SM13247494	SAO MIGUEL DO ARAGUAIA	02/11/2020 09:12	02/11/2020 10:57	02/11/2020 10:47	02/11/2020 10:57	0,17	3	0,50	CHI
202011137972	NOVO PLANALTO	SM13247494	SAO MIGUEL DO ARAGUAIA	02/11/2020 09:12	02/11/2020 10:57	02/11/2020 10:47	02/11/2020 10:57	0,17	313	52,60	CHI
202011137972	SAO MIGUEL DO ARAGUAIA	SM13247494	SAO MIGUEL DO ARAGUAIA	02/11/2020 09:12	02/11/2020 10:57	02/11/2020 10:47	02/11/2020 10:57	0,17	114	19,16	CHI
2020114120	PIRENOPOLIS	PV21273400	SAO FRANCISCO DE GOIAS	02/11/2020 09:13	02/11/2020 13:19	02/11/2020 09:13	02/11/2020 13:19	4,08	2	8,17	CHI
2020114121	GOIAS	GS12020848	MATRINCHA	02/11/2020 09:14	02/11/2020 16:36	02/11/2020 09:14	02/11/2020 16:36	7,35	1	7,35	CHI
2020114126	IPORA	730125932	IPORA	02/11/2020 09:15	02/11/2020 10:32	02/11/2020 09:15	02/11/2020 10:32	1,27	1	1,27	CHI
2020114131	URUACU	640130082	URUACU	02/11/2020 09:17	02/11/2020 11:40	02/11/2020 09:17	02/11/2020 11:40	2,38	1	2,38	CHI
2020114138	GOIANIA	GN11167774	ATLANTICO S1	02/11/2020 09:19	02/11/2020 12:00	02/11/2020 09:19	02/11/2020 12:00	2,68	93	249,34	CHI
2020114140	FAINA	IK12310818	ITAPURANGA	02/11/2020 09:20	02/11/2020 12:32	02/11/2020 09:20	02/11/2020 12:32	3,20	14	44,78	CHI
2020114144	ANAPOLIS	AN11015854	JUNDIAI S1	02/11/2020 09:20	02/11/2020 11:05	02/11/2020 09:20	02/11/2020 11:05	1,74	170	295,23	CHI
2020114150	NOVO GAMA	2460105648	PACAEMBU S1	02/11/2020 09:21	02/11/2020 09:51	02/11/2020 09:21	02/11/2020 09:51	0,49	1	0,49	CHI
2020114166	ANAPOLIS	AN12258782	ANAPOLIS UNIVERSITARIO S2	02/11/2020 09:21	02/11/2020 10:15	02/11/2020 09:21	02/11/2020 10:15	0,89	19	16,89	CHI
2020114296	MONTIVIDIU DO NORTE	MX12143658	PORANGATU	02/11/2020 09:25	02/11/2020 15:30	02/11/2020 09:25	02/11/2020 15:30	6,07	14	84,94	CHI
2020114398	SAO MIGUEL DO ARAGUAIA	SM12083961	SAO MIGUEL DO ARAGUAIA	02/11/2020 09:25	02/11/2020 15:09	02/11/2020 09:25	02/11/2020 15:09	5,72	2	11,44	CHI
2020114165	FORMOSA	610199882	ITUIQUIRA	02/11/2020 09:26	02/11/2020 11:07	02/11/2020 09:26	02/11/2020 11:07	1,68	1	1,68	CHI
2020114521	FAZENDA NOVA	NB12396253	JUSSARA	02/11/2020 09:26	02/11/2020 13:52	02/11/2020 09:26	02/11/2020 13:52	4,43	13	57,60	CHI
2020114521	JUSSARA	NB12396253	JUSSARA	02/11/2020 09:26	02/11/2020 13:52	02/11/2020 09:26	02/11/2020 13:52	4,43	1	4,43	CHI
2020114170	CALDAS NOVAS	760364503	CALDAS NOVAS S2	02/11/2020 09:27	02/11/2020 12:19	02/11/2020 09:27	02/11/2020 12:19	2,86	1	2,86	CHI
2020114179	PARAUNA	PU21167154	PARAUNA	02/11/2020 09:30	02/11/2020 18:13	02/11/2020 09:30	02/11/2020 18:13	8,72	1	8,72	CHI
2020114192	CAVALCANTE	TI12156216RE	MINACU	02/11/2020 09:34	02/11/2020 14:00	02/11/2020 09:34	02/11/2020 14:00	4,43	68	301,41	CHI
2020114192	COLINAS DO SUL	TI12156216RE	MINACU	02/11/2020 09:34	02/11/2020 14:00	02/11/2020 09:34	02/11/2020 14:00	4,43	42	186,17	CHI
2020114193	ITABERAI	IB12032276	ITABERAI S2	02/11/2020 09:34	02/11/2020 13:10	02/11/2020 09:34	02/11/2020 13:10	3,59	1	3,59	CHI
2020114195	MAIRIPOTABA	MI21060560	PONTALINA	02/11/2020 09:35	02/11/2020 14:07	02/11/2020 09:35	02/11/2020 14:07	4,53	1	4,53	CHI
2020114196	BELA VISTA DE GOIAS	BV12080617	BELA VISTA S2	02/11/2020 09:35	02/11/2020 11:09	02/11/2020 09:35	02/11/2020 11:09	1,56	6	9,38	CHI
2020114198	INHUMAS	IN11378278	INHUMAS S2	02/11/2020 09:35	02/11/2020 10:59	02/11/2020 09:35	02/11/2020 10:59	1,39	67	93,19	CHI
2020114200	SANTA TEREZA DE GOIAS	SE21136960	MARA ROSA	02/11/2020 09:36	02/11/2020 19:40	02/11/2020 09:36	02/11/2020 19:40	10,07	1	10,07	CHI
2020114208	FORMOSA	FA12381552	ITUIQUIRA	02/11/2020 09:37	02/11/2020 11:50	02/11/2020 09:37	02/11/2020 11:50	2,21	2	4,43	CHI
2020114214	DAMOLANDIA	DL21014352	INHUMAS S1	02/11/2020 09:39	02/11/2020 12:31	02/11/2020 09:39	02/11/2020 12:31	2,86	1	2,86	CHI
2020114215	ANAPOLIS	AN21107983	ANAPOLIS UNIVERSITARIO S1	02/11/2020 09:39	02/11/2020 13:51	02/11/2020 09:39	02/11/2020 13:51	4,19	2	8,38	CHI

2020114220	BOM JARDIM DE GOIAS	BM21335420	BOM JARDIM	02/11/2020 09:41	02/11/2020 11:28	02/11/2020 09:41	02/11/2020 11:28	1,78	1	1,78	CHI
2020114230	APARECIDA DE GOIANIA	13695060	INDEPENDENCIA S1	02/11/2020 09:47	02/11/2020 10:41	02/11/2020 09:47	02/11/2020 10:41	0,90	1	0,90	CHI
2020114257	ANICUNS	AC12031299	ANICUNS	02/11/2020 09:48	02/11/2020 14:32	02/11/2020 09:48	02/11/2020 14:32	4,72	3	14,16	CHI
2020114243	FORMOSA	610137086	ITUIQUIRA	02/11/2020 09:50	02/11/2020 14:49	02/11/2020 09:50	02/11/2020 14:49	4,97	1	4,97	CHI
2020114245	MORRINHOS	150152607	MORRINHOS	02/11/2020 09:51	02/11/2020 13:49	02/11/2020 09:51	02/11/2020 13:49	3,97	1	3,97	CHI
2020114246	MATRINCHA	MP12299774	MATRINCHA	02/11/2020 09:52	02/11/2020 12:49	02/11/2020 09:52	02/11/2020 12:49	2,94	1	2,94	CHI
2020114248	ITAPURANGA	10020341006	ITAPURANGA	02/11/2020 09:52	02/11/2020 13:30	02/11/2020 09:52	02/11/2020 13:30	3,62	1	3,62	CHI
2020114470	CATALAO	CT12399870	CATALAO S1	02/11/2020 09:52	02/11/2020 22:10	02/11/2020 09:52	02/11/2020 22:10	12,29	12	147,48	CHI
2020114249	LUZIANIA	10002506457	RIO VERMELHO	02/11/2020 09:53	02/11/2020 11:46	02/11/2020 09:53	02/11/2020 11:46	1,88	1	1,88	CHI
202011137940	CAMPINACU	UC12197189	PORANGATU	02/11/2020 09:55	02/11/2020 12:07	02/11/2020 09:55	02/11/2020 12:07	2,19	67	146,71	CHI
2020114259	CALDAS NOVAS	MG12120776	VILA CORUMBA	02/11/2020 09:56	02/11/2020 11:15	02/11/2020 09:56	02/11/2020 11:15	1,31	1	1,31	CHI
2020114262	URUACU	UR21147041	URUACU	02/11/2020 09:57	02/11/2020 14:47	02/11/2020 09:57	02/11/2020 14:47	4,83	3	14,50	CHI
2020114274	SILVANIA	SV21326679	VIANOPOLIS	02/11/2020 10:00	02/11/2020 11:44	02/11/2020 10:00	02/11/2020 11:44	1,73	3	5,19	CHI
2020114275	VARJAO	VJ31096188	GUAPO S2	02/11/2020 10:00	02/11/2020 16:39	02/11/2020 10:00	02/11/2020 16:39	6,64	1	6,64	CHI
2020114276	MUTUNOPOLIS	MU21194975	MARA ROSA	02/11/2020 10:01	02/11/2020 12:28	02/11/2020 10:01	02/11/2020 12:28	2,45	1	2,45	CHI
2020114283	ALVORADA DO NORTE	AQ12204159	IACIARA S2	02/11/2020 10:03	03/11/2020 18:48	02/11/2020 10:03	03/11/2020 18:48	32,76	21	687,87	CHI
2020114287	GOIANIA	17366458	CAMPINAS S1	02/11/2020 10:03	02/11/2020 12:02	02/11/2020 10:03	02/11/2020 12:02	1,97	1	1,97	CHI
2020114290	SANTA TEREZINHA DE GOIAS	SG21317001	SANTA TEREZINHA	02/11/2020 10:04	02/11/2020 15:14	02/11/2020 10:04	02/11/2020 15:14	5,15	1	5,15	CHI
2020114291	GOIANIA	10114440	GOIANIA LESTE S2	02/11/2020 10:04	02/11/2020 11:44	02/11/2020 10:04	02/11/2020 11:44	1,65	1	1,65	CHI
2020114293	CAMPOS BELOS	MA12209854	SAO DOMINGOS	02/11/2020 10:05	03/11/2020 18:17	02/11/2020 10:05	02/11/2020 20:14	10,15	4	40,59	CHI
2020114293	MONTE ALEGRE DE GOIAS	MA12209854	SAO DOMINGOS	02/11/2020 10:05	03/11/2020 18:17	02/11/2020 10:05	02/11/2020 20:14	10,15	1	10,15	CHI
2020114293	MONTE ALEGRE DE GOIAS	MA12209854	SAO DOMINGOS	02/11/2020 10:05	03/11/2020 18:17	02/11/2020 10:05	02/11/2020 21:34	11,49	2	22,97	CHI
2020114293	MONTE ALEGRE DE GOIAS	MA12209854	SAO DOMINGOS	02/11/2020 10:05	03/11/2020 18:17	02/11/2020 10:05	03/11/2020 18:17	32,21	15	483,12	CHI
2020114293	CAMPOS BELOS	MA12209854	SAO DOMINGOS	02/11/2020 10:05	03/11/2020 18:17	03/11/2020 14:53	03/11/2020 18:17	3,40	4	13,60	CHI
2020114293	MONTE ALEGRE DE GOIAS	MA12209854	SAO DOMINGOS	02/11/2020 10:05	03/11/2020 18:17	03/11/2020 14:53	03/11/2020 18:17	3,40	3	10,20	CHI
2020114298	APARECIDA DE GOIANIA	10002585055	INDEPENDENCIA S2	02/11/2020 10:08	02/11/2020 11:59	02/11/2020 10:08	02/11/2020 11:59	1,84	1	1,84	CHI
2020114300	SAO FRANCISCO DE GOIAS	PV21253301	SAO FRANCISCO DE GOIAS	02/11/2020 10:09	02/11/2020 11:49	02/11/2020 10:09	02/11/2020 11:49	1,66	1	1,66	CHI
2020114301	GOIANIA	GN21066375	XAVANTES	02/11/2020 10:09	02/11/2020 11:10	02/11/2020 10:55	02/11/2020 11:10	0,25	1	0,25	CHI
2020114302	PORANGATU	PO12230420	NOVO PLANALTO	02/11/2020 10:09	02/11/2020 12:12	02/11/2020 10:09	02/11/2020 12:12	2,04	3	6,12	CHI
2020114304	APARECIDA DE GOIANIA	14623316	INDEPENDENCIA S2	02/11/2020 10:09	02/11/2020 12:00	02/11/2020 10:09	02/11/2020 12:00	1,84	1	1,84	CHI
2020114307	CAIAPONIA	CP11184362	CAIAPONIA	02/11/2020 10:10	02/11/2020 10:45	02/11/2020 10:10	02/11/2020 10:45	0,58	68	39,21	CHI
2020114308	BOM JESUS DE GOIAS	1250014922	BOM JESUS DE GOIAS	02/11/2020 10:10	02/11/2020 16:15	02/11/2020 10:10	02/11/2020 16:15	6,07	1	6,07	CHI
2020114312	ORIZONA	OZ21382058	PIRES DO RIO S2	02/11/2020 10:13	02/11/2020 13:29	02/11/2020 10:13	02/11/2020 13:29	3,26	2	6,53	CHI
2020114322	APARECIDA DE GOIANIA	10015610525	ANHANGUERA	02/11/2020 10:15	02/11/2020 12:39	02/11/2020 10:15	02/11/2020 12:39	2,39	1	2,39	CHI
2020114323	INHUMAS	30047640	INHUMAS S2	02/11/2020 10:15	02/11/2020 11:57	02/11/2020 10:15	02/11/2020 11:57	1,69	1	1,69	CHI
2020114326	ANICUNS	AC21376302	FIRMINOPOLIS S2	02/11/2020 10:16	02/11/2020 14:53	02/11/2020 10:16	02/11/2020 14:53	4,60	2	9,21	CHI
2020114327	GOIANIA	GN11001684	CAMPINAS S2	02/11/2020 10:16	02/11/2020 12:51	02/11/2020 10:16	02/11/2020 12:51	2,57	19	48,83	CHI
2020114329	PIRACANJUBA	PJ21199457	MORRINHOS	02/11/2020 10:17	02/11/2020 15:52	02/11/2020 10:17	02/11/2020 15:52	5,57	1	5,57	CHI
2020114330	FORMOSO	FO12377609	MARA ROSA	02/11/2020 10:18	02/11/2020 12:01	02/11/2020 10:18	02/11/2020 12:01	1,72	8	13,73	CHI
2020114333	CATALAO	1990298737	CATALAO S1	02/11/2020 10:19	02/11/2020 11:34	02/11/2020 10:19	02/11/2020 11:34	1,25	1	1,25	CHI
2020114337	SANTA RITA DO NOVO DESTINO	BA21070652	BARRO ALTO	02/11/2020 10:20	02/11/2020 12:40	02/11/2020 10:20	02/11/2020 12:40	2,32	1	2,32	CHI
2020114338	GOIANIA	TR32050493	TRINDADE	02/11/2020 10:21	02/11/2020 11:43	02/11/2020 10:21	02/11/2020 11:43	1,36	8	10,91	CHI
2020114344	ITABERAI	IB21107107	ITABERAI S2	02/11/2020 10:22	02/11/2020 14:45	02/11/2020 10:22	02/11/2020 14:45	4,37	2	8,74	CHI
2020114381	URUACU	UR12380056	URUACU	02/11/2020 10:22	02/11/2020 12:27	02/11/2020 10:22	02/11/2020 12:27	2,07	98	203,11	CHI
2020114355	BURITI ALEGRE	BG21190973	ITUMBIARA VELHA S2	02/11/2020 10:25	02/11/2020 12:33	02/11/2020 10:25	02/11/2020 12:33	2,12	1	2,12	CHI
2020114358	SAO FRANCISCO DE GOIAS	PG21230686	PETROLINA	02/11/2020 10:26	02/11/2020 15:14	02/11/2020 10:26	02/11/2020 15:14	4,79	1	4,79	CHI
2020114360	PIRACANJUBA	PJ12000054	PIRACANJUBA	02/11/2020 10:28	03/11/2020 08:03	02/11/2020 10:28	03/11/2020 08:03	21,58	28	604,26	CHI
2020114361	BONFINOPOLIS	10016964371	CEPAIGO S2	02/11/2020 10:28	02/11/2020 12:07	02/11/2020 10:28	02/11/2020 12:07	1,64	1	1,64	CHI
2020114365	INHUMAS	30127464	INHUMAS S2	02/11/2020 10:29	02/11/2020 11:07	02/11/2020 10:29	02/11/2020 11:07	0,63	1	0,63	CHI
2020114367	BALIZA	BH21193429	BOM JARDIM	02/11/2020 10:29	02/11/2020 12:01	02/11/2020 10:29	02/11/2020 12:01	1,52	1	1,52	CHI

2020114372	CRISTALINA	KR12351414	PAMPLONA	02/11/2020 10:30	02/11/2020 16:23	02/11/2020 10:30	02/11/2020 16:23	5,88	6	35,29	CHI
2020114820	GUARAITA	GK12299411	ITAPURANGA	02/11/2020 10:30	02/11/2020 15:11	02/11/2020 10:30	02/11/2020 15:11	4,67	19	88,71	CHI
2020114375	SENADOR CANEDO	190006511	SENADOR CANEDO	02/11/2020 10:31	02/11/2020 11:23	02/11/2020 10:31	02/11/2020 11:23	0,86	1	0,86	CHI
2020114379	CALDAS NOVAS	CN12102170	CALDAS NOVAS S1	02/11/2020 10:31	02/11/2020 13:00	02/11/2020 10:31	02/11/2020 13:00	2,47	161	397,40	CHI
2020114450	CRISTALINA	KR12323382	PAMPLONA	02/11/2020 10:32	02/11/2020 18:42	02/11/2020 10:32	02/11/2020 14:15	3,72	16	59,44	CHI
2020114450	CRISTALINA	KR12323382	PAMPLONA	02/11/2020 10:32	02/11/2020 18:42	02/11/2020 10:32	02/11/2020 18:42	8,17	5	40,83	CHI
2020114384	ANAPOLIS	10014795483	JUNDIAI S1	02/11/2020 10:34	02/11/2020 13:23	02/11/2020 10:34	02/11/2020 13:23	2,82	1	2,82	CHI
2020114390	ALEXANIA	AX12374674	ALEXANIA	02/11/2020 10:36	02/11/2020 12:49	02/11/2020 10:36	02/11/2020 12:49	2,21	8	17,70	CHI
2020114390	CORUMBA DE GOIAS	AX12374674	ALEXANIA	02/11/2020 10:36	02/11/2020 12:49	02/11/2020 10:36	02/11/2020 12:49	2,21	2	4,42	CHI
2020114392	GOIAS	GS12165445	ITABERAI S1	02/11/2020 10:37	02/11/2020 11:32	02/11/2020 10:37	02/11/2020 11:32	0,90	12	10,82	CHI
2020114393	SANTO ANTONIO DO DESCOBERTO	10011300149	AGUAS LINDAS DE GOIAS S2	02/11/2020 10:38	02/11/2020 12:41	02/11/2020 10:38	02/11/2020 12:41	2,04	1	2,04	CHI
2020114354	SAO JOAO D ALIANCA	JL12383338	SAO JOAO D ALIANCA	02/11/2020 10:44	03/11/2020 08:22	02/11/2020 10:44	02/11/2020 15:35	4,85	39	189,09	CHI
2020114354	SAO JOAO D ALIANCA	JL12383335	SAO JOAO D ALIANCA	02/11/2020 10:44	03/11/2020 08:22	02/11/2020 15:30	03/11/2020 08:22	16,86	11	185,44	CHI
2020114407	DIORAMA	DI12065691	IPORA	02/11/2020 10:44	02/11/2020 15:45	02/11/2020 10:44	02/11/2020 15:45	5,02	8	40,12	CHI
2020114414	ITUMBIARA	IT12309005	ITUMBIARA VELHA S1	02/11/2020 10:46	02/11/2020 13:18	02/11/2020 10:46	02/11/2020 13:18	2,53	66	166,78	CHI
2020114415	ARAGOIANIA	680015061	INDEPENDENCIA S2	02/11/2020 10:46	02/11/2020 14:04	02/11/2020 10:46	02/11/2020 14:04	3,29	1	3,29	CHI
2020114416	APARECIDA DE GOIANIA	200127640	ANHANGUERA	02/11/2020 10:46	02/11/2020 12:40	02/11/2020 10:46	02/11/2020 12:40	1,89	1	1,89	CHI
2020114426	GOIANIA	13080611	GOYA S1	02/11/2020 10:51	02/11/2020 13:52	02/11/2020 10:51	02/11/2020 13:52	3,00	1	3,00	CHI
2020114428	FLORES DE GOIAS	FB21426442	IACIARA S2	02/11/2020 10:52	02/11/2020 13:21	02/11/2020 10:52	02/11/2020 13:21	2,48	1	2,48	CHI
2020114448	AGUAS LINDAS DE GOIAS	10026551240	AGUAS LINDAS DE GOIAS S2	02/11/2020 10:55	02/11/2020 12:30	02/11/2020 10:55	02/11/2020 12:30	1,58	1	1,58	CHI
2020114452	GOIANESIA	1100000115	GOIANESIA S1	02/11/2020 10:56	02/11/2020 15:23	02/11/2020 10:56	02/11/2020 15:23	4,44	1	4,44	CHI
2020114455	BELA VISTA DE GOIAS	BV21157860	BELA VISTA S1	02/11/2020 10:57	02/11/2020 13:53	02/11/2020 10:57	02/11/2020 13:53	2,92	1	2,92	CHI
2020114457	SANTA CRUZ DE GOIAS	CN21226667	CALDAS NOVAS S1	02/11/2020 10:58	02/11/2020 16:30	02/11/2020 10:58	02/11/2020 16:30	5,53	2	11,05	CHI
2020114468	SENADOR CANEDO	10023428501	CEPAIGO S1	02/11/2020 11:03	02/11/2020 13:00	02/11/2020 11:03	02/11/2020 13:00	1,94	1	1,94	CHI
2020114471	IPAMERI	IP12073342	CAMPO ALEGRE DE GOIAS	02/11/2020 11:03	02/11/2020 14:17	02/11/2020 11:03	02/11/2020 14:17	3,22	1	3,22	CHI
2020114473	FLORES DE GOIAS	FB11278025	IACIARA S2	02/11/2020 11:03	02/11/2020 11:26	02/11/2020 11:03	02/11/2020 11:26	0,37	1	0,37	CHI
2020114472	PLANALTINA	PI12053554	PLANALTINA	02/11/2020 11:04	02/11/2020 13:25	02/11/2020 11:04	02/11/2020 13:25	2,34	1	2,34	CHI
2020114485	GOIANIA	GN11246236	GOIANIA LESTE S3	02/11/2020 11:06	02/11/2020 15:05	02/11/2020 11:06	02/11/2020 15:05	3,97	14	55,62	CHI
2020114630	IPORA	IR12222997	ARENOPOLIS	02/11/2020 11:06	02/11/2020 15:21	02/11/2020 11:06	02/11/2020 15:21	4,25	1	4,25	CHI
2020114630	IVOLANDIA	IR12222997	ARENOPOLIS	02/11/2020 11:06	02/11/2020 15:21	02/11/2020 11:06	02/11/2020 15:21	4,25	2	8,50	CHI
2020114630	PALESTINA DE GOIAS	IR12222997	ARENOPOLIS	02/11/2020 11:06	02/11/2020 15:21	02/11/2020 11:06	02/11/2020 15:21	4,25	3	12,75	CHI
2020114487	GOIANESIA	550121237	GOIANESIA S2	02/11/2020 11:08	02/11/2020 12:35	02/11/2020 11:08	02/11/2020 12:35	1,45	1	1,45	CHI
2020114495	GOIANIA	14169071	GOYA S2	02/11/2020 11:10	02/11/2020 15:16	02/11/2020 11:10	02/11/2020 15:16	4,10	1	4,10	CHI
2020114592	CRIXAS	CX12151609RE	SANTA TEREZINHA	02/11/2020 11:11	03/11/2020 10:52	02/11/2020 11:11	02/11/2020 16:02	4,85	29	140,59	CHI
2020114592	CRIXAS	CX12151609RE	SANTA TEREZINHA	02/11/2020 11:11	03/11/2020 10:52	02/11/2020 17:04	02/11/2020 20:34	3,51	29	101,69	CHI
2020114592	CRIXAS	CX12151609RE	SANTA TEREZINHA	02/11/2020 11:11	03/11/2020 10:52	02/11/2020 11:11	02/11/2020 21:05	9,90	6	59,43	CHI
2020114592	CRIXAS	CX12151609RE	SANTA TEREZINHA	02/11/2020 11:11	03/11/2020 10:52	03/11/2020 07:57	03/11/2020 09:01	1,08	35	37,67	CHI
2020114592	CRIXAS	CX12151609RE	SANTA TEREZINHA	02/11/2020 11:11	03/11/2020 10:52	02/11/2020 11:11	03/11/2020 10:52	23,68	1	23,68	CHI
2020114502	ANAPOLIS	20530626	ANAPOLIS UNIVERSITARIO S2	02/11/2020 11:13	02/11/2020 12:25	02/11/2020 11:13	02/11/2020 12:25	1,20	1	1,20	CHI
2020114508	MONTE ALEGRE DE GOIAS	MA12209853	SAO DOMINGOS	02/11/2020 11:15	02/11/2020 13:30	02/11/2020 11:15	02/11/2020 13:30	2,25	1	2,25	CHI
2020114591	IPAMERI	IP12112780	IPAMERI	02/11/2020 11:16	02/11/2020 19:47	02/11/2020 11:16	02/11/2020 19:24	8,14	9	73,27	CHI
2020114591	IPAMERI	IP12112780	IPAMERI	02/11/2020 11:16	02/11/2020 19:47	02/11/2020 11:16	02/11/2020 19:47	8,52	2	17,03	CHI
2020114514	OUVIDOR	OU12061150	CATALAO S1	02/11/2020 11:17	02/11/2020 13:43	02/11/2020 11:17	02/11/2020 13:43	2,43	1	2,43	CHI
2020114519	CRISTALINA	1060016180	CRISTALINA S1	02/11/2020 11:17	02/11/2020 12:32	02/11/2020 11:17	02/11/2020 12:32	1,23	1	1,23	CHI
2020114601	ALVORADA DO NORTE	AQ12265971	IACIARA S2	02/11/2020 11:17	02/11/2020 14:57	02/11/2020 11:17	02/11/2020 14:57	3,66	3	10,98	CHI
2020114522	SANTA CRUZ DE GOIAS	BC12023183	CRISTIANOPOLIS	02/11/2020 11:19	02/11/2020 15:11	02/11/2020 11:19	02/11/2020 15:11	3,85	42	161,78	CHI
2020114525	ANAPOLIS	AN21377549	ANAPOLIS UNIVERSITARIO S2	02/11/2020 11:20	02/11/2020 13:09	02/11/2020 11:20	02/11/2020 13:09	1,81	2	3,61	CHI
2020114968	BELA VISTA DE GOIAS	BV12018394	BELA VISTA S1	02/11/2020 11:20	03/11/2020 10:16	02/11/2020 11:20	03/11/2020 10:16	22,92	3	68,76	CHI
2020114968	PIRACANJUBA	BV12018394	BELA VISTA S1	02/11/2020 11:20	03/11/2020 10:16	02/11/2020 11:20	03/11/2020 10:16	22,92	33	756,35	CHI
2020114529	ABADIA DE GOIAS	GN32052059	CARAJAS S1	02/11/2020 11:21	02/11/2020 15:00	02/11/2020 11:21	02/11/2020 15:00	3,64	2	7,28	CHI
2020114535	GOIANIA	16615244	XAVANTES	02/11/2020 11:23	02/11/2020 12:24	02/11/2020 11:23	02/11/2020 12:24	1,00	1	1,00	CHI

2020114882	ITAPIRAPUA	IU11000009	MATRINCHA	02/11/2020 11:23	02/11/2020 17:09	02/11/2020 11:23	02/11/2020 17:09	5,76	84	483,79	CHI
2020114542	SENADOR CANEDO	10018881953	SENADOR CANEDO	02/11/2020 11:26	02/11/2020 11:43	02/11/2020 11:26	02/11/2020 11:43	0,28	1	0,28	CHI
2020114547	VILA BOA	2880001682	IACIARA S2	02/11/2020 11:28	02/11/2020 11:49	02/11/2020 11:28	02/11/2020 11:49	0,34	1	0,34	CHI
2020114553	PLANALTINA	PI21135172	PLANALTINA	02/11/2020 11:31	03/11/2020 10:08	02/11/2020 11:31	03/11/2020 10:08	22,60	1	22,60	CHI
2020114611	TRINDADE	TR11291620	TRINDADE	02/11/2020 11:31	02/11/2020 13:28	02/11/2020 11:31	02/11/2020 13:28	1,94	55	106,43	CHI
2020114563	GOIATUBA	GT21013088	GOIATUBA S2	02/11/2020 11:35	02/11/2020 18:02	02/11/2020 11:35	02/11/2020 18:02	6,44	2	12,87	CHI
2020114565	MATRINCHA	MP21241635	MATRINCHA	02/11/2020 11:36	02/11/2020 14:39	02/11/2020 11:36	02/11/2020 14:39	3,04	1	3,04	CHI
2020114570	GUAPO	710037480	GUAPO S1	02/11/2020 11:37	02/11/2020 14:46	02/11/2020 11:37	02/11/2020 14:46	3,13	1	3,13	CHI
2020114571	MORRINHOS	MR21160306	MORRINHOS	02/11/2020 11:38	02/11/2020 15:52	02/11/2020 11:38	02/11/2020 15:52	4,23	1	4,23	CHI
2020114572	ITUMBIARA	690323384	ITUMBIARA VELHA S1	02/11/2020 11:38	02/11/2020 15:59	02/11/2020 11:38	02/11/2020 15:59	4,34	1	4,34	CHI
2020114574	CRIXAS	CX21342238	RUBIATABA	02/11/2020 11:38	02/11/2020 20:40	02/11/2020 11:38	02/11/2020 20:40	9,03	1	9,03	CHI
2020114640	SAO MIGUEL DO ARAGUAIA	SM12086469	SAO MIGUEL DO ARAGUAIA	02/11/2020 11:40	02/11/2020 14:24	02/11/2020 11:40	02/11/2020 14:24	2,73	485	1323,92	CHI
2020114586	IACIARA	10005288698	IACIARA S1	02/11/2020 11:41	02/11/2020 13:48	02/11/2020 11:41	02/11/2020 13:48	2,11	1	2,11	CHI
2020114613	MORRINHOS	10029540370	MORRINHOS	02/11/2020 11:54	02/11/2020 15:04	02/11/2020 11:54	02/11/2020 15:04	3,17	1	3,17	CHI
2020114675	PIRES DO RIO	BC12031273	PIRES DO RIO S2	02/11/2020 11:55	02/11/2020 19:10	02/11/2020 11:55	02/11/2020 19:10	7,25	2	14,50	CHI
2020114675	SANTA CRUZ DE GOIAS	BC12031273	PIRES DO RIO S2	02/11/2020 11:55	02/11/2020 19:10	02/11/2020 11:55	02/11/2020 19:10	7,25	1	7,25	CHI
2020114620	ANAPOLIS	AN21313067	ANAPOLIS UNIVERSITARIO S1	02/11/2020 11:57	02/11/2020 14:49	02/11/2020 11:57	02/11/2020 14:49	2,86	1	2,86	CHI
2020114622	GOIANIA	10005304936	CARAJAS S2	02/11/2020 11:57	02/11/2020 14:02	02/11/2020 11:57	02/11/2020 14:02	2,08	1	2,08	CHI
2020114624	APARECIDA DE GOIANIA	12721670	ANHANGUERA	02/11/2020 11:58	02/11/2020 14:18	02/11/2020 11:58	02/11/2020 14:18	2,33	1	2,33	CHI
2020114625	CRISTALINA	3490015858	PAMPLONA	02/11/2020 11:58	02/11/2020 16:46	02/11/2020 11:58	02/11/2020 16:46	4,79	1	4,79	CHI
2020114643	NIQUELANDIA	NQ10396041	NIQUELANDIA SUBTRANSMISSAO	02/11/2020 12:02	03/11/2020 08:08	02/11/2020 12:02	02/11/2020 14:57	2,92	283	825,57	CHI
2020114643	NIQUELANDIA	NQ10396041	NIQUELANDIA SUBTRANSMISSAO	02/11/2020 12:02	03/11/2020 08:08	02/11/2020 14:58	02/11/2020 17:36	2,64	38	100,17	CHI
2020114643	NIQUELANDIA	NQ13096761	NIQUELANDIA SUBTRANSMISSAO	02/11/2020 12:02	03/11/2020 08:08	02/11/2020 14:58	03/11/2020 00:22	9,40	166	1560,26	CHI
2020114643	NIQUELANDIA	NQ13235653	NIQUELANDIA SUBTRANSMISSAO	02/11/2020 12:02	03/11/2020 08:08	02/11/2020 14:58	03/11/2020 07:15	16,29	67	1091,39	CHI
2020114643	NIQUELANDIA	NQ12095766	NIQUELANDIA SUBTRANSMISSAO	02/11/2020 12:02	03/11/2020 08:08	02/11/2020 12:02	03/11/2020 08:08	20,11	61	1226,46	CHI
2020114643	URUACU	NQ12095766	NIQUELANDIA SUBTRANSMISSAO	02/11/2020 12:02	03/11/2020 08:08	02/11/2020 12:02	03/11/2020 08:08	20,11	3	60,32	CHI
2020114643	NIQUELANDIA	NQ12095766	NIQUELANDIA SUBTRANSMISSAO	02/11/2020 12:02	03/11/2020 08:08	02/11/2020 14:58	03/11/2020 08:08	17,17	12	205,99	CHI
2020115410	AMARALINA	LC12230319	NOVA CRIXAS	02/11/2020 12:03	02/11/2020 20:25	02/11/2020 12:03	02/11/2020 20:25	8,35	3	25,06	CHI
2020114642	GOIANIA	GN21162199	ATLANTICO S2	02/11/2020 12:05	02/11/2020 14:57	02/11/2020 12:05	02/11/2020 14:57	2,86	1	2,86	CHI
2020114648	GOIANIA	10359424	CAMPINAS S1	02/11/2020 12:10	02/11/2020 15:16	02/11/2020 12:10	02/11/2020 15:16	3,10	1	3,10	CHI
2020114655	GOIANIA	10013794530	GOYA S1	02/11/2020 12:14	02/11/2020 16:02	02/11/2020 12:14	02/11/2020 16:02	3,80	1	3,80	CHI
2020114656	GOIAS	GS11222213	GOIAS	02/11/2020 12:14	02/11/2020 15:10	02/11/2020 12:14	02/11/2020 15:10	2,93	1	2,93	CHI
2020114658	FAINA	GS12158701	GOIAS	02/11/2020 12:15	02/11/2020 14:24	02/11/2020 12:15	02/11/2020 14:24	2,14	1	2,14	CHI
2020114706	MOZARLANDIA	MZ12051179	MOZARLANDIA	02/11/2020 12:20	02/11/2020 14:16	02/11/2020 12:20	02/11/2020 14:16	1,92	15	28,81	CHI
2020114674	INHUMAS	30033950	INHUMAS S2	02/11/2020 12:22	02/11/2020 14:59	02/11/2020 12:22	02/11/2020 14:59	2,62	1	2,62	CHI
2020114678	MUNDO NOVO DE GOIAS	MH21134332	NOVA CRIXAS	02/11/2020 12:24	02/11/2020 14:44	02/11/2020 12:24	02/11/2020 14:44	2,32	1	2,32	CHI
2020114679	GOIANIA	GN11289073	ATLANTICO S1	02/11/2020 12:24	02/11/2020 14:08	02/11/2020 12:24	02/11/2020 14:08	1,72	78	134,18	CHI
2020114682	GOIANIA	GN11139574	ATLANTICO S2	02/11/2020 12:25	02/11/2020 16:31	02/11/2020 12:25	02/11/2020 16:31	4,09	24	98,17	CHI
2020114683	GOIANIA	GN11002662	ATLANTICO S3	02/11/2020 12:26	02/11/2020 15:00	02/11/2020 12:26	02/11/2020 15:00	2,56	126	322,98	CHI
2020114685	PALMEIRAS DE GOIAS	PL21051401	PALMEIRAS	02/11/2020 12:27	02/11/2020 15:30	02/11/2020 12:27	02/11/2020 15:30	3,04	2	6,08	CHI
2020115017	FLORES DE GOIAS	FB21409983	FLORES DE GOIAS	02/11/2020 12:29	02/11/2020 16:06	02/11/2020 12:29	02/11/2020 16:06	3,61	1	3,61	CHI
2020114689	ANICUNS	AC21222012	ANICUNS	02/11/2020 12:33	02/11/2020 17:07	02/11/2020 12:33	02/11/2020 17:07	4,56	2	9,12	CHI
2020114692	ITABERAI	10031656178	ITABERAI S2	02/11/2020 12:34	02/11/2020 17:14	02/11/2020 12:34	02/11/2020 17:14	4,65	1	4,65	CHI
2020114710	BURITI DE GOIAS	BS12304459	FIRMINOPOLIS S2	02/11/2020 12:37	02/11/2020 14:10	02/11/2020 12:37	02/11/2020 14:10	1,55	10	15,48	CHI
2020114710	MOSSAMEDES	BS12304459	FIRMINOPOLIS S2	02/11/2020 12:37	02/11/2020 14:10	02/11/2020 12:37	02/11/2020 14:10	1,55	4	6,19	CHI
2020114710	SANCLERLANDIA	BS12304459	FIRMINOPOLIS S2	02/11/2020 12:37	02/11/2020 14:10	02/11/2020 12:37	02/11/2020 14:10	1,55	1	1,55	CHI
2020114702	OURO VERDE DE GOIAS	OV12384176	NEROPOLIS S1	02/11/2020 12:38	02/11/2020 15:03	02/11/2020 12:38	02/11/2020 15:03	2,41	11	26,53	CHI
2020114877	CAMPOS BELOS	CH11102305	SAO DOMINGOS	02/11/2020 12:40	02/11/2020 15:39	02/11/2020 12:40	02/11/2020 15:39	2,98	150	446,96	CHI
2020114709	ITUMBIARA	690389565	ITUMBIARA VELHA S1	02/11/2020 12:41	02/11/2020 16:37	02/11/2020 12:41	02/11/2020 16:37	3,93	1	3,93	CHI
2020114712	ORIZONA	VN12072138	VIANOPOLIS	02/11/2020 12:42	02/11/2020 15:13	02/11/2020 12:42	02/11/2020 15:13	2,50	23	57,54	CHI
2020114712	VIANOPOLIS	VN12072138	VIANOPOLIS	02/11/2020 12:42	02/11/2020 15:13	02/11/2020 12:42	02/11/2020 15:13	2,50	87	217,67	CHI

2020114714	ITUMBIARA	BJ11093523	BOM JESUS DE GOIAS	02/11/2020 12:44	02/11/2020 16:56	02/11/2020 12:44	02/11/2020 16:56	4,19	58	242,91	CHI
2020114725	JUSSARA	JR21320018	BRITANIA	02/11/2020 12:48	02/11/2020 15:30	02/11/2020 12:48	02/11/2020 15:30	2,69	1	2,69	CHI
2020114914	CAMPOS BELOS	CH12208695	SAO DOMINGOS	02/11/2020 12:49	02/11/2020 16:30	02/11/2020 12:49	02/11/2020 16:30	3,68	260	956,66	CHI
2020114734	MINACU	IH11262530	MINACU	02/11/2020 12:53	02/11/2020 22:50	02/11/2020 12:53	02/11/2020 22:50	9,95	22	218,86	CHI
2020114741	CAMPOS BELOS	10023114531	SAO DOMINGOS	02/11/2020 12:54	02/11/2020 16:49	02/11/2020 12:54	02/11/2020 16:49	3,91	1	3,91	CHI
2020114742	GOIANIA	GN11149609	CARAJAS S2	02/11/2020 12:54	02/11/2020 14:47	02/11/2020 12:54	02/11/2020 14:47	1,88	197	369,54	CHI
2020114745	MONTES CLAROS DE GOIAS	ME21155687	IPORA	02/11/2020 12:55	02/11/2020 14:07	02/11/2020 12:55	02/11/2020 14:07	1,20	1	1,20	CHI
2020114804	CROMINIA	CQ12000222	PONTALINA	02/11/2020 12:55	03/11/2020 08:29	02/11/2020 12:55	03/11/2020 08:29	19,56	7	136,95	CHI
2020114804	MAIRIPOTABA	CQ12000222	PONTALINA	02/11/2020 12:55	03/11/2020 08:29	02/11/2020 12:55	03/11/2020 08:29	19,56	2	39,13	CHI
2020114748	MUNDO NOVO DE GOIAS	MH12242017	NOVA CRIXAS	02/11/2020 12:56	02/11/2020 21:14	02/11/2020 12:56	02/11/2020 21:14	8,29	4	33,17	CHI
2020114750	GUARINOS	GF21314371	SANTA TEREZINHA	02/11/2020 12:57	02/11/2020 15:23	02/11/2020 12:57	02/11/2020 15:23	2,42	1	2,42	CHI
2020114756	ANAPOLIS	20968292	ANAPOLIS UNIVERSITARIO S1	02/11/2020 13:01	02/11/2020 16:48	02/11/2020 13:01	02/11/2020 16:48	3,77	1	3,77	CHI
2020114758	AGUA FRIA DE GOIAS	TL12164659	SAO JOAO D ALIANCA	02/11/2020 13:02	02/11/2020 18:37	02/11/2020 13:02	02/11/2020 18:37	5,58	45	251,10	CHI
2020114762	PIRENOPOLIS	PV21121851	CORUMBA	02/11/2020 13:03	02/11/2020 22:11	02/11/2020 13:03	02/11/2020 22:11	9,12	1	9,12	CHI
2020114765	CATALAO	1990148326	CATALAO S2	02/11/2020 13:04	02/11/2020 14:46	02/11/2020 13:04	02/11/2020 14:46	1,69	1	1,69	CHI
2020114787	MINACU	IH12182309	MINACU	02/11/2020 13:04	02/11/2020 15:17	02/11/2020 13:04	02/11/2020 15:17	2,21	16	35,36	CHI
2020114767	APARECIDA DE GOIANIA	200670890	ANHANGUERA	02/11/2020 13:06	02/11/2020 14:43	02/11/2020 13:06	02/11/2020 14:43	1,61	1	1,61	CHI
2020114777	PIRACANJUBA	PJ21040821	PIRACANJUBA	02/11/2020 13:12	02/11/2020 16:45	02/11/2020 13:12	02/11/2020 16:45	3,55	1	3,55	CHI
2020114784	APARECIDA DE GOIANIA	15031111	INDEPENDENCIA S1	02/11/2020 13:13	02/11/2020 15:17	02/11/2020 13:13	02/11/2020 15:17	2,06	1	2,06	CHI
2020114788	ANAPOLIS	20980670	ANAPOLIS UNIVERSITARIO S2	02/11/2020 13:14	02/11/2020 14:24	02/11/2020 13:14	02/11/2020 14:24	1,16	1	1,16	CHI
2020114790	CAMPINORTE	UR21243263	MARA ROSA	02/11/2020 13:15	02/11/2020 16:16	02/11/2020 13:15	02/11/2020 16:16	3,01	2	6,02	CHI
2020114793	NOVA ROMA	ND12392238	IACIARA S2	02/11/2020 13:16	02/11/2020 15:59	02/11/2020 13:16	02/11/2020 15:59	2,70	235	635,15	CHI
2020114794	ANICUNS	AC12020526	ANICUNS	02/11/2020 13:17	02/11/2020 16:27	02/11/2020 13:17	02/11/2020 16:27	3,15	9	28,39	CHI
2020114800	NIQUELANDIA	NQ12357749	NIQUELANDIA SUBTRANSMISSAO	02/11/2020 13:20	02/11/2020 20:03	02/11/2020 13:20	02/11/2020 20:03	6,70	1	6,70	CHI
2020115052	SAO MIGUEL DO ARAGUAIA	830076876	SAO MIGUEL DO ARAGUAIA	02/11/2020 13:20	02/11/2020 16:37	02/11/2020 13:20	02/11/2020 16:37	3,27	1	3,27	CHI
2020115092	DIVINOPOLIS DE GOIAS	GH12272677	SAO DOMINGOS	02/11/2020 13:22	02/11/2020 19:09	02/11/2020 13:22	02/11/2020 19:09	5,77	15	86,61	CHI
2020114810	TRINDADE	TR21218059	TRINDADE	02/11/2020 13:23	02/11/2020 15:27	02/11/2020 13:23	02/11/2020 15:27	2,06	1	2,06	CHI
2020115163	ARUANA	AK11183261	ARUANA	02/11/2020 13:23	02/11/2020 17:12	02/11/2020 13:23	02/11/2020 17:12	3,82	103	393,09	CHI
2020114812	NOVO GAMA	2460039251	PACAEMBU S1	02/11/2020 13:24	02/11/2020 15:32	02/11/2020 13:24	02/11/2020 15:32	2,12	1	2,12	CHI
2020114814	ANAPOLIS	AN21201282	ANAPOLIS UNIVERSITARIO S2	02/11/2020 13:25	02/11/2020 15:42	02/11/2020 13:25	02/11/2020 15:42	2,28	1	2,28	CHI
2020114855	GOIANESIA	GE18423654TS	GOIANESIA S2	02/11/2020 13:26	02/11/2020 16:05	02/11/2020 13:26	02/11/2020 16:05	2,64	171	451,77	CHI
2020114855	VILA PROPICIO	GE18423654TS	GOIANESIA S2	02/11/2020 13:26	02/11/2020 16:05	02/11/2020 13:26	02/11/2020 16:05	2,64	18	47,55	CHI
2020114831	PARAUNA	5760224	PARAUNA	02/11/2020 13:27	02/11/2020 22:07	02/11/2020 13:30	02/11/2020 14:59	1,50	3	4,49	CHI
2020114831	PARAUNA	PU13349314	PARAUNA	02/11/2020 13:27	02/11/2020 22:07	02/11/2020 13:30	02/11/2020 17:24	3,91	838	3272,86	CHI
2020114831	PARAUNA	5760224	PARAUNA	02/11/2020 13:27	02/11/2020 22:07	02/11/2020 20:36	02/11/2020 20:40	0,08	3	0,23	CHI
2020114831	PARAUNA	PU13349314	PARAUNA	02/11/2020 13:27	02/11/2020 22:07	02/11/2020 13:30	02/11/2020 22:07	8,62	2	17,25	CHI
2020114831	PARAUNA	PU13349314	PARAUNA	02/11/2020 13:27	02/11/2020 22:07	02/11/2020 20:36	02/11/2020 22:07	1,52	838	1274,23	CHI
2020114821	CATALAO	CT21306685	CATALAO S1	02/11/2020 13:28	02/11/2020 22:35	02/11/2020 13:28	02/11/2020 22:35	9,11	1	9,11	CHI
2020114826	VALPARAISO DE GOIAS	10012395062	PACAEMBU S1	02/11/2020 13:29	02/11/2020 14:47	02/11/2020 13:29	02/11/2020 14:47	1,30	1	1,30	CHI
2020114828	GOIANESIA	10028406190	GOIANESIA S2	02/11/2020 13:29	02/11/2020 16:52	02/11/2020 13:29	02/11/2020 16:52	3,37	1	3,37	CHI
2020114835	COCALZINHO DE GOIAS	10011603834	COCALZINHO	02/11/2020 13:34	02/11/2020 14:41	02/11/2020 13:34	02/11/2020 14:41	1,11	1	1,11	CHI
2020114838	PORANGATU	PO12363572	PORANGATU	02/11/2020 13:36	02/11/2020 15:28	02/11/2020 13:36	02/11/2020 15:28	1,86	9	16,78	CHI
2020114941	GUARANI DE GOIAS	2090424	SAO DOMINGOS	02/11/2020 13:37	02/11/2020 17:46	02/11/2020 13:37	02/11/2020 14:06	0,49	153	74,55	CHI
2020114941	MONTE ALEGRE DE GOIAS	2090424	SAO DOMINGOS	02/11/2020 13:37	02/11/2020 17:46	02/11/2020 13:37	02/11/2020 14:06	0,49	1	0,49	CHI
2020114941	NOVA ROMA	2090424	SAO DOMINGOS	02/11/2020 13:37	02/11/2020 17:46	02/11/2020 13:37	02/11/2020 14:06	0,49	3	1,46	CHI
2020114941	SAO DOMINGOS	2090424	SAO DOMINGOS	02/11/2020 13:37	02/11/2020 17:46	02/11/2020 13:37	02/11/2020 14:06	0,49	1184	576,87	CHI
2020114941	GUARANI DE GOIAS	2090424	SAO DOMINGOS	02/11/2020 13:37	02/11/2020 17:46	02/11/2020 14:14	02/11/2020 14:24	0,18	2	0,35	CHI
2020114941	SAO DOMINGOS	2090424	SAO DOMINGOS	02/11/2020 13:37	02/11/2020 17:46	02/11/2020 14:14	02/11/2020 14:24	0,18	543	95,33	CHI
2020114941	SAO DOMINGOS	2090424	SAO DOMINGOS	02/11/2020 13:37	02/11/2020 17:46	02/11/2020 14:30	02/11/2020 15:39	1,14	61	69,51	CHI
2020114941	GUARANI DE GOIAS	SD13102563	SAO DOMINGOS	02/11/2020 13:37	02/11/2020 17:46	02/11/2020 14:30	02/11/2020 17:06	2,59	2	5,18	CHI
2020114941	SAO DOMINGOS	SD13102563	SAO DOMINGOS	02/11/2020 13:37	02/11/2020 17:46	02/11/2020 14:30	02/11/2020 17:06	2,59	243	629,50	CHI

2020114941	SAO DOMINGOS	SD13102564	SAO DOMINGOS	02/11/2020 13:37	02/11/2020 17:46	02/11/2020 14:30	02/11/2020 17:25	2,91	52	151,48	CHI
2020114941	SAO DOMINGOS	SD13103880	SAO DOMINGOS	02/11/2020 13:37	02/11/2020 17:46	02/11/2020 14:30	02/11/2020 17:42	3,20	187	598,14	CHI
2020114941	GUARANI DE GOIAS	SD10401447	SAO DOMINGOS	02/11/2020 13:37	02/11/2020 17:46	02/11/2020 14:14	02/11/2020 17:46	3,54	3	10,62	CHI
2020114941	MONTE ALEGRE DE GOIAS	SD10401447	SAO DOMINGOS	02/11/2020 13:37	02/11/2020 17:46	02/11/2020 14:14	02/11/2020 17:46	3,54	1	3,54	CHI
2020114941	NOVA ROMA	SD10401447	SAO DOMINGOS	02/11/2020 13:37	02/11/2020 17:46	02/11/2020 14:14	02/11/2020 17:46	3,54	3	10,62	CHI
2020114941	SAO DOMINGOS	SD10401447	SAO DOMINGOS	02/11/2020 13:37	02/11/2020 17:46	02/11/2020 14:14	02/11/2020 17:46	3,54	604	2137,66	CHI
2020114941	GUARANI DE GOIAS	SD10409757	SAO DOMINGOS	02/11/2020 13:37	02/11/2020 17:46	02/11/2020 14:14	02/11/2020 17:46	3,54	148	523,88	CHI
2020114941	SAO DOMINGOS	SD10409757	SAO DOMINGOS	02/11/2020 13:37	02/11/2020 17:46	02/11/2020 14:14	02/11/2020 17:46	3,54	65	230,08	CHI
2020114846	ITUMBIARA	IT21309919	ITUMBIARA NOVA	02/11/2020 13:40	02/11/2020 16:16	02/11/2020 13:40	02/11/2020 16:16	2,59	1	2,59	CHI
2020114848	CALDAS NOVAS	760396360	SERRA DE CALDAS	02/11/2020 13:41	02/11/2020 15:50	02/11/2020 13:41	02/11/2020 15:50	2,14	1	2,14	CHI
2020114857	SAO JOAO D ALIANCA	JL21117433	SAO JOAO D ALIANCA	02/11/2020 13:45	03/11/2020 09:40	02/11/2020 13:45	03/11/2020 09:40	19,92	1	19,92	CHI
2020114859	CALDAS NOVAS	CN21028959	CALDAS NOVAS S2	02/11/2020 13:45	02/11/2020 17:32	02/11/2020 13:45	02/11/2020 17:32	3,77	1	3,77	CHI
2020114866	VALPARAISO DE GOIAS	10002048750	PACAEMBU S1	02/11/2020 13:48	02/11/2020 16:09	02/11/2020 13:48	02/11/2020 16:09	2,35	1	2,35	CHI
2020114867	COCALZINHO DE GOIAS	ZN11327439	GOIANESIA S1	02/11/2020 13:48	02/11/2020 18:24	02/11/2020 13:48	02/11/2020 18:24	4,59	1	4,59	CHI
2020114873	ANAPOLIS	AN21077868	ANAPOLIS UNIVERSITARIO S2	02/11/2020 13:49	02/11/2020 17:48	02/11/2020 13:49	02/11/2020 17:48	3,97	1	3,97	CHI
2020115560	ADELANDIA	DN11018612	FIRMINOPOLIS S2	02/11/2020 13:49	02/11/2020 18:27	02/11/2020 13:49	02/11/2020 18:27	4,63	94	434,83	CHI
2020114880	ABADIANIA	AA12258349LD	DAIA S2	02/11/2020 13:52	02/11/2020 18:50	02/11/2020 13:52	02/11/2020 18:50	4,96	8	39,66	CHI
2020114884	HIDROLANDIA	HD31046393	INDEPENDENCIA S1	02/11/2020 13:54	02/11/2020 15:24	02/11/2020 13:54	02/11/2020 15:24	1,50	2	2,99	CHI
2020114888	GOIANIA	11830554	ATLANTICO S2	02/11/2020 13:54	02/11/2020 21:10	02/11/2020 13:54	02/11/2020 21:10	7,26	1	7,26	CHI
2020114889	GOIANIRA	390084281	MEIA PONTE	02/11/2020 13:55	02/11/2020 16:22	02/11/2020 13:55	02/11/2020 16:22	2,45	1	2,45	CHI
2020114892	GOIANIA	GN11002490	GOIANIA LESTE S2	02/11/2020 13:55	02/11/2020 16:16	02/11/2020 14:34	02/11/2020 16:16	1,70	57	96,92	CHI
2020114893	MUNDO NOVO DE GOIAS	MH12058014	NOVA CRIXAS	02/11/2020 13:55	02/11/2020 16:22	02/11/2020 13:55	02/11/2020 16:22	2,44	1	2,44	CHI
2020114897	GOIANIA	GN11162034	FERROVIARIO S3	02/11/2020 13:56	02/11/2020 16:03	02/11/2020 13:56	02/11/2020 16:03	2,11	38	80,17	CHI
2020114907	INHUMAS	30053729	INHUMAS S2	02/11/2020 13:59	02/11/2020 16:07	02/11/2020 13:59	02/11/2020 16:07	2,12	1	2,12	CHI
2020115072	BURITINOPOLIS	MB12314303	IACIARA S2	02/11/2020 13:59	03/11/2020 10:57	02/11/2020 13:59	03/11/2020 10:57	20,96	2	41,92	CHI
2020115072	MAMBAI	MB12314303	IACIARA S2	02/11/2020 13:59	03/11/2020 10:57	02/11/2020 13:59	03/11/2020 10:57	20,96	4	83,84	CHI
2020114962	AGUA FRIA DE GOIAS	TL12320523	SAO JOAO D ALIANCA	02/11/2020 14:01	02/11/2020 15:22	02/11/2020 14:01	02/11/2020 15:22	1,35	12	16,20	CHI
2020114926	MARA ROSA	2260029973	MARA ROSA	02/11/2020 14:08	02/11/2020 15:52	02/11/2020 14:08	02/11/2020 15:52	1,72	1	1,72	CHI
2020115272	NIQUELANDIA	4260000185	URUACU	02/11/2020 14:08	02/11/2020 22:57	02/11/2020 14:08	02/11/2020 22:57	8,83	1	8,83	CHI
2020114927	MONTE ALEGRE DE GOIAS	MA12129814	SAO DOMINGOS	02/11/2020 14:10	02/11/2020 16:23	02/11/2020 14:10	02/11/2020 16:23	2,22	31	68,67	CHI
2020115124	MORRINHOS	MR12000281	MORRINHOS	02/11/2020 14:12	03/11/2020 00:47	02/11/2020 14:12	03/11/2020 00:47	10,58	20	211,69	CHI
2020114937	PIRES DO RIO	PR12402554	PIRES DO RIO S1	02/11/2020 14:14	02/11/2020 17:27	02/11/2020 14:14	02/11/2020 17:27	3,20	4	12,81	CHI
2020114938	CAIAPONIA	CP21155675	CAIAPONIA	02/11/2020 14:15	02/11/2020 16:41	02/11/2020 14:15	02/11/2020 16:41	2,43	1	2,43	CHI
2020115002	PLANALTINA	PI12257785	PLANALTINA	02/11/2020 14:17	02/11/2020 18:18	02/11/2020 14:17	02/11/2020 18:18	4,01	3	12,04	CHI
2020114948	APARECIDA DE GOIANIA	12242226	REAL S1	02/11/2020 14:18	02/11/2020 15:17	02/11/2020 14:18	02/11/2020 15:17	0,98	1	0,98	CHI
2020114951	MUTUNOPOLIS	MU21302567	MARA ROSA	02/11/2020 14:19	02/11/2020 17:03	02/11/2020 14:19	02/11/2020 17:03	2,73	1	2,73	CHI
2020114978	IPAMERI	IP12247907	CRISTALINA S2	02/11/2020 14:19	02/11/2020 20:27	02/11/2020 14:19	02/11/2020 20:27	6,13	24	147,03	CHI
2020114958	CRISTALINA	1060086004	CRISTALINA S1	02/11/2020 14:21	02/11/2020 16:55	02/11/2020 14:21	02/11/2020 16:55	2,55	1	2,55	CHI
2020114983	GUARINOS	GF12380720	SANTA TEREZINHA	02/11/2020 14:21	02/11/2020 16:13	02/11/2020 14:21	02/11/2020 16:13	1,86	17	31,69	CHI
2020114960	MONTE ALEGRE DE GOIAS	MA21282247	SAO DOMINGOS	02/11/2020 14:22	02/11/2020 20:24	02/11/2020 14:22	02/11/2020 20:24	6,03	1	6,03	CHI
2020114969	INDIARA	1890009020	EDEIA	02/11/2020 14:27	02/11/2020 19:28	02/11/2020 14:27	02/11/2020 19:28	5,00	1	5,00	CHI
2020114975	SENADOR CANEDO	190113443	SENADOR CANEDO	02/11/2020 14:30	02/11/2020 15:32	02/11/2020 14:30	02/11/2020 15:32	1,03	1	1,03	CHI
2020115175	AGUA FRIA DE GOIAS	TL12381390	SAO JOAO D ALIANCA	02/11/2020 14:30	02/11/2020 16:46	02/11/2020 14:30	02/11/2020 16:46	2,25	3	6,76	CHI
2020115175	PLANALTINA	TL12381390	SAO JOAO D ALIANCA	02/11/2020 14:30	02/11/2020 16:46	02/11/2020 14:30	02/11/2020 16:46	2,25	21	47,31	CHI
2020114985	SANCLERLANDIA	SC21190733	FIRMINOPOLIS S2	02/11/2020 14:33	02/11/2020 15:46	02/11/2020 14:33	02/11/2020 15:46	1,21	1	1,21	CHI
2020114988	MONTIVIDU DO NORTE	MX12270910	PORANGATU	02/11/2020 14:36	02/11/2020 16:40	02/11/2020 14:36	02/11/2020 16:40	2,07	7	14,46	CHI
2020114990	GOIANIA	12095710	GOYA S1	02/11/2020 14:36	02/11/2020 15:56	02/11/2020 14:36	02/11/2020 15:56	1,33	1	1,33	CHI
2020114997	AGUAS LINDAS DE GOIAS	LA11346862	AGUAS LINDAS DE GOIAS S1	02/11/2020 14:39	02/11/2020 18:52	02/11/2020 14:39	02/11/2020 18:52	4,22	122	514,23	CHI
2020114998	ITAGUARU	IC12065277	ITABERAI S1	02/11/2020 14:39	02/11/2020 17:07	02/11/2020 14:39	02/11/2020 17:07	2,46	2	4,91	CHI
2020115000	APARECIDA DE GOIANIA	10012643155	INDEPENDENCIA S1	02/11/2020 14:40	02/11/2020 15:49	02/11/2020 14:40	02/11/2020 15:49	1,14	1	1,14	CHI
2020115003	PANAMA	PX21171357	GOIATUBA S1	02/11/2020 14:42	03/11/2020 03:50	02/11/2020 14:42	03/11/2020 03:50	13,13	1	13,13	CHI

2020115008	CACHOEIRA DOURADA	CD12000228	CACHOEIRA DOURADA	02/11/2020 14:42	02/11/2020 21:37	02/11/2020 14:42	02/11/2020 21:37	6,90	2	13,80	CHI
2020115008	ITUMBIARA	CD12000228	CACHOEIRA DOURADA	02/11/2020 14:42	02/11/2020 21:37	02/11/2020 14:42	02/11/2020 21:37	6,90	1	6,90	CHI
2020115386	BOM JESUS DE GOIAS	BJ12389715	BOM JESUS DE GOIAS	02/11/2020 14:43	03/11/2020 15:02	03/11/2020 13:26	03/11/2020 15:01	1,57	1	1,57	CHI
2020115386	QUIRINOPOLIS	BJ12389715	BOM JESUS DE GOIAS	02/11/2020 14:43	03/11/2020 15:02	03/11/2020 13:26	03/11/2020 15:01	1,57	2	3,13	CHI
2020115386	BOM JESUS DE GOIAS	BJ21190802	BOM JESUS DE GOIAS	02/11/2020 14:43	03/11/2020 15:02	03/11/2020 13:26	03/11/2020 15:02	1,58	1	1,58	CHI
2020115068	SAO MIGUEL DO ARAGUAIA	830022569	SAO MIGUEL DO ARAGUAIA	02/11/2020 14:44	03/11/2020 09:09	02/11/2020 14:44	03/11/2020 09:09	18,40	1	18,40	CHI
2020115073	GOIANIRA	GR11069001	GOIANIRA	02/11/2020 14:46	02/11/2020 17:49	02/11/2020 14:46	02/11/2020 17:49	3,04	156	474,11	CHI
2020115015	DOVERLANDIA	DV11204216	CAIAPONIA	02/11/2020 14:47	03/11/2020 02:30	02/11/2020 14:47	03/11/2020 02:30	11,71	1	11,71	CHI
2020115024	EDEIA	EA21249768	VICENTINOPOLIS	02/11/2020 14:48	02/11/2020 18:34	02/11/2020 14:48	02/11/2020 18:34	3,76	1	3,76	CHI
2020115027	ANAPOLIS	AN12258163	ANAPOLIS UNIVERSITARIO S1	02/11/2020 14:48	02/11/2020 16:31	02/11/2020 14:48	02/11/2020 16:31	1,70	5	8,50	CHI
2020115116	PIRENOPOLIS	PV21350844	CORUMBA	02/11/2020 14:48	02/11/2020 18:03	02/11/2020 14:48	02/11/2020 18:03	3,24	1	3,24	CHI
2020115031	FORMOSA	4920224	SAO JOAO D ALIANCA	02/11/2020 14:50	03/11/2020 01:26	02/11/2020 14:50	02/11/2020 20:20	5,49	283	1554,30	CHI
2020115031	FORMOSA	FA16407043	SAO JOAO D ALIANCA	02/11/2020 14:50	03/11/2020 01:26	02/11/2020 14:50	02/11/2020 22:01	7,19	53	381,06	CHI
2020115031	FORMOSA	FA13042705	SAO JOAO D ALIANCA	02/11/2020 14:50	03/11/2020 01:26	02/11/2020 14:50	03/11/2020 00:34	9,73	20	194,56	CHI
2020115031	FORMOSA	FA13042705	SAO JOAO D ALIANCA	02/11/2020 14:50	03/11/2020 01:26	02/11/2020 19:34	03/11/2020 00:34	4,99	88	439,24	CHI
2020115031	FORMOSA	FA13042688	SAO JOAO D ALIANCA	02/11/2020 14:50	03/11/2020 01:26	03/11/2020 01:04	03/11/2020 01:26	0,36	54	19,37	CHI
2020115038	COCALZINHO DE GOIAS	ZN11327461	GOIANESIA S1	02/11/2020 14:53	02/11/2020 18:57	02/11/2020 14:53	02/11/2020 18:57	4,05	1	4,05	CHI
2020115237	CAMPOS BELOS	CH12180781	SAO DOMINGOS	02/11/2020 14:54	02/11/2020 18:15	02/11/2020 17:18	02/11/2020 17:49	0,53	58	30,74	CHI
2020115237	CAMPOS BELOS	CH11180782	SAO DOMINGOS	02/11/2020 14:54	02/11/2020 18:15	02/11/2020 14:54	02/11/2020 18:15	3,35	74	247,98	CHI
2020115043	PLANALTINA	PI12324338	SAO JOAO D ALIANCA	02/11/2020 14:55	03/11/2020 10:16	02/11/2020 14:55	03/11/2020 10:16	19,35	6	116,10	CHI
2020115048	ANAPOLIS	AN21135878	ANAPOLIS UNIVERSITARIO S2	02/11/2020 14:56	02/11/2020 15:59	02/11/2020 14:56	02/11/2020 15:59	1,05	1	1,05	CHI
2020115086	GOIANIA	GN11203715	CARAJAS S1	02/11/2020 14:56	02/11/2020 17:56	02/11/2020 14:56	02/11/2020 17:56	3,00	49	146,78	CHI
2020115054	PLANALTINA	PI21243161	PLANALTINA	02/11/2020 14:58	02/11/2020 16:38	02/11/2020 14:58	02/11/2020 16:38	1,66	1	1,66	CHI
2020115069	ITUMBIARA	IT21222500	ITUMBIARA NOVA	02/11/2020 14:59	02/11/2020 17:38	02/11/2020 14:59	02/11/2020 17:38	2,64	1	2,64	CHI
2020115070	VALPARAISO DE GOIAS	10001885241	MARAJOARA	02/11/2020 14:59	02/11/2020 15:58	02/11/2020 14:59	02/11/2020 15:58	0,97	1	0,97	CHI
2020115076	JANDAIA	JD12008610	PALMEIRAS	02/11/2020 15:00	02/11/2020 17:33	02/11/2020 15:00	02/11/2020 17:33	2,54	8	20,29	CHI
2020115098	APARECIDA DE GOIANIA	AP11162242	ANHANGUERA	02/11/2020 15:00	02/11/2020 16:32	02/11/2020 15:00	02/11/2020 16:32	1,52	69	104,84	CHI
2020115081	ITABERAI	IB21000127	ITABERAI S2	02/11/2020 15:03	02/11/2020 16:21	02/11/2020 15:03	02/11/2020 16:21	1,29	1	1,29	CHI
2020115115	MOZARLANDIA	MZ12051179	MOZARLANDIA	02/11/2020 15:06	02/11/2020 17:56	02/11/2020 15:06	02/11/2020 17:56	2,82	15	42,36	CHI
2020115097	ABADIANIA	AA21127322	ANAPOLIS UNIVERSITARIO S1	02/11/2020 15:07	02/11/2020 18:33	02/11/2020 15:07	02/11/2020 18:33	3,43	1	3,43	CHI
2020115103	GOIANIA	11517530	CAMPINAS S2	02/11/2020 15:10	02/11/2020 15:51	02/11/2020 15:10	02/11/2020 15:51	0,67	1	0,67	CHI
2020115274	BARRO ALTO	1150017986	BARRO ALTO	02/11/2020 15:11	03/11/2020 00:17	02/11/2020 15:11	03/11/2020 00:17	9,09	1	9,09	CHI
2020115111	APARECIDA DE GOIANIA	AP21008202	CEPAIGO S1	02/11/2020 15:13	02/11/2020 17:46	02/11/2020 15:13	02/11/2020 17:46	2,54	1	2,54	CHI
2020115467	PIRENOPOLIS	220049180	CORUMBA	02/11/2020 15:15	02/11/2020 18:14	02/11/2020 15:15	02/11/2020 18:14	2,98	1	2,98	CHI
2020115123	LUZIANIA	LZ12375907	VIANOPOLIS	02/11/2020 15:16	02/11/2020 17:20	02/11/2020 15:16	02/11/2020 17:20	2,06	3	6,18	CHI
2020115275	COLINAS DO SUL	TI12135666	NIQUELANDIA SUBTRANSMISSAO	02/11/2020 15:16	02/11/2020 21:51	02/11/2020 15:16	02/11/2020 21:51	6,58	33	217,09	CHI
2020115534	VILA PROPICIO	PV12086528	GOIANESIA S1	02/11/2020 15:17	02/11/2020 22:43	02/11/2020 15:17	02/11/2020 22:43	7,43	18	133,72	CHI
2020115128	IVOLANDIA	IV21062795	IPORA	02/11/2020 15:18	02/11/2020 16:47	02/11/2020 15:18	02/11/2020 16:47	1,48	1	1,48	CHI
2020115129	ANAPOLIS	20126578	ANAPOLIS UNIVERSITARIO S2	02/11/2020 15:18	02/11/2020 15:56	02/11/2020 15:18	02/11/2020 15:56	0,62	1	0,62	CHI
2020115130	ITUMBIARA	CD12097345RE	BOM JESUS DE GOIAS	02/11/2020 15:18	02/11/2020 19:10	02/11/2020 15:18	02/11/2020 19:10	3,86	9	34,71	CHI
2020115166	CAMPINORTE	CR12282384	MARA ROSA	02/11/2020 15:18	02/11/2020 17:12	02/11/2020 15:18	02/11/2020 17:12	1,89	1	1,89	CHI
2020115166	URUACU	CR12282384	MARA ROSA	02/11/2020 15:18	02/11/2020 17:12	02/11/2020 15:18	02/11/2020 17:12	1,89	3	5,66	CHI
2020115417	NOVO PLANALTO	TA11071427	NOVO PLANALTO	02/11/2020 15:18	02/11/2020 19:01	02/11/2020 15:18	02/11/2020 19:01	3,70	44	162,87	CHI
2020115137	EDEIA	EA21142885	EDEIA	02/11/2020 15:19	02/11/2020 17:37	02/11/2020 15:19	02/11/2020 17:37	2,29	1	2,29	CHI
2020115149	PIRENOPOLIS	220006234	CORUMBA	02/11/2020 15:27	02/11/2020 16:05	02/11/2020 15:27	02/11/2020 16:05	0,63	1	0,63	CHI
2020115155	ORIZONA	VN12072138	VIANOPOLIS	02/11/2020 15:30	02/11/2020 19:21	02/11/2020 15:30	02/11/2020 19:21	3,85	23	88,54	CHI
2020115155	VIANOPOLIS	VN12072138	VIANOPOLIS	02/11/2020 15:30	02/11/2020 19:21	02/11/2020 15:30	02/11/2020 19:21	3,85	88	338,78	CHI
2020115158	NOVA AMERICA	NM21359373	RUBIATABA	02/11/2020 15:30	03/11/2020 08:07	02/11/2020 15:30	03/11/2020 08:07	16,60	1	16,60	CHI
2020115187	PORANGATU	PO12104347	PORANGATU	02/11/2020 15:30	02/11/2020 17:06	02/11/2020 15:30	02/11/2020 17:06	1,59	8	12,75	CHI
2020115160	CEZARINA	CZ21312595	CEZARINA	02/11/2020 15:31	02/11/2020 18:06	02/11/2020 15:31	02/11/2020 18:06	2,58	1	2,58	CHI
2020115168	CATURAI	CK21399822	GOIANIRA	02/11/2020 15:36	02/11/2020 17:50	02/11/2020 15:36	02/11/2020 17:50	2,22	1	2,22	CHI

2020115172	ANAPOLIS	AN21313067	ANAPOLIS UNIVERSITARIO S1	02/11/2020 15:37	02/11/2020 16:46	02/11/2020 15:37	02/11/2020 16:46	1,14	1	1,14	CHI
2020115178	AGUA FRIA DE GOIAS	JL12262352	SAO JOAO D ALIANCA	02/11/2020 15:39	02/11/2020 17:23	02/11/2020 15:39	02/11/2020 17:23	1,73	6	10,37	CHI
2020115178	SAO JOAO D ALIANCA	JL12262352	SAO JOAO D ALIANCA	02/11/2020 15:39	02/11/2020 17:23	02/11/2020 15:39	02/11/2020 17:23	1,73	107	184,87	CHI
2020115181	CATALAO	1990148326	CATALAO S2	02/11/2020 15:40	02/11/2020 19:37	02/11/2020 15:40	02/11/2020 19:37	3,94	1	3,94	CHI
2020116048	CAVALCANTE	CJ12319290	MINACU	02/11/2020 15:40	03/11/2020 12:23	02/11/2020 15:40	03/11/2020 12:23	20,72	11	227,87	CHI
2020115183	SANTA TEREZA DE GOIAS	SE11061004	MARA ROSA	02/11/2020 15:41	02/11/2020 21:26	02/11/2020 15:41	02/11/2020 21:26	5,74	107	614,27	CHI
2020115184	ABADIANIA	AA21291808	ANAPOLIS UNIVERSITARIO S1	02/11/2020 15:41	02/11/2020 18:53	02/11/2020 15:41	02/11/2020 18:53	3,19	1	3,19	CHI
2020115191	PLANALTINA	PI12067828	PLANALTINA	02/11/2020 15:43	03/11/2020 15:14	02/11/2020 15:43	03/11/2020 15:14	23,51	5	117,56	CHI
2020115195	ABADIA DE GOIAS	GN32052059	CARAJAS S1	02/11/2020 15:44	02/11/2020 17:40	02/11/2020 15:44	02/11/2020 17:40	1,93	2	3,86	CHI
2020115196	CALDAZINHA	BV21059724	SENADOR CANEDO	02/11/2020 15:46	02/11/2020 17:40	02/11/2020 15:46	02/11/2020 17:40	1,89	3	5,68	CHI
2020115198	PILAR DE GOIAS	GG21230687	SANTA TEREZINHA	02/11/2020 15:47	03/11/2020 00:06	02/11/2020 15:47	03/11/2020 00:06	8,31	1	8,31	CHI
2020115199	PADRE BERNARDO	PB21392258	PADRE BERNARDO	02/11/2020 15:47	02/11/2020 17:19	02/11/2020 15:47	02/11/2020 17:19	1,52	1	1,52	CHI
2020115201	CAMPO LIMPO	AN12258806	NEROPOLIS S1	02/11/2020 15:49	02/11/2020 17:39	02/11/2020 15:49	02/11/2020 17:39	1,83	2	3,66	CHI
2020115204	ITAPACI	IW12379430	ITAPACI	02/11/2020 15:49	02/11/2020 18:34	02/11/2020 15:49	02/11/2020 18:34	2,73	2	5,47	CHI
2020115205	PILAR DE GOIAS	GG21341532	SANTA TEREZINHA	02/11/2020 15:49	03/11/2020 09:46	02/11/2020 15:49	03/11/2020 09:46	17,93	1	17,93	CHI
2020115206	ABADIANIA	AA21122905	ANAPOLIS UNIVERSITARIO S1	02/11/2020 15:49	02/11/2020 18:07	02/11/2020 15:49	02/11/2020 18:07	2,28	2	4,57	CHI
2020115248	CRIXAS	CX12190130	SANTA TEREZINHA	02/11/2020 15:49	02/11/2020 19:28	02/11/2020 15:49	02/11/2020 19:28	3,64	7	25,50	CHI
2020115209	QUIRINOPOLIS	QI21191885	BOM JESUS DE GOIAS	02/11/2020 15:51	02/11/2020 18:38	02/11/2020 15:51	02/11/2020 18:38	2,77	1	2,77	CHI
2020115220	TRINDADE	TR11207467	TRINDADE	02/11/2020 15:55	02/11/2020 16:54	02/11/2020 15:55	02/11/2020 16:54	0,97	58	56,36	CHI
2020115226	POSSE	PS21242868	IACIARA S2	02/11/2020 15:56	02/11/2020 17:14	02/11/2020 15:56	02/11/2020 17:14	1,29	1	1,29	CHI
2020115227	EDEALINA	ED21013591	PONTALINA	02/11/2020 15:56	02/11/2020 22:55	02/11/2020 15:56	02/11/2020 22:55	6,97	1	6,97	CHI
2020115242	ARAGARCAS	AG10396203	ARAGARCAS	02/11/2020 15:56	02/11/2020 17:51	02/11/2020 15:56	02/11/2020 17:51	1,92	108	206,88	CHI
2020115242	BOM JARDIM DE GOIAS	AG10396203	ARAGARCAS	02/11/2020 15:56	02/11/2020 17:51	02/11/2020 15:56	02/11/2020 17:51	1,92	52	99,61	CHI
2020115228	GOIANIA	15090425	XAVANTES	02/11/2020 15:57	02/11/2020 17:17	02/11/2020 15:57	02/11/2020 17:17	1,32	1	1,32	CHI
2020115603	BARRO ALTO	BA12210734	BARRO ALTO	02/11/2020 15:57	02/11/2020 19:41	02/11/2020 15:57	02/11/2020 19:41	3,72	4	14,88	CHI
2020115232	SILVANIA	SV21144065	VIANOPOLIS	02/11/2020 15:58	02/11/2020 17:14	02/11/2020 15:58	02/11/2020 17:14	1,26	1	1,26	CHI
2020115236	CRISTALINA	KR21351495	CRISTALINA S1	02/11/2020 15:59	02/11/2020 23:24	02/11/2020 15:59	02/11/2020 23:24	7,41	2	14,83	CHI
2020115238	VILA PROPICIO	NP11253317	GOIANESIA S1	02/11/2020 15:59	02/11/2020 22:19	02/11/2020 15:59	02/11/2020 22:19	6,32	1	6,32	CHI
2020115243	INDIARA	2710046058	EDEIA	02/11/2020 16:00	02/11/2020 18:43	02/11/2020 16:00	02/11/2020 18:43	2,71	1	2,71	CHI
2020115245	NOVA IGUACU DE GOIAS	NH12166555	SANTA TEREZINHA	02/11/2020 16:01	03/11/2020 12:23	02/11/2020 16:01	03/11/2020 12:23	20,36	2	40,72	CHI
2020115245	PILAR DE GOIAS	NH12166555	SANTA TEREZINHA	02/11/2020 16:01	03/11/2020 12:23	02/11/2020 16:01	03/11/2020 12:23	20,36	2	40,72	CHI
2020115247	JUSSARA	JR21138355	IPORA	02/11/2020 16:02	02/11/2020 18:24	02/11/2020 16:02	02/11/2020 18:24	2,37	1	2,37	CHI
2020115249	GOIANIA	12531649	ATLANTICO S2	02/11/2020 16:02	02/11/2020 17:45	02/11/2020 16:02	02/11/2020 17:45	1,71	1	1,71	CHI
2020115253	NIQUELANDIA	NQ12235313	NIQUELANDIA SUBTRANSMISSAO	02/11/2020 16:04	03/11/2020 11:58	02/11/2020 16:04	03/11/2020 11:58	19,89	5	99,43	CHI
2020115282	GOIAS	IK12250614	ITAPURANGA	02/11/2020 16:05	02/11/2020 17:19	02/11/2020 16:05	02/11/2020 17:19	1,22	2	2,45	CHI
2020115282	GUARAITA	IK12250614	ITAPURANGA	02/11/2020 16:05	02/11/2020 17:19	02/11/2020 16:05	02/11/2020 17:19	1,22	18	22,02	CHI
2020115282	ITAPURANGA	IK12250614	ITAPURANGA	02/11/2020 16:05	02/11/2020 17:19	02/11/2020 16:05	02/11/2020 17:19	1,22	22	26,91	CHI
2020115262	GOIANIA	GN11001008	CAMPINAS S1	02/11/2020 16:08	02/11/2020 16:54	02/11/2020 16:42	02/11/2020 16:54	0,19	167	31,68	CHI
2020115264	CALDAS NOVAS	CN21363392	CALDAS NOVAS S1	02/11/2020 16:09	02/11/2020 17:24	02/11/2020 16:09	02/11/2020 17:24	1,24	1	1,24	CHI
2020115270	BOM JESUS DE GOIAS	1250009173	BOM JESUS DE GOIAS	02/11/2020 16:10	02/11/2020 18:30	02/11/2020 16:10	02/11/2020 18:30	2,32	1	2,32	CHI
2020115301	MONTIVIDU DO NORTE	MX12203423	PORANGATU	02/11/2020 16:10	02/11/2020 21:59	02/11/2020 16:10	02/11/2020 21:59	5,81	17	98,82	CHI
2020115278	CACHOEIRA DE GOIAS	1260004901	FIRMINOPOLIS S2	02/11/2020 16:11	02/11/2020 18:24	02/11/2020 16:11	02/11/2020 18:24	2,21	1	2,21	CHI
2020115280	GOIANIA	11757541	CAMPINAS S2	02/11/2020 16:12	02/11/2020 16:31	02/11/2020 16:12	02/11/2020 16:31	0,31	1	0,31	CHI
2020115281	BONOPOLIS	BX12236531	SAO MIGUEL DO ARAGUAIA	02/11/2020 16:12	03/11/2020 15:16	02/11/2020 16:12	03/11/2020 15:16	23,07	2	46,14	CHI
2020115283	CALDAS NOVAS	CN12102170	CALDAS NOVAS S1	02/11/2020 16:14	02/11/2020 21:28	02/11/2020 16:14	02/11/2020 20:00	3,76	161	605,90	CHI
2020115283	CALDAS NOVAS	CN12102170	CALDAS NOVAS S1	02/11/2020 16:14	02/11/2020 21:28	02/11/2020 20:29	02/11/2020 21:28	0,98	161	158,05	CHI
2020115306	NEROPOLIS	TJ10401463	DAIA S2	02/11/2020 16:16	02/11/2020 21:41	02/11/2020 16:16	02/11/2020 18:19	2,05	44	89,99	CHI
2020115306	TEREZOPOLIS DE GOIAS	TJ10401463	DAIA S2	02/11/2020 16:16	02/11/2020 21:41	02/11/2020 16:16	02/11/2020 18:19	2,05	7	14,32	CHI
2020115306	NEROPOLIS	GP13089025	DAIA S2	02/11/2020 16:16	02/11/2020 21:41	02/11/2020 16:16	02/11/2020 18:35	2,31	3	6,94	CHI
2020115306	TEREZOPOLIS DE GOIAS	GP13089025	DAIA S2	02/11/2020 16:16	02/11/2020 21:41	02/11/2020 16:16	02/11/2020 18:35	2,31	61	141,05	CHI
2020115306	NEROPOLIS	TJ10401463	DAIA S2	02/11/2020 16:16	02/11/2020 21:41	02/11/2020 18:36	02/11/2020 18:47	0,18	44	7,96	CHI

2020115306	TEREZOPOLIS DE GOIAS	TJ10401463	DAIA S2	02/11/2020 16:16	02/11/2020 21:41	02/11/2020 18:36	02/11/2020 18:47	0,18	7	1,27	CHI
2020115306	NEROPOLIS	GP13089025	DAIA S2	02/11/2020 16:16	02/11/2020 21:41	02/11/2020 18:36	02/11/2020 21:25	2,82	3	8,45	CHI
2020115306	TEREZOPOLIS DE GOIAS	GP13089025	DAIA S2	02/11/2020 16:16	02/11/2020 21:41	02/11/2020 18:36	02/11/2020 21:25	2,82	61	171,83	CHI
2020115306	ANAPOLIS	TJ12243061LD	DAIA S2	02/11/2020 16:16	02/11/2020 21:41	02/11/2020 16:16	02/11/2020 21:41	5,43	1	5,43	CHI
2020115306	TEREZOPOLIS DE GOIAS	TJ12243061LD	DAIA S2	02/11/2020 16:16	02/11/2020 21:41	02/11/2020 16:16	02/11/2020 21:41	5,43	80	434,00	CHI
2020115387	BARRO ALTO	BA12210746	BARRO ALTO	02/11/2020 16:18	02/11/2020 20:17	02/11/2020 16:18	02/11/2020 20:17	3,97	13	51,58	CHI
2020115387	SANTA RITA DO NOVO DESTINO	BA12210746	BARRO ALTO	02/11/2020 16:18	02/11/2020 20:17	02/11/2020 16:18	02/11/2020 20:17	3,97	5	19,84	CHI
2020115297	GOIANIA	15700409	GOYA S1	02/11/2020 16:19	02/11/2020 17:41	02/11/2020 16:19	02/11/2020 17:41	1,36	1	1,36	CHI
2020115298	OURO VERDE DE GOIAS	OV21208971	NEROPOLIS S1	02/11/2020 16:19	02/11/2020 18:10	02/11/2020 16:19	02/11/2020 18:10	1,84	1	1,84	CHI
2020115299	GOIANESIA	GE21031715	GOIANESIA S2	02/11/2020 16:20	02/11/2020 18:00	02/11/2020 16:20	02/11/2020 18:00	1,66	1	1,66	CHI
2020115300	CAIAPONIA	CP12259429	CAIAPONIA	02/11/2020 16:21	03/11/2020 00:51	02/11/2020 16:21	03/11/2020 00:51	8,49	1	8,49	CHI
2020115302	CAMPOS BELOS	CH12170029	SAO DOMINGOS	02/11/2020 16:21	02/11/2020 23:10	02/11/2020 16:21	02/11/2020 23:10	6,81	22	149,72	CHI
2020115303	CRISTALINA	KR21248617	CRISTALINA S2	02/11/2020 16:21	02/11/2020 18:16	02/11/2020 16:21	02/11/2020 18:16	1,90	1	1,90	CHI
2020115305	ABADIANIA	AA11043979	ANAPOLIS UNIVERSITARIO S1	02/11/2020 16:22	02/11/2020 21:27	02/11/2020 16:22	02/11/2020 21:27	5,07	62	314,65	CHI
2020115319	VILA BOA	2880000136	IACIARA S2	02/11/2020 16:27	02/11/2020 17:37	02/11/2020 16:27	02/11/2020 17:37	1,16	1	1,16	CHI
2020115320	GOIANIA	13234390	ATLANTICO S1	02/11/2020 16:27	02/11/2020 17:50	02/11/2020 16:27	02/11/2020 17:50	1,38	1	1,38	CHI
2020115321	PIRANHAS	PH12342187	PIRANHAS	02/11/2020 16:27	02/11/2020 18:42	02/11/2020 16:27	02/11/2020 18:42	2,24	2	4,48	CHI
2020115322	FORMOSA	2920000361	ITUIQUIRA	02/11/2020 16:27	02/11/2020 21:34	02/11/2020 16:27	02/11/2020 21:34	5,10	1	5,10	CHI
2020115323	ARAGOIANIA	10031410535	GUAPO S2	02/11/2020 16:28	02/11/2020 19:53	02/11/2020 16:28	02/11/2020 19:53	3,42	1	3,42	CHI
2020115325	SENADOR CANEDO	10023971485	SENADOR CANEDO	02/11/2020 16:29	02/11/2020 18:16	02/11/2020 16:29	02/11/2020 18:16	1,78	1	1,78	CHI
2020115333	SAO MIGUEL DO ARAGUAIA	SM12262623	SAO MIGUEL DO ARAGUAIA	02/11/2020 16:32	03/11/2020 11:54	02/11/2020 16:32	03/11/2020 11:54	19,36	3	58,08	CHI
2020115450	ARAGOIANIA	AO12095512	GUAPO S2	02/11/2020 16:32	02/11/2020 19:19	02/11/2020 16:32	02/11/2020 19:19	2,79	19	52,93	CHI
2020115450	GUAPO	AO12095512	GUAPO S2	02/11/2020 16:32	02/11/2020 19:19	02/11/2020 16:32	02/11/2020 19:19	2,79	10	27,86	CHI
2020115334	GUARAITA	GK21289066	ITAPURANGA	02/11/2020 16:33	02/11/2020 19:20	02/11/2020 16:33	02/11/2020 19:20	2,77	1	2,77	CHI
2020115336	FLORES DE GOIAS	FB21409969	FLORES DE GOIAS	02/11/2020 16:35	02/11/2020 16:49	02/11/2020 16:35	02/11/2020 16:49	0,23	1	0,23	CHI
2020115339	GOIANIA	15144161	CAMPINAS S1	02/11/2020 16:35	02/11/2020 19:20	02/11/2020 16:35	02/11/2020 19:20	2,74	1	2,74	CHI
2020115340	ARUANA	AK21217218	MOZARLANDIA	02/11/2020 16:36	03/11/2020 09:42	02/11/2020 16:36	03/11/2020 09:42	17,10	1	17,10	CHI
2020115346	ALTO HORIZONTE	9640003201	SANTA TEREZINHA	02/11/2020 16:37	03/11/2020 09:56	02/11/2020 16:37	03/11/2020 09:56	17,31	1	17,31	CHI
2020115348	VILA PROPICIO	NP21344907	BARRO ALTO	02/11/2020 16:38	02/11/2020 23:18	02/11/2020 16:38	02/11/2020 23:18	6,67	1	6,67	CHI
2020115352	BOM JESUS DE GOIAS	BJ11352621	BOM JESUS DE GOIAS	02/11/2020 16:38	02/11/2020 18:27	02/11/2020 16:38	02/11/2020 18:27	1,80	20	36,07	CHI
2020115368	VILA BOA	2880010245	IACIARA S2	02/11/2020 16:45	02/11/2020 18:30	02/11/2020 16:45	02/11/2020 18:30	1,74	1	1,74	CHI
2020115369	NIQUELANDIA	NQ12293885	URUACU	02/11/2020 16:46	02/11/2020 21:19	02/11/2020 16:46	02/11/2020 21:19	4,53	5	22,67	CHI
2020115372	PADRE BERNARDO	PB12284769	PADRE BERNARDO	02/11/2020 16:47	02/11/2020 19:24	02/11/2020 16:47	02/11/2020 19:24	2,60	68	176,99	CHI
2020115374	GUAPO	GA12381319	GUAPO S2	02/11/2020 16:48	02/11/2020 22:43	02/11/2020 16:48	02/11/2020 22:43	5,91	7	41,39	CHI
2020115381	ALOANDIA	AD12087354	GOIATUBA S1	02/11/2020 16:48	02/11/2020 18:13	02/11/2020 16:48	02/11/2020 18:13	1,43	23	32,90	CHI
2020115381	MORRINHOS	AD12087354	GOIATUBA S1	02/11/2020 16:48	02/11/2020 18:13	02/11/2020 16:48	02/11/2020 18:13	1,43	2	2,86	CHI
2020115444	SAO MIGUEL DO ARAGUAIA	SM12128351	SAO MIGUEL DO ARAGUAIA	02/11/2020 16:49	02/11/2020 17:49	02/11/2020 16:49	02/11/2020 17:49	0,99	20	19,90	CHI
2020115378	AGUA FRIA DE GOIAS	TL21232756	SAO JOAO D ALIANCA	02/11/2020 16:50	02/11/2020 18:32	02/11/2020 16:50	02/11/2020 18:32	1,70	5	8,48	CHI
2020115666	NOVA IGUAUCU DE GOIAS	NH12136479	SANTA TEREZINHA	02/11/2020 16:52	02/11/2020 21:53	02/11/2020 16:52	02/11/2020 21:53	5,00	3	15,00	CHI
2020115384	FORMOSA	610018759	ITUIQUIRA	02/11/2020 16:53	02/11/2020 18:17	02/11/2020 16:53	02/11/2020 18:17	1,40	1	1,40	CHI
2020115391	TRINDADE	TR11005102	TRINDADE	02/11/2020 16:54	02/11/2020 18:48	02/11/2020 16:54	02/11/2020 18:48	1,89	90	170,22	CHI
2020115393	CRISTALINA	KR11078398	CRISTALINA S1	02/11/2020 16:55	02/11/2020 17:52	02/11/2020 16:55	02/11/2020 17:52	0,94	1	0,94	CHI
2020115399	NIQUELANDIA	NQ12345119	NIQUELANDIA SUBTRANSMISSAO	02/11/2020 16:57	03/11/2020 15:51	02/11/2020 16:57	03/11/2020 15:51	22,89	7	160,24	CHI
2020115415	PILAR DE GOIAS	GG12181616	SANTA TEREZINHA	02/11/2020 16:57	02/11/2020 23:01	02/11/2020 16:57	02/11/2020 23:01	6,06	3	18,18	CHI
2020115415	SANTA TEREZINHA DE GOIAS	GG12181616	SANTA TEREZINHA	02/11/2020 16:57	02/11/2020 23:01	02/11/2020 16:57	02/11/2020 23:01	6,06	6	36,37	CHI
2020115409	ANAPOLIS	AN12262498	ANAPOLIS UNIVERSITARIO S1	02/11/2020 16:58	02/11/2020 19:28	02/11/2020 16:58	02/11/2020 19:28	2,49	13	32,37	CHI
2020115403	ITAPACI	IW21213064	ITAPACI	02/11/2020 16:59	02/11/2020 20:35	02/11/2020 16:59	02/11/2020 20:35	3,59	1	3,59	CHI
2020115581	SANTA TEREZINHA DE GOIAS	GG12171180	SANTA TEREZINHA	02/11/2020 17:00	02/11/2020 19:49	02/11/2020 17:00	02/11/2020 19:49	2,80	46	128,92	CHI
2020115418	FORMOSA	FA12085562	ITUIQUIRA	02/11/2020 17:05	02/11/2020 23:41	02/11/2020 17:05	02/11/2020 23:41	6,60	4	26,40	CHI
2020115419	PADRE BERNARDO	PB12389377	PADRE BERNARDO	02/11/2020 17:05	02/11/2020 19:20	02/11/2020 17:05	02/11/2020 19:20	2,24	2	4,47	CHI
2020115420	TRINDADE	40008575	TRINDADE	02/11/2020 17:05	02/11/2020 20:07	02/11/2020 17:05	02/11/2020 20:07	3,02	1	3,02	CHI

2020115423	NOVO GAMA	2460190500	PACAEMBU S1	02/11/2020 17:08	02/11/2020 18:10	02/11/2020 17:08	02/11/2020 18:10	1,03	1	1,03	CHI
2020115425	VARJAO	10026761392	GUAPO S2	02/11/2020 17:09	03/11/2020 00:15	02/11/2020 17:09	03/11/2020 00:15	7,09	1	7,09	CHI
2020115427	ARUANA	2380000627	ARUANA	02/11/2020 17:09	02/11/2020 22:25	02/11/2020 17:09	02/11/2020 22:25	5,25	1	5,25	CHI
2020115429	CAMPOS BELOS	820027881	SAO DOMINGOS	02/11/2020 17:10	02/11/2020 20:13	02/11/2020 17:10	02/11/2020 20:13	3,04	1	3,04	CHI
2020115431	UIRAPURU	UP21093019	SANTA TEREZINHA	02/11/2020 17:11	03/11/2020 12:09	02/11/2020 17:11	03/11/2020 12:09	18,96	1	18,96	CHI
2020115434	GOIANIA	15277069	CARAJAS S1	02/11/2020 17:12	02/11/2020 19:50	02/11/2020 17:12	02/11/2020 19:50	2,62	1	2,62	CHI
2020115435	MONTIVIDIU DO NORTE	MX21153526	PORANGATU	02/11/2020 17:13	03/11/2020 02:02	02/11/2020 17:13	03/11/2020 02:02	8,82	1	8,82	CHI
2020115436	PILAR DE GOIAS	GG21341577	URUACU	02/11/2020 17:13	02/11/2020 19:09	02/11/2020 17:13	02/11/2020 19:09	1,92	3	5,77	CHI
2020115440	APARECIDA DE GOIANIA	AP12036019	CEPAIGO S1	02/11/2020 17:15	02/11/2020 21:06	02/11/2020 17:15	02/11/2020 21:06	3,85	26	100,03	CHI
2020115443	AGUAS LINDAS DE GOIAS	4830381232	AGUAS LINDAS DE GOIAS S1	02/11/2020 17:15	02/11/2020 18:51	02/11/2020 17:15	02/11/2020 18:51	1,59	1	1,59	CHI
2020115482	CAIAPONIA	MY10401498	CAIAPONIA	02/11/2020 17:15	02/11/2020 17:37	02/11/2020 17:15	02/11/2020 17:18	0,05	62	3,39	CHI
2020115482	DOVERLANDIA	MY10401498	CAIAPONIA	02/11/2020 17:15	02/11/2020 17:37	02/11/2020 17:15	02/11/2020 17:18	0,05	3	0,16	CHI
2020115482	CAIAPONIA	MY10401498	JATAI S1	02/11/2020 17:15	02/11/2020 17:37	02/11/2020 17:15	02/11/2020 17:18	0,05	20	1,09	CHI
2020115482	CAIAPONIA	MY10401498	JATAI S1	02/11/2020 17:15	02/11/2020 17:37	02/11/2020 17:15	02/11/2020 17:18	0,05	39	2,13	CHI
2020115482	JATAI	MY10401498	JATAI S1	02/11/2020 17:15	02/11/2020 17:37	02/11/2020 17:15	02/11/2020 17:18	0,05	304	16,64	CHI
2020115482	JATAI	MY10401498	JATAI S1	02/11/2020 17:15	02/11/2020 17:37	02/11/2020 17:15	02/11/2020 17:18	0,05	162	8,86	CHI
2020115482	MINEIROS	MY10401498	JATAI S1	02/11/2020 17:15	02/11/2020 17:37	02/11/2020 17:15	02/11/2020 17:18	0,05	2	0,11	CHI
2020115482	PEROLANDIA	MY10401498	JATAI S1	02/11/2020 17:15	02/11/2020 17:37	02/11/2020 17:15	02/11/2020 17:18	0,05	1036	56,69	CHI
2020115482	PEROLANDIA	MY10401498	JATAI S1	02/11/2020 17:15	02/11/2020 17:37	02/11/2020 17:15	02/11/2020 17:18	0,05	41	2,24	CHI
2020115482	PEROLANDIA	MY10401498	JATAI S1	02/11/2020 17:15	02/11/2020 17:37	02/11/2020 17:15	02/11/2020 17:18	0,05	57	3,12	CHI
2020115482	PEROLANDIA	MY10401498	JATAI S1	02/11/2020 17:15	02/11/2020 17:37	02/11/2020 17:15	02/11/2020 17:18	0,05	46	2,52	CHI
2020115482	JATAI	MY10401498	PARQUE DAS EMAS	02/11/2020 17:15	02/11/2020 17:37	02/11/2020 17:15	02/11/2020 17:18	0,05	29	1,59	CHI
2020115482	MINEIROS	MY10401498	PARQUE DAS EMAS	02/11/2020 17:15	02/11/2020 17:37	02/11/2020 17:15	02/11/2020 17:18	0,05	53	2,90	CHI
2020115482	PEROLANDIA	MY10401498	PARQUE DAS EMAS	02/11/2020 17:15	02/11/2020 17:37	02/11/2020 17:15	02/11/2020 17:18	0,05	20	1,09	CHI
2020115482	MINEIROS	MY10409363	PARQUE DAS EMAS	02/11/2020 17:15	02/11/2020 17:37	02/11/2020 17:15	02/11/2020 17:34	0,31	94	29,04	CHI
2020115482	SERRANOPOLIS	MY10409363	PARQUE DAS EMAS	02/11/2020 17:15	02/11/2020 17:37	02/11/2020 17:15	02/11/2020 17:34	0,31	7	2,16	CHI
2020115482	MINEIROS	MY10408758	PARQUE DAS EMAS	02/11/2020 17:15	02/11/2020 17:37	02/11/2020 17:15	02/11/2020 17:37	0,36	37	13,30	CHI
2020115569	SANTA CRUZ DE GOIAS	BC12023183	CRISTIANOPOLIS	02/11/2020 17:15	02/11/2020 19:08	02/11/2020 17:15	02/11/2020 19:08	1,88	42	78,86	CHI
2020115447	NOVO GAMA	4990079013	PACAEMBU S1	02/11/2020 17:16	02/11/2020 19:02	02/11/2020 17:16	02/11/2020 19:02	1,76	1	1,76	CHI
2020115448	GOIANIA	16850440	SENADOR CANEDO	02/11/2020 17:17	02/11/2020 18:46	02/11/2020 17:17	02/11/2020 18:46	1,48	1	1,48	CHI
2020115449	SOCALZINHO DE GOIAS	ZN12353427	COCALZINHO	02/11/2020 17:17	02/11/2020 19:27	02/11/2020 17:17	02/11/2020 19:27	2,16	6	12,97	CHI
2020115452	CAO LUIZ DO NORTE	SZ12090338	ITAPACI	02/11/2020 17:18	02/11/2020 18:16	02/11/2020 17:18	02/11/2020 18:16	0,96	292	281,37	CHI
2020115453	NOVO GAMA	NJ11183763	PACAEMBU S1	02/11/2020 17:18	02/11/2020 20:42	02/11/2020 17:18	02/11/2020 20:42	3,39	12	40,73	CHI
2020115500	PLANALTINA	PI12103612	PLANALTINA	02/11/2020 17:18	02/11/2020 20:42	02/11/2020 17:18	02/11/2020 20:42	3,40	20	67,94	CHI
2020115456	PADRE BERNARDO	PB21387827	PADRE BERNARDO	02/11/2020 17:19	02/11/2020 20:48	02/11/2020 17:19	02/11/2020 20:48	3,48	2	6,97	CHI
2020115459	AGUAS LINDAS DE GOIAS	LA12214904	AGUAS LINDAS DE GOIAS S1	02/11/2020 17:19	02/11/2020 19:29	02/11/2020 17:19	02/11/2020 19:29	2,15	43	92,62	CHI
2020115463	IVOLANDIA	IV21158478	IPORA	02/11/2020 17:19	02/11/2020 19:46	02/11/2020 17:19	02/11/2020 19:46	2,44	1	2,44	CHI
2020115470	PLANALTINA	PI12072310	PLANALTINA	02/11/2020 17:23	02/11/2020 22:13	02/11/2020 17:23	02/11/2020 22:13	4,83	10	48,26	CHI
2020115487	BALIZA	BH12331446	CAIAPONIA	02/11/2020 17:27	03/11/2020 02:22	02/11/2020 17:27	03/11/2020 02:22	8,90	9	80,10	CHI
2020115486	MINACU	IH21242053	MINACU	02/11/2020 17:29	02/11/2020 23:18	02/11/2020 17:29	02/11/2020 23:18	5,81	4	23,23	CHI
2020115553	MUNDO NOVO DE GOIAS	MH12084354	NOVA CRIXAS	02/11/2020 17:30	02/11/2020 21:01	02/11/2020 17:30	02/11/2020 21:01	3,51	6	21,07	CHI
2020115491	APARECIDA DE GOIANIA	200247475	INDEPENDENCIA S2	02/11/2020 17:31	02/11/2020 19:14	02/11/2020 17:31	02/11/2020 19:14	1,71	1	1,71	CHI
2020115493	EDEALINA	ED21030212	PONTALINA	02/11/2020 17:32	02/11/2020 21:05	02/11/2020 17:32	02/11/2020 21:05	3,55	1	3,55	CHI
2020115497	BONOPOLIS	BX21083875	SAO MIGUEL DO ARAGUAIA	02/11/2020 17:33	03/11/2020 08:35	02/11/2020 17:33	03/11/2020 08:35	15,02	1	15,02	CHI
2020115498	PLANALTINA	PI12322789	PLANALTINA	02/11/2020 17:33	03/11/2020 23:26	02/11/2020 17:33	02/11/2020 22:28	4,91	10	49,14	CHI
2020115498	PLANALTINA	PI12322789	PLANALTINA	02/11/2020 17:33	03/11/2020 23:26	02/11/2020 17:33	02/11/2020 22:28	4,91	28	137,60	CHI
2020115498	PLANALTINA	PI21130373	PLANALTINA	02/11/2020 17:33	03/11/2020 23:26	03/11/2020 11:09	03/11/2020 11:20	0,18	1	0,18	CHI
2020115498	PLANALTINA	PI21130373	PLANALTINA	02/11/2020 17:33	03/11/2020 23:26	03/11/2020 22:18	03/11/2020 23:26	1,14	1	1,14	CHI
2020115505	EDEIA	EA21000048	EDEIA	02/11/2020 17:36	02/11/2020 19:23	02/11/2020 17:36	02/11/2020 19:23	1,78	1	1,78	CHI
2020115509	DISTRITO FEDERAL	FA12383392	ITUIQUIRA	02/11/2020 17:38	02/11/2020 19:09	02/11/2020 17:38	02/11/2020 19:09	1,51	2	3,01	CHI
2020115512	CAMPOS BELOS	820056340	SAO DOMINGOS	02/11/2020 17:39	02/11/2020 23:29	02/11/2020 17:39	02/11/2020 23:29	5,82	1	5,82	CHI

2020115521	GOIANESIA	GE11185432	GOIANESIA S2	02/11/2020 17:45	02/11/2020 21:56	02/11/2020 17:45	02/11/2020 21:56	4,18	154	644,19	CHI
2020115526	ANAPOLIS	20221290	ANAPOLIS UNIVERSITARIO S2	02/11/2020 17:46	02/11/2020 19:29	02/11/2020 17:46	02/11/2020 19:29	1,70	1	1,70	CHI
2020115536	GUARINOS	GF12164881	SANTA TEREZINHA	02/11/2020 17:49	02/11/2020 22:11	02/11/2020 17:49	02/11/2020 22:11	4,36	36	157,12	CHI
2020115540	INHUMAS	IN11144335	INHUMAS S2	02/11/2020 17:51	02/11/2020 19:19	02/11/2020 17:51	02/11/2020 19:19	1,46	125	182,78	CHI
2020115545	IPAMERI	580052643	IPAMERI	02/11/2020 17:52	02/11/2020 23:08	02/11/2020 17:52	02/11/2020 23:08	5,25	1	5,25	CHI
2020115781	CAMPINACU	UC12236229	PORANGATU	02/11/2020 17:55	03/11/2020 00:53	02/11/2020 17:55	03/11/2020 00:53	6,95	29	201,56	CHI
2020115559	FORMOSA	FA12042563	ITIQUEIRA	02/11/2020 17:57	04/11/2020 18:17	02/11/2020 17:57	03/11/2020 12:41	18,72	32	599,19	CHI
2020115559	FORMOSA	FA12042563	ITIQUEIRA	02/11/2020 17:57	04/11/2020 18:17	02/11/2020 17:57	04/11/2020 18:17	48,33	20	966,51	CHI
2020115564	JARAGUA	JA21081260	JARAGUA	02/11/2020 17:59	02/11/2020 19:20	02/11/2020 17:59	02/11/2020 19:20	1,33	1	1,33	CHI
2020115566	ARAGARCAS	BM12223161	ARAGARCAS	02/11/2020 18:00	02/11/2020 22:27	02/11/2020 18:00	02/11/2020 22:27	4,45	2	8,90	CHI
2020115574	AGUA FRIA DE GOIAS	PI12048037	SAO JOAO D ALIANCA	02/11/2020 18:02	02/11/2020 21:33	02/11/2020 18:02	02/11/2020 21:33	3,51	7	24,55	CHI
2020115573	SAO MIGUEL DO ARAGUAIA	SM11246986	SAO MIGUEL DO ARAGUAIA	02/11/2020 18:03	03/11/2020 09:38	02/11/2020 18:03	03/11/2020 09:38	15,57	1	15,57	CHI
2020115578	NOVA CRIXAS	NA12229610	NOVA CRIXAS	02/11/2020 18:05	03/11/2020 09:29	02/11/2020 18:05	03/11/2020 09:29	15,39	10	153,94	CHI
2020115618	SAO JOAO D ALIANCA	JL12218487	SAO JOAO D ALIANCA	02/11/2020 18:08	02/11/2020 23:01	02/11/2020 18:08	02/11/2020 23:01	4,88	2	9,76	CHI
2020115712	AGUA FRIA DE GOIAS	TL12208773	SAO JOAO D ALIANCA	02/11/2020 18:08	02/11/2020 19:46	02/11/2020 18:08	02/11/2020 19:46	1,62	14	22,70	CHI
2020115712	MIMOSO DE GOIAS	TL12208773	SAO JOAO D ALIANCA	02/11/2020 18:08	02/11/2020 19:46	02/11/2020 18:08	02/11/2020 19:46	1,62	29	47,01	CHI
2020116172	SAO JOAO D ALIANCA	JL12218487	SAO JOAO D ALIANCA	02/11/2020 18:08	02/11/2020 23:01	02/11/2020 18:08	02/11/2020 23:01	4,88	6	29,28	CHI
2020116368	SAO JOAO D ALIANCA	JL11218465	SAO JOAO D ALIANCA	02/11/2020 18:08	03/11/2020 00:06	02/11/2020 18:08	03/11/2020 00:06	5,96	3	17,89	CHI
2020115590	MARZAGAO	MG11045242	VILA CORUMBA	02/11/2020 18:09	02/11/2020 19:20	02/11/2020 18:09	02/11/2020 19:20	1,19	132	156,46	CHI
2020115592	PIRENOPOLIS	PV11240432	CORUMBA	02/11/2020 18:09	02/11/2020 20:42	02/11/2020 18:09	02/11/2020 20:42	2,54	104	263,64	CHI
2020115635	NOVA ROMA	ND12051336	IACIARA S2	02/11/2020 18:09	03/11/2020 00:32	02/11/2020 18:09	03/11/2020 00:32	6,38	5	31,91	CHI
2020115595	JOVIANIA	PK12106143	GOIATUBA S1	02/11/2020 18:11	02/11/2020 19:54	02/11/2020 18:11	02/11/2020 19:54	1,71	1	1,71	CHI
2020115595	PONTALINA	PK12106143	GOIATUBA S1	02/11/2020 18:11	02/11/2020 19:54	02/11/2020 18:11	02/11/2020 19:54	1,71	4	6,82	CHI
2020115596	TRINDADE	TR12093220LD	TRINDADE	02/11/2020 18:11	02/11/2020 21:03	02/11/2020 18:11	02/11/2020 21:03	2,86	2109	6027,64	CHI
2020115596	TRINDADE	TR10413695	TRINDADE	02/11/2020 18:11	02/11/2020 21:03	02/11/2020 20:57	02/11/2020 21:03	0,09	1133	97,56	CHI
2020115604	LUZIANIA	LZ21261114	MARAJOARA	02/11/2020 18:15	02/11/2020 20:05	02/11/2020 18:15	02/11/2020 20:05	1,82	1	1,82	CHI
2020115611	APARECIDA DE GOIANIA	200384867	INDEPENDENCIA S2	02/11/2020 18:17	02/11/2020 18:48	02/11/2020 18:17	02/11/2020 18:48	0,51	1	0,51	CHI
2020115612	CAMPO LIMPO	AN21258878	NEROPOLIS S1	02/11/2020 18:17	02/11/2020 22:32	02/11/2020 18:17	02/11/2020 22:32	4,24	2	8,49	CHI
2020115615	SAO LUIS DE MONTES BELOS	SL21144876	SAO LUIZ DOS MONTES BELOS	02/11/2020 18:17	02/11/2020 20:38	02/11/2020 18:17	02/11/2020 20:38	2,33	2	4,67	CHI
2020115745	GOIATUBA	GT12000285	BOM JESUS DE GOIAS	02/11/2020 18:17	02/11/2020 22:39	02/11/2020 18:17	02/11/2020 22:39	4,36	30	130,72	CHI
2020115619	SAO MIGUEL DO ARAGUAIA	SM11394280	SAO MIGUEL DO ARAGUAIA	02/11/2020 18:20	03/11/2020 11:22	02/11/2020 18:20	03/11/2020 11:22	17,03	1	17,03	CHI
2020115649	BONFINOPOLIS	BO12400463	CEPAIGO S2	02/11/2020 18:20	02/11/2020 20:27	02/11/2020 18:20	02/11/2020 20:27	2,10	28	58,85	CHI
2020115649	LEOPOLDO DE BULHOES	BO12400463	CEPAIGO S2	02/11/2020 18:20	02/11/2020 20:27	02/11/2020 18:20	02/11/2020 20:27	2,10	12	25,22	CHI
2020115629	URUACU	640040822	URUACU	02/11/2020 18:22	02/11/2020 19:47	02/11/2020 18:22	02/11/2020 19:47	1,41	1	1,41	CHI
2020115630	CRIXAS	CX12166640	SANTA TEREZINHA	02/11/2020 18:22	03/11/2020 02:44	02/11/2020 18:22	03/11/2020 02:44	8,36	26	217,48	CHI
2020115656	SAO LUIZ DO NORTE	10027858250	ITAPACI	02/11/2020 18:23	02/11/2020 20:03	02/11/2020 18:23	02/11/2020 20:03	1,66	1	1,66	CHI
2020115637	LUZIANIA	LZ12200111	VIANOPOLIS	02/11/2020 18:24	02/11/2020 20:26	02/11/2020 18:24	02/11/2020 20:26	2,03	17	34,49	CHI
2020115646	PIRENOPOLIS	PV21291885	CORUMBA	02/11/2020 18:25	02/11/2020 21:35	02/11/2020 18:25	02/11/2020 21:35	3,16	1	3,16	CHI
2020115650	MARA ROSA	MQ21209320	SANTA TEREZINHA	02/11/2020 18:26	02/11/2020 22:38	02/11/2020 18:26	02/11/2020 22:38	4,20	1	4,20	CHI
2020115651	IVOLANDIA	IV12201972	IPORA	02/11/2020 18:26	02/11/2020 21:01	02/11/2020 18:26	02/11/2020 21:01	2,58	2	5,16	CHI
2020115651	MOIPORA	IV12201972	IPORA	02/11/2020 18:26	02/11/2020 21:01	02/11/2020 18:26	02/11/2020 21:01	2,58	7	18,05	CHI
2020115658	CAMPO LIMPO	AN21246308	NEROPOLIS S1	02/11/2020 18:27	02/11/2020 21:49	02/11/2020 18:27	02/11/2020 21:49	3,37	1	3,37	CHI
2020115661	JANDAIA	JD21008268	PALMEIRAS	02/11/2020 18:27	02/11/2020 23:15	02/11/2020 18:27	02/11/2020 23:15	4,79	1	4,79	CHI
2020115670	LUZIANIA	120288606	RIO VERMELHO	02/11/2020 18:29	02/11/2020 20:53	02/11/2020 18:29	02/11/2020 20:53	2,39	1	2,39	CHI
2020115681	PIRACANJUBA	PJ21120687	CALDAS NOVAS S1	02/11/2020 18:32	02/11/2020 21:00	02/11/2020 18:32	02/11/2020 21:00	2,46	1	2,46	CHI
2020116295	CALDAS NOVAS	10010265315	CALDAS NOVAS S1	02/11/2020 18:33	02/11/2020 23:15	02/11/2020 18:33	02/11/2020 23:15	4,69	1	4,69	CHI
2020115685	PLANALTINA	2960161422	PLANALTINA	02/11/2020 18:34	02/11/2020 21:12	02/11/2020 18:34	02/11/2020 21:12	2,63	1	2,63	CHI
2020115690	CALDAZINHA	DE21098035	CEPAIGO S2	02/11/2020 18:35	02/11/2020 21:02	02/11/2020 18:35	02/11/2020 21:02	2,45	2	4,89	CHI
2020115691	TRINDADE	TR21119538	TRINDADE	02/11/2020 18:35	02/11/2020 20:19	02/11/2020 18:35	02/11/2020 20:19	1,73	1	1,73	CHI
2020115692	PONTALINA	PK12070376	PONTALINA	02/11/2020 18:35	02/11/2020 21:03	02/11/2020 18:35	02/11/2020 21:03	2,45	3	7,35	CHI
2020115706	EDEIA	EA21363390	EDEIA	02/11/2020 18:42	02/11/2020 21:26	02/11/2020 18:42	02/11/2020 21:26	2,72	1	2,72	CHI

2020115714	PLANALTINA	2960230201	PLANALTINA	02/11/2020 18:44	03/11/2020 01:03	02/11/2020 18:44	03/11/2020 01:03	6,31	1	6,31	CHI
2020115784	MUNDO NOVO DE GOIAS	MH12362454	NOVA CRIXAS	02/11/2020 18:44	02/11/2020 21:51	02/11/2020 18:44	02/11/2020 21:51	3,10	123	381,47	CHI
2020115814	GOIATUBA	VI12329055	VICENTINOPOLIS	02/11/2020 18:44	03/11/2020 07:16	02/11/2020 18:44	03/11/2020 07:16	12,52	13	162,80	CHI
2020115814	VICENTINOPOLIS	VI12329055	VICENTINOPOLIS	02/11/2020 18:44	03/11/2020 07:16	02/11/2020 18:44	03/11/2020 07:16	12,52	23	288,02	CHI
2020116305	MUNDO NOVO DE GOIAS	MH11275009	NOVA CRIXAS	02/11/2020 18:44	03/11/2020 09:53	02/11/2020 18:44	03/11/2020 09:53	15,13	1	15,13	CHI
2020115722	URUACU	640131645	URUACU	02/11/2020 18:45	03/11/2020 01:20	02/11/2020 18:45	03/11/2020 01:20	6,58	1	6,58	CHI
2020115723	GOIANIA	13284757	SENADOR CANEDO	02/11/2020 18:45	02/11/2020 20:04	02/11/2020 18:45	02/11/2020 20:04	1,31	1	1,31	CHI
2020115724	ARUANA	AK21088216	BRITANIA	02/11/2020 18:45	02/11/2020 20:38	02/11/2020 18:45	02/11/2020 20:38	1,88	1	1,88	CHI
2020115726	APARECIDA DE GOIANIA	17420088	INDEPENDENCIA S2	02/11/2020 18:45	02/11/2020 20:21	02/11/2020 18:45	02/11/2020 20:21	1,59	1	1,59	CHI
2020115727	AMORINOPOLIS	AM21312069	IPORA	02/11/2020 18:45	02/11/2020 20:49	02/11/2020 18:45	02/11/2020 20:49	2,06	1	2,06	CHI
2020115729	IPAMERI	580030271	IPAMERI	02/11/2020 18:45	02/11/2020 22:35	02/11/2020 18:45	02/11/2020 22:35	3,82	1	3,82	CHI
2020115732	GOIANIA	15941140	GOIANIA LESTE S2	02/11/2020 18:46	02/11/2020 20:42	02/11/2020 18:46	02/11/2020 20:42	1,92	1	1,92	CHI
2020115736	GOIANIA	11386680	GOIANIA LESTE S3	02/11/2020 18:48	02/11/2020 20:29	02/11/2020 18:48	02/11/2020 20:29	1,68	1	1,68	CHI
2020115738	DIVINOPOLIS DE GOIAS	10002297416	SAO DOMINGOS	02/11/2020 18:48	02/11/2020 20:59	02/11/2020 18:48	02/11/2020 20:59	2,17	1	2,17	CHI
2020115744	APARECIDA DE GOIANIA	14219580	ATLANTICO S2	02/11/2020 18:50	02/11/2020 20:50	02/11/2020 18:50	02/11/2020 20:50	1,99	1	1,99	CHI
2020116052	FORMOSA	FA12383279	ITUIQUIRA	02/11/2020 18:50	02/11/2020 20:29	02/11/2020 18:50	02/11/2020 20:29	1,64	32	52,40	CHI
2020115748	GOIANIA	10786612	CARAIAS S1	02/11/2020 18:51	02/11/2020 21:13	02/11/2020 18:51	02/11/2020 21:13	2,36	1	2,36	CHI
2020115749	ADELANDIA	DN11018612	FIRMINOPOLIS S2	02/11/2020 18:51	02/11/2020 19:24	02/11/2020 18:51	02/11/2020 19:24	0,54	94	51,20	CHI
2020115776	ITABERAI	II12300400	ITABERAI S1	02/11/2020 18:51	02/11/2020 20:35	02/11/2020 18:51	02/11/2020 20:35	1,72	20	34,34	CHI
2020115776	ITAGUARI	II12300400	ITABERAI S1	02/11/2020 18:51	02/11/2020 20:35	02/11/2020 18:51	02/11/2020 20:35	1,72	25	42,93	CHI
2020115772	CIDADE OCIDENTAL	DH11199687	MARAJOARA	02/11/2020 18:52	02/11/2020 20:37	02/11/2020 18:52	02/11/2020 20:37	1,74	28	48,58	CHI
2020115766	APARECIDA DE GOIANIA	14409057	REAL S1	02/11/2020 18:54	03/11/2020 02:36	02/11/2020 18:54	03/11/2020 02:36	7,69	1	7,69	CHI
2020115767	COLINAS DO SUL	TI21333945	MINACU	02/11/2020 18:54	03/11/2020 04:20	02/11/2020 18:54	03/11/2020 04:20	9,42	1	9,42	CHI
2020115885	CAIAPONIA	CP12287621	PALESTINA	02/11/2020 18:54	02/11/2020 22:19	02/11/2020 18:54	02/11/2020 22:19	3,40	15	51,03	CHI
2020115775	BURITI ALEGRE	AL16408059	ITUMBIARA VELHA S2	02/11/2020 18:55	02/11/2020 20:08	02/11/2020 18:55	02/11/2020 20:05	1,16	534	621,52	CHI
2020115775	BURITI ALEGRE	BG16408159	ITUMBIARA VELHA S2	02/11/2020 18:55	02/11/2020 20:08	02/11/2020 18:55	02/11/2020 20:07	1,19	13	15,45	CHI
2020115775	ITUMBIARA	BG16408159	ITUMBIARA VELHA S2	02/11/2020 18:55	02/11/2020 20:08	02/11/2020 18:55	02/11/2020 20:07	1,19	22	26,14	CHI
2020115775	BURITI ALEGRE	BG16408494	ITUMBIARA VELHA S2	02/11/2020 18:55	02/11/2020 20:08	02/11/2020 18:55	02/11/2020 20:08	1,20	62	74,66	CHI
2020116147	ITUMBIARA	BG12384546	ITUMBIARA VELHA S2	02/11/2020 18:55	02/11/2020 22:44	02/11/2020 18:55	02/11/2020 22:44	3,80	9	34,22	CHI
2020116147	ITUMBIARA	BG12384546	ITUMBIARA VELHA S2	02/11/2020 18:55	02/11/2020 22:44	02/11/2020 19:09	02/11/2020 22:44	3,57	2	7,14	CHI
2020115780	SENADOR CANEDO	10005003413	SENADOR CANEDO	02/11/2020 18:56	02/11/2020 20:47	02/11/2020 18:56	02/11/2020 20:47	1,84	1	1,84	CHI
2020115787	MINACU	4020038625	MINACU	02/11/2020 18:58	02/11/2020 20:02	02/11/2020 18:58	02/11/2020 20:02	1,07	1	1,07	CHI
2020115789	GOIANIA	16980750	ATLANTICO S1	02/11/2020 18:58	02/11/2020 20:41	02/11/2020 18:58	02/11/2020 20:41	1,70	1	1,70	CHI
2020115794	ABADIANIA	10028810340	DAIA S2	02/11/2020 19:00	02/11/2020 22:11	02/11/2020 19:00	02/11/2020 22:11	3,18	1	3,18	CHI
2020115801	PLANALTINA	PI12131790	PLANALTINA	02/11/2020 19:01	02/11/2020 21:15	02/11/2020 19:01	02/11/2020 21:15	2,22	19	42,21	CHI
2020115805	SILVANIA	SV21158391	VIANOPOLIS	02/11/2020 19:02	02/11/2020 21:18	02/11/2020 19:02	02/11/2020 21:18	2,25	1	2,25	CHI
2020115808	PLANALTINA	10016160418	PLANALTINA	02/11/2020 19:03	02/11/2020 20:13	02/11/2020 19:03	02/11/2020 20:13	1,17	1	1,17	CHI
2020115819	NIQUELANDIA	NQ21255458	NIQUELANDIA SUBTRANSMISSAO	02/11/2020 19:04	03/11/2020 02:57	02/11/2020 19:04	03/11/2020 02:57	7,87	1	7,87	CHI
202011137957	MONTVIDIU DO NORTE	MX12276731	PORANGATU	02/11/2020 19:04	03/11/2020 15:59	02/11/2020 19:04	03/11/2020 15:59	20,91	15	313,68	CHI
2020115822	NIQUELANDIA	NQ12256561	URUACU	02/11/2020 19:06	03/11/2020 08:21	02/11/2020 19:06	03/11/2020 08:21	13,25	2	26,50	CHI
2020115827	SAO MIGUEL DO ARAGUAIA	SM11246962	SAO MIGUEL DO ARAGUAIA	02/11/2020 19:06	03/11/2020 08:45	02/11/2020 19:06	03/11/2020 08:45	13,64	1	13,64	CHI
2020115832	APARECIDA DE GOIANIA	10002965591	INDEPENDENCIA S2	02/11/2020 19:07	02/11/2020 20:10	02/11/2020 19:07	02/11/2020 20:10	1,05	1	1,05	CHI
2020115835	NIQUELANDIA	NQ21197573	URUACU	02/11/2020 19:07	03/11/2020 08:46	02/11/2020 19:07	03/11/2020 08:46	13,64	1	13,64	CHI
2020115839	INHUMAS	30099640	INHUMAS S2	02/11/2020 19:08	02/11/2020 21:09	02/11/2020 19:08	02/11/2020 21:09	2,00	1	2,00	CHI
2020115848	SANTA TEREZINHA DE GOIAS	SG12181444	SANTA TEREZINHA	02/11/2020 19:09	03/11/2020 11:29	02/11/2020 19:09	03/11/2020 11:29	16,32	1	16,32	CHI
2020115848	UIRAPURU	SG12181444	SANTA TEREZINHA	02/11/2020 19:09	03/11/2020 11:29	02/11/2020 19:09	03/11/2020 11:29	16,32	2	32,63	CHI
2020115856	SANTA FE DE GOIAS	RN21220288	BRITANIA	02/11/2020 19:11	02/11/2020 20:40	02/11/2020 19:11	02/11/2020 20:40	1,48	1	1,48	CHI
2020115917	GOIANIA	GN11127467	MEIA PONTE	02/11/2020 19:11	02/11/2020 20:43	02/11/2020 19:11	02/11/2020 20:43	1,52	181	274,87	CHI
2020115949	CAMPOS VERDES	VD11136357	SANTA TEREZINHA	02/11/2020 19:13	03/11/2020 00:53	02/11/2020 19:13	03/11/2020 00:53	5,66	137	775,91	CHI
2020115871	URUACU	640020940	URUACU	02/11/2020 19:14	03/11/2020 08:32	02/11/2020 19:14	03/11/2020 08:32	13,30	1	13,30	CHI
2020115874	INHUMAS	30092097	INHUMAS S2	02/11/2020 19:14	02/11/2020 22:06	02/11/2020 19:14	02/11/2020 22:06	2,86	1	2,86	CHI

2020115880	CRISTALINA	KR21351960	CRISTALINA S2	02/11/2020 19:16	02/11/2020 20:45	02/11/2020 19:16	02/11/2020 20:45	1,48	3	4,44	CHI
2020115882	PARAUNA	PU21161508	PARAUNA	02/11/2020 19:16	02/11/2020 22:07	02/11/2020 19:16	02/11/2020 22:07	2,84	2	5,68	CHI
2020115889	ANAPOLIS	20723854	ANAPOLIS UNIVERSITARIO S1	02/11/2020 19:19	02/11/2020 20:55	02/11/2020 19:19	02/11/2020 20:55	1,60	1	1,60	CHI
2020115901	PLANALTINA	PI21364057	PLANALTINA	02/11/2020 19:21	02/11/2020 22:50	02/11/2020 19:21	02/11/2020 22:50	3,47	2	6,94	CHI
2020115906	CRIXAS	CX11399922	RUBIATABA	02/11/2020 19:23	03/11/2020 09:38	02/11/2020 19:23	03/11/2020 09:38	14,25	1	14,25	CHI
2020115913	GOIANIA	13403813	CARAJAS S1	02/11/2020 19:23	02/11/2020 21:57	02/11/2020 19:23	02/11/2020 21:57	2,55	1	2,55	CHI
2020115916	INHUMAS	IN11132757	INHUMAS S2	02/11/2020 19:24	02/11/2020 22:44	02/11/2020 19:24	02/11/2020 22:44	3,33	75	249,42	CHI
2020115924	BONOPOLIS	BX21165449	SAO MIGUEL DO ARAGUAIA	02/11/2020 19:26	02/11/2020 22:59	02/11/2020 19:26	02/11/2020 22:59	3,55	1	3,55	CHI
2020115944	VALPARAISO DE GOIAS	VA11192928	PACAEMBU S2	02/11/2020 19:26	02/11/2020 21:23	02/11/2020 19:26	02/11/2020 21:23	1,95	188	366,44	CHI
2020115930	MORRO AGUDO DE GOIAS	MS12239817	ITAPURANGA	02/11/2020 19:27	02/11/2020 21:33	02/11/2020 19:27	02/11/2020 21:33	2,10	3	6,29	CHI
2020115931	SANTO ANTONIO DE GOIAS	1360003773	NEROPOLIS S1	02/11/2020 19:27	02/11/2020 21:14	02/11/2020 19:27	02/11/2020 21:14	1,78	1	1,78	CHI
2020115953	PLANALTINA	10024842140	PLANALTINA	02/11/2020 19:31	02/11/2020 20:53	02/11/2020 19:31	02/11/2020 20:53	1,37	1	1,37	CHI
2020115956	VILA BOA	FA12309083	ITUIQUIRA	02/11/2020 19:31	03/11/2020 09:15	02/11/2020 19:31	03/11/2020 09:15	13,72	5	68,61	CHI
2020115957	LUZIANIA	LZ12031082	RIO VERMELHO	02/11/2020 19:31	02/11/2020 20:29	02/11/2020 19:31	02/11/2020 20:29	0,95	513	489,34	CHI
2020115960	PLANALTINA	PI12248193	PLANALTINA	02/11/2020 19:32	02/11/2020 22:20	02/11/2020 19:32	02/11/2020 22:20	2,79	4	11,18	CHI
2020115963	CALDAS NOVAS	MR12059843	MORRINHOS	02/11/2020 19:32	02/11/2020 23:54	02/11/2020 19:32	02/11/2020 23:54	4,35	7	30,47	CHI
2020115963	MORRINHOS	MR12059843	MORRINHOS	02/11/2020 19:32	02/11/2020 23:54	02/11/2020 19:32	02/11/2020 23:54	4,35	12	52,24	CHI
2020115963	PIRACANJUBA	MR12059843	MORRINHOS	02/11/2020 19:32	02/11/2020 23:54	02/11/2020 19:32	02/11/2020 23:54	4,35	4	17,41	CHI
2020116174	ITAGUARI	IC12219937	ITABERAI S1	02/11/2020 19:33	03/11/2020 07:18	02/11/2020 19:33	03/11/2020 07:18	11,74	26	305,21	CHI
2020116174	ITAGUARU	IC12219937	ITABERAI S1	02/11/2020 19:33	03/11/2020 07:18	02/11/2020 19:33	03/11/2020 07:18	11,74	2	23,48	CHI
2020115971	APARECIDA DE GOIANIA	200433260	INDEPENDENCIA S1	02/11/2020 19:34	02/11/2020 22:07	02/11/2020 19:34	02/11/2020 22:07	2,54	1	2,54	CHI
2020115976	PLANALTINA	10025892108	PLANALTINA	02/11/2020 19:35	02/11/2020 22:28	02/11/2020 19:35	02/11/2020 22:28	2,88	1	2,88	CHI
2020116024	JARAGUA	JA11000044	JARAGUA	02/11/2020 19:37	02/11/2020 21:35	02/11/2020 19:37	02/11/2020 21:35	1,97	101	198,63	CHI
2020116019	CABECEIRAS	CW21154479	ITUIQUIRA	02/11/2020 19:41	02/11/2020 21:50	02/11/2020 19:41	02/11/2020 21:50	2,14	1	2,14	CHI
2020116032	SENADOR CANEDO	10003105553	SENADOR CANEDO	02/11/2020 19:44	02/11/2020 21:46	02/11/2020 19:44	02/11/2020 21:46	2,03	1	2,03	CHI
2020116038	ADELANDIA	2330004030	FIRMINOPOLIS S2	02/11/2020 19:46	02/11/2020 22:40	02/11/2020 19:46	02/11/2020 22:40	2,90	1	2,90	CHI
2020116041	GOIANIA	11161814	CAMPINAS S2	02/11/2020 19:46	02/11/2020 21:32	02/11/2020 19:46	02/11/2020 21:32	1,76	1	1,76	CHI
2020116045	SILVANIA	SV12074798	VIANOPOLIS	02/11/2020 19:47	03/11/2020 02:56	02/11/2020 19:47	03/11/2020 02:56	7,15	3	21,44	CHI
2020116046	ANAPOLIS	AN12000547	JUNDIAI S1	02/11/2020 19:47	02/11/2020 20:47	02/11/2020 19:47	02/11/2020 20:47	1,00	480	478,27	CHI
2020116049	DOVERLANDIA	DV11227891	CAIAPONIA	02/11/2020 19:47	03/11/2020 00:27	02/11/2020 19:47	03/11/2020 00:27	4,66	1	4,66	CHI
2020116062	GOIANIA	11605777	FERROVIARIO S1	02/11/2020 19:49	02/11/2020 22:00	02/11/2020 19:49	02/11/2020 22:00	2,17	1	2,17	CHI
2020116077	CRIXAS	GF12243493	SANTA TEREZINHA	02/11/2020 19:51	03/11/2020 03:57	02/11/2020 19:51	03/11/2020 03:57	8,09	3	24,26	CHI
2020116077	GUARINOS	GF12243493	SANTA TEREZINHA	02/11/2020 19:51	03/11/2020 03:57	02/11/2020 19:51	03/11/2020 03:57	8,09	14	113,22	CHI
2020116125	GOIANESIA	GE11275435	GOIANESIA S2	02/11/2020 19:52	03/11/2020 00:06	02/11/2020 19:52	03/11/2020 00:06	4,23	107	452,70	CHI
2020116084	PADRE BERNARDO	PB12163248	PADRE BERNARDO	02/11/2020 19:53	03/11/2020 08:48	02/11/2020 19:53	03/11/2020 08:48	12,90	16	206,45	CHI
2020116086	FORMOSA	FA12261901	ITUIQUIRA	02/11/2020 19:54	03/11/2020 08:23	02/11/2020 19:54	03/11/2020 08:23	12,48	1	12,48	CHI
2020116095	APARECIDA DE GOIANIA	10013244157	INDEPENDENCIA S2	02/11/2020 19:58	02/11/2020 20:48	02/11/2020 19:58	02/11/2020 20:48	0,83	1	0,83	CHI
2020116106	JARAGUA	JA21099139	JARAGUA	02/11/2020 20:01	02/11/2020 21:21	02/11/2020 20:01	02/11/2020 21:21	1,32	1	1,32	CHI
2020116108	LUZIANIA	LZ11209506	RIO VERMELHO	02/11/2020 20:02	02/11/2020 22:00	02/11/2020 20:02	02/11/2020 22:00	1,96	75	146,69	CHI
2020116112	PALMEIRAS DE GOIAS	PP12000036RE	PALMEIRAS	02/11/2020 20:04	02/11/2020 21:23	02/11/2020 20:04	02/11/2020 21:23	1,31	53	69,24	CHI
2020116112	PALMINOPOLIS	PP12000036RE	PALMEIRAS	02/11/2020 20:04	02/11/2020 21:23	02/11/2020 20:04	02/11/2020 21:23	1,31	35	45,72	CHI
2020116124	MAMBAI	1570015949	IACIARA S2	02/11/2020 20:07	02/11/2020 22:04	02/11/2020 20:07	02/11/2020 22:04	1,95	1	1,95	CHI
2020116135	GOIANDIRA	2010004870	CATALAO S1	02/11/2020 20:10	02/11/2020 21:15	02/11/2020 20:10	02/11/2020 21:15	1,07	1	1,07	CHI
2020116140	SAO FRANCISCO DE GOIAS	SF21155629	SAO FRANCISCO DE GOIAS	02/11/2020 20:12	02/11/2020 21:42	02/11/2020 20:12	02/11/2020 21:42	1,50	3	4,50	CHI
2020116145	MONTE ALEGRE DE GOIAS	MA12211597	SAO DOMINGOS	02/11/2020 20:13	02/11/2020 21:16	02/11/2020 20:13	02/11/2020 21:16	1,03	10	10,35	CHI
2020116151	APARECIDA DE GOIANIA	10007133438	INDEPENDENCIA S2	02/11/2020 20:18	03/11/2020 03:53	02/11/2020 20:18	03/11/2020 03:53	7,58	1	7,58	CHI
2020116154	GOIANIA	10834291	GOIANIA LESTE S1	02/11/2020 20:21	02/11/2020 21:25	02/11/2020 20:21	02/11/2020 21:25	1,06	1	1,06	CHI
2020116166	GOIANIA	10001804616	CAMPINAS S2	02/11/2020 20:28	02/11/2020 21:28	02/11/2020 20:28	02/11/2020 21:28	1,00	1	1,00	CHI
2020116168	ITABERAI	IB21310510	ITABERAI S1	02/11/2020 20:29	02/11/2020 22:26	02/11/2020 20:29	02/11/2020 22:26	1,95	1	1,95	CHI
2020116173	ABADIANIA	AA12413566	DAIA S2	02/11/2020 20:31	03/11/2020 01:05	02/11/2020 20:31	03/11/2020 01:05	4,55	8	36,40	CHI
2020116273	PALESTINA DE GOIAS	PY12187293	PALESTINA	02/11/2020 20:34	03/11/2020 01:17	02/11/2020 20:34	03/11/2020 01:17	4,70	21	98,76	CHI

2020116182	MORRINHOS	MR12000396	MORRINHOS	02/11/2020 20:36	02/11/2020 22:21	02/11/2020 20:36	02/11/2020 22:21	1,74	3	5,21	CHI
2020116186	ITAPACI	IW21379429	ITAPACI	02/11/2020 20:41	03/11/2020 03:04	02/11/2020 20:41	03/11/2020 03:04	6,37	1	6,37	CHI
2020116223	ITAPACI	IW12078035	ITAPACI	02/11/2020 20:41	03/11/2020 08:07	02/11/2020 20:41	03/11/2020 08:07	11,43	20	228,67	CHI
2020116223	NOVA GLORIA	IW12078035	ITAPACI	02/11/2020 20:41	03/11/2020 08:07	02/11/2020 20:41	03/11/2020 08:07	11,43	1	11,43	CHI
2020116915	ITAPACI	IW21294820	ITAPACI	02/11/2020 20:41	03/11/2020 09:14	02/11/2020 20:41	03/11/2020 09:14	12,55	1	12,55	CHI
2020116188	BELA VISTA DE GOIAS	240084329	BELA VISTA S1	02/11/2020 20:43	02/11/2020 22:41	02/11/2020 20:43	02/11/2020 22:41	1,96	1	1,96	CHI
2020116190	APARECIDA DE GOIANIA	AP11070531	INDEPENDENCIA S2	02/11/2020 20:43	02/11/2020 23:12	02/11/2020 20:43	02/11/2020 23:12	2,47	153	377,49	CHI
2020116191	CAIAPONIA	CP11268533	CAIAPONIA	02/11/2020 20:44	03/11/2020 02:08	02/11/2020 20:44	03/11/2020 02:08	5,40	6	32,40	CHI
2020116194	POSSE	PS12254489	IACIARA S2	02/11/2020 20:45	03/11/2020 10:46	02/11/2020 20:45	03/11/2020 10:46	14,02	13	182,21	CHI
2020116202	ANAPOLIS	21250583	JUNDIAI S1	02/11/2020 20:50	02/11/2020 21:51	02/11/2020 20:50	02/11/2020 21:51	1,02	1	1,02	CHI
2020116203	CALDAZINHA	BV21094986	CEPAIGO S2	02/11/2020 20:50	02/11/2020 22:24	02/11/2020 20:50	02/11/2020 22:24	1,55	1	1,55	CHI
2020116220	PALMEIRAS DE GOIAS	PL11312588	PALMEIRAS	02/11/2020 20:53	02/11/2020 22:07	02/11/2020 20:53	02/11/2020 22:07	1,22	412	502,07	CHI
2020116211	GOIANIRA	390039184	GOIANIRA	02/11/2020 20:56	02/11/2020 22:03	02/11/2020 20:56	02/11/2020 22:03	1,11	1	1,11	CHI
2020116215	PADRE BERNARDO	PB21330747	PADRE BERNARDO	02/11/2020 20:58	03/11/2020 00:13	02/11/2020 20:58	03/11/2020 00:13	3,25	1	3,25	CHI
2020116230	ANAPOLIS	AN12039265	ANAPOLIS UNIVERSITARIO S2	02/11/2020 21:01	02/11/2020 21:55	02/11/2020 21:01	02/11/2020 21:55	0,89	342	304,86	CHI
2020116234	CALDAS NOVAS	10027572372	SERRA DE CALDAS	02/11/2020 21:08	02/11/2020 22:40	02/11/2020 21:08	02/11/2020 22:40	1,54	1	1,54	CHI
2020116244	AGUAS LINDAS DE GOIAS	LA11356418	AGUAS LINDAS DE GOIAS S1	02/11/2020 21:14	02/11/2020 23:43	02/11/2020 21:14	02/11/2020 23:43	2,48	81	200,74	CHI
2020116246	VILA BOA	VB12243008	IACIARA S2	02/11/2020 21:15	03/11/2020 10:07	02/11/2020 21:15	03/11/2020 10:07	12,86	3	38,59	CHI
2020116253	GOIANIA	14233460	CARAJAS S2	02/11/2020 21:22	02/11/2020 22:46	02/11/2020 21:22	02/11/2020 22:46	1,40	1	1,40	CHI
2020116275	NEROPOLIS	NR11187209	NEROPOLIS S2	02/11/2020 21:33	02/11/2020 22:17	02/11/2020 21:33	02/11/2020 22:17	0,72	179	128,98	CHI
2020116276	SAO MIGUEL DO ARAGUAIA	830044723	SAO MIGUEL DO ARAGUAIA	02/11/2020 21:33	03/11/2020 12:46	02/11/2020 21:33	03/11/2020 12:46	15,20	1	15,20	CHI
2020116279	ITUMBIARA	BG12273858	ITUMBIARA VELHA S2	02/11/2020 21:36	02/11/2020 23:52	02/11/2020 21:36	02/11/2020 23:52	2,27	1	2,27	CHI
2020116280	LUZIANIA	120143872	RIO VERMELHO	02/11/2020 21:38	03/11/2020 00:38	02/11/2020 21:38	03/11/2020 00:38	3,00	1	3,00	CHI
2020116282	GOIANIA	GN11051623	GOIA S1	02/11/2020 21:38	02/11/2020 22:48	02/11/2020 21:38	02/11/2020 22:48	1,16	5	5,78	CHI
2020116291	GOIANIA	10005102438	MEIA PONTE	02/11/2020 21:49	02/11/2020 22:58	02/11/2020 21:49	02/11/2020 22:58	1,15	1	1,15	CHI
2020116293	ANAPOLIS	20249111	ANAPOLIS UNIVERSITARIO S1	02/11/2020 21:50	02/11/2020 23:37	02/11/2020 21:50	02/11/2020 23:37	1,78	1	1,78	CHI
2020116301	GOIAS	GS12220498	GOIAS	02/11/2020 21:56	03/11/2020 00:16	02/11/2020 21:56	03/11/2020 00:16	2,33	45	104,86	CHI
2020116307	GOIANIA	10657629	CAMPINAS S3	02/11/2020 22:03	02/11/2020 23:21	02/11/2020 22:03	02/11/2020 23:21	1,29	1	1,29	CHI
2020116321	CRISTALINA	KR21245993	CRISTALINA S2	02/11/2020 22:19	02/11/2020 23:04	02/11/2020 22:19	02/11/2020 23:04	0,74	1	0,74	CHI
2020116323	SENADOR CANEDO	190140458	SENADOR CANEDO	02/11/2020 22:23	03/11/2020 00:22	02/11/2020 22:23	03/11/2020 00:22	1,98	1	1,98	CHI
2020116324	SENADOR CANEDO	12877580	SENADOR CANEDO	02/11/2020 22:23	03/11/2020 23:24	02/11/2020 22:23	03/11/2020 23:24	1,01	1	1,01	CHI
2020116326	LUZIANIA	KR12080375	PAMPLONA	02/11/2020 22:23	03/11/2020 01:11	02/11/2020 22:23	03/11/2020 01:11	2,79	4	11,15	CHI
2020116498	AMARALINA	MH12418306	NOVA CRIXAS	02/11/2020 22:23	03/11/2020 08:47	02/11/2020 22:23	03/11/2020 08:47	10,39	1	10,39	CHI
2020116498	MUNDO NOVO DE GOIAS	MH12418306	NOVA CRIXAS	02/11/2020 22:23	03/11/2020 08:47	02/11/2020 22:23	03/11/2020 08:47	10,39	7	72,73	CHI
2020116914	PADRE BERNARDO	PB12344764	PADRE BERNARDO	02/11/2020 22:35	03/11/2020 10:19	02/11/2020 22:35	03/11/2020 10:19	11,73	10	117,33	CHI
2020116352	GOIANIA	10657599	CAMPINAS S3	02/11/2020 22:50	02/11/2020 23:33	02/11/2020 22:50	02/11/2020 23:33	0,71	1	0,71	CHI
2020116357	ANAPOLIS	20442427	ANAPOLIS UNIVERSITARIO S2	02/11/2020 23:01	03/11/2020 00:34	02/11/2020 23:01	03/11/2020 00:34	1,54	1	1,54	CHI
2020116359	ITABERAI	IB12382593	ANICUNS	02/11/2020 23:05	03/11/2020 12:27	02/11/2020 23:05	03/11/2020 10:53	11,80	7	82,62	CHI
2020116359	ITABERAI	IB12382593	ANICUNS	02/11/2020 23:05	03/11/2020 12:27	02/11/2020 23:05	03/11/2020 12:27	13,38	1	13,38	CHI
2020116365	APARECIDA DE GOIANIA	13325553	INDEPENDENCIA S2	02/11/2020 23:09	03/11/2020 00:57	02/11/2020 23:09	03/11/2020 00:57	1,80	1	1,80	CHI
2020116369	PLANALTINA	PI21398572	PLANALTINA	02/11/2020 23:12	03/11/2020 00:03	02/11/2020 23:12	03/11/2020 00:03	0,84	1	0,84	CHI
2020116372	GOIANIA	10011827724	MEIA PONTE	02/11/2020 23:21	03/11/2020 03:29	02/11/2020 23:21	03/11/2020 03:29	4,12	1	4,12	CHI
2020116377	GOIANIA	11099290	CAMPINAS S3	02/11/2020 23:45	03/11/2020 00:56	02/11/2020 23:45	03/11/2020 00:56	1,17	1	1,17	CHI
2020116378	GOIANIA	10657551	CAMPINAS S3	02/11/2020 23:47	03/11/2020 01:31	02/11/2020 23:47	03/11/2020 01:31	1,73	1	1,73	CHI
2020116383	LUZIANIA	LZ12000240	RIO VERMELHO	02/11/2020 23:55	03/11/2020 01:02	02/11/2020 23:55	03/11/2020 01:02	1,12	891	994,70	CHI
2020116391	GOIANIA	14051813	CARAJAS S1	03/11/2020 00:06	03/11/2020 01:25	03/11/2020 00:06	03/11/2020 01:25	1,30	1	1,30	CHI
2020116404	TRINDADE	40080961	TRINDADE	03/11/2020 00:52	03/11/2020 02:29	03/11/2020 00:52	03/11/2020 02:29	1,61	1	1,61	CHI
2020116405	SANTA BARBARA DE GOIAS	SB11215439	TRINDADE	03/11/2020 00:53	03/11/2020 02:08	03/11/2020 00:53	03/11/2020 02:08	1,24	90	111,63	CHI
2020116408	ABADIANIA	AA21295579	DAIA S2	03/11/2020 01:10	03/11/2020 01:45	03/11/2020 01:10	03/11/2020 01:45	0,57	3	1,71	CHI
2020116411	GOIANIA	15145499	CARAJAS S1	03/11/2020 01:37	03/11/2020 03:04	03/11/2020 01:37	03/11/2020 03:04	1,44	1	1,44	CHI
2020116414	VIANOPOLIS	VN21102971	VIANOPOLIS	03/11/2020 01:49	03/11/2020 12:55	03/11/2020 01:49	03/11/2020 12:55	11,11	1	11,11	CHI

2020116416	GOIANESIA	GE11275435	GOIANESIA S2	03/11/2020 02:32	03/11/2020 12:53	03/11/2020 09:22	03/11/2020 12:53	3,50	107	374,71	CHI
2020116420	IPORA	IR11014380	IPORA	03/11/2020 03:07	03/11/2020 11:29	03/11/2020 03:07	03/11/2020 11:29	8,36	74	618,93	CHI
2020116422	GOIANIA	13836018	CARAJAS S1	03/11/2020 03:10	03/11/2020 04:19	03/11/2020 03:10	03/11/2020 04:19	1,14	1	1,14	CHI
2020116429	GOIANIA	13947618	CARAJAS S1	03/11/2020 04:08	03/11/2020 04:16	03/11/2020 04:08	03/11/2020 04:16	0,13	1	0,13	CHI
2020116431	GOIANIA	14641835	CARAJAS S1	03/11/2020 04:10	03/11/2020 04:24	03/11/2020 04:10	03/11/2020 04:24	0,22	1	0,22	CHI
2020116432	PLANALTINA	PI12131790	PLANALTINA	03/11/2020 04:13	03/11/2020 10:43	03/11/2020 04:13	03/11/2020 10:43	6,49	19	123,38	CHI
2020116434	PALESTINA DE GOIAS	PY12187293	PALESTINA	03/11/2020 04:30	03/11/2020 11:04	03/11/2020 04:30	03/11/2020 11:04	6,56	21	137,66	CHI
2020116437	SENADOR CANEDO	SW11205665	SENADOR CANEDO	03/11/2020 04:36	03/11/2020 07:47	03/11/2020 04:36	03/11/2020 07:47	3,18	10	31,78	CHI
2020116439	GOIANIA	GN11001129	AEROPORTO S1	03/11/2020 05:03	03/11/2020 05:59	03/11/2020 05:03	03/11/2020 05:59	0,93	129	119,40	CHI
2020116442	CRISTALINA	KR21118884	PAMPLONA	03/11/2020 05:12	03/11/2020 08:27	03/11/2020 05:12	03/11/2020 08:27	3,24	1	3,24	CHI
2020116443	CRISTALINA	KR21351946	CRISTALINA S1	03/11/2020 05:12	03/11/2020 09:00	03/11/2020 05:12	03/11/2020 09:00	3,79	3	11,36	CHI
2020116469	PIRACANJUBA	PJ12038085LD	BELA VISTA S1	03/11/2020 05:23	03/11/2020 10:45	03/11/2020 05:23	03/11/2020 10:45	5,37	54	289,81	CHI
2020116446	VALPARAISO DE GOIAS	20829006	PACAEMBU S1	03/11/2020 05:27	03/11/2020 08:01	03/11/2020 05:27	03/11/2020 08:01	2,56	230	588,74	CHI
2020116447	SANTA TEREZA DE GOIAS	SE12171135	MARA ROSA	03/11/2020 05:27	03/11/2020 10:38	03/11/2020 05:27	03/11/2020 10:38	5,17	1	5,17	CHI
2020116448	GOIATUBA	GT11218098	GOIATUBA S2	03/11/2020 05:28	03/11/2020 06:00	03/11/2020 05:28	03/11/2020 06:00	0,53	79	41,78	CHI
2020116606	AMARALINA	UP12294696	NOVA CRIXAS	03/11/2020 05:29	03/11/2020 09:53	03/11/2020 05:29	03/11/2020 09:53	4,40	54	237,44	CHI
2020116606	MARA ROSA	UP12294696	NOVA CRIXAS	03/11/2020 05:29	03/11/2020 09:53	03/11/2020 05:29	03/11/2020 09:53	4,40	43	189,07	CHI
2020116606	SANTA TEREZINHA DE GOIAS	UP12294696	NOVA CRIXAS	03/11/2020 05:29	03/11/2020 09:53	03/11/2020 05:29	03/11/2020 09:53	4,40	1	4,40	CHI
2020116606	UIRAPURU	UP12294696	NOVA CRIXAS	03/11/2020 05:29	03/11/2020 09:53	03/11/2020 05:29	03/11/2020 09:53	4,40	4	17,59	CHI
2020116452	IPAMERI	IP12247907	CRISTALINA S2	03/11/2020 05:31	03/11/2020 08:39	03/11/2020 05:31	03/11/2020 08:39	3,13	23	71,89	CHI
2020116735	IPAMERI	IP21133616	CRISTALINA S2	03/11/2020 05:31	03/11/2020 10:21	03/11/2020 05:31	03/11/2020 10:21	4,83	1	4,83	CHI
2020116468	PORANGATU	PO12239639	MARA ROSA	03/11/2020 05:32	03/11/2020 07:40	03/11/2020 05:32	03/11/2020 07:40	2,13	31	65,96	CHI
2020116458	VILA PROPICIO	PV12102018	GOIANESIA S1	03/11/2020 05:41	03/11/2020 09:55	03/11/2020 05:41	03/11/2020 09:55	4,23	4	16,91	CHI
2020116463	ITUMBIARA	IT12007665	ITUMBIARA VELHA S1	03/11/2020 05:47	03/11/2020 07:12	03/11/2020 05:47	03/11/2020 07:12	1,41	1	1,41	CHI
2020116464	ITABERAI	IB12078567	ITABERAI S1	03/11/2020 05:48	03/11/2020 07:58	03/11/2020 05:48	03/11/2020 07:58	2,15	6	12,92	CHI
2020116464	ITAUCU	IB12078567	ITABERAI S1	03/11/2020 05:48	03/11/2020 07:58	03/11/2020 05:48	03/11/2020 07:58	2,15	1	2,15	CHI
2020116465	GAMELEIRA DE GOIAS	SV31090397	DAIA S2	03/11/2020 05:48	03/11/2020 07:31	03/11/2020 05:48	03/11/2020 07:31	1,70	1	1,70	CHI
2020116467	IACIARA	IA21211518	IACIARA S2	03/11/2020 05:51	03/11/2020 07:28	03/11/2020 05:51	03/11/2020 07:28	1,60	1	1,60	CHI
2020116474	GOIANIRA	390035749	GOIANIRA	03/11/2020 05:59	03/11/2020 08:12	03/11/2020 05:59	03/11/2020 08:12	2,21	1	2,21	CHI
2020116476	ANAPOLIS	AN21258665	ANAPOLIS UNIVERSITARIO S2	03/11/2020 06:00	03/11/2020 07:46	03/11/2020 06:00	03/11/2020 07:46	1,76	1	1,76	CHI
2020116480	CORUMBA DE GOIAS	CB12381237	CORUMBA	03/11/2020 06:02	03/11/2020 08:17	03/11/2020 06:02	03/11/2020 08:17	2,23	11	24,58	CHI
2020116484	CAIAPONIA	CP21243939	PIRANHAS	03/11/2020 06:07	03/11/2020 09:25	03/11/2020 06:07	03/11/2020 09:25	3,29	1	3,29	CHI
2020116683	CAMPO ALEGRE DE GOIAS	CT12338757	CATALAO S1	03/11/2020 06:07	03/11/2020 09:23	03/11/2020 06:07	03/11/2020 09:23	3,26	2	6,51	CHI
2020116683	CATALAO	CT12338757	CATALAO S1	03/11/2020 06:07	03/11/2020 09:23	03/11/2020 06:07	03/11/2020 09:23	3,26	11	35,82	CHI
2020116488	BRITANIA	BT12013469	BRITANIA	03/11/2020 06:13	03/11/2020 09:02	03/11/2020 06:13	03/11/2020 09:02	2,80	5	14,02	CHI
2020116489	MONTES CLAROS DE GOIAS	1440025025	BRITANIA	03/11/2020 06:13	03/11/2020 11:47	03/11/2020 06:13	03/11/2020 11:47	5,55	1	5,55	CHI
2020116490	ARENOPOLIS	AY12010416	ARENOPOLIS	03/11/2020 06:15	03/11/2020 08:05	03/11/2020 06:15	03/11/2020 08:05	1,83	5	9,16	CHI
2020116492	GOIATUBA	GT11218097	GOIATUBA S2	03/11/2020 06:18	03/11/2020 08:37	03/11/2020 06:18	03/11/2020 08:37	2,30	38	87,51	CHI
2020116588	CAMPINORTE	CR12285376	CAMPINORTE	03/11/2020 06:22	03/11/2020 09:23	03/11/2020 06:22	03/11/2020 09:23	3,00	7	21,03	CHI
2020116505	ITUMBIARA	IT11222472	ITUMBIARA VELHA S1	03/11/2020 06:27	03/11/2020 07:34	03/11/2020 06:27	03/11/2020 07:34	1,12	31	34,62	CHI
2020116506	CATALAO	CT21203137	CATALAO S1	03/11/2020 06:27	03/11/2020 08:36	03/11/2020 06:27	03/11/2020 08:36	2,15	1	2,15	CHI
2020116535	DIORAMA	IR12014523RE	IPORA	03/11/2020 06:27	03/11/2020 09:17	03/11/2020 06:27	03/11/2020 09:17	2,82	10	28,23	CHI
2020116535	IPORA	IR12014523RE	IPORA	03/11/2020 06:27	03/11/2020 09:17	03/11/2020 06:27	03/11/2020 09:17	2,82	45	127,03	CHI
2020116535	ISRAELANDIA	IR12014523RE	IPORA	03/11/2020 06:27	03/11/2020 09:17	03/11/2020 06:27	03/11/2020 09:17	2,82	3	8,47	CHI
2020116535	JAUPACI	IR12014523RE	IPORA	03/11/2020 06:27	03/11/2020 09:17	03/11/2020 06:27	03/11/2020 09:17	2,82	18	50,81	CHI
2020116764	SAO DOMINGOS	SD12257734	SAO DOMINGOS	03/11/2020 06:30	04/11/2020 17:48	03/11/2020 06:30	04/11/2020 17:48	35,29	57	2011,34	CHI
2020116516	VICENTINOPOLIS	VI11038917	VICENTINOPOLIS	03/11/2020 06:34	03/11/2020 16:17	03/11/2020 06:34	03/11/2020 16:17	9,71	87	844,41	CHI
2020116518	CORUMBAIBA	CI21000531	VILA CORUMBA	03/11/2020 06:34	03/11/2020 09:49	03/11/2020 06:34	03/11/2020 09:49	3,24	1	3,24	CHI
2020116520	APARECIDA DE GOIANIA	10018112810	REAL S1	03/11/2020 06:35	03/11/2020 08:34	03/11/2020 06:35	03/11/2020 08:34	1,98	1	1,98	CHI
2020116521	FAZENDA NOVA	FN21250946	IPORA	03/11/2020 06:36	03/11/2020 16:03	03/11/2020 06:36	03/11/2020 11:02	4,43	1	4,43	CHI
2020116521	FAZENDA NOVA	FN21250946	IPORA	03/11/2020 06:36	03/11/2020 16:03	03/11/2020 11:54	03/11/2020 16:03	4,14	1	4,14	CHI

2020116523	PLANALTINA	PI12375541	PLANALTINA	03/11/2020 06:36	03/11/2020 09:30	03/11/2020 06:36	03/11/2020 09:30	2,89	189	545,95	CHI
2020116524	CAMPINACU	UC21239730	PORANGATU	03/11/2020 06:37	03/11/2020 11:15	03/11/2020 06:37	03/11/2020 11:15	4,63	1	4,63	CHI
2020116527	PORANGATU	PO11349910	MARA ROSA	03/11/2020 06:40	03/11/2020 08:37	03/11/2020 06:40	03/11/2020 08:37	1,94	1	1,94	CHI
2020116761	CEZARINA	PL12304466	PALMEIRAS	03/11/2020 06:40	03/11/2020 09:42	03/11/2020 06:40	03/11/2020 09:42	3,04	1	3,04	CHI
2020116761	PALMEIRAS DE GOIAS	PL12304466	PALMEIRAS	03/11/2020 06:40	03/11/2020 09:42	03/11/2020 06:40	03/11/2020 09:42	3,04	12	36,52	CHI
2020116761	PALMEIRAS DE GOIAS	PL12349353	PALMEIRAS	03/11/2020 06:40	03/11/2020 09:42	03/11/2020 09:02	03/11/2020 09:42	0,68	3	2,04	CHI
2020116529	PLANALTINA	PI12085567	PLANALTINA	03/11/2020 06:41	03/11/2020 11:27	03/11/2020 06:41	03/11/2020 11:27	4,77	5	23,83	CHI
2020116530	CALDAS NOVAS	CN21246673	SERRA DE CALDAS	03/11/2020 06:41	03/11/2020 07:48	03/11/2020 06:41	03/11/2020 07:48	1,11	1	1,11	CHI
2020116533	AGUA LIMPA	AL21075703	VILA CORUMBA	03/11/2020 06:42	03/11/2020 10:03	03/11/2020 06:42	03/11/2020 10:03	3,34	1	3,34	CHI
2020116445	PALMEIRAS DE GOIAS	JD12005405	PALMEIRAS	03/11/2020 06:43	03/11/2020 15:36	03/11/2020 06:43	03/11/2020 15:36	8,89	40	355,44	CHI
2020116445	JANDAIA	JD12005405	PALMEIRAS	03/11/2020 06:43	03/11/2020 15:36	03/11/2020 10:53	03/11/2020 15:36	4,72	10	47,19	CHI
2020116445	PALMEIRAS DE GOIAS	JD12005405	PALMEIRAS	03/11/2020 06:43	03/11/2020 15:36	03/11/2020 10:53	03/11/2020 15:36	4,72	16	75,51	CHI
2020116536	CATALAO	CT21281467	CATALAO S1	03/11/2020 06:44	03/11/2020 10:30	03/11/2020 06:44	03/11/2020 10:30	3,76	1	3,76	CHI
2020116543	GUAPO	AO12000031	GUAPO S2	03/11/2020 06:49	03/11/2020 08:40	03/11/2020 06:49	03/11/2020 08:40	1,84	10	18,37	CHI
2020116544	NOVA CRIXAS	NA21091637	NOVA CRIXAS	03/11/2020 06:49	03/11/2020 11:41	03/11/2020 06:49	03/11/2020 11:41	4,85	1	4,85	CHI
2020116552	MATRINCHA	MP12066029	MATRINCHA	03/11/2020 06:53	03/11/2020 16:26	03/11/2020 06:53	03/11/2020 16:26	9,55	1	9,55	CHI
2020116553	CRISTALINA	KR12090782	PAMPLONA	03/11/2020 06:54	03/11/2020 12:26	03/11/2020 06:54	03/11/2020 12:26	5,53	2	11,06	CHI
2020116556	JUSSARA	JR12220059	JUSSARA	03/11/2020 06:54	03/11/2020 09:01	03/11/2020 06:54	03/11/2020 09:01	2,10	12	25,25	CHI
2020116562	OURO VERDE DE GOIAS	OV12080997	NEROPOLIS S1	03/11/2020 06:56	03/11/2020 09:38	03/11/2020 06:56	03/11/2020 09:38	2,69	110	295,99	CHI
2020116925	OURO VERDE DE GOIAS	OV11090473	NEROPOLIS S1	03/11/2020 06:56	03/11/2020 10:55	03/11/2020 06:56	03/11/2020 10:55	3,97	129	512,67	CHI
2020116567	TURVANIA	TV12083145	FIRMINOPOLIS S2	03/11/2020 06:59	03/11/2020 09:48	03/11/2020 06:59	03/11/2020 09:48	2,81	2	5,62	CHI
2020116589	GOIAS	GS12336540	GOIAS	03/11/2020 07:00	03/11/2020 09:11	03/11/2020 07:00	03/11/2020 09:11	2,17	9	19,56	CHI
2020116576	TRINDADE	TR12193070	GOYA S1	03/11/2020 07:02	03/11/2020 10:29	03/11/2020 07:02	03/11/2020 10:29	3,45	32	110,38	CHI
2020116578	CAMPO LIMPO	AN12265111	ANAPOLIS UNIVERSITARIO S2	03/11/2020 07:02	03/11/2020 08:05	03/11/2020 07:02	03/11/2020 08:05	1,04	5	5,22	CHI
2020116579	SANCLERLANDIA	MD12016332	FIRMINOPOLIS S2	03/11/2020 07:02	03/11/2020 08:50	03/11/2020 07:02	03/11/2020 08:50	1,79	14	25,11	CHI
2020116581	APARECIDA DE GOIANIA	10006132284	INDEPENDENCIA S1	03/11/2020 07:02	03/11/2020 07:52	03/11/2020 07:02	03/11/2020 07:52	0,83	1	0,83	CHI
2020116583	INDIARA	IY21031935	EDEIA	03/11/2020 07:04	03/11/2020 10:06	03/11/2020 07:04	03/11/2020 10:06	3,03	1	3,03	CHI
2020116590	ITAPURANGA	170042236	ITAPURANGA	03/11/2020 07:06	03/11/2020 12:03	03/11/2020 07:06	03/11/2020 12:03	4,95	1	4,95	CHI
2020116597	PIRANHAS	PH21343527	CAIAPONIA	03/11/2020 07:07	03/11/2020 09:42	03/11/2020 07:07	03/11/2020 09:42	2,58	1	2,58	CHI
2020116598	ARUANA	AK12066603	ARUANA	03/11/2020 07:07	03/11/2020 09:47	03/11/2020 07:07	03/11/2020 09:47	2,66	4	10,63	CHI
2020116603	CATALAO	CT12229926	CATALAO S1	03/11/2020 07:09	03/11/2020 08:26	03/11/2020 07:09	03/11/2020 08:26	1,28	4	5,12	CHI
2020116605	PORANGATU	PO12189555	PORANGATU	03/11/2020 07:09	03/11/2020 09:01	03/11/2020 07:09	03/11/2020 09:01	1,86	8	14,89	CHI
2020117429	MUNDO NOVO DE GOIAS	MH12342078	NOVA CRIXAS	03/11/2020 07:09	03/11/2020 11:59	03/11/2020 07:09	03/11/2020 11:59	4,82	11	53,02	CHI
2020116615	PADRE BERNARDO	PB12112920	PADRE BERNARDO	03/11/2020 07:11	03/11/2020 09:45	03/11/2020 07:11	03/11/2020 09:45	2,56	22	56,22	CHI
2020116623	SITIO D ABADIA	SI12302925	IACIARA S2	03/11/2020 07:11	03/11/2020 16:26	03/11/2020 07:11	03/11/2020 16:26	9,24	12	110,88	CHI
2020116617	APARECIDA DE GOIANIA	AP11137039	INDEPENDENCIA S2	03/11/2020 07:12	03/11/2020 11:27	03/11/2020 07:12	03/11/2020 11:27	4,25	6	25,48	CHI
2020116619	FORMOSA	610131898	ITUIQUIRA	03/11/2020 07:12	03/11/2020 10:51	03/11/2020 07:12	03/11/2020 10:51	3,64	1	3,64	CHI
2020116620	CRISTALINA	KR21031886	CRISTALINA S2	03/11/2020 07:12	03/11/2020 08:29	03/11/2020 07:12	03/11/2020 08:29	1,27	1	1,27	CHI
2020116626	PLANALTINA	PI21364057	PLANALTINA	03/11/2020 07:14	03/11/2020 12:32	03/11/2020 07:14	03/11/2020 12:32	5,28	2	10,57	CHI
2020116629	NOVA CRIXAS	NA12300441	MOZARLANDIA	03/11/2020 07:17	03/11/2020 09:28	03/11/2020 07:17	03/11/2020 09:28	2,17	3	6,51	CHI
2020116632	NOVA CRIXAS	NA12321769	MOZARLANDIA	03/11/2020 07:18	03/11/2020 15:22	03/11/2020 07:18	03/11/2020 15:22	8,07	11	88,76	CHI
2020116638	ANAPOLIS	20529922	JUNDIAI S2	03/11/2020 07:19	03/11/2020 08:51	03/11/2020 07:19	03/11/2020 08:51	1,52	1	1,52	CHI
2020116640	IACIARA	IA21373149	IACIARA S1	03/11/2020 07:20	03/11/2020 08:57	03/11/2020 07:20	03/11/2020 08:57	1,62	1	1,62	CHI
2020116642	HIDROLANDIA	HD11288248	CEPAIGO S2	03/11/2020 07:20	03/11/2020 10:03	03/11/2020 07:20	03/11/2020 09:45	2,41	1	2,41	CHI
2020116642	HIDROLANDIA	HD12268836	CEPAIGO S2	03/11/2020 07:20	03/11/2020 10:03	03/11/2020 07:20	03/11/2020 10:03	2,71	3	8,13	CHI
2020116645	PLANALTINA	PI21257784	PLANALTINA	03/11/2020 07:21	03/11/2020 11:44	03/11/2020 07:21	03/11/2020 11:44	4,37	1	4,37	CHI
2020116646	LUZIANIA	120433930	RIO VERMELHO	03/11/2020 07:21	03/11/2020 08:11	03/11/2020 07:21	03/11/2020 08:11	0,82	1	0,82	CHI
2020116648	CALDAS NOVAS	CN21110343	SERRA DE CALDAS	03/11/2020 07:23	03/11/2020 08:06	03/11/2020 07:23	03/11/2020 08:06	0,71	2	1,43	CHI
2020116658	ITUMBIARA	690211363	ITUMBIARA NOVA	03/11/2020 07:27	03/11/2020 09:21	03/11/2020 07:27	03/11/2020 09:21	1,90	1	1,90	CHI
2020116663	SIMOLANDIA	1940014740	IACIARA S2	03/11/2020 07:27	03/11/2020 11:42	03/11/2020 07:27	03/11/2020 11:42	4,24	1	4,24	CHI
2020117108	ALEXANIA	AX12402036	ALEXANIA	03/11/2020 07:27	03/11/2020 11:37	03/11/2020 07:27	03/11/2020 10:46	3,31	37	122,51	CHI

2020117108	ALEXANIA	AX12402036	ALEXANIA	03/11/2020 07:27	03/11/2020 11:37	03/11/2020 07:27	03/11/2020 11:37	4,16	12	49,93	CHI
2020117108	SANTO ANTONIO DO DESCOBERTO	AX12402036	ALEXANIA	03/11/2020 07:27	03/11/2020 11:37	03/11/2020 07:27	03/11/2020 11:37	4,16	1	4,16	CHI
2020117361	NOVA CRIXAS	NA12229095	NOVA CRIXAS	03/11/2020 07:27	03/11/2020 11:43	03/11/2020 07:27	03/11/2020 11:43	4,27	31	132,22	CHI
2020116668	FAZENDA NOVA	FN21259561	FIRMINOPOLIS S2	03/11/2020 07:28	03/11/2020 10:03	03/11/2020 07:28	03/11/2020 10:03	2,57	1	2,57	CHI
2020116671	CABECEIRAS	CW12108823	ITUIQUIRA	03/11/2020 07:29	03/11/2020 08:20	03/11/2020 07:29	03/11/2020 08:20	0,84	8	6,74	CHI
2020116673	ORIZONA	OZ21159585	PIRES DO RIO S2	03/11/2020 07:30	03/11/2020 09:54	03/11/2020 07:30	03/11/2020 09:54	2,40	1	2,40	CHI
2020116675	PLANALTINA	PI21088191	PLANALTINA	03/11/2020 07:30	03/11/2020 10:50	03/11/2020 07:30	03/11/2020 10:50	3,33	1	3,33	CHI
2020116677	PLANALTINA	TL12206256	SAO JOAO D ALIANCA	03/11/2020 07:30	03/11/2020 12:51	03/11/2020 07:30	03/11/2020 12:51	5,34	4	21,37	CHI
2020116681	PLANALTINA	2960225461	PLANALTINA	03/11/2020 07:32	03/11/2020 11:24	03/11/2020 07:32	03/11/2020 11:24	3,86	1	3,86	CHI
2020116747	UIRAPURU	UP12243502	SANTA TEREZINHA	03/11/2020 07:32	03/11/2020 10:19	03/11/2020 07:32	03/11/2020 10:19	2,77	4	11,08	CHI
2020116685	CATURAI	CK21297314	INHUMAS S1	03/11/2020 07:33	03/11/2020 08:45	03/11/2020 07:33	03/11/2020 08:45	1,19	1	1,19	CHI
2020116689	CORUMBAIBA	CI21076932	VILA CORUMBA	03/11/2020 07:34	03/11/2020 12:22	03/11/2020 07:34	03/11/2020 12:22	4,80	1	4,80	CHI
2020116703	ISRAELANDIA	IS12260037	IPORA	03/11/2020 07:35	03/11/2020 10:09	03/11/2020 07:35	03/11/2020 10:09	2,55	1	2,55	CHI
2020116706	BRITANIA	BT12349125	BRITANIA	03/11/2020 07:37	03/11/2020 10:15	03/11/2020 07:37	03/11/2020 10:15	2,63	1	2,63	CHI
2020116707	PLANALTINA	PI12361252	PLANALTINA	03/11/2020 07:38	03/11/2020 13:29	03/11/2020 07:38	03/11/2020 13:29	5,85	31	181,34	CHI
2020116729	PALMEIRAS DE GOIAS	PL31167192	PALMEIRAS	03/11/2020 07:41	03/11/2020 08:56	03/11/2020 07:41	03/11/2020 08:56	1,25	1	1,25	CHI
2020116731	VICENTINOPOLIS	VI21031559	VICENTINOPOLIS	03/11/2020 07:41	03/11/2020 10:50	03/11/2020 07:41	03/11/2020 10:50	3,14	1	3,14	CHI
2020116732	CATALAO	CT11281399	CATALAO S2	03/11/2020 07:41	03/11/2020 08:31	03/11/2020 07:41	03/11/2020 08:31	0,82	83	68,01	CHI
2020116734	PONTALINA	MI12060671	PONTALINA	03/11/2020 07:42	03/11/2020 11:23	03/11/2020 07:42	03/11/2020 11:23	3,68	3	11,05	CHI
2020116737	FLORES DE GOIAS	FB11255046	FLORES DE GOIAS	03/11/2020 07:43	04/11/2020 08:03	03/11/2020 07:43	04/11/2020 08:03	24,33	11	267,63	CHI
2020116742	PLANALTINA	PI21151813	PLANALTINA	03/11/2020 07:43	03/11/2020 09:45	03/11/2020 07:43	03/11/2020 09:45	2,02	1	2,02	CHI
2020117296	FLORES DE GOIAS	FB12085509	FLORES DE GOIAS	03/11/2020 07:43	04/11/2020 00:00	03/11/2020 07:43	04/11/2020 00:00	16,27	6	97,61	CHI
2020116745	LUZIANIA	120417315	RIO VERMELHO	03/11/2020 07:44	03/11/2020 08:56	03/11/2020 07:44	03/11/2020 08:56	1,20	1	1,20	CHI
2020116750	CAMPO ALEGRE DE GOIAS	CM21071194	CAMPO ALEGRE DE GOIAS	03/11/2020 07:45	03/11/2020 09:03	03/11/2020 07:45	03/11/2020 09:03	1,30	1	1,30	CHI
2020116778	COCALZINHO DE GOIAS	ZN12216781	PADRE BERNARDO	03/11/2020 07:52	03/11/2020 11:40	03/11/2020 07:52	03/11/2020 11:40	3,80	12	45,58	CHI
2020116780	BOM JARDIM DE GOIAS	BM12360370	BOM JARDIM	03/11/2020 07:53	03/11/2020 10:03	03/11/2020 07:53	03/11/2020 10:03	2,16	1	2,16	CHI
2020116784	GOIANIA	GN21133713	GOYA S2	03/11/2020 07:54	03/11/2020 09:51	03/11/2020 07:54	03/11/2020 09:51	1,95	1	1,95	CHI
2020116795	TRINDADE	TR12036568	TRINDADE	03/11/2020 07:56	03/11/2020 10:00	03/11/2020 07:56	03/11/2020 10:00	2,07	7	14,46	CHI
2020116798	DIVINOPOLIS DE GOIAS	GH12248894	SAO DOMINGOS	03/11/2020 07:56	03/11/2020 14:59	03/11/2020 07:56	03/11/2020 14:59	7,04	4	28,16	CHI
2020116802	PADRE BERNARDO	PB21330891	PADRE BERNARDO	03/11/2020 07:57	03/11/2020 09:14	03/11/2020 07:57	03/11/2020 09:14	1,27	1	1,27	CHI
2020116806	SAO JOAO D ALIANCA	JL11218465	SAO JOAO D ALIANCA	03/11/2020 07:58	03/11/2020 10:41	03/11/2020 07:58	03/11/2020 10:41	2,71	3	8,12	CHI
2020116807	GOIANIA	14251164	GOYA S1	03/11/2020 07:58	03/11/2020 08:56	03/11/2020 07:58	03/11/2020 08:56	0,96	1	0,96	CHI
2020116808	CRISTALINA	KR12245975	CRISTALINA S1	03/11/2020 07:58	03/11/2020 09:48	03/11/2020 07:58	03/11/2020 09:48	1,82	5	9,11	CHI
2020117249	AGUA FRIA DE GOIAS	PI12048037	SAO JOAO D ALIANCA	03/11/2020 07:58	03/11/2020 11:44	03/11/2020 07:58	03/11/2020 11:44	3,76	7	26,31	CHI
2020116813	FIRMINOPOLIS	TV12105311	FIRMINOPOLIS S1	03/11/2020 07:59	03/11/2020 08:54	03/11/2020 07:59	03/11/2020 08:54	0,91	6	5,45	CHI
2020116819	EDEALINA	ED21088175	PONTALINA	03/11/2020 08:00	03/11/2020 17:31	03/11/2020 08:00	03/11/2020 17:31	9,51	1	9,51	CHI
2020116821	IACIARA	1550023205	IACIARA S1	03/11/2020 08:01	03/11/2020 10:34	03/11/2020 08:01	03/11/2020 10:34	2,54	1	2,54	CHI
2020116823	PORANGATU	840040970	PORANGATU	03/11/2020 08:01	03/11/2020 11:50	03/11/2020 08:01	03/11/2020 11:50	3,80	1	3,80	CHI
2020116826	FLORES DE GOIAS	FB21256387	FLORES DE GOIAS	03/11/2020 08:02	03/11/2020 10:59	03/11/2020 08:02	03/11/2020 10:59	2,94	1	2,94	CHI
2020116832	ANAPOLIS	AN11072485	ANAPOLIS UNIVERSITARIO S2	03/11/2020 08:03	03/11/2020 12:40	03/11/2020 08:03	03/11/2020 12:40	4,62	39	180,01	CHI
2020116834	CRISTALINA	KR12230156	PAMPLONA	03/11/2020 08:03	03/11/2020 10:59	03/11/2020 08:03	03/11/2020 10:59	2,92	22	64,34	CHI
2020116838	IPORA	IR12070239	IPORA	03/11/2020 08:04	03/11/2020 09:40	03/11/2020 08:04	03/11/2020 09:40	1,61	16	25,75	CHI
2020116843	OUVIDOR	OU21141010	CATALAO S1	03/11/2020 08:05	03/11/2020 09:34	03/11/2020 08:05	03/11/2020 09:34	1,48	1	1,48	CHI
2020116844	PLANALTINA	10024400260	PLANALTINA	03/11/2020 08:05	03/11/2020 11:25	03/11/2020 08:05	03/11/2020 11:25	3,33	1	3,33	CHI
2020116854	ITAPURANGA	IK21376323	ITAPURANGA	03/11/2020 08:06	03/11/2020 10:04	03/11/2020 08:06	03/11/2020 10:04	1,95	1	1,95	CHI
2020116856	CUMARI	CY12306730RE	CATALAO S1	03/11/2020 08:07	03/11/2020 10:13	03/11/2020 08:07	03/11/2020 10:13	2,10	134	281,18	CHI
2020116867	ITABERAÍ	IB21281095	ANICUNS	03/11/2020 08:08	03/11/2020 10:47	03/11/2020 08:08	03/11/2020 10:47	2,64	1	2,64	CHI
2020116870	SANTO ANTONIO DO DESCOBERTO	10001550401	ALEXANIA	03/11/2020 08:08	03/11/2020 09:11	03/11/2020 08:08	03/11/2020 09:11	1,03	1	1,03	CHI
2020116907	GOIAS	GS12410738	GOIAS	03/11/2020 08:08	03/11/2020 11:08	03/11/2020 08:08	03/11/2020 11:08	3,00	37	111,06	CHI
2020116871	BRITANIA	BT12130431	BRITANIA	03/11/2020 08:09	03/11/2020 14:26	03/11/2020 08:09	03/11/2020 14:26	6,28	7	43,97	CHI
2020116872	MUNDO NOVO DE GOIAS	MH11274936	NOVA CRIXAS	03/11/2020 08:09	03/11/2020 10:44	03/11/2020 08:09	03/11/2020 10:44	2,58	1	2,58	CHI

2020117078	BOM JARDIM DE GOIAS	BM12208863	BOM JARDIM	03/11/2020 08:10	03/11/2020 12:30	03/11/2020 08:10	03/11/2020 12:30	4,32	8	34,57	CHI
2020116887	GOIAS	GS12310670	GOIAS	03/11/2020 08:12	04/11/2020 12:58	03/11/2020 08:12	03/11/2020 21:57	13,76	2	27,52	CHI
2020116887	GOIAS	GS12310670	GOIAS	03/11/2020 08:12	04/11/2020 12:58	03/11/2020 08:12	04/11/2020 10:10	25,97	2	51,94	CHI
2020116887	GOIAS	GS12310670	GOIAS	03/11/2020 08:12	04/11/2020 12:58	04/11/2020 10:26	04/11/2020 11:02	0,60	2	1,20	CHI
2020116887	GOIAS	GS12310670	GOIAS	03/11/2020 08:12	04/11/2020 12:58	03/11/2020 08:12	04/11/2020 12:58	28,77	2	57,54	CHI
2020116887	GOIAS	GS12201028LD	GOIAS	03/11/2020 08:12	04/11/2020 12:58	04/11/2020 10:25	04/11/2020 12:58	2,54	2	5,08	CHI
2020116888	AGUAS LINDAS DE GOIAS	10011117034	AGUAS LINDAS DE GOIAS S1	03/11/2020 08:12	03/11/2020 09:28	03/11/2020 08:12	03/11/2020 09:28	1,26	1	1,26	CHI
2020116892	APARECIDA DE GOIANIA	16669400	REAL S1	03/11/2020 08:12	03/11/2020 09:40	03/11/2020 08:12	03/11/2020 09:40	1,46	1	1,46	CHI
2020117201	CRIXAS	CX12394923	RUBIATABA	03/11/2020 08:12	03/11/2020 12:39	03/11/2020 08:12	03/11/2020 12:39	4,45	13	57,79	CHI
2020116897	BARRO ALTO	10001529976	BARRO ALTO	03/11/2020 08:13	03/11/2020 15:29	03/11/2020 08:13	03/11/2020 15:29	7,26	1	7,26	CHI
2020116898	GOIANIA	11547388	GOIANIA LESTE S1	03/11/2020 08:13	03/11/2020 09:52	03/11/2020 08:13	03/11/2020 09:52	1,64	1	1,64	CHI
2020116901	MARA ROSA	MQ12135696	MARA ROSA	03/11/2020 08:13	03/11/2020 10:20	03/11/2020 08:13	03/11/2020 10:20	2,10	10	21,02	CHI
2020116906	NEROPOLIS	160015250	NEROPOLIS S2	03/11/2020 08:15	03/11/2020 09:33	03/11/2020 08:15	03/11/2020 09:33	1,30	1	1,30	CHI
2020116910	INHUMAS	30086127	INHUMAS S2	03/11/2020 08:15	03/11/2020 10:51	03/11/2020 08:15	03/11/2020 10:51	2,59	1	2,59	CHI
2020116911	PADRE BERNARDO	PB21251048	PADRE BERNARDO	03/11/2020 08:15	03/11/2020 10:12	03/11/2020 08:15	03/11/2020 10:12	1,94	1	1,94	CHI
2020116918	CRIXAS	CX21280699	RUBIATABA	03/11/2020 08:16	04/11/2020 00:51	03/11/2020 08:16	04/11/2020 00:51	16,57	2	33,13	CHI
2020116923	FORMOSO	FO21181076	MARA ROSA	03/11/2020 08:18	03/11/2020 12:00	03/11/2020 08:18	03/11/2020 12:00	3,69	2	7,38	CHI
2020117165	ESTRELA DO NORTE	ET12036513	MARA ROSA	03/11/2020 08:18	03/11/2020 14:19	03/11/2020 08:18	03/11/2020 14:19	6,01	3	18,03	CHI
2020117165	FORMOSO	ET12036513	MARA ROSA	03/11/2020 08:18	03/11/2020 14:19	03/11/2020 08:18	03/11/2020 14:19	6,01	1	6,01	CHI
2020117165	MARA ROSA	ET12036513	MARA ROSA	03/11/2020 08:18	03/11/2020 14:19	03/11/2020 08:18	03/11/2020 14:19	6,01	6	36,05	CHI
2020116931	CRIXAS	2490026714	SERRA DO OURO	03/11/2020 08:20	03/11/2020 17:10	03/11/2020 08:20	03/11/2020 17:10	8,83	1	8,83	CHI
2020116932	AVELINOPOLIS	AV21343019	ANICUNS	03/11/2020 08:20	03/11/2020 10:17	03/11/2020 08:20	03/11/2020 10:17	1,95	1	1,95	CHI
2020116934	JUSSARA	7630000247	IPORA	03/11/2020 08:21	03/11/2020 13:55	03/11/2020 08:21	03/11/2020 13:55	5,55	1	5,55	CHI
2020116944	OUVIDOR	2180021957	CATALAO S1	03/11/2020 08:22	03/11/2020 10:26	03/11/2020 08:22	03/11/2020 10:26	2,05	1	2,05	CHI
2020116948	ALEXANIA	10031811114	ALEXANIA	03/11/2020 08:23	03/11/2020 09:28	03/11/2020 08:23	03/11/2020 09:28	1,08	1	1,08	CHI
2020116953	GOIANIA	10311427	CAMPINAS S1	03/11/2020 08:23	03/11/2020 11:25	03/11/2020 08:23	03/11/2020 11:25	3,02	1	3,02	CHI
2020116956	RUBIATABA	780038629	RUBIATABA	03/11/2020 08:24	03/11/2020 10:48	03/11/2020 08:24	03/11/2020 10:48	2,40	1	2,40	CHI
2020116957	ITUMBIARA	690249081	ITUMBIARA NOVA	03/11/2020 08:24	03/11/2020 09:28	03/11/2020 08:24	03/11/2020 09:28	1,06	1	1,06	CHI
2020116959	ITAPURANGA	IK12300173	ITAPURANGA	03/11/2020 08:24	03/11/2020 18:02	03/11/2020 08:24	03/11/2020 18:02	9,63	2	19,26	CHI
2020117042	MINACU	IH12339952	MINACU	03/11/2020 08:24	03/11/2020 17:23	03/11/2020 08:24	03/11/2020 17:23	8,98	16	143,64	CHI
2020116974	PLANALTINA	PI12085571	PLANALTINA	03/11/2020 08:26	03/11/2020 13:01	03/11/2020 08:26	03/11/2020 13:01	4,57	47	214,69	CHI
2020116975	SAO DOMINGOS	10011279336	SAO DOMINGOS	03/11/2020 08:27	03/11/2020 19:16	03/11/2020 08:27	03/11/2020 19:16	10,83	1	10,83	CHI
2020116976	BURITINOPOLIS	3610003362	IACIARA S2	03/11/2020 08:27	03/11/2020 10:38	03/11/2020 08:27	03/11/2020 10:38	2,18	1	2,18	CHI
2020116980	AGUA FRIA DE GOIAS	TL21227588	SAO JOAO D ALIANCA	03/11/2020 08:27	03/11/2020 13:30	03/11/2020 08:27	03/11/2020 13:30	5,04	1	5,04	CHI
2020116981	MINACU	6803597	MINACU	03/11/2020 08:28	03/11/2020 22:00	03/11/2020 08:28	03/11/2020 22:00	13,53	1	13,53	CHI
2020117957	SAO JOAO D ALIANCA	JL12314488	SAO JOAO D ALIANCA	03/11/2020 08:28	04/11/2020 11:19	03/11/2020 08:28	04/11/2020 11:19	26,84	8	214,71	CHI
2020118688	MINACU	IH21129789	MINACU	03/11/2020 08:28	03/11/2020 22:07	03/11/2020 08:28	03/11/2020 21:36	13,15	1	13,15	CHI
2020118688	MINACU	IH12182346LD	MINACU	03/11/2020 08:28	03/11/2020 22:07	03/11/2020 19:48	03/11/2020 22:07	2,32	36	83,48	CHI
2020116988	GOIANIA	GN11000014	FERROVIARIO S3	03/11/2020 08:29	03/11/2020 12:02	03/11/2020 10:33	03/11/2020 12:02	1,48	23	34,12	CHI
2020116989	CAMPINORTE	UR21243263	MARA ROSA	03/11/2020 08:30	03/11/2020 12:18	03/11/2020 08:30	03/11/2020 12:18	3,80	2	7,59	CHI
2020116990	CALDAS NOVAS	CN12073020	CALDAS NOVAS S1	03/11/2020 08:30	03/11/2020 12:03	03/11/2020 08:30	03/11/2020 12:03	3,54	2	7,09	CHI
2020116992	PIRENOPOLIS	220039999	CORUMBA	03/11/2020 08:30	03/11/2020 09:52	03/11/2020 08:30	03/11/2020 09:52	1,36	1	1,36	CHI
2020116996	ARUANA	AK12210602	MOZARLANDIA	03/11/2020 08:32	03/11/2020 21:30	03/11/2020 08:32	03/11/2020 21:30	12,98	1	12,98	CHI
2020116996	ARUANA	AK12264829	MOZARLANDIA	03/11/2020 08:32	03/11/2020 21:30	03/11/2020 20:10	03/11/2020 21:30	1,34	30	40,33	CHI
2020117001	GOIATUBA	GT21048451	GOIATUBA S1	03/11/2020 08:32	03/11/2020 09:57	03/11/2020 08:32	03/11/2020 09:57	1,40	1	1,40	CHI
2020117006	GOIANIRA	390003268	GOIANIRA	03/11/2020 08:34	03/11/2020 09:51	03/11/2020 08:34	03/11/2020 09:51	1,27	1	1,27	CHI
2020117007	APARECIDA DE GOIANIA	13839780	REAL S1	03/11/2020 08:34	03/11/2020 10:22	03/11/2020 08:34	03/11/2020 10:22	1,79	1	1,79	CHI
2020117017	VICENTINOPOLIS	VI21263279	VICENTINOPOLIS	03/11/2020 08:36	03/11/2020 10:18	03/11/2020 08:36	03/11/2020 10:18	1,70	1	1,70	CHI
2020117019	PANAMA	PX21263942	GOIATUBA S1	03/11/2020 08:36	03/11/2020 10:54	03/11/2020 08:36	03/11/2020 10:54	2,30	1	2,30	CHI
2020117033	POSSE	PS21132019	IACIARA S2	03/11/2020 08:38	03/11/2020 12:44	03/11/2020 08:38	03/11/2020 12:44	4,09	1	4,09	CHI
2020117035	GOIANIA	GN21153713	AEROPORTO S3	03/11/2020 08:38	03/11/2020 09:31	03/11/2020 08:38	03/11/2020 09:31	0,87	1	0,87	CHI

2020117114	PORANGATU	PO12363572	PORANGATU	03/11/2020 08:38	04/11/2020 18:01	03/11/2020 08:38	04/11/2020 18:01	33,39	9	300,53	CHI
2020117354	GOIANIA	GN11000511	CAMPINAS S3	03/11/2020 08:41	03/11/2020 10:20	03/11/2020 08:41	03/11/2020 10:20	1,64	58	95,01	CHI
2020117046	JANDAIA	JD12308473	PALMEIRAS	03/11/2020 08:42	03/11/2020 10:04	03/11/2020 08:42	03/11/2020 10:04	1,36	7	9,49	CHI
2020117047	INHUMAS	IN21033378	INHUMAS S2	03/11/2020 08:42	03/11/2020 10:22	03/11/2020 08:42	03/11/2020 10:22	1,66	2	3,31	CHI
2020117048	MUNDO NOVO DE GOIAS	MH21286618	NOVA CRIXAS	03/11/2020 08:42	03/11/2020 10:24	03/11/2020 08:42	03/11/2020 10:24	1,69	1	1,69	CHI
2020117049	APARECIDA DE GOIANIA	10001662641	ANHANGUERA	03/11/2020 08:43	03/11/2020 11:05	03/11/2020 08:43	03/11/2020 11:05	2,37	1	2,37	CHI
2020117051	ITAPURANGA	360009750	ITAPURANGA	03/11/2020 08:43	03/11/2020 14:02	03/11/2020 08:43	03/11/2020 14:02	5,31	1	5,31	CHI
2020117054	AMORINOPOLIS	AM12312073	IPORA	03/11/2020 08:44	03/11/2020 12:38	03/11/2020 08:44	03/11/2020 12:38	3,90	3	11,70	CHI
2020117062	BOM JARDIM DE GOIAS	1880014881	BOM JARDIM	03/11/2020 08:45	03/11/2020 15:07	03/11/2020 08:45	03/11/2020 15:07	6,36	1	6,36	CHI
2020117064	ARAGOIANIA	AO11050059	GUAPO S2	03/11/2020 08:45	03/11/2020 18:00	03/11/2020 14:00	03/11/2020 18:00	4,00	144	576,00	CHI
2020117066	APARECIDA DE GOIANIA	14518466	INDEPENDENCIA S2	03/11/2020 08:46	03/11/2020 09:58	03/11/2020 08:46	03/11/2020 09:58	1,20	1	1,20	CHI
2020117067	UIRAPURU	UP12243590	NOVA CRIXAS	03/11/2020 08:46	03/11/2020 11:38	03/11/2020 08:46	03/11/2020 11:38	2,86	5	14,30	CHI
2020117072	GOIAS	GS21311081	GOIAS	03/11/2020 08:46	03/11/2020 10:36	03/11/2020 08:46	03/11/2020 10:36	1,82	2	3,64	CHI
2020117074	ANAPOLIS	AN21135878	ANAPOLIS UNIVERSITARIO S2	03/11/2020 08:47	03/11/2020 19:46	03/11/2020 08:47	03/11/2020 19:46	10,98	1	10,98	CHI
2020117083	EDEIA	EA12223417	EDEIA	03/11/2020 08:47	03/11/2020 11:42	03/11/2020 08:47	03/11/2020 11:42	2,90	1	2,90	CHI
2020117095	SAO FRANCISCO DE GOIAS	PV21236038	SAO FRANCISCO DE GOIAS	03/11/2020 08:51	03/11/2020 11:01	03/11/2020 08:51	03/11/2020 11:01	2,16	2	4,33	CHI
2020117098	GAMELEIRA DE GOIAS	SV12027617	DAIA S2	03/11/2020 08:51	03/11/2020 10:54	03/11/2020 08:51	03/11/2020 10:54	2,04	22	44,78	CHI
2020117104	PIRES DO RIO	460024085	PIRES DO RIO S1	03/11/2020 08:52	03/11/2020 14:53	03/11/2020 08:52	03/11/2020 14:53	6,02	1	6,02	CHI
2020117106	NOVA CRIXAS	NA21091712	NOVA CRIXAS	03/11/2020 08:52	03/11/2020 14:22	03/11/2020 08:52	03/11/2020 14:22	5,49	1	5,49	CHI
2020117938	FIRMINOPOLIS	FR12061388	FIRMINOPOLIS S1	03/11/2020 08:52	03/11/2020 16:01	03/11/2020 08:52	03/11/2020 13:54	5,03	1	5,03	CHI
2020117938	SAO LUIS DE MONTES BELOS	FR12061388	FIRMINOPOLIS S1	03/11/2020 08:52	03/11/2020 16:01	03/11/2020 08:52	03/11/2020 13:54	5,03	3	15,09	CHI
2020117938	FIRMINOPOLIS	FR12061388	FIRMINOPOLIS S1	03/11/2020 08:52	03/11/2020 16:01	03/11/2020 08:52	03/11/2020 16:01	7,15	1	7,15	CHI
2020117109	GOIANIA	11200546	ATLANTICO S1	03/11/2020 08:53	03/11/2020 09:45	03/11/2020 08:53	03/11/2020 09:45	0,86	1	0,86	CHI
2020117113	ITUMBIARA	BG12000055	ITUMBIARA VELHA S2	03/11/2020 08:53	03/11/2020 10:22	03/11/2020 08:53	03/11/2020 10:22	1,48	1	1,48	CHI
2020117115	FAINA	FC12147790	GOIAS	03/11/2020 08:53	03/11/2020 11:23	03/11/2020 08:53	03/11/2020 11:23	2,48	6	14,90	CHI
2020117116	JARAGUA	JA12059976	JARAGUA	03/11/2020 08:54	03/11/2020 10:58	03/11/2020 08:54	03/11/2020 10:58	2,06	2	4,13	CHI
2020117116	PIRENOPOLIS	JA12059976	JARAGUA	03/11/2020 08:54	03/11/2020 10:58	03/11/2020 08:54	03/11/2020 10:58	2,06	98	202,23	CHI
2020117117	LEOPOLDO DE BULHOES	LB21089007	DAIA S2	03/11/2020 08:54	03/11/2020 10:13	03/11/2020 08:54	03/11/2020 10:13	1,31	2	2,63	CHI
2020117130	ANAPOLIS	AN21247699	JUNDIAI S2	03/11/2020 08:57	03/11/2020 12:16	03/11/2020 08:57	03/11/2020 12:16	3,31	1	3,31	CHI
2020117132	CORUMBAIBA	10008185008	VILA CORUMBA	03/11/2020 08:57	03/11/2020 16:01	03/11/2020 08:57	03/11/2020 16:01	7,05	1	7,05	CHI
2020117133	MAMBAI	MB12361315	IACIARA S2	03/11/2020 08:57	03/11/2020 12:09	03/11/2020 08:57	03/11/2020 12:09	3,18	53	168,80	CHI
2020117138	APARECIDA DE GOIANIA	17244110	INDEPENDENCIA S1	03/11/2020 08:59	03/11/2020 10:26	03/11/2020 08:59	03/11/2020 10:26	1,44	1	1,44	CHI
2020117703	CRIXAS	CX12391789	RUBIATABA	03/11/2020 08:59	03/11/2020 19:28	03/11/2020 08:59	03/11/2020 19:28	10,47	8	83,74	CHI
2020117141	MINACU	IH21363350	MINACU	03/11/2020 09:00	03/11/2020 16:05	03/11/2020 09:00	03/11/2020 16:05	7,08	1	7,08	CHI
2020117253	CORUMBA DE GOIAS	CB12381243	CORUMBA	03/11/2020 09:00	04/11/2020 12:22	03/11/2020 09:00	04/11/2020 12:22	27,36	7	191,49	CHI
2020117150	SANCLERLANDIA	SC21163968	FIRMINOPOLIS S2	03/11/2020 09:01	03/11/2020 10:01	03/11/2020 09:01	03/11/2020 10:01	1,00	1	1,00	CHI
2020117158	ABADIANIA	AA21219007	DAIA S2	03/11/2020 09:02	03/11/2020 12:31	03/11/2020 09:02	03/11/2020 12:31	3,47	1	3,47	CHI
2020117166	BALIZA	BH12360382	BOM JARDIM	03/11/2020 09:02	03/11/2020 11:09	03/11/2020 09:02	03/11/2020 11:09	2,10	3	6,30	CHI
2020117170	BURITI ALEGRE	BG12244080	ITUMBIARA VELHA S2	03/11/2020 09:03	03/11/2020 10:52	03/11/2020 09:03	03/11/2020 10:52	1,80	1	1,80	CHI
2020117175	JUSSARA	JR21149407	IPORA	03/11/2020 09:05	03/11/2020 10:42	03/11/2020 09:05	03/11/2020 10:42	1,60	1	1,60	CHI
2020117179	SILVANIA	660057785	VIANOPOLIS	03/11/2020 09:07	03/11/2020 10:19	03/11/2020 09:07	03/11/2020 10:19	1,19	1	1,19	CHI
2020117180	CATALAO	IP12157299RE	IPAMERI	03/11/2020 09:07	03/11/2020 18:50	03/11/2020 09:07	03/11/2020 18:50	9,71	7	67,98	CHI
2020117180	GOIANDIRA	IP12157299RE	IPAMERI	03/11/2020 09:07	03/11/2020 18:50	03/11/2020 09:07	03/11/2020 18:50	9,71	15	145,67	CHI
2020117180	IPAMERI	IP12157299RE	IPAMERI	03/11/2020 09:07	03/11/2020 18:50	03/11/2020 09:07	03/11/2020 18:50	9,71	55	534,11	CHI
2020117181	CAMPOS BELOS	820031902	SAO DOMINGOS	03/11/2020 09:08	03/11/2020 17:14	03/11/2020 09:08	03/11/2020 17:14	8,10	1	8,10	CHI
2020117185	CIDADE OCIDENTAL	DH12277121	MARAJOARA	03/11/2020 09:08	03/11/2020 12:50	03/11/2020 09:08	03/11/2020 12:50	3,69	39	143,94	CHI
2020117186	ABADIANIA	AA21184584	DAIA S2	03/11/2020 09:08	03/11/2020 14:45	03/11/2020 09:08	03/11/2020 14:45	5,61	1	5,61	CHI
2020117192	CALDAS NOVAS	RQ21196405	VILA CORUMBA	03/11/2020 09:09	03/11/2020 14:29	03/11/2020 09:09	03/11/2020 14:29	5,34	2	10,68	CHI
2020117202	PALMEIRAS DE GOIAS	10006108863	PALMEIRAS	03/11/2020 09:12	03/11/2020 10:28	03/11/2020 09:12	03/11/2020 10:28	1,26	1	1,26	CHI
2020117204	NIQUELANDIA	NQ21156247	URUACU	03/11/2020 09:12	03/11/2020 12:32	03/11/2020 09:12	03/11/2020 12:32	3,33	1	3,33	CHI
2020117205	AGUAS LINDAS DE GOIAS	10004420720	AGUAS LINDAS DE GOIAS S1	03/11/2020 09:12	03/11/2020 12:46	03/11/2020 09:12	03/11/2020 12:46	3,56	1	3,56	CHI

2020117208	JARAGUA	70051239	JARAGUA	03/11/2020 09:12	03/11/2020 18:20	03/11/2020 09:12	03/11/2020 18:20	9,12	1	9,12	CHI
2020117211	APARECIDA DE GOIANIA	10475989	REAL S1	03/11/2020 09:14	03/11/2020 10:07	03/11/2020 09:14	03/11/2020 10:07	0,87	1	0,87	CHI
2020117216	PADRE BERNARDO	PB12313952	PADRE BERNARDO	03/11/2020 09:15	03/11/2020 11:30	03/11/2020 09:15	03/11/2020 11:30	2,25	2	4,50	CHI
2020117217	NOVA AURORA	NE21311815	CATALAO S1	03/11/2020 09:15	03/11/2020 10:53	03/11/2020 09:15	03/11/2020 10:53	1,63	1	1,63	CHI
2020117221	BOM JARDIM DE GOIAS	1880004840	BOM JARDIM	03/11/2020 09:16	03/11/2020 15:31	03/11/2020 09:16	03/11/2020 15:31	6,25	1	6,25	CHI
2020117226	JARAGUA	JA21017337	JARAGUA	03/11/2020 09:16	03/11/2020 11:35	03/11/2020 09:16	03/11/2020 11:35	2,30	1	2,30	CHI
2020117227	CRISTALINA	KR12290455LD	PAMPLONA	03/11/2020 09:17	03/11/2020 11:46	03/11/2020 09:17	03/11/2020 11:46	2,48	2	4,97	CHI
2020117233	NIQUELANDIA	NQ21294227	URUACU	03/11/2020 09:17	03/11/2020 12:34	03/11/2020 09:17	03/11/2020 12:34	3,27	1	3,27	CHI
2020117236	INHUMAS	IN21012385	INHUMAS S2	03/11/2020 09:18	03/11/2020 12:17	03/11/2020 09:18	03/11/2020 12:17	2,98	1	2,98	CHI
2020117237	SAO JOAO D ALIANCA	JL12324141	SAO JOAO D ALIANCA	03/11/2020 09:18	03/11/2020 11:54	03/11/2020 09:18	03/11/2020 11:54	2,59	3	7,77	CHI
2020117389	JARAGUA	JA12068133	GOIANESIA S2	03/11/2020 09:18	03/11/2020 11:13	03/11/2020 09:18	03/11/2020 11:13	1,90	8	15,24	CHI
2020117243	JUSSARA	1290021585	JUSSARA	03/11/2020 09:19	03/11/2020 10:58	03/11/2020 09:19	03/11/2020 10:58	1,64	1	1,64	CHI
2020117248	NOVA ROMA	ND21159882	IACIARA S2	03/11/2020 09:20	03/11/2020 11:53	03/11/2020 09:20	03/11/2020 11:53	2,53	1	2,53	CHI
2020110300027	BONFINOPOLIS	1360508	NOVO PLANALTO	03/11/2020 09:20	03/11/2020 09:23	03/11/2020 09:20	03/11/2020 09:23	0,05	1	0,05	CHI
2020110300027	BONOPOLIS	1360508	NOVO PLANALTO	03/11/2020 09:20	03/11/2020 09:23	03/11/2020 09:20	03/11/2020 09:23	0,05	53	2,65	CHI
2020110300027	NOVO PLANALTO	1360508	NOVO PLANALTO	03/11/2020 09:20	03/11/2020 09:23	03/11/2020 09:20	03/11/2020 09:23	0,05	539	26,95	CHI
2020110300027	NOVO PLANALTO	1360508	NOVO PLANALTO	03/11/2020 09:20	03/11/2020 09:23	03/11/2020 09:20	03/11/2020 09:23	0,05	837	41,85	CHI
2020110300027	NOVO PLANALTO	1360508	NOVO PLANALTO	03/11/2020 09:20	03/11/2020 09:23	03/11/2020 09:20	03/11/2020 09:23	0,05	13	0,65	CHI
2020110300027	NOVO PLANALTO	1360508	NOVO PLANALTO	03/11/2020 09:20	03/11/2020 09:23	03/11/2020 09:20	03/11/2020 09:23	0,05	97	4,85	CHI
2020110300027	PORANGATU	1360508	NOVO PLANALTO	03/11/2020 09:20	03/11/2020 09:23	03/11/2020 09:20	03/11/2020 09:23	0,05	244	12,20	CHI
2020110300027	PORANGATU	1360508	NOVO PLANALTO	03/11/2020 09:20	03/11/2020 09:23	03/11/2020 09:20	03/11/2020 09:23	0,05	28	1,40	CHI
2020117254	GOIANIA	10000089760	CARAJAS S1	03/11/2020 09:21	03/11/2020 10:37	03/11/2020 09:21	03/11/2020 10:37	1,25	1	1,25	CHI
2020117258	MARA ROSA	MQ21182280	MARA ROSA	03/11/2020 09:22	03/11/2020 11:03	03/11/2020 09:22	03/11/2020 11:03	1,68	1	1,68	CHI
2020117261	CALDAS NOVAS	CN11103878	SERRA DE CALDAS	03/11/2020 09:22	03/11/2020 11:17	03/11/2020 09:22	03/11/2020 11:17	1,91	67	127,73	CHI
2020117262	GOIATUBA	JV21030314	GOIATUBA S1	03/11/2020 09:22	03/11/2020 12:56	03/11/2020 09:22	03/11/2020 12:56	3,55	1	3,55	CHI
2020117712	PLANALTINA	PI12355774	PLANALTINA	03/11/2020 09:22	03/11/2020 13:17	03/11/2020 09:22	03/11/2020 13:17	3,91	3	11,72	CHI
2020117265	TRINDADE	40158883	TRINDADE	03/11/2020 09:24	03/11/2020 10:55	03/11/2020 09:24	03/11/2020 10:55	1,51	1	1,51	CHI
2020117271	PIRES DO RIO	460081627	PIRES DO RIO S1	03/11/2020 09:25	03/11/2020 16:31	03/11/2020 09:25	03/11/2020 16:31	7,09	1	7,09	CHI
2020117275	GOIANIA	17021194	CAMPINAS S3	03/11/2020 09:26	03/11/2020 16:08	03/11/2020 09:26	03/11/2020 16:08	6,70	1	6,70	CHI
2020117277	ANAPOLIS	AN21258213	ANAPOLIS UNIVERSITARIO S2	03/11/2020 09:26	03/11/2020 10:45	03/11/2020 09:26	03/11/2020 10:45	1,31	4	5,24	CHI
2020117280	GOIANIA	11776882	CAMPINAS S3	03/11/2020 09:26	03/11/2020 11:31	03/11/2020 09:26	03/11/2020 11:31	2,07	1	2,07	CHI
2020117283	CAMPOS BELOS	CH21247440	SAO DOMINGOS	03/11/2020 09:27	03/11/2020 11:03	03/11/2020 09:27	03/11/2020 11:03	1,60	2	3,20	CHI
2020117410	EDEALINA	EA12044531	EDEIA	03/11/2020 09:27	03/11/2020 10:44	03/11/2020 09:27	03/11/2020 10:44	1,27	1	1,27	CHI
2020117410	EDEIA	EA12044531	EDEIA	03/11/2020 09:27	03/11/2020 10:44	03/11/2020 09:27	03/11/2020 10:44	1,27	1	1,27	CHI
2020117583	BONOPOLIS	BX12262764	SAO MIGUEL DO ARAGUAIA	03/11/2020 09:29	03/11/2020 14:44	03/11/2020 09:29	03/11/2020 14:44	5,24	1	5,24	CHI
2020117583	SAO MIGUEL DO ARAGUAIA	BX12262764	SAO MIGUEL DO ARAGUAIA	03/11/2020 09:29	03/11/2020 14:44	03/11/2020 09:29	03/11/2020 14:44	5,24	1	5,24	CHI
2020117584	NOVO PLANALTO	SM12099146RE	SAO MIGUEL DO ARAGUAIA	03/11/2020 09:29	03/11/2020 11:28	03/11/2020 09:29	03/11/2020 11:28	1,97	0	0,00	CHI
2020117584	SAO MIGUEL DO ARAGUAIA	SM12099146RE	SAO MIGUEL DO ARAGUAIA	03/11/2020 09:29	03/11/2020 11:28	03/11/2020 09:29	03/11/2020 11:28	1,97	53	104,54	CHI
2020117314	CRIXAS	CX12181366	SANTA TEREZINHA	03/11/2020 09:32	03/11/2020 22:30	03/11/2020 09:32	03/11/2020 22:30	12,96	4	51,85	CHI
2020117320	GOIANIA	14781426	CAMPINAS S2	03/11/2020 09:33	03/11/2020 11:58	03/11/2020 09:33	03/11/2020 11:58	2,41	1	2,41	CHI
2020117333	CRIXAS	CX12391851	SANTA TEREZINHA	03/11/2020 09:35	03/11/2020 17:27	03/11/2020 09:35	03/11/2020 17:27	7,86	2	15,73	CHI
2020117352	GOIANESIA	GE21425634	GOIANESIA S2	03/11/2020 09:41	03/11/2020 13:17	03/11/2020 09:41	03/11/2020 13:17	3,59	1	3,59	CHI
2020117356	PIRES DO RIO	PR21186603	PIRES DO RIO S1	03/11/2020 09:42	03/11/2020 14:38	03/11/2020 09:42	03/11/2020 14:38	4,93	1	4,93	CHI
2020117357	ALTO PARAISO DE GOIAS	BF12365259	SAO JOAO D ALIANCA	03/11/2020 09:42	04/11/2020 00:19	03/11/2020 09:42	04/11/2020 00:19	14,61	6	87,64	CHI
2020117366	PORANGATU	TA21141122	NOVO PLANALTO	03/11/2020 09:43	03/11/2020 18:22	03/11/2020 09:43	03/11/2020 18:22	8,65	1	8,65	CHI
2020117369	GOIANIA	13415270	AEROPORTO S3	03/11/2020 09:45	03/11/2020 12:02	03/11/2020 09:45	03/11/2020 12:02	2,28	1	2,28	CHI
2020117377	FORMOSA	FA21129986	SAO JOAO D ALIANCA	03/11/2020 09:47	03/11/2020 13:02	03/11/2020 09:47	03/11/2020 13:02	3,23	1	3,23	CHI
2020117380	NIQUELANDIA	NQ12362142	NIQUELANDIA SUBTRANSMISSAO	03/11/2020 09:48	03/11/2020 15:18	03/11/2020 09:48	03/11/2020 15:18	5,49	9	49,40	CHI
2020117388	JUSSARA	JR12101970RE	BRITANIA	03/11/2020 09:49	03/11/2020 16:18	03/11/2020 09:49	03/11/2020 14:53	5,06	9	45,56	CHI
2020117388	JUSSARA	JR12105382	BRITANIA	03/11/2020 09:49	03/11/2020 16:18	03/11/2020 09:49	03/11/2020 16:18	6,48	2	12,97	CHI
2020117392	CERES	RB12110430	RUBIATABA	03/11/2020 09:51	03/11/2020 23:42	03/11/2020 09:51	03/11/2020 23:42	13,86	14	194,09	CHI

2020117392	CERES	RB12110430	RUBIATABA	03/11/2020 09:51	03/11/2020 23:42	03/11/2020 22:52	03/11/2020 23:42	0,84	1	0,84	CHI
2020117399	GOIANIA	12405437	GOYA S2	03/11/2020 09:52	03/11/2020 12:16	03/11/2020 09:52	03/11/2020 12:16	2,39	1	2,39	CHI
2020117401	FORMOSA	10020637720	ITUIQUIRA	03/11/2020 09:52	03/11/2020 11:51	03/11/2020 09:52	03/11/2020 11:51	1,97	1	1,97	CHI
2020117414	NIQUELANDIA	NQ12330279	NIQUELANDIA SUBTRANSMISSAO	03/11/2020 09:57	03/11/2020 14:21	03/11/2020 09:57	03/11/2020 14:21	4,39	4	17,57	CHI
2020117421	GOIANIA	14652470	REAL S2	03/11/2020 09:57	03/11/2020 11:56	03/11/2020 09:57	03/11/2020 11:56	1,97	1	1,97	CHI
2020117422	SENADOR CANEDO	190056400	SENADOR CANEDO	03/11/2020 09:57	03/11/2020 11:13	03/11/2020 09:57	03/11/2020 11:13	1,25	1	1,25	CHI
2020117427	NIQUELANDIA	NQ21288148	URUACU	03/11/2020 09:58	03/11/2020 11:18	03/11/2020 09:58	03/11/2020 11:18	1,32	1	1,32	CHI
2020119680	NIQUELANDIA	2750121900	NIQUELANDIA SUBTRANSMISSAO	03/11/2020 09:58	04/11/2020 04:05	03/11/2020 09:58	04/11/2020 04:05	18,10	1	18,10	CHI
2020117430	GOIANIA	GN21047151	AEROPORTO S1	03/11/2020 09:59	03/11/2020 11:05	03/11/2020 10:33	03/11/2020 11:05	0,53	25	13,34	CHI
2020117431	FORMOSA	10005714131	ITUIQUIRA	03/11/2020 09:59	03/11/2020 11:36	03/11/2020 09:59	03/11/2020 11:36	1,61	1	1,61	CHI
2020117433	GOIANIA	16610878	CAMPINAS S2	03/11/2020 10:00	03/11/2020 11:20	03/11/2020 10:00	03/11/2020 11:20	1,33	1	1,33	CHI
2020117440	GOIANIA	15130678	REAL S2	03/11/2020 10:01	03/11/2020 14:09	03/11/2020 10:01	03/11/2020 14:09	4,12	1	4,12	CHI
2020117443	ITAPIRAPUA	IU21073515	MATRINCHA	03/11/2020 10:02	03/11/2020 12:50	03/11/2020 10:02	03/11/2020 12:50	2,79	1	2,79	CHI
2020117444	APARECIDA DE GOIANIA	200619275	INDEPENDENCIA S1	03/11/2020 10:02	03/11/2020 11:15	03/11/2020 10:02	03/11/2020 11:15	1,21	1	1,21	CHI
2020117451	OUVIDOR	10014231164	CATALAO S1	03/11/2020 10:03	03/11/2020 13:11	03/11/2020 10:03	03/11/2020 13:11	3,12	1	3,12	CHI
2020117453	FAINA	FC12228930	GOIAS	03/11/2020 10:04	03/11/2020 12:48	03/11/2020 10:04	03/11/2020 12:48	2,73	12	32,74	CHI
2020117572	AGUA FRIA DE GOIAS	JL12261887	SAO JOAO D ALIANCA	03/11/2020 10:04	03/11/2020 15:17	03/11/2020 10:04	03/11/2020 15:17	5,21	1	5,21	CHI
2020117572	SAO JOAO D ALIANCA	JL12261887	SAO JOAO D ALIANCA	03/11/2020 10:04	03/11/2020 15:17	03/11/2020 10:04	03/11/2020 15:17	5,21	10	52,11	CHI
2020117462	AMORINOPOLIS	1240008767	IPORA	03/11/2020 10:05	03/11/2020 16:37	03/11/2020 10:05	03/11/2020 16:37	6,54	1	6,54	CHI
2020117465	CALDAS NOVAS	CN21038976	CALDAS NOVAS S1	03/11/2020 10:06	03/11/2020 14:38	03/11/2020 10:06	03/11/2020 14:38	4,52	2	9,05	CHI
2020117478	ANAPOLIS	20508750	ANAPOLIS UNIVERSITARIO S2	03/11/2020 10:10	03/11/2020 11:40	03/11/2020 10:10	03/11/2020 11:40	1,50	1	1,50	CHI
2020117479	CAMPO ALEGRE DE GOIAS	CM12066212	CAMPO ALEGRE DE GOIAS	03/11/2020 10:10	03/11/2020 12:03	03/11/2020 10:10	03/11/2020 12:03	1,87	1	1,87	CHI
2020117483	IPAMERI	IP21319002	IPAMERI	03/11/2020 10:12	03/11/2020 11:08	03/11/2020 10:12	03/11/2020 11:08	0,93	1	0,93	CHI
2020117488	NIQUELANDIA	4360001096	URUACU	03/11/2020 10:13	03/11/2020 17:15	03/11/2020 10:13	03/11/2020 17:15	7,02	1	7,02	CHI
2020117501	ARAGOIANIA	AO12095512	GUAPO S2	03/11/2020 10:14	03/11/2020 16:51	03/11/2020 10:14	03/11/2020 13:16	3,04	19	57,83	CHI
2020117501	GUAPO	AO12000031	GUAPO S2	03/11/2020 10:14	03/11/2020 16:51	03/11/2020 10:14	03/11/2020 13:55	3,69	10	36,94	CHI
2020117501	GUAPO	GA12064827	GUAPO S2	03/11/2020 10:14	03/11/2020 16:51	03/11/2020 15:47	03/11/2020 16:51	1,08	1	1,08	CHI
2020117497	GOIANESIA	GE21258540	GOIANESIA S1	03/11/2020 10:15	03/11/2020 12:28	03/11/2020 10:15	03/11/2020 12:28	2,22	2	4,43	CHI
2020119987	NIQUELANDIA	8420000336	NIQUELANDIA SUBTRANSMISSAO	03/11/2020 10:15	03/11/2020 22:30	03/11/2020 10:15	03/11/2020 22:30	12,24	1	12,24	CHI
2020117504	ITAPACI	10000213088	ITAPACI	03/11/2020 10:16	03/11/2020 11:32	03/11/2020 10:16	03/11/2020 11:32	1,26	1	1,26	CHI
2020117510	CRIXAS	CX21330106	SANTA TEREZINHA	03/11/2020 10:17	04/11/2020 10:53	03/11/2020 10:17	04/11/2020 10:53	24,59	1	24,59	CHI
2020117513	FAZENDA NOVA	FN12183426	IPORA	03/11/2020 10:17	03/11/2020 15:43	03/11/2020 10:17	03/11/2020 15:43	5,42	9	48,78	CHI
2020117535	CAMPO ALEGRE DE GOIAS	CT10394223	CATALAO S1	03/11/2020 10:17	04/11/2020 02:15	03/11/2020 10:17	03/11/2020 10:31	0,22	1	0,22	CHI
2020117535	CATALAO	CT10394223	CATALAO S1	03/11/2020 10:17	04/11/2020 02:15	03/11/2020 10:17	03/11/2020 10:31	0,22	26	5,85	CHI
2020117535	DAVINOPOLIS	CT10394223	CATALAO S1	03/11/2020 10:17	04/11/2020 02:15	03/11/2020 10:17	03/11/2020 10:31	0,22	6	1,35	CHI
2020117535	CATALAO	CT10394223	CATALAO S1	03/11/2020 10:17	04/11/2020 02:15	03/11/2020 10:17	04/11/2020 02:12	15,91	1330	21163,26	CHI
2020117535	DAVINOPOLIS	CT10394223	CATALAO S1	03/11/2020 10:17	04/11/2020 02:15	03/11/2020 10:17	04/11/2020 02:12	15,91	6	95,47	CHI
2020117535	CAMPO ALEGRE DE GOIAS	CT10394223	CATALAO S1	03/11/2020 10:17	04/11/2020 02:15	03/11/2020 10:17	04/11/2020 02:15	15,97	2	31,94	CHI
2020117535	CATALAO	CT10394223	CATALAO S1	03/11/2020 10:17	04/11/2020 02:15	03/11/2020 10:17	04/11/2020 02:15	15,97	235	3753,15	CHI
2020117535	DISTRITO FEDERAL	CT10394223	CATALAO S1	03/11/2020 10:17	04/11/2020 02:15	03/11/2020 10:17	04/11/2020 02:15	15,97	1	15,97	CHI
202011137892	CATALAO	CT11377087	CATALAO S1	03/11/2020 10:17	03/11/2020 22:55	03/11/2020 10:17	03/11/2020 22:55	12,62	14	176,70	CHI
2020117517	SANTA CRUZ DE GOIAS	BC12023183	CRISTIANOPOLIS	03/11/2020 10:18	04/11/2020 22:16	03/11/2020 10:18	03/11/2020 14:04	3,76	25	94,11	CHI
2020117517	SANTA CRUZ DE GOIAS	BC12300730LD	CRISTIANOPOLIS	03/11/2020 10:18	04/11/2020 22:16	03/11/2020 10:18	03/11/2020 18:35	8,29	7	58,02	CHI
2020117517	SANTA CRUZ DE GOIAS	CF12027146LD	CRISTIANOPOLIS	03/11/2020 10:18	04/11/2020 22:16	03/11/2020 10:18	03/11/2020 19:59	9,68	8	77,42	CHI
2020117517	SANTA CRUZ DE GOIAS	BC12186561LD	CRISTIANOPOLIS	03/11/2020 10:18	04/11/2020 22:16	03/11/2020 10:18	03/11/2020 22:03	11,75	1	11,75	CHI
2020117517	SANTA CRUZ DE GOIAS	BC12023183	CRISTIANOPOLIS	03/11/2020 10:18	04/11/2020 22:16	03/11/2020 10:18	04/11/2020 22:16	35,97	1	35,97	CHI
2020117517	SANTA CRUZ DE GOIAS	BC12023183	CRISTIANOPOLIS	03/11/2020 10:18	04/11/2020 22:16	04/11/2020 18:15	04/11/2020 22:16	4,03	41	165,31	CHI
2020117519	CEZARINA	CZ12323632	CEZARINA	03/11/2020 10:19	03/11/2020 14:41	03/11/2020 10:19	03/11/2020 14:41	4,37	2	8,74	CHI
2020117519	INDIARA	CZ12323632	CEZARINA	03/11/2020 10:19	03/11/2020 14:41	03/11/2020 10:19	03/11/2020 14:41	4,37	3	13,12	CHI
2020117522	SIMOLANDIA	1940007784	IACIARA S2	03/11/2020 10:20	03/11/2020 21:43	03/11/2020 10:20	03/11/2020 21:43	11,37	1	11,37	CHI
2020117523	ITUMBIARA	IT21040299	PARANAIBA	03/11/2020 10:20	03/11/2020 11:25	03/11/2020 10:20	03/11/2020 11:25	1,07	1	1,07	CHI

2020117527	SAO FRANCISCO DE GOIAS	SF21343942	SAO FRANCISCO DE GOIAS	03/11/2020 10:21	03/11/2020 17:32	03/11/2020 10:21	03/11/2020 17:32	7,17	1	7,17	CHI
2020118359	BRITANIA	BT21255577	BRITANIA	03/11/2020 10:23	03/11/2020 16:16	03/11/2020 10:23	03/11/2020 16:16	5,88	1	5,88	CHI
2020117549	PARAUNA	PU12314958	PARAUNA	03/11/2020 10:26	03/11/2020 12:24	03/11/2020 10:26	03/11/2020 12:24	1,95	2	3,90	CHI
2020117549	RIO VERDE	PU12314958	PARAUNA	03/11/2020 10:26	03/11/2020 12:24	03/11/2020 10:26	03/11/2020 12:24	1,95	1	1,95	CHI
2020117551	ITAPURANGA	170006372	ITAPURANGA	03/11/2020 10:27	03/11/2020 16:08	03/11/2020 10:27	03/11/2020 16:08	5,68	1	5,68	CHI
2020117555	GOIANIA	10009295109	CARAJAS S2	03/11/2020 10:27	03/11/2020 11:57	03/11/2020 10:27	03/11/2020 11:57	1,49	1	1,49	CHI
2020117574	JUSSARA	JR12375831	BRITANIA	03/11/2020 10:30	03/11/2020 15:13	03/11/2020 10:30	03/11/2020 15:13	4,70	6	28,23	CHI
2020117576	GOIANIA	12482651	GOIANIA LESTE S2	03/11/2020 10:31	03/11/2020 11:08	03/11/2020 10:31	03/11/2020 11:08	0,62	1	0,62	CHI
2020117581	APARECIDA DE GOIANIA	10031333085	INDEPENDENCIA S2	03/11/2020 10:32	03/11/2020 11:29	03/11/2020 10:32	03/11/2020 11:29	0,95	1	0,95	CHI
2020117600	APARECIDA DE GOIANIA	AP11062674	ANHANGUERA	03/11/2020 10:35	03/11/2020 12:17	03/11/2020 10:35	03/11/2020 12:17	1,70	260	440,70	CHI
2020117604	PIRACANJUBA	PJ21233835	PIRACANJUBA	03/11/2020 10:36	03/11/2020 12:24	03/11/2020 10:36	03/11/2020 12:24	1,78	1	1,78	CHI
2020117605	FORMOSA	FA21432200	SAO JOAO D ALIANCA	03/11/2020 10:37	03/11/2020 18:40	03/11/2020 10:37	03/11/2020 18:40	8,04	1	8,04	CHI
2020117610	ANAPOLIS	AN21285291	ANAPOLIS UNIVERSITARIO S1	03/11/2020 10:38	03/11/2020 12:57	03/11/2020 10:38	03/11/2020 12:57	2,31	1	2,31	CHI
2020117615	PONTALINA	10032674684	PONTALINA	03/11/2020 10:40	03/11/2020 16:30	03/11/2020 10:40	03/11/2020 16:30	5,83	1	5,83	CHI
2020117617	CATALAO	1990091523	CATALAO S2	03/11/2020 10:40	03/11/2020 16:29	03/11/2020 10:40	03/11/2020 16:29	5,81	1	5,81	CHI
2020117636	GOIANIA	GN11166608	CARAJAS S2	03/11/2020 10:41	03/11/2020 12:46	03/11/2020 11:32	03/11/2020 12:46	1,23	24	29,53	CHI
2020117768	DOVERLANDIA	DV12171957	CAIAPONIA	03/11/2020 10:41	03/11/2020 15:08	03/11/2020 10:41	03/11/2020 15:08	4,44	24	106,67	CHI
2020117625	CALDAS NOVAS	MG12120776	VILA CORUMBA	03/11/2020 10:42	03/11/2020 18:32	03/11/2020 10:42	03/11/2020 18:32	7,83	1	7,83	CHI
2020117625	MARZAGAO	MG12120776	VILA CORUMBA	03/11/2020 10:42	03/11/2020 18:32	03/11/2020 10:42	03/11/2020 18:32	7,83	1	7,83	CHI
2020117628	ANAPOLIS	21236630	JUNDIAI S1	03/11/2020 10:42	03/11/2020 18:55	03/11/2020 10:42	03/11/2020 18:55	8,21	1	8,21	CHI
2020117659	AMERICANO DO BRASIL	KB11361931	ANICUNS	03/11/2020 10:48	03/11/2020 12:04	03/11/2020 10:48	03/11/2020 12:04	1,26	66	83,40	CHI
2020117660	ITUMBIARA	IT21273839	ITUMBIARA NOVA	03/11/2020 10:48	03/11/2020 12:18	03/11/2020 10:48	03/11/2020 12:18	1,49	1	1,49	CHI
2020117671	GUARANI DE GOIAS	GY21293725	IACIARA S1	03/11/2020 10:51	04/11/2020 00:36	03/11/2020 10:51	04/11/2020 00:36	13,74	1	13,74	CHI
2020117678	JUSSARA	1290031402	JUSSARA	03/11/2020 10:55	03/11/2020 15:20	03/11/2020 10:55	03/11/2020 15:20	4,41	1	4,41	CHI
2020117680	GOIANIA	14316500	MEIA PONTE	03/11/2020 10:56	03/11/2020 16:08	03/11/2020 10:56	03/11/2020 16:08	5,20	1	5,20	CHI
2020117694	PIRENOPOLIS	PV12000119	CORUMBA	03/11/2020 10:58	03/11/2020 13:44	03/11/2020 10:58	03/11/2020 13:44	2,76	6	16,57	CHI
2020117710	IPAMERI	580112822	IPAMERI	03/11/2020 10:59	03/11/2020 16:27	03/11/2020 10:59	03/11/2020 16:27	5,46	1	5,46	CHI
2020117932	CATURAI	GR12033390	GOIANIRA	03/11/2020 10:59	03/11/2020 13:23	03/11/2020 10:59	03/11/2020 13:23	2,40	162	388,75	CHI
2020117932	GOIANIRA	GR12033390	GOIANIRA	03/11/2020 10:59	03/11/2020 13:23	03/11/2020 10:59	03/11/2020 13:23	2,40	19	45,59	CHI
2020117932	INHUMAS	GR12033390	GOIANIRA	03/11/2020 10:59	03/11/2020 13:23	03/11/2020 10:59	03/11/2020 13:23	2,40	9	21,60	CHI
2020117713	PARAUNA	980018717	PARAUNA	03/11/2020 11:00	03/11/2020 17:12	03/11/2020 11:00	03/11/2020 17:12	6,19	1	6,19	CHI
2020117718	GOIANIA	10357804	CAMPINAS S1	03/11/2020 11:01	03/11/2020 14:37	03/11/2020 11:01	03/11/2020 14:37	3,59	1	3,59	CHI
2020117727	GOIANIA	10233180	CAMPINAS S3	03/11/2020 11:03	03/11/2020 16:52	03/11/2020 11:03	03/11/2020 16:52	5,80	1	5,80	CHI
2020117735	FORMOSA	610328621	ITUIQUIRA	03/11/2020 11:06	03/11/2020 15:34	03/11/2020 11:06	03/11/2020 15:34	4,47	1	4,47	CHI
2020117736	AMARALINA	MQ12210288	NOVA CRIXAS	03/11/2020 11:06	03/11/2020 15:41	03/11/2020 11:06	03/11/2020 15:41	4,58	6	27,49	CHI
2020117737	JARAGUA	JA21238154	JARAGUA	03/11/2020 11:06	03/11/2020 14:33	03/11/2020 11:06	03/11/2020 14:33	3,44	2	6,88	CHI
2020117741	ORIZONA	VN12072138	VIANOPOLIS	03/11/2020 11:08	03/11/2020 12:36	03/11/2020 11:08	03/11/2020 12:36	1,46	23	33,58	CHI
2020117741	VIANOPOLIS	VN12072138	VIANOPOLIS	03/11/2020 11:08	03/11/2020 12:36	03/11/2020 11:08	03/11/2020 12:36	1,46	88	128,48	CHI
2020117744	TRINDADE	10020997700	TRINDADE	03/11/2020 11:09	03/11/2020 13:33	03/11/2020 11:09	03/11/2020 13:33	2,39	1	2,39	CHI
2020117755	MINACU	IH21137695	MINACU	03/11/2020 11:12	04/11/2020 08:07	03/11/2020 11:12	04/11/2020 08:07	20,90	1	20,90	CHI
2020117760	MARA ROSA	MQ21136496	MARA ROSA	03/11/2020 11:14	03/11/2020 13:48	03/11/2020 11:14	03/11/2020 13:48	2,57	2	5,13	CHI
2020117761	CIDADE OCIDENTAL	DH11149850	MARAJOARA	03/11/2020 11:14	03/11/2020 13:15	03/11/2020 11:14	03/11/2020 13:15	2,01	360	724,20	CHI
2020117765	CAMPO LIMPO	AN21258878	NEROPOLIS S1	03/11/2020 11:15	03/11/2020 14:33	03/11/2020 11:15	03/11/2020 14:33	3,29	2	6,58	CHI
2020117771	VIANOPOLIS	OZ21153244	PIRES DO RIO S2	03/11/2020 11:16	03/11/2020 15:26	03/11/2020 11:16	03/11/2020 15:26	4,16	2	8,32	CHI
2020117775	URUACU	640113163	URUACU	03/11/2020 11:16	03/11/2020 17:55	03/11/2020 11:16	03/11/2020 17:55	6,64	1	6,64	CHI
2020117778	NOVA CRIXAS	NA21213679	NOVA CRIXAS	03/11/2020 11:17	03/11/2020 18:20	03/11/2020 11:17	03/11/2020 18:20	7,04	2	14,07	CHI
2020117779	MONTE ALEGRE DE GOIAS	MA21233202	SAO DOMINGOS	03/11/2020 11:17	03/11/2020 18:20	03/11/2020 11:17	03/11/2020 18:20	7,04	2	14,07	CHI
2020117782	CAMPOS BELOS	820001510	SAO DOMINGOS	03/11/2020 11:18	03/11/2020 13:31	03/11/2020 11:18	03/11/2020 13:31	2,21	1	2,21	CHI
2020117783	PALMEIRAS DE GOIAS	590036294	PALMEIRAS	03/11/2020 11:18	03/11/2020 15:26	03/11/2020 11:18	03/11/2020 15:26	4,12	1	4,12	CHI
2020117785	PORANGATU	PO21357400	PORANGATU	03/11/2020 11:18	03/11/2020 14:46	03/11/2020 11:18	03/11/2020 14:46	3,45	1	3,45	CHI
2020117790	TRINDADE	TR21119538	TRINDADE	03/11/2020 11:19	03/11/2020 17:11	03/11/2020 11:19	03/11/2020 17:11	5,86	1	5,86	CHI

2020117800	GOIANIA	GN21063578	MEIA PONTE	03/11/2020 11:22	03/11/2020 12:25	03/11/2020 11:22	03/11/2020 12:25	1,05	8	8,39	CHI
2020117802	GOIANIA	15222330	XAVANTES	03/11/2020 11:22	03/11/2020 13:56	03/11/2020 11:22	03/11/2020 13:56	2,56	1	2,56	CHI
2020118290	PORANGATU	PO12022073	PORANGATU	03/11/2020 11:22	03/11/2020 16:25	03/11/2020 11:22	03/11/2020 16:25	5,05	47	237,32	CHI
2020117807	MUNDO NOVO DE GOIAS	MH21037756	NOVA CRIXAS	03/11/2020 11:24	03/11/2020 14:45	03/11/2020 11:24	03/11/2020 14:45	3,35	1	3,35	CHI
2020118772	AMARALINA	LC12286013	NOVA CRIXAS	03/11/2020 11:25	03/11/2020 19:41	03/11/2020 11:25	03/11/2020 19:41	8,25	9	74,28	CHI
2020118772	MARA ROSA	LC12286013	NOVA CRIXAS	03/11/2020 11:25	03/11/2020 19:41	03/11/2020 11:25	03/11/2020 19:41	8,25	1	8,25	CHI
2020117819	PIRENOPOLIS	PV21230706	CORUMBA	03/11/2020 11:26	03/11/2020 15:06	03/11/2020 11:26	03/11/2020 15:06	3,66	1	3,66	CHI
2020117841	SILVANIA	660020671	VIANOPOLIS	03/11/2020 11:34	03/11/2020 15:00	03/11/2020 11:34	03/11/2020 15:00	3,43	1	3,43	CHI
2020117842	GOIANIA	GN21401046	GOIANIA LESTE S3	03/11/2020 11:34	03/11/2020 14:50	03/11/2020 14:19	03/11/2020 14:50	0,52	1	0,52	CHI
2020117845	GOIANIA	10012495423	GOYA S1	03/11/2020 11:34	03/11/2020 13:13	03/11/2020 11:34	03/11/2020 13:13	1,63	1	1,63	CHI
2020117848	APARECIDA DE GOIANIA	10006554030	INDEPENDENCIA S2	03/11/2020 11:35	03/11/2020 13:28	03/11/2020 11:35	03/11/2020 13:28	1,87	1	1,87	CHI
2020117850	NOVA CRIXAS	SM12099600	SAO MIGUEL DO ARAGUAIA	03/11/2020 11:36	04/11/2020 08:43	03/11/2020 11:36	04/11/2020 08:43	21,11	1	21,11	CHI
2020117850	SAO MIGUEL DO ARAGUAIA	SM12099600	SAO MIGUEL DO ARAGUAIA	03/11/2020 11:36	04/11/2020 08:43	03/11/2020 11:36	04/11/2020 08:43	21,11	87	1836,96	CHI
2020117851	GOIANIRA	390001570	GOIANIRA	03/11/2020 11:36	03/11/2020 14:18	03/11/2020 11:36	03/11/2020 14:18	2,69	1	2,69	CHI
2020117853	GOIANIA	12132780	CAMPINAS S2	03/11/2020 11:36	03/11/2020 15:11	03/11/2020 11:36	03/11/2020 15:11	3,58	1	3,58	CHI
2020117868	UIRAPURU	UP21181255	SANTA TEREZINHA	03/11/2020 11:40	03/11/2020 17:14	03/11/2020 11:40	03/11/2020 17:14	5,55	1	5,55	CHI
2020117879	PORANGATU	PO21145201	PORANGATU	03/11/2020 11:40	03/11/2020 14:37	03/11/2020 11:40	03/11/2020 14:37	2,94	1	2,94	CHI
2020118220	IPAMERI	IP12112780	IPAMERI	03/11/2020 11:40	03/11/2020 16:44	03/11/2020 11:40	03/11/2020 16:44	5,05	11	55,58	CHI
2020110300023	GOIANIA	610294	CAMPINAS S2	03/11/2020 11:40	03/11/2020 11:45	03/11/2020 11:40	03/11/2020 11:45	0,08	8346	695,50	CHI
2020117873	JARAGUA	10009274179	JARAGUA	03/11/2020 11:41	03/11/2020 15:21	03/11/2020 11:41	03/11/2020 15:21	3,66	1	3,66	CHI
2020117877	PORANGATU	PO12240727	PORANGATU	03/11/2020 11:42	03/11/2020 20:30	03/11/2020 11:42	03/11/2020 20:30	8,79	1	8,79	CHI
2020117878	GOIAS	90042657	GOIAS	03/11/2020 11:42	03/11/2020 14:04	03/11/2020 11:42	03/11/2020 14:04	2,37	1	2,37	CHI
2020117884	CORUMBAIBA	CI21330060	VILA CORUMBA	03/11/2020 11:43	03/11/2020 13:37	03/11/2020 11:43	03/11/2020 13:37	1,89	1	1,89	CHI
2020117885	APARECIDA DE GOIANIA	10013064108	INDEPENDENCIA S1	03/11/2020 11:44	03/11/2020 12:11	03/11/2020 11:44	03/11/2020 12:11	0,44	1	0,44	CHI
2020117890	MUNDO NOVO DE GOIAS	MH21248575	NOVA CRIXAS	03/11/2020 11:46	03/11/2020 13:30	03/11/2020 11:46	03/11/2020 13:30	1,72	1	1,72	CHI
2020117892	PIRENOPOLIS	220087404	CORUMBA	03/11/2020 11:47	03/11/2020 15:00	03/11/2020 11:47	03/11/2020 15:00	3,22	1	3,22	CHI
2020117908	GOIANIA	GN11203603	REAL S2	03/11/2020 11:48	03/11/2020 12:35	03/11/2020 11:48	03/11/2020 12:35	0,77	88	67,59	CHI
2020117899	ESTRELA DO NORTE	ET12088710	MARA ROSA	03/11/2020 11:49	03/11/2020 18:29	03/11/2020 11:49	03/11/2020 18:29	6,66	1	6,66	CHI
2020117909	VALPARAISO DE GOIAS	2860258729	MARAJOA	03/11/2020 11:50	03/11/2020 13:40	03/11/2020 11:50	03/11/2020 13:40	1,84	1	1,84	CHI
2020117995	SAO LUIS DE MONTES BELOS	SL12007006	FIRMINOPOLIS S1	03/11/2020 11:50	03/11/2020 16:32	03/11/2020 11:50	03/11/2020 16:32	4,70	10	46,98	CHI
2020118067	ITABERAI	IB12102567	ITABERAI S1	03/11/2020 11:50	03/11/2020 14:40	03/11/2020 11:50	03/11/2020 14:40	2,82	1	2,82	CHI
2020118067	ITAUCU	IB12102567	ITABERAI S1	03/11/2020 11:50	03/11/2020 14:40	03/11/2020 11:50	03/11/2020 14:40	2,82	1	2,82	CHI
2020117915	ABADIANIA	AA12388796	DAIA S2	03/11/2020 11:51	03/11/2020 14:58	03/11/2020 11:51	03/11/2020 14:58	3,10	35	108,67	CHI
2020118074	GOIANDIRA	GD12127686	CATALAO S1	03/11/2020 11:51	03/11/2020 18:08	03/11/2020 11:51	03/11/2020 18:08	6,27	2	12,54	CHI
2020110300024	GOIANIA	610294	CAMPINAS S2	03/11/2020 11:52	03/11/2020 12:01	03/11/2020 11:52	03/11/2020 12:01	0,15	8346	1251,90	CHI
2020117928	ALEXANIA	480029404	ALEXANIA	03/11/2020 11:56	03/11/2020 13:59	03/11/2020 11:56	03/11/2020 13:59	2,04	1	2,04	CHI
2020117929	SAO MIGUEL DO ARAGUAIA	830069896	SAO MIGUEL DO ARAGUAIA	03/11/2020 11:56	03/11/2020 13:52	03/11/2020 11:56	03/11/2020 13:52	1,93	1	1,93	CHI
2020117941	GOIANIA	GN11039688	GOIANIA LESTE S3	03/11/2020 11:58	03/11/2020 16:06	03/11/2020 11:58	03/11/2020 16:06	4,12	16	65,92	CHI
2020116366	PALMEIRAS DE GOIAS	PL11312588	PALMEIRAS	03/11/2020 12:02	03/11/2020 16:11	03/11/2020 12:02	03/11/2020 16:11	4,14	412	1704,31	CHI
2020117945	CRISTALINA	KR12133609	CRISTALINA S1	03/11/2020 12:03	03/11/2020 16:13	03/11/2020 12:03	03/11/2020 16:13	4,16	5	20,79	CHI
2020117945	IPAMERI	KR12133609	CRISTALINA S1	03/11/2020 12:03	03/11/2020 16:13	03/11/2020 12:03	03/11/2020 16:13	4,16	5	20,79	CHI
2020117954	PADRE BERNARDO	10006837253	PADRE BERNARDO	03/11/2020 12:05	03/11/2020 14:40	03/11/2020 12:05	03/11/2020 14:40	2,57	1	2,57	CHI
2020117955	ITAPURANGA	HE21087868	ITAPURANGA	03/11/2020 12:05	03/11/2020 19:32	03/11/2020 12:05	03/11/2020 19:32	7,44	1	7,44	CHI
2020117960	ITAPURANGA	170066678	ITAPURANGA	03/11/2020 12:07	03/11/2020 19:58	03/11/2020 12:07	03/11/2020 19:58	7,85	1	7,85	CHI
2020117962	GOIANIA	15413792	GOIANIA LESTE S1	03/11/2020 12:07	03/11/2020 14:36	03/11/2020 12:07	03/11/2020 14:36	2,48	1	2,48	CHI
2020117963	NOVO GAMA	2460055074	PACAEMBU S1	03/11/2020 12:07	03/11/2020 15:24	03/11/2020 12:07	03/11/2020 15:24	3,27	1	3,27	CHI
2020117964	FORMOSA	FA11242930	SAO JOAO D ALIANCA	03/11/2020 12:08	03/11/2020 16:47	03/11/2020 12:08	03/11/2020 16:47	4,65	12	55,80	CHI
2020117972	CATALAO	CT21042496	CATALAO S2	03/11/2020 12:12	03/11/2020 18:04	03/11/2020 12:12	03/11/2020 18:04	5,87	2	11,73	CHI
2020118031	NOVA ROMA	ND12256420	IACIARA S2	03/11/2020 12:13	03/11/2020 16:08	03/11/2020 12:13	03/11/2020 16:08	3,91	30	117,43	CHI
2020117981	CATALAO	CT11077304	CATALAO S1	03/11/2020 12:14	03/11/2020 17:44	03/11/2020 12:14	03/11/2020 17:44	5,50	49	269,30	CHI
2020117495	PLANALTINA	PI12383324	PLANALTINA	03/11/2020 12:20	03/11/2020 17:27	03/11/2020 12:20	03/11/2020 17:27	5,10	23	117,34	CHI

2020118206	COLINAS DO SUL	TI12355503	MINACU	03/11/2020 12:26	03/11/2020 16:05	03/11/2020 12:26	03/11/2020 16:05	3,65	9	32,83	CHI
2020118019	BELA VISTA DE GOIAS	240021319	BELA VISTA S1	03/11/2020 12:29	03/11/2020 15:13	03/11/2020 12:29	03/11/2020 15:13	2,72	1	2,72	CHI
2020118227	VALPARAISO DE GOIAS	VA11149838	MARAJOARA	03/11/2020 12:30	03/11/2020 14:55	03/11/2020 12:30	03/11/2020 14:55	2,40	72	172,94	CHI
2020118025	APARECIDA DE GOIANIA	16447086	INDEPENDENCIA S1	03/11/2020 12:32	03/11/2020 13:11	03/11/2020 12:32	03/11/2020 13:11	0,65	1	0,65	CHI
2020118027	ORIZONA	OZ21064883	PIRES DO RIO S2	03/11/2020 12:32	03/11/2020 14:25	03/11/2020 12:32	03/11/2020 14:25	1,88	1	1,88	CHI
2020118029	PIRACANJUBA	60084170	PIRACANJUBA	03/11/2020 12:32	03/11/2020 14:40	03/11/2020 12:32	03/11/2020 14:40	2,12	1	2,12	CHI
2020118033	GOIANIA	13914649	FERROVIARIO S3	03/11/2020 12:33	03/11/2020 17:28	03/11/2020 12:33	03/11/2020 17:28	4,91	1	4,91	CHI
2020118036	AMARALINA	LC11276179	SAO MIGUEL DO ARAGUAIA	03/11/2020 12:34	03/11/2020 16:49	03/11/2020 12:34	03/11/2020 16:49	4,24	1	4,24	CHI
2020118473	URUACU	UR11210918	URUACU	03/11/2020 12:34	03/11/2020 16:15	03/11/2020 12:34	03/11/2020 16:15	3,68	107	393,79	CHI
2020118040	APARECIDA DE GOIANIA	AP11140140	INDEPENDENCIA S2	03/11/2020 12:36	03/11/2020 15:13	03/11/2020 12:36	03/11/2020 15:13	2,61	138	360,41	CHI
2020118049	VALPARAISO DE GOIAS	10008773112	PACAEMBU S1	03/11/2020 12:37	03/11/2020 16:31	03/11/2020 12:37	03/11/2020 16:31	3,89	1	3,89	CHI
2020118055	GOIAS	90005715	GOIAS	03/11/2020 12:38	03/11/2020 14:42	03/11/2020 12:38	03/11/2020 14:42	2,06	1	2,06	CHI
2020118056	SENADOR CANEDO	10010673073	SENADOR CANEDO	03/11/2020 12:38	03/11/2020 15:04	03/11/2020 12:38	03/11/2020 15:04	2,43	1	2,43	CHI
2020118253	CATALAO	CT11000069	CATALAO S2	03/11/2020 12:40	03/11/2020 15:04	03/11/2020 12:40	03/11/2020 15:04	2,38	144	343,28	CHI
2020118065	GOIANAPOLIS	GP12388837	DAIA S2	03/11/2020 12:41	03/11/2020 19:23	03/11/2020 12:41	03/11/2020 19:23	6,70	3	20,09	CHI
2020118071	TACUARAL DE GOIAS	TQ21247845	ITABERAI S1	03/11/2020 12:42	03/11/2020 16:55	03/11/2020 12:42	03/11/2020 16:55	4,20	1	4,20	CHI
2020118075	PORANGATU	PO21312703	PORANGATU	03/11/2020 12:44	04/11/2020 09:48	03/11/2020 12:44	04/11/2020 09:48	21,06	1	21,06	CHI
2020118077	NIQUELANDIA	NQ21270116	SAO JOAO D ALIANCA	03/11/2020 12:44	03/11/2020 21:58	03/11/2020 12:44	03/11/2020 21:58	9,22	1	9,22	CHI
2020118245	SITIO D ABADIA	SI12143367	IACIARA S2	03/11/2020 12:45	03/11/2020 18:04	03/11/2020 12:45	03/11/2020 18:04	5,31	23	122,03	CHI
2020118081	CARMO DO RIO VERDE	IK21308325	ITAPURANGA	03/11/2020 12:46	03/11/2020 18:28	03/11/2020 12:46	03/11/2020 18:28	5,69	1	5,69	CHI
2020118086	NOVA CRIXAS	NA11229680	NOVA CRIXAS	03/11/2020 12:47	03/11/2020 16:57	03/11/2020 12:47	03/11/2020 16:57	4,16	1	4,16	CHI
2020118091	PLANALTINA	PI21364046	PLANALTINA	03/11/2020 12:49	03/11/2020 18:10	03/11/2020 12:49	03/11/2020 18:10	5,34	1	5,34	CHI
2020118092	ITUMBIARA	690228650	ITUMBIARA VELHA S1	03/11/2020 12:49	03/11/2020 15:12	03/11/2020 12:49	03/11/2020 15:12	2,37	1	2,37	CHI
2020118096	PIRENOPOLIS	PV21312672	COCALZINHO	03/11/2020 12:51	04/11/2020 02:08	03/11/2020 12:51	04/11/2020 02:08	13,28	1	13,28	CHI
2020118157	CAMPINORTE	CR12282384	MARA ROSA	03/11/2020 12:51	03/11/2020 21:09	03/11/2020 12:51	03/11/2020 21:09	8,29	1	8,29	CHI
2020118157	URUACU	CR12282384	MARA ROSA	03/11/2020 12:51	03/11/2020 21:09	03/11/2020 12:51	03/11/2020 21:09	8,29	5	41,47	CHI
2020118101	SILVANIA	SV12265097	VIANOPOLIS	03/11/2020 12:52	03/11/2020 14:55	03/11/2020 12:52	03/11/2020 14:55	2,04	1	2,04	CHI
2020118104	GOIANIA	GN21000638	CAMPINAS S1	03/11/2020 12:53	03/11/2020 17:10	03/11/2020 12:53	03/11/2020 17:10	4,27	1	4,27	CHI
2020118256	SAO DOMINGOS	SD12132214	SAO DOMINGOS	03/11/2020 12:54	03/11/2020 16:23	03/11/2020 12:54	03/11/2020 16:23	3,48	3	10,44	CHI
2020118116	NOVA CRIXAS	NA21084411	NOVA CRIXAS	03/11/2020 12:56	03/11/2020 17:06	03/11/2020 12:56	03/11/2020 17:06	4,15	1	4,15	CHI
2020118124	POSSE	PS12257684	IACIARA S2	03/11/2020 12:58	03/11/2020 16:14	03/11/2020 12:58	03/11/2020 16:14	3,25	5	16,26	CHI
2020118125	GOIANIA	11256072	GOIANIA LESTE S1	03/11/2020 12:59	03/11/2020 15:51	03/11/2020 12:59	03/11/2020 15:51	2,86	1	2,86	CHI
2020118127	NOVO GAMA	2460016676	PACAEMBU S1	03/11/2020 12:59	03/11/2020 15:48	03/11/2020 12:59	03/11/2020 15:48	2,80	1	2,80	CHI
2020118488	PIRENOPOLIS	PV12381210	CORUMBA	03/11/2020 12:59	03/11/2020 16:46	03/11/2020 12:59	03/11/2020 16:46	3,77	10	37,71	CHI
2020118128	ITAPURANGA	170068377	ITAPURANGA	03/11/2020 13:01	03/11/2020 15:09	03/11/2020 13:01	03/11/2020 15:09	2,13	1	2,13	CHI
2020118136	CAMPOS BELOS	CH12150394	SAO DOMINGOS	03/11/2020 13:02	03/11/2020 17:55	03/11/2020 13:02	03/11/2020 17:55	4,88	10	48,82	CHI
2020118138	TRINDADE	40040823	TRINDADE	03/11/2020 13:02	03/11/2020 18:31	03/11/2020 13:02	03/11/2020 18:31	5,48	1	5,48	CHI
2020118140	JARAGUA	JA11273157	JARAGUA	03/11/2020 13:02	03/11/2020 15:45	03/11/2020 13:02	03/11/2020 15:45	2,71	89	240,94	CHI
2020118142	BELA VISTA DE GOIAS	BV31022385	SENADOR CANEDO	03/11/2020 13:02	03/11/2020 16:22	03/11/2020 13:02	03/11/2020 16:22	3,32	1	3,32	CHI
2020118143	VILA BOA	10003234647	IACIARA S2	03/11/2020 13:02	03/11/2020 17:34	03/11/2020 13:02	03/11/2020 17:34	4,52	1	4,52	CHI
2020118144	CAVALCANTE	CJ21412212	MINACU	03/11/2020 13:03	03/11/2020 21:56	03/11/2020 13:03	03/11/2020 21:56	8,88	1	8,88	CHI
2020118145	NIQUELANDIA	10003605858	SAO JOAO D ALIANCA	03/11/2020 13:03	03/11/2020 20:38	03/11/2020 13:03	03/11/2020 20:38	7,58	1	7,58	CHI
2020118149	PORANGATU	10026403151	PORANGATU	03/11/2020 13:03	03/11/2020 15:28	03/11/2020 13:03	03/11/2020 15:28	2,40	1	2,40	CHI
2020118164	CAVALCANTE	CJ12409486	MINACU	03/11/2020 13:11	03/11/2020 20:50	03/11/2020 13:11	03/11/2020 20:50	7,65	1	7,65	CHI
2020118168	OUIDOR	10020883640	CATALAO S1	03/11/2020 13:11	03/11/2020 18:56	03/11/2020 13:11	03/11/2020 18:56	5,74	1	5,74	CHI
2020118169	NOVO GAMA	2900004634	MARAJOARA	03/11/2020 13:11	03/11/2020 17:56	03/11/2020 13:11	03/11/2020 17:56	4,74	1	4,74	CHI
2020118177	SANTO ANTONIO DE GOIAS	GR21232090	NEROPOLIS S1	03/11/2020 13:14	03/11/2020 15:28	03/11/2020 13:14	03/11/2020 15:28	2,22	1	2,22	CHI
2020118184	FORMOSA	FA21122069	PLANALTINA	03/11/2020 13:17	03/11/2020 19:03	03/11/2020 13:17	03/11/2020 19:03	5,75	1	5,75	CHI
2020118187	PONTALINA	210074267	PONTALINA	03/11/2020 13:18	03/11/2020 17:27	03/11/2020 13:18	03/11/2020 17:27	4,13	1	4,13	CHI
2020118394	AGUA FRIA DE GOIAS	PI12048037	SAO JOAO D ALIANCA	03/11/2020 13:18	03/11/2020 17:51	03/11/2020 13:18	03/11/2020 17:51	4,54	7	31,81	CHI
2020118191	PADRE BERNARDO	PB11275513	PADRE BERNARDO	03/11/2020 13:20	03/11/2020 17:28	03/11/2020 13:20	03/11/2020 17:28	4,13	2	8,26	CHI

2020118195	INACIOLANDIA	CD21000091	CACHOEIRA DOURADA	03/11/2020 13:21	03/11/2020 15:11	03/11/2020 13:21	03/11/2020 15:11	1,83	1	1,83	CHI
2020118210	ITUMBIARA	10010563324	ITUMBIARA NOVA	03/11/2020 13:25	03/11/2020 14:58	03/11/2020 13:25	03/11/2020 14:58	1,55	1	1,55	CHI
2020118212	GOIANIA	11596065	AEROPORTO S2	03/11/2020 13:25	03/11/2020 16:35	03/11/2020 13:25	03/11/2020 16:35	3,16	1	3,16	CHI
2020118216	LUZIANIA	120259679	RIO VERMELHO	03/11/2020 13:27	03/11/2020 14:41	03/11/2020 13:27	03/11/2020 14:41	1,23	1	1,23	CHI
2020118218	CEZARINA	1510404	PONTALINA	03/11/2020 13:28	03/11/2020 20:34	03/11/2020 15:06	03/11/2020 15:33	0,45	40	17,99	CHI
2020118218	CROMINIA	1510404	PONTALINA	03/11/2020 13:28	03/11/2020 20:34	03/11/2020 15:06	03/11/2020 15:33	0,45	1802	810,40	CHI
2020118218	CROMINIA	1510404	PONTALINA	03/11/2020 13:28	03/11/2020 20:34	03/11/2020 15:06	03/11/2020 15:33	0,45	20	8,99	CHI
2020118218	CROMINIA	1510404	PONTALINA	03/11/2020 13:28	03/11/2020 20:34	03/11/2020 15:06	03/11/2020 15:33	0,45	2	0,90	CHI
2020118218	CROMINIA	1510404	PONTALINA	03/11/2020 13:28	03/11/2020 20:34	03/11/2020 15:06	03/11/2020 15:33	0,45	17	7,65	CHI
2020118218	CROMINIA	1510404	PONTALINA	03/11/2020 13:28	03/11/2020 20:34	03/11/2020 15:06	03/11/2020 15:33	0,45	45	20,24	CHI
2020118218	CROMINIA	1510404	PONTALINA	03/11/2020 13:28	03/11/2020 20:34	03/11/2020 15:06	03/11/2020 15:33	0,45	12	5,40	CHI
2020118218	CROMINIA	1510404	PONTALINA	03/11/2020 13:28	03/11/2020 20:34	03/11/2020 15:06	03/11/2020 15:33	0,45	10	4,50	CHI
2020118218	HIDROLANDIA	1510404	PONTALINA	03/11/2020 13:28	03/11/2020 20:34	03/11/2020 15:06	03/11/2020 15:33	0,45	188	84,55	CHI
2020118218	HIDROLANDIA	1510404	PONTALINA	03/11/2020 13:28	03/11/2020 20:34	03/11/2020 15:06	03/11/2020 15:33	0,45	76	34,18	CHI
2020118218	HIDROLANDIA	1510404	PONTALINA	03/11/2020 13:28	03/11/2020 20:34	03/11/2020 15:06	03/11/2020 15:33	0,45	4	1,80	CHI
2020118218	MAIRIPOTABA	1510404	PONTALINA	03/11/2020 13:28	03/11/2020 20:34	03/11/2020 15:06	03/11/2020 15:33	0,45	66	29,68	CHI
2020118218	MAIRIPOTABA	1510404	PONTALINA	03/11/2020 13:28	03/11/2020 20:34	03/11/2020 15:06	03/11/2020 15:33	0,45	788	354,38	CHI
2020118218	MAIRIPOTABA	1510404	PONTALINA	03/11/2020 13:28	03/11/2020 20:34	03/11/2020 15:06	03/11/2020 15:33	0,45	10	4,50	CHI
2020118218	MAIRIPOTABA	1510404	PONTALINA	03/11/2020 13:28	03/11/2020 20:34	03/11/2020 15:06	03/11/2020 15:33	0,45	364	163,70	CHI
2020118218	MAIRIPOTABA	1510404	PONTALINA	03/11/2020 13:28	03/11/2020 20:34	03/11/2020 15:06	03/11/2020 15:33	0,45	8	3,60	CHI
2020118218	MAIRIPOTABA	1510404	PONTALINA	03/11/2020 13:28	03/11/2020 20:34	03/11/2020 15:06	03/11/2020 15:33	0,45	2	0,90	CHI
2020118218	MAIRIPOTABA	1510404	PONTALINA	03/11/2020 13:28	03/11/2020 20:34	03/11/2020 15:06	03/11/2020 15:33	0,45	3	1,35	CHI
2020118218	PONTALINA	1510404	PONTALINA	03/11/2020 13:28	03/11/2020 20:34	03/11/2020 15:06	03/11/2020 15:33	0,45	34	15,29	CHI
2020118218	PONTALINA	1510404	PONTALINA	03/11/2020 13:28	03/11/2020 20:34	03/11/2020 15:06	03/11/2020 15:33	0,45	3	1,35	CHI
2020118218	PONTALINA	1510404	PONTALINA	03/11/2020 13:28	03/11/2020 20:34	03/11/2020 15:06	03/11/2020 15:33	0,45	61	27,43	CHI
2020118218	PROFESSOR JAMIL SAFADY	1510404	PONTALINA	03/11/2020 13:28	03/11/2020 20:34	03/11/2020 15:06	03/11/2020 15:33	0,45	14	6,30	CHI
2020118218	PROFESSOR JAMIL SAFADY	1510404	PONTALINA	03/11/2020 13:28	03/11/2020 20:34	03/11/2020 15:06	03/11/2020 15:33	0,45	43	19,34	CHI
2020118218	VARJAO	1510404	PONTALINA	03/11/2020 13:28	03/11/2020 20:34	03/11/2020 15:06	03/11/2020 15:33	0,45	1	0,45	CHI
2020118218	CROMINIA	1510404	ROCHEDO	03/11/2020 13:28	03/11/2020 20:34	03/11/2020 15:06	03/11/2020 15:33	0,45	42	18,89	CHI
2020118218	CROMINIA	1510404	ROCHEDO	03/11/2020 13:28	03/11/2020 20:34	03/11/2020 15:06	03/11/2020 15:33	0,45	2	0,90	CHI
2020118218	HIDROLANDIA	1510404	ROCHEDO	03/11/2020 13:28	03/11/2020 20:34	03/11/2020 15:06	03/11/2020 15:33	0,45	9	4,05	CHI
2020118218	PIRACANJUBA	1510404	ROCHEDO	03/11/2020 13:28	03/11/2020 20:34	03/11/2020 15:06	03/11/2020 15:33	0,45	50	22,49	CHI
2020118218	PIRACANJUBA	1510404	ROCHEDO	03/11/2020 13:28	03/11/2020 20:34	03/11/2020 15:06	03/11/2020 15:33	0,45	296	133,12	CHI
2020118218	PIRACANJUBA	1510404	ROCHEDO	03/11/2020 13:28	03/11/2020 20:34	03/11/2020 15:06	03/11/2020 15:33	0,45	1	0,45	CHI
2020118218	PROFESSOR JAMIL SAFADY	1510404	ROCHEDO	03/11/2020 13:28	03/11/2020 20:34	03/11/2020 15:06	03/11/2020 15:33	0,45	28	12,59	CHI
2020118218	PROFESSOR JAMIL SAFADY	1510404	ROCHEDO	03/11/2020 13:28	03/11/2020 20:34	03/11/2020 15:06	03/11/2020 15:33	0,45	858	385,86	CHI
2020118218	PROFESSOR JAMIL SAFADY	1510404	ROCHEDO	03/11/2020 13:28	03/11/2020 20:34	03/11/2020 15:06	03/11/2020 15:33	0,45	667	299,96	CHI
2020118218	PROFESSOR JAMIL SAFADY	1510404	ROCHEDO	03/11/2020 13:28	03/11/2020 20:34	03/11/2020 15:06	03/11/2020 15:33	0,45	7	3,15	CHI
2020118218	MAIRIPOTABA	1510404	PONTALINA	03/11/2020 13:28	03/11/2020 20:34	03/11/2020 15:06	03/11/2020 18:06	3,00	152	456,13	CHI
2020118218	MORRINHOS	1510404	PONTALINA	03/11/2020 13:28	03/11/2020 20:34	03/11/2020 15:06	03/11/2020 18:06	3,00	4	12,00	CHI
2020118218	PIRACANJUBA	1510404	PONTALINA	03/11/2020 13:28	03/11/2020 20:34	03/11/2020 15:06	03/11/2020 18:06	3,00	1	3,00	CHI
2020118218	PONTALINA	1510404	PONTALINA	03/11/2020 13:28	03/11/2020 20:34	03/11/2020 15:06	03/11/2020 18:06	3,00	51	153,04	CHI
2020118218	PROFESSOR JAMIL SAFADY	1510404	PONTALINA	03/11/2020 13:28	03/11/2020 20:34	03/11/2020 15:06	03/11/2020 18:06	3,00	8	24,01	CHI
2020118218	MAIRIPOTABA	PK13204487	PONTALINA	03/11/2020 13:28	03/11/2020 20:34	03/11/2020 20:17	03/11/2020 20:22	0,08	152	11,61	CHI
2020118218	MORRINHOS	PK13204487	PONTALINA	03/11/2020 13:28	03/11/2020 20:34	03/11/2020 20:17	03/11/2020 20:22	0,08	4	0,31	CHI
2020118218	PIRACANJUBA	PK13204487	PONTALINA	03/11/2020 13:28	03/11/2020 20:34	03/11/2020 20:17	03/11/2020 20:22	0,08	1	0,08	CHI
2020118218	PONTALINA	PK13204487	PONTALINA	03/11/2020 13:28	03/11/2020 20:34	03/11/2020 20:17	03/11/2020 20:22	0,08	51	3,90	CHI
2020118218	PROFESSOR JAMIL SAFADY	PK13204487	PONTALINA	03/11/2020 13:28	03/11/2020 20:34	03/11/2020 20:17	03/11/2020 20:22	0,08	8	0,61	CHI
2020118218	CEZARINA	PJ13329053	PONTALINA	03/11/2020 13:28	03/11/2020 20:34	03/11/2020 19:15	03/11/2020 20:34	1,33	40	53,16	CHI
2020118218	CROMINIA	PJ13329053	PONTALINA	03/11/2020 13:28	03/11/2020 20:34	03/11/2020 19:15	03/11/2020 20:34	1,33	1802	2394,66	CHI
2020118218	CROMINIA	PJ13329053	PONTALINA	03/11/2020 13:28	03/11/2020 20:34	03/11/2020 19:15	03/11/2020 20:34	1,33	20	26,58	CHI

2020118218	CROMINIA	PJ13329053	PONTALINA	03/11/2020 13:28	03/11/2020 20:34	03/11/2020 19:15	03/11/2020 20:34	1,33	2	2,66	CHI
2020118218	CROMINIA	PJ13329053	PONTALINA	03/11/2020 13:28	03/11/2020 20:34	03/11/2020 19:15	03/11/2020 20:34	1,33	17	22,59	CHI
2020118218	CROMINIA	PJ13329053	PONTALINA	03/11/2020 13:28	03/11/2020 20:34	03/11/2020 19:15	03/11/2020 20:34	1,33	12	15,95	CHI
2020118218	CROMINIA	PJ13329053	PONTALINA	03/11/2020 13:28	03/11/2020 20:34	03/11/2020 19:15	03/11/2020 20:34	1,33	10	13,29	CHI
2020118218	HIDROLANDIA	PJ13329053	PONTALINA	03/11/2020 13:28	03/11/2020 20:34	03/11/2020 19:15	03/11/2020 20:34	1,33	188	249,83	CHI
2020118218	HIDROLANDIA	PJ13329053	PONTALINA	03/11/2020 13:28	03/11/2020 20:34	03/11/2020 19:15	03/11/2020 20:34	1,33	76	101,00	CHI
2020118218	HIDROLANDIA	PJ13329053	PONTALINA	03/11/2020 13:28	03/11/2020 20:34	03/11/2020 19:15	03/11/2020 20:34	1,33	4	5,32	CHI
2020118218	MAIRIPOTABA	PJ13329053	PONTALINA	03/11/2020 13:28	03/11/2020 20:34	03/11/2020 19:15	03/11/2020 20:34	1,33	67	89,04	CHI
2020118218	MAIRIPOTABA	PJ13329053	PONTALINA	03/11/2020 13:28	03/11/2020 20:34	03/11/2020 19:15	03/11/2020 20:34	1,33	788	1047,16	CHI
2020118218	MAIRIPOTABA	PJ13329053	PONTALINA	03/11/2020 13:28	03/11/2020 20:34	03/11/2020 19:15	03/11/2020 20:34	1,33	10	13,29	CHI
2020118218	MAIRIPOTABA	PJ13329053	PONTALINA	03/11/2020 13:28	03/11/2020 20:34	03/11/2020 19:15	03/11/2020 20:34	1,33	364	483,72	CHI
2020118218	MAIRIPOTABA	PJ13329053	PONTALINA	03/11/2020 13:28	03/11/2020 20:34	03/11/2020 19:15	03/11/2020 20:34	1,33	2	2,66	CHI
2020118218	MAIRIPOTABA	PJ13329053	PONTALINA	03/11/2020 13:28	03/11/2020 20:34	03/11/2020 19:15	03/11/2020 20:34	1,33	3	3,99	CHI
2020118218	PONTALINA	PJ13329053	PONTALINA	03/11/2020 13:28	03/11/2020 20:34	03/11/2020 19:15	03/11/2020 20:34	1,33	34	45,18	CHI
2020118218	PONTALINA	PJ13329053	PONTALINA	03/11/2020 13:28	03/11/2020 20:34	03/11/2020 19:15	03/11/2020 20:34	1,33	3	3,99	CHI
2020118218	PONTALINA	PJ13329053	PONTALINA	03/11/2020 13:28	03/11/2020 20:34	03/11/2020 19:15	03/11/2020 20:34	1,33	60	79,73	CHI
2020118218	PROFESSOR JAMIL SAFADY	PJ13329053	PONTALINA	03/11/2020 13:28	03/11/2020 20:34	03/11/2020 19:15	03/11/2020 20:34	1,33	14	18,60	CHI
2020118218	VARJAO	PJ13329053	PONTALINA	03/11/2020 13:28	03/11/2020 20:34	03/11/2020 19:15	03/11/2020 20:34	1,33	1	1,33	CHI
2020118219	BELA VISTA DE GOIAS	BV21079688	BELA VISTA S1	03/11/2020 13:28	03/11/2020 15:22	03/11/2020 13:28	03/11/2020 15:22	1,90	1	1,90	CHI
2020118226	CAMPO ALEGRE DE GOIAS	CM21372849	CAMPO ALEGRE DE GOIAS	03/11/2020 13:30	03/11/2020 14:43	03/11/2020 13:30	03/11/2020 14:43	1,20	1	1,20	CHI
2020118228	HIDROLANDIA	HD21291462	CEPAIGO S2	03/11/2020 13:30	03/11/2020 16:30	03/11/2020 13:30	03/11/2020 16:30	2,99	1	2,99	CHI
2020118233	MARA ROSA	MQ21182280	MARA ROSA	03/11/2020 13:32	03/11/2020 15:02	03/11/2020 13:32	03/11/2020 15:02	1,50	1	1,50	CHI
2020118239	BELA VISTA DE GOIAS	BV12388288	BELA VISTA S1	03/11/2020 13:33	03/11/2020 16:27	03/11/2020 13:33	03/11/2020 16:27	2,90	1	2,90	CHI
2020118241	ITABERAI	1000650682	ITABERAI S2	03/11/2020 13:33	03/11/2020 16:55	03/11/2020 13:33	03/11/2020 16:55	3,36	1	3,36	CHI
2020118264	IPORA	IR21097735	IPORA	03/11/2020 13:38	03/11/2020 15:17	03/11/2020 13:38	03/11/2020 15:17	1,64	1	1,64	CHI
2020118267	VILA PROPICIO	2850008492	GOIANESIA S1	03/11/2020 13:39	03/11/2020 19:15	03/11/2020 13:39	03/11/2020 19:15	5,59	1	5,59	CHI
2020118277	APARECIDA DE GOIANIA	10010719375	ATLANTICO S2	03/11/2020 13:43	03/11/2020 14:52	03/11/2020 13:43	03/11/2020 14:52	1,14	1	1,14	CHI
2020118291	GOIANIA	11690331	REAL S1	03/11/2020 13:48	03/11/2020 15:59	03/11/2020 13:48	03/11/2020 15:59	2,17	1	2,17	CHI
2020118612	URUACU	UR12232449RE	URUACU	03/11/2020 13:48	03/11/2020 21:29	03/11/2020 13:48	03/11/2020 21:29	7,67	55	422,05	CHI
2020118303	PLANALTIMA	PI11355716	PLANALTIMA	03/11/2020 13:49	03/11/2020 14:15	03/11/2020 13:49	03/11/2020 14:15	0,42	1	0,42	CHI
2020118305	VICENTINOPOLIS	VI11263799	VICENTINOPOLIS	03/11/2020 13:50	03/11/2020 20:46	03/11/2020 13:50	03/11/2020 20:46	6,93	42	291,02	CHI
2020118984	CRISTALINA	KR12348546RE	PAMPLONA	03/11/2020 13:50	03/11/2020 20:01	03/11/2020 13:50	03/11/2020 20:01	6,18	22	135,95	CHI
2020118307	INHUMAS	30134092	INHUMAS S2	03/11/2020 13:51	03/11/2020 15:07	03/11/2020 13:51	03/11/2020 15:07	1,26	1	1,26	CHI
2020118308	JARAGUA	70007299	JARAGUA	03/11/2020 13:51	03/11/2020 15:24	03/11/2020 13:51	03/11/2020 15:24	1,55	1	1,55	CHI
2020118314	SENADOR CANEDO	10032247190	SENADOR CANEDO	03/11/2020 13:52	03/11/2020 16:44	03/11/2020 13:52	03/11/2020 16:44	2,85	1	2,85	CHI
2020118209	AGUAS LINDAS DE GOIAS	LA12163854	AGUAS LINDAS DE GOIAS S2	03/11/2020 13:54	03/11/2020 16:12	03/11/2020 15:43	03/11/2020 16:12	0,49	16	7,86	CHI
2020118321	APARECIDA DE GOIANIA	200235990	INDEPENDENCIA S1	03/11/2020 13:54	03/11/2020 14:50	03/11/2020 13:54	03/11/2020 14:50	0,93	1	0,93	CHI
2020118529	BARRO ALTO	GE12000092	GOIANESIA S1	03/11/2020 13:54	03/11/2020 16:55	03/11/2020 13:54	03/11/2020 16:55	3,00	2	6,00	CHI
2020118529	GOIANESIA	GE12000092	GOIANESIA S1	03/11/2020 13:54	03/11/2020 16:55	03/11/2020 13:54	03/11/2020 16:55	3,00	18	54,01	CHI
2020118328	CORUMBA DE GOIAS	CB21134341	CORUMBA	03/11/2020 13:55	04/11/2020 09:23	03/11/2020 13:55	04/11/2020 09:23	19,46	1	19,46	CHI
2020118333	PALMEIRAS DE GOIAS	PL12000033	PALMEIRAS	03/11/2020 13:56	03/11/2020 18:04	03/11/2020 13:56	03/11/2020 18:04	4,13	1	4,13	CHI
2020118335	HIDROLANDIA	180069263	ANHANGUERA	03/11/2020 13:56	03/11/2020 15:07	03/11/2020 13:56	03/11/2020 15:07	1,18	1	1,18	CHI
2020118336	AGUA FRIA DE GOIAS	TL21202255	SAO JOAO D ALIANCA	03/11/2020 13:57	04/11/2020 07:45	03/11/2020 13:57	04/11/2020 07:45	17,80	1	17,80	CHI
2020118338	GOIANIA	10017382244	CAMPINAS S2	03/11/2020 13:57	03/11/2020 15:40	03/11/2020 13:57	03/11/2020 15:40	1,71	1	1,71	CHI
2020118402	ANAPOLIS	AN12262491	ANAPOLIS UNIVERSITARIO S1	03/11/2020 13:57	03/11/2020 15:10	03/11/2020 13:57	03/11/2020 15:10	1,21	38	46,02	CHI
2020119126	BOM JESUS DE GOIAS	JV12222565RE	VICENTINOPOLIS	03/11/2020 13:59	03/11/2020 19:16	03/11/2020 13:59	03/11/2020 19:16	5,27	3	15,80	CHI
2020119126	GOIATUBA	JV12222565RE	VICENTINOPOLIS	03/11/2020 13:59	03/11/2020 19:16	03/11/2020 13:59	03/11/2020 19:16	5,27	15	79,00	CHI
2020119126	JOVIANIA	JV12222565RE	VICENTINOPOLIS	03/11/2020 13:59	03/11/2020 19:16	03/11/2020 13:59	03/11/2020 19:16	5,27	5	26,33	CHI
2020119126	VICENTINOPOLIS	JV12222565RE	VICENTINOPOLIS	03/11/2020 13:59	03/11/2020 19:16	03/11/2020 13:59	03/11/2020 19:16	5,27	2	10,53	CHI
2020119932	JOVIANIA	JV21222532	VICENTINOPOLIS	03/11/2020 13:59	03/11/2020 23:19	03/11/2020 13:59	03/11/2020 23:19	9,32	1	9,32	CHI
2020118396	NOVO BRASIL	NB12087607	JUSSARA	03/11/2020 14:00	03/11/2020 16:02	03/11/2020 14:00	03/11/2020 16:02	2,02	10	20,21	CHI

2020118357	AMARALINA	LC12270203	SAO MIGUEL DO ARAGUAIA	03/11/2020 14:01	03/11/2020 15:57	03/11/2020 14:01	03/11/2020 15:57	1,92	8	15,34	CHI
2020118370	GOIANIA	GN12043070	CARAJAS S2	03/11/2020 14:02	03/11/2020 18:38	03/11/2020 14:02	03/11/2020 18:38	4,59	153	701,68	CHI
2020118367	AGUAS LINDAS DE GOIAS	10010456625	AGUAS LINDAS DE GOIAS S1	03/11/2020 14:04	03/11/2020 15:30	03/11/2020 14:04	03/11/2020 15:30	1,42	1	1,42	CHI
2020118368	GOIANIA	10980738	FERROVIARIO S3	03/11/2020 14:04	03/11/2020 16:30	03/11/2020 14:04	03/11/2020 16:30	2,42	1	2,42	CHI
2020118374	LUZIANIA	KR12080375	PAMPLONA	03/11/2020 14:06	03/11/2020 16:40	03/11/2020 14:06	03/11/2020 16:40	2,57	4	10,29	CHI
2020118411	GOIANIA	GN11003175	GOYA S1	03/11/2020 14:06	03/11/2020 16:10	03/11/2020 14:06	03/11/2020 16:10	2,06	70	143,87	CHI
2020118378	SANCLERLANDIA	SC21249348	SAO LUIZ DOS MONTES BELOS	03/11/2020 14:07	03/11/2020 19:02	03/11/2020 14:07	03/11/2020 19:02	4,91	1	4,91	CHI
2020118379	PORANGATU	PO21139203	PORANGATU	03/11/2020 14:07	03/11/2020 16:38	03/11/2020 14:07	03/11/2020 16:38	2,51	3	7,53	CHI
2020118380	PORANGATU	TB21337388	PORANGATU	03/11/2020 14:07	04/11/2020 22:37	03/11/2020 14:07	04/11/2020 22:37	32,49	1	32,49	CHI
2020118383	PLANALTINA	PI21325482	PLANALTINA	03/11/2020 14:08	03/11/2020 19:57	03/11/2020 14:08	03/11/2020 19:57	5,81	2	11,62	CHI
2020119684	COLINAS DO SUL	TI12357757	NIQUELANDIA SUBTRANSMISSAO	03/11/2020 14:08	04/11/2020 02:56	03/11/2020 14:08	04/11/2020 02:56	12,78	7	89,49	CHI
2020118389	APARECIDA DE GOIANIA	AP21105196	CEPAIGO S1	03/11/2020 14:09	03/11/2020 16:46	03/11/2020 14:09	03/11/2020 16:46	2,61	4	10,43	CHI
2020118392	GOIANIA	13951610	MEIA PONTE	03/11/2020 14:10	03/11/2020 17:23	03/11/2020 14:10	03/11/2020 17:23	3,20	1	3,20	CHI
2020118393	CRISTALINA	KR21203777	CRISTALINA S1	03/11/2020 14:11	03/11/2020 15:15	03/11/2020 14:11	03/11/2020 15:15	1,07	1	1,07	CHI
2020118410	IPAMERI	IP21231615	CRISTALINA S2	03/11/2020 14:15	03/11/2020 15:07	03/11/2020 14:15	03/11/2020 15:07	0,86	1	0,86	CHI
2020118418	GOIANIA	14781426	CAMPINAS S2	03/11/2020 14:17	03/11/2020 20:31	03/11/2020 14:17	03/11/2020 20:31	6,22	1	6,22	CHI
2020118419	ITABERAI	IB12274216	ITABERAI S2	03/11/2020 14:17	03/11/2020 17:49	03/11/2020 14:17	03/11/2020 17:49	3,52	3	10,56	CHI
2020118657	BARRO ALTO	SJ12006466	GOIANESIA S1	03/11/2020 14:17	03/11/2020 17:12	03/11/2020 14:17	03/11/2020 17:12	2,91	1	2,91	CHI
2020118657	GOIANESIA	SJ12006466	GOIANESIA S1	03/11/2020 14:17	03/11/2020 17:12	03/11/2020 14:17	03/11/2020 17:12	2,91	8	23,27	CHI
2020118657	VILA PROPICIO	SJ12006466	GOIANESIA S1	03/11/2020 14:17	03/11/2020 17:12	03/11/2020 14:17	03/11/2020 17:12	2,91	1	2,91	CHI
2020118423	FIRMINOPOLIS	FR31167165	SAO LUIZ DOS MONTES BELOS	03/11/2020 14:18	03/11/2020 15:49	03/11/2020 14:18	03/11/2020 15:49	1,50	2	3,00	CHI
2020118424	ITABERAI	50004372	ITABERAI S2	03/11/2020 14:18	03/11/2020 15:43	03/11/2020 14:18	03/11/2020 15:43	1,40	1	1,40	CHI
2020118429	JUSSARA	JR21224236	BRITANIA	03/11/2020 14:19	03/11/2020 18:28	03/11/2020 14:19	03/11/2020 18:28	4,13	1	4,13	CHI
2020118946	JOVIANA	PK12106143	GOIATUBA S1	03/11/2020 14:20	03/11/2020 23:33	03/11/2020 14:20	03/11/2020 23:33	9,21	3	27,63	CHI
2020118946	PONTALINA	PK12106143	GOIATUBA S1	03/11/2020 14:20	03/11/2020 23:33	03/11/2020 14:20	03/11/2020 23:33	9,21	15	138,16	CHI
2020118444	PORANGATU	PO21139111	NOVO PLANALTO	03/11/2020 14:22	03/11/2020 17:49	03/11/2020 14:22	03/11/2020 17:49	3,44	1	3,44	CHI
2020118448	GUAPO	GA21217773	GUAPO S2	03/11/2020 14:22	03/11/2020 21:14	03/11/2020 14:22	03/11/2020 21:14	6,86	1	6,86	CHI
2020118466	PLANALTINA	7364258	PLANALTINA	03/11/2020 14:25	03/11/2020 21:09	03/11/2020 14:25	03/11/2020 21:09	6,72	5	33,61	CHI
2020118467	PADRE BERNARDO	PB12330893	PADRE BERNARDO	03/11/2020 14:25	03/11/2020 18:04	03/11/2020 14:25	03/11/2020 18:04	3,64	4	14,55	CHI
2020118468	PADRE BERNARDO	PB12170167	PADRE BERNARDO	03/11/2020 14:25	03/11/2020 16:30	03/11/2020 14:25	03/11/2020 16:30	2,07	56	115,75	CHI
2020118478	NOVA GLORIA	NG12181400	ITAPACI	03/11/2020 14:27	04/11/2020 13:00	03/11/2020 14:27	04/11/2020 13:00	22,55	14	315,67	CHI
2020118487	AGUA FRIA DE GOIAS	10016335536	SAO JOAO D ALIANCA	03/11/2020 14:28	03/11/2020 17:12	03/11/2020 14:28	03/11/2020 17:12	2,72	1	2,72	CHI
2020118498	PALESTINA DE GOIAS	PY12342606	PALESTINA	03/11/2020 14:30	03/11/2020 16:50	03/11/2020 14:30	03/11/2020 16:50	2,32	6	13,94	CHI
2020118500	NIQUELANDIA	NQ21311504	URUACU	03/11/2020 14:31	04/11/2020 03:57	03/11/2020 14:31	04/11/2020 03:57	13,43	1	13,43	CHI
2020118507	GOIANIRA	390098863	MEIA PONTE	03/11/2020 14:32	03/11/2020 16:13	03/11/2020 14:32	03/11/2020 16:13	1,68	1	1,68	CHI
2020118527	LUZIANIA	LZ21304852	PAMPLONA	03/11/2020 14:34	03/11/2020 17:52	03/11/2020 14:34	03/11/2020 17:52	3,29	1	3,29	CHI
2020118532	NOVO GAMA	10027023620	MARAJOARA	03/11/2020 14:36	03/11/2020 19:13	03/11/2020 14:36	03/11/2020 19:13	4,61	1	4,61	CHI
2020118541	PIRANHAS	PH21040154	PIRANHAS	03/11/2020 14:37	03/11/2020 17:14	03/11/2020 14:37	03/11/2020 17:14	2,61	1	2,61	CHI
2020118548	ANAPOLIS	21131466	JUNDIAI S2	03/11/2020 14:38	03/11/2020 19:35	03/11/2020 14:38	03/11/2020 19:35	4,93	1	4,93	CHI
2020118837	AMARALINA	LC12230319	NOVA CRIXAS	03/11/2020 14:45	03/11/2020 21:48	03/11/2020 14:45	03/11/2020 21:48	7,04	3	21,11	CHI
2020118591	CAIAPONIA	CP21075062	PALESTINA	03/11/2020 14:50	03/11/2020 17:09	03/11/2020 14:50	03/11/2020 17:09	2,31	1	2,31	CHI
2020118592	CUMARI	CY21064075	CATALAO S2	03/11/2020 14:50	03/11/2020 20:29	03/11/2020 14:50	03/11/2020 20:29	5,64	1	5,64	CHI
2020118698	PLANALTINA	PI11206106	PLANALTINA	03/11/2020 14:52	03/11/2020 19:23	03/11/2020 14:52	03/11/2020 19:23	4,50	17	76,52	CHI
2020118601	TRINDADE	10023116860	TRINDADE	03/11/2020 14:54	03/11/2020 19:07	03/11/2020 14:54	03/11/2020 19:07	4,21	1	4,21	CHI
2020118607	ITUMBIARA	690190268	ITUMBIARA NOVA	03/11/2020 14:55	03/11/2020 17:56	03/11/2020 14:55	03/11/2020 17:56	3,00	1	3,00	CHI
2020118640	SILVANIA	VN12282832	VIANOPOLIS	03/11/2020 14:57	03/11/2020 16:41	03/11/2020 14:57	03/11/2020 16:41	1,72	124	213,31	CHI
2020118640	VIANOPOLIS	VN12282832	VIANOPOLIS	03/11/2020 14:57	03/11/2020 16:41	03/11/2020 14:57	03/11/2020 16:41	1,72	10	17,20	CHI
2020118621	ANAPOLIS	AN21285291	ANAPOLIS UNIVERSITARIO S1	03/11/2020 14:59	03/11/2020 15:57	03/11/2020 14:59	03/11/2020 15:57	0,96	1	0,96	CHI
2020118626	JARAGUA	JA21297922	SAO FRANCISCO DE GOIAS	03/11/2020 15:01	03/11/2020 20:24	03/11/2020 15:01	03/11/2020 20:24	5,37	1	5,37	CHI
2020119054	NIQUELANDIA	NQ12133382	NIQUELANDIA SUBTRANSMISSAO	03/11/2020 15:01	03/11/2020 19:11	03/11/2020 15:01	03/11/2020 19:11	4,15	15	62,31	CHI
2020118632	FORMOSA	10023058925	ITUIQUIRA	03/11/2020 15:02	03/11/2020 15:51	03/11/2020 15:02	03/11/2020 15:51	0,81	1	0,81	CHI

2020118639	PIRENOPOLIS	PV21119805	CORUMBA	03/11/2020 15:05	03/11/2020 22:41	03/11/2020 15:05	03/11/2020 22:41	7,60	2	15,20	CHI
2020118642	SAO DOMINGOS	SD12268132	SAO DOMINGOS	03/11/2020 15:05	04/11/2020 09:59	03/11/2020 15:05	04/11/2020 09:59	18,89	35	661,06	CHI
2020118770	ALEXANIA	AX12311876	ALEXANIA	03/11/2020 15:06	03/11/2020 17:17	03/11/2020 15:06	03/11/2020 17:17	2,18	115	250,41	CHI
2020118652	NOVA AMERICA	NM21188921	RUBIATABA	03/11/2020 15:08	04/11/2020 08:43	03/11/2020 15:08	04/11/2020 08:43	17,57	2	35,14	CHI
2020118944	ABADIANIA	AA12349442	ANAPOLIS UNIVERSITARIO S1	03/11/2020 15:11	03/11/2020 19:03	03/11/2020 15:11	03/11/2020 19:03	3,85	16	61,64	CHI
2020118171	ALEXANIA	AX12221351	ALEXANIA	03/11/2020 15:12	03/11/2020 18:18	03/11/2020 15:12	03/11/2020 16:26	1,22	161	196,78	CHI
2020118171	ALEXANIA	AX12221351	ALEXANIA	03/11/2020 15:12	03/11/2020 18:18	03/11/2020 15:12	03/11/2020 18:18	3,09	79	244,02	CHI
2020118667	GOIANIA	14106516	ATLANTICO S1	03/11/2020 15:12	03/11/2020 17:44	03/11/2020 15:12	03/11/2020 17:44	2,53	1	2,53	CHI
2020118668	AGUA LIMPA	AL12172363	VILA CORUMBA	03/11/2020 15:12	03/11/2020 18:43	03/11/2020 15:12	03/11/2020 18:43	3,51	7	24,57	CHI
2020118672	GOIANIA	10031394823	MEIA PONTE	03/11/2020 15:13	03/11/2020 18:47	03/11/2020 15:13	03/11/2020 18:47	3,56	1	3,56	CHI
2020118675	VIANOPOLIS	510018725	VIANOPOLIS	03/11/2020 15:13	03/11/2020 16:21	03/11/2020 15:13	03/11/2020 16:21	1,12	1	1,12	CHI
2020118691	JARAGUA	JA21194258	JARAGUA	03/11/2020 15:17	03/11/2020 21:30	03/11/2020 15:17	03/11/2020 21:30	6,21	1	6,21	CHI
2020118699	IPAMERI	IP12235395	PIRES DO RIO S2	03/11/2020 15:17	04/11/2020 00:37	03/11/2020 15:17	04/11/2020 00:37	9,33	4	37,30	CHI
2020119328	ALEXANIA	AX12313240	ALEXANIA	03/11/2020 15:22	03/11/2020 21:51	03/11/2020 15:22	03/11/2020 21:51	6,48	18	116,64	CHI
2020118728	INDIARA	IY11035273	EDEIA	03/11/2020 15:25	03/11/2020 16:26	03/11/2020 15:25	03/11/2020 16:26	1,01	172	173,82	CHI
2020118752	MUNDO NOVO DE GOIAS	MH12362454	NOVA CRIXAS	03/11/2020 15:26	03/11/2020 17:21	03/11/2020 15:26	03/11/2020 17:21	1,91	118	225,94	CHI
2020118740	CAIAPONIA	930056073	CAIAPONIA	03/11/2020 15:28	03/11/2020 16:18	03/11/2020 15:28	03/11/2020 16:18	0,83	1	0,83	CHI
2020118741	ANICUNS	10029091495	ANICUNS	03/11/2020 15:28	03/11/2020 18:30	03/11/2020 15:28	03/11/2020 18:30	3,04	1	3,04	CHI
2020118747	ARAGOIANIA	HD12000067	INDEPENDENCIA S1	03/11/2020 15:29	03/11/2020 19:52	03/11/2020 15:29	03/11/2020 19:52	4,39	5	21,97	CHI
2020118747	HIDROLANDIA	HD12000067	INDEPENDENCIA S1	03/11/2020 15:29	03/11/2020 19:52	03/11/2020 15:29	03/11/2020 19:52	4,39	11	48,32	CHI
2020118748	GOIANIA	14072210	GOYA S2	03/11/2020 15:29	03/11/2020 16:41	03/11/2020 15:29	03/11/2020 16:41	1,20	1	1,20	CHI
2020118753	MOSSAMEDES	1310008118	FIRMINOPOLIS S2	03/11/2020 15:30	03/11/2020 17:36	03/11/2020 15:30	03/11/2020 17:36	2,09	1	2,09	CHI
2020118754	ITABERAI	IB21108188	INHUMAS S1	03/11/2020 15:31	03/11/2020 18:18	03/11/2020 15:31	03/11/2020 18:18	2,78	2	5,56	CHI
2020118759	MORRINHOS	MR21375775	MORRINHOS	03/11/2020 15:31	03/11/2020 17:09	03/11/2020 15:31	03/11/2020 17:09	1,62	1	1,62	CHI
2020118766	APARECIDA DE GOIANIA	16555144	INDEPENDENCIA S2	03/11/2020 15:32	03/11/2020 16:40	03/11/2020 15:32	03/11/2020 16:40	1,12	1	1,12	CHI
2020118774	ALEXANIA	480029404	ALEXANIA	03/11/2020 15:33	04/11/2020 00:20	03/11/2020 15:33	04/11/2020 00:20	8,77	1	8,77	CHI
2020118777	SANTO ANTONIO DE GOIAS	BW21139726	NEROPOLIS S1	03/11/2020 15:34	03/11/2020 19:16	03/11/2020 15:34	03/11/2020 19:16	3,70	1	3,70	CHI
2020118797	TRINDADE	10017791098	TRINDADE	03/11/2020 15:41	03/11/2020 17:24	03/11/2020 15:41	03/11/2020 17:24	1,71	1	1,71	CHI
2020118801	PORANGATU	PO211102903	PORANGATU	03/11/2020 15:42	03/11/2020 17:21	03/11/2020 15:42	03/11/2020 17:21	1,65	1	1,65	CHI
2020118802	PORANGATU	PO21208581	NOVO PLANALTO	03/11/2020 15:42	03/11/2020 22:20	03/11/2020 15:42	03/11/2020 22:20	6,62	1	6,62	CHI
2020118804	CRISTALINA	KR12074918	CRISTALINA S2	03/11/2020 15:42	03/11/2020 18:38	03/11/2020 15:42	03/11/2020 18:38	2,92	8	23,35	CHI
2020118811	CAMPO LIMPO	AN21258878	NEROPOLIS S1	03/11/2020 15:44	03/11/2020 17:12	03/11/2020 15:44	03/11/2020 17:12	1,45	2	2,91	CHI
2020118978	ALEXANIA	AX12071331	ALEXANIA	03/11/2020 15:44	03/11/2020 19:50	03/11/2020 15:44	03/11/2020 19:50	4,10	9	36,86	CHI
2020118978	SANTO ANTONIO DO DESCOBERTO	AX12071331	ALEXANIA	03/11/2020 15:44	03/11/2020 19:50	03/11/2020 15:44	03/11/2020 19:50	4,10	2	8,19	CHI
2020118819	AGUAS LINDAS DE GOIAS	10030961201	AGUAS LINDAS DE GOIAS S1	03/11/2020 15:46	03/11/2020 17:28	03/11/2020 15:46	03/11/2020 17:28	1,69	1	1,69	CHI
2020118820	MORRINHOS	MR21142330	MORRINHOS	03/11/2020 15:46	03/11/2020 18:16	03/11/2020 15:46	03/11/2020 18:16	2,49	1	2,49	CHI
2020118920	FORMOSO	TB10396085	PORANGATU	03/11/2020 15:46	04/11/2020 15:13	03/11/2020 15:46	03/11/2020 18:04	2,30	2	4,60	CHI
2020118920	MONTIVIDIU DO NORTE	TB10396085	PORANGATU	03/11/2020 15:46	04/11/2020 15:13	03/11/2020 15:46	03/11/2020 18:04	2,30	1744	4009,26	CHI
2020118920	TROMBAS	TB10396085	PORANGATU	03/11/2020 15:46	04/11/2020 15:13	03/11/2020 15:46	03/11/2020 18:04	2,30	276	634,49	CHI
2020118920	TROMBAS	6492388	PORANGATU	03/11/2020 15:46	04/11/2020 15:13	03/11/2020 15:46	04/11/2020 15:13	23,44	1	23,44	CHI
2020118827	SENADOR CANEDO	SW21084085	CEPAIGO S1	03/11/2020 15:48	03/11/2020 19:30	03/11/2020 15:48	03/11/2020 19:30	3,70	1	3,70	CHI
2020118835	PILAR DE GOIAS	GG12245205	SANTA TEREZINHA	03/11/2020 15:50	03/11/2020 20:03	03/11/2020 15:50	03/11/2020 20:03	4,21	14	58,98	CHI
2020118839	FAINA	FC12299779	MATRINCHA	03/11/2020 15:51	03/11/2020 17:59	03/11/2020 15:51	03/11/2020 17:59	2,13	16	34,09	CHI
2020118839	MATRINCHA	FC12299779	MATRINCHA	03/11/2020 15:51	03/11/2020 17:59	03/11/2020 15:51	03/11/2020 17:59	2,13	37	78,84	CHI
2020118841	PROFESSOR JAMIL SAFADY	JS21381453	ROCHEDO	03/11/2020 15:51	03/11/2020 22:19	03/11/2020 15:51	03/11/2020 22:19	6,47	1	6,47	CHI
2020118842	CAIAPONIA	CP12243936	PIRANHAS	03/11/2020 15:51	03/11/2020 20:20	03/11/2020 15:51	03/11/2020 20:20	4,47	1	4,47	CHI
2020118846	BARRO ALTO	BA21065924	BARRO ALTO	03/11/2020 15:52	04/11/2020 14:48	03/11/2020 15:52	04/11/2020 14:48	22,92	1	22,92	CHI
2020118958	SILVANIA	SV12053522	VIANOPOLIS	03/11/2020 15:53	03/11/2020 17:48	03/11/2020 15:53	03/11/2020 17:48	1,91	43	82,25	CHI
2020118868	PIRES DO RIO	1480234	PIRES DO RIO S1	03/11/2020 15:54	03/11/2020 22:42	03/11/2020 15:54	03/11/2020 15:59	0,08	1073	80,77	CHI
2020118868	PIRES DO RIO	PR16418888	PIRES DO RIO S1	03/11/2020 15:54	03/11/2020 22:42	03/11/2020 16:00	03/11/2020 16:08	0,14	666	92,87	CHI
2020118868	PIRES DO RIO	PR16418888	PIRES DO RIO S1	03/11/2020 15:54	03/11/2020 22:42	03/11/2020 16:20	03/11/2020 17:17	0,95	554	523,68	CHI

2020118868	PIRES DO RIO	PR13231380	PIRES DO RIO S1	03/11/2020 15:54	03/11/2020 22:42	03/11/2020 16:20	03/11/2020 22:35	6,25	112	699,66	CHI
2020118868	PIRES DO RIO	1480234	PIRES DO RIO S1	03/11/2020 15:54	03/11/2020 22:42	03/11/2020 15:54	03/11/2020 22:42	6,80	983	6679,49	CHI
2020118861	LUZIANIA	LZ21336024	CRISTALINA S2	03/11/2020 15:55	03/11/2020 19:18	03/11/2020 15:55	03/11/2020 19:18	3,38	1	3,38	CHI
2020119685	CAVALCANTE	TI12162624	NIQUELANDIA SUBTRANSMISSAO	03/11/2020 15:57	04/11/2020 16:14	03/11/2020 15:57	04/11/2020 16:14	24,29	29	704,38	CHI
2020119685	CAVALCANTE	TI12162624	NIQUELANDIA SUBTRANSMISSAO	03/11/2020 15:57	04/11/2020 16:14	04/11/2020 05:31	04/11/2020 16:14	10,72	29	310,93	CHI
2020119685	COLINAS DO SUL	TI12162624	NIQUELANDIA SUBTRANSMISSAO	03/11/2020 15:57	04/11/2020 16:14	04/11/2020 05:31	04/11/2020 16:14	10,72	18	192,99	CHI
2020118874	MORRINHOS	MR21119775	MORRINHOS	03/11/2020 15:58	03/11/2020 17:56	03/11/2020 15:58	03/11/2020 17:56	1,96	1	1,96	CHI
2020118878	INHUMAS	10030376775	INHUMAS S2	03/11/2020 15:58	03/11/2020 16:43	03/11/2020 15:58	03/11/2020 16:43	0,74	1	0,74	CHI
2020118892	ITABERAI	IB21099049	ITABERAI S2	03/11/2020 16:01	03/11/2020 16:59	03/11/2020 16:01	03/11/2020 16:59	0,96	2	1,92	CHI
2020118895	COCALZINHO DE GOIAS	ZN21137244	AGUAS LINDAS DE GOIAS S2	03/11/2020 16:02	03/11/2020 17:13	03/11/2020 16:02	03/11/2020 17:13	1,18	2	2,36	CHI
2020118902	CABECEIRAS	860005355	ITIQUIRA	03/11/2020 16:03	03/11/2020 16:59	03/11/2020 16:03	03/11/2020 16:59	0,92	1	0,92	CHI
2020119333	LUZIANIA	LZ12164807	CRISTALINA S2	03/11/2020 16:05	03/11/2020 21:32	03/11/2020 16:05	03/11/2020 21:32	5,45	3	16,34	CHI
2020119695	FLORES DE GOIAS	FB12239102	IACIARA S2	03/11/2020 16:05	03/11/2020 19:49	03/11/2020 16:05	03/11/2020 19:49	3,73	19	70,81	CHI
2020118913	GOIANIA	127114433	GOYA S1	03/11/2020 16:06	03/11/2020 17:08	03/11/2020 16:06	03/11/2020 17:08	1,02	1	1,02	CHI
2020118970	ITABERAI	II12217217	ITABERAI S1	03/11/2020 16:07	03/11/2020 17:49	03/11/2020 16:07	03/11/2020 17:49	1,70	22	37,50	CHI
2020118970	ITAGUARI	II12217217	ITABERAI S1	03/11/2020 16:07	03/11/2020 17:49	03/11/2020 16:07	03/11/2020 17:49	1,70	42	71,59	CHI
2020118970	TAQUARAL DE GOIAS	II12217217	ITABERAI S1	03/11/2020 16:07	03/11/2020 17:49	03/11/2020 16:07	03/11/2020 17:49	1,70	46	78,40	CHI
2020119447	ANAPOLIS	AN21285291	ANAPOLIS UNIVERSITARIO S1	03/11/2020 16:07	03/11/2020 22:14	03/11/2020 16:07	03/11/2020 22:14	6,11	1	6,11	CHI
2020118927	ITUMBIARA	690328187	ITUMBIARA VELHA S1	03/11/2020 16:10	03/11/2020 21:20	03/11/2020 16:10	03/11/2020 21:20	5,16	1	5,16	CHI
2020118929	SANTA TEREZINHA DE GOIAS	SG21153352	SANTA TEREZINHA	03/11/2020 16:11	03/11/2020 23:53	03/11/2020 16:11	03/11/2020 23:53	7,70	1	7,70	CHI
2020118934	CRISTALINA	KR21261552	CRISTALINA S1	03/11/2020 16:11	04/11/2020 13:01	03/11/2020 16:11	04/11/2020 13:01	20,82	1	20,82	CHI
2020118935	GOIANIRA	390086873	GOIANIRA	03/11/2020 16:11	03/11/2020 17:41	03/11/2020 16:11	03/11/2020 17:41	1,48	1	1,48	CHI
2020118936	LUZIANIA	LZ21086764	VIANOPOLIS	03/11/2020 16:12	03/11/2020 18:50	03/11/2020 16:12	03/11/2020 18:50	2,65	1	2,65	CHI
2020118943	NOFINOPOLIS	920021426	CEPAIGO S2	03/11/2020 16:13	03/11/2020 17:41	03/11/2020 16:13	03/11/2020 17:41	1,45	1	1,45	CHI
2020119668	NIQUELANDIA	NQ12182463	NIQUELANDIA SUBTRANSMISSAO	03/11/2020 16:16	03/11/2020 20:09	03/11/2020 16:16	03/11/2020 20:09	3,88	23	89,30	CHI
2020118959	SAO JOAO D ALIANCA	JL11131832	SAO JOAO D ALIANCA	03/11/2020 16:18	03/11/2020 19:37	03/11/2020 16:18	03/11/2020 19:37	3,31	28	92,70	CHI
2020118960	ANAPOLIS	AN12335408	ANAPOLIS UNIVERSITARIO S1	03/11/2020 16:18	03/11/2020 21:00	03/11/2020 16:18	03/11/2020 21:00	4,69	4	18,76	CHI
2020118961	VALPARAISO DE GOIAS	2860032387	MARAJOARA	03/11/2020 16:18	03/11/2020 20:47	03/11/2020 16:18	03/11/2020 20:47	4,47	1	4,47	CHI
2020118975	ITABERAI	IB21206919	ITABERAI S1	03/11/2020 16:18	03/11/2020 18:36	03/11/2020 16:18	03/11/2020 18:36	2,28	1	2,28	CHI
2020118964	GOIANIA	15834943	XAVANTES	03/11/2020 16:19	03/11/2020 18:58	03/11/2020 16:19	03/11/2020 18:58	2,65	1	2,65	CHI
2020118972	SANTA TEREZINHA DE GOIAS	10032314726	SANTA TEREZINHA	03/11/2020 16:20	03/11/2020 18:20	03/11/2020 16:20	03/11/2020 18:20	2,01	1	2,01	CHI
2020118994	MUNDO NOVO DE GOIAS	MH12208600	NOVA CRIXAS	03/11/2020 16:27	03/11/2020 18:59	03/11/2020 16:27	03/11/2020 18:59	2,52	3	7,57	CHI
2020118994	UIRAPURU	MH12208600	NOVA CRIXAS	03/11/2020 16:27	03/11/2020 18:59	03/11/2020 16:27	03/11/2020 18:59	2,52	15	37,85	CHI
2020118995	GOIANIA	14241780	CAMPINAS S2	03/11/2020 16:27	03/11/2020 17:31	03/11/2020 16:27	03/11/2020 17:31	1,06	1	1,06	CHI
2020118997	BOM JESUS DE GOIAS	1250071346	BOM JESUS DE GOIAS	03/11/2020 16:28	03/11/2020 20:54	03/11/2020 16:28	03/11/2020 20:54	4,43	1	4,43	CHI
2020119011	IACIARA	ND12218839	IACIARA S2	03/11/2020 16:30	03/11/2020 18:39	03/11/2020 16:30	03/11/2020 18:39	2,15	22	47,24	CHI
2020119011	SAO DOMINGOS	ND12218839	IACIARA S2	03/11/2020 16:30	03/11/2020 18:39	03/11/2020 16:30	03/11/2020 18:39	2,15	3	6,44	CHI
2020119730	GOIANAPOLIS	GP12191015	DAIA S2	03/11/2020 16:30	03/11/2020 20:39	03/11/2020 16:30	03/11/2020 20:39	4,14	2	8,27	CHI
2020119017	PORANGATU	PO21049573	PORANGATU	03/11/2020 16:31	03/11/2020 20:45	03/11/2020 16:31	03/11/2020 20:45	4,22	1	4,22	CHI
2020119025	TEREZOPOLIS DE GOIAS	TJ21382763	JUNDIAI S2	03/11/2020 16:34	03/11/2020 19:21	03/11/2020 16:34	03/11/2020 19:21	2,77	1	2,77	CHI
2020119030	CALDAS NOVAS	CN11163567	SERRA DE CALDAS	03/11/2020 16:36	03/11/2020 19:45	03/11/2020 16:36	03/11/2020 19:45	3,15	90	283,27	CHI
2020119155	CATALAO	CT12306664	CATALAO S1	03/11/2020 16:36	03/11/2020 18:06	03/11/2020 16:36	03/11/2020 18:06	1,49	4	5,95	CHI
2020119155	OUVIDOR	CT12306664	CATALAO S1	03/11/2020 16:36	03/11/2020 18:06	03/11/2020 16:36	03/11/2020 18:06	1,49	2	2,98	CHI
2020119063	ANAPOLIS	21176814	ANAPOLIS UNIVERSITARIO S2	03/11/2020 16:41	03/11/2020 18:19	03/11/2020 16:41	03/11/2020 18:19	1,62	1	1,62	CHI
2020119532	TRINDADE	TR12311261	TRINDADE	03/11/2020 16:42	03/11/2020 19:03	03/11/2020 16:42	03/11/2020 19:03	2,34	235	550,55	CHI
2020119067	TURVANIA	1220019760	FIRMINOPOLIS S2	03/11/2020 16:44	03/11/2020 19:05	03/11/2020 16:44	03/11/2020 19:05	2,35	1	2,35	CHI
2020119073	BOM JESUS DE GOIAS	1250051785	BOM JESUS DE GOIAS	03/11/2020 16:46	03/11/2020 22:02	03/11/2020 16:46	03/11/2020 22:02	5,25	1	5,25	CHI
2020119076	GOIANIA	10016357505	REAL S1	03/11/2020 16:47	03/11/2020 18:17	03/11/2020 16:47	03/11/2020 18:17	1,49	1	1,49	CHI
2020119079	APARECIDA DE GOIANIA	AP21048921	CEPAIGO S1	03/11/2020 16:47	03/11/2020 18:04	03/11/2020 16:47	03/11/2020 18:04	1,27	1	1,27	CHI
2020119092	ORIZONA	OZ12084921RE	PIRES DO RIO S2	03/11/2020 16:47	03/11/2020 17:54	03/11/2020 16:47	03/11/2020 17:54	1,10	110	121,24	CHI
2020119092	VIANOPOLIS	OZ12084921RE	PIRES DO RIO S2	03/11/2020 16:47	03/11/2020 17:54	03/11/2020 16:47	03/11/2020 17:54	1,10	17	18,74	CHI

2020119086	CIDADE OCIDENTAL	DH11261053	MARAJOARA	03/11/2020 16:49	03/11/2020 19:00	03/11/2020 16:49	03/11/2020 19:00	2,18	43	93,66	CHI
2020119096	ANAPOLIS	AN31068056	ANAPOLIS UNIVERSITARIO S2	03/11/2020 16:50	03/11/2020 20:32	03/11/2020 16:50	03/11/2020 20:32	3,69	1	3,69	CHI
2020119098	GOIANIA	GN11000464	AEROPORTO S1	03/11/2020 16:50	03/11/2020 23:49	03/11/2020 16:50	03/11/2020 23:49	6,97	43	299,63	CHI
2020119298	GOIANIA	GN11166599	CAMPINAS S2	03/11/2020 16:51	03/11/2020 18:56	03/11/2020 16:51	03/11/2020 18:56	2,08	115	238,98	CHI
2020119108	SAO LUIS DE MONTES BELOS	SL21206314	FIRMINOPOLIS S1	03/11/2020 16:53	03/11/2020 18:44	03/11/2020 16:53	03/11/2020 18:44	1,86	4	7,43	CHI
2020119109	APARECIDA DE GOIANIA	200392566	INDEPENDENCIA S2	03/11/2020 16:53	03/11/2020 17:48	03/11/2020 16:53	03/11/2020 17:48	0,90	1	0,90	CHI
2020119112	GOIANIA	17024705	CARAJAS S1	03/11/2020 16:54	03/11/2020 20:31	03/11/2020 16:54	03/11/2020 20:31	3,61	1	3,61	CHI
2020119114	MORRINHOS	MR11000054	MORRINHOS	03/11/2020 16:55	03/11/2020 18:08	03/11/2020 16:55	03/11/2020 18:08	1,21	233	282,32	CHI
2020119122	MATRINCHA	MP12165386	MOZARLANDIA	03/11/2020 16:59	03/11/2020 21:04	03/11/2020 16:59	03/11/2020 21:04	4,08	2	8,16	CHI
2020119123	CAMPESTRE DE GOIAS	GC21057451	TRINDADE	03/11/2020 16:59	03/11/2020 20:01	03/11/2020 16:59	03/11/2020 20:01	3,03	1	3,03	CHI
2020119233	NOVA IGUACU DE GOIAS	NH12202113	SANTA TEREZINHA	03/11/2020 17:00	04/11/2020 00:00	03/11/2020 17:00	04/11/2020 00:00	6,99	64	447,09	CHI
2020119148	ANAPOLIS	20509340	JUNDIAI S2	03/11/2020 17:06	03/11/2020 21:11	03/11/2020 17:06	03/11/2020 21:11	4,08	1	4,08	CHI
2020119149	GOIANIA	GN11058035	GOYA S1	03/11/2020 17:06	03/11/2020 20:31	03/11/2020 17:06	03/11/2020 20:31	3,41	115	391,70	CHI
2020119151	NEROPOLIS	10024126770	NEROPOLIS S2	03/11/2020 17:07	03/11/2020 19:57	03/11/2020 17:07	03/11/2020 19:57	2,83	1	2,83	CHI
2020119153	CEZARINA	CZ12010864	CEZARINA	03/11/2020 17:07	03/11/2020 19:04	03/11/2020 17:07	03/11/2020 19:04	1,94	9	17,46	CHI
2020119154	FLORES DE GOIAS	FB12321129	IACIARA S2	03/11/2020 17:07	03/11/2020 19:40	03/11/2020 17:07	03/11/2020 19:40	2,54	7	17,75	CHI
2020119154	FORMOSA	FB12321129	IACIARA S2	03/11/2020 17:07	03/11/2020 19:40	03/11/2020 17:07	03/11/2020 19:40	2,54	1	2,54	CHI
2020119154	VILA BOA	FB12321129	IACIARA S2	03/11/2020 17:07	03/11/2020 19:40	03/11/2020 17:07	03/11/2020 19:40	2,54	2	5,07	CHI
2020119169	EDEIA	EA21013543	EDEIA	03/11/2020 17:10	04/11/2020 00:21	03/11/2020 17:10	04/11/2020 00:21	7,17	2	14,34	CHI
2020119171	PLANALTINA	10008673410	PLANALTINA	03/11/2020 17:10	03/11/2020 22:18	03/11/2020 17:10	03/11/2020 22:18	5,12	1	5,12	CHI
2020119178	NIQUELANDIA	NQ21235665	URUACU	03/11/2020 17:12	03/11/2020 23:33	03/11/2020 17:12	03/11/2020 23:33	6,34	1	6,34	CHI
2020119290	RUBIATABA	RB12194289	RUBIATABA	03/11/2020 17:12	03/11/2020 20:42	03/11/2020 17:12	03/11/2020 20:42	3,49	1	3,49	CHI
2020119194	IPAMERI	IP12112268	PIRES DO RIO S2	03/11/2020 17:13	03/11/2020 20:51	03/11/2020 17:13	03/11/2020 20:51	3,63	20	72,52	CHI
2020119323	NOVA IGUACU DE GOIAS	NH12317131	CAMPINORTE	03/11/2020 17:13	04/11/2020 00:47	03/11/2020 17:13	04/11/2020 00:47	7,56	44	332,48	CHI
2020119189	NOVA CRIXAS	NA21344748	NOVA CRIXAS	03/11/2020 17:15	04/11/2020 01:03	03/11/2020 17:15	04/11/2020 01:03	7,80	1	7,80	CHI
2020119197	FAINA	FC21244277	GOIAS	03/11/2020 17:16	03/11/2020 19:00	03/11/2020 17:16	03/11/2020 19:00	1,73	1	1,73	CHI
2020119204	SANTA RITA DO NOVO DESTINO	BA12211709	BARRO ALTO	03/11/2020 17:17	04/11/2020 01:31	03/11/2020 22:05	04/11/2020 01:01	2,94	2	5,88	CHI
2020119204	SANTA RITA DO NOVO DESTINO	BA11068064	BARRO ALTO	03/11/2020 17:17	04/11/2020 01:31	03/11/2020 17:17	04/11/2020 01:31	8,24	97	798,96	CHI
2020119209	PIRES DO RIO	PR21075303	PIRES DO RIO S2	03/11/2020 17:18	03/11/2020 19:02	03/11/2020 17:18	03/11/2020 19:02	1,72	1	1,72	CHI
2020119231	ABADIANA	AA10394593	ANAPOLIS UNIVERSITARIO S1	03/11/2020 17:20	03/11/2020 17:55	03/11/2020 17:20	03/11/2020 17:55	0,60	317	189,50	CHI
2020119231	CORUMBA DE GOIAS	AA10394593	ANAPOLIS UNIVERSITARIO S1	03/11/2020 17:20	03/11/2020 17:55	03/11/2020 17:20	03/11/2020 17:55	0,60	4	2,39	CHI
2020119231	GAMELEIRA DE GOIAS	AA10394593	ANAPOLIS UNIVERSITARIO S1	03/11/2020 17:20	03/11/2020 17:55	03/11/2020 17:20	03/11/2020 17:55	0,60	1	0,60	CHI
2020119220	AGUA FRIA DE GOIAS	TL21076116	SAO JOAO D ALIANCA	03/11/2020 17:22	03/11/2020 18:01	03/11/2020 17:22	03/11/2020 18:01	0,64	1	0,64	CHI
2020119484	AMARALINA	MH12362454	NOVA CRIXAS	03/11/2020 17:22	03/11/2020 19:49	03/11/2020 17:22	03/11/2020 19:49	2,45	1	2,45	CHI
2020119484	MUNDO NOVO DE GOIAS	MH12362454	NOVA CRIXAS	03/11/2020 17:22	03/11/2020 19:49	03/11/2020 17:22	03/11/2020 19:49	2,45	301	736,28	CHI
2020119230	MORRINHOS	GT21197108	GOIATUBA S1	03/11/2020 17:24	04/11/2020 10:48	03/11/2020 17:24	04/11/2020 10:48	17,39	1	17,39	CHI
2020119232	BOM JARDIM DE GOIAS	BM12334813	IPORA	03/11/2020 17:25	03/11/2020 21:59	03/11/2020 17:25	03/11/2020 21:59	4,57	15	68,49	CHI
2020119236	FORMOSA	610108189	ITIQUEIRA	03/11/2020 17:25	03/11/2020 19:32	03/11/2020 17:25	03/11/2020 19:32	2,10	1	2,10	CHI
2020119238	JARAGUA	70121539	JARAGUA	03/11/2020 17:26	03/11/2020 22:11	03/11/2020 17:26	03/11/2020 22:11	4,75	1	4,75	CHI
2020119246	ITAPURANGA	170060858	ITAPURANGA	03/11/2020 17:27	03/11/2020 20:55	03/11/2020 17:27	03/11/2020 20:55	3,46	1	3,46	CHI
2020119261	GOIANIA	13070186	REAL S2	03/11/2020 17:29	03/11/2020 19:34	03/11/2020 17:29	03/11/2020 19:34	2,08	1	2,08	CHI
2020119264	LUZIANIA	10018163759	RIO VERMELHO	03/11/2020 17:30	03/11/2020 21:39	03/11/2020 17:30	03/11/2020 21:39	4,15	1	4,15	CHI
2020119271	SANTO ANTONIO DO DESCOBERTO	SN11183717	MARAJOARA	03/11/2020 17:32	03/11/2020 19:42	03/11/2020 17:32	03/11/2020 19:42	2,16	3	6,48	CHI
2020119397	BELA VISTA DE GOIAS	BV12086489	CEPAIGO S2	03/11/2020 17:33	03/11/2020 20:31	03/11/2020 17:33	03/11/2020 20:31	2,96	13	38,51	CHI
2020119397	SILVANIA	BV12086489	CEPAIGO S2	03/11/2020 17:33	03/11/2020 20:31	03/11/2020 17:33	03/11/2020 20:31	2,96	1	2,96	CHI
2020119283	NOVA CRIXAS	NA11229694	NOVA CRIXAS	03/11/2020 17:34	03/11/2020 21:35	03/11/2020 17:34	03/11/2020 21:35	4,00	1	4,00	CHI
2020119284	GOIANIRA	10006348155	GOIANIRA	03/11/2020 17:34	03/11/2020 22:37	03/11/2020 17:34	03/11/2020 22:37	5,04	1	5,04	CHI
2020111750	SAO MIGUEL DO ARAGUAIA	SM11100748	SAO MIGUEL DO ARAGUAIA	03/11/2020 17:37	05/11/2020 14:50	03/11/2020 17:37	05/11/2020 14:50	45,20	63	2847,76	CHI
2020119300	SILVANIA	SV21041060	VIANOPOLIS	03/11/2020 17:39	03/11/2020 20:42	03/11/2020 17:39	03/11/2020 20:42	3,04	1	3,04	CHI
2020119304	LUZIANIA	120284066	RIO VERMELHO	03/11/2020 17:39	03/11/2020 21:31	03/11/2020 17:39	03/11/2020 21:31	3,85	1	3,85	CHI
2020119319	GOIANIA	10367846	CARAJAS S2	03/11/2020 17:43	03/11/2020 19:38	03/11/2020 17:43	03/11/2020 19:38	1,90	1	1,90	CHI

2020119325	CRISTALINA	KR21025857	PAMPLONA	03/11/2020 17:45	03/11/2020 20:14	03/11/2020 17:45	03/11/2020 20:14	2,47	1	2,47	CHI
2020119326	CATURAI	CK12060917	ARACU	03/11/2020 17:45	03/11/2020 20:02	03/11/2020 17:45	03/11/2020 20:02	2,27	1	2,27	CHI
2020119376	APARECIDA DE GOIANIA	AP11006206	ANHANGUERA	03/11/2020 17:45	03/11/2020 19:16	03/11/2020 17:45	03/11/2020 19:16	1,50	182	273,71	CHI
2020119330	CALDAS NOVAS	10021320100	SERRA DE CALDAS	03/11/2020 17:46	03/11/2020 18:49	03/11/2020 17:46	03/11/2020 18:49	1,04	1	1,04	CHI
2020119332	GOIANIRA	390027339	GOIANIRA	03/11/2020 17:46	03/11/2020 23:36	03/11/2020 17:46	03/11/2020 23:36	5,82	1	5,82	CHI
2020119443	MUNDO NOVO DE GOIAS	NA12035650	NOVA CRIXAS	03/11/2020 17:50	03/11/2020 22:32	03/11/2020 17:50	03/11/2020 22:32	4,70	8	37,57	CHI
2020119443	NOVA CRIXAS	NA12035650	NOVA CRIXAS	03/11/2020 17:50	03/11/2020 22:32	03/11/2020 17:50	03/11/2020 22:32	4,70	24	112,71	CHI
2020119472	SAO DOMINGOS	SD12132214	SAO DOMINGOS	03/11/2020 17:51	04/11/2020 01:13	03/11/2020 17:51	04/11/2020 01:13	7,36	3	22,08	CHI
2020119362	IPAMERI	OZ12137542RE	PIRES DO RIO S2	03/11/2020 17:52	03/11/2020 20:40	03/11/2020 17:52	03/11/2020 20:40	2,79	10	27,89	CHI
2020119366	APARECIDA DE GOIANIA	200404489	CEPAIGO S1	03/11/2020 17:53	03/11/2020 20:07	03/11/2020 17:53	03/11/2020 20:07	2,23	1	2,23	CHI
2020119372	SANTO ANTONIO DO DESCOBERTO	8205304	MARAJOARA	03/11/2020 17:54	04/11/2020 15:17	04/11/2020 09:48	04/11/2020 14:06	4,29	4	17,16	CHI
2020119372	SANTO ANTONIO DO DESCOBERTO	SN12085984LD	MARAJOARA	03/11/2020 17:54	04/11/2020 15:17	03/11/2020 17:54	04/11/2020 15:17	21,38	21	449,07	CHI
2020119698	JESUPOLIS	SF12066036	SAO FRANCISCO DE GOIAS	03/11/2020 17:56	03/11/2020 23:00	03/11/2020 17:56	03/11/2020 23:00	5,05	16	80,86	CHI
2020119386	MARA ROSA	MQ11072701	MARA ROSA	03/11/2020 17:57	03/11/2020 23:20	03/11/2020 17:57	03/11/2020 23:20	5,38	154	828,69	CHI
2020119388	URUACU	UR11076068	URUACU	03/11/2020 17:58	03/11/2020 21:50	03/11/2020 17:58	03/11/2020 21:50	3,87	186	719,20	CHI
2020119390	APARECIDA DE GOIANIA	200558705	ANHANGUERA	03/11/2020 17:58	03/11/2020 19:23	03/11/2020 17:58	03/11/2020 19:23	1,41	1	1,41	CHI
2020119392	ALTO PARAISO DE GOIAS	BF12128334	SAO JOAO D ALIANCA	03/11/2020 17:59	03/11/2020 22:44	03/11/2020 17:59	03/11/2020 22:44	4,75	3	14,25	CHI
2020119394	URUACU	10024154170	URUACU	03/11/2020 17:59	03/11/2020 22:46	03/11/2020 17:59	03/11/2020 22:46	4,77	1	4,77	CHI
2020119518	ABADIANIA	AX12351038	ALEXANIA	03/11/2020 17:59	04/11/2020 10:50	03/11/2020 17:59	04/11/2020 10:50	16,84	3	50,53	CHI
2020119518	ALEXANIA	AX12351038	ALEXANIA	03/11/2020 17:59	04/11/2020 10:50	03/11/2020 17:59	04/11/2020 10:50	16,84	40	673,68	CHI
2020119518	ABADIANIA	AX12351038	ALEXANIA	03/11/2020 17:59	04/11/2020 10:50	03/11/2020 20:00	04/11/2020 10:50	14,84	4	59,35	CHI
202011137928	ALEXANIA	AX11068050	ALEXANIA	03/11/2020 17:59	04/11/2020 11:19	03/11/2020 17:59	04/11/2020 11:19	17,33	23	398,64	CHI
2020119406	PLANALTINA	PI12379178	PLANALTINA	03/11/2020 18:01	04/11/2020 04:49	03/11/2020 18:01	04/11/2020 04:49	10,79	2	21,58	CHI
2020119407	AGUAS LINDAS DE GOIAS	4830193725	AGUAS LINDAS DE GOIAS S1	03/11/2020 18:01	03/11/2020 22:01	03/11/2020 18:01	03/11/2020 22:01	3,99	1	3,99	CHI
2020119408	CRIXAS	CX12140958	SANTA TEREZINHA	03/11/2020 18:01	04/11/2020 05:11	03/11/2020 18:01	04/11/2020 05:11	11,15	9	100,38	CHI
2020119418	PLANALTINA	PI21380138	PLANALTINA	03/11/2020 18:02	03/11/2020 22:03	03/11/2020 18:02	03/11/2020 22:03	4,00	1	4,00	CHI
2020119425	NIQUELANDIA	NQ21156247	URUACU	03/11/2020 18:05	04/11/2020 12:07	03/11/2020 18:05	04/11/2020 12:07	18,02	1	18,02	CHI
2020119426	TRINDADE	10009975509	MEIA PONTE	03/11/2020 18:05	03/11/2020 21:46	03/11/2020 18:05	03/11/2020 21:46	3,67	1	3,67	CHI
2020119435	ITABERAI	II12217217	ITABERAI S1	03/11/2020 18:08	03/11/2020 22:50	03/11/2020 18:08	03/11/2020 22:50	4,69	22	103,27	CHI
2020119435	ITAGUARI	II12217217	ITABERAI S1	03/11/2020 18:08	03/11/2020 22:50	03/11/2020 18:08	03/11/2020 22:50	4,69	42	197,15	CHI
2020119435	TAQUARAL DE GOIAS	II12217217	ITABERAI S1	03/11/2020 18:08	03/11/2020 22:50	03/11/2020 18:08	03/11/2020 22:50	4,69	46	215,93	CHI
2020119438	PLANALTINA	PI11355805	PLANALTINA	03/11/2020 18:08	04/11/2020 08:48	03/11/2020 18:08	04/11/2020 08:48	14,66	1	14,66	CHI
2020119451	IPAMERI	IP12376252	CRISTALINA S2	03/11/2020 18:08	03/11/2020 23:07	03/11/2020 18:08	03/11/2020 23:07	4,97	19	94,44	CHI
20201110244	IPAMERI	IP21248618	CRISTALINA S2	03/11/2020 18:08	04/11/2020 08:38	03/11/2020 18:08	04/11/2020 08:38	14,49	1	14,49	CHI
2020119452	DIVINOPOLIS DE GOIAS	GH12248894	SAO DOMINGOS	03/11/2020 18:12	03/11/2020 21:29	03/11/2020 18:12	03/11/2020 21:29	3,27	4	13,10	CHI
2020119455	GOIANIA	10008448971	INDEPENDENCIA S2	03/11/2020 18:13	03/11/2020 20:48	03/11/2020 18:13	03/11/2020 20:48	2,57	1	2,57	CHI
2020119494	SAO MIGUEL DO ARAGUAIA	SM12074411	SAO MIGUEL DO ARAGUAIA	03/11/2020 18:13	03/11/2020 22:35	03/11/2020 18:13	03/11/2020 22:35	4,36	8	34,90	CHI
2020119457	ABADIANIA	AA11196996	ANAPOLIS UNIVERSITARIO S1	03/11/2020 18:14	03/11/2020 21:05	03/11/2020 18:14	03/11/2020 21:05	2,84	64	181,85	CHI
2020119460	GOIANIA	17061714	INDEPENDENCIA S2	03/11/2020 18:14	03/11/2020 21:27	03/11/2020 18:14	03/11/2020 21:27	3,20	1	3,20	CHI
2020119561	NIQUELANDIA	NQ12280978	URUACU	03/11/2020 18:14	03/11/2020 19:57	03/11/2020 18:14	03/11/2020 19:57	1,70	72	122,58	CHI
2020119536	DIORAMA	DI12065691	IPORA	03/11/2020 18:16	03/11/2020 21:15	03/11/2020 18:16	03/11/2020 21:15	2,98	8	23,83	CHI
2020119473	PIRACANJUBA	HD21283358	ROCHEDO	03/11/2020 18:17	03/11/2020 23:34	03/11/2020 18:17	03/11/2020 23:34	5,28	2	10,55	CHI
2020119906	AMARALINA	MQ12182369	MARA ROSA	03/11/2020 18:17	04/11/2020 15:48	03/11/2020 18:17	04/11/2020 15:48	21,52	25	537,88	CHI
2020119906	MARA ROSA	MQ12182369	MARA ROSA	03/11/2020 18:17	04/11/2020 15:48	03/11/2020 18:17	04/11/2020 15:48	21,52	3	64,55	CHI
20201110060	PIRES DO RIO	PR12000045	PIRES DO RIO S1	03/11/2020 18:17	04/11/2020 01:14	03/11/2020 18:17	04/11/2020 01:14	6,93	271	1879,23	CHI
2020119478	IACIARA	IA12262059	IACIARA S1	03/11/2020 18:18	04/11/2020 13:04	03/11/2020 18:18	03/11/2020 22:39	4,35	1	4,35	CHI
2020119478	IACIARA	IA12262059	IACIARA S1	03/11/2020 18:18	04/11/2020 13:04	03/11/2020 18:18	04/11/2020 09:30	15,21	16	243,30	CHI
2020119478	IACIARA	IA12262059	IACIARA S1	03/11/2020 18:18	04/11/2020 13:04	03/11/2020 18:18	04/11/2020 10:31	16,23	4	64,91	CHI
2020119478	IACIARA	IA12262059	IACIARA S1	03/11/2020 18:18	04/11/2020 13:04	03/11/2020 18:18	04/11/2020 13:04	18,77	1	18,77	CHI
2020119496	SAO MIGUEL DO ARAGUAIA	SM10388763	SAO MIGUEL DO ARAGUAIA	03/11/2020 18:18	04/11/2020 15:47	03/11/2020 19:08	03/11/2020 21:40	2,53	92	232,53	CHI
2020119496	SAO MIGUEL DO ARAGUAIA	SM13380422	SAO MIGUEL DO ARAGUAIA	03/11/2020 18:18	04/11/2020 15:47	03/11/2020 19:08	04/11/2020 00:03	4,90	21	102,98	CHI

2020119496	SAO MIGUEL DO ARAGUAIA	SM10404183	SAO MIGUEL DO ARAGUAIA	03/11/2020 18:18	04/11/2020 15:47	03/11/2020 18:18	04/11/2020 01:19	7,00	8	56,02	CHI
2020119496	SAO MIGUEL DO ARAGUAIA	SM13182436	SAO MIGUEL DO ARAGUAIA	03/11/2020 18:18	04/11/2020 15:47	03/11/2020 19:08	04/11/2020 02:52	7,72	96	740,96	CHI
2020119496	SAO MIGUEL DO ARAGUAIA	SM10404183	SAO MIGUEL DO ARAGUAIA	03/11/2020 18:18	04/11/2020 15:47	03/11/2020 18:18	04/11/2020 03:19	9,02	102	919,70	CHI
2020119496	SAO MIGUEL DO ARAGUAIA	SM10388763	SAO MIGUEL DO ARAGUAIA	03/11/2020 18:18	04/11/2020 15:47	04/11/2020 02:55	04/11/2020 03:19	0,41	121	50,08	CHI
2020119496	SAO MIGUEL DO ARAGUAIA	SM10404183	SAO MIGUEL DO ARAGUAIA	03/11/2020 18:18	04/11/2020 15:47	04/11/2020 09:59	04/11/2020 10:12	0,22	23	5,04	CHI
2020119496	SAO MIGUEL DO ARAGUAIA	SM13182436	SAO MIGUEL DO ARAGUAIA	03/11/2020 18:18	04/11/2020 15:47	04/11/2020 02:55	04/11/2020 10:39	7,74	34	263,11	CHI
2020119496	SAO MIGUEL DO ARAGUAIA	SM13241984	SAO MIGUEL DO ARAGUAIA	03/11/2020 18:18	04/11/2020 15:47	04/11/2020 02:55	04/11/2020 12:17	9,37	42	393,63	CHI
2020119496	SAO MIGUEL DO ARAGUAIA	SM13315099	SAO MIGUEL DO ARAGUAIA	03/11/2020 18:18	04/11/2020 15:47	04/11/2020 02:55	04/11/2020 14:17	11,38	14	159,32	CHI
2020119496	SAO MIGUEL DO ARAGUAIA	SM12031421	SAO MIGUEL DO ARAGUAIA	03/11/2020 18:18	04/11/2020 15:47	03/11/2020 18:18	04/11/2020 15:30	21,20	17	360,40	CHI
2020119496	SAO MIGUEL DO ARAGUAIA	SM12313435LD	SAO MIGUEL DO ARAGUAIA	03/11/2020 18:18	04/11/2020 15:47	04/11/2020 02:55	04/11/2020 15:47	12,87	6	77,20	CHI
2020119490	SANTA ROSA DE GOIAS	540013766	INHUMAS S1	03/11/2020 18:20	03/11/2020 19:53	03/11/2020 18:20	03/11/2020 19:53	1,55	1	1,55	CHI
2020119499	NOVO GAMA	2460054320	PACAEMBU S1	03/11/2020 18:20	03/11/2020 20:43	03/11/2020 18:20	03/11/2020 20:43	2,37	1	2,37	CHI
2020119507	SENADOR CANEDO	10001614108	SENADOR CANEDO	03/11/2020 18:22	03/11/2020 20:09	03/11/2020 18:22	03/11/2020 20:09	1,78	1	1,78	CHI
2020119508	ITABERAÍ	IB21183398	ITABERAÍ S1	03/11/2020 18:22	04/11/2020 12:20	03/11/2020 18:22	04/11/2020 12:20	17,96	1	17,96	CHI
2020119509	ABADIANIA	350025022	ANAPOLIS UNIVERSITARIO S1	03/11/2020 18:22	04/11/2020 09:07	03/11/2020 18:22	04/11/2020 09:07	14,75	1	14,75	CHI
2020119514	ALEXANIA	AX11285381	ALEXANIA	03/11/2020 18:24	03/11/2020 22:28	03/11/2020 18:24	03/11/2020 22:28	4,06	14	56,88	CHI
2020119516	TRES RANCHOS	TH21063790	CATALAO S1	03/11/2020 18:24	03/11/2020 21:05	03/11/2020 18:24	03/11/2020 21:05	2,67	5	13,35	CHI
2020119520	ORIZONA	OZ12084921RE	PIRES DO RIO S2	03/11/2020 18:25	04/11/2020 00:27	03/11/2020 18:25	04/11/2020 00:27	6,02	110	662,75	CHI
2020119520	VIANOPOLIS	OZ12084921RE	PIRES DO RIO S2	03/11/2020 18:25	04/11/2020 00:27	03/11/2020 18:25	04/11/2020 00:27	6,02	17	102,42	CHI
2020119523	NIQUELANDIA	NQ21221621	URUACU	03/11/2020 18:26	04/11/2020 03:16	03/11/2020 18:26	04/11/2020 03:16	8,83	17	150,11	CHI
2020119526	ANAPOLIS	20788060	ANAPOLIS UNIVERSITARIO S2	03/11/2020 18:27	03/11/2020 19:34	03/11/2020 18:27	03/11/2020 19:34	1,11	1	1,11	CHI
2020119551	AURILANDIA	AI21247539	FIRMINOPOLIS S2	03/11/2020 18:30	03/11/2020 18:35	03/11/2020 18:30	03/11/2020 18:35	0,09	1	0,09	CHI
2020119534	CRISTALINA	10019896806	CRISTALINA S1	03/11/2020 18:31	03/11/2020 21:26	03/11/2020 18:31	03/11/2020 21:26	2,92	1	2,92	CHI
2020119539	GOIANIA	17046002	GOIANIA LESTE S3	03/11/2020 18:31	03/11/2020 20:49	03/11/2020 18:31	03/11/2020 20:49	2,28	1	2,28	CHI
2020119543	APARECIDA DE GOIANIA	200244000	INDEPENDENCIA S2	03/11/2020 18:32	03/11/2020 19:34	03/11/2020 18:32	03/11/2020 19:34	1,02	1	1,02	CHI
2020119544	GOIANIA	10007571281	XAVANTES	03/11/2020 18:33	03/11/2020 20:06	03/11/2020 18:33	03/11/2020 20:06	1,55	1	1,55	CHI
2020119548	GOIANIA	12801768	GOIANIA LESTE S2	03/11/2020 18:33	03/11/2020 19:59	03/11/2020 18:33	03/11/2020 19:59	1,42	1	1,42	CHI
2020119555	IPORA	IR21286366	IPORA	03/11/2020 18:34	03/11/2020 21:49	03/11/2020 18:34	03/11/2020 21:49	3,24	1	3,24	CHI
2020119558	NOVO BRASIL	NB21064410	MATRINCHA	03/11/2020 18:35	04/11/2020 04:35	03/11/2020 18:35	04/11/2020 04:35	9,99	1	9,99	CHI
2020119568	LUZIANIA	LZ12376193	MARAJOARA	03/11/2020 18:37	03/11/2020 20:47	03/11/2020 18:37	03/11/2020 20:47	2,16	16	34,55	CHI
2020119577	BARRO ALTO	GE12115071	GOIANESIA S1	03/11/2020 18:40	03/11/2020 21:40	03/11/2020 18:40	03/11/2020 21:40	2,99	2	5,97	CHI
2020119577	GOIANESIA	GE12115071	GOIANESIA S1	03/11/2020 18:40	03/11/2020 21:40	03/11/2020 18:40	03/11/2020 21:40	2,99	9	26,88	CHI
2020119585	ITABERAÍ	IB11379754	ITABERAÍ S2	03/11/2020 18:42	03/11/2020 20:15	03/11/2020 18:42	03/11/2020 20:15	1,54	40	61,73	CHI
2020119596	CRISTALINA	KR21171048	CRISTALINA S2	03/11/2020 18:46	03/11/2020 23:36	03/11/2020 18:46	03/11/2020 23:36	4,83	1	4,83	CHI
2020119598	FORMOSO	FO12393887	PORANGATU	03/11/2020 18:46	03/11/2020 21:11	03/11/2020 18:46	03/11/2020 21:11	2,40	8	19,20	CHI
2020119611	GOIANIA	GN11000381	GOIANIA LESTE S1	03/11/2020 18:48	03/11/2020 21:10	03/11/2020 19:50	03/11/2020 21:10	1,33	40	53,34	CHI
2020119670	IPORA	IR11005994	IPORA	03/11/2020 18:50	03/11/2020 19:53	03/11/2020 18:50	03/11/2020 19:53	1,05	98	102,76	CHI
2020119634	ALEXANIA	AX21258479	ALEXANIA	03/11/2020 18:54	04/11/2020 08:57	03/11/2020 18:54	04/11/2020 08:57	14,04	1	14,04	CHI
2020119635	LUZIANIA	10014849680	RIO VERMELHO	03/11/2020 18:54	03/11/2020 22:22	03/11/2020 18:54	03/11/2020 22:22	3,45	1	3,45	CHI
2020119641	ANAPOLIS	20855096	JUNDIAI S1	03/11/2020 18:55	03/11/2020 21:56	03/11/2020 18:55	03/11/2020 21:56	3,00	1	3,00	CHI
2020119647	AGUAS LINDAS DE GOIAS	LA11203791	AGUAS LINDAS DE GOIAS S1	03/11/2020 18:56	03/11/2020 20:05	03/11/2020 18:56	03/11/2020 20:05	1,14	1	1,14	CHI
2020119649	BELA VISTA DE GOIAS	BV12059732	SENADOR CANEDO	03/11/2020 18:57	03/11/2020 23:07	03/11/2020 18:57	03/11/2020 23:07	4,16	5	20,82	CHI
2020119649	CALDAZINHA	BV12059732	SENADOR CANEDO	03/11/2020 18:57	03/11/2020 23:07	03/11/2020 18:57	03/11/2020 23:07	4,16	8	33,31	CHI
2020119661	APARECIDA DE GOIANIA	14045643	ATLANTICO S2	03/11/2020 19:01	03/11/2020 20:41	03/11/2020 19:01	03/11/2020 20:41	1,67	1	1,67	CHI
2020119663	ARAGARCAS	BM21369815	BOM JARDIM	03/11/2020 19:01	04/11/2020 00:55	03/11/2020 19:01	04/11/2020 00:55	5,90	2	11,79	CHI
2020119666	BALIZA	BH11187390	BOM JARDIM	03/11/2020 19:02	03/11/2020 21:28	03/11/2020 19:02	03/11/2020 21:28	2,44	73	178,34	CHI
2020119674	GOIANIA	15349196	REAL S1	03/11/2020 19:04	03/11/2020 21:07	03/11/2020 19:04	03/11/2020 21:07	2,04	1	2,04	CHI
2020119676	MONTIVIDIU DO NORTE	PO12370546	PORANGATU	03/11/2020 19:04	04/11/2020 16:43	03/11/2020 19:04	04/11/2020 16:43	21,64	4	86,54	CHI
2020119843	GOIANIA	GN11002407	FERROVIARIO S1	03/11/2020 19:04	03/11/2020 21:09	03/11/2020 19:04	03/11/2020 21:09	2,08	103	213,93	CHI
2020119707	ANAPOLIS	AN11217372	ANAPOLIS UNIVERSITARIO S2	03/11/2020 19:05	03/11/2020 20:49	03/11/2020 19:05	03/11/2020 20:49	1,73	114	197,47	CHI
2020119694	GOIANIA	10006578649	REAL S1	03/11/2020 19:08	03/11/2020 20:23	03/11/2020 19:08	03/11/2020 20:23	1,24	1	1,24	CHI

2020119700	COCALZINHO DE GOIAS	ZN12326323	COCALZINHO	03/11/2020 19:10	04/11/2020 02:08	03/11/2020 19:10	04/11/2020 02:08	6,96	6	41,77	CHI
2020119700	PIRENOPOLIS	ZN12326323	COCALZINHO	03/11/2020 19:10	04/11/2020 02:08	03/11/2020 19:10	04/11/2020 02:08	6,96	30	208,83	CHI
2020119701	UIRAPURU	UP21190341	NOVA CRIXAS	03/11/2020 19:10	03/11/2020 21:25	03/11/2020 19:10	03/11/2020 21:25	2,24	1	2,24	CHI
2020119766	PETROLINA DE GOIAS	PG12038042	INHUMAS S1	03/11/2020 19:10	03/11/2020 20:32	03/11/2020 19:10	03/11/2020 20:32	1,36	15	20,34	CHI
2020119704	SANTO ANTONIO DO DESCOBERTO	10004017070	ALEXANIA	03/11/2020 19:11	04/11/2020 09:57	03/11/2020 19:11	04/11/2020 09:57	14,76	1	14,76	CHI
2020119719	BRITANIA	BT21009937	BRITANIA	03/11/2020 19:15	04/11/2020 14:59	03/11/2020 19:15	04/11/2020 14:59	19,72	1	19,72	CHI
2020119720	VILA PROPICIO	PV21140667	GOIANESIA S2	03/11/2020 19:15	03/11/2020 23:37	03/11/2020 19:15	03/11/2020 23:37	4,35	1	4,35	CHI
2020119722	GOIANIA	10016472606	FERROVIARIO S1	03/11/2020 19:16	03/11/2020 21:33	03/11/2020 19:16	03/11/2020 21:33	2,27	1	2,27	CHI
2020119725	GOIANIA	10004044388	AEROPORTO S1	03/11/2020 19:17	03/11/2020 20:33	03/11/2020 19:17	03/11/2020 20:33	1,25	1	1,25	CHI
2020119737	POSSE	PS21256173	IACIARA S2	03/11/2020 19:22	03/11/2020 22:04	03/11/2020 19:22	03/11/2020 22:04	2,69	1	2,69	CHI
2020119745	ARAGOIANIA	AO11092570	GUAPO S2	03/11/2020 19:25	03/11/2020 23:07	03/11/2020 19:25	03/11/2020 23:07	3,69	33	121,65	CHI
2020119749	NEROPOLIS	10017048379	NEROPOLIS S2	03/11/2020 19:27	03/11/2020 21:24	03/11/2020 19:27	03/11/2020 21:24	1,95	1	1,95	CHI
20201110181	JANDAIA	JD12233369	PALMEIRAS	03/11/2020 19:27	04/11/2020 06:31	03/11/2020 19:27	04/11/2020 06:31	11,07	5	55,33	CHI
2020119755	SENADOR CANEDO	12425552	SENADOR CANEDO	03/11/2020 19:29	03/11/2020 21:12	03/11/2020 19:29	03/11/2020 21:12	1,71	1	1,71	CHI
2020119756	GOIANIA	14415070	XAVANTES	03/11/2020 19:30	03/11/2020 21:14	03/11/2020 19:30	03/11/2020 21:14	1,73	1	1,73	CHI
2020119757	GOIANIA	15177520	CARAJAS S1	03/11/2020 19:30	03/11/2020 20:48	03/11/2020 19:30	03/11/2020 20:48	1,29	1	1,29	CHI
2020119839	JUSSARA	JR12074365	BRITANIA	03/11/2020 19:31	04/11/2020 00:24	03/11/2020 19:31	04/11/2020 00:24	4,87	37	180,36	CHI
2020119839	SANTA FE DE GOIAS	JR12074365	BRITANIA	03/11/2020 19:31	04/11/2020 00:24	03/11/2020 19:31	04/11/2020 00:24	4,87	21	102,37	CHI
2020119810	AGUAS LINDAS DE GOIAS	LA11349021	AGUAS LINDAS DE GOIAS S1	03/11/2020 19:32	03/11/2020 20:29	03/11/2020 19:32	03/11/2020 20:29	0,94	142	133,09	CHI
2020119767	PADRE BERNARDO	PB12284769	PADRE BERNARDO	03/11/2020 19:33	03/11/2020 21:30	03/11/2020 19:33	03/11/2020 21:30	1,94	68	131,83	CHI
2020119781	MUTUNOPOLIS	MU12068520	MARA ROSA	03/11/2020 19:37	04/11/2020 09:41	03/11/2020 19:37	04/11/2020 09:41	14,05	2	28,10	CHI
2020119781	PORANGATU	MU12068520	MARA ROSA	03/11/2020 19:37	04/11/2020 09:41	03/11/2020 19:37	04/11/2020 09:41	14,05	12	168,60	CHI
2020119909	FORMOSO	SE12053856	MARA ROSA	03/11/2020 19:38	03/11/2020 23:17	03/11/2020 19:38	03/11/2020 23:17	3,64	6	21,83	CHI
2020119909	SANTA TEREZA DE GOIAS	SE12053856	MARA ROSA	03/11/2020 19:38	03/11/2020 23:17	03/11/2020 19:38	03/11/2020 23:17	3,64	3	10,91	CHI
2020119834	GOIAS	GS12206865	MATRINCHA	03/11/2020 19:41	03/11/2020 23:36	03/11/2020 19:41	03/11/2020 23:36	3,91	68	265,67	CHI
2020119817	ANAPOLIS	21167084	ANAPOLIS UNIVERSITARIO S1	03/11/2020 19:47	03/11/2020 21:07	03/11/2020 19:47	03/11/2020 21:07	1,32	1	1,32	CHI
2020119859	PADRE BERNARDO	PB12261461	PADRE BERNARDO	03/11/2020 19:47	03/11/2020 20:39	03/11/2020 19:47	03/11/2020 20:39	0,85	286	243,26	CHI
2020119821	PALMEIRAS DE GOIAS	PL11276876	PALMEIRAS	03/11/2020 19:48	03/11/2020 22:17	03/11/2020 19:48	03/11/2020 22:17	2,48	1	2,48	CHI
2020119826	PORANGATU	PO12241996	PORANGATU	03/11/2020 19:49	04/11/2020 11:30	03/11/2020 19:49	04/11/2020 11:30	15,67	80	1253,84	CHI
2020119832	PORANGATU	840148770	PORANGATU	03/11/2020 19:51	03/11/2020 22:18	03/11/2020 19:51	03/11/2020 22:18	2,45	1	2,45	CHI
2020119835	UIRAPURU	UP21147330	SANTA TEREZINHA	03/11/2020 19:53	03/11/2020 22:44	03/11/2020 19:53	03/11/2020 22:44	2,84	1	2,84	CHI
2020119844	ITABERAI	50015734	ITABERAI S2	03/11/2020 19:55	03/11/2020 20:57	03/11/2020 19:55	03/11/2020 20:57	1,03	1	1,03	CHI
2020119850	CAMPINACU	UC12239728	PORANGATU	03/11/2020 19:56	04/11/2020 04:00	03/11/2020 19:56	04/11/2020 04:00	8,06	8	64,45	CHI
2020119851	SANTO ANTONIO DO DESCOBERTO	10027403686	MARAJOARA	03/11/2020 19:56	03/11/2020 21:29	03/11/2020 19:56	03/11/2020 21:29	1,54	1	1,54	CHI
2020119858	CAIAPONIA	CP12259426	CAIAPONIA	03/11/2020 19:58	03/11/2020 22:06	03/11/2020 19:58	03/11/2020 22:06	2,12	11	23,37	CHI
2020119861	SITIO D ABADIA	SI12131972	IACIARA S2	03/11/2020 19:59	03/11/2020 20:39	03/11/2020 19:59	03/11/2020 20:39	0,66	46	30,25	CHI
2020119862	VALPARAISO DE GOIAS	VA11192928	PACAEMBU S2	03/11/2020 19:59	03/11/2020 20:52	03/11/2020 19:59	03/11/2020 20:52	0,87	188	163,46	CHI
20201110055	COCALZINHO DE GOIAS	PB12382216	PADRE BERNARDO	03/11/2020 20:00	04/11/2020 08:56	03/11/2020 20:00	04/11/2020 08:56	12,93	1	12,93	CHI
20201110055	PADRE BERNARDO	PB12382216	PADRE BERNARDO	03/11/2020 20:00	04/11/2020 08:56	03/11/2020 20:00	04/11/2020 08:56	12,93	7	90,52	CHI
2020119870	FORMOSA	610097787	ITIQUIRA	03/11/2020 20:02	03/11/2020 21:06	03/11/2020 20:02	03/11/2020 21:06	1,05	1	1,05	CHI
2020119872	LUZIANIA	LZ11041554	RIO VERMELHO	03/11/2020 20:03	03/11/2020 23:53	03/11/2020 20:03	03/11/2020 23:53	3,83	191	730,63	CHI
2020119884	AMARALINA	LC12325787	NOVA CRIXAS	03/11/2020 20:03	04/11/2020 20:18	03/11/2020 20:03	04/11/2020 20:18	24,24	3	72,72	CHI
2020119881	GOIANESIA	550014809	GOIANESIA S1	03/11/2020 20:05	03/11/2020 21:21	03/11/2020 20:05	03/11/2020 21:21	1,27	1	1,27	CHI
2020119900	ANAPOLIS	10016840400	ANAPOLIS UNIVERSITARIO S2	03/11/2020 20:09	03/11/2020 21:50	03/11/2020 20:09	03/11/2020 21:50	1,67	1	1,67	CHI
2020119919	GAMELEIRA DE GOIAS	AN11273366	DAIA S1	03/11/2020 20:12	03/11/2020 23:06	03/11/2020 20:12	03/11/2020 23:06	2,90	27	78,19	CHI
2020119948	PORANGATU	PO12104347	PORANGATU	03/11/2020 20:17	03/11/2020 22:37	03/11/2020 20:17	03/11/2020 22:37	2,32	8	18,58	CHI
20201110004	RUBIATABA	RB12028116	RUBIATABA	03/11/2020 20:18	04/11/2020 07:49	03/11/2020 20:18	04/11/2020 07:49	11,51	93	1070,48	CHI
2020119935	MUTUNOPOLIS	MU12127950	MARA ROSA	03/11/2020 20:19	03/11/2020 22:39	03/11/2020 20:19	03/11/2020 22:39	2,33	2	4,66	CHI
2020119939	UIRAPURU	UP21181461	SANTA TEREZINHA	03/11/2020 20:20	04/11/2020 11:05	03/11/2020 20:20	04/11/2020 11:05	14,74	1	14,74	CHI
20201110034	BURITINOPOLIS	BQ12194634	IACIARA S2	03/11/2020 20:24	03/11/2020 22:27	03/11/2020 20:24	03/11/2020 22:27	2,04	51	104,24	CHI
20201110034	MAMBAL	BQ12194634	IACIARA S2	03/11/2020 20:24	03/11/2020 22:27	03/11/2020 20:24	03/11/2020 22:27	2,04	1	2,04	CHI

2020119958	VALPARAISO DE GOIAS	VA11169023	PACAEMBU S2	03/11/2020 20:25	03/11/2020 21:23	03/11/2020 20:25	03/11/2020 21:23	0,95	92	87,83	CHI
2020119960	SITIO D ABADIA	SI21238723	IACIARA S2	03/11/2020 20:26	04/11/2020 10:26	03/11/2020 20:26	04/11/2020 10:26	14,00	1	14,00	CHI
2020119962	SANTA FE DE GOIAS	2070012093	BRITANIA	03/11/2020 20:26	03/11/2020 22:50	03/11/2020 20:26	03/11/2020 22:50	2,39	1	2,39	CHI
20201110182	NIQUELANDIA	NQ12317176	NIQUELANDIA SUBTRANSMISSAO	03/11/2020 20:27	04/11/2020 02:16	03/11/2020 20:27	04/11/2020 02:16	5,82	77	447,78	CHI
2020119982	ITAGUARI	IC12390107	ITABERAI S1	03/11/2020 20:35	04/11/2020 00:17	03/11/2020 20:35	04/11/2020 00:17	3,69	41	151,35	CHI
2020119998	POSSE	PS12344418	IACIARA S1	03/11/2020 20:40	04/11/2020 08:39	03/11/2020 20:40	04/11/2020 08:39	11,98	41	490,98	CHI
20201110013	ANAPOLIS	20573170	ANAPOLIS UNIVERSITARIO S2	03/11/2020 20:46	03/11/2020 23:30	03/11/2020 20:46	03/11/2020 23:30	2,72	1	2,72	CHI
20201110017	JARAGUA	JA21099139	JARAGUA	03/11/2020 20:49	03/11/2020 23:52	03/11/2020 20:49	03/11/2020 23:52	3,04	1	3,04	CHI
20201110303	SAO MIGUEL DO ARAGUAIA	SM12240798	SAO MIGUEL DO ARAGUAIA	03/11/2020 20:49	04/11/2020 08:03	03/11/2020 20:49	04/11/2020 08:03	11,22	4	44,90	CHI
20201110032	FAZENDA NOVA	FN12378821	JUSSARA	03/11/2020 20:53	04/11/2020 04:08	03/11/2020 20:53	04/11/2020 04:08	7,24	6	43,47	CHI
20201110033	VILA PROPICIO	NP11253310	GOIANESIA S1	03/11/2020 20:53	04/11/2020 01:15	03/11/2020 20:53	04/11/2020 01:15	4,36	1	4,36	CHI
20201110042	NIQUELANDIA	NQ12353860	URUACU	03/11/2020 20:57	04/11/2020 01:44	03/11/2020 20:57	04/11/2020 01:44	4,77	6	28,65	CHI
20201110047	PIRANHAS	PH12259448RE	PIRANHAS	03/11/2020 21:00	04/11/2020 00:24	03/11/2020 21:00	04/11/2020 00:24	3,39	96	325,28	CHI
20201110054	ALVORADA DO NORTE	AQ21268280	IACIARA S2	03/11/2020 21:04	04/11/2020 11:47	03/11/2020 21:04	04/11/2020 11:47	14,71	1	14,71	CHI
20201110061	SAO JOAO D ALIANCA	JL11242951	SAO JOAO D ALIANCA	03/11/2020 21:08	03/11/2020 22:11	03/11/2020 21:08	03/11/2020 22:11	1,05	94	98,44	CHI
20201110065	FORMOSA	FA12085629	ITUIQUIRA	03/11/2020 21:09	04/11/2020 00:12	03/11/2020 21:09	03/11/2020 22:30	1,34	458	612,58	CHI
20201110065	FORMOSA	FA12085629	ITUIQUIRA	03/11/2020 21:09	04/11/2020 00:12	03/11/2020 21:09	03/11/2020 23:53	0,37	458	168,44	CHI
20201110065	FORMOSA	FA12085629	ITUIQUIRA	03/11/2020 21:09	04/11/2020 00:12	03/11/2020 21:09	04/11/2020 00:12	3,05	89	271,45	CHI
20201110066	SAO JOAO D ALIANCA	JL12211646	SAO JOAO D ALIANCA	03/11/2020 21:09	03/11/2020 23:15	03/11/2020 21:09	03/11/2020 23:15	2,09	179	373,41	CHI
20201110071	GOIANAPOLIS	GP21319672	DAIA S2	03/11/2020 21:11	03/11/2020 23:21	03/11/2020 21:11	03/11/2020 23:21	2,15	1	2,15	CHI
20201110089	SAO MIGUEL DO ARAGUAIA	SM11109036	SAO MIGUEL DO ARAGUAIA	03/11/2020 21:18	04/11/2020 16:32	03/11/2020 21:18	04/11/2020 16:32	19,23	6	115,40	CHI
20201110011	PADRE BERNARDO	PB11336044	PADRE BERNARDO	03/11/2020 21:19	04/11/2020 00:21	03/11/2020 21:19	04/11/2020 00:21	3,02	30	90,60	CHI
20201110146	JANDAIA	JD12005405	PALMEIRAS	03/11/2020 21:19	04/11/2020 16:54	03/11/2020 21:19	04/11/2020 12:13	14,91	6	89,43	CHI
20201110146	PALMEIRAS DE GOIAS	JD12005405	PALMEIRAS	03/11/2020 21:19	04/11/2020 16:54	03/11/2020 21:19	04/11/2020 12:13	14,91	16	238,49	CHI
20201110146	JANDAIA	JD12005405	PALMEIRAS	03/11/2020 21:19	04/11/2020 16:54	03/11/2020 21:19	04/11/2020 12:13	9,47	4	37,89	CHI
20201110146	PALMEIRAS DE GOIAS	JD12005405	PALMEIRAS	03/11/2020 21:19	04/11/2020 16:54	03/11/2020 21:19	04/11/2020 16:54	19,58	20	391,61	CHI
20201112659	PALMEIRAS DE GOIAS	PL12143287	PALMEIRAS	03/11/2020 21:19	04/11/2020 16:54	03/11/2020 21:19	04/11/2020 16:54	19,58	20	391,61	CHI
20201110130	PARAUNA	PU21103348	PARAUNA	03/11/2020 21:29	03/11/2020 22:57	03/11/2020 21:29	03/11/2020 22:57	1,46	3	4,37	CHI
20201110144	IPORA	AM12402911	IPORA	03/11/2020 21:36	03/11/2020 23:43	03/11/2020 21:36	03/11/2020 23:43	2,11	45	95,16	CHI
20201110158	CAVALCANTE	CJ21404465	MINACU	03/11/2020 21:42	04/11/2020 00:50	03/11/2020 21:42	04/11/2020 00:50	3,13	1	3,13	CHI
20201110164	SAO MIGUEL DO ARAGUAIA	10019510258	SAO MIGUEL DO ARAGUAIA	03/11/2020 21:45	04/11/2020 15:56	03/11/2020 21:45	04/11/2020 15:56	18,17	1	18,17	CHI
20201110168	FAZENDA NOVA	JP12075632	IPORA	03/11/2020 21:48	04/11/2020 00:03	03/11/2020 21:48	04/11/2020 00:03	2,24	3	6,73	CHI
20201110184	SAO FRANCISCO DE GOIAS	SF12000177	SAO FRANCISCO DE GOIAS	03/11/2020 21:49	03/11/2020 23:53	03/11/2020 21:49	03/11/2020 23:53	2,05	4	8,20	CHI
20201110239	ITAPIRAPUA	IU12089735	MATRINCHA	03/11/2020 21:51	04/11/2020 02:20	03/11/2020 21:51	04/11/2020 02:20	4,48	8	35,85	CHI
20201110185	ITAPACI	IW12405202	ITAPACI	03/11/2020 22:00	04/11/2020 07:28	03/11/2020 22:00	04/11/2020 07:28	9,46	17	160,75	CHI
20201110185	NOVA GLORIA	IW12405202	ITAPACI	03/11/2020 22:00	04/11/2020 07:28	03/11/2020 22:00	04/11/2020 07:28	9,46	1	9,46	CHI
20201110190	ITAPIRAPUA	IU21401157	JUSSARA	03/11/2020 22:02	04/11/2020 07:45	03/11/2020 22:02	04/11/2020 07:45	9,70	2	19,41	CHI
20201110197	VILA BOA	2880009280	IACIARA S2	03/11/2020 22:09	03/11/2020 23:31	03/11/2020 22:09	03/11/2020 23:31	1,35	1	1,35	CHI
20201110204	VALPARAISO DE GOIAS	VA11350307	PACAEMBU S1	03/11/2020 22:13	03/11/2020 23:30	03/11/2020 22:13	03/11/2020 23:30	1,28	77	98,26	CHI
20201110218	POSSE	10001108717	IACIARA S2	03/11/2020 22:41	04/11/2020 07:26	03/11/2020 22:41	04/11/2020 07:26	8,74	1	8,74	CHI
20201110233	FLORES DE GOIAS	IA12046295	IACIARA S2	03/11/2020 23:02	04/11/2020 07:03	03/11/2020 23:02	04/11/2020 07:03	8,01	1	8,01	CHI
20201110233	IACIARA	IA12046295	IACIARA S2	03/11/2020 23:02	04/11/2020 07:03	03/11/2020 23:02	04/11/2020 07:03	8,01	62	496,36	CHI
20201110234	MUNDO NOVO DE GOIAS	MH11275602	NOVA CRIXAS	03/11/2020 23:03	04/11/2020 09:01	03/11/2020 23:03	04/11/2020 09:01	9,95	1	9,95	CHI
20201110243	COCALZINHO DE GOIAS	LA12290759	AGUAS LINDAS DE GOIAS S2	03/11/2020 23:24	04/11/2020 09:37	03/11/2020 23:24	04/11/2020 09:37	10,21	34	347,03	CHI
20201110243	PADRE BERNARDO	LA12290759	AGUAS LINDAS DE GOIAS S2	03/11/2020 23:24	04/11/2020 09:37	03/11/2020 23:24	04/11/2020 09:37	10,21	1	10,21	CHI
20201110361	NOVA CRIXAS	NA12035650	NOVA CRIXAS	03/11/2020 23:35	05/11/2020 18:31	03/11/2020 23:35	04/11/2020 12:11	12,61	11	138,72	CHI
20201110361	MUNDO NOVO DE GOIAS	NA12035650	NOVA CRIXAS	03/11/2020 23:35	05/11/2020 18:31	03/11/2020 23:35	04/11/2020 15:30	15,93	8	127,42	CHI
20201110361	NOVA CRIXAS	NA12035650	NOVA CRIXAS	03/11/2020 23:35	05/11/2020 18:31	03/11/2020 23:35	04/11/2020 15:30	15,93	1	15,93	CHI
20201110361	MUNDO NOVO DE GOIAS	NA12035650	NOVA CRIXAS	03/11/2020 23:35	05/11/2020 18:31	04/11/2020 21:57	04/11/2020 23:12	1,24	8	9,96	CHI
20201110361	NOVA CRIXAS	NA12035650	NOVA CRIXAS	03/11/2020 23:35	05/11/2020 18:31	04/11/2020 21:57	04/11/2020 23:12	1,24	12	14,93	CHI
20201110361	NOVA CRIXAS	NA12035650	NOVA CRIXAS	03/11/2020 23:35	05/11/2020 18:31	03/11/2020 23:35	05/11/2020 17:38	42,06	3	126,18	CHI

20201110361	NOVA CRIXAS	NA12035650	NOVA CRIXAS	03/11/2020 23:35	05/11/2020 18:31	03/11/2020 23:35	05/11/2020 18:31	42,93	9	386,40	CHI
20201110274	URUACU	UR12384347	URUACU	04/11/2020 01:08	04/11/2020 08:01	04/11/2020 01:08	04/11/2020 08:01	6,88	25	171,88	CHI
20201110279	MONTES CLAROS DE GOIAS	ME12203472	IPORA	04/11/2020 01:50	04/11/2020 03:40	04/11/2020 01:50	04/11/2020 03:40	1,83	8	14,64	CHI
20201110284	JUSSARA	JR10395391	BRITANIA	04/11/2020 02:14	04/11/2020 20:10	04/11/2020 02:14	04/11/2020 09:06	6,88	9	61,94	CHI
20201110284	JUSSARA	JR10395391	BRITANIA	04/11/2020 02:14	04/11/2020 20:10	04/11/2020 11:03	04/11/2020 11:24	0,35	9	3,16	CHI
20201110284	JUSSARA	JR10395391	BRITANIA	04/11/2020 02:14	04/11/2020 20:10	04/11/2020 02:14	04/11/2020 12:13	9,99	2	19,97	CHI
20201110284	JUSSARA	JR12074365	BRITANIA	04/11/2020 02:14	04/11/2020 20:10	04/11/2020 02:14	04/11/2020 13:12	10,97	37	405,88	CHI
20201110284	SANTA FE DE GOIAS	JR12074365	BRITANIA	04/11/2020 02:14	04/11/2020 20:10	04/11/2020 02:14	04/11/2020 13:12	10,97	21	230,36	CHI
20201110284	JUSSARA	JR10395391	BRITANIA	04/11/2020 02:14	04/11/2020 20:10	04/11/2020 13:29	04/11/2020 13:36	0,12	48	5,97	CHI
20201110284	SANTA FE DE GOIAS	JR10395391	BRITANIA	04/11/2020 02:14	04/11/2020 20:10	04/11/2020 13:29	04/11/2020 13:36	0,12	21	2,61	CHI
20201110284	JUSSARA	JR12378816LD	BRITANIA	04/11/2020 02:14	04/11/2020 20:10	04/11/2020 02:14	04/11/2020 15:10	12,94	2	25,88	CHI
20201110284	JUSSARA	JR12378816LD	BRITANIA	04/11/2020 02:14	04/11/2020 20:10	04/11/2020 02:14	04/11/2020 15:51	13,62	5	68,10	CHI
20201110284	JUSSARA	JR12160972	BRITANIA	04/11/2020 02:14	04/11/2020 20:10	04/11/2020 02:14	04/11/2020 15:58	13,74	4	54,94	CHI
20201110284	JUSSARA	JR12378816LD	BRITANIA	04/11/2020 02:14	04/11/2020 20:10	04/11/2020 02:14	04/11/2020 18:12	15,98	2	31,95	CHI
20201110284	JUSSARA	JR12378816LD	BRITANIA	04/11/2020 02:14	04/11/2020 20:10	04/11/2020 02:14	04/11/2020 18:48	16,57	1	16,57	CHI
20201110284	JUSSARA	JR12378816LD	BRITANIA	04/11/2020 02:14	04/11/2020 20:10	04/11/2020 02:14	04/11/2020 20:10	17,94	1	17,94	CHI
20201110285	CAIAPONIA	CP12020892LD	CAIAPONIA	04/11/2020 02:57	04/11/2020 14:20	04/11/2020 02:57	04/11/2020 14:20	11,38	6	68,27	CHI
20201110396	FORMOSO	SE12053856	MARA ROSA	04/11/2020 03:03	04/11/2020 09:47	04/11/2020 03:03	04/11/2020 09:07	6,06	5	30,30	CHI
20201110396	SANTA TEREZA DE GOIAS	SE12053856	MARA ROSA	04/11/2020 03:03	04/11/2020 09:47	04/11/2020 03:03	04/11/2020 09:07	6,06	3	18,18	CHI
20201110396	FORMOSO	FO12295264	MARA ROSA	04/11/2020 03:03	04/11/2020 09:47	04/11/2020 03:03	04/11/2020 09:47	6,73	1	6,73	CHI
20201110289	ITAGUARI	IC12300156	ITABERAI S1	04/11/2020 03:19	04/11/2020 07:50	04/11/2020 03:19	04/11/2020 07:50	4,51	6	27,06	CHI
20201110289	ITAGUARU	IC12300156	ITABERAI S1	04/11/2020 03:19	04/11/2020 07:50	04/11/2020 03:19	04/11/2020 07:50	4,51	3	13,53	CHI
20201110300	BRITANIA	RN13292827	BRITANIA	04/11/2020 03:35	04/11/2020 11:30	04/11/2020 03:35	04/11/2020 07:30	3,91	11	43,04	CHI
20201110300	JUSSARA	RN13292827	BRITANIA	04/11/2020 03:35	04/11/2020 11:30	04/11/2020 03:35	04/11/2020 07:30	3,91	11	43,04	CHI
20201110300	SANTA FE DE GOIAS	RN13292827	BRITANIA	04/11/2020 03:35	04/11/2020 11:30	04/11/2020 03:35	04/11/2020 07:30	3,91	10	39,13	CHI
20201110300	BRITANIA	3210414	BRITANIA	04/11/2020 03:35	04/11/2020 11:30	04/11/2020 03:35	04/11/2020 08:59	5,40	9	48,64	CHI
20201110300	BRITANIA	3210414	BRITANIA	04/11/2020 03:35	04/11/2020 11:30	04/11/2020 03:35	04/11/2020 10:54	7,32	15	109,76	CHI
20201110300	BRITANIA	3210414	BRITANIA	04/11/2020 03:35	04/11/2020 11:30	04/11/2020 10:39	04/11/2020 10:54	0,25	9	2,29	CHI
20201110300	BRITANIA	3210414	BRITANIA	04/11/2020 03:35	04/11/2020 11:30	04/11/2020 03:35	04/11/2020 11:20	7,75	3	23,26	CHI
20201110300	BRITANIA	3210414	BRITANIA	04/11/2020 03:35	04/11/2020 11:30	04/11/2020 03:35	04/11/2020 11:30	7,92	18	142,61	CHI
20201110324	ADELANDIA	AC16409753	ANICUNS	04/11/2020 03:40	04/11/2020 13:29	04/11/2020 03:40	04/11/2020 10:02	6,36	31	197,27	CHI
20201110324	AMERICANO DO BRASIL	AC16409753	ANICUNS	04/11/2020 03:40	04/11/2020 13:29	04/11/2020 03:40	04/11/2020 10:02	6,36	26	165,45	CHI
20201110324	ANICUNS	AC16409753	ANICUNS	04/11/2020 03:40	04/11/2020 13:29	04/11/2020 03:40	04/11/2020 10:02	6,36	38	241,82	CHI
20201110324	MOSSAMEDES	AC16409753	ANICUNS	04/11/2020 03:40	04/11/2020 13:29	04/11/2020 03:40	04/11/2020 10:02	6,36	32	203,64	CHI
20201110324	AMERICANO DO BRASIL	KB13000001	ANICUNS	04/11/2020 03:40	04/11/2020 13:29	04/11/2020 03:40	04/11/2020 13:00	9,34	6	56,01	CHI
20201110324	AMERICANO DO BRASIL	KB13000001	ANICUNS	04/11/2020 03:40	04/11/2020 13:29	04/11/2020 09:10	04/11/2020 13:00	3,83	3	11,49	CHI
20201110324	ADELANDIA	KB13419304	ANICUNS	04/11/2020 03:40	04/11/2020 13:29	04/11/2020 13:14	04/11/2020 13:29	0,24	31	7,59	CHI
20201110324	AMERICANO DO BRASIL	KB13419304	ANICUNS	04/11/2020 03:40	04/11/2020 13:29	04/11/2020 13:14	04/11/2020 13:29	0,24	26	6,37	CHI
20201110324	ANICUNS	KB13419304	ANICUNS	04/11/2020 03:40	04/11/2020 13:29	04/11/2020 13:14	04/11/2020 13:29	0,24	38	9,31	CHI
20201110324	MOSSAMEDES	KB13419304	ANICUNS	04/11/2020 03:40	04/11/2020 13:29	04/11/2020 13:14	04/11/2020 13:29	0,24	32	7,84	CHI
20201110996	SAO MIGUEL DO ARAGUAIA	SM12074411	SAO MIGUEL DO ARAGUAIA	04/11/2020 03:42	04/11/2020 11:30	04/11/2020 03:42	04/11/2020 11:30	7,79	8	62,30	CHI
20201110342	PIRENOPOLIS	PV12394331RE	CORUMBA	04/11/2020 04:11	04/11/2020 19:29	04/11/2020 04:11	04/11/2020 08:52	4,67	77	359,89	CHI
20201110342	JARAGUA	PV12394331RE	CORUMBA	04/11/2020 04:11	04/11/2020 19:29	04/11/2020 04:11	04/11/2020 10:52	6,69	3	20,06	CHI
20201110342	JARAGUA	PV12394331RE	CORUMBA	04/11/2020 04:11	04/11/2020 19:29	04/11/2020 04:11	04/11/2020 13:30	9,31	2	18,61	CHI
20201110342	JARAGUA	PV12394331RE	CORUMBA	04/11/2020 04:11	04/11/2020 19:29	04/11/2020 04:11	04/11/2020 19:29	15,30	8	122,41	CHI
20201110342	JARAGUA	PV13000445	CORUMBA	04/11/2020 04:11	04/11/2020 19:29	04/11/2020 17:05	04/11/2020 19:29	2,41	5	12,04	CHI
20201110305	BARRO ALTO	BA10400377	GOIANESIA S1	04/11/2020 04:16	04/11/2020 12:13	04/11/2020 04:16	04/11/2020 07:09	2,87	4	11,50	CHI
20201110305	BARRO ALTO	BA12342220LD	GOIANESIA S1	04/11/2020 04:16	04/11/2020 12:13	04/11/2020 04:16	04/11/2020 12:13	7,95	1	7,95	CHI
20201110400	FAINA	FC12038664	GOIAS	04/11/2020 04:22	04/11/2020 08:25	04/11/2020 04:22	04/11/2020 08:25	4,05	10	40,49	CHI
20201110307	ITAGUARI	IC12036612	ITABERAI S1	04/11/2020 04:27	04/11/2020 08:50	04/11/2020 04:27	04/11/2020 08:50	4,38	16	70,01	CHI
20201110307	ITAGUARU	IC12036612	ITABERAI S1	04/11/2020 04:27	04/11/2020 08:50	04/11/2020 04:27	04/11/2020 08:50	4,38	21	91,89	CHI

20201110307	JARAGUA	IC12036612	ITABERAI S1	04/11/2020 04:27	04/11/2020 08:50	04/11/2020 04:27	04/11/2020 08:50	4,38	95	415,70	CHI
20201110313	BARRO ALTO	BA12414688	BARRO ALTO	04/11/2020 04:49	04/11/2020 22:18	04/11/2020 04:49	04/11/2020 14:55	10,10	23	232,22	CHI
20201110313	BARRO ALTO	BA12414688	BARRO ALTO	04/11/2020 04:49	04/11/2020 22:18	04/11/2020 04:49	04/11/2020 22:18	17,48	9	157,32	CHI
20201110319	CAIAPONIA	CP12200875	CAIAPONIA	04/11/2020 05:16	04/11/2020 07:23	04/11/2020 05:16	04/11/2020 07:23	2,10	9	18,93	CHI
20201110321	FAINA	FC12160891	GOIAS	04/11/2020 05:18	04/11/2020 09:27	04/11/2020 05:18	04/11/2020 09:27	4,14	13	53,86	CHI
20201110321	ITAPURANGA	FC12160891	GOIAS	04/11/2020 05:18	04/11/2020 09:27	04/11/2020 05:18	04/11/2020 09:27	4,14	2	8,29	CHI
20201110321	MORRO AGUDO DE GOIAS	FC12160891	GOIAS	04/11/2020 05:18	04/11/2020 09:27	04/11/2020 05:18	04/11/2020 09:27	4,14	2	8,29	CHI
20201110445	ALEXANIA	AX12061853	ALEXANIA	04/11/2020 05:25	04/11/2020 08:40	04/11/2020 05:25	04/11/2020 08:40	3,24	5	16,22	CHI
20201110326	MOZARLANDIA	MZ12058584	MOZARLANDIA	04/11/2020 05:27	04/11/2020 07:41	04/11/2020 05:27	04/11/2020 07:41	2,23	13	29,03	CHI
20201110330	FIRMINOPOLIS	2940001541	FIRMINOPOLIS S1	04/11/2020 05:29	04/11/2020 08:47	04/11/2020 05:29	04/11/2020 08:47	3,28	1	3,28	CHI
20201110468	FORMOSO	FO12145370RE	MARA ROSA	04/11/2020 05:31	04/11/2020 08:16	04/11/2020 05:31	04/11/2020 08:16	2,73	59	161,33	CHI
20201110332	VILA BOA	2880009711	IACIARA S2	04/11/2020 05:32	04/11/2020 07:11	04/11/2020 05:32	04/11/2020 07:11	1,64	1	1,64	CHI
20201110337	MORRO AGUDO DE GOIAS	MS21036228	ITAPURANGA	04/11/2020 05:37	04/11/2020 07:42	04/11/2020 05:37	04/11/2020 07:42	2,07	1	2,07	CHI
20201110344	PARAUNA	PU13299054	PARAUNA	04/11/2020 05:41	04/11/2020 12:37	04/11/2020 05:41	04/11/2020 12:37	6,93	69	477,88	CHI
20201110344	PARAUNA	PU13299054	PARAUNA	04/11/2020 05:41	04/11/2020 12:37	04/11/2020 09:17	04/11/2020 12:37	3,33	12	39,96	CHI
20201110343	PLANALTINA	PI12211502	PLANALTINA	04/11/2020 05:42	04/11/2020 07:40	04/11/2020 05:42	04/11/2020 07:40	1,96	187	365,74	CHI
20201110345	NIQUELANDIA	NQ12035673	NIQUELANDIA SUBTRANSMISSAO	04/11/2020 05:43	04/11/2020 07:33	04/11/2020 05:43	04/11/2020 07:33	1,83	423	772,56	CHI
20201111926	PORANGATU	PO12230423	NOVO PLANALTO	04/11/2020 05:50	05/11/2020 09:08	04/11/2020 05:50	05/11/2020 09:08	27,29	3	81,87	CHI
20201110353	MARA ROSA	MQ12140367	MARA ROSA	04/11/2020 05:55	04/11/2020 10:27	04/11/2020 05:55	04/11/2020 10:27	4,54	55	249,49	CHI
20201110353	MARA ROSA	MQ12140367	MARA ROSA	04/11/2020 05:55	04/11/2020 10:27	04/11/2020 10:02	04/11/2020 10:27	0,42	2	0,84	CHI
20201110354	PADRE BERNARDO	PB12163248	PADRE BERNARDO	04/11/2020 05:55	04/11/2020 08:14	04/11/2020 05:55	04/11/2020 08:14	2,31	7	16,14	CHI
20201110363	MONTES CLAROS DE GOIAS	ME21029536	BRITANIA	04/11/2020 06:02	04/11/2020 08:32	04/11/2020 06:02	04/11/2020 08:32	2,49	1	2,49	CHI
20201110380	CRISTALINA	KR12249234	PAMPLONA	04/11/2020 06:10	04/11/2020 08:03	04/11/2020 06:10	04/11/2020 08:03	1,87	3	5,61	CHI
20201111074	BARRO ALTO	BA12066363	BARRO ALTO	04/11/2020 06:11	04/11/2020 10:06	04/11/2020 06:11	04/11/2020 10:06	3,91	7	27,38	CHI
20201110090	BRITANIA	BT18073348TS	BRITANIA	04/11/2020 06:12	04/11/2020 16:03	04/11/2020 06:12	04/11/2020 16:03	9,84	49	482,36	CHI
20201110386	FLORES DE GOIAS	3480023950	FLORES DE GOIAS	04/11/2020 06:13	04/11/2020 09:38	04/11/2020 06:13	04/11/2020 09:38	3,43	1	3,43	CHI
20201110404	SAO MIGUEL DO ARAGUAIA	SM12151000	SAO MIGUEL DO ARAGUAIA	04/11/2020 06:15	04/11/2020 07:30	04/11/2020 06:15	04/11/2020 07:30	1,24	18	22,23	CHI
20201110558	MOZARLANDIA	MZ12015614	MOZARLANDIA	04/11/2020 06:16	04/11/2020 09:23	04/11/2020 06:16	04/11/2020 09:23	3,11	14	43,49	CHI
20201110397	NOVO PLANALTO	TA12391932	NOVO PLANALTO	04/11/2020 06:18	04/11/2020 08:56	04/11/2020 06:18	04/11/2020 08:56	2,63	6	15,76	CHI
20201110399	SANTA TEREZINHA DE GOIAS	SG12390506	SANTA TEREZINHA	04/11/2020 06:19	04/11/2020 20:32	04/11/2020 06:19	04/11/2020 10:35	4,27	9	38,46	CHI
20201110399	PILAR DE GOIAS	SG12390506	SANTA TEREZINHA	04/11/2020 06:19	04/11/2020 20:32	04/11/2020 06:19	04/11/2020 20:32	14,22	3	42,65	CHI
20201110399	SANTA TEREZINHA DE GOIAS	SG12390506	SANTA TEREZINHA	04/11/2020 06:19	04/11/2020 20:32	04/11/2020 06:19	04/11/2020 20:32	14,22	40	568,67	CHI
20201110408	NOVO PLANALTO	TA12365617	SAO MIGUEL DO ARAGUAIA	04/11/2020 06:22	05/11/2020 00:22	04/11/2020 06:22	05/11/2020 00:22	17,99	1	17,99	CHI
20201110416	SAO LUIZ DO NORTE	SZ12066080	ITAPACI	04/11/2020 06:24	04/11/2020 10:29	04/11/2020 06:24	04/11/2020 10:29	4,07	2	8,14	CHI
20201110421	PIRANHAS	PH21343752	CAIAPONIA	04/11/2020 06:26	04/11/2020 08:46	04/11/2020 06:26	04/11/2020 08:46	2,33	1	2,33	CHI
20201110424	ABADIANIA	AA12385098	ANAPOLIS UNIVERSITARIO S1	04/11/2020 06:27	04/11/2020 13:17	04/11/2020 06:27	04/11/2020 13:17	6,82	6	40,93	CHI
20201110484	GOIAS	GS12071260	GOIAS	04/11/2020 06:29	04/11/2020 08:26	04/11/2020 06:29	04/11/2020 08:26	1,93	9	17,41	CHI
20201110443	ABADIANIA	AN12001083	ANAPOLIS UNIVERSITARIO S2	04/11/2020 06:36	04/11/2020 09:23	04/11/2020 06:36	04/11/2020 09:23	2,78	31	86,22	CHI
20201110448	VILA PROPICIO	PV12115145	GOIANESIA S1	04/11/2020 06:37	04/11/2020 12:24	04/11/2020 06:37	04/11/2020 12:24	5,78	15	86,68	CHI
20201111927	PORANGATU	PO12365601	NOVO PLANALTO	04/11/2020 06:37	05/11/2020 15:33	04/11/2020 06:37	05/11/2020 15:33	32,92	4	131,68	CHI
20201110452	CRISTALINA	KR12025856	PAMPLONA	04/11/2020 06:38	04/11/2020 09:21	04/11/2020 06:38	04/11/2020 09:21	2,70	7	18,92	CHI
20201110460	ALEXANIA	AX21319858	ALEXANIA	04/11/2020 06:41	04/11/2020 10:44	04/11/2020 06:41	04/11/2020 10:44	4,04	1	4,04	CHI
20201110461	AGUA FRIA DE GOIAS	TL12279981	SAO JOAO D ALIANCA	04/11/2020 06:41	04/11/2020 10:14	04/11/2020 06:41	04/11/2020 10:14	3,54	37	131,09	CHI
20201112759	AGUA FRIA DE GOIAS	TL11279958	SAO JOAO D ALIANCA	04/11/2020 06:41	04/11/2020 16:18	04/11/2020 06:41	04/11/2020 16:18	9,61	5	48,05	CHI
20201111536	BARRO ALTO	BA12414688	BARRO ALTO	04/11/2020 06:44	04/11/2020 22:18	04/11/2020 21:09	04/11/2020 22:18	1,16	23	26,58	CHI
20201110472	CRIXAS	CX12297040	SERRA DO OURO	04/11/2020 06:46	04/11/2020 18:15	04/11/2020 06:46	04/11/2020 18:15	11,48	1	11,48	CHI
20201110474	CABECEIRAS	CW21184531	ITUIQUIRA	04/11/2020 06:47	04/11/2020 08:57	04/11/2020 06:47	04/11/2020 08:57	2,17	1	2,17	CHI
20201110476	MIMOSO DE GOIAS	PB12095000	PADRE BERNARDO	04/11/2020 06:47	04/11/2020 10:16	04/11/2020 06:47	04/11/2020 10:16	3,48	1	3,48	CHI
20201110476	PADRE BERNARDO	PB12095000	PADRE BERNARDO	04/11/2020 06:47	04/11/2020 10:16	04/11/2020 06:47	04/11/2020 10:16	3,48	17	59,20	CHI
20201110476	VILA PROPICIO	PB12095000	PADRE BERNARDO	04/11/2020 06:47	04/11/2020 10:16	04/11/2020 06:47	04/11/2020 10:16	3,48	7	24,38	CHI
20201110483	IVOLANDIA	IV21165806	IPORA	04/11/2020 06:49	04/11/2020 10:14	04/11/2020 06:49	04/11/2020 10:14	3,40	1	3,40	CHI

20201110485	ITABERAI	IB12300082	ITABERAI S2	04/11/2020 06:51	04/11/2020 08:43	04/11/2020 06:51	04/11/2020 08:43	1,86	16	29,71	CHI
20201110485	ITAPURANGA	IB12300082	ITABERAI S2	04/11/2020 06:51	04/11/2020 08:43	04/11/2020 06:51	04/11/2020 08:43	1,86	1	1,86	CHI
20201110550	MOZARLANDIA	MZ12065623	MOZARLANDIA	04/11/2020 06:54	04/11/2020 16:16	04/11/2020 06:54	04/11/2020 11:42	4,79	16	76,66	CHI
20201110550	MOZARLANDIA	MZ12065623	MOZARLANDIA	04/11/2020 06:54	04/11/2020 16:16	04/11/2020 11:51	04/11/2020 15:14	3,40	3	10,19	CHI
20201110550	MOZARLANDIA	MZ12033552LD	MOZARLANDIA	04/11/2020 06:54	04/11/2020 16:16	04/11/2020 11:51	04/11/2020 16:16	4,42	6	26,53	CHI
20201110550	MOZARLANDIA	MZ12065623	MOZARLANDIA	04/11/2020 06:54	04/11/2020 16:16	04/11/2020 11:51	04/11/2020 16:16	4,42	7	30,96	CHI
20201111123	NIQUELANDIA	NQ12255371	NIQUELANDIA SUBTRANSMISSAO	04/11/2020 06:55	04/11/2020 11:52	04/11/2020 06:55	04/11/2020 11:52	4,94	19	93,89	CHI
20201110497	ANAPOLIS	2080000129	ANAPOLIS UNIVERSITARIO S1	04/11/2020 06:57	04/11/2020 08:39	04/11/2020 06:57	04/11/2020 08:39	1,69	1	1,69	CHI
20201110499	SANTA TEREZA DE GOIAS	SE21053835	MARA ROSA	04/11/2020 06:57	04/11/2020 10:31	04/11/2020 06:57	04/11/2020 10:31	3,55	1	3,55	CHI
20201110501	SAO MIGUEL DO ARAGUAIA	SM12089544	SAO MIGUEL DO ARAGUAIA	04/11/2020 06:58	04/11/2020 08:13	04/11/2020 06:58	04/11/2020 08:13	1,24	20	24,89	CHI
20201110569	PORANGATU	PO12348288	PORANGATU	04/11/2020 06:59	04/11/2020 11:43	04/11/2020 06:59	04/11/2020 11:43	4,73	8	37,80	CHI
20201110508	MIMOSO DE GOIAS	4560216	BARRO ALTO	04/11/2020 07:02	04/11/2020 11:30	04/11/2020 07:02	04/11/2020 11:30	4,46	9	40,15	CHI
20201110508	NIQUELANDIA	4560216	BARRO ALTO	04/11/2020 07:02	04/11/2020 11:30	04/11/2020 07:02	04/11/2020 11:30	4,46	184	820,95	CHI
20201110508	VILA PROPICIO	4560216	BARRO ALTO	04/11/2020 07:02	04/11/2020 11:30	04/11/2020 07:02	04/11/2020 11:30	4,46	50	223,08	CHI
20201110514	IACIARA	IA12264175	IACIARA S2	04/11/2020 07:04	04/11/2020 07:20	04/11/2020 07:04	04/11/2020 07:20	0,26	5	1,29	CHI
20201111013	MONTE ALEGRE DE GOIAS	SD12322677	SAO DOMINGOS	04/11/2020 07:04	04/11/2020 13:02	04/11/2020 07:04	04/11/2020 13:02	5,95	1	5,95	CHI
20201111013	NOVA ROMA	SD12322677	SAO DOMINGOS	04/11/2020 07:04	04/11/2020 13:02	04/11/2020 07:04	04/11/2020 13:02	5,95	3	17,85	CHI
20201111013	SAO DOMINGOS	SD12322677	SAO DOMINGOS	04/11/2020 07:04	04/11/2020 13:02	04/11/2020 07:04	04/11/2020 13:02	5,95	36	214,22	CHI
20201110521	ITAPACI	IW12330143	RUBIATABA	04/11/2020 07:05	04/11/2020 11:03	04/11/2020 07:05	04/11/2020 11:03	3,95	5	19,76	CHI
20201110521	NOVA AMERICA	IW12330143	RUBIATABA	04/11/2020 07:05	04/11/2020 11:03	04/11/2020 07:05	04/11/2020 11:03	3,95	11	43,47	CHI
20201110526	ALEXANIA	480044259	ALEXANIA	04/11/2020 07:07	04/11/2020 10:10	04/11/2020 07:07	04/11/2020 10:10	3,04	1	3,04	CHI
20201110544	URUACU	UR10404200	URUACU	04/11/2020 07:07	04/11/2020 10:03	04/11/2020 07:07	04/11/2020 07:10	0,05	580	29,97	CHI
20201110544	URUACU	UR10404200	URUACU	04/11/2020 07:07	04/11/2020 10:03	04/11/2020 07:07	04/11/2020 07:11	0,08	214	17,24	CHI
20201110544	URUACU	UR10404200	URUACU	04/11/2020 07:07	04/11/2020 10:03	04/11/2020 07:07	04/11/2020 08:04	0,96	259	247,42	CHI
20201110544	URUACU	UR10404200	URUACU	04/11/2020 07:07	04/11/2020 10:03	04/11/2020 07:07	04/11/2020 08:07	1,01	384	389,55	CHI
20201110544	URUACU	UR10404200	URUACU	04/11/2020 07:07	04/11/2020 10:03	04/11/2020 07:07	04/11/2020 10:03	2,94	308	905,78	CHI
20201111928	PORANGATU	PO21268145	NOVO PLANALTO	04/11/2020 07:09	04/11/2020 21:10	04/11/2020 07:09	04/11/2020 21:10	14,01	1	14,01	CHI
20201110541	PORANGATU	10017692901	PORANGATU	04/11/2020 07:11	04/11/2020 12:36	04/11/2020 07:11	04/11/2020 12:36	5,41	1	5,41	CHI
20201110546	JUSSARA	JR21093795	JUSSARA	04/11/2020 07:12	04/11/2020 10:45	04/11/2020 07:12	04/11/2020 10:45	3,55	2	7,11	CHI
20201110559	PIRENOPOLIS	PV21294308	CORUMBA	04/11/2020 07:13	04/11/2020 14:32	04/11/2020 07:13	04/11/2020 14:32	7,32	1	7,32	CHI
20201110560	NOVO PLANALTO	TA21282222	NOVO PLANALTO	04/11/2020 07:15	04/11/2020 17:51	04/11/2020 07:15	04/11/2020 17:51	10,59	1	10,59	CHI
20201110924	ANAPOLIS	AN12258395	JUNDIAI S2	04/11/2020 07:16	04/11/2020 10:15	04/11/2020 07:16	04/11/2020 10:15	2,97	13	38,66	CHI
20201110075	PORANGATU	PO12022073	PORANGATU	04/11/2020 07:17	04/11/2020 21:36	04/11/2020 07:17	04/11/2020 21:36	14,31	42	601,15	CHI
20201110075	PORANGATU	PO12022073	PORANGATU	04/11/2020 07:17	04/11/2020 21:36	04/11/2020 19:11	04/11/2020 21:36	2,41	5	12,05	CHI
20201110572	FORMOSA	FA11397678	ITUIQUIRA	04/11/2020 07:18	04/11/2020 10:00	04/11/2020 07:18	04/11/2020 10:00	2,69	1	2,69	CHI
20201110854	NOVO PLANALTO	TA12139138	NOVO PLANALTO	04/11/2020 07:19	04/11/2020 15:10	04/11/2020 07:19	04/11/2020 15:10	7,84	2	15,68	CHI
20201111014	MONTES CLAROS DE GOIAS	ME12215841	IPORA	04/11/2020 07:22	04/11/2020 11:12	04/11/2020 07:22	04/11/2020 11:12	3,82	15	57,27	CHI
20201110588	BONOPOLIS	BX12364678	SAO MIGUEL DO ARAGUAIA	04/11/2020 07:24	05/11/2020 07:18	04/11/2020 07:24	05/11/2020 07:18	23,90	16	382,40	CHI
20201110597	NOVA ROMA	8720010372	IACIARA S2	04/11/2020 07:26	04/11/2020 12:45	04/11/2020 07:26	04/11/2020 12:45	5,31	1	5,31	CHI
20201110611	DOVERLANDIA	DV12389846	CAIAPONIA	04/11/2020 07:28	04/11/2020 10:12	04/11/2020 07:28	04/11/2020 10:12	2,72	5	13,62	CHI
20201110614	PALMEIRAS DE GOIAS	PL12000092	PALMEIRAS	04/11/2020 07:29	04/11/2020 09:41	04/11/2020 07:29	04/11/2020 09:41	2,19	3	6,57	CHI
20201110628	MONTIVIDIU DO NORTE	MX12187943	PORANGATU	04/11/2020 07:33	04/11/2020 22:53	04/11/2020 07:33	04/11/2020 22:53	15,32	3	45,97	CHI
20201110637	PORANGATU	PO11349886	MARA ROSA	04/11/2020 07:35	04/11/2020 10:33	04/11/2020 07:35	04/11/2020 10:33	2,96	1	2,96	CHI
20201110639	AMARALINA	MQ12210288	NOVA CRIXAS	04/11/2020 07:35	04/11/2020 17:50	04/11/2020 07:35	04/11/2020 17:50	10,24	6	61,44	CHI
20201110686	CORREGO DO OURO	BS12009575	FIRMINOPOLIS S2	04/11/2020 07:36	04/11/2020 09:08	04/11/2020 07:36	04/11/2020 09:08	1,53	11	16,86	CHI
20201110645	COLINAS DO SUL	TI21292485	NIQUELANDIA SUBTRANSMISSAO	04/11/2020 07:37	04/11/2020 13:37	04/11/2020 07:37	04/11/2020 13:37	5,99	1	5,99	CHI
20201110650	CRISTALINA	KR21290456	PAMPLONA	04/11/2020 07:38	04/11/2020 14:16	04/11/2020 07:38	04/11/2020 14:16	6,62	1	6,62	CHI
20201110662	TAQUARAL DE GOIAS	II21185819	ITABERAI S1	04/11/2020 07:40	04/11/2020 11:07	04/11/2020 07:40	04/11/2020 11:07	3,44	1	3,44	CHI
20201110671	ALTO HORIZONTE	AJ21210315	MARA ROSA	04/11/2020 07:44	04/11/2020 09:07	04/11/2020 07:44	04/11/2020 09:07	1,37	1	1,37	CHI
20201110673	AGUAS LINDAS DE GOIAS	4830267794	AGUAS LINDAS DE GOIAS S1	04/11/2020 07:45	04/11/2020 10:03	04/11/2020 07:45	04/11/2020 10:03	2,29	1	2,29	CHI
20201110682	SAO JOAO D ALIANCA	JL11218465	SAO JOAO D ALIANCA	04/11/2020 07:47	04/11/2020 09:11	04/11/2020 07:47	04/11/2020 09:11	1,39	3	4,17	CHI

20201110710	LUZIANIA	LZ12330887	RIO VERMELHO	04/11/2020 07:54	04/11/2020 11:36	04/11/2020 07:54	04/11/2020 11:36	3,69	32	118,23	CHI
20201110725	NIQUELANDIA	NQ12391958	NIQUELANDIA SUBTRANSMISSAO	04/11/2020 07:56	04/11/2020 15:17	04/11/2020 07:56	04/11/2020 15:17	7,34	2	14,68	CHI
20201110738	GOIANESIA	GE21156797	GOIANESIA S1	04/11/2020 07:59	04/11/2020 14:25	04/11/2020 07:59	04/11/2020 14:25	6,43	1	6,43	CHI
20201110739	ALTO PARAISO DE GOIAS	BF21170232	FLORES DE GOIAS	04/11/2020 07:59	04/11/2020 12:14	04/11/2020 07:59	04/11/2020 12:14	4,24	1	4,24	CHI
20201110750	MOZARLANDIA	410021416	MOZARLANDIA	04/11/2020 08:02	04/11/2020 12:45	04/11/2020 08:02	04/11/2020 12:45	4,71	1	4,71	CHI
20201110838	MINACU	IH12315089	MINACU	04/11/2020 08:03	04/11/2020 09:18	04/11/2020 08:03	04/11/2020 09:18	1,24	2	2,47	CHI
20201110990	CABECEIRAS	CW12108823	ITUIQUIRA	04/11/2020 08:03	04/11/2020 09:42	04/11/2020 08:03	04/11/2020 09:42	1,64	19	31,10	CHI
20201110757	MUNDO NOVO DE GOIAS	MH11220749	NOVA CRIXAS	04/11/2020 08:04	04/11/2020 13:38	04/11/2020 08:04	04/11/2020 13:38	5,56	1	5,56	CHI
20201110759	SAO DOMINGOS	SD21348629	SAO DOMINGOS	04/11/2020 08:04	04/11/2020 10:58	04/11/2020 08:04	04/11/2020 10:58	2,89	1	2,89	CHI
20201110768	IPAMERI	IP12412786	CRISTALINA S1	04/11/2020 08:05	04/11/2020 13:14	04/11/2020 08:05	04/11/2020 13:14	5,14	5	25,68	CHI
20201110777	FORMOSO	TB12372648	PORANGATU	04/11/2020 08:06	04/11/2020 09:52	04/11/2020 08:06	04/11/2020 09:52	1,75	1	1,75	CHI
20201110777	TROMBAS	TB12372648	PORANGATU	04/11/2020 08:06	04/11/2020 09:52	04/11/2020 08:06	04/11/2020 09:52	1,75	67	117,31	CHI
20201111675	CRIXAS	CX12181532	SERRA DO OURO	04/11/2020 08:06	04/11/2020 13:46	04/11/2020 08:06	04/11/2020 13:46	5,65	11	62,20	CHI
20201110788	SAO JOAO D ALIANCA	JL12383335	SAO JOAO D ALIANCA	04/11/2020 08:08	04/11/2020 10:07	04/11/2020 08:08	04/11/2020 10:07	1,98	11	21,75	CHI
20201110792	TROMBAS	TB12245290	PORANGATU	04/11/2020 08:09	04/11/2020 12:54	04/11/2020 08:09	04/11/2020 12:54	4,74	7	33,20	CHI
20201110794	ANAPOLIS	AN12000925	JUNDIAI S1	04/11/2020 08:09	04/11/2020 09:45	04/11/2020 08:09	04/11/2020 09:45	1,59	51	81,08	CHI
20201110795	IACIARA	IA12385169	IACIARA S2	04/11/2020 08:09	04/11/2020 11:09	04/11/2020 08:09	04/11/2020 11:09	2,99	1	2,99	CHI
20201110799	CRISTALINA	KR12376152	CRISTALINA S1	04/11/2020 08:10	04/11/2020 16:32	04/11/2020 08:10	04/11/2020 16:32	8,36	3	25,09	CHI
20201110801	FAINA	FC12188057	GOIAS	04/11/2020 08:10	04/11/2020 10:22	04/11/2020 08:10	04/11/2020 10:22	2,19	1	2,19	CHI
20201110807	ITAPURANGA	IK12073152	ITAPURANGA	04/11/2020 08:11	04/11/2020 09:38	04/11/2020 08:11	04/11/2020 09:38	1,44	5	7,20	CHI
20201110817	MARA ROSA	MQ12353877	SANTA TEREZINHA	04/11/2020 08:13	04/11/2020 13:00	04/11/2020 08:13	04/11/2020 13:00	4,77	4	19,07	CHI
20201110820	ANAPOLIS	AN21247699	JUNDIAI S2	04/11/2020 08:14	04/11/2020 10:38	04/11/2020 08:14	04/11/2020 10:38	2,39	1	2,39	CHI
20201110829	PIRENOPOLIS	PV21230706	CORUMBA	04/11/2020 08:15	04/11/2020 10:16	04/11/2020 08:15	04/11/2020 10:16	2,02	1	2,02	CHI
20201110835	ARUANA	AK12310723	BRITANIA	04/11/2020 08:15	04/11/2020 11:34	04/11/2020 08:15	04/11/2020 11:34	3,30	4	13,21	CHI
20201111359	CAMPINACU	UC12239728	PORANGATU	04/11/2020 08:15	04/11/2020 13:53	04/11/2020 08:15	04/11/2020 13:53	5,63	9	50,69	CHI
20201110840	AGUA FRIA DE GOIAS	TL21218505	SAO JOAO D ALIANCA	04/11/2020 08:16	04/11/2020 12:45	04/11/2020 08:16	04/11/2020 12:45	4,47	1	4,47	CHI
20201110859	ABADIANIA	10001486738	CORUMBA	04/11/2020 08:18	04/11/2020 22:53	04/11/2020 08:18	04/11/2020 22:53	14,58	1	14,58	CHI
20201110861	NIQUELANDIA	NQ21345142	NIQUELANDIA SUBTRANSMISSAO	04/11/2020 08:19	04/11/2020 10:56	04/11/2020 08:19	04/11/2020 10:56	2,62	2	5,23	CHI
20201110862	IVOLANDIA	IV21165782	IPORA	04/11/2020 08:19	04/11/2020 09:31	04/11/2020 08:19	04/11/2020 09:31	1,20	1	1,20	CHI
20201110864	LEOPOLDO DE BULHOES	LB12028215	DAIA S2	04/11/2020 08:19	04/11/2020 12:33	04/11/2020 08:19	04/11/2020 12:33	4,23	6	25,39	CHI
20201110871	SAO JOAO D ALIANCA	JL21154490	SAO JOAO D ALIANCA	04/11/2020 08:21	04/11/2020 16:10	04/11/2020 08:21	04/11/2020 16:10	7,82	1	7,82	CHI
20201110873	AMARALINA	UP12294696	NOVA CRIXAS	04/11/2020 08:21	04/11/2020 17:50	04/11/2020 08:21	04/11/2020 17:50	9,48	38	360,29	CHI
20201110873	MARA ROSA	UP12294696	NOVA CRIXAS	04/11/2020 08:21	04/11/2020 17:50	04/11/2020 08:21	04/11/2020 17:50	9,48	41	388,74	CHI
20201110873	SANTA TEREZINHA DE GOIAS	UP12294696	NOVA CRIXAS	04/11/2020 08:21	04/11/2020 17:50	04/11/2020 08:21	04/11/2020 17:50	9,48	1	9,48	CHI
20201110873	UIRAPURU	UP12294696	NOVA CRIXAS	04/11/2020 08:21	04/11/2020 17:50	04/11/2020 08:21	04/11/2020 17:50	9,48	4	37,93	CHI
20201110875	FORMOSA	10005714913	ITUIQUIRA	04/11/2020 08:21	04/11/2020 09:44	04/11/2020 08:21	04/11/2020 09:44	1,38	1	1,38	CHI
20201110878	NOVA IGUACU DE GOIAS	NH21242587	CAMPINORTE	04/11/2020 08:21	04/11/2020 11:07	04/11/2020 08:21	04/11/2020 11:07	2,76	1	2,76	CHI
20201111286	MONTIVIDIU DO NORTE	MX12203423	PORANGATU	04/11/2020 08:22	04/11/2020 14:49	04/11/2020 08:22	04/11/2020 14:49	6,44	17	109,48	CHI
20201110887	SAO MIGUEL DO ARAGUAIA	SM21228632	SAO MIGUEL DO ARAGUAIA	04/11/2020 08:23	04/11/2020 14:20	04/11/2020 08:23	04/11/2020 14:20	5,95	1	5,95	CHI
20201110891	CAIAPONIA	CP12342197	CAIAPONIA	04/11/2020 08:24	04/11/2020 12:16	04/11/2020 08:24	04/11/2020 12:16	3,85	2	7,71	CHI
20201110902	SAO LUIS DE MONTES BELOS	500033730	SAO LUIZ DOS MONTES BELOS	04/11/2020 08:26	04/11/2020 11:23	04/11/2020 08:26	04/11/2020 11:23	2,95	1	2,95	CHI
20201110925	PLANALTINA	PI21099211	PLANALTINA	04/11/2020 08:29	04/11/2020 12:22	04/11/2020 08:29	04/11/2020 12:22	3,88	1	3,88	CHI
20201110952	LUZIANIA	LZ12305050RE	CRISTALINA S2	04/11/2020 08:29	04/11/2020 21:34	04/11/2020 08:29	04/11/2020 20:27	11,97	10	119,66	CHI
20201110952	LUZIANIA	LZ12305050RE	CRISTALINA S2	04/11/2020 08:29	04/11/2020 21:34	04/11/2020 11:50	04/11/2020 20:27	8,62	7	60,33	CHI
20201110952	LUZIANIA	LZ12305050RE	CRISTALINA S2	04/11/2020 08:29	04/11/2020 21:34	04/11/2020 08:29	04/11/2020 21:34	13,09	5	65,46	CHI
20201110940	PADRE BERNARDO	PB11261459	PADRE BERNARDO	04/11/2020 08:31	04/11/2020 09:25	04/11/2020 08:31	04/11/2020 09:25	0,89	126	112,17	CHI
20201110950	FIRMINOPOLIS	TV12005563RE	FIRMINOPOLIS S1	04/11/2020 08:33	04/11/2020 11:30	04/11/2020 08:33	04/11/2020 11:30	2,94	63	185,48	CHI
20201110950	TURVANIA	TV12005563RE	FIRMINOPOLIS S1	04/11/2020 08:33	04/11/2020 11:30	04/11/2020 08:33	04/11/2020 11:30	2,94	12	35,33	CHI
20201110961	IPAMERI	6940003741	CRISTALINA S1	04/11/2020 08:35	04/11/2020 09:46	04/11/2020 08:35	04/11/2020 09:46	1,18	1	1,18	CHI
20201110966	PADRE BERNARDO	PB12275695	PADRE BERNARDO	04/11/2020 08:35	04/11/2020 12:12	04/11/2020 08:35	04/11/2020 12:12	3,61	6	21,64	CHI
20201110973	NOVA CRIXAS	NA12091692	NOVA CRIXAS	04/11/2020 08:36	05/11/2020 01:05	04/11/2020 08:36	05/11/2020 01:05	16,47	22	362,42	CHI

20201110974	GOIAS	GS12217051	GOIAS	04/11/2020 08:36	04/11/2020 16:17	04/11/2020 08:36	04/11/2020 16:17	7,67	235	1803,04	CHI
20201110975	ANAPOLIS	AN21258755	ANAPOLIS UNIVERSITARIO S2	04/11/2020 08:37	04/11/2020 11:35	04/11/2020 08:37	04/11/2020 11:35	2,96	1	2,96	CHI
20201110983	MONTIVIDIU DO NORTE	MX21245229	PORANGATU	04/11/2020 08:38	05/11/2020 09:38	04/11/2020 08:38	05/11/2020 09:38	25,00	1	25,00	CHI
20201111324	POSSE	PS12302648	IACIARA S2	04/11/2020 08:38	04/11/2020 11:13	04/11/2020 08:38	04/11/2020 11:13	2,58	4	10,33	CHI
20201110989	ALEXANIA	480042822	ALEXANIA	04/11/2020 08:39	04/11/2020 17:10	04/11/2020 08:39	04/11/2020 17:10	8,51	1	8,51	CHI
20201110994	VALPARAISO DE GOIAS	2860017866	PACAEMBU S1	04/11/2020 08:40	04/11/2020 09:38	04/11/2020 08:40	04/11/2020 09:38	0,96	1	0,96	CHI
20201111003	ANAPOLIS	20297452	JUNDIAI S1	04/11/2020 08:40	04/11/2020 11:22	04/11/2020 08:40	04/11/2020 11:22	2,71	1	2,71	CHI
20201111008	CAIAPONIA	CP12374268	CAIAPONIA	04/11/2020 08:42	04/11/2020 13:47	04/11/2020 08:42	04/11/2020 13:47	5,08	1	5,08	CHI
20201111009	PIRANHAS	PH12201915	ARENOPOLIS	04/11/2020 08:42	04/11/2020 11:27	04/11/2020 08:42	04/11/2020 11:27	2,74	6	16,44	CHI
20201111010	FAINA	FC11101085	GOIAS	04/11/2020 08:43	04/11/2020 13:19	04/11/2020 08:43	04/11/2020 13:19	4,60	2	9,20	CHI
20201111016	POSSE	1480081751	IACIARA S2	04/11/2020 08:44	04/11/2020 11:15	04/11/2020 08:44	04/11/2020 11:15	2,52	1	2,52	CHI
20201111032	CRISTALINA	1060086004	CRISTALINA S1	04/11/2020 08:46	04/11/2020 10:31	04/11/2020 08:46	04/11/2020 10:31	1,74	1	1,74	CHI
20201111356	TROMBAS	TB12288232	PORANGATU	04/11/2020 08:49	04/11/2020 18:12	04/11/2020 08:49	04/11/2020 18:12	9,38	22	206,40	CHI
20201111055	SAO MIGUEL DO ARAGUAIA	SM21096101	SAO MIGUEL DO ARAGUAIA	04/11/2020 08:50	04/11/2020 10:05	04/11/2020 08:50	04/11/2020 10:05	1,24	1	1,24	CHI
20201111068	ALEXANIA	AX11285269	ALEXANIA	04/11/2020 08:52	04/11/2020 12:15	04/11/2020 08:52	04/11/2020 12:15	3,37	9	30,36	CHI
20201111081	MINACU	4020007320	MINACU	04/11/2020 08:53	04/11/2020 11:33	04/11/2020 08:53	04/11/2020 11:33	2,65	1	2,65	CHI
20201111095	URUACU	10024151414	URUACU	04/11/2020 08:56	04/11/2020 10:07	04/11/2020 08:56	04/11/2020 10:07	1,18	1	1,18	CHI
20201111100	ANAPOLIS	21357699	JUNDIAI S2	04/11/2020 08:57	04/11/2020 12:22	04/11/2020 08:57	04/11/2020 12:22	3,42	1	3,42	CHI
20201111108	CAMPOS VERDES	VD12049788	SANTA TEREZINHA	04/11/2020 08:58	05/11/2020 08:57	04/11/2020 08:58	05/11/2020 08:57	23,97	1	23,97	CHI
20201111114	SANCLERLANDIA	SC12376301	FIRMINOPOLIS S2	04/11/2020 08:59	04/11/2020 11:47	04/11/2020 08:59	04/11/2020 11:47	2,79	97	270,95	CHI
20201111125	JARAGUA	JA11258146	JARAGUA	04/11/2020 09:01	04/11/2020 13:16	04/11/2020 09:01	04/11/2020 13:16	4,25	15	63,72	CHI
20201111130	SAO DOMINGOS	SD12132214	SAO DOMINGOS	04/11/2020 09:01	04/11/2020 16:25	04/11/2020 09:01	04/11/2020 16:25	7,39	3	22,17	CHI
20201111149	ANAPOLIS	20578131	JUNDIAI S2	04/11/2020 09:05	04/11/2020 10:12	04/11/2020 09:05	04/11/2020 10:12	1,11	1	1,11	CHI
20201111156	MINACU	CR11257430	PORANGATU	04/11/2020 09:06	05/11/2020 03:16	04/11/2020 09:06	05/11/2020 03:16	18,15	1	18,15	CHI
20201111160	NOVA IGUACU DE GOIAS	7830006646	CAMPINORTE	04/11/2020 09:07	04/11/2020 16:18	04/11/2020 09:07	04/11/2020 16:18	7,19	1	7,19	CHI
20201111164	CORUMBA DE GOIAS	CB21147430	CORUMBA	04/11/2020 09:07	04/11/2020 12:08	04/11/2020 09:07	04/11/2020 12:08	3,01	1	3,01	CHI
20201111182	MINACU	4020093181	MINACU	04/11/2020 09:10	04/11/2020 17:50	04/11/2020 09:10	04/11/2020 17:50	8,67	1	8,67	CHI
20201111188	FORMOSA	FA21106899	SAO JOAO D ALIANCA	04/11/2020 09:12	04/11/2020 12:55	04/11/2020 09:12	04/11/2020 12:55	3,71	1	3,71	CHI
20201111582	COCALZINHO DE GOIAS	ZN12390201	COCALZINHO	04/11/2020 09:12	04/11/2020 12:03	04/11/2020 09:12	04/11/2020 12:03	2,85	562	1600,14	CHI
20201111205	FORMOSA	10014563515	ITUIQUIRA	04/11/2020 09:15	04/11/2020 10:12	04/11/2020 09:15	04/11/2020 10:12	0,95	1	0,95	CHI
20201111212	SAO MIGUEL DO ARAGUAIA	SM12211095	SAO MIGUEL DO ARAGUAIA	04/11/2020 09:17	04/11/2020 11:26	04/11/2020 09:17	04/11/2020 11:26	2,15	130	279,36	CHI
20201111252	CAMPOS BELOS	CH21218851	SAO DOMINGOS	04/11/2020 09:24	04/11/2020 11:12	04/11/2020 09:24	04/11/2020 11:12	1,79	1	1,79	CHI
20201111280	FORMOSA	10011947649	ITUIQUIRA	04/11/2020 09:30	04/11/2020 10:57	04/11/2020 09:30	04/11/2020 10:57	1,45	1	1,45	CHI
20201111308	AGUAS LINDAS DE GOIAS	10020147900	AGUAS LINDAS DE GOIAS S1	04/11/2020 09:38	04/11/2020 11:19	04/11/2020 09:38	04/11/2020 11:19	1,68	1	1,68	CHI
20201111309	AMARALINA	LC21266007	MARA ROSA	04/11/2020 09:38	04/11/2020 11:30	04/11/2020 09:38	04/11/2020 11:30	1,86	1	1,86	CHI
20201111315	NIQUELANDIA	NQ12057925	NIQUELANDIA SUBTRANSMISSAO	04/11/2020 09:40	04/11/2020 18:21	04/11/2020 09:40	04/11/2020 18:21	8,70	36	313,06	CHI
20201111321	AGUAS LINDAS DE GOIAS	4830268725	AGUAS LINDAS DE GOIAS S2	04/11/2020 09:41	04/11/2020 11:27	04/11/2020 09:41	04/11/2020 11:27	1,76	1	1,76	CHI
20201111327	GOIANESIA	10032703234	GOIANESIA S1	04/11/2020 09:43	04/11/2020 21:59	04/11/2020 09:43	04/11/2020 21:59	12,27	1	12,27	CHI
20201111346	HIDROLINA	GG12392056LD	URUACU	04/11/2020 09:47	04/11/2020 20:15	04/11/2020 09:47	04/11/2020 19:40	9,88	5	49,41	CHI
20201111346	PILAR DE GOIAS	GG12392056LD	URUACU	04/11/2020 09:47	04/11/2020 20:15	04/11/2020 09:47	04/11/2020 19:40	9,88	23	227,30	CHI
20201111346	PILAR DE GOIAS	GG21141601	URUACU	04/11/2020 09:47	04/11/2020 20:15	04/11/2020 15:13	04/11/2020 20:00	4,80	1	4,80	CHI
20201111346	PILAR DE GOIAS	GG21291240	URUACU	04/11/2020 09:47	04/11/2020 20:15	04/11/2020 15:32	04/11/2020 20:15	4,71	1	4,71	CHI
20201111366	PORANGATU	PO11254767	PORANGATU	04/11/2020 09:51	05/11/2020 16:28	04/11/2020 09:51	05/11/2020 16:28	30,61	2	61,22	CHI
20201111643	CRISTALINA	KR12376280	PAMPLONA	04/11/2020 09:51	04/11/2020 12:43	04/11/2020 09:51	04/11/2020 12:43	2,86	11	31,43	CHI
20201111385	SANTA TEREZINHA DE GOIAS	SG21210188	SANTA TEREZINHA	04/11/2020 09:55	04/11/2020 13:19	04/11/2020 09:55	04/11/2020 13:19	3,39	2	6,79	CHI
20201111391	PLANALTINA	PI12322789	PLANALTINA	04/11/2020 09:56	04/11/2020 12:15	04/11/2020 09:56	04/11/2020 12:15	2,31	38	87,74	CHI
20201111399	NIQUELANDIA	NQ12362142	NIQUELANDIA SUBTRANSMISSAO	04/11/2020 09:58	04/11/2020 16:06	04/11/2020 09:58	04/11/2020 16:06	6,13	1	6,13	CHI
20201111418	PLANALTINA	PI12100878	PLANALTINA	04/11/2020 10:02	04/11/2020 12:38	04/11/2020 10:02	04/11/2020 12:38	2,59	23	59,67	CHI
20201111431	NIQUELANDIA	NQ21243379	URUACU	04/11/2020 10:06	04/11/2020 13:03	04/11/2020 10:06	04/11/2020 13:03	2,95	10	29,45	CHI
20201111442	ANAPOLIS	20922565	ANAPOLIS UNIVERSITARIO S2	04/11/2020 10:09	04/11/2020 13:12	04/11/2020 10:09	04/11/2020 13:12	3,05	1	3,05	CHI
20201111445	LUZIANIA	120390048	RIO VERMELHO	04/11/2020 10:10	04/11/2020 14:00	04/11/2020 10:10	04/11/2020 14:00	3,83	1	3,83	CHI

2020111453	FORMOSA	610141417	ITUIQUIRA	04/11/2020 10:12	04/11/2020 11:54	04/11/2020 10:12	04/11/2020 11:54	1,69	1	1,69	CHI
2020111463	FORMOSA	FA11233727	SAO JOAO D ALIANCA	04/11/2020 10:14	04/11/2020 14:16	04/11/2020 10:14	04/11/2020 14:16	4,02	2	8,04	CHI
2020111473	ANAPOLIS	AN16415818	JUNDIAI S1	04/11/2020 10:16	04/11/2020 11:01	04/11/2020 10:17	04/11/2020 10:37	0,34	1272	428,59	CHI
2020111473	ANAPOLIS	AN12000925	JUNDIAI S1	04/11/2020 10:16	04/11/2020 11:01	04/11/2020 10:17	04/11/2020 11:01	0,73	51	37,05	CHI
2020111475	PIRENOPOLIS	PV21056035	CORUMBA	04/11/2020 10:18	04/11/2020 11:55	04/11/2020 10:18	04/11/2020 11:55	1,61	1	1,61	CHI
2020111481	LUZIANIA	10014866747	MARAJOARA	04/11/2020 10:20	04/11/2020 16:03	04/11/2020 10:20	04/11/2020 16:03	5,71	1	5,71	CHI
2020111482	POSSE	SA11195801	IACIARA S2	04/11/2020 10:20	04/11/2020 13:51	04/11/2020 10:20	04/11/2020 13:51	3,51	1	3,51	CHI
2020111492	JARAGUA	JA21339860	JARAGUA	04/11/2020 10:22	04/11/2020 11:46	04/11/2020 10:22	04/11/2020 11:46	1,39	1	1,39	CHI
2020111495	CRISTALINA	1060050204	CRISTALINA S1	04/11/2020 10:23	04/11/2020 11:09	04/11/2020 10:23	04/11/2020 11:09	0,76	1	0,76	CHI
2020111507	POSSE	PS11195991	IACIARA S2	04/11/2020 10:26	04/11/2020 11:35	04/11/2020 10:26	04/11/2020 11:35	1,14	12	13,73	CHI
2020111515	ANAPOLIS	21134080	JUNDIAI S1	04/11/2020 10:28	04/11/2020 11:15	04/11/2020 10:28	04/11/2020 11:15	0,77	1	0,77	CHI
2020111539	ESTRELA DO NORTE	2420004201	MARA ROSA	04/11/2020 10:35	04/11/2020 12:38	04/11/2020 10:35	04/11/2020 12:38	2,05	1	2,05	CHI
2020111554	SAO JOAO D ALIANCA	JL21314627	SAO JOAO D ALIANCA	04/11/2020 10:39	04/11/2020 14:48	04/11/2020 10:39	04/11/2020 14:48	4,15	1	4,15	CHI
2020111556	CRIXAS	CX21190128	SANTA TEREZINHA	04/11/2020 10:39	04/11/2020 17:28	04/11/2020 10:39	04/11/2020 17:28	6,80	1	6,80	CHI
2020111575	AGUAS LINDAS DE GOIAS	4830206185	AGUAS LINDAS DE GOIAS S2	04/11/2020 10:44	04/11/2020 12:09	04/11/2020 10:44	04/11/2020 12:09	1,40	1	1,40	CHI
2020111590	NIQUELANDIA	2750125450	NIQUELANDIA SUBTRANSMISSAO	04/11/2020 10:48	04/11/2020 17:05	04/11/2020 10:48	04/11/2020 17:05	6,28	1	6,28	CHI
2020111592	ANAPOLIS	20172539	ANAPOLIS UNIVERSITARIO S2	04/11/2020 10:50	04/11/2020 13:57	04/11/2020 10:50	04/11/2020 13:57	3,11	1	3,11	CHI
2020111613	GOIANESIA	550109456	GOIANESIA S2	04/11/2020 10:55	04/11/2020 16:01	04/11/2020 10:55	04/11/2020 16:01	5,09	1	5,09	CHI
2020111615	LUZIANIA	120085537	RIO VERMELHO	04/11/2020 10:56	04/11/2020 12:43	04/11/2020 10:56	04/11/2020 12:43	1,78	1	1,78	CHI
2020111625	NIQUELANDIA	2750070758	NIQUELANDIA SUBTRANSMISSAO	04/11/2020 11:00	04/11/2020 16:22	04/11/2020 11:00	04/11/2020 16:22	5,35	1	5,35	CHI
2020111633	PLANALTINA	2960082091	PLANALTINA	04/11/2020 11:01	04/11/2020 16:53	04/11/2020 11:01	04/11/2020 16:53	5,86	1	5,86	CHI
2020111640	ANAPOLIS	AN12258730	ANAPOLIS UNIVERSITARIO S2	04/11/2020 11:03	04/11/2020 14:48	04/11/2020 11:03	04/11/2020 14:48	3,75	9	33,73	CHI
2020111672	ITAPACI	IW12181387	ITAPACI	04/11/2020 11:03	04/11/2020 11:58	04/11/2020 11:03	04/11/2020 11:58	0,91	4	3,64	CHI
2020111672	NOVA GLORIA	IW12181387	ITAPACI	04/11/2020 11:03	04/11/2020 11:58	04/11/2020 11:03	04/11/2020 11:58	0,91	4	3,64	CHI
2020111653	LUZIANIA	10000513065	RIO VERMELHO	04/11/2020 11:06	04/11/2020 12:05	04/11/2020 11:06	04/11/2020 12:05	0,98	1	0,98	CHI
2020111669	AGUA FRIA DE GOIAS	TL11279972	SAO JOAO D ALIANCA	04/11/2020 11:10	04/11/2020 15:31	04/11/2020 11:10	04/11/2020 15:31	4,34	3	13,01	CHI
2020111673	LUZIANIA	120209627	RIO VERMELHO	04/11/2020 11:11	04/11/2020 12:56	04/11/2020 11:11	04/11/2020 12:56	1,74	1	1,74	CHI
2020111676	ANAPOLIS	10004525530	JUNDIAI S1	04/11/2020 11:12	04/11/2020 12:59	04/11/2020 11:12	04/11/2020 12:59	1,78	1	1,78	CHI
20201112640	MUTUNOPOLIS	PO12391912	PORANGATU	04/11/2020 11:13	04/11/2020 16:47	04/11/2020 11:13	04/11/2020 16:47	5,55	35	194,41	CHI
20201112640	PORANGATU	PO12391912	PORANGATU	04/11/2020 11:13	04/11/2020 16:47	04/11/2020 11:13	04/11/2020 16:47	5,55	58	322,16	CHI
2020110400042	NOVO GAMA	MAJ-TR2	MARAJOARA	04/11/2020 11:14	04/11/2020 11:27	04/11/2020 11:24	04/11/2020 11:27	0,05	1	0,05	CHI
20201111687	MUTUNOPOLIS	MU21137743	MARA ROSA	04/11/2020 11:15	04/11/2020 13:45	04/11/2020 11:15	04/11/2020 13:45	2,50	1	2,50	CHI
20201111700	LUZIANIA	3200251813	MARAJOARA	04/11/2020 11:18	04/11/2020 12:02	04/11/2020 11:18	04/11/2020 12:02	0,73	1	0,73	CHI
20201111701	ANAPOLIS	10032509985	ANAPOLIS UNIVERSITARIO S2	04/11/2020 11:19	04/11/2020 16:47	04/11/2020 11:19	04/11/2020 16:47	5,46	1	5,46	CHI
20201111720	PORANGATU	PO21204833	PORANGATU	04/11/2020 11:24	05/11/2020 13:05	04/11/2020 11:24	05/11/2020 13:05	25,68	1	25,68	CHI
2020110400041	VALPARAISO DE GOIAS	VA16415830	PACAEMBU S1	04/11/2020 11:24	04/11/2020 13:35	04/11/2020 11:24	04/11/2020 11:36	0,20	6300	1265,25	CHI
2020110400041	VALPARAISO DE GOIAS	VA16410073	PACAEMBU S1	04/11/2020 11:24	04/11/2020 13:35	04/11/2020 11:24	04/11/2020 11:36	0,20	7823	1581,98	CHI
2020110400041	DISTRITO FEDERAL	60414	MARAJOARA	04/11/2020 11:24	04/11/2020 13:35	04/11/2020 11:36	04/11/2020 12:50	1,23	756	929,04	CHI
2020110400041	DISTRITO FEDERAL	60414	MARAJOARA	04/11/2020 11:24	04/11/2020 13:35	04/11/2020 11:36	04/11/2020 12:50	1,23	536	658,68	CHI
2020110400041	NOVO GAMA	60414	MARAJOARA	04/11/2020 11:24	04/11/2020 13:35	04/11/2020 11:36	04/11/2020 12:50	1,23	3116	3829,22	CHI
2020110400041	NOVO GAMA	60414	MARAJOARA	04/11/2020 11:24	04/11/2020 13:35	04/11/2020 11:36	04/11/2020 12:50	1,23	3794	4662,40	CHI
2020110400041	SANTO ANTONIO DO DESCOBERTO	60414	MARAJOARA	04/11/2020 11:24	04/11/2020 13:35	04/11/2020 11:36	04/11/2020 12:50	1,23	114	140,09	CHI
2020110400041	SANTO ANTONIO DO DESCOBERTO	1350414	MARAJOARA	04/11/2020 11:24	04/11/2020 13:35	04/11/2020 11:36	04/11/2020 12:50	1,23	54	66,34	CHI
2020110400041	NOVO GAMA	PAC-TR1	PACAEMBU S1	04/11/2020 11:24	04/11/2020 13:35	04/11/2020 11:24	04/11/2020 12:57	1,55	14119	21837,39	CHI
2020110400041	SANTO ANTONIO DO DESCOBERTO	PAC-TR1	PACAEMBU S1	04/11/2020 11:24	04/11/2020 13:35	04/11/2020 11:24	04/11/2020 12:57	1,55	30	46,40	CHI
2020110400041	NOVO GAMA	PAC-TR1	PACAEMBU S1	04/11/2020 11:24	04/11/2020 13:35	04/11/2020 11:24	04/11/2020 12:57	1,56	1234	1920,24	CHI
2020110400041	VALPARAISO DE GOIAS	PAC-TR1	PACAEMBU S1	04/11/2020 11:24	04/11/2020 13:35	04/11/2020 11:24	04/11/2020 12:57	1,56	576	896,32	CHI
2020110400041	VALPARAISO DE GOIAS	PAC-TR1	PACAEMBU S1	04/11/2020 11:24	04/11/2020 13:35	04/11/2020 11:24	04/11/2020 13:06	1,69	3961	6702,89	CHI
2020110400041	DISTRITO FEDERAL	PAC-TR1	PACAEMBU S1	04/11/2020 11:24	04/11/2020 13:35	04/11/2020 11:24	04/11/2020 13:12	1,79	1	1,79	CHI
2020110400041	NOVO GAMA	PAC-TR1	PACAEMBU S1	04/11/2020 11:24	04/11/2020 13:35	04/11/2020 11:24	04/11/2020 13:12	1,79	7645	13703,66	CHI
2020110400041	VALPARAISO DE GOIAS	PAC-TR1	PACAEMBU S1	04/11/2020 11:24	04/11/2020 13:35	04/11/2020 11:24	04/11/2020 13:12	1,79	6718	12042,02	CHI

2020110400041	VALPARAISO DE GOIAS	VA16415830	PACAEMBU S1	04/11/2020 11:24	04/11/2020 13:35	04/11/2020 13:28	04/11/2020 13:35	0,11	6415	732,38	CHI
20201111723	UIRAPURU	4210001601	NOVA CRIXAS	04/11/2020 11:25	04/11/2020 17:40	04/11/2020 11:25	04/11/2020 17:40	6,24	1	6,24	CHI
20201111727	VALPARAISO DE GOIAS	2860185520	MARAJOARA	04/11/2020 11:25	04/11/2020 15:20	04/11/2020 11:25	04/11/2020 15:20	3,90	1	3,90	CHI
20201111756	ALEXANIA	AX10394596	ALEXANIA	04/11/2020 11:29	04/11/2020 15:06	04/11/2020 14:54	04/11/2020 15:06	0,19	153	29,50	CHI
20201111756	CORUMBA DE GOIAS	AX10394596	ALEXANIA	04/11/2020 11:29	04/11/2020 15:06	04/11/2020 14:54	04/11/2020 15:06	0,19	7	1,35	CHI
20201111756	SANTO ANTONIO DO DESCOBERTO	AX10394596	ALEXANIA	04/11/2020 11:29	04/11/2020 15:06	04/11/2020 14:54	04/11/2020 15:06	0,19	3	0,58	CHI
20201111761	LUZIANIA	120030251	MARAJOARA	04/11/2020 11:29	04/11/2020 14:43	04/11/2020 11:29	04/11/2020 14:43	3,23	1	3,23	CHI
20201111847	JARAGUA	JA21191289	JARAGUA	04/11/2020 11:38	04/11/2020 21:00	04/11/2020 11:38	04/11/2020 21:00	9,35	1	9,35	CHI
20201111857	PADRE BERNARDO	PB12133181	PADRE BERNARDO	04/11/2020 11:40	04/11/2020 13:36	04/11/2020 11:40	04/11/2020 13:36	1,93	2	3,86	CHI
20201111888	SAO JOAO D ALIANCA	JL12049201	SAO JOAO D ALIANCA	04/11/2020 11:44	04/11/2020 13:47	04/11/2020 11:44	04/11/2020 13:47	2,05	95	194,67	CHI
20201111916	CAMPINORTE	CR12135585	MARA ROSA	04/11/2020 11:49	05/11/2020 11:02	04/11/2020 11:49	05/11/2020 11:02	23,21	1	23,21	CHI
20201111920	VALPARAISO DE GOIAS	VA16408336	PACAEMBU S2	04/11/2020 11:50	04/11/2020 18:07	04/11/2020 11:50	04/11/2020 17:23	5,56	238	1322,49	CHI
20201111920	VALPARAISO DE GOIAS	VA12401722	PACAEMBU S2	04/11/2020 11:50	04/11/2020 18:07	04/11/2020 18:01	04/11/2020 18:07	0,11	238	25,19	CHI
20201111935	FORMOSA	610136021	ITUIQUIRA	04/11/2020 11:51	04/11/2020 15:30	04/11/2020 11:51	04/11/2020 15:30	3,64	1	3,64	CHI
20201111944	NOVA CRIXAS	NA12158761	NOVA CRIXAS	04/11/2020 11:53	04/11/2020 20:52	04/11/2020 11:53	04/11/2020 20:52	8,98	2	17,95	CHI
20201111953	PADRE BERNARDO	10007452843	PADRE BERNARDO	04/11/2020 11:55	04/11/2020 15:23	04/11/2020 11:55	04/11/2020 15:23	3,47	1	3,47	CHI
20201112040	TERESINA DE GOIAS	TE21328384	FLORES DE GOIAS	04/11/2020 12:13	04/11/2020 16:14	04/11/2020 12:13	04/11/2020 16:14	4,01	1	4,01	CHI
20201112047	URUACU	10024153131	URUACU	04/11/2020 12:14	04/11/2020 15:25	04/11/2020 12:14	04/11/2020 15:25	3,18	1	3,18	CHI
20201112049	PLANALTINA	PI21379176	PLANALTINA	04/11/2020 12:14	04/11/2020 14:48	04/11/2020 12:14	04/11/2020 14:48	2,55	1	2,55	CHI
20201112050	LUZIANIA	3200120354	MARAJOARA	04/11/2020 12:14	04/11/2020 15:43	04/11/2020 12:14	04/11/2020 15:43	3,47	1	3,47	CHI
20201112054	PORANGATU	PO12236042	NOVO PLANALTO	04/11/2020 12:15	05/11/2020 11:31	04/11/2020 12:15	05/11/2020 11:31	23,26	5	116,32	CHI
20201112058	SAO DOMINGOS	SD21192197	SAO DOMINGOS	04/11/2020 12:15	04/11/2020 17:47	04/11/2020 12:15	04/11/2020 17:23	5,13	1	5,13	CHI
20201112058	SAO DOMINGOS	SD12161809	SAO DOMINGOS	04/11/2020 12:15	04/11/2020 17:47	04/11/2020 12:15	04/11/2020 17:47	5,53	11	60,80	CHI
20201112101	COCALZINHO DE GOIAS	ZN11388036	GOIANESIA S1	04/11/2020 12:16	04/11/2020 15:27	04/11/2020 12:16	04/11/2020 15:27	3,18	2	6,37	CHI
2020110400037	COCALZINHO DE GOIAS	18431	GOIANESIA S1	04/11/2020 12:16	04/11/2020 12:24	04/11/2020 12:16	04/11/2020 12:24	0,13	255	34,00	CHI
2020110400037	GOIANESIA	46401	GOIANESIA S1	04/11/2020 12:16	04/11/2020 12:24	04/11/2020 12:16	04/11/2020 12:24	0,13	396	52,80	CHI
2020110400037	GOIANESIA	46402	GOIANESIA S1	04/11/2020 12:16	04/11/2020 12:24	04/11/2020 12:16	04/11/2020 12:24	0,13	610	81,33	CHI
2020110400037	GOIANESIA	560434	GOIANESIA S1	04/11/2020 12:16	04/11/2020 12:24	04/11/2020 12:16	04/11/2020 12:24	0,13	20	2,67	CHI
2020110400037	NOVA GLORIA	46401	GOIANESIA S1	04/11/2020 12:16	04/11/2020 12:24	04/11/2020 12:16	04/11/2020 12:24	0,13	2	0,27	CHI
2020110400037	PIRENOPOLIS	18401	GOIANESIA S1	04/11/2020 12:16	04/11/2020 12:24	04/11/2020 12:16	04/11/2020 12:24	0,13	33	4,40	CHI
2020110400037	PIRENOPOLIS	18402	GOIANESIA S1	04/11/2020 12:16	04/11/2020 12:24	04/11/2020 12:16	04/11/2020 12:24	0,13	1	0,13	CHI
2020110400037	SANTA ISABEL	46401	GOIANESIA S1	04/11/2020 12:16	04/11/2020 12:24	04/11/2020 12:16	04/11/2020 12:24	0,13	2	0,27	CHI
2020110400037	SANTA ISABEL	46402	GOIANESIA S1	04/11/2020 12:16	04/11/2020 12:24	04/11/2020 12:16	04/11/2020 12:24	0,13	31	4,13	CHI
2020110400037	SAO LUIZ DO NORTE	46401	GOIANESIA S1	04/11/2020 12:16	04/11/2020 12:24	04/11/2020 12:16	04/11/2020 12:24	0,13	21	2,80	CHI
2020110400037	VILA PROPICIO	18401	GOIANESIA S1	04/11/2020 12:16	04/11/2020 12:24	04/11/2020 12:16	04/11/2020 12:24	0,13	814	108,53	CHI
2020110400037	VILA PROPICIO	18402	GOIANESIA S1	04/11/2020 12:16	04/11/2020 12:24	04/11/2020 12:16	04/11/2020 12:24	0,13	141	18,80	CHI
2020110400037	VILA PROPICIO	18431	GOIANESIA S1	04/11/2020 12:16	04/11/2020 12:24	04/11/2020 12:16	04/11/2020 12:24	0,13	178	23,73	CHI
2020110400037	VILA PROPICIO	560434	GOIANESIA S1	04/11/2020 12:16	04/11/2020 12:24	04/11/2020 12:16	04/11/2020 12:24	0,13	141	18,80	CHI
20201112097	NOVA CRIXAS	8570030310	NOVA CRIXAS	04/11/2020 12:22	04/11/2020 18:54	04/11/2020 12:22	04/11/2020 18:54	6,53	1	6,53	CHI
20201112131	URUACU	UR11374732	URUACU	04/11/2020 12:29	05/11/2020 06:55	04/11/2020 12:29	05/11/2020 06:55	18,42	49	902,53	CHI
20201112132	JARAGUA	JA21099711	GOIANESIA S2	04/11/2020 12:30	04/11/2020 22:58	04/11/2020 12:30	04/11/2020 22:58	10,46	1	10,46	CHI
20201112165	PIRENOPOLIS	PV21227845	CORUMBA	04/11/2020 12:37	04/11/2020 16:16	04/11/2020 12:37	04/11/2020 16:16	3,64	1	3,64	CHI
20201112185	COCALZINHO DE GOIAS	ZN12307708	GOIANESIA S1	04/11/2020 12:43	04/11/2020 16:08	04/11/2020 12:43	04/11/2020 16:08	3,41	3	10,24	CHI
20201112226	NIQUELANDIA	4760001063	NIQUELANDIA SUBTRANSMISSAO	04/11/2020 12:52	05/11/2020 11:17	04/11/2020 12:52	05/11/2020 11:17	22,41	1	22,41	CHI
20201112234	FORMOSA	FA21194554	SAO JOAO D ALIANCA	04/11/2020 12:53	04/11/2020 13:07	04/11/2020 12:53	04/11/2020 13:07	0,23	1	0,23	CHI
20201112257	SAO JOAO D ALIANCA	JL121255333	IACIARA S2	04/11/2020 12:58	04/11/2020 19:31	04/11/2020 12:58	04/11/2020 19:31	6,54	3	19,62	CHI
20201112265	CRISTALINA	KR12304816	CRISTALINA S2	04/11/2020 12:59	04/11/2020 15:57	04/11/2020 12:59	04/11/2020 15:57	2,95	15	44,31	CHI
20201112272	GOIANESIA	550127173	GOIANESIA S2	04/11/2020 13:00	04/11/2020 18:41	04/11/2020 13:00	04/11/2020 18:41	5,67	1	5,67	CHI
20201112278	LUZIANIA	LZ21305303	RIO VERMELHO	04/11/2020 13:01	04/11/2020 14:14	04/11/2020 13:01	04/11/2020 14:14	1,21	1	1,21	CHI
20201112297	LUZIANIA	LZ11351418	RIO VERMELHO	04/11/2020 13:06	04/11/2020 14:36	04/11/2020 13:06	04/11/2020 14:36	1,50	5	7,50	CHI
20201112336	LUZIANIA	10002996780	RIO VERMELHO	04/11/2020 13:17	04/11/2020 19:42	04/11/2020 13:17	04/11/2020 19:42	6,42	1	6,42	CHI

20201112358	BONOPOLIS	BX21145171	SAO MIGUEL DO ARAGUAIA	04/11/2020 13:22	04/11/2020 22:26	04/11/2020 13:22	04/11/2020 22:26	9,06	2	18,12	CHI
20201112408	NOVO PLANALTO	TA12391932	NOVO PLANALTO	04/11/2020 13:31	04/11/2020 16:48	04/11/2020 13:31	04/11/2020 16:48	3,27	6	19,63	CHI
20201112409	PLANALTINA	PI12379178	PLANALTINA	04/11/2020 13:31	04/11/2020 14:48	04/11/2020 13:31	04/11/2020 14:48	1,28	1	1,28	CHI
20201112426	PADRE BERNARDO	PB21330891	PADRE BERNARDO	04/11/2020 13:38	04/11/2020 15:57	04/11/2020 13:38	04/11/2020 15:57	2,30	1	2,30	CHI
20201112443	LUZIANIA	LZ21330698	MARAJOARA	04/11/2020 13:42	04/11/2020 17:58	04/11/2020 13:42	04/11/2020 17:58	4,25	1	4,25	CHI
20201112453	JARAGUA	JA21116896	JARAGUA	04/11/2020 13:44	04/11/2020 19:42	04/11/2020 13:44	04/11/2020 19:42	5,97	1	5,97	CHI
20201112461	FLORES DE GOIAS	FB11285964	FLORES DE GOIAS	04/11/2020 13:46	04/11/2020 15:30	04/11/2020 13:46	04/11/2020 15:30	1,73	1	1,73	CHI
20201112469	FORMOSA	10007624016	ITIQUEIRA	04/11/2020 13:48	04/11/2020 14:45	04/11/2020 13:48	04/11/2020 14:45	0,95	1	0,95	CHI
20201112474	COCALZINHO DE GOIAS	ZN21215025	AGUAS LINDAS DE GOIAS S1	04/11/2020 13:49	04/11/2020 15:27	04/11/2020 13:49	04/11/2020 15:27	1,63	6	9,75	CHI
20201112527	SITIO D ABADIA	SI12010205	IACIARA S2	04/11/2020 13:49	04/11/2020 16:50	04/11/2020 13:49	04/11/2020 16:50	3,02	66	199,10	CHI
20201112477	SILVANIA	GL21319216	DAIA S2	04/11/2020 13:51	04/11/2020 19:40	04/11/2020 13:51	04/11/2020 19:40	5,82	1	5,82	CHI
20201112479	PLANALTINA	PI21218360	PLANALTINA	04/11/2020 13:51	04/11/2020 16:45	04/11/2020 13:51	04/11/2020 16:45	2,90	2	5,81	CHI
20201112493	SAO JOAO D ALIANCA	10010351246	SAO JOAO D ALIANCA	04/11/2020 13:56	04/11/2020 17:49	04/11/2020 13:56	04/11/2020 17:49	3,89	1	3,89	CHI
20201112577	NOVA CRIXAS	NA12229641	NOVA CRIXAS	04/11/2020 13:59	04/11/2020 18:09	04/11/2020 13:59	04/11/2020 18:09	4,16	13	54,03	CHI
20201112507	JARAGUA	JA21146822	JARAGUA	04/11/2020 14:00	04/11/2020 23:26	04/11/2020 14:00	04/11/2020 23:26	9,42	1	9,42	CHI
20201112510	MARA ROSA	MQ11373740	MARA ROSA	04/11/2020 14:01	04/11/2020 23:02	04/11/2020 14:01	04/11/2020 23:02	9,00	1	9,00	CHI
20201112513	MIMOSO DE GOIAS	MJ21154819	PADRE BERNARDO	04/11/2020 14:02	04/11/2020 15:52	04/11/2020 14:02	04/11/2020 15:52	1,83	1	1,83	CHI
20201112544	AGUAS LINDAS DE GOIAS	10007459597	AGUAS LINDAS DE GOIAS S1	04/11/2020 14:09	04/11/2020 15:14	04/11/2020 14:09	04/11/2020 15:14	1,07	1	1,07	CHI
20201112549	POSSE	PS12257684	IACIARA S2	04/11/2020 14:11	04/11/2020 15:41	04/11/2020 14:11	04/11/2020 15:41	1,49	5	7,47	CHI
20201112551	NOVO GAMA	10003750793	MARAJOARA	04/11/2020 14:12	04/11/2020 17:21	04/11/2020 14:12	04/11/2020 17:21	3,14	1	3,14	CHI
20201112566	NOVA CRIXAS	NA21314678	NOVA CRIXAS	04/11/2020 14:16	04/11/2020 20:11	04/11/2020 14:16	04/11/2020 20:11	5,91	2	11,83	CHI
20201112579	CABECEIRAS	CW21181809	ITIQUEIRA	04/11/2020 14:19	04/11/2020 17:46	04/11/2020 14:19	04/11/2020 17:46	3,45	1	3,45	CHI
20201112585	IACIARA	2980000948	IACIARA S1	04/11/2020 14:20	04/11/2020 16:58	04/11/2020 14:20	04/11/2020 16:58	2,62	1	2,62	CHI
20201112603	URUACU	UR21156458	CAMPINORTE	04/11/2020 14:26	04/11/2020 17:05	04/11/2020 14:26	04/11/2020 17:05	2,65	1	2,65	CHI
20201112613	ANAPOLIS	AN12204075LD	ANAPOLIS UNIVERSITARIO S2	04/11/2020 14:27	05/11/2020 12:01	04/11/2020 14:27	05/11/2020 12:01	21,57	1	21,57	CHI
20201112613	ANAPOLIS	AN12204075LD	ANAPOLIS UNIVERSITARIO S2	04/11/2020 14:27	05/11/2020 12:01	05/11/2020 10:15	05/11/2020 12:01	1,78	232	412,70	CHI
20201112888	NIQUELANDIA	NQ21221621	URUACU	04/11/2020 14:30	04/11/2020 18:23	04/11/2020 14:30	04/11/2020 18:23	3,87	17	65,78	CHI
20201112636	COCALZINHO DE GOIAS	ZN12104981	AGUAS LINDAS DE GOIAS S2	04/11/2020 14:32	04/11/2020 16:51	04/11/2020 14:32	04/11/2020 16:51	2,30	3	6,90	CHI
20201112667	POSSE	10012677203	IACIARA S2	04/11/2020 14:43	04/11/2020 15:46	04/11/2020 14:43	04/11/2020 15:46	1,04	1	1,04	CHI
20201112668	LUZIANIA	120123460	MARAJOARA	04/11/2020 14:44	04/11/2020 17:42	04/11/2020 14:44	04/11/2020 17:42	2,97	1	2,97	CHI
20201112713	ANAPOLIS	20064664	ANAPOLIS UNIVERSITARIO S2	04/11/2020 14:50	04/11/2020 16:42	04/11/2020 14:50	04/11/2020 16:42	1,87	1	1,87	CHI
20201112758	ALEXANIA	1980224	ALEXANIA	04/11/2020 14:51	04/11/2020 14:54	04/11/2020 14:51	04/11/2020 14:54	0,06	1453	81,93	CHI
20201112735	MINACU	IH11202455	MINACU	04/11/2020 14:53	04/11/2020 16:50	04/11/2020 14:53	04/11/2020 16:50	1,94	78	151,04	CHI
20201112736	ALVORADA DO NORTE	AQ21184668	FLORES DE GOIAS	04/11/2020 14:53	04/11/2020 19:15	04/11/2020 14:53	04/11/2020 19:15	4,36	1	4,36	CHI
20201112765	LUZIANIA	120032582	RIO VERMELHO	04/11/2020 14:58	04/11/2020 16:37	04/11/2020 14:58	04/11/2020 16:37	1,65	1	1,65	CHI
20201112771	GOIANESIA	GE12028322	GOIANESIA S2	04/11/2020 14:59	04/11/2020 23:09	04/11/2020 14:59	04/11/2020 23:09	8,16	2	16,32	CHI
20201112796	FORMOSA	2920001705	ITIQUEIRA	04/11/2020 15:03	04/11/2020 21:56	04/11/2020 15:03	04/11/2020 21:56	6,88	1	6,88	CHI
20201113013	FLORES DE GOIAS	FB12044974RE	IACIARA S2	04/11/2020 15:03	04/11/2020 16:53	04/11/2020 15:03	04/11/2020 16:53	1,83	225	412,50	CHI
20201113013	FORMOSA	FB12044974RE	IACIARA S2	04/11/2020 15:03	04/11/2020 16:53	04/11/2020 15:03	04/11/2020 16:53	1,83	1	1,83	CHI
20201113013	VILA BOA	FB12044974RE	IACIARA S2	04/11/2020 15:03	04/11/2020 16:53	04/11/2020 15:03	04/11/2020 16:53	1,83	2	3,67	CHI
20201112801	NOVO PLANALTO	TA21121343	SAO MIGUEL DO ARAGUAIA	04/11/2020 15:05	05/11/2020 12:16	04/11/2020 15:05	05/11/2020 12:16	21,18	1	21,18	CHI
20201112834	FORMOSA	610334578	ITIQUEIRA	04/11/2020 15:14	04/11/2020 16:12	04/11/2020 15:14	04/11/2020 16:12	0,95	1	0,95	CHI
20201112950	CRISTALINA	KR21132668	CRISTALINA S2	04/11/2020 15:17	04/11/2020 23:58	04/11/2020 15:17	04/11/2020 22:30	7,21	1	7,21	CHI
20201112950	CRISTALINA	KR12230276	CRISTALINA S2	04/11/2020 15:17	04/11/2020 23:58	04/11/2020 15:17	04/11/2020 23:58	8,68	14	121,49	CHI
20201112874	MINACU	IH21339950	MINACU	04/11/2020 15:23	04/11/2020 17:59	04/11/2020 15:23	04/11/2020 17:59	2,60	1	2,60	CHI
20201112877	CRISTALINA	KR21183804	PAMPLONA	04/11/2020 15:24	04/11/2020 20:14	04/11/2020 15:24	04/11/2020 20:14	4,83	1	4,83	CHI
20201112882	FORMOSA	FA21000140	ITIQUEIRA	04/11/2020 15:26	04/11/2020 17:54	04/11/2020 15:26	04/11/2020 17:54	2,47	1	2,47	CHI
20201112889	PADRE BERNARDO	10009050033	PADRE BERNARDO	04/11/2020 15:27	04/11/2020 20:12	04/11/2020 15:27	04/11/2020 20:12	4,75	1	4,75	CHI
20201112893	VALPARAISO DE GOIAS	3350073357	PACAEMBU S2	04/11/2020 15:28	04/11/2020 16:19	04/11/2020 15:28	04/11/2020 16:19	0,83	1	0,83	CHI
20201112969	SAO JOAO D ALIANCA	JL12049201	SAO JOAO D ALIANCA	04/11/2020 15:31	04/11/2020 17:55	04/11/2020 15:31	04/11/2020 17:55	2,39	95	227,50	CHI
20201112925	ANAPOLIS	AN12258100	ANAPOLIS UNIVERSITARIO S2	04/11/2020 15:37	04/11/2020 16:45	04/11/2020 15:37	04/11/2020 16:45	1,12	447	500,52	CHI

20201112958	MARA ROSA	2260019232	MARA ROSA	04/11/2020 15:46	04/11/2020 19:21	04/11/2020 15:46	04/11/2020 19:21	3,57	1	3,57	CHI
20201113028	NOVA GLORIA	NG12328831	ITAPACI	04/11/2020 15:46	04/11/2020 17:38	04/11/2020 15:46	04/11/2020 17:38	1,86	4	7,44	CHI
20201112974	SAO PATRICIO	RB21255944	RUBIATABA	04/11/2020 15:51	04/11/2020 18:27	04/11/2020 15:51	04/11/2020 18:27	2,60	1	2,60	CHI
20201112984	ANAPOLIS	20564909	ANAPOLIS UNIVERSITARIO S2	04/11/2020 15:53	04/11/2020 17:41	04/11/2020 15:53	04/11/2020 17:41	1,80	1	1,80	CHI
20201112988	URUACU	UR21212328	URUACU	04/11/2020 15:54	05/11/2020 11:45	04/11/2020 15:54	05/11/2020 11:43	19,81	1	19,81	CHI
20201112988	URUACU	UR12212334LD	URUACU	04/11/2020 15:54	05/11/2020 11:45	05/11/2020 09:39	05/11/2020 11:45	2,10	18	37,77	CHI
20201112996	NOVA GLORIA	NG12181404	RUBIATABA	04/11/2020 15:57	04/11/2020 19:13	04/11/2020 15:57	04/11/2020 19:13	3,27	2	6,53	CHI
20201113004	NOVA CRIXAS	8570018541	NOVA CRIXAS	04/11/2020 15:58	05/11/2020 14:08	04/11/2020 15:58	05/11/2020 14:08	22,15	1	22,15	CHI
20201113010	ANAPOLIS	21299699	DAIA S1	04/11/2020 16:00	04/11/2020 17:00	04/11/2020 16:00	04/11/2020 17:00	1,01	1	1,01	CHI
20201113012	NIQUELANDIA	NQ21280340	NIQUELANDIA SUBTRANSMISSAO	04/11/2020 16:00	05/11/2020 10:35	04/11/2020 16:00	05/11/2020 10:35	18,57	1	18,57	CHI
20201113017	VALPARAISO DE GOIAS	VA11078412	PACAEMBU S2	04/11/2020 16:02	04/11/2020 18:03	04/11/2020 16:02	04/11/2020 18:03	2,01	136	274,00	CHI
20201113037	ALVORADA DO NORTE	AQ12268456	IACIARA S2	04/11/2020 16:06	05/11/2020 10:50	04/11/2020 16:06	05/11/2020 10:50	18,72	3	56,16	CHI
20201113053	SAO JOAO D ALIANCA	JL11218474	SAO JOAO D ALIANCA	04/11/2020 16:11	04/11/2020 19:25	04/11/2020 16:11	04/11/2020 19:25	3,23	3	9,69	CHI
20201113481	JARAGUA	JA12000206	JARAGUA	04/11/2020 16:14	04/11/2020 18:49	04/11/2020 16:14	04/11/2020 18:49	2,57	7	18,02	CHI
20201113169	CIDADE OCIDENTAL	10004279822	MARAJOARA	04/11/2020 16:39	04/11/2020 20:13	04/11/2020 16:39	04/11/2020 20:13	3,57	1	3,57	CHI
20201113193	ABADIANIA	10019064916	ANAPOLIS UNIVERSITARIO S1	04/11/2020 16:44	04/11/2020 18:47	04/11/2020 16:44	04/11/2020 18:47	2,04	1	2,04	CHI
20201113202	IACIARA	IA12257594	IACIARA S2	04/11/2020 16:46	05/11/2020 11:41	04/11/2020 20:02	04/11/2020 22:10	2,13	2	4,27	CHI
20201113202	IACIARA	IA12286108LD	IACIARA S2	04/11/2020 16:46	05/11/2020 11:41	04/11/2020 16:46	05/11/2020 08:26	15,67	2	31,33	CHI
20201113202	IACIARA	IA12286108LD	IACIARA S2	04/11/2020 16:46	05/11/2020 11:41	04/11/2020 16:46	05/11/2020 11:41	18,91	1	18,91	CHI
20201113216	GOIANESIA	550065544	GOIANESIA S2	04/11/2020 16:49	04/11/2020 17:47	04/11/2020 16:49	04/11/2020 17:47	0,98	1	0,98	CHI
20201113226	MONTE ALEGRE DE GOIAS	MA21349977	SAO DOMINGOS	04/11/2020 16:50	04/11/2020 19:54	04/11/2020 16:50	04/11/2020 19:54	3,06	2	6,12	CHI
20201113234	GOIANESIA	GE11297275	GOIANESIA S1	04/11/2020 16:52	04/11/2020 21:25	04/11/2020 16:52	04/11/2020 21:25	4,55	1	4,55	CHI
20201113235	SAO JOAO D ALIANCA	JL21401343	SAO JOAO D ALIANCA	04/11/2020 16:52	04/11/2020 21:57	04/11/2020 16:52	04/11/2020 21:57	5,08	1	5,08	CHI
20201113285	IPAMERI	IP21323368	CRISTALINA S1	04/11/2020 17:01	04/11/2020 22:01	04/11/2020 17:01	04/11/2020 22:01	4,99	1	4,99	CHI
20201113290	ANAPOLIS	20260453	JUNDIAI S2	04/11/2020 17:02	04/11/2020 19:08	04/11/2020 17:02	04/11/2020 19:08	2,09	1	2,09	CHI
20201113342	ANAPOLIS	AN11258074	ANAPOLIS UNIVERSITARIO S2	04/11/2020 17:11	04/11/2020 17:25	04/11/2020 17:11	04/11/2020 17:25	0,23	84	19,53	CHI
20201113348	CRISTALINA	KR21206514	PAMPLONA	04/11/2020 17:15	05/11/2020 00:42	04/11/2020 17:15	05/11/2020 00:42	7,45	1	7,45	CHI
20201113350	CIDADE OCIDENTAL	2680175342	MARAJOARA	04/11/2020 17:15	04/11/2020 19:35	04/11/2020 17:15	04/11/2020 19:35	2,32	1	2,32	CHI
20201113377	FORMOSA	FA11397055	ITUIQUIRA	04/11/2020 17:24	04/11/2020 20:05	04/11/2020 17:24	04/11/2020 20:05	2,67	1	2,67	CHI
20201113431	JARAGUA	JA12278873	JARAGUA	04/11/2020 17:32	05/11/2020 07:27	04/11/2020 17:32	05/11/2020 07:27	13,91	15	208,66	CHI
20201113441	VALPARAISO DE GOIAS	10002656670	PACAEMBU S2	04/11/2020 17:35	04/11/2020 22:06	04/11/2020 17:35	04/11/2020 22:06	4,50	1	4,50	CHI
20201114433	SAO JOAO D ALIANCA	JL11325933	SAO JOAO D ALIANCA	04/11/2020 17:36	05/11/2020 09:06	04/11/2020 17:36	05/11/2020 09:06	15,50	1	15,50	CHI
20201113445	LUZIANIA	10019660640	MARAJOARA	04/11/2020 17:38	04/11/2020 19:29	04/11/2020 17:38	04/11/2020 19:29	1,83	1	1,83	CHI
20201113526	JARAGUA	JA12374473LD	JARAGUA	04/11/2020 17:43	05/11/2020 17:58	04/11/2020 17:43	05/11/2020 09:49	16,10	133	2141,30	CHI
20201113526	JARAGUA	JA12374473LD	JARAGUA	04/11/2020 17:43	05/11/2020 17:58	04/11/2020 17:43	05/11/2020 11:21	17,63	56	987,39	CHI
20201113526	JARAGUA	JA12374473LD	JARAGUA	04/11/2020 17:43	05/11/2020 17:58	04/11/2020 17:43	05/11/2020 14:13	20,50	21	430,60	CHI
20201113526	JARAGUA	JA12374473LD	JARAGUA	04/11/2020 17:43	05/11/2020 17:58	04/11/2020 17:43	05/11/2020 16:57	23,23	45	1045,36	CHI
20201113526	JARAGUA	JA12374473LD	JARAGUA	04/11/2020 17:43	05/11/2020 17:58	04/11/2020 17:43	05/11/2020 17:16	23,54	50	1177,17	CHI
20201113526	JARAGUA	JA12194403	JARAGUA	04/11/2020 17:43	05/11/2020 17:58	05/11/2020 17:06	05/11/2020 17:58	0,87	29	25,25	CHI
20201114194	CRISTALINA	KR12128717	PAMPLONA	04/11/2020 17:48	04/11/2020 22:51	04/11/2020 17:48	04/11/2020 22:51	5,04	19	95,79	CHI
20201113561	CRISTALINA	KR11313925	PAMPLONA	04/11/2020 17:49	04/11/2020 21:54	04/11/2020 17:49	04/11/2020 21:54	4,07	149	606,35	CHI
20201113493	AGUAS LINDAS DE GOIAS	10008442388	AGUAS LINDAS DE GOIAS S1	04/11/2020 17:54	04/11/2020 18:35	04/11/2020 17:54	04/11/2020 18:35	0,68	1	0,68	CHI
20201113527	NOVA ROMA	ND12392238	IACIARA S2	04/11/2020 18:03	04/11/2020 20:47	04/11/2020 18:03	04/11/2020 20:47	2,72	245	667,15	CHI
20201113532	PLANALTINA	PI12325505	PLANALTINA	04/11/2020 18:04	04/11/2020 20:31	04/11/2020 18:04	04/11/2020 20:31	2,45	5	12,23	CHI
20201113540	PLANALTINA	2960058982	PLANALTINA	04/11/2020 18:06	04/11/2020 20:37	04/11/2020 18:06	04/11/2020 20:37	2,51	1	2,51	CHI
20201113547	NOVO GAMA	2460038015	PACAEMBU S1	04/11/2020 18:09	04/11/2020 23:28	04/11/2020 18:09	04/11/2020 23:28	5,31	1	5,31	CHI
20201113554	SANTO ANTONIO DO DESCOBERTO	SN11131982	MARAJOARA	04/11/2020 18:10	04/11/2020 20:05	04/11/2020 18:10	04/11/2020 20:05	1,91	54	102,93	CHI
20201113876	PIRENOPOLIS	PV12000067	CORUMBA	04/11/2020 18:10	04/11/2020 22:07	04/11/2020 18:10	04/11/2020 22:07	3,94	18	70,91	CHI
20201113786	BONFINOPOLIS	GP12210815	DAIA S2	04/11/2020 18:15	04/11/2020 20:19	04/11/2020 18:15	04/11/2020 20:19	2,06	54	111,15	CHI
20201113786	GAMELEIRA DE GOIAS	GP12210815	DAIA S2	04/11/2020 18:15	04/11/2020 20:19	04/11/2020 18:15	04/11/2020 20:19	2,06	2	4,12	CHI
20201113786	GOIANAPOLIS	GP12210815	DAIA S2	04/11/2020 18:15	04/11/2020 20:19	04/11/2020 18:15	04/11/2020 20:19	2,06	34	69,98	CHI

20201113786	LEOPOLDO DE BULHOES	GP12210815	DAIA S2	04/11/2020 18:15	04/11/2020 20:19	04/11/2020 18:15	04/11/2020 20:19	2,06	65	133,79	CHI
20201113601	CIDADE OCIDENTAL	10007971808	MARAJOARA	04/11/2020 18:21	04/11/2020 21:33	04/11/2020 18:21	04/11/2020 21:33	3,20	1	3,20	CHI
20201114247	GAMELEIRA DE GOIAS	AN12311953	DAIA S1	04/11/2020 18:24	04/11/2020 22:03	04/11/2020 18:24	04/11/2020 22:03	3,63	79	287,08	CHI
20201113616	AGUAS LINDAS DE GOIAS	LA11349021	AGUAS LINDAS DE GOIAS S1	04/11/2020 18:25	04/11/2020 19:16	04/11/2020 18:25	04/11/2020 19:16	0,85	142	120,15	CHI
20201113622	PLANALTINA	PI21302909	PLANALTINA	04/11/2020 18:26	04/11/2020 19:37	04/11/2020 18:26	04/11/2020 19:37	1,17	1	1,17	CHI
20201113758	ANAPOLIS	AN12039265	ANAPOLIS UNIVERSITARIO S2	04/11/2020 18:27	04/11/2020 19:27	04/11/2020 18:27	04/11/2020 19:27	0,99	342	340,10	CHI
20201113648	SAO JOAO D ALIANCA	JL21309751	SAO JOAO D ALIANCA	04/11/2020 18:34	05/11/2020 10:24	04/11/2020 18:34	05/11/2020 10:24	15,83	1	15,83	CHI
20201113679	PIRENOPOLIS	PV11319203	CORUMBA	04/11/2020 18:35	04/11/2020 21:24	04/11/2020 18:35	04/11/2020 21:24	2,81	21	58,94	CHI
20201113657	SANTO ANTONIO DO DESCOBERTO	2210158765	ALEXANIA	04/11/2020 18:36	04/11/2020 20:43	04/11/2020 18:36	04/11/2020 20:43	2,12	1	2,12	CHI
20201113658	TERESINA DE GOIAS	TE21218389	FLORES DE GOIAS	04/11/2020 18:36	04/11/2020 20:05	04/11/2020 18:36	04/11/2020 20:05	1,48	1	1,48	CHI
20201113664	VILA PROPICIO	NP21298195	BARRO ALTO	04/11/2020 18:37	05/11/2020 01:25	04/11/2020 18:37	05/11/2020 01:25	6,78	1	6,78	CHI
20201113671	ANAPOLIS	20460144	ANAPOLIS UNIVERSITARIO S2	04/11/2020 18:39	04/11/2020 20:01	04/11/2020 18:39	04/11/2020 20:01	1,35	1	1,35	CHI
20201113672	LUZIANIA	LZ11209572	RIO VERMELHO	04/11/2020 18:40	04/11/2020 20:45	04/11/2020 18:40	04/11/2020 20:45	2,08	20	41,55	CHI
20201113675	ANAPOLIS	10000575850	ANAPOLIS UNIVERSITARIO S2	04/11/2020 18:41	04/11/2020 20:01	04/11/2020 18:41	04/11/2020 20:01	1,33	1	1,33	CHI
20201113685	CRISTALINA	KR12335968	CRISTALINA S2	04/11/2020 18:43	04/11/2020 20:47	04/11/2020 18:43	04/11/2020 20:47	2,06	1	2,06	CHI
20201113713	CRISTALINA	KR11206723	PAMPLONA	04/11/2020 18:47	04/11/2020 22:31	04/11/2020 18:47	04/11/2020 22:31	3,73	134	499,34	CHI
20201113788	CRISTALINA	KR11032819	PAMPLONA	04/11/2020 18:47	04/11/2020 22:11	04/11/2020 18:47	04/11/2020 22:11	3,40	71	241,18	CHI
20201113715	ANAPOLIS	20328382	ANAPOLIS UNIVERSITARIO S2	04/11/2020 18:48	04/11/2020 20:43	04/11/2020 18:48	04/11/2020 20:43	1,91	1	1,91	CHI
20201113718	LUZIANIA	120123782	RIO VERMELHO	04/11/2020 18:48	04/11/2020 21:17	04/11/2020 18:48	04/11/2020 21:17	2,48	1	2,48	CHI
20201113743	ANAPOLIS	10021901188	ANAPOLIS UNIVERSITARIO S2	04/11/2020 18:52	04/11/2020 21:22	04/11/2020 18:52	04/11/2020 21:22	2,49	1	2,49	CHI
20201113910	ANAPOLIS	GP12346839	JUNDIAI S2	04/11/2020 18:56	04/11/2020 20:56	04/11/2020 18:56	04/11/2020 20:56	2,00	5	9,99	CHI
20201113910	TEREZOPOLIS DE GOIAS	GP12346839	JUNDIAI S2	04/11/2020 18:56	04/11/2020 20:56	04/11/2020 18:56	04/11/2020 20:56	2,00	18	35,95	CHI
20201113807	PLANALTINA	PI11000032	PLANALTINA	04/11/2020 18:57	04/11/2020 19:54	04/11/2020 18:57	04/11/2020 19:54	0,94	347	326,66	CHI
20201113833	FLORES DE GOIAS	FB21409881	FLORES DE GOIAS	04/11/2020 19:07	05/11/2020 11:36	04/11/2020 19:07	05/11/2020 11:36	16,47	1	16,47	CHI
20201113923	FORMOSA	10023396499	ITUIQUIRA	04/11/2020 19:25	04/11/2020 20:22	04/11/2020 19:25	04/11/2020 20:22	0,96	1	0,96	CHI
20201113963	FORMOSA	FA11361418	ITUIQUIRA	04/11/2020 19:34	04/11/2020 21:07	04/11/2020 19:34	04/11/2020 21:07	1,54	112	172,11	CHI
20201113981	CABECEIRAS	CW21157369	ITUIQUIRA	04/11/2020 19:39	04/11/2020 20:54	04/11/2020 19:39	04/11/2020 20:54	1,25	2	2,50	CHI
20201114151	PLANALTINA	10023392698	PLANALTINA	04/11/2020 20:17	04/11/2020 22:32	04/11/2020 20:17	04/11/2020 22:32	2,25	1	2,25	CHI
20201114260	PLANALTINA	PI11131839	PLANALTINA	04/11/2020 20:28	04/11/2020 21:44	04/11/2020 20:28	04/11/2020 21:44	1,25	108	135,39	CHI
20201114205	SAO JOAO D ALIANCA	JL21255333	IACIARA S2	04/11/2020 20:32	05/11/2020 11:01	04/11/2020 20:32	05/11/2020 11:01	14,47	3	43,41	CHI
20201114289	IACIARA	IA21149612	IACIARA S2	04/11/2020 21:03	04/11/2020 21:32	04/11/2020 21:03	04/11/2020 21:32	0,47	1	0,47	CHI
20201114302	PLANALTINA	PI11129906	PLANALTINA	04/11/2020 21:09	04/11/2020 22:32	04/11/2020 21:09	04/11/2020 22:32	1,37	126	172,23	CHI
20201114383	FORMOSA	FA12254223	ITUIQUIRA	04/11/2020 21:45	05/11/2020 00:43	04/11/2020 21:45	05/11/2020 00:43	2,95	21	61,97	CHI
20201114393	CAVALCANTE	740000469	FLORES DE GOIAS	04/11/2020 21:49	05/11/2020 13:02	04/11/2020 21:49	05/11/2020 13:02	15,21	1	15,21	CHI
20201114438	FORMOSA	FA11257641	ITUIQUIRA	04/11/2020 22:25	04/11/2020 23:38	04/11/2020 22:25	04/11/2020 23:38	1,21	182	220,37	CHI
20201114455	FORMOSA	FA12096349	ITUIQUIRA	04/11/2020 22:46	05/11/2020 08:27	04/11/2020 22:46	05/11/2020 08:27	9,67	16	154,76	CHI
20201114570	FLORES DE GOIAS	FB12218612	FLORES DE GOIAS	05/11/2020 05:35	05/11/2020 13:38	05/11/2020 05:35	05/11/2020 13:38	8,04	2	16,09	CHI
20201114590	FORMOSA	FA11269916	ITUIQUIRA	05/11/2020 05:55	05/11/2020 10:54	05/11/2020 05:55	05/11/2020 10:54	4,97	1	4,97	CHI
20201114622	IACIARA	IA21373149	IACIARA S1	05/11/2020 06:18	05/11/2020 09:22	05/11/2020 06:18	05/11/2020 09:22	3,06	1	3,06	CHI
20201114648	FORMOSA	FA11000035	ITUIQUIRA	05/11/2020 06:29	05/11/2020 07:56	05/11/2020 06:29	05/11/2020 07:56	1,44	128	184,46	CHI
20201114732	FLORES DE GOIAS	VB12320614	IACIARA S2	05/11/2020 06:36	05/11/2020 09:03	05/11/2020 06:36	05/11/2020 09:03	2,43	1	2,43	CHI
20201114732	VILA BOA	VB12320614	IACIARA S2	05/11/2020 06:36	05/11/2020 09:03	05/11/2020 06:36	05/11/2020 09:03	2,43	13	31,64	CHI
20201114694	DIVINOPOLIS DE GOIAS	GH12241928	SAO DOMINGOS	05/11/2020 06:49	05/11/2020 09:36	05/11/2020 06:49	05/11/2020 09:36	2,77	41	113,75	CHI
20201114694	MONTE ALEGRE DE GOIAS	GH12241928	SAO DOMINGOS	05/11/2020 06:49	05/11/2020 09:36	05/11/2020 06:49	05/11/2020 09:36	2,77	2	5,55	CHI
20201114694	SAO DOMINGOS	GH12241928	SAO DOMINGOS	05/11/2020 06:49	05/11/2020 09:36	05/11/2020 06:49	05/11/2020 09:36	2,77	12	33,29	CHI
20201114707	CABECEIRAS	CW21108840	ITUIQUIRA	05/11/2020 06:56	05/11/2020 07:48	05/11/2020 06:56	05/11/2020 07:48	0,85	1	0,85	CHI
20201114727	FORMOSA	FA12383272	ITUIQUIRA	05/11/2020 07:04	05/11/2020 13:37	05/11/2020 07:04	05/11/2020 13:37	6,54	39	255,03	CHI
20201114789	FORMOSA	FA12394152	ITUIQUIRA	05/11/2020 07:05	05/11/2020 11:23	05/11/2020 07:05	05/11/2020 11:23	4,29	2	8,57	CHI
20201114788	CABECEIRAS	CW12108823	ITUIQUIRA	05/11/2020 07:21	05/11/2020 09:14	05/11/2020 07:21	05/11/2020 09:14	1,88	8	15,04	CHI
20201114902	PLANALTINA	PI12375567	PLANALTINA	05/11/2020 07:31	05/11/2020 12:23	05/11/2020 07:31	05/11/2020 12:23	4,86	45	218,69	CHI
20201114891	FORMOSA	10002987188	ITUIQUIRA	05/11/2020 07:37	05/11/2020 11:37	05/11/2020 07:37	05/11/2020 11:37	3,98	1	3,98	CHI

20201114948	NOVA ROMA	10002112882	IACIARA S2	05/11/2020 07:49	05/11/2020 11:45	05/11/2020 07:49	05/11/2020 11:45	3,92	1	3,92	CHI
20201114950	PLANALTINA	PI21265756	SAO JOAO D ALIANCA	05/11/2020 07:50	05/11/2020 10:44	05/11/2020 07:50	05/11/2020 10:44	2,89	1	2,89	CHI
20201114951	SAO JOAO D ALIANCA	JL12348100LD	SAO JOAO D ALIANCA	05/11/2020 07:50	05/11/2020 10:31	05/11/2020 07:50	05/11/2020 10:31	2,67	1	2,67	CHI
20201115111	FLORES DE GOIAS	FB21320594	FLORES DE GOIAS	05/11/2020 08:18	05/11/2020 10:35	05/11/2020 08:18	05/11/2020 10:35	2,27	1	2,27	CHI
20201115186	PLANALTINA	PI21125115	SAO JOAO D ALIANCA	05/11/2020 08:30	05/11/2020 11:27	05/11/2020 08:30	05/11/2020 11:27	2,94	1	2,94	CHI
20201115237	SITIO D ABADIA	SI12300503	IACIARA S2	05/11/2020 08:38	05/11/2020 10:44	05/11/2020 08:38	05/11/2020 10:44	2,10	1	2,10	CHI
20201115269	IACIARA	IA21195771	IACIARA S1	05/11/2020 08:44	05/11/2020 13:34	05/11/2020 08:44	05/11/2020 13:34	4,83	1	4,83	CHI
20201115764	BURITINOPOLIS	BQ12320638	IACIARA S2	05/11/2020 08:44	05/11/2020 12:23	05/11/2020 08:44	05/11/2020 12:23	3,65	50	182,32	CHI
20201115279	SAO DOMINGOS	SD12131345	SAO DOMINGOS	05/11/2020 08:46	05/11/2020 10:55	05/11/2020 08:46	05/11/2020 10:55	2,15	5	10,73	CHI
20201115366	POSSE	PS21124631	IACIARA S2	05/11/2020 09:01	05/11/2020 11:39	05/11/2020 09:01	05/11/2020 11:39	2,62	1	2,62	CHI
20201115418	AGUA FRIA DE GOIAS	4140008211	SAO JOAO D ALIANCA	05/11/2020 09:11	05/11/2020 12:32	05/11/2020 09:11	05/11/2020 12:32	3,35	1	3,35	CHI
20201115431	FORMOSA	610290680	ITIQUEIRA	05/11/2020 09:15	05/11/2020 10:47	05/11/2020 09:15	05/11/2020 10:47	1,53	1	1,53	CHI
20201115507	FORMOSA	FA21000140	ITIQUEIRA	05/11/2020 09:34	05/11/2020 11:15	05/11/2020 09:34	05/11/2020 11:15	1,68	1	1,68	CHI
20201115522	FORMOSA	610247487	ITIQUEIRA	05/11/2020 09:36	05/11/2020 13:25	05/11/2020 09:36	05/11/2020 13:25	3,80	1	3,80	CHI
20201115600	SITIO D ABADIA	SI12318200	IACIARA S2	05/11/2020 09:41	05/11/2020 12:02	05/11/2020 09:41	05/11/2020 12:02	2,34	8	18,69	CHI
20201115611	FORMOSA	FA21330297	PLANALTINA	05/11/2020 09:56	05/11/2020 12:02	05/11/2020 09:56	05/11/2020 12:02	2,11	1	2,11	CHI
20201115621	FORMOSA	10026532350	ITIQUEIRA	05/11/2020 09:59	05/11/2020 12:43	05/11/2020 09:59	05/11/2020 12:43	2,72	1	2,72	CHI
20201115681	POSSE	PS21132019	IACIARA S2	05/11/2020 10:06	05/11/2020 12:39	05/11/2020 10:06	05/11/2020 12:39	2,54	1	2,54	CHI
20201115785	PLANALTINA	PI21218360	PLANALTINA	05/11/2020 10:33	05/11/2020 12:56	05/11/2020 10:33	05/11/2020 12:56	2,37	2	4,74	CHI
20201115828	AGUA FRIA DE GOIAS	TL21205634	SAO JOAO D ALIANCA	05/11/2020 10:42	05/11/2020 13:52	05/11/2020 10:42	05/11/2020 13:52	3,16	2	6,33	CHI
20201116059	CAVALCANTE	CJ11320542	FLORES DE GOIAS	05/11/2020 10:44	05/11/2020 16:47	05/11/2020 10:44	05/11/2020 16:47	6,04	167	1008,22	CHI
20201115844	AGUA FRIA DE GOIAS	PI12048041	SAO JOAO D ALIANCA	05/11/2020 10:45	05/11/2020 13:36	05/11/2020 10:45	05/11/2020 13:36	2,84	8	22,70	CHI
20201116657	PLANALTINA	PI11322664	PLANALTINA	05/11/2020 11:13	05/11/2020 17:05	05/11/2020 11:13	05/11/2020 17:05	5,85	61	356,92	CHI
20201115985	AGUA FRIA DE GOIAS	TL21330872	SAO JOAO D ALIANCA	05/11/2020 11:22	05/11/2020 14:20	05/11/2020 11:22	05/11/2020 14:20	2,96	1	2,96	CHI
20201116252	IACIARA	IA12211563	IACIARA S1	05/11/2020 11:58	06/11/2020 00:57	05/11/2020 11:58	05/11/2020 20:41	8,72	4	34,89	CHI
20201116252	IACIARA	IA12218832LD	IACIARA S1	05/11/2020 11:58	06/11/2020 00:57	05/11/2020 11:58	06/11/2020 00:57	12,98	5	64,90	CHI
20201116119	MAMBAI	MB11170557	IACIARA S2	05/11/2020 12:06	05/11/2020 16:02	05/11/2020 12:06	05/11/2020 16:02	3,92	2	7,85	CHI
20201116216	SAO JOAO D ALIANCA	JL21042757	SAO JOAO D ALIANCA	05/11/2020 12:43	05/11/2020 19:00	05/11/2020 12:43	05/11/2020 19:00	6,30	1	6,30	CHI
20201116219	IACIARA	IA21257593	IACIARA S2	05/11/2020 12:43	05/11/2020 13:01	05/11/2020 12:43	05/11/2020 13:01	0,28	1	0,28	CHI
20201116227	SAO JOAO D ALIANCA	JL21364052	SAO JOAO D ALIANCA	05/11/2020 12:44	05/11/2020 20:15	05/11/2020 12:44	05/11/2020 20:15	7,51	1	7,51	CHI
20201116284	PLANALTINA	PI10400576	PLANALTINA	05/11/2020 13:04	05/11/2020 18:34	05/11/2020 13:04	05/11/2020 15:53	2,82	100	281,86	CHI
20201116284	PADRE BERNARDO	PI12099216LD	PLANALTINA	05/11/2020 13:04	05/11/2020 18:34	05/11/2020 13:04	05/11/2020 18:02	4,97	15	74,60	CHI
20201116284	PLANALTINA	PI12099216LD	PLANALTINA	05/11/2020 13:04	05/11/2020 18:34	05/11/2020 13:04	05/11/2020 18:02	4,97	124	616,73	CHI
20201116284	PLANALTINA	PI12139508	PLANALTINA	05/11/2020 13:04	05/11/2020 18:34	05/11/2020 13:04	05/11/2020 18:34	5,51	33	181,71	CHI
20201116291	IACIARA	IA12218688	IACIARA S2	05/11/2020 13:07	05/11/2020 17:00	05/11/2020 13:07	05/11/2020 17:00	3,88	3	11,64	CHI
20201116304	IACIARA	IA21373149	IACIARA S1	05/11/2020 13:12	05/11/2020 19:10	05/11/2020 13:12	05/11/2020 19:10	5,95	1	5,95	CHI
20201116310	PLANALTINA	2960016343	PLANALTINA	05/11/2020 13:15	05/11/2020 16:04	05/11/2020 13:15	05/11/2020 16:04	2,82	1	2,82	CHI
20201116352	CABECEIRAS	CW21157388	ITIQUEIRA	05/11/2020 13:27	05/11/2020 17:36	05/11/2020 13:27	05/11/2020 17:36	4,14	1	4,14	CHI
202011137943	ALTO PARAISO DE GOIAS	JL12302830	SAO JOAO D ALIANCA	05/11/2020 13:34	05/11/2020 18:26	05/11/2020 13:34	05/11/2020 18:26	4,86	3	14,58	CHI
202011137943	SAO JOAO D ALIANCA	JL12302830	SAO JOAO D ALIANCA	05/11/2020 13:34	05/11/2020 18:26	05/11/2020 13:34	05/11/2020 18:26	4,86	245	1190,36	CHI
20201116423	SAO DOMINGOS	SD12384774	SAO DOMINGOS	05/11/2020 13:48	05/11/2020 16:08	05/11/2020 13:48	05/11/2020 16:08	2,32	84	194,93	CHI
20201116496	FLORES DE GOIAS	FB12344288	FLORES DE GOIAS	05/11/2020 14:06	05/11/2020 18:40	05/11/2020 14:06	05/11/2020 18:40	4,56	2	9,12	CHI
20201116496	FORMOSA	FB12344288	FLORES DE GOIAS	05/11/2020 14:06	05/11/2020 18:40	05/11/2020 14:06	05/11/2020 18:40	4,56	1	4,56	CHI
20201116609	IACIARA	10006915408	IACIARA S1	05/11/2020 14:41	05/11/2020 16:21	05/11/2020 14:41	05/11/2020 16:21	1,66	1	1,66	CHI
20201116739	MONTE ALEGRE DE GOIAS	SD12322677	SAO DOMINGOS	05/11/2020 15:00	05/11/2020 17:10	05/11/2020 15:00	05/11/2020 17:10	2,15	1	2,15	CHI
20201116739	NOVA ROMA	SD12322677	SAO DOMINGOS	05/11/2020 15:00	05/11/2020 17:10	05/11/2020 15:00	05/11/2020 17:10	2,15	3	6,46	CHI
20201116739	SAO DOMINGOS	SD12322677	SAO DOMINGOS	05/11/2020 15:00	05/11/2020 17:10	05/11/2020 15:00	05/11/2020 17:10	2,15	36	77,56	CHI
20201116741	NOVA ROMA	ND21291858	IACIARA S2	05/11/2020 15:16	05/11/2020 17:32	05/11/2020 15:16	05/11/2020 17:32	2,25	12	27,04	CHI
20201116910	FORMOSA	FA12051040	ITIQUEIRA	05/11/2020 15:18	05/11/2020 17:14	05/11/2020 15:18	05/11/2020 17:14	1,93	11	21,22	CHI
20201116774	ALVORADA DO NORTE	AQ21387141	IACIARA S2	05/11/2020 15:24	05/11/2020 19:44	05/11/2020 15:24	05/11/2020 19:44	4,33	1	4,33	CHI
20201117056	FORMOSA	10032741101	SAO JOAO D ALIANCA	05/11/2020 16:28	05/11/2020 22:04	05/11/2020 16:28	05/11/2020 22:04	5,60	1	5,60	CHI

20201117071	FORMOSA	FA21195878	ITIQUEIRA	05/11/2020 16:31	06/11/2020 13:30	05/11/2020 16:31	06/11/2020 13:30	20,97	1	20,97	CHI
20201117178	ALVORADA DO NORTE	AQ12257608	FLORES DE GOIAS	05/11/2020 16:52	05/11/2020 20:24	05/11/2020 16:52	05/11/2020 20:24	3,53	10	35,27	CHI
20201117178	IACIARA	AQ12257608	FLORES DE GOIAS	05/11/2020 16:52	05/11/2020 20:24	05/11/2020 16:52	05/11/2020 20:24	3,53	4	14,11	CHI
20201117178	POSSE	AQ12257608	FLORES DE GOIAS	05/11/2020 16:52	05/11/2020 20:24	05/11/2020 16:52	05/11/2020 20:24	3,53	2	7,05	CHI
20201117157	MAMBAI	MB11161460	IACIARA S2	05/11/2020 17:02	05/11/2020 19:02	05/11/2020 17:02	05/11/2020 19:02	1,98	3	5,95	CHI
20201117235	FORMOSA	FA21106953	ITIQUEIRA	05/11/2020 17:26	05/11/2020 20:57	05/11/2020 17:26	05/11/2020 20:57	3,51	1	3,51	CHI
20201117314	ALTO PARAISO DE GOIAS	10028541292	FLORES DE GOIAS	05/11/2020 17:49	05/11/2020 21:31	05/11/2020 17:49	05/11/2020 21:31	3,69	1	3,69	CHI
20201117320	VILA BOA	10005361786	IACIARA S2	05/11/2020 17:51	05/11/2020 19:36	05/11/2020 17:51	05/11/2020 19:36	1,74	1	1,74	CHI
20201117741	SITIO D ABADIA	SI12329755	IACIARA S2	05/11/2020 18:01	05/11/2020 21:28	05/11/2020 18:01	05/11/2020 21:28	3,44	7	24,06	CHI
20201117639	PLANALTINA	PI11153072	PLANALTINA	05/11/2020 18:59	05/11/2020 21:20	05/11/2020 18:59	05/11/2020 21:20	2,35	328	769,43	CHI
20201117720	FORMOSA	FA11131871	ITIQUEIRA	05/11/2020 19:09	05/11/2020 20:55	05/11/2020 19:09	05/11/2020 20:55	1,76	197	345,79	CHI
20201117707	SAO JOAO D ALIANCA	3840017863	SAO JOAO D ALIANCA	05/11/2020 19:23	05/11/2020 22:20	05/11/2020 19:23	05/11/2020 22:20	2,95	1	2,95	CHI

5. Plotagem das Ocorrências conforme a Especialização das Chuvas

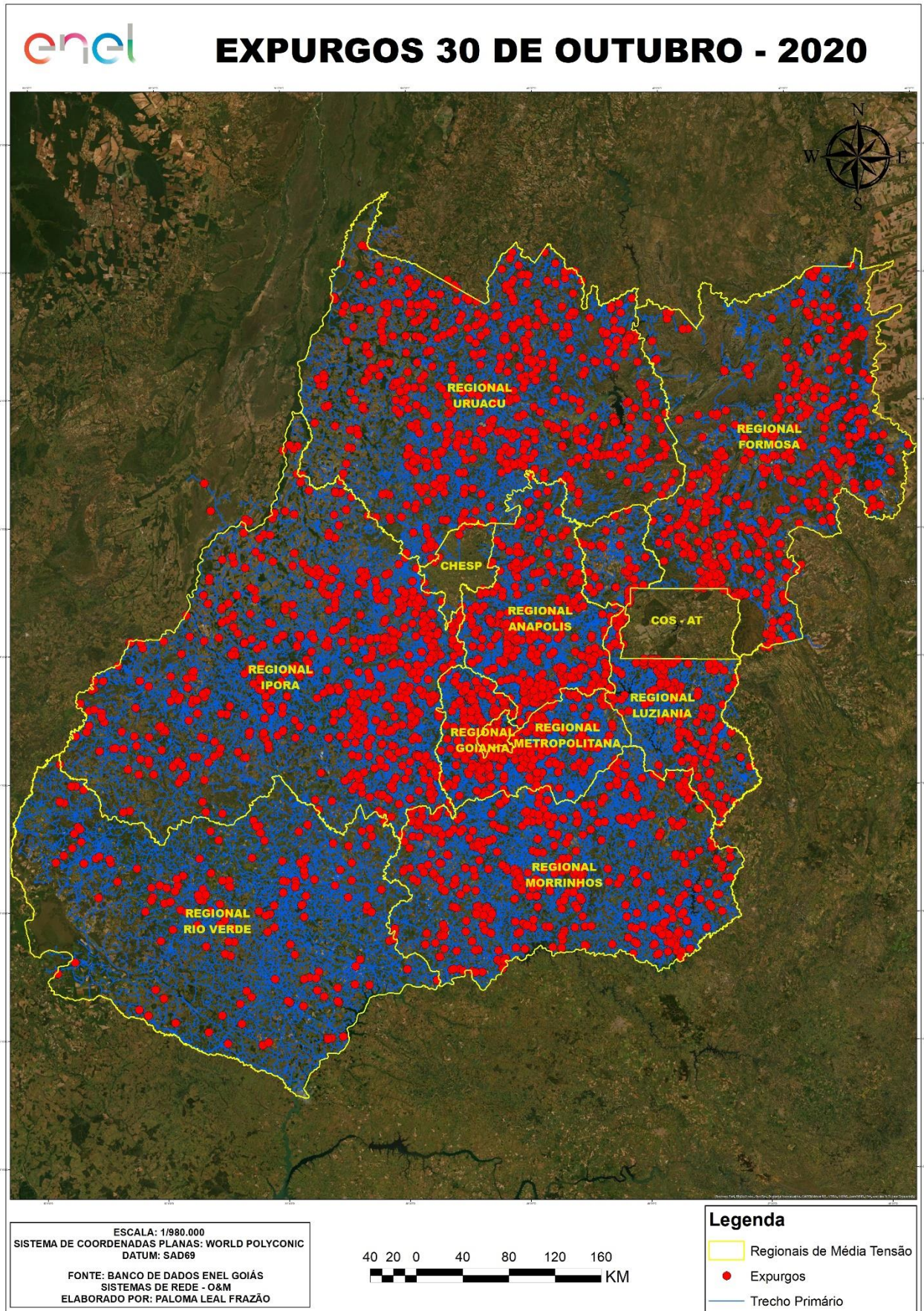

6. Clientes Afetados e Impactos Globais

Em análise ao número de clientes interrompidos (CI) na área de concessão da ENEL GO, a figura abaixo apresenta a atipicidade vivenciada no dia 30 de outubro a 05 de novembro de 2020, data esta que, conforme laudo meteorológico emitido por empresa especializada, a referida concessão passou por um período de condições climáticas de extrema severidade.

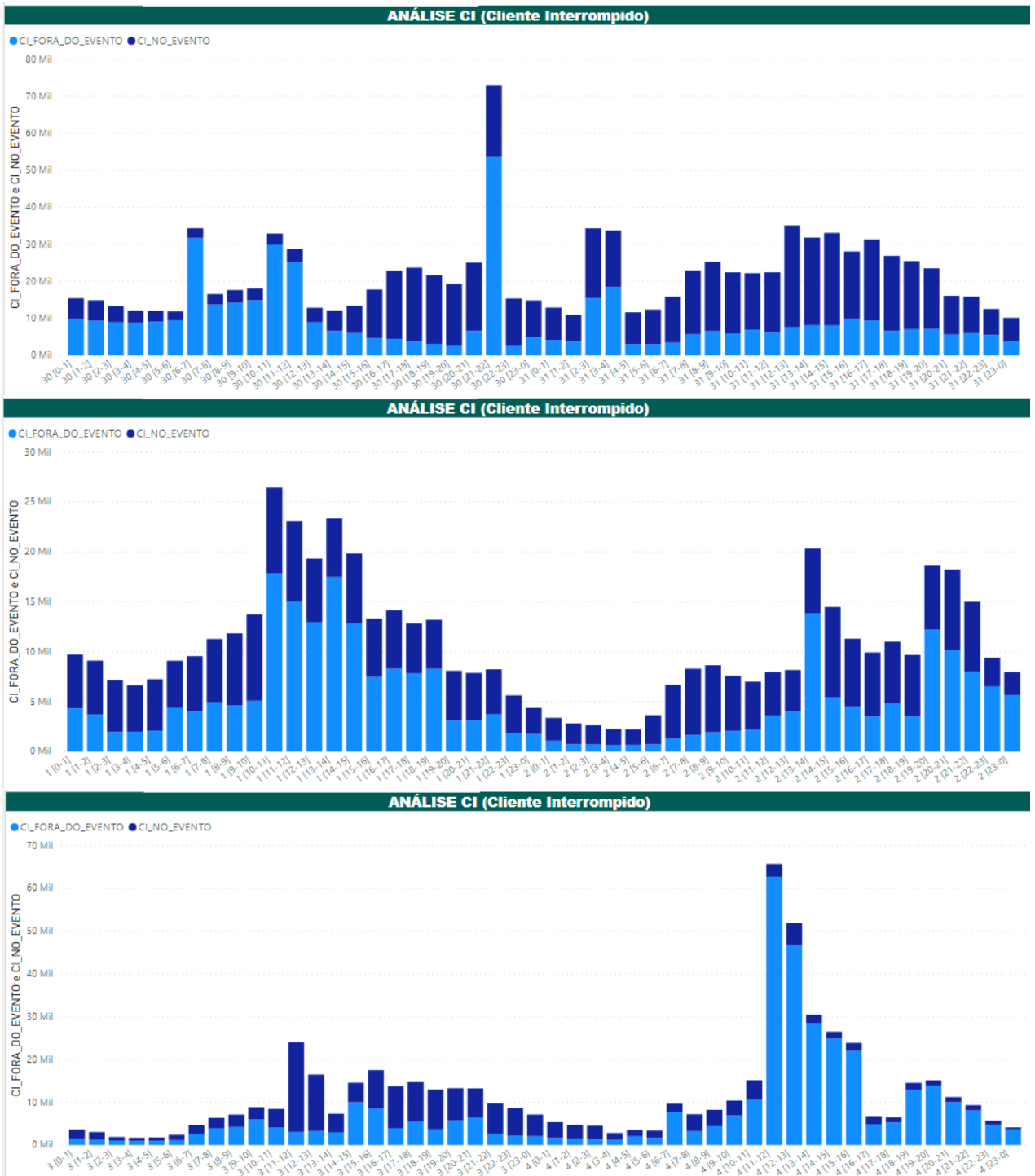

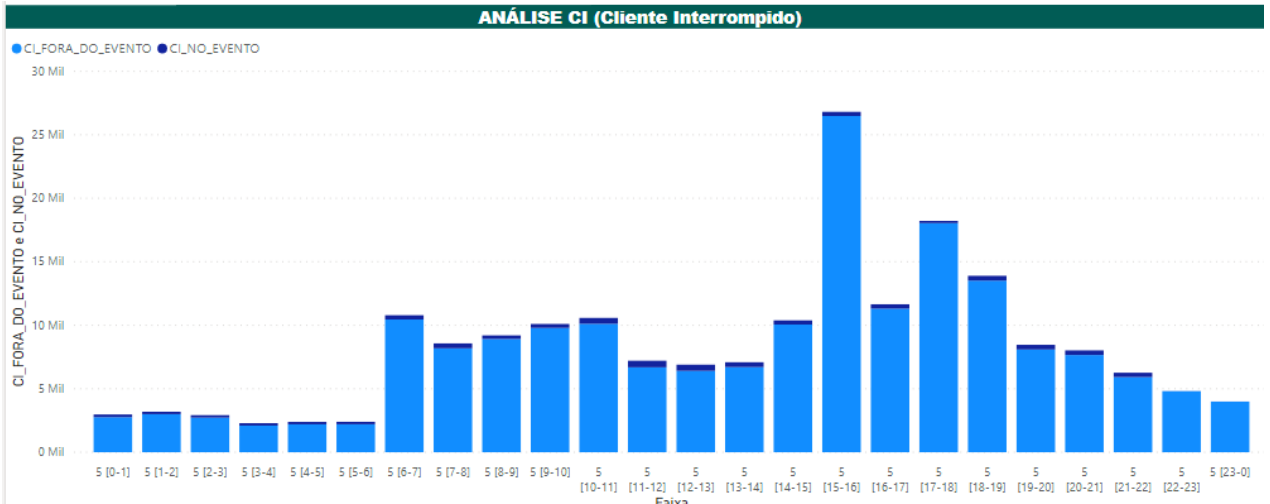

Figuras – Clientes Interrompidos em intervalos de horas

Na figura acima, as barras em azul claro representam a quantidade de clientes interrompidos simultaneamente em condições normais de operação, e as barras azul escuro os clientes interrompidos simultaneamente no período do evento.

7. Diagramas Unifilares

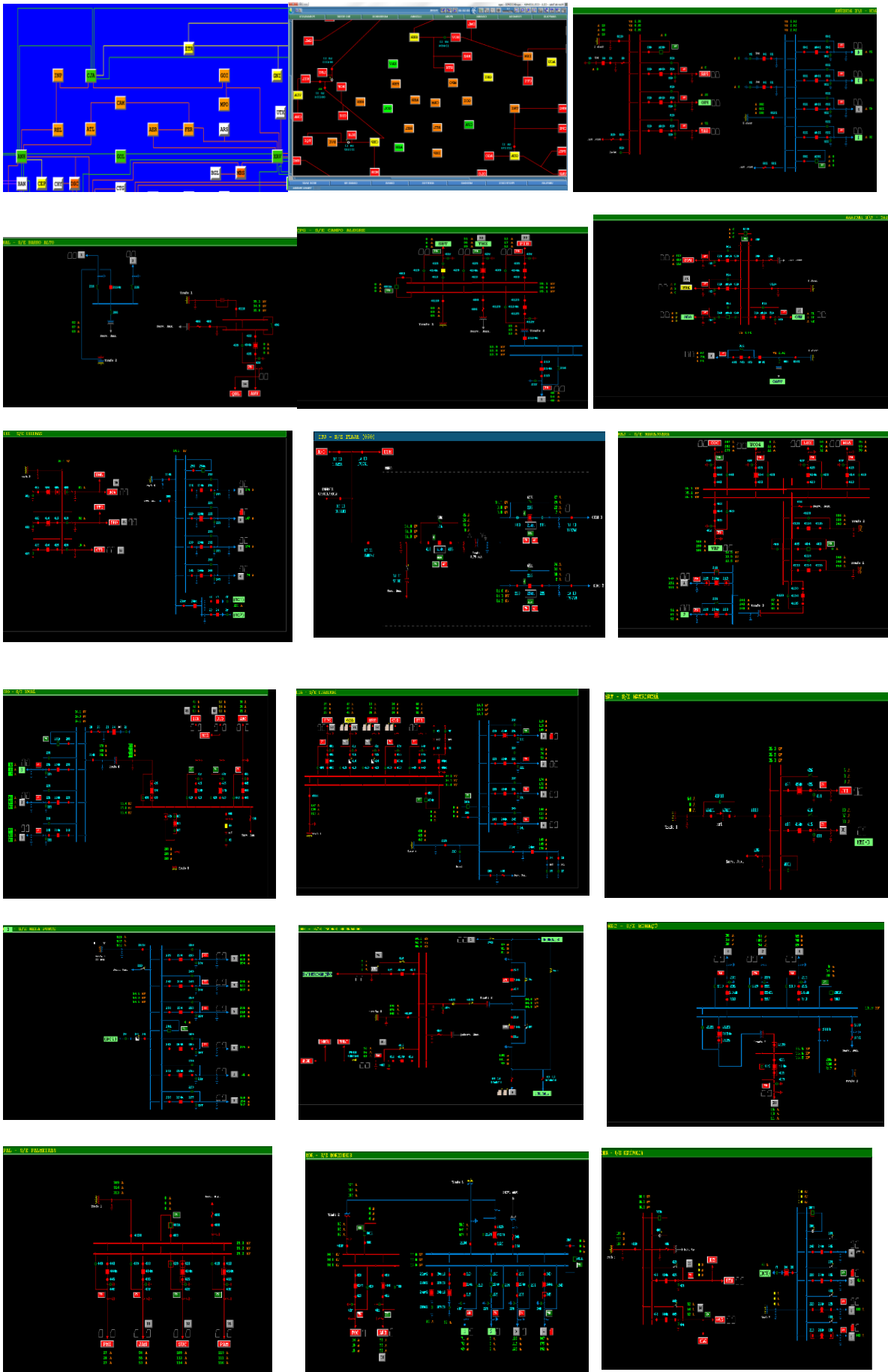

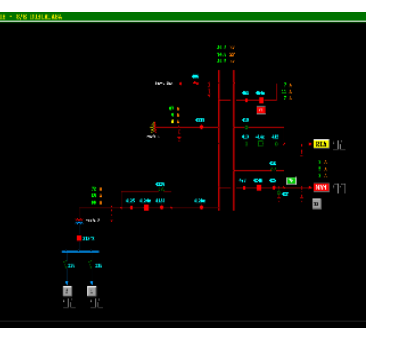
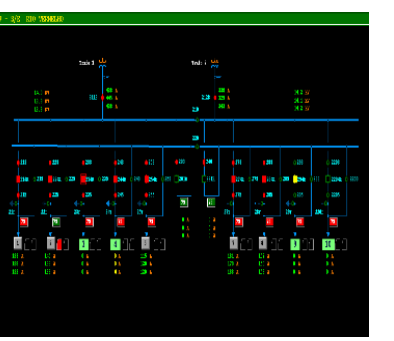
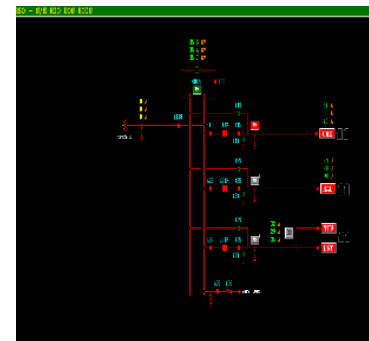
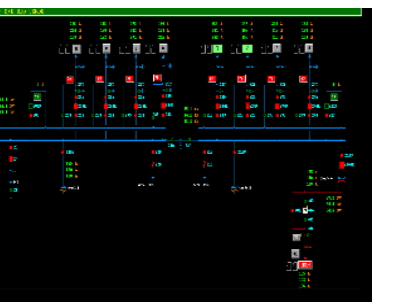
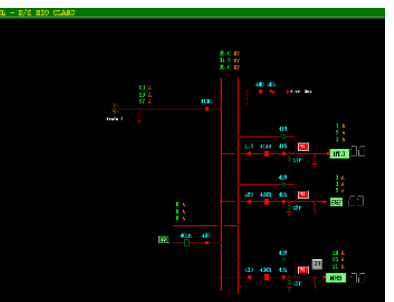
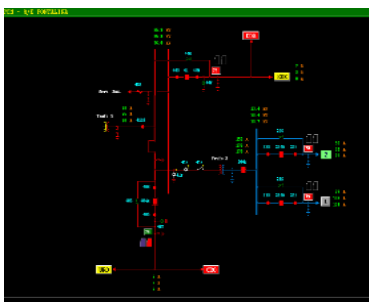
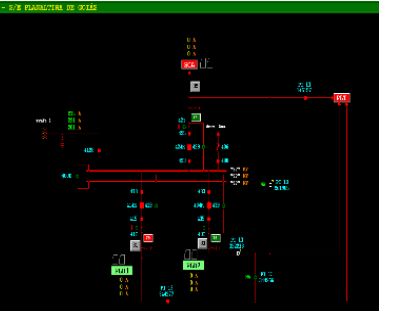
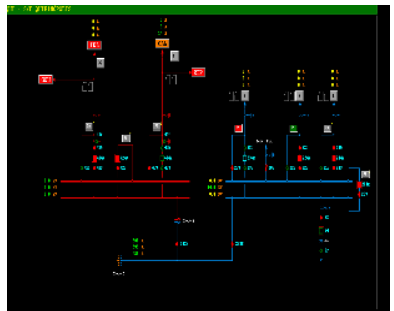
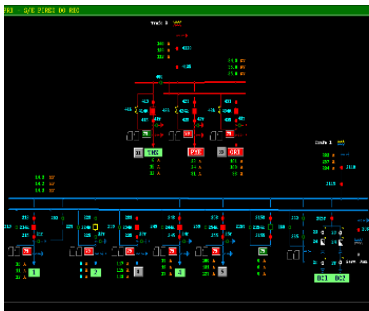
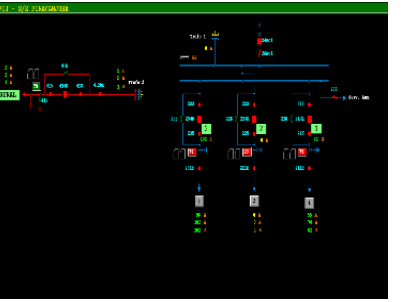
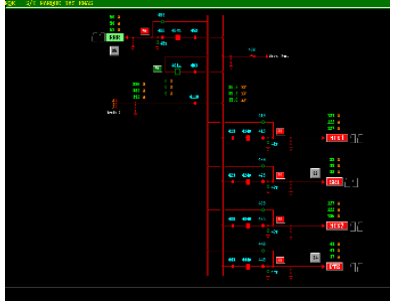
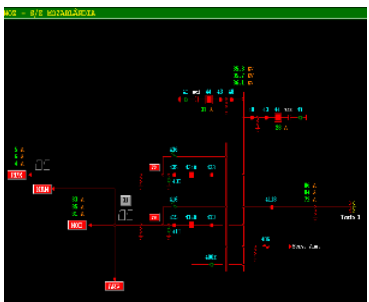
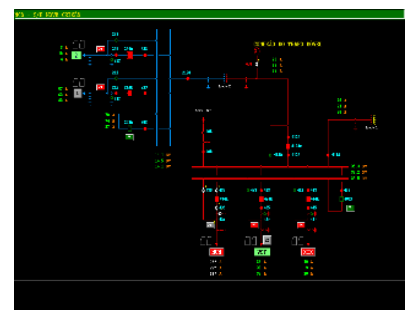
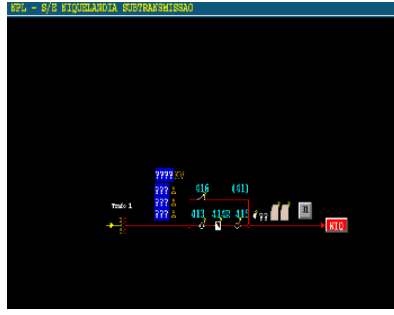

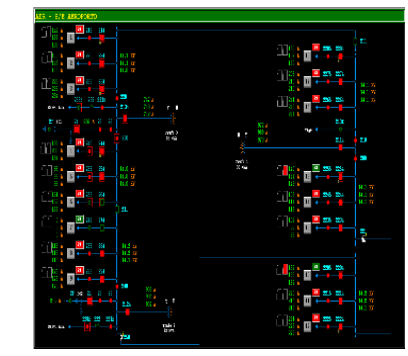
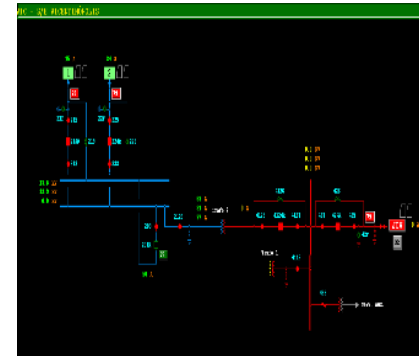
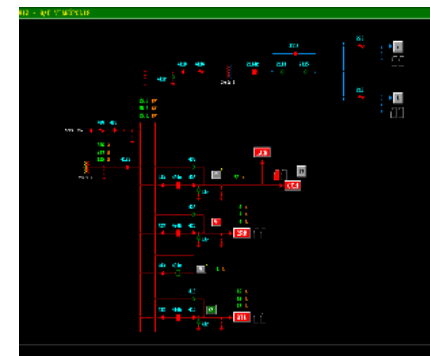
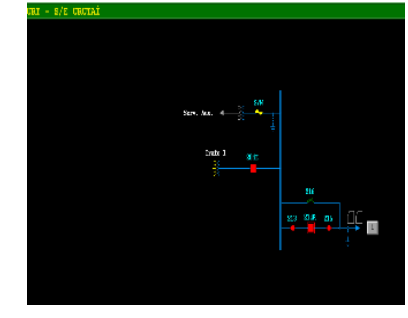
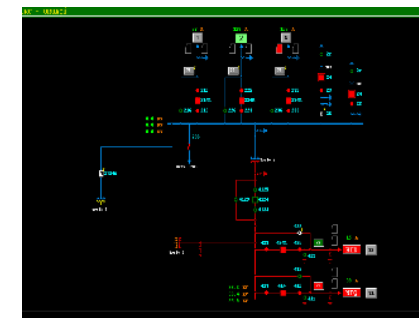
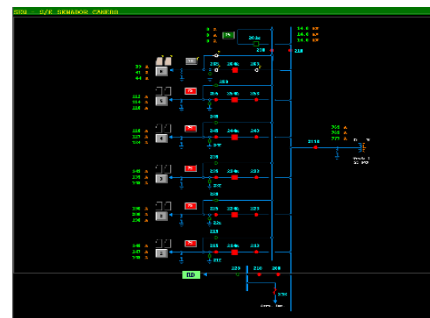
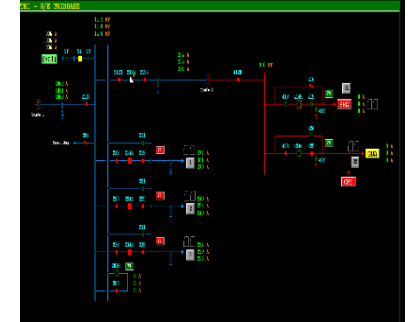
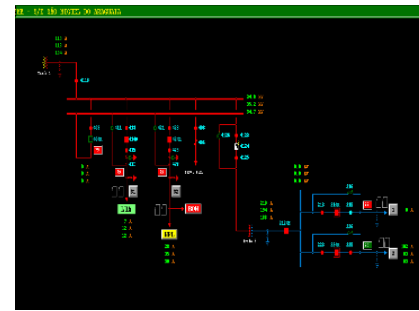
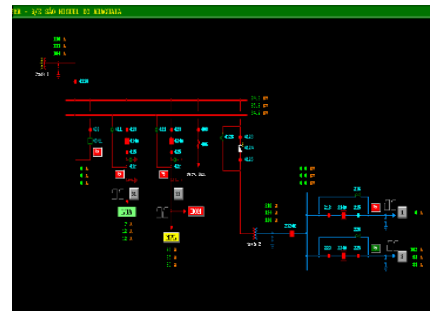
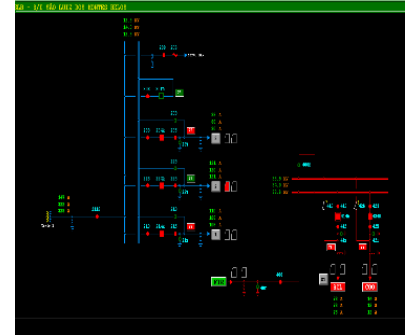
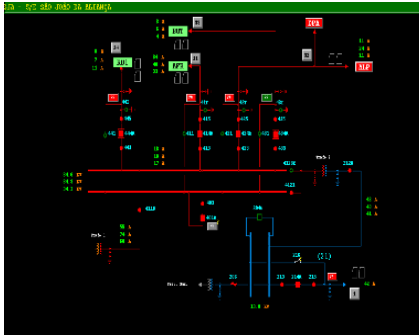
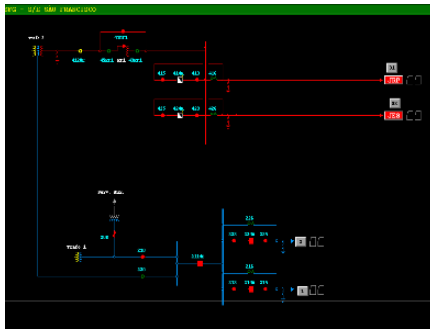
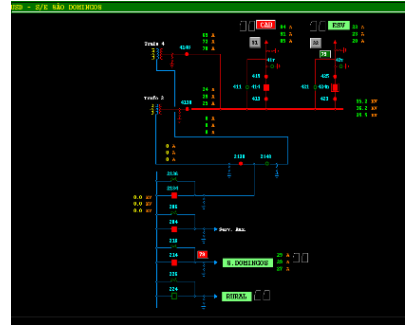
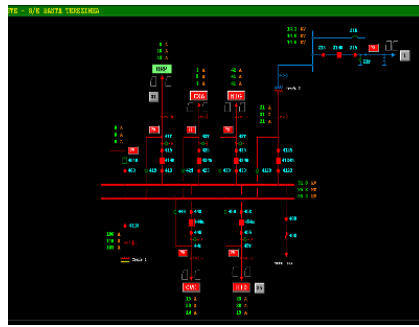
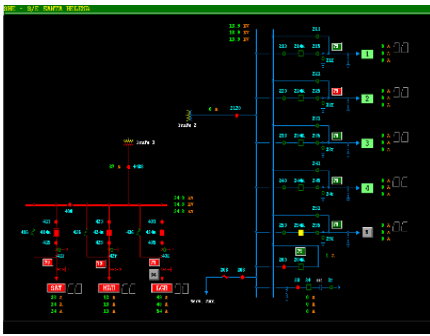

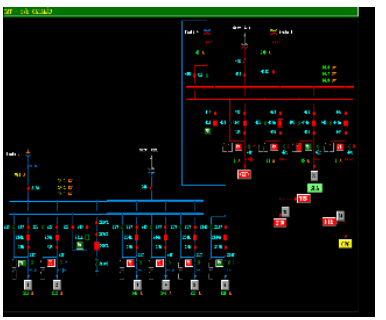
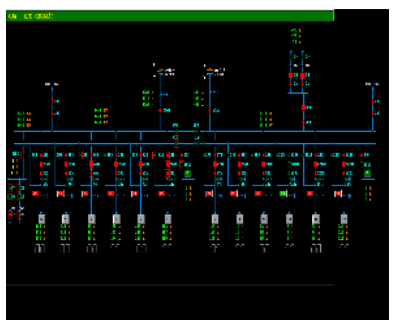
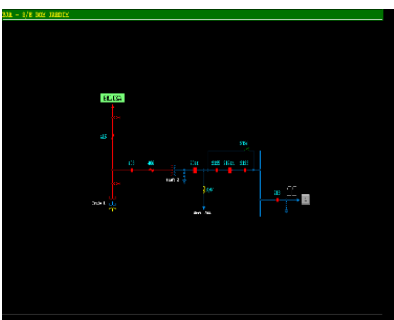
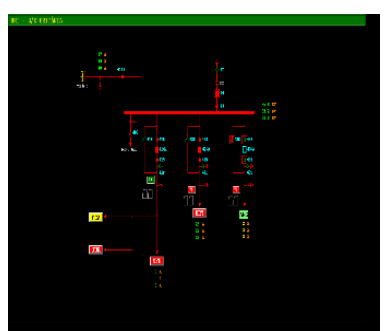
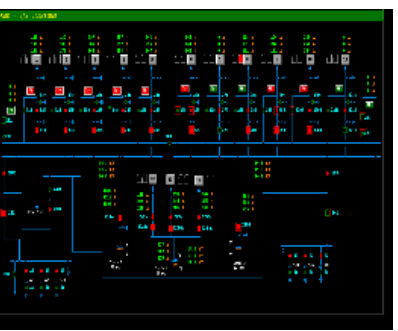
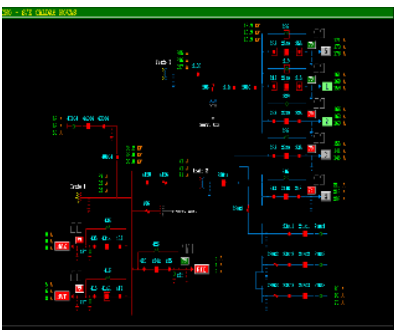
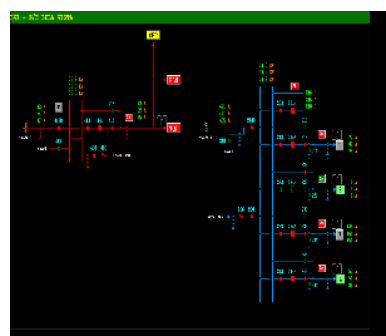
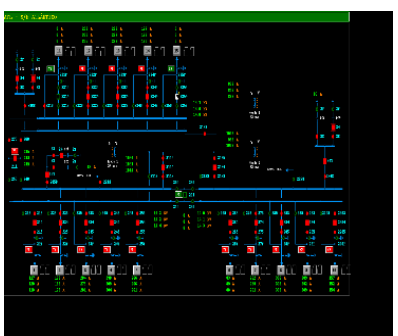
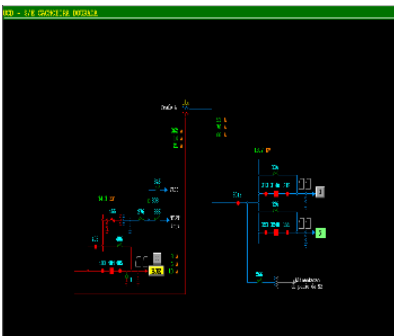
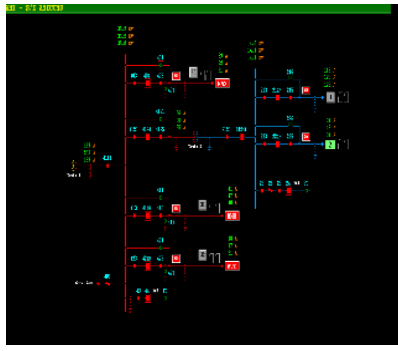
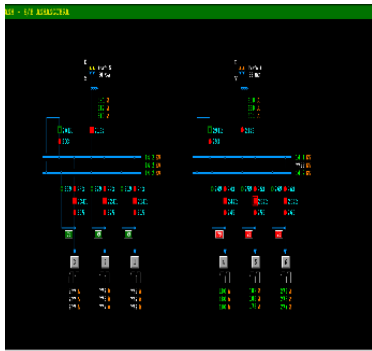
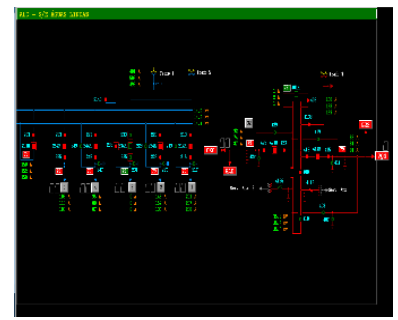
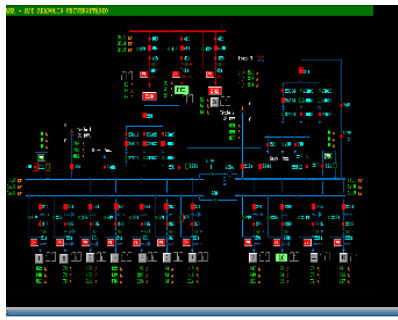
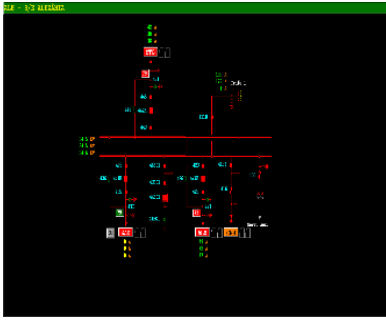

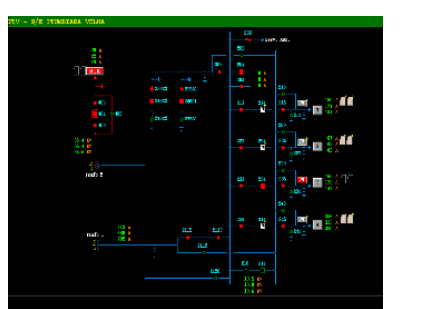
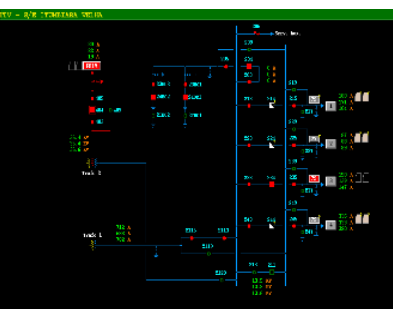
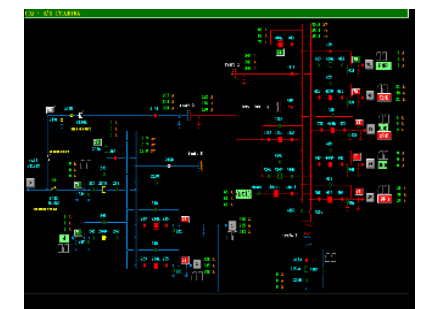
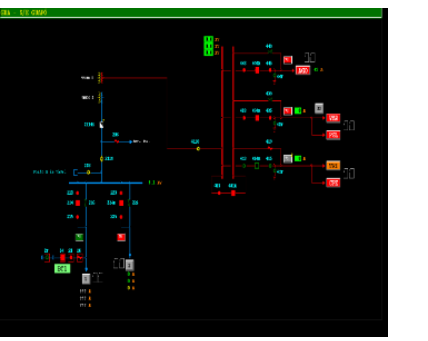
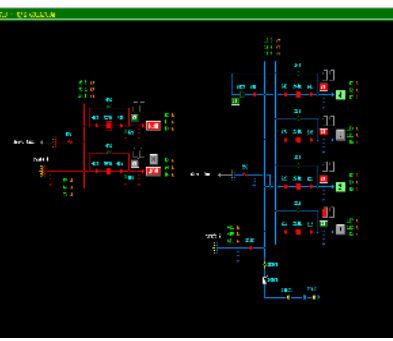
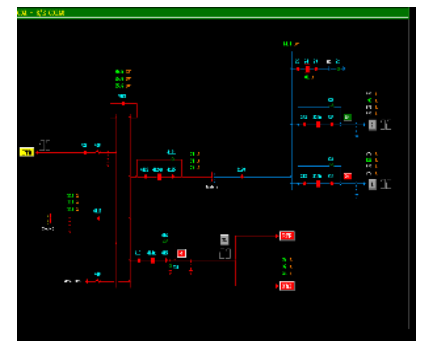
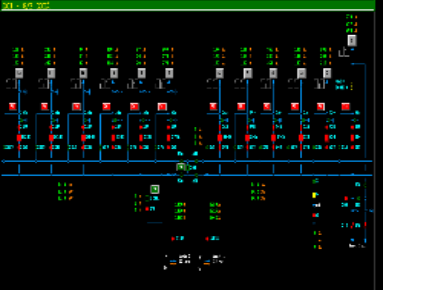
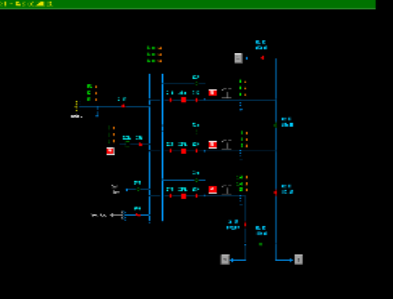
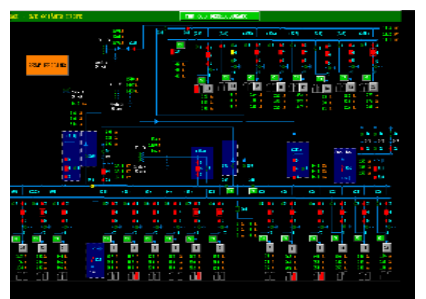
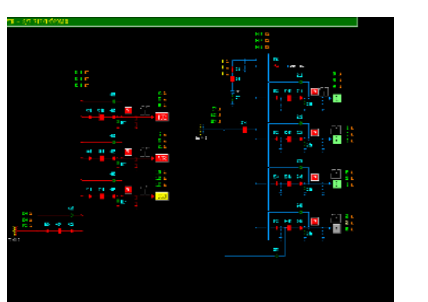
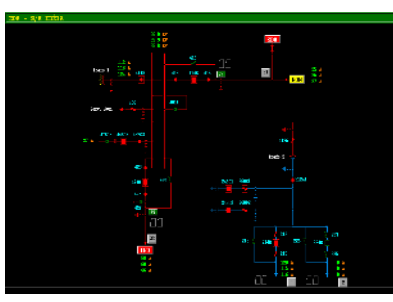
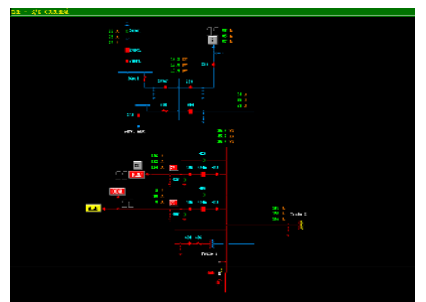
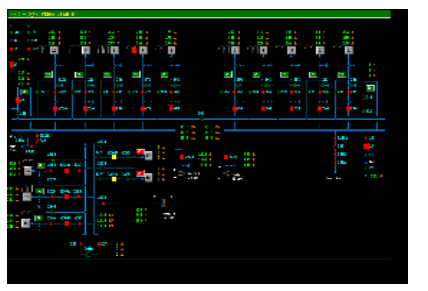
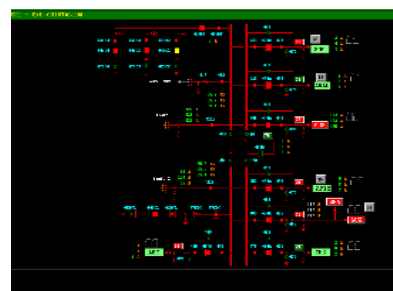
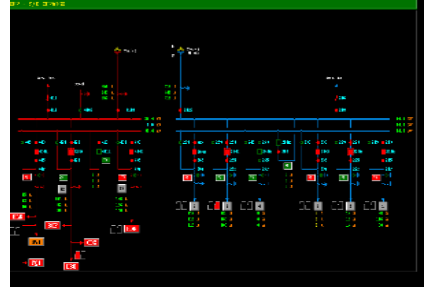
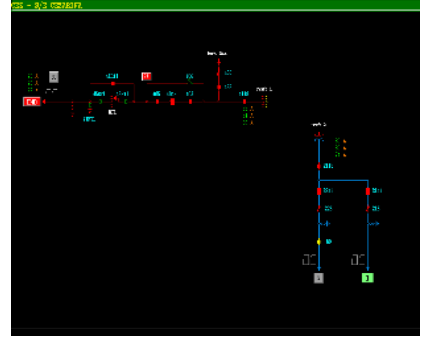
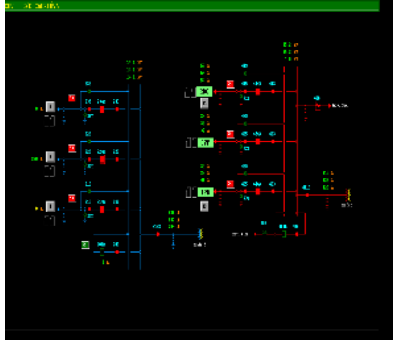
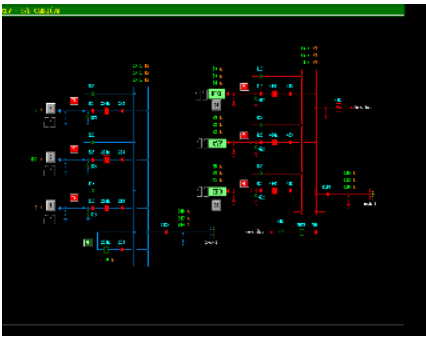

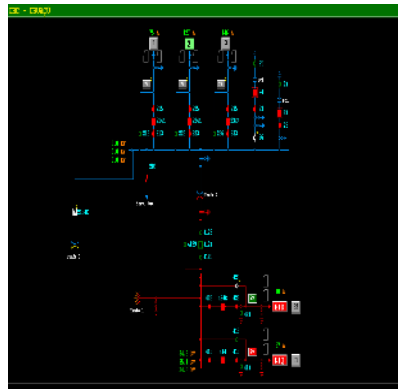
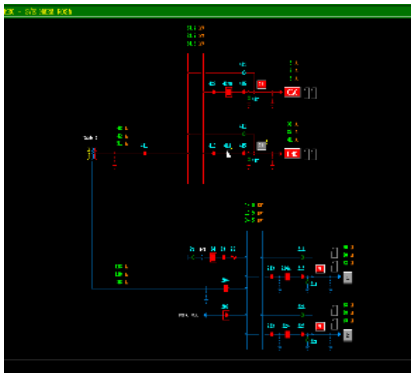
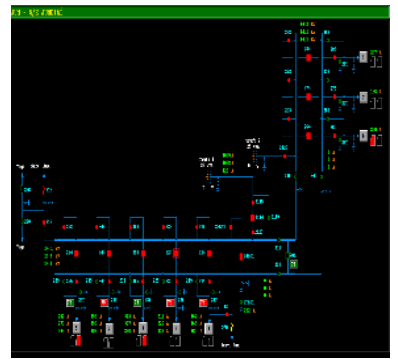
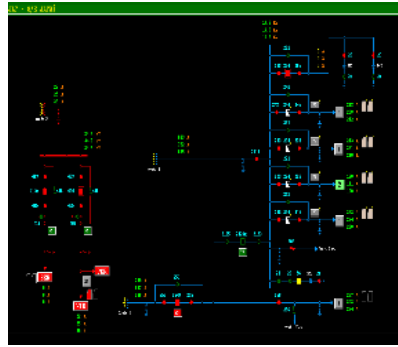
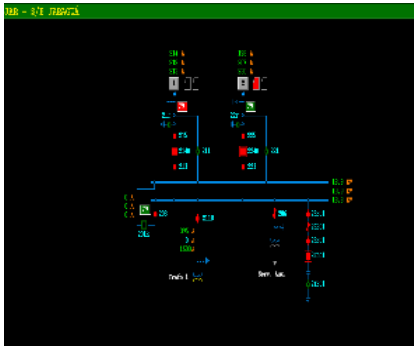

8. DEMAIS EVIDÊNCIAS

8.1. DADOS TÉCNICO - OPERACIONAIS ENEL GO

Enel - GO

TMAE e OE por Dia - Outubro 2020

● Contagem de Ocorrências ● TMAE

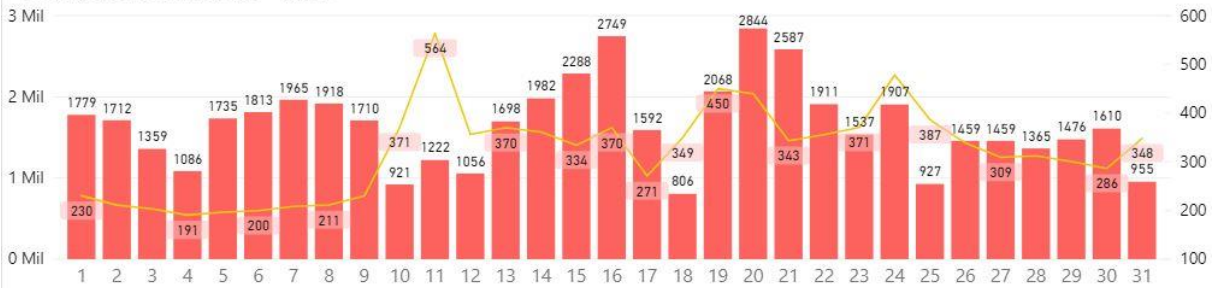

TMAE e OE por Dia - Novembro 2020

● Contagem de Ocorrências ● TMAE

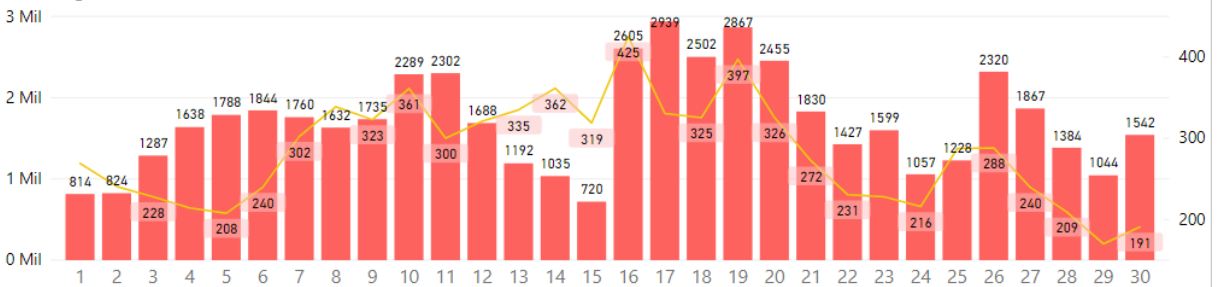

Regional Anápolis – GO

TMAE e OE por Dia - Outubro 2020

● Contagem de Ocorrências ● TMAE



TMAE e OE por Dia - Novembro 2020

● Contagem de Ocorrências ● TMAE

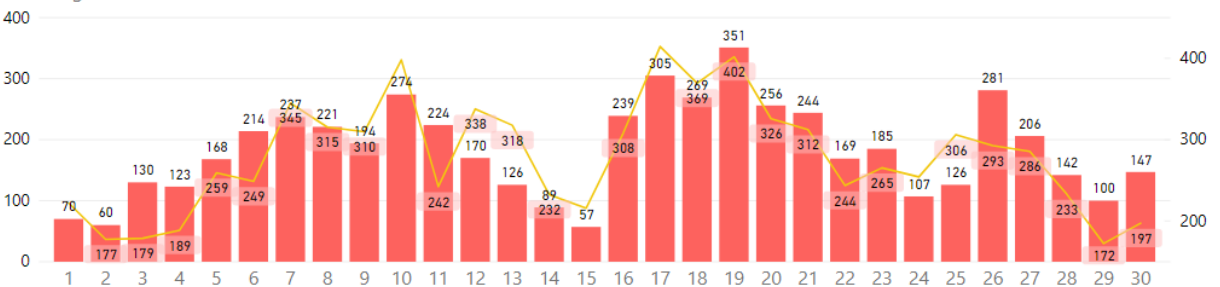

Regional Formosa – GO

TMAE e OE por Dia - Outubro 2020

● Contagem de Ocorrências ● TMAE

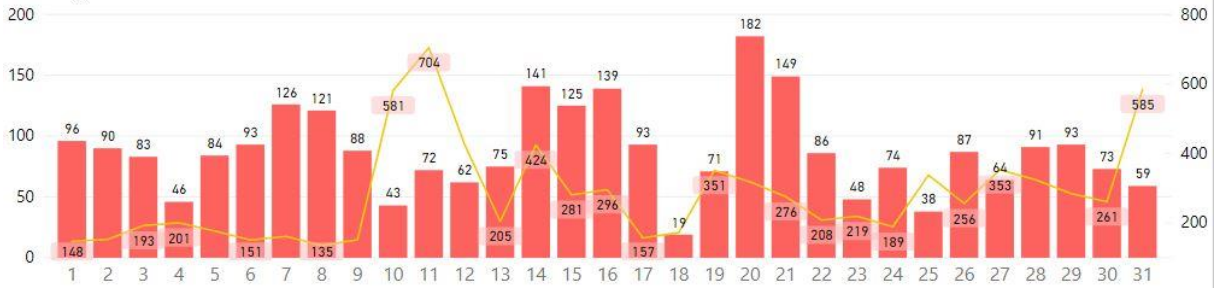

TMAE e OE por Dia - Novembro 2020

● Contagem de Ocorrências ● TMAE

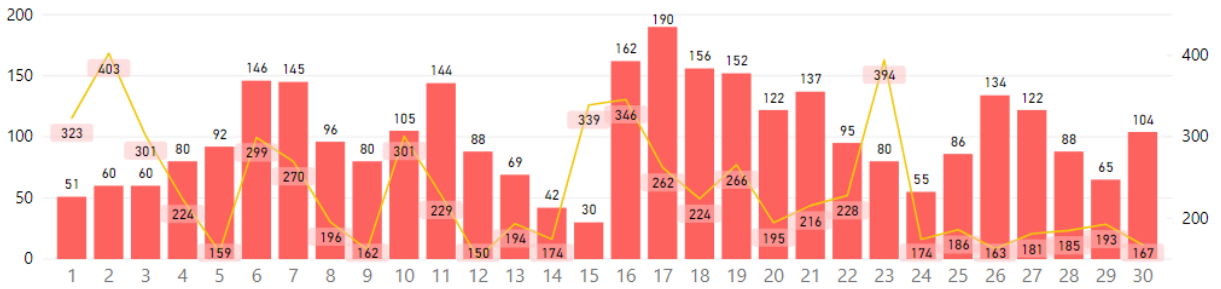

Regional Goiânia – GO

TMAE e OE por Dia - Outubro 2020

● Contagem de Ocorrências ● TMAE



TMAE e OE por Dia - Novembro 2020

● Contagem de Ocorrências ● TMAE

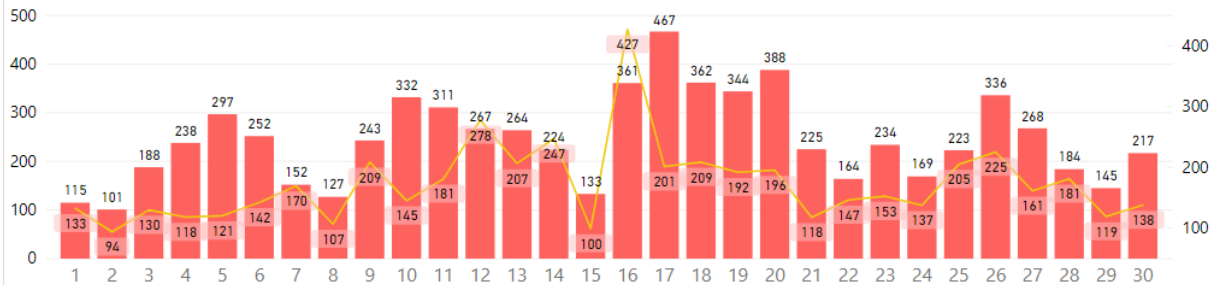

Regional Iporá – GO

TMAE e OE por Dia - Outubro 2020

● Contagem de Ocorrências ● TMAE



TMAE e OE por Dia - Novembro 2020

● Contagem de Ocorrências ● TMAE

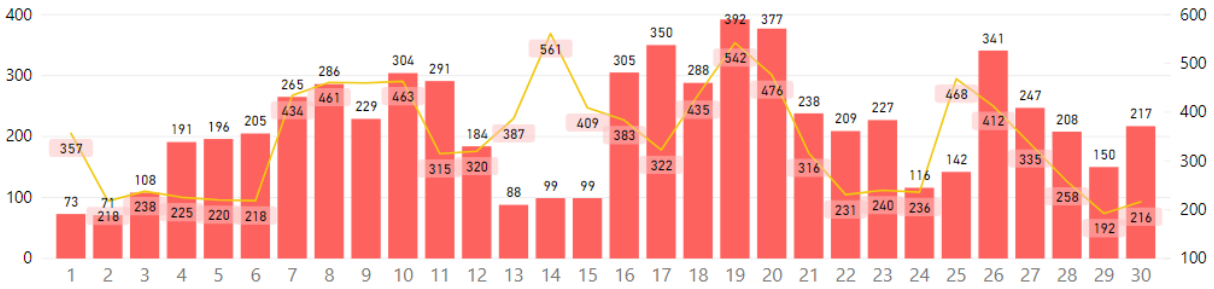

Regional Luziânia – GO

TMAE e OE por Dia - Outubro 2020

● Contagem de Ocorrências ● TMAE



TMAE e OE por Dia - Novembro 2020

● Contagem de Ocorrências ● TMAE

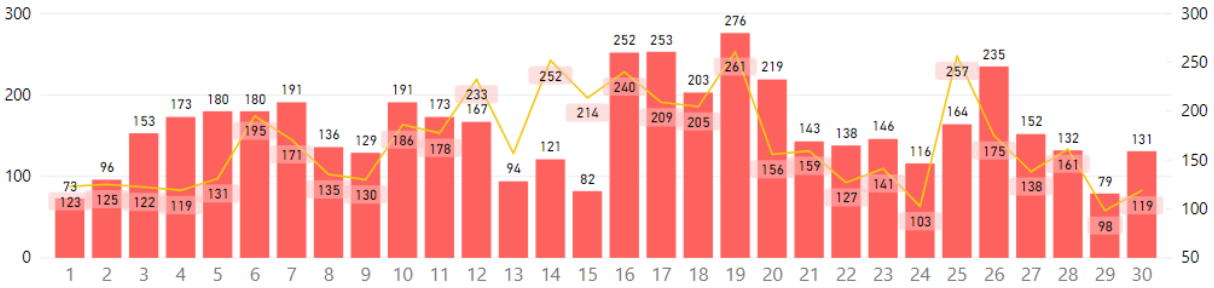

Regional Metropolitana – GO

TMAE e OE por Dia - Outubro 2020

● Contagem de Ocorrências ● TMAE



TMAE e OE por Dia - Novembro 2020

● Contagem de Ocorrências ● TMAE

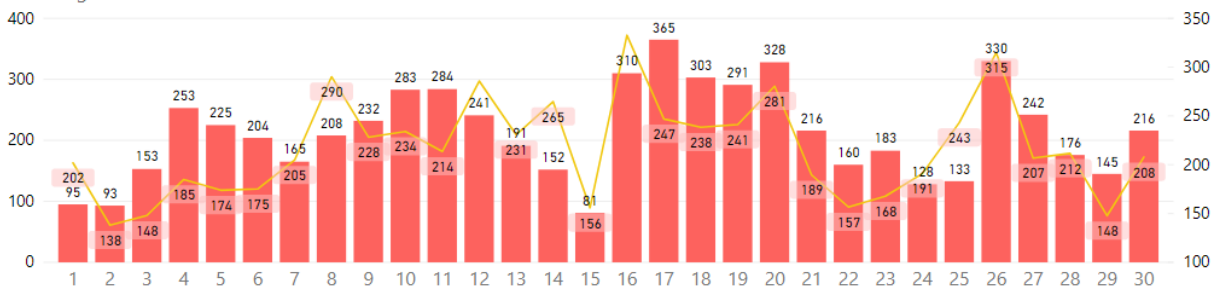

Regional Morrinhos – GO

TMAE e OE por Dia - Outubro 2020

● Contagem de Ocorrências ● TMAE

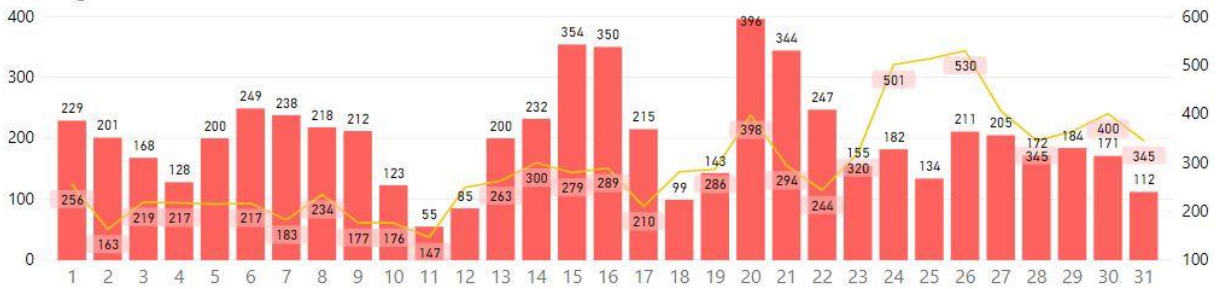

TMAE e OE por Dia - Novembro 2020

● Contagem de Ocorrências ● TMAE

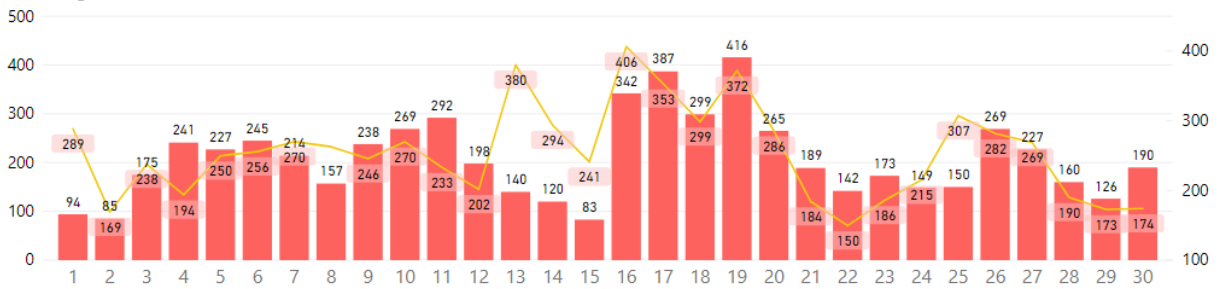

Regional Rio Verde – GO

TMAE e OE por Dia - Outubro 2020

● Contagem de Ocorrências ● TMAE



TMAE e OE por Dia - Novembro 2020

● Contagem de Ocorrências ● TMAE

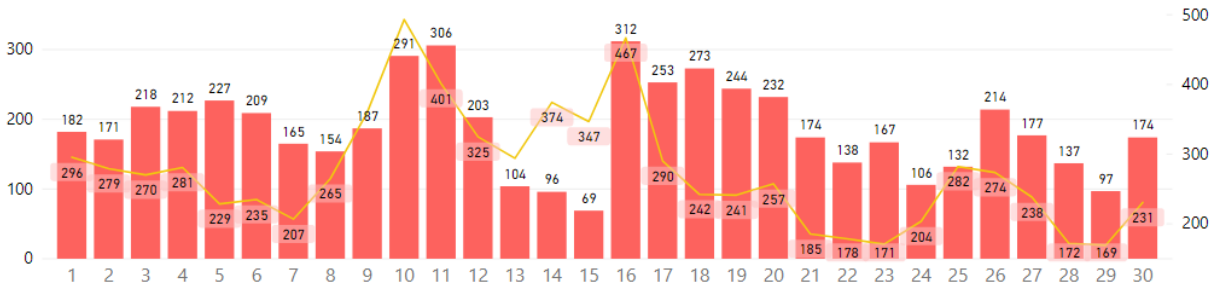

Regional Uruaçu - GO

TMAE e OE por Dia - Outubro 2020

● Contagem de Ocorrências ● TMAE

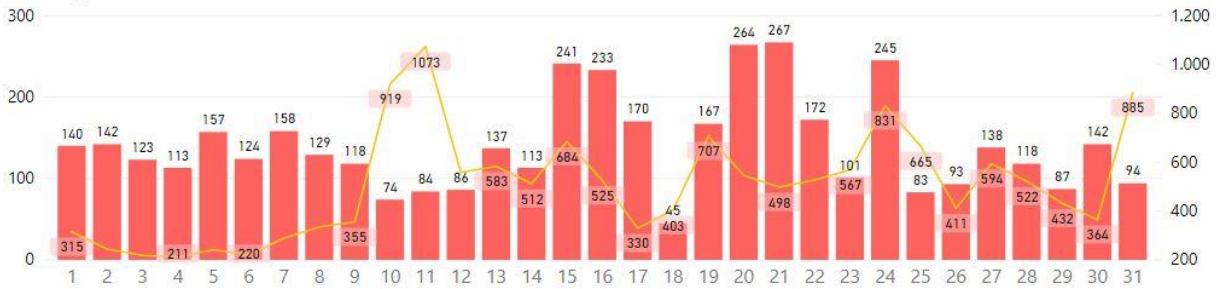

TMAE e OE por Dia - Novembro 2020

● Contagem de Ocorrências ● TMAE

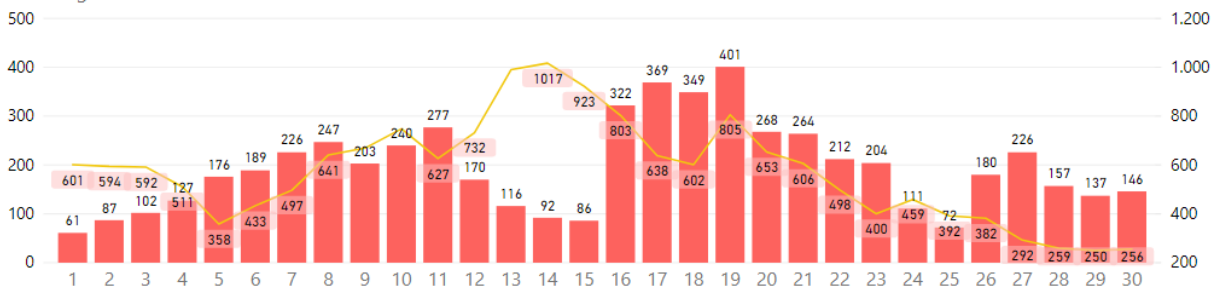

8.2. Dados climatológicos pelo INMET

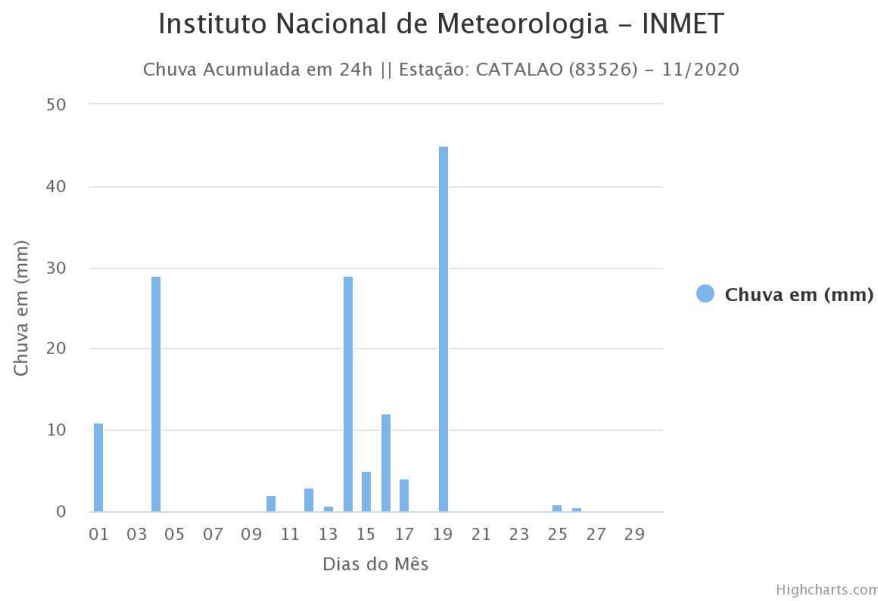
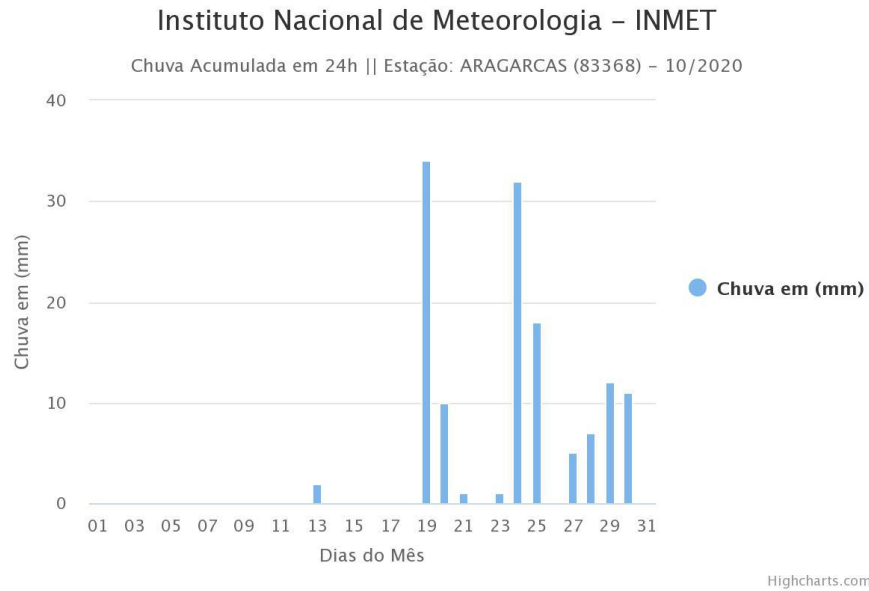

Instituto Nacional de Meteorologia – INMET

Chuva Acumulada em 24h || Estação: FORMOSA (83379) – 10/2020

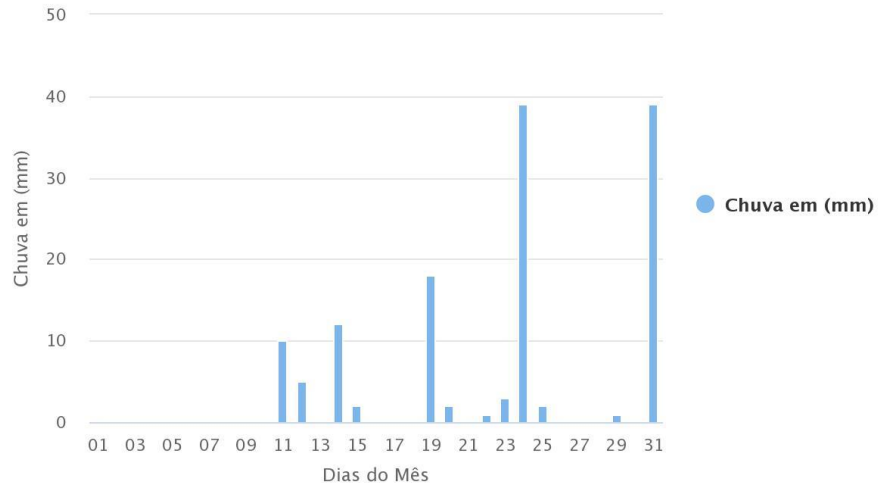

Highcharts.com

Instituto Nacional de Meteorologia – INMET

Chuva Acumulada em 24h || Estação: FORMOSA (83379) – 11/2020

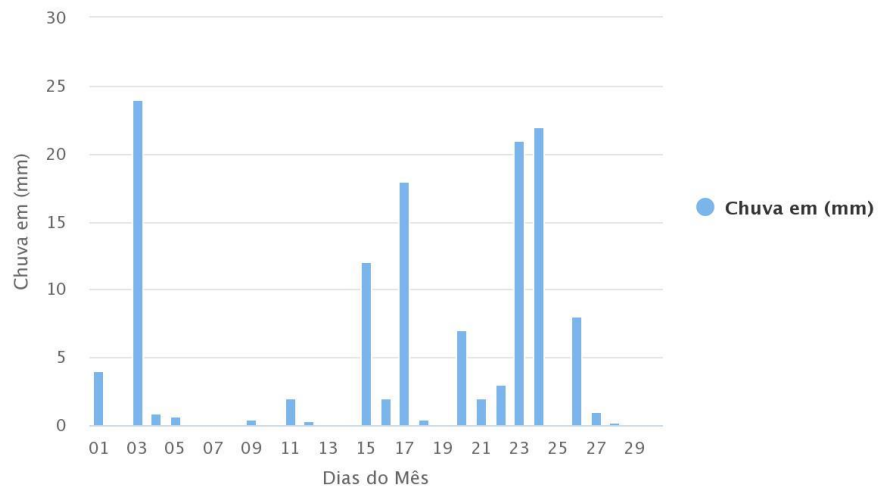

Highcharts.com

Instituto Nacional de Meteorologia – INMET

Chuva Acumulada em 24h || Estação: GOIANIA (83423) – 10/2020

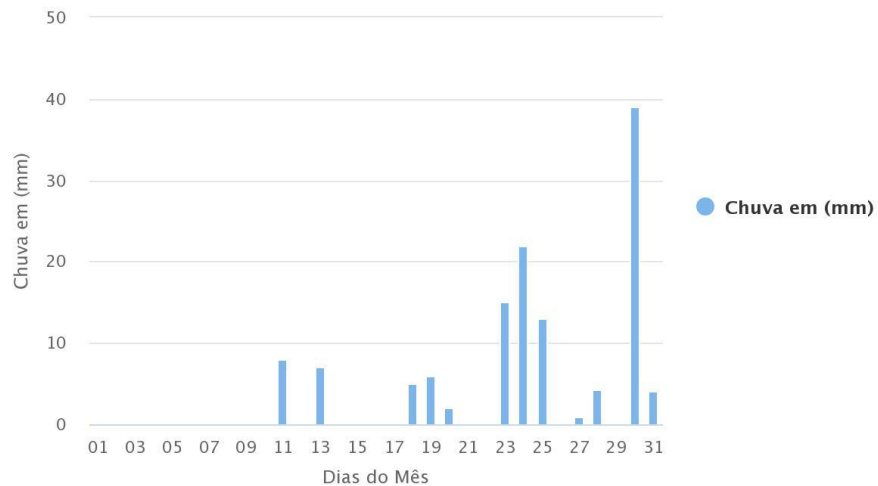

Highcharts.com

Instituto Nacional de Meteorologia – INMET

Chuva Acumulada em 24h || Estação: IPAMERI (83522) – 10/2020

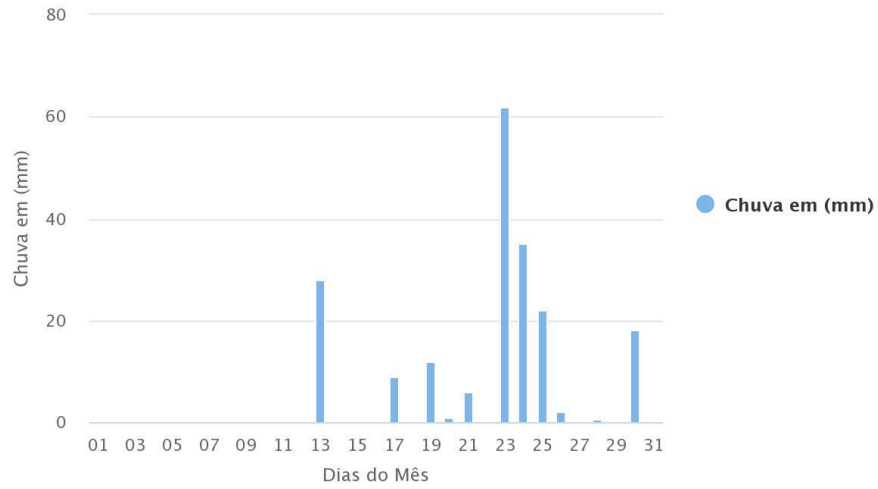

Highcharts.com

Instituto Nacional de Meteorologia – INMET

Chuva Acumulada em 24h || Estação: IPAMERI (83522) – 11/2020

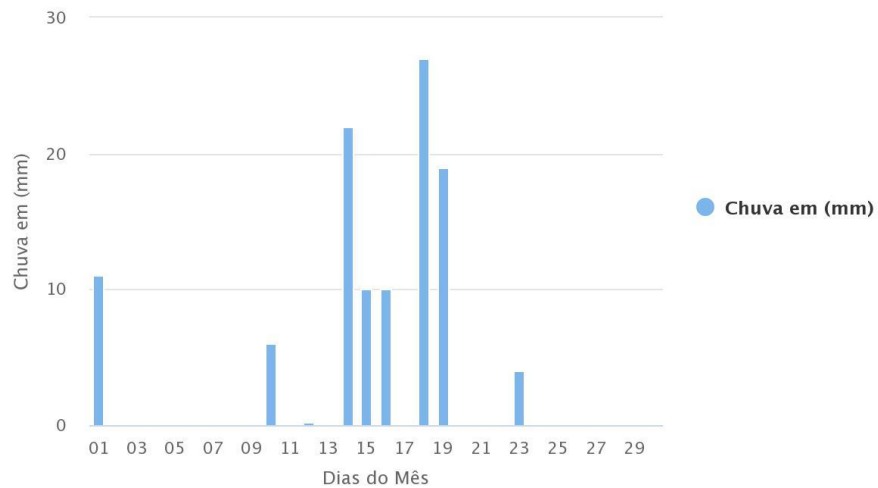

Highcharts.com

Instituto Nacional de Meteorologia – INMET

Chuva Acumulada em 24h || Estação: JATAI (83464) – 10/2020

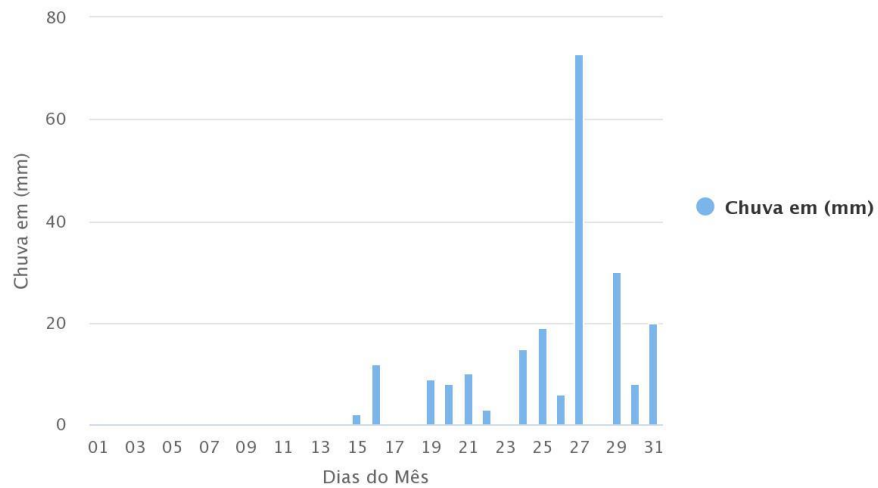

Highcharts.com

Instituto Nacional de Meteorologia – INMET

Chuva Acumulada em 24h || Estação: PIRENOPOLIS (83376) – 10/2020

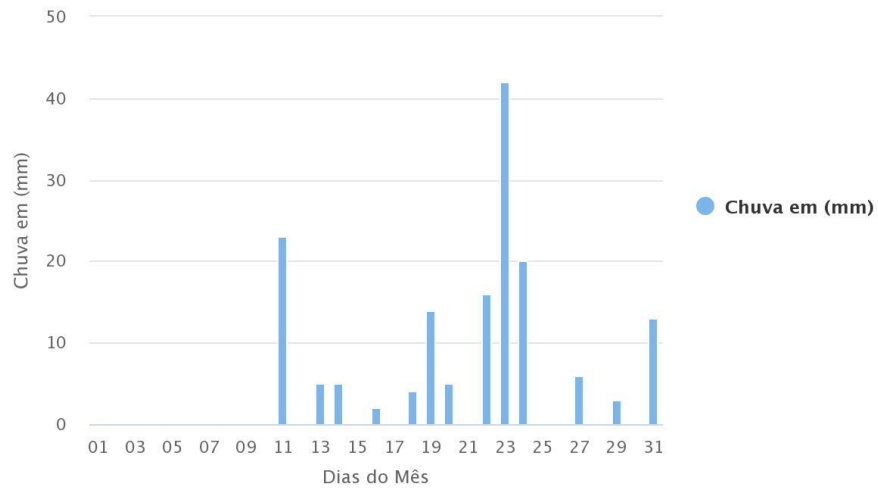

Highcharts.com

Instituto Nacional de Meteorologia – INMET

Chuva Acumulada em 24h || Estação: PIRENOPOLIS (83376) – 11/2020

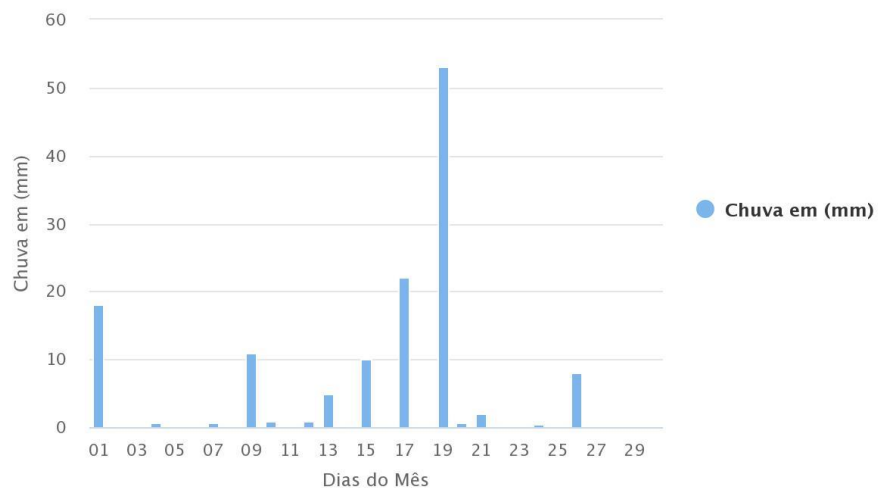

Highcharts.com

Instituto Nacional de Meteorologia – INMET

Chuva Acumulada em 24h || Estação: POSSE (83332) – 10/2020

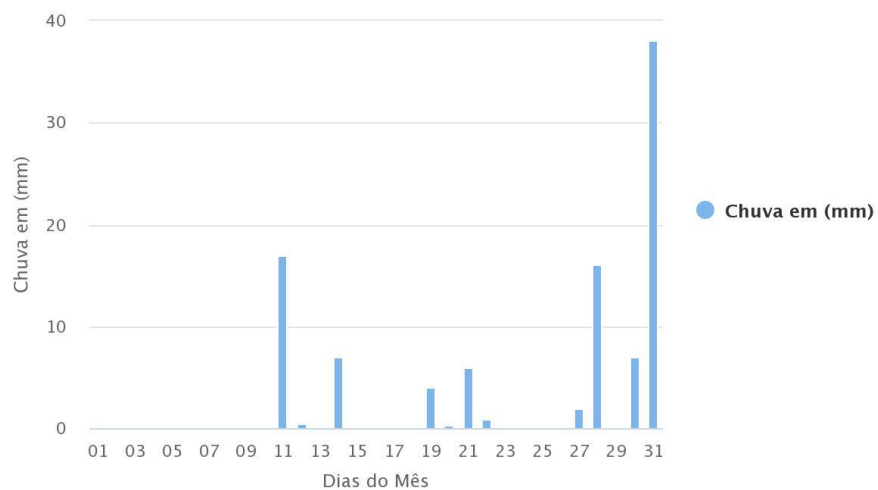

Highcharts.com

Instituto Nacional de Meteorologia – INMET

Chuva Acumulada em 24h || Estação: POSSE (83332) – 11/2020

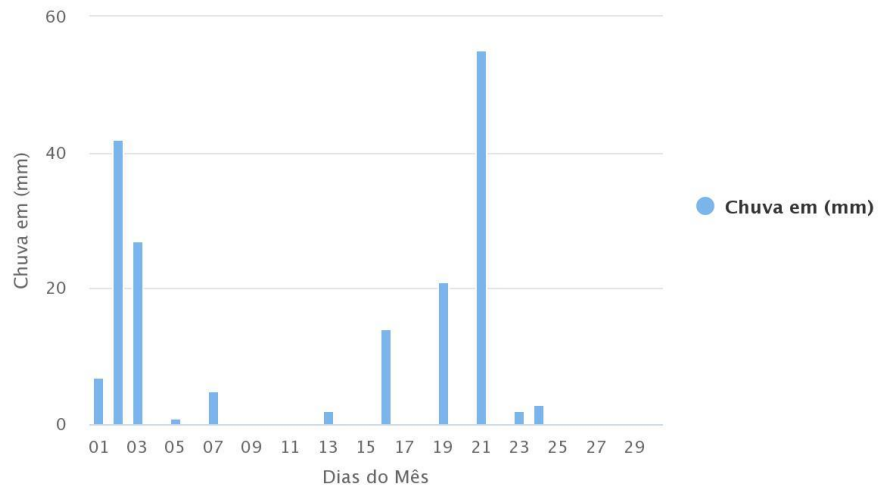

Highcharts.com

Instituto Nacional de Meteorologia – INMET

Chuva Acumulada em 24h || Estação: RIO VERDE (83470) – 10/2020

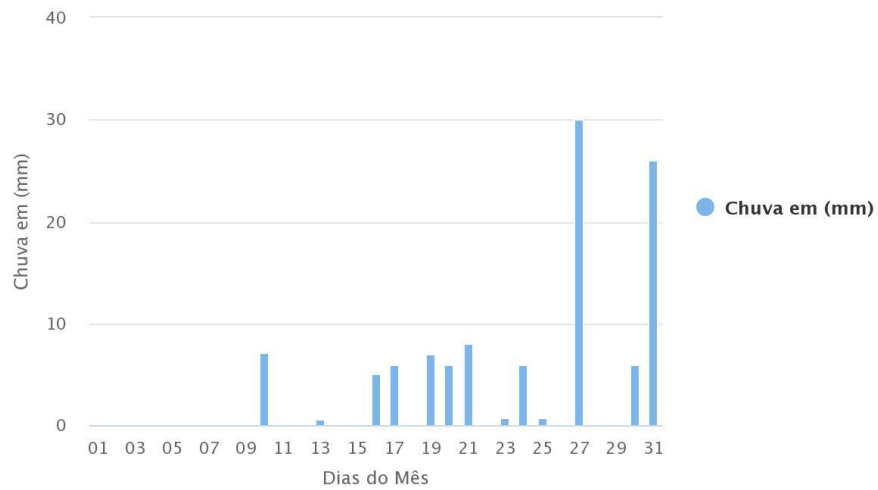

Highcharts.com

9. NOTÍCIAS RELACIONADAS

<https://diariodegoias.com.br/fortes-chuvas-em-luziania-provoca-transtornos-no-patio-da-policia-militar-do-municipio/>

Forte chuva em Luziânia provoca destruição no pátio da Polícia Militar e estragos no Hospital de Campanha

by DIÁRIO DE GOIÁS - 30/10/2020 AA 0



Chuva causa estragos em Luziânia, no entorno do DF

As chuvas da tarde desta sexta-feira (30/10) provocaram estragos em Luziânia, no entorno do Distrito Federal. No pátio do estacionamento da Polícia Militar do município o resultado foi uma verdadeira destruição.

Segundo relatos de testemunhas, a chuva acompanhada de forte vento começou por volta das 16h40 e durou aproximadamente 30 minutos. Foi o suficiente para causar transtornos em vários pontos da cidade. Apesar dos estragos no pátio da Polícia Militar não houve dano físico em nenhuma pessoa que estava no local.

<https://www.instagram.com/p/CG-8dAqFeCl/>



maisgoias • Seguindo



maisgoias Tempo: a forte chuva que caiu nessa tarde causou estragos na cidade de Luziânia, na região do Entorno do DF. Imagens registradas no Batalhão de Polícia da cidade. Aguarde mais informações! (Por @altemargo)

8 sem



divinaemodesto Realmente este ano tá muito difícil mais se Deus quiser vamos ver 🙏 todos



8 sem Responder



89.873 visualizações

30 DE OUTUBRO

Adicione um comentário...

Publicar

10. Laudo Técnico

CLIMATEMPO

**Laudo Meteorológico de Evento Climático
- ENEL Goiás - 30 de outubro de 2020**

São Paulo, SP, Brasil

Novembro de 2020

Sumário

1	ANÁLISE DE EVENTO METEOROLÓGICO.....	2
1.1	Descrição do Evento.....	2
1.2	Abrangência do Evento.....	7
2	CLASSIFICAÇÃO COBRADE.....	17
3	RESUMO DO EVENTO.....	18
4	REFERÊNCIAS.....	21
	ANEXOS.....	22

1. Análise de Evento Meteorológico

1.1. Descrição do Evento

Na figura a seguir é apresentada a área de concessão da ENEL DISTRIBUIÇÃO GOIÁS, dividida em regiões, a serem analisadas neste relatório.



Figura 1 – Regiões atendidas pela ENEL Goiás.

A formação e manutenção de uma Zona de Convergência do Atlântico Sul (ZCAS) favoreceu a organização de áreas de instabilidade sobre o estado de Goiás a partir do dia 30 de outubro de 2020.

Nas Figuras 2 e 3 são apresentadas as descargas atmosféricas nuvem-solo (raios) e nuvem-nuvem detectadas pelo sistema Earth Networks. Entre as 09h40 do dia 30 de outubro e 19h10 do dia 05 de novembro de 2020 foram registrados 13230 raios nuvem-solo e 37750 descargas nuvem-nuvem sobre a área da ENEL DISTRIBUIÇÃO GOIÁS.

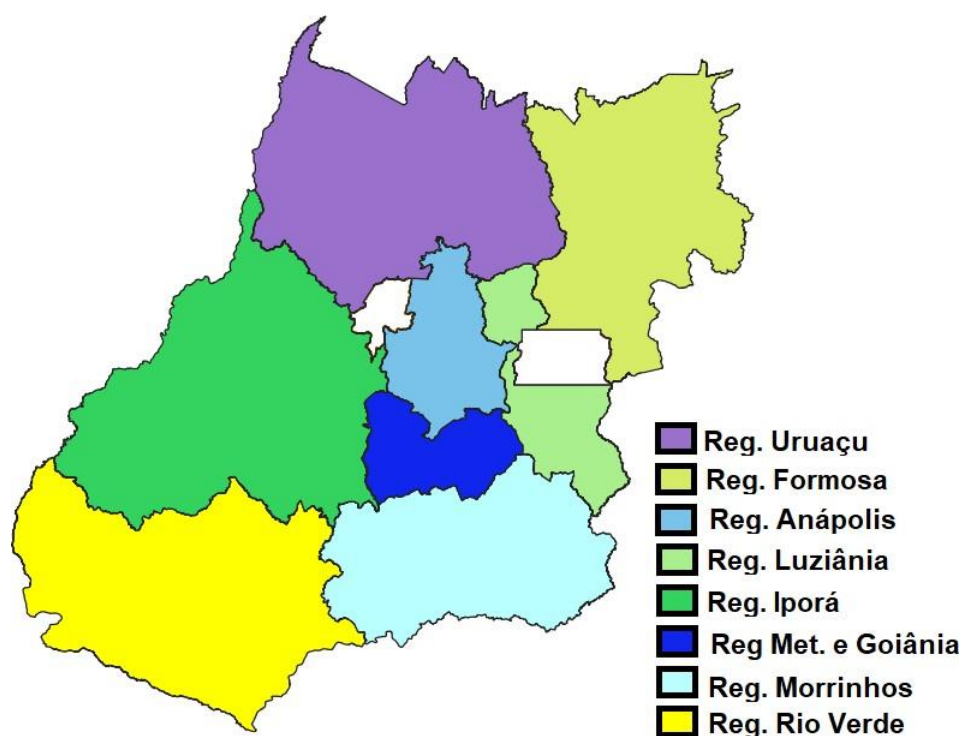

Figura 2 – Descargas atmosféricas nuvem-solo (em preto) detectadas pelo sistema Earth Networks entre 09h40 do dia 30 de outubro e 19h10 do dia 05 de novembro de 2020 sobre a área de concessão da ENEL DISTRIBUIÇÃO GOIÁS.



Figura 3 – Descargas atmosféricas nuvem-nuvem (em vermelho) detectadas pelo sistema Earth Networks entre 09h40 do dia 30 de outubro e 19h10 do dia 05 de novembro de 2020 sobre a área de concessão da ENEL DISTRIBUIÇÃO GOIÁS.

Na tabela 1 são apresentadas as rajadas de vento iguais ou superiores a 50 km/h registradas por estações do Instituto Nacional de Meteorologia (INMET) representativas da área de concessão da ENEL DISTRIBUIÇÃO GOIÁS. Como é possível observar, o maior valor registrado foi de 66,6 km/h na estação de Monte Alegre de Goiás entre as 12h e 13h do dia 02 de novembro, vento classificado como ventania pela escala Beaufort.

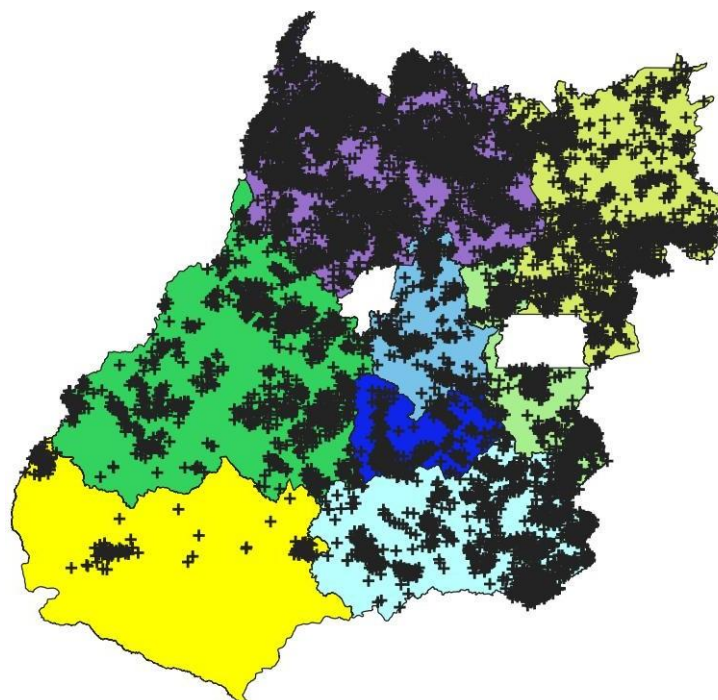
Tabela 1 – Rajadas de vento maiores ou iguais a 50 km/h registradas pelo INMET. Segundo a escala Beaufort, ventos entre 50 e 61 km/h são classificados como vento forte e entre 62 e 74 km/h como ventania.

Estação	Horário	Rajada (km/h)
Monte Alegre de Goiás	Entre 12h e 13h do dia 2/11/2020	66.6
Monte Alegre de Goiás	Entre 13h e 14h do dia 2/11/2020	65.9
Morrinhos	Entre 15h e 16h do dia 31/10/2020	52.2
Morrinhos	Entre 16h e 17h do dia 31/10/2020	52.2

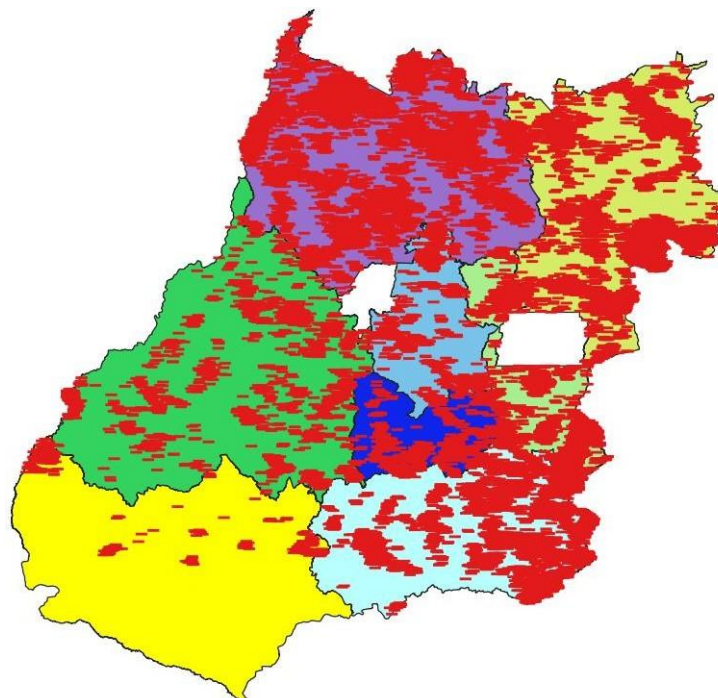
Estações do Instituto Nacional de Meteorologia (INMET), representativas da área de concessão da ENEL DISTRIBUIÇÃO GOIÁS, registraram chuva forte (segundo a American Meteorological Society - Sociedade Meteorológica Americana -, chuvas com taxa entre 2,5mm a 7,6 mm por hora são consideradas moderadas e aquelas com taxa superior a 7,6 mm por hora são consideradas chuva forte). Na tabela 2 são apresentados os registros de acumulados horários superiores a 7,6 mm. Na cidade de Goiás foram acumulados em apenas duas horas (entre 06h00 e 08h00 do dia 31 de outubro) 70,8 mm, volume que corresponde a aproximadamente 48% da média climatológica para todo o mês de outubro na região.

Nas tabelas de 3 a 7 são apresentados os acumulados diários registrados pelas estações do INMET. Como é possível observar, entre as 09h00 do dia 30 e as 09h00 do dia 31 de outubro (horário de Brasília) foram acumulados 85,8 mm na estação de Goiás, aproximadamente 58% da média climatológica de chuva para um mês de outubro na região. Entre as 09h00 do dia 01 e as 09h00 do dia 02 de novembro foram acumulados 48,6 mm em Posse, acumulado que corresponde a quase 41% da média para o mês.

Tabela 2 – Acumulado horário de chuva registrada pelo INMET.

Estação	Horário	Precipitação (mm)
Alto Paraíso de Goiás	Entre 3h e 4h do dia 31/10/2020	8.6
Alto Paraíso de Goiás	Entre 5h e 6h do dia 31/10/2020	10.6
Alto Paraíso de Goiás	Entre 7h e 8h do dia 31/10/2020	12.6
Alto Paraíso de Goiás	Entre 8h e 9h do dia 31/10/2020	11.6
Alto Paraíso de Goiás	Entre 14h e 15h do dia 2/11/2020	11.6
Alto Paraíso de Goiás	Entre 15h e 16h do dia 2/11/2020	10.2
Alto Paraíso de Goiás	Entre 16h e 17h do dia 2/11/2020	8.0
Alto Paraíso de Goiás	Entre 16h e 17h do dia 5/11/2020	16.4
Catalão	Entre 14h e 15h do dia 3/11/2020	9.2
Goiás	Entre 12h e 13h do dia 30/10/2020	8.4
Goiás	Entre 6h e 7h do dia 31/10/2020	41.8
Goiás	Entre 7h e 8h do dia 31/10/2020	29.0
Goiás	Entre 10h e 11h do dia 31/10/2020	8.8
Itumbiara	Entre 22h e 23h do dia 30/10/2020	11.8
Monte Alegre de Goiás	Entre 6h e 7h do dia 31/10/2020	8.2
Morrinhos	Entre 15h e 16h do dia 30/10/2020	13.0
Posse	Entre 2h e 3h do dia 31/10/2020	8.6
Posse	Entre 7h e 8h do dia 31/10/2020	17.4
Posse	Entre 8h e 9h do dia 31/10/2020	10.4
Posse	Entre 17h e 18h do dia 1/11/2020	9.0
Posse	Entre 18h e 19h do dia 1/11/2020	24.8
Posse	Entre 20h e 21h do dia 1/11/2020	9.6
Posse	Entre 13h e 14h do dia 2/11/2020	22.0
Silvânia	Entre 12h e 13h do dia 31/10/2020	17.0

Tabela 3 – Precipitação acumulada entre 09h do dia 30 e 09h do dia 31 de outubro de 2020. FONTE: INMET

Estação	Precipitação Acumulada(mm)
GOIÁS	85.8
ALTO PARAISO DE GOIAS	76
MONTE ALEGRE DE GOIAS	59.2
POSSE	45.4
FORMOSA	39.0
POSSE	38.0
RIO VERDE	26
JATAI	20.0

Tabela 4 – Precipitação acumulada entre 09h do dia 31 de outubro e 09h do dia 01 de novembro de 2019. FONTE: INMET

Estação	Precipitação Acumulada(mm)
SILVANIA	28.4
GOIÁS	23.0

Tabela 5 – Precipitação acumulada entre 09h do dia 01 e 09h do dia 02 de novembro de 2019. FONTE: INMET

Estação	Precipitação Acumulada(mm)
POSSE	48.6

Tabela 6 – Precipitação acumulada entre 09h do dia 02 e 09h do dia 03 de novembro de 2019. FONTE: INMET

Estação	Precipitação Acumulada(mm)
ALTO PARAISO DE GOIAS	40
CRISTALINA (FAZENDA SANTA MÔNICA)	40
POSSE	33.8
FORMOSA	24.0

Tabela 7 – Precipitação acumulada entre 09h do dia 03 e 09h do dia 04 de novembro de 2019. FONTE: INMET

Estação	Precipitação Acumulada(mm)
CATALAO	29.0

1.2. Abrangência do Evento

A seguir são apresentadas as imagens realçadas do satélite GOES-16 entre as 11h00 do dia 30 e 18h00 do dia 05 de novembro de 2020. Os tons em vermelho e preto indicam a presença de nuvens de grande desenvolvimento vertical, geralmente associadas à ocorrência de tempo severo.

11h00 - 30 de Outubro de 2020 - BRT



Figura 4 – Imagens realçadas do satélite GOES-16 das 11h00 do dia 30 de Outubro de 2020.
FONTE: Cptec/INPE.

15h00 - 30 de Outubro de 2020 - BRT

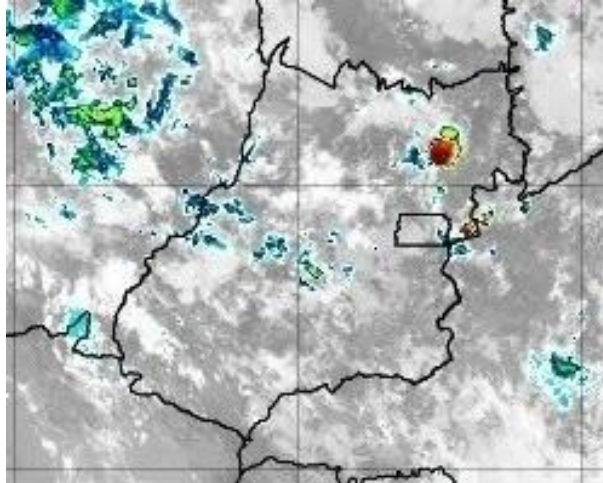

Figura 5 – Imagens realçadas do satélite GOES-16 das 15h00 do dia 30 de Outubro de 2020.
FONTE: Cptec/INPE.

19h00 - 30 de Outubro de 2020 - BRT

Figura 6 – Imagens realçadas do satélite GOES-16 das 19h00 do dia 30 de Outubro de 2020. FONTE: Cptec/INPE.

23h00 - 30 de Outubro de 2020 - BRT

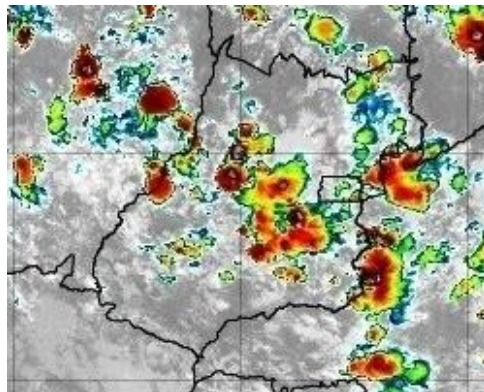
Figura 7 – Imagens realçadas do satélite GOES-16 das 23h00 do dia 30 de Outubro de 2020. FONTE: Cptec/INPE.

7h00 - 31 de Outubro de 2020 - BRT

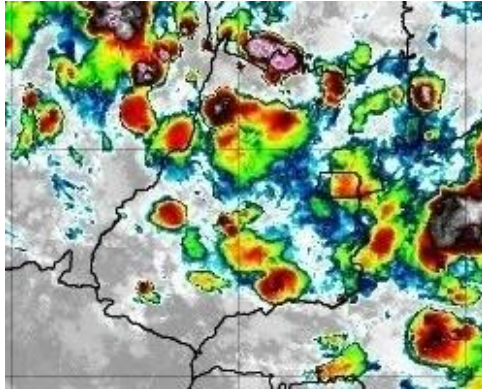
Figura 8 – Imagens realçadas do satélite GOES-16 das 7h00 do dia 31 de Outubro de 2020. FONTE: Cptec/INPE.

11h00 - 31 de Outubro de 2020 - BRT

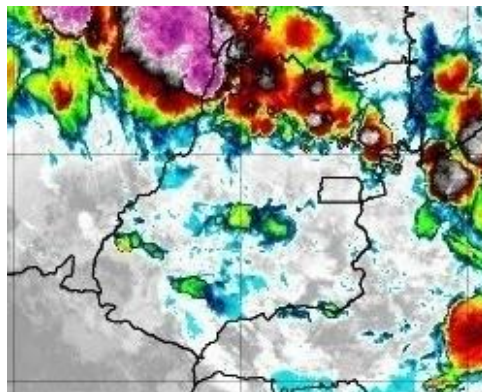
Figura 9 – Imagens realçadas do satélite GOES-16 das 11h00 do dia 31 de Outubro de 2020.
FONTE: Cptec/INPE.

15h00 - 31 de Outubro de 2020 - BRT

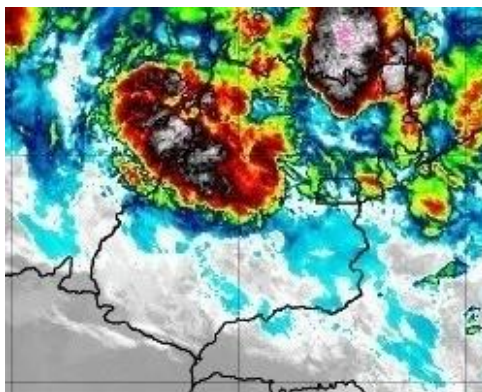
Figura 10 – Imagens realçadas do satélite GOES-16 das 15h00 do dia 31 de Outubro de 2020.
FONTE: Cptec/INPE.

19h00 - 31 de Outubro de 2020 - BRT

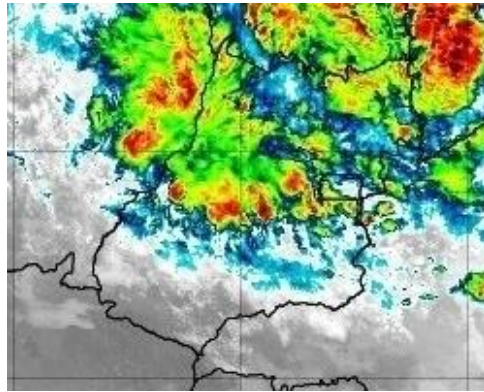
Figura 11 – Imagens realçadas do satélite GOES-16 das 19h00 do dia 31 de Outubro de 2020.
FONTE: Cptec/INPE.

0h00 - 01 de Novembro de 2020 - BRT

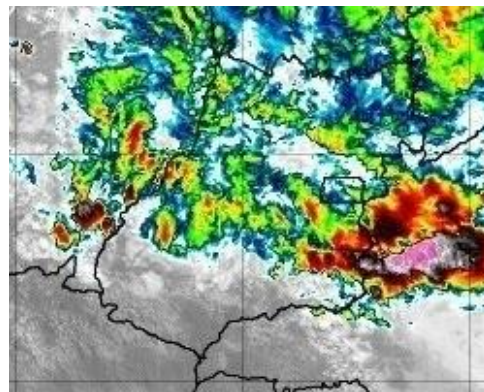
Figura 12 – Imagens realçadas do satélite GOES-16 das 0h00 do dia 01 de Novembro de 2020. FONTE: Cptec/INPE.

6h00 - 01 de Novembro de 2020 - BRT

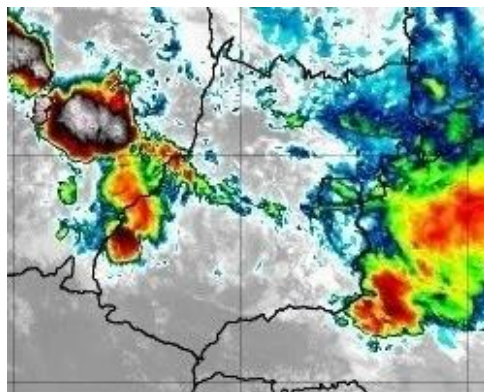
Figura 13 – Imagens realçadas do satélite GOES-16 das 6h00 do dia 01 de Novembro de 2020. FONTE: Cptec/INPE.

12h00 - 01 de Novembro de 2020 - BRT

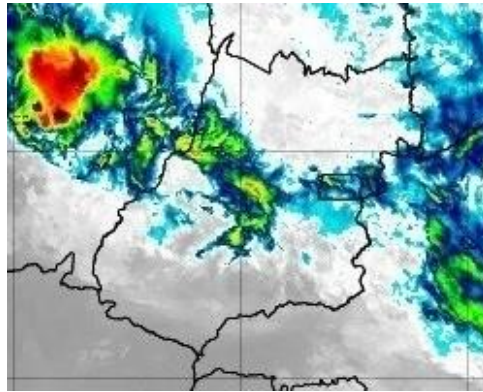
Figura 14 – Imagens realçadas do satélite GOES-16 das 12h00 do dia 01 de Novembro de 2020. FONTE: Cptec/INPE.

18h00 - 01 de Novembro de 2020 - BRT

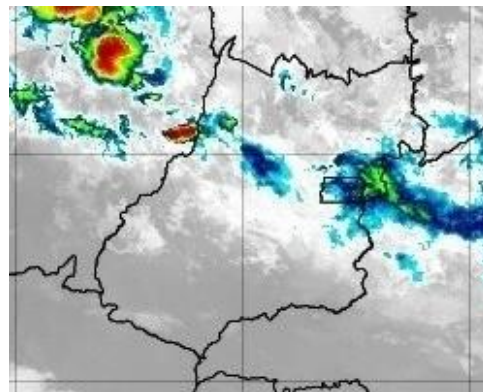
Figura 15 – Imagens realçadas do satélite GOES-16 das 18h00 do dia 01 de Novembro de 2020. FONTE: Cptec/INPE.

0h00 - 02 de Novembro de 2020 - BRT

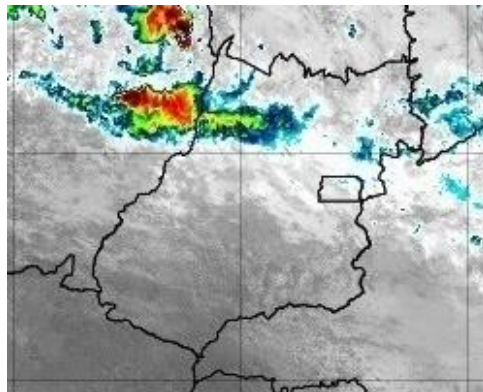
Figura 16 – Imagens realçadas do satélite GOES-16 das 0h00 do dia 02 de Novembro de 2020. FONTE: Cptec/INPE.

6h00 - 02 de Novembro de 2020 - BRT

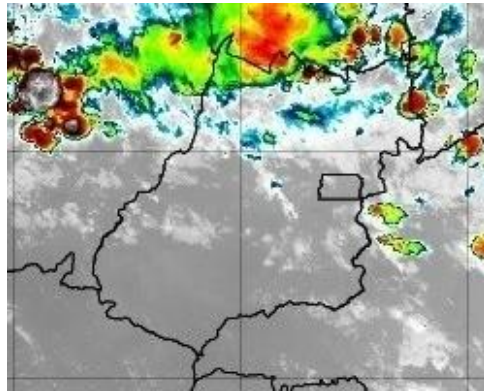
Figura 17 – Imagens realçadas do satélite GOES-16 das 6h00 do dia 02 de Novembro de 2020. FONTE: Cptec/INPE.

12h00 - 02 de Novembro de 2020 - BRT

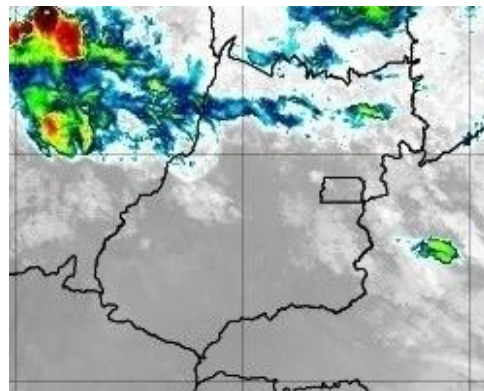
Figura 18 – Imagens realçadas do satélite GOES-16 das 12h00 do dia 02 de Novembro de 2020. FONTE: Cptec/INPE.

18h00 - 02 de Novembro de 2020 - BRT

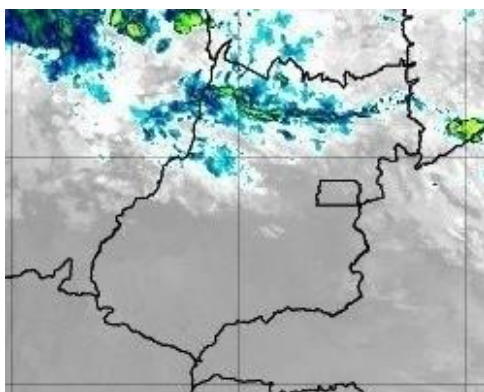
Figura 19 – Imagens realçadas do satélite GOES-16 das 18h00 do dia 02 de Novembro de 2020. FONTE: Cptec/INPE.

0h00 - 03 de Novembro de 2020 - BRT

Figura 20 – Imagens realçadas do satélite GOES-16 das 0h00 do dia 03 de Novembro de 2020. FONTE: Cptec/INPE.

6h00 - 03 de Novembro de 2020 - BRT

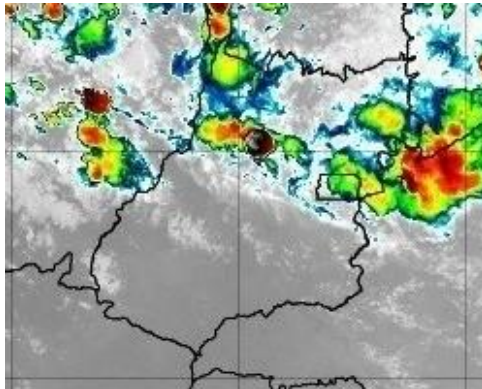
Figura 21 – Imagens realçadas do satélite GOES-16 das 6h00 do dia 03 de Novembro de 2020. FONTE: Cptec/INPE.

12h00 - 03 de Novembro de 2020 - BRT

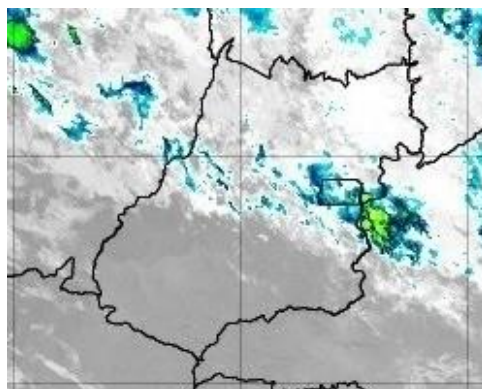
Figura 22 – Imagens realçadas do satélite GOES-16 das 12h00 do dia 03 de Novembro de 2020. FONTE: Cptec/INPE.

18h00 - 03 de Novembro de 2020 - BRT

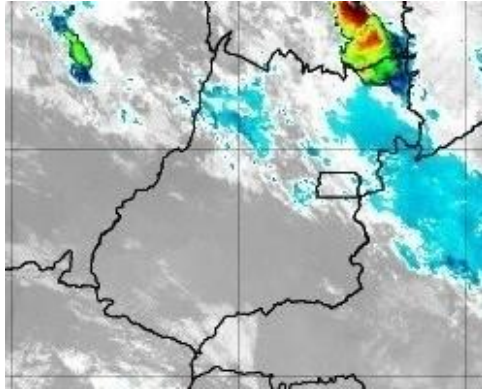
Figura 23 – Imagens realçadas do satélite GOES-16 das 18h00 do dia 03 de Novembro de 2020. FONTE: Cptec/INPE.

0h00 - 04 de Novembro de 2020 - BRT

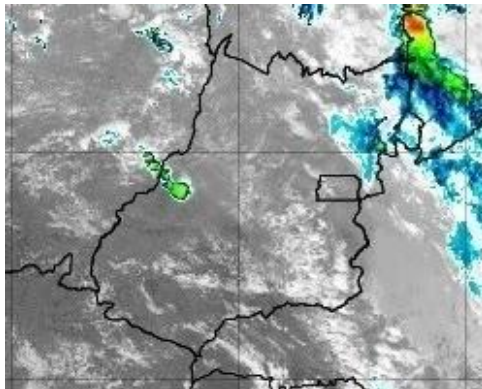
Figura 24 – Imagens realçadas do satélite GOES-16 das 0h00 do dia 04 de Novembro de 2020. FONTE: Cptec/INPE.

6h00 - 04 de Novembro de 2020 - BRT

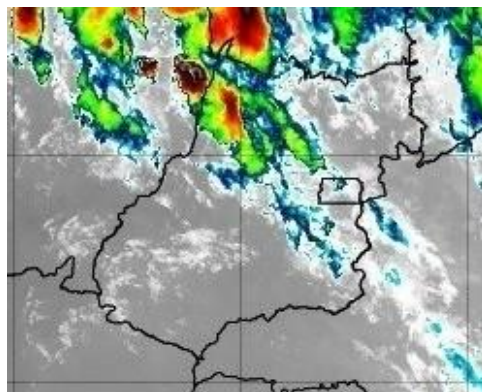
Figura 25 – Imagens realçadas do satélite GOES-16 das 6h00 do dia 04 de Novembro de 2020. FONTE: Cptec/INPE.

12h00 - 04 de Novembro de 2020 - BRT

Figura 26 – Imagens realçadas do satélite GOES-16 das 12h00 do dia 04 de Novembro de 2020. FONTE: Cptec/INPE.

18h00 - 04 de Novembro de 2020 - BRT

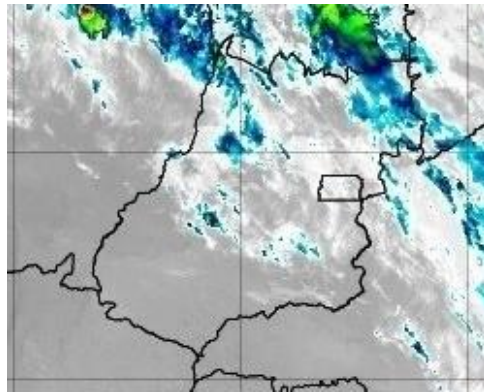
Figura 27 – Imagens realçadas do satélite GOES-16 das 18h00 do dia 04 de Novembro de 2020. FONTE: Cptec/INPE.

0h00 - 05 de Novembro de 2020 - BRT

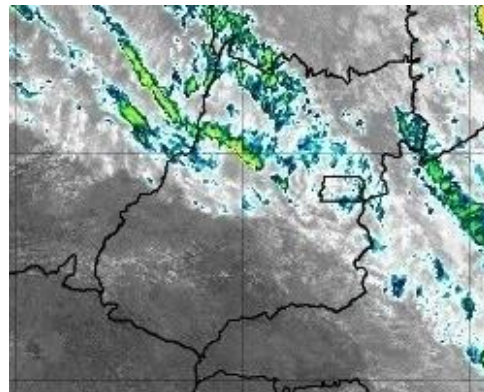
Figura 28 – Imagens realçadas do satélite GOES-16 das 0h00 do dia 05 de Novembro de 2020. FONTE: Cptec/INPE.

6h00 - 05 de Novembro de 2020 - BRT

Figura 29 – Imagens realçadas do satélite GOES-16 das 6h00 do dia 05 de Novembro de 2020. FONTE: Cptec/INPE.

12h00 - 05 de Novembro de 2020 - BRT

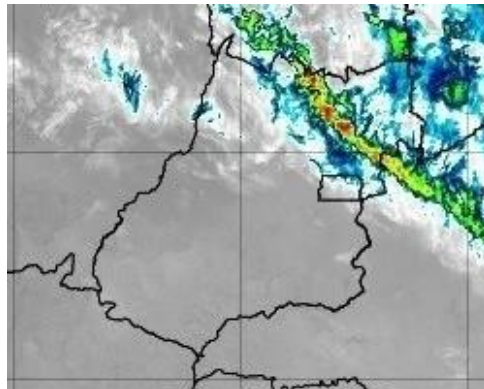

Figura 30 – Imagens realçadas do satélite GOES-16 das 12h00 do dia 05 de Novembro de 2020. FONTE: Cptec/INPE.

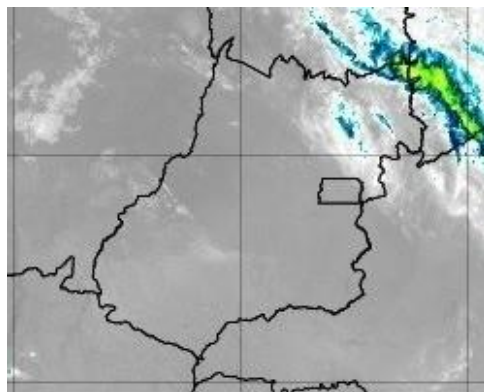
18h00 - 05 de Novembro de 2020 - BRT

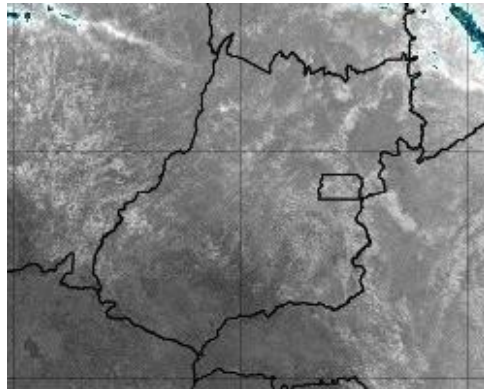

Figura 31 – Imagens realçadas do satélite GOES-16 das 18h00 do dia 05 de Novembro de 2020. FONTE: Cptec/INPE.

2. Classificação COBRADE

O COBRADE (Classificação e Codificação Brasileira de Desastres) foi criado com o intuito de adequar a classificação brasileira à classificação utilizada pela ONU na classificação de desastres e nivelar o país aos demais organismos de gestão de desastres do mundo.

Baseados nos dados analisados nos itens anteriores, podemos classificar o evento ocorrido sobre a área de concessão da ENEL DISTRIBUIÇÃO GOIÁS como Zona de Convergência (Código 1.3.1.2.0).

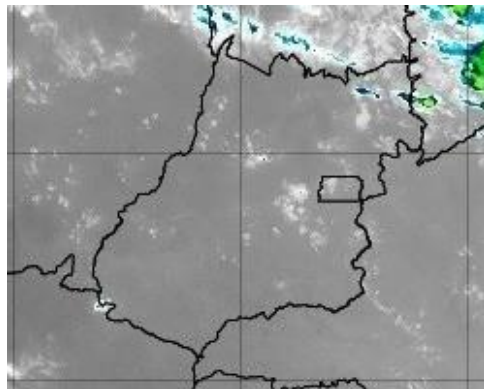
3. Resumo do Evento

Nuvens de tempestade associadas a formação e manutenção de uma Zona de Convergência do Atlântico Sul atuaram sobre o estado de Goiás entre o fim da manhã do dia 30 e a noite do dia 05 de novembro de 2020.

O sistema de detecção da Earth Networks registrou 50980 descargas atmosféricas sobre a área de concessão da ENEL em Goiás entre as 09h40 do dia 30 de outubro e 19h10 do dia 05 de novembro de 2020.

Rajadas de vento classificadas como vento forte e ventania pela escala Beaufort foram registrados em estações do INMET representativas da região durante o período. Na cidade de Monte Alegre de Goipas rajadas de até 66,6 km/h foram registradas na tarde do dia 02 de novembro.

Chuvas volumosas também foram registradas pelo INMET durante o evento. Em apenas duas horas a estação de Goias acumulou o equivalente a 48% da média de chuva para o mês. Entre as 06h e 08h do dia 31 de outubro acumulou-se 70,8 mm.

Tabela 8 – Resumo do evento Regional Rio Verde

Número/Código do Evento	
Número/Código do Relatório	
Descrição	Região ligada à tempestade causada por uma zona de baixa pressão atmosférica, provocando forte deslocamento de massas de ar, vendavais, chuvas intensa e possível queda de granizo.
Código COBRADE	1.3.1.2.0 – Zona de Convergência
Hora início do evento	15h30 do dia 30 de outubro de 2020
Hora fim do evento	19h30 do dia 31 de outubro de 2020
Abrangência	Regional Rio Verde

Tabela 9 – Resumo do evento Regional Morrinhos

Número/Código do Evento	
Número/Código do Relatório	
Descrição	Região ligada à tempestade causada por uma zona de baixa pressão atmosférica, provocando forte deslocamento de massas de ar, vendavais, chuvas intensa e possível queda de granizo.
Código COBRADE	1.3.1.2.0 – Zona de Convergência
Hora início do evento	11h00 do dia 30 de outubro de 2020
Hora de fim do evento	18h30 do dia 03 de novembro de 2020
Abrangência	Regional Morrinhos

Tabela 10 – Resumo do evento Regional Metropolitana e Goiânia

Número/Código do Evento	
Número/Código do Relatório	
Descrição	Região ligada à tempestade causada por uma zona de baixa pressão atmosférica, provocando forte deslocamento de massas de ar, vendavais, chuvas intensa e possível queda de granizo.
Código COBRADE	1.3.1.2.0 – Zona de Convergência
Hora início do evento	11h30 do dia 30 de outubro de 2020
Hora de fim do evento	19h30 do dia 03 de novembro de 2020
Abrangência	Regional Metropolitana e Goiânia

Tabela 11 – Resumo do evento Regional Iporá

Número/Código do Evento	
Número/Código do Relatório	
Descrição	Região ligada à tempestade causada por uma zona de baixa pressão atmosférica, provocando forte deslocamento de massas de ar, vendavais, chuvas intensa e possível queda de granizo.
Código COBRADE	1.3.1.2.0 – Zona de Convergência
Hora início do evento	11h00 do dia 30 de outubro de 2020
Hora de fim do evento	06h30 do dia 04 de novembro de 2020
Abrangência	Regional Iporá

Tabela 12 – Resumo do evento Regional Luziânia

Número/Código do Evento	
Número/Código do Relatório	
Descrição	Região ligada à tempestade causada por uma zona de baixa pressão atmosférica, provocando forte deslocamento de massas de ar, vendavais, chuvas intensa e possível queda de granizo.
Código COBRADE	1.3.1.2.0 – Zona de Convergência
Hora início do evento	12h00 do dia 30 de outubro de 2020
Hora de fim do evento	19h00 do dia 04 de novembro de 2020
Abrangência	Regional Luziânia

Tabela 13 – Resumo do evento Regional Anápolis

Número/Código do Evento	
Número/Código do Relatório	
Descrição	Região ligada à tempestade causada por uma zona de baixa pressão atmosférica, provocando forte deslocamento de massas de ar, vendavais, chuvas intensa e possível queda de granizo.
Código COBRADE	1.3.1.2.0 – Zona de Convergência
Hora início do evento	11h30 do dia 30 de outubro de 2020
Hora de fim do evento	19h00 do dia 04 de novembro de 2020
Abrangência	Regional Anápolis

Tabela 14 – Resumo do evento Regional Uruaçu

Número/Código do Evento	
Número/Código do Relatório	
Descrição	Região ligada à tempestade causada por uma zona de baixa pressão atmosférica, provocando forte deslocamento de massas de ar, vendavais, chuvas intensa e possível queda de granizo.
Código COBRADE	1.3.1.2.0 – Zona de Convergência
Hora início do evento	11h00 do dia 30 de outubro de 2020
Hora de fim do evento	16h00 do dia 04 de novembro de 2020
Abrangência	Regional Uruaçu

Tabela 15 – Resumo do evento Regional Formosa

Número/Código do Evento	
Número/Código do Relatório	
Descrição	Região ligada à tempestade causada por uma zona de baixa pressão atmosférica, provocando forte deslocamento de massas de ar, vendavais, chuvas intensa e possível queda de granizo.
Código COBRADE	1.3.1.2.0 – Zona de Convergência
Hora início do evento	09h30 do dia 30 de outubro de 2020
Hora de fim do evento	19h30 do dia 05 de novembro de 2020
Abrangência	Regional Formosa

4. Referências

- RMets Royal Meteorological Society – Beaufort Scale -

<https://www.rmets.org/weather-and-climate/observing/beaufort-scale>

- Instituto Nacional de Meteorologia (INMET) - <http://www.inmet.gov.br>

- Cptec/INPE

<https://www.cptec.inpe.br/>

- Centro de Hidrografia da Marinha do Brasil -

<https://www.marinha.mil.br/chm/>

- Meteorology Glossary - American Meteorological Society -

<http://glossary.ametsoc.org/>

Anexos

A.1. Carta Sinótica

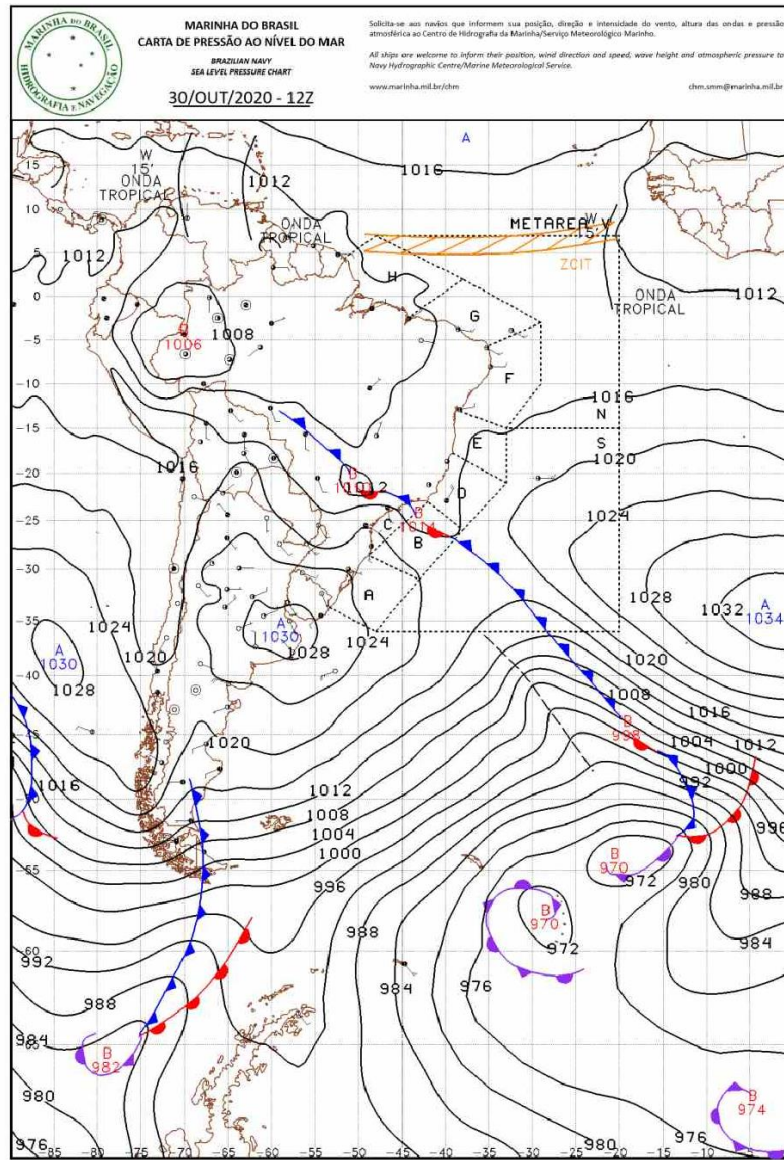

LEGENDA			
	Frente Fria	A	Alta Pressão
	Frente Quente	B	Baixa Pressão
	Instabilidade		Zona de Convergência

Figura A1 - Carta sinótica da Marinha do Brasil para as 1200Z do dia 30 de outubro de 2020 (09h00 do dia 30 de outubro de 2020, hora local).



Figura A2 - Carta sinótica da Marinha do Brasil para as 1200Z do dia 31 de outubro de 2020 (09h00 do dia 31 de outubro de 2020, hora local).



LEGENDA			
	Frente Fria	A	Alta Pressão
	Frente Quente	B	Baixa Pressão
	Instabilidade		Zona de Convergência

Figura A3 - Carta sinótica da Marinha do Brasil para as 1200Z do dia 01 de novembro de 2020 (09h00 do dia 01 de novembro de 2020, hora local).

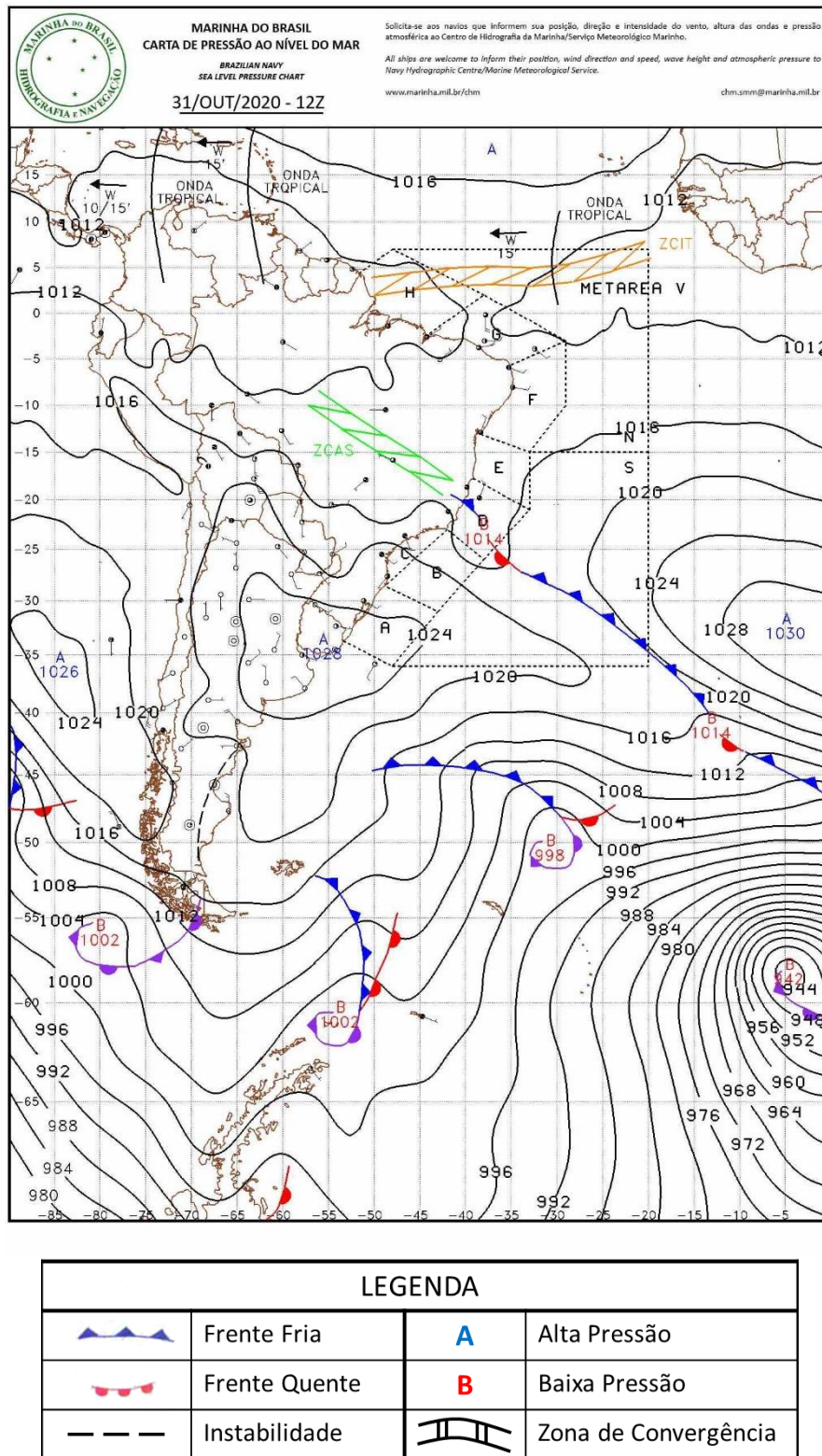
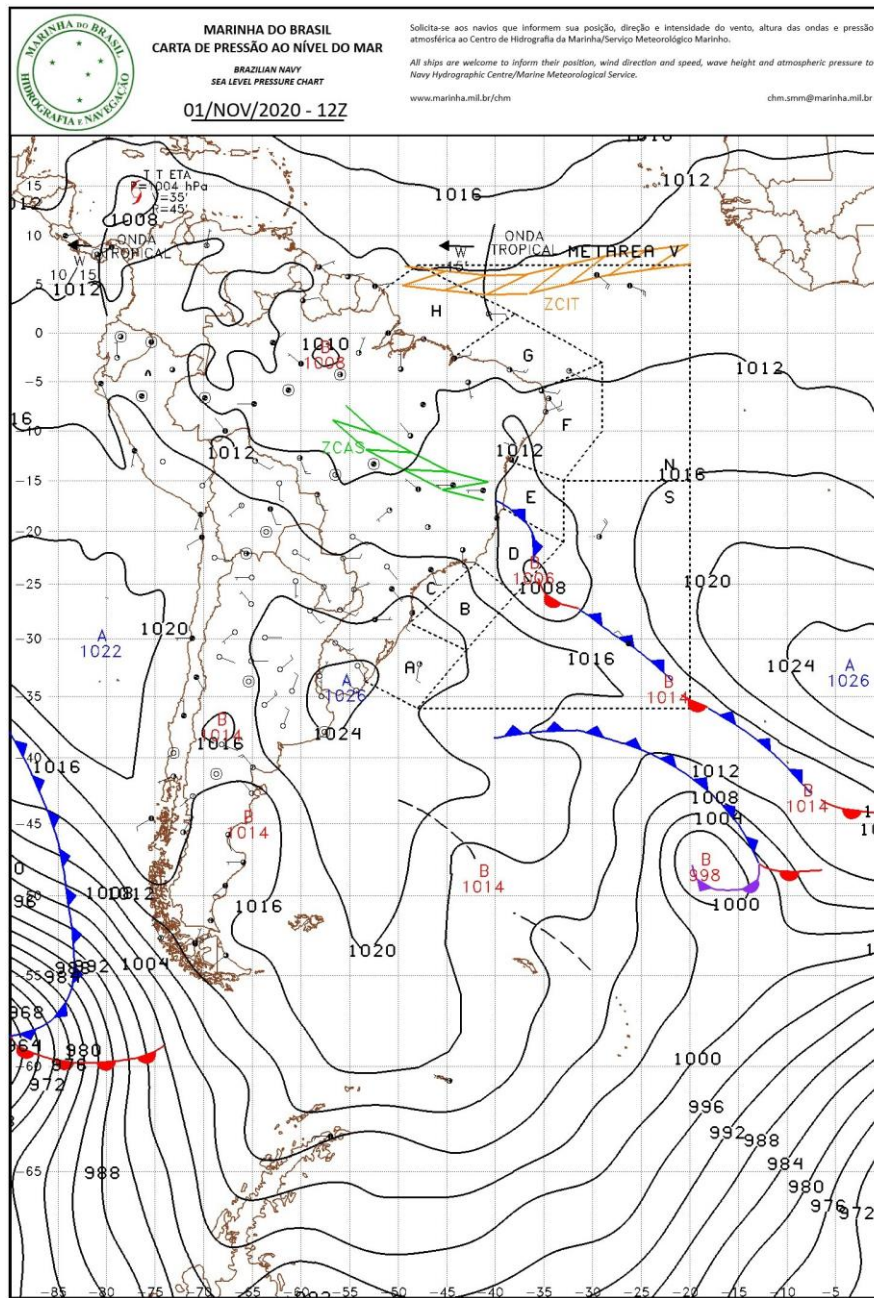
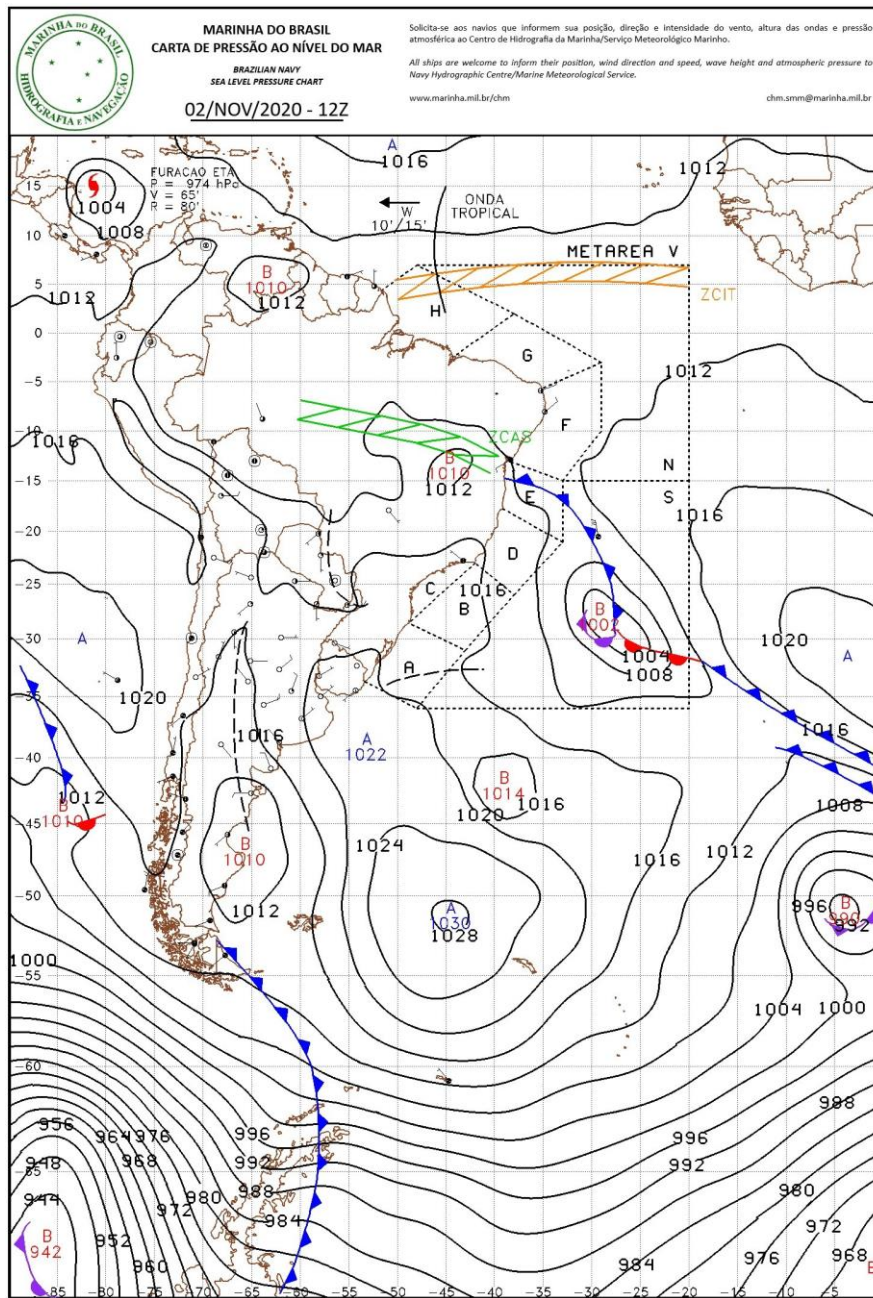

LEGENDA			
	Frente Fria	A	Alta Pressão
	Frente Quente	B	Baixa Pressão
	Instabilidade		Zona de Convergência

Figura A4 - Carta sinótica da Marinha do Brasil para as 1200Z do dia 02 de novembro de 2020 (09h00 do dia 02 de novembro de 2020, hora local).



Figura A5 - Carta sinótica da Marinha do Brasil para as 1200Z do dia 03 de novembro de 2020 (09h00 do dia 03 de novembro de 2020, hora local).



Figura A6 - Carta sinótica da Marinha do Brasil para as 1200Z do dia 04 de novembro de 2020 (09h00 do dia 04 de novembro de 2020, hora local).

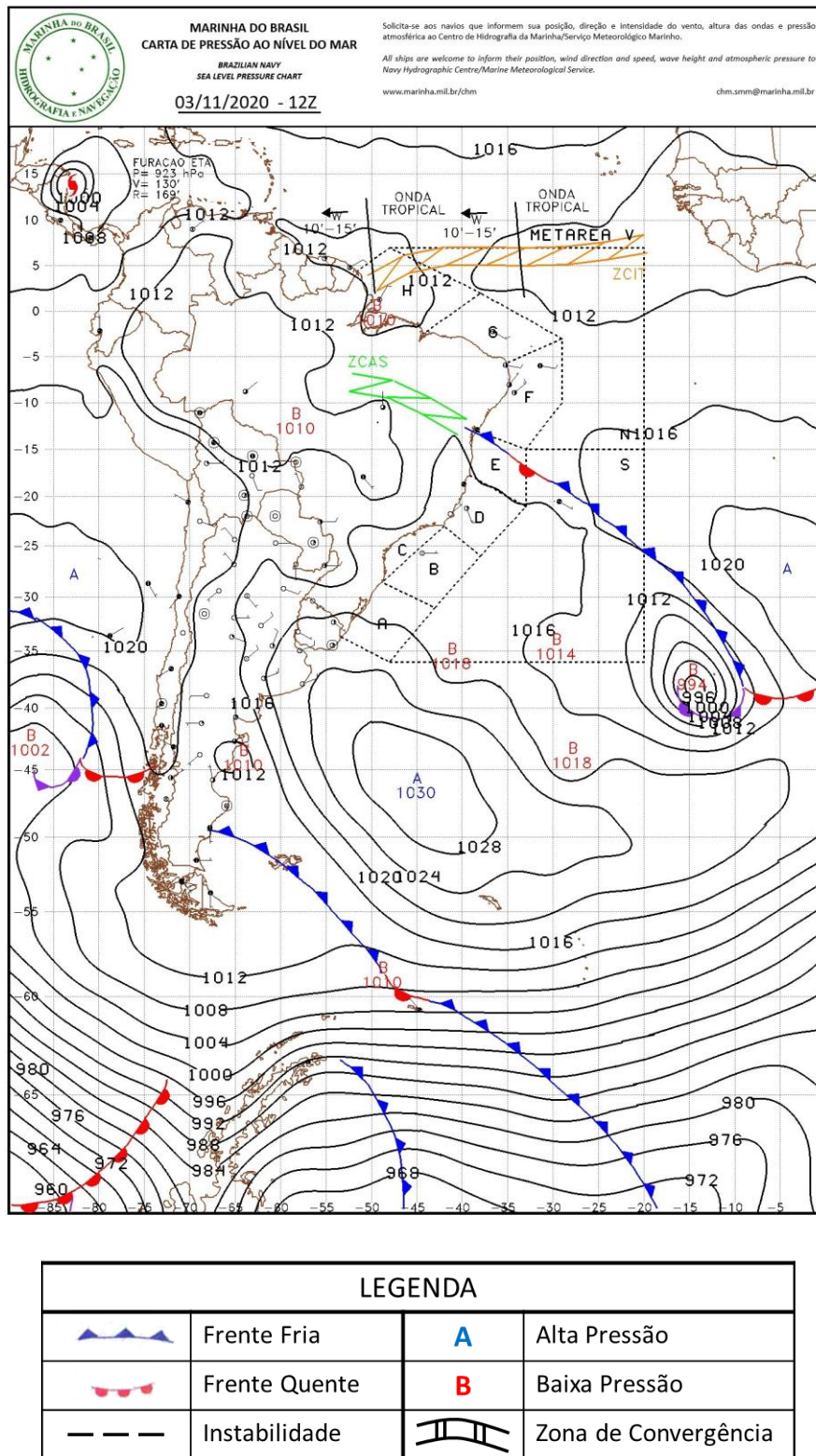

LEGENDA			
	Frente Fria	A	Alta Pressão
	Frente Quente	B	Baixa Pressão
	Instabilidade		Zona de Convergência

Figura A7 - Carta sinótica da Marinha do Brasil para as 1200Z do dia 05 de novembro de 2020 (09h00 do dia 05 de novembro de 2020, hora local).

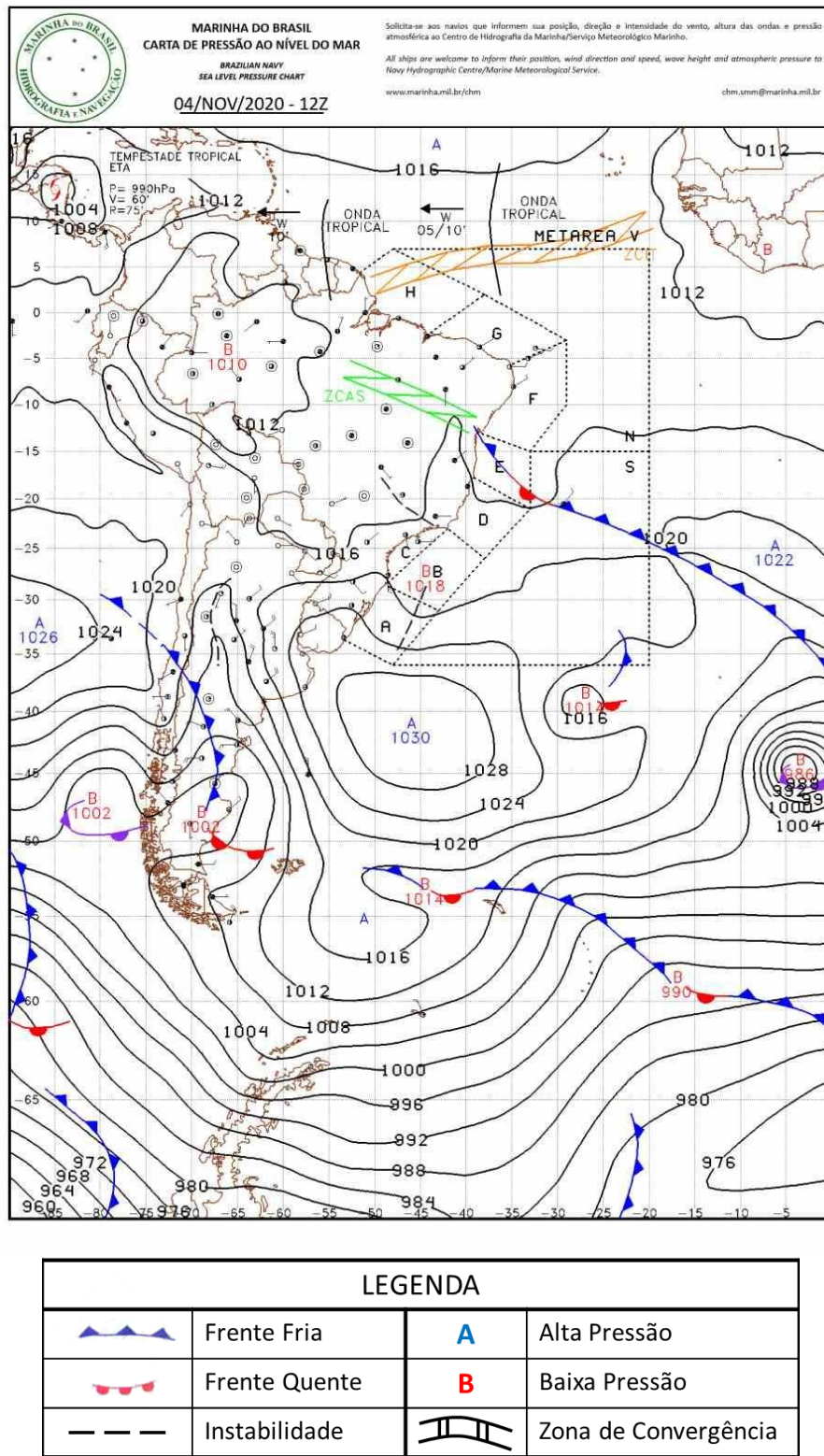
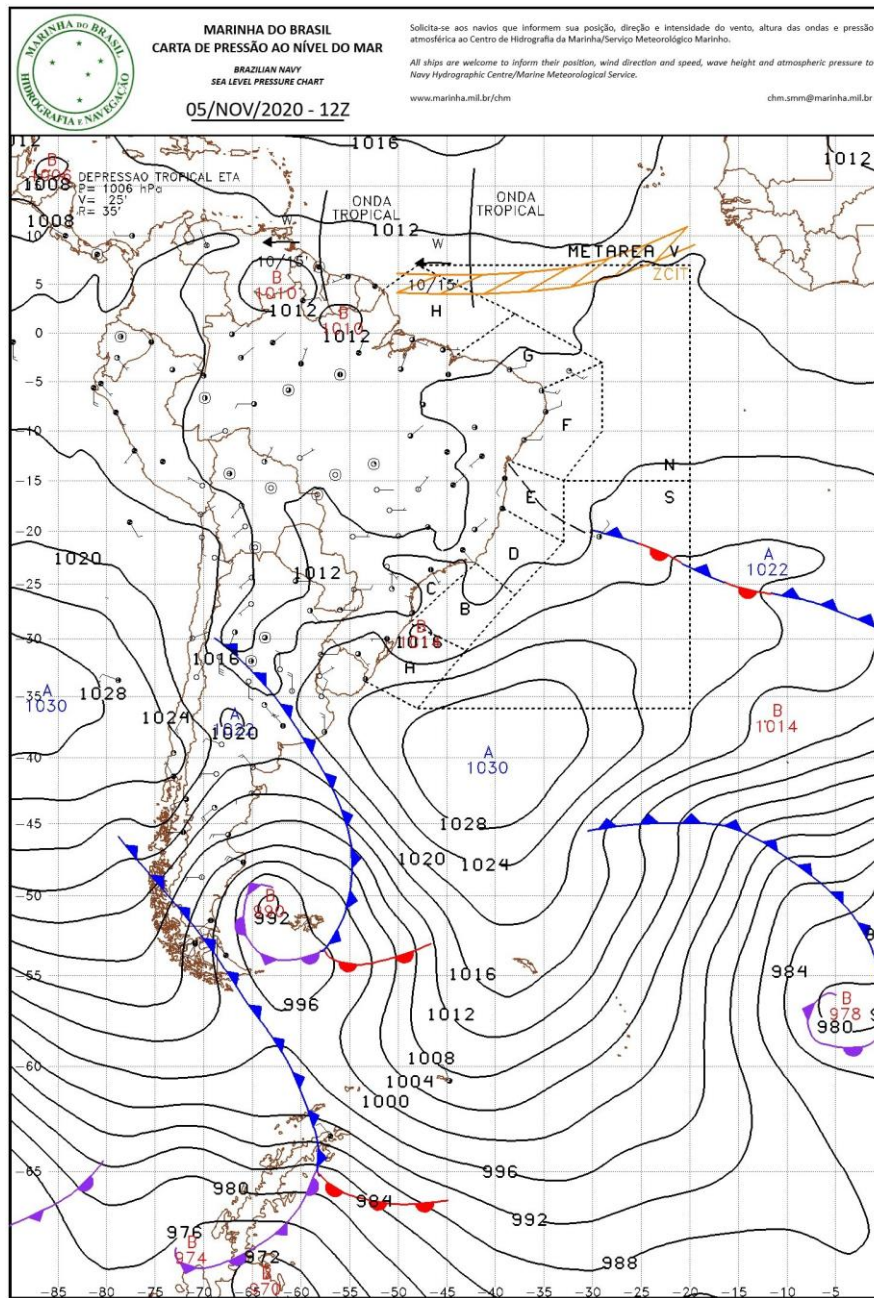
A.2. Notícias associadas

- Forte chuva em Luziânia provoca destruição no pátio da Polícia Militar e estragos no Hospital de Campanha

<https://diariodegoias.com.br/fortes-chuvas-em-luziania-provoca-transtornos-no-patio-da-policia-militar-do-municipio/>

- Chuva forte causa desabamento em batalhão da PM, em Luziânia

<http://ohoje.com/noticia/cidades/n/182003/t/chuva-forte-causa-desabamento-em-batalhao-da-pm-em-luziania>

- Telhado do Centro de Operações da Polícia Militar desaba no Entorno

<https://www.metropoles.com/distrito-federal/telhado-do-centro-de-operacoes-da-policia-militar-desaba-no-entorno>

Bianca Lobo Silva
Meteorologista CREA
5063840461

