

ENEL DISTRIBUIÇÃO GOLÁS



Relatório de Evento em Situação de Emergência

Nº CHI-054

1.	INTRODUÇÃO.....	3
2.	DEFINIÇÃO	3
3.	RESUMO EXECUTIVO.....	5
3.1.	RELATÓRIO DE OCORRÊNCIAS DO PERÍODO.....	5
4.	LISTA DE OCORRÊNCIAS	9
5.	PLOTAGEM DAS OCORRÊNCIAS CONFORME A ESPACIALIZAÇÃO DAS CHUVAS.....	46
6.	CLIENTES AFETADOS E IMPACTOS GLOBAIS	47
7.	DIAGRAMAS UNIFILARES	48
8.	DEMAIS EVIDÊNCIAS	54
8.1.	DADOS TÉCNICO - OPERACIONAIS ENEL GO.....	54
8.2.	DADOS CLIMATOLÓGICOS PELO INMET	56
9.	NOTÍCIAS RELACIONADAS.....	59
10.	LAUDO TÉCNICO	61

1. Introdução

As concessionárias do serviço público de distribuição de energia elétrica devem prover o serviço de forma adequada, buscando sempre a eficiência, conforme disposto na legislação e nos respectivos contratos de concessão.

Dentre a legislação vigente, destacam-se os Procedimentos de Distribuição de Energia Elétrica no Sistema Elétrico Nacional – PRODIST, que consistem em documentos elaborados pela Agência Nacional de Energia Elétrica – ANEEL, com a participação dos agentes de distribuição e de outras entidades e associações do setor elétrico nacional, que normatizam e padronizam as atividades técnicas relacionadas ao funcionamento e desempenho dos sistemas de distribuição de energia elétrica.

O Módulo 8 do PRODIST – Revisão 11, mais especificamente em sua Seção 8.2, regulamenta a qualidade do serviço prestado pelas distribuidoras de energia elétrica, estabelecendo a metodologia para apuração dos indicadores de continuidade e dos tempos de atendimento a ocorrências emergenciais.

O referido regulamento prevê que, na apuração dos indicadores coletivos e individuais deverão ser consideradas todas as interrupções de longa duração que atingirem as unidades consumidoras, admitidas algumas exceções (denominadas expurgos), que podem ser encontradas no Item 5.6.2.2 da seção 8.2 do Módulo 8 do PRODIST, transcrito abaixo:

5.6.2.2 Na apuração dos indicadores DEC e FEC devem ser consideradas todas as interrupções, admitidas apenas as seguintes exceções:

i. falha nas instalações da unidade consumidora que não provoque interrupção em instalações de terceiros;

ii. interrupção decorrente de obras de interesse exclusivo do consumidor e que afete somente a unidade consumidora do mesmo;

iii. Interrupção em Situação de Emergência;

iv. suspensão por inadimplemento do consumidor ou por deficiência técnica e/ou de segurança das instalações da unidade consumidora que não provoque interrupção em instalações de terceiros, previstas em regulamentação;

v. vinculadas a programas de racionamento instituídos pela União;

vi. ocorridas em Dia Crítico;

vii. oriundas de atuação de Esquema Regional de Alívio de Carga estabelecido pelo ONS. [grifos nossos]

Para os casos de expurgo por Interrupção em Situação de Emergência (ISE), a alínea “h” do Item 5.12.1 da seção 8.2 do Módulo 8 do PRODIST estabelece a obrigatoriedade das distribuidoras em disponibilizar, em seu sítio eletrônico, relatórios digitais com as evidências do evento que tenha gerado tais interrupções enquadradas no inciso iii do Item 5.6.2.2 do mesmo.

Nesta seara, o presente documento, visa apresentar as evidências de um evento ocorrido na área de concessão da Eletropaulo, bem como informações relevantes a respeito das interrupções em Situação de Emergência decorrentes do mesmo.

Destaca-se que, para o entendimento completo das regras de apuração dos indicadores de continuidade e expurgos, faz-se necessário também a observação das regras contidas nos Módulos 1 e 6 do PRODIST. Todos os módulos destes procedimentos encontram-se disponíveis para consulta no site da ANEEL (www.aneel.gov.br) e as principais definições relacionadas ao tema estão contidas no item 2 deste documento.

2. Definição

Seção 1.2 do Módulo 1 do PRODIST – Revisão 10

2.198 Evento

Acontecimento que afete as condições normais de funcionamento de uma rede elétrica, podendo gerar uma ou mais interrupções no fornecimento de energia.

2.131 e 2.158 DIC

Duração de interrupção individual por unidade consumidora, ou seja, intervalo de tempo que, no período de apuração, em cada unidade consumidora ou ponto de conexão ocorreu descontinuidade da distribuição de energia elétrica.

2.216 e 2.220 FIC

Frequência de interrupção individual por unidade consumidora, ou seja, Número de interrupções ocorridas, no período de apuração, em cada unidade consumidora ou ponto de conexão.

2.87 Consumidor Hora Interrompido (CHI):

Somatório dos DICs dos consumidores atingidos por interrupção no fornecimento de energia, expresso em horas e centésimos de horas.

2.251 Interrupção em Situação de Emergência:

Interrupção originada no sistema de distribuição, resultante de Evento que comprovadamente impossibilite a atuação imediata da distribuidora e que não tenha sido provocada ou agravada por esta e que seja:

- Decorrentes de evento associado a Decreto de Declaração de Situação de Emergência ou Estado de Calamidade Pública emitido por órgão competente; ou
- Decorrentes de Evento cuja soma do CHI das interrupções ocorridas no sistema de distribuição seja superior ao calculado conforme equação a seguir:

$$2.612 \times N^{0,35}$$

N – número de unidades consumidoras faturadas e atendidas em BT ou MT, com 2 (duas) casas decimais, do mês de outubro do ano anterior ao período de apuração

3. Resumo Executivo

O Presente Relatório tem como objetivo a incorporação de informações que sejam relevantes para que se possa fazer a devida associação aos dados contidos no documento objeto da classificação de Situação de Emergência caracterizada pelo Módulo 8 do Prodist. Este enquadramento se apresenta na maioria das vezes em condições climáticas adversas com severidade dos fatores inerentes a situação, caracterizado na maioria dos casos por fortes ventos e chuvas de grande intensidade e continuidade.

A partir do final da manhã do dia 09/11/2020 – terça-feira – Nuvens de tempestade associadas ao ar quente e úmido, reforçadas por uma área de baixa pressão sobre o continente, avançaram sobre o estado de Goiás.

Conforme informações do Climatempo Meteorologia, o Instituto Nacional de Meteorologia (INMET) detectou rajadas de vento acima de 50km/h registradas por estações representativas da área de concessão da ENEL Distribuição Goiás. Na estação de Goiânia, o maior valor registrado foi de 57,6 km/h entre as 13h e 14h do dia 09 de novembro de 2020, classificada como vento forte, segundo a escala Beaufort.

O sistema de detecção da EarthNetworks registrou 21.271 descargas atmosféricas (3.982 nuvem-solo e 17.289 nuvem-nuvem) sobre a área de concessão da ENEL em Goiás entre as 11h45 do dia 09 de novembro de 2020 e 09h30 do dia 10 de novembro de 2020, causando grande instabilidade na rede.

Chuva forte foi registrada pelo INMET em estações representativas da área de concessão da ENEL Distribuição Goiás. Na estação de Itumbiara foram acumulados 15,8 mm de chuva entre as 20h e as 21h do dia 09 de novembro de 2020.

3.1. Relatório de Ocorrências do período

Em todo o Estado de Goiás verificou-se também que a intensidade da chuva e dos ventos danificaram a rede de distribuição de energia elétrica em diversos pontos, registrando aproximadamente 174 mil clientes com interrupção no fornecimento de energia elétrica devido a eventos relacionados ao temporal, afetando 217 municípios e 264 Subestações.

Para otimizar o volume de atendimentos e reduzir os tempos de interrupção foram mobilizados os recursos extras da empresa que aumentou o contingente em relação a situação normal de operação. O acompanhamento da quantidade de equipes e o Tempo Médio de Atendimento podem ser consultados na Pág.08 do Relatório em anexo.

O impacto e severidade do evento estão relatados em artigos de mídia, como fotos e reportagens que demonstram os danos na Rede de Distribuição, oriundos dos eventos climáticos no período. Eventos estes que afetaram 173.740 consumidores com CHI de 563.821,20 superior ao de 482.597,74 estabelecido como limite para definição de Situação de Emergência, conforme resumo das informações obrigatórias.

Empresa		ENEL DISTRIBUIÇÃO GOIÁS			
Código do Relatório		CHI-054 - ENEL DISTRIBUIÇÃO GOIÁS			
Evento:		TEMPORAL NA AREA DE CONCESSÃO DA ENEL DISTRIBUIÇÃO GOIAS			
Código COBRADE:	1.3.1.2.0	Data Inicio	09/11/2020	Hora início	11h30
Código do Evento:	CHI-054-ENEL GO	Data Término	10/11/2020	Hora Término	10h00
Valor CHI (Limite e Real)	482.597,74	563.821,20			
Código do Decreto (Se Houver):					
Quantidade de Interrupções (Evento)		1.841			
Início 1ª Incidência (Data e Hora)	09/11/2020 11:53	Subestações Atingidas	ABADIANIA / ACREUNA / ADELANDIA / AEROPORTO / AGUA LIMPA (MARZAGAO) / AGUAS LINDAS / ALEXANIA / ALEXANIA TRANSMISSAO / ALMERINDONOPOLIS / ALTO HORIZONTE / ALTO PARAISO DE GOIAS / ALVORADA DO NORTE / AMERICANO DO BRASIL / AMORINOPOLIS / ANAPOLIS UNIVERSITARIA / ANHANGUERA / ANICUNS / ANTONIO DO VITTO / APARECIDA DO RIO DOCE / APORE / ARACU / ARAGARCAS / ARAGOIANIA / ARAGUAPAZ / ARARAS / AREIAS / ARENOPOLIS / ARUANA / ASA BRANCA / ATLANTICO / AURILANDIA / AVELINOPOLIS / BACURI (RIO VERDE) / BARBOSELANDIA / BARCELONA / BARREIRO (PORANGATU) / BARRO ALTO / BELA VISTA (TRANSMISSAO) / BOA VISTA / BOM JARDIM / BOM JESUS DE GOIAS / BONOPOLIS / BRITANIA / BRITANIA (TRANSMISSAO) / BURITI ALEGRE / BURITI DE GOIAS / CABECEIRAS / CABRIUVA (RIO VERDE) / CACHOEIRA ALTA / CACHOEIRA DOURADA / CACHOEIRA NOVA / CACHOEIRINHA (ITARUMA) / CACU / CAIAPONIA / CALCILANDIA / CALDAS NOVAS / CALDAZINHA / CAMPINAS / CAMPINORTE / CAMPO ALEGRE DE GOIAS / CAMPO NOVO / CAMPOS BELOS / CAMPOS VERDES / CARAIBAS / CARAJAS / CATALAO / CEBRASA FABRICA DA AMBEV / CEPAIAGO / CEZARINA / CHAPADAO DO CEU / CIDADE OCIDENTAL / COCALZINHO / CORREGO DO OURO / CORUMBA / CORUMBAIBA / CRISTALINA / CRISTALINA TRANSMISSAO / CRISTIANOPOLIS / CRIXAS / CUMARI / DAIA - ANAPOLIS / DAVINOPOLIS / DESFECHO / DESTILARIA BRASIL CENTRAL / DOVERLANDIA / EDEALINA / EDEIA / ENERSUL / ESTRELA DO NORTE / FAINA / FAZENDA CANADA / FERROVIARIO / FIRMINOPOLIS / FLORES DE GOIAS / FORMIGA / FORMOSO / FRONTEIRA / GAMELEIRA / GIRASSOL / GOIANAPOLIS / GOIANDIRA / GOIANESIA / GOIANIA LESTE / GOIANIRA / GOIAS / GOIATUBA / GOUVERLANDIA / GOYA / GUAPO / HIDROLANDIA / IACIARA / INACIOLANDIA / INDEPENDENCIA / INDIARA / INHUMAS / IPAMERI / IPEGUARI / IPORA / ISRAELANDIA / ITABERAI / ITAGUARI / ITAGUARU / ITAJA / ITAPACI / ITAPACI (TRANSMISSAO) / ITAPIRAPUA / ITAPURANGA / ITARUMA / ITAUCU / ITIQUIRA (FORMOSA) / ITUMBIARA NOVA / ITUMBIARA VELHA / JACILANDIA / JANDAIA / JARAGUA / JATAI / JAUPACI / JOVIANIA / JUNDIAI / JUSCELANDIA / JUSSARA / LAGES / LEOPOLDO DE BULHOES / LUZIANIA / MAMBAI / MARA ROSA / MARAJOARA / MATO GRANDE / MATRINCHA / MAURILANDIA / MEIA PONTE / MINACU / MINEIROS / MINEIROS TRANSMISSAO / MOIPORA / MONTE ALEGRE / MONTIVIDIU T / MORRINHOS / MORRO AGUDO / MOSSAMEDES / MOZARLANDIA / MOZARLANDIA (TRANSMISSAO) / MUNDO NOVO DE GOIAS / MUTUNOPOLIS / NAVESLANDIA (JATAI) / NAZARIO / NEROPOLIS / NIQUELANDIA / NIQUELANDIA 69KV / NOVA AMERICA / NOVA AURORA / NOVA CRIXAS (TRANSMISSAO) / NOVA IGUACU / NOVA PONTE / NOVA VENEZA / NOVO BRASIL / NOVO PLANALTO / OLHOS DAGUA / ORIZONA / OURO VERDE DE GOIAS / PACAEMBU (NOVO GAMA) / PADRE BERNARDO / PALESTINA / PALMEIRAS / PALMEIRAS DE GOIAS / PALMELO / PALMINOPOLIS / PAMPLONA / PANAMA / PARANA / PARANAIBA / PARANAIGUARA / PARAUNA SE ALTA TENSAO / PARQUE DAS EMAS (MINEIROS) / PARQUE DAS NACOES / PEROLANDIA / PETROLINA / PILOANDIA / PIRACANJUBA / PIRANHAS T / PIRENOPOLIS / PIRES BELO / PIRES DO RIO / PLANALTINA / PLANALTINA (TRANSMISSAO) / PONTALINA / PORANGATU / PORTEIRAO / PORTELANDIA / QUEBRA LINHA / QUIRINOPOLIS / REAL / RETIRO / GOIAS / RIO CLARO JATAI MONTIVIDIU / RIO PRETO / RIO QUENTE / RIO VERDE / RIO VERMELHO / RIVERLANDIA (RIO VERDE) / RUBIATABA / SANCLERLANDIA / SANTA BARBARA / SANTA FE DE GOIAS / SANTA HELENA / SANTA ROSA / SANTA ROSA DE GOIAS / SANTA ROSA DO MEIA PONTE / SANTA TEREZA DE GOIAS / SANTA TEREZINHA / SANTANA / SANTO ANTONIO DE GOIAS / SANTO ANTONIO DO DESCOBERTO / SAO BARTOLOMEU / SAO DOMINGOS / SAO FRANCISCO DE GOIAS / SAO JOAO D ALIANCA / SAO JOAO DA PARAUNA / SAO LUIZ DOS MONTES BELOS / SAO MIGUEL DO ARAGUAIA / SENADOR CANEDO TRANSMISSAO / SERRA DE CALDAS / SILVANIA / SITIO DABADIA / SOUZALANDIA / SUCURI / TAIOBA / TEREZOPOLIS / TERRA VERMELHA / TRES BARRAS / TRINDADE / TURVANIA / TURVELANDIA / URUACU / USINA MAMBAI / VALPARAISO / VARJAO / VENDA SECA / VIANOPOLIS / VICENTINOPOLIS / VILA CORUMBA / VILA PROPICIO / XAVANTES / XIXA / ZELANDIA		
Início Ultima Incidência (Data e Hora)	10/11/2020 09:57	Municípios Atingidos	ABADIA DE GOIAS / ABADIANIA / ACREUNA / AGUA FRIA DE GOIAS / AGUA LIMPA / AGUAS LINDAS DE GOIAS / ALEXANIA / ALTO HORIZONTE / ALTO PARAISO DE GOIAS / AMARALINA / AMERICANO DO BRASIL / AMORINOPOLIS		
Média de Duração das Incidências (h)	7,33				

Duração da Incidência mais longa (h)	67,01	
Total de Clientes afetados	173.740	<p>/ ANAPOLIS / ANHANGUERA / ANICUNS / APARECIDA DE GOIANIA / APARECIDA DO RIO DOCE / APORE / ARACU / ARAGARCAS / ARAGOIANIA / ARAGUAPAZ / ARENOPOLIS / ARUANA / AURILANDIA / AVELINOPOLIS / BALIZA / BARRO ALTO / BELA VISTA DE GOIAS / BOM JARDIM DE GOIAS / BOM JESUS DE GOIAS / BONOPOLIS / BRAZABRANTES / BRITANIA / BURITI ALEGRE / BURITI DE GOIAS / CABECEIRAS / CACHOEIRA ALTA / CACHOEIRA DE GOIAS / CACHOEIRA DOURADA / CACU / CAIAPONIA / CALDAS NOVAS / CALDAZINHA / CAMPESTRE DE GOIAS / CAMPINACU / CAMPINORTE / CAMPO ALEGRE DE GOIAS / CAMPO LIMPO / CAMPOS BELOS / CAMPOS VERDES / CATALAO / CATURAI / CAVALCANTE / CEZARINA / CHAPADAO DO CEU / CIDADE OCIDENTAL / COCALZINHO DE GOIAS / CORREGO DO OURO / CORUMBA DE GOIAS / CORUMBAIBA / CRISTALINA / CRISTIANOPOLIS / CRIXAS / CUMARI / DAMIANOPOLIS / DAMOLANDIA / DAVINOPOLIS / DIORAMA / DISTRITO FEDERAL / DIVINOPOLIS DE GOIAS / DOVERLANDIA / EDEALINA / EDEIA / ESTRELA DO NORTE / FAINA / FAZENDA NOVA / FIRMINOPOLIS / FLORES DE GOIAS / FORMOSA / FORMOSO / GAMELEIRA DE GOIAS / GOIANAPOLIS / GOIANDIRA / GOIANESIA / GOIANIA / GOIANIRA / GOIAS / GOIATUBA / GOUVELANDIA / GUAPO / GUARAITA / HIDROLANDIA / HIDROLINA / IACIARA / INACIOLANDIA / INDIARA / INHUMAS / IPAMERI / IPORA / ISRAELANDIA / ITABERAI / ITAGUARI / ITAGUARU / ITAJA / ITAPACI / ITAPIRAPUA / ITAPURANGA / ITARUMA / ITAUCU / ITUMBIARA / IVOLANDIA / JANDAIA / JARAGUA / JATAI / JAUPACI / JESUPOLIS / JOVIANIA / JUSSARA / LAGOA SANTA / LEOPOLDO DE BULHOES / LUZIANIA / MAIRIPOTABA / MARA ROSA / MAURILANDIA / MIMOSO DE GOIAS / MINACU / MINEIROS / MOIPORA / MONTE ALEGRE DE GOIAS / MONTES CLAROS DE GOIAS / MONTIVIDIU / MONTIVIDIU DO NORTE / MORRINHOS / MORRO AGUDO DE GOIAS / MOSSAMEDES / MOZARLANDIA / MUNDO NOVO DE GOIAS / MUTUNOPOLIS / NAZARIO / NEROPOLIS / NIQUELANDIA / NOVA AMERICA / NOVA AURORA / NOVA CRIXAS / NOVA IGUACU DE GOIAS / NOVA ROMA / NOVA VENEZA / NOVO BRASIL / NOVO GAMA / ORIZONA / OURO VERDE DE GOIAS / PADRE BERNARDO / PALESTINA DE GOIAS / PALMEIRAS DE GOIAS / PALMINOPOLIS / PANAMA / PARANAIGUARA / PARAUNA / PEROLANDIA / PETROLINA DE GOIAS / PILAR DE GOIAS / PIRACANJUBA / PIRANHAS / PIRENOPOLIS / PIRES DO RIO / PLANALTINA / PONTALINA / PORANGATU / PORTEIRAO / PORTELANDIA / POSSE / QUIRINOPOLIS / RIO QUENTE / RIO VERDE / RUBIATABA / SANCLERLANDIA / SANTA BARBARA DE GOIAS / SANTA CRUZ DE GOIAS / SANTA FE DE GOIAS / SANTA HELENA DE GOIAS / SANTA RITA DO NOVO DESTINO / SANTA ROSA DE GOIAS / SANTA TEREZA DE GOIAS / SANTA TEREZINHA DE GOIAS / SANTO ANTONIO DA BARRA / SANTO ANTONIO DE GOIAS / SANTO ANTONIO DO DESCOBERTO / SAO DOMINGOS / SAO FRANCISCO DE GOIAS / SAO JOAO DA PARAUNA / SAO LUIS DE MONTES BELOS / SAO LUIZ DO NORTE / SAO MIGUEL DO ARAGUAIA / SAO MIGUEL DO PASSA QUATRO / SAO SIMAO / SENADOR CANEDO / SERRANOPOLIS / SILVANIA / SIMOLANDIA / SITIO D ABADIA / TAQUARAL DE GOIAS / TERESINA DE GOIAS / TEREZOPOLIS DE GOIAS / TRINDADE / TROMBAS / TURVANIA / TURVELANDIA / UIRAPURU / URUACU / URUANA / VALPARAISO DE GOIAS / VARJAO / VIANOPOLIS / VICENTINOPOLIS / VILA BOA / VILA PROPICIO</p>

DANOS CAUSADOS			
Equipamentos Danificado	Importância para o Sistema	Local	Quantidade
Disjuntor/Religador Operado	Proteção do Alimentador	Área de Concessão	41
Chaves Fusíveis Operada	Proteção de Ramais de Alimentadores	Área de Concessão	508
Transformador Operado	Proteção do Transformador	Área de Concessão	395

Relato técnico sobre a Intervenção realizada em Goiânia e Região Metropolitana			
Informações sobre Equipes	09/11	10/11	
Quantidade Usual	1.098	1.124	turmas
Quantidade Adicional	0	9	turmas
Quantidade Total	1.098	1.133	turmas
Tempos Médios			
Preparação	3,54	4,14	Horas
Deslocamento	0,92	0,88	Horas
Execução	0,93	1,01	Horas
TMAE	5,38	6,02	Horas

Principais Dificuldades Encontradas:

Chuvas com ventos fortes provocaram muitos pontos de alagamento e enxurrada, trânsito impedido por vários semáforos desligados dificultando a chegada ao atendimento das ocorrências emergenciais. Em determinadas regiões, decorrente dos fortes ventos, houve o tombamento de árvores nas estruturas de alimentação de média tensão, danos em ramais de ligação dos clientes, impedimentos

Empresa	ENEL DISTRIBUIÇÃO GOIAS		
Valor CHI (Limite e Real)	482.597,74		563.821,20

4. Lista de Ocorrências

DOC ORIGEM	MIUNICIPIO	EQP_ORIGEM	CONJUNTO	INI_OCORRENC	FIM_OCORRENC	DT_INI_EVENTO	DT_FIM_EVENTO	DURAÇ	UC INT	CHI	EXPURGO
20201133146	JARAGUA	JA21070666	JARAGUA	09/11/2020 11:53	09/11/2020 19:51	09/11/2020 11:53	09/11/2020 19:51	7,96	2	15,93	CHI
20201133183	ANICUNS	910079274	ANICUNS	09/11/2020 12:00	09/11/2020 13:39	09/11/2020 12:00	09/11/2020 13:39	1,64	1	1,64	CHI
20201133205	ARAGUAPAZ	AZ12010440	MOZARLANDIA	09/11/2020 12:00	10/11/2020 10:57	09/11/2020 12:00	10/11/2020 10:57	22,96	15	344,39	CHI
20201133198	NOVO GAMA	NJ11330571	PACAEMBU S1	09/11/2020 12:03	09/11/2020 12:55	09/11/2020 12:03	09/11/2020 12:55	0,86	57	49,15	CHI
20201133206	GOIAS	GS11063136	GOIAS	09/11/2020 12:05	09/11/2020 17:47	09/11/2020 12:05	09/11/2020 17:47	5,70	77	438,54	CHI
20201136197	MIMOSO DE GOIAS	NQ13269861	BARRO ALTO	09/11/2020 12:08	09/11/2020 21:50	09/11/2020 12:08	09/11/2020 21:50	9,69	9	87,25	CHI
20201136197	NIQUELANDIA	NQ13269861	BARRO ALTO	09/11/2020 12:08	09/11/2020 21:50	09/11/2020 12:08	09/11/2020 21:50	9,69	184	1783,83	CHI
20201136197	VILA PROPICIO	NQ13269861	BARRO ALTO	09/11/2020 12:08	09/11/2020 21:50	09/11/2020 12:08	09/11/2020 21:50	9,69	50	484,74	CHI
20201133236	LUZIANIA	LZ12000278	MARAJOARA	09/11/2020 12:12	09/11/2020 22:24	09/11/2020 12:12	09/11/2020 16:12	3,99	7	27,93	CHI
20201133236	LUZIANIA	LZ12000278	MARAJOARA	09/11/2020 12:12	09/11/2020 22:24	09/11/2020 12:12	09/11/2020 22:24	10,20	12	122,35	CHI
20201133237	PIRANHAS	PH21341826	PIRANHAS	09/11/2020 12:12	09/11/2020 13:34	09/11/2020 12:12	09/11/2020 13:34	1,36	2	2,71	CHI
20201135034	LUZIANIA	LZ12149807LD	MARAJOARA	09/11/2020 12:12	09/11/2020 22:24	09/11/2020 12:12	09/11/2020 22:24	10,20	6	61,18	CHI
20201135034	LUZIANIA	LZ12149807LD	MARAJOARA	09/11/2020 12:12	09/11/2020 22:24	09/11/2020 19:58	09/11/2020 22:24	2,43	1	2,43	CHI
20201133252	INDIARA	IY21233454	CEZARINA	09/11/2020 12:15	09/11/2020 17:41	09/11/2020 12:15	09/11/2020 17:41	5,42	1	5,42	CHI
20201133253	GOIANESIA	10013479049	GOIANESIA S2	09/11/2020 12:16	09/11/2020 20:32	09/11/2020 12:16	09/11/2020 20:32	8,27	1	8,27	CHI
20201133271	SAO LUIS DE MONTES BELOS	SL12111612	FIRMINOPOLIS S1	09/11/2020 12:19	10/11/2020 05:15	09/11/2020 12:19	10/11/2020 05:15	16,92	3	50,76	CHI
20201133313	COCALZINHO DE GOIAS	ZN12302398	COCALZINHO	09/11/2020 12:20	09/11/2020 14:54	09/11/2020 12:20	09/11/2020 14:54	2,57	11	28,23	CHI
20201133337	GOIANESIA	GE12115090	GOIANESIA S2	09/11/2020 12:20	09/11/2020 16:29	09/11/2020 12:20	09/11/2020 16:29	4,15	298	1235,29	CHI
20201133294	MOSSAMEDES	1310007667	FIRMINOPOLIS S2	09/11/2020 12:25	09/11/2020 16:04	09/11/2020 12:25	09/11/2020 16:04	3,65	1	3,65	CHI
20201133321	GOIANIA	14715697	GOYA S1	09/11/2020 12:34	09/11/2020 14:56	09/11/2020 12:34	09/11/2020 14:56	2,35	1	2,35	CHI
20201133324	DOVERLANDIA	DV12207831	CAIAPONIA	09/11/2020 12:35	09/11/2020 14:33	09/11/2020 12:35	09/11/2020 14:33	1,95	3	5,86	CHI
20201133343	ITAPURANGA	IK21311327	ITAPURANGA	09/11/2020 12:40	09/11/2020 18:50	09/11/2020 12:40	09/11/2020 18:50	6,16	3	18,48	CHI
20201133344	GOIANIA	10012931770	XAVANTES	09/11/2020 12:40	09/11/2020 18:48	09/11/2020 12:40	09/11/2020 18:48	6,12	1	6,12	CHI
20201133579	GOIAS	IK12250721	GOIAS	09/11/2020 12:46	09/11/2020 17:51	09/11/2020 12:46	09/11/2020 17:51	5,07	14	70,94	CHI
20201133579	ITABERAÍ	IK12250721	GOIAS	09/11/2020 12:46	09/11/2020 17:51	09/11/2020 12:46	09/11/2020 17:51	5,07	3	15,20	CHI
20201133579	ITAPURANGA	IK12250721	GOIAS	09/11/2020 12:46	09/11/2020 17:51	09/11/2020 12:46	09/11/2020 17:51	5,07	3	15,20	CHI
20201133367	JARAGUA	JA12298122	JARAGUA	09/11/2020 12:47	10/11/2020 11:36	09/11/2020 12:47	10/11/2020 11:36	22,80	1	22,80	CHI
20201133371	GOIANIA	GN11324160	XAVANTES	09/11/2020 12:48	09/11/2020 15:08	09/11/2020 14:02	09/11/2020 15:08	1,10	77	84,70	CHI
20201133375	PALMEIRAS DE GOIAS	PL12000225	PALMEIRAS	09/11/2020 12:50	09/11/2020 15:47	09/11/2020 12:50	09/11/2020 15:47	2,95	11	32,42	CHI
20201133378	MONTIVIDIU DO NORTE	MX11276714	PORANGATU	09/11/2020 12:51	10/11/2020 20:52	09/11/2020 12:51	10/11/2020 20:52	32,02	1	32,02	CHI
20201133380	ALTO PARAISO DE GOIAS	3870024067	FLORES DE GOIAS	09/11/2020 12:51	09/11/2020 16:18	09/11/2020 12:51	09/11/2020 16:18	3,44	1	3,44	CHI
20201133391	NOVA IGUACU DE GOIAS	NH21164027	MARA ROSA	09/11/2020 12:54	09/11/2020 21:33	09/11/2020 12:54	09/11/2020 21:33	8,64	1	8,64	CHI
20201133398	INHUMAS	10015874190	INHUMAS S2	09/11/2020 12:56	09/11/2020 17:41	09/11/2020 12:56	09/11/2020 17:41	4,73	1	4,73	CHI
20201133403	MARA ROSA	MQ21117951	MARA ROSA	09/11/2020 12:57	10/11/2020 19:24	09/11/2020 12:57	10/11/2020 19:24	30,44	1	30,44	CHI
20201133414	GOIANIA	GN16409447	CAMPINAS S2	09/11/2020 12:58	09/11/2020 14:33	09/11/2020 13:52	09/11/2020 14:33	0,68	239	162,92	CHI
20201133411	GOIANIRA	GR11197487	GOIANIRA	09/11/2020 12:59	09/11/2020 16:48	09/11/2020 12:59	09/11/2020 16:48	3,80	37	140,77	CHI
20201133436	CAVALCANTE	MA12408812	SAO DOMINGOS	09/11/2020 13:08	09/11/2020 17:54	09/11/2020 13:08	09/11/2020 17:54	4,76	31	147,52	CHI
20201133436	MONTE ALEGRE DE GOIAS	MA12408812	SAO DOMINGOS	09/11/2020 13:08	09/11/2020 17:54	09/11/2020 13:08	09/11/2020 17:54	4,76	45	214,14	CHI
20201133437	SAO MIGUEL DO ARAGUAIA	SM21282201	SAO MIGUEL DO ARAGUAIA	09/11/2020 13:08	09/11/2020 16:24	09/11/2020 13:08	09/11/2020 16:24	3,25	1	3,25	CHI
20201133445	URUACU	UR11375630	URUACU	09/11/2020 13:11	10/11/2020 04:21	09/11/2020 13:11	10/11/2020 04:21	15,15	20	303,05	CHI
20201133451	IACIARA	1550038350	IACIARA S1	09/11/2020 13:13	09/11/2020 14:23	09/11/2020 13:13	09/11/2020 14:23	1,16	1	1,16	CHI
20201133459	SENADOR CANEDO	13868263	SENADOR CANEDO	09/11/2020 13:15	09/11/2020 14:35	09/11/2020 13:15	09/11/2020 14:35	1,33	1	1,33	CHI
20201133546	ALEXANIA	AX12066452	ALEXANIA	09/11/2020 13:17	10/11/2020 07:18	09/11/2020 13:17	10/11/2020 07:18	18,00	24	432,01	CHI
20201133716	ITAPACI	IW21405279	ITAPACI	09/11/2020 13:18	09/11/2020 18:46	09/11/2020 13:18	09/11/2020 18:46	5,45	1	5,45	CHI
20201133473	ANAPOLIS	AN11101504	ANAPOLIS UNIVERSITARIO S2	09/11/2020 13:20	09/11/2020 17:42	09/11/2020 13:20	09/11/2020 17:42	4,37	188	820,99	CHI

20201133480	FLORES DE GOIAS	IA12046295	IACIARA S2	09/11/2020 13:21	09/11/2020 15:27	09/11/2020 13:21	09/11/2020 15:27	2,09	1	2,09	CHI
20201133480	IACIARA	IA12046295	IACIARA S2	09/11/2020 13:21	09/11/2020 15:27	09/11/2020 13:21	09/11/2020 15:27	2,09	87	182,17	CHI
20201133488	APARECIDA DE GOIANIA	16361532	INDEPENDENCIA S2	09/11/2020 13:23	09/11/2020 14:28	09/11/2020 13:23	09/11/2020 14:28	1,07	1	1,07	CHI
20201133489	URUACU	UR12003415	URUACU	09/11/2020 13:24	09/11/2020 15:12	09/11/2020 13:24	09/11/2020 15:12	1,80	25	44,88	CHI
20201133503	PETROLINA DE GOIAS	PV21072284	SAO FRANCISCO DE GOIAS	09/11/2020 13:26	09/11/2020 20:00	09/11/2020 13:26	09/11/2020 20:00	6,56	1	6,56	CHI
20201136430	AMARALINA	MU12384317	MARA ROSA	09/11/2020 13:28	10/11/2020 10:00	09/11/2020 13:28	10/11/2020 10:00	20,53	4	82,11	CHI
20201136430	MUTUNOPOLIS	MU12384317	MARA ROSA	09/11/2020 13:28	10/11/2020 10:00	09/11/2020 13:28	10/11/2020 10:00	20,53	20	410,53	CHI
20201133523	GOIANESIA	GE21095878	GOIANESIA S2	09/11/2020 13:29	09/11/2020 22:11	09/11/2020 13:29	09/11/2020 22:11	8,69	1	8,69	CHI
20201133525	DOVERLANDIA	DV21259941	CAIAPONIA	09/11/2020 13:30	09/11/2020 22:37	09/11/2020 13:30	09/11/2020 22:37	9,11	1	9,11	CHI
20201135775	ITAGUARU	IC11089314	ITABERAI S1	09/11/2020 13:32	09/11/2020 19:13	09/11/2020 13:32	09/11/2020 19:13	5,67	73	414,15	CHI
20201133536	CRISTALINA	1060080300	CRISTALINA S1	09/11/2020 13:33	09/11/2020 17:57	09/11/2020 13:33	09/11/2020 17:57	4,40	1	4,40	CHI
20201133537	ANAPOLIS	10013396437	JUNDIAI S1	09/11/2020 13:34	09/11/2020 15:35	09/11/2020 13:34	09/11/2020 15:35	2,01	1	2,01	CHI
20201133548	INACIOLANDIA	2810000433	QUIRINOPOLIS	09/11/2020 13:35	09/11/2020 14:39	09/11/2020 13:35	09/11/2020 14:39	1,05	1	1,05	CHI
20201133553	CIDADE OCIDENTAL	10008307421	MARAJOARA	09/11/2020 13:36	09/11/2020 15:19	09/11/2020 13:36	09/11/2020 15:19	1,70	1	1,70	CHI
20201134688	DISTRITO FEDERAL	FA12322759	ITUIQUIRA	09/11/2020 13:36	09/11/2020 17:38	09/11/2020 13:36	09/11/2020 17:38	4,02	1	4,02	CHI
20201134688	FORMOSA	FA12322759	ITUIQUIRA	09/11/2020 13:36	09/11/2020 17:38	09/11/2020 13:36	09/11/2020 17:38	4,02	38	152,89	CHI
20201133561	ALTO PARAISO DE GOIAS	BF21265759	FLORES DE GOIAS	09/11/2020 13:38	09/11/2020 15:02	09/11/2020 13:38	09/11/2020 15:02	1,39	1	1,39	CHI
20201133568	PALMEIRAS DE GOIAS	10029517778	PALMEIRAS	09/11/2020 13:41	09/11/2020 14:53	09/11/2020 13:41	09/11/2020 14:53	1,19	1	1,19	CHI
20201133573	JARAGUA	JA21129669	JARAGUA	09/11/2020 13:42	10/11/2020 09:53	09/11/2020 13:42	10/11/2020 09:53	20,18	2	40,36	CHI
20201133576	TEREZOPOLIS DE GOIAS	TJ12075859	DAIA S2	09/11/2020 13:42	09/11/2020 19:26	09/11/2020 13:42	09/11/2020 19:26	5,73	373	2138,12	CHI
20201133577	JATAI	290306437	JATAI S2	09/11/2020 13:42	10/11/2020 09:01	09/11/2020 13:42	10/11/2020 09:01	19,30	1	19,30	CHI
20201133598	CHAPADAO DO CEU	DJ12248365	CHAPADAO DO CEU	09/11/2020 13:47	09/11/2020 16:11	09/11/2020 13:47	09/11/2020 16:11	2,40	4	9,59	CHI
20201136351	INHUMAS	IN32066288	INHUMAS S2	09/11/2020 13:48	09/11/2020 20:38	09/11/2020 13:48	09/11/2020 20:38	6,82	8	54,58	CHI
20201133631	GOIANESIA	GE11219075	GOIANESIA S2	09/11/2020 13:49	09/11/2020 15:29	09/11/2020 15:00	09/11/2020 15:29	0,47	96	45,09	CHI
20201133613	GOIANIA	10008670330	CAMPINAS S1	09/11/2020 13:50	09/11/2020 17:30	09/11/2020 13:50	09/11/2020 17:30	3,67	1	3,67	CHI
20201133617	AGUA FRIA DE GOIAS	TL21314282	SAO JOAO D ALIANCA	09/11/2020 13:51	09/11/2020 15:28	09/11/2020 13:51	09/11/2020 15:28	1,63	1	1,63	CHI
20201133620	INHUMAS	30056410	INHUMAS S2	09/11/2020 13:51	09/11/2020 15:26	09/11/2020 13:51	09/11/2020 15:26	1,58	1	1,58	CHI
20201133623	NAZARIO	NZ21226982	TRINDADE	09/11/2020 13:51	09/11/2020 16:15	09/11/2020 13:51	09/11/2020 16:15	2,39	1	2,39	CHI
20201133625	JARAGUA	JA11246363	JARAGUA	09/11/2020 13:51	09/11/2020 17:47	09/11/2020 13:51	09/11/2020 17:47	3,92	141	552,60	CHI
2020110900051	APARECIDA DE GOIANIA	570224	REAL S1	09/11/2020 13:56	09/11/2020 15:00	09/11/2020 13:56	09/11/2020 15:00	1,07	1	1,07	CHI
2020110900051	GOIANIA	570224	REAL S1	09/11/2020 13:56	09/11/2020 15:00	09/11/2020 13:56	09/11/2020 15:00	1,07	425	453,33	CHI
20201134019	PALMEIRAS DE GOIAS	3300444	PALMEIRAS	09/11/2020 13:57	09/11/2020 20:04	09/11/2020 13:57	09/11/2020 16:02	2,09	6	12,51	CHI
20201134019	PALMINOPOLIS	3300444	PALMEIRAS	09/11/2020 13:57	09/11/2020 20:04	09/11/2020 13:57	09/11/2020 20:01	6,06	1	6,06	CHI
20201134019	PALMEIRAS DE GOIAS	3300444	PALMEIRAS	09/11/2020 13:57	09/11/2020 20:04	09/11/2020 13:57	09/11/2020 20:04	6,11	82	501,29	CHI
20201134019	PALMINOPOLIS	3300444	PALMEIRAS	09/11/2020 13:57	09/11/2020 20:04	09/11/2020 13:57	09/11/2020 20:04	6,11	88	537,97	CHI
20201134019	JANDAIA	3300444	PALMEIRAS	09/11/2020 13:57	09/11/2020 20:04	09/11/2020 13:57	09/11/2020 20:04	6,12	54	330,44	CHI
20201134019	PALMEIRAS DE GOIAS	3300444	PALMEIRAS	09/11/2020 13:57	09/11/2020 20:04	09/11/2020 13:57	09/11/2020 20:04	6,12	53	324,32	CHI
20201134019	PALMINOPOLIS	3300444	PALMEIRAS	09/11/2020 13:57	09/11/2020 20:04	09/11/2020 13:57	09/11/2020 20:04	6,12	1743	10665,71	CHI
20201133655	LUZIANIA	LZ21041505	VIANOPOLIS	09/11/2020 13:58	09/11/2020 18:24	09/11/2020 13:58	09/11/2020 18:24	4,43	1	4,43	CHI
20201133667	PIRENOPOLIS	PV21244350	CORUMBA	09/11/2020 13:59	10/11/2020 11:54	09/11/2020 13:59	10/11/2020 11:54	21,91	1	21,91	CHI
20201133669	MOIPORA	MO21073404	IPORA	09/11/2020 13:59	09/11/2020 20:16	09/11/2020 13:59	09/11/2020 20:16	6,28	1	6,28	CHI
20201134095	MUTUNOPOLIS	MU12268746	MARA ROSA	09/11/2020 14:02	10/11/2020 16:41	09/11/2020 14:02	09/11/2020 21:00	6,96	6	41,74	CHI
20201134095	MUTUNOPOLIS	MU12268746	MARA ROSA	09/11/2020 14:02	10/11/2020 16:41	09/11/2020 21:01	10/11/2020 16:41	19,67	6	118,03	CHI
20201134363	JARAGUA	JA12205735	JARAGUA	09/11/2020 14:02	09/11/2020 16:45	09/11/2020 14:02	09/11/2020 16:45	2,72	264	716,83	CHI
20201135937	JARAGUA	JA11140540	JARAGUA	09/11/2020 14:02	10/11/2020 01:04	09/11/2020 14:02	10/11/2020 01:04	11,03	111	1224,58	CHI
20201133789	GOIAS	GS11162299	GOIAS	09/11/2020 14:05	09/11/2020 17:36	09/11/2020 14:05	09/11/2020 17:36	3,51	2	7,02	CHI
20201133931	GOIANIA	NR10400766	NEROPOLIS S2	09/11/2020 14:06	10/11/2020 01:32	09/11/2020 14:06	09/11/2020 15:11	1,09	233	254,10	CHI
20201133931	NEROPOLIS	NR10400766	NEROPOLIS S2	09/11/2020 14:06	10/11/2020 01:32	09/11/2020 14:06	09/11/2020 15:11	1,09	75	81,79	CHI
20201133931	SANTO ANTONIO DE GOIAS	NR10400766	NEROPOLIS S2	09/11/2020 14:06	10/11/2020 01:32	09/11/2020 14:06	09/11/2020 15:11	1,09	76	82,88	CHI
20201133931	TEREZOPOLIS DE GOIAS	NR10400766	NEROPOLIS S2	09/11/2020 14:06	10/11/2020 01:32	09/11/2020 14:06	09/11/2020 15:11	1,09	1	1,09	CHI
20201133931	GOIANIA	GN12219046LD	NEROPOLIS S2	09/11/2020 14:06	10/11/2020 01:32	09/11/2020 14:06	09/11/2020 16:46	2,67	2	5,35	CHI

20201133931	GOIANIA	NR10400766	NEROPOLIS S2	09/11/2020 14:06	10/11/2020 01:32	09/11/2020 14:06	10/11/2020 01:32	11,43	10	114,33	CHI
20201133931	SANTO ANTONIO DE GOIAS	NR10400766	NEROPOLIS S2	09/11/2020 14:06	10/11/2020 01:32	09/11/2020 14:06	10/11/2020 01:32	11,43	1	11,43	CHI
20201133875	APARECIDA DE GOIANIA	10009524639	INDEPENDENCIA S2	09/11/2020 14:09	10/11/2020 07:17	09/11/2020 14:09	10/11/2020 07:17	17,12	1	17,12	CHI
20201133938	GOIANIA	GN12322843	NEROPOLIS S1	09/11/2020 14:10	09/11/2020 16:05	09/11/2020 14:10	09/11/2020 16:05	1,90	109	207,19	CHI
20201133911	SAO MIGUEL DO ARAGUAIA	SM21147578	SAO MIGUEL DO ARAGUAIA	09/11/2020 14:11	09/11/2020 16:20	09/11/2020 14:11	09/11/2020 16:20	2,14	1	2,14	CHI
20201133922	CAIAPONIA	CP12200764	MONTIVIDIU T	09/11/2020 14:11	10/11/2020 22:35	09/11/2020 14:11	10/11/2020 22:35	32,38	4	129,54	CHI
20201134172	BELA VISTA DE GOIAS	BV11000006	BELA VISTA S1	09/11/2020 14:11	09/11/2020 18:37	09/11/2020 14:11	09/11/2020 18:37	4,42	104	460,06	CHI
20201134265	RIO VERDE	RV12200774	CABRIUVA S2	09/11/2020 14:11	09/11/2020 17:42	09/11/2020 14:11	09/11/2020 17:42	3,51	10	35,09	CHI
20201135677	CAIAPONIA	CP12160772	MONTIVIDIU T	09/11/2020 14:11	11/11/2020 00:19	09/11/2020 14:11	10/11/2020 22:35	32,38	19	615,30	CHI
20201135677	RIO VERDE	CP12160772	MONTIVIDIU T	09/11/2020 14:11	11/11/2020 00:19	09/11/2020 14:11	10/11/2020 22:35	32,38	11	356,23	CHI
20201135677	JATAI	CP12160772	MONTIVIDIU T	09/11/2020 14:11	11/11/2020 00:19	09/11/2020 14:11	11/11/2020 00:19	34,12	7	238,83	CHI
20201135677	RIO VERDE	CP12160772	MONTIVIDIU T	09/11/2020 14:11	11/11/2020 00:19	09/11/2020 14:11	11/11/2020 00:19	34,12	1	34,12	CHI
20201133929	DISTRITO FEDERAL	16029940	GOIANIA LESTE S3	09/11/2020 14:12	09/11/2020 15:26	09/11/2020 14:12	09/11/2020 15:26	1,23	5	6,14	CHI
20201133948	JATAI	JT11164168	JATAI S3	09/11/2020 14:12	09/11/2020 16:09	09/11/2020 14:12	09/11/2020 16:09	1,94	151	293,07	CHI
20201133940	SANTO ANTONIO DO DESCOBERTO	SN21273183	MARAJOARA	09/11/2020 14:17	09/11/2020 16:50	09/11/2020 14:17	09/11/2020 16:50	2,55	1	2,55	CHI
20201133956	APARECIDA DE GOIANIA	10007783475	REAL S2	09/11/2020 14:19	09/11/2020 15:45	09/11/2020 14:19	09/11/2020 15:45	1,42	1	1,42	CHI
20201134137	GOIANIA	GN11235719	XAVANTES	09/11/2020 14:19	09/11/2020 16:40	09/11/2020 14:19	09/11/2020 16:40	2,34	36	84,27	CHI
20201133961	NEROPOLIS	NR11199326	NEROPOLIS S2	09/11/2020 14:20	09/11/2020 18:58	09/11/2020 14:20	09/11/2020 18:58	4,63	89	412,32	CHI
20201133964	PIRENOPOLIS	PV12362322	CORUMBA	09/11/2020 14:20	10/11/2020 23:16	09/11/2020 14:20	10/11/2020 23:16	32,93	25	823,24	CHI
20201134201	ABADIANIA	50414	ANAPOLIS UNIVERSITARIO S1	09/11/2020 14:20	09/11/2020 15:27	09/11/2020 14:20	09/11/2020 15:27	1,11	22	24,43	CHI
20201134201	ANAPOLIS	50414	ANAPOLIS UNIVERSITARIO S1	09/11/2020 14:20	09/11/2020 15:27	09/11/2020 14:20	09/11/2020 15:27	1,11	66	73,30	CHI
20201133970	SENADOR CANEDO	10030825430	SENADOR CANEDO	09/11/2020 14:21	09/11/2020 16:19	09/11/2020 14:21	09/11/2020 16:19	1,96	1	1,96	CHI
20201133975	GOIANIA	15382783	CARAJAS S2	09/11/2020 14:21	09/11/2020 16:31	09/11/2020 14:21	09/11/2020 16:31	2,16	1	2,16	CHI
20201133977	GOIANIA	GN11052087	GOIANIA LESTE S3	09/11/2020 14:22	09/11/2020 23:28	09/11/2020 15:00	09/11/2020 23:28	8,47	134	1134,57	CHI
20201133997	ALEXANIA	AX10402636	CORUMBA	09/11/2020 14:22	10/11/2020 21:28	09/11/2020 14:22	09/11/2020 16:19	1,95	23	44,88	CHI
20201133997	CORUMBA DE GOIAS	AX10402636	CORUMBA	09/11/2020 14:22	10/11/2020 21:28	09/11/2020 14:22	09/11/2020 16:19	1,95	4	7,81	CHI
20201133997	ALEXANIA	AX12155965	CORUMBA	09/11/2020 14:22	10/11/2020 21:28	09/11/2020 14:22	10/11/2020 21:28	31,10	6	186,60	CHI
20201133997	CORUMBA DE GOIAS	AX12155965	CORUMBA	09/11/2020 14:22	10/11/2020 21:28	09/11/2020 14:22	10/11/2020 21:28	31,10	11	342,11	CHI
20201134719	JARAGUA	JA11350789	JARAGUA	09/11/2020 14:22	10/11/2020 13:09	09/11/2020 14:22	10/11/2020 13:09	22,78	45	1025,06	CHI
20201133990	SENADOR CANEDO	SW21026491	SENADOR CANEDO	09/11/2020 14:23	09/11/2020 16:00	09/11/2020 14:23	09/11/2020 16:00	1,61	1	1,61	CHI
20201134001	TRINDADE	40218454	TRINDADE	09/11/2020 14:24	09/11/2020 17:05	09/11/2020 14:24	09/11/2020 17:05	2,67	1	2,67	CHI
20201135589	ANAPOLIS	AN11000310	ANAPOLIS UNIVERSITARIO S2	09/11/2020 14:26	09/11/2020 20:54	09/11/2020 14:26	09/11/2020 20:54	6,46	128	826,67	CHI
20201135589	ANAPOLIS	AN12000085	ANAPOLIS UNIVERSITARIO S2	09/11/2020 14:26	09/11/2020 20:54	09/11/2020 20:01	09/11/2020 20:54	0,88	336	296,89	CHI
20201134029	BARRO ALTO	BA21163321	BARRO ALTO	09/11/2020 14:29	09/11/2020 18:56	09/11/2020 14:29	09/11/2020 18:56	4,45	1	4,45	CHI
20201134035	ITARUMA	IM12191627	CACHOEIRA ALTA	09/11/2020 14:29	09/11/2020 19:45	09/11/2020 14:29	09/11/2020 19:45	5,25	13	68,29	CHI
20201134036	PARAUNA	2440043728	ACREUNA	09/11/2020 14:29	09/11/2020 20:45	09/11/2020 14:29	09/11/2020 20:45	6,26	1	6,26	CHI
20201134040	COCALZINHO DE GOIAS	SN12379515	ALEXANIA	09/11/2020 14:30	10/11/2020 14:15	09/11/2020 14:30	10/11/2020 14:15	23,74	2	47,49	CHI
20201134040	SANTO ANTONIO DO DESCOBERTO	SN12379515	ALEXANIA	09/11/2020 14:30	10/11/2020 14:15	09/11/2020 14:30	10/11/2020 14:15	23,74	2	47,49	CHI
20201134057	GOIANIA	GN11162131	CAMPINAS S2	09/11/2020 14:30	09/11/2020 17:17	09/11/2020 14:30	09/11/2020 17:17	2,78	117	325,62	CHI
20201134233	GOIANIA	GN11040772	XAVANTES	09/11/2020 14:31	09/11/2020 17:50	09/11/2020 14:31	09/11/2020 17:50	3,31	158	522,67	CHI
20201134066	NOVA CRIXAS	10011097882	NOVA CRIXAS	09/11/2020 14:33	10/11/2020 12:50	09/11/2020 14:33	10/11/2020 12:50	22,27	1	22,27	CHI
20201134345	SAO JOAO DA PARAUNA	PU12361902	PARAUNA	09/11/2020 14:33	10/11/2020 12:43	09/11/2020 14:33	10/11/2020 12:43	22,17	16	354,79	CHI
20201134084	MINEIROS	MY12324447	PARQUE DAS EMAS	09/11/2020 14:34	10/11/2020 13:55	09/11/2020 14:34	10/11/2020 13:55	23,34	1	23,34	CHI
20201134096	ANAPOLIS	AN10383789	JUNDIAI S1	09/11/2020 14:34	10/11/2020 01:45	09/11/2020 14:34	09/11/2020 15:59	1,41	470	663,35	CHI
20201134096	ANAPOLIS	AN10383789	JUNDIAI S1	09/11/2020 14:34	10/11/2020 01:45	09/11/2020 14:34	09/11/2020 20:27	5,87	37	217,18	CHI
20201134096	ANAPOLIS	AN13085938	JUNDIAI S1	09/11/2020 14:34	10/11/2020 01:45	09/11/2020 14:34	09/11/2020 20:27	5,87	30	176,09	CHI
20201134096	CAMPO LIMPO	AN10383789	JUNDIAI S1	09/11/2020 14:34	10/11/2020 01:45	09/11/2020 14:34	09/11/2020 20:27	5,87	8	46,96	CHI
20201134096	CAMPO LIMPO	AN13085938	JUNDIAI S1	09/11/2020 14:34	10/11/2020 01:45	09/11/2020 14:34	09/11/2020 20:27	5,87	2	11,74	CHI
20201134096	ANAPOLIS	AN10383789	JUNDIAI S1	09/11/2020 14:34	10/11/2020 01:45	09/11/2020 14:34	10/11/2020 01:45	11,17	1	11,17	CHI
20201134159	SANTO ANTONIO DE GOIAS	BW10401401	NEROPOLIS S1	09/11/2020 14:34	09/11/2020 18:05	09/11/2020 14:34	09/11/2020 18:05	3,52	1	3,52	CHI
20201134195	CACHOEIRA ALTA	CAL-TR3	CACHOEIRA ALTA	09/11/2020 14:34	10/11/2020 02:11	09/11/2020 14:34	09/11/2020 14:45	0,19	91	17,14	CHI

20201134195	CACHOEIRA ALTA	CAL-TR3	CACHOEIRA ALTA	09/11/2020 14:34	10/11/2020 02:11	09/11/2020 14:34	09/11/2020 14:45	0,19	4365	822,08	CHI
20201134195	CACHOEIRA ALTA	CAL-TR3	CACHOEIRA ALTA	09/11/2020 14:34	10/11/2020 02:11	09/11/2020 14:34	09/11/2020 14:45	0,19	90	16,95	CHI
20201134195	CACU	CAL-TR3	CACHOEIRA ALTA	09/11/2020 14:34	10/11/2020 02:11	09/11/2020 14:34	09/11/2020 14:45	0,19	6	1,13	CHI
20201134195	CACU	CAL-TR3	CACHOEIRA ALTA	09/11/2020 14:34	10/11/2020 02:11	09/11/2020 14:34	09/11/2020 14:45	0,19	59	11,11	CHI
20201134195	ITARUMA	CAL-TR3	CACHOEIRA ALTA	09/11/2020 14:34	10/11/2020 02:11	09/11/2020 14:34	09/11/2020 14:45	0,19	7	1,32	CHI
20201134195	PARANAIGUARA	CAL-TR3	CACHOEIRA ALTA	09/11/2020 14:34	10/11/2020 02:11	09/11/2020 14:34	09/11/2020 14:45	0,19	34	6,40	CHI
20201134195	CACHOEIRA ALTA	270444	CACHOEIRA ALTA	09/11/2020 14:34	10/11/2020 02:11	09/11/2020 14:44	09/11/2020 16:39	1,92	11	21,09	CHI
20201134195	CACU	270444	CACHOEIRA ALTA	09/11/2020 14:34	10/11/2020 02:11	09/11/2020 14:44	09/11/2020 16:39	1,92	139	266,53	CHI
20201134195	ITARUMA	IM13205217	CACHOEIRA ALTA	09/11/2020 14:34	10/11/2020 02:11	09/11/2020 14:44	10/11/2020 01:22	10,63	12	127,53	CHI
20201134195	ITARUMA	IM12035382	CACHOEIRA ALTA	09/11/2020 14:34	10/11/2020 02:11	09/11/2020 14:44	10/11/2020 02:11	11,45	7	80,13	CHI
20201134075	GOIANIA	GN12340461	XAVANTES	09/11/2020 14:35	09/11/2020 21:39	09/11/2020 14:35	09/11/2020 21:39	7,07	83	586,51	CHI
20201134076	ANAPOLIS	10032845039	ANAPOLIS UNIVERSITARIO S2	09/11/2020 14:35	09/11/2020 16:32	09/11/2020 14:35	09/11/2020 16:32	1,96	1	1,96	CHI
20201134091	GOIANIA	GN11086732	MEIA PONTE	09/11/2020 14:36	09/11/2020 17:07	09/11/2020 14:36	09/11/2020 17:07	2,51	179	449,44	CHI
20201134092	GOIANIA	GN12044137	GOYA S2	09/11/2020 14:36	09/11/2020 18:13	09/11/2020 14:36	09/11/2020 18:13	3,61	3	10,82	CHI
20201134135	GOIANIA	2330214	MEIA PONTE	09/11/2020 14:37	09/11/2020 16:55	09/11/2020 14:37	09/11/2020 16:55	2,30	1	2,30	CHI
20201135143	ABADIANIA	CB12272931	CORUMBA	09/11/2020 14:37	10/11/2020 10:21	09/11/2020 14:37	09/11/2020 19:39	5,02	1	5,02	CHI
20201135143	CORUMBA DE GOIAS	CB12272931	CORUMBA	09/11/2020 14:37	10/11/2020 10:21	09/11/2020 14:37	09/11/2020 19:39	5,02	98	492,12	CHI
20201135143	CORUMBA DE GOIAS	CB12272931	CORUMBA	09/11/2020 14:37	10/11/2020 10:21	09/11/2020 14:37	10/11/2020 09:26	18,81	12	225,75	CHI
20201135143	CORUMBA DE GOIAS	CB12272931	CORUMBA	09/11/2020 14:37	10/11/2020 10:21	09/11/2020 14:37	10/11/2020 10:21	19,73	6	118,37	CHI
20201134110	LEOPOLDO DE BULHOES	1910000222	DAIA S2	09/11/2020 14:38	09/11/2020 19:50	09/11/2020 14:38	09/11/2020 19:50	5,20	1	5,20	CHI
20201134119	APARECIDA DE GOIANIA	AP11378625	ANHANGUERA	09/11/2020 14:38	09/11/2020 16:27	09/11/2020 14:38	09/11/2020 16:27	1,81	41	74,08	CHI
20201134122	GOIANIA	GN11166599	CAMPINAS S2	09/11/2020 14:38	09/11/2020 18:12	09/11/2020 14:38	09/11/2020 18:12	3,55	115	408,28	CHI
20201134132	PIRENOPOLIS	PV21144475	CORUMBA	09/11/2020 14:39	10/11/2020 13:45	09/11/2020 14:39	10/11/2020 13:45	23,09	1	23,09	CHI
20201134376	GOIANIA	GN11180081	XAVANTES	09/11/2020 14:39	09/11/2020 19:20	09/11/2020 14:39	09/11/2020 19:20	4,68	139	649,94	CHI
20201134153	ABADIANIA	AN10384953	ANAPOLIS UNIVERSITARIO S2	09/11/2020 14:40	10/11/2020 02:30	09/11/2020 14:40	09/11/2020 20:09	5,47	178	973,81	CHI
20201134153	ANAPOLIS	AN10384953	ANAPOLIS UNIVERSITARIO S2	09/11/2020 14:40	10/11/2020 02:30	09/11/2020 14:40	09/11/2020 20:09	5,47	3	16,41	CHI
20201134153	ABADIANIA	AA13382392	ANAPOLIS UNIVERSITARIO S2	09/11/2020 14:40	10/11/2020 02:30	09/11/2020 14:40	09/11/2020 21:56	7,25	10	72,50	CHI
20201134153	ABADIANIA	AA13077873	ANAPOLIS UNIVERSITARIO S2	09/11/2020 14:40	10/11/2020 02:30	09/11/2020 14:40	09/11/2020 23:18	8,63	38	327,80	CHI
20201134153	ABADIANIA	AA12059632	ANAPOLIS UNIVERSITARIO S2	09/11/2020 14:40	10/11/2020 02:30	09/11/2020 14:40	10/11/2020 02:30	11,83	48	567,91	CHI
20201134153	CORUMBA DE GOIAS	AA12059632	ANAPOLIS UNIVERSITARIO S2	09/11/2020 14:40	10/11/2020 02:30	09/11/2020 14:40	10/11/2020 02:30	11,83	1	11,83	CHI
20201134162	CAIAPONIA	CP21040195	CAIAPONIA	09/11/2020 14:43	09/11/2020 15:55	09/11/2020 14:43	09/11/2020 15:55	1,19	1	1,19	CHI
20201135152	ANAPOLIS	AN11003277	ANAPOLIS UNIVERSITARIO S1	09/11/2020 14:43	09/11/2020 17:50	09/11/2020 14:43	09/11/2020 17:50	3,10	159	493,43	CHI
20201134784	GOIANESIA	GE12000211	GOIANESIA S2	09/11/2020 14:44	09/11/2020 17:25	09/11/2020 14:44	09/11/2020 17:25	2,68	5	13,40	CHI
20201134181	SANTO ANTONIO DE GOIAS	BW11233006	NEROPOLIS S1	09/11/2020 14:45	09/11/2020 21:48	09/11/2020 21:08	09/11/2020 21:48	0,66	114	75,21	CHI
20201134183	IPORA	IR12222997	ARENOPOLIS	09/11/2020 14:45	10/11/2020 10:45	09/11/2020 14:45	10/11/2020 10:45	20,00	11	220,01	CHI
20201134183	IVOLANDIA	IR12222997	ARENOPOLIS	09/11/2020 14:45	10/11/2020 10:45	09/11/2020 14:45	10/11/2020 10:45	20,00	36	720,04	CHI
20201134183	PALESTINA DE GOIAS	IR12222997	ARENOPOLIS	09/11/2020 14:45	10/11/2020 10:45	09/11/2020 14:45	10/11/2020 10:45	20,00	37	740,04	CHI
20201134186	ALEXANIA	AX11000032	ALEXANIA	09/11/2020 14:45	10/11/2020 03:01	09/11/2020 14:45	10/11/2020 03:01	12,25	31	379,83	CHI
20201134805	ANAPOLIS	AN12000085	ANAPOLIS UNIVERSITARIO S2	09/11/2020 14:45	09/11/2020 17:19	09/11/2020 14:45	09/11/2020 17:19	2,56	336	860,44	CHI
20201134190	SENADOR CANEDO	190088850	SENADOR CANEDO	09/11/2020 14:46	09/11/2020 16:20	09/11/2020 14:46	09/11/2020 16:20	1,56	1	1,56	CHI
20201134200	NAZARIO	440018912	ANICUNS	09/11/2020 14:47	10/11/2020 19:37	09/11/2020 14:47	10/11/2020 19:37	28,83	1	28,83	CHI
20201134206	APARECIDA DE GOIANIA	200076541	INDEPENDENCIA S2	09/11/2020 14:47	09/11/2020 16:12	09/11/2020 14:47	09/11/2020 16:12	1,41	1	1,41	CHI
20201134214	ABADIANIA	10026482787	ANAPOLIS UNIVERSITARIO S1	09/11/2020 14:48	09/11/2020 22:06	09/11/2020 14:48	09/11/2020 22:06	7,30	1	7,30	CHI
20201134216	SAO MIGUEL DO ARAGUAIA	SM21282205	SAO MIGUEL DO ARAGUAIA	09/11/2020 14:48	10/11/2020 10:11	09/11/2020 14:48	10/11/2020 10:11	19,38	2	38,76	CHI
20201134237	MARA ROSA	MQ12338191	SANTA TEREZINHA	09/11/2020 14:50	09/11/2020 20:27	09/11/2020 14:50	09/11/2020 20:27	5,61	3	16,83	CHI
20201134241	GOIANIA	GN11229116	GOYA S2	09/11/2020 14:50	09/11/2020 16:34	09/11/2020 14:50	09/11/2020 16:34	1,72	92	158,37	CHI
20201134243	GOIANIA	GN11148156	MEIA PONTE	09/11/2020 14:50	10/11/2020 02:05	09/11/2020 14:50	10/11/2020 02:05	11,24	174	1955,13	CHI
20201134444	TRINDADE	TR11053497	TRINDADE	09/11/2020 14:50	09/11/2020 16:06	09/11/2020 14:50	09/11/2020 16:06	1,26	302	380,77	CHI
20201134249	PIRENOPOLIS	PV21080502	CORUMBA	09/11/2020 14:51	10/11/2020 14:27	09/11/2020 14:51	10/11/2020 14:27	23,59	1	23,59	CHI
20201134254	GOIANIA	GN11148157	MEIA PONTE	09/11/2020 14:51	10/11/2020 11:30	09/11/2020 14:51	10/11/2020 11:30	20,64	193	3982,72	CHI
20201134473	GOIANIA	GN11001477	AEROPORTO S3	09/11/2020 14:51	09/11/2020 18:07	09/11/2020 14:51	09/11/2020 18:07	3,25	26	84,57	CHI

20201134560	SANTO ANTONIO DE GOIAS	BW11233005	NEROPOLIS S1	09/11/2020 14:51	09/11/2020 20:25	09/11/2020 14:51	09/11/2020 20:25	5,55	106	588,36	CHI
20201134600	GOIANIA	GN11147722	MEIA PONTE	09/11/2020 14:51	10/11/2020 00:04	09/11/2020 14:51	10/11/2020 00:04	9,22	168	1548,26	CHI
20201134263	NEROPOLIS	10010134326	NEROPOLIS S2	09/11/2020 14:52	09/11/2020 22:56	09/11/2020 14:52	09/11/2020 22:56	8,06	1	8,06	CHI
20201134613	PIRENOPOLIS	PV12034069	CORUMBA	09/11/2020 14:52	10/11/2020 14:02	09/11/2020 14:52	09/11/2020 22:04	7,20	27	194,35	CHI
20201134613	PIRENOPOLIS	PV12034069	CORUMBA	09/11/2020 14:52	10/11/2020 14:02	09/11/2020 14:52	09/11/2020 23:53	9,02	38	342,90	CHI
20201134613	PIRENOPOLIS	PV12034069	CORUMBA	09/11/2020 14:52	10/11/2020 14:02	09/11/2020 14:52	10/11/2020 14:02	23,16	15	347,45	CHI
20201134613	PIRENOPOLIS	PV12382173LD	CORUMBA	09/11/2020 14:52	10/11/2020 14:02	10/11/2020 13:08	10/11/2020 14:02	0,90	38	34,09	CHI
20201134266	JATAI	290231905	JATAI S3	09/11/2020 14:53	10/11/2020 09:46	09/11/2020 14:53	10/11/2020 09:46	18,89	1	18,89	CHI
20201134281	TRINDADE	10004221816	TRINDADE	09/11/2020 14:54	09/11/2020 19:56	09/11/2020 14:54	09/11/2020 19:56	5,02	1	5,02	CHI
20201134292	FORMOSA	FA21243175	ITIQUIRA	09/11/2020 14:55	09/11/2020 17:10	09/11/2020 14:55	09/11/2020 17:10	2,24	1	2,24	CHI
20201134300	GOIANESIA	550008019	GOIANESIA S2	09/11/2020 14:56	09/11/2020 16:23	09/11/2020 14:56	09/11/2020 16:23	1,44	1	1,44	CHI
20201134628	APARECIDA DE GOIANIA	AP11161731	INDEPENDENCIA S2	09/11/2020 14:56	09/11/2020 17:16	09/11/2020 14:56	09/11/2020 17:16	2,33	175	408,38	CHI
20201136834	CORUMBA DE GOIAS	CB12381204	CORUMBA	09/11/2020 14:56	10/11/2020 13:55	10/11/2020 10:23	10/11/2020 13:55	3,54	6	21,22	CHI
20201134308	SAO LUIS DE MONTES BELOS	SL21306951	FIRMINOPOLIS S2	09/11/2020 14:58	10/11/2020 09:42	09/11/2020 14:58	10/11/2020 09:42	18,73	5	93,65	CHI
20201134315	ANAPOLIS	10004714758	ANAPOLIS UNIVERSITARIO S2	09/11/2020 14:59	09/11/2020 18:15	09/11/2020 14:59	09/11/2020 18:15	3,26	1	3,26	CHI
20201134331	INHUMAS	30017749	INHUMAS S2	09/11/2020 15:01	09/11/2020 18:59	09/11/2020 15:01	09/11/2020 18:59	3,96	1	3,96	CHI
20201134381	GOIANIA	GN11094552	ATLANTICO S1	09/11/2020 15:01	09/11/2020 16:45	09/11/2020 15:01	09/11/2020 16:45	1,72	90	155,25	CHI
20201134352	APARECIDA DO RIO DOCE	3650008413	CACHOEIRA ALTA	09/11/2020 15:04	09/11/2020 22:19	09/11/2020 15:04	09/11/2020 22:19	7,24	1	7,24	CHI
20201134730	GOIANIA	GN12343252	GOYA S2	09/11/2020 15:06	09/11/2020 18:13	09/11/2020 15:06	09/11/2020 18:13	3,12	318	991,72	CHI
20201135680	ANAPOLIS	AN11204207	ANAPOLIS UNIVERSITARIO S2	09/11/2020 15:06	09/11/2020 19:34	09/11/2020 15:06	09/11/2020 19:34	4,45	132	587,58	CHI
20201134374	BURITI DE GOIAS	BS12079946	FIRMINOPOLIS S2	09/11/2020 15:07	09/11/2020 17:37	09/11/2020 15:07	09/11/2020 17:37	2,50	3	7,49	CHI
20201138659	JARAGUA	JA21198326	JARAGUA	09/11/2020 15:07	10/11/2020 12:35	09/11/2020 20:04	10/11/2020 12:35	16,50	1	16,50	CHI
202011118492	JARAGUA	JA12374473	JARAGUA	09/11/2020 15:07	10/11/2020 08:03	09/11/2020 20:04	10/11/2020 08:03	11,97	303	3626,91	CHI
202011118603	JARAGUA	JA21238928	JARAGUA	09/11/2020 15:07	10/11/2020 08:03	09/11/2020 15:07	10/11/2020 08:03	16,93	1	16,93	CHI
20201134385	NIQUELANDIA	NQ12239432	URUACU	09/11/2020 15:08	09/11/2020 21:34	09/11/2020 15:08	09/11/2020 21:34	6,42	21	134,91	CHI
20201134399	ITARUMA	IM11382660	ITAJA S2	09/11/2020 15:11	09/11/2020 19:49	09/11/2020 15:11	09/11/2020 19:49	4,64	2	9,27	CHI
20201134403	ARENOPOLIS	AY21359610	ARENOPOLIS	09/11/2020 15:11	09/11/2020 17:06	09/11/2020 15:11	09/11/2020 17:06	1,91	1	1,91	CHI
20201134470	ITABERAI	IB12027692	ITABERAI S2	09/11/2020 15:12	09/11/2020 17:30	09/11/2020 15:12	09/11/2020 17:30	2,29	6	13,73	CHI
20201134410	ITARUMA	2310011910	CACHOEIRA ALTA	09/11/2020 15:13	09/11/2020 18:33	09/11/2020 15:13	09/11/2020 18:33	3,33	1	3,33	CHI
20201134412	ITABERAI	50067679	ITABERAI S2	09/11/2020 15:13	09/11/2020 19:49	09/11/2020 15:13	09/11/2020 19:49	4,59	1	4,59	CHI
20201134414	GOIANIA	12854736	GOIANIA LESTE S2	09/11/2020 15:13	09/11/2020 18:30	09/11/2020 15:13	09/11/2020 18:30	3,27	1	3,27	CHI
20201135317	JARAGUA	JA11068657	ITABERAI S1	09/11/2020 15:13	10/11/2020 00:07	09/11/2020 15:13	10/11/2020 00:07	8,89	50	444,28	CHI
20201135754	MUNDO NOVO DE GOIAS	MH12394971	NOVA CRIXAS	09/11/2020 15:13	10/11/2020 07:05	09/11/2020 15:13	10/11/2020 07:05	15,85	6	95,11	CHI
20201134445	GOIAS	IB12210550	ITABERAI S1	09/11/2020 15:14	09/11/2020 18:53	09/11/2020 17:31	09/11/2020 18:53	1,35	2	2,71	CHI
20201134445	ITABERAI	IB12210550	ITABERAI S1	09/11/2020 15:14	09/11/2020 18:53	09/11/2020 17:31	09/11/2020 18:53	1,35	34	46,03	CHI
20201134431	GOIANIA	GN11227516	CARAIAS S1	09/11/2020 15:15	09/11/2020 16:52	09/11/2020 15:15	09/11/2020 16:52	1,61	57	92,05	CHI
20201134965	GOIAS	GS12037513	GOIAS	09/11/2020 15:15	09/11/2020 22:04	09/11/2020 15:15	09/11/2020 20:49	5,56	43	239,20	CHI
20201134965	GOIAS	GS12037513	GOIAS	09/11/2020 15:15	09/11/2020 22:04	09/11/2020 15:15	09/11/2020 22:04	6,81	299	2035,03	CHI
20201135081	ALEXANIA	AX12061884	ALEXANIA	09/11/2020 15:15	09/11/2020 20:42	09/11/2020 15:15	09/11/2020 20:42	5,44	16	87,10	CHI
20201135670	ITAGUARI	II12220226	ITABERAI S1	09/11/2020 15:15	09/11/2020 20:32	09/11/2020 15:15	09/11/2020 20:32	5,27	7	36,87	CHI
20201134446	APARECIDA DE GOIANIA	16015733	REAL S1	09/11/2020 15:16	09/11/2020 18:04	09/11/2020 15:16	09/11/2020 18:04	2,79	1	2,79	CHI
20201134749	ANAPOLIS	AN11203748	ANAPOLIS UNIVERSITARIO S1	09/11/2020 15:16	09/11/2020 18:45	09/11/2020 15:16	09/11/2020 18:45	3,48	116	403,91	CHI
20201136746	GOIANIA	GN11240991	CAMPINAS S2	09/11/2020 15:16	09/11/2020 21:26	09/11/2020 15:16	09/11/2020 21:26	6,15	72	442,84	CHI
20201134453	SENADOR CANEDO	10029696761	SENADOR CANEDO	09/11/2020 15:17	09/11/2020 17:23	09/11/2020 15:17	09/11/2020 17:23	2,08	1	2,08	CHI
20201134757	GOIANIRA	GR11275300	MEIA PONTE	09/11/2020 15:17	09/11/2020 16:29	09/11/2020 15:17	09/11/2020 16:29	1,20	89	106,73	CHI
20201134995	FIRMINOPOLIS	8081784	FIRMINOPOLIS S1	09/11/2020 15:18	10/11/2020 11:16	09/11/2020 15:18	10/11/2020 11:16	19,96	34	678,57	CHI
20201134995	TURVANIA	8081784	FIRMINOPOLIS S1	09/11/2020 15:18	10/11/2020 11:16	09/11/2020 15:18	10/11/2020 11:16	19,96	1	19,96	CHI
20201134469	GOIANIA	GN11133702	GOYA S2	09/11/2020 15:20	09/11/2020 17:49	09/11/2020 15:20	09/11/2020 17:49	2,47	115	283,95	CHI
20201134612	ANAPOLIS	AN10410472	ANAPOLIS UNIVERSITARIO S2	09/11/2020 15:20	09/11/2020 16:24	09/11/2020 15:20	09/11/2020 15:50	0,50	7517	3785,64	CHI
20201134612	CAMPO LIMPO	AN10410472	ANAPOLIS UNIVERSITARIO S2	09/11/2020 15:20	09/11/2020 16:24	09/11/2020 15:20	09/11/2020 15:50	0,50	7	3,53	CHI
20201134612	ANAPOLIS	AN16407972	ANAPOLIS UNIVERSITARIO S2	09/11/2020 15:20	09/11/2020 16:24	09/11/2020 15:20	09/11/2020 15:51	0,51	329	167,33	CHI

20201134612	CAMPO LIMPO	AN16407972	ANAPOLIS UNIVERSITARIO S2	09/11/2020 15:20	09/11/2020 16:24	09/11/2020 15:20	09/11/2020 15:51	0,51	11	5,59	CHI
20201134612	ANAPOLIS	AN16401592	ANAPOLIS UNIVERSITARIO S2	09/11/2020 15:20	09/11/2020 16:24	09/11/2020 15:20	09/11/2020 15:51	0,52	411	213,26	CHI
20201134612	PIRENOPOLIS	AN16401592	ANAPOLIS UNIVERSITARIO S2	09/11/2020 15:20	09/11/2020 16:24	09/11/2020 15:20	09/11/2020 15:51	0,52	57	29,58	CHI
20201134612	ANAPOLIS	AN10404178	ANAPOLIS UNIVERSITARIO S2	09/11/2020 15:20	09/11/2020 16:24	09/11/2020 15:20	09/11/2020 15:52	0,54	1	0,54	CHI
20201134612	ANAPOLIS	AN16404672	ANAPOLIS UNIVERSITARIO S2	09/11/2020 15:20	09/11/2020 16:24	09/11/2020 15:20	09/11/2020 15:59	0,64	590	377,93	CHI
20201134612	ANAPOLIS	AN10410472	ANAPOLIS UNIVERSITARIO S2	09/11/2020 15:20	09/11/2020 16:24	09/11/2020 15:53	09/11/2020 15:59	0,10	8257	825,70	CHI
20201134612	CAMPO LIMPO	AN10410472	ANAPOLIS UNIVERSITARIO S2	09/11/2020 15:20	09/11/2020 16:24	09/11/2020 15:53	09/11/2020 15:59	0,10	18	1,80	CHI
20201134612	PIRENOPOLIS	AN10410472	ANAPOLIS UNIVERSITARIO S2	09/11/2020 15:20	09/11/2020 16:24	09/11/2020 15:53	09/11/2020 15:59	0,10	57	5,70	CHI
20201134612	ABADIANIA	AN10404178	ANAPOLIS UNIVERSITARIO S2	09/11/2020 15:20	09/11/2020 16:24	09/11/2020 15:20	09/11/2020 16:24	1,06	18	19,07	CHI
20201134612	ANAPOLIS	AN10404178	ANAPOLIS UNIVERSITARIO S2	09/11/2020 15:20	09/11/2020 16:24	09/11/2020 15:20	09/11/2020 16:24	1,06	211	223,54	CHI
20201134612	PIRENOPOLIS	AN10404178	ANAPOLIS UNIVERSITARIO S2	09/11/2020 15:20	09/11/2020 16:24	09/11/2020 15:20	09/11/2020 16:24	1,06	30	31,78	CHI
20201135977	CACU	CC12075919	CACHOEIRA ALTA	09/11/2020 15:21	09/11/2020 20:32	09/11/2020 15:21	09/11/2020 20:32	5,17	1	5,17	CHI
20201135977	ITARUMA	CC12075919	CACHOEIRA ALTA	09/11/2020 15:21	09/11/2020 20:32	09/11/2020 15:21	09/11/2020 20:32	5,17	4	20,69	CHI
202011137069	COCALZINHO DE GOIAS	ZN16416296	COCALZINHO	09/11/2020 15:21	10/11/2020 00:02	09/11/2020 15:23	09/11/2020 15:32	0,16	957	149,93	CHI
202011137069	CORUMBA DE GOIAS	ZN16416296	COCALZINHO	09/11/2020 15:21	10/11/2020 00:02	09/11/2020 15:23	09/11/2020 15:32	0,16	166	26,01	CHI
202011137069	COCALZINHO DE GOIAS	ZN16411518	COCALZINHO	09/11/2020 15:21	10/11/2020 00:02	09/11/2020 15:23	09/11/2020 15:33	0,17	37	6,28	CHI
202011137069	CORUMBA DE GOIAS	ZN16411518	COCALZINHO	09/11/2020 15:21	10/11/2020 00:02	09/11/2020 15:23	09/11/2020 15:33	0,17	152	25,80	CHI
202011137069	COCALZINHO DE GOIAS	ZN10271882	COCALZINHO	09/11/2020 15:21	10/11/2020 00:02	09/11/2020 15:23	09/11/2020 15:37	0,24	285	69,59	CHI
202011137069	PADRE BERNARDO	ZN10271882	COCALZINHO	09/11/2020 15:21	10/11/2020 00:02	09/11/2020 15:23	09/11/2020 15:37	0,24	1	0,24	CHI
202011137069	VILA PROPICIO	ZN10271882	COCALZINHO	09/11/2020 15:21	10/11/2020 00:02	09/11/2020 15:23	09/11/2020 15:37	0,24	1	0,24	CHI
202011137069	AGUAS LINDAS DE GOIAS	ZN10398171	AGUAS LINDAS DE GOIAS S2	09/11/2020 15:21	10/11/2020 00:02	09/11/2020 17:14	09/11/2020 17:18	0,06	1	0,06	CHI
202011137069	COCALZINHO DE GOIAS	ZN10398171	AGUAS LINDAS DE GOIAS S2	09/11/2020 15:21	10/11/2020 00:02	09/11/2020 17:14	09/11/2020 17:18	0,06	74	4,52	CHI
202011137069	CORUMBA DE GOIAS	ZN10398171	AGUAS LINDAS DE GOIAS S2	09/11/2020 15:21	10/11/2020 00:02	09/11/2020 17:14	09/11/2020 17:18	0,06	5	0,31	CHI
202011137069	SANTO ANTONIO DO DESCOBERTO	ZN10398171	AGUAS LINDAS DE GOIAS S2	09/11/2020 15:21	10/11/2020 00:02	09/11/2020 17:14	09/11/2020 17:18	0,06	35	2,14	CHI
202011137069	COCALZINHO DE GOIAS	ZN16416296	COCALZINHO	09/11/2020 15:21	10/11/2020 00:02	09/11/2020 17:14	09/11/2020 17:23	0,14	713	99,82	CHI
202011137069	CORUMBA DE GOIAS	ZN16416296	COCALZINHO	09/11/2020 15:21	10/11/2020 00:02	09/11/2020 17:14	09/11/2020 17:23	0,14	94	13,16	CHI
202011137069	COCALZINHO DE GOIAS	ZN16411518	COCALZINHO	09/11/2020 15:21	10/11/2020 00:02	09/11/2020 17:14	09/11/2020 17:28	0,24	19	4,47	CHI
202011137069	CORUMBA DE GOIAS	ZN16411518	COCALZINHO	09/11/2020 15:21	10/11/2020 00:02	09/11/2020 17:14	09/11/2020 17:28	0,24	96	22,56	CHI
202011137069	COCALZINHO DE GOIAS	ZN10398171	COCALZINHO	09/11/2020 15:21	10/11/2020 00:02	09/11/2020 18:19	09/11/2020 18:22	0,06	957	57,69	CHI
202011137069	CORUMBA DE GOIAS	ZN10398171	COCALZINHO	09/11/2020 15:21	10/11/2020 00:02	09/11/2020 18:19	09/11/2020 18:22	0,06	166	10,01	CHI
202011137069	COCALZINHO DE GOIAS	ZN10398171	COCALZINHO	09/11/2020 15:21	10/11/2020 00:02	09/11/2020 18:19	09/11/2020 18:23	0,07	37	2,45	CHI
202011137069	CORUMBA DE GOIAS	ZN10398171	COCALZINHO	09/11/2020 15:21	10/11/2020 00:02	09/11/2020 18:19	09/11/2020 18:23	0,07	152	10,05	CHI
202011137069	COCALZINHO DE GOIAS	5745114	COCALZINHO	09/11/2020 15:21	10/11/2020 00:02	09/11/2020 15:23	09/11/2020 23:03	7,68	3450	26485,46	CHI
202011137069	COCALZINHO DE GOIAS	5745114	COCALZINHO	09/11/2020 15:21	10/11/2020 00:02	09/11/2020 15:23	09/11/2020 23:03	7,68	399	3063,10	CHI
202011137069	CORUMBA DE GOIAS	5745114	COCALZINHO	09/11/2020 15:21	10/11/2020 00:02	09/11/2020 15:23	09/11/2020 23:03	7,68	20	153,54	CHI
202011137069	CORUMBA DE GOIAS	5745114	COCALZINHO	09/11/2020 15:21	10/11/2020 00:02	09/11/2020 15:23	09/11/2020 23:03	7,68	2	15,35	CHI
202011137069	PIRENOPOLIS	5745114	COCALZINHO	09/11/2020 15:21	10/11/2020 00:02	09/11/2020 15:23	09/11/2020 23:03	7,68	34	261,02	CHI
202011137069	PIRENOPOLIS	5745114	COCALZINHO	09/11/2020 15:21	10/11/2020 00:02	09/11/2020 15:23	09/11/2020 23:03	7,68	49	376,17	CHI
202011137069	COCALZINHO DE GOIAS	ZN16411513	COCALZINHO	09/11/2020 15:21	10/11/2020 00:02	09/11/2020 17:14	09/11/2020 23:09	5,91	148	874,35	CHI
202011137069	PADRE BERNARDO	ZN16411513	COCALZINHO	09/11/2020 15:21	10/11/2020 00:02	09/11/2020 17:14	09/11/2020 23:09	5,91	1	5,91	CHI
202011137069	COCALZINHO DE GOIAS	ZN10271882	COCALZINHO	09/11/2020 15:21	10/11/2020 00:02	09/11/2020 18:27	09/11/2020 23:19	4,85	994	4825,04	CHI
202011137069	CORUMBA DE GOIAS	ZN10271882	COCALZINHO	09/11/2020 15:21	10/11/2020 00:02	09/11/2020 18:27	09/11/2020 23:19	4,85	318	1543,63	CHI
202011137069	CORUMBA DE GOIAS	CB12297652	CORUMBA	09/11/2020 15:21	10/11/2020 00:02	09/11/2020 19:27	10/11/2020 00:02	4,58	4	18,34	CHI
20201135734	MOSSAMEDES	SC12376375	FIRMINOPOLIS S2	09/11/2020 15:23	10/11/2020 02:35	09/11/2020 15:23	10/11/2020 02:35	11,20	28	313,55	CHI
20201135734	SANCLERLANDIA	SC12376375	FIRMINOPOLIS S2	09/11/2020 15:23	10/11/2020 02:35	09/11/2020 15:23	10/11/2020 02:35	11,20	11	123,18	CHI
20201134500	URUACU	10013000754	URUACU	09/11/2020 15:25	10/11/2020 08:53	09/11/2020 15:25	10/11/2020 08:53	17,47	1	17,47	CHI
20201134506	INHUMAS	30003805	INHUMAS S2	09/11/2020 15:25	09/11/2020 22:25	09/11/2020 15:25	09/11/2020 22:25	6,99	1	6,99	CHI
20201135401	ANAPOLIS	AN12001025	ANAPOLIS UNIVERSITARIO S2	09/11/2020 15:25	09/11/2020 21:50	09/11/2020 15:25	09/11/2020 21:50	6,40	5	32,01	CHI
20201134514	AGUAS LINDAS DE GOIAS	10010837300	AGUAS LINDAS DE GOIAS S2	09/11/2020 15:26	09/11/2020 16:55	09/11/2020 15:26	09/11/2020 16:55	1,48	1	1,48	CHI
20201134515	IPORA	IR122112737	IPORA	09/11/2020 15:26	09/11/2020 17:44	09/11/2020 15:26	09/11/2020 17:44	2,29	12	27,48	CHI
20201134517	ALEXANIA	AX21318552	ALEXANIA	09/11/2020 15:26	10/11/2020 12:32	09/11/2020 15:26	10/11/2020 12:32	21,09	1	21,09	CHI

20201135886	TRINDADE	TR12013977	GOYA S1	09/11/2020 15:26	09/11/2020 19:35	09/11/2020 15:26	09/11/2020 19:35	4,15	177	734,06	CHI
20201134524	ABADIANIA	AA21297740	ANAPOLIS UNIVERSITARIO S1	09/11/2020 15:27	09/11/2020 21:12	09/11/2020 15:27	09/11/2020 21:12	5,74	4	22,97	CHI
20201134529	FAZENDA NOVA	FN21051872	FIRMINOPOLIS S2	09/11/2020 15:27	09/11/2020 18:15	09/11/2020 15:27	09/11/2020 18:15	2,79	1	2,79	CHI
20201134822	GOIANIA	GN11000854	FERROVIARIO S1	09/11/2020 15:27	09/11/2020 17:23	09/11/2020 15:27	09/11/2020 17:23	1,92	130	249,60	CHI
20201134551	NIQUELANDIA	NQ21147005	URUACU	09/11/2020 15:30	09/11/2020 18:47	09/11/2020 15:30	09/11/2020 18:47	3,28	2	6,57	CHI
20201134552	CEZARINA	CZ12010354	CEZARINA	09/11/2020 15:30	09/11/2020 16:57	09/11/2020 15:30	09/11/2020 16:57	1,45	2	2,90	CHI
20201134771	SAO LUIZ DO NORTE	SZ12348617	ITAPACI	09/11/2020 15:30	09/11/2020 18:47	09/11/2020 15:30	09/11/2020 18:47	3,28	8	26,22	CHI
20201134577	ANAPOLIS	AN12258794	JUNDIAI S2	09/11/2020 15:32	09/11/2020 21:27	09/11/2020 15:32	09/11/2020 21:27	5,90	3	17,71	CHI
20201134578	INHUMAS	30081154	INHUMAS S2	09/11/2020 15:33	09/11/2020 18:27	09/11/2020 15:33	09/11/2020 18:27	2,90	1	2,90	CHI
20201134581	ARUANA	AK11183370	ARUANA	09/11/2020 15:33	09/11/2020 17:09	09/11/2020 15:33	09/11/2020 17:09	1,61	13	20,93	CHI
20201134584	ANAPOLIS	AN21258401	JUNDIAI S2	09/11/2020 15:33	09/11/2020 22:08	09/11/2020 15:33	09/11/2020 22:08	6,57	2	13,15	CHI
20201134585	SANTO ANTONIO DO DESCOBERTO	10000412102	ALEXANIA	09/11/2020 15:33	09/11/2020 19:34	09/11/2020 15:33	09/11/2020 19:34	4,01	1	4,01	CHI
20201134586	SILVANIA	SV12317628	DAIA S2	09/11/2020 15:33	10/11/2020 01:24	09/11/2020 15:33	10/11/2020 01:24	9,84	77	757,55	CHI
20201134595	SAO LUIZ DO NORTE	10019120450	ITAPACI	09/11/2020 15:34	09/11/2020 17:41	09/11/2020 15:34	09/11/2020 17:41	2,11	1	2,11	CHI
20201134597	PILAR DE GOIAS	GG21135889	SANTA TEREZINHA	09/11/2020 15:34	10/11/2020 08:03	09/11/2020 15:34	10/11/2020 08:03	16,48	1	16,48	CHI
20201134602	TERESINA DE GOIAS	7207326	FLORES DE GOIAS	09/11/2020 15:34	09/11/2020 22:40	09/11/2020 15:34	09/11/2020 22:40	7,09	1	7,09	CHI
20201134825	GOIANIA	GN12133835	GOIANIA LESTE S3	09/11/2020 15:34	09/11/2020 17:33	09/11/2020 15:34	09/11/2020 17:33	1,98	20	39,56	CHI
20201134637	ANAPOLIS	AN11107982	ANAPOLIS UNIVERSITARIO S2	09/11/2020 15:35	09/11/2020 17:16	09/11/2020 15:35	09/11/2020 17:16	1,68	101	170,04	CHI
20201134623	BOM JARDIM DE GOIAS	BM12201958	BOM JARDIM	09/11/2020 15:36	09/11/2020 16:46	09/11/2020 15:36	09/11/2020 16:46	1,15	156	179,49	CHI
20201134676	ALEXANIA	AX11000006	ALEXANIA	09/11/2020 15:36	09/11/2020 19:19	09/11/2020 15:36	09/11/2020 19:19	3,71	75	278,21	CHI
20201134799	TRINDADE	TR11134052	GOYA S2	09/11/2020 15:36	09/11/2020 22:11	09/11/2020 15:36	09/11/2020 22:11	6,57	129	847,46	CHI
20201136173	FLORES DE GOIAS	FB12426833	IACIARA S2	09/11/2020 15:36	09/11/2020 20:54	09/11/2020 15:36	09/11/2020 20:54	5,29	16	84,67	CHI
20201134631	GOIANIA	GN12291550	INDEPENDENCIA S2	09/11/2020 15:37	09/11/2020 17:44	09/11/2020 15:37	09/11/2020 17:44	2,11	141	296,84	CHI
20201134648	LUIZANIA	LZ11162755	MARAJOARA	09/11/2020 15:37	09/11/2020 17:13	09/11/2020 15:37	09/11/2020 17:13	1,60	195	311,40	CHI
20201134696	AURILANDIA	RP12076381RE	FIRMINOPOLIS S2	09/11/2020 15:37	09/11/2020 17:17	09/11/2020 15:37	09/11/2020 17:17	1,65	4	6,61	CHI
20201134696	SAO JOAO DA PARAUNA	RP12076381RE	FIRMINOPOLIS S2	09/11/2020 15:37	09/11/2020 17:17	09/11/2020 15:37	09/11/2020 17:17	1,65	33	54,53	CHI
20201134786	FAZENDA NOVA	FN12390152	IPORA	09/11/2020 15:37	09/11/2020 20:10	09/11/2020 15:37	09/11/2020 20:10	4,53	12	54,41	CHI
20201134786	ISRAELANDIA	FN12390152	IPORA	09/11/2020 15:37	09/11/2020 20:10	09/11/2020 15:37	09/11/2020 20:10	4,53	2	9,07	CHI
20201134642	JANDAIA	JD21013327	PALMEIRAS	09/11/2020 15:38	09/11/2020 19:25	09/11/2020 15:38	09/11/2020 19:25	3,77	1	3,77	CHI
20201135544	ANAPOLIS	AN11226755	ANAPOLIS UNIVERSITARIO S1	09/11/2020 15:38	09/11/2020 19:37	09/11/2020 15:38	09/11/2020 19:37	3,98	113	449,24	CHI
20201134931	RIO VERDE	RV13058116	RIO VERDE S1	09/11/2020 15:40	09/11/2020 19:48	09/11/2020 19:38	09/11/2020 19:48	0,15	847	131,05	CHI
20201134655	DAMIANOPOLIS	DA12196512	IACIARA S2	09/11/2020 15:41	09/11/2020 16:25	09/11/2020 15:41	09/11/2020 16:25	0,73	67	49,13	CHI
20201134663	PORANGATU	PO11345598	PORANGATU	09/11/2020 15:42	10/11/2020 02:34	09/11/2020 15:42	10/11/2020 02:34	10,85	2	21,71	CHI
20201134674	FLORES DE GOIAS	FB21421842	FLORES DE GOIAS	09/11/2020 15:43	09/11/2020 18:33	09/11/2020 15:43	09/11/2020 18:33	2,82	1	2,82	CHI
20201135490	AVELINOPOLIS	AV12241071	ANICUNS	09/11/2020 15:43	09/11/2020 19:11	09/11/2020 15:43	09/11/2020 19:11	3,46	128	443,48	CHI
20201135490	SANTA BARBARA DE GOIAS	AV12241071	ANICUNS	09/11/2020 15:43	09/11/2020 19:11	09/11/2020 15:43	09/11/2020 19:11	3,46	8	27,72	CHI
20201134760	GOIANIA	GN11122842	CARAJAS S1	09/11/2020 15:44	09/11/2020 22:17	09/11/2020 15:44	09/11/2020 22:17	6,55	108	707,28	CHI
20201134878	ANAPOLIS	AN11098871	ANAPOLIS UNIVERSITARIO S1	09/11/2020 15:45	09/11/2020 18:46	09/11/2020 15:45	09/11/2020 18:46	3,01	111	334,26	CHI
20201134693	TRINDADE	10007121413	TRINDADE	09/11/2020 15:46	09/11/2020 21:34	09/11/2020 15:46	09/11/2020 21:34	5,79	1	5,79	CHI
20201134695	CAMPINORTE	CR11400085	CAMPINORTE	09/11/2020 15:46	09/11/2020 17:16	09/11/2020 15:46	09/11/2020 17:16	1,49	70	104,28	CHI
20201134706	ABADIANIA	AA12302403	CORUMBA	09/11/2020 15:47	09/11/2020 21:56	09/11/2020 15:47	09/11/2020 21:56	6,14	6	36,81	CHI
20201134706	CORUMBA DE GOIAS	AA12302403	CORUMBA	09/11/2020 15:47	09/11/2020 21:56	09/11/2020 15:47	09/11/2020 21:56	6,14	1	6,14	CHI
20201134735	CAMPINORTE	CR11333961	CAMPINORTE	09/11/2020 15:47	09/11/2020 23:20	09/11/2020 15:47	09/11/2020 23:20	7,54	192	1448,05	CHI
20201134761	GOIANIA	GN12000145	REAL S2	09/11/2020 15:48	09/11/2020 17:53	09/11/2020 15:48	09/11/2020 17:53	2,07	355	735,64	CHI
20201135423	BRAZABRANTES	NV12000117	INHUMAS S1	09/11/2020 15:48	10/11/2020 18:43	09/11/2020 15:48	10/11/2020 18:43	26,92	59	1588,00	CHI
20201135423	INHUMAS	NV12000117	INHUMAS S1	09/11/2020 15:48	10/11/2020 18:43	09/11/2020 15:48	10/11/2020 18:43	26,92	19	511,39	CHI
20201135423	NOVA VENEZA	NV12000117	INHUMAS S1	09/11/2020 15:48	10/11/2020 18:43	09/11/2020 15:48	10/11/2020 18:43	26,92	86	2314,71	CHI
20201135440	ABADIANIA	AA12258356	ANAPOLIS UNIVERSITARIO S1	09/11/2020 15:48	09/11/2020 20:18	09/11/2020 15:48	09/11/2020 20:18	4,50	12	53,96	CHI
20201142196	BRAZABRANTES	BR21009619	INHUMAS S1	09/11/2020 15:48	10/11/2020 22:42	09/11/2020 15:48	10/11/2020 22:42	30,89	1	30,89	CHI
20201134722	NIQUELANDIA	NQ21234283	NIQUELANDIA SUBTRANSMISSAO	09/11/2020 15:50	10/11/2020 10:22	09/11/2020 15:50	10/11/2020 10:22	18,53	1	18,53	CHI
20201135464	GOIANIA	GN11215891	GOYA S1	09/11/2020 15:50	10/11/2020 02:12	09/11/2020 15:50	10/11/2020 02:12	10,36	111	1150,11	CHI

20201134729	RIO VERDE	10019795210	RIO VERDE S1	09/11/2020 15:51	09/11/2020 17:21	09/11/2020 15:51	09/11/2020 17:21	1,50	1	1,50	CHI
20201134731	GOIANAPOLIS	10013411274	DAIA S2	09/11/2020 15:51	09/11/2020 20:32	09/11/2020 15:51	09/11/2020 20:32	4,67	1	4,67	CHI
20201134734	CRIXAS	2490027159	SERRA DO OURO	09/11/2020 15:51	09/11/2020 20:03	09/11/2020 15:51	09/11/2020 20:03	4,19	1	4,19	CHI
20201134738	NIQUELANDIA	NQ21265771	BARRO ALTO	09/11/2020 15:52	09/11/2020 17:42	09/11/2020 15:52	09/11/2020 17:42	1,83	0	0,00	CHI
20201134745	ANAPOLIS	AN12008855	ANAPOLIS UNIVERSITARIO S2	09/11/2020 15:53	09/11/2020 19:51	09/11/2020 15:53	09/11/2020 19:51	3,95	9	35,57	CHI
20201134748	JARAGUA	JA21376548	GOIANESIA S2	09/11/2020 15:54	10/11/2020 15:03	09/11/2020 15:54	10/11/2020 15:03	23,15	2	46,29	CHI
20201134752	AGUAS LINDAS DE GOIAS	4830450230	AGUAS LINDAS DE GOIAS S1	09/11/2020 15:54	09/11/2020 17:00	09/11/2020 15:54	09/11/2020 17:00	1,09	1	1,09	CHI
20201134753	FORMOSA	FA12376671	ITIQUEIRA	09/11/2020 15:54	09/11/2020 18:00	09/11/2020 15:54	09/11/2020 18:00	2,09	34	71,02	CHI
20201136039	GOIAS	GS12085888	GOIAS	09/11/2020 15:54	10/11/2020 10:39	09/11/2020 15:54	10/11/2020 10:39	18,74	34	637,02	CHI
20201134764	JATAI	JT11336947	JATAI S3	09/11/2020 15:56	10/11/2020 07:44	09/11/2020 15:56	10/11/2020 07:44	15,79	112	1768,70	CHI
20201134765	GOIAS	GS21135025	GOIAS	09/11/2020 15:56	10/11/2020 10:01	09/11/2020 15:56	10/11/2020 10:01	18,07	1	18,07	CHI
20201134770	FLORES DE GOIAS	FB12211537	IACIARA S2	09/11/2020 15:57	09/11/2020 18:29	09/11/2020 15:57	09/11/2020 18:29	2,53	63	159,28	CHI
20201134772	GOIATUBA	BG21244939	GOIATUBA S2	09/11/2020 15:57	09/11/2020 17:32	09/11/2020 15:57	09/11/2020 17:32	1,57	1	1,57	CHI
20201135825	MONTES CLAROS DE GOIAS	ME12091253	ARENOPOLIS	09/11/2020 15:58	10/11/2020 15:35	09/11/2020 15:58	10/11/2020 15:35	23,61	11	259,67	CHI
20201134781	TRINDADE	11567521	GOYA S2	09/11/2020 15:59	09/11/2020 17:00	09/11/2020 15:59	09/11/2020 17:00	1,03	1	1,03	CHI
20201134783	GOIANIA	GN12001303	AEROPORTO S2	09/11/2020 15:59	09/11/2020 17:51	09/11/2020 15:59	09/11/2020 17:51	1,86	300	557,42	CHI
20201134789	BOM JARDIM DE GOIAS	BM12333265	ARAGARCAS	09/11/2020 16:00	09/11/2020 18:52	09/11/2020 16:00	09/11/2020 18:52	2,86	4	11,44	CHI
20201134804	ITAPIRAPUA	IU12259771	MATRINCHA	09/11/2020 16:02	10/11/2020 15:22	09/11/2020 16:02	10/11/2020 15:22	23,34	31	723,50	CHI
20201134809	LUZIANIA	LZ12290851	MARAJOARA	09/11/2020 16:02	09/11/2020 22:20	09/11/2020 16:02	09/11/2020 22:20	6,29	24	150,88	CHI
20201135278	MONTES CLAROS DE GOIAS	ME12038971	IPORA	09/11/2020 16:02	10/11/2020 09:40	09/11/2020 22:14	09/11/2020 23:50	1,61	4	6,46	CHI
20201135278	MONTES CLAROS DE GOIAS	ME12140008	IPORA	09/11/2020 16:02	10/11/2020 09:40	09/11/2020 16:02	10/11/2020 02:18	10,26	17	174,46	CHI
20201135278	MONTES CLAROS DE GOIAS	ME12140008	IPORA	09/11/2020 16:02	10/11/2020 09:40	09/11/2020 16:02	10/11/2020 09:40	17,63	1	17,63	CHI
20201134797	ANAPOLIS	AN21000092	ANAPOLIS UNIVERSITARIO S2	09/11/2020 16:05	09/11/2020 20:40	09/11/2020 16:05	09/11/2020 20:40	4,58	1	4,58	CHI
20201134829	CAIAPONIA	2840009803	MONTIVIDIU T	09/11/2020 16:05	10/11/2020 14:24	09/11/2020 16:05	09/11/2020 14:24	22,31	1	22,31	CHI
20201135271	CAIAPONIA	PY18020934TS	PALESTINA	09/11/2020 16:06	11/11/2020 14:20	09/11/2020 16:06	09/11/2020 21:30	5,40	39	210,56	CHI
20201135271	CAIAPONIA	PY18020934TS	PALESTINA	09/11/2020 16:06	11/11/2020 14:20	09/11/2020 16:06	10/11/2020 09:30	17,40	64	1113,58	CHI
20201135271	PALESTINA DE GOIAS	PY18020934TS	PALESTINA	09/11/2020 16:06	11/11/2020 14:20	09/11/2020 16:06	10/11/2020 09:30	17,40	25	434,99	CHI
20201135271	CAIAPONIA	CP12119234LD	PALESTINA	09/11/2020 16:06	11/11/2020 14:20	09/11/2020 16:06	10/11/2020 14:34	22,47	73	1639,99	CHI
20201135271	CAIAPONIA	CP12119234LD	PALESTINA	09/11/2020 16:06	11/11/2020 14:20	09/11/2020 21:38	10/11/2020 14:34	16,92	1	16,92	CHI
20201135271	CAIAPONIA	CP12119234LD	PALESTINA	09/11/2020 16:06	11/11/2020 14:20	09/11/2020 16:06	11/11/2020 14:20	46,23	31	1433,24	CHI
20201135271	CAIAPONIA	CP12119234LD	PALESTINA	09/11/2020 16:06	11/11/2020 14:20	09/11/2020 04:21	11/11/2020 14:20	9,98	76	758,71	CHI
20201135271	CAIAPONIA	PY18020934TS	PALESTINA	09/11/2020 16:06	11/11/2020 14:20	11/11/2020 12:10	11/11/2020 14:20	2,17	64	138,74	CHI
20201135271	PALESTINA DE GOIAS	PY18020934TS	PALESTINA	09/11/2020 16:06	11/11/2020 14:20	11/11/2020 12:10	11/11/2020 14:20	2,17	25	54,19	CHI
20201134843	BOM JARDIM DE GOIAS	BM11380932	BOM JARDIM	09/11/2020 16:07	10/11/2020 12:02	09/11/2020 16:07	10/11/2020 12:02	19,91	88	1752,30	CHI
20201134853	LUZIANIA	LZ21329120	RIO VERMELHO	09/11/2020 16:08	09/11/2020 22:01	09/11/2020 16:08	09/11/2020 22:01	5,87	1	5,87	CHI
20201134866	NOVA VENEZA	300004692	INHUMAS S1	09/11/2020 16:09	10/11/2020 22:47	09/11/2020 16:09	10/11/2020 22:47	30,62	1	30,62	CHI
20201135799	SAO MIGUEL DO PASSA QUATRO	SV12102994	VIANOPOLIS	09/11/2020 16:09	10/11/2020 10:28	09/11/2020 16:09	10/11/2020 10:28	18,30	62	1134,91	CHI
20201135799	SILVANIA	SV12102994	VIANOPOLIS	09/11/2020 16:09	10/11/2020 10:28	09/11/2020 16:09	10/11/2020 10:28	18,30	76	1391,18	CHI
20201135799	VIANOPOLIS	SV12102994	VIANOPOLIS	09/11/2020 16:09	10/11/2020 10:28	09/11/2020 16:09	10/11/2020 10:28	18,30	123	2251,51	CHI
20201134871	ANAPOLIS	AN11129406	ANAPOLIS UNIVERSITARIO S2	09/11/2020 16:10	09/11/2020 18:51	09/11/2020 16:10	09/11/2020 18:51	2,68	128	342,47	CHI
20201134890	GAMELEIRA DE GOIAS	SV12070048	DAIA S2	09/11/2020 16:10	09/11/2020 19:30	09/11/2020 16:10	09/11/2020 19:30	3,33	3	9,99	CHI
20201134890	SILVANIA	SV12070048	DAIA S2	09/11/2020 16:10	09/11/2020 19:30	09/11/2020 16:10	09/11/2020 19:30	3,33	15	49,94	CHI
20201134909	ANICUNS	AC16410183	ANICUNS	09/11/2020 16:10	09/11/2020 16:16	09/11/2020 16:10	09/11/2020 16:14	0,06	1056	68,35	CHI
20201134909	ANICUNS	AC16410182	ANICUNS	09/11/2020 16:10	09/11/2020 16:16	09/11/2020 16:10	09/11/2020 16:16	0,10	2201	228,05	CHI
20201134909	TURVANIA	AC16410182	ANICUNS	09/11/2020 16:10	09/11/2020 16:16	09/11/2020 16:10	09/11/2020 16:16	0,10	3	0,31	CHI
20201134892	CAIAPONIA	CP11020865	CAIAPONIA	09/11/2020 16:12	09/11/2020 17:42	09/11/2020 16:12	09/11/2020 17:42	1,49	117	173,91	CHI
20201135361	SANTA HELENA DE GOIAS	1660434	SANTA HELENA S1	09/11/2020 16:12	11/11/2020 08:32	09/11/2020 16:12	09/11/2020 19:09	2,93	1	2,93	CHI
20201135361	SANTA HELENA DE GOIAS	1660434	SANTA HELENA S1	09/11/2020 16:12	11/11/2020 08:32	09/11/2020 16:14	09/11/2020 19:09	2,91	5	14,54	CHI
20201135361	SANTA HELENA DE GOIAS	1660434	SANTA HELENA S1	09/11/2020 16:12	11/11/2020 08:32	09/11/2020 16:12	11/11/2020 08:32	40,32	9	362,90	CHI
20201135967	ANAPOLIS	AN11217369	ANAPOLIS UNIVERSITARIO S2	09/11/2020 16:12	09/11/2020 20:22	09/11/2020 16:12	09/11/2020 20:22	4,16	95	395,44	CHI
20201134883	RIO VERDE	MV21260888	MONTIVIDIU T	09/11/2020 16:13	09/11/2020 18:24	09/11/2020 16:13	09/11/2020 18:24	2,18	1	2,18	CHI

20201134895	ARACU	120206	ARACU	09/11/2020 16:14	10/11/2020 16:23	09/11/2020 16:14	09/11/2020 17:43	1,47	31	45,60	CHI
20201134895	CATURAI	120206	ARACU	09/11/2020 16:14	10/11/2020 16:23	09/11/2020 16:14	09/11/2020 17:43	1,47	79	116,20	CHI
20201134895	GOIANIRA	120206	ARACU	09/11/2020 16:14	10/11/2020 16:23	09/11/2020 16:14	09/11/2020 17:43	1,47	1	1,47	CHI
20201134895	INHUMAS	120206	ARACU	09/11/2020 16:14	10/11/2020 16:23	09/11/2020 16:14	09/11/2020 17:43	1,47	6	8,82	CHI
20201134895	ITABERAI	120206	ARACU	09/11/2020 16:14	10/11/2020 16:23	09/11/2020 16:14	09/11/2020 17:43	1,47	10	14,71	CHI
20201134895	ANICUNS	120206	ARACU	09/11/2020 16:14	10/11/2020 16:23	09/11/2020 16:14	09/11/2020 17:59	1,74	71	123,40	CHI
20201134895	ARACU	120206	ARACU	09/11/2020 16:14	10/11/2020 16:23	09/11/2020 16:14	09/11/2020 17:59	1,74	1341	2330,73	CHI
20201134895	CATURAI	120206	ARACU	09/11/2020 16:14	10/11/2020 16:23	09/11/2020 16:14	09/11/2020 17:59	1,74	100	173,81	CHI
20201134895	INHUMAS	120206	ARACU	09/11/2020 16:14	10/11/2020 16:23	09/11/2020 16:14	09/11/2020 17:59	1,74	119	206,83	CHI
20201134895	ITABERAI	120206	ARACU	09/11/2020 16:14	10/11/2020 16:23	09/11/2020 16:14	09/11/2020 17:59	1,74	64	111,24	CHI
20201134895	ITAUCU	120206	ARACU	09/11/2020 16:14	10/11/2020 16:23	09/11/2020 16:14	09/11/2020 17:59	1,74	9	15,64	CHI
20201134895	ARACU	AR11132756	ARACU	09/11/2020 16:14	10/11/2020 16:23	09/11/2020 16:14	09/11/2020 20:00	3,75	125	469,24	CHI
20201134895	ARACU	AR11074064	ARACU	09/11/2020 16:14	10/11/2020 16:23	09/11/2020 17:50	09/11/2020 22:08	4,30	110	473,00	CHI
20201134895	ANICUNS	AR10400696	ARACU	09/11/2020 16:14	10/11/2020 16:23	09/11/2020 21:45	09/11/2020 23:03	1,29	70	90,49	CHI
20201134895	ARACU	AR10400696	ARACU	09/11/2020 16:14	10/11/2020 16:23	09/11/2020 21:45	09/11/2020 23:03	1,29	52	67,22	CHI
20201134895	ITABERAI	AR10400696	ARACU	09/11/2020 16:14	10/11/2020 16:23	09/11/2020 21:45	09/11/2020 23:03	1,29	40	51,71	CHI
20201134895	ANICUNS	AR10400696	ARACU	09/11/2020 16:14	10/11/2020 16:23	09/11/2020 21:45	10/11/2020 16:23	18,62	1	18,62	CHI
20201134895	ARACU	AR10400696	ARACU	09/11/2020 16:14	10/11/2020 16:23	09/11/2020 21:45	10/11/2020 16:23	18,62	46	856,58	CHI
20201134895	ITABERAI	AR10400696	ARACU	09/11/2020 16:14	10/11/2020 16:23	09/11/2020 21:45	10/11/2020 16:23	18,62	12	223,46	CHI
20201134895	ITAUCU	AR10400696	ARACU	09/11/2020 16:14	10/11/2020 16:23	09/11/2020 21:45	10/11/2020 16:23	18,62	9	167,59	CHI
20201136547	TEREZOPOLIS DE GOIAS	TJ12080977	JUNDAIA S2	09/11/2020 16:16	10/11/2020 07:27	09/11/2020 16:16	10/11/2020 07:27	15,17	4	60,69	CHI
20201134913	ANAPOLIS	AN11167584	ANAPOLIS UNIVERSITARIO S2	09/11/2020 16:17	09/11/2020 19:56	09/11/2020 16:17	09/11/2020 19:56	3,66	157	574,36	CHI
20201134914	APARECIDA DE GOIANIA	12395353	INDEPENDENCIA S2	09/11/2020 16:17	09/11/2020 20:46	09/11/2020 16:17	09/11/2020 20:46	4,47	1	4,47	CHI
20201134981	TEREZOPOLIS DE GOIAS	TJ11273110	DAIA S2	09/11/2020 16:17	09/11/2020 22:12	09/11/2020 16:17	09/11/2020 22:12	5,92	64	378,61	CHI
20201135482	ORIZONA	3600216	VIANOPOLIS	09/11/2020 16:18	09/11/2020 19:50	09/11/2020 16:18	09/11/2020 19:50	3,54	45	159,26	CHI
20201135482	VIANOPOLIS	3600216	VIANOPOLIS	09/11/2020 16:18	09/11/2020 19:50	09/11/2020 16:18	09/11/2020 19:50	3,54	368	1302,41	CHI
20201134925	AGUAS LINDAS DE GOIAS	4830196337	AGUAS LINDAS DE GOIAS S1	09/11/2020 16:19	09/11/2020 17:25	09/11/2020 16:19	09/11/2020 17:25	1,09	1	1,09	CHI
20201134929	CAIAPONIA	930047989	CAIAPONIA	09/11/2020 16:20	09/11/2020 17:46	09/11/2020 16:20	09/11/2020 17:46	1,43	1	1,43	CHI
20201134930	GOIAS	90084986	GOIAS	09/11/2020 16:20	10/11/2020 10:11	09/11/2020 16:20	10/11/2020 10:11	17,84	1	17,84	CHI
20201134932	FORMOSA	FA11245398	ITUIQUIRA	09/11/2020 16:20	09/11/2020 20:57	09/11/2020 16:20	09/11/2020 20:57	4,61	12	55,34	CHI
20201134933	RIO VERDE	RV11360678	RIO VERDE S2	09/11/2020 16:20	11/11/2020 12:27	09/11/2020 16:20	10/11/2020 15:46	23,42	10	234,24	CHI
20201134933	RIO VERDE	RV13301688	RIO VERDE S2	09/11/2020 16:20	11/11/2020 12:27	09/11/2020 23:38	10/11/2020 15:46	16,13	237	3821,89	CHI
20201134933	RIO VERDE	RV10396883	RIO VERDE S2	09/11/2020 16:20	11/11/2020 12:27	09/11/2020 19:27	10/11/2020 19:08	23,70	141	3341,19	CHI
20201134933	RIO VERDE	RV10396883	RIO VERDE S2	09/11/2020 16:20	11/11/2020 12:27	09/11/2020 19:27	11/11/2020 12:27	41,01	89	3649,89	CHI
20201134937	CORUMBA DE GOIAS	3310001190	CORUMBA	09/11/2020 16:21	10/11/2020 11:13	09/11/2020 16:21	10/11/2020 11:13	18,86	1	18,86	CHI
20201134948	ANAPOLIS	AN11215206	ANAPOLIS UNIVERSITARIO S2	09/11/2020 16:24	09/11/2020 18:43	09/11/2020 16:24	09/11/2020 18:43	2,31	56	129,28	CHI
20201134951	CAIAPONIA	930016270	CAIAPONIA	09/11/2020 16:24	10/11/2020 10:43	09/11/2020 16:24	10/11/2020 10:43	18,30	1	18,30	CHI
20201135308	PIRES DO RIO	PR12095357	PIRES DO RIO S1	09/11/2020 16:24	10/11/2020 01:18	09/11/2020 16:24	10/11/2020 01:18	8,89	8	71,13	CHI
20201134956	ANAPOLIS	AN21062671	ANAPOLIS UNIVERSITARIO S2	09/11/2020 16:25	10/11/2020 01:57	09/11/2020 16:25	10/11/2020 01:57	9,52	1	9,52	CHI
20201135279	ANAPOLIS	AN12259031	ANAPOLIS UNIVERSITARIO S2	09/11/2020 16:25	09/11/2020 19:59	09/11/2020 16:25	09/11/2020 19:59	3,56	12	42,69	CHI
20201134972	NOVO GAMA	NJ11183774	PACAEMBU S1	09/11/2020 16:26	09/11/2020 19:12	09/11/2020 16:26	09/11/2020 19:12	2,75	39	107,35	CHI
20201134968	CABECEIRAS	CW21139864	ITUIQUIRA	09/11/2020 16:27	09/11/2020 17:53	09/11/2020 16:27	09/11/2020 17:53	1,42	1	1,42	CHI
20201134973	DIVINOPOLIS DE GOIAS	GH21269330	SAO DOMINGOS	09/11/2020 16:28	09/11/2020 19:20	09/11/2020 16:28	09/11/2020 19:20	2,86	1	2,86	CHI
20201134977	AMORINOPOLIS	AM12133498	IPORA	09/11/2020 16:28	09/11/2020 18:30	09/11/2020 16:28	09/11/2020 18:30	2,02	179	361,68	CHI
20201134978	TRINDADE	TR12313010	TRINDADE	09/11/2020 16:28	09/11/2020 23:03	09/11/2020 16:28	09/11/2020 23:03	6,57	53	348,20	CHI
20201135466	CAIAPONIA	CP11000007	CAIAPONIA	09/11/2020 16:28	09/11/2020 19:21	09/11/2020 16:28	09/11/2020 19:21	2,87	105	301,70	CHI
20201134983	PIRANHAS	1930027063	PIRANHAS	09/11/2020 16:29	09/11/2020 18:02	09/11/2020 16:29	09/11/2020 18:02	1,54	1	1,54	CHI
20201134988	CAMPINACU	5700013567	PORANGATU	09/11/2020 16:29	09/11/2020 23:17	09/11/2020 16:29	09/11/2020 23:17	6,78	1	6,78	CHI
20201134999	PIRANHAS	PH11052933	PIRANHAS	09/11/2020 16:29	09/11/2020 17:18	09/11/2020 16:29	09/11/2020 17:18	0,80	121	97,00	CHI
20201134994	BOM JARDIM DE GOIAS	BM21187411	BOM JARDIM	09/11/2020 16:30	10/11/2020 09:39	09/11/2020 16:30	10/11/2020 09:39	17,14	2	34,29	CHI
20201134997	GOIANIA	13876478	MEIA PONTE	09/11/2020 16:30	09/11/2020 23:01	09/11/2020 16:30	09/11/2020 23:01	6,50	1	6,50	CHI

20201135861	ANAPOLIS	AN11129422	ANAPOLIS UNIVERSITARIO S2	09/11/2020 16:30	09/11/2020 19:50	09/11/2020 16:30	09/11/2020 19:50	3,33	91	303,21	CHI
20201135002	GOIANIA	15024283	REAL S1	09/11/2020 16:31	09/11/2020 19:40	09/11/2020 16:31	09/11/2020 19:40	3,14	1	3,14	CHI
20201135003	VIANOPOLIS	VN11126409	VIANOPOLIS	09/11/2020 16:31	10/11/2020 01:22	09/11/2020 16:31	10/11/2020 01:22	8,84	30	265,15	CHI
20201135006	CRISTALINA	KR21025857	PAMPLONA	09/11/2020 16:31	09/11/2020 18:38	09/11/2020 16:31	09/11/2020 18:38	2,10	1	2,10	CHI
20201135010	ALTO HORIZONTE	AJ21317167	SANTA TEREZINHA	09/11/2020 16:32	09/11/2020 18:59	09/11/2020 16:32	09/11/2020 18:59	2,45	1	2,45	CHI
20201135144	APORE	IJ12202625RE	ITAJA S2	09/11/2020 16:32	09/11/2020 23:02	09/11/2020 16:32	09/11/2020 23:02	6,49	3	19,47	CHI
20201135144	ITAJA	IJ12202625RE	ITAJA S2	09/11/2020 16:32	09/11/2020 23:02	09/11/2020 16:32	09/11/2020 23:02	6,49	25	162,26	CHI
20201135702	INHUMAS	IX12000030	INHUMAS S1	09/11/2020 16:32	09/11/2020 19:47	09/11/2020 16:32	09/11/2020 19:47	3,24	11	35,66	CHI
20201135702	ITAUCU	IX12000030	INHUMAS S1	09/11/2020 16:32	09/11/2020 19:47	09/11/2020 16:32	09/11/2020 19:47	3,24	4	12,97	CHI
20201135050	PORANGATU	PO12208614	PORANGATU	09/11/2020 16:33	09/11/2020 19:23	09/11/2020 16:33	09/11/2020 19:23	2,82	10	28,19	CHI
20201135728	TRINDADE	TR12087490	TRINDADE	09/11/2020 16:33	09/11/2020 20:09	09/11/2020 16:33	09/11/2020 20:09	3,59	440	1581,19	CHI
20201135028	JATAI	10018120987	JATAI S2	09/11/2020 16:34	10/11/2020 09:49	09/11/2020 16:34	10/11/2020 09:49	17,24	1	17,24	CHI
20201135035	GAMELEIRA DE GOIAS	SV21032724	DAIA S2	09/11/2020 16:34	09/11/2020 21:48	09/11/2020 16:34	09/11/2020 21:48	5,22	2	10,43	CHI
20201137343	RIO VERDE	QI12126464	QUIRINOPOLIS	09/11/2020 16:34	10/11/2020 10:01	09/11/2020 16:34	10/11/2020 10:01	17,44	10	174,40	CHI
20201135042	FIRMINOPOLIS	10029803070	FIRMINOPOLIS S1	09/11/2020 16:35	10/11/2020 11:38	09/11/2020 16:35	10/11/2020 11:38	19,04	1	19,04	CHI
20201135044	RIO VERDE	RV12230656	CABRIUVA S2	09/11/2020 16:35	10/11/2020 02:07	09/11/2020 16:35	10/11/2020 02:07	9,52	1	9,52	CHI
20201135045	VIANOPOLIS	VN21011480	VIANOPOLIS	09/11/2020 16:35	09/11/2020 23:16	09/11/2020 16:35	09/11/2020 23:16	6,67	1	6,67	CHI
20201135117	ANHANGUERA	AH12082016RE	CATALAO S1	09/11/2020 16:35	10/11/2020 09:18	09/11/2020 16:35	10/11/2020 09:18	16,71	11	183,86	CHI
20201135117	CUMARI	AH12082016RE	CATALAO S1	09/11/2020 16:35	10/11/2020 09:18	09/11/2020 16:35	10/11/2020 09:18	16,71	21	351,01	CHI
20201136236	RIO VERDE	RV12230656	CABRIUVA S2	09/11/2020 16:35	10/11/2020 02:07	09/11/2020 16:35	10/11/2020 02:07	9,52	8	76,19	CHI
20201136294	ABADIANIA	AN12221398	ANAPOLIS UNIVERSITARIO S2	09/11/2020 16:35	09/11/2020 21:35	09/11/2020 16:35	09/11/2020 21:35	4,99	4	19,97	CHI
20201136294	ANAPOLIS	AN12221398	ANAPOLIS UNIVERSITARIO S2	09/11/2020 16:35	09/11/2020 21:35	09/11/2020 16:35	09/11/2020 21:35	4,99	2	9,99	CHI
20201136294	PIRENOPOLIS	AN12221398	ANAPOLIS UNIVERSITARIO S2	09/11/2020 16:35	09/11/2020 21:35	09/11/2020 16:35	09/11/2020 21:35	4,99	1	4,99	CHI
20201135054	CATALAO	CT12266969	CATALAO S1	09/11/2020 16:36	09/11/2020 21:43	09/11/2020 16:36	09/11/2020 21:43	5,11	5	25,54	CHI
20201135055	GUAPO	GA21216295	GUAPO S1	09/11/2020 16:36	09/11/2020 18:21	09/11/2020 16:36	09/11/2020 18:21	1,74	1	1,74	CHI
20201135056	GOIANIRA	GR12393579	GOIANIRA	09/11/2020 16:36	09/11/2020 19:58	09/11/2020 16:36	09/11/2020 19:58	3,35	8	26,82	CHI
20201135057	RIO VERDE	RV11191817	MONTIVIDIU T	09/11/2020 16:36	09/11/2020 20:16	09/11/2020 16:36	09/11/2020 20:16	3,65	5	18,25	CHI
20201135058	GOIANIA	17070247	ATLANTICO S1	09/11/2020 16:36	09/11/2020 20:34	09/11/2020 16:36	09/11/2020 20:34	3,95	1	3,95	CHI
20201135064	FORMOSO	2410022310	PORANGATU	09/11/2020 16:37	10/11/2020 03:15	09/11/2020 16:37	10/11/2020 03:15	10,62	1	10,62	CHI
20201135065	ANAPOLIS	20495808	JUNDIAI S1	09/11/2020 16:37	09/11/2020 18:42	09/11/2020 16:37	09/11/2020 18:42	2,07	1	2,07	CHI
20201135312	RIO VERDE	2450424	CABRIUVA S2	09/11/2020 16:37	09/11/2020 16:49	09/11/2020 16:37	09/11/2020 16:46	0,16	8	1,29	CHI
20201135312	JATAI	RV10402461	CABRIUVA S2	09/11/2020 16:37	09/11/2020 16:49	09/11/2020 16:37	09/11/2020 16:48	0,18	16	2,96	CHI
20201135312	RIO VERDE	RV10402461	CABRIUVA S2	09/11/2020 16:37	09/11/2020 16:49	09/11/2020 16:37	09/11/2020 16:48	0,18	32	5,92	CHI
20201135312	RIO VERDE	RV10409378	CABRIUVA S2	09/11/2020 16:37	09/11/2020 16:49	09/11/2020 16:37	09/11/2020 16:48	0,19	35	6,73	CHI
20201135312	JATAI	RV10402217	CABRIUVA S2	09/11/2020 16:37	09/11/2020 16:49	09/11/2020 16:37	09/11/2020 16:49	0,20	12	2,43	CHI
20201135312	RIO VERDE	RV10402217	CABRIUVA S2	09/11/2020 16:37	09/11/2020 16:49	09/11/2020 16:37	09/11/2020 16:49	0,20	53	10,72	CHI
20201135066	PLANALTINA	PI12326688	SAO JOAO D ALIANCA	09/11/2020 16:38	09/11/2020 20:26	09/11/2020 16:38	09/11/2020 20:26	3,80	4	15,19	CHI
20201135068	SAO LUIS DE MONTES BELOS	500053145	SAO LUIZ DOS MONTES BELOS	09/11/2020 16:38	09/11/2020 17:58	09/11/2020 16:38	09/11/2020 17:58	1,33	1	1,33	CHI
20201142946	ANICUNS	AC11105825	ANICUNS	09/11/2020 16:38	10/11/2020 23:40	09/11/2020 16:41	10/11/2020 23:40	30,97	161	4986,71	CHI
20201135075	CALDAS NOVAS	CN18414869TS	RIO QUENTE	09/11/2020 16:39	09/11/2020 20:14	09/11/2020 16:39	09/11/2020 20:14	3,58	96	343,84	CHI
20201135075	MORRINHOS	CN18414869TS	RIO QUENTE	09/11/2020 16:39	09/11/2020 20:14	09/11/2020 16:39	09/11/2020 20:14	3,58	8	28,65	CHI
20201135075	PIRACANJUBA	CN18414869TS	RIO QUENTE	09/11/2020 16:39	09/11/2020 20:14	09/11/2020 16:39	09/11/2020 20:14	3,58	1	3,58	CHI
20201135075	RIO QUENTE	CN18414869TS	RIO QUENTE	09/11/2020 16:39	09/11/2020 20:14	09/11/2020 16:39	09/11/2020 20:14	3,58	2	7,16	CHI
20201135080	RIO VERDE	RV21406014	CABRIUVA S2	09/11/2020 16:39	09/11/2020 18:13	09/11/2020 16:39	09/11/2020 18:13	1,55	1	1,55	CHI
20201135082	BOM JARDIM DE GOIAS	BM11193453	BOM JARDIM	09/11/2020 16:39	09/11/2020 18:58	09/11/2020 16:39	09/11/2020 18:58	2,30	99	227,92	CHI
20201135140	GOIANIA	GN10383650	REAL S2	09/11/2020 16:39	09/11/2020 16:56	09/11/2020 16:42	09/11/2020 16:46	0,06	5145	288,69	CHI
20201135140	GOIANIA	GN10380347	GOIANIA LESTE S2	09/11/2020 16:39	09/11/2020 16:56	09/11/2020 16:42	09/11/2020 16:50	0,12	3818	468,77	CHI
20201135140	GOIANIA	GN16416183	GOIANIA LESTE S2	09/11/2020 16:39	09/11/2020 16:56	09/11/2020 16:42	09/11/2020 16:55	0,22	1635	366,97	CHI
20201135140	GOIANIA	GN10380347	GOIANIA LESTE S2	09/11/2020 16:39	09/11/2020 16:56	09/11/2020 16:52	09/11/2020 16:55	0,05	3818	193,02	CHI
20201135140	GOIANIA	GN10380010	GOIANIA LESTE S2	09/11/2020 16:39	09/11/2020 16:56	09/11/2020 16:43	09/11/2020 16:56	0,22	1560	335,83	CHI
20201135163	SILVANIA	SV12032728	DAIA S2	09/11/2020 16:39	09/11/2020 23:07	09/11/2020 16:39	09/11/2020 23:07	6,46	19	122,73	CHI

20201135658	GOIANIA	GN12052690	MEIA PONTE	09/11/2020 16:39	09/11/2020 23:15	09/11/2020 16:39	09/11/2020 23:15	6,59	4	26,37	CHI
20201135083	PARAUNA	PU12079038	PARAUNA	09/11/2020 16:40	09/11/2020 19:07	09/11/2020 16:40	09/11/2020 19:07	2,45	2	4,89	CHI
202011136616	GOIANIA	GN11329403	ATLANTICO S3	09/11/2020 16:40	09/11/2020 22:10	09/11/2020 16:42	09/11/2020 22:10	5,46	28	152,78	CHI
20201135089	GOIANIA	GN11000877	FERROVIARIO S1	09/11/2020 16:41	09/11/2020 19:22	09/11/2020 16:41	09/11/2020 19:22	2,69	61	164,19	CHI
20201135234	TURVELANDIA	TD16408753	RIO DOS BOIS	09/11/2020 16:41	11/11/2020 15:07	09/11/2020 16:46	09/11/2020 19:01	2,25	28	62,95	CHI
20201135234	MAURILANDIA	ML10418406	RIO DOS BOIS	09/11/2020 16:41	11/11/2020 15:07	09/11/2020 16:46	09/11/2020 20:19	3,54	8	28,35	CHI
20201135234	SANTA HELENA DE GOIAS	ML10418406	RIO DOS BOIS	09/11/2020 16:41	11/11/2020 15:07	09/11/2020 16:46	09/11/2020 20:19	3,54	18	63,79	CHI
20201135234	TURVELANDIA	ML10418406	RIO DOS BOIS	09/11/2020 16:41	11/11/2020 15:07	09/11/2020 16:46	09/11/2020 20:19	3,54	3	10,63	CHI
20201135234	MAURILANDIA	ML10418406	RIO DOS BOIS	09/11/2020 16:41	11/11/2020 15:07	10/11/2020 00:16	10/11/2020 00:30	0,23	8	1,83	CHI
20201135234	SANTA HELENA DE GOIAS	ML10418406	RIO DOS BOIS	09/11/2020 16:41	11/11/2020 15:07	10/11/2020 00:16	10/11/2020 00:30	0,23	18	4,12	CHI
20201135234	TURVELANDIA	ML10418406	RIO DOS BOIS	09/11/2020 16:41	11/11/2020 15:07	10/11/2020 00:16	10/11/2020 00:30	0,23	3	0,69	CHI
20201135234	MAURILANDIA	ML10418406	RIO DOS BOIS	09/11/2020 16:41	11/11/2020 15:07	09/11/2020 16:46	10/11/2020 11:19	18,56	3	55,67	CHI
20201135234	SANTA HELENA DE GOIAS	ML10418406	RIO DOS BOIS	09/11/2020 16:41	11/11/2020 15:07	09/11/2020 16:46	10/11/2020 11:19	18,56	8	148,45	CHI
20201135234	TURVELANDIA	ML10418406	RIO DOS BOIS	09/11/2020 16:41	11/11/2020 15:07	09/11/2020 16:46	10/11/2020 11:19	18,56	3	55,67	CHI
20201135234	MAURILANDIA	ML10418406	RIO DOS BOIS	09/11/2020 16:41	11/11/2020 15:07	10/11/2020 12:47	10/11/2020 20:13	7,43	7	52,04	CHI
20201135234	SANTA HELENA DE GOIAS	ML10418406	RIO DOS BOIS	09/11/2020 16:41	11/11/2020 15:07	10/11/2020 12:47	10/11/2020 20:13	7,43	1	7,43	CHI
20201135234	MAURILANDIA	ML10418406	RIO DOS BOIS	09/11/2020 16:41	11/11/2020 15:07	10/11/2020 12:47	10/11/2020 20:46	7,99	3	23,97	CHI
20201135234	SANTA HELENA DE GOIAS	ML10418406	RIO DOS BOIS	09/11/2020 16:41	11/11/2020 15:07	10/11/2020 12:47	10/11/2020 20:46	7,99	8	63,91	CHI
20201135234	TURVELANDIA	ML10418406	RIO DOS BOIS	09/11/2020 16:41	11/11/2020 15:07	10/11/2020 12:47	10/11/2020 20:46	7,99	3	23,97	CHI
20201135234	SANTA HELENA DE GOIAS	SH12023767	RIO DOS BOIS	09/11/2020 16:41	11/11/2020 15:07	10/11/2020 12:47	10/11/2020 21:55	9,14	2	18,27	CHI
20201135234	SANTA HELENA DE GOIAS	SH12301068	RIO DOS BOIS	09/11/2020 16:41	11/11/2020 15:07	10/11/2020 12:47	10/11/2020 22:12	9,41	3	28,24	CHI
20201135234	SANTA HELENA DE GOIAS	SH12023761	RIO DOS BOIS	09/11/2020 16:41	11/11/2020 15:07	10/11/2020 12:47	10/11/2020 22:35	9,80	3	29,40	CHI
20201135234	MAURILANDIA	ML12306607	RIO DOS BOIS	09/11/2020 16:41	11/11/2020 15:07	10/11/2020 12:47	10/11/2020 23:23	10,61	1	10,61	CHI
20201135234	TURVELANDIA	ML12306607	RIO DOS BOIS	09/11/2020 16:41	11/11/2020 15:07	10/11/2020 12:47	10/11/2020 23:23	10,61	1	10,61	CHI
20201135234	MAURILANDIA	ML10418406	RIO DOS BOIS	09/11/2020 16:41	11/11/2020 15:07	11/11/2020 00:53	11/11/2020 02:40	1,79	11	19,66	CHI
20201135234	SANTA HELENA DE GOIAS	ML10418406	RIO DOS BOIS	09/11/2020 16:41	11/11/2020 15:07	11/11/2020 00:53	11/11/2020 02:40	1,79	17	30,39	CHI
20201135234	TURVELANDIA	ML10418406	RIO DOS BOIS	09/11/2020 16:41	11/11/2020 15:07	11/11/2020 00:53	11/11/2020 02:40	1,79	4	7,15	CHI
20201135234	MAURILANDIA	ML10418406	RIO DOS BOIS	09/11/2020 16:41	11/11/2020 15:07	11/11/2020 08:29	11/11/2020 10:14	1,76	1	1,76	CHI
20201135234	MAURILANDIA	ML12301060RE	RIO DOS BOIS	09/11/2020 16:41	11/11/2020 15:07	11/11/2020 08:29	11/11/2020 11:12	2,71	6	16,29	CHI
20201135234	SANTA HELENA DE GOIAS	ML12301060RE	RIO DOS BOIS	09/11/2020 16:41	11/11/2020 15:07	11/11/2020 08:29	11/11/2020 11:12	2,71	1	2,71	CHI
20201135234	SANTA HELENA DE GOIAS	SH12023761	RIO DOS BOIS	09/11/2020 16:41	11/11/2020 15:07	11/11/2020 08:29	11/11/2020 11:24	2,91	3	8,74	CHI
20201135234	MAURILANDIA	ML12306607	RIO DOS BOIS	09/11/2020 16:41	11/11/2020 15:07	11/11/2020 08:29	11/11/2020 11:33	3,06	1	3,06	CHI
20201135234	TURVELANDIA	ML12306607	RIO DOS BOIS	09/11/2020 16:41	11/11/2020 15:07	11/11/2020 08:29	11/11/2020 11:33	3,06	1	3,06	CHI
20201135234	SANTA HELENA DE GOIAS	SH12023767	RIO DOS BOIS	09/11/2020 16:41	11/11/2020 15:07	11/11/2020 08:29	11/11/2020 11:48	3,31	2	6,63	CHI
20201135234	SANTA HELENA DE GOIAS	SH12301068	RIO DOS BOIS	09/11/2020 16:41	11/11/2020 15:07	11/11/2020 08:29	11/11/2020 11:51	3,36	3	10,09	CHI
20201135234	MAURILANDIA	ML10418406	RIO DOS BOIS	09/11/2020 16:41	11/11/2020 15:07	11/11/2020 11:57	11/11/2020 12:01	0,05	8	0,44	CHI
20201135234	SANTA HELENA DE GOIAS	ML10418406	RIO DOS BOIS	09/11/2020 16:41	11/11/2020 15:07	11/11/2020 11:57	11/11/2020 12:01	0,05	9	0,49	CHI
20201135234	TURVELANDIA	ML10418406	RIO DOS BOIS	09/11/2020 16:41	11/11/2020 15:07	11/11/2020 11:57	11/11/2020 12:01	0,05	1	0,05	CHI
20201135234	MAURILANDIA	ML10418406	RIO DOS BOIS	09/11/2020 16:41	11/11/2020 15:07	11/11/2020 08:29	11/11/2020 12:06	3,62	3	10,85	CHI
20201135234	SANTA HELENA DE GOIAS	ML10418406	RIO DOS BOIS	09/11/2020 16:41	11/11/2020 15:07	11/11/2020 08:29	11/11/2020 12:06	3,62	8	28,93	CHI
20201135234	TURVELANDIA	ML10418406	RIO DOS BOIS	09/11/2020 16:41	11/11/2020 15:07	11/11/2020 08:29	11/11/2020 12:06	3,62	3	10,85	CHI
20201135234	SANTA HELENA DE GOIAS	SH12038291	RIO DOS BOIS	09/11/2020 16:41	11/11/2020 15:07	09/11/2020 16:46	11/11/2020 12:44	43,96	7	307,71	CHI
20201135234	TURVELANDIA	SH12038291	RIO DOS BOIS	09/11/2020 16:41	11/11/2020 15:07	09/11/2020 16:46	11/11/2020 12:44	43,96	5	219,79	CHI
20201135234	SANTA HELENA DE GOIAS	SH12301080RE	RIO DOS BOIS	09/11/2020 16:41	11/11/2020 15:07	09/11/2020 16:46	11/11/2020 13:05	44,31	10	443,09	CHI
20201135234	TURVELANDIA	SH12301080RE	RIO DOS BOIS	09/11/2020 16:41	11/11/2020 15:07	09/11/2020 16:46	11/11/2020 13:05	44,31	6	265,86	CHI
20201135234	SANTA HELENA DE GOIAS	SH12301080RE	RIO DOS BOIS	09/11/2020 16:41	11/11/2020 15:07	09/11/2020 16:46	11/11/2020 13:22	44,60	9	401,36	CHI
20201135234	SANTA HELENA DE GOIAS	SH12301071	RIO DOS BOIS	09/11/2020 16:41	11/11/2020 15:07	10/11/2020 12:47	11/11/2020 14:27	25,66	2	51,33	CHI
20201135234	TURVELANDIA	SH12301071	RIO DOS BOIS	09/11/2020 16:41	11/11/2020 15:07	10/11/2020 12:47	11/11/2020 14:49	26,03	2	52,07	CHI
20201135234	SANTA HELENA DE GOIAS	SH12301071	RIO DOS BOIS	09/11/2020 16:41	11/11/2020 15:07	10/11/2020 12:47	11/11/2020 14:57	26,17	6	157,01	CHI
20201135234	SANTA HELENA DE GOIAS	SH12301071	RIO DOS BOIS	09/11/2020 16:41	11/11/2020 15:07	10/11/2020 12:47	11/11/2020 15:07	26,34	1	26,34	CHI
20201135111	FORMOSA	FA21428934	SAO JOAO D ALIANCA	09/11/2020 16:43	09/11/2020 20:32	09/11/2020 16:43	09/11/2020 20:32	3,81	1	3,81	CHI

20201135121	GOIAS	GS21220338	GOIAS	09/11/2020 16:44	10/11/2020 10:17	09/11/2020 16:44	10/11/2020 10:17	17,54	2	35,08	CHI
20201135129	PARANAIGUARA	QI10409360	QUIRINOPOLIS	09/11/2020 16:44	10/11/2020 13:33	09/11/2020 16:44	09/11/2020 17:57	1,23	109	134,16	CHI
20201135129	QUIRINOPOLIS	QI10409360	QUIRINOPOLIS	09/11/2020 16:44	10/11/2020 13:33	09/11/2020 16:44	09/11/2020 17:57	1,23	35	43,08	CHI
20201135129	PARANAIGUARA	PC13355060	QUIRINOPOLIS	09/11/2020 16:44	10/11/2020 13:33	09/11/2020 16:44	09/11/2020 20:01	3,29	63	207,58	CHI
20201135129	QUIRINOPOLIS	PC13355060	QUIRINOPOLIS	09/11/2020 16:44	10/11/2020 13:33	09/11/2020 16:44	09/11/2020 20:01	3,29	75	247,12	CHI
20201135129	PARANAIGUARA	QI10409360	QUIRINOPOLIS	09/11/2020 16:44	10/11/2020 13:33	09/11/2020 20:07	09/11/2020 20:36	0,48	109	52,71	CHI
20201135129	QUIRINOPOLIS	QI10409360	QUIRINOPOLIS	09/11/2020 16:44	10/11/2020 13:33	09/11/2020 20:07	09/11/2020 20:36	0,48	35	16,93	CHI
20201135129	PARANAIGUARA	PC10400581	QUIRINOPOLIS	09/11/2020 16:44	10/11/2020 13:33	09/11/2020 16:44	09/11/2020 20:51	4,13	44	181,62	CHI
20201135129	PARANAIGUARA	QI10409360	QUIRINOPOLIS	09/11/2020 16:44	10/11/2020 13:33	09/11/2020 22:46	09/11/2020 23:02	0,27	109	29,04	CHI
20201135129	QUIRINOPOLIS	QI10409360	QUIRINOPOLIS	09/11/2020 16:44	10/11/2020 13:33	09/11/2020 22:46	09/11/2020 23:02	0,27	35	9,32	CHI
20201135129	PARANAIGUARA	QI10409360	QUIRINOPOLIS	09/11/2020 16:44	10/11/2020 13:33	10/11/2020 08:55	10/11/2020 09:25	0,49	109	53,44	CHI
20201135129	QUIRINOPOLIS	QI10409360	QUIRINOPOLIS	09/11/2020 16:44	10/11/2020 13:33	10/11/2020 08:55	10/11/2020 09:25	0,49	35	17,16	CHI
20201135129	QUIRINOPOLIS	PC13355060	QUIRINOPOLIS	09/11/2020 16:44	10/11/2020 13:33	09/11/2020 20:07	10/11/2020 12:10	16,04	2	32,08	CHI
20201135129	PARANAIGUARA	PC12306052	QUIRINOPOLIS	09/11/2020 16:44	10/11/2020 13:33	09/11/2020 20:07	10/11/2020 12:33	16,42	6	98,55	CHI
20201135129	QUIRINOPOLIS	PC12306052	QUIRINOPOLIS	09/11/2020 16:44	10/11/2020 13:33	09/11/2020 20:07	10/11/2020 12:33	16,42	3	49,27	CHI
20201135129	PARANAIGUARA	QI12279808RE	QUIRINOPOLIS	09/11/2020 16:44	10/11/2020 13:33	09/11/2020 20:07	10/11/2020 12:42	16,58	47	779,12	CHI
20201135129	QUIRINOPOLIS	QI12279808RE	QUIRINOPOLIS	09/11/2020 16:44	10/11/2020 13:33	09/11/2020 20:07	10/11/2020 12:42	16,58	64	1060,92	CHI
20201135129	QUIRINOPOLIS	QI12100484	QUIRINOPOLIS	09/11/2020 16:44	10/11/2020 13:33	09/11/2020 20:07	10/11/2020 12:58	16,84	4	67,36	CHI
20201135129	PARANAIGUARA	PC12100483	QUIRINOPOLIS	09/11/2020 16:44	10/11/2020 13:33	09/11/2020 20:07	10/11/2020 13:02	16,90	10	169,04	CHI
20201135129	QUIRINOPOLIS	PC12100483	QUIRINOPOLIS	09/11/2020 16:44	10/11/2020 13:33	09/11/2020 20:07	10/11/2020 13:02	16,90	1	16,90	CHI
20201135129	QUIRINOPOLIS	QI12160242	QUIRINOPOLIS	09/11/2020 16:44	10/11/2020 13:33	09/11/2020 20:07	10/11/2020 13:33	17,44	1	17,44	CHI
20201135130	ITABERAI	IB12284866	ITABERAI S1	09/11/2020 16:45	10/11/2020 11:45	09/11/2020 16:45	10/11/2020 11:15	18,50	1	18,50	CHI
20201135130	ITABERAI	IB12284866	ITABERAI S1	09/11/2020 16:45	10/11/2020 11:45	09/11/2020 16:45	10/11/2020 11:35	18,83	1	18,83	CHI
20201135130	ITABERAI	IB12284866	ITABERAI S1	09/11/2020 16:45	10/11/2020 11:45	09/11/2020 16:45	10/11/2020 11:45	18,99	1	18,99	CHI
20201136900	ANAPOLIS	AN12259043	ANAPOLIS UNIVERSITARIO S2	09/11/2020 16:45	10/11/2020 12:48	09/11/2020 16:45	10/11/2020 12:48	20,06	4	80,23	CHI
20201135137	MUNDO NOVO DE GOIAS	MH11269569	NOVA CRIXAS	09/11/2020 16:46	09/11/2020 20:59	09/11/2020 16:46	09/11/2020 20:59	4,21	1	4,21	CHI
20201135142	CRISTALINA	KR10409768	CRISTALINA S2	09/11/2020 16:46	10/11/2020 05:31	10/11/2020 00:16	10/11/2020 00:33	0,27	46	12,31	CHI
20201135142	CRISTALINA	KR10409768	PAMPLONA	09/11/2020 16:46	10/11/2020 05:31	10/11/2020 00:16	10/11/2020 00:33	0,27	79	21,13	CHI
20201135142	LUZIANIA	KR10409768	PAMPLONA	09/11/2020 16:46	10/11/2020 05:31	10/11/2020 00:16	10/11/2020 00:33	0,27	1	0,27	CHI
20201135142	CRISTALINA	KR12031670	PAMPLONA	09/11/2020 16:46	10/11/2020 05:31	09/11/2020 16:46	10/11/2020 05:31	12,74	1	12,74	CHI
20201135142	CRISTALINA	3460414	PAMPLONA	09/11/2020 16:46	10/11/2020 05:31	10/11/2020 00:40	10/11/2020 05:31	4,85	15	72,77	CHI
20201135142	LUZIANIA	3460414	PAMPLONA	09/11/2020 16:46	10/11/2020 05:31	10/11/2020 00:40	10/11/2020 05:31	4,85	77	373,56	CHI
20201135156	FLORES DE GOIAS	FB21254487	FLORES DE GOIAS	09/11/2020 16:47	09/11/2020 20:34	09/11/2020 16:47	09/11/2020 20:34	3,77	1	3,77	CHI
20201135157	MINEIROS	MY12271476	PARQUE DAS EMAS	09/11/2020 16:47	10/11/2020 10:44	09/11/2020 16:47	10/11/2020 10:44	17,93	1	17,93	CHI
20201135553	ANAPOLIS	AN12414610	ANAPOLIS UNIVERSITARIO S2	09/11/2020 16:47	10/11/2020 08:20	09/11/2020 16:47	10/11/2020 08:20	15,55	10	155,46	CHI
20201135553	CAMPO LIMPO	AN12414610	ANAPOLIS UNIVERSITARIO S2	09/11/2020 16:47	10/11/2020 08:20	09/11/2020 16:47	10/11/2020 08:20	15,55	3	46,64	CHI
20201136163	BOM JARDIM DE GOIAS	BM12201959	BOM JARDIM	09/11/2020 16:47	10/11/2020 10:34	09/11/2020 16:47	10/11/2020 10:34	17,77	87	1546,33	CHI
20201135160	GAMELEIRA DE GOIAS	GL11251740	DAIA S2	09/11/2020 16:48	09/11/2020 20:50	09/11/2020 16:48	09/11/2020 20:50	4,03	119	479,07	CHI
20201135165	JUSSARA	JR12101970RE	BRITANIA	09/11/2020 16:48	10/11/2020 14:20	09/11/2020 16:48	10/11/2020 09:58	17,16	8	137,25	CHI
20201135165	JUSSARA	JR12101970RE	BRITANIA	09/11/2020 16:48	10/11/2020 14:20	09/11/2020 16:48	10/11/2020 14:20	21,52	3	64,56	CHI
20201135946	ANICUNS	AV12323525	ANICUNS	09/11/2020 16:48	10/11/2020 10:37	09/11/2020 16:48	10/11/2020 10:37	17,81	48	854,92	CHI
20201135946	AVELINOPOLIS	AV12323525	ANICUNS	09/11/2020 16:48	10/11/2020 10:37	09/11/2020 16:48	10/11/2020 10:37	17,81	9	160,30	CHI
20201135179	RIO VERDE	10029355786	CABRIUVA S1	09/11/2020 16:49	10/11/2020 07:54	09/11/2020 16:49	10/11/2020 07:54	15,08	1	15,08	CHI
20201135468	ANAPOLIS	AN11017659	ANAPOLIS UNIVERSITARIO S2	09/11/2020 16:49	10/11/2020 00:22	09/11/2020 16:49	10/11/2020 00:22	7,55	113	853,02	CHI
20201135192	SAO MIGUEL DO PASSA QUATRO	VN12311677	PIRES DO RIO S2	09/11/2020 16:50	09/11/2020 22:02	09/11/2020 16:50	09/11/2020 22:02	5,19	2	10,37	CHI
20201135192	GOIANOPOLIS	VN12311677	PIRES DO RIO S2	09/11/2020 16:50	09/11/2020 22:02	09/11/2020 16:50	09/11/2020 22:02	5,19	8	41,49	CHI
20201135190	GOIANIRA	10020398229	GOIANIRA	09/11/2020 16:51	10/11/2020 00:48	09/11/2020 16:51	10/11/2020 00:48	7,95	1	7,95	CHI
20201135193	GOIAS	GS21148819	GOIAS	09/11/2020 16:51	10/11/2020 12:21	09/11/2020 16:51	10/11/2020 12:21	19,50	1	19,50	CHI
20201135197	MONTIVIDIU	RV12062709	MONTIVIDIU T	09/11/2020 16:51	09/11/2020 19:02	09/11/2020 16:51	09/11/2020 19:02	2,17	18	39,02	CHI
20201135203	JATAI	JT13264275	JATAI S1	09/11/2020 16:52	11/11/2020 05:30	09/11/2020 16:52	09/11/2020 21:11	4,32	45	194,20	CHI
20201135203	SERRANOPOLIS	JT13264275	JATAI S1	09/11/2020 16:52	11/11/2020 05:30	09/11/2020 16:52	09/11/2020 21:11	4,32	29	125,15	CHI

20201135203	JATAI	SX10400642	JATAI S1	09/11/2020 16:52	11/11/2020 05:30	09/11/2020 21:32	09/11/2020 21:43	0,18	36	6,35	CHI
20201135203	SERRANOPOLIS	SX10400642	JATAI S1	09/11/2020 16:52	11/11/2020 05:30	09/11/2020 21:32	09/11/2020 21:43	0,18	2	0,35	CHI
20201135203	JATAI	JT10413490	JATAI S1	09/11/2020 16:52	11/11/2020 05:30	09/11/2020 21:32	09/11/2020 22:46	1,23	61	75,08	CHI
20201135203	JATAI	JT10413490	JATAI S1	09/11/2020 16:52	11/11/2020 05:30	10/11/2020 14:02	10/11/2020 14:28	0,43	219	94,05	CHI
20201135203	SERRANOPOLIS	JT10413490	JATAI S1	09/11/2020 16:52	11/11/2020 05:30	10/11/2020 14:02	10/11/2020 14:28	0,43	6	2,58	CHI
20201135203	JATAI	JT10413490	JATAI S1	09/11/2020 16:52	11/11/2020 05:30	10/11/2020 18:32	10/11/2020 18:47	0,25	118	29,50	CHI
20201135203	PEROLANDIA	JT10413490	JATAI S1	09/11/2020 16:52	11/11/2020 05:30	10/11/2020 18:32	10/11/2020 18:47	0,25	13	3,25	CHI
20201135203	SERRANOPOLIS	JT10413490	JATAI S1	09/11/2020 16:52	11/11/2020 05:30	10/11/2020 18:32	10/11/2020 18:47	0,25	1	0,25	CHI
20201135203	JATAI	JT13264275	JATAI S1	09/11/2020 16:52	11/11/2020 05:30	09/11/2020 21:32	11/11/2020 04:25	30,88	14	432,30	CHI
20201135203	JATAI	JT13264279	JATAI S1	09/11/2020 16:52	11/11/2020 05:30	09/11/2020 21:32	11/11/2020 04:59	31,44	9	282,95	CHI
20201135203	JATAI	JT13241743	JATAI S1	09/11/2020 16:52	11/11/2020 05:30	09/11/2020 21:32	11/11/2020 05:30	31,95	27	862,75	CHI
20201135203	SERRANOPOLIS	JT13241743	JATAI S1	09/11/2020 16:52	11/11/2020 05:30	09/11/2020 21:32	11/11/2020 05:30	31,95	33	1054,47	CHI
20201136381	INHUMAS	IN12326287	INHUMAS S2	09/11/2020 16:52	09/11/2020 21:37	09/11/2020 16:52	09/11/2020 21:37	4,75	10	47,45	CHI
20201135215	JARAGUA	70007111	JARAGUA	09/11/2020 16:53	09/11/2020 18:52	09/11/2020 16:53	09/11/2020 18:52	1,97	1	1,97	CHI
20201135580	TRINDADE	TR12000037	TRINDADE	09/11/2020 16:53	09/11/2020 19:48	09/11/2020 16:53	09/11/2020 19:48	2,91	459	1337,47	CHI
20201136467	AMERICANO DO BRASIL	KB12065194	ANICUNS	09/11/2020 16:53	10/11/2020 12:15	09/11/2020 16:53	10/11/2020 12:15	19,36	29	561,31	CHI
20201136467	MOSSAMEDES	KB12065194	ANICUNS	09/11/2020 16:53	10/11/2020 12:15	09/11/2020 16:53	10/11/2020 12:15	19,36	13	251,62	CHI
20201135231	CRISTIANOPOLIS	CF12300861	CRISTIANOPOLIS	09/11/2020 16:55	09/11/2020 18:56	09/11/2020 16:55	09/11/2020 18:56	2,01	4	8,04	CHI
20201135535	GOIANIA	GN11002044	CAMPINAS S2	09/11/2020 16:55	09/11/2020 20:04	09/11/2020 16:55	09/11/2020 20:04	3,14	117	367,18	CHI
20201135240	GOIANIA	GN11246200	GOIANIA LESTE S3	09/11/2020 16:56	09/11/2020 20:21	09/11/2020 16:56	09/11/2020 20:21	3,41	16	54,60	CHI
20201135243	GOIANIA	10374670	CAMPINAS S1	09/11/2020 16:56	09/11/2020 18:29	09/11/2020 16:56	09/11/2020 18:29	1,54	1	1,54	CHI
20201135245	GUAPO	GA11254379	GUAPO S1	09/11/2020 16:56	09/11/2020 18:55	09/11/2020 16:56	09/11/2020 18:55	1,97	8	15,75	CHI
20201135246	POSSE	PS21268300	IACIARA S2	09/11/2020 16:56	09/11/2020 18:23	09/11/2020 16:56	09/11/2020 18:23	1,44	2	2,87	CHI
20201135560	MONTE ALEGRE DE GOIAS	SD12322677	SAO DOMINGOS	09/11/2020 16:56	09/11/2020 19:49	09/11/2020 16:56	09/11/2020 19:49	2,88	1	2,88	CHI
20201135560	NOVA ROMA	SD12322677	SAO DOMINGOS	09/11/2020 16:56	09/11/2020 19:49	09/11/2020 16:56	09/11/2020 19:49	2,88	3	8,65	CHI
20201135560	SAO DOMINGOS	SD12322677	SAO DOMINGOS	09/11/2020 16:56	09/11/2020 19:49	09/11/2020 16:56	09/11/2020 19:49	2,88	36	103,76	CHI
20201135386	DOVERLANDIA	DV12259468	CAIAPONIA	09/11/2020 16:57	09/11/2020 21:49	09/11/2020 16:57	09/11/2020 21:49	4,87	3	14,60	CHI
20201135255	RIO VERDE	RV11370235	CABRIUVA S1	09/11/2020 16:58	09/11/2020 20:20	09/11/2020 16:58	09/11/2020 20:20	3,37	105	353,47	CHI
20201135902	GOIANIRA	GR11133812	GOIANIRA	09/11/2020 16:59	09/11/2020 19:38	09/11/2020 16:59	09/11/2020 19:38	2,64	132	348,59	CHI
20201135272	GOIAS	GS21203869	ITABERAII S2	09/11/2020 17:00	10/11/2020 12:09	09/11/2020 17:00	10/11/2020 12:09	19,13	3	57,40	CHI
20201135285	CACHOEIRA DOURADA	CD10407487	CACHOEIRA DOURADA	09/11/2020 17:00	11/11/2020 11:50	09/11/2020 17:00	09/11/2020 21:23	4,39	16	70,26	CHI
20201135285	CACHOEIRA DOURADA	CD10407487	CACHOEIRA DOURADA	09/11/2020 17:00	11/11/2020 11:50	09/11/2020 17:00	09/11/2020 21:51	4,86	28	135,98	CHI
20201135285	INACIOLANDIA	CD10407487	CACHOEIRA DOURADA	09/11/2020 17:00	11/11/2020 11:50	09/11/2020 17:00	09/11/2020 21:51	4,86	2	9,71	CHI
20201135285	CACHOEIRA DOURADA	CD10407487	CACHOEIRA DOURADA	09/11/2020 17:00	11/11/2020 11:50	09/11/2020 22:54	09/11/2020 23:30	0,60	44	26,40	CHI
20201135285	INACIOLANDIA	CD10407487	CACHOEIRA DOURADA	09/11/2020 17:00	11/11/2020 11:50	09/11/2020 22:54	09/11/2020 23:30	0,60	2	1,20	CHI
20201135285	CACHOEIRA DOURADA	CD10407487	CACHOEIRA DOURADA	09/11/2020 17:00	11/11/2020 11:50	09/11/2020 17:00	11/11/2020 03:08	34,13	1	34,13	CHI
20201135285	INACIOLANDIA	CD10407487	CACHOEIRA DOURADA	09/11/2020 17:00	11/11/2020 11:50	09/11/2020 17:00	11/11/2020 03:08	34,13	85	2900,93	CHI
20201135285	INACIOLANDIA	CD13000011	CACHOEIRA DOURADA	09/11/2020 17:00	11/11/2020 11:50	09/11/2020 17:00	11/11/2020 03:08	34,13	18	614,32	CHI
20201135285	ITUMBIARA	CD13000011	CACHOEIRA DOURADA	09/11/2020 17:00	11/11/2020 11:50	09/11/2020 17:00	11/11/2020 03:08	34,13	13	443,67	CHI
20201135285	CACHOEIRA DOURADA	2670214	CACHOEIRA DOURADA	09/11/2020 17:00	11/11/2020 11:50	11/11/2020 03:17	11/11/2020 05:02	1,74	419	731,15	CHI
20201135285	CACHOEIRA DOURADA	2670214	CACHOEIRA DOURADA	09/11/2020 17:00	11/11/2020 11:50	11/11/2020 03:17	11/11/2020 05:02	1,74	720	1256,40	CHI
20201135285	INACIOLANDIA	2670214	CACHOEIRA DOURADA	09/11/2020 17:00	11/11/2020 11:50	11/11/2020 03:17	11/11/2020 05:02	1,74	2	3,49	CHI
20201135285	ITUMBIARA	2670214	CACHOEIRA DOURADA	09/11/2020 17:00	11/11/2020 11:50	11/11/2020 03:17	11/11/2020 05:02	1,74	38	66,31	CHI
20201135285	CACHOEIRA DOURADA	CD13000011	CACHOEIRA DOURADA	09/11/2020 17:00	11/11/2020 11:50	11/11/2020 03:17	11/11/2020 05:35	2,29	1	2,29	CHI
20201135285	INACIOLANDIA	CD13000011	CACHOEIRA DOURADA	09/11/2020 17:00	11/11/2020 11:50	11/11/2020 03:17	11/11/2020 05:35	2,29	103	235,76	CHI
20201135285	ITUMBIARA	CD13000011	CACHOEIRA DOURADA	09/11/2020 17:00	11/11/2020 11:50	11/11/2020 03:17	11/11/2020 05:35	2,29	13	29,76	CHI
20201135285	CACHOEIRA DOURADA	CD12071299LD	CACHOEIRA DOURADA	09/11/2020 17:00	11/11/2020 11:50	11/11/2020 03:17	11/11/2020 10:53	7,59	11	83,50	CHI
20201135285	CACHOEIRA DOURADA	CD12191000	CACHOEIRA DOURADA	09/11/2020 17:00	11/11/2020 11:50	11/11/2020 03:17	11/11/2020 11:50	8,54	7	59,78	CHI
20201135277	MONTIVIDIU	MV12226282	MONTIVIDIU T	09/11/2020 17:01	09/11/2020 21:05	09/11/2020 17:01	09/11/2020 21:05	4,06	1	4,06	CHI
20201135596	NOVA CRIXAS	NA12057172	MOZARLANDIA	09/11/2020 17:01	10/11/2020 21:17	09/11/2020 17:01	10/11/2020 21:17	28,26	22	621,80	CHI
20201136160	JARAGUA	JA12070670	JARAGUA	09/11/2020 17:01	09/11/2020 22:30	09/11/2020 17:01	09/11/2020 22:30	5,47	10	54,71	CHI

20201135283	GOIANIA	GN11246235	GOIANIA LESTE S3	09/11/2020 17:02	09/11/2020 19:10	09/11/2020 17:02	09/11/2020 19:10	2,14	8	17,08	CHI
20201135288	RIO VERDE	RV21383920	RIO VERDE S1	09/11/2020 17:02	09/11/2020 23:48	09/11/2020 17:02	09/11/2020 23:48	6,76	2	13,51	CHI
20201135727	SANTA HELENA DE GOIAS	EU12026832	RIO DOS BOIS	09/11/2020 17:02	09/11/2020 20:39	09/11/2020 17:02	09/11/2020 20:39	3,61	16	57,81	CHI
20201135727	TURVELANDIA	EU12026832	RIO DOS BOIS	09/11/2020 17:02	09/11/2020 20:39	09/11/2020 17:02	09/11/2020 20:39	3,61	8	28,90	CHI
20201135295	EDEIA	ED21044481	PONTALINA	09/11/2020 17:03	09/11/2020 23:24	09/11/2020 17:03	09/11/2020 23:24	6,34	1	6,34	CHI
20201136005	BELA VISTA DE GOIAS	BV11169905	BELA VISTA S1	09/11/2020 17:03	09/11/2020 20:09	09/11/2020 17:03	09/11/2020 20:09	3,09	20	61,88	CHI
20201135307	PALMEIRAS DE GOIAS	PL12085273	PALMEIRAS	09/11/2020 17:04	09/11/2020 22:07	09/11/2020 17:04	09/11/2020 22:07	5,04	1	5,04	CHI
20201135547	URUACU	UR11284464	URUACU	09/11/2020 17:04	09/11/2020 19:10	09/11/2020 17:04	09/11/2020 19:10	2,09	125	261,81	CHI
20201136282	ALEXANIA	AX12095958	CORUMBA	09/11/2020 17:04	10/11/2020 09:26	09/11/2020 17:04	10/11/2020 09:26	16,36	7	114,50	CHI
20201136282	CORUMBA DE GOIAS	AX12095958	CORUMBA	09/11/2020 17:04	10/11/2020 09:26	09/11/2020 17:04	10/11/2020 09:26	16,36	3	49,07	CHI
20201135314	ARUANA	AK21135183	MOZARLANDIA	09/11/2020 17:05	09/11/2020 18:56	09/11/2020 17:05	09/11/2020 18:56	1,85	1	1,85	CHI
20201135320	SANTA TEREZINHA DE GOIAS	SG12243403	SANTA TEREZINHA	09/11/2020 17:06	10/11/2020 01:18	09/11/2020 17:06	10/11/2020 01:18	8,19	1	8,19	CHI
20201135379	MOSSAMEDES	MD12299595	ITABERAI S2	09/11/2020 17:06	09/11/2020 22:22	09/11/2020 17:06	09/11/2020 22:22	5,27	9	47,45	CHI
20201135493	GOIANIA	GN11048758	CARAJAS S2	09/11/2020 17:06	09/11/2020 19:16	09/11/2020 17:06	09/11/2020 19:16	2,16	114	246,33	CHI
20201135711	SILVANIA	SV12400020	VIANOPOLIS	09/11/2020 17:06	09/11/2020 23:55	09/11/2020 17:06	09/11/2020 23:55	6,80	42	285,79	CHI
20201135711	VIANOPOLIS	SV12400020	VIANOPOLIS	09/11/2020 17:06	09/11/2020 23:55	09/11/2020 17:06	09/11/2020 23:55	6,80	1	6,80	CHI
20201135327	RIO VERDE	RV11000035	RIO VERDE S2	09/11/2020 17:07	09/11/2020 22:35	09/11/2020 17:07	09/11/2020 22:35	5,47	166	907,28	CHI
20201135332	MAURILANDIA	ML11000005	RIO DOS BOIS	09/11/2020 17:07	09/11/2020 18:39	09/11/2020 17:07	09/11/2020 18:39	1,52	61	92,94	CHI
20201135867	JARAGUA	JA12006407	JARAGUA	09/11/2020 17:07	09/11/2020 19:28	09/11/2020 17:07	09/11/2020 19:28	2,34	26	60,87	CHI
20201135339	GOIANIA	GN11002579	CAMPINAS S2	09/11/2020 17:09	09/11/2020 20:35	09/11/2020 17:09	09/11/2020 20:35	3,43	148	507,15	CHI
20201135345	BURITI DE GOIAS	CO21039216	FIRMINOPOLIS S2	09/11/2020 17:09	09/11/2020 19:46	09/11/2020 17:09	09/11/2020 19:46	2,60	4	10,40	CHI
20201135608	BOM JARDIM DE GOIAS	BM12241374	BOM JARDIM	09/11/2020 17:09	10/11/2020 11:31	09/11/2020 17:09	10/11/2020 11:31	18,35	3	55,06	CHI
20201135478	GOIANIA	GN11094552	ATLANTICO S1	09/11/2020 17:10	09/11/2020 18:41	09/11/2020 17:10	09/11/2020 18:41	1,51	90	136,12	CHI
20201135984	MARA ROSA	MQ11072697	MARA ROSA	09/11/2020 17:10	10/11/2020 11:14	09/11/2020 17:10	10/11/2020 11:14	18,06	142	2564,80	CHI
20201135355	ARUANA	AK21278245	MOZARLANDIA	09/11/2020 17:11	09/11/2020 19:20	09/11/2020 17:11	09/11/2020 19:20	2,15	1	2,15	CHI
20201135407	COCALZINHO DE GOIAS	PB10400401	PADRE BERNARDO	09/11/2020 17:12	10/11/2020 08:20	09/11/2020 23:42	10/11/2020 00:07	0,42	85	35,98	CHI
20201135407	DISTRITO FEDERAL	PB10400401	PADRE BERNARDO	09/11/2020 17:12	10/11/2020 08:20	09/11/2020 23:42	10/11/2020 00:07	0,42	9	3,81	CHI
20201135407	ITARUMA	PB10400401	PADRE BERNARDO	09/11/2020 17:12	10/11/2020 08:20	09/11/2020 23:42	10/11/2020 00:07	0,42	1	0,42	CHI
20201135407	PADRE BERNARDO	PB10400401	PADRE BERNARDO	09/11/2020 17:12	10/11/2020 08:20	09/11/2020 23:42	10/11/2020 00:07	0,42	977	413,60	CHI
20201135407	PLANALTINA	PB10400401	PADRE BERNARDO	09/11/2020 17:12	10/11/2020 08:20	09/11/2020 23:42	10/11/2020 00:07	0,42	14	5,93	CHI
20201135407	DISTRITO FEDERAL	PB10400733	PADRE BERNARDO	09/11/2020 17:12	10/11/2020 08:20	09/11/2020 17:12	10/11/2020 02:02	8,83	1	8,83	CHI
20201135407	ITARUMA	PB10400733	PADRE BERNARDO	09/11/2020 17:12	10/11/2020 08:20	09/11/2020 17:12	10/11/2020 02:02	8,83	1	8,83	CHI
20201135407	PADRE BERNARDO	PB10400733	PADRE BERNARDO	09/11/2020 17:12	10/11/2020 08:20	09/11/2020 17:12	10/11/2020 02:02	8,83	12	105,99	CHI
20201135407	COCALZINHO DE GOIAS	PB10400401	PADRE BERNARDO	09/11/2020 17:12	10/11/2020 08:20	10/11/2020 02:03	10/11/2020 02:12	0,16	85	13,53	CHI
20201135407	DISTRITO FEDERAL	PB10400401	PADRE BERNARDO	09/11/2020 17:12	10/11/2020 08:20	10/11/2020 02:03	10/11/2020 02:12	0,16	9	1,43	CHI
20201135407	ITARUMA	PB10400401	PADRE BERNARDO	09/11/2020 17:12	10/11/2020 08:20	10/11/2020 02:03	10/11/2020 02:12	0,16	1	0,16	CHI
20201135407	PADRE BERNARDO	PB10400401	PADRE BERNARDO	09/11/2020 17:12	10/11/2020 08:20	10/11/2020 02:03	10/11/2020 02:12	0,16	977	155,51	CHI
20201135407	PLANALTINA	PB10400401	PADRE BERNARDO	09/11/2020 17:12	10/11/2020 08:20	10/11/2020 02:03	10/11/2020 02:12	0,16	14	2,23	CHI
20201135407	PADRE BERNARDO	PB10400733	PADRE BERNARDO	09/11/2020 17:12	10/11/2020 08:20	09/11/2020 17:12	10/11/2020 08:00	14,80	3	44,40	CHI
20201135407	DISTRITO FEDERAL	PB13082087	PADRE BERNARDO	09/11/2020 17:12	10/11/2020 08:20	10/11/2020 02:03	10/11/2020 08:00	5,95	1	5,95	CHI
20201135407	ITARUMA	PB13082087	PADRE BERNARDO	09/11/2020 17:12	10/11/2020 08:20	10/11/2020 02:03	10/11/2020 08:00	5,95	1	5,95	CHI
20201135407	PADRE BERNARDO	PB13082087	PADRE BERNARDO	09/11/2020 17:12	10/11/2020 08:20	10/11/2020 02:03	10/11/2020 08:00	5,95	12	71,35	CHI
20201135407	COCALZINHO DE GOIAS	PB13082086	PADRE BERNARDO	09/11/2020 17:12	10/11/2020 08:20	09/11/2020 17:12	10/11/2020 08:20	15,13	7	105,93	CHI
20201135407	PADRE BERNARDO	PB10400733	PADRE BERNARDO	09/11/2020 17:12	10/11/2020 08:20	09/11/2020 17:12	10/11/2020 08:20	15,13	3712	56171,84	CHI
20201135407	PADRE BERNARDO	PB10400733	PADRE BERNARDO	09/11/2020 17:12	10/11/2020 08:20	09/11/2020 17:12	10/11/2020 08:20	15,13	206	3117,29	CHI
20201135407	PADRE BERNARDO	PB13082086	PADRE BERNARDO	09/11/2020 17:12	10/11/2020 08:20	09/11/2020 17:12	10/11/2020 08:20	15,13	26	393,44	CHI
20201135557	ITAPURANGA	IK11108192	ITAPURANGA	09/11/2020 17:12	09/11/2020 21:04	09/11/2020 17:12	09/11/2020 21:04	3,86	129	497,55	CHI
20201135376	QUIRINOPOLIS	QI31052461	QUIRINOPOLIS	09/11/2020 17:14	10/11/2020 04:35	09/11/2020 17:14	10/11/2020 04:35	11,35	1	11,35	CHI
20201135383	SANTA TEREZA DE GOIAS	SE12390457	MARA ROSA	09/11/2020 17:14	09/11/2020 23:35	09/11/2020 17:14	09/11/2020 23:35	6,34	5	31,69	CHI
20201135384	NOVO GAMA	4990011820	PACAEMBU S1	09/11/2020 17:14	09/11/2020 20:34	09/11/2020 17:14	09/11/2020 20:34	3,32	1	3,32	CHI
20201135261	ITAJA	IM13158546	CACHOEIRA ALTA	09/11/2020 17:15	10/11/2020 11:32	09/11/2020 17:15	10/11/2020 01:25	8,15	7	57,08	CHI

20201135261	ITARUMA	IM13158546	CACHOEIRA ALTA	09/11/2020 17:15	10/11/2020 11:32	09/11/2020 17:15	10/11/2020 01:25	8,15	22	179,40	CHI
20201135261	ITARUMA	IM13158546	CACHOEIRA ALTA	09/11/2020 17:15	10/11/2020 11:32	10/11/2020 00:40	10/11/2020 01:25	0,75	20	15,00	CHI
20201135261	ITAIA	IM13158546	CACHOEIRA ALTA	09/11/2020 17:15	10/11/2020 11:32	10/11/2020 02:04	10/11/2020 11:32	9,46	7	66,25	CHI
20201135261	ITARUMA	IM13158546	CACHOEIRA ALTA	09/11/2020 17:15	10/11/2020 11:32	10/11/2020 02:04	10/11/2020 11:32	9,46	44	416,40	CHI
20201135394	CATALAO	CT21266731	CATALAO S1	09/11/2020 17:15	09/11/2020 19:54	09/11/2020 17:15	09/11/2020 19:54	2,63	1	2,63	CHI
20201135404	AGUAS LINDAS DE GOIAS	10017676205	AGUAS LINDAS DE GOIAS S2	09/11/2020 17:17	09/11/2020 20:00	09/11/2020 17:17	09/11/2020 20:00	2,72	1	2,72	CHI
20201135549	ALEXANIA	AX12313240	ALEXANIA	09/11/2020 17:17	09/11/2020 22:57	09/11/2020 17:17	09/11/2020 22:57	5,66	18	101,86	CHI
20201135420	GOIANIA	11487525	REAL S2	09/11/2020 17:19	09/11/2020 18:48	09/11/2020 17:19	09/11/2020 18:48	1,48	1	1,48	CHI
20201135434	GOIANIA	BW12151470	NEROPOLIS S1	09/11/2020 17:19	09/11/2020 21:07	09/11/2020 17:19	09/11/2020 21:07	3,80	129	490,16	CHI
20201135434	SANTO ANTONIO DE GOIAS	BW12151470	NEROPOLIS S1	09/11/2020 17:19	09/11/2020 21:07	09/11/2020 17:19	09/11/2020 21:07	3,80	2	7,60	CHI
20201135441	APARECIDA DE GOIANIA	AP11161731	INDEPENDENCIA S2	09/11/2020 17:19	10/11/2020 02:41	09/11/2020 17:19	10/11/2020 02:41	9,36	175	1638,15	CHI
20201135429	INHUMAS	30175021	INHUMAS S2	09/11/2020 17:20	10/11/2020 05:59	09/11/2020 17:20	10/11/2020 05:59	12,66	1	12,66	CHI
20201135437	ANAPOLIS	AN11214725	JUNDIAI S1	09/11/2020 17:21	09/11/2020 18:54	09/11/2020 17:21	09/11/2020 18:54	1,54	55	84,49	CHI
20201135656	GOIAS	GS12183182	GOIAS	09/11/2020 17:21	10/11/2020 09:33	09/11/2020 17:21	10/11/2020 09:33	16,21	3	48,62	CHI
20201135451	SENADOR CANEDO	10012009693	SENADOR CANEDO	09/11/2020 17:24	09/11/2020 18:30	09/11/2020 17:24	09/11/2020 18:30	1,10	1	1,10	CHI
20201135452	RIO QUENTE	RQ21263096	VILA CORUMBA	09/11/2020 17:24	09/11/2020 19:18	09/11/2020 17:24	09/11/2020 19:18	1,90	1	1,90	CHI
20201135455	CHAPADAO DO CEU	DJ12162533	CHAPADAO DO CEU	09/11/2020 17:24	09/11/2020 19:33	09/11/2020 17:24	09/11/2020 19:33	2,14	2	4,29	CHI
20201135455	MINEIROS	DJ12162533	CHAPADAO DO CEU	09/11/2020 17:24	09/11/2020 19:33	09/11/2020 17:24	09/11/2020 19:33	2,14	1	2,14	CHI
20201135457	PIRES DO RIO	460078781	PIRES DO RIO S1	09/11/2020 17:24	09/11/2020 19:30	09/11/2020 17:24	09/11/2020 19:30	2,09	1	2,09	CHI
20201135813	GUAPO	GA12099059	GUAPO S1	09/11/2020 17:24	09/11/2020 20:30	09/11/2020 17:24	09/11/2020 20:30	3,10	15	46,45	CHI
20201135465	INHUMAS	10027028389	INHUMAS S2	09/11/2020 17:25	09/11/2020 22:54	09/11/2020 17:25	09/11/2020 22:54	5,48	1	5,48	CHI
20201135471	TRINDADE	40069187	TRINDADE	09/11/2020 17:26	09/11/2020 19:45	09/11/2020 17:26	09/11/2020 19:45	2,31	1	2,31	CHI
20201135476	JARAGUA	JA12328482	GOIANESIA S2	09/11/2020 17:27	09/11/2020 21:56	09/11/2020 17:27	09/11/2020 21:56	4,48	8	35,83	CHI
20201135481	SILVANIA	SV21245599	VIANOPOLIS	09/11/2020 17:27	09/11/2020 18:57	09/11/2020 17:27	09/11/2020 18:57	1,49	1	1,49	CHI
20201135839	SANTA HELENA DE GOIAS	SH12295844	IPEGUARI	09/11/2020 17:28	10/11/2020 00:19	09/11/2020 17:28	10/11/2020 00:19	6,83	18	123,02	CHI
20201136201	NEROPOLIS	NR11355436	NEROPOLIS S2	09/11/2020 17:28	09/11/2020 20:35	09/11/2020 17:28	09/11/2020 20:35	3,11	58	180,22	CHI
20201135495	DOVERLANDIA	DV12188456	CAIAPONIA	09/11/2020 17:29	09/11/2020 21:12	09/11/2020 17:29	09/11/2020 21:12	3,71	2	7,41	CHI
20201135602	ANICUNS	TV12005585	FIRMINOPOLIS S2	09/11/2020 17:29	09/11/2020 19:28	09/11/2020 17:29	09/11/2020 19:28	1,98	21	41,59	CHI
20201135602	TURVANIA	TV12005585	FIRMINOPOLIS S2	09/11/2020 17:29	09/11/2020 19:28	09/11/2020 17:29	09/11/2020 19:28	1,98	17	33,67	CHI
20201135948	MAURILANDIA	ML12303327	RIO DOS BOIS	09/11/2020 17:30	11/11/2020 17:52	09/11/2020 17:30	10/11/2020 14:20	20,84	5	104,21	CHI
20201135948	MAURILANDIA	ML12303327	RIO DOS BOIS	09/11/2020 17:30	11/11/2020 17:52	09/11/2020 17:30	11/11/2020 16:07	46,62	15	699,32	CHI
20201135948	MAURILANDIA	ML32249037LD	RIO DOS BOIS	09/11/2020 17:30	11/11/2020 17:52	09/11/2020 17:30	11/11/2020 17:52	48,36	5	241,80	CHI
20201136868	AVELINOPOLIS	AV12020475	ANICUNS	09/11/2020 17:32	10/11/2020 10:51	09/11/2020 17:32	10/11/2020 10:51	17,31	18	311,59	CHI
20201136868	ITABERAI	AV12020475	ANICUNS	09/11/2020 17:32	10/11/2020 10:51	09/11/2020 17:32	10/11/2020 10:51	17,31	28	484,70	CHI
20201136078	AVELINOPOLIS	AV11252602	ANICUNS	09/11/2020 17:33	09/11/2020 20:16	09/11/2020 17:33	09/11/2020 20:16	2,70	126	340,72	CHI
20201135521	FORMOSA	610203472	ITUIQUIRA	09/11/2020 17:34	09/11/2020 19:12	09/11/2020 17:34	09/11/2020 19:12	1,63	1	1,63	CHI
20201135522	GOIAS	GS12234099	GOIAS	09/11/2020 17:34	10/11/2020 11:20	09/11/2020 17:34	10/11/2020 11:20	17,76	3	53,28	CHI
20201135527	CALDAS NOVAS	10001113915	SERRA DE CALDAS	09/11/2020 17:35	09/11/2020 19:50	09/11/2020 17:35	09/11/2020 19:50	2,25	1	2,25	CHI
20201135528	CRISTALINA	1060055305	CRISTALINA S1	09/11/2020 17:35	09/11/2020 20:36	09/11/2020 17:35	09/11/2020 20:36	3,01	1	3,01	CHI
20201136389	JARAGUA	JA12221349	JARAGUA	09/11/2020 17:35	09/11/2020 21:55	09/11/2020 17:35	09/11/2020 21:55	4,32	6	25,93	CHI
20201135587	ITAUCU	IX12016023	INHUMAS S1	09/11/2020 17:37	09/11/2020 19:11	09/11/2020 17:37	09/11/2020 19:11	1,56	5	7,82	CHI
20201136954	NIQUELANDIA	NQ12280469	URUACU	09/11/2020 17:39	10/11/2020 11:00	09/11/2020 17:39	10/11/2020 11:00	17,34	3	52,02	CHI
20201135555	ANAPOLIS	AN12000738	ANAPOLIS UNIVERSITARIO S2	09/11/2020 17:40	10/11/2020 15:24	09/11/2020 17:40	10/11/2020 15:24	21,72	4	86,89	CHI
20201135556	JARAGUA	70103835	JARAGUA	09/11/2020 17:40	09/11/2020 21:29	09/11/2020 17:40	09/11/2020 21:29	3,80	1	3,80	CHI
20201135743	ARAGARCAS	AG11000013	ARAGARCAS	09/11/2020 17:40	09/11/2020 21:57	09/11/2020 17:40	09/11/2020 21:57	4,28	127	543,07	CHI
20201135563	GOUVELANDIA	QI12295738	QUIRINOPOLIS	09/11/2020 17:41	09/11/2020 21:46	09/11/2020 17:41	09/11/2020 21:46	4,07	2	8,14	CHI
20201135566	PIRES DO RIO	460122400	PIRES DO RIO S1	09/11/2020 17:42	09/11/2020 20:16	09/11/2020 17:42	09/11/2020 20:16	2,57	1	2,57	CHI
20201135582	ANAPOLIS	AN11000433	JUNDIAI S1	09/11/2020 17:42	10/11/2020 00:04	09/11/2020 17:42	10/11/2020 00:04	6,36	161	1023,56	CHI
20201135801	GOIANIA	GN11076707	ATLANTICO S1	09/11/2020 17:43	09/11/2020 21:49	09/11/2020 17:43	09/11/2020 21:49	4,09	63	257,70	CHI
202011138008	INDIARA	10011512448	EDEIA	09/11/2020 17:43	10/11/2020 06:23	09/11/2020 17:43	10/11/2020 06:23	12,65	1	12,65	CHI
20201135593	ANAPOLIS	10000887151	JUNDIAI S1	09/11/2020 17:45	09/11/2020 21:43	09/11/2020 17:45	09/11/2020 21:43	3,96	1	3,96	CHI

20201135650	PIRANHAS	PH12243804	PIRANHAS	09/11/2020 17:45	09/11/2020 19:27	09/11/2020 17:45	09/11/2020 19:27	1,69	169	284,91	CHI
20201135607	MINACU	4020063735	MINACU	09/11/2020 17:47	09/11/2020 21:02	09/11/2020 17:47	09/11/2020 21:02	3,24	1	3,24	CHI
20201135609	CEZARINA	CZ12025257	CEZARINA	09/11/2020 17:47	10/11/2020 11:52	09/11/2020 17:47	10/11/2020 11:52	18,07	8	144,56	CHI
20201135610	JATAI	JT12264444	PARQUE DAS EMAS	09/11/2020 17:47	11/11/2020 00:00	09/11/2020 17:47	11/11/2020 00:00	30,21	5	151,05	CHI
20201135614	APARECIDA DE GOIANIA	200110834	INDEPENDENCIA S1	09/11/2020 17:48	09/11/2020 19:04	09/11/2020 17:48	09/11/2020 19:04	1,26	1	1,26	CHI
20201135768	CAMPINORTE	CR12070384	CAMPINORTE	09/11/2020 17:48	10/11/2020 04:24	09/11/2020 17:48	10/11/2020 04:24	10,60	8	84,77	CHI
20201135768	NOVA IGUAÇU DE GOIAS	CR12070384	CAMPINORTE	09/11/2020 17:48	10/11/2020 04:24	09/11/2020 17:48	10/11/2020 04:24	10,60	23	243,70	CHI
20201135629	INHUMAS	30029909	INHUMAS S2	09/11/2020 17:50	10/11/2020 05:13	09/11/2020 17:50	10/11/2020 05:13	11,38	1	11,38	CHI
20201135634	PARAUNA	PU21167141	PARAUNA	09/11/2020 17:50	09/11/2020 22:54	09/11/2020 17:50	09/11/2020 22:54	5,05	1	5,05	CHI
20201136340	RIO VERDE	4150214	CABRIUVA S2	09/11/2020 17:51	10/11/2020 17:02	09/11/2020 17:51	10/11/2020 17:02	23,17	134	3105,04	CHI
20201136340	RIO VERDE	RV13260735	CABRIUVA S2	09/11/2020 17:51	10/11/2020 17:02	10/11/2020 03:50	10/11/2020 17:02	13,19	34	448,62	CHI
20201135641	SAO JOAO DA PARAUNA	RP21102378	PARAUNA	09/11/2020 17:52	09/11/2020 21:09	09/11/2020 17:52	09/11/2020 21:09	3,28	1	3,28	CHI
20201135648	ITAUCU	110005545	INHUMAS S1	09/11/2020 17:53	09/11/2020 21:00	09/11/2020 17:53	09/11/2020 21:00	3,11	1	3,11	CHI
20201135983	PIRACANJUBA	MR12000203RE	MORRINHOS	09/11/2020 17:53	10/11/2020 14:48	09/11/2020 17:53	10/11/2020 14:48	20,92	38	794,81	CHI
20201136654	AVELINOPOLIS	AV12020485	ANICUNS	09/11/2020 17:53	10/11/2020 11:09	09/11/2020 17:53	10/11/2020 11:09	17,25	25	431,37	CHI
20201135652	PLANALTIMA	PI12066045	PLANALTIMA	09/11/2020 17:55	09/11/2020 21:34	09/11/2020 17:55	09/11/2020 21:34	3,65	6	21,88	CHI
20201135667	EDEALINA	ED12000006	PONTALINA	09/11/2020 17:56	10/11/2020 07:43	09/11/2020 17:56	10/11/2020 07:43	13,77	4	55,08	CHI
20201135667	PONTALINA	ED12000006	PONTALINA	09/11/2020 17:56	10/11/2020 07:43	09/11/2020 17:56	10/11/2020 07:43	13,77	19	261,64	CHI
20201135661	APARECIDA DE GOIANIA	200076541	INDEPENDENCIA S2	09/11/2020 17:57	10/11/2020 00:23	09/11/2020 17:57	10/11/2020 00:23	6,43	1	6,43	CHI
20201136783	RIO VERDE	630311316	CABRIUVA S1	09/11/2020 17:58	10/11/2020 01:10	09/11/2020 17:58	10/11/2020 01:10	7,18	1	7,18	CHI
20201135672	ALEXANIA	AX11051476	ALEXANIA	09/11/2020 17:59	10/11/2020 11:35	09/11/2020 17:59	10/11/2020 11:35	17,59	32	562,92	CHI
20201135675	FORMOSA	FA21309101	ITUIQUIRA	09/11/2020 17:59	09/11/2020 21:39	09/11/2020 17:59	09/11/2020 21:39	3,66	1	3,66	CHI
20201135678	GOIANIA	GN21200168	FERROVIARIO S1	09/11/2020 17:59	09/11/2020 23:02	09/11/2020 17:59	09/11/2020 23:02	5,04	25	125,88	CHI
20201135697	ANAPOLIS	20423070	JUNDIAI S1	09/11/2020 18:01	10/11/2020 01:42	09/11/2020 18:01	10/11/2020 01:42	7,67	1	7,67	CHI
20201135927	ITAJA	IJ12194908	ITAJA S2	09/11/2020 18:01	09/11/2020 21:13	09/11/2020 18:01	09/11/2020 21:13	3,19	4	12,78	CHI
20201136045	GAMELEIRA DE GOIAS	SV12056333	DAIA S2	09/11/2020 18:01	09/11/2020 23:25	09/11/2020 18:01	09/11/2020 23:25	5,40	37	199,78	CHI
20201136045	SILVANIA	SV12056333	DAIA S2	09/11/2020 18:01	09/11/2020 23:25	09/11/2020 18:01	09/11/2020 23:25	5,40	1	5,40	CHI
20201135704	MOZARLANDIA	MZ12181621	MOZARLANDIA	09/11/2020 18:02	09/11/2020 21:07	09/11/2020 18:02	09/11/2020 21:07	3,08	9	27,69	CHI
20201135705	QUIRINOPOLIS	80082210	QUIRINOPOLIS	09/11/2020 18:02	09/11/2020 19:20	09/11/2020 18:02	09/11/2020 19:20	1,29	1	1,29	CHI
20201135931	GOIAS	GS12307627	GOIAS	09/11/2020 18:02	09/11/2020 23:05	09/11/2020 18:02	09/11/2020 23:05	5,04	5	25,20	CHI
20201135713	ANAPOLIS	20873323	JUNDIAI S1	09/11/2020 18:03	09/11/2020 19:42	09/11/2020 18:03	09/11/2020 19:42	1,64	1	1,64	CHI
20201135753	RIO VERDE	RV12260256	RIO VERDE S1	09/11/2020 18:03	10/11/2020 10:05	09/11/2020 18:03	10/11/2020 10:05	16,03	19	304,50	CHI
20201136141	CRISTALINA	KR12244309	CRISTALINA S1	09/11/2020 18:03	09/11/2020 23:55	09/11/2020 18:03	09/11/2020 23:55	5,86	88	515,39	CHI
20201135723	GOIANESIA	GE21000295	GOIANESIA S1	09/11/2020 18:04	09/11/2020 23:05	09/11/2020 18:04	09/11/2020 23:05	5,01	1	5,01	CHI
20201135819	APORE	IJ12131593	ITAJA S2	09/11/2020 18:04	10/11/2020 12:25	09/11/2020 18:04	10/11/2020 12:25	18,34	1	18,34	CHI
20201135819	ITAJA	IJ12131593	ITAJA S2	09/11/2020 18:04	10/11/2020 12:25	09/11/2020 18:04	10/11/2020 12:25	18,34	10	183,43	CHI
20201135868	QUIRINOPOLIS	QI12101226	QUIRINOPOLIS	09/11/2020 18:05	09/11/2020 22:00	09/11/2020 18:05	09/11/2020 22:00	3,91	18	70,41	CHI
20201135760	ANAPOLIS	VN21127037	VIANOPOLIS	09/11/2020 18:08	09/11/2020 20:35	09/11/2020 18:08	09/11/2020 20:35	2,44	2	4,88	CHI
20201135770	RIO VERDE	10032319825	RIO VERDE S2	09/11/2020 18:09	09/11/2020 21:18	09/11/2020 18:09	09/11/2020 21:18	3,14	1	3,14	CHI
20201135773	PIRES DO RIO	PR11166940	PIRES DO RIO S1	09/11/2020 18:10	09/11/2020 20:05	09/11/2020 18:10	09/11/2020 20:05	1,92	73	139,84	CHI
20201135778	PORTELANDIA	7078512	PARQUE DAS EMAS	09/11/2020 18:11	10/11/2020 04:56	09/11/2020 18:11	10/11/2020 04:56	10,75	1	10,75	CHI
20201135794	APARECIDA DE GOIANIA	10024358523	CEPAIGO S1	09/11/2020 18:13	09/11/2020 20:45	09/11/2020 18:13	09/11/2020 20:45	2,53	1	2,53	CHI
20201135798	JARAGUA	JA21000115	JARAGUA	09/11/2020 18:14	10/11/2020 01:02	09/11/2020 18:14	10/11/2020 01:02	6,79	1	6,79	CHI
20201135806	ANAPOLIS	10032095722	JUNDIAI S1	09/11/2020 18:15	09/11/2020 19:26	09/11/2020 18:15	09/11/2020 19:26	1,17	1	1,17	CHI
20201135808	SILVANIA	SV12022221	DAIA S2	09/11/2020 18:15	09/11/2020 21:32	09/11/2020 18:15	09/11/2020 21:32	3,27	3	9,81	CHI
20201135822	LUZIANIA	10023125169	MARAJOARA	09/11/2020 18:17	09/11/2020 21:15	09/11/2020 18:17	09/11/2020 21:15	2,96	1	2,96	CHI
20201135837	CATALAO	CT21077481	CATALAO S1	09/11/2020 18:18	09/11/2020 21:08	09/11/2020 18:18	09/11/2020 21:08	2,82	1	2,82	CHI
20201135849	GOUVELANDIA	QI31163436	QUIRINOPOLIS	09/11/2020 18:20	09/11/2020 22:43	09/11/2020 18:20	09/11/2020 22:43	4,37	1	4,37	CHI
20201136446	LAGOA SANTA	LS11160503	ITAJA S2	09/11/2020 18:20	10/11/2020 11:58	09/11/2020 18:20	10/11/2020 11:58	17,63	51	898,99	CHI
20201135925	MINACU	IH11182443	MINACU	09/11/2020 18:21	09/11/2020 20:18	09/11/2020 18:21	09/11/2020 20:18	1,94	139	269,74	CHI
20201136012	BOM JESUS DE GOIAS	ID12128250	QUIRINOPOLIS	09/11/2020 18:21	10/11/2020 00:09	09/11/2020 18:21	10/11/2020 00:09	5,79	72	417,12	CHI

20201136012	INACIOLANDIA	ID12128250	QUIRINOPOLIS	09/11/2020 18:21	10/11/2020 00:09	09/11/2020 18:21	10/11/2020 00:09	5,79	9	52,14	CHI
20201136199	ARACU	AR12200075	ARACU	09/11/2020 18:21	10/11/2020 08:16	09/11/2020 18:21	10/11/2020 08:16	13,92	227	3159,71	CHI
20201136199	INHUMAS	AR12200075	ARACU	09/11/2020 18:21	10/11/2020 08:16	09/11/2020 18:21	10/11/2020 08:16	13,92	23	320,15	CHI
20201136199	ITAUCU	AR12200075	ARACU	09/11/2020 18:21	10/11/2020 08:16	09/11/2020 18:21	10/11/2020 08:16	13,92	6	83,52	CHI
20201135864	VALPARAISO DE GOIAS	2860039898	MARAJOARA	09/11/2020 18:22	09/11/2020 20:26	09/11/2020 18:22	09/11/2020 20:26	2,06	1	2,06	CHI
20201135889	GOIANIA	12407264	GOYA S2	09/11/2020 18:22	10/11/2020 09:03	09/11/2020 18:22	10/11/2020 09:03	14,68	1	14,68	CHI
20201135921	ITARUMA	IM12086918	CACHOEIRA ALTA	09/11/2020 18:23	10/11/2020 09:57	09/11/2020 18:23	10/11/2020 09:57	15,57	6	93,40	CHI
20201135884	CAMPO ALEGRE DE GOIAS	CM21304105	CAMPO ALEGRE DE GOIAS	09/11/2020 18:24	09/11/2020 20:11	09/11/2020 18:24	09/11/2020 20:11	1,77	1	1,77	CHI
20201135935	CACU	CC16419978	CACHOEIRA ALTA	09/11/2020 18:24	09/11/2020 18:32	09/11/2020 18:24	09/11/2020 18:27	0,05	153	8,37	CHI
20201135935	CACU	CC16408754	CACHOEIRA ALTA	09/11/2020 18:24	09/11/2020 18:32	09/11/2020 18:24	09/11/2020 18:28	0,07	698	45,37	CHI
20201135935	APARECIDA DO RIO DOCE	CC10394754	CACHOEIRA ALTA	09/11/2020 18:24	09/11/2020 18:32	09/11/2020 18:24	09/11/2020 18:28	0,07	10	0,74	CHI
20201135935	CACU	CC10394754	CACHOEIRA ALTA	09/11/2020 18:24	09/11/2020 18:32	09/11/2020 18:24	09/11/2020 18:28	0,07	168	12,37	CHI
20201135935	CACU	CC10400449	CACHOEIRA ALTA	09/11/2020 18:24	09/11/2020 18:32	09/11/2020 18:24	09/11/2020 18:32	0,13	8	1,05	CHI
20201135935	CACU	CC10400449	CACHOEIRA ALTA	09/11/2020 18:24	09/11/2020 18:32	09/11/2020 18:24	09/11/2020 18:32	0,13	125	16,46	CHI
20201135935	ITARUMA	CC10400449	CACHOEIRA ALTA	09/11/2020 18:24	09/11/2020 18:32	09/11/2020 18:24	09/11/2020 18:32	0,13	2	0,26	CHI
20201135935	JATAI	CC10400449	CACHOEIRA ALTA	09/11/2020 18:24	09/11/2020 18:32	09/11/2020 18:24	09/11/2020 18:32	0,13	9	1,19	CHI
20201135935	QUIRINOPOLIS	CC10400449	CACHOEIRA ALTA	09/11/2020 18:24	09/11/2020 18:32	09/11/2020 18:24	09/11/2020 18:32	0,13	1	0,13	CHI
20201135893	ITUMBIARA	IT21208195	BOM JESUS DE GOIAS	09/11/2020 18:26	10/11/2020 13:18	09/11/2020 18:26	10/11/2020 13:18	18,86	1	18,86	CHI
20201135895	MONTE ALEGRE DE GOIAS	MA12236705	SAO DOMINGOS	09/11/2020 18:26	09/11/2020 19:53	09/11/2020 18:26	09/11/2020 19:53	1,44	11	15,81	CHI
20201135895	NOVA ROMA	MA12236705	SAO DOMINGOS	09/11/2020 18:26	09/11/2020 19:53	09/11/2020 18:26	09/11/2020 19:53	1,44	57	81,91	CHI
202011137962	GOIAS	8657119	ITABERAI S2	09/11/2020 18:26	10/11/2020 20:38	09/11/2020 18:26	10/11/2020 20:38	26,19	2	52,39	CHI
20201135906	JUSSARA	BT21118477	BRITANIA	09/11/2020 18:28	10/11/2020 03:02	09/11/2020 18:28	10/11/2020 03:02	8,56	1	8,56	CHI
20201135908	URUACU	UR12327259	CAMPINORTE	09/11/2020 18:28	10/11/2020 15:08	09/11/2020 18:28	10/11/2020 15:08	20,66	1	20,66	CHI
20201136230	SANTA TEREZINHA DE GOIAS	SG12350024	SANTA TEREZINHA	09/11/2020 18:28	10/11/2020 16:43	09/11/2020 18:28	10/11/2020 16:43	22,25	16	355,95	CHI
20201135916	GOUVELANDIA	GB12303270	QUIRINOPOLIS	09/11/2020 18:29	10/11/2020 02:21	09/11/2020 18:29	10/11/2020 02:21	7,86	8	62,91	CHI
20201135922	ANICUNS	AC21186481	FIRMINOPOLIS S2	09/11/2020 18:30	10/11/2020 16:31	09/11/2020 18:30	10/11/2020 16:31	22,01	1	22,01	CHI
20201135939	SAO MIGUEL DO ARAGUAIA	SM21147578	SAO MIGUEL DO ARAGUAIA	09/11/2020 18:31	10/11/2020 04:38	09/11/2020 18:31	10/11/2020 04:38	10,10	1	10,10	CHI
20201135974	JATAI	JT11324811	JATAI S2	09/11/2020 18:31	09/11/2020 20:31	09/11/2020 18:31	09/11/2020 20:31	2,00	82	163,73	CHI
20201136068	JATAI	JT11418276	JATAI S3	09/11/2020 18:31	10/11/2020 00:27	09/11/2020 18:31	10/11/2020 00:27	5,92	112	663,16	CHI
202011137963	DISTRITO FEDERAL	LS12157872	ITAJA S2	09/11/2020 18:31	10/11/2020 13:30	09/11/2020 18:31	10/11/2020 13:30	18,97	1	18,97	CHI
202011137963	LAGOA SANTA	LS12157872	ITAJA S2	09/11/2020 18:31	10/11/2020 13:30	09/11/2020 18:31	10/11/2020 13:30	18,97	9	170,73	CHI
20201135940	CACHOEIRA ALTA	1090006357	CACHOEIRA ALTA	09/11/2020 18:32	09/11/2020 23:58	09/11/2020 18:32	09/11/2020 23:58	5,43	1	5,43	CHI
20201135957	GOIANIA	13888158	MEIA PONTE	09/11/2020 18:35	10/11/2020 10:27	09/11/2020 18:35	10/11/2020 10:27	15,86	1	15,86	CHI
20201135961	EDEALINA	ED21307907	PONTALINA	09/11/2020 18:35	09/11/2020 22:37	09/11/2020 18:35	09/11/2020 22:37	4,02	1	4,02	CHI
20201136139	RIO VERDE	RV11131600	CABRIUVA S1	09/11/2020 18:35	10/11/2020 09:09	09/11/2020 18:35	10/11/2020 09:09	14,55	112	1629,66	CHI
20201135968	BRITANIA	BT12124815	BRITANIA	09/11/2020 18:36	10/11/2020 17:02	09/11/2020 18:36	10/11/2020 17:02	22,44	13	291,74	CHI
20201135968	JUSSARA	BT12124815	BRITANIA	09/11/2020 18:36	10/11/2020 17:02	09/11/2020 18:36	10/11/2020 17:02	22,44	5	112,21	CHI
20201136008	CATALAO	340234	CATALAO S2	09/11/2020 18:36	09/11/2020 18:40	09/11/2020 18:36	09/11/2020 18:39	0,06	3424	197,83	CHI
20201136008	CATALAO	340234	CATALAO S2	09/11/2020 18:36	09/11/2020 18:40	09/11/2020 18:36	09/11/2020 18:40	0,06	1476	93,48	CHI
20201135994	INACIOLANDIA	ID12128157	QUIRINOPOLIS	09/11/2020 18:39	10/11/2020 09:21	09/11/2020 18:39	10/11/2020 09:21	14,70	2	29,40	CHI
20201136838	RIO VERDE	RV12271417	CABRIUVA S2	09/11/2020 18:43	10/11/2020 11:32	09/11/2020 18:43	10/11/2020 11:32	16,80	6	100,82	CHI
20201136022	FORMOSA	FA21428834	SAO JOAO D ALIANCA	09/11/2020 18:44	09/11/2020 21:54	09/11/2020 18:44	09/11/2020 21:54	3,17	1	3,17	CHI
20201136028	GOIANIA	13640094	CARAJAS S1	09/11/2020 18:45	10/11/2020 09:32	09/11/2020 18:45	10/11/2020 09:32	14,78	1	14,78	CHI
20201133026	JATAI	JT13214392	JATAI S1	09/11/2020 18:46	10/11/2020 12:06	09/11/2020 18:46	10/11/2020 09:21	14,58	125	1822,88	CHI
20201133026	JATAI	JT13184167	JATAI S1	09/11/2020 18:46	10/11/2020 12:06	09/11/2020 18:46	10/11/2020 11:15	16,47	174	2866,21	CHI
20201133026	JATAI	JT12196200LD	JATAI S1	09/11/2020 18:46	10/11/2020 12:06	09/11/2020 18:46	10/11/2020 12:06	17,34	222	3848,74	CHI
20201133026	SERRANOPOLIS	JT12196200LD	JATAI S1	09/11/2020 18:46	10/11/2020 12:06	09/11/2020 18:46	10/11/2020 12:06	17,34	66	1144,22	CHI
20201136368	AURILANDIA	SL12003853	SAO LUIZ DOS MONTES BELOS	09/11/2020 18:47	09/11/2020 21:55	09/11/2020 18:47	09/11/2020 21:55	3,13	1	3,13	CHI
20201136368	SAO LUIS DE MONTES BELOS	SL12003853	SAO LUIZ DOS MONTES BELOS	09/11/2020 18:47	09/11/2020 21:55	09/11/2020 18:47	09/11/2020 21:55	3,13	3	9,39	CHI
20201136793	SAO LUIS DE MONTES BELOS	SL11004168	SAO LUIZ DOS MONTES BELOS	09/11/2020 18:47	09/11/2020 22:30	09/11/2020 18:47	09/11/2020 22:30	3,71	51	189,39	CHI
20201136052	JATAI	JT21093816	CACHOEIRA ALTA	09/11/2020 18:49	10/11/2020 15:23	09/11/2020 18:49	10/11/2020 15:23	20,57	1	20,57	CHI

20201136053	SANTA HELENA DE GOIAS	SH21000227	IPEGUARI	09/11/2020 18:50	10/11/2020 04:57	09/11/2020 18:50	10/11/2020 04:57	10,12	1	10,12	CHI
20201136054	ANAPOLIS	10008691299	ANAPOLIS UNIVERSITARIO S1	09/11/2020 18:50	09/11/2020 23:53	09/11/2020 18:50	09/11/2020 23:53	5,05	1	5,05	CHI
20201136056	CEZARINA	2150001713	CEZARINA	09/11/2020 18:50	10/11/2020 12:56	09/11/2020 18:50	10/11/2020 12:56	18,09	1	18,09	CHI
20201136057	TRINDADE	40291431	TRINDADE	09/11/2020 18:50	09/11/2020 20:40	09/11/2020 18:50	09/11/2020 20:40	1,83	1	1,83	CHI
20201136062	CABECEIRAS	4720000059	ITUIQUIRA	09/11/2020 18:50	09/11/2020 19:37	09/11/2020 18:50	09/11/2020 19:37	0,77	1	0,77	CHI
20201136156	AURILANDIA	AI10396206	FIRMINOPOLIS S2	09/11/2020 18:50	10/11/2020 02:54	09/11/2020 18:55	10/11/2020 02:00	7,09	37	262,30	CHI
20201136156	AURILANDIA	AI10396206	FIRMINOPOLIS S2	09/11/2020 18:50	10/11/2020 02:54	09/11/2020 18:55	10/11/2020 02:06	7,18	47	337,30	CHI
20201136156	CACHOEIRA DE GOIAS	AI10396206	FIRMINOPOLIS S2	09/11/2020 18:50	10/11/2020 02:54	09/11/2020 18:55	10/11/2020 02:06	7,18	446	3200,79	CHI
20201136156	AURILANDIA	CG16409245	FIRMINOPOLIS S2	09/11/2020 18:50	10/11/2020 02:54	09/11/2020 18:55	10/11/2020 02:54	7,99	26	207,74	CHI
20201136156	CACHOEIRA DE GOIAS	CG16409245	FIRMINOPOLIS S2	09/11/2020 18:50	10/11/2020 02:54	09/11/2020 18:55	10/11/2020 02:54	7,99	369	2948,31	CHI
20201136156	MOIPIORA	CG16409245	FIRMINOPOLIS S2	09/11/2020 18:50	10/11/2020 02:54	09/11/2020 18:55	10/11/2020 02:54	7,99	1	7,99	CHI
20201136156	PARAUNA	CG16409245	FIRMINOPOLIS S2	09/11/2020 18:50	10/11/2020 02:54	09/11/2020 18:55	10/11/2020 02:54	7,99	32	255,68	CHI
20201136288	GOIATUBA	GT12052893RE	GOIATUBA S1	09/11/2020 18:50	09/11/2020 21:47	09/11/2020 18:50	09/11/2020 21:47	2,94	7	20,56	CHI
20201136288	JOVIANIA	GT12052893RE	GOIATUBA S1	09/11/2020 18:50	09/11/2020 21:47	09/11/2020 18:50	09/11/2020 21:47	2,94	18	52,88	CHI
20201136709	EDEIA	EA12044006	EDEIA	09/11/2020 18:50	09/11/2020 23:02	09/11/2020 18:50	09/11/2020 23:02	4,19	12	50,24	CHI
20201136064	PIRACANJUBA	PJ21073030	CALDAS NOVAS S1	09/11/2020 18:51	09/11/2020 22:57	09/11/2020 18:51	09/11/2020 22:57	4,10	1	4,10	CHI
20201136072	EDEALINA	ED21008800	PONTALINA	09/11/2020 18:52	10/11/2020 01:13	09/11/2020 18:52	10/11/2020 01:13	6,34	1	6,34	CHI
20201136075	ITAJA	IJ11000005	ITAJA S2	09/11/2020 18:53	10/11/2020 01:28	09/11/2020 18:53	10/11/2020 01:28	6,58	53	348,90	CHI
20201136084	INACIOLANDIA	2810008511	QUIRINOPOLIS	09/11/2020 18:54	10/11/2020 06:54	09/11/2020 18:54	10/11/2020 06:54	11,99	1	11,99	CHI
20201136086	SILVANIA	SV12280207	DAIA S2	09/11/2020 18:54	09/11/2020 23:33	09/11/2020 18:54	09/11/2020 23:33	4,64	7	32,49	CHI
20201136088	EDEALINA	ED31008907	PONTALINA	09/11/2020 18:54	09/11/2020 23:28	09/11/2020 18:54	09/11/2020 23:28	4,55	1	4,55	CHI
20201136094	CALDAZINHA	DE21129556	CEPAIGO S2	09/11/2020 18:55	09/11/2020 19:30	09/11/2020 18:55	09/11/2020 19:30	0,57	1	0,57	CHI
20201136165	JATAI	JT11377343	JATAI S2	09/11/2020 18:55	09/11/2020 20:59	09/11/2020 18:55	09/11/2020 20:59	2,06	71	146,10	CHI
20201136101	ARACU	AR21132780	ARACU	09/11/2020 18:56	10/11/2020 13:02	09/11/2020 18:56	10/11/2020 13:02	18,09	3	54,28	CHI
20201136103	ANAPOLIS	20858656	JUNDAIA S2	09/11/2020 18:56	10/11/2020 11:44	09/11/2020 18:56	10/11/2020 11:44	16,79	1	16,79	CHI
20201136105	TRINDADE	10016993304	GOYA S2	09/11/2020 18:56	09/11/2020 23:05	09/11/2020 18:56	09/11/2020 23:05	4,14	1	4,14	CHI
20201136107	HIDROLANDIA	HD12326297	CEPAIGO S2	09/11/2020 18:56	10/11/2020 01:10	09/11/2020 18:56	10/11/2020 01:10	6,22	5	31,11	CHI
20201136112	SILVANIA	SV12112223	VIANOPOLIS	09/11/2020 18:57	10/11/2020 04:36	09/11/2020 18:57	10/11/2020 04:36	9,65	8	77,18	CHI
20201136120	ITAPACI	100075952	ITAPACI	09/11/2020 18:57	10/11/2020 08:17	09/11/2020 18:57	10/11/2020 08:17	13,32	1	13,32	CHI
20201136291	GOIANIA	GN12000504	FERROVIARIO S1	09/11/2020 18:57	09/11/2020 19:50	09/11/2020 18:57	09/11/2020 19:50	0,87	535	467,38	CHI
20201136328	ANAPOLIS	AN11130801	JUNDAIA S2	09/11/2020 18:57	09/11/2020 20:09	09/11/2020 18:57	09/11/2020 20:09	1,19	126	149,66	CHI
20201136127	NIQUELANDIA	NQ11151012	NIQUELANDIA SUBTRANSMISSAO	09/11/2020 18:58	09/11/2020 23:58	09/11/2020 18:58	09/11/2020 23:58	5,00	62	309,76	CHI
20201136144	ANAPOLIS	10008681706	ANAPOLIS UNIVERSITARIO S2	09/11/2020 19:00	10/11/2020 10:04	09/11/2020 19:00	10/11/2020 10:04	15,05	1	15,05	CHI
20201136308	GOIANIA	GN12383189	GOYA S2	09/11/2020 19:00	09/11/2020 21:56	09/11/2020 19:00	09/11/2020 21:56	2,93	158	462,50	CHI
20201136158	NEROPOLIS	NR12319547	NEROPOLIS S2	09/11/2020 19:02	10/11/2020 09:33	09/11/2020 19:02	10/11/2020 09:33	14,51	4	58,05	CHI
20201136159	BRITANIA	BT12259804	BRITANIA	09/11/2020 19:02	10/11/2020 10:10	09/11/2020 19:02	10/11/2020 10:10	15,13	2	30,25	CHI
20201136162	CACHOEIRA ALTA	CA12075233	CACHOEIRA ALTA	09/11/2020 19:02	10/11/2020 07:19	09/11/2020 19:02	10/11/2020 07:19	12,27	4	49,10	CHI
20201136166	CACHOEIRA ALTA	CA12080005	CACHOEIRA ALTA	09/11/2020 19:02	10/11/2020 02:21	09/11/2020 19:02	10/11/2020 02:21	7,30	7	51,11	CHI
20201136167	GOIANIA	14070200	MEIA PONTE	09/11/2020 19:02	10/11/2020 11:29	09/11/2020 19:02	10/11/2020 11:29	16,43	1	16,43	CHI
20201136169	FAINA	FC12024780LD	GOIAS	09/11/2020 19:03	09/11/2020 23:03	09/11/2020 19:03	09/11/2020 23:03	4,01	1	4,01	CHI
20201136176	RIO VERDE	RV12260254	RIO VERDE S1	09/11/2020 19:04	09/11/2020 23:05	09/11/2020 19:04	09/11/2020 23:05	4,01	2	8,03	CHI
20201136227	QUIRINOPOLIS	80015694	QUIRINOPOLIS	09/11/2020 19:10	10/11/2020 07:09	09/11/2020 19:10	10/11/2020 07:09	11,98	1	11,98	CHI
20201136237	INACIOLANDIA	ID21296644	QUIRINOPOLIS	09/11/2020 19:11	10/11/2020 10:03	09/11/2020 19:11	10/11/2020 10:03	14,86	1	14,86	CHI
20201136242	GOIANESIA	GE12413944	GOIANESIA S2	09/11/2020 19:11	09/11/2020 23:13	09/11/2020 19:11	09/11/2020 23:13	4,02	12	48,21	CHI
20201136251	ANAPOLIS	20935810	DAIA S1	09/11/2020 19:13	09/11/2020 20:22	09/11/2020 19:13	09/11/2020 20:22	1,15	1	1,15	CHI
20201136259	LEOPOLDO DE BULHOES	10020154877	DAIA S2	09/11/2020 19:14	09/11/2020 21:12	09/11/2020 19:14	09/11/2020 21:12	1,97	1	1,97	CHI
20201136273	LUZIANIA	LZ12089611	RIO VERMELHO	09/11/2020 19:15	09/11/2020 20:12	09/11/2020 19:15	09/11/2020 20:12	0,93	244	228,07	CHI
20201136335	IPAMERI	IP12112268	PIRES DO RIO S2	09/11/2020 19:15	09/11/2020 22:21	09/11/2020 19:15	09/11/2020 22:21	3,09	19	58,66	CHI
20201136274	PORANGATU	PO12294487	SAO MIGUEL DO ARAGUAIA	09/11/2020 19:16	09/11/2020 21:16	09/11/2020 19:16	09/11/2020 21:16	1,99	1	1,99	CHI
20201136283	GOIANIA	14836117	MEIA PONTE	09/11/2020 19:17	10/11/2020 11:52	09/11/2020 19:17	10/11/2020 11:52	16,57	1	16,57	CHI
20201137070	ARACU	AR11019227	ARACU	09/11/2020 19:17	09/11/2020 23:58	09/11/2020 19:17	09/11/2020 23:58	4,68	83	388,32	CHI

20201136284	FAINA	FC21234873	GOIAS	09/11/2020 19:18	10/11/2020 12:54	09/11/2020 19:18	10/11/2020 12:54	17,60	2	35,19	CHI
20201136285	SAO LUIS DE MONTES BELOS	10009564487	SAO LUIZ DOS MONTES BELOS	09/11/2020 19:18	10/11/2020 09:21	09/11/2020 19:18	10/11/2020 09:21	14,04	1	14,04	CHI
20201136289	ANAPOLIS	10031634140	ANAPOLIS UNIVERSITARIO S2	09/11/2020 19:18	09/11/2020 21:17	09/11/2020 19:18	09/11/2020 21:17	1,97	1	1,97	CHI
20201136293	TRINDADE	40312586	GOYA S1	09/11/2020 19:19	09/11/2020 21:49	09/11/2020 19:19	09/11/2020 21:49	2,49	1	2,49	CHI
20201136298	VILA PROPICIO	PV21151980	GOIANESIA S1	09/11/2020 19:20	09/11/2020 23:46	09/11/2020 19:20	09/11/2020 23:46	4,43	1	4,43	CHI
20201136305	LEOPOLDO DE BULHOES	LB12382739	DAIA S2	09/11/2020 19:21	09/11/2020 22:52	09/11/2020 19:21	09/11/2020 22:52	3,50	3	10,50	CHI
20201136316	NAZARIO	NZ21144250	ANICUNS	09/11/2020 19:23	10/11/2020 15:59	09/11/2020 19:23	10/11/2020 15:59	20,58	1	20,58	CHI
20201136319	EDEIA	EA12070748	EDEIA	09/11/2020 19:24	10/11/2020 04:07	09/11/2020 19:24	10/11/2020 04:07	8,71	3	26,14	CHI
20201136319	INDIARA	EA12070748	EDEIA	09/11/2020 19:24	10/11/2020 04:07	09/11/2020 19:24	10/11/2020 04:07	8,71	1	8,71	CHI
20201136322	NEROPOLIS	10017576057	NEROPOLIS S2	09/11/2020 19:24	10/11/2020 01:59	09/11/2020 19:24	10/11/2020 01:59	6,57	1	6,57	CHI
20201136325	RIO VERDE	RV21091887	CABRIUVA S1	09/11/2020 19:25	09/11/2020 22:50	09/11/2020 19:25	09/11/2020 22:50	3,42	1	3,42	CHI
20201136362	TRINDADE	TR11157607	GOYA S2	09/11/2020 19:25	09/11/2020 20:59	09/11/2020 19:25	09/11/2020 20:59	1,56	127	198,23	CHI
20201136336	GOIANESIA	550128815	GOIANESIA S2	09/11/2020 19:26	10/11/2020 12:18	09/11/2020 19:26	10/11/2020 12:18	16,86	1	16,86	CHI
20201136754	CORUMBAlBA	CI12120757	CATALAO S1	09/11/2020 19:26	10/11/2020 07:43	09/11/2020 19:26	10/11/2020 07:43	12,28	10	122,83	CHI
20201136342	ITAJA	IJ21200697	ITAJA S2	09/11/2020 19:27	10/11/2020 10:10	09/11/2020 19:27	10/11/2020 10:10	14,71	1	14,71	CHI
20201136349	CAMPOS BELOS	CH21338301	SAO DOMINGOS	09/11/2020 19:28	09/11/2020 20:49	09/11/2020 19:28	09/11/2020 20:49	1,34	1	1,34	CHI
20201136361	AMARALINA	LC12050751	MARA ROSA	09/11/2020 19:29	09/11/2020 23:58	09/11/2020 19:29	09/11/2020 23:58	4,48	12	53,79	CHI
20201136361	MARA ROSA	LC12050751	MARA ROSA	09/11/2020 19:29	09/11/2020 23:58	09/11/2020 19:29	09/11/2020 23:58	4,48	5	22,41	CHI
20201136367	PIRACANJUBA	PJ12000062	PIRACANJUBA	09/11/2020 19:30	09/11/2020 22:57	09/11/2020 19:30	09/11/2020 22:57	3,45	1	3,45	CHI
20201136480	EDEIA	EA12043985	EDEIA	09/11/2020 19:30	10/11/2020 09:54	09/11/2020 19:30	10/11/2020 09:54	14,39	5	71,95	CHI
20201136374	CACHOEIRA DOURADA	CD21190998	BOM JESUS DE GOIAS	09/11/2020 19:31	10/11/2020 15:09	09/11/2020 19:31	10/11/2020 15:09	19,63	1	19,63	CHI
20201136391	AMORINOPOLIS	AM11000005	IPORA	09/11/2020 19:32	10/11/2020 08:40	09/11/2020 19:32	10/11/2020 08:40	13,13	114	1496,95	CHI
20201136388	ITARUMA	IM21271703	CACHOEIRA ALTA	09/11/2020 19:33	10/11/2020 10:58	09/11/2020 19:33	10/11/2020 10:58	15,41	2	30,83	CHI
20201136390	NOVA CRIXAS	9320003986	NOVA CRIXAS	09/11/2020 19:33	10/11/2020 15:40	09/11/2020 19:33	10/11/2020 15:40	20,10	1	20,10	CHI
20201136410	GOIAS	GS11162299	GOIAS	09/11/2020 19:34	10/11/2020 13:56	09/11/2020 19:34	10/11/2020 13:56	18,35	2	36,71	CHI
20201136435	TRINDADE	10018841170	GOYA S2	09/11/2020 19:36	09/11/2020 22:25	09/11/2020 19:36	09/11/2020 22:25	2,82	1	2,82	CHI
20201136840	ITAUCU	IX12016023	INHUMAS S1	09/11/2020 19:36	10/11/2020 02:43	09/11/2020 19:36	10/11/2020 02:43	7,12	4	28,47	CHI
20201137081	SAO DOMINGOS	10018796107	SAO DOMINGOS	09/11/2020 19:36	10/11/2020 00:36	09/11/2020 19:36	10/11/2020 00:36	5,01	1	5,01	CHI
20201136447	RIO VERDE	4080002507	SANTA HELENA S1	09/11/2020 19:37	10/11/2020 15:27	09/11/2020 19:37	10/11/2020 15:27	19,83	1	19,83	CHI
20201136450	ITAPIRAPUA	IU11293784	MATRINCHA	09/11/2020 19:37	10/11/2020 01:41	09/11/2020 19:37	10/11/2020 01:41	6,06	36	218,02	CHI
20201136881	FORMOSA	FA11131864	ITUIQUIRA	09/11/2020 19:37	09/11/2020 21:39	09/11/2020 19:37	09/11/2020 21:39	2,02	69	139,71	CHI
20201136147	VILA PROPICIO	NP12247183	GOIANESIA S1	09/11/2020 19:38	10/11/2020 08:46	09/11/2020 19:38	10/11/2020 08:46	13,13	4	52,53	CHI
20201136712	MINACU	IH12307129	MINACU	09/11/2020 19:38	09/11/2020 21:58	09/11/2020 19:38	09/11/2020 21:58	2,33	13	30,28	CHI
20201136463	ITABERAI	IB11307602	ITABERAI S2	09/11/2020 19:39	10/11/2020 01:33	09/11/2020 19:39	10/11/2020 01:33	5,90	280	1651,77	CHI
20201136531	SAO FRANCISCO DE GOIAS	SF12000177	SAO FRANCISCO DE GOIAS	09/11/2020 19:40	09/11/2020 20:31	09/11/2020 19:40	09/11/2020 20:31	0,85	4	3,39	CHI
20201136477	SANTA HELENA DE GOIAS	SH11053078	IPEGUARI	09/11/2020 19:42	10/11/2020 02:07	09/11/2020 19:42	10/11/2020 02:07	6,41	94	602,88	CHI
20201136485	GOIANIA	16873324	GOIANIA LESTE S2	09/11/2020 19:43	09/11/2020 22:02	09/11/2020 19:43	09/11/2020 22:02	2,31	1	2,31	CHI
20201136490	ANAPOLIS	20848456	ANAPOLIS UNIVERSITARIO S2	09/11/2020 19:43	09/11/2020 21:27	09/11/2020 19:43	09/11/2020 21:27	1,72	1	1,72	CHI
20201136494	ITUMBARA	CD12097345RE	BOM JESUS DE GOIAS	09/11/2020 19:44	10/11/2020 11:31	09/11/2020 19:44	10/11/2020 11:31	15,78	8	126,23	CHI
20201136683	PORANGATU	PO12020947	PORANGATU	09/11/2020 19:44	10/11/2020 01:09	09/11/2020 19:44	10/11/2020 01:09	5,41	44	238,25	CHI
20201136508	AGUAS LINDAS DE GOIAS	LA11203799	AGUAS LINDAS DE GOIAS S1	09/11/2020 19:46	09/11/2020 22:35	09/11/2020 19:46	09/11/2020 22:35	2,82	130	366,02	CHI
20201136530	JARAGUA	SF12377528	SAO FRANCISCO DE GOIAS	09/11/2020 19:48	10/11/2020 02:00	09/11/2020 19:48	10/11/2020 02:00	6,19	1	6,19	CHI
20201136555	CIDADE OCCIDENTAL	DH11199612	MARAJOARA	09/11/2020 19:48	09/11/2020 21:33	09/11/2020 19:48	09/11/2020 21:33	1,74	123	213,58	CHI
20201136540	INACIOLANDIA	ID21406329	QUIRINOPOLIS	09/11/2020 19:49	10/11/2020 14:05	09/11/2020 19:49	10/11/2020 14:05	18,26	2	36,52	CHI
20201136542	GOIANIA	16395347	FERROVIARIO S1	09/11/2020 19:49	09/11/2020 23:13	09/11/2020 19:49	09/11/2020 23:13	3,39	0	0,00	CHI
20201136544	GOIANIA	GN11247725	GOIANIA LESTE S3	09/11/2020 19:49	10/11/2020 01:13	09/11/2020 19:49	10/11/2020 01:13	5,39	75	404,08	CHI
20201136549	FAINA	FC21148758	GOIAS	09/11/2020 19:50	10/11/2020 11:28	09/11/2020 19:50	10/11/2020 11:28	15,62	1	15,62	CHI
20201136550	GOIANIA	10304733	CAMPINAS S2	09/11/2020 19:50	10/11/2020 09:52	09/11/2020 19:50	10/11/2020 09:52	14,02	1	14,02	CHI
20201136553	APARECIDA DE GOIANIA	16775960	INDEPENDENCIA S2	09/11/2020 19:51	09/11/2020 21:18	09/11/2020 19:51	09/11/2020 21:18	1,45	1	1,45	CHI
20201136621	AURILANDIA	AI12057065	FIRMINOPOLIS S2	09/11/2020 19:51	09/11/2020 23:10	09/11/2020 19:51	09/11/2020 23:10	3,31	57	188,69	CHI
20201136660	CALDAS NOVAS	CN11054002	SERRA DE CALDAS	09/11/2020 19:51	09/11/2020 20:34	09/11/2020 19:51	09/11/2020 20:34	0,72	98	70,26	CHI

20201136571	VILA PROPICIO	PV12255981	GOIANESIA S1	09/11/2020 19:52	10/11/2020 09:54	09/11/2020 19:52	10/11/2020 09:54	14,02	3	42,06	CHI
20201136579	SANTA HELENA DE GOIAS	SH21360569	IPEGUARI	09/11/2020 19:54	09/11/2020 23:57	09/11/2020 19:54	09/11/2020 23:57	4,05	1	4,05	CHI
20201136584	ALTO PARAISO DE GOIAS	BF11130060	FLORES DE GOIAS	09/11/2020 19:54	09/11/2020 21:20	09/11/2020 19:54	09/11/2020 21:20	1,42	128	181,87	CHI
20201136937	URUACU	CR12375637	CAMPINORTE	09/11/2020 19:54	10/11/2020 02:42	09/11/2020 19:54	10/11/2020 02:42	6,79	120	814,57	CHI
20201136589	BELA VISTA DE GOIAS	BV21097971	BELA VISTA S1	09/11/2020 19:55	09/11/2020 21:42	09/11/2020 19:55	09/11/2020 21:42	1,78	2	3,56	CHI
20201136594	AURILANDIA	SL12003839	SAO LUIZ DOS MONTES BELOS	09/11/2020 19:55	10/11/2020 11:19	09/11/2020 19:55	10/11/2020 11:19	15,38	16	246,14	CHI
20201136594	SAO LUIS DE MONTES BELOS	SL12003839	SAO LUIZ DOS MONTES BELOS	09/11/2020 19:55	10/11/2020 11:19	09/11/2020 19:55	10/11/2020 11:19	15,38	9	138,45	CHI
20201136791	ITUMBIARA	IT11000131	PARANAIBA	09/11/2020 19:55	10/11/2020 07:59	09/11/2020 19:55	10/11/2020 07:59	12,06	17	205,01	CHI
20201136603	SAO LUIZ DO NORTE	SZ21143121	ITAPACI	09/11/2020 19:58	10/11/2020 11:51	09/11/2020 19:58	10/11/2020 11:51	15,88	1	15,88	CHI
20201136609	APARECIDA DE GOIANIA	10000058538	INDEPENDENCIA S2	09/11/2020 19:59	09/11/2020 23:03	09/11/2020 19:59	09/11/2020 23:03	3,06	1	3,06	CHI
20201136612	URUACU	10006138940	URUACU	09/11/2020 19:59	10/11/2020 17:25	09/11/2020 19:59	10/11/2020 17:25	21,42	1	21,42	CHI
20201136820	RIO VERDE	RV12123331	RIO VERDE S1	09/11/2020 19:59	10/11/2020 00:23	09/11/2020 19:59	10/11/2020 00:23	4,40	47	206,73	CHI
20201136614	MINEIROS	MY21301798	PARQUE DAS EMAS	09/11/2020 20:00	10/11/2020 10:39	09/11/2020 20:00	10/11/2020 10:39	14,65	1	14,65	CHI
20201136622	GOIANIA	15499133	MEIA PONTE	09/11/2020 20:00	10/11/2020 04:22	09/11/2020 20:00	10/11/2020 04:22	8,35	1	8,35	CHI
20201136624	RIO VERDE	RV21123336	RIO VERDE S1	09/11/2020 20:00	09/11/2020 23:55	09/11/2020 20:00	09/11/2020 23:55	3,90	1	3,90	CHI
20201136632	ANAPOLIS	10000473594	ANAPOLIS UNIVERSITARIO S2	09/11/2020 20:02	09/11/2020 22:02	09/11/2020 20:02	09/11/2020 22:02	1,99	1	1,99	CHI
20201136634	MORRINHOS	MR12381119	MORRINHOS	09/11/2020 20:03	09/11/2020 21:54	09/11/2020 20:03	09/11/2020 21:54	1,86	22	40,82	CHI
20201136637	CIDADE OCIDENTAL	10017330724	MARAJOARA	09/11/2020 20:04	09/11/2020 21:06	09/11/2020 20:04	09/11/2020 21:06	1,03	1	1,03	CHI
20201136730	GOIANIA	TR11160587	GOYA S2	09/11/2020 20:04	10/11/2020 06:06	09/11/2020 20:04	10/11/2020 06:06	10,02	91	912,20	CHI
20201136645	JATAI	JT18000231TS	JATAI S1	09/11/2020 20:05	09/11/2020 21:19	09/11/2020 20:05	09/11/2020 21:19	1,23	73	89,63	CHI
20201136645	PEROLANDIA	JT18000231TS	JATAI S1	09/11/2020 20:05	09/11/2020 21:19	09/11/2020 20:05	09/11/2020 21:19	1,23	3	3,68	CHI
20201136651	ANAPOLIS	20983761	ANAPOLIS UNIVERSITARIO S2	09/11/2020 20:06	09/11/2020 21:02	09/11/2020 20:06	09/11/2020 21:02	0,93	1	0,93	CHI
20201136653	SANTA TEREZINHA DE GOIAS	SG12237481	SANTA TEREZINHA	09/11/2020 20:06	10/11/2020 07:53	09/11/2020 20:06	10/11/2020 07:53	11,78	16	188,45	CHI
20201136672	AGUAS LINDAS DE GOIAS	10031612103	AGUAS LINDAS DE GOIAS S1	09/11/2020 20:09	09/11/2020 22:52	09/11/2020 20:09	09/11/2020 22:52	2,70	1	2,70	CHI
20201136675	ANICUNS	TV12304696	FIRMINOPOLIS S2	09/11/2020 20:09	10/11/2020 01:46	09/11/2020 20:09	10/11/2020 01:46	5,61	3	16,82	CHI
20201136675	TURVANIA	TV12304696	FIRMINOPOLIS S2	09/11/2020 20:09	10/11/2020 01:46	09/11/2020 20:09	10/11/2020 01:46	5,61	15	84,12	CHI
20201136693	MUNDO NOVO DE GOIAS	MH12340154	NOVA CRIXAS	09/11/2020 20:09	10/11/2020 09:21	09/11/2020 20:09	10/11/2020 09:21	13,20	2	26,39	CHI
20201136677	SAO DOMINGOS	SD21254367	SAO DOMINGOS	09/11/2020 20:10	09/11/2020 22:10	09/11/2020 20:10	09/11/2020 22:10	1,99	2	3,98	CHI
20201137106	PARANAIGUARA	SO12000023RE	CACHOEIRA ALTA	09/11/2020 20:11	10/11/2020 03:55	09/11/2020 20:11	10/11/2020 03:55	7,72	65	501,73	CHI
20201137106	SAO SIMAO	SO12000023RE	CACHOEIRA ALTA	09/11/2020 20:11	10/11/2020 03:55	09/11/2020 20:11	10/11/2020 03:55	7,72	35	270,16	CHI
20201136684	SAO MIGUEL DO ARAGUAIA	SM12059999	SAO MIGUEL DO ARAGUAIA	09/11/2020 20:12	09/11/2020 23:39	09/11/2020 20:12	09/11/2020 23:39	3,45	10	34,49	CHI
20201136686	SANTO ANTONIO DO DESCOBERTO	2210149340	ALEXANIA	09/11/2020 20:12	10/11/2020 12:10	09/11/2020 20:12	10/11/2020 12:10	15,96	1	15,96	CHI
20201136731	MINEIROS	MY12377570	PARQUE DAS EMAS	09/11/2020 20:12	09/11/2020 23:14	09/11/2020 20:12	09/11/2020 23:14	3,02	171	515,99	CHI
20201136965	NIQUELANDIA	NQ11197692	NIQUELANDIA SUBTRANSMISSAO	09/11/2020 20:15	10/11/2020 04:31	09/11/2020 20:15	10/11/2020 04:31	8,26	140	1155,93	CHI
20201136711	TRINDADE	TR11091183	TRINDADE	09/11/2020 20:16	10/11/2020 01:00	09/11/2020 20:16	10/11/2020 01:00	4,73	185	874,43	CHI
20201136715	ANAPOLIS	AN12026164	ANAPOLIS UNIVERSITARIO S2	09/11/2020 20:17	10/11/2020 17:58	09/11/2020 20:17	10/11/2020 17:58	21,68	1	21,68	CHI
20201136716	APARECIDA DE GOIANIA	200322916	ANHANGUERA	09/11/2020 20:17	10/11/2020 12:28	09/11/2020 20:17	10/11/2020 12:28	16,17	1	16,17	CHI
20201136722	EDEIA	EA11190306	EDEIA	09/11/2020 20:18	10/11/2020 13:46	10/11/2020 13:03	10/11/2020 13:46	0,72	89	63,78	CHI
20201136725	CORUMBAIBA	IP21151169	IPAMERI	09/11/2020 20:18	09/11/2020 22:40	09/11/2020 20:18	09/11/2020 22:40	2,35	1	2,35	CHI
20201136735	GOIATUBA	GT12273783	GOIATUBA S2	09/11/2020 20:20	09/11/2020 23:48	09/11/2020 20:20	09/11/2020 23:48	3,45	5	17,27	CHI
20201136769	CATALAO	CT12270721	CATALAO S2	09/11/2020 20:21	09/11/2020 22:02	09/11/2020 20:21	09/11/2020 22:02	1,68	454	761,08	CHI
20201136741	PARANAIGUARA	PC11295733	CACHOEIRA ALTA	09/11/2020 20:22	09/11/2020 22:12	09/11/2020 20:22	09/11/2020 22:12	1,82	128	233,28	CHI
20201136749	MINEIROS	1390132540	PARQUE DAS EMAS	09/11/2020 20:24	09/11/2020 21:29	09/11/2020 20:24	09/11/2020 21:29	1,07	1	1,07	CHI
20201136757	ANAPOLIS	AN21057914	ANAPOLIS UNIVERSITARIO S2	09/11/2020 20:25	09/11/2020 22:05	09/11/2020 20:25	09/11/2020 22:05	1,65	1	1,65	CHI
20201136795	ITUMBIARA	IT11000086	ITUMBIARA NOVA	09/11/2020 20:25	10/11/2020 10:09	09/11/2020 20:25	10/11/2020 10:09	13,72	117	1605,11	CHI
20201136775	BOM JARDIM DE GOIAS	BM10400614	BOM JARDIM	09/11/2020 20:26	10/11/2020 18:37	09/11/2020 20:26	10/11/2020 20:31	0,08	298	22,93	CHI
20201136775	PIRANHAS	BM10400614	BOM JARDIM	09/11/2020 20:26	10/11/2020 18:37	09/11/2020 20:26	09/11/2020 20:31	0,08	36	2,77	CHI
20201136775	BOM JARDIM DE GOIAS	BM10400614	BOM JARDIM	09/11/2020 20:26	10/11/2020 18:37	09/11/2020 20:32	10/11/2020 09:13	12,68	285	3614,04	CHI
20201136775	PIRANHAS	BM10400614	BOM JARDIM	09/11/2020 20:26	10/11/2020 18:37	09/11/2020 20:32	10/11/2020 09:13	12,68	36	456,51	CHI
20201136775	BOM JARDIM DE GOIAS	BM10400614	BOM JARDIM	09/11/2020 20:26	10/11/2020 18:37	09/11/2020 20:32	10/11/2020 18:37	22,08	13	287,08	CHI
20201136775	BOM JARDIM DE GOIAS	BM10400614	BOM JARDIM	09/11/2020 20:26	10/11/2020 18:37	10/11/2020 09:15	10/11/2020 18:37	9,36	285	2669,02	CHI

20201136775	PIRANHAS	BM10400614	BOM JARDIM	09/11/2020 20:26	10/11/2020 18:37	10/11/2020 09:15	10/11/2020 18:37	9,36	36	337,14	CHI
20201136764	TRINDADE	40149936	MEIA PONTE	09/11/2020 20:27	09/11/2020 22:56	09/11/2020 20:27	09/11/2020 22:56	2,47	1	2,47	CHI
20201137105	ARAGARCAS	10029176946	ARAGARCAS	09/11/2020 20:29	10/11/2020 09:33	09/11/2020 20:29	10/11/2020 09:33	13,06	1	13,06	CHI
20201136772	MONTIVIDIU	MV21260820	MONTIVIDIU T	09/11/2020 20:30	09/11/2020 23:35	09/11/2020 20:30	09/11/2020 23:35	3,08	1	3,08	CHI
20201136773	AURILANDIA	1010019500	FIRMINOPOLIS S2	09/11/2020 20:30	10/11/2020 13:28	09/11/2020 20:30	10/11/2020 13:28	16,96	1	16,96	CHI
20201136889	PALMINOPOLIS	PP11000037	PALMEIRAS	09/11/2020 20:32	10/11/2020 03:34	09/11/2020 20:32	10/11/2020 03:34	7,03	191	1342,78	CHI
20201136803	ANAPOLIS	20800850	ANAPOLIS UNIVERSITARIO S2	09/11/2020 20:36	10/11/2020 01:50	09/11/2020 20:36	10/11/2020 01:50	5,23	1	5,23	CHI
20201136830	ITAJA	IJ12226574	ITAJA S2	09/11/2020 20:36	10/11/2020 08:02	09/11/2020 20:36	10/11/2020 08:02	11,42	8	91,38	CHI
20201136809	NOVO GAMA	4990033130	PACAEMBU S1	09/11/2020 20:37	09/11/2020 22:05	09/11/2020 20:37	09/11/2020 22:05	1,46	1	1,46	CHI
20201136819	FAZENDA NOVA	NB12034635	JUSSARA	09/11/2020 20:39	09/11/2020 22:13	09/11/2020 20:39	09/11/2020 22:13	1,56	31	48,36	CHI
20201136819	JUSSARA	NB12034635	JUSSARA	09/11/2020 20:39	09/11/2020 22:13	09/11/2020 20:39	09/11/2020 22:13	1,56	1	1,56	CHI
20201136819	NOVO BRASIL	NB12034635	JUSSARA	09/11/2020 20:39	09/11/2020 22:13	09/11/2020 20:39	09/11/2020 22:13	1,56	8	12,48	CHI
20201136826	APARECIDA DE GOIANIA	200524951	ANHANGUERA	09/11/2020 20:40	10/11/2020 04:09	09/11/2020 20:40	10/11/2020 04:09	7,47	1	7,47	CHI
20201136832	GOIANIA	GN11002117	GOYA S1	09/11/2020 20:42	10/11/2020 09:21	09/11/2020 20:42	10/11/2020 09:21	12,64	47	594,03	CHI
20201136836	GOIANIA	15783595	CAMPINAS S2	09/11/2020 20:43	09/11/2020 23:52	09/11/2020 20:43	09/11/2020 23:52	3,14	1	3,14	CHI
20201136841	CRIXAS	2490038900	SERRA DO OURO	09/11/2020 20:44	10/11/2020 00:19	09/11/2020 20:44	10/11/2020 00:19	3,57	1	3,57	CHI
20201136848	BOM JESUS DE GOIAS	230424	BOM JESUS DE GOIAS	09/11/2020 20:44	10/11/2020 12:22	09/11/2020 20:44	10/11/2020 12:22	1,98	23	45,50	CHI
20201136848	GOIATUBA	230424	BOM JESUS DE GOIAS	09/11/2020 20:44	10/11/2020 12:22	09/11/2020 20:44	09/11/2020 12:22	1,98	11	21,76	CHI
20201136848	ITUMBIARA	230424	BOM JESUS DE GOIAS	09/11/2020 20:44	10/11/2020 12:22	09/11/2020 20:44	09/11/2020 12:22	1,98	3	5,94	CHI
20201136848	GOIATUBA	GT13134949	BOM JESUS DE GOIAS	09/11/2020 20:44	10/11/2020 12:22	09/11/2020 20:44	10/11/2020 01:20	4,59	10	45,92	CHI
20201136848	BOM JESUS DE GOIAS	230424	BOM JESUS DE GOIAS	09/11/2020 20:44	10/11/2020 12:22	10/11/2020 06:26	10/11/2020 06:30	0,06	23	1,42	CHI
20201136848	GOIATUBA	230424	BOM JESUS DE GOIAS	09/11/2020 20:44	10/11/2020 12:22	10/11/2020 06:26	10/11/2020 06:30	0,06	21	1,29	CHI
20201136848	ITUMBIARA	230424	BOM JESUS DE GOIAS	09/11/2020 20:44	10/11/2020 12:22	10/11/2020 06:26	10/11/2020 06:30	0,06	3	0,18	CHI
20201136848	GOIATUBA	230424	BOM JESUS DE GOIAS	09/11/2020 20:44	10/11/2020 12:22	09/11/2020 20:44	10/11/2020 12:22	15,63	132	2063,23	CHI
20201136848	GOIATUBA	230424	BOM JESUS DE GOIAS	09/11/2020 20:44	10/11/2020 12:22	09/11/2020 20:44	10/11/2020 12:22	15,63	102	1594,32	CHI
20201136848	GOIATUBA	GT13000320	BOM JESUS DE GOIAS	09/11/2020 20:44	10/11/2020 12:22	09/11/2020 20:44	10/11/2020 12:22	15,63	5	78,15	CHI
20201136843	QUIRINOPOLIS	80075540	QUIRINOPOLIS	09/11/2020 20:45	10/11/2020 02:54	09/11/2020 20:45	10/11/2020 02:54	6,14	1	6,14	CHI
20201136845	GOIANIA	17176372	XAVANTES	09/11/2020 20:46	10/11/2020 02:50	09/11/2020 20:46	10/11/2020 02:50	6,06	1	6,06	CHI
20201136849	GAMELEIRA DE GOIAS	SV21076027	DAIA S2	09/11/2020 20:47	10/11/2020 00:00	09/11/2020 20:47	10/11/2020 00:00	3,22	1	3,22	CHI
20201136852	PONTALINA	PK12047211	PONTALINA	09/11/2020 20:48	09/11/2020 22:38	09/11/2020 20:48	09/11/2020 22:38	1,83	7	12,81	CHI
20201136858	EDEIA	EA12223418	EDEIA	09/11/2020 20:50	10/11/2020 12:04	09/11/2020 23:53	10/11/2020 07:21	7,46	71	529,78	CHI
20201136858	EDEIA	EA12223418	EDEIA	09/11/2020 20:50	10/11/2020 12:04	10/11/2020 08:17	10/11/2020 11:34	3,27	71	232,17	CHI
20201136858	EDEIA	EA11142398	EDEIA	09/11/2020 20:50	10/11/2020 12:04	09/11/2020 20:50	10/11/2020 12:04	15,24	143	2179,40	CHI
20201136861	GOIAS	IB12210550	ITABERAI S1	09/11/2020 20:51	10/11/2020 03:11	09/11/2020 20:51	10/11/2020 03:11	6,33	2	12,66	CHI
20201136861	ITABERAI	IB12210550	ITABERAI S1	09/11/2020 20:51	10/11/2020 03:11	09/11/2020 20:51	10/11/2020 03:11	6,33	34	215,16	CHI
20201136884	DAMOLANDIA	NV31188761	INHUMAS S1	09/11/2020 20:51	10/11/2020 14:45	09/11/2020 20:51	10/11/2020 14:30	17,64	3	52,92	CHI
20201136884	NOVA VENEZA	NV21214650	INHUMAS S1	09/11/2020 20:51	10/11/2020 14:45	09/11/2020 20:51	10/11/2020 14:40	17,81	1	17,81	CHI
20201136884	NOVA VENEZA	NV21364283	INHUMAS S1	09/11/2020 20:51	10/11/2020 14:45	09/11/2020 20:51	10/11/2020 14:45	17,89	1	17,89	CHI
20201137023	JATAI	JT11390565	JATAI S3	09/11/2020 20:51	10/11/2020 06:50	09/11/2020 20:51	10/11/2020 06:50	9,97	92	917,16	CHI
20201136869	ITABERAI	IB21222055	ITABERAI S2	09/11/2020 20:52	10/11/2020 15:24	09/11/2020 20:52	10/11/2020 15:24	18,53	1	18,53	CHI
20201137452	INHUMAS	IN32066288	INHUMAS S2	09/11/2020 20:52	10/11/2020 12:25	09/11/2020 20:52	10/11/2020 12:25	15,55	8	124,37	CHI
20201136874	ANAPOLIS	AN11129422	ANAPOLIS UNIVERSITARIO S2	09/11/2020 20:53	10/11/2020 03:01	09/11/2020 20:53	10/11/2020 03:01	6,14	91	558,61	CHI
20201136876	FORMOSA	FA12207282	ITUIQUIRA	09/11/2020 20:53	09/11/2020 23:17	09/11/2020 20:53	09/11/2020 23:17	2,38	15	35,77	CHI
20201136978	ITABERAI	IB12079203	ITABERAI S1	09/11/2020 20:54	10/11/2020 06:55	09/11/2020 20:54	10/11/2020 06:55	10,01	23	230,27	CHI
20201136885	GOIATUBA	GT21143940	GOIATUBA S2	09/11/2020 20:55	10/11/2020 12:11	09/11/2020 20:55	10/11/2020 12:11	15,25	1	15,25	CHI
20201136890	GOIANDIRA	GD12127561	CATALAO S1	09/11/2020 20:57	10/11/2020 01:00	09/11/2020 20:57	10/11/2020 01:00	4,05	3	12,15	CHI
20201136901	NIQUELANDIA	2750054455	NIQUELANDIA SUBTRANSMISSAO	09/11/2020 21:01	09/11/2020 23:46	09/11/2020 21:01	09/11/2020 23:46	2,75	1	2,75	CHI
20201136905	ANAPOLIS	21032816	ANAPOLIS UNIVERSITARIO S1	09/11/2020 21:02	10/11/2020 01:54	09/11/2020 21:02	10/11/2020 01:54	4,86	1	4,86	CHI
20201136908	SANTA TEREZINHA DE GOIAS	SG12090800LD	SANTA TEREZINHA	09/11/2020 21:03	10/11/2020 14:08	09/11/2020 21:03	10/11/2020 14:08	17,07	2	34,13	CHI
20201136909	ITUMBIARA	IT12232598	ITUMBIARA VELHA S1	09/11/2020 21:04	10/11/2020 11:08	09/11/2020 21:04	10/11/2020 11:08	14,07	2	28,13	CHI
20201136911	ALEXANIA	AX21066460	ALEXANIA	09/11/2020 21:05	10/11/2020 03:54	09/11/2020 21:05	10/11/2020 03:54	6,81	1	6,81	CHI

20201136914	CAMPINORTE	CR21164105	CAMPINORTE	09/11/2020 21:05	10/11/2020 10:36	09/11/2020 21:05	10/11/2020 10:36	13,50	1	13,50	CHI
20201136917	PIRENOPOLIS	PV21090223	CORUMBA	09/11/2020 21:07	10/11/2020 17:40	09/11/2020 21:07	10/11/2020 17:40	20,55	1	20,55	CHI
20201136922	LAGOA SANTA	3900002755	ITAJA S2	09/11/2020 21:08	10/11/2020 14:03	09/11/2020 21:08	10/11/2020 14:03	16,91	1	16,91	CHI
20201137135	RIO VERDE	RV11380696	CABRIUVA S1	09/11/2020 21:08	10/11/2020 07:31	09/11/2020 21:08	10/11/2020 07:31	10,37	136	1410,40	CHI
20201136935	ACREUNA	80414	ACREUNA	09/11/2020 21:10	10/11/2020 19:41	09/11/2020 21:10	10/11/2020 08:19	11,14	48	534,56	CHI
20201136935	ACREUNA	80414	ACREUNA	09/11/2020 21:10	10/11/2020 19:41	09/11/2020 21:10	10/11/2020 09:16	12,08	64	773,40	CHI
20201136935	SANTO ANTONIO DA BARRA	80414	ACREUNA	09/11/2020 21:10	10/11/2020 19:41	09/11/2020 21:10	10/11/2020 09:16	12,08	14	169,18	CHI
20201136935	ACREUNA	80414	ACREUNA	09/11/2020 21:10	10/11/2020 19:41	10/11/2020 08:20	10/11/2020 11:59	3,64	31	112,84	CHI
20201136935	ACREUNA	EU13409380	ACREUNA	09/11/2020 21:10	10/11/2020 19:41	10/11/2020 08:20	10/11/2020 16:08	7,79	17	132,47	CHI
20201136935	ACREUNA	EU13111123	ACREUNA	09/11/2020 21:10	10/11/2020 19:41	10/11/2020 19:08	10/11/2020 19:41	0,55	64	34,97	CHI
20201136935	SANTO ANTONIO DA BARRA	EU13111123	ACREUNA	09/11/2020 21:10	10/11/2020 19:41	10/11/2020 19:08	10/11/2020 19:41	0,55	14	7,65	CHI
20201136931	GUAPO	VJ12061544	GUAPO S2	09/11/2020 21:11	09/11/2020 23:47	09/11/2020 21:11	09/11/2020 23:47	2,60	1	2,60	CHI
20201136931	VARJAO	VJ12061544	GUAPO S2	09/11/2020 21:11	09/11/2020 23:47	09/11/2020 21:11	09/11/2020 23:47	2,60	19	49,36	CHI
20201136933	DOVERLANDIA	DV12138334	CAIAPONIA	09/11/2020 21:13	10/11/2020 01:10	09/11/2020 21:13	10/11/2020 01:10	3,94	15	59,16	CHI
20201136945	ITAGUARI	II12220226	ITABERAI S1	09/11/2020 21:16	10/11/2020 11:12	09/11/2020 21:16	10/11/2020 11:12	13,94	7	97,55	CHI
20201136947	PARAUNA	PU21136112	FIRMINOPOLIS S2	09/11/2020 21:18	10/11/2020 10:40	09/11/2020 21:18	10/11/2020 10:40	13,36	1	13,36	CHI
20201136949	NOVO GAMA	LZ21092875	MARAJOARA	09/11/2020 21:19	10/11/2020 00:57	09/11/2020 21:19	10/11/2020 00:57	3,63	1	3,63	CHI
20201136968	GOIAS	GS12220505	GOIAS	09/11/2020 21:20	10/11/2020 10:45	09/11/2020 21:20	10/11/2020 10:45	13,40	209	2800,83	CHI
20201136969	ITAPURANGA	10003122830	ITAPURANGA	09/11/2020 21:25	10/11/2020 02:01	09/11/2020 21:25	10/11/2020 02:01	4,59	1	4,59	CHI
20201136975	JARAGUA	10000697573	JARAGUA	09/11/2020 21:28	10/11/2020 09:19	09/11/2020 21:28	10/11/2020 09:19	11,85	1	11,85	CHI
20201136995	EDEIA	ED21328995	PONTALINA	09/11/2020 21:31	09/11/2020 23:06	09/11/2020 21:31	09/11/2020 23:06	1,57	1	1,57	CHI
20201137009	PETROLINA DE GOIAS	PG10395831	PETROLINA	09/11/2020 21:31	10/11/2020 01:04	09/11/2020 21:31	09/11/2020 22:17	0,76	224	170,86	CHI
20201137009	PETROLINA DE GOIAS	PG10395831	PETROLINA	09/11/2020 21:31	10/11/2020 01:04	09/11/2020 21:31	10/11/2020 00:12	2,68	27	72,35	CHI
20201137009	JESUPOLIS	PG12015788	PETROLINA	09/11/2020 21:31	10/11/2020 01:04	09/11/2020 21:31	10/11/2020 01:04	3,55	1	3,55	CHI
20201137009	PETROLINA DE GOIAS	PG12015788	PETROLINA	09/11/2020 21:31	10/11/2020 01:04	09/11/2020 21:31	10/11/2020 01:04	3,55	78	276,53	CHI
20201137119	ARAGARCAS	1820002606	ARAGARCAS	09/11/2020 21:31	10/11/2020 09:49	09/11/2020 21:31	10/11/2020 09:49	12,29	1	12,29	CHI
20201136999	PORANGATU	PO11020802	PORANGATU	09/11/2020 21:34	10/11/2020 09:47	09/11/2020 21:34	10/11/2020 09:47	12,21	64	781,46	CHI
20201137029	MINEIROS	MY13290181	PARQUE DAS EMAS	09/11/2020 21:36	10/11/2020 08:21	09/11/2020 21:36	10/11/2020 08:21	10,75	87	935,15	CHI
20201137006	PLANALTINA	2960019629	PLANALTINA	09/11/2020 21:37	09/11/2020 22:18	09/11/2020 21:37	09/11/2020 22:18	0,67	1	0,67	CHI
20201137173	SANTA HELENA DE GOIAS	SH11159483	IPEGUARI	09/11/2020 21:38	10/11/2020 04:00	09/11/2020 21:38	10/11/2020 04:00	6,35	59	374,80	CHI
20201137015	ARAGARCAS	1820012480	ARAGARCAS	09/11/2020 21:40	10/11/2020 04:15	09/11/2020 21:40	10/11/2020 04:15	6,58	1	6,58	CHI
20201137017	MINACU	IH21192478	MINACU	09/11/2020 21:41	09/11/2020 23:26	09/11/2020 21:41	09/11/2020 23:26	1,73	1	1,73	CHI
20201137535	NIQUELANDIA	NQ12147615RE	URUACU	09/11/2020 21:42	10/11/2020 07:15	09/11/2020 21:42	10/11/2020 07:15	9,53	327	3117,58	CHI
20201137033	ORIZONA	OZ11047553	PIRES DO RIO S2	09/11/2020 21:43	09/11/2020 22:42	09/11/2020 21:43	09/11/2020 22:42	0,97	155	150,48	CHI
20201137027	ANAPOLIS	10017544775	JUNDIAI S1	09/11/2020 21:44	09/11/2020 22:50	09/11/2020 21:44	09/11/2020 22:50	1,10	1	1,10	CHI
20201137038	GOIATUBA	GT10408745	GOIATUBA S2	09/11/2020 21:46	11/11/2020 10:21	09/11/2020 21:46	10/11/2020 04:04	6,31	56	353,25	CHI
20201137038	GOIATUBA	GT10408745	GOIATUBA S2	09/11/2020 21:46	11/11/2020 10:21	10/11/2020 05:27	10/11/2020 05:53	0,43	56	23,92	CHI
20201137038	BURITI ALEGRE	GT10408745	GOIATUBA S2	09/11/2020 21:46	11/11/2020 10:21	09/11/2020 21:46	10/11/2020 12:00	14,25	31	441,60	CHI
20201137038	GOIATUBA	GT10408745	GOIATUBA S2	09/11/2020 21:46	11/11/2020 10:21	09/11/2020 21:46	10/11/2020 12:00	14,25	30	427,35	CHI
20201137038	MORRINHOS	GT10408745	GOIATUBA S2	09/11/2020 21:46	11/11/2020 10:21	09/11/2020 21:46	10/11/2020 12:00	14,25	26	370,37	CHI
20201137038	GOIATUBA	GT12000102LD	GOIATUBA S2	09/11/2020 21:46	11/11/2020 10:21	09/11/2020 21:46	10/11/2020 12:28	14,71	12	176,50	CHI
20201137038	BURITI ALEGRE	GT10408745	GOIATUBA S2	09/11/2020 21:46	11/11/2020 10:21	10/11/2020 12:35	10/11/2020 13:56	1,36	31	42,08	CHI
20201137038	GOIATUBA	GT10408745	GOIATUBA S2	09/11/2020 21:46	11/11/2020 10:21	10/11/2020 12:35	10/11/2020 13:56	1,36	86	116,74	CHI
20201137038	MORRINHOS	GT10408745	GOIATUBA S2	09/11/2020 21:46	11/11/2020 10:21	10/11/2020 12:35	10/11/2020 13:56	1,36	26	35,29	CHI
20201137038	BURITI ALEGRE	GT10408745	GOIATUBA S2	09/11/2020 21:46	11/11/2020 10:21	10/11/2020 14:47	10/11/2020 14:58	0,17	31	5,39	CHI
20201137038	GOIATUBA	GT10408745	GOIATUBA S2	09/11/2020 21:46	11/11/2020 10:21	10/11/2020 14:47	10/11/2020 14:58	0,17	86	14,95	CHI
20201137038	MORRINHOS	GT10408745	GOIATUBA S2	09/11/2020 21:46	11/11/2020 10:21	10/11/2020 14:47	10/11/2020 14:58	0,17	26	4,52	CHI
20201137038	BURITI ALEGRE	GT10408745	GOIATUBA S2	09/11/2020 21:46	11/11/2020 10:21	10/11/2020 15:28	10/11/2020 18:06	2,64	31	81,90	CHI
20201137038	GOIATUBA	GT10408745	GOIATUBA S2	09/11/2020 21:46	11/11/2020 10:21	10/11/2020 15:28	10/11/2020 18:06	2,64	66	174,37	CHI
20201137038	MORRINHOS	GT10408745	GOIATUBA S2	09/11/2020 21:46	11/11/2020 10:21	10/11/2020 15:28	10/11/2020 18:06	2,64	26	68,69	CHI
20201137038	GOIATUBA	GT12048442LD	GOIATUBA S2	09/11/2020 21:46	11/11/2020 10:21	10/11/2020 15:28	10/11/2020 19:24	3,94	20	78,86	CHI

20201137038	GOIATUBA	GT10408745	GOIATUBA S2	09/11/2020 21:46	11/11/2020 10:21	10/11/2020 18:24	10/11/2020 19:24	1,00	39	39,04	CHI
20201137038	GOIATUBA	GT12000102LD	GOIATUBA S2	09/11/2020 21:46	11/11/2020 10:21	10/11/2020 12:35	10/11/2020 19:58	7,39	12	88,69	CHI
20201137038	BURITI ALEGRE	MR13044925	GOIATUBA S2	09/11/2020 21:46	11/11/2020 10:21	10/11/2020 18:24	10/11/2020 20:27	2,04	7	14,30	CHI
20201137038	GOIATUBA	MR13044925	GOIATUBA S2	09/11/2020 21:46	11/11/2020 10:21	10/11/2020 18:24	10/11/2020 20:27	2,04	10	20,42	CHI
20201137038	BURITI ALEGRE	BG13000035	GOIATUBA S2	09/11/2020 21:46	11/11/2020 10:21	10/11/2020 18:24	10/11/2020 20:39	2,25	24	53,93	CHI
20201137038	GOIATUBA	BG13000035	GOIATUBA S2	09/11/2020 21:46	11/11/2020 10:21	10/11/2020 18:24	10/11/2020 20:39	2,25	17	38,20	CHI
20201137038	MORRINHOS	BG13000035	GOIATUBA S2	09/11/2020 21:46	11/11/2020 10:21	10/11/2020 18:24	10/11/2020 20:39	2,25	26	58,42	CHI
20201137038	GOIATUBA	MR12048422	GOIATUBA S2	09/11/2020 21:46	11/11/2020 10:21	09/11/2020 21:46	10/11/2020 20:50	23,07	8	184,59	CHI
20201137038	BURITI ALEGRE	GT10408745	GOIATUBA S2	09/11/2020 21:46	11/11/2020 10:21	10/11/2020 20:59	10/11/2020 21:09	0,17	31	5,16	CHI
20201137038	GOIATUBA	GT10408745	GOIATUBA S2	09/11/2020 21:46	11/11/2020 10:21	10/11/2020 20:59	10/11/2020 21:09	0,17	98	16,31	CHI
20201137038	MORRINHOS	GT10408745	GOIATUBA S2	09/11/2020 21:46	11/11/2020 10:21	10/11/2020 20:59	10/11/2020 21:09	0,17	26	4,33	CHI
20201137038	GOIATUBA	GT10408745	GOIATUBA S2	09/11/2020 21:46	11/11/2020 10:21	10/11/2020 22:08	11/11/2020 09:17	11,14	56	623,76	CHI
20201137038	BURITI ALEGRE	GT13000033	GOIATUBA S2	09/11/2020 21:46	11/11/2020 10:21	10/11/2020 22:08	11/11/2020 09:28	11,32	31	350,90	CHI
20201137038	GOIATUBA	GT13000033	GOIATUBA S2	09/11/2020 21:46	11/11/2020 10:21	10/11/2020 22:08	11/11/2020 09:28	11,32	42	475,42	CHI
20201137038	MORRINHOS	GT13000033	GOIATUBA S2	09/11/2020 21:46	11/11/2020 10:21	10/11/2020 22:08	11/11/2020 09:28	11,32	26	294,31	CHI
20201137038	GOIATUBA	MR12048422	GOIATUBA S2	09/11/2020 21:46	11/11/2020 10:21	10/11/2020 20:59	11/11/2020 10:21	13,36	8	106,89	CHI
202011137935	APORE	4320224	ITAJA S1	09/11/2020 21:47	10/11/2020 17:06	09/11/2020 21:47	10/11/2020 12:45	14,96	9	134,66	CHI
202011137935	APORE	AE13377330	ITAJA S1	09/11/2020 21:47	10/11/2020 17:06	09/11/2020 21:47	10/11/2020 17:06	19,32	47	907,88	CHI
20201137041	TRINDADE	40005045	TRINDADE	09/11/2020 21:48	09/11/2020 23:15	09/11/2020 21:48	09/11/2020 23:15	1,43	1	1,43	CHI
20201137045	JANDAIA	PP10404111	PALMEIRAS	09/11/2020 21:49	10/11/2020 13:52	09/11/2020 21:49	10/11/2020 13:52	16,05	56	898,88	CHI
20201137045	PALMINOPOLIS	PP10404111	PALMEIRAS	09/11/2020 21:49	10/11/2020 13:52	09/11/2020 21:49	10/11/2020 13:52	16,05	163	2616,38	CHI
20201137042	PARAUNA	980011176	PARAUNA	09/11/2020 21:50	10/11/2020 12:30	09/11/2020 21:50	10/11/2020 12:30	14,68	1	14,68	CHI
20201137043	GAMELEIRA DE GOIAS	SV31068087	DAIA S2	09/11/2020 21:51	10/11/2020 05:02	09/11/2020 21:51	10/11/2020 05:02	7,18	1	7,18	CHI
20201137044	URUACU	UR12202170	URUACU	09/11/2020 21:51	10/11/2020 02:22	09/11/2020 21:51	10/11/2020 02:22	4,52	5	22,60	CHI
20201137374	ACREUNA	EU12260946	ACREUNA	09/11/2020 21:54	10/11/2020 12:47	09/11/2020 21:54	10/11/2020 12:47	14,88	24	357,20	CHI
20201137053	RIO VERDE	10000416140	RIO VERDE S1	09/11/2020 21:55	10/11/2020 09:37	09/11/2020 21:55	10/11/2020 09:37	11,69	1	11,69	CHI
20201136925	ANAPOLIS	20327365	ANAPOLIS UNIVERSITARIO S2	09/11/2020 21:59	10/11/2020 10:05	09/11/2020 21:59	10/11/2020 10:05	12,10	1	12,10	CHI
20201137062	IPAMERI	IP12000085	IPAMERI	09/11/2020 21:59	10/11/2020 08:25	09/11/2020 21:59	10/11/2020 08:25	10,43	2	20,86	CHI
20201137064	FIRMINOPOLIS	FR12081367	FIRMINOPOLIS S1	09/11/2020 21:59	10/11/2020 08:54	09/11/2020 21:59	10/11/2020 08:54	10,92	5	54,58	CHI
20201137082	GOIANESIA	GE12000035	GOIANESIA S2	09/11/2020 22:10	10/11/2020 01:29	09/11/2020 22:10	10/11/2020 01:29	3,31	5	16,57	CHI
20201137082	VILA PROPICIO	GE12000035	GOIANESIA S2	09/11/2020 22:10	10/11/2020 01:29	09/11/2020 22:10	10/11/2020 01:29	3,31	8	26,51	CHI
20201137092	GOIAS	GS21116961	MATRINCHA	09/11/2020 22:11	10/11/2020 18:40	09/11/2020 22:11	10/11/2020 18:40	20,47	1	20,47	CHI
20201137096	PORANGATU	TB12262770	PORANGATU	09/11/2020 22:11	10/11/2020 09:47	09/11/2020 22:11	10/11/2020 09:47	11,60	1	11,60	CHI
20201137096	SANTA TEREZA DE GOIAS	TB12262770	PORANGATU	09/11/2020 22:11	10/11/2020 09:47	09/11/2020 22:11	10/11/2020 09:47	11,60	5	57,98	CHI
20201137096	TROMBAS	TB12262770	PORANGATU	09/11/2020 22:11	10/11/2020 09:47	09/11/2020 22:11	10/11/2020 09:47	11,60	13	150,75	CHI
20201137262	FAINA	FC12038664	GOIAS	09/11/2020 22:12	10/11/2020 08:55	09/11/2020 22:12	10/11/2020 08:55	10,72	10	107,20	CHI
20201137095	COCALZINHO DE GOIAS	NP12402058	GOIANESIA S1	09/11/2020 22:15	10/11/2020 04:15	09/11/2020 22:15	10/11/2020 04:15	6,00	1	6,00	CHI
20201137095	PADRE BERNARDO	NP12402058	GOIANESIA S1	09/11/2020 22:15	10/11/2020 04:15	09/11/2020 22:15	10/11/2020 04:15	6,00	11	65,97	CHI
20201137095	VILA PROPICIO	NP12402058	GOIANESIA S1	09/11/2020 22:15	10/11/2020 04:15	09/11/2020 22:15	10/11/2020 04:15	6,00	94	563,74	CHI
20201137097	RIO VERDE	RV12260610	CABRIUVA S1	09/11/2020 22:16	10/11/2020 09:16	09/11/2020 22:16	10/11/2020 09:16	10,99	3	32,97	CHI
20201137110	PARAUNA	980020591	PARAUNA	09/11/2020 22:22	10/11/2020 08:38	09/11/2020 22:22	10/11/2020 08:38	10,28	1	10,28	CHI
20201138417	PARAUNA	PU12081329	PARAUNA	09/11/2020 22:22	10/11/2020 12:14	09/11/2020 22:22	10/11/2020 09:30	11,12	27	300,32	CHI
20201138417	PARAUNA	PU12081329	PARAUNA	09/11/2020 22:22	10/11/2020 12:14	09/11/2020 22:22	10/11/2020 12:14	13,86	41	568,11	CHI
20201137112	MORRINHOS	PK12189260	PONTALINA	09/11/2020 22:23	10/11/2020 10:16	09/11/2020 22:23	10/11/2020 10:16	11,87	1	11,87	CHI
20201137112	PONTALINA	PK12189260	PONTALINA	09/11/2020 22:23	10/11/2020 10:16	09/11/2020 22:23	10/11/2020 10:16	11,87	1	11,87	CHI
20201137113	GOIANESIA	550075872	GOIANESIA S2	09/11/2020 22:24	10/11/2020 00:23	09/11/2020 22:24	10/11/2020 00:23	1,98	1	1,98	CHI
20201137115	SANTO ANTONIO DO DESCOBERTO	10029402202	ALEXANIA	09/11/2020 22:24	10/11/2020 11:18	09/11/2020 22:24	10/11/2020 11:18	12,89	1	12,89	CHI
20201137116	SÃO MIGUEL DO ARAGUAIA	SM21380799	SÃO MIGUEL DO ARAGUAIA	09/11/2020 22:24	10/11/2020 09:43	09/11/2020 22:24	10/11/2020 09:43	11,31	1	11,31	CHI
20201137128	VICENTINOPOLIS	1970014791	VICENTINOPOLIS	09/11/2020 22:34	10/11/2020 08:07	09/11/2020 22:34	10/11/2020 08:07	9,53	1	9,53	CHI
20201137129	JOVIANIA	JV21359713	GOIATUBA S1	09/11/2020 22:35	10/11/2020 10:16	09/11/2020 22:35	10/11/2020 10:16	11,68	1	11,68	CHI
20201140338	SILVANIA	SV32111243	DAIA S2	09/11/2020 22:38	10/11/2020 17:30	09/11/2020 22:38	10/11/2020 17:30	18,87	19	358,46	CHI

20201137143	MINEIROS	1390157020	PARQUE DAS EMAS	09/11/2020 22:43	10/11/2020 12:22	09/11/2020 22:43	10/11/2020 12:22	13,64	1	13,64	CHI
20201137145	TRINDADE	40091508	TRINDADE	09/11/2020 22:44	09/11/2020 23:40	09/11/2020 22:44	09/11/2020 23:40	0,92	1	0,92	CHI
20201137670	JANDAIA	JD12008673	PALMEIRAS	09/11/2020 22:46	10/11/2020 17:49	09/11/2020 22:46	10/11/2020 17:49	19,03	13	247,44	CHI
20201137166	APARECIDA DE GOIANIA	16718392	INDEPENDENCIA S1	09/11/2020 22:53	10/11/2020 00:23	09/11/2020 22:53	10/11/2020 00:23	1,49	1	1,49	CHI
20201137167	AGUAS LINDAS DE GOIAS	LA11203799	AGUAS LINDAS DE GOIAS S1	09/11/2020 22:54	10/11/2020 00:26	09/11/2020 22:54	10/11/2020 00:26	1,53	130	199,33	CHI
20201137170	UIRAPURU	UP21181268	SANTA TEREZINHA	09/11/2020 22:54	10/11/2020 00:05	09/11/2020 22:54	10/11/2020 00:05	1,17	2	2,34	CHI
20201137203	INHUMAS	800414	INHUMAS S1	09/11/2020 23:14	10/11/2020 11:14	09/11/2020 23:14	10/11/2020 01:35	2,35	162	380,93	CHI
20201137203	ARACU	800414	INHUMAS S1	09/11/2020 23:14	10/11/2020 11:14	09/11/2020 23:14	10/11/2020 02:43	3,50	8	27,99	CHI
20201137203	INHUMAS	800414	INHUMAS S1	09/11/2020 23:14	10/11/2020 11:14	09/11/2020 23:14	10/11/2020 02:43	3,50	10	34,99	CHI
20201137203	INHUMAS	800414	INHUMAS S1	09/11/2020 23:14	10/11/2020 11:14	09/11/2020 23:14	10/11/2020 02:43	3,50	173	605,36	CHI
20201137203	ITABERAI	800414	INHUMAS S1	09/11/2020 23:14	10/11/2020 11:14	09/11/2020 23:14	10/11/2020 02:43	3,50	73	255,44	CHI
20201137203	ITAUCU	800414	INHUMAS S1	09/11/2020 23:14	10/11/2020 11:14	09/11/2020 23:14	10/11/2020 02:43	3,50	742	2596,38	CHI
20201137203	ITAUCU	800414	INHUMAS S1	09/11/2020 23:14	10/11/2020 11:14	09/11/2020 23:14	10/11/2020 02:43	3,50	6	21,00	CHI
20201137203	ITAUCU	800414	INHUMAS S1	09/11/2020 23:14	10/11/2020 11:14	09/11/2020 23:14	10/11/2020 02:43	3,50	2770	9692,69	CHI
20201137203	ITAUCU	800414	INHUMAS S1	09/11/2020 23:14	10/11/2020 11:14	09/11/2020 23:14	10/11/2020 02:43	3,50	1	3,50	CHI
20201137203	ITAUCU	IX13140450	INHUMAS S1	09/11/2020 23:14	10/11/2020 11:14	09/11/2020 23:14	10/11/2020 02:43	3,50	4	14,00	CHI
20201137203	JARAGUA	800414	INHUMAS S1	09/11/2020 23:14	10/11/2020 11:14	09/11/2020 23:14	10/11/2020 02:43	3,50	40	139,97	CHI
20201137203	JESUPOLIS	800414	INHUMAS S1	09/11/2020 23:14	10/11/2020 11:14	09/11/2020 23:14	10/11/2020 02:43	3,50	24	83,98	CHI
20201137203	PETROLINA DE GOIAS	800414	INHUMAS S1	09/11/2020 23:14	10/11/2020 11:14	09/11/2020 23:14	10/11/2020 02:43	3,50	131	458,39	CHI
20201137203	SANTA ROSA DE GOIAS	800414	INHUMAS S1	09/11/2020 23:14	10/11/2020 11:14	09/11/2020 23:14	10/11/2020 02:43	3,50	603	2110,00	CHI
20201137203	SANTA ROSA DE GOIAS	800414	INHUMAS S1	09/11/2020 23:14	10/11/2020 11:14	09/11/2020 23:14	10/11/2020 02:43	3,50	931	3257,72	CHI
20201137203	SANTA ROSA DE GOIAS	IX13140450	INHUMAS S1	09/11/2020 23:14	10/11/2020 11:14	09/11/2020 23:14	10/11/2020 02:43	3,50	7	24,49	CHI
20201137203	TAQUARAL DE GOIAS	800414	INHUMAS S1	09/11/2020 23:14	10/11/2020 11:14	09/11/2020 23:14	10/11/2020 02:43	3,50	48	167,96	CHI
20201137203	TAQUARAL DE GOIAS	800414	INHUMAS S1	09/11/2020 23:14	10/11/2020 11:14	09/11/2020 23:14	10/11/2020 02:43	3,50	45	157,46	CHI
20201137203	TAQUARAL DE GOIAS	IX13140450	INHUMAS S1	09/11/2020 23:14	10/11/2020 11:14	09/11/2020 23:14	10/11/2020 02:43	3,50	4	14,00	CHI
20201137203	INHUMAS	IN13230622	INHUMAS S1	09/11/2020 23:14	10/11/2020 11:14	10/11/2020 08:30	10/11/2020 10:43	2,23	158	351,55	CHI
20201137203	INHUMAS	IN13230622	INHUMAS S1	09/11/2020 23:14	10/11/2020 11:14	10/11/2020 09:27	10/11/2020 10:43	1,26	2	2,53	CHI
20201137203	INHUMAS	800414	INHUMAS S1	09/11/2020 23:14	10/11/2020 11:14	09/11/2020 23:14	10/11/2020 11:14	12,00	19	228,00	CHI
20201137203	ITAUCU	800414	INHUMAS S1	09/11/2020 23:14	10/11/2020 11:14	09/11/2020 23:14	10/11/2020 11:14	12,00	3	36,00	CHI
20201137399	PALMEIRAS DE GOIAS	PL12000269	PALMEIRAS	09/11/2020 23:17	10/11/2020 06:44	09/11/2020 23:17	10/11/2020 06:44	7,45	193	1436,99	CHI
20201137215	GOIANIA	GN12001259	ATLANTICO S2	09/11/2020 23:42	10/11/2020 02:18	09/11/2020 23:42	10/11/2020 02:18	2,59	255	659,74	CHI
20201137656	FAINA	FC12220907	GOIAS	09/11/2020 23:47	10/11/2020 13:29	09/11/2020 23:47	10/11/2020 13:29	13,70	11	150,69	CHI
20201137230	RIO VERDE	RV16402238	RIO VERDE S2	09/11/2020 23:52	09/11/2020 23:56	09/11/2020 23:52	09/11/2020 23:56	0,07	1468	108,06	CHI
20201137246	ABADIA DE GOIAS	GA12048137LD	GUAPO S1	09/11/2020 23:59	10/11/2020 06:05	09/11/2020 23:59	10/11/2020 06:05	6,11	163	996,43	CHI
20201137246	GUAPO	GA12048137LD	GUAPO S1	09/11/2020 23:59	10/11/2020 06:05	09/11/2020 23:59	10/11/2020 06:05	6,11	780	4768,18	CHI
20201137246	TRINDADE	GA12048137LD	GUAPO S1	09/11/2020 23:59	10/11/2020 06:05	09/11/2020 23:59	10/11/2020 06:05	6,11	5	30,57	CHI
20201137234	HIDROLANDIA	HD11251854	CEPAIGO S2	10/11/2020 00:06	10/11/2020 11:34	10/11/2020 00:06	10/11/2020 11:34	11,46	82	939,95	CHI
20201137238	BELA VISTA DE GOIAS	240046766	BELA VISTA S2	10/11/2020 00:08	10/11/2020 00:44	10/11/2020 00:08	10/11/2020 00:44	0,59	1	0,59	CHI
20201137641	GOIANIA	GN12000678	CAMPINAS S1	10/11/2020 00:09	10/11/2020 15:45	10/11/2020 00:09	10/11/2020 15:45	15,60	506	7895,57	CHI
20201137241	ITABERAI	IB11333980	ITABERAI S2	10/11/2020 00:10	10/11/2020 01:58	10/11/2020 00:10	10/11/2020 01:58	1,80	65	116,69	CHI
20201137435	GOIANIA	GN11000913	GOYA S2	10/11/2020 00:27	10/11/2020 07:21	10/11/2020 00:27	10/11/2020 07:21	6,89	188	1295,42	CHI
20201137259	GOIANIA	14801838	INDEPENDENCIA S2	10/11/2020 00:30	10/11/2020 09:01	10/11/2020 00:30	10/11/2020 09:01	8,50	1	8,50	CHI
20201137263	GOIANIA	GN16407616	GOYA S2	10/11/2020 00:35	11/11/2020 00:21	10/11/2020 17:39	10/11/2020 17:42	0,06	5318	305,78	CHI
20201137263	GOIANIA	GN11401359	GOYA S2	10/11/2020 00:35	11/11/2020 00:21	10/11/2020 00:35	10/11/2020 19:03	18,47	53	979,01	CHI
20201137263	GOIANIA	GN11401359	GOYA S2	10/11/2020 00:35	11/11/2020 00:21	10/11/2020 23:40	11/11/2020 00:21	0,67	53	35,67	CHI
20201137284	GOIANIA	572204	REAL S2	10/11/2020 00:39	10/11/2020 07:58	10/11/2020 00:39	10/11/2020 00:46	0,13	2435	305,73	CHI
20201137284	APARECIDA DE GOIANIA	572204	REAL S2	10/11/2020 00:39	10/11/2020 07:58	10/11/2020 00:39	10/11/2020 00:51	0,21	935	193,75	CHI
20201137284	GOIANIA	572204	REAL S2	10/11/2020 00:39	10/11/2020 07:58	10/11/2020 00:39	10/11/2020 00:51	0,21	1186	245,77	CHI
20201137284	APARECIDA DE GOIANIA	572204	REAL S2	10/11/2020 00:39	10/11/2020 07:58	10/11/2020 00:39	10/11/2020 07:58	7,33	576	4219,52	CHI
20201137268	CAIAPONIA	CP12349672	CAIAPONIA	10/11/2020 00:43	10/11/2020 04:53	10/11/2020 00:43	10/11/2020 04:53	4,16	7	29,14	CHI
20201137294	CEZARINA	CZ11349274	CEZARINA	10/11/2020 00:50	10/11/2020 17:53	10/11/2020 00:50	10/11/2020 17:53	17,05	39	664,81	CHI

20201137498	APARECIDA DE GOIANIA	AP12000026	INDEPENDENCIA S1	10/11/2020 00:56	10/11/2020 09:24	10/11/2020 00:56	10/11/2020 09:24	8,45	600	5072,33	CHI
20201137751	GOIANIA	GN12072714	GOYA S1	10/11/2020 01:02	10/11/2020 08:33	10/11/2020 01:02	10/11/2020 08:33	7,53	1122	8443,67	CHI
20201137302	ANAPOLIS	AN12000236	ANAPOLIS UNIVERSITARIO S2	10/11/2020 01:09	10/11/2020 03:10	10/11/2020 01:09	10/11/2020 03:10	2,01	113	227,57	CHI
20201137533	URUACU	UR12398011	URUACU	10/11/2020 01:14	10/11/2020 07:18	10/11/2020 01:14	10/11/2020 07:18	6,05	4	24,21	CHI
20201137316	APARECIDA DO RIO DOCE	3390224	CACHOEIRA ALTA	10/11/2020 01:20	10/11/2020 20:41	10/11/2020 01:20	10/11/2020 05:41	4,34	631	2738,89	CHI
20201137316	APARECIDA DO RIO DOCE	3390224	CACHOEIRA ALTA	10/11/2020 01:20	10/11/2020 20:41	10/11/2020 01:20	10/11/2020 20:41	19,35	8	154,80	CHI
20201137316	CACHOEIRA ALTA	3390224	CACHOEIRA ALTA	10/11/2020 01:20	10/11/2020 20:41	10/11/2020 01:20	10/11/2020 20:41	19,35	3	58,05	CHI
20201137316	JATAI	3390224	CACHOEIRA ALTA	10/11/2020 01:20	10/11/2020 20:41	10/11/2020 01:20	10/11/2020 20:41	19,35	1	19,35	CHI
20201137316	RIO VERDE	3390224	CACHOEIRA ALTA	10/11/2020 01:20	10/11/2020 20:41	10/11/2020 01:20	10/11/2020 20:41	19,35	168	3250,75	CHI
20201137327	EDEALINA	ED10400591	PONTALINA	10/11/2020 01:20	10/11/2020 18:28	10/11/2020 01:36	10/11/2020 05:14	3,64	173	630,10	CHI
20201137327	EDEIA	ED10400591	PONTALINA	10/11/2020 01:20	10/11/2020 18:28	10/11/2020 01:36	10/11/2020 05:14	3,64	133	484,42	CHI
20201137327	PONTALINA	ED10400591	PONTALINA	10/11/2020 01:20	10/11/2020 18:28	10/11/2020 01:36	10/11/2020 05:14	3,64	5	18,21	CHI
20201137327	CEZARINA	ED16411373	PONTALINA	10/11/2020 01:20	10/11/2020 18:28	10/11/2020 06:48	10/11/2020 06:52	0,07	2	0,13	CHI
20201137327	EDEALINA	ED16411373	PONTALINA	10/11/2020 01:20	10/11/2020 18:28	10/11/2020 06:48	10/11/2020 06:52	0,07	670	44,67	CHI
20201137327	INDIARA	ED16411373	PONTALINA	10/11/2020 01:20	10/11/2020 18:28	10/11/2020 06:48	10/11/2020 06:52	0,07	2	0,13	CHI
20201137327	EDEALINA	ED10400591	PONTALINA	10/11/2020 01:20	10/11/2020 18:28	10/11/2020 06:49	10/11/2020 08:30	1,68	106	178,26	CHI
20201137327	EDEIA	ED10400591	PONTALINA	10/11/2020 01:20	10/11/2020 18:28	10/11/2020 06:49	10/11/2020 08:30	1,68	133	223,66	CHI
20201137327	PONTALINA	ED10400591	PONTALINA	10/11/2020 01:20	10/11/2020 18:28	10/11/2020 06:49	10/11/2020 08:30	1,68	5	8,41	CHI
20201137327	EDEALINA	ED10400591	PONTALINA	10/11/2020 01:20	10/11/2020 18:28	10/11/2020 06:49	10/11/2020 18:28	11,66	67	781,15	CHI
20201137318	PORANGATU	PO12022073	PORANGATU	10/11/2020 01:27	10/11/2020 08:35	10/11/2020 01:27	10/11/2020 08:35	7,13	43	306,72	CHI
20201137353	ITAJA	7953862	CACHOEIRA ALTA	10/11/2020 01:43	12/11/2020 20:46	10/11/2020 01:46	10/11/2020 14:04	12,30	8	98,40	CHI
20201137353	LAGOA SANTA	7953862	CACHOEIRA ALTA	10/11/2020 01:43	12/11/2020 20:46	10/11/2020 01:46	10/11/2020 14:04	12,30	1	12,30	CHI
20201137353	ITAJA	7953862	CACHOEIRA ALTA	10/11/2020 01:43	12/11/2020 20:46	10/11/2020 01:46	10/11/2020 16:20	14,57	4	58,27	CHI
20201137353	LAGOA SANTA	IJ13131612	CACHOEIRA ALTA	10/11/2020 01:43	12/11/2020 20:46	10/11/2020 01:46	11/11/2020 11:39	33,89	44	1491,36	CHI
20201137353	ITAJA	3700224	CACHOEIRA ALTA	10/11/2020 01:43	12/11/2020 20:46	11/11/2020 11:39	11/11/2020 12:27	0,80	28	22,42	CHI
20201137353	ITARUMA	3700224	CACHOEIRA ALTA	10/11/2020 01:43	12/11/2020 20:46	11/11/2020 11:39	11/11/2020 12:27	0,80	6	4,80	CHI
20201137353	LAGOA SANTA	3700224	CACHOEIRA ALTA	10/11/2020 01:43	12/11/2020 20:46	11/11/2020 11:39	11/11/2020 12:27	0,80	12	9,61	CHI
20201137353	ITAJA	IJ13131612	CACHOEIRA ALTA	10/11/2020 01:43	12/11/2020 20:46	10/11/2020 01:46	11/11/2020 14:16	36,50	11	401,51	CHI
20201137353	LAGOA SANTA	IJ13131612	CACHOEIRA ALTA	10/11/2020 01:43	12/11/2020 20:46	10/11/2020 01:46	11/11/2020 14:16	36,50	4	146,00	CHI
20201137353	ITAJA	IJ13131612	CACHOEIRA ALTA	10/11/2020 01:43	12/11/2020 20:46	11/11/2020 11:39	11/11/2020 14:16	2,61	2	5,21	CHI
20201137353	LAGOA SANTA	IJ13110421	CACHOEIRA ALTA	10/11/2020 01:43	12/11/2020 20:46	11/11/2020 13:27	11/11/2020 15:44	2,28	5	11,40	CHI
20201137353	LAGOA SANTA	IJ13110422	CACHOEIRA ALTA	10/11/2020 01:43	12/11/2020 20:46	11/11/2020 13:27	11/11/2020 16:40	3,21	7	22,47	CHI
20201137353	LAGOA SANTA	IJ13110423	CACHOEIRA ALTA	10/11/2020 01:43	12/11/2020 20:46	11/11/2020 13:27	11/11/2020 18:17	4,83	30	144,94	CHI
20201137353	ITAJA	3700224	CACHOEIRA ALTA	10/11/2020 01:43	12/11/2020 20:46	12/11/2020 18:57	12/11/2020 19:05	0,13	40	5,13	CHI
20201137353	ITARUMA	3700224	CACHOEIRA ALTA	10/11/2020 01:43	12/11/2020 20:46	12/11/2020 18:57	12/11/2020 19:05	0,13	6	0,77	CHI
20201137353	LAGOA SANTA	3700224	CACHOEIRA ALTA	10/11/2020 01:43	12/11/2020 20:46	12/11/2020 18:57	12/11/2020 19:05	0,13	17	2,18	CHI
20201137353	LAGOA SANTA	IJ13112761	CACHOEIRA ALTA	10/11/2020 01:43	12/11/2020 20:46	11/11/2020 13:27	12/11/2020 20:43	31,26	2	62,51	CHI
20201137353	ITAJA	7953862	CACHOEIRA ALTA	10/11/2020 01:43	12/11/2020 20:46	10/11/2020 01:46	12/11/2020 20:46	67,01	5	335,07	CHI
20201137353	LAGOA SANTA	7953862	CACHOEIRA ALTA	10/11/2020 01:43	12/11/2020 20:46	10/11/2020 01:46	12/11/2020 20:46	67,01	2	134,03	CHI
20201137337	ARAGARCAS	BM12204860	BOM JARDIM	10/11/2020 02:06	10/11/2020 07:03	10/11/2020 02:06	10/11/2020 07:03	4,95	1	4,95	CHI
20201137337	BOM JARDIM DE GOIAS	BM12204860	BOM JARDIM	10/11/2020 02:06	10/11/2020 07:03	10/11/2020 02:06	10/11/2020 07:03	4,95	7	34,62	CHI
20201137492	MONTES CLAROS DE GOIAS	ME12023299	IPORA	10/11/2020 02:18	10/11/2020 06:51	10/11/2020 02:18	10/11/2020 06:51	4,53	7	31,74	CHI
20201137347	ANAPOLIS	2370254	JUNDIAI S1	10/11/2020 02:20	10/11/2020 11:21	10/11/2020 02:20	10/11/2020 02:24	0,07	6234	406,94	CHI
20201137347	ANAPOLIS	2370254	JUNDIAI S1	10/11/2020 02:20	10/11/2020 11:21	10/11/2020 02:20	10/11/2020 02:24	0,07	6635	481,04	CHI
20201137347	Terezopolis de Goias	2370254	JUNDIAI S1	10/11/2020 02:20	10/11/2020 11:21	10/11/2020 02:20	10/11/2020 02:24	0,07	11	0,80	CHI
20201137347	ANAPOLIS	2370254	JUNDIAI S1	10/11/2020 02:20	10/11/2020 11:21	10/11/2020 02:20	10/11/2020 02:25	0,08	5	0,40	CHI
20201137347	GOIANAPOLIS	2370254	JUNDIAI S1	10/11/2020 02:20	10/11/2020 11:21	10/11/2020 02:20	10/11/2020 02:25	0,08	156	12,44	CHI
20201137347	Terezopolis de Goias	2370254	JUNDIAI S1	10/11/2020 02:20	10/11/2020 11:21	10/11/2020 02:20	10/11/2020 02:25	0,08	47	3,75	CHI
20201137347	ANAPOLIS	2370254	JUNDIAI S1	10/11/2020 02:20	10/11/2020 11:21	10/11/2020 02:20	10/11/2020 03:08	0,81	1148	927,01	CHI
20201137347	GOIANAPOLIS	2370254	JUNDIAI S1	10/11/2020 02:20	10/11/2020 11:21	10/11/2020 02:20	10/11/2020 03:08	0,81	46	37,14	CHI
20201137347	LEOPOLDO DE BULHOES	2370254	JUNDIAI S1	10/11/2020 02:20	10/11/2020 11:21	10/11/2020 02:20	10/11/2020 03:08	0,81	5	4,04	CHI

20201137347	ANAPOLIS	AN10400651	JUNDIAI S2	10/11/2020 02:20	10/11/2020 11:21	10/11/2020 03:02	10/11/2020 03:11	0,14	2410	338,74	CHI
20201137347	ANAPOLIS	2370254	JUNDIAI S1	10/11/2020 02:20	10/11/2020 11:21	10/11/2020 02:20	10/11/2020 04:10	1,83	207	379,21	CHI
20201137347	ANAPOLIS	AN10400651	JUNDIAI S1	10/11/2020 02:20	10/11/2020 11:21	10/11/2020 03:02	10/11/2020 05:22	2,32	5577	12957,23	CHI
20201137347	ANAPOLIS	AN10400651	JUNDIAI S1	10/11/2020 02:20	10/11/2020 11:21	10/11/2020 03:02	10/11/2020 11:21	8,31	1058	8792,57	CHI
20201137347	TEREZOPOLIS DE GOIAS	AN10400651	JUNDIAI S1	10/11/2020 02:20	10/11/2020 11:21	10/11/2020 03:02	10/11/2020 11:21	8,31	11	91,42	CHI
20201137394	GOIANIA	GN11001600	REAL S2	10/11/2020 02:36	10/11/2020 10:24	10/11/2020 02:36	10/11/2020 10:24	7,79	154	1199,83	CHI
20201137351	TRINDADE	TR21167027	GOYA S2	10/11/2020 02:38	10/11/2020 13:42	10/11/2020 02:38	10/11/2020 13:42	11,06	2	22,12	CHI
20201137476	CORUMBA DE GOIAS	CB12297787	CORUMBA	10/11/2020 02:39	10/11/2020 20:47	10/11/2020 02:39	10/11/2020 20:47	18,12	15	271,84	CHI
20201137801	DIORAMA	DI12070162	IPORA	10/11/2020 02:57	10/11/2020 08:45	10/11/2020 02:57	10/11/2020 08:45	5,79	1	5,79	CHI
20201137801	JAUPACI	DI12070162	IPORA	10/11/2020 02:57	10/11/2020 08:45	10/11/2020 02:57	10/11/2020 08:45	5,79	8	46,35	CHI
20201137368	VARJAO	940006066	GUAPO S2	10/11/2020 03:20	10/11/2020 08:03	10/11/2020 03:20	10/11/2020 08:03	4,70	1	4,70	CHI
20201138247	SANTO ANTONIO DO DESCOBERTO	SN12037174	MARAJOARA	10/11/2020 03:21	10/11/2020 12:16	10/11/2020 03:21	10/11/2020 12:16	8,91	7	62,34	CHI
20201137373	CALDAS NOVAS	10031328626	CALDAS NOVAS S2	10/11/2020 03:31	10/11/2020 07:24	10/11/2020 03:31	10/11/2020 07:24	3,88	1	3,88	CHI
20201138438	AURILANDIA	RP12076381RE	FIRMINOPOLIS S2	10/11/2020 03:47	10/11/2020 12:09	10/11/2020 03:47	10/11/2020 12:09	8,35	4	33,42	CHI
20201138438	SAO JOAO DA PARAUNA	RP12076381RE	FIRMINOPOLIS S2	10/11/2020 03:47	10/11/2020 12:09	10/11/2020 03:47	10/11/2020 12:09	8,35	33	275,71	CHI
20201137389	HIDROLANDIA	HD12275718	CEPAIGO S2	10/11/2020 03:55	10/11/2020 05:08	10/11/2020 03:55	10/11/2020 05:08	1,22	8	9,78	CHI
20201137455	JARAGUA	JA12059983	JARAGUA	10/11/2020 03:55	10/11/2020 07:47	10/11/2020 03:55	10/11/2020 07:47	3,85	91	350,58	CHI
20201137391	RIO VERDE	RV12200718LD	RIO VERDE S2	10/11/2020 03:59	10/11/2020 08:06	10/11/2020 03:59	10/11/2020 08:06	4,10	22	90,25	CHI
20201137391	SANTA HELENA DE GOIAS	RV12200718LD	RIO VERDE S2	10/11/2020 03:59	10/11/2020 08:06	10/11/2020 03:59	10/11/2020 08:06	4,10	70	287,16	CHI
20201137791	MORRO AGUDO DE GOIAS	MS12113277	ITAPURANGA	10/11/2020 04:00	10/11/2020 09:05	10/11/2020 04:00	10/11/2020 09:05	5,07	18	91,28	CHI
20201137467	NOVA CRIXAS	NA12087039	NOVA CRIXAS	10/11/2020 04:12	10/11/2020 15:09	10/11/2020 04:12	10/11/2020 15:09	10,94	4	43,77	CHI
20201137403	GOIANIA	12739352	ATLANTICO S1	10/11/2020 04:15	10/11/2020 09:43	10/11/2020 04:15	10/11/2020 09:43	5,46	1	5,46	CHI
20201137404	TRINDADE	TR11191008	GOYA S2	10/11/2020 04:18	10/11/2020 13:13	10/11/2020 04:18	10/11/2020 13:13	8,91	128	1140,98	CHI
20201137573	GOIANIA	GN12340461	XAVANTES	10/11/2020 04:21	10/11/2020 07:13	10/11/2020 04:21	10/11/2020 07:13	2,86	83	237,56	CHI
20201138256	PALMEIRAS DE GOIAS	PL12000093	PALMEIRAS	10/11/2020 04:21	10/11/2020 10:12	10/11/2020 04:21	10/11/2020 10:12	5,85	48	280,69	CHI
20201138075	GOIANIA	GN11097479	CAMPINAS S3	10/11/2020 04:22	10/11/2020 10:14	10/11/2020 04:22	10/11/2020 10:14	5,86	55	322,51	CHI
20201137411	CRISTALINA	KR10406671	CRISTALINA S2	10/11/2020 04:24	10/11/2020 11:05	10/11/2020 04:24	10/11/2020 08:35	4,18	10	41,77	CHI
20201137411	CRISTALINA	KR13352847	CRISTALINA S2	10/11/2020 04:24	10/11/2020 11:05	10/11/2020 04:24	10/11/2020 08:52	4,46	95	423,41	CHI
20201137411	CRISTALINA	KR12171556LD	CRISTALINA S2	10/11/2020 04:24	10/11/2020 11:05	10/11/2020 04:24	10/11/2020 11:05	6,67	158	1054,52	CHI
20201137408	INHUMAS	IX12408649	INHUMAS S1	10/11/2020 04:25	10/11/2020 16:50	10/11/2020 04:25	10/11/2020 16:50	12,41	137	1699,75	CHI
20201137408	ITAUCU	IX12408649	INHUMAS S1	10/11/2020 04:25	10/11/2020 16:50	10/11/2020 04:25	10/11/2020 16:50	12,41	35	434,24	CHI
20201137655	MORRINHOS	MR12381119	MORRINHOS	10/11/2020 04:26	10/11/2020 07:35	10/11/2020 04:26	10/11/2020 07:35	3,14	23	72,27	CHI
20201139551	GAMELEIRA DE GOIAS	SV12075804	DAIA S2	10/11/2020 04:28	10/11/2020 12:09	10/11/2020 04:28	10/11/2020 12:09	7,68	527	4047,21	CHI
20201137415	ITAPIRAPUA	IU12018777	JUSSARA	10/11/2020 04:33	10/11/2020 10:50	10/11/2020 04:33	10/11/2020 10:50	6,28	12	75,35	CHI
20201137422	GOIANAPOLIS	GP11180129	DAIA S2	10/11/2020 04:42	10/11/2020 13:25	10/11/2020 07:30	10/11/2020 13:25	5,92	90	532,50	CHI
20201137423	MONTIVIDIU	MV12249172	MONTIVIDIU T	10/11/2020 04:43	10/11/2020 08:33	10/11/2020 04:43	10/11/2020 08:33	3,82	4	15,29	CHI
20201137426	RIO VERDE	RV11038453	RIO VERDE S1	10/11/2020 04:46	10/11/2020 12:03	10/11/2020 04:46	10/11/2020 12:03	7,28	96	698,43	CHI
20201137427	GOIAS	GS12310594	ITABERAI S1	10/11/2020 04:47	10/11/2020 21:03	10/11/2020 04:47	10/11/2020 21:03	16,28	5	81,39	CHI
20201137427	ITABERAI	GS12310594	ITABERAI S1	10/11/2020 04:47	10/11/2020 21:03	10/11/2020 04:47	10/11/2020 21:03	16,28	25	406,93	CHI
20201137428	FORMOSO	FO12088777RE	MARA ROSA	10/11/2020 04:48	10/11/2020 10:02	10/11/2020 04:48	10/11/2020 10:02	5,23	32	167,36	CHI
20201138126	FORMOSO	FO21143622	MARA ROSA	10/11/2020 04:48	10/11/2020 11:29	10/11/2020 04:48	10/11/2020 11:29	6,68	1	6,68	CHI
20201137429	MONTES CLAROS DE GOIAS	ME12062838	IPORA	10/11/2020 04:52	10/11/2020 09:21	10/11/2020 04:52	10/11/2020 09:21	4,47	15	67,11	CHI
20201137430	ITAIA	IJ21161292	ITAIA S2	10/11/2020 04:52	10/11/2020 09:34	10/11/2020 04:52	10/11/2020 09:34	4,69	1	4,69	CHI
20201137434	SAO MIGUEL DO ARAGUAIA	SM12013236	SAO MIGUEL DO ARAGUAIA	10/11/2020 04:52	10/11/2020 08:04	10/11/2020 04:52	10/11/2020 08:04	3,18	6	19,10	CHI
20201139721	SAO MIGUEL DO ARAGUAIA	SM21135123	SAO MIGUEL DO ARAGUAIA	10/11/2020 04:52	10/11/2020 12:52	10/11/2020 04:52	10/11/2020 12:52	7,98	1	7,98	CHI
20201137432	GOIANESIA	GE12255876	GOIANESIA S2	10/11/2020 04:54	10/11/2020 09:06	10/11/2020 04:54	10/11/2020 09:06	4,20	38	159,44	CHI
20201139499	JAUPACI	JP12193319	IPORA	10/11/2020 04:57	10/11/2020 17:13	10/11/2020 04:57	10/11/2020 17:13	12,26	4	49,03	CHI
20201137442	SILVANIA	7296409	DAIA S2	10/11/2020 05:09	10/11/2020 12:50	10/11/2020 05:09	10/11/2020 11:44	6,58	54	355,19	CHI
20201137442	SILVANIA	SV12322411	DAIA S2	10/11/2020 05:09	10/11/2020 12:50	10/11/2020 11:07	10/11/2020 12:18	1,18	6	7,09	CHI
20201137442	SILVANIA	SV12032728	DAIA S2	10/11/2020 05:09	10/11/2020 12:50	10/11/2020 11:07	10/11/2020 12:34	1,45	18	26,16	CHI
20201137442	SILVANIA	SV12317628	DAIA S2	10/11/2020 05:09	10/11/2020 12:50	10/11/2020 05:09	10/11/2020 12:50	7,67	78	598,63	CHI

20201137444	CATALAO	CT12318674	CATALAO S1	10/11/2020 05:10	10/11/2020 09:51	10/11/2020 05:10	10/11/2020 09:51	4,69	2	9,38	CHI
20201137444	DAVINOPOLIS	CT12318674	CATALAO S1	10/11/2020 05:10	10/11/2020 09:51	10/11/2020 05:10	10/11/2020 09:51	4,69	3	14,07	CHI
20201137987	ANICUNS	TV12005585	FIRMINOPOLIS S2	10/11/2020 05:10	10/11/2020 17:10	10/11/2020 05:10	10/11/2020 17:10	12,00	3	36,00	CHI
20201137987	TURVANIA	TV12005585	FIRMINOPOLIS S2	10/11/2020 05:10	10/11/2020 17:10	10/11/2020 05:10	10/11/2020 17:10	12,00	17	204,00	CHI
20201137446	PALMEIRAS DE GOIAS	PL12000219	PALMEIRAS	10/11/2020 05:12	10/11/2020 08:20	10/11/2020 05:12	10/11/2020 08:20	3,12	13	40,57	CHI
20201137579	MONTIVIDIU DO NORTE	MX12187848	PORANGATU	10/11/2020 05:18	10/11/2020 07:14	10/11/2020 05:18	10/11/2020 07:14	1,92	15	28,81	CHI
20201137579	TROMBAS	MX12187848	PORANGATU	10/11/2020 05:18	10/11/2020 07:14	10/11/2020 05:18	10/11/2020 07:14	1,92	1	1,92	CHI
20201137826	PIRENOPOLIS	ZN12273387	COCALZINHO	10/11/2020 05:19	10/11/2020 10:39	10/11/2020 05:19	10/11/2020 10:39	5,32	15	79,80	CHI
20201137468	PORANGATU	PO12187955	PORANGATU	10/11/2020 05:26	10/11/2020 12:07	10/11/2020 05:26	10/11/2020 12:07	6,67	2	13,34	CHI
20201137469	ITUMBIARA	IT11134523	ITUMBIARA NOVA	10/11/2020 05:27	10/11/2020 14:33	10/11/2020 05:27	10/11/2020 14:33	9,09	279	2535,33	CHI
20201137474	PIRACANJUBA	PJ32057770	PIRACANJUBA	10/11/2020 05:29	10/11/2020 11:02	10/11/2020 05:29	10/11/2020 08:20	2,84	15	42,63	CHI
20201137474	PIRACANJUBA	PJ32057770	PIRACANJUBA	10/11/2020 05:29	10/11/2020 11:02	10/11/2020 09:10	10/11/2020 11:02	1,87	15	27,99	CHI
20201137192	NIQUELANDIA	NQ12056788	URUACU	10/11/2020 05:32	10/11/2020 08:52	10/11/2020 05:32	10/11/2020 08:52	3,32	94	312,03	CHI
20201137483	IPAMERI	IP12272798	IPAMERI	10/11/2020 05:33	10/11/2020 07:14	10/11/2020 05:33	10/11/2020 07:14	1,67	7	11,69	CHI
20201137494	ITAPIRAPUA	IU12018852	MATRINCHA	10/11/2020 05:40	11/11/2020 04:17	10/11/2020 05:40	11/11/2020 04:17	22,61	36	813,86	CHI
20201137497	PALMEIRAS DE GOIAS	PL12000058	PALMEIRAS	10/11/2020 05:41	10/11/2020 18:53	10/11/2020 05:41	10/11/2020 18:53	13,20	6	79,20	CHI
20201137500	CALDAS NOVAS	CN12213850	CALDAS NOVAS S2	10/11/2020 05:42	10/11/2020 07:32	10/11/2020 05:42	10/11/2020 07:32	1,82	15	27,32	CHI
20201137501	APARECIDA DE GOIANIA	AP12008304	CEPAIGO S1	10/11/2020 05:43	10/11/2020 08:30	10/11/2020 05:43	10/11/2020 08:30	2,78	30	83,47	CHI
20201137501	GOIANIA	AP12008304	CEPAIGO S1	10/11/2020 05:43	10/11/2020 08:30	10/11/2020 05:43	10/11/2020 08:30	2,78	62	172,51	CHI
20201137501	SENADOR CANEDO	AP12008304	CEPAIGO S1	10/11/2020 05:43	10/11/2020 08:30	10/11/2020 05:43	10/11/2020 08:30	2,78	437	1215,95	CHI
20201137984	AMARALINA	UP12294696	NOVA CRIXAS	10/11/2020 05:43	10/11/2020 10:11	10/11/2020 05:43	10/11/2020 10:11	4,46	53	236,20	CHI
20201137984	MARA ROSA	UP12294696	NOVA CRIXAS	10/11/2020 05:43	10/11/2020 10:11	10/11/2020 05:43	10/11/2020 10:11	4,46	43	191,64	CHI
20201137984	SANTA TEREZINHA DE GOIAS	UP12294696	NOVA CRIXAS	10/11/2020 05:43	10/11/2020 10:11	10/11/2020 05:43	10/11/2020 10:11	4,46	1	4,46	CHI
20201137984	UIRAPURU	UP12294696	NOVA CRIXAS	10/11/2020 05:43	10/11/2020 10:11	10/11/2020 05:43	10/11/2020 10:11	4,46	4	17,83	CHI
20201138458	GOIAS	GK12299661	ITAPURANGA	10/11/2020 05:43	10/11/2020 11:36	10/11/2020 05:43	10/11/2020 11:36	5,88	20	117,52	CHI
20201138458	GUARAITA	GK12299661	ITAPURANGA	10/11/2020 05:43	10/11/2020 11:36	10/11/2020 05:43	10/11/2020 11:36	5,88	19	111,64	CHI
20201138278	NAZARIO	NZ12000021	ANICUNS	10/11/2020 05:45	10/11/2020 09:43	10/11/2020 05:45	10/11/2020 09:43	3,95	2	7,90	CHI
20201138278	PALMEIRAS DE GOIAS	NZ12000021	ANICUNS	10/11/2020 05:45	10/11/2020 09:43	10/11/2020 05:45	10/11/2020 09:43	3,95	18	71,11	CHI
20201137512	MONTES CLAROS DE GOIAS	ME12155653	IPORA	10/11/2020 05:46	10/11/2020 17:03	10/11/2020 05:46	10/11/2020 17:03	11,28	39	439,73	CHI
20201137513	ITUMBIARA	IT21007665	ITUMBIARA VELHA S1	10/11/2020 05:46	10/11/2020 09:26	10/11/2020 05:46	10/11/2020 09:26	3,66	1	3,66	CHI
20201138102	ORIZONA	OZ12084915RE	PIRES DO RIO S2	10/11/2020 05:46	10/11/2020 09:09	10/11/2020 05:46	10/11/2020 09:09	3,38	3	10,14	CHI
20201138102	VIANOPOLIS	OZ12084915RE	PIRES DO RIO S2	10/11/2020 05:46	10/11/2020 09:09	10/11/2020 05:46	10/11/2020 09:09	3,38	36	121,64	CHI
20201137517	PIRANHAS	PH12038598	PIRANHAS	10/11/2020 05:48	10/11/2020 09:17	10/11/2020 05:48	10/11/2020 09:17	3,48	33	114,74	CHI
20201137519	EDEIA	TD12040336	RIO DOS BOIS	10/11/2020 05:48	10/11/2020 20:00	10/11/2020 05:48	10/11/2020 20:00	14,19	1	14,19	CHI
20201137519	TURVELANDIA	TD12040336	RIO DOS BOIS	10/11/2020 05:48	10/11/2020 20:00	10/11/2020 05:48	10/11/2020 20:00	14,19	3	42,56	CHI
20201137521	NIQUELANDIA	NQ12237500	URUACU	10/11/2020 05:49	11/11/2020 11:34	10/11/2020 05:49	11/11/2020 11:34	29,75	3	89,26	CHI
20201137525	GOIANIA	GN12001859	AEROPORTO S1	10/11/2020 05:51	10/11/2020 07:39	10/11/2020 05:51	10/11/2020 07:39	1,79	296	530,33	CHI
20201138058	ITAPIRAPUA	NB12396088	JUSSARA	10/11/2020 05:51	10/11/2020 08:45	10/11/2020 05:51	10/11/2020 08:45	2,89	4	11,57	CHI
20201138058	NOVO BRASIL	NB12396088	JUSSARA	10/11/2020 05:51	10/11/2020 08:45	10/11/2020 05:51	10/11/2020 08:45	2,89	5	14,46	CHI
20201137529	UIRAPURU	UP12321028	SANTA TEREZINHA	10/11/2020 05:53	10/11/2020 08:08	10/11/2020 05:53	10/11/2020 08:08	2,25	7	15,72	CHI
20201137532	INACIOLANDIA	ID21015508	QUIRINOPOLIS	10/11/2020 05:54	10/11/2020 10:46	10/11/2020 05:54	10/11/2020 10:46	4,85	1	4,85	CHI
20201137546	APARECIDA DE GOIANIA	AP11193023	INDEPENDENCIA S1	10/11/2020 05:58	10/11/2020 07:59	10/11/2020 05:58	10/11/2020 07:59	2,02	122	245,97	CHI
20201137547	ITAIA	IU12060005	ITAIA S2	10/11/2020 05:58	10/11/2020 16:46	10/11/2020 05:58	10/11/2020 16:46	10,79	5	53,96	CHI
20201137550	SAO DOMINGOS	SD12254356	SAO DOMINGOS	10/11/2020 05:58	10/11/2020 11:41	10/11/2020 05:58	10/11/2020 11:41	5,70	8	45,64	CHI
20201138202	ITUMBIARA	IT12263432	ITUMBIARA VELHA S2	10/11/2020 05:58	10/11/2020 10:52	10/11/2020 05:58	10/11/2020 10:52	4,89	96	469,57	CHI
20201138266	JUSSARA	JR12074365	BRITANIA	10/11/2020 06:00	10/11/2020 12:19	10/11/2020 06:00	10/11/2020 12:19	6,31	37	233,45	CHI
20201138266	SANTA FE DE GOIAS	JR12074365	BRITANIA	10/11/2020 06:00	10/11/2020 12:19	10/11/2020 06:00	10/11/2020 12:19	6,31	21	132,50	CHI
20201138381	AMORINOPOLIS	AM12039409	IPORA	10/11/2020 06:00	10/11/2020 09:29	10/11/2020 06:00	10/11/2020 09:29	3,47	5	17,34	CHI
20201138381	IPORA	AM12039409	IPORA	10/11/2020 06:00	10/11/2020 09:29	10/11/2020 06:00	10/11/2020 09:29	3,47	1	3,47	CHI
20201137716	URUACU	UR12384347	URUACU	10/11/2020 06:01	10/11/2020 08:39	10/11/2020 06:01	10/11/2020 08:39	2,62	25	65,49	CHI
20201139213	GOIATUBA	JV12000028	GOIATUBA S1	10/11/2020 06:02	10/11/2020 11:28	10/11/2020 06:02	10/11/2020 11:28	5,43	9	48,87	CHI

20201139213	JOVIANIA	JV12000028	GOIATUBA S1	10/11/2020 06:02	10/11/2020 11:28	10/11/2020 06:02	10/11/2020 11:28	5,43	12	65,16	CHI
20201139213	VICENTINOPOLIS	JV12000028	GOIATUBA S1	10/11/2020 06:02	10/11/2020 11:28	10/11/2020 06:02	10/11/2020 11:28	5,43	3	16,29	CHI
20201137559	CORUMBA DE GOIAS	CB12203650	ALEXANIA	10/11/2020 06:03	10/11/2020 10:17	10/11/2020 06:03	10/11/2020 10:17	4,23	3	12,69	CHI
20201137872	CORUMBAIBA	IP12152359	IPAMERI	10/11/2020 06:03	10/11/2020 15:12	10/11/2020 06:03	10/11/2020 15:12	9,15	8	73,24	CHI
20201137872	IPAMERI	IP12152359	IPAMERI	10/11/2020 06:03	10/11/2020 15:12	10/11/2020 06:03	10/11/2020 15:12	9,15	7	64,08	CHI
20201138121	PORANGATU	PO12282160	PORANGATU	10/11/2020 06:03	10/11/2020 10:12	10/11/2020 06:03	10/11/2020 10:12	4,14	11	45,58	CHI
20201137611	IPORA	IR12014480	IPORA	10/11/2020 06:04	10/11/2020 11:12	10/11/2020 06:04	10/11/2020 11:12	5,12	14	71,67	CHI
20201137792	NOVA CRIXAS	NA12027812	NOVA CRIXAS	10/11/2020 06:04	11/11/2020 01:43	10/11/2020 06:04	11/11/2020 01:43	19,64	6	117,83	CHI
20201138959	IPORA	IR12014557	IPORA	10/11/2020 06:05	10/11/2020 15:12	10/11/2020 06:05	10/11/2020 15:12	9,11	22	200,52	CHI
20201137620	SAO LUIS DE MONTES BELOS	SL12076452	SAO LUIZ DOS MONTES BELOS	10/11/2020 06:06	10/11/2020 11:57	10/11/2020 06:06	10/11/2020 11:57	5,84	180	1051,40	CHI
20201137580	ABADIA DE GOIAS	10012107997	INDEPENDENCIA S2	10/11/2020 06:08	10/11/2020 09:53	10/11/2020 06:08	10/11/2020 09:53	3,74	1	3,74	CHI
20201137582	CORREGO DO OURO	CO12055677	SAO LUIZ DOS MONTES BELOS	10/11/2020 06:08	10/11/2020 10:33	10/11/2020 06:08	10/11/2020 10:33	4,40	16	70,47	CHI
20201137582	MOIPORA	CO12055677	SAO LUIZ DOS MONTES BELOS	10/11/2020 06:08	10/11/2020 10:33	10/11/2020 06:08	10/11/2020 10:33	4,40	2	8,81	CHI
20201137702	IVOLANDIA	IV12015643	IPORA	10/11/2020 06:08	10/11/2020 11:10	10/11/2020 06:08	10/11/2020 11:10	5,02	66	331,63	CHI
20201137585	SAO MIGUEL DO ARAGUAIA	SM21230613	SAO MIGUEL DO ARAGUAIA	10/11/2020 06:09	10/11/2020 08:14	10/11/2020 06:09	10/11/2020 08:14	2,08	1	2,08	CHI
20201137586	FORMOSA	FA12013352	ITIQUIRA	10/11/2020 06:09	10/11/2020 13:50	10/11/2020 06:09	10/11/2020 10:24	4,26	1	4,26	CHI
20201137586	FORMOSA	FA12013352	ITIQUIRA	10/11/2020 06:09	10/11/2020 13:50	10/11/2020 06:09	10/11/2020 13:00	6,85	1	6,85	CHI
20201137586	FORMOSA	FA12013352	ITIQUIRA	10/11/2020 06:09	10/11/2020 13:50	10/11/2020 06:09	10/11/2020 13:50	7,68	1	7,68	CHI
20201138038	JATAI	JT12338643	JATAI S3	10/11/2020 06:09	10/11/2020 09:46	10/11/2020 06:09	10/11/2020 09:46	3,62	131	473,60	CHI
20201137593	SILVANIA	SV12270688	VIANOPOLIS	10/11/2020 06:10	10/11/2020 11:42	10/11/2020 06:10	10/11/2020 11:42	5,52	8	44,15	CHI
20201138046	HIDROLINA	UR16405084	URUACU	10/11/2020 06:10	10/11/2020 13:33	10/11/2020 06:10	10/11/2020 09:32	3,37	15	50,59	CHI
20201138046	URUACU	UR16405084	URUACU	10/11/2020 06:10	10/11/2020 13:33	10/11/2020 06:10	10/11/2020 09:32	3,37	1697	5723,60	CHI
20201138046	URUACU	UR16405248	URUACU	10/11/2020 06:10	10/11/2020 13:33	10/11/2020 06:10	10/11/2020 09:38	3,47	214	743,35	CHI
20201138046	URUACU	UR16410901	URUACU	10/11/2020 06:10	10/11/2020 13:33	10/11/2020 06:10	10/11/2020 13:33	7,38	358	2642,64	CHI
20201138046	URUACU	20389875	URUACU	10/11/2020 06:10	10/11/2020 13:33	10/11/2020 10:17	10/11/2020 13:33	3,26	222	724,58	CHI
20201137594	SANTA CRUZ DE GOIAS	BC21075758	PIRES DO RIO S2	10/11/2020 06:11	10/11/2020 11:36	10/11/2020 06:11	10/11/2020 11:36	5,41	1	5,41	CHI
20201137598	SANTA HELENA DE GOIAS	SH21160715	IPEGUARI	10/11/2020 06:11	10/11/2020 19:31	10/11/2020 06:11	10/11/2020 19:31	13,32	1	13,32	CHI
20201137600	ITAPURANGA	IK12364740	ITAPURANGA	10/11/2020 06:11	10/11/2020 08:41	10/11/2020 06:11	10/11/2020 08:41	2,48	12	29,81	CHI
20201137600	MORRO AGUDO DE GOIAS	IK12364740	ITAPURANGA	10/11/2020 06:11	10/11/2020 08:41	10/11/2020 06:11	10/11/2020 08:41	2,48	15	37,26	CHI
20201137686	DOVERLANDIA	DV12123974	CAIAPONIA	10/11/2020 06:12	10/11/2020 08:17	10/11/2020 06:12	10/11/2020 08:17	2,08	12	24,96	CHI
20201139603	DOVERLANDIA	DV12259474	CAIAPONIA	10/11/2020 06:12	10/11/2020 11:51	10/11/2020 06:12	10/11/2020 11:51	5,64	38	214,19	CHI
20201137649	INDIARA	IY10423999	EDEIA	10/11/2020 06:13	11/11/2020 03:51	10/11/2020 06:13	10/11/2020 07:04	0,84	304	256,29	CHI
20201137649	INDIARA	IY12387728LD	EDEIA	10/11/2020 06:13	11/11/2020 03:51	10/11/2020 06:13	10/11/2020 09:27	3,23	9	29,10	CHI
20201137649	INDIARA	IY10423999	EDEIA	10/11/2020 06:13	11/11/2020 03:51	10/11/2020 06:13	10/11/2020 11:57	5,73	31	177,50	CHI
20201137649	PALMEIRAS DE GOIAS	IY10423999	EDEIA	10/11/2020 06:13	11/11/2020 03:51	10/11/2020 06:13	10/11/2020 11:57	5,73	11	62,98	CHI
20201137649	INDIARA	IY10423999	EDEIA	10/11/2020 06:13	11/11/2020 03:51	10/11/2020 12:47	10/11/2020 13:37	0,84	313	262,31	CHI
20201137649	INDIARA	IY10423999	EDEIA	10/11/2020 06:13	11/11/2020 03:51	10/11/2020 06:13	11/11/2020 02:19	20,09	71	1426,67	CHI
20201137649	PALMEIRAS DE GOIAS	IY10423999	EDEIA	10/11/2020 06:13	11/11/2020 03:51	10/11/2020 06:13	11/11/2020 02:19	20,09	5	100,47	CHI
20201137649	INDIARA	RT00116215S	EDEIA	10/11/2020 06:13	11/11/2020 03:51	10/11/2020 12:47	11/11/2020 02:19	13,53	32	432,91	CHI
20201137649	PALMEIRAS DE GOIAS	RT00116215S	EDEIA	10/11/2020 06:13	11/11/2020 03:51	10/11/2020 12:47	11/11/2020 02:19	13,53	11	148,81	CHI
20201137649	CEZARINA	IY10423999	EDEIA	10/11/2020 06:13	11/11/2020 03:51	10/11/2020 06:13	11/11/2020 03:51	21,63	13	281,16	CHI
20201137649	INDIARA	IY10423999	EDEIA	10/11/2020 06:13	11/11/2020 03:51	10/11/2020 06:13	11/11/2020 03:51	21,63	79	1708,62	CHI
20201137614	GOIAS	GS12145730	ITABERAI S1	10/11/2020 06:14	10/11/2020 10:26	10/11/2020 06:14	10/11/2020 10:26	4,19	9	37,69	CHI
20201137642	GOUVELANDIA	GB12303270	QUIRINOPOLIS	10/11/2020 06:15	10/11/2020 15:22	10/11/2020 06:15	10/11/2020 15:22	9,10	8	72,82	CHI
20201138115	MONTES CLAROS DE GOIAS	ME12088949	IPORA	10/11/2020 06:15	10/11/2020 08:25	10/11/2020 06:15	10/11/2020 08:25	2,15	50	107,72	CHI
20201137624	ABADIA DE GOIAS	GN31052067	CARAJAS S1	10/11/2020 06:16	10/11/2020 09:07	10/11/2020 06:16	10/11/2020 09:07	2,84	3	8,53	CHI
20201137627	ABADIA DE GOIAS	GA12048137LD	GUAPO S1	10/11/2020 06:17	10/11/2020 10:57	10/11/2020 06:17	10/11/2020 10:57	4,66	47	219,24	CHI
20201137627	GUAPO	GA12048137LD	GUAPO S1	10/11/2020 06:17	10/11/2020 10:57	10/11/2020 06:17	10/11/2020 10:57	4,66	753	3512,54	CHI
20201137627	TRINDADE	GA12048137LD	GUAPO S1	10/11/2020 06:17	10/11/2020 10:57	10/11/2020 06:17	10/11/2020 10:57	4,66	3	13,99	CHI
20201137629	QUIRINOPOLIS	QI12000227	QUIRINOPOLIS	10/11/2020 06:17	10/11/2020 10:41	10/11/2020 06:17	10/11/2020 10:41	4,40	40	175,83	CHI
20201137647	COCALZINHO DE GOIAS	ZN12389411	AGUAS LINDAS DE GOIAS S2	10/11/2020 06:18	10/11/2020 10:02	10/11/2020 06:18	10/11/2020 10:02	3,73	125	466,28	CHI

20201137647	PADRE BERNARDO	ZN12389411	AGUAS LINDAS DE GOIAS S2	10/11/2020 06:18	10/11/2020 10:02	10/11/2020 06:18	10/11/2020 10:02	3,73	4	14,92	CHI
20201137664	ANAPOLIS	AN12261185	ANAPOLIS UNIVERSITARIO S2	10/11/2020 06:18	10/11/2020 07:54	10/11/2020 06:18	10/11/2020 07:54	1,59	12	19,13	CHI
20201138078	ESTRELA DO NORTE	ET12136395	MARA ROSA	10/11/2020 06:18	10/11/2020 10:04	10/11/2020 06:18	10/11/2020 10:04	3,76	11	41,36	CHI
20201138078	MARA ROSA	ET12136395	MARA ROSA	10/11/2020 06:18	10/11/2020 10:04	10/11/2020 06:18	10/11/2020 10:04	3,76	9	33,84	CHI
20201137646	PETROLINA DE GOIAS	PG21117050	PETROLINA	10/11/2020 06:19	10/11/2020 17:44	10/11/2020 06:19	10/11/2020 17:25	11,10	1	11,10	CHI
20201137646	DAMOLANDIA	PG12335038	PETROLINA	10/11/2020 06:19	10/11/2020 17:44	10/11/2020 15:10	10/11/2020 17:44	2,57	1	2,57	CHI
20201137646	PETROLINA DE GOIAS	PG12335038	PETROLINA	10/11/2020 06:19	10/11/2020 17:44	10/11/2020 15:10	10/11/2020 17:44	2,57	23	59,18	CHI
20201137711	ALTO HORIZONTE	MQ12181177	MARA ROSA	10/11/2020 06:19	10/11/2020 11:58	10/11/2020 06:19	10/11/2020 11:58	5,64	3	16,93	CHI
20201137711	MARA ROSA	MQ12181177	MARA ROSA	10/11/2020 06:19	10/11/2020 11:58	10/11/2020 06:19	10/11/2020 11:58	5,64	28	157,98	CHI
20201137711	URUACU	MQ12181177	MARA ROSA	10/11/2020 06:19	10/11/2020 11:58	10/11/2020 06:19	10/11/2020 11:58	5,64	1	5,64	CHI
20201137652	LUZIANIA	LZ12200111	VIANOPOLIS	10/11/2020 06:20	10/11/2020 12:15	10/11/2020 06:20	10/11/2020 12:15	5,91	11	65,00	CHI
20201137653	CAMPINACU	10032511009	PORANGATU	10/11/2020 06:20	10/11/2020 14:08	10/11/2020 06:20	10/11/2020 14:08	7,79	1	7,79	CHI
20201137658	JARAGUA	70021259	JARAGUA	10/11/2020 06:21	10/11/2020 09:53	10/11/2020 06:21	10/11/2020 09:53	3,52	1	3,52	CHI
20201137665	ARACU	AR12188601	ARACU	10/11/2020 06:22	10/11/2020 16:19	10/11/2020 06:22	10/11/2020 16:19	9,94	2	19,87	CHI
20201137691	IACIARA	IA12394108	IACIARA S1	10/11/2020 06:22	10/11/2020 08:50	10/11/2020 06:22	10/11/2020 08:50	2,46	7	17,23	CHI
20201137668	JARAGUA	JA12298041	JARAGUA	10/11/2020 06:23	10/11/2020 08:03	10/11/2020 06:23	10/11/2020 08:03	1,66	63	104,42	CHI
20201137679	SANTA BARBARA DE GOIAS	6704336	TRINDADE	10/11/2020 06:26	10/11/2020 08:31	10/11/2020 06:26	10/11/2020 08:31	2,08	2	4,16	CHI
20201137680	INACIOLANDIA	ID21306048	QUIRINOPOLIS	10/11/2020 06:26	10/11/2020 11:52	10/11/2020 06:26	10/11/2020 11:52	5,43	1	5,43	CHI
20201137682	NIQUELANDIA	NQ12235660	NIQUELANDIA SUBTRANSMISSAO	10/11/2020 06:26	10/11/2020 09:37	10/11/2020 06:26	10/11/2020 09:37	3,18	159	505,27	CHI
20201137704	AMARALINA	LC12215796	MARA ROSA	10/11/2020 06:26	11/11/2020 11:08	10/11/2020 06:26	11/11/2020 11:08	28,70	13	373,08	CHI
20201137688	MAIRIPOTABA	MI21000314	PONTALINA	10/11/2020 06:27	10/11/2020 10:26	10/11/2020 06:27	10/11/2020 10:26	3,97	1	3,97	CHI
20201137698	ESTRELA DO NORTE	ET12143710	MARA ROSA	10/11/2020 06:29	10/11/2020 15:24	10/11/2020 06:29	10/11/2020 15:24	8,91	4	35,64	CHI
20201137698	SANTA TEREZA DE GOIAS	ET12143710	MARA ROSA	10/11/2020 06:29	10/11/2020 15:24	10/11/2020 06:29	10/11/2020 15:24	8,91	4	35,64	CHI
20201137788	MOSSAMEDES	MD12039138	FIRMINOPOLIS S2	10/11/2020 06:30	10/11/2020 13:56	10/11/2020 06:30	10/11/2020 13:56	7,43	14	104,02	CHI
20201137907	JUSSARA	JR12259810	BRITANIA	10/11/2020 06:32	11/11/2020 00:03	10/11/2020 06:32	11/11/2020 00:03	17,51	50	875,61	CHI
20201138010	ACREUNA	EU12044258LD	ACREUNA	10/11/2020 06:32	10/11/2020 18:34	10/11/2020 06:32	10/11/2020 18:34	12,03	32	384,86	CHI
20201138010	JANDAIA	EU12044258LD	ACREUNA	10/11/2020 06:32	10/11/2020 18:34	10/11/2020 06:32	10/11/2020 18:34	12,03	7	84,19	CHI
20201138010	PARAUNA	EU12044258LD	ACREUNA	10/11/2020 06:32	10/11/2020 18:34	10/11/2020 06:32	10/11/2020 18:34	12,03	39	469,05	CHI
20201138403	DOVERLANDIA	DV12086883	CAIAPONIA	10/11/2020 06:32	10/11/2020 11:32	10/11/2020 06:32	10/11/2020 11:32	5,00	4	19,99	CHI
20201139429	RUBIATABA	RB12003201	RUBIATABA	10/11/2020 06:33	10/11/2020 15:01	10/11/2020 06:33	10/11/2020 15:01	8,45	17	143,72	CHI
20201137941	JATAI	JT11324811	JATAI S2	10/11/2020 06:34	10/11/2020 09:09	10/11/2020 06:34	10/11/2020 09:09	2,57	82	210,79	CHI
20201138604	MIMOSO DE GOIAS	4560216	BARRO ALTO	10/11/2020 06:34	10/11/2020 10:45	10/11/2020 06:34	10/11/2020 10:45	4,17	9	37,51	CHI
20201138604	NIQUELANDIA	4560216	BARRO ALTO	10/11/2020 06:34	10/11/2020 10:45	10/11/2020 06:34	10/11/2020 10:45	4,17	184	766,82	CHI
20201138604	VILA PROPICIO	4560216	BARRO ALTO	10/11/2020 06:34	10/11/2020 10:45	10/11/2020 06:34	10/11/2020 10:45	4,17	50	208,37	CHI
20201137730	FLORES DE GOIAS	FB12320627	FLORES DE GOIAS	10/11/2020 06:36	10/11/2020 08:09	10/11/2020 06:36	10/11/2020 08:09	1,54	28	43,08	CHI
20201137731	OURO VERDE DE GOIAS	OV12356179	INHUMAS S1	10/11/2020 06:36	10/11/2020 18:24	10/11/2020 06:36	10/11/2020 18:24	11,79	25	294,65	CHI
20201137986	PARAUNA	PU12110555	PARAUNA	10/11/2020 06:36	10/11/2020 13:10	10/11/2020 06:36	10/11/2020 13:10	6,57	16	105,05	CHI
20201138104	DIORAMA	IR12014524	IPORA	10/11/2020 06:36	10/11/2020 09:37	10/11/2020 06:36	10/11/2020 09:37	3,01	4	12,05	CHI
20201138104	IPORA	IR12014524	IPORA	10/11/2020 06:36	10/11/2020 09:37	10/11/2020 06:36	10/11/2020 09:37	3,01	3	9,04	CHI
20201137734	EDEIA	1120006093	EDEIA	10/11/2020 06:37	10/11/2020 18:39	10/11/2020 06:37	10/11/2020 18:39	12,03	1	12,03	CHI
20201137744	CACHOEIRA DOURADA	CD11122282	CACHOEIRA DOURADA	10/11/2020 06:38	10/11/2020 08:05	10/11/2020 06:38	10/11/2020 08:05	1,45	50	72,36	CHI
20201137749	DIVINOPOLIS DE GOIAS	GH12156343RE	SAO DOMINGOS	10/11/2020 06:39	10/11/2020 08:36	10/11/2020 06:39	10/11/2020 08:36	1,94	127	246,56	CHI
20201137749	MONTE ALEGRE DE GOIAS	GH12156343RE	SAO DOMINGOS	10/11/2020 06:39	10/11/2020 08:36	10/11/2020 06:39	10/11/2020 08:36	1,94	15	29,12	CHI
20201137749	SAO DOMINGOS	GH12156343RE	SAO DOMINGOS	10/11/2020 06:39	10/11/2020 08:36	10/11/2020 06:39	10/11/2020 08:36	1,94	1	1,94	CHI
20201137750	BONOPOLIS	BX21254042	NOVO PLANALTO	10/11/2020 06:39	10/11/2020 11:41	10/11/2020 06:39	10/11/2020 11:41	5,02	1	5,02	CHI
20201137762	SAO MIGUEL DO ARAGUAIA	SM21291155	SAO MIGUEL DO ARAGUAIA	10/11/2020 06:43	10/11/2020 08:30	10/11/2020 06:43	10/11/2020 08:30	1,77	1	1,77	CHI
20201138313	IVOLANDIA	MO12336568	IPORA	10/11/2020 06:43	10/11/2020 18:30	10/11/2020 06:43	10/11/2020 18:30	11,78	6	70,67	CHI
20201138313	MOIPORA	MO12336568	IPORA	10/11/2020 06:43	10/11/2020 18:30	10/11/2020 06:43	10/11/2020 18:30	11,78	6	70,67	CHI
20201139611	ARAGUAPAZ	AZ12041200	GOIAS	10/11/2020 06:45	10/11/2020 15:09	10/11/2020 06:45	10/11/2020 15:09	8,39	3	25,17	CHI
20201137770	APARECIDA DE GOIANIA	10027747970	INDEPENDENCIA S2	10/11/2020 06:46	10/11/2020 07:57	10/11/2020 06:46	10/11/2020 07:57	1,17	1	1,17	CHI
20201137776	APARECIDA DE GOIANIA	14162386	REAL S2	10/11/2020 06:48	10/11/2020 08:53	10/11/2020 06:48	10/11/2020 08:53	2,08	1	2,08	CHI

20201137780	GOIATUBA	GT21190815	GOIATUBA S2	10/11/2020 06:49	10/11/2020 10:51	10/11/2020 06:49	10/11/2020 10:51	4,03	1	4,03	CHI
20201138255	GOIANIA	GN21395214	REAL S2	10/11/2020 06:49	10/11/2020 14:18	10/11/2020 06:49	10/11/2020 11:12	4,38	1	4,38	CHI
20201138255	GOIANIA	GN12193180LD	REAL S2	10/11/2020 06:49	10/11/2020 14:18	10/11/2020 11:11	10/11/2020 14:09	2,95	1	2,95	CHI
20201138255	GOIANIA	GN21395214	REAL S2	10/11/2020 06:49	10/11/2020 14:18	10/11/2020 11:34	10/11/2020 14:18	2,74	1	2,74	CHI
20201137789	GOIANIA	10013951597	CAMPINAS S2	10/11/2020 06:51	10/11/2020 08:29	10/11/2020 06:51	10/11/2020 08:29	1,63	1	1,63	CHI
20201137795	AGUA LIMPA	AL11263184	VILA CORUMBA	10/11/2020 06:53	10/11/2020 09:54	10/11/2020 06:53	10/11/2020 09:54	3,00	86	258,12	CHI
20201137797	SAO JOAO DA PARAUNA	RP21033037	FIRMINOPOLIS S2	10/11/2020 06:54	10/11/2020 16:15	10/11/2020 06:54	10/11/2020 16:15	9,35	1	9,35	CHI
20201138475	ITAGUARU	IC12065273	ITABERAI S1	10/11/2020 06:54	10/11/2020 12:56	10/11/2020 06:54	10/11/2020 12:56	6,02	11	66,20	CHI
20201138655	SAO FRANCISCO DE GOIAS	SF12000173	SAO FRANCISCO DE GOIAS	10/11/2020 06:54	10/11/2020 11:29	10/11/2020 06:54	10/11/2020 11:29	4,58	11	50,40	CHI
20201137806	SILVANIA	SV12022221	DAIA S2	10/11/2020 06:55	10/11/2020 11:41	10/11/2020 06:55	10/11/2020 11:41	4,76	3	14,29	CHI
20201137810	ARAGARCAS	BM12372345	BOM JARDIM	10/11/2020 06:55	10/11/2020 12:44	10/11/2020 06:55	10/11/2020 12:44	5,80	23	133,43	CHI
20201137814	PORANGATU	PO12361688	NOVO PLANALTO	10/11/2020 06:56	10/11/2020 10:22	10/11/2020 06:56	10/11/2020 10:22	3,42	2	6,85	CHI
20201137815	APORE	AE12038902	ITAJA S1	10/11/2020 06:56	10/11/2020 10:30	10/11/2020 06:56	10/11/2020 10:30	3,56	7	24,89	CHI
20201137931	EDEALINA	EA12257919RE	EDEIA	10/11/2020 06:56	10/11/2020 08:54	10/11/2020 06:56	10/11/2020 08:54	1,97	1	1,97	CHI
20201137931	EDEIA	EA12257919RE	EDEIA	10/11/2020 06:56	10/11/2020 08:54	10/11/2020 06:56	10/11/2020 08:54	1,97	48	94,41	CHI
20201137821	SANTA FE DE GOIAS	RN11220170	BRITANIA	10/11/2020 06:57	10/11/2020 15:33	10/11/2020 06:57	10/11/2020 15:33	8,59	81	696,17	CHI
20201138216	PORTEIROAO	CL12230803	RIO DOS BOIS	10/11/2020 06:57	10/11/2020 18:24	10/11/2020 06:57	10/11/2020 18:24	11,44	6	68,64	CHI
20201140460	CEZARINA	CZ12228898	CEZARINA	10/11/2020 06:57	10/11/2020 16:59	10/11/2020 06:57	10/11/2020 16:59	10,03	9	90,30	CHI
20201137824	NIQUELANDIA	NQ21316273	BARRO ALTO	10/11/2020 06:58	10/11/2020 13:32	10/11/2020 06:58	10/11/2020 13:32	6,56	1	6,56	CHI
20201137835	PIRES DO RIO	PR21195125	PIRES DO RIO S2	10/11/2020 06:59	10/11/2020 07:57	10/11/2020 06:59	10/11/2020 07:57	0,95	1	0,95	CHI
20201139249	ANICUNS	AC11098894	ANICUNS	10/11/2020 06:59	10/11/2020 12:10	10/11/2020 06:59	10/11/2020 12:10	5,17	147	759,83	CHI
20201137838	SANTA RITA DO NOVO DESTINO	DF12252675	BARRO ALTO	10/11/2020 07:00	10/11/2020 20:42	10/11/2020 07:00	10/11/2020 20:42	13,69	1	13,69	CHI
20201137840	AMARALINA	LC21244195	MARA ROSA	10/11/2020 07:00	10/11/2020 12:46	10/11/2020 07:00	10/11/2020 12:46	5,75	1	5,75	CHI
20201137844	AGUAS LINDAS DE GOIAS	LA11375284	AGUAS LINDAS DE GOIAS S1	10/11/2020 07:01	10/11/2020 12:29	10/11/2020 07:01	10/11/2020 12:29	5,46	188	1026,90	CHI
20201137845	IPORA	IR21260030	IPORA	10/11/2020 07:01	10/11/2020 09:34	10/11/2020 07:01	10/11/2020 09:34	2,54	1	2,54	CHI
20201138511	ANAPOLIS	TJ12353479	DAIA S2	10/11/2020 07:02	10/11/2020 09:35	10/11/2020 07:02	10/11/2020 09:35	2,55	1	2,55	CHI
20201138511	TEREZOPOLIS DE GOIAS	TJ12353479	DAIA S2	10/11/2020 07:02	10/11/2020 09:35	10/11/2020 07:02	10/11/2020 09:35	2,55	13	33,11	CHI
20201137862	GOIANIA	15420504	CARAIAS S2	10/11/2020 07:03	10/11/2020 11:42	10/11/2020 07:03	10/11/2020 11:42	4,65	1	4,65	CHI
20201137866	JUSSARA	BT21118477	BRITANIA	10/11/2020 07:03	10/11/2020 17:30	10/11/2020 07:03	10/11/2020 17:30	10,44	1	10,44	CHI
20201137867	CAMPESTRE DE GOIAS	GC12053748	GUAPU S1	10/11/2020 07:03	10/11/2020 09:33	10/11/2020 07:03	10/11/2020 09:33	2,48	6	14,91	CHI
20201138958	URUACU	CR12375637	CAMPINORTE	10/11/2020 07:03	10/11/2020 13:49	10/11/2020 07:03	10/11/2020 13:49	6,76	120	810,87	CHI
20201137873	FORMOSA	FA12195886	ITUIQUIRA	10/11/2020 07:04	10/11/2020 09:09	10/11/2020 07:04	10/11/2020 09:09	2,08	48	99,76	CHI
20201137876	ABADIANIA	AA12348146	ANAPOLIS UNIVERSITARIO S2	10/11/2020 07:04	11/11/2020 16:56	10/11/2020 07:04	10/11/2020 15:26	8,37	117	979,55	CHI
20201137876	ANAPOLIS	AA12348146	ANAPOLIS UNIVERSITARIO S2	10/11/2020 07:04	11/11/2020 16:56	10/11/2020 07:04	10/11/2020 15:26	8,37	1	8,37	CHI
20201137876	ABADIANIA	AA12348146	ANAPOLIS UNIVERSITARIO S2	10/11/2020 07:04	11/11/2020 16:56	10/11/2020 07:04	10/11/2020 17:22	10,30	17	175,02	CHI
20201137876	ABADIANIA	AA12348146	ANAPOLIS UNIVERSITARIO S2	10/11/2020 07:04	11/11/2020 16:56	10/11/2020 07:04	10/11/2020 18:15	11,19	10	111,86	CHI
20201137876	ABADIANIA	AA12348146	ANAPOLIS UNIVERSITARIO S2	10/11/2020 07:04	11/11/2020 16:56	10/11/2020 07:04	10/11/2020 19:16	12,19	6	73,15	CHI
20201137876	ABADIANIA	AA13077873	ANAPOLIS UNIVERSITARIO S2	10/11/2020 07:04	11/11/2020 16:56	10/11/2020 11:08	10/11/2020 19:16	8,13	48	390,41	CHI
20201137876	CORUMBA DE GOIAS	AA13077873	ANAPOLIS UNIVERSITARIO S2	10/11/2020 07:04	11/11/2020 16:56	10/11/2020 11:08	10/11/2020 19:16	8,13	1	8,13	CHI
20201137876	ABADIANIA	AA12348146	ANAPOLIS UNIVERSITARIO S2	10/11/2020 07:04	11/11/2020 16:56	11/11/2020 11:37	11/11/2020 13:54	2,28	198	452,37	CHI
20201137876	ANAPOLIS	AA12348146	ANAPOLIS UNIVERSITARIO S2	10/11/2020 07:04	11/11/2020 16:56	11/11/2020 11:37	11/11/2020 13:54	2,28	1	2,28	CHI
20201137876	CORUMBA DE GOIAS	AA12348146	ANAPOLIS UNIVERSITARIO S2	10/11/2020 07:04	11/11/2020 16:56	11/11/2020 11:37	11/11/2020 13:54	2,28	1	2,28	CHI
20201137876	ABADIANIA	AA12348146	ANAPOLIS UNIVERSITARIO S2	10/11/2020 07:04	11/11/2020 16:56	10/11/2020 07:04	11/11/2020 16:56	33,86	32	1083,60	CHI
20201137881	APARECIDA DE GOIANIA	AP11053046	INDEPENDENCIA S1	10/11/2020 07:04	10/11/2020 11:35	10/11/2020 07:04	10/11/2020 11:35	4,50	164	738,14	CHI
20201138729	GOIAS	GS12162479	GOIAS	10/11/2020 07:04	10/11/2020 14:17	10/11/2020 07:04	10/11/2020 14:17	7,20	3	21,61	CHI
20201138892	NIQUELANDIA	NQ12235131	URUACU	10/11/2020 07:04	10/11/2020 13:13	10/11/2020 07:04	10/11/2020 13:13	6,14	4	24,57	CHI
20201137882	RIO VERDE	7111882	CABRIUVA S2	10/11/2020 07:05	10/11/2020 15:27	10/11/2020 07:05	10/11/2020 15:27	8,37	1	8,37	CHI
20201137882	RIO VERDE	7111882	CABRIUVA S2	10/11/2020 07:05	10/11/2020 15:27	10/11/2020 12:00	10/11/2020 15:27	3,46	1	3,46	CHI
20201137885	ANAPOLIS	20908660	ANAPOLIS UNIVERSITARIO S2	10/11/2020 07:05	10/11/2020 08:59	10/11/2020 07:05	10/11/2020 08:59	1,89	1	1,89	CHI
20201137890	VICENTINOPOLIS	VI21263848	VICENTINOPOLIS	10/11/2020 07:05	10/11/2020 22:29	10/11/2020 07:05	10/11/2020 22:29	15,39	1	15,39	CHI
20201138036	GOIANIRA	TR12016262	GOIANIRA	10/11/2020 07:05	10/11/2020 17:35	10/11/2020 07:05	10/11/2020 17:35	10,49	1	10,49	CHI

20201138036	TRINDADE	TR12016262	GOIANIRA	10/11/2020 07:05	10/11/2020 17:35	10/11/2020 07:05	10/11/2020 17:35	10,49	29	304,21	CHI
20201138402	DOVERLANDIA	DV12169484	CAIAPONIA	10/11/2020 07:05	10/11/2020 11:07	10/11/2020 07:05	10/11/2020 11:07	4,02	45	180,76	CHI
20201137898	QUIRINOPOLIS	80058802	QUIRINOPOLIS	10/11/2020 07:07	10/11/2020 12:45	10/11/2020 07:07	10/11/2020 12:45	5,63	1	5,63	CHI
20201137903	IPAMERI	IP21100331	IPAMERI	10/11/2020 07:07	10/11/2020 11:44	10/11/2020 07:07	10/11/2020 11:44	4,60	1	4,60	CHI
20201138355	ITAUCU	IX12016023	INHUMAS S1	10/11/2020 07:07	10/11/2020 11:04	10/11/2020 07:07	10/11/2020 11:04	3,94	5	19,68	CHI
20201140471	INHUMAS	IX12408649	INHUMAS S1	10/11/2020 07:07	11/11/2020 08:38	10/11/2020 16:58	10/11/2020 17:04	0,09	32	2,76	CHI
20201140471	ITAUCU	IX12408649	INHUMAS S1	10/11/2020 07:07	11/11/2020 08:38	10/11/2020 16:58	10/11/2020 17:04	0,09	33	2,85	CHI
20201140471	INHUMAS	IX12408649	INHUMAS S1	10/11/2020 07:07	11/11/2020 08:38	10/11/2020 16:58	10/11/2020 19:23	2,42	105	253,78	CHI
20201140471	ITAUCU	IX12408649	INHUMAS S1	10/11/2020 07:07	11/11/2020 08:38	10/11/2020 16:58	10/11/2020 19:23	2,42	2	4,83	CHI
20201140471	INHUMAS	IX12408649	INHUMAS S1	10/11/2020 07:07	11/11/2020 08:38	10/11/2020 17:05	10/11/2020 19:23	2,30	32	73,56	CHI
20201140471	ITAUCU	IX12408649	INHUMAS S1	10/11/2020 07:07	11/11/2020 08:38	10/11/2020 17:05	10/11/2020 19:23	2,30	30	68,96	CHI
20201140471	ITAUCU	IX12408649	INHUMAS S1	10/11/2020 07:07	11/11/2020 08:38	10/11/2020 20:00	10/11/2020 22:34	2,58	9	23,22	CHI
20201140471	ITAUCU	IX12408649	INHUMAS S1	10/11/2020 07:07	11/11/2020 08:38	10/11/2020 22:45	10/11/2020 23:11	0,42	9	3,80	CHI
20201140471	ITAUCU	IX12408649	INHUMAS S1	10/11/2020 07:07	11/11/2020 08:38	11/11/2020 02:31	11/11/2020 02:56	0,41	9	3,70	CHI
20201140471	INHUMAS	IX13402840	INHUMAS S1	10/11/2020 07:07	11/11/2020 08:38	10/11/2020 20:00	11/11/2020 08:05	12,09	32	386,95	CHI
20201140471	ITAUCU	IX13402840	INHUMAS S1	10/11/2020 07:07	11/11/2020 08:38	10/11/2020 20:00	11/11/2020 08:05	12,09	20	241,84	CHI
20201140471	INHUMAS	IX13402840	INHUMAS S1	10/11/2020 07:07	11/11/2020 08:38	10/11/2020 20:00	11/11/2020 08:34	12,57	105	1319,50	CHI
20201140471	ITAUCU	IX13402840	INHUMAS S1	10/11/2020 07:07	11/11/2020 08:38	10/11/2020 20:00	11/11/2020 08:34	12,57	2	25,13	CHI
20201140471	ITAUCU	IX12279016LD	INHUMAS S1	10/11/2020 07:07	11/11/2020 08:38	10/11/2020 17:05	11/11/2020 08:35	15,50	3	46,49	CHI
20201140471	ITAUCU	IX13402840	INHUMAS S1	10/11/2020 07:07	11/11/2020 08:38	10/11/2020 20:00	11/11/2020 08:38	12,65	1	12,65	CHI
20201138608	ANICUNS	AC11000002	ANICUNS	10/11/2020 07:08	10/11/2020 12:22	10/11/2020 07:08	10/11/2020 12:22	5,22	97	506,18	CHI
20201137911	BALIZA	BH12334823	BOM JARDIM	10/11/2020 07:09	10/11/2020 11:21	10/11/2020 07:09	10/11/2020 11:21	4,20	201	843,98	CHI
20201137912	SIMOLANDIA	1940017777	IACIARA S2	10/11/2020 07:09	10/11/2020 09:48	10/11/2020 07:09	10/11/2020 09:48	2,65	1	2,65	CHI
20201137913	SITIO D ABADIA	SI12384217	IACIARA S2	10/11/2020 07:09	10/11/2020 10:01	10/11/2020 07:09	10/11/2020 10:01	2,87	10	28,65	CHI
20201137915	HIDROLANDIA	180051430	CEPAIGO S2	10/11/2020 07:09	10/11/2020 09:24	10/11/2020 07:09	10/11/2020 09:24	2,25	1	2,25	CHI
20201137916	JOVIANIA	JV12263916	GOIATUBA S1	10/11/2020 07:09	10/11/2020 10:18	10/11/2020 07:09	10/11/2020 10:18	3,15	2	6,29	CHI
20201137918	MINEIROS	1390051642	PARQUE DAS EMAS	10/11/2020 07:09	10/11/2020 12:05	10/11/2020 07:09	10/11/2020 12:05	4,94	1	4,94	CHI
20201137919	RIO VERDE	630139600	RIO VERDE S2	10/11/2020 07:09	10/11/2020 12:12	10/11/2020 07:09	10/11/2020 12:12	5,04	1	5,04	CHI
20201137925	ACREUNA	2440045683	ACREUNA	10/11/2020 07:10	10/11/2020 20:07	10/11/2020 07:10	10/11/2020 20:07	12,94	1	12,94	CHI
20201138764	MONTIVIDIU	MV12267634	MONTIVIDIU T	10/11/2020 07:10	10/11/2020 13:51	10/11/2020 07:10	10/11/2020 13:51	6,67	17	113,35	CHI
20201138931	FAINA	FC12345744	GOIAS	10/11/2020 07:11	10/11/2020 11:34	10/11/2020 07:11	10/11/2020 11:34	4,38	7	30,63	CHI
20201137936	RIO VERDE	RV21240302	RIO VERDE S1	10/11/2020 07:12	10/11/2020 09:24	10/11/2020 07:12	10/11/2020 09:24	2,20	1	2,20	CHI
20201137950	RIO VERDE	RV21000317	RIO VERDE S1	10/11/2020 07:13	10/11/2020 10:46	10/11/2020 07:13	10/11/2020 10:46	3,54	1	3,54	CHI
20201137951	FORMOSA	FA21130043	ITIQUEIRA	10/11/2020 07:13	10/11/2020 11:00	10/11/2020 07:13	10/11/2020 11:00	3,77	1	3,77	CHI
20201138165	ANAPOLIS	AN11221396	ANAPOLIS UNIVERSITARIO S2	10/11/2020 07:14	10/11/2020 16:59	10/11/2020 07:14	10/11/2020 16:59	9,75	36	350,96	CHI
20201138396	IPORA	IR11040180	IPORA	10/11/2020 07:14	10/11/2020 13:18	10/11/2020 07:14	10/11/2020 13:18	6,06	62	375,81	CHI
20201138873	ABADIANIA	AA12258356	ANAPOLIS UNIVERSITARIO S1	10/11/2020 07:15	10/11/2020 17:08	10/11/2020 07:15	10/11/2020 17:08	9,88	12	118,51	CHI
20201139470	ANAPOLIS	AN12084744	NEROPOLIS S1	10/11/2020 07:15	10/11/2020 14:45	10/11/2020 07:15	10/11/2020 14:45	7,50	4	29,99	CHI
20201138135	QUIRINOPOLIS	QI12385800	CACHOEIRA ALTA	10/11/2020 07:16	10/11/2020 11:54	10/11/2020 07:16	10/11/2020 11:54	4,62	6	27,73	CHI
20201139533	NIQUELANDIA	10019070460	NIQUELANDIA SUBTRANSMISSAO	10/11/2020 07:16	10/11/2020 11:55	10/11/2020 07:16	10/11/2020 11:55	4,64	1	4,64	CHI
20201137975	INDIARA	10027493251	PALMEIRAS	10/11/2020 07:17	10/11/2020 21:25	10/11/2020 07:17	10/11/2020 21:25	14,13	1	14,13	CHI
20201137979	RIO VERDE	RV12230629	CABRIUVA S2	10/11/2020 07:17	10/11/2020 10:52	10/11/2020 07:17	10/11/2020 10:52	3,57	7	24,99	CHI
20201139741	RIO VERDE	RV21361109	CABRIUVA S2	10/11/2020 07:17	10/11/2020 13:40	10/11/2020 07:17	10/11/2020 13:40	6,37	1	6,37	CHI
20201140496	INDIARA	JD12391452	PALMEIRAS	10/11/2020 07:18	10/11/2020 19:23	10/11/2020 07:18	10/11/2020 19:23	12,08	5	60,41	CHI
20201140496	JANDAIA	JD12391452	PALMEIRAS	10/11/2020 07:18	10/11/2020 19:23	10/11/2020 07:18	10/11/2020 19:23	12,08	4	48,33	CHI
20201137989	ITAUCU	IX21172675	INHUMAS S1	10/11/2020 07:23	10/11/2020 11:59	10/11/2020 07:23	10/11/2020 11:59	4,59	1	4,59	CHI
20201138363	ACREUNA	EU12263395	RIO DOS BOIS	10/11/2020 07:23	11/11/2020 16:14	10/11/2020 07:23	11/11/2020 16:14	32,84	8	262,72	CHI
20201138363	EDEIA	EU12263395	RIO DOS BOIS	10/11/2020 07:23	11/11/2020 16:14	10/11/2020 07:23	11/11/2020 16:14	32,84	1	32,84	CHI
20201138433	PARAUNA	PU12007923	PARAUNA	10/11/2020 07:24	10/11/2020 11:06	10/11/2020 07:24	10/11/2020 11:06	3,70	8	29,59	CHI
20201138433	SAO JOAO DA PARAUNA	PU12007923	PARAUNA	10/11/2020 07:24	10/11/2020 11:06	10/11/2020 07:24	10/11/2020 11:06	3,70	4	14,80	CHI
20201137996	APARECIDA DE GOIANIA	14406275	INDEPENDENCIA S2	10/11/2020 07:25	10/11/2020 09:46	10/11/2020 07:25	10/11/2020 09:46	2,35	1	2,35	CHI

20201137999	INHUMAS	IN21336728	INHUMAS S2	10/11/2020 07:25	10/11/2020 18:53	10/11/2020 07:25	10/11/2020 18:53	11,46	1	11,46	CHI
20201138193	SAO MIGUEL DO ARAGUAIA	SM12100371	SAO MIGUEL DO ARAGUAIA	10/11/2020 07:25	10/11/2020 10:42	10/11/2020 07:25	10/11/2020 10:42	3,28	76	249,55	CHI
20201138282	JARAGUA	UA12078282	JARAGUA	10/11/2020 07:27	10/11/2020 09:52	10/11/2020 07:27	10/11/2020 09:52	2,40	3	7,21	CHI
20201138282	URUANA	UA12078282	JARAGUA	10/11/2020 07:27	10/11/2020 09:52	10/11/2020 07:27	10/11/2020 09:52	2,40	7	16,83	CHI
20201138007	JARAGUA	JA21283336	JARAGUA	10/11/2020 07:29	10/11/2020 10:54	10/11/2020 07:29	10/11/2020 10:54	3,41	2	6,81	CHI
20201139085	JARAGUA	JA12278873	JARAGUA	10/11/2020 07:30	10/11/2020 11:59	10/11/2020 07:30	10/11/2020 11:59	4,47	2	8,94	CHI
20201138012	PETROLINA DE GOIAS	PG21070548	PETROLINA	10/11/2020 07:31	10/11/2020 13:08	10/11/2020 07:31	10/11/2020 13:08	5,61	2	11,23	CHI
20201138016	JATAI	JT12248447	JATAI S3	10/11/2020 07:32	10/11/2020 09:52	10/11/2020 07:32	10/11/2020 09:52	2,33	6	13,96	CHI
20201138025	AMARALINA	LC21245317	MARA ROSA	10/11/2020 07:33	11/11/2020 13:00	10/11/2020 07:33	11/11/2020 13:00	29,45	1	29,45	CHI
20201138027	INDIARA	IY12033386	EDEIA	10/11/2020 07:33	11/11/2020 07:14	10/11/2020 07:33	11/11/2020 07:14	23,67	1	23,67	CHI
20201138028	CALDAS NOVAS	CN21182802	CALDAS NOVAS S2	10/11/2020 07:33	10/11/2020 08:52	10/11/2020 07:33	10/11/2020 08:52	1,30	240	313,07	CHI
20201138030	SITIO D ABADIA	SI12131972	IACIARA S2	10/11/2020 07:34	10/11/2020 08:49	10/11/2020 07:34	10/11/2020 08:49	1,25	46	57,50	CHI
20201138035	GAMELEIRA DE GOIAS	SV12077018	DAIA S2	10/11/2020 07:34	10/11/2020 11:52	10/11/2020 07:34	10/11/2020 11:52	4,29	3	12,88	CHI
20201138042	RIO VERDE	RV12338619	CABRIUVA S2	10/11/2020 07:34	10/11/2020 10:45	10/11/2020 07:34	10/11/2020 10:45	3,17	1	3,17	CHI
20201138200	ITABERAI	II12217217	ITABERAI S1	10/11/2020 07:34	10/11/2020 12:08	10/11/2020 07:34	10/11/2020 12:08	4,55	22	100,14	CHI
20201138200	ITAGUARI	II12217217	ITABERAI S1	10/11/2020 07:34	10/11/2020 12:08	10/11/2020 07:34	10/11/2020 12:08	4,55	42	191,18	CHI
20201138200	TAQUARAL DE GOIAS	II12217217	ITABERAI S1	10/11/2020 07:34	10/11/2020 12:08	10/11/2020 07:34	10/11/2020 12:08	4,55	45	204,84	CHI
20201138407	DOVERLANDIA	DV12259468	CAIAPONIA	10/11/2020 07:34	10/11/2020 10:06	10/11/2020 07:34	10/11/2020 10:06	2,52	3	7,55	CHI
20201138825	RIO VERDE	RV12228296	MONTIVIDIU T	10/11/2020 07:34	10/11/2020 11:33	10/11/2020 07:34	10/11/2020 11:33	3,97	7	27,77	CHI
20201137099	BURITI ALEGRE	PX10406967	GOIATUBA S1	10/11/2020 07:35	10/11/2020 17:07	10/11/2020 07:35	10/11/2020 17:07	9,55	2	19,09	CHI
20201137099	GOIATUBA	PX10406967	GOIATUBA S1	10/11/2020 07:35	10/11/2020 17:07	10/11/2020 07:35	10/11/2020 17:07	9,55	135	1288,69	CHI
20201137099	ITUMBIARA	PX10406967	GOIATUBA S1	10/11/2020 07:35	10/11/2020 17:07	10/11/2020 07:35	10/11/2020 17:07	9,55	1	9,55	CHI
20201137099	PANAMA	PX10406967	GOIATUBA S1	10/11/2020 07:35	10/11/2020 17:07	10/11/2020 07:35	10/11/2020 17:07	9,55	16	152,73	CHI
20201137099	RUBIATABA	PX10406967	GOIATUBA S1	10/11/2020 07:35	10/11/2020 17:07	10/11/2020 07:35	10/11/2020 17:07	9,55	1	9,55	CHI
20201138057	IACIARA	IA12264175	IACIARA S2	10/11/2020 07:36	10/11/2020 13:02	10/11/2020 07:36	10/11/2020 13:02	5,43	5	27,17	CHI
20201138065	PIRACANJUBA	PJ12024136	PIRACANJUBA	10/11/2020 07:37	10/11/2020 14:26	10/11/2020 07:37	10/11/2020 14:26	6,82	3	20,45	CHI
20201138079	ITUMBIARA	10016810056	ITUMBIARA NOVA	10/11/2020 07:37	10/11/2020 18:04	10/11/2020 07:37	10/11/2020 18:04	10,45	1	10,45	CHI
20201138082	IACIARA	1550024386	IACIARA S1	10/11/2020 07:37	10/11/2020 11:23	10/11/2020 07:37	10/11/2020 11:23	3,76	1	3,76	CHI
20201138473	MONTIVIDIU	MV12126908	MONTIVIDIU T	10/11/2020 07:37	10/11/2020 17:49	10/11/2020 07:37	10/11/2020 17:49	10,21	4	40,82	CHI
20201138473	RIO VERDE	MV12126908	MONTIVIDIU T	10/11/2020 07:37	10/11/2020 17:49	10/11/2020 07:37	10/11/2020 17:49	10,21	1	10,21	CHI
20201138518	PETROLINA DE GOIAS	PG12116335	PETROLINA	10/11/2020 07:37	10/11/2020 10:18	10/11/2020 07:37	10/11/2020 10:18	2,67	34	90,94	CHI
20201138359	GOIANESIA	GE11215135	GOIANESIA S2	10/11/2020 07:38	10/11/2020 11:31	10/11/2020 07:38	10/11/2020 11:31	3,87	98	379,53	CHI
20201138095	BELA VISTA DE GOIAS	BV12000040LD	BELA VISTA S1	10/11/2020 07:39	10/11/2020 12:56	10/11/2020 07:39	10/11/2020 12:56	5,29	5	26,45	CHI
20201138099	COCALZINHO DE GOIAS	ZN12297582	COCALZINHO	10/11/2020 07:39	10/11/2020 09:41	10/11/2020 07:39	10/11/2020 09:41	2,02	2	4,04	CHI
20201138105	CACHOEIRA ALTA	CA11101957	CACHOEIRA ALTA	10/11/2020 07:40	10/11/2020 11:52	10/11/2020 07:40	10/11/2020 11:52	4,20	152	638,02	CHI
20201138109	PARANAIGUARA	2230020013	CACHOEIRA ALTA	10/11/2020 07:40	10/11/2020 09:19	10/11/2020 07:40	10/11/2020 09:19	1,64	1	1,64	CHI
20201138113	CALDAS NOVAS	760141630	CALDAS NOVAS S1	10/11/2020 07:40	10/11/2020 09:08	10/11/2020 07:40	10/11/2020 09:08	1,45	1	1,45	CHI
20201138118	CATURAI	CK12131260	ARACU	10/11/2020 07:41	10/11/2020 14:15	10/11/2020 07:41	10/11/2020 14:15	6,56	3	19,68	CHI
20201138120	ACREUNA	EU12233439	ACREUNA	10/11/2020 07:41	10/11/2020 14:10	10/11/2020 07:41	10/11/2020 14:10	6,47	1	6,47	CHI
20201138123	MAURILANDIA	1040004262	RIO DOS BOIS	10/11/2020 07:41	10/11/2020 23:26	10/11/2020 07:41	10/11/2020 23:26	15,74	1	15,74	CHI
20201138125	ORIZONA	OZ12000351RE	PIRES DO RIO S1	10/11/2020 07:41	10/11/2020 09:25	10/11/2020 07:41	10/11/2020 09:25	1,72	57	98,10	CHI
20201138125	PIRES DO RIO	OZ12000351RE	PIRES DO RIO S1	10/11/2020 07:41	10/11/2020 09:25	10/11/2020 07:41	10/11/2020 09:25	1,72	4	6,88	CHI
20201138129	PADRE BERNARDO	PB12305108	PADRE BERNARDO	10/11/2020 07:41	10/11/2020 10:33	10/11/2020 07:41	10/11/2020 10:33	2,85	4	11,40	CHI
20201138138	GOUVELANDIA	GB12402363	QUIRINOPOLIS	10/11/2020 07:42	10/11/2020 10:30	10/11/2020 07:42	10/11/2020 10:30	2,78	6	16,71	CHI
20201138145	NEROPOLIS	GR12133315	NEROPOLIS S1	10/11/2020 07:43	10/11/2020 09:37	10/11/2020 07:43	10/11/2020 09:37	1,89	17	32,14	CHI
20201138145	SANTO ANTONIO DE GOIAS	GR12133315	NEROPOLIS S1	10/11/2020 07:43	10/11/2020 09:37	10/11/2020 07:43	10/11/2020 09:37	1,89	5	9,45	CHI
20201138147	ITAPIRAPUA	IU12336387	MATRINCHA	10/11/2020 07:43	11/11/2020 09:54	10/11/2020 07:43	11/11/2020 09:54	26,17	2	52,34	CHI
20201138167	MONTES CLAROS DE GOIAS	3220000457	IPORA	10/11/2020 07:45	10/11/2020 18:49	10/11/2020 07:45	10/11/2020 18:49	11,06	1	11,06	CHI
20201138171	ITUMBIARA	690280877	ITUMBIARA VELHA S1	10/11/2020 07:45	10/11/2020 10:22	10/11/2020 07:45	10/11/2020 10:22	2,60	1	2,60	CHI
20201138175	CRISTALINA	10001973035	PAMPLONA	10/11/2020 07:45	10/11/2020 13:32	10/11/2020 07:45	10/11/2020 13:32	5,77	1	5,77	CHI
20201138177	MOZARLANDIA	MZ12055640	MOZARLANDIA	10/11/2020 07:46	10/11/2020 18:49	10/11/2020 07:46	10/11/2020 18:49	11,05	9	99,44	CHI

20201141245	PARAUNA	PU12301614	PARAUNA	10/11/2020 07:47	10/11/2020 21:33	10/11/2020 07:47	10/11/2020 21:33	13,76	2	27,52	CHI
20201138195	CATALAO	CT11203126	CATALAO S2	10/11/2020 07:48	10/11/2020 10:56	10/11/2020 07:48	10/11/2020 10:56	3,13	60	188,00	CHI
20201138201	IACIARA	IA21373149	IACIARA S1	10/11/2020 07:48	10/11/2020 09:54	10/11/2020 07:48	10/11/2020 09:54	2,09	1	2,09	CHI
20201138204	CAMPINORTE	2040006674	CAMPINORTE	10/11/2020 07:48	10/11/2020 14:14	10/11/2020 07:48	10/11/2020 14:14	6,42	1	6,42	CHI
20201138556	GOIANDIRA	GD12131094	CATALAO S1	10/11/2020 07:48	10/11/2020 10:15	10/11/2020 07:48	10/11/2020 10:15	2,45	7	17,12	CHI
20201138556	NOVA AURORA	GD12131094	CATALAO S1	10/11/2020 07:48	10/11/2020 10:15	10/11/2020 07:48	10/11/2020 10:15	2,45	2	4,89	CHI
20201138207	CAMPOS VERDES	VD12264097	SANTA TEREZINHA	10/11/2020 07:49	10/11/2020 09:28	10/11/2020 07:49	10/11/2020 09:28	1,64	6	9,86	CHI
20201138210	ITAPURANGA	170038646	ITAPURANGA	10/11/2020 07:49	10/11/2020 11:07	10/11/2020 07:49	10/11/2020 11:07	3,29	1	3,29	CHI
20201138220	VIANOPOLIS	VN21275130	PIRES DO RIO S2	10/11/2020 07:50	10/11/2020 14:47	10/11/2020 07:50	10/11/2020 14:47	6,94	1	6,94	CHI
20201138270	TRINDADE	TR12200202	TRINDADE	10/11/2020 07:51	10/11/2020 10:21	10/11/2020 07:51	10/11/2020 10:21	2,49	2	4,98	CHI
20201138319	CORREGO DO OURO	FN12253655	IPORA	10/11/2020 07:51	10/11/2020 16:02	10/11/2020 07:51	10/11/2020 16:02	8,17	3	24,52	CHI
20201138319	FAZENDA NOVA	FN12253655	IPORA	10/11/2020 07:51	10/11/2020 16:02	10/11/2020 07:51	10/11/2020 16:02	8,17	11	89,92	CHI
20201140007	ABADIANIA	AN12221398	ANAPOLIS UNIVERSITARIO S2	10/11/2020 07:51	10/11/2020 16:32	10/11/2020 07:51	10/11/2020 16:32	8,68	4	34,72	CHI
20201140007	ANAPOLIS	AN12221398	ANAPOLIS UNIVERSITARIO S2	10/11/2020 07:51	10/11/2020 16:32	10/11/2020 07:51	10/11/2020 16:32	8,68	1	8,68	CHI
20201140007	PIRENOPOLIS	AN12221398	ANAPOLIS UNIVERSITARIO S2	10/11/2020 07:51	10/11/2020 16:32	10/11/2020 07:51	10/11/2020 16:32	8,68	2	17,36	CHI
20201138246	TRINDADE	40024933	TRINDADE	10/11/2020 07:52	10/11/2020 11:32	10/11/2020 07:52	10/11/2020 11:32	3,65	1	3,65	CHI
20201138261	RUBIATABA	RB12255942	RUBIATABA	10/11/2020 07:52	10/11/2020 19:01	10/11/2020 07:52	10/11/2020 19:01	11,14	49	546,08	CHI
20201138422	SANTA HELENA DE GOIAS	SH12295844	IPEGUARI	10/11/2020 07:52	11/11/2020 10:25	10/11/2020 07:52	11/11/2020 10:25	26,56	18	477,99	CHI
20201138457	SANTA FE DE GOIAS	RN11250634	BRITANIA	10/11/2020 07:52	10/11/2020 20:33	10/11/2020 07:52	10/11/2020 20:33	12,68	37	469,06	CHI
20201138251	GOIANIA	10026897090	GOYA S2	10/11/2020 07:53	10/11/2020 10:30	10/11/2020 07:53	10/11/2020 10:30	2,61	1	2,61	CHI
20201138258	URUACU	640104654	URUACU	10/11/2020 07:54	10/11/2020 21:26	10/11/2020 07:54	10/11/2020 21:26	13,53	1	13,53	CHI
20201138260	GOIANIA	11056393	XAVANTES	10/11/2020 07:54	10/11/2020 09:06	10/11/2020 07:54	10/11/2020 09:06	1,19	1	1,19	CHI
20201138269	MINACU	IH21314758	MINACU	10/11/2020 07:55	10/11/2020 08:55	10/11/2020 07:55	10/11/2020 08:55	0,99	1	0,99	CHI
20201138271	GOIAS	GS12093357	MATRINCHA	10/11/2020 07:56	10/11/2020 12:23	10/11/2020 07:56	10/11/2020 12:23	4,45	6	26,70	CHI
20201138274	SENADOR CANEDO	SW12079060	CEPAIGO S2	10/11/2020 07:56	10/11/2020 10:18	10/11/2020 07:56	10/11/2020 10:18	2,36	115	271,37	CHI
20201138276	TRINDADE	TR12169657	TRINDADE	10/11/2020 07:56	10/11/2020 12:25	10/11/2020 07:56	10/11/2020 12:25	4,47	1	4,47	CHI
20201138853	ITABERAI	IB12336526	ITABERAI S1	10/11/2020 07:57	10/11/2020 12:36	10/11/2020 07:57	10/11/2020 12:36	4,64	3	13,93	CHI
20201138289	APARECIDA DE GOIANIA	AP21272177	INDEPENDENCIA S2	10/11/2020 07:58	10/11/2020 12:21	10/11/2020 07:58	10/11/2020 12:21	4,38	1	4,38	CHI
20201138479	SANTA CRUZ DE GOIAS	BC12068916	PIRES DO RIO S2	10/11/2020 07:59	10/11/2020 11:22	10/11/2020 07:59	10/11/2020 11:22	3,38	12	40,54	CHI
20201138889	SANTA TEREZINHA DE GOIAS	SG12213220RE	SANTA TEREZINHA	10/11/2020 07:59	10/11/2020 11:27	10/11/2020 07:59	10/11/2020 11:27	3,45	48	165,71	CHI
20201138306	PALMEIRAS DE GOIAS	PL21073233	PALMEIRAS	10/11/2020 08:00	10/11/2020 11:42	10/11/2020 08:00	10/11/2020 11:42	3,70	1	3,70	CHI
20201138308	GOIANIA	GN11169930	ATLANTICO S2	10/11/2020 08:00	10/11/2020 11:19	10/11/2020 08:56	10/11/2020 11:19	2,38	36	85,80	CHI
20201138309	CALDAS NOVAS	CN21163538	CALDAS NOVAS S1	10/11/2020 08:00	10/11/2020 09:43	10/11/2020 08:00	10/11/2020 09:43	1,71	1	1,71	CHI
20201138315	BRAZABRANTES	30093624	INHUMAS S1	10/11/2020 08:01	10/11/2020 21:59	10/11/2020 08:01	10/11/2020 21:59	13,96	1	13,96	CHI
20201138317	TURVANIA	TV12047523	FIRMINOPOLIS S2	10/11/2020 08:01	10/11/2020 18:31	10/11/2020 08:01	10/11/2020 18:31	10,49	2	20,98	CHI
20201138318	GOIANIA	12169079	ATLANTICO S1	10/11/2020 08:01	10/11/2020 12:42	10/11/2020 08:01	10/11/2020 12:42	4,67	1	4,67	CHI
20201137849	JATAI	290163912	JATAI S3	10/11/2020 08:02	10/11/2020 09:57	10/11/2020 08:02	10/11/2020 09:57	1,91	1	1,91	CHI
20201138330	RIO VERDE	RV11347741	RIO VERDE S2	10/11/2020 08:03	10/11/2020 09:24	10/11/2020 08:03	10/11/2020 09:24	1,35	122	164,56	CHI
20201138337	APARECIDA DE GOIANIA	AP12002063	CEPAIGO S1	10/11/2020 08:03	10/11/2020 12:00	10/11/2020 08:03	10/11/2020 12:00	3,94	2	7,87	CHI
20201138347	CATALAO	CT21127664	CATALAO S1	10/11/2020 08:04	10/11/2020 13:27	10/11/2020 08:04	10/11/2020 13:27	5,37	1	5,37	CHI
20201138352	SAO FRANCISCO DE GOIAS	SF12000171	SAO FRANCISCO DE GOIAS	10/11/2020 08:05	10/11/2020 11:53	10/11/2020 08:05	10/11/2020 11:53	3,80	16	60,78	CHI
20201138358	MONTES CLAROS DE GOIAS	ME21138683	IPORA	10/11/2020 08:05	10/11/2020 11:40	10/11/2020 08:05	10/11/2020 11:40	3,57	1	3,57	CHI
20201138360	AGUA FRIA DE GOIAS	TL12205640	SAO JOAO D ALIANCA	10/11/2020 08:05	10/11/2020 11:08	10/11/2020 08:05	10/11/2020 11:08	3,04	2	6,07	CHI
20201139271	EDEALINA	VI12072970	VICENTINOPOLIS	10/11/2020 08:05	10/11/2020 15:02	10/11/2020 08:05	10/11/2020 15:02	6,94	6	41,64	CHI
20201138366	NOVO BRASIL	NB12396250	JUSSARA	10/11/2020 08:06	10/11/2020 10:48	10/11/2020 08:06	10/11/2020 10:48	2,69	4	10,76	CHI
20201138369	VALPARAISO DE GOIAS	VA11183666	MARAJOARA	10/11/2020 08:06	10/11/2020 09:46	10/11/2020 08:06	10/11/2020 09:46	1,65	23	38,01	CHI
20201138377	PIRENOPOLIS	PV21135427	JARAGUA	10/11/2020 08:07	10/11/2020 18:09	10/11/2020 08:07	10/11/2020 18:09	10,03	1	10,03	CHI
20201138378	PIRACANJUBA	PJ12212152	PIRACANJUBA	10/11/2020 08:07	10/11/2020 13:58	10/11/2020 08:07	10/11/2020 13:58	5,84	38	221,92	CHI
20201138382	LUZIANIA	LZ21183667	MARAJOARA	10/11/2020 08:07	10/11/2020 10:10	10/11/2020 08:07	10/11/2020 10:10	2,04	1	2,04	CHI
202011137964	GAMELEIRA DE GOIAS	SV12056334	DAIA S2	10/11/2020 08:07	10/11/2020 11:56	10/11/2020 08:07	10/11/2020 11:56	3,80	11	41,83	CHI
202011137964	SILVANIA	SV12056334	DAIA S2	10/11/2020 08:07	10/11/2020 11:56	10/11/2020 08:07	10/11/2020 11:56	3,80	4	15,21	CHI

20201138384	IPAMERI	IP21242596	IPAMERI	10/11/2020 08:08	10/11/2020 13:24	10/11/2020 08:08	10/11/2020 13:24	5,26	1	5,26	CHI
20201138386	BRITANIA	BT21114046	BRITANIA	10/11/2020 08:08	10/11/2020 11:00	10/11/2020 08:08	10/11/2020 11:00	2,87	1	2,87	CHI
20201138389	GOIANIA	GN21072690	NEROPOLIS S1	10/11/2020 08:08	10/11/2020 09:48	10/11/2020 08:08	10/11/2020 09:48	1,66	2	3,31	CHI
20201138392	ACREUNA	EU21044254	ACREUNA	10/11/2020 08:08	10/11/2020 18:01	10/11/2020 08:08	10/11/2020 18:01	9,87	1	9,87	CHI
20201138964	CUMARI	CY12083285	CATALAO S1	10/11/2020 08:08	10/11/2020 11:03	10/11/2020 08:08	10/11/2020 11:03	2,90	8	23,22	CHI
20201141285	SANTA FE DE GOIAS	RN11402994	BRITANIA	10/11/2020 08:08	10/11/2020 23:10	10/11/2020 08:08	10/11/2020 23:10	15,02	1	15,02	CHI
20201138397	PADRE BERNARDO	PB12163248	PADRE BERNARDO	10/11/2020 08:09	10/11/2020 11:00	10/11/2020 08:09	10/11/2020 11:00	2,85	7	19,93	CHI
20201138399	RIO QUENTE	RQ21263096	VILA CORUMBA	10/11/2020 08:09	10/11/2020 11:44	10/11/2020 08:09	10/11/2020 11:44	3,58	1	3,58	CHI
20201138419	NIQUELANDIA	NQ12222646	URUACU	10/11/2020 08:10	11/11/2020 09:04	10/11/2020 08:10	11/11/2020 09:04	24,89	8	199,13	CHI
20201138446	GOIANAPOLIS	GP11180137	DAIA S2	10/11/2020 08:10	10/11/2020 17:19	10/11/2020 08:10	10/11/2020 17:19	9,14	76	694,47	CHI
20201144023	NIQUELANDIA	NQ21221866	URUACU	10/11/2020 08:10	11/11/2020 10:38	10/11/2020 08:10	11/11/2020 10:38	26,46	2	52,92	CHI
20201138428	CRISTALINA	KR12170316	PAMPLONA	10/11/2020 08:11	10/11/2020 11:12	10/11/2020 08:11	10/11/2020 11:12	3,01	1	3,01	CHI
20201138429	FORMOSA	FA12202282	ITIQUEIRA	10/11/2020 08:11	10/11/2020 10:57	10/11/2020 08:11	10/11/2020 10:57	2,76	5	13,79	CHI
20201138443	FIRMINOPOLIS	RP12206100	FIRMINOPOLIS S2	10/11/2020 08:13	10/11/2020 14:57	10/11/2020 08:13	10/11/2020 14:57	6,73	3	20,19	CHI
20201138443	SAO JOAO DA PARAUNA	RP12206100	FIRMINOPOLIS S2	10/11/2020 08:13	10/11/2020 14:57	10/11/2020 08:13	10/11/2020 14:57	6,73	2	13,46	CHI
20201138456	CAMPOS VERDES	VD12257334	SANTA TEREZINHA	10/11/2020 08:13	10/11/2020 10:50	10/11/2020 08:13	10/11/2020 10:50	2,60	5	13,02	CHI
20201140099	ANICUNS	AC12391412	ANICUNS	10/11/2020 08:13	10/11/2020 14:22	10/11/2020 08:13	10/11/2020 14:22	6,15	28	172,15	CHI
20201140099	AVELINOPOLIS	AC12391412	ANICUNS	10/11/2020 08:13	10/11/2020 14:22	10/11/2020 08:13	10/11/2020 14:22	6,15	1	6,15	CHI
20201138453	GOIAS	IB12106151LD	ITABERAI S1	10/11/2020 08:14	10/11/2020 15:47	10/11/2020 08:14	10/11/2020 15:47	7,55	2	15,10	CHI
20201138453	ITABERAI	IB12106151LD	ITABERAI S1	10/11/2020 08:14	10/11/2020 15:47	10/11/2020 08:14	10/11/2020 15:47	7,55	29	218,92	CHI
20201138464	CATALAO	1990193460	CATALAO S2	10/11/2020 08:15	10/11/2020 10:53	10/11/2020 08:15	10/11/2020 10:53	2,63	1	2,63	CHI
20201138466	ITAPIRAPUA	IU11293784	MATRINCHA	10/11/2020 08:15	10/11/2020 09:33	10/11/2020 08:15	10/11/2020 09:33	1,29	36	46,51	CHI
20201138469	GOIANAPOLIS	GP21374643	DAIA S2	10/11/2020 08:16	10/11/2020 13:03	10/11/2020 08:16	10/11/2020 13:03	4,78	2	9,56	CHI
20201139119	MINEIROS	MY12071574	PARQUE DAS EMAS	10/11/2020 08:16	10/11/2020 15:26	10/11/2020 08:16	10/11/2020 15:26	7,15	5	35,75	CHI
20201139907	ITAGUARI	JA12300098	ITABERAI S1	10/11/2020 08:16	10/11/2020 15:49	10/11/2020 08:16	10/11/2020 15:49	7,54	1	7,54	CHI
20201139907	JARAGUA	JA12300098	ITABERAI S1	10/11/2020 08:16	10/11/2020 15:49	10/11/2020 08:16	10/11/2020 15:49	7,54	10	75,36	CHI
20201138481	PIRENOPOLIS	PV21185093	ANAPOLIS UNIVERSITARIO S2	10/11/2020 08:17	10/11/2020 14:08	10/11/2020 08:17	10/11/2020 14:08	5,84	1	5,84	CHI
20201138491	VILA BOA	FA21322702	ITIQUEIRA	10/11/2020 08:18	10/11/2020 12:08	10/11/2020 08:18	10/11/2020 12:08	3,83	1	3,83	CHI
20201138495	ANAPOLIS	AN12258730	ANAPOLIS UNIVERSITARIO S2	10/11/2020 08:18	10/11/2020 15:19	10/11/2020 08:18	10/11/2020 15:19	7,00	1	7,00	CHI
20201138497	MONTIVIDIU DO NORTE	10020793055	PORANGATU	10/11/2020 08:18	10/11/2020 15:01	10/11/2020 08:18	10/11/2020 15:01	6,70	1	6,70	CHI
20201141450	URUACU	UR12202170	URUACU	10/11/2020 08:18	11/11/2020 12:53	10/11/2020 08:18	11/11/2020 12:53	28,59	5	142,94	CHI
20201138501	SENADOR CANEDO	10015027951	SENADOR CANEDO	10/11/2020 08:19	10/11/2020 09:24	10/11/2020 08:19	10/11/2020 09:24	1,07	1	1,07	CHI
20201138502	FORMOSA	FA11245398	ITIQUEIRA	10/11/2020 08:19	10/11/2020 11:06	10/11/2020 08:19	10/11/2020 11:06	2,77	12	33,27	CHI
20201138513	RUBIATABA	780029434	RUBIATABA	10/11/2020 08:20	10/11/2020 17:08	10/11/2020 08:20	10/11/2020 17:08	8,79	1	8,79	CHI
20201138525	GOIAS	GS12362356	MATRINCHA	10/11/2020 08:21	10/11/2020 15:20	10/11/2020 08:21	10/11/2020 15:20	6,97	1	6,97	CHI
20201138579	NIQUELANDIA	NQ12171129	BARRO ALTO	10/11/2020 08:21	10/11/2020 11:38	10/11/2020 08:21	10/11/2020 11:38	3,28	8	26,26	CHI
20201138528	PIRES DO RIO	PR12402554	PIRES DO RIO S1	10/11/2020 08:22	10/11/2020 12:01	10/11/2020 08:22	10/11/2020 12:01	3,65	4	14,60	CHI
20201138534	MORRINHOS	10012705886	MORRINHOS	10/11/2020 08:22	10/11/2020 09:31	10/11/2020 08:22	10/11/2020 09:31	1,14	1	1,14	CHI
20201139912	CAIAPONIA	RV12030683	MONTIVIDIU T	10/11/2020 08:22	10/11/2020 16:56	10/11/2020 08:22	10/11/2020 16:56	8,56	212	1814,25	CHI
20201139912	RIO VERDE	RV12030683	MONTIVIDIU T	10/11/2020 08:22	10/11/2020 16:56	10/11/2020 08:22	10/11/2020 16:56	8,56	3	25,67	CHI
20201139270	GOIANIA	GN12196741	GOYA S2	10/11/2020 08:23	10/11/2020 12:41	10/11/2020 08:23	10/11/2020 12:41	4,29	453	1944,00	CHI
20201138546	CACU	CC12164172	CACHOEIRA ALTA	10/11/2020 08:24	10/11/2020 11:02	10/11/2020 08:24	10/11/2020 11:02	2,63	85	223,69	CHI
20201138547	URUACU	UR11094174	URUACU	10/11/2020 08:24	11/11/2020 04:53	10/11/2020 08:24	10/11/2020 22:53	14,48	26	376,59	CHI
20201138547	URUACU	UR11094174	URUACU	10/11/2020 08:24	11/11/2020 04:53	10/11/2020 23:20	11/11/2020 03:52	4,53	26	117,82	CHI
20201138547	URUACU	UR11094174	URUACU	10/11/2020 08:24	11/11/2020 04:53	11/11/2020 03:57	11/11/2020 04:53	0,92	26	23,93	CHI
20201138550	GOIANAPOLIS	950011848	DAIA S2	10/11/2020 08:24	10/11/2020 15:43	10/11/2020 08:24	10/11/2020 15:43	7,31	1	7,31	CHI
20201139192	BALIZA	BH12331164	CAIAPONIA	10/11/2020 08:25	10/11/2020 13:24	10/11/2020 08:25	10/11/2020 13:24	4,97	10	49,71	CHI
20201138564	CIDADE OCIDENTAL	DH11277128	MARAJOARA	10/11/2020 08:26	10/11/2020 11:34	10/11/2020 08:26	10/11/2020 11:34	3,12	1	3,12	CHI
20201138568	CHAPADAO DO CEU	DJ21336990	CHAPADAO DO CEU	10/11/2020 08:27	10/11/2020 20:11	10/11/2020 08:27	10/11/2020 20:11	11,72	1	11,72	CHI
20201139951	URUACU	UR12325199	URUACU	10/11/2020 08:27	11/11/2020 07:33	10/11/2020 08:27	11/11/2020 07:33	23,09	9	207,80	CHI
20201138577	MINACU	IH12320901	MINACU	10/11/2020 08:28	10/11/2020 12:16	10/11/2020 08:28	10/11/2020 12:16	3,80	5	18,98	CHI

20201138582	SAO JOAO DA PARAUNA	RP21087032	FIRMINOPOLIS S2	10/11/2020 08:28	10/11/2020 15:33	10/11/2020 08:28	10/11/2020 15:33	7,07	1	7,07	CHI
20201138585	ITAPACI	IW11282284	ITAPACI	10/11/2020 08:28	10/11/2020 12:56	10/11/2020 08:28	10/11/2020 12:56	4,45	106	471,88	CHI
20201139359	NIQUELANDIA	NQ12235115	URUACU	10/11/2020 08:29	10/11/2020 12:08	10/11/2020 08:29	10/11/2020 12:08	3,63	27	98,13	CHI
20201138594	PADRE BERNARDO	PB12078964	PADRE BERNARDO	10/11/2020 08:30	10/11/2020 11:38	10/11/2020 08:30	10/11/2020 11:38	3,12	141	440,31	CHI
20201138598	MONTIVIDIU	MV21249079	MONTIVIDIU T	10/11/2020 08:30	10/11/2020 20:27	10/11/2020 08:30	10/11/2020 20:27	11,94	1	11,94	CHI
20201138599	GOIANAPOLIS	10002381581	DAIA S2	10/11/2020 08:31	10/11/2020 18:57	10/11/2020 08:31	10/11/2020 18:57	10,43	1	10,43	CHI
20201138600	DISTRITO FEDERAL	PB21313515	PADRE BERNARDO	10/11/2020 08:31	10/11/2020 10:44	10/11/2020 08:31	10/11/2020 10:44	2,21	1	2,21	CHI
20201138602	SENADOR CANEDO	190122638	SENADOR CANEDO	10/11/2020 08:31	10/11/2020 09:44	10/11/2020 08:31	10/11/2020 09:44	1,20	1	1,20	CHI
20201136487	NOVA CRIXAS	NA12386663	NOVA CRIXAS	10/11/2020 08:33	10/11/2020 14:46	10/11/2020 08:33	10/11/2020 14:46	6,21	42	260,90	CHI
20201138613	BELA VISTA DE GOIAS	BV21193010	BELA VISTA S2	10/11/2020 08:33	10/11/2020 10:46	10/11/2020 08:33	10/11/2020 10:46	2,21	1	2,21	CHI
20201138618	CACHOEIRA ALTA	CA12371281	CACHOEIRA ALTA	10/11/2020 08:33	10/11/2020 09:47	10/11/2020 08:33	10/11/2020 09:47	1,22	1	1,22	CHI
20201138950	TURVELANDIA	TD12278657	RIO DOS BOIS	10/11/2020 08:33	11/11/2020 10:32	10/11/2020 08:33	11/11/2020 10:32	25,98	6	155,89	CHI
20201138621	EDEIA	EA12257978	EDEIA	10/11/2020 08:34	10/11/2020 12:11	10/11/2020 08:34	10/11/2020 12:11	3,61	92	332,50	CHI
20201138622	JATAI	290022782	JATAI S2	10/11/2020 08:34	10/11/2020 14:27	10/11/2020 08:34	10/11/2020 14:27	5,88	1	5,88	CHI
20201138638	PORANGATU	TA12114216	NOVO PLANALTO	10/11/2020 08:36	10/11/2020 14:57	10/11/2020 08:36	10/11/2020 14:57	6,34	6	38,02	CHI
20201138647	SILVANIA	SV21138870	DAIA S2	10/11/2020 08:37	10/11/2020 13:55	10/11/2020 08:37	10/11/2020 13:55	5,30	2	10,59	CHI
20201138827	CATALAO	CT12250333	CATALAO S1	10/11/2020 08:37	10/11/2020 12:57	10/11/2020 08:37	10/11/2020 12:57	4,33	41	177,53	CHI
20201140407	NOVA AMERICA	NM11047535	RUBIATABA	10/11/2020 08:37	10/11/2020 15:22	10/11/2020 08:37	10/11/2020 15:22	6,74	93	627,26	CHI
20201138656	CACHOEIRA ALTA	CA12080005	CACHOEIRA ALTA	10/11/2020 08:38	11/11/2020 13:51	10/11/2020 08:38	11/11/2020 13:51	29,21	7	204,46	CHI
20201138780	NOVA CRIXAS	NA10396027	NOVA CRIXAS	10/11/2020 08:38	10/11/2020 22:06	10/11/2020 08:38	10/11/2020 14:20	5,71	19	108,41	CHI
20201138780	NOVA CRIXAS	NA10396027	NOVA CRIXAS	10/11/2020 08:38	10/11/2020 22:06	10/11/2020 08:38	10/11/2020 15:08	6,50	6	38,99	CHI
20201138780	MUNDO NOVO DE GOIAS	NA13351137	NOVA CRIXAS	10/11/2020 08:38	10/11/2020 22:06	10/11/2020 08:38	10/11/2020 17:00	8,37	37	309,74	CHI
20201138780	NOVA CRIXAS	NA13351137	NOVA CRIXAS	10/11/2020 08:38	10/11/2020 22:06	10/11/2020 08:38	10/11/2020 17:00	8,37	115	962,71	CHI
20201138780	MUNDO NOVO DE GOIAS	NA10396027	NOVA CRIXAS	10/11/2020 08:38	10/11/2020 22:06	10/11/2020 17:20	10/11/2020 17:58	0,64	37	23,55	CHI
20201138780	NOVA CRIXAS	NA10396027	NOVA CRIXAS	10/11/2020 08:38	10/11/2020 22:06	10/11/2020 17:20	10/11/2020 17:58	0,64	149	94,82	CHI
20201138780	MUNDO NOVO DE GOIAS	NA10396027	NOVA CRIXAS	10/11/2020 08:38	10/11/2020 22:06	10/11/2020 18:09	10/11/2020 18:18	0,15	37	5,63	CHI
20201138780	NOVA CRIXAS	NA10396027	NOVA CRIXAS	10/11/2020 08:38	10/11/2020 22:06	10/11/2020 18:09	10/11/2020 18:18	0,15	149	22,68	CHI
20201138780	NOVA CRIXAS	NA10396027	NOVA CRIXAS	10/11/2020 08:38	10/11/2020 22:06	10/11/2020 08:38	10/11/2020 21:40	13,03	8	104,24	CHI
20201138780	MUNDO NOVO DE GOIAS	NA10396027	NOVA CRIXAS	10/11/2020 08:38	10/11/2020 22:06	10/11/2020 18:31	10/11/2020 21:40	3,14	37	116,06	CHI
20201138780	NOVA CRIXAS	NA10396027	NOVA CRIXAS	10/11/2020 08:38	10/11/2020 22:06	10/11/2020 18:31	10/11/2020 21:40	3,14	149	467,36	CHI
20201138780	MUNDO NOVO DE GOIAS	NA10396027	NOVA CRIXAS	10/11/2020 08:38	10/11/2020 22:06	10/11/2020 20:34	10/11/2020 21:40	1,10	8	8,76	CHI
20201138780	NOVA CRIXAS	NA10396027	NOVA CRIXAS	10/11/2020 08:38	10/11/2020 22:06	10/11/2020 20:34	10/11/2020 21:40	1,10	24	26,28	CHI
20201138780	NOVA CRIXAS	NA10396027	NOVA CRIXAS	10/11/2020 08:38	10/11/2020 22:06	10/11/2020 08:38	10/11/2020 22:06	13,48	12	161,72	CHI
20201138660	ARAGOIANIA	AO21340494	GUAPO S2	10/11/2020 08:39	10/11/2020 13:09	10/11/2020 08:39	10/11/2020 13:09	4,49	1	4,49	CHI
20201138665	URUACU	10029272724	URUACU	10/11/2020 08:40	10/11/2020 23:00	10/11/2020 08:40	10/11/2020 23:00	14,33	1	14,33	CHI
20201138955	APORE	AE12219491	ITAJA S1	10/11/2020 08:40	10/11/2020 16:36	10/11/2020 08:40	10/11/2020 16:36	7,93	12	95,16	CHI
20201139550	CORUMBA DE GOIAS	CB12121725	CORUMBA	10/11/2020 08:40	11/11/2020 08:35	10/11/2020 08:40	11/11/2020 08:35	23,90	6	143,41	CHI
20201138671	GOIANIA	16387417	CARAJAS S1	10/11/2020 08:41	10/11/2020 12:12	10/11/2020 08:41	10/11/2020 12:12	3,50	1	3,50	CHI
20201139117	MINEIROS	MY12070299	PARQUE DAS EMAS	10/11/2020 08:41	10/11/2020 12:14	10/11/2020 08:41	10/11/2020 12:14	3,54	29	102,55	CHI
20201138695	SANTA RITA DO NOVO DESTINO	DF12215093	GOIANESIA S1	10/11/2020 08:42	10/11/2020 13:28	10/11/2020 08:42	10/11/2020 13:28	4,76	2	9,51	CHI
20201138696	INDIARA	IY12391395	EDEIA	10/11/2020 08:42	11/11/2020 10:42	10/11/2020 08:42	11/11/2020 10:42	25,99	5	129,94	CHI
20201140054	IPORA	IR12013989	IPORA	10/11/2020 08:42	10/11/2020 15:59	10/11/2020 08:42	10/11/2020 15:59	7,28	5	36,38	CHI
20201138701	VALPARAISO DE GOIAS	2860020350	PACAEMBU S1	10/11/2020 08:43	10/11/2020 10:58	10/11/2020 08:43	10/11/2020 10:58	2,25	1	2,25	CHI
20201138704	PIRES DO RIO	UT21300790	PIRES DO RIO S1	10/11/2020 08:43	10/11/2020 11:20	10/11/2020 08:43	10/11/2020 11:20	2,61	3	7,83	CHI
20201138708	ANAPOLIS	20398440	ANAPOLIS UNIVERSITARIO S2	10/11/2020 08:43	10/11/2020 11:05	10/11/2020 08:43	10/11/2020 11:05	2,35	1	2,35	CHI
20201138709	SANTA HELENA DE GOIAS	SH11159456	IPEGUARI	10/11/2020 08:44	10/11/2020 18:33	10/11/2020 08:44	10/11/2020 18:33	9,82	1	9,82	CHI
20201138734	VILA PROPICIO	GE12196931	GOIANESIA S1	10/11/2020 08:44	10/11/2020 10:17	10/11/2020 08:44	10/11/2020 10:17	1,55	9	13,94	CHI
20201138716	GOIANIRA	10017278781	GOIANIRA	10/11/2020 08:45	10/11/2020 11:27	10/11/2020 08:45	10/11/2020 11:27	2,70	1	2,70	CHI
20201138718	RIO VERDE	RV21240006	RIO VERDE S2	10/11/2020 08:45	10/11/2020 11:46	10/11/2020 08:45	10/11/2020 11:46	3,01	2	6,03	CHI
20201138722	ITAGUARI	IC21233236	ITABERAI S1	10/11/2020 08:45	10/11/2020 17:42	10/11/2020 08:45	10/11/2020 17:42	8,94	1	8,94	CHI
20201138730	DIORAMA	JP12074459	IPORA	10/11/2020 08:46	10/11/2020 21:36	10/11/2020 08:46	10/11/2020 21:36	12,82	3	38,47	CHI

20201138730	JAUPACI	JP12074459	IPORA	10/11/2020 08:46	10/11/2020 21:36	10/11/2020 08:46	10/11/2020 21:36	12,82	5	64,12	CHI
20201138732	GOIANIA	GN21000071	REAL S2	10/11/2020 08:46	10/11/2020 15:45	10/11/2020 08:46	10/11/2020 15:45	6,97	1	6,97	CHI
20201138733	ANAPOLIS	21144588	ANAPOLIS UNIVERSITARIO S2	10/11/2020 08:46	10/11/2020 12:18	10/11/2020 08:46	10/11/2020 12:18	3,52	1	3,52	CHI
20201138738	BALIZA	BH12331445	CAIAPONIA	10/11/2020 08:46	10/11/2020 14:29	10/11/2020 08:46	10/11/2020 14:29	5,70	17	96,92	CHI
20201138740	GOIANIA	12322623	GOIANIA LESTE S2	10/11/2020 08:47	10/11/2020 10:09	10/11/2020 08:47	10/11/2020 10:09	1,37	1	1,37	CHI
20201138744	GOIANIA	10026840896	CARAIAS S1	10/11/2020 08:47	10/11/2020 12:03	10/11/2020 08:47	10/11/2020 12:03	3,26	1	3,26	CHI
20201139122	ITABERAI	IB12079205	ITABERAI S1	10/11/2020 08:47	10/11/2020 13:57	10/11/2020 08:47	10/11/2020 13:57	5,17	4	20,66	CHI
20201140131	CACU	CC12191712	CACHOEIRA ALTA	10/11/2020 08:48	10/11/2020 13:50	10/11/2020 08:48	10/11/2020 13:50	5,03	6	30,16	CHI
20201138758	CORUMBA DE GOIAS	CB21243951	COCALZINHO	10/11/2020 08:49	10/11/2020 20:29	10/11/2020 08:49	10/11/2020 20:29	11,66	1	11,66	CHI
20201138760	ITAJA	IJ21214286	ITAJA S2	10/11/2020 08:49	10/11/2020 15:18	10/11/2020 08:49	10/11/2020 15:18	6,48	1	6,48	CHI
20201138762	ANAPOLIS	21256287	ANAPOLIS UNIVERSITARIO S2	10/11/2020 08:49	10/11/2020 12:56	10/11/2020 08:49	10/11/2020 12:56	4,10	1	4,10	CHI
20201139582	ANICUNS	AC12304649	ANICUNS	10/11/2020 08:49	10/11/2020 14:24	10/11/2020 08:49	10/11/2020 14:24	5,58	5	27,90	CHI
20201138769	ALTO HORIZONTE	AJ21091796	SANTA TEREZINHA	10/11/2020 08:50	10/11/2020 15:20	10/11/2020 08:50	10/11/2020 15:20	6,49	2	12,98	CHI
20201140103	ESTRELA DO NORTE	ET12094692	MARA ROSA	10/11/2020 08:50	10/11/2020 15:24	10/11/2020 08:50	10/11/2020 15:24	6,56	9	59,08	CHI
20201138771	JATAI	JT11390565	JATAI S3	10/11/2020 08:51	10/11/2020 11:21	10/11/2020 08:51	10/11/2020 11:21	2,49	92	229,41	CHI
20201138772	CORUMBAIBA	CI11093855	VILA CORUMBA	10/11/2020 08:51	10/11/2020 11:07	10/11/2020 08:51	10/11/2020 11:07	2,26	79	178,50	CHI
20201138778	VALPARAISO DE GOIAS	10017702931	MARAJOARA	10/11/2020 08:52	10/11/2020 10:12	10/11/2020 08:52	10/11/2020 10:12	1,33	1	1,33	CHI
20201138779	ANAPOLIS	10004287434	ANAPOLIS UNIVERSITARIO S2	10/11/2020 08:52	10/11/2020 14:13	10/11/2020 08:52	10/11/2020 14:13	5,35	1	5,35	CHI
20201138783	RIO VERDE	630239216	CABRIUVA S1	10/11/2020 08:52	10/11/2020 10:55	10/11/2020 08:52	10/11/2020 10:55	2,04	1	2,04	CHI
20201138788	NIQUELANDIA	NQ11353862	URUACU	10/11/2020 08:52	10/11/2020 12:18	10/11/2020 08:52	10/11/2020 12:18	3,42	1	3,42	CHI
20201138791	ITUMBIARA	690147909	ITUMBIARA VELHA S1	10/11/2020 08:53	10/11/2020 12:24	10/11/2020 08:53	10/11/2020 12:24	3,51	1	3,51	CHI
20201138794	GOIATUBA	10019470000	GOIATUBA S2	10/11/2020 08:53	10/11/2020 21:04	10/11/2020 08:53	10/11/2020 21:04	12,17	1	12,17	CHI
20201138799	BARRO ALTO	BA21095435	GOIANESIA S1	10/11/2020 08:54	10/11/2020 11:28	10/11/2020 08:54	10/11/2020 11:28	2,56	1	2,56	CHI
20201138800	ANAPOLIS	AN21144038	ANAPOLIS UNIVERSITARIO S2	10/11/2020 08:54	10/11/2020 11:35	10/11/2020 08:54	10/11/2020 11:35	2,67	1	2,67	CHI
20201139430	NAZARIO	NZ11005226	ANICUNS	10/11/2020 08:54	10/11/2020 14:54	10/11/2020 08:54	10/11/2020 14:54	5,99	80	479,42	CHI
20201138803	PADRE BERNARDO	PB12377285	PADRE BERNARDO	10/11/2020 08:55	10/11/2020 12:06	10/11/2020 08:55	10/11/2020 12:06	3,18	3	9,54	CHI
20201138813	PIRENOPOLIS	220083850	CORUMBA	10/11/2020 08:56	10/11/2020 19:31	10/11/2020 08:56	10/11/2020 19:31	10,57	1	10,57	CHI
20201138817	IPORA	IR21316799	IPORA	10/11/2020 08:57	10/11/2020 19:19	10/11/2020 08:57	10/11/2020 19:19	10,36	1	10,36	CHI
20201138818	NEROPOLIS	NR21016675	NEROPOLIS S2	10/11/2020 08:57	10/11/2020 11:48	10/11/2020 08:57	10/11/2020 11:48	2,85	1	2,85	CHI
20201138821	ANAPOLIS	AN21360257	ANAPOLIS UNIVERSITARIO S1	10/11/2020 08:57	10/11/2020 11:56	10/11/2020 08:57	10/11/2020 11:56	2,97	2	5,94	CHI
20201138824	VARJAO	VJ11008894	GUAPO S2	10/11/2020 08:58	10/11/2020 10:45	10/11/2020 08:58	10/11/2020 10:45	1,78	6	10,68	CHI
20201138828	CALDAS NOVAS	760356373	CALDAS NOVAS S1	10/11/2020 08:58	10/11/2020 10:47	10/11/2020 08:58	10/11/2020 10:47	1,81	1	1,81	CHI
20201138832	EDEALINA	EA12026048	PONTALINA	10/11/2020 08:58	10/11/2020 11:36	10/11/2020 08:58	10/11/2020 11:36	2,62	7	18,36	CHI
20201138837	PALMEIRAS DE GOIAS	PL12205903	PALMEIRAS	10/11/2020 08:59	10/11/2020 13:27	10/11/2020 08:59	10/11/2020 13:27	4,47	4	17,86	CHI
20201138840	PONTALINA	PK21083065	PONTALINA	10/11/2020 08:59	10/11/2020 13:35	10/11/2020 08:59	10/11/2020 13:35	4,59	1	4,59	CHI
20201138961	PIRACANJUBA	PJ12038085LD	BELA VISTA S1	10/11/2020 08:59	10/11/2020 11:25	10/11/2020 08:59	10/11/2020 11:25	2,42	56	135,78	CHI
20201139425	NIQUELANDIA	NQ12265966	NIQUELANDIA SUBTRANSMISSAO	10/11/2020 08:59	10/11/2020 12:34	10/11/2020 08:59	10/11/2020 12:34	3,58	25	89,52	CHI
20201138845	ORIZONA	OZ21300770	PIRES DO RIO S2	10/11/2020 09:00	10/11/2020 12:01	10/11/2020 09:00	10/11/2020 12:01	3,02	2	6,03	CHI
20201138852	ITUMBIARA	IT21309003	ITUMBIARA NOVA	10/11/2020 09:00	10/11/2020 14:11	10/11/2020 09:00	10/11/2020 14:11	5,17	1	5,17	CHI
20201142072	URUACU	UR11284464	URUACU	10/11/2020 09:03	10/11/2020 23:10	10/11/2020 09:03	10/11/2020 23:10	14,10	125	1762,88	CHI
20201138881	VICENTINOPOLIS	VI21263279	VICENTINOPOLIS	10/11/2020 09:04	10/11/2020 12:39	10/11/2020 09:04	10/11/2020 12:39	3,57	1	3,57	CHI
20201138890	CACHOEIRA DOURADA	130010376	CACHOEIRA DOURADA	10/11/2020 09:06	11/11/2020 12:18	10/11/2020 09:06	11/11/2020 12:18	27,20	1	27,20	CHI
20201138895	ITUMBIARA	CD21122327	CACHOEIRA DOURADA	10/11/2020 09:06	10/11/2020 21:59	10/11/2020 09:06	10/11/2020 21:59	12,87	1	12,87	CHI
20201138901	URUACU	10015072620	URUACU	10/11/2020 09:07	11/11/2020 03:51	10/11/2020 09:07	11/11/2020 03:51	18,73	1	18,73	CHI
20201138973	NIQUELANDIA	NQ12396797	URUACU	10/11/2020 09:17	10/11/2020 15:08	10/11/2020 09:17	10/11/2020 15:08	5,84	2	11,67	CHI
20201138974	CRISTALINA	6759243	CRISTALINA S2	10/11/2020 09:17	10/11/2020 11:13	10/11/2020 09:17	10/11/2020 11:13	1,92	56	107,41	CHI
20201140909	NIQUELANDIA	NQ12374779	URUACU	10/11/2020 09:17	10/11/2020 19:17	10/11/2020 09:17	10/11/2020 19:17	9,99	21	209,70	CHI
20201141117	NOVA CRIXAS	NA12349203	NOVA CRIXAS	10/11/2020 09:20	10/11/2020 23:12	10/11/2020 09:20	10/11/2020 23:12	13,87	4	55,46	CHI
20201139041	MINACU	IH21245142	MINACU	10/11/2020 09:27	10/11/2020 10:28	10/11/2020 09:27	10/11/2020 10:28	1,01	1	1,01	CHI
20201139046	CALDAS NOVAS	10019660420	SERRA DE CALDAS	10/11/2020 09:27	10/11/2020 11:52	10/11/2020 09:27	10/11/2020 11:52	2,40	1	2,40	CHI
20201139049	URUACU	10025728480	URUACU	10/11/2020 09:28	10/11/2020 16:56	10/11/2020 09:28	10/11/2020 16:56	7,46	1	7,46	CHI

20201141197	ESTRELA DO NORTE	ET12089891	MARA ROSA	10/11/2020 09:28	10/11/2020 22:56	10/11/2020 09:28	10/11/2020 22:56	13,45	8	107,63	CHI
20201139060	VICENTINOPOLIS	JV12029701	GOIATUBA S1	10/11/2020 09:30	10/11/2020 11:01	10/11/2020 09:30	10/11/2020 11:01	1,51	5	7,54	CHI
20201139095	PONTALINA	6461810	PONTALINA	10/11/2020 09:35	10/11/2020 12:18	10/11/2020 09:35	10/11/2020 12:18	2,71	14	37,96	CHI
20201139096	NOVO GAMA	4990068740	PACAEMBU S2	10/11/2020 09:35	10/11/2020 10:37	10/11/2020 09:35	10/11/2020 10:37	1,03	1	1,03	CHI
20201139097	EDEIA	EA11285694	EDEIA	10/11/2020 09:35	10/11/2020 15:54	10/11/2020 09:35	10/11/2020 15:54	6,31	27	170,27	CHI
20201139112	GOIATUBA	GT12000091	GOIATUBA S2	10/11/2020 09:37	10/11/2020 11:29	10/11/2020 09:37	10/11/2020 11:29	1,86	10	18,60	CHI
20201139127	AGUAS LINDAS DE GOIAS	LA21290641	AGUAS LINDAS DE GOIAS S1	10/11/2020 09:40	10/11/2020 10:41	10/11/2020 09:40	10/11/2020 10:41	1,01	3	3,04	CHI
20201140034	EDEIA	EA12393856	EDEIA	10/11/2020 09:40	10/11/2020 14:36	10/11/2020 09:40	10/11/2020 14:36	4,92	7	34,46	CHI
20201139187	GOIATUBA	GT21257124	VICENTINOPOLIS	10/11/2020 09:49	10/11/2020 21:42	10/11/2020 09:49	10/11/2020 21:42	11,87	2	23,74	CHI
20201139211	BOM JESUS DE GOIAS	1250052923	BOM JESUS DE GOIAS	10/11/2020 09:52	11/11/2020 00:20	10/11/2020 09:52	11/11/2020 00:20	14,45	1	14,45	CHI
20201139232	CORUMBAIBA	560007498	VILA CORUMBA	10/11/2020 09:57	10/11/2020 14:31	10/11/2020 09:57	10/11/2020 14:31	4,57	1	4,57	CHI

5. Plotagem das Ocorrências conforme a Especialização das Chuvas

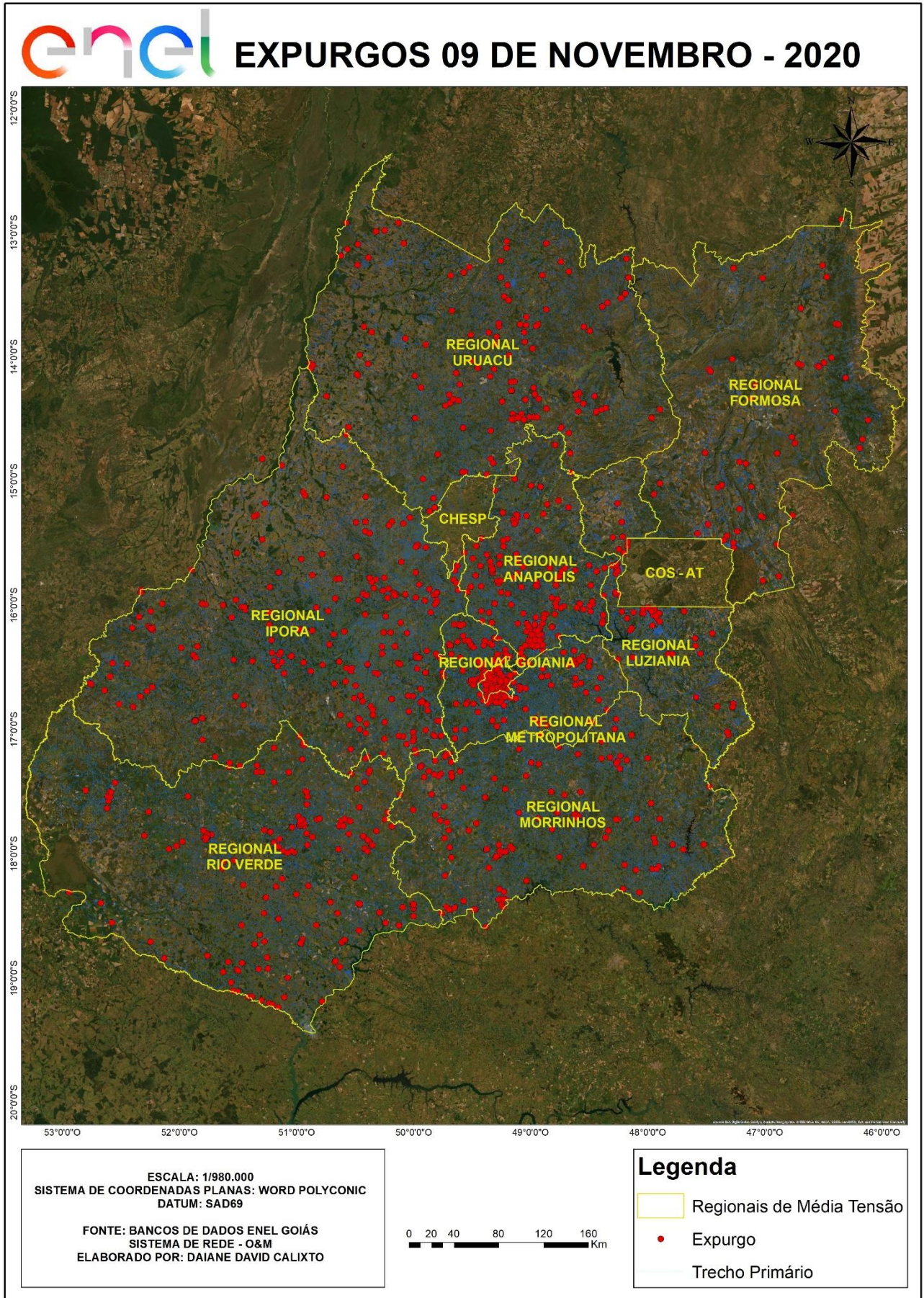

6. Clientes Afetados e Impactos Globais

Em análise ao número de clientes interrompidos (CI) na área de concessão da ENEL GO, a figura abaixo apresenta a atipicidade vivenciada no dia 09 e 10 de novembro de 2020, data esta que, conforme laudo meteorológico emitido por empresa especializada, a referida concessão passou por um período de condições climáticas de extrema severidade.

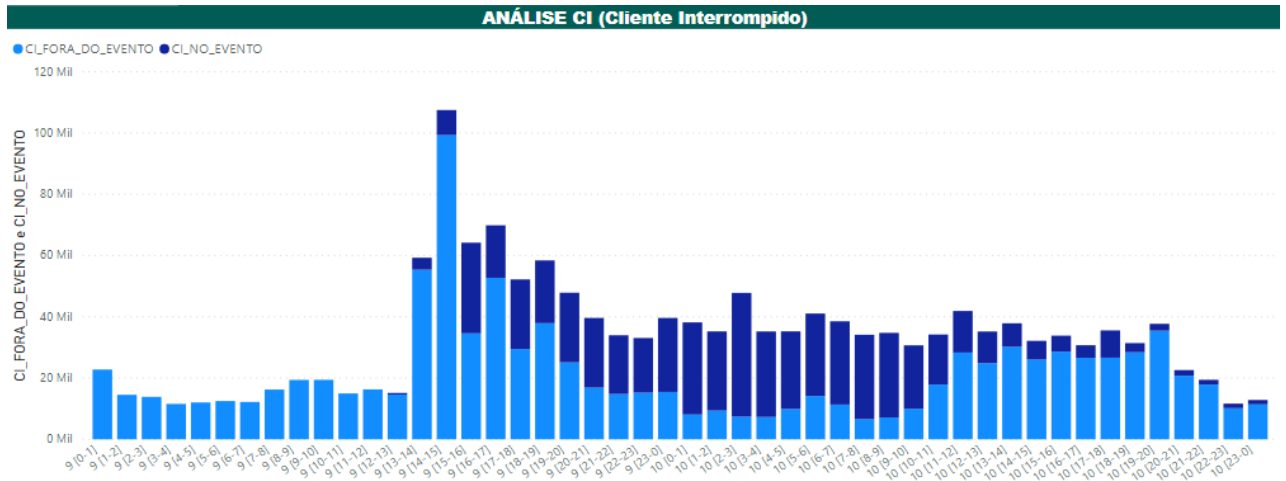

Figuras – Clientes Interrompidos em intervalos de horas

Na figura acima, as barras em azul claro representam a quantidade de clientes interrompidos simultaneamente em condições normais de operação, e as barras azul escuro os clientes interrompidos simultaneamente no período do evento.

7. Diagramas Unifilares

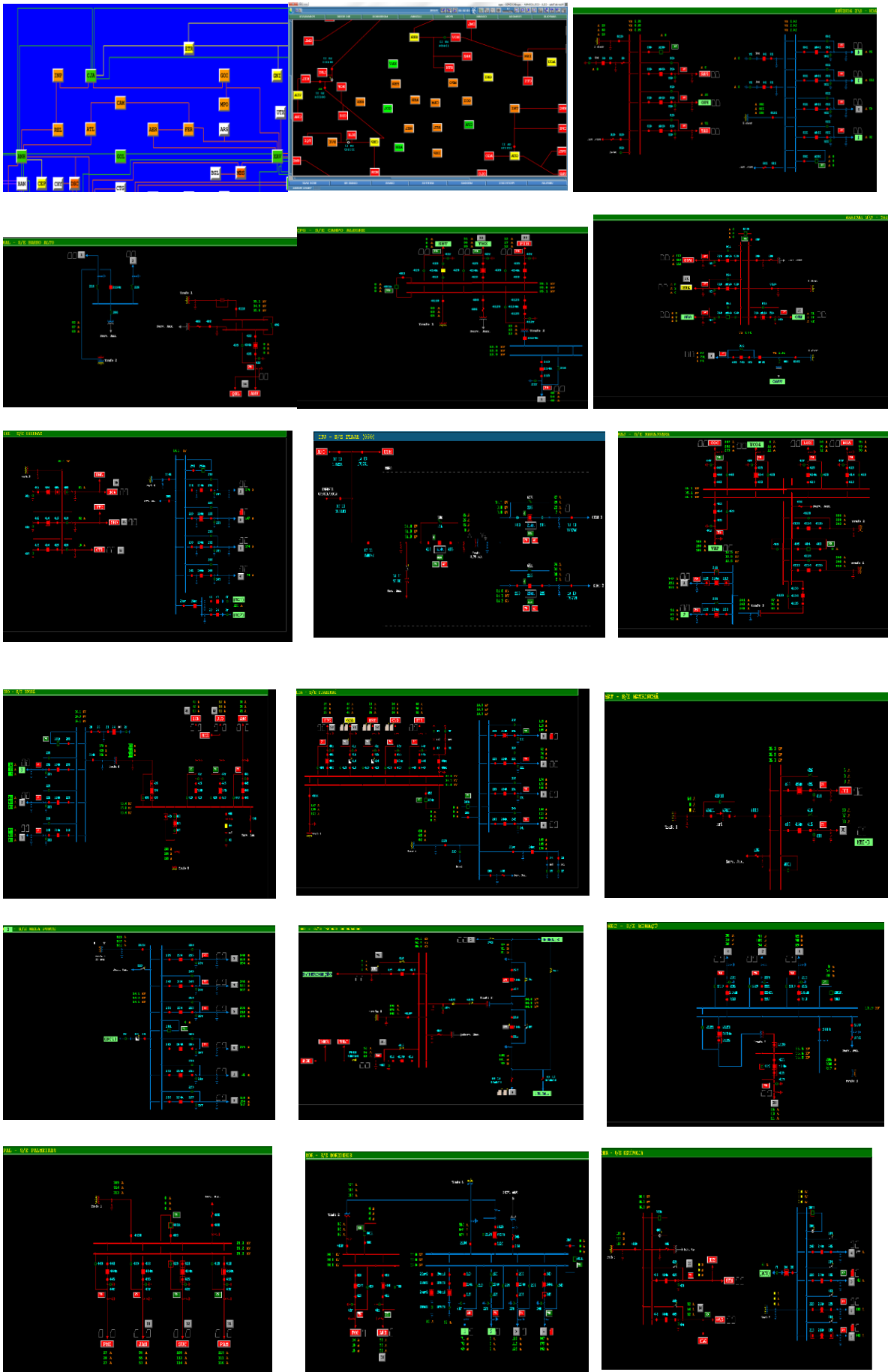

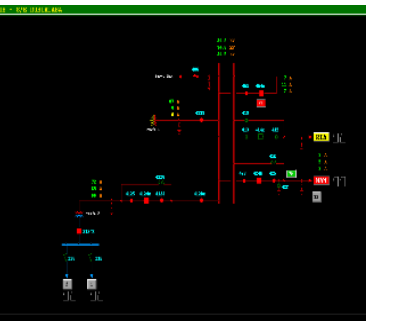
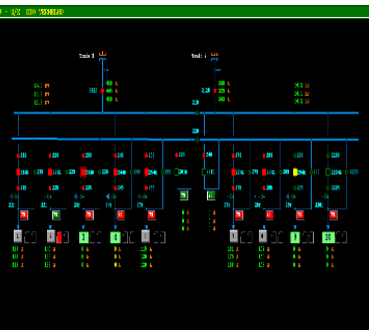
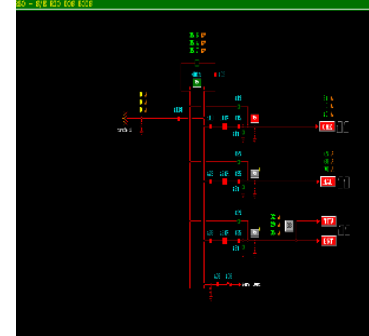
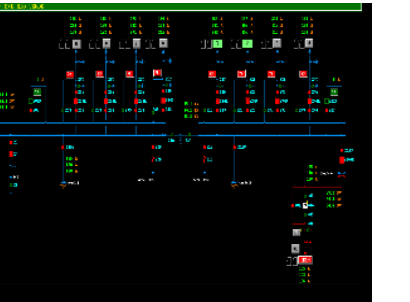
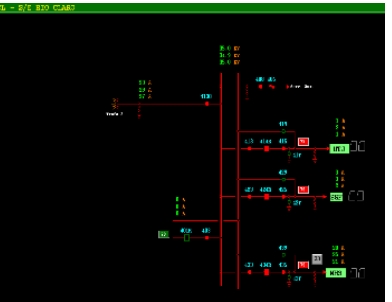
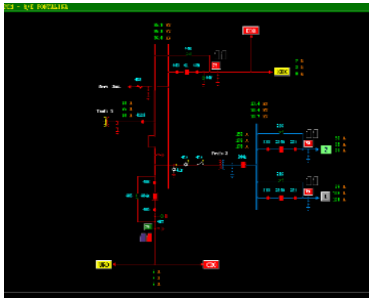
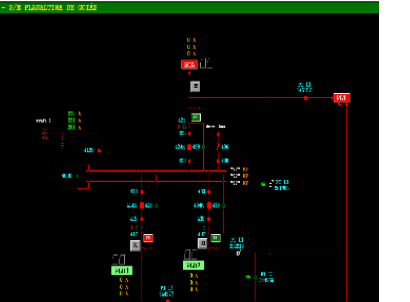
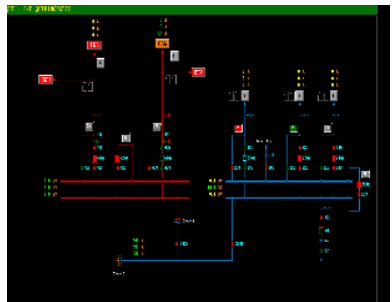
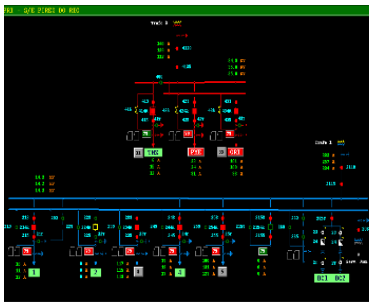
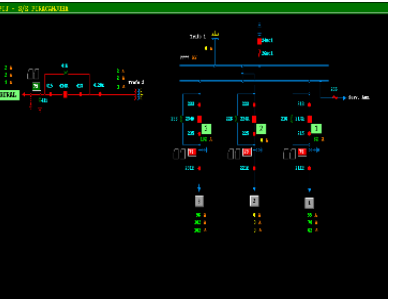
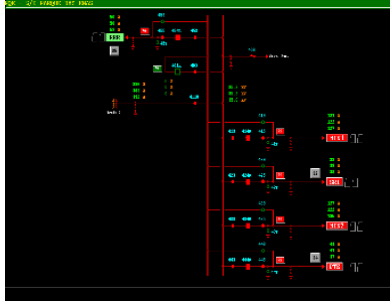
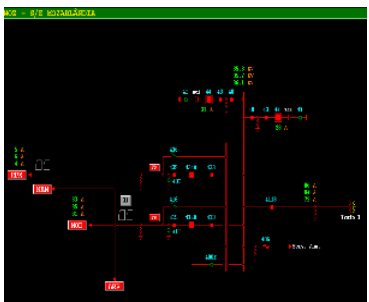
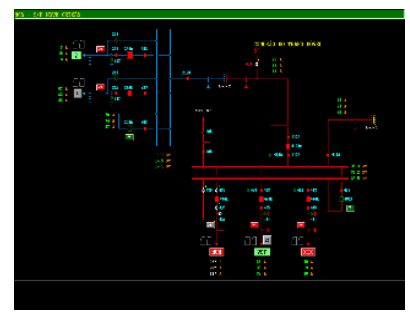

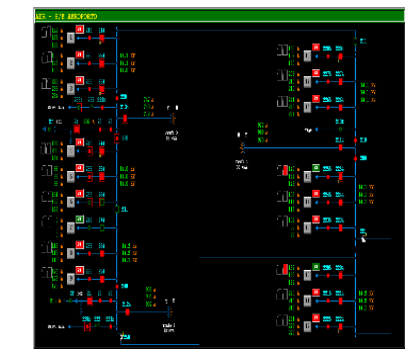
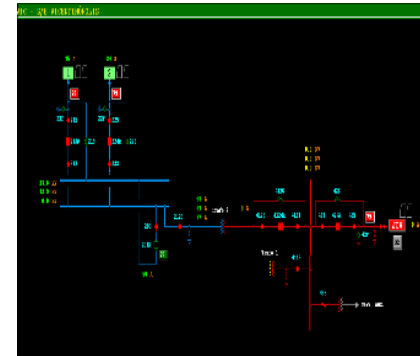
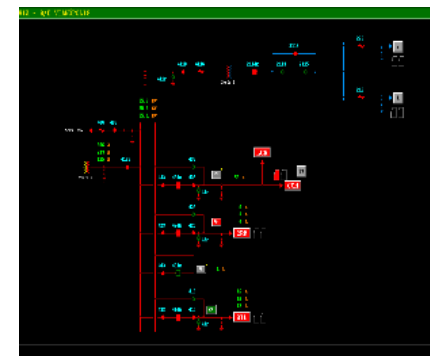
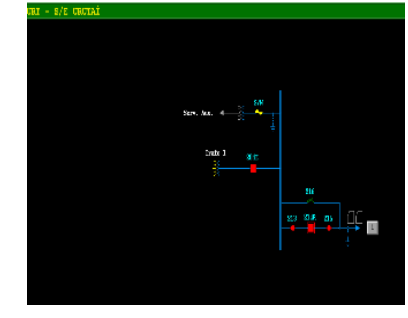
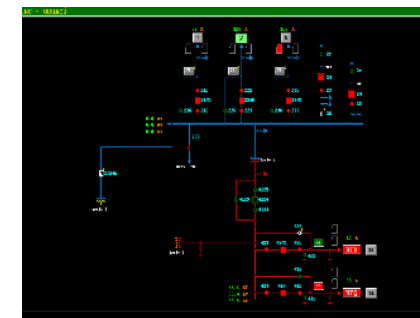
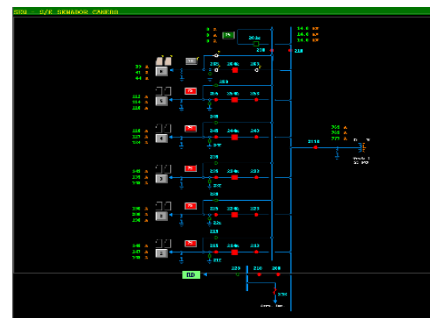
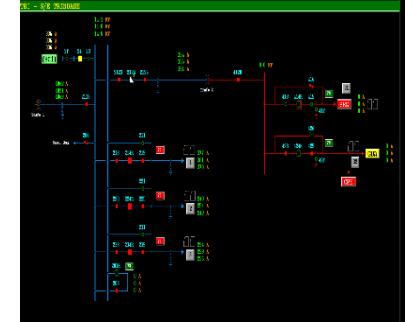
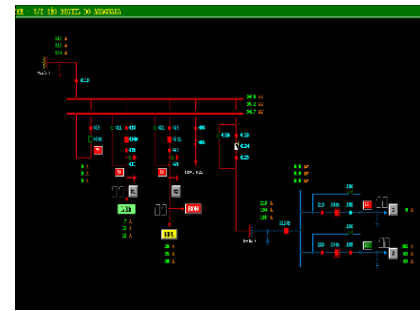
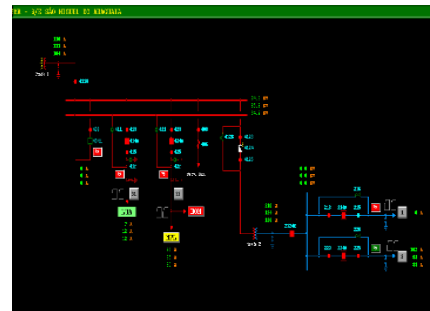
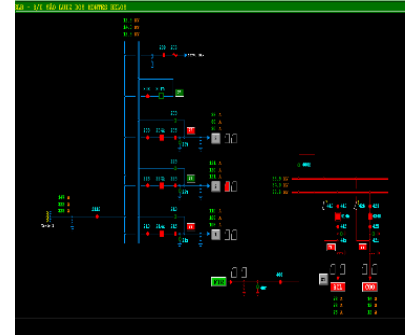
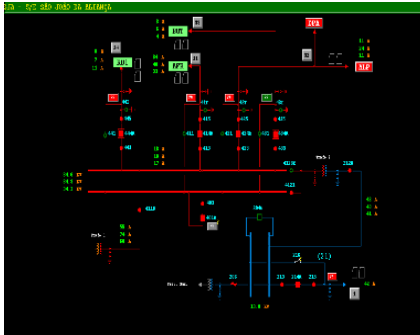
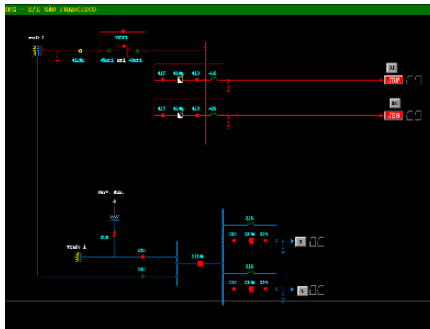
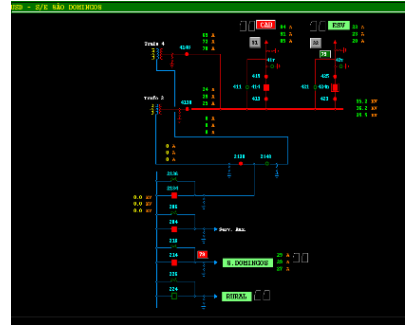
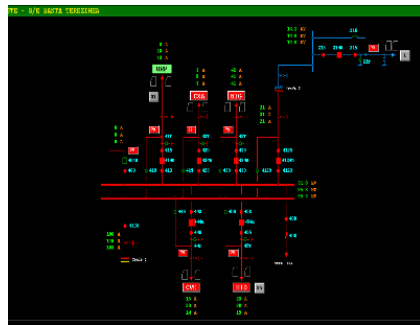
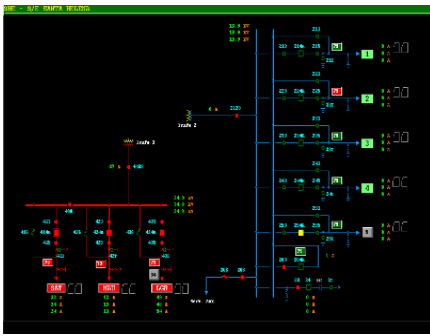

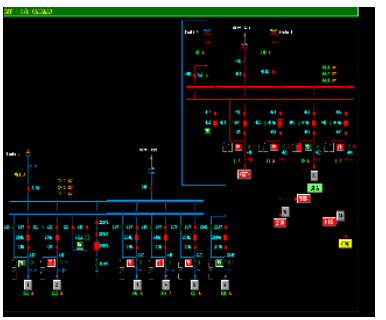
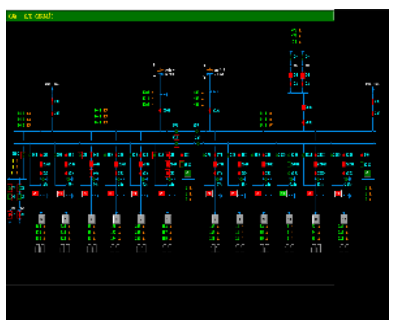
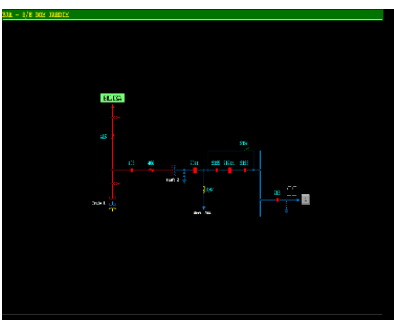
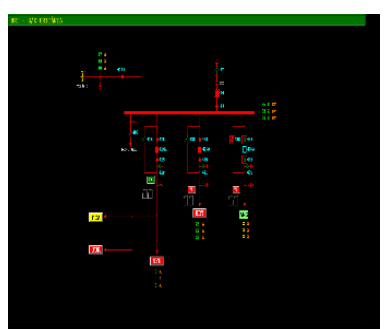
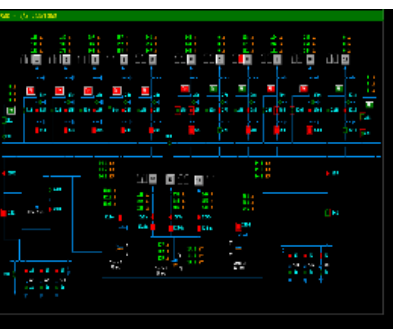
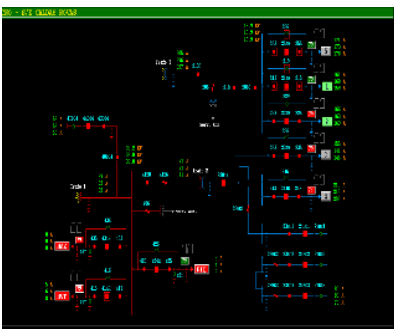
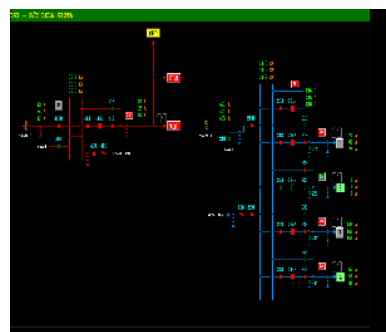
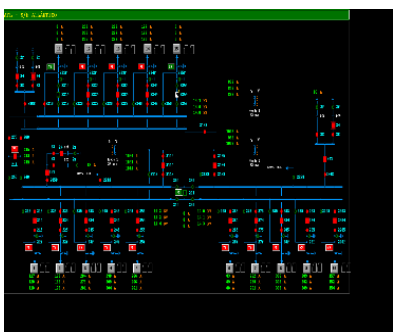
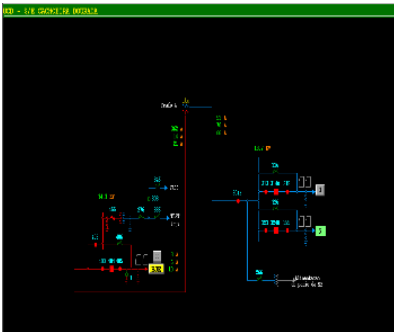
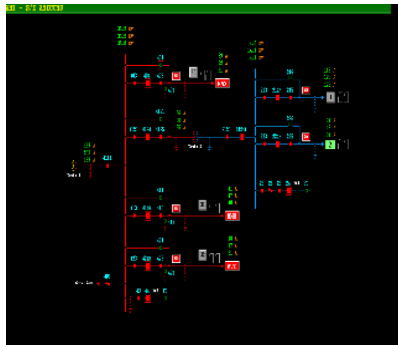
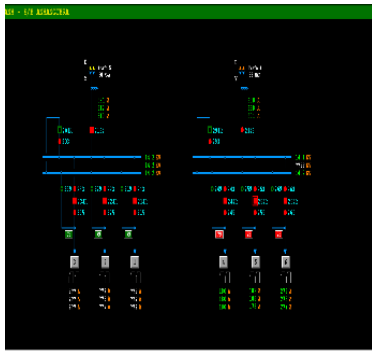
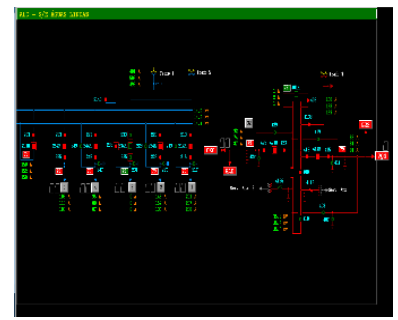
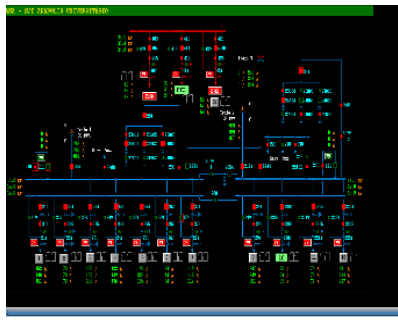
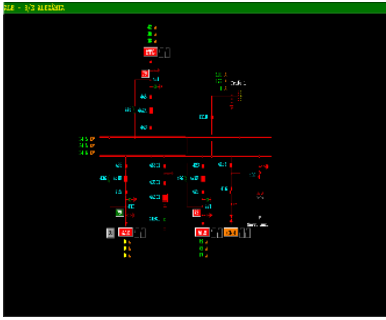

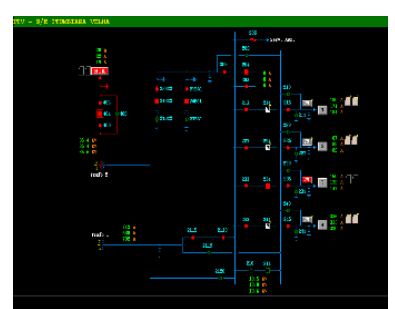
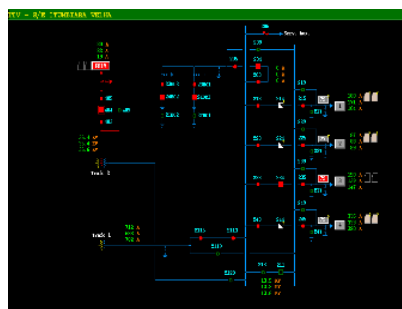
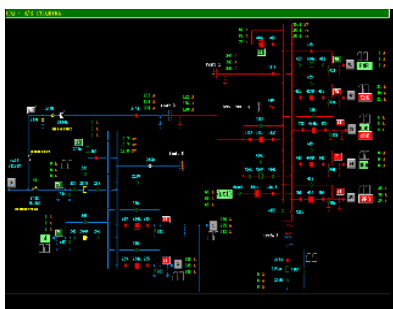
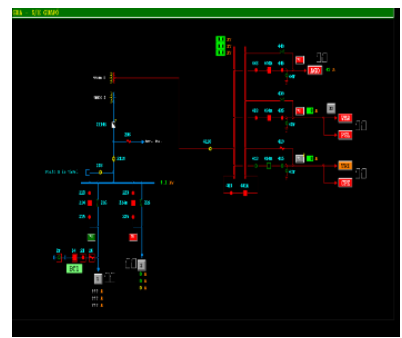
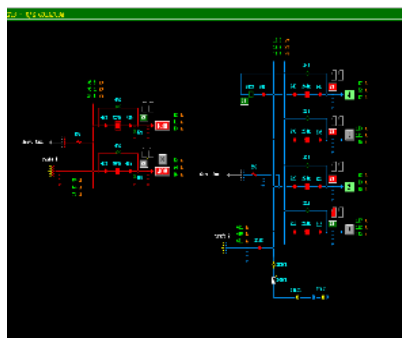
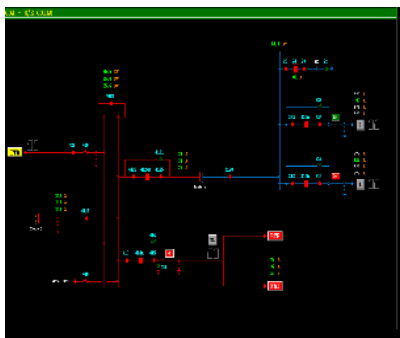
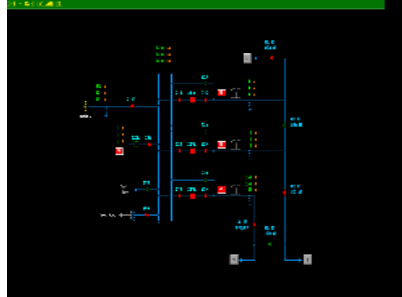
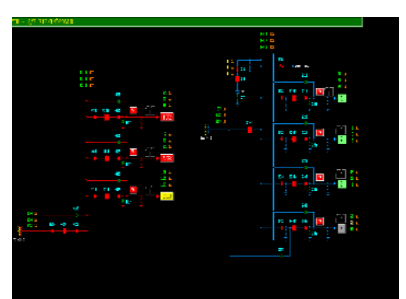
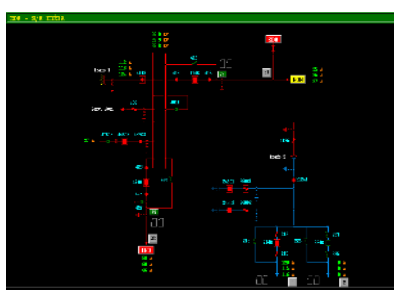
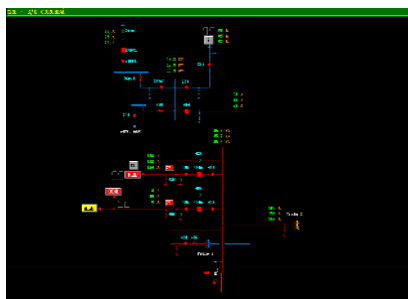
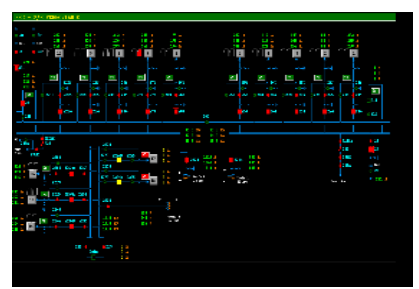
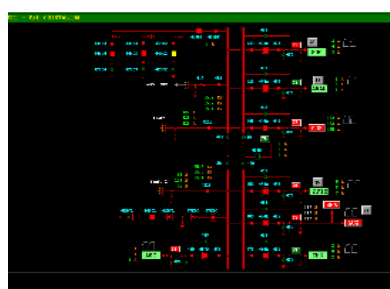
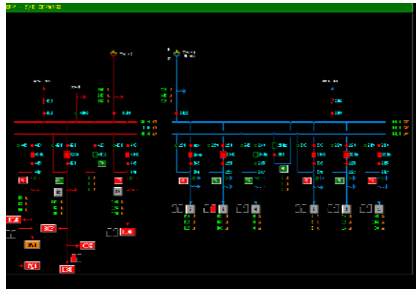
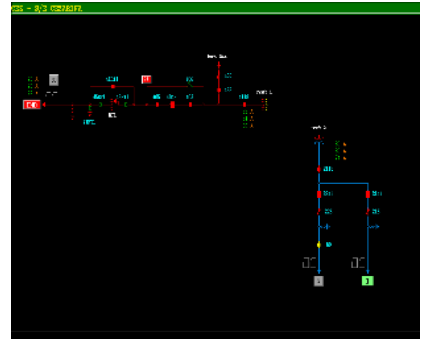
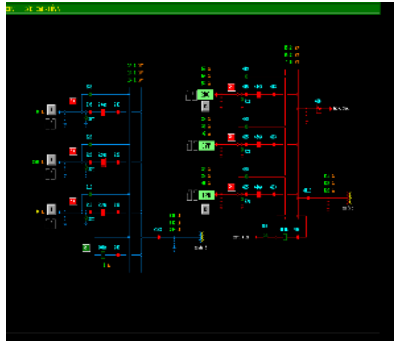
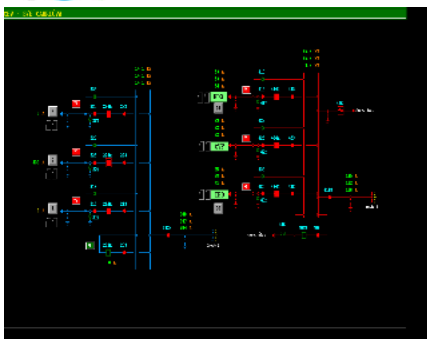

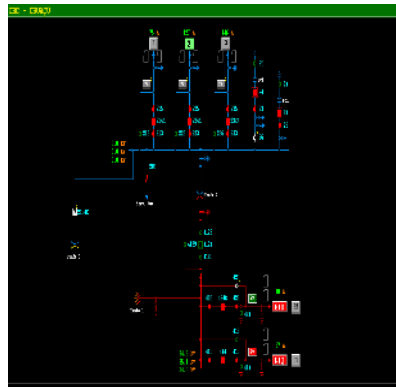
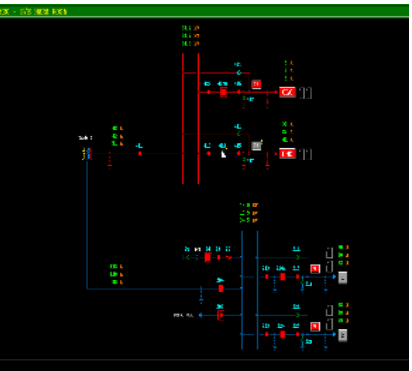
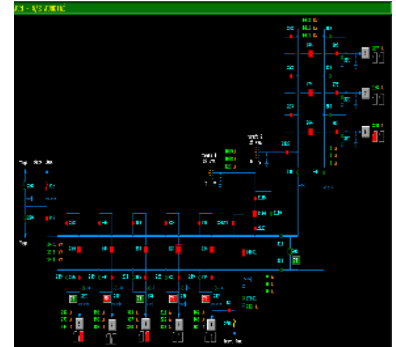
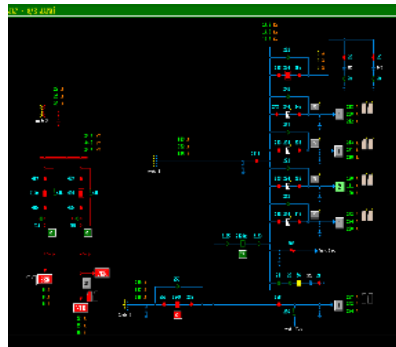
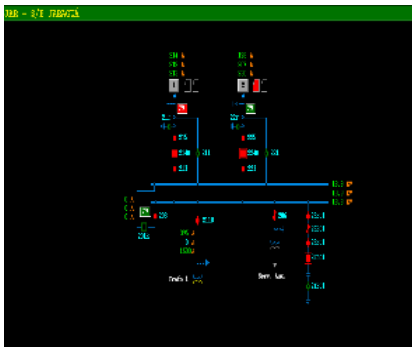

8. DEMAIS EVIDÊNCIAS

8.1. DADOS TÉCNICO - OPERACIONAIS ENEL GO

Enel - GO

TMAE e OE por Dia - Novembro 2020

● Contagem de Ocorrências ● TMAE

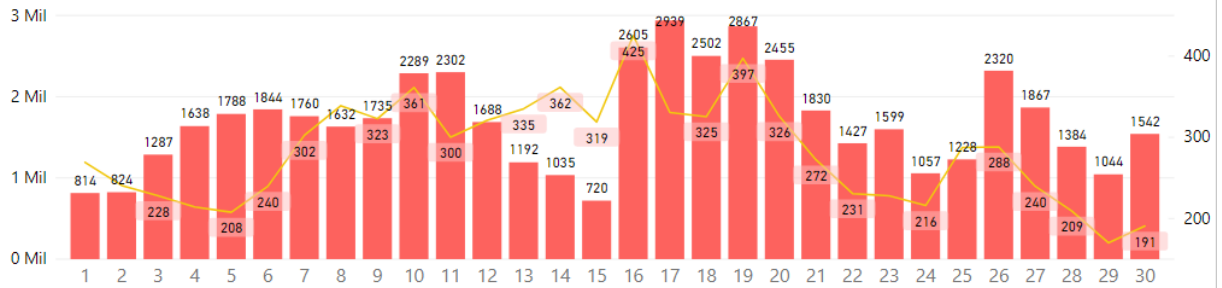

Regional Anápolis – GO

TMAE e OE por Dia - Novembro 2020

● Contagem de Ocorrências ● TMAE

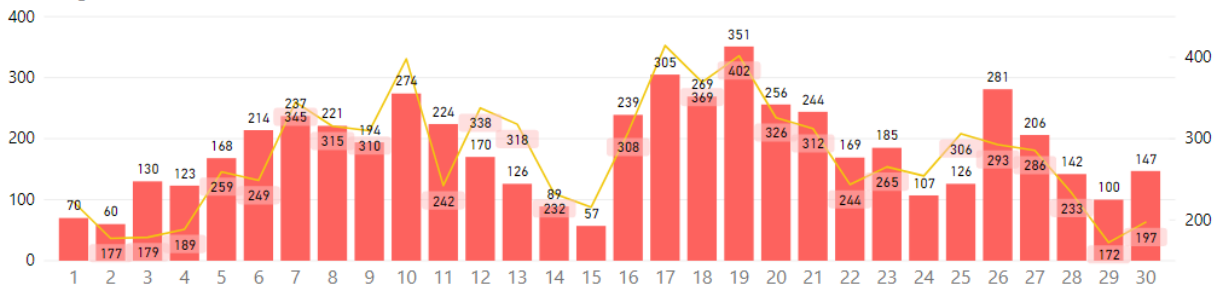

Regional Formosa – GO

TMAE e OE por Dia - Novembro 2020

● Contagem de Ocorrências ● TMAE

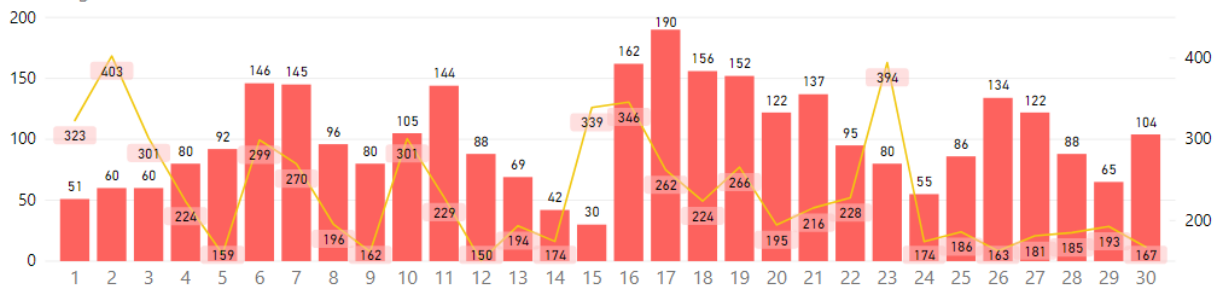

Regional Goiânia – GO

TMAE e OE por Dia - Novembro 2020

● Contagem de Ocorrências ● TMAE

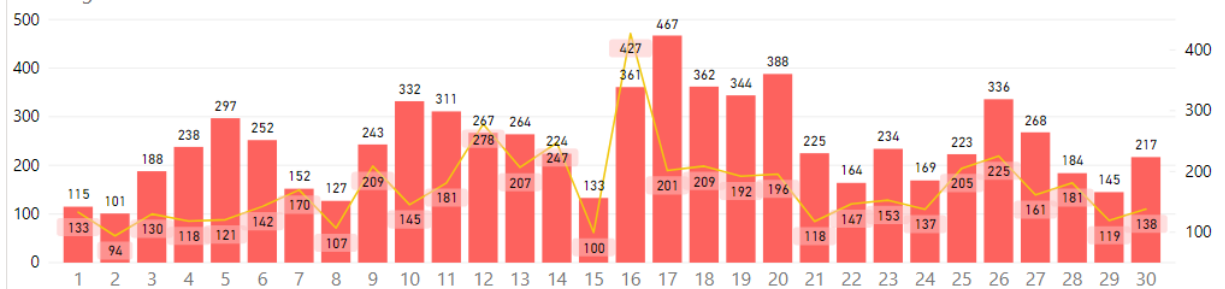

Regional Iporá – GO

TMAE e OE por Dia - Novembro 2020

● Contagem de Ocorrências ● TMAE

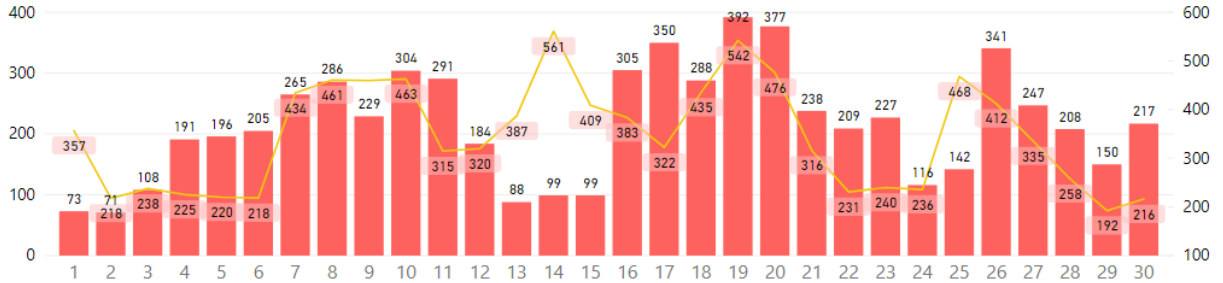

Regional Luziânia – GO

TMAE e OE por Dia - Novembro 2020

● Contagem de Ocorrências ● TMAE

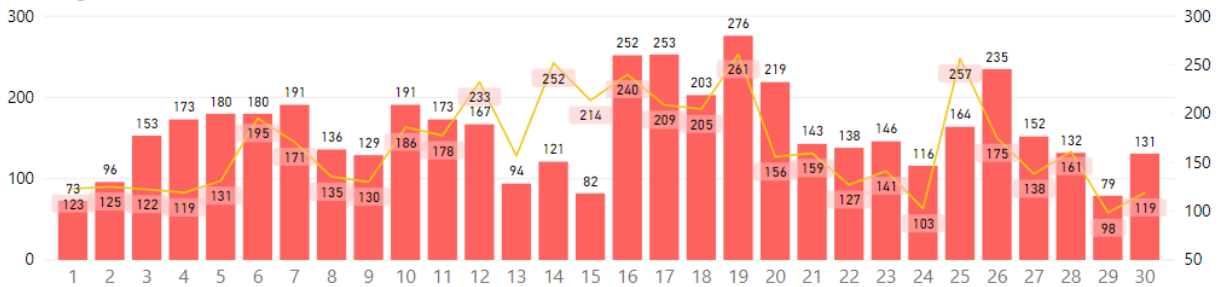

Regional Metropolitana – GO

TMAE e OE por Dia - Novembro 2020

● Contagem de Ocorrências ● TMAE

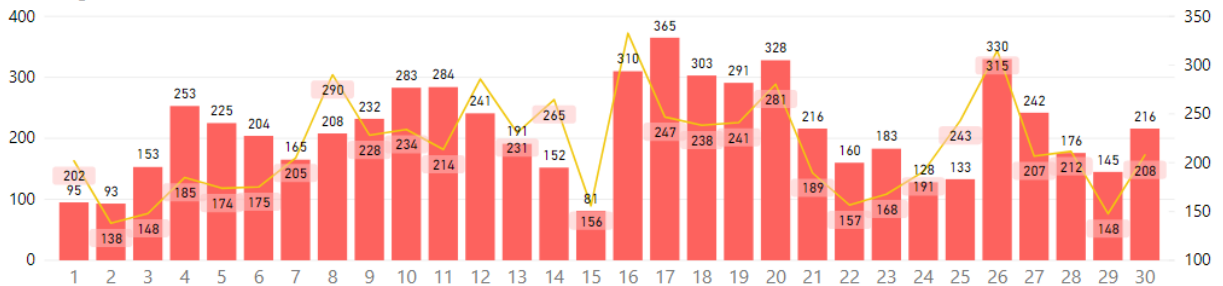

Regional Morrinhos – GO

TMAE e OE por Dia - Novembro 2020

● Contagem de Ocorrências ● TMAE

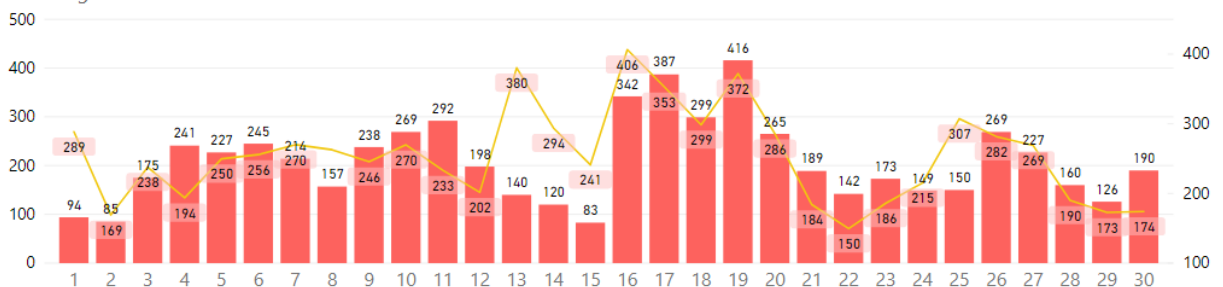

Regional Rio Verde – GO

TMAE e OE por Dia - Novembro 2020

● Contagem de Ocorrências ● TMAE

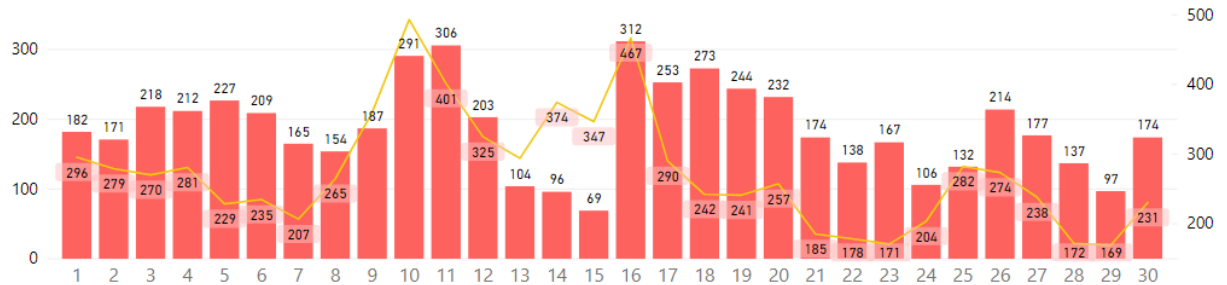

Regional Uruaçu - GO

TMAE e OE por Dia - Novembro 2020

● Contagem de Ocorrências ● TMAE

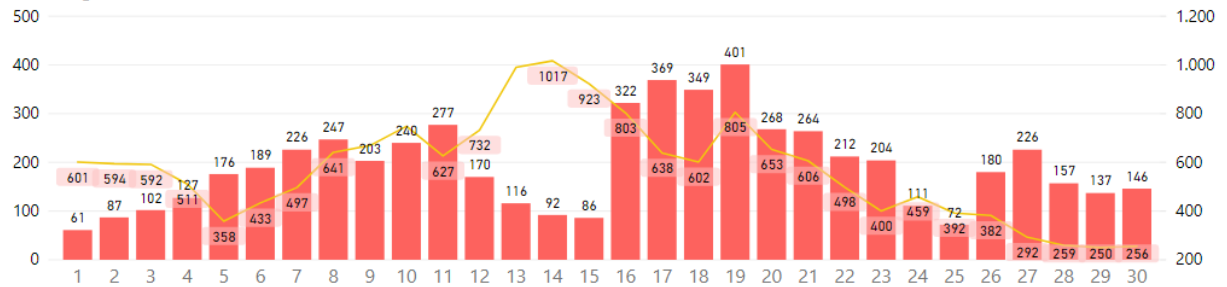

8.2. Dados climatológicos pelo INMET

Instituto Nacional de Meteorologia – INMET

Chuva Acumulada em 24h || Estação: ARAGARCAS (83368) – 11/2020

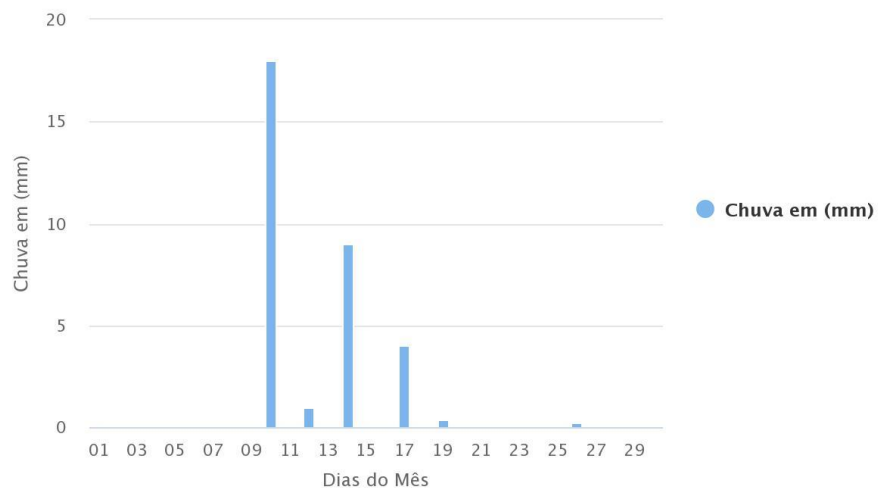

Instituto Nacional de Meteorologia – INMET

Chuva Acumulada em 24h || Estação: CATALAO (83526) – 11/2020

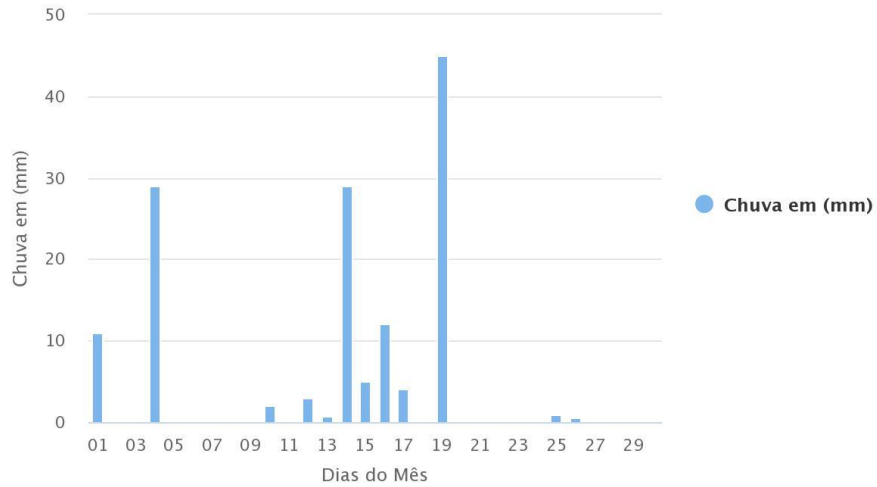

Highcharts.com

Instituto Nacional de Meteorologia – INMET

Chuva Acumulada em 24h || Estação: FORMOSA (83379) – 11/2020

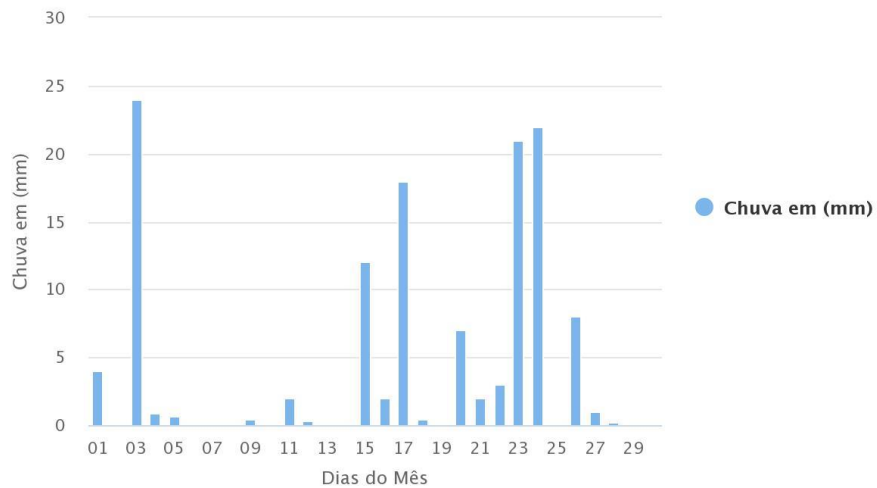

Highcharts.com

Instituto Nacional de Meteorologia – INMET

Chuva Acumulada em 24h || Estação: GOIANIA (83423) – 11/2020

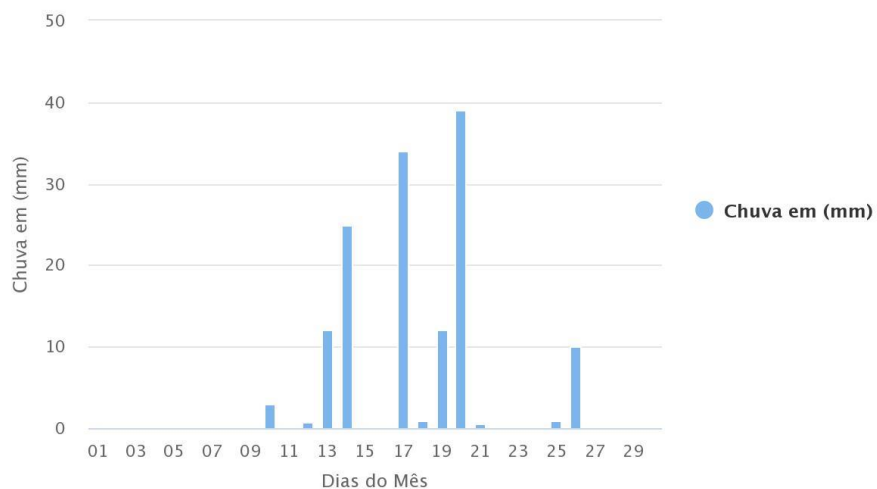

Highcharts.com

Instituto Nacional de Meteorologia – INMET

Chuva Acumulada em 24h || Estação: IPAMERI (83522) – 11/2020



Highcharts.com

Instituto Nacional de Meteorologia – INMET

Chuva Acumulada em 24h || Estação: PIRENOPOLIS (83376) – 11/2020

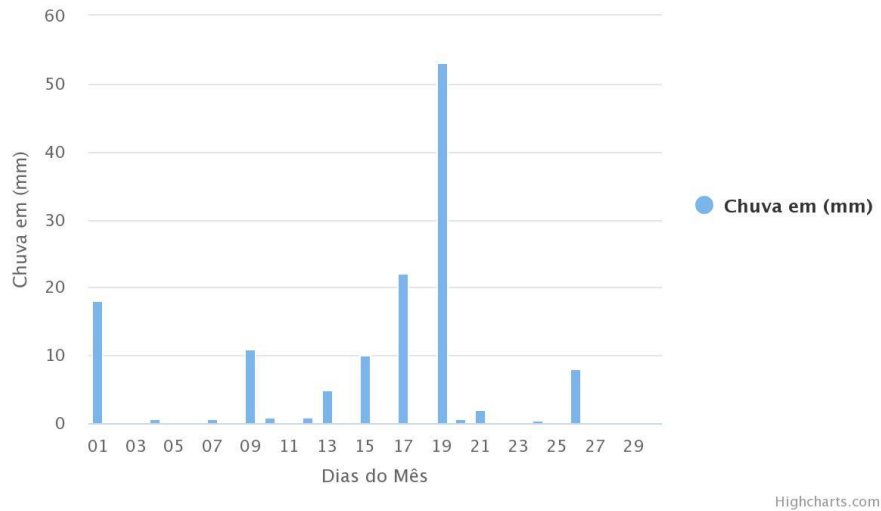

Highcharts.com

Instituto Nacional de Meteorologia – INMET

Chuva Acumulada em 24h || Estação: RIO VERDE (83470) – 11/2020

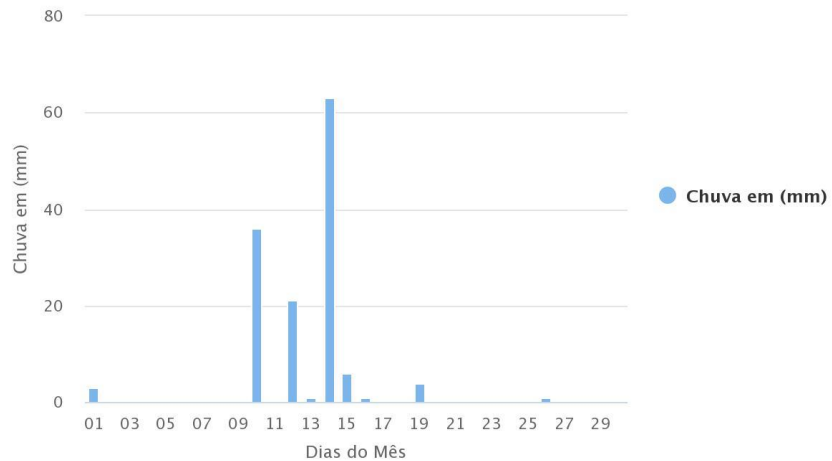

Highcharts.com

9. NOTÍCIAS RELACIONADAS

<https://globoplay.globo.com/v/9011222/>



<https://www.instagram.com/p/CHdyiqbFYee/>



<https://www.instagram.com/p/CHaHWpzlYT4/>

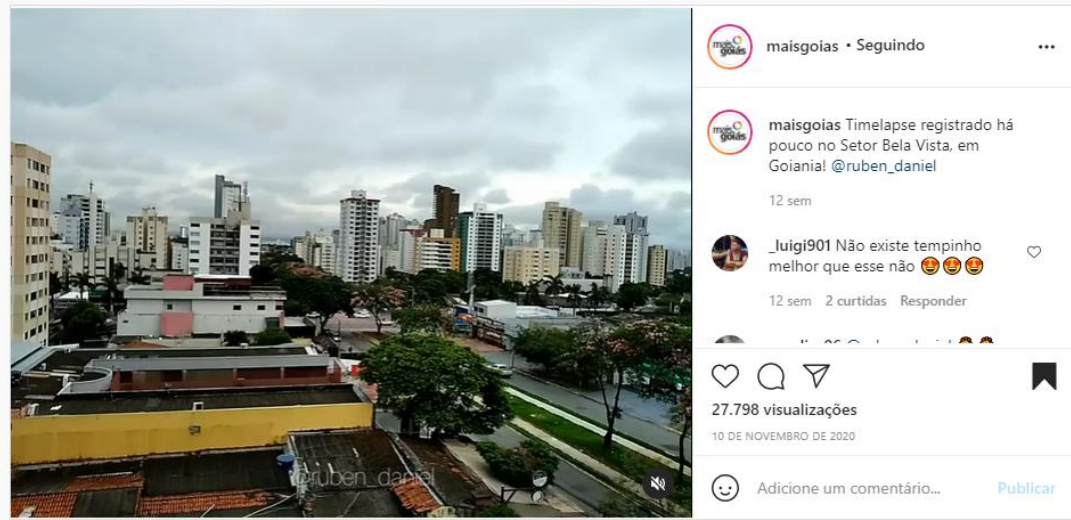

<https://www.instagram.com/p/CHdxwqMFwyh/>



Contingência Operacional

09/11 a 10/11

Regional Morrinhos



09/11 – OE – 31898– Cruzeta danificada

09/11 – OE – 34144 – Cabo Rompido na bucha fase B transformador

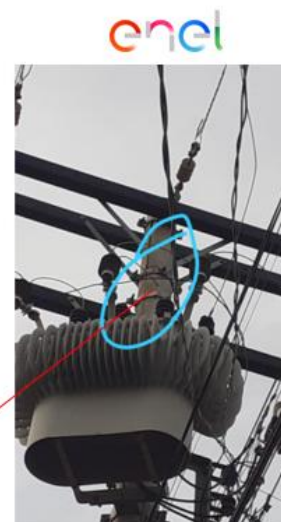

10. Laudo Técnico

CLIMATEMPO

**Laudo Meteorológico de Evento Climático
- ENEL Goiás - 09 de novembro de 2020**

São Paulo, SP, Brasil

Novembro de 2020

Sumário

1	ANÁLISE DE EVENTO METEOROLÓGICO.....	2
1.1	Descrição do Evento.....	2
1.2	Abrangência do Evento.....	5
2	CLASSIFICAÇÃO COBRADE.....	9
3	RESUMO DO EVENTO.....	10
4	REFERÊNCIAS.....	14
	ANEXOS.....	15

1. Análise de Evento Meteorológico

1.1. Descrição do Evento

Na figura a seguir é apresentada a área de concessão da ENEL DISTRIBUIÇÃO GOIÁS, dividida em regiões, a serem analisadas neste relatório.



Figura 1 – Regiões atendidas pela ENEL Goiás.

No dia 09 de novembro de 2020 uma massa de ar quente e úmido e a presença de uma área de baixa pressão sobre o continente predominavam as condições meteorológicas sobre o estado de Goiás. As condições eram favoráveis à formação de áreas de instabilidade sobre a área de concessão da ENEL GO.

Nas Figuras 2 e 3 são apresentadas as descargas atmosféricas nuvem-solo (raios) e nuvem-nuvem detectadas pelo sistema Earth Networks. Entre as 11h45 do dia 09 e 09h30 do dia 10 de novembro de 2020 foram registrados 3982 raios nuvem-solo e 17289 descargas nuvem-nuvem sobre a área da ENEL DISTRIBUIÇÃO GOIÁS.

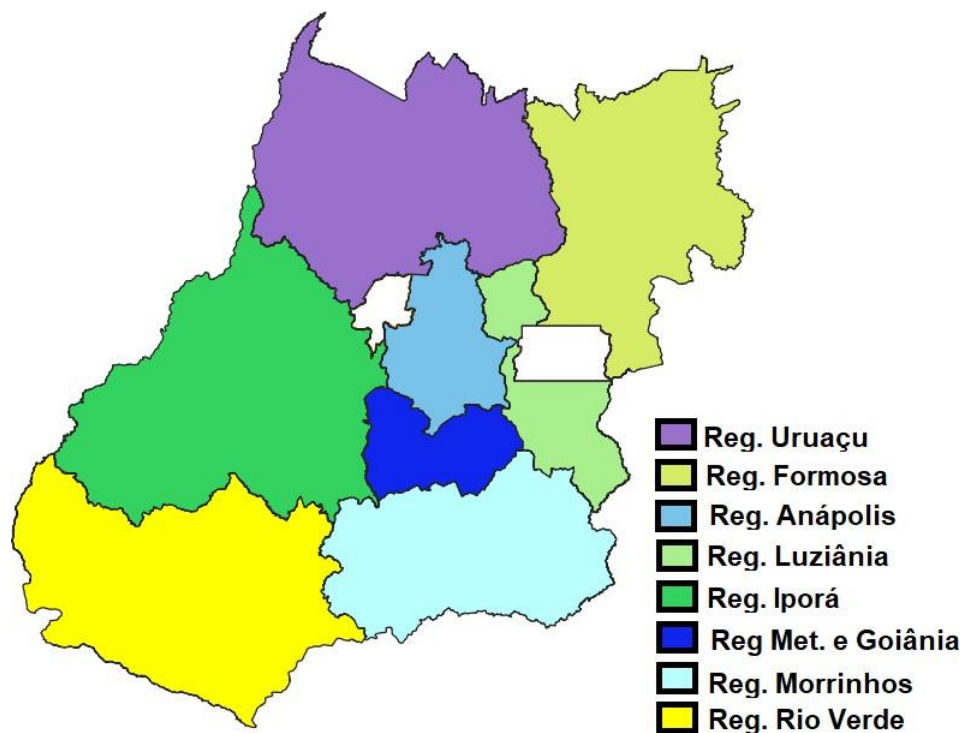

Figura 2 – Descargas atmosféricas nuvem-solo (em preto) detectadas pelo sistema Earth Networks entre 11h45 do dia 09 e 09h30 do dia 10 de novembro de 2020 sobre a área de concessão da ENEL DISTRIBUIÇÃO GOIÁS.

Na tabela 1 são apresentadas as rajadas de vento iguais ou superiores a 50 km/h registradas por estações do Instituto Nacional de Meteorologia (INMET) representativas da área de concessão da ENEL DISTRIBUIÇÃO GOIÁS. Como é possível observar, o maior valor registrado foi de 57,6 km/h na estação de Goiânia entre as 13h e 14h do dia 09 de novembro, vento classificado como vento forte pela escala Beaufort.

Tabela 1 – Rajadas de vento maiores ou iguais a 50 km/h registradas pelo INMET. Segundo a escala Beaufort, ventos entre 50 e 61 km/h são classificados como vento forte.

Estação	Horário	Rajada (km/h)
Goiânia	Entre 13h e 14h do dia 9/11/2020	57.6
Goiânia	Entre 14h e 15h do dia 9/11/2020	52.9
Paraúna	Entre 19h e 20h do dia 9/11/2020	51.5

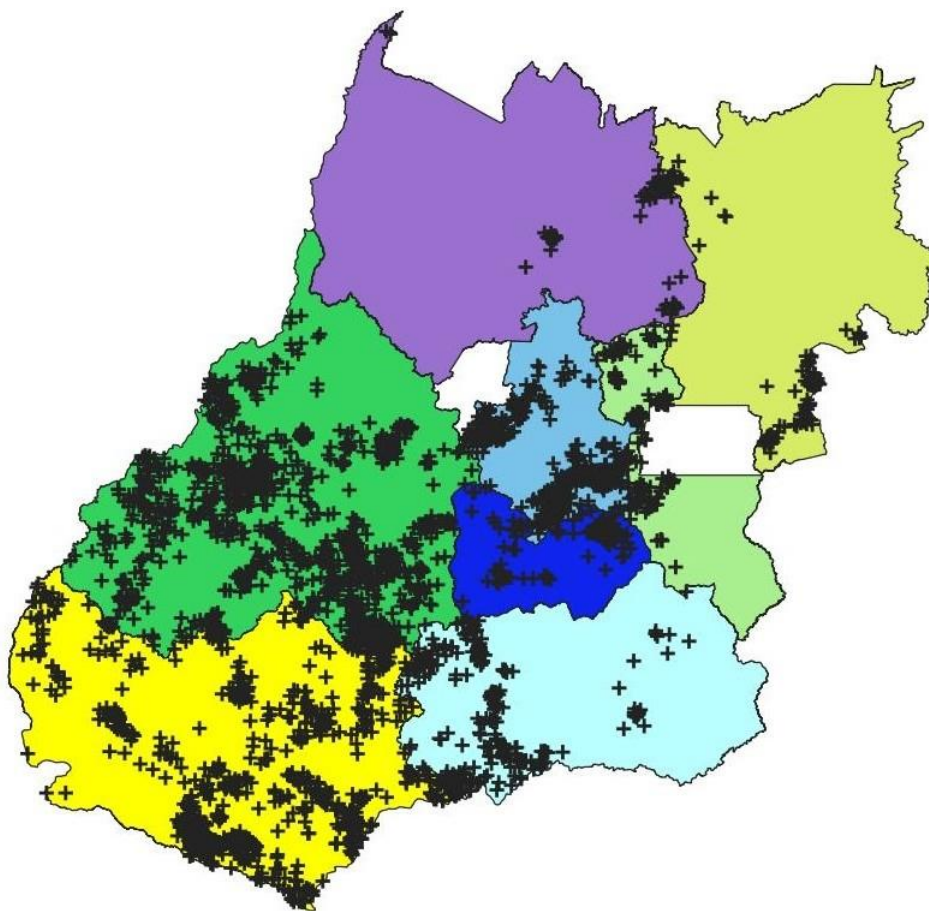

Figura 3 – Descargas atmosféricas nuvem-nuvem (em vermelho) detectadas pelo sistema Earth Networks entre 11h45 do dia 09 e 09h30 do dia 10 de novembro de 2020 sobre a área de concessão da ENEL DISTRIBUIÇÃO GOIÁS.

Estações do Instituto Nacional de Meteorologia (INMET), representativas da área de concessão da ENEL DISTRIBUIÇÃO GOIÁS, registraram chuva forte (segundo a American Meteorological Society - Sociedade Meteorológica Americana -, chuvas com taxa entre 2,5mm a 7,6 mm por hora são consideradas moderadas e aquelas com taxa superior a 7,6 mm por hora são consideradas chuva forte). Na tabela 2 são apresentados os registros de acumulados horários superiores a 7,6 mm.

Tabela 2 – Acumulado horário de chuva registrada pelo INMET.

Estação	Horário	Precipitação (mm)
Itumbiar a	Entre 20h e 21h do dia 9/11/2020	15.8
Aragarças	Entre 2h e 3h do dia 10/11/2020	12.4
Paraúna	Entre 3h e 4h do dia 10/11/2020	8.4

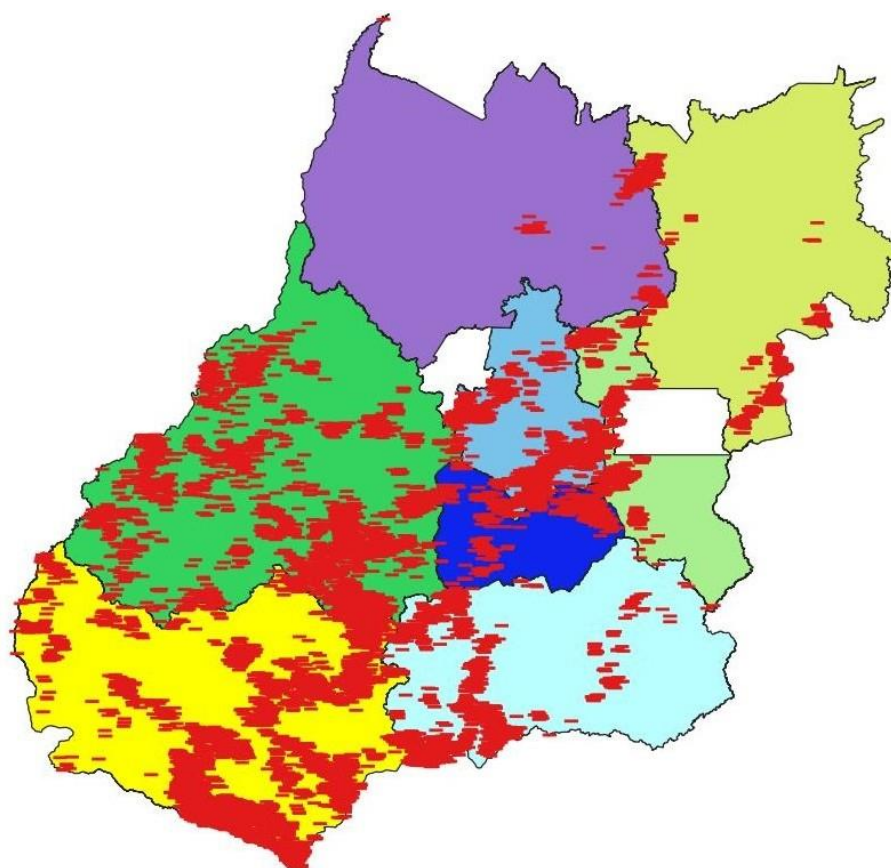
1.2. Abrangência do Evento

A seguir são apresentadas as imagens realçadas do satélite GOES-16 entre as 12h00 do dia 09 e 09h00 do dia 10 de novembro de 2020. Os tons em vermelho e preto indicam a presença de nuvens de grande desenvolvimento vertical, geralmente associadas à ocorrência de tempo severo.

12h00 - 09 de Novembro de 2020 - BRT



Figura 4 – Imagens realçadas do satélite GOES-16 das 12h00 do dia 09 de Novembro de 2020.
FONTE: Cptec/INPE.

15h00 - 09 de Novembro de 2020 - BRT



Figura 5 – Imagens realçadas do satélite GOES-16 das 15h00 do dia 09 de Novembro de 2020.
FONTE: Cptec/INPE.

18h00 - 09 de Novembro de 2020 - BRT



Figura 6 – Imagens realçadas do satélite GOES-16 das 18h00 do dia 09 de Novembro de 2020.
FONTE: Cptec/INPE.

21h00 - 9 de Novembro de 2020 - BRT

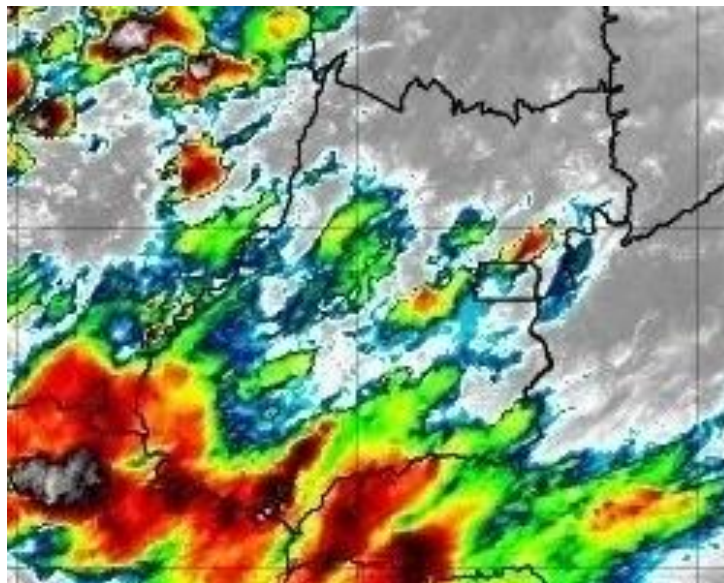

Figura 7 – Imagens realçadas do satélite GOES-16 das 21h00 do dia 9 de Novembro de 2020.
FONTE: Cptec/INPE.

0h00 - 10 de Novembro de 2020 - BRT

Figura 8 – Imagens realçadas do satélite GOES-16 das 0h00 do dia 10 de Novembro de 2020.
FONTE: Cptec/INPE.

3h00 - 10 de Novembro de 2020 - BRT

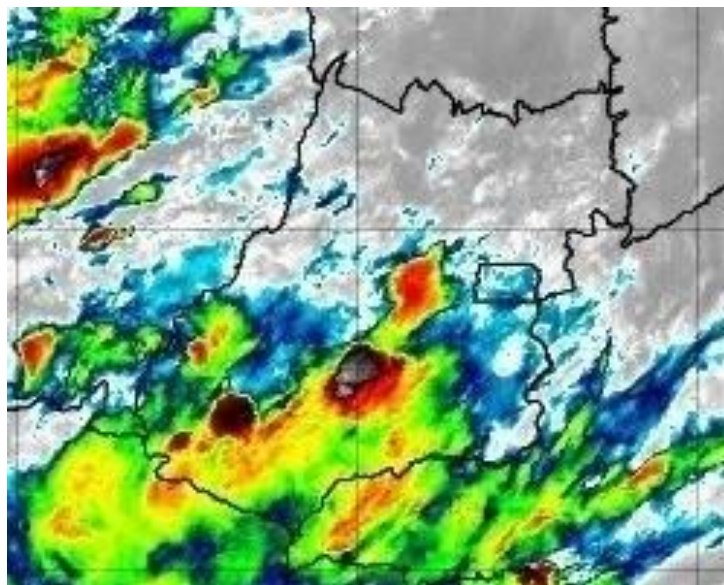
Figura 9 – Imagens realçadas do satélite GOES-16 das 3h00 do dia 10 de Novembro de 2020.
FONTE: Cptec/INPE.

6h00 - 10 de Novembro de 2020 - BRT

Figura 10 – Imagens realçadas do satélite GOES-16 das 6h00 do dia 10 de Novembro de 2020.
FONTE: Cptec/INPE.

9h00 - 10 de Novembro de 2020 - BRT

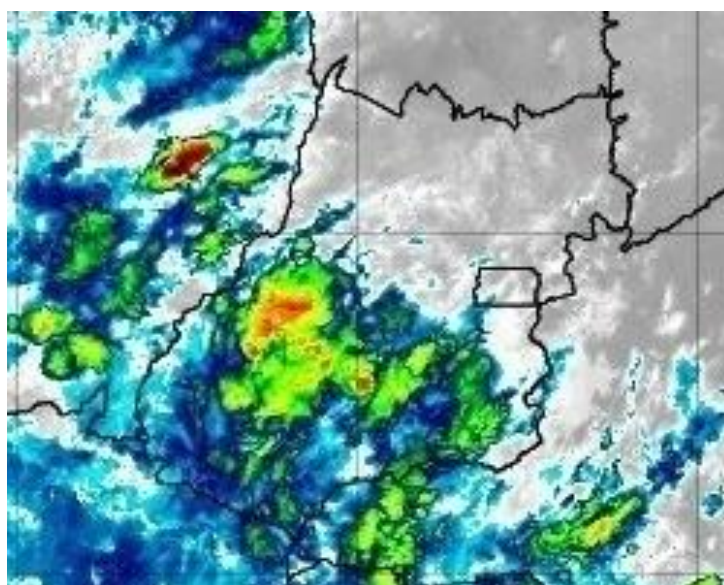
Figura 11 – Imagens realçadas do satélite GOES-16 das 9h00 do dia 10 de Novembro de 2020.
FONTE: Cptec/INPE.

2. Classificação COBRADE

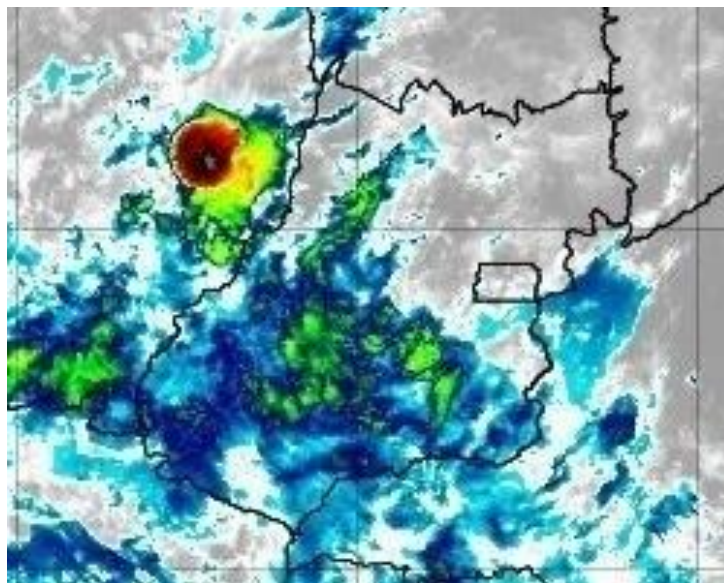
O COBRADE (Classificação e Codificação Brasileira de Desastres) foi criado com o intuito de adequar a classificação brasileira à classificação utilizada pela ONU na classificação de desastres e nivelar o país aos demais organismos de gestão de desastres do mundo.

Baseados nos dados analisados nos itens anteriores, podemos classificar o evento ocorrido sobre a área de concessão da ENEL Distribuição Goiás como Tempestade de Raios (Código 1.3.2.1.2), Chuvas Intensas (Código 1.3.2.1.4) e Vendaval (Código 1.3.2.1.5).

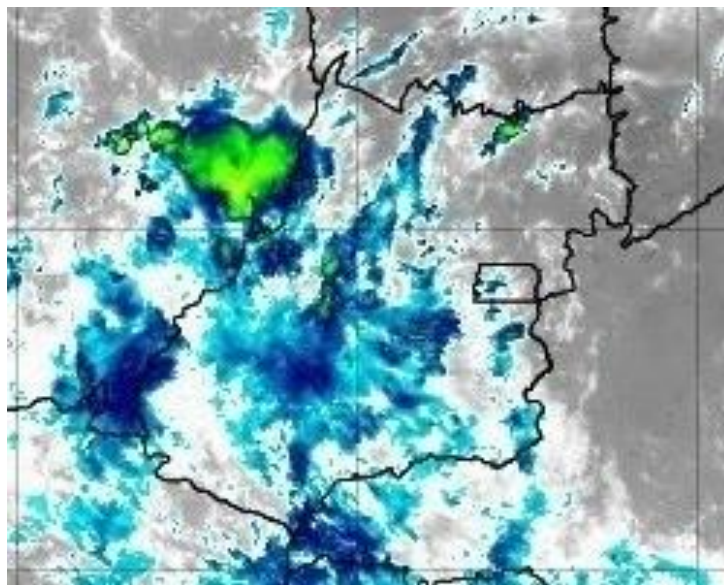
3. Resumo do Evento

Áreas de instabilidade associadas ao ar quente e úmido e reforçadas por uma área de baixa pressão favoreceram a formação de nuvens de tempestade que avançaram sobre o estado de Goiás entre a manhã do dia 09 e a manhã do dia 10 de novembro de 2020.

O sistema de detecção da Earth Networks registrou 21271 descargas atmosféricas sobre a área de concessão da ENEL em Goiás entre as 11h45 do dia 09 e 09h30 do dia 10 de novembro de 2020.

Rajadas de vento classificadas como vento forte pela escala Beaufort foram registrados em estações do INMET representativas da região durante o período. Na cidade de Goiânia rajadas de até 57,6 km/h foram registradas na tarde do dia 09 de novembro.

Chuva forte também foi registrada pelo INMET durante o evento. Em apenas uma hora a estação de Itumbiara acumulou 15,8 mm (chuvas com taxa superior a 7,6 mm por hora são consideradas chuva forte).

Tabela 3 – Resumo do evento Regional Rio Verde

Número/Código do Evento	
Número/Código do Relatório	
Descrição	Tempestade com intensa atividade elétrica no interior das nuvens, com grande desenvolvimento vertical. Chuvas que ocorrem com acumulados significativos. Forte deslocamento de uma massa de ar em uma região.
Código COBRADE	1.3.2.1.2 - Tempestade de Raios, 1.3.2.1.4 - Chuvas Intensas e 1.3.2.1.5 - Vendaval
Hora início do evento	13h30 do dia 09 de novembro de 2020
Hora fim do evento	03h00 do dia 10 de novembro de 2020
Abrangência	Regional Rio Verde

Tabela 4 – Resumo do evento Regional Morrinhos

Número/Código do Evento	
Número/Código do Relatório	
Descrição	Tempestade com intensa atividade elétrica no interior das nuvens, com grande desenvolvimento vertical. Chuvas que ocorrem com acumulados significativos. Forte deslocamento de uma massa de ar em uma região.
Código COBRADE	1.3.2.1.2 - Tempestade de Raios, 1.3.2.1.4 - Chuvas Intensas e 1.3.2.1.5 - Vendaval
Hora início do evento	15h45 do dia 09 de novembro de 2020
Hora de fim do evento	10h00 do dia 10 de novembro de 2020
Abrangência	Regional Morrinhos

Tabela 5 – Resumo do evento Regional Metropolitana e Goiânia

Número/Código do Evento	
Número/Código do Relatório	
Descrição	Tempestade com intensa atividade elétrica no interior das nuvens, com grande desenvolvimento vertical. Chuvas que ocorrem com acumulados significativos. Forte deslocamento de uma massa de ar em uma região.
Código COBRADE	1.3.2.1.2 - Tempestade de Raios, 1.3.2.1.4 - Chuvas Intensas e 1.3.2.1.5 - Vendaval
Hora início do evento	12h30 do dia 09 de novembro de 2020
Hora de fim do evento	02h30 do dia 10 de novembro de 2020
Abrangência	Regional Metropolitana e Goiânia

Tabela 6 – Resumo do evento Regional Iporá

Número/Código do Evento	
Número/Código do Relatório	
Descrição	Tempestade com intensa atividade elétrica no interior das nuvens, com grande desenvolvimento vertical. Chuvas que ocorrem com acumulados significativos. Forte deslocamento de uma massa de ar em uma região.
Código COBRADE	1.3.2.1.2 - Tempestade de Raios, 1.3.2.1.4 - Chuvas Intensas e 1.3.2.1.5 - Vendaval
Hora início do evento	12h00 do dia 09 de novembro de 2020
Hora de fim do evento	05h00 do dia 10 de novembro de 2020
Abrangência	Regional Iporá

Tabela 7 – Resumo do evento Regional Luziânia

Número/Código do Evento	
Número/Código do Relatório	
Descrição	Tempestade com intensa atividade elétrica no interior das nuvens, com grande desenvolvimento vertical. Chuvas que ocorrem com acumulados significativos. Forte deslocamento de uma massa de ar em uma região.
Código COBRADE	1.3.2.1.2 - Tempestade de Raios, 1.3.2.1.4 - Chuvas Intensas e 1.3.2.1.5 - Vendaval
Hora início do evento	12h00 do dia 09 de novembro de 2020
Hora de fim do evento	10h00 do dia 10 de novembro de 2020
Abrangência	Regional Luziânia

Tabela 8 – Resumo do evento Regional Anápolis

Número/Código do Evento	
Número/Código do Relatório	
Descrição	Tempestade com intensa atividade elétrica no interior das nuvens, com grande desenvolvimento vertical. Chuvas que ocorrem com acumulados significativos. Forte deslocamento de uma massa de ar em uma região.
Código COBRADE	1.3.2.1.2 - Tempestade de Raios, 1.3.2.1.4 - Chuvas Intensas e 1.3.2.1.5 - Vendaval
Hora início do evento	11h30 do dia 09 de novembro de 2020
Hora de fim do evento	09h00 do dia 10 de novembro de 2020
Abrangência	Regional Anápolis

Tabela 9 – Resumo do evento Regional Uruaçu

Número/Código do Evento	
Número/Código do Relatório	
Descrição	Tempestade com intensa atividade elétrica no interior das nuvens, com grande desenvolvimento vertical. Chuvas que ocorrem com acumulados significativos. Forte deslocamento de uma massa de ar em uma região.
Código COBRADE	1.3.2.1.2 - Tempestade de Raios, 1.3.2.1.4 - Chuvas Intensas e 1.3.2.1.5 - Vendaval
Hora início do evento	12h30 do dia 09 de novembro de 2020
Hora de fim do evento	09h30 do dia 10 de novembro de 2020
Abrangência	Regional Uruaçu

Tabela 10 – Resumo do evento Regional Formosa

Número/Código do Evento	
Número/Código do Relatório	
Descrição	Tempestade com intensa atividade elétrica no interior das nuvens, com grande desenvolvimento vertical. Chuvas que ocorrem com acumulados significativos. Forte deslocamento de uma massa de ar em uma região.
Código COBRADE	1.3.2.1.2 - Tempestade de Raios, 1.3.2.1.4 - Chuvas Intensas e 1.3.2.1.5 - Vendaval
Hora início do evento	12h30 do dia 09 de novembro de 2020
Hora de fim do evento	08h30 do dia 10 de novembro de 2020
Abrangência	Regional Formosa

4. Referências

- RMets Royal Meteorological Society – Beaufort Scale -
<https://www.rmets.org/weather-and-climate/observing/beaufort-scale>
- Instituto Nacional de Meteorologia (INMET) - <http://www.inmet.gov.br>
- Cptec/INPE
<https://www.cptec.inpe.br/>
- Centro de Hidrografia da Marinha do Brasil -
<https://www.marinha.mil.br/chm/>
- Meteorology Glossary - American Meteorological Society - <http://glossary.ametsoc.org/>

Anexos

A.1. Carta Sinótica



Figura A1 - Carta sinótica da Marinha do Brasil para as 1200Z do dia 09 de novembro de 2020 (09h00 do dia 09 de novembro de 2020, hora local).

A.2. Notícias associadas

- Temporal alaga imóveis em Anápolis <https://globoplay.globo.com/v/9011222/programa/>

Bianca Lobo Silva
Meteorologista
CREA 5063840461

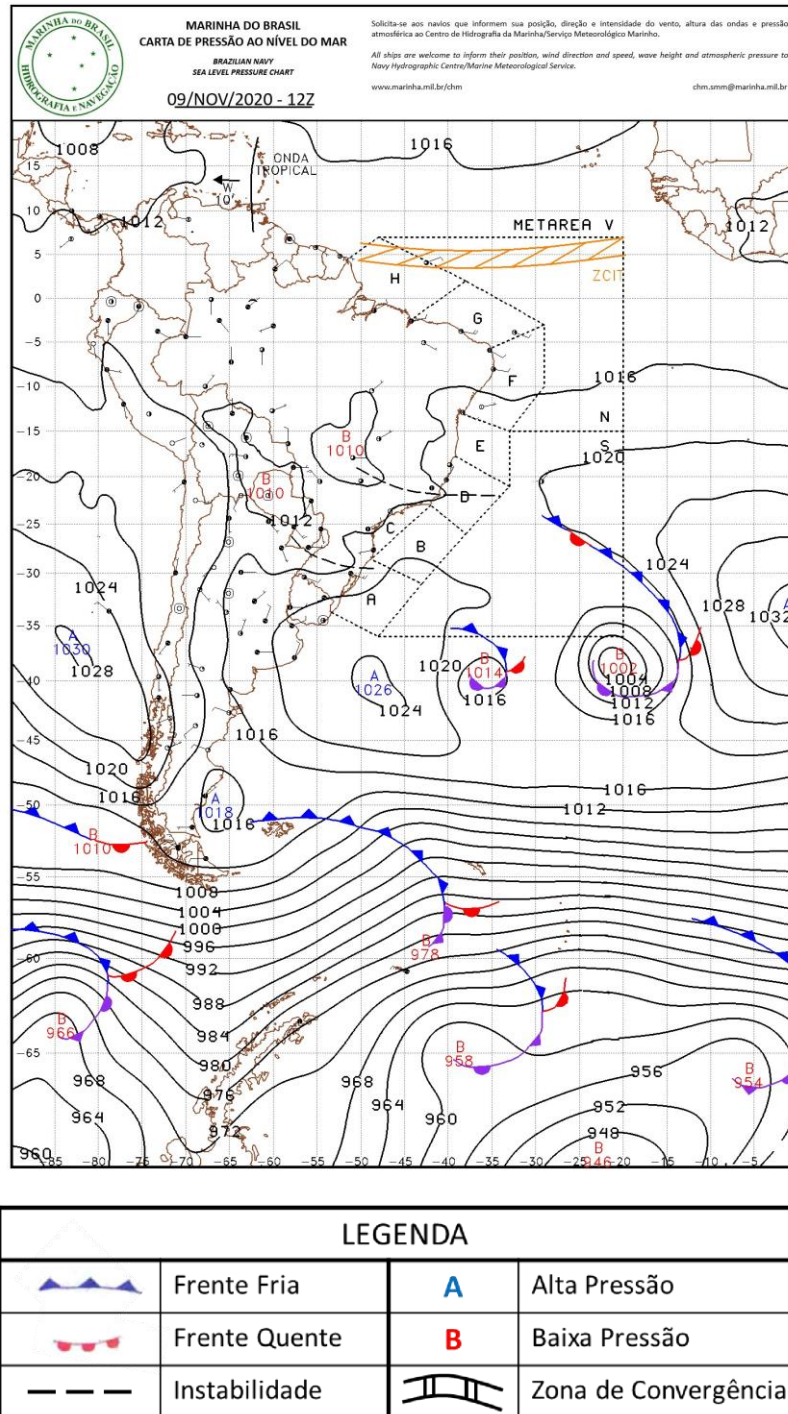