

## **ENEL DISTRIBUIÇÃO GOLÁS**



**Relatório de Evento em Situação de Emergência**

**Nº CHI-055**

1.	INTRODUÇÃO.....	3
2.	DEFINIÇÃO .....	3
3.	RESUMO EXECUTIVO.....	5
3.1.	RELATÓRIO DE OCORRÊNCIAS DO PERÍODO.....	5
4.	LISTA DE OCORRÊNCIAS .....	9
5.	PLOTAGEM DAS OCORRÊNCIAS CONFORME A ESPACIALIZAÇÃO DAS CHUVAS.....	157
6.	CLIENTES AFETADOS E IMPACTOS GLOBAIS .....	158
7.	DIAGRAMAS UNIFILARES .....	160
8.	DEMAIS EVIDÊNCIAS .....	166
8.1.	DADOS TÉCNICO - OPERACIONAIS ENEL GO.....	166
8.2.	DADOS CLIMATOLÓGICOS PELO INMET .....	168
9.	NOTÍCIAS RELACIONADAS.....	171
10.	LAUDO TÉCNICO .....	178

## 1. Introdução

As concessionárias do serviço público de distribuição de energia elétrica devem prover o serviço de forma adequada, buscando sempre a eficiência, conforme disposto na legislação e nos respectivos contratos de concessão.

Dentre a legislação vigente, destacam-se os Procedimentos de Distribuição de Energia Elétrica no Sistema Elétrico Nacional – PRODIST, que consistem em documentos elaborados pela Agência Nacional de Energia Elétrica – ANEEL, com a participação dos agentes de distribuição e de outras entidades e associações do setor elétrico nacional, que normatizam e padronizam as atividades técnicas relacionadas ao funcionamento e desempenho dos sistemas de distribuição de energia elétrica.

O Módulo 8 do PRODIST – Revisão 11, mais especificamente em sua Seção 8.2, regulamenta a qualidade do serviço prestado pelas distribuidoras de energia elétrica, estabelecendo a metodologia para apuração dos indicadores de continuidade e dos tempos de atendimento a ocorrências emergenciais.

O referido regulamento prevê que, na apuração dos indicadores coletivos e individuais deverão ser consideradas todas as interrupções de longa duração que atingirem as unidades consumidoras, admitidas algumas exceções (denominadas expurgos), que podem ser encontradas no Item 5.6.2.2 da seção 8.2 do Módulo 8 do PRODIST, transcrito abaixo:

*5.6.2.2 Na apuração dos indicadores DEC e FEC devem ser consideradas todas as interrupções, admitidas apenas as seguintes exceções:*

*i. falha nas instalações da unidade consumidora que não provoque interrupção em instalações de terceiros;*

*ii. interrupção decorrente de obras de interesse exclusivo do consumidor e que afete somente a unidade consumidora do mesmo;*

**iii. Interrupção em Situação de Emergência;**

*iv. suspensão por inadimplemento do consumidor ou por deficiência técnica e/ou de segurança das instalações da unidade consumidora que não provoque interrupção em instalações de terceiros, previstas em regulamentação;*

*v. vinculadas a programas de racionamento instituídos pela União;*

*vi. ocorridas em Dia Crítico;*

*vii. oriundas de atuação de Esquema Regional de Alívio de Carga estabelecido pelo ONS. [grifos nossos]*

Para os casos de expurgo por Interrupção em Situação de Emergência (ISE), a alínea “h” do Item 5.12.1 da seção 8.2 do Módulo 8 do PRODIST estabelece a obrigatoriedade das distribuidoras em disponibilizar, em seu sítio eletrônico, relatórios digitais com as evidências do evento que tenha gerado tais interrupções enquadradas no inciso iii do Item 5.6.2.2 do mesmo.

Nesta seara, o presente documento, visa apresentar as evidências de um evento ocorrido na área de concessão da Eletropaulo, bem como informações relevantes a respeito das interrupções em Situação de Emergência decorrentes do mesmo.

Destaca-se que, para o entendimento completo das regras de apuração dos indicadores de continuidade e expurgos, faz-se necessário também a observação das regras contidas nos Módulos 1 e 6 do PRODIST. Todos os módulos destes procedimentos encontram-se disponíveis para consulta no site da ANEEL ([www.aneel.gov.br](http://www.aneel.gov.br)) e as principais definições relacionadas ao tema estão contidas no item 2 deste documento.

## 2. Definição

Seção 1.2 do Módulo 1 do PRODIST – Revisão 10

### **2.198 Evento**

Acontecimento que afete as condições normais de funcionamento de uma rede elétrica, podendo gerar uma ou mais interrupções no fornecimento de energia.

**2.131 e 2.158 DIC**

Duração de interrupção individual por unidade consumidora, ou seja, intervalo de tempo que, no período de apuração, em cada unidade consumidora ou ponto de conexão ocorreu descontinuidade da distribuição de energia elétrica.

**2.216 e 2.220 FIC**

Frequência de interrupção individual por unidade consumidora, ou seja, Número de interrupções ocorridas, no período de apuração, em cada unidade consumidora ou ponto de conexão.

**2.87 Consumidor Hora Interrompido (CHI):**

Somatório dos DICs dos consumidores atingidos por interrupção no fornecimento de energia, expresso em horas e centésimos de horas.

**2.251 Interrupção em Situação de Emergência:**

Interrupção originada no sistema de distribuição, resultante de Evento que comprovadamente impossibilite a atuação imediata da distribuidora e que não tenha sido provocada ou agravada por esta e que seja:

- Decorrentes de evento associado a Decreto de Declaração de Situação de Emergência ou Estado de Calamidade Pública emitido por órgão competente; ou
- Decorrentes de Evento cuja soma do CHI das interrupções ocorridas no sistema de distribuição seja superior ao calculado conforme equação a seguir:

$$2.612 \times N^{0,35}$$

N – número de unidades consumidoras faturadas e atendidas em BT ou MT, com 2 (duas) casas decimais, do mês de outubro do ano anterior ao período de apuração



### 3. Resumo Executivo

O Presente Relatório tem como objetivo a incorporação de informações que sejam relevantes para que se possa fazer a devida associação aos dados contidos no documento objeto da classificação de Situação de Emergência caracterizada pelo Módulo 8 do Prodist. Este enquadramento se apresenta na maioria das vezes em condições climáticas adversas com severidade dos fatores inerentes a situação, caracterizado na maioria dos casos por fortes ventos e chuvas de grande intensidade e continuidade.

A partir do final da manhã do dia 12/11/2020 – quinta-feira – Nuvens de tempestade associadas a passagem de um cavado atmosférico, formando áreas de baixa pressão e convergência de umidade, avançaram sobre o estado de Goiás, provocando chuva significativa, descargas elétricas atmosféricas e vento forte na área de concessão da ENEL GO.

Conforme informações do Climatempo Meteorologia, o Instituto Nacional de Meteorologia (INMET) detectou rajadas de vento acima de 50km/h registradas por estações representativas da área de concessão da ENEL Distribuição Goiás. Na estação de Caiapônia, o maior valor registrado foi de 61,9 km/h entre as 16h e 17h do dia 14 de novembro de 2020, classificada como vento forte, segundo a escala Beaufort.

O sistema de detecção da EarthNetworks registrou 241.363 descargas atmosféricas (59.531 nuvem-solo e 181.832 nuvem-nuvem) sobre a área de concessão da ENEL em Goiás entre as 10h00 do dia 12 de novembro de 2020 e 04h10 do dia 16 de novembro de 2020, causando grande instabilidade na rede.

Chuva forte foi registrada pelo INMET em estações representativas da área de concessão da ENEL Distribuição Goiás. Na estação de Silvânia foram acumulados 96,0 mm de chuva entre as 09h do dia 12 e as 09h do dia 14 de novembro de 2020, aproximadamente 48% da média climatológica para o mês na região.

#### 3.1. Relatório de Ocorrências do período

Em todo o Estado de Goiás verificou-se também que a intensidade da chuva e dos ventos danificaram a rede de distribuição de energia elétrica em diversos pontos, registrando aproximadamente 542 mil clientes com interrupção no fornecimento de energia elétrica devido a eventos relacionados ao temporal, afetando 245 municípios e 324 Subestações.

Para otimizar o volume de atendimentos e reduzir os tempos de interrupção foram mobilizados os recursos extras da empresa que aumentou o contingente em relação a situação normal de operação. O acompanhamento da quantidade de equipes e o Tempo Médio de Atendimento podem ser consultados na Pág.08 do Relatório em anexo.

O impacto e severidade do evento estão relatados em artigos de mídia, como fotos e reportagens que demonstram os danos na Rede de Distribuição, oriundos dos eventos climáticos no período. Eventos estes que afetaram 541.553 consumidores com CHI de 1.555.775,35 superior ao de 482.597,74 estabelecido como limite para definição de Situação de Emergência, conforme resumo das informações obrigatórias.

<b>Empresa</b>		ENEL DISTRIBUIÇÃO GOIÁS			
<b>Código do Relatório</b>		CHI-055 - ENEL DISTRIBUIÇÃO GOIÁS			
<b>Evento:</b>		TEMPORAL NA AREA DE CONCESSÃO DA ENEL DISTRIBUIÇÃO GOIAS			
<b>Código COBRADE:</b>	1.3.1.2.0	<b>Data Início</b>	12/11/2020	<b>Hora início</b>	10h00
<b>Código do Evento:</b>	CHI-055-ENEL GO	<b>Data Término</b>	16/11/2020	<b>Hora Término</b>	08h59
<b>Valor CHI (Limite e Real)</b>	482.597,74	1.555.775,35			
<b>Código do Decreto (Se Houver):</b>					
<b>Quantidade de Interrupções (Evento)</b>	7.506				
<b>Início 1ª Incidência (Data e Hora)</b>	12/11/2020 10:00		<b>Subestações Atingidas</b>	ABADIANIA / ABC / ACREUNA / ADELANDIA / AEROPORTO / AGUA LIMPA (MARZAGAO) / AGUAS LINDAS / ALEXANIA / ALEXANIA TRANSMISSAO / ALMERINDONOPOLIS / ALOANDIA / ALPHAVILLE / ALTO BURITI / ALTO HORIZONTE / ALTO PARAISO DE GOIAS / ALVORADA DO NORTE / AMERICANO ( RIO VERDE ) / AMERICANO DO BRASIL / AMORINOPOLIS / ANAPOLIS UNIVERSITARIA / ANHANGUERA / ANICUNS / ANTONIO DO VITTO / APARECIDA DO RIO DOCE / APORE / ARACU / ARAGARCAS / ARAGOIANA / ARAGUAPAZ / ARARAS / AREIAS / ARENOPOLIS / ARUANA / ARUANA (TRANSMISSAO) / ASA BRANCA / ATLANTICO / AURILANDIA / AVELINOPOLIS / BACURI (RIO VERDE) / BARBOSELANDIA / BARCELONA / BARREIRO (PORANGATU) / BARRO ALTO / BELA VISTA (TRANSMISSAO) / BOA VISTA / BOM JARDIM / BOM JESUS DE GOIAS / BONFINOPOLIS / BONITO / BONOPOLIS / BRAZABRANTES / BRITANIA / BRITANIA (TRANSMISSAO) / BURITI ALEGRE / BURITI DE GOIAS / BURITIZINHO / CABECEIRAS / CABRIUVA (RIO VERDE) / CACHOEIRA ALTA / CACHOEIRA DOURADA / CACHOEIRA NOVA / CACHOEIRINHA (ITARUMA) / CACU / CAIAPONIA / CALCILANDIA / CALDAS NOVAS / CALDAZINHA / CAMPESTRE / CAMPINAS / CAMPINORTE / CAMPO ALEGRE DE GOIAS / CAMPO LIMPO DE GOIAS / CAMPO NOVO / CAMPOS BELOS / CAMPOS VERDES / CARAIBAS / CARAJAS / CASTELANDIA / CATALAO / CATURAI / CEBRASA FABRICA DA AMBEV / CEMAT/BALIZA / CEPALGO / CEZARINA / CHAPADAO DO CEU / CIDADE OCIDENTAL / COCALZINHO / COLINACU / CORREGO DO OURO / CORUMBA / CORUMBAIBA / CRISTALINA / CRISTALINA TRANSMISSAO / CRISTIANOPOLIS / CRIXAS / CROMINIA / CUMARI / DAIA - ANAPOLIS / DAMOLANDIA / DAVINOPOLIS / DESFECHO / DESTILARIA ALTO PARAISO / DESTILARIA BRASIL CENTRAL / DIMIC / DIORAMA / DORCELINO PEIXOTO DE MORAES / DOVERLANDIA / EDEALINA / EDEIA / ENERSUL / ESTANIFERA / ESTRELA DO NORTE / FAINA / FAZENDA CANADA / FAZENDA NOVA / FERROVIARIO / FIRMINOPOLIS / FLORES DE GOIAS / FORMIGA / FORMOSO / FRONTEIRA / GAMELEIRA / GIRASSOL / GOIANAPOLIS / GOIANDIRA / GOIANESIA / GOIANIA LESTE / GOIANIRA / GOIAS / GOIATUBA / GOUVERLANDIA / GOYA / GUAPO / HEITORAI / HIDROLANDIA / HIDROLINA / IACIARA / INDEPENDENCIA / INDIARA / INHUMAS / IPAMERI / IPEGUARI / IPORA / ISRAELANDIA / ITABERAI / ITAGUARI / ITAGUARU / ITAJA / ITAPACI / ITAPACI (TRANSMISSAO) / ITAPIRAPUA / ITAPURANGA / ITAPURANGA (TRANSMISSAO) / ITARUMA / ITAUCU / ITIQUIRA (FORMOSA) / ITUMBIARA NOVA / ITUMBIARA VELHA / JACILANDIA / JANDAIA / JARAGUA / JARANAPOLIS / JATAI / JAUPACI / JESUPOLIS / JOVIANIA / JUNDIAI / JURUMIRIM / JUSCELANDIA / JUSSARA / LAGES / LAGOA DA SERRA / LAGOA DO BAUZINHO (RIO VERDE) / LEOPOLDO DE BULHOES / LUZIANIA / MAIRIPOTABA / MAMBAI / MARA ROSA / MARAJOARA / MARCIANOPOLIS / MARIAPOLIS (PADRE BERNARDO) / MARZAGAO / MATO GRANDE / MATRINCHA / MAURILANDIA / MEIA PONTE / MINACU / MINEIROS / MINEIROS TRANSMISSAO / MOIPORA / MONTE ALEGRE / MONTES CLAROS DE GOIAS / MONTIVIDIU T / MORRINHOS / MORRO AGUDO / MOSSAMEDES / MOZARLANDIA / MOZARLANDIA (TRANSMISSAO) / MUNDO NOVO DE GOIAS / MUTUNOPOLIS / NAVESLANDIA ( JATAI ) / NAZARIO / NEROPOLIS / NIQUELANDIA / NIQUELANDIA 69KV / NOVA AMERICA / NOVA AURORA / NOVA CRIXAS (TRANSMISSAO) / NOVA IGUACU / NOVA PONTE / NOVA VENEZA / NOVO BRASIL / NOVO GAMA / NOVO PLANALTO / OLHOS DAGUA / OLOANA / ORIZONA / OURO VERDE DE GOIAS / OUVIDOR / PACAEMBU (NOVO GAMA) / PADRE BERNARDO / PALESTINA / PALMEIRAS / PALMEIRAS DE GOIAS / PALMELO / PALMINOPOLIS / PAMPLONA / PANAMA / PARANA / PARANAIBA / PARANAIGUARA / PARAUNA SE ALTA TENSAO / PARQUE DAS EMAS (MINEIROS) / PARQUE DAS NACOES / PEROLANDIA / PETROLINA / PILAR / PILOANDIA / PIRACANJUBA / PIRANHAS T / PIRENOPOLIS / PIRES BELO / PIRES DO RIO / PLANALTINA / PLANALTINA (TRANSMISSAO) / PLANALTO / PONTALINA / PORANGATU / PORTEIRAO / PORTELANDIA / POSSE / POSSELANDIA / PROFESSOR JAMIL / QUEBRA LINHA / QUIRINOPOLIS / REAL / RETIRO / GOIAS / RIO CLARO JATAI MONTIVIDIU / RIO DO PEIXE / RIO DOS BOIS (MAURILANDIA) / RIO PRETO / RIO QUENTE / RIO VERDE / RIO VERMELHO / RIVERLANDIA (RIO VERDE) / ROCHEDO (UEH) / RUBIATABA / SANCLERLANDIA / SANTA BARBARA / SANTA FE DE GOIAS / SANTA HELENA / SANTA RITA DO ARAGUAIA / SANTA ROSA / SANTA ROSA DE GOIAS / SANTA ROSA DO MEIA PONTE / SANTA TEREZA DE GOIAS / SANTA TEREZINHA / SANTANA / SANTO ANTONIO DA BARRA / SANTO ANTONIO DE GOIAS / SANTO ANTONIO DO DESCOBERTO / SAO	

			BARTOLOMEU / SAO DOMINGOS / SAO FRANCISCO DE GOIAS / SAO GABRIEL DE GOIAS / SAO JOAO D ALIANCA / SAO JOAO DA PARAUNA / SAO LUIZ DOS MONTES BELOS / SAO MIGUEL DO ARAGUAIA / SAO MIGUEL DO PASSA QUATRO / SAO SIMAO / SENADOR CANEDO TRANSMISSAO / SERRA AZUL (JATAI) / SERRA DE CALDAS / SERRANOPOLIS / SILVANIA / SOUZALANDIA / SUCURI / TAIOBA / TAQUARAL / TAQUARI / TEREZOPOLIS / TERRA VERMELHA / TRAJANOPOLIS (PADRE BERNARDO) / TRES BARRAS / TRES RANCHOS / TRINDADE / TURVANIA / TURVELANDIA / URU / URUACU / URUTAI / USINA DE ACUCAR DE GOIANESIA / VALPARAISO / VARJAO / VENDA SECA / VIANOPOLIS / VICENTINOPOLIS / VILA BOA / VILA CORUMBA / VILA PROPICIO / XAVANTES / XIXA / ZELANDIA
<b>Início Última Incidência (Data e Hora)</b>	16/11/2020 08:59		
<b>Média de Duração das Incidências (h)</b>	7,56		
<b>Duração da Incidência mais longa (h)</b>	100,82		
<b>Total de Clientes afetados</b>	541.553	<b>Municípios Atingidos</b>	ABADIA DE GOIAS / ABADIANIA / ACREUNA / ADELANDIA / AGUA FRIA DE GOIAS / AGUA LIMPA / AGUAS LINDAS DE GOIAS / ALEXANIA / ALOANDIA / ALTO HORIZONTE / ALTO PARAISO DE GOIAS / ALVORADA DO NORTE / AMARALINA / AMERICANO DO BRASIL / AMORINOPOLIS / ANAPOLIS / ANHANGUERA / ANICUNS / APARECIDA DE GOIANIA / APARECIDA DO RIO DOCE / APORE / ARACU / ARAGARCAS / ARAGOIANIA / ARAGUAPAZ / ARENOPOLIS / ARUANA / AURILANDIA / AVELINOPOLIS / BALIZA / BARRO ALTO / BELA VISTA DE GOIAS / BOM JARDIM DE GOIAS / BOM JESUS DE GOIAS / BONFINOPOLIS / BONOPOLIS / BRAZABRANTES / BRITANIA / BURITI ALEGRE / BURITI DE GOIAS / BURITINOPOLIS / CABECEIRAS / CACHOEIRA ALTA / CACHOEIRA DE GOIAS / CACHOEIRA DOURADA / CACU / CAIAPONIA / CALDAS NOVAS / CALDAZINHA / CAMPESTRE DE GOIAS / CAMPINACU / CAMPINORTE / CAMPO ALEGRE DE GOIAS / CAMPO LIMPO / CAMPOS BELOS / CAMPOS VERDES / CARMO DO RIO VERDE / CASTELANDIA / CATALAO / CATURAI / CAVALCANTE / CERES / CEZARINA / CHAPADAO DO CEU / CIDADE OCIDENTAL / COCALZINHO DE GOIAS / COLINAS DO SUL / CORREGO DO OURO / CORUMBA DE GOIAS / CORUMBAIBA / CRISTALINA / CRISTIANOPOLIS / CRIXAS / CROMINIA / CUMARI / DAMIANOPOLIS / DAMOLANDIA / DAVINOPOLIS / DIORAMA / DISTRITO FEDERAL / DIVINOPOLIS DE GOIAS / DOVERLANDIA / EDEALINA / EDEIA / ESTRELA DO NORTE / FAINA / FAZENDA NOVA / FIRMINOPOLIS / FLORES DE GOIAS / FORMOSA / FORMOSO / GAMELEIRA DE GOIAS / GOIANAPOLIS / GOIANDIRA / GOIANESIA / GOIANIA / GOIANIRA / GOIAS / GOIATUBA / GOUVELANDIA / GUAPO / GUARAITA / GUARANI DE GOIAS / GUARINOS / HEITORAI / HIDROLANDIA / HIDROLINA / IACIARA / INACIOLANDIA / INDIARA / INHUMAS / IPAMERI / IPIRANGA DE GOIAS / IPORA / ISRAELANDIA / ITABERAI / ITAGUARI / ITAGUARU / ITAJA / ITAPACI / ITAPIRAPUA / ITAPURANGA / ITARUMA / ITAUCU / ITUMBIARA / IVOLANDIA / JANDAIA / JARAGUA / JATAI / JAUPACI / JESUPOLIS / JOVIANIA / JUSSARA / LAGOA SANTA / LEOPOLDO DE BULHOES / LUZIANIA / MAIRIPOTABA / MAMBAI / MARA ROSA / MARZAGAO / MATRINCHA / MAURILANDIA / MIMOSO DE GOIAS / MINACU / MINEIROS / MOIPORA / MONTE ALEGRE DE GOIAS / MONTES CLAROS DE GOIAS / MONTIVIDIU / MONTIVIDIU DO NORTE / MORRINHOS / MORRO AGUDO DE GOIAS / MOSSAMEDES / MOZARLANDIA / MUNDO NOVO DE GOIAS / MUTUNOPOLIS / NAZARIO / NEROPOLIS / NIQUELANDIA / NOVA AMERICA / NOVA AURORA / NOVA CRIXAS / NOVA GLORIA / NOVA IGUACU DE GOIAS / NOVA ROMA / NOVA VENEZA / NOVO BRASIL / NOVO GAMA / NOVO PLANALTO / ORIZONA / OURO VERDE DE GOIAS / OUVIDOR / PADRE BERNARDO / PALESTINA DE GOIAS / PALMEIRAS DE GOIAS / PALMELO / PALMINOPOLIS / PANAMA / PARANAIGUARA / PARAUNA / PEROLANDIA / PETROLINA DE GOIAS / PILAR DE GOIAS / PIRACANJUBA / PIRANHAS / PIRENOPOLIS / PIRES DO RIO / PLANALTINA / PONTALINA / PORANGATU / PORTEIRAO / PORTELANDIA / POSSE / PROFESSOR JAMIL SAFADY / QUIRINOPOLIS / RIALMA / RIO QUENTE / RIO VERDE / RUBIATABA / SANCLERLANDIA / SANTA BARBARA DE GOIAS / SANTA CRUZ DE GOIAS / SANTA FE DE GOIAS / SANTA HELENA DE GOIAS / SANTA ISABEL / SANTA RITA DO ARAGUAIA / SANTA RITA DO NOVO DESTINO / SANTA ROSA DE GOIAS / SANTA TEREZA DE GOIAS / SANTA TEREZINHA DE GOIAS / SANTO ANTONIO DA BARRA / SANTO ANTONIO DE GOIAS / SANTO ANTONIO DO DESCOBERTO / SAO DOMINGOS / SAO FRANCISCO DE GOIAS / SAO JOAO D ALIANCA / SAO JOAO DA PARAUNA / SAO LUIS DE MONTES BELOS / SAO LUIZ DO NORTE / SAO MIGUEL DO ARAGUAIA / SAO MIGUEL DO PASSA QUATRO / SAO PATRICIO / SAO SIMAO / SENADOR CANEDO / SERRANOPOLIS / SILVANIA / SIMOLANDIA / SITIO D ABADIA / TAQUARAL DE GOIAS / TERESINA DE GOIAS / TEREZOPOLIS DE GOIAS / TRES RANCHOS / TRINDADE / TROMBAS / TURVANIA / TURVELANDIA / UIRAPURU / URUACU / URUTAI / VALPARAISO DE GOIAS / VARJAO / VIANOPOLIS / VICENTINOPOLIS / VILA BOA / VILA PROPICIO

DANOS CAUSADOS			
Equipamentos Danificado	Importância para o Sistema	Local	Quantidade
Disjuntor/Religador Operado	Proteção do Alimentador	Área de Concessão	100
Chaves Fusíveis Operada	Proteção de Ramais de Alimentadores	Área de Concessão	2.237
Transformador Operado	Proteção do Transformador	Área de Concessão	1.662

Relato técnico sobre a Intervenção realizada em Goiânia e Região Metropolitana						
Informações sobre Equipes	12/11	13/11	14/11	15/11	16/11	
Quantidade Usual	1.124	1.119	958	776	1.078	turmas
Quantidade Adicional	12	0	1	25	0	turmas
Quantidade Total	1.136	1.119	959	801	1.078	turmas
Tempos Médios						
Preparação	3,46	3,93	4,54	3,62	5,00	Horas
Deslocamento	0,91	0,77	0,69	0,97	0,96	Horas
Execução	0,97	0,89	0,80	0,73	1,13	Horas
TMAE	5,35	5,59	6,03	5,32	7,09	Horas

#### Principais Dificuldades Encontradas:

Chuvas com ventos fortes provocaram muitos pontos de alagamento e enxurrada, trânsito impedido por vários semáforos desligados dificultando a chegada ao atendimento das ocorrências emergenciais. Em determinadas regiões, decorrente dos fortes ventos, houve o tombamento de árvores nas estruturas de alimentação de média tensão, danos em ramais de ligação dos clientes, impedimentos

Empresa	ENEL DISTRIBUIÇÃO GOIAS		
Valor CHI (Limite e Real)	<b>482.597,74</b>		<b>1.555.775,35</b>

#### 4. Lista de Ocorrências

DOC ORIGEM	MIUNICIPIO	EQP_ORIGEM	CONJUNTO	INI_OCORRENC	FIM_OCORRENC	DT_INI_EVENTO	DT_FIM_EVENTO	DURAÇ	UC INT	CHI	EXPURGO
20201149554	APARECIDA DE GOIANIA	10032144529	REAL S1	12/11/2020 10:00	12/11/2020 12:12	12/11/2020 10:00	12/11/2020 12:12	2,20	1	2,20	CHI
20201149590	GOIANIA	GN12288620	CARAJAS S1	12/11/2020 10:03	12/11/2020 11:11	12/11/2020 10:03	12/11/2020 11:11	1,13	928	1046,06	CHI
20201149585	GUAPO	3040001290	GUAPO S2	12/11/2020 10:04	12/11/2020 15:19	12/11/2020 10:04	12/11/2020 15:19	5,23	1	5,23	CHI
20201149599	SANTA RITA DO NOVO DESTINO	BA12156230	BARRO ALTO	12/11/2020 10:04	12/11/2020 12:42	12/11/2020 10:04	12/11/2020 12:42	2,63	6	15,78	CHI
20201150473	SANTA RITA DO NOVO DESTINO	BA21156227	BARRO ALTO	12/11/2020 10:04	13/11/2020 12:47	12/11/2020 10:04	13/11/2020 12:47	26,72	2	53,43	CHI
20201149632	COCALZINHO DE GOIAS	ZN12351596	COCALZINHO	12/11/2020 10:13	12/11/2020 15:15	12/11/2020 10:13	12/11/2020 15:15	5,02	2	10,05	CHI
20201149643	GOIANIRA	10009096858	MEIA PONTE	12/11/2020 10:17	12/11/2020 12:15	12/11/2020 10:17	12/11/2020 12:15	1,96	1	1,96	CHI
20201149646	VIANOPOLIS	VN21037575	VIANOPOLIS	12/11/2020 10:18	12/11/2020 12:11	12/11/2020 10:18	12/11/2020 12:11	1,88	1	1,88	CHI
20201149648	GOIANIA	GN11233010	GOIANIA LESTE S3	12/11/2020 10:18	12/11/2020 12:58	12/11/2020 10:18	12/11/2020 12:58	2,66	31	82,58	CHI
20201149650	HIDROLANDIA	HD11291624	CEPAIGO S2	12/11/2020 10:18	12/11/2020 13:14	12/11/2020 10:18	12/11/2020 13:14	2,93	39	114,17	CHI
20201149679	CAMPO LIMPO	AN21055362	NEROPOLIS S1	12/11/2020 10:24	12/11/2020 11:57	12/11/2020 10:24	12/11/2020 11:57	1,54	5	7,70	CHI
20201149700	SAO SIMAO	2240046096	CACHOEIRA ALTA	12/11/2020 10:30	12/11/2020 12:47	12/11/2020 10:30	12/11/2020 12:47	2,28	1	2,28	CHI
20201149701	APARECIDA DE GOIANIA	200050175	INDEPENDENCIA S1	12/11/2020 10:30	12/11/2020 11:07	12/11/2020 10:30	12/11/2020 11:07	0,61	1	0,61	CHI
20201149710	BARRO ALTO	10003056161	BARRO ALTO	12/11/2020 10:31	13/11/2020 04:25	12/11/2020 10:31	13/11/2020 04:25	17,88	1	17,88	CHI
20201149711	MONTIVIDIU	2840007922	MONTIVIDIU T	12/11/2020 10:32	12/11/2020 18:13	12/11/2020 10:32	12/11/2020 18:13	7,68	1	7,68	CHI
20201149722	APARECIDA DE GOIANIA	16825858	INDEPENDENCIA S2	12/11/2020 10:34	12/11/2020 12:49	12/11/2020 10:34	12/11/2020 12:49	2,24	1	2,24	CHI
20201149734	GOIANESIA	GE21063286	GOIANESIA S1	12/11/2020 10:37	12/11/2020 23:12	12/11/2020 10:37	12/11/2020 23:12	12,58	2	25,16	CHI
20201149743	ANAPOLIS	AN11394318	ANAPOLIS UNIVERSITARIO S2	12/11/2020 10:40	12/11/2020 12:54	12/11/2020 10:40	12/11/2020 12:54	2,23	194	433,00	CHI
20201149756	GOIANIA	14803513	CAMPINAS S1	12/11/2020 10:42	12/11/2020 12:11	12/11/2020 10:42	12/11/2020 12:11	1,47	0	0,00	CHI
20201150585	RIO VERDE	RV21302027	ACREUNA	12/11/2020 10:43	12/11/2020 22:50	12/11/2020 10:43	12/11/2020 22:50	12,10	2	24,21	CHI
20201149775	GOIANESIA	GE12115059	GOIANESIA S2	12/11/2020 10:47	13/11/2020 11:35	12/11/2020 10:47	13/11/2020 11:35	24,79	1	24,79	CHI
20201149778	FLORES DE GOIAS	FB21141432	IACIARA S2	12/11/2020 10:47	12/11/2020 13:46	12/11/2020 10:47	12/11/2020 13:46	2,97	1	2,97	CHI
20201149844	GOIANIA	GN11155656	REAL S1	12/11/2020 10:48	12/11/2020 15:28	12/11/2020 10:48	12/11/2020 15:28	4,65	106	493,25	CHI
20201149877	JATAI	JT12000101	JATAI S2	12/11/2020 10:48	12/11/2020 11:50	12/11/2020 10:48	12/11/2020 11:50	1,03	482	496,06	CHI
20201149789	ANAPOLIS	10023779053	ANAPOLIS UNIVERSITARIO S2	12/11/2020 10:49	12/11/2020 11:09	12/11/2020 10:49	12/11/2020 11:09	0,32	1	0,32	CHI
20201149794	GOIANIA	GN21164294	XAVANTES	12/11/2020 10:50	12/11/2020 13:19	12/11/2020 10:50	12/11/2020 13:19	2,47	1	2,47	CHI
20201149795	GOIANIA	15552202	GOYA S1	12/11/2020 10:50	12/11/2020 13:21	12/11/2020 10:50	12/11/2020 13:21	2,51	1	2,51	CHI
20201149801	JATAI	290344062	JATAI S3	12/11/2020 10:52	12/11/2020 14:29	12/11/2020 10:52	12/11/2020 14:29	3,61	1	3,61	CHI
20201149806	GOIANIA	11830554	ATLANTICO S2	12/11/2020 10:53	12/11/2020 13:16	12/11/2020 10:53	12/11/2020 13:16	2,37	1	2,37	CHI
20201149816	CACU	CC21323961	CACHOEIRA ALTA	12/11/2020 10:56	12/11/2020 16:16	12/11/2020 10:56	12/11/2020 16:16	5,32	1	5,32	CHI
20201149817	CORUMBA DE GOIAS	CB12382200	CORUMBA	12/11/2020 10:56	12/11/2020 12:32	12/11/2020 10:56	12/11/2020 12:32	1,58	54	85,59	CHI
20201149836	ANAPOLIS	AN11000628	JUNDIAI S1	12/11/2020 10:59	12/11/2020 13:30	12/11/2020 10:59	12/11/2020 13:30	2,51	123	308,53	CHI
20201149843	ABADIANIA	20414	ANAPOLIS UNIVERSITARIO S1	12/11/2020 11:02	12/11/2020 14:18	12/11/2020 11:02	12/11/2020 14:18	2,43	67	162,83	CHI
20201149843	ABADIANIA	20414	ANAPOLIS UNIVERSITARIO S1	12/11/2020 11:02	12/11/2020 14:18	12/11/2020 11:02	12/11/2020 14:18	2,43	136	330,52	CHI
20201149843	ANAPOLIS	20414	ANAPOLIS UNIVERSITARIO S1	12/11/2020 11:02	12/11/2020 14:18	12/11/2020 11:02	12/11/2020 14:18	2,43	241	585,70	CHI
20201149843	ANAPOLIS	20414	ANAPOLIS UNIVERSITARIO S1	12/11/2020 11:02	12/11/2020 14:18	12/11/2020 11:02	12/11/2020 14:18	2,43	335	814,14	CHI
20201149843	GAMELEIRA DE GOIAS	20414	ANAPOLIS UNIVERSITARIO S1	12/11/2020 11:02	12/11/2020 14:18	12/11/2020 11:02	12/11/2020 14:18	2,43	32	77,77	CHI
20201149851	TRINDADE	40295254	TRINDADE	12/11/2020 11:03	12/11/2020 14:28	12/11/2020 11:03	12/11/2020 14:28	3,41	1	3,41	CHI
20201149857	GOIANIA	12952011	XAVANTES	12/11/2020 11:04	12/11/2020 11:54	12/11/2020 11:04	12/11/2020 11:54	0,83	1	0,83	CHI
20201149858	ARUANA	AK21278245	MOZARLANDIA	12/11/2020 11:04	12/11/2020 17:17	12/11/2020 11:04	12/11/2020 17:17	6,21	1	6,21	CHI
20201149859	APARECIDA DE GOIANIA	AP11167485	REAL S1	12/11/2020 11:04	12/11/2020 12:51	12/11/2020 11:04	12/11/2020 12:51	1,77	26	46,06	CHI
20201149864	PARAUNA	980035752	PARAUNA	12/11/2020 11:05	12/11/2020 16:07	12/11/2020 11:05	12/11/2020 16:07	5,02	1	5,02	CHI
20201150097	GAMELEIRA DE GOIAS	SV12278872	DAIA S2	12/11/2020 11:05	12/11/2020 15:00	12/11/2020 11:05	12/11/2020 15:00	3,90	32	124,84	CHI
20201149884	GOIANIA	16874559	GOYA S2	12/11/2020 11:11	12/11/2020 12:13	12/11/2020 11:11	12/11/2020 12:13	1,02	1	1,02	CHI
20201149892	ANAPOLIS	AN21239270	ANAPOLIS UNIVERSITARIO S2	12/11/2020 11:14	12/11/2020 13:20	12/11/2020 11:14	12/11/2020 13:20	2,08	3	6,25	CHI

20201149905	ABADIANA	AA21062504	ANAPOLIS UNIVERSITARIO S1	12/11/2020 11:17	12/11/2020 15:42	12/11/2020 11:17	12/11/2020 15:42	4,42	1	4,42	CHI
20201149911	COCALZINHO DE GOIAS	ZN21295703	COCALZINHO	12/11/2020 11:19	12/11/2020 16:35	12/11/2020 11:19	12/11/2020 16:35	5,26	1	5,26	CHI
20201149916	SENADOR CANEDO	10009283720	SENADOR CANEDO	12/11/2020 11:20	12/11/2020 12:49	12/11/2020 11:20	12/11/2020 12:49	1,47	1	1,47	CHI
20201149918	GOIANIA	GN11340452	CARAJAS S1	12/11/2020 11:20	12/11/2020 14:22	12/11/2020 11:20	12/11/2020 14:22	3,02	58	174,98	CHI
20201149963	CACU	CC10394736	CACHOEIRA ALTA	12/11/2020 11:21	12/11/2020 23:49	12/11/2020 11:21	12/11/2020 13:48	2,44	417	1016,09	CHI
20201149963	QUIRINOPOLIS	CC10394736	CACHOEIRA ALTA	12/11/2020 11:21	12/11/2020 23:49	12/11/2020 11:21	12/11/2020 13:48	2,44	1	2,44	CHI
20201149963	CACU	CC13349509	CACHOEIRA ALTA	12/11/2020 11:21	12/11/2020 23:49	12/11/2020 11:21	12/11/2020 16:01	4,65	2	9,30	CHI
20201149963	CACU	CC13350892	CACHOEIRA ALTA	12/11/2020 11:21	12/11/2020 23:49	12/11/2020 11:21	12/11/2020 16:55	5,56	9	50,04	CHI
20201149963	CACU	CC12322236	CACHOEIRA ALTA	12/11/2020 11:21	12/11/2020 23:49	12/11/2020 20:19	12/11/2020 23:39	3,33	1	3,33	CHI
20201149963	CACU	CC13241707	CACHOEIRA ALTA	12/11/2020 11:21	12/11/2020 23:49	12/11/2020 11:21	12/11/2020 23:49	12,45	44	547,91	CHI
20201149963	ITARUMA	CC13241707	CACHOEIRA ALTA	12/11/2020 11:21	12/11/2020 23:49	12/11/2020 11:21	12/11/2020 23:49	12,45	37	460,74	CHI
20201149940	GOIANIA	14739320	GOYA S2	12/11/2020 11:25	12/11/2020 12:38	12/11/2020 11:25	12/11/2020 12:38	1,20	1	1,20	CHI
20201149955	IPORA	IR12024610	ARENOPOLIS	12/11/2020 11:30	12/11/2020 16:11	12/11/2020 11:30	12/11/2020 16:11	4,67	20	93,34	CHI
20201149961	ALEXANIA	AX21318552	ALEXANIA	12/11/2020 11:33	12/11/2020 17:34	12/11/2020 11:33	12/11/2020 17:34	6,01	1	6,01	CHI
20201149988	ALEXANIA	3190414	ALEXANIA	12/11/2020 11:34	13/11/2020 08:27	12/11/2020 11:34	12/11/2020 14:39	3,10	8	24,76	CHI
20201149988	CORUMBA DE GOIAS	3190414	ALEXANIA	12/11/2020 11:34	13/11/2020 08:27	12/11/2020 11:34	12/11/2020 14:39	3,10	15	46,43	CHI
20201149988	ALEXANIA	3190414	ALEXANIA	12/11/2020 11:34	13/11/2020 08:27	12/11/2020 11:34	12/11/2020 15:41	4,12	30	123,64	CHI
20201149988	ALEXANIA	3190414	CORUMBA	12/11/2020 11:34	13/11/2020 08:27	12/11/2020 11:34	12/11/2020 15:41	4,12	899	3705,13	CHI
20201149988	CORUMBA DE GOIAS	3190414	CORUMBA	12/11/2020 11:34	13/11/2020 08:27	12/11/2020 11:34	12/11/2020 15:41	4,12	359	1479,58	CHI
20201149988	ALEXANIA	3190414	ALEXANIA	12/11/2020 11:34	13/11/2020 08:27	12/11/2020 16:52	12/11/2020 17:08	0,27	29	7,77	CHI
20201149988	ALEXANIA	3190414	CORUMBA	12/11/2020 11:34	13/11/2020 08:27	12/11/2020 16:52	12/11/2020 17:08	0,27	899	240,98	CHI
20201149988	CORUMBA DE GOIAS	3190414	CORUMBA	12/11/2020 11:34	13/11/2020 08:27	12/11/2020 16:52	12/11/2020 17:08	0,27	359	96,23	CHI
20201149988	CORUMBA DE GOIAS	CB13108434	ALEXANIA	12/11/2020 11:34	13/11/2020 08:27	12/11/2020 14:46	12/11/2020 17:29	2,71	7	19,00	CHI
20201149988	CORUMBA DE GOIAS	CB13108434	ALEXANIA	12/11/2020 11:34	13/11/2020 08:27	12/11/2020 18:24	12/11/2020 18:50	0,43	7	3,02	CHI
20201149988	ALEXANIA	AX10406655	CORUMBA	12/11/2020 11:34	13/11/2020 08:27	12/11/2020 17:29	12/11/2020 19:06	1,61	898	1445,03	CHI
20201149988	CORUMBA DE GOIAS	AX10406655	CORUMBA	12/11/2020 11:34	13/11/2020 08:27	12/11/2020 17:29	12/11/2020 19:06	1,61	357	574,47	CHI
20201149988	ALEXANIA	AX13172016	ALEXANIA	12/11/2020 11:34	13/11/2020 08:27	12/11/2020 14:46	12/11/2020 19:41	4,92	8	39,33	CHI
20201149988	CORUMBA DE GOIAS	AX13172016	ALEXANIA	12/11/2020 11:34	13/11/2020 08:27	12/11/2020 14:46	12/11/2020 19:41	4,92	3	14,75	CHI
20201149988	CORUMBA DE GOIAS	AX13172016	ALEXANIA	12/11/2020 11:34	13/11/2020 08:27	12/11/2020 14:46	13/11/2020 08:27	17,69	5	88,43	CHI
20201153629	ALEXANIA	AX31082610	CORUMBA	12/11/2020 11:34	12/11/2020 21:48	12/11/2020 17:29	12/11/2020 21:48	4,30	1	4,30	CHI
20201149969	CAIAPONIA	PH12343754	CAIAPONIA	12/11/2020 11:35	12/11/2020 15:44	12/11/2020 11:35	12/11/2020 15:44	4,14	1	4,14	CHI
20201149969	PIRANHAS	PH12343754	CAIAPONIA	12/11/2020 11:35	12/11/2020 15:44	12/11/2020 11:35	12/11/2020 15:44	4,14	8	33,11	CHI
20201149973	JAUPACI	JP21381060	IPORA	12/11/2020 11:37	12/11/2020 13:46	12/11/2020 11:37	12/11/2020 13:46	2,14	1	2,14	CHI
20201150101	CALDAS NOVAS	CN12213873	CALDAS NOVAS S2	12/11/2020 11:38	12/11/2020 16:17	12/11/2020 11:38	12/11/2020 16:17	4,65	8	37,16	CHI
20201149990	BRAZABRANTES	IN21073283	INHUMAS S1	12/11/2020 11:42	12/11/2020 17:44	12/11/2020 11:42	12/11/2020 17:44	6,02	1	6,02	CHI
20201149992	PARANAIGUARA	2230003143	CACHOEIRA ALTA	12/11/2020 11:43	12/11/2020 16:28	12/11/2020 11:43	12/11/2020 16:28	4,74	1	4,74	CHI
20201149993	ALEXANIA	AX11000032	ALEXANIA	12/11/2020 11:43	12/11/2020 13:30	12/11/2020 11:43	12/11/2020 13:30	1,77	31	55,02	CHI
20201149994	ALEXANIA	AX31135872	ALEXANIA	12/11/2020 11:43	12/11/2020 20:53	12/11/2020 11:43	12/11/2020 20:53	9,16	1	9,16	CHI
20201149998	JATAI	JT12398520	JATAI S1	12/11/2020 11:43	12/11/2020 13:29	12/11/2020 11:43	12/11/2020 13:29	1,77	9	15,90	CHI
20201149999	PIRACANJUBA	PJ21307858	PIRACANJUBA	12/11/2020 11:46	12/11/2020 13:18	12/11/2020 11:46	12/11/2020 13:18	1,52	1	1,52	CHI
20201150054	ITAPIRAPUA	JR12087418	JUSSARA	12/11/2020 11:48	12/11/2020 15:08	12/11/2020 11:48	12/11/2020 15:08	3,33	1	3,33	CHI
20201150054	JUSSARA	JR12087418	JUSSARA	12/11/2020 11:48	12/11/2020 15:08	12/11/2020 11:48	12/11/2020 15:08	3,33	11	36,58	CHI
20201150007	PADRE BERNARDO	3160004932	PADRE BERNARDO	12/11/2020 11:49	12/11/2020 16:53	12/11/2020 11:49	12/11/2020 16:53	5,06	1	5,06	CHI
20201150009	CRIXAS	CX12181532	SERRA DO OURO	12/11/2020 11:49	12/11/2020 14:32	12/11/2020 11:49	12/11/2020 14:32	2,70	11	29,71	CHI
20201150300	ITAPURANGA	IK12000021	ITAPURANGA	12/11/2020 11:52	12/11/2020 15:05	12/11/2020 11:52	12/11/2020 15:05	3,21	426	1366,87	CHI
20201150022	JARAGUA	JA21006445	JARAGUA	12/11/2020 11:53	12/11/2020 20:56	12/11/2020 11:53	12/11/2020 20:56	9,05	1	9,05	CHI
20201150023	VALPARAISO DE GOIAS	2860175836	PACAEMBU S2	12/11/2020 11:53	12/11/2020 14:14	12/11/2020 11:53	12/11/2020 14:14	2,34	1	2,34	CHI
20201150026	PIRENOPOLIS	3100001112	SAO FRANCISCO DE GOIAS	12/11/2020 11:53	12/11/2020 16:29	12/11/2020 11:53	12/11/2020 16:29	4,59	1	4,59	CHI
20201150028	LUZIANIA	LZ12261767	CRISTALINA S2	12/11/2020 11:54	12/11/2020 17:34	12/11/2020 11:54	12/11/2020 15:55	4,02	5	20,12	CHI
20201150028	LUZIANIA	LZ12090973LD	CRISTALINA S2	12/11/2020 11:54	12/11/2020 17:34	12/11/2020 11:54	12/11/2020 17:34	5,68	7	39,75	CHI
20201150035	SAO JOAO DA PARAUNA	RP21156229	FIRMINOPOLIS S2	12/11/2020 11:55	13/11/2020 01:23	12/11/2020 11:55	13/11/2020 01:23	13,45	2	26,91	CHI



20201150037	CRIXAS	CX21288816	SANTA TEREZINHA	12/11/2020 11:56	12/11/2020 14:41	12/11/2020 11:56	12/11/2020 14:41	2,74	1	2,74	CHI
20201150149	ITAUCU	PV12271945	CORUMBA	12/11/2020 11:56	12/11/2020 15:10	12/11/2020 11:56	12/11/2020 15:10	3,23	1	3,23	CHI
20201150149	PIRENOPOLIS	PV12271945	CORUMBA	12/11/2020 11:56	12/11/2020 15:10	12/11/2020 11:56	12/11/2020 15:10	3,23	12	38,80	CHI
20201150125	MINEIROS	MY12156811RE	PARQUE DAS EMAS	12/11/2020 11:57	12/11/2020 14:11	12/11/2020 11:57	12/11/2020 14:11	2,23	17	37,90	CHI
20201150048	MINACU	4020115462	MINACU	12/11/2020 11:58	12/11/2020 17:19	12/11/2020 11:58	12/11/2020 17:19	5,34	1	5,34	CHI
20201150484	SAO JOAO D ALIANCA	JL12383340	SAO JOAO D ALIANCA	12/11/2020 11:58	12/11/2020 14:40	12/11/2020 11:58	12/11/2020 14:40	2,68	77	206,68	CHI
20201150055	AMORINOPOLIS	1240006760	IPORA	12/11/2020 12:00	12/11/2020 17:04	12/11/2020 12:00	12/11/2020 17:04	5,06	1	5,06	CHI
20201150074	GOIANIA	13395348	CAMPINAS S2	12/11/2020 12:04	12/11/2020 14:56	12/11/2020 12:04	12/11/2020 14:56	2,85	1	2,85	CHI
20201150123	PALMEIRAS DE GOIAS	PL11252059	PALMEIRAS	12/11/2020 12:04	12/11/2020 13:30	12/11/2020 12:04	12/11/2020 13:30	1,42	105	149,39	CHI
20201152037	MONTES CLAROS DE GOIAS	ME12204930	IPORA	12/11/2020 12:06	12/11/2020 19:02	12/11/2020 12:06	12/11/2020 19:02	6,93	4	27,72	CHI
20201150099	ITABERAI	50041745	ITABERAI S2	12/11/2020 12:10	12/11/2020 16:15	12/11/2020 12:10	12/11/2020 16:15	4,07	1	4,07	CHI
20201150160	ACREUNA	EU12260946	ACREUNA	12/11/2020 12:10	12/11/2020 23:20	12/11/2020 12:10	12/11/2020 14:30	2,33	20	46,65	CHI
20201150160	ACREUNA	EU12000186LD	ACREUNA	12/11/2020 12:10	12/11/2020 23:20	12/11/2020 12:10	12/11/2020 23:20	11,16	4	44,64	CHI
20201150160	ACREUNA	EU12000186LD	ACREUNA	12/11/2020 12:10	12/11/2020 23:20	12/11/2020 22:28	12/11/2020 23:20	0,87	12	10,45	CHI
20201150104	BURITI ALEGRE	BG21000095	ITUMBIARA VELHA S2	12/11/2020 12:11	12/11/2020 16:16	12/11/2020 12:11	12/11/2020 16:16	4,08	1	4,08	CHI
20201150111	GOIANIA	12533026	INDEPENDENCIA S1	12/11/2020 12:13	12/11/2020 12:49	12/11/2020 12:13	12/11/2020 12:49	0,60	0	0,00	CHI
20201150115	URUACU	UR11000007	URUACU	12/11/2020 12:13	13/11/2020 15:33	12/11/2020 12:13	13/11/2020 15:33	27,33	107	2923,95	CHI
20201150120	APARECIDA DE GOIANIA	10027174202	INDEPENDENCIA S2	12/11/2020 12:14	12/11/2020 15:27	12/11/2020 12:14	12/11/2020 15:27	3,21	1	3,21	CHI
20201150162	ALTO PARAISO DE GOIAS	BF10400373	FLORES DE GOIAS	12/11/2020 12:15	12/11/2020 19:56	12/11/2020 12:15	12/11/2020 12:20	0,09	24	2,24	CHI
20201150162	CAVALCANTE	BF10400373	FLORES DE GOIAS	12/11/2020 12:15	12/11/2020 19:56	12/11/2020 12:15	12/11/2020 12:20	0,09	2808	262,08	CHI
20201150162	NOVA ROMA	BF10400373	FLORES DE GOIAS	12/11/2020 12:15	12/11/2020 19:56	12/11/2020 12:15	12/11/2020 12:20	0,09	32	2,99	CHI
20201150162	TERESINA DE GOIAS	BF10400373	FLORES DE GOIAS	12/11/2020 12:15	12/11/2020 19:56	12/11/2020 12:15	12/11/2020 12:20	0,09	1121	104,63	CHI
20201150162	FLORES DE GOIAS	2830434	FLORES DE GOIAS	12/11/2020 12:15	12/11/2020 19:56	12/11/2020 12:17	12/11/2020 16:02	3,75	3	11,24	CHI
20201150162	SAO JOAO D ALIANCA	2830434	FLORES DE GOIAS	12/11/2020 12:15	12/11/2020 19:56	12/11/2020 12:17	12/11/2020 16:02	3,75	6	22,48	CHI
20201150162	ALTO PARAISO DE GOIAS	BF13275538	FLORES DE GOIAS	12/11/2020 12:15	12/11/2020 19:56	12/11/2020 12:17	12/11/2020 17:56	5,65	7	39,53	CHI
20201150162	SAO JOAO D ALIANCA	BF13275538	FLORES DE GOIAS	12/11/2020 12:15	12/11/2020 19:56	12/11/2020 12:17	12/11/2020 17:56	5,65	2	11,30	CHI
20201150162	ALTO PARAISO DE GOIAS	BF13275011	FLORES DE GOIAS	12/11/2020 12:15	12/11/2020 19:56	12/11/2020 12:17	12/11/2020 19:56	7,65	8	61,20	CHI
20201150396	CORUMBA DE GOIAS	CB12114209	CORUMBA	12/11/2020 12:15	12/11/2020 22:44	12/11/2020 12:15	12/11/2020 18:14	5,97	37	220,83	CHI
20201150396	CORUMBA DE GOIAS	CB12114209	CORUMBA	12/11/2020 12:15	12/11/2020 22:44	12/11/2020 12:15	12/11/2020 22:44	10,47	3	31,41	CHI
20201153372	CORUMBA DE GOIAS	CB12121725	CORUMBA	12/11/2020 12:15	12/11/2020 22:44	12/11/2020 12:15	12/11/2020 22:44	10,47	3	31,41	CHI
20201150131	SILVANIA	SV12389456	VIANOPOLIS	12/11/2020 12:16	12/11/2020 15:09	12/11/2020 12:16	12/11/2020 15:09	2,87	110	315,82	CHI
20201150133	BELA VISTA DE GOIAS	10015891800	BELA VISTA S2	12/11/2020 12:17	12/11/2020 15:58	12/11/2020 12:17	12/11/2020 15:58	3,68	1	3,68	CHI
20201150161	BARRO ALTO	BA21095435	GOIANESIA S1	12/11/2020 12:25	12/11/2020 21:21	12/11/2020 12:25	12/11/2020 21:21	8,93	1	8,93	CHI
20201150164	CEZARINA	CZ21299257	GUAPO S2	12/11/2020 12:26	12/11/2020 20:32	12/11/2020 12:26	12/11/2020 20:32	8,10	2	16,20	CHI
20201150168	SANTO ANTONIO DO DESCOBERTO	2210041540	ALEXANIA	12/11/2020 12:27	12/11/2020 15:03	12/11/2020 12:27	12/11/2020 15:03	2,61	1	2,61	CHI
20201150174	FORMOSO	FO12185324	PORANGATU	12/11/2020 12:28	12/11/2020 15:04	12/11/2020 12:28	12/11/2020 15:04	2,59	2	5,17	CHI
20201150178	PLANALTINA	PI21065582	PLANALTINA	12/11/2020 12:29	12/11/2020 16:44	12/11/2020 12:29	12/11/2020 16:44	4,24	14	59,36	CHI
20201150183	PONTALINA	PK21046034	PONTALINA	12/11/2020 12:30	12/11/2020 15:08	12/11/2020 12:30	12/11/2020 15:08	2,63	1	2,63	CHI
20201150220	CAIAPONIA	CP12411285	CAIAPONIA	12/11/2020 12:30	12/11/2020 18:27	12/11/2020 12:30	12/11/2020 18:27	5,94	3	17,81	CHI
20201150463	ITABERAI	IB13144320	ITABERAI S1	12/11/2020 12:30	13/11/2020 19:47	12/11/2020 12:30	12/11/2020 19:14	6,73	148	996,20	CHI
20201150463	ITABERAI	1790226	ITABERAI S1	12/11/2020 12:30	13/11/2020 19:47	12/11/2020 19:18	12/11/2020 19:24	0,10	148	14,35	CHI
20201150463	ITABERAI	1790226	ITABERAI S1	12/11/2020 12:30	13/11/2020 19:47	13/11/2020 02:58	13/11/2020 03:19	0,35	148	51,84	CHI
20201150463	HEITORAI	IB13144319	ITABERAI S1	12/11/2020 12:30	13/11/2020 19:47	12/11/2020 12:30	13/11/2020 16:39	28,16	24	675,73	CHI
20201150463	ITABERAI	IB13144319	ITABERAI S1	12/11/2020 12:30	13/11/2020 19:47	12/11/2020 12:30	13/11/2020 16:39	28,16	20	563,11	CHI
20201150463	GOIAS	IB13144319	ITABERAI S1	12/11/2020 12:30	13/11/2020 19:47	12/11/2020 12:30	13/11/2020 19:11	30,67	33	1012,27	CHI
20201150463	HEITORAI	IB13144319	ITABERAI S1	12/11/2020 12:30	13/11/2020 19:47	13/11/2020 18:30	13/11/2020 19:11	0,68	24	16,34	CHI
20201150463	ITABERAI	IB13144319	ITABERAI S1	12/11/2020 12:30	13/11/2020 19:47	13/11/2020 18:30	13/11/2020 19:11	0,68	20	13,62	CHI
20201150463	GOIAS	IB13144319	ITABERAI S1	12/11/2020 12:30	13/11/2020 19:47	12/11/2020 12:30	13/11/2020 19:47	31,28	7	218,94	CHI
20201150463	HEITORAI	IB13144319	ITABERAI S1	12/11/2020 12:30	13/11/2020 19:47	12/11/2020 12:30	13/11/2020 19:47	31,28	2	62,55	CHI
20201150463	ITABERAI	IB13144319	ITABERAI S1	12/11/2020 12:30	13/11/2020 19:47	12/11/2020 12:30	13/11/2020 19:47	31,28	55	1720,25	CHI
20201150189	ITUMBIARA	IT21232608	ITUMBIARA NOVA	12/11/2020 12:31	12/11/2020 16:52	12/11/2020 12:31	12/11/2020 16:52	4,34	1	4,34	CHI

20201150888	JATAI	SX12264387RE	JATAI S1	12/11/2020 12:32	12/11/2020 21:17	12/11/2020 12:32	12/11/2020 21:17	8,75	7	61,22	CHI
20201150888	SERRANOPOLIS	SX12264387RE	JATAI S1	12/11/2020 12:32	12/11/2020 21:17	12/11/2020 12:32	12/11/2020 21:17	8,75	23	201,16	CHI
202011137977	GAMELEIRA DE GOIAS	SV12211132	VIANOPOLIS	12/11/2020 12:32	13/11/2020 18:25	12/11/2020 12:32	13/11/2020 18:25	29,88	20	597,54	CHI
202011137977	SILVANIA	SV12211132	VIANOPOLIS	12/11/2020 12:32	13/11/2020 18:25	12/11/2020 12:32	13/11/2020 18:25	29,88	44	1314,59	CHI
20201151809	BARRO ALTO	BA12132080	GOIANESIA S1	12/11/2020 12:33	13/11/2020 11:06	12/11/2020 12:33	13/11/2020 11:06	22,55	6	135,29	CHI
20201152008	COCALZINHO DE GOIAS	ZN21297573	COCALZINHO	12/11/2020 12:34	12/11/2020 20:31	12/11/2020 12:34	12/11/2020 20:31	7,94	1	7,94	CHI
20201150205	RIO VERDE	10013128521	RIO VERDE S1	12/11/2020 12:35	12/11/2020 20:39	12/11/2020 12:35	12/11/2020 20:39	8,06	1	8,06	CHI
20201150214	ITAPURANGA	IK21238167	ITAPURANGA	12/11/2020 12:38	12/11/2020 15:53	12/11/2020 12:38	12/11/2020 15:53	3,25	1	3,25	CHI
20201150216	BURITI ALEGRE	BG21280860	ITUMBIARA VELHA S2	12/11/2020 12:38	12/11/2020 17:06	12/11/2020 12:38	12/11/2020 17:06	4,46	1	4,46	CHI
20201150219	ITABERAI	IX12000065	INHUMAS S1	12/11/2020 12:38	12/11/2020 14:47	12/11/2020 12:38	12/11/2020 14:47	2,14	41	87,58	CHI
20201150219	ITAUCU	IX12000065	INHUMAS S1	12/11/2020 12:38	12/11/2020 14:47	12/11/2020 12:38	12/11/2020 14:47	2,14	39	83,31	CHI
20201150224	APARECIDA DE GOIANIA	10007887297	ANHANGUERA	12/11/2020 12:40	12/11/2020 14:24	12/11/2020 12:40	12/11/2020 14:24	1,73	1	1,73	CHI
20201150225	NIQUELANDIA	NQ21234719	NIQUELANDIA SUBTRANSMISSAO	12/11/2020 12:40	12/11/2020 22:05	12/11/2020 12:40	12/11/2020 22:05	9,40	1	9,40	CHI
20201150237	ANAPOLIS	AN10396190	ANAPOLIS UNIVERSITARIO S2	12/11/2020 12:41	12/11/2020 21:34	12/11/2020 12:41	12/11/2020 14:34	1,88	1	1,88	CHI
20201150237	ABADIANIA	AN13000582	ANAPOLIS UNIVERSITARIO S2	12/11/2020 12:41	12/11/2020 21:34	12/11/2020 12:41	12/11/2020 15:26	2,74	97	266,10	CHI
20201150237	ANAPOLIS	AN10396190	ANAPOLIS UNIVERSITARIO S2	12/11/2020 12:41	12/11/2020 21:34	12/11/2020 12:41	12/11/2020 15:26	2,74	812	2227,59	CHI
20201150237	ANAPOLIS	AN13000582	ANAPOLIS UNIVERSITARIO S2	12/11/2020 12:41	12/11/2020 21:34	12/11/2020 12:41	12/11/2020 15:26	2,74	281	770,88	CHI
20201150237	ANAPOLIS	AN10396190	ANAPOLIS UNIVERSITARIO S2	12/11/2020 12:41	12/11/2020 21:34	12/11/2020 15:28	12/11/2020 15:56	0,47	601	283,64	CHI
20201150237	ABADIANIA	AN13000582	ANAPOLIS UNIVERSITARIO S2	12/11/2020 12:41	12/11/2020 21:34	12/11/2020 15:28	12/11/2020 21:34	6,10	97	591,65	CHI
20201150237	ANAPOLIS	AN13000582	ANAPOLIS UNIVERSITARIO S2	12/11/2020 12:41	12/11/2020 21:34	12/11/2020 15:28	12/11/2020 21:34	6,10	493	3007,03	CHI
20201150237	ANAPOLIS	AN13000582	ANAPOLIS UNIVERSITARIO S2	12/11/2020 12:41	12/11/2020 21:34	12/11/2020 20:54	12/11/2020 21:34	0,67	600	400,50	CHI
20201150332	ITABERAI	IB10395409	ITABERAI S2	12/11/2020 12:41	13/11/2020 11:18	12/11/2020 12:41	13/11/2020 11:18	22,63	81	1832,76	CHI
20201150332	TAQUARAL DE GOIAS	IB10395409	ITABERAI S2	12/11/2020 12:41	13/11/2020 11:18	12/11/2020 12:41	13/11/2020 11:18	22,63	2	45,25	CHI
20201150412	COCALZINHO DE GOIAS	ZN11155157	COCALZINHO	12/11/2020 12:41	12/11/2020 20:10	12/11/2020 12:41	12/11/2020 20:10	7,48	93	695,23	CHI
20201150245	MATRINCHA	MP21183173	MATRINCHA	12/11/2020 12:44	12/11/2020 15:23	12/11/2020 12:44	12/11/2020 15:23	2,64	6	15,85	CHI
20201150249	JARAGUA	JA21158317	JARAGUA	12/11/2020 12:45	12/11/2020 22:21	12/11/2020 12:45	12/11/2020 22:21	9,59	1	9,59	CHI
20201150676	COCALZINHO DE GOIAS	ZN12273000RE	COCALZINHO	12/11/2020 12:45	12/11/2020 16:21	12/11/2020 12:45	12/11/2020 16:21	3,59	19	68,18	CHI
20201150676	CORUMBA DE GOIAS	ZN12273000RE	COCALZINHO	12/11/2020 12:45	12/11/2020 16:21	12/11/2020 12:45	12/11/2020 16:21	3,59	18	64,59	CHI
20201150676	PIRENOPOLIS	ZN12273000RE	COCALZINHO	12/11/2020 12:45	12/11/2020 16:21	12/11/2020 12:45	12/11/2020 16:21	3,59	2	7,18	CHI
20201150256	SAO MIGUEL DO ARAGUAIA	SM11000010	SAO MIGUEL DO ARAGUAIA	12/11/2020 12:47	12/11/2020 17:45	12/11/2020 12:47	12/11/2020 17:45	4,96	70	347,01	CHI
20201150613	LUZIANIA	OZ12195112	PIRES DO RIO S2	12/11/2020 12:47	12/11/2020 15:03	12/11/2020 12:47	12/11/2020 15:03	2,26	72	162,38	CHI
20201150279	AMARALINA	LC12286013	NOVA CRIXAS	12/11/2020 12:50	13/11/2020 21:04	12/11/2020 12:50	13/11/2020 21:04	32,22	9	289,96	CHI
20201150279	MARA ROSA	LC12286013	NOVA CRIXAS	12/11/2020 12:50	13/11/2020 21:04	12/11/2020 12:50	13/11/2020 21:04	32,22	1	32,22	CHI
20201150270	BOM JESUS DE GOIAS	1250074256	BOM JESUS DE GOIAS	12/11/2020 12:52	12/11/2020 16:52	12/11/2020 12:52	12/11/2020 16:52	4,00	1	4,00	CHI
20201150277	RIO VERDE	RV11136155	RIO VERDE S1	12/11/2020 12:53	12/11/2020 18:23	12/11/2020 12:53	12/11/2020 18:23	5,49	101	554,99	CHI
20201150280	BURITI ALEGRE	BG21190980	ALTO BURITI	12/11/2020 12:54	12/11/2020 13:33	12/11/2020 12:54	12/11/2020 13:33	0,65	1	0,65	CHI
20201150281	SANTA CRUZ DE GOIAS	BC12023183	CRISTIANOPOLIS	12/11/2020 12:54	12/11/2020 15:51	12/11/2020 12:54	12/11/2020 15:51	2,95	42	124,05	CHI
20201150284	APARECIDA DE GOIANIA	200134401	INDEPENDENCIA S1	12/11/2020 12:54	12/11/2020 14:30	12/11/2020 12:54	12/11/2020 14:30	1,59	1	1,59	CHI
20201150341	NOVO PLANALTO	1360414	NOVO PLANALTO	12/11/2020 12:55	14/11/2020 16:13	12/11/2020 12:55	12/11/2020 16:00	3,07	11	33,75	CHI
20201150341	PORANGATU	1360414	NOVO PLANALTO	12/11/2020 12:55	14/11/2020 16:13	12/11/2020 12:55	12/11/2020 16:00	3,07	7	21,48	CHI
20201150341	PORANGATU	PO13083034	NOVO PLANALTO	12/11/2020 12:55	14/11/2020 16:13	12/11/2020 12:55	13/11/2020 15:59	27,06	7	189,39	CHI
20201150341	NOVO PLANALTO	PO13083035	NOVO PLANALTO	12/11/2020 12:55	14/11/2020 16:13	12/11/2020 12:55	14/11/2020 14:08	49,21	2	98,43	CHI
20201150341	PORANGATU	PO13083035	NOVO PLANALTO	12/11/2020 12:55	14/11/2020 16:13	12/11/2020 12:55	14/11/2020 14:08	49,21	14	688,99	CHI
20201150341	PORANGATU	PO13328110	NOVO PLANALTO	12/11/2020 12:55	14/11/2020 16:13	14/11/2020 15:29	14/11/2020 16:13	0,74	7	5,16	CHI
20201150297	ABADIANIA	AA21201386	CORUMBA	12/11/2020 12:56	12/11/2020 19:05	12/11/2020 12:56	12/11/2020 19:05	6,13	1	6,13	CHI
20201150302	ANAPOLIS	AN12401787	ANAPOLIS UNIVERSITARIO S2	12/11/2020 12:57	12/11/2020 15:16	12/11/2020 12:57	12/11/2020 15:16	2,31	51	117,68	CHI
20201150305	GOIANIA	15599462	FERROVIARIO S1	12/11/2020 12:58	12/11/2020 14:54	12/11/2020 12:58	12/11/2020 14:54	1,93	1	1,93	CHI
20201150309	LUZIANIA	LZ21261348	MARAJOARA	12/11/2020 12:58	12/11/2020 15:00	12/11/2020 12:58	12/11/2020 15:00	2,03	2	4,05	CHI
20201150312	CAIAPONIA	CP21245125	PALESTINA	12/11/2020 12:59	12/11/2020 16:29	12/11/2020 12:59	12/11/2020 16:29	3,50	1	3,50	CHI
20201150314	ARAGUAPAZ	AZ11238786	RUBIATABA	12/11/2020 12:59	12/11/2020 14:25	12/11/2020 12:59	12/11/2020 14:25	1,42	1	1,42	CHI
20201150319	SAO LUIS DE MONTES BELOS	10024987784	SAO LUIZ DOS MONTES BELOS	12/11/2020 13:00	12/11/2020 15:26	12/11/2020 13:00	12/11/2020 15:26	2,43	1	2,43	CHI



20201150321	JUSSARA	1290089593	JUSSARA	12/11/2020 13:00	12/11/2020 17:02	12/11/2020 13:00	12/11/2020 17:02	4,03	1	4,03	CHI
20201150324	BALIZA	BH21397237	BOM JARDIM	12/11/2020 13:01	12/11/2020 16:36	12/11/2020 13:01	12/11/2020 16:36	3,58	1	3,58	CHI
20201150710	ALTO PARAISO DE GOIAS	BF12128334	SAO JOAO D ALIANCA	12/11/2020 13:01	12/11/2020 22:20	12/11/2020 13:01	12/11/2020 22:20	9,31	5	46,57	CHI
20201151529	ITAUCU	IX12016023	INHUMAS S1	12/11/2020 13:01	12/11/2020 18:44	12/11/2020 13:01	12/11/2020 18:44	5,71	7	40,00	CHI
20201150328	PLANALTINA	2960036548	PLANALTINA	12/11/2020 13:02	12/11/2020 13:51	12/11/2020 13:02	12/11/2020 13:51	0,81	1	0,81	CHI
20201150330	DIORAMA	DI21117649	IPORA	12/11/2020 13:03	12/11/2020 14:34	12/11/2020 13:03	12/11/2020 14:34	1,52	1	1,52	CHI
20201150627	TRINDADE	TR11340373	TRINDADE	12/11/2020 13:05	12/11/2020 15:13	12/11/2020 13:05	12/11/2020 15:13	2,13	43	91,54	CHI
20201150351	ALEXANIA	AX21421349	ALEXANIA	12/11/2020 13:06	13/11/2020 09:20	12/11/2020 13:06	13/11/2020 09:20	20,23	1	20,23	CHI
20201150354	GOIANIRA	10012480507	MEIA PONTE	12/11/2020 13:06	12/11/2020 13:46	12/11/2020 13:06	12/11/2020 13:46	0,65	1	0,65	CHI
20201150376	PLANALTINA	2960043188	PLANALTINA	12/11/2020 13:08	12/11/2020 14:30	12/11/2020 13:08	12/11/2020 14:30	1,37	1	1,37	CHI
20201150379	CALDAS NOVAS	CN12332905	CALDAS NOVAS S1	12/11/2020 13:08	12/11/2020 19:42	12/11/2020 13:08	12/11/2020 19:42	6,56	30	196,69	CHI
20201150380	FLORES DE GOIAS	10031613525	FLORES DE GOIAS	12/11/2020 13:08	12/11/2020 19:25	12/11/2020 13:08	12/11/2020 19:25	6,27	1	6,27	CHI
20201150445	CRISTALINA	KR10413345	CRISTALINA S2	12/11/2020 13:08	12/11/2020 15:25	12/11/2020 13:11	12/11/2020 14:10	0,99	12	11,91	CHI
20201150445	CRISTALINA	KR13401323	CRISTALINA S2	12/11/2020 13:08	12/11/2020 15:25	12/11/2020 13:11	12/11/2020 15:01	1,83	25	45,84	CHI
20201150445	CRISTALINA	KR10414293	CRISTALINA S2	12/11/2020 13:08	12/11/2020 15:25	12/11/2020 13:08	12/11/2020 15:25	2,30	78	179,12	CHI
20201150445	IPAMERI	KR10414293	CRISTALINA S2	12/11/2020 13:08	12/11/2020 15:25	12/11/2020 13:08	12/11/2020 15:25	2,30	112	257,20	CHI
20201150523	COCALZINHO DE GOIAS	ZN12326323	COCALZINHO	12/11/2020 13:08	12/11/2020 17:07	12/11/2020 13:08	12/11/2020 17:07	3,97	7	27,82	CHI
20201150523	PIRENOPOLIS	ZN12326323	COCALZINHO	12/11/2020 13:08	12/11/2020 17:07	12/11/2020 13:08	12/11/2020 17:07	3,97	31	123,20	CHI
20201151249	CRISTALINA	KR12210364	CRISTALINA S2	12/11/2020 13:08	12/11/2020 20:17	12/11/2020 13:08	12/11/2020 20:17	7,15	2	14,29	CHI
20201150406	GOIAS	IB12091705	ITABERAI S1	12/11/2020 13:09	12/11/2020 16:51	12/11/2020 13:09	12/11/2020 16:51	3,69	7	25,83	CHI
20201150406	ITABERAI	IB12091705	ITABERAI S1	12/11/2020 13:09	12/11/2020 16:51	12/11/2020 13:09	12/11/2020 16:51	3,69	3	11,07	CHI
20201150693	ITABERAI	IB11250618	ITABERAI S2	12/11/2020 13:09	12/11/2020 14:56	12/11/2020 13:09	12/11/2020 14:56	1,78	115	204,13	CHI
20201150391	ITAPACI	100041255	ITAPACI	12/11/2020 13:10	12/11/2020 19:01	12/11/2020 13:10	12/11/2020 19:01	5,84	1	5,84	CHI
20201150718	ALVORADA DO NORTE	FB12143258	IACIARA S2	12/11/2020 13:11	12/11/2020 19:35	12/11/2020 13:11	12/11/2020 19:35	6,39	30	191,60	CHI
20201150718	FLORES DE GOIAS	FB12143258	IACIARA S2	12/11/2020 13:11	12/11/2020 19:35	12/11/2020 13:11	12/11/2020 19:35	6,39	27	172,44	CHI
20201150400	SILVANIA	SV10394762	VIANOPOLIS	12/11/2020 13:12	13/11/2020 18:25	12/11/2020 16:11	13/11/2020 03:19	11,13	225	2503,56	CHI
20201150400	SILVANIA	SV10394762	VIANOPOLIS	12/11/2020 13:12	13/11/2020 18:25	12/11/2020 13:12	13/11/2020 17:56	28,74	7	201,16	CHI
20201150400	LUZIANIA	SV10394762	VIANOPOLIS	12/11/2020 13:12	13/11/2020 18:25	12/11/2020 16:11	13/11/2020 17:56	25,75	24	618,06	CHI
20201150400	SILVANIA	SV10394762	VIANOPOLIS	12/11/2020 13:12	13/11/2020 18:25	12/11/2020 16:11	13/11/2020 17:56	25,75	13	334,78	CHI
20201150400	LUZIANIA	SV10394762	VIANOPOLIS	12/11/2020 13:12	13/11/2020 18:25	12/11/2020 16:11	13/11/2020 18:25	26,23	324	8497,53	CHI
20201150400	SILVANIA	SV10394762	VIANOPOLIS	12/11/2020 13:12	13/11/2020 18:25	12/11/2020 16:11	13/11/2020 18:25	26,23	1	26,23	CHI
20201150400	LUZIANIA	SV13333168	VIANOPOLIS	12/11/2020 13:12	13/11/2020 18:25	13/11/2020 02:17	13/11/2020 18:25	16,12	56	902,94	CHI
20201150415	ALEXANIA	10017215763	ALEXANIA	12/11/2020 13:15	12/11/2020 18:08	12/11/2020 13:15	12/11/2020 18:08	4,88	1	4,88	CHI
20201151069	CAMPINACU	UC12197189	PORANGATU	12/11/2020 13:15	13/11/2020 16:56	12/11/2020 13:15	13/11/2020 14:20	25,08	49	1228,78	CHI
20201151069	CAMPINACU	UC12197189	PORANGATU	12/11/2020 13:15	13/11/2020 16:56	12/11/2020 13:15	13/11/2020 16:56	27,69	17	470,79	CHI
20201150417	RIO VERDE	RV12379654	RIO VERDE S2	12/11/2020 13:16	12/11/2020 19:00	12/11/2020 13:16	12/11/2020 19:00	5,72	17	97,32	CHI
202011137931	RIO VERDE	RV12018072LD	SANTA HELENA S1	12/11/2020 13:16	13/11/2020 17:03	12/11/2020 13:16	13/11/2020 08:59	19,72	7	138,02	CHI
202011137931	RIO VERDE	RV12018072LD	SANTA HELENA S1	12/11/2020 13:16	13/11/2020 17:03	12/11/2020 13:16	13/11/2020 17:03	27,78	3	83,33	CHI
20201150422	ITAPACI	IW12044978	ITAPACI	12/11/2020 13:17	12/11/2020 15:55	12/11/2020 13:17	12/11/2020 15:55	2,63	6	15,80	CHI
20201150423	NAZARIO	440018468	ANICUNS	12/11/2020 13:17	12/11/2020 16:16	12/11/2020 13:17	12/11/2020 16:16	2,97	1	2,97	CHI
20201150435	CORUMBA DE GOIAS	CB12382397	CORUMBA	12/11/2020 13:19	13/11/2020 07:31	12/11/2020 13:19	13/11/2020 07:31	18,19	33	600,33	CHI
20201150440	MAURILANDIA	1040004456	RIO DOS BOIS	12/11/2020 13:19	13/11/2020 11:00	12/11/2020 13:19	13/11/2020 11:00	21,67	1	21,67	CHI
20201150546	AURILANDIA	CG12391526	FIRMINOPOLIS S2	12/11/2020 13:19	12/11/2020 21:31	12/11/2020 13:19	12/11/2020 20:45	7,44	2	14,88	CHI
20201150546	CACHOEIRA DE GOIAS	CG12391526	FIRMINOPOLIS S2	12/11/2020 13:19	12/11/2020 21:31	12/11/2020 13:19	12/11/2020 20:45	7,44	5	37,20	CHI
20201150546	PARAUNA	CG12391526	FIRMINOPOLIS S2	12/11/2020 13:19	12/11/2020 21:31	12/11/2020 13:19	12/11/2020 20:45	7,44	15	111,59	CHI
20201150546	CACHOEIRA DE GOIAS	CG12391526	FIRMINOPOLIS S2	12/11/2020 13:19	12/11/2020 21:31	12/11/2020 13:19	12/11/2020 21:31	8,21	6	49,23	CHI
20201150546	PARAUNA	CG12391526	FIRMINOPOLIS S2	12/11/2020 13:19	12/11/2020 21:31	12/11/2020 13:19	12/11/2020 21:31	8,21	17	139,49	CHI
20201150452	MORRINHOS	MR12098214	MORRINHOS	12/11/2020 13:22	12/11/2020 15:00	12/11/2020 13:22	12/11/2020 15:00	1,62	12	19,43	CHI
20201150453	UIRAPURU	UP12190106	SANTA TEREZINHA	12/11/2020 13:22	12/11/2020 15:33	12/11/2020 13:22	12/11/2020 15:33	2,17	12	26,01	CHI
20201150456	NIQUELANDIA	NQ12378334	NIQUELANDIA SUBTRANSMISSAO	12/11/2020 13:22	12/11/2020 14:01	12/11/2020 13:22	12/11/2020 14:01	0,63	2	1,27	CHI
20201150467	INHUMAS	IX10383769	INHUMAS S1	12/11/2020 13:24	12/11/2020 18:46	12/11/2020 13:24	12/11/2020 15:36	0,06	172	10,13	CHI

20201150467	ITAUCU	IX10383769	INHUMAS S1	12/11/2020 13:24	12/11/2020 18:46	12/11/2020 15:33	12/11/2020 15:36	0,06	231	13,60	CHI
20201150467	ITAUCU	IX10383769	INHUMAS S1	12/11/2020 13:24	12/11/2020 18:46	12/11/2020 15:33	12/11/2020 15:36	0,06	2770	163,12	CHI
20201150467	ITAUCU	IB10400386	INHUMAS S1	12/11/2020 13:24	12/11/2020 18:46	12/11/2020 15:33	12/11/2020 15:36	0,06	1	0,06	CHI
20201150467	TAQUARAL DE GOIAS	IX10383769	INHUMAS S1	12/11/2020 13:24	12/11/2020 18:46	12/11/2020 15:33	12/11/2020 15:36	0,06	48	2,83	CHI
20201150467	ITAUCU	IB10400386	ITABERAI S1	12/11/2020 13:24	12/11/2020 18:46	12/11/2020 15:33	12/11/2020 15:36	0,06	93	5,48	CHI
20201150467	ITAUCU	IX10400371	INHUMAS S1	12/11/2020 13:24	12/11/2020 18:46	12/11/2020 15:33	12/11/2020 16:00	0,44	4	1,78	CHI
20201150467	SANTA ROSA DE GOIAS	IX10400371	INHUMAS S1	12/11/2020 13:24	12/11/2020 18:46	12/11/2020 15:33	12/11/2020 16:00	0,44	6	2,67	CHI
20201150467	TAQUARAL DE GOIAS	IX10400371	INHUMAS S1	12/11/2020 13:24	12/11/2020 18:46	12/11/2020 15:33	12/11/2020 16:00	0,44	4	1,78	CHI
20201150467	INHUMAS	IN13201079	INHUMAS S1	12/11/2020 13:24	12/11/2020 18:46	12/11/2020 16:02	12/11/2020 16:21	0,31	19	5,84	CHI
20201150467	ITAUCU	IN13201079	INHUMAS S1	12/11/2020 13:24	12/11/2020 18:46	12/11/2020 16:02	12/11/2020 16:21	0,31	3	0,92	CHI
20201150467	ITAUCU	IX10400371	INHUMAS S1	12/11/2020 13:24	12/11/2020 18:46	12/11/2020 16:01	12/11/2020 17:06	1,08	4	4,32	CHI
20201150467	SANTA ROSA DE GOIAS	IX10400371	INHUMAS S1	12/11/2020 13:24	12/11/2020 18:46	12/11/2020 16:01	12/11/2020 17:06	1,08	6	6,47	CHI
20201150467	TAQUARAL DE GOIAS	IX10400371	INHUMAS S1	12/11/2020 13:24	12/11/2020 18:46	12/11/2020 16:01	12/11/2020 17:06	1,08	4	4,32	CHI
20201150467	JARAGUA	IX10383769	INHUMAS S1	12/11/2020 13:24	12/11/2020 18:46	12/11/2020 15:33	12/11/2020 17:43	2,17	40	86,88	CHI
20201150467	JESUPOLIS	IX10383769	INHUMAS S1	12/11/2020 13:24	12/11/2020 18:46	12/11/2020 15:33	12/11/2020 17:43	2,17	24	52,13	CHI
20201150467	SANTA ROSA DE GOIAS	IX10383769	INHUMAS S1	12/11/2020 13:24	12/11/2020 18:46	12/11/2020 15:33	12/11/2020 17:43	2,17	920	1998,19	CHI
20201150467	SANTA ROSA DE GOIAS	IX10400371	INHUMAS S1	12/11/2020 13:24	12/11/2020 18:46	12/11/2020 15:33	12/11/2020 17:43	2,17	1	2,17	CHI
20201150467	TAQUARAL DE GOIAS	IX10383769	INHUMAS S1	12/11/2020 13:24	12/11/2020 18:46	12/11/2020 15:33	12/11/2020 17:43	2,17	45	97,74	CHI
20201150467	ITAUCU	IX10400371	INHUMAS S1	12/11/2020 13:24	12/11/2020 18:46	12/11/2020 17:11	12/11/2020 17:43	0,53	4	2,14	CHI
20201150467	SANTA ROSA DE GOIAS	IX10400371	INHUMAS S1	12/11/2020 13:24	12/11/2020 18:46	12/11/2020 17:11	12/11/2020 17:43	0,53	6	3,20	CHI
20201150467	TAQUARAL DE GOIAS	IX10400371	INHUMAS S1	12/11/2020 13:24	12/11/2020 18:46	12/11/2020 17:11	12/11/2020 17:43	0,53	4	2,14	CHI
20201150467	SANTA ROSA DE GOIAS	3040214	INHUMAS S1	12/11/2020 13:24	12/11/2020 18:46	12/11/2020 13:24	12/11/2020 17:43	4,32	2	8,63	CHI
20201150467	ITAUCU	3040214	INHUMAS S1	12/11/2020 13:24	12/11/2020 18:46	12/11/2020 13:24	12/11/2020 18:46	5,36	6	32,18	CHI
20201150467	PETROLINA DE GOIAS	3040214	INHUMAS S1	12/11/2020 13:24	12/11/2020 18:46	12/11/2020 13:24	12/11/2020 18:46	5,36	129	691,80	CHI
20201150467	SANTA ROSA DE GOIAS	3040214	INHUMAS S1	12/11/2020 13:24	12/11/2020 18:46	12/11/2020 13:24	12/11/2020 18:46	5,36	470	2520,51	CHI
20201150467	PETROLINA DE GOIAS	3040214	INHUMAS S1	12/11/2020 13:24	12/11/2020 18:46	12/11/2020 17:44	12/11/2020 18:46	1,04	2	2,08	CHI
20201150467	SANTA ROSA DE GOIAS	3040214	INHUMAS S1	12/11/2020 13:24	12/11/2020 18:46	12/11/2020 17:44	12/11/2020 18:46	1,04	131	136,46	CHI
20201150469	RIO VERDE	RV12296070	RIO VERDE S1	12/11/2020 13:25	13/11/2020 07:23	12/11/2020 13:25	13/11/2020 07:23	17,96	1	17,96	CHI
20201153074	ITAUCU	IX12018278	INHUMAS S1	12/11/2020 13:25	12/11/2020 23:36	12/11/2020 13:25	12/11/2020 23:36	10,17	75	762,77	CHI
20201150474	GOIANIA	GN12000542	CAMPINAS S3	12/11/2020 13:26	12/11/2020 16:08	12/11/2020 13:26	12/11/2020 16:08	2,70	311	839,61	CHI
20201150478	JUSSARA	1290057051	JUSSARA	12/11/2020 13:26	12/11/2020 16:08	12/11/2020 13:26	12/11/2020 16:08	2,69	1	2,69	CHI
20201150729	CALDAS NOVAS	CN12223514	CALDAS NOVAS S1	12/11/2020 13:26	12/11/2020 16:38	12/11/2020 13:26	12/11/2020 16:38	3,21	124	397,42	CHI
20201154017	SANTA ROSA DE GOIAS	SR12019027	INHUMAS S1	12/11/2020 13:27	13/11/2020 20:01	12/11/2020 13:27	13/11/2020 20:01	30,56	8	244,51	CHI
20201150480	PIRACANJUBA	PJ21307858	PIRACANJUBA	12/11/2020 13:28	12/11/2020 14:10	12/11/2020 13:28	12/11/2020 14:10	0,69	1	0,69	CHI
20201150482	NIQUELANDIA	2750134098	NIQUELANDIA SUBTRANSMISSAO	12/11/2020 13:28	12/11/2020 14:57	12/11/2020 13:28	12/11/2020 14:57	1,47	1	1,47	CHI
20201150487	NIQUELANDIA	NQ11262916	URUACU	12/11/2020 13:29	12/11/2020 16:46	12/11/2020 13:29	12/11/2020 16:46	3,27	17	55,58	CHI
20201151727	PIRENOPOLIS	PV12297744	CORUMBA	12/11/2020 13:30	12/11/2020 20:05	12/11/2020 13:30	12/11/2020 20:05	6,57	32	210,37	CHI
20201150494	LEOPOLDO DE BULHOES	LB21355831	CEPAIGO S2	12/11/2020 13:31	12/11/2020 15:41	12/11/2020 13:31	12/11/2020 15:41	2,16	1	2,16	CHI
20201150495	ANAPOLIS	AN11203748	ANAPOLIS UNIVERSITARIO S1	12/11/2020 13:31	12/11/2020 20:38	12/11/2020 13:31	12/11/2020 20:38	7,10	116	823,86	CHI
20201150497	AGUA FRIA DE GOIAS	TL21337515	SAO JOAO D ALIANCA	12/11/2020 13:32	12/11/2020 21:53	12/11/2020 13:32	12/11/2020 21:53	8,35	1	8,35	CHI
20201150498	FORMOSA	FA21241373	SAO JOAO D ALIANCA	12/11/2020 13:32	12/11/2020 15:59	12/11/2020 13:32	12/11/2020 15:59	2,44	1	2,44	CHI
20201150590	ITABERAI	IB12078567	ITABERAI S1	12/11/2020 13:32	13/11/2020 10:00	12/11/2020 13:32	13/11/2020 10:00	20,45	12	245,42	CHI
20201150590	ITAUCU	IB12078567	ITABERAI S1	12/11/2020 13:32	13/11/2020 10:00	12/11/2020 13:32	13/11/2020 10:00	20,45	1	20,45	CHI
20201150793	AGUA LIMPA	RQ12263111	VILA CORUMBA	12/11/2020 13:32	12/11/2020 15:57	12/11/2020 13:32	12/11/2020 15:57	2,41	9	21,70	CHI
20201150793	MORRINHOS	RQ12263111	VILA CORUMBA	12/11/2020 13:32	12/11/2020 15:57	12/11/2020 13:32	12/11/2020 15:57	2,41	5	12,05	CHI
20201150793	RIO QUENTE	RQ12263111	VILA CORUMBA	12/11/2020 13:32	12/11/2020 15:57	12/11/2020 13:32	12/11/2020 15:57	2,41	15	36,16	CHI
20201150803	IPIRANGA DE GOIAS	RB12003338	RUBIATABA	12/11/2020 13:32	12/11/2020 19:25	12/11/2020 13:32	12/11/2020 19:25	5,87	1	5,87	CHI
20201150803	ITAPACI	RB12003338	RUBIATABA	12/11/2020 13:32	12/11/2020 19:25	12/11/2020 13:32	12/11/2020 19:25	5,87	10	58,71	CHI
20201150803	RUBIATABA	RB12003338	RUBIATABA	12/11/2020 13:32	12/11/2020 19:25	12/11/2020 13:32	12/11/2020 19:25	5,87	128	751,43	CHI
20201150508	ANAPOLIS	AN21261145	ANAPOLIS UNIVERSITARIO S2	12/11/2020 13:33	12/11/2020 15:07	12/11/2020 13:33	12/11/2020 15:07	1,56	1	1,56	CHI
20201150509	CACU	CC21198075	CACHOEIRA ALTA	12/11/2020 13:33	12/11/2020 18:10	12/11/2020 13:33	12/11/2020 18:10	4,61	1	4,61	CHI

20201150701	ALEXANIA	AX12295598	ALEXANIA	12/11/2020 13:33	12/11/2020 16:50	12/11/2020 13:33	12/11/2020 16:50	3,28	9	29,49	CHI
20201150514	SANTA CRUZ DE GOIAS	BC21027023	PIRES DO RIO S2	12/11/2020 13:35	12/11/2020 19:12	12/11/2020 13:35	12/11/2020 19:12	5,62	1	5,62	CHI
20201150526	GOIANIA	15419228	MEIA PONTE	12/11/2020 13:37	12/11/2020 14:30	12/11/2020 13:37	12/11/2020 14:30	0,88	1	0,88	CHI
20201150531	JATAI	JT12260447LD	JATAI S1	12/11/2020 13:38	12/11/2020 15:33	12/11/2020 13:38	12/11/2020 15:33	1,92	52	99,58	CHI
20201150533	GUAPO	GA21000064	GUAPO S2	12/11/2020 13:38	12/11/2020 17:27	12/11/2020 13:38	12/11/2020 17:27	3,81	1	3,81	CHI
20201150547	BURITI ALEGRE	BG21222262	ALTO BURITI	12/11/2020 13:40	12/11/2020 23:44	12/11/2020 13:40	12/11/2020 23:44	10,06	1	10,06	CHI
20201150550	BOM JARDIM DE GOIAS	BM11020270	BOM JARDIM	12/11/2020 13:41	12/11/2020 15:22	12/11/2020 13:41	12/11/2020 15:22	1,68	87	146,26	CHI
20201150705	NOVO GAMA	LZ12000279	PACAEMBU S2	12/11/2020 13:41	12/11/2020 15:22	12/11/2020 13:41	12/11/2020 15:22	1,67	10	16,71	CHI
20201150570	GOIANIA	11891063	GOYA S2	12/11/2020 13:45	12/11/2020 16:57	12/11/2020 13:45	12/11/2020 16:57	3,19	1	3,19	CHI
20201150574	SAO LUIS DE MONTES BELOS	500000621	SAO LUIZ DOS MONTES BELOS	12/11/2020 13:45	12/11/2020 16:32	12/11/2020 13:45	12/11/2020 16:32	2,77	1	2,77	CHI
20201150579	FORMOSA	610210452	ITUIQUIRA	12/11/2020 13:46	12/11/2020 14:56	12/11/2020 13:46	12/11/2020 14:56	1,15	1	1,15	CHI
20201150582	RUBIATABA	RB21114305	RUBIATABA	12/11/2020 13:47	13/11/2020 09:41	12/11/2020 13:47	13/11/2020 09:41	19,90	2	39,79	CHI
20201150586	AGUA FRIA DE GOIAS	TL21150880	SAO JOAO D ALIANCA	12/11/2020 13:47	12/11/2020 19:46	12/11/2020 13:47	12/11/2020 19:46	5,97	1	5,97	CHI
20201150602	PORANGATU	PO10400350	PORANGATU	12/11/2020 13:47	13/11/2020 01:09	12/11/2020 13:47	12/11/2020 15:33	1,77	80	141,91	CHI
20201150602	PORANGATU	PO10400350	PORANGATU	12/11/2020 13:47	13/11/2020 01:09	12/11/2020 13:47	12/11/2020 16:45	2,97	11	32,69	CHI
20201150602	PORANGATU	PO10400350	PORANGATU	12/11/2020 13:47	13/11/2020 01:09	12/11/2020 17:00	12/11/2020 18:16	1,26	91	114,26	CHI
20201150602	PORANGATU	PO12241996	PORANGATU	12/11/2020 13:47	13/11/2020 01:09	12/11/2020 13:47	12/11/2020 20:36	6,82	82	559,17	CHI
20201150602	PORANGATU	PO10400350	PORANGATU	12/11/2020 13:47	13/11/2020 01:09	12/11/2020 13:47	13/11/2020 01:09	11,36	144	1635,88	CHI
20201150709	MARZAGAO	MG12078867	VILA CORUMBA	12/11/2020 13:47	12/11/2020 16:21	12/11/2020 13:47	12/11/2020 16:21	2,56	3	7,69	CHI
20201150619	CRISTALINA	KR13396443	CRISTALINA S1	12/11/2020 13:49	13/11/2020 13:35	12/11/2020 13:49	12/11/2020 20:05	6,28	307	1928,47	CHI
20201150619	IPAMERI	KR13396443	CRISTALINA S1	12/11/2020 13:49	13/11/2020 13:35	12/11/2020 13:49	12/11/2020 20:05	6,28	5	31,41	CHI
20201150619	CRISTALINA	KR13252683	CRISTALINA S1	12/11/2020 13:49	13/11/2020 13:35	13/11/2020 09:26	13/11/2020 12:51	3,40	5	17,02	CHI
20201150619	CRISTALINA	3470434	CRISTALINA S1	12/11/2020 13:49	13/11/2020 13:35	12/11/2020 13:49	13/11/2020 13:35	23,77	4	95,07	CHI
20201150694	MINEIROS	MY12043892RE	PARQUE DAS EMAS	12/11/2020 13:49	12/11/2020 16:12	12/11/2020 13:49	12/11/2020 16:12	2,38	14	33,38	CHI
20201150671	GOIANESIA	GE12004544	GOIANESIA S2	12/11/2020 13:50	14/11/2020 16:17	12/11/2020 13:50	13/11/2020 17:44	27,91	8	223,26	CHI
20201150671	VILA PROPICIO	GE12004544	GOIANESIA S2	12/11/2020 13:50	14/11/2020 16:17	12/11/2020 13:50	13/11/2020 17:44	27,91	21	586,05	CHI
20201150671	VILA PROPICIO	GE12004544	GOIANESIA S2	12/11/2020 13:50	14/11/2020 16:17	12/11/2020 13:50	14/11/2020 15:23	49,54	2	99,09	CHI
20201150671	GOIANESIA	GE12004544	GOIANESIA S2	12/11/2020 13:50	14/11/2020 16:17	12/11/2020 13:50	14/11/2020 16:17	50,45	4	201,81	CHI
20201150671	VILA PROPICIO	GE12004544	GOIANESIA S2	12/11/2020 13:50	14/11/2020 16:17	12/11/2020 13:50	14/11/2020 16:17	50,45	8	403,61	CHI
20201151209	ITABERAI	IB12000047	ITABERAI S2	12/11/2020 13:50	12/11/2020 18:32	12/11/2020 13:50	12/11/2020 18:32	4,69	9	42,18	CHI
20201150611	JUSSARA	JR21020145	BRITANIA	12/11/2020 13:51	12/11/2020 16:18	12/11/2020 13:51	12/11/2020 16:18	2,45	1	2,45	CHI
20201150649	MINEIROS	MY11171859	PARQUE DAS EMAS	12/11/2020 13:51	12/11/2020 15:47	12/11/2020 13:51	12/11/2020 15:47	1,93	124	238,91	CHI
20201151525	INHUMAS	IN32066319	INHUMAS S2	12/11/2020 13:51	13/11/2020 09:06	12/11/2020 13:51	13/11/2020 09:06	19,24	23	442,41	CHI
20201150617	ALEXANIA	480082170	ALEXANIA	12/11/2020 13:52	12/11/2020 18:27	12/11/2020 13:52	12/11/2020 18:27	4,57	1	4,57	CHI
20201150809	GOIAS	GS12206917	ITABERAI S1	12/11/2020 13:52	13/11/2020 01:09	12/11/2020 13:52	13/11/2020 01:09	11,27	7	78,89	CHI
20201150632	LUZIANIA	LZ13162853	CRISTALINA S2	12/11/2020 13:54	13/11/2020 17:13	12/11/2020 13:54	12/11/2020 22:10	8,26	81	669,19	CHI
20201150632	LUZIANIA	LZ12383059	CRISTALINA S2	12/11/2020 13:54	13/11/2020 17:13	12/11/2020 13:54	13/11/2020 12:53	22,97	2	45,95	CHI
20201150632	LUZIANIA	LZ12383059	CRISTALINA S2	12/11/2020 13:54	13/11/2020 17:13	12/11/2020 20:41	13/11/2020 12:53	16,19	7	113,30	CHI
20201150632	LUZIANIA	LZ12051365	CRISTALINA S2	12/11/2020 13:54	13/11/2020 17:13	13/11/2020 05:30	13/11/2020 13:43	8,23	7	57,61	CHI
20201150632	LUZIANIA	LZ12313593	CRISTALINA S2	12/11/2020 13:54	13/11/2020 17:13	12/11/2020 20:41	13/11/2020 13:45	17,06	18	307,16	CHI
20201150632	LUZIANIA	LZ12051365	CRISTALINA S2	12/11/2020 13:54	13/11/2020 17:13	13/11/2020 14:36	13/11/2020 15:33	0,96	7	6,75	CHI
20201150632	LUZIANIA	LZ12051365	CRISTALINA S2	12/11/2020 13:54	13/11/2020 17:13	13/11/2020 05:30	13/11/2020 17:10	11,67	47	548,35	CHI
20201150632	LUZIANIA	LZ12051365	CRISTALINA S2	12/11/2020 13:54	13/11/2020 17:13	13/11/2020 05:30	13/11/2020 17:13	11,73	68	797,77	CHI
20201150625	NOVO GAMA	2460066461	PACAEMBU S1	12/11/2020 13:55	13/11/2020 00:10	12/11/2020 13:55	13/11/2020 00:10	10,25	1	10,25	CHI
20201150626	SENADOR CANEDO	SW11141242	SENADOR CANEDO	12/11/2020 13:55	12/11/2020 15:55	12/11/2020 14:20	12/11/2020 15:55	1,58	217	342,38	CHI
20201150630	PORTELANDIA	PW21241835	PARQUE DAS EMAS	12/11/2020 13:55	12/11/2020 21:53	12/11/2020 13:55	12/11/2020 21:53	7,95	1	7,95	CHI
20201150781	CASTELANDIA	RV12026916	RIO DOS BOIS	12/11/2020 13:55	12/11/2020 19:57	12/11/2020 13:55	12/11/2020 19:57	6,02	12	72,29	CHI
20201150781	RIO VERDE	RV12026916	RIO DOS BOIS	12/11/2020 13:55	12/11/2020 19:57	12/11/2020 13:55	12/11/2020 19:57	6,02	2	12,05	CHI
20201152071	CORUMBA DE GOIAS	CB12033602	CORUMBA	12/11/2020 13:56	13/11/2020 07:58	12/11/2020 13:56	13/11/2020 07:58	18,02	6	108,11	CHI
20201150642	PIRANHAS	PH12074241	ARENOPOLIS	12/11/2020 13:57	12/11/2020 15:11	12/11/2020 13:57	12/11/2020 15:11	1,22	7	8,56	CHI
20201150643	SAO SIMAO	SO21000017	CACHOEIRA ALTA	12/11/2020 13:57	12/11/2020 18:50	12/11/2020 13:57	12/11/2020 18:50	4,87	1	4,87	CHI

20201151382	CAVALCANTE	TI12162624	NIQUELANDIA SUBTRANSMISSAO	12/11/2020 13:57	12/11/2020 19:40	12/11/2020 13:57	12/11/2020 19:40	5,72	50	285,82	CHI
20201151382	COLINAS DO SUL	TI12162624	NIQUELANDIA SUBTRANSMISSAO	12/11/2020 13:57	12/11/2020 19:40	12/11/2020 13:57	12/11/2020 19:40	5,72	6	34,30	CHI
20201150655	RIO VERDE	10002018070	RIO VERDE S2	12/11/2020 14:00	12/11/2020 17:16	12/11/2020 14:00	12/11/2020 17:16	3,26	1	3,26	CHI
20201150906	MIMOSO DE GOIAS	MJ12252532	PADRE BERNARDO	12/11/2020 14:00	12/11/2020 18:33	12/11/2020 14:00	12/11/2020 17:00	2,99	5	14,93	CHI
20201150906	MIMOSO DE GOIAS	MJ12252533	PADRE BERNARDO	12/11/2020 14:00	12/11/2020 18:33	12/11/2020 17:01	12/11/2020 18:33	1,53	1	1,53	CHI
20201150658	SENADOR CANEDO	SW31079101	SENADOR CANEDO	12/11/2020 14:01	12/11/2020 16:35	12/11/2020 14:01	12/11/2020 16:35	2,56	8	20,51	CHI
20201150662	GOIANIA	GN11000813	GOIANIA LESTE S1	12/11/2020 14:02	12/11/2020 15:31	12/11/2020 14:39	12/11/2020 15:31	0,87	141	122,20	CHI
20201150665	GUARINOS	GF12164877	SANTA TEREZINHA	12/11/2020 14:02	12/11/2020 18:22	12/11/2020 14:02	12/11/2020 18:22	4,32	14	60,53	CHI
20201150708	JARAGUA	JA11273157	JARAGUA	12/11/2020 14:02	12/11/2020 15:54	12/11/2020 14:02	12/11/2020 15:54	1,86	89	165,37	CHI
20201150666	CALDAS NOVAS	10010166783	SERRA DE CALDAS	12/11/2020 14:03	12/11/2020 16:19	12/11/2020 14:03	12/11/2020 16:19	2,27	1	2,27	CHI
20201150689	CAMPO ALEGRE DE GOIAS	CM10415017	PIRES DO RIO S2	12/11/2020 14:03	13/11/2020 16:22	12/11/2020 14:03	12/11/2020 22:02	7,99	20	159,72	CHI
20201150689	IPAMERI	CM10415017	PIRES DO RIO S2	12/11/2020 14:03	13/11/2020 16:22	12/11/2020 14:03	12/11/2020 22:02	7,99	268	2140,20	CHI
20201150689	ORIZONA	CM10415017	PIRES DO RIO S2	12/11/2020 14:03	13/11/2020 16:22	12/11/2020 14:03	12/11/2020 22:02	7,99	1	7,99	CHI
20201150689	URUTAI	CM10415017	PIRES DO RIO S2	12/11/2020 14:03	13/11/2020 16:22	12/11/2020 14:03	12/11/2020 22:02	7,99	6	47,91	CHI
20201150689	ORIZONA	1480414	PIRES DO RIO S2	12/11/2020 14:03	13/11/2020 16:22	12/11/2020 14:03	13/11/2020 09:06	19,04	8	152,33	CHI
20201150689	PIRES DO RIO	1480414	PIRES DO RIO S2	12/11/2020 14:03	13/11/2020 16:22	12/11/2020 14:03	13/11/2020 09:06	19,04	7	133,29	CHI
20201150689	URUTAI	1480414	PIRES DO RIO S2	12/11/2020 14:03	13/11/2020 16:22	12/11/2020 14:03	13/11/2020 09:06	19,04	98	1866,08	CHI
20201150689	PIRES DO RIO	1480414	PIRES DO RIO S2	12/11/2020 14:03	13/11/2020 16:22	12/11/2020 14:03	13/11/2020 16:22	26,32	3	78,95	CHI
20201150674	GOIANIA	11504274	CAMPINAS S3	12/11/2020 14:05	12/11/2020 16:20	12/11/2020 14:05	12/11/2020 16:20	2,24	1	2,24	CHI
20201150675	APARECIDA DE GOIANIA	200148965	INDEPENDENCIA S2	12/11/2020 14:05	12/11/2020 15:11	12/11/2020 14:05	12/11/2020 15:11	1,09	1	1,09	CHI
20201151065	URUACU	UR11000028	URUACU	12/11/2020 14:06	12/11/2020 17:19	12/11/2020 14:06	12/11/2020 17:19	3,20	61	195,28	CHI
20201150684	ITABERAÍ	50020614	ITABERAÍ S2	12/11/2020 14:07	12/11/2020 17:23	12/11/2020 14:07	12/11/2020 17:23	3,26	1	3,26	CHI
20201150688	SANTA ROSA DE GOIAS	SR21117272	INHUMAS S1	12/11/2020 14:08	13/11/2020 21:31	12/11/2020 14:08	13/11/2020 20:59	30,85	1	30,85	CHI
20201150688	SANTA ROSA DE GOIAS	SR12019025LD	INHUMAS S1	12/11/2020 14:08	13/11/2020 21:31	13/11/2020 14:42	13/11/2020 21:31	6,80	16	108,87	CHI
20201150717	CRISTALINA	KR21171350	PAMPLONA	12/11/2020 14:12	12/11/2020 17:43	12/11/2020 14:12	12/11/2020 17:43	3,51	1	3,51	CHI
20201150723	SERRANOPOLIS	SX21264461	JATAÍ S1	12/11/2020 14:13	13/11/2020 09:59	12/11/2020 14:13	13/11/2020 09:59	19,75	1	19,75	CHI
20201150726	GOIANIA	14844175	GOIANIA LESTE S3	12/11/2020 14:14	12/11/2020 15:59	12/11/2020 14:14	12/11/2020 15:59	1,75	1	1,75	CHI
20201151447	RUBIATABA	RB12003316	RUBIATABA	12/11/2020 14:15	12/11/2020 18:23	12/11/2020 14:15	12/11/2020 18:23	4,12	44	181,43	CHI
20201150739	LUZIANIA	LZ11030593	RIO VERMELHO	12/11/2020 14:16	12/11/2020 16:16	12/11/2020 14:16	12/11/2020 16:16	2,00	141	281,69	CHI
20201150745	NOVA CRIXAS	MH12182458	NOVA CRIXAS	12/11/2020 14:16	13/11/2020 12:55	12/11/2020 14:16	13/11/2020 12:55	22,64	1	22,64	CHI
20201150749	CRISTALINA	KR12031672	CRISTALINA S1	12/11/2020 14:17	12/11/2020 21:57	12/11/2020 14:17	12/11/2020 21:57	7,66	1	7,66	CHI
20201150759	RUBIATABA	RB21191311	RUBIATABA	12/11/2020 14:19	12/11/2020 16:22	12/11/2020 14:19	12/11/2020 16:22	2,04	1	2,04	CHI
20201150760	MAURILANDIA	1040007159	RIO DOS BOIS	12/11/2020 14:19	12/11/2020 17:39	12/11/2020 14:19	12/11/2020 17:39	3,32	1	3,32	CHI
20201150763	NEROPOLIS	10002314957	NEROPOLIS S2	12/11/2020 14:20	12/11/2020 17:25	12/11/2020 14:20	12/11/2020 17:25	3,08	1	3,08	CHI
20201150764	RIO VERDE	630001352	RIO VERDE S2	12/11/2020 14:21	12/11/2020 17:22	12/11/2020 14:21	12/11/2020 17:22	3,01	1	3,01	CHI
20201150765	ALTO PARAISO DE GOIAS	BF12365282	SAO JOAO D ALIANCA	12/11/2020 14:21	12/11/2020 18:23	12/11/2020 14:21	12/11/2020 18:23	4,03	45	181,39	CHI
20201150777	NIQUELANDIA	NQ10396041	NIQUELANDIA SUBTRANSMISSAO	12/11/2020 14:21	12/11/2020 18:57	12/11/2020 14:21	12/11/2020 16:57	2,61	204	531,93	CHI
20201150777	NIQUELANDIA	NQ13235653	NIQUELANDIA SUBTRANSMISSAO	12/11/2020 14:21	12/11/2020 18:57	12/11/2020 14:21	12/11/2020 18:02	3,69	79	291,73	CHI
20201150777	NIQUELANDIA	NQ12235365LD	NIQUELANDIA SUBTRANSMISSAO	12/11/2020 14:21	12/11/2020 18:57	12/11/2020 14:21	12/11/2020 18:57	4,60	61	280,33	CHI
20201150777	URUACU	NQ12235365LD	NIQUELANDIA SUBTRANSMISSAO	12/11/2020 14:21	12/11/2020 18:57	12/11/2020 14:21	12/11/2020 18:57	4,60	3	13,79	CHI
20201151822	APORE	4320214	ITAJA S1	12/11/2020 14:22	12/11/2020 22:33	12/11/2020 14:22	12/11/2020 17:40	3,29	92	303,11	CHI
20201151822	SERRANOPOLIS	4320214	ITAJA S1	12/11/2020 14:22	12/11/2020 22:33	12/11/2020 14:22	12/11/2020 17:40	3,29	8	26,36	CHI
20201151822	APORE	AE13365052	ITAJA S1	12/11/2020 14:22	12/11/2020 22:33	12/11/2020 14:22	12/11/2020 22:33	8,18	5	40,92	CHI
20201151822	SERRANOPOLIS	AE13365052	ITAJA S1	12/11/2020 14:22	12/11/2020 22:33	12/11/2020 14:22	12/11/2020 22:33	8,18	38	310,99	CHI
20201150774	IACIARA	IA21218834	IACIARA S2	12/11/2020 14:23	12/11/2020 16:32	12/11/2020 14:23	12/11/2020 16:32	2,14	1	2,14	CHI
20201151186	ANAPOLIS	20811032	ANAPOLIS UNIVERSITARIO S1	12/11/2020 14:24	12/11/2020 17:59	12/11/2020 14:24	12/11/2020 17:59	3,58	1	3,58	CHI
20201150782	CRISTALINA	3940406	CRISTALINA S2	12/11/2020 14:25	12/11/2020 17:18	12/11/2020 14:25	12/11/2020 17:18	2,89	275	794,44	CHI
20201150782	CRISTALINA	3940406	CRISTALINA S2	12/11/2020 14:25	12/11/2020 17:18	12/11/2020 14:25	12/11/2020 17:18	2,89	640	1848,89	CHI
20201150784	AGUA LIMPA	AL11273798	VILA CORUMBA	12/11/2020 14:25	12/11/2020 23:06	12/11/2020 14:25	12/11/2020 23:06	8,68	24	208,40	CHI
20201150796	ANAPOLIS	20865776	JUNDIAI S2	12/11/2020 14:26	12/11/2020 16:25	12/11/2020 14:26	12/11/2020 16:25	1,98	1	1,98	CHI
20201151847	COCALZINHO DE GOIAS	NP12229017	GOIANESIA S1	12/11/2020 14:27	12/11/2020 23:14	12/11/2020 14:27	12/11/2020 23:14	8,78	1	8,78	CHI

20201151847	VILA PROPICIO	NP12229017	GOIANESIA S1	12/11/2020 14:27	12/11/2020 23:14	12/11/2020 14:27	12/11/2020 23:14	8,78	12	105,37	CHI
20201150814	ITUMBIARA	IT21208055	ITUMBIARA NOVA	12/11/2020 14:28	12/11/2020 17:53	12/11/2020 14:28	12/11/2020 17:53	3,41	2	6,82	CHI
20201150815	FLORES DE GOIAS	10031465607	FLORES DE GOIAS	12/11/2020 14:28	12/11/2020 20:23	12/11/2020 14:28	12/11/2020 20:23	5,91	1	5,91	CHI
20201150861	PARAUNA	PU12205943	PARAUNA	12/11/2020 14:28	13/11/2020 14:59	12/11/2020 14:28	12/11/2020 20:40	6,19	8	49,52	CHI
20201150861	PARAUNA	PU12205943	PARAUNA	12/11/2020 14:28	13/11/2020 14:59	12/11/2020 14:28	12/11/2020 22:26	7,96	7	55,69	CHI
20201150861	PARAUNA	PU13314817	PARAUNA	12/11/2020 14:28	13/11/2020 14:59	12/11/2020 18:02	12/11/2020 22:26	4,40	6	26,40	CHI
20201150861	JANDAIA	PU12205943	PARAUNA	12/11/2020 14:28	13/11/2020 14:59	12/11/2020 14:28	13/11/2020 14:59	24,52	2	49,04	CHI
20201150861	PARAUNA	PU12205943	PARAUNA	12/11/2020 14:28	13/11/2020 14:59	12/11/2020 14:28	13/11/2020 14:59	24,52	6	147,12	CHI
20201150861	JANDAIA	PU13314817	PARAUNA	12/11/2020 14:28	13/11/2020 14:59	12/11/2020 18:02	13/11/2020 14:59	20,96	1	20,96	CHI
20201150861	PARAUNA	PU13314817	PARAUNA	12/11/2020 14:28	13/11/2020 14:59	13/11/2020 11:40	13/11/2020 14:59	3,33	13	43,25	CHI
20201151287	NOVO BRASIL	NB12206882	JUSSARA	12/11/2020 14:28	12/11/2020 19:48	12/11/2020 14:28	12/11/2020 19:48	5,33	4	21,31	CHI
20201151849	VILA PROPICIO	NP12240133	GOIANESIA S1	12/11/2020 14:28	12/11/2020 17:43	12/11/2020 14:28	12/11/2020 17:43	3,23	53	171,41	CHI
20201150820	PIRANHAS	PH12341757	CAIAPONIA	12/11/2020 14:29	12/11/2020 17:15	12/11/2020 14:29	12/11/2020 17:15	2,78	2	5,56	CHI
20201150979	TROMBAS	TB12187857	PORANGATU	12/11/2020 14:29	13/11/2020 06:50	12/11/2020 14:29	13/11/2020 06:50	16,35	8	130,77	CHI
2020111200045	GOIANIA	620244	GOYA S1	12/11/2020 14:29	12/11/2020 14:57	12/11/2020 14:29	12/11/2020 14:57	0,47	693	323,40	CHI
20201150831	SENADOR CANEDO	10031078662	SENADOR CANEDO	12/11/2020 14:30	12/11/2020 14:52	12/11/2020 14:30	12/11/2020 14:52	0,36	1	0,36	CHI
20201150828	FORMOSA	FA11000044	ITUIQUIRA	12/11/2020 14:31	12/11/2020 16:02	12/11/2020 14:31	12/11/2020 16:02	1,51	69	103,94	CHI
20201151067	RUBIATABA	RB12241451	RUBIATABA	12/11/2020 14:31	13/11/2020 08:54	12/11/2020 14:31	13/11/2020 08:54	18,37	10	183,68	CHI
20201150834	APARECIDA DE GOIANIA	10028290117	INDEPENDENCIA S1	12/11/2020 14:32	12/11/2020 15:54	12/11/2020 14:32	12/11/2020 15:54	1,36	1	1,36	CHI
20201151055	GAMELEIRA DE GOIAS	AN12273054	ANAPOLIS UNIVERSITARIO S2	12/11/2020 14:32	13/11/2020 01:20	12/11/2020 14:32	13/11/2020 01:20	10,79	34	366,94	CHI
20201151055	SILVANIA	AN12273054	ANAPOLIS UNIVERSITARIO S2	12/11/2020 14:32	13/11/2020 01:20	12/11/2020 14:32	13/11/2020 01:20	10,79	1	10,79	CHI
20201150840	PLANALTINA	2960229843	PLANALTINA	12/11/2020 14:33	12/11/2020 16:11	12/11/2020 14:33	12/11/2020 16:11	1,63	1	1,63	CHI
20201150843	GOIANDIRA	GD21000016	CATALAO S1	12/11/2020 14:33	12/11/2020 20:30	12/11/2020 14:33	12/11/2020 20:30	5,96	1	5,96	CHI
20201150847	NOVO GAMA	LZ12000486LD	PACAEMBU S2	12/11/2020 14:34	12/11/2020 23:17	12/11/2020 14:34	12/11/2020 22:49	8,25	34	280,51	CHI
20201150847	NOVO GAMA	LZ12000486LD	PACAEMBU S2	12/11/2020 14:34	12/11/2020 23:17	12/11/2020 14:34	12/11/2020 23:17	8,72	257	2241,75	CHI
20201150849	GOIANIA	GN11154547	CARAJAS S1	12/11/2020 14:34	12/11/2020 17:17	12/11/2020 14:34	12/11/2020 17:17	2,71	108	293,10	CHI
20201150857	ITABERAI	IB11250617	ITABERAI S2	12/11/2020 14:35	12/11/2020 15:22	12/11/2020 14:35	12/11/2020 15:22	0,79	136	106,84	CHI
20201152354	URUACU	UR11000022	URUACU	12/11/2020 14:35	12/11/2020 20:11	12/11/2020 14:35	12/11/2020 20:11	5,59	130	726,95	CHI
20201153759	JATAI	SX12013892LD	JATAI S1	12/11/2020 14:35	13/11/2020 09:52	12/11/2020 14:35	13/11/2020 09:52	19,29	13	250,75	CHI
20201153759	SERRANOPOLIS	SX12013892LD	JATAI S1	12/11/2020 14:35	13/11/2020 09:52	12/11/2020 14:35	13/11/2020 09:52	19,29	140	2700,37	CHI
20201150999	MINEIROS	SU13191740	SANTA RITA DO ARAGUAIA	12/11/2020 14:37	12/11/2020 16:25	12/11/2020 14:37	12/11/2020 16:25	1,80	33	59,44	CHI
20201150999	SANTA RITA DO ARAGUAIA	SU13191740	SANTA RITA DO ARAGUAIA	12/11/2020 14:37	12/11/2020 16:25	12/11/2020 14:37	12/11/2020 16:25	1,80	2037	3668,86	CHI
20201150892	VALPARAISO DE GOIAS	10000019540	PACAEMBU S2	12/11/2020 14:38	12/11/2020 17:18	12/11/2020 14:38	12/11/2020 17:18	2,66	1	2,66	CHI
20201150895	GOIAS	GS12310670	GOIAS	12/11/2020 14:38	12/11/2020 18:03	12/11/2020 14:38	12/11/2020 18:03	3,40	6	20,42	CHI
20201150939	GOIANIA	GN12001259	ATLANTICO S2	12/11/2020 14:38	12/11/2020 15:55	12/11/2020 14:38	12/11/2020 15:55	1,29	255	328,67	CHI
20201151223	RUBIATABA	RB12000039	RUBIATABA	12/11/2020 14:38	12/11/2020 21:03	12/11/2020 14:38	12/11/2020 21:03	6,40	98	627,64	CHI
20201150898	SERRANOPOLIS	SX11324818	JATAI S1	12/11/2020 14:39	12/11/2020 18:11	12/11/2020 14:39	12/11/2020 18:11	3,53	48	169,39	CHI
20201150909	CAIAPONIA	MV12030666	MONTIVIDIU T	12/11/2020 14:39	12/11/2020 17:14	12/11/2020 14:39	12/11/2020 17:14	2,57	17	43,67	CHI
20201150909	MONTIVIDIU	MV12030666	MONTIVIDIU T	12/11/2020 14:39	12/11/2020 17:14	12/11/2020 14:39	12/11/2020 17:14	2,57	22	56,52	CHI
20201150904	RIO VERDE	RV21240302	RIO VERDE S1	12/11/2020 14:40	12/11/2020 22:57	12/11/2020 14:40	12/11/2020 22:57	8,28	1	8,28	CHI
20201150916	PLANALTINA	2960088263	PLANALTINA	12/11/2020 14:42	12/11/2020 16:18	12/11/2020 14:42	12/11/2020 16:18	1,60	1	1,60	CHI
20201151135	PROFESSOR JAMIL SAFADY	PJ12063080	ROCHEDO	12/11/2020 14:42	12/11/2020 19:16	12/11/2020 14:42	12/11/2020 19:16	4,55	13	59,20	CHI
20201151337	PIRENOPOLIS	PV12295641	SAO FRANCISCO DE GOIAS	12/11/2020 14:43	12/11/2020 18:30	12/11/2020 14:43	12/11/2020 18:30	3,77	182	685,79	CHI
20201153426	PIRENOPOLIS	PV21006540	SAO FRANCISCO DE GOIAS	12/11/2020 14:43	13/11/2020 03:30	12/11/2020 14:43	13/11/2020 03:30	12,77	3	38,30	CHI
20201150944	ITAJA	IJ12200626	ITAJA S2	12/11/2020 14:45	12/11/2020 18:18	12/11/2020 14:45	12/11/2020 18:18	3,54	6	21,22	CHI
20201150945	MINEIROS	1390017919	PARQUE DAS EMAS	12/11/2020 14:45	12/11/2020 18:56	12/11/2020 14:45	12/11/2020 18:56	4,17	1	4,17	CHI
20201151264	MUTUNOPOLIS	MU12129781	MARA ROSA	12/11/2020 14:45	13/11/2020 09:25	12/11/2020 14:45	13/11/2020 09:25	18,66	7	130,59	CHI
20201152613	VILA PROPICIO	NP11090262	GOIANESIA S1	12/11/2020 14:46	13/11/2020 12:56	12/11/2020 17:33	13/11/2020 12:56	19,37	106	2052,98	CHI
202011138055	VILA PROPICIO	2850005958	GOIANESIA S1	12/11/2020 14:46	12/11/2020 17:33	12/11/2020 14:46	12/11/2020 17:33	2,79	1	2,79	CHI
20201150964	NIQUELANDIA	NQ12356446	URUACU	12/11/2020 14:48	14/11/2020 15:52	12/11/2020 14:48	14/11/2020 15:52	49,05	1	49,05	CHI
20201151088	ORIZONA	6444202	PIRES DO RIO S1	12/11/2020 14:48	13/11/2020 14:05	12/11/2020 14:48	13/11/2020 14:05	23,27	11	255,99	CHI



20201151088	PIRES DO RIO	6444202	PIRES DO RIO S1	12/11/2020 14:48	13/11/2020 14:05	12/11/2020 14:48	13/11/2020 14:05	23,27	3	69,82	CHI
20201150967	GOUVELANDIA	GB21303171	QUIRINOPOLIS	12/11/2020 14:49	12/11/2020 16:18	12/11/2020 14:49	12/11/2020 16:18	1,48	1	1,48	CHI
20201150973	GOIAS	IB12000044	ITABERAÍ S2	12/11/2020 14:49	12/11/2020 18:19	12/11/2020 14:49	12/11/2020 18:19	3,49	1	3,49	CHI
20201150973	ITABERAÍ	IB12000044	ITABERAÍ S2	12/11/2020 14:49	12/11/2020 18:19	12/11/2020 14:49	12/11/2020 18:19	3,49	7	24,41	CHI
20201150977	JANDAIA	PP10404111	PALMEIRAS	12/11/2020 14:49	12/11/2020 18:26	12/11/2020 14:49	12/11/2020 18:26	3,60	56	201,63	CHI
20201150977	PALMINOPOLIS	PP10404111	PALMEIRAS	12/11/2020 14:49	12/11/2020 18:26	12/11/2020 14:49	12/11/2020 18:26	3,60	163	586,89	CHI
20201150978	AGUAS LINDAS DE GOIAS	4830325137	AGUAS LINDAS DE GOIAS S1	12/11/2020 14:50	12/11/2020 17:35	12/11/2020 14:50	12/11/2020 17:35	2,75	1	2,75	CHI
20201151898	GOIANESIA	GE21236842	GOIANESIA S2	12/11/2020 14:51	13/11/2020 13:52	12/11/2020 14:51	13/11/2020 13:52	23,01	1	23,01	CHI
20201152784	GOIANESIA	GE12357338	GOIANESIA S2	12/11/2020 14:51	12/11/2020 18:55	12/11/2020 14:51	12/11/2020 18:55	4,06	14	56,84	CHI
20201151001	SENADOR CANEDO	12852363	GOIANIA LESTE S1	12/11/2020 14:52	12/11/2020 16:35	12/11/2020 14:52	12/11/2020 16:35	1,71	1	1,71	CHI
20201151795	ANAPOLIS	AN12270323	ANAPOLIS UNIVERSITARIO S2	12/11/2020 14:52	14/11/2020 13:46	12/11/2020 14:52	14/11/2020 10:56	44,08	3	132,23	CHI
20201151795	PIRENOPOLIS	AN12270323	ANAPOLIS UNIVERSITARIO S2	12/11/2020 14:52	14/11/2020 13:46	12/11/2020 14:52	14/11/2020 10:56	44,08	2	88,15	CHI
20201151795	PIRENOPOLIS	AN12270323	ANAPOLIS UNIVERSITARIO S2	12/11/2020 14:52	14/11/2020 13:46	12/11/2020 18:50	14/11/2020 10:56	40,11	11	441,21	CHI
20201151795	ANAPOLIS	AN12270323	ANAPOLIS UNIVERSITARIO S2	12/11/2020 14:52	14/11/2020 13:46	12/11/2020 14:52	14/11/2020 10:57	44,08	1	44,08	CHI
20201151795	ANAPOLIS	AN12270323	ANAPOLIS UNIVERSITARIO S2	12/11/2020 14:52	14/11/2020 13:46	12/11/2020 18:50	14/11/2020 10:57	40,12	1	40,12	CHI
20201151795	PIRENOPOLIS	AN12270323	ANAPOLIS UNIVERSITARIO S2	12/11/2020 14:52	14/11/2020 13:46	12/11/2020 14:52	14/11/2020 12:55	46,06	2	92,11	CHI
20201151795	ANAPOLIS	AN12089153	ANAPOLIS UNIVERSITARIO S2	12/11/2020 14:52	14/11/2020 13:46	12/11/2020 18:50	14/11/2020 12:55	42,09	1	42,09	CHI
20201151795	PIRENOPOLIS	AN12089153	ANAPOLIS UNIVERSITARIO S2	12/11/2020 14:52	14/11/2020 13:46	12/11/2020 18:50	14/11/2020 12:55	42,09	11	463,01	CHI
20201151795	PIRENOPOLIS	AN12270323	ANAPOLIS UNIVERSITARIO S2	12/11/2020 14:52	14/11/2020 13:46	12/11/2020 14:52	14/11/2020 13:46	46,90	4	187,62	CHI
20201151795	ANAPOLIS	AN12319783	ANAPOLIS UNIVERSITARIO S2	12/11/2020 14:52	14/11/2020 13:46	12/11/2020 18:50	14/11/2020 13:46	42,94	1	42,94	CHI
20201151795	PIRENOPOLIS	AN12319783	ANAPOLIS UNIVERSITARIO S2	12/11/2020 14:52	14/11/2020 13:46	12/11/2020 18:50	14/11/2020 13:46	42,94	14	601,14	CHI
20201151006	SANTA CRUZ DE GOIAS	BC21124192	PIRES DO RIO S2	12/11/2020 14:53	12/11/2020 21:37	12/11/2020 14:53	12/11/2020 21:37	6,73	1	6,73	CHI
20201152107	BARRO ALTO	1150010815	BARRO ALTO	12/11/2020 14:53	13/11/2020 20:26	12/11/2020 14:53	13/11/2020 20:26	29,54	1	29,54	CHI
20201151017	LUZIANIA	LZ12261442	MARAJOARA	12/11/2020 14:54	12/11/2020 21:21	12/11/2020 14:54	12/11/2020 21:21	6,44	4	25,78	CHI
20201151018	MINEIROS	MY12348107	PARQUE DAS EMAS	12/11/2020 14:54	13/11/2020 09:38	12/11/2020 14:54	13/11/2020 09:38	18,73	11	205,98	CHI
20201151019	BURITI ALEGRE	10032558072	ITUMBIARA VELHA S2	12/11/2020 14:54	12/11/2020 19:28	12/11/2020 14:54	12/11/2020 19:28	4,57	1	4,57	CHI
20201151027	SAO JOAO D ALIANCA	JL12049201	SAO JOAO D ALIANCA	12/11/2020 14:55	12/11/2020 16:22	12/11/2020 14:55	12/11/2020 16:22	1,44	95	136,93	CHI
20201151029	ANAPOLIS	AN12258561	ANAPOLIS UNIVERSITARIO S2	12/11/2020 14:55	12/11/2020 17:43	12/11/2020 14:55	12/11/2020 17:43	2,78	54	150,36	CHI
20201151091	GOIANESIA	GE11140955	GOIANESIA S2	12/11/2020 14:55	12/11/2020 18:39	12/11/2020 14:55	12/11/2020 18:39	3,73	137	510,48	CHI
20201151033	FLORES DE GOIAS	FB12286863	FLORES DE GOIAS	12/11/2020 14:57	12/11/2020 18:02	12/11/2020 14:57	12/11/2020 18:02	3,08	76	234,33	CHI
20201151633	JESUPOLIS	PG12111252	PETROLINA	12/11/2020 14:57	12/11/2020 18:57	12/11/2020 14:57	12/11/2020 18:57	3,99	1	3,99	CHI
20201151633	PETROLINA DE GOIAS	PG12111252	PETROLINA	12/11/2020 14:57	12/11/2020 18:57	12/11/2020 14:57	12/11/2020 18:57	3,99	30	119,71	CHI
20201151038	CIDADE OCIDENTAL	LZ21120211	MARAJOARA	12/11/2020 14:58	12/11/2020 23:52	12/11/2020 14:58	12/11/2020 23:52	8,90	1	8,90	CHI
20201151042	APORE	AE21205126	ITAJA S1	12/11/2020 14:58	13/11/2020 07:47	12/11/2020 14:58	13/11/2020 07:47	16,81	1	16,81	CHI
20201151046	GOIANIA	10029931612	GOYA S2	12/11/2020 14:58	12/11/2020 16:33	12/11/2020 14:58	12/11/2020 16:33	1,57	1	1,57	CHI
20201151047	PLANALTINA	PI21170801	PLANALTINA	12/11/2020 14:59	12/11/2020 17:54	12/11/2020 14:59	12/11/2020 17:54	2,91	1	2,91	CHI
20201151054	ABADIANA	AA12295550	ANAPOLIS UNIVERSITARIO S1	12/11/2020 14:59	12/11/2020 19:25	12/11/2020 14:59	12/11/2020 19:25	4,42	5	22,10	CHI
20201151098	GOIANIA	GN11001154	GOIANIA LESTE S1	12/11/2020 14:59	12/11/2020 19:02	12/11/2020 14:59	12/11/2020 19:02	4,04	214	865,45	CHI
20201151058	NEROPOLIS	NR21283816	NEROPOLIS S2	12/11/2020 15:00	13/11/2020 04:17	12/11/2020 15:00	13/11/2020 04:17	13,28	2	26,56	CHI
20201151060	PLANALTINA	PI11325403	PLANALTINA	12/11/2020 15:00	12/11/2020 17:14	12/11/2020 15:00	12/11/2020 17:14	2,23	11	24,55	CHI
20201151062	ARAGARCAS	AG11000013	ARAGARCAS	12/11/2020 15:00	12/11/2020 16:17	12/11/2020 15:00	12/11/2020 16:17	1,28	127	162,03	CHI
20201151071	PARANAIGUARA	PC21000108	QUIRINOPOLIS	12/11/2020 15:01	12/11/2020 19:56	12/11/2020 15:01	12/11/2020 19:56	4,91	1	4,91	CHI
20201151073	LUZIANIA	LZ11149808	MARAJOARA	12/11/2020 15:01	12/11/2020 15:37	12/11/2020 15:01	12/11/2020 15:37	0,59	103	60,80	CHI
20201151124	GOIANESIA	GE10400378	GOIANESIA S1	12/11/2020 15:01	12/11/2020 22:31	12/11/2020 15:01	12/11/2020 16:08	1,11	396	440,44	CHI
20201151124	GOIANESIA	GE10400378	GOIANESIA S1	12/11/2020 15:01	12/11/2020 22:31	12/11/2020 15:01	12/11/2020 16:08	1,11	608	676,23	CHI
20201151124	GOIANESIA	GE10400378	GOIANESIA S1	12/11/2020 15:01	12/11/2020 22:31	12/11/2020 15:01	12/11/2020 16:08	1,11	1	1,11	CHI
20201151124	NOVA GLORIA	GE10400378	GOIANESIA S1	12/11/2020 15:01	12/11/2020 22:31	12/11/2020 15:01	12/11/2020 16:08	1,11	2	2,22	CHI
20201151124	SANTA ISABEL	GE10400378	GOIANESIA S1	12/11/2020 15:01	12/11/2020 22:31	12/11/2020 15:01	12/11/2020 16:08	1,11	2	2,22	CHI
20201151124	SANTA ISABEL	GE10400378	GOIANESIA S1	12/11/2020 15:01	12/11/2020 22:31	12/11/2020 15:01	12/11/2020 16:08	1,11	31	34,48	CHI
20201151124	SAO LUIZ DO NORTE	GE10400378	GOIANESIA S1	12/11/2020 15:01	12/11/2020 22:31	12/11/2020 15:01	12/11/2020 16:08	1,11	21	23,36	CHI
20201151124	GOIANESIA	GE10400378	GOIANESIA S1	12/11/2020 15:01	12/11/2020 22:31	12/11/2020 15:01	12/11/2020 18:24	3,38	5	16,90	CHI

20201151124	GOIANESIA	4640414	GOIANESIA S1	12/11/2020 15:01	12/11/2020 22:31	12/11/2020 22:21	12/11/2020 22:31	0,17	395	65,28	CHI
20201151124	GOIANESIA	4640414	GOIANESIA S1	12/11/2020 15:01	12/11/2020 22:31	12/11/2020 22:21	12/11/2020 22:31	0,17	611	100,98	CHI
20201151124	GOIANESIA	GE13294243	GOIANESIA S1	12/11/2020 15:01	12/11/2020 22:31	12/11/2020 22:21	12/11/2020 22:31	0,17	1	0,17	CHI
20201151124	NOVA GLORIA	4640414	GOIANESIA S1	12/11/2020 15:01	12/11/2020 22:31	12/11/2020 22:21	12/11/2020 22:31	0,17	2	0,33	CHI
20201151124	SANTA ISABEL	4640414	GOIANESIA S1	12/11/2020 15:01	12/11/2020 22:31	12/11/2020 22:21	12/11/2020 22:31	0,17	2	0,33	CHI
20201151124	SANTA ISABEL	4640414	GOIANESIA S1	12/11/2020 15:01	12/11/2020 22:31	12/11/2020 22:21	12/11/2020 22:31	0,17	31	5,12	CHI
20201151124	SAO LUIZ DO NORTE	4640414	GOIANESIA S1	12/11/2020 15:01	12/11/2020 22:31	12/11/2020 22:21	12/11/2020 22:31	0,17	21	3,47	CHI
20201151455	GOIANIA	GN10380003	GOIANIA LESTE S1	12/11/2020 15:01	12/11/2020 15:05	12/11/2020 15:01	12/11/2020 15:05	0,06	396	24,64	CHI
20201151455	SENADOR CANEDO	GN10380003	GOIANIA LESTE S1	12/11/2020 15:01	12/11/2020 15:05	12/11/2020 15:01	12/11/2020 15:05	0,06	2328	144,85	CHI
20201151082	ITABERAI	IB12000049	ITABERAI S2	12/11/2020 15:02	12/11/2020 18:18	12/11/2020 15:02	12/11/2020 18:18	3,26	16	52,12	CHI
20201151086	GOIANESIA	550159897	GOIANESIA S2	12/11/2020 15:02	13/11/2020 00:14	12/11/2020 15:02	13/11/2020 00:14	9,19	1	9,19	CHI
20201151770	CIDADE OCIDENTAL	DH12170612	MARAJOARA	12/11/2020 15:02	12/11/2020 22:29	12/11/2020 15:02	12/11/2020 22:29	7,45	15	111,75	CHI
20201152144	ORIZONA	OZ12000351RE	PIRES DO RIO S1	12/11/2020 15:03	12/11/2020 20:15	12/11/2020 15:03	12/11/2020 20:15	5,18	57	295,51	CHI
20201152144	PIRES DO RIO	OZ12000351RE	PIRES DO RIO S1	12/11/2020 15:03	12/11/2020 20:15	12/11/2020 15:03	12/11/2020 20:15	5,18	4	20,74	CHI
20201151619	PORANGATU	PO12028196	PORANGATU	12/11/2020 15:04	12/11/2020 18:14	12/11/2020 15:04	12/11/2020 18:14	3,15	5	15,76	CHI
20201151742	BARRO ALTO	BA12194375	BARRO ALTO	12/11/2020 15:04	12/11/2020 18:43	12/11/2020 15:04	12/11/2020 18:43	3,63	7	25,44	CHI
20201153087	ITABERAI	IB12016899	INHUMAS S1	12/11/2020 15:04	13/11/2020 08:30	12/11/2020 15:04	13/11/2020 08:30	17,42	29	505,20	CHI
20201153765	SILVANIA	VN12282832	VIANOPOLIS	12/11/2020 15:04	13/11/2020 11:30	12/11/2020 15:04	12/11/2020 21:36	6,53	5	32,65	CHI
20201153765	SILVANIA	VN12282832	VIANOPOLIS	12/11/2020 15:04	13/11/2020 11:30	12/11/2020 15:04	13/11/2020 11:30	20,43	119	2431,17	CHI
20201153765	VIANOPOLIS	VN12282832	VIANOPOLIS	12/11/2020 15:04	13/11/2020 11:30	12/11/2020 15:04	13/11/2020 11:30	20,43	10	204,30	CHI
20201151110	GOIANIA	16378179	CAMPINAS S2	12/11/2020 15:05	12/11/2020 16:36	12/11/2020 15:05	12/11/2020 16:36	1,51	1	1,51	CHI
20201151115	PIRACANJUBA	PJ21287335	CALDAS NOVAS S1	12/11/2020 15:05	13/11/2020 02:40	12/11/2020 15:05	13/11/2020 02:40	11,57	1	11,57	CHI
20201151119	PETROLINA DE GOIAS	PG21337640	PETROLINA	12/11/2020 15:06	12/11/2020 19:55	12/11/2020 15:06	12/11/2020 19:55	4,81	1	4,81	CHI
20201151126	GOIANDIRA	GD12250481LD	CATALAO S1	12/11/2020 15:07	12/11/2020 20:30	12/11/2020 15:07	12/11/2020 20:30	5,39	67	360,89	CHI
20201151128	JATAI	JT21267533	JATAI S1	12/11/2020 15:07	12/11/2020 17:39	12/11/2020 15:07	12/11/2020 17:39	2,52	1	2,52	CHI
20201151131	PIRES DO RIO	PR12328727	PIRES DO RIO S2	12/11/2020 15:07	12/11/2020 18:22	12/11/2020 15:07	12/11/2020 18:22	3,23	5	16,17	CHI
20201151133	MINACU	IH21328846	MINACU	12/11/2020 15:07	13/11/2020 10:15	12/11/2020 15:07	13/11/2020 10:15	19,12	2	38,23	CHI
20201151152	GOIANIA	GN10406883	SENADOR CANEDO	12/11/2020 15:07	12/11/2020 18:00	12/11/2020 15:07	12/11/2020 18:00	2,89	4	11,55	CHI
20201151152	SENADOR CANEDO	GN13406883B	SENADOR CANEDO	12/11/2020 15:07	12/11/2020 18:00	12/11/2020 15:07	12/11/2020 18:00	2,89	107	309,05	CHI
20201151152	SENADOR CANEDO	GN13406883B	SENADOR CANEDO	12/11/2020 15:07	12/11/2020 18:00	12/11/2020 15:09	12/11/2020 18:00	2,85	143	407,31	CHI
20201151350	ANAPOLIS	AN12380132	ANAPOLIS UNIVERSITARIO S2	12/11/2020 15:07	12/11/2020 17:00	12/11/2020 15:07	12/11/2020 17:00	1,87	20	37,39	CHI
20201151137	PORANGATU	840022360	PORANGATU	12/11/2020 15:08	12/11/2020 16:49	12/11/2020 15:08	12/11/2020 16:49	1,68	1	1,68	CHI
20201151146	GOIANIA	GN11002012	GOIANIA LESTE S2	12/11/2020 15:08	12/11/2020 18:47	12/11/2020 15:08	12/11/2020 18:47	3,64	2	7,28	CHI
20201151155	IACIARA	IA21373149	IACIARA S1	12/11/2020 15:11	12/11/2020 16:51	12/11/2020 15:11	12/11/2020 16:51	1,66	1	1,66	CHI
20201151285	SANTO ANTONIO DA BARRA	BZ12428466	ACREUNA	12/11/2020 15:12	12/11/2020 17:32	12/11/2020 15:12	12/11/2020 17:32	2,33	13	30,29	CHI
20201154133	NOVA CRIXAS	NA12334349	NOVA CRIXAS	12/11/2020 15:12	12/11/2020 22:25	12/11/2020 15:12	12/11/2020 22:25	7,21	86	620,25	CHI
20201151169	GOIAS	GS12068612	MATRINCHA	12/11/2020 15:13	13/11/2020 09:08	12/11/2020 15:13	13/11/2020 09:08	17,90	3	53,71	CHI
20201151396	TRINDADE	TR11258430	TRINDADE	12/11/2020 15:13	12/11/2020 17:30	12/11/2020 15:13	12/11/2020 17:30	2,28	26	59,32	CHI
20201152409	JESUPOLIS	SF12066036	SAO FRANCISCO DE GOIAS	12/11/2020 15:13	12/11/2020 19:23	12/11/2020 15:13	12/11/2020 19:23	4,16	16	66,54	CHI
20201151189	GOIANIA	GN11040397	CARAJAS S2	12/11/2020 15:15	12/11/2020 16:14	12/11/2020 15:15	12/11/2020 16:14	0,97	128	124,55	CHI
20201151274	AGUA FRIA DE GOIAS	PI12048037	SAO JOAO D ALIANCA	12/11/2020 15:16	12/11/2020 16:40	12/11/2020 15:16	12/11/2020 16:40	1,39	7	9,70	CHI
20201153079	ITAUCU	10017630639	INHUMAS S1	12/11/2020 15:16	13/11/2020 03:49	12/11/2020 15:16	13/11/2020 03:49	12,55	1	12,55	CHI
20201151206	GOIANIA	12665630	GOIANIA LESTE S1	12/11/2020 15:18	12/11/2020 17:51	12/11/2020 15:18	12/11/2020 17:51	2,55	1	2,55	CHI
20201151211	ITAPURANGA	10030927593	ITAPURANGA	12/11/2020 15:18	12/11/2020 16:09	12/11/2020 15:18	12/11/2020 16:09	0,84	1	0,84	CHI
20201151213	IPAMERI	10032896202	IPAMERI	12/11/2020 15:18	12/11/2020 20:42	12/11/2020 15:18	12/11/2020 20:42	5,39	1	5,39	CHI
20201151214	FORMOSA	610077922	ITUIQUIRA	12/11/2020 15:18	12/11/2020 16:59	12/11/2020 15:18	12/11/2020 16:59	1,67	1	1,67	CHI
20201151239	BARRO ALTO	BA21064550	BARRO ALTO	12/11/2020 15:20	12/11/2020 17:22	12/11/2020 15:20	12/11/2020 17:22	2,02	3	6,05	CHI
20201151348	AGUA FRIA DE GOIAS	TL12394165	SAO JOAO D ALIANCA	12/11/2020 15:20	12/11/2020 17:34	12/11/2020 15:20	12/11/2020 17:34	2,22	20	44,44	CHI
20201158646	PORANGATU	PO12391912	PORANGATU	12/11/2020 15:20	14/11/2020 19:13	12/11/2020 15:20	14/11/2020 09:04	41,72	1	41,72	CHI
20201158646	MUTUNOPOLIS	PO12391912	PORANGATU	12/11/2020 15:20	14/11/2020 19:13	12/11/2020 15:20	14/11/2020 14:02	46,69	31	1447,40	CHI
20201158646	PORANGATU	PO12391912	PORANGATU	12/11/2020 15:20	14/11/2020 19:13	12/11/2020 15:20	14/11/2020 14:02	46,69	43	2007,68	CHI

20201158646	MUTUNOPOLIS	PO12391912	PORANGATU	12/11/2020 15:20	14/11/2020 19:13	12/11/2020 15:20	14/11/2020 19:13	51,87	2	103,75	CHI
20201151240	MONTIVIDIU	MV21106357	MONTIVIDIU T	12/11/2020 15:21	12/11/2020 18:43	12/11/2020 15:21	12/11/2020 18:43	3,37	1	3,37	CHI
20201151527	ANAPOLIS	AN12048812	ANAPOLIS UNIVERSITARIO S1	12/11/2020 15:21	12/11/2020 17:23	12/11/2020 15:21	12/11/2020 17:23	2,03	29	58,93	CHI
20201151255	SAO SIMAO	SO11000027	CACHOEIRA ALTA	12/11/2020 15:22	12/11/2020 18:01	12/11/2020 15:22	12/11/2020 18:01	2,64	125	329,72	CHI
20201152873	RUBIATABA	RB11210812	RUBIATABA	12/11/2020 15:22	12/11/2020 22:06	12/11/2020 15:22	12/11/2020 22:06	6,72	84	564,90	CHI
20201151256	PLANALTINA	2960036548	PLANALTINA	12/11/2020 15:23	12/11/2020 18:45	12/11/2020 15:23	12/11/2020 18:45	3,37	1	3,37	CHI
20201151263	CUMARI	CY12034703	CATALAO S1	12/11/2020 15:23	12/11/2020 18:33	12/11/2020 15:23	12/11/2020 18:33	3,16	4	12,64	CHI
20201151272	NOVA CRIXAS	NA12227101	NOVA CRIXAS	12/11/2020 15:24	12/11/2020 21:46	12/11/2020 15:24	12/11/2020 21:46	6,36	25	159,03	CHI
20201151295	ITABERAI	IB11250617	ITABERAI S2	12/11/2020 15:26	12/11/2020 18:31	12/11/2020 15:26	12/11/2020 18:31	3,07	136	417,56	CHI
20201154192	GOIANDIRA	GD12000012	CATALAO S1	12/11/2020 15:26	13/11/2020 01:22	12/11/2020 15:26	13/11/2020 01:22	9,93	22	218,47	CHI
20201151292	CAMPINACU	FO12197186RE	PORANGATU	12/11/2020 15:27	12/11/2020 21:12	12/11/2020 15:27	12/11/2020 21:12	5,74	5	28,72	CHI
20201151292	CAMPINORTE	FO12197186RE	PORANGATU	12/11/2020 15:27	12/11/2020 21:12	12/11/2020 15:27	12/11/2020 21:12	5,74	30	172,33	CHI
20201151292	FORMOSO	FO12197186RE	PORANGATU	12/11/2020 15:27	12/11/2020 21:12	12/11/2020 15:27	12/11/2020 21:12	5,74	2	11,49	CHI
20201151294	ESTRELA DO NORTE	ET12000003	MARA ROSA	12/11/2020 15:27	13/11/2020 13:22	12/11/2020 15:27	13/11/2020 13:22	21,91	1	21,91	CHI
20201151294	MARA ROSA	ET12000003	MARA ROSA	12/11/2020 15:27	13/11/2020 13:22	12/11/2020 15:27	13/11/2020 13:22	21,91	2	43,82	CHI
20201151303	SANTA HELENA DE GOIAS	400076421	IPEGUARI	12/11/2020 15:28	13/11/2020 07:49	12/11/2020 15:28	13/11/2020 07:49	16,34	1	16,34	CHI
20201154349	PIRENOPOLIS	PV12093290	SAO FRANCISCO DE GOIAS	12/11/2020 15:29	13/11/2020 02:19	12/11/2020 15:29	13/11/2020 02:19	10,83	3	32,50	CHI
20201151357	LUZIANIA	LZ12261750	CRISTALINA S2	12/11/2020 15:30	12/11/2020 18:31	12/11/2020 15:30	12/11/2020 18:31	3,02	6	18,09	CHI
20201152927	BARRO ALTO	BA12064537	BARRO ALTO	12/11/2020 15:30	13/11/2020 17:00	12/11/2020 15:30	13/11/2020 17:00	25,50	7	178,47	CHI
20201152927	VILA PROPICIO	BA12064537	BARRO ALTO	12/11/2020 15:30	13/11/2020 17:00	12/11/2020 15:30	13/11/2020 17:00	25,50	2	50,99	CHI
20201151331	ORIZONA	OZ21250251	PIRES DO RIO S2	12/11/2020 15:32	12/11/2020 17:16	12/11/2020 15:32	12/11/2020 17:16	1,73	1	1,73	CHI
20201153667	MIMOSO DE GOIAS	MJ12305245	PADRE BERNARDO	12/11/2020 15:32	13/11/2020 15:54	12/11/2020 15:32	13/11/2020 15:54	24,37	14	341,18	CHI
20201151341	RIO VERDE	RV21154031	MONTIVIDIU T	12/11/2020 15:33	13/11/2020 07:20	12/11/2020 15:33	13/11/2020 07:20	15,78	1	15,78	CHI
20201151354	SANTA CRUZ DE GOIAS	PJ21122102	CALDAS NOVAS S1	12/11/2020 15:35	13/11/2020 08:23	12/11/2020 15:35	13/11/2020 08:23	16,80	1	16,80	CHI
20201151359	RUBIATABA	790000167	RUBIATABA	12/11/2020 15:35	13/11/2020 09:50	12/11/2020 15:35	13/11/2020 09:50	18,25	1	18,25	CHI
20201151366	RIO VERDE	RV12230942	SANTA HELENA S1	12/11/2020 15:35	12/11/2020 18:57	12/11/2020 15:35	12/11/2020 18:57	3,38	2	6,76	CHI
20201151584	EDEIA	EA12223550RE	EDEIA	12/11/2020 15:35	14/11/2020 19:12	12/11/2020 15:35	13/11/2020 05:26	13,86	18	249,46	CHI
20201151584	EDEALINA	EA12223550RE	EDEIA	12/11/2020 15:35	14/11/2020 19:12	12/11/2020 15:35	13/11/2020 09:02	17,46	14	244,37	CHI
20201151584	EDEIA	EA12223550RE	EDEIA	12/11/2020 15:35	14/11/2020 19:12	12/11/2020 15:35	13/11/2020 09:02	17,46	7	122,19	CHI
20201151584	INDIARA	EA12223550RE	EDEIA	12/11/2020 15:35	14/11/2020 19:12	12/11/2020 15:35	13/11/2020 09:02	17,46	1	17,46	CHI
20201151584	EDEALINA	EA12223550RE	EDEIA	12/11/2020 15:35	14/11/2020 19:12	12/11/2020 15:35	13/11/2020 20:16	28,69	13	372,98	CHI
20201151584	EDEALINA	EA12223550RE	EDEIA	12/11/2020 15:35	14/11/2020 19:12	12/11/2020 15:35	14/11/2020 19:12	51,63	25	1290,81	CHI
20201151584	INDIARA	EA12223550RE	EDEIA	12/11/2020 15:35	14/11/2020 19:12	12/11/2020 15:35	14/11/2020 19:12	51,63	6	309,80	CHI
20201151584	EDEALINA	ED13349855	EDEIA	12/11/2020 15:35	14/11/2020 19:12	14/11/2020 18:17	14/11/2020 19:12	0,93	13	12,08	CHI
20201151383	LUZIANIA	LZ12320237	VIANOPOLIS	12/11/2020 15:38	12/11/2020 20:20	12/11/2020 15:38	12/11/2020 20:20	4,69	6	28,16	CHI
20201151384	PARANAIGUARA	PC21066115	QUIRINOPOLIS	12/11/2020 15:38	12/11/2020 22:24	12/11/2020 15:38	12/11/2020 22:24	6,76	1	6,76	CHI
20201151436	ANAPOLIS	AN12267878	NEROPOLIS S1	12/11/2020 15:38	12/11/2020 23:49	12/11/2020 15:38	12/11/2020 23:49	8,17	16	130,68	CHI
20201151390	IPAMERI	IP12215693	URUTAI	12/11/2020 15:39	12/11/2020 20:18	12/11/2020 15:39	12/11/2020 20:18	4,65	4	18,60	CHI
20201151398	BOM JARDIM DE GOIAS	BM12205302	BOM JARDIM	12/11/2020 15:40	12/11/2020 21:01	12/11/2020 15:40	12/11/2020 21:01	5,34	8	42,75	CHI
20201151401	SAO MIGUEL DO ARAGUAIA	SM21089300	SAO MIGUEL DO ARAGUAIA	12/11/2020 15:41	13/11/2020 10:23	12/11/2020 15:41	13/11/2020 10:23	18,70	1	18,70	CHI
20201151404	ALEXANIA	480103045	ALEXANIA	12/11/2020 15:41	12/11/2020 22:04	12/11/2020 15:41	12/11/2020 22:04	6,38	1	6,38	CHI
20201151420	BRAZABRANTES	IN13162030	INHUMAS S2	12/11/2020 15:41	13/11/2020 13:49	12/11/2020 18:16	12/11/2020 21:18	3,04	40	121,44	CHI
20201151420	GOIANIRA	IN13162030	INHUMAS S2	12/11/2020 15:41	13/11/2020 13:49	12/11/2020 18:16	12/11/2020 21:18	3,04	11	33,40	CHI
20201151420	INHUMAS	IN13162030	INHUMAS S2	12/11/2020 15:41	13/11/2020 13:49	12/11/2020 18:16	12/11/2020 21:18	3,04	11	33,40	CHI
20201151420	CATURAI	IN12015933	INHUMAS S2	12/11/2020 15:41	13/11/2020 13:49	12/11/2020 15:41	13/11/2020 13:49	22,13	1	22,13	CHI
20201151420	INHUMAS	IN12015933	INHUMAS S2	12/11/2020 15:41	13/11/2020 13:49	12/11/2020 15:41	13/11/2020 13:49	22,13	21	464,81	CHI
20201151410	EDEALINA	ED21013591	PONTALINA	12/11/2020 15:42	12/11/2020 18:45	12/11/2020 15:42	12/11/2020 18:45	3,05	1	3,05	CHI
20201151412	RUBIATABA	RB21127738	RUBIATABA	12/11/2020 15:42	13/11/2020 10:41	12/11/2020 15:42	13/11/2020 10:41	18,98	1	18,98	CHI
20201151415	VALPARAISO DE GOIAS	10005017210	PACAEMBU S1	12/11/2020 15:42	12/11/2020 21:13	12/11/2020 15:42	12/11/2020 21:13	5,51	1	5,51	CHI
20201152480	INHUMAS	IN11000048	INHUMAS S2	12/11/2020 15:43	12/11/2020 20:08	12/11/2020 15:43	12/11/2020 20:08	4,41	108	476,31	CHI
20201151428	CAMPINACU	UC12269659	MARA ROSA	12/11/2020 15:44	14/11/2020 13:00	12/11/2020 15:44	14/11/2020 13:00	45,25	17	769,30	CHI



20201151430	CATALAO	CT12267054	CATALAO S1	12/11/2020 15:45	15/11/2020 21:18	12/11/2020 15:45	13/11/2020 22:36	30,85	6	185,12	CHI
20201151430	CATALAO	CT12149164RE	CATALAO S1	12/11/2020 15:45	15/11/2020 21:18	14/11/2020 16:04	14/11/2020 17:18	1,24	128	158,79	CHI
20201151430	CATALAO	CT12149164RE	CATALAO S1	12/11/2020 15:45	15/11/2020 21:18	13/11/2020 22:46	15/11/2020 20:14	45,47	6	272,83	CHI
20201151430	CATALAO	CT12267054	CATALAO S1	12/11/2020 15:45	15/11/2020 21:18	12/11/2020 15:45	15/11/2020 21:18	77,55	12	930,63	CHI
20201151531	CEZARINA	CZ12233347	CEZARINA	12/11/2020 15:46	13/11/2020 12:15	12/11/2020 15:46	13/11/2020 12:15	20,47	3	61,40	CHI
20201152794	MARA ROSA	MQ12208423	MARA ROSA	12/11/2020 15:47	13/11/2020 07:33	12/11/2020 15:47	13/11/2020 07:33	15,75	13	204,76	CHI
20201151514	FORMOSA	FA12218264	ITUIQUIRA	12/11/2020 15:48	12/11/2020 16:49	12/11/2020 15:48	12/11/2020 16:49	1,00	96	96,00	CHI
20201151514	VILA BOA	FA12218264	ITUIQUIRA	12/11/2020 15:48	12/11/2020 16:49	12/11/2020 15:48	12/11/2020 16:49	1,00	4	4,00	CHI
20201153201	CIDADE OCIDENTAL	DH12136594	MARAJOARA	12/11/2020 15:48	12/11/2020 19:44	12/11/2020 15:48	12/11/2020 19:44	3,92	560	2193,80	CHI
20201151463	GUARANI DE GOIAS	GY12271764	IACIARA S1	12/11/2020 15:49	12/11/2020 17:52	12/11/2020 15:49	12/11/2020 17:52	2,05	3	6,15	CHI
20201151468	INDIARA	IY12158916	CEZARINA	12/11/2020 15:49	12/11/2020 19:17	12/11/2020 15:49	12/11/2020 19:17	3,46	3	10,38	CHI
20201154177	URUACU	UR12117971	URUACU	12/11/2020 15:49	13/11/2020 01:18	12/11/2020 15:49	13/11/2020 01:18	9,47	19	180,02	CHI
20201151486	PORANGATU	PO21230387	PORANGATU	12/11/2020 15:52	13/11/2020 15:40	12/11/2020 15:52	13/11/2020 15:40	23,80	1	23,80	CHI
20201151558	PIRENOPOLIS	PV12355148	CORUMBA	12/11/2020 15:52	12/11/2020 20:09	12/11/2020 15:52	12/11/2020 20:09	4,27	25	106,80	CHI
20201151640	AGUAS LINDAS DE GOIAS	LA11335974	AGUAS LINDAS DE GOIAS S1	12/11/2020 15:52	12/11/2020 17:54	12/11/2020 15:52	12/11/2020 17:54	2,03	69	140,09	CHI
20201152148	ITABERAI	IB12310500	ITABERAI S1	12/11/2020 15:52	13/11/2020 02:15	12/11/2020 15:52	13/11/2020 02:15	10,37	13	134,84	CHI
2020111200131	SAO DOMINGOS	2090504	SAO DOMINGOS	12/11/2020 15:53	12/11/2020 18:00	12/11/2020 15:53	12/11/2020 16:20	0,44	2442	1071,09	CHI
2020111200131	GUARANI DE GOIAS	2090504	SAO DOMINGOS	12/11/2020 15:53	12/11/2020 18:00	12/11/2020 15:53	12/11/2020 16:20	0,45	153	68,85	CHI
2020111200131	MONTE ALEGRE DE GOIAS	2090504	SAO DOMINGOS	12/11/2020 15:53	12/11/2020 18:00	12/11/2020 15:53	12/11/2020 16:20	0,45	1	0,45	CHI
2020111200131	NOVA ROMA	2090504	SAO DOMINGOS	12/11/2020 15:53	12/11/2020 18:00	12/11/2020 15:53	12/11/2020 16:20	0,45	3	1,35	CHI
2020111200131	SAO DOMINGOS	2090504	SAO DOMINGOS	12/11/2020 15:53	12/11/2020 18:00	12/11/2020 15:53	12/11/2020 16:20	0,45	1187	534,15	CHI
2020111200131	GUARANI DE GOIAS	USD-TR4	SAO DOMINGOS	12/11/2020 15:53	12/11/2020 18:00	12/11/2020 16:44	12/11/2020 18:00	1,27	153	193,67	CHI
2020111200131	SAO DOMINGOS	USD-TR4	SAO DOMINGOS	12/11/2020 15:53	12/11/2020 18:00	12/11/2020 16:44	12/11/2020 18:00	1,27	1154	1460,77	CHI
2020111200131	CAMPOS BELOS	2090504	SAO DOMINGOS	12/11/2020 15:53	12/11/2020 18:00	12/11/2020 15:53	12/11/2020 18:00	2,12	102	216,35	CHI
2020111200131	DIVINOPOLIS DE GOIAS	2090504	SAO DOMINGOS	12/11/2020 15:53	12/11/2020 18:00	12/11/2020 15:53	12/11/2020 18:00	2,12	2292	4861,59	CHI
2020111200131	MONTE ALEGRE DE GOIAS	2090504	SAO DOMINGOS	12/11/2020 15:53	12/11/2020 18:00	12/11/2020 15:53	12/11/2020 18:00	2,12	158	335,14	CHI
2020111200131	SAO DOMINGOS	2090504	SAO DOMINGOS	12/11/2020 15:53	12/11/2020 18:00	12/11/2020 15:53	12/11/2020 18:00	2,12	450	954,50	CHI
20201151505	PIRENOPOLIS	10026670303	CORUMBA	12/11/2020 15:54	13/11/2020 02:19	12/11/2020 15:54	13/11/2020 02:19	10,42	1	10,42	CHI
20201151579	BOM JESUS DE GOIAS	3270414	RIO DOS BOIS	12/11/2020 15:54	12/11/2020 23:42	12/11/2020 15:54	12/11/2020 18:27	2,56	5	12,81	CHI
20201151579	BOM JESUS DE GOIAS	3270414	RIO DOS BOIS	12/11/2020 15:54	12/11/2020 23:42	12/11/2020 15:54	12/11/2020 18:27	2,56	5	12,81	CHI
20201151579	CASTELANDIA	3270414	RIO DOS BOIS	12/11/2020 15:54	12/11/2020 23:42	12/11/2020 15:54	12/11/2020 18:27	2,56	1564	4008,18	CHI
20201151579	CASTELANDIA	3270414	RIO DOS BOIS	12/11/2020 15:54	12/11/2020 23:42	12/11/2020 15:54	12/11/2020 18:27	2,56	1	2,56	CHI
20201151579	CASTELANDIA	3270414	RIO DOS BOIS	12/11/2020 15:54	12/11/2020 23:42	12/11/2020 15:54	12/11/2020 18:27	2,56	2	5,13	CHI
20201151579	GOIAS	3270414	RIO DOS BOIS	12/11/2020 15:54	12/11/2020 23:42	12/11/2020 15:54	12/11/2020 18:27	2,56	1	2,56	CHI
20201151579	GOIATUBA	3270414	RIO DOS BOIS	12/11/2020 15:54	12/11/2020 23:42	12/11/2020 15:54	12/11/2020 18:27	2,56	20	51,26	CHI
20201151579	GOIATUBA	3270414	RIO DOS BOIS	12/11/2020 15:54	12/11/2020 23:42	12/11/2020 15:54	12/11/2020 18:27	2,56	399	1022,55	CHI
20201151579	GOIATUBA	3270414	RIO DOS BOIS	12/11/2020 15:54	12/11/2020 23:42	12/11/2020 15:54	12/11/2020 18:27	2,56	19	48,69	CHI
20201151579	GOIATUBA	3270414	RIO DOS BOIS	12/11/2020 15:54	12/11/2020 23:42	12/11/2020 15:54	12/11/2020 18:27	2,56	5	12,81	CHI
20201151579	MAURILANDIA	3270414	RIO DOS BOIS	12/11/2020 15:54	12/11/2020 23:42	12/11/2020 15:54	12/11/2020 18:27	2,56	2	5,13	CHI
20201151579	MAURILANDIA	3270414	RIO DOS BOIS	12/11/2020 15:54	12/11/2020 23:42	12/11/2020 15:54	12/11/2020 18:27	2,56	4	10,25	CHI
20201151579	MAURILANDIA	3270414	RIO DOS BOIS	12/11/2020 15:54	12/11/2020 23:42	12/11/2020 15:54	12/11/2020 18:27	2,56	11	28,19	CHI
20201151579	PORTEIRAO	3270414	RIO DOS BOIS	12/11/2020 15:54	12/11/2020 23:42	12/11/2020 15:54	12/11/2020 18:27	2,56	7	17,94	CHI
20201151579	PORTEIRAO	3270414	RIO DOS BOIS	12/11/2020 15:54	12/11/2020 23:42	12/11/2020 15:54	12/11/2020 18:27	2,56	2	5,13	CHI
20201151579	PORTEIRAO	3270414	RIO DOS BOIS	12/11/2020 15:54	12/11/2020 23:42	12/11/2020 15:54	12/11/2020 18:27	2,56	6	15,38	CHI
20201151579	PORTEIRAO	3270414	RIO DOS BOIS	12/11/2020 15:54	12/11/2020 23:42	12/11/2020 15:54	12/11/2020 18:27	2,56	4	10,25	CHI
20201151579	QUIRINOPOLIS	3270414	RIO DOS BOIS	12/11/2020 15:54	12/11/2020 23:42	12/11/2020 15:54	12/11/2020 18:27	2,56	43	110,20	CHI
20201151579	GOIATUBA	3270414	RIO DOS BOIS	12/11/2020 15:54	12/11/2020 23:42	12/11/2020 15:57	12/11/2020 18:27	2,51	1	2,51	CHI
20201151579	GOIATUBA	3270414	RIO DOS BOIS	12/11/2020 15:54	12/11/2020 23:42	12/11/2020 15:57	12/11/2020 18:27	2,51	1	2,51	CHI
20201151579	BOM JESUS DE GOIAS	3270414	RIO DOS BOIS	12/11/2020 15:54	12/11/2020 23:42	12/11/2020 15:54	12/11/2020 20:37	4,72	16	75,58	CHI
20201151579	CASTELANDIA	3270414	RIO DOS BOIS	12/11/2020 15:54	12/11/2020 23:42	12/11/2020 15:54	12/11/2020 20:37	4,72	32	151,16	CHI
20201151579	MAURILANDIA	3270414	RIO DOS BOIS	12/11/2020 15:54	12/11/2020 23:42	12/11/2020 15:54	12/11/2020 23:42	7,82	2	15,63	CHI

20201152496	VILA PROPICIO	PV12069121	GOIANESIA S1	12/11/2020 15:54	14/11/2020 20:37	12/11/2020 15:54	13/11/2020 12:29	20,57	3	61,71	CHI
20201152496	BARRO ALTO	PV12069121	GOIANESIA S1	12/11/2020 15:54	14/11/2020 20:37	12/11/2020 19:35	13/11/2020 12:29	16,90	1	16,90	CHI
20201152496	VILA PROPICIO	PV12069121	GOIANESIA S1	12/11/2020 15:54	14/11/2020 20:37	12/11/2020 19:35	13/11/2020 12:29	16,90	3	50,70	CHI
20201152496	VILA PROPICIO	PV12069121	GOIANESIA S1	12/11/2020 15:54	14/11/2020 20:37	12/11/2020 15:54	14/11/2020 20:37	52,71	1	52,71	CHI
20201152496	VILA PROPICIO	PV12069121	GOIANESIA S1	12/11/2020 15:54	14/11/2020 20:37	12/11/2020 19:35	14/11/2020 20:37	49,04	1	49,04	CHI
20201152496	VILA PROPICIO	PV12069121	GOIANESIA S1	12/11/2020 15:54	14/11/2020 20:37	13/11/2020 09:55	14/11/2020 20:37	34,70	1	34,70	CHI
20201152496	BARRO ALTO	PV12069121	GOIANESIA S1	12/11/2020 15:54	14/11/2020 20:37	14/11/2020 19:45	14/11/2020 20:37	0,87	1	0,87	CHI
20201152496	VILA PROPICIO	PV12069121	GOIANESIA S1	12/11/2020 15:54	14/11/2020 20:37	14/11/2020 19:45	14/11/2020 20:37	0,87	8	6,95	CHI
20201151510	GOIANIA	10888226	GOIANIA LESTE S3	12/11/2020 15:55	13/11/2020 17:30	12/11/2020 15:55	12/11/2020 17:30	1,58	1	1,58	CHI
20201151518	JATAI	JT12182140	JATAI S1	12/11/2020 15:55	13/11/2020 02:10	12/11/2020 15:55	13/11/2020 02:10	10,25	7	71,72	CHI
20201151518	SERRANOPOLIS	JT12182140	JATAI S1	12/11/2020 15:55	13/11/2020 02:10	12/11/2020 15:55	13/11/2020 02:10	10,25	2	20,49	CHI
20201151518	JATAI	JT12182140	JATAI S1	12/11/2020 15:55	13/11/2020 02:10	12/11/2020 21:49	13/11/2020 02:10	4,35	2	8,70	CHI
20201151523	ITUMBIARA	BG21294255	ITUMBIARA VELHA S2	12/11/2020 15:56	12/11/2020 19:06	12/11/2020 15:56	12/11/2020 19:06	3,16	1	3,16	CHI
20201151562	SILVANIA	SV12151524	VIANOPOLIS	12/11/2020 15:56	12/11/2020 20:19	12/11/2020 15:56	12/11/2020 20:19	4,37	9	39,36	CHI
20201154698	NOVA IGUACU DE GOIAS	20472979	URUACU	12/11/2020 15:56	13/11/2020 11:07	12/11/2020 15:56	13/11/2020 11:07	19,18	21	402,84	CHI
20201154698	PILAR DE GOIAS	20472979	URUACU	12/11/2020 15:56	13/11/2020 11:07	12/11/2020 15:56	13/11/2020 11:07	19,18	1	19,18	CHI
20201154698	URUACU	20472979	URUACU	12/11/2020 15:56	13/11/2020 11:07	12/11/2020 15:56	13/11/2020 11:07	19,18	110	2110,14	CHI
20201151771	PIRENOPOLIS	PV12050124	SAO FRANCISCO DE GOIAS	12/11/2020 15:57	12/11/2020 19:02	12/11/2020 15:57	12/11/2020 19:02	3,07	8	24,54	CHI
20201151546	GOIANIA	GN21340524	AEROPORTO S2	12/11/2020 15:58	12/11/2020 19:23	12/11/2020 15:58	12/11/2020 19:23	3,42	1	3,42	CHI
20201151550	GOIANIA	16215588	CARAJAS S2	12/11/2020 15:58	12/11/2020 18:04	12/11/2020 15:58	12/11/2020 18:04	2,09	1	2,09	CHI
20201151551	SENADOR CANEDO	SW11380277	SENADOR CANEDO	12/11/2020 15:58	12/11/2020 23:17	12/11/2020 15:58	12/11/2020 23:17	7,30	134	978,50	CHI
20201151559	FORMOSA	10005457201	ITUIQUIRA	12/11/2020 15:59	12/11/2020 17:43	12/11/2020 15:59	12/11/2020 17:43	1,73	1	1,73	CHI
20201151561	ITAJA	IJ21000076	CACHOEIRA ALTA	12/11/2020 15:59	12/11/2020 19:34	12/11/2020 15:59	12/11/2020 19:34	3,57	1	3,57	CHI
20201151689	BARRO ALTO	BA12414688	BARRO ALTO	12/11/2020 15:59	13/11/2020 00:19	12/11/2020 15:59	13/11/2020 00:19	8,33	32	266,58	CHI
202011137978	CATALAO	CT12130972	CATALAO S2	12/11/2020 15:59	12/11/2020 21:30	12/11/2020 15:59	12/11/2020 21:30	5,52	27	149,08	CHI
202011137978	CUMARI	CT12130972	CATALAO S2	12/11/2020 15:59	12/11/2020 21:30	12/11/2020 15:59	12/11/2020 21:30	5,52	1	5,52	CHI
20201151566	PALMINOPOLIS	TV12005542	FIRMINOPOLIS S2	12/11/2020 16:00	12/11/2020 18:11	12/11/2020 16:00	12/11/2020 18:11	2,18	23	50,17	CHI
20201151566	TURVANIA	TV12005542	FIRMINOPOLIS S2	12/11/2020 16:00	12/11/2020 18:11	12/11/2020 16:00	12/11/2020 18:11	2,18	52	113,43	CHI
20201151613	JAUPACI	30902214	IPORA	12/11/2020 16:00	12/11/2020 23:55	12/11/2020 16:00	12/11/2020 19:04	3,06	1057	3232,07	CHI
20201151613	FAZENDA NOVA	3090416	IPORA	12/11/2020 16:00	12/11/2020 23:55	12/11/2020 18:39	12/11/2020 19:08	0,49	394	192,18	CHI
20201151613	DIORAMA	30902214	IPORA	12/11/2020 16:00	12/11/2020 23:55	12/11/2020 16:00	12/11/2020 23:55	7,90	12	94,84	CHI
20201151613	FAZENDA NOVA	30902214	IPORA	12/11/2020 16:00	12/11/2020 23:55	12/11/2020 16:00	12/11/2020 23:55	7,90	24	189,69	CHI
20201151613	JAUPACI	30902214	IPORA	12/11/2020 16:00	12/11/2020 23:55	12/11/2020 16:00	12/11/2020 23:55	7,90	354	2797,88	CHI
20201153835	JAUPACI	JP21021461	IPORA	12/11/2020 16:00	13/11/2020 02:27	12/11/2020 16:00	13/11/2020 02:27	10,43	1	10,43	CHI
20201151572	FAZENDA NOVA	FN11362419	JUSSARA	12/11/2020 16:01	12/11/2020 17:29	12/11/2020 16:01	12/11/2020 17:29	1,47	27	39,61	CHI
20201153660	BARRO ALTO	SJ12006466	GOIANESIA S1	12/11/2020 16:01	12/11/2020 20:54	12/11/2020 16:01	12/11/2020 20:54	4,88	1	4,88	CHI
20201153660	GOIANESIA	SJ12006466	GOIANESIA S1	12/11/2020 16:01	12/11/2020 20:54	12/11/2020 16:01	12/11/2020 20:54	4,88	8	39,05	CHI
20201153660	VILA PROPICIO	SJ12006466	GOIANESIA S1	12/11/2020 16:01	12/11/2020 20:54	12/11/2020 16:01	12/11/2020 20:54	4,88	1	4,88	CHI
20201151590	ANAPOLIS	10001659080	JUNDIAI S1	12/11/2020 16:02	12/11/2020 18:17	12/11/2020 16:02	12/11/2020 18:17	2,25	1	2,25	CHI
20201151592	CATALAO	CT21127870	CATALAO S1	12/11/2020 16:02	12/11/2020 22:49	12/11/2020 16:02	12/11/2020 22:49	6,77	2	13,54	CHI
20201151593	URUTAI	UT12384509	URUTAI	12/11/2020 16:03	12/11/2020 22:43	12/11/2020 16:03	12/11/2020 22:43	6,67	2	13,33	CHI
20201151596	SAO MIGUEL DO ARAGUAIA	SM21135293	SAO MIGUEL DO ARAGUAIA	12/11/2020 16:03	13/11/2020 07:15	12/11/2020 16:03	13/11/2020 07:15	15,19	1	15,19	CHI
20201151598	ITARUMA	IM12097096	CACHOEIRA ALTA	12/11/2020 16:03	12/11/2020 19:30	12/11/2020 16:03	12/11/2020 19:30	3,44	2	6,89	CHI
20201151935	GOIANIA	GN12030497	GOIANIA LESTE S2	12/11/2020 16:04	12/11/2020 18:47	12/11/2020 16:04	12/11/2020 18:47	2,71	54	146,13	CHI
20201152983	GOIANIA	GN12000145	REAL S2	12/11/2020 16:04	12/11/2020 21:12	12/11/2020 16:04	12/11/2020 21:12	5,13	295	1514,25	CHI
20201154717	GOIANIA	GN11161565	REAL S2	12/11/2020 16:04	13/11/2020 02:49	12/11/2020 16:04	13/11/2020 02:49	10,74	60	644,33	CHI
20201151627	FLORES DE GOIAS	FB11255062	FLORES DE GOIAS	12/11/2020 16:06	12/11/2020 19:30	12/11/2020 16:06	12/11/2020 19:30	3,39	14	47,41	CHI
20201151637	PIRES DO RIO	PR12404727	PIRES DO RIO S1	12/11/2020 16:07	12/11/2020 23:24	12/11/2020 16:07	12/11/2020 23:24	7,27	4	29,08	CHI
20201151641	ANAPOLIS	AN21390614	ANAPOLIS UNIVERSITARIO S2	12/11/2020 16:08	12/11/2020 17:44	12/11/2020 16:08	12/11/2020 17:44	1,59	1	1,59	CHI
20201152847	GOIANIA	GN11042134	ATLANTICO S3	12/11/2020 16:08	13/11/2020 02:28	12/11/2020 16:08	13/11/2020 02:28	10,32	117	1207,34	CHI
202011137942	NOVA IGUACU DE GOIAS	NH12202113	SANTA TEREZINHA	12/11/2020 16:08	13/11/2020 11:02	12/11/2020 16:08	13/11/2020 11:02	18,89	65	1227,69	CHI

202011136071	SILVANIA	5400214	VIANOPOLIS	12/11/2020 16:10	13/11/2020 18:25	12/11/2020 16:13	13/11/2020 03:19	11,10	2	22,20	CHI
202011136071	SILVANIA	5400214	VIANOPOLIS	12/11/2020 16:10	13/11/2020 18:25	13/11/2020 09:24	13/11/2020 18:25	9,02	227	2046,78	CHI
20201152581	ALVORADA DO NORTE	AQ12257628	FLORES DE GOIAS	12/11/2020 16:12	12/11/2020 19:11	12/11/2020 16:12	12/11/2020 19:11	2,98	10	29,75	CHI
20201152581	POSSE	AQ12257628	FLORES DE GOIAS	12/11/2020 16:12	12/11/2020 19:11	12/11/2020 16:12	12/11/2020 19:11	2,98	1	2,98	CHI
20201154041	EDEIA	EA11094420	EDEIA	12/11/2020 16:12	13/11/2020 01:33	12/11/2020 16:12	13/11/2020 01:33	9,34	211	1971,44	CHI
20201151678	GOIANIA	10019687883	GOYA S1	12/11/2020 16:13	12/11/2020 17:02	12/11/2020 16:13	12/11/2020 17:02	0,82	1	0,82	CHI
20201151681	AGUAS LINDAS DE GOIAS	10007909630	AGUAS LINDAS DE GOIAS S1	12/11/2020 16:13	12/11/2020 18:54	12/11/2020 16:13	12/11/2020 18:54	2,67	1	2,67	CHI
20201154179	GOIANESIA	GE12006525	GOIANESIA S1	12/11/2020 16:13	13/11/2020 03:55	12/11/2020 16:13	13/11/2020 03:55	11,70	3	35,10	CHI
20201151686	CUMARI	CY12000309	CATALAO S1	12/11/2020 16:14	12/11/2020 17:50	12/11/2020 16:14	12/11/2020 17:50	1,59	12	19,08	CHI
20201154058	GOIANIA	3570214	NEROPOLIS S1	12/11/2020 16:14	12/11/2020 20:18	12/11/2020 16:37	12/11/2020 20:18	3,69	141	520,88	CHI
20201154058	SANTO ANTONIO DE GOIAS	3570214	NEROPOLIS S1	12/11/2020 16:14	12/11/2020 20:18	12/11/2020 16:37	12/11/2020 20:18	3,69	97	358,33	CHI
20201151690	IPAMERI	IP21133581	CRISTALINA S2	12/11/2020 16:15	12/11/2020 21:43	12/11/2020 16:15	12/11/2020 21:43	5,47	1	5,47	CHI
20201151703	URUACU	CR21051926	MARA ROSA	12/11/2020 16:16	13/11/2020 21:50	12/11/2020 16:16	13/11/2020 21:50	29,57	2	59,13	CHI
20201151896	PARAUNA	EU12295898LD	ACREUNA	12/11/2020 16:16	13/11/2020 00:57	12/11/2020 16:16	13/11/2020 00:57	8,68	75	651,23	CHI
20201151706	APARECIDA DE GOIANIA	200568772	INDEPENDENCIA S2	12/11/2020 16:17	13/11/2020 08:36	12/11/2020 16:17	13/11/2020 08:36	16,32	1	16,32	CHI
20201151998	ESTRELA DO NORTE	ET12136395	MARA ROSA	12/11/2020 16:17	13/11/2020 00:48	12/11/2020 16:17	13/11/2020 00:48	8,52	11	93,67	CHI
20201151998	MARA ROSA	ET12136395	MARA ROSA	12/11/2020 16:17	13/11/2020 00:48	12/11/2020 16:17	13/11/2020 00:48	8,52	9	76,64	CHI
20201151715	APARECIDA DE GOIANIA	10011055276	INDEPENDENCIA S1	12/11/2020 16:18	13/11/2020 17:23	12/11/2020 16:18	13/11/2020 17:23	25,08	1	25,08	CHI
20201151721	GOIANIA	10282142	CAMPINAS S2	12/11/2020 16:18	12/11/2020 17:53	12/11/2020 16:18	12/11/2020 17:53	1,57	1	1,57	CHI
20201151725	GOIANESIA	GE21000259	GOIANESIA S2	12/11/2020 16:19	12/11/2020 21:24	12/11/2020 16:19	12/11/2020 21:24	5,08	1	5,08	CHI
20201151751	CATALAO	CM21195284	CATALAO S1	12/11/2020 16:21	12/11/2020 18:44	12/11/2020 16:21	12/11/2020 18:44	2,37	1	2,37	CHI
20201153379	GOIANESIA	GE12372623	GOIANESIA S1	12/11/2020 16:21	12/11/2020 21:05	12/11/2020 16:21	12/11/2020 21:05	4,73	30	141,79	CHI
20201151657	IACIARA	IA12211664	IACIARA S2	12/11/2020 16:22	12/11/2020 22:27	12/11/2020 16:22	12/11/2020 22:04	5,70	8	45,60	CHI
20201151657	IACIARA	IA12211664	IACIARA S2	12/11/2020 16:22	12/11/2020 22:27	12/11/2020 16:22	12/11/2020 22:27	6,08	1	6,08	CHI
20201151755	INHUMAS	IN21253104	INHUMAS S1	12/11/2020 16:22	12/11/2020 18:55	12/11/2020 16:22	12/11/2020 18:55	2,54	1	2,54	CHI
20201151756	SENADOR CANEDO	10007708430	CEPAIGO S2	12/11/2020 16:22	12/11/2020 17:38	12/11/2020 16:22	12/11/2020 17:38	1,26	1	1,26	CHI
20201151763	URUACU	CR12282384	MARA ROSA	12/11/2020 16:23	13/11/2020 01:31	12/11/2020 16:23	12/11/2020 22:50	6,45	5	32,25	CHI
20201151763	CAMPINORTE	CR12282384	MARA ROSA	12/11/2020 16:23	13/11/2020 01:31	12/11/2020 16:23	13/11/2020 01:31	9,14	1	9,14	CHI
20201151767	IPAMERI	IP21192765	CRISTALINA S2	12/11/2020 16:23	12/11/2020 22:09	12/11/2020 16:23	12/11/2020 22:09	5,76	1	5,76	CHI
20201153897	SERRANOPOLIS	SX12296514	JATAI S1	12/11/2020 16:24	13/11/2020 10:45	12/11/2020 16:24	13/11/2020 10:45	18,35	24	440,30	CHI
20201151784	SENADOR CANEDO	190145857	SENADOR CANEDO	12/11/2020 16:25	12/11/2020 17:27	12/11/2020 16:25	12/11/2020 17:27	1,02	1	1,02	CHI
20201152151	CRIXAS	CX12392063	SANTA TEREZINHA	12/11/2020 16:25	12/11/2020 20:06	12/11/2020 16:25	12/11/2020 20:06	3,67	28	102,74	CHI
20201152151	ITAPACI	CX12392063	SANTA TEREZINHA	12/11/2020 16:25	12/11/2020 20:06	12/11/2020 16:25	12/11/2020 20:06	3,67	4	14,68	CHI
20201153844	CALDAS NOVAS	CN12190314	SERRA DE CALDAS	12/11/2020 16:26	13/11/2020 10:38	12/11/2020 16:26	13/11/2020 09:14	16,79	1	16,79	CHI
20201153844	CALDAS NOVAS	CN12190314	SERRA DE CALDAS	12/11/2020 16:26	13/11/2020 10:38	12/11/2020 16:26	13/11/2020 10:38	18,20	14	254,77	CHI
20201151798	LUZIANIA	120191404	RIO VERMELHO	12/11/2020 16:27	12/11/2020 18:58	12/11/2020 16:27	12/11/2020 18:58	2,51	1	2,51	CHI
20201152550	NEROPOLIS	BW12100382	NEROPOLIS S1	12/11/2020 16:27	12/11/2020 23:23	12/11/2020 16:27	12/11/2020 21:11	4,73	16	75,61	CHI
20201152550	NOVA VENEZA	BW12100382	NEROPOLIS S1	12/11/2020 16:27	12/11/2020 23:23	12/11/2020 16:27	12/11/2020 21:11	4,73	1	4,73	CHI
20201152550	SANTO ANTONIO DE GOIAS	BW12100382	NEROPOLIS S1	12/11/2020 16:27	12/11/2020 23:23	12/11/2020 16:27	12/11/2020 21:11	4,73	28	132,32	CHI
20201152550	SANTO ANTONIO DE GOIAS	BW12100382	NEROPOLIS S1	12/11/2020 16:27	12/11/2020 23:23	12/11/2020 16:27	12/11/2020 23:23	6,93	2	13,85	CHI
20201152860	SANTO ANTONIO DE GOIAS	GR21133800	NEROPOLIS S1	12/11/2020 16:27	13/11/2020 01:20	12/11/2020 16:27	13/11/2020 01:20	8,88	2	17,75	CHI
20201151823	NAZARIO	PL12186333	PALMEIRAS	12/11/2020 16:30	13/11/2020 13:48	12/11/2020 16:30	13/11/2020 13:48	21,29	4	85,17	CHI
20201151823	PALMEIRAS DE GOIAS	PL12186333	PALMEIRAS	12/11/2020 16:30	13/11/2020 13:48	12/11/2020 16:30	13/11/2020 13:48	21,29	19	404,55	CHI
20201152004	SANTA RITA DO NOVO DESTINO	DF12315581	BARRO ALTO	12/11/2020 16:31	12/11/2020 22:30	12/11/2020 16:31	12/11/2020 22:30	5,97	20	119,42	CHI
20201151834	LUZIANIA	120344683	RIO VERMELHO	12/11/2020 16:32	12/11/2020 18:50	12/11/2020 16:32	12/11/2020 18:50	2,29	1	2,29	CHI
20201152787	GOIANESIA	GE12321377	GOIANESIA S2	12/11/2020 16:32	12/11/2020 23:28	12/11/2020 16:32	12/11/2020 23:28	6,93	15	103,92	CHI
20201152787	VILA PROPICIO	GE12321377	GOIANESIA S2	12/11/2020 16:32	12/11/2020 23:28	12/11/2020 16:32	12/11/2020 23:28	6,93	9	62,35	CHI
20201151848	GOIANESIA	GE21309580	GOIANESIA S1	12/11/2020 16:33	12/11/2020 23:01	12/11/2020 16:33	12/11/2020 23:01	6,45	1	6,45	CHI
20201151858	GAMELEIRA DE GOIAS	SV21146836	DAIA S2	12/11/2020 16:33	12/11/2020 19:21	12/11/2020 16:33	12/11/2020 19:21	2,78	1	2,78	CHI
20201151864	GOIANDIRA	GD12389996	CATALAO S1	12/11/2020 16:34	12/11/2020 20:26	12/11/2020 16:34	12/11/2020 20:26	3,85	1	3,85	CHI
20201151894	GOIANIA	GN10383648	CAMPINAS S1	12/11/2020 16:35	12/11/2020 16:38	12/11/2020 16:35	12/11/2020 16:38	0,05	4955	264,27	CHI

20201151875	GOIANDIRA	CT12231642	CATALAO S1	12/11/2020 16:36	12/11/2020 20:20	12/11/2020 16:36	12/11/2020 20:20	3,72	3	11,17	CHI
20201151986	GOIANIA	GN12383183	XAVANTES	12/11/2020 16:36	12/11/2020 21:17	12/11/2020 16:36	12/11/2020 21:17	4,67	236	1102,05	CHI
20201151884	CUMARI	CY12000312	CATALAO S1	12/11/2020 16:37	12/11/2020 19:14	12/11/2020 16:37	12/11/2020 19:14	2,60	1	2,60	CHI
20201151891	JARAGUA	JA21000178	JARAGUA	12/11/2020 16:38	13/11/2020 02:16	12/11/2020 16:38	13/11/2020 02:16	9,62	1	9,62	CHI
20201151892	COCALZINHO DE GOIAS	ZN21382317	COCALZINHO	12/11/2020 16:38	12/11/2020 19:18	12/11/2020 16:38	12/11/2020 19:18	2,65	1	2,65	CHI
20201151897	PIRENOPOLIS	PV12381249	CORUMBA	12/11/2020 16:39	12/11/2020 23:28	12/11/2020 16:39	12/11/2020 23:28	6,81	6	40,86	CHI
20201151908	ALTO PARAISO DE GOIAS	BF21256412	NIQUELANDIA SUBTRANSMISSAO	12/11/2020 16:40	12/11/2020 20:35	12/11/2020 16:40	12/11/2020 20:35	3,91	2	7,83	CHI
20201151914	AGUAS LINDAS DE GOIAS	10020953753	AGUAS LINDAS DE GOIAS S1	12/11/2020 16:40	12/11/2020 19:35	12/11/2020 16:40	12/11/2020 19:35	2,90	1	2,90	CHI
20201151918	GOIANIA	GN11064107	XAVANTES	12/11/2020 16:41	12/11/2020 19:54	12/11/2020 16:41	12/11/2020 19:54	3,21	103	330,37	CHI
20201153659	MIMOSO DE GOIAS	MJ12126284	PADRE BERNARDO	12/11/2020 16:41	13/11/2020 00:19	12/11/2020 16:41	13/11/2020 00:19	7,62	4	30,48	CHI
20201152388	GOIANIA	GN11002182	FERROVIARIO S1	12/11/2020 16:42	13/11/2020 10:26	12/11/2020 16:42	13/11/2020 10:26	17,72	158	2800,02	CHI
20201152063	GOIANIA	602224	ATLANTICO S3	12/11/2020 16:43	12/11/2020 16:50	12/11/2020 16:43	12/11/2020 16:47	0,06	7460	431,02	CHI
20201152063	GOIANIA	602224	ATLANTICO S3	12/11/2020 16:43	12/11/2020 16:50	12/11/2020 16:43	12/11/2020 16:49	0,10	1430	139,82	CHI
20201152063	GOIANIA	602224	ATLANTICO S3	12/11/2020 16:43	12/11/2020 16:50	12/11/2020 16:43	12/11/2020 16:50	0,11	1327	143,39	CHI
2020111200135	SAO DOMINGOS	2090214	SAO DOMINGOS	12/11/2020 16:43	12/11/2020 18:00	12/11/2020 16:43	12/11/2020 18:00	1,28	2442	3133,90	CHI
20201151939	CALDAS NOVAS	CN12337979	RIO QUENTE	12/11/2020 16:44	12/11/2020 22:09	12/11/2020 16:44	12/11/2020 22:09	5,41	1	5,41	CHI
20201151942	ITAPURANGA	IK121307293	ITAPURANGA	12/11/2020 16:44	12/11/2020 18:46	12/11/2020 16:44	12/11/2020 18:46	2,03	1	2,03	CHI
20201152056	BURITI ALEGRE	BG12161937	ITUMBIARA VELHA S2	12/11/2020 16:45	12/11/2020 20:20	12/11/2020 16:45	12/11/2020 20:20	3,58	12	42,94	CHI
2020111200052	APARECIDA DE GOIANIA	572214	REAL S2	12/11/2020 16:45	12/11/2020 16:51	12/11/2020 16:45	12/11/2020 16:51	0,10	10590	1059,00	CHI
2020111200052	GOIANIA	572214	REAL S2	12/11/2020 16:45	12/11/2020 16:51	12/11/2020 16:45	12/11/2020 16:51	0,10	1187	118,70	CHI
20201151954	JATAI	JT12226592	JATAI S1	12/11/2020 16:46	12/11/2020 19:13	12/11/2020 16:46	12/11/2020 19:13	2,46	7	17,21	CHI
20201151965	PIRACANJUBA	PJ21373962	ROCHEDO	12/11/2020 16:47	12/11/2020 22:06	12/11/2020 16:47	12/11/2020 22:06	5,31	1	5,31	CHI
20201151967	FAZENDA NOVA	FN11124899	IPORA	12/11/2020 16:47	12/11/2020 18:00	12/11/2020 16:47	12/11/2020 18:00	1,22	34	41,58	CHI
20201153375	GUARAITA	GK12299466	ITAPURANGA	12/11/2020 16:48	12/11/2020 20:37	12/11/2020 16:48	12/11/2020 20:37	3,80	28	106,42	CHI
20201153375	ITAPURANGA	GK12299466	ITAPURANGA	12/11/2020 16:48	12/11/2020 20:37	12/11/2020 16:48	12/11/2020 20:37	3,80	19	72,22	CHI
20201153923	GOIANIA	GN11047718	ATLANTICO S3	12/11/2020 16:48	12/11/2020 23:02	12/11/2020 16:48	12/11/2020 23:02	6,22	99	616,14	CHI
20201151992	JATAI	JT21191681	JATAI S2	12/11/2020 16:49	12/11/2020 20:22	12/11/2020 16:49	12/11/2020 20:22	3,55	1	3,55	CHI
20201151994	ITAPURANGA	IK12311323	ITAPURANGA	12/11/2020 16:49	12/11/2020 17:21	12/11/2020 16:49	12/11/2020 17:21	0,53	7	3,70	CHI
20201151997	FORMOSO	SE12053856	MARA ROSA	12/11/2020 16:49	14/11/2020 11:57	12/11/2020 16:49	14/11/2020 11:57	43,14	6	258,82	CHI
20201151997	SANTA TEREZA DE GOIAS	SE12053856	MARA ROSA	12/11/2020 16:49	14/11/2020 11:57	12/11/2020 16:49	14/11/2020 11:57	43,14	3	129,41	CHI
20201152621	GOIANIA	GN11012184	ATLANTICO S2	12/11/2020 16:49	13/11/2020 05:32	12/11/2020 16:49	13/11/2020 05:32	12,70	214	2717,98	CHI
20201152826	APARECIDA DE GOIANIA	AP12147249	ATLANTICO S2	12/11/2020 16:49	12/11/2020 22:31	12/11/2020 16:49	12/11/2020 22:31	5,70	325	1852,14	CHI
20201152218	GOIANIA	GN11162195	CARAJAS S2	12/11/2020 16:50	12/11/2020 23:16	12/11/2020 16:50	12/11/2020 23:16	6,42	101	648,70	CHI
20201153069	MINEIROS	MY12197173	PARQUE DAS EMAS	12/11/2020 16:52	12/11/2020 22:04	12/11/2020 16:52	12/11/2020 22:04	5,20	21	109,20	CHI
20201153128	GUARAITA	IK12064427	ITAPURANGA	12/11/2020 16:52	12/11/2020 22:05	12/11/2020 16:52	12/11/2020 22:05	5,21	1	5,21	CHI
20201153128	ITAPURANGA	IK12064427	ITAPURANGA	12/11/2020 16:52	12/11/2020 22:05	12/11/2020 16:52	12/11/2020 22:05	5,21	15	78,20	CHI
20201152041	GOIANIA	10630879	AEROPORTO S2	12/11/2020 16:53	12/11/2020 18:00	12/11/2020 16:53	12/11/2020 18:00	1,11	1	1,11	CHI
20201152615	GOIANIA	GN11002297	ATLANTICO S3	12/11/2020 16:53	13/11/2020 04:10	12/11/2020 16:53	13/11/2020 04:10	11,28	153	1725,92	CHI
20201152664	GOIANIA	GN11040985	ATLANTICO S3	12/11/2020 16:53	13/11/2020 00:03	12/11/2020 16:53	13/11/2020 00:03	7,15	139	994,24	CHI
20201153221	GAMELEIRA DE GOIAS	SV12278872	DAIA S2	12/11/2020 16:53	12/11/2020 22:56	12/11/2020 16:53	12/11/2020 22:56	6,04	39	235,46	CHI
20201153223	RIO VERDE	RV12296155	SANTA HELENA S1	12/11/2020 16:53	12/11/2020 20:31	12/11/2020 16:53	12/11/2020 20:31	3,63	70	253,91	CHI
20201153223	SANTA HELENA DE GOIAS	RV12296155	SANTA HELENA S1	12/11/2020 16:53	12/11/2020 20:31	12/11/2020 16:53	12/11/2020 20:31	3,63	1	3,63	CHI
20201152055	MORRINHOS	MR21000152	MORRINHOS	12/11/2020 16:54	12/11/2020 22:46	12/11/2020 16:54	12/11/2020 22:46	5,86	1	5,86	CHI
20201152060	APARECIDA DE GOIANIA	12137870	REAL S1	12/11/2020 16:54	12/11/2020 19:14	12/11/2020 16:54	12/11/2020 19:14	2,32	1	2,32	CHI
20201152061	GOIANESIA	GE21366648	GOIANESIA S1	12/11/2020 16:54	12/11/2020 22:20	12/11/2020 16:54	12/11/2020 22:20	5,42	1	5,42	CHI
20201153767	MORRINHOS	MR12189857	MORRINHOS	12/11/2020 16:54	12/11/2020 20:21	12/11/2020 16:54	12/11/2020 20:21	3,43	388	1332,24	CHI
20201152078	ANAPOLIS	10017969814	ANAPOLIS UNIVERSITARIO S2	12/11/2020 16:55	12/11/2020 18:25	12/11/2020 16:55	12/11/2020 18:25	1,49	1	1,49	CHI
20201152153	APARECIDA DE GOIANIA	AP11340501	INDEPENDENCIA S2	12/11/2020 16:55	13/11/2020 00:13	12/11/2020 16:55	13/11/2020 00:13	7,29	85	619,86	CHI
20201152500	GOIANIA	GN12035176	ATLANTICO S3	12/11/2020 16:55	12/11/2020 19:40	12/11/2020 16:55	12/11/2020 19:40	2,73	641	1752,60	CHI
20201152666	GOIANIA	GN11000662	ATLANTICO S2	12/11/2020 16:55	13/11/2020 10:33	12/11/2020 16:55	13/11/2020 10:33	17,63	142	2503,66	CHI
20201153804	AGUA FRIA DE GOIAS	TL12204618	SAO JOAO D ALIANCA	12/11/2020 16:55	12/11/2020 20:40	12/11/2020 16:55	12/11/2020 20:40	3,74	6	22,44	CHI

20201154524	APARECIDA DE GOIANIA	AP11058855	INDEPENDENCIA S2	12/11/2020 16:55	13/11/2020 05:25	12/11/2020 16:55	13/11/2020 05:25	12,49	136	1698,98	CHI
20201152083	CAMPO ALEGRE DE GOIAS	CM12192739	CAMPO ALEGRE DE GOIAS	12/11/2020 16:56	13/11/2020 02:27	12/11/2020 16:56	13/11/2020 02:27	9,52	3	28,57	CHI
20201152217	APARECIDA DE GOIANIA	AP11149478	INDEPENDENCIA S2	12/11/2020 16:56	13/11/2020 02:07	12/11/2020 16:56	13/11/2020 02:07	9,18	142	1303,01	CHI
20201152497	APARECIDA DE GOIANIA	AP16407501	REAL S2	12/11/2020 16:56	12/11/2020 23:16	12/11/2020 16:56	12/11/2020 18:17	1,35	5672	7636,72	CHI
20201152497	GOIANIA	AP16407501	REAL S2	12/11/2020 16:56	12/11/2020 23:16	12/11/2020 16:56	12/11/2020 18:17	1,35	980	1319,46	CHI
20201152497	APARECIDA DE GOIANIA	572214	REAL S2	12/11/2020 16:56	12/11/2020 23:16	12/11/2020 16:56	12/11/2020 18:46	1,84	1087	2001,89	CHI
20201152497	APARECIDA DE GOIANIA	572214	REAL S2	12/11/2020 16:56	12/11/2020 23:16	12/11/2020 20:03	12/11/2020 20:07	0,06	1258	79,67	CHI
20201152497	APARECIDA DE GOIANIA	AP16407250	REAL S2	12/11/2020 16:56	12/11/2020 23:16	12/11/2020 16:56	12/11/2020 23:02	6,11	671	4098,32	CHI
20201152497	APARECIDA DE GOIANIA	AP12000705LD	REAL S2	12/11/2020 16:56	12/11/2020 23:16	12/11/2020 16:56	12/11/2020 23:16	6,33	2819	17838,79	CHI
20201152547	APARECIDA DE GOIANIA	AP11092437	ANHANGUERA	12/11/2020 16:56	12/11/2020 18:32	12/11/2020 16:56	12/11/2020 18:32	1,59	154	244,48	CHI
20201153191	FAZENDA NOVA	FN12033218RE	IPORA	12/11/2020 16:56	13/11/2020 20:06	12/11/2020 16:56	12/11/2020 19:35	2,63	12	31,61	CHI
20201153191	ISRAELANDIA	FN12033218RE	IPORA	12/11/2020 16:56	13/11/2020 20:06	12/11/2020 16:56	12/11/2020 19:35	2,63	11	28,98	CHI
20201153191	FAZENDA NOVA	FN12033218RE	IPORA	12/11/2020 16:56	13/11/2020 20:06	12/11/2020 16:56	12/11/2020 21:15	4,30	14	60,21	CHI
20201153191	FAZENDA NOVA	FN12033218RE	IPORA	12/11/2020 16:56	13/11/2020 20:06	12/11/2020 16:56	13/11/2020 20:06	27,16	18	488,88	CHI
20201153191	ISRAELANDIA	FN12033218RE	IPORA	12/11/2020 16:56	13/11/2020 20:06	12/11/2020 16:56	13/11/2020 20:06	27,16	2	54,32	CHI
20201152092	ANAPOLIS	21297587	JUNDIAI S1	12/11/2020 16:57	12/11/2020 18:16	12/11/2020 16:57	12/11/2020 18:16	1,33	1	1,33	CHI
20201152099	GOIANIA	GN11246235	GOIANIA LESTE S3	12/11/2020 16:57	12/11/2020 18:40	12/11/2020 16:57	12/11/2020 18:40	1,71	8	13,68	CHI
20201152110	ANHANGUERA	CY12071516	CATALAO S1	12/11/2020 16:58	12/11/2020 21:08	12/11/2020 16:58	12/11/2020 21:08	4,16	3	12,48	CHI
20201152110	CUMARI	CY12071516	CATALAO S1	12/11/2020 16:58	12/11/2020 21:08	12/11/2020 16:58	12/11/2020 21:08	4,16	13	54,07	CHI
20201152111	MOZARLANDIA	MZ21057158	MOZARLANDIA	12/11/2020 16:58	12/11/2020 20:28	12/11/2020 16:58	12/11/2020 20:28	3,49	1	3,49	CHI
20201152125	JUSSARA	1290012468	JUSSARA	12/11/2020 16:59	12/11/2020 21:05	12/11/2020 16:59	12/11/2020 21:05	4,09	1	4,09	CHI
20201152489	APARECIDA DE GOIANIA	AP16413221	REAL S2	12/11/2020 16:59	12/11/2020 20:56	12/11/2020 16:59	12/11/2020 17:03	0,07	35	2,53	CHI
20201152489	APARECIDA DE GOIANIA	AP16413875	REAL S2	12/11/2020 16:59	12/11/2020 20:56	12/11/2020 16:59	12/11/2020 17:04	0,08	7	0,59	CHI
20201152489	GOIANIA	GN16409433	GOIANIA LESTE S2	12/11/2020 16:59	12/11/2020 20:56	12/11/2020 16:59	12/11/2020 17:06	0,12	2315	275,23	CHI
20201152489	GOIANIA	GN16409433	REAL S2	12/11/2020 16:59	12/11/2020 20:56	12/11/2020 16:59	12/11/2020 17:06	0,12	2862	340,26	CHI
20201152489	GOIANIA	AP10406877	REAL S2	12/11/2020 16:59	12/11/2020 20:56	12/11/2020 16:59	12/11/2020 20:35	3,60	141	507,13	CHI
20201152489	GOIANIA	AP10406877	REAL S2	12/11/2020 16:59	12/11/2020 20:56	12/11/2020 16:59	12/11/2020 20:56	3,95	237	936,54	CHI
20201152489	GOIANIA	GN12395299	REAL S2	12/11/2020 16:59	12/11/2020 20:56	12/11/2020 17:05	12/11/2020 20:56	3,85	99	380,79	CHI
20201152585	APARECIDA DE GOIANIA	AP11161137	ATLANTICO S1	12/11/2020 16:59	13/11/2020 02:35	12/11/2020 16:59	13/11/2020 02:35	9,59	49	470,03	CHI
20201152133	GOIANIA	17141771	ATLANTICO S3	12/11/2020 17:00	12/11/2020 19:45	12/11/2020 17:00	12/11/2020 19:45	2,74	1	2,74	CHI
20201152336	GOIANIA	GN11000705	ATLANTICO S2	12/11/2020 17:00	12/11/2020 23:55	12/11/2020 17:00	12/11/2020 23:55	6,90	171	1180,19	CHI
20201153159	LUZIANIA	OZ12195112	PIRES DO RIO S2	12/11/2020 17:00	12/11/2020 20:08	12/11/2020 17:00	12/11/2020 20:08	3,12	73	227,74	CHI
20201152145	GOIANIA	GN21323278	CAMPINAS S1	12/11/2020 17:01	13/11/2020 10:41	12/11/2020 21:01	13/11/2020 10:41	13,66	1	13,66	CHI
20201152149	APARECIDA DE GOIANIA	14652614	INDEPENDENCIA S2	12/11/2020 17:01	13/11/2020 19:59	12/11/2020 17:01	13/11/2020 19:59	26,96	1	26,96	CHI
20201152235	APARECIDA DE GOIANIA	AP11164430	INDEPENDENCIA S2	12/11/2020 17:01	13/11/2020 17:34	12/11/2020 17:01	13/11/2020 17:34	24,54	106	2600,89	CHI
20201150924	RIO VERDE	RV12022605	CABRIUVA S1	12/11/2020 17:02	12/11/2020 20:44	12/11/2020 17:02	12/11/2020 20:44	3,69	1	3,69	CHI
20201152172	GOIANIA	13659819	ATLANTICO S1	12/11/2020 17:02	12/11/2020 19:20	12/11/2020 17:02	12/11/2020 19:20	2,29	1	2,29	CHI
20201152253	APARECIDA DE GOIANIA	AP11040752	INDEPENDENCIA S2	12/11/2020 17:02	13/11/2020 01:41	12/11/2020 17:02	13/11/2020 01:41	8,65	217	1876,33	CHI
20201152271	URUACU	1800424	URUACU	12/11/2020 17:02	13/11/2020 01:56	12/11/2020 17:02	12/11/2020 19:59	2,95	180	530,95	CHI
20201152271	HIDROLINA	HL13480129B	URUACU	12/11/2020 17:02	13/11/2020 01:56	12/11/2020 17:02	12/11/2020 20:08	3,11	108	335,73	CHI
20201152271	PILAR DE GOIAS	HL13480129B	URUACU	12/11/2020 17:02	13/11/2020 01:56	12/11/2020 17:02	12/11/2020 20:08	3,11	5	15,54	CHI
20201152271	URUACU	1800424	URUACU	12/11/2020 17:02	13/11/2020 01:56	12/11/2020 17:02	12/11/2020 22:43	5,69	41	233,46	CHI
20201152271	HIDROLINA	1800424	URUACU	12/11/2020 17:02	13/11/2020 01:56	12/11/2020 17:02	13/11/2020 00:57	7,92	71	562,30	CHI
20201152271	PILAR DE GOIAS	1800424	URUACU	12/11/2020 17:02	13/11/2020 01:56	12/11/2020 17:02	13/11/2020 00:57	7,92	24	190,07	CHI
20201152271	URUACU	1800424	URUACU	12/11/2020 17:02	13/11/2020 01:56	12/11/2020 17:02	13/11/2020 00:57	7,92	1	7,92	CHI
20201152271	HIDROLINA	1800424	URUACU	12/11/2020 17:02	13/11/2020 01:56	12/11/2020 17:02	13/11/2020 01:56	8,91	5	44,56	CHI
20201152271	NOVA IGUACU DE GOIAS	1800424	URUACU	12/11/2020 17:02	13/11/2020 01:56	12/11/2020 17:02	13/11/2020 01:56	8,91	1	8,91	CHI
20201152271	PILAR DE GOIAS	1800424	URUACU	12/11/2020 17:02	13/11/2020 01:56	12/11/2020 17:02	13/11/2020 01:56	8,91	1	8,91	CHI
20201152271	URUACU	1800424	URUACU	12/11/2020 17:02	13/11/2020 01:56	12/11/2020 17:02	13/11/2020 01:56	8,91	101	900,11	CHI
20201152552	GOIANIA	GN11130379	ATLANTICO S2	12/11/2020 17:02	13/11/2020 00:21	12/11/2020 17:02	13/11/2020 00:21	7,30	104	759,69	CHI
20201152855	GOIANIA	GN12035177	ATLANTICO S3	12/11/2020 17:02	12/11/2020 20:11	12/11/2020 17:02	12/11/2020 20:11	3,15	443	1393,36	CHI



20201153503	GOIANIA	GN11165046	ATLANTICO S1	12/11/2020 17:02	13/11/2020 01:41	12/11/2020 17:02	13/11/2020 01:41	8,65	79	683,33	CHI
20201152192	PORANGATU	PO21357391	PORANGATU	12/11/2020 17:03	12/11/2020 20:03	12/11/2020 17:03	12/11/2020 20:03	2,99	1	2,99	CHI
20201152194	AVELINOPOLIS	AV11346946	ANICUNS	12/11/2020 17:03	12/11/2020 19:44	12/11/2020 17:03	12/11/2020 19:44	2,67	23	61,42	CHI
20201152200	CRISTALINA	KR12025856	PAMPLONA	12/11/2020 17:03	12/11/2020 20:00	12/11/2020 17:03	12/11/2020 20:00	2,93	7	20,54	CHI
20201157992	VILA PROPICIO	PV12102018	GOIANESIA S1	12/11/2020 17:03	13/11/2020 19:15	12/11/2020 17:03	13/11/2020 19:15	26,20	4	104,78	CHI
20201152202	GOUVELANDIA	GB12303256	QUIRINOPOLIS	12/11/2020 17:04	12/11/2020 19:02	12/11/2020 17:04	12/11/2020 19:02	1,97	107	210,34	CHI
20201152206	GOIANIA	AP11340335	ATLANTICO S2	12/11/2020 17:04	12/11/2020 21:19	12/11/2020 17:04	12/11/2020 21:19	4,25	79	335,40	CHI
20201152211	GOIANIA	12216010	CAMPINAS S2	12/11/2020 17:04	12/11/2020 19:51	12/11/2020 17:04	12/11/2020 19:51	2,77	1	2,77	CHI
20201152407	GOIANIA	GN11093393	ATLANTICO S2	12/11/2020 17:04	13/11/2020 06:20	12/11/2020 17:04	13/11/2020 06:20	13,26	105	1392,50	CHI
20201152227	FORMOSA	FA11233628	SAO JOAO D ALIANCA	12/11/2020 17:05	12/11/2020 21:12	12/11/2020 17:05	12/11/2020 21:12	4,11	1	4,11	CHI
20201152229	APARECIDA DE GOIANIA	AP11137821	INDEPENDENCIA S2	12/11/2020 17:05	12/11/2020 22:34	12/11/2020 17:05	12/11/2020 22:34	5,47	139	760,64	CHI
20201152230	GOIANIA	14961519	GOIANIA LESTE S1	12/11/2020 17:05	13/11/2020 02:50	12/11/2020 17:05	13/11/2020 02:50	9,74	1	9,74	CHI
20201152240	PALMEIRAS DE GOIAS	590008006	PALMEIRAS	12/11/2020 17:06	12/11/2020 17:53	12/11/2020 17:06	12/11/2020 17:53	0,77	1	0,77	CHI
20201152424	GOIANIA	GN10383685	GOIANIA LESTE S2	12/11/2020 17:06	12/11/2020 22:54	12/11/2020 17:07	12/11/2020 17:15	0,13	2315	291,30	CHI
20201152424	GOIANIA	GN16420136	GOIANIA LESTE S2	12/11/2020 17:06	12/11/2020 22:54	12/11/2020 17:07	12/11/2020 18:17	1,16	638	741,14	CHI
20201152424	GOIANIA	GN16420136	GOIANIA LESTE S2	12/11/2020 17:06	12/11/2020 22:54	12/11/2020 17:07	12/11/2020 18:48	1,67	2316	3876,73	CHI
20201152424	GOIANIA	GN16420136	GOIANIA LESTE S2	12/11/2020 17:06	12/11/2020 22:54	12/11/2020 17:07	12/11/2020 18:55	1,79	854	1532,69	CHI
20201152424	GOIANIA	GN16420136	GOIANIA LESTE S2	12/11/2020 17:06	12/11/2020 22:54	12/11/2020 17:07	12/11/2020 22:54	5,78	1635	9442,58	CHI
20201152256	ARENOPOLIS	AY21308726	ARENOPOLIS	12/11/2020 17:07	12/11/2020 19:59	12/11/2020 17:07	12/11/2020 19:59	2,85	1	2,85	CHI
20201152627	APARECIDA DE GOIANIA	AP11156894	REAL S1	12/11/2020 17:07	13/11/2020 11:19	12/11/2020 17:07	13/11/2020 11:19	18,19	166	3020,09	CHI
20201152839	ITAPACI	IW12071383	ITAPACI	12/11/2020 17:07	12/11/2020 20:12	12/11/2020 17:07	12/11/2020 20:12	3,07	45	138,10	CHI
20201152875	NOVA IGUACU DE GOIAS	UR12000054RE	CAMPINORTE	12/11/2020 17:07	13/11/2020 09:44	12/11/2020 17:07	13/11/2020 09:44	16,61	15	249,22	CHI
20201152875	URUACU	UR12000054RE	CAMPINORTE	12/11/2020 17:07	13/11/2020 09:44	12/11/2020 17:07	13/11/2020 09:44	16,61	93	1545,17	CHI
20201152260	INHUMAS	IN21274334	INHUMAS S1	12/11/2020 17:08	12/11/2020 19:57	12/11/2020 17:08	12/11/2020 19:57	2,81	1	2,81	CHI
20201152261	APARECIDA DE GOIANIA	AP21248049	ATLANTICO S2	12/11/2020 17:08	12/11/2020 21:23	12/11/2020 17:08	12/11/2020 21:23	4,24	9	38,20	CHI
20201152262	FAZENDA NOVA	NB12020229	JUSSARA	12/11/2020 17:08	12/11/2020 21:50	12/11/2020 17:08	12/11/2020 21:50	4,69	12	56,33	CHI
20201152262	NOVO BRASIL	NB12020229	JUSSARA	12/11/2020 17:08	12/11/2020 21:50	12/11/2020 17:08	12/11/2020 21:50	4,69	25	117,36	CHI
20201152264	TURVELANDIA	TD12025763	RIO DOS BOIS	12/11/2020 17:08	13/11/2020 10:05	12/11/2020 17:08	13/11/2020 10:05	16,94	1	16,94	CHI
20201152528	MARA ROSA	MQ11000002	MARA ROSA	12/11/2020 17:08	13/11/2020 01:12	12/11/2020 17:08	13/11/2020 01:12	8,06	111	894,35	CHI
20201153369	GOIANIA	AP12005089	REAL S2	12/11/2020 17:08	12/11/2020 21:56	12/11/2020 17:08	12/11/2020 21:56	4,80	383	1838,40	CHI
20201152802	PIRENOPOLIS	PV12381257	CORUMBA	12/11/2020 17:09	12/11/2020 21:57	12/11/2020 17:09	12/11/2020 21:57	4,79	131	627,42	CHI
20201152583	GOIAS	GK12299432	ITAPURANGA	12/11/2020 17:10	12/11/2020 22:38	12/11/2020 17:10	12/11/2020 22:38	5,46	32	174,84	CHI
20201152583	GUARAITA	GK12299432	ITAPURANGA	12/11/2020 17:10	12/11/2020 22:38	12/11/2020 17:10	12/11/2020 22:38	5,46	156	852,37	CHI
20201152318	CIDADE OCIDENTAL	2680059949	MARAJOARA	12/11/2020 17:11	12/11/2020 22:42	12/11/2020 17:11	12/11/2020 22:42	5,51	1	5,51	CHI
20201152823	SAO MIGUEL DO PASSA QUATRO	SV12107881	VIANOPOLIS	12/11/2020 17:11	12/11/2020 19:43	12/11/2020 17:11	12/11/2020 19:43	2,52	62	156,41	CHI
20201152823	SILVANIA	SV12107881	VIANOPOLIS	12/11/2020 17:11	12/11/2020 19:43	12/11/2020 17:11	12/11/2020 19:43	2,52	33	83,25	CHI
20201152823	VIANOPOLIS	SV12107881	VIANOPOLIS	12/11/2020 17:11	12/11/2020 19:43	12/11/2020 17:11	12/11/2020 19:43	2,52	104	262,37	CHI
20201152844	MORRINHOS	MR12000100	MORRINHOS	12/11/2020 17:11	12/11/2020 19:23	12/11/2020 17:11	12/11/2020 19:23	2,19	8	17,50	CHI
20201152339	GOIANIA	15682134	GOYA S1	12/11/2020 17:12	12/11/2020 20:05	12/11/2020 17:12	12/11/2020 20:05	2,87	1	2,87	CHI
20201152618	APARECIDA DE GOIANIA	AP11166220	REAL S1	12/11/2020 17:12	13/11/2020 18:14	12/11/2020 17:12	13/11/2020 18:14	25,02	78	1951,32	CHI
20201153560	GOIANIA	GN12127447	ATLANTICO S1	12/11/2020 17:12	13/11/2020 03:57	12/11/2020 17:12	12/11/2020 23:05	5,88	430	2528,52	CHI
20201153560	GOIANIA	GN11189680	ATLANTICO S1	12/11/2020 17:12	13/11/2020 03:57	12/11/2020 17:12	13/11/2020 03:57	10,75	69	741,65	CHI
20201153697	GOIANIA	GN11064108	XAVANTES	12/11/2020 17:12	12/11/2020 21:01	12/11/2020 17:12	12/11/2020 21:01	3,81	52	198,09	CHI
20201152350	APARECIDA DE GOIANIA	10024822688	REAL S1	12/11/2020 17:13	12/11/2020 20:33	12/11/2020 17:13	12/11/2020 20:33	3,33	1	3,33	CHI
20201152356	CAMPESTRE DE GOIAS	GC21092761	TRINDADE	12/11/2020 17:13	13/11/2020 03:56	12/11/2020 17:13	13/11/2020 03:56	10,70	1	10,70	CHI
20201154080	PANAMA	GT12249848	GOIATUBA S1	12/11/2020 17:13	13/11/2020 20:51	12/11/2020 17:13	13/11/2020 20:51	27,64	8	221,12	CHI
20201152371	MARA ROSA	MQ12391677	MARA ROSA	12/11/2020 17:15	13/11/2020 18:35	12/11/2020 17:15	13/11/2020 18:35	25,32	2	50,64	CHI
20201152377	ANAPOLIS	10005800291	ANAPOLIS UNIVERSITARIO S2	12/11/2020 17:16	12/11/2020 20:32	12/11/2020 17:16	12/11/2020 20:32	3,26	1	3,26	CHI
20201152643	PANAMA	PX11166415	GOIATUBA S1	12/11/2020 17:16	12/11/2020 20:35	12/11/2020 17:16	12/11/2020 20:35	3,32	37	122,73	CHI
20201152770	APARECIDA DE GOIANIA	AP11085125	ATLANTICO S1	12/11/2020 17:17	13/11/2020 02:36	12/11/2020 17:17	13/11/2020 02:36	9,31	93	865,60	CHI
20201152419	BURITI DE GOIAS	1680008083	FIRMINOPOLIS S2	12/11/2020 17:18	12/11/2020 20:10	12/11/2020 17:18	12/11/2020 20:10	2,86	1	2,86	CHI

20201153037	PORANGATU	PO12079340	PORANGATU	12/11/2020 17:18	13/11/2020 14:29	12/11/2020 17:18	13/11/2020 14:29	21,18	6	127,07	CHI
20201152438	MINACU	IH12288133	PORANGATU	12/11/2020 17:19	15/11/2020 13:32	12/11/2020 17:19	15/11/2020 13:32	68,22	2	136,44	CHI
20201152795	JANDAIA	JD12260012	PALMEIRAS	12/11/2020 17:19	12/11/2020 23:03	12/11/2020 17:19	12/11/2020 23:03	5,72	14	80,04	CHI
20201153546	EDEIA	EA11263276	EDEIA	12/11/2020 17:19	12/11/2020 23:18	12/11/2020 17:19	12/11/2020 23:18	5,98	70	418,41	CHI
20201152475	BOM JARDIM DE GOIAS	BM21208980	ARAGARCAS	12/11/2020 17:21	12/11/2020 19:30	12/11/2020 17:21	12/11/2020 19:30	2,16	1	2,16	CHI
20201152481	VALPARAISO DE GOIAS	10002040547	MARAJOARA	12/11/2020 17:21	13/11/2020 00:35	12/11/2020 17:21	13/11/2020 00:35	7,22	1	7,22	CHI
20201153118	GOIANIA	GN11093394	ATLANTICO S2	12/11/2020 17:21	13/11/2020 09:33	12/11/2020 17:21	13/11/2020 09:33	16,19	104	1683,56	CHI
20201152488	APARECIDA DE GOIANIA	AP11167485	REAL S1	12/11/2020 17:22	13/11/2020 12:36	12/11/2020 17:22	13/11/2020 12:36	19,22	26	499,84	CHI
20201152698	GOIANIA	AP11005068	REAL S2	12/11/2020 17:22	13/11/2020 10:22	12/11/2020 17:22	13/11/2020 10:22	16,98	147	2496,63	CHI
20201153115	GOIANIA	GN11247972	ATLANTICO S2	12/11/2020 17:22	13/11/2020 12:27	12/11/2020 17:22	13/11/2020 12:27	19,07	30	572,03	CHI
20201153575	GOIANIA	GN11155419	AEROPORTO S1	12/11/2020 17:23	12/11/2020 20:53	12/11/2020 17:23	12/11/2020 20:53	3,50	53	185,43	CHI
20201152944	ITAPIRAPUA	IU12034913	MATRINCHA	12/11/2020 17:24	13/11/2020 02:42	12/11/2020 17:24	13/11/2020 02:42	9,29	7	65,05	CHI
20201152522	SANTA RITA DO ARAGUAIA	SU11092349	SANTA RITA DO ARAGUAIA	12/11/2020 17:25	12/11/2020 18:51	12/11/2020 17:25	12/11/2020 18:51	1,43	82	117,37	CHI
20201152524	BRAZABRANTES	BR11199248	INHUMAS S2	12/11/2020 17:25	12/11/2020 18:31	12/11/2020 17:25	12/11/2020 18:31	1,10	55	60,33	CHI
20201152540	APORE	AE12234187	ITAJA S2	12/11/2020 17:26	13/11/2020 02:02	12/11/2020 17:26	13/11/2020 02:02	8,60	2	17,19	CHI
20201152546	RIO VERDE	630252890	RIO VERDE S2	12/11/2020 17:26	13/11/2020 05:58	12/11/2020 17:26	13/11/2020 05:58	12,54	1	12,54	CHI
20201152693	GOIANIA	GN11193241	ATLANTICO S1	12/11/2020 17:27	12/11/2020 18:46	12/11/2020 17:27	12/11/2020 18:46	1,30	100	130,11	CHI
20201152574	CAVALCANTE	CJ12346073	MINACU	12/11/2020 17:29	13/11/2020 10:56	12/11/2020 17:29	13/11/2020 10:56	17,44	143	2494,08	CHI
20201152584	GOIANIA	12034812	CAMPINAS S3	12/11/2020 17:30	13/11/2020 10:45	12/11/2020 17:30	13/11/2020 10:45	17,24	1	17,24	CHI
20201152820	EDEIA	EA11000003	EDEIA	12/11/2020 17:30	12/11/2020 23:17	12/11/2020 17:30	12/11/2020 23:17	5,78	84	485,36	CHI
20201153265	GOIANIA	GN11151347	ATLANTICO S3	12/11/2020 17:30	13/11/2020 00:10	12/11/2020 17:30	13/11/2020 00:10	6,66	92	612,87	CHI
20201153097	VALPARAISO DE GOIAS	VA12370665	PACAEMBU S2	12/11/2020 17:31	12/11/2020 20:32	12/11/2020 17:31	12/11/2020 20:32	3,01	513	1544,56	CHI
20201152598	PADRE BERNARDO	PB12162859	PADRE BERNARDO	12/11/2020 17:32	12/11/2020 21:08	12/11/2020 17:32	12/11/2020 21:08	3,60	1	3,60	CHI
20201153417	APARECIDA DE GOIANIA	AP11167711	ATLANTICO S1	12/11/2020 17:34	12/11/2020 23:58	12/11/2020 17:34	12/11/2020 23:58	6,39	89	568,73	CHI
20201152625	IPAMERI	IP21133652	CRISTALINA S2	12/11/2020 17:35	12/11/2020 22:45	12/11/2020 17:35	12/11/2020 22:45	5,17	1	5,17	CHI
20201152631	PARAUNA	PU12301614	PARAUNA	12/11/2020 17:35	13/11/2020 09:32	12/11/2020 17:35	13/11/2020 09:32	15,95	2	31,91	CHI
20201152803	APARECIDA DE GOIANIA	AP11157886	ATLANTICO S2	12/11/2020 17:35	13/11/2020 01:24	12/11/2020 17:35	13/11/2020 01:24	7,80	139	1084,82	CHI
20201152645	PALMEIRAS DE GOIAS	PL12000118	PALMEIRAS	12/11/2020 17:36	13/11/2020 07:57	12/11/2020 17:36	13/11/2020 07:57	14,34	4	57,35	CHI
20201152647	ITAUCU	IX21319558	INHUMAS S1	12/11/2020 17:36	13/11/2020 01:02	12/11/2020 17:36	13/11/2020 01:02	7,42	1	7,42	CHI
20201152657	MAMBAI	MB11109324	IACIARA S2	12/11/2020 17:37	12/11/2020 19:01	12/11/2020 17:37	12/11/2020 19:01	1,38	94	130,11	CHI
20201152661	CIDADE OCIDENTAL	DH11128795	MARAJOARA	12/11/2020 17:37	12/11/2020 19:22	12/11/2020 17:37	12/11/2020 19:22	1,73	94	163,09	CHI
20201152923	GOIANIA	GN11001188	ATLANTICO S1	12/11/2020 17:37	12/11/2020 21:22	12/11/2020 17:37	12/11/2020 21:22	3,74	74	276,68	CHI
20201152658	LEOPOLDO DE BULHOES	LB12065982	DAIA S2	12/11/2020 17:38	12/11/2020 20:35	12/11/2020 17:38	12/11/2020 20:35	2,95	11	32,42	CHI
20201152665	GOIANIA	GN21347322	ATLANTICO S3	12/11/2020 17:38	13/11/2020 12:34	12/11/2020 17:38	13/11/2020 12:34	18,92	1	18,92	CHI
20201152673	AGUAS LINDAS DE GOIAS	10000074037	AGUAS LINDAS DE GOIAS S1	12/11/2020 17:39	12/11/2020 20:13	12/11/2020 17:39	12/11/2020 20:13	2,55	1	2,55	CHI
20201152836	APARECIDA DE GOIANIA	AP12004870	ATLANTICO S1	12/11/2020 17:39	13/11/2020 01:30	12/11/2020 17:39	13/11/2020 01:30	7,85	461	3618,34	CHI
20201152682	GOIANIA	GN11346129	CAMPINAS S1	12/11/2020 17:40	12/11/2020 22:06	12/11/2020 17:40	12/11/2020 22:06	4,42	80	353,47	CHI
20201152689	CALDAS NOVAS	CN21000082	CALDAS NOVAS S2	12/11/2020 17:41	12/11/2020 22:43	12/11/2020 17:41	12/11/2020 22:43	5,03	1	5,03	CHI
20201152809	TRINDADE	TR12293992	TRINDADE	12/11/2020 17:43	12/11/2020 20:27	12/11/2020 17:43	12/11/2020 20:27	2,72	16	43,56	CHI
20201153424	MORRINHOS	MR12212264RE	GOIATUBA S1	12/11/2020 17:43	12/11/2020 22:22	12/11/2020 17:43	12/11/2020 22:22	4,64	61	283,01	CHI
20201153674	APARECIDA DE GOIANIA	AP11035946	REAL S1	12/11/2020 17:43	13/11/2020 05:23	12/11/2020 17:43	13/11/2020 05:23	11,66	121	1410,39	CHI
20201152720	APORE	AE21264437	ITAJA S1	12/11/2020 17:44	13/11/2020 02:14	12/11/2020 17:44	13/11/2020 02:14	8,49	1	8,49	CHI
20201152731	ITAPIRAPUA	IU21198628	MATRINCHA	12/11/2020 17:44	12/11/2020 23:25	12/11/2020 17:44	12/11/2020 23:25	5,67	1	5,67	CHI
20201152752	SANTA TEREZINHA DE GOIAS	UP10398079	SANTA TEREZINHA	12/11/2020 17:45	14/11/2020 14:44	12/11/2020 17:45	12/11/2020 20:08	2,37	84	199,36	CHI
20201152752	UIRAPURU	UP10398079	SANTA TEREZINHA	12/11/2020 17:45	14/11/2020 14:44	12/11/2020 17:45	12/11/2020 20:08	2,37	20	47,47	CHI
20201152752	SANTA TEREZINHA DE GOIAS	SG12323395LD	SANTA TEREZINHA	12/11/2020 17:45	14/11/2020 14:44	12/11/2020 17:45	12/11/2020 22:25	4,66	20	93,18	CHI
20201152752	CAMPOS VERDES	SG13323396	SANTA TEREZINHA	12/11/2020 17:45	14/11/2020 14:44	12/11/2020 17:45	13/11/2020 03:54	10,15	1	10,15	CHI
20201152752	MARA ROSA	SG13323396	SANTA TEREZINHA	12/11/2020 17:45	14/11/2020 14:44	12/11/2020 17:45	13/11/2020 03:54	10,15	28	284,16	CHI
20201152752	SANTA TEREZINHA DE GOIAS	SG13323396	SANTA TEREZINHA	12/11/2020 17:45	14/11/2020 14:44	12/11/2020 17:45	13/11/2020 03:54	10,15	20	202,97	CHI
20201152752	MARA ROSA	MQ12232537LD	SANTA TEREZINHA	12/11/2020 17:45	14/11/2020 14:44	12/11/2020 17:45	13/11/2020 12:47	19,02	15	285,34	CHI
20201152752	MARA ROSA	MQ12251030	SANTA TEREZINHA	12/11/2020 17:45	14/11/2020 14:44	12/11/2020 17:45	13/11/2020 13:32	19,78	2	39,57	CHI

20201152752	MARA ROSA	MQ13297142	SANTA TEREZINHA	12/11/2020 17:45	14/11/2020 14:44	12/11/2020 17:45	13/11/2020 13:56	20,19	34	686,31	CHI
20201152752	CAMPOS VERDES	UP10398079	SANTA TEREZINHA	12/11/2020 17:45	14/11/2020 14:44	13/11/2020 14:00	13/11/2020 14:33	0,55	1	0,55	CHI
20201152752	MARA ROSA	UP10398079	SANTA TEREZINHA	12/11/2020 17:45	14/11/2020 14:44	13/11/2020 14:00	13/11/2020 14:33	0,55	45	24,76	CHI
20201152752	SANTA TEREZINHA DE GOIAS	UP10398079	SANTA TEREZINHA	12/11/2020 17:45	14/11/2020 14:44	13/11/2020 14:00	13/11/2020 14:33	0,55	124	68,23	CHI
20201152752	UIRAPURU	UP10398079	SANTA TEREZINHA	12/11/2020 17:45	14/11/2020 14:44	13/11/2020 14:00	13/11/2020 14:33	0,55	20	11,01	CHI
20201152752	MARA ROSA	MQ13297142	SANTA TEREZINHA	12/11/2020 17:45	14/11/2020 14:44	13/11/2020 14:00	13/11/2020 16:19	2,32	20	46,48	CHI
20201152752	MARA ROSA	MQ13192414	SANTA TEREZINHA	12/11/2020 17:45	14/11/2020 14:44	13/11/2020 14:00	14/11/2020 11:12	21,21	9	190,88	CHI
20201152752	MARA ROSA	MQ12264921	SANTA TEREZINHA	12/11/2020 17:45	14/11/2020 14:44	13/11/2020 14:00	14/11/2020 13:48	23,80	1	23,80	CHI
20201152752	MARA ROSA	MQ12391777	SANTA TEREZINHA	12/11/2020 17:45	14/11/2020 14:44	13/11/2020 14:00	14/11/2020 14:44	24,73	4	98,92	CHI
20201152936	GOIANIA	GN11001378	ATLANTICO S2	12/11/2020 17:45	12/11/2020 19:59	12/11/2020 17:45	12/11/2020 19:59	2,23	59	131,52	CHI
20201152747	MONTIVIDIU	MV21260784	MONTIVIDIU T	12/11/2020 17:46	12/11/2020 20:39	12/11/2020 17:46	12/11/2020 20:39	2,87	3	8,62	CHI
20201153096	JARAGUA	JA12297403	GOIANESIA S2	12/11/2020 17:46	12/11/2020 21:13	12/11/2020 17:46	12/11/2020 21:13	3,44	4	13,74	CHI
20201152753	RIO QUENTE	RQ12050875	VILA CORUMBA	12/11/2020 17:47	12/11/2020 21:27	12/11/2020 17:47	12/11/2020 21:27	3,67	14	51,32	CHI
20201152761	BONFINOPOLIS	BO12400465	CEPAIGO S2	12/11/2020 17:48	12/11/2020 19:58	12/11/2020 17:48	12/11/2020 19:58	2,15	3	6,45	CHI
20201152761	LEOPOLDO DE BULHOES	BO12400465	CEPAIGO S2	12/11/2020 17:48	12/11/2020 19:58	12/11/2020 17:48	12/11/2020 19:58	2,15	12	25,82	CHI
20201152771	APARECIDA DE GOIANIA	200535304	ANHANGUERA	12/11/2020 17:49	13/11/2020 01:25	12/11/2020 17:49	13/11/2020 01:25	7,59	1	7,59	CHI
20201152791	SANTA RITA DO ARAGUAIA	SU12306464	SANTA RITA DO ARAGUAIA	12/11/2020 17:50	12/11/2020 19:31	12/11/2020 17:50	12/11/2020 19:31	1,68	79	132,37	CHI
20201152819	GUAPO	GA11048134	GUAPO S1	12/11/2020 17:50	12/11/2020 22:17	12/11/2020 17:50	12/11/2020 22:17	4,45	189	840,79	CHI
20201152833	BONFINOPOLIS	GN10380011	GOIANIA LESTE S2	12/11/2020 17:50	12/11/2020 23:44	12/11/2020 17:50	12/11/2020 18:15	0,42	88	36,67	CHI
20201152833	GOIANAPOLIS	GN10380011	GOIANIA LESTE S2	12/11/2020 17:50	12/11/2020 23:44	12/11/2020 17:50	12/11/2020 18:15	0,42	30	12,50	CHI
20201152833	GOIANIA	GN10380011	GOIANIA LESTE S2	12/11/2020 17:50	12/11/2020 23:44	12/11/2020 17:50	12/11/2020 18:15	0,42	1837	765,42	CHI
20201152833	SENADOR CANEDO	GN10380011	GOIANIA LESTE S2	12/11/2020 17:50	12/11/2020 23:44	12/11/2020 17:50	12/11/2020 18:15	0,42	1644	685,00	CHI
20201152833	GOIANIA	GN16416162	GOIANIA LESTE S2	12/11/2020 17:50	12/11/2020 23:44	12/11/2020 17:50	12/11/2020 18:24	0,55	55	30,34	CHI
20201152833	GOIANIA	GN16435386	GOIANIA LESTE S2	12/11/2020 17:50	12/11/2020 23:44	12/11/2020 17:50	12/11/2020 19:30	1,66	326	542,43	CHI
20201152833	GOIANIA	GN13028114	GOIANIA LESTE S2	12/11/2020 17:50	12/11/2020 23:44	12/11/2020 17:50	12/11/2020 23:03	5,21	346	1803,04	CHI
20201152833	GOIANIA	GN11323283	GOIANIA LESTE S2	12/11/2020 17:50	12/11/2020 23:44	12/11/2020 17:50	12/11/2020 23:44	5,90	58	342,23	CHI
20201153199	LEOPOLDO DE BULHOES	GP12039292	DAIA S2	12/11/2020 17:52	12/11/2020 20:54	12/11/2020 17:52	12/11/2020 20:54	3,03	9	27,28	CHI
20201153262	BARRO ALTO	BA12185125	BARRO ALTO	12/11/2020 17:52	12/11/2020 21:14	12/11/2020 17:52	12/11/2020 21:14	3,36	40	134,23	CHI
20201153668	SAO MIGUEL DO ARAGUAIA	SM12143671	SAO MIGUEL DO ARAGUAIA	12/11/2020 17:52	12/11/2020 23:06	12/11/2020 17:52	12/11/2020 23:06	5,22	275	1435,12	CHI
20201154093	GOIANIA	GN21203601	ATLANTICO S3	12/11/2020 17:52	13/11/2020 01:19	12/11/2020 17:52	13/11/2020 01:19	7,44	60	446,37	CHI
20201152831	MAMBAI	MB12109336	ACIARA S2	12/11/2020 17:53	12/11/2020 20:26	12/11/2020 17:53	12/11/2020 20:26	2,53	38	96,28	CHI
20201152952	BELA VISTA DE GOIAS	BV11036348	BELA VISTA S1	12/11/2020 17:53	12/11/2020 19:47	12/11/2020 17:53	12/11/2020 19:47	1,89	171	322,43	CHI
20201152900	APARECIDA DE GOIANIA	AP11169140	REAL S1	12/11/2020 17:54	13/11/2020 00:05	12/11/2020 17:54	13/11/2020 00:05	6,17	61	376,34	CHI
20201153218	GOIANIA	GN11002249	REAL S2	12/11/2020 17:54	12/11/2020 20:13	12/11/2020 17:54	12/11/2020 20:13	2,33	134	312,22	CHI
20201153693	ABADIANIA	AA12265423	CORUMBA	12/11/2020 17:55	12/11/2020 21:07	12/11/2020 17:55	12/11/2020 21:07	3,19	4	12,78	CHI
20201153351	ANICUNS	TV12005577	FIRMINOPOLIS S2	12/11/2020 17:56	12/11/2020 19:26	12/11/2020 17:56	12/11/2020 19:26	1,49	23	34,31	CHI
20201153351	TURVANIA	TV12005577	FIRMINOPOLIS S2	12/11/2020 17:56	12/11/2020 19:26	12/11/2020 17:56	12/11/2020 19:26	1,49	109	162,59	CHI
20201153890	SAO LUIS DE MONTES BELOS	SL11349348	SAO LUIZ DOS MONTES BELOS	12/11/2020 17:57	12/11/2020 21:45	12/11/2020 17:57	12/11/2020 21:45	3,80	58	220,30	CHI
20201152892	COCAZINHO DE GOIAS	PB12382216	PADRE BERNARDO	12/11/2020 17:59	12/11/2020 19:56	12/11/2020 17:59	12/11/2020 19:56	1,95	1	1,95	CHI
20201152892	PADRE BERNARDO	PB12382216	PADRE BERNARDO	12/11/2020 17:59	12/11/2020 19:56	12/11/2020 17:59	12/11/2020 19:56	1,95	6	11,69	CHI
20201152899	JANDAIA	JD12308479	PALMEIRAS	12/11/2020 17:59	13/11/2020 01:49	12/11/2020 17:59	13/11/2020 01:49	7,82	149	1165,22	CHI
20201152899	PARAUNA	JD12308479	PALMEIRAS	12/11/2020 17:59	13/11/2020 01:49	12/11/2020 17:59	13/11/2020 01:49	7,82	6	46,92	CHI
20201152903	MARA ROSA	MQ21338224	MARA ROSA	12/11/2020 18:00	13/11/2020 08:40	12/11/2020 18:00	13/11/2020 08:40	14,66	1	14,66	CHI
20201152904	GOIANIA	16692858	FERROVIARIO S1	12/11/2020 18:00	13/11/2020 03:36	12/11/2020 18:00	13/11/2020 03:36	9,59	1	9,59	CHI
20201152916	GOIANIA	10004034986	GOYA S1	12/11/2020 18:01	12/11/2020 22:52	12/11/2020 18:01	12/11/2020 22:52	4,85	1	4,85	CHI
20201152919	ITAPURANGA	IK12206764	ITAPURANGA	12/11/2020 18:01	12/11/2020 22:45	12/11/2020 18:01	12/11/2020 22:45	4,73	5	23,65	CHI
20201152938	MIMOSO DE GOIAS	MJ12377231	PADRE BERNARDO	12/11/2020 18:02	12/11/2020 20:29	12/11/2020 18:02	12/11/2020 20:29	2,44	45	109,98	CHI
20201153743	APARECIDA DE GOIANIA	AP11035299	REAL S1	12/11/2020 18:02	13/11/2020 03:36	12/11/2020 18:02	13/11/2020 03:36	9,56	204	1949,62	CHI
20201153114	GOIANIA	GN11154668	ATLANTICO S2	12/11/2020 18:03	12/11/2020 22:25	12/11/2020 18:03	12/11/2020 22:25	4,36	137	597,13	CHI
20201153123	GOIANESIA	GE11000036	GOIANESIA S2	12/11/2020 18:03	12/11/2020 22:05	12/11/2020 18:03	12/11/2020 22:05	4,02	139	558,74	CHI
20201153411	MINEIROS	MY12043892RE	PARQUE DAS EMAS	12/11/2020 18:04	13/11/2020 08:10	12/11/2020 18:04	13/11/2020 08:10	14,09	14	197,19	CHI



20201154021	GOIANIA	AP12168635	REAL S2	12/11/2020 18:04	13/11/2020 11:45	12/11/2020 18:04	13/11/2020 11:45	17,67	52	918,75	CHI
20201152977	APARECIDA DE GOIANIA	13394733	REAL S2	12/11/2020 18:06	13/11/2020 07:46	12/11/2020 18:06	13/11/2020 07:46	13,67	1	13,67	CHI
20201152988	GOIANIA	GN12034282	ATLANTICO S2	12/11/2020 18:07	12/11/2020 21:48	12/11/2020 18:07	12/11/2020 21:48	3,68	320	1176,89	CHI
20201152993	PONTALINA	MI21349850	PONTALINA	12/11/2020 18:07	12/11/2020 19:49	12/11/2020 18:07	12/11/2020 19:49	1,69	1	1,69	CHI
20201152998	CAMPINACU	UC12269659	MARA ROSA	12/11/2020 18:07	14/11/2020 13:00	12/11/2020 18:07	14/11/2020 13:00	42,87	2	85,74	CHI
20201153228	PALMEIRAS DE GOIAS	PL12000219	PALMEIRAS	12/11/2020 18:07	12/11/2020 20:26	12/11/2020 18:07	12/11/2020 20:26	2,31	11	25,43	CHI
20201153486	APARECIDA DE GOIANIA	AP11169470	ATLANTICO S2	12/11/2020 18:07	13/11/2020 00:40	12/11/2020 18:07	13/11/2020 00:40	6,54	115	752,13	CHI
20201153530	GOIANESIA	GE11058404	GOIANESIA S2	12/11/2020 18:07	12/11/2020 23:05	12/11/2020 18:07	12/11/2020 23:05	4,95	161	797,53	CHI
20201154052	APARECIDA DE GOIANIA	AP11377665	INDEPENDENCIA S2	12/11/2020 18:07	13/11/2020 00:51	12/11/2020 18:07	13/11/2020 00:51	6,73	106	713,06	CHI
20201154626	GOIANIA	GN11127358	ATLANTICO S2	12/11/2020 18:07	13/11/2020 01:41	12/11/2020 18:07	13/11/2020 01:41	7,56	111	839,31	CHI
20201153384	CORUMBAIBA	CI12064619	VILA CORUMBA	12/11/2020 18:08	12/11/2020 22:35	12/11/2020 18:08	12/11/2020 22:35	4,44	38	168,62	CHI
20201153021	MONTES CLAROS DE GOIAS	3220000263	IPORA	12/11/2020 18:09	12/11/2020 20:48	12/11/2020 18:09	12/11/2020 20:48	2,64	1	2,64	CHI
20201153892	PIRACANJUBA	MR12000241	MORRINHOS	12/11/2020 18:09	12/11/2020 21:08	12/11/2020 18:09	12/11/2020 21:08	2,98	6	17,90	CHI
20201153027	GOIANIA	GN11001396	FERROVIARIO S1	12/11/2020 18:10	13/11/2020 11:48	12/11/2020 18:10	13/11/2020 11:48	17,63	101	1780,46	CHI
20201153030	TRINDADE	TR12331568LD	TRINDADE	12/11/2020 18:10	13/11/2020 02:44	12/11/2020 23:34	13/11/2020 01:44	2,18	2	4,35	CHI
20201153030	TRINDADE	TR21331567	TRINDADE	12/11/2020 18:10	13/11/2020 02:44	12/11/2020 18:10	13/11/2020 02:07	7,95	2	15,89	CHI
20201153030	CAMPRESTRE DE GOIAS	TR12000108	TRINDADE	12/11/2020 18:10	13/11/2020 02:44	13/11/2020 02:30	13/11/2020 02:44	0,23	3	0,70	CHI
20201153030	TRINDADE	TR12000108	TRINDADE	12/11/2020 18:10	13/11/2020 02:44	13/11/2020 02:30	13/11/2020 02:44	0,23	7	1,63	CHI
20201153031	CAMPINORTE	MQ12380774	MARA ROSA	12/11/2020 18:10	14/11/2020 09:15	12/11/2020 18:10	14/11/2020 09:15	39,07	1	39,07	CHI
20201153031	MARA ROSA	MQ12380774	MARA ROSA	12/11/2020 18:10	14/11/2020 09:15	12/11/2020 18:10	14/11/2020 09:15	39,07	5	195,34	CHI
20201153034	ITABERAI	IB12070829	ITABERAI S1	12/11/2020 18:11	13/11/2020 11:55	12/11/2020 18:11	13/11/2020 11:55	17,73	3	53,19	CHI
20201153036	GOIANIA	16486833	ATLANTICO S1	12/11/2020 18:11	13/11/2020 02:27	12/11/2020 18:11	13/11/2020 02:27	8,26	1	8,26	CHI
20201153582	ANICUNS	AC18000072TS	ANICUNS	12/11/2020 18:12	12/11/2020 21:05	12/11/2020 18:12	12/11/2020 21:05	2,87	59	169,17	CHI
20201153051	GOIANIA	13779382	GOIANIA LESTE S1	12/11/2020 18:13	13/11/2020 05:49	12/11/2020 18:13	13/11/2020 05:49	11,59	1	11,59	CHI
20201153066	CRIXAS	CX10394718	SERRA DO OURO	12/11/2020 18:13	14/11/2020 04:10	12/11/2020 18:13	12/11/2020 20:04	1,85	6	11,12	CHI
20201153066	CRIXAS	CX12072150LD	SERRA DO OURO	12/11/2020 18:13	14/11/2020 04:10	12/11/2020 18:13	12/11/2020 20:17	2,07	76	157,47	CHI
20201153066	CRIXAS	CX12201615LD	SERRA DO OURO	12/11/2020 18:13	14/11/2020 04:10	12/11/2020 18:13	12/11/2020 20:54	2,69	1	2,69	CHI
20201153066	NOVA CRIXAS	CX12201615LD	SERRA DO OURO	12/11/2020 18:13	14/11/2020 04:10	12/11/2020 18:13	12/11/2020 20:54	2,69	1	2,69	CHI
20201153066	CRIXAS	CX12201615LD	SERRA DO OURO	12/11/2020 18:13	14/11/2020 04:10	12/11/2020 18:13	12/11/2020 22:46	4,54	79	358,88	CHI
20201153066	CRIXAS	CX12201615LD	SERRA DO OURO	12/11/2020 18:13	14/11/2020 04:10	12/11/2020 18:13	13/11/2020 04:55	10,69	5	53,47	CHI
20201153066	CRIXAS	CX12201615LD	SERRA DO OURO	12/11/2020 18:13	14/11/2020 04:10	12/11/2020 18:13	13/11/2020 11:43	17,50	18	314,94	CHI
20201153066	CRIXAS	CX12201615LD	SERRA DO OURO	12/11/2020 18:13	14/11/2020 04:10	12/11/2020 18:13	14/11/2020 03:17	33,07	4	132,26	CHI
20201153066	CRIXAS	CX13243673	SERRA DO OURO	12/11/2020 18:13	14/11/2020 04:10	14/11/2020 01:54	14/11/2020 03:17	1,38	18	24,82	CHI
20201153066	CRIXAS	CX12201615LD	SERRA DO OURO	12/11/2020 18:13	14/11/2020 04:10	12/11/2020 18:13	14/11/2020 04:10	33,94	37	1255,82	CHI
20201153066	NOVA CRIXAS	CX12201615LD	SERRA DO OURO	12/11/2020 18:13	14/11/2020 04:10	12/11/2020 18:13	14/11/2020 04:10	33,94	5	169,71	CHI
20201153469	AMERICANO DO BRASIL	AC12314939	ANICUNS	12/11/2020 18:13	12/11/2020 22:36	12/11/2020 18:13	12/11/2020 22:36	4,38	6	26,28	CHI
20201153469	ANICUNS	AC12314939	ANICUNS	12/11/2020 18:13	12/11/2020 22:36	12/11/2020 18:13	12/11/2020 22:36	4,38	121	530,08	CHI
20201153469	ITABERAI	AC12314939	ANICUNS	12/11/2020 18:13	12/11/2020 22:36	12/11/2020 18:13	12/11/2020 22:36	4,38	2	8,76	CHI
20201153090	CAMPOS BELOS	GH10401448	SAO DOMINGOS	12/11/2020 18:14	12/11/2020 18:25	12/11/2020 18:14	12/11/2020 18:25	0,18	102	17,88	CHI
20201153090	DIVINOPOLIS DE GOIAS	GH10401448	SAO DOMINGOS	12/11/2020 18:14	12/11/2020 18:25	12/11/2020 18:14	12/11/2020 18:25	0,18	576	100,96	CHI
20201153090	MONTE ALEGRE DE GOIAS	GH10401448	SAO DOMINGOS	12/11/2020 18:14	12/11/2020 18:25	12/11/2020 18:14	12/11/2020 18:25	0,18	158	27,69	CHI
20201153090	SAO DOMINGOS	GH10401448	SAO DOMINGOS	12/11/2020 18:14	12/11/2020 18:25	12/11/2020 18:14	12/11/2020 18:25	0,18	185	32,43	CHI
20201153065	APARECIDA DE GOIANIA	10006880418	ANHANGUERA	12/11/2020 18:15	13/11/2020 08:22	12/11/2020 18:15	13/11/2020 08:22	14,12	1	14,12	CHI
20201153070	CRISTALINA	KR12090200	CRISTALINA S1	12/11/2020 18:16	12/11/2020 22:46	12/11/2020 18:16	12/11/2020 22:46	4,49	5	22,47	CHI
20201153365	ITAPURANGA	IK11021617	ITAPURANGA	12/11/2020 18:16	12/11/2020 21:17	12/11/2020 18:16	12/11/2020 21:17	3,01	35	105,29	CHI
20201153241	APARECIDA DE GOIANIA	AP11169108	REAL S1	12/11/2020 18:17	12/11/2020 23:07	12/11/2020 18:17	12/11/2020 23:07	4,82	237	1142,27	CHI
20201153254	PANAMA	IT12000094	PARANAIBA	12/11/2020 18:17	12/11/2020 21:50	12/11/2020 18:17	12/11/2020 21:50	3,54	20	70,78	CHI
20201153476	HIDROLANDIA	HD11000143	ANHANGUERA	12/11/2020 18:17	13/11/2020 10:50	12/11/2020 18:17	13/11/2020 10:50	16,55	97	1605,22	CHI
20201153107	PADRE BERNARDO	PB12277183	PADRE BERNARDO	12/11/2020 18:19	12/11/2020 20:43	12/11/2020 18:19	12/11/2020 20:43	2,39	52	124,14	CHI
20201153143	ANICUNS	AC12323460	ANICUNS	12/11/2020 18:19	13/11/2020 00:06	12/11/2020 18:19	13/11/2020 00:06	5,78	7	40,47	CHI
20201153143	TURVANIA	AC12323460	ANICUNS	12/11/2020 18:19	13/11/2020 00:06	12/11/2020 18:19	13/11/2020 00:06	5,78	3	17,34	CHI

20201153958	NIQUELANDIA	NQ12234274	NIQUELANDIA SUBTRANSMISSAO	12/11/2020 18:19	13/11/2020 10:40	12/11/2020 18:19	13/11/2020 10:40	16,35	8	130,76	CHI
20201153111	MARA ROSA	MQ12295285	MARA ROSA	12/11/2020 18:20	13/11/2020 16:15	12/11/2020 18:20	13/11/2020 16:15	21,92	5	109,62	CHI
20201153126	SANTO ANTONIO DE GOIAS	BW11417477	NEROPOLIS S1	12/11/2020 18:21	12/11/2020 21:38	12/11/2020 18:21	12/11/2020 21:38	3,27	18	58,93	CHI
20201153127	VIANOPOLIS	510027052	VIANOPOLIS	12/11/2020 18:21	12/11/2020 22:50	12/11/2020 18:21	12/11/2020 22:50	4,47	1	4,47	CHI
20201153130	SERRANOPOLIS	3000010772	JATAI S1	12/11/2020 18:22	13/11/2020 08:26	12/11/2020 18:22	13/11/2020 08:26	14,06	1	14,06	CHI
20201153131	ACREUNA	2440081249	ACREUNA	12/11/2020 18:22	13/11/2020 09:30	12/11/2020 18:22	13/11/2020 09:30	15,14	1	15,14	CHI
20201155765	CAMPINORTE	CR12309721	MARA ROSA	12/11/2020 18:22	13/11/2020 11:43	12/11/2020 18:22	13/11/2020 11:43	17,34	4	69,34	CHI
20201155765	NOVA IGUACU DE GOIAS	CR12309721	MARA ROSA	12/11/2020 18:22	13/11/2020 11:43	12/11/2020 18:22	13/11/2020 11:43	17,34	2	34,67	CHI
20201157043	NOVA IGUACU DE GOIAS	2040017519	MARA ROSA	12/11/2020 18:22	13/11/2020 14:49	12/11/2020 18:22	13/11/2020 14:49	20,44	1	20,44	CHI
20201153650	APARECIDA DE GOIANIA	AP11004608	ANHANGUERA	12/11/2020 18:23	13/11/2020 00:45	12/11/2020 18:23	13/11/2020 00:45	6,37	9	57,35	CHI
20201153654	APARECIDA DE GOIANIA	AP12161134	ATLANTICO S1	12/11/2020 18:24	13/11/2020 02:05	12/11/2020 18:24	13/11/2020 02:05	7,67	50	383,53	CHI
20201153152	BELA VISTA DE GOIAS	BV21010095	CRISTIANOPOLIS	12/11/2020 18:25	12/11/2020 21:12	12/11/2020 18:25	12/11/2020 21:12	2,78	2	5,56	CHI
20201153165	AMORINOPOLIS	AM21312069	IPORA	12/11/2020 18:25	12/11/2020 21:36	12/11/2020 18:25	12/11/2020 21:36	3,18	1	3,18	CHI
20201153735	APARECIDA DE GOIANIA	AP11407202	INDEPENDENCIA S2	12/11/2020 18:26	13/11/2020 01:15	12/11/2020 18:26	13/11/2020 01:15	6,81	48	327,05	CHI
20201154294	AMERICANO DO BRASIL	KB11000009	ANICUNS	12/11/2020 18:26	13/11/2020 01:27	12/11/2020 18:26	13/11/2020 01:27	7,01	169	1183,89	CHI
20201153197	SERRANOPOLIS	SX21264357	JATAI S1	12/11/2020 18:27	13/11/2020 11:11	12/11/2020 18:27	13/11/2020 11:11	16,73	1	16,73	CHI
20201153210	APARECIDA DE GOIANIA	200402006	INDEPENDENCIA S1	12/11/2020 18:27	13/11/2020 01:38	12/11/2020 18:27	13/11/2020 01:38	7,17	1	7,17	CHI
20201153689	MONTIVIDIU DO NORTE	MX12187845RE	PORANGATU	12/11/2020 18:27	13/11/2020 09:13	12/11/2020 18:27	13/11/2020 09:13	14,76	13	191,91	CHI
20201153215	APARECIDA DE GOIANIA	10020311190	INDEPENDENCIA S2	12/11/2020 18:28	13/11/2020 02:10	12/11/2020 18:28	13/11/2020 02:10	7,69	1	7,69	CHI
20201153217	MONTES CLAROS DE GOIAS	10025215947	IPORA	12/11/2020 18:28	12/11/2020 20:33	12/11/2020 18:28	12/11/2020 20:33	2,07	1	2,07	CHI
20201153569	APARECIDA DE GOIANIA	AP11095067	ANHANGUERA	12/11/2020 18:29	12/11/2020 20:31	12/11/2020 18:29	12/11/2020 20:31	2,02	49	99,06	CHI
20201153234	QUIRINOPOLIS	QI31255788	QUIRINOPOLIS	12/11/2020 18:31	12/11/2020 21:36	12/11/2020 18:31	12/11/2020 21:36	3,07	2	6,15	CHI
20201153240	APARECIDA DE GOIANIA	10024749425	ANHANGUERA	12/11/2020 18:31	13/11/2020 09:47	12/11/2020 18:31	13/11/2020 09:47	15,25	1	15,25	CHI
20201153243	PADRE BERNARDO	PB12089582	PADRE BERNARDO	12/11/2020 18:32	13/11/2020 12:33	12/11/2020 18:32	13/11/2020 12:33	18,02	3	54,07	CHI
20201153249	MAMBAI	10008593416	IACIARA S2	12/11/2020 18:32	12/11/2020 19:35	12/11/2020 18:32	12/11/2020 19:35	1,04	1	1,04	CHI
20201153251	SANTO ANTONIO DO DESCOBERTO	SN12078108	MARAJOARA	12/11/2020 18:32	13/11/2020 09:44	12/11/2020 18:32	13/11/2020 09:44	15,19	4	60,75	CHI
20201153253	APARECIDA DE GOIANIA	10011344480	ANHANGUERA	12/11/2020 18:32	13/11/2020 09:35	12/11/2020 18:32	13/11/2020 09:35	15,04	1	15,04	CHI
20201153255	PORANGATU	10014305192	PORANGATU	12/11/2020 18:32	13/11/2020 00:18	12/11/2020 18:32	13/11/2020 00:18	5,75	1	5,75	CHI
20201157925	AMARALINA	MU12394938	MARA ROSA	12/11/2020 18:32	14/11/2020 10:20	12/11/2020 18:32	14/11/2020 10:20	39,80	6	238,79	CHI
20201157925	BONOPOLIS	MU12394938	MARA ROSA	12/11/2020 18:32	14/11/2020 10:20	12/11/2020 18:32	14/11/2020 10:20	39,80	2	79,60	CHI
20201157925	MUTUNOPOLIS	MU12394938	MARA ROSA	12/11/2020 18:32	14/11/2020 10:20	12/11/2020 18:32	14/11/2020 10:20	39,80	14	557,17	CHI
20201157925	PORANGATU	MU12394938	MARA ROSA	12/11/2020 18:32	14/11/2020 10:20	12/11/2020 18:32	14/11/2020 10:20	39,80	74	2945,06	CHI
20201153268	LEOPOLDO DE BULHOES	LB21141936	DAIA S2	12/11/2020 18:34	12/11/2020 23:15	12/11/2020 18:34	12/11/2020 23:15	4,68	1	4,68	CHI
20201153271	CRISTALINA	KR21163140	CRISTALINA S1	12/11/2020 18:34	13/11/2020 00:13	12/11/2020 18:34	13/11/2020 00:13	5,65	1	5,65	CHI
20201153275	HIDROLINA	10031579289	URUACU	12/11/2020 18:34	13/11/2020 08:36	12/11/2020 18:34	13/11/2020 08:36	14,03	1	14,03	CHI
20201153279	ANAPOLIS	21046025	ANAPOLIS UNIVERSITARIO S1	12/11/2020 18:34	12/11/2020 22:41	12/11/2020 18:34	12/11/2020 22:41	4,10	1	4,10	CHI
20201154416	EDEIA	EA12044508	EDEIA	12/11/2020 18:34	13/11/2020 00:29	12/11/2020 18:34	13/11/2020 00:29	5,90	2	11,80	CHI
20201154002	APARECIDA DE GOIANIA	AP12040116	ATLANTICO S1	12/11/2020 18:35	12/11/2020 22:01	12/11/2020 18:35	12/11/2020 22:01	3,43	303	1040,72	CHI
20201153356	APARECIDA DE GOIANIA	15342979	REAL S1	12/11/2020 18:37	13/11/2020 09:16	12/11/2020 18:37	13/11/2020 09:16	14,65	1	14,65	CHI
20201153357	MUNDO NOVO DE GOIAS	MH12035583	NOVA CRIXAS	12/11/2020 18:37	13/11/2020 08:50	12/11/2020 18:37	13/11/2020 08:50	14,21	11	156,33	CHI
20201167910	ESTRELA DO NORTE	2420003774	MARA ROSA	12/11/2020 18:37	15/11/2020 18:01	12/11/2020 18:37	15/11/2020 18:01	71,40	1	71,40	CHI
20201153370	APARECIDA DE GOIANIA	12815056	REAL S1	12/11/2020 18:38	13/11/2020 04:19	12/11/2020 18:38	13/11/2020 04:19	9,68	1	9,68	CHI
20201153371	JANDAIA	JD12206438	PALMEIRAS	12/11/2020 18:38	13/11/2020 10:16	12/11/2020 18:38	13/11/2020 10:16	15,63	4	62,51	CHI
20201153374	AGUAS LINDAS DE GOIAS	4830323785	AGUAS LINDAS DE GOIAS S1	12/11/2020 18:39	12/11/2020 20:44	12/11/2020 18:39	12/11/2020 20:44	2,08	1	2,08	CHI
20201154053	MUNDO NOVO DE GOIAS	MH12362454	NOVA CRIXAS	12/11/2020 18:39	13/11/2020 07:36	12/11/2020 18:39	13/11/2020 07:36	12,95	123	1592,58	CHI
20201153383	COCALZINHO DE GOIAS	ZN12216782	PADRE BERNARDO	12/11/2020 18:40	13/11/2020 11:19	12/11/2020 18:40	13/11/2020 11:19	16,65	22	366,20	CHI
20201153383	PADRE BERNARDO	ZN12216782	PADRE BERNARDO	12/11/2020 18:40	13/11/2020 11:19	12/11/2020 18:40	13/11/2020 11:19	16,65	3	49,94	CHI
20201153385	RIO QUENTE	RQ21064966	VILA CORUMBA	12/11/2020 18:40	12/11/2020 23:11	12/11/2020 18:40	12/11/2020 23:11	4,51	1	4,51	CHI
20201153391	GOIANIA	12992537	MEIA PONTE	12/11/2020 18:41	13/11/2020 08:43	12/11/2020 18:41	13/11/2020 08:43	14,03	1	14,03	CHI
20201153401	CRISTALINA	KR21213952	CRISTALINA S2	12/11/2020 18:41	12/11/2020 22:13	12/11/2020 18:41	12/11/2020 22:13	3,52	1	3,52	CHI
20201153459	ALEXANIA	AX12095965	ALEXANIA	12/11/2020 18:41	12/11/2020 22:22	12/11/2020 18:41	12/11/2020 22:22	3,67	4	14,68	CHI

20201153669	RIO VERDE	RV11018078	SANTA HELENA S1	12/11/2020 18:41	12/11/2020 21:24	12/11/2020 18:41	12/11/2020 21:24	2,70	131	354,28	CHI
20201153404	PIRENOPOLIS	PV21280569	SAO FRANCISCO DE GOIAS	12/11/2020 18:42	13/11/2020 01:13	12/11/2020 18:42	13/11/2020 01:13	6,51	1	6,51	CHI
20201153410	PORANGATU	PO11239634	MARA ROSA	12/11/2020 18:43	14/11/2020 14:40	12/11/2020 18:43	14/11/2020 14:40	43,95	1	43,95	CHI
20201153413	LUZIANIA	LZ21152857	CRISTALINA S2	12/11/2020 18:43	12/11/2020 18:53	12/11/2020 18:43	12/11/2020 18:53	0,16	1	0,16	CHI
20201153415	BOM JESUS DE GOIAS	BJ21000269	BOM JESUS DE GOIAS	12/11/2020 18:43	12/11/2020 20:42	12/11/2020 18:43	12/11/2020 20:42	1,98	1	1,98	CHI
20201153420	RIO VERDE	RV31191874	QUIRINOPOLIS	12/11/2020 18:43	13/11/2020 00:42	12/11/2020 18:43	13/11/2020 00:42	5,97	2	11,93	CHI
20201153871	CAMPOS VERDES	SG12318464	SANTA TEREZINHA	12/11/2020 18:44	13/11/2020 09:48	12/11/2020 18:44	13/11/2020 09:48	15,06	13	195,75	CHI
20201153871	SANTA TEREZINHA DE GOIAS	SG12318464	SANTA TEREZINHA	12/11/2020 18:44	13/11/2020 09:48	12/11/2020 18:44	13/11/2020 09:48	15,06	32	481,85	CHI
20201153871	UIRAPURU	SG12318464	SANTA TEREZINHA	12/11/2020 18:44	13/11/2020 09:48	12/11/2020 18:44	13/11/2020 09:48	15,06	13	195,75	CHI
20201153430	SAO JOAO D ALIANCA	JL12268121	SAO JOAO D ALIANCA	12/11/2020 18:45	12/11/2020 20:44	12/11/2020 18:45	12/11/2020 20:44	1,98	8	15,86	CHI
20201153431	GUAPO	GA31054258	GUAPO S2	12/11/2020 18:45	12/11/2020 20:53	12/11/2020 18:45	12/11/2020 20:53	2,13	1	2,13	CHI
20201153432	SENADOR CANEDO	10025951384	SENADOR CANEDO	12/11/2020 18:45	12/11/2020 21:36	12/11/2020 18:45	12/11/2020 21:36	2,85	1	2,85	CHI
20201153776	AVELINOPOLIS	AV12079346	ANICUNS	12/11/2020 18:45	13/11/2020 07:54	12/11/2020 18:45	13/11/2020 07:54	13,15	7	92,02	CHI
20201153442	URUACU	UR21082981	URUACU	12/11/2020 18:46	13/11/2020 13:38	12/11/2020 18:46	13/11/2020 13:38	18,86	1	18,86	CHI
20201153443	ARAGOIANIA	5580020367	INDEPENDENCIA S2	12/11/2020 18:46	13/11/2020 03:05	12/11/2020 18:46	13/11/2020 03:05	8,31	1	8,31	CHI
20201153450	BURITI ALEGRE	BG21127070	ITUMBIARA VELHA S2	12/11/2020 18:47	12/11/2020 23:00	12/11/2020 18:47	12/11/2020 23:00	4,21	1	4,21	CHI
20201153457	PLANALTINA	PI21400951	PLANALTINA	12/11/2020 18:47	12/11/2020 19:58	12/11/2020 18:47	12/11/2020 19:58	1,17	2	2,34	CHI
20201153724	GOIANIA	GN11144799	ATLANTICO S3	12/11/2020 18:47	13/11/2020 01:18	12/11/2020 18:47	13/11/2020 01:18	6,51	69	449,08	CHI
20201153470	SANTA ROSA DE GOIAS	SR12000047	INHUMAS S1	12/11/2020 18:48	13/11/2020 08:05	12/11/2020 18:48	13/11/2020 08:05	13,27	53	703,27	CHI
20201153540	RIO VERDE	SH12306604LD	RIO VERDE S2	12/11/2020 18:48	12/11/2020 20:48	12/11/2020 18:48	12/11/2020 20:48	2,00	12	23,97	CHI
20201153540	SANTA HELENA DE GOIAS	SH12306604LD	RIO VERDE S2	12/11/2020 18:48	12/11/2020 20:48	12/11/2020 18:48	12/11/2020 20:48	2,00	35	69,91	CHI
20201153596	CORUMBA DE GOIAS	CB12327779	CORUMBA	12/11/2020 18:48	13/11/2020 00:00	12/11/2020 18:48	13/11/2020 00:00	5,19	7	36,34	CHI
20201153699	ANAPOLIS	AN12346422	ANAPOLIS UNIVERSITARIO S2	12/11/2020 18:48	12/11/2020 20:10	12/11/2020 18:48	12/11/2020 20:10	1,35	317	428,48	CHI
20201154097	ANAPOLIS	AN11130759	ANAPOLIS UNIVERSITARIO S2	12/11/2020 18:48	12/11/2020 22:33	12/11/2020 18:48	12/11/2020 22:33	3,73	135	504,19	CHI
20201153481	CALDAS NOVAS	760014048	SERRA DE CALDAS	12/11/2020 18:50	12/11/2020 23:47	12/11/2020 18:50	12/11/2020 23:47	4,94	1	4,94	CHI
20201153482	GUARANI DE GOIAS	1580002629	IACIARA S1	12/11/2020 18:50	13/11/2020 00:35	12/11/2020 18:50	13/11/2020 00:35	5,74	1	5,74	CHI
20201153491	SAO LUIZ DO NORTE	SZ12190056	ITAPACI	12/11/2020 18:51	13/11/2020 07:45	12/11/2020 18:51	13/11/2020 07:45	12,89	3	38,68	CHI
20201153492	POSSE	PS11218716	IACIARA S2	12/11/2020 18:51	12/11/2020 20:39	12/11/2020 18:51	12/11/2020 20:39	1,79	16	28,68	CHI
20201153839	CAMPOS VERDES	VD11029478	SANTA TEREZINHA	12/11/2020 18:51	13/11/2020 08:56	12/11/2020 18:51	13/11/2020 08:56	14,08	54	760,44	CHI
20201154355	CAMPINORTE	CR12078290	MARA ROSA	12/11/2020 18:51	13/11/2020 08:48	12/11/2020 18:51	13/11/2020 08:48	13,94	6	83,63	CHI
20201153682	PALMINOPOLIS	PP12006641	PALMEIRAS	12/11/2020 18:52	12/11/2020 22:37	12/11/2020 18:52	12/11/2020 22:37	3,75	13	48,74	CHI
20201153768	SAO MIGUEL DO ARAGUAIA	SM11262647	SAO MIGUEL DO ARAGUAIA	12/11/2020 18:54	12/11/2020 22:40	12/11/2020 18:54	12/11/2020 22:40	3,75	62	232,66	CHI
20201153525	SANTA TEREZINHA DE GOIAS	SG21341384	SANTA TEREZINHA	12/11/2020 18:55	13/11/2020 11:55	12/11/2020 18:55	13/11/2020 11:55	17,00	1	17,00	CHI
20201153836	ANICUNS	AC12259090	FIRMINOPOLIS S2	12/11/2020 18:56	12/11/2020 23:13	12/11/2020 18:56	12/11/2020 23:13	4,28	30	128,42	CHI
20201153545	ANAPOLIS	20493733	JUNDIAI S1	12/11/2020 18:57	12/11/2020 22:48	12/11/2020 18:57	12/11/2020 22:48	3,85	1	3,85	CHI
20201153548	SANTA ROSA DE GOIAS	SR12107586	INHUMAS S1	12/11/2020 18:57	12/11/2020 19:47	12/11/2020 18:57	12/11/2020 19:47	0,83	63	52,15	CHI
20201154645	ABADIA DE GOIAS	GN12099642	CARAJAS S1	12/11/2020 18:58	13/11/2020 01:22	12/11/2020 18:58	13/11/2020 01:22	6,39	120	766,23	CHI
20201153673	MAURILANDIA	ML12303327	RIO DOS BOIS	12/11/2020 18:59	13/11/2020 10:18	12/11/2020 18:59	13/11/2020 08:35	13,61	20	272,24	CHI
20201153673	MAURILANDIA	ML12303327	RIO DOS BOIS	12/11/2020 18:59	13/11/2020 10:18	12/11/2020 18:59	13/11/2020 09:12	14,23	2	28,46	CHI
20201153673	MAURILANDIA	ML12303327	RIO DOS BOIS	12/11/2020 18:59	13/11/2020 10:18	12/11/2020 18:59	13/11/2020 10:18	15,32	3	45,95	CHI
20201153857	PIRENOPOLIS	PV11090372	SAO FRANCISCO DE GOIAS	12/11/2020 18:59	13/11/2020 00:03	12/11/2020 18:59	13/11/2020 00:03	5,06	78	394,59	CHI
20201154006	ANICUNS	AC12259088	ANICUNS	12/11/2020 18:59	12/11/2020 23:08	12/11/2020 18:59	12/11/2020 23:08	4,15	56	232,26	CHI
20201153568	GOIANIA	GN11141403	CARAJAS S2	12/11/2020 19:00	13/11/2020 10:47	12/11/2020 19:00	13/11/2020 10:47	15,78	133	2098,59	CHI
20201153586	ABADIA DE GOIAS	10026601964	GUAPO S1	12/11/2020 19:02	13/11/2020 00:29	12/11/2020 19:02	13/11/2020 00:29	5,45	1	5,45	CHI
20201153600	APARECIDA DE GOIANIA	10017419580	INDEPENDENCIA S2	12/11/2020 19:03	13/11/2020 08:16	12/11/2020 19:03	13/11/2020 08:16	13,21	1	13,21	CHI
20201153603	SILVANIA	SV12245113	VIANOPOLIS	12/11/2020 19:03	12/11/2020 23:16	12/11/2020 19:03	12/11/2020 23:16	4,20	3	12,61	CHI
20201153608	VIANOPOLIS	510003953	VIANOPOLIS	12/11/2020 19:04	13/11/2020 00:13	12/11/2020 19:04	13/11/2020 00:13	5,15	1	5,15	CHI
20201153838	APARECIDA DE GOIANIA	AP11326531	REAL S1	12/11/2020 19:04	12/11/2020 23:11	12/11/2020 19:04	12/11/2020 23:11	4,13	148	610,99	CHI
20201153616	SANTA ROSA DE GOIAS	SR11271881	INHUMAS S1	12/11/2020 19:05	12/11/2020 23:32	12/11/2020 19:05	12/11/2020 23:32	4,43	66	292,71	CHI
20201153623	ANAPOLIS	AN11214762	JUNDIAI S2	12/11/2020 19:06	12/11/2020 21:23	12/11/2020 19:06	12/11/2020 21:23	2,28	23	52,33	CHI
20201153624	APARECIDA DE GOIANIA	12539326	INDEPENDENCIA S2	12/11/2020 19:06	12/11/2020 22:48	12/11/2020 19:06	12/11/2020 22:48	3,69	1	3,69	CHI

20201153626	PIRENOPOLIS	PV21056287	SAO FRANCISCO DE GOIAS	12/11/2020 19:06	12/11/2020 19:27	12/11/2020 19:06	12/11/2020 19:27	0,34	1	0,34	CHI
20201154079	GOIANIA	GN1169930	ATLANTICO S2	12/11/2020 19:06	13/11/2020 00:32	12/11/2020 19:06	13/11/2020 00:32	5,42	36	195,12	CHI
20201153639	CRISTALINA	KR21330523	CRISTALINA S2	12/11/2020 19:09	13/11/2020 00:47	12/11/2020 19:09	13/11/2020 00:47	5,63	1	5,63	CHI
20201153640	MINEIROS	MY12336359	PARQUE DAS EMAS	12/11/2020 19:09	12/11/2020 23:02	12/11/2020 19:09	12/11/2020 23:02	3,87	3	11,61	CHI
20201153657	SANTO ANTONIO DO DESCOBERTO	2210143026	ALEXANIA	12/11/2020 19:12	12/11/2020 22:00	12/11/2020 19:12	12/11/2020 22:00	2,79	1	2,79	CHI
20201153662	BURITINOPOLIS	BQ12204633RE	IACIARA S2	12/11/2020 19:12	12/11/2020 21:28	12/11/2020 19:12	12/11/2020 21:28	2,26	52	117,29	CHI
20201153662	POSSE	BQ12204633RE	IACIARA S2	12/11/2020 19:12	12/11/2020 21:28	12/11/2020 19:12	12/11/2020 21:28	2,26	112	252,62	CHI
20201153662	SIMOLANDIA	BQ12204633RE	IACIARA S2	12/11/2020 19:12	12/11/2020 21:28	12/11/2020 19:12	12/11/2020 21:28	2,26	63	142,10	CHI
20201153478	SANTA HELENA DE GOIAS	SH12273765	SANTA HELENA S1	12/11/2020 19:13	13/11/2020 14:01	12/11/2020 19:13	13/11/2020 09:37	14,39	2	28,78	CHI
20201153478	SANTA HELENA DE GOIAS	SH12273765	SANTA HELENA S1	12/11/2020 19:13	13/11/2020 14:01	13/11/2020 00:09	13/11/2020 09:37	9,45	1	9,45	CHI
20201153478	SANTA HELENA DE GOIAS	SH12273765	SANTA HELENA S1	12/11/2020 19:13	13/11/2020 14:01	12/11/2020 19:13	13/11/2020 13:26	18,21	7	127,46	CHI
20201153478	SANTA HELENA DE GOIAS	SH12273765	SANTA HELENA S1	12/11/2020 19:13	13/11/2020 14:01	12/11/2020 19:13	13/11/2020 13:37	18,40	2	36,81	CHI
20201153478	RIO VERDE	SH12273765	SANTA HELENA S1	12/11/2020 19:13	13/11/2020 14:01	12/11/2020 19:13	13/11/2020 14:01	18,79	3	56,38	CHI
20201153478	SANTA HELENA DE GOIAS	SH12273765	SANTA HELENA S1	12/11/2020 19:13	13/11/2020 14:01	12/11/2020 19:13	13/11/2020 14:01	18,79	3	56,38	CHI
20201153670	SAO LUIS DE MONTES BELOS	10006769185	SAO LUIZ DOS MONTES BELOS	12/11/2020 19:13	12/11/2020 23:02	12/11/2020 19:13	12/11/2020 23:02	3,81	1	3,81	CHI
20201153952	CRISTALINA	KR12304912	CRISTALINA S2	12/11/2020 19:13	12/11/2020 22:22	12/11/2020 19:13	12/11/2020 22:22	3,14	3	9,42	CHI
20201153677	MORRINHOS	MR21150872	MORRINHOS	12/11/2020 19:14	13/11/2020 07:07	12/11/2020 19:14	12/11/2020 07:07	11,88	1	11,88	CHI
20201153684	APARECIDA DE GOIANIA	AP21006208	ANHANGUERA	12/11/2020 19:14	13/11/2020 09:54	12/11/2020 19:14	13/11/2020 09:54	14,66	1	14,66	CHI
20201153695	PADRE BERNARDO	2760020387	PADRE BERNARDO	12/11/2020 19:15	12/11/2020 21:50	12/11/2020 19:15	12/11/2020 21:50	2,57	1	2,57	CHI
20201153984	GOIANIA	GN11001599	REAL S2	12/11/2020 19:15	12/11/2020 22:52	12/11/2020 19:15	12/11/2020 22:52	3,61	62	223,70	CHI
20201153965	GOIANIA	GN11059718	REAL S2	12/11/2020 19:17	12/11/2020 22:19	12/11/2020 19:17	12/11/2020 22:19	3,02	157	474,58	CHI
20201153715	FORMOSA	FA21180550	ITUIQUIRA	12/11/2020 19:18	12/11/2020 22:20	12/11/2020 19:18	12/11/2020 22:20	3,03	1	3,03	CHI
20201153722	MONTIVIDIU	MV21104893	MONTIVIDIU T	12/11/2020 19:19	12/11/2020 23:22	12/11/2020 19:19	12/11/2020 23:22	4,04	1	4,04	CHI
20201153726	ITARUMA	IM21122636	CACHOEIRA ALTA	12/11/2020 19:19	13/11/2020 00:36	12/11/2020 19:19	13/11/2020 00:36	5,27	1	5,27	CHI
20201154499	GOIANIA	GN11168459	GOIANIA LESTE S2	12/11/2020 19:19	13/11/2020 09:58	12/11/2020 19:19	13/11/2020 09:58	14,65	81	1186,52	CHI
20201153727	CRISTALINA	KR12304801	CRISTALINA S2	12/11/2020 19:20	13/11/2020 00:30	12/11/2020 19:20	13/11/2020 00:30	5,17	5	25,83	CHI
20201153729	GOIANIA	10755469	CAMPINAS S1	12/11/2020 19:20	13/11/2020 09:10	12/11/2020 19:20	13/11/2020 09:10	13,82	1	13,82	CHI
20201154259	VIANOPOLIS	VN12017544RE	VIANOPOLIS	12/11/2020 19:20	13/11/2020 13:25	12/11/2020 19:20	13/11/2020 11:30	16,16	4	64,62	CHI
20201154259	VIANOPOLIS	VN12017544RE	VIANOPOLIS	12/11/2020 19:20	13/11/2020 13:25	12/11/2020 19:20	13/11/2020 11:30	16,16	31	500,81	CHI
20201154259	VIANOPOLIS	VN12017544RE	VIANOPOLIS	12/11/2020 19:20	13/11/2020 13:25	12/11/2020 19:20	13/11/2020 13:25	18,09	2	36,17	CHI
20201153733	SANTA HELENA DE GOIAS	400112954	IPEGUARI	12/11/2020 19:21	13/11/2020 11:36	12/11/2020 19:21	13/11/2020 11:36	16,25	1	16,25	CHI
20201153737	SENADOR CANEDO	16369040	SENADOR CANEDO	12/11/2020 19:21	13/11/2020 05:33	12/11/2020 19:21	13/11/2020 05:33	10,21	1	10,21	CHI
20201153749	NAZARIO	NZ12000034	ANICUNS	12/11/2020 19:22	13/11/2020 10:10	12/11/2020 19:22	13/11/2020 10:10	14,79	8	118,29	CHI
20201153751	GOIANIA	15897072	FERROVIARIO S1	12/11/2020 19:23	12/11/2020 22:50	12/11/2020 19:23	12/11/2020 22:50	3,45	1	3,45	CHI
20201153753	GOIANIA	10011582896	CARAJAS S1	12/11/2020 19:23	13/11/2020 10:32	12/11/2020 19:23	13/11/2020 10:32	15,15	1	15,15	CHI
20201153754	CORUMBA DE GOIAS	CB12221423	CORUMBA	12/11/2020 19:23	13/11/2020 12:01	12/11/2020 19:23	13/11/2020 12:01	16,63	79	1313,70	CHI
20201153762	FAZENDA NOVA	FN21009689	IPORA	12/11/2020 19:23	13/11/2020 00:28	12/11/2020 19:23	13/11/2020 00:28	5,07	1	5,07	CHI
20201154123	PORANGATU	PO12282160	PORANGATU	12/11/2020 19:23	13/11/2020 04:09	12/11/2020 19:23	13/11/2020 04:09	8,76	11	96,34	CHI
20201153763	RIO VERDE	4090006145	SANTA HELENA S1	12/11/2020 19:24	12/11/2020 22:27	12/11/2020 19:24	12/11/2020 22:27	3,05	1	3,05	CHI
20201153766	GUAPO	10020564838	GUAPO S1	12/11/2020 19:24	13/11/2020 05:11	12/11/2020 19:24	13/11/2020 05:11	9,78	1	9,78	CHI
20201153775	COCALZINHO DE GOIAS	ZN21297600	COCALZINHO	12/11/2020 19:25	13/11/2020 11:13	12/11/2020 19:25	13/11/2020 11:13	15,79	1	15,79	CHI
20201153788	GOIATUBA	JV12044857	GOIATUBA S1	12/11/2020 19:28	12/11/2020 22:14	12/11/2020 19:28	12/11/2020 22:14	2,75	6	16,51	CHI
20201153953	ITABERAI	IB12401037	ITABERAI S1	12/11/2020 19:29	13/11/2020 10:37	12/11/2020 19:29	13/11/2020 07:06	11,60	4	46,41	CHI
20201153953	ITABERAI	IB12401037	ITABERAI S1	12/11/2020 19:29	13/11/2020 10:37	12/11/2020 19:29	13/11/2020 10:37	15,12	1	15,12	CHI
20201153795	NOVA CRIXAS	NA12147208	NOVA CRIXAS	12/11/2020 19:30	13/11/2020 08:50	12/11/2020 19:30	13/11/2020 08:50	13,33	83	1106,64	CHI
20201153798	GOIANIA	10552418	REAL S2	12/11/2020 19:30	13/11/2020 17:31	12/11/2020 19:30	13/11/2020 17:31	22,01	1	22,01	CHI
20201153800	LEOPOLDO DE BULHOES	GP21273008	DAIA S2	12/11/2020 19:31	12/11/2020 23:57	12/11/2020 19:31	12/11/2020 23:57	4,43	1	4,43	CHI
20201153806	JATAI	10017665599	JATAI S3	12/11/2020 19:32	13/11/2020 01:52	12/11/2020 19:32	13/11/2020 01:52	6,32	1	6,32	CHI
20201153807	RIO VERDE	10032953800	RIO VERDE S1	12/11/2020 19:32	13/11/2020 04:42	12/11/2020 19:32	13/11/2020 04:42	9,15	1	9,15	CHI
20201153808	GOIANESIA	550031844	GOIANESIA S2	12/11/2020 19:33	13/11/2020 00:51	12/11/2020 19:33	13/11/2020 00:51	5,30	1	5,30	CHI
20201153810	COCALZINHO DE GOIAS	ZN21297511	COCALZINHO	12/11/2020 19:33	13/11/2020 10:14	12/11/2020 19:33	13/11/2020 10:14	14,68	3	44,04	CHI

20201153811	CAMPOS VERDES	VD11113698	SANTA TEREZINHA	12/11/2020 19:33	13/11/2020 10:01	12/11/2020 19:33	13/11/2020 10:01	14,46	46	665,17	CHI
20201153815	JATAI	JT12228519	JATAI S1	12/11/2020 19:33	13/11/2020 08:13	12/11/2020 19:33	13/11/2020 08:13	12,66	4	50,62	CHI
20201153821	MORRINHOS	MR12000282	MORRINHOS	12/11/2020 19:34	13/11/2020 17:13	12/11/2020 19:34	13/11/2020 17:13	21,65	4	86,58	CHI
20201153823	APARECIDA DE GOIANIA	17132332	ANHANGUERA	12/11/2020 19:34	12/11/2020 22:30	12/11/2020 19:34	12/11/2020 22:30	2,93	1	2,93	CHI
20201153832	PIRANHAS	PH12170744	PIRANHAS	12/11/2020 19:35	12/11/2020 22:08	12/11/2020 19:35	12/11/2020 22:08	2,54	7	17,77	CHI
20201153837	NOVA CRIXAS	NA12282358	MOZARLANDIA	12/11/2020 19:36	13/11/2020 10:01	12/11/2020 19:36	13/11/2020 10:01	14,41	3	43,22	CHI
20201153842	MONTES CLAROS DE GOIAS	10025795323	IPORA	12/11/2020 19:37	13/11/2020 04:21	12/11/2020 19:37	13/11/2020 04:21	8,72	1	8,72	CHI
20201153845	VIANOPOLIS	3800001029	VIANOPOLIS	12/11/2020 19:38	13/11/2020 01:19	12/11/2020 19:38	13/11/2020 01:19	5,68	1	5,68	CHI
20201153921	GOIANIA	GN11050040	ATLANTICO S1	12/11/2020 19:40	13/11/2020 11:48	12/11/2020 19:40	13/11/2020 11:48	16,13	97	1564,93	CHI
20201153873	MORRINHOS	MR11031102	MORRINHOS	12/11/2020 19:41	12/11/2020 21:22	12/11/2020 19:41	12/11/2020 21:22	1,68	246	413,28	CHI
20201154348	SANTA ROSA DE GOIAS	SR11000017	INHUMAS S1	12/11/2020 19:41	13/11/2020 01:29	12/11/2020 19:41	13/11/2020 01:29	5,80	76	440,82	CHI
20201153867	SANTA HELENA DE GOIAS	400138402	IPEGUARI	12/11/2020 19:42	13/11/2020 15:11	12/11/2020 19:42	13/11/2020 15:11	19,48	1	19,48	CHI
20201153874	RIO VERDE	630547610	RIO VERDE S1	12/11/2020 19:43	12/11/2020 23:51	12/11/2020 19:43	12/11/2020 23:51	4,13	1	4,13	CHI
20201153875	ALTO HORIZONTE	AJ121213234	SANTA TEREZINHA	12/11/2020 19:43	13/11/2020 15:01	12/11/2020 19:43	13/11/2020 15:01	19,29	1	19,29	CHI
20201153878	ITABERAÍ	IB21281182	ITABERAÍ S1	12/11/2020 19:43	13/11/2020 10:53	12/11/2020 19:43	13/11/2020 10:53	15,15	1	15,15	CHI
20201153880	TURVANIA	TV21158665	ANICUNS	12/11/2020 19:44	13/11/2020 03:43	12/11/2020 19:44	13/11/2020 03:43	7,98	1	7,98	CHI
20201153881	ITABERAÍ	IB12078577	ITABERAÍ S2	12/11/2020 19:44	13/11/2020 11:40	12/11/2020 19:44	13/11/2020 11:40	15,94	13	207,22	CHI
20201153882	TRINDADE	13563798	GOYA S2	12/11/2020 19:44	13/11/2020 08:24	12/11/2020 19:44	13/11/2020 08:24	12,66	1	12,66	CHI
20201153883	NAZARIO	NZ12299080	ANICUNS	12/11/2020 19:44	13/11/2020 09:32	12/11/2020 19:44	13/11/2020 09:32	13,79	4	55,15	CHI
20201153888	TRINDADE	TR12200202	TRINDADE	12/11/2020 19:45	13/11/2020 09:00	12/11/2020 19:45	13/11/2020 09:00	13,23	2	26,47	CHI
20201154217	DIORAMA	DI12065691	IPORA	12/11/2020 19:45	13/11/2020 07:25	12/11/2020 19:45	13/11/2020 07:25	11,66	8	93,25	CHI
20201153893	SANTA HELENA DE GOIAS	SH21301279	ACREUNA	12/11/2020 19:47	13/11/2020 09:59	12/11/2020 19:47	13/11/2020 09:59	14,20	1	14,20	CHI
20201153910	POSSE	PS21143784	IACIARA S2	12/11/2020 19:50	12/11/2020 21:55	12/11/2020 19:50	12/11/2020 21:55	2,08	1	2,08	CHI
20201153948	GOIATUBA	GT12000195	GOIATUBA S1	12/11/2020 19:51	13/11/2020 09:03	12/11/2020 19:51	13/11/2020 09:03	13,19	8	105,56	CHI
20201153915	INDIARA	IY21010961	EDEIA	12/11/2020 19:52	13/11/2020 07:13	12/11/2020 19:52	13/11/2020 07:13	11,34	1	11,34	CHI
20201153922	AGUAS LINDAS DE GOIAS	LA11349021	AGUAS LINDAS DE GOIAS S1	12/11/2020 19:53	12/11/2020 20:36	12/11/2020 19:53	12/11/2020 20:36	0,70	142	99,79	CHI
20201153930	ANICUNS	AC12012920	ANICUNS	12/11/2020 19:55	13/11/2020 09:18	12/11/2020 19:55	13/11/2020 09:18	13,37	4	53,47	CHI
20201153933	GOIANIA	13083338	GOYA S1	12/11/2020 19:56	13/11/2020 09:04	12/11/2020 19:56	13/11/2020 09:04	13,13	1	13,13	CHI
20201153934	CRISTALINA	KR21248322	CRISTALINA S2	12/11/2020 19:56	12/11/2020 21:46	12/11/2020 19:56	12/11/2020 21:46	1,82	1	1,82	CHI
20201153942	GOIANIA	10120282	FERROVIARIO S1	12/11/2020 19:58	13/11/2020 00:21	12/11/2020 19:58	13/11/2020 00:21	4,38	1	4,38	CHI
20201153983	MONTIVIDIU	MV12226282	MONTIVIDIU T	12/11/2020 20:00	12/11/2020 21:54	12/11/2020 20:00	12/11/2020 21:54	1,90	1	1,90	CHI
20201153970	JARAGUA	JA12081265	JARAGUA	12/11/2020 20:03	12/11/2020 21:33	12/11/2020 20:03	12/11/2020 21:33	1,48	50	74,19	CHI
20201153971	SENADOR CANEDO	16654705	GOIANIA LESTE S1	12/11/2020 20:05	12/11/2020 21:27	12/11/2020 20:05	12/11/2020 21:27	1,36	1	1,36	CHI
20201153985	ITARUMA	IM12097706	CACHOEIRA ALTA	12/11/2020 20:07	12/11/2020 22:43	12/11/2020 20:07	12/11/2020 22:43	2,59	4	10,37	CHI
20201153986	FAZENDA NOVA	FN21316466	IPORA	12/11/2020 20:07	13/11/2020 01:22	12/11/2020 20:07	13/11/2020 01:22	5,24	1	5,24	CHI
20201153987	MARA ROSA	2260022838	MARA ROSA	12/11/2020 20:07	13/11/2020 09:58	12/11/2020 20:07	13/11/2020 09:58	13,84	1	13,84	CHI
20201154360	SENADOR CANEDO	SW11380275	SENADOR CANEDO	12/11/2020 20:07	13/11/2020 00:06	12/11/2020 20:07	13/11/2020 00:06	3,98	79	314,71	CHI
20201153989	PLANALTIMA	PI21243161	PLANALTIMA	12/11/2020 20:08	12/11/2020 21:48	12/11/2020 20:08	12/11/2020 21:48	1,67	1	1,67	CHI
20201153991	PORANGATU	PO12100815	NOVO PLANALTO	12/11/2020 20:08	13/11/2020 16:55	12/11/2020 20:08	13/11/2020 16:55	20,79	2	41,58	CHI
20201154034	PALMEIRAS DE GOIAS	PL12098938	PALMEIRAS	12/11/2020 20:09	13/11/2020 11:40	12/11/2020 20:09	13/11/2020 11:40	15,51	5	77,56	CHI
20201154018	FORMOSA	FA21309101	ITIQUEIRA	12/11/2020 20:11	12/11/2020 22:55	12/11/2020 20:11	12/11/2020 22:55	2,73	1	2,73	CHI
20201154025	RIO VERDE	10004295356	RIO VERDE S1	12/11/2020 20:12	13/11/2020 08:06	12/11/2020 20:12	13/11/2020 08:06	11,89	1	11,89	CHI
20201154030	ANAPOLIS	20902165	ANAPOLIS UNIVERSITARIO S1	12/11/2020 20:13	12/11/2020 22:36	12/11/2020 20:13	12/11/2020 22:36	2,38	1	2,38	CHI
20201154035	ITAGUARI	I121188697	ITABERAÍ S1	12/11/2020 20:14	13/11/2020 09:36	12/11/2020 20:14	13/11/2020 09:36	13,35	1	13,35	CHI
20201154042	PALESTINA DE GOIAS	PY18040163TS	PALESTINA	12/11/2020 20:15	13/11/2020 16:57	12/11/2020 20:15	13/11/2020 16:57	20,70	81	1676,36	CHI
20201154042	CAIAPONIA	PY18040163TS	PALESTINA	12/11/2020 20:15	13/11/2020 16:57	13/11/2020 13:13	13/11/2020 16:57	3,74	46	172,05	CHI
20201154042	PALESTINA DE GOIAS	PY18040163TS	PALESTINA	12/11/2020 20:15	13/11/2020 16:57	13/11/2020 13:13	13/11/2020 16:57	3,74	21	78,55	CHI
20201154043	NIQUELANDIA	2750080181	NIQUELANDIA SUBTRANSMISSAO	12/11/2020 20:15	13/11/2020 08:06	12/11/2020 20:15	13/11/2020 08:06	11,83	1	11,83	CHI
20201154047	SILVANIA	6846045	VIANOPOLIS	12/11/2020 20:16	13/11/2020 10:00	12/11/2020 20:16	13/11/2020 10:00	13,72	8	109,76	CHI
20201154049	PIRENOPOLIS	PV21122025	CORUMBA	12/11/2020 20:17	12/11/2020 21:54	12/11/2020 20:17	12/11/2020 21:54	1,60	1	1,60	CHI
20201154069	GOIANIA	GN11000703	ATLANTICO S3	12/11/2020 20:19	13/11/2020 00:05	12/11/2020 20:19	13/11/2020 00:05	3,76	153	575,45	CHI



20201154065	MUNDO NOVO DE GOIAS	MH12269269	NOVA CRIXAS	12/11/2020 20:22	13/11/2020 08:12	12/11/2020 20:22	13/11/2020 08:12	11,83	7	82,78	CHI
20201154075	CRIXAS	NM12273704	RUBIATABA	12/11/2020 20:24	13/11/2020 10:49	12/11/2020 20:24	13/11/2020 10:49	14,41	1	14,41	CHI
20201154075	NOVA AMERICA	NM12273704	RUBIATABA	12/11/2020 20:24	13/11/2020 10:49	12/11/2020 20:24	13/11/2020 10:49	14,41	6	86,43	CHI
20201154081	HIDROLANDIA	HD21007488	PONTALINA	12/11/2020 20:25	12/11/2020 22:42	12/11/2020 20:25	12/11/2020 22:42	2,27	1	2,27	CHI
20201154084	MARA ROSA	MQ21187916	MARA ROSA	12/11/2020 20:25	14/11/2020 16:07	12/11/2020 20:25	14/11/2020 16:07	43,68	1	43,68	CHI
20201154089	ARAGARCAS	AG11212889	ARAGARCAS	12/11/2020 20:26	12/11/2020 23:53	12/11/2020 20:26	12/11/2020 23:53	3,44	58	199,66	CHI
20201154155	GOIAS	GS12071260	GOIAS	12/11/2020 20:26	13/11/2020 11:19	12/11/2020 20:26	13/11/2020 11:19	14,89	9	133,98	CHI
20201154101	CABECEIRAS	860019184	ITUIQUIRA	12/11/2020 20:27	12/11/2020 22:21	12/11/2020 20:27	12/11/2020 22:21	1,89	1	1,89	CHI
20201154423	APARECIDA DE GOIANIA	AP12004614	REAL S1	12/11/2020 20:27	12/11/2020 23:10	12/11/2020 20:27	12/11/2020 23:10	2,71	579	1566,20	CHI
20201154492	APARECIDA DE GOIANIA	AP12166247	REAL S1	12/11/2020 20:27	13/11/2020 03:30	12/11/2020 20:27	13/11/2020 03:30	7,05	368	2595,32	CHI
20201154102	JATAI	290311020	JATAI S2	12/11/2020 20:29	12/11/2020 22:29	12/11/2020 20:29	12/11/2020 22:29	1,99	1	1,99	CHI
20201154105	EDEIA	EA12073913	EDEIA	12/11/2020 20:30	12/11/2020 21:54	12/11/2020 20:30	12/11/2020 21:54	1,39	1	1,39	CHI
20201154283	SANTA TEREZINHA DE GOIAS	SG12048775	SANTA TEREZINHA	12/11/2020 20:31	13/11/2020 14:11	12/11/2020 20:31	13/11/2020 14:11	17,66	11	194,24	CHI
20201154118	PALMINOPOLIS	PP21019885	PALMEIRAS	12/11/2020 20:32	13/11/2020 02:39	12/11/2020 20:32	13/11/2020 02:39	6,11	1	6,11	CHI
20201154281	APARECIDA DE GOIANIA	AP11091707	REAL S1	12/11/2020 20:32	12/11/2020 22:52	12/11/2020 20:32	12/11/2020 22:52	2,33	296	690,75	CHI
20201154125	SANTO ANTONIO DA BARRA	BZ12301420	ACREUNA	12/11/2020 20:34	13/11/2020 08:38	12/11/2020 20:34	13/11/2020 08:38	12,06	2	24,12	CHI
20201154570	APARECIDA DE GOIANIA	AP12167646	REAL S1	12/11/2020 20:34	13/11/2020 09:40	12/11/2020 20:34	13/11/2020 08:44	12,18	103	1254,08	CHI
20201154570	APARECIDA DE GOIANIA	AP11167509	REAL S1	12/11/2020 20:34	13/11/2020 09:40	12/11/2020 20:34	13/11/2020 09:40	13,10	85	1113,83	CHI
20201154127	BURITI ALEGRE	BG21090572	ITUMBIARA VELHA S2	12/11/2020 20:35	13/11/2020 00:42	12/11/2020 20:35	13/11/2020 00:42	4,12	1	4,12	CHI
20201154137	JOVIANIA	PK12106143	GOIATUBA S1	12/11/2020 20:35	13/11/2020 10:53	12/11/2020 20:35	13/11/2020 10:53	14,28	1	14,28	CHI
20201154137	PONTALINA	PK12106143	GOIATUBA S1	12/11/2020 20:35	13/11/2020 10:53	12/11/2020 20:35	13/11/2020 10:53	14,28	4	57,14	CHI
20201154193	BONOPOLIS	BX10403944	SAO MIGUEL DO ARAGUAIA	12/11/2020 20:37	13/11/2020 17:42	12/11/2020 20:37	13/11/2020 17:42	21,07	277	5837,47	CHI
20201153745	PORANGATU	PO12139169	PORANGATU	12/11/2020 20:39	13/11/2020 13:40	12/11/2020 20:39	13/11/2020 13:40	17,02	107	1821,44	CHI
20201154200	NOVA CRIXAS	NA21243597	NOVA CRIXAS	12/11/2020 20:41	13/11/2020 16:31	12/11/2020 20:41	13/11/2020 16:31	19,82	1	19,82	CHI
20201154202	CORUMBA DE GOIAS	CB12381244	CORUMBA	12/11/2020 20:41	13/11/2020 12:54	12/11/2020 20:41	13/11/2020 12:54	16,20	1	16,20	CHI
20201154203	ABADIANIA	AA21403679	DAIA S2	12/11/2020 20:41	13/11/2020 02:38	12/11/2020 20:41	13/11/2020 02:38	5,93	2	11,87	CHI
20201154391	APARECIDA DE GOIANIA	AP11166146	REAL S1	12/11/2020 20:42	13/11/2020 05:59	12/11/2020 20:42	13/11/2020 05:59	9,28	62	575,52	CHI
20201154207	SERRANOPOLIS	SX12167853	JATAI S1	12/11/2020 20:43	14/11/2020 12:00	12/11/2020 20:43	14/11/2020 12:00	39,28	3	117,85	CHI
20201154334	PIRACANJUBA	PJ12212156	PIRACANJUBA	12/11/2020 20:43	13/11/2020 20:15	12/11/2020 20:43	13/11/2020 10:30	13,77	9	123,91	CHI
20201154334	PIRACANJUBA	PJ12000215	PIRACANJUBA	12/11/2020 20:43	13/11/2020 20:15	13/11/2020 16:27	13/11/2020 17:15	0,79	21	16,63	CHI
20201154334	PIRACANJUBA	PJ12212156	PIRACANJUBA	12/11/2020 20:43	13/11/2020 20:15	12/11/2020 20:43	13/11/2020 19:41	22,96	16	367,30	CHI
20201154334	PIRACANJUBA	PJ12212156	PIRACANJUBA	12/11/2020 20:43	13/11/2020 20:15	13/11/2020 15:37	13/11/2020 19:41	4,07	9	36,62	CHI
20201154334	PIRACANJUBA	PJ12212156	PIRACANJUBA	12/11/2020 20:43	13/11/2020 20:15	12/11/2020 20:43	13/11/2020 19:41	22,96	9	206,61	CHI
20201154334	PIRACANJUBA	PJ12212156	PIRACANJUBA	12/11/2020 20:43	13/11/2020 20:15	12/11/2020 20:43	13/11/2020 20:15	23,52	1	23,52	CHI
20201154215	SENADOR CANEDO	15199939	GOIANIA LESTE S1	12/11/2020 20:44	12/11/2020 21:43	12/11/2020 20:44	12/11/2020 21:43	0,98	1	0,98	CHI
20201154227	MAURILANDIA	ML21303718	SANTA HELENA S1	12/11/2020 20:49	13/11/2020 05:20	12/11/2020 20:49	13/11/2020 05:20	8,51	1	8,51	CHI
20201154239	CRISTALINA	KR11170187	CRISTALINA S1	12/11/2020 20:52	12/11/2020 23:28	12/11/2020 20:52	12/11/2020 23:28	2,59	23	59,63	CHI
20201154245	PIRACANJUBA	PJ12027534	PIRACANJUBA	12/11/2020 20:52	13/11/2020 09:38	12/11/2020 20:52	13/11/2020 09:38	12,77	8	102,12	CHI
20201154244	GOIANIA	GN11001819	AEROPORTO S2	12/11/2020 20:53	13/11/2020 04:32	12/11/2020 20:53	13/11/2020 04:32	7,64	5	38,22	CHI
20201154246	APARECIDA DE GOIANIA	13326028	REAL S1	12/11/2020 20:53	13/11/2020 08:25	12/11/2020 20:53	13/11/2020 08:25	11,52	1	11,52	CHI
20201154338	ITABERAI	IB12311232	ITABERAI S1	12/11/2020 20:55	13/11/2020 08:03	12/11/2020 20:55	13/11/2020 08:03	11,12	3	33,36	CHI
20201154430	APARECIDA DE GOIANIA	AP11161509	REAL S1	12/11/2020 20:56	13/11/2020 03:07	12/11/2020 20:56	13/11/2020 03:07	6,18	178	1100,39	CHI
20201154278	IACIARA	IA12394108	IACIARA S1	12/11/2020 20:59	12/11/2020 22:18	12/11/2020 20:59	12/11/2020 22:18	1,32	7	9,21	CHI
20201154298	GOIANDIRA	GD21157529	CATALAO S1	12/11/2020 21:01	13/11/2020 08:41	12/11/2020 21:01	13/11/2020 08:41	11,66	1	11,66	CHI
20201154304	BURITI ALEGRE	BG12263568RE	ITUMBIARA VELHA S2	12/11/2020 21:03	12/11/2020 22:57	12/11/2020 21:03	12/11/2020 22:57	1,90	15	28,46	CHI
20201154304	ITUMBIARA	BG12263568RE	ITUMBIARA VELHA S2	12/11/2020 21:03	12/11/2020 22:57	12/11/2020 21:03	12/11/2020 22:57	1,90	119	225,77	CHI
20201154310	VALPARAISO DE GOIAS	2860076743	MARAJOARA	12/11/2020 21:03	13/11/2020 03:00	12/11/2020 21:03	13/11/2020 03:00	5,94	1	5,94	CHI
20201154312	CALDAS NOVAS	760335229	SERRA DE CALDAS	12/11/2020 21:03	13/11/2020 00:18	12/11/2020 21:03	13/11/2020 00:18	3,23	1	3,23	CHI
20201154321	VICENTINOPOLIS	VI21252534	VICENTINOPOLIS	12/11/2020 21:06	13/11/2020 07:33	12/11/2020 21:06	13/11/2020 07:33	10,44	5	52,19	CHI
20201154328	APARECIDA DE GOIANIA	16755145	INDEPENDENCIA S1	12/11/2020 21:09	13/11/2020 10:44	12/11/2020 21:09	13/11/2020 10:44	13,57	1	13,57	CHI
20201154394	GOIANIA	GN12034199	ATLANTICO S2	12/11/2020 21:10	13/11/2020 01:25	12/11/2020 21:10	13/11/2020 01:25	4,24	59	250,19	CHI

20201154333	MINEIROS	MY12212642	PARQUE DAS EMAS	12/11/2020 21:11	13/11/2020 12:38	12/11/2020 21:11	13/11/2020 12:38	15,45	3	46,35	CHI
20201154337	TRINDADE	17345029	GOYA S2	12/11/2020 21:11	13/11/2020 13:11	12/11/2020 21:11	13/11/2020 13:11	15,99	1	15,99	CHI
20201154340	CIDADE OCIDENTAL	10002526709	MARAJOARA	12/11/2020 21:12	12/11/2020 22:59	12/11/2020 21:12	12/11/2020 22:59	1,78	1	1,78	CHI
20201154351	PIRACANJUBA	PJ12045336	PIRACANJUBA	12/11/2020 21:12	13/11/2020 10:09	12/11/2020 21:12	13/11/2020 10:09	12,95	21	271,95	CHI
20201154462	FAINA	FC12307346	GOIAS	12/11/2020 21:12	13/11/2020 12:29	12/11/2020 21:12	13/11/2020 12:29	15,28	24	366,73	CHI
20201154345	FORMOSO	FO12143711RE	MARA ROSA	12/11/2020 21:13	12/11/2020 22:32	12/11/2020 21:13	12/11/2020 22:32	1,31	23	30,18	CHI
20201154346	GOIANDIRA	GD12160912	CATALAO S1	12/11/2020 21:14	12/11/2020 23:31	12/11/2020 21:14	12/11/2020 23:31	2,29	1	2,29	CHI
20201154365	APARECIDA DE GOIANIA	AP11007824	ANHANGUERA	12/11/2020 21:16	12/11/2020 23:36	12/11/2020 21:16	12/11/2020 23:36	2,32	262	608,93	CHI
20201154359	DOVERLANDIA	DV11227874	CAIAPONIA	12/11/2020 21:18	12/11/2020 22:01	12/11/2020 21:18	12/11/2020 22:01	0,71	1	0,71	CHI
20201154378	GOIANIA	GN11141146	ATLANTICO S3	12/11/2020 21:19	13/11/2020 02:42	12/11/2020 21:19	13/11/2020 02:42	5,38	159	855,46	CHI
20201154371	CALDAS NOVAS	760142786	SERRA DE CALDAS	12/11/2020 21:21	13/11/2020 01:23	12/11/2020 21:21	13/11/2020 01:23	4,02	1	4,02	CHI
20201154373	RIO VERDE	RV12260118	CABRIUVA S1	12/11/2020 21:22	13/11/2020 00:17	12/11/2020 21:22	13/11/2020 00:17	2,91	12	34,91	CHI
20201154377	SANTA FE DE GOIAS	RN12009764	BRITANIA	12/11/2020 21:24	13/11/2020 08:34	12/11/2020 21:24	13/11/2020 08:34	11,17	6	67,00	CHI
20201154380	NOVA VENEZA	300011088	INHUMAS S1	12/11/2020 21:24	12/11/2020 22:58	12/11/2020 21:24	12/11/2020 22:58	1,56	1	1,56	CHI
20201154388	GOIANIA	GN12039566	GOIANIA LESTE S3	12/11/2020 21:25	13/11/2020 11:06	12/11/2020 21:25	13/11/2020 11:06	13,68	5	68,38	CHI
20201154390	ANICUNS	AC12035306	ANICUNS	12/11/2020 21:26	13/11/2020 00:52	12/11/2020 21:26	13/11/2020 00:52	3,43	20	68,65	CHI
20201154397	ANAPOLIS	20569622	JUNDAI S1	12/11/2020 21:27	13/11/2020 01:12	12/11/2020 21:27	13/11/2020 01:12	3,75	1	3,75	CHI
20201154404	ACREUNA	EU12301173	ACREUNA	12/11/2020 21:29	13/11/2020 10:32	12/11/2020 21:29	13/11/2020 10:32	13,05	11	143,51	CHI
20201154406	SENADOR CANEDO	190128999	SENADOR CANEDO	12/11/2020 21:29	12/11/2020 23:48	12/11/2020 21:29	12/11/2020 23:48	2,31	1	2,31	CHI
20201154410	ARUANA	AK12157845	MOZARLANDIA	12/11/2020 21:30	13/11/2020 09:35	12/11/2020 21:30	13/11/2020 09:35	12,08	61	736,68	CHI
20201154411	TRINDADE	TR21232789	TRINDADE	12/11/2020 21:31	13/11/2020 07:58	12/11/2020 21:31	13/11/2020 07:58	10,45	2	20,90	CHI
20201154412	PADRE BERNARDO	PB12382938	PADRE BERNARDO	12/11/2020 21:31	13/11/2020 02:45	12/11/2020 21:31	13/11/2020 02:45	5,23	6	31,38	CHI
20201154414	ORIZONA	OZ12000353LD	PIRES DO RIO S1	12/11/2020 21:32	13/11/2020 14:50	12/11/2020 21:32	13/11/2020 01:00	3,45	36	124,34	CHI
20201154414	ORIZONA	OZ12000353LD	PIRES DO RIO S1	12/11/2020 21:32	13/11/2020 14:50	13/11/2020 01:01	13/11/2020 13:29	12,47	9	112,20	CHI
20201154414	ORIZONA	OZ12114853LD	PIRES DO RIO S1	12/11/2020 21:32	13/11/2020 14:50	13/11/2020 01:01	13/11/2020 14:20	13,32	24	319,60	CHI
20201154414	ORIZONA	OZ12083185	PIRES DO RIO S1	12/11/2020 21:32	13/11/2020 14:50	13/11/2020 01:01	13/11/2020 14:50	13,83	3	41,48	CHI
20201154562	CAMPINORTE	CR12164041	MARA ROSA	12/11/2020 21:33	13/11/2020 03:11	12/11/2020 21:33	13/11/2020 03:11	5,63	16	90,08	CHI
20201154562	URUACU	CR12164041	MARA ROSA	12/11/2020 21:33	13/11/2020 03:11	12/11/2020 21:33	13/11/2020 03:11	5,63	6	33,78	CHI
20201154439	FORMOSA	FA12254232	ITUIQUIRA	12/11/2020 21:45	12/11/2020 23:42	12/11/2020 21:45	12/11/2020 23:42	1,94	12	23,30	CHI
20201154442	GOIAS	8050232	GOIAS	12/11/2020 21:46	13/11/2020 00:23	12/11/2020 21:46	13/11/2020 00:23	2,61	4	10,43	CHI
20201154443	ITABERAÍ	AC21333871	ARACU	12/11/2020 21:46	13/11/2020 07:17	12/11/2020 21:46	13/11/2020 07:17	9,50	1	9,50	CHI
20201154450	SERRANOPOLIS	DJ12164065	CHAPADAO DO CEU	12/11/2020 21:49	13/11/2020 09:11	12/11/2020 21:49	13/11/2020 09:11	11,36	2	22,72	CHI
20201154454	GOIANIA	17059290	GOYA S2	12/11/2020 21:52	13/11/2020 08:09	12/11/2020 21:52	13/11/2020 08:09	10,28	1	10,28	CHI
20201154459	GOIANDIRA	GD12127537	CATALAO S1	12/11/2020 21:54	13/11/2020 03:27	12/11/2020 21:54	13/11/2020 03:27	5,54	8	44,29	CHI
20201154484	PIRACANJUBA	PJ12013344	MORRINHOS	12/11/2020 21:55	13/11/2020 09:39	12/11/2020 21:55	13/11/2020 09:39	11,72	12	140,69	CHI
20201154468	GOIANIA	12993062	REAL S2	12/11/2020 22:00	13/11/2020 08:04	12/11/2020 22:00	13/11/2020 08:04	10,06	1	10,06	CHI
20201154473	PIRANHAS	PH12349758	PIRANHAS	12/11/2020 22:05	13/11/2020 19:52	12/11/2020 22:05	13/11/2020 19:52	21,77	1	21,77	CHI
20201154486	MOZARLANDIA	MZ21072416	MOZARLANDIA	12/11/2020 22:10	13/11/2020 00:42	12/11/2020 22:10	13/11/2020 00:42	2,53	1	2,53	CHI
20201154496	GOIANIA	12548480	ATLANTICO S3	12/11/2020 22:15	13/11/2020 10:38	12/11/2020 22:15	13/11/2020 10:38	12,37	1	12,37	CHI
20201154523	GUARANI DE GOIAS	GY12271764	IACIARA S1	12/11/2020 22:16	12/11/2020 23:25	12/11/2020 22:16	12/11/2020 23:25	1,14	4	4,57	CHI
20201154501	GOIANIA	AP11168557	REAL S2	12/11/2020 22:17	13/11/2020 11:39	12/11/2020 22:17	13/11/2020 11:39	13,35	41	547,38	CHI
20201154527	JARAGUA	JA12374473	JARAGUA	12/11/2020 22:33	13/11/2020 02:16	12/11/2020 22:33	13/11/2020 02:16	3,70	304	1125,31	CHI
20201158197	PORANGATU	PO12136349	NOVO PLANALTO	12/11/2020 22:36	14/11/2020 10:43	12/11/2020 22:36	14/11/2020 10:43	36,10	23	830,41	CHI
202011137975	BONOPOLIS	SM10400363	SAO MIGUEL DO ARAGUAIA	12/11/2020 22:36	13/11/2020 16:55	12/11/2020 22:36	13/11/2020 00:48	2,19	3	6,57	CHI
202011137975	NOVO PLANALTO	SM10400363	SAO MIGUEL DO ARAGUAIA	12/11/2020 22:36	13/11/2020 16:55	12/11/2020 22:36	13/11/2020 00:48	2,19	313	685,64	CHI
202011137975	SAO MIGUEL DO ARAGUAIA	SM10400363	SAO MIGUEL DO ARAGUAIA	12/11/2020 22:36	13/11/2020 16:55	12/11/2020 22:36	13/11/2020 00:48	2,19	114	249,72	CHI
202011137975	SAO MIGUEL DO ARAGUAIA	SM10400363	SAO MIGUEL DO ARAGUAIA	12/11/2020 22:36	13/11/2020 16:55	12/11/2020 22:36	13/11/2020 01:15	2,65	59	156,25	CHI
202011137975	NOVO PLANALTO	SM10400363	SAO MIGUEL DO ARAGUAIA	12/11/2020 22:36	13/11/2020 16:55	12/11/2020 22:36	13/11/2020 05:30	6,89	1	6,89	CHI
202011137975	SAO MIGUEL DO ARAGUAIA	SM10400363	SAO MIGUEL DO ARAGUAIA	12/11/2020 22:36	13/11/2020 16:55	12/11/2020 22:36	13/11/2020 05:30	6,89	23	158,46	CHI
202011137975	NOVO PLANALTO	SM10400363	SAO MIGUEL DO ARAGUAIA	12/11/2020 22:36	13/11/2020 16:55	12/11/2020 22:36	13/11/2020 08:50	10,23	11	112,53	CHI
202011137975	SAO MIGUEL DO ARAGUAIA	SM10400363	SAO MIGUEL DO ARAGUAIA	12/11/2020 22:36	13/11/2020 16:55	12/11/2020 22:36	13/11/2020 08:50	10,23	3	30,69	CHI

202011137975	NOVO PLANALTO	SM10400363	SAO MIGUEL DO ARAGUAIA	12/11/2020 22:36	13/11/2020 16:55	13/11/2020 09:25	13/11/2020 09:47	0,37	12	4,47	CHI
202011137975	SAO MIGUEL DO ARAGUAIA	SM10400363	SAO MIGUEL DO ARAGUAIA	12/11/2020 22:36	13/11/2020 16:55	13/11/2020 09:25	13/11/2020 09:47	0,37	85	31,66	CHI
202011137975	NOVO PLANALTO	SM10400363	SAO MIGUEL DO ARAGUAIA	12/11/2020 22:36	13/11/2020 16:55	12/11/2020 22:36	13/11/2020 11:04	12,46	1	12,46	CHI
202011137975	BONFINOPOLIS	SM10400363	NOVO PLANALTO	12/11/2020 22:36	13/11/2020 16:55	12/11/2020 22:36	13/11/2020 16:55	18,32	1	18,32	CHI
202011137975	BONOPOLIS	SM10400363	NOVO PLANALTO	12/11/2020 22:36	13/11/2020 16:55	12/11/2020 22:36	13/11/2020 16:55	18,32	53	970,97	CHI
202011137975	PORANGATU	SM10400363	NOVO PLANALTO	12/11/2020 22:36	13/11/2020 16:55	12/11/2020 22:36	13/11/2020 16:55	18,32	125	2290,03	CHI
202011137975	AMARALINA	SM10400363	SAO MIGUEL DO ARAGUAIA	12/11/2020 22:36	13/11/2020 16:55	12/11/2020 22:36	13/11/2020 16:55	18,32	222	4067,10	CHI
202011137975	BONOPOLIS	SM10400363	SAO MIGUEL DO ARAGUAIA	12/11/2020 22:36	13/11/2020 16:55	12/11/2020 22:36	13/11/2020 16:55	18,32	795	14564,62	CHI
202011137975	BONOPOLIS	SM10400363	SAO MIGUEL DO ARAGUAIA	12/11/2020 22:36	13/11/2020 16:55	12/11/2020 22:36	13/11/2020 16:55	18,32	285	5221,28	CHI
202011137975	BONOPOLIS	SM10400363	SAO MIGUEL DO ARAGUAIA	12/11/2020 22:36	13/11/2020 16:55	12/11/2020 22:36	13/11/2020 16:55	18,32	20	366,41	CHI
202011137975	CACU	SM10400363	SAO MIGUEL DO ARAGUAIA	12/11/2020 22:36	13/11/2020 16:55	12/11/2020 22:36	13/11/2020 16:55	18,32	1	18,32	CHI
202011137975	NOVO PLANALTO	SM10400363	SAO MIGUEL DO ARAGUAIA	12/11/2020 22:36	13/11/2020 16:55	12/11/2020 22:36	13/11/2020 16:55	18,32	2	36,64	CHI
202011137975	PORANGATU	SM10400363	SAO MIGUEL DO ARAGUAIA	12/11/2020 22:36	13/11/2020 16:55	12/11/2020 22:36	13/11/2020 16:55	18,32	1	18,32	CHI
20201154534	AGUAS LINDAS DE GOIAS	LA11078056	AGUAS LINDAS DE GOIAS S1	12/11/2020 22:38	12/11/2020 23:38	12/11/2020 22:38	12/11/2020 23:38	0,99	166	164,71	CHI
20201154554	APARECIDA DE GOIANIA	12279638	REAL S2	12/11/2020 22:41	13/11/2020 09:11	12/11/2020 22:41	13/11/2020 09:11	10,49	1	10,49	CHI
20201154566	SERRANOPOLIS	SX21267482	JATAI S1	12/11/2020 22:51	13/11/2020 08:42	12/11/2020 22:51	13/11/2020 08:42	9,84	1	9,84	CHI
20201154572	CIDADE OCIDENTAL	10016705759	MARAJOARA	12/11/2020 22:53	13/11/2020 00:58	12/11/2020 22:53	13/11/2020 00:58	2,08	1	2,08	CHI
20201154573	GOIANIA	GN12098424	XAVANTES	12/11/2020 22:53	13/11/2020 09:54	12/11/2020 22:53	13/11/2020 09:54	11,01	19	209,25	CHI
20201154594	VALPARAISO DE GOIAS	VA11200519	PACAEMBU S2	12/11/2020 22:53	13/11/2020 00:21	12/11/2020 22:53	13/11/2020 00:21	1,46	132	192,17	CHI
20201154673	GOIANIA	GN11094552	ATLANTICO S1	12/11/2020 22:56	13/11/2020 01:08	12/11/2020 22:56	13/11/2020 01:08	2,20	90	197,80	CHI
20201154585	ALEXANIA	480046311	ALEXANIA	12/11/2020 22:58	13/11/2020 03:27	12/11/2020 22:58	13/11/2020 03:27	4,48	1	4,48	CHI
20201154587	SANCLERLANDIA	SC12008814	FIRMINOPOLIS S2	12/11/2020 22:58	13/11/2020 00:03	12/11/2020 22:58	13/11/2020 00:03	1,08	19	20,54	CHI
20201154590	FORMOSA	FA12359113	ITUIQUIRA	12/11/2020 23:03	13/11/2020 00:22	12/11/2020 23:03	13/11/2020 00:22	1,31	12	15,77	CHI
20201154591	GOIANIA	10006151580	CARAJAS S2	12/11/2020 23:03	13/11/2020 08:03	12/11/2020 23:03	13/11/2020 08:03	9,00	1	9,00	CHI
20201154606	PIRACANJUBA	60073913	PIRACANJUBA	12/11/2020 23:11	13/11/2020 01:44	12/11/2020 23:11	13/11/2020 01:44	2,54	1	2,54	CHI
20201154611	GOIANIA	10109080	GOIANIA LESTE S3	12/11/2020 23:12	13/11/2020 11:44	12/11/2020 23:12	13/11/2020 11:44	12,53	1	12,53	CHI
20201154742	APARECIDA DE GOIANIA	AP12166247	REAL S1	12/11/2020 23:12	13/11/2020 03:30	12/11/2020 23:12	13/11/2020 03:30	4,30	84	360,94	CHI
20201154624	RIO VERDE	630245630	RIO VERDE S2	12/11/2020 23:23	13/11/2020 09:39	12/11/2020 23:23	13/11/2020 09:39	10,27	1	10,27	CHI
20201154628	SAO DOMINGOS	SD21161777	SAO DOMINGOS	12/11/2020 23:28	13/11/2020 02:06	12/11/2020 23:28	13/11/2020 02:06	2,63	2	5,25	CHI
20201154631	BALIZA	BH12356956	BOM JARDIM	12/11/2020 23:32	13/11/2020 03:55	12/11/2020 23:32	13/11/2020 03:55	4,37	2	8,75	CHI
20201154639	MINACU	IH12375476	MINACU	12/11/2020 23:38	13/11/2020 03:56	12/11/2020 23:38	13/11/2020 03:56	4,29	51	218,68	CHI
20201154640	IPORA	IR12231240	IPORA	12/11/2020 23:39	13/11/2020 03:00	12/11/2020 23:39	13/11/2020 03:00	3,34	6	20,02	CHI
20201154641	APORE	AE18122767TS	ITAJA S1	12/11/2020 23:40	13/11/2020 10:04	12/11/2020 23:40	13/11/2020 10:04	10,39	29	301,38	CHI
20201154647	SENADOR CANEDO	10010752550	SENADOR CANEDO	12/11/2020 23:44	13/11/2020 02:00	12/11/2020 23:44	13/11/2020 02:00	2,26	1	2,26	CHI
202011137987	APARECIDA DE GOIANIA	AP12000273	REAL S2	12/11/2020 23:46	13/11/2020 07:21	12/11/2020 23:46	13/11/2020 07:21	7,57	1101	8338,85	CHI
20201154656	NOVA ROMA	ND21117574	IACIARA S2	12/11/2020 23:50	13/11/2020 04:51	12/11/2020 23:50	13/11/2020 04:51	5,00	1	5,00	CHI
20201154657	GOIANIA	GN21001312	CAMPINAS S2	12/11/2020 23:51	13/11/2020 08:34	12/11/2020 23:51	13/11/2020 08:34	8,71	1	8,71	CHI
20201154678	SAO LUIZ DO NORTE	GE12352313	GOIANESIA S1	13/11/2020 00:22	13/11/2020 09:00	13/11/2020 00:22	13/11/2020 08:05	7,70	1	7,70	CHI
20201154678	GOIANESIA	GE12352313	GOIANESIA S1	13/11/2020 00:22	13/11/2020 09:00	13/11/2020 00:22	13/11/2020 09:00	8,62	25	215,57	CHI
20201154678	SAO LUIZ DO NORTE	GE12352313	GOIANESIA S1	13/11/2020 00:22	13/11/2020 09:00	13/11/2020 00:22	13/11/2020 09:00	8,62	20	172,46	CHI
20201154679	PADRE BERNARDO	2760053393	PADRE BERNARDO	13/11/2020 00:22	13/11/2020 12:42	13/11/2020 00:22	13/11/2020 12:42	12,32	1	12,32	CHI
20201154684	APARECIDA DE GOIANIA	AP11093008	REAL S2	13/11/2020 00:34	13/11/2020 02:19	13/11/2020 00:34	13/11/2020 02:19	1,74	78	135,83	CHI
20201154686	JANDAIA	JD12289836	PALMEIRAS	13/11/2020 00:42	13/11/2020 12:32	13/11/2020 00:42	13/11/2020 12:32	11,82	5	59,09	CHI
20201155105	APARECIDA DE GOIANIA	AP11166570	REAL S2	13/11/2020 01:02	13/11/2020 15:50	13/11/2020 07:25	13/11/2020 15:50	8,40	53	445,41	CHI
20201154723	GOIANIA	12355010	GOIANIA LESTE S2	13/11/2020 01:04	13/11/2020 09:28	13/11/2020 01:04	13/11/2020 09:28	8,40	1	8,40	CHI
20201154726	SANTO ANTONIO DE GOIAS	1360000887	NEROPOLIS S1	13/11/2020 01:10	13/11/2020 03:02	13/11/2020 01:10	13/11/2020 03:02	1,85	1	1,85	CHI
20201155684	GOIANIA	GN11164470	REAL S2	13/11/2020 01:16	13/11/2020 15:34	13/11/2020 01:16	13/11/2020 15:34	14,30	50	714,99	CHI
20201154730	BELA VISTA DE GOIAS	BV21170317	BELA VISTA S2	13/11/2020 01:18	13/11/2020 04:32	13/11/2020 01:18	13/11/2020 04:32	3,22	1	3,22	CHI
20201154886	FAZENDA NOVA	FN12073183	BRITANIA	13/11/2020 01:19	13/11/2020 08:34	13/11/2020 01:19	13/11/2020 08:34	7,25	69	499,94	CHI
20201154732	GOIANIRA	10022051382	MEIA PONTE	13/11/2020 01:24	13/11/2020 07:31	13/11/2020 01:24	13/11/2020 07:31	6,10	1	6,10	CHI
20201154735	GOIANIA	GN21379234	GOIANIA LESTE S3	13/11/2020 01:28	13/11/2020 07:25	13/11/2020 01:28	13/11/2020 07:25	5,94	1	5,94	CHI



20201154739	CACU	CC21322238	CACHOEIRA ALTA	13/11/2020 01:38	13/11/2020 08:31	13/11/2020 01:38	13/11/2020 08:31	6,88	1	6,88	CHI
20201154743	APARECIDA DE GOIANIA	AP11004608	ANHANGUERA	13/11/2020 01:43	13/11/2020 09:10	13/11/2020 01:43	13/11/2020 09:10	7,44	9	67,00	CHI
20201155084	GOIANIA	AP12048793	REAL S2	13/11/2020 01:50	13/11/2020 07:25	13/11/2020 01:50	13/11/2020 07:25	5,57	263	1464,84	CHI
20201154752	HIDROLINA	UR12243633RE	URUACU	13/11/2020 01:59	16/11/2020 21:02	13/11/2020 01:59	14/11/2020 09:38	31,65	5	158,25	CHI
20201154752	URUACU	UR12243633RE	URUACU	13/11/2020 01:59	16/11/2020 21:02	13/11/2020 01:59	14/11/2020 09:38	31,65	52	1645,79	CHI
20201154752	PILAR DE GOIAS	UR13237209	URUACU	13/11/2020 01:59	16/11/2020 21:02	13/11/2020 01:59	15/11/2020 14:10	60,18	1	60,18	CHI
20201154752	URUACU	UR13237209	URUACU	13/11/2020 01:59	16/11/2020 21:02	13/11/2020 01:59	15/11/2020 14:10	60,18	4	240,70	CHI
20201154752	URUACU	UR12196418LD	URUACU	13/11/2020 01:59	16/11/2020 21:02	13/11/2020 01:59	15/11/2020 14:13	60,23	21	1264,75	CHI
20201154752	NOVA IGUACU DE GOIAS	UR12280996	URUACU	13/11/2020 01:59	16/11/2020 21:02	13/11/2020 01:59	15/11/2020 14:38	60,64	1	60,64	CHI
20201154752	URUACU	UR12280996	URUACU	13/11/2020 01:59	16/11/2020 21:02	13/11/2020 01:59	15/11/2020 14:38	60,64	23	1394,77	CHI
20201154752	HIDROLINA	UR12243633RE	URUACU	13/11/2020 01:59	16/11/2020 21:02	15/11/2020 15:00	16/11/2020 09:45	18,75	5	93,75	CHI
20201154752	URUACU	UR12243633RE	URUACU	13/11/2020 01:59	16/11/2020 21:02	15/11/2020 15:00	16/11/2020 09:45	18,75	52	975,01	CHI
20201154752	NOVA IGUACU DE GOIAS	UR13237209	URUACU	13/11/2020 01:59	16/11/2020 21:02	15/11/2020 15:00	16/11/2020 11:36	20,61	1	20,61	CHI
20201154752	PILAR DE GOIAS	UR13237209	URUACU	13/11/2020 01:59	16/11/2020 21:02	15/11/2020 15:00	16/11/2020 11:36	20,61	1	20,61	CHI
20201154752	URUACU	UR13237209	URUACU	13/11/2020 01:59	16/11/2020 21:02	15/11/2020 15:00	16/11/2020 11:36	20,61	48	989,37	CHI
20201154752	PILAR DE GOIAS	UR12237211	URUACU	13/11/2020 01:59	16/11/2020 21:02	13/11/2020 01:59	16/11/2020 16:09	86,17	0	0,00	CHI
20201154752	URUACU	UR12237211	URUACU	13/11/2020 01:59	16/11/2020 21:02	13/11/2020 01:59	16/11/2020 16:09	86,17	1	86,17	CHI
20201154752	HIDROLINA	UR12243633RE	URUACU	13/11/2020 01:59	16/11/2020 21:02	16/11/2020 16:22	16/11/2020 20:29	4,11	5	20,55	CHI
20201154752	URUACU	UR12243633RE	URUACU	13/11/2020 01:59	16/11/2020 21:02	16/11/2020 16:22	16/11/2020 20:29	4,11	52	213,68	CHI
20201154752	NOVA IGUACU DE GOIAS	UR12243633RE	URUACU	13/11/2020 01:59	16/11/2020 21:02	16/11/2020 16:22	16/11/2020 21:02	4,66	1	4,66	CHI
20201154752	PILAR DE GOIAS	UR12243633RE	URUACU	13/11/2020 01:59	16/11/2020 21:02	16/11/2020 16:22	16/11/2020 21:02	4,66	1	4,66	CHI
20201154752	URUACU	UR12243633RE	URUACU	13/11/2020 01:59	16/11/2020 21:02	16/11/2020 16:22	16/11/2020 21:02	4,66	49	228,37	CHI
20201154873	BARRO ALTO	BA18000051FS	BARRO ALTO	13/11/2020 02:24	13/11/2020 10:27	13/11/2020 02:24	13/11/2020 10:27	8,04	129	1036,91	CHI
20201154873	NIQUELANDIA	BA18000051FS	BARRO ALTO	13/11/2020 02:24	13/11/2020 10:27	13/11/2020 02:24	13/11/2020 10:27	8,04	119	956,53	CHI
20201156667	NIQUELANDIA	NQ21232488	BARRO ALTO	13/11/2020 02:24	13/11/2020 12:24	13/11/2020 02:24	13/11/2020 12:24	9,99	1	9,99	CHI
20201154759	DOVERLANDIA	DV12259468	CAIAPONIA	13/11/2020 02:28	13/11/2020 07:32	13/11/2020 02:28	13/11/2020 07:32	5,05	3	15,16	CHI
20201154839	FORMOSO	FO12143711RE	MARA ROSA	13/11/2020 02:35	13/11/2020 12:03	13/11/2020 02:35	13/11/2020 11:40	9,08	20	181,58	CHI
20201154839	FORMOSO	SE12170967	MARA ROSA	13/11/2020 02:35	13/11/2020 12:03	13/11/2020 02:35	13/11/2020 12:03	9,46	3	28,37	CHI
20201154962	EDEALINA	ED12041768	PONTALINA	13/11/2020 02:41	13/11/2020 08:40	13/11/2020 02:41	13/11/2020 08:40	5,98	3	17,93	CHI
20201154801	RIO VERDE	RV12303286	CABRIUVA S2	13/11/2020 02:44	13/11/2020 07:10	13/11/2020 02:44	13/11/2020 07:10	4,43	7	31,01	CHI
20201155048	GOIAS	GS12061668	IABERAI S1	13/11/2020 02:44	13/11/2020 08:12	13/11/2020 02:44	13/11/2020 08:12	5,46	18	98,21	CHI
20201154769	GUARANI DE GOIAS	GY21267329	IACIARA S2	13/11/2020 02:55	13/11/2020 07:51	13/11/2020 02:55	13/11/2020 07:51	4,92	2	9,84	CHI
20201155602	APARECIDA DE GOIANIA	AP12161135	ATLANTICO S1	13/11/2020 02:55	13/11/2020 08:46	13/11/2020 02:55	13/11/2020 08:46	5,84	49	286,11	CHI
20201154772	GUARANI DE GOIAS	GY21267306	IACIARA S2	13/11/2020 02:59	13/11/2020 09:09	13/11/2020 02:59	13/11/2020 09:09	6,16	1	6,16	CHI
20201154774	RIO VERDE	10001278876	RIO VERDE S1	13/11/2020 03:01	13/11/2020 10:20	13/11/2020 03:01	13/11/2020 10:20	7,30	1	7,30	CHI
20201154775	FLORES DE GOIAS	FA13361342	ITUIQUIRA	13/11/2020 03:02	13/11/2020 08:14	13/11/2020 03:02	13/11/2020 08:14	5,19	3	15,57	CHI
20201154775	FORMOSA	FA13361342	ITUIQUIRA	13/11/2020 03:02	13/11/2020 08:14	13/11/2020 03:02	13/11/2020 08:14	5,19	579	3005,33	CHI
20201154775	SAO JOAO D ALIANCA	FA13361342	ITUIQUIRA	13/11/2020 03:02	13/11/2020 08:14	13/11/2020 03:02	13/11/2020 08:14	5,19	225	1167,88	CHI
20201154775	VILA BOA	FA13361342	ITUIQUIRA	13/11/2020 03:02	13/11/2020 08:14	13/11/2020 03:02	13/11/2020 08:14	5,19	5	25,95	CHI
20201155291	ANICUNS	AC12019279	ANICUNS	13/11/2020 03:08	13/11/2020 09:21	13/11/2020 03:08	13/11/2020 09:21	6,21	22	136,53	CHI
20201154782	CAMPINORTE	CR12000060RE	CAMPINORTE	13/11/2020 03:24	13/11/2020 10:52	13/11/2020 03:24	13/11/2020 10:52	7,46	9	67,13	CHI
20201154782	MARA ROSA	CR12000060RE	CAMPINORTE	13/11/2020 03:24	13/11/2020 10:52	13/11/2020 03:24	13/11/2020 10:52	7,46	1	7,46	CHI
20201154782	NOVA IGUACU DE GOIAS	CR12000060RE	CAMPINORTE	13/11/2020 03:24	13/11/2020 10:52	13/11/2020 03:24	13/11/2020 10:52	7,46	107	798,07	CHI
20201154785	APARECIDA DE GOIANIA	AP11000096	REAL S2	13/11/2020 03:35	13/11/2020 13:31	13/11/2020 13:13	13/11/2020 13:31	0,29	84	24,43	CHI
20201154810	GOIATUBA	CL12295982LD	RIO DOS BOIS	13/11/2020 03:35	13/11/2020 08:22	13/11/2020 03:35	13/11/2020 08:22	4,77	19	90,68	CHI
20201154810	PORTEIRAO	CL12295982LD	RIO DOS BOIS	13/11/2020 03:35	13/11/2020 08:22	13/11/2020 03:35	13/11/2020 08:22	4,77	13	62,05	CHI
20201154789	MINACU	IH16407770	MINACU	13/11/2020 03:42	13/11/2020 14:48	13/11/2020 03:42	13/11/2020 04:35	0,89	949	843,29	CHI
20201154789	MINACU	IH16407770	MINACU	13/11/2020 03:42	13/11/2020 14:48	13/11/2020 03:42	13/11/2020 14:48	11,11	2128	23639,12	CHI
20201156049	GOIANESIA	GE12357338	GOIANESIA S2	13/11/2020 03:42	13/11/2020 14:18	13/11/2020 03:42	13/11/2020 14:18	10,59	14	148,27	CHI
20201161185	MINACU	6803464	MINACU	13/11/2020 03:42	14/11/2020 14:00	13/11/2020 14:54	14/11/2020 14:00	23,09	19	438,80	CHI
20201154788	RIO VERDE	RV21200704	CACHOEIRA ALTA	13/11/2020 03:46	13/11/2020 09:30	13/11/2020 03:46	13/11/2020 09:30	5,73	1	5,73	CHI

20201154795	GOIANIA	GN12283038	GOIANIA LESTE S2	13/11/2020 04:21	13/11/2020 05:01	13/11/2020 04:21	13/11/2020 05:01	0,67	225	151,00	CHI
20201154798	APARECIDA DE GOIANIA	AP12002098LD	REAL S2	13/11/2020 04:31	13/11/2020 11:08	13/11/2020 04:31	13/11/2020 07:40	3,14	411	1290,65	CHI
20201154798	APARECIDA DE GOIANIA	AP12002098LD	REAL S2	13/11/2020 04:31	13/11/2020 11:08	13/11/2020 07:44	13/11/2020 11:08	3,41	411	1401,97	CHI
20201156266	GOIANIA	GN21002284	ATLANTICO S2	13/11/2020 04:40	13/11/2020 09:59	13/11/2020 04:40	13/11/2020 09:59	5,31	32	169,99	CHI
20201154925	JARAGUA	JA12059976	JARAGUA	13/11/2020 04:51	13/11/2020 08:54	13/11/2020 04:51	13/11/2020 08:54	4,05	2	8,09	CHI
20201154925	PIRENOPOLIS	JA12059976	JARAGUA	13/11/2020 04:51	13/11/2020 08:54	13/11/2020 04:51	13/11/2020 08:54	4,05	98	396,57	CHI
20201154807	PORANGATU	PO12403391	PORANGATU	13/11/2020 04:54	13/11/2020 07:00	13/11/2020 04:54	13/11/2020 07:00	2,09	32	66,99	CHI
20201154808	BARRO ALTO	BA21000009	BARRO ALTO	13/11/2020 04:55	13/11/2020 10:35	13/11/2020 04:55	13/11/2020 10:35	5,66	1	5,66	CHI
20201155078	BELA VISTA DE GOIAS	PJ12200040	BELA VISTA S1	13/11/2020 04:55	13/11/2020 11:51	13/11/2020 04:55	13/11/2020 11:51	6,92	1	6,92	CHI
20201155078	PIRACANJUBA	PJ12200040	BELA VISTA S1	13/11/2020 04:55	13/11/2020 11:51	13/11/2020 04:55	13/11/2020 11:51	6,92	16	110,72	CHI
20201154811	EDEIA	EA21156295	VICENTINOPOLIS	13/11/2020 05:02	13/11/2020 10:05	13/11/2020 05:02	13/11/2020 10:05	5,04	1	5,04	CHI
20201154812	GOIANESIA	550148048	GOIANESIA S2	13/11/2020 05:03	13/11/2020 14:29	13/11/2020 05:03	13/11/2020 14:29	9,43	1	9,43	CHI
20201154814	PIRACANJUBA	PJ10394717	PIRACANJUBA	13/11/2020 05:06	13/11/2020 14:02	13/11/2020 05:06	13/11/2020 14:02	8,92	173	1543,21	CHI
20201155180	ACREUNA	EU12260946	ACREUNA	13/11/2020 05:11	13/11/2020 10:31	13/11/2020 05:11	13/11/2020 10:31	5,32	24	127,71	CHI
20201154979	MAMBAI	MB12170571	IACIARA S2	13/11/2020 05:14	13/11/2020 08:25	13/11/2020 05:14	13/11/2020 08:25	3,18	98	311,86	CHI
20201154852	GOIAS	GK12220543	ITAPURANGA	13/11/2020 05:17	13/11/2020 08:29	13/11/2020 05:17	13/11/2020 08:29	3,19	12	38,23	CHI
20201154852	GUARAITA	GK12220543	ITAPURANGA	13/11/2020 05:17	13/11/2020 08:29	13/11/2020 05:17	13/11/2020 08:29	3,19	22	70,08	CHI
20201154918	ITAGUARI	IC12036612	ITABERAI S1	13/11/2020 05:17	13/11/2020 08:07	13/11/2020 05:17	13/11/2020 08:07	2,83	16	45,24	CHI
20201154918	ITAGUARU	IC12036612	ITABERAI S1	13/11/2020 05:17	13/11/2020 08:07	13/11/2020 05:17	13/11/2020 08:07	2,83	21	59,38	CHI
20201154918	JARAGUA	IC12036612	ITABERAI S1	13/11/2020 05:17	13/11/2020 08:07	13/11/2020 05:17	13/11/2020 08:07	2,83	95	268,61	CHI
20201155848	MUTUNOPOLIS	MU12068520	MARA ROSA	13/11/2020 05:19	15/11/2020 09:26	13/11/2020 05:19	15/11/2020 09:26	52,11	2	104,22	CHI
20201155848	PORANGATU	MU12068520	MARA ROSA	13/11/2020 05:19	15/11/2020 09:26	13/11/2020 05:19	15/11/2020 09:26	52,11	12	625,29	CHI
20201154829	IACIARA	IA12085526LD	IACIARA S1	13/11/2020 05:20	13/11/2020 09:31	13/11/2020 05:20	13/11/2020 09:31	4,18	36	150,60	CHI
20201154830	PORANGATU	PO12239639	MARA ROSA	13/11/2020 05:21	13/11/2020 11:03	13/11/2020 05:21	13/11/2020 11:03	5,70	29	165,16	CHI
20201155827	GOIANIA	GN11012183	ATLANTICO S2	13/11/2020 05:22	13/11/2020 10:24	13/11/2020 05:22	13/11/2020 10:24	5,02	124	622,51	CHI
20201155012	GOIANESIA	GE10400378	GOIANESIA S1	13/11/2020 05:23	13/11/2020 09:00	13/11/2020 05:23	13/11/2020 09:00	3,62	122	441,37	CHI
20201155012	GOIANESIA	GE10400378	GOIANESIA S1	13/11/2020 05:23	13/11/2020 09:00	13/11/2020 05:23	13/11/2020 09:00	3,62	583	2109,16	CHI
20201155012	GOIANESIA	GE10400378	GOIANESIA S1	13/11/2020 05:23	13/11/2020 09:00	13/11/2020 05:23	13/11/2020 09:00	3,62	6	21,71	CHI
20201155012	NOVA GLORIA	GE10400378	GOIANESIA S1	13/11/2020 05:23	13/11/2020 09:00	13/11/2020 05:23	13/11/2020 09:00	3,62	2	7,24	CHI
20201155012	SANTA ISABEL	GE10400378	GOIANESIA S1	13/11/2020 05:23	13/11/2020 09:00	13/11/2020 05:23	13/11/2020 09:00	3,62	2	7,24	CHI
20201155012	SANTA ISABEL	GE10400378	GOIANESIA S1	13/11/2020 05:23	13/11/2020 09:00	13/11/2020 05:23	13/11/2020 09:00	3,62	31	112,15	CHI
20201155790	GOIANIA	GN11169451	ATLANTICO S3	13/11/2020 05:23	13/11/2020 15:22	13/11/2020 05:23	13/11/2020 15:22	9,99	35	349,71	CHI
20201154838	CAMPINACU	UC12354229	MARA ROSA	13/11/2020 05:24	13/11/2020 08:12	13/11/2020 05:24	13/11/2020 08:12	2,79	17	47,36	CHI
20201155796	PARAUNA	EU12295898LD	ACREUNA	13/11/2020 05:24	13/11/2020 20:27	13/11/2020 05:24	13/11/2020 17:56	12,53	56	701,80	CHI
20201155796	PARAUNA	EU12295898LD	ACREUNA	13/11/2020 05:24	13/11/2020 20:27	13/11/2020 05:24	13/11/2020 19:42	14,30	10	143,04	CHI
20201155796	PARAUNA	EU12295898LD	ACREUNA	13/11/2020 05:24	13/11/2020 20:27	13/11/2020 05:24	13/11/2020 20:27	15,05	9	135,49	CHI
20201154840	PORANGATU	PO21265508	PORANGATU	13/11/2020 05:26	14/11/2020 09:42	13/11/2020 05:26	14/11/2020 09:42	28,26	1	28,26	CHI
20201155339	MINEIROS	MY12274100RE	PARQUE DAS EMAS	13/11/2020 05:27	13/11/2020 08:38	13/11/2020 05:27	13/11/2020 08:38	3,18	16	50,85	CHI
20201156040	MARA ROSA	MQ12146959	MARA ROSA	13/11/2020 05:27	14/11/2020 12:00	13/11/2020 05:27	14/11/2020 12:00	30,53	10	305,34	CHI
20201156040	NOVA IGUACU DE GOIAS	MQ12146959	MARA ROSA	13/11/2020 05:27	14/11/2020 12:00	13/11/2020 05:27	14/11/2020 12:00	30,53	12	366,41	CHI
20201155875	AMERICANO DO BRASIL	AC12304639	ANICUNS	13/11/2020 05:29	13/11/2020 12:19	13/11/2020 05:29	13/11/2020 12:19	6,82	1	6,82	CHI
20201155875	ANICUNS	AC12304639	ANICUNS	13/11/2020 05:29	13/11/2020 12:19	13/11/2020 05:29	13/11/2020 12:19	6,82	17	116,02	CHI
20201155589	GOIAS	GS12073672	MATRINCHA	13/11/2020 05:31	13/11/2020 10:31	13/11/2020 05:31	13/11/2020 10:31	4,99	38	189,57	CHI
20201155589	ITAPIRAPUA	GS12073672	MATRINCHA	13/11/2020 05:31	13/11/2020 10:31	13/11/2020 05:31	13/11/2020 10:31	4,99	1	4,99	CHI
20201155589	NOVO BRASIL	GS12073672	MATRINCHA	13/11/2020 05:31	13/11/2020 10:31	13/11/2020 05:31	13/11/2020 10:31	4,99	36	179,59	CHI
20201154677	RIO VERDE	RV12260132LD	CABRIUVA S2	13/11/2020 05:32	13/11/2020 10:13	13/11/2020 05:32	13/11/2020 10:13	4,68	20	93,61	CHI
20201154849	MARZAGAO	MG21078837	VILA CORUMBA	13/11/2020 05:32	13/11/2020 08:46	13/11/2020 05:32	13/11/2020 08:46	3,22	1	3,22	CHI
20201154919	PORANGATU	PO12020947	PORANGATU	13/11/2020 05:35	13/11/2020 09:11	13/11/2020 05:35	13/11/2020 09:11	3,59	44	157,84	CHI
20201154863	SAO MIGUEL DO ARAGUAIA	SM12342059	SAO MIGUEL DO ARAGUAIA	13/11/2020 05:38	13/11/2020 09:13	13/11/2020 05:38	13/11/2020 09:13	3,57	9	32,14	CHI
20201154972	JANDAIA	JD12008607LD	PALMEIRAS	13/11/2020 05:39	13/11/2020 15:50	13/11/2020 05:39	13/11/2020 15:50	10,17	84	854,02	CHI
20201154972	PARAUNA	JD12008607LD	PALMEIRAS	13/11/2020 05:39	13/11/2020 15:50	13/11/2020 05:39	13/11/2020 15:50	10,17	6	61,00	CHI

20201155637	GOIANIA	GN11133583	REAL S2	13/11/2020 05:40	13/11/2020 12:48	13/11/2020 05:40	13/11/2020 12:48	7,13	110	784,54	CHI
20201155251	NOVO PLANALTO	SM12074386RE	SAO MIGUEL DO ARAGUAIA	13/11/2020 05:42	13/11/2020 10:58	13/11/2020 05:42	13/11/2020 10:58	5,25	6	31,51	CHI
20201155251	SAO MIGUEL DO ARAGUAIA	SM12074386RE	SAO MIGUEL DO ARAGUAIA	13/11/2020 05:42	13/11/2020 10:58	13/11/2020 05:42	13/11/2020 10:58	5,25	134	703,72	CHI
20201154876	NIQUELANDIA	4560224	BARRO ALTO	13/11/2020 05:44	14/11/2020 15:06	13/11/2020 05:44	13/11/2020 11:20	5,59	33	184,48	CHI
20201154876	VILA PROPICIO	4560224	BARRO ALTO	13/11/2020 05:44	14/11/2020 15:06	13/11/2020 05:44	13/11/2020 11:20	5,59	12	67,08	CHI
20201154876	NIQUELANDIA	4560224	BARRO ALTO	13/11/2020 05:44	14/11/2020 15:06	13/11/2020 08:40	13/11/2020 11:20	2,66	7	18,60	CHI
20201154876	VILA PROPICIO	4560224	BARRO ALTO	13/11/2020 05:44	14/11/2020 15:06	13/11/2020 08:40	13/11/2020 11:20	2,66	19	50,50	CHI
20201154876	NIQUELANDIA	4560224	BARRO ALTO	13/11/2020 05:44	14/11/2020 15:06	13/11/2020 05:44	13/11/2020 11:40	5,92	530	3136,27	CHI
20201154876	NIQUELANDIA	NQ10404181	BARRO ALTO	13/11/2020 05:44	14/11/2020 15:06	13/11/2020 08:40	13/11/2020 11:40	2,98	215	641,77	CHI
20201154876	MIMOSO DE GOIAS	4560224	BARRO ALTO	13/11/2020 05:44	14/11/2020 15:06	13/11/2020 05:44	13/11/2020 12:40	6,93	4	27,73	CHI
20201154876	NIQUELANDIA	4560224	BARRO ALTO	13/11/2020 05:44	14/11/2020 15:06	13/11/2020 05:44	13/11/2020 12:40	6,93	243	1684,73	CHI
20201154876	NIQUELANDIA	4560224	BARRO ALTO	13/11/2020 05:44	14/11/2020 15:06	13/11/2020 08:40	13/11/2020 12:40	4,00	2	8,00	CHI
20201154876	NIQUELANDIA	4560224	BARRO ALTO	13/11/2020 05:44	14/11/2020 15:06	13/11/2020 05:44	13/11/2020 22:46	17,02	1	17,02	CHI
20201154876	NIQUELANDIA	4560224	BARRO ALTO	13/11/2020 05:44	14/11/2020 15:06	13/11/2020 05:44	14/11/2020 15:06	33,36	15	500,45	CHI
20201154876	NIQUELANDIA	4560224	BARRO ALTO	13/11/2020 05:44	14/11/2020 15:06	13/11/2020 08:40	14/11/2020 15:06	30,43	5	152,16	CHI
20201155120	NAZARIO	NZ12000033	ANICUNS	13/11/2020 05:44	13/11/2020 08:57	13/11/2020 05:44	13/11/2020 08:57	3,21	5	16,03	CHI
20201154877	MARA ROSA	MQ12051834	MARA ROSA	13/11/2020 05:45	13/11/2020 11:04	13/11/2020 05:45	13/11/2020 11:04	5,31	14	74,33	CHI
20201154878	NOVA CRIXAS	NA12334349	NOVA CRIXAS	13/11/2020 05:45	13/11/2020 08:02	13/11/2020 05:45	13/11/2020 08:02	2,27	86	195,63	CHI
20201156633	AMARALINA	LC12278480	MARA ROSA	13/11/2020 05:46	13/11/2020 22:54	13/11/2020 05:46	13/11/2020 22:54	17,12	3	51,37	CHI
20201154883	MINACU	IH11052538	MINACU	13/11/2020 05:48	13/11/2020 23:07	13/11/2020 05:48	13/11/2020 23:07	17,31	76	1315,26	CHI
20201156120	BARRO ALTO	DF12401901LD	BARRO ALTO	13/11/2020 05:49	13/11/2020 12:33	13/11/2020 05:49	13/11/2020 12:33	6,73	24	161,52	CHI
20201156120	SANTA RITA DO NOVO DESTINO	DF12401901LD	BARRO ALTO	13/11/2020 05:49	13/11/2020 12:33	13/11/2020 05:49	13/11/2020 12:33	6,73	167	1123,91	CHI
20201154888	LUZIANIA	LZ12304992	VIANOPOLIS	13/11/2020 05:51	13/11/2020 09:06	13/11/2020 05:51	13/11/2020 09:06	3,24	75	243,35	CHI
20201154890	JARAGUA	JA12081265	JARAGUA	13/11/2020 05:51	13/11/2020 08:57	13/11/2020 05:51	13/11/2020 08:57	3,09	50	154,36	CHI
20201155576	PIRACANJUBA	PJ12212163	PIRACANJUBA	13/11/2020 05:51	13/11/2020 10:21	13/11/2020 05:51	13/11/2020 10:21	4,50	33	148,39	CHI
20201154894	ANICUNS	AC12388920	ANICUNS	13/11/2020 05:53	13/11/2020 10:39	13/11/2020 05:53	13/11/2020 10:39	4,75	7	33,28	CHI
20201154897	GOIANIA	14106462	REAL S2	13/11/2020 05:54	13/11/2020 08:14	13/11/2020 05:54	13/11/2020 08:14	2,33	1	2,33	CHI
20201154901	MINEIROS	MY12390605RE	PARQUE DAS EMAS	13/11/2020 05:54	13/11/2020 10:15	13/11/2020 05:54	13/11/2020 10:15	4,34	16	69,39	CHI
20201154906	SAO MIGUEL DO ARAGUAIA	SM12228636	SAO MIGUEL DO ARAGUAIA	13/11/2020 05:58	13/11/2020 09:59	13/11/2020 05:58	13/11/2020 09:59	4,02	58	232,95	CHI
20201154909	APARECIDA DE GOIANIA	AP11045629	REAL S2	13/11/2020 05:58	13/11/2020 10:54	13/11/2020 05:58	13/11/2020 10:54	4,93	85	419,00	CHI
20201154913	BURITI ALEGRE	BG12000110	ITUMBIARA VELHA S2	13/11/2020 06:01	13/11/2020 11:10	13/11/2020 06:01	13/11/2020 11:10	5,14	7	36,01	CHI
20201154914	JARAGUA	70075621	JARAGUA	13/11/2020 06:01	13/11/2020 06:49	13/11/2020 06:01	13/11/2020 06:49	0,79	1	0,79	CHI
20201154917	SAO MIGUEL DO ARAGUAIA	SM21020632	SAO MIGUEL DO ARAGUAIA	13/11/2020 06:02	13/11/2020 09:03	13/11/2020 06:02	13/11/2020 09:03	3,00	1	3,00	CHI
20201155132	ESTRELA DO NORTE	ET12136395	MARA ROSA	13/11/2020 06:02	14/11/2020 17:48	13/11/2020 06:02	14/11/2020 17:48	35,76	11	393,41	CHI
20201155132	MARA ROSA	ET12136395	MARA ROSA	13/11/2020 06:02	14/11/2020 17:48	13/11/2020 06:02	14/11/2020 17:48	35,76	9	321,88	CHI
20201157071	PETROLINA DE GOIAS	PG12101826	PETROLINA	13/11/2020 06:02	13/11/2020 13:17	13/11/2020 06:02	13/11/2020 13:17	7,25	10	72,46	CHI
20201154931	BARRO ALTO	BA12210738	BARRO ALTO	13/11/2020 06:07	13/11/2020 16:45	13/11/2020 06:07	13/11/2020 16:45	10,63	1	10,63	CHI
20201154935	GOIAS	IK12250614	ITAPURANGA	13/11/2020 06:07	13/11/2020 20:23	13/11/2020 06:07	13/11/2020 20:23	14,26	2	28,52	CHI
20201154935	GUARAITA	IK12250614	ITAPURANGA	13/11/2020 06:07	13/11/2020 20:23	13/11/2020 06:07	13/11/2020 20:23	14,26	18	256,65	CHI
20201154935	ITAPURANGA	IK12250614	ITAPURANGA	13/11/2020 06:07	13/11/2020 20:23	13/11/2020 06:07	13/11/2020 20:23	14,26	23	327,94	CHI
20201154936	FAINA	FC12234276	GOIAS	13/11/2020 06:07	13/11/2020 10:56	13/11/2020 06:07	13/11/2020 10:56	4,80	3	14,41	CHI
20201156709	RUBIATABA	RB12111237	RUBIATABA	13/11/2020 06:07	13/11/2020 14:54	13/11/2020 06:07	13/11/2020 14:54	8,78	5	43,92	CHI
20201154941	SAO MIGUEL DO ARAGUAIA	SM12074411	SAO MIGUEL DO ARAGUAIA	13/11/2020 06:09	13/11/2020 10:57	13/11/2020 06:09	13/11/2020 10:57	4,79	13	62,28	CHI
20201154946	CUMARI	CY21266832	CATALAO S1	13/11/2020 06:11	13/11/2020 09:57	13/11/2020 06:11	13/11/2020 09:57	3,76	1	3,76	CHI
20201161835	PORANGATU	PO12202569	PORANGATU	13/11/2020 06:11	14/11/2020 11:31	13/11/2020 06:11	14/11/2020 11:31	29,33	7	205,30	CHI
20201154032	CAMPOS VERDES	VD12145521	SANTA TEREZINHA	13/11/2020 06:12	13/11/2020 13:39	13/11/2020 06:12	13/11/2020 13:39	7,45	2	14,90	CHI
20201154032	SANTA TEREZINHA DE GOIAS	VD12145521	SANTA TEREZINHA	13/11/2020 06:12	13/11/2020 13:39	13/11/2020 06:12	13/11/2020 13:39	7,45	29	215,99	CHI
20201154958	BURITI ALEGRE	BG12000136	ITUMBIARA VELHA S2	13/11/2020 06:12	13/11/2020 17:24	13/11/2020 06:12	13/11/2020 17:24	11,19	2	22,38	CHI
20201154955	JATAI	JT12000178	JATAI S2	13/11/2020 06:14	13/11/2020 20:12	13/11/2020 06:14	13/11/2020 11:47	5,55	1	5,55	CHI
20201154955	JATAI	JT12000178	JATAI S2	13/11/2020 06:14	13/11/2020 20:12	13/11/2020 06:14	13/11/2020 20:12	13,96	1	13,96	CHI
20201155618	SITIO D ABADIA	SI12329755	IACIARA S2	13/11/2020 06:14	13/11/2020 10:54	13/11/2020 06:14	13/11/2020 10:54	4,66	5	23,31	CHI

20201157277	JATAI	JT21166057	JATAI S2	13/11/2020 06:14	13/11/2020 20:12	13/11/2020 06:14	13/11/2020 20:12	13,96	1	13,96	CHI
20201158395	JATAI	JT12036242LD	JATAI S2	13/11/2020 06:14	13/11/2020 20:12	13/11/2020 06:14	13/11/2020 20:12	13,96	2	27,93	CHI
20201154970	ALVORADA DO NORTE	AQ12160975	IACIARA S2	13/11/2020 06:15	13/11/2020 08:26	13/11/2020 06:15	13/11/2020 08:26	2,17	17	36,88	CHI
20201154971	BONOPOLIS	BX12262454LD	SAO MIGUEL DO ARAGUAIA	13/11/2020 06:15	18/11/2020 08:21	14/11/2020 10:10	18/11/2020 08:21	94,18	2	188,36	CHI
20201154971	BONOPOLIS	BX12262454LD	SAO MIGUEL DO ARAGUAIA	13/11/2020 06:15	18/11/2020 08:21	14/11/2020 11:00	18/11/2020 08:21	93,35	1	93,35	CHI
20201155151	GOIANIA	GN12000119LD	REAL S2	13/11/2020 06:15	13/11/2020 11:31	13/11/2020 06:15	13/11/2020 11:16	5,02	225	1129,69	CHI
20201155151	GOIANIA	GN12282810LD	REAL S2	13/11/2020 06:15	13/11/2020 11:31	13/11/2020 06:15	13/11/2020 11:31	5,27	380	2002,49	CHI
20201154974	PILAR DE GOIAS	GG12262855	ITAPACI	13/11/2020 06:16	13/11/2020 09:03	13/11/2020 06:16	13/11/2020 09:03	2,78	5	13,90	CHI
20201155851	GOIAS	GK12299661	ITAPURANGA	13/11/2020 06:16	13/11/2020 09:20	13/11/2020 06:16	13/11/2020 09:20	3,07	20	61,32	CHI
20201155851	GUARAITA	GK12299661	ITAPURANGA	13/11/2020 06:16	13/11/2020 09:20	13/11/2020 06:16	13/11/2020 09:20	3,07	19	58,25	CHI
20201154980	DIVINOPOLIS DE GOIAS	GH12156343RE	SAO DOMINGOS	13/11/2020 06:17	13/11/2020 08:57	13/11/2020 06:17	13/11/2020 08:57	2,65	127	337,11	CHI
20201154980	MONTE ALEGRE DE GOIAS	GH12156343RE	SAO DOMINGOS	13/11/2020 06:17	13/11/2020 08:57	13/11/2020 06:17	13/11/2020 08:57	2,65	15	39,82	CHI
20201154980	SAO DOMINGOS	GH12156343RE	SAO DOMINGOS	13/11/2020 06:17	13/11/2020 08:57	13/11/2020 06:17	13/11/2020 08:57	2,65	1	2,65	CHI
20201154983	VICENTINOPOLIS	VI12026551	VICENTINOPOLIS	13/11/2020 06:17	13/11/2020 08:25	13/11/2020 06:17	13/11/2020 08:25	2,12	1	2,12	CHI
20201154984	COCALZINHO DE GOIAS	ZN11388041	GOIANESIA S1	13/11/2020 06:18	13/11/2020 11:23	13/11/2020 06:18	13/11/2020 11:23	5,08	1	5,08	CHI
20201154985	SERRANOPOLIS	SX12260314	JATAI S1	13/11/2020 06:18	13/11/2020 13:59	13/11/2020 06:18	13/11/2020 13:59	7,67	4	30,69	CHI
20201154990	MINACU	IH12208345	MINACU	13/11/2020 06:19	13/11/2020 14:30	13/11/2020 06:19	13/11/2020 13:22	7,06	49	345,76	CHI
20201154990	MINACU	IH12182290	MINACU	13/11/2020 06:19	13/11/2020 14:30	13/11/2020 06:19	13/11/2020 14:30	8,18	49	400,94	CHI
20201155774	BURITI ALEGRE	7132211	ITUMBIARA VELHA S2	13/11/2020 06:19	13/11/2020 18:47	13/11/2020 06:19	13/11/2020 18:47	12,46	26	323,91	CHI
20201155774	ITUMBIARA	7132211	ITUMBIARA VELHA S2	13/11/2020 06:19	13/11/2020 18:47	13/11/2020 06:19	13/11/2020 18:47	12,46	123	1532,34	CHI
20201157093	BARRO ALTO	BA12414688	BARRO ALTO	13/11/2020 06:20	13/11/2020 16:32	13/11/2020 06:20	13/11/2020 16:32	10,20	32	326,38	CHI
20201155030	JATAI	JT10394612	JATAI S2	13/11/2020 06:23	13/11/2020 06:37	13/11/2020 06:23	13/11/2020 06:37	0,24	120	28,53	CHI
20201155080	VIANOPOLIS	VN12014680	VIANOPOLIS	13/11/2020 06:23	13/11/2020 08:28	13/11/2020 06:23	13/11/2020 08:28	2,07	11	22,76	CHI
20201155415	MUTUNOPOLIS	SE12352924	MARA ROSA	13/11/2020 06:23	13/11/2020 08:58	13/11/2020 06:23	13/11/2020 08:58	2,58	5	12,90	CHI
20201155415	SANTA TEREZA DE GOIAS	SE12352924	MARA ROSA	13/11/2020 06:23	13/11/2020 08:58	13/11/2020 06:23	13/11/2020 08:58	2,58	1	2,58	CHI
20201155727	GUARINOS	IW12281203	ITAPACI	13/11/2020 06:23	13/11/2020 09:49	13/11/2020 06:23	13/11/2020 09:49	3,43	5	17,16	CHI
20201155727	ITAPACI	IW12281203	ITAPACI	13/11/2020 06:23	13/11/2020 09:49	13/11/2020 06:23	13/11/2020 09:49	3,43	2	6,86	CHI
20201155020	APARECIDA DE GOIANIA	10002074689	REAL S1	13/11/2020 06:24	13/11/2020 10:00	13/11/2020 06:24	13/11/2020 10:00	3,59	1	3,59	CHI
20201156073	MARA ROSA	MQ12295280	MARA ROSA	13/11/2020 06:26	14/11/2020 16:15	13/11/2020 06:26	14/11/2020 16:15	33,81	4	135,24	CHI
20201155033	SAO LUIS DE MONTES BELOS	SL31206331	SAO LUIZ DOS MONTES BELOS	13/11/2020 06:28	13/11/2020 08:13	13/11/2020 06:28	13/11/2020 08:13	1,75	1	1,75	CHI
20201155037	MINEIROS	MY12322128RE	PARQUE DAS EMAS	13/11/2020 06:29	13/11/2020 13:25	13/11/2020 06:29	13/11/2020 13:25	6,93	4	27,73	CHI
20201155042	FORMOSA	FA12262405	ITUIQUIRA	13/11/2020 06:30	13/11/2020 11:59	13/11/2020 06:30	13/11/2020 11:59	5,48	92	504,29	CHI
20201155046	SANTA HELENA DE GOIAS	SH12295849	IPEGUARI	13/11/2020 06:30	13/11/2020 08:40	13/11/2020 06:30	13/11/2020 08:40	2,16	2	4,31	CHI
20201155051	GOIAS	GS11061605	GOIAS	13/11/2020 06:32	13/11/2020 11:00	13/11/2020 06:32	13/11/2020 11:00	4,47	10	44,74	CHI
20201155054	BARRO ALTO	BA12169965	BARRO ALTO	13/11/2020 06:32	13/11/2020 18:22	13/11/2020 06:32	13/11/2020 18:22	11,82	1	11,82	CHI
20201155200	SILVANIA	SV12056199	DAIA S2	13/11/2020 06:32	13/11/2020 08:34	13/11/2020 06:32	13/11/2020 08:34	2,02	9	18,20	CHI
20201156816	GOIAS	GS12220477	GOIAS	13/11/2020 06:32	14/11/2020 11:33	13/11/2020 06:32	14/11/2020 11:33	29,02	11	319,20	CHI
20201155066	ALTO PARAISO DE GOIAS	BF121403597	NIQUELÂNDIA SUBTRANSMISSAO	13/11/2020 06:34	13/11/2020 07:52	13/11/2020 06:34	13/11/2020 07:52	1,30	1	1,30	CHI
20201155068	CORUMBAIBA	IP12071444	IPAMERI	13/11/2020 06:34	13/11/2020 09:15	13/11/2020 06:34	13/11/2020 09:15	2,68	3	8,03	CHI
20201155068	IPAMERI	IP12071444	IPAMERI	13/11/2020 06:34	13/11/2020 09:15	13/11/2020 06:34	13/11/2020 09:15	2,68	13	34,78	CHI
20201155071	ITAPIRAPUA	IU12008889	MATRINCHA	13/11/2020 06:35	13/11/2020 11:24	13/11/2020 06:35	13/11/2020 11:24	4,82	9	43,38	CHI
20201155163	MONTE ALEGRE DE GOIAS	SD12322677	SAO DOMINGOS	13/11/2020 06:36	13/11/2020 09:38	13/11/2020 06:36	13/11/2020 09:38	3,02	1	3,02	CHI
20201155163	NOVA ROMA	SD12322677	SAO DOMINGOS	13/11/2020 06:36	13/11/2020 09:38	13/11/2020 06:36	13/11/2020 09:38	3,02	3	9,07	CHI
20201155163	SAO DOMINGOS	SD12322677	SAO DOMINGOS	13/11/2020 06:36	13/11/2020 09:38	13/11/2020 06:36	13/11/2020 09:38	3,02	36	108,90	CHI
20201155856	PORANGATU	PO12343307	PORANGATU	13/11/2020 06:36	13/11/2020 17:12	13/11/2020 06:36	13/11/2020 17:12	10,58	23	243,44	CHI
20201155655	JUSSARA	RN12057000	BRITANIA	13/11/2020 06:37	13/11/2020 09:55	13/11/2020 06:37	13/11/2020 09:55	3,30	4	13,20	CHI
20201155655	SANTA FE DE GOIAS	RN12057000	BRITANIA	13/11/2020 06:37	13/11/2020 09:55	13/11/2020 06:37	13/11/2020 09:55	3,30	1	3,30	CHI
20201155089	APORE	AE12209702	ITAJA S1	13/11/2020 06:38	13/11/2020 10:20	13/11/2020 06:38	13/11/2020 10:20	3,70	2	7,40	CHI
20201157044	NOVA IGUAÇU DE GOIAS	6196276	MARA ROSA	13/11/2020 06:38	13/11/2020 17:00	13/11/2020 06:38	13/11/2020 17:00	10,36	2	20,73	CHI
20201155095	CAMPINACU	UC11269603	MARA ROSA	13/11/2020 06:39	13/11/2020 08:50	13/11/2020 06:39	13/11/2020 08:50	2,18	1	2,18	CHI
20201155104	AGUA LIMPA	RQ12122106	VILA CORUMBA	13/11/2020 06:40	13/11/2020 09:02	13/11/2020 06:40	13/11/2020 09:02	2,35	6	14,11	CHI

20201155104	RIO QUENTE	RQ12122106	VILA CORUMBA	13/11/2020 06:40	13/11/2020 09:02	13/11/2020 06:40	13/11/2020 09:02	2,35	7	16,46	CHI
20201155107	SAO MIGUEL DO ARAGUAIA	SM12013036	SAO MIGUEL DO ARAGUAIA	13/11/2020 06:41	14/11/2020 08:29	13/11/2020 06:41	14/11/2020 08:29	25,79	22	567,48	CHI
20201155038	FAZENDA NOVA	3090416	IPORA	13/11/2020 06:42	13/11/2020 09:05	13/11/2020 06:42	13/11/2020 08:59	2,30	444	1019,23	CHI
20201155038	DIORAMA	3090416	IPORA	13/11/2020 06:42	13/11/2020 09:05	13/11/2020 06:42	13/11/2020 09:05	2,39	12	28,72	CHI
20201155038	FAZENDA NOVA	3090416	IPORA	13/11/2020 06:42	13/11/2020 09:05	13/11/2020 06:42	13/11/2020 09:05	2,39	24	57,43	CHI
20201155038	JAUPACI	3090416	IPORA	13/11/2020 06:42	13/11/2020 09:05	13/11/2020 06:42	13/11/2020 09:05	2,39	1313	3142,08	CHI
20201155187	GOIANIA	GN11191075	CARAJAS S2	13/11/2020 06:42	13/11/2020 07:58	13/11/2020 06:42	13/11/2020 07:58	1,26	109	137,49	CHI
20201157777	MINEIROS	SU12157162	SANTA RITA DO ARAGUAIA	13/11/2020 06:42	13/11/2020 16:44	13/11/2020 06:42	13/11/2020 16:44	10,03	6	60,15	CHI
20201155124	ITAUCU	IX21000067	INHUMAS S1	13/11/2020 06:43	13/11/2020 12:37	13/11/2020 06:43	13/11/2020 12:37	5,89	1	5,89	CHI
20201155126	GOIAS	GS12093357	MATRINCHA	13/11/2020 06:44	14/11/2020 21:57	13/11/2020 06:44	14/11/2020 15:05	32,35	5	161,74	CHI
20201155126	GOIAS	GS12093357	MATRINCHA	13/11/2020 06:44	14/11/2020 21:57	14/11/2020 15:37	14/11/2020 16:24	0,78	5	3,90	CHI
20201155126	GOIAS	GS12090818LD	MATRINCHA	13/11/2020 06:44	14/11/2020 21:57	13/11/2020 06:44	14/11/2020 21:57	39,23	2	78,46	CHI
20201155136	JANDAIA	PL12000049	PALMEIRAS	13/11/2020 06:45	13/11/2020 09:40	13/11/2020 06:45	13/11/2020 09:40	2,91	8	23,30	CHI
20201155136	PALESTINA DE GOIAS	PL12000049	PALMEIRAS	13/11/2020 06:45	13/11/2020 09:40	13/11/2020 06:45	13/11/2020 09:40	2,91	1	2,91	CHI
20201155136	PALMEIRAS DE GOIAS	PL12000049	PALMEIRAS	13/11/2020 06:45	13/11/2020 09:40	13/11/2020 06:45	13/11/2020 09:40	2,91	28	81,55	CHI
20201155138	ANAPOLIS	AN12001176	ANAPOLIS UNIVERSITARIO S2	13/11/2020 06:45	13/11/2020 11:50	13/11/2020 06:45	13/11/2020 11:50	5,08	2	10,16	CHI
20201155139	ALTO PARAISO DE GOIAS	BF21146144	FLORES DE GOIAS	13/11/2020 06:45	13/11/2020 09:10	13/11/2020 06:45	13/11/2020 09:10	2,41	1	2,41	CHI
20201155140	APARECIDA DE GOIANIA	AP11397541	REAL S2	13/11/2020 06:45	13/11/2020 11:01	13/11/2020 06:45	13/11/2020 11:01	4,26	27	114,95	CHI
20201155444	ARAGOIANIA	AO12221194	INDEPENDENCIA S2	13/11/2020 06:45	13/11/2020 11:03	13/11/2020 06:45	13/11/2020 11:03	4,29	15	64,30	CHI
20201155144	MONTIVIDIU	MV21213383	MONTIVIDIU T	13/11/2020 06:46	13/11/2020 09:06	13/11/2020 06:46	13/11/2020 09:06	2,32	1	2,32	CHI
20201155147	GOIANIRA	TR21207580	GOIANIRA	13/11/2020 06:47	13/11/2020 09:18	13/11/2020 06:47	13/11/2020 09:18	2,52	2	5,03	CHI
20201155150	RIO VERDE	RV21123260	ACREUNA	13/11/2020 06:47	13/11/2020 16:33	13/11/2020 06:47	13/11/2020 16:33	9,75	1	9,75	CHI
20201155153	QUIRINOPOLIS	QI12303585	SANTA HELENA S1	13/11/2020 06:48	13/11/2020 08:50	13/11/2020 06:48	13/11/2020 08:50	2,02	35	70,74	CHI
20201155154	APARECIDA DE GOIANIA	14375667	ATLANTICO S2	13/11/2020 06:48	13/11/2020 08:55	13/11/2020 06:48	13/11/2020 08:55	2,10	1	2,10	CHI
20201156086	PETROLINA DE GOIAS	PV12295527	SAO FRANCISCO DE GOIAS	13/11/2020 06:49	13/11/2020 13:23	13/11/2020 06:49	13/11/2020 13:23	6,56	3	19,67	CHI
20201156086	PIRENOPOLIS	PV12295527	SAO FRANCISCO DE GOIAS	13/11/2020 06:49	13/11/2020 13:23	13/11/2020 06:49	13/11/2020 13:23	6,56	8	52,46	CHI
20201154560	SANTA HELENA DE GOIAS	SH12301284	IPEGUARI	13/11/2020 06:51	13/11/2020 12:06	13/11/2020 06:51	13/11/2020 12:06	5,25	8	41,98	CHI
20201155172	CATALAO	CT21127526	CATALAO S1	13/11/2020 06:51	13/11/2020 11:43	13/11/2020 06:51	13/11/2020 11:43	4,85	1	4,85	CHI
20201155246	GOIANIA	GN12127447	ATLANTICO S1	13/11/2020 06:51	13/11/2020 09:01	13/11/2020 06:51	13/11/2020 09:01	2,16	430	926,77	CHI
20201155178	GOIANESIA	SJ21006522	GOIANESIA S1	13/11/2020 06:52	13/11/2020 10:23	13/11/2020 06:52	13/11/2020 10:23	3,51	1	3,51	CHI
20201155734	APARECIDA DE GOIANIA	AP11166146	REAL S1	13/11/2020 06:53	13/11/2020 09:35	13/11/2020 06:53	13/11/2020 09:35	2,69	62	166,56	CHI
20201155191	JARAGUA	JA12354194	JARAGUA	13/11/2020 06:54	13/11/2020 12:10	13/11/2020 06:54	13/11/2020 12:10	5,26	1	5,26	CHI
20201155886	SAO MIGUEL DO ARAGUAIA	SM12349178	SAO MIGUEL DO ARAGUAIA	13/11/2020 06:55	15/11/2020 22:49	13/11/2020 06:55	15/11/2020 21:30	62,59	38	2378,24	CHI
20201155886	SAO MIGUEL DO ARAGUAIA	SM12349178	SAO MIGUEL DO ARAGUAIA	13/11/2020 06:55	15/11/2020 22:49	13/11/2020 06:55	15/11/2020 22:49	63,90	3	191,70	CHI
20201155197	SANTA BARBARA DE GOIAS	1030004630	TRINDADE	13/11/2020 06:56	13/11/2020 10:39	13/11/2020 06:56	13/11/2020 10:39	3,71	1	3,71	CHI
20201155198	BOM JESUS DE GOIAS	1250070998	BOM JESUS DE GOIAS	13/11/2020 06:56	13/11/2020 16:51	13/11/2020 06:56	13/11/2020 16:51	9,91	1	9,91	CHI
20201155199	SERRANOPOLIS	JT21211191	JATAI S1	13/11/2020 06:56	13/11/2020 12:57	13/11/2020 06:56	13/11/2020 12:57	6,00	1	6,00	CHI
20201155231	APARECIDA DE GOIANIA	AP11164773	ATLANTICO S2	13/11/2020 06:56	13/11/2020 08:40	13/11/2020 06:56	13/11/2020 08:40	1,73	149	258,02	CHI
20201155203	JATAI	290117896	JATAI S3	13/11/2020 06:57	13/11/2020 10:24	13/11/2020 06:57	13/11/2020 10:24	3,45	1	3,45	CHI
20201155208	NAZARIO	NZ12000032	ANICUNS	13/11/2020 06:58	13/11/2020 09:24	13/11/2020 06:58	13/11/2020 09:24	2,42	1	2,42	CHI
20201155210	CAMPOS VERDES	VD21252839	SANTA TEREZINHA	13/11/2020 06:59	13/11/2020 11:29	13/11/2020 06:59	13/11/2020 11:29	4,50	1	4,50	CHI
20201155213	SAO MIGUEL DO ARAGUAIA	830065143	SAO MIGUEL DO ARAGUAIA	13/11/2020 06:59	13/11/2020 08:55	13/11/2020 06:59	13/11/2020 08:55	1,93	1	1,93	CHI
20201155214	LUZIANIA	LZ11336019	RIO VERMELHO	13/11/2020 06:59	13/11/2020 09:55	13/11/2020 09:26	13/11/2020 09:55	0,48	27	12,86	CHI
20201155234	CRISTALINA	KR12170191	CRISTALINA S1	13/11/2020 07:00	13/11/2020 07:44	13/11/2020 07:00	13/11/2020 07:44	0,73	61	44,58	CHI
20201155721	PILAR DE GOIAS	GG12128447RE	SANTA TEREZINHA	13/11/2020 07:00	13/11/2020 11:02	13/11/2020 07:00	13/11/2020 11:02	4,02	40	160,93	CHI
20201155812	MONTIVIDIU DO NORTE	MX12192265	PORANGATU	13/11/2020 07:01	13/11/2020 10:15	13/11/2020 07:01	13/11/2020 10:15	3,22	65	209,44	CHI
20201155454	ANICUNS	AC12259090	FIRMINOPOLIS S2	13/11/2020 07:02	13/11/2020 10:53	13/11/2020 07:02	13/11/2020 10:53	3,85	30	115,45	CHI
20201155837	SANTA HELENA DE GOIAS	TD12213488	RIO DOS BOIS	13/11/2020 07:02	13/11/2020 10:52	13/11/2020 07:02	13/11/2020 10:52	3,83	3	11,48	CHI
20201155837	TURVELANDIA	TD12213488	RIO DOS BOIS	13/11/2020 07:02	13/11/2020 10:52	13/11/2020 07:02	13/11/2020 10:52	3,83	5	19,13	CHI
20201155239	CAIAPONIA	PH12390191	CAIAPONIA	13/11/2020 07:03	13/11/2020 10:02	13/11/2020 07:03	13/11/2020 10:02	2,98	2	5,96	CHI
20201155239	PIRANHAS	PH12390191	CAIAPONIA	13/11/2020 07:03	13/11/2020 10:02	13/11/2020 07:03	13/11/2020 10:02	2,98	7	20,87	CHI



20201155242	NOVA IGUAÇU DE GOIÁS	NH21293530	SANTA TEREZINHA	13/11/2020 07:03	14/11/2020 12:05	13/11/2020 07:03	14/11/2020 12:05	29,02	1	29,02	CHI
20201155244	COCALZINHO DE GOIÁS	ZN11388036	GOIANESIA S1	13/11/2020 07:04	13/11/2020 11:36	13/11/2020 07:04	13/11/2020 11:36	4,53	2	9,06	CHI
20201155247	SAO MIGUEL DO ARAGUAIA	SM12240639	SAO MIGUEL DO ARAGUAIA	13/11/2020 07:04	13/11/2020 15:16	13/11/2020 07:04	13/11/2020 15:16	8,19	2	16,38	CHI
20201155392	GOIANIA	GN16407273	FERROVIARIO S2	13/11/2020 07:04	13/11/2020 12:42	13/11/2020 07:11	13/11/2020 07:23	0,20	1482	294,34	CHI
20201155392	GOIANIA	590254	FERROVIARIO S1	13/11/2020 07:04	13/11/2020 12:42	13/11/2020 07:15	13/11/2020 07:23	0,15	1492	216,75	CHI
20201155392	GOIANIA	GN16409237	FERROVIARIO S2	13/11/2020 07:04	13/11/2020 12:42	13/11/2020 07:09	13/11/2020 07:23	0,23	2824	659,72	CHI
20201155392	GOIANIA	590254	FERROVIARIO S2	13/11/2020 07:04	13/11/2020 12:42	13/11/2020 07:15	13/11/2020 07:34	0,33	1022	336,41	CHI
20201155392	GOIANIA	590254	FERROVIARIO S2	13/11/2020 07:04	13/11/2020 12:42	13/11/2020 07:15	13/11/2020 09:34	2,33	109	254,12	CHI
20201155392	GOIANIA	590254	FERROVIARIO S2	13/11/2020 07:04	13/11/2020 12:42	13/11/2020 07:15	13/11/2020 12:42	5,46	403	2199,37	CHI
20201155582	SANTA HELENA DE GOIÁS	SH16416687	IPEGUARI	13/11/2020 07:04	13/11/2020 08:53	13/11/2020 07:04	13/11/2020 07:56	0,86	1293	1109,47	CHI
20201155582	SANTA HELENA DE GOIÁS	SH13404084B	IPEGUARI	13/11/2020 07:04	13/11/2020 08:53	13/11/2020 08:50	13/11/2020 08:53	0,06	102	5,78	CHI
20201155254	AURILANDIA	AI12383536	FIRMINOPOLIS S2	13/11/2020 07:05	13/11/2020 08:38	13/11/2020 07:05	13/11/2020 08:38	1,54	3	4,63	CHI
20201155278	APARECIDA DE GOIANIA	12928823	ATLANTICO S2	13/11/2020 07:07	13/11/2020 09:05	13/11/2020 07:07	13/11/2020 09:05	1,96	1	1,96	CHI
20201155577	VILA PROPICIO	NP12240133	GOIANESIA S1	13/11/2020 07:07	13/11/2020 15:50	13/11/2020 07:07	13/11/2020 15:50	8,71	52	453,01	CHI
20201155293	PADRE BERNARDO	ZN12342164	PADRE BERNARDO	13/11/2020 07:09	13/11/2020 13:05	13/11/2020 07:09	13/11/2020 13:05	5,92	5	29,59	CHI
20201155392	GOIANIA	590254	FERROVIARIO S1	13/11/2020 07:09	13/11/2020 12:42	13/11/2020 07:09	13/11/2020 07:12	0,06	1492	95,32	CHI
20201155392	GOIANIA	GN16407273	FERROVIARIO S1	13/11/2020 07:09	13/11/2020 12:42	13/11/2020 07:09	13/11/2020 07:23	0,25	2306	568,81	CHI
20201155300	ITAJA	IJ21148226	CACHOEIRA ALTA	13/11/2020 07:10	13/11/2020 09:30	13/11/2020 07:10	13/11/2020 09:30	2,32	1	2,32	CHI
20201155771	ITAPURANGA	IK12299350	ITAPURANGA	13/11/2020 07:10	13/11/2020 11:32	13/11/2020 07:10	13/11/2020 11:32	4,36	13	56,63	CHI
20201155313	URUACU	UR21064421	URUACU	13/11/2020 07:11	13/11/2020 20:04	13/11/2020 07:11	13/11/2020 20:04	12,87	2	25,74	CHI
20201155531	BELA VISTA DE GOIÁS	BV12000046	CEPAIGO S2	13/11/2020 07:11	13/11/2020 11:09	13/11/2020 07:11	13/11/2020 11:09	3,97	31	122,93	CHI
20201155319	CACHOEIRA ALTA	CA12194883	CACHOEIRA ALTA	13/11/2020 07:12	13/11/2020 08:10	13/11/2020 07:12	13/11/2020 08:10	0,96	6	5,76	CHI
20201155319	PARANAIGUARA	CA12194883	CACHOEIRA ALTA	13/11/2020 07:12	13/11/2020 08:10	13/11/2020 07:12	13/11/2020 08:10	0,96	2	1,92	CHI
20201155322	GOIANIA	GN12001162	AEROPORTO S1	13/11/2020 07:12	13/11/2020 08:40	13/11/2020 07:12	13/11/2020 08:40	1,46	49	71,50	CHI
20201155729	TURVELANDIA	TD12246842	RIO DOS BOIS	13/11/2020 07:12	13/11/2020 09:35	13/11/2020 07:12	13/11/2020 09:35	2,38	7	16,68	CHI
20201155330	GOIANIA	13591460	CAMPINAS S2	13/11/2020 07:13	13/11/2020 08:48	13/11/2020 07:13	13/11/2020 08:48	1,57	1	1,57	CHI
20201156217	CORUMBAIBA	CI12392158	VILA CORUMBA	13/11/2020 07:13	13/11/2020 12:58	13/11/2020 07:13	13/11/2020 12:58	5,74	10	57,42	CHI
20201155672	MIMOSO DE GOIÁS	MJ12377249	PADRE BERNARDO	13/11/2020 07:14	13/11/2020 10:23	13/11/2020 07:14	13/11/2020 10:23	3,15	18	56,65	CHI
20201155355	TERESINA DE GOIÁS	TE21236378	FLORES DE GOIÁS	13/11/2020 07:15	13/11/2020 11:28	13/11/2020 07:15	13/11/2020 11:28	4,20	2	8,40	CHI
20201155587	PETROLINA DE GOIÁS	PG12298070	PETROLINA	13/11/2020 07:15	13/11/2020 11:00	13/11/2020 07:15	13/11/2020 11:00	3,74	19	71,14	CHI
20201155717	GOIANIA	GN11001953	ATLANTICO S3	13/11/2020 07:15	13/11/2020 09:34	13/11/2020 07:15	13/11/2020 09:34	2,31	70	161,82	CHI
20201155532	GUARANI DE GOIÁS	GY12465246	IACIARA S1	13/11/2020 07:16	13/11/2020 10:01	13/11/2020 07:16	13/11/2020 10:01	2,74	14	38,29	CHI
20201155532	IACIARA	GY12465246	IACIARA S1	13/11/2020 07:16	13/11/2020 10:01	13/11/2020 07:16	13/11/2020 10:01	2,74	3	8,21	CHI
20201155371	JATAI	7421584	CACHOEIRA ALTA	13/11/2020 07:17	13/11/2020 11:13	13/11/2020 07:17	13/11/2020 11:13	3,92	1	3,92	CHI
20201155371	RIO VERDE	7421584	CACHOEIRA ALTA	13/11/2020 07:17	13/11/2020 11:13	13/11/2020 07:17	13/11/2020 11:13	3,92	5	19,60	CHI
20201155372	GOIANIA	13634033	ATLANTICO S3	13/11/2020 07:17	13/11/2020 10:14	13/11/2020 07:17	13/11/2020 10:14	2,94	1	2,94	CHI
20201155374	APARECIDA DE GOIANIA	12442033	INDEPENDENCIA S2	13/11/2020 07:18	13/11/2020 09:56	13/11/2020 07:18	13/11/2020 09:56	2,62	1	2,62	CHI
20201155482	IACIARA	IA12394108	IACIARA S1	13/11/2020 07:18	13/11/2020 10:30	13/11/2020 07:18	13/11/2020 10:30	3,19	7	22,30	CHI
20201155725	GAMELEIRA DE GOIÁS	SV12278872	DAIA S2	13/11/2020 07:19	13/11/2020 09:44	13/11/2020 07:19	13/11/2020 09:44	2,41	39	93,85	CHI
20201155916	CAMPINORTE	CR12172326	MARA ROSA	13/11/2020 07:20	13/11/2020 14:26	13/11/2020 07:20	13/11/2020 14:26	7,10	3	21,30	CHI
20201155916	FORMOSO	CR12172326	MARA ROSA	13/11/2020 07:20	13/11/2020 14:26	13/11/2020 07:20	13/11/2020 14:26	7,10	3	21,30	CHI
20201155403	ITARUMA	AE12216728	ITAJA S1	13/11/2020 07:21	13/11/2020 12:51	13/11/2020 07:21	13/11/2020 12:51	5,48	1	5,48	CHI
20201155404	GOIANIRA	390062297	GOIANIRA	13/11/2020 07:21	13/11/2020 10:31	13/11/2020 07:21	13/11/2020 10:31	3,15	1	3,15	CHI
20201155411	CAMPO ALEGRE DE GOIÁS	CM21304105	CAMPO ALEGRE DE GOIÁS	13/11/2020 07:22	13/11/2020 12:46	13/11/2020 07:22	13/11/2020 12:46	5,39	1	5,39	CHI
20201155414	RIO VERDE	RV31191874	QUIRINOPOLIS	13/11/2020 07:23	13/11/2020 09:40	13/11/2020 07:23	13/11/2020 09:40	2,28	2	4,56	CHI
20201154923	MONTES CLAROS DE GOIÁS	ME12038971	IPORA	13/11/2020 07:24	13/11/2020 13:31	13/11/2020 07:24	13/11/2020 13:31	6,12	22	134,55	CHI
20201155426	ANAPOLIS	AN12382890	ANAPOLIS UNIVERSITARIO S1	13/11/2020 07:25	13/11/2020 15:17	13/11/2020 07:25	13/11/2020 15:17	7,86	3	23,59	CHI
20201155862	PADRE BERNARDO	PB12330893	PADRE BERNARDO	13/11/2020 07:25	13/11/2020 10:43	13/11/2020 07:25	13/11/2020 10:43	3,29	4	13,18	CHI
20201156303	GOIATUBA	GT12273783	GOIATUBA S2	13/11/2020 07:26	13/11/2020 10:29	13/11/2020 07:26	13/11/2020 10:29	3,05	56	170,61	CHI
20201156303	MORRINHOS	GT12273783	GOIATUBA S2	13/11/2020 07:26	13/11/2020 10:29	13/11/2020 07:26	13/11/2020 10:29	3,05	2	6,09	CHI
20201155438	IPAMERI	580008666	IPAMERI	13/11/2020 07:27	13/11/2020 11:45	13/11/2020 07:27	13/11/2020 11:45	4,30	1	4,30	CHI

20201163629	MARA ROSA	MQ12338247	MARA ROSA	13/11/2020 07:27	15/11/2020 11:24	13/11/2020 07:27	15/11/2020 11:24	51,94	1	51,94	CHI
20201155449	PIRENOPOLIS	PV21403284	SAO FRANCISCO DE GOIAS	13/11/2020 07:28	13/11/2020 10:25	13/11/2020 07:28	13/11/2020 10:25	2,95	2	5,89	CHI
20201155450	TURVANIA	TV12289727	FIRMINOPOLIS S2	13/11/2020 07:28	13/11/2020 09:20	13/11/2020 07:28	13/11/2020 09:20	1,86	3	5,58	CHI
20201155456	ANAPOLIS	20558960	ANAPOLIS UNIVERSITARIO S2	13/11/2020 07:28	13/11/2020 10:58	13/11/2020 07:28	13/11/2020 10:58	3,49	1	3,49	CHI
20201155573	ITAUCU	IX12000044	INHUMAS S1	13/11/2020 07:28	13/11/2020 13:53	13/11/2020 07:28	13/11/2020 13:53	6,41	5	32,05	CHI
20201155467	ORIZONA	OZ12017068	PIRES DO RIO S2	13/11/2020 07:30	13/11/2020 09:36	13/11/2020 07:30	13/11/2020 09:36	2,10	19	39,82	CHI
20201156243	MOZARLANDIA	MZ12057424	MOZARLANDIA	13/11/2020 07:30	13/11/2020 11:18	13/11/2020 07:30	13/11/2020 11:18	3,80	19	72,12	CHI
20201157821	APARECIDA DE GOIANIA	AP12004870	ATLANTICO S1	13/11/2020 07:30	13/11/2020 16:06	13/11/2020 07:30	13/11/2020 16:06	8,59	308	2646,66	CHI
20201155481	AMARALINA	MU11215756	MARA ROSA	13/11/2020 07:31	14/11/2020 10:49	13/11/2020 07:31	14/11/2020 10:49	27,29	2	54,58	CHI
20201155500	JARAGUA	JA21000178	JARAGUA	13/11/2020 07:32	13/11/2020 14:50	13/11/2020 07:32	13/11/2020 14:50	7,29	1	7,29	CHI
20201155501	PADRE BERNARDO	2760031646	PADRE BERNARDO	13/11/2020 07:32	13/11/2020 15:11	13/11/2020 07:32	13/11/2020 15:11	7,64	1	7,64	CHI
20201155503	PIRENOPOLIS	ZN21295692	COCALZINHO	13/11/2020 07:32	13/11/2020 12:38	13/11/2020 07:32	13/11/2020 12:38	5,09	1	5,09	CHI
20201155505	BELA VISTA DE GOIAS	10019462024	BELA VISTA S1	13/11/2020 07:32	13/11/2020 11:40	13/11/2020 07:32	13/11/2020 11:40	4,12	1	4,12	CHI
20201155508	TRINDADE	TR12119047	TRINDADE	13/11/2020 07:33	13/11/2020 13:23	13/11/2020 07:33	13/11/2020 13:23	5,83	2	11,65	CHI
20201155508	TRINDADE	TR12119047	TRINDADE	13/11/2020 07:33	13/11/2020 13:23	13/11/2020 10:40	13/11/2020 13:23	2,72	1	2,72	CHI
20201155626	MONTES CLAROS DE GOIAS	ME12380972	IPORA	13/11/2020 07:35	13/11/2020 12:42	13/11/2020 07:35	13/11/2020 12:42	5,11	8	40,89	CHI
20201155527	SANTA CRUZ DE GOIAS	BC12027030	PIRES DO RIO S2	13/11/2020 07:36	13/11/2020 11:40	13/11/2020 07:36	13/11/2020 11:40	4,06	25	101,61	CHI
20201155529	GOIANIA	12416290	CAMPINAS S2	13/11/2020 07:36	13/11/2020 10:57	13/11/2020 07:36	13/11/2020 10:57	3,35	1	3,35	CHI
20201155540	PIRENOPOLIS	PV12334671	CORUMBA	13/11/2020 07:37	13/11/2020 12:37	13/11/2020 07:37	13/11/2020 12:37	4,99	26	129,86	CHI
20201157028	GOIANIA	GN11167932	ATLANTICO S3	13/11/2020 07:37	13/11/2020 12:53	13/11/2020 07:37	13/11/2020 12:53	5,26	14	73,71	CHI
20201155556	GOIANESIA	10020292161	GOIANESIA S2	13/11/2020 07:38	13/11/2020 12:22	13/11/2020 07:38	13/11/2020 12:22	4,72	1	4,72	CHI
20201155703	SERRANOPOLIS	SX12390576	JATAI S1	13/11/2020 07:38	13/11/2020 11:49	13/11/2020 07:38	13/11/2020 11:49	4,18	10	41,83	CHI
20201156044	ARAGUAPAZ	CX12058576RE	RUBIATABA	13/11/2020 07:38	16/11/2020 16:37	13/11/2020 07:38	15/11/2020 13:59	54,34	1	54,34	CHI
20201156044	CRIXAS	CX12058576RE	RUBIATABA	13/11/2020 07:38	16/11/2020 16:37	13/11/2020 07:38	15/11/2020 13:59	54,34	1	54,34	CHI
20201156044	ARAGUAPAZ	CX12058576RE	RUBIATABA	13/11/2020 07:38	16/11/2020 16:37	15/11/2020 18:45	15/11/2020 19:33	0,81	1	0,81	CHI
20201156044	CRIXAS	CX12058576RE	RUBIATABA	13/11/2020 07:38	16/11/2020 16:37	15/11/2020 18:45	15/11/2020 19:33	0,81	1	0,81	CHI
20201156044	ARAGUAPAZ	CX12058576RE	RUBIATABA	13/11/2020 07:38	16/11/2020 16:37	13/11/2020 07:38	16/11/2020 16:37	80,98	5	404,88	CHI
20201155557	ANAPOLIS	20123978	ANAPOLIS UNIVERSITARIO S2	13/11/2020 07:39	13/11/2020 14:09	13/11/2020 07:39	13/11/2020 14:09	6,50	1	6,50	CHI
20201155559	SAO MIGUEL DO ARAGUAIA	SM21328034	SAO MIGUEL DO ARAGUAIA	13/11/2020 07:39	13/11/2020 11:24	13/11/2020 07:39	13/11/2020 11:24	3,75	1	3,75	CHI
20201155564	GOIANIA	10568608	REAL S2	13/11/2020 07:39	13/11/2020 10:45	13/11/2020 07:39	13/11/2020 10:45	3,08	1	3,08	CHI
20201155815	NIQUELANDIA	NQ12262919	NIQUELANDIA SUBTRANSMISSAO	13/11/2020 07:39	13/11/2020 09:25	13/11/2020 07:39	13/11/2020 09:25	1,76	10	17,62	CHI
20201155568	GOIANIRA	GR12241334	GOIANIRA	13/11/2020 07:40	13/11/2020 11:13	13/11/2020 07:40	13/11/2020 11:13	3,54	92	325,86	CHI
20201155575	MINEIROS	MY12209687	PARQUE DAS EMAS	13/11/2020 07:40	13/11/2020 10:05	13/11/2020 07:40	13/11/2020 10:05	2,40	9	21,63	CHI
20201157333	VILA PROPICIO	NP12240133	GOIANESIA S1	13/11/2020 07:40	13/11/2020 15:50	13/11/2020 07:40	13/11/2020 15:50	8,15	1	8,15	CHI
20201155462	BONOPOLIS	SM16404035	SAO MIGUEL DO ARAGUAIA	13/11/2020 07:41	14/11/2020 02:09	13/11/2020 07:41	14/11/2020 02:09	18,48	100	1848,11	CHI
20201155462	SAO MIGUEL DO ARAGUAIA	SM16404035	SAO MIGUEL DO ARAGUAIA	13/11/2020 07:41	14/11/2020 02:09	13/11/2020 07:41	14/11/2020 02:09	18,48	1	18,48	CHI
20201155462	BONOPOLIS	SM16404035	SAO MIGUEL DO ARAGUAIA	13/11/2020 07:41	14/11/2020 02:09	13/11/2020 15:07	14/11/2020 02:09	11,05	4	44,18	CHI
20201155462	SAO MIGUEL DO ARAGUAIA	SM16404035	SAO MIGUEL DO ARAGUAIA	13/11/2020 07:41	14/11/2020 02:09	13/11/2020 15:07	14/11/2020 02:09	11,05	9	99,41	CHI
20201155581	CORUMBA DE GOIAS	CB21086607	CORUMBA	13/11/2020 07:41	13/11/2020 09:34	13/11/2020 07:41	13/11/2020 09:34	1,88	1	1,88	CHI
20201155585	CAMPINORTE	MQ12181686	MARA ROSA	13/11/2020 07:41	13/11/2020 10:40	13/11/2020 07:41	13/11/2020 10:40	2,97	4	11,87	CHI
20201155585	MARA ROSA	MQ12181686	MARA ROSA	13/11/2020 07:41	13/11/2020 10:40	13/11/2020 07:41	13/11/2020 10:40	2,97	1	2,97	CHI
20201155957	GOIANIA	GN12047759	ATLANTICO S1	13/11/2020 07:41	13/11/2020 13:20	13/11/2020 10:19	13/11/2020 13:20	3,02	102	307,79	CHI
20201155592	ITUMBIARA	IT21315862	ITUMBIARA VELHA S1	13/11/2020 07:43	13/11/2020 12:03	13/11/2020 07:43	13/11/2020 12:03	4,34	1	4,34	CHI
20201155593	PONTALINA	JV12218123	GOIATUBA S1	13/11/2020 07:43	13/11/2020 11:33	13/11/2020 07:43	13/11/2020 11:33	3,83	4	15,31	CHI
20201155594	GOIANIA	15897072	FERROVIARIO S1	13/11/2020 07:43	13/11/2020 10:13	13/11/2020 07:43	13/11/2020 10:13	2,49	1	2,49	CHI
20201155597	PIRENOPOLIS	220046141	CORUMBA	13/11/2020 07:43	13/11/2020 16:30	13/11/2020 07:43	13/11/2020 16:30	8,79	1	8,79	CHI
20201155598	GOIANIA	10587986	ATLANTICO S3	13/11/2020 07:43	13/11/2020 12:04	13/11/2020 07:43	13/11/2020 12:04	4,34	1	4,34	CHI
20201155601	BURITI ALEGRE	BG12000161	ITUMBIARA VELHA S2	13/11/2020 07:43	13/11/2020 09:14	13/11/2020 07:43	13/11/2020 09:14	1,50	2	3,00	CHI
20201156630	AVELINOPOLIS	AV12020309	ANICUNS	13/11/2020 07:43	13/11/2020 12:50	13/11/2020 07:43	13/11/2020 12:50	5,11	22	112,33	CHI
20201155607	DOVERLANDIA	DV12138335	CAIAPONIA	13/11/2020 07:44	13/11/2020 10:11	13/11/2020 07:44	13/11/2020 10:11	2,44	37	90,25	CHI
20201155612	CIDADE OCIDENTAL	2680174556	MARAJOARA	13/11/2020 07:44	13/11/2020 09:23	13/11/2020 07:44	13/11/2020 09:23	1,63	1	1,63	CHI



20201155622	JATAI	290321980	JATAI S2	13/11/2020 07:46	13/11/2020 09:48	13/11/2020 07:46	13/11/2020 09:48	2,03	1	2,03	CHI
20201155631	BOM JARDIM DE GOIAS	BM12253664	BOM JARDIM	13/11/2020 07:46	13/11/2020 08:38	13/11/2020 07:46	13/11/2020 08:38	0,85	8	6,83	CHI
20201155632	VILA PROPICIO	NP12254111	BARRO ALTO	13/11/2020 07:46	14/11/2020 19:00	13/11/2020 07:46	14/11/2020 19:00	35,22	1	35,22	CHI
20201155754	SAO DOMINGOS	2090504	SAO DOMINGOS	13/11/2020 07:46	13/11/2020 07:49	13/11/2020 07:46	13/11/2020 07:49	0,05	2442	122,78	CHI
20201155754	GUARANI DE GOIAS	2090504	SAO DOMINGOS	13/11/2020 07:46	13/11/2020 07:49	13/11/2020 07:46	13/11/2020 07:49	0,06	153	9,65	CHI
20201155754	SAO DOMINGOS	2090504	SAO DOMINGOS	13/11/2020 07:46	13/11/2020 07:49	13/11/2020 07:46	13/11/2020 07:49	0,06	1174	74,03	CHI
20201155636	SAO MIGUEL DO ARAGUAIA	SM21013039	SAO MIGUEL DO ARAGUAIA	13/11/2020 07:47	13/11/2020 11:57	13/11/2020 07:47	13/11/2020 11:57	4,16	1	4,16	CHI
20201155638	VALPARAISO DE GOIAS	VA11041608	MARAJOARA	13/11/2020 07:47	13/11/2020 09:07	13/11/2020 07:47	13/11/2020 09:07	1,32	9	11,89	CHI
20201155639	HIDROLANDIA	HD21388751	CEPAIGO S2	13/11/2020 07:47	13/11/2020 10:27	13/11/2020 07:47	13/11/2020 10:27	2,65	1	2,65	CHI
20201155649	CORUMBA DE GOIAS	CB21171462	CORUMBA	13/11/2020 07:49	13/11/2020 10:22	13/11/2020 07:49	13/11/2020 10:22	2,55	1	2,55	CHI
20201155664	TRES RANCHOS	TH21281449	CATALAO S1	13/11/2020 07:50	13/11/2020 10:21	13/11/2020 07:50	13/11/2020 10:21	2,50	1	2,50	CHI
20201155666	MARA ROSA	10012459800	MARA ROSA	13/11/2020 07:51	13/11/2020 10:51	13/11/2020 07:51	13/11/2020 10:51	3,00	1	3,00	CHI
20201155673	POSSE	PS21235419	IACIARA S2	13/11/2020 07:52	13/11/2020 17:05	13/11/2020 07:52	13/11/2020 17:05	9,22	1	9,22	CHI
20201155677	BELA VISTA DE GOIAS	240016166	BELA VISTA S1	13/11/2020 07:52	13/11/2020 10:22	13/11/2020 07:52	13/11/2020 10:22	2,50	1	2,50	CHI
20201155839	PONTALINA	PK12000100	PONTALINA	13/11/2020 07:52	13/11/2020 09:15	13/11/2020 07:52	13/11/2020 09:15	1,37	11	15,06	CHI
20201156587	BARRO ALTO	DF12382135	BARRO ALTO	13/11/2020 07:52	13/11/2020 12:07	13/11/2020 07:52	13/11/2020 12:07	4,24	34	144,08	CHI
20201156587	SANTA RITA DO NOVO DESTINO	DF12382135	BARRO ALTO	13/11/2020 07:52	13/11/2020 12:07	13/11/2020 07:52	13/11/2020 12:07	4,24	2	8,48	CHI
20201155969	GOIANIA	GN12001527	GOYA S1	13/11/2020 07:53	13/11/2020 10:05	13/11/2020 07:53	13/11/2020 10:05	2,18	60	131,07	CHI
20201155696	GOIANESIA	SJ21006513	GOIANESIA S1	13/11/2020 07:54	13/11/2020 09:43	13/11/2020 07:54	13/11/2020 09:43	1,80	1	1,80	CHI
20201154220	MUNDO NOVO DE GOIAS	MH11255523	NOVA CRIXAS	13/11/2020 07:55	13/11/2020 09:44	13/11/2020 07:55	13/11/2020 09:44	1,81	67	121,33	CHI
20201155699	BELA VISTA DE GOIAS	BV21189893	BELA VISTA S1	13/11/2020 07:55	13/11/2020 10:48	13/11/2020 07:55	13/11/2020 10:48	2,88	1	2,88	CHI
20201155705	GOIANIA	12211710	GOIANIA LESTE S2	13/11/2020 07:56	13/11/2020 12:11	13/11/2020 07:56	13/11/2020 12:11	4,24	1	4,24	CHI
20201155708	GOIANIA	14829071	ATLANTICO S2	13/11/2020 07:56	13/11/2020 12:29	13/11/2020 07:56	13/11/2020 12:29	4,53	1	4,53	CHI
20201155933	DOVERLANDIA	DV12221021	CAIAPONIA	13/11/2020 07:56	13/11/2020 10:56	13/11/2020 07:56	13/11/2020 10:56	2,99	22	65,88	CHI
20201161833	PORANGATU	PO12220778	PORANGATU	13/11/2020 07:56	14/11/2020 10:01	13/11/2020 07:56	14/11/2020 10:01	26,07	1	26,07	CHI
20201155709	ITUMBIARA	BJ12068986	CACHOEIRA DOURADA	13/11/2020 07:57	13/11/2020 10:59	13/11/2020 07:57	13/11/2020 10:59	3,03	4	12,12	CHI
20201155710	GOIANESIA	GE12372696	GOIANESIA S2	13/11/2020 07:57	13/11/2020 17:14	13/11/2020 07:57	13/11/2020 17:14	9,28	8	74,24	CHI
20201155711	ESTRELA DO NORTE	MQ12150566	MARA ROSA	13/11/2020 07:57	13/11/2020 19:21	13/11/2020 07:57	13/11/2020 19:21	11,40	7	79,77	CHI
20201155711	MARA ROSA	MQ12150566	MARA ROSA	13/11/2020 07:57	13/11/2020 19:21	13/11/2020 07:57	13/11/2020 19:21	11,40	7	79,77	CHI
20201155723	AGUA FRIA DE GOIAS	TL12337434	SAO JOAO D ALIANCA	13/11/2020 07:58	13/11/2020 09:34	13/11/2020 07:58	13/11/2020 09:34	1,59	1	1,59	CHI
20201155724	SAO LUIS DE MONTES BELOS	SL21233430	FIRMINOPOLIS S2	13/11/2020 07:58	13/11/2020 09:06	13/11/2020 07:58	13/11/2020 09:06	1,12	1	1,12	CHI
20201155726	CORUMBA DE GOIAS	AX12000153	CORUMBA	13/11/2020 07:59	13/11/2020 09:51	13/11/2020 07:59	13/11/2020 09:51	1,86	8	14,91	CHI
20201155739	GOUVELANDIA	GB12402360RE	QUIRINOPOLIS	13/11/2020 08:00	13/11/2020 11:21	13/11/2020 08:00	13/11/2020 11:21	3,34	8	26,69	CHI
20201155739	QUIRINOPOLIS	GB12402360RE	QUIRINOPOLIS	13/11/2020 08:00	13/11/2020 11:21	13/11/2020 08:00	13/11/2020 11:21	3,34	4	13,35	CHI
20201155743	TAQUARAL DE GOIAS	TQ12376431	ITABERAI S1	13/11/2020 08:01	13/11/2020 14:33	13/11/2020 08:01	13/11/2020 14:33	6,53	21	137,04	CHI
20201155750	PILAR DE GOIAS	9220001128	SANTA TEREZINHA	13/11/2020 08:02	14/11/2020 09:41	13/11/2020 08:02	14/11/2020 09:41	25,65	1	25,65	CHI
20201155752	CRISTALINA	KR21214920	CRISTALINA S1	13/11/2020 08:02	13/11/2020 08:31	13/11/2020 08:02	13/11/2020 08:31	0,48	1	0,48	CHI
20201156290	GOIANIA	GN11169930	ATLANTICO S2	13/11/2020 08:02	13/11/2020 14:54	13/11/2020 08:02	13/11/2020 14:54	6,85	36	246,69	CHI
20201155762	ANAPOLIS	20865776	JUNDIAI S2	13/11/2020 08:03	13/11/2020 10:36	13/11/2020 08:03	13/11/2020 10:36	2,54	1	2,54	CHI
20201155775	EDEIA	EA12305961	RIO DOS BOIS	13/11/2020 08:04	13/11/2020 15:35	13/11/2020 08:04	13/11/2020 15:35	7,51	1	7,51	CHI
20201155779	GOIANIA	14886674	XAVANTES	13/11/2020 08:04	13/11/2020 12:53	13/11/2020 08:04	13/11/2020 12:53	4,81	1	4,81	CHI
20201155780	GOIANIA	10028069380	CAMPINAS S1	13/11/2020 08:04	13/11/2020 10:01	13/11/2020 08:04	13/11/2020 10:01	1,94	1	1,94	CHI
20201156112	RUBIATABA	RB12187182	RUBIATABA	13/11/2020 08:04	13/11/2020 09:26	13/11/2020 08:04	13/11/2020 09:26	1,36	11	14,98	CHI
20201155788	PIRACANJUBA	PJ21105684	PIRACANJUBA	13/11/2020 08:05	13/11/2020 10:49	13/11/2020 08:05	13/11/2020 10:49	2,72	1	2,72	CHI
20201155797	PIRACANJUBA	PJ12027582	PIRACANJUBA	13/11/2020 08:07	13/11/2020 10:31	13/11/2020 08:07	13/11/2020 10:31	2,40	8	19,20	CHI
20201155800	ALEXANIA	AX12370321	ALEXANIA	13/11/2020 08:07	13/11/2020 11:29	13/11/2020 08:07	13/11/2020 11:29	3,36	4	13,45	CHI
20201155845	ABADIANIA	AA21184559	ANAPOLIS UNIVERSITARIO S1	13/11/2020 08:07	13/11/2020 10:55	13/11/2020 08:07	13/11/2020 10:55	2,80	1	2,80	CHI
20201156829	ALTO HORIZONTE	AJ12243571LD	SANTA TEREZINHA	13/11/2020 08:07	14/11/2020 10:33	13/11/2020 08:07	14/11/2020 10:33	26,43	234	6185,60	CHI
20201156829	ALTO HORIZONTE	AJ12243571LD	SANTA TEREZINHA	13/11/2020 08:07	14/11/2020 10:33	13/11/2020 12:26	14/11/2020 10:33	22,12	85	1880,06	CHI
20201155808	ANAPOLIS	AN11326827	JUNDIAI S1	13/11/2020 08:08	13/11/2020 19:47	13/11/2020 08:08	13/11/2020 19:47	11,65	40	465,97	CHI
20201155813	CATALAO	CT12103430	CATALAO S1	13/11/2020 08:08	13/11/2020 10:32	13/11/2020 08:08	13/11/2020 10:32	2,39	2	4,78	CHI

20201155824	GOIANIA	10734211	ATLANTICO S1	13/11/2020 08:10	13/11/2020 12:03	13/11/2020 08:10	13/11/2020 12:03	3,88	1	3,88	CHI
20201155830	SILVANIA	SV12229372	VIANOPOLIS	13/11/2020 08:10	13/11/2020 10:48	13/11/2020 08:10	13/11/2020 10:48	2,62	4	10,49	CHI
20201155832	GOIANIA	10777702	ATLANTICO S1	13/11/2020 08:11	13/11/2020 10:07	13/11/2020 08:11	13/11/2020 10:07	1,93	1	1,93	CHI
20201155836	SANTA ROSA DE GOIAS	SR21222233	INHUMAS S1	13/11/2020 08:11	13/11/2020 10:41	13/11/2020 08:11	13/11/2020 10:41	2,50	1	2,50	CHI
20201155843	GOIANIA	10856936	GOIANIA LESTE S3	13/11/2020 08:11	13/11/2020 17:11	13/11/2020 08:11	13/11/2020 17:11	8,98	1	8,98	CHI
20201155850	RIO VERDE	RV21361141	RIO VERDE S1	13/11/2020 08:12	13/11/2020 11:42	13/11/2020 08:12	13/11/2020 11:42	3,49	1	3,49	CHI
20201155852	GOIANDIRA	GD21161076	CATALAO S1	13/11/2020 08:12	13/11/2020 10:25	13/11/2020 08:12	13/11/2020 10:25	2,21	1	2,21	CHI
20201155859	ITAPURANGA	IK21235704	ITAPURANGA	13/11/2020 08:13	13/11/2020 10:49	13/11/2020 08:13	13/11/2020 10:49	2,60	2	5,20	CHI
20201155864	CAIAPONIA	MV12267740	MONTIVIDIU T	13/11/2020 08:13	13/11/2020 10:46	13/11/2020 08:13	13/11/2020 10:46	2,54	11	27,97	CHI
20201155864	MONTIVIDIU	MV12267740	MONTIVIDIU T	13/11/2020 08:13	13/11/2020 10:46	13/11/2020 08:13	13/11/2020 10:46	2,54	1	2,54	CHI
20201155865	JANDAIA	JD12008662	PALMEIRAS	13/11/2020 08:13	13/11/2020 15:12	13/11/2020 08:13	13/11/2020 15:12	6,97	31	216,22	CHI
20201155871	NIQUELANDIA	2750128505	NIQUELANDIA SUBTRANSMISSAO	13/11/2020 08:14	13/11/2020 11:14	13/11/2020 08:14	13/11/2020 11:14	2,99	1	2,99	CHI
20201156965	ANAPOLIS	AN12341913	JUNDIAI S1	13/11/2020 08:14	13/11/2020 12:42	13/11/2020 08:14	13/11/2020 12:42	4,46	1	4,46	CHI
20201156965	GOIANAPOLIS	AN12341913	JUNDIAI S1	13/11/2020 08:14	13/11/2020 12:42	13/11/2020 08:14	13/11/2020 12:42	4,46	2	8,91	CHI
20201155885	ORIZONA	OZ21382069	PIRES DO RIO S2	13/11/2020 08:16	13/11/2020 10:22	13/11/2020 08:16	13/11/2020 10:22	2,09	3	6,26	CHI
20201156619	AMARALINA	MU12166513	MARA ROSA	13/11/2020 08:16	14/11/2020 09:31	13/11/2020 08:16	14/11/2020 09:31	25,25	20	504,99	CHI
20201155937	CAMPO LIMPO	AN12129397	NEROPOLIS S1	13/11/2020 08:17	13/11/2020 11:04	13/11/2020 08:17	13/11/2020 11:04	2,78	232	644,51	CHI
20201155891	RUBIATABA	780037352	RUBIATABA	13/11/2020 08:18	13/11/2020 13:00	13/11/2020 08:18	13/11/2020 13:00	4,70	1	4,70	CHI
20201155899	QUIRINOPOLIS	QI12112137	QUIRINOPOLIS	13/11/2020 08:19	13/11/2020 09:50	13/11/2020 08:19	13/11/2020 09:50	1,50	13	19,55	CHI
20201155901	LUZIANIA	LZ12261445	MARAJOARA	13/11/2020 08:20	13/11/2020 14:10	13/11/2020 08:20	13/11/2020 14:10	5,82	3	17,46	CHI
20201155905	GOIANIA	13756370	ATLANTICO S1	13/11/2020 08:21	13/11/2020 11:56	13/11/2020 08:21	13/11/2020 11:56	3,58	1	3,58	CHI
20201155909	PADRE BERNARDO	PB12214844	PADRE BERNARDO	13/11/2020 08:21	13/11/2020 14:31	13/11/2020 08:21	13/11/2020 14:31	6,16	1	6,16	CHI
20201156682	PALMEIRAS DE GOIAS	PL12021690	PALMEIRAS	13/11/2020 08:21	13/11/2020 11:10	13/11/2020 08:21	13/11/2020 11:10	2,81	9	25,29	CHI
20201155920	APARECIDAS DE GOIANIA	10018885908	INDEPENDENCIA S2	13/11/2020 08:22	13/11/2020 09:31	13/11/2020 08:22	13/11/2020 09:31	1,14	1	1,14	CHI
20201155922	GOIANIA	17033275	MEIA PONTE	13/11/2020 08:23	13/11/2020 10:56	13/11/2020 08:23	13/11/2020 10:56	2,54	1	2,54	CHI
20201155924	SAO JOAO D ALIANCA	JL11321172	SAO JOAO D ALIANCA	13/11/2020 08:24	13/11/2020 12:33	13/11/2020 08:24	13/11/2020 12:33	4,15	1	4,15	CHI
20201155927	ALEXANIA	AX21094491	ALEXANIA	13/11/2020 08:24	13/11/2020 12:09	13/11/2020 08:24	13/11/2020 12:09	3,74	2	7,48	CHI
20201155930	NIQUELANDIA	NQ12374779	URUACU	13/11/2020 08:24	15/11/2020 10:23	13/11/2020 08:24	15/11/2020 10:23	49,98	20	999,67	CHI
20201155930	NIQUELANDIA	NQ12374779	URUACU	13/11/2020 08:24	15/11/2020 10:23	13/11/2020 17:01	15/11/2020 10:23	41,37	9	372,33	CHI
20201155931	FORMOSA	FA21071407	ITUIQUIRA	13/11/2020 08:25	13/11/2020 09:40	13/11/2020 08:25	13/11/2020 09:40	1,25	1	1,25	CHI
20201155944	MINACU	IH12205585	MINACU	13/11/2020 08:27	16/11/2020 15:43	13/11/2020 08:27	16/11/2020 15:43	79,27	5	396,35	CHI
20201155951	ANAPOLIS	AN11274974	JUNDIAI S1	13/11/2020 08:27	13/11/2020 11:24	13/11/2020 08:27	13/11/2020 11:24	2,93	57	167,25	CHI
20201156611	RUBIATABA	RB12060958	RUBIATABA	13/11/2020 08:27	13/11/2020 12:55	13/11/2020 08:27	13/11/2020 12:55	4,45	8	35,63	CHI
20201156912	ANAPOLIS	AN11247607	JUNDIAI S1	13/11/2020 08:27	13/11/2020 14:19	13/11/2020 08:27	13/11/2020 14:19	5,85	42	245,74	CHI
20201155958	ITABERAÍ	IB21274433	ITABERAÍ S2	13/11/2020 08:28	13/11/2020 10:36	13/11/2020 08:28	13/11/2020 10:36	2,12	1	2,12	CHI
20201155961	ABADIA DE GOIAS	AO12007309	INDEPENDENCIA S2	13/11/2020 08:29	13/11/2020 13:14	13/11/2020 08:29	13/11/2020 13:14	4,75	40	189,99	CHI
20201155967	JANDAIA	JD12377185	PALMEIRAS	13/11/2020 08:29	14/11/2020 08:03	13/11/2020 08:29	14/11/2020 08:03	23,55	5	117,76	CHI
20201155971	NOVO GAMA	LZ21067378	PACAEMBU S2	13/11/2020 08:30	13/11/2020 10:28	13/11/2020 08:30	13/11/2020 10:28	1,95	2	3,90	CHI
20201156297	VILA PROPICIO	PV12073537	GOIANESIA S1	13/11/2020 08:30	13/11/2020 15:57	13/11/2020 08:30	13/11/2020 15:57	7,44	2	14,89	CHI
20201156279	SANTA ROSA DE GOIAS	SR12078941	INHUMAS S1	13/11/2020 08:31	13/11/2020 10:14	13/11/2020 08:31	13/11/2020 10:14	1,71	14	23,98	CHI
20201155981	LUZIANIA	120209925	RIO VERMELHO	13/11/2020 08:32	13/11/2020 10:37	13/11/2020 08:32	13/11/2020 10:37	2,08	1	2,08	CHI
20201155984	SAO MIGUEL DO ARAGUAIA	SM21300971	SAO MIGUEL DO ARAGUAIA	13/11/2020 08:32	13/11/2020 11:50	13/11/2020 08:32	13/11/2020 11:50	3,29	1	3,29	CHI
20201161834	PORANGATU	PO12189564	PORANGATU	13/11/2020 08:32	14/11/2020 13:33	13/11/2020 08:32	14/11/2020 13:33	29,01	2	58,01	CHI
20201155990	DOVERLANDIA	DV11204216	CAIAPONIA	13/11/2020 08:33	13/11/2020 15:02	13/11/2020 08:33	13/11/2020 15:02	6,48	1	6,48	CHI
20201155997	IACIARA	IA12160053	IACIARA S1	13/11/2020 08:33	13/11/2020 12:06	13/11/2020 08:33	13/11/2020 12:06	3,54	2	7,08	CHI
20201155998	CATALAO	1990206478	CATALAO S2	13/11/2020 08:33	13/11/2020 11:24	13/11/2020 08:33	13/11/2020 11:24	2,84	1	2,84	CHI
20201156001	GOIAS	GS12061617	ITABERAÍ S1	13/11/2020 08:33	13/11/2020 12:05	13/11/2020 08:33	13/11/2020 12:05	3,52	10	35,17	CHI
20201154218	RIO VERDE	RV12296154LD	SANTA HELENA S1	13/11/2020 08:34	13/11/2020 13:17	13/11/2020 08:34	13/11/2020 13:17	4,72	63	297,46	CHI
20201154218	SANTA HELENA DE GOIAS	RV12296154LD	SANTA HELENA S1	13/11/2020 08:34	13/11/2020 13:17	13/11/2020 08:34	13/11/2020 13:17	4,72	1	4,72	CHI
20201154218	RIO VERDE	RV12296155	SANTA HELENA S1	13/11/2020 08:34	13/11/2020 13:17	13/11/2020 13:00	13/11/2020 13:17	0,29	7	2,01	CHI
20201156014	PIRANHAS	PH11356631	PIRANHAS	13/11/2020 08:35	13/11/2020 10:38	13/11/2020 08:35	13/11/2020 10:38	2,04	1	2,04	CHI

20201156530	SERRANOPOLIS	SX12260467	JATAI S1	13/11/2020 08:35	13/11/2020 11:46	13/11/2020 08:35	13/11/2020 11:46	3,18	8	25,44	CHI
20201156018	ANAPOLIS	20214182	ANAPOLIS UNIVERSITARIO S2	13/11/2020 08:36	13/11/2020 11:14	13/11/2020 08:36	13/11/2020 11:14	2,63	1	2,63	CHI
20201156948	CACU	CC12191705	CACHOEIRA ALTA	13/11/2020 08:36	13/11/2020 11:55	13/11/2020 08:36	13/11/2020 11:55	3,30	47	155,23	CHI
20201156041	PIRENOPOLIS	PV12316020	CORUMBA	13/11/2020 08:37	13/11/2020 18:50	13/11/2020 08:37	13/11/2020 18:50	10,21	14	142,93	CHI
20201156189	TRINDADE	40007741	TRINDADE	13/11/2020 08:37	13/11/2020 11:33	13/11/2020 08:37	13/11/2020 11:33	2,93	1	2,93	CHI
20201156058	COCALZINHO DE GOIAS	ZN12345237	COCALZINHO	13/11/2020 08:38	13/11/2020 11:58	13/11/2020 08:38	13/11/2020 11:58	3,33	3	9,99	CHI
20201156062	ACREUNA	2440017663	ACREUNA	13/11/2020 08:38	13/11/2020 12:27	13/11/2020 08:38	13/11/2020 12:27	3,81	1	3,81	CHI
20201156078	RIO VERDE	RV21200706	CACHOEIRA ALTA	13/11/2020 08:39	13/11/2020 09:46	13/11/2020 08:39	13/11/2020 09:46	1,11	2	2,23	CHI
20201156084	GOIANAPOLIS	GP21353516	DAIA S2	13/11/2020 08:40	13/11/2020 10:38	13/11/2020 08:40	13/11/2020 10:38	1,96	1	1,96	CHI
20201156085	GUARAITA	GK21289051	ITAPURANGA	13/11/2020 08:40	13/11/2020 12:26	13/11/2020 08:40	13/11/2020 12:26	3,76	1	3,76	CHI
20201156089	APARECIDA DE GOIANIA	10014363761	INDEPENDENCIA S2	13/11/2020 08:40	13/11/2020 09:52	13/11/2020 08:40	13/11/2020 09:52	1,19	1	1,19	CHI
20201156091	BURITI ALEGRE	BG11143982	ITUMBIARA VELHA S2	13/11/2020 08:40	13/11/2020 22:44	13/11/2020 08:40	13/11/2020 22:44	14,06	40	562,22	CHI
20201156093	ITAPURANGA	IK12311030	ITAPURANGA	13/11/2020 08:40	13/11/2020 13:40	13/11/2020 08:40	13/11/2020 13:40	4,99	2	9,97	CHI
20201156095	LEOPOLDO DE BULHOES	LB21425864	DAIA S2	13/11/2020 08:41	13/11/2020 11:36	13/11/2020 08:41	13/11/2020 11:36	2,91	2	5,82	CHI
20201156098	BRAZABRANTES	BR21129672	INHUMAS S1	13/11/2020 08:41	13/11/2020 09:49	13/11/2020 08:41	13/11/2020 09:49	1,12	1	1,12	CHI
20201156099	ITABERAI	AV21193596	ANICUNS	13/11/2020 08:41	13/11/2020 12:02	13/11/2020 08:41	13/11/2020 12:02	3,34	1	3,34	CHI
20201156110	ITUMBIARA	BG12263567	ITUMBIARA VELHA S2	13/11/2020 08:42	13/11/2020 13:09	13/11/2020 08:42	13/11/2020 13:09	4,44	2	8,89	CHI
20201156113	QUIRINOPOLIS	QI12370080	QUIRINOPOLIS	13/11/2020 08:42	13/11/2020 11:26	13/11/2020 08:42	13/11/2020 11:26	2,72	3	8,16	CHI
20201156294	ANAPOLIS	AN12381272	ANAPOLIS UNIVERSITARIO S2	13/11/2020 08:42	13/11/2020 17:27	13/11/2020 08:42	13/11/2020 17:27	8,75	12	104,99	CHI
20201156431	DOVERLANDIA	DV12395475	CAIAPONIA	13/11/2020 08:42	13/11/2020 10:49	13/11/2020 08:42	13/11/2020 10:49	2,11	11	23,18	CHI
20201156131	TRINDADE	TR21119159	TRINDADE	13/11/2020 08:43	13/11/2020 11:52	13/11/2020 08:43	13/11/2020 11:52	3,13	1	3,13	CHI
20201156138	FORMOSA	610240201	ITUIQUIRA	13/11/2020 08:44	13/11/2020 09:05	13/11/2020 08:44	13/11/2020 09:05	0,35	1	0,35	CHI
20201156149	NEROPOLIS	BW12100382	NEROPOLIS S1	13/11/2020 08:44	13/11/2020 15:31	13/11/2020 08:44	13/11/2020 15:31	6,77	17	115,14	CHI
20201156149	SANTO ANTONIO DE GOIAS	BW12100382	NEROPOLIS S1	13/11/2020 08:44	13/11/2020 15:31	13/11/2020 08:44	13/11/2020 15:31	6,77	30	203,18	CHI
20201156160	NOVA AURORA	NE21311815	CATALAO S1	13/11/2020 08:45	13/11/2020 11:24	13/11/2020 08:45	13/11/2020 11:24	2,65	1	2,65	CHI
20201156163	JATAI	JT12115871	JATAI S1	13/11/2020 08:45	13/11/2020 10:11	13/11/2020 08:45	13/11/2020 10:11	1,42	7	9,96	CHI
20201156168	APARECIDA DE GOIANIA	11280773	REAL S2	13/11/2020 08:46	13/11/2020 10:13	13/11/2020 08:46	13/11/2020 10:13	1,45	1	1,45	CHI
20201156171	CAMPOS BELOS	MA12209854	SAO DOMINGOS	13/11/2020 08:46	13/11/2020 10:40	13/11/2020 08:46	13/11/2020 10:40	1,90	4	7,59	CHI
20201156171	MONTE ALEGRE DE GOIAS	MA12209854	SAO DOMINGOS	13/11/2020 08:46	13/11/2020 10:40	13/11/2020 08:46	13/11/2020 10:40	1,90	18	34,15	CHI
20201156178	CIDADE OCIDENTAL	2680012519	MARAJOARA	13/11/2020 08:46	13/11/2020 12:53	13/11/2020 08:46	13/11/2020 12:53	4,10	1	4,10	CHI
20201156193	GOIANIA	11366564	ATLANTICO S2	13/11/2020 08:47	13/11/2020 10:40	13/11/2020 08:47	13/11/2020 10:40	1,87	1	1,87	CHI
20201156195	MAURILANDIA	ML31028050	RIO DOS BOIS	13/11/2020 08:47	13/11/2020 10:34	13/11/2020 08:47	13/11/2020 10:34	1,77	1	1,77	CHI
20201156203	SANTA TEREZA DE GOIAS	SE12253996	MARA ROSA	13/11/2020 08:48	13/11/2020 19:26	13/11/2020 08:48	13/11/2020 19:26	10,62	2	21,24	CHI
20201156205	CATALAO	1990069943	CATALAO S2	13/11/2020 08:48	13/11/2020 12:18	13/11/2020 08:48	13/11/2020 12:18	3,48	1	3,48	CHI
20201156207	SILVANIA	10010949362	VIANOPOLIS	13/11/2020 08:49	13/11/2020 10:16	13/11/2020 08:49	13/11/2020 10:16	1,45	1	1,45	CHI
20201156213	BOM JARDIM DE GOIAS	BM21136783	BOM JARDIM	13/11/2020 08:49	13/11/2020 09:56	13/11/2020 08:49	13/11/2020 09:56	1,10	1	1,10	CHI
20201156215	SAO MIGUEL DO ARAGUAIA	SM21141775	SAO MIGUEL DO ARAGUAIA	13/11/2020 08:50	13/11/2020 10:38	13/11/2020 08:50	13/11/2020 10:38	1,79	1	1,79	CHI
20201156219	GOIANIA	GN11001992	GOIANIA LESTE S1	13/11/2020 08:50	13/11/2020 12:25	13/11/2020 11:50	13/11/2020 12:25	0,58	80	46,67	CHI
20201156220	INDIARA	27100168352	EDEIA	13/11/2020 08:50	13/11/2020 13:00	13/11/2020 08:50	13/11/2020 13:00	4,16	1	4,16	CHI
20201156223	SANTA RITA DO NOVO DESTINO	BA21140672	BARRO ALTO	13/11/2020 08:51	13/11/2020 19:53	13/11/2020 08:51	13/11/2020 19:53	11,03	1	11,03	CHI
20201156226	ITAPURANGA	IK21299526	ITAPURANGA	13/11/2020 08:51	13/11/2020 21:47	13/11/2020 08:51	13/11/2020 21:47	12,93	1	12,93	CHI
20201156228	PIRACANJUBA	PJ21120803	PIRACANJUBA	13/11/2020 08:51	13/11/2020 11:15	13/11/2020 08:51	13/11/2020 11:15	2,39	1	2,39	CHI
20201156229	COCALZINHO DE GOIAS	10008535815	AGUAS LINDAS DE GOIAS S2	13/11/2020 08:51	13/11/2020 10:02	13/11/2020 08:51	13/11/2020 10:02	1,17	1	1,17	CHI
20201156231	ITABERAI	IB21353040	ITABERAI S1	13/11/2020 08:52	13/11/2020 10:48	13/11/2020 08:52	13/11/2020 10:48	1,93	1	1,93	CHI
20201156233	APARECIDA DE GOIANIA	10029812451	REAL S1	13/11/2020 08:52	13/11/2020 10:12	13/11/2020 08:52	13/11/2020 10:12	1,34	1	1,34	CHI
20201156235	PLANALTINA	PI12320492	PLANALTINA	13/11/2020 08:52	13/11/2020 11:24	13/11/2020 08:52	13/11/2020 11:24	2,53	1	2,53	CHI
20201156238	SANTO ANTONIO DE GOIAS	GR12002131	NEROPOLIS S1	13/11/2020 08:52	13/11/2020 15:31	13/11/2020 08:52	13/11/2020 15:31	6,64	1	6,64	CHI
20201156248	INHUMAS	IN21000179	ARACU	13/11/2020 08:54	13/11/2020 11:02	13/11/2020 08:54	13/11/2020 11:02	2,12	1	2,12	CHI
20201156250	QUIRINOPOLIS	QI12303196	RIO DOS BOIS	13/11/2020 08:54	13/11/2020 12:36	13/11/2020 08:54	13/11/2020 12:36	3,68	5	18,42	CHI
20201156862	AMARALINA	LC12230319	NOVA CRIXAS	13/11/2020 08:54	14/11/2020 14:20	13/11/2020 08:54	14/11/2020 14:20	29,42	3	88,27	CHI
20201156251	LEOPOLDO DE BULHOES	LB21324183	DAIA S2	13/11/2020 08:55	13/11/2020 17:04	13/11/2020 08:55	13/11/2020 17:04	8,15	3	24,44	CHI

20201156257	RIO VERDE	630100445	CABRIUVA S1	13/11/2020 08:55	13/11/2020 11:44	13/11/2020 08:55	13/11/2020 11:44	2,81	1	2,81	CHI
20201156391	CACHOEIRA ALTA	CA12040332	CACHOEIRA ALTA	13/11/2020 08:55	13/11/2020 09:57	13/11/2020 08:55	13/11/2020 09:57	1,03	11	11,28	CHI
20201156577	CALDAS NOVAS	IP12195206	IPAMERI	13/11/2020 08:55	13/11/2020 12:18	13/11/2020 08:55	13/11/2020 12:18	3,38	3	10,14	CHI
20201156577	IPAMERI	IP12195206	IPAMERI	13/11/2020 08:55	13/11/2020 12:18	13/11/2020 08:55	13/11/2020 12:18	3,38	13	43,95	CHI
20201158834	FORMOSO	FO12200415RE	MARA ROSA	13/11/2020 08:58	13/11/2020 22:03	13/11/2020 08:58	13/11/2020 22:03	13,07	17	222,18	CHI
20201156282	NIQUELANDIA	NQ12280978	URUACU	13/11/2020 09:00	13/11/2020 14:43	13/11/2020 09:00	13/11/2020 14:43	5,71	90	513,93	CHI
20201156283	PIRENOPOLIS	PV21287798	CORUMBA	13/11/2020 09:00	13/11/2020 15:44	13/11/2020 09:00	13/11/2020 15:44	6,72	1	6,72	CHI
20201156286	DOVERLANDIA	DV21303690	PARQUE DAS EMAS	13/11/2020 09:00	13/11/2020 18:21	13/11/2020 09:00	13/11/2020 18:21	9,34	1	9,34	CHI
20201156292	LUZIANIA	LZ21261377	RIO VERMELHO	13/11/2020 09:01	13/11/2020 11:56	13/11/2020 09:01	13/11/2020 11:56	2,91	2	5,82	CHI
20201156296	RIO VERDE	630252890	RIO VERDE S2	13/11/2020 09:01	13/11/2020 12:45	13/11/2020 09:01	13/11/2020 12:45	3,72	1	3,72	CHI
20201156299	MINEIROS	10031968706	PARQUE DAS EMAS	13/11/2020 09:01	13/11/2020 16:32	13/11/2020 09:01	13/11/2020 16:32	7,51	1	7,51	CHI
20201156302	CRISTALINA	KR11170188	CRISTALINA S1	13/11/2020 09:02	13/11/2020 10:02	13/11/2020 09:02	13/11/2020 10:02	1,00	20	19,91	CHI
20201156327	JUSSARA	JR12204874	BRITANIA	13/11/2020 09:02	13/11/2020 13:24	13/11/2020 09:02	13/11/2020 13:24	4,36	3	13,08	CHI
20201156331	PALESTINA DE GOIAS	PY12358571	PALESTINA	13/11/2020 09:02	13/11/2020 11:08	13/11/2020 09:02	13/11/2020 11:08	2,08	2	4,17	CHI
20201156335	PIRES DO RIO	460054200	PIRES DO RIO S1	13/11/2020 09:03	13/11/2020 14:56	13/11/2020 09:03	13/11/2020 14:56	5,88	1	5,88	CHI
20201156340	GOIANESIA	GE12213695	GOIANESIA S1	13/11/2020 09:04	13/11/2020 13:52	13/11/2020 09:04	13/11/2020 13:52	4,80	5	24,00	CHI
20201156346	JANDIAIA	JD21307051	PALMEIRAS	13/11/2020 09:05	13/11/2020 16:50	13/11/2020 09:05	13/11/2020 16:50	7,74	1	7,74	CHI
20201156349	SERRANOPOLIS	SX12267584	JATAI S1	13/11/2020 09:05	13/11/2020 09:26	13/11/2020 09:05	13/11/2020 09:26	0,35	1	0,35	CHI
20201156363	GOIANIA	10297170	CAMPINAS S2	13/11/2020 09:08	13/11/2020 12:22	13/11/2020 09:08	13/11/2020 12:22	3,23	1	3,23	CHI
20201156367	LEOPOLDO DE BULHOES	LB21353667	DAIA S2	13/11/2020 09:08	13/11/2020 12:51	13/11/2020 09:08	13/11/2020 12:51	3,70	9	33,32	CHI
20201158580	GOIANESIA	GE10400378	GOIANESIA S1	13/11/2020 09:08	13/11/2020 23:20	13/11/2020 23:16	13/11/2020 23:20	0,07	5	0,37	CHI
20201156374	CATALAO	1990226118	CATALAO S2	13/11/2020 09:09	13/11/2020 10:15	13/11/2020 09:09	13/11/2020 10:15	1,09	1	1,09	CHI
20201156376	GOIANIA	10635397	AEROPORTO S2	13/11/2020 09:09	13/11/2020 11:18	13/11/2020 09:09	13/11/2020 11:18	2,14	1	2,14	CHI
20201156377	SANTA HELENA DE GOIAS	SH21295842	IPEGUARI	13/11/2020 09:09	13/11/2020 13:02	13/11/2020 09:09	13/11/2020 13:02	3,88	1	3,88	CHI
20201156383	VARJAO	GA31054279	GUAPO S2	13/11/2020 09:10	13/11/2020 12:00	13/11/2020 09:10	13/11/2020 12:00	2,83	1	2,83	CHI
20201156388	GOIANIA	10024723531	CAMPINAS S3	13/11/2020 09:11	13/11/2020 12:10	13/11/2020 09:11	13/11/2020 12:10	2,97	1	2,97	CHI
20201156389	PONTALINA	210006365	PONTALINA	13/11/2020 09:12	13/11/2020 10:52	13/11/2020 09:12	13/11/2020 10:52	1,67	1	1,67	CHI
20201156394	GOIATUBA	GT21230730	GOIATUBA S2	13/11/2020 09:12	13/11/2020 11:02	13/11/2020 09:12	13/11/2020 11:02	1,83	2	3,65	CHI
20201156397	GOIAS	IB12404553	ITABERAI S1	13/11/2020 09:12	13/11/2020 16:14	13/11/2020 09:12	13/11/2020 16:14	7,02	5	35,11	CHI
20201156404	SANTA ISABEL	GE21205721	GOIANESIA S1	13/11/2020 09:14	13/11/2020 19:23	13/11/2020 09:14	13/11/2020 19:23	10,15	1	10,15	CHI
20201156406	ARAGOIANIA	AO12352047	GUAPO S2	13/11/2020 09:14	13/11/2020 12:14	13/11/2020 09:14	13/11/2020 12:14	2,99	114	341,02	CHI
20201156410	ANAPOLIS	20368367	JUNDIAI S1	13/11/2020 09:15	13/11/2020 12:12	13/11/2020 09:15	13/11/2020 12:12	2,95	1	2,95	CHI
20201156420	CORUMBA DE GOIAS	CB12377442	CORUMBA	13/11/2020 09:16	13/11/2020 13:27	13/11/2020 09:16	13/11/2020 13:27	4,17	8	33,37	CHI
20201156424	BARRO ALTO	BA12063573	GOIANESIA S1	13/11/2020 09:17	13/11/2020 18:12	13/11/2020 09:17	13/11/2020 18:12	8,92	1	8,92	CHI
20201156425	SAO JOAO DA PARAUNA	RP12391404	FIRMINOPOLIS S2	13/11/2020 09:17	13/11/2020 18:00	13/11/2020 09:17	13/11/2020 18:00	8,72	5	43,58	CHI
20201156432	CAMPOS VERDES	10002935730	SANTA TEREZINHA	13/11/2020 09:18	13/11/2020 11:31	13/11/2020 09:18	13/11/2020 11:31	2,21	1	2,21	CHI
20201156434	CIDADE OCIDENTAL	2680059883	MARAJOARA	13/11/2020 09:18	13/11/2020 10:51	13/11/2020 09:18	13/11/2020 10:51	1,54	1	1,54	CHI
20201156435	GOIANIA	11226500	CARAJAS S2	13/11/2020 09:18	13/11/2020 13:09	13/11/2020 09:18	13/11/2020 13:09	3,83	1	3,83	CHI
20201156436	MINEIROS	PW21206292	PARQUE DAS EMAS	13/11/2020 09:19	14/11/2020 13:49	13/11/2020 09:19	13/11/2020 17:34	8,25	1	8,25	CHI
20201156436	MINEIROS	MY13000248	PARQUE DAS EMAS	13/11/2020 09:19	14/11/2020 13:49	13/11/2020 17:34	13/11/2020 20:50	3,28	52	170,62	CHI
20201156436	MINEIROS	MY13000268	PARQUE DAS EMAS	13/11/2020 09:19	14/11/2020 13:49	13/11/2020 17:34	14/11/2020 13:49	20,25	14	283,54	CHI
20201156436	PORTELANDIA	MY13000268	PARQUE DAS EMAS	13/11/2020 09:19	14/11/2020 13:49	13/11/2020 17:34	14/11/2020 13:49	20,25	47	951,89	CHI
20201156436	PORTELANDIA	MY13000268	PARQUE DAS EMAS	13/11/2020 09:19	14/11/2020 13:49	13/11/2020 18:16	14/11/2020 13:49	19,55	2	39,10	CHI
20201156440	PALMEIRAS DE GOIAS	PL12393659	FIRMINOPOLIS S2	13/11/2020 09:19	13/11/2020 11:31	13/11/2020 09:19	13/11/2020 11:31	2,19	1	2,19	CHI
20201156441	TURVELANDIA	TD12303734	RIO DOS BOIS	13/11/2020 09:19	13/11/2020 12:45	13/11/2020 09:19	13/11/2020 12:45	3,42	2	6,84	CHI
20201156636	CAIAPONIA	CP12160772	MONTIVIDIU T	13/11/2020 09:19	13/11/2020 14:04	13/11/2020 09:19	13/11/2020 14:04	4,74	12	56,92	CHI
20201156636	JATAI	CP12160772	MONTIVIDIU T	13/11/2020 09:19	13/11/2020 14:04	13/11/2020 09:19	13/11/2020 14:04	4,74	6	28,46	CHI
20201156636	RIO VERDE	CP12160772	MONTIVIDIU T	13/11/2020 09:19	13/11/2020 14:04	13/11/2020 09:19	13/11/2020 14:04	4,74	11	52,18	CHI
20201156457	SAO MIGUEL DO PASSA QUATRO	SQ21088118	CRISTIANOPOLIS	13/11/2020 09:21	13/11/2020 11:59	13/11/2020 09:21	13/11/2020 11:59	2,62	1	2,62	CHI
20201156463	GOIANIA	10966134	CAMPINAS S3	13/11/2020 09:22	13/11/2020 11:58	13/11/2020 09:22	13/11/2020 11:58	2,59	1	2,59	CHI
20201156466	GOIAS	GS11162384	MATRINCHA	13/11/2020 09:23	13/11/2020 17:15	13/11/2020 09:23	13/11/2020 17:15	7,87	2	15,73	CHI

20201156469	SERRANOPOLIS	JT21172835	JATAI S1	13/11/2020 09:23	13/11/2020 10:23	13/11/2020 09:23	13/11/2020 10:23	0,99	1	0,99	CHI
20201158414	CRIXAS	CX12252919	RUBIATABA	13/11/2020 09:25	15/11/2020 12:18	13/11/2020 09:25	15/11/2020 12:18	50,87	6	305,22	CHI
20201158234	JARAGUA	JA12221349	JARAGUA	13/11/2020 09:27	13/11/2020 20:01	13/11/2020 09:27	13/11/2020 20:01	10,56	6	63,34	CHI
20201156512	LEOPOLDO DE BULHOES	LB12350491	DAIA S2	13/11/2020 09:29	13/11/2020 17:22	13/11/2020 09:29	13/11/2020 17:22	7,87	4	31,49	CHI
20201156515	ANAPOLIS	AN21001124	ANAPOLIS UNIVERSITARIO S1	13/11/2020 09:30	13/11/2020 13:08	13/11/2020 09:30	13/11/2020 13:08	3,63	1	3,63	CHI
20201156516	VICENTINOPOLIS	VI21166495	VICENTINOPOLIS	13/11/2020 09:30	13/11/2020 11:28	13/11/2020 09:30	13/11/2020 11:28	1,96	2	3,93	CHI
20201156517	MAIRIPOTABA	10001836712	PONTALINA	13/11/2020 09:30	13/11/2020 17:36	13/11/2020 09:30	13/11/2020 17:36	8,09	1	8,09	CHI
20201156521	SAO SIMAO	SO11129691	CACHOEIRA ALTA	13/11/2020 09:30	13/11/2020 12:46	13/11/2020 09:30	13/11/2020 12:46	3,25	157	511,03	CHI
20201156523	GOIANESIA	550197102	GOIANESIA S2	13/11/2020 09:30	13/11/2020 17:15	13/11/2020 09:30	13/11/2020 17:15	7,74	1	7,74	CHI
20201156531	BOM JESUS DE GOIAS	BJ21062911	BOM JESUS DE GOIAS	13/11/2020 09:32	13/11/2020 12:14	13/11/2020 09:32	13/11/2020 12:14	2,70	1	2,70	CHI
20201156546	SANTA BARBARA DE GOIAS	SB21248903	TRINDADE	13/11/2020 09:33	13/11/2020 11:36	13/11/2020 09:33	13/11/2020 11:36	2,04	2	4,08	CHI
20201156551	ANICUNS	AC21023397	ANICUNS	13/11/2020 09:34	13/11/2020 11:32	13/11/2020 09:34	13/11/2020 11:32	1,96	3	5,88	CHI
20201156557	POSSE	PS21160038	IACIARA S2	13/11/2020 09:35	13/11/2020 14:19	13/11/2020 09:35	13/11/2020 14:19	4,72	1	4,72	CHI
20201156564	GOIANESIA	550036222	GOIANESIA S2	13/11/2020 09:38	13/11/2020 13:38	13/11/2020 09:38	13/11/2020 13:38	4,00	1	4,00	CHI
20201156565	NEROPOLIS	10018971529	NEROPOLIS S2	13/11/2020 09:38	13/11/2020 11:54	13/11/2020 09:38	13/11/2020 11:54	2,27	1	2,27	CHI
20201156571	GOIATUBA	BJ12091327	RIO DOS BOIS	13/11/2020 09:38	13/11/2020 13:38	13/11/2020 09:38	13/11/2020 13:38	3,99	1	3,99	CHI
20201156581	CACU	CC21125815	CACHOEIRA ALTA	13/11/2020 09:40	13/11/2020 14:37	13/11/2020 09:40	13/11/2020 14:37	4,94	1	4,94	CHI
20201156582	VIANOPOLIS	VN21127034	VIANOPOLIS	13/11/2020 09:40	13/11/2020 11:31	13/11/2020 09:40	13/11/2020 11:31	1,84	2	3,67	CHI
20201156585	MINEIROS	MY21332664	PARQUE DAS EMAS	13/11/2020 09:40	13/11/2020 19:21	13/11/2020 09:40	13/11/2020 19:21	9,67	1	9,67	CHI
20201156589	DIORAMA	DI21280714	IPORA	13/11/2020 09:41	13/11/2020 11:43	13/11/2020 09:41	13/11/2020 11:43	2,02	1	2,02	CHI
20201156604	NOVA AMERICA	NM21172915	RUBIATABA	13/11/2020 09:44	14/11/2020 10:30	13/11/2020 09:44	14/11/2020 10:30	24,76	1	24,76	CHI
20201157275	MUNDO NOVO DE GOIAS	MH12318486	NOVA CRIXAS	13/11/2020 09:44	13/11/2020 14:53	13/11/2020 09:44	13/11/2020 14:53	5,15	46	236,89	CHI
20201156608	CRIXAS	CX11398105	SERRA DO OURO	13/11/2020 09:45	13/11/2020 15:25	13/11/2020 09:45	13/11/2020 15:25	5,67	1	5,67	CHI
20201156609	BARRO ALTO	BA21161158	BARRO ALTO	13/11/2020 09:45	13/11/2020 17:19	13/11/2020 09:45	13/11/2020 17:19	7,57	2	15,13	CHI
20201156614	GOIANDIRA	2010018418	CATALAO S1	13/11/2020 09:45	13/11/2020 12:53	13/11/2020 09:45	13/11/2020 12:53	3,12	1	3,12	CHI
20201156616	SENADOR CANEDO	16653841	GOIANIA LESTE S1	13/11/2020 09:46	13/11/2020 11:11	13/11/2020 09:46	13/11/2020 11:11	1,41	1	1,41	CHI
20201156618	GOIANESIA	GE21107711	GOIANESIA S1	13/11/2020 09:46	13/11/2020 12:47	13/11/2020 09:46	13/11/2020 12:47	3,00	1	3,00	CHI
20201156620	GAMELEIRA DE GOIAS	GL12261184	ANAPOLIS UNIVERSITARIO S2	13/11/2020 09:46	13/11/2020 12:59	13/11/2020 09:46	13/11/2020 12:59	3,20	1	3,20	CHI
20201156625	CRISTALINA	KR16408333	CRISTALINA S2	13/11/2020 09:47	13/11/2020 16:06	13/11/2020 12:56	13/11/2020 16:06	3,15	87	274,34	CHI
20201156626	GOIATUBA	GT12000196	GOIATUBA S1	13/11/2020 09:48	13/11/2020 11:22	13/11/2020 09:48	13/11/2020 11:22	1,56	4	6,26	CHI
20201156627	RIO VERDE	RV21136196	RIO VERDE S1	13/11/2020 09:48	13/11/2020 12:20	13/11/2020 09:48	13/11/2020 12:20	2,53	1	2,53	CHI
20201156632	RIO VERDE	RV21239991	RIO VERDE S1	13/11/2020 09:49	13/11/2020 10:53	13/11/2020 09:49	13/11/2020 10:53	1,06	1	1,06	CHI
20201156640	APARECIDA DE GOIANIA	200130687	INDEPENDENCIA S2	13/11/2020 09:49	13/11/2020 12:39	13/11/2020 09:49	13/11/2020 12:39	2,82	1	2,82	CHI
20201156643	IACIARA	IA12262079	IACIARA S1	13/11/2020 09:50	13/11/2020 12:16	13/11/2020 09:50	13/11/2020 12:16	2,43	21	50,97	CHI
20201156644	RIO VERDE	630068264	RIO VERDE S1	13/11/2020 09:50	13/11/2020 12:23	13/11/2020 09:50	13/11/2020 12:23	2,54	1	2,54	CHI
20201154791	FAZENDA NOVA	JP12089836	IPORA	13/11/2020 09:51	14/11/2020 01:08	13/11/2020 09:51	13/11/2020 14:43	4,87	35	170,52	CHI
20201154791	FAZENDA NOVA	JP12089836	IPORA	13/11/2020 09:51	14/11/2020 01:08	13/11/2020 09:51	13/11/2020 20:26	10,58	63	666,66	CHI
20201154791	FAZENDA NOVA	JP12089836	IPORA	13/11/2020 09:51	14/11/2020 01:08	13/11/2020 09:51	14/11/2020 01:08	15,29	5	76,44	CHI
20201156648	CRISTALINA	KR21305288	CRISTALINA S1	13/11/2020 09:51	13/11/2020 10:38	13/11/2020 09:51	13/11/2020 10:38	0,78	1	0,78	CHI
20201158350	MINEIROS	MY11166061	PARQUE DAS EMAS	13/11/2020 09:51	13/11/2020 19:19	13/11/2020 09:51	13/11/2020 19:19	9,46	55	520,06	CHI
20201156656	MINEIROS	10014378963	PARQUE DAS EMAS	13/11/2020 09:52	13/11/2020 12:32	13/11/2020 09:52	13/11/2020 12:32	2,66	1	2,66	CHI
20201156668	VILA PROPICIO	NP11228729	GOIANESIA S1	13/11/2020 09:52	14/11/2020 13:34	13/11/2020 09:52	14/11/2020 13:34	27,69	1	27,69	CHI
20201156670	BARRO ALTO	BA21000016	BARRO ALTO	13/11/2020 09:53	13/11/2020 18:43	13/11/2020 09:53	13/11/2020 18:43	8,83	1	8,83	CHI
20201156672	NOVA AMERICA	NM21297111	RUBIATABA	13/11/2020 09:53	14/11/2020 10:53	13/11/2020 09:53	14/11/2020 10:53	24,99	1	24,99	CHI
20201156690	MINEIROS	1390088320	PARQUE DAS EMAS	13/11/2020 09:56	13/11/2020 12:14	13/11/2020 09:56	13/11/2020 12:14	2,30	1	2,30	CHI
20201156694	RIO VERDE	RV21190701	CABRIUVA S2	13/11/2020 09:56	13/11/2020 14:31	13/11/2020 09:56	13/11/2020 14:31	4,58	2	9,15	CHI
20201156695	AMORINOPOLIS	1240010877	IPORA	13/11/2020 09:56	13/11/2020 12:45	13/11/2020 09:56	13/11/2020 12:45	2,80	1	2,80	CHI
20201156696	PADRE BERNARDO	2760021586	PADRE BERNARDO	13/11/2020 09:56	13/11/2020 12:29	13/11/2020 09:56	13/11/2020 12:29	2,53	1	2,53	CHI
20201156697	PONTALINA	PK21293195	PONTALINA	13/11/2020 09:57	13/11/2020 11:25	13/11/2020 09:57	13/11/2020 11:25	1,47	1	1,47	CHI
20201156701	APARECIDA DE GOIANIA	16003676	INDEPENDENCIA S1	13/11/2020 09:57	13/11/2020 11:41	13/11/2020 09:57	13/11/2020 11:41	1,72	1	1,72	CHI
20201156702	SANTA HELENA DE GOIAS	SH10394752	IPEGUARI	13/11/2020 09:57	13/11/2020 17:19	13/11/2020 09:57	13/11/2020 17:19	7,36	11	80,93	CHI



20201156702	SANTA HELENA DE GOIAS	SH10394752	IPEGUARI	13/11/2020 09:57	13/11/2020 17:19	13/11/2020 17:13	13/11/2020 17:19	0,10	92	9,23	CHI
20201157614	ORIZONA	OZ12084921RE	PIRES DO RIO S2	13/11/2020 09:58	13/11/2020 16:40	13/11/2020 09:58	13/11/2020 16:40	6,70	108	723,45	CHI
20201157614	VIANOPOLIS	OZ12084921RE	PIRES DO RIO S2	13/11/2020 09:58	13/11/2020 16:40	13/11/2020 09:58	13/11/2020 16:40	6,70	17	113,88	CHI
20201156711	APARECIDA DE GOIANIA	AP11004875	REAL S1	13/11/2020 09:59	13/11/2020 17:44	13/11/2020 09:59	13/11/2020 17:44	7,75	130	1006,92	CHI
20201156715	PORANGATU	PO21136972	PORANGATU	13/11/2020 10:00	13/11/2020 12:15	13/11/2020 10:00	13/11/2020 12:15	2,24	1	2,24	CHI
20201156717	ALTO PARAISO DE GOIAS	BF21243125	NIQUELANDIA SUBTRANSMISSAO	13/11/2020 10:00	13/11/2020 18:09	13/11/2020 10:00	13/11/2020 18:09	8,13	1	8,13	CHI
20201156718	ACREUNA	EU21097083	ACREUNA	13/11/2020 10:00	13/11/2020 13:18	13/11/2020 10:00	13/11/2020 13:18	3,28	2	6,57	CHI
20201156721	VIANOPOLIS	VN21255630	VIANOPOLIS	13/11/2020 10:01	13/11/2020 12:30	13/11/2020 10:01	13/11/2020 12:30	2,48	1	2,48	CHI
20201156723	GOIANIA	15677618	ATLANTICO S1	13/11/2020 10:01	13/11/2020 10:59	13/11/2020 10:01	13/11/2020 10:59	0,96	1	0,96	CHI
20201156724	CACU	CC12235900	CACHOEIRA ALTA	13/11/2020 10:01	13/11/2020 15:36	13/11/2020 10:01	13/11/2020 15:36	5,57	1	5,57	CHI
20201156736	FAZENDA NOVA	FN12250853	FIRMINOPOLIS S2	13/11/2020 10:04	13/11/2020 13:15	13/11/2020 10:04	13/11/2020 13:15	3,17	4	12,67	CHI
20201156737	SAO MIGUEL DO ARAGUAIA	SM21020683	SAO MIGUEL DO ARAGUAIA	13/11/2020 10:04	14/11/2020 20:14	13/11/2020 10:04	14/11/2020 20:14	34,15	1	34,15	CHI
20201156739	CRISTALINA	KR21261275	CRISTALINA S2	13/11/2020 10:05	13/11/2020 12:26	13/11/2020 10:05	13/11/2020 12:26	2,35	1	2,35	CHI
20201156740	CRISTALINA	KR12331959	CRISTALINA S1	13/11/2020 10:05	13/11/2020 12:46	13/11/2020 10:05	13/11/2020 12:46	2,68	1	2,68	CHI
20201156741	ITAPIRAPUA	IU12250837	MATRINCHA	13/11/2020 10:05	13/11/2020 11:07	13/11/2020 10:05	13/11/2020 11:07	1,03	2	2,05	CHI
20201157315	ALEXANIA	AX12095965	ALEXANIA	13/11/2020 10:06	13/11/2020 12:59	13/11/2020 10:06	13/11/2020 12:59	2,88	4	11,53	CHI
20201156752	HEITORAI	HE1274497	ITAPURANGA	13/11/2020 10:07	14/11/2020 09:00	13/11/2020 10:07	14/11/2020 09:00	22,88	1	22,88	CHI
20201156758	RIO VERDE	RV21340822	RIO VERDE S1	13/11/2020 10:08	13/11/2020 10:51	13/11/2020 10:08	13/11/2020 10:51	0,71	1	0,71	CHI
20201156759	MORRINHOS	MR31232080	MORRINHOS	13/11/2020 10:08	13/11/2020 12:43	13/11/2020 10:08	13/11/2020 12:43	2,57	2	5,14	CHI
20201159805	BURITI ALEGRE	420028833	ITUMBIARA VELHA S2	13/11/2020 10:08	13/11/2020 23:08	13/11/2020 10:08	13/11/2020 23:08	13,00	1	13,00	CHI
20201156773	CUMARI	GD21237103	CATALAO S2	13/11/2020 10:11	13/11/2020 13:10	13/11/2020 10:11	13/11/2020 13:10	2,99	0	0,00	CHI
20201156777	GAMELEIRA DE GOIAS	SV12278872	DAIA S2	13/11/2020 10:11	13/11/2020 15:13	13/11/2020 10:11	13/11/2020 15:13	5,02	39	195,81	CHI
20201156794	MOIPORA	MO21073404	IPORA	13/11/2020 10:13	13/11/2020 15:24	13/11/2020 10:13	13/11/2020 15:24	5,17	1	5,17	CHI
20201156796	BURITI ALEGRE	BG12000162	ALTO BURITI	13/11/2020 10:13	13/11/2020 11:00	13/11/2020 10:13	13/11/2020 11:00	0,78	13	10,17	CHI
20201156796	ITUMBIARA	BG12000162	ALTO BURITI	13/11/2020 10:13	13/11/2020 11:00	13/11/2020 10:13	13/11/2020 11:00	0,78	10	7,82	CHI
20201157079	PALMEIRAS DE GOIAS	PL12143287	PALMEIRAS	13/11/2020 10:13	13/11/2020 21:52	13/11/2020 10:13	13/11/2020 21:52	11,64	38	442,49	CHI
20201156795	PADRE BERNARDO	PB21206624	PADRE BERNARDO	13/11/2020 10:14	13/11/2020 14:24	13/11/2020 10:14	13/11/2020 14:24	4,17	1	4,17	CHI
20201156798	FLORES DE GOIAS	FB12248200	FLORES DE GOIAS	13/11/2020 10:15	13/11/2020 13:07	13/11/2020 10:15	13/11/2020 13:07	2,86	1	2,86	CHI
20201156799	APARECIDA DE GOIANIA	14517139	REAL S1	13/11/2020 10:15	13/11/2020 12:08	13/11/2020 10:15	13/11/2020 12:08	1,88	1	1,88	CHI
20201156909	ANICUNS	AC12091322	ANICUNS	13/11/2020 10:16	13/11/2020 16:39	13/11/2020 10:16	13/11/2020 16:39	6,38	8	51,06	CHI
20201157811	SERRANOPOLIS	SX12166082	JATAI S1	13/11/2020 10:16	13/11/2020 18:22	13/11/2020 10:16	13/11/2020 18:22	8,08	19	153,59	CHI
20201156817	TERESINA DE GOIAS	TE11256156	FLORES DE GOIAS	13/11/2020 10:17	13/11/2020 12:56	13/11/2020 10:17	13/11/2020 12:56	2,64	2	5,29	CHI
20201156820	SENADOR CANEDO	190018045	SENADOR CANEDO	13/11/2020 10:17	13/11/2020 11:50	13/11/2020 10:17	13/11/2020 11:50	1,54	1	1,54	CHI
20201156824	QUIRINOPOLIS	QI21116468	QUIRINOPOLIS	13/11/2020 10:18	13/11/2020 11:56	13/11/2020 10:18	13/11/2020 11:56	1,62	1	1,62	CHI
20201156825	BARRO ALTO	BA21194300	BARRO ALTO	13/11/2020 10:19	13/11/2020 22:03	13/11/2020 10:19	13/11/2020 22:03	11,72	4	46,88	CHI
20201156876	CACHOEIRA DE GOIAS	CG12165601	FIRMINOPOLIS S2	13/11/2020 10:19	13/11/2020 11:47	13/11/2020 10:19	13/11/2020 11:47	1,45	3	4,36	CHI
20201156831	VIANOPOLIS	VN21102971	VIANOPOLIS	13/11/2020 10:21	13/11/2020 12:52	13/11/2020 10:21	13/11/2020 12:52	2,52	1	2,52	CHI
20201156842	RIO VERDE	630138126	RIO VERDE S1	13/11/2020 10:23	13/11/2020 11:12	13/11/2020 10:23	13/11/2020 11:12	0,81	1	0,81	CHI
20201156931	MINEIROS	MY12197173	PARQUE DAS EMAS	13/11/2020 10:24	13/11/2020 19:07	13/11/2020 10:24	13/11/2020 19:07	8,71	21	182,99	CHI
20201156850	SANTA HELENA DE GOIAS	SH21296124	IPEGUARI	13/11/2020 10:25	13/11/2020 20:59	13/11/2020 10:25	13/11/2020 20:59	10,55	3	31,66	CHI
20201156864	JARAGUA	JA21116896	JARAGUA	13/11/2020 10:26	13/11/2020 17:28	13/11/2020 10:26	13/11/2020 17:28	7,03	1	7,03	CHI
20201159219	MUTUNOPOLIS	SE12352924	MARA ROSA	13/11/2020 10:26	13/11/2020 18:31	13/11/2020 10:26	13/11/2020 18:31	8,07	6	48,44	CHI
20201159219	SANTA TEREZA DE GOIAS	SE12352924	MARA ROSA	13/11/2020 10:26	13/11/2020 18:31	13/11/2020 10:26	13/11/2020 18:31	8,07	1	8,07	CHI
20201156871	SAO MIGUEL DO ARAGUAIA	SM21135293	SAO MIGUEL DO ARAGUAIA	13/11/2020 10:27	13/11/2020 17:43	13/11/2020 10:27	13/11/2020 17:43	7,26	1	7,26	CHI
20201156872	MORRINHOS	10024846579	MORRINHOS	13/11/2020 10:27	13/11/2020 16:23	13/11/2020 10:27	13/11/2020 16:23	5,92	1	5,92	CHI
20201156873	LUZIANIA	LZ21092843	PAMPLONA	13/11/2020 10:27	13/11/2020 12:33	13/11/2020 10:27	13/11/2020 12:33	2,08	1	2,08	CHI
20201157529	PORANGATU	PO12020947	PORANGATU	13/11/2020 10:27	14/11/2020 04:20	13/11/2020 10:27	14/11/2020 04:20	17,88	44	786,77	CHI
20201156874	ANAPOLIS	20477922	JUNDIAI S1	13/11/2020 10:28	13/11/2020 16:03	13/11/2020 10:28	13/11/2020 16:03	5,58	1	5,58	CHI
20201156894	AGUAS LINDAS DE GOIAS	10010455653	AGUAS LINDAS DE GOIAS S1	13/11/2020 10:30	13/11/2020 11:23	13/11/2020 10:30	13/11/2020 11:23	0,88	0	0,00	CHI
20201157125	GOIAS	GS12237058	ITAPURANGA	13/11/2020 10:30	13/11/2020 16:41	13/11/2020 10:30	13/11/2020 16:41	6,17	2	12,35	CHI
20201156897	IVOLANDIA	10005065397	IPORA	13/11/2020 10:31	13/11/2020 13:00	13/11/2020 10:31	13/11/2020 13:00	2,48	1	2,48	CHI

20201156903	ITABERAÍ	IB12300301	ITABERAÍ S2	13/11/2020 10:32	13/11/2020 16:57	13/11/2020 10:32	13/11/2020 16:57	6,41	2	12,83	CHI
20201156907	SENADOR CANEDO	190139481	SENADOR CANEDO	13/11/2020 10:32	13/11/2020 11:54	13/11/2020 10:32	13/11/2020 11:54	1,35	1	1,35	CHI
20201156921	GOIANIA	GN11012183	ATLANTICO S2	13/11/2020 10:35	13/11/2020 16:28	13/11/2020 10:35	13/11/2020 16:28	5,87	124	728,40	CHI
20201156949	CRISTIANOPOLIS	CF12112079	CRISTIANOPOLIS	13/11/2020 10:36	13/11/2020 14:21	13/11/2020 10:36	13/11/2020 14:21	3,74	5	18,70	CHI
20201157094	BARRO ALTO	BA12185125	BARRO ALTO	13/11/2020 10:36	13/11/2020 18:28	13/11/2020 10:36	13/11/2020 18:28	7,86	40	314,33	CHI
20201156926	MONTIVÍDIU	MV21338526	MONTIVÍDIU T	13/11/2020 10:37	13/11/2020 13:38	13/11/2020 10:37	13/11/2020 13:38	3,02	1	3,02	CHI
20201157310	ARUANA	AK11015597	ARUANA	13/11/2020 10:37	13/11/2020 16:23	13/11/2020 10:37	13/11/2020 16:23	5,76	46	264,92	CHI
20201156936	CALDAS NOVAS	760342246	SERRA DE CALDAS	13/11/2020 10:38	13/11/2020 11:28	13/11/2020 10:38	13/11/2020 11:28	0,82	1	0,82	CHI
20201156940	MINACU	IH12202490	MINACU	13/11/2020 10:39	13/11/2020 17:13	13/11/2020 10:39	13/11/2020 17:13	6,55	3	19,65	CHI
20201156942	ITABERAÍ	IB21000141	ITABERAÍ S2	13/11/2020 10:40	13/11/2020 17:07	13/11/2020 10:40	13/11/2020 17:07	6,44	2	12,88	CHI
20201156952	GOIANESIA	550036313	GOIANESIA S2	13/11/2020 10:42	13/11/2020 12:22	13/11/2020 10:42	13/11/2020 12:22	1,66	1	1,66	CHI
20201156955	RIO QUENTE	RQ21312822	RIO QUENTE	13/11/2020 10:42	13/11/2020 15:19	13/11/2020 10:42	13/11/2020 15:19	4,61	1	4,61	CHI
20201156958	CACHOEIRA ALTA	1090011201	CACHOEIRA ALTA	13/11/2020 10:43	13/11/2020 12:06	13/11/2020 10:43	13/11/2020 12:06	1,38	1	1,38	CHI
20201162778	PORANGATU	PO12227072LD	PORANGATU	13/11/2020 10:43	14/11/2020 14:35	13/11/2020 10:43	14/11/2020 14:35	27,86	4	111,44	CHI
20201156961	CATALAO	CT21127664	CATALAO S1	13/11/2020 10:44	13/11/2020 16:13	13/11/2020 10:44	13/11/2020 16:13	5,48	1	5,48	CHI
20201156964	SANTA HELENA DE GOIAS	SH21296187	IPEGUARI	13/11/2020 10:44	13/11/2020 15:07	13/11/2020 10:44	13/11/2020 15:07	4,39	1	4,39	CHI
20201156966	ITAPURANGA	IK12325980	ITAPURANGA	13/11/2020 10:44	14/11/2020 14:38	13/11/2020 10:44	14/11/2020 14:38	27,90	2	55,80	CHI
20201156968	CAMPINORTE	MQ12220618	MARA ROSA	13/11/2020 10:45	13/11/2020 20:49	13/11/2020 10:45	13/11/2020 20:49	10,07	2	20,13	CHI
20201156968	MARA ROSA	MQ12220618	MARA ROSA	13/11/2020 10:45	13/11/2020 20:49	13/11/2020 10:45	13/11/2020 20:49	10,07	4	40,26	CHI
20201156971	ITAPACI	IW21267466	ITAPACI	13/11/2020 10:45	13/11/2020 14:49	13/11/2020 10:45	13/11/2020 14:49	4,05	1	4,05	CHI
20201157011	ALTO HORIZONTE	AJ12070402LD	SANTA TEREZINHA	13/11/2020 10:45	14/11/2020 19:35	13/11/2020 10:53	14/11/2020 19:35	32,70	46	1504,15	CHI
20201157011	CAMPOS VERDES	AJ12070402LD	SANTA TEREZINHA	13/11/2020 10:45	14/11/2020 19:35	13/11/2020 10:53	14/11/2020 19:35	32,70	3	98,10	CHI
20201157011	CAMPOS VERDES	AJ12070402LD	SANTA TEREZINHA	13/11/2020 10:45	14/11/2020 19:35	13/11/2020 10:53	14/11/2020 19:35	32,70	5	163,49	CHI
20201157011	PILAR DE GOIAS	AJ12070402LD	SANTA TEREZINHA	13/11/2020 10:45	14/11/2020 19:35	13/11/2020 10:53	14/11/2020 19:35	32,70	1	32,70	CHI
20201157743	CAMPOS VERDES	NH12396799	SANTA TEREZINHA	13/11/2020 10:45	14/11/2020 19:35	13/11/2020 10:53	14/11/2020 19:35	32,70	1	32,70	CHI
20201157743	ALTO HORIZONTE	NH12396799	SANTA TEREZINHA	13/11/2020 10:45	14/11/2020 19:35	13/11/2020 13:20	14/11/2020 19:35	30,24	11	332,69	CHI
20201156977	PIRENOPOLIS	PV21155080	CORUMBA	13/11/2020 10:47	13/11/2020 13:50	13/11/2020 10:47	13/11/2020 13:50	3,04	1	3,04	CHI
20201156979	MORRINHOS	MR21196330	GOIATUBA S1	13/11/2020 10:47	13/11/2020 16:26	13/11/2020 10:47	13/11/2020 16:26	5,64	1	5,64	CHI
20201157675	MINACU	IH12088797	MINACU	13/11/2020 10:47	13/11/2020 19:11	13/11/2020 10:47	13/11/2020 19:11	8,40	179	1503,05	CHI
20201156983	ANAPOLIS	10004219455	ANAPOLIS UNIVERSITARIO S2	13/11/2020 10:48	13/11/2020 12:07	13/11/2020 10:48	13/11/2020 12:07	1,31	1	1,31	CHI
20201156987	PADRE BERNARDO	PB11196355	PADRE BERNARDO	13/11/2020 10:48	13/11/2020 13:42	13/11/2020 10:48	13/11/2020 13:42	2,89	2	5,77	CHI
20201156996	CASTELANDIA	RV21028053	RIO DOS BOIS	13/11/2020 10:50	13/11/2020 18:27	13/11/2020 10:50	13/11/2020 18:27	7,61	1	7,61	CHI
20201157147	SANTA CRUZ DE GOIAS	BC12023183	CRISTIANOPOLIS	13/11/2020 10:52	13/11/2020 17:34	13/11/2020 10:52	13/11/2020 17:34	6,69	42	280,91	CHI
20201157008	CEZARINA	1650026290	CEZARINA	13/11/2020 10:54	13/11/2020 16:38	13/11/2020 10:54	13/11/2020 16:38	5,73	1	5,73	CHI
20201157422	INHUMAS	IN12066292	INHUMAS S2	13/11/2020 10:54	13/11/2020 14:45	13/11/2020 10:54	13/11/2020 14:45	3,84	10	38,36	CHI
20201157016	GOIANIA	10585928	ATLANTICO S2	13/11/2020 10:55	13/11/2020 15:00	13/11/2020 10:55	13/11/2020 15:00	4,07	1	4,07	CHI
20201157018	AGUAS LINDAS DE GOIAS	10002297335	AGUAS LINDAS DE GOIAS S1	13/11/2020 10:56	13/11/2020 12:57	13/11/2020 10:56	13/11/2020 12:57	2,02	1	2,02	CHI
20201157019	JATAI	JT11241648	JATAI S3	13/11/2020 10:56	13/11/2020 13:15	13/11/2020 10:56	13/11/2020 13:15	2,31	146	336,98	CHI
20201157020	MINEIROS	1390022599	PARQUE DAS EMAS	13/11/2020 10:56	13/11/2020 14:06	13/11/2020 10:56	13/11/2020 14:06	3,16	1	3,16	CHI
20201158085	ARUANA	AK12310723	BRITANIA	13/11/2020 10:57	13/11/2020 19:55	13/11/2020 10:57	13/11/2020 19:55	8,96	4	35,85	CHI
20201157040	CRISTALINA	KR12170316	PAMPLONA	13/11/2020 10:58	13/11/2020 17:14	13/11/2020 10:58	13/11/2020 17:14	6,26	1	6,26	CHI
20201157045	CHAPADAO DO CEU	9880002501	CHAPADAO DO CEU	13/11/2020 11:00	13/11/2020 14:24	13/11/2020 11:00	13/11/2020 14:24	3,40	1	3,40	CHI
20201157048	FORMOSA	FA21309101	ITUIQUIRA	13/11/2020 11:00	13/11/2020 12:59	13/11/2020 11:00	13/11/2020 12:59	1,98	1	1,98	CHI
20201157063	CACHOEIRA DOURADA	CD13000013	CACHOEIRA DOURADA	13/11/2020 11:00	13/11/2020 21:28	13/11/2020 11:00	13/11/2020 21:28	10,46	59	617,37	CHI
20201157063	ITUMBIARA	CD13000013	CACHOEIRA DOURADA	13/11/2020 11:00	13/11/2020 21:28	13/11/2020 11:00	13/11/2020 21:28	10,46	32	334,84	CHI
20201157063	CACHOEIRA DOURADA	CD13000013	CACHOEIRA DOURADA	13/11/2020 11:00	13/11/2020 21:28	13/11/2020 11:03	13/11/2020 21:28	10,41	35	364,46	CHI
20201157063	ITUMBIARA	CD13000013	CACHOEIRA DOURADA	13/11/2020 11:00	13/11/2020 21:28	13/11/2020 11:03	13/11/2020 21:28	10,41	6	62,48	CHI
20201157059	AURILANDIA	PU21008166	FIRMINOPOLIS S2	13/11/2020 11:01	13/11/2020 12:25	13/11/2020 11:01	13/11/2020 12:25	1,39	1	1,39	CHI
20201157210	PORANGATU	PO12390257	PORANGATU	13/11/2020 11:01	13/11/2020 16:28	13/11/2020 11:01	13/11/2020 16:28	5,44	4	21,76	CHI
20201157066	RUBIATABA	RB21000002	RUBIATABA	13/11/2020 11:02	13/11/2020 12:14	13/11/2020 11:02	13/11/2020 12:14	1,19	1	1,19	CHI
20201157073	RIO VERDE	RV11213369	CABRIUVA S1	13/11/2020 11:04	13/11/2020 13:57	13/11/2020 11:04	13/11/2020 13:57	2,87	8	23,00	CHI

20201157076	PLANALTINA	10013258930	PLANALTINA	13/11/2020 11:05	13/11/2020 14:04	13/11/2020 11:05	13/11/2020 14:04	2,98	1	2,98	CHI
20201153543	MARA ROSA	MQ12338191	SANTA TEREZINHA	13/11/2020 11:07	14/11/2020 12:24	13/11/2020 11:07	14/11/2020 12:24	25,27	3	75,81	CHI
20201157086	SENADOR CANEDO	10001645011	SENADOR CANEDO	13/11/2020 11:07	13/11/2020 11:58	13/11/2020 11:07	13/11/2020 11:58	0,84	1	0,84	CHI
20201157088	GOIANIA	14467793	MEIA PONTE	13/11/2020 11:07	13/11/2020 12:53	13/11/2020 11:07	13/11/2020 12:53	1,75	1	1,75	CHI
20201158736	BOM JESUS DE GOIAS	IT12034458RE	CACHOEIRA DOURADA	13/11/2020 11:12	13/11/2020 20:48	13/11/2020 11:12	13/11/2020 20:48	9,59	3	28,77	CHI
20201158736	ITUMBIARA	IT12034458RE	CACHOEIRA DOURADA	13/11/2020 11:12	13/11/2020 20:48	13/11/2020 11:12	13/11/2020 20:48	9,59	65	623,37	CHI
20201158736	PANAMA	IT12034458RE	CACHOEIRA DOURADA	13/11/2020 11:12	13/11/2020 20:48	13/11/2020 11:12	13/11/2020 20:48	9,59	13	124,67	CHI
20201157116	GOIANIA	16813170	GOIANIA LESTE S2	13/11/2020 11:14	13/11/2020 15:22	13/11/2020 11:14	13/11/2020 15:22	4,13	1	4,13	CHI
20201157120	GOIANIA	GN11262068	GOIANIA LESTE S2	13/11/2020 11:14	13/11/2020 13:43	13/11/2020 12:29	13/11/2020 13:43	1,23	76	93,73	CHI
20201157130	APARECIDA DE GOIANIA	200121224	INDEPENDENCIA S2	13/11/2020 11:16	13/11/2020 12:38	13/11/2020 11:16	13/11/2020 12:38	1,37	1	1,37	CHI
20201157135	ARENOPOLIS	AY12369839	ARENOPOLIS	13/11/2020 11:17	13/11/2020 17:50	13/11/2020 11:17	13/11/2020 17:50	6,53	2	13,07	CHI
20201157137	GOIANIA	10293206	CAMPINAS S2	13/11/2020 11:18	13/11/2020 13:27	13/11/2020 11:18	13/11/2020 13:27	2,14	1	2,14	CHI
20201157145	PORTEIRO	CL21214134	RIO DOS BOIS	13/11/2020 11:20	13/11/2020 20:46	13/11/2020 11:20	13/11/2020 20:46	9,43	1	9,43	CHI
20201157148	RIO VERDE	RV12000300	RIO VERDE S1	13/11/2020 11:20	13/11/2020 13:42	13/11/2020 11:20	13/11/2020 13:42	2,35	1	2,35	CHI
20201157149	PALMEIRAS DE GOIAS	10031411981	PALMEIRAS	13/11/2020 11:20	13/11/2020 16:19	13/11/2020 11:20	13/11/2020 16:19	4,97	1	4,97	CHI
20201157152	SANTA FE DE GOIAS	RN12167348	BRITANIA	13/11/2020 11:21	13/11/2020 15:34	13/11/2020 11:21	13/11/2020 15:34	4,21	1	4,21	CHI
20201157154	SAO JOAO D ALIANCA	JL12322707	SAO JOAO D ALIANCA	13/11/2020 11:21	13/11/2020 14:41	13/11/2020 11:21	13/11/2020 14:41	3,32	1	3,32	CHI
20201157159	MAURILANDIA	ML21223168	RIO DOS BOIS	13/11/2020 11:23	14/11/2020 00:24	13/11/2020 11:23	14/11/2020 00:24	13,01	1	13,01	CHI
20201157162	JATAI	JT21296398	JATAI S1	13/11/2020 11:24	13/11/2020 12:21	13/11/2020 11:24	13/11/2020 12:21	0,95	1	0,95	CHI
20201157163	TRINDADE	10032984217	TRINDADE	13/11/2020 11:24	13/11/2020 12:58	13/11/2020 11:24	13/11/2020 12:58	1,56	0	0,00	CHI
20201157167	CAMPO LIMPO	AN21058912	NEROPOLIS S1	13/11/2020 11:25	13/11/2020 14:03	13/11/2020 11:25	13/11/2020 14:03	2,63	1	2,63	CHI
20201157169	GOIANIA	10000403049	CAMPINAS S2	13/11/2020 11:25	13/11/2020 17:55	13/11/2020 11:25	13/11/2020 17:55	6,49	1	6,49	CHI
20201157176	COCALZINHO DE GOIAS	ZN12307708	GOIANESIA S1	13/11/2020 11:26	14/11/2020 03:32	13/11/2020 11:26	14/11/2020 03:32	16,09	3	48,26	CHI
20201157317	RORIZONA	OZ12275794	PIRES DO RIO S2	13/11/2020 11:26	13/11/2020 15:03	13/11/2020 11:26	13/11/2020 15:03	3,61	12	43,31	CHI
20201157179	MARA ROSA	MQ12237347	MARA ROSA	13/11/2020 11:28	14/11/2020 00:43	13/11/2020 11:28	14/11/2020 00:43	13,25	3	39,74	CHI
20201157180	ITABERAI	IB21406609	ITABERAI S1	13/11/2020 11:28	13/11/2020 15:02	13/11/2020 11:28	13/11/2020 15:02	3,56	1	3,56	CHI
20201157182	NOVA ROMA	ND21117578	IACIARA S2	13/11/2020 11:28	13/11/2020 12:56	13/11/2020 11:28	13/11/2020 12:56	1,45	1	1,45	CHI
20201157194	MARA ROSA	2260026250	MARA ROSA	13/11/2020 11:33	13/11/2020 14:07	13/11/2020 11:33	13/11/2020 14:07	2,56	1	2,56	CHI
20201157195	EDEIA	EA21038800	EDEIA	13/11/2020 11:33	13/11/2020 23:18	13/11/2020 11:33	13/11/2020 23:18	11,74	1	11,74	CHI
20201157208	APARECIDA DE GOIANIA	AP11356837	ATLANTICO S1	13/11/2020 11:35	13/11/2020 15:17	13/11/2020 11:35	13/11/2020 15:17	3,70	39	144,29	CHI
20201157209	GOIANIA	11229378	REAL S1	13/11/2020 11:35	13/11/2020 16:20	13/11/2020 11:35	13/11/2020 16:20	4,75	1	4,75	CHI
20201158858	PORANGATU	PO12012430	PORANGATU	13/11/2020 11:35	13/11/2020 18:08	13/11/2020 11:35	13/11/2020 18:08	6,54	3	19,62	CHI
20201157214	SAO JOAO D ALIANCA	JL12218396	SAO JOAO D ALIANCA	13/11/2020 11:36	13/11/2020 14:20	13/11/2020 11:36	13/11/2020 14:20	2,73	7	19,10	CHI
20201157215	AGUA FRIA DE GOIAS	TL1244619	SAO JOAO D ALIANCA	13/11/2020 11:36	13/11/2020 14:30	13/11/2020 11:36	13/11/2020 14:30	2,89	1	2,89	CHI
20201157220	SAO JOAO D ALIANCA	JL12383340	SAO JOAO D ALIANCA	13/11/2020 11:37	13/11/2020 13:50	13/11/2020 11:37	13/11/2020 13:50	2,21	77	170,41	CHI
20201157223	PLANALTINA	PI12262264	PLANALTINA	13/11/2020 11:38	13/11/2020 14:26	13/11/2020 11:38	13/11/2020 14:26	2,80	1	2,80	CHI
20201157325	CRIXAS	NM12273704	RUBIATABA	13/11/2020 11:39	13/11/2020 14:52	13/11/2020 11:39	13/11/2020 14:52	3,20	1	3,20	CHI
20201157325	NOVA AMERICA	NM12273704	RUBIATABA	13/11/2020 11:39	13/11/2020 14:52	13/11/2020 11:39	13/11/2020 14:52	3,20	7	22,43	CHI
20201157238	ITUMBIARA	10028650180	ITUMBIARA NOVA	13/11/2020 11:40	13/11/2020 15:22	13/11/2020 11:40	13/11/2020 15:22	3,69	1	3,69	CHI
20201157242	EDEALINA	ED21007686	PONTALINA	13/11/2020 11:41	13/11/2020 13:40	13/11/2020 11:41	13/11/2020 13:40	1,98	1	1,98	CHI
20201157243	ITAPIRAPUA	IU21198760	MATRINCHA	13/11/2020 11:41	13/11/2020 16:16	13/11/2020 11:41	13/11/2020 16:16	4,57	1	4,57	CHI
20201157247	APARECIDA DE GOIANIA	14268036	ATLANTICO S2	13/11/2020 11:42	13/11/2020 15:20	13/11/2020 11:42	13/11/2020 15:20	3,63	1	3,63	CHI
20201157249	ITABERAI	IB21336885	INHUMAS S1	13/11/2020 11:42	13/11/2020 14:21	13/11/2020 11:42	13/11/2020 14:21	2,64	1	2,64	CHI
20201157250	GOIANIA	GN21323278	CAMPINAS S1	13/11/2020 11:42	13/11/2020 15:37	13/11/2020 11:42	13/11/2020 15:37	3,90	1	3,90	CHI
20201157261	LUZIANIA	120191404	RIO VERMELHO	13/11/2020 11:45	13/11/2020 13:47	13/11/2020 11:45	13/11/2020 13:47	2,02	1	2,02	CHI
20201158273	NOVA IGUACU DE GOIAS	NH12374720	URUACU	13/11/2020 11:45	13/11/2020 17:25	13/11/2020 11:45	13/11/2020 17:25	5,67	7	39,66	CHI
20201157270	SANTA FE DE GOIAS	RN21323882	JUSSARA	13/11/2020 11:49	13/11/2020 22:27	13/11/2020 11:49	13/11/2020 22:27	10,63	1	10,63	CHI
20201157272	IPORA	730044040	IPORA	13/11/2020 11:49	13/11/2020 13:20	13/11/2020 11:49	13/11/2020 13:20	1,50	1	1,50	CHI
20201158166	MUNDO NOVO DE GOIAS	MH12269056	NOVA CRIXAS	13/11/2020 11:51	13/11/2020 15:31	13/11/2020 11:51	13/11/2020 15:31	3,66	22	80,54	CHI
20201157278	PALMEIRAS DE GOIAS	10030631112	PALMEIRAS	13/11/2020 11:52	13/11/2020 13:20	13/11/2020 11:52	13/11/2020 13:20	1,46	1	1,46	CHI
20201157287	APARECIDA DE GOIANIA	14271138	ATLANTICO S1	13/11/2020 11:54	13/11/2020 13:55	13/11/2020 11:54	13/11/2020 13:55	2,01	1	2,01	CHI

20201160332	NOVA IGUACU DE GOIAS	NH12398038	CAMPINORTE	13/11/2020 11:54	14/11/2020 22:42	13/11/2020 11:54	14/11/2020 22:42	34,81	5	174,03	CHI
20201155982	PORANGATU	PO21020594	PORANGATU	13/11/2020 11:56	14/11/2020 08:18	13/11/2020 11:56	14/11/2020 08:18	20,35	2	40,70	CHI
20201157297	CRISTALINA	KR12248743	CRISTALINA S2	13/11/2020 11:56	13/11/2020 14:11	13/11/2020 11:56	13/11/2020 14:11	2,24	3	6,72	CHI
20201157297	CRISTALINA	KR12248743	CRISTALINA S2	13/11/2020 11:56	13/11/2020 14:11	13/11/2020 11:56	13/11/2020 14:11	2,24	3	6,72	CHI
20201157301	ANAPOLIS	21150539	ANAPOLIS UNIVERSITARIO S2	13/11/2020 11:57	13/11/2020 15:07	13/11/2020 11:57	13/11/2020 15:07	3,17	1	3,17	CHI
20201157304	ITAGUARI	II21217195	ITABERAI S1	13/11/2020 11:57	13/11/2020 17:16	13/11/2020 11:57	13/11/2020 17:16	5,30	2	10,60	CHI
20201157305	GOIANIA	10019083996	XAVANTES	13/11/2020 11:57	13/11/2020 13:51	13/11/2020 11:57	13/11/2020 13:51	1,88	1	1,88	CHI
20201159110	PIRENOPOLIS	PV12290060	GOIANESIA S1	13/11/2020 11:57	13/11/2020 23:17	13/11/2020 11:57	13/11/2020 23:17	11,32	7	79,25	CHI
20201157308	RIO VERDE	RV21340822	RIO VERDE S1	13/11/2020 11:58	13/11/2020 15:49	13/11/2020 11:58	13/11/2020 15:49	3,85	1	3,85	CHI
20201157311	VILA PROPICIO	BA12210749	GOIANESIA S1	13/11/2020 11:59	13/11/2020 12:52	13/11/2020 11:59	13/11/2020 12:52	0,88	1	0,88	CHI
20201157755	RIO VERDE	RV11191084	RIO VERDE S1	13/11/2020 11:59	13/11/2020 19:46	13/11/2020 11:59	13/11/2020 19:46	7,77	184	1430,40	CHI
20201157316	GOIANIA	10022809919	XAVANTES	13/11/2020 12:00	13/11/2020 16:13	13/11/2020 12:00	13/11/2020 16:13	4,21	1	4,21	CHI
20201157323	AURILANDIA	AI12032969	FIRMINOPOLIS S2	13/11/2020 12:02	13/11/2020 16:08	13/11/2020 12:02	13/11/2020 16:08	4,10	25	102,45	CHI
20201157324	ALTO PARAISO DE GOIAS	BF21159090	NIQUELANDIA SUBTRANSMISSAO	13/11/2020 12:02	13/11/2020 22:56	13/11/2020 12:02	13/11/2020 22:56	10,90	1	10,90	CHI
20201157351	MAMBAI	MB11302672	IACIARA S2	13/11/2020 12:02	13/11/2020 13:08	13/11/2020 12:02	13/11/2020 13:08	1,08	82	88,86	CHI
20201157330	GOIANIA	12019525	CAMPINAS S3	13/11/2020 12:03	13/11/2020 16:42	13/11/2020 12:03	13/11/2020 16:42	4,65	1	4,65	CHI
20201157336	RIO VERDE	7600105	SANTA HELENA S1	13/11/2020 12:06	13/11/2020 17:10	13/11/2020 12:06	13/11/2020 17:10	5,07	1	5,07	CHI
20201157425	PALMEIRAS DE GOIAS	PL12039931	PALMEIRAS	13/11/2020 12:06	13/11/2020 15:43	13/11/2020 12:06	13/11/2020 15:43	3,60	3	10,81	CHI
20201157826	RIO VERDE	RV12230829	MONTIVIDIU T	13/11/2020 12:06	13/11/2020 14:44	13/11/2020 12:06	13/11/2020 14:44	2,63	17	44,63	CHI
20201157341	URUACU	UR12285343	CAMPINORTE	13/11/2020 12:07	14/11/2020 13:36	13/11/2020 12:07	14/11/2020 09:43	21,59	1	21,59	CHI
20201157341	URUACU	CR12163492LD	CAMPINORTE	13/11/2020 12:07	14/11/2020 13:36	13/11/2020 12:07	14/11/2020 13:36	25,48	6	152,91	CHI
20201157342	AVELINOPOLIS	AV12111008	ANICUNS	13/11/2020 12:07	13/11/2020 17:57	13/11/2020 12:07	13/11/2020 17:57	5,82	1	5,82	CHI
20201157344	CRISTALINA	KR21219771	CRISTALINA S2	13/11/2020 12:08	13/11/2020 13:37	13/11/2020 12:08	13/11/2020 13:37	1,48	1	1,48	CHI
20201157787	SERRANOPOLIS	SX12234200LD	JATAI S1	13/11/2020 12:08	13/11/2020 22:33	13/11/2020 12:08	13/11/2020 22:33	10,40	19	197,66	CHI
20201157350	CORUMBA DE GOIAS	CB12382386	CORUMBA	13/11/2020 12:09	13/11/2020 14:33	13/11/2020 12:09	13/11/2020 14:33	2,39	2	4,78	CHI
20201157355	GOIANIA	12016603	FERROVIARIO S2	13/11/2020 12:10	13/11/2020 14:12	13/11/2020 12:10	13/11/2020 14:12	2,03	1	2,03	CHI
20201157356	ITABERAI	IB12379732	ITABERAI S1	13/11/2020 12:10	13/11/2020 17:05	13/11/2020 12:10	13/11/2020 17:05	4,90	2	9,80	CHI
20201157357	CIDADE OCIDENTAL	2680059949	MARAJOARA	13/11/2020 12:10	13/11/2020 13:28	13/11/2020 12:10	13/11/2020 13:28	1,29	1	1,29	CHI
20201157360	MARA ROSA	2260002669	MARA ROSA	13/11/2020 12:11	13/11/2020 15:08	13/11/2020 12:11	13/11/2020 15:08	2,94	1	2,94	CHI
20201157361	ORIZONA	OZ11073421	PIRES DO RIO S2	13/11/2020 12:12	13/11/2020 21:57	13/11/2020 12:12	13/11/2020 21:57	9,75	24	233,92	CHI
20201157362	JATAI	JT12334184	JATAI S1	13/11/2020 12:12	14/11/2020 08:02	13/11/2020 12:12	14/11/2020 08:02	19,83	1	19,83	CHI
20201157363	LUZIANIA	10024839246	RIO VERMELHO	13/11/2020 12:12	13/11/2020 15:24	13/11/2020 12:12	13/11/2020 15:24	3,20	1	3,20	CHI
20201157612	PARANAIGUARA	QI12360936	QUIRINOPOLIS	13/11/2020 12:13	13/11/2020 15:41	13/11/2020 12:13	13/11/2020 15:41	3,45	6	20,72	CHI
20201157369	MUNDO NOVO DE GOIAS	4240022801	NOVA CRIXAS	13/11/2020 12:14	14/11/2020 15:35	13/11/2020 12:14	14/11/2020 15:35	27,34	1	27,34	CHI
20201157374	TRES RANCHOS	10028807519	CATALAO S1	13/11/2020 12:15	13/11/2020 22:18	13/11/2020 12:15	13/11/2020 22:18	10,04	1	10,04	CHI
20201157601	GOIANIA	GN11001225	FERROVIARIO S2	13/11/2020 12:15	13/11/2020 16:52	13/11/2020 12:15	13/11/2020 16:52	4,61	90	414,83	CHI
20201157376	GOIANIA	14804244	ATLANTICO S2	13/11/2020 12:17	13/11/2020 14:57	13/11/2020 12:17	13/11/2020 14:57	2,67	1	2,67	CHI
20201157378	SAO JOAO D ALIANCA	JL11130014	SAO JOAO D ALIANCA	13/11/2020 12:17	13/11/2020 17:31	13/11/2020 12:17	13/11/2020 17:31	5,23	4	20,92	CHI
20201157454	URUACU	UR12232461	URUACU	13/11/2020 12:17	13/11/2020 16:26	13/11/2020 12:17	13/11/2020 16:26	4,15	7	29,03	CHI
20201157384	ABADIANIA	AA21059653	ANAPOLIS UNIVERSITARIO S2	13/11/2020 12:18	13/11/2020 20:15	13/11/2020 12:18	13/11/2020 20:15	7,95	1	7,95	CHI
20201157385	PORANGATU	PO21151806	PORANGATU	13/11/2020 12:18	13/11/2020 17:14	13/11/2020 12:18	13/11/2020 17:14	4,92	1	4,92	CHI
20201157411	ORIZONA	OZ16414874	PIRES DO RIO S2	13/11/2020 12:18	13/11/2020 19:10	13/11/2020 12:23	13/11/2020 13:18	0,93	320	296,27	CHI
20201157411	ORIZONA	1880234	PIRES DO RIO S2	13/11/2020 12:18	13/11/2020 19:10	13/11/2020 13:01	13/11/2020 13:18	0,29	2996	859,69	CHI
20201157411	VIANOPOLIS	1880234	PIRES DO RIO S2	13/11/2020 12:18	13/11/2020 19:10	13/11/2020 13:01	13/11/2020 13:18	0,29	125	35,87	CHI
20201157411	ORIZONA	OZ10405706	PIRES DO RIO S2	13/11/2020 12:18	13/11/2020 19:10	13/11/2020 13:15	13/11/2020 13:18	0,06	50	2,90	CHI
20201157411	ORIZONA	OZ16414874	PIRES DO RIO S2	13/11/2020 12:18	13/11/2020 19:10	13/11/2020 12:23	13/11/2020 14:58	2,58	357	922,65	CHI
20201157411	PIRES DO RIO	OZ16414874	PIRES DO RIO S2	13/11/2020 12:18	13/11/2020 19:10	13/11/2020 12:23	13/11/2020 14:58	2,58	70	180,91	CHI
20201157411	ORIZONA	OZ10300913	PIRES DO RIO S2	13/11/2020 12:18	13/11/2020 19:10	13/11/2020 12:23	13/11/2020 15:00	2,62	245	641,63	CHI
20201157411	PIRES DO RIO	OZ10300913	PIRES DO RIO S2	13/11/2020 12:18	13/11/2020 19:10	13/11/2020 12:23	13/11/2020 15:00	2,62	11	28,81	CHI
20201157411	SAO MIGUEL DO PASSA QUATRO	OZ10300913	PIRES DO RIO S2	13/11/2020 12:18	13/11/2020 19:10	13/11/2020 12:23	13/11/2020 15:00	2,62	2	5,24	CHI
20201157411	VIANOPOLIS	OZ10300913	PIRES DO RIO S2	13/11/2020 12:18	13/11/2020 19:10	13/11/2020 12:23	13/11/2020 15:00	2,62	82	214,75	CHI

20201157411	ORIZONA	OZ16414874	PIRES DO RIO S2	13/11/2020 12:18	13/11/2020 19:10	13/11/2020 12:23	13/11/2020 19:10	6,78	42	284,90	CHI
20201157386	LEOPOLDO DE BULHOES	950014000	DAIA S2	13/11/2020 12:19	13/11/2020 14:59	13/11/2020 12:19	13/11/2020 14:59	2,66	1	2,66	CHI
20201157461	GOIAS	IK12250721	GOIAS	13/11/2020 12:19	13/11/2020 17:59	13/11/2020 12:19	13/11/2020 17:59	5,66	14	79,24	CHI
20201157461	ITABERAI	IK12250721	GOIAS	13/11/2020 12:19	13/11/2020 17:59	13/11/2020 12:19	13/11/2020 17:59	5,66	3	16,98	CHI
20201157461	ITAPURANGA	IK12250721	GOIAS	13/11/2020 12:19	13/11/2020 17:59	13/11/2020 12:19	13/11/2020 17:59	5,66	3	16,98	CHI
20201157704	PORANGATU	PO11053328	PORANGATU	13/11/2020 12:19	13/11/2020 22:00	13/11/2020 12:19	13/11/2020 22:00	9,68	98	948,20	CHI
20201157395	BONFINOPOLIS	LB12012607	GOIANIA LESTE S2	13/11/2020 12:20	13/11/2020 16:08	13/11/2020 12:20	13/11/2020 16:08	3,79	3	11,36	CHI
20201157396	TRES RANCHOS	TH12149178	CATALAO S1	13/11/2020 12:20	13/11/2020 16:38	13/11/2020 12:20	13/11/2020 16:38	4,29	15	64,29	CHI
20201157401	SERRANOPOLIS	SX21267517	JATAI S1	13/11/2020 12:22	14/11/2020 11:51	13/11/2020 12:22	14/11/2020 11:51	23,48	1	23,48	CHI
20201157403	JANDAIA	JD21213780	PALMEIRAS	13/11/2020 12:23	14/11/2020 17:49	13/11/2020 12:23	14/11/2020 17:49	29,43	1	29,43	CHI
20201157405	CATALAO	CT12266154	CATALAO S1	13/11/2020 12:23	13/11/2020 20:22	13/11/2020 12:23	13/11/2020 20:22	7,98	6	47,87	CHI
20201157405	GOIANDIRA	CT12266154	CATALAO S1	13/11/2020 12:23	13/11/2020 20:22	13/11/2020 12:23	13/11/2020 20:22	7,98	1	7,98	CHI
20201157409	TURVANIA	TV21266587	ANICUNS	13/11/2020 12:23	13/11/2020 15:04	13/11/2020 12:23	13/11/2020 15:04	2,67	1	2,67	CHI
20201157865	NOVO GAMA	NJ11183935	PACAEMBU S1	13/11/2020 12:23	13/11/2020 14:40	13/11/2020 12:23	13/11/2020 14:40	2,28	112	255,92	CHI
20201157412	APARECIDA DE GOIANIA	10020832166	INDEPENDENCIA S2	13/11/2020 12:24	13/11/2020 15:38	13/11/2020 12:24	13/11/2020 15:38	3,23	1	3,23	CHI
20201157417	CAMPINORTE	CR21135529	MARA ROSA	13/11/2020 12:24	13/11/2020 15:10	13/11/2020 12:24	13/11/2020 15:10	2,75	1	2,75	CHI
20201157844	IACIARA	IA12394108	IACIARA S1	13/11/2020 12:24	13/11/2020 14:46	13/11/2020 12:24	13/11/2020 14:46	2,35	7	16,46	CHI
20201157420	SAO LUIZ DO NORTE	SZ12348593	ITAPACI	13/11/2020 12:25	13/11/2020 16:42	13/11/2020 12:25	13/11/2020 16:42	4,27	2	8,54	CHI
20201159044	AGUA LIMPA	RQ12063059RE	VILA CORUMBA	13/11/2020 12:25	13/11/2020 18:03	13/11/2020 12:25	13/11/2020 18:03	5,62	16	89,88	CHI
20201159044	CALDAS NOVAS	RQ12063059RE	VILA CORUMBA	13/11/2020 12:25	13/11/2020 18:03	13/11/2020 12:25	13/11/2020 18:03	5,62	18	101,12	CHI
20201159044	MORRINHOS	RQ12063059RE	VILA CORUMBA	13/11/2020 12:25	13/11/2020 18:03	13/11/2020 12:25	13/11/2020 18:03	5,62	5	28,09	CHI
20201159044	RIO QUENTE	RQ12063059RE	VILA CORUMBA	13/11/2020 12:25	13/11/2020 18:03	13/11/2020 12:25	13/11/2020 18:03	5,62	114	640,43	CHI
20201157602	GOIANIA	GN11001338	XAVANTES	13/11/2020 12:26	13/11/2020 14:10	13/11/2020 12:26	13/11/2020 14:10	1,72	98	168,29	CHI
20201157431	CORUMBA DE GOIAS	CB21141571	CORUMBA	13/11/2020 12:28	13/11/2020 15:19	13/11/2020 12:28	13/11/2020 15:19	2,85	1	2,85	CHI
20201157435	GOIANIA	11048293	REAL S1	13/11/2020 12:28	13/11/2020 15:12	13/11/2020 12:28	13/11/2020 15:12	2,72	1	2,72	CHI
20201157439	NIQUELANDIA	10005811447	URUACU	13/11/2020 12:29	13/11/2020 23:02	13/11/2020 12:29	13/11/2020 23:02	10,54	1	10,54	CHI
20201157622	GOIANIA	GN12035177	ATLANTICO S3	13/11/2020 12:29	13/11/2020 14:29	13/11/2020 12:29	13/11/2020 14:29	2,00	443	885,63	CHI
20201157442	ITABERAI	50031326	ITABERAI S2	13/11/2020 12:30	14/11/2020 03:41	13/11/2020 12:30	14/11/2020 03:41	15,18	1	15,18	CHI
20201157446	AGUA FRIA DE GOIAS	TL21390885	SAO JOAO D ALIANCA	13/11/2020 12:30	13/11/2020 18:57	13/11/2020 12:30	13/11/2020 18:57	6,44	1	6,44	CHI
20201157449	GUARAITA	GK12307511	ITAPURANGA	13/11/2020 12:30	14/11/2020 12:11	13/11/2020 12:30	14/11/2020 12:11	23,67	1	23,67	CHI
20201157453	URUACU	UR21280455	URUACU	13/11/2020 12:31	13/11/2020 18:58	13/11/2020 12:31	13/11/2020 18:58	6,45	1	6,45	CHI
20201157455	GOIANIA	11740486	REAL S2	13/11/2020 12:31	13/11/2020 15:24	13/11/2020 12:31	13/11/2020 15:24	2,88	1	2,88	CHI
20201157457	CRISTALINA	1060089091	CRISTALINA S1	13/11/2020 12:31	13/11/2020 14:26	13/11/2020 12:31	13/11/2020 14:26	1,91	1	1,91	CHI
20201157458	LUZIANIA	LZ21153850	MARAJOARA	13/11/2020 12:31	13/11/2020 17:12	13/11/2020 12:31	13/11/2020 17:12	4,67	1	4,67	CHI
20201157463	GOIANIA	GN21127118	GOIANIA LESTE S3	13/11/2020 12:33	13/11/2020 15:55	13/11/2020 12:33	13/11/2020 15:55	3,36	1	3,36	CHI
20201157480	CAMPOS VERDES	SG12181588	SANTA TEREZINHA	13/11/2020 12:36	13/11/2020 18:44	13/11/2020 12:36	13/11/2020 18:44	6,12	8	48,99	CHI
20201157480	SANTA TEREZINHA DE GOIAS	SG12181588	SANTA TEREZINHA	13/11/2020 12:36	13/11/2020 18:44	13/11/2020 12:36	13/11/2020 18:44	6,12	6	36,74	CHI
20201157483	CIDADE OCIDENTAL	LZ21087037	MARAJOARA	13/11/2020 12:37	13/11/2020 16:17	13/11/2020 12:37	13/11/2020 16:17	3,67	1	3,67	CHI
20201157484	ITABERAI	10001726763	ITABERAI S2	13/11/2020 12:37	13/11/2020 17:46	13/11/2020 12:37	13/11/2020 17:46	5,15	1	5,15	CHI
20201157487	DIVINOPOLIS DE GOIAS	GH12208671	SAO DOMINGOS	13/11/2020 12:37	13/11/2020 16:57	13/11/2020 12:37	13/11/2020 16:57	4,33	549	2374,58	CHI
20201157489	GOIANIA	11899920	XAVANTES	13/11/2020 12:37	13/11/2020 16:46	13/11/2020 12:37	13/11/2020 16:46	4,14	1	4,14	CHI
20201157494	QUIRINOPOLIS	80082282	QUIRINOPOLIS	13/11/2020 12:39	13/11/2020 15:02	13/11/2020 12:39	13/11/2020 15:02	2,37	1	2,37	CHI
20201157679	GOIANIA	GN11000400	FERROVIARIO S1	13/11/2020 12:40	13/11/2020 13:59	13/11/2020 12:40	13/11/2020 13:59	1,30	114	148,71	CHI
20201157640	BELA VISTA DE GOIAS	440414	CRISTIANOPOLIS	13/11/2020 12:41	13/11/2020 16:50	13/11/2020 16:01	13/11/2020 16:50	0,82	1	0,82	CHI
20201157734	SAO JOAO D ALIANCA	JL12383335	SAO JOAO D ALIANCA	13/11/2020 12:41	13/11/2020 17:37	13/11/2020 12:41	13/11/2020 17:37	4,92	11	54,12	CHI
20201157507	PARAUNA	PU21136886	PARAUNA	13/11/2020 12:42	13/11/2020 21:45	13/11/2020 12:42	13/11/2020 21:45	9,05	1	9,05	CHI
20201157508	APARECIDA DE GOIANIA	13199079	ATLANTICO S2	13/11/2020 12:42	13/11/2020 14:24	13/11/2020 12:42	13/11/2020 14:24	1,69	1	1,69	CHI
20201158592	SERRANOPOLIS	SX12166103	JATAI S1	13/11/2020 12:42	13/11/2020 18:58	13/11/2020 12:42	13/11/2020 18:58	6,25	5	31,26	CHI
20201157728	RIO VERDE	RV12025958	RIO VERDE S1	13/11/2020 12:44	13/11/2020 17:42	13/11/2020 12:44	13/11/2020 17:42	4,95	47	232,75	CHI
20201159296	NIQUELANDIA	NQ12398048	URUACU	13/11/2020 12:44	14/11/2020 03:40	13/11/2020 12:44	14/11/2020 03:40	14,92	104	1551,56	CHI
20201157531	GOUVELANDIA	GB12303158	QUIRINOPOLIS	13/11/2020 12:45	13/11/2020 14:41	13/11/2020 12:45	13/11/2020 14:41	1,92	6	11,54	CHI



20201157534	APARECIDA DE GOIANIA	11876736	REAL S2	13/11/2020 12:46	13/11/2020 13:27	13/11/2020 12:46	13/11/2020 13:27	0,68	1	0,68	CHI
20201157536	CRIXAS	CX12151609RE	SANTA TEREZINHA	13/11/2020 12:46	13/11/2020 14:35	13/11/2020 12:46	13/11/2020 14:35	1,81	35	63,30	CHI
20201157538	SAO DOMINGOS	SD21428661	SAO DOMINGOS	13/11/2020 12:46	13/11/2020 14:37	13/11/2020 12:46	13/11/2020 14:37	1,84	1	1,84	CHI
20201157581	PIRACANJUBA	PJ12249876	PIRACANJUBA	13/11/2020 12:47	13/11/2020 14:37	13/11/2020 12:47	13/11/2020 14:37	1,82	38	69,07	CHI
20201157548	HIDROLINA	1020015606	URUACU	13/11/2020 12:48	14/11/2020 10:48	13/11/2020 12:48	14/11/2020 10:48	21,99	1	21,99	CHI
20201157551	APARECIDA DE GOIANIA	12534699	INDEPENDENCIA S1	13/11/2020 12:48	13/11/2020 14:41	13/11/2020 12:48	13/11/2020 14:41	1,87	1	1,87	CHI
20201157552	QUIRINOPOLIS	80148372	QUIRINOPOLIS	13/11/2020 12:48	13/11/2020 14:27	13/11/2020 12:48	13/11/2020 14:27	1,64	1	1,64	CHI
20201157554	PALMEIRAS DE GOIAS	PL21098938	PALMEIRAS	13/11/2020 12:49	13/11/2020 16:32	13/11/2020 12:49	13/11/2020 16:32	3,72	1	3,72	CHI
20201157806	ORIZONA	PR12000082RE	PIRES DO RIO S1	13/11/2020 12:50	15/11/2020 15:54	13/11/2020 12:50	14/11/2020 11:40	22,84	5	114,20	CHI
20201157806	PIRES DO RIO	PR12000082RE	PIRES DO RIO S1	13/11/2020 12:50	15/11/2020 15:54	13/11/2020 12:50	14/11/2020 11:40	22,84	10	228,39	CHI
20201157806	PIRES DO RIO	PR12000082RE	PIRES DO RIO S1	13/11/2020 12:50	15/11/2020 15:54	13/11/2020 17:20	14/11/2020 11:40	18,35	5	91,74	CHI
20201157806	PIRES DO RIO	PR12000082RE	PIRES DO RIO S1	13/11/2020 12:50	15/11/2020 15:54	13/11/2020 17:20	15/11/2020 15:54	46,58	5	232,90	CHI
20201157806	PIRES DO RIO	PR12064871LD	PIRES DO RIO S1	13/11/2020 12:50	15/11/2020 15:54	13/11/2020 17:20	15/11/2020 15:54	46,58	9	419,22	CHI
20201158233	JATAI	JT12360972	CABRIUVA S2	13/11/2020 12:50	13/11/2020 17:43	13/11/2020 12:50	13/11/2020 17:43	4,87	5	24,36	CHI
20201158758	NOVA CRIXAS	NA12334349	NOVA CRIXAS	13/11/2020 12:51	13/11/2020 23:53	13/11/2020 12:51	13/11/2020 23:53	11,03	86	948,34	CHI
20201157574	SANTO ANTONIO DA BARRA	BZ21301424	ACREUNA	13/11/2020 12:52	13/11/2020 14:34	13/11/2020 12:52	13/11/2020 14:34	1,69	2	3,38	CHI
20201157594	APORE	AE12219494	ITAJA S1	13/11/2020 12:55	14/11/2020 14:50	13/11/2020 12:55	14/11/2020 14:50	25,91	2	51,83	CHI
20201158591	SERRANOPOLIS	SX12260526	JATAI S1	13/11/2020 12:55	13/11/2020 23:39	13/11/2020 12:55	13/11/2020 23:39	10,73	1	10,73	CHI
202011137889	CALDAS NOVAS	830204	IPAMERI	13/11/2020 12:58	14/11/2020 15:22	13/11/2020 12:58	13/11/2020 14:14	1,26	11	13,88	CHI
202011137889	CATALAO	830204	IPAMERI	13/11/2020 12:58	14/11/2020 15:22	13/11/2020 12:58	13/11/2020 14:14	1,26	7	8,83	CHI
202011137889	CORUMBAIBA	830204	IPAMERI	13/11/2020 12:58	14/11/2020 15:22	13/11/2020 12:58	13/11/2020 14:14	1,26	19	23,97	CHI
202011137889	GOIANDIRA	830204	IPAMERI	13/11/2020 12:58	14/11/2020 15:22	13/11/2020 12:58	13/11/2020 14:14	1,26	15	18,92	CHI
202011137889	IPAMERI	830204	IPAMERI	13/11/2020 12:58	14/11/2020 15:22	13/11/2020 12:58	13/11/2020 14:14	1,26	6790	8566,72	CHI
202011137889	NOVA AURORA	830204	IPAMERI	13/11/2020 12:58	14/11/2020 15:22	13/11/2020 12:58	13/11/2020 14:14	1,26	2	2,52	CHI
202011137889	URUTAI	830204	IPAMERI	13/11/2020 12:58	14/11/2020 15:22	13/11/2020 12:58	13/11/2020 14:14	1,26	3	3,78	CHI
202011137889	IPAMERI	830204	IPAMERI	13/11/2020 12:58	14/11/2020 15:22	13/11/2020 12:58	13/11/2020 15:14	2,27	2788	6321,79	CHI
202011137889	CORUMBAIBA	IP10375985	IPAMERI	13/11/2020 12:58	14/11/2020 15:22	13/11/2020 15:12	13/11/2020 15:19	0,11	16	1,77	CHI
202011137889	IPAMERI	IP10375985	IPAMERI	13/11/2020 12:58	14/11/2020 15:22	13/11/2020 15:12	13/11/2020 15:19	0,11	235	25,98	CHI
202011137889	NOVA AURORA	IP10375985	IPAMERI	13/11/2020 12:58	14/11/2020 15:22	13/11/2020 15:12	13/11/2020 15:19	0,11	2	0,22	CHI
202011137889	CATALAO	830204	IPAMERI	13/11/2020 12:58	14/11/2020 15:22	13/11/2020 16:22	13/11/2020 17:39	1,29	7	9,05	CHI
202011137889	GOIANDIRA	830204	IPAMERI	13/11/2020 12:58	14/11/2020 15:22	13/11/2020 16:22	13/11/2020 17:39	1,29	15	19,39	CHI
202011137889	IPAMERI	830204	IPAMERI	13/11/2020 12:58	14/11/2020 15:22	13/11/2020 16:22	13/11/2020 17:39	1,29	4140	5352,10	CHI
202011137889	IPAMERI	830204	IPAMERI	13/11/2020 12:58	14/11/2020 15:22	13/11/2020 16:22	13/11/2020 17:42	1,33	420	560,35	CHI
202011137889	IPAMERI	830204	IPAMERI	13/11/2020 12:58	14/11/2020 15:22	13/11/2020 16:22	13/11/2020 17:44	1,38	1568	2163,84	CHI
202011137889	IPAMERI	830204	IPAMERI	13/11/2020 12:58	14/11/2020 15:22	13/11/2020 16:22	13/11/2020 17:45	1,39	187	259,67	CHI
202011137889	URUTAI	830204	IPAMERI	13/11/2020 12:58	14/11/2020 15:22	13/11/2020 16:22	13/11/2020 17:45	1,39	3	4,17	CHI
202011137889	IPAMERI	830204	IPAMERI	13/11/2020 12:58	14/11/2020 15:22	13/11/2020 12:58	13/11/2020 18:11	5,20	376	1956,66	CHI
202011137889	IPAMERI	830204	IPAMERI	13/11/2020 12:58	14/11/2020 15:22	13/11/2020 16:22	13/11/2020 18:11	1,81	2788	5056,35	CHI
202011137889	GOIANDIRA	GD12195324	CATALAO S1	13/11/2020 12:58	14/11/2020 15:22	14/11/2020 06:36	14/11/2020 07:01	0,41	94	38,17	CHI
202011137889	IPAMERI	GD13333419	IPAMERI	13/11/2020 12:58	14/11/2020 15:22	13/11/2020 15:21	14/11/2020 07:54	16,56	80	1324,47	CHI
202011137889	IPAMERI	IP10375985	IPAMERI	13/11/2020 12:58	14/11/2020 15:22	13/11/2020 15:21	14/11/2020 14:51	23,51	63	1481,16	CHI
202011137889	CALDAS NOVAS	IP10375985	IPAMERI	13/11/2020 12:58	14/11/2020 15:22	13/11/2020 15:12	14/11/2020 15:22	24,15	11	265,69	CHI
202011137889	CORUMBAIBA	IP10375985	IPAMERI	13/11/2020 12:58	14/11/2020 15:22	13/11/2020 15:12	14/11/2020 15:22	24,15	3	72,46	CHI
202011137889	IPAMERI	IP10375985	IPAMERI	13/11/2020 12:58	14/11/2020 15:22	13/11/2020 15:12	14/11/2020 15:22	24,15	240	5796,93	CHI
202011137889	CORUMBAIBA	IP10375985	IPAMERI	13/11/2020 12:58	14/11/2020 15:22	13/11/2020 15:21	14/11/2020 15:22	24,02	16	384,28	CHI
202011137889	IPAMERI	IP10375985	IPAMERI	13/11/2020 12:58	14/11/2020 15:22	13/11/2020 15:21	14/11/2020 15:22	24,02	92	2209,61	CHI
202011137889	NOVA AURORA	IP10375985	IPAMERI	13/11/2020 12:58	14/11/2020 15:22	13/11/2020 15:21	14/11/2020 15:22	24,02	2	48,04	CHI
202011137889	IPAMERI	IP10375985	IPAMERI	13/11/2020 12:58	14/11/2020 15:22	14/11/2020 15:11	14/11/2020 15:22	0,18	63	11,11	CHI
2020111300027	CATALAO	4601	IPAMERI	13/11/2020 13:00	13/11/2020 14:13	13/11/2020 13:00	13/11/2020 14:13	1,22	22	26,77	CHI
2020111300027	IPAMERI	4601	IPAMERI	13/11/2020 13:00	13/11/2020 14:13	13/11/2020 13:00	13/11/2020 14:13	1,22	48	58,40	CHI
2020111300027	IPAMERI	830404	IPAMERI	13/11/2020 13:00	13/11/2020 14:13	13/11/2020 13:00	13/11/2020 14:13	1,22	258	313,90	CHI

20201157656	MINACU	IH21262711	MINACU	13/11/2020 13:07	14/11/2020 03:00	13/11/2020 13:07	14/11/2020 03:00	13,87	1	13,87	CHI
20201157672	GUAPO	GA12007340	GUAPO S1	13/11/2020 13:10	13/11/2020 15:25	13/11/2020 13:10	13/11/2020 15:25	2,24	24	53,71	CHI
20201157674	DISTRITO FEDERAL	SN12237830	MARAJOARA	13/11/2020 13:10	13/11/2020 16:31	13/11/2020 13:10	13/11/2020 16:31	3,34	3	10,01	CHI
20201157674	SANTO ANTONIO DO DESCOBERTO	SN12237830	MARAJOARA	13/11/2020 13:10	13/11/2020 16:31	13/11/2020 13:10	13/11/2020 16:31	3,34	25	83,40	CHI
20201158776	SANTA RITA DO NOVO DESTINO	DF12315581	BARRO ALTO	13/11/2020 13:10	13/11/2020 20:19	13/11/2020 13:10	13/11/2020 20:19	7,14	20	142,72	CHI
20201157683	GOIANIA	11375784	ATLANTICO S1	13/11/2020 13:11	13/11/2020 16:21	13/11/2020 13:11	13/11/2020 16:21	3,15	1	3,15	CHI
20201157684	ANAPOLIS	20916966	DAIA S1	13/11/2020 13:11	13/11/2020 18:26	13/11/2020 13:11	13/11/2020 18:26	5,23	1	5,23	CHI
20201160183	MINACU	IH12063612	MINACU	13/11/2020 13:12	14/11/2020 00:56	13/11/2020 13:12	14/11/2020 00:56	11,73	412	4834,02	CHI
20201157744	NOVA IGUACU DE GOIAS	NH12202113	SANTA TEREZINHA	13/11/2020 13:13	13/11/2020 15:56	13/11/2020 13:13	13/11/2020 15:56	2,72	65	176,53	CHI
20201157701	JATAI	JT21154692	CACHOEIRA ALTA	13/11/2020 13:15	13/11/2020 21:37	13/11/2020 13:15	13/11/2020 21:37	8,36	1	8,36	CHI
20201157702	NAZARIO	NZ21299197	ANICUNS	13/11/2020 13:15	13/11/2020 17:54	13/11/2020 13:15	13/11/2020 17:54	4,64	1	4,64	CHI
20201157706	GOIAS	GS21068594	GOIAS	13/11/2020 13:16	14/11/2020 15:20	13/11/2020 13:16	14/11/2020 15:20	26,06	1	26,06	CHI
20201157711	GOIANIA	15404687	CARAJAS S1	13/11/2020 13:16	13/11/2020 15:12	13/11/2020 13:16	13/11/2020 15:12	1,92	1	1,92	CHI
20201157712	GOIANIA	GN12000165	AEROPORTO S2	13/11/2020 13:16	13/11/2020 14:19	13/11/2020 13:16	13/11/2020 14:19	1,04	124	128,86	CHI
20201160026	MUTUNOPOLIS	MU12127950	MARA ROSA	13/11/2020 13:16	14/11/2020 09:08	13/11/2020 13:16	14/11/2020 09:08	19,86	2	39,72	CHI
20201157719	JARAGUA	JA21216809	JARAGUA	13/11/2020 13:17	13/11/2020 19:31	13/11/2020 13:17	13/11/2020 19:31	6,23	1	6,23	CHI
20201157758	SAO JOAO D ALIANCA	JL21106967	SAO JOAO D ALIANCA	13/11/2020 13:22	13/11/2020 15:01	13/11/2020 13:22	13/11/2020 15:01	1,65	1	1,65	CHI
20201158001	ACREUNA	EU12044265	ACREUNA	13/11/2020 13:22	13/11/2020 16:18	13/11/2020 13:22	13/11/2020 16:18	2,92	8	23,38	CHI
20201158001	PARAUNA	EU12044265	ACREUNA	13/11/2020 13:22	13/11/2020 16:18	13/11/2020 13:22	13/11/2020 16:18	2,92	4	11,69	CHI
20201156592	SANTO ANTONIO DA BARRA	BZ21241217	ACREUNA	13/11/2020 13:23	13/11/2020 14:15	13/11/2020 13:23	13/11/2020 14:15	0,85	1	0,85	CHI
20201157766	SAO MIGUEL DO PASSA QUATRO	BV21086406	CRISTIANOPOLIS	13/11/2020 13:23	13/11/2020 16:01	13/11/2020 13:23	13/11/2020 16:01	2,63	2	5,25	CHI
20201157767	GOUVELANDIA	QI21000105	QUIRINOPOLIS	13/11/2020 13:23	13/11/2020 15:09	13/11/2020 13:23	13/11/2020 15:09	1,76	1	1,76	CHI
20201157773	SAO MIGUEL DO ARAGUAIA	SM11265599	SAO MIGUEL DO ARAGUAIA	13/11/2020 13:23	14/11/2020 11:41	13/11/2020 13:23	14/11/2020 11:41	22,28	1	22,28	CHI
20201157794	APARECIDA DE GOIANIA	200374539	INDEPENDENCIA S2	13/11/2020 13:27	13/11/2020 14:55	13/11/2020 13:27	13/11/2020 14:55	1,45	1	1,45	CHI
20201157807	SAO JOAO D ALIANCA	JL12218655	SAO JOAO D ALIANCA	13/11/2020 13:30	13/11/2020 16:05	13/11/2020 13:30	13/11/2020 16:05	2,58	2	5,15	CHI
20201157822	ARAGARCAS	10016521003	ARAGARCAS	13/11/2020 13:34	13/11/2020 15:52	13/11/2020 13:34	13/11/2020 15:52	2,29	1	2,29	CHI
20201157825	BOM JESUS DE GOIAS	BJ21310063	CACHOEIRA DOURADA	13/11/2020 13:35	13/11/2020 19:01	13/11/2020 13:35	13/11/2020 19:01	5,43	1	5,43	CHI
20201157828	OURO VERDE DE GOIAS	OV21208984	NEROPOLIS S1	13/11/2020 13:35	13/11/2020 23:57	13/11/2020 13:35	13/11/2020 23:57	10,36	1	10,36	CHI
20201157830	VIANOPOLIS	510044852	CRISTIANOPOLIS	13/11/2020 13:36	13/11/2020 15:11	13/11/2020 13:36	13/11/2020 15:11	1,58	1	1,58	CHI
20201157831	PORANGATU	4140214	PORANGATU	13/11/2020 13:36	13/11/2020 22:36	13/11/2020 13:36	13/11/2020 22:36	8,99	168	1509,62	CHI
20201157833	GOIANIA	12436331	INDEPENDENCIA S2	13/11/2020 13:37	13/11/2020 15:00	13/11/2020 13:37	13/11/2020 15:00	1,38	1	1,38	CHI
20201157835	GOIANIA	10020878883	GOIANIA LESTE S1	13/11/2020 13:38	13/11/2020 15:53	13/11/2020 13:38	13/11/2020 15:53	2,25	1	2,25	CHI
20201157839	ITABERAI	IB21310579	ITABERAI S2	13/11/2020 13:39	13/11/2020 15:47	13/11/2020 13:39	13/11/2020 15:47	2,13	1	2,13	CHI
20201157846	LAGOA SANTA	IJ21148227	CACHOEIRA ALTA	13/11/2020 13:39	13/11/2020 23:14	13/11/2020 13:39	13/11/2020 23:14	9,58	1	9,58	CHI
20201157853	ITUMBIARA	690095156	ITUMBIARA NOVA	13/11/2020 13:40	13/11/2020 17:39	13/11/2020 13:40	13/11/2020 17:39	3,98	1	3,98	CHI
20201157860	GOUVELANDIA	GB21303273	QUIRINOPOLIS	13/11/2020 13:41	13/11/2020 15:10	13/11/2020 13:41	13/11/2020 15:10	1,47	1	1,47	CHI
20201158045	SAO JOAO D ALIANCA	JL12048019	SAO JOAO D ALIANCA	13/11/2020 13:41	13/11/2020 17:05	13/11/2020 13:41	13/11/2020 17:05	3,39	43	145,79	CHI
20201158241	TERESINA DE GOIAS	TE12328343	FLORES DE GOIAS	13/11/2020 13:42	13/11/2020 18:20	13/11/2020 13:42	13/11/2020 18:20	4,62	6	27,72	CHI
20201157869	ITABERAI	AV21193593	ARACU	13/11/2020 13:44	13/11/2020 20:16	13/11/2020 13:44	13/11/2020 20:16	6,53	1	6,53	CHI
20201157877	ITUMBIARA	IT21000106	ITUMBIARA VELHA S1	13/11/2020 13:45	13/11/2020 17:57	13/11/2020 13:45	13/11/2020 17:57	4,20	3	12,59	CHI
20201157878	FLORES DE GOIAS	FB21409939	FLORES DE GOIAS	13/11/2020 13:45	13/11/2020 18:09	13/11/2020 13:45	13/11/2020 18:09	4,39	1	4,39	CHI
20201157881	TRINDADE	40181716	TRINDADE	13/11/2020 13:46	13/11/2020 23:11	13/11/2020 13:46	13/11/2020 23:11	9,40	1	9,40	CHI
20201159283	ALEXANIA	AX12094490	ALEXANIA	13/11/2020 13:47	13/11/2020 18:37	13/11/2020 13:47	13/11/2020 18:37	4,83	3	14,48	CHI
20201157890	URUACU	UR12292470	URUACU	13/11/2020 13:48	13/11/2020 20:15	13/11/2020 13:48	13/11/2020 20:15	6,45	2	12,89	CHI
20201157893	SANTA RITA DO ARAGUAIA	2130000545	SANTA RITA DO ARAGUAIA	13/11/2020 13:48	13/11/2020 21:11	13/11/2020 13:48	13/11/2020 21:11	7,38	1	7,38	CHI
20201157895	PIRACANJUBA	PJ21182710	PIRACANJUBA	13/11/2020 13:48	13/11/2020 19:30	13/11/2020 13:48	13/11/2020 19:30	5,69	1	5,69	CHI
20201157898	PARAUNA	PU21303603	PARAUNA	13/11/2020 13:49	13/11/2020 21:50	13/11/2020 13:49	13/11/2020 21:50	8,01	1	8,01	CHI
20201157904	SANTA CRUZ DE GOIAS	BC21025344	PIRES DO RIO S2	13/11/2020 13:50	14/11/2020 01:21	13/11/2020 13:50	14/11/2020 01:21	11,51	1	11,51	CHI
20201157907	CRISTALINA	19845604	CRISTALINA S2	13/11/2020 13:51	13/11/2020 16:10	13/11/2020 13:51	13/11/2020 16:10	2,30	4	9,21	CHI
20201157912	SAO JOAO D ALIANCA	JL21146131	SAO JOAO D ALIANCA	13/11/2020 13:52	13/11/2020 20:24	13/11/2020 13:52	13/11/2020 20:24	6,52	1	6,52	CHI
20201158782	SAO JOAO D ALIANCA	JL12049197	SAO JOAO D ALIANCA	13/11/2020 13:52	13/11/2020 20:24	13/11/2020 13:52	13/11/2020 20:24	6,52	5	32,60	CHI

20201161290	INDIARA	8587179	ACREUNA	13/11/2020 13:52	14/11/2020 11:51	13/11/2020 13:52	14/11/2020 11:51	21,98	1	21,98	CHI
20201157918	FLORES DE GOIAS	20788122	IACIARA S2	13/11/2020 13:53	13/11/2020 19:23	13/11/2020 13:53	13/11/2020 19:23	5,49	7	38,44	CHI
20201157929	MARA ROSA	10015524122	MARA ROSA	13/11/2020 13:54	13/11/2020 15:38	13/11/2020 13:54	13/11/2020 15:38	1,72	1	1,72	CHI
20201158278	SILVANIA	VN12400027	VIANOPOLIS	13/11/2020 13:54	13/11/2020 17:49	13/11/2020 13:54	13/11/2020 17:49	3,91	1	3,91	CHI
20201158278	VIANOPOLIS	VN12400027	VIANOPOLIS	13/11/2020 13:54	13/11/2020 17:49	13/11/2020 13:54	13/11/2020 17:49	3,91	8	31,29	CHI
20201159933	VIANOPOLIS	SV21158449	VIANOPOLIS	13/11/2020 13:54	13/11/2020 21:23	13/11/2020 13:54	13/11/2020 21:23	7,48	1	7,48	CHI
20201157935	FORMOSA	FA12041996	ITIQUEIRA	13/11/2020 13:55	13/11/2020 14:44	13/11/2020 13:55	13/11/2020 14:44	0,80	415	333,73	CHI
20201157936	GOIANIA	GN11001763	AEROPORTO S3	13/11/2020 13:55	13/11/2020 16:12	13/11/2020 13:55	13/11/2020 16:12	2,27	14	31,76	CHI
20201157939	PALESTINA DE GOIAS	PY21140059	ARENOPOLIS	13/11/2020 13:56	13/11/2020 18:30	13/11/2020 13:56	13/11/2020 18:30	4,55	1	4,55	CHI
20201158147	FORMOSA	FA12233612	ITIQUEIRA	13/11/2020 13:56	13/11/2020 18:24	13/11/2020 13:56	13/11/2020 18:24	4,46	61	272,04	CHI
20201157947	ITAPIRAPUA	1420030570	MATRINCHA	13/11/2020 13:58	13/11/2020 18:24	13/11/2020 13:58	13/11/2020 18:24	4,43	1	4,43	CHI
20201157952	MINACU	IH21187926	MINACU	13/11/2020 13:59	14/11/2020 15:04	13/11/2020 13:59	14/11/2020 15:04	25,07	2	50,15	CHI
20201157954	PLANALTINA	2960088950	PLANALTINA	13/11/2020 13:59	13/11/2020 15:36	13/11/2020 13:59	13/11/2020 15:36	1,61	1	1,61	CHI
20201158119	TROMBAS	TB12156807	PORANGATU	13/11/2020 13:59	13/11/2020 15:37	13/11/2020 13:59	13/11/2020 15:37	1,63	73	118,71	CHI
20201157963	ALTO PARAISO DE GOIAS	BF12180779	NIQUELANDIA SUBTRANSMISSAO	13/11/2020 14:00	14/11/2020 22:39	13/11/2020 14:00	14/11/2020 09:55	19,90	15	298,54	CHI
20201157963	ALTO PARAISO DE GOIAS	BF21232055	NIQUELANDIA SUBTRANSMISSAO	13/11/2020 14:00	14/11/2020 22:39	13/11/2020 14:00	14/11/2020 22:39	32,65	2	65,30	CHI
20201158009	URUACU	UR12117971	URUACU	13/11/2020 14:00	13/11/2020 15:04	13/11/2020 14:00	13/11/2020 15:04	1,05	19	20,01	CHI
20201157964	ANAPOLIS	AN21380130	ANAPOLIS UNIVERSITARIO S2	13/11/2020 14:01	13/11/2020 23:05	13/11/2020 14:01	13/11/2020 23:05	9,06	1	9,06	CHI
20201157999	CASTELANDIA	DM16407789	RIO DOS BOIS	13/11/2020 14:01	14/11/2020 12:52	13/11/2020 14:01	13/11/2020 18:03	4,04	703	2836,61	CHI
20201157999	BOM JESUS DE GOIAS	DM10406869	RIO DOS BOIS	13/11/2020 14:01	14/11/2020 12:52	13/11/2020 14:01	13/11/2020 18:04	4,05	4	16,20	CHI
20201157999	CASTELANDIA	DM10406869	RIO DOS BOIS	13/11/2020 14:01	14/11/2020 12:52	13/11/2020 14:01	13/11/2020 18:04	4,05	20	81,02	CHI
20201157999	GOIATUBA	DM10406869	RIO DOS BOIS	13/11/2020 14:01	14/11/2020 12:52	13/11/2020 14:01	13/11/2020 18:04	4,05	21	85,07	CHI
20201157999	MAURILANDIA	DM10406869	RIO DOS BOIS	13/11/2020 14:01	14/11/2020 12:52	13/11/2020 14:01	13/11/2020 18:04	4,05	1	4,05	CHI
20201157999	PORTEIRAO	DM10406869	RIO DOS BOIS	13/11/2020 14:01	14/11/2020 12:52	13/11/2020 14:01	13/11/2020 18:04	4,05	7	28,36	CHI
20201157999	BOM JESUS DE GOIAS	DM16407789	RIO DOS BOIS	13/11/2020 14:01	14/11/2020 12:52	13/11/2020 14:01	13/11/2020 22:21	8,32	9	74,92	CHI
20201157999	CASTELANDIA	DM16407789	RIO DOS BOIS	13/11/2020 14:01	14/11/2020 12:52	13/11/2020 14:01	13/11/2020 22:21	8,32	32	266,38	CHI
20201157999	BOM JESUS DE GOIAS	DM10406868	RIO DOS BOIS	13/11/2020 14:01	14/11/2020 12:52	13/11/2020 22:52	14/11/2020 09:35	10,72	9	96,49	CHI
20201157999	CASTELANDIA	DM10406868	RIO DOS BOIS	13/11/2020 14:01	14/11/2020 12:52	13/11/2020 22:52	14/11/2020 09:35	10,72	27	289,48	CHI
20201157999	BOM JESUS DE GOIAS	DM16407789	RIO DOS BOIS	13/11/2020 14:01	14/11/2020 12:52	13/11/2020 14:01	14/11/2020 09:50	19,82	7	138,71	CHI
20201157999	CASTELANDIA	DM12303636	RIO DOS BOIS	13/11/2020 14:01	14/11/2020 12:52	13/11/2020 22:52	14/11/2020 10:25	11,55	1	11,55	CHI
20201157999	CASTELANDIA	DM12303637	RIO DOS BOIS	13/11/2020 14:01	14/11/2020 12:52	13/11/2020 22:52	14/11/2020 11:08	12,27	1	12,27	CHI
20201157999	CASTELANDIA	DM12303627	RIO DOS BOIS	13/11/2020 14:01	14/11/2020 12:52	13/11/2020 22:52	14/11/2020 12:52	14,01	3	42,02	CHI
20201157979	GOIATUBA	GT21052890	GOIATUBA S1	13/11/2020 14:04	13/11/2020 17:15	13/11/2020 14:04	13/11/2020 17:15	3,18	1	3,18	CHI
20201157982	TRINDADE	TR11035135	GOYA S1	13/11/2020 14:05	13/11/2020 22:25	13/11/2020 14:05	13/11/2020 22:25	8,33	191	1591,03	CHI
20201157988	JATAI	JT12234396	JATAI S1	13/11/2020 14:06	13/11/2020 16:06	13/11/2020 14:06	13/11/2020 16:06	2,00	9	18,00	CHI
20201157989	GOIANESIA	550077420	GOIANESIA S2	13/11/2020 14:06	13/11/2020 17:35	13/11/2020 14:06	13/11/2020 17:35	3,48	1	3,48	CHI
20201157997	FORMOSA	610044473	ITIQUEIRA	13/11/2020 14:07	13/11/2020 16:02	13/11/2020 14:07	13/11/2020 16:02	1,91	1	1,91	CHI
20201158011	FLORES DE GOIAS	FB11211524	FLORES DE GOIAS	13/11/2020 14:09	13/11/2020 16:56	13/11/2020 14:09	13/11/2020 16:56	2,77	3	8,30	CHI
20201158012	PLANALTINA	PI21151810	PLANALTINA	13/11/2020 14:10	13/11/2020 18:33	13/11/2020 14:10	13/11/2020 18:33	4,38	1	4,38	CHI
20201158054	PROFESSOR JAMIL SAFADY	JS12000118	ROCHEDO	13/11/2020 14:10	13/11/2020 17:22	13/11/2020 14:10	13/11/2020 17:22	3,18	37	117,83	CHI
20201158022	INHUMAS	IN21254319	GOIANIRA	13/11/2020 14:13	13/11/2020 18:37	13/11/2020 14:13	13/11/2020 18:37	4,39	2	8,79	CHI
20201158037	PLANALTINA	PI11048030	PLANALTINA	13/11/2020 14:16	13/11/2020 16:51	13/11/2020 14:16	13/11/2020 16:51	2,58	66	170,11	CHI
20201158038	RIO VERDE	RV21076340	RIO VERDE S1	13/11/2020 14:16	13/11/2020 16:29	13/11/2020 14:16	13/11/2020 16:29	2,21	1	2,21	CHI
20201158039	AMARALINA	LC21208318	MARA ROSA	13/11/2020 14:16	15/11/2020 20:37	13/11/2020 14:16	15/11/2020 20:37	54,34	1	54,34	CHI
20201158129	CATURAI	IN12015933	INHUMAS S2	13/11/2020 14:16	13/11/2020 15:59	13/11/2020 14:16	13/11/2020 15:59	1,71	1	1,71	CHI
20201158129	INHUMAS	IN12015933	INHUMAS S2	13/11/2020 14:16	13/11/2020 15:59	13/11/2020 14:16	13/11/2020 15:59	1,71	21	36,01	CHI
20201159358	PARAUNA	PU12332611	PARAUNA	13/11/2020 14:16	13/11/2020 19:45	13/11/2020 14:16	13/11/2020 19:45	5,48	6	32,88	CHI
20201159361	FORMOSO	FO12060936RE	MARA ROSA	13/11/2020 14:18	13/11/2020 19:46	13/11/2020 14:18	13/11/2020 19:46	5,45	5	27,26	CHI
20201159361	SANTA TEREZA DE GOIAS	FO12060936RE	MARA ROSA	13/11/2020 14:18	13/11/2020 19:46	13/11/2020 14:18	13/11/2020 19:46	5,45	36	196,24	CHI
20201158067	GAMELEIRA DE GOIAS	GL21268526	ANAPOLIS UNIVERSITARIO S2	13/11/2020 14:20	13/11/2020 15:47	13/11/2020 14:20	13/11/2020 15:47	1,44	1	1,44	CHI
20201158113	APARECIDA DE GOIANIA	AP10383623	ANHANGUERA	13/11/2020 14:20	13/11/2020 18:26	13/11/2020 14:20	13/11/2020 14:26	0,09	3941	347,03	CHI

20201158113	APARECIDA DE GOIANIA	AP16401506	ANHANGUERA	13/11/2020 14:20	13/11/2020 18:26	13/11/2020 14:20	13/11/2020 16:54	2,57	3	7,70	CHI
20201158113	HIDROLANDIA	AP16401506	ANHANGUERA	13/11/2020 14:20	13/11/2020 18:26	13/11/2020 14:20	13/11/2020 16:54	2,57	52	133,39	CHI
20201158113	APARECIDA DE GOIANIA	AP16401506	ANHANGUERA	13/11/2020 14:20	13/11/2020 18:26	13/11/2020 14:20	13/11/2020 18:21	4,01	6	24,08	CHI
20201158113	HIDROLANDIA	AP16401506	ANHANGUERA	13/11/2020 14:20	13/11/2020 18:26	13/11/2020 14:20	13/11/2020 18:21	4,01	1361	5462,90	CHI
20201158113	HIDROLANDIA	AP16401506	ANHANGUERA	13/11/2020 14:20	13/11/2020 18:26	13/11/2020 14:20	13/11/2020 18:25	4,08	648	2640,96	CHI
20201158113	HIDROLANDIA	AP16401506	ANHANGUERA	13/11/2020 14:20	13/11/2020 18:26	13/11/2020 14:20	13/11/2020 18:26	4,09	102	416,81	CHI
20201158315	SILVANIA	SV12012809	VIANOPOLIS	13/11/2020 14:21	13/11/2020 16:33	13/11/2020 14:21	13/11/2020 16:33	2,21	68	150,37	CHI
20201158075	GOIATUBA	GT21143992	GOIATUBA S1	13/11/2020 14:22	14/11/2020 12:56	13/11/2020 14:22	14/11/2020 12:56	22,57	1	22,57	CHI
20201158078	APARECIDA DE GOIANIA	10015411883	ANHANGUERA	13/11/2020 14:23	13/11/2020 15:38	13/11/2020 14:23	13/11/2020 15:38	1,26	1	1,26	CHI
20201158248	APARECIDA DE GOIANIA	AP11004077	REAL S2	13/11/2020 14:24	13/11/2020 17:21	13/11/2020 14:24	13/11/2020 17:21	2,93	117	343,33	CHI
20201158094	GUARAITA	IK12064427	ITAPURANGA	13/11/2020 14:25	13/11/2020 17:46	13/11/2020 14:25	13/11/2020 17:46	3,33	1	3,33	CHI
20201158094	ITAPURANGA	IK12064427	ITAPURANGA	13/11/2020 14:25	13/11/2020 17:46	13/11/2020 14:25	13/11/2020 17:46	3,33	15	50,02	CHI
20201158098	BRITANIA	2110016559	BRITANIA	13/11/2020 14:26	13/11/2020 15:10	13/11/2020 14:26	13/11/2020 15:10	0,74	1	0,74	CHI
20201158107	SILVANIA	SV12199936	VIANOPOLIS	13/11/2020 14:27	13/11/2020 16:30	13/11/2020 14:27	13/11/2020 16:30	2,05	15	30,74	CHI
20201158110	SENADOR CANEDO	190015792	SENADOR CANEDO	13/11/2020 14:27	13/11/2020 17:11	13/11/2020 14:27	13/11/2020 17:11	2,73	1	2,73	CHI
20201158122	BRAZABRANTES	IN12015984	INHUMAS S2	13/11/2020 14:28	14/11/2020 02:11	13/11/2020 14:28	14/11/2020 02:11	11,70	2	23,40	CHI
20201158122	INHUMAS	IN12015984	INHUMAS S2	13/11/2020 14:28	14/11/2020 02:11	13/11/2020 14:28	14/11/2020 02:11	11,70	1	11,70	CHI
20201158381	ITAPURANGA	IK11124781	ITAPURANGA	13/11/2020 14:28	13/11/2020 23:15	13/11/2020 14:28	13/11/2020 23:15	8,78	178	1562,64	CHI
20201158124	IPORA	IR12065120	IPORA	13/11/2020 14:29	13/11/2020 15:50	13/11/2020 14:29	13/11/2020 15:50	1,35	7	9,45	CHI
20201158137	CAIAPONIA	CP12119577	CAIAPONIA	13/11/2020 14:30	13/11/2020 17:24	13/11/2020 14:30	13/11/2020 17:24	2,89	67	193,56	CHI
20201158137	DOVERLANDIA	CP12119577	CAIAPONIA	13/11/2020 14:30	13/11/2020 17:24	13/11/2020 14:30	13/11/2020 17:24	2,89	7	20,22	CHI
20201158140	IPORA	IR21065129	IPORA	13/11/2020 14:30	13/11/2020 16:13	13/11/2020 14:30	13/11/2020 16:13	1,70	1	1,70	CHI
20201158146	GOIANIA	13234663	CAMPINAS S2	13/11/2020 14:31	13/11/2020 16:34	13/11/2020 14:31	13/11/2020 16:34	2,03	1	2,03	CHI
20201158154	ITAPACI	IW12071383	ITAPACI	13/11/2020 14:33	13/11/2020 16:05	13/11/2020 14:33	13/11/2020 16:05	1,52	44	66,90	CHI
20201158156	ANAPOLIS	AN21267787	NEROPOLIS S1	13/11/2020 14:35	14/11/2020 00:08	13/11/2020 14:35	14/11/2020 00:08	9,55	1	9,55	CHI
20201158157	MONTE ALEGRE DE GOIAS	MA12236748	SAO DOMINGOS	13/11/2020 14:35	13/11/2020 18:37	13/11/2020 14:35	13/11/2020 18:37	4,02	2	8,05	CHI
20201158157	NOVA ROMA	MA12236748	SAO DOMINGOS	13/11/2020 14:35	13/11/2020 18:37	13/11/2020 14:35	13/11/2020 18:37	4,02	57	229,36	CHI
20201160201	ITAPURANGA	IK12249439	ITAPURANGA	13/11/2020 14:35	13/11/2020 21:10	13/11/2020 14:35	13/11/2020 21:10	6,58	530	3487,99	CHI
20201161054	ITAPURANGA	IK11249442	ITAPURANGA	13/11/2020 14:35	14/11/2020 01:03	13/11/2020 14:35	14/11/2020 01:03	10,45	81	846,65	CHI
20201158169	CHAPADAO DO CEU	DJ12248481	CHAPADAO DO CEU	13/11/2020 14:36	13/11/2020 23:07	13/11/2020 14:36	13/11/2020 23:07	8,51	2	17,02	CHI
20201158560	MONTES CLAROS DE GOIAS	ME12062838	IPORA	13/11/2020 14:36	13/11/2020 18:46	13/11/2020 14:36	13/11/2020 18:46	4,16	15	62,42	CHI
20201158174	MAMBAI	MB11109315	IACIARA S2	13/11/2020 14:37	13/11/2020 16:42	13/11/2020 14:37	13/11/2020 16:42	2,07	6	12,42	CHI
20201158181	PIRACANJUBA	PJ21293280	PIRACANJUBA	13/11/2020 14:38	13/11/2020 18:23	13/11/2020 14:38	13/11/2020 18:23	3,74	1	3,74	CHI
20201158185	CAIAPONIA	MV21260593	MONTIVIDIU T	13/11/2020 14:39	13/11/2020 18:47	13/11/2020 14:39	13/11/2020 18:47	4,14	1	4,14	CHI
20201158188	BELA VISTA DE GOIAS	BV12055686	BELA VISTA S2	13/11/2020 14:39	13/11/2020 17:38	13/11/2020 14:39	13/11/2020 17:38	2,97	101	300,05	CHI
20201158190	PETROLINA DE GOIAS	PG12072526	PETROLINA	13/11/2020 14:39	13/11/2020 16:19	13/11/2020 14:39	13/11/2020 16:19	1,65	2	3,31	CHI
20201161173	CALDAZINHA	BV12033394	SENADOR CANEDO	13/11/2020 14:39	14/11/2020 02:36	13/11/2020 14:39	14/11/2020 02:36	11,94	20	238,83	CHI
20201159302	SAO MIGUEL DO ARAGUAIA	SM12350501	SAO MIGUEL DO ARAGUAIA	13/11/2020 14:40	14/11/2020 15:58	13/11/2020 14:40	14/11/2020 15:58	25,29	6	151,76	CHI
20201158202	RIO VERDE	RV11306527	CABRIUVA S1	13/11/2020 14:41	13/11/2020 16:18	13/11/2020 14:41	13/11/2020 16:18	1,61	34	54,82	CHI
20201158229	PILAR DE GOIAS	GG12128447RE	SANTA TEREZINHA	13/11/2020 14:41	14/11/2020 17:36	13/11/2020 14:41	14/11/2020 17:36	26,91	40	1076,34	CHI
20201158219	CORUMBA DE GOIAS	CB12215044	CORUMBA	13/11/2020 14:43	13/11/2020 16:12	13/11/2020 14:43	13/11/2020 16:12	1,47	23	33,87	CHI
20201158219	PIRENOPOLIS	CB12215044	CORUMBA	13/11/2020 14:43	13/11/2020 16:12	13/11/2020 14:43	13/11/2020 16:12	1,47	2	2,95	CHI
20201158355	GOIANIA	GN10380031	ATLANTICO S3	13/11/2020 14:43	13/11/2020 16:08	13/11/2020 14:43	13/11/2020 14:47	0,07	5077	356,80	CHI
20201158355	GOIANIA	GN10380031	ATLANTICO S3	13/11/2020 14:43	13/11/2020 16:08	13/11/2020 14:43	13/11/2020 14:48	0,09	937	83,55	CHI
20201158355	GOIANIA	GN10383773	ATLANTICO S3	13/11/2020 14:43	13/11/2020 16:08	13/11/2020 14:43	13/11/2020 14:50	0,11	871	96,54	CHI
20201158355	APARECIDA DE GOIANIA	602234	ATLANTICO S3	13/11/2020 14:43	13/11/2020 16:08	13/11/2020 14:43	13/11/2020 14:50	0,12	40	4,83	CHI
20201158355	GOIANIA	602234	ATLANTICO S3	13/11/2020 14:43	13/11/2020 16:08	13/11/2020 14:43	13/11/2020 14:50	0,12	1621	195,87	CHI
20201158355	GOIANIA	602234	ATLANTICO S3	13/11/2020 14:43	13/11/2020 16:08	13/11/2020 14:43	13/11/2020 16:08	1,42	1404	1987,05	CHI
20201158988	BELA VISTA DE GOIAS	BV12103250	SENADOR CANEDO	13/11/2020 14:43	13/11/2020 23:55	13/11/2020 14:43	13/11/2020 23:55	9,19	18	165,49	CHI
20201158988	CALDAZINHA	BV12103250	SENADOR CANEDO	13/11/2020 14:43	13/11/2020 23:55	13/11/2020 14:43	13/11/2020 23:55	9,19	3	27,58	CHI
20201158225	ORIZONA	OZ12288381	PIRES DO RIO S2	13/11/2020 14:44	13/11/2020 19:49	13/11/2020 14:44	13/11/2020 19:49	5,08	48	243,93	CHI

20201158225	VIANOPOLIS	OZ12288381	PIRES DO RIO S2	13/11/2020 14:44	13/11/2020 19:49	13/11/2020 14:44	13/11/2020 19:49	5,08	68	345,57	CHI
20201158226	HIDROLANDIA	HD31156909	CEPAIGO S2	13/11/2020 14:44	14/11/2020 12:29	13/11/2020 14:44	14/11/2020 12:29	21,75	1	21,75	CHI
20201158349	BELA VISTA DE GOIAS	BV31016320	BELA VISTA S2	13/11/2020 14:44	13/11/2020 20:46	13/11/2020 14:44	13/11/2020 20:46	6,02	7	42,15	CHI
20201158471	MONTIVIDIU DO NORTE	MX12143686RE	PORANGATU	13/11/2020 14:44	13/11/2020 18:46	13/11/2020 14:44	13/11/2020 18:46	4,03	104	419,38	CHI
20201158236	SILVANIA	SV21049492	VIANOPOLIS	13/11/2020 14:45	13/11/2020 16:24	13/11/2020 14:45	13/11/2020 16:24	1,65	1	1,65	CHI
20201158239	SANTA HELENA DE GOIAS	SH21000208	IPEGUARI	13/11/2020 14:45	13/11/2020 19:55	13/11/2020 14:45	13/11/2020 19:55	5,16	3	15,49	CHI
20201158242	FIRMINOPOLIS	TV12098088	FIRMINOPOLIS S1	13/11/2020 14:46	13/11/2020 17:49	13/11/2020 14:46	13/11/2020 17:49	3,04	1	3,04	CHI
20201158242	TURVANIA	TV12098088	FIRMINOPOLIS S1	13/11/2020 14:46	13/11/2020 17:49	13/11/2020 14:46	13/11/2020 17:49	3,04	5	15,21	CHI
20201158252	GOUVELANDIA	QI12053194RE	QUIRINOPOLIS	13/11/2020 14:47	13/11/2020 17:18	13/11/2020 14:47	13/11/2020 17:18	2,50	2	5,01	CHI
20201158252	QUIRINOPOLIS	QI12053194RE	QUIRINOPOLIS	13/11/2020 14:47	13/11/2020 17:18	13/11/2020 14:47	13/11/2020 17:18	2,50	50	125,13	CHI
20201158254	PADRE BERNARDO	3160003710	PADRE BERNARDO	13/11/2020 14:47	13/11/2020 16:02	13/11/2020 14:47	13/11/2020 16:02	1,24	1	1,24	CHI
20201158256	APARECIDA DE GOIANIA	AP11000016	INDEPENDENCIA S1	13/11/2020 14:48	13/11/2020 15:47	13/11/2020 14:48	13/11/2020 15:47	0,98	123	120,92	CHI
20201158259	APARECIDA DE GOIANIA	AP12008304	CEPAIGO S1	13/11/2020 14:48	13/11/2020 17:06	13/11/2020 14:48	13/11/2020 17:06	2,30	30	69,03	CHI
20201158259	GOIANIA	AP12008304	CEPAIGO S1	13/11/2020 14:48	13/11/2020 17:06	13/11/2020 14:48	13/11/2020 17:06	2,30	60	138,07	CHI
20201158259	SENADOR CANEDO	AP12008304	CEPAIGO S1	13/11/2020 14:48	13/11/2020 17:06	13/11/2020 14:48	13/11/2020 17:06	2,30	436	1003,28	CHI
20201158264	VARJAO	VJ21366465	GUAPO S2	13/11/2020 14:48	13/11/2020 16:44	13/11/2020 14:48	13/11/2020 16:44	1,92	1	1,92	CHI
20201159701	NIQUELANDIA	NQ11097486	NIQUELANDIA SUBTRANSMISSAO	13/11/2020 14:48	13/11/2020 22:51	13/11/2020 14:48	13/11/2020 22:51	8,05	34	273,54	CHI
20201158283	GOIANIA	GN11072173	CAMPINAS S2	13/11/2020 14:50	13/11/2020 20:49	13/11/2020 16:28	13/11/2020 20:49	4,34	81	351,25	CHI
20201158284	ANAPOLIS	AN12351080	ANAPOLIS UNIVERSITARIO S2	13/11/2020 14:50	13/11/2020 17:21	13/11/2020 14:50	13/11/2020 17:21	2,50	277	693,27	CHI
20201158360	APARECIDA DE GOIANIA	AP11045812	REAL S1	13/11/2020 14:50	13/11/2020 16:38	13/11/2020 14:50	13/11/2020 16:38	1,79	187	333,80	CHI
20201158910	MINACU	IH21230524	MINACU	13/11/2020 14:50	14/11/2020 18:51	13/11/2020 14:50	14/11/2020 18:51	28,01	1	28,01	CHI
20201159702	NIQUELANDIA	NQ12264236	NIQUELANDIA SUBTRANSMISSAO	13/11/2020 14:50	14/11/2020 04:01	13/11/2020 14:50	14/11/2020 04:01	13,18	2	26,35	CHI
20201158291	SANTO ANTONIO DA BARRA	BZ21301424	ACREUNA	13/11/2020 14:51	13/11/2020 22:11	13/11/2020 14:51	13/11/2020 22:11	7,33	2	14,66	CHI
20201158883	MONTIVIDIU DO NORTE	MX10400351	PORANGATU	13/11/2020 14:51	15/11/2020 15:30	13/11/2020 14:51	14/11/2020 10:29	19,63	5	98,14	CHI
20201158883	MONTIVIDIU DO NORTE	MX10400351	PORANGATU	13/11/2020 14:51	15/11/2020 15:30	13/11/2020 14:51	14/11/2020 11:22	20,51	22	451,32	CHI
20201158883	MONTIVIDIU DO NORTE	MX10400351	PORANGATU	13/11/2020 14:51	15/11/2020 15:30	13/11/2020 14:51	14/11/2020 11:57	21,10	205	4325,90	CHI
20201158883	MONTIVIDIU DO NORTE	MX13334345	PORANGATU	13/11/2020 14:51	15/11/2020 15:30	13/11/2020 21:35	14/11/2020 11:57	14,38	351	5048,16	CHI
20201158883	MONTIVIDIU DO NORTE	MX12192266RE	PORANGATU	13/11/2020 14:51	15/11/2020 15:30	13/11/2020 21:35	14/11/2020 16:21	18,77	6	112,61	CHI
20201158883	MONTIVIDIU DO NORTE	MX10400351	PORANGATU	13/11/2020 14:51	15/11/2020 15:30	14/11/2020 18:11	14/11/2020 19:29	1,30	583	759,03	CHI
20201158883	MONTIVIDIU DO NORTE	MX12192266RE	PORANGATU	13/11/2020 14:51	15/11/2020 15:30	14/11/2020 18:11	14/11/2020 20:10	1,99	6	11,92	CHI
20201158883	MONTIVIDIU DO NORTE	MX12192266RE	PORANGATU	13/11/2020 14:51	15/11/2020 15:30	15/11/2020 09:35	15/11/2020 13:03	3,45	6	20,72	CHI
20201158883	MONTIVIDIU DO NORTE	MX12192266RE	PORANGATU	13/11/2020 14:51	15/11/2020 15:30	13/11/2020 21:35	15/11/2020 15:30	41,93	56	2348,17	CHI
20201158883	TROMBAS	MX12192266RE	PORANGATU	13/11/2020 14:51	15/11/2020 15:30	13/11/2020 21:35	15/11/2020 15:30	41,93	24	1006,36	CHI
20201158883	MONTIVIDIU DO NORTE	MX12192266RE	PORANGATU	13/11/2020 14:51	15/11/2020 15:30	15/11/2020 14:59	15/11/2020 15:30	0,52	6	3,13	CHI
20201158301	JATAI	JT12182190	JATAI S1	13/11/2020 14:52	14/11/2020 13:27	13/11/2020 14:52	14/11/2020 01:34	10,70	3	32,09	CHI
20201158301	JATAI	JT12182190	JATAI S1	13/11/2020 14:52	14/11/2020 13:27	13/11/2020 22:17	14/11/2020 01:34	3,28	6	19,66	CHI
20201158301	JATAI	JT12182190	JATAI S1	13/11/2020 14:52	14/11/2020 13:27	13/11/2020 14:52	14/11/2020 10:36	19,73	3	59,19	CHI
20201158301	JATAI	JT13214351	JATAI S1	13/11/2020 14:52	14/11/2020 13:27	13/11/2020 22:17	14/11/2020 10:36	12,31	3	36,93	CHI
20201158301	JATAI	JT12192093	JATAI S1	13/11/2020 14:52	14/11/2020 13:27	13/11/2020 22:17	14/11/2020 12:21	14,06	8	112,45	CHI
20201158301	JATAI	JT12101410	JATAI S1	13/11/2020 14:52	14/11/2020 13:27	13/11/2020 22:17	14/11/2020 13:27	15,17	2	30,34	CHI
20201158519	MINACU	IH12230480	MINACU	13/11/2020 14:52	13/11/2020 17:18	13/11/2020 14:52	13/11/2020 17:18	2,42	17	41,16	CHI
20201158827	GUAPO	GA12098724	GUAPO S2	13/11/2020 14:52	13/11/2020 17:32	13/11/2020 14:52	13/11/2020 17:32	2,66	7	18,65	CHI
20201158307	ITUMBIARA	690190359	ITUMBIARA VELHA S1	13/11/2020 14:53	14/11/2020 01:49	13/11/2020 14:53	14/11/2020 01:49	10,93	1	10,93	CHI
20201158310	CATALAO	CT21286315	CATALAO S1	13/11/2020 14:53	13/11/2020 16:27	13/11/2020 14:53	13/11/2020 16:27	1,56	1	1,56	CHI
20201158318	DIORAMA	DI21188340	IPORA	13/11/2020 14:54	13/11/2020 17:00	13/11/2020 14:54	13/11/2020 17:00	2,09	1	2,09	CHI
20201158495	APARECIDA DE GOIANIA	AP11000088	REAL S2	13/11/2020 14:55	14/11/2020 01:40	13/11/2020 14:55	14/11/2020 01:40	10,74	217	2329,68	CHI
20201158327	BURITI ALEGRE	BG12066333	ITUMBIARA VELHA S2	13/11/2020 14:56	13/11/2020 18:20	13/11/2020 14:56	13/11/2020 18:20	3,40	2	6,80	CHI
20201158327	ITUMBIARA	BG12066333	ITUMBIARA VELHA S2	13/11/2020 14:56	13/11/2020 18:20	13/11/2020 14:56	13/11/2020 18:20	3,40	4	13,59	CHI
20201158330	DAMOLANDIA	IN21026257	INHUMAS S1	13/11/2020 14:56	13/11/2020 20:40	13/11/2020 14:56	13/11/2020 20:40	5,72	3	17,17	CHI
20201158757	FORMOSA	FA12376643	ITUIQUIRA	13/11/2020 14:56	13/11/2020 18:48	13/11/2020 14:56	13/11/2020 18:48	3,86	100	385,86	CHI
20201158332	GOIANIA	12909117	ATLANTICO S2	13/11/2020 14:57	13/11/2020 16:43	13/11/2020 14:57	13/11/2020 16:43	1,77	1	1,77	CHI



20201158342	IPORA	730041165	IPORA	13/11/2020 14:58	13/11/2020 16:11	13/11/2020 14:58	13/11/2020 16:11	1,20	1	1,20	CHI
20201158679	COLINAS DO SUL	TI12357757	NIQUELANDIA SUBTRANSMISSAO	13/11/2020 14:58	13/11/2020 18:11	13/11/2020 14:58	13/11/2020 18:11	3,20	7	22,41	CHI
20201158959	NIQUELANDIA	NQ12197552RE	NIQUELANDIA SUBTRANSMISSAO	13/11/2020 14:58	14/11/2020 16:26	13/11/2020 14:58	14/11/2020 16:26	25,46	39	992,84	CHI
20201158345	CRISTALINA	7500866	PAMPLONA	13/11/2020 14:59	13/11/2020 22:31	13/11/2020 14:59	13/11/2020 22:31	7,52	3	22,57	CHI
20201159757	CAMPO ALEGRE DE GOIAS	CT10400691	CATALAO S1	13/11/2020 15:00	14/11/2020 16:19	13/11/2020 18:40	13/11/2020 20:15	1,59	1	1,59	CHI
20201159757	CATALAO	340404	CATALAO S1	13/11/2020 15:00	14/11/2020 16:19	13/11/2020 18:40	13/11/2020 20:15	1,59	71	113,24	CHI
20201159757	CATALAO	CT10400691	CATALAO S1	13/11/2020 15:00	14/11/2020 16:19	13/11/2020 18:40	13/11/2020 20:15	1,59	26	41,47	CHI
20201159757	DAVINOPOLIS	340404	CATALAO S1	13/11/2020 15:00	14/11/2020 16:19	13/11/2020 18:40	13/11/2020 20:15	1,59	565	901,17	CHI
20201159757	DAVINOPOLIS	340404	CATALAO S1	13/11/2020 15:00	14/11/2020 16:19	13/11/2020 18:40	13/11/2020 20:15	1,59	339	540,70	CHI
20201159757	DAVINOPOLIS	CT10400691	CATALAO S1	13/11/2020 15:00	14/11/2020 16:19	13/11/2020 18:40	13/11/2020 20:15	1,59	7	11,16	CHI
20201159757	DISTRITO FEDERAL	340404	CATALAO S1	13/11/2020 15:00	14/11/2020 16:19	13/11/2020 18:40	13/11/2020 20:15	1,59	12	19,14	CHI
20201159757	OUVIDOR	340404	CATALAO S1	13/11/2020 15:00	14/11/2020 16:19	13/11/2020 18:40	13/11/2020 20:15	1,59	176	280,72	CHI
20201159757	OUVIDOR	340404	CATALAO S1	13/11/2020 15:00	14/11/2020 16:19	13/11/2020 18:40	13/11/2020 20:15	1,59	246	392,37	CHI
20201159757	TRES RANCHOS	340404	CATALAO S1	13/11/2020 15:00	14/11/2020 16:19	13/11/2020 18:40	13/11/2020 20:15	1,59	5	7,97	CHI
20201159757	CATALAO	OU10401443	CATALAO S1	13/11/2020 15:00	14/11/2020 16:19	13/11/2020 18:40	13/11/2020 20:15	1,58	14	22,15	CHI
20201159757	DAVINOPOLIS	OU10401443	CATALAO S1	13/11/2020 15:00	14/11/2020 16:19	13/11/2020 18:40	13/11/2020 20:15	1,58	107	169,33	CHI
20201159757	OUVIDOR	OU10401443	CATALAO S1	13/11/2020 15:00	14/11/2020 16:19	13/11/2020 18:40	13/11/2020 20:15	1,58	1	1,58	CHI
20201159757	CATALAO	OU10401443	CATALAO S1	13/11/2020 15:00	14/11/2020 16:19	13/11/2020 20:19	13/11/2020 20:26	0,11	85	9,28	CHI
20201159757	DAVINOPOLIS	OU10401443	CATALAO S1	13/11/2020 15:00	14/11/2020 16:19	13/11/2020 20:19	13/11/2020 20:26	0,11	672	73,36	CHI
20201159757	DAVINOPOLIS	OU10401443	CATALAO S1	13/11/2020 15:00	14/11/2020 16:19	13/11/2020 20:19	13/11/2020 20:26	0,11	339	37,01	CHI
20201159757	DAVINOPOLIS	CT10406645	CATALAO S1	13/11/2020 15:00	14/11/2020 16:19	13/11/2020 20:19	13/11/2020 20:26	0,11	1	0,11	CHI
20201159757	DISTRITO FEDERAL	OU10401443	CATALAO S1	13/11/2020 15:00	14/11/2020 16:19	13/11/2020 20:19	13/11/2020 20:26	0,11	12	1,31	CHI
20201159757	OUVIDOR	OU10401443	CATALAO S1	13/11/2020 15:00	14/11/2020 16:19	13/11/2020 20:19	13/11/2020 20:26	0,11	176	19,21	CHI
20201159757	OUVIDOR	OU10401443	CATALAO S1	13/11/2020 15:00	14/11/2020 16:19	13/11/2020 20:19	13/11/2020 20:26	0,11	247	26,96	CHI
20201159757	TRES RANCHOS	OU10401443	CATALAO S1	13/11/2020 15:00	14/11/2020 16:19	13/11/2020 20:19	13/11/2020 20:26	0,11	5	0,55	CHI
20201159757	CATALAO	CT10400691	CATALAO S1	13/11/2020 15:00	14/11/2020 16:19	13/11/2020 18:40	13/11/2020 20:37	1,95	1	1,95	CHI
20201159757	CATALAO	340404	CATALAO S1	13/11/2020 15:00	14/11/2020 16:19	13/11/2020 22:20	14/11/2020 00:15	1,92	1	1,92	CHI
20201159757	CATALAO	CT13266276	CATALAO S1	13/11/2020 15:00	14/11/2020 16:19	14/11/2020 10:41	14/11/2020 16:19	5,63	1	5,63	CHI
20201160347	ITAPURANGA	IK12234789	ITAPURANGA	13/11/2020 15:00	14/11/2020 09:32	13/11/2020 15:00	14/11/2020 09:32	18,53	6	111,16	CHI
20201158356	NOVO GAMA	2460108807	PACAEMBU S1	13/11/2020 15:01	13/11/2020 16:14	13/11/2020 15:01	13/11/2020 16:14	1,22	1	1,22	CHI
20201158357	APARECIDA DE GOIANIA	AP11278728	INDEPENDENCIA S2	13/11/2020 15:01	13/11/2020 16:41	13/11/2020 15:01	13/11/2020 16:41	1,66	157	261,27	CHI
20201158419	NOVA ROMA	ND12392238	IACIARA S2	13/11/2020 15:01	13/11/2020 17:52	13/11/2020 15:01	13/11/2020 17:52	2,85	235	668,97	CHI
20201158370	CATALAO	CT21266817	CATALAO S1	13/11/2020 15:04	13/11/2020 16:15	13/11/2020 15:04	13/11/2020 16:15	1,18	2	2,36	CHI
20201158374	ITARUMA	IM21205230	CACHOEIRA ALTA	13/11/2020 15:04	13/11/2020 19:11	13/11/2020 15:04	13/11/2020 19:11	4,10	1	4,10	CHI
20201158439	HIDROLANDIA	HD16424180	CEPAIGO S2	13/11/2020 15:05	14/11/2020 02:12	13/11/2020 15:09	13/11/2020 16:37	1,47	175	257,25	CHI
20201158439	HIDROLANDIA	HD13402815	CEPAIGO S2	13/11/2020 15:05	14/11/2020 02:12	13/11/2020 22:41	14/11/2020 02:08	3,45	3	10,36	CHI
20201158439	BELA VISTA DE GOIAS	HD16424180	CEPAIGO S2	13/11/2020 15:05	14/11/2020 02:12	13/11/2020 15:09	14/11/2020 02:12	11,05	8	88,39	CHI
20201158439	HIDROLANDIA	HD16424180	CEPAIGO S2	13/11/2020 15:05	14/11/2020 02:12	13/11/2020 15:09	14/11/2020 02:12	11,05	100	1104,86	CHI
20201158439	HIDROLANDIA	HD16424180	CEPAIGO S2	13/11/2020 15:05	14/11/2020 02:12	13/11/2020 16:41	14/11/2020 02:12	9,52	176	1675,52	CHI
20201158389	PORANGATU	PO21242435	PORANGATU	13/11/2020 15:06	14/11/2020 11:05	13/11/2020 15:06	14/11/2020 11:05	19,97	1	19,97	CHI
20201159240	CRISTIANOPOLIS	BC12389810	PIRES DO RIO S2	13/11/2020 15:06	13/11/2020 19:13	13/11/2020 15:06	13/11/2020 19:13	4,11	7	28,80	CHI
20201158398	ANAPOLIS	10018575631	JUNDIAI S1	13/11/2020 15:07	13/11/2020 20:05	13/11/2020 15:07	13/11/2020 20:05	4,95	1	4,95	CHI
20201158415	SANTA CRUZ DE GOIAS	BC12300692	PIRES DO RIO S2	13/11/2020 15:07	13/11/2020 21:31	13/11/2020 15:07	13/11/2020 21:31	6,40	10	63,96	CHI
20201160724	ALTO PARAISO DE GOIAS	BF12253174	NIQUELANDIA SUBTRANSMISSAO	13/11/2020 15:07	13/11/2020 21:31	13/11/2020 15:07	13/11/2020 21:31	6,39	4	25,57	CHI
20201160724	COLINAS DO SUL	BF12253174	NIQUELANDIA SUBTRANSMISSAO	13/11/2020 15:07	13/11/2020 21:31	13/11/2020 15:07	13/11/2020 21:31	6,39	3	19,18	CHI
20201158400	NOVA ROMA	6550000745	IACIARA S2	13/11/2020 15:09	13/11/2020 19:31	13/11/2020 15:09	13/11/2020 19:31	4,35	1	4,35	CHI
20201158402	QUIRINOPOLIS	QI21319948	QUIRINOPOLIS	13/11/2020 15:09	13/11/2020 21:20	13/11/2020 15:09	13/11/2020 21:20	6,17	1	6,17	CHI
20201158403	FORMOSO	2410019610	PORANGATU	13/11/2020 15:10	13/11/2020 23:45	13/11/2020 15:10	13/11/2020 23:45	8,58	1	8,58	CHI
20201158623	CRISTALINA	KR10406671	CRISTALINA S2	13/11/2020 15:10	13/11/2020 19:31	13/11/2020 15:12	13/11/2020 17:28	2,27	105	238,38	CHI
20201158623	CRISTALINA	KR12171556LD	CRISTALINA S2	13/11/2020 15:10	13/11/2020 19:31	13/11/2020 15:12	13/11/2020 19:14	4,04	26	105,00	CHI
20201158623	CRISTALINA	KR12400537	CRISTALINA S2	13/11/2020 15:10	13/11/2020 19:31	13/11/2020 15:12	13/11/2020 19:31	4,32	131	566,21	CHI

20201158410	CAMPO ALEGRE DE GOIAS	CM12338743	CAMPO ALEGRE DE GOIAS	13/11/2020 15:11	14/11/2020 09:36	13/11/2020 15:11	14/11/2020 09:36	18,41	13	239,36	CHI
20201158416	JATAI	AW21342532	CACHOEIRA ALTA	13/11/2020 15:11	14/11/2020 02:16	13/11/2020 15:11	14/11/2020 02:16	11,07	1	11,07	CHI
20201158417	GOIANIA	12567966	ATLANTICO S3	13/11/2020 15:11	13/11/2020 17:00	13/11/2020 15:11	13/11/2020 17:00	1,81	1	1,81	CHI
20201158432	PORANGATU	PO12208396	PORANGATU	13/11/2020 15:12	14/11/2020 10:39	13/11/2020 15:12	14/11/2020 10:39	19,44	1	19,44	CHI
20201158421	BRAZABRANTES	BR21129672	INHUMAS S1	13/11/2020 15:12	13/11/2020 17:26	13/11/2020 15:12	13/11/2020 17:26	2,23	1	2,23	CHI
20201158424	GOIANIA	GN11034730	ATLANTICO S3	13/11/2020 15:12	13/11/2020 21:00	13/11/2020 15:12	13/11/2020 21:00	5,80	97	562,98	CHI
20201158428	CRISTALINA	KR11304752	CRISTALINA S1	13/11/2020 15:13	13/11/2020 17:55	13/11/2020 15:13	13/11/2020 17:55	2,69	2	5,39	CHI
20201158431	BARRO ALTO	BA21294054	BARRO ALTO	13/11/2020 15:13	13/11/2020 21:27	13/11/2020 15:13	13/11/2020 21:27	6,22	2	12,44	CHI
20201158642	ESTRELA DO NORTE	MU12075219	MARA ROSA	13/11/2020 15:14	14/11/2020 10:06	13/11/2020 15:14	14/11/2020 10:06	18,86	1	18,86	CHI
20201158642	MUTUNOPOLIS	MU12075219	MARA ROSA	13/11/2020 15:14	14/11/2020 10:06	13/11/2020 15:14	14/11/2020 10:06	18,86	8	150,91	CHI
20201158444	CRISTALINA	KR12230241	CRISTALINA S2	13/11/2020 15:15	13/11/2020 17:12	13/11/2020 15:15	13/11/2020 17:12	1,93	5	9,67	CHI
20201158452	CACHOEIRA ALTA	CA21322218	CACHOEIRA ALTA	13/11/2020 15:17	13/11/2020 16:51	13/11/2020 15:17	13/11/2020 16:51	1,56	1	1,56	CHI
20201158456	APARECIDA DE GOIANIA	10004217592	INDEPENDENCIA S2	13/11/2020 15:17	13/11/2020 17:13	13/11/2020 15:17	13/11/2020 17:13	1,92	1	1,92	CHI
20201158458	SANTA TEREZINHA DE GOIAS	SG21141134	SANTA TEREZINHA	13/11/2020 15:17	13/11/2020 20:15	13/11/2020 15:17	13/11/2020 20:15	4,95	1	4,95	CHI
20201158459	ARACU	AR12019199	ARACU	13/11/2020 15:17	13/11/2020 20:40	13/11/2020 15:17	13/11/2020 18:11	2,88	190	548,10	CHI
20201158459	INHUMAS	AR12019199	ARACU	13/11/2020 15:17	13/11/2020 20:40	13/11/2020 15:17	13/11/2020 18:11	2,88	8	23,08	CHI
20201158459	ARACU	AR11132756	ARACU	13/11/2020 15:17	13/11/2020 20:40	13/11/2020 17:54	13/11/2020 20:40	2,78	125	347,22	CHI
20201158461	ANAPOLIS	10008691426	ANAPOLIS UNIVERSITARIO S2	13/11/2020 15:18	13/11/2020 20:08	13/11/2020 15:18	13/11/2020 20:08	4,83	1	4,83	CHI
20201158469	FORMOSO	FO12151052	PORANGATU	13/11/2020 15:19	13/11/2020 21:09	13/11/2020 15:19	13/11/2020 21:09	5,83	6	34,97	CHI
20201158470	TRINDADE	10000105358	TRINDADE	13/11/2020 15:19	13/11/2020 22:38	13/11/2020 15:19	13/11/2020 22:38	7,31	1	7,31	CHI
20201159034	CAMPINORTE	CR21164017	MARA ROSA	13/11/2020 15:19	13/11/2020 22:37	13/11/2020 15:19	13/11/2020 22:37	7,29	2	14,57	CHI
20201158477	CRISTALINA	KR21304913	CRISTALINA S2	13/11/2020 15:20	13/11/2020 18:34	13/11/2020 15:20	13/11/2020 18:34	3,23	1	3,23	CHI
20201158478	AGUA FRIA DE GOIAS	TL21076103	SAO JOAO D ALIANCA	13/11/2020 15:20	13/11/2020 17:32	13/11/2020 15:20	13/11/2020 17:32	2,19	1	2,19	CHI
20201158480	MONTIVIDIU	MV21210332	MONTIVIDIU T	13/11/2020 15:20	13/11/2020 20:18	13/11/2020 15:20	13/11/2020 20:18	4,95	2	9,91	CHI
20201158481	LEOPOLDO DE BULHOES	LB21272424	DAIA S2	13/11/2020 15:20	13/11/2020 17:01	13/11/2020 15:20	13/11/2020 17:01	1,67	1	1,67	CHI
20201158526	ITUMBIARA	980224	ITUMBIARA NOVA	13/11/2020 15:20	13/11/2020 18:50	13/11/2020 15:20	13/11/2020 15:24	0,06	197	12,48	CHI
20201158526	ITUMBIARA	980224	ITUMBIARA NOVA	13/11/2020 15:20	13/11/2020 18:50	13/11/2020 15:20	13/11/2020 15:24	0,07	4904	332,38	CHI
20201158526	ITUMBIARA	980224	ITUMBIARA NOVA	13/11/2020 15:20	13/11/2020 18:50	13/11/2020 15:20	13/11/2020 16:30	1,17	1940	2272,49	CHI
20201158526	ITUMBIARA	980224	ITUMBIARA NOVA	13/11/2020 15:20	13/11/2020 18:50	13/11/2020 15:20	13/11/2020 18:50	3,51	119	417,19	CHI
20201158483	FORMOSA	10005673621	ITUIQUIRA	13/11/2020 15:21	13/11/2020 16:45	13/11/2020 15:21	13/11/2020 16:45	1,40	1	1,40	CHI
20201158486	SAO JOAO D ALIANCA	JL12268121	SAO JOAO D ALIANCA	13/11/2020 15:21	13/11/2020 18:17	13/11/2020 15:21	13/11/2020 18:17	2,93	8	23,44	CHI
20201158537	ITAPURANGA	IK12250613	ITAPURANGA	13/11/2020 15:21	13/11/2020 18:07	13/11/2020 15:21	13/11/2020 18:07	2,76	29	79,96	CHI
20201158496	FORMOSA	FA21245449	ITUIQUIRA	13/11/2020 15:22	13/11/2020 18:25	13/11/2020 15:22	13/11/2020 18:25	3,04	1	3,04	CHI
20201158658	CARMO DO RIO VERDE	RB12391473RE	RUBIATABA	13/11/2020 15:23	13/11/2020 17:05	13/11/2020 15:23	13/11/2020 17:05	1,71	3	5,12	CHI
20201158658	CERES	RB12391473RE	RUBIATABA	13/11/2020 15:23	13/11/2020 17:05	13/11/2020 15:23	13/11/2020 17:05	1,71	28	47,76	CHI
20201158658	IPIRANGA DE GOIAS	RB12391473RE	RUBIATABA	13/11/2020 15:23	13/11/2020 17:05	13/11/2020 15:23	13/11/2020 17:05	1,71	3	5,12	CHI
20201158658	RUBIATABA	RB12391473RE	RUBIATABA	13/11/2020 15:23	13/11/2020 17:05	13/11/2020 15:23	13/11/2020 17:05	1,71	275	469,10	CHI
20201158658	SAO PATRICIO	RB12391473RE	RUBIATABA	13/11/2020 15:23	13/11/2020 17:05	13/11/2020 15:23	13/11/2020 17:05	1,71	20	34,12	CHI
20201158516	MONTIVIDIU	RV21200161	MONTIVIDIU T	13/11/2020 15:25	13/11/2020 22:11	13/11/2020 15:25	13/11/2020 22:11	6,75	1	6,75	CHI
20201158520	ALTO PARAISO DE GOIAS	BF21144666	NIQUELANDIA SUBTRANSMISSAO	13/11/2020 15:26	13/11/2020 21:05	13/11/2020 15:26	13/11/2020 21:05	5,65	2	11,29	CHI
20201159159	BURITI ALEGRE	BG12000067RE	ITUMBIARA VELHA S2	13/11/2020 15:26	14/11/2020 16:30	13/11/2020 15:26	14/11/2020 12:04	20,64	19	392,11	CHI
20201159159	ITUMBIARA	BG12000067RE	ITUMBIARA VELHA S2	13/11/2020 15:26	14/11/2020 16:30	13/11/2020 15:26	14/11/2020 12:04	20,64	16	330,20	CHI
20201159159	BURITI ALEGRE	BG12000067RE	ITUMBIARA VELHA S2	13/11/2020 15:26	14/11/2020 16:30	13/11/2020 15:26	14/11/2020 16:30	25,07	27	676,91	CHI
20201159159	GOIATUBA	BG12000067RE	ITUMBIARA VELHA S2	13/11/2020 15:26	14/11/2020 16:30	13/11/2020 15:26	14/11/2020 16:30	25,07	2	50,14	CHI
20201159159	ITUMBIARA	BG12000067RE	ITUMBIARA VELHA S2	13/11/2020 15:26	14/11/2020 16:30	13/11/2020 15:26	14/11/2020 16:30	25,07	9	225,64	CHI
20201158538	RIO VERDE	RV21155851	SANTA HELENA S1	13/11/2020 15:27	13/11/2020 18:51	13/11/2020 15:27	13/11/2020 18:51	3,39	1	3,39	CHI
20201158608	BELA VISTA DE GOIAS	BV12308991RE	BELA VISTA S1	13/11/2020 15:27	13/11/2020 18:09	13/11/2020 15:27	13/11/2020 18:09	2,71	114	308,75	CHI
20201158608	CALDAZINHA	BV12308991RE	BELA VISTA S1	13/11/2020 15:27	13/11/2020 18:09	13/11/2020 15:27	13/11/2020 18:09	2,71	20	54,17	CHI
20201159146	CORUMBA DE GOIAS	ZN12273073	COCALZINHO	13/11/2020 15:27	14/11/2020 08:47	13/11/2020 15:27	14/11/2020 08:47	17,33	2	34,66	CHI
20201159146	PIRENOPOLIS	ZN12273073	COCALZINHO	13/11/2020 15:27	14/11/2020 08:47	13/11/2020 15:27	14/11/2020 08:47	17,33	14	242,65	CHI
20201158542	MARA ROSA	MQ12359537	MARA ROSA	13/11/2020 15:28	15/11/2020 13:09	13/11/2020 15:28	15/11/2020 13:09	45,68	1	45,68	CHI

20201158545	RUBIATABA	RB21114276	RUBIATABA	13/11/2020 15:28	13/11/2020 17:36	13/11/2020 15:28	13/11/2020 17:36	2,13	2	4,26	CHI
20201158773	RIO VERDE	RV12360702	MONTIVIDIU T	13/11/2020 15:28	13/11/2020 17:23	13/11/2020 15:28	13/11/2020 17:23	1,90	12	22,83	CHI
20201160256	NIQUELANDIA	NQ12213022	NIQUELANDIA SUBTRANSMISSAO	13/11/2020 15:28	14/11/2020 04:35	13/11/2020 15:28	14/11/2020 04:35	13,11	9	118,02	CHI
20201158552	SAO MIGUEL DO ARAGUAIA	SM21081431	SAO MIGUEL DO ARAGUAIA	13/11/2020 15:29	14/11/2020 03:43	13/11/2020 15:29	14/11/2020 03:43	12,24	1	12,24	CHI
20201158553	QUIRINOPOLIS	80022571	QUIRINOPOLIS	13/11/2020 15:29	13/11/2020 18:28	13/11/2020 15:29	13/11/2020 18:28	2,98	1	2,98	CHI
20201158555	GOUVELANDIA	GB12303270	QUIRINOPOLIS	13/11/2020 15:29	13/11/2020 18:37	13/11/2020 15:29	13/11/2020 18:37	3,13	8	25,01	CHI
20201159311	ITARUMA	IM12097096	CACHOEIRA ALTA	13/11/2020 15:29	13/11/2020 23:29	13/11/2020 15:29	13/11/2020 23:29	7,99	2	15,98	CHI
20201158563	RIO QUENTE	RQ12098228	RIO QUENTE	13/11/2020 15:30	13/11/2020 17:58	13/11/2020 15:30	13/11/2020 17:58	2,45	12	29,41	CHI
20201158575	APARECIDA DE GOIANIA	200102898	INDEPENDENCIA S2	13/11/2020 15:32	13/11/2020 16:16	13/11/2020 15:32	13/11/2020 16:16	0,73	1	0,73	CHI
20201158584	GOIANIA	GN21044087	GOYA S1	13/11/2020 15:33	13/11/2020 17:06	13/11/2020 15:33	13/11/2020 17:06	1,54	1	1,54	CHI
20201158593	TURVANIA	1220014919	FIRMINOPOLIS S2	13/11/2020 15:34	13/11/2020 17:54	13/11/2020 15:34	13/11/2020 17:54	2,33	1	2,33	CHI
20201158594	JANDAIA	JD21193728	PALMEIRAS	13/11/2020 15:34	14/11/2020 12:08	13/11/2020 15:34	14/11/2020 12:08	20,56	2	41,12	CHI
20201158685	NIQUELANDIA	NQ12208518	NIQUELANDIA SUBTRANSMISSAO	13/11/2020 15:34	13/11/2020 19:38	13/11/2020 15:34	13/11/2020 19:38	4,07	95	386,52	CHI
20201158598	CAMPINORTE	CR21320944	MARA ROSA	13/11/2020 15:35	14/11/2020 05:25	13/11/2020 15:35	14/11/2020 05:25	13,83	2	27,67	CHI
20201158600	TAQUARAL DE GOIAS	10014950020	ITABERAI S1	13/11/2020 15:35	13/11/2020 18:21	13/11/2020 15:35	13/11/2020 18:21	2,76	1	2,76	CHI
20201158604	ITUMBIARA	IT21122347	PARANAIBA	13/11/2020 15:36	14/11/2020 09:08	13/11/2020 15:36	14/11/2020 09:08	17,53	1	17,53	CHI
20201158610	LUZIANIA	120381825	RIO VERMELHO	13/11/2020 15:36	13/11/2020 17:07	13/11/2020 15:36	13/11/2020 17:07	1,50	1	1,50	CHI
20201158817	NIQUELANDIA	NQ12239432	URUACU	13/11/2020 15:36	15/11/2020 09:19	13/11/2020 15:36	15/11/2020 09:19	41,72	21	876,05	CHI
20201158607	APARECIDA DE GOIANIA	10001942334	REAL S1	13/11/2020 15:37	13/11/2020 17:03	13/11/2020 15:37	13/11/2020 17:03	1,43	1	1,43	CHI
20201158618	SAO DOMINGOS	SD21160006	SAO DOMINGOS	13/11/2020 15:37	14/11/2020 00:55	13/11/2020 15:37	14/11/2020 00:55	9,29	2	18,58	CHI
20201158994	CORUMBA DE GOIAS	CB12000040	CORUMBA	13/11/2020 15:37	13/11/2020 20:45	13/11/2020 15:37	13/11/2020 20:45	5,13	142	728,30	CHI
20201158630	DOVERLANDIA	DV21207490	CAIAPONIA	13/11/2020 15:39	13/11/2020 21:15	13/11/2020 15:39	13/11/2020 21:15	5,61	1	5,61	CHI
20201161229	ITAPURANGA	IK11012850	ITAPURANGA	13/11/2020 15:40	14/11/2020 00:27	13/11/2020 15:40	14/11/2020 00:27	8,77	311	2727,04	CHI
20201158644	ACREUNA	EU11189127	ACREUNA	13/11/2020 15:41	14/11/2020 00:16	13/11/2020 15:41	14/11/2020 00:16	8,58	40	343,26	CHI
20201158654	URUACU	10002470509	URUACU	13/11/2020 15:42	13/11/2020 18:59	13/11/2020 15:42	13/11/2020 18:59	3,28	1	3,28	CHI
20201158655	CAVALCANTE	CJ12346073	MINACU	13/11/2020 15:42	15/11/2020 13:44	13/11/2020 15:42	15/11/2020 13:44	46,03	193	8882,88	CHI
20201158657	MORRINHOS	MR12074576	GOIATUBA S1	13/11/2020 15:42	14/11/2020 09:02	13/11/2020 15:42	14/11/2020 09:02	17,32	2	34,64	CHI
20201158666	ANAPOLIS	21311213	ANAPOLIS UNIVERSITARIO S2	13/11/2020 15:43	13/11/2020 18:17	13/11/2020 15:43	13/11/2020 18:17	2,55	1	2,55	CHI
20201158974	CORUMBA DE GOIAS	CB12319748	CORUMBA	13/11/2020 15:43	13/11/2020 19:21	13/11/2020 15:43	13/11/2020 19:21	3,62	13	47,12	CHI
20201159035	NOVA IGUAU DE GOIAS	NH21086279	MARA ROSA	13/11/2020 15:43	13/11/2020 23:49	13/11/2020 15:43	13/11/2020 23:49	8,09	1	8,09	CHI
20201158694	SAO MIGUEL DO ARAGUAIA	SM11262690	SAO MIGUEL DO ARAGUAIA	13/11/2020 15:44	13/11/2020 18:18	13/11/2020 15:44	13/11/2020 18:18	2,55	63	160,77	CHI
20201159009	ITUMBIARA	BJ12000002	BOM JESUS DE GOIAS	13/11/2020 15:44	13/11/2020 17:58	13/11/2020 15:44	13/11/2020 17:58	2,23	246	549,33	CHI
20201161836	PORANGATU	PO12202421	PORANGATU	13/11/2020 15:44	14/11/2020 10:43	13/11/2020 15:44	14/11/2020 10:43	18,97	6	113,84	CHI
20201159251	ITUMBIARA	IT12309855RE	PARANAIBA	13/11/2020 15:45	13/11/2020 17:59	13/11/2020 15:45	13/11/2020 17:59	2,23	30	66,90	CHI
20201158941	SANTA RITA DO ARAGUAIA	SU12374325RE	SANTA RITA DO ARAGUAIA	13/11/2020 15:46	13/11/2020 18:59	13/11/2020 15:46	13/11/2020 18:59	3,20	29	92,84	CHI
20201158707	CORUMBA DE GOIAS	CB21130824	CORUMBA	13/11/2020 15:47	13/11/2020 23:42	13/11/2020 15:47	13/11/2020 23:42	7,90	1	7,90	CHI
20201158709	SENADOR CANEDO	SW12402763	SENADOR CANEDO	13/11/2020 15:47	13/11/2020 17:05	13/11/2020 15:47	13/11/2020 17:05	1,28	127	163,02	CHI
20201158710	CALDAZINHA	LB21200297	CEPAIGO S2	13/11/2020 15:48	13/11/2020 18:09	13/11/2020 15:48	13/11/2020 18:09	2,35	1	2,35	CHI
20201158715	MINEIROS	10031647497	PARQUE DAS EMAS	13/11/2020 15:48	13/11/2020 20:43	13/11/2020 15:48	13/11/2020 20:43	4,91	1	4,91	CHI
20201158717	APARECIDA DE GOIANIA	16630981	INDEPENDENCIA S1	13/11/2020 15:48	13/11/2020 17:13	13/11/2020 15:48	13/11/2020 17:13	1,41	1	1,41	CHI
20201158730	ITAPURANGA	IK12250518	ITAPURANGA	13/11/2020 15:48	13/11/2020 21:50	13/11/2020 15:48	13/11/2020 21:50	6,02	3	18,07	CHI
20201161080	ITAPURANGA	IK21236934	ITAPURANGA	13/11/2020 15:48	14/11/2020 15:23	13/11/2020 15:48	14/11/2020 15:23	23,57	1	23,57	CHI
20201164451	ESTRELA DO NORTE	ET11053273	MARA ROSA	13/11/2020 15:48	15/11/2020 13:41	13/11/2020 15:48	15/11/2020 13:41	45,87	200	9174,78	CHI
20201158721	CACU	CC12322236	CACHOEIRA ALTA	13/11/2020 15:49	13/11/2020 19:54	13/11/2020 15:49	13/11/2020 19:54	4,09	1	4,09	CHI
20201160016	GAMELEIRA DE GOIAS	SV12278872	DAIA S2	13/11/2020 15:49	14/11/2020 15:46	13/11/2020 15:49	14/11/2020 15:46	23,95	32	766,33	CHI
20201161015	GAMELEIRA DE GOIAS	SV12278872	DAIA S2	13/11/2020 15:49	14/11/2020 15:46	13/11/2020 15:49	14/11/2020 15:46	23,95	7	167,63	CHI
20201158733	BRITANIA	BT12206760	BRITANIA	13/11/2020 15:50	13/11/2020 17:20	13/11/2020 15:50	13/11/2020 17:20	1,50	2	3,00	CHI
20201159031	ABADIANIA	AA12335610	ANAPOLIS UNIVERSITARIO S1	13/11/2020 15:50	13/11/2020 22:41	13/11/2020 15:50	13/11/2020 22:41	6,83	9	61,51	CHI
20201158739	BURITI ALEGRE	BG21320261	ALTO BURITI	13/11/2020 15:51	14/11/2020 01:36	13/11/2020 15:51	14/11/2020 01:36	9,75	1	9,75	CHI
20201158740	SANTO ANTONIO DE GOIAS	GR12002127	NEROPOLIS S1	13/11/2020 15:51	13/11/2020 19:38	13/11/2020 15:51	13/11/2020 19:38	3,78	2	7,56	CHI
20201158743	NOVA CRIXAS	10004298312	NOVA CRIXAS	13/11/2020 15:51	14/11/2020 21:18	13/11/2020 15:51	14/11/2020 21:18	29,44	1	29,44	CHI

20201158752	INHUMAS	IN12066292	INHUMAS S2	13/11/2020 15:52	13/11/2020 21:23	13/11/2020 15:52	13/11/2020 21:23	5,51	7	38,55	CHI
20201158755	FORMOSA	10010934586	ITIQUEIRA	13/11/2020 15:52	13/11/2020 19:12	13/11/2020 15:52	13/11/2020 19:12	3,32	1	3,32	CHI
20201159714	NIQUELANDIA	NQ12235223	NIQUELANDIA SUBTRANSMISSAO	13/11/2020 15:52	14/11/2020 08:08	13/11/2020 15:52	14/11/2020 08:08	16,26	26	422,66	CHI
20201161145	INHUMAS	IN21106220	INHUMAS S2	13/11/2020 15:52	13/11/2020 23:25	13/11/2020 15:52	13/11/2020 23:25	7,54	1	7,54	CHI
20201158763	VALPARAISO DE GOIAS	10007810103	MARAJOARA	13/11/2020 15:53	13/11/2020 18:11	13/11/2020 15:53	13/11/2020 18:11	2,29	1	2,29	CHI
20201158764	GUAPO	GA11276664	GUAPO S2	13/11/2020 15:53	13/11/2020 20:12	13/11/2020 15:53	13/11/2020 20:12	4,30	1	4,30	CHI
20201158947	SAO MIGUEL DO ARAGUAIA	SM12032000	SAO MIGUEL DO ARAGUAIA	13/11/2020 15:53	13/11/2020 21:47	13/11/2020 15:53	13/11/2020 21:47	5,89	5	29,45	CHI
20201158767	PIRANHAS	1930013970	PIRANHAS	13/11/2020 15:54	13/11/2020 17:27	13/11/2020 15:54	13/11/2020 17:27	1,55	1	1,55	CHI
20201158774	GOIANIA	17179520	ATLANTICO S2	13/11/2020 15:55	13/11/2020 17:27	13/11/2020 15:55	13/11/2020 17:27	1,53	1	1,53	CHI
20201158797	GOIANIA	GN10394643	XAVANTES	13/11/2020 15:55	14/11/2020 03:08	13/11/2020 15:55	13/11/2020 18:37	2,71	7	18,97	CHI
20201158797	GOIANIA	GN10394643	XAVANTES	13/11/2020 15:55	14/11/2020 03:08	13/11/2020 19:46	13/11/2020 20:13	0,45	7	3,12	CHI
20201158797	GOIANIA	GN13050578	XAVANTES	13/11/2020 15:55	14/11/2020 03:08	13/11/2020 15:55	13/11/2020 23:12	7,30	526	3837,61	CHI
20201158797	GOIANIA	GN10394643	XAVANTES	13/11/2020 15:55	14/11/2020 03:08	14/11/2020 00:28	14/11/2020 00:35	0,11	533	61,29	CHI
20201158797	GOIANIA	GN13066497	XAVANTES	13/11/2020 15:55	14/11/2020 03:08	13/11/2020 15:55	14/11/2020 02:44	10,83	1	10,83	CHI
20201158797	GOIANIA	GN12373691LD	XAVANTES	13/11/2020 15:55	14/11/2020 03:08	13/11/2020 15:55	14/11/2020 03:08	11,23	62	696,21	CHI
20201158797	NEROPOLIS	GN12373691LD	XAVANTES	13/11/2020 15:55	14/11/2020 03:08	13/11/2020 15:55	14/11/2020 03:08	11,23	26	291,96	CHI
20201158797	GOIANIA	GN21001133	XAVANTES	13/11/2020 15:55	14/11/2020 03:08	13/11/2020 15:55	14/11/2020 03:08	11,23	2	22,46	CHI
202011138052	ESTRELA DO NORTE	ET18050738FS	MARA ROSA	13/11/2020 15:56	14/11/2020 13:21	13/11/2020 15:56	14/11/2020 13:21	21,41	12	256,94	CHI
202011138052	FORMOSO	ET18050738FS	MARA ROSA	13/11/2020 15:56	14/11/2020 13:21	13/11/2020 15:56	14/11/2020 13:21	21,41	74	1584,48	CHI
202011138052	MARA ROSA	ET18050738FS	MARA ROSA	13/11/2020 15:56	14/11/2020 13:21	13/11/2020 15:56	14/11/2020 13:21	21,41	65	1391,78	CHI
20201158791	INHUMAS	30033846	INHUMAS S2	13/11/2020 15:57	13/11/2020 17:34	13/11/2020 15:57	13/11/2020 17:34	1,61	1	1,61	CHI
20201158814	CAIAPONIA	CP12235316	PIRANHAS	13/11/2020 15:57	13/11/2020 19:13	13/11/2020 15:57	13/11/2020 19:13	3,25	6	19,50	CHI
20201158794	CALDAS NOVAS	CN21110301	CALDAS NOVAS S1	13/11/2020 15:58	13/11/2020 18:14	13/11/2020 15:58	13/11/2020 18:14	2,27	1	2,27	CHI
20201158798	CORUMBA DE GOIAS	CB12215012	CORUMBA	13/11/2020 15:58	14/11/2020 00:55	13/11/2020 15:58	14/11/2020 00:55	8,94	5	44,70	CHI
20201158803	GOIANIA	10939258	FERROVIARIO S1	13/11/2020 15:59	13/11/2020 17:19	13/11/2020 15:59	13/11/2020 17:19	1,32	1	1,32	CHI
20201158804	SAO JOAO D ALIANCA	JL11239884	ITIQUEIRA	13/11/2020 15:59	13/11/2020 20:01	13/11/2020 15:59	13/11/2020 20:01	4,02	1	4,02	CHI
20201158806	ITARUMA	IM11045790	CACHOEIRA ALTA	13/11/2020 15:59	13/11/2020 22:55	13/11/2020 15:59	13/11/2020 22:55	6,92	2	13,84	CHI
20201158816	CEZARINA	CZ21399818	GUAPO S2	13/11/2020 16:01	13/11/2020 18:29	13/11/2020 16:01	13/11/2020 18:29	2,46	1	2,46	CHI
20201158820	GOIANAPOLIS	TJ12388838	DAIA S2	13/11/2020 16:01	14/11/2020 14:06	13/11/2020 16:01	14/11/2020 14:06	22,07	5	110,35	CHI
20201158823	MINACU	IH12328048	MINACU	13/11/2020 16:01	14/11/2020 01:27	13/11/2020 16:01	14/11/2020 01:27	9,42	222	2090,93	CHI
20201158826	ITUMBIARA	IT11282406	ITUMBIARA VELHA S1	13/11/2020 16:02	13/11/2020 16:59	13/11/2020 16:02	13/11/2020 16:59	0,95	74	69,95	CHI
20201158831	CAIAPONIA	MV11301393	MONTIVIDIU T	13/11/2020 16:03	13/11/2020 20:45	13/11/2020 16:03	13/11/2020 20:36	4,56	93	424,05	CHI
20201158831	CAIAPONIA	CP12052996	MONTIVIDIU T	13/11/2020 16:03	13/11/2020 20:45	13/11/2020 18:40	13/11/2020 20:45	2,09	119	248,45	CHI
20201158832	ANAPOLIS	AN11346901	JUNDIAI S1	13/11/2020 16:03	13/11/2020 20:50	13/11/2020 16:03	13/11/2020 20:50	4,78	33	157,67	CHI
20201158859	CACHOEIRA ALTA	CC10251897	CACHOEIRA ALTA	13/11/2020 16:04	13/11/2020 22:15	13/11/2020 16:04	13/11/2020 19:07	3,04	9	27,35	CHI
20201158859	CACU	CC10251897	CACHOEIRA ALTA	13/11/2020 16:04	13/11/2020 22:15	13/11/2020 16:04	13/11/2020 19:07	3,04	1	3,04	CHI
20201158859	CACHOEIRA ALTA	CC10251897	CACHOEIRA ALTA	13/11/2020 16:04	13/11/2020 22:15	13/11/2020 16:04	13/11/2020 19:20	3,27	58	189,37	CHI
20201158859	CACHOEIRA ALTA	CC10251897	CACHOEIRA ALTA	13/11/2020 16:04	13/11/2020 22:15	13/11/2020 19:21	13/11/2020 19:37	0,26	9	2,37	CHI
20201158859	CACU	CC10251897	CACHOEIRA ALTA	13/11/2020 16:04	13/11/2020 22:15	13/11/2020 19:21	13/11/2020 19:37	0,26	1	0,26	CHI
20201158859	CACHOEIRA ALTA	CA13136208	CACHOEIRA ALTA	13/11/2020 16:04	13/11/2020 22:15	13/11/2020 19:21	13/11/2020 21:59	2,62	58	152,01	CHI
20201158859	APARECIDA DO RIO DOCE	CC10251897	CACHOEIRA ALTA	13/11/2020 16:04	13/11/2020 22:15	13/11/2020 16:04	13/11/2020 22:15	6,18	600	3705,33	CHI
20201158859	APARECIDA DO RIO DOCE	CC10251897	CACHOEIRA ALTA	13/11/2020 16:04	13/11/2020 22:15	13/11/2020 16:04	13/11/2020 22:15	6,18	639	3946,18	CHI
20201158859	APARECIDA DO RIO DOCE	CC10251897	CACHOEIRA ALTA	13/11/2020 16:04	13/11/2020 22:15	13/11/2020 16:04	13/11/2020 22:15	6,18	25	154,39	CHI
20201158859	CACHOEIRA ALTA	CC10251897	CACHOEIRA ALTA	13/11/2020 16:04	13/11/2020 22:15	13/11/2020 16:04	13/11/2020 22:15	6,18	67	413,76	CHI
20201158859	CACHOEIRA ALTA	CC10251897	CACHOEIRA ALTA	13/11/2020 16:04	13/11/2020 22:15	13/11/2020 16:04	13/11/2020 22:15	6,18	3	18,53	CHI
20201158859	CACHOEIRA ALTA	CC10251897	CACHOEIRA ALTA	13/11/2020 16:04	13/11/2020 22:15	13/11/2020 16:04	13/11/2020 22:15	6,18	94	580,50	CHI
20201158859	JATAI	CC10251897	CACHOEIRA ALTA	13/11/2020 16:04	13/11/2020 22:15	13/11/2020 16:04	13/11/2020 22:15	6,18	35	216,14	CHI
20201158859	JATAI	CC10251897	CACHOEIRA ALTA	13/11/2020 16:04	13/11/2020 22:15	13/11/2020 16:04	13/11/2020 22:15	6,18	1	6,18	CHI
20201158859	RIO VERDE	CC10251897	CACHOEIRA ALTA	13/11/2020 16:04	13/11/2020 22:15	13/11/2020 16:04	13/11/2020 22:15	6,18	8	49,40	CHI
20201158859	RIO VERDE	CC10251897	CACHOEIRA ALTA	13/11/2020 16:04	13/11/2020 22:15	13/11/2020 16:04	13/11/2020 22:15	6,18	168	1037,49	CHI
20201158859	RIO VERDE	CC10251897	CACHOEIRA ALTA	13/11/2020 16:04	13/11/2020 22:15	13/11/2020 16:04	13/11/2020 22:15	6,18	10	61,76	CHI

20201158843	CABECEIRAS	CW21146046	ITIQUIRA	13/11/2020 16:05	13/11/2020 22:33	13/11/2020 16:05	13/11/2020 22:33	6,46	2	12,91	CHI
20201158845	ITABERAÍ	IB21021861	ITABERAÍ S2	13/11/2020 16:05	13/11/2020 19:22	13/11/2020 16:05	13/11/2020 19:22	3,27	1	3,27	CHI
20201158992	GOIANIA	GN11240463	FERROVIARIO S1	13/11/2020 16:05	13/11/2020 19:07	13/11/2020 16:05	13/11/2020 19:07	3,02	168	506,85	CHI
20201158930	NIQUELANDIA	NQ12316271	BARRO ALTO	13/11/2020 16:06	13/11/2020 19:58	13/11/2020 16:06	13/11/2020 19:58	3,86	3	11,59	CHI
20201158861	BELA VISTA DE GOIAS	BV21193010	BELA VISTA S2	13/11/2020 16:07	14/11/2020 00:10	13/11/2020 16:07	14/11/2020 00:10	8,04	1	8,04	CHI
20201159633	PIRACANJUBA	PJ12419689	PIRACANJUBA	13/11/2020 16:07	13/11/2020 20:54	13/11/2020 16:07	13/11/2020 20:54	4,78	2	9,55	CHI
20201158862	ITARUMA	IM21154729	CACHOEIRA ALTA	13/11/2020 16:08	13/11/2020 17:54	13/11/2020 16:08	13/11/2020 17:54	1,76	1	1,76	CHI
20201158864	LUZIANIA	LZ12092820	RIO VERMELHO	13/11/2020 16:08	13/11/2020 20:04	13/11/2020 16:08	13/11/2020 20:04	3,93	3	11,79	CHI
20201158865	GOIANIA	GN11240944	REAL S2	13/11/2020 16:08	13/11/2020 21:50	13/11/2020 16:08	13/11/2020 21:50	5,69	8	45,54	CHI
20201158874	PLANALTINA	PI12324338	SAO JOAO D ALIANCA	13/11/2020 16:09	13/11/2020 20:13	13/11/2020 16:09	13/11/2020 20:13	4,06	6	24,37	CHI
20201158876	MINACU	IH11212282	MINACU	13/11/2020 16:09	15/11/2020 03:21	13/11/2020 16:09	15/11/2020 03:21	35,19	9	316,74	CHI
20201159075	ARAGOIANIA	AO32094616	GUAPO S2	13/11/2020 16:10	13/11/2020 21:45	13/11/2020 16:10	13/11/2020 21:45	5,57	15	83,53	CHI
20201159075	HIDROLANDIA	AO32094616	GUAPO S2	13/11/2020 16:10	13/11/2020 21:45	13/11/2020 16:10	13/11/2020 21:45	5,57	1	5,57	CHI
20201161039	MINACU	IH12181637	MINACU	13/11/2020 16:10	14/11/2020 08:37	13/11/2020 16:10	14/11/2020 08:37	16,44	7	115,10	CHI
20201158888	SIMOLANDIA	SA21267205	IACIARA S2	13/11/2020 16:11	13/11/2020 21:20	13/11/2020 16:11	13/11/2020 21:20	5,15	1	5,15	CHI
20201158901	ABADIANIA	AA12285384	ANAPOLIS UNIVERSITARIO S1	13/11/2020 16:12	13/11/2020 18:31	13/11/2020 16:12	13/11/2020 18:31	2,31	51	117,57	CHI
20201160934	CRIXAS	CX12314423	RUBIATABA	13/11/2020 16:12	15/11/2020 08:45	13/11/2020 16:12	15/11/2020 08:45	40,54	9	364,85	CHI
20201158913	JARAGUA	JA21116888	JARAGUA	13/11/2020 16:13	13/11/2020 20:52	13/11/2020 16:13	13/11/2020 20:52	4,64	1	4,64	CHI
20201159248	CORUMBA DE GOIAS	CB12034262	CORUMBA	13/11/2020 16:13	13/11/2020 20:09	13/11/2020 16:13	13/11/2020 20:09	3,92	15	58,85	CHI
20201158914	CAIAPONIA	CP12190337	CAIAPONIA	13/11/2020 16:14	13/11/2020 21:20	13/11/2020 16:14	13/11/2020 21:20	5,09	2	10,19	CHI
20201158923	GOIANIA	10607791	AEROPORTO S2	13/11/2020 16:15	13/11/2020 17:47	13/11/2020 16:15	13/11/2020 17:47	1,52	1	1,52	CHI
20201159615	ARAGOIANIA	HD12058875RE	INDEPENDENCIA S1	13/11/2020 16:16	13/11/2020 21:03	13/11/2020 16:16	13/11/2020 21:03	4,77	30	143,10	CHI
20201159615	HIDROLANDIA	HD12058875RE	INDEPENDENCIA S1	13/11/2020 16:16	13/11/2020 21:03	13/11/2020 16:16	13/11/2020 21:03	4,77	44	209,88	CHI
20201158933	GOIANIA	GN21000481	GOIANIA LESTE S3	13/11/2020 16:17	13/11/2020 21:19	13/11/2020 16:17	13/11/2020 21:19	5,03	2	10,05	CHI
20201158934	PARAUNA	PU21228087	PARAUNA	13/11/2020 16:17	13/11/2020 17:34	13/11/2020 16:17	13/11/2020 17:34	1,28	1	1,28	CHI
20201158936	CROMINIA	CQ21017429	PONTALINA	13/11/2020 16:17	13/11/2020 21:02	13/11/2020 16:17	13/11/2020 21:02	4,74	1	4,74	CHI
20201159440	PIRACANJUBA	PJ11182881	PIRACANJUBA	13/11/2020 16:17	13/11/2020 20:16	13/11/2020 16:17	13/11/2020 20:16	3,98	72	286,66	CHI
20201158943	LUZIANIA	LZ21304790	PAMPLONA	13/11/2020 16:18	13/11/2020 19:45	13/11/2020 16:18	13/11/2020 19:45	3,44	1	3,44	CHI
20201158998	URUACU	UR12317135	URUACU	13/11/2020 16:18	13/11/2020 20:35	13/11/2020 16:18	13/11/2020 20:35	4,28	11	47,08	CHI
20201158950	POSSE	1480072403	IACIARA S2	13/11/2020 16:19	13/11/2020 18:14	13/11/2020 16:19	13/11/2020 18:14	1,92	1	1,92	CHI
20201158890	INHUMAS	IN12015946	INHUMAS S2	13/11/2020 16:21	14/11/2020 12:51	13/11/2020 16:21	14/11/2020 12:51	20,50	10	205,03	CHI
20201158964	AURILANDIA	RP12076381RE	FIRMINOPOLIS S2	13/11/2020 16:22	13/11/2020 18:29	13/11/2020 16:22	13/11/2020 18:29	2,11	4	8,45	CHI
20201158964	SAO JOAO DA PARAUNA	RP12076381RE	FIRMINOPOLIS S2	13/11/2020 16:22	13/11/2020 18:29	13/11/2020 16:22	13/11/2020 18:29	2,11	33	69,74	CHI
20201158965	SAO JOAO D ALIANCA	JL21316936	SAO JOAO D ALIANCA	13/11/2020 16:23	13/11/2020 19:34	13/11/2020 16:23	13/11/2020 19:34	3,18	1	3,18	CHI
20201158968	LUZIANIA	LZ21061801	RIO VERMELHO	13/11/2020 16:23	13/11/2020 20:21	13/11/2020 16:23	13/11/2020 20:21	3,96	1	3,96	CHI
20201158971	GOIANIA	10005231122	GOYA S1	13/11/2020 16:24	13/11/2020 21:12	13/11/2020 16:24	13/11/2020 21:12	4,80	1	4,80	CHI
20201158980	PEROLANDIA	DP11324692	JATAI S1	13/11/2020 16:24	13/11/2020 18:20	13/11/2020 16:24	13/11/2020 18:20	1,92	98	188,16	CHI
20201159716	NIQUELANDIA	NQ12256617	NIQUELANDIA SUBTRANSMISSAO	13/11/2020 16:24	16/11/2020 08:25	13/11/2020 16:24	16/11/2020 08:25	64,01	35	2240,27	CHI
202011137984	CRIXAS	CX12145539	RUBIATABA	13/11/2020 16:24	14/11/2020 14:01	13/11/2020 16:24	14/11/2020 14:01	21,61	19	410,68	CHI
20201158984	ESTRELA DO NORTE	ET12012492	MARA ROSA	13/11/2020 16:25	14/11/2020 10:18	13/11/2020 16:25	14/11/2020 10:18	17,88	7	125,17	CHI
20201158985	ALTO PARAISO DE GOIAS	BF12146192	NIQUELANDIA SUBTRANSMISSAO	13/11/2020 16:25	13/11/2020 20:12	13/11/2020 16:25	13/11/2020 20:12	3,78	1	3,78	CHI
20201159672	ITUMBIARA	IT12088613	PARANAIBA	13/11/2020 16:25	13/11/2020 19:12	13/11/2020 16:25	13/11/2020 19:12	2,78	5	13,89	CHI
20201160065	CATURAI	IN12015933	INHUMAS S2	13/11/2020 16:25	14/11/2020 12:51	13/11/2020 16:25	14/11/2020 12:51	20,44	1	20,44	CHI
20201160065	INHUMAS	IN12015933	INHUMAS S2	13/11/2020 16:25	14/11/2020 12:51	13/11/2020 16:25	14/11/2020 12:51	20,44	11	224,86	CHI
20201159002	PARAUNA	PU21007984	PARAUNA	13/11/2020 16:26	13/11/2020 22:13	13/11/2020 16:26	13/11/2020 22:13	5,77	2	11,53	CHI
20201159006	FORMOSA	1002581470	ITIQUIRA	13/11/2020 16:27	13/11/2020 18:23	13/11/2020 16:27	13/11/2020 18:23	1,93	1	1,93	CHI
20201159008	PORANGATU	PO21172410	PORANGATU	13/11/2020 16:27	14/11/2020 07:30	13/11/2020 16:27	14/11/2020 07:30	15,04	1	15,04	CHI
20201159012	NAZARIO	PL12000123	PALMEIRAS	13/11/2020 16:28	14/11/2020 09:10	13/11/2020 16:28	14/11/2020 09:10	16,71	2	33,42	CHI
20201159013	CRISTALINA	1060051543	CRISTALINA S1	13/11/2020 16:28	13/11/2020 17:31	13/11/2020 16:28	13/11/2020 17:31	1,04	1	1,04	CHI
20201159099	CAMPO LIMPO	AN12084795	NEROPOLIS S1	13/11/2020 16:28	13/11/2020 18:23	13/11/2020 16:28	13/11/2020 18:23	1,90	14	26,63	CHI
20201159094	MARA ROSA	MQ11135680	MARA ROSA	13/11/2020 16:30	13/11/2020 20:58	13/11/2020 16:30	13/11/2020 20:58	4,46	50	222,92	CHI



20201159032	MONTIVIDIU	MV21370217	MONTIVIDIU T	13/11/2020 16:31	13/11/2020 23:45	13/11/2020 16:31	13/11/2020 23:45	7,23	1	7,23	CHI
20201159053	ITAPURANGA	IK21093428	ITAPURANGA	13/11/2020 16:33	14/11/2020 07:13	13/11/2020 16:33	14/11/2020 07:13	14,66	2	29,31	CHI
20201160340	URUACU	CR12375637	CAMPINORTE	13/11/2020 16:33	14/11/2020 03:23	13/11/2020 16:33	14/11/2020 03:23	10,82	119	1287,58	CHI
20201159057	FORMOSA	FA11000065	ITUIQUIRA	13/11/2020 16:34	13/11/2020 17:08	13/11/2020 16:34	13/11/2020 17:08	0,57	142	80,27	CHI
2020111300100	AMARALINA	35202	MARA ROSA	13/11/2020 16:34	13/11/2020 16:37	13/11/2020 16:34	13/11/2020 16:37	0,05	121	6,05	CHI
2020111300100	ESTRELA DO NORTE	4701	MARA ROSA	13/11/2020 16:34	13/11/2020 16:37	13/11/2020 16:34	13/11/2020 16:37	0,05	1	0,05	CHI
2020111300100	ESTRELA DO NORTE	20701	MARA ROSA	13/11/2020 16:34	13/11/2020 16:37	13/11/2020 16:34	13/11/2020 16:37	0,05	3	0,15	CHI
2020111300100	ESTRELA DO NORTE	4731	MARA ROSA	13/11/2020 16:34	13/11/2020 16:37	13/11/2020 16:34	13/11/2020 16:37	0,05	35	1,75	CHI
2020111300100	ESTRELA DO NORTE	1120414	MARA ROSA	13/11/2020 16:34	13/11/2020 16:37	13/11/2020 16:34	13/11/2020 16:37	0,05	19	0,95	CHI
2020111300100	ESTRELA DO NORTE	4732	MARA ROSA	13/11/2020 16:34	13/11/2020 16:37	13/11/2020 16:34	13/11/2020 16:37	0,05	1	0,05	CHI
2020111300100	FORMOSO	20701	MARA ROSA	13/11/2020 16:34	13/11/2020 16:37	13/11/2020 16:34	13/11/2020 16:37	0,05	82	4,10	CHI
2020111300100	FORMOSO	4731	MARA ROSA	13/11/2020 16:34	13/11/2020 16:37	13/11/2020 16:34	13/11/2020 16:37	0,05	7	0,35	CHI
2020111300100	MARA ROSA	1120414	MARA ROSA	13/11/2020 16:34	13/11/2020 16:37	13/11/2020 16:34	13/11/2020 16:37	0,05	79	3,95	CHI
2020111300100	MUTUNOPOLIS	35201	MARA ROSA	13/11/2020 16:34	13/11/2020 16:37	13/11/2020 16:34	13/11/2020 16:37	0,05	218	10,90	CHI
2020111300100	MUTUNOPOLIS	35202	MARA ROSA	13/11/2020 16:34	13/11/2020 16:37	13/11/2020 16:34	13/11/2020 16:37	0,05	1452	72,60	CHI
2020111300100	MUTUNOPOLIS	4732	MARA ROSA	13/11/2020 16:34	13/11/2020 16:37	13/11/2020 16:34	13/11/2020 16:37	0,05	1	0,05	CHI
2020111300100	PORANGATU	20701	MARA ROSA	13/11/2020 16:34	13/11/2020 16:37	13/11/2020 16:34	13/11/2020 16:37	0,05	3	0,15	CHI
2020111300100	PORANGATU	35201	MARA ROSA	13/11/2020 16:34	13/11/2020 16:37	13/11/2020 16:34	13/11/2020 16:37	0,05	65	3,25	CHI
2020111300100	SANTA TEREZA DE GOIAS	20701	MARA ROSA	13/11/2020 16:34	13/11/2020 16:37	13/11/2020 16:34	13/11/2020 16:37	0,05	1683	84,15	CHI
20201159069	SILVANIA	SV12012028	VIANOPOLIS	13/11/2020 16:35	14/11/2020 17:02	13/11/2020 16:35	14/11/2020 08:01	15,42	3	46,27	CHI
20201159069	SILVANIA	SV12012113LD	VIANOPOLIS	13/11/2020 16:35	14/11/2020 17:02	13/11/2020 16:35	14/11/2020 10:56	18,35	4	73,39	CHI
20201159069	SILVANIA	SV12012113LD	VIANOPOLIS	13/11/2020 16:35	14/11/2020 17:02	13/11/2020 16:35	14/11/2020 17:02	24,44	4	97,77	CHI
20201159207	PALMEIRAS DE GOIAS	PL12048169	PALMEIRAS	13/11/2020 16:35	13/11/2020 19:25	13/11/2020 16:35	13/11/2020 19:25	2,83	5	14,17	CHI
20201159074	SAO JOAO D ALIANCA	JL21255333	IACIARA S2	13/11/2020 16:36	13/11/2020 23:07	13/11/2020 16:36	13/11/2020 23:07	6,51	3	19,54	CHI
20201159077	ALEXANIA	480014966	ALEXANIA	13/11/2020 16:36	14/11/2020 03:58	13/11/2020 16:36	14/11/2020 03:58	11,36	1	11,36	CHI
20201159081	GOIANIA	14245383	ATLANTICO S3	13/11/2020 16:36	13/11/2020 18:58	13/11/2020 16:36	13/11/2020 18:58	2,35	1	2,35	CHI
20201159085	FIRMINOPOLIS	FR12096973	FIRMINOPOLIS S1	13/11/2020 16:36	13/11/2020 18:39	13/11/2020 16:36	13/11/2020 18:39	2,03	9	18,31	CHI
20201159093	SENADOR CANEDO	190040671	SENADOR CANEDO	13/11/2020 16:37	13/11/2020 18:15	13/11/2020 16:37	13/11/2020 18:15	1,63	1	1,63	CHI
20201159103	ARAGUAPAZ	10019048775	MOZARLANDIA	13/11/2020 16:38	13/11/2020 17:59	13/11/2020 16:38	13/11/2020 17:59	1,34	1	1,34	CHI
20201159107	IPORA	730110515	IPORA	13/11/2020 16:38	13/11/2020 20:01	13/11/2020 16:38	13/11/2020 20:01	3,38	1	3,38	CHI
20201159112	GOIANDIRA	GD21323456	CATALAO S1	13/11/2020 16:39	13/11/2020 20:28	13/11/2020 16:39	13/11/2020 20:28	3,81	1	3,81	CHI
20201159116	ANAPOLIS	20144167	JUNDIAI S2	13/11/2020 16:39	13/11/2020 22:36	13/11/2020 16:39	13/11/2020 22:36	5,93	1	5,93	CHI
20201159119	MINACU	IH12208342	MINACU	13/11/2020 16:40	13/11/2020 23:33	13/11/2020 16:40	13/11/2020 23:33	6,88	1	6,88	CHI
20201159128	ACREUNA	EU21317022	ACREUNA	13/11/2020 16:41	13/11/2020 20:56	13/11/2020 16:41	13/11/2020 20:56	4,24	1	4,24	CHI
20201159298	CAMPO ALEGRE DE GOIAS	CM12338708	CAMPO ALEGRE DE GOIAS	13/11/2020 16:41	14/11/2020 09:52	13/11/2020 16:41	14/11/2020 09:52	17,18	3	51,55	CHI
20201159470	CACU	CC12028172	CACHOEIRA ALTA	13/11/2020 16:41	14/11/2020 12:31	13/11/2020 16:41	14/11/2020 12:31	19,82	20	396,41	CHI
20201160072	PIRACANJUBA	PJ12000213	PIRACANJUBA	13/11/2020 16:43	13/11/2020 22:38	13/11/2020 16:43	13/11/2020 22:38	5,90	5	29,51	CHI
20201160855	MINACU	IH12245144	MINACU	13/11/2020 16:45	14/11/2020 08:12	13/11/2020 16:45	14/11/2020 08:12	15,45	6	92,67	CHI
20201159171	SANCLERLANDIA	10017292946	FIRMINOPOLIS S2	13/11/2020 16:48	13/11/2020 19:13	13/11/2020 16:48	13/11/2020 19:13	2,41	1	2,41	CHI
20201159234	TRINDADE	TR12000037	TRINDADE	13/11/2020 16:48	13/11/2020 20:32	13/11/2020 16:48	13/11/2020 20:32	3,73	459	1711,05	CHI
20201159301	ARAGOIANIA	HD12000067	INDEPENDENCIA S1	13/11/2020 16:50	14/11/2020 17:15	13/11/2020 16:50	14/11/2020 17:15	24,40	5	122,00	CHI
20201159301	HIDROLANDIA	HD12000067	INDEPENDENCIA S1	13/11/2020 16:50	14/11/2020 17:15	13/11/2020 16:50	14/11/2020 17:15	24,40	11	268,41	CHI
20201159186	GAMELEIRA DE GOIAS	SV12062486	DAIA S2	13/11/2020 16:51	13/11/2020 20:32	13/11/2020 16:51	13/11/2020 20:32	3,68	15	55,18	CHI
20201159500	CORUMBA DE GOIAS	CB12382386	CORUMBA	13/11/2020 16:52	13/11/2020 21:10	13/11/2020 16:52	13/11/2020 21:10	4,30	2	8,59	CHI
20201159205	VILA PROPICIO	NP21309711	BARRO ALTO	13/11/2020 16:53	14/11/2020 22:14	13/11/2020 16:53	14/11/2020 22:14	29,34	1	29,34	CHI
20201159214	UIRAPURU	4200004680	SANTA TEREZINHA	13/11/2020 16:54	13/11/2020 19:31	13/11/2020 16:54	13/11/2020 19:31	2,61	1	2,61	CHI
20201159216	AGUAS LINDAS DE GOIAS	4830402120	AGUAS LINDAS DE GOIAS S1	13/11/2020 16:54	13/11/2020 20:05	13/11/2020 16:54	13/11/2020 20:05	3,17	1	3,17	CHI
20201159282	CALDAS NOVAS	3850424	VILA CORUMBA	13/11/2020 16:54	14/11/2020 21:20	13/11/2020 16:54	14/11/2020 08:51	15,94	1	15,94	CHI
20201159282	CALDAS NOVAS	3850424	VILA CORUMBA	13/11/2020 16:54	14/11/2020 21:20	13/11/2020 16:54	14/11/2020 21:20	28,42	54	1534,80	CHI
20201164578	ESTRELA DO NORTE	ET11329972	MARA ROSA	13/11/2020 16:54	15/11/2020 11:55	13/11/2020 16:54	15/11/2020 11:55	43,00	47	2021,07	CHI
20201159220	CRISTALINA	KR21237943	CRISTALINA S1	13/11/2020 16:55	13/11/2020 21:03	13/11/2020 16:55	13/11/2020 21:03	4,13	1	4,13	CHI

20201159222	JATAI	JT21103867	MONTIVIDIU T	13/11/2020 16:55	13/11/2020 21:28	13/11/2020 16:55	13/11/2020 21:28	4,54	1	4,54	CHI
20201160163	CATALAO	CT12044351	CATALAO S2	13/11/2020 16:56	13/11/2020 20:19	13/11/2020 16:56	13/11/2020 20:19	3,37	21	70,76	CHI
20201161124	CAMPINORTE	CR11000025	CAMPINORTE	13/11/2020 16:56	14/11/2020 16:39	14/11/2020 14:05	14/11/2020 16:39	2,57	68	174,55	CHI
20201159230	APORE	AE12340774	ITAJA S2	13/11/2020 16:57	13/11/2020 20:37	13/11/2020 16:57	13/11/2020 20:37	3,66	1	3,66	CHI
20201159245	ANAPOLIS	20944238	ANAPOLIS UNIVERSITARIO S2	13/11/2020 16:59	13/11/2020 19:44	13/11/2020 16:59	13/11/2020 19:44	2,74	1	2,74	CHI
20201160197	RUBIATABA	RB12270448	RUBIATABA	13/11/2020 16:59	14/11/2020 00:34	13/11/2020 16:59	14/11/2020 00:34	7,57	124	938,65	CHI
20201159252	CORUMBA DE GOIAS	CB21148333	CORUMBA	13/11/2020 17:00	13/11/2020 22:26	13/11/2020 17:00	13/11/2020 22:26	5,42	1	5,42	CHI
20201159256	SANTA TEREZINHA DE GOIAS	2480023534	SANTA TEREZINHA	13/11/2020 17:01	14/11/2020 01:46	13/11/2020 17:01	14/11/2020 01:46	8,75	1	8,75	CHI
20201159257	GOUVELANDIA	GB21296586	QUIRINOPOLIS	13/11/2020 17:01	13/11/2020 20:31	13/11/2020 17:01	13/11/2020 20:31	3,50	1	3,50	CHI
20201160055	FAINA	FC12275448	GOIAS	13/11/2020 17:01	14/11/2020 01:17	13/11/2020 17:01	14/11/2020 01:17	8,27	8	66,13	CHI
20201159265	ESTRELA DO NORTE	ET12012488	MARA ROSA	13/11/2020 17:02	14/11/2020 11:06	13/11/2020 17:02	14/11/2020 11:06	18,05	19	343,02	CHI
20201159983	MUTUNOPOLIS	MU12320905	MARA ROSA	13/11/2020 17:02	14/11/2020 08:48	13/11/2020 17:02	14/11/2020 08:48	15,76	6	94,54	CHI
20201159272	EDEIA	EA21028191	EDEIA	13/11/2020 17:04	13/11/2020 22:31	13/11/2020 17:04	13/11/2020 22:31	5,45	2	10,89	CHI
20201159286	ITAPACI	10016253980	ITAPACI	13/11/2020 17:07	14/11/2020 03:01	13/11/2020 17:07	14/11/2020 03:01	9,89	1	9,89	CHI
20201159504	ITABERAI	IB12000056	ITABERAI S2	13/11/2020 17:08	13/11/2020 18:19	13/11/2020 17:08	13/11/2020 18:19	1,18	11	12,95	CHI
20201159306	CACHOEIRA ALTA	1090037007	CACHOEIRA ALTA	13/11/2020 17:09	13/11/2020 23:35	13/11/2020 17:09	13/11/2020 23:35	6,42	1	6,42	CHI
20201159756	MARA ROSA	MQ12051834	MARA ROSA	13/11/2020 17:09	14/11/2020 22:32	13/11/2020 17:09	14/11/2020 15:30	22,35	12	268,20	CHI
20201159756	MARA ROSA	MQ12051834	MARA ROSA	13/11/2020 17:09	14/11/2020 22:32	13/11/2020 17:09	14/11/2020 22:32	29,38	1	29,38	CHI
20201159810	CORUMBA DE GOIAS	CB12000012	CORUMBA	13/11/2020 17:10	13/11/2020 19:53	13/11/2020 17:10	13/11/2020 19:53	2,71	1	2,71	CHI
20201159321	CORUMBA DE GOIAS	CB21148174	CORUMBA	13/11/2020 17:11	13/11/2020 21:53	13/11/2020 17:11	13/11/2020 21:53	4,69	1	4,69	CHI
20201159516	SANTO ANTONIO DO DESCOBERTO	SN12379433	ALEXANIA	13/11/2020 17:11	13/11/2020 20:39	13/11/2020 17:11	13/11/2020 20:39	3,45	23	79,39	CHI
20201159330	GOIANESIA	GE12000150	GOIANESIA S1	13/11/2020 17:12	13/11/2020 19:16	13/11/2020 17:12	13/11/2020 19:16	2,06	3	6,18	CHI
20201159406	PILAR DE GOIAS	1020014316	SANTA TEREZINHA	13/11/2020 17:13	13/11/2020 21:01	13/11/2020 17:13	13/11/2020 21:01	3,78	1	3,78	CHI
20201159471	MARA ROSA	MQ12051065	MARA ROSA	13/11/2020 17:14	13/11/2020 21:41	13/11/2020 17:14	13/11/2020 21:41	4,45	20	88,93	CHI
20201159556	LUZIANIA	LZ12097563	CRISTALINA S2	13/11/2020 17:15	13/11/2020 23:31	13/11/2020 17:15	13/11/2020 23:31	6,28	5	31,39	CHI
20201159353	CAMPINORTE	CR12309721	MARA ROSA	13/11/2020 17:16	13/11/2020 23:38	13/11/2020 17:16	13/11/2020 23:38	6,36	4	25,45	CHI
20201159353	NOVA IGUACU DE GOIAS	CR12309721	MARA ROSA	13/11/2020 17:16	13/11/2020 23:38	13/11/2020 17:16	13/11/2020 23:38	6,36	2	12,73	CHI
20201159354	CAMPINORTE	CR21262877	MARA ROSA	13/11/2020 17:16	14/11/2020 09:31	13/11/2020 17:16	14/11/2020 09:31	16,24	1	16,24	CHI
20201159360	ANAPOLIS	21159063	ANAPOLIS UNIVERSITARIO S2	13/11/2020 17:17	13/11/2020 20:28	13/11/2020 17:17	13/11/2020 20:28	3,18	1	3,18	CHI
20201159947	ALEXANIA	AX12319851	ALEXANIA	13/11/2020 17:17	13/11/2020 23:07	13/11/2020 17:17	13/11/2020 23:07	5,82	21	122,17	CHI
20201159616	CATALAO	CT12266062RE	CATALAO S1	13/11/2020 17:18	13/11/2020 20:45	13/11/2020 17:18	13/11/2020 20:45	3,45	83	286,26	CHI
20201159616	OUVIDOR	CT12266062RE	CATALAO S1	13/11/2020 17:18	13/11/2020 20:45	13/11/2020 17:18	13/11/2020 20:45	3,45	1	3,45	CHI
20201159370	ITABERAI	IB21388563	ITABERAI S1	13/11/2020 17:19	13/11/2020 19:10	13/11/2020 17:19	13/11/2020 19:10	1,85	1	1,85	CHI
20201159376	ALEXANIA	AX12398940	ALEXANIA	13/11/2020 17:20	14/11/2020 08:25	13/11/2020 17:20	14/11/2020 08:25	15,08	4	60,33	CHI
20201159934	ESTRELA DO NORTE	ET12000003	MARA ROSA	13/11/2020 17:20	14/11/2020 11:37	13/11/2020 17:20	14/11/2020 11:37	18,28	1	18,28	CHI
20201159934	MARA ROSA	ET12000003	MARA ROSA	13/11/2020 17:20	14/11/2020 11:37	13/11/2020 17:20	14/11/2020 11:37	18,28	2	36,55	CHI
20201159413	PALMEIRAS DE GOIAS	10021956454	PALMEIRAS	13/11/2020 17:24	14/11/2020 00:46	13/11/2020 17:24	14/11/2020 00:46	7,37	1	7,37	CHI
20201159418	CAMPINORTE	CR12172326	MARA ROSA	13/11/2020 17:24	14/11/2020 13:52	13/11/2020 17:24	14/11/2020 13:52	20,45	3	61,35	CHI
20201159418	FORMOSO	CR12172326	MARA ROSA	13/11/2020 17:24	14/11/2020 13:52	13/11/2020 17:24	14/11/2020 13:52	20,45	3	61,35	CHI
20201159422	BARRO ALTO	BA21161160	BARRO ALTO	13/11/2020 17:25	13/11/2020 23:09	13/11/2020 17:25	13/11/2020 23:09	5,73	1	5,73	CHI
20201159424	CATALAO	1990299791	CATALAO S1	13/11/2020 17:25	13/11/2020 19:37	13/11/2020 17:25	13/11/2020 19:37	2,19	1	2,19	CHI
20201159425	PARAUNA	EU21279648	ACREUNA	13/11/2020 17:25	14/11/2020 02:46	13/11/2020 17:25	14/11/2020 02:46	9,34	1	9,34	CHI
20201159502	NOVA IGUACU DE GOIAS	NH12202113	SANTA TEREZINHA	13/11/2020 17:25	15/11/2020 23:05	13/11/2020 17:25	14/11/2020 09:00	15,59	32	498,84	CHI
20201159502	NOVA IGUACU DE GOIAS	NH12202113	SANTA TEREZINHA	13/11/2020 17:25	15/11/2020 23:05	13/11/2020 17:25	14/11/2020 10:20	16,92	5	84,62	CHI
20201159502	NOVA IGUACU DE GOIAS	NH12202113	SANTA TEREZINHA	13/11/2020 17:25	15/11/2020 23:05	14/11/2020 21:11	14/11/2020 22:27	1,28	37	47,23	CHI
20201159502	NOVA IGUACU DE GOIAS	NH12202113	SANTA TEREZINHA	13/11/2020 17:25	15/11/2020 23:05	13/11/2020 17:25	15/11/2020 12:41	43,27	24	1038,47	CHI
20201159502	NOVA IGUACU DE GOIAS	NH12202113	SANTA TEREZINHA	13/11/2020 17:25	15/11/2020 23:05	13/11/2020 17:25	15/11/2020 20:47	51,37	2	102,74	CHI
20201159502	NOVA IGUACU DE GOIAS	NH12202113	SANTA TEREZINHA	13/11/2020 17:25	15/11/2020 23:05	13/11/2020 17:25	15/11/2020 21:53	52,48	1	52,48	CHI
20201159502	NOVA IGUACU DE GOIAS	NH12202113	SANTA TEREZINHA	13/11/2020 17:25	15/11/2020 23:05	13/11/2020 17:25	15/11/2020 23:05	53,68	1	53,68	CHI
20201161112	SANTA HELENA DE GOIAS	400111251	IPEGUARI	13/11/2020 17:25	14/11/2020 07:44	13/11/2020 17:25	14/11/2020 07:44	14,30	1	14,30	CHI
20201159433	HIDROLANDIA	10010870073	ANHANGUERA	13/11/2020 17:26	14/11/2020 02:44	13/11/2020 17:26	14/11/2020 02:44	9,28	1	9,28	CHI

20201159437	NIQUELANDIA	NQ21274801	BARRO ALTO	13/11/2020 17:27	14/11/2020 09:41	13/11/2020 17:27	14/11/2020 09:41	16,23	2	32,45	CHI
20201160208	MARA ROSA	MQ11051084	MARA ROSA	13/11/2020 17:27	14/11/2020 07:26	13/11/2020 17:27	14/11/2020 07:26	13,97	132	1844,33	CHI
20201159452	DOVERLANDIA	DV11253420	CAIAPONIA	13/11/2020 17:29	13/11/2020 22:46	13/11/2020 17:29	13/11/2020 22:46	5,28	1	5,28	CHI
20201159453	ITAPURANGA	IK21299930	ITAPURANGA	13/11/2020 17:29	14/11/2020 16:59	13/11/2020 17:29	14/11/2020 16:59	23,49	2	46,99	CHI
20201159657	IPORA	IR12381025	IPORA	13/11/2020 17:29	13/11/2020 22:32	13/11/2020 17:29	13/11/2020 22:32	5,05	13	65,62	CHI
20201159461	MORRO AGUDO DE GOIAS	MS21412937	ITAPURANGA	13/11/2020 17:30	14/11/2020 10:12	13/11/2020 17:30	14/11/2020 10:12	16,70	1	16,70	CHI
20201159465	ITUMBIARA	690134654	ITUMBIARA VELHA S1	13/11/2020 17:30	13/11/2020 23:30	13/11/2020 17:30	13/11/2020 23:30	5,99	1	5,99	CHI
20201159755	CAMPINORTE	MQ12082973	MARA ROSA	13/11/2020 17:30	13/11/2020 20:04	13/11/2020 17:30	13/11/2020 20:04	2,56	1	2,56	CHI
20201159755	MARA ROSA	MQ12082973	MARA ROSA	13/11/2020 17:30	13/11/2020 20:04	13/11/2020 17:30	13/11/2020 20:04	2,56	2	5,11	CHI
20201161113	SANTA HELENA DE GOIAS	10001528759	IPEGUARI	13/11/2020 17:30	14/11/2020 08:23	13/11/2020 17:30	14/11/2020 08:23	14,87	1	14,87	CHI
20201159479	GOIANIA	16109375	ATLANTICO S1	13/11/2020 17:32	13/11/2020 19:02	13/11/2020 17:32	13/11/2020 19:02	1,50	1	1,50	CHI
20201159480	TAQUARAL DE GOIAS	TQ12025623	ITABERAI S1	13/11/2020 17:32	14/11/2020 10:37	13/11/2020 17:32	14/11/2020 10:37	17,08	14	239,13	CHI
20201159483	URUACU	UR12232449RE	URUACU	13/11/2020 17:32	14/11/2020 17:23	13/11/2020 17:32	14/11/2020 17:23	23,85	55	1311,51	CHI
20201159484	FORMOSA	FA21058614	ITUIQUIRA	13/11/2020 17:32	13/11/2020 21:18	13/11/2020 17:32	13/11/2020 21:18	3,76	1	3,76	CHI
20201159485	PARAUNA	980034371	PARAUNA	13/11/2020 17:32	13/11/2020 18:39	13/11/2020 17:32	13/11/2020 18:39	1,11	1	1,11	CHI
20201159554	APARECIDA DE GOIANIA	AP11004867	ATLANTICO S1	13/11/2020 17:32	13/11/2020 18:29	13/11/2020 17:32	13/11/2020 18:29	0,94	73	68,72	CHI
20201161139	VILA PROPICIO	NP11273281	GOIANESIA S1	13/11/2020 17:32	14/11/2020 23:00	13/11/2020 17:32	14/11/2020 23:00	29,46	80	2356,96	CHI
20201159833	GOIANIA	GN11132348	GOYA S1	13/11/2020 17:33	13/11/2020 23:51	13/11/2020 17:33	13/11/2020 23:51	6,30	127	800,10	CHI
20201159505	FORMOSA	10028840680	ITUIQUIRA	13/11/2020 17:35	13/11/2020 20:23	13/11/2020 17:35	13/11/2020 20:23	2,80	1	2,80	CHI
20201159511	PIRES DO RIO	PR21195125	PIRES DO RIO S2	13/11/2020 17:35	13/11/2020 20:52	13/11/2020 17:35	13/11/2020 20:52	3,27	1	3,27	CHI
20201159549	TRES RANCHOS	TH11165256	CATALAO S1	13/11/2020 17:35	14/11/2020 05:38	13/11/2020 17:35	14/11/2020 05:38	12,04	182	2191,48	CHI
20201159530	GOIANIA	10002625847	REAL S2	13/11/2020 17:38	13/11/2020 19:14	13/11/2020 17:38	13/11/2020 19:14	1,58	1	1,58	CHI
20201159586	MIMOSO DE GOIAS	MJ18071960FS	PADRE BERNARDO	13/11/2020 17:38	13/11/2020 18:47	13/11/2020 17:38	13/11/2020 18:47	1,14	160	182,09	CHI
20201159586	NIQUELANDIA	MJ18071960FS	PADRE BERNARDO	13/11/2020 17:38	13/11/2020 18:47	13/11/2020 17:38	13/11/2020 18:47	1,14	1	1,14	CHI
20201159550	SENADOR CANEDO	SW11200035	CEPAIGO S2	13/11/2020 17:42	13/11/2020 21:43	13/11/2020 17:42	13/11/2020 21:18	3,60	15	54,07	CHI
20201159550	BELA VISTA DE GOIAS	SW12211419LD	CEPAIGO S2	13/11/2020 17:42	13/11/2020 21:43	13/11/2020 19:45	13/11/2020 21:43	1,97	1	1,97	CHI
20201159550	SENADOR CANEDO	SW12211419LD	CEPAIGO S2	13/11/2020 17:42	13/11/2020 21:43	13/11/2020 19:45	13/11/2020 21:43	1,97	43	84,71	CHI
20201159553	CORUMBA DE GOIAS	CB12381206	CORUMBA	13/11/2020 17:42	14/11/2020 09:28	13/11/2020 17:42	14/11/2020 09:28	15,76	4	63,02	CHI
202011137982	NOVO PLANALTO	TA12192346	SAO MIGUEL DO ARAGUAIA	13/11/2020 17:42	13/11/2020 22:00	13/11/2020 17:42	13/11/2020 22:00	4,29	83	356,07	CHI
20201159561	GOIANIA	15807812	CAMPINAS S2	13/11/2020 17:43	13/11/2020 19:50	13/11/2020 17:43	13/11/2020 19:50	2,11	1	2,11	CHI
20201159570	JATAI	JT21158058	JATAI S2	13/11/2020 17:44	13/11/2020 19:33	13/11/2020 17:44	13/11/2020 19:33	1,80	1	1,80	CHI
20201159734	OUIDOR	OUI11363451	CATALAO S1	13/11/2020 17:44	13/11/2020 22:24	13/11/2020 17:44	13/11/2020 22:24	4,66	39	181,67	CHI
20201159573	MARA ROSA	MQ12208523	MARA ROSA	13/11/2020 17:45	14/11/2020 22:32	13/11/2020 17:45	14/11/2020 22:32	28,78	1	28,78	CHI
20201159577	BONOPOLIS	BX13064902	SAO MIGUEL DO ARAGUAIA	13/11/2020 17:45	14/11/2020 17:20	14/11/2020 03:24	14/11/2020 09:22	5,97	18	107,39	CHI
20201159577	BONOPOLIS	BX13064904	SAO MIGUEL DO ARAGUAIA	13/11/2020 17:45	14/11/2020 17:20	13/11/2020 17:51	14/11/2020 16:02	22,19	60	1331,42	CHI
20201159577	PORANGATU	BX13064904	SAO MIGUEL DO ARAGUAIA	13/11/2020 17:45	14/11/2020 17:20	13/11/2020 17:51	14/11/2020 16:02	22,19	1	22,19	CHI
20201159577	BONFINOPOLIS	TA10400556	NOVO PLANALTO	13/11/2020 17:45	14/11/2020 17:20	14/11/2020 16:30	14/11/2020 16:33	0,06	1	0,06	CHI
20201159577	BONOPOLIS	TA10400556	NOVO PLANALTO	13/11/2020 17:45	14/11/2020 17:20	14/11/2020 16:30	14/11/2020 16:33	0,06	53	3,40	CHI
20201159577	PORANGATU	TA10400556	NOVO PLANALTO	13/11/2020 17:45	14/11/2020 17:20	14/11/2020 16:30	14/11/2020 16:33	0,06	166	10,65	CHI
20201159577	BONOPOLIS	BX10403944	SAO MIGUEL DO ARAGUAIA	13/11/2020 17:45	14/11/2020 17:20	14/11/2020 03:24	14/11/2020 16:39	13,24	259	3429,95	CHI
20201159577	BONOPOLIS	BX10403944	SAO MIGUEL DO ARAGUAIA	13/11/2020 17:45	14/11/2020 17:20	14/11/2020 16:30	14/11/2020 16:39	0,15	27	4,10	CHI
20201159577	BONOPOLIS	BX13433858B	SAO MIGUEL DO ARAGUAIA	13/11/2020 17:45	14/11/2020 17:20	14/11/2020 17:15	14/11/2020 17:20	0,08	286	22,48	CHI
20201159599	IACIARA	IA21344334	IACIARA S2	13/11/2020 17:47	14/11/2020 00:27	13/11/2020 17:47	14/11/2020 00:27	6,65	1	6,65	CHI
20201159604	SILVANIA	SV21105539	VIANOPOLIS	13/11/2020 17:48	13/11/2020 22:12	13/11/2020 17:48	13/11/2020 22:12	4,39	16	70,20	CHI
20201159611	PIRANHAS	PH21023561	PIRANHAS	13/11/2020 17:49	13/11/2020 19:50	13/11/2020 17:49	13/11/2020 19:50	2,00	1	2,00	CHI
20201159729	RIO VERDE	RV11023372	RIO VERDE S2	13/11/2020 17:49	13/11/2020 19:58	13/11/2020 17:49	13/11/2020 19:58	2,14	122	260,81	CHI
20201159614	GOIANIA	GN21139025	ATLANTICO S1	13/11/2020 17:50	13/11/2020 19:45	13/11/2020 17:50	13/11/2020 19:45	1,91	1	1,91	CHI
20201159623	ITABERAI	IB11336862	INHUMAS S1	13/11/2020 17:50	13/11/2020 19:24	13/11/2020 17:50	13/11/2020 19:24	1,55	1	1,55	CHI
20201159842	TRES RANCHOS	TH11000133	CATALAO S1	13/11/2020 17:50	13/11/2020 20:58	13/11/2020 17:50	13/11/2020 20:58	3,12	75	233,94	CHI
20201160252	GOIANIA	GN11001086	GOIANIA LESTE S2	13/11/2020 17:50	14/11/2020 12:53	13/11/2020 17:50	14/11/2020 12:53	19,03	21	399,73	CHI
20201159624	CIDADE OCIDENTAL	LZ21087037	MARAJOARA	13/11/2020 17:51	13/11/2020 22:02	13/11/2020 17:51	13/11/2020 22:02	4,18	1	4,18	CHI

20201159634	APARECIDA DE GOIANIA	10006880418	ANHANGUERA	13/11/2020 17:52	13/11/2020 19:25	13/11/2020 17:52	13/11/2020 19:25	1,54	1	1,54	CHI
20201159635	SENADOR CANEDO	10006603767	SENADOR CANEDO	13/11/2020 17:52	13/11/2020 19:52	13/11/2020 17:52	13/11/2020 19:52	1,99	1	1,99	CHI
20201159641	GOIANIA	GN11161565	REAL S2	13/11/2020 17:53	13/11/2020 21:57	13/11/2020 17:53	13/11/2020 21:57	4,06	60	243,55	CHI
20201159644	GOIANIA	13968970	GOYA S2	13/11/2020 17:54	13/11/2020 21:37	13/11/2020 17:54	13/11/2020 21:37	3,71	1	3,71	CHI
20201159652	MARA ROSA	MQ12390473	MARA ROSA	13/11/2020 17:55	15/11/2020 17:05	13/11/2020 17:55	15/11/2020 17:05	47,16	1	47,16	CHI
20201159653	CACHOEIRA ALTA	CA21322218	CACHOEIRA ALTA	13/11/2020 17:55	13/11/2020 22:22	13/11/2020 17:55	13/11/2020 22:22	4,44	1	4,44	CHI
20201159909	MINEIROS	MY16405756	PARQUE DAS EMAS	13/11/2020 17:55	13/11/2020 21:01	13/11/2020 17:55	13/11/2020 18:33	0,64	174	111,31	CHI
20201159909	MINEIROS	MY16401140	PARQUE DAS EMAS	13/11/2020 17:55	13/11/2020 21:01	13/11/2020 17:55	13/11/2020 20:47	2,88	85	244,94	CHI
20201159909	MINEIROS	MY16401140	PARQUE DAS EMAS	13/11/2020 17:55	13/11/2020 21:01	13/11/2020 20:55	13/11/2020 21:01	0,11	324	34,92	CHI
20201159654	LUZIANIA	LZ21000446	MARAJOARA	13/11/2020 17:56	13/11/2020 20:55	13/11/2020 17:56	13/11/2020 20:55	2,98	1	2,98	CHI
20201160527	PIRACANJUBA	PJ12027582	PIRACANJUBA	13/11/2020 17:57	14/11/2020 07:44	13/11/2020 17:57	14/11/2020 07:44	13,78	8	110,21	CHI
20201159667	BONOPOLIS	BX12364681	SAO MIGUEL DO ARAGUAIA	13/11/2020 17:58	13/11/2020 19:22	13/11/2020 17:58	13/11/2020 19:22	1,40	4	5,58	CHI
20201160194	PIRACANJUBA	PJ12381140	PIRACANJUBA	13/11/2020 17:58	14/11/2020 15:09	13/11/2020 17:58	14/11/2020 00:54	6,93	5	34,67	CHI
20201160194	PIRACANJUBA	PJ12381140	PIRACANJUBA	13/11/2020 17:58	14/11/2020 15:09	13/11/2020 17:58	14/11/2020 15:09	21,19	3	63,56	CHI
20201160194	PIRACANJUBA	PJ12381140	PIRACANJUBA	13/11/2020 17:58	14/11/2020 15:09	14/11/2020 13:20	14/11/2020 15:09	1,82	5	9,11	CHI
20201159826	CRISTIANOPOLIS	SQ12309689	CRISTIANOPOLIS	13/11/2020 17:59	14/11/2020 01:33	13/11/2020 17:59	14/11/2020 01:33	7,57	5	37,84	CHI
20201159826	SAO MIGUEL DO PASSA QUATRO	SQ12309689	CRISTIANOPOLIS	13/11/2020 17:59	14/11/2020 01:33	13/11/2020 17:59	14/11/2020 01:33	7,57	1	7,57	CHI
20201160095	MAURILANDIA	ML12303327	RIO DOS BOIS	13/11/2020 18:00	13/11/2020 23:49	13/11/2020 18:00	13/11/2020 23:49	5,81	25	145,16	CHI
20201159728	SANTA TEREZINHA DE GOIAS	SG21197526	SANTA TEREZINHA	13/11/2020 18:01	13/11/2020 23:45	13/11/2020 18:01	13/11/2020 23:45	5,73	1	5,73	CHI
20201159730	ANAPOLIS	PV21406097	ANAPOLIS UNIVERSITARIO S2	13/11/2020 18:01	14/11/2020 00:38	13/11/2020 18:01	14/11/2020 00:38	6,61	1	6,61	CHI
20201159733	ITUMBIARA	IT21409285	PARANAIBA	13/11/2020 18:03	13/11/2020 20:04	13/11/2020 18:03	13/11/2020 20:04	2,00	1	2,00	CHI
20201159744	MONTE ALEGRE DE GOIAS	MA12261965	SAO DOMINGOS	13/11/2020 18:06	13/11/2020 19:16	13/11/2020 18:06	13/11/2020 19:16	1,15	3	3,46	CHI
20201160126	GOIANAPOLIS	GP12351049	DAIA S2	13/11/2020 18:06	13/11/2020 21:20	13/11/2020 18:06	13/11/2020 21:20	3,23	5	16,16	CHI
20201160126	TEREZOPOLIS DE GOIAS	GP12351049	DAIA S2	13/11/2020 18:06	13/11/2020 21:20	13/11/2020 18:06	13/11/2020 21:20	3,23	37	119,56	CHI
20201160941	TEREZOPOLIS DE GOIAS	TJ11197113	DAIA S2	13/11/2020 18:06	13/11/2020 22:51	13/11/2020 18:06	13/11/2020 22:51	4,75	10	47,48	CHI
20201159749	CATALAO	CT11306648	CATALAO S2	13/11/2020 18:07	13/11/2020 22:35	13/11/2020 18:07	13/11/2020 22:35	4,45	99	440,80	CHI
20201159750	TRINDADE	10031326747	TRINDADE	13/11/2020 18:07	13/11/2020 20:33	13/11/2020 18:07	13/11/2020 20:33	2,42	1	2,42	CHI
20201160969	NIQUELANDIA	NQ12362142	NIQUELANDIA SUBTRANSMISSAO	13/11/2020 18:07	14/11/2020 10:24	13/11/2020 18:07	14/11/2020 10:24	16,27	9	146,47	CHI
20201159811	PIRACANJUBA	MR12000241	MORRINHOS	13/11/2020 18:10	13/11/2020 21:21	13/11/2020 18:10	13/11/2020 21:21	3,17	6	19,04	CHI
20201160248	ANAPOLIS	AN11392173	ANAPOLIS UNIVERSITARIO S2	13/11/2020 18:11	13/11/2020 20:28	13/11/2020 18:11	13/11/2020 20:28	2,27	92	209,22	CHI
20201159782	GUAPO	710032341	GUAPO S1	13/11/2020 18:13	13/11/2020 23:41	13/11/2020 18:13	13/11/2020 23:41	5,47	1	5,47	CHI
20201159794	PLANALTINA	2960114341	PLANALTINA	13/11/2020 18:14	13/11/2020 19:12	13/11/2020 18:14	13/11/2020 19:12	0,96	1	0,96	CHI
20201159797	ABADIANIA	AA21283595	ANAPOLIS UNIVERSITARIO S1	13/11/2020 18:14	13/11/2020 20:18	13/11/2020 18:14	13/11/2020 20:18	2,05	3	6,16	CHI
20201159808	URUACU	UR12003408	URUACU	13/11/2020 18:15	13/11/2020 21:06	13/11/2020 18:15	13/11/2020 21:06	2,85	4	11,39	CHI
20201160558	NAZARIO	PL12308590	ANICUNS	13/11/2020 18:15	14/11/2020 08:05	13/11/2020 18:15	14/11/2020 08:05	13,82	3	41,47	CHI
20201160558	PALMEIRAS DE GOIAS	PL12308590	ANICUNS	13/11/2020 18:15	14/11/2020 08:05	13/11/2020 18:15	14/11/2020 08:05	13,82	2	27,65	CHI
20201160939	ITAPURANGA	170048871	ITAPURANGA	13/11/2020 18:15	14/11/2020 12:03	13/11/2020 18:15	14/11/2020 12:03	17,80	1	17,80	CHI
20201159814	BARRO ALTO	2770000075	BARRO ALTO	13/11/2020 18:16	14/11/2020 10:20	13/11/2020 18:16	14/11/2020 10:20	16,05	1	16,05	CHI
20201159992	PIRACANJUBA	PJ12012972	CALDAS NOVAS S1	13/11/2020 18:16	13/11/2020 21:29	13/11/2020 18:16	13/11/2020 21:29	3,20	7	22,42	CHI
20201159816	VILA PROPICIO	NP21235942	GOIANESIA S2	13/11/2020 18:17	14/11/2020 02:33	13/11/2020 18:17	14/11/2020 02:33	8,26	1	8,26	CHI
20201159817	ARACU	AR11132831	ARACU	13/11/2020 18:17	13/11/2020 21:44	13/11/2020 18:17	13/11/2020 21:44	3,44	124	426,73	CHI
20201159819	FAINA	FC12147805	GOIAS	13/11/2020 18:17	13/11/2020 23:49	13/11/2020 18:17	13/11/2020 23:49	5,53	1	5,53	CHI
20201159822	NOVA AMERICA	2160011247	RUBIATABA	13/11/2020 18:18	14/11/2020 10:04	13/11/2020 18:18	14/11/2020 10:04	15,76	1	15,76	CHI
20201160557	TRINDADE	TR12200202	TRINDADE	13/11/2020 18:18	13/11/2020 21:36	13/11/2020 18:18	13/11/2020 21:36	3,30	1	3,30	CHI
20201160031	PADRE BERNARDO	PB12377283	PADRE BERNARDO	13/11/2020 18:20	13/11/2020 20:00	13/11/2020 18:20	13/11/2020 20:00	1,65	162	267,89	CHI
20201159840	CRISTALINA	KR21351498	CRISTALINA S1	13/11/2020 18:21	14/11/2020 00:53	13/11/2020 18:21	14/11/2020 00:53	6,52	5	32,61	CHI
20201159841	SENADOR CANEDO	10021942909	GOIANIA LESTE S1	13/11/2020 18:21	13/11/2020 21:57	13/11/2020 18:21	13/11/2020 21:57	3,59	1	3,59	CHI
20201159843	SANTA HELENA DE GOIAS	SH12247775	SANTA HELENA S1	13/11/2020 18:21	13/11/2020 21:33	13/11/2020 18:21	13/11/2020 21:33	3,18	2	6,37	CHI
20201159845	GOIANIA	16656301	GOYA S1	13/11/2020 18:22	13/11/2020 20:47	13/11/2020 18:22	13/11/2020 20:47	2,41	1	2,41	CHI
20201159846	PORANGATU	840058792	PORANGATU	13/11/2020 18:22	14/11/2020 07:56	13/11/2020 18:22	14/11/2020 07:56	13,58	1	13,58	CHI
20201159850	RIO VERDE	RV12018072LD	SANTA HELENA S1	13/11/2020 18:22	14/11/2020 19:30	13/11/2020 18:22	13/11/2020 22:53	4,50	10	45,04	CHI

20201159850	RIO VERDE	RV12018072LD	SANTA HELENA S1	13/11/2020 18:22	14/11/2020 19:30	13/11/2020 18:22	13/11/2020 23:53	5,51	2	11,02	CHI
20201159850	RIO VERDE	RV12018072LD	SANTA HELENA S1	13/11/2020 18:22	14/11/2020 19:30	13/11/2020 18:22	14/11/2020 19:30	25,12	1	25,12	CHI
20201159944	ARACU	AV12020305	ANICUNS	13/11/2020 18:22	13/11/2020 19:28	13/11/2020 18:22	13/11/2020 19:28	1,09	13	14,20	CHI
20201159944	AVELINOPOLIS	AV12020305	ANICUNS	13/11/2020 18:22	13/11/2020 19:28	13/11/2020 18:22	13/11/2020 19:28	1,09	109	119,05	CHI
20201159944	CATURAI	AV12020305	ANICUNS	13/11/2020 18:22	13/11/2020 19:28	13/11/2020 18:22	13/11/2020 19:28	1,09	9	9,83	CHI
20201159944	ITABERAI	AV12020305	ANICUNS	13/11/2020 18:22	13/11/2020 19:28	13/11/2020 18:22	13/11/2020 19:28	1,09	1	1,09	CHI
20201159859	APARECIDA DE GOIANIA	11756834	REAL S2	13/11/2020 18:23	13/11/2020 21:15	13/11/2020 18:23	13/11/2020 21:15	2,86	1	2,86	CHI
20201159863	NOVA AMERICA	NM21273701	RUBIATABA	13/11/2020 18:23	14/11/2020 11:10	13/11/2020 18:23	14/11/2020 11:10	16,77	2	33,55	CHI
20201160150	GOIANIA	GN11169110	ATLANTICO S3	13/11/2020 18:23	13/11/2020 19:56	13/11/2020 18:23	13/11/2020 19:56	1,54	45	69,37	CHI
20201159532	DIVINOPOLIS DE GOIAS	GH12208671	SAO DOMINGOS	13/11/2020 18:24	13/11/2020 22:16	13/11/2020 18:24	13/11/2020 19:15	0,85	440	372,04	CHI
20201159532	DIVINOPOLIS DE GOIAS	GH12208671	SAO DOMINGOS	13/11/2020 18:24	13/11/2020 22:16	13/11/2020 18:24	13/11/2020 21:57	3,54	109	385,83	CHI
20201159532	DIVINOPOLIS DE GOIAS	GH12256733LD	SAO DOMINGOS	13/11/2020 18:24	13/11/2020 22:16	13/11/2020 19:59	13/11/2020 22:16	2,29	93	212,53	CHI
20201159872	NOVA ROMA	ND12229410	IACIARA S2	13/11/2020 18:24	13/11/2020 20:42	13/11/2020 18:24	13/11/2020 20:42	2,28	3	6,85	CHI
20201159878	PIRANHAS	PH12184343	ARENOPOLIS	13/11/2020 18:25	13/11/2020 20:17	13/11/2020 18:25	13/11/2020 20:17	1,85	3	5,56	CHI
20201160226	SANTA HELENA DE GOIAS	TD12213488	RIO DOS BOIS	13/11/2020 18:25	14/11/2020 00:08	13/11/2020 18:25	14/11/2020 00:08	5,71	3	17,14	CHI
20201160226	TURVELANDIA	TD12213488	RIO DOS BOIS	13/11/2020 18:25	14/11/2020 00:08	13/11/2020 18:25	14/11/2020 00:08	5,71	6	34,29	CHI
20201159895	GOIANIA	12514380	GOIANIA LESTE S2	13/11/2020 18:27	14/11/2020 10:49	13/11/2020 18:27	14/11/2020 10:49	16,35	1	16,35	CHI
20201159989	VICENTINOPOLIS	VI12128635	VICENTINOPOLIS	13/11/2020 18:29	13/11/2020 22:02	13/11/2020 18:29	13/11/2020 22:02	3,54	353	1250,60	CHI
20201159911	PALMEIRAS DE GOIAS	PL21000114	PALMEIRAS	13/11/2020 18:30	13/11/2020 21:26	13/11/2020 18:30	13/11/2020 21:26	2,93	1	2,93	CHI
20201159929	URUTAI	UT12080655	URUTAI	13/11/2020 18:31	13/11/2020 20:39	13/11/2020 18:31	13/11/2020 20:39	2,13	4	8,52	CHI
20201159930	TRINDADE	TR12311261	TRINDADE	13/11/2020 18:31	13/11/2020 21:59	13/11/2020 18:31	13/11/2020 21:59	3,46	235	814,14	CHI
20201159941	PETROLINA DE GOIAS	PG21196438	PETROLINA	13/11/2020 18:32	13/11/2020 22:58	13/11/2020 18:32	13/11/2020 22:58	4,42	1	4,42	CHI
20201159942	GOIANIA	15480185	CAMPINAS S1	13/11/2020 18:32	13/11/2020 21:11	13/11/2020 18:32	13/11/2020 21:11	2,64	1	2,64	CHI
20201159950	IPAMERI	IP12300933	IPAMERI	13/11/2020 18:33	14/11/2020 00:06	13/11/2020 18:33	14/11/2020 00:06	5,54	57	315,84	CHI
20201159950	URUTAI	IP12300933	IPAMERI	13/11/2020 18:33	14/11/2020 00:06	13/11/2020 18:33	14/11/2020 00:06	5,54	3	16,62	CHI
20201160291	ITAPIRAPUA	IU12362956	JUSSARA	13/11/2020 18:33	13/11/2020 23:45	13/11/2020 18:33	13/11/2020 23:45	5,19	5	25,96	CHI
20201159959	RIO VERDE	630228814	RIO VERDE S1	13/11/2020 18:34	13/11/2020 20:01	13/11/2020 18:34	13/11/2020 20:01	1,44	1	1,44	CHI
20201159960	RIO QUENTE	RQ21310350	VILA CORUMBA	13/11/2020 18:34	13/11/2020 21:42	13/11/2020 18:34	13/11/2020 21:42	3,13	1	3,13	CHI
20201159968	NIQUELANDIA	2750048571	NIQUELANDIA SUBTRANSMISSAO	13/11/2020 18:36	14/11/2020 15:20	13/11/2020 18:36	14/11/2020 15:20	20,73	1	20,73	CHI
20201159969	JATAI	JT21380678	JATAI S1	13/11/2020 18:36	13/11/2020 21:46	13/11/2020 18:36	13/11/2020 21:46	3,16	1	3,16	CHI
20201159970	SILVANIA	SV21015029	VIANOPOLIS	13/11/2020 18:36	14/11/2020 00:10	13/11/2020 18:36	14/11/2020 00:10	5,56	1	5,56	CHI
20201161294	MINACU	IH11311570	MINACU	13/11/2020 18:37	14/11/2020 08:43	13/11/2020 18:37	14/11/2020 08:43	14,09	53	746,65	CHI
20201159979	HIDROLANDIA	HD21373532	PONTALINA	13/11/2020 18:38	14/11/2020 00:32	13/11/2020 18:38	14/11/2020 00:32	5,90	2	11,79	CHI
20201160610	HIDROLANDIA	HD11000133	ANHANGUERA	13/11/2020 18:38	14/11/2020 12:21	13/11/2020 18:38	14/11/2020 12:21	17,71	54	956,29	CHI
20201159997	MORRINHOS	MR12352594	MORRINHOS	13/11/2020 18:39	13/11/2020 21:59	13/11/2020 18:39	13/11/2020 21:59	3,32	7	23,22	CHI
20201159997	PIRACANJUBA	MR12352594	MORRINHOS	13/11/2020 18:39	13/11/2020 21:59	13/11/2020 18:39	13/11/2020 21:59	3,32	3	9,95	CHI
20201160013	HIDROLANDIA	HD11006283	ANHANGUERA	13/11/2020 18:39	13/11/2020 23:08	13/11/2020 18:39	13/11/2020 23:08	4,47	130	580,96	CHI
20201160004	POSSE	PS12256102	IACIARA S2	13/11/2020 18:40	14/11/2020 07:55	13/11/2020 18:40	14/11/2020 07:55	13,24	7	92,67	CHI
20201160008	ARAGOIANIA	HD12313035LD	CEPAIGO S2	13/11/2020 18:40	14/11/2020 04:40	13/11/2020 18:40	14/11/2020 04:40	9,98	16	159,75	CHI
20201160008	HIDROLANDIA	HD12313035LD	CEPAIGO S2	13/11/2020 18:40	14/11/2020 04:40	13/11/2020 18:40	14/11/2020 04:40	9,98	291	2905,39	CHI
20201160086	GOIANIA	GN11001206	GOIANIA LESTE S3	13/11/2020 18:40	13/11/2020 23:27	13/11/2020 18:40	13/11/2020 23:27	4,77	124	591,96	CHI
20201160088	APARECIDA DE GOIANIA	AP12000209	INDEPENDENCIA S2	13/11/2020 18:40	13/11/2020 21:48	13/11/2020 18:40	13/11/2020 21:48	3,13	588	1840,44	CHI
20201160023	CORUMBA DE GOIAS	CB21171922	CORUMBA	13/11/2020 18:43	14/11/2020 02:35	13/11/2020 18:43	14/11/2020 02:35	7,85	1	7,85	CHI
20201161300	SANTA HELENA DE GOIAS	SH12000123	IPEGUARI	13/11/2020 18:43	14/11/2020 11:15	13/11/2020 18:43	14/11/2020 11:15	16,52	2	33,03	CHI
20201161300	TURVELANDIA	SH12000123	IPEGUARI	13/11/2020 18:43	14/11/2020 11:15	13/11/2020 18:43	14/11/2020 11:15	16,52	9	148,66	CHI
20201160456	TRINDADE	TR31057452	TRINDADE	13/11/2020 18:44	14/11/2020 08:51	13/11/2020 18:44	14/11/2020 08:51	14,10	1	14,10	CHI
20201160038	PLANALTINA	PI21105569	PLANALTINA	13/11/2020 18:45	13/11/2020 21:38	13/11/2020 18:45	13/11/2020 21:38	2,88	1	2,88	CHI
20201160040	ACREUNA	EU21279072	RIO DOS BOIS	13/11/2020 18:45	14/11/2020 02:18	13/11/2020 18:45	14/11/2020 02:18	7,55	2	15,09	CHI
20201160983	TRINDADE	10028879455	TRINDADE	13/11/2020 18:45	14/11/2020 05:36	13/11/2020 18:45	14/11/2020 05:36	10,86	1	10,86	CHI
20201160052	GOIANIA	13606013	ATLANTICO S1	13/11/2020 18:46	13/11/2020 20:01	13/11/2020 18:46	13/11/2020 20:01	1,25	1	1,25	CHI
20201160057	TAQUARAL DE GOIAS	TQ21217522	ITABERAI S1	13/11/2020 18:46	14/11/2020 08:52	13/11/2020 18:46	14/11/2020 08:52	14,10	1	14,10	CHI



20201160073	ANICUNS	AC12304642	ANICUNS	13/11/2020 18:46	14/11/2020 00:03	13/11/2020 18:46	14/11/2020 00:03	5,28	7	36,96	CHI
20201160068	GOIANIRA	GR12313284	MEIA PONTE	13/11/2020 18:47	13/11/2020 20:59	13/11/2020 18:47	13/11/2020 20:59	2,19	302	661,80	CHI
20201160148	GOIANIA	GN11199202	GOIANIA LESTE S2	13/11/2020 18:47	13/11/2020 22:57	13/11/2020 18:47	13/11/2020 22:57	4,16	32	133,14	CHI
20201160708	IPAMERI	IP12056133	IPAMERI	13/11/2020 18:47	13/11/2020 21:33	13/11/2020 18:47	13/11/2020 21:33	2,76	463	1280,19	CHI
20201160074	GOIANIA	GR12321567	MEIA PONTE	13/11/2020 18:48	13/11/2020 20:27	13/11/2020 18:48	13/11/2020 20:27	1,65	11	18,15	CHI
20201160074	GOIANIRA	GR12321567	MEIA PONTE	13/11/2020 18:48	13/11/2020 20:27	13/11/2020 18:48	13/11/2020 20:27	1,65	56	92,38	CHI
20201160076	GOIANESIA	GE12372623	GOIANESIA S1	13/11/2020 18:48	13/11/2020 21:20	13/11/2020 18:48	13/11/2020 21:20	2,53	30	75,85	CHI
20201160177	GOIANIA	GN11160123	CAMPINAS S1	13/11/2020 18:48	14/11/2020 00:11	13/11/2020 18:48	14/11/2020 00:11	5,37	70	376,04	CHI
20201160384	RIO QUENTE	RQ12050905	VILA CORUMBA	13/11/2020 18:49	14/11/2020 06:13	13/11/2020 18:49	14/11/2020 06:13	11,40	12	136,74	CHI
20201160093	SAO MIGUEL DO PASSA QUATRO	SQ211125981	CRISTIANOPOLIS	13/11/2020 18:50	14/11/2020 03:22	13/11/2020 18:50	14/11/2020 03:22	8,52	1	8,52	CHI
20201160109	TRINDADE	TR12001811	GOYA S1	13/11/2020 18:50	13/11/2020 21:23	13/11/2020 18:50	13/11/2020 21:23	2,53	24	60,81	CHI
20201160111	CAMPINORTE	2040011566	CAMPINORTE	13/11/2020 18:53	14/11/2020 07:32	13/11/2020 18:53	14/11/2020 07:32	12,65	1	12,65	CHI
20201160116	MARA ROSA	MQ12295258	MARA ROSA	13/11/2020 18:53	15/11/2020 13:58	13/11/2020 18:53	15/11/2020 13:58	43,08	2	86,16	CHI
20201160119	SANTA TEREZINHA DE GOIAS	SG12371040	SANTA TEREZINHA	13/11/2020 18:53	13/11/2020 23:23	13/11/2020 18:53	13/11/2020 23:23	4,49	2	8,98	CHI
20201160266	BELA VISTA DE GOIAS	BV32017324	BELA VISTA S1	13/11/2020 18:53	13/11/2020 21:17	13/11/2020 18:53	13/11/2020 21:17	2,40	27	64,70	CHI
20201160266	CALDAZINHA	BV32017324	BELA VISTA S1	13/11/2020 18:53	13/11/2020 21:17	13/11/2020 18:53	13/11/2020 21:17	2,40	20	47,92	CHI
20201160127	PIRENOPOLIS	PV21119830	CORUMBA	13/11/2020 18:55	14/11/2020 13:24	13/11/2020 18:55	14/11/2020 13:24	18,48	1	18,48	CHI
20201160140	APARECIDA DE GOIANIA	200142987	INDEPENDENCIA S2	13/11/2020 18:56	14/11/2020 00:02	13/11/2020 18:56	14/11/2020 00:02	5,09	1	5,09	CHI
20201160144	ITABERAI	IB21281148	ITABERAI S2	13/11/2020 18:57	13/11/2020 21:15	13/11/2020 18:57	13/11/2020 21:15	2,30	1	2,30	CHI
20201160151	MIMOSO DE GOIAS	3170010023	SAO JOAO D ALIANCA	13/11/2020 18:57	13/11/2020 20:50	13/11/2020 18:57	13/11/2020 20:50	1,88	1	1,88	CHI
20201160152	VILA BOA	2880010245	IACIARA S2	13/11/2020 18:57	14/11/2020 07:04	13/11/2020 18:57	14/11/2020 07:04	12,10	1	12,10	CHI
20201160400	TURVELANDIA	TD12306313	RIO DOS BOIS	13/11/2020 18:57	13/11/2020 22:32	13/11/2020 18:57	13/11/2020 22:32	3,58	10	35,77	CHI
20201160506	TRINDADE	TR31052845	TRINDADE	13/11/2020 18:57	14/11/2020 04:11	13/11/2020 18:57	14/11/2020 04:11	9,22	1	9,22	CHI
20201160155	CAIAPONIA	CP12355597	CAIAPONIA	13/11/2020 18:58	14/11/2020 00:02	13/11/2020 18:58	14/11/2020 00:02	5,06	6	30,35	CHI
20201160156	CAMPO LIMPO	AN21055362	NEROPOLIS S1	13/11/2020 18:58	14/11/2020 01:17	13/11/2020 18:58	14/11/2020 01:17	6,31	5	31,53	CHI
20201160157	GOIANIA	11501376	GOIANIA LESTE S2	13/11/2020 18:58	14/11/2020 04:28	13/11/2020 18:58	14/11/2020 04:28	9,49	1	9,49	CHI
20201160159	NIQUELANDIA	10019623460	NIQUELANDIA SUBTRANSMISSAO	13/11/2020 18:59	14/11/2020 23:30	13/11/2020 18:59	14/11/2020 23:30	28,52	1	28,52	CHI
20201160164	BURITI ALEGRE	BG12263568RE	ITUMBIARA VELHA S2	13/11/2020 18:59	14/11/2020 02:56	13/11/2020 18:59	14/11/2020 02:56	7,95	27	214,58	CHI
20201160164	ITUMBIARA	BG12263568RE	ITUMBIARA VELHA S2	13/11/2020 18:59	14/11/2020 02:56	13/11/2020 18:59	14/11/2020 02:56	7,95	123	977,54	CHI
20201160167	GOIANIA	14243350	GOIANIA LESTE S3	13/11/2020 19:00	14/11/2020 13:30	13/11/2020 19:00	14/11/2020 13:30	18,51	1	18,51	CHI
20201160168	TRINDADE	10030160241	TRINDADE	13/11/2020 19:00	13/11/2020 22:14	13/11/2020 19:00	13/11/2020 22:14	3,22	1	3,22	CHI
20201160178	RIO QUENTE	RQ12070139	VILA CORUMBA	13/11/2020 19:00	13/11/2020 20:21	13/11/2020 19:00	13/11/2020 20:21	1,34	2	2,68	CHI
20201160612	HIDROLANDIA	HD11000143	ANHANGUERA	13/11/2020 19:00	14/11/2020 03:32	13/11/2020 19:00	14/11/2020 03:32	8,52	97	826,74	CHI
20201160556	MARA ROSA	MQ12383636	MARA ROSA	13/11/2020 19:02	14/11/2020 14:52	13/11/2020 19:02	14/11/2020 14:52	19,82	3	59,46	CHI
20201160188	FAINA	FC21252453	GOIAS	13/11/2020 19:03	13/11/2020 22:02	13/11/2020 19:03	13/11/2020 22:02	2,98	1	2,98	CHI
20201160193	UIRAPURU	UP21190104	SANTA TEREZINHA	13/11/2020 19:03	13/11/2020 21:38	13/11/2020 19:03	13/11/2020 21:38	2,58	1	2,58	CHI
20201160198	NIQUELANDIA	NQ11333938	NIQUELANDIA SUBTRANSMISSAO	13/11/2020 19:05	14/11/2020 10:46	13/11/2020 19:05	14/11/2020 10:46	15,68	1	15,68	CHI
20201160262	GOIANIA	GN11041611	CAMPINAS S1	13/11/2020 19:06	13/11/2020 22:11	13/11/2020 19:06	13/11/2020 22:11	3,08	64	196,89	CHI
20201160237	ARAGUAPAZ	MP12299732	MATRINCHA	13/11/2020 19:07	13/11/2020 21:23	13/11/2020 19:07	13/11/2020 21:23	2,26	1	2,26	CHI
20201160237	FAINA	MP12299732	MATRINCHA	13/11/2020 19:07	13/11/2020 21:23	13/11/2020 19:07	13/11/2020 21:23	2,26	67	151,59	CHI
20201160237	MATRINCHA	MP12299732	MATRINCHA	13/11/2020 19:07	13/11/2020 21:23	13/11/2020 19:07	13/11/2020 21:23	2,26	62	140,27	CHI
20201160244	HIDROLANDIA	HD12006326	CEPAIGO S2	13/11/2020 19:07	14/11/2020 15:03	13/11/2020 19:07	14/11/2020 02:16	7,15	5	35,76	CHI
20201160244	HIDROLANDIA	HD12060905LD	CEPAIGO S2	13/11/2020 19:07	14/11/2020 15:03	13/11/2020 19:07	14/11/2020 02:34	7,45	33	245,77	CHI
20201160244	HIDROLANDIA	HD12006326	CEPAIGO S2	13/11/2020 19:07	14/11/2020 15:03	14/11/2020 02:46	14/11/2020 03:10	0,39	44	17,26	CHI
20201160244	HIDROLANDIA	HD12035991LD	CEPAIGO S2	13/11/2020 19:07	14/11/2020 15:03	13/11/2020 19:07	14/11/2020 15:02	19,92	5	99,60	CHI
20201160244	HIDROLANDIA	HD12006326	CEPAIGO S2	13/11/2020 19:07	14/11/2020 15:03	14/11/2020 02:46	14/11/2020 15:02	12,27	10	122,67	CHI
20201160244	HIDROLANDIA	HD12006326	CEPAIGO S2	13/11/2020 19:07	14/11/2020 15:03	14/11/2020 13:32	14/11/2020 15:02	1,51	44	66,59	CHI
20201160244	HIDROLANDIA	HD12035991LD	CEPAIGO S2	13/11/2020 19:07	14/11/2020 15:03	13/11/2020 19:07	14/11/2020 15:03	19,92	1	19,92	CHI
20201160220	CUMARI	CY12034703	CATALAO S1	13/11/2020 19:08	13/11/2020 23:11	13/11/2020 19:08	13/11/2020 23:11	4,04	4	16,15	CHI
20201160300	GOIANIA	GN12322843	NEROPOLIS S1	13/11/2020 19:08	13/11/2020 22:58	13/11/2020 19:08	13/11/2020 22:58	3,82	109	416,41	CHI
20201160227	CRIXAS	CX21322636	SANTA TEREZINHA	13/11/2020 19:09	14/11/2020 08:37	13/11/2020 19:09	14/11/2020 08:37	13,46	1	13,46	CHI

20201160228	CRIXAS	CX12285344	SANTA TEREZINHA	13/11/2020 19:09	14/11/2020 20:55	13/11/2020 19:09	14/11/2020 20:55	25,76	8	206,10	CHI
20201160242	ITAPIRAPUA	IU12018776	JUSSARA	13/11/2020 19:10	14/11/2020 02:02	13/11/2020 19:10	14/11/2020 02:02	6,85	3	20,56	CHI
20201160250	VICENTINOPOLIS	VI12352541	VICENTINOPOLIS	13/11/2020 19:12	15/11/2020 17:17	14/11/2020 11:42	15/11/2020 09:56	22,22	4	88,90	CHI
20201160250	EDEIA	VI12328992LD	VICENTINOPOLIS	13/11/2020 19:12	15/11/2020 17:17	13/11/2020 19:12	15/11/2020 17:17	46,08	8	368,61	CHI
20201160250	VICENTINOPOLIS	VI12328992LD	VICENTINOPOLIS	13/11/2020 19:12	15/11/2020 17:17	13/11/2020 19:12	15/11/2020 17:17	46,08	15	691,14	CHI
20201160250	VICENTINOPOLIS	VI12328992LD	VICENTINOPOLIS	13/11/2020 19:12	15/11/2020 17:17	15/11/2020 11:41	15/11/2020 17:17	5,59	8	44,72	CHI
20201160251	LUZIANIA	LZ12290683	MARAJOARA	13/11/2020 19:12	14/11/2020 01:59	13/11/2020 19:12	14/11/2020 01:59	6,77	17	115,05	CHI
20201160260	NOVA CRIXAS	NA21213191	MOZARLANDIA	13/11/2020 19:13	14/11/2020 09:47	13/11/2020 19:13	14/11/2020 09:47	14,55	1	14,55	CHI
20201160270	CALDAS NOVAS	RQ21196405	VILA CORUMBA	13/11/2020 19:15	13/11/2020 22:34	13/11/2020 19:15	13/11/2020 22:34	3,31	2	6,61	CHI
20201160287	EDEIA	TD12040336	RIO DOS BOIS	13/11/2020 19:16	14/11/2020 12:40	13/11/2020 19:16	14/11/2020 12:40	17,40	1	17,40	CHI
20201160287	TURVELANDIA	TD12040336	RIO DOS BOIS	13/11/2020 19:16	14/11/2020 12:40	13/11/2020 19:16	14/11/2020 12:40	17,40	3	52,19	CHI
20201160289	IVOLANDIA	AM21244918	IPORA	13/11/2020 19:16	13/11/2020 21:10	13/11/2020 19:16	13/11/2020 21:10	1,89	1	1,89	CHI
20201160468	GOIANESIA	GE12000150	GOIANESIA S1	13/11/2020 19:17	15/11/2020 17:47	13/11/2020 19:17	15/11/2020 17:47	46,50	3	139,50	CHI
20201160598	COCALZINHO DE GOIAS	ZN12376728	AGUAS LINDAS DE GOIAS S2	13/11/2020 19:17	13/11/2020 22:09	13/11/2020 19:17	13/11/2020 22:09	2,86	17	48,64	CHI
20201160294	RIO QUENTE	RQ21153374	VILA CORUMBA	13/11/2020 19:18	13/11/2020 21:02	13/11/2020 19:18	13/11/2020 21:02	1,73	1	1,73	CHI
20201160298	SILVANIA	SV21205400	VIANOPOLIS	13/11/2020 19:19	14/11/2020 09:34	13/11/2020 19:19	14/11/2020 09:34	14,24	2	28,48	CHI
20201160299	LUZIANIA	LZ21153655	MARAJOARA	13/11/2020 19:19	14/11/2020 00:26	13/11/2020 19:19	14/11/2020 00:26	5,10	1	5,10	CHI
20201160302	PORANGATU	PO11239648	MARA ROSA	13/11/2020 19:19	14/11/2020 10:32	13/11/2020 19:19	14/11/2020 10:32	15,20	1	15,20	CHI
20201160441	SANTO ANTONIO DE GOIAS	GR12002121	NEROPOLIS S1	13/11/2020 19:20	13/11/2020 22:21	13/11/2020 19:20	13/11/2020 22:21	3,01	41	123,34	CHI
20201160315	GOIANIA	10011561821	XAVANTES	13/11/2020 19:21	14/11/2020 01:41	13/11/2020 19:21	14/11/2020 01:41	6,32	1	6,32	CHI
20201160317	ITAUCU	IX11141972	INHUMAS S1	13/11/2020 19:22	13/11/2020 22:11	13/11/2020 19:22	13/11/2020 22:11	2,82	205	577,36	CHI
20201160325	TRINDADE	TR32027168	TRINDADE	13/11/2020 19:24	13/11/2020 21:59	13/11/2020 19:24	13/11/2020 21:59	2,57	40	102,96	CHI
20201160326	MINACU	IH21241970	MINACU	13/11/2020 19:25	14/11/2020 11:23	13/11/2020 19:25	14/11/2020 11:23	15,96	3	47,89	CHI
20201160329	MINACU	IH11240653	MINACU	13/11/2020 19:25	13/11/2020 22:48	13/11/2020 19:25	13/11/2020 22:48	3,37	1	3,37	CHI
20201160335	PIRACANJUBA	PJ12394016	CRISTIANOPOLIS	13/11/2020 19:26	13/11/2020 22:38	13/11/2020 19:26	13/11/2020 22:38	3,19	2	6,37	CHI
20201160387	VALPARAISO DE GOIAS	VA11169042	MARAJOARA	13/11/2020 19:27	13/11/2020 20:58	13/11/2020 19:27	13/11/2020 20:58	1,50	189	284,34	CHI
20201160348	PLANALTINA	PI11164636	PLANALTINA	13/11/2020 19:28	13/11/2020 20:43	13/11/2020 19:28	13/11/2020 20:43	1,24	371	461,38	CHI
20201160353	RIO VERDE	RV21280387	CABRIUVA S2	13/11/2020 19:29	14/11/2020 08:42	13/11/2020 19:29	14/11/2020 08:42	13,21	1	13,21	CHI
20201160509	CATALAO	CT11000052	CATALAO S2	13/11/2020 19:29	13/11/2020 21:17	13/11/2020 19:29	13/11/2020 21:17	1,78	165	294,48	CHI
20201160363	CALDAS NOVAS	CN12212735LD	RIO QUENTE	13/11/2020 19:31	13/11/2020 22:36	13/11/2020 19:31	13/11/2020 22:36	3,07	64	196,39	CHI
20201160363	MORRINHOS	CN12212735LD	RIO QUENTE	13/11/2020 19:31	13/11/2020 22:36	13/11/2020 19:31	13/11/2020 22:36	3,07	1	3,07	CHI
20201160363	PIRACANJUBA	CN12212735LD	RIO QUENTE	13/11/2020 19:31	13/11/2020 22:36	13/11/2020 19:31	13/11/2020 22:36	3,07	1	3,07	CHI
20201160369	FORMOSA	610061264	ITIQUEIRA	13/11/2020 19:33	13/11/2020 21:17	13/11/2020 19:33	13/11/2020 21:17	1,73	1	1,73	CHI
20201160373	QUIRINOPOLIS	QI32052457	QUIRINOPOLIS	13/11/2020 19:33	13/11/2020 22:03	13/11/2020 19:33	13/11/2020 22:03	2,50	9	22,46	CHI
20201160375	COCALZINHO DE GOIAS	ZN12302460	COCALZINHO	13/11/2020 19:34	13/11/2020 22:56	13/11/2020 19:34	13/11/2020 22:56	3,36	2	6,72	CHI
20201160385	VILA PROPICIO	NP21382233	PADRE BERNARDO	13/11/2020 19:35	14/11/2020 17:49	13/11/2020 19:35	14/11/2020 17:49	22,22	1	22,22	CHI
20201160388	SANTA HELENA DE GOIAS	10020368605	IPEGUARI	13/11/2020 19:36	14/11/2020 09:21	13/11/2020 19:36	14/11/2020 09:21	13,75	1	13,75	CHI
20201160389	MUNDO NOVO DE GOIAS	4240021122	NOVA CRIXAS	13/11/2020 19:36	14/11/2020 01:41	13/11/2020 19:36	14/11/2020 01:41	6,08	1	6,08	CHI
20201160393	CAMPINORTE	CR21252004	MARA ROSA	13/11/2020 19:36	14/11/2020 10:31	13/11/2020 19:36	14/11/2020 10:31	14,91	1	14,91	CHI
20201160402	ABADIANIA	AA21285233	DAIA S2	13/11/2020 19:38	14/11/2020 09:12	13/11/2020 19:38	14/11/2020 09:12	13,56	7	94,94	CHI
20201160403	SANTA HELENA DE GOIAS	400087613	ACREUNA	13/11/2020 19:38	14/11/2020 01:11	13/11/2020 19:38	14/11/2020 01:11	5,54	1	5,54	CHI
20201160645	CAIAPONIA	CP12190363	CAIAPONIA	13/11/2020 19:40	14/11/2020 01:21	13/11/2020 19:40	14/11/2020 01:21	5,68	4	22,71	CHI
20201160645	DOVERLANDIA	CP12190363	CAIAPONIA	13/11/2020 19:40	14/11/2020 01:21	13/11/2020 19:40	14/11/2020 01:21	5,68	6	34,06	CHI
20201160422	GOIANIA	10019294040	GOYA S2	13/11/2020 19:41	14/11/2020 00:02	13/11/2020 19:41	14/11/2020 00:02	4,35	1	4,35	CHI
20201160428	CASTELANDIA	DM21252740	RIO DOS BOIS	13/11/2020 19:41	14/11/2020 09:40	13/11/2020 19:41	14/11/2020 09:40	13,97	7	97,79	CHI
20201160432	COCALZINHO DE GOIAS	ZN21185687	COCALZINHO	13/11/2020 19:42	14/11/2020 11:33	13/11/2020 19:42	14/11/2020 11:33	15,85	1	15,85	CHI
20201160436	AGUAS LINDAS DE GOIAS	LA11113295	AGUAS LINDAS DE GOIAS S1	13/11/2020 19:42	13/11/2020 20:37	13/11/2020 19:42	13/11/2020 20:37	0,90	277	249,45	CHI
20201160444	MARA ROSA	MQ21283223	MARA ROSA	13/11/2020 19:44	15/11/2020 16:44	13/11/2020 19:44	15/11/2020 16:44	45,00	1	45,00	CHI
20201160446	GOIANIA	GN12001501	XAVANTES	13/11/2020 19:44	14/11/2020 22:40	13/11/2020 19:44	14/11/2020 02:03	6,32	170	1074,49	CHI
20201160446	GOIANIA	GN12150418LD	XAVANTES	13/11/2020 19:44	14/11/2020 22:40	13/11/2020 19:44	14/11/2020 09:57	14,22	53	753,78	CHI
20201160446	GOIANIA	8518035	XAVANTES	13/11/2020 19:44	14/11/2020 22:40	13/11/2020 19:44	14/11/2020 22:40	26,93	1	26,93	CHI

20201160601	BOM JARDIM DE GOIAS	BM12253664	BOM JARDIM	13/11/2020 19:44	13/11/2020 23:34	13/11/2020 19:44	13/11/2020 23:34	3,82	8	30,55	CHI
20201160450	ALEXANIA	AX12071329	ALEXANIA	13/11/2020 19:45	14/11/2020 01:59	13/11/2020 19:45	14/11/2020 01:59	6,23	14	87,27	CHI
20201160450	SANTO ANTONIO DO DESCOBERTO	AX12071329	ALEXANIA	13/11/2020 19:45	14/11/2020 01:59	13/11/2020 19:45	14/11/2020 01:59	6,23	1	6,23	CHI
20201160452	GOIANIA	10005390034	CARAJAS S1	13/11/2020 19:45	13/11/2020 23:39	13/11/2020 19:45	13/11/2020 23:39	3,89	1	3,89	CHI
20201160508	TRINDADE	TR32045221	TRINDADE	13/11/2020 19:45	13/11/2020 23:11	13/11/2020 19:45	13/11/2020 23:11	3,43	9	30,84	CHI
20201160458	PARAUNA	PU12205943	PARAUNA	13/11/2020 19:47	15/11/2020 01:16	13/11/2020 19:47	14/11/2020 11:55	16,13	8	129,02	CHI
20201160458	PARAUNA	PU12205943	PARAUNA	13/11/2020 19:47	15/11/2020 01:16	14/11/2020 14:07	14/11/2020 16:22	2,25	8	18,02	CHI
20201160458	PARAUNA	PU12205943	PARAUNA	13/11/2020 19:47	15/11/2020 01:16	13/11/2020 19:47	15/11/2020 00:57	29,17	13	379,20	CHI
20201160458	JANDAIA	PU12205943	PARAUNA	13/11/2020 19:47	15/11/2020 01:16	13/11/2020 19:47	15/11/2020 01:16	29,48	3	88,45	CHI
20201160458	PARAUNA	PU12205943	PARAUNA	13/11/2020 19:47	15/11/2020 01:16	13/11/2020 19:47	15/11/2020 01:16	29,48	6	176,90	CHI
20201160467	GOIANIA	GN11140402	XAVANTES	13/11/2020 19:47	14/11/2020 04:10	13/11/2020 19:47	14/11/2020 04:10	8,37	63	527,19	CHI
20201160542	ALEXANIA	AX12384864	ALEXANIA	13/11/2020 19:48	13/11/2020 21:37	13/11/2020 19:48	13/11/2020 21:37	1,80	79	142,44	CHI
20201160466	ALEXANIA	SN12330532	MARAJOARA	13/11/2020 19:49	13/11/2020 22:45	13/11/2020 19:49	13/11/2020 22:45	2,93	4	11,73	CHI
20201160466	SANTO ANTONIO DO DESCOBERTO	SN12330532	MARAJOARA	13/11/2020 19:49	13/11/2020 22:45	13/11/2020 19:49	13/11/2020 22:45	2,93	31	90,93	CHI
20201160514	ALEXANIA	10011153375	ALEXANIA	13/11/2020 19:49	13/11/2020 22:40	13/11/2020 19:49	13/11/2020 22:40	2,84	1	2,84	CHI
20201160621	SANTO ANTONIO DO DESCOBERTO	SN12085981	MARAJOARA	13/11/2020 19:53	14/11/2020 20:55	13/11/2020 19:53	13/11/2020 23:02	3,16	4	12,63	CHI
20201160621	SANTO ANTONIO DO DESCOBERTO	SN12085981	MARAJOARA	13/11/2020 19:53	14/11/2020 20:55	14/11/2020 20:55	14/11/2020 12:51	2,03	4	8,12	CHI
20201160621	SANTO ANTONIO DO DESCOBERTO	SN12085984LD	MARAJOARA	13/11/2020 19:53	14/11/2020 20:55	13/11/2020 19:53	14/11/2020 19:52	23,99	21	503,76	CHI
20201160621	SANTO ANTONIO DO DESCOBERTO	SN12085981	MARAJOARA	13/11/2020 19:53	14/11/2020 20:55	14/11/2020 20:40	14/11/2020 20:55	0,26	25	6,41	CHI
20201164590	ESTRELA DO NORTE	ET12231930	MARA ROSA	13/11/2020 19:53	15/11/2020 10:40	13/11/2020 19:53	15/11/2020 10:40	38,78	4	155,13	CHI
20201160492	RIO VERDE	RV11380664	CABRIUVA S1	13/11/2020 19:54	14/11/2020 00:20	13/11/2020 21:55	14/11/2020 00:20	2,41	22	52,95	CHI
20201160614	HIDROLANDIA	HD11000145	ANHANGUERA	13/11/2020 19:55	14/11/2020 04:23	13/11/2020 19:55	14/11/2020 04:23	8,47	37	313,27	CHI
20201160496	FLORES DE GOIAS	FB12243041LD	IACIARA S2	13/11/2020 19:56	13/11/2020 21:38	13/11/2020 19:56	13/11/2020 21:38	1,69	1	1,69	CHI
20201160501	QUIRINOPOLIS	QI21116447	QUIRINOPOLIS	13/11/2020 19:57	14/11/2020 00:17	13/11/2020 19:57	14/11/2020 00:17	4,33	1	4,33	CHI
20201160517	GOIANIA	15502697	CAMPINAS S3	13/11/2020 19:58	13/11/2020 20:24	13/11/2020 19:58	13/11/2020 20:24	0,42	1	0,42	CHI
20201161204	SANTA HELENA DE GOIAS	SH12246719	ACREUNA	13/11/2020 20:01	14/11/2020 09:07	13/11/2020 20:01	14/11/2020 09:07	13,09	34	444,97	CHI
202011137983	GOIANIA	GN12001058	XAVANTES	13/11/2020 20:01	14/11/2020 10:36	13/11/2020 20:01	14/11/2020 10:36	14,57	14	203,98	CHI
20201160529	ANICUNS	AC21232046	ANICUNS	13/11/2020 20:02	14/11/2020 07:38	13/11/2020 20:02	14/11/2020 07:38	11,60	1	11,60	CHI
20201160533	ARENOPOLIS	PH12243855	PIRANHAS	13/11/2020 20:02	13/11/2020 21:53	13/11/2020 20:02	13/11/2020 21:53	1,84	1	1,84	CHI
20201160534	FORMOSA	FA11100260	ITUIQUIRA	13/11/2020 20:02	13/11/2020 22:21	13/11/2020 20:02	13/11/2020 22:21	2,30	68	156,48	CHI
20201160636	SAO MIGUEL DO ARAGUAIA	SM12000063RE	SAO MIGUEL DO ARAGUAIA	13/11/2020 20:02	15/11/2020 22:52	13/11/2020 20:02	14/11/2020 19:42	23,66	19	449,56	CHI
20201160636	SAO MIGUEL DO ARAGUAIA	SM12000063RE	SAO MIGUEL DO ARAGUAIA	13/11/2020 20:02	15/11/2020 22:52	14/11/2020 19:48	15/11/2020 17:08	21,34	15	320,13	CHI
20201160636	SAO MIGUEL DO ARAGUAIA	SM12000063RE	SAO MIGUEL DO ARAGUAIA	13/11/2020 20:02	15/11/2020 22:52	13/11/2020 20:02	15/11/2020 22:06	50,07	16	801,09	CHI
20201160636	SAO MIGUEL DO ARAGUAIA	SM13371090	SAO MIGUEL DO ARAGUAIA	13/11/2020 20:02	15/11/2020 22:52	14/11/2020 19:48	15/11/2020 22:52	27,07	4	108,28	CHI
20201160536	PETROLINA DE GOIAS	PG12031546	PETROLINA	13/11/2020 20:03	14/11/2020 00:34	13/11/2020 20:03	14/11/2020 00:34	4,51	25	112,84	CHI
20201160582	JATAI	SX12264387RE	JATAI S1	13/11/2020 20:03	14/11/2020 11:29	13/11/2020 20:03	14/11/2020 11:29	15,42	7	107,96	CHI
20201160582	SERRANOPOLIS	SX12264387RE	JATAI S1	13/11/2020 20:03	14/11/2020 11:29	13/11/2020 20:03	14/11/2020 11:29	15,42	23	354,73	CHI
20201160545	IACIARA	IA21062096	IACIARA S1	13/11/2020 20:04	14/11/2020 02:53	13/11/2020 20:04	14/11/2020 02:53	6,80	1	6,80	CHI
20201160546	ARAGUAPAZ	AZ21120473	GOIAS	13/11/2020 20:05	14/11/2020 09:43	13/11/2020 20:05	14/11/2020 09:43	13,63	2	27,26	CHI
20201160549	TERESINA DE GOIAS	TE21328390	FLORES DE GOIAS	13/11/2020 20:06	13/11/2020 22:04	13/11/2020 20:06	13/11/2020 22:04	1,96	1	1,96	CHI
20201160554	ANAPOLIS	20723131	ANAPOLIS UNIVERSITARIO S2	13/11/2020 20:07	13/11/2020 20:54	13/11/2020 20:07	13/11/2020 20:54	0,78	1	0,78	CHI
20201160563	GOIANIA	GN12052690	MEIA PONTE	13/11/2020 20:09	14/11/2020 00:17	13/11/2020 20:09	14/11/2020 00:17	4,12	4	16,47	CHI
20201160589	ANICUNS	AC12259090	FIRMINOPOLIS S2	13/11/2020 20:09	14/11/2020 04:26	13/11/2020 20:09	14/11/2020 04:26	8,27	30	248,13	CHI
20201160568	SAO LUIS DE MONTES BELOS	500073570	SAO LUIZ DOS MONTES BELOS	13/11/2020 20:11	13/11/2020 20:56	13/11/2020 20:11	13/11/2020 20:56	0,74	1	0,74	CHI
20201160670	PALMEIRAS DE GOIAS	PL12000121	PALMEIRAS	13/11/2020 20:13	13/11/2020 23:52	13/11/2020 20:13	13/11/2020 23:52	3,65	9	32,81	CHI
20201160595	BOM JESUS DE GOIAS	10021452448	BOM JESUS DE GOIAS	13/11/2020 20:18	13/11/2020 23:18	13/11/2020 20:18	13/11/2020 23:18	2,99	1	2,99	CHI
20201160832	GOIANIA	GN11003196	GOIANIA LESTE S1	13/11/2020 20:23	14/11/2020 04:56	13/11/2020 20:23	14/11/2020 04:56	8,53	27	230,42	CHI
20201161016	PORANGATU	TA12114216	NOVO PLANALTO	13/11/2020 20:24	14/11/2020 09:50	13/11/2020 20:24	14/11/2020 09:50	13,43	6	80,55	CHI
20201160638	CALDAZINHA	DE21270822	SENADOR CANEDO	13/11/2020 20:28	13/11/2020 23:50	13/11/2020 20:28	13/11/2020 23:50	3,36	1	3,36	CHI
20201160646	ALEXANIA	480055877	ALEXANIA	13/11/2020 20:30	14/11/2020 05:06	13/11/2020 20:30	14/11/2020 05:06	8,60	1	8,60	CHI
20201160667	GOIAS	GS12310416	ITABERAI S1	13/11/2020 20:30	14/11/2020 08:28	13/11/2020 20:30	14/11/2020 08:28	11,98	18	215,66	CHI

20201160669	GOIAS	GS12217234	MATRINCHA	13/11/2020 20:30	14/11/2020 09:15	13/11/2020 20:30	13/11/2020 22:36	2,11	45	94,77	CHI
20201160669	GOIAS	GS12217234	MATRINCHA	13/11/2020 20:30	14/11/2020 09:15	13/11/2020 20:30	14/11/2020 09:15	12,75	38	484,35	CHI
20201160669	ITAPIRAPUA	GS12217234	MATRINCHA	13/11/2020 20:30	14/11/2020 09:15	13/11/2020 20:30	14/11/2020 09:15	12,75	1	12,75	CHI
20201160669	NOVO BRASIL	GS12217234	MATRINCHA	13/11/2020 20:30	14/11/2020 09:15	13/11/2020 20:30	14/11/2020 09:15	12,75	36	458,86	CHI
20201160664	ALVORADA DO NORTE	10018936030	IACIARA S2	13/11/2020 20:31	14/11/2020 00:03	13/11/2020 20:31	14/11/2020 00:03	3,54	1	3,54	CHI
20201160668	RIO VERDE	630485653	RIO VERDE S2	13/11/2020 20:32	13/11/2020 23:05	13/11/2020 20:32	13/11/2020 23:05	2,55	1	2,55	CHI
20201160674	GOIANIA	10004926470	XAVANTES	13/11/2020 20:32	14/11/2020 04:02	13/11/2020 20:32	14/11/2020 04:02	7,49	1	7,49	CHI
20201160706	MIMOSO DE GOIAS	3170010047	SAO JOAO D ALIANCA	13/11/2020 20:32	13/11/2020 21:49	13/11/2020 20:32	13/11/2020 21:49	1,27	1	1,27	CHI
20201160676	ALTO PARAISO DE GOIAS	BF21072308	SAO JOAO D ALIANCA	13/11/2020 20:33	14/11/2020 08:24	13/11/2020 20:33	14/11/2020 08:24	11,85	1	11,85	CHI
20201160677	CAIAPONIA	930003949	CAIAPONIA	13/11/2020 20:33	14/11/2020 07:42	13/11/2020 20:33	14/11/2020 07:42	11,14	1	11,14	CHI
20201160679	CORUMBA DE GOIAS	260015260	CORUMBA	13/11/2020 20:33	14/11/2020 09:57	13/11/2020 20:33	14/11/2020 09:57	13,39	1	13,39	CHI
20201160703	BONOPOLIS	BX12364617	SAO MIGUEL DO ARAGUAIA	13/11/2020 20:36	14/11/2020 02:46	13/11/2020 20:36	14/11/2020 02:46	6,16	7	43,15	CHI
20201160705	ITABERAI	IB12000060	ITABERAI S2	13/11/2020 20:36	14/11/2020 00:09	13/11/2020 20:36	14/11/2020 00:09	3,54	35	124,01	CHI
20201161128	GOIANIA	GN11078477	CAMPINAS S1	13/11/2020 20:36	13/11/2020 23:54	13/11/2020 20:36	13/11/2020 23:54	3,29	65	213,74	CHI
20201160713	IPAMERI	580007121	IPAMERI	13/11/2020 20:37	14/11/2020 09:41	13/11/2020 20:37	14/11/2020 09:41	13,05	1	13,05	CHI
20201160722	CALDAS NOVAS	RQ21361153	VILA CORUMBA	13/11/2020 20:39	13/11/2020 23:27	13/11/2020 20:39	13/11/2020 23:27	2,79	1	2,79	CHI
20201160727	GOIANIA	GN21071226	XAVANTES	13/11/2020 20:40	13/11/2020 22:28	13/11/2020 20:40	13/11/2020 22:28	1,80	1	1,80	CHI
20201160729	CUMARI	CY21000512	CATALAO S1	13/11/2020 20:40	14/11/2020 11:17	13/11/2020 20:40	14/11/2020 11:17	14,60	1	14,60	CHI
20201160730	PARAUNA	PU21152650	PARAUNA	13/11/2020 20:41	13/11/2020 22:13	13/11/2020 20:41	13/11/2020 22:13	1,53	1	1,53	CHI
20201160735	ABADIANIA	AN11141560	ANAPOLIS UNIVERSITARIO S2	13/11/2020 20:42	13/11/2020 23:47	13/11/2020 20:42	13/11/2020 23:47	3,08	17	52,36	CHI
20201160742	ANAPOLIS	AN11135749	ANAPOLIS UNIVERSITARIO S1	13/11/2020 20:42	13/11/2020 22:32	13/11/2020 20:42	13/11/2020 22:32	1,83	123	225,26	CHI
20201160747	SENADOR CANEDO	GN21002363	GOIANIA LESTE S2	13/11/2020 20:44	13/11/2020 22:31	13/11/2020 20:44	13/11/2020 22:31	1,78	2	3,55	CHI
20201160749	VICENTINOPOLIS	VI11218197	VICENTINOPOLIS	13/11/2020 20:44	14/11/2020 01:53	13/11/2020 20:44	14/11/2020 01:53	5,14	95	488,12	CHI
20201161085	MARA ROSA	MQ12156024	MARA ROSA	13/11/2020 20:44	15/11/2020 10:21	13/11/2020 20:44	14/11/2020 21:08	24,40	4	97,61	CHI
20201161085	MARA ROSA	MQ12156024	MARA ROSA	13/11/2020 20:44	15/11/2020 10:21	13/11/2020 20:44	14/11/2020 21:28	24,74	2	49,48	CHI
20201161085	MARA ROSA	MQ12156024	MARA ROSA	13/11/2020 20:44	15/11/2020 10:21	13/11/2020 20:44	15/11/2020 10:21	37,61	3	112,83	CHI
20201160752	PORTELANDIA	PW12318143	PARQUE DAS EMAS	13/11/2020 20:45	14/11/2020 10:43	13/11/2020 20:45	14/11/2020 10:43	13,96	3	41,87	CHI
20201160753	GOIANAPOLIS	GP12351033	DAIA S2	13/11/2020 20:45	14/11/2020 09:58	13/11/2020 20:45	14/11/2020 09:58	13,20	22	290,48	CHI
20201160984	TRINDADE	TR12052787	TRINDADE	13/11/2020 20:45	14/11/2020 08:51	13/11/2020 20:45	14/11/2020 08:51	12,09	82	990,99	CHI
20201160755	ANAPOLIS	AN21262480	ANAPOLIS UNIVERSITARIO S2	13/11/2020 20:46	13/11/2020 22:32	13/11/2020 20:46	13/11/2020 22:32	1,76	1	1,76	CHI
20201160913	HEITORAI	IC12376461	ITABERAI S1	13/11/2020 20:46	14/11/2020 11:40	13/11/2020 20:46	14/11/2020 11:40	14,90	8	119,16	CHI
20201160913	ITAGUARU	IC12376461	ITABERAI S1	13/11/2020 20:46	14/11/2020 11:40	13/11/2020 20:46	14/11/2020 11:40	14,90	46	685,18	CHI
20201160760	ANAPOLIS	21284222	ANAPOLIS UNIVERSITARIO S2	13/11/2020 20:47	13/11/2020 21:24	13/11/2020 20:47	13/11/2020 21:24	0,62	1	0,62	CHI
20201160876	TEREZOPOLIS DE GOIAS	TJ16411481	DAIA S2	13/11/2020 20:47	14/11/2020 07:37	13/11/2020 20:47	13/11/2020 21:05	0,31	947	295,41	CHI
20201160876	GOIANAPOLIS	TJ10403906	DAIA S2	13/11/2020 20:47	14/11/2020 07:37	13/11/2020 20:47	13/11/2020 21:07	0,34	2	0,69	CHI
20201160876	TEREZOPOLIS DE GOIAS	TJ10403906	DAIA S2	13/11/2020 20:47	14/11/2020 07:37	13/11/2020 20:47	13/11/2020 21:07	0,34	539	185,95	CHI
20201160876	TEREZOPOLIS DE GOIAS	TJ10402664	DAIA S2	13/11/2020 20:47	14/11/2020 07:37	13/11/2020 20:47	13/11/2020 22:46	1,98	477	946,84	CHI
20201160876	ANAPOLIS	TJ10402664	DAIA S2	13/11/2020 20:47	14/11/2020 07:37	13/11/2020 20:47	14/11/2020 04:11	7,41	1	7,41	CHI
20201160876	NEROPOLIS	TJ10402664	DAIA S2	13/11/2020 20:47	14/11/2020 07:37	13/11/2020 20:47	14/11/2020 04:11	7,41	49	363,10	CHI
20201160876	TEREZOPOLIS DE GOIAS	TJ10402664	DAIA S2	13/11/2020 20:47	14/11/2020 07:37	13/11/2020 20:47	14/11/2020 04:11	7,41	308	2282,37	CHI
20201160876	TEREZOPOLIS DE GOIAS	TJ10402664	DAIA S2	13/11/2020 20:47	14/11/2020 07:37	14/11/2020 02:14	14/11/2020 04:11	1,95	477	931,61	CHI
20201160876	GOIANAPOLIS	TJ16411481	DAIA S2	13/11/2020 20:47	14/11/2020 07:37	14/11/2020 03:58	14/11/2020 04:11	0,23	2	0,45	CHI
20201160876	TEREZOPOLIS DE GOIAS	TJ16411481	DAIA S2	13/11/2020 20:47	14/11/2020 07:37	14/11/2020 03:58	14/11/2020 04:11	0,23	1521	344,34	CHI
20201160876	TEREZOPOLIS DE GOIAS	TJ10402664	DAIA S2	13/11/2020 20:47	14/11/2020 07:37	13/11/2020 20:47	14/11/2020 07:37	10,85	4	43,40	CHI
20201160876	ANAPOLIS	TJ10402664	DAIA S2	13/11/2020 20:47	14/11/2020 07:37	14/11/2020 04:13	14/11/2020 07:37	3,41	1	3,41	CHI
20201160876	NEROPOLIS	TJ10402664	DAIA S2	13/11/2020 20:47	14/11/2020 07:37	14/11/2020 04:13	14/11/2020 07:37	3,41	49	166,93	CHI
20201160876	TEREZOPOLIS DE GOIAS	TJ10402664	DAIA S2	13/11/2020 20:47	14/11/2020 07:37	14/11/2020 04:13	14/11/2020 07:37	3,41	342	1165,08	CHI
20201160876	TEREZOPOLIS DE GOIAS	TJ10402664	DAIA S2	13/11/2020 20:47	14/11/2020 07:37	14/11/2020 07:27	14/11/2020 07:37	0,17	477	79,37	CHI
20201160766	IPAMERI	IP21265568	CAMPO ALEGRE DE GOIAS	13/11/2020 20:48	14/11/2020 01:23	13/11/2020 20:48	14/11/2020 01:23	4,58	1	4,58	CHI
20201160768	GOIANIA	10006934798	MEIA PONTE	13/11/2020 20:48	14/11/2020 04:35	13/11/2020 20:48	14/11/2020 04:35	7,78	1	7,78	CHI
20201160769	RIO VERDE	RV21214146	CABRIUVA S2	13/11/2020 20:48	14/11/2020 06:20	13/11/2020 20:48	14/11/2020 06:20	9,53	1	9,53	CHI

20201160772	EDEIA	EA21182595	VICENTINOPOLIS	13/11/2020 20:48	14/11/2020 00:15	13/11/2020 20:48	14/11/2020 00:15	3,44	1	3,44	CHI
20201160868	GOIANIA	590214	FERROVIARIO S1	13/11/2020 20:49	14/11/2020 00:00	13/11/2020 20:49	13/11/2020 20:55	0,10	1493	142,25	CHI
20201160868	GOIANIA	GN16425900	FERROVIARIO S1	13/11/2020 20:49	14/11/2020 00:00	13/11/2020 20:52	13/11/2020 20:55	0,05	5774	290,30	CHI
20201160868	GOIANIA	590214	FERROVIARIO S1	13/11/2020 20:49	14/11/2020 00:00	13/11/2020 20:49	13/11/2020 20:56	0,12	1504	173,38	CHI
20201160868	GOIANIA	590214	FERROVIARIO S1	13/11/2020 20:49	14/11/2020 00:00	13/11/2020 20:49	13/11/2020 20:58	0,15	1250	181,94	CHI
20201160868	GOIANIA	GN10407656	FERROVIARIO S1	13/11/2020 20:49	14/11/2020 00:00	13/11/2020 20:51	13/11/2020 20:58	0,11	121	12,87	CHI
20201160868	GOIANIA	590214	FERROVIARIO S1	13/11/2020 20:49	14/11/2020 00:00	13/11/2020 20:49	13/11/2020 22:57	2,14	50	107,07	CHI
20201160868	GOIANIA	GN16413413	FERROVIARIO S1	13/11/2020 20:49	14/11/2020 00:00	13/11/2020 23:00	13/11/2020 23:03	0,07	151	9,90	CHI
20201160868	GOIANIA	GN16421013	FERROVIARIO S1	13/11/2020 20:49	14/11/2020 00:00	13/11/2020 23:05	13/11/2020 23:33	0,47	2457	1147,28	CHI
20201160868	GOIANIA	590214	FERROVIARIO S1	13/11/2020 20:49	14/11/2020 00:00	13/11/2020 20:49	14/11/2020 00:00	3,18	61	193,93	CHI
20201160806	MONTE ALEGRE DE GOIAS	1620005429	SAO DOMINGOS	13/11/2020 20:53	13/11/2020 22:18	13/11/2020 20:53	13/11/2020 22:18	1,41	1	1,41	CHI
20201160816	RIO QUENTE	RQ21316157	VILA CORUMBA	13/11/2020 20:54	14/11/2020 05:20	13/11/2020 20:54	14/11/2020 05:20	8,42	1	8,42	CHI
20201160954	GOIANIRA	GR11280119	MEIA PONTE	13/11/2020 20:56	13/11/2020 23:10	13/11/2020 20:56	13/11/2020 23:10	2,22	95	210,85	CHI
20201160848	MINEIROS	MY21306439	PARQUE DAS EMAS	13/11/2020 20:58	14/11/2020 11:40	13/11/2020 20:58	14/11/2020 11:40	14,69	1	14,69	CHI
20201160851	MINEIROS	MY12182115	PARQUE DAS EMAS	13/11/2020 20:59	13/11/2020 23:29	13/11/2020 20:59	13/11/2020 23:29	2,50	96	240,00	CHI
20201161605	PARAUNA	PU12194221	ACREUNA	13/11/2020 20:59	14/11/2020 08:23	13/11/2020 20:59	14/11/2020 08:23	11,39	38	432,93	CHI
20201160906	MORRINHOS	MR12092023	MORRINHOS	13/11/2020 21:00	13/11/2020 23:17	13/11/2020 21:00	13/11/2020 23:17	2,29	7	16,05	CHI
20201160862	CACHOEIRA ALTA	CA21139904	QUIRINOPOLIS	13/11/2020 21:01	14/11/2020 00:34	13/11/2020 21:01	14/11/2020 00:34	3,53	1	3,53	CHI
20201160866	GOIANIA	16082953	GOYA S2	13/11/2020 21:02	14/11/2020 01:18	13/11/2020 21:02	14/11/2020 01:18	4,26	1	4,26	CHI
20201160867	NOVO GAMA	2460004420	PACAEMBU S1	13/11/2020 21:02	13/11/2020 23:00	13/11/2020 21:02	13/11/2020 23:00	1,95	1	1,95	CHI
20201160871	RIO VERDE	RV21155154	SANTA HELENA S1	13/11/2020 21:05	14/11/2020 00:13	13/11/2020 21:05	14/11/2020 00:13	3,13	2	6,27	CHI
20201160874	VILA BOA	2880009670	IACIARA S2	13/11/2020 21:05	14/11/2020 00:03	13/11/2020 21:05	14/11/2020 00:03	2,96	1	2,96	CHI
20201160879	SANTO ANTONIO DE GOIAS	GR12002127	NEROPOLIS S1	13/11/2020 21:06	14/11/2020 00:04	13/11/2020 21:06	14/11/2020 00:04	2,96	2	5,92	CHI
20201160884	ARACU	AV21272363	ANICUNS	13/11/2020 21:07	14/11/2020 09:12	13/11/2020 21:07	14/11/2020 09:12	12,07	1	12,07	CHI
20201160885	GOIANIA	GN21000498	GOIANIA LESTE S3	13/11/2020 21:08	14/11/2020 09:07	14/11/2020 08:26	14/11/2020 09:07	0,68	1	0,68	CHI
20201161190	LUZIANIA	LZ12059634	CRISTALINA S2	13/11/2020 21:10	14/11/2020 08:50	13/11/2020 21:10	14/11/2020 08:50	11,66	18	209,90	CHI
20201160895	RIO VERDE	630168556	CABRIUVA S1	13/11/2020 21:11	14/11/2020 11:18	13/11/2020 21:11	14/11/2020 11:18	14,11	1	14,11	CHI
20201160897	CAIAPONIA	3800226	PALESTINA	13/11/2020 21:12	14/11/2020 03:47	13/11/2020 21:12	14/11/2020 03:47	6,59	480	3161,33	CHI
20201160897	PALESTINA DE GOIAS	3800226	PALESTINA	13/11/2020 21:12	14/11/2020 03:47	13/11/2020 21:12	14/11/2020 03:47	6,59	350	2305,14	CHI
20201160908	PIRENOPOLIS	PV21123141	CORUMBA	13/11/2020 21:16	14/11/2020 10:19	13/11/2020 21:16	14/11/2020 10:19	13,03	1	13,03	CHI
20201160915	FORMOSA	FA12233612	ITUIQUIRA	13/11/2020 21:22	14/11/2020 10:11	13/11/2020 21:22	14/11/2020 10:11	12,82	61	781,83	CHI
20201160916	GOIANIA	15637748	GOYA S2	13/11/2020 21:22	14/11/2020 00:37	13/11/2020 21:22	14/11/2020 00:37	3,25	1	3,25	CHI
20201160921	CRISTALINA	KR21330475	CRISTALINA S2	13/11/2020 21:23	13/11/2020 23:26	13/11/2020 21:23	13/11/2020 23:26	2,05	1	2,05	CHI
20201161750	GOIATUBA	GT12273783	GOIATUBA S2	13/11/2020 21:25	14/11/2020 08:58	13/11/2020 21:25	14/11/2020 08:58	11,54	38	438,43	CHI
20201160937	GOIANIA	13219510	GOYA S2	13/11/2020 21:26	14/11/2020 05:20	13/11/2020 21:26	14/11/2020 05:20	7,90	1	7,90	CHI
20201160948	VICENTINOPOLIS	VI10400587	VICENTINOPOLIS	13/11/2020 21:27	15/11/2020 00:50	13/11/2020 21:27	14/11/2020 00:48	3,34	5	16,70	CHI
20201160948	JOVIANIA	JV10400589	VICENTINOPOLIS	13/11/2020 21:27	15/11/2020 00:50	13/11/2020 21:27	14/11/2020 02:11	4,73	6	28,36	CHI
20201160948	BOM JESUS DE GOIAS	VI10400587	VICENTINOPOLIS	13/11/2020 21:27	15/11/2020 00:50	13/11/2020 21:27	15/11/2020 00:50	27,37	3	82,12	CHI
20201160948	GOIATUBA	VI10400587	VICENTINOPOLIS	13/11/2020 21:27	15/11/2020 00:50	13/11/2020 21:27	15/11/2020 00:50	27,37	15	410,60	CHI
20201160948	JOVIANIA	VI10400587	VICENTINOPOLIS	13/11/2020 21:27	15/11/2020 00:50	13/11/2020 21:27	15/11/2020 00:50	27,37	11	301,11	CHI
20201160948	VICENTINOPOLIS	VI10400587	VICENTINOPOLIS	13/11/2020 21:27	15/11/2020 00:50	13/11/2020 21:27	15/11/2020 00:50	27,37	4	109,49	CHI
20201160948	VICENTINOPOLIS	VI10400587	VICENTINOPOLIS	13/11/2020 21:27	15/11/2020 00:50	14/11/2020 10:23	15/11/2020 00:50	14,44	5	72,18	CHI
20201160955	CACU	CC12028258	CACHOEIRA ALTA	13/11/2020 21:31	14/11/2020 00:51	13/11/2020 21:31	14/11/2020 00:51	3,32	1	3,32	CHI
20201160955	CACU	CC12028258	CACHOEIRA ALTA	13/11/2020 21:31	14/11/2020 00:51	13/11/2020 21:31	14/11/2020 00:51	3,32	59	195,93	CHI
20201160955	QUIRINOPOLIS	CC12028258	CACHOEIRA ALTA	13/11/2020 21:31	14/11/2020 00:51	13/11/2020 21:31	14/11/2020 00:51	3,32	1	3,32	CHI
20201160981	JOVIANIA	VI12218198RE	VICENTINOPOLIS	13/11/2020 21:31	14/11/2020 10:35	13/11/2020 21:31	14/11/2020 10:35	13,05	30	391,53	CHI
20201160981	PONTALINA	VI12218198RE	VICENTINOPOLIS	13/11/2020 21:31	14/11/2020 10:35	13/11/2020 21:31	14/11/2020 10:35	13,05	25	326,28	CHI
20201160981	VICENTINOPOLIS	VI12218198RE	VICENTINOPOLIS	13/11/2020 21:31	14/11/2020 10:35	13/11/2020 21:31	14/11/2020 10:35	13,05	16	208,82	CHI
20201160958	GOIANIRA	GR11313230	MEIA PONTE	13/11/2020 21:32	13/11/2020 22:01	13/11/2020 21:32	13/11/2020 22:01	0,48	120	57,73	CHI
20201160960	SANTO ANTONIO DE GOIAS	BW11280876	NEROPOLIS S1	13/11/2020 21:33	14/11/2020 01:32	13/11/2020 21:33	14/11/2020 01:32	3,97	9	35,76	CHI
20201160966	ITUMBIARA	IT12000242	ITUMBIARA NOVA	13/11/2020 21:35	14/11/2020 07:08	13/11/2020 21:35	14/11/2020 07:08	9,55	3	28,64	CHI



20201160972	GUARANI DE GOIAS	GY12393812	IACIARA S1	13/11/2020 21:37	13/11/2020 23:11	13/11/2020 21:37	13/11/2020 23:11	1,55	22	34,21	CHI
20201160979	ORIZONA	OZ21382057	PIRES DO RIO S2	13/11/2020 21:40	13/11/2020 23:16	13/11/2020 21:40	13/11/2020 23:16	1,60	1	1,60	CHI
20201161002	AGUAS LINDAS DE GOIAS	LA11375248	AGUAS LINDAS DE GOIAS S1	13/11/2020 21:44	13/11/2020 23:17	13/11/2020 21:44	13/11/2020 23:17	1,53	218	334,39	CHI
20201161069	NOVO PLANALTO	TA12139136	SAO MIGUEL DO ARAGUAIA	13/11/2020 21:46	17/11/2020 16:20	13/11/2020 21:46	17/11/2020 14:18	88,54	1	88,54	CHI
20201161069	BONOPOLIS	TA13371841	SAO MIGUEL DO ARAGUAIA	13/11/2020 21:46	17/11/2020 16:20	13/11/2020 21:46	17/11/2020 16:20	90,56	1	90,56	CHI
20201161069	NOVO PLANALTO	TA13371841	SAO MIGUEL DO ARAGUAIA	13/11/2020 21:46	17/11/2020 16:20	13/11/2020 21:46	17/11/2020 16:20	90,56	3	271,68	CHI
20201161001	TRES RANCHOS	TH21161403	CATALAO S1	13/11/2020 21:49	14/11/2020 00:02	13/11/2020 21:49	14/11/2020 00:02	2,22	2	4,43	CHI
20201161004	ARAGARCAS	BM12155745	BOM JARDIM	13/11/2020 21:51	14/11/2020 02:45	13/11/2020 21:51	14/11/2020 02:45	4,89	12	58,63	CHI
20201161004	BOM JARDIM DE GOIAS	BM12155745	BOM JARDIM	13/11/2020 21:51	14/11/2020 02:45	13/11/2020 21:51	14/11/2020 02:45	4,89	33	161,24	CHI
20201161007	MINEIROS	MY12374381	PARQUE DAS EMAS	13/11/2020 21:52	14/11/2020 02:17	13/11/2020 21:52	14/11/2020 02:17	4,41	4	17,64	CHI
20201161009	APARECIDA DE GOIANIA	200023858	INDEPENDENCIA S1	13/11/2020 21:54	14/11/2020 01:02	13/11/2020 21:54	14/11/2020 01:02	3,12	1	3,12	CHI
20201161010	ITAUCU	110034454	INHUMAS S1	13/11/2020 21:55	14/11/2020 07:38	13/11/2020 21:55	14/11/2020 07:38	9,72	1	9,72	CHI
20201161011	GOIANIA	11692728	AEROPORTO S2	13/11/2020 21:55	14/11/2020 01:06	13/11/2020 21:55	14/11/2020 01:06	3,17	1	3,17	CHI
20201161032	GOIANIA	GN12137199	GOIANIA LESTE S2	13/11/2020 22:05	14/11/2020 01:25	13/11/2020 22:05	14/11/2020 01:25	3,33	76	252,91	CHI
20201161049	CALDAZINHA	DE21334856	SENADOR CANEDO	13/11/2020 22:08	14/11/2020 00:11	13/11/2020 22:08	14/11/2020 00:11	2,04	6	12,26	CHI
20201161044	ALEXANIA	AX21302408	ALEXANIA	13/11/2020 22:09	14/11/2020 09:55	13/11/2020 22:09	14/11/2020 09:55	11,76	4	47,02	CHI
20201161045	VICENTINOPOLIS	VI11128634	VICENTINOPOLIS	13/11/2020 22:10	13/11/2020 23:45	13/11/2020 22:10	13/11/2020 23:45	1,58	153	241,14	CHI
20201161046	ITAPIRAPUA	IU12142823	MATRINCHA	13/11/2020 22:11	14/11/2020 08:39	13/11/2020 22:11	14/11/2020 08:39	10,47	3	31,40	CHI
20201161203	PETROLINA DE GOIAS	PG12116335	PETROLINA	13/11/2020 22:11	14/11/2020 01:22	13/11/2020 22:11	14/11/2020 01:22	3,18	34	107,95	CHI
20201161051	CATALAO	10030474769	CATALAO S2	13/11/2020 22:13	14/11/2020 08:31	13/11/2020 22:13	14/11/2020 08:31	10,29	1	10,29	CHI
20201161058	GOIANESIA	GE11375697	GOIANESIA S1	13/11/2020 22:18	14/11/2020 00:33	13/11/2020 22:18	14/11/2020 00:33	2,25	1	2,25	CHI
20201161082	MUNDO NOVO DE GOIAS	NA12035650	NOVA CRIXAS	13/11/2020 22:18	14/11/2020 00:17	13/11/2020 22:18	14/11/2020 00:17	1,97	8	15,74	CHI
20201161082	NOVA CRIXAS	NA12035650	NOVA CRIXAS	13/11/2020 22:18	14/11/2020 00:17	13/11/2020 22:18	14/11/2020 00:17	1,97	24	47,22	CHI
20201161063	MINACU	IH21230526	MINACU	13/11/2020 22:19	14/11/2020 11:06	13/11/2020 22:19	14/11/2020 11:06	12,78	1	12,78	CHI
20201161066	IPAMERI	IP11375423	IPAMERI	13/11/2020 22:19	14/11/2020 00:27	13/11/2020 22:19	14/11/2020 00:27	2,12	74	157,15	CHI
20201161067	BONFINOPOLIS	BO12200129	CEPAIGO S2	13/11/2020 22:19	14/11/2020 00:53	13/11/2020 22:19	14/11/2020 00:53	2,55	13	33,17	CHI
20201161067	CALDAZINHA	BO12200129	CEPAIGO S2	13/11/2020 22:19	14/11/2020 00:53	13/11/2020 22:19	14/11/2020 00:53	2,55	2	5,10	CHI
20201161067	LEOPOLDO DE BULHOES	BO12200129	CEPAIGO S2	13/11/2020 22:19	14/11/2020 00:53	13/11/2020 22:19	14/11/2020 00:53	2,55	35	89,31	CHI
20201161067	SENADOR CANEDO	BO12200129	CEPAIGO S2	13/11/2020 22:19	14/11/2020 00:53	13/11/2020 22:19	14/11/2020 00:53	2,55	2	5,10	CHI
20201161076	ALTO HORIZONTE	10016867252	SANTA TEREZINHA	13/11/2020 22:21	14/11/2020 11:14	13/11/2020 22:21	14/11/2020 11:14	12,87	1	12,87	CHI
20201161079	CATALAO	10026236387	CATALAO S2	13/11/2020 22:22	14/11/2020 14:12	13/11/2020 22:22	14/11/2020 14:12	15,83	1	15,83	CHI
20201161081	BELA VISTA DE GOIAS	BV12291753RE	BELA VISTA S1	13/11/2020 22:23	14/11/2020 00:47	13/11/2020 22:23	14/11/2020 00:47	2,39	89	212,54	CHI
20201161087	IPAMERI	IP12321692	IPAMERI	13/11/2020 22:27	14/11/2020 10:16	13/11/2020 22:27	14/11/2020 10:16	11,81	1	11,81	CHI
20201161089	ITAGUARI	II2250783	ITABERAI S1	13/11/2020 22:28	14/11/2020 10:28	13/11/2020 22:28	14/11/2020 10:28	12,00	11	131,95	CHI
20201161089	JARAGUA	II2250783	ITABERAI S1	13/11/2020 22:28	14/11/2020 10:28	13/11/2020 22:28	14/11/2020 10:28	12,00	9	107,96	CHI
20201161091	TRINDADE	TR32055832	TRINDADE	13/11/2020 22:30	14/11/2020 00:24	13/11/2020 22:30	14/11/2020 00:24	1,90	5	9,48	CHI
20201161098	HIDROLANDIA	HD12000191	ANHANGUERA	13/11/2020 22:33	14/11/2020 14:26	13/11/2020 22:33	14/11/2020 14:10	15,60	28	436,91	CHI
20201161098	HIDROLANDIA	HD11006283	ANHANGUERA	13/11/2020 22:33	14/11/2020 14:26	14/11/2020 10:00	14/11/2020 14:26	4,44	130	576,59	CHI
20201161143	MINEIROS	MY121114029	PARQUE DAS EMAS	13/11/2020 22:36	14/11/2020 09:40	13/11/2020 22:36	14/11/2020 09:40	11,06	7	77,42	CHI
20201161102	TURVELANDIA	TD12303248	RIO DOS BOIS	13/11/2020 22:37	14/11/2020 02:34	13/11/2020 22:37	14/11/2020 02:34	3,94	5	19,72	CHI
20201161105	MARA ROSA	MQ12390471	MARA ROSA	13/11/2020 22:39	14/11/2020 20:00	13/11/2020 22:39	14/11/2020 20:00	21,33	2	42,67	CHI
20201161107	CALDAS NOVAS	760356531	SERRA DE CALDAS	13/11/2020 22:40	13/11/2020 23:07	13/11/2020 22:40	13/11/2020 23:07	0,44	1	0,44	CHI
20201161110	ARAGARCAS	AG12000006	ARAGARCAS	13/11/2020 22:41	14/11/2020 06:57	13/11/2020 22:41	14/11/2020 06:57	8,25	42	346,70	CHI
20201161197	CEZARINA	CZ12323632	CEZARINA	13/11/2020 22:41	14/11/2020 08:20	13/11/2020 22:41	14/11/2020 08:20	9,65	4	38,59	CHI
20201161197	INDIARA	CZ12323632	CEZARINA	13/11/2020 22:41	14/11/2020 08:20	13/11/2020 22:41	14/11/2020 08:20	9,65	3	28,95	CHI
20201161129	JUSSARA	10003491100	BRITANIA	13/11/2020 22:46	14/11/2020 06:02	13/11/2020 22:46	14/11/2020 06:02	7,28	1	7,28	CHI
20201161140	UIRAPURU	UP11243370	SANTA TEREZINHA	13/11/2020 22:48	14/11/2020 06:54	13/11/2020 22:48	14/11/2020 06:54	8,10	88	712,56	CHI
20201161138	BOM JARDIM DE GOIAS	ME10400382	IPORA	13/11/2020 22:50	14/11/2020 21:13	13/11/2020 22:50	14/11/2020 01:45	2,91	18	52,38	CHI
20201161138	MONTES CLAROS DE GOIAS	ME10400382	IPORA	13/11/2020 22:50	14/11/2020 21:13	13/11/2020 22:50	14/11/2020 01:45	2,91	14	40,74	CHI
20201161138	BOM JARDIM DE GOIAS	ME10400382	IPORA	13/11/2020 22:50	14/11/2020 21:13	14/11/2020 04:26	14/11/2020 04:44	0,30	18	5,32	CHI
20201161138	MONTES CLAROS DE GOIAS	ME10400382	IPORA	13/11/2020 22:50	14/11/2020 21:13	14/11/2020 04:26	14/11/2020 04:44	0,30	14	4,13	CHI

20201161138	BOM JARDIM DE GOIAS	ME10400382	IPORA	13/11/2020 22:50	14/11/2020 21:13	14/11/2020 13:21	14/11/2020 13:36	0,23	18	4,23	CHI
20201161138	MONTES CLAROS DE GOIAS	ME10400382	IPORA	13/11/2020 22:50	14/11/2020 21:13	14/11/2020 13:21	14/11/2020 13:36	0,23	14	3,29	CHI
20201161138	ARENOPOLIS	ME10400382	IPORA	13/11/2020 22:50	14/11/2020 21:13	13/11/2020 22:50	14/11/2020 21:13	22,39	108	2418,03	CHI
20201161138	ARENOPOLIS	ME10400382	IPORA	13/11/2020 22:50	14/11/2020 21:13	13/11/2020 22:50	14/11/2020 21:13	22,39	136	3044,93	CHI
20201161138	MONTES CLAROS DE GOIAS	ME10400382	IPORA	13/11/2020 22:50	14/11/2020 21:13	13/11/2020 22:50	14/11/2020 21:13	22,39	86	1925,47	CHI
20201161138	MONTES CLAROS DE GOIAS	ME10400382	IPORA	13/11/2020 22:50	14/11/2020 21:13	13/11/2020 22:50	14/11/2020 21:13	22,39	13	291,06	CHI
20201161138	PIRANHAS	ME10400382	IPORA	13/11/2020 22:50	14/11/2020 21:13	13/11/2020 22:50	14/11/2020 21:13	22,39	2	44,78	CHI
20201161171	GOIANIA	GN16413429	GOIANIA LESTE S2	13/11/2020 22:58	14/11/2020 04:29	13/11/2020 22:58	14/11/2020 04:29	5,51	228	1256,34	CHI
20201161171	GOIANIA	GN16413429	GOIANIA LESTE S2	13/11/2020 22:58	14/11/2020 04:29	14/11/2020 04:26	14/11/2020 04:29	0,05	720	36,20	CHI
20201161732	PARAUNA	PU12332611	PARAUNA	13/11/2020 22:59	14/11/2020 10:05	13/11/2020 22:59	14/11/2020 10:05	11,10	6	66,58	CHI
20201161192	ITARUMA	CC12000108	CACHOEIRA ALTA	13/11/2020 23:17	14/11/2020 12:10	13/11/2020 23:17	14/11/2020 12:10	12,87	20	257,35	CHI
20201162203	JANDAIA	JD12008607LD	PALMEIRAS	13/11/2020 23:17	14/11/2020 14:47	13/11/2020 23:17	14/11/2020 14:47	15,49	82	1269,79	CHI
20201162203	PARAUNA	JD12008607LD	PALMEIRAS	13/11/2020 23:17	14/11/2020 14:47	13/11/2020 23:17	14/11/2020 14:47	15,49	6	92,91	CHI
20201161195	JARAGUA	70046359	JARAGUA	13/11/2020 23:18	14/11/2020 00:42	13/11/2020 23:18	14/11/2020 00:42	1,39	1	1,39	CHI
20201161200	JAUPACI	ME12204866	IPORA	13/11/2020 23:20	14/11/2020 09:00	13/11/2020 23:20	14/11/2020 09:00	9,67	7	67,66	CHI
20201161200	MONTES CLAROS DE GOIAS	ME12204866	IPORA	13/11/2020 23:20	14/11/2020 09:00	13/11/2020 23:20	14/11/2020 09:00	9,67	9	86,99	CHI
20201161201	PALMEIRAS DE GOIAS	PL12000113	PALMEIRAS	13/11/2020 23:20	14/11/2020 09:48	13/11/2020 23:20	14/11/2020 09:48	10,46	1	10,46	CHI
20201161218	GOIANESIA	GE13294243	GOIANESIA S1	13/11/2020 23:33	14/11/2020 12:36	14/11/2020 09:42	14/11/2020 12:36	2,89	1	2,89	CHI
20201161219	TRES RANCHOS	TH21195262	CATALAO S1	13/11/2020 23:38	14/11/2020 10:00	13/11/2020 23:38	14/11/2020 10:00	10,36	2	20,71	CHI
20201161227	SILVANIA	SV12011740	VIANOPOLIS	13/11/2020 23:46	14/11/2020 01:32	13/11/2020 23:46	14/11/2020 01:32	1,76	2	3,52	CHI
20201161228	BELA VISTA DE GOIAS	BV12208886RE	BELA VISTA S1	13/11/2020 23:47	14/11/2020 02:01	13/11/2020 23:47	14/11/2020 02:01	2,22	65	144,44	CHI
20201161230	BELA VISTA DE GOIAS	BV12410339	BELA VISTA S2	13/11/2020 23:52	14/11/2020 02:55	13/11/2020 23:52	14/11/2020 02:55	3,04	7	21,30	CHI
20201161239	ITAJA	IM10394710	CACHOEIRA ALTA	13/11/2020 23:53	14/11/2020 10:11	13/11/2020 23:53	14/11/2020 08:04	8,19	1	8,19	CHI
20201161239	ITARUMA	IM10394710	CACHOEIRA ALTA	13/11/2020 23:53	14/11/2020 10:11	13/11/2020 23:53	14/11/2020 08:04	8,19	86	704,32	CHI
20201161239	JATAI	IM10394710	CACHOEIRA ALTA	13/11/2020 23:53	14/11/2020 10:11	13/11/2020 23:53	14/11/2020 08:04	8,19	12	98,28	CHI
20201161239	ITARUMA	IM10394710	CACHOEIRA ALTA	13/11/2020 23:53	14/11/2020 10:11	13/11/2020 23:53	14/11/2020 09:23	9,50	9	85,47	CHI
20201161239	ITARUMA	IM10394710	CACHOEIRA ALTA	13/11/2020 23:53	14/11/2020 10:11	13/11/2020 23:53	14/11/2020 10:11	10,31	28	288,61	CHI
20201161239	SERRANOPOLIS	IM10394710	CACHOEIRA ALTA	13/11/2020 23:53	14/11/2020 10:11	13/11/2020 23:53	14/11/2020 10:11	10,31	51	525,68	CHI
20201161231	GOIANIA	16742345	GOIANIA LESTE S3	13/11/2020 23:54	14/11/2020 03:41	13/11/2020 23:54	14/11/2020 03:41	3,77	1	3,77	CHI
20201161232	TRINDADE	10032287885	MEIA PONTE	13/11/2020 23:54	14/11/2020 08:55	13/11/2020 23:54	14/11/2020 08:55	9,01	1	9,01	CHI
20201161659	SANTA CRUZ DE GOIAS	BC12300692	PIRES DO RIO S2	13/11/2020 23:55	14/11/2020 10:43	13/11/2020 23:55	14/11/2020 10:43	10,79	10	107,88	CHI
20201161238	CIDADE OCIDENTAL	2680139568	MARAJOARA	13/11/2020 23:59	14/11/2020 01:09	13/11/2020 23:59	14/11/2020 01:09	1,16	1	1,16	CHI
20201161244	CACHOEIRA DOURADA	CD11273796	CACHOEIRA DOURADA	14/11/2020 00:09	14/11/2020 11:32	14/11/2020 00:09	14/11/2020 11:32	11,37	168	1909,83	CHI
20201162071	CACHOEIRA ALTA	CA12074103	CACHOEIRA ALTA	14/11/2020 00:09	14/11/2020 09:05	14/11/2020 00:09	14/11/2020 09:05	8,92	11	98,12	CHI
20201161262	SANTA FE DE GOIAS	RN11055348	BRITANIA	14/11/2020 00:19	14/11/2020 07:50	14/11/2020 00:19	14/11/2020 07:50	7,51	139	1043,77	CHI
20201161252	PIRANHAS	PH11052933	PIRANHAS	14/11/2020 00:23	14/11/2020 01:02	14/11/2020 00:23	14/11/2020 01:02	0,64	121	77,41	CHI
20201161260	JARAGUA	JA21297963	JARAGUA	14/11/2020 00:39	14/11/2020 02:01	14/11/2020 00:39	14/11/2020 02:01	1,36	1	1,36	CHI
20201162086	ALEXANIA	AX12000041	ALEXANIA	14/11/2020 00:39	14/11/2020 08:51	14/11/2020 00:39	14/11/2020 08:51	8,19	89	728,64	CHI
20201161263	ITAPURANGA	IK21290404	ITAPURANGA	14/11/2020 00:41	14/11/2020 15:48	14/11/2020 00:41	14/11/2020 15:48	15,10	2	30,20	CHI
20201161711	MINEIROS	MY12209755	PARQUE DAS EMAS	14/11/2020 00:43	14/11/2020 09:11	14/11/2020 00:43	14/11/2020 09:11	8,46	17	143,86	CHI
20201161577	NOVO PLANALTO	SM12328903	SAO MIGUEL DO ARAGUAIA	14/11/2020 00:44	15/11/2020 13:40	14/11/2020 00:44	15/11/2020 13:40	36,93	10	369,31	CHI
20201161789	ORIZONA	OZ11140712	PIRES DO RIO S2	14/11/2020 00:44	14/11/2020 07:44	14/11/2020 00:44	14/11/2020 07:44	7,00	149	1042,79	CHI
20201161270	GOIANESIA	550093096	GOIANESIA S2	14/11/2020 00:51	14/11/2020 02:18	14/11/2020 00:51	14/11/2020 02:18	1,45	1	1,45	CHI
20201161278	SILVANIA	SV12107840	VIANOPOLIS	14/11/2020 01:09	14/11/2020 03:04	14/11/2020 01:09	14/11/2020 03:04	1,90	15	28,55	CHI
20201161280	ACREUNA	10023618092	ACREUNA	14/11/2020 01:11	14/11/2020 08:16	14/11/2020 01:11	14/11/2020 08:16	7,07	1	7,07	CHI
20201161282	IPAMERI	1002437213	IPAMERI	14/11/2020 01:16	14/11/2020 07:58	14/11/2020 01:16	14/11/2020 07:58	6,69	1	6,69	CHI
20201161284	VICENTINOPOLIS	1970012836	VICENTINOPOLIS	14/11/2020 01:16	14/11/2020 02:09	14/11/2020 01:16	14/11/2020 02:09	0,87	1	0,87	CHI
20201161781	DOVERLANDIA	DV12217563	CAIAPONIA	14/11/2020 01:19	14/11/2020 08:16	14/11/2020 01:19	14/11/2020 08:16	6,95	128	889,46	CHI
20201161286	MORRINHOS	MR12035913	MORRINHOS	14/11/2020 01:21	14/11/2020 12:31	14/11/2020 01:21	14/11/2020 04:01	2,67	11	29,35	CHI
20201161286	MORRINHOS	MR13249765	MORRINHOS	14/11/2020 01:21	14/11/2020 12:31	14/11/2020 04:25	14/11/2020 12:31	8,10	11	89,14	CHI
20201161594	MINACU	IH11101954	MINACU	14/11/2020 01:27	14/11/2020 18:27	14/11/2020 01:27	14/11/2020 18:27	16,99	118	2005,12	CHI

20201161289	CATALAO	CT11306648	CATALAO S2	14/11/2020 01:39	14/11/2020 19:18	14/11/2020 01:39	14/11/2020 19:18	17,63	99	1745,81	CHI
20201161307	SANTA RITA DO ARAGUAIA	SU10402666	SANTA RITA DO ARAGUAIA	14/11/2020 01:56	14/11/2020 13:06	14/11/2020 01:56	14/11/2020 05:35	3,64	57	207,56	CHI
20201161307	SANTA RITA DO ARAGUAIA	SU12248425	SANTA RITA DO ARAGUAIA	14/11/2020 01:56	14/11/2020 13:06	14/11/2020 01:56	14/11/2020 07:54	5,96	13	77,42	CHI
20201161307	BURITINOPOLIS	SU10402666	SANTA RITA DO ARAGUAIA	14/11/2020 01:56	14/11/2020 13:06	14/11/2020 01:56	14/11/2020 09:25	7,47	1	7,47	CHI
20201161307	SANTA RITA DO ARAGUAIA	SU10402666	SANTA RITA DO ARAGUAIA	14/11/2020 01:56	14/11/2020 13:06	14/11/2020 01:56	14/11/2020 09:25	7,47	29	216,70	CHI
20201161307	BURITINOPOLIS	SU10402666	SANTA RITA DO ARAGUAIA	14/11/2020 01:56	14/11/2020 13:06	14/11/2020 09:44	14/11/2020 09:50	0,11	1	0,11	CHI
20201161307	SANTA RITA DO ARAGUAIA	SU10402666	SANTA RITA DO ARAGUAIA	14/11/2020 01:56	14/11/2020 13:06	14/11/2020 09:44	14/11/2020 09:50	0,11	99	10,89	CHI
20201161307	MINEIROS	SU10402666	SANTA RITA DO ARAGUAIA	14/11/2020 01:56	14/11/2020 13:06	14/11/2020 01:56	14/11/2020 13:06	11,16	11	122,74	CHI
20201161307	SANTA RITA DO ARAGUAIA	SU10402666	SANTA RITA DO ARAGUAIA	14/11/2020 01:56	14/11/2020 13:06	14/11/2020 01:56	14/11/2020 13:06	11,16	94	1048,83	CHI
20201161816	MINEIROS	MY12043894RE	PARQUE DAS EMAS	14/11/2020 01:56	14/11/2020 08:40	14/11/2020 01:56	14/11/2020 08:40	6,73	102	686,40	CHI
20201161297	APARECIDA DE GOIANIA	AP11164487	INDEPENDENCIA S2	14/11/2020 01:58	14/11/2020 13:08	14/11/2020 01:58	14/11/2020 13:08	11,17	88	982,84	CHI
20201161298	BELA VISTA DE GOIAS	BV12103250	SENADOR CANEDO	14/11/2020 02:00	14/11/2020 05:11	14/11/2020 02:00	14/11/2020 05:11	3,17	16	50,71	CHI
20201161298	CALDAZINHA	BV12103250	SENADOR CANEDO	14/11/2020 02:00	14/11/2020 05:11	14/11/2020 02:00	14/11/2020 05:11	3,17	3	9,51	CHI
20201161301	BELA VISTA DE GOIAS	BV32066370	BELA VISTA S1	14/11/2020 02:07	14/11/2020 04:27	14/11/2020 02:07	14/11/2020 04:27	2,32	18	41,73	CHI
20201161302	JATAI	JT11036871	JATAI S2	14/11/2020 02:10	14/11/2020 07:40	14/11/2020 02:10	14/11/2020 07:40	5,48	68	372,89	CHI
20201161304	FAINA	MS12036227	ITAPURANGA	14/11/2020 02:12	14/11/2020 08:06	14/11/2020 02:12	14/11/2020 08:06	5,89	11	64,84	CHI
20201161304	MORRO AGUDO DE GOIAS	MS12036227	ITAPURANGA	14/11/2020 02:12	14/11/2020 08:06	14/11/2020 02:12	14/11/2020 08:06	5,89	21	123,78	CHI
20201161306	VICENTINOPOLIS	VI121235022	VICENTINOPOLIS	14/11/2020 02:19	14/11/2020 03:01	14/11/2020 02:19	14/11/2020 03:01	0,70	1	0,70	CHI
20201162042	BOM JESUS DE GOIAS	BJ11134665	BOM JESUS DE GOIAS	14/11/2020 02:25	14/11/2020 13:15	14/11/2020 02:25	14/11/2020 13:15	10,82	162	1752,44	CHI
20201161311	EDEIA	EA12044037	EDEIA	14/11/2020 02:36	14/11/2020 05:42	14/11/2020 02:36	14/11/2020 05:42	3,09	37	114,48	CHI
20201161887	ITABERAI	IB12000060	ITABERAI S2	14/11/2020 02:36	14/11/2020 14:04	14/11/2020 02:36	14/11/2020 14:04	11,46	35	401,27	CHI
20201161317	JOVIANIA	PK12106143	GOIATUBA S1	14/11/2020 02:39	14/11/2020 10:56	14/11/2020 02:39	14/11/2020 10:56	8,27	1	8,27	CHI
20201161317	PONTALINA	PK12106143	GOIATUBA S1	14/11/2020 02:39	14/11/2020 10:56	14/11/2020 02:39	14/11/2020 10:56	8,27	4	33,10	CHI
20201161437	TAPURAL DE GOIAS	TQ12022436	ITABERAI S1	14/11/2020 02:40	14/11/2020 08:21	14/11/2020 02:40	14/11/2020 08:21	5,67	46	260,82	CHI
20201161364	INHUMAS	IX12326257	INHUMAS S1	14/11/2020 02:44	14/11/2020 09:15	14/11/2020 02:44	14/11/2020 09:15	6,51	18	117,20	CHI
20201161323	GOIAS	GS12037790	GOIAS	14/11/2020 02:47	14/11/2020 07:42	14/11/2020 02:47	14/11/2020 07:42	4,91	105	516,07	CHI
20201161326	CORUMBA DE GOIAS	CB21132355	CORUMBA	14/11/2020 02:52	14/11/2020 04:03	14/11/2020 02:52	14/11/2020 04:03	1,17	1	1,17	CHI
20201161966	CAIAPONIA	CP12119577	CAIAPONIA	14/11/2020 03:10	14/11/2020 10:17	14/11/2020 03:10	14/11/2020 10:17	7,11	67	476,33	CHI
20201161966	DOVERLANDIA	CP12119577	CAIAPONIA	14/11/2020 03:10	14/11/2020 10:17	14/11/2020 03:10	14/11/2020 10:17	7,11	7	49,77	CHI
20201161335	SAO LUIZ DO NORTE	SZ21353578	ITAPACI	14/11/2020 03:13	14/11/2020 08:43	14/11/2020 03:13	14/11/2020 08:43	5,48	1	5,48	CHI
20201161336	FAZENDA NOVA	NB12292881	JUSSARA	14/11/2020 03:15	14/11/2020 08:47	14/11/2020 03:15	14/11/2020 08:47	5,52	4	22,09	CHI
20201161336	NOVO BRASIL	NB12292881	JUSSARA	14/11/2020 03:15	14/11/2020 08:47	14/11/2020 03:15	14/11/2020 08:47	5,52	9	49,69	CHI
20201161341	RUBIATABA	RB12003201	RUBIATABA	14/11/2020 03:20	14/11/2020 13:35	14/11/2020 03:20	14/11/2020 13:35	10,24	17	174,01	CHI
20201162612	ITUMBIARA	BG12263572	ITUMBIARA VELHA S2	14/11/2020 03:20	14/11/2020 10:32	14/11/2020 03:20	14/11/2020 10:32	7,19	2	14,38	CHI
20201161555	ALTO HORIZONTE	AJ12320992RE	SANTA TEREZINHA	14/11/2020 03:32	14/11/2020 18:26	14/11/2020 03:32	14/11/2020 18:26	14,89	47	700,01	CHI
20201161349	ITAIA	2300017447	ITAIA S2	14/11/2020 03:38	14/11/2020 08:22	14/11/2020 03:38	14/11/2020 08:22	4,73	1	4,73	CHI
20201161350	CRISTIANOPOLIS	SQ12309689	CRISTIANOPOLIS	14/11/2020 03:40	14/11/2020 21:44	14/11/2020 03:40	14/11/2020 21:44	18,07	1	18,07	CHI
20201161351	APARECIDA DE GOIANIA	10020901206	INDEPENDENCIA S2	14/11/2020 03:49	14/11/2020 10:06	14/11/2020 03:49	14/11/2020 10:06	6,28	1	6,28	CHI
20201161469	CAIAPONIA	DV12332038	CAIAPONIA	14/11/2020 04:04	14/11/2020 07:26	14/11/2020 04:04	14/11/2020 07:26	3,37	23	77,40	CHI
20201161469	DOVERLANDIA	DV12332038	CAIAPONIA	14/11/2020 04:04	14/11/2020 07:26	14/11/2020 04:04	14/11/2020 07:26	3,37	13	43,75	CHI
20201161475	MORRO AGUDO DE GOIAS	MS12136795	ITAPURANGA	14/11/2020 04:10	14/11/2020 07:31	14/11/2020 04:10	14/11/2020 07:31	3,35	37	123,82	CHI
20201162105	SANTA TEREZINHA DE GOIAS	SG12048775	SANTA TEREZINHA	14/11/2020 04:12	14/11/2020 17:26	14/11/2020 04:12	14/11/2020 17:26	13,23	11	145,52	CHI
20201162283	NOVA CRIXAS	NA12086286	NOVA CRIXAS	14/11/2020 04:12	15/11/2020 05:17	14/11/2020 04:12	15/11/2020 05:17	25,07	9	225,67	CHI
20201161967	CAIAPONIA	CP12072079	CAIAPONIA	14/11/2020 04:19	14/11/2020 09:27	14/11/2020 04:19	14/11/2020 09:27	5,12	6	30,71	CHI
20201161363	SANTA RITA DO NOVO DESTINO	DF21267438	BARRO ALTO	14/11/2020 04:22	14/11/2020 18:42	14/11/2020 04:22	14/11/2020 18:42	14,33	1	14,33	CHI
20201161365	BELA VISTA DE GOIAS	BV12410339	BELA VISTA S2	14/11/2020 04:23	14/11/2020 10:01	14/11/2020 04:23	14/11/2020 10:01	5,63	5	28,16	CHI
20201161368	TRINDADE	10030838817	TRINDADE	14/11/2020 04:26	14/11/2020 09:56	14/11/2020 04:26	14/11/2020 09:56	5,50	1	5,50	CHI
20201161450	MORRINHOS	PK12293231	PONTALINA	14/11/2020 04:29	14/11/2020 09:14	14/11/2020 04:29	14/11/2020 09:14	4,75	1	4,75	CHI
20201161450	PONTALINA	PK12293231	PONTALINA	14/11/2020 04:29	14/11/2020 09:14	14/11/2020 04:29	14/11/2020 09:14	4,75	19	90,22	CHI
20201161374	NOVA VENEZA	NV12010125	INHUMAS S1	14/11/2020 04:31	14/11/2020 07:55	14/11/2020 04:31	14/11/2020 07:55	3,38	12	40,60	CHI
20201161519	BALIZA	BH10406688	BOM JARDIM	14/11/2020 04:31	14/11/2020 13:05	14/11/2020 04:31	14/11/2020 13:05	8,56	52	445,32	CHI

20201162295	SILVANIA	SV12107840	VIANOPOLIS	14/11/2020 04:32	14/11/2020 11:42	14/11/2020 04:32	14/11/2020 11:42	7,16	15	107,47	CHI
20201161382	ARENOPOLIS	PH12231197	ARENOPOLIS	14/11/2020 04:35	15/11/2020 19:04	14/11/2020 04:35	14/11/2020 08:00	3,41	2	6,82	CHI
20201161382	ARENOPOLIS	PH12231197	ARENOPOLIS	14/11/2020 04:35	15/11/2020 19:04	14/11/2020 04:35	14/11/2020 18:02	13,45	11	147,99	CHI
20201161382	ARENOPOLIS	PH12231197	ARENOPOLIS	14/11/2020 04:35	15/11/2020 19:04	14/11/2020 04:35	14/11/2020 18:20	13,75	27	371,13	CHI
20201161382	ARENOPOLIS	PH12231197	ARENOPOLIS	14/11/2020 04:35	15/11/2020 19:04	14/11/2020 04:35	14/11/2020 19:21	14,77	12	177,18	CHI
20201161382	DIORAMA	PH12231197	ARENOPOLIS	14/11/2020 04:35	15/11/2020 19:04	14/11/2020 04:35	14/11/2020 19:21	14,77	9	132,89	CHI
20201161382	DIORAMA	PH12231197	ARENOPOLIS	14/11/2020 04:35	15/11/2020 19:04	14/11/2020 04:35	15/11/2020 18:44	38,16	3	114,47	CHI
20201161382	MONTES CLAROS DE GOIAS	PH12231197	ARENOPOLIS	14/11/2020 04:35	15/11/2020 19:04	14/11/2020 04:35	15/11/2020 18:44	38,16	6	228,95	CHI
20201161382	ARENOPOLIS	PH12231197	ARENOPOLIS	14/11/2020 04:35	15/11/2020 19:04	14/11/2020 04:35	15/11/2020 19:04	38,48	6	230,85	CHI
20201161382	MONTES CLAROS DE GOIAS	PH12231197	ARENOPOLIS	14/11/2020 04:35	15/11/2020 19:04	14/11/2020 04:35	15/11/2020 19:04	38,48	19	731,04	CHI
20201161384	SAO MIGUEL DO ARAGUAIA	SM12228636	SAO MIGUEL DO ARAGUAIA	14/11/2020 04:37	14/11/2020 10:59	14/11/2020 04:37	14/11/2020 10:59	6,36	23	146,32	CHI
20201162654	SAO MIGUEL DO ARAGUAIA	SM12228636	SAO MIGUEL DO ARAGUAIA	14/11/2020 04:37	14/11/2020 10:59	14/11/2020 04:37	14/11/2020 10:59	6,36	35	222,66	CHI
20201161392	PROFESSOR JAMIL SAFADY	JS12344648	ROCHEDO	14/11/2020 04:43	14/11/2020 08:33	14/11/2020 04:43	14/11/2020 08:33	3,82	17	64,93	CHI
20201161650	NOVO BRASIL	NB12019396	JUSSARA	14/11/2020 04:44	14/11/2020 10:35	14/11/2020 04:44	14/11/2020 10:35	5,84	41	239,30	CHI
20201161396	RIO VERDE	RV21194485	MONTIVIDIU T	14/11/2020 04:49	14/11/2020 10:01	14/11/2020 04:49	14/11/2020 10:01	5,19	1	5,19	CHI
20201161778	GOIANIA	GN12042255	REAL S2	14/11/2020 04:50	14/11/2020 09:06	14/11/2020 04:50	14/11/2020 09:06	4,26	356	1515,37	CHI
20201161399	CRISTALINA	KR12168460	CRISTALINA S1	14/11/2020 04:52	14/11/2020 08:28	14/11/2020 04:52	14/11/2020 08:28	3,59	5	17,96	CHI
20201161400	NOVA CRIXAS	NA12025131	NOVA CRIXAS	14/11/2020 04:52	14/11/2020 14:14	14/11/2020 04:52	14/11/2020 14:14	9,36	2	18,71	CHI
20201162940	MINEIROS	MY12156849	PARQUE DAS EMAS	14/11/2020 04:58	14/11/2020 11:31	14/11/2020 04:58	14/11/2020 11:31	6,55	11	72,02	CHI
20201161403	CALDAS NOVAS	760417106	SERRA DE CALDAS	14/11/2020 04:59	14/11/2020 11:18	14/11/2020 04:59	14/11/2020 11:18	6,31	1	6,31	CHI
20201161404	CACHOEIRA DE GOIAS	CG12018660	FIRMINOPOLIS S2	14/11/2020 05:01	14/11/2020 10:14	14/11/2020 05:01	14/11/2020 10:14	5,20	38	197,78	CHI
20201161489	VARJAO	VJ12085702	CEZARINA	14/11/2020 05:09	14/11/2020 08:03	14/11/2020 05:09	14/11/2020 08:03	2,89	7	20,25	CHI
20201161707	AMARALINA	LC12189854	MARA ROSA	14/11/2020 05:09	14/11/2020 11:11	14/11/2020 05:09	14/11/2020 11:11	6,02	8	48,17	CHI
20201161707	MARA ROSA	LC12189854	MARA ROSA	14/11/2020 05:09	14/11/2020 11:11	14/11/2020 05:09	14/11/2020 11:11	6,02	2	12,04	CHI
20201161411	EDEALINA	ED12114696	PONTALINA	14/11/2020 05:10	14/11/2020 08:11	14/11/2020 05:10	14/11/2020 08:11	3,01	7	21,09	CHI
20201161412	LUZIANIA	OZ12186208	PIRES DO RIO S2	14/11/2020 05:11	14/11/2020 10:28	14/11/2020 05:11	14/11/2020 10:28	5,28	32	168,96	CHI
20201161776	PARAUNA	AI12008084	FIRMINOPOLIS S2	14/11/2020 05:13	14/11/2020 08:19	14/11/2020 05:13	14/11/2020 08:19	3,08	6	18,51	CHI
20201161418	PALESTINA DE GOIAS	PY12138375	PALESTINA	14/11/2020 05:15	14/11/2020 10:41	14/11/2020 05:15	14/11/2020 10:41	5,42	24	130,15	CHI
20201161847	PONTALINA	PK12047065	PONTALINA	14/11/2020 05:15	14/11/2020 08:58	14/11/2020 05:15	14/11/2020 08:58	3,71	10	37,15	CHI
20201161421	BURITI ALEGRE	BG12000110	ITUMBIARA VELHA S2	14/11/2020 05:22	14/11/2020 10:28	14/11/2020 05:22	14/11/2020 10:28	5,10	7	35,67	CHI
20201161958	AURILANDIA	RP12076381RE	FIRMINOPOLIS S2	14/11/2020 05:22	14/11/2020 16:29	14/11/2020 05:22	14/11/2020 16:29	11,11	4	44,42	CHI
20201161958	SAO JOAO DA PARAUNA	RP12076381RE	FIRMINOPOLIS S2	14/11/2020 05:22	14/11/2020 16:29	14/11/2020 05:22	14/11/2020 16:29	11,11	33	366,47	CHI
20201162727	CALDAS NOVAS	CN12180276	CALDAS NOVAS S1	14/11/2020 05:26	17/11/2020 20:48	14/11/2020 05:26	14/11/2020 23:01	17,58	10	175,77	CHI
20201162727	SANTA CRUZ DE GOIAS	CN12180276	CALDAS NOVAS S1	14/11/2020 05:26	17/11/2020 20:48	14/11/2020 05:26	14/11/2020 23:01	17,58	40	703,10	CHI
20201162727	CALDAS NOVAS	CN12114775	CALDAS NOVAS S1	14/11/2020 05:26	17/11/2020 20:48	15/11/2020 20:55	16/11/2020 09:26	12,52	24	300,55	CHI
20201162727	SANTA CRUZ DE GOIAS	CN12114775	CALDAS NOVAS S1	14/11/2020 05:26	17/11/2020 20:48	15/11/2020 20:55	16/11/2020 09:26	12,52	39	488,40	CHI
20201162727	CALDAS NOVAS	CN12180276	CALDAS NOVAS S1	14/11/2020 05:26	17/11/2020 20:48	15/11/2020 20:55	16/11/2020 09:47	12,88	10	128,81	CHI
20201162727	SANTA CRUZ DE GOIAS	CN12180276	CALDAS NOVAS S1	14/11/2020 05:26	17/11/2020 20:48	15/11/2020 20:55	16/11/2020 09:47	12,88	40	515,24	CHI
20201162727	SANTA CRUZ DE GOIAS	CN12409033	CALDAS NOVAS S1	14/11/2020 05:26	17/11/2020 20:48	14/11/2020 05:26	16/11/2020 11:16	53,84	3	161,53	CHI
20201162727	SANTA CRUZ DE GOIAS	CN12114775	CALDAS NOVAS S1	14/11/2020 05:26	17/11/2020 20:48	16/11/2020 13:14	17/11/2020 11:27	22,23	3	66,69	CHI
20201162727	CALDAS NOVAS	CN12114775	CALDAS NOVAS S1	14/11/2020 05:26	17/11/2020 20:48	17/11/2020 11:15	17/11/2020 11:27	0,22	34	7,32	CHI
20201162727	SANTA CRUZ DE GOIAS	CN12114775	CALDAS NOVAS S1	14/11/2020 05:26	17/11/2020 20:48	17/11/2020 11:15	17/11/2020 11:27	0,22	80	17,22	CHI
20201162727	SANTA CRUZ DE GOIAS	CN12409033	CALDAS NOVAS S1	14/11/2020 05:26	17/11/2020 20:48	14/11/2020 05:26	17/11/2020 12:19	78,88	3	236,63	CHI
20201162727	SANTA CRUZ DE GOIAS	BC12248207LD	CALDAS NOVAS S1	14/11/2020 05:26	17/11/2020 20:48	14/11/2020 05:26	17/11/2020 19:32	86,11	3	258,32	CHI
20201162727	SANTA CRUZ DE GOIAS	CN12409033	CALDAS NOVAS S1	14/11/2020 05:26	17/11/2020 20:48	14/11/2020 05:26	17/11/2020 20:48	87,37	3	262,12	CHI
20201161430	JATAI	JT12286459	CABRIUVA S2	14/11/2020 05:31	14/11/2020 14:18	14/11/2020 05:31	14/11/2020 14:18	8,78	9	79,00	CHI
20201161434	SAO LUIS DE MONTES BELOS	SL21004169	FIRMINOPOLIS S2	14/11/2020 05:33	14/11/2020 10:34	14/11/2020 05:33	14/11/2020 10:34	5,01	1	5,01	CHI
20201161435	CACHOEIRA ALTA	RV12071929LD	CACHOEIRA ALTA	14/11/2020 05:33	14/11/2020 11:40	14/11/2020 05:33	14/11/2020 11:40	6,11	2	12,22	CHI
20201161435	RIO VERDE	RV12071929LD	CACHOEIRA ALTA	14/11/2020 05:33	14/11/2020 11:40	14/11/2020 05:33	14/11/2020 11:40	6,11	21	128,31	CHI
20201161462	PALMEIRAS DE GOIAS	PL12000219	PALMEIRAS	14/11/2020 05:33	14/11/2020 07:07	14/11/2020 05:33	14/11/2020 07:07	1,56	11	17,21	CHI
20201161442	VILA PROPICIO	GE21319338	GOIANESIA S1	14/11/2020 05:36	14/11/2020 16:46	14/11/2020 05:36	14/11/2020 16:46	11,17	1	11,17	CHI

20201161447	LUZIANIA	LZ12030517	RIO VERMELHO	14/11/2020 05:39	14/11/2020 08:33	14/11/2020 05:39	14/11/2020 08:33	2,89	196	567,37	CHI
20201161448	LUZIANIA	LZ12349112	MARAJOARA	14/11/2020 05:40	14/11/2020 09:03	14/11/2020 05:40	14/11/2020 09:03	3,38	33	111,56	CHI
20201161452	PARAUNA	EU21295890	ACREUNA	14/11/2020 05:41	14/11/2020 17:24	14/11/2020 05:41	14/11/2020 17:24	11,70	2	23,40	CHI
20201161454	CORUMBA DE GOIAS	CB12215013	CORUMBA	14/11/2020 05:42	14/11/2020 07:35	14/11/2020 05:42	14/11/2020 07:35	1,88	1	1,88	CHI
20201161545	MOSSAMEDES	MD12006197	FIRMINOPOLIS S2	14/11/2020 05:42	14/11/2020 06:53	14/11/2020 05:42	14/11/2020 06:53	1,18	24	28,23	CHI
20201161457	JARAGUA	JA12374473	JARAGUA	14/11/2020 05:44	14/11/2020 07:42	14/11/2020 05:44	14/11/2020 07:42	1,96	304	596,18	CHI
20201161459	URUACU	UR12000015	URUACU	14/11/2020 05:44	14/11/2020 08:13	14/11/2020 05:44	14/11/2020 08:13	2,47	174	429,88	CHI
20201161543	CAMPINACU	UC12269888	MARA ROSA	14/11/2020 05:44	14/11/2020 12:02	14/11/2020 05:44	14/11/2020 12:02	6,30	29	182,78	CHI
20201161460	BARRO ALTO	BA21342222	GOIANESIA S1	14/11/2020 05:45	14/11/2020 21:33	14/11/2020 05:45	14/11/2020 21:33	15,79	1	15,79	CHI
20201161464	CORUMBAIBA	CI12120756RE	VILA CORUMBA	14/11/2020 05:45	14/11/2020 20:05	14/11/2020 05:45	14/11/2020 07:30	1,74	48	83,31	CHI
20201161464	CORUMBAIBA	CI12120756RE	VILA CORUMBA	14/11/2020 05:45	14/11/2020 20:05	14/11/2020 07:38	14/11/2020 20:05	12,46	47	585,45	CHI
20201162201	FAINA	FC12299792	GOIAS	14/11/2020 05:45	14/11/2020 11:05	14/11/2020 05:45	14/11/2020 11:05	5,32	53	282,21	CHI
20201161468	GUAPO	GC12000274	GUAPO S1	14/11/2020 05:48	14/11/2020 11:27	14/11/2020 05:48	14/11/2020 11:27	5,65	41	231,51	CHI
20201161468	TRINDADE	GC12000274	GUAPO S1	14/11/2020 05:48	14/11/2020 11:27	14/11/2020 05:48	14/11/2020 11:27	5,65	36	203,28	CHI
20201161738	CACHOEIRA DE GOIAS	CG12165605	FIRMINOPOLIS S2	14/11/2020 05:52	14/11/2020 11:28	14/11/2020 05:52	14/11/2020 11:28	5,60	9	50,38	CHI
20201161474	PALMEIRAS DE GOIAS	PL11361555	PALMEIRAS	14/11/2020 05:53	14/11/2020 15:46	14/11/2020 05:53	14/11/2020 15:46	9,87	45	444,09	CHI
20201162028	PARAUNA	PU12391518	PARAUNA	14/11/2020 05:54	14/11/2020 12:51	14/11/2020 05:54	14/11/2020 12:51	6,93	25	173,36	CHI
20201161481	NOVA CRIXAS	SM12099600	SAO MIGUEL DO ARAGUAIA	14/11/2020 05:55	14/11/2020 08:52	14/11/2020 05:55	14/11/2020 08:52	2,93	1	2,93	CHI
20201161481	SAO MIGUEL DO ARAGUAIA	SM12099600	SAO MIGUEL DO ARAGUAIA	14/11/2020 05:55	14/11/2020 08:52	14/11/2020 05:55	14/11/2020 08:52	2,93	87	255,30	CHI
202011137986	COLINAS DO SUL	TI12355503	MINACU	14/11/2020 05:55	14/11/2020 14:21	14/11/2020 05:55	14/11/2020 14:21	8,43	9	75,89	CHI
20201162864	SAO MIGUEL DO PASSA QUATRO	SQ12074831	CRISTIANOPOLIS	14/11/2020 05:57	14/11/2020 11:16	14/11/2020 05:57	14/11/2020 11:16	5,31	18	95,53	CHI
20201161485	MARA ROSA	2260002359	MARA ROSA	14/11/2020 05:58	15/11/2020 19:17	14/11/2020 05:58	15/11/2020 19:17	37,31	1	37,31	CHI
20201161487	BARRO ALTO	BA12068485	BARRO ALTO	14/11/2020 05:58	14/11/2020 20:54	14/11/2020 05:58	14/11/2020 20:54	14,93	1	14,93	CHI
20201161487	SANTA RITA DO NOVO DESTINO	BA12068485	BARRO ALTO	14/11/2020 05:58	14/11/2020 20:54	14/11/2020 05:58	14/11/2020 20:54	14,93	32	477,66	CHI
20201161492	URUACU	UR12341322	URUACU	14/11/2020 05:59	14/11/2020 08:59	14/11/2020 05:59	14/11/2020 08:59	2,99	6	17,92	CHI
20201161493	CUMARI	CY12034702	CATALAO S1	14/11/2020 05:59	14/11/2020 20:02	14/11/2020 05:59	14/11/2020 20:02	14,04	1	14,04	CHI
20201161494	ITAGUARU	IC12219942	ITABERAI S1	14/11/2020 05:59	14/11/2020 12:23	14/11/2020 05:59	14/11/2020 12:23	6,39	100	638,56	CHI
20201161495	FORMOSA	FA12051040	ITUIQUIRA	14/11/2020 06:00	14/11/2020 07:57	14/11/2020 06:00	14/11/2020 07:57	1,95	11	21,43	CHI
20201161497	VILA PROPICIO	NP21293998	GOIANESIA S1	14/11/2020 06:00	14/11/2020 19:55	14/11/2020 06:00	14/11/2020 19:55	13,91	1	13,91	CHI
20201161500	PALESTINA DE GOIAS	PY12374896	PALESTINA	14/11/2020 06:02	14/11/2020 08:05	14/11/2020 06:02	14/11/2020 08:05	2,04	12	24,44	CHI
20201161501	GOIAS	GS12336438	GOIAS	14/11/2020 06:02	14/11/2020 09:58	14/11/2020 06:02	14/11/2020 09:58	3,92	36	141,11	CHI
20201161503	GOIANIA	GN21000313	XAVANTES	14/11/2020 06:02	14/11/2020 10:02	14/11/2020 06:02	14/11/2020 10:02	3,98	1	3,98	CHI
20201161516	BOM JARDIM DE GOIAS	BM12380951	ARAGARCAS	14/11/2020 06:02	14/11/2020 08:40	14/11/2020 06:02	14/11/2020 08:40	2,62	3	7,86	CHI
20201162543	PORTEIRO	TD12230952	RIO DOS BOIS	14/11/2020 06:02	14/11/2020 18:53	14/11/2020 06:02	14/11/2020 18:53	12,85	1	12,85	CHI
20201162543	TURVELANDIA	TD12230952	RIO DOS BOIS	14/11/2020 06:02	14/11/2020 18:53	14/11/2020 06:02	14/11/2020 18:53	12,85	5	64,25	CHI
20201161505	FLORES DE GOIAS	VB12320614	IACIARA S2	14/11/2020 06:03	14/11/2020 08:23	14/11/2020 06:03	14/11/2020 08:23	2,32	1	2,32	CHI
20201161505	VILA BOA	VB12320614	IACIARA S2	14/11/2020 06:03	14/11/2020 08:23	14/11/2020 06:03	14/11/2020 08:23	2,32	13	30,22	CHI
20201161745	MAURILANDIA	RV12026891	SANTA HELENA S1	14/11/2020 06:03	14/11/2020 13:50	14/11/2020 06:03	14/11/2020 13:50	7,77	6	46,65	CHI
20201161568	VICENTINOPOLIS	VI12263852	VICENTINOPOLIS	14/11/2020 06:04	14/11/2020 09:01	14/11/2020 06:04	14/11/2020 09:01	2,93	8	23,47	CHI
20201161713	PORANGATU	PO12020947	PORANGATU	14/11/2020 06:04	15/11/2020 07:20	14/11/2020 06:04	14/11/2020 07:44	1,65	39	64,46	CHI
20201161713	PORANGATU	PO12020947	PORANGATU	14/11/2020 06:04	15/11/2020 07:20	14/11/2020 06:04	15/11/2020 07:20	25,25	5	126,26	CHI
20201161665	FORMOSA	FA12383249	ITUIQUIRA	14/11/2020 06:05	14/11/2020 08:32	14/11/2020 06:05	14/11/2020 08:32	2,44	10	24,43	CHI
20201161866	JUSSARA	JR12271953	IPORA	14/11/2020 06:05	14/11/2020 11:26	14/11/2020 06:05	14/11/2020 11:26	5,35	20	106,90	CHI
20201161518	RIO VERDE	RV12338619	CABRIUVA S2	14/11/2020 06:06	14/11/2020 10:13	14/11/2020 06:06	14/11/2020 10:13	4,10	1	4,10	CHI
20201164412	MARA ROSA	MQ12059925	MARA ROSA	14/11/2020 06:06	14/11/2020 18:05	14/11/2020 06:06	14/11/2020 18:05	11,98	10	119,79	CHI
20201162353	SAO MIGUEL DO ARAGUAIA	SM21208402	SAO MIGUEL DO ARAGUAIA	14/11/2020 06:07	17/11/2020 09:27	14/11/2020 06:07	17/11/2020 09:27	75,33	1	75,33	CHI
20201162353	SAO MIGUEL DO ARAGUAIA	SM12031421	SAO MIGUEL DO ARAGUAIA	14/11/2020 06:07	17/11/2020 09:27	14/11/2020 20:35	17/11/2020 09:27	60,86	16	973,84	CHI
20201161522	SANTA CRUZ DE GOIAS	BC12332235	CRISTIANOPOLIS	14/11/2020 06:09	14/11/2020 09:42	14/11/2020 06:09	14/11/2020 09:42	3,54	6	21,24	CHI
20201161526	PIRANHAS	PH12092232	BOM JARDIM	14/11/2020 06:09	14/11/2020 08:34	14/11/2020 06:09	14/11/2020 08:34	2,40	8	19,20	CHI
20201161930	ABADIANIA	AA11101783	ANAPOLIS UNIVERSITARIO S1	14/11/2020 06:09	14/11/2020 10:34	14/11/2020 06:09	14/11/2020 10:34	4,40	95	418,16	CHI
20201161627	CAMPO ALEGRE DE GOIAS	CM11039867	CAMPO ALEGRE DE GOIAS	14/11/2020 06:10	14/11/2020 15:28	14/11/2020 06:10	14/11/2020 15:28	9,28	92	854,14	CHI



20201161532	CACHOEIRA ALTA	CA12079000	CACHOEIRA ALTA	14/11/2020 06:11	14/11/2020 18:54	14/11/2020 06:11	14/11/2020 18:54	12,72	9	114,48	CHI
20201161536	MUNDO NOVO DE GOIAS	MH12391949	NOVA CRIXAS	14/11/2020 06:13	14/11/2020 08:14	14/11/2020 06:13	14/11/2020 08:14	2,02	41	82,68	CHI
20201161539	JATAI	JT12264349LD	JATAI S1	14/11/2020 06:13	14/11/2020 11:20	14/11/2020 06:13	14/11/2020 11:20	5,11	60	306,63	CHI
20201161541	SILVANIA	SV12131990	VIANOPOLIS	14/11/2020 06:13	14/11/2020 10:26	14/11/2020 06:13	14/11/2020 10:26	4,20	35	147,12	CHI
20201161701	RIO VERDE	RV12000159LD	RIO VERDE S1	14/11/2020 06:13	14/11/2020 15:38	14/11/2020 06:13	14/11/2020 15:38	9,43	634	5976,68	CHI
20201161701	RIO VERDE	RV16394817	RIO VERDE S1	14/11/2020 06:13	14/11/2020 15:38	14/11/2020 15:09	14/11/2020 15:38	0,48	142	68,71	CHI
20201162032	PORANGATU	PO12100797	PORANGATU	14/11/2020 06:13	14/11/2020 10:51	14/11/2020 06:13	14/11/2020 10:51	4,62	9	41,58	CHI
20201161547	ITUMBIARA	IT21000163	PARANAIBA	14/11/2020 06:14	14/11/2020 21:04	14/11/2020 06:14	14/11/2020 21:04	14,82	1	14,82	CHI
20201161771	RIO VERDE	RV12230629	CABRIUVA S2	14/11/2020 06:15	14/11/2020 09:56	14/11/2020 06:15	14/11/2020 09:56	3,67	8	29,35	CHI
20201161551	ABADIANIA	AA21297633	ANAPOLIS UNIVERSITARIO S1	14/11/2020 06:16	14/11/2020 10:45	14/11/2020 06:16	14/11/2020 10:45	4,48	1	4,48	CHI
20201161557	PLANALTINA	PB12281764	PADRE BERNARDO	14/11/2020 06:18	14/11/2020 09:31	14/11/2020 06:18	14/11/2020 09:31	3,22	13	41,82	CHI
20201161558	PALESTINA DE GOIAS	PY12244052	PALESTINA	14/11/2020 06:19	14/11/2020 09:11	14/11/2020 06:19	14/11/2020 09:11	2,87	1	2,87	CHI
20201161571	PALMEIRAS DE GOIAS	10028822348	PALMEIRAS	14/11/2020 06:22	14/11/2020 17:33	14/11/2020 06:22	14/11/2020 17:33	11,17	1	11,17	CHI
20201161742	SAO MIGUEL DO ARAGUAIA	SM12000018	SAO MIGUEL DO ARAGUAIA	14/11/2020 06:22	14/11/2020 09:42	14/11/2020 06:22	14/11/2020 09:42	3,33	4	13,30	CHI
20201161575	ESTRELA DO NORTE	ET12143705	MARA ROSA	14/11/2020 06:23	14/11/2020 10:57	14/11/2020 06:23	14/11/2020 10:57	4,56	9	41,02	CHI
20201161575	FORMOSO	ET12143705	MARA ROSA	14/11/2020 06:23	14/11/2020 10:57	14/11/2020 06:23	14/11/2020 10:57	4,56	7	31,91	CHI
20201162286	TROMBAS	TB12187857	PORANGATU	14/11/2020 06:23	15/11/2020 06:35	14/11/2020 06:23	15/11/2020 06:35	24,19	8	193,54	CHI
20201161580	JATAI	JT12252746	JATAI S1	14/11/2020 06:24	14/11/2020 09:32	14/11/2020 06:24	14/11/2020 09:32	3,13	2	6,26	CHI
20201161582	GOIANIRA	GR11313229	MEIA PONTE	14/11/2020 06:24	14/11/2020 08:09	14/11/2020 06:24	14/11/2020 08:09	1,74	66	114,97	CHI
20201161583	SAO MIGUEL DO ARAGUAIA	SM21208577	SAO MIGUEL DO ARAGUAIA	14/11/2020 06:24	14/11/2020 07:25	14/11/2020 06:24	14/11/2020 07:25	1,00	1	1,00	CHI
20201162836	NOVA IGUAÇU DE GOIAS	NH12202119	CAMPINORTE	14/11/2020 06:24	14/11/2020 18:00	14/11/2020 06:24	14/11/2020 18:00	11,59	8	92,74	CHI
20201161585	AGUAS LINDAS DE GOIAS	LA11149042	AGUAS LINDAS DE GOIAS S1	14/11/2020 06:25	14/11/2020 08:50	14/11/2020 06:25	14/11/2020 08:50	2,41	184	442,62	CHI
20201161586	PONTALINA	PK31047342	VICENTINOPOLIS	14/11/2020 06:26	14/11/2020 12:07	14/11/2020 06:26	14/11/2020 12:07	5,67	1	5,67	CHI
20201161587	PIRENOPOLIS	PV12352327	CORUMBA	14/11/2020 06:26	14/11/2020 09:11	14/11/2020 06:26	14/11/2020 09:11	2,74	18	49,25	CHI
20201161588	IPAMERI	10022829952	IPAMERI	14/11/2020 06:26	14/11/2020 10:02	14/11/2020 06:26	14/11/2020 10:02	3,59	1	3,59	CHI
20201161591	CACU	CC12075924	CACHOEIRA ALTA	14/11/2020 06:30	14/11/2020 11:56	14/11/2020 06:30	14/11/2020 11:56	5,43	3	16,30	CHI
20201162734	SANTA ROSA DE GOIAS	SR12074398	INHUMAS S1	14/11/2020 06:30	14/11/2020 11:11	14/11/2020 06:30	14/11/2020 11:11	4,67	13	60,70	CHI
20201161598	IACIARA	IA21373149	IACIARA S1	14/11/2020 06:32	14/11/2020 07:31	14/11/2020 06:32	14/11/2020 07:31	0,97	1	0,97	CHI
20201161635	AMARALINA	LC12050751	MARA ROSA	14/11/2020 06:32	14/11/2020 10:28	14/11/2020 06:32	14/11/2020 10:28	3,92	12	47,10	CHI
20201161635	MARA ROSA	LC12050751	MARA ROSA	14/11/2020 06:32	14/11/2020 10:28	14/11/2020 06:32	14/11/2020 10:28	3,92	5	19,62	CHI
20201162342	ALTO HORIZONTE	AJ12405233LD	SANTA TEREZINHA	14/11/2020 06:32	15/11/2020 02:02	15/11/2020 00:54	15/11/2020 01:14	0,33	2	0,67	CHI
20201162342	ALTO HORIZONTE	AJ11232404	SANTA TEREZINHA	14/11/2020 06:32	15/11/2020 02:02	14/11/2020 06:32	15/11/2020 02:02	19,51	99	1931,46	CHI
20201161599	COLINAS DO SUL	20104272	MINACU	14/11/2020 06:33	14/11/2020 10:43	14/11/2020 06:33	14/11/2020 10:43	4,16	2	8,32	CHI
20201161697	HIDROLANDIA	HD12058903	ANHANGUERA	14/11/2020 06:33	14/11/2020 08:42	14/11/2020 06:33	14/11/2020 08:42	2,14	168	359,80	CHI
20201161606	JATAI	JT12000173	JATAI S1	14/11/2020 06:34	14/11/2020 12:51	14/11/2020 06:34	14/11/2020 12:51	6,28	11	69,04	CHI
20201161610	LUZIANIA	LZ12013824	VIANOPOLIS	14/11/2020 06:34	14/11/2020 09:17	14/11/2020 06:34	14/11/2020 09:17	2,70	17	45,93	CHI
20201161842	CAIAPONIA	CP12139786	CAIAPONIA	14/11/2020 06:34	14/11/2020 09:39	14/11/2020 06:34	14/11/2020 09:39	3,07	11	33,77	CHI
20201161842	DOVERLANDIA	CP12139786	CAIAPONIA	14/11/2020 06:34	14/11/2020 09:39	14/11/2020 06:34	14/11/2020 09:39	3,07	3	9,21	CHI
20201161971	CAIAPONIA	CP12243821	CAIAPONIA	14/11/2020 06:35	14/11/2020 15:58	14/11/2020 06:35	14/11/2020 15:58	9,38	15	140,66	CHI
20201161619	CAMPINORTE	CR12190203	MARA ROSA	14/11/2020 06:36	14/11/2020 11:53	14/11/2020 06:36	14/11/2020 11:53	5,27	2	10,53	CHI
20201161621	BELA VISTA DE GOIAS	SQ12066258	BELA VISTA S1	14/11/2020 06:38	14/11/2020 12:23	14/11/2020 06:38	14/11/2020 12:23	5,74	11	63,18	CHI
20201161628	MINEIROS	MY12322128RE	PARQUE DAS EMAS	14/11/2020 06:39	14/11/2020 12:14	14/11/2020 06:39	14/11/2020 12:14	5,58	4	22,33	CHI
20201161633	SILVANIA	510039820	VIANOPOLIS	14/11/2020 06:41	14/11/2020 12:29	14/11/2020 06:41	14/11/2020 12:29	5,80	1	5,80	CHI
20201161634	BOM JARDIM DE GOIAS	BM12342013	BOM JARDIM	14/11/2020 06:41	14/11/2020 08:50	14/11/2020 06:41	14/11/2020 08:50	2,15	13	27,90	CHI
20201161636	EDEIA	EA12263391	EDEIA	14/11/2020 06:41	14/11/2020 08:49	14/11/2020 06:41	14/11/2020 08:49	2,13	21	44,68	CHI
20201161637	PORANGATU	PO12048411	PORANGATU	14/11/2020 06:41	14/11/2020 09:08	14/11/2020 06:41	14/11/2020 09:08	2,44	17	41,56	CHI
20201161639	CALDAS NOVAS	MR10396045	MORRINHOS	14/11/2020 06:41	14/11/2020 11:08	14/11/2020 06:41	14/11/2020 09:21	2,66	2	5,33	CHI
20201161639	MORRINHOS	MR10396045	MORRINHOS	14/11/2020 06:41	14/11/2020 11:08	14/11/2020 06:41	14/11/2020 09:21	2,66	237	631,14	CHI
20201161639	MORRINHOS	MR10396045	MORRINHOS	14/11/2020 06:41	14/11/2020 11:08	14/11/2020 06:41	14/11/2020 09:21	2,66	322	857,50	CHI
20201161639	MORRINHOS	MR10396045	MORRINHOS	14/11/2020 06:41	14/11/2020 11:08	14/11/2020 06:41	14/11/2020 09:21	2,66	16	42,61	CHI
20201161639	RIO QUENTE	MR10396045	MORRINHOS	14/11/2020 06:41	14/11/2020 11:08	14/11/2020 06:41	14/11/2020 09:21	2,66	20	53,26	CHI

20201161639	MORRINHOS	MR10396045	MORRINHOS	14/11/2020 06:41	14/11/2020 11:08	14/11/2020 06:42	14/11/2020 09:21	2,65	1	2,65	CHI
20201161639	MORRINHOS	MR10396045	MORRINHOS	14/11/2020 06:41	14/11/2020 11:08	14/11/2020 06:42	14/11/2020 09:21	2,65	3	7,94	CHI
20201161639	MORRINHOS	MR12128686LD	MORRINHOS	14/11/2020 06:41	14/11/2020 11:08	14/11/2020 06:41	14/11/2020 10:49	4,13	13	53,70	CHI
20201161639	MORRINHOS	MR12249858LD	MORRINHOS	14/11/2020 06:41	14/11/2020 11:08	14/11/2020 06:41	14/11/2020 11:08	4,46	15	66,83	CHI
20201161642	CALDAS NOVAS	CN12392139	VILA CORUMBA	14/11/2020 06:45	14/11/2020 08:01	14/11/2020 06:45	14/11/2020 08:01	1,25	2	2,51	CHI
20201163751	MINACU	IH12252364	MINACU	14/11/2020 06:49	15/11/2020 09:52	14/11/2020 06:49	15/11/2020 09:52	27,04	8	216,29	CHI
20201161651	PADRE BERNARDO	PB12163212	PADRE BERNARDO	14/11/2020 06:50	14/11/2020 09:59	14/11/2020 06:50	14/11/2020 09:59	3,14	18	56,59	CHI
20201161655	NOVA ROMA	ND12392238	IACIARA S2	14/11/2020 06:52	14/11/2020 08:43	14/11/2020 06:52	14/11/2020 08:43	1,84	235	432,27	CHI
20201161675	ANAPOLIS	AN10411436	ANAPOLIS UNIVERSITARIO S2	14/11/2020 06:52	14/11/2020 12:10	14/11/2020 06:52	14/11/2020 06:56	0,07	1115	80,22	CHI
20201161675	ANAPOLIS	AN16407093	ANAPOLIS UNIVERSITARIO S2	14/11/2020 06:52	14/11/2020 12:10	14/11/2020 06:52	14/11/2020 06:56	0,08	1485	113,85	CHI
20201161675	ANAPOLIS	AN16411667	ANAPOLIS UNIVERSITARIO S2	14/11/2020 06:52	14/11/2020 12:10	14/11/2020 06:52	14/11/2020 08:07	1,25	997	1242,65	CHI
20201161675	ANAPOLIS	AN16411667	ANAPOLIS UNIVERSITARIO S2	14/11/2020 06:52	14/11/2020 12:10	14/11/2020 06:52	14/11/2020 08:22	1,51	892	1347,91	CHI
20201161675	ANAPOLIS	AN16411667	ANAPOLIS UNIVERSITARIO S2	14/11/2020 06:52	14/11/2020 12:10	14/11/2020 06:52	14/11/2020 12:10	5,30	257	1361,17	CHI
20201161675	GAMELEIRA DE GOIAS	AN16411667	ANAPOLIS UNIVERSITARIO S2	14/11/2020 06:52	14/11/2020 12:10	14/11/2020 06:52	14/11/2020 12:10	5,30	104	550,82	CHI
20201161675	LEOPOLDO DE BULHOES	AN16411667	ANAPOLIS UNIVERSITARIO S2	14/11/2020 06:52	14/11/2020 12:10	14/11/2020 06:52	14/11/2020 12:10	5,30	1	5,30	CHI
20201161675	SILVANIA	AN16411667	ANAPOLIS UNIVERSITARIO S2	14/11/2020 06:52	14/11/2020 12:10	14/11/2020 06:52	14/11/2020 12:10	5,30	41	217,15	CHI
20201161675	ANAPOLIS	AN13413937	ANAPOLIS UNIVERSITARIO S2	14/11/2020 06:52	14/11/2020 12:10	14/11/2020 06:56	14/11/2020 12:10	5,23	2	10,47	CHI
20201161656	ORIZONA	OZ12084921RE	PIRES DO RIO S2	14/11/2020 06:53	14/11/2020 09:13	14/11/2020 06:53	14/11/2020 09:13	2,33	87	202,47	CHI
20201161656	VIANOPOLIS	OZ12084921RE	PIRES DO RIO S2	14/11/2020 06:53	14/11/2020 09:13	14/11/2020 06:53	14/11/2020 09:13	2,33	17	39,56	CHI
20201161976	PARAUNA	PU12295915LD	ACREUNA	14/11/2020 06:54	14/11/2020 16:36	14/11/2020 06:54	14/11/2020 16:36	9,70	19	184,21	CHI
20201161676	CAMPINORTE	CR21164019	MARA ROSA	14/11/2020 06:57	14/11/2020 16:11	14/11/2020 06:57	14/11/2020 16:11	9,22	1	9,22	CHI
20201161680	MINACU	4020071872	MINACU	14/11/2020 06:58	15/11/2020 08:23	14/11/2020 06:58	15/11/2020 08:23	25,41	1	25,41	CHI
20201161682	AGUAS LINDAS DE GOIAS	LA12345961	AGUAS LINDAS DE GOIAS S2	14/11/2020 06:58	14/11/2020 09:51	14/11/2020 06:58	14/11/2020 09:51	2,87	1	2,87	CHI
20201161687	ABADIA DE GOIAS	GN32050559	TRINDADE	14/11/2020 06:59	14/11/2020 12:13	14/11/2020 06:59	14/11/2020 12:13	5,23	13	68,02	CHI
20201166000	CASTELANDIA	RV12026916	RIO DOS BOIS	14/11/2020 06:59	15/11/2020 00:06	14/11/2020 06:59	15/11/2020 00:06	17,11	12	205,36	CHI
20201166000	RIO VERDE	RV12026916	RIO DOS BOIS	14/11/2020 06:59	15/11/2020 00:06	14/11/2020 06:59	15/11/2020 00:06	17,11	2	34,23	CHI
20201160622	MINEIROS	MY12036636	PARQUE DAS EMAS	14/11/2020 07:00	14/11/2020 11:28	14/11/2020 07:00	14/11/2020 11:28	4,45	53	236,11	CHI
20201160622	MINEIROS	MY12036636	PARQUE DAS EMAS	14/11/2020 07:00	14/11/2020 11:28	14/11/2020 07:00	14/11/2020 11:28	4,45	8	35,64	CHI
20201161751	GUARANI DE GOIAS	GY12465246	IACIARA S1	14/11/2020 07:00	14/11/2020 09:55	14/11/2020 07:00	14/11/2020 09:55	2,91	13	37,83	CHI
20201161751	IACIARA	GY12465246	IACIARA S1	14/11/2020 07:00	14/11/2020 09:55	14/11/2020 07:00	14/11/2020 09:55	2,91	3	8,73	CHI
20201161696	JATAI	JT12021080	JATAI S3	14/11/2020 07:01	14/11/2020 08:58	14/11/2020 07:01	14/11/2020 08:58	1,94	4	7,76	CHI
20201161844	ORIZONA	OZ12186210	PIRES DO RIO S2	14/11/2020 07:01	14/11/2020 11:30	14/11/2020 07:01	14/11/2020 11:30	4,47	22	98,31	CHI
20201163905	ARAGARCAS	AG12354688	ARAGARCAS	14/11/2020 07:01	14/11/2020 17:38	14/11/2020 07:01	14/11/2020 17:38	10,60	3	31,81	CHI
20201161703	ANAPOLIS	10029200677	JUNDIAI S2	14/11/2020 07:02	14/11/2020 11:15	14/11/2020 07:02	14/11/2020 11:15	4,21	1	4,21	CHI
20201161706	GOIANDIRA	GD21323421	CATALAO S1	14/11/2020 07:03	14/11/2020 08:52	14/11/2020 07:03	14/11/2020 08:52	1,81	2	3,62	CHI
20201162456	CORUMBAIBA	CI12064619	VILA CORUMBA	14/11/2020 07:03	14/11/2020 18:36	14/11/2020 07:03	14/11/2020 18:36	11,55	38	438,72	CHI
20201161710	GOIANESIA	GE12006498	GOIANESIA S2	14/11/2020 07:04	14/11/2020 09:51	14/11/2020 07:04	14/11/2020 09:51	2,77	9	24,95	CHI
20201161712	CAIAPONIA	RV12030683	MONTIVIDIU T	14/11/2020 07:04	14/11/2020 08:45	14/11/2020 07:04	14/11/2020 08:45	1,67	212	354,22	CHI
20201161712	RIO VERDE	RV12030683	MONTIVIDIU T	14/11/2020 07:04	14/11/2020 08:45	14/11/2020 07:04	14/11/2020 08:45	1,67	3	5,01	CHI
20201161716	HIDROLANDIA	HD12321570	INDEPENDENCIA S1	14/11/2020 07:05	14/11/2020 10:07	14/11/2020 07:05	14/11/2020 10:07	3,02	7	21,17	CHI
20201161718	GOIANIA	11241743	REAL S1	14/11/2020 07:05	14/11/2020 10:03	14/11/2020 07:05	14/11/2020 10:03	2,95	1	2,95	CHI
20201161724	IPAMERI	IP21265568	CAMPO ALEGRE DE GOIAS	14/11/2020 07:06	14/11/2020 09:15	14/11/2020 07:06	14/11/2020 09:15	2,14	1	2,14	CHI
20201161782	BARRO ALTO	BA12064537	BARRO ALTO	14/11/2020 07:06	14/11/2020 13:20	14/11/2020 07:06	14/11/2020 13:20	6,23	7	43,61	CHI
20201161782	VILA PROPICIO	BA12064537	BARRO ALTO	14/11/2020 07:06	14/11/2020 13:20	14/11/2020 07:06	14/11/2020 13:20	6,23	2	12,46	CHI
20201161846	AURILANDIA	AI12000010	FIRMINOPOLIS S2	14/11/2020 07:06	14/11/2020 09:30	14/11/2020 07:06	14/11/2020 09:30	2,39	2	4,78	CHI
20201161846	FIRMINOPOLIS	AI12000010	FIRMINOPOLIS S2	14/11/2020 07:06	14/11/2020 09:30	14/11/2020 07:06	14/11/2020 09:30	2,39	6	14,35	CHI
20201161728	ANICUNS	AC21079281	ANICUNS	14/11/2020 07:07	14/11/2020 09:13	14/11/2020 07:07	14/11/2020 09:13	2,10	1	2,10	CHI
20201161734	LUZIANIA	LZ21407448	VIANOPOLIS	14/11/2020 07:08	14/11/2020 11:26	14/11/2020 07:08	14/11/2020 11:26	4,29	1	4,29	CHI
20201161735	GUARINOS	GG12237782	URUACU	14/11/2020 07:08	14/11/2020 19:45	14/11/2020 07:08	14/11/2020 19:45	12,60	3	37,81	CHI
20201161735	SANTA TEREZINHA DE GOIAS	GG12237782	URUACU	14/11/2020 07:08	14/11/2020 19:45	14/11/2020 07:08	14/11/2020 19:45	12,60	1	12,60	CHI
20201161737	MAURILANDIA	1040026040	RIO DOS BOIS	14/11/2020 07:08	14/11/2020 13:16	14/11/2020 07:08	14/11/2020 13:16	6,12	1	6,12	CHI

20201161740	SANTA RITA DO NOVO DESTINO	BA21152594	BARRO ALTO	14/11/2020 07:09	14/11/2020 13:49	14/11/2020 07:09	14/11/2020 13:49	6,66	1	6,66	CHI
20201161744	ADELANDIA	DN12145856	FIRMINOPOLIS S2	14/11/2020 07:09	14/11/2020 08:32	14/11/2020 07:09	14/11/2020 08:32	1,37	20	27,41	CHI
20201163677	GOIANIA	GN12390540	GOIANIA LESTE S2	14/11/2020 07:09	14/11/2020 14:30	14/11/2020 07:09	14/11/2020 14:30	7,35	507	3724,48	CHI
20201164258	CRIXAS	2490035820	SERRA DO OURO	14/11/2020 07:10	14/11/2020 14:27	14/11/2020 07:10	14/11/2020 14:27	7,28	1	7,28	CHI
20201161752	IPAMERI	IP21095263	IPAMERI	14/11/2020 07:12	14/11/2020 09:02	14/11/2020 07:12	14/11/2020 09:02	1,82	2	3,64	CHI
20201161960	PIRACANJUBA	PJ12320300	ROCHEDO	14/11/2020 07:12	14/11/2020 09:49	14/11/2020 07:12	14/11/2020 09:49	2,60	2	5,20	CHI
20201161757	PEROLANDIA	DP12260360	JATAI S1	14/11/2020 07:13	14/11/2020 08:57	14/11/2020 07:13	14/11/2020 08:57	1,73	3	5,18	CHI
20201161759	HIDROLANDIA	HD21013397	INDEPENDENCIA S1	14/11/2020 07:14	14/11/2020 17:00	14/11/2020 07:14	14/11/2020 17:00	9,76	2	19,53	CHI
20201161760	SILVANIA	SV21284585	VIANOPOLIS	14/11/2020 07:14	14/11/2020 14:33	14/11/2020 07:14	14/11/2020 14:33	7,31	1	7,31	CHI
20201161761	NIQUELANDIA	NQ11292641	NIQUELANDIA SUBTRANSMISSAO	14/11/2020 07:14	14/11/2020 09:31	14/11/2020 07:14	14/11/2020 09:31	2,27	64	145,37	CHI
20201161764	HEITORAI	HE12193579	ITAPURANGA	14/11/2020 07:14	14/11/2020 10:20	14/11/2020 07:14	14/11/2020 10:20	3,09	7	21,61	CHI
20201162010	PIRENOPOLIS	PV12370305	CORUMBA	14/11/2020 07:14	14/11/2020 13:37	14/11/2020 07:14	14/11/2020 13:37	6,37	18	114,63	CHI
20201162139	GOIAS	GS12249339	MATRINCHA	14/11/2020 07:15	14/11/2020 09:43	14/11/2020 07:15	14/11/2020 09:43	2,46	10	24,61	CHI
20201161777	ANICUNS	AC12126246	ANICUNS	14/11/2020 07:16	14/11/2020 10:07	14/11/2020 07:16	14/11/2020 10:07	2,85	8	22,77	CHI
20201161780	HIDROLANDIA	HD31133480	INDEPENDENCIA S1	14/11/2020 07:16	15/11/2020 08:26	14/11/2020 07:16	15/11/2020 08:26	25,15	1	25,15	CHI
20201161785	SAO LUIS DE MONTES BELOS	SL11145800	SAO LUIZ DOS MONTES BELOS	14/11/2020 07:18	14/11/2020 12:20	14/11/2020 07:18	14/11/2020 12:20	5,03	10	50,33	CHI
20201161786	GOIANIA	GN11131500	ATLANTICO S3	14/11/2020 07:18	14/11/2020 10:43	14/11/2020 07:18	14/11/2020 10:43	3,42	145	495,34	CHI
20201161787	MORRINHOS	MR12252186	GOIATUBA S1	14/11/2020 07:18	14/11/2020 11:51	14/11/2020 07:18	14/11/2020 11:51	4,55	3	13,64	CHI
20201161790	GOIANIA	GN12150474	XAVANTES	14/11/2020 07:18	14/11/2020 12:51	14/11/2020 07:18	14/11/2020 12:51	5,54	1	5,54	CHI
20201161790	SANTO ANTONIO DE GOIAS	GN12150474	XAVANTES	14/11/2020 07:18	14/11/2020 12:51	14/11/2020 07:18	14/11/2020 12:51	5,54	5	27,69	CHI
20201161792	GOIANIRA	10014930380	MEIA PONTE	14/11/2020 07:19	14/11/2020 09:51	14/11/2020 07:19	14/11/2020 09:51	2,53	1	2,53	CHI
20201161796	MIMOSO DE GOIAS	MJ21313511	PADRE BERNARDO	14/11/2020 07:20	14/11/2020 10:19	14/11/2020 07:20	14/11/2020 10:19	2,98	1	2,98	CHI
20201163614	PORANGATU	PO12282160	PORANGATU	14/11/2020 07:21	14/11/2020 17:33	14/11/2020 07:21	14/11/2020 17:33	10,19	11	112,11	CHI
20201163111	ITARUMA	IM12107441	CACHOEIRA ALTA	14/11/2020 07:22	14/11/2020 13:16	14/11/2020 07:22	14/11/2020 13:16	5,89	12	70,63	CHI
20201165719	ALTO HORIZONTE	AJ11353558	SANTA TEREZINHA	14/11/2020 07:23	15/11/2020 02:09	14/11/2020 07:23	15/11/2020 02:09	18,76	17	318,96	CHI
20201161811	AGUA FRIA DE GOIAS	PI12206198	SAO JOAO D ALIANCA	14/11/2020 07:26	14/11/2020 09:34	14/11/2020 07:26	14/11/2020 09:34	2,13	1	2,13	CHI
20201161819	CORUMBAIBA	CI21000472	VILA CORUMBA	14/11/2020 07:27	14/11/2020 12:40	14/11/2020 07:27	14/11/2020 12:40	5,20	1	5,20	CHI
20201162607	PONTALINA	VI12047300	VICENTINOPOLIS	14/11/2020 07:27	14/11/2020 10:23	14/11/2020 07:27	14/11/2020 10:23	2,93	2	5,86	CHI
20201162607	VICENTINOPOLIS	VI12047300	VICENTINOPOLIS	14/11/2020 07:27	14/11/2020 10:23	14/11/2020 07:27	14/11/2020 10:23	2,93	3	8,79	CHI
20201165255	MONTIVIDU DO NORTE	TB12156640	PORANGATU	14/11/2020 07:27	15/11/2020 08:18	14/11/2020 07:27	15/11/2020 08:18	24,85	1	24,85	CHI
20201165255	TROMBAS	TB12156640	PORANGATU	14/11/2020 07:27	15/11/2020 08:18	14/11/2020 07:27	15/11/2020 08:18	24,85	50	1242,50	CHI
20201161822	PONTALINA	VI21166496	VICENTINOPOLIS	14/11/2020 07:28	14/11/2020 11:37	14/11/2020 07:28	14/11/2020 11:37	4,14	1	4,14	CHI
20201161823	GOIAS	GS12056682	GOIAS	14/11/2020 07:28	14/11/2020 10:12	14/11/2020 07:28	14/11/2020 10:12	2,73	7	19,08	CHI
20201162176	SANTO ANTONIO DO DESCOBERTO	SN12275494	MARAJOARA	14/11/2020 07:28	14/11/2020 12:43	14/11/2020 07:28	14/11/2020 12:43	5,24	8	41,90	CHI
20201162386	BELA VISTA DE GOIAS	HD12000169	CEPAIGO S2	14/11/2020 07:28	14/11/2020 12:49	14/11/2020 07:28	14/11/2020 12:49	5,34	1	5,34	CHI
20201162386	HIDROLANDIA	HD12000169	CEPAIGO S2	14/11/2020 07:28	14/11/2020 12:49	14/11/2020 07:28	14/11/2020 12:49	5,34	38	202,83	CHI
20201161828	IPAMERI	IP21017012	IPAMERI	14/11/2020 07:29	14/11/2020 16:42	14/11/2020 07:29	14/11/2020 16:42	9,21	1	9,21	CHI
20201161841	CABECEIRAS	10017266171	ITUIQUIRA	14/11/2020 07:30	14/11/2020 08:22	14/11/2020 07:30	14/11/2020 08:22	0,86	1	0,86	CHI
20201162012	ARAGARCAS	BM12372332	BOM JARDIM	14/11/2020 07:30	14/11/2020 10:38	14/11/2020 07:30	14/11/2020 10:38	3,13	16	50,08	CHI
20201162012	BOM JARDIM DE GOIAS	BM12372332	BOM JARDIM	14/11/2020 07:30	14/11/2020 10:38	14/11/2020 07:30	14/11/2020 10:38	3,13	1	3,13	CHI
20201161843	APARECIDA DE GOIANIA	17226181	INDEPENDENCIA S2	14/11/2020 07:31	14/11/2020 10:38	14/11/2020 07:31	14/11/2020 10:38	3,12	1	3,12	CHI
20201161857	ARENOPOLIS	AY12000042	ARENOPOLIS	14/11/2020 07:31	14/11/2020 10:42	14/11/2020 07:31	14/11/2020 10:42	3,18	23	73,05	CHI
20201161853	BELA VISTA DE GOIAS	BV12000030	BELA VISTA S1	14/11/2020 07:32	14/11/2020 09:43	14/11/2020 07:32	14/11/2020 09:43	2,18	13	28,34	CHI
20201161853	HIDROLANDIA	BV12000030	BELA VISTA S1	14/11/2020 07:32	14/11/2020 09:43	14/11/2020 07:32	14/11/2020 09:43	2,18	1	2,18	CHI
20201161853	PIRACANJUBA	BV12000030	BELA VISTA S1	14/11/2020 07:32	14/11/2020 09:43	14/11/2020 07:32	14/11/2020 09:43	2,18	2	4,36	CHI
20201161856	APORE	AE21293450	ITAJA S1	14/11/2020 07:32	14/11/2020 17:30	14/11/2020 07:32	14/11/2020 17:30	9,95	1	9,95	CHI
20201161858	SANTA HELENA DE GOIAS	SH12295844	IPEGUARI	14/11/2020 07:32	14/11/2020 10:20	14/11/2020 07:32	14/11/2020 10:20	2,79	18	50,13	CHI
20201161862	AURILANDIA	AI21101623	FIRMINOPOLIS S2	14/11/2020 07:33	14/11/2020 11:37	14/11/2020 07:33	14/11/2020 11:37	4,05	1	4,05	CHI
20201161946	BARRO ALTO	BA12156230	BARRO ALTO	14/11/2020 07:33	14/11/2020 12:02	14/11/2020 07:33	14/11/2020 12:02	4,47	40	178,99	CHI
20201161946	SANTA RITA DO NOVO DESTINO	BA12156230	BARRO ALTO	14/11/2020 07:33	14/11/2020 12:02	14/11/2020 07:33	14/11/2020 12:02	4,47	18	80,54	CHI
20201161864	CRIXAS	CX12336667	RUBIATABA	14/11/2020 07:34	16/11/2020 20:40	14/11/2020 07:34	15/11/2020 11:25	27,85	4	111,39	CHI

20201161864	CRIXAS	CX12336667	RUBIATABA	14/11/2020 07:34	16/11/2020 20:40	14/11/2020 07:34	16/11/2020 20:40	61,10	1	61,10	CHI
20201161867	GOIANIA	11901731	REAL S1	14/11/2020 07:34	14/11/2020 10:23	14/11/2020 07:34	14/11/2020 10:23	2,81	1	2,81	CHI
20201161870	PIRANHAS	PH12311822	PIRANHAS	14/11/2020 07:34	14/11/2020 14:40	14/11/2020 07:34	14/11/2020 14:40	7,10	4	28,41	CHI
20201162510	INHUMAS	IX12000030	INHUMAS S1	14/11/2020 07:34	14/11/2020 09:37	14/11/2020 07:34	14/11/2020 09:37	2,05	11	22,52	CHI
20201162510	ITAUCU	IX12000030	INHUMAS S1	14/11/2020 07:34	14/11/2020 09:37	14/11/2020 07:34	14/11/2020 09:37	2,05	4	8,19	CHI
20201161874	CORUMBA DE GOIAS	CB12065715	CORUMBA	14/11/2020 07:35	14/11/2020 10:52	14/11/2020 07:35	14/11/2020 10:52	3,28	3	9,84	CHI
20201161876	SANCLERLANDIA	SC12019473	SAO LUIZ DOS MONTES BELOS	14/11/2020 07:35	14/11/2020 09:07	14/11/2020 07:35	14/11/2020 09:07	1,53	5	7,65	CHI
20201161877	ITAJA	IJ12370148	ITAJA S2	14/11/2020 07:35	14/11/2020 09:24	14/11/2020 07:35	14/11/2020 09:24	1,81	2	3,63	CHI
20201161880	PIRACANJUBA	PJ1257902	CALDAS NOVAS S1	14/11/2020 07:35	14/11/2020 11:39	14/11/2020 07:35	14/11/2020 11:39	4,05	1	4,05	CHI
20201161881	JARAGUA	JA21328492	JARAGUA	14/11/2020 07:35	14/11/2020 08:37	14/11/2020 07:35	14/11/2020 08:37	1,02	1	1,02	CHI
20201161882	PIRES DO RIO	460036701	PIRES DO RIO S1	14/11/2020 07:35	14/11/2020 11:59	14/11/2020 07:35	14/11/2020 11:59	4,38	1	4,38	CHI
20201162140	MONTIVIDIU	MV12340904	MONTIVIDIU T	14/11/2020 07:36	14/11/2020 14:02	14/11/2020 07:36	14/11/2020 12:52	5,26	3	15,78	CHI
20201162140	CAIAPONIA	MV12340904	MONTIVIDIU T	14/11/2020 07:36	14/11/2020 14:02	14/11/2020 07:36	14/11/2020 14:02	6,43	1	6,43	CHI
20201162140	MONTIVIDIU	MV12340904	MONTIVIDIU T	14/11/2020 07:36	14/11/2020 14:02	14/11/2020 07:36	14/11/2020 14:02	6,43	7	45,01	CHI
20201162140	MONTIVIDIU	MV12214230LD	MONTIVIDIU T	14/11/2020 07:36	14/11/2020 14:02	14/11/2020 12:09	14/11/2020 14:02	1,89	6	11,35	CHI
20201162220	GOIANESIA	GE12016189	GOIANESIA S2	14/11/2020 07:36	14/11/2020 10:40	14/11/2020 07:36	14/11/2020 10:40	3,05	5	15,27	CHI
20201161894	PORANGATU	PO21227056	PORANGATU	14/11/2020 07:37	14/11/2020 08:17	14/11/2020 07:37	14/11/2020 08:17	0,66	1	0,66	CHI
20201162035	AGUA LIMPA	AL12391494RE	VILA CORUMBA	14/11/2020 07:37	14/11/2020 10:41	14/11/2020 07:37	14/11/2020 10:41	3,06	15	45,83	CHI
20201162223	CAMPINACU	UC12239716	PORANGATU	14/11/2020 07:37	14/11/2020 17:37	14/11/2020 07:37	14/11/2020 17:37	9,99	36	359,56	CHI
20201163681	CRIXAS	CX12391833	RUBIATABA	14/11/2020 07:37	15/11/2020 08:25	14/11/2020 07:37	15/11/2020 08:25	24,79	7	173,50	CHI
20201163681	NOVA IGUAUCU DE GOIAS	CX12391833	RUBIATABA	14/11/2020 07:37	15/11/2020 08:25	14/11/2020 07:37	15/11/2020 08:25	24,79	1	24,79	CHI
20201161905	HIDROLANDIA	HD21200276	CEPAIGO S2	14/11/2020 07:38	14/11/2020 16:02	14/11/2020 07:38	14/11/2020 16:02	8,40	2	16,80	CHI
20201161906	PIRES DO RIO	460062311	PIRES DO RIO S1	14/11/2020 07:38	14/11/2020 12:30	14/11/2020 07:38	14/11/2020 12:30	4,86	1	4,86	CHI
20201161907	GOIANESIA	GE12255877	GOIANESIA S2	14/11/2020 07:38	14/11/2020 18:25	14/11/2020 07:38	14/11/2020 18:25	10,77	1	10,77	CHI
20201161908	ITAPURANGA	IK12199526	ITAPURANGA	14/11/2020 07:38	14/11/2020 16:05	14/11/2020 07:38	14/11/2020 16:05	8,44	1	8,44	CHI
20201163448	GOIATUBA	JV12000028	GOIATUBA S1	14/11/2020 07:39	14/11/2020 20:11	14/11/2020 07:39	14/11/2020 20:11	12,53	9	112,77	CHI
20201163448	JOVIANIA	JV12000028	GOIATUBA S1	14/11/2020 07:39	14/11/2020 20:11	14/11/2020 07:39	14/11/2020 20:11	12,53	12	150,36	CHI
20201163448	VICENTINOPOLIS	JV12000028	GOIATUBA S1	14/11/2020 07:39	14/11/2020 20:11	14/11/2020 07:39	14/11/2020 20:11	12,53	3	37,59	CHI
20201161919	FORMOSA	FA21302739	ITUIQUIRA	14/11/2020 07:40	14/11/2020 09:57	14/11/2020 07:40	14/11/2020 09:57	2,27	1	2,27	CHI
20201161922	TRINDADE	TR32033962	TRINDADE	14/11/2020 07:41	14/11/2020 09:26	14/11/2020 07:41	14/11/2020 09:26	1,74	10	17,36	CHI
20201159982	CAMPO ALEGRE DE GOIAS	CM12192738RE	CAMPO ALEGRE DE GOIAS	14/11/2020 07:42	14/11/2020 11:54	14/11/2020 07:42	14/11/2020 11:54	4,18	47	196,67	CHI
20201161923	COCALZINHO DE GOIAS	ZN21293873	AGUAS LINDAS DE GOIAS S2	14/11/2020 07:42	14/11/2020 09:40	14/11/2020 07:42	14/11/2020 09:40	1,96	2	3,93	CHI
20201161924	NIQUELANDIA	NQ21312685	BARRO ALTO	14/11/2020 07:42	15/11/2020 10:59	14/11/2020 07:42	15/11/2020 10:59	27,28	1	27,28	CHI
20201161934	MAMBAI	MB12170571	IACIARA S2	14/11/2020 07:44	14/11/2020 12:08	14/11/2020 07:44	14/11/2020 12:08	4,39	98	430,47	CHI
20201161941	CEZARINA	CZ12011071	CEZARINA	14/11/2020 07:46	14/11/2020 10:02	14/11/2020 07:46	14/11/2020 10:02	2,26	2	4,53	CHI
20201161941	PALMEIRAS DE GOIAS	CZ12011071	CEZARINA	14/11/2020 07:46	14/11/2020 10:02	14/11/2020 07:46	14/11/2020 10:02	2,26	4	9,05	CHI
20201161943	MINEIROS	MY21303458	PARQUE DAS EMAS	14/11/2020 07:46	14/11/2020 09:51	14/11/2020 07:46	14/11/2020 09:51	2,07	2	4,14	CHI
20201161944	SAO MIGUEL DO ARAGUAIA	SM12208936	SAO MIGUEL DO ARAGUAIA	14/11/2020 07:47	14/11/2020 09:00	14/11/2020 07:47	14/11/2020 09:00	1,21	9	10,90	CHI
20201161947	ALTO PARAISO DE GOIAS	3870001985	FLORES DE GOIAS	14/11/2020 07:47	14/11/2020 09:12	14/11/2020 07:47	14/11/2020 09:12	1,40	1	1,40	CHI
20201161950	RIO VERDE	RV21231879	CACHOEIRA ALTA	14/11/2020 07:48	14/11/2020 10:21	14/11/2020 07:48	14/11/2020 10:21	2,54	1	2,54	CHI
20201161951	FAINA	MP12096007	MATRINCHA	14/11/2020 07:48	14/11/2020 08:58	14/11/2020 07:48	14/11/2020 08:58	1,15	8	9,22	CHI
20201161953	GOIAS	GS12217959	GOIAS	14/11/2020 07:49	14/11/2020 10:47	14/11/2020 07:49	14/11/2020 10:47	2,96	6	17,77	CHI
20201162031	PALMEIRAS DE GOIAS	PL12000058	PALMEIRAS	14/11/2020 07:52	14/11/2020 11:03	14/11/2020 07:52	14/11/2020 11:03	3,18	6	19,06	CHI
20201161962	JARAGUA	JA12064317	JARAGUA	14/11/2020 07:53	14/11/2020 10:02	14/11/2020 07:53	14/11/2020 10:02	2,14	50	107,08	CHI
20201161980	VARJAO	VJ31099612	GUAPU S2	14/11/2020 07:54	14/11/2020 11:03	14/11/2020 07:54	14/11/2020 11:03	3,13	1	3,13	CHI
20201162245	ARAGOIANIA	HD12000076	INDEPENDENCIA S1	14/11/2020 07:54	14/11/2020 10:35	14/11/2020 07:54	14/11/2020 10:35	2,67	12	32,03	CHI
20201162245	HIDROLANDIA	HD12000076	INDEPENDENCIA S1	14/11/2020 07:54	14/11/2020 10:35	14/11/2020 07:54	14/11/2020 10:35	2,67	24	64,05	CHI
20201161983	ITARUMA	IM21097094	CACHOEIRA ALTA	14/11/2020 07:55	14/11/2020 10:54	14/11/2020 07:55	14/11/2020 10:54	2,98	1	2,98	CHI
20201163778	PORTELANDIA	PW12303418	PARQUE DAS EMAS	14/11/2020 07:55	16/11/2020 22:14	14/11/2020 07:55	14/11/2020 16:15	8,35	1	8,35	CHI
20201163778	PORTELANDIA	PW12303418	PARQUE DAS EMAS	14/11/2020 07:55	16/11/2020 22:14	15/11/2020 14:38	15/11/2020 21:55	7,28	1	7,28	CHI
20201163778	PORTELANDIA	PW12303418	PARQUE DAS EMAS	14/11/2020 07:55	16/11/2020 22:14	16/11/2020 03:35	16/11/2020 04:29	0,90	1	0,90	CHI

20201163778	PORTELANDIA	PW12324411	PARQUE DAS EMAS	14/11/2020 07:55	16/11/2020 22:14	16/11/2020 13:42	16/11/2020 17:05	3,38	2	6,76	CHI
20201163778	PORTELANDIA	PW12303418	PARQUE DAS EMAS	14/11/2020 07:55	16/11/2020 22:14	14/11/2020 07:55	16/11/2020 17:59	58,08	1	58,08	CHI
20201163778	PORTELANDIA	PW12303418	PARQUE DAS EMAS	14/11/2020 07:55	16/11/2020 22:14	16/11/2020 17:31	16/11/2020 17:59	0,47	1	0,47	CHI
20201163778	PORTELANDIA	PW12303418	PARQUE DAS EMAS	14/11/2020 07:55	16/11/2020 22:14	14/11/2020 07:55	16/11/2020 19:16	59,36	1	59,36	CHI
20201163778	PORTELANDIA	PW12303418	PARQUE DAS EMAS	14/11/2020 07:55	16/11/2020 22:14	16/11/2020 19:01	16/11/2020 19:16	0,26	2	0,52	CHI
20201163778	PORTELANDIA	PW12303418	PARQUE DAS EMAS	14/11/2020 07:55	16/11/2020 22:14	14/11/2020 07:55	16/11/2020 22:06	62,19	1	62,19	CHI
20201163778	PORTELANDIA	PW12303418	PARQUE DAS EMAS	14/11/2020 07:55	16/11/2020 22:14	14/11/2020 07:55	16/11/2020 22:06	62,20	1	62,20	CHI
20201163778	PORTELANDIA	PW12303418	PARQUE DAS EMAS	14/11/2020 07:55	16/11/2020 22:14	14/11/2020 07:55	16/11/2020 22:14	62,32	1	62,32	CHI
20201161998	CORUMBA DE GOIAS	CB21232604	CORUMBA	14/11/2020 07:56	14/11/2020 12:07	14/11/2020 07:56	14/11/2020 12:07	4,18	1	4,18	CHI
20201161999	NEROPOLIS	NR21010626	NEROPOLIS S2	14/11/2020 07:56	14/11/2020 08:33	14/11/2020 07:56	14/11/2020 08:33	0,61	1	0,61	CHI
20201162000	CAIAPONIA	CP12413420	PALESTINA	14/11/2020 07:56	14/11/2020 13:22	14/11/2020 07:56	14/11/2020 13:22	5,43	23	124,85	CHI
20201162002	ANAPOLIS	7756837	DAIA S2	14/11/2020 07:56	14/11/2020 14:48	14/11/2020 07:56	14/11/2020 14:48	6,86	1	6,86	CHI
20201162002	NEROPOLIS	7756837	DAIA S2	14/11/2020 07:56	14/11/2020 14:48	14/11/2020 07:56	14/11/2020 14:48	6,86	49	336,25	CHI
20201162002	TEREZOPOLIS DE GOIAS	7756837	DAIA S2	14/11/2020 07:56	14/11/2020 14:48	14/11/2020 07:56	14/11/2020 14:48	6,86	154	1056,78	CHI
20201162002	TEREZOPOLIS DE GOIAS	TJ10402664	DAIA S2	14/11/2020 07:56	14/11/2020 14:48	14/11/2020 14:45	14/11/2020 14:48	0,05	611	32,93	CHI
20201162004	GOIANIRA	GR12016569	GOIANIRA	14/11/2020 07:56	14/11/2020 17:15	14/11/2020 07:56	14/11/2020 17:15	9,30	3	27,90	CHI
20201162036	GOIANIA	AP13403037	REAL S2	14/11/2020 07:56	14/11/2020 16:20	14/11/2020 12:11	14/11/2020 12:15	0,07	210	13,65	CHI
20201162036	GOIANIA	AP13401609	REAL S2	14/11/2020 07:56	14/11/2020 16:20	14/11/2020 14:53	14/11/2020 16:20	1,44	55	79,09	CHI
20201162569	SANTA HELENA DE GOIAS	SH12301071	RIO DOS BOIS	14/11/2020 07:56	14/11/2020 13:17	14/11/2020 07:56	14/11/2020 13:17	5,35	5	26,73	CHI
20201162569	TURVELANDIA	SH12301071	RIO DOS BOIS	14/11/2020 07:56	14/11/2020 13:17	14/11/2020 07:56	14/11/2020 13:17	5,35	1	5,35	CHI
20201162006	RIO VERDE	RV11028160	SANTA HELENA S1	14/11/2020 07:57	14/11/2020 14:53	14/11/2020 07:57	14/11/2020 14:53	6,93	7	48,53	CHI
20201162009	IPAMERI	IP12068500	CRISTALINA S2	14/11/2020 07:57	14/11/2020 10:00	14/11/2020 07:57	14/11/2020 10:00	2,03	47	95,59	CHI
20201162192	ITARUMA	IM12058060	CACHOEIRA ALTA	14/11/2020 07:57	14/11/2020 10:00	14/11/2020 07:57	14/11/2020 10:00	2,05	16	32,78	CHI
20201162016	DOVERLANDIA	DV12209145	CAIAPONIA	14/11/2020 07:58	14/11/2020 09:52	14/11/2020 07:58	14/11/2020 09:52	1,89	1	1,89	CHI
20201162021	VICENTINOPOLIS	VI11000002	VICENTINOPOLIS	14/11/2020 07:59	14/11/2020 19:23	14/11/2020 07:59	14/11/2020 19:23	11,39	68	774,75	CHI
20201162023	GOIATUBA	JV12026571	GOIATUBA S1	14/11/2020 07:59	15/11/2020 01:59	14/11/2020 07:59	15/11/2020 01:59	18,00	4	72,02	CHI
20201162024	GOIANIA	GN21319482	XAVANTES	14/11/2020 07:59	14/11/2020 10:56	14/11/2020 07:59	14/11/2020 10:56	2,93	3	8,80	CHI
20201162027	GOIAS	GS21310394	ITABERAI S1	14/11/2020 08:00	14/11/2020 13:50	14/11/2020 08:00	14/11/2020 13:50	5,83	1	5,83	CHI
20201162033	SANTA FE DE GOIAS	RN12089861	BRITANIA	14/11/2020 08:00	14/11/2020 10:22	14/11/2020 08:00	14/11/2020 10:22	2,36	7	16,52	CHI
20201162034	MORRO AGUDO DE GOIAS	MS12376415	ITAPURANGA	14/11/2020 08:00	14/11/2020 09:55	14/11/2020 08:00	14/11/2020 09:55	1,91	8	15,27	CHI
20201162038	GOIANIA	GN11078477	CAMPINAS S1	14/11/2020 08:00	14/11/2020 09:45	14/11/2020 08:00	14/11/2020 09:45	1,74	65	112,92	CHI
20201162276	GOIANIA	SW12200298	GOIANIA LESTE S2	14/11/2020 08:01	14/11/2020 15:04	14/11/2020 08:01	14/11/2020 15:04	7,04	5	35,21	CHI
20201162450	HIDROLANDIA	HD11000134	ANHANGUERA	14/11/2020 08:01	14/11/2020 19:34	14/11/2020 08:01	14/11/2020 19:34	11,54	102	1177,59	CHI
20201162048	GOIANAPOLIS	GP11273147	DAIA S2	14/11/2020 08:02	14/11/2020 09:48	14/11/2020 08:02	14/11/2020 09:48	1,76	11	19,40	CHI
20201162049	RUBIATABA	RB12003316	RUBIATABA	14/11/2020 08:02	14/11/2020 11:47	14/11/2020 08:02	14/11/2020 11:47	3,75	44	164,89	CHI
20201162053	GOIATUBA	GT21131722	BOM JESUS DE GOIAS	14/11/2020 08:02	14/11/2020 12:04	14/11/2020 08:02	14/11/2020 12:04	4,03	1	4,03	CHI
20201162060	TRINDADE	TR21000127	TRINDADE	14/11/2020 08:02	15/11/2020 14:50	14/11/2020 08:02	15/11/2020 14:50	30,79	1	30,79	CHI
20201162060	TRINDADE	TR12200202	TRINDADE	14/11/2020 08:02	15/11/2020 14:50	15/11/2020 12:25	15/11/2020 14:50	2,42	2	4,84	CHI
20201162613	ARAGARCAS	AG12234256	ARAGARCAS	14/11/2020 08:02	14/11/2020 14:50	14/11/2020 08:02	14/11/2020 14:50	6,79	18	122,26	CHI
20201162306	CORREGO DO OURO	CO12040666	FIRMINOPOLIS S2	14/11/2020 08:03	14/11/2020 09:30	14/11/2020 08:03	14/11/2020 09:30	1,45	13	18,80	CHI
20201162306	FAZENDA NOVA	CO12040666	FIRMINOPOLIS S2	14/11/2020 08:03	14/11/2020 09:30	14/11/2020 08:03	14/11/2020 09:30	1,45	8	11,57	CHI
20201162790	ITUMBIARA	BG12000046	ITUMBIARA VELHA S2	14/11/2020 08:03	14/11/2020 13:03	14/11/2020 08:03	14/11/2020 13:03	4,99	7	34,92	CHI
20201162074	SANTA HELENA DE GOIAS	SH12296018	IPEGUARI	14/11/2020 08:04	14/11/2020 10:38	14/11/2020 08:04	14/11/2020 10:38	2,56	3	7,68	CHI
20201162504	GOIANIA	GN12000950	XAVANTES	14/11/2020 08:04	14/11/2020 18:38	14/11/2020 08:04	14/11/2020 18:38	10,56	2	21,12	CHI
20201163958	BARRO ALTO	BA12414688	BARRO ALTO	14/11/2020 08:04	14/11/2020 16:09	14/11/2020 08:04	14/11/2020 16:09	8,08	28	226,11	CHI
20201162083	TRINDADE	40283628	TRINDADE	14/11/2020 08:05	14/11/2020 10:15	14/11/2020 08:05	14/11/2020 10:15	2,17	1	2,17	CHI
20201162085	IPORA	IR21087105	IPORA	14/11/2020 08:05	14/11/2020 09:41	14/11/2020 08:05	14/11/2020 09:41	1,60	1	1,60	CHI
20201162089	CATALAO	1990070805	CATALAO S2	14/11/2020 08:05	14/11/2020 10:09	14/11/2020 08:05	14/11/2020 10:09	2,05	1	2,05	CHI
20201161604	CATALAO	TH12013600RE	CATALAO S1	14/11/2020 08:06	15/11/2020 15:18	14/11/2020 08:06	14/11/2020 10:27	2,36	174	410,06	CHI
20201161604	CUMARI	TH12013600RE	CATALAO S1	14/11/2020 08:06	15/11/2020 15:18	14/11/2020 08:06	14/11/2020 10:27	2,36	1	2,36	CHI
20201161604	TRES RANCHOS	TH12013600RE	CATALAO S1	14/11/2020 08:06	15/11/2020 15:18	14/11/2020 08:06	14/11/2020 10:27	2,36	126	296,94	CHI



20201161604	CATALAO	CT13266260	CATALAO S1	14/11/2020 08:06	15/11/2020 15:18	14/11/2020 10:28	14/11/2020 23:32	13,06	230	3004,82	CHI
20201161604	CUMARI	CT13266260	CATALAO S1	14/11/2020 08:06	15/11/2020 15:18	14/11/2020 10:28	14/11/2020 23:32	13,06	1	13,06	CHI
20201161604	DISTRITO FEDERAL	CT13266260	CATALAO S1	14/11/2020 08:06	15/11/2020 15:18	14/11/2020 10:28	14/11/2020 23:32	13,06	1	13,06	CHI
20201161604	TRES RANCHOS	CT13266260	CATALAO S1	14/11/2020 08:06	15/11/2020 15:18	14/11/2020 10:28	14/11/2020 23:32	13,06	90	1175,80	CHI
20201161604	CATALAO	OU13000061	CATALAO S1	14/11/2020 08:06	15/11/2020 15:18	14/11/2020 23:07	15/11/2020 00:05	0,96	5	4,80	CHI
20201161604	OUVIDOR	OU13000061	CATALAO S1	14/11/2020 08:06	15/11/2020 15:18	14/11/2020 23:07	15/11/2020 00:05	0,96	58	55,71	CHI
20201161604	TRES RANCHOS	OU13000061	CATALAO S1	14/11/2020 08:06	15/11/2020 15:18	14/11/2020 23:07	15/11/2020 00:05	0,96	24	23,05	CHI
20201161604	TRES RANCHOS	TH12013600RE	CATALAO S1	14/11/2020 08:06	15/11/2020 15:18	14/11/2020 10:28	15/11/2020 15:18	28,82	36	1037,63	CHI
20201162104	GOIANIA	GN12151727	XAVANTES	14/11/2020 08:06	14/11/2020 10:36	14/11/2020 08:06	14/11/2020 10:36	2,50	13	32,50	CHI
20201162097	SANTA BARBARA DE GOIAS	SB12234175	TRINDADE	14/11/2020 08:07	14/11/2020 10:13	14/11/2020 08:07	14/11/2020 10:13	2,09	12	25,13	CHI
20201162097	TRINDADE	SB12234175	TRINDADE	14/11/2020 08:07	14/11/2020 10:13	14/11/2020 08:07	14/11/2020 10:13	2,09	1	2,09	CHI
20201162098	RIO VERDE	RV21273753	CABRIUVA S2	14/11/2020 08:07	14/11/2020 10:39	14/11/2020 08:07	14/11/2020 10:39	2,53	2	5,05	CHI
20201162100	PIRENOPOLIS	PV12381291	CORUMBA	14/11/2020 08:07	14/11/2020 10:19	14/11/2020 08:07	14/11/2020 10:19	2,19	3	6,57	CHI
20201162101	PIRANHAS	PH21023561	PIRANHAS	14/11/2020 08:07	14/11/2020 09:51	14/11/2020 08:07	14/11/2020 09:51	1,72	1	1,72	CHI
20201162732	CORUMBA DE GOIAS	CB12382386	CORUMBA	14/11/2020 08:07	14/11/2020 11:30	14/11/2020 08:07	14/11/2020 11:30	3,38	2	6,75	CHI
20201162951	PALMEIRAS DE GOIAS	PL12000091	ANICUNS	14/11/2020 08:08	14/11/2020 10:40	14/11/2020 08:08	14/11/2020 10:40	2,52	7	17,65	CHI
20201162594	ALOANDIA	MR12249786	GOIATUBA S1	14/11/2020 08:09	14/11/2020 10:28	14/11/2020 08:09	14/11/2020 10:28	2,32	15	34,74	CHI
20201162594	MORRINHOS	MR12249786	GOIATUBA S1	14/11/2020 08:09	14/11/2020 10:28	14/11/2020 08:09	14/11/2020 10:28	2,32	6	13,90	CHI
20201162594	PONTALINA	MR12249786	GOIATUBA S1	14/11/2020 08:09	14/11/2020 10:28	14/11/2020 08:09	14/11/2020 10:28	2,32	6	13,90	CHI
20201162741	PIRANHAS	PH12207935	PIRANHAS	14/11/2020 08:09	14/11/2020 14:32	14/11/2020 08:09	14/11/2020 14:32	6,38	4	25,52	CHI
20201162120	IACIARA	IA21262093	IACIARA S1	14/11/2020 08:10	14/11/2020 10:17	14/11/2020 08:10	14/11/2020 10:17	2,11	1	2,11	CHI
20201162123	ARAGUAPAZ	FC12242721	GOIAS	14/11/2020 08:10	14/11/2020 15:46	14/11/2020 08:10	14/11/2020 15:46	7,59	6	45,52	CHI
20201162126	GOIANIA	11617950	AEROPORTO S3	14/11/2020 08:11	14/11/2020 09:34	14/11/2020 08:11	14/11/2020 09:34	1,38	1	1,38	CHI
20201162130	ALEXANIA	AX11096652	ALEXANIA	14/11/2020 08:11	14/11/2020 09:03	14/11/2020 08:11	14/11/2020 09:03	0,86	15	12,83	CHI
20201162290	MARA ROSA	MQ12208421	MARA ROSA	14/11/2020 08:11	14/11/2020 10:49	14/11/2020 08:11	14/11/2020 10:49	2,63	13	34,16	CHI
20201162133	PALESTINA DE GOIAS	PY12395436	PALESTINA	14/11/2020 08:12	14/11/2020 10:26	14/11/2020 08:12	14/11/2020 10:26	2,23	5	11,17	CHI
20201163969	MUTUNOPOLIS	PO12391912	PORANGATU	14/11/2020 08:14	14/11/2020 14:02	14/11/2020 08:14	14/11/2020 14:02	5,79	1	5,79	CHI
20201163969	PORANGATU	PO12391912	PORANGATU	14/11/2020 08:14	14/11/2020 14:02	14/11/2020 08:14	14/11/2020 14:02	5,79	4	23,18	CHI
20201162158	SAO LUIS DE MONTES BELOS	SL21031284	SAO LUIZ DOS MONTES BELOS	14/11/2020 08:16	14/11/2020 13:13	14/11/2020 08:16	14/11/2020 13:13	4,94	3	14,81	CHI
20201161802	MAURILANDIA	ML12303327	RIO DOS BOIS	14/11/2020 08:17	14/11/2020 18:56	14/11/2020 08:17	14/11/2020 18:56	10,64	25	266,04	CHI
20201162164	ITAPACI	IW21123092	RUBIATABA	14/11/2020 08:17	14/11/2020 12:32	14/11/2020 08:17	14/11/2020 12:32	4,24	1	4,24	CHI
20201162165	PALESTINA DE GOIAS	PY21251341	IPORA	14/11/2020 08:18	14/11/2020 10:03	14/11/2020 08:18	14/11/2020 10:03	1,74	1	1,74	CHI
20201171975	MINACU	4020050110	MINACU	14/11/2020 08:18	16/11/2020 08:41	14/11/2020 08:18	16/11/2020 08:41	48,39	1	48,39	CHI
20201162168	BOM JESUS DE GOIAS	BJ2208027	BOM JESUS DE GOIAS	14/11/2020 08:19	14/11/2020 10:35	14/11/2020 08:19	14/11/2020 10:35	2,27	5	11,33	CHI
20201162170	GOIANIA	15536464	FERROVIARIO S3	14/11/2020 08:19	14/11/2020 11:49	14/11/2020 08:19	14/11/2020 11:49	3,51	1	3,51	CHI
20201162173	JATAI	290058065	JATAI S3	14/11/2020 08:19	14/11/2020 09:59	14/11/2020 08:19	14/11/2020 09:59	1,66	1	1,66	CHI
20201162174	PADRE BERNARDO	PB12163211	PADRE BERNARDO	14/11/2020 08:19	14/11/2020 11:12	14/11/2020 08:19	14/11/2020 11:12	2,88	3	8,63	CHI
20201162177	MUNDO NOVO DE GOIAS	MH21037797	NOVA CRIXAS	14/11/2020 08:19	14/11/2020 10:43	14/11/2020 08:19	14/11/2020 10:43	2,39	1	2,39	CHI
20201162630	APARECIDA DE GOIANIA	AP11163698	REAL S1	14/11/2020 08:19	14/11/2020 13:30	14/11/2020 08:19	14/11/2020 13:30	5,18	94	486,82	CHI
20201162185	ADELANDIA	DN12021716	ANICUNS	14/11/2020 08:20	14/11/2020 10:30	14/11/2020 08:20	14/11/2020 10:30	2,16	10	21,61	CHI
20201162186	INHUMAS	10001652620	INHUMAS S2	14/11/2020 08:20	14/11/2020 10:33	14/11/2020 08:20	14/11/2020 10:33	2,21	1	2,21	CHI
20201162190	SANTA HELENA DE GOIAS	SH12296215	IPEGUARI	14/11/2020 08:20	14/11/2020 12:52	14/11/2020 08:20	14/11/2020 12:52	4,52	5	22,60	CHI
20201162198	MUTUNOPOLIS	MU21134092	MARA ROSA	14/11/2020 08:21	18/11/2020 08:23	14/11/2020 08:21	18/11/2020 08:23	96,02	1	96,02	CHI
20201162923	GOIATUBA	GT12000212	BOM JESUS DE GOIAS	14/11/2020 08:21	14/11/2020 15:37	14/11/2020 08:21	14/11/2020 13:29	5,14	4	20,58	CHI
20201162923	GOIATUBA	JV12293221LD	BOM JESUS DE GOIAS	14/11/2020 08:21	14/11/2020 15:37	14/11/2020 08:21	14/11/2020 15:37	7,27	1	7,27	CHI
20201162202	ANAPOLIS	10020861522	ANAPOLIS UNIVERSITARIO S2	14/11/2020 08:22	14/11/2020 10:24	14/11/2020 08:22	14/11/2020 10:24	2,02	1	2,02	CHI
20201162548	SAO MIGUEL DO PASSA QUATRO	SQ12104016	BELA VISTA S2	14/11/2020 08:23	14/11/2020 10:45	14/11/2020 08:23	14/11/2020 10:45	2,37	12	28,38	CHI
20201162548	SILVANIA	SQ12104016	BELA VISTA S2	14/11/2020 08:23	14/11/2020 10:45	14/11/2020 08:23	14/11/2020 10:45	2,37	1	2,37	CHI
20201162214	CACHOEIRA ALTA	CA12322217	CACHOEIRA ALTA	14/11/2020 08:25	14/11/2020 10:03	14/11/2020 08:25	14/11/2020 10:03	1,63	1	1,63	CHI
20201162215	RIO VERDE	10024208173	RIO VERDE S2	14/11/2020 08:25	14/11/2020 10:29	14/11/2020 08:25	14/11/2020 10:29	2,06	1	2,06	CHI
20201162219	BURITI DE GOIAS	BS12332910	FIRMINOPOLIS S2	14/11/2020 08:25	14/11/2020 12:29	14/11/2020 08:25	14/11/2020 12:29	4,05	4	16,22	CHI

20201162224	INDIARA	IY21044019	ACREUNA	14/11/2020 08:25	14/11/2020 11:58	14/11/2020 08:25	14/11/2020 11:58	3,55	1	3,55	CHI
20201162225	PIRENOPOLIS	PV21385773	CORUMBA	14/11/2020 08:26	14/11/2020 12:39	14/11/2020 08:26	14/11/2020 12:39	4,21	4	16,85	CHI
20201160854	GOIATUBA	GT12008246	BOM JESUS DE GOIAS	14/11/2020 08:27	14/11/2020 09:55	14/11/2020 08:27	14/11/2020 09:55	1,46	6	8,74	CHI
20201160975	ITUMBIARA	IT12037085	CACHOEIRA DOURADA	14/11/2020 08:27	14/11/2020 11:17	14/11/2020 08:27	14/11/2020 11:17	2,82	12	33,82	CHI
20201160975	PANAMA	IT12037085	CACHOEIRA DOURADA	14/11/2020 08:27	14/11/2020 11:17	14/11/2020 08:27	14/11/2020 11:17	2,82	12	33,82	CHI
20201162231	MUNDO NOVO DE GOIAS	MH21035579	NOVA CRIXAS	14/11/2020 08:27	14/11/2020 11:48	14/11/2020 08:27	14/11/2020 11:48	3,35	1	3,35	CHI
20201162233	RIO VERDE	RV12024714	RIO VERDE S1	14/11/2020 08:27	14/11/2020 11:54	14/11/2020 08:27	14/11/2020 11:54	3,44	7	24,11	CHI
20201162238	CRISTALINA	KR21165875	CRISTALINA S2	14/11/2020 08:27	14/11/2020 10:35	14/11/2020 08:27	14/11/2020 10:35	2,12	2	4,25	CHI
20201162240	HIDROLANDIA	HD21007411	CEPAIGO S2	14/11/2020 08:27	14/11/2020 16:24	14/11/2020 08:27	14/11/2020 16:24	7,95	1	7,95	CHI
20201162241	RIO VERDE	RV11271718	RIO VERDE S2	14/11/2020 08:27	14/11/2020 23:12	14/11/2020 08:27	14/11/2020 23:12	14,74	13	191,60	CHI
20201162242	CORUMBA DE GOIAS	CB21381643	CORUMBA	14/11/2020 08:27	14/11/2020 11:11	14/11/2020 08:27	14/11/2020 11:11	2,72	1	2,72	CHI
20201162309	TRINDADE	TR32032838	TRINDADE	14/11/2020 08:27	14/11/2020 12:33	14/11/2020 08:27	14/11/2020 12:33	4,09	14	57,28	CHI
20201163029	SANTA FE DE GOIAS	RN12274295	BRITANIA	14/11/2020 08:28	14/11/2020 11:18	14/11/2020 08:28	14/11/2020 11:18	2,83	2	5,66	CHI
20201162252	GOIANIA	10018451894	CARAJAS S2	14/11/2020 08:29	14/11/2020 10:05	14/11/2020 08:29	14/11/2020 10:05	1,60	1	1,60	CHI
20201162253	NIQUELANDIA	NQ11280496	NIQUELANDIA SUBTRANSMISSAO	14/11/2020 08:29	15/11/2020 08:34	14/11/2020 08:29	15/11/2020 08:34	24,08	1	24,08	CHI
20201162254	IPORA	730007832	IPORA	14/11/2020 08:29	14/11/2020 10:20	14/11/2020 08:29	14/11/2020 10:20	1,85	1	1,85	CHI
20201162260	NOVA CRIXAS	NA21103787	MOZARLANDIA	14/11/2020 08:29	14/11/2020 11:00	14/11/2020 08:29	14/11/2020 11:00	2,51	1	2,51	CHI
20201162263	GOIANIA	GN11169133	CARAJAS S1	14/11/2020 08:29	14/11/2020 13:05	14/11/2020 08:29	14/11/2020 13:05	4,59	48	220,20	CHI
20201162264	ABADIANIA	AA21050461	ANAPOLIS UNIVERSITARIO S1	14/11/2020 08:29	14/11/2020 13:46	14/11/2020 08:29	14/11/2020 13:46	5,27	1	5,27	CHI
20201162377	GOIANIA	GN10394643	XAVANTES	14/11/2020 08:29	14/11/2020 19:16	14/11/2020 08:32	14/11/2020 10:57	2,42	9	21,78	CHI
20201162377	GOIANIA	GN13050578	XAVANTES	14/11/2020 08:29	14/11/2020 19:16	14/11/2020 08:32	14/11/2020 11:26	2,89	526	1522,33	CHI
20201162377	GOIANIA	GN13066497	XAVANTES	14/11/2020 08:29	14/11/2020 19:16	14/11/2020 08:32	14/11/2020 12:43	4,18	35	146,19	CHI
20201162377	GOIANIA	GN12090095LD	XAVANTES	14/11/2020 08:29	14/11/2020 19:16	14/11/2020 08:32	14/11/2020 15:02	6,50	16	104,04	CHI
20201162377	GOIANIA	GN12000859LD	XAVANTES	14/11/2020 08:29	14/11/2020 19:16	14/11/2020 08:32	14/11/2020 17:09	8,61	9	77,53	CHI
20201162377	NEROPOLIS	GN12000859LD	XAVANTES	14/11/2020 08:29	14/11/2020 19:16	14/11/2020 08:32	14/11/2020 17:09	8,61	16	137,83	CHI
20201162377	GOIANIA	GN12162544LD	XAVANTES	14/11/2020 08:29	14/11/2020 19:16	14/11/2020 08:32	14/11/2020 19:16	10,73	3	32,19	CHI
20201162377	NEROPOLIS	GN12162544LD	XAVANTES	14/11/2020 08:29	14/11/2020 19:16	14/11/2020 08:32	14/11/2020 19:16	10,73	10	107,29	CHI
20201163059	PIRACANJUBA	PJ12000104	CALDAS NOVAS S1	14/11/2020 08:29	14/11/2020 14:01	14/11/2020 08:29	14/11/2020 14:01	5,52	13	71,81	CHI
20201163386	HIDROLANDIA	HD12120557	CEPAIGO S2	14/11/2020 08:29	14/11/2020 16:50	14/11/2020 08:29	14/11/2020 16:50	8,34	18	150,20	CHI
20201162271	CORUMBA DE GOIAS	CB21235598	CORUMBA	14/11/2020 08:30	14/11/2020 13:09	14/11/2020 08:30	14/11/2020 13:09	4,64	1	4,64	CHI
20201162273	GOIANESIA	GE21000209	GOIANESIA S2	14/11/2020 08:30	14/11/2020 18:52	14/11/2020 08:30	14/11/2020 18:52	10,36	1	10,36	CHI
20201162516	INHUMAS	IN12000220	INHUMAS S2	14/11/2020 08:30	14/11/2020 09:38	14/11/2020 08:30	14/11/2020 09:38	1,14	687	784,13	CHI
20201162572	TURVELANDIA	TD12000243	RIO DOS BOIS	14/11/2020 08:30	15/11/2020 02:21	14/11/2020 08:30	15/11/2020 02:21	17,86	14	250,09	CHI
20201162572	TURVELANDIA	TD12000243	RIO DOS BOIS	14/11/2020 08:30	15/11/2020 02:21	14/11/2020 22:49	15/11/2020 02:21	3,54	5	17,70	CHI
20201162278	ALTO PARAISO DE GOIAS	BF12253174	NIQUELANDIA SUBTRANSMISSAO	14/11/2020 08:31	14/11/2020 11:56	14/11/2020 08:31	14/11/2020 11:56	3,41	4	13,63	CHI
20201162278	COLINAS DO SUL	BF12253174	NIQUELANDIA SUBTRANSMISSAO	14/11/2020 08:31	14/11/2020 11:56	14/11/2020 08:31	14/11/2020 11:56	3,41	3	10,22	CHI
20201162846	ANICUNS	AR12326202	ARACU	14/11/2020 08:31	14/11/2020 22:56	14/11/2020 08:31	14/11/2020 22:56	14,40	33	475,27	CHI
20201162846	ITABERAI	AR12326202	ARACU	14/11/2020 08:31	14/11/2020 22:56	14/11/2020 08:31	14/11/2020 22:56	14,40	3	43,21	CHI
20201163083	ANICUNS	910076121	ANICUNS	14/11/2020 08:31	14/11/2020 23:45	14/11/2020 08:31	14/11/2020 23:45	15,22	1	15,22	CHI
20201162287	PARAUNA	PU21336642	ACREUNA	14/11/2020 08:32	14/11/2020 23:27	14/11/2020 08:32	14/11/2020 23:27	14,91	1	14,91	CHI
20201162292	VILA PROPICIO	PV21074934	GOIANESIA S1	14/11/2020 08:32	14/11/2020 17:41	14/11/2020 08:32	14/11/2020 17:41	9,14	1	9,14	CHI
20201162412	IVOLANDIA	IV12381057	IPORA	14/11/2020 08:32	14/11/2020 11:24	14/11/2020 08:32	14/11/2020 11:24	2,86	8	22,91	CHI
20201162294	JATAI	JT11083534	JATAI S2	14/11/2020 08:33	14/11/2020 10:30	14/11/2020 08:33	14/11/2020 10:30	1,95	1	1,95	CHI
20201162298	NIQUELANDIA	NQ11280416	NIQUELANDIA SUBTRANSMISSAO	14/11/2020 08:33	15/11/2020 07:41	14/11/2020 08:33	15/11/2020 07:41	23,12	1	23,12	CHI
20201162300	SIMOLANDIA	SA12268176	IACIARA S2	14/11/2020 08:33	14/11/2020 10:10	14/11/2020 08:33	14/11/2020 10:10	1,61	1	1,61	CHI
20201162407	GOIATUBA	BJ12000128	BOM JESUS DE GOIAS	14/11/2020 08:33	14/11/2020 16:48	14/11/2020 08:33	14/11/2020 16:48	8,24	8	65,90	CHI
20201165642	MINACU	IH12088797	MINACU	14/11/2020 08:33	14/11/2020 22:16	14/11/2020 08:33	14/11/2020 22:16	13,72	179	2455,28	CHI
20201162313	SANTO ANTONIO DE GOIAS	10008344076	NEROPOLIS S1	14/11/2020 08:34	14/11/2020 15:49	14/11/2020 08:34	14/11/2020 15:49	7,24	1	7,24	CHI
20201162419	IACIARA	IA12394108	IACIARA S1	14/11/2020 08:34	14/11/2020 10:11	14/11/2020 08:34	14/11/2020 10:11	1,60	7	11,22	CHI
20201162318	ALTO PARAISO DE GOIAS	BF21280069	NIQUELANDIA SUBTRANSMISSAO	14/11/2020 08:35	14/11/2020 10:16	14/11/2020 08:35	14/11/2020 10:16	1,68	1	1,68	CHI
20201162326	JARAGUA	JA21116888	JARAGUA	14/11/2020 08:36	14/11/2020 11:56	14/11/2020 08:36	14/11/2020 11:56	3,33	1	3,33	CHI

20201162330	JARAGUA	JA21130466	JARAGUA	14/11/2020 08:36	14/11/2020 13:08	14/11/2020 08:36	14/11/2020 13:08	4,52	1	4,52	CHI
20201162332	INDIARA	JD12391452	PALMEIRAS	14/11/2020 08:36	14/11/2020 22:33	14/11/2020 08:36	14/11/2020 22:33	13,94	5	69,69	CHI
20201162332	JANDAIA	JD12391452	PALMEIRAS	14/11/2020 08:36	14/11/2020 22:33	14/11/2020 08:36	14/11/2020 22:33	13,94	4	55,76	CHI
20201162333	SAO MIGUEL DO ARAGUAIA	SM21328609	SAO MIGUEL DO ARAGUAIA	14/11/2020 08:36	14/11/2020 14:07	14/11/2020 08:36	14/11/2020 14:07	5,50	1	5,50	CHI
20201162334	URUACU	UR21050044	URUACU	14/11/2020 08:36	14/11/2020 14:39	14/11/2020 08:36	14/11/2020 14:39	6,03	2	12,07	CHI
20201162335	QUIRINOPOLIS	QI12091109	QUIRINOPOLIS	14/11/2020 08:37	14/11/2020 10:19	14/11/2020 08:37	14/11/2020 10:19	1,70	3	5,10	CHI
20201162338	APARECIDA DE GOIANIA	AP11377665	INDEPENDENCIA S2	14/11/2020 08:37	14/11/2020 15:48	14/11/2020 08:37	14/11/2020 15:48	7,17	106	760,34	CHI
20201162339	GOIANDIRA	GD21237114	CATALAO S1	14/11/2020 08:37	14/11/2020 19:50	14/11/2020 08:37	14/11/2020 19:50	11,21	1	11,21	CHI
20201162341	SILVANIA	VN12036451RE	VIANOPOLIS	14/11/2020 08:37	14/11/2020 20:01	14/11/2020 08:37	14/11/2020 20:01	11,39	73	831,29	CHI
20201162341	VIANOPOLIS	VN12036451RE	VIANOPOLIS	14/11/2020 08:37	14/11/2020 20:01	14/11/2020 08:37	14/11/2020 20:01	11,39	23	261,91	CHI
20201162343	GOIANIA	15981253	ATLANTICO S3	14/11/2020 08:37	14/11/2020 11:14	14/11/2020 08:37	14/11/2020 11:14	2,60	1	2,60	CHI
20201162408	PIRACANJUBA	PJ12263070	PIRACANJUBA	14/11/2020 08:37	14/11/2020 17:46	14/11/2020 08:37	14/11/2020 17:46	9,14	5	45,69	CHI
20201162464	CATALAO	CT12394011RE	CATALAO S1	14/11/2020 08:37	14/11/2020 12:57	14/11/2020 08:37	14/11/2020 12:57	4,33	53	229,49	CHI
20201162464	OUVIDOR	CT12394011RE	CATALAO S1	14/11/2020 08:37	14/11/2020 12:57	14/11/2020 08:37	14/11/2020 12:57	4,33	36	155,88	CHI
20201162346	GOIANIA	14589709	REAL S2	14/11/2020 08:38	14/11/2020 16:10	14/11/2020 08:38	14/11/2020 16:10	7,53	1	7,53	CHI
20201162351	MONTIVIDIU	MV21296203	MONTIVIDIU T	14/11/2020 08:38	14/11/2020 10:26	14/11/2020 08:38	14/11/2020 10:26	1,78	1	1,78	CHI
20201163139	ABADIANIA	AA12302116	ANAPOLIS UNIVERSITARIO S1	14/11/2020 08:38	14/11/2020 11:54	14/11/2020 08:38	14/11/2020 11:54	3,26	16	52,08	CHI
20201163139	CORUMBA DE GOIAS	AA12302116	ANAPOLIS UNIVERSITARIO S1	14/11/2020 08:38	14/11/2020 11:54	14/11/2020 08:38	14/11/2020 11:54	3,26	1	3,26	CHI
20201163295	HIDROLANDIA	HD12046375	INDEPENDENCIA S1	14/11/2020 08:38	14/11/2020 15:29	14/11/2020 08:38	14/11/2020 15:29	6,85	6	41,07	CHI
20201162358	LUZIANIA	LZ12396829	MARAJOARA	14/11/2020 08:40	14/11/2020 10:26	14/11/2020 08:40	14/11/2020 10:26	1,77	2	3,53	CHI
20201162359	SAO JOAO D ALIANCA	JL12268121	SAO JOAO D ALIANCA	14/11/2020 08:40	14/11/2020 10:39	14/11/2020 08:40	14/11/2020 10:39	1,98	8	15,86	CHI
20201162360	TURVELANDIA	1760006443	RIO DOS BOIS	14/11/2020 08:40	15/11/2020 01:03	14/11/2020 08:40	15/11/2020 01:03	16,38	1	16,38	CHI
20201162361	LEOPOLDO DE BULHOES	LB11347621	DAIA S2	14/11/2020 08:40	15/11/2020 10:36	14/11/2020 08:40	15/11/2020 10:36	25,93	6	155,57	CHI
20201162362	PIRENOPOLIS	PV21171287	CORUMBA	14/11/2020 08:40	14/11/2020 15:03	14/11/2020 08:40	14/11/2020 15:03	6,38	1	6,38	CHI
20201163038	MOSSAMEDES	MD12266391	FIRMINOPOLIS S2	14/11/2020 08:41	14/11/2020 11:22	14/11/2020 08:41	14/11/2020 11:22	2,67	85	226,78	CHI
20201162391	PORTEIRO	CL12195964	RIO DOS BOIS	14/11/2020 08:42	14/11/2020 10:58	14/11/2020 08:42	14/11/2020 10:58	2,26	1	2,26	CHI
20201162395	SANTA HELENA DE GOIAS	19934605	IPEGUARI	14/11/2020 08:42	14/11/2020 17:17	14/11/2020 08:42	14/11/2020 17:17	8,58	2	17,16	CHI
20201162404	SAO LUIS DE MONTES BELOS	SL12125618	FIRMINOPOLIS S1	14/11/2020 08:44	14/11/2020 12:30	14/11/2020 08:44	14/11/2020 12:30	3,77	2	7,53	CHI
20201162405	GOIANIA	GN12098424	XAVANTES	14/11/2020 08:44	14/11/2020 20:57	14/11/2020 08:44	14/11/2020 20:57	12,21	19	232,07	CHI
20201164433	GOIANDIRA	GD12127686	CATALAO S1	14/11/2020 08:44	14/11/2020 16:35	14/11/2020 08:44	14/11/2020 16:35	7,84	2	15,67	CHI
20201162418	SAO LUIS DE MONTES BELOS	SL31145796	SAO LUIZ DOS MONTES BELOS	14/11/2020 08:45	14/11/2020 17:33	14/11/2020 08:45	14/11/2020 17:33	8,80	1	8,80	CHI
20201162424	GOIANIA	10001169210	GOYA S2	14/11/2020 08:45	14/11/2020 11:17	14/11/2020 08:45	14/11/2020 11:17	2,52	1	2,52	CHI
202011137989	ANICUNS	AC12158912	FIRMINOPOLIS S2	14/11/2020 08:45	14/11/2020 13:20	14/11/2020 08:45	14/11/2020 13:20	4,57	59	269,73	CHI
20201162426	TRINDADE	TR31052845	TRINDADE	14/11/2020 08:46	14/11/2020 10:17	14/11/2020 08:46	14/11/2020 10:17	1,51	1	1,51	CHI
20201162427	CAIAPONIA	CP12334952	CAIAPONIA	14/11/2020 08:46	14/11/2020 10:59	14/11/2020 08:46	14/11/2020 10:59	2,21	37	81,82	CHI
20201162432	URUTAI	UT21107765	URUTAI	14/11/2020 08:46	14/11/2020 11:50	14/11/2020 08:46	14/11/2020 11:50	3,05	1	3,05	CHI
20201162436	LUZIANIA	LZ12376136	CRISTALINA S2	14/11/2020 08:47	14/11/2020 10:30	14/11/2020 08:47	14/11/2020 10:30	1,70	5	8,52	CHI
20201164629	CALDAS NOVAS	MR12189844	MORRINHOS	14/11/2020 08:47	14/11/2020 22:23	14/11/2020 08:47	14/11/2020 22:23	13,59	7	95,11	CHI
20201164629	MORRINHOS	MR12189844	MORRINHOS	14/11/2020 08:47	14/11/2020 22:23	14/11/2020 08:47	14/11/2020 22:23	13,59	20	271,76	CHI
20201164629	PIRACANJUBA	MR12189844	MORRINHOS	14/11/2020 08:47	14/11/2020 22:23	14/11/2020 08:47	14/11/2020 22:23	13,59	48	652,21	CHI
20201162767	SANTA CRUZ DE GOIAS	PJ12212218	PIRACANJUBA	14/11/2020 08:48	14/11/2020 13:07	14/11/2020 08:48	14/11/2020 13:07	4,31	16	68,95	CHI
20201162962	GOIANIA	GN11104829	REAL S2	14/11/2020 08:48	14/11/2020 14:54	14/11/2020 08:48	14/11/2020 14:54	6,09	91	554,47	CHI
20201162459	AGUA FRIA DE GOIAS	TL12204618	SAO JOAO D ALIANCA	14/11/2020 08:50	14/11/2020 12:15	14/11/2020 08:50	14/11/2020 12:15	3,42	6	20,49	CHI
20201162460	APARECIDA DE GOIANIA	AP11025495	ANHANGUERA	14/11/2020 08:50	14/11/2020 12:41	14/11/2020 08:50	14/11/2020 12:41	3,85	147	565,70	CHI
20201163172	PARAUNA	RV12306606	MONTIVIDIU T	14/11/2020 08:50	14/11/2020 15:55	14/11/2020 08:50	14/11/2020 15:55	7,08	16	113,29	CHI
20201162468	PALMEIRAS DE GOIAS	PL12276902	PALMEIRAS	14/11/2020 08:51	14/11/2020 11:57	14/11/2020 08:51	14/11/2020 11:57	3,09	67	207,35	CHI
20201162817	GOIANIA	GN11002187	MEIA PONTE	14/11/2020 08:51	14/11/2020 12:19	14/11/2020 08:51	14/11/2020 12:19	3,46	134	463,57	CHI
20201162476	CIDADE OCIDENTAL	DH11169048	MARAJOARA	14/11/2020 08:52	14/11/2020 12:01	14/11/2020 08:52	14/11/2020 12:01	3,15	117	368,16	CHI
20201162479	PIRACANJUBA	PJ21267288	PIRACANJUBA	14/11/2020 08:52	14/11/2020 12:48	14/11/2020 08:52	14/11/2020 12:48	3,93	2	7,86	CHI
20201162481	PADRE BERNARDO	PB21344760	PADRE BERNARDO	14/11/2020 08:52	14/11/2020 12:09	14/11/2020 08:52	14/11/2020 12:09	3,27	1	3,27	CHI
20201162487	ALEXANIA	AX12094490	ALEXANIA	14/11/2020 08:53	15/11/2020 20:31	14/11/2020 08:53	15/11/2020 20:31	35,62	3	106,86	CHI

20201162493	MOIPORA	MO21374960	IPORA	14/11/2020 08:54	14/11/2020 11:05	14/11/2020 08:54	14/11/2020 11:05	2,17	1	2,17	CHI
20201162826	BELA VISTA DE GOIAS	BV12000239RE	BELA VISTA S1	14/11/2020 08:54	14/11/2020 16:21	14/11/2020 08:54	14/11/2020 16:21	7,44	10	74,38	CHI
20201162826	PIRACANJUBA	BV12000239RE	BELA VISTA S1	14/11/2020 08:54	14/11/2020 16:21	14/11/2020 08:54	14/11/2020 16:21	7,44	18	133,89	CHI
20201162506	PETROLINA DE GOIAS	PG21152966	PETROLINA	14/11/2020 08:55	14/11/2020 15:52	14/11/2020 08:55	14/11/2020 15:52	6,94	2	13,87	CHI
20201162507	GOIANIA	12012713	REAL S2	14/11/2020 08:55	14/11/2020 10:47	14/11/2020 08:55	14/11/2020 10:47	1,85	1	1,85	CHI
20201162511	ANAPOLIS	20051530	JUNDIAI S2	14/11/2020 08:56	14/11/2020 12:11	14/11/2020 08:56	14/11/2020 12:11	3,25	1	3,25	CHI
20201162519	FORMOSA	10032973797	ITUIQUIRA	14/11/2020 08:56	14/11/2020 10:36	14/11/2020 08:56	14/11/2020 10:36	1,65	0	0,00	CHI
20201162524	GOIANIRA	GR31045841	MEIA PONTE	14/11/2020 08:57	14/11/2020 10:51	14/11/2020 08:57	14/11/2020 10:51	1,90	5	9,48	CHI
20201162641	CAIAPONIA	CP12235316	PIRANHAS	14/11/2020 08:57	14/11/2020 12:20	14/11/2020 08:57	14/11/2020 12:20	3,37	6	20,21	CHI
20201163097	NIQUELANDIA	NQ12281264	NIQUELANDIA SUBTRANSMISSAO	14/11/2020 08:57	14/11/2020 13:48	14/11/2020 08:57	14/11/2020 13:48	4,84	32	154,87	CHI
20201162535	BOM JARDIM DE GOIAS	BM21155802	ARAGARCAS	14/11/2020 08:58	14/11/2020 11:06	14/11/2020 08:58	14/11/2020 11:06	2,13	2	4,26	CHI
20201162537	PADRE BERNARDO	PB12330834	PADRE BERNARDO	14/11/2020 08:58	14/11/2020 11:59	14/11/2020 08:58	14/11/2020 11:59	3,01	2	6,01	CHI
20201163583	CAMPINORTE	MQ12051960	MARA ROSA	14/11/2020 08:58	14/11/2020 17:30	14/11/2020 08:58	14/11/2020 17:30	8,52	2	17,04	CHI
20201162541	AGUAS LINDAS DE GOIAS	10002999577	AGUAS LINDAS DE GOIAS S1	14/11/2020 08:59	14/11/2020 11:42	14/11/2020 08:59	14/11/2020 11:42	2,71	1	2,71	CHI
20201162546	ACREUNA	3330000865	ACREUNA	14/11/2020 08:59	14/11/2020 11:50	14/11/2020 08:59	14/11/2020 11:50	2,83	1	2,83	CHI
20201162550	JATAI	JT21327044	CABRIUVA S2	14/11/2020 09:00	14/11/2020 23:01	14/11/2020 09:00	14/11/2020 23:01	14,01	1	14,01	CHI
20201162551	RIO VERDE	630587152	RIO VERDE S1	14/11/2020 09:00	14/11/2020 11:04	14/11/2020 09:00	14/11/2020 11:04	2,06	1	2,06	CHI
20201162554	JATAI	JT12264321	JATAI S2	14/11/2020 09:00	14/11/2020 11:01	14/11/2020 09:00	14/11/2020 11:01	2,01	72	144,84	CHI
20201162559	LUZIANIA	LZ12051365	CRISTALINA S2	14/11/2020 09:01	15/11/2020 13:10	14/11/2020 09:01	15/11/2020 13:10	28,15	3	84,44	CHI
20201162559	LUZIANIA	LZ12051365	CRISTALINA S2	14/11/2020 09:01	15/11/2020 13:10	14/11/2020 14:10	15/11/2020 13:10	22,99	4	91,97	CHI
20201162571	ANAPOLIS	AN12261221	ANAPOLIS UNIVERSITARIO S1	14/11/2020 09:02	14/11/2020 11:41	14/11/2020 09:02	14/11/2020 11:41	2,64	6	15,82	CHI
20201162574	BOM JARDIM DE GOIAS	BM12369833	BOM JARDIM	14/11/2020 09:03	14/11/2020 11:28	14/11/2020 09:03	14/11/2020 11:28	2,41	5	12,05	CHI
20201162576	RIO VERDE	RV12260611	CABRIUVA S1	14/11/2020 09:03	14/11/2020 12:06	14/11/2020 09:03	14/11/2020 12:06	3,04	1	3,04	CHI
20201162620	AMARALINA	LC12227062	MARA ROSA	14/11/2020 09:03	14/11/2020 11:43	14/11/2020 09:03	14/11/2020 11:43	2,65	3	7,95	CHI
20201162578	ITABERAI	IB12388562	ITABERAI S1	14/11/2020 09:04	14/11/2020 12:22	14/11/2020 09:04	14/11/2020 12:22	3,30	3	9,89	CHI
20201162745	CORUMBA DE GOIAS	CB12348149	CORUMBA	14/11/2020 09:04	14/11/2020 10:53	14/11/2020 09:04	14/11/2020 10:53	1,80	2	3,60	CHI
20201162902	ACREUNA	EU12296081	ACREUNA	14/11/2020 09:04	15/11/2020 08:55	14/11/2020 09:04	15/11/2020 08:55	23,84	7	166,85	CHI
20201162902	PARAUNA	EU12296081	ACREUNA	14/11/2020 09:04	15/11/2020 08:55	14/11/2020 09:04	15/11/2020 08:55	23,84	1	23,84	CHI
20201162593	PIRANHAS	PH12231174	ARENOPOLIS	14/11/2020 09:05	14/11/2020 11:53	14/11/2020 09:05	14/11/2020 11:53	2,79	3	8,38	CHI
20201162598	GOIANIA	GN11113565	CAMPINAS S3	14/11/2020 09:05	14/11/2020 12:45	14/11/2020 09:05	14/11/2020 12:45	3,66	91	332,66	CHI
20201163159	BELA VISTA DE GOIAS	SQ12318949RE	CRISTIANOPOLIS	14/11/2020 09:05	14/11/2020 12:41	14/11/2020 09:05	14/11/2020 12:41	3,59	18	64,63	CHI
20201163159	SAO MIGUEL DO PASSA QUATRO	SQ12318949RE	CRISTIANOPOLIS	14/11/2020 09:05	14/11/2020 12:41	14/11/2020 09:05	14/11/2020 12:41	3,59	5	17,95	CHI
20201163344	MORRINHOS	MR12239051	MORRINHOS	14/11/2020 09:05	14/11/2020 20:26	14/11/2020 09:05	14/11/2020 20:26	11,34	10	113,40	CHI
20201162603	CATALAO	10023358864	CATALAO S2	14/11/2020 09:06	14/11/2020 16:57	14/11/2020 09:06	14/11/2020 16:57	7,85	1	7,85	CHI
20201162619	TRINDADE	40132158	TRINDADE	14/11/2020 09:07	14/11/2020 12:12	14/11/2020 09:07	14/11/2020 12:12	3,07	1	3,07	CHI
20201162621	NIQUELANDIA	NQ12330278	NIQUELANDIA SUBTRANSMISSAO	14/11/2020 09:07	14/11/2020 23:06	14/11/2020 09:07	14/11/2020 23:06	13,97	6	83,80	CHI
20201162728	HIDROLINA	2600424	ITAPACI	14/11/2020 09:07	14/11/2020 09:23	14/11/2020 09:07	14/11/2020 09:14	0,11	53	5,86	CHI
20201162728	SAO LUIZ DO NORTE	2600424	ITAPACI	14/11/2020 09:07	14/11/2020 09:23	14/11/2020 09:07	14/11/2020 09:14	0,11	1006	111,22	CHI
20201162728	SAO LUIZ DO NORTE	2600424	ITAPACI	14/11/2020 09:07	14/11/2020 09:23	14/11/2020 09:07	14/11/2020 09:15	0,12	902	110,24	CHI
20201162728	HIDROLINA	2600424	ITAPACI	14/11/2020 09:07	14/11/2020 09:23	14/11/2020 09:07	14/11/2020 09:15	0,12	112	13,84	CHI
20201162728	SAO LUIZ DO NORTE	2600424	ITAPACI	14/11/2020 09:07	14/11/2020 09:23	14/11/2020 09:07	14/11/2020 09:15	0,12	10	1,24	CHI
20201162728	ITAPACI	2600424	ITAPACI	14/11/2020 09:07	14/11/2020 09:23	14/11/2020 09:07	14/11/2020 09:22	0,24	3	0,73	CHI
20201162728	NOVA GLORIA	2600424	ITAPACI	14/11/2020 09:07	14/11/2020 09:23	14/11/2020 09:07	14/11/2020 09:22	0,24	1	0,24	CHI
20201162728	SAO LUIZ DO NORTE	2600424	ITAPACI	14/11/2020 09:07	14/11/2020 09:23	14/11/2020 09:07	14/11/2020 09:22	0,24	117	28,44	CHI
20201162728	SAO LUIZ DO NORTE	SZ10395412	ITAPACI	14/11/2020 09:07	14/11/2020 09:23	14/11/2020 09:09	14/11/2020 09:22	0,22	1	0,22	CHI
20201162728	GOIANESIA	2600424	ITAPACI	14/11/2020 09:07	14/11/2020 09:23	14/11/2020 09:07	14/11/2020 09:23	0,25	12	3,04	CHI
20201162728	SANTA ISABEL	2600424	ITAPACI	14/11/2020 09:07	14/11/2020 09:23	14/11/2020 09:07	14/11/2020 09:23	0,25	5	1,27	CHI
20201162728	SAO LUIZ DO NORTE	2600424	ITAPACI	14/11/2020 09:07	14/11/2020 09:23	14/11/2020 09:07	14/11/2020 09:23	0,25	152	38,46	CHI
20201162728	GOIANESIA	2600424	GOIANESIA S1	14/11/2020 09:07	14/11/2020 09:23	14/11/2020 09:09	14/11/2020 09:23	0,23	396	92,62	CHI
20201162728	GOIANESIA	2600424	GOIANESIA S1	14/11/2020 09:07	14/11/2020 09:23	14/11/2020 09:09	14/11/2020 09:23	0,23	608	142,20	CHI
20201162728	GOIANESIA	2600424	GOIANESIA S1	14/11/2020 09:07	14/11/2020 09:23	14/11/2020 09:09	14/11/2020 09:23	0,23	1	0,23	CHI

20201162728	NOVA GLORIA	2600424	GOIANESIA S1	14/11/2020 09:07	14/11/2020 09:23	14/11/2020 09:09	14/11/2020 09:23	0,23	2	0,47	CHI
20201162728	SANTA ISABEL	2600424	GOIANESIA S1	14/11/2020 09:07	14/11/2020 09:23	14/11/2020 09:09	14/11/2020 09:23	0,23	2	0,47	CHI
20201162728	SANTA ISABEL	2600424	GOIANESIA S1	14/11/2020 09:07	14/11/2020 09:23	14/11/2020 09:09	14/11/2020 09:23	0,23	31	7,25	CHI
20201162728	SAO LUIZ DO NORTE	2600424	GOIANESIA S1	14/11/2020 09:07	14/11/2020 09:23	14/11/2020 09:09	14/11/2020 09:23	0,23	21	4,91	CHI
20201162728	SAO LUIZ DO NORTE	SZ10410838	ITAPACI	14/11/2020 09:07	14/11/2020 09:23	14/11/2020 09:09	14/11/2020 09:23	0,23	1	0,23	CHI
20201162797	CAIAPONIA	CP12207988	CAIAPONIA	14/11/2020 09:07	14/11/2020 10:37	14/11/2020 09:07	14/11/2020 10:37	1,49	2	2,98	CHI
20201162978	MONTIVIDIU DO NORTE	MX12143686RE	PORANGATU	14/11/2020 09:07	15/11/2020 09:31	14/11/2020 09:07	15/11/2020 09:31	24,39	104	2536,91	CHI
20201163899	AMARALINA	LC12216163	MARA ROSA	14/11/2020 09:07	14/11/2020 14:49	14/11/2020 09:07	14/11/2020 14:49	5,70	5	28,48	CHI
20201162622	PORTELANDIA	PW12072215	PARQUE DAS EMAS	14/11/2020 09:08	14/11/2020 17:25	14/11/2020 09:08	14/11/2020 17:25	8,28	3	24,85	CHI
20201162623	CUMARI	CY21071479	CATALAO S1	14/11/2020 09:08	14/11/2020 14:47	14/11/2020 09:08	14/11/2020 14:47	5,65	1	5,65	CHI
20201162624	PIRACANJUBA	PJ21115882	PIRACANJUBA	14/11/2020 09:08	14/11/2020 12:03	14/11/2020 09:08	14/11/2020 12:03	2,91	1	2,91	CHI
20201162631	GOIANIA	10468500	AEROPORTO S2	14/11/2020 09:08	14/11/2020 15:25	14/11/2020 09:08	14/11/2020 15:25	6,27	1	6,27	CHI
20201162634	GOIANIA	16209679	FERROVIARIO S1	14/11/2020 09:08	14/11/2020 10:33	14/11/2020 09:08	14/11/2020 10:33	1,40	1	1,40	CHI
20201162652	ANICUNS	AC12259090	FIRMINOPOLIS S2	14/11/2020 09:08	14/11/2020 17:24	14/11/2020 09:08	14/11/2020 17:24	8,26	30	247,66	CHI
20201162642	TRINDADE	TR12051537	TRINDADE	14/11/2020 09:09	14/11/2020 12:51	14/11/2020 09:09	14/11/2020 12:51	3,69	6	22,13	CHI
20201162647	CORREGO DO OURO	CO12383516	FIRMINOPOLIS S2	14/11/2020 09:10	14/11/2020 10:25	14/11/2020 09:10	14/11/2020 10:25	1,25	8	9,98	CHI
20201162651	APARECIDA DE GOIANIA	AP11032407	REAL S1	14/11/2020 09:10	14/11/2020 13:53	14/11/2020 09:10	14/11/2020 13:53	4,71	83	390,56	CHI
20201162653	CORUMBA DE GOIAS	CB21148321	CORUMBA	14/11/2020 09:10	14/11/2020 12:05	14/11/2020 09:10	14/11/2020 12:05	2,90	1	2,90	CHI
20201163071	GUAPO	VJ12000056	GUAPO S2	14/11/2020 09:10	14/11/2020 12:48	14/11/2020 09:10	14/11/2020 12:48	3,63	48	174,27	CHI
20201163071	VARJAO	VJ12000056	GUAPO S2	14/11/2020 09:10	14/11/2020 12:48	14/11/2020 09:10	14/11/2020 12:48	3,63	78	283,18	CHI
20201162656	IPORA	IR12243781	IPORA	14/11/2020 09:11	14/11/2020 15:49	14/11/2020 09:11	14/11/2020 15:49	6,64	4	26,56	CHI
20201162657	CATALAO	CT12166743RE	CATALAO S1	14/11/2020 09:11	14/11/2020 15:59	14/11/2020 09:11	14/11/2020 15:59	6,80	31	210,71	CHI
20201162660	PIRACANJUBA	PJ12394016	CRISTIANOPOLIS	14/11/2020 09:11	14/11/2020 11:09	14/11/2020 09:11	14/11/2020 11:09	1,95	2	3,91	CHI
20201162664	TRINDADE	10005812982	TRINDADE	14/11/2020 09:12	14/11/2020 13:43	14/11/2020 09:12	14/11/2020 13:43	4,51	1	4,51	CHI
20201162669	SAO MIGUEL DO ARAGUAIA	SM12039297	SAO MIGUEL DO ARAGUAIA	14/11/2020 09:13	15/11/2020 22:26	14/11/2020 09:13	15/11/2020 22:26	37,21	1	37,21	CHI
20201162670	GOIANIA	10019544829	AEROPORTO S2	14/11/2020 09:13	14/11/2020 13:05	14/11/2020 09:13	14/11/2020 13:05	3,86	1	3,86	CHI
20201162671	CACHOEIRA DOURADA	CD21296952	CACHOEIRA DOURADA	14/11/2020 09:13	14/11/2020 12:42	14/11/2020 09:13	14/11/2020 12:42	3,48	1	3,48	CHI
20201162672	ITABERAI	IB21172726	ITABERAI S2	14/11/2020 09:13	14/11/2020 17:06	14/11/2020 09:13	14/11/2020 17:06	7,88	1	7,88	CHI
20201162680	GOIANIA	12112811	FERROVIARIO S2	14/11/2020 09:13	14/11/2020 14:43	14/11/2020 09:13	14/11/2020 14:43	5,49	1	5,49	CHI
20201162686	GOIATUBA	VI21026555	VICENTINOPOLIS	14/11/2020 09:14	14/11/2020 18:42	14/11/2020 09:14	14/11/2020 18:42	9,46	1	9,46	CHI
20201163052	AVELINOPOLIS	AV12020475	ANICUNS	14/11/2020 09:14	14/11/2020 14:29	14/11/2020 09:14	14/11/2020 14:29	5,24	18	94,39	CHI
20201163052	ITABERAI	AV12020475	ANICUNS	14/11/2020 09:14	14/11/2020 14:29	14/11/2020 09:14	14/11/2020 14:29	5,24	28	146,82	CHI
20201163320	JATAI	JT12337053	JATAI S1	14/11/2020 09:14	14/11/2020 15:04	14/11/2020 09:14	14/11/2020 15:04	5,82	12	69,84	CHI
20201162689	FORMOSA	610198221	ITUIQUIRA	14/11/2020 09:15	14/11/2020 11:09	14/11/2020 09:15	14/11/2020 11:09	1,90	1	1,90	CHI
20201162694	TRINDADE	40296106	TRINDADE	14/11/2020 09:15	14/11/2020 13:12	14/11/2020 09:15	14/11/2020 13:12	3,94	1	3,94	CHI
20201162698	RIO VERDE	RV12260127	CABRIUVA S1	14/11/2020 09:16	14/11/2020 12:07	14/11/2020 09:16	14/11/2020 12:07	2,85	2	5,70	CHI
20201162702	ARAGUAPAZ	AZ21143354	GOIAS	14/11/2020 09:17	14/11/2020 12:05	14/11/2020 09:17	14/11/2020 12:05	2,79	1	2,79	CHI
20201162703	PARAUNA	PU21136886	PARAUNA	14/11/2020 09:17	15/11/2020 08:07	14/11/2020 09:17	15/11/2020 08:07	22,82	1	22,82	CHI
20201162710	CORUMBA DE GOIAS	CB21342460	CORUMBA	14/11/2020 09:17	14/11/2020 12:40	14/11/2020 09:17	14/11/2020 12:40	3,37	1	3,37	CHI
20201163887	PETROLINA DE GOIAS	PG12031546	PETROLINA	14/11/2020 09:17	14/11/2020 14:44	14/11/2020 09:17	14/11/2020 14:44	5,43	25	135,87	CHI
20201162714	BOM JESUS DE GOIAS	BJ12293328	BOM JESUS DE GOIAS	14/11/2020 09:18	14/11/2020 12:10	14/11/2020 09:18	14/11/2020 12:10	2,86	1	2,86	CHI
20201162716	MINEIROS	MY21341157	PARQUE DAS EMAS	14/11/2020 09:18	14/11/2020 10:46	14/11/2020 09:18	14/11/2020 10:46	1,46	1	1,46	CHI
20201162719	PLANALTINA	PI11216393	PLANALTINA	14/11/2020 09:18	14/11/2020 12:24	14/11/2020 09:18	14/11/2020 12:24	3,09	199	614,30	CHI
20201162720	MINACU	IH21230507	MINACU	14/11/2020 09:18	15/11/2020 13:34	14/11/2020 09:18	15/11/2020 13:34	28,26	1	28,26	CHI
20201162725	JANDAIA	JD21007128	PALMEIRAS	14/11/2020 09:19	14/11/2020 12:21	14/11/2020 09:19	14/11/2020 12:21	3,03	2	6,06	CHI
20201162726	COLINAS DO SUL	TI21236625	MINACU	14/11/2020 09:19	14/11/2020 11:42	14/11/2020 09:19	14/11/2020 11:42	2,38	2	4,76	CHI
20201162729	SANTA ROSA DE GOIAS	SR12080992	INHUMAS S1	14/11/2020 09:19	14/11/2020 12:16	14/11/2020 09:19	14/11/2020 12:16	2,94	2	5,88	CHI
20201162731	PORANGATU	10029968648	PORANGATU	14/11/2020 09:19	14/11/2020 20:05	14/11/2020 09:19	14/11/2020 20:05	10,75	1	10,75	CHI
20201162733	RUBIATABA	780054039	RUBIATABA	14/11/2020 09:19	14/11/2020 20:42	14/11/2020 09:19	14/11/2020 20:42	11,37	1	11,37	CHI
20201162739	CORUMBA DE GOIAS	CB21270337	ANAPOLIS UNIVERSITARIO S1	14/11/2020 09:21	14/11/2020 16:07	14/11/2020 09:21	14/11/2020 16:07	6,76	1	6,76	CHI
20201163687	BURITI DE GOIAS	BS12287581	FIRMINOPOLIS S2	14/11/2020 09:21	14/11/2020 13:33	14/11/2020 09:21	14/11/2020 13:33	4,19	11	46,14	CHI



20201162747	URUACU	UR12028316	URUACU	14/11/2020 09:22	14/11/2020 11:16	14/11/2020 09:22	14/11/2020 11:16	1,90	2	3,79	CHI
20201162749	RIO VERDE	10015296677	CABRIUVA S1	14/11/2020 09:22	14/11/2020 11:41	14/11/2020 09:22	14/11/2020 11:41	2,31	1	2,31	CHI
20201162750	CRIXAS	CX12276585	SERRA DO OURO	14/11/2020 09:22	14/11/2020 18:24	14/11/2020 09:22	14/11/2020 18:24	9,03	2	18,06	CHI
20201162752	GOIANIRA	390071857	GOIANIRA	14/11/2020 09:22	14/11/2020 16:41	14/11/2020 09:22	14/11/2020 16:41	7,31	1	7,31	CHI
20201162755	MORRINHOS	MR21000111	GOIATUBA S1	14/11/2020 09:22	14/11/2020 12:34	14/11/2020 09:22	14/11/2020 12:34	3,19	1	3,19	CHI
20201162762	CABECEIRAS	CW21129740	ITUIQUIRA	14/11/2020 09:23	14/11/2020 10:09	14/11/2020 09:23	14/11/2020 10:09	0,76	1	0,76	CHI
20201162763	CAMPINORTE	CR21262822	MARA ROSA	14/11/2020 09:24	14/11/2020 16:51	14/11/2020 09:24	14/11/2020 16:51	7,45	1	7,45	CHI
20201162771	APARECIDA DE GOIANIA	AP12265224	ANHANGUERA	14/11/2020 09:25	14/11/2020 12:38	14/11/2020 09:25	14/11/2020 12:38	3,22	93	299,15	CHI
20201162774	GOIATUBA	GT12295933	RIO DOS BOIS	14/11/2020 09:25	14/11/2020 12:46	14/11/2020 09:25	14/11/2020 12:46	3,34	4	13,34	CHI
20201162775	IPORA	IR11138374	IPORA	14/11/2020 09:25	14/11/2020 10:49	14/11/2020 09:25	14/11/2020 10:49	1,38	1	1,38	CHI
20201162781	QUIRINOPOLIS	80084126	QUIRINOPOLIS	14/11/2020 09:26	14/11/2020 11:30	14/11/2020 09:26	14/11/2020 11:30	2,06	1	2,06	CHI
20201162782	ANAPOLIS	10005562757	ANAPOLIS UNIVERSITARIO S1	14/11/2020 09:26	14/11/2020 18:29	14/11/2020 09:26	14/11/2020 18:29	9,03	1	9,03	CHI
20201162784	CRIXAS	6338392	RUBIATABA	14/11/2020 09:27	15/11/2020 10:34	14/11/2020 09:27	15/11/2020 10:34	25,11	4	100,45	CHI
20201162788	ANAPOLIS	AN11288615	JUNDIAI S2	14/11/2020 09:27	14/11/2020 10:27	14/11/2020 09:27	14/11/2020 10:27	0,99	40	39,72	CHI
20201162789	ANAPOLIS	AN21000650	ANAPOLIS UNIVERSITARIO S2	14/11/2020 09:27	14/11/2020 12:11	14/11/2020 09:27	14/11/2020 12:11	2,72	1	2,72	CHI
20201162798	SANTO ANTONIO DE GOIAS	BW12145999	NEROPOLIS S1	14/11/2020 09:28	14/11/2020 14:30	14/11/2020 09:28	14/11/2020 14:30	5,02	1	5,02	CHI
20201162803	CAIAPONIA	CP12158231	CAIAPONIA	14/11/2020 09:29	14/11/2020 14:22	14/11/2020 09:29	14/11/2020 14:22	4,88	5	24,38	CHI
20201162810	GOUVELANDIA	GB12000204	QUIRINOPOLIS	14/11/2020 09:29	14/11/2020 12:34	14/11/2020 09:29	14/11/2020 12:34	3,08	3	9,23	CHI
20201163188	AURILANDIA	AI12032163	FIRMINOPOLIS S2	14/11/2020 09:29	14/11/2020 12:13	14/11/2020 09:29	14/11/2020 12:13	2,73	8	21,83	CHI
20201163182	GOIANIA	GN11001172	AEROPORTO S2	14/11/2020 09:30	14/11/2020 12:18	14/11/2020 09:30	14/11/2020 12:18	2,80	39	109,15	CHI
20201163374	GOIAS	GS12042305	ITABERAI S1	14/11/2020 09:30	14/11/2020 15:22	14/11/2020 09:30	14/11/2020 15:22	5,85	11	64,36	CHI
20201162820	INACIOLANDIA	ID21104445	CACHOEIRA DOURADA	14/11/2020 09:32	14/11/2020 11:41	14/11/2020 09:32	14/11/2020 11:41	2,15	2	4,29	CHI
20201162885	PALMELO	1480214	PIRES DO RIO S1	14/11/2020 09:32	14/11/2020 09:41	14/11/2020 09:32	14/11/2020 09:41	0,15	9	1,34	CHI
20201162885	PIRES DO RIO	1480214	PIRES DO RIO S1	14/11/2020 09:32	14/11/2020 09:41	14/11/2020 09:32	14/11/2020 09:41	0,15	605	90,25	CHI
20201162885	SANTA CRUZ DE GOIAS	1480214	PIRES DO RIO S1	14/11/2020 09:32	14/11/2020 09:41	14/11/2020 09:32	14/11/2020 09:41	0,15	1	0,15	CHI
20201162885	URUTAI	1480214	PIRES DO RIO S1	14/11/2020 09:32	14/11/2020 09:41	14/11/2020 09:32	14/11/2020 09:41	0,15	1	0,15	CHI
20201162827	ANICUNS	AC12036078	ARACU	14/11/2020 09:33	15/11/2020 08:35	14/11/2020 09:33	15/11/2020 08:35	23,03	5	115,14	CHI
20201162829	CACHOEIRA DOURADA	CD12000179	CACHOEIRA DOURADA	14/11/2020 09:33	14/11/2020 13:56	14/11/2020 09:33	14/11/2020 13:56	4,37	4	17,47	CHI
20201162829	ITUMBIARA	CD12000179	CACHOEIRA DOURADA	14/11/2020 09:33	14/11/2020 13:56	14/11/2020 09:33	14/11/2020 13:56	4,37	5	21,84	CHI
20201162832	ITAGUARI	II21217195	ITABERAI S1	14/11/2020 09:34	14/11/2020 12:14	14/11/2020 09:34	14/11/2020 12:14	2,66	2	5,32	CHI
20201162996	MORRINHOS	MR12381119	MORRINHOS	14/11/2020 09:34	14/11/2020 14:20	14/11/2020 09:34	14/11/2020 14:20	4,76	23	109,56	CHI
20201163054	ORIZONA	OZ12036983	PIRES DO RIO S2	14/11/2020 09:34	14/11/2020 13:47	14/11/2020 09:34	14/11/2020 13:47	4,21	1	4,21	CHI
20201163054	VIANOPOLIS	OZ12036983	PIRES DO RIO S2	14/11/2020 09:34	14/11/2020 13:47	14/11/2020 09:34	14/11/2020 13:47	4,21	10	42,11	CHI
20201162843	PADRE BERNARDO	PB21109552	PADRE BERNARDO	14/11/2020 09:35	14/11/2020 12:16	14/11/2020 09:35	14/11/2020 12:16	2,67	1	2,67	CHI
20201162845	PORTELANDIA	PW21303423	PARQUE DAS EMAS	14/11/2020 09:35	14/11/2020 13:44	14/11/2020 09:35	14/11/2020 13:44	4,13	1	4,13	CHI
20201162917	GOIANIA	GN11001110	CAMPINAS S2	14/11/2020 09:35	14/11/2020 11:47	14/11/2020 09:35	14/11/2020 11:47	2,19	68	148,98	CHI
20201162847	LUZIANIA	10032930079	MARAJOARA	14/11/2020 09:36	14/11/2020 12:31	14/11/2020 09:36	14/11/2020 12:31	2,91	1	2,91	CHI
20201162852	APORE	AE12340774	ITAJA S2	14/11/2020 09:36	14/11/2020 16:08	14/11/2020 09:36	14/11/2020 16:08	6,52	1	6,52	CHI
20201162856	MINEIROS	MY21278395	PARQUE DAS EMAS	14/11/2020 09:37	14/11/2020 13:01	14/11/2020 09:37	14/11/2020 13:01	3,40	1	3,40	CHI
20201162858	GOIANIA	13870361	REAL S2	14/11/2020 09:37	14/11/2020 17:00	14/11/2020 09:37	14/11/2020 17:00	7,37	1	7,37	CHI
20201162859	SANTA HELENA DE GOIAS	SH12301270	ACREUNA	14/11/2020 09:37	14/11/2020 11:40	14/11/2020 09:37	14/11/2020 11:40	2,04	3	6,12	CHI
20201162862	PIRES DO RIO	PR21115589	PIRES DO RIO S1	14/11/2020 09:37	14/11/2020 15:37	14/11/2020 09:37	14/11/2020 15:37	5,99	1	5,99	CHI
20201162870	FAZENDA NOVA	FN12223049	IPORA	14/11/2020 09:38	14/11/2020 14:40	14/11/2020 09:38	14/11/2020 14:40	5,03	8	40,23	CHI
20201162870	ISRAELANDIA	FN12223049	IPORA	14/11/2020 09:38	14/11/2020 14:40	14/11/2020 09:38	14/11/2020 14:40	5,03	2	10,06	CHI
20201162905	CALDAS NOVAS	PJ12263230	CALDAS NOVAS S1	14/11/2020 09:38	14/11/2020 13:08	14/11/2020 09:38	14/11/2020 13:08	3,50	1	3,50	CHI
20201162905	PIRACANJUBA	PJ12263230	CALDAS NOVAS S1	14/11/2020 09:38	14/11/2020 13:08	14/11/2020 09:38	14/11/2020 13:08	3,50	17	59,49	CHI
20201163050	SAO LUIS DE MONTES BELOS	SL12028642	FIRMINOPOLIS S2	14/11/2020 09:38	14/11/2020 15:49	14/11/2020 09:38	14/11/2020 15:49	6,18	9	55,61	CHI
20201163324	MONTES CLAROS DE GOIAS	ME12085895	IPORA	14/11/2020 09:38	14/11/2020 17:00	14/11/2020 09:38	14/11/2020 17:00	7,35	22	161,75	CHI
20201162880	SANTO ANTONIO DE GOIAS	10018501204	NEROPOLIS S1	14/11/2020 09:39	14/11/2020 15:33	14/11/2020 09:39	14/11/2020 15:33	5,90	1	5,90	CHI
20201162881	IPAMERI	IP12107641	IPAMERI	14/11/2020 09:39	14/11/2020 12:39	14/11/2020 09:39	14/11/2020 12:39	3,00	21	62,92	CHI
20201162890	BURITI ALEGRE	BG12263531	ALTO BURITI	14/11/2020 09:40	14/11/2020 19:52	14/11/2020 09:40	14/11/2020 19:52	10,19	6	61,15	CHI

20201163025	PIRACANJUBA	PJ12097886	BELA VISTA S1	14/11/2020 09:40	14/11/2020 13:20	14/11/2020 09:40	14/11/2020 13:20	3,66	6	21,94	CHI
20201162893	SENADOR CANEDO	10028466223	GOIANIA LESTE S1	14/11/2020 09:41	14/11/2020 10:59	14/11/2020 09:41	14/11/2020 10:59	1,30	1	1,30	CHI
20201162894	GOIANESIA	GE21000117	GOIANESIA S1	14/11/2020 09:41	14/11/2020 12:09	14/11/2020 09:41	14/11/2020 12:09	2,46	1	2,46	CHI
20201162896	INHUMAS	30144000	INHUMAS S2	14/11/2020 09:41	14/11/2020 12:19	14/11/2020 09:41	14/11/2020 12:19	2,63	1	2,63	CHI
20201162900	NIQUELANDIA	NQ21197559	NIQUELANDIA SUBTRANSMISSAO	14/11/2020 09:41	15/11/2020 03:40	14/11/2020 09:41	15/11/2020 03:40	17,97	1	17,97	CHI
20201162901	ABADIA DE GOIAS	5580016832	CARAJAS S1	14/11/2020 09:41	14/11/2020 17:14	14/11/2020 09:41	14/11/2020 17:14	7,54	1	7,54	CHI
20201162914	CACU	CC21085731	CACHOEIRA ALTA	14/11/2020 09:43	14/11/2020 12:03	14/11/2020 09:43	14/11/2020 12:03	2,32	1	2,32	CHI
20201163202	ITAPIRAPUA	IU12037339	JUSSARA	14/11/2020 09:43	14/11/2020 13:04	14/11/2020 09:43	14/11/2020 13:04	3,33	7	23,34	CHI
20201163202	NOVO BRASIL	IU12037339	JUSSARA	14/11/2020 09:43	14/11/2020 13:04	14/11/2020 09:43	14/11/2020 13:04	3,33	1	3,33	CHI
20201162921	BELA VISTA DE GOIAS	240059920	BELA VISTA S2	14/11/2020 09:45	14/11/2020 11:53	14/11/2020 09:45	14/11/2020 11:53	2,13	1	2,13	CHI
20201162930	DOVERLANDIA	DV12138337	CAIAPONIA	14/11/2020 09:46	14/11/2020 13:00	14/11/2020 09:46	14/11/2020 13:00	3,22	3	9,67	CHI
20201162939	MORRINHOS	MR21021499	MORRINHOS	14/11/2020 09:48	14/11/2020 14:15	14/11/2020 09:48	14/11/2020 14:15	4,44	1	4,44	CHI
20201162950	RIO VERDE	630362270	MONTIVIDIU T	14/11/2020 09:49	14/11/2020 22:57	14/11/2020 09:49	14/11/2020 22:57	13,12	1	13,12	CHI
20201162954	VALPARAISO DE GOIAS	10026364610	MARAJOARA	14/11/2020 09:50	14/11/2020 14:21	14/11/2020 09:50	14/11/2020 14:21	4,51	1	4,51	CHI
20201163131	GUAPO	GA12276655	GUAPO S2	14/11/2020 09:50	14/11/2020 13:37	14/11/2020 09:50	14/11/2020 13:37	3,77	42	158,28	CHI
20201162970	JANDAIA	JD21328166	PALMEIRAS	14/11/2020 09:52	15/11/2020 12:51	14/11/2020 09:52	15/11/2020 12:51	26,97	1	26,97	CHI
20201162971	APARECIDA DE GOIANIA	13469058	REAL S1	14/11/2020 09:53	14/11/2020 13:44	14/11/2020 09:53	14/11/2020 13:44	3,85	1	3,85	CHI
20201162972	GOIAS	GS12029627	GOIAS	14/11/2020 09:53	15/11/2020 21:14	14/11/2020 09:53	15/11/2020 21:14	35,34	10	353,43	CHI
20201164485	ARENOPOLIS	6524215	ARENOPOLIS	14/11/2020 09:54	14/11/2020 22:32	14/11/2020 09:54	14/11/2020 22:32	12,62	6	75,70	CHI
20201162984	ORIZONA	OZ12022850RE	PIRES DO RIO S2	14/11/2020 09:55	14/11/2020 11:48	14/11/2020 09:55	14/11/2020 11:48	1,88	10	18,83	CHI
20201162984	PIRES DO RIO	OZ12022850RE	PIRES DO RIO S2	14/11/2020 09:55	14/11/2020 11:48	14/11/2020 09:55	14/11/2020 11:48	1,88	61	114,87	CHI
20201162999	CALDAS NOVAS	CN21221966	MORRINHOS	14/11/2020 09:56	14/11/2020 13:06	14/11/2020 09:56	14/11/2020 13:06	3,16	1	3,16	CHI
20201163002	NIQUELANDIA	NQ12236707	NIQUELANDIA SUBTRANSMISSAO	14/11/2020 09:56	14/11/2020 14:51	14/11/2020 09:56	14/11/2020 14:51	4,91	6	29,44	CHI
20201163003	ABADIA DE GOIAS	LG21245587	CARAJAS S1	14/11/2020 09:57	14/11/2020 17:33	14/11/2020 09:57	14/11/2020 17:33	7,60	3	22,80	CHI
20201163005	ARAGARCAS	AG21193712	ARAGARCAS	14/11/2020 09:57	14/11/2020 13:08	14/11/2020 09:57	14/11/2020 13:08	3,18	1	3,18	CHI
20201163008	GOIANESIA	GE11000066	GOIANESIA S2	14/11/2020 09:57	14/11/2020 14:02	14/11/2020 09:57	14/11/2020 14:02	4,07	45	183,04	CHI
20201163010	ALOANDIA	AD21199476	GOIATUBA S1	14/11/2020 09:58	14/11/2020 11:57	14/11/2020 09:58	14/11/2020 11:57	1,98	1	1,98	CHI
20201163011	FORMOSA	FA21428495	SAO JOAO D ALIANCA	14/11/2020 09:58	14/11/2020 13:21	14/11/2020 09:58	14/11/2020 13:21	3,38	1	3,38	CHI
20201163020	CALDAS NOVAS	10005190329	SERRA DE CALDAS	14/11/2020 09:59	14/11/2020 13:39	14/11/2020 09:59	14/11/2020 13:39	3,66	1	3,66	CHI
20201163030	SENADOR CANEDO	SW11366024	SENADOR CANEDO	14/11/2020 10:00	14/11/2020 11:24	14/11/2020 10:00	14/11/2020 11:24	1,38	101	139,74	CHI
20201163033	FORMOSA	FA21180998	ITUIQUIRA	14/11/2020 10:01	14/11/2020 10:42	14/11/2020 10:01	14/11/2020 10:42	0,67	1	0,67	CHI
20201163325	MONTES CLAROS DE GOIAS	ME12204930	IPORA	14/11/2020 10:01	14/11/2020 18:43	14/11/2020 10:01	14/11/2020 18:43	8,71	4	34,83	CHI
20201163036	COCALZINHO DE GOIAS	1200010362	COCALZINHO	14/11/2020 10:02	14/11/2020 12:50	14/11/2020 10:02	14/11/2020 12:50	2,79	1	2,79	CHI
20201163041	MORRINHOS	MR12070371	MORRINHOS	14/11/2020 10:03	14/11/2020 14:57	14/11/2020 10:03	14/11/2020 14:57	4,89	1	4,89	CHI
20201163051	GOIANIA	10016962018	CARAJAS S1	14/11/2020 10:05	14/11/2020 11:09	14/11/2020 10:05	14/11/2020 11:09	1,06	1	1,06	CHI
20201163055	APARECIDA DE GOIANIA	12358472	REAL S2	14/11/2020 10:06	14/11/2020 13:27	14/11/2020 10:06	14/11/2020 13:27	3,35	1	3,35	CHI
20201163058	GOIANIA	10027140480	GOYA S2	14/11/2020 10:06	14/11/2020 13:15	14/11/2020 10:06	14/11/2020 13:15	3,14	1	3,14	CHI
20201163066	SANTA TEREZINHA DE GOIAS	2480024769	SANTA TEREZINHA	14/11/2020 10:07	14/11/2020 23:54	14/11/2020 10:07	14/11/2020 23:54	13,78	1	13,78	CHI
20201163079	INHUMAS	IN12000220	INHUMAS S2	14/11/2020 10:07	14/11/2020 11:38	14/11/2020 10:07	14/11/2020 11:38	1,50	687	1032,22	CHI
20201163074	CAMPO ALEGRE DE GOIAS	CM12333445RE	CAMPO ALEGRE DE GOIAS	14/11/2020 10:08	14/11/2020 17:55	14/11/2020 10:08	14/11/2020 17:55	7,79	30	233,66	CHI
20201163074	CATALAO	CM12333445RE	CAMPO ALEGRE DE GOIAS	14/11/2020 10:08	14/11/2020 17:55	14/11/2020 10:08	14/11/2020 17:55	7,79	1	7,79	CHI
20201163074	CAMPO ALEGRE DE GOIAS	CM12333445RE	CAMPO ALEGRE DE GOIAS	14/11/2020 10:08	14/11/2020 17:55	14/11/2020 17:16	14/11/2020 17:55	0,65	39	25,27	CHI
20201163074	CATALAO	CM12333445RE	CAMPO ALEGRE DE GOIAS	14/11/2020 10:08	14/11/2020 17:55	14/11/2020 17:16	14/11/2020 17:55	0,65	17	11,02	CHI
20201163074	IPAMERI	CM12333445RE	CAMPO ALEGRE DE GOIAS	14/11/2020 10:08	14/11/2020 17:55	14/11/2020 17:16	14/11/2020 17:55	0,65	9	5,83	CHI
20201163075	GOIANIA	GN21000313	XAVANTES	14/11/2020 10:08	14/11/2020 11:25	14/11/2020 10:08	14/11/2020 11:25	1,27	1	1,27	CHI
20201163078	GOIANIA	12690016	GOIANIA LESTE S1	14/11/2020 10:09	14/11/2020 14:15	14/11/2020 10:09	14/11/2020 14:15	4,10	1	4,10	CHI
20201163389	CATURAI	CK12386231	INHUMAS S1	14/11/2020 10:09	14/11/2020 14:19	14/11/2020 10:09	14/11/2020 14:19	4,16	38	158,22	CHI
20201163389	GOIANIRA	CK12386231	INHUMAS S1	14/11/2020 10:09	14/11/2020 14:19	14/11/2020 10:09	14/11/2020 14:19	4,16	6	24,98	CHI
20201160920	SAO MIGUEL DO ARAGUAIA	SM12378931LD	SAO MIGUEL DO ARAGUAIA	14/11/2020 10:10	14/11/2020 21:27	14/11/2020 10:10	14/11/2020 21:27	11,28	20	225,59	CHI
20201160920	SAO MIGUEL DO ARAGUAIA	SM12378931LD	SAO MIGUEL DO ARAGUAIA	14/11/2020 10:10	14/11/2020 21:27	14/11/2020 14:41	14/11/2020 21:27	6,76	3	20,27	CHI
20201163183	CRISTALINA	KR10413321	CRISTALINA S1	14/11/2020 10:10	14/11/2020 10:13	14/11/2020 10:10	14/11/2020 10:13	0,06	242	14,92	CHI

20201163181	CORUMBAIBA	CI12107485	VILA CORUMBA	14/11/2020 10:11	14/11/2020 12:53	14/11/2020 10:11	14/11/2020 12:53	2,69	11	29,61	CHI
20201163110	MONTE ALEGRE DE GOIAS	MA21262236	SAO DOMINGOS	14/11/2020 10:12	14/11/2020 12:13	14/11/2020 10:12	14/11/2020 12:13	2,01	3	6,02	CHI
20201163112	GOIANIA	GN21013460	XAVANTES	14/11/2020 10:13	14/11/2020 11:54	14/11/2020 10:13	14/11/2020 11:54	1,68	1	1,68	CHI
20201163115	GOIANIA	13700704	MEIA PONTE	14/11/2020 10:13	14/11/2020 22:17	14/11/2020 10:13	14/11/2020 22:17	12,06	0	0,00	CHI
20201163119	ITUMBIARA	BJ21000283	CACHOEIRA DOURADA	14/11/2020 10:13	14/11/2020 15:38	14/11/2020 10:13	14/11/2020 15:38	5,41	1	5,41	CHI
20201163208	CAMPOS BELOS	CH11262267	SAO DOMINGOS	14/11/2020 10:13	14/11/2020 13:28	14/11/2020 10:13	14/11/2020 13:28	3,24	123	398,79	CHI
20201163136	RIO VERDE	RV21106420	MONTIVIDIU T	14/11/2020 10:14	14/11/2020 16:53	14/11/2020 10:14	14/11/2020 16:53	6,64	1	6,64	CHI
20201164310	HIDROLANDIA	PJ12293368	ROCHEDO	14/11/2020 10:14	14/11/2020 18:38	14/11/2020 10:14	14/11/2020 18:38	8,40	9	75,57	CHI
20201164310	PIRACANJUBA	PJ12293368	ROCHEDO	14/11/2020 10:14	14/11/2020 18:38	14/11/2020 10:14	14/11/2020 18:38	8,40	2	16,79	CHI
20201163146	GOIANIA	16353420	MEIA PONTE	14/11/2020 10:15	14/11/2020 22:30	14/11/2020 10:15	14/11/2020 22:30	12,24	1	12,24	CHI
20201163148	CACHOEIRA DOURADA	CD12000172	CACHOEIRA DOURADA	14/11/2020 10:15	14/11/2020 13:15	14/11/2020 10:15	14/11/2020 13:15	3,00	3	8,99	CHI
20201163531	GOIANIA	GN11000880	FERROVIARIO S3	14/11/2020 10:15	14/11/2020 20:11	14/11/2020 10:15	14/11/2020 20:11	9,92	164	1627,61	CHI
20201163150	BRITANIA	BT11124881	BRITANIA	14/11/2020 10:16	14/11/2020 12:20	14/11/2020 10:16	14/11/2020 12:20	2,06	109	224,90	CHI
20201163151	CABECEIRAS	CW21325504	ITUIQUIRA	14/11/2020 10:16	14/11/2020 10:54	14/11/2020 10:16	14/11/2020 10:54	0,63	2	1,26	CHI
20201163156	ITUMBIARA	IT12143989	ITUMBIARA NOVA	14/11/2020 10:17	14/11/2020 11:53	14/11/2020 10:17	14/11/2020 11:53	1,60	1	1,60	CHI
20201163160	GOIANIA	15916376	ANTANTICO S2	14/11/2020 10:17	14/11/2020 14:39	14/11/2020 10:17	14/11/2020 14:39	4,36	1	4,36	CHI
20201163995	HIDROLANDIA	HD11000143	ANHANGUERA	14/11/2020 10:17	14/11/2020 21:05	14/11/2020 10:17	14/11/2020 21:05	10,80	97	1047,20	CHI
20201163171	GOIANIA	17031916	ATLANTICO S1	14/11/2020 10:18	14/11/2020 11:54	14/11/2020 10:18	14/11/2020 11:54	1,60	1	1,60	CHI
20201163605	IPAMERI	UT12166947LD	URUTAI	14/11/2020 10:19	14/11/2020 16:13	14/11/2020 10:19	14/11/2020 16:13	5,90	78	460,33	CHI
20201163605	URUTAI	UT12166947LD	URUTAI	14/11/2020 10:19	14/11/2020 16:13	14/11/2020 10:19	14/11/2020 16:13	5,90	218	1286,56	CHI
20201163192	PADRE BERNARDO	PB11196355	PADRE BERNARDO	14/11/2020 10:20	14/11/2020 12:52	14/11/2020 10:20	14/11/2020 12:52	2,53	2	5,05	CHI
20201163200	GOIANIA	10030643048	MEIA PONTE	14/11/2020 10:22	14/11/2020 18:26	14/11/2020 10:22	14/11/2020 18:26	8,07	1	8,07	CHI
20201163203	OUVIDOR	OU11161393	CATALAO S1	14/11/2020 10:23	14/11/2020 20:48	14/11/2020 10:23	14/11/2020 20:48	10,42	6	62,49	CHI
20201163211	CABECEIRAS	490000086	ITUIQUIRA	14/11/2020 10:24	14/11/2020 11:59	14/11/2020 10:24	14/11/2020 11:59	1,58	1	1,58	CHI
20201163255	ARENOPOLIS	AY12390167	ARENOPOLIS	14/11/2020 10:24	14/11/2020 14:01	14/11/2020 10:24	14/11/2020 14:01	3,61	14	50,50	CHI
20201163297	FORMOSA	FA11257837	ITUIQUIRA	14/11/2020 10:24	14/11/2020 11:59	14/11/2020 10:24	14/11/2020 11:59	1,58	57	89,90	CHI
20201163222	MINEIROS	MY21303458	PARQUE DAS EMAS	14/11/2020 10:27	14/11/2020 12:29	14/11/2020 10:27	14/11/2020 12:29	2,02	2	4,05	CHI
20201163225	ALVORADA DO NORTE	1510017280	IACIARA S2	14/11/2020 10:27	14/11/2020 13:12	14/11/2020 10:27	14/11/2020 13:12	2,75	1	2,75	CHI
20201163229	PORANGATU	PO12139105	PORANGATU	14/11/2020 10:28	14/11/2020 12:19	14/11/2020 10:28	14/11/2020 12:19	1,85	3	5,55	CHI
20201163230	INACIOLANDIA	CD12000110	CACHOEIRA DOURADA	14/11/2020 10:28	14/11/2020 12:06	14/11/2020 10:28	14/11/2020 12:06	1,63	2	3,26	CHI
20201163237	BELA VISTA DE GOIAS	PJ12026346	BELA VISTA S1	14/11/2020 10:29	14/11/2020 14:16	14/11/2020 10:29	14/11/2020 14:16	3,78	3	11,33	CHI
20201163237	PIRACANJUBA	PJ12026346	BELA VISTA S1	14/11/2020 10:29	14/11/2020 14:16	14/11/2020 10:29	14/11/2020 14:16	3,78	3	11,33	CHI
20201163750	ARAGOIANIA	AO12094834	GUAPO S2	14/11/2020 10:29	14/11/2020 15:59	14/11/2020 10:29	14/11/2020 15:59	5,49	11	60,41	CHI
20201163246	APARECIDA DE GOIANIA	10023219783	INDEPENDENCIA S1	14/11/2020 10:31	14/11/2020 12:51	14/11/2020 10:31	14/11/2020 12:51	2,33	1	2,33	CHI
20201163248	CABECEIRAS	CW12245168	ITUIQUIRA	14/11/2020 10:31	14/11/2020 15:12	14/11/2020 10:31	14/11/2020 15:12	4,67	1	4,67	CHI
20201163249	GOIANIA	13846528	INDEPENDENCIA S2	14/11/2020 10:31	14/11/2020 13:25	14/11/2020 10:31	14/11/2020 13:25	2,89	1	2,89	CHI
20201163268	NIQUELANDIA	NQ12253797	URUACU	14/11/2020 10:31	15/11/2020 13:28	14/11/2020 10:31	15/11/2020 11:36	25,07	5	125,35	CHI
20201163268	NIQUELANDIA	NQ12253797	URUACU	14/11/2020 10:31	15/11/2020 13:28	14/11/2020 10:31	15/11/2020 12:10	25,64	11	282,09	CHI
20201163268	URUACU	NQ12280444	URUACU	14/11/2020 10:31	15/11/2020 13:28	15/11/2020 11:10	15/11/2020 12:10	1,00	13	13,06	CHI
20201163268	NIQUELANDIA	NQ12253797	URUACU	14/11/2020 10:31	15/11/2020 13:28	14/11/2020 10:31	15/11/2020 12:30	25,98	3	77,93	CHI
20201163268	NIQUELANDIA	NQ12253797	URUACU	14/11/2020 10:31	15/11/2020 13:28	14/11/2020 10:31	15/11/2020 13:28	26,94	3	80,81	CHI
20201163257	FIRMINOPOLIS	900026418	FIRMINOPOLIS S1	14/11/2020 10:33	14/11/2020 16:29	14/11/2020 10:33	14/11/2020 16:29	5,93	1	5,93	CHI
20201163260	COCALZINHO DE GOIAS	ZN12273061	COCALZINHO	14/11/2020 10:33	14/11/2020 13:48	14/11/2020 10:33	14/11/2020 13:48	3,25	28	91,00	CHI
20201163262	ALTO PARAISO DE GOIAS	BF12180928	SAO JOAO D ALIANCA	14/11/2020 10:34	14/11/2020 17:26	14/11/2020 10:34	14/11/2020 17:26	6,86	2	13,73	CHI
20201163265	APARECIDA DE GOIANIA	12511468	REAL S1	14/11/2020 10:34	14/11/2020 14:54	14/11/2020 10:34	14/11/2020 14:54	4,33	1	4,33	CHI
20201163272	ABADIA DE GOIAS	GN11211416	INDEPENDENCIA S2	14/11/2020 10:34	14/11/2020 12:27	14/11/2020 10:34	14/11/2020 12:27	1,87	13	24,30	CHI
20201163378	ITAJA	IJ12087676	ITAJA S2	14/11/2020 10:34	14/11/2020 12:17	14/11/2020 10:34	14/11/2020 12:17	1,70	2	3,40	CHI
20201163401	CATALAO	CT12231540RE	CATALAO S1	14/11/2020 10:34	14/11/2020 14:33	14/11/2020 10:34	14/11/2020 14:33	3,97	11	43,67	CHI
20201163447	APARECIDA DE GOIANIA	AP12035280	REAL S2	14/11/2020 10:34	14/11/2020 12:46	14/11/2020 10:34	14/11/2020 12:46	2,20	463	1016,80	CHI
20201163275	CAMPO ALEGRE DE GOIAS	6947884	CAMPO ALEGRE DE GOIAS	14/11/2020 10:35	15/11/2020 10:27	14/11/2020 10:35	15/11/2020 10:27	23,87	5	119,33	CHI
20201163279	SANTA CRUZ DE GOIAS	BC12332235	CRISTIANOPOLIS	14/11/2020 10:35	14/11/2020 17:28	14/11/2020 10:35	14/11/2020 17:28	6,88	6	41,28	CHI

20201163284	PETROLINA DE GOIAS	PG12070558	PETROLINA	14/11/2020 10:35	14/11/2020 20:26	14/11/2020 10:35	14/11/2020 20:26	9,84	1	9,84	CHI
20201163292	ANAPOLIS	AN12341913	JUNDIAI S1	14/11/2020 10:37	14/11/2020 13:04	14/11/2020 10:37	14/11/2020 13:04	2,45	2	4,90	CHI
20201163292	GOIANAPOLIS	AN12341913	JUNDIAI S1	14/11/2020 10:37	14/11/2020 13:04	14/11/2020 10:37	14/11/2020 13:04	2,45	4	9,79	CHI
20201163294	ANAPOLIS	AN11288606	JUNDIAI S2	14/11/2020 10:37	14/11/2020 12:46	14/11/2020 10:37	14/11/2020 12:46	2,14	13	27,85	CHI
20201163299	APARECIDA DE GOIANIA	10003063354	INDEPENDENCIA S2	14/11/2020 10:38	14/11/2020 15:32	14/11/2020 10:38	14/11/2020 15:32	4,89	1	4,89	CHI
20201163302	MONTIVIDIU	MV21213426	MONTIVIDIU T	14/11/2020 10:39	14/11/2020 16:11	14/11/2020 10:39	14/11/2020 16:11	5,54	2	11,07	CHI
20201163860	SANTA HELENA DE GOIAS	SH12301752	IPEGUARI	14/11/2020 10:39	14/11/2020 20:16	14/11/2020 10:39	14/11/2020 20:16	9,62	11	105,85	CHI
20201163319	MARA ROSA	MQ21156460	MARA ROSA	14/11/2020 10:42	14/11/2020 18:55	14/11/2020 10:42	14/11/2020 18:55	8,22	1	8,22	CHI
20201163329	RIO VERDE	RV21361109	CABRIUVA S2	14/11/2020 10:43	14/11/2020 12:12	14/11/2020 10:43	14/11/2020 12:12	1,48	1	1,48	CHI
20201163339	GUAPO	GA12099059	GUAPO S1	14/11/2020 10:45	14/11/2020 14:28	14/11/2020 10:45	14/11/2020 14:28	3,71	18	66,75	CHI
20201163340	APARECIDA DE GOIANIA	200284990	INDEPENDENCIA S1	14/11/2020 10:45	14/11/2020 13:28	14/11/2020 10:45	14/11/2020 13:28	2,71	1	2,71	CHI
20201163342	APARECIDA DE GOIANIA	200043262	INDEPENDENCIA S1	14/11/2020 10:45	14/11/2020 15:43	14/11/2020 10:45	14/11/2020 15:43	4,95	1	4,95	CHI
20201163362	CRISTALINA	KR10413321	CRISTALINA S1	14/11/2020 10:45	14/11/2020 20:57	14/11/2020 10:45	14/11/2020 10:48	0,05	24	1,21	CHI
20201163362	IPAMERI	KR10413321	CRISTALINA S1	14/11/2020 10:45	14/11/2020 20:57	14/11/2020 10:45	14/11/2020 10:48	0,05	5	0,25	CHI
20201163362	CRISTALINA	KR10413321	CRISTALINA S2	14/11/2020 10:45	14/11/2020 20:57	14/11/2020 10:45	14/11/2020 10:48	0,05	12	0,61	CHI
20201163362	IPAMERI	KR10413321	CRISTALINA S2	14/11/2020 10:45	14/11/2020 20:57	14/11/2020 10:45	14/11/2020 10:48	0,05	11	0,56	CHI
20201163362	CRISTALINA	KR10413321	CRISTALINA S1	14/11/2020 10:45	14/11/2020 20:57	14/11/2020 10:45	14/11/2020 14:19	3,55	10	35,54	CHI
20201163362	CRISTALINA	KR12246115LD	CRISTALINA S1	14/11/2020 10:45	14/11/2020 20:57	14/11/2020 10:45	14/11/2020 15:59	5,22	87	454,19	CHI
20201163362	CRISTALINA	KR10413321	CRISTALINA S1	14/11/2020 10:45	14/11/2020 20:57	14/11/2020 10:45	14/11/2020 20:30	9,74	13	126,68	CHI
20201163362	CRISTALINA	KR10413321	CRISTALINA S1	14/11/2020 10:45	14/11/2020 20:57	14/11/2020 10:45	14/11/2020 20:57	10,19	132	1345,48	CHI
20201163345	ITUMBIARA	IT21034478	CACHOEIRA DOURADA	14/11/2020 10:46	14/11/2020 17:53	14/11/2020 10:46	14/11/2020 17:53	7,11	2	14,22	CHI
20201163346	LEOPOLDO DE BULHOES	SV21284649	DAIA S2	14/11/2020 10:46	14/11/2020 15:39	14/11/2020 10:46	14/11/2020 15:39	4,88	1	4,88	CHI
20201163742	PIRES DO RIO	PR12270810	PIRES DO RIO S1	14/11/2020 10:46	14/11/2020 17:46	14/11/2020 10:46	14/11/2020 17:46	6,99	30	209,57	CHI
20201163358	GOIAS	GS21332742	GOIAS	14/11/2020 10:48	15/11/2020 09:36	14/11/2020 10:48	15/11/2020 09:36	22,79	2	45,58	CHI
20201163363	CALDAS NOVAS	CN12363789	SERRA DE CALDAS	14/11/2020 10:49	14/11/2020 17:28	14/11/2020 10:49	14/11/2020 17:28	6,64	5	33,21	CHI
20201163367	PLANALTINA	10015848971	PLANALTINA	14/11/2020 10:49	14/11/2020 12:08	14/11/2020 10:49	14/11/2020 12:08	1,30	1	1,30	CHI
20201163554	PIRES DO RIO	PR12051693	PIRES DO RIO S2	14/11/2020 10:50	14/11/2020 16:59	14/11/2020 10:50	14/11/2020 16:59	6,14	15	92,08	CHI
20201163554	SANTA CRUZ DE GOIAS	PR12051693	PIRES DO RIO S2	14/11/2020 10:50	14/11/2020 16:59	14/11/2020 10:50	14/11/2020 16:59	6,14	2	12,28	CHI
20201163380	BONOPOLIS	BX11364677	SAO MIGUEL DO ARAGUAIA	14/11/2020 10:51	15/11/2020 15:19	14/11/2020 10:51	15/11/2020 15:19	28,45	1	28,45	CHI
20201163381	CRISTALINA	KR12168460	CRISTALINA S1	14/11/2020 10:52	14/11/2020 14:42	14/11/2020 10:52	14/11/2020 14:42	3,83	5	19,16	CHI
20201163382	BRITANIA	BT21118474	BRITANIA	14/11/2020 10:52	14/11/2020 12:08	14/11/2020 10:52	14/11/2020 12:08	1,27	1	1,27	CHI
20201163399	GOIANIA	GN21051054	MEIA PONTE	14/11/2020 10:54	14/11/2020 13:35	14/11/2020 10:54	14/11/2020 13:35	2,67	2	5,34	CHI
20201164225	PORANGATU	TA12114216	NOVO PLANALTO	14/11/2020 10:55	14/11/2020 17:26	14/11/2020 10:55	14/11/2020 17:26	6,51	6	39,06	CHI
20201163412	GOUVELANDIA	QI21000126	QUIRINOPOLIS	14/11/2020 10:56	14/11/2020 15:30	14/11/2020 10:56	14/11/2020 15:30	4,56	1	4,56	CHI
20201163414	ANAPOLIS	AN12288618	JUNDIAI S2	14/11/2020 10:56	14/11/2020 12:46	14/11/2020 10:56	14/11/2020 12:46	1,83	88	160,70	CHI
20201163417	PARAUNA	PU12194221	ACREUNA	14/11/2020 10:56	14/11/2020 21:31	14/11/2020 10:56	14/11/2020 21:31	10,57	37	391,21	CHI
20201163704	FAINA	FC12274380	GOIAS	14/11/2020 10:57	14/11/2020 12:37	14/11/2020 10:57	14/11/2020 12:37	1,66	2	3,31	CHI
20201164118	LEOPOLDO DE BULHOES	LB12040371	DAIA S2	14/11/2020 10:57	14/11/2020 14:38	14/11/2020 10:57	14/11/2020 14:38	3,67	6	22,03	CHI
20201163719	TAQUARAL DE GOIAS	TQ12022436	ITABERAI S1	14/11/2020 10:58	14/11/2020 19:50	14/11/2020 10:58	14/11/2020 14:04	3,10	2	6,21	CHI
20201163719	TAQUARAL DE GOIAS	TQ12022436	ITABERAI S1	14/11/2020 10:58	14/11/2020 19:50	14/11/2020 10:58	14/11/2020 16:12	5,24	22	115,21	CHI
20201163719	TAQUARAL DE GOIAS	TQ12022436	ITABERAI S1	14/11/2020 10:58	14/11/2020 19:50	14/11/2020 10:58	14/11/2020 17:36	6,64	7	46,46	CHI
20201163719	TAQUARAL DE GOIAS	TQ12000087	ITABERAI S1	14/11/2020 10:58	14/11/2020 19:50	14/11/2020 17:06	14/11/2020 17:36	0,50	22	11,05	CHI
20201163719	TAQUARAL DE GOIAS	TQ12022436	ITABERAI S1	14/11/2020 10:58	14/11/2020 19:50	14/11/2020 10:58	14/11/2020 19:32	8,56	9	77,06	CHI
20201163719	TAQUARAL DE GOIAS	TQ12022436	ITABERAI S1	14/11/2020 10:58	14/11/2020 19:50	14/11/2020 10:58	14/11/2020 19:50	8,87	6	53,22	CHI
20201164831	ADELANDIA	DN12047420	FIRMINOPOLIS S2	14/11/2020 10:58	14/11/2020 17:24	14/11/2020 10:58	14/11/2020 17:24	6,43	3	19,28	CHI
20201164831	ANICUNS	DN12047420	FIRMINOPOLIS S2	14/11/2020 10:58	14/11/2020 17:24	14/11/2020 10:58	14/11/2020 17:24	6,43	45	289,20	CHI
20201163434	CAMPO ALEGRE DE GOIAS	IP21048128	PIRES DO RIO S2	14/11/2020 10:59	14/11/2020 14:16	14/11/2020 10:59	14/11/2020 14:16	3,27	1	3,27	CHI
20201163435	FIRMINOPOLIS	FR21096978	FIRMINOPOLIS S1	14/11/2020 11:00	14/11/2020 15:58	14/11/2020 11:00	14/11/2020 15:58	4,96	1	4,96	CHI
20201163437	FORMOSO	FO21050725	MARA ROSA	14/11/2020 11:00	14/11/2020 15:11	14/11/2020 11:00	14/11/2020 15:11	4,17	1	4,17	CHI
20201163438	APARECIDA DE GOIANIA	200336885	INDEPENDENCIA S2	14/11/2020 11:00	14/11/2020 15:48	14/11/2020 11:00	14/11/2020 15:48	4,78	1	4,78	CHI
20201163439	VARJAO	940014099	GUAPO S2	14/11/2020 11:00	14/11/2020 15:33	14/11/2020 11:00	14/11/2020 15:33	4,53	1	4,53	CHI

20201163449	SAO FRANCISCO DE GOIAS	10020395718	SAO FRANCISCO DE GOIAS	14/11/2020 11:03	14/11/2020 14:23	14/11/2020 11:03	14/11/2020 14:23	3,32	1	3,32	CHI
20201163451	GOIANIA	GN11053241	GOYA S2	14/11/2020 11:03	14/11/2020 13:27	14/11/2020 11:03	14/11/2020 13:27	2,39	62	147,94	CHI
20201163518	ANAPOLIS	AN10410472	ANAPOLIS UNIVERSITARIO S2	14/11/2020 11:03	14/11/2020 11:09	14/11/2020 11:03	14/11/2020 11:09	0,10	7517	747,52	CHI
20201163518	CAMPO LIMPO	AN10410472	ANAPOLIS UNIVERSITARIO S2	14/11/2020 11:03	14/11/2020 11:09	14/11/2020 11:03	14/11/2020 11:09	0,10	7	0,70	CHI
20201163518	ABADIANIA	AN16407972	ANAPOLIS UNIVERSITARIO S2	14/11/2020 11:03	14/11/2020 11:09	14/11/2020 11:03	14/11/2020 11:09	0,11	18	1,99	CHI
20201163518	ANAPOLIS	AN16407972	ANAPOLIS UNIVERSITARIO S2	14/11/2020 11:03	14/11/2020 11:09	14/11/2020 11:03	14/11/2020 11:09	0,11	1534	169,59	CHI
20201163518	CAMPO LIMPO	AN16407972	ANAPOLIS UNIVERSITARIO S2	14/11/2020 11:03	14/11/2020 11:09	14/11/2020 11:03	14/11/2020 11:09	0,11	11	1,22	CHI
20201163518	PIRENOPOLIS	AN16407972	ANAPOLIS UNIVERSITARIO S2	14/11/2020 11:03	14/11/2020 11:09	14/11/2020 11:03	14/11/2020 11:09	0,11	56	6,19	CHI
20201163457	TRINDADE	40190766	TRINDADE	14/11/2020 11:04	14/11/2020 17:17	14/11/2020 11:04	14/11/2020 17:17	6,21	1	6,21	CHI
20201163463	CRISTALINA	KR21237873	CRISTALINA S2	14/11/2020 11:05	14/11/2020 12:47	14/11/2020 11:05	14/11/2020 12:47	1,70	1	1,70	CHI
20201163464	CAIAPONIA	930051142	CAIAPONIA	14/11/2020 11:05	14/11/2020 17:25	14/11/2020 11:05	14/11/2020 17:25	6,33	1	6,33	CHI
20201163471	RUBIATABA	RB12197854	RUBIATABA	14/11/2020 11:05	14/11/2020 15:20	14/11/2020 11:05	14/11/2020 15:20	4,24	10	42,44	CHI
20201163473	MORRINHOS	MR12000097	MORRINHOS	14/11/2020 11:06	14/11/2020 14:30	14/11/2020 11:06	14/11/2020 14:30	3,39	1	3,39	CHI
20201163474	GOIANIA	10214112	FERROVIARIO S3	14/11/2020 11:06	14/11/2020 17:03	14/11/2020 11:06	14/11/2020 17:03	5,94	1	5,94	CHI
20201163475	GOIAS	GS12073668	MATRINCHA	14/11/2020 11:06	14/11/2020 16:03	14/11/2020 11:06	14/11/2020 16:03	4,94	1	4,94	CHI
20201163477	GOIANIA	11691013	XAVANTES	14/11/2020 11:07	14/11/2020 18:07	14/11/2020 11:07	14/11/2020 18:07	7,00	1	7,00	CHI
20201163561	CRISTALINA	KR10406671	CRISTALINA S2	14/11/2020 11:07	14/11/2020 18:51	14/11/2020 11:07	14/11/2020 14:50	3,73	103	383,96	CHI
20201163561	CRISTALINA	KR10406671	CRISTALINA S2	14/11/2020 11:07	14/11/2020 18:51	14/11/2020 11:07	14/11/2020 14:50	3,72	2	7,43	CHI
20201163561	CRISTALINA	KR12171556LD	CRISTALINA S2	14/11/2020 11:07	14/11/2020 18:51	14/11/2020 11:07	14/11/2020 18:10	7,06	64	451,89	CHI
20201163561	CRISTALINA	KR10406671	CRISTALINA S2	14/11/2020 11:07	14/11/2020 18:51	14/11/2020 11:07	14/11/2020 18:51	7,74	94	727,85	CHI
20201164857	MAIRIPOTABA	MR12263701	MORRINHOS	14/11/2020 11:07	14/11/2020 17:50	14/11/2020 11:07	14/11/2020 17:50	6,71	2	13,42	CHI
20201164857	PIRACANJUBA	MR12263701	MORRINHOS	14/11/2020 11:07	14/11/2020 17:50	14/11/2020 11:07	14/11/2020 17:50	6,71	6	40,25	CHI
20201163489	ANAPOLIS	AN21288945	ANAPOLIS UNIVERSITARIO S2	14/11/2020 11:09	14/11/2020 18:12	14/11/2020 11:09	14/11/2020 18:12	7,04	1	7,04	CHI
20201163683	JUSSARA	JR12206847	JUSSARA	14/11/2020 11:09	14/11/2020 14:50	14/11/2020 11:09	14/11/2020 14:50	3,68	25	91,88	CHI
20201163493	ANAPOLIS	AN21270286	ANAPOLIS UNIVERSITARIO S2	14/11/2020 11:10	14/11/2020 13:25	14/11/2020 11:10	14/11/2020 13:25	2,24	2	4,49	CHI
20201163498	SAO LUIZ DO NORTE	SZ21220582	ITAPACI	14/11/2020 11:11	14/11/2020 16:16	14/11/2020 11:11	14/11/2020 16:16	5,08	1	5,08	CHI
20201163505	URUACU	UR21003450	CAMPINORTE	14/11/2020 11:11	15/11/2020 02:35	14/11/2020 11:11	15/11/2020 02:35	15,39	1	15,39	CHI
20201163506	PORTEIRO	TD21213458	RIO DOS BOIS	14/11/2020 11:11	14/11/2020 15:19	14/11/2020 11:11	14/11/2020 15:19	4,12	1	4,12	CHI
20201163509	CRISTALINA	KR21165522	CRISTALINA S2	14/11/2020 11:12	15/11/2020 01:28	14/11/2020 11:12	15/11/2020 01:28	14,26	1	14,26	CHI
20201163512	RIO VERDE	RV12260131	CABRIUVA S1	14/11/2020 11:12	14/11/2020 13:04	14/11/2020 11:12	14/11/2020 13:04	1,86	1	1,86	CHI
20201163530	SENADOR CANEDO	SW21094026	CEPAIGO S2	14/11/2020 11:16	14/11/2020 13:31	14/11/2020 13:10	14/11/2020 13:31	0,34	1	0,34	CHI
20201163535	ANAPOLIS	20748840	ANAPOLIS UNIVERSITARIO S1	14/11/2020 11:18	14/11/2020 13:25	14/11/2020 11:18	14/11/2020 13:25	2,12	1	2,12	CHI
20201163538	GOIANIA	14584359	GOYA S2	14/11/2020 11:18	14/11/2020 16:10	14/11/2020 11:18	14/11/2020 16:10	4,86	1	4,86	CHI
20201163575	PARAUNA	PU12301174	ACREUNA	14/11/2020 11:18	15/11/2020 15:54	14/11/2020 11:18	15/11/2020 15:54	28,60	13	371,79	CHI
20201160275	GOIAS	IK12250721	GOIAS	14/11/2020 11:20	14/11/2020 13:36	14/11/2020 11:20	14/11/2020 13:36	2,26	14	31,60	CHI
20201160275	ITABERAÍ	IK12250721	GOIAS	14/11/2020 11:20	14/11/2020 13:36	14/11/2020 11:20	14/11/2020 13:36	2,26	3	6,77	CHI
20201160275	ITAPURANGA	IK12250721	GOIAS	14/11/2020 11:20	14/11/2020 13:36	14/11/2020 11:20	14/11/2020 13:36	2,26	3	6,77	CHI
20201163551	ANAPOLIS	AN12267911	ANAPOLIS UNIVERSITARIO S2	14/11/2020 11:20	14/11/2020 15:40	14/11/2020 11:20	14/11/2020 15:40	4,33	43	186,27	CHI
20201163551	CAMPO LIMPO	AN12267911	ANAPOLIS UNIVERSITARIO S2	14/11/2020 11:20	14/11/2020 15:40	14/11/2020 11:20	14/11/2020 15:40	4,33	2	8,66	CHI
20201163650	RIO VERDE	RV12303286	CABRIUVA S2	14/11/2020 11:20	14/11/2020 15:58	14/11/2020 11:20	14/11/2020 15:58	4,62	8	36,95	CHI
20201163560	PONTALINA	AD12028538	GOIATUBA S1	14/11/2020 11:21	14/11/2020 11:40	14/11/2020 11:21	14/11/2020 11:40	0,32	1	0,32	CHI
20201163564	SANTA HELENA DE GOIAS	400055065	IPEGUARI	14/11/2020 11:22	14/11/2020 15:02	14/11/2020 11:22	14/11/2020 15:02	3,66	1	3,66	CHI
20201163565	HIDROLANDIA	HD11346203	ANHANGUERA	14/11/2020 11:22	14/11/2020 23:03	14/11/2020 11:22	14/11/2020 22:25	11,06	3	33,18	CHI
20201163565	APARECIDA DE GOIANIA	20177382	ANHANGUERA	14/11/2020 11:22	14/11/2020 23:03	14/11/2020 14:32	14/11/2020 23:03	8,51	1	8,51	CHI
20201163565	HIDROLANDIA	20177382	ANHANGUERA	14/11/2020 11:22	14/11/2020 23:03	14/11/2020 14:32	14/11/2020 23:03	8,51	39	331,77	CHI
20201163576	RIO VERDE	630168556	CABRIUVA S1	14/11/2020 11:23	14/11/2020 22:23	14/11/2020 11:23	14/11/2020 22:23	10,99	1	10,99	CHI
20201163577	BURITI ALEGRE	BG12000162	ALTO BURITI	14/11/2020 11:24	15/11/2020 06:40	14/11/2020 11:24	15/11/2020 06:40	19,26	13	250,44	CHI
20201163577	ITUMBIARA	BG12000162	ALTO BURITI	14/11/2020 11:24	15/11/2020 06:40	14/11/2020 11:24	15/11/2020 06:40	19,26	8	154,12	CHI
20201163582	ANICUNS	AC12000020	ANICUNS	14/11/2020 11:26	14/11/2020 17:25	14/11/2020 11:26	14/11/2020 17:25	5,98	3	17,93	CHI
20201163593	CAIAPONIA	CP21155675	CAIAPONIA	14/11/2020 11:27	14/11/2020 13:48	14/11/2020 11:27	14/11/2020 13:48	2,34	1	2,34	CHI
20201163608	ALTO HORIZONTE	2490214	SANTA TEREZINHA	14/11/2020 11:27	14/11/2020 11:31	14/11/2020 11:27	14/11/2020 11:31	0,08	9	0,68	CHI



20201163608	CAMPOS VERDES	2490214	SANTA TEREZINHA	14/11/2020 11:27	14/11/2020 11:31	14/11/2020 11:27	14/11/2020 11:31	0,08	1872	142,48	CHI
20201163608	MARA ROSA	2490214	SANTA TEREZINHA	14/11/2020 11:27	14/11/2020 11:31	14/11/2020 11:27	14/11/2020 11:31	0,08	60	4,57	CHI
20201163608	PILAR DE GOIAS	2490214	SANTA TEREZINHA	14/11/2020 11:27	14/11/2020 11:31	14/11/2020 11:27	14/11/2020 11:31	0,08	6	0,46	CHI
20201163608	SANTA TEREZINHA DE GOIAS	2490214	SANTA TEREZINHA	14/11/2020 11:27	14/11/2020 11:31	14/11/2020 11:27	14/11/2020 11:31	0,08	50	3,81	CHI
20201163608	CAMPOS VERDES	2490214	SANTA TEREZINHA	14/11/2020 11:27	14/11/2020 11:31	14/11/2020 11:27	14/11/2020 11:31	0,08	153	12,71	CHI
20201163713	ANICUNS	AC12020338	ANICUNS	14/11/2020 11:27	14/11/2020 18:02	14/11/2020 11:27	14/11/2020 18:02	6,58	21	138,09	CHI
20201163598	ITUMBIARA	IT21166416	CACHOEIRA DOURADA	14/11/2020 11:28	14/11/2020 14:08	14/11/2020 11:28	14/11/2020 14:08	2,67	1	2,67	CHI
20201163599	APARECIDA DE GOIANIA	AP11313337	REAL S2	14/11/2020 11:28	14/11/2020 13:46	14/11/2020 11:28	14/11/2020 13:46	2,30	69	158,60	CHI
20201163606	FIRMINOPOLIS	AI21000006	FIRMINOPOLIS S2	14/11/2020 11:29	14/11/2020 22:55	14/11/2020 11:29	14/11/2020 22:55	11,43	1	11,43	CHI
20201164021	PALMEIRAS DE GOIAS	PL12390265	PALMEIRAS	14/11/2020 11:29	14/11/2020 15:02	14/11/2020 11:29	14/11/2020 15:02	3,54	5	17,72	CHI
20201163610	COCALZINHO DE GOIAS	ZN21154749	AGUAS LINDAS DE GOIAS S2	14/11/2020 11:30	14/11/2020 13:43	14/11/2020 11:30	14/11/2020 13:43	2,21	2	4,41	CHI
20201163632	RIO VERDE	RV21260225	CABRIUVA S1	14/11/2020 11:33	14/11/2020 13:46	14/11/2020 11:33	14/11/2020 13:46	2,22	1	2,22	CHI
20201163635	VILA PROPICIO	NP12210742	GOIANESIA S1	14/11/2020 11:33	14/11/2020 16:56	14/11/2020 11:33	14/11/2020 16:56	5,38	5	26,89	CHI
20201163636	CRISTALINA	KR21261612	CRISTALINA S2	14/11/2020 11:33	14/11/2020 23:01	14/11/2020 11:33	14/11/2020 23:01	11,45	1	11,45	CHI
20201163640	GOIATUBA	MR12160393	GOIATUBA S1	14/11/2020 11:35	14/11/2020 17:44	14/11/2020 11:35	14/11/2020 17:44	6,15	2	12,29	CHI
20201163643	GUAPO	GA12026082LD	GUAPO S1	14/11/2020 11:35	15/11/2020 16:03	14/11/2020 11:35	15/11/2020 16:03	28,46	9	256,11	CHI
20201163646	TRINDADE	TR21028701	GUAPO S1	14/11/2020 11:35	14/11/2020 13:18	14/11/2020 11:35	14/11/2020 13:18	1,70	1	1,70	CHI
20201163647	GOIANIA	17332321	FERROVIARIO S2	14/11/2020 11:35	14/11/2020 23:10	14/11/2020 11:35	14/11/2020 23:10	11,57	1	11,57	CHI
20201163648	GOIANIA	GN21049574	GOYA S2	14/11/2020 11:36	14/11/2020 16:18	14/11/2020 11:36	14/11/2020 16:18	4,69	1	4,69	CHI
20201163651	ANAPOLIS	10016402411	DAIA S1	14/11/2020 11:36	14/11/2020 14:18	14/11/2020 11:36	14/11/2020 14:18	2,69	1	2,69	CHI
20201163654	FORMOSA	610264254	ITUIQUIRA	14/11/2020 11:37	14/11/2020 14:29	14/11/2020 11:37	14/11/2020 14:29	2,87	1	2,87	CHI
20201163659	PLANALTINA	PI12262264	PLANALTINA	14/11/2020 11:38	14/11/2020 16:39	14/11/2020 11:38	14/11/2020 16:39	5,02	1	5,02	CHI
20201164329	CATALAO	CT12333638RE	CATALAO S1	14/11/2020 11:38	14/11/2020 19:38	14/11/2020 11:38	14/11/2020 19:38	7,99	64	511,06	CHI
20201163669	BRITANIA	BT11060642	BRITANIA	14/11/2020 11:39	14/11/2020 17:30	14/11/2020 11:39	14/11/2020 17:30	5,84	7	40,88	CHI
20201163671	URUACU	640059144	URUACU	14/11/2020 11:39	14/11/2020 22:08	14/11/2020 11:39	14/11/2020 22:08	10,47	1	10,47	CHI
20201163678	JATAI	10000686695	JATAI S3	14/11/2020 11:40	14/11/2020 13:44	14/11/2020 11:40	14/11/2020 13:44	2,06	1	2,06	CHI
20201163680	CRISTALINA	KR21165523	CRISTALINA S2	14/11/2020 11:41	14/11/2020 23:21	14/11/2020 11:41	14/11/2020 23:21	11,65	1	11,65	CHI
20201163682	APARECIDA DE GOIANIA	16926109	REAL S2	14/11/2020 11:42	14/11/2020 15:59	14/11/2020 11:42	14/11/2020 15:59	4,28	1	4,28	CHI
20201163691	APARECIDA DE GOIANIA	12573309	INDEPENDENCIA S2	14/11/2020 11:45	14/11/2020 15:30	14/11/2020 11:45	14/11/2020 15:30	3,74	1	3,74	CHI
20201163698	AMORINOPOLIS	AM12000015	IPORA	14/11/2020 11:45	14/11/2020 12:34	14/11/2020 11:45	14/11/2020 12:34	0,81	4	3,24	CHI
20201163709	PIRES DO RIO	1480214	PIRES DO RIO S1	14/11/2020 11:45	14/11/2020 22:54	14/11/2020 11:45	14/11/2020 11:48	0,05	267	13,50	CHI
20201163709	PALMELO	1480214	PIRES DO RIO S1	14/11/2020 11:45	14/11/2020 22:54	14/11/2020 11:45	14/11/2020 15:10	3,41	9	30,68	CHI
20201163709	PIRES DO RIO	1480214	PIRES DO RIO S1	14/11/2020 11:45	14/11/2020 22:54	14/11/2020 11:45	14/11/2020 15:10	3,41	104	354,52	CHI
20201163709	PIRES DO RIO	1480214	PIRES DO RIO S1	14/11/2020 11:45	14/11/2020 22:54	14/11/2020 11:45	14/11/2020 22:54	11,15	70	780,40	CHI
20201163709	SANTA CRUZ DE GOIAS	1480214	PIRES DO RIO S1	14/11/2020 11:45	14/11/2020 22:54	14/11/2020 11:45	14/11/2020 22:54	11,15	1	11,15	CHI
20201163709	URUTAI	1480214	PIRES DO RIO S1	14/11/2020 11:45	14/11/2020 22:54	14/11/2020 11:45	14/11/2020 22:54	11,15	1	11,15	CHI
20201163709	PIRES DO RIO	PR16435082	PIRES DO RIO S1	14/11/2020 11:45	14/11/2020 22:54	14/11/2020 11:46	14/11/2020 22:54	11,13	1	11,13	CHI
20201163695	BELA VISTA DE GOIAS	BV21264516	BELA VISTA S1	14/11/2020 11:46	14/11/2020 15:15	14/11/2020 11:46	14/11/2020 14:59	3,22	1	3,22	CHI
20201163695	BELA VISTA DE GOIAS	BV12000073	BELA VISTA S1	14/11/2020 11:46	14/11/2020 15:15	14/11/2020 11:46	14/11/2020 15:15	3,48	5	17,40	CHI
20201163696	APARECIDA DE GOIANIA	14169848	INDEPENDENCIA S2	14/11/2020 11:46	14/11/2020 16:13	14/11/2020 11:46	14/11/2020 16:13	4,44	1	4,44	CHI
20201164730	NOVO PLANALTO	SM12020677	SAO MIGUEL DO ARAGUAIA	14/11/2020 11:46	18/11/2020 16:35	14/11/2020 11:46	17/11/2020 17:39	77,88	2	155,76	CHI
20201164730	SAO MIGUEL DO ARAGUAIA	SM12020677	SAO MIGUEL DO ARAGUAIA	14/11/2020 11:46	18/11/2020 16:35	14/11/2020 11:46	17/11/2020 17:39	77,88	6	467,27	CHI
20201164730	SAO MIGUEL DO ARAGUAIA	SM12020677	SAO MIGUEL DO ARAGUAIA	14/11/2020 11:46	18/11/2020 16:35	14/11/2020 11:46	17/11/2020 18:05	78,31	8	626,49	CHI
20201164730	NOVO PLANALTO	SM12020677	SAO MIGUEL DO ARAGUAIA	14/11/2020 11:46	18/11/2020 16:35	14/11/2020 11:46	17/11/2020 18:14	78,46	3	235,38	CHI
20201164730	SAO MIGUEL DO ARAGUAIA	SM12020677	SAO MIGUEL DO ARAGUAIA	14/11/2020 11:46	18/11/2020 16:35	14/11/2020 11:46	17/11/2020 18:14	78,46	6	470,76	CHI
20201164730	SAO MIGUEL DO ARAGUAIA	SM12020677	SAO MIGUEL DO ARAGUAIA	14/11/2020 11:46	18/11/2020 16:35	14/11/2020 11:46	17/11/2020 18:22	78,60	4	314,40	CHI
20201164730	NOVO PLANALTO	SM12020677	SAO MIGUEL DO ARAGUAIA	14/11/2020 11:46	18/11/2020 16:35	14/11/2020 11:46	17/11/2020 20:12	80,44	2	160,88	CHI
20201164730	SAO MIGUEL DO ARAGUAIA	SM12020677	SAO MIGUEL DO ARAGUAIA	14/11/2020 11:46	18/11/2020 16:35	14/11/2020 11:46	17/11/2020 20:12	80,44	6	482,63	CHI
20201164730	SAO MIGUEL DO ARAGUAIA	SM12020677	SAO MIGUEL DO ARAGUAIA	14/11/2020 11:46	18/11/2020 16:35	14/11/2020 11:46	18/11/2020 16:35	100,82	7	705,71	CHI
20201163706	CAMPO ALEGRE DE GOIAS	CM12338743	CAMPO ALEGRE DE GOIAS	14/11/2020 11:48	15/11/2020 18:37	14/11/2020 11:48	15/11/2020 18:37	30,83	8	246,61	CHI
20201163706	CAMPO ALEGRE DE GOIAS	CM12338743	CAMPO ALEGRE DE GOIAS	14/11/2020 11:48	15/11/2020 18:37	14/11/2020 23:30	15/11/2020 18:37	19,12	5	95,58	CHI

20201163710	SANTA HELENA DE GOIAS	10019276590	IPEGUARI	14/11/2020 11:48	14/11/2020 13:56	14/11/2020 11:48	14/11/2020 13:56	2,12	1	2,12	CHI
20201164016	MORRINHOS	MR12098214	MORRINHOS	14/11/2020 11:48	14/11/2020 15:54	14/11/2020 11:48	14/11/2020 15:54	4,09	15	61,42	CHI
20201164665	PETROLINA DE GOIAS	PG12298074	PETROLINA	14/11/2020 11:48	14/11/2020 17:10	14/11/2020 11:48	14/11/2020 17:10	5,36	11	59,00	CHI
20201159647	ESTRELA DO NORTE	ET12000002LD	MARA ROSA	14/11/2020 11:49	14/11/2020 15:01	14/11/2020 11:49	14/11/2020 15:01	3,19	112	357,28	CHI
20201159647	MARA ROSA	ET12000002LD	MARA ROSA	14/11/2020 11:49	14/11/2020 15:01	14/11/2020 11:49	14/11/2020 15:01	3,19	32	102,08	CHI
20201163721	RIO VERDE	630077411	RIO VERDE S1	14/11/2020 11:50	14/11/2020 14:15	14/11/2020 11:50	14/11/2020 14:15	2,41	1	2,41	CHI
20201163724	SANTO ANTONIO DE GOIAS	GR21092412	XAVANTES	14/11/2020 11:50	14/11/2020 17:16	14/11/2020 11:50	14/11/2020 17:16	5,42	1	5,42	CHI
20201163743	PIRANHAS	PH12243813	PIRANHAS	14/11/2020 11:51	14/11/2020 15:29	14/11/2020 11:51	14/11/2020 15:29	3,62	7	25,37	CHI
20201163745	FORMOSA	FA12062329	ITUIQUIRA	14/11/2020 11:52	14/11/2020 13:22	14/11/2020 11:52	14/11/2020 13:22	1,50	7	10,50	CHI
20201163754	TRINDADE	TR31010288	TRINDADE	14/11/2020 11:53	14/11/2020 17:32	14/11/2020 11:53	14/11/2020 17:32	5,64	3	16,91	CHI
20201163755	HIDROLANDIA	HD11251854	CEPAIGO S2	14/11/2020 11:53	14/11/2020 14:51	14/11/2020 11:53	14/11/2020 14:51	2,95	82	242,04	CHI
20201163971	SAO JOAO D ALIANCA	JL12383335	SAO JOAO D ALIANCA	14/11/2020 11:55	14/11/2020 14:15	14/11/2020 11:55	14/11/2020 14:15	2,33	11	25,60	CHI
20201163770	IPORA	IR12014497	IPORA	14/11/2020 11:57	14/11/2020 15:03	14/11/2020 11:57	14/11/2020 15:03	3,08	223	687,65	CHI
20201163772	PORANGATU	840138957	PORANGATU	14/11/2020 11:58	14/11/2020 15:04	14/11/2020 11:58	14/11/2020 15:04	3,10	1	3,10	CHI
20201163775	ITAPURANGA	IK12300236	ITAPURANGA	14/11/2020 11:59	14/11/2020 14:29	14/11/2020 11:59	14/11/2020 14:29	2,49	11	27,42	CHI
20201163777	ALEXANIA	480026191	ALEXANIA	14/11/2020 11:59	14/11/2020 15:06	14/11/2020 11:59	14/11/2020 15:06	3,13	1	3,13	CHI
20201163780	CORUMBA DE GOIAS	CB21235579	CORUMBA	14/11/2020 11:59	14/11/2020 14:34	14/11/2020 11:59	14/11/2020 14:34	2,57	1	2,57	CHI
20201163781	GOIANIA	10019556819	INDEPENDENCIA S2	14/11/2020 12:00	14/11/2020 16:28	14/11/2020 12:00	14/11/2020 16:28	4,47	1	4,47	CHI
20201163782	LUZIANIA	LZ21209588	MARAJOARA	14/11/2020 12:00	14/11/2020 14:37	14/11/2020 12:00	14/11/2020 14:37	2,61	1	2,61	CHI
20201163783	AMARALINA	LC21334391	MARA ROSA	14/11/2020 12:00	14/11/2020 19:38	14/11/2020 12:00	14/11/2020 19:38	7,63	1	7,63	CHI
20201163784	TURVELANDIA	TD21306005	RIO DOS BOIS	14/11/2020 12:00	14/11/2020 16:16	14/11/2020 12:00	14/11/2020 16:16	4,25	1	4,25	CHI
20201163789	JARAGUA	JA21191235	JARAGUA	14/11/2020 12:01	14/11/2020 13:32	14/11/2020 12:01	14/11/2020 13:32	1,50	1	1,50	CHI
20201164183	ANICUNS	AC12391410	ANICUNS	14/11/2020 12:01	14/11/2020 16:56	14/11/2020 12:01	14/11/2020 16:56	4,90	3	14,71	CHI
20201164887	COLINAS DO SUL	TI12397518RE	NIQUELANDIA SUBTRANSMISSAO	14/11/2020 12:01	15/11/2020 01:01	14/11/2020 12:01	15/11/2020 01:01	12,98	5	64,92	CHI
20201164887	NIQUELANDIA	TI12397518RE	NIQUELANDIA SUBTRANSMISSAO	14/11/2020 12:01	15/11/2020 01:01	14/11/2020 12:01	15/11/2020 01:01	12,98	127	1649,02	CHI
20201163798	GOIANIA	16550493	SENADOR CANEDO	14/11/2020 12:04	14/11/2020 18:31	14/11/2020 12:04	14/11/2020 18:31	6,44	1	6,44	CHI
20201163800	PLANALTINA	PI12043463	PLANALTINA	14/11/2020 12:04	14/11/2020 12:58	14/11/2020 12:04	14/11/2020 12:58	0,88	18	15,91	CHI
20201163801	CRIXAS	CX21171138	SERRA DO OURO	14/11/2020 12:05	14/11/2020 14:13	14/11/2020 12:05	14/11/2020 14:13	2,13	1	2,13	CHI
20201163802	IACIARA	IA11096328	IACIARA S1	14/11/2020 12:05	14/11/2020 13:13	14/11/2020 12:05	14/11/2020 13:13	1,13	120	135,13	CHI
20201163826	GOIATUBA	GT21295932	RIO DOS BOIS	14/11/2020 12:07	14/11/2020 20:40	14/11/2020 12:07	14/11/2020 20:40	8,54	1	8,54	CHI
20201163831	GOIANIA	13922051	MEIA PONTE	14/11/2020 12:10	14/11/2020 15:41	14/11/2020 12:10	14/11/2020 15:41	3,51	1	3,51	CHI
20201163857	ALTO PARAISO DE GOIAS	ND12302636	IACIARA S2	14/11/2020 12:10	14/11/2020 16:34	14/11/2020 12:10	14/11/2020 16:34	4,39	19	83,35	CHI
20201163857	NOVA ROMA	ND12302636	IACIARA S2	14/11/2020 12:10	14/11/2020 16:34	14/11/2020 12:10	14/11/2020 16:34	4,39	101	443,08	CHI
20201163857	SAO JOAO D ALIANCA	ND12302636	IACIARA S2	14/11/2020 12:10	14/11/2020 16:34	14/11/2020 12:10	14/11/2020 16:34	4,39	13	57,03	CHI
20201163837	CALDAZINHA	BV12282971	SENADOR CANEDO	14/11/2020 12:11	14/11/2020 14:08	14/11/2020 12:11	14/11/2020 14:08	1,94	1	1,94	CHI
20201163841	NOVA IGUAU DE GOIAS	NH21325727	URUACU	14/11/2020 12:11	15/11/2020 19:10	14/11/2020 12:11	15/11/2020 19:10	30,97	1	30,97	CHI
20201163842	CAIAPONIA	CP12354353	CAIAPONIA	14/11/2020 12:11	14/11/2020 14:30	14/11/2020 12:11	14/11/2020 14:30	2,30	1	2,30	CHI
20201163849	SILVANIA	SV12107840	VIANOPOLIS	14/11/2020 12:12	14/11/2020 15:57	14/11/2020 12:12	14/11/2020 15:57	3,74	15	56,04	CHI
20201163851	AMARALINA	LC12308828	MARA ROSA	14/11/2020 12:13	14/11/2020 20:56	14/11/2020 12:13	14/11/2020 20:56	8,71	2	17,43	CHI
20201163851	MARA ROSA	LC12308828	MARA ROSA	14/11/2020 12:13	14/11/2020 20:56	14/11/2020 12:13	14/11/2020 20:56	8,71	1	8,71	CHI
20201163916	FORMOSA	3740234	ITUIQUIRA	14/11/2020 12:15	14/11/2020 12:20	14/11/2020 12:15	14/11/2020 12:19	0,07	859	57,98	CHI
20201163916	FORMOSA	3740234	ITUIQUIRA	14/11/2020 12:15	14/11/2020 12:20	14/11/2020 12:15	14/11/2020 12:20	0,08	5310	411,52	CHI
20201163978	DISTRITO FEDERAL	3740414	ITUIQUIRA	14/11/2020 12:15	14/11/2020 12:22	14/11/2020 12:15	14/11/2020 12:22	0,11	2	0,22	CHI
20201163978	FORMOSA	3740414	ITUIQUIRA	14/11/2020 12:15	14/11/2020 12:22	14/11/2020 12:15	14/11/2020 12:22	0,11	16	1,76	CHI
20201163861	JATAI	290261107	JATAI S2	14/11/2020 12:17	14/11/2020 20:47	14/11/2020 12:17	14/11/2020 20:47	8,50	1	8,50	CHI
20201164004	IPAMERI	IP12000023	IPAMERI	14/11/2020 12:17	14/11/2020 13:47	14/11/2020 12:17	14/11/2020 13:47	1,49	129	192,78	CHI
20201164894	LUZIANIA	LZ12057501	VIANOPOLIS	14/11/2020 12:17	15/11/2020 12:20	14/11/2020 12:17	15/11/2020 12:20	24,04	5	120,22	CHI
20201163870	ANAPOLIS	AN11385776	ANAPOLIS UNIVERSITARIO S2	14/11/2020 12:18	14/11/2020 16:50	14/11/2020 12:18	14/11/2020 16:50	4,52	140	632,45	CHI
20201163871	FORMOSA	FA12262137	ITUIQUIRA	14/11/2020 12:19	14/11/2020 13:55	14/11/2020 12:19	14/11/2020 13:55	1,60	1	1,60	CHI
20201163872	SAO MIGUEL DO ARAGUAIA	SM122220658	SAO MIGUEL DO ARAGUAIA	14/11/2020 12:19	15/11/2020 08:21	14/11/2020 12:19	15/11/2020 08:21	20,03	4	80,13	CHI
20201163881	ESTRELA DO NORTE	ET12050729	MARA ROSA	14/11/2020 12:20	14/11/2020 16:22	14/11/2020 12:20	14/11/2020 16:22	4,02	2	8,04	CHI

20201163882	CAVALCANTE	TI12162624	NIQUELANDIA SUBTRANSMISSAO	14/11/2020 12:20	14/11/2020 18:52	14/11/2020 12:20	14/11/2020 18:52	6,52	20	130,37	CHI
20201163882	COLINAS DO SUL	TI12162624	NIQUELANDIA SUBTRANSMISSAO	14/11/2020 12:20	14/11/2020 18:52	14/11/2020 12:20	14/11/2020 18:52	6,52	6	39,11	CHI
20201163885	MINEIROS	MY12260468	PARQUE DAS EMAS	14/11/2020 12:21	14/11/2020 14:38	14/11/2020 12:21	14/11/2020 14:38	2,28	5	11,39	CHI
20201163886	ARAGOIANIA	AO32000295	GUAPO S2	14/11/2020 12:21	14/11/2020 17:26	14/11/2020 12:21	14/11/2020 17:26	5,07	7	35,49	CHI
20201164160	NOVO PLANALTO	TA12293705	SAO MIGUEL DO ARAGUAIA	14/11/2020 12:21	17/11/2020 00:29	14/11/2020 12:21	16/11/2020 22:47	58,43	15	876,42	CHI
20201164160	NOVO PLANALTO	TA12293705	SAO MIGUEL DO ARAGUAIA	14/11/2020 12:21	17/11/2020 00:29	14/11/2020 12:21	17/11/2020 00:29	60,12	1	60,12	CHI
20201164160	NOVO PLANALTO	TA12293705	SAO MIGUEL DO ARAGUAIA	14/11/2020 12:21	17/11/2020 00:29	17/11/2020 00:17	17/11/2020 00:29	0,20	15	3,00	CHI
20201163896	BELA VISTA DE GOIAS	BV21117056	BELA VISTA S2	14/11/2020 12:22	14/11/2020 15:09	14/11/2020 12:22	14/11/2020 14:34	2,20	1	2,20	CHI
20201163896	BELA VISTA DE GOIAS	BV32045544LD	BELA VISTA S2	14/11/2020 12:22	14/11/2020 15:09	14/11/2020 14:06	14/11/2020 15:09	1,04	5	5,20	CHI
20201163902	RIO VERDE	630042858	RIO VERDE S2	14/11/2020 12:24	15/11/2020 03:13	14/11/2020 12:24	15/11/2020 03:13	14,82	1	14,82	CHI
20201164120	MORRINHOS	MR12352594	MORRINHOS	14/11/2020 12:25	14/11/2020 15:14	14/11/2020 12:25	14/11/2020 15:14	2,81	6	16,89	CHI
20201164120	PIRACANJUBA	MR12352594	MORRINHOS	14/11/2020 12:25	14/11/2020 15:14	14/11/2020 12:25	14/11/2020 15:14	2,81	3	8,44	CHI
20201163910	PLANALTINA	PI12139508	PLANALTINA	14/11/2020 12:26	14/11/2020 18:33	14/11/2020 12:26	14/11/2020 18:33	6,13	33	202,29	CHI
20201163912	CAIAPONIA	CP12265311	MONTIVIDIU T	14/11/2020 12:26	14/11/2020 15:06	14/11/2020 12:26	14/11/2020 15:06	2,66	11	29,22	CHI
20201164668	TRES RANCHOS	TH12131002	CATALAO S1	14/11/2020 12:26	14/11/2020 18:04	14/11/2020 12:26	14/11/2020 18:04	5,62	34	191,12	CHI
20201163917	ITUMBIARA	690063805	ITUMBIARA VELHA S1	14/11/2020 12:27	14/11/2020 13:39	14/11/2020 12:27	14/11/2020 13:39	1,19	1	1,19	CHI
20201164107	FIRMINOPOLIS	SL12111569RE	FIRMINOPOLIS S1	14/11/2020 12:28	14/11/2020 13:54	14/11/2020 12:28	14/11/2020 13:54	1,42	17	24,13	CHI
20201164107	SAO LUIS DE MONTES BELOS	SL12111569RE	FIRMINOPOLIS S1	14/11/2020 12:28	14/11/2020 13:54	14/11/2020 12:28	14/11/2020 13:54	1,42	63	89,43	CHI
20201164107	TURVANIA	SL12111569RE	FIRMINOPOLIS S1	14/11/2020 12:28	14/11/2020 13:54	14/11/2020 12:28	14/11/2020 13:54	1,42	8	11,36	CHI
20201163925	INACIOLANDIA	IT12293335	CACHOEIRA DOURADA	14/11/2020 12:29	14/11/2020 16:09	14/11/2020 12:29	14/11/2020 16:09	3,67	2	7,33	CHI
20201163926	CEZARINA	1650020962	CEZARINA	14/11/2020 12:29	15/11/2020 12:33	14/11/2020 12:29	15/11/2020 12:33	24,07	1	24,07	CHI
20201163928	GOIANIA	GN12401386	GOYA S2	14/11/2020 12:30	14/11/2020 15:43	14/11/2020 12:30	14/11/2020 15:43	3,22	162	520,92	CHI
20201163933	TRES RANCHOS	TH21149121	CATALAO S1	14/11/2020 12:31	15/11/2020 04:01	14/11/2020 12:31	15/11/2020 04:01	15,50	1	15,50	CHI
20201164752	FAZENDA NOVA	JR12139962	JUSSARA	14/11/2020 12:31	14/11/2020 16:24	14/11/2020 12:31	14/11/2020 16:24	3,87	6	23,23	CHI
20201164752	JUSSARA	JR12139962	JUSSARA	14/11/2020 12:31	14/11/2020 16:24	14/11/2020 12:31	14/11/2020 16:24	3,87	134	518,84	CHI
20201164091	COLINAS DO SUL	TI12236619	MINACU	14/11/2020 12:32	14/11/2020 20:27	14/11/2020 12:32	14/11/2020 20:27	7,91	4	31,65	CHI
20201164179	MORRINHOS	MR12223454RE	MORRINHOS	14/11/2020 12:32	14/11/2020 20:29	14/11/2020 12:32	14/11/2020 20:29	7,94	14	111,11	CHI
20201164179	PONTALINA	MR12223454RE	MORRINHOS	14/11/2020 12:32	14/11/2020 20:29	14/11/2020 12:32	14/11/2020 20:29	7,94	5	39,68	CHI
20201163944	TRINDADE	TR21012975	TRINDADE	14/11/2020 12:33	14/11/2020 15:14	14/11/2020 12:33	14/11/2020 15:14	2,67	1	2,67	CHI
20201163951	GOIANIA	GN11401617	ATLANTICO S3	14/11/2020 12:34	14/11/2020 19:30	14/11/2020 12:34	14/11/2020 19:30	6,92	66	456,67	CHI
20201164143	CAMPO ALEGRE DE GOIAS	CM12230607	CAMPO ALEGRE DE GOIAS	14/11/2020 12:36	14/11/2020 21:05	14/11/2020 12:36	14/11/2020 21:05	8,47	2	16,93	CHI
20201164143	IPAMERI	CM12230607	CAMPO ALEGRE DE GOIAS	14/11/2020 12:36	14/11/2020 21:05	14/11/2020 12:36	14/11/2020 21:05	8,47	13	110,08	CHI
20201164261	GOIATUBA	GT12044907	GOIATUBA S2	14/11/2020 12:36	14/11/2020 15:04	14/11/2020 12:36	14/11/2020 15:04	2,46	11	27,03	CHI
20201163965	LUZIANIA	LZ21261348	MARAJOARA	14/11/2020 12:37	14/11/2020 22:12	14/11/2020 12:37	14/11/2020 22:12	9,58	2	19,16	CHI
20201163966	PIRACANJUBA	PJ21199394	PIRACANJUBA	14/11/2020 12:37	14/11/2020 15:30	14/11/2020 12:37	14/11/2020 15:30	2,88	2	5,76	CHI
20201163967	GOIANIA	11014106	FERROVIARIO S3	14/11/2020 12:37	14/11/2020 15:45	14/11/2020 12:37	14/11/2020 15:45	3,13	1	3,13	CHI
20201163968	RIO VERDE	RV21194485	MONTIVIDIU T	14/11/2020 12:37	15/11/2020 02:30	14/11/2020 12:37	15/11/2020 02:30	13,87	1	13,87	CHI
20201163972	FORMOSA	FA12051113	ITUIQUIRA	14/11/2020 12:39	14/11/2020 13:41	14/11/2020 12:39	14/11/2020 13:41	1,03	521	537,93	CHI
20201163977	APARECIDA DE GOIANIA	200419237	INDEPENDENCIA S1	14/11/2020 12:39	14/11/2020 14:49	14/11/2020 12:39	14/11/2020 14:49	2,16	1	2,16	CHI
20201163979	ABADIA DE GOIAS	LG11282703	TRINDADE	14/11/2020 12:39	14/11/2020 15:58	14/11/2020 12:39	14/11/2020 15:58	3,30	3	9,91	CHI
20201163984	ITUMBIARA	IT21309890	CACHOEIRA DOURADA	14/11/2020 12:40	14/11/2020 18:40	14/11/2020 12:40	14/11/2020 18:40	6,00	1	6,00	CHI
20201163988	CORUMBA DE GOIAS	CB21355215	ALEXANIA	14/11/2020 12:41	14/11/2020 19:27	14/11/2020 12:41	14/11/2020 19:27	6,77	2	13,53	CHI
20201163989	SAO MIGUEL DO PASSA QUATRO	SQ12074827	CRISTIANOPOLIS	14/11/2020 12:41	14/11/2020 15:10	14/11/2020 12:41	14/11/2020 15:10	2,47	8	19,77	CHI
20201163990	CRISTALINA	KR21385519	CRISTALINA S2	14/11/2020 12:41	14/11/2020 23:06	14/11/2020 12:41	14/11/2020 23:06	10,40	2	20,81	CHI
20201163991	GOIANIA	11340113	ATLANTICO S3	14/11/2020 12:42	14/11/2020 17:57	14/11/2020 12:42	14/11/2020 17:57	5,25	1	5,25	CHI
20201163992	PIRES DO RIO	PR21099998	PIRES DO RIO S1	14/11/2020 12:42	14/11/2020 20:38	14/11/2020 12:42	14/11/2020 20:38	7,93	1	7,93	CHI
20201164005	GOIANIA	GN11374161	MEIA PONTE	14/11/2020 12:42	14/11/2020 14:03	14/11/2020 12:42	14/11/2020 14:03	1,34	124	165,88	CHI
20201163998	GOIANIA	14910317	GOIANIA LESTE S3	14/11/2020 12:43	14/11/2020 19:45	14/11/2020 12:43	14/11/2020 19:45	7,03	1	7,03	CHI
20201164015	INDIARA	370404	CEZARINA	14/11/2020 12:43	15/11/2020 20:36	14/11/2020 12:43	14/11/2020 14:19	1,60	41	65,59	CHI
20201164015	CEZARINA	370404	CEZARINA	14/11/2020 12:43	15/11/2020 20:36	14/11/2020 12:43	14/11/2020 15:51	3,13	258	808,69	CHI
20201164015	INDIARA	370404	CEZARINA	14/11/2020 12:43	15/11/2020 20:36	14/11/2020 12:43	14/11/2020 15:51	3,13	8	25,08	CHI

20201164015	CEZARINA	370404	CEZARINA	14/11/2020 12:43	15/11/2020 20:36	14/11/2020 12:43	14/11/2020 23:26	10,71	1	10,71	CHI
20201164015	CEZARINA	370404	CEZARINA	14/11/2020 12:43	15/11/2020 20:36	14/11/2020 12:43	15/11/2020 20:05	31,37	7	219,58	CHI
20201164015	INDIARA	370404	CEZARINA	14/11/2020 12:43	15/11/2020 20:36	14/11/2020 12:43	15/11/2020 20:05	31,37	3	94,10	CHI
20201164015	CEZARINA	CZ13215265	CEZARINA	14/11/2020 12:43	15/11/2020 20:36	15/11/2020 20:24	15/11/2020 20:36	0,19	1	0,19	CHI
20201164003	ANAPOLIS	20709869	JUNDIAI S1	14/11/2020 12:44	14/11/2020 21:03	14/11/2020 12:44	14/11/2020 21:03	8,31	1	8,31	CHI
20201164006	CORUMBA DE GOIAS	SN10395421	ALEXANIA	14/11/2020 12:44	14/11/2020 23:33	14/11/2020 12:44	14/11/2020 23:33	10,81	13	140,54	CHI
20201164006	SANTO ANTONIO DO DESCOBERTO	SN10395421	ALEXANIA	14/11/2020 12:44	14/11/2020 23:33	14/11/2020 12:44	14/11/2020 23:33	10,81	17	183,78	CHI
20201164006	SANTO ANTONIO DO DESCOBERTO	SN10395421	ALEXANIA	14/11/2020 12:44	14/11/2020 23:33	14/11/2020 23:19	14/11/2020 23:33	0,23	185	42,91	CHI
20201164010	CACHOEIRA DE GOIAS	CG21165616	FIRMINOPOLIS S2	14/11/2020 12:45	14/11/2020 21:48	14/11/2020 12:45	14/11/2020 21:48	9,04	1	9,04	CHI
20201164040	AMARALINA	LC12189854	MARA ROSA	14/11/2020 12:46	14/11/2020 18:54	14/11/2020 12:46	14/11/2020 18:54	6,13	8	49,02	CHI
20201164040	MARA ROSA	LC12189854	MARA ROSA	14/11/2020 12:46	14/11/2020 18:54	14/11/2020 12:46	14/11/2020 18:54	6,13	2	12,26	CHI
20201164029	CORUMBA DE GOIAS	CB21327971	ANAPOLIS UNIVERSITARIO S1	14/11/2020 12:49	14/11/2020 18:27	14/11/2020 12:49	14/11/2020 18:27	5,63	1	5,63	CHI
20201164030	GOIANIA	GN21319482	XAVANTES	14/11/2020 12:49	14/11/2020 20:25	14/11/2020 12:49	14/11/2020 20:25	7,59	3	22,76	CHI
20201164111	DISTRITO FEDERAL	SN12237830	MARAJOARA	14/11/2020 12:49	14/11/2020 15:43	14/11/2020 12:49	14/11/2020 15:43	2,90	3	8,69	CHI
20201164111	SANTO ANTONIO DO DESCOBERTO	SN12237830	MARAJOARA	14/11/2020 12:49	14/11/2020 15:43	14/11/2020 12:49	14/11/2020 15:43	2,90	25	72,38	CHI
20201164033	QUIRINOPOLIS	QI12303196	RIO DOS BOIS	14/11/2020 12:50	14/11/2020 16:42	14/11/2020 12:50	14/11/2020 16:42	3,87	5	19,33	CHI
20201164036	SAO MIGUEL DO ARAGUAIA	SM12228636	SAO MIGUEL DO ARAGUAIA	14/11/2020 12:50	14/11/2020 18:41	14/11/2020 12:50	14/11/2020 18:41	5,84	58	338,96	CHI
20201164037	FORMOSA	610051696	ITIQUIRA	14/11/2020 12:50	14/11/2020 14:02	14/11/2020 12:50	14/11/2020 14:02	1,19	1	1,19	CHI
20201164046	PARAUNA	PU12233886	PARAUNA	14/11/2020 12:51	15/11/2020 12:12	14/11/2020 12:51	15/11/2020 12:12	23,34	18	420,11	CHI
20201164047	ANAPOLIS	AN11000126	ANAPOLIS UNIVERSITARIO S2	14/11/2020 12:52	14/11/2020 17:51	14/11/2020 12:52	14/11/2020 17:51	4,97	62	308,00	CHI
20201164208	CAMPO ALEGRE DE GOIAS	CM12420390	CAMPO ALEGRE DE GOIAS	14/11/2020 12:52	14/11/2020 17:57	14/11/2020 12:52	14/11/2020 17:57	5,08	24	121,95	CHI
20201164050	RIO VERDE	630462276	RIO VERDE S1	14/11/2020 12:54	15/11/2020 01:16	14/11/2020 12:54	15/11/2020 01:16	12,37	1	12,37	CHI
20201164051	JATAI	JT21000135	JATAI S2	14/11/2020 12:55	14/11/2020 13:30	14/11/2020 12:55	14/11/2020 13:30	0,58	1	0,58	CHI
20201164053	ANAPOLIS	AN11288615	JUNDIAI S2	14/11/2020 12:55	14/11/2020 17:51	14/11/2020 12:55	14/11/2020 17:51	4,92	40	196,86	CHI
20201164102	FIRMINOPOLIS	FR12028946	FIRMINOPOLIS S1	14/11/2020 12:58	14/11/2020 15:40	14/11/2020 12:58	14/11/2020 15:40	2,68	21	56,38	CHI
20201164236	NOVO BRASIL	NB12019396	JUSSARA	14/11/2020 12:58	14/11/2020 15:35	14/11/2020 12:58	14/11/2020 15:35	2,61	40	104,24	CHI
20201164072	ACREUNA	2440003056	ACREUNA	14/11/2020 12:59	14/11/2020 15:09	14/11/2020 12:59	14/11/2020 15:09	2,16	1	2,16	CHI
20201164288	GOIAS	GS12206917	ITABERAI S1	14/11/2020 13:01	14/11/2020 16:26	14/11/2020 13:01	14/11/2020 16:26	3,41	13	44,34	CHI
20201164553	MORRINHOS	MR12035913	MORRINHOS	14/11/2020 13:02	15/11/2020 16:21	14/11/2020 13:02	14/11/2020 19:21	6,32	4	25,27	CHI
20201164553	MORRINHOS	MR12035913	MORRINHOS	14/11/2020 13:02	15/11/2020 16:21	14/11/2020 13:02	15/11/2020 16:21	27,32	7	191,23	CHI
20201164553	MORRINHOS	MR12035913	MORRINHOS	14/11/2020 13:02	15/11/2020 16:21	15/11/2020 15:20	15/11/2020 16:21	1,01	4	4,06	CHI
20201164089	GOIANIA	13549807	GOIANIA LESTE S1	14/11/2020 13:03	14/11/2020 21:13	14/11/2020 13:03	14/11/2020 21:13	8,17	1	8,17	CHI
20201164153	ANICUNS	AC12228150LD	ANICUNS	14/11/2020 13:03	14/11/2020 20:22	14/11/2020 13:03	14/11/2020 20:22	7,32	52	380,73	CHI
20201164153	AVELINOPOLIS	AC12228150LD	ANICUNS	14/11/2020 13:03	14/11/2020 20:22	14/11/2020 13:03	14/11/2020 20:22	7,32	1	7,32	CHI
20201164153	ANICUNS	AC12228150LD	ANICUNS	14/11/2020 13:03	14/11/2020 20:22	14/11/2020 15:50	14/11/2020 20:22	4,54	59	267,86	CHI
20201164231	CRISTALINA	KR12330533	CRISTALINA S1	14/11/2020 13:03	14/11/2020 15:16	14/11/2020 13:03	14/11/2020 15:16	2,21	35	77,46	CHI
20201164231	IPAMERI	KR12330533	CRISTALINA S1	14/11/2020 13:03	14/11/2020 15:16	14/11/2020 13:03	14/11/2020 15:16	2,21	1	2,21	CHI
20201164231	LUZIANIA	KR12330533	CRISTALINA S1	14/11/2020 13:03	14/11/2020 15:16	14/11/2020 13:03	14/11/2020 15:16	2,21	8	17,70	CHI
20201164092	SENADOR CANEDO	10007464710	SENADOR CANEDO	14/11/2020 13:04	14/11/2020 14:45	14/11/2020 13:04	14/11/2020 14:45	1,68	1	1,68	CHI
20201164096	CRISTALINA	1060081985	CRISTALINA S1	14/11/2020 13:04	15/11/2020 01:31	14/11/2020 13:04	15/11/2020 01:31	12,44	1	12,44	CHI
20201164103	GOIANIA	10000876168	MEIA PONTE	14/11/2020 13:06	14/11/2020 21:33	14/11/2020 13:06	14/11/2020 21:33	8,44	1	8,44	CHI
20201164113	EDEALINA	ED11359988	PONTALINA	14/11/2020 13:08	14/11/2020 16:13	14/11/2020 13:08	14/11/2020 16:13	3,08	5	15,42	CHI
20201164114	BURITI DE GOIAS	BS21332940	FIRMINOPOLIS S2	14/11/2020 13:08	14/11/2020 16:19	14/11/2020 13:08	14/11/2020 16:19	3,18	1	3,18	CHI
20201164116	GOIANIA	10028197621	ATLANTICO S1	14/11/2020 13:08	14/11/2020 19:22	14/11/2020 13:08	14/11/2020 19:22	6,23	1	6,23	CHI
20201164117	ABADIANIA	AA12414271	ANAPOLIS UNIVERSITARIO S1	14/11/2020 13:08	15/11/2020 12:09	14/11/2020 13:08	15/11/2020 12:09	23,01	3	69,02	CHI
20201165078	ORIZONA	OZ12275794	PIRES DO RIO S2	14/11/2020 13:09	14/11/2020 17:52	14/11/2020 13:09	14/11/2020 17:52	4,70	12	56,43	CHI
20201164134	APARECIDA DE GOIANIA	AP11166592	REAL S2	14/11/2020 13:11	14/11/2020 16:31	14/11/2020 13:11	14/11/2020 16:31	3,33	146	485,98	CHI
20201164140	IPAMERI	580067944	IPAMERI	14/11/2020 13:14	15/11/2020 07:40	14/11/2020 13:14	15/11/2020 07:40	18,42	1	18,42	CHI
20201164141	CALDAS NOVAS	CN11309377	CALDAS NOVAS S1	14/11/2020 13:14	14/11/2020 17:55	14/11/2020 13:14	14/11/2020 17:55	4,67	34	158,69	CHI
20201164489	NIQUELANDIA	NQ12234274	NIQUELANDIA SUBTRANSMISSAO	14/11/2020 13:14	16/11/2020 09:47	14/11/2020 13:14	16/11/2020 09:47	44,54	8	356,32	CHI
20201164142	JATAI	290148170	JATAI S3	14/11/2020 13:15	14/11/2020 15:33	14/11/2020 13:15	14/11/2020 15:33	2,30	1	2,30	CHI

20201164146	CHAPADAO DO CEU	DJ12148315	CHAPADAO DO CEU	14/11/2020 13:15	14/11/2020 15:10	14/11/2020 13:15	14/11/2020 15:10	1,91	5	9,56	CHI
20201164150	FORMOSA	FA11404587	ITUIQUIRA	14/11/2020 13:15	14/11/2020 20:21	14/11/2020 13:15	14/11/2020 20:21	7,09	6	42,52	CHI
20201164427	PONTALINA	PK12047233	PONTALINA	14/11/2020 13:15	14/11/2020 15:07	14/11/2020 13:15	14/11/2020 15:07	1,86	14	26,01	CHI
20201164161	FORMOSA	4920224	SAO JOAO D ALIANCA	14/11/2020 13:19	14/11/2020 15:59	14/11/2020 13:19	14/11/2020 15:40	2,35	489	1148,47	CHI
20201164161	FORMOSA	FA11202296	SAO JOAO D ALIANCA	14/11/2020 13:19	14/11/2020 15:59	14/11/2020 13:19	14/11/2020 15:59	2,67	9	23,99	CHI
20201164165	IACIARA	1550012177	IACIARA S1	14/11/2020 13:19	14/11/2020 14:14	14/11/2020 13:19	14/11/2020 14:14	0,90	1	0,90	CHI
20201164166	RIO VERDE	RV21296075	RIO VERDE S1	14/11/2020 13:20	14/11/2020 23:03	14/11/2020 13:20	14/11/2020 23:03	9,71	1	9,71	CHI
20201164168	GOIANIA	13612360	CAMPINAS S2	14/11/2020 13:20	14/11/2020 15:25	14/11/2020 13:20	14/11/2020 15:25	2,08	1	2,08	CHI
20201164171	FIRMINOPOLIS	FR12186311	FIRMINOPOLIS S1	14/11/2020 13:21	14/11/2020 17:11	14/11/2020 13:21	14/11/2020 17:11	3,83	3	11,49	CHI
20201164172	CRISTALINA	KR12383034	CRISTALINA S1	14/11/2020 13:21	14/11/2020 23:00	14/11/2020 13:21	14/11/2020 23:00	9,64	3	28,93	CHI
20201164174	URUTAI	UT21382048	PIRES DO RIO S2	14/11/2020 13:21	14/11/2020 16:37	14/11/2020 13:21	14/11/2020 16:37	3,25	1	3,25	CHI
20201164480	ALEXANIA	SN12389382	MARAJOARA	14/11/2020 13:21	14/11/2020 17:46	14/11/2020 13:21	14/11/2020 17:46	4,40	2	8,80	CHI
20201164480	SANTO ANTONIO DO DESCOBERTO	SN12389382	MARAJOARA	14/11/2020 13:21	14/11/2020 17:46	14/11/2020 13:21	14/11/2020 17:46	4,40	74	325,72	CHI
20201164175	CASTELANDIA	DM12200714	RIO DOS BOIS	14/11/2020 13:22	14/11/2020 14:12	14/11/2020 13:22	14/11/2020 13:56	0,57	1	0,57	CHI
20201164175	CASTELANDIA	DM11099519	RIO DOS BOIS	14/11/2020 13:22	14/11/2020 14:12	14/11/2020 13:22	14/11/2020 14:12	0,85	96	81,28	CHI
20201164178	GOIANIA	13559709	GOIANIA LESTE S3	14/11/2020 13:22	14/11/2020 21:53	14/11/2020 13:22	14/11/2020 21:53	8,51	1	8,51	CHI
20201164280	SANTA HELENA DE GOIAS	SH11134330	IPEGUARI	14/11/2020 13:22	14/11/2020 18:02	14/11/2020 13:22	14/11/2020 18:02	4,66	117	544,90	CHI
20201164192	JUSSARA	JR12073379	BRITANIA	14/11/2020 13:25	14/11/2020 22:44	14/11/2020 13:25	14/11/2020 22:44	9,32	9	83,85	CHI
20201164356	ANAPOLIS	AN11394318	ANAPOLIS UNIVERSITARIO S2	14/11/2020 13:25	14/11/2020 16:50	14/11/2020 13:25	14/11/2020 16:50	3,41	194	662,02	CHI
20201164207	HIDROLANDIA	HD21047200	CEPAIGO S2	14/11/2020 13:27	14/11/2020 16:53	14/11/2020 13:27	14/11/2020 16:53	3,43	5	17,15	CHI
20201164212	SAO SIMAO	SO12000102	CACHOEIRA ALTA	14/11/2020 13:27	14/11/2020 14:32	14/11/2020 13:27	14/11/2020 14:32	1,08	744	800,83	CHI
20201166053	AVELINOPOLIS	AV12054063	ANICUNS	14/11/2020 13:27	14/11/2020 21:56	14/11/2020 13:27	14/11/2020 21:56	8,48	3	25,45	CHI
20201164214	ITARUMA	IM12097096	CACHOEIRA ALTA	14/11/2020 13:28	14/11/2020 17:45	14/11/2020 13:28	14/11/2020 17:45	4,28	2	8,56	CHI
20201164215	PARAUNA	PU21007984	PARAUNA	14/11/2020 13:28	14/11/2020 17:43	14/11/2020 13:28	14/11/2020 17:43	4,25	2	8,49	CHI
20201164216	APARECIDA DE GOIANIA	13594850	ATLANTICO S3	14/11/2020 13:28	14/11/2020 16:29	14/11/2020 13:28	14/11/2020 16:29	3,01	1	3,01	CHI
20201164219	ITUMBIARA	IT21119041	ITUMBIARA NOVA	14/11/2020 13:28	14/11/2020 21:40	14/11/2020 13:28	14/11/2020 21:40	8,19	1	8,19	CHI
20201164229	SAO SIMAO	SO12000002RE	CACHOEIRA ALTA	14/11/2020 13:30	14/11/2020 15:31	14/11/2020 13:30	14/11/2020 15:31	2,01	560	1125,13	CHI
20201164230	CIDADE OCIDENTAL	2680077186	MARAJOARA	14/11/2020 13:30	14/11/2020 15:11	14/11/2020 13:30	14/11/2020 15:11	1,68	1	1,68	CHI
20201164238	PORTEIRAO	DM21191982	RIO DOS BOIS	14/11/2020 13:32	14/11/2020 23:55	14/11/2020 13:32	14/11/2020 23:55	10,38	1	10,38	CHI
20201164245	CRISTALINA	7514264	CRISTALINA S2	14/11/2020 13:33	14/11/2020 20:43	14/11/2020 13:33	14/11/2020 20:43	7,15	1	7,15	CHI
20201164245	IPAMERI	7514264	CRISTALINA S2	14/11/2020 13:33	14/11/2020 20:43	14/11/2020 13:33	14/11/2020 20:43	7,15	2	14,30	CHI
20201164247	HIDROLANDIA	HD21093310	CEPAIGO S2	14/11/2020 13:34	15/11/2020 04:14	14/11/2020 13:34	15/11/2020 04:14	14,66	1	14,66	CHI
20201164248	IPAMERI	580029062	IPAMERI	14/11/2020 13:34	14/11/2020 21:42	14/11/2020 13:34	14/11/2020 21:42	8,12	1	8,12	CHI
20201164284	ITAGUARI	TQ12028650LD	ITABERAI S1	14/11/2020 13:34	14/11/2020 15:17	14/11/2020 13:34	14/11/2020 15:17	1,71	132	225,13	CHI
20201164284	ITAGUARU	TQ12028650LD	ITABERAI S1	14/11/2020 13:34	14/11/2020 15:17	14/11/2020 13:34	14/11/2020 15:17	1,71	1	1,71	CHI
20201164495	BONOPOLIS	PO12090602	MARA ROSA	14/11/2020 13:35	14/11/2020 21:36	14/11/2020 13:35	14/11/2020 21:36	8,01	2	16,01	CHI
20201164495	PORANGATU	PO12090602	MARA ROSA	14/11/2020 13:35	14/11/2020 21:36	14/11/2020 13:35	14/11/2020 21:36	8,01	65	520,40	CHI
20201165511	NOVA IGUACU DE GOIAS	NH21270883	CAMPINORTE	14/11/2020 13:35	14/11/2020 21:09	14/11/2020 13:35	14/11/2020 21:09	7,56	1	7,56	CHI
20201164264	PALMEIRAS DE GOIAS	PL12087671	PALMEIRAS	14/11/2020 13:37	14/11/2020 17:12	14/11/2020 13:37	14/11/2020 17:12	3,57	1	3,57	CHI
20201164387	ALEXANIA	AX12384864	ALEXANIA	14/11/2020 13:39	14/11/2020 17:26	14/11/2020 13:39	14/11/2020 17:26	3,77	79	297,76	CHI
20201164548	MORRINHOS	MR12000403	MORRINHOS	14/11/2020 13:40	14/11/2020 16:04	14/11/2020 13:40	14/11/2020 16:04	2,39	14	33,49	CHI
20201164282	SILVANIA	SV21372129	VIANOPOLIS	14/11/2020 13:41	14/11/2020 15:33	14/11/2020 13:41	14/11/2020 15:33	1,86	1	1,86	CHI
20201164623	CRISTALINA	KR12163117	CRISTALINA S1	14/11/2020 13:41	14/11/2020 16:57	14/11/2020 13:41	14/11/2020 16:57	3,25	7	22,76	CHI
20201164840	NOVO PLANALTO	SM12074386RE	SAO MIGUEL DO ARAGUAIA	14/11/2020 13:41	15/11/2020 10:44	14/11/2020 13:41	15/11/2020 10:44	21,04	6	126,24	CHI
20201164840	SAO MIGUEL DO ARAGUAIA	SM12074386RE	SAO MIGUEL DO ARAGUAIA	14/11/2020 13:41	15/11/2020 10:44	14/11/2020 13:41	15/11/2020 10:44	21,04	135	2840,40	CHI
20201164504	ITAGUARI	IC12219937	ITABERAI S1	14/11/2020 13:42	14/11/2020 15:47	14/11/2020 13:42	14/11/2020 15:47	2,08	26	54,14	CHI
20201164504	ITAGUARU	IC12219937	ITABERAI S1	14/11/2020 13:42	14/11/2020 15:47	14/11/2020 13:42	14/11/2020 15:47	2,08	2	4,16	CHI
20201164549	JATAI	JT12260431RE	JATAI S1	14/11/2020 13:42	14/11/2020 17:30	14/11/2020 13:42	14/11/2020 17:30	3,79	23	87,23	CHI
20201164549	SERRANOPOLIS	JT12260431RE	JATAI S1	14/11/2020 13:42	14/11/2020 17:30	14/11/2020 13:42	14/11/2020 17:30	3,79	19	72,06	CHI
20201165322	CATALAO	CT12130976	CATALAO S1	14/11/2020 13:43	15/11/2020 09:04	14/11/2020 13:43	15/11/2020 09:04	19,34	12	232,10	CHI
20201164298	CRISTALINA	IP12100702	CRISTALINA S2	14/11/2020 13:44	14/11/2020 21:26	14/11/2020 13:44	14/11/2020 21:26	7,70	1	7,70	CHI



20201164303	FLORES DE GOIAS	FB11255058	FLORES DE GOIAS	14/11/2020 13:44	14/11/2020 17:54	14/11/2020 13:44	14/11/2020 17:54	4,15	18	74,75	CHI
20201164304	ORIZONA	OZ11047552	PIRES DO RIO S2	14/11/2020 13:45	14/11/2020 15:30	14/11/2020 13:45	14/11/2020 15:30	1,74	150	260,29	CHI
20201164349	CATALAO	CT12009651	CATALAO S2	14/11/2020 13:45	14/11/2020 15:01	14/11/2020 13:45	14/11/2020 15:01	1,25	872	1091,21	CHI
20201164475	AMARALINA	LC12248963	MARA ROSA	14/11/2020 13:46	14/11/2020 17:39	14/11/2020 13:46	14/11/2020 17:39	3,87	23	88,96	CHI
20201164687	URUACU	UR12353573	URUACU	14/11/2020 13:48	18/11/2020 15:58	14/11/2020 13:48	14/11/2020 19:45	5,95	4	23,78	CHI
20201164687	URUACU	UR12353573	URUACU	14/11/2020 13:48	18/11/2020 15:58	14/11/2020 13:48	15/11/2020 12:31	22,72	6	136,31	CHI
20201164687	URUACU	UR12353573	URUACU	14/11/2020 13:48	18/11/2020 15:58	14/11/2020 22:12	15/11/2020 12:31	14,32	1	14,32	CHI
20201164687	URUACU	UR12353573	URUACU	14/11/2020 13:48	18/11/2020 15:58	15/11/2020 14:00	17/11/2020 16:59	50,99	7	356,94	CHI
20201164687	URUACU	UR12353573	URUACU	14/11/2020 13:48	18/11/2020 15:58	15/11/2020 14:00	17/11/2020 17:05	51,08	1	51,08	CHI
20201164687	URUACU	UR12353573	URUACU	14/11/2020 13:48	18/11/2020 15:58	14/11/2020 22:12	18/11/2020 15:58	89,77	1	89,77	CHI
20201164687	URUACU	UR12353573	URUACU	14/11/2020 13:48	18/11/2020 15:58	15/11/2020 14:00	18/11/2020 15:58	73,97	1	73,97	CHI
20201164687	URUACU	UR12353573	URUACU	14/11/2020 13:48	18/11/2020 15:58	18/11/2020 09:25	18/11/2020 15:58	6,54	8	52,35	CHI
20201164319	GOIANESIA	GE13294243	GOIANESIA S1	14/11/2020 13:49	15/11/2020 20:25	14/11/2020 16:54	15/11/2020 19:32	26,63	1	26,63	CHI
20201164319	GOIANESIA	4640404	GOIANESIA S1	14/11/2020 13:49	15/11/2020 20:25	15/11/2020 20:20	15/11/2020 20:25	0,08	395	32,26	CHI
20201164319	GOIANESIA	4640404	GOIANESIA S1	14/11/2020 13:49	15/11/2020 20:25	15/11/2020 20:20	15/11/2020 20:25	0,08	611	49,90	CHI
20201164319	NOVA GLORIA	4640404	GOIANESIA S1	14/11/2020 13:49	15/11/2020 20:25	15/11/2020 20:20	15/11/2020 20:25	0,08	2	0,16	CHI
20201164319	SANTA ISABEL	4640404	GOIANESIA S1	14/11/2020 13:49	15/11/2020 20:25	15/11/2020 20:20	15/11/2020 20:25	0,08	2	0,16	CHI
20201164319	SANTA ISABEL	4640404	GOIANESIA S1	14/11/2020 13:49	15/11/2020 20:25	15/11/2020 20:20	15/11/2020 20:25	0,08	31	2,53	CHI
20201164319	SAO LUIZ DO NORTE	4640404	GOIANESIA S1	14/11/2020 13:49	15/11/2020 20:25	15/11/2020 20:20	15/11/2020 20:25	0,08	21	1,72	CHI
20201164321	NAZARIO	440031291	ANICUNS	14/11/2020 13:49	14/11/2020 21:02	14/11/2020 13:49	14/11/2020 21:02	7,21	1	7,21	CHI
20201164352	MARA ROSA	NQ10400364	URUACU	14/11/2020 13:50	14/11/2020 13:56	14/11/2020 13:50	14/11/2020 13:56	0,09	1	0,09	CHI
20201164352	NIQUELANDIA	NQ10400364	URUACU	14/11/2020 13:50	14/11/2020 13:56	14/11/2020 13:50	14/11/2020 13:56	0,09	1295	119,07	CHI
20201164340	CIDADE OCIDENTAL	LZ12249979	MARAJOARA	14/11/2020 13:53	14/11/2020 17:45	14/11/2020 13:53	14/11/2020 17:45	3,86	1	3,86	CHI
20201164362	LUZIANIA	120211130	RIO VERMELHO	14/11/2020 13:55	14/11/2020 21:09	14/11/2020 13:55	14/11/2020 21:09	7,22	1	7,22	CHI
20201164363	GOIANAPOLIS	GP21124506	JUNDIAI S1	14/11/2020 13:55	14/11/2020 18:50	14/11/2020 13:55	14/11/2020 18:50	4,91	3	14,72	CHI
20201164365	MORRINHOS	MR21035894	MORRINHOS	14/11/2020 13:55	14/11/2020 23:09	14/11/2020 13:55	14/11/2020 23:09	9,22	1	9,22	CHI
20201164403	BRITANIA	2700414	BRITANIA	14/11/2020 13:55	15/11/2020 18:30	14/11/2020 13:55	14/11/2020 16:01	2,10	11	23,09	CHI
20201164403	ITAPIRAPUA	2700414	BRITANIA	14/11/2020 13:55	15/11/2020 18:30	14/11/2020 13:55	14/11/2020 16:01	2,10	2	4,20	CHI
20201164403	JUSSARA	2700414	BRITANIA	14/11/2020 13:55	15/11/2020 18:30	14/11/2020 13:55	14/11/2020 16:01	2,10	11	23,09	CHI
20201164403	SANTA FE DE GOIAS	2700414	BRITANIA	14/11/2020 13:55	15/11/2020 18:30	14/11/2020 13:55	14/11/2020 16:01	2,10	34	71,37	CHI
20201164403	SANTA FE DE GOIAS	2700414	BRITANIA	14/11/2020 13:55	15/11/2020 18:30	14/11/2020 13:55	14/11/2020 16:01	2,10	10	20,99	CHI
20201164403	JUSSARA	2700414	BRITANIA	14/11/2020 13:55	15/11/2020 18:30	14/11/2020 13:55	14/11/2020 16:49	2,89	9	25,99	CHI
20201164403	SANTA FE DE GOIAS	2700414	BRITANIA	14/11/2020 13:55	15/11/2020 18:30	14/11/2020 13:55	14/11/2020 16:49	2,89	6	17,33	CHI
20201164403	JUSSARA	2700414	BRITANIA	14/11/2020 13:55	15/11/2020 18:30	14/11/2020 13:55	15/11/2020 17:38	27,71	1	27,71	CHI
20201164403	SANTA FE DE GOIAS	2700414	BRITANIA	14/11/2020 13:55	15/11/2020 18:30	14/11/2020 13:55	15/11/2020 17:38	27,71	15	415,61	CHI
20201164403	SANTA FE DE GOIAS	2700414	BRITANIA	14/11/2020 13:55	15/11/2020 18:30	14/11/2020 13:55	15/11/2020 18:30	28,58	17	485,82	CHI
20201164373	PORTELANDIA	PW21303807	PARQUE DAS EMAS	14/11/2020 13:57	14/11/2020 21:33	14/11/2020 13:57	14/11/2020 21:33	7,59	1	7,59	CHI
20201164376	CABECEIRAS	CW12108823	ITIQUIRA	14/11/2020 13:58	14/11/2020 16:19	14/11/2020 13:58	14/11/2020 16:19	2,34	18	42,12	CHI
20201164390	FLORES DE GOIAS	2590206	ITIQUIRA	14/11/2020 13:58	14/11/2020 19:43	14/11/2020 13:58	14/11/2020 19:43	5,74	3	17,21	CHI
20201164390	FORMOSA	2590206	ITIQUIRA	14/11/2020 13:58	14/11/2020 19:43	14/11/2020 13:58	14/11/2020 19:43	5,74	573	3287,43	CHI
20201164390	SAO JOAO D ALIANCA	2590206	ITIQUIRA	14/11/2020 13:58	14/11/2020 19:43	14/11/2020 13:58	14/11/2020 19:43	5,74	225	1290,88	CHI
20201164390	VILA BOA	2590206	ITIQUIRA	14/11/2020 13:58	14/11/2020 19:43	14/11/2020 13:58	14/11/2020 19:43	5,74	6	34,42	CHI
20201164671	ALEXANIA	AX12000057	ALEXANIA	14/11/2020 13:59	14/11/2020 16:40	14/11/2020 13:59	14/11/2020 16:40	2,68	10	26,78	CHI
20201164671	SANTO ANTONIO DO DESCOBERTO	AX12000057	ALEXANIA	14/11/2020 13:59	14/11/2020 16:40	14/11/2020 13:59	14/11/2020 16:40	2,68	1	2,68	CHI
20201164383	BOM JARDIM DE GOIAS	BM12060899	ARAGARCAS	14/11/2020 14:00	14/11/2020 17:33	14/11/2020 14:00	14/11/2020 17:33	3,54	35	124,04	CHI
20201164385	GUAPO	GA11276661	GUAPO S2	14/11/2020 14:00	15/11/2020 08:31	14/11/2020 14:00	15/11/2020 08:31	18,50	1	18,50	CHI
20201166266	RIO VERDE	RV12131656	RIO VERDE S1	14/11/2020 14:01	15/11/2020 04:35	14/11/2020 14:01	15/11/2020 04:35	14,55	7	101,86	CHI
20201164471	PIRACANJUBA	PJ12084826	PIRACANJUBA	14/11/2020 14:03	14/11/2020 19:07	14/11/2020 14:03	14/11/2020 19:07	5,05	11	55,57	CHI
20201164410	LUZIANIA	OZ12402562RE	PIRES DO RIO S2	14/11/2020 14:05	14/11/2020 19:31	14/11/2020 14:05	14/11/2020 19:31	5,42	133	720,53	CHI
20201164410	ORIZONA	OZ12402562RE	PIRES DO RIO S2	14/11/2020 14:05	14/11/2020 19:31	14/11/2020 14:05	14/11/2020 19:31	5,42	7	37,92	CHI
20201164758	ALEXANIA	AX12317789	ALEXANIA	14/11/2020 14:06	14/11/2020 16:38	14/11/2020 14:06	14/11/2020 16:38	2,53	13	32,83	CHI

20201164420	ITAPIRAPUA	3270000155	MATRINCHA	14/11/2020 14:07	14/11/2020 19:10	14/11/2020 14:07	14/11/2020 19:10	5,04	1	5,04	CHI
20201164606	NOVO PLANALTO	SM12099146RE	SAO MIGUEL DO ARAGUAIA	14/11/2020 14:07	15/11/2020 09:54	14/11/2020 14:07	15/11/2020 09:54	19,77	0	0,00	CHI
20201164606	SAO MIGUEL DO ARAGUAIA	SM12099146RE	SAO MIGUEL DO ARAGUAIA	14/11/2020 14:07	15/11/2020 09:54	14/11/2020 14:07	15/11/2020 09:54	19,77	53	1047,80	CHI
20201164424	BELA VISTA DE GOIAS	SV21196568	CEPAIGO S2	14/11/2020 14:08	14/11/2020 17:11	14/11/2020 14:08	14/11/2020 17:11	3,04	2	6,08	CHI
20201164432	ANAPOLIS	10002563035	ANAPOLIS UNIVERSITARIO S2	14/11/2020 14:10	14/11/2020 15:53	14/11/2020 14:10	14/11/2020 15:53	1,70	1	1,70	CHI
20201164444	SAO DOMINGOS	SD12218642	SAO DOMINGOS	14/11/2020 14:13	14/11/2020 16:31	14/11/2020 14:13	14/11/2020 16:31	2,29	87	198,99	CHI
20201164447	APARECIDA DE GOIANIA	200256762	ANHANGUERA	14/11/2020 14:13	14/11/2020 19:09	14/11/2020 14:13	14/11/2020 19:09	4,92	1	4,92	CHI
20201164473	GOIATUBA	BJ21091328	RIO DOS BOIS	14/11/2020 14:15	14/11/2020 22:12	14/11/2020 14:15	14/11/2020 22:12	7,95	1	7,95	CHI
20201164476	FIRMINOPOLIS	FR21096808	FIRMINOPOLIS S1	14/11/2020 14:16	14/11/2020 18:50	14/11/2020 14:16	14/11/2020 18:50	4,57	1	4,57	CHI
20201164477	SANTA RITA DO ARAGUAIA	SU12090636	SANTA RITA DO ARAGUAIA	14/11/2020 14:16	14/11/2020 17:20	14/11/2020 14:16	14/11/2020 17:20	3,06	3	9,18	CHI
20201164483	CHAPADAO DO CEU	DJ21121697	CHAPADAO DO CEU	14/11/2020 14:17	14/11/2020 16:29	14/11/2020 14:17	14/11/2020 16:29	2,19	2	4,38	CHI
20201164484	ITAJA	IJ2200688	ITAJA S2	14/11/2020 14:18	14/11/2020 20:09	14/11/2020 14:18	14/11/2020 20:09	5,86	3	17,58	CHI
20201164484	ITAJA	IJ2200688	ITAJA S2	14/11/2020 14:18	14/11/2020 20:09	14/11/2020 16:04	14/11/2020 20:09	4,09	1	4,09	CHI
20201164490	GOIANIA	14800676	CAMPINAS S2	14/11/2020 14:18	14/11/2020 16:33	14/11/2020 14:18	14/11/2020 16:33	2,24	1	2,24	CHI
20201164501	RIO QUENTE	RQ21103122	VILA CORUMBA	14/11/2020 14:21	14/11/2020 18:44	14/11/2020 14:21	14/11/2020 18:44	4,38	1	4,38	CHI
20201164503	CRIXAS	7957454	SERRA DO OURO	14/11/2020 14:21	14/11/2020 20:22	14/11/2020 14:21	14/11/2020 20:22	6,02	1	6,02	CHI
20201164509	INACIOLANDIA	ID12271589	CACHOEIRA DOURADA	14/11/2020 14:22	14/11/2020 18:03	14/11/2020 14:22	14/11/2020 18:03	3,67	16	58,75	CHI
20201164511	AGUAS LINDAS DE GOIAS	4830413830	AGUAS LINDAS DE GOIAS S1	14/11/2020 14:22	14/11/2020 15:39	14/11/2020 14:22	14/11/2020 15:39	1,27	1	1,27	CHI
20201164827	CABECEIRAS	CW12262301	ITIQUEIRA	14/11/2020 14:22	14/11/2020 19:26	14/11/2020 14:22	14/11/2020 19:26	5,06	43	217,46	CHI
20201164827	DISTRITO FEDERAL	CW12262301	ITIQUEIRA	14/11/2020 14:22	14/11/2020 19:26	14/11/2020 14:22	14/11/2020 19:26	5,06	1	5,06	CHI
20201164513	SANTA RITA DO NOVO DESTINO	DF12315586	BARRO ALTO	14/11/2020 14:23	14/11/2020 20:02	14/11/2020 14:23	14/11/2020 20:02	5,65	3	16,94	CHI
20201164514	MINEIROS	MY12043894RE	PARQUE DAS EMAS	14/11/2020 14:23	14/11/2020 16:05	14/11/2020 14:23	14/11/2020 16:05	1,69	99	167,72	CHI
20201164521	APARECIDA DE GOIANIA	12743410	INDEPENDENCIA S2	14/11/2020 14:24	14/11/2020 15:44	14/11/2020 14:24	14/11/2020 15:44	1,32	1	1,32	CHI
20201164523	NOVA CRIXAS	8570042737	NOVA CRIXAS	14/11/2020 14:24	14/11/2020 16:46	14/11/2020 14:24	14/11/2020 16:46	2,35	1	2,35	CHI
20201164529	CORUMBAIBA	CI21230588	VILA CORUMBA	14/11/2020 14:26	14/11/2020 14:58	14/11/2020 14:26	14/11/2020 14:58	0,53	1	0,53	CHI
20201165341	MINACU	IH12396737	MINACU	14/11/2020 14:26	15/11/2020 00:18	14/11/2020 14:26	15/11/2020 00:18	9,87	14	138,13	CHI
202011138042	MINACU	IH12208345	MINACU	14/11/2020 14:27	16/11/2020 09:44	14/11/2020 14:27	16/11/2020 09:44	43,28	98	4241,20	CHI
20201165261	APARECIDA DE GOIANIA	15485547	INDEPENDENCIA S2	14/11/2020 14:28	15/11/2020 00:42	14/11/2020 14:28	15/11/2020 00:42	10,22	1	10,22	CHI
20201164817	INDIARA	IY12391438	EDEIA	14/11/2020 14:30	14/11/2020 16:13	14/11/2020 14:30	14/11/2020 16:13	1,70	13	22,16	CHI
20201164817	JANDAIA	IY12391438	EDEIA	14/11/2020 14:30	14/11/2020 16:13	14/11/2020 14:30	14/11/2020 16:13	1,70	1	1,70	CHI
20201164817	PALMEIRAS DE GOIAS	IY12391438	EDEIA	14/11/2020 14:30	14/11/2020 16:13	14/11/2020 14:30	14/11/2020 16:13	1,70	1	1,70	CHI
20201164554	ITABERAÍ	IB12311098	ITABERAÍ S1	14/11/2020 14:31	14/11/2020 21:27	14/11/2020 14:31	14/11/2020 21:27	6,93	2	13,87	CHI
20201164557	CRISTALINA	KR21206514	PAMPLONA	14/11/2020 14:31	14/11/2020 22:14	14/11/2020 14:31	14/11/2020 22:14	7,70	1	7,70	CHI
20201164558	SANTA HELENA DE GOIAS	SH21360627	IPEGUARI	14/11/2020 14:32	14/11/2020 18:57	14/11/2020 14:32	14/11/2020 18:57	4,42	1	4,42	CHI
20201164564	SAO MIGUEL DO PASSA QUATRO	1490014230	CRISTIANOPOLIS	14/11/2020 14:33	14/11/2020 15:59	14/11/2020 14:33	14/11/2020 15:59	1,43	1	1,43	CHI
20201164568	CRIXAS	CX12221633RE	RUBIATABA	14/11/2020 14:33	16/11/2020 09:07	14/11/2020 14:33	16/11/2020 09:07	42,55	132	5616,97	CHI
20201164568	NOVA CRIXAS	CX12221633RE	RUBIATABA	14/11/2020 14:33	16/11/2020 09:07	14/11/2020 14:33	16/11/2020 09:07	42,55	1	42,55	CHI
20201164570	GOIANIA	13934727	MEIA PONTE	14/11/2020 14:34	14/11/2020 17:27	14/11/2020 14:34	14/11/2020 17:27	2,88	1	2,88	CHI
20201164574	SENADOR CANEDO	13672370	SENADOR CANEDO	14/11/2020 14:35	14/11/2020 15:21	14/11/2020 14:35	14/11/2020 15:21	0,76	1	0,76	CHI
20201164620	FORMOSA	FA10396080	ITIQUEIRA	14/11/2020 14:36	14/11/2020 20:19	14/11/2020 14:36	14/11/2020 16:50	2,23	7	15,61	CHI
20201164620	FORMOSA	FA10396080	ITIQUEIRA	14/11/2020 14:36	14/11/2020 20:19	14/11/2020 17:28	14/11/2020 17:33	0,09	7	0,60	CHI
20201164620	CABECEIRAS	FA10396080	ITIQUEIRA	14/11/2020 14:36	14/11/2020 20:19	14/11/2020 14:36	14/11/2020 20:19	5,71	39	222,79	CHI
20201164620	DISTRITO FEDERAL	FA10396080	ITIQUEIRA	14/11/2020 14:36	14/11/2020 20:19	14/11/2020 14:36	14/11/2020 20:19	5,71	1	5,71	CHI
20201164620	FORMOSA	FA10396080	ITIQUEIRA	14/11/2020 14:36	14/11/2020 20:19	14/11/2020 14:36	14/11/2020 20:19	5,71	188	1073,95	CHI
20201165405	CAMPOS VERDES	VD12243626	SANTA TEREZINHA	14/11/2020 14:36	14/11/2020 20:09	14/11/2020 14:36	14/11/2020 20:09	5,54	20	110,71	CHI
20201164601	GOIANIA	15920653	CARAIAS S1	14/11/2020 14:37	14/11/2020 15:55	14/11/2020 14:37	14/11/2020 15:55	1,30	1	1,30	CHI
20201164618	ITABERAÍ	IB21360504	ITABERAÍ S1	14/11/2020 14:39	14/11/2020 18:00	14/11/2020 14:39	14/11/2020 18:00	3,35	1	3,35	CHI
20201164628	ITAJA	IM10394710	CACHOEIRA ALTA	14/11/2020 14:39	14/11/2020 19:17	14/11/2020 14:39	14/11/2020 17:47	3,13	1	3,13	CHI
20201164628	ITARUMA	IM10394710	CACHOEIRA ALTA	14/11/2020 14:39	14/11/2020 19:17	14/11/2020 14:39	14/11/2020 17:47	3,13	86	269,23	CHI
20201164628	JATAÍ	IM10394710	CACHOEIRA ALTA	14/11/2020 14:39	14/11/2020 19:17	14/11/2020 14:39	14/11/2020 17:47	3,13	12	37,57	CHI
20201164628	ITARUMA	IM10394710	CACHOEIRA ALTA	14/11/2020 14:39	14/11/2020 19:17	14/11/2020 14:39	14/11/2020 19:17	4,63	37	171,19	CHI

20201164628	SERRANOPOLIS	IM10394710	CACHOEIRA ALTA	14/11/2020 14:39	14/11/2020 19:17	14/11/2020 14:39	14/11/2020 19:17	4,63	51	235,96	CHI
20201164741	CAIAPONIA	CP12190363	CAIAPONIA	14/11/2020 14:40	16/11/2020 12:21	14/11/2020 14:40	15/11/2020 19:38	28,98	2	57,95	CHI
20201164741	DOVERLANDIA	CP12190363	CAIAPONIA	14/11/2020 14:40	16/11/2020 12:21	14/11/2020 14:40	15/11/2020 19:38	28,98	1	28,98	CHI
20201164741	DOVERLANDIA	CP12190363	CAIAPONIA	14/11/2020 14:40	16/11/2020 12:21	14/11/2020 14:40	16/11/2020 11:36	44,95	5	224,74	CHI
20201164741	CAIAPONIA	CP12190363	CAIAPONIA	14/11/2020 14:40	16/11/2020 12:21	14/11/2020 14:40	16/11/2020 12:21	45,68	2	91,37	CHI
20201164640	MORRINHOS	MR21172946	MORRINHOS	14/11/2020 14:42	14/11/2020 17:40	14/11/2020 14:42	14/11/2020 17:40	2,96	1	2,96	CHI
20201164970	IPORA	IR12358519	IPORA	14/11/2020 14:42	15/11/2020 03:46	14/11/2020 14:42	15/11/2020 03:46	13,05	12	156,62	CHI
20201164970	IVOLANDIA	IR12358519	IPORA	14/11/2020 14:42	15/11/2020 03:46	14/11/2020 14:42	15/11/2020 03:46	13,05	2	26,10	CHI
20201164864	JATAI	JT12072680	JATAI S1	14/11/2020 14:44	14/11/2020 19:03	14/11/2020 14:44	14/11/2020 19:03	4,31	15	64,70	CHI
20201164659	GOIANIA	10004346244	GOIANIA LESTE S2	14/11/2020 14:45	14/11/2020 22:47	14/11/2020 14:45	14/11/2020 22:47	8,03	1	8,03	CHI
20201167152	MARA ROSA	MQ21192391	MARA ROSA	14/11/2020 14:45	15/11/2020 14:31	14/11/2020 14:45	15/11/2020 14:31	23,75	1	23,75	CHI
20201164664	PLANALTINA	2960174386	PLANALTINA	14/11/2020 14:46	14/11/2020 17:15	14/11/2020 14:46	14/11/2020 17:15	2,47	1	2,47	CHI
20201166543	CRISTALINA	KR12248700	CRISTALINA S2	14/11/2020 14:46	14/11/2020 21:58	14/11/2020 14:46	14/11/2020 21:58	7,19	18	129,35	CHI
20201164675	FORMOSA	FA13361367	ITUIQUIRA	14/11/2020 14:47	15/11/2020 02:46	14/11/2020 14:47	15/11/2020 02:46	11,98	21	251,52	CHI
20201164675	FORMOSA	FA13361367	ITUIQUIRA	14/11/2020 14:47	15/11/2020 02:46	15/11/2020 01:36	15/11/2020 02:46	1,16	24	27,72	CHI
20201165015	GOIATUBA	GT12008246	BOM JESUS DE GOIAS	14/11/2020 14:47	14/11/2020 19:47	14/11/2020 14:47	14/11/2020 19:47	4,99	6	29,92	CHI
20201164677	APARECIDA DE GOIANIA	200606220	INDEPENDENCIA S1	14/11/2020 14:49	14/11/2020 16:19	14/11/2020 14:49	14/11/2020 16:19	1,49	1	1,49	CHI
20201164681	RIO VERDE	RV10402217	CABRIUVA S2	14/11/2020 14:50	14/11/2020 22:14	14/11/2020 14:50	14/11/2020 17:35	2,76	13	35,90	CHI
20201164681	JATAI	RV10402217	CABRIUVA S2	14/11/2020 14:50	14/11/2020 22:14	14/11/2020 14:50	14/11/2020 22:14	7,41	12	88,88	CHI
20201164681	RIO VERDE	RV10402217	CABRIUVA S2	14/11/2020 14:50	14/11/2020 22:14	14/11/2020 14:50	14/11/2020 22:14	7,41	40	296,26	CHI
20201164681	RIO VERDE	RV10402217	CABRIUVA S2	14/11/2020 14:50	14/11/2020 22:14	14/11/2020 17:47	14/11/2020 22:14	4,45	13	57,83	CHI
20201164727	JATAI	JT10413490	JATAI S1	14/11/2020 14:51	14/11/2020 18:43	14/11/2020 14:51	14/11/2020 14:56	0,08	149	12,00	CHI
20201164727	PEROLANDIA	JT10413490	JATAI S1	14/11/2020 14:51	14/11/2020 18:43	14/11/2020 14:51	14/11/2020 14:56	0,08	9	0,73	CHI
20201164727	CAIAPONIA	JT10413490	CAIAPONIA	14/11/2020 14:51	14/11/2020 18:43	14/11/2020 14:51	14/11/2020 18:43	3,86	62	239,53	CHI
20201164727	DOVERLANDIA	JT10413490	CAIAPONIA	14/11/2020 14:51	14/11/2020 18:43	14/11/2020 14:51	14/11/2020 18:43	3,86	3	11,59	CHI
20201164727	CAIAPONIA	JT10413490	JATAI S1	14/11/2020 14:51	14/11/2020 18:43	14/11/2020 14:51	14/11/2020 18:43	3,86	20	77,27	CHI
20201164727	CAIAPONIA	JT10413490	JATAI S1	14/11/2020 14:51	14/11/2020 18:43	14/11/2020 14:51	14/11/2020 18:43	3,86	39	150,67	CHI
20201164727	JATAI	JT10413490	JATAI S1	14/11/2020 14:51	14/11/2020 18:43	14/11/2020 14:51	14/11/2020 18:43	3,86	305	1178,32	CHI
20201164727	JATAI	JT10413490	JATAI S1	14/11/2020 14:51	14/11/2020 18:43	14/11/2020 14:51	14/11/2020 18:43	3,86	12	46,36	CHI
20201164727	MINEIROS	JT10413490	JATAI S1	14/11/2020 14:51	14/11/2020 18:43	14/11/2020 14:51	14/11/2020 18:43	3,86	2	7,73	CHI
20201164727	MINEIROS	JT10413490	JATAI S1	14/11/2020 14:51	14/11/2020 18:43	14/11/2020 14:51	14/11/2020 18:43	3,86	3	11,59	CHI
20201164727	PEROLANDIA	JT10413490	JATAI S1	14/11/2020 14:51	14/11/2020 18:43	14/11/2020 14:51	14/11/2020 18:43	3,86	1036	4002,41	CHI
20201164727	PEROLANDIA	JT10413490	JATAI S1	14/11/2020 14:51	14/11/2020 18:43	14/11/2020 14:51	14/11/2020 18:43	3,86	41	158,40	CHI
20201164727	PEROLANDIA	JT10413490	JATAI S1	14/11/2020 14:51	14/11/2020 18:43	14/11/2020 14:51	14/11/2020 18:43	3,86	136	525,41	CHI
20201164727	PEROLANDIA	JT10413490	JATAI S1	14/11/2020 14:51	14/11/2020 18:43	14/11/2020 14:51	14/11/2020 18:43	3,86	37	142,94	CHI
20201164689	JATAI	JT21138848	CACHOEIRA ALTA	14/11/2020 14:53	15/11/2020 08:58	14/11/2020 14:53	15/11/2020 08:58	18,08	1	18,08	CHI
20201165332	RIO VERDE	RV12260127	CABRIUVA S1	14/11/2020 14:53	14/11/2020 17:27	14/11/2020 14:53	14/11/2020 17:27	2,57	2	5,13	CHI
20201164711	CRISTALINA	KR21805420	CRISTALINA S1	14/11/2020 14:54	15/11/2020 00:17	14/11/2020 14:54	15/11/2020 00:17	9,37	1	9,37	CHI
20201164712	MORRINHOS	MR21279100	MORRINHOS	14/11/2020 14:55	14/11/2020 17:43	14/11/2020 14:55	14/11/2020 17:43	2,80	1	2,80	CHI
20201165313	MINACU	IH12236222	MINACU	14/11/2020 14:55	15/11/2020 09:56	14/11/2020 14:55	15/11/2020 09:56	19,00	20	380,05	CHI
20201165127	ABADIA DE GOIAS	7885500	INDEPENDENCIA S2	14/11/2020 14:56	14/11/2020 19:56	14/11/2020 14:56	14/11/2020 19:56	5,00	28	140,06	CHI
20201164722	GOIANIA	11204588	REAL S1	14/11/2020 14:57	14/11/2020 20:24	14/11/2020 14:57	14/11/2020 20:24	5,44	1	5,44	CHI
20201164723	TRINDADE	12497976	GOYA S2	14/11/2020 14:57	14/11/2020 16:52	14/11/2020 14:57	14/11/2020 16:52	1,91	1	1,91	CHI
20201164724	NIQUELANDIA	NQ21151019	NIQUELANDIA SUBTRANSMISSAO	14/11/2020 14:57	15/11/2020 02:50	14/11/2020 14:57	15/11/2020 02:50	11,87	2	23,74	CHI
20201164726	MORRINHOS	MR21029544	MORRINHOS	14/11/2020 14:58	14/11/2020 18:16	14/11/2020 14:58	14/11/2020 18:16	3,30	1	3,30	CHI
20201164728	BARRO ALTO	BA21329105	BARRO ALTO	14/11/2020 14:58	14/11/2020 23:24	14/11/2020 14:58	14/11/2020 23:24	8,43	2	16,86	CHI
20201164731	IPORA	IR21102670	IPORA	14/11/2020 14:58	14/11/2020 16:30	14/11/2020 14:58	14/11/2020 16:30	1,52	1	1,52	CHI
20201164733	GOIANIA	14916605	MEIA PONTE	14/11/2020 14:58	14/11/2020 22:54	14/11/2020 14:58	14/11/2020 22:54	7,92	1	7,92	CHI
20201164737	MONTIVIDIU	RV21030647	MONTIVIDIU T	14/11/2020 14:59	14/11/2020 19:25	14/11/2020 14:59	14/11/2020 19:25	4,42	1	4,42	CHI
20201164802	NIQUELANDIA	NQ12262679	URUACU	14/11/2020 14:59	14/11/2020 22:21	14/11/2020 14:59	14/11/2020 22:21	7,36	19	139,85	CHI
20201165026	MARA ROSA	NQ12243364RE	URUACU	14/11/2020 14:59	14/11/2020 20:17	14/11/2020 14:59	14/11/2020 20:17	5,29	1	5,29	CHI

20201165026	NIQUELANDIA	NQ12243364RE	URUACU	14/11/2020 14:59	14/11/2020 20:17	14/11/2020 14:59	14/11/2020 20:17	5,29	27	142,73	CHI
20201164742	IPORA	IR12207857	IPORA	14/11/2020 15:00	14/11/2020 15:47	14/11/2020 15:00	14/11/2020 15:47	0,77	13	10,05	CHI
20201164746	SAO DOMINGOS	10018271470	SAO DOMINGOS	14/11/2020 15:01	14/11/2020 17:41	14/11/2020 15:01	14/11/2020 17:41	2,66	1	2,66	CHI
20201164750	UIRAPURU	4200002888	SANTA TEREZINHA	14/11/2020 15:01	15/11/2020 10:33	14/11/2020 15:01	15/11/2020 10:33	19,52	1	19,52	CHI
20201165596	CAMPESTRE DE GOIAS	GC12000125	TRINDADE	14/11/2020 15:01	14/11/2020 18:59	14/11/2020 15:01	14/11/2020 18:59	3,97	6	23,80	CHI
20201165940	ANICUNS	AC11158910	ANICUNS	14/11/2020 15:01	14/11/2020 18:56	14/11/2020 15:01	14/11/2020 18:56	3,91	56	218,80	CHI
20201164754	INHUMAS	30068230	INHUMAS S2	14/11/2020 15:02	14/11/2020 16:59	14/11/2020 15:02	14/11/2020 16:59	1,94	1	1,94	CHI
20201164772	MATRINCHA	MP12122364	MATRINCHA	14/11/2020 15:02	15/11/2020 06:44	14/11/2020 15:02	15/11/2020 06:44	15,69	11	172,63	CHI
20201165050	MINACU	IH12339952	MINACU	14/11/2020 15:02	14/11/2020 20:28	14/11/2020 15:02	14/11/2020 20:28	5,42	16	86,68	CHI
20201164759	APARECIDA DE GOIANIA	200614850	INDEPENDENCIA S1	14/11/2020 15:04	14/11/2020 16:11	14/11/2020 15:04	14/11/2020 16:11	1,11	1	1,11	CHI
20201164850	FORMOSA	FA12364319	SAO JOAO D ALIANCA	14/11/2020 15:04	14/11/2020 20:36	14/11/2020 15:04	14/11/2020 20:36	5,52	12	66,22	CHI
20201164954	NIQUELANDIA	NQ12265691	URUACU	14/11/2020 15:04	14/11/2020 17:41	14/11/2020 15:04	14/11/2020 17:41	2,61	18	47,06	CHI
20201164764	JUSSARA	JR12079474	JUSSARA	14/11/2020 15:06	14/11/2020 23:08	14/11/2020 15:06	14/11/2020 23:08	8,05	132	1062,01	CHI
20201164765	ARAGARCAS	AG21234271	ARAGARCAS	14/11/2020 15:06	15/11/2020 00:03	14/11/2020 15:06	15/11/2020 00:03	8,94	1	8,94	CHI
20201164768	AGUA FRIA DE GOIAS	4140012330	SAO JOAO D ALIANCA	14/11/2020 15:07	14/11/2020 17:43	14/11/2020 15:07	14/11/2020 17:43	2,60	1	2,60	CHI
20201165455	LUZIANIA	LZ12000383	MARAJOARA	14/11/2020 15:08	14/11/2020 20:10	14/11/2020 15:08	14/11/2020 20:10	4,86	910	4425,13	CHI
20201165455	LUZIANIA	LZ11000292	MARAJOARA	14/11/2020 15:08	14/11/2020 20:10	14/11/2020 15:08	14/11/2020 20:10	5,03	137	689,03	CHI
20201164784	HIDROLANDIA	10002903456	CEPAIGO S2	14/11/2020 15:10	15/11/2020 08:46	14/11/2020 15:10	15/11/2020 08:46	17,59	1	17,59	CHI
20201164800	GOIANIA	16401694	XAVANTES	14/11/2020 15:13	15/11/2020 00:16	14/11/2020 15:13	15/11/2020 00:16	9,05	1	9,05	CHI
20201166336	AVELINOPOLIS	NZ12000025	ANICUNS	14/11/2020 15:13	15/11/2020 09:26	14/11/2020 15:13	15/11/2020 09:26	18,22	3	54,65	CHI
20201166336	NAZARIO	NZ12000025	ANICUNS	14/11/2020 15:13	15/11/2020 09:26	14/11/2020 15:13	15/11/2020 09:26	18,22	2	36,43	CHI
20201164806	SAO SIMAO	SO12000102	CACHOEIRA ALTA	14/11/2020 15:15	14/11/2020 16:51	14/11/2020 15:15	14/11/2020 16:51	1,60	744	1189,37	CHI
20201164809	GOIANIRA	GR21403437	GOIANIRA	14/11/2020 15:15	14/11/2020 16:39	14/11/2020 15:15	14/11/2020 16:39	1,39	1	1,39	CHI
20201166034	NIQUELANDIA	NQ12146984	URUACU	14/11/2020 15:16	14/11/2020 23:46	14/11/2020 15:16	14/11/2020 23:46	8,50	89	756,18	CHI
20201164841	ABADIANIA	AA12180462	DAIA S2	14/11/2020 15:17	14/11/2020 19:00	14/11/2020 15:17	14/11/2020 19:00	3,71	3	11,12	CHI
20201164829	PIRES DO RIO	PR21000009	PIRES DO RIO S1	14/11/2020 15:18	14/11/2020 19:32	14/11/2020 15:18	14/11/2020 19:32	4,22	1	4,22	CHI
20201167181	PORANGATU	PO12022073	PORANGATU	14/11/2020 15:18	15/11/2020 04:03	14/11/2020 15:18	15/11/2020 04:03	12,74	47	598,75	CHI
20201169601	MARA ROSA	MQ12113200	MARA ROSA	14/11/2020 15:21	15/11/2020 23:58	14/11/2020 15:21	15/11/2020 23:58	32,60	1	32,60	CHI
20201164849	MORRINHOS	MR31090567	MORRINHOS	14/11/2020 15:22	14/11/2020 19:21	14/11/2020 15:22	14/11/2020 19:21	3,98	1	3,98	CHI
20201165097	NIQUELANDIA	NQ12232446	BARRO ALTO	14/11/2020 15:23	14/11/2020 18:05	14/11/2020 15:23	14/11/2020 18:05	2,70	9	24,27	CHI
20201164869	RIO VERDE	10010144283	RIO VERDE S1	14/11/2020 15:24	15/11/2020 08:50	14/11/2020 15:24	15/11/2020 08:50	17,42	1	17,42	CHI
20201164871	SAO MIGUEL DO ARAGUAIA	SM12328594	SAO MIGUEL DO ARAGUAIA	14/11/2020 15:25	14/11/2020 21:38	14/11/2020 15:25	14/11/2020 21:38	6,22	1	6,22	CHI
20201164879	SAO MIGUEL DO ARAGUAIA	SM12020625	SAO MIGUEL DO ARAGUAIA	14/11/2020 15:25	15/11/2020 23:05	14/11/2020 15:25	15/11/2020 16:32	25,11	1	25,11	CHI
20201164879	SAO MIGUEL DO ARAGUAIA	SM12020625	SAO MIGUEL DO ARAGUAIA	14/11/2020 15:25	15/11/2020 23:05	14/11/2020 15:25	15/11/2020 23:05	31,66	5	158,30	CHI
20201165802	PORTEIRO	CL12303607	RIO DOS BOIS	14/11/2020 15:25	14/11/2020 21:23	14/11/2020 15:25	14/11/2020 21:23	5,97	2	11,93	CHI
20201164881	APARECIDA DE GOIANIA	200131321	INDEPENDENCIA S2	14/11/2020 15:26	14/11/2020 19:06	14/11/2020 15:26	14/11/2020 19:06	3,67	1	3,67	CHI
20201164885	MAMBAI	MB12302924	IACIARA S2	14/11/2020 15:26	14/11/2020 17:06	14/11/2020 15:26	14/11/2020 17:06	1,65	33	54,56	CHI
20201164964	GUARANI DE GOIAS	GY12393812	IACIARA S1	14/11/2020 15:27	14/11/2020 16:31	14/11/2020 15:27	14/11/2020 16:31	1,05	22	23,19	CHI
20201166626	NOVA CRIXAS	NA12091692	NOVA CRIXAS	14/11/2020 15:27	16/11/2020 19:50	14/11/2020 15:27	16/11/2020 19:50	52,37	22	1152,16	CHI
20201164905	INACIOLANDIA	ID21104445	CACHOEIRA DOURADA	14/11/2020 15:29	14/11/2020 18:01	14/11/2020 15:29	14/11/2020 18:01	2,53	2	5,05	CHI
20201164906	HIDROLANDIA	HD21007285	CEPAIGO S2	14/11/2020 15:29	14/11/2020 17:24	14/11/2020 15:29	14/11/2020 17:24	1,91	1	1,91	CHI
20201164907	NIQUELANDIA	NQ12392035	URUACU	14/11/2020 15:29	15/11/2020 10:42	14/11/2020 15:29	15/11/2020 10:42	19,21	4	76,83	CHI
20201165626	COCALZINHO DE GOIAS	ZN12104981	AGUAS LINDAS DE GOIAS S2	14/11/2020 15:29	14/11/2020 19:42	14/11/2020 15:29	14/11/2020 19:42	4,21	3	12,63	CHI
20201164920	IPORA	730134209	IPORA	14/11/2020 15:31	14/11/2020 17:04	14/11/2020 15:31	14/11/2020 17:04	1,54	1	1,54	CHI
20201164923	CATALAO	CT12190484	CATALAO S2	14/11/2020 15:32	14/11/2020 18:15	14/11/2020 15:32	14/11/2020 18:15	2,71	205	555,38	CHI
20201164927	CHAPADAO DO CEU	DJ21124327	CHAPADAO DO CEU	14/11/2020 15:33	14/11/2020 16:43	14/11/2020 15:33	14/11/2020 16:43	1,16	2	2,31	CHI
20201164936	GOIANIA	GN11189275	REAL S2	14/11/2020 15:33	14/11/2020 22:15	14/11/2020 15:33	14/11/2020 22:15	6,70	41	274,67	CHI
20201165744	CATALAO	CT12009651	CATALAO S2	14/11/2020 15:35	14/11/2020 18:17	14/11/2020 15:35	14/11/2020 18:17	2,70	685	1849,50	CHI
20201166513	MINACU	IH12230473	MINACU	14/11/2020 15:35	16/11/2020 09:17	14/11/2020 15:35	16/11/2020 09:17	41,69	7	291,80	CHI
20201164941	MINEIROS	MY12390605RE	PARQUE DAS EMAS	14/11/2020 15:36	14/11/2020 21:06	14/11/2020 15:36	14/11/2020 21:06	5,50	16	87,96	CHI
20201164944	SAO LUIZ DO NORTE	3090006325	ITAPACI	14/11/2020 15:36	14/11/2020 18:04	14/11/2020 15:36	14/11/2020 18:04	2,46	1	2,46	CHI

20201164955	SITIO D ABADIA	AQ12344369	IACIARA S2	14/11/2020 15:37	14/11/2020 19:43	14/11/2020 15:37	14/11/2020 19:43	4,09	3	12,26	CHI
20201165377	JUSSARA	JR12198907	BRITANIA	14/11/2020 15:37	15/11/2020 01:32	14/11/2020 15:37	15/11/2020 01:32	9,92	37	366,89	CHI
20201164968	CRISTALINA	KR12074918	CRISTALINA S2	14/11/2020 15:40	14/11/2020 22:05	14/11/2020 15:40	14/11/2020 22:05	6,41	8	51,29	CHI
20201164972	SERRANOPOLIS	JT21134919	JATAI S1	14/11/2020 15:41	15/11/2020 10:32	14/11/2020 15:41	15/11/2020 10:32	18,85	1	18,85	CHI
20201164973	GOIANIA	10023620020	XAVANTES	14/11/2020 15:41	15/11/2020 00:32	14/11/2020 15:41	15/11/2020 00:32	8,84	1	8,84	CHI
20201164983	APARECIDA DE GOIANIA	15467170	INDEPENDENCIA S1	14/11/2020 15:43	14/11/2020 18:06	14/11/2020 15:43	14/11/2020 18:06	2,38	1	2,38	CHI
20201164984	VILA BOA	2880008214	IACIARA S2	14/11/2020 15:43	14/11/2020 21:49	14/11/2020 15:43	14/11/2020 21:49	6,09	1	6,09	CHI
20201165135	PARAUNA	PU11000009	PARAUNA	14/11/2020 15:43	14/11/2020 18:14	14/11/2020 15:43	14/11/2020 18:14	2,50	91	227,80	CHI
20201164990	ANAPOLIS	21304038	ANAPOLIS UNIVERSITARIO S2	14/11/2020 15:45	14/11/2020 23:01	14/11/2020 15:45	14/11/2020 23:01	7,26	1	7,26	CHI
20201164991	URUACU	UR21003382	URUACU	14/11/2020 15:45	14/11/2020 19:52	14/11/2020 15:45	14/11/2020 19:52	4,11	1	4,11	CHI
20201164999	NIQUELANDIA	NQ12254342	NIQUELANDIA SUBTRANSMISSAO	14/11/2020 15:47	15/11/2020 12:26	14/11/2020 15:47	15/11/2020 12:26	20,65	1	20,65	CHI
20201165001	TRINDADE	10028028560	MEIA PONTE	14/11/2020 15:47	14/11/2020 17:02	14/11/2020 15:47	14/11/2020 17:02	1,24	1	1,24	CHI
20201165006	BELA VISTA DE GOIAS	BV21264516	BELA VISTA S1	14/11/2020 15:47	14/11/2020 19:27	14/11/2020 15:47	14/11/2020 19:27	3,67	1	3,67	CHI
20201165009	ITUMBIARA	690402727	ITUMBIARA NOVA	14/11/2020 15:50	14/11/2020 17:17	14/11/2020 15:50	14/11/2020 17:17	1,44	1	1,44	CHI
20201165013	SILVANIA	SV21284585	VIANOPOLIS	14/11/2020 15:51	15/11/2020 02:53	14/11/2020 15:51	15/11/2020 02:53	11,03	1	11,03	CHI
20201165018	TAQUARAL DE GOIAS	TQ21220149	ITABERA S1	14/11/2020 15:52	14/11/2020 19:00	14/11/2020 15:52	14/11/2020 19:00	3,14	1	3,14	CHI
20201165019	APARECIDA DE GOIANIA	10005263385	INDEPENDENCIA S1	14/11/2020 15:52	14/11/2020 17:16	14/11/2020 15:52	14/11/2020 17:16	1,39	1	1,39	CHI
20201165020	ACREUNA	2440033164	ACREUNA	14/11/2020 15:52	14/11/2020 19:14	14/11/2020 15:52	14/11/2020 19:14	3,35	1	3,35	CHI
20201165343	FORMOSO	ET12143681	MARA ROSA	14/11/2020 15:52	14/11/2020 21:55	14/11/2020 15:52	14/11/2020 21:55	6,04	13	78,46	CHI
20201166877	FORMOSO	FO12377609	MARA ROSA	14/11/2020 15:52	15/11/2020 05:34	14/11/2020 15:52	15/11/2020 05:34	13,69	8	109,49	CHI
20201165027	DOVERLANDIA	DV12217563	CAIAPONIA	14/11/2020 15:53	14/11/2020 19:37	14/11/2020 15:53	14/11/2020 19:37	3,72	128	476,62	CHI
20201165041	CORREGO DO OURO	CO12004040	FIRMINOPOLIS S2	14/11/2020 15:56	14/11/2020 17:14	14/11/2020 15:56	14/11/2020 17:14	1,29	4	5,14	CHI
20201165043	GOIANIA	11375565	GOIANIA LESTE S1	14/11/2020 15:57	14/11/2020 22:03	14/11/2020 15:57	14/11/2020 22:03	6,10	1	6,10	CHI
20201165046	CRISTALINA	KR11276404	CRISTALINA S2	14/11/2020 15:57	15/11/2020 00:36	14/11/2020 15:57	15/11/2020 00:36	8,64	1	8,64	CHI
20201165051	APARECIDA DE GOIANIA	16991400	ANHANGUERA	14/11/2020 15:58	14/11/2020 17:06	14/11/2020 15:58	14/11/2020 17:06	1,12	1	1,12	CHI
20201165053	GOIANESIA	550060315	GOIANESIA S2	14/11/2020 15:59	14/11/2020 16:55	14/11/2020 15:59	14/11/2020 16:55	0,93	1	0,93	CHI
20201166460	MUTUNOPOLIS	PO12374520	PORANGATU	14/11/2020 15:59	14/11/2020 23:11	14/11/2020 15:59	14/11/2020 23:11	7,20	20	143,98	CHI
20201166460	PORANGATU	PO12374520	PORANGATU	14/11/2020 15:59	14/11/2020 23:11	14/11/2020 15:59	14/11/2020 23:11	7,20	19	136,78	CHI
20201167192	PORANGATU	PO12208614	PORANGATU	14/11/2020 15:59	15/11/2020 00:12	14/11/2020 15:59	15/11/2020 00:12	8,22	10	82,16	CHI
20201165054	ARAGOIANIA	AO21387317	GUAPO S2	14/11/2020 16:00	14/11/2020 21:43	14/11/2020 16:00	14/11/2020 21:43	5,72	2	11,43	CHI
20201165056	GOIANIA	13581582	INDEPENDENCIA S1	14/11/2020 16:00	14/11/2020 20:49	14/11/2020 16:00	14/11/2020 20:49	4,82	1	4,82	CHI
20201165290	JANDAIA	JD12026382	PALMEIRAS	14/11/2020 16:00	14/11/2020 19:15	14/11/2020 16:00	14/11/2020 19:15	3,25	12	38,94	CHI
20201165564	BALIZA	BH10406688	BOM JARDIM	14/11/2020 16:00	17/11/2020 14:17	14/11/2020 16:00	15/11/2020 11:10	19,17	11	210,90	CHI
20201165564	BALIZA	BH12334824LD	BOM JARDIM	14/11/2020 16:00	17/11/2020 14:17	14/11/2020 16:00	15/11/2020 15:01	23,03	16	368,42	CHI
20201165564	BALIZA	BH10406688	BOM JARDIM	14/11/2020 16:00	17/11/2020 14:17	16/11/2020 14:20	16/11/2020 17:30	3,18	11	35,01	CHI
20201165564	BALIZA	BH10406688	BOM JARDIM	14/11/2020 16:00	17/11/2020 14:17	16/11/2020 21:24	16/11/2020 23:30	2,11	11	23,25	CHI
20201165564	BALIZA	BH10406688	BOM JARDIM	14/11/2020 16:00	17/11/2020 14:17	17/11/2020 01:01	17/11/2020 01:53	0,87	11	9,53	CHI
20201165564	BALIZA	BH10406688	BOM JARDIM	14/11/2020 16:00	17/11/2020 14:17	17/11/2020 04:07	17/11/2020 04:26	0,30	11	3,33	CHI
20201165564	BALIZA	BH12334824LD	BOM JARDIM	14/11/2020 16:00	17/11/2020 14:17	16/11/2020 14:20	17/11/2020 11:52	21,54	7	150,78	CHI
20201165564	BALIZA	BH12334824LD	BOM JARDIM	14/11/2020 16:00	17/11/2020 14:17	16/11/2020 14:20	17/11/2020 12:00	21,67	3	65,01	CHI
20201165564	BALIZA	BH12334824LD	BOM JARDIM	14/11/2020 16:00	17/11/2020 14:17	16/11/2020 14:20	17/11/2020 12:57	22,62	6	135,73	CHI
20201165564	BALIZA	BH10406688	BOM JARDIM	14/11/2020 16:00	17/11/2020 14:17	14/11/2020 16:00	17/11/2020 13:19	69,33	6	415,97	CHI
20201165564	BALIZA	BH13297367	BOM JARDIM	14/11/2020 16:00	17/11/2020 14:17	14/11/2020 16:00	17/11/2020 14:17	70,29	19	1335,56	CHI
20201165067	ABADIA DE GOIAS	LG12282702	TRINDADE	14/11/2020 16:01	14/11/2020 21:54	14/11/2020 16:01	14/11/2020 21:54	5,88	9	52,88	CHI
20201165070	FIRMINOPOLIS	FR21079112	FIRMINOPOLIS S1	14/11/2020 16:02	14/11/2020 17:23	14/11/2020 16:02	14/11/2020 17:23	1,35	1	1,35	CHI
20201165071	SENADOR CANEDO	14945034	SENADOR CANEDO	14/11/2020 16:02	14/11/2020 19:25	14/11/2020 16:02	14/11/2020 19:25	3,37	1	3,37	CHI
20201165181	PARAUNA	PU12110565	MONTIVIDIU T	14/11/2020 16:02	14/11/2020 22:34	14/11/2020 16:02	14/11/2020 22:34	6,53	12	78,36	CHI
20201165716	CAMPINACU	UC12285921	PORANGATU	14/11/2020 16:03	14/11/2020 19:33	14/11/2020 16:03	14/11/2020 19:33	3,48	42	146,31	CHI
20201165087	HIDROLANDIA	HD21285499	CEPAIGO S2	14/11/2020 16:05	14/11/2020 17:53	14/11/2020 16:05	14/11/2020 17:53	1,80	1	1,80	CHI
20201166519	DISTRITO FEDERAL	SN12237830	MARAJOARA	14/11/2020 16:05	15/11/2020 01:06	14/11/2020 16:05	15/11/2020 01:06	9,01	3	27,04	CHI
20201166519	SANTO ANTONIO DO DESCOBERTO	SN12237830	MARAJOARA	14/11/2020 16:05	15/11/2020 01:06	14/11/2020 16:05	15/11/2020 01:06	9,01	25	225,31	CHI



20201165092	JUSSARA	JR12331769	JUSSARA	14/11/2020 16:07	15/11/2020 07:58	14/11/2020 16:07	15/11/2020 07:58	15,85	2	31,70	CHI
20201165096	GOIANIRA	390073362	MEIA PONTE	14/11/2020 16:07	14/11/2020 17:48	14/11/2020 16:07	14/11/2020 17:48	1,67	1	1,67	CHI
20201165110	MORRINHOS	MR21239066	MORRINHOS	14/11/2020 16:09	14/11/2020 19:01	14/11/2020 16:09	14/11/2020 19:01	2,86	1	2,86	CHI
20201165113	TRINDADE	TR11258430	TRINDADE	14/11/2020 16:09	14/11/2020 17:40	14/11/2020 16:09	14/11/2020 17:40	1,51	26	39,15	CHI
20201165371	ORIZONA	OZ12084921RE	PIRES DO RIO S2	14/11/2020 16:09	14/11/2020 19:16	14/11/2020 16:09	14/11/2020 19:16	3,12	109	339,57	CHI
20201165371	VIANOPOLIS	OZ12084921RE	PIRES DO RIO S2	14/11/2020 16:09	14/11/2020 19:16	14/11/2020 16:09	14/11/2020 19:16	3,12	17	52,96	CHI
20201165117	NIQUELANDIA	NQ12197750	URUACU	14/11/2020 16:10	14/11/2020 17:40	14/11/2020 16:10	14/11/2020 17:40	1,50	20	29,92	CHI
20201165820	JUSSARA	JR12076133	BRITANIA	14/11/2020 16:10	15/11/2020 03:30	14/11/2020 16:10	15/11/2020 03:30	11,33	3	33,99	CHI
20201165389	SANTA FE DE GOIAS	RN12080831	JUSSARA	14/11/2020 16:11	15/11/2020 23:00	14/11/2020 16:11	15/11/2020 16:38	24,45	7	171,13	CHI
20201165389	SANTA FE DE GOIAS	RN12080831	JUSSARA	14/11/2020 16:11	15/11/2020 23:00	14/11/2020 16:11	15/11/2020 23:00	30,81	10	308,14	CHI
20201165883	GOIANIA	GN12383183	XAVANTES	14/11/2020 16:11	14/11/2020 19:28	14/11/2020 16:11	14/11/2020 19:28	3,27	146	477,83	CHI
20201166268	FAZENDA NOVA	FN12371907	IPORA	14/11/2020 16:11	14/11/2020 21:49	14/11/2020 16:11	14/11/2020 21:49	5,62	5	28,10	CHI
20201166306	PIRES DO RIO	BC12031273	PIRES DO RIO S2	14/11/2020 16:12	14/11/2020 21:59	14/11/2020 16:12	14/11/2020 21:59	5,78	3	17,35	CHI
20201166306	SANTA CRUZ DE GOIAS	BC12031273	PIRES DO RIO S2	14/11/2020 16:12	14/11/2020 21:59	14/11/2020 16:12	14/11/2020 21:59	5,78	1	5,78	CHI
20201165138	BOM JARDIM DE GOIAS	BM12286263	BOM JARDIM	14/11/2020 16:13	14/11/2020 17:48	14/11/2020 16:13	14/11/2020 17:48	1,57	5	7,85	CHI
20201165139	CATALAO	CT12077408	CATALAO S1	14/11/2020 16:13	14/11/2020 18:34	14/11/2020 16:13	14/11/2020 18:34	2,34	6	14,04	CHI
20201165179	FORMOSA	FA12140789	ITUIQUIRA	14/11/2020 16:17	14/11/2020 18:28	14/11/2020 16:17	14/11/2020 18:28	2,18	14	30,51	CHI
20201165186	NEROPOLIS	20044773	NEROPOLIS S2	14/11/2020 16:18	14/11/2020 18:03	14/11/2020 16:18	14/11/2020 18:03	1,74	42	73,03	CHI
20201165288	FORMOSA	FA12000016	ITUIQUIRA	14/11/2020 16:18	15/11/2020 08:19	14/11/2020 16:18	15/11/2020 08:19	16,02	80	1281,60	CHI
20201165192	MINEIROS	MY21303458	PARQUE DAS EMAS	14/11/2020 16:20	14/11/2020 20:11	14/11/2020 16:20	14/11/2020 20:11	3,84	2	7,68	CHI
20201165195	APARECIDA DE GOIANIA	10011279573	INDEPENDENCIA S2	14/11/2020 16:21	14/11/2020 23:30	14/11/2020 16:21	14/11/2020 23:30	7,16	1	7,16	CHI
20201165197	VIANOPOLIS	VN11343146	VIANOPOLIS	14/11/2020 16:21	14/11/2020 19:45	14/11/2020 16:21	14/11/2020 19:45	3,39	65	220,46	CHI
20201165460	JUSSARA	JR12364553	BRITANIA	14/11/2020 16:21	14/11/2020 22:09	14/11/2020 16:21	14/11/2020 22:09	5,79	18	104,22	CHI
20201165200	RIO VERDE	RV12000265	RIO VERDE S1	14/11/2020 16:22	15/11/2020 01:39	14/11/2020 16:22	14/11/2020 23:56	7,58	2	15,15	CHI
20201165200	RIO VERDE	RV12000265	RIO VERDE S1	14/11/2020 16:22	15/11/2020 01:39	14/11/2020 16:22	15/11/2020 00:31	8,16	4	32,63	CHI
20201165200	RIO VERDE	RV12000265	RIO VERDE S1	14/11/2020 16:22	15/11/2020 01:39	14/11/2020 16:22	15/11/2020 01:39	9,29	9	83,65	CHI
20201165200	RIO VERDE	RV12105924LD	RIO VERDE S1	14/11/2020 16:22	15/11/2020 01:39	14/11/2020 16:22	15/11/2020 01:39	9,29	1	9,29	CHI
20201165200	RIO VERDE	RV12105924LD	RIO VERDE S1	14/11/2020 16:22	15/11/2020 01:39	14/11/2020 19:39	15/11/2020 01:39	6,00	16	96,03	CHI
20201165202	SANTO ANTONIO DE GOIAS	BW12145999	NEROPOLIS S1	14/11/2020 16:22	14/11/2020 18:35	14/11/2020 16:22	14/11/2020 18:35	2,21	1	2,21	CHI
20201165203	PIRES DO RIO	460075380	PIRES DO RIO S1	14/11/2020 16:22	14/11/2020 18:52	14/11/2020 16:22	14/11/2020 18:52	2,49	1	2,49	CHI
20201165227	MORRINHOS	MR32076974	MORRINHOS	14/11/2020 16:22	14/11/2020 19:29	14/11/2020 16:22	14/11/2020 19:29	3,10	10	31,01	CHI
20201166315	CIDADE OCIDENTAL	DH11163805	MARAJOARA	14/11/2020 16:23	14/11/2020 23:43	14/11/2020 16:23	14/11/2020 23:43	7,32	197	1441,71	CHI
20201165213	PALMEIRAS DE GOIAS	590013920	PALMEIRAS	14/11/2020 16:24	15/11/2020 17:27	14/11/2020 16:24	15/11/2020 17:27	25,04	1	25,04	CHI
20201165246	MORRO AGUDO DE GOIAS	MS12113277	ITAPURANGA	14/11/2020 16:24	14/11/2020 19:28	14/11/2020 16:24	14/11/2020 19:28	3,05	18	54,92	CHI
20201165972	CIDADE OCIDENTAL	DH11183856	MARAJOARA	14/11/2020 16:24	15/11/2020 03:11	14/11/2020 16:24	15/11/2020 03:11	10,78	169	1822,20	CHI
20201165216	APARECIDA DE GOIANIA	10004659510	INDEPENDENCIA S1	14/11/2020 16:25	14/11/2020 20:37	14/11/2020 16:25	14/11/2020 20:37	4,20	1	4,20	CHI
20201165217	MINEIROS	MY21031585	PARQUE DAS EMAS	14/11/2020 16:25	14/11/2020 19:38	14/11/2020 16:25	14/11/2020 19:38	3,22	2	6,43	CHI
20201165220	CRISTALINA	KR21209629	CRISTALINA S1	14/11/2020 16:25	14/11/2020 22:28	14/11/2020 16:25	14/11/2020 22:28	6,05	1	6,05	CHI
20201165229	ARAGARCAS	AG12358778	ARAGARCAS	14/11/2020 16:26	14/11/2020 23:13	14/11/2020 16:26	14/11/2020 23:13	6,78	3	20,35	CHI
20201165230	PIRACANJUBA	PJ21253024	BELA VISTA S1	14/11/2020 16:26	14/11/2020 20:07	14/11/2020 16:26	14/11/2020 20:07	3,68	2	7,35	CHI
20201165237	FORMOSO	2410022310	PORANGATU	14/11/2020 16:27	14/11/2020 20:02	14/11/2020 16:27	14/11/2020 20:02	3,57	1	3,57	CHI
20201165238	ARAGOIANIA	AO21197411	GUAPO S2	14/11/2020 16:27	15/11/2020 13:00	14/11/2020 16:27	15/11/2020 13:00	20,54	1	20,54	CHI
20201165844	CIDADE OCIDENTAL	DH11128895	MARAJOARA	14/11/2020 16:27	14/11/2020 23:43	14/11/2020 16:27	14/11/2020 23:43	7,26	300	2177,58	CHI
20201166562	CIDADE OCIDENTAL	DH11172222	MARAJOARA	14/11/2020 16:27	14/11/2020 22:53	14/11/2020 16:27	14/11/2020 22:53	6,43	109	700,48	CHI
20201165239	GOIANIA	12347309	ATLANTICO S1	14/11/2020 16:28	14/11/2020 19:23	14/11/2020 16:28	14/11/2020 19:23	2,90	1	2,90	CHI
20201165247	FORMOSO	10016805621	PORANGATU	14/11/2020 16:30	15/11/2020 02:23	14/11/2020 16:30	15/11/2020 02:23	9,87	1	9,87	CHI
20201165251	RIO VERDE	RV21327003	RIO VERDE S2	14/11/2020 16:31	14/11/2020 17:41	14/11/2020 16:31	14/11/2020 17:41	1,16	1	1,16	CHI
20201166733	ARAGOIANIA	AO32094616	GUAPO S2	14/11/2020 16:32	14/11/2020 21:59	14/11/2020 16:32	14/11/2020 21:59	5,45	15	81,69	CHI
20201166733	HIDROLANDIA	AO32094616	GUAPO S2	14/11/2020 16:32	14/11/2020 21:59	14/11/2020 16:32	14/11/2020 21:59	5,45	1	5,45	CHI
20201165419	CIDADE OCIDENTAL	DH11209579	MARAJOARA	14/11/2020 16:33	14/11/2020 22:49	14/11/2020 16:33	14/11/2020 22:49	6,25	42	262,54	CHI
20201165271	MINEIROS	MY21070320	PARQUE DAS EMAS	14/11/2020 16:34	14/11/2020 18:20	14/11/2020 16:34	14/11/2020 18:20	1,77	1	1,77	CHI

20201165274	DIORAMA	DI12063504	IPORA	14/11/2020 16:34	14/11/2020 17:37	14/11/2020 16:34	14/11/2020 17:37	1,04	6	6,21	CHI
20201165274	IPORA	DI12063504	IPORA	14/11/2020 16:34	14/11/2020 17:37	14/11/2020 16:34	14/11/2020 17:37	1,04	5	5,18	CHI
20201165276	GOIANIA	14804657	CARAIAS S2	14/11/2020 16:35	14/11/2020 19:45	14/11/2020 16:35	14/11/2020 19:45	3,16	1	3,16	CHI
20201165279	ANICUNS	AC21299243	FIRMINOPOLIS S2	14/11/2020 16:35	15/11/2020 02:24	14/11/2020 16:35	15/11/2020 02:24	9,81	1	9,81	CHI
20201165286	FIRMINOPOLIS	900008933	FIRMINOPOLIS S1	14/11/2020 16:36	14/11/2020 21:47	14/11/2020 16:36	14/11/2020 21:47	5,17	1	5,17	CHI
20201165291	SANTA HELENA DE GOIAS	SH21361111	IPEGUARI	14/11/2020 16:37	14/11/2020 19:19	14/11/2020 16:37	14/11/2020 19:19	2,69	1	2,69	CHI
20201165889	ABADIANA	AA12258346	ANAPOLIS UNIVERSITARIO S1	14/11/2020 16:37	14/11/2020 21:06	14/11/2020 16:37	14/11/2020 21:06	4,48	20	89,64	CHI
20201165889	CORUMBA DE GOIAS	AA12258346	ANAPOLIS UNIVERSITARIO S1	14/11/2020 16:37	14/11/2020 21:06	14/11/2020 16:37	14/11/2020 21:06	4,48	2	8,96	CHI
20201165427	CIDADE OCIDENTAL	DH11133215	MARAJOARA	14/11/2020 16:39	14/11/2020 20:28	14/11/2020 16:39	14/11/2020 20:28	3,81	109	415,56	CHI
20201165436	NOVA CRIXAS	NA12057201	MOZARLANDIA	14/11/2020 16:39	14/11/2020 21:03	14/11/2020 16:39	14/11/2020 21:03	4,40	11	48,35	CHI
20201165310	MUNDO NOVO DE GOIAS	MH12350029	NOVA CRIXAS	14/11/2020 16:40	15/11/2020 12:10	14/11/2020 16:40	15/11/2020 12:10	19,50	3	58,49	CHI
20201165549	FIRMINOPOLIS	SL12111569RE	FIRMINOPOLIS S1	14/11/2020 16:40	14/11/2020 18:10	14/11/2020 16:40	14/11/2020 18:10	1,49	17	25,33	CHI
20201165549	SAO LUIS DE MONTES BELOS	SL12111569RE	FIRMINOPOLIS S1	14/11/2020 16:40	14/11/2020 18:10	14/11/2020 16:40	14/11/2020 18:10	1,49	63	93,87	CHI
20201165549	TURVANIA	SL12111569RE	FIRMINOPOLIS S1	14/11/2020 16:40	14/11/2020 18:10	14/11/2020 16:40	14/11/2020 18:10	1,49	8	11,92	CHI
20201165323	GOIANIA	14809503	XAVANTES	14/11/2020 16:43	15/11/2020 01:36	14/11/2020 16:43	15/11/2020 01:36	8,88	1	8,88	CHI
20201165658	RIO VERDE	RV12200718LD	RIO VERDE S2	14/11/2020 16:43	14/11/2020 21:25	14/11/2020 16:43	14/11/2020 21:25	4,69	25	117,19	CHI
20201165658	SANTA HELENA DE GOIAS	RV12200718LD	RIO VERDE S2	14/11/2020 16:43	14/11/2020 21:25	14/11/2020 16:43	14/11/2020 21:25	4,69	70	328,14	CHI
20201165678	FAZENDA NOVA	FN12292871	IPORA	14/11/2020 16:43	14/11/2020 20:32	14/11/2020 16:43	14/11/2020 20:32	3,80	35	133,04	CHI
20201165442	ITABERAI	IB12108138	ITABERAI S2	14/11/2020 16:44	14/11/2020 19:30	14/11/2020 16:44	14/11/2020 19:30	2,76	28	77,27	CHI
20201165344	SANTA CRUZ DE GOIAS	3570002005	PIRES DO RIO S2	14/11/2020 16:45	15/11/2020 06:52	14/11/2020 16:45	15/11/2020 06:52	14,11	1	14,11	CHI
20201165346	NIQUELANDIA	NO21232466	BARRO ALTO	14/11/2020 16:45	15/11/2020 08:41	14/11/2020 16:45	15/11/2020 08:41	15,92	1	15,92	CHI
20201165445	MOZARLANDIA	MZ12055646	MOZARLANDIA	14/11/2020 16:45	14/11/2020 19:42	14/11/2020 16:45	14/11/2020 19:42	2,95	3	8,85	CHI
20201165349	TRINDADE	40157283	TRINDADE	14/11/2020 16:46	14/11/2020 20:40	14/11/2020 16:46	14/11/2020 20:40	3,89	1	3,89	CHI
20201165353	ACREUNA	2440009964	ACREUNA	14/11/2020 16:47	14/11/2020 22:24	14/11/2020 16:47	14/11/2020 22:24	5,61	1	5,61	CHI
20201165771	PORANGATU	PO12064911	NOVO PLANALTO	14/11/2020 16:47	15/11/2020 09:04	14/11/2020 16:47	15/11/2020 09:04	16,27	133	2164,06	CHI
20201165374	FAZENDA NOVA	IS13349695	IPORA	14/11/2020 16:49	15/11/2020 11:29	14/11/2020 16:52	14/11/2020 23:30	6,63	3	19,90	CHI
20201165374	ISRAELANDIA	IS13349695	IPORA	14/11/2020 16:49	15/11/2020 11:29	14/11/2020 16:52	14/11/2020 23:30	6,63	105	696,56	CHI
20201165374	FAZENDA NOVA	FN13204809	IPORA	14/11/2020 16:49	15/11/2020 11:29	14/11/2020 16:52	15/11/2020 01:53	9,02	165	1489,03	CHI
20201165374	CORREGO DO OURO	FN12253655	IPORA	14/11/2020 16:49	15/11/2020 11:29	14/11/2020 16:52	15/11/2020 09:08	16,27	3	48,82	CHI
20201165374	FAZENDA NOVA	FN12253655	IPORA	14/11/2020 16:49	15/11/2020 11:29	14/11/2020 16:52	15/11/2020 09:08	16,27	11	179,00	CHI
20201165374	FAZENDA NOVA	FN12355367	IPORA	14/11/2020 16:49	15/11/2020 11:29	14/11/2020 16:52	15/11/2020 10:41	17,82	4	71,27	CHI
20201165374	FAZENDA NOVA	FN12223692LD	IPORA	14/11/2020 16:49	15/11/2020 11:29	14/11/2020 16:52	15/11/2020 11:29	18,62	16	297,97	CHI
20201165391	SAO DOMINGOS	SD12257734	SAO DOMINGOS	14/11/2020 16:52	14/11/2020 18:57	14/11/2020 16:52	14/11/2020 18:57	2,07	39	80,65	CHI
20201165393	ALEXANIA	AX21091382	ALEXANIA	14/11/2020 16:53	15/11/2020 01:58	14/11/2020 16:53	15/11/2020 01:58	9,08	1	9,08	CHI
20201165395	GOIANIA	16003780	ATLANTICO S2	14/11/2020 16:53	14/11/2020 21:38	14/11/2020 16:53	14/11/2020 21:38	4,74	1	4,74	CHI
20201165396	CABECEIRAS	CW21371006	ITUIQUIRA	14/11/2020 16:53	14/11/2020 20:21	14/11/2020 16:53	14/11/2020 20:21	3,46	2	6,91	CHI
20201165398	FORMOSA	FA11397378	SAO JOAO D ALIANCA	14/11/2020 16:53	15/11/2020 08:46	14/11/2020 16:53	15/11/2020 08:46	15,87	1	15,87	CHI
20201165403	SANTO ANTONIO DO DESCOBERTO	SN21390551	MARAJOARA	14/11/2020 16:54	14/11/2020 18:25	14/11/2020 16:54	14/11/2020 18:25	1,51	1	1,51	CHI
20201165412	OURO VERDE DE GOIAS	OV12384200	NEROPOLIS S1	14/11/2020 16:55	15/11/2020 00:38	14/11/2020 16:55	15/11/2020 00:38	7,71	8	61,66	CHI
20201166194	URUTAI	UT12083190	URUTAI	14/11/2020 16:56	15/11/2020 11:37	14/11/2020 16:56	15/11/2020 11:37	18,69	18	336,46	CHI
20201165423	RIO VERDE	RV21361109	CABRIUVA S2	14/11/2020 16:57	14/11/2020 19:59	14/11/2020 16:57	14/11/2020 19:59	3,03	1	3,03	CHI
20201165425	GOIANIA	13691569	CAMPINAS S1	14/11/2020 16:57	14/11/2020 19:09	14/11/2020 16:57	14/11/2020 19:09	2,19	1	2,19	CHI
20201165426	FIRMINOPOLIS	FR12323491	FIRMINOPOLIS S2	14/11/2020 16:57	14/11/2020 19:21	14/11/2020 16:57	14/11/2020 19:21	2,39	3	7,16	CHI
20201165484	BARRO ALTO	3620214	GOIANESIA S1	14/11/2020 16:59	14/11/2020 17:13	14/11/2020 16:59	14/11/2020 17:03	0,06	129	8,35	CHI
20201165484	GOIANESIA	3620214	GOIANESIA S1	14/11/2020 16:59	14/11/2020 17:13	14/11/2020 16:59	14/11/2020 17:03	0,06	111	7,18	CHI
20201165484	VILA PROPICIO	3620214	GOIANESIA S1	14/11/2020 16:59	14/11/2020 17:13	14/11/2020 16:59	14/11/2020 17:03	0,06	551	35,66	CHI
20201165484	COCALZINHO DE GOIAS	BA10397359	GOIANESIA S1	14/11/2020 16:59	14/11/2020 17:13	14/11/2020 16:59	14/11/2020 17:13	0,23	1	0,23	CHI
20201165484	PADRE BERNARDO	BA10397359	GOIANESIA S1	14/11/2020 16:59	14/11/2020 17:13	14/11/2020 16:59	14/11/2020 17:13	0,23	11	2,49	CHI
20201165484	VILA PROPICIO	BA10397359	GOIANESIA S1	14/11/2020 16:59	14/11/2020 17:13	14/11/2020 16:59	14/11/2020 17:13	0,23	347	78,56	CHI
20201165471	JATAI	JT10394711	JATAI S3	14/11/2020 17:00	15/11/2020 11:13	14/11/2020 17:00	14/11/2020 20:10	3,17	35	111,10	CHI
20201165471	JATAI	JT10394711	JATAI S3	14/11/2020 17:00	15/11/2020 11:13	14/11/2020 17:00	15/11/2020 00:04	7,06	27	190,61	CHI

20201165471	JATAI	JT10394711	JATAI S3	14/11/2020 17:00	15/11/2020 11:13	14/11/2020 17:00	15/11/2020 03:51	10,84	71	769,86	CHI
20201165471	RIO VERDE	JT10394711	JATAI S3	14/11/2020 17:00	15/11/2020 11:13	14/11/2020 17:00	15/11/2020 03:51	10,84	3	32,53	CHI
20201165471	JATAI	JT10394711	JATAI S3	14/11/2020 17:00	15/11/2020 11:13	14/11/2020 17:00	15/11/2020 08:55	15,91	13	206,83	CHI
20201165471	JATAI	JT12125885LD	JATAI S3	14/11/2020 17:00	15/11/2020 11:13	14/11/2020 17:00	15/11/2020 10:25	17,41	7	121,87	CHI
20201165471	RIO VERDE	JT12125885LD	JATAI S3	14/11/2020 17:00	15/11/2020 11:13	14/11/2020 17:00	15/11/2020 10:25	17,41	5	87,05	CHI
20201165471	JATAI	JT10394711	JATAI S3	14/11/2020 17:00	15/11/2020 11:13	14/11/2020 17:00	15/11/2020 11:13	18,23	20	364,50	CHI
20201165980	CATALAO	CT12231540RE	CATALAO S1	14/11/2020 17:00	14/11/2020 20:11	14/11/2020 17:00	14/11/2020 20:11	3,18	11	34,96	CHI
20201165443	TRINDADE	40141135	TRINDADE	14/11/2020 17:01	14/11/2020 20:07	14/11/2020 17:01	14/11/2020 20:07	3,10	1	3,10	CHI
20201165444	CRISTALINA	KR21165512	CRISTALINA S1	14/11/2020 17:01	15/11/2020 00:35	14/11/2020 17:01	15/11/2020 00:35	7,56	1	7,56	CHI
20201165453	CIDADE OCIDENTAL	LZ12031093	RIO VERMELHO	14/11/2020 17:02	14/11/2020 20:40	14/11/2020 18:44	14/11/2020 20:40	1,93	9	17,37	CHI
20201165453	LUZIANIA	LZ12031093	RIO VERMELHO	14/11/2020 17:02	14/11/2020 20:40	14/11/2020 18:44	14/11/2020 20:40	1,93	41	79,12	CHI
20201165454	RUBIATABA	RB21111236	RUBIATABA	14/11/2020 17:02	15/11/2020 09:45	14/11/2020 17:02	15/11/2020 09:45	16,71	1	16,71	CHI
20201165778	CAMPO LIMPO	OV12317357	NEROPOLIS S2	14/11/2020 17:02	14/11/2020 19:48	14/11/2020 17:02	14/11/2020 19:48	2,75	2	5,51	CHI
20201165778	OURO VERDE DE GOIAS	OV12317357	NEROPOLIS S2	14/11/2020 17:02	14/11/2020 19:48	14/11/2020 17:02	14/11/2020 19:48	2,75	33	90,85	CHI
20201166631	ITAGUARU	IC12063042	ITABERAI S1	14/11/2020 17:02	15/11/2020 11:59	14/11/2020 17:02	15/11/2020 11:59	18,95	2	37,90	CHI
20201165464	GOIANIA	11461676	GOIANIA LESTE S1	14/11/2020 17:04	14/11/2020 23:17	14/11/2020 17:04	14/11/2020 23:17	6,21	1	6,21	CHI
20201165466	MATRINCHA	MP21051598	MATRINCHA	14/11/2020 17:04	15/11/2020 09:26	14/11/2020 17:04	15/11/2020 09:26	16,36	1	16,36	CHI
20201165483	DAVINOPOLIS	2950000144	CATALAO S1	14/11/2020 17:05	14/11/2020 23:42	14/11/2020 17:05	14/11/2020 23:42	6,61	1	6,61	CHI
20201165485	JUSSARA	JR21120546	JUSSARA	14/11/2020 17:05	15/11/2020 08:52	14/11/2020 17:05	15/11/2020 08:52	15,77	1	15,77	CHI
20201165763	NIQUELANDIA	NQ12378040	NIQUELANDIA SUBTRANSMISSAO	14/11/2020 17:05	14/11/2020 19:23	14/11/2020 17:05	14/11/2020 19:23	2,30	24	55,19	CHI
20201165489	CIDADE OCIDENTAL	DH11163801	MARAJOARA	14/11/2020 17:06	14/11/2020 22:51	14/11/2020 17:06	14/11/2020 22:51	5,75	238	1368,24	CHI
20201165490	BOM JESUS DE GOIAS	10022708934	BOM JESUS DE GOIAS	14/11/2020 17:06	14/11/2020 18:34	14/11/2020 17:06	14/11/2020 18:34	1,47	1	1,47	CHI
20201165533	SANTA HELENA DE GOIAS	SH10394752	IPEGUARI	14/11/2020 17:06	14/11/2020 17:11	14/11/2020 17:06	14/11/2020 17:11	0,07	113	7,91	CHI
20201165495	GOIATUBA	VI21263312	VICENTINOPOLIS	14/11/2020 17:07	14/11/2020 18:24	14/11/2020 17:07	14/11/2020 18:24	1,28	1	1,28	CHI
20201165496	CRISTALINA	KR21097543	CRISTALINA S1	14/11/2020 17:07	14/11/2020 23:18	14/11/2020 17:07	14/11/2020 23:18	6,18	1	6,18	CHI
20201165497	GOIANIA	15087360	MEIA PONTE	14/11/2020 17:07	15/11/2020 00:50	14/11/2020 17:07	15/11/2020 00:50	7,71	1	7,71	CHI
20201165498	APARECIDA DE GOIANIA	12983184	ATLANTICO S2	14/11/2020 17:07	15/11/2020 03:45	14/11/2020 17:07	15/11/2020 03:45	10,63	1	10,63	CHI
20201166173	CABECEIRAS	CW12398925	ITUIQUIRA	14/11/2020 17:07	14/11/2020 23:18	14/11/2020 17:07	14/11/2020 23:18	6,17	28	172,72	CHI
20201166331	MUTUNOPOLIS	MU12320905	MARA ROSA	14/11/2020 17:08	15/11/2020 11:06	14/11/2020 17:08	15/11/2020 11:06	17,95	6	107,71	CHI
20201165974	JATAI	JT11378101	JATAI S2	14/11/2020 17:09	14/11/2020 19:46	14/11/2020 17:09	14/11/2020 19:46	2,62	73	190,98	CHI
20201165514	GOIANIA	10006423602	GOYA S1	14/11/2020 17:10	14/11/2020 19:33	14/11/2020 17:10	14/11/2020 19:33	2,37	1	2,37	CHI
20201165522	GOIANIA	GN12338048	FERROVIARIO S3	14/11/2020 17:11	14/11/2020 18:26	14/11/2020 17:11	14/11/2020 18:26	1,23	926	1142,84	CHI
20201165536	DOVERLANDIA	DV12138334	CAIAPONIA	14/11/2020 17:11	14/11/2020 20:14	14/11/2020 17:11	14/11/2020 20:14	3,05	15	45,68	CHI
20201165540	CAIAPONIA	DV12023480	CAIAPONIA	14/11/2020 17:12	14/11/2020 19:06	14/11/2020 17:12	14/11/2020 19:06	1,89	7	13,26	CHI
20201165540	DOVERLANDIA	DV12023480	CAIAPONIA	14/11/2020 17:12	14/11/2020 19:06	14/11/2020 17:12	14/11/2020 19:06	1,89	4	7,57	CHI
20201165540	PIRANHAS	DV12023480	CAIAPONIA	14/11/2020 17:12	14/11/2020 19:06	14/11/2020 17:12	14/11/2020 19:06	1,89	1	1,89	CHI
20201165691	FORMOSA	FA32042714	SAO JOAO D ALIANCA	14/11/2020 17:12	14/11/2020 21:45	14/11/2020 17:12	14/11/2020 21:45	4,54	10	45,39	CHI
20201165538	FORMOSA	FA12427569	SAO JOAO D ALIANCA	14/11/2020 17:13	15/11/2020 01:09	14/11/2020 17:13	15/11/2020 01:09	7,92	3	23,76	CHI
20201165659	RIO VERDE	RV12123340	RIO VERDE S1	14/11/2020 17:13	14/11/2020 18:11	14/11/2020 17:13	14/11/2020 18:11	0,97	6	5,79	CHI
20201165544	MOZARLANDIA	MZ12058584	MOZARLANDIA	14/11/2020 17:14	14/11/2020 19:20	14/11/2020 17:14	14/11/2020 19:20	2,08	12	25,01	CHI
20201165887	CAIAPONIA	CP11020865	CAIAPONIA	14/11/2020 17:14	14/11/2020 19:18	14/11/2020 17:14	14/11/2020 19:18	2,06	117	241,02	CHI
20201166448	CIDADE OCIDENTAL	DH11199637	MARAJOARA	14/11/2020 17:16	14/11/2020 20:59	14/11/2020 17:16	14/11/2020 20:59	3,71	109	404,03	CHI
20201165639	CARMO DO RIO VERDE	RB12051013	RUBIATABA	14/11/2020 17:18	15/11/2020 08:07	14/11/2020 17:18	15/11/2020 08:07	14,80	3	44,41	CHI
20201165639	SAO PATRICIO	RB12051013	RUBIATABA	14/11/2020 17:18	15/11/2020 08:07	14/11/2020 17:18	15/11/2020 08:07	14,80	3	44,41	CHI
20201165574	PALMEIRAS DE GOIAS	PL21000013	PALMEIRAS	14/11/2020 17:19	15/11/2020 15:32	14/11/2020 17:19	15/11/2020 15:32	22,21	1	22,21	CHI
20201165589	CALDAZINHA	2340010993	SENADOR CANEDO	14/11/2020 17:20	14/11/2020 19:03	14/11/2020 17:20	14/11/2020 19:03	1,71	1	1,71	CHI
20201165599	ARAGOIANIA	680028869	INDEPENDENCIA S2	14/11/2020 17:21	15/11/2020 08:42	14/11/2020 17:21	15/11/2020 08:42	15,34	1	15,34	CHI
20201165816	LUZIANIA	LZ11209506	RIO VERMELHO	14/11/2020 17:21	14/11/2020 19:24	14/11/2020 17:21	14/11/2020 19:24	2,05	75	153,38	CHI
20201165610	CABECEIRAS	CW21344407	ITUIQUIRA	14/11/2020 17:23	15/11/2020 02:04	14/11/2020 17:23	15/11/2020 02:04	8,68	2	17,35	CHI
20201165615	LUZIANIA	LZ12390037	MARAJOARA	14/11/2020 17:23	14/11/2020 20:42	14/11/2020 17:23	14/11/2020 20:42	3,30	103	340,10	CHI
20201165631	JESUPOLIS	JE13350791	SAO FRANCISCO DE GOIAS	14/11/2020 17:23	14/11/2020 19:25	14/11/2020 17:23	14/11/2020 19:25	2,04	156	317,72	CHI

20201165631	SAO FRANCISCO DE GOIAS	JE13350791	SAO FRANCISCO DE GOIAS	14/11/2020 17:23	14/11/2020 19:25	14/11/2020 17:23	14/11/2020 19:25	2,04	86	175,15	CHI
20201165618	CIDADE OCIDENTAL	DH11199614	MARAJOARA	14/11/2020 17:24	15/11/2020 04:10	14/11/2020 17:24	15/11/2020 04:10	10,76	111	1194,79	CHI
20201165619	CAMPOS VERDES	SG12252883	SANTA TEREZINHA	14/11/2020 17:24	14/11/2020 21:41	14/11/2020 17:24	14/11/2020 21:41	4,28	1	4,28	CHI
20201166372	CIDADE OCIDENTAL	DH11199613	MARAJOARA	14/11/2020 17:24	14/11/2020 23:56	14/11/2020 17:24	14/11/2020 23:56	6,52	82	534,48	CHI
20201165632	APARECIDA DE GOIANIA	13665595	INDEPENDENCIA S2	14/11/2020 17:26	14/11/2020 18:43	14/11/2020 17:26	14/11/2020 18:43	1,28	1	1,28	CHI
20201165959	BURITI DE GOIAS	CO13024052	FIRMINOPOLIS S2	14/11/2020 17:26	14/11/2020 21:29	14/11/2020 17:26	14/11/2020 21:29	4,04	61	246,27	CHI
20201165959	CORREGO DO OURO	CO13024052	FIRMINOPOLIS S2	14/11/2020 17:26	14/11/2020 21:29	14/11/2020 17:26	14/11/2020 21:29	4,04	109	440,06	CHI
20201165959	NOVO BRASIL	CO13024052	FIRMINOPOLIS S2	14/11/2020 17:26	14/11/2020 21:29	14/11/2020 17:26	14/11/2020 21:29	4,04	16	64,60	CHI
20201165641	JARAGUA	JA12278873	JARAGUA	14/11/2020 17:27	14/11/2020 21:51	14/11/2020 17:27	14/11/2020 21:51	4,39	2	8,77	CHI
20201167138	RIO VERDE	RV21361108	CABRIUVA S2	14/11/2020 17:27	15/11/2020 08:01	14/11/2020 17:27	15/11/2020 08:01	14,57	1	14,57	CHI
20201165650	JATAI	JT12260447LD	JATAI S1	14/11/2020 17:28	14/11/2020 23:59	14/11/2020 17:28	14/11/2020 23:59	6,51	52	338,35	CHI
20201165657	PALMEIRAS DE GOIAS	PL12357854	PALMEIRAS	14/11/2020 17:29	15/11/2020 14:59	14/11/2020 17:29	15/11/2020 14:59	21,49	2	42,99	CHI
20201165660	APARECIDA DE GOIANIA	14310673	INDEPENDENCIA S2	14/11/2020 17:29	14/11/2020 19:55	14/11/2020 17:29	14/11/2020 19:55	2,42	1	2,42	CHI
20201165662	SANTA RITA DO ARAGUAIA	2130017715	SANTA RITA DO ARAGUAIA	14/11/2020 17:30	14/11/2020 21:53	14/11/2020 17:30	14/11/2020 21:53	4,38	1	4,38	CHI
20201165663	IVOLANDIA	IV12097764	IPORA	14/11/2020 17:30	15/11/2020 03:08	14/11/2020 17:30	15/11/2020 03:08	9,63	3	28,89	CHI
20201165663	MOIPORA	IV12097764	IPORA	14/11/2020 17:30	15/11/2020 03:08	14/11/2020 17:30	15/11/2020 03:08	9,63	9	86,67	CHI
20201165676	PLANALTINA	PI11164572	PLANALTINA	14/11/2020 17:32	14/11/2020 18:28	14/11/2020 17:32	14/11/2020 18:28	0,93	92	85,51	CHI
20201166679	URUTAI	UT12107859	URUTAI	14/11/2020 17:32	15/11/2020 00:00	14/11/2020 17:32	15/11/2020 00:00	6,46	17	109,90	CHI
20201165687	CORUMBA DE GOIAS	CB12211842	CORUMBA	14/11/2020 17:33	14/11/2020 22:21	14/11/2020 17:33	14/11/2020 22:21	4,79	2	9,58	CHI
20201165995	SANTA HELENA DE GOIAS	SH10394752	IPEGUARI	14/11/2020 17:33	15/11/2020 19:53	14/11/2020 17:33	14/11/2020 22:11	4,63	60	277,63	CHI
20201165995	SANTA HELENA DE GOIAS	SH12296172LD	IPEGUARI	14/11/2020 17:33	15/11/2020 19:53	14/11/2020 17:33	15/11/2020 02:02	8,48	52	440,82	CHI
20201165995	SANTA HELENA DE GOIAS	SH10394752	IPEGUARI	14/11/2020 17:33	15/11/2020 19:53	15/11/2020 14:19	15/11/2020 17:12	2,88	60	173,08	CHI
20201165995	SANTA HELENA DE GOIAS	SH12296172LD	IPEGUARI	14/11/2020 17:33	15/11/2020 19:53	14/11/2020 17:33	15/11/2020 19:01	25,45	1	25,45	CHI
20201165995	SANTA HELENA DE GOIAS	SH12296172LD	IPEGUARI	14/11/2020 17:33	15/11/2020 19:53	15/11/2020 14:19	15/11/2020 19:01	4,69	17	79,66	CHI
20201165995	SANTA HELENA DE GOIAS	SH10394752	IPEGUARI	14/11/2020 17:33	15/11/2020 19:53	15/11/2020 19:02	15/11/2020 19:08	0,10	60	5,98	CHI
20201165995	SANTA HELENA DE GOIAS	SH12296172LD	IPEGUARI	14/11/2020 17:33	15/11/2020 19:53	15/11/2020 14:19	15/11/2020 19:53	5,56	24	133,41	CHI
20201165995	SANTA HELENA DE GOIAS	SH12296172LD	IPEGUARI	14/11/2020 17:33	15/11/2020 19:53	15/11/2020 19:02	15/11/2020 19:53	0,86	18	15,41	CHI
20201165995	SANTA HELENA DE GOIAS	SH12296189	IPEGUARI	14/11/2020 17:33	15/11/2020 19:53	15/11/2020 14:19	15/11/2020 19:53	5,56	11	61,20	CHI
20201166091	BURITINOPOLIS	BQ12168775	IACIARA S2	14/11/2020 17:33	14/11/2020 19:05	14/11/2020 17:33	14/11/2020 19:05	1,53	40	61,02	CHI
20201165698	RIO VERDE	10031233625	RIO VERDE S1	14/11/2020 17:34	15/11/2020 09:18	14/11/2020 17:34	15/11/2020 09:18	15,72	1	15,72	CHI
20201165710	RUBIATABA	RB12358938	RUBIATABA	14/11/2020 17:36	15/11/2020 11:16	14/11/2020 17:36	15/11/2020 11:16	17,65	2	35,30	CHI
20201165722	CIDADE OCIDENTAL	DH11199619	MARAJOARA	14/11/2020 17:36	14/11/2020 21:08	14/11/2020 17:36	14/11/2020 21:08	3,53	137	483,04	CHI
20201165712	IPAMERI	IP12000086	IPAMERI	14/11/2020 17:37	15/11/2020 02:05	14/11/2020 17:37	15/11/2020 02:05	8,46	5	42,32	CHI
20201165807	JUSSARA	JR12220059	JUSSARA	14/11/2020 17:38	15/11/2020 10:18	14/11/2020 17:38	15/11/2020 10:18	16,66	12	199,87	CHI
20201165821	BARRO ALTO	GE12000087	GOIANESIA S2	14/11/2020 17:40	14/11/2020 19:04	14/11/2020 17:40	14/11/2020 19:04	1,40	1	1,40	CHI
20201165821	GOIANESIA	GE12000087	GOIANESIA S2	14/11/2020 17:40	14/11/2020 19:04	14/11/2020 17:40	14/11/2020 19:04	1,40	12	16,76	CHI
20201165736	JARAGUA	10015458863	JARAGUA	14/11/2020 17:41	14/11/2020 21:37	14/11/2020 17:41	14/11/2020 21:37	3,93	1	3,93	CHI
20201165737	SANTA HELENA DE GOIAS	10019276590	IPEGUARI	14/11/2020 17:41	14/11/2020 22:08	14/11/2020 17:41	14/11/2020 22:08	4,44	1	4,44	CHI
20201165740	VALPARAISO DE GOIAS	VA11000273	MARAJOARA	14/11/2020 17:41	14/11/2020 21:21	14/11/2020 17:41	14/11/2020 21:21	3,65	87	317,74	CHI
20201166217	SILVANIA	SV12287460	VIANOPOLIS	14/11/2020 17:41	14/11/2020 21:42	14/11/2020 17:41	14/11/2020 21:42	4,01	88	353,00	CHI
20201165747	BELA VISTA DE GOIAS	BV21000059	BELA VISTA S1	14/11/2020 17:42	15/11/2020 02:31	14/11/2020 17:42	15/11/2020 02:01	8,32	1	8,32	CHI
20201165747	BELA VISTA DE GOIAS	BV12000040LD	BELA VISTA S1	14/11/2020 17:42	15/11/2020 02:31	14/11/2020 22:40	15/11/2020 02:31	3,85	4	15,39	CHI
20201167046	MARA ROSA	MQ12146959	MARA ROSA	14/11/2020 17:42	15/11/2020 11:15	14/11/2020 17:42	15/11/2020 11:15	17,53	11	192,88	CHI
20201167046	NOVA IGUACU DE GOIAS	MQ12146959	MARA ROSA	14/11/2020 17:42	15/11/2020 11:15	14/11/2020 17:42	15/11/2020 11:15	17,53	12	210,41	CHI
20201165832	CORUMBA DE GOIAS	AX12000153	CORUMBA	14/11/2020 17:44	15/11/2020 10:59	14/11/2020 17:44	15/11/2020 10:59	17,24	10	172,43	CHI
20201165782	NOVA CRIXAS	NA10396027	NOVA CRIXAS	14/11/2020 17:45	16/11/2020 17:25	14/11/2020 17:45	14/11/2020 19:03	1,30	39	50,55	CHI
20201165782	NOVA CRIXAS	NA10396027	NOVA CRIXAS	14/11/2020 17:45	16/11/2020 17:25	14/11/2020 21:27	14/11/2020 22:00	0,55	39	21,63	CHI
20201165782	NOVA CRIXAS	NA10396027	NOVA CRIXAS	14/11/2020 17:45	16/11/2020 17:25	15/11/2020 10:04	15/11/2020 10:34	0,48	39	18,90	CHI
20201165782	NOVA CRIXAS	NA10396027	NOVA CRIXAS	14/11/2020 17:45	16/11/2020 17:25	14/11/2020 17:45	15/11/2020 11:17	17,54	6	105,24	CHI
20201165782	MUNDO NOVO DE GOIAS	NA12035650	NOVA CRIXAS	14/11/2020 17:45	16/11/2020 17:25	14/11/2020 17:45	15/11/2020 11:45	18,01	8	144,06	CHI
20201165782	NOVA CRIXAS	NA12035650	NOVA CRIXAS	14/11/2020 17:45	16/11/2020 17:25	14/11/2020 17:45	15/11/2020 11:45	18,01	24	432,19	CHI

20201165782	NOVA CRIXAS	NA10396027	NOVA CRIXAS	14/11/2020 17:45	16/11/2020 17:25	14/11/2020 17:45	16/11/2020 13:59	44,24	2	88,48	CHI
20201165782	MUNDO NOVO DE GOIAS	NA10396027	NOVA CRIXAS	14/11/2020 17:45	16/11/2020 17:25	16/11/2020 15:45	16/11/2020 15:48	0,05	8	0,44	CHI
20201165782	NOVA CRIXAS	NA10396027	NOVA CRIXAS	14/11/2020 17:45	16/11/2020 17:25	16/11/2020 15:45	16/11/2020 15:48	0,05	71	3,87	CHI
20201165782	NOVA CRIXAS	NA12263044LD	NOVA CRIXAS	14/11/2020 17:45	16/11/2020 17:25	14/11/2020 17:45	16/11/2020 16:40	46,92	87	4081,94	CHI
20201165782	MUNDO NOVO DE GOIAS	NA12034791LD	NOVA CRIXAS	14/11/2020 17:45	16/11/2020 17:25	14/11/2020 17:45	16/11/2020 17:11	47,44	37	1755,16	CHI
20201165782	NOVA CRIXAS	NA12034791LD	NOVA CRIXAS	14/11/2020 17:45	16/11/2020 17:25	14/11/2020 17:45	16/11/2020 17:11	47,44	31	1470,54	CHI
20201165782	NOVA CRIXAS	NA12291260	NOVA CRIXAS	14/11/2020 17:45	16/11/2020 17:25	14/11/2020 17:45	16/11/2020 17:25	47,67	7	333,72	CHI
20201165799	QUIRINOPOLIS	QI12279582	QUIRINOPOLIS	14/11/2020 17:45	14/11/2020 19:21	14/11/2020 17:45	14/11/2020 19:21	1,59	14	22,20	CHI
20201165784	SENADOR CANEDO	SW12080143	SENADOR CANEDO	14/11/2020 17:47	15/11/2020 00:33	14/11/2020 17:47	15/11/2020 00:33	6,76	5	33,80	CHI
20201166078	ITUMBIARA	IT12033777	CACHOEIRA DOURADA	14/11/2020 17:47	14/11/2020 19:46	14/11/2020 17:47	14/11/2020 19:46	1,97	13	25,57	CHI
20201165790	SAO JOAO D ALIANCA	JL12049201	SAO JOAO D ALIANCA	14/11/2020 17:48	14/11/2020 23:55	14/11/2020 17:48	14/11/2020 20:34	2,78	56	155,63	CHI
20201165790	SAO JOAO D ALIANCA	JL12049201	SAO JOAO D ALIANCA	14/11/2020 17:48	14/11/2020 23:55	14/11/2020 17:48	14/11/2020 23:11	5,38	34	183,00	CHI
20201165790	SAO JOAO D ALIANCA	JL12049201	SAO JOAO D ALIANCA	14/11/2020 17:48	14/11/2020 23:55	14/11/2020 17:48	14/11/2020 23:55	6,12	5	30,60	CHI
20201165793	TURVELANDIA	TD21384562	RIO DOS BOIS	14/11/2020 17:48	15/11/2020 00:17	14/11/2020 17:48	15/11/2020 00:17	6,48	1	6,48	CHI
20201165797	MAMBAI	MB11164513	IACIARA S2	14/11/2020 17:48	14/11/2020 20:28	14/11/2020 17:48	14/11/2020 20:28	2,65	103	273,24	CHI
20201166084	JARAGUA	JA12161736	JARAGUA	14/11/2020 17:48	14/11/2020 19:26	14/11/2020 17:48	14/11/2020 19:26	1,63	234	380,70	CHI
20201165798	MONTIVIDIU	2840033921	MONTIVIDIU T	14/11/2020 17:49	14/11/2020 20:27	14/11/2020 17:49	14/11/2020 20:27	2,65	1	2,65	CHI
20201165808	ALTO PARAISO DE GOIAS	BF12349123	FLORES DE GOIAS	14/11/2020 17:49	15/11/2020 02:50	14/11/2020 17:49	15/11/2020 02:50	9,00	4	36,00	CHI
20201165808	SAO JOAO D ALIANCA	BF12349123	FLORES DE GOIAS	14/11/2020 17:49	15/11/2020 02:50	14/11/2020 17:49	15/11/2020 02:50	9,00	2	18,00	CHI
20201165926	VICENTINOPOLIS	VI11095407	VICENTINOPOLIS	14/11/2020 17:49	14/11/2020 19:41	14/11/2020 17:49	14/11/2020 19:41	1,86	119	221,27	CHI
20201165809	FORMOSA	FA12426798	SAO JOAO D ALIANCA	14/11/2020 17:50	15/11/2020 10:48	14/11/2020 17:50	15/11/2020 10:48	16,96	62	1051,50	CHI
20201165818	SANTO ANTONIO DO DESCOBERTO	2210013428	AGUAS LINDAS DE GOIAS S2	14/11/2020 17:52	14/11/2020 21:14	14/11/2020 17:52	14/11/2020 21:14	3,37	1	3,37	CHI
20201165824	SAO LUIS DE MONTES BELOS	SL21387557	FIRMINOPOLIS S2	14/11/2020 17:52	14/11/2020 20:14	14/11/2020 17:52	14/11/2020 20:14	2,36	3	7,08	CHI
20201165827	QUIRINOPOLIS	QI21139099	QUIRINOPOLIS	14/11/2020 17:52	14/11/2020 20:51	14/11/2020 17:52	14/11/2020 20:51	2,97	1	2,97	CHI
20201165830	BARRO ALTO	GE12115071	GOIANESIA S1	14/11/2020 17:53	14/11/2020 20:52	14/11/2020 17:53	14/11/2020 20:52	2,98	2	5,96	CHI
20201165830	GOIANESIA	GE12115071	GOIANESIA S1	14/11/2020 17:53	14/11/2020 20:52	14/11/2020 17:53	14/11/2020 20:52	2,98	9	26,84	CHI
20201165834	CATALAO	CT12394021	CATALAO S1	14/11/2020 17:53	15/11/2020 09:23	14/11/2020 17:53	15/11/2020 09:23	15,49	6	92,95	CHI
20201165834	DAVINOPOLIS	CT12394021	CATALAO S1	14/11/2020 17:53	15/11/2020 09:23	14/11/2020 17:53	15/11/2020 09:23	15,49	4	61,96	CHI
20201165842	ANICUNS	AC21073832	ANICUNS	14/11/2020 17:55	15/11/2020 10:11	14/11/2020 17:55	15/11/2020 10:11	16,26	2	32,52	CHI
20201165847	CABEIRAS	860007868	ITUIQUIRA	14/11/2020 17:55	15/11/2020 08:35	14/11/2020 17:55	15/11/2020 08:35	14,66	1	14,66	CHI
20201165848	SANTA RITA DO NOVO DESTINO	BA21156227	BARRO ALTO	14/11/2020 17:55	15/11/2020 01:12	14/11/2020 17:55	15/11/2020 01:12	7,27	2	14,54	CHI
20201166471	IVOLANDIA	IV12062833	IPORA	14/11/2020 17:55	15/11/2020 02:22	14/11/2020 17:55	15/11/2020 02:22	8,44	18	151,96	CHI
20201165851	ANAPOLIS	10028888470	ANAPOLIS UNIVERSITARIO S2	14/11/2020 17:56	14/11/2020 19:45	14/11/2020 17:56	14/11/2020 19:45	1,81	1	1,81	CHI
20201165852	AMORINOPOLIS	AM12312073	IPORA	14/11/2020 17:56	15/11/2020 08:36	14/11/2020 17:56	15/11/2020 08:36	14,66	3	43,99	CHI
20201165858	CRISTALINA	KR10406853	CRISTALINA S2	14/11/2020 17:56	15/11/2020 14:45	14/11/2020 23:43	14/11/2020 23:50	0,12	31	3,87	CHI
20201165858	LUZIANIA	KR10406853	CRISTALINA S2	14/11/2020 17:56	15/11/2020 14:45	14/11/2020 23:43	14/11/2020 23:50	0,12	53	6,61	CHI
20201165858	LUZIANIA	LZ12383049	CRISTALINA S2	14/11/2020 17:56	15/11/2020 14:45	14/11/2020 17:56	15/11/2020 03:29	9,54	19	181,22	CHI
20201165858	LUZIANIA	LZ12383049	CRISTALINA S2	14/11/2020 17:56	15/11/2020 14:45	14/11/2020 17:56	15/11/2020 08:53	14,95	21	314,04	CHI
20201165858	LUZIANIA	LZ12383049	CRISTALINA S2	14/11/2020 17:56	15/11/2020 14:45	14/11/2020 23:43	15/11/2020 08:53	9,18	5	45,90	CHI
20201165858	LUZIANIA	LZ12383050LD	CRISTALINA S2	14/11/2020 17:56	15/11/2020 14:45	15/11/2020 09:02	15/11/2020 10:01	0,98	4	3,91	CHI
20201165858	LUZIANIA	LZ12383049	CRISTALINA S2	14/11/2020 17:56	15/11/2020 14:45	15/11/2020 11:14	15/11/2020 11:37	0,38	19	7,20	CHI
20201165858	LUZIANIA	LZ12383050LD	CRISTALINA S2	14/11/2020 17:56	15/11/2020 14:45	15/11/2020 10:14	15/11/2020 12:22	2,12	4	8,50	CHI
20201165858	LUZIANIA	LZ12383052LD	CRISTALINA S2	14/11/2020 17:56	15/11/2020 14:45	14/11/2020 23:43	15/11/2020 12:50	13,11	1	13,11	CHI
20201165858	LUZIANIA	LZ12333211	CRISTALINA S2	14/11/2020 17:56	15/11/2020 14:45	15/11/2020 09:02	15/11/2020 14:10	5,12	22	112,62	CHI
20201165858	LUZIANIA	LZ12383049	CRISTALINA S2	14/11/2020 17:56	15/11/2020 14:45	14/11/2020 17:56	15/11/2020 14:20	20,40	45	918,19	CHI
20201165858	LUZIANIA	LZ12383049	CRISTALINA S2	14/11/2020 17:56	15/11/2020 14:45	14/11/2020 17:56	15/11/2020 14:45	20,80	38	790,59	CHI
20201166113	SAO MIGUEL DO ARAGUAIA	SM12192362	SAO MIGUEL DO ARAGUAIA	14/11/2020 17:56	15/11/2020 08:44	14/11/2020 17:56	15/11/2020 08:44	14,80	2	29,59	CHI
20201165868	APARECIDA DE GOIANIA	10031251755	REAL S2	14/11/2020 17:58	15/11/2020 12:52	14/11/2020 17:58	15/11/2020 12:52	18,89	1	18,89	CHI
20201165880	CATALAO	CT12103631	CATALAO S1	14/11/2020 18:00	15/11/2020 10:48	14/11/2020 18:00	15/11/2020 10:48	16,80	8	134,39	CHI
20201165884	RIO VERDE	RV21348175	RIO VERDE S1	14/11/2020 18:00	14/11/2020 18:44	14/11/2020 18:00	14/11/2020 18:44	0,72	1	0,72	CHI
20201165908	MINEIROS	MY21301856	PARQUE DAS EMAS	14/11/2020 18:00	14/11/2020 19:56	14/11/2020 18:00	14/11/2020 19:56	1,93	1	1,93	CHI



20201166208	SILVANIA	VN12017544RE	VIANOPOLIS	14/11/2020 18:01	14/11/2020 20:59	14/11/2020 18:01	14/11/2020 20:59	2,97	119	352,90	CHI
20201166208	VIANOPOLIS	VN12017544RE	VIANOPOLIS	14/11/2020 18:01	14/11/2020 20:59	14/11/2020 18:01	14/11/2020 20:59	2,97	47	139,38	CHI
20201166242	BALIZA	BH11259312	CAIAPONIA	14/11/2020 18:01	14/11/2020 23:20	14/11/2020 18:01	14/11/2020 23:20	5,32	1	5,32	CHI
20201166473	GOIANIA	GN11197043	FERROVIARIO S2	14/11/2020 18:01	14/11/2020 21:41	14/11/2020 18:01	14/11/2020 21:41	3,66	15	54,92	CHI
20201165898	MORRINHOS	150005945	MORRINHOS	14/11/2020 18:02	14/11/2020 22:27	14/11/2020 18:02	14/11/2020 22:27	4,40	1	4,40	CHI
20201166195	MAMBAI	MB12140432	IACIARA S2	14/11/2020 18:02	14/11/2020 19:53	14/11/2020 18:02	14/11/2020 19:53	1,84	17	31,23	CHI
20201165901	SAO JOAO D ALIANCA	JL21314627	SAO JOAO D ALIANCA	14/11/2020 18:03	14/11/2020 20:56	14/11/2020 18:03	14/11/2020 20:56	2,88	1	2,88	CHI
20201166063	PLANALTINA	PI12355773	PLANALTINA	14/11/2020 18:03	14/11/2020 20:58	14/11/2020 18:03	14/11/2020 20:58	2,91	47	136,81	CHI
20201165904	GOIANIRA	390071857	GOIANIRA	14/11/2020 18:04	14/11/2020 19:44	14/11/2020 18:04	14/11/2020 19:44	1,67	1	1,67	CHI
20201165909	CAIAPONIA	CP12075058	CAIAPONIA	14/11/2020 18:04	14/11/2020 21:29	14/11/2020 18:04	14/11/2020 21:29	3,41	20	68,14	CHI
20201165921	IPAMERI	IP12080281	PIRES DO RIO S2	14/11/2020 18:05	15/11/2020 04:35	14/11/2020 18:05	15/11/2020 04:35	10,49	4	41,96	CHI
20201165921	ORIZONA	IP12080281	PIRES DO RIO S2	14/11/2020 18:05	15/11/2020 04:35	14/11/2020 18:05	15/11/2020 04:35	10,49	1	10,49	CHI
20201165922	JAUPACI	JP12074031	IPORA	14/11/2020 18:05	14/11/2020 19:39	14/11/2020 18:05	14/11/2020 19:39	1,55	3	4,66	CHI
20201166913	APARECIDA DE GOIANIA	AP12000049	CEPAIGO S1	14/11/2020 18:05	15/11/2020 13:20	14/11/2020 18:05	15/11/2020 13:20	19,24	40	769,60	CHI
20201165938	GUAPO	710033369	GUAPO S1	14/11/2020 18:07	14/11/2020 19:35	14/11/2020 18:07	14/11/2020 19:35	1,46	1	1,46	CHI
20201165941	PETROLINA DE GOIAS	3040214	INHUMAS S1	14/11/2020 18:08	14/11/2020 21:53	14/11/2020 18:08	14/11/2020 21:53	3,75	47	176,24	CHI
20201165941	SANTA ROSA DE GOIAS	3040214	INHUMAS S1	14/11/2020 18:08	14/11/2020 21:53	14/11/2020 18:08	14/11/2020 21:53	3,75	507	1901,11	CHI
20201165956	MINEIROS	MY12360720RE	PARQUE DAS EMAS	14/11/2020 18:10	14/11/2020 20:10	14/11/2020 18:10	14/11/2020 20:10	2,00	4	7,99	CHI
20201165958	VILA PROPICIO	7587203	GOIANESIA S1	14/11/2020 18:10	14/11/2020 21:31	14/11/2020 18:10	14/11/2020 21:31	3,34	91	304,04	CHI
20201165964	GOIANIA	14315671	ATLANTICO S2	14/11/2020 18:11	15/11/2020 01:12	14/11/2020 18:11	15/11/2020 01:12	7,01	1	7,01	CHI
20201165967	CIDADE OCCIDENTAL	DH11209475	MARAJOARA	14/11/2020 18:11	14/11/2020 22:23	14/11/2020 18:11	14/11/2020 22:23	4,19	70	293,22	CHI
20201167003	AMARALINA	LC21248961	MARA ROSA	14/11/2020 18:12	14/11/2020 22:49	14/11/2020 18:12	14/11/2020 22:49	4,60	1	4,60	CHI
20201165981	NIQUELANDIA	NQ21345056	URUACU	14/11/2020 18:14	15/11/2020 11:23	14/11/2020 18:14	15/11/2020 11:23	17,14	1	17,14	CHI
20201165982	RIO VERDE	RV12301462	ACREUNA	14/11/2020 18:14	14/11/2020 21:25	14/11/2020 18:14	14/11/2020 21:25	3,18	9	28,66	CHI
20201165989	ANICUNS	AC12259091	ANICUNS	14/11/2020 18:15	15/11/2020 07:57	14/11/2020 18:15	15/11/2020 07:57	13,69	44	602,20	CHI
20201167095	AGUA FRIA DE GOIAS	PI12325588	SAO JOAO D ALIANCA	14/11/2020 18:15	15/11/2020 09:10	14/11/2020 18:15	15/11/2020 09:10	14,92	1	14,92	CHI
20201167095	PLANALTINA	PI12325588	SAO JOAO D ALIANCA	14/11/2020 18:15	15/11/2020 09:10	14/11/2020 18:15	15/11/2020 09:10	14,92	102	1521,33	CHI
20201165990	FORMOSA	FA21096304	SAO JOAO D ALIANCA	14/11/2020 18:16	14/11/2020 21:37	14/11/2020 18:16	14/11/2020 21:37	3,34	2	6,68	CHI
20201166015	ALTO PARAISO DE GOIAS	BF21361347	NIQUELANDIA SUBTRANSMISSAO	14/11/2020 18:18	15/11/2020 11:42	14/11/2020 18:18	15/11/2020 11:42	17,40	1	17,40	CHI
20201166080	MAURILANDIA	ML12303576	RIO DOS BOIS	14/11/2020 18:19	14/11/2020 22:43	14/11/2020 18:19	14/11/2020 22:43	4,39	4	17,56	CHI
20201166344	ABADIANIA	AA12413567	ANAPOLIS UNIVERSITARIO S1	14/11/2020 18:19	15/11/2020 09:56	14/11/2020 18:19	15/11/2020 09:56	15,61	5	78,05	CHI
20201166025	PLANALTINA	PI12355774	PLANALTINA	14/11/2020 18:20	14/11/2020 20:22	14/11/2020 18:20	14/11/2020 20:22	2,02	3	6,06	CHI
20201166085	CAIAPONIA	CP12160772	MONTIVIDIU T	14/11/2020 18:20	14/11/2020 22:32	14/11/2020 18:20	14/11/2020 22:32	4,19	12	50,23	CHI
20201166085	JATAI	CP12160772	MONTIVIDIU T	14/11/2020 18:20	14/11/2020 22:32	14/11/2020 18:20	14/11/2020 22:32	4,19	6	25,11	CHI
20201166085	RIO VERDE	CP12160772	MONTIVIDIU T	14/11/2020 18:20	14/11/2020 22:32	14/11/2020 18:20	14/11/2020 22:32	4,19	11	46,04	CHI
20201166032	FLORES DE GOIAS	FB12409931	FLORES DE GOIAS	14/11/2020 18:21	15/11/2020 00:11	14/11/2020 18:21	15/11/2020 00:11	5,83	44	256,63	CHI
20201166033	SENADOR CANEDO	10020073710	SENADOR CANEDO	14/11/2020 18:21	15/11/2020 16:26	14/11/2020 18:21	15/11/2020 16:26	22,07	1	22,07	CHI
20201166035	SAO MIGUEL DO PASSA QUATRO	SQ21216513	BELA VISTA S2	14/11/2020 18:22	14/11/2020 22:15	14/11/2020 18:22	14/11/2020 22:15	3,88	1	3,88	CHI
20201166167	GAMELEIRA DE GOIAS	SV12056335	DAIA S2	14/11/2020 18:23	14/11/2020 21:24	14/11/2020 18:23	14/11/2020 21:24	3,01	7	21,09	CHI
20201166202	MONTES CLAROS DE GOIAS	ME12204934	IPORA	14/11/2020 18:24	14/11/2020 23:22	14/11/2020 18:24	14/11/2020 23:22	4,95	12	59,42	CHI
20201166056	SANTO ANTONIO DO DESCOBERTO	SN21082853	MARAJOARA	14/11/2020 18:25	14/11/2020 19:57	14/11/2020 18:25	14/11/2020 19:57	1,52	1	1,52	CHI
20201166060	FAZENDA NOVA	FN21278005	JUSSARA	14/11/2020 18:25	15/11/2020 02:53	14/11/2020 18:25	15/11/2020 02:53	8,45	1	8,45	CHI
20201166065	APARECIDA DE GOIANIA	15306707	INDEPENDENCIA S2	14/11/2020 18:26	15/11/2020 02:09	14/11/2020 18:26	15/11/2020 02:09	7,71	1	7,71	CHI
20201166069	FORMOSA	FA21334133	SAO JOAO D ALIANCA	14/11/2020 18:26	14/11/2020 23:11	14/11/2020 18:26	14/11/2020 23:11	4,74	1	4,74	CHI
20201166070	CACHEIRA DOURADA	CD21424206	CACHEIRA DOURADA	14/11/2020 18:27	14/11/2020 22:18	14/11/2020 18:27	14/11/2020 22:18	3,85	1	3,85	CHI
20201166076	MAMBAI	MB11302676	IACIARA S2	14/11/2020 18:27	14/11/2020 20:53	14/11/2020 18:27	14/11/2020 20:53	2,42	2	4,85	CHI
20201166436	SILVANIA	SV12199936	VIANOPOLIS	14/11/2020 18:28	15/11/2020 10:05	14/11/2020 18:28	15/11/2020 10:05	15,61	15	234,17	CHI
20201166358	GAMELEIRA DE GOIAS	SV12051679	DAIA S2	14/11/2020 18:31	14/11/2020 21:59	14/11/2020 18:31	14/11/2020 21:59	3,46	4	13,83	CHI
20201166358	SILVANIA	SV12051679	DAIA S2	14/11/2020 18:31	14/11/2020 21:59	14/11/2020 18:31	14/11/2020 21:59	3,46	17	58,80	CHI
20201166147	HIDROLANDIA	HD12366272	CEPAIGO S2	14/11/2020 18:33	15/11/2020 09:50	14/11/2020 18:33	15/11/2020 09:50	15,28	8	122,25	CHI
20201166180	APARECIDA DE GOIANIA	AP12035280	REAL S2	14/11/2020 18:33	14/11/2020 20:04	14/11/2020 18:33	14/11/2020 20:04	1,51	463	697,20	CHI

20201166116	LUZIANIA	10008212820	RIO VERMELHO	14/11/2020 18:35	14/11/2020 21:47	14/11/2020 18:35	14/11/2020 21:47	3,19	1	3,19	CHI
20201166121	LUZIANIA	120200764	RIO VERMELHO	14/11/2020 18:35	14/11/2020 21:16	14/11/2020 18:35	14/11/2020 21:16	2,67	1	2,67	CHI
20201166151	FAINA	FC10410192	GOIAS	14/11/2020 18:35	14/11/2020 18:39	14/11/2020 18:35	14/11/2020 18:38	0,05	48	2,41	CHI
20201166151	ITABERAI	FC10410192	GOIAS	14/11/2020 18:35	14/11/2020 18:39	14/11/2020 18:35	14/11/2020 18:38	0,05	1	0,05	CHI
20201166151	ARAGUAPAZ	FC10410192	GOIAS	14/11/2020 18:35	14/11/2020 18:39	14/11/2020 18:35	14/11/2020 18:39	0,07	166	11,67	CHI
20201166151	FAINA	FC10410192	GOIAS	14/11/2020 18:35	14/11/2020 18:39	14/11/2020 18:35	14/11/2020 18:39	0,07	378	26,57	CHI
20201166397	GOIANIA	GN12040872	FERROVIARIO S3	14/11/2020 18:35	14/11/2020 20:29	14/11/2020 18:35	14/11/2020 20:29	1,89	496	935,51	CHI
20201166123	VILA PROPICIO	PV21141671	GOIANESIA S1	14/11/2020 18:36	15/11/2020 01:35	14/11/2020 18:36	15/11/2020 01:35	6,97	1	6,97	CHI
20201166390	GOIAS	GS12410738	GOIAS	14/11/2020 18:36	15/11/2020 02:50	14/11/2020 18:36	15/11/2020 02:50	8,22	37	304,29	CHI
20201166131	SAO LUIS DE MONTES BELOS	SL31111604	FIRMINOPOLIS S1	14/11/2020 18:37	14/11/2020 21:01	14/11/2020 18:37	14/11/2020 21:01	2,39	1	2,39	CHI
20201166136	GAMELEIRA DE GOIAS	SV21151512	ANAPOLIS UNIVERSITARIO S2	14/11/2020 18:37	14/11/2020 23:45	14/11/2020 18:37	14/11/2020 23:45	5,12	1	5,12	CHI
20201166367	CIDADE OCIDENTAL	DH11199615	MARAJOARA	14/11/2020 18:37	14/11/2020 21:23	14/11/2020 18:37	14/11/2020 21:23	2,75	145	399,31	CHI
20201169602	CAMPINORTE	MQ21345550	MARA ROSA	14/11/2020 18:37	16/11/2020 10:09	14/11/2020 18:37	16/11/2020 10:09	39,52	1	39,52	CHI
20201166140	MINACU	IH12230530	MINACU	14/11/2020 18:38	16/11/2020 10:14	14/11/2020 18:38	16/11/2020 10:14	39,59	3	118,77	CHI
20201166497	ANICUNS	AC12259090	FIRMINOPOLIS S2	14/11/2020 18:38	14/11/2020 20:44	14/11/2020 18:38	14/11/2020 20:44	2,09	30	62,82	CHI
20201166143	OURO VERDE DE GOIAS	OV21146668	NEROPOLIS S1	14/11/2020 18:39	14/11/2020 20:39	14/11/2020 18:39	14/11/2020 20:39	2,00	3	6,00	CHI
20201166150	VARJAO	GA31066162	CEZARINA	14/11/2020 18:39	14/11/2020 23:42	14/11/2020 18:39	14/11/2020 23:42	5,03	0	0,00	CHI
20201166209	PIRACANJUBA	PJ12039733	PIRACANJUBA	14/11/2020 18:39	15/11/2020 10:38	14/11/2020 18:39	14/11/2020 23:21	4,70	25	117,58	CHI
20201166209	PIRACANJUBA	PJ12039733	PIRACANJUBA	14/11/2020 18:39	15/11/2020 10:38	14/11/2020 18:39	15/11/2020 10:38	15,98	3	47,95	CHI
20201166153	LUZIANIA	120042836	RIO VERMELHO	14/11/2020 18:40	14/11/2020 22:41	14/11/2020 18:40	14/11/2020 22:41	4,01	1	4,01	CHI
20201166155	FAINA	FC12147795	GOIAS	14/11/2020 18:40	14/11/2020 19:48	14/11/2020 18:40	14/11/2020 19:48	1,12	6	6,74	CHI
20201166156	NIQUELANDIA	NQ21271142	BARRO ALTO	14/11/2020 18:40	15/11/2020 10:27	14/11/2020 18:40	15/11/2020 10:27	15,77	1	15,77	CHI
20201166159	SANTO ANTONIO DO DESCOBERTO	SN21324145	MARAJOARA	14/11/2020 18:41	14/11/2020 20:36	14/11/2020 18:41	14/11/2020 20:36	1,91	2	3,82	CHI
20201166165	TRINDADE	40028010	TRINDADE	14/11/2020 18:41	14/11/2020 21:34	14/11/2020 18:41	14/11/2020 21:34	2,87	1	2,87	CHI
20201167214	CABECEIRAS	CW12108823	ITUIQUIRA	14/11/2020 18:42	15/11/2020 02:04	14/11/2020 18:42	15/11/2020 02:04	7,36	16	117,80	CHI
20201166174	ALTO HORIZONTE	AJ12384910RE	MARA ROSA	14/11/2020 18:43	17/11/2020 10:57	14/11/2020 18:43	15/11/2020 11:50	17,10	17	290,77	CHI
20201166174	MARA ROSA	AJ12384910RE	MARA ROSA	14/11/2020 18:43	17/11/2020 10:57	14/11/2020 18:43	15/11/2020 11:50	17,10	2	34,21	CHI
20201166174	ALTO HORIZONTE	AJ12384910RE	MARA ROSA	14/11/2020 18:43	17/11/2020 10:57	14/11/2020 18:43	17/11/2020 10:04	63,34	17	1076,82	CHI
20201166174	MARA ROSA	AJ12384910RE	MARA ROSA	14/11/2020 18:43	17/11/2020 10:57	14/11/2020 18:43	17/11/2020 10:04	63,34	3	190,03	CHI
20201166174	ALTO HORIZONTE	AJ12384910RE	MARA ROSA	14/11/2020 18:43	17/11/2020 10:57	14/11/2020 18:43	17/11/2020 10:57	64,22	2	128,45	CHI
20201166176	MONTIVIDIU	MV12340904	MONTIVIDIU T	14/11/2020 18:44	15/11/2020 15:50	14/11/2020 18:44	15/11/2020 15:34	20,84	2	41,69	CHI
20201166176	MONTIVIDIU	MV12340904	MONTIVIDIU T	14/11/2020 18:44	15/11/2020 15:50	14/11/2020 21:48	15/11/2020 15:34	17,78	1	17,78	CHI
20201166176	CAIAPONIA	MV12340904	MONTIVIDIU T	14/11/2020 18:44	15/11/2020 15:50	14/11/2020 18:44	15/11/2020 15:50	21,11	1	21,11	CHI
20201166176	MONTIVIDIU	MV12340904	MONTIVIDIU T	14/11/2020 18:44	15/11/2020 15:50	14/11/2020 18:44	15/11/2020 15:50	21,11	7	147,77	CHI
20201166176	MONTIVIDIU	RV12030646	MONTIVIDIU T	14/11/2020 18:44	15/11/2020 15:50	14/11/2020 21:48	15/11/2020 15:50	18,05	7	126,35	CHI
20201166181	ACREUNA	2440054556	ACREUNA	14/11/2020 18:44	15/11/2020 03:09	14/11/2020 18:44	15/11/2020 03:09	8,41	1	8,41	CHI
20201166430	IPAMERI	IP12272798	IPAMERI	14/11/2020 18:44	14/11/2020 23:59	14/11/2020 18:44	14/11/2020 23:59	5,24	7	36,69	CHI
20201166187	AMARALINA	LC21327559	MARA ROSA	14/11/2020 18:45	14/11/2020 21:59	14/11/2020 18:45	14/11/2020 21:59	3,22	1	3,22	CHI
20201166188	ANICUNS	AC12299011	FIRMINOPOLIS S2	14/11/2020 18:45	14/11/2020 19:53	14/11/2020 18:45	14/11/2020 19:53	1,12	10	11,19	CHI
20201166191	CAMPINACU	UC21244548	PORANGATU	14/11/2020 18:46	14/11/2020 20:33	14/11/2020 18:46	14/11/2020 20:33	1,77	1	1,77	CHI
20201166196	VALPARAISO DE GOIAS	VA11192832	MARAJOARA	14/11/2020 18:47	14/11/2020 22:01	14/11/2020 18:47	14/11/2020 22:01	3,23	19	61,38	CHI
20201166198	FAZENDA NOVA	NB21116397	JUSSARA	14/11/2020 18:47	15/11/2020 10:15	14/11/2020 18:47	15/11/2020 10:15	15,46	1	15,46	CHI
20201166212	ALTO PARAISO DE GOIAS	BF10409732	SAO JOAO D ALIANCA	14/11/2020 18:47	15/11/2020 12:01	14/11/2020 18:47	14/11/2020 22:43	3,93	60	235,72	CHI
20201166212	ALTO PARAISO DE GOIAS	BF10409732	SAO JOAO D ALIANCA	14/11/2020 18:47	15/11/2020 12:01	15/11/2020 00:55	15/11/2020 01:25	0,50	60	30,15	CHI
20201166212	ALTO PARAISO DE GOIAS	BF10409732	SAO JOAO D ALIANCA	14/11/2020 18:47	15/11/2020 12:01	15/11/2020 08:46	15/11/2020 10:06	1,35	60	80,85	CHI
20201166212	ALTO PARAISO DE GOIAS	BF12155974LD	SAO JOAO D ALIANCA	14/11/2020 18:47	15/11/2020 12:01	14/11/2020 18:47	15/11/2020 10:11	15,40	105	1616,88	CHI
20201166212	ALTO PARAISO DE GOIAS	BF12244628LD	SAO JOAO D ALIANCA	14/11/2020 18:47	15/11/2020 12:01	14/11/2020 18:47	15/11/2020 10:55	16,13	34	548,47	CHI
20201166212	ALTO PARAISO DE GOIAS	BF12365360LD	SAO JOAO D ALIANCA	14/11/2020 18:47	15/11/2020 12:01	14/11/2020 18:47	15/11/2020 12:01	17,24	33	568,94	CHI
20201166204	CRISTALINA	KR11276397	CRISTALINA S2	14/11/2020 18:48	15/11/2020 00:00	14/11/2020 18:48	15/11/2020 00:00	5,19	2	10,39	CHI
20201166210	EDEALINA	1130003003	PONTALINA	14/11/2020 18:48	14/11/2020 22:06	14/11/2020 18:48	14/11/2020 22:06	3,29	1	3,29	CHI
20201166295	ARENOPOLIS	AY12000004	ARENOPOLIS	14/11/2020 18:48	14/11/2020 21:36	14/11/2020 18:48	14/11/2020 21:36	2,79	4	11,17	CHI

20201166398	FAZENDA NOVA	FN11249644	JUSSARA	14/11/2020 18:48	15/11/2020 00:42	14/11/2020 18:48	15/11/2020 00:42	5,90	55	324,24	CHI
20201166248	LUZIANIA	120405064	RIO VERMELHO	14/11/2020 18:52	14/11/2020 21:51	14/11/2020 18:52	14/11/2020 21:51	2,97	1	2,97	CHI
20201166249	JATAI	JT21296408	JATAI S1	14/11/2020 18:53	15/11/2020 03:04	14/11/2020 18:53	15/11/2020 03:04	8,18	1	8,18	CHI
20201166256	RIO VERDE	RV21348175	RIO VERDE S1	14/11/2020 18:54	15/11/2020 00:35	14/11/2020 18:54	15/11/2020 00:35	5,68	1	5,68	CHI
20201166258	JATAI	JT12191634	JATAI S2	14/11/2020 18:54	15/11/2020 08:53	14/11/2020 18:54	15/11/2020 08:53	13,99	1	13,99	CHI
20201166262	SAO MIGUEL DO ARAGUAIA	SM21083952	SAO MIGUEL DO ARAGUAIA	14/11/2020 18:55	16/11/2020 04:11	14/11/2020 18:55	16/11/2020 04:11	33,27	1	33,27	CHI
20201166399	CATALAO	CT11077319	CATALAO S2	14/11/2020 18:55	14/11/2020 21:29	14/11/2020 18:55	14/11/2020 21:29	2,55	121	308,92	CHI
20201166662	SAO MIGUEL DO ARAGUAIA	SM12228636	SAO MIGUEL DO ARAGUAIA	14/11/2020 18:55	15/11/2020 09:03	14/11/2020 18:55	15/11/2020 09:03	14,12	58	819,02	CHI
20201166737	ARENOPOLIS	AY12139436	ARENOPOLIS	14/11/2020 18:55	14/11/2020 23:44	14/11/2020 18:55	14/11/2020 23:44	4,81	16	76,92	CHI
20201166737	IPORA	AY12139436	ARENOPOLIS	14/11/2020 18:55	14/11/2020 23:44	14/11/2020 18:55	14/11/2020 23:44	4,81	11	52,88	CHI
20201166276	CATALAO	CT12333401	CATALAO S1	14/11/2020 18:56	15/11/2020 09:36	14/11/2020 18:56	15/11/2020 09:36	14,66	7	102,59	CHI
20201166838	URUTAI	UT12080701	URUTAI	14/11/2020 18:56	15/11/2020 01:27	14/11/2020 18:56	15/11/2020 01:27	6,51	5	32,53	CHI
20201166291	CATALAO	CT21127870	CATALAO S1	14/11/2020 18:57	15/11/2020 13:06	14/11/2020 18:57	15/11/2020 13:06	18,15	2	36,30	CHI
20201166294	SILVANIA	SV21141626	DAIA S2	14/11/2020 18:57	14/11/2020 22:46	14/11/2020 18:57	14/11/2020 22:46	3,81	2	7,62	CHI
20201166296	CATALAO	1990201146	CATALAO S2	14/11/2020 18:57	14/11/2020 20:20	14/11/2020 18:57	14/11/2020 20:20	1,37	1	1,37	CHI
20201166304	GOIANIRA	GR11393563	GOIANIRA	14/11/2020 18:59	14/11/2020 20:16	14/11/2020 18:59	14/11/2020 20:16	1,27	135	172,05	CHI
20201166530	CIDADE OCIDENTAL	DH11068388	MARAJOARA	14/11/2020 18:59	14/11/2020 22:08	14/11/2020 18:59	14/11/2020 22:08	3,15	347	1092,66	CHI
20201166341	DOVERLANDIA	DV11260040	CAIAPONIA	14/11/2020 19:00	14/11/2020 20:05	14/11/2020 19:00	14/11/2020 20:05	1,08	92	99,54	CHI
20201166324	GUAPO	GA21150404	GUAPO S2	14/11/2020 19:02	14/11/2020 23:03	14/11/2020 19:02	14/11/2020 23:03	4,01	1	4,01	CHI
20201166325	NOVA GLORIA	8700511	ITAPACI	14/11/2020 19:02	14/11/2020 21:19	14/11/2020 19:06	14/11/2020 21:19	2,22	6	13,32	CHI
20201166338	GOIANIA	GN11189627	ATLANTICO S3	14/11/2020 19:03	15/11/2020 01:38	14/11/2020 19:03	15/11/2020 01:38	6,57	17	111,66	CHI
20201166620	LUZIANIA	LZ11330782	MARAJOARA	14/11/2020 19:04	15/11/2020 01:01	14/11/2020 19:04	15/11/2020 01:01	5,94	3	17,83	CHI
20201166349	RIO VERDE	630516730	RIO VERDE S1	14/11/2020 19:05	15/11/2020 08:07	14/11/2020 19:05	15/11/2020 08:07	13,02	1	13,02	CHI
20201166350	GOIANIA	10534313	REAL S2	14/11/2020 19:05	14/11/2020 20:01	14/11/2020 19:05	14/11/2020 20:01	0,92	1	0,92	CHI
20201167083	SAO JOAO D ALIANCA	JL12146226	SAO JOAO D ALIANCA	14/11/2020 19:05	15/11/2020 00:41	14/11/2020 19:05	15/11/2020 00:41	5,59	71	396,77	CHI
20201166521	AGUA FRIA DE GOIAS	JL12117446	SAO JOAO D ALIANCA	14/11/2020 19:06	15/11/2020 01:08	14/11/2020 19:06	15/11/2020 01:08	6,03	20	120,51	CHI
20201166521	SAO JOAO D ALIANCA	JL12117446	SAO JOAO D ALIANCA	14/11/2020 19:06	15/11/2020 01:08	14/11/2020 19:06	15/11/2020 01:08	6,03	26	156,66	CHI
20201166357	CRIXAS	UP12171811	SANTA TEREZINHA	14/11/2020 19:07	15/11/2020 11:43	14/11/2020 19:07	15/11/2020 11:43	16,60	4	66,39	CHI
20201166357	UIRAPURU	UP12171811	SANTA TEREZINHA	14/11/2020 19:07	15/11/2020 11:43	14/11/2020 19:07	15/11/2020 11:43	16,60	23	381,74	CHI
20201166357	CRIXAS	UP12171811	SANTA TEREZINHA	14/11/2020 19:07	15/11/2020 11:43	15/11/2020 10:30	15/11/2020 11:43	1,22	2	2,43	CHI
20201166357	UIRAPURU	UP12171811	SANTA TEREZINHA	14/11/2020 19:07	15/11/2020 11:43	15/11/2020 10:30	15/11/2020 11:43	1,22	9	10,95	CHI
20201166360	GOVIANIA	570007240	GOIATUBA S1	14/11/2020 19:07	15/11/2020 04:46	14/11/2020 19:07	15/11/2020 04:46	9,64	1	9,64	CHI
20201166361	ANAPOLIS	10009076040	ANAPOLIS UNIVERSITARIO S1	14/11/2020 19:08	14/11/2020 20:38	14/11/2020 19:08	14/11/2020 20:38	1,50	1	1,50	CHI
20201166364	FORMOSA	610239030	ITIQUIRA	14/11/2020 19:09	14/11/2020 20:28	14/11/2020 19:09	14/11/2020 20:28	1,31	1	1,31	CHI
20201166371	NOVA CRIXAS	NA11229688	NOVA CRIXAS	14/11/2020 19:10	17/11/2020 20:28	14/11/2020 19:10	17/11/2020 20:28	73,29	1	73,29	CHI
20201166476	LUZIANIA	LZ12084512	CRISTALINA S2	14/11/2020 19:10	14/11/2020 22:39	14/11/2020 19:10	14/11/2020 22:39	3,48	27	93,88	CHI
20201166375	INHUMAS	IN32066288	INHUMAS S2	14/11/2020 19:11	14/11/2020 21:06	14/11/2020 19:11	14/11/2020 21:06	1,91	8	15,31	CHI
20201167180	LUZIANIA	LZ12276294	MARAJOARA	14/11/2020 19:11	15/11/2020 01:01	14/11/2020 19:11	15/11/2020 01:01	5,83	2	11,65	CHI
20201166404	APARECIDA DE GOIANIA	AP11104269	INDEPENDENCIA S1	14/11/2020 19:12	14/11/2020 21:59	14/11/2020 19:12	14/11/2020 21:59	2,79	160	446,76	CHI
20201166385	GOIANIA	14583458	GOYA S2	14/11/2020 19:13	15/11/2020 08:17	14/11/2020 19:13	15/11/2020 08:17	13,06	1	13,06	CHI
20201166392	SAO LUIS DE MONTES BELOS	SL21180351	SAO LUIZ DOS MONTES BELOS	14/11/2020 19:14	14/11/2020 23:46	14/11/2020 19:14	14/11/2020 23:46	4,53	1	4,53	CHI
20201166927	BONFINOPOLIS	GP12210815	DAIA S2	14/11/2020 19:14	14/11/2020 22:52	14/11/2020 19:14	14/11/2020 22:52	3,62	54	195,74	CHI
20201166927	GAMELEIRA DE GOIAS	GP12210815	DAIA S2	14/11/2020 19:14	14/11/2020 22:52	14/11/2020 19:14	14/11/2020 22:52	3,62	2	7,25	CHI
20201166927	GOIANAPOLIS	GP12210815	DAIA S2	14/11/2020 19:14	14/11/2020 22:52	14/11/2020 19:14	14/11/2020 22:52	3,62	34	123,24	CHI
20201166927	LEOPOLDO DE BULHOES	GP12210815	DAIA S2	14/11/2020 19:14	14/11/2020 22:52	14/11/2020 19:14	14/11/2020 22:52	3,62	68	246,48	CHI
20201166402	AGUA FRIA DE GOIAS	JL12261886	SAO JOAO D ALIANCA	14/11/2020 19:16	14/11/2020 21:41	14/11/2020 19:16	14/11/2020 21:41	2,40	10	24,03	CHI
20201166434	PLANALTINA	PI11146248	PLANALTINA	14/11/2020 19:17	14/11/2020 22:01	14/11/2020 19:17	14/11/2020 22:01	2,72	433	1177,88	CHI
20201166416	JATAI	290144644	JATAI S2	14/11/2020 19:19	14/11/2020 22:24	14/11/2020 19:19	14/11/2020 22:24	3,07	1	3,07	CHI
20201166490	FAINA	FC12124752	GOIAS	14/11/2020 19:19	14/11/2020 20:45	14/11/2020 19:19	14/11/2020 20:45	1,43	26	37,19	CHI
20201166425	ANAPOLIS	20901215	ANAPOLIS UNIVERSITARIO S2	14/11/2020 19:21	14/11/2020 21:32	14/11/2020 19:21	14/11/2020 21:32	2,17	1	2,17	CHI
20201166480	JATAI	JT12109029	JATAI S1	14/11/2020 19:21	14/11/2020 22:12	14/11/2020 19:21	14/11/2020 22:12	2,85	29	82,66	CHI

20201166439	ITAPIRAPUA	IU21089793	MATRINCHA	14/11/2020 19:23	15/11/2020 10:05	14/11/2020 19:23	15/11/2020 10:05	14,70	1	14,70	CHI
20201166445	APARECIDA DE GOIANIA	14355929	CARAJAS S1	14/11/2020 19:24	15/11/2020 03:24	14/11/2020 19:24	15/11/2020 03:24	7,99	1	7,99	CHI
20201166467	RIO VERDE	RV21207120	RIO VERDE S1	14/11/2020 19:26	14/11/2020 23:16	14/11/2020 19:26	14/11/2020 23:16	3,82	2	7,65	CHI
20201166468	JATAI	JT12182190	JATAI S1	14/11/2020 19:26	15/11/2020 13:16	15/11/2020 09:41	15/11/2020 10:29	0,80	4	3,22	CHI
20201166468	JATAI	JT13214371	JATAI S1	14/11/2020 19:26	15/11/2020 13:16	15/11/2020 09:41	15/11/2020 13:16	3,58	20	71,65	CHI
20201166468	JATAI	JT12324801	JATAI S1	14/11/2020 19:26	15/11/2020 13:16	14/11/2020 19:26	15/11/2020 13:16	17,84	1	17,84	CHI
20201166511	FAINA	FC12147790	GOIAS	14/11/2020 19:26	16/11/2020 11:31	14/11/2020 19:26	16/11/2020 11:31	40,09	6	240,53	CHI
20201166474	NAZARIO	NZ21037857	ANICUNS	14/11/2020 19:27	14/11/2020 21:42	14/11/2020 19:27	14/11/2020 21:42	2,25	1	2,25	CHI
20201167007	ARAGARCAS	ME12193486	IPORA	14/11/2020 19:27	15/11/2020 03:27	14/11/2020 19:27	15/11/2020 03:27	7,99	1	7,99	CHI
20201167007	MONTES CLAROS DE GOIAS	ME12193486	IPORA	14/11/2020 19:27	15/11/2020 03:27	14/11/2020 19:27	15/11/2020 03:27	7,99	3	23,96	CHI
20201166536	URUACU	HL12292170	URUACU	14/11/2020 19:28	15/11/2020 09:14	14/11/2020 19:28	15/11/2020 09:14	13,75	5	68,77	CHI
20201167077	GOIANIA	GN11002192	FERROVIARIO S3	14/11/2020 19:28	14/11/2020 23:49	14/11/2020 19:28	14/11/2020 23:49	4,36	84	365,96	CHI
20201166489	PORANGATU	PO12020608	NOVO PLANALTO	14/11/2020 19:30	15/11/2020 12:01	14/11/2020 19:30	15/11/2020 12:01	16,51	3	49,52	CHI
20201166491	ARAGARCAS	10012305071	ARAGARCAS	14/11/2020 19:30	15/11/2020 09:24	14/11/2020 19:30	15/11/2020 09:24	13,89	1	13,89	CHI
20201166494	CHAPADAO DO CEU	AE12086834	CHAPADAO DO CEU	14/11/2020 19:31	15/11/2020 01:43	14/11/2020 19:31	15/11/2020 01:43	6,19	1	6,19	CHI
20201166955	SAO MIGUEL DO ARAGUAIA	SM12390459	SAO MIGUEL DO ARAGUAIA	14/11/2020 19:31	15/11/2020 10:17	14/11/2020 19:31	15/11/2020 10:17	14,76	3	44,29	CHI
20201166496	ORIZONA	OZ21137519	PIRES DO RIO S2	14/11/2020 19:33	14/11/2020 23:45	14/11/2020 19:33	14/11/2020 23:45	4,20	1	4,20	CHI
20201166503	SENADOR CANEDO	SW21082422	CEPAIGO S2	14/11/2020 19:33	14/11/2020 22:22	14/11/2020 19:33	14/11/2020 22:22	2,81	1	2,81	CHI
20201166506	GOIANIA	12379463	AEROPORTO S1	14/11/2020 19:34	15/11/2020 03:24	14/11/2020 19:34	15/11/2020 03:24	7,83	1	7,83	CHI
20201166607	BARRO ALTO	GE12000087	GOIANESIA S2	14/11/2020 19:34	14/11/2020 21:32	14/11/2020 19:34	14/11/2020 21:32	1,96	2	3,91	CHI
20201166607	GOIANESIA	GE12000087	GOIANESIA S2	14/11/2020 19:34	14/11/2020 21:32	14/11/2020 19:34	14/11/2020 21:32	1,96	14	27,40	CHI
20201166547	DOVERLANDIA	DV12139919	CAIAPONIA	14/11/2020 19:35	14/11/2020 22:09	14/11/2020 19:35	14/11/2020 22:09	2,56	49	125,48	CHI
20201166516	CAIAPONIA	290255715	JATAI S1	14/11/2020 19:36	15/11/2020 12:08	14/11/2020 19:36	15/11/2020 12:08	16,54	1	16,54	CHI
20201166518	TRUVELANDIA	TD12025738LD	RIO DOS BOIS	14/11/2020 19:37	15/11/2020 08:23	14/11/2020 19:37	15/11/2020 08:23	12,77	19	242,55	CHI
20201166624	FAINA	FC12084192	GOIAS	14/11/2020 19:39	14/11/2020 21:58	14/11/2020 19:39	14/11/2020 21:58	2,31	4	9,25	CHI
20201166526	MINACU	4020030158	MINACU	14/11/2020 19:40	15/11/2020 05:10	14/11/2020 19:40	15/11/2020 05:10	9,50	1	9,50	CHI
20201166527	LUZIANIA	120073158	RIO VERMELHO	14/11/2020 19:40	14/11/2020 21:15	14/11/2020 19:40	14/11/2020 21:15	1,58	1	1,58	CHI
20201166533	JATAI	10027934282	JATAI S3	14/11/2020 19:42	15/11/2020 12:40	14/11/2020 19:42	15/11/2020 12:40	16,96	1	16,96	CHI
20201166540	TRINDADE	40023412	TRINDADE	14/11/2020 19:44	14/11/2020 20:50	14/11/2020 19:44	14/11/2020 20:50	1,09	1	1,09	CHI
20201166545	CORUMBA DE GOIAS	CB21270337	ANAPOLIS UNIVERSITARIO S1	14/11/2020 19:47	15/11/2020 01:30	14/11/2020 19:47	15/11/2020 01:30	5,72	1	5,72	CHI
20201166585	MUNDO NOVO DE GOIAS	MH12084354	NOVA CRIXAS	14/11/2020 19:47	15/11/2020 11:27	14/11/2020 19:47	15/11/2020 11:27	15,66	6	93,98	CHI
20201166635	ARAGUAPAZ	FC12250653LD	GOIAS	14/11/2020 19:48	15/11/2020 14:29	14/11/2020 19:48	15/11/2020 14:29	18,68	166	3100,05	CHI
20201166635	FAINA	FC12250653LD	GOIAS	14/11/2020 19:48	15/11/2020 14:29	14/11/2020 19:48	15/11/2020 14:29	18,68	378	7059,15	CHI
20201166635	FAINA	FC12250653LD	GOIAS	14/11/2020 19:48	15/11/2020 14:29	15/11/2020 12:25	15/11/2020 14:29	2,07	46	95,35	CHI
20201166635	ITABERAÍ	FC12250653LD	GOIAS	14/11/2020 19:48	15/11/2020 14:29	15/11/2020 12:25	15/11/2020 14:29	2,07	1	2,07	CHI
20201166555	SANTA TEREZINHA DE GOIAS	SG12181444	SANTA TEREZINHA	14/11/2020 19:49	15/11/2020 23:44	14/11/2020 19:49	15/11/2020 23:44	27,90	1	27,90	CHI
20201166555	UIRAPURU	SG12181444	SANTA TEREZINHA	14/11/2020 19:49	15/11/2020 23:44	14/11/2020 19:49	15/11/2020 23:44	27,90	2	55,81	CHI
20201166561	RIO VERDE	RV21260549	CABRIUVA S2	14/11/2020 19:50	14/11/2020 23:39	14/11/2020 19:50	14/11/2020 23:39	3,81	1	3,81	CHI
20201166890	ITAPURANGA	IK12220548	ITAPURANGA	14/11/2020 19:51	14/11/2020 23:34	14/11/2020 19:51	14/11/2020 23:34	3,70	11	40,72	CHI
20201166594	PLANALTINA	PI12202846	PADRE BERNARDO	14/11/2020 19:52	15/11/2020 09:18	14/11/2020 19:52	15/11/2020 09:18	13,42	3	40,27	CHI
20201166595	ABADIA DE GOIAS	GN11211453	INDEPENDENCIA S2	14/11/2020 19:52	14/11/2020 23:06	14/11/2020 19:52	14/11/2020 23:06	3,22	17	54,74	CHI
20201166611	BARRO ALTO	GE12255886	GOIANESIA S1	14/11/2020 19:55	15/11/2020 04:32	14/11/2020 19:55	15/11/2020 04:32	8,61	1	8,61	CHI
20201166611	GOIANESIA	GE12255886	GOIANESIA S1	14/11/2020 19:55	15/11/2020 04:32	14/11/2020 19:55	15/11/2020 04:32	8,61	5	43,07	CHI
20201166612	GOIANIA	10026741294	ATLANTICO S1	14/11/2020 19:55	14/11/2020 22:25	14/11/2020 19:55	14/11/2020 22:25	2,50	1	2,50	CHI
20201166614	IACIARA	FB21242834	FLORES DE GOIAS	14/11/2020 19:56	14/11/2020 22:46	14/11/2020 19:56	14/11/2020 22:46	2,82	1	2,82	CHI
20201166619	PLANALTINA	PI21243161	PLANALTINA	14/11/2020 19:57	14/11/2020 21:53	14/11/2020 19:57	14/11/2020 21:53	1,92	1	1,92	CHI
20201166621	ANAPOLIS	20486807	ANAPOLIS UNIVERSITARIO S2	14/11/2020 19:58	14/11/2020 21:20	14/11/2020 19:58	14/11/2020 21:20	1,36	1	1,36	CHI
20201166630	ITAPIRAPUA	IU12209220	MATRINCHA	14/11/2020 20:00	15/11/2020 11:03	14/11/2020 20:00	15/11/2020 11:03	15,04	6	90,22	CHI
20201166633	HIDROLANDIA	HD12000308LD	ANHANGUERA	14/11/2020 20:00	15/11/2020 00:26	14/11/2020 22:44	15/11/2020 00:26	1,71	651	1111,94	CHI
20201166633	HIDROLANDIA	HD11000137	ANHANGUERA	14/11/2020 20:00	15/11/2020 00:26	14/11/2020 20:00	15/11/2020 00:26	4,43	59	261,52	CHI
20201166641	SAO MIGUEL DO ARAGUAIA	SM21228632	SAO MIGUEL DO ARAGUAIA	14/11/2020 20:02	15/11/2020 19:36	14/11/2020 20:02	15/11/2020 19:36	23,56	1	23,56	CHI

20201166722	MOZARLANDIA	MZ12220375	MOZARLANDIA	14/11/2020 20:02	15/11/2020 07:26	14/11/2020 20:02	15/11/2020 07:26	11,39	32	364,52	CHI
20201166646	PLANALTINA	10006403733	PLANALTINA	14/11/2020 20:04	14/11/2020 23:43	14/11/2020 20:04	14/11/2020 23:43	3,65	1	3,65	CHI
20201166648	CATALAO	1990078592	CATALAO S2	14/11/2020 20:04	14/11/2020 22:07	14/11/2020 20:04	14/11/2020 22:07	2,04	1	2,04	CHI
20201166651	CALDAS NOVAS	CN11000003	CALDAS NOVAS S2	14/11/2020 20:04	14/11/2020 22:42	14/11/2020 20:04	14/11/2020 22:42	2,62	51	133,63	CHI
20201166655	GOIANIA	10030810670	GOIANIA LESTE S3	14/11/2020 20:05	15/11/2020 02:17	14/11/2020 20:05	15/11/2020 02:17	6,20	1	6,20	CHI
20201166660	CAIAPONIA	CP21134310	CAIAPONIA	14/11/2020 20:06	14/11/2020 23:52	14/11/2020 20:06	14/11/2020 23:52	3,75	1	3,75	CHI
20201166664	HIDROLANDIA	HD11346221	ANHANGUERA	14/11/2020 20:06	15/11/2020 00:42	14/11/2020 20:06	15/11/2020 00:42	4,59	40	183,52	CHI
20201166704	CABECEIRAS	CW12262301	ITIQUEIRA	14/11/2020 20:07	15/11/2020 00:46	14/11/2020 20:07	15/11/2020 00:46	4,65	43	199,94	CHI
20201166704	DISTRITO FEDERAL	CW12262301	ITIQUEIRA	14/11/2020 20:07	15/11/2020 00:46	14/11/2020 20:07	15/11/2020 00:46	4,65	1	4,65	CHI
20201166668	NOVA CRIXAS	NA12377684	NOVA CRIXAS	14/11/2020 20:09	16/11/2020 20:30	14/11/2020 20:09	16/11/2020 20:30	48,34	95	4592,70	CHI
20201166669	LUZIANIA	120345912	RIO VERMELHO	14/11/2020 20:09	14/11/2020 22:13	14/11/2020 20:09	14/11/2020 22:13	2,05	1	2,05	CHI
20201167094	ESTRELA DO NORTE	ET11171881	MARA ROSA	14/11/2020 20:09	15/11/2020 09:43	14/11/2020 20:09	15/11/2020 09:43	13,56	62	840,96	CHI
20201166694	SANTA CRUZ DE GOIAS	BC21033279	CRISTIANOPOLIS	14/11/2020 20:12	15/11/2020 02:52	14/11/2020 20:12	15/11/2020 02:52	6,65	3	19,96	CHI
20201166697	GOIANDIRA	CT12390288	CATALAO S1	14/11/2020 20:13	15/11/2020 02:14	14/11/2020 20:13	15/11/2020 02:14	6,00	2	12,01	CHI
20201166914	AGUA FRIA DE GOIAS	TL12302766	SAO JOAO D ALIANCA	14/11/2020 20:13	15/11/2020 12:13	14/11/2020 20:13	15/11/2020 10:02	13,83	28	387,15	CHI
20201166914	AGUA FRIA DE GOIAS	TL12302766	SAO JOAO D ALIANCA	14/11/2020 20:13	15/11/2020 12:13	15/11/2020 10:04	15/11/2020 11:56	1,87	28	52,33	CHI
20201166914	AGUA FRIA DE GOIAS	TL12302766	SAO JOAO D ALIANCA	14/11/2020 20:13	15/11/2020 12:13	14/11/2020 20:13	15/11/2020 12:13	16,01	51	816,64	CHI
20201166914	SAO JOAO D ALIANCA	TL12302766	SAO JOAO D ALIANCA	14/11/2020 20:13	15/11/2020 12:13	14/11/2020 20:13	15/11/2020 12:13	16,01	1	16,01	CHI
20201167012	FORMOSA	FA12383249	ITIQUEIRA	14/11/2020 20:13	15/11/2020 00:44	14/11/2020 20:13	15/11/2020 00:44	4,50	10	45,04	CHI
20201167452	FAINA	GS12042217	GOIAS	14/11/2020 20:16	15/11/2020 17:19	14/11/2020 20:16	15/11/2020 17:19	21,04	75	1578,08	CHI
20201166714	CAMPINORTE	CR21168839	MARA ROSA	14/11/2020 20:18	17/11/2020 12:36	14/11/2020 20:18	17/11/2020 12:36	64,30	1	64,30	CHI
20201166724	IPORA	IR12381025	IPORA	14/11/2020 20:22	15/11/2020 08:52	14/11/2020 20:22	15/11/2020 08:52	12,52	13	162,70	CHI
20201166727	PARAUNA	8450000284	MONTIVIDIU T	14/11/2020 20:25	15/11/2020 14:19	14/11/2020 20:25	15/11/2020 14:19	17,91	1	17,91	CHI
20201166729	SANTO ANTONIO DO DESCOBERTO	SN12317793LD	ALEXANIA	14/11/2020 20:25	15/11/2020 21:50	14/11/2020 20:25	15/11/2020 21:50	25,41	3	76,22	CHI
20201166729	SANTO ANTONIO DO DESCOBERTO	SN12317793LD	ALEXANIA	14/11/2020 20:25	15/11/2020 21:50	15/11/2020 17:54	15/11/2020 21:50	3,92	12	47,08	CHI
20201166730	GOIANIA	GN11001522	AEROPORTO S3	14/11/2020 20:25	14/11/2020 22:22	14/11/2020 20:25	14/11/2020 22:22	1,94	23	44,59	CHI
20201167174	PLANALTINA	PI12316968LD	PLANALTINA	14/11/2020 20:27	15/11/2020 00:03	14/11/2020 20:27	15/11/2020 00:03	3,59	183	656,72	CHI
20201166744	JARAGUA	JA12354194	JARAGUA	14/11/2020 20:29	15/11/2020 00:27	14/11/2020 20:29	15/11/2020 00:27	3,95	1	3,95	CHI
20201166747	MONTE ALEGRE DE GOIAS	MA12211597	SAO DOMINGOS	14/11/2020 20:30	14/11/2020 21:46	14/11/2020 20:30	14/11/2020 21:46	1,26	10	12,59	CHI
20201166771	SAO FRANCISCO DE GOIAS	SF12335087	SAO FRANCISCO DE GOIAS	14/11/2020 20:30	14/11/2020 23:06	14/11/2020 20:30	14/11/2020 23:06	2,59	11	28,47	CHI
20201167073	JATAI	JT12219384LD	JATAI S3	14/11/2020 20:30	15/11/2020 01:12	14/11/2020 20:30	15/11/2020 01:12	4,69	82	384,44	CHI
20201166763	TRINDADE	TR12326279	TRINDADE	14/11/2020 20:31	14/11/2020 22:12	14/11/2020 20:31	14/11/2020 22:12	1,67	3	5,02	CHI
20201166756	GOIANIA	15457620	GOIANIA LESTE S2	14/11/2020 20:33	15/11/2020 01:13	14/11/2020 20:33	15/11/2020 01:13	4,66	1	4,66	CHI
20201166768	MORRINHOS	MR12223454RE	MORRINHOS	14/11/2020 20:36	15/11/2020 10:09	14/11/2020 20:36	15/11/2020 10:09	13,54	14	189,53	CHI
20201166768	PONTALINA	MR12223454RE	MORRINHOS	14/11/2020 20:36	15/11/2020 10:09	14/11/2020 20:36	15/11/2020 10:09	13,54	5	67,69	CHI
20201166774	ITUMBIARA	IT11208052	PARANAIBA	14/11/2020 20:38	15/11/2020 01:16	14/11/2020 20:38	15/11/2020 01:16	4,63	59	273,28	CHI
20201166843	TRINDADE	TR11044076	GOYA S2	14/11/2020 20:38	15/11/2020 02:08	14/11/2020 20:38	15/11/2020 02:08	5,49	120	658,50	CHI
20201166779	IVOLANDIA	IV12325761	MONTIVIDIU T	14/11/2020 20:39	15/11/2020 09:17	14/11/2020 20:39	15/11/2020 09:17	12,62	8	100,98	CHI
20201166781	AGUA FRIA DE GOIAS	PI12048039	SAO JOAO D ALIANCA	14/11/2020 20:42	15/11/2020 18:34	14/11/2020 20:42	15/11/2020 18:34	21,85	38	830,32	CHI
20201166783	AGUAS LINDAS DE GOIAS	LA12087830	AGUAS LINDAS DE GOIAS S1	14/11/2020 20:43	14/11/2020 21:57	14/11/2020 20:43	14/11/2020 21:57	1,23	245	301,55	CHI
20201166840	URUTAI	600009063	URUTAI	14/11/2020 20:43	15/11/2020 09:33	14/11/2020 20:43	15/11/2020 09:33	12,83	1	12,83	CHI
20201166789	AGUAS LINDAS DE GOIAS	LA11305234	AGUAS LINDAS DE GOIAS S2	14/11/2020 20:44	15/11/2020 01:21	14/11/2020 20:44	15/11/2020 01:21	4,61	234	1077,83	CHI
20201166878	GOIANIA	GN11123485	GOYA S1	14/11/2020 20:44	15/11/2020 02:52	14/11/2020 20:44	15/11/2020 02:52	6,12	160	979,78	CHI
20201166792	BELA VISTA DE GOIAS	BV21010792	BELA VISTA S1	14/11/2020 20:45	14/11/2020 23:46	14/11/2020 20:45	14/11/2020 23:46	3,01	1	3,01	CHI
20201166793	GOIANDIRA	GD12077527LD	CATALAO S1	14/11/2020 20:45	15/11/2020 00:09	14/11/2020 20:45	15/11/2020 00:09	3,40	207	703,46	CHI
20201166793	NOVA AURORA	GD12077527LD	CATALAO S1	14/11/2020 20:45	15/11/2020 00:09	14/11/2020 20:45	15/11/2020 00:09	3,40	14	47,58	CHI
20201166794	FORMOSA	FA21106956	ITIQUEIRA	14/11/2020 20:45	14/11/2020 23:46	14/11/2020 20:45	14/11/2020 23:46	3,01	1	3,01	CHI
20201166795	MINEIROS	MY12197152	PARQUE DAS EMAS	14/11/2020 20:45	15/11/2020 09:38	14/11/2020 20:45	15/11/2020 09:38	12,87	3	38,61	CHI
20201166799	LEOPOLDO DE BULHOES	LB21302272	DAIA S2	14/11/2020 20:46	14/11/2020 22:28	14/11/2020 20:46	14/11/2020 22:28	1,69	1	1,69	CHI
20201166802	GOIANIA	10574323	GOIANIA LESTE S2	14/11/2020 20:46	15/11/2020 00:49	14/11/2020 20:46	15/11/2020 00:49	4,04	1	4,04	CHI
20201166823	PORANGATU	PO12020947	PORANGATU	14/11/2020 20:46	15/11/2020 10:39	14/11/2020 20:46	15/11/2020 10:39	13,88	33	457,98	CHI



20201166851	GOIANIA	GN11151347	ATLANTICO S3	14/11/2020 20:46	14/11/2020 23:00	14/11/2020 20:46	14/11/2020 23:00	2,23	92	205,29	CHI
20201166809	RIO VERDE	RV21384689	RIO VERDE S2	14/11/2020 20:48	15/11/2020 10:33	14/11/2020 20:48	15/11/2020 10:33	13,74	2	27,48	CHI
20201166810	AURILANDIA	SL12388876	SAO LUIZ DOS MONTES BELOS	14/11/2020 20:48	14/11/2020 23:18	14/11/2020 20:48	14/11/2020 23:18	2,49	1	2,49	CHI
20201166810	SAO LUIS DE MONTES BELOS	SL12388876	SAO LUIZ DOS MONTES BELOS	14/11/2020 20:48	14/11/2020 23:18	14/11/2020 20:48	14/11/2020 23:18	2,49	2	4,98	CHI
20201167644	PALMEIRAS DE GOIAS	PL12000219	PALMEIRAS	14/11/2020 20:49	15/11/2020 07:16	14/11/2020 20:49	15/11/2020 07:16	10,45	11	114,93	CHI
20201166819	INHUMAS	AR12019217	ARACU	14/11/2020 20:50	14/11/2020 22:53	14/11/2020 20:50	14/11/2020 22:53	2,05	15	30,73	CHI
20201166911	TRINDADE	TR12051853	GOYA S2	14/11/2020 20:50	15/11/2020 00:48	14/11/2020 20:50	15/11/2020 00:48	3,95	245	968,23	CHI
20201166829	EDEALINA	ED12047058RE	PONTALINA	14/11/2020 20:52	15/11/2020 03:33	14/11/2020 20:52	15/11/2020 03:33	6,68	24	160,31	CHI
20201166829	EDEIA	ED12047058RE	PONTALINA	14/11/2020 20:52	15/11/2020 03:33	14/11/2020 20:52	15/11/2020 03:33	6,68	2	13,36	CHI
20201166841	APARECIDA DE GOIANIA	AP11166592	REAL S2	14/11/2020 20:53	14/11/2020 22:52	14/11/2020 20:53	14/11/2020 22:52	1,98	146	288,43	CHI
20201166952	APARECIDA DE GOIANIA	AP11169724	INDEPENDENCIA S1	14/11/2020 20:54	15/11/2020 10:40	14/11/2020 20:54	15/11/2020 10:40	13,76	123	1691,90	CHI
20201166846	APARECIDA DE GOIANIA	AP11338065	INDEPENDENCIA S1	14/11/2020 20:55	15/11/2020 12:39	14/11/2020 20:55	15/11/2020 12:39	15,75	111	1747,82	CHI
20201166848	JAUPACI	JP12009677	IPORA	14/11/2020 20:55	14/11/2020 23:08	14/11/2020 20:55	14/11/2020 23:08	2,21	3	6,63	CHI
20201166854	CIDADE OCIDENTAL	2680042962	MARAJOARA	14/11/2020 20:55	15/11/2020 09:38	14/11/2020 20:55	15/11/2020 09:38	12,70	1	12,70	CHI
20201166866	GOIATUBA	JV12000028	GOIATUBA S1	14/11/2020 20:55	15/11/2020 13:35	14/11/2020 20:55	15/11/2020 11:45	14,82	9	133,39	CHI
20201166866	JOVIANIA	JV12000028	GOIATUBA S1	14/11/2020 20:55	15/11/2020 13:35	14/11/2020 20:55	15/11/2020 11:45	14,82	11	163,03	CHI
20201166866	VICENTINOPOLIS	JV12000028	GOIATUBA S1	14/11/2020 20:55	15/11/2020 13:35	14/11/2020 20:55	15/11/2020 11:45	14,82	3	44,46	CHI
20201166866	JOVIANIA	JV12000028	GOIATUBA S1	14/11/2020 20:55	15/11/2020 13:35	14/11/2020 20:55	15/11/2020 13:35	16,67	1	16,67	CHI
20201166866	GOIATUBA	JV12000028	GOIATUBA S1	14/11/2020 20:55	15/11/2020 13:35	15/11/2020 11:59	15/11/2020 13:35	1,60	9	14,39	CHI
20201166866	JOVIANIA	JV12000028	GOIATUBA S1	14/11/2020 20:55	15/11/2020 13:35	15/11/2020 11:59	15/11/2020 13:35	1,60	11	17,59	CHI
20201166866	VICENTINOPOLIS	JV12000028	GOIATUBA S1	14/11/2020 20:55	15/11/2020 13:35	15/11/2020 11:59	15/11/2020 13:35	1,60	3	4,80	CHI
20201166865	MONTIVIDIU	MV21248993	MONTIVIDIU T	14/11/2020 20:58	15/11/2020 00:10	14/11/2020 20:58	15/11/2020 00:10	3,19	1	3,19	CHI
20201166873	EDEALINA	VI12072970	VICENTINOPOLIS	14/11/2020 20:59	15/11/2020 02:22	14/11/2020 20:59	15/11/2020 02:22	5,37	6	32,20	CHI
20201166974	GOIANIA	GN11051445	CARAJAS S1	14/11/2020 20:59	14/11/2020 22:24	14/11/2020 20:59	14/11/2020 22:24	1,41	194	273,32	CHI
20201166881	APARECIDA DE GOIANIA	10005093897	REAL S1	14/11/2020 21:00	14/11/2020 22:53	14/11/2020 21:00	14/11/2020 22:53	1,87	1	1,87	CHI
20201166882	GOIANESIA	GE12317825RE	GOIANESIA S2	14/11/2020 21:01	15/11/2020 11:38	14/11/2020 21:01	15/11/2020 08:32	11,52	5	57,59	CHI
20201166882	GOIANESIA	GE12317825RE	GOIANESIA S2	14/11/2020 21:01	15/11/2020 11:38	14/11/2020 22:00	15/11/2020 08:32	10,53	6	63,21	CHI
20201166882	GOIANESIA	GE12317825RE	GOIANESIA S2	14/11/2020 21:01	15/11/2020 11:38	14/11/2020 21:01	15/11/2020 10:18	13,29	12	159,44	CHI
20201166882	GOIANESIA	GE13376591	GOIANESIA S2	14/11/2020 21:01	15/11/2020 11:38	14/11/2020 22:00	15/11/2020 10:18	12,30	21	258,36	CHI
20201166882	GOIANESIA	GE12317825RE	GOIANESIA S2	14/11/2020 21:01	15/11/2020 11:38	14/11/2020 21:01	15/11/2020 11:38	14,62	38	555,70	CHI
20201166938	APARECIDA DE GOIANIA	AP11099880	INDEPENDENCIA S1	14/11/2020 21:01	15/11/2020 05:45	14/11/2020 21:01	15/11/2020 05:45	8,72	161	1404,37	CHI
20201167013	COCALZINHO DE GOIAS	ZN12402010RE	COCALZINHO	14/11/2020 21:02	15/11/2020 00:37	14/11/2020 21:02	15/11/2020 00:37	3,57	158	563,88	CHI
20201167013	VILA PROPICIO	ZN12402010RE	COCALZINHO	14/11/2020 21:02	15/11/2020 00:37	14/11/2020 21:02	15/11/2020 00:37	3,57	1	3,57	CHI
20201166899	GOIANIA	16164696	GOIANIA LESTE S2	14/11/2020 21:04	15/11/2020 02:41	14/11/2020 21:04	15/11/2020 02:41	5,60	1	5,60	CHI
20201162347	ANICUNS	AC12259090	FIRMINOPOLIS S2	14/11/2020 21:05	15/11/2020 12:15	14/11/2020 21:05	15/11/2020 12:15	15,18	30	455,28	CHI
20201166979	ORIZONA	OZ12114502	PIRES DO RIO S2	14/11/2020 21:06	14/11/2020 22:48	14/11/2020 21:06	14/11/2020 22:48	1,70	15	25,50	CHI
20201166916	BURITINOPOLIS	MB11196528	IACIARA S2	14/11/2020 21:08	14/11/2020 23:25	14/11/2020 21:08	14/11/2020 23:25	2,27	4	9,07	CHI
20201166917	SAO LUIS DE MONTES BELOS	SL32145789	SAO LUIZ DOS MONTES BELOS	14/11/2020 21:09	15/11/2020 00:54	14/11/2020 21:09	15/11/2020 00:54	3,75	3	11,25	CHI
20201166920	APARECIDA DE GOIANIA	14707172	INDEPENDENCIA S2	14/11/2020 21:10	15/11/2020 12:13	14/11/2020 21:10	15/11/2020 12:13	15,04	1	15,04	CHI
20201167597	SAO MIGUEL DO ARAGUAIA	SM12000018	SAO MIGUEL DO ARAGUAIA	14/11/2020 21:12	15/11/2020 14:59	14/11/2020 21:12	15/11/2020 14:59	17,78	4	71,10	CHI
20201166929	EDEALINA	PK12181909RE	PONTALINA	14/11/2020 21:13	14/11/2020 22:55	14/11/2020 21:13	14/11/2020 22:55	1,69	4	6,76	CHI
20201166929	PONTALINA	PK12181909RE	PONTALINA	14/11/2020 21:13	14/11/2020 22:55	14/11/2020 21:13	14/11/2020 22:55	1,69	9	15,20	CHI
20201166930	CACU	IM12234538	CACHOEIRA ALTA	14/11/2020 21:13	14/11/2020 22:34	14/11/2020 21:13	14/11/2020 22:34	1,34	24	32,11	CHI
20201166930	ITARUMA	IM12234538	CACHOEIRA ALTA	14/11/2020 21:13	14/11/2020 22:34	14/11/2020 21:13	14/11/2020 22:34	1,34	9	12,04	CHI
20201166937	ARAGOIANIA	GN12035540	INDEPENDENCIA S2	14/11/2020 21:15	14/11/2020 21:32	14/11/2020 21:15	14/11/2020 21:32	0,28	3	0,83	CHI
20201166940	APARECIDA DE GOIANIA	AP11104953	INDEPENDENCIA S2	14/11/2020 21:17	15/11/2020 02:03	14/11/2020 21:17	15/11/2020 02:03	4,77	47	224,12	CHI
20201166949	PORTEIRAO	GT12010520	RIO DOS BOIS	14/11/2020 21:19	15/11/2020 17:03	14/11/2020 21:19	15/11/2020 17:03	19,73	2	39,45	CHI
20201166953	ACREUNA	EA10425122	RIO DOS BOIS	14/11/2020 21:20	17/11/2020 07:10	16/11/2020 16:56	16/11/2020 17:23	0,45	1	0,45	CHI
20201166953	EDEIA	EA10425122	RIO DOS BOIS	14/11/2020 21:20	17/11/2020 07:10	16/11/2020 16:56	16/11/2020 17:23	0,45	13	5,91	CHI
20201166953	TURVELANDIA	EA10425122	RIO DOS BOIS	14/11/2020 21:20	17/11/2020 07:10	16/11/2020 16:56	16/11/2020 17:23	0,45	8	3,64	CHI
20201166953	EDEIA	EA12033673	RIO DOS BOIS	14/11/2020 21:20	17/11/2020 07:10	14/11/2020 21:20	17/11/2020 06:52	57,54	3	172,62	CHI

20201166953	EDEIA	EA12033673	RIO DOS BOIS	14/11/2020 21:20	17/11/2020 07:10	14/11/2020 21:20	17/11/2020 07:10	57,83	4	231,30	CHI
20201166954	CEZARINA	CZ12126201LD	CEZARINA	14/11/2020 21:20	15/11/2020 04:10	14/11/2020 21:20	15/11/2020 04:10	6,82	31	211,49	CHI
20201166954	INDIARA	CZ12126201LD	CEZARINA	14/11/2020 21:20	15/11/2020 04:10	14/11/2020 21:20	15/11/2020 04:10	6,82	9	61,40	CHI
20201166958	GOIANIA	GN21000285	XAVANTES	14/11/2020 21:21	15/11/2020 02:05	14/11/2020 21:21	15/11/2020 02:05	4,73	1	4,73	CHI
20201166965	CIDADE OCIDENTAL	2680025186	MARAJOARA	14/11/2020 21:23	15/11/2020 15:00	14/11/2020 21:23	15/11/2020 15:00	17,62	1	17,62	CHI
20201166966	APARECIDA DE GOIANIA	10008683822	INDEPENDENCIA S2	14/11/2020 21:23	15/11/2020 00:36	14/11/2020 21:23	15/11/2020 00:36	3,21	1	3,21	CHI
20201166973	GOIANIA	11984650	GOIANIA LESTE S1	14/11/2020 21:25	15/11/2020 03:44	14/11/2020 21:25	15/11/2020 03:44	6,31	1	6,31	CHI
20201166977	CRISTALINA	10022369889	CRISTALINA S1	14/11/2020 21:26	15/11/2020 00:53	14/11/2020 21:26	15/11/2020 00:53	3,44	1	3,44	CHI
20201166980	GOIANIA	GN11001014	CAMPINAS S1	14/11/2020 21:27	14/11/2020 22:49	14/11/2020 21:27	14/11/2020 22:49	1,36	136	185,45	CHI
20201167050	GOIANIA	GN11003084	GOYA S2	14/11/2020 21:27	15/11/2020 03:49	14/11/2020 21:27	15/11/2020 03:49	6,36	200	1272,56	CHI
20201166983	VIANOPOLIS	VN21051235	VIANOPOLIS	14/11/2020 21:28	15/11/2020 01:30	14/11/2020 21:28	15/11/2020 01:30	4,03	1	4,03	CHI
20201166986	SAO FRANCISCO DE GOIAS	SF21374420	SAO FRANCISCO DE GOIAS	14/11/2020 21:29	15/11/2020 00:40	14/11/2020 21:29	15/11/2020 00:40	3,18	1	3,18	CHI
20201166988	MINEIROS	SU12184127	SANTA RITA DO ARAGUAIA	14/11/2020 21:30	15/11/2020 00:49	14/11/2020 21:30	15/11/2020 00:49	3,31	14	46,28	CHI
20201167041	TRINDADE	TR12169947	GOYA S2	14/11/2020 21:31	14/11/2020 23:18	14/11/2020 21:31	14/11/2020 23:18	1,78	126	223,89	CHI
20201167004	CAMPESTRE DE GOIAS	GA16414994	GUAPO S2	14/11/2020 21:33	15/11/2020 11:06	14/11/2020 21:33	15/11/2020 11:06	13,56	13	176,27	CHI
20201167004	GUAPO	GA16414994	GUAPO S2	14/11/2020 21:33	15/11/2020 11:06	14/11/2020 21:33	15/11/2020 11:06	13,56	157	2128,75	CHI
20201167004	VARJAO	GA16414994	GUAPO S2	14/11/2020 21:33	15/11/2020 11:06	14/11/2020 21:33	15/11/2020 11:06	13,56	1	13,56	CHI
20201167002	MIMOSO DE GOIAS	MJ21071980	PADRE BERNARDO	14/11/2020 21:34	14/11/2020 23:00	14/11/2020 21:34	14/11/2020 23:00	1,43	1	1,43	CHI
20201167061	APARECIDA DE GOIANIA	AP11241338	INDEPENDENCIA S1	14/11/2020 21:36	14/11/2020 23:57	14/11/2020 21:36	14/11/2020 23:57	2,35	185	434,18	CHI
20201167015	SILVANIA	SV21338919	DAIA S2	14/11/2020 21:37	15/11/2020 12:47	14/11/2020 21:37	15/11/2020 12:47	15,15	1	15,15	CHI
20201167033	INDIARA	IY12057339	EDEIA	14/11/2020 21:37	15/11/2020 00:04	14/11/2020 21:37	15/11/2020 00:04	2,45	21	51,42	CHI
20201167033	PALMEIRAS DE GOIAS	IY12057339	EDEIA	14/11/2020 21:37	15/11/2020 00:04	14/11/2020 21:37	15/11/2020 00:04	2,45	5	12,24	CHI
20201167019	COLINAS DO SUL	TI12236619	MINACU	14/11/2020 21:38	15/11/2020 03:26	14/11/2020 21:38	15/11/2020 03:26	5,79	4	23,17	CHI
20201167024	TRINDADE	40275991	TRINDADE	14/11/2020 21:40	14/11/2020 23:02	14/11/2020 21:40	14/11/2020 23:02	1,36	1	1,36	CHI
20201167031	ANAPOLIS	20598026	ANAPOLIS UNIVERSITARIO S2	14/11/2020 21:43	14/11/2020 22:47	14/11/2020 21:43	14/11/2020 22:47	1,06	1	1,06	CHI
20201167042	FAZENDA NOVA	FN21250946	IPORA	14/11/2020 21:46	15/11/2020 09:04	14/11/2020 21:46	15/11/2020 09:04	11,30	1	11,30	CHI
20201167044	ALTO PARAISO DE GOIAS	BF21180889	NIQUELANDIA SUBTRANSMISSAO	14/11/2020 21:46	15/11/2020 12:50	14/11/2020 21:46	15/11/2020 12:50	15,06	1	15,06	CHI
20201167048	BELA VISTA DE GOIAS	BV32097920	BELA VISTA S2	14/11/2020 21:48	15/11/2020 03:34	14/11/2020 21:48	15/11/2020 03:34	5,75	21	120,81	CHI
20201167053	CRISTALINA	LZ12261748	CRISTALINA S2	14/11/2020 21:50	15/11/2020 00:17	14/11/2020 21:50	15/11/2020 00:17	2,44	2	4,89	CHI
20201167053	LUZIANIA	LZ12261748	CRISTALINA S2	14/11/2020 21:50	15/11/2020 00:17	14/11/2020 21:50	15/11/2020 00:17	2,44	2	4,89	CHI
20201167054	JATAI	290063607	JATAI S2	14/11/2020 21:50	15/11/2020 08:02	14/11/2020 21:50	15/11/2020 08:02	10,19	1	10,19	CHI
20201167058	LUZIANIA	LZ12305050RE	CRISTALINA S2	14/11/2020 21:52	15/11/2020 03:06	14/11/2020 21:52	15/11/2020 03:06	5,22	14	73,10	CHI
20201167062	FORMOSA	FA31042717	SAO JOAO D ALIANCA	14/11/2020 21:53	15/11/2020 13:09	14/11/2020 21:53	15/11/2020 13:09	15,26	1	15,26	CHI
20201167066	GOIANIA	17480851	FERROVIARIO S2	14/11/2020 21:54	14/11/2020 23:37	14/11/2020 21:54	14/11/2020 23:37	1,70	1	1,70	CHI
20201167070	CASTELANDIA	DM21295924	RIO DOS BOIS	14/11/2020 21:57	15/11/2020 08:06	14/11/2020 21:57	15/11/2020 08:06	10,13	4	40,54	CHI
20201167074	GOIATUBA	420016260	GOIATUBA S2	14/11/2020 21:59	15/11/2020 02:16	14/11/2020 21:59	15/11/2020 02:16	4,29	1	4,29	CHI
20201167273	GOIANIA	GN12001664	CAMPINAS S2	14/11/2020 21:59	15/11/2020 01:46	14/11/2020 21:59	15/11/2020 01:46	3,78	187	706,86	CHI
20201167169	GOIANIA	GN11405602	GOYA S1	14/11/2020 22:06	15/11/2020 00:08	14/11/2020 22:06	15/11/2020 00:08	2,03	36	73,15	CHI
20201167097	SANTA HELENA DE GOIAS	SH21249424	RIO VERDE S2	14/11/2020 22:08	15/11/2020 01:07	14/11/2020 22:08	15/11/2020 01:07	2,97	2	5,95	CHI
20201167099	HIDROLANDIA	HD12200261	CEPAIGO S2	14/11/2020 22:08	15/11/2020 02:05	14/11/2020 22:08	15/11/2020 02:05	3,94	31	122,11	CHI
20201167100	GUAPO	GA12187645LD	GUAPO S1	14/11/2020 22:09	15/11/2020 01:33	14/11/2020 22:09	15/11/2020 01:33	3,40	7	23,78	CHI
20201167101	FORMOSA	FA12376692	ITIQUIRA	14/11/2020 22:09	14/11/2020 23:38	14/11/2020 22:09	14/11/2020 23:38	1,47	490	719,89	CHI
20201167104	PALMEIRAS DE GOIAS	PL12205913	PALMEIRAS	14/11/2020 22:12	15/11/2020 16:30	14/11/2020 22:12	15/11/2020 16:30	18,30	4	73,20	CHI
20201167121	BARRO ALTO	1150007877	BARRO ALTO	14/11/2020 22:15	15/11/2020 10:40	14/11/2020 22:15	15/11/2020 10:40	12,41	1	12,41	CHI
20201167226	JOVIANA	VI12218198RE	VICENTINOPOLIS	14/11/2020 22:17	15/11/2020 10:28	14/11/2020 22:17	15/11/2020 10:28	12,17	12	146,03	CHI
20201167226	PONTALINA	VI12218198RE	VICENTINOPOLIS	14/11/2020 22:17	15/11/2020 10:28	14/11/2020 22:17	15/11/2020 10:28	12,17	25	304,23	CHI
20201167226	VICENTINOPOLIS	VI12218198RE	VICENTINOPOLIS	14/11/2020 22:17	15/11/2020 10:28	14/11/2020 22:17	15/11/2020 10:28	12,17	12	146,03	CHI
20201167132	FAZENDA NOVA	FN11371911	IPORA	14/11/2020 22:19	15/11/2020 04:57	14/11/2020 22:19	15/11/2020 04:57	6,62	1	6,62	CHI
20201167136	FORMOSA	610124936	ITIQUIRA	14/11/2020 22:20	15/11/2020 08:36	14/11/2020 22:20	15/11/2020 08:36	10,26	1	10,26	CHI
20201167885	PALMEIRAS DE GOIAS	PL12086233	PALMEIRAS	14/11/2020 22:22	15/11/2020 09:12	14/11/2020 22:22	15/11/2020 09:12	10,82	11	119,01	CHI
20201167139	PIRACANJUBA	PJ12000022	PIRACANJUBA	14/11/2020 22:23	15/11/2020 01:07	14/11/2020 22:23	15/11/2020 01:07	2,72	20	54,44	CHI

20201167150	RIO VERDE	10015243530	CABRIUVA S2	14/11/2020 22:23	15/11/2020 21:46	14/11/2020 22:23	15/11/2020 21:46	23,38	1	23,38	CHI
20201167188	GOIANIA	GN11001029	ATLANTICO S1	14/11/2020 22:26	14/11/2020 23:57	14/11/2020 22:26	14/11/2020 23:57	1,51	129	195,04	CHI
20201167231	RIO VERDE	SH12018087	SANTA HELENA S1	14/11/2020 22:26	15/11/2020 01:02	14/11/2020 22:26	15/11/2020 01:02	2,59	3	7,77	CHI
20201167165	CALDAS NOVAS	CN11160333	SERRA DE CALDAS	14/11/2020 22:32	15/11/2020 00:21	14/11/2020 22:32	15/11/2020 00:21	1,80	17	30,64	CHI
2020111400087	ARUANA	3200434	ARUANA	14/11/2020 22:37	14/11/2020 22:43	14/11/2020 22:37	14/11/2020 22:43	0,10	7	0,70	CHI
20201167177	ITARUMA	IM12226503	CACHOEIRA ALTA	14/11/2020 22:40	15/11/2020 02:55	14/11/2020 22:40	15/11/2020 02:55	4,24	11	46,59	CHI
20201167199	APARECIDA DE GOIANIA	AP11193023	INDEPENDENCIA S1	14/11/2020 22:42	15/11/2020 02:36	14/11/2020 22:42	15/11/2020 02:36	3,90	122	475,53	CHI
20201167190	CASTELANDIA	DM21252740	RIO DOS BOIS	14/11/2020 22:49	15/11/2020 01:34	14/11/2020 22:49	15/11/2020 01:34	2,74	7	19,17	CHI
20201167197	MONTIVIDIU	2840018348	MONTIVIDIU T	14/11/2020 22:52	15/11/2020 05:20	14/11/2020 22:52	15/11/2020 05:20	6,46	1	6,46	CHI
20201167198	RIO VERDE	RV12301462	ACREUNA	14/11/2020 22:52	15/11/2020 11:44	14/11/2020 22:52	15/11/2020 11:44	12,86	16	205,72	CHI
20201167198	SANTO ANTONIO DA BARRA	RV12301462	ACREUNA	14/11/2020 22:52	15/11/2020 11:44	14/11/2020 22:52	15/11/2020 11:44	12,86	1	12,86	CHI
202011138047	MONTIVIDIU	MV11301459	MONTIVIDIU T	14/11/2020 22:57	15/11/2020 10:02	14/11/2020 22:57	15/11/2020 10:02	11,08	75	831,35	CHI
20201167209	ARUANA	AK12264829	MOZARLANDIA	14/11/2020 22:58	15/11/2020 09:15	14/11/2020 22:58	15/11/2020 09:15	10,27	33	338,91	CHI
20201167211	ANAPOLIS	21074938	JUNDIAI S2	14/11/2020 23:02	14/11/2020 23:56	14/11/2020 23:02	14/11/2020 23:56	0,89	1	0,89	CHI
20201167212	CACHOEIRA DOURADA	CD12000044	CACHOEIRA DOURADA	14/11/2020 23:02	14/11/2020 23:48	14/11/2020 23:02	14/11/2020 23:48	0,75	8	6,04	CHI
20201167213	SANTA TEREZINHA DE GOIAS	2480013127	SANTA TEREZINHA	14/11/2020 23:02	15/11/2020 01:51	14/11/2020 23:02	15/11/2020 01:51	2,80	1	2,80	CHI
20201167219	RIO VERDE	630168994	RIO VERDE S1	14/11/2020 23:08	15/11/2020 10:54	14/11/2020 23:08	15/11/2020 10:54	11,76	1	11,76	CHI
20201167228	GOIANIRA	10002256728	MEIA PONTE	14/11/2020 23:14	15/11/2020 04:50	14/11/2020 23:14	15/11/2020 04:50	5,58	1	5,58	CHI
20201168006	BARRO ALTO	GE12006481	BARRO ALTO	14/11/2020 23:14	15/11/2020 12:37	14/11/2020 23:14	15/11/2020 12:37	13,37	21	280,71	CHI
20201168006	SANTA RITA DO NOVO DESTINO	GE12006481	BARRO ALTO	14/11/2020 23:14	15/11/2020 12:37	14/11/2020 23:14	15/11/2020 12:37	13,37	10	133,67	CHI
20201167234	CAIAPONIA	CP12200764	MONTIVIDIU T	14/11/2020 23:18	15/11/2020 05:28	14/11/2020 23:18	15/11/2020 05:28	6,16	4	24,64	CHI
20201167236	AGUA FRIA DE GOIAS	PI12048039	SAO JOAO D ALIANCA	14/11/2020 23:20	15/11/2020 08:20	14/11/2020 23:20	15/11/2020 08:20	9,00	5	44,99	CHI
20201167239	RIO VERDE	630116787	RIO VERDE S1	14/11/2020 23:22	15/11/2020 18:33	14/11/2020 23:22	15/11/2020 18:33	19,18	1	19,18	CHI
20201167243	SANTA ROSA DE GOIAS	SR12107586	INHUMAS S1	14/11/2020 23:25	15/11/2020 00:57	14/11/2020 23:25	15/11/2020 00:57	1,53	63	96,39	CHI
20201167244	PARAUNA	PU11362837	PARAUNA	14/11/2020 23:25	15/11/2020 00:06	14/11/2020 23:25	15/11/2020 00:06	0,68	57	38,51	CHI
20201167245	CRIXAS	CX12097448RE	SANTA TEREZINHA	14/11/2020 23:26	15/11/2020 12:10	14/11/2020 23:26	15/11/2020 12:10	12,73	25	318,20	CHI
20201167245	GUARINOS	CX12097448RE	SANTA TEREZINHA	14/11/2020 23:26	15/11/2020 12:10	14/11/2020 23:26	15/11/2020 12:10	12,73	46	585,49	CHI
20201167246	INHUMAS	30118530	INHUMAS S2	14/11/2020 23:28	15/11/2020 06:55	14/11/2020 23:28	15/11/2020 06:55	7,44	1	7,44	CHI
20201167248	BELA VISTA DE GOIAS	BV12272141	BELA VISTA S2	14/11/2020 23:32	15/11/2020 03:39	14/11/2020 23:32	15/11/2020 03:39	4,11	34	139,84	CHI
20201167248	SAO MIGUEL DO PASSA QUATRO	BV12272141	BELA VISTA S2	14/11/2020 23:32	15/11/2020 03:39	14/11/2020 23:32	15/11/2020 03:39	4,11	91	374,29	CHI
20201167251	ITABERAÍ	IB13250730	ITABERAÍ S1	14/11/2020 23:37	15/11/2020 07:57	14/11/2020 23:37	15/11/2020 01:20	1,72	3	5,15	CHI
20201167251	ITABERAÍ	IX10400372	ITABERAÍ S1	14/11/2020 23:37	15/11/2020 07:57	14/11/2020 23:37	15/11/2020 01:20	1,72	1	1,72	CHI
20201167251	ITAUCU	IX10400372	ITABERAÍ S1	14/11/2020 23:37	15/11/2020 07:57	14/11/2020 23:37	15/11/2020 01:20	1,72	94	161,31	CHI
20201167251	TAQUARAL DE GOIAS	IB13250730	ITABERAÍ S1	14/11/2020 23:37	15/11/2020 07:57	14/11/2020 23:37	15/11/2020 01:20	1,72	1716	2944,85	CHI
20201167251	TAQUARAL DE GOIAS	IB13250730	ITABERAÍ S1	14/11/2020 23:37	15/11/2020 07:57	14/11/2020 23:37	15/11/2020 01:20	1,72	141	241,97	CHI
20201167251	TAQUARAL DE GOIAS	IX10400372	ITABERAÍ S1	14/11/2020 23:37	15/11/2020 07:57	14/11/2020 23:37	15/11/2020 01:20	1,72	3	5,15	CHI
20201167251	ITABERAÍ	880404	ITABERAÍ S1	14/11/2020 23:37	15/11/2020 07:57	15/11/2020 01:23	15/11/2020 02:38	1,25	47	58,87	CHI
20201167251	ITABERAÍ	IB10400717	ITABERAÍ S1	14/11/2020 23:37	15/11/2020 07:57	14/11/2020 23:37	15/11/2020 03:53	4,28	49	209,53	CHI
20201167251	ITAUCU	IB10400717	ITABERAÍ S1	14/11/2020 23:37	15/11/2020 07:57	14/11/2020 23:37	15/11/2020 03:53	4,28	2	8,55	CHI
20201167251	ITABERAÍ	IB13274548	ITABERAÍ S1	14/11/2020 23:37	15/11/2020 07:57	15/11/2020 03:49	15/11/2020 07:32	3,72	18	66,97	CHI
20201167251	ITABERAÍ	IB13376371	ITABERAÍ S1	14/11/2020 23:37	15/11/2020 07:57	15/11/2020 07:48	15/11/2020 07:57	0,14	50	7,17	CHI
20201167251	ITAUCU	IB13376371	ITABERAÍ S1	14/11/2020 23:37	15/11/2020 07:57	15/11/2020 07:48	15/11/2020 07:57	0,14	2	0,29	CHI
20201167253	PIRACANJUBA	PJ12020064	MORRINHOS	14/11/2020 23:40	15/11/2020 08:34	14/11/2020 23:40	15/11/2020 08:34	8,89	15	133,37	CHI
20201167300	TAQUARAL DE GOIAS	TQ12000107	ITABERAÍ S1	14/11/2020 23:43	15/11/2020 07:07	14/11/2020 23:43	15/11/2020 07:07	7,39	23	169,93	CHI
20201167327	FORMOSA	FA12042010	ITUIQUIRA	14/11/2020 23:45	15/11/2020 04:28	14/11/2020 23:45	15/11/2020 04:28	4,70	21	98,75	CHI
20201167268	GUARANI DE GOIAS	SD12153745	SAO DOMINGOS	14/11/2020 23:48	15/11/2020 03:09	14/11/2020 23:48	15/11/2020 03:09	3,35	2	6,70	CHI
20201167268	SAO DOMINGOS	SD12153745	SAO DOMINGOS	14/11/2020 23:48	15/11/2020 03:09	14/11/2020 23:48	15/11/2020 03:09	3,35	216	723,60	CHI
20201167269	SENADOR CANEDO	SW11168965	SENADOR CANEDO	14/11/2020 23:48	15/11/2020 01:49	14/11/2020 23:48	15/11/2020 01:49	2,00	146	292,28	CHI
20201167271	RIO VERDE	10003500738	RIO VERDE S2	14/11/2020 23:49	15/11/2020 12:48	14/11/2020 23:49	15/11/2020 12:48	12,97	1	12,97	CHI
20201167276	ITAPACI	IW21123092	RUBIATABA	14/11/2020 23:53	15/11/2020 09:20	14/11/2020 23:53	15/11/2020 09:20	9,45	1	9,45	CHI
20201167292	APARECIDA DE GOIANIA	10014677863	INDEPENDENCIA S2	15/11/2020 00:08	15/11/2020 02:59	15/11/2020 00:08	15/11/2020 02:59	2,84	1	2,84	CHI

2020111500021	ABADIANIA	ALE-TR1	ALEXANIA	15/11/2020 00:13	15/11/2020 01:16	15/11/2020 00:23	15/11/2020 01:16	0,88	21	18,46	CHI
2020111500021	ALEXANIA	ALE-TR1	ALEXANIA	15/11/2020 00:13	15/11/2020 01:16	15/11/2020 00:23	15/11/2020 01:16	0,88	4227	3715,06	CHI
2020111500021	ALEXANIA	ALE-TR1	ALEXANIA	15/11/2020 00:13	15/11/2020 01:16	15/11/2020 00:23	15/11/2020 01:16	0,88	518	455,26	CHI
2020111500021	ALEXANIA	ALE-TR1	ALEXANIA	15/11/2020 00:13	15/11/2020 01:16	15/11/2020 00:23	15/11/2020 01:16	0,88	1827	1605,73	CHI
2020111500021	ALEXANIA	ALE-TR1	ALEXANIA	15/11/2020 00:13	15/11/2020 01:16	15/11/2020 00:23	15/11/2020 01:16	0,88	70	61,52	CHI
2020111500021	ALEXANIA	ALE-TR1	ALEXANIA	15/11/2020 00:13	15/11/2020 01:16	15/11/2020 00:23	15/11/2020 01:16	0,88	4873	4282,83	CHI
2020111500021	ALEXANIA	ALE-TR1	ALEXANIA	15/11/2020 00:13	15/11/2020 01:16	15/11/2020 00:23	15/11/2020 01:16	0,88	860	755,84	CHI
2020111500021	ALEXANIA	ALE-TR1	ALEXANIA	15/11/2020 00:13	15/11/2020 01:16	15/11/2020 00:23	15/11/2020 01:16	0,88	34	29,88	CHI
2020111500021	ALEXANIA	ALE-TR1	ALEXANIA	15/11/2020 00:13	15/11/2020 01:16	15/11/2020 00:23	15/11/2020 01:16	0,88	2	1,76	CHI
2020111500021	ALEXANIA	ALE-TR1	ALEXANIA	15/11/2020 00:13	15/11/2020 01:16	15/11/2020 00:23	15/11/2020 01:16	0,88	295	259,27	CHI
2020111500021	ALEXANIA	ALE-TR1	ALEXANIA	15/11/2020 00:13	15/11/2020 01:16	15/11/2020 00:23	15/11/2020 01:16	0,88	26	22,85	CHI
2020111500021	BARRO ALTO	ALE-TR1	ALEXANIA	15/11/2020 00:13	15/11/2020 01:16	15/11/2020 00:23	15/11/2020 01:16	0,88	3	2,64	CHI
2020111500021	COCALZINHO DE GOIAS	ALE-TR1	ALEXANIA	15/11/2020 00:13	15/11/2020 01:16	15/11/2020 00:23	15/11/2020 01:16	0,88	2	1,76	CHI
2020111500021	CORUMBA DE GOIAS	ALE-TR1	ALEXANIA	15/11/2020 00:13	15/11/2020 01:16	15/11/2020 00:23	15/11/2020 01:16	0,88	124	108,98	CHI
2020111500021	CORUMBA DE GOIAS	ALE-TR1	ALEXANIA	15/11/2020 00:13	15/11/2020 01:16	15/11/2020 00:23	15/11/2020 01:16	0,88	13	11,43	CHI
2020111500021	CORUMBA DE GOIAS	ALE-TR1	ALEXANIA	15/11/2020 00:13	15/11/2020 01:16	15/11/2020 00:23	15/11/2020 01:16	0,88	7	6,15	CHI
2020111500021	CORUMBA DE GOIAS	ALE-TR1	ALEXANIA	15/11/2020 00:13	15/11/2020 01:16	15/11/2020 00:23	15/11/2020 01:16	0,88	3	2,64	CHI
2020111500021	JARAGUA	ALE-TR1	ALEXANIA	15/11/2020 00:13	15/11/2020 01:16	15/11/2020 00:23	15/11/2020 01:16	0,88	73	64,16	CHI
2020111500021	SANTO ANTONIO DO DESCOBERTO	ALE-TR1	ALEXANIA	15/11/2020 00:13	15/11/2020 01:16	15/11/2020 00:23	15/11/2020 01:16	0,88	1	0,88	CHI
2020111500021	SANTO ANTONIO DO DESCOBERTO	ALE-TR1	ALEXANIA	15/11/2020 00:13	15/11/2020 01:16	15/11/2020 00:23	15/11/2020 01:16	0,88	11692	10275,97	CHI
2020111500021	SANTO ANTONIO DO DESCOBERTO	ALE-TR1	ALEXANIA	15/11/2020 00:13	15/11/2020 01:16	15/11/2020 00:23	15/11/2020 01:16	0,88	3	2,64	CHI
2020111500021	SANTO ANTONIO DO DESCOBERTO	ALE-TR1	ALEXANIA	15/11/2020 00:13	15/11/2020 01:16	15/11/2020 00:23	15/11/2020 01:16	0,88	185	162,59	CHI
2020111500021	SANTO ANTONIO DO DESCOBERTO	ALE-TR1	ALEXANIA	15/11/2020 00:13	15/11/2020 01:16	15/11/2020 00:23	15/11/2020 01:16	0,88	1	0,88	CHI
2020111500021	SANTO ANTONIO DO DESCOBERTO	ALE-TR1	ALEXANIA	15/11/2020 00:13	15/11/2020 01:16	15/11/2020 00:23	15/11/2020 01:16	0,88	37	32,52	CHI
2020111500021	ALEXANIA	ALE-TR1	CORUMBA	15/11/2020 00:13	15/11/2020 01:16	15/11/2020 00:23	15/11/2020 01:16	0,88	899	790,12	CHI
2020111500021	CORUMBA DE GOIAS	ALE-TR1	CORUMBA	15/11/2020 00:13	15/11/2020 01:16	15/11/2020 00:23	15/11/2020 01:16	0,88	359	315,52	CHI
20201167698	MUNDO NOVO DE GOIAS	MH12362454	NOVA CRIXAS	15/11/2020 00:18	15/11/2020 22:42	15/11/2020 00:18	15/11/2020 22:42	22,41	121	2711,51	CHI
20201167698	AMARALINA	MH12362454	NOVA CRIXAS	15/11/2020 00:18	15/11/2020 22:42	15/11/2020 11:25	15/11/2020 22:42	11,29	1	11,29	CHI
20201167698	MUNDO NOVO DE GOIAS	MH12362454	NOVA CRIXAS	15/11/2020 00:18	15/11/2020 22:42	15/11/2020 11:25	15/11/2020 22:42	11,29	180	2032,65	CHI
20201167303	COCALZINHO DE GOIAS	4190226	AGUAS LINDAS DE GOIAS S2	15/11/2020 00:20	15/11/2020 04:56	15/11/2020 00:20	15/11/2020 04:56	4,61	3185	14675,77	CHI
20201167303	PADRE BERNARDO	4190226	AGUAS LINDAS DE GOIAS S2	15/11/2020 00:20	15/11/2020 04:56	15/11/2020 00:20	15/11/2020 04:56	4,61	4	18,43	CHI
20201167303	RIALMA	4190226	AGUAS LINDAS DE GOIAS S2	15/11/2020 00:20	15/11/2020 04:56	15/11/2020 00:20	15/11/2020 04:56	4,61	6	27,65	CHI
20201167304	LUZIANIA	LZ11092920	RIO VERMELHO	15/11/2020 00:21	15/11/2020 02:58	15/11/2020 00:21	15/11/2020 02:58	2,61	101	264,06	CHI
20201167347	HIDROLANDIA	HD11000143	ANHANGUERA	15/11/2020 00:47	15/11/2020 02:38	15/11/2020 01:36	15/11/2020 02:38	1,03	97	100,23	CHI
20201167348	GOIANIA	15280032	GOYA S2	15/11/2020 00:49	15/11/2020 09:58	15/11/2020 00:49	15/11/2020 09:58	9,14	1	9,14	CHI
20201167362	NEROPOLIS	NR10396916	NEROPOLIS S2	15/11/2020 01:03	15/11/2020 12:05	15/11/2020 01:03	15/11/2020 10:37	9,56	18	172,06	CHI
20201167362	ANAPOLIS	NR12268437	NEROPOLIS S2	15/11/2020 01:03	15/11/2020 12:05	15/11/2020 01:03	15/11/2020 11:16	10,21	13	132,67	CHI
20201167362	NEROPOLIS	NR12268437	NEROPOLIS S2	15/11/2020 01:03	15/11/2020 12:05	15/11/2020 01:03	15/11/2020 11:16	10,21	30	306,16	CHI
20201167362	OURO VERDE DE GOIAS	NR12268437	NEROPOLIS S2	15/11/2020 01:03	15/11/2020 12:05	15/11/2020 01:03	15/11/2020 11:16	10,21	1	10,21	CHI
20201167362	NEROPOLIS	NR12029257	NEROPOLIS S2	15/11/2020 01:03	15/11/2020 12:05	15/11/2020 01:03	15/11/2020 11:24	10,35	12	124,16	CHI
20201167362	NEROPOLIS	NR10396916	NEROPOLIS S2	15/11/2020 01:03	15/11/2020 12:05	15/11/2020 01:03	15/11/2020 11:42	10,64	5	53,22	CHI
20201167362	NEROPOLIS	NR12164391	NEROPOLIS S2	15/11/2020 01:03	15/11/2020 12:05	15/11/2020 01:03	15/11/2020 11:48	10,74	1	10,74	CHI
20201167362	NEROPOLIS	NR12317362	NEROPOLIS S2	15/11/2020 01:03	15/11/2020 12:05	15/11/2020 01:03	15/11/2020 11:50	10,78	11	118,54	CHI
20201167362	NEROPOLIS	NR12000035	NEROPOLIS S2	15/11/2020 01:03	15/11/2020 12:05	15/11/2020 01:03	15/11/2020 12:05	11,03	7	77,21	CHI
20201167360	CRISTALINA	KR12412108	CRISTALINA S2	15/11/2020 01:08	15/11/2020 09:09	15/11/2020 01:08	15/11/2020 09:09	8,01	5	40,03	CHI
20201167364	ABADIANIA	AA12258346	ANAPOLIS UNIVERSITARIO S1	15/11/2020 01:19	15/11/2020 04:05	15/11/2020 01:19	15/11/2020 04:05	2,77	20	55,33	CHI
20201167364	CORUMBA DE GOIAS	AA12258346	ANAPOLIS UNIVERSITARIO S1	15/11/2020 01:19	15/11/2020 04:05	15/11/2020 01:19	15/11/2020 04:05	2,77	2	5,53	CHI
20201168525	FAINA	FC12147795	GOIAS	15/11/2020 01:19	15/11/2020 15:39	15/11/2020 01:19	15/11/2020 15:39	14,32	6	85,94	CHI
20201167375	PALMINOPOLIS	PP10404113	PALMEIRAS	15/11/2020 01:29	15/11/2020 12:38	15/11/2020 01:29	15/11/2020 12:38	11,14	44	490,10	CHI
20201167517	FORMOSO	SE12053856	MARA ROSA	15/11/2020 01:32	15/11/2020 08:25	15/11/2020 01:32	15/11/2020 08:25	6,87	6	41,23	CHI
20201167517	SANTA TEREZA DE GOIAS	SE12053856	MARA ROSA	15/11/2020 01:32	15/11/2020 08:25	15/11/2020 01:32	15/11/2020 08:25	6,87	3	20,62	CHI

20201167379	MOZARLANDIA	410005691	MOZARLANDIA	15/11/2020 01:44	15/11/2020 10:37	15/11/2020 01:44	15/11/2020 10:37	8,88	1	8,88	CHI
20201167381	JUSSARA	JR21259827	BRITANIA	15/11/2020 01:53	15/11/2020 08:06	15/11/2020 01:53	15/11/2020 08:06	6,21	1	6,21	CHI
20201167551	CACHOEIRA ALTA	CA12074103	CACHOEIRA ALTA	15/11/2020 01:56	15/11/2020 07:11	15/11/2020 01:56	15/11/2020 07:11	5,25	11	57,72	CHI
20201167386	RIO VERDE	RV12000265	RIO VERDE S1	15/11/2020 01:57	15/11/2020 09:30	15/11/2020 01:57	15/11/2020 09:30	7,54	26	196,12	CHI
20201167386	RIO VERDE	RV12000265	RIO VERDE S1	15/11/2020 01:57	15/11/2020 09:30	15/11/2020 05:23	15/11/2020 09:30	4,11	6	24,65	CHI
20201167391	ALEXANIA	3190444	ALEXANIA	15/11/2020 02:07	15/11/2020 10:16	15/11/2020 02:07	15/11/2020 02:11	0,06	27	1,68	CHI
20201167391	ALEXANIA	3190444	ALEXANIA	15/11/2020 02:07	15/11/2020 10:16	15/11/2020 02:07	15/11/2020 10:16	8,14	634	5163,75	CHI
20201167391	ALEXANIA	3190444	ALEXANIA	15/11/2020 02:07	15/11/2020 10:16	15/11/2020 02:07	15/11/2020 10:16	8,14	70	570,13	CHI
20201167391	ALEXANIA	3190444	ALEXANIA	15/11/2020 02:07	15/11/2020 10:16	15/11/2020 02:07	15/11/2020 10:16	8,14	860	7004,46	CHI
20201167391	BARRO ALTO	3190444	ALEXANIA	15/11/2020 02:07	15/11/2020 10:16	15/11/2020 02:07	15/11/2020 10:16	8,14	3	24,43	CHI
20201167391	SANTO ANTONIO DO DESCOBERTO	3190444	ALEXANIA	15/11/2020 02:07	15/11/2020 10:16	15/11/2020 02:07	15/11/2020 10:16	8,14	1	8,14	CHI
20201167391	SANTO ANTONIO DO DESCOBERTO	3190444	ALEXANIA	15/11/2020 02:07	15/11/2020 10:16	15/11/2020 02:07	15/11/2020 10:16	8,14	182	1482,34	CHI
20201167391	SANTO ANTONIO DO DESCOBERTO	3190444	ALEXANIA	15/11/2020 02:07	15/11/2020 10:16	15/11/2020 02:10	15/11/2020 10:16	8,10	1	8,10	CHI
20201167400	ARAGUAPAZ	AZ10395388	GOIAS	15/11/2020 02:20	16/11/2020 14:57	15/11/2020 02:20	16/11/2020 13:39	35,31	3	105,92	CHI
20201167400	ARAGUAPAZ	AZ12299828	GOIAS	15/11/2020 02:20	16/11/2020 14:57	15/11/2020 02:20	16/11/2020 13:57	35,62	3	106,86	CHI
20201167400	ARAGUAPAZ	AZ13210557	GOIAS	15/11/2020 02:20	16/11/2020 14:57	15/11/2020 02:20	16/11/2020 14:20	36,00	188	6768,16	CHI
20201167400	FAINA	AZ13210557	GOIAS	15/11/2020 02:20	16/11/2020 14:57	15/11/2020 02:20	16/11/2020 14:20	36,00	12	432,01	CHI
20201167400	MOZARLANDIA	AZ13210557	GOIAS	15/11/2020 02:20	16/11/2020 14:57	15/11/2020 02:20	16/11/2020 14:20	36,00	3	108,00	CHI
20201167400	ARAGUAPAZ	AZ12299868	GOIAS	15/11/2020 02:20	16/11/2020 14:57	15/11/2020 02:20	16/11/2020 14:35	36,25	7	253,74	CHI
20201167400	FAINA	AZ12299868	GOIAS	15/11/2020 02:20	16/11/2020 14:57	15/11/2020 02:20	16/11/2020 14:35	36,25	1	36,25	CHI
20201167400	ARAGUAPAZ	AZ12238246	GOIAS	15/11/2020 02:20	16/11/2020 14:57	15/11/2020 02:20	16/11/2020 14:57	36,61	3	109,84	CHI
20201167396	CAIAPONIA	CP12151179	CAIAPONIA	15/11/2020 02:26	15/11/2020 22:37	15/11/2020 02:26	15/11/2020 22:37	20,18	89	1795,75	CHI
20201167403	ITAPIRAPUA	IU12018777	JUSSARA	15/11/2020 02:34	15/11/2020 08:03	15/11/2020 02:34	15/11/2020 08:03	5,47	12	65,68	CHI
20201167441	PETROLINA DE GOIAS	PG12298071	PETROLINA	15/11/2020 02:36	15/11/2020 07:07	15/11/2020 02:36	15/11/2020 07:07	4,51	44	198,40	CHI
20201167441	SAO FRANCISCO DE GOIAS	PG12298071	PETROLINA	15/11/2020 02:36	15/11/2020 07:07	15/11/2020 02:36	15/11/2020 07:07	4,51	1	4,51	CHI
20201167405	ALEXANIA	AX12248870	ALEXANIA	15/11/2020 02:37	15/11/2020 11:43	15/11/2020 02:37	15/11/2020 11:43	9,10	37	336,66	CHI
20201167418	ALTO HORIZONTE	AJ12320992RE	SANTA TEREZINHA	15/11/2020 02:40	15/11/2020 08:17	15/11/2020 02:40	15/11/2020 08:17	5,61	47	263,70	CHI
20201167409	PANAMA	PX12000451	GOIATUBA S1	15/11/2020 02:45	15/11/2020 05:56	15/11/2020 02:45	15/11/2020 05:56	3,18	21	66,85	CHI
20201167470	AGUAS LINDAS DE GOIAS	LA12165006	AGUAS LINDAS DE GOIAS S2	15/11/2020 02:46	15/11/2020 06:47	15/11/2020 02:46	15/11/2020 06:47	4,01	1553	6234,43	CHI
20201167839	NOVA CRIXAS	NA12282176	NOVA CRIXAS	15/11/2020 02:53	15/11/2020 16:59	15/11/2020 02:53	15/11/2020 16:59	14,10	111	1564,79	CHI
20201167417	IPORA	IR12184346	ARENOPOLIS	15/11/2020 03:09	15/11/2020 08:17	15/11/2020 03:09	15/11/2020 08:17	5,12	5	25,62	CHI
20201167422	QUIRINOPOLIS	QI32058080	QUIRINOPOLIS	15/11/2020 03:21	15/11/2020 08:12	15/11/2020 03:21	15/11/2020 08:12	4,84	10	48,39	CHI
20201167511	ITAPIRAPUA	IU12018756	MATRINCHA	15/11/2020 03:21	15/11/2020 09:19	15/11/2020 03:21	15/11/2020 09:19	5,96	2	11,91	CHI
20201167511	SANTA FE DE GOIAS	IU12018756	MATRINCHA	15/11/2020 03:21	15/11/2020 09:19	15/11/2020 03:21	15/11/2020 09:19	5,96	2	11,91	CHI
20201167426	APARECIDA DE GOIANIA	AP11104953	INDEPENDENCIA S2	15/11/2020 03:27	15/11/2020 10:21	15/11/2020 03:27	15/11/2020 10:21	6,89	47	323,71	CHI
20201167431	GOIANIA	14916605	MEIA PONTE	15/11/2020 03:39	15/11/2020 07:05	15/11/2020 03:39	15/11/2020 07:05	3,42	1	3,42	CHI
20201167432	RIO VERDE	630235569	RIO VERDE S1	15/11/2020 03:41	15/11/2020 12:03	15/11/2020 03:41	15/11/2020 12:03	8,35	1	8,35	CHI
20201167933	GOIANESIA	SZ12366599	GOIANESIA S1	15/11/2020 03:57	15/11/2020 11:19	15/11/2020 03:57	15/11/2020 11:19	7,36	11	80,99	CHI
20201167469	CAMPINORTE	CR12101042	CAMPINORTE	15/11/2020 04:08	15/11/2020 07:18	15/11/2020 04:08	15/11/2020 07:18	3,17	8	25,32	CHI
20201168463	CARMO DO RIO VERDE	IK12310871	ITAPURANGA	15/11/2020 04:08	15/11/2020 09:27	15/11/2020 04:08	15/11/2020 09:27	5,30	34	180,30	CHI
20201168463	ITAPURANGA	IK12310871	ITAPURANGA	15/11/2020 04:08	15/11/2020 09:27	15/11/2020 04:08	15/11/2020 09:27	5,30	271	1437,13	CHI
20201168016	DAMOLANDIA	IN12014368	INHUMAS S1	15/11/2020 04:14	15/11/2020 12:40	15/11/2020 04:14	15/11/2020 12:40	8,42	61	513,91	CHI
20201168016	INHUMAS	IN12014368	INHUMAS S1	15/11/2020 04:14	15/11/2020 12:40	15/11/2020 04:14	15/11/2020 12:40	8,42	54	454,94	CHI
20201168016	PETROLINA DE GOIAS	IN12014368	INHUMAS S1	15/11/2020 04:14	15/11/2020 12:40	15/11/2020 04:14	15/11/2020 12:40	8,42	6	50,55	CHI
20201167448	PORANGATU	PO12192371	PORANGATU	15/11/2020 04:17	15/11/2020 08:34	15/11/2020 04:17	15/11/2020 08:34	4,27	12	51,26	CHI
20201167447	PIRACANJUBA	PJ12000096	PIRACANJUBA	15/11/2020 04:19	15/11/2020 08:21	15/11/2020 04:19	15/11/2020 08:21	4,02	34	136,79	CHI
20201167457	AMERICANO DO BRASIL	KB12382581	ANICUNS	15/11/2020 04:24	15/11/2020 11:56	15/11/2020 04:24	15/11/2020 11:56	7,53	9	67,73	CHI
20201167457	ANICUNS	KB12382581	ANICUNS	15/11/2020 04:24	15/11/2020 11:56	15/11/2020 04:24	15/11/2020 11:56	7,53	13	97,83	CHI
20201167735	MATRINCHA	MP12010442	MOZARLANDIA	15/11/2020 04:30	15/11/2020 17:13	15/11/2020 04:30	15/11/2020 17:13	12,70	4	50,81	CHI
20201169145	GOIANAPOLIS	GP21351015	DAIA S2	15/11/2020 04:30	15/11/2020 12:32	15/11/2020 04:30	15/11/2020 12:32	8,04	1	8,04	CHI
20201167472	OURO VERDE DE GOIAS	PG12060031	PETROLINA	15/11/2020 04:45	15/11/2020 10:36	15/11/2020 04:45	15/11/2020 10:36	5,84	23	134,31	CHI



20201168757	PIRES DO RIO	PR12027079	PIRES DO RIO S1	15/11/2020 04:48	15/11/2020 11:58	15/11/2020 04:48	15/11/2020 11:58	7,16	8	57,28	CHI
20201167609	PORTELANDIA	PW12302930	PARQUE DAS EMAS	15/11/2020 04:52	15/11/2020 16:14	15/11/2020 04:52	15/11/2020 16:14	11,35	13	147,55	CHI
20201167697	BARRO ALTO	BA12068485	BARRO ALTO	15/11/2020 04:55	15/11/2020 12:47	15/11/2020 04:55	15/11/2020 12:47	7,86	1	7,86	CHI
20201167697	SANTA RITA DO NOVO DESTINO	BA12068485	BARRO ALTO	15/11/2020 04:55	15/11/2020 12:47	15/11/2020 04:55	15/11/2020 12:47	7,86	32	251,52	CHI
20201167473	ANAPOLIS	7302272	NEROPOLIS S1	15/11/2020 05:00	15/11/2020 11:25	15/11/2020 05:00	15/11/2020 11:25	6,40	18	115,21	CHI
20201167585	GOIANDIRA	GD12377061	CATALAO S1	15/11/2020 05:01	15/11/2020 11:31	15/11/2020 05:01	15/11/2020 11:31	6,49	14	90,91	CHI
20201167733	MUNDO NOVO DE GOIAS	MH12391950	NOVA CRIXAS	15/11/2020 05:06	16/11/2020 10:46	15/11/2020 05:06	16/11/2020 10:46	29,65	102	3024,36	CHI
20201167478	GOIANIA	13067588	ATLANTICO S1	15/11/2020 05:07	15/11/2020 08:21	15/11/2020 05:07	15/11/2020 08:21	3,22	1	3,22	CHI
20201167509	AMORINOPOLIS	IV12390141	IPORA	15/11/2020 05:08	15/11/2020 07:22	15/11/2020 05:08	15/11/2020 07:22	2,23	3	6,69	CHI
20201167509	IVOLANDIA	IV12390141	IPORA	15/11/2020 05:08	15/11/2020 07:22	15/11/2020 05:08	15/11/2020 07:22	2,23	59	131,52	CHI
202011137990	GOIANESIA	GE12321396	GOIANESIA S2	15/11/2020 05:09	15/11/2020 09:21	15/11/2020 05:09	15/11/2020 09:21	4,20	50	209,82	CHI
202011137990	VILA PROPICIO	GE12321396	GOIANESIA S2	15/11/2020 05:09	15/11/2020 09:21	15/11/2020 05:09	15/11/2020 09:21	4,20	18	75,53	CHI
20201167481	FAINA	MS12036227	ITAPURANGA	15/11/2020 05:11	15/11/2020 09:30	15/11/2020 05:11	15/11/2020 09:30	4,32	11	47,55	CHI
20201167481	MORRO AGUDO DE GOIAS	MS12036227	ITAPURANGA	15/11/2020 05:11	15/11/2020 09:30	15/11/2020 05:11	15/11/2020 09:30	4,32	27	116,71	CHI
20201167482	SAO FRANCISCO DE GOIAS	SF12216699	SAO FRANCISCO DE GOIAS	15/11/2020 05:11	15/11/2020 07:37	15/11/2020 05:11	15/11/2020 07:37	2,43	4	9,70	CHI
20201168044	LUZIANIA	OZ12186208	PIRES DO RIO S2	15/11/2020 05:13	15/11/2020 09:19	15/11/2020 05:13	15/11/2020 09:19	4,09	30	122,67	CHI
20201167484	FORLOSA	FA11233626	SAO JOAO D ALIANCA	15/11/2020 05:15	15/11/2020 09:25	15/11/2020 05:15	15/11/2020 09:25	4,16	1	4,16	CHI
20201168501	CAIAPONIA	CP12207864RE	CAIAPONIA	15/11/2020 05:15	15/11/2020 16:16	15/11/2020 05:15	15/11/2020 16:16	11,00	43	473,20	CHI
20201167493	EDEALINA	PK12181909RE	PONTALINA	15/11/2020 05:16	15/11/2020 07:29	15/11/2020 05:16	15/11/2020 07:29	2,20	4	8,81	CHI
20201167493	PONTALINA	PK12181909RE	PONTALINA	15/11/2020 05:16	15/11/2020 07:29	15/11/2020 05:16	15/11/2020 07:29	2,20	9	19,82	CHI
20201168193	NOVA AMERICA	NM12243668	RUBIATABA	15/11/2020 05:16	15/11/2020 13:40	15/11/2020 05:16	15/11/2020 13:40	8,41	28	235,48	CHI
20201167728	NAZARIO	NZ12003900	ANICUNS	15/11/2020 05:17	15/11/2020 08:00	15/11/2020 05:17	15/11/2020 08:00	2,71	12	32,57	CHI
20201167494	ITAPURANGA	IK12250515	ITAPURANGA	15/11/2020 05:24	15/11/2020 11:14	15/11/2020 05:24	15/11/2020 11:14	5,83	5	29,17	CHI
20201167495	SANTO ANTONIO DO DESCOBERTO	SN12078120	MARAJOARA	15/11/2020 05:24	15/11/2020 13:36	15/11/2020 05:24	15/11/2020 13:36	8,20	15	122,97	CHI
20201167496	BONOPOLIS	BX121203386	SAO MIGUEL DO ARAGUAIA	15/11/2020 05:25	15/11/2020 13:58	15/11/2020 05:25	15/11/2020 13:58	8,54	1	8,54	CHI
20201167497	ITABERAI	IB12108138	ITABERAI S2	15/11/2020 05:27	15/11/2020 08:30	15/11/2020 05:27	15/11/2020 08:30	3,05	28	85,33	CHI
20201167498	PIRACANJUBA	PJ121058242	PIRACANJUBA	15/11/2020 05:27	15/11/2020 10:47	15/11/2020 05:27	15/11/2020 10:47	5,32	3	15,97	CHI
20201167502	PONTALINA	PK21102280	PONTALINA	15/11/2020 05:30	15/11/2020 09:06	15/11/2020 05:30	15/11/2020 09:06	3,59	1	3,59	CHI
20201167503	JUSSARA	JR11289193	JUSSARA	15/11/2020 05:30	15/11/2020 10:30	15/11/2020 05:30	15/11/2020 10:30	5,00	132	660,26	CHI
20201167566	ORIZONA	OZ12000353LD	PIRES DO RIO S1	15/11/2020 05:35	15/11/2020 09:37	15/11/2020 05:35	15/11/2020 09:37	4,02	36	144,61	CHI
20201167507	FAZENDA NOVA	FN12354616	BRITANIA	15/11/2020 05:36	15/11/2020 13:36	15/11/2020 05:36	15/11/2020 13:36	7,99	46	367,67	CHI
20201167507	JUSSARA	FN12354616	BRITANIA	15/11/2020 05:36	15/11/2020 13:36	15/11/2020 05:36	15/11/2020 13:36	7,99	11	87,92	CHI
20201168007	MORRO AGUDO DE GOIAS	MS12247278	RUBIATABA	15/11/2020 05:37	15/11/2020 11:55	15/11/2020 05:37	15/11/2020 11:55	6,29	3	18,86	CHI
20201167510	JARAGUA	JA12059976	JARAGUA	15/11/2020 05:38	15/11/2020 08:46	15/11/2020 05:38	15/11/2020 08:46	3,12	2	6,25	CHI
20201167510	PIRENOPOLIS	JA12059976	JARAGUA	15/11/2020 05:38	15/11/2020 08:46	15/11/2020 05:38	15/11/2020 08:46	3,12	98	306,09	CHI
20201167512	NOVO BRASIL	NB12376361	FIRMINOPOLIS S2	15/11/2020 05:39	15/11/2020 09:36	15/11/2020 05:39	15/11/2020 09:36	3,95	7	27,62	CHI
20201167514	DOVERLANDIA	DV11171937	CAIAPONIA	15/11/2020 05:39	15/11/2020 07:59	15/11/2020 05:39	15/11/2020 07:59	2,32	2	4,65	CHI
20201167535	ITAPURANGA	IK12022966	ITAPURANGA	15/11/2020 05:39	15/11/2020 07:31	15/11/2020 05:39	15/11/2020 07:31	1,85	2	3,70	CHI
20201168823	ACREUNA	TD12246829	RIO DOS BOIS	15/11/2020 05:42	15/11/2020 11:30	15/11/2020 05:42	15/11/2020 11:30	5,80	5	28,98	CHI
20201168823	SANTA HELENA DE GOIAS	TD12246829	RIO DOS BOIS	15/11/2020 05:42	15/11/2020 11:30	15/11/2020 05:42	15/11/2020 11:30	5,80	18	104,34	CHI
20201168823	TURVELANDIA	TD12246829	RIO DOS BOIS	15/11/2020 05:42	15/11/2020 11:30	15/11/2020 05:42	15/11/2020 11:30	5,80	24	139,12	CHI
20201167521	FAINA	GS12061648	MATRINCHA	15/11/2020 05:43	15/11/2020 10:58	15/11/2020 05:43	15/11/2020 10:58	5,24	34	178,29	CHI
20201167521	MATRINCHA	GS12061648	MATRINCHA	15/11/2020 05:43	15/11/2020 10:58	15/11/2020 05:43	15/11/2020 10:58	5,24	2	10,49	CHI
20201167524	SANTA TEREZA DE GOIAS	TB12182394	PORANGATU	15/11/2020 05:44	15/11/2020 12:30	15/11/2020 05:44	15/11/2020 12:30	6,76	3	20,27	CHI
20201167524	TROMBAS	TB12182394	PORANGATU	15/11/2020 05:44	15/11/2020 12:30	15/11/2020 05:44	15/11/2020 12:30	6,76	119	803,94	CHI
20201167526	FIRMINOPOLIS	FR1233491	FIRMINOPOLIS S2	15/11/2020 05:44	15/11/2020 08:41	15/11/2020 05:44	15/11/2020 08:41	2,94	3	8,81	CHI
20201169035	PARAUNA	PU12205010	PARAUNA	15/11/2020 05:44	15/11/2020 14:13	15/11/2020 05:44	15/11/2020 14:13	8,47	13	110,13	CHI
20201167601	CORUMBA DE GOIAS	CB12215012	CORUMBA	15/11/2020 05:45	15/11/2020 07:41	15/11/2020 05:45	15/11/2020 07:41	1,93	6	11,57	CHI
20201167529	PORANGATU	PO12390257	PORANGATU	15/11/2020 05:46	15/11/2020 10:16	15/11/2020 05:46	15/11/2020 10:16	4,50	4	17,98	CHI
20201167530	AMARALINA	LC12182362	MARA ROSA	15/11/2020 05:46	15/11/2020 11:19	15/11/2020 05:46	15/11/2020 11:19	5,54	93	515,63	CHI
20201167530	MARA ROSA	LC12182362	MARA ROSA	15/11/2020 05:46	15/11/2020 11:19	15/11/2020 05:46	15/11/2020 11:19	5,54	8	44,36	CHI

20201167530	MUTUNOPOLIS	LC12182362	MARA ROSA	15/11/2020 05:46	15/11/2020 11:19	15/11/2020 05:46	15/11/2020 11:19	5,54	2	11,09	CHI
20201167531	MAURILANDIA	ML12303327	RIO DOS BOIS	15/11/2020 05:46	15/11/2020 08:44	15/11/2020 05:46	15/11/2020 08:44	2,96	25	73,95	CHI
20201167824	MIMOSO DE GOIAS	NQ12213063	BARRO ALTO	15/11/2020 05:48	15/11/2020 09:43	15/11/2020 05:48	15/11/2020 09:43	3,91	9	35,23	CHI
20201167824	NIQUELANDIA	NQ12213063	BARRO ALTO	15/11/2020 05:48	15/11/2020 09:43	15/11/2020 05:48	15/11/2020 09:43	3,91	4	15,66	CHI
20201167824	VILA PROPICIO	NQ12213063	BARRO ALTO	15/11/2020 05:48	15/11/2020 09:43	15/11/2020 05:48	15/11/2020 09:43	3,91	10	39,14	CHI
20201167537	CORUMBA DE GOIAS	CB21155245	CORUMBA	15/11/2020 05:49	15/11/2020 08:19	15/11/2020 05:49	15/11/2020 08:19	2,49	1	2,49	CHI
20201167539	RIO VERDE	RV21159341	RIO VERDE S2	15/11/2020 05:50	15/11/2020 14:09	15/11/2020 05:50	15/11/2020 14:09	8,31	1	8,31	CHI
20201168503	CAIAPONIA	DV12023480	CAIAPONIA	15/11/2020 05:51	15/11/2020 11:18	15/11/2020 05:51	15/11/2020 11:18	5,44	146	793,63	CHI
20201168503	DOVERLANDIA	DV12023480	CAIAPONIA	15/11/2020 05:51	15/11/2020 11:18	15/11/2020 05:51	15/11/2020 11:18	5,44	11	59,79	CHI
20201168503	PIRANHAS	DV12023480	CAIAPONIA	15/11/2020 05:51	15/11/2020 11:18	15/11/2020 05:51	15/11/2020 11:18	5,44	77	418,56	CHI
20201167586	ITAPURANGA	IK12310899	ITAPURANGA	15/11/2020 05:56	15/11/2020 08:02	15/11/2020 05:56	15/11/2020 08:02	2,09	21	43,95	CHI
20201167556	FORMOSA	FA21316944	ITIQUEIRA	15/11/2020 05:58	15/11/2020 12:00	15/11/2020 05:58	15/11/2020 12:00	6,02	1	6,02	CHI
20201167558	CORREGO DO OURO	RE12000003	FIRMINOPOLIS S2	15/11/2020 05:59	15/11/2020 07:35	15/11/2020 05:59	15/11/2020 07:35	1,59	27	42,97	CHI
20201167947	AMARALINA	LC12270112	SAO MIGUEL DO ARAGUAIA	15/11/2020 06:00	15/11/2020 08:15	15/11/2020 06:00	15/11/2020 08:15	2,25	62	139,21	CHI
20201167565	CACHOEIRA DE GOIAS	CG12087363	FIRMINOPOLIS S2	15/11/2020 06:01	15/11/2020 17:09	15/11/2020 06:01	15/11/2020 17:09	11,14	20	222,74	CHI
20201168201	BARRO ALTO	GE12000087	GOIANESIA S2	15/11/2020 06:02	15/11/2020 12:22	15/11/2020 06:02	15/11/2020 12:22	6,32	2	12,65	CHI
20201168201	GOIANESIA	GE12000087	GOIANESIA S2	15/11/2020 06:02	15/11/2020 12:22	15/11/2020 06:02	15/11/2020 12:22	6,32	14	88,53	CHI
20201167634	CROMINIA	MI12000428	PONTALINA	15/11/2020 06:03	15/11/2020 10:39	15/11/2020 06:03	15/11/2020 10:39	4,59	2	9,19	CHI
20201167634	MAIRIPOTABA	MI12000428	PONTALINA	15/11/2020 06:03	15/11/2020 10:39	15/11/2020 06:03	15/11/2020 10:39	4,59	2	9,19	CHI
20201167569	HIDROLANDIA	HD12126656	CEPAIGO S2	15/11/2020 06:05	15/11/2020 09:01	15/11/2020 06:05	15/11/2020 09:01	2,93	6	17,58	CHI
20201167571	CRISTALINA	10030204176	CRISTALINA S2	15/11/2020 06:05	15/11/2020 12:14	15/11/2020 06:05	15/11/2020 12:14	6,14	1	6,14	CHI
20201167572	CATALAO	CT11077319	CATALAO S2	15/11/2020 06:05	15/11/2020 07:21	15/11/2020 06:05	15/11/2020 07:21	1,25	121	151,55	CHI
20201167574	SAO MIGUEL DO PASSA QUATRO	BV12211127	CRISTIANOPOLIS	15/11/2020 06:06	15/11/2020 09:23	15/11/2020 06:06	15/11/2020 09:23	3,27	12	39,28	CHI
20201167575	CAVALCANTE	MA12392319	SAO DOMINGOS	15/11/2020 06:07	15/11/2020 10:35	15/11/2020 06:07	15/11/2020 10:35	4,47	31	138,47	CHI
20201167575	MONTE ALEGRE DE GOIAS	MA12392319	SAO DOMINGOS	15/11/2020 06:07	15/11/2020 10:35	15/11/2020 06:07	15/11/2020 10:35	4,47	108	482,40	CHI
20201167576	MONTIVIDIU	MV21191794	MONTIVIDIU T	15/11/2020 06:07	15/11/2020 10:47	15/11/2020 06:07	15/11/2020 10:47	4,66	1	4,66	CHI
20201167215	PORANGATU	PO12020580	PORANGATU	15/11/2020 06:08	15/11/2020 09:30	15/11/2020 06:08	15/11/2020 09:30	3,35	68	227,91	CHI
20201167580	ACREUNA	EU12260951	ACREUNA	15/11/2020 06:08	15/11/2020 08:46	15/11/2020 06:08	15/11/2020 08:46	2,63	3	7,89	CHI
20201167580	SANTO ANTONIO DA BARRA	EU12260951	ACREUNA	15/11/2020 06:08	15/11/2020 08:46	15/11/2020 06:08	15/11/2020 08:46	2,63	1	2,63	CHI
20201167583	PETROLINA DE GOIAS	PG21231856	PETROLINA	15/11/2020 06:08	15/11/2020 09:40	15/11/2020 06:08	15/11/2020 09:40	3,52	2	7,03	CHI
20201167590	ITARUMA	IM21068690	CACHOEIRA ALTA	15/11/2020 06:11	15/11/2020 08:07	15/11/2020 06:11	15/11/2020 08:07	1,92	1	1,92	CHI
20201167737	ARAGUAPAZ	AZ12042979	MOZARLANDIA	15/11/2020 06:11	15/11/2020 07:54	15/11/2020 06:11	15/11/2020 07:54	1,71	10	17,11	CHI
20201167618	CALDAS NOVAS	CN12311854	CALDAS NOVAS S1	15/11/2020 06:12	15/11/2020 07:32	15/11/2020 06:12	15/11/2020 07:32	1,33	4	5,33	CHI
20201167710	PIRACANJUBA	60053781	CALDAS NOVAS S1	15/11/2020 06:12	15/11/2020 10:55	15/11/2020 06:12	15/11/2020 10:55	4,71	1	4,71	CHI
20201167602	FAZENDA NOVA	FN11246060	IPORA	15/11/2020 06:13	15/11/2020 11:59	15/11/2020 06:13	15/11/2020 11:59	5,75	1	5,75	CHI
20201167937	CORUMBA DE GOIAS	260037606	CORUMBA	15/11/2020 06:13	15/11/2020 10:34	15/11/2020 06:13	15/11/2020 10:34	4,34	1	4,34	CHI
20201168100	DOVERLANDIA	DV12123974	CAIAPONIA	15/11/2020 06:13	15/11/2020 10:38	15/11/2020 06:13	15/11/2020 10:38	4,41	12	52,97	CHI
20201167605	QUIRINOPOLIS	QI12273812	QUIRINOPOLIS	15/11/2020 06:14	15/11/2020 07:37	15/11/2020 06:14	15/11/2020 07:37	1,37	7	9,62	CHI
20201167607	SANTA ROSA DE GOIAS	SR12107586	INHUMAS S1	15/11/2020 06:14	15/11/2020 08:33	15/11/2020 06:14	15/11/2020 08:33	2,30	63	144,93	CHI
20201168441	COCALZINHO DE GOIAS	ZN12345302	COCALZINHO	15/11/2020 06:15	15/11/2020 17:27	15/11/2020 06:15	15/11/2020 17:27	11,18	8	89,48	CHI
20201167611	AMARALINA	BX12351972	SAO MIGUEL DO ARAGUAIA	15/11/2020 06:16	15/11/2020 07:55	15/11/2020 06:16	15/11/2020 07:55	1,65	66	108,64	CHI
20201167612	NIQUELANDIA	NQ12232417	BARRO ALTO	15/11/2020 06:16	15/11/2020 08:04	15/11/2020 06:16	15/11/2020 08:04	1,79	1	1,79	CHI
20201167613	BURITINOPOLIS	BQ12149628	IACIARA S2	15/11/2020 06:17	15/11/2020 09:44	15/11/2020 06:17	15/11/2020 09:44	3,45	36	124,07	CHI
20201167617	ANAPOLIS	20655277	ANAPOLIS UNIVERSITARIO S2	15/11/2020 06:17	15/11/2020 10:23	15/11/2020 06:17	15/11/2020 10:23	4,09	1	4,09	CHI
20201167749	MORRO AGUDO DE GOIAS	RB12126565	RUBIATABA	15/11/2020 06:17	15/11/2020 10:27	15/11/2020 06:17	15/11/2020 10:27	4,16	5	20,78	CHI
20201167749	RUBIATABA	RB12126565	RUBIATABA	15/11/2020 06:17	15/11/2020 10:27	15/11/2020 06:17	15/11/2020 10:27	4,16	58	241,10	CHI
20201167822	ESTRELA DO NORTE	ET12143710	MARA ROSA	15/11/2020 06:18	15/11/2020 12:58	15/11/2020 06:18	15/11/2020 12:58	6,65	4	26,60	CHI
20201167822	SANTA TEREZA DE GOIAS	ET12143710	MARA ROSA	15/11/2020 06:18	15/11/2020 12:58	15/11/2020 06:18	15/11/2020 12:58	6,65	4	26,60	CHI
20201167960	PORANGATU	PO12390476	MARA ROSA	15/11/2020 06:18	15/11/2020 10:20	15/11/2020 06:18	15/11/2020 10:20	4,03	48	193,28	CHI
20201167622	CALDAS NOVAS	CN11309377	CALDAS NOVAS S1	15/11/2020 06:19	15/11/2020 07:25	15/11/2020 06:19	15/11/2020 07:25	1,10	34	37,41	CHI
20201167627	CORUMBAIBA	CI12041817	VILA CORUMBA	15/11/2020 06:19	15/11/2020 07:33	15/11/2020 06:19	15/11/2020 07:33	1,23	2	2,46	CHI

20201168217	PALMEIRAS DE GOIAS	PL12313331	TRINDADE	15/11/2020 06:20	15/11/2020 13:00	15/11/2020 06:20	15/11/2020 13:00	6,66	6	39,94	CHI
20201167633	GOIANIRA	10012964792	GOIANIRA	15/11/2020 06:21	15/11/2020 07:44	15/11/2020 06:21	15/11/2020 07:44	1,37	1	1,37	CHI
20201167683	CATALAO	CT12399851	CATALAO S1	15/11/2020 06:21	15/11/2020 08:42	15/11/2020 06:21	15/11/2020 08:42	2,34	74	173,39	CHI
20201167940	NIQUELANDIA	NQ12317176	NIQUELANDIA SUBTRANSMISSAO	15/11/2020 06:21	15/11/2020 11:12	15/11/2020 06:21	15/11/2020 11:12	4,84	77	372,85	CHI
20201167636	GOIATUBA	GT12008246	BOM JESUS DE GOIAS	15/11/2020 06:22	15/11/2020 09:11	15/11/2020 06:22	15/11/2020 09:11	2,82	6	16,89	CHI
20201167639	TRINDADE	10029633034	GOIANIRA	15/11/2020 06:23	15/11/2020 07:45	15/11/2020 06:23	15/11/2020 07:45	1,36	1	1,36	CHI
20201167826	APORE	AE18122767TS	ITAJA S1	15/11/2020 06:23	15/11/2020 09:05	15/11/2020 06:23	15/11/2020 09:05	2,69	29	78,15	CHI
20201167645	CUMARI	CY21130916	CATALAO S1	15/11/2020 06:24	15/11/2020 09:45	15/11/2020 06:24	15/11/2020 09:45	3,34	1	3,34	CHI
20201167647	CRISTALINA	KR12183725	CRISTALINA S2	15/11/2020 06:25	15/11/2020 07:44	15/11/2020 06:25	15/11/2020 07:44	1,31	1	1,31	CHI
20201167756	VILA PROPICIO	7587203	GOIANESIA S1	15/11/2020 06:26	15/11/2020 16:29	15/11/2020 06:26	15/11/2020 16:29	10,03	91	913,18	CHI
20201169337	ITAPURANGA	IK12250609	ITAPURANGA	15/11/2020 06:26	15/11/2020 15:14	15/11/2020 06:26	15/11/2020 15:14	8,79	22	193,28	CHI
20201167652	SAO JOAO D ALIANCA	JL11130015	SAO JOAO D ALIANCA	15/11/2020 06:27	15/11/2020 07:47	15/11/2020 06:27	15/11/2020 07:47	1,33	7	9,32	CHI
20201167655	URUACU	UR12237468	URUACU	15/11/2020 06:27	15/11/2020 10:34	15/11/2020 06:27	15/11/2020 10:34	4,11	7	28,79	CHI
20201167656	VARJAO	GA31066162	CEZARINA	15/11/2020 06:27	15/11/2020 18:42	15/11/2020 06:27	15/11/2020 18:42	12,24	0	0,00	CHI
20201167657	PIRANHAS	PH21201931	PIRANHAS	15/11/2020 06:27	15/11/2020 08:42	15/11/2020 06:27	15/11/2020 08:42	2,23	1	2,23	CHI
20201167747	ARAGUAPAZ	AZ12404547	MOZARLANDIA	15/11/2020 06:27	15/11/2020 16:35	15/11/2020 06:27	15/11/2020 16:35	10,13	4	40,52	CHI
20201167662	NIQUELANDIA	NQ121232491	URUACU	15/11/2020 06:29	15/11/2020 11:09	15/11/2020 06:29	15/11/2020 11:09	4,66	1	4,66	CHI
20201167664	JATAI	JT12184065	JATAI S2	15/11/2020 06:30	15/11/2020 09:07	15/11/2020 06:30	15/11/2020 09:07	2,61	12	31,36	CHI
20201167665	PIRACANJUBA	60057142	PIRACANJUBA	15/11/2020 06:30	15/11/2020 08:44	15/11/2020 06:30	15/11/2020 08:44	2,22	1	2,22	CHI
20201167666	GOIANIA	GN12044467	GOYA S2	15/11/2020 06:32	15/11/2020 08:53	15/11/2020 06:32	15/11/2020 08:53	2,35	128	300,30	CHI
20201167668	CATALAO	CT12250361	CATALAO S1	15/11/2020 06:32	15/11/2020 11:33	15/11/2020 06:32	15/11/2020 11:33	5,01	4	20,02	CHI
20201168608	URUACU	UR12398055	URUACU	15/11/2020 06:32	15/11/2020 12:14	15/11/2020 06:32	15/11/2020 12:14	5,69	12	68,28	CHI
20201167671	POSSE	PS12124649	IACIARA S2	15/11/2020 06:33	15/11/2020 08:33	15/11/2020 06:33	15/11/2020 08:33	1,99	22	43,71	CHI
20201167682	TRINDADE	TR12326279	TRINDADE	15/11/2020 06:33	15/11/2020 08:02	15/11/2020 06:33	15/11/2020 08:02	1,47	3	4,42	CHI
20201167776	ARAQOIANIA	VJ12034625	GUAPO S2	15/11/2020 06:35	15/11/2020 12:05	15/11/2020 06:35	15/11/2020 12:05	5,50	1	5,50	CHI
20201167776	GUAPO	VJ12034625	GUAPO S2	15/11/2020 06:35	15/11/2020 12:05	15/11/2020 06:35	15/11/2020 12:05	5,50	2	11,00	CHI
20201167776	VARJAO	VJ12034625	GUAPO S2	15/11/2020 06:35	15/11/2020 12:05	15/11/2020 06:35	15/11/2020 12:05	5,50	8	44,00	CHI
20201167678	FORMOSA	610301512	ITUIQUIRA	15/11/2020 06:36	15/11/2020 08:47	15/11/2020 06:36	15/11/2020 08:47	2,18	1	2,18	CHI
20201167778	NIQUELANDIA	NQ12257262	URUACU	15/11/2020 06:36	15/11/2020 10:26	15/11/2020 06:36	15/11/2020 10:26	3,83	10	38,32	CHI
20201167684	MORRINHOS	MR12074567	MORRINHOS	15/11/2020 06:37	15/11/2020 08:54	15/11/2020 06:37	15/11/2020 08:54	2,28	4	9,10	CHI
20201168032	CORUMBA DE GOIAS	CB12382200	CORUMBA	15/11/2020 06:37	15/11/2020 09:14	15/11/2020 06:37	15/11/2020 09:14	2,61	54	140,79	CHI
20201167963	ITAPURANGA	IK12300186	ITAPURANGA	15/11/2020 06:42	15/11/2020 08:06	15/11/2020 06:42	15/11/2020 08:06	1,39	41	56,84	CHI
20201167701	BARRO ALTO	GE12255886	GOIANESIA S1	15/11/2020 06:43	15/11/2020 16:24	15/11/2020 06:43	15/11/2020 16:24	9,68	1	9,68	CHI
20201167701	GOIANESIA	GE12255886	GOIANESIA S1	15/11/2020 06:43	15/11/2020 16:24	15/11/2020 06:43	15/11/2020 16:24	9,68	5	48,40	CHI
20201167832	BOM JESUS DE GOIAS	DM12345983	RIO DOS BOIS	15/11/2020 06:43	15/11/2020 09:55	15/11/2020 06:43	15/11/2020 09:55	3,19	9	28,71	CHI
20201167832	CASTELANDIA	DM12345983	RIO DOS BOIS	15/11/2020 06:43	15/11/2020 09:55	15/11/2020 06:43	15/11/2020 09:55	3,19	18	57,42	CHI
20201167706	NOVA AURORA	NE12127536	CATALAO S1	15/11/2020 06:44	15/11/2020 11:09	15/11/2020 06:44	15/11/2020 11:09	4,42	8	35,32	CHI
20201168248	DAVINOPOLIS	IO12266778	CATALAO S1	15/11/2020 06:44	15/11/2020 10:41	15/11/2020 06:44	15/11/2020 10:41	3,94	13	51,16	CHI
20201168248	DISTRITO FEDERAL	IO12266778	CATALAO S1	15/11/2020 06:44	15/11/2020 10:41	15/11/2020 06:44	15/11/2020 10:41	3,94	1	3,94	CHI
20201167711	RIO VERDE	RV13371493	RIO VERDE S1	15/11/2020 06:45	15/11/2020 16:06	15/11/2020 06:45	15/11/2020 12:27	5,71	64	365,40	CHI
20201167711	SANTA HELENA DE GOIAS	RV13371493	RIO VERDE S1	15/11/2020 06:45	15/11/2020 16:06	15/11/2020 06:45	15/11/2020 12:27	5,71	11	62,80	CHI
20201167711	RIO VERDE	RV13371493	RIO VERDE S1	15/11/2020 06:45	15/11/2020 16:06	15/11/2020 10:40	15/11/2020 12:27	1,80	2	3,59	CHI
20201167711	RIO VERDE	RV15408106	RIO VERDE S1	15/11/2020 06:45	15/11/2020 16:06	15/11/2020 06:45	15/11/2020 15:50	9,08	2	18,17	CHI
20201167711	RIO VERDE	RV13305871	RIO VERDE S1	15/11/2020 06:45	15/11/2020 16:06	15/11/2020 06:45	15/11/2020 16:05	9,34	154	1438,49	CHI
20201167711	RIO VERDE	RV13305871	RIO VERDE S1	15/11/2020 06:45	15/11/2020 16:06	15/11/2020 10:40	15/11/2020 16:05	5,43	3	16,28	CHI
20201167711	RIO VERDE	RV12260256	RIO VERDE S1	15/11/2020 06:45	15/11/2020 16:06	15/11/2020 10:40	15/11/2020 16:06	5,43	19	103,23	CHI
20201167716	CORUMBAIBA	CI21107559	VILA CORUMBA	15/11/2020 06:46	15/11/2020 09:25	15/11/2020 06:46	15/11/2020 09:25	2,64	1	2,64	CHI
20201167129	ESTRELA DO NORTE	ET11100731	MARA ROSA	15/11/2020 06:47	15/11/2020 14:13	15/11/2020 06:47	15/11/2020 14:13	7,43	132	980,21	CHI
20201167717	BURITINOPOLIS	10031385069	IACIARA S2	15/11/2020 06:47	15/11/2020 08:33	15/11/2020 06:47	15/11/2020 08:33	1,77	1	1,77	CHI
20201168299	PORANGATU	PO12262596	PORANGATU	15/11/2020 06:47	16/11/2020 01:27	15/11/2020 06:47	16/11/2020 01:27	18,65	38	708,87	CHI
20201167727	ITABERAÍ	IB12250615	ITABERAÍ S2	15/11/2020 06:48	15/11/2020 08:50	15/11/2020 06:48	15/11/2020 08:50	2,02	527	1065,27	CHI

20201167729	ARAGOIANA	AO32097682	GUAPO S2	15/11/2020 06:49	15/11/2020 21:30	15/11/2020 06:49	15/11/2020 21:30	14,68	3	44,04	CHI
20201167729	HIDROLANDIA	AO32097682	GUAPO S2	15/11/2020 06:49	15/11/2020 21:30	15/11/2020 06:49	15/11/2020 21:30	14,68	1	14,68	CHI
20201167729	ARAGOIANA	AO32097677	GUAPO S2	15/11/2020 06:49	15/11/2020 21:30	15/11/2020 20:46	15/11/2020 21:30	0,73	4	2,93	CHI
20201167729	HIDROLANDIA	AO32097677	GUAPO S2	15/11/2020 06:49	15/11/2020 21:30	15/11/2020 20:46	15/11/2020 21:30	0,73	37	27,14	CHI
20201167732	TURVELANDIA	TD21306617	RIO DOS BOIS	15/11/2020 06:50	15/11/2020 09:40	15/11/2020 06:50	15/11/2020 09:40	2,83	1	2,83	CHI
20201167734	ITUMBIARA	IT12143989	ITUMBIARA NOVA	15/11/2020 06:50	15/11/2020 08:22	15/11/2020 06:50	15/11/2020 08:22	1,53	1	1,53	CHI
20201167738	FORMOSA	FA12376692	ITUIQUIRA	15/11/2020 06:50	15/11/2020 08:41	15/11/2020 06:50	15/11/2020 08:41	1,83	490	898,61	CHI
20201167739	CACU	CC12170573	CACHOEIRA ALTA	15/11/2020 06:51	15/11/2020 08:37	15/11/2020 06:51	15/11/2020 08:37	1,76	3	5,28	CHI
20201167906	GOIANIRA	GR12247734	GOIANIRA	15/11/2020 06:51	15/11/2020 09:06	15/11/2020 06:51	15/11/2020 09:06	2,24	623	1397,08	CHI
20201167906	TRINDADE	GR12247734	GOIANIRA	15/11/2020 06:51	15/11/2020 09:06	15/11/2020 06:51	15/11/2020 09:06	2,24	196	439,53	CHI
20201167744	IACIARA	ND12046258	IACIARA S2	15/11/2020 06:52	15/11/2020 08:01	15/11/2020 06:52	15/11/2020 08:01	1,14	2	2,28	CHI
20201168202	NOVA CRIXAS	NA12055690	MOZARLANDIA	15/11/2020 06:52	15/11/2020 12:24	15/11/2020 06:52	15/11/2020 12:24	5,53	10	55,33	CHI
20201168202	NOVA CRIXAS	NA12055690	MOZARLANDIA	15/11/2020 06:52	15/11/2020 12:24	15/11/2020 06:52	15/11/2020 12:24	5,53	8	44,26	CHI
20201168481	ARAGOIANA	AO32097662	GUAPO S2	15/11/2020 06:52	15/11/2020 13:28	15/11/2020 06:52	15/11/2020 13:28	6,60	4	26,39	CHI
20201168481	VARJAO	AO32097662	GUAPO S2	15/11/2020 06:52	15/11/2020 13:28	15/11/2020 06:52	15/11/2020 13:28	6,60	4	26,39	CHI
20201169007	MUNDO NOVO DE GOIAS	MH12208600	NOVA CRIXAS	15/11/2020 06:53	15/11/2020 13:20	15/11/2020 06:53	15/11/2020 13:20	6,44	3	19,33	CHI
20201169007	UIRAPURU	MH12208600	NOVA CRIXAS	15/11/2020 06:53	15/11/2020 13:20	15/11/2020 06:53	15/11/2020 13:20	6,44	15	96,67	CHI
20201168102	MINACU	IH12341446	MINACU	15/11/2020 06:54	15/11/2020 11:10	15/11/2020 06:54	15/11/2020 11:10	4,25	35	148,82	CHI
20201167758	JARAGUA	JA12278873	JARAGUA	15/11/2020 06:55	15/11/2020 08:47	15/11/2020 06:55	15/11/2020 08:47	1,86	15	27,87	CHI
20201167759	DOVERLANDIA	DV21253634	CAIAPONIA	15/11/2020 06:55	15/11/2020 09:55	15/11/2020 06:55	15/11/2020 09:55	2,99	1	2,99	CHI
20201167919	MOZARLANDIA	MZ12057146	MOZARLANDIA	15/11/2020 06:55	15/11/2020 22:26	15/11/2020 06:55	15/11/2020 22:26	15,51	3	46,53	CHI
20201167919	NOVA CRIXAS	MZ12057146	MOZARLANDIA	15/11/2020 06:55	15/11/2020 22:26	15/11/2020 06:55	15/11/2020 22:26	15,51	27	418,78	CHI
20201167763	ARAGARCAS	AG21245906	ARAGARCAS	15/11/2020 06:56	15/11/2020 09:04	15/11/2020 06:56	15/11/2020 09:04	2,13	1	2,13	CHI
20201167767	CRISTALINA	LZ12383044	CRISTALINA S2	15/11/2020 06:58	15/11/2020 10:51	15/11/2020 06:58	15/11/2020 10:51	3,87	20	77,46	CHI
20201167767	LUZIANIA	LZ12383044	CRISTALINA S2	15/11/2020 06:58	15/11/2020 10:51	15/11/2020 06:58	15/11/2020 10:51	3,87	32	123,93	CHI
20201167771	ABADIA DE GOIAS	AP10414495	INDEPENDENCIA S2	15/11/2020 06:58	15/11/2020 11:16	15/11/2020 06:58	15/11/2020 09:43	2,76	98	270,51	CHI
20201167771	APARECIDA DE GOIANIA	AP10414495	INDEPENDENCIA S2	15/11/2020 06:58	15/11/2020 11:16	15/11/2020 06:58	15/11/2020 09:43	2,76	12	33,12	CHI
20201167771	GOIANIA	AP10414495	INDEPENDENCIA S2	15/11/2020 06:58	15/11/2020 11:16	15/11/2020 06:58	15/11/2020 09:43	2,76	1413	3900,27	CHI
20201167771	GOIANIA	AP10414495	INDEPENDENCIA S2	15/11/2020 06:58	15/11/2020 11:16	15/11/2020 06:58	15/11/2020 11:01	4,05	15	60,74	CHI
20201167771	GOIANIA	AP10414495	INDEPENDENCIA S2	15/11/2020 06:58	15/11/2020 11:16	15/11/2020 06:58	15/11/2020 11:16	4,30	174	748,44	CHI
20201167769	VIANOPOLIS	VN12009490	VIANOPOLIS	15/11/2020 06:59	15/11/2020 08:26	15/11/2020 06:59	15/11/2020 08:26	1,46	2	2,91	CHI
20201167796	NIQUELANDIA	NQ12243553	URUACU	15/11/2020 07:00	15/11/2020 09:26	15/11/2020 07:00	15/11/2020 09:26	2,42	7	16,96	CHI
20201167942	NIQUELANDIA	NQ12345105	NIQUELANDIA SUBTRANSMISSAO	15/11/2020 07:00	15/11/2020 10:08	15/11/2020 07:00	15/11/2020 10:08	3,12	11	34,36	CHI
20201167777	BELA VISTA DE GOIAS	BV12012595	BELA VISTA S1	15/11/2020 07:03	15/11/2020 10:40	15/11/2020 07:03	15/11/2020 10:40	3,61	3	10,84	CHI
20201167781	ACREUNA	TD12025721	RIO DOS BOIS	15/11/2020 07:03	15/11/2020 10:37	15/11/2020 07:03	15/11/2020 10:37	3,55	21	74,57	CHI
20201167781	TURVELANDIA	TD12025721	RIO DOS BOIS	15/11/2020 07:03	15/11/2020 10:37	15/11/2020 07:03	15/11/2020 10:37	3,55	34	120,73	CHI
20201168218	CABECEIRAS	CW12184624	ITUIQUIRA	15/11/2020 07:03	15/11/2020 10:00	15/11/2020 07:03	15/11/2020 10:00	2,95	5	14,73	CHI
20201167783	RIO VERDE	RV12207197	MONTIVIDU T	15/11/2020 07:04	15/11/2020 09:20	15/11/2020 07:04	15/11/2020 09:20	2,26	1	2,26	CHI
20201167790	AURILANDIA	AI12289760	FIRMINOPOLIS S2	15/11/2020 07:04	15/11/2020 09:57	15/11/2020 07:04	15/11/2020 09:57	2,87	6	17,21	CHI
20201167793	CALDAS NOVAS	CN11160333	SERRA DE CALDAS	15/11/2020 07:05	15/11/2020 09:18	15/11/2020 07:05	15/11/2020 09:18	2,21	17	37,55	CHI
20201167795	COCALZINHO DE GOIAS	ZN11209270	COCALZINHO	15/11/2020 07:05	15/11/2020 12:18	15/11/2020 07:05	15/11/2020 12:18	5,20	119	619,36	CHI
20201167932	PIRACANJUBA	PJ12045336	PIRACANJUBA	15/11/2020 07:05	15/11/2020 09:56	15/11/2020 07:05	15/11/2020 09:56	2,84	21	59,63	CHI
20201167798	INHUMAS	IX21277394	INHUMAS S1	15/11/2020 07:06	15/11/2020 09:36	15/11/2020 07:06	15/11/2020 09:36	2,50	1	2,50	CHI
20201167802	SAO MIGUEL DO ARAGUAIA	SM21000024	SAO MIGUEL DO ARAGUAIA	15/11/2020 07:06	16/11/2020 11:53	15/11/2020 07:06	16/11/2020 11:53	28,77	1	28,77	CHI
20201167859	PARAUNA	PU12301167	ACREUNA	15/11/2020 07:06	15/11/2020 09:21	15/11/2020 07:06	15/11/2020 09:21	2,24	15	33,53	CHI
20201168321	SANTA RITA DO NOVO DESTINO	BA12163300	BARRO ALTO	15/11/2020 07:06	15/11/2020 13:33	15/11/2020 07:06	15/11/2020 13:33	6,44	11	70,84	CHI
20201167914	COCALZINHO DE GOIAS	ZN12390553LD	AGUAS LINDAS DE GOIAS S2	15/11/2020 07:07	15/11/2020 11:10	15/11/2020 07:07	15/11/2020 11:10	4,04	42	169,65	CHI
20201167914	RIALMA	ZN12390553LD	AGUAS LINDAS DE GOIAS S2	15/11/2020 07:07	15/11/2020 11:10	15/11/2020 07:07	15/11/2020 11:10	4,04	4	16,16	CHI
20201167914	COCALZINHO DE GOIAS	ZN12390553LD	AGUAS LINDAS DE GOIAS S2	15/11/2020 07:07	15/11/2020 11:10	15/11/2020 09:59	15/11/2020 11:10	1,18	10	11,78	CHI
20201167914	RIALMA	ZN12390553LD	AGUAS LINDAS DE GOIAS S2	15/11/2020 07:07	15/11/2020 11:10	15/11/2020 09:59	15/11/2020 11:10	1,18	1	1,18	CHI
20201168555	BARRO ALTO	BA12382485	BARRO ALTO	15/11/2020 07:07	15/11/2020 15:08	15/11/2020 07:07	15/11/2020 15:08	8,01	9	72,07	CHI

20201161035	CAMPINACU	IH12360453	MINACU	15/11/2020 07:08	16/11/2020 07:33	15/11/2020 07:08	16/11/2020 07:33	24,41	5	122,07	CHI
20201161035	MINACU	IH12360453	MINACU	15/11/2020 07:08	16/11/2020 07:33	15/11/2020 07:08	16/11/2020 07:33	24,41	80	1953,18	CHI
20201167813	GOIANIA	10011960122	CARAIAS S1	15/11/2020 07:10	15/11/2020 10:03	15/11/2020 07:10	15/11/2020 10:03	2,87	1	2,87	CHI
20201167817	FAINA	FC21113595	GOIAS	15/11/2020 07:11	16/11/2020 04:20	15/11/2020 07:11	16/11/2020 04:20	21,15	1	21,15	CHI
20201167818	CAMPESTRE DE GOIAS	GC21033579	TRINDADE	15/11/2020 07:11	15/11/2020 09:58	15/11/2020 07:11	15/11/2020 09:58	2,78	1	2,78	CHI
20201167949	ITAPURANGA	IK12073123	ITAPURANGA	15/11/2020 07:11	15/11/2020 10:33	15/11/2020 07:11	15/11/2020 10:33	3,37	35	117,79	CHI
20201167827	AGUA LIMPA	AL12242538	VILA CORUMBA	15/11/2020 07:13	15/11/2020 11:34	15/11/2020 07:13	15/11/2020 11:34	4,34	4	17,34	CHI
20201167833	CRISTALINA	19845824	CRISTALINA S2	15/11/2020 07:14	15/11/2020 11:22	15/11/2020 07:14	15/11/2020 11:22	4,12	17	70,11	CHI
20201167834	ISRAELANDIA	IS21237256	IPORA	15/11/2020 07:14	15/11/2020 13:59	15/11/2020 07:14	15/11/2020 13:59	6,73	1	6,73	CHI
20201168658	PORANGATU	TA12114216	NOVO PLANALTO	15/11/2020 07:14	17/11/2020 04:26	15/11/2020 07:14	17/11/2020 04:01	44,79	4	179,16	CHI
20201168658	PORANGATU	TA12114216	NOVO PLANALTO	15/11/2020 07:14	17/11/2020 04:26	15/11/2020 07:14	17/11/2020 04:26	45,22	2	90,43	CHI
20201167838	PIRES DO RIO	OZ12022847	PIRES DO RIO S2	15/11/2020 07:15	15/11/2020 10:44	15/11/2020 07:15	15/11/2020 10:44	3,47	8	27,79	CHI
20201167841	ITAPURANGA	19646967	ITAPURANGA	15/11/2020 07:15	15/11/2020 11:06	15/11/2020 07:15	15/11/2020 11:06	3,83	2	7,67	CHI
20201167843	GOIANIA	GN12227004	CAMPINAS S2	15/11/2020 07:16	15/11/2020 08:20	15/11/2020 07:16	15/11/2020 08:20	1,06	296	315,08	CHI
20201167844	BONOPOLIS	BX21333257	SAO MIGUEL DO ARAGUAIA	15/11/2020 07:16	15/11/2020 22:22	15/11/2020 07:16	15/11/2020 22:22	15,10	1	15,10	CHI
20201167936	MORRINHOS	MR12100140	MORRINHOS	15/11/2020 07:16	15/11/2020 09:20	15/11/2020 07:16	15/11/2020 09:20	2,07	5	10,33	CHI
20201167848	NOVA VENEZA	NV12098840	INHUMAS S1	15/11/2020 07:17	15/11/2020 09:22	15/11/2020 07:17	15/11/2020 09:22	2,07	9	18,62	CHI
20201168280	GOIAS	GS12310594	ITABERAI S1	15/11/2020 07:17	15/11/2020 11:39	15/11/2020 07:17	15/11/2020 11:39	4,35	5	21,75	CHI
20201168280	ITABERAI	GS12310594	ITABERAI S1	15/11/2020 07:17	15/11/2020 11:39	15/11/2020 07:17	15/11/2020 11:39	4,35	25	108,76	CHI
20201167857	CRISTIANOPOLIS	CF12112079	CRISTIANOPOLIS	15/11/2020 07:19	15/11/2020 16:56	15/11/2020 07:19	15/11/2020 16:56	9,60	5	48,02	CHI
20201167860	NIQUELANDIA	NQ11146978	URUACU	15/11/2020 07:20	15/11/2020 08:15	15/11/2020 07:20	15/11/2020 08:15	0,91	25	22,80	CHI
20201168005	RIO VERDE	RV12222622LD	RIO VERDE S2	15/11/2020 07:20	15/11/2020 13:05	15/11/2020 07:20	15/11/2020 13:05	5,74	13	74,59	CHI
20201168005	SANTA HELENA DE GOIAS	RV12222622LD	RIO VERDE S2	15/11/2020 07:20	15/11/2020 13:05	15/11/2020 07:20	15/11/2020 13:05	5,74	68	390,19	CHI
20201167866	BARRO ALTO	BA21063674	GOIANESIA S1	15/11/2020 07:21	15/11/2020 11:49	15/11/2020 07:21	15/11/2020 11:49	4,45	1	4,45	CHI
20201167869	ANAPOLIS	AN12201240	ANAPOLIS UNIVERSITARIO S2	15/11/2020 07:22	15/11/2020 08:36	15/11/2020 07:22	15/11/2020 08:36	1,23	9	11,03	CHI
20201167871	VALPARAISO DE GOIAS	VA11041608	MARAJOARA	15/11/2020 07:22	15/11/2020 09:49	15/11/2020 07:22	15/11/2020 09:49	2,44	9	21,95	CHI
20201168010	JUSSARA	JR12259810	BRITANIA	15/11/2020 07:22	16/11/2020 13:40	15/11/2020 07:22	15/11/2020 14:55	7,55	45	339,61	CHI
20201168010	JUSSARA	JR12259810	BRITANIA	15/11/2020 07:22	16/11/2020 13:40	15/11/2020 07:22	16/11/2020 12:10	28,80	2	57,59	CHI
20201168010	JUSSARA	JR12259810	BRITANIA	15/11/2020 07:22	16/11/2020 13:40	15/11/2020 07:22	16/11/2020 13:22	30,01	1	30,01	CHI
20201168010	JUSSARA	JR12259810	BRITANIA	15/11/2020 07:22	16/11/2020 13:40	15/11/2020 07:22	16/11/2020 13:40	30,31	2	60,61	CHI
20201167909	AURILANDIA	RP12076381RE	FIRMINOPOLIS S2	15/11/2020 07:23	15/11/2020 11:53	15/11/2020 07:23	15/11/2020 11:53	4,48	4	17,94	CHI
20201167909	SAO JOAO DA PARAUNA	RP12076381RE	FIRMINOPOLIS S2	15/11/2020 07:23	15/11/2020 11:53	15/11/2020 07:23	15/11/2020 11:53	4,48	33	148,00	CHI
202011137993	AMARALINA	MQ12050047	MARA ROSA	15/11/2020 07:23	15/11/2020 14:44	15/11/2020 07:23	15/11/2020 14:44	7,34	232	1701,72	CHI
20201167876	FAINA	MP21096002	MATRINCHA	15/11/2020 07:24	15/11/2020 11:53	15/11/2020 07:24	15/11/2020 11:53	4,48	2	8,96	CHI
20201167879	URUACU	UR12210930	URUACU	15/11/2020 07:24	15/11/2020 08:57	15/11/2020 07:24	15/11/2020 08:57	1,54	11	16,91	CHI
20201168544	MOZARLANDIA	MZ12055640	MOZARLANDIA	15/11/2020 07:24	15/11/2020 19:47	15/11/2020 07:24	15/11/2020 19:47	12,38	9	111,43	CHI
20201167884	PIRENOPOLIS	PV12384891	CORUMBA	15/11/2020 07:25	15/11/2020 08:57	15/11/2020 07:25	15/11/2020 08:57	1,52	15	22,83	CHI
20201167891	CAIAPONIA	CP12308693	PALESTINA	15/11/2020 07:25	15/11/2020 12:12	15/11/2020 07:25	15/11/2020 12:12	4,78	8	38,27	CHI
20201168647	ANICUNS	AC12307109	FIRMINOPOLIS S2	15/11/2020 07:26	15/11/2020 10:55	15/11/2020 07:26	15/11/2020 10:55	3,47	11	38,18	CHI
20201167889	GAMELEIRA DE GOIAS	SV21161123	DAIA S2	15/11/2020 07:27	15/11/2020 09:45	15/11/2020 07:27	15/11/2020 09:45	2,29	2	4,58	CHI
20201167896	GUAPO	GA12035172LD	GUAPO S2	15/11/2020 07:28	15/11/2020 12:16	15/11/2020 07:28	15/11/2020 12:16	4,80	14	67,19	CHI
20201167901	ITAPURANGA	IK21310094	ITAPURANGA	15/11/2020 07:28	15/11/2020 09:55	15/11/2020 07:28	15/11/2020 09:55	2,44	1	2,44	CHI
20201167905	GOIANDIRA	GD12077527LD	CATALAO S1	15/11/2020 07:29	15/11/2020 12:41	15/11/2020 07:29	15/11/2020 11:31	4,03	72	289,88	CHI
20201167905	GOIANDIRA	GD16419721	CATALAO S1	15/11/2020 07:29	15/11/2020 12:41	15/11/2020 07:29	15/11/2020 12:18	4,81	116	558,48	CHI
20201167905	NOVA AURORA	GD16419721	CATALAO S1	15/11/2020 07:29	15/11/2020 12:41	15/11/2020 07:29	15/11/2020 12:18	4,81	14	67,40	CHI
20201167905	GOIANDIRA	GD16419721	CATALAO S1	15/11/2020 07:29	15/11/2020 12:41	15/11/2020 10:53	15/11/2020 12:18	1,42	5	7,08	CHI
20201167905	GOIANDIRA	GD13358391	CATALAO S1	15/11/2020 07:29	15/11/2020 12:41	15/11/2020 12:05	15/11/2020 12:41	0,60	86	51,60	CHI
20201170359	FAINA	FC12160891	GOIAS	15/11/2020 07:29	15/11/2020 21:20	15/11/2020 07:29	15/11/2020 21:20	13,84	13	179,94	CHI
20201170359	ITAPURANGA	FC12160891	GOIAS	15/11/2020 07:29	15/11/2020 21:20	15/11/2020 07:29	15/11/2020 21:20	13,84	2	27,68	CHI
20201170359	MORRO AGUDO DE GOIAS	FC12160891	GOIAS	15/11/2020 07:29	15/11/2020 21:20	15/11/2020 07:29	15/11/2020 21:20	13,84	2	27,68	CHI
20201167908	SANTA ROSA DE GOIAS	SR21080991	INHUMAS S1	15/11/2020 07:30	15/11/2020 09:07	15/11/2020 07:30	15/11/2020 09:07	1,61	1	1,61	CHI



20201167915	EDEIA	TD12040336	RIO DOS BOIS	15/11/2020 07:31	15/11/2020 12:09	15/11/2020 07:31	15/11/2020 12:09	4,62	1	4,62	CHI
20201167915	TURVELANDIA	TD12040336	RIO DOS BOIS	15/11/2020 07:31	15/11/2020 12:09	15/11/2020 07:31	15/11/2020 12:09	4,62	3	13,87	CHI
20201167917	ITAPURANGA	IK12023682	ITAPURANGA	15/11/2020 07:31	15/11/2020 11:59	15/11/2020 07:31	15/11/2020 11:59	4,45	7	31,15	CHI
20201167926	PIRES DO RIO	PR21231449	PIRES DO RIO S1	15/11/2020 07:35	15/11/2020 13:21	15/11/2020 07:35	15/11/2020 13:21	5,76	1	5,76	CHI
20201167929	EDEALINA	ED21067515	PONTALINA	15/11/2020 07:35	15/11/2020 10:23	15/11/2020 07:35	15/11/2020 10:23	2,79	2	5,57	CHI
20201167930	GOIANIA	12533063	ATLANTICO S1	15/11/2020 07:35	15/11/2020 09:40	15/11/2020 07:35	15/11/2020 09:40	2,07	1	2,07	CHI
20201167935	BRITANIA	BT12210591	BRITANIA	15/11/2020 07:37	15/11/2020 08:46	15/11/2020 07:37	15/11/2020 08:46	1,15	7	8,05	CHI
20201167939	PALMEIRAS DE GOIAS	PL21034687	PALMEIRAS	15/11/2020 07:38	15/11/2020 14:14	15/11/2020 07:38	15/11/2020 14:14	6,60	2	13,20	CHI
20201167943	ANAPOLIS	20695706	JUNDIAI S2	15/11/2020 07:38	15/11/2020 08:37	15/11/2020 07:38	15/11/2020 08:37	0,97	1	0,97	CHI
20201167944	SILVANIA	SV12403479	VIANOPOLIS	15/11/2020 07:39	15/11/2020 10:27	15/11/2020 07:39	15/11/2020 10:27	2,80	2	5,60	CHI
20201167945	CATALAO	CT12209404	CATALAO S1	15/11/2020 07:39	15/11/2020 10:08	15/11/2020 07:39	15/11/2020 10:08	2,48	3	7,43	CHI
20201167950	ARAGARCAS	BM12372360	BOM JARDIM	15/11/2020 07:39	15/11/2020 12:58	15/11/2020 07:39	15/11/2020 12:58	5,31	42	223,17	CHI
20201167950	BOM JARDIM DE GOIAS	BM12372360	BOM JARDIM	15/11/2020 07:39	15/11/2020 12:58	15/11/2020 07:39	15/11/2020 12:58	5,31	1	5,31	CHI
20201167951	GOIANIA	12277940	CARAIAS S1	15/11/2020 07:39	15/11/2020 11:21	15/11/2020 07:39	15/11/2020 11:21	3,68	1	3,68	CHI
20201167953	AMORINOPOLIS	AM21000028	IPORA	15/11/2020 07:39	15/11/2020 09:41	15/11/2020 07:39	15/11/2020 09:41	2,02	1	2,02	CHI
20201167956	MOZARLANDIA	MZ12055646	MOZARLANDIA	15/11/2020 07:40	15/11/2020 17:21	15/11/2020 07:40	15/11/2020 17:21	9,68	3	29,04	CHI
20201167961	NOVA ROMA	ND12394125	IAZIARA S2	15/11/2020 07:40	15/11/2020 08:35	15/11/2020 07:40	15/11/2020 08:35	0,90	7	6,32	CHI
20201168231	ARENOPOLIS	AY12390169	ARENOPOLIS	15/11/2020 07:41	15/11/2020 12:12	15/11/2020 07:41	15/11/2020 12:12	4,51	22	99,12	CHI
20201168231	DIORAMA	AY12390169	ARENOPOLIS	15/11/2020 07:41	15/11/2020 12:12	15/11/2020 07:41	15/11/2020 12:12	4,51	3	13,52	CHI
20201167973	VICENTINOPOLIS	20367947	VICENTINOPOLIS	15/11/2020 07:43	15/11/2020 17:07	15/11/2020 07:43	15/11/2020 16:30	8,78	5	43,92	CHI
20201167973	VICENTINOPOLIS	VI11403306	VICENTINOPOLIS	15/11/2020 07:43	15/11/2020 17:07	15/11/2020 15:08	15/11/2020 16:35	1,45	2	2,90	CHI
20201167973	VICENTINOPOLIS	VI13218209	VICENTINOPOLIS	15/11/2020 07:43	15/11/2020 17:07	15/11/2020 07:43	15/11/2020 17:07	9,40	133	1250,13	CHI
20201169296	ITAPURANGA	IK12299350	ITAPURANGA	15/11/2020 07:43	15/11/2020 16:58	15/11/2020 07:43	15/11/2020 16:58	9,24	13	120,11	CHI
20201167978	PIRES DO RIO	BC12031273	PIRES DO RIO S2	15/11/2020 07:44	15/11/2020 15:28	15/11/2020 07:44	15/11/2020 11:30	3,76	1	3,76	CHI
20201167978	PIRES DO RIO	BC12031273	PIRES DO RIO S2	15/11/2020 07:44	15/11/2020 15:28	15/11/2020 07:44	15/11/2020 15:28	7,73	2	15,45	CHI
20201167978	SANTA CRUZ DE GOIAS	BC12031273	PIRES DO RIO S2	15/11/2020 07:44	15/11/2020 15:28	15/11/2020 07:44	15/11/2020 15:28	7,73	1	7,73	CHI
20201167981	AGUAS LINDAS DE GOIAS	4830185741	AGUAS LINDAS DE GOIAS S1	15/11/2020 07:44	15/11/2020 09:39	15/11/2020 07:44	15/11/2020 09:39	1,91	1	1,91	CHI
20201167984	CRISTALINA	KR21328698	CRISTALINA S1	15/11/2020 07:45	15/11/2020 13:51	15/11/2020 07:45	15/11/2020 13:51	6,09	1	6,09	CHI
20201167985	PIRACANJUBA	PJ12381140	PIRACANJUBA	15/11/2020 07:45	15/11/2020 11:00	15/11/2020 07:45	15/11/2020 11:00	3,24	8	25,93	CHI
20201167986	GUARINOS	GF21231993	SANTA TEREZINHA	15/11/2020 07:45	15/11/2020 14:13	15/11/2020 07:45	15/11/2020 14:13	6,45	1	6,45	CHI
20201167991	RIO VERDE	RV12071120	RIO VERDE S1	15/11/2020 07:46	15/11/2020 10:35	15/11/2020 07:46	15/11/2020 10:35	2,81	2	5,62	CHI
20201168634	CAMPO ALEGRE DE GOIAS	CM12266823	CAMPO ALEGRE DE GOIAS	15/11/2020 07:46	15/11/2020 14:50	15/11/2020 07:46	15/11/2020 14:50	7,07	40	282,61	CHI
20201167996	FORMOSA	FA12245453	ITUIQUIRA	15/11/2020 07:47	15/11/2020 10:42	15/11/2020 07:47	15/11/2020 10:42	2,92	4	11,66	CHI
20201167999	DAMIANOPOLIS	1520008317	IACIARA S2	15/11/2020 07:47	15/11/2020 11:07	15/11/2020 07:47	15/11/2020 11:07	3,32	1	3,32	CHI
20201168000	VIANOPOLIS	OZ21083152	VIANOPOLIS	15/11/2020 07:47	15/11/2020 09:06	15/11/2020 07:47	15/11/2020 09:06	1,30	1	1,30	CHI
20201168002	MONTES CLAROS DE GOIAS	ME21144406	IPORA	15/11/2020 07:48	15/11/2020 09:16	15/11/2020 07:48	15/11/2020 09:16	1,46	1	1,46	CHI
20201168003	PONTALINA	PK21223351	PONTALINA	15/11/2020 07:48	15/11/2020 09:04	15/11/2020 07:48	15/11/2020 09:04	1,25	1	1,25	CHI
20201168011	BARRO ALTO	BA21342222	GOIANESIA S1	15/11/2020 07:49	15/11/2020 12:20	15/11/2020 07:49	15/11/2020 12:20	4,51	1	4,51	CHI
20201168012	ARAGOIANIA	AO21162982	GUAPO S2	15/11/2020 07:49	15/11/2020 12:01	15/11/2020 07:49	15/11/2020 12:01	4,19	1	4,19	CHI
20201168017	ANAPOLIS	AN11107995	ANAPOLIS UNIVERSITARIO S2	15/11/2020 07:50	15/11/2020 11:29	15/11/2020 07:50	15/11/2020 11:29	3,64	130	473,56	CHI
20201168473	GOIAS	NB12092962	MATRINCHA	15/11/2020 07:50	15/11/2020 15:43	15/11/2020 07:50	15/11/2020 15:43	7,87	3	23,62	CHI
20201168473	ITAPIRAPUA	NB12092962	MATRINCHA	15/11/2020 07:50	15/11/2020 15:43	15/11/2020 07:50	15/11/2020 15:43	7,87	1	7,87	CHI
20201168473	NOVO BRASIL	NB12092962	MATRINCHA	15/11/2020 07:50	15/11/2020 15:43	15/11/2020 07:50	15/11/2020 15:43	7,87	5	39,36	CHI
20201168030	SITIO D ABADIA	AQ12381614	IACIARA S2	15/11/2020 07:52	15/11/2020 10:45	15/11/2020 07:52	15/11/2020 10:45	2,87	5	14,37	CHI
20201168034	GOIANIA	GN12026988	FERROVIARIO S3	15/11/2020 07:53	15/11/2020 09:02	15/11/2020 07:53	15/11/2020 09:02	1,14	464	530,25	CHI
20201168048	CATALAO	GD12127624RE	CATALAO S1	15/11/2020 07:53	15/11/2020 13:39	15/11/2020 07:53	15/11/2020 13:39	5,76	14	80,68	CHI
20201168048	GOIANDIRA	GD12127624RE	CATALAO S1	15/11/2020 07:53	15/11/2020 13:39	15/11/2020 07:53	15/11/2020 13:39	5,76	17	97,97	CHI
20201168048	IPAMERI	GD12127624RE	CATALAO S1	15/11/2020 07:53	15/11/2020 13:39	15/11/2020 07:53	15/11/2020 13:39	5,76	7	40,34	CHI
20201168037	PARAUNA	PU21318893	ACREUNA	15/11/2020 07:54	15/11/2020 19:14	15/11/2020 07:54	15/11/2020 19:14	11,33	1	11,33	CHI
20201168040	ALOANDIA	AD21384517	GOIATUBA S1	15/11/2020 07:54	15/11/2020 10:25	15/11/2020 07:54	15/11/2020 10:25	2,51	1	2,51	CHI
20201168041	ITUMBIARA	IT12005924	ITUMBIARA NOVA	15/11/2020 07:54	15/11/2020 09:31	15/11/2020 07:54	15/11/2020 09:31	1,61	176	283,07	CHI

20201168042	JATAI	290323850	JATAI S2	15/11/2020 07:54	15/11/2020 11:11	15/11/2020 07:54	15/11/2020 11:11	3,27	1	3,27	CHI
20201168047	ANAPOLIS	TJ12353479	DAIA S2	15/11/2020 07:55	15/11/2020 09:28	15/11/2020 07:55	15/11/2020 09:28	1,54	1	1,54	CHI
20201168047	TEREZOPOLIS DE GOIAS	TJ12353479	DAIA S2	15/11/2020 07:55	15/11/2020 09:28	15/11/2020 07:55	15/11/2020 09:28	1,54	13	20,06	CHI
20201168052	EDEALINA	ED21160449	VICENTINOPOLIS	15/11/2020 07:56	15/11/2020 17:43	15/11/2020 07:56	15/11/2020 17:43	9,77	1	9,77	CHI
20201168297	GOIANIA	GN12047178	XAVANTES	15/11/2020 07:56	15/11/2020 09:33	15/11/2020 07:56	15/11/2020 09:33	1,60	297	476,03	CHI
20201168053	ITAUCU	IX21319558	INHUMAS S1	15/11/2020 07:57	15/11/2020 10:14	15/11/2020 07:57	15/11/2020 10:14	2,28	1	2,28	CHI
20201168055	LUZIANIA	LZ11209465	RIO VERMELHO	15/11/2020 07:57	15/11/2020 09:40	15/11/2020 07:57	15/11/2020 09:40	1,71	61	104,23	CHI
20201168061	NOVA ROMA	ND21286027	IACIARA S2	15/11/2020 07:59	15/11/2020 09:39	15/11/2020 07:59	15/11/2020 09:39	1,66	2	3,32	CHI
20201168063	CORUMBA DE GOIAS	CB12072262	COCALZINHO	15/11/2020 07:59	15/11/2020 13:35	15/11/2020 07:59	15/11/2020 13:35	5,59	6	33,53	CHI
20201168066	NIQUELANDIA	NQ21210209	BARRO ALTO	15/11/2020 07:59	15/11/2020 11:18	15/11/2020 07:59	15/11/2020 11:18	3,30	1	3,30	CHI
20201168068	CABECEIRAS	CW21157340	ITUIQUIRA	15/11/2020 08:00	15/11/2020 11:01	15/11/2020 08:00	15/11/2020 11:01	3,01	1	3,01	CHI
20201168132	AGUA FRIA DE GOIAS	JL12262352	SAO JOAO D ALIANCA	15/11/2020 08:01	15/11/2020 18:46	15/11/2020 08:01	15/11/2020 15:43	7,69	6	46,13	CHI
20201168132	SAO JOAO D ALIANCA	JL12262352	SAO JOAO D ALIANCA	15/11/2020 08:01	15/11/2020 18:46	15/11/2020 08:01	15/11/2020 15:43	7,69	108	830,34	CHI
20201168132	AGUA FRIA DE GOIAS	JL12262352	SAO JOAO D ALIANCA	15/11/2020 08:01	15/11/2020 18:46	15/11/2020 15:48	15/11/2020 18:46	2,97	6	17,80	CHI
20201168132	SAO JOAO D ALIANCA	JL12262352	SAO JOAO D ALIANCA	15/11/2020 08:01	15/11/2020 18:46	15/11/2020 15:48	15/11/2020 18:46	2,97	108	320,40	CHI
20201168080	PIRENOPOLIS	PV12381262	CORUMBA	15/11/2020 08:02	15/11/2020 10:07	15/11/2020 08:02	15/11/2020 10:07	2,08	5	10,38	CHI
20201169239	AURILANDIA	AI12073526	FIRMINOPOLIS S2	15/11/2020 08:02	15/11/2020 15:03	15/11/2020 08:02	15/11/2020 15:03	7,02	13	91,21	CHI
20201169239	CACHOEIRA DE GOIAS	AI12073526	FIRMINOPOLIS S2	15/11/2020 08:02	15/11/2020 15:03	15/11/2020 08:02	15/11/2020 15:03	7,02	3	21,05	CHI
20201168090	LUZIANIA	LZ12376169	CRISTALINA S2	15/11/2020 08:03	15/11/2020 11:16	15/11/2020 08:03	15/11/2020 11:16	3,21	73	234,59	CHI
20201168092	BOM JESUS DE GOIAS	BJ12000208	CACHOEIRA DOURADA	15/11/2020 08:03	15/11/2020 11:50	15/11/2020 08:03	15/11/2020 11:50	3,78	10	37,77	CHI
20201168093	FORMOSA	FA32218560	SAO JOAO D ALIANCA	15/11/2020 08:03	15/11/2020 13:02	15/11/2020 08:03	15/11/2020 13:02	4,97	1	4,97	CHI
20201168496	ARENOPOLIS	AY12381016	IPORA	15/11/2020 08:04	15/11/2020 16:10	15/11/2020 08:04	15/11/2020 16:10	8,09	45	363,93	CHI
20201168496	PIRANHAS	AY12381016	IPORA	15/11/2020 08:04	15/11/2020 16:10	15/11/2020 08:04	15/11/2020 16:10	8,09	1	8,09	CHI
20201168707	PIRENOPOLIS	PV12122926	CORUMBA	15/11/2020 08:04	15/11/2020 10:43	15/11/2020 08:04	15/11/2020 10:43	2,64	4	10,58	CHI
20201168106	PORANGATU	PO12230365	PORANGATU	15/11/2020 08:05	15/11/2020 16:19	15/11/2020 08:05	15/11/2020 16:19	8,23	2	16,46	CHI
20201168107	UIRAPURU	UP12391844	SANTA TEREZINHA	15/11/2020 08:05	15/11/2020 18:29	15/11/2020 08:05	15/11/2020 18:29	10,41	3	31,24	CHI
20201168107	UIRAPURU	UP12391844	SANTA TEREZINHA	15/11/2020 08:05	15/11/2020 18:29	15/11/2020 17:08	15/11/2020 18:29	1,36	3	4,08	CHI
20201168116	ANICUNS	AC11102398	ANICUNS	15/11/2020 08:05	15/11/2020 11:54	15/11/2020 08:05	15/11/2020 11:54	3,81	55	209,66	CHI
20201168756	CAMPO ALEGRE DE GOIAS	CM12338771	CAMPO ALEGRE DE GOIAS	15/11/2020 08:06	15/11/2020 11:37	15/11/2020 08:06	15/11/2020 11:37	3,50	15	52,54	CHI
20201168118	GOIAS	GS12274255	ITABERAÍ S1	15/11/2020 08:07	15/11/2020 11:27	15/11/2020 08:07	15/11/2020 11:27	3,33	2	6,66	CHI
20201168125	NOVO PLANALTO	SM12000073	SAO MIGUEL DO ARAGUAIA	15/11/2020 08:07	17/11/2020 10:48	15/11/2020 08:07	15/11/2020 10:48	50,68	3	152,03	CHI
20201168131	ITAPURANGA	IK12325980	ITAPURANGA	15/11/2020 08:09	15/11/2020 14:40	15/11/2020 08:09	15/11/2020 14:40	6,52	2	13,03	CHI
20201168133	MORRINHOS	MR12000396	MORRINHOS	15/11/2020 08:09	15/11/2020 10:29	15/11/2020 08:09	15/11/2020 10:29	2,33	3	6,99	CHI
20201168134	ITABERAÍ	IB21360504	ITABERAÍ S1	15/11/2020 08:09	15/11/2020 14:23	15/11/2020 08:09	15/11/2020 14:23	6,23	1	6,23	CHI
20201168136	VILA BOA	VB21243081	IACIARA S2	15/11/2020 08:09	15/11/2020 10:32	15/11/2020 08:09	15/11/2020 10:32	2,37	1	2,37	CHI
20201168138	PONTALINA	PK21184884	PONTALINA	15/11/2020 08:09	15/11/2020 09:45	15/11/2020 08:09	15/11/2020 09:45	1,59	1	1,59	CHI
20201168542	SANTA HELENA DE GOIAS	SH12214105	ACREUNA	15/11/2020 08:09	15/11/2020 11:25	15/11/2020 08:09	15/11/2020 11:25	3,26	8	26,05	CHI
20201168158	MARA ROSA	MQ21295306	MARA ROSA	15/11/2020 08:10	15/11/2020 10:05	15/11/2020 08:10	15/11/2020 10:05	1,90	1	1,90	CHI
20201168159	NOVA AMERICA	NM12363582	RUBIATABA	15/11/2020 08:10	15/11/2020 12:14	15/11/2020 08:10	15/11/2020 12:14	4,05	3	12,16	CHI
20201168844	PADRE BERNARDO	PB12255470	PADRE BERNARDO	15/11/2020 08:10	15/11/2020 12:16	15/11/2020 08:10	15/11/2020 12:16	4,09	6	24,56	CHI
20201168161	EDEALINA	ED11359988	PONTALINA	15/11/2020 08:11	15/11/2020 13:58	15/11/2020 08:11	15/11/2020 13:58	5,78	5	28,91	CHI
20201168163	BELA VISTA DE GOIAS	BV32197951	BELA VISTA S1	15/11/2020 08:11	15/11/2020 09:42	15/11/2020 08:11	15/11/2020 09:42	1,50	1	1,50	CHI
20201170407	CAIAPONIA	CP12381056	CAIAPONIA	15/11/2020 08:11	15/11/2020 21:05	15/11/2020 08:11	15/11/2020 21:05	12,89	18	231,98	CHI
20201168168	ITABERAÍ	IB12300330	ITABERAÍ S2	15/11/2020 08:12	15/11/2020 10:34	15/11/2020 08:12	15/11/2020 10:34	2,37	14	33,17	CHI
20201168170	PARAUNA	PU21152655	PARAUNA	15/11/2020 08:12	15/11/2020 17:21	15/11/2020 08:12	15/11/2020 17:21	9,14	1	9,14	CHI
20201168171	RIO VERDE	RV11271718	RIO VERDE S2	15/11/2020 08:12	15/11/2020 15:45	15/11/2020 08:12	15/11/2020 15:45	7,54	13	98,05	CHI
20201168176	EDEIA	EA12038795	EDEIA	15/11/2020 08:12	15/11/2020 12:30	15/11/2020 08:12	15/11/2020 12:30	4,30	8	34,40	CHI
20201168340	ITAPURANGA	IK12310784	ITAPURANGA	15/11/2020 08:12	15/11/2020 12:03	15/11/2020 08:12	15/11/2020 12:03	3,84	11	42,26	CHI
20201168173	AGUAS LINDAS DE GOIAS	10011923936	AGUAS LINDAS DE GOIAS S1	15/11/2020 08:13	15/11/2020 09:59	15/11/2020 08:13	15/11/2020 09:59	1,76	1	1,76	CHI
20201168174	EDEALINA	ED21000013	PONTALINA	15/11/2020 08:13	15/11/2020 13:10	15/11/2020 08:13	15/11/2020 13:10	4,94	1	4,94	CHI
20201168179	CRIXAS	CX21252964	SANTA TEREZINHA	15/11/2020 08:15	15/11/2020 12:45	15/11/2020 08:15	15/11/2020 12:45	4,49	2	8,99	CHI

20201169625	BELA VISTA DE GOIAS	BC12382052	PIRES DO RIO S2	15/11/2020 08:15	15/11/2020 15:28	15/11/2020 08:15	15/11/2020 15:28	7,21	2	14,42	CHI
20201169625	CRISTIANOPOLIS	BC12382052	PIRES DO RIO S2	15/11/2020 08:15	15/11/2020 15:28	15/11/2020 08:15	15/11/2020 15:28	7,21	30	216,37	CHI
20201169625	PIRES DO RIO	BC12382052	PIRES DO RIO S2	15/11/2020 08:15	15/11/2020 15:28	15/11/2020 08:15	15/11/2020 15:28	7,21	74	533,70	CHI
20201169625	SANTA CRUZ DE GOIAS	BC12382052	PIRES DO RIO S2	15/11/2020 08:15	15/11/2020 15:28	15/11/2020 08:15	15/11/2020 15:28	7,21	35	252,43	CHI
20201168183	ITARUMA	IM12058060	CACHOEIRA ALTA	15/11/2020 08:16	15/11/2020 09:45	15/11/2020 08:16	15/11/2020 09:45	1,48	17	25,08	CHI
20201168194	LUZIANIA	LZ12016676	RIO VERMELHO	15/11/2020 08:16	15/11/2020 10:05	15/11/2020 08:16	15/11/2020 10:05	1,80	27	48,63	CHI
20201168188	EDEALINA	ED12223334	VICENTINOPOLIS	15/11/2020 08:17	15/11/2020 12:46	15/11/2020 08:17	15/11/2020 12:46	4,48	1	4,48	CHI
20201168190	APARECIDA DE GOIANIA	10030494590	ANHANGUERA	15/11/2020 08:17	15/11/2020 09:16	15/11/2020 08:17	15/11/2020 09:16	0,98	1	0,98	CHI
20201168192	MINEIROS	MY12244676	PARQUE DAS EMAS	15/11/2020 08:17	15/11/2020 12:41	15/11/2020 08:17	15/11/2020 12:41	4,39	9	39,50	CHI
20201168925	ITAPURANGA	IK12311314	ITAPURANGA	15/11/2020 08:17	15/11/2020 12:44	15/11/2020 08:17	15/11/2020 12:44	4,45	7	31,15	CHI
20201168195	TURVANIA	TV12083145	FIRMINOPOLIS S2	15/11/2020 08:18	15/11/2020 10:25	15/11/2020 08:18	15/11/2020 10:25	2,12	2	4,23	CHI
20201168196	CORUMBA DE GOIAS	CB21146621	CORUMBA	15/11/2020 08:18	15/11/2020 09:31	15/11/2020 08:18	15/11/2020 09:31	1,21	1	1,21	CHI
20201168204	GOIANIRA	390055165	GOIANIRA	15/11/2020 08:19	15/11/2020 09:33	15/11/2020 08:19	15/11/2020 09:33	1,23	1	1,23	CHI
20201168206	APARECIDA DE GOIANIA	13487036	INDEPENDENCIA S1	15/11/2020 08:19	15/11/2020 12:14	15/11/2020 08:19	15/11/2020 12:14	3,91	1	3,91	CHI
20201168211	MORRO AGUDO DE GOIAS	MS21147277	ITAPURANGA	15/11/2020 08:20	15/11/2020 17:37	15/11/2020 08:20	15/11/2020 17:37	9,28	1	9,28	CHI
20201168222	LEOPOLDO DE BULHOES	LB21270621	DAIA S2	15/11/2020 08:21	15/11/2020 09:50	15/11/2020 08:21	15/11/2020 09:50	1,47	1	1,47	CHI
20201169708	ALTO HORIZONTE	AJ123175361	SANTA TEREZINHA	15/11/2020 08:21	16/11/2020 03:16	15/11/2020 08:21	16/11/2020 03:16	18,91	1	18,91	CHI
20201168223	BOM JARDIM DE GOIAS	PH12201913	PIRANHAS	15/11/2020 08:22	15/11/2020 13:19	15/11/2020 08:22	15/11/2020 13:19	4,95	2	9,90	CHI
20201168223	PIRANHAS	PH12201913	PIRANHAS	15/11/2020 08:22	15/11/2020 13:19	15/11/2020 08:22	15/11/2020 13:19	4,95	11	54,44	CHI
20201168230	GOIANIA	GN11162208	GOIANIA LESTE S2	15/11/2020 08:22	15/11/2020 10:07	15/11/2020 10:03	15/11/2020 10:07	0,07	34	2,27	CHI
20201168257	ALEXANIA	CB12295651	ALEXANIA	15/11/2020 08:22	15/11/2020 13:53	15/11/2020 08:22	15/11/2020 13:53	5,51	2	11,03	CHI
20201168257	CORUMBA DE GOIAS	CB12295651	ALEXANIA	15/11/2020 08:22	15/11/2020 13:53	15/11/2020 08:22	15/11/2020 13:53	5,51	10	55,13	CHI
20201168765	GOIANIA	GN11000772	GOIANIA LESTE S3	15/11/2020 08:22	15/11/2020 12:15	15/11/2020 08:22	15/11/2020 12:15	3,88	19	73,79	CHI
20201168235	IPAMERI	IP21265568	CAMPO ALEGRE DE GOIAS	15/11/2020 08:23	15/11/2020 09:51	15/11/2020 08:23	15/11/2020 09:51	1,47	1	1,47	CHI
20201168251	ARAGOIANIA	AO21111921	GUAPO S2	15/11/2020 08:24	15/11/2020 10:05	15/11/2020 08:24	15/11/2020 10:05	1,67	2	3,34	CHI
20201168253	HIDROLANDIA	HD12007406	CEPAIGO S2	15/11/2020 08:25	15/11/2020 11:02	15/11/2020 08:25	15/11/2020 11:02	2,61	1	2,61	CHI
20201168254	RIO VERDE	630493080	RIO VERDE S1	15/11/2020 08:25	15/11/2020 19:33	15/11/2020 08:25	15/11/2020 19:33	11,13	1	11,13	CHI
20201168255	JARAGUA	JA12221349	JARAGUA	15/11/2020 08:25	15/11/2020 09:23	15/11/2020 08:25	15/11/2020 09:23	0,96	6	5,77	CHI
20201168287	GOIANESIA	GE10360300	GOIANESIA S2	15/11/2020 08:26	15/11/2020 09:55	15/11/2020 08:26	15/11/2020 09:55	1,49	507	753,60	CHI
20201168287	JARAGUA	GE10360300	GOIANESIA S2	15/11/2020 08:26	15/11/2020 09:55	15/11/2020 08:26	15/11/2020 09:55	1,49	496	737,25	CHI
20201168287	PIRENOPOLIS	GE10360300	GOIANESIA S2	15/11/2020 08:26	15/11/2020 09:55	15/11/2020 08:26	15/11/2020 09:55	1,49	1	1,49	CHI
20201168259	LUZIANIA	LZ21330648	PACAEMBU S2	15/11/2020 08:27	15/11/2020 11:42	15/11/2020 08:27	15/11/2020 11:42	3,25	1	3,25	CHI
20201168263	BONOPOLIS	BX12328842	NOVO PLANALTO	15/11/2020 08:27	15/11/2020 16:48	15/11/2020 08:27	15/11/2020 16:48	8,34	1	8,34	CHI
20201168331	ITUMBIARA	IT11352767	ITUMBIARA VELHA S1	15/11/2020 08:27	15/11/2020 09:45	15/11/2020 08:27	15/11/2020 09:45	1,29	53	68,31	CHI
20201168268	PLANALTINA	PI12139508	PLANALTINA	15/11/2020 08:28	15/11/2020 11:28	15/11/2020 08:28	15/11/2020 11:28	2,99	33	98,59	CHI
20201168271	FAINA	FC21084314	GOIAS	15/11/2020 08:29	16/11/2020 14:00	15/11/2020 08:29	16/11/2020 14:00	29,51	1	29,51	CHI
20201168273	PORTEIRAO	CL21301098	RIO DOS BOIS	15/11/2020 08:29	15/11/2020 21:03	15/11/2020 08:29	15/11/2020 21:03	12,55	1	12,55	CHI
20201168759	NOVA CRIXAS	NA12281144	NOVA CRIXAS	15/11/2020 08:30	15/11/2020 15:20	15/11/2020 08:30	15/11/2020 15:20	6,82	3	20,46	CHI
20201168290	GOIAS	IK21274271	GOIAS	15/11/2020 08:31	15/11/2020 13:22	15/11/2020 08:31	15/11/2020 13:22	4,83	1	4,83	CHI
20201168305	MARA ROSA	MQ12248126	MARA ROSA	15/11/2020 08:31	15/11/2020 11:22	15/11/2020 08:31	15/11/2020 11:22	2,85	17	48,39	CHI
20201168886	SANTA TEREZA DE GOIAS	SE12039889	MARA ROSA	15/11/2020 08:31	15/11/2020 16:30	15/11/2020 08:31	15/11/2020 16:30	7,98	34	271,41	CHI
20201168293	VIANOPOLIS	VN21107923	VIANOPOLIS	15/11/2020 08:32	15/11/2020 09:40	15/11/2020 08:32	15/11/2020 09:40	1,13	1	1,13	CHI
20201168294	SANTA HELENA DE GOIAS	SH12340820	SANTA HELENA S1	15/11/2020 08:32	15/11/2020 15:29	15/11/2020 08:32	15/11/2020 15:29	6,94	2	13,88	CHI
20201168295	IACIARA	IA12262079	IACIARA S1	15/11/2020 08:32	15/11/2020 11:21	15/11/2020 08:32	15/11/2020 11:21	2,80	21	58,85	CHI
20201168301	CORUMBA DE GOIAS	260008333	CORUMBA	15/11/2020 08:33	15/11/2020 11:04	15/11/2020 08:33	15/11/2020 11:04	2,50	1	2,50	CHI
20201168564	CRIXAS	CX12226949	SANTA TEREZINHA	15/11/2020 08:34	16/11/2020 10:17	15/11/2020 08:34	16/11/2020 10:17	25,71	11	282,79	CHI
20201168313	FORMOSA	FA31034753	SAO JOAO D ALIANCA	15/11/2020 08:36	15/11/2020 12:15	15/11/2020 08:36	15/11/2020 12:15	3,65	2	7,30	CHI
20201168315	RIO VERDE	RV21305754	MONTIVIDU T	15/11/2020 08:36	15/11/2020 11:43	15/11/2020 08:36	15/11/2020 11:43	3,11	1	3,11	CHI
20201164847	ESTRELA DO NORTE	MQ12150566	MARA ROSA	15/11/2020 08:37	16/11/2020 08:38	15/11/2020 08:37	16/11/2020 08:38	24,01	7	168,07	CHI
20201164847	MARA ROSA	MQ12150566	MARA ROSA	15/11/2020 08:37	16/11/2020 08:38	15/11/2020 08:37	16/11/2020 08:38	24,01	7	168,07	CHI
20201168319	CRISTALINA	KR21304809	CRISTALINA S2	15/11/2020 08:37	15/11/2020 12:41	15/11/2020 08:37	15/11/2020 12:41	4,05	1	4,05	CHI

20201169092	NOVA CRIXAS	NA12087039	NOVA CRIXAS	15/11/2020 08:37	16/11/2020 14:34	15/11/2020 08:37	16/11/2020 14:34	29,94	4	119,78	CHI
20201168322	RIO VERDE	RV12246752LD	CABRIUVA S2	15/11/2020 08:38	15/11/2020 14:55	15/11/2020 08:38	15/11/2020 14:55	6,28	18	113,00	CHI
20201168329	CRISTALINA	KR21320028	PAMPLONA	15/11/2020 08:40	15/11/2020 11:16	15/11/2020 08:40	15/11/2020 11:16	2,60	1	2,60	CHI
20201168335	MORRINHOS	MR12000104	MORRINHOS	15/11/2020 08:41	15/11/2020 10:02	15/11/2020 08:41	15/11/2020 10:02	1,34	3	4,02	CHI
20201168337	BOM JARDIM DE GOIAS	BM12286263	BOM JARDIM	15/11/2020 08:41	15/11/2020 10:30	15/11/2020 08:41	15/11/2020 10:30	1,80	5	9,00	CHI
20201168342	JATAI	JT21334168	JATAI S3	15/11/2020 08:42	15/11/2020 10:48	15/11/2020 08:42	15/11/2020 10:48	2,09	1	2,09	CHI
20201168345	SAO JOAO D ALIANCA	3840005502	SAO JOAO D ALIANCA	15/11/2020 08:43	15/11/2020 21:23	15/11/2020 08:43	15/11/2020 21:23	12,66	1	12,66	CHI
20201168348	MONTE ALEGRE DE GOIAS	MA12280214	SAO DOMINGOS	15/11/2020 08:44	15/11/2020 11:10	15/11/2020 08:44	15/11/2020 11:10	2,43	5	12,17	CHI
20201168354	CALDAS NOVAS	CN12110095	SERRA DE CALDAS	15/11/2020 08:44	15/11/2020 11:23	15/11/2020 08:44	15/11/2020 11:23	2,64	5	13,21	CHI
20201168371	ORIZONA	OZ12113707	PIRES DO RIO S2	15/11/2020 08:44	15/11/2020 15:08	15/11/2020 08:44	15/11/2020 15:08	6,39	4	25,56	CHI
20201168600	EDEIA	EA12394167	EDEIA	15/11/2020 08:44	15/11/2020 13:50	15/11/2020 08:44	15/11/2020 13:50	5,10	6	30,57	CHI
20201168881	NIQUELANDIA	NQ12262783	URUACU	15/11/2020 08:44	15/11/2020 10:55	15/11/2020 08:44	15/11/2020 10:55	2,18	3	6,53	CHI
20201168361	NOVA CRIXAS	NA12386663	NOVA CRIXAS	15/11/2020 08:45	17/11/2020 10:11	15/11/2020 08:45	17/11/2020 10:11	49,42	42	2075,54	CHI
20201168664	GOIAS	IK12274567	GOIAS	15/11/2020 08:45	15/11/2020 14:25	15/11/2020 08:45	15/11/2020 14:25	5,66	5	28,30	CHI
20201168363	SANTO ANTONIO DO DESCOBERTO	SN11128771	ALEXANIA	15/11/2020 08:46	15/11/2020 13:19	15/11/2020 08:46	15/11/2020 13:19	4,55	195	887,14	CHI
20201168662	PADRE BERNARDO	PB12234573	PADRE BERNARDO	15/11/2020 08:47	15/11/2020 10:59	15/11/2020 08:47	15/11/2020 10:59	2,20	7	15,37	CHI
20201168370	APARECIDA DE GOIANIA	15008850	REAL S1	15/11/2020 08:48	15/11/2020 11:19	15/11/2020 08:48	15/11/2020 11:19	2,52	1	2,52	CHI
20201168376	LEOPOLDO DE BULHOES	870021230	DAIA S2	15/11/2020 08:48	15/11/2020 11:52	15/11/2020 08:48	15/11/2020 11:52	3,05	1	3,05	CHI
20201168382	GOIANIA	14771986	GOIANIA LESTE S3	15/11/2020 08:49	15/11/2020 10:05	15/11/2020 08:49	15/11/2020 10:05	1,26	1	1,26	CHI
20201168393	GOIANIA	10947954	GOIANIA LESTE S2	15/11/2020 08:49	15/11/2020 10:59	15/11/2020 08:49	15/11/2020 10:59	2,16	1	2,16	CHI
20201168394	APARECIDA DE GOIANIA	200237550	INDEPENDENCIA S2	15/11/2020 08:50	15/11/2020 11:33	15/11/2020 08:50	15/11/2020 11:33	2,72	1	2,72	CHI
20201168396	CORUMBA DE GOIAS	CB21155245	CORUMBA	15/11/2020 08:50	15/11/2020 13:39	15/11/2020 08:50	15/11/2020 13:39	4,81	1	4,81	CHI
20201168398	PALMEIRAS DE GOIAS	PL12085225	PALMEIRAS	15/11/2020 08:50	15/11/2020 18:54	15/11/2020 08:50	15/11/2020 18:54	10,06	2	20,12	CHI
20201168400	ANAPOLIS	AN12000037	ANAPOLIS UNIVERSITARIO S2	15/11/2020 08:50	15/11/2020 09:25	15/11/2020 08:50	15/11/2020 09:25	0,57	450	258,12	CHI
20201168406	ANAPOLIS	AN12000026	ANAPOLIS UNIVERSITARIO S2	15/11/2020 08:51	15/11/2020 11:38	15/11/2020 08:51	15/11/2020 11:38	2,78	108	300,15	CHI
20201168408	CRISTALINA	KR21163686	CRISTALINA S1	15/11/2020 08:51	15/11/2020 12:52	15/11/2020 08:51	15/11/2020 12:52	4,01	1	4,01	CHI
20201168449	CALDAS NOVAS	320414	CALDAS NOVAS S1	15/11/2020 08:51	15/11/2020 13:33	15/11/2020 08:51	15/11/2020 09:30	0,65	287	185,35	CHI
20201168449	PIRACANJUBA	320414	CALDAS NOVAS S1	15/11/2020 08:51	15/11/2020 13:33	15/11/2020 08:51	15/11/2020 09:30	0,65	7	4,52	CHI
20201168449	SANTA CRUZ DE GOIAS	320414	CALDAS NOVAS S1	15/11/2020 08:51	15/11/2020 13:33	15/11/2020 08:51	15/11/2020 09:30	0,65	8	5,17	CHI
20201168449	CALDAS NOVAS	320414	CALDAS NOVAS S1	15/11/2020 08:51	15/11/2020 13:33	15/11/2020 08:51	15/11/2020 13:17	4,44	1	4,44	CHI
20201168449	CALDAS NOVAS	CN13092049	CALDAS NOVAS S1	15/11/2020 08:51	15/11/2020 13:33	15/11/2020 08:52	15/11/2020 13:17	4,43	2	8,86	CHI
20201168449	CALDAS NOVAS	320414	CALDAS NOVAS S1	15/11/2020 08:51	15/11/2020 13:33	15/11/2020 08:51	15/11/2020 13:33	4,69	1	4,69	CHI
20201168449	CALDAS NOVAS	320414	CALDAS NOVAS S1	15/11/2020 08:51	15/11/2020 13:33	15/11/2020 08:51	15/11/2020 13:33	4,69	5	23,46	CHI
20201168449	CALDAS NOVAS	320414	CALDAS NOVAS S1	15/11/2020 08:51	15/11/2020 13:33	15/11/2020 08:51	15/11/2020 13:33	4,69	4	18,77	CHI
20201168449	PIRACANJUBA	320414	CALDAS NOVAS S1	15/11/2020 08:51	15/11/2020 13:33	15/11/2020 08:51	15/11/2020 13:33	4,69	157	736,68	CHI
20201168449	PIRACANJUBA	320414	CALDAS NOVAS S1	15/11/2020 08:51	15/11/2020 13:33	15/11/2020 08:51	15/11/2020 13:33	4,69	77	361,30	CHI
20201168449	PIRACANJUBA	320414	CALDAS NOVAS S1	15/11/2020 08:51	15/11/2020 13:33	15/11/2020 08:51	15/11/2020 13:33	4,69	2	9,38	CHI
20201168449	SANTA CRUZ DE GOIAS	320414	CALDAS NOVAS S1	15/11/2020 08:51	15/11/2020 13:33	15/11/2020 08:51	15/11/2020 13:33	4,69	1	4,69	CHI
20201168449	PIRACANJUBA	320414	CALDAS NOVAS S1	15/11/2020 08:51	15/11/2020 13:33	15/11/2020 08:52	15/11/2020 13:33	4,69	10	46,86	CHI
20201168449	PIRACANJUBA	320414	CALDAS NOVAS S1	15/11/2020 08:51	15/11/2020 13:33	15/11/2020 08:52	15/11/2020 13:33	4,69	4	18,74	CHI
20201168421	INHUMAS	IN12012214	INHUMAS S2	15/11/2020 08:53	15/11/2020 10:03	15/11/2020 08:53	15/11/2020 10:03	1,16	180	208,35	CHI
20201168422	RIO VERDE	RV21355121	CABRIUVA S1	15/11/2020 08:53	15/11/2020 15:59	15/11/2020 08:53	15/11/2020 15:59	7,09	1	7,09	CHI
20201168423	HIDROLANDIA	HD21007411	CEPAIGO S2	15/11/2020 08:53	15/11/2020 12:56	15/11/2020 08:53	15/11/2020 12:56	4,04	1	4,04	CHI
20201168424	CORUMBA DE GOIAS	260037485	CORUMBA	15/11/2020 08:54	15/11/2020 12:26	15/11/2020 08:54	15/11/2020 12:26	3,53	1	3,53	CHI
20201168442	IPORA	IR12231138	ARENOPOLIS	15/11/2020 08:54	15/11/2020 12:12	15/11/2020 08:54	15/11/2020 12:12	3,30	1	3,30	CHI
20201168602	TAQUARAL DE GOIAS	TQ1229573	ITABERAÍ S1	15/11/2020 08:54	15/11/2020 14:39	15/11/2020 08:54	15/11/2020 14:39	5,74	22	126,36	CHI
20201168619	TAQUARAL DE GOIAS	TQ12376431	ITABERAÍ S1	15/11/2020 08:55	15/11/2020 15:16	15/11/2020 08:55	15/11/2020 15:16	6,34	8	50,75	CHI
20201168432	INACIOLANDIA	ID12128131	QUIRINOPOLIS	15/11/2020 08:56	15/11/2020 10:33	15/11/2020 08:56	15/11/2020 10:33	1,61	11	17,76	CHI
20201168434	ANAPOLIS	21060630	ANAPOLIS UNIVERSITARIO S2	15/11/2020 08:56	15/11/2020 10:18	15/11/2020 08:56	15/11/2020 10:18	1,36	1	1,36	CHI
20201168466	CROMINIA	CQ12000224	PONTALINA	15/11/2020 08:57	15/11/2020 11:40	15/11/2020 08:57	15/11/2020 11:40	2,71	3	8,14	CHI
20201168466	MAIRIPOTABA	CQ12000224	PONTALINA	15/11/2020 08:57	15/11/2020 11:40	15/11/2020 08:57	15/11/2020 11:40	2,71	2	5,43	CHI

20201168444	ANAPOLIS	20739126	ANAPOLIS UNIVERSITARIO S2	15/11/2020 08:58	15/11/2020 11:19	15/11/2020 08:58	15/11/2020 11:19	2,34	1	2,34	CHI
20201168446	MAURILANDIA	ML21303545	RIO DOS BOIS	15/11/2020 08:59	15/11/2020 10:41	15/11/2020 08:59	15/11/2020 10:41	1,70	1	1,70	CHI
20201168451	ANAPOLIS	10019116398	ANAPOLIS UNIVERSITARIO S2	15/11/2020 08:59	15/11/2020 10:21	15/11/2020 08:59	15/11/2020 10:21	1,35	1	1,35	CHI
20201168455	GOIATUBA	JV12026571	GOIATUBA S1	15/11/2020 09:00	15/11/2020 11:00	15/11/2020 09:00	15/11/2020 11:00	1,99	4	7,94	CHI
20201168456	CATALAO	CT21195418	CATALAO S1	15/11/2020 09:00	15/11/2020 09:59	15/11/2020 09:00	15/11/2020 09:59	0,97	1	0,97	CHI
20201168458	JUSSARA	1290030070	JUSSARA	15/11/2020 09:01	15/11/2020 12:22	15/11/2020 09:01	15/11/2020 12:22	3,35	1	3,35	CHI
20201168459	IPAMERI	IP12080281	PIRES DO RIO S2	15/11/2020 09:01	15/11/2020 19:24	15/11/2020 09:01	15/11/2020 19:24	10,38	4	41,50	CHI
20201168459	ORIZONA	IP12080281	PIRES DO RIO S2	15/11/2020 09:01	15/11/2020 19:24	15/11/2020 09:01	15/11/2020 19:24	10,38	1	10,38	CHI
20201168467	GOIANIA	GN21282852	GOIANIA LESTE S3	15/11/2020 09:04	15/11/2020 11:17	15/11/2020 09:04	15/11/2020 11:17	2,22	1	2,22	CHI
20201168469	CORUMBA DE GOIAS	260022834	CORUMBA	15/11/2020 09:04	15/11/2020 11:31	15/11/2020 09:04	15/11/2020 11:31	2,44	1	2,44	CHI
20201168471	CATALAO	CT21266971	CATALAO S1	15/11/2020 09:05	15/11/2020 10:08	15/11/2020 09:05	15/11/2020 10:08	1,05	2	2,09	CHI
20201171420	CAIAPONIA	CP12354340	CAIAPONIA	15/11/2020 09:06	16/11/2020 04:03	15/11/2020 09:06	16/11/2020 04:03	18,94	13	246,19	CHI
20201168482	MINEIROS	PW21206292	PARQUE DAS EMAS	15/11/2020 09:07	15/11/2020 12:14	15/11/2020 09:07	15/11/2020 12:14	3,11	1	3,11	CHI
20201168486	GOIANIA	11825200	CAMPINAS S2	15/11/2020 09:08	15/11/2020 11:11	15/11/2020 09:08	15/11/2020 11:11	2,05	1	2,05	CHI
20201168487	PARAUNA	PU21319339	PARAUNA	15/11/2020 09:08	15/11/2020 18:32	15/11/2020 09:08	15/11/2020 18:32	9,39	1	9,39	CHI
20201168488	CIDADE OCIDENTAL	DH12370719	MARAJOARA	15/11/2020 09:08	15/11/2020 10:48	15/11/2020 09:08	15/11/2020 10:48	1,66	6	9,96	CHI
20201168490	BRITANIA	BT21124837	BRITANIA	15/11/2020 09:08	15/11/2020 12:29	15/11/2020 09:08	15/11/2020 12:29	3,34	1	3,34	CHI
20201168491	SANTO ANTONIO DE GOIAS	GR12090049	NEROPOLIS S1	15/11/2020 09:08	15/11/2020 11:10	15/11/2020 09:08	15/11/2020 11:10	2,02	2	4,05	CHI
20201169709	ALTO HORIZONTE	AJ12375644	SANTA TEREZINHA	15/11/2020 09:08	15/11/2020 16:14	15/11/2020 09:08	15/11/2020 16:14	7,10	9	63,89	CHI
20201169709	PILAR DE GOIAS	AJ12375644	SANTA TEREZINHA	15/11/2020 09:08	15/11/2020 16:14	15/11/2020 09:08	15/11/2020 16:14	7,10	1	7,10	CHI
20201168495	PONTALINA	JV21352535	GOIATUBA S1	15/11/2020 09:09	15/11/2020 11:26	15/11/2020 09:09	15/11/2020 11:26	2,27	4	9,08	CHI
20201168499	BOM JESUS DE GOIAS	BJ21316678	CACHOEIRA DOURADA	15/11/2020 09:10	15/11/2020 13:00	15/11/2020 09:10	15/11/2020 13:00	3,82	1	3,82	CHI
20201168521	CAIAPONIA	CP12235069	CAIAPONIA	15/11/2020 09:10	15/11/2020 17:17	15/11/2020 09:10	15/11/2020 17:17	8,10	6	48,61	CHI
20201168526	GOIANIA	12940173	REAL S2	15/11/2020 09:12	15/11/2020 10:10	15/11/2020 09:12	15/11/2020 10:10	0,95	1	0,95	CHI
20201168528	RIO VERDE	RV11136155	RIO VERDE S1	15/11/2020 09:13	15/11/2020 11:56	15/11/2020 09:13	15/11/2020 11:56	2,71	101	273,74	CHI
20201168530	PIRACANJUBA	PJ21020067	MORRINHOS	15/11/2020 09:14	15/11/2020 10:33	15/11/2020 09:14	15/11/2020 10:33	1,31	1	1,31	CHI
20201168531	RIO VERDE	630073790	RIO VERDE S1	15/11/2020 09:14	15/11/2020 17:39	15/11/2020 09:14	15/11/2020 17:39	8,41	1	8,41	CHI
20201168540	GOIANIA	15203049	GOYA S1	15/11/2020 09:15	15/11/2020 12:25	15/11/2020 09:15	15/11/2020 12:25	3,15	1	3,15	CHI
20201168548	PORANGATU	PO21236239	NOVO PLANALTO	15/11/2020 09:18	15/11/2020 11:39	15/11/2020 09:18	15/11/2020 11:39	2,34	1	2,34	CHI
20201168549	PORTEIRAO	CL12303607	RIO DOS BOIS	15/11/2020 09:18	15/11/2020 12:47	15/11/2020 09:18	15/11/2020 12:47	3,48	2	6,95	CHI
20201168618	SAO MIGUEL DO ARAGUAIA	SM12151032	SAO MIGUEL DO ARAGUAIA	15/11/2020 09:18	15/11/2020 14:20	15/11/2020 09:18	15/11/2020 14:20	5,02	9	45,16	CHI
20201168857	MARZAGAO	MG12098609	VILA CORUMBA	15/11/2020 09:19	15/11/2020 13:12	15/11/2020 09:19	15/11/2020 13:12	3,88	5	19,40	CHI
20201168560	CORREGO DO OURO	CO21311136	SAO LUIZ DOS MONTES BELOS	15/11/2020 09:20	15/11/2020 10:58	15/11/2020 09:20	15/11/2020 10:58	1,63	1	1,63	CHI
20201168561	MAMBAI	MB11109324	IACIARA S2	15/11/2020 09:20	15/11/2020 09:43	15/11/2020 09:20	15/11/2020 09:43	0,37	94	34,68	CHI
20201168563	ANAPOLIS	20714210	JUNDIAI S2	15/11/2020 09:21	15/11/2020 11:32	15/11/2020 09:21	15/11/2020 11:32	2,18	1	2,18	CHI
20201168571	MOZARLANDIA	MZ21058553	MOZARLANDIA	15/11/2020 09:22	15/11/2020 21:52	15/11/2020 09:22	15/11/2020 21:52	12,49	1	12,49	CHI
20201169486	PORTEIRAO	TD12230952	RIO DOS BOIS	15/11/2020 09:22	15/11/2020 20:20	15/11/2020 09:22	15/11/2020 20:20	10,96	1	10,96	CHI
20201169486	TURVELANDIA	TD12230952	RIO DOS BOIS	15/11/2020 09:22	15/11/2020 20:20	15/11/2020 09:22	15/11/2020 20:20	10,96	5	54,82	CHI
20201169173	CRIXAS	GF12243493	SANTA TEREZINHA	15/11/2020 09:23	15/11/2020 17:19	15/11/2020 09:23	15/11/2020 17:19	7,93	3	23,78	CHI
20201169173	GUARINOS	GF12243493	SANTA TEREZINHA	15/11/2020 09:23	15/11/2020 17:19	15/11/2020 09:23	15/11/2020 17:19	7,93	13	103,05	CHI
20201168576	PARANAIGUARA	PC12035750LD	CACHOEIRA ALTA	15/11/2020 09:24	15/11/2020 18:05	15/11/2020 09:24	15/11/2020 18:05	8,68	32	277,66	CHI
20201168578	APARECIDA DE GOIANIA	AP11350595	ANHANGUERA	15/11/2020 09:24	15/11/2020 12:04	15/11/2020 09:24	15/11/2020 12:04	2,66	56	148,82	CHI
20201168579	CAMPO ALEGRE DE GOIAS	CM21073555	CAMPO ALEGRE DE GOIAS	15/11/2020 09:24	15/11/2020 15:10	15/11/2020 09:24	15/11/2020 15:10	5,75	1	5,75	CHI
20201168670	CAIAPONIA	CP12235316	PIRANHAS	15/11/2020 09:24	15/11/2020 14:58	15/11/2020 09:24	15/11/2020 14:58	5,57	6	33,40	CHI
20201168584	GOIANIA	15280068	GOYA S2	15/11/2020 09:25	15/11/2020 10:15	15/11/2020 09:25	15/11/2020 10:15	0,83	1	0,83	CHI
20201168587	CIDADE OCIDENTAL	2680000955	MARAJOARA	15/11/2020 09:26	15/11/2020 19:11	15/11/2020 09:26	15/11/2020 19:11	9,75	1	9,75	CHI
20201168589	GOIANIRA	10027028222	GOIANIRA	15/11/2020 09:26	15/11/2020 10:06	15/11/2020 09:26	15/11/2020 10:06	0,66	1	0,66	CHI
20201168611	CACHOEIRA DOURADA	CD12222457	CACHOEIRA DOURADA	15/11/2020 09:26	15/11/2020 10:51	15/11/2020 09:26	15/11/2020 10:51	1,41	3	4,23	CHI
20201168593	NIQUELANDIA	NQ21360527	NIQUELANDIA SUBTRANSMISSAO	15/11/2020 09:27	15/11/2020 11:09	15/11/2020 09:27	15/11/2020 11:09	1,70	2	3,40	CHI
20201168596	PLANALTINA	PB12281764	PADRE BERNARDO	15/11/2020 09:27	15/11/2020 12:50	15/11/2020 09:27	15/11/2020 12:50	3,37	13	43,79	CHI
20201168673	GOIANIRA	GR12343414	GOIANIRA	15/11/2020 09:27	15/11/2020 10:59	15/11/2020 09:27	15/11/2020 10:59	1,53	212	323,30	CHI



20201168598	CUMARI	CT21344512	CATALAO S2	15/11/2020 09:29	15/11/2020 11:27	15/11/2020 09:29	15/11/2020 11:27	1,97	1	1,97	CHI
20201168603	RIO VERDE	RV12151915	SANTA HELENA S1	15/11/2020 09:30	15/11/2020 12:47	15/11/2020 09:30	15/11/2020 12:47	3,27	11	35,94	CHI
20201168605	RIO VERDE	RV21350910	SANTA HELENA S1	15/11/2020 09:31	15/11/2020 12:19	15/11/2020 09:31	15/11/2020 12:19	2,80	1	2,80	CHI
20201168606	GOIANIA	10649177	CAMPINAS S3	15/11/2020 09:31	15/11/2020 10:39	15/11/2020 09:31	15/11/2020 10:39	1,12	1	1,12	CHI
20201168607	FORMOSA	FA21208710	ITUIQUIRA	15/11/2020 09:32	15/11/2020 11:14	15/11/2020 09:32	15/11/2020 11:14	1,69	1	1,69	CHI
20201168760	GOIANESIA	550210295	GOIANESIA S2	15/11/2020 09:33	15/11/2020 17:49	15/11/2020 09:33	15/11/2020 17:49	8,26	1	8,26	CHI
20201169153	SERRANOPOLIS	SX12260467	JATAI S1	15/11/2020 09:33	15/11/2020 16:11	15/11/2020 09:33	15/11/2020 16:11	6,62	8	52,95	CHI
20201168625	AURILANDIA	AI12000010	FIRMINOPOLIS S2	15/11/2020 09:34	15/11/2020 11:24	15/11/2020 09:34	15/11/2020 11:24	1,82	2	3,64	CHI
20201168625	FIRMINOPOLIS	AI12000010	FIRMINOPOLIS S2	15/11/2020 09:34	15/11/2020 11:24	15/11/2020 09:34	15/11/2020 11:24	1,82	6	10,91	CHI
20201168628	PILAR DE GOIAS	GG21238005	SANTA TEREZINHA	15/11/2020 09:35	15/11/2020 13:12	15/11/2020 09:35	15/11/2020 13:12	3,60	1	3,60	CHI
20201168656	PLANALTINA	PI12085617RE	PLANALTINA	15/11/2020 09:36	15/11/2020 10:20	15/11/2020 09:36	15/11/2020 10:20	0,73	415	302,26	CHI
20201168696	FORMOSA	FA12427569	SAO JOAO D ALIANCA	15/11/2020 09:36	15/11/2020 15:59	15/11/2020 09:36	15/11/2020 15:59	6,37	3	19,11	CHI
20201168636	SANTA HELENA DE GOIAS	SH21000187	IPEGUARI	15/11/2020 09:39	15/11/2020 13:08	15/11/2020 09:39	15/11/2020 13:08	3,47	1	3,47	CHI
20201168642	PIRENOPOLIS	PV12302141	SAO FRANCISCO DE GOIAS	15/11/2020 09:40	15/11/2020 10:49	15/11/2020 09:40	15/11/2020 10:49	1,15	94	108,00	CHI
20201168643	SAO LUIS DE MONTES BELOS	SL32145789	SAO LUIZ DOS MONTES BELOS	15/11/2020 09:40	15/11/2020 17:49	15/11/2020 09:40	15/11/2020 17:49	8,15	3	24,44	CHI
20201168644	SENADOR CANEDO	SW21082422	CEPAIGO S2	15/11/2020 09:40	15/11/2020 11:42	15/11/2020 09:40	15/11/2020 11:42	2,03	1	2,03	CHI
20201168645	FAZENDA NOVA	FN21183349	IPORA	15/11/2020 09:40	15/11/2020 12:00	15/11/2020 09:40	15/11/2020 12:00	2,32	1	2,32	CHI
20201168653	NOVA ROMA	SD12067690	IACIARA S2	15/11/2020 09:40	15/11/2020 11:48	15/11/2020 09:40	15/11/2020 11:48	2,12	1	2,12	CHI
20201168653	SAO DOMINGOS	SD12067690	IACIARA S2	15/11/2020 09:40	15/11/2020 11:48	15/11/2020 09:40	15/11/2020 11:48	2,12	2	4,25	CHI
20201168655	GOIANIA	13772363	CAMPINAS S2	15/11/2020 09:42	15/11/2020 11:31	15/11/2020 09:42	15/11/2020 11:31	1,82	1	1,82	CHI
20201168661	GOIANIRA	390075322	GOIANIRA	15/11/2020 09:43	15/11/2020 12:18	15/11/2020 09:43	15/11/2020 12:18	2,58	1	2,58	CHI
20201168666	GOIANIA	11887850	GOYA S2	15/11/2020 09:43	15/11/2020 11:16	15/11/2020 09:43	15/11/2020 11:16	1,54	1	1,54	CHI
20201168672	PONTALINA	PK12181924	VICENTINOPOLIS	15/11/2020 09:45	15/11/2020 16:18	15/11/2020 09:45	15/11/2020 16:18	6,54	21	137,35	CHI
20201168678	PIRENOPOLIS	PV12008496	CORUMBA	15/11/2020 09:47	15/11/2020 12:43	15/11/2020 09:47	15/11/2020 12:43	2,93	3	8,80	CHI
20201168679	PADRE BERNARDO	PB12092844	PADRE BERNARDO	15/11/2020 09:47	15/11/2020 11:28	15/11/2020 09:47	15/11/2020 11:28	1,68	5	8,40	CHI
20201168681	PIRACANJUBA	PJ12083085	PIRACANJUBA	15/11/2020 09:47	15/11/2020 12:43	15/11/2020 09:47	15/11/2020 12:43	2,93	9	26,37	CHI
20201168683	PALMEIRAS DE GOIAS	PL12000095	PALMEIRAS	15/11/2020 09:47	15/11/2020 10:34	15/11/2020 09:47	15/11/2020 10:34	0,77	12	9,29	CHI
20201169082	SANTA TEREZINHA DE GOIAS	SG12048775	SANTA TEREZINHA	15/11/2020 09:47	15/11/2020 20:23	15/11/2020 09:47	15/11/2020 18:27	8,65	9	77,87	CHI
20201169082	SANTA TEREZINHA DE GOIAS	SG12277264LD	SANTA TEREZINHA	15/11/2020 09:47	15/11/2020 20:23	15/11/2020 09:47	15/11/2020 20:23	10,59	2	21,18	CHI
20201168688	PIRENOPOLIS	PV21290054	SAO FRANCISCO DE GOIAS	15/11/2020 09:48	15/11/2020 11:29	15/11/2020 09:48	15/11/2020 11:29	1,68	1	1,68	CHI
20201168769	LUZIANIA	LZ12013824	VIANOPOLIS	15/11/2020 09:48	15/11/2020 15:05	15/11/2020 09:48	15/11/2020 15:05	5,27	17	89,60	CHI
20201170440	PORANGATU	PO12020580	PORANGATU	15/11/2020 09:48	17/11/2020 19:35	15/11/2020 09:48	15/11/2020 21:08	11,34	5	56,68	CHI
20201170440	PORANGATU	PO12020580	PORANGATU	15/11/2020 09:48	17/11/2020 19:35	16/11/2020 17:45	16/11/2020 18:20	0,58	5	2,89	CHI
20201170440	PORANGATU	PO12020580	PORANGATU	15/11/2020 09:48	17/11/2020 19:35	16/11/2020 20:06	16/11/2020 21:25	1,31	5	6,56	CHI
20201170440	PORANGATU	PO12020580	PORANGATU	15/11/2020 09:48	17/11/2020 19:35	15/11/2020 09:48	17/11/2020 13:53	52,09	13	677,13	CHI
20201170440	PORANGATU	PO12020580	PORANGATU	15/11/2020 09:48	17/11/2020 19:35	15/11/2020 09:48	17/11/2020 16:21	54,56	3	163,68	CHI
20201170440	PORANGATU	PO12020580	PORANGATU	15/11/2020 09:48	17/11/2020 19:35	15/11/2020 09:48	17/11/2020 17:33	55,76	23	1282,50	CHI
20201170440	PORANGATU	PO12020580	PORANGATU	15/11/2020 09:48	17/11/2020 19:35	15/11/2020 09:48	17/11/2020 18:33	56,76	20	1135,28	CHI
20201170440	PORANGATU	PO12020580	PORANGATU	15/11/2020 09:48	17/11/2020 19:35	15/11/2020 09:48	17/11/2020 19:35	57,79	4	231,16	CHI
20201168692	ITAPURANGA	10017031565	ITAPURANGA	15/11/2020 09:49	15/11/2020 11:46	15/11/2020 09:49	15/11/2020 11:46	1,94	1	1,94	CHI
20201168923	NOVA IGUACU DE GOIAS	NH12262884	SANTA TEREZINHA	15/11/2020 09:50	15/11/2020 22:33	15/11/2020 09:50	15/11/2020 22:33	12,71	5	63,55	CHI
20201168698	MONTES CLAROS DE GOIAS	ME21227847	IPORA	15/11/2020 09:51	15/11/2020 10:51	15/11/2020 09:51	15/11/2020 10:51	1,00	1	1,00	CHI
20201168701	PIRES DO RIO	PR12083163	PIRES DO RIO S1	15/11/2020 09:51	15/11/2020 18:31	15/11/2020 09:51	15/11/2020 18:31	8,65	5	43,25	CHI
20201168705	AGUA FRIA DE GOIAS	TL21337425	SAO JOAO D ALIANCA	15/11/2020 09:52	15/11/2020 20:04	15/11/2020 09:52	15/11/2020 20:04	10,19	1	10,19	CHI
20201168723	FORMOSA	FA12218278	SAO JOAO D ALIANCA	15/11/2020 09:54	15/11/2020 11:32	15/11/2020 09:54	15/11/2020 11:32	1,62	3	4,85	CHI
20201171345	MOZARLANDIA	MZ12057110	MOZARLANDIA	15/11/2020 09:54	16/11/2020 01:07	15/11/2020 09:54	16/11/2020 01:07	15,21	5	76,03	CHI
20201168716	ANAPOLIS	AN21285309	ANAPOLIS UNIVERSITARIO S2	15/11/2020 09:55	15/11/2020 12:16	15/11/2020 09:55	15/11/2020 12:16	2,35	1	2,35	CHI
20201168719	GOIANIA	12603557	GOIANIA LESTE S3	15/11/2020 09:55	15/11/2020 11:08	15/11/2020 09:55	15/11/2020 11:08	1,20	1	1,20	CHI
20201168870	PORANGATU	PO12136349	NOVO PLANALTO	15/11/2020 09:55	15/11/2020 14:19	15/11/2020 09:55	15/11/2020 14:19	4,39	23	101,00	CHI
20201168721	CORUMBA DE GOIAS	CB12382386	CORUMBA	15/11/2020 09:56	15/11/2020 14:18	15/11/2020 09:56	15/11/2020 14:18	4,36	2	8,73	CHI
20201168722	CORUMBA DE GOIAS	10006426881	CORUMBA	15/11/2020 09:56	15/11/2020 12:33	15/11/2020 09:56	15/11/2020 12:33	2,61	1	2,61	CHI

20201168726	CRISTALINA	LZ12261748	CRISTALINA S2	15/11/2020 09:56	15/11/2020 12:56	15/11/2020 09:56	15/11/2020 12:56	2,99	2	5,98	CHI
20201168726	LUZIANIA	LZ12261748	CRISTALINA S2	15/11/2020 09:56	15/11/2020 12:56	15/11/2020 09:56	15/11/2020 12:56	2,99	2	5,98	CHI
20201168907	CAMPO LIMPO	OV12317357	NEROPOLIS S2	15/11/2020 09:56	15/11/2020 12:17	15/11/2020 09:56	15/11/2020 12:17	2,34	2	4,67	CHI
20201168907	OURO VERDE DE GOIAS	OV12317357	NEROPOLIS S2	15/11/2020 09:56	15/11/2020 12:17	15/11/2020 09:56	15/11/2020 12:17	2,34	33	77,06	CHI
20201168739	FORMOSA	FA11357442	SAO JOAO D ALIANCA	15/11/2020 09:57	15/11/2020 12:16	15/11/2020 09:57	15/11/2020 12:16	2,31	1	2,31	CHI
20201168740	SAO MIGUEL DO ARAGUAIA	SM21000023	SAO MIGUEL DO ARAGUAIA	15/11/2020 09:57	17/11/2020 07:42	15/11/2020 09:57	17/11/2020 07:42	45,74	1	45,74	CHI
20201168746	PLANALTINA	PI13361361	SAO JOAO D ALIANCA	15/11/2020 09:57	15/11/2020 12:30	15/11/2020 10:26	15/11/2020 12:30	2,05	50	102,71	CHI
20201168872	GOIANESIA	GE18423654TS	GOIANESIA S2	15/11/2020 09:57	15/11/2020 14:50	15/11/2020 09:57	15/11/2020 14:50	4,87	171	832,30	CHI
20201168872	VILA PROPICIO	GE18423654TS	GOIANESIA S2	15/11/2020 09:57	15/11/2020 14:50	15/11/2020 09:57	15/11/2020 14:50	4,87	18	87,61	CHI
20201169050	PADRE BERNARDO	PB12169086	PADRE BERNARDO	15/11/2020 09:57	15/11/2020 13:11	15/11/2020 09:57	15/11/2020 13:11	3,23	3	9,68	CHI
20201168743	ABADIA DE GOIAS	10032306901	TRINDADE	15/11/2020 09:58	15/11/2020 13:05	15/11/2020 09:58	15/11/2020 13:05	3,12	1	3,12	CHI
20201168744	GOIATUBA	GT12052877	GOIATUBA S1	15/11/2020 09:58	15/11/2020 12:28	15/11/2020 09:58	15/11/2020 12:28	2,50	4	10,00	CHI
20201168748	GOIANIRA	390052176	GOIANIRA	15/11/2020 09:59	15/11/2020 11:27	15/11/2020 09:59	15/11/2020 11:27	1,46	1	1,46	CHI
20201168750	ALTO HORIZONTE	AJ12162968	SANTA TEREZINHA	15/11/2020 09:59	15/11/2020 16:27	15/11/2020 09:59	15/11/2020 16:27	6,46	2	12,92	CHI
20201168761	SANTO ANTONIO DO DESCOBERTO	SN21338485	MARAJOARA	15/11/2020 10:01	15/11/2020 11:17	15/11/2020 10:01	15/11/2020 11:17	1,25	1	1,25	CHI
20201168763	PIRACANJUBA	PJ12016720	MORRINHOS	15/11/2020 10:02	15/11/2020 11:25	15/11/2020 10:02	15/11/2020 11:25	1,37	5	6,87	CHI
20201168768	BURITINOPOLIS	1000983096	IACIARA S2	15/11/2020 10:03	15/11/2020 11:22	15/11/2020 10:03	15/11/2020 11:22	1,32	1	1,32	CHI
20201168774	CORREGO DO OURO	CO12319967	FIRMINOPOLIS S2	15/11/2020 10:05	15/11/2020 12:57	15/11/2020 10:05	15/11/2020 12:57	2,86	4	11,44	CHI
20201168776	SAO MIGUEL DO ARAGUAIA	SM21208918	SAO MIGUEL DO ARAGUAIA	15/11/2020 10:06	16/11/2020 11:53	15/11/2020 10:06	16/11/2020 11:53	25,78	1	25,78	CHI
20201169541	NOVA CRIXAS	NA12158763	NOVA CRIXAS	15/11/2020 10:06	16/11/2020 19:10	15/11/2020 10:06	16/11/2020 19:10	33,05	16	528,87	CHI
20201168781	INHUMAS	IN12320360	INHUMAS S2	15/11/2020 10:07	15/11/2020 12:11	15/11/2020 10:07	15/11/2020 12:11	2,06	170	349,87	CHI
20201168988	ITAPURANGA	IK12311013	ITAPURANGA	15/11/2020 10:07	15/11/2020 14:49	15/11/2020 10:07	15/11/2020 14:49	4,69	38	178,22	CHI
20201168786	TRINDADE	16996720	GOYA S2	15/11/2020 10:08	15/11/2020 16:26	15/11/2020 10:08	15/11/2020 16:26	6,29	1	6,29	CHI
20201168789	CACU	CC12080196	CACHOEIRA ALTA	15/11/2020 10:09	15/11/2020 11:42	15/11/2020 10:09	15/11/2020 11:42	1,54	5	7,72	CHI
20201168792	NOVA IGUAQU DE GOIAS	CR12161154	MARA ROSA	15/11/2020 10:09	15/11/2020 12:50	15/11/2020 10:09	15/11/2020 12:50	2,67	4	10,67	CHI
20201168798	ANAPOLIS	20120072	ANAPOLIS UNIVERSITARIO S2	15/11/2020 10:10	15/11/2020 10:56	15/11/2020 10:10	15/11/2020 10:56	0,76	1	0,76	CHI
20201168801	RIO VERDE	RV21062678	MONTIVIDIU T	15/11/2020 10:11	15/11/2020 13:16	15/11/2020 10:11	15/11/2020 13:16	3,08	1	3,08	CHI
20201168804	SERRANOPOLIS	SX21264357	JATAI S1	15/11/2020 10:11	15/11/2020 14:14	15/11/2020 10:11	15/11/2020 14:14	4,04	1	4,04	CHI
20201168807	JATAI	290134020	JATAI S2	15/11/2020 10:13	15/11/2020 10:53	15/11/2020 10:13	15/11/2020 10:53	0,67	1	0,67	CHI
20201168809	JARAGUA	JA21328492	JARAGUA	15/11/2020 10:13	15/11/2020 11:03	15/11/2020 10:13	15/11/2020 11:03	0,83	1	0,83	CHI
20201169029	PIRACANJUBA	PJ12000032	PIRACANJUBA	15/11/2020 10:14	15/11/2020 12:22	15/11/2020 10:14	15/11/2020 12:22	2,12	3	6,36	CHI
20201168815	ARAGOIANIA	AO21387317	GUAPO S2	15/11/2020 10:15	15/11/2020 17:51	15/11/2020 10:15	15/11/2020 17:51	7,60	2	15,20	CHI
20201168818	JARAGUA	JA12059976	JARAGUA	15/11/2020 10:15	15/11/2020 13:07	15/11/2020 10:15	15/11/2020 13:07	2,85	2	5,71	CHI
20201168818	PIRENOPOLIS	JA12059976	JARAGUA	15/11/2020 10:15	15/11/2020 13:07	15/11/2020 10:15	15/11/2020 13:07	2,85	98	279,74	CHI
20201168819	NOVO GAMA	10000659329	PACAEMBU S1	15/11/2020 10:16	15/11/2020 12:58	15/11/2020 10:16	15/11/2020 12:58	2,70	1	2,70	CHI
20201168820	JARAGUA	JA21099139	JARAGUA	15/11/2020 10:16	15/11/2020 11:50	15/11/2020 10:16	15/11/2020 11:50	1,56	1	1,56	CHI
20201168827	CALDAS NOVAS	CN12392135	VILA CORUMBA	15/11/2020 10:16	15/11/2020 12:50	15/11/2020 10:16	15/11/2020 12:50	2,56	2	5,11	CHI
20201168972	CALDAZINHA	SW12317421	SENADOR CANEDO	15/11/2020 10:16	15/11/2020 11:50	15/11/2020 10:16	15/11/2020 11:50	1,56	28	43,67	CHI
20201168972	SENADOR CANEDO	SW12317421	SENADOR CANEDO	15/11/2020 10:16	15/11/2020 11:50	15/11/2020 10:16	15/11/2020 11:50	1,56	5	7,80	CHI
20201168835	JATAI	JT21205200	JATAI S1	15/11/2020 10:18	15/11/2020 17:50	15/11/2020 10:18	15/11/2020 17:50	7,53	1	7,53	CHI
20201168885	DOVERLANDIA	DV12171957	CAIAPONIA	15/11/2020 10:18	15/11/2020 11:34	15/11/2020 10:18	15/11/2020 11:34	1,27	24	30,37	CHI
20201168836	LUZIANIA	LZ11031098	RIO VERMELHO	15/11/2020 10:19	15/11/2020 12:19	15/11/2020 10:19	15/11/2020 12:19	2,00	9	18,00	CHI
20201168838	PIRACANJUBA	PJ21182747	PIRACANJUBA	15/11/2020 10:19	15/11/2020 12:16	15/11/2020 10:19	15/11/2020 12:16	1,94	1	1,94	CHI
20201168841	ALEXANIA	AX11393481	ALEXANIA	15/11/2020 10:20	15/11/2020 12:31	15/11/2020 10:20	15/11/2020 12:31	2,18	25	54,50	CHI
20201168842	TURVELANDIA	TD21240366	RIO DOS BOIS	15/11/2020 10:20	15/11/2020 22:19	15/11/2020 10:20	15/11/2020 22:19	11,98	1	11,98	CHI
20201168843	NIQUELANDIA	NQ21083025	URUACU	15/11/2020 10:20	15/11/2020 13:13	15/11/2020 10:20	15/11/2020 13:13	2,87	1	2,87	CHI
20201168854	ORIZONA	OZ12094841	PIRES DO RIO S2	15/11/2020 10:22	15/11/2020 14:45	15/11/2020 10:22	15/11/2020 14:45	4,37	6	26,24	CHI
20201168856	SAO MIGUEL DO ARAGUAIA	SM21138134	SAO MIGUEL DO ARAGUAIA	15/11/2020 10:22	16/11/2020 12:26	15/11/2020 10:22	16/11/2020 12:26	26,05	1	26,05	CHI
20201168865	CRISTALINA	KR21163113	CRISTALINA S1	15/11/2020 10:25	15/11/2020 15:56	15/11/2020 10:25	15/11/2020 15:56	5,50	1	5,50	CHI
20201170799	CAIAPONIA	CP21117510	CAIAPONIA	15/11/2020 10:25	16/11/2020 04:23	15/11/2020 10:25	16/11/2020 04:23	17,97	1	17,97	CHI
20201168873	TRINDADE	11569232	GOYA S2	15/11/2020 10:26	15/11/2020 13:12	15/11/2020 10:26	15/11/2020 13:12	2,76	1	2,76	CHI

20201168906	MONTIVIDIU DO NORTE	MX12391928	PORANGATU	15/11/2020 10:26	17/11/2020 18:45	15/11/2020 10:26	16/11/2020 09:04	22,63	12	271,61	CHI
20201168906	MONTIVIDIU DO NORTE	MX12391928	PORANGATU	15/11/2020 10:26	17/11/2020 18:45	15/11/2020 10:26	16/11/2020 09:54	23,47	6	140,79	CHI
20201168906	MONTIVIDIU DO NORTE	MX12391928	PORANGATU	15/11/2020 10:26	17/11/2020 18:45	15/11/2020 10:26	17/11/2020 18:45	56,31	2	112,62	CHI
20201168876	ALEXANIA	AX21159091	ALEXANIA	15/11/2020 10:27	15/11/2020 16:56	15/11/2020 10:27	15/11/2020 16:56	6,47	2	12,94	CHI
20201169592	TROMBAS	TB12240756	PORANGATU	15/11/2020 10:29	15/11/2020 15:52	15/11/2020 10:29	15/11/2020 15:52	5,38	47	252,99	CHI
20201168888	CAMPINORTE	CR21101011	CAMPINORTE	15/11/2020 10:30	15/11/2020 16:20	15/11/2020 10:30	15/11/2020 16:20	5,83	1	5,83	CHI
20201168889	RIO VERDE	RV12091961LD	SANTA HELENA S1	15/11/2020 10:30	15/11/2020 14:43	15/11/2020 10:30	15/11/2020 14:43	4,21	3	12,63	CHI
20201168892	ITAPURANGA	10012965438	ITAPURANGA	15/11/2020 10:31	15/11/2020 17:00	15/11/2020 10:31	15/11/2020 17:00	6,48	1	6,48	CHI
20201168894	NIQUELANDIA	NQ12210221	URUACU	15/11/2020 10:31	15/11/2020 14:22	15/11/2020 10:31	15/11/2020 14:22	3,84	2	7,67	CHI
20201168896	ORIZONA	OZ11073421	PIRES DO RIO S2	15/11/2020 10:32	15/11/2020 11:49	15/11/2020 10:32	15/11/2020 11:49	1,28	24	30,77	CHI
20201168900	PIRACANJUBA	PJ12082241LD	PIRACANJUBA	15/11/2020 10:34	16/11/2020 12:21	15/11/2020 10:34	16/11/2020 12:21	25,78	8	206,20	CHI
20201168902	ITAPACI	IW21081376	ITAPACI	15/11/2020 10:34	15/11/2020 15:51	15/11/2020 10:34	15/11/2020 15:51	5,28	1	5,28	CHI
20201168903	GOIANESIA	GE21256008	GOIANESIA S2	15/11/2020 10:34	15/11/2020 16:19	15/11/2020 10:34	15/11/2020 16:19	5,73	1	5,73	CHI
20201168909	CATALAO	CT21143442	CATALAO S1	15/11/2020 10:36	15/11/2020 12:05	15/11/2020 10:36	15/11/2020 12:05	1,47	2	2,94	CHI
20201168912	ABADIA DE GOIAS	TR12391385	GUAPO S1	15/11/2020 10:37	15/11/2020 12:55	15/11/2020 10:37	15/11/2020 12:55	2,29	106	243,18	CHI
20201168912	GUAPO	TR12391385	GUAPO S1	15/11/2020 10:37	15/11/2020 12:55	15/11/2020 10:37	15/11/2020 12:55	2,29	4	9,18	CHI
20201168914	RIO VERDE	630038843	RIO VERDE S1	15/11/2020 10:37	15/11/2020 14:50	15/11/2020 10:37	15/11/2020 14:50	4,20	1	4,20	CHI
20201168934	CRISTALINA	KR21074916	CRISTALINA S2	15/11/2020 10:41	15/11/2020 11:37	15/11/2020 10:41	15/11/2020 11:37	0,93	1	0,93	CHI
20201169264	CALDAS NOVAS	CN12110281	CALDAS NOVAS S1	15/11/2020 10:41	15/11/2020 18:23	15/11/2020 10:41	15/11/2020 18:23	7,70	17	130,86	CHI
20201168935	ANAPOLIS	AN21270423	ANAPOLIS UNIVERSITARIO S2	15/11/2020 10:42	15/11/2020 12:42	15/11/2020 10:42	15/11/2020 12:42	2,00	1	2,00	CHI
20201168936	LEOPOLDO DE BULHOES	870021096	DAIA S2	15/11/2020 10:42	15/11/2020 12:33	15/11/2020 10:42	15/11/2020 12:33	1,85	1	1,85	CHI
20201168938	PIRENOPOLIS	PV21080644	CORUMBA	15/11/2020 10:42	15/11/2020 11:18	15/11/2020 10:42	15/11/2020 11:18	0,59	2	1,18	CHI
20201168939	BELA VISTA DE GOIAS	SV12383417	DAIA S2	15/11/2020 10:42	15/11/2020 13:56	15/11/2020 10:42	15/11/2020 13:56	3,22	1	3,22	CHI
20201168939	CALDAZINHA	SV12383417	DAIA S2	15/11/2020 10:42	15/11/2020 13:56	15/11/2020 10:42	15/11/2020 13:56	3,22	34	109,48	CHI
20201168939	LEOPOLDO DE BULHOES	SV12383417	DAIA S2	15/11/2020 10:42	15/11/2020 13:56	15/11/2020 10:42	15/11/2020 13:56	3,22	3	9,66	CHI
20201168939	SILVANIA	SV12383417	DAIA S2	15/11/2020 10:42	15/11/2020 13:56	15/11/2020 10:42	15/11/2020 13:56	3,22	55	177,10	CHI
20201169508	PLANALTINA	PI12129929	PLANALTINA	15/11/2020 10:43	15/11/2020 17:49	15/11/2020 10:43	15/11/2020 17:49	7,10	32	227,16	CHI
20201168945	ITAUCU	IX12000013	INHUMAS S1	15/11/2020 10:44	15/11/2020 12:58	15/11/2020 10:44	15/11/2020 12:58	2,23	349	778,95	CHI
20201168221	ALTO HORIZONTE	9640008120	SANTA TEREZINHA	15/11/2020 10:46	15/11/2020 15:16	15/11/2020 10:46	15/11/2020 15:16	4,49	1	4,49	CHI
20201168957	NIQUELANDIA	NQ21088705	URUACU	15/11/2020 10:48	15/11/2020 13:01	15/11/2020 10:48	15/11/2020 13:01	2,21	2	4,43	CHI
20201168959	ALTO HORIZONTE	9640010862	SANTA TEREZINHA	15/11/2020 10:48	17/11/2020 15:21	15/11/2020 10:48	15/11/2020 15:21	52,54	1	52,54	CHI
20201169511	CAIAPONIA	CP12338830	CAIAPONIA	15/11/2020 10:49	16/11/2020 03:08	15/11/2020 10:49	16/11/2020 03:08	16,31	12	195,71	CHI
20201168964	CABECEIRAS	CW21184629	ITUIQUIRA	15/11/2020 10:50	15/11/2020 11:53	15/11/2020 10:50	15/11/2020 11:53	1,03	1	1,03	CHI
20201168968	CATURAI	10028278915	GOIANIRA	15/11/2020 10:52	15/11/2020 14:12	15/11/2020 10:52	15/11/2020 14:12	3,32	1	3,32	CHI
20201168971	SANTA HELENA DE GOIAS	400055223	IPEGUARI	15/11/2020 10:54	15/11/2020 13:56	15/11/2020 10:54	15/11/2020 13:56	3,03	1	3,03	CHI
20201168973	RIO VERDE	RV21204142	CABRIUVA S2	15/11/2020 10:55	15/11/2020 15:35	15/11/2020 10:55	15/11/2020 15:35	4,67	1	4,67	CHI
20201168976	JUSSARA	JR12101204	JUSSARA	15/11/2020 10:55	15/11/2020 20:26	15/11/2020 10:55	15/11/2020 20:26	9,50	30	285,05	CHI
20201168980	BELA VISTA DE GOIAS	BV12054821	BELA VISTA S1	15/11/2020 10:57	15/11/2020 11:49	15/11/2020 10:57	15/11/2020 11:49	0,87	9	7,79	CHI
20201168981	ANAPOLIS	AN21376556	ANAPOLIS UNIVERSITARIO S2	15/11/2020 10:57	15/11/2020 12:18	15/11/2020 10:57	15/11/2020 12:18	1,34	2	2,69	CHI
20201168985	CATALAO	1990150552	CATALAO S2	15/11/2020 10:58	15/11/2020 13:14	15/11/2020 10:58	15/11/2020 13:14	2,26	1	2,26	CHI
20201168991	PLANALTINA	PI12329786	SAO JOAO D ALIANCA	15/11/2020 11:00	15/11/2020 12:40	15/11/2020 11:00	15/11/2020 12:40	1,67	2	3,33	CHI
20201168993	ITAPURANGA	IK21210461	ITAPURANGA	15/11/2020 11:00	15/11/2020 14:06	15/11/2020 11:00	15/11/2020 14:06	3,10	1	3,10	CHI
20201170252	TROMBAS	TB12397527	PORANGATU	15/11/2020 11:00	16/11/2020 23:32	15/11/2020 11:00	16/11/2020 23:32	36,53	17	621,08	CHI
20201168997	AGUAS LINDAS DE GOIAS	4830072119	AGUAS LINDAS DE GOIAS S1	15/11/2020 11:01	15/11/2020 12:52	15/11/2020 11:01	15/11/2020 12:52	1,85	1	1,85	CHI
20201168998	GOIANIA	GN21338083	AEROPORTO S3	15/11/2020 11:01	15/11/2020 15:10	15/11/2020 11:01	15/11/2020 15:10	4,15	1	4,15	CHI
20201168999	CAVALCANTE	TI12162624	NIQUELANDIA SUBTRANSMISSAO	15/11/2020 11:01	15/11/2020 14:05	15/11/2020 11:01	15/11/2020 14:05	3,06	49	149,93	CHI
20201168999	COLINAS DO SUL	TI12162624	NIQUELANDIA SUBTRANSMISSAO	15/11/2020 11:01	15/11/2020 14:05	15/11/2020 11:01	15/11/2020 14:05	3,06	6	18,36	CHI
20201169000	ANAPOLIS	20490033	ANAPOLIS UNIVERSITARIO S2	15/11/2020 11:01	15/11/2020 12:26	15/11/2020 11:01	15/11/2020 12:26	1,41	1	1,41	CHI
20201169001	ITAPURANGA	IK21311327	ITAPURANGA	15/11/2020 11:02	15/11/2020 15:10	15/11/2020 11:02	15/11/2020 15:10	4,13	3	12,40	CHI
20201169009	PIRANHAS	PH12188274	PIRANHAS	15/11/2020 11:03	15/11/2020 22:19	15/11/2020 11:03	15/11/2020 22:19	11,25	1	11,25	CHI
20201169699	PORANGATU	PO12020945	PORANGATU	15/11/2020 11:03	16/11/2020 04:32	15/11/2020 11:03	16/11/2020 04:32	17,48	6	104,89	CHI

20201169010	IPAMERI	580029414	IPAMERI	15/11/2020 11:04	15/11/2020 15:01	15/11/2020 11:04	15/11/2020 15:01	3,94	1	3,94	CHI
20201169011	ANICUNS	AC21299243	FIRMINOPOLIS S2	15/11/2020 11:04	15/11/2020 14:43	15/11/2020 11:04	15/11/2020 14:43	3,64	1	3,64	CHI
20201169015	AGUAS LINDAS DE GOIAS	4830334321	AGUAS LINDAS DE GOIAS S1	15/11/2020 11:06	15/11/2020 12:26	15/11/2020 11:06	15/11/2020 12:26	1,33	1	1,33	CHI
20201169060	DOVERLANDIA	DV12381010	CAIAPONIA	15/11/2020 11:06	15/11/2020 13:27	15/11/2020 11:06	15/11/2020 13:27	2,34	4	9,36	CHI
20201169402	ANAPOLIS	AN12000680	JUNDIAI S1	15/11/2020 11:06	15/11/2020 15:35	15/11/2020 11:06	15/11/2020 15:35	4,48	315	1410,06	CHI
20201169021	CATALAO	1990000750	CATALAO S2	15/11/2020 11:07	15/11/2020 16:50	15/11/2020 11:07	15/11/2020 16:50	5,70	1	5,70	CHI
20201168375	MOZARLANDIA	MZ12064155	MOZARLANDIA	15/11/2020 11:08	16/11/2020 01:02	15/11/2020 11:08	16/11/2020 01:02	13,89	14	194,48	CHI
20201169804	FAINA	MS12036227	ITAPURANGA	15/11/2020 11:08	15/11/2020 19:18	15/11/2020 11:08	15/11/2020 19:18	8,16	11	89,80	CHI
20201169804	MORRO AGUDO DE GOIAS	MS12036227	ITAPURANGA	15/11/2020 11:08	15/11/2020 19:18	15/11/2020 11:08	15/11/2020 19:18	8,16	27	220,41	CHI
20201169028	PIRES DO RIO	PR12404749	PIRES DO RIO S1	15/11/2020 11:09	15/11/2020 13:27	15/11/2020 11:09	15/11/2020 13:27	2,30	1	2,30	CHI
20201169034	GOIANIA	13209553	FERROVIARIO S1	15/11/2020 11:09	15/11/2020 12:01	15/11/2020 11:09	15/11/2020 12:01	0,85	1	0,85	CHI
20201169113	ABADIANIA	AX12351038	ALEXANIA	15/11/2020 11:10	15/11/2020 14:31	15/11/2020 11:10	15/11/2020 14:31	3,34	7	23,35	CHI
20201169113	ALEXANIA	AX12351038	ALEXANIA	15/11/2020 11:10	15/11/2020 14:31	15/11/2020 11:10	15/11/2020 14:31	3,34	63	210,16	CHI
20201169732	AGUA FRIA DE GOIAS	TL12320523	SAO JOAO D ALIANCA	15/11/2020 11:10	15/11/2020 19:39	15/11/2020 11:10	15/11/2020 19:39	8,47	12	101,67	CHI
20201169062	TRINDADE	40181716	TRINDADE	15/11/2020 11:17	15/11/2020 12:41	15/11/2020 11:17	15/11/2020 12:41	1,39	1	1,39	CHI
20201169063	LEOPOLDO DE BULHOES	10032747347	DAIA S1	15/11/2020 11:18	15/11/2020 13:46	15/11/2020 11:18	15/11/2020 13:46	2,46	1	2,46	CHI
20201169065	SENADOR CANEDO	10030331259	SENADOR CANEDO	15/11/2020 11:20	15/11/2020 12:58	15/11/2020 11:20	15/11/2020 12:58	1,62	1	1,62	CHI
20201169066	MINACU	IH21293567	MINACU	15/11/2020 11:20	18/11/2020 09:12	15/11/2020 11:20	18/11/2020 09:12	69,85	2	139,70	CHI
20201169071	APARECIDA DE GOIANIA	200240808	INDEPENDENCIA S1	15/11/2020 11:22	15/11/2020 12:15	15/11/2020 11:22	15/11/2020 12:15	0,87	1	0,87	CHI
20201169085	VILA PROPICIO	NP12382400	GOIANESIA S1	15/11/2020 11:26	15/11/2020 19:42	15/11/2020 11:26	15/11/2020 19:42	8,25	5	41,27	CHI
20201169086	APARECIDA DE GOIANIA	200461485	INDEPENDENCIA S2	15/11/2020 11:27	15/11/2020 13:46	15/11/2020 11:27	15/11/2020 13:46	2,32	1	2,32	CHI
20201169089	JATAI	290242721	JATAI S3	15/11/2020 11:27	15/11/2020 16:29	15/11/2020 11:27	15/11/2020 16:29	5,02	1	5,02	CHI
20201169090	IPORA	IR21340577	ARENOPOLIS	15/11/2020 11:27	15/11/2020 15:55	15/11/2020 11:27	15/11/2020 15:55	4,46	1	4,46	CHI
20201169093	QUIRINOPOLIS	80024592	QUIRINOPOLIS	15/11/2020 11:29	15/11/2020 13:41	15/11/2020 11:29	15/11/2020 13:41	2,20	1	2,20	CHI
20201169095	ITAPURANGA	IK21250913	ITAPURANGA	15/11/2020 11:30	15/11/2020 19:56	15/11/2020 11:30	15/11/2020 19:56	8,43	1	8,43	CHI
20201169096	SANTO ANTONIO DE GOIAS	BW12145999	NEROPOLIS S1	15/11/2020 11:30	15/11/2020 14:09	15/11/2020 11:30	15/11/2020 14:09	2,66	51	135,76	CHI
20201169107	GOIAS	HE10400387	ITABERAI S1	15/11/2020 11:31	15/11/2020 12:21	15/11/2020 12:17	15/11/2020 12:21	0,08	40	3,06	CHI
20201169107	HEITORAI	HE10400387	ITABERAI S1	15/11/2020 11:31	15/11/2020 12:21	15/11/2020 12:17	15/11/2020 12:21	0,08	26	1,99	CHI
20201169107	HEITORAI	IB13140204	ITABERAI S1	15/11/2020 11:31	15/11/2020 12:21	15/11/2020 12:17	15/11/2020 12:21	0,08	2	0,15	CHI
20201169107	ITABERAI	HE10400387	ITABERAI S1	15/11/2020 11:31	15/11/2020 12:21	15/11/2020 12:17	15/11/2020 12:21	0,08	222	16,96	CHI
20201169107	ITABERAI	IB13140204	ITABERAI S1	15/11/2020 11:31	15/11/2020 12:21	15/11/2020 12:17	15/11/2020 12:21	0,08	5	0,38	CHI
20201169142	JATAI	JT11182142	JATAI S3	15/11/2020 11:31	15/11/2020 13:29	15/11/2020 11:31	15/11/2020 13:29	1,96	57	111,66	CHI
20201169105	CABECEIRAS	CW12181812	ITUIQUIRA	15/11/2020 11:33	15/11/2020 13:12	15/11/2020 11:33	15/11/2020 13:12	1,65	2	3,30	CHI
20201169106	JARAGUA	70079201	JARAGUA	15/11/2020 11:33	15/11/2020 13:13	15/11/2020 11:33	15/11/2020 13:13	1,65	1	1,65	CHI
20201169112	CACU	CC21305851	CACHOEIRA ALTA	15/11/2020 11:34	15/11/2020 14:23	15/11/2020 11:34	15/11/2020 14:23	2,80	1	2,80	CHI
20201169151	GOIANIA	BW16407507	NEROPOLIS S1	15/11/2020 11:34	15/11/2020 12:26	15/11/2020 11:34	15/11/2020 12:26	0,86	141	121,14	CHI
20201169151	NEROPOLIS	BW16407507	NEROPOLIS S1	15/11/2020 11:34	15/11/2020 12:26	15/11/2020 11:34	15/11/2020 12:26	0,86	17	14,61	CHI
20201169151	NOVA VENEZA	BW16407507	NEROPOLIS S1	15/11/2020 11:34	15/11/2020 12:26	15/11/2020 11:34	15/11/2020 12:26	0,86	1	0,86	CHI
20201169151	SANTO ANTONIO DE GOIAS	BW16407507	NEROPOLIS S1	15/11/2020 11:34	15/11/2020 12:26	15/11/2020 11:34	15/11/2020 12:26	0,86	588	505,19	CHI
20201169136	RUBIATABA	RB12201363	RUBIATABA	15/11/2020 11:35	15/11/2020 13:12	15/11/2020 11:35	15/11/2020 13:12	1,61	14	22,53	CHI
20201169120	PONTALINA	PK21381132	PONTALINA	15/11/2020 11:36	15/11/2020 13:20	15/11/2020 11:36	15/11/2020 13:20	1,73	1	1,73	CHI
20201169122	QUIRINOPOLIS	80005275	QUIRINOPOLIS	15/11/2020 11:36	15/11/2020 12:57	15/11/2020 11:36	15/11/2020 12:57	1,34	1	1,34	CHI
20201169124	CALDAS NOVAS	760201493	SERRA DE CALDAS	15/11/2020 11:37	15/11/2020 16:56	15/11/2020 11:37	15/11/2020 16:56	5,31	1	5,31	CHI
20201169179	TRES RANCHOS	TH12063818RE	CATALAO S1	15/11/2020 11:37	15/11/2020 14:35	15/11/2020 11:37	15/11/2020 14:35	2,96	69	204,57	CHI
20201169209	VARJAO	VJ12346703	GUAPO S2	15/11/2020 11:37	15/11/2020 14:12	15/11/2020 11:37	15/11/2020 14:12	2,57	5	12,84	CHI
20201169129	GAMELEIRA DE GOIAS	SV21076023	DAIA S2	15/11/2020 11:38	15/11/2020 13:17	15/11/2020 11:38	15/11/2020 13:17	1,65	1	1,65	CHI
20201169131	SITIO D ABADIA	SI12325441	IACIARA S2	15/11/2020 11:38	15/11/2020 14:55	15/11/2020 11:38	15/11/2020 14:55	3,28	4	13,10	CHI
20201169132	GOIANIA	10949410	FERROVIARIO S1	15/11/2020 11:38	15/11/2020 13:05	15/11/2020 11:38	15/11/2020 13:05	1,44	1	1,44	CHI
20201169133	SERRANOPOLIS	JT21267521	JATAI S1	15/11/2020 11:38	15/11/2020 13:47	15/11/2020 11:38	15/11/2020 13:47	2,14	1	2,14	CHI
20201169135	APARECIDA DE GOIANIA	200327604	INDEPENDENCIA S1	15/11/2020 11:38	15/11/2020 14:50	15/11/2020 11:38	15/11/2020 14:50	3,18	1	3,18	CHI
20201169137	HIDROLANDIA	HD21062183	CEPAIGO S1	15/11/2020 11:41	15/11/2020 15:07	15/11/2020 11:41	15/11/2020 15:07	3,43	1	3,43	CHI

20201169138	COCALZINHO DE GOIAS	ZN21193810	COCALZINHO	15/11/2020 11:41	15/11/2020 17:37	15/11/2020 11:41	15/11/2020 17:37	5,92	1	5,92	CHI
20201169144	VALPARAISO DE GOIAS	10007903500	PACAEMBU S1	15/11/2020 11:42	15/11/2020 17:08	15/11/2020 11:42	15/11/2020 17:08	5,43	1	5,43	CHI
20201169146	DOVERLANDIA	DV12380973	CAIAPONIA	15/11/2020 11:43	15/11/2020 14:09	15/11/2020 11:43	15/11/2020 14:09	2,43	2	4,87	CHI
20201169149	NIQUELANDIA	NQ12237524	URUACU	15/11/2020 11:45	16/11/2020 12:37	15/11/2020 11:45	16/11/2020 12:37	24,88	5	124,40	CHI
20201169155	SAO MIGUEL DO ARAGUAIA	SM12059987	SAO MIGUEL DO ARAGUAIA	15/11/2020 11:46	16/11/2020 05:40	15/11/2020 11:46	16/11/2020 05:40	17,90	3	53,70	CHI
20201169156	VIANOPOLIS	VN21286036	VIANOPOLIS	15/11/2020 11:46	15/11/2020 12:48	15/11/2020 11:46	15/11/2020 12:48	1,03	1	1,03	CHI
20201169158	FORMOSA	FA31051149	SAO JOAO D ALIANCA	15/11/2020 11:47	15/11/2020 13:03	15/11/2020 11:47	15/11/2020 13:03	1,26	1	1,26	CHI
20201169162	CRISTALINA	KR21165875	CRISTALINA S2	15/11/2020 11:49	15/11/2020 13:19	15/11/2020 11:49	15/11/2020 13:19	1,50	2	2,99	CHI
20201169163	SENADOR CANEDO	11557758	CEPAIGO S1	15/11/2020 11:49	15/11/2020 14:35	15/11/2020 11:49	15/11/2020 14:35	2,76	1	2,76	CHI
20201169169	AGUA FRIA DE GOIAS	TL21385506	SAO JOAO D ALIANCA	15/11/2020 11:49	15/11/2020 18:06	15/11/2020 11:49	15/11/2020 18:06	6,27	1	6,27	CHI
20201169171	AGUA FRIA DE GOIAS	TL12356189	SAO JOAO D ALIANCA	15/11/2020 11:49	15/11/2020 22:34	15/11/2020 11:49	15/11/2020 22:34	10,73	4	42,94	CHI
20201169874	SAO JOAO D ALIANCA	JL12144641	SAO JOAO D ALIANCA	15/11/2020 11:50	15/11/2020 17:00	15/11/2020 11:50	15/11/2020 17:00	5,15	6	30,93	CHI
20201169183	SAO JOAO D ALIANCA	JL12383340	SAO JOAO D ALIANCA	15/11/2020 11:55	15/11/2020 16:13	15/11/2020 11:55	15/11/2020 16:13	4,29	77	330,16	CHI
20201169570	SANTA TEREZINHA DE GOIAS	VD12251078	SANTA TEREZINHA	15/11/2020 11:56	15/11/2020 16:01	15/11/2020 11:56	15/11/2020 16:01	4,08	3	12,23	CHI
20201169457	MARA ROSA	MQ12146959	MARA ROSA	15/11/2020 11:57	16/11/2020 00:39	15/11/2020 11:57	15/11/2020 18:49	6,86	3	20,59	CHI
20201169457	MARA ROSA	MQ12187990LD	MARA ROSA	15/11/2020 11:57	16/11/2020 00:39	15/11/2020 11:57	16/11/2020 00:39	12,70	8	101,62	CHI
20201169457	NOVA IGUACU DE GOIAS	MQ12187990LD	MARA ROSA	15/11/2020 11:57	16/11/2020 00:39	15/11/2020 11:57	16/11/2020 00:39	12,70	12	152,43	CHI
20201169189	GUAPO	GA21160676	GUAPO S2	15/11/2020 11:58	15/11/2020 13:13	15/11/2020 11:58	15/11/2020 13:13	1,25	1	1,25	CHI
20201169191	NOVA VENEZA	NV16424172	INHUMAS S1	15/11/2020 11:58	15/11/2020 15:53	15/11/2020 11:58	15/11/2020 15:53	3,92	4	15,69	CHI
20201169191	BRAZABRANTES	NV16424172	INHUMAS S1	15/11/2020 11:58	15/11/2020 15:53	15/11/2020 15:49	15/11/2020 15:53	0,07	60	4,13	CHI
20201169191	INHUMAS	NV16424172	INHUMAS S1	15/11/2020 11:58	15/11/2020 15:53	15/11/2020 15:49	15/11/2020 15:53	0,07	19	1,31	CHI
20201169191	NOVA VENEZA	NV16424172	INHUMAS S1	15/11/2020 11:58	15/11/2020 15:53	15/11/2020 15:49	15/11/2020 15:53	0,07	442	30,45	CHI
20201169194	MATRINCHA	4380006002	MATRINCHA	15/11/2020 11:59	15/11/2020 15:19	15/11/2020 11:59	15/11/2020 15:19	3,32	1	3,32	CHI
20201170013	CATALAO	CT12067758	CATALAO S2	15/11/2020 12:01	15/11/2020 17:54	15/11/2020 12:01	15/11/2020 17:54	5,88	8	47,00	CHI
20201169202	NIQUELANDIA	NQ12157261	URUACU	15/11/2020 12:02	15/11/2020 14:00	15/11/2020 12:02	15/11/2020 14:00	1,96	1	1,96	CHI
20201168659	SANTO ANTONIO DO DESCOBERTO	SN21363559	MARAJOARA	15/11/2020 12:03	15/11/2020 19:14	15/11/2020 12:03	15/11/2020 19:14	7,18	1	7,18	CHI
20201169220	GAMELEIRA DE GOIAS	AN12285354	ANAPOLIS UNIVERSITARIO S2	15/11/2020 12:03	15/11/2020 14:50	15/11/2020 12:03	15/11/2020 14:50	2,77	8	22,16	CHI
20201169220	SILVANIA	AN12285354	ANAPOLIS UNIVERSITARIO S2	15/11/2020 12:03	15/11/2020 14:50	15/11/2020 12:03	15/11/2020 14:50	2,77	20	55,41	CHI
20201169208	VIANOPOLIS	VN12051613	VIANOPOLIS	15/11/2020 12:04	15/11/2020 14:45	15/11/2020 12:04	15/11/2020 14:45	2,68	15	40,24	CHI
20201169497	ACREUNA	EU12044265	ACREUNA	15/11/2020 12:04	15/11/2020 17:58	15/11/2020 12:04	15/11/2020 17:58	5,90	8	47,18	CHI
20201169497	PARAUNA	EU12044265	ACREUNA	15/11/2020 12:04	15/11/2020 17:58	15/11/2020 12:04	15/11/2020 17:58	5,90	4	23,59	CHI
20201169218	BOM JARDIM DE GOIAS	BM21382224	BOM JARDIM	15/11/2020 12:07	15/11/2020 14:38	15/11/2020 12:07	15/11/2020 14:38	2,51	1	2,51	CHI
20201169219	PADRE BERNARDO	PB12163212	PADRE BERNARDO	15/11/2020 12:07	15/11/2020 13:11	15/11/2020 12:07	15/11/2020 13:11	1,06	22	23,29	CHI
20201169221	GOIANIA	14465541	XAVANTES	15/11/2020 12:07	15/11/2020 14:55	15/11/2020 12:07	15/11/2020 14:55	2,79	1	2,79	CHI
20201169228	FORMOSA	610173388	ITIQUIRA	15/11/2020 12:09	15/11/2020 15:07	15/11/2020 12:09	15/11/2020 15:07	2,96	1	2,96	CHI
20201169229	NIQUELANDIA	NQ12378056	NIQUELANDIA SUBTRANSMISSAO	15/11/2020 12:10	15/11/2020 14:14	15/11/2020 12:10	15/11/2020 14:14	2,07	5	10,33	CHI
20201169233	ITAPIRAPUA	3270001676	MATRINCHA	15/11/2020 12:10	15/11/2020 14:03	15/11/2020 12:10	15/11/2020 14:03	1,87	1	1,87	CHI
20201169234	VICENTINOPOLIS	VI21309823	VICENTINOPOLIS	15/11/2020 12:11	15/11/2020 18:55	15/11/2020 12:11	15/11/2020 18:55	6,73	1	6,73	CHI
20201169235	APARECIDA DE GOIANIA	AP11044782	INDEPENDENCIA S2	15/11/2020 12:11	15/11/2020 16:15	15/11/2020 12:11	15/11/2020 16:15	4,06	129	523,88	CHI
20201169243	AGUA FRIA DE GOIAS	JL12270094	SAO JOAO D ALIANCA	15/11/2020 12:11	15/11/2020 15:13	15/11/2020 12:11	15/11/2020 15:13	3,02	1	3,02	CHI
20201169243	SAO JOAO D ALIANCA	JL12270094	SAO JOAO D ALIANCA	15/11/2020 12:11	15/11/2020 15:13	15/11/2020 12:11	15/11/2020 15:13	3,02	8	24,19	CHI
20201169240	ANAPOLIS	LB12078506	DAIA S2	15/11/2020 12:12	15/11/2020 13:26	15/11/2020 12:12	15/11/2020 13:26	1,22	9	10,98	CHI
20201169240	LEOPOLDO DE BULHOES	LB12078506	DAIA S2	15/11/2020 12:12	15/11/2020 13:26	15/11/2020 12:12	15/11/2020 13:26	1,22	6	7,32	CHI
20201170310	ORIZONA	OZ12275794	PIRES DO RIO S2	15/11/2020 12:12	15/11/2020 19:00	15/11/2020 12:12	15/11/2020 19:00	6,80	12	81,58	CHI
20201169246	AGUA LIMPA	AL21263207	VILA CORUMBA	15/11/2020 12:14	15/11/2020 14:00	15/11/2020 12:14	15/11/2020 14:00	1,77	1	1,77	CHI
20201169254	CRIXAS	UP12171789RE	SANTA TEREZINHA	15/11/2020 12:14	15/11/2020 16:35	15/11/2020 12:14	15/11/2020 16:35	4,34	14	60,77	CHI
20201169254	UIRAPURU	UP12171789RE	SANTA TEREZINHA	15/11/2020 12:14	15/11/2020 16:35	15/11/2020 12:14	15/11/2020 16:35	4,34	48	208,36	CHI
20201170435	NOVO PLANALTO	SM12074386RE	SAO MIGUEL DO ARAGUAIA	15/11/2020 12:15	16/11/2020 00:33	15/11/2020 12:15	16/11/2020 00:33	12,29	6	73,75	CHI
20201170435	SAO MIGUEL DO ARAGUAIA	SM12074386RE	SAO MIGUEL DO ARAGUAIA	15/11/2020 12:15	16/11/2020 00:33	15/11/2020 12:15	16/11/2020 00:33	12,29	135	1659,41	CHI
20201169259	SENADOR CANEDO	10008462672	SENADOR CANEDO	15/11/2020 12:16	15/11/2020 13:29	15/11/2020 12:16	15/11/2020 13:29	1,21	1	1,21	CHI
20201169261	FAZENDA NOVA	FN21051872	FIRMINOPOLIS S2	15/11/2020 12:16	16/11/2020 13:25	15/11/2020 12:16	16/11/2020 13:25	25,14	1	25,14	CHI



20201169263	CAMPINACU	IH10284240	MINACU	15/11/2020 12:17	16/11/2020 03:47	15/11/2020 12:17	15/11/2020 14:09	1,87	24	44,94	CHI
20201169263	MINACU	IH10284240	MINACU	15/11/2020 12:17	16/11/2020 03:47	15/11/2020 12:17	15/11/2020 14:09	1,87	1608	3010,98	CHI
20201169263	TROMBAS	IH10284240	MINACU	15/11/2020 12:17	16/11/2020 03:47	15/11/2020 12:17	15/11/2020 14:09	1,87	6	11,23	CHI
20201169263	CAMPINACU	IH10284240	MINACU	15/11/2020 12:17	16/11/2020 03:47	15/11/2020 14:12	15/11/2020 14:15	0,05	24	1,25	CHI
20201169263	MINACU	IH10284240	MINACU	15/11/2020 12:17	16/11/2020 03:47	15/11/2020 14:12	15/11/2020 14:15	0,05	386	20,05	CHI
20201169263	MINACU	IH10284240	MINACU	15/11/2020 12:17	16/11/2020 03:47	15/11/2020 14:12	15/11/2020 20:17	6,08	357	2170,56	CHI
20201169263	MINACU	IH10284240	MINACU	15/11/2020 12:17	16/11/2020 03:47	15/11/2020 14:12	15/11/2020 21:00	6,80	578	3932,97	CHI
20201169263	MINACU	IH10284240	MINACU	15/11/2020 12:17	16/11/2020 03:47	15/11/2020 14:12	15/11/2020 21:03	6,84	272	1860,86	CHI
20201169263	MINACU	IH10284240	MINACU	15/11/2020 12:17	16/11/2020 03:47	15/11/2020 14:12	16/11/2020 03:47	13,57	2	27,14	CHI
20201169265	DOVERLANDIA	DV21092250	CAIAPONIA	15/11/2020 12:17	15/11/2020 13:19	15/11/2020 12:17	15/11/2020 13:19	1,03	1	1,03	CHI
20201170733	MINACU	IH12396734	MINACU	15/11/2020 12:17	17/11/2020 14:55	15/11/2020 14:12	17/11/2020 14:55	48,71	61	2971,02	CHI
20201170733	TROMBAS	IH12396734	MINACU	15/11/2020 12:17	17/11/2020 14:55	15/11/2020 14:12	17/11/2020 14:55	48,71	6	292,23	CHI
20201169267	SANTO ANTONIO DO DESCOBERTO	7596983	ALEXANIA	15/11/2020 12:18	15/11/2020 16:33	15/11/2020 12:18	15/11/2020 16:33	4,25	11	46,74	CHI
20201169273	MORRINHOS	MR21112471	MORRINHOS	15/11/2020 12:19	15/11/2020 13:55	15/11/2020 12:19	15/11/2020 13:55	1,59	1	1,59	CHI
20201169277	NIQUELANDIA	NQ21218706	SAO JOAO D ALIANCA	15/11/2020 12:21	15/11/2020 18:38	15/11/2020 12:21	15/11/2020 18:38	6,27	1	6,27	CHI
20201169452	FAZENDA NOVA	FN12060710	IPORA	15/11/2020 12:21	15/11/2020 15:04	15/11/2020 12:21	15/11/2020 15:04	2,70	48	129,81	CHI
20201169280	CAMPOS BELOS	MA12209854	SAO DOMINGOS	15/11/2020 12:22	15/11/2020 13:21	15/11/2020 12:22	15/11/2020 13:21	0,98	4	3,93	CHI
20201169280	MONTE ALEGRE DE GOIAS	MA12209854	SAO DOMINGOS	15/11/2020 12:22	15/11/2020 13:21	15/11/2020 12:22	15/11/2020 13:21	0,98	18	17,70	CHI
20201169281	CABECEIRAS	860018556	ITIQUEIRA	15/11/2020 12:22	15/11/2020 16:57	15/11/2020 12:22	15/11/2020 16:57	4,58	1	4,58	CHI
20201169286	APARECIDA DE GOIANIA	13884920	INDEPENDENCIA S2	15/11/2020 12:22	15/11/2020 14:24	15/11/2020 12:22	15/11/2020 14:24	2,03	1	2,03	CHI
20201169294	ANAPOLIS	AN21008375	ANAPOLIS UNIVERSITARIO S2	15/11/2020 12:23	15/11/2020 13:48	15/11/2020 12:23	15/11/2020 13:48	1,40	1	1,40	CHI
20201169312	SAO JOAO D ALIANCA	JL12049201	SAO JOAO D ALIANCA	15/11/2020 12:23	15/11/2020 15:14	15/11/2020 12:23	15/11/2020 15:14	2,84	95	270,20	CHI
20201170569	NOVA CRIXAS	NA11061588	NOVA CRIXAS	15/11/2020 12:23	16/11/2020 04:16	15/11/2020 12:23	16/11/2020 04:16	15,87	59	936,61	CHI
20201169295	PLANALTINA	PI21139688	PLANALTINA	15/11/2020 12:24	15/11/2020 19:39	15/11/2020 12:24	15/11/2020 19:39	7,25	1	7,25	CHI
20201169297	CORUMBAIBA	560033011	VILA CORUMBA	15/11/2020 12:24	15/11/2020 14:45	15/11/2020 12:24	15/11/2020 14:45	2,34	1	2,34	CHI
20201170317	ACREUNA	TD12025737	RIO DOS BOIS	15/11/2020 12:24	15/11/2020 19:01	15/11/2020 12:24	15/11/2020 19:01	6,60	26	171,62	CHI
20201170317	SANTA HELENA DE GOIAS	TD12025737	RIO DOS BOIS	15/11/2020 12:24	15/11/2020 19:01	15/11/2020 12:24	15/11/2020 19:01	6,60	18	118,82	CHI
20201170317	TURVELANDIA	TD12025737	RIO DOS BOIS	15/11/2020 12:24	15/11/2020 19:01	15/11/2020 12:24	15/11/2020 19:01	6,60	65	429,05	CHI
20201169593	VILA PROPICIO	NP12196266	GOIANESIA S1	15/11/2020 12:25	15/11/2020 15:52	15/11/2020 12:25	15/11/2020 15:52	3,44	23	79,02	CHI
20201169304	JUSSARA	JR12093790	JUSSARA	15/11/2020 12:26	15/11/2020 16:59	15/11/2020 12:26	15/11/2020 16:59	4,54	2	9,08	CHI
20201169305	APARECIDA DE GOIANIA	AP11166115	INDEPENDENCIA S2	15/11/2020 12:26	15/11/2020 14:19	15/11/2020 12:26	15/11/2020 14:19	1,87	36	67,35	CHI
20201169313	NIQUELANDIA	NQ21317672	BARRO ALTO	15/11/2020 12:29	15/11/2020 15:47	15/11/2020 12:29	15/11/2020 15:47	3,30	1	3,30	CHI
20201169672	INHUMAS	IX12324563	INHUMAS S1	15/11/2020 12:29	15/11/2020 15:21	15/11/2020 12:29	15/11/2020 15:21	2,86	12	34,29	CHI
20201169672	ITAUCU	IX12324563	INHUMAS S1	15/11/2020 12:29	15/11/2020 15:21	15/11/2020 12:29	15/11/2020 15:21	2,86	4	11,43	CHI
20201169315	ANICUNS	AC21304581	FIRMINOPOLIS S2	15/11/2020 12:30	15/11/2020 14:12	15/11/2020 12:30	15/11/2020 14:12	1,70	1	1,70	CHI
20201169316	APARECIDA DE GOIANIA	16062528	REAL S2	15/11/2020 12:31	15/11/2020 14:30	15/11/2020 12:31	15/11/2020 14:30	1,98	1	1,98	CHI
20201169318	BRITANIA	2110023692	BRITANIA	15/11/2020 12:31	15/11/2020 16:23	15/11/2020 12:31	15/11/2020 16:23	3,85	1	3,85	CHI
20201169319	GOIATUBA	GT21048486	GOIATUBA S1	15/11/2020 12:31	15/11/2020 13:29	15/11/2020 12:31	15/11/2020 13:29	0,95	2	1,91	CHI
20201169325	GOIANESIA	550109456	GOIANESIA S2	15/11/2020 12:35	16/11/2020 10:03	15/11/2020 12:35	16/11/2020 10:03	21,46	1	21,46	CHI
20201169327	CRISTALINA	KR21313605	CRISTALINA S2	15/11/2020 12:35	15/11/2020 14:40	15/11/2020 12:35	15/11/2020 14:40	2,07	1	2,07	CHI
20201169329	CAMPOS VERDES	3790016730	SANTA TEREZINHA	15/11/2020 12:36	15/11/2020 16:52	15/11/2020 12:36	15/11/2020 16:52	4,26	1	4,26	CHI
20201169332	GOIANIA	11263179	ATLANTICO S3	15/11/2020 12:37	15/11/2020 15:05	15/11/2020 12:37	15/11/2020 15:05	2,47	1	2,47	CHI
20201169336	MINEIROS	MY21260445	PARQUE DAS EMAS	15/11/2020 12:38	15/11/2020 19:25	15/11/2020 12:38	15/11/2020 19:25	6,78	1	6,78	CHI
20201169360	SAO DOMINGOS	2090424	SAO DOMINGOS	15/11/2020 12:38	15/11/2020 15:16	15/11/2020 12:38	15/11/2020 14:09	1,51	61	92,23	CHI
20201169360	GUARANI DE GOIAS	2090424	SAO DOMINGOS	15/11/2020 12:38	15/11/2020 15:16	15/11/2020 12:38	15/11/2020 15:13	2,59	2	5,18	CHI
20201169360	SAO DOMINGOS	2090424	SAO DOMINGOS	15/11/2020 12:38	15/11/2020 15:16	15/11/2020 12:38	15/11/2020 15:13	2,59	242	627,05	CHI
20201169360	SAO DOMINGOS	2090424	SAO DOMINGOS	15/11/2020 12:38	15/11/2020 15:16	15/11/2020 12:38	15/11/2020 15:15	2,61	1	2,61	CHI
20201169360	GUARANI DE GOIAS	SD13102564	SAO DOMINGOS	15/11/2020 12:38	15/11/2020 15:16	15/11/2020 12:38	15/11/2020 15:16	2,63	151	396,79	CHI
20201169360	MONTE ALEGRE DE GOIAS	SD13102564	SAO DOMINGOS	15/11/2020 12:38	15/11/2020 15:16	15/11/2020 12:38	15/11/2020 15:16	2,63	1	2,63	CHI
20201169360	NOVA ROMA	SD13102564	SAO DOMINGOS	15/11/2020 12:38	15/11/2020 15:16	15/11/2020 12:38	15/11/2020 15:16	2,63	3	7,88	CHI
20201169360	SAO DOMINGOS	2090424	SAO DOMINGOS	15/11/2020 12:38	15/11/2020 15:16	15/11/2020 12:38	15/11/2020 15:16	2,63	239	628,04	CHI

20201169360	SAO DOMINGOS	SD13102564	SAO DOMINGOS	15/11/2020 12:38	15/11/2020 15:16	15/11/2020 12:38	15/11/2020 15:16	2,63	658	1729,08	CHI
20201169346	JATAI	290320343	JATAI S3	15/11/2020 12:39	15/11/2020 16:47	15/11/2020 12:39	15/11/2020 16:47	4,13	1	4,13	CHI
20201169347	RIO VERDE	10026288794	RIO VERDE S1	15/11/2020 12:39	15/11/2020 14:17	15/11/2020 12:39	15/11/2020 14:17	1,63	1	1,63	CHI
20201169370	EDEIA	EA21182595	VICENTINOPOLIS	15/11/2020 12:39	15/11/2020 14:56	15/11/2020 12:39	15/11/2020 14:56	2,28	1	2,28	CHI
20201169356	APARECIDA DE GOIANIA	15080869	REAL S2	15/11/2020 12:41	15/11/2020 14:30	15/11/2020 12:41	15/11/2020 14:30	1,81	1	1,81	CHI
20201169357	ADELANDIA	DN12021725	FIRMINOPOLIS S2	15/11/2020 12:41	15/11/2020 18:11	15/11/2020 12:41	15/11/2020 18:11	5,49	2	10,98	CHI
20201169367	LUZIANIA	LZ31057555	VIANOPOLIS	15/11/2020 12:41	15/11/2020 13:10	15/11/2020 12:41	15/11/2020 13:10	0,48	1	0,48	CHI
20201169361	VIANOPOLIS	VN21073529	VIANOPOLIS	15/11/2020 12:43	15/11/2020 20:08	15/11/2020 12:43	15/11/2020 20:08	7,41	1	7,41	CHI
20201169363	GOIANIA	15131555	FERROVIARIO S1	15/11/2020 12:43	15/11/2020 13:21	15/11/2020 12:43	15/11/2020 13:21	0,62	1	0,62	CHI
20201169366	GOIANDIRA	CT21250241	CATALAO S1	15/11/2020 12:44	15/11/2020 16:58	15/11/2020 12:44	15/11/2020 16:58	4,23	1	4,23	CHI
20201169369	APARECIDA DE GOIANIA	12646088	ATLANTICO S3	15/11/2020 12:44	15/11/2020 15:44	15/11/2020 12:44	15/11/2020 15:44	2,99	1	2,99	CHI
20201169440	SAO JOAO D ALIANCA	JL12106845	SAO JOAO D ALIANCA	15/11/2020 12:44	16/11/2020 00:28	15/11/2020 12:44	15/11/2020 23:51	11,13	14	155,80	CHI
20201169440	SAO JOAO D ALIANCA	JL12106845	SAO JOAO D ALIANCA	15/11/2020 12:44	16/11/2020 00:28	15/11/2020 12:44	16/11/2020 00:28	11,73	1	11,73	CHI
20201169465	SAO MIGUEL DO ARAGUAIA	SM10388763	SAO MIGUEL DO ARAGUAIA	15/11/2020 12:46	17/11/2020 19:27	15/11/2020 12:46	15/11/2020 22:49	10,04	4	40,17	CHI
20201169465	SAO MIGUEL DO ARAGUAIA	SM10388763	SAO MIGUEL DO ARAGUAIA	15/11/2020 12:46	17/11/2020 19:27	15/11/2020 12:46	15/11/2020 23:05	10,31	168	1732,03	CHI
20201169465	SAO MIGUEL DO ARAGUAIA	SM10388763	SAO MIGUEL DO ARAGUAIA	15/11/2020 12:46	17/11/2020 19:27	15/11/2020 22:49	15/11/2020 23:05	0,26	7	1,83	CHI
20201169465	SAO MIGUEL DO ARAGUAIA	SM10388763	SAO MIGUEL DO ARAGUAIA	15/11/2020 12:46	17/11/2020 19:27	15/11/2020 23:07	16/11/2020 07:57	8,83	55	485,85	CHI
20201169465	SAO MIGUEL DO ARAGUAIA	SM10388763	SAO MIGUEL DO ARAGUAIA	15/11/2020 12:46	17/11/2020 19:27	15/11/2020 12:46	16/11/2020 09:25	20,65	22	454,37	CHI
20201169465	SAO MIGUEL DO ARAGUAIA	SM13182440	SAO MIGUEL DO ARAGUAIA	15/11/2020 12:46	17/11/2020 19:27	15/11/2020 22:49	16/11/2020 09:25	10,61	1	10,61	CHI
20201169465	SAO MIGUEL DO ARAGUAIA	SM13182440	SAO MIGUEL DO ARAGUAIA	15/11/2020 12:46	17/11/2020 19:27	15/11/2020 23:07	16/11/2020 09:25	10,31	37	381,61	CHI
20201169465	SAO MIGUEL DO ARAGUAIA	SM13380422	SAO MIGUEL DO ARAGUAIA	15/11/2020 12:46	17/11/2020 19:27	15/11/2020 23:07	16/11/2020 11:23	12,27	20	245,41	CHI
20201169465	SAO MIGUEL DO ARAGUAIA	SM13380422	SAO MIGUEL DO ARAGUAIA	15/11/2020 12:46	17/11/2020 19:27	15/11/2020 23:07	17/11/2020 11:26	36,32	28	1016,85	CHI
20201169465	SAO MIGUEL DO ARAGUAIA	SM13380422	SAO MIGUEL DO ARAGUAIA	15/11/2020 12:46	17/11/2020 19:27	16/11/2020 14:08	17/11/2020 11:26	21,29	21	447,03	CHI
20201169465	SAO MIGUEL DO ARAGUAIA	SM13380422	SAO MIGUEL DO ARAGUAIA	15/11/2020 12:46	17/11/2020 19:27	15/11/2020 23:07	17/11/2020 19:27	44,33	20	886,69	CHI
20201175998	SAO MIGUEL DO ARAGUAIA	SM10388763	SAO MIGUEL DO ARAGUAIA	15/11/2020 12:46	18/11/2020 14:45	16/11/2020 14:41	16/11/2020 20:49	6,14	37	227,03	CHI
20201175998	SAO MIGUEL DO ARAGUAIA	SM10388763	SAO MIGUEL DO ARAGUAIA	15/11/2020 12:46	18/11/2020 14:45	16/11/2020 14:41	16/11/2020 22:25	7,74	18	139,25	CHI
20201175998	SAO MIGUEL DO ARAGUAIA	SM10388763	SAO MIGUEL DO ARAGUAIA	15/11/2020 12:46	18/11/2020 14:45	16/11/2020 14:41	17/11/2020 09:27	18,76	147	2758,13	CHI
20201175998	SAO MIGUEL DO ARAGUAIA	SM21420257	SAO MIGUEL DO ARAGUAIA	15/11/2020 12:46	18/11/2020 14:45	17/11/2020 11:52	17/11/2020 12:17	0,42	1	0,42	CHI
20201175998	SAO MIGUEL DO ARAGUAIA	SM12281727	SAO MIGUEL DO ARAGUAIA	15/11/2020 12:46	18/11/2020 14:45	17/11/2020 12:25	17/11/2020 12:39	0,23	3	0,68	CHI
20201175998	SAO MIGUEL DO ARAGUAIA	SM12291179LD	SAO MIGUEL DO ARAGUAIA	15/11/2020 12:46	18/11/2020 14:45	15/11/2020 23:07	17/11/2020 12:55	37,81	20	756,22	CHI
20201175998	SAO MIGUEL DO ARAGUAIA	SM10388763	SAO MIGUEL DO ARAGUAIA	15/11/2020 12:46	18/11/2020 14:45	17/11/2020 13:04	17/11/2020 14:32	1,47	296	434,38	CHI
20201175998	SAO MIGUEL DO ARAGUAIA	SM10388763	SAO MIGUEL DO ARAGUAIA	15/11/2020 12:46	18/11/2020 14:45	17/11/2020 15:25	17/11/2020 16:07	0,70	296	208,68	CHI
20201175998	SAO MIGUEL DO ARAGUAIA	SM12291179LD	SAO MIGUEL DO ARAGUAIA	15/11/2020 12:46	18/11/2020 14:45	17/11/2020 13:04	17/11/2020 17:07	4,06	5	20,30	CHI
20201175998	SAO MIGUEL DO ARAGUAIA	SM12291179LD	SAO MIGUEL DO ARAGUAIA	15/11/2020 12:46	18/11/2020 14:45	17/11/2020 13:04	17/11/2020 19:27	6,38	14	89,38	CHI
20201175998	SAO MIGUEL DO ARAGUAIA	SM13405432B	SAO MIGUEL DO ARAGUAIA	15/11/2020 12:46	18/11/2020 14:45	17/11/2020 20:30	17/11/2020 20:40	0,16	12	1,97	CHI
20201175998	SAO MIGUEL DO ARAGUAIA	SM12291179LD	SAO MIGUEL DO ARAGUAIA	15/11/2020 12:46	18/11/2020 14:45	17/11/2020 13:04	18/11/2020 14:45	25,68	1	25,68	CHI
20201169379	CORUMBA DE GOIAS	CB11316137	CORUMBA	15/11/2020 12:47	15/11/2020 20:39	15/11/2020 12:47	15/11/2020 20:39	7,87	1	7,87	CHI
20201169381	FLORES DE GOIAS	FB12404992	FLORES DE GOIAS	15/11/2020 12:47	15/11/2020 14:55	15/11/2020 12:47	15/11/2020 14:55	2,13	3	6,39	CHI
20201169381	FORMOSA	FB12404992	FLORES DE GOIAS	15/11/2020 12:47	15/11/2020 14:55	15/11/2020 12:47	15/11/2020 14:55	2,13	3	6,39	CHI
20201169383	VALPARAISO DE GOIAS	2860180625	MARAJOARA	15/11/2020 12:47	15/11/2020 15:10	15/11/2020 12:47	15/11/2020 15:10	2,37	1	2,37	CHI
20201169396	GOIANIA	GN10385838	ATLANTICO S1	15/11/2020 12:47	15/11/2020 12:54	15/11/2020 12:47	15/11/2020 12:54	0,12	2358	287,55	CHI
20201169469	MINEIROS	MY12153058RE	PARQUE DAS EMAS	15/11/2020 12:47	15/11/2020 16:00	15/11/2020 12:47	15/11/2020 16:00	3,21	13	41,72	CHI
20201169469	SANTA RITA DO ARAGUAIA	MY12153058RE	PARQUE DAS EMAS	15/11/2020 12:47	15/11/2020 16:00	15/11/2020 12:47	15/11/2020 16:00	3,21	6	19,26	CHI
20201169386	CIDADE OCIDENTAL	DH12370719	MARAJOARA	15/11/2020 12:49	15/11/2020 15:54	15/11/2020 12:49	15/11/2020 15:54	3,08	6	18,49	CHI
20201169388	APARECIDA DE GOIANIA	14784439	INDEPENDENCIA S1	15/11/2020 12:49	15/11/2020 15:33	15/11/2020 12:49	15/11/2020 15:33	2,73	1	2,73	CHI
20201169392	PIRENOPOLIS	PV21028719	CORUMBA	15/11/2020 12:50	15/11/2020 13:59	15/11/2020 12:50	15/11/2020 13:59	1,15	1	1,15	CHI
20201169395	CRIXAS	NA12171143	NOVA CRIXAS	15/11/2020 12:51	16/11/2020 08:40	15/11/2020 12:51	16/11/2020 08:40	19,81	3	59,42	CHI
20201169400	PLANALTINA	PI21180833	PLANALTINA	15/11/2020 12:52	15/11/2020 13:54	15/11/2020 12:52	15/11/2020 13:54	1,02	2	2,05	CHI
20201169623	FORMOSO	FO12285186	PORANGATU	15/11/2020 12:52	15/11/2020 20:04	15/11/2020 12:52	15/11/2020 20:04	7,19	82	589,33	CHI
20201169403	GOIANIRA	GR21016584	GOIANIRA	15/11/2020 12:53	15/11/2020 14:50	15/11/2020 12:53	15/11/2020 14:50	1,94	1	1,94	CHI
20201169404	ALTO PARAISO DE GOIAS	JL12257606	SAO JOAO D ALIANCA	15/11/2020 12:53	15/11/2020 17:33	15/11/2020 12:53	15/11/2020 17:33	4,66	2	9,31	CHI

20201169404	SAO JOAO D ALIANCA	JL12257606	SAO JOAO D ALIANCA	15/11/2020 12:53	15/11/2020 17:33	15/11/2020 12:53	15/11/2020 17:33	4,66	83	386,50	CHI
20201169405	JATAI	290008141	JATAI S2	15/11/2020 12:53	15/11/2020 17:18	15/11/2020 12:53	15/11/2020 17:18	4,40	1	4,40	CHI
20201169407	MOZARLANDIA	MZ21089903	MOZARLANDIA	15/11/2020 12:54	16/11/2020 16:14	15/11/2020 12:54	16/11/2020 16:14	27,33	1	27,33	CHI
20201169412	BURITI ALEGRE	BG21167897	ALTO BURITI	15/11/2020 12:55	15/11/2020 15:52	15/11/2020 12:55	15/11/2020 15:52	2,95	1	2,95	CHI
20201169416	PORANGATU	PO21151026	NOVO PLANALTO	15/11/2020 12:56	16/11/2020 17:34	15/11/2020 12:56	16/11/2020 17:34	28,63	1	28,63	CHI
20201169417	JAUPACI	JP21156173	IPORA	15/11/2020 12:56	15/11/2020 14:57	15/11/2020 12:56	15/11/2020 14:57	2,01	1	2,01	CHI
20201169428	ACREUNA	2440009964	ACREUNA	15/11/2020 13:00	15/11/2020 16:12	15/11/2020 13:00	15/11/2020 16:12	3,19	1	3,19	CHI
20201169430	SENADOR CANEDO	SW11141244	SENADOR CANEDO	15/11/2020 13:01	15/11/2020 14:12	15/11/2020 13:01	15/11/2020 14:12	1,18	103	121,88	CHI
20201169703	GOIATUBA	VI12329055	VICENTINOPOLIS	15/11/2020 13:01	16/11/2020 08:03	15/11/2020 13:01	16/11/2020 08:03	19,02	12	228,26	CHI
20201169703	VICENTINOPOLIS	VI12329055	VICENTINOPOLIS	15/11/2020 13:01	16/11/2020 08:03	15/11/2020 13:01	16/11/2020 08:03	19,02	22	418,48	CHI
20201169574	IPIRANGA DE GOIAS	RB12003338	RUBIATABA	15/11/2020 13:04	15/11/2020 16:15	15/11/2020 13:04	15/11/2020 16:15	3,17	1	3,17	CHI
20201169574	ITAPACI	RB12003338	RUBIATABA	15/11/2020 13:04	15/11/2020 16:15	15/11/2020 13:04	15/11/2020 16:15	3,17	10	31,69	CHI
20201169574	RUBIATABA	RB12003338	RUBIATABA	15/11/2020 13:04	15/11/2020 16:15	15/11/2020 13:04	15/11/2020 16:15	3,17	127	402,48	CHI
20201169444	NIQUELANDIA	NQ21270116	SAO JOAO D ALIANCA	15/11/2020 13:06	15/11/2020 17:08	15/11/2020 13:06	15/11/2020 17:08	4,03	1	4,03	CHI
20201169447	MONTIVIDIU	MV21271676	MONTIVIDIU T	15/11/2020 13:06	15/11/2020 18:03	15/11/2020 13:06	15/11/2020 18:03	4,94	1	4,94	CHI
20201169455	FORMOSA	PI12131899	PLANALTINA	15/11/2020 13:09	15/11/2020 16:42	15/11/2020 13:09	15/11/2020 16:42	3,56	55	195,74	CHI
20201169455	PLANALTINA	PI12131899	PLANALTINA	15/11/2020 13:09	15/11/2020 16:42	15/11/2020 13:09	15/11/2020 16:42	3,56	192	683,31	CHI
20201169458	POSSE	PS21256248	IACIARA S2	15/11/2020 13:09	15/11/2020 14:23	15/11/2020 13:09	15/11/2020 14:23	1,22	2	2,44	CHI
20201170556	ITAPURANGA	IK12073126	ITAPURANGA	15/11/2020 13:09	15/11/2020 20:52	15/11/2020 13:09	15/11/2020 20:52	7,72	7	54,02	CHI
20201169462	NIQUELANDIA	NQ21221890	URUACU	15/11/2020 13:11	15/11/2020 15:01	15/11/2020 13:11	15/11/2020 15:01	1,83	1	1,83	CHI
20201169518	SENADOR CANEDO	SW11092177	SENADOR CANEDO	15/11/2020 13:11	15/11/2020 19:15	15/11/2020 13:11	15/11/2020 19:15	6,06	149	902,28	CHI
20201169479	NIQUELANDIA	NQ12396795	URUACU	15/11/2020 13:16	15/11/2020 17:16	15/11/2020 13:16	15/11/2020 17:16	4,00	303	1211,66	CHI
20201169481	GOIANIA	GN21066331	ATLANTICO S1	15/11/2020 13:16	15/11/2020 14:19	15/11/2020 13:16	15/11/2020 14:19	1,04	2	2,08	CHI
20201169677	PLANALTINA	PI12106870	PLANALTINA	15/11/2020 13:16	15/11/2020 17:21	15/11/2020 13:16	15/11/2020 17:21	4,08	172	701,66	CHI
20201169483	ANAPOLIS	20610208	ANAPOLIS UNIVERSITARIO S2	15/11/2020 13:17	15/11/2020 14:17	15/11/2020 13:17	15/11/2020 14:17	0,99	1	0,99	CHI
20201169484	ARAGARCAS	ME12193486	IPORA	15/11/2020 13:17	15/11/2020 16:15	15/11/2020 13:17	15/11/2020 16:15	2,95	1	2,95	CHI
20201169484	MONTES CLAROS DE GOIAS	ME12193486	IPORA	15/11/2020 13:17	15/11/2020 16:15	15/11/2020 13:17	15/11/2020 16:15	2,95	3	8,85	CHI
20201169487	JATAI	JT12099233	JATAI S1	15/11/2020 13:19	15/11/2020 16:10	15/11/2020 13:19	15/11/2020 16:10	2,84	3	8,53	CHI
20201169488	IPORA	10009495272	IPORA	15/11/2020 13:19	15/11/2020 17:07	15/11/2020 13:19	15/11/2020 17:07	3,81	1	3,81	CHI
20201169490	VALPARAISO DE GOIAS	10011043812	PACAEMBU S2	15/11/2020 13:21	15/11/2020 16:05	15/11/2020 13:21	15/11/2020 16:05	2,73	1	2,73	CHI
20201169492	CEZARINA	IY12010391	EDEIA	15/11/2020 13:21	15/11/2020 21:32	15/11/2020 13:21	15/11/2020 21:32	8,17	3	24,51	CHI
20201169492	INDIARA	IY12010391	EDEIA	15/11/2020 13:21	15/11/2020 21:32	15/11/2020 13:21	15/11/2020 21:32	8,17	2	16,34	CHI
20201169650	PLANALTINA	PI12324485	PLANALTINA	15/11/2020 13:21	15/11/2020 17:47	15/11/2020 13:21	15/11/2020 17:47	4,42	19	83,96	CHI
20201170769	CAIAPONIA	DV12023480	CAIAPONIA	15/11/2020 13:26	15/11/2020 21:30	15/11/2020 13:26	15/11/2020 21:30	8,06	146	1176,88	CHI
20201170769	DOVERLANDIA	DV12023480	CAIAPONIA	15/11/2020 13:26	15/11/2020 21:30	15/11/2020 13:26	15/11/2020 21:30	8,06	9	72,55	CHI
20201170769	PIRANHAS	DV12023480	CAIAPONIA	15/11/2020 13:26	15/11/2020 21:30	15/11/2020 13:26	15/11/2020 21:30	8,06	76	612,62	CHI
20201169528	VIANOPOLIS	VN21036445	VIANOPOLIS	15/11/2020 13:30	15/11/2020 17:33	15/11/2020 13:30	15/11/2020 17:33	4,03	1	4,03	CHI
20201169545	ALEXANIA	AX12319851	ALEXANIA	15/11/2020 13:30	15/11/2020 16:57	15/11/2020 13:30	15/11/2020 16:57	3,44	21	72,16	CHI
20201169582	APARECIDA DE GOIANIA	AP11168689	ATLANTICO S1	15/11/2020 13:30	15/11/2020 15:17	15/11/2020 13:30	15/11/2020 15:17	1,77	89	157,28	CHI
20201170104	URUACU	UR12232449RE	URUACU	15/11/2020 13:30	15/11/2020 19:28	15/11/2020 13:30	15/11/2020 19:28	5,96	55	327,71	CHI
20201169513	PIRES DO RIO	PR12417430	PIRES DO RIO S1	15/11/2020 13:31	15/11/2020 15:36	15/11/2020 13:31	15/11/2020 15:36	2,08	1	2,08	CHI
20201169530	EDEIA	EA21198262	VICENTINOPOLIS	15/11/2020 13:31	15/11/2020 15:17	15/11/2020 13:31	15/11/2020 15:17	1,76	1	1,76	CHI
20201169538	RIO VERDE	630194014	RIO VERDE S2	15/11/2020 13:33	15/11/2020 18:21	15/11/2020 13:33	15/11/2020 18:21	4,79	1	4,79	CHI
20201169830	PIRES DO RIO	PR12422115	PIRES DO RIO S2	15/11/2020 13:34	15/11/2020 21:11	15/11/2020 13:34	15/11/2020 21:11	7,62	3	22,85	CHI
20201169543	BONFINOPOLIS	LB12012607	GOIANIA LESTE S2	15/11/2020 13:35	15/11/2020 15:52	15/11/2020 13:35	15/11/2020 15:52	2,27	3	6,82	CHI
20201169564	PONTALINA	PK12406193	PONTALINA	15/11/2020 13:41	15/11/2020 17:18	15/11/2020 13:41	15/11/2020 17:18	3,61	1	3,61	CHI
20201169928	CATALAO	GD12127624RE	CATALAO S1	15/11/2020 13:43	15/11/2020 20:18	15/11/2020 13:43	15/11/2020 20:18	6,57	14	92,04	CHI
20201169928	GOIANDIRA	GD12127624RE	CATALAO S1	15/11/2020 13:43	15/11/2020 20:18	15/11/2020 13:43	15/11/2020 20:18	6,57	17	111,76	CHI
20201169928	IPAMERI	GD12127624RE	CATALAO S1	15/11/2020 13:43	15/11/2020 20:18	15/11/2020 13:43	15/11/2020 20:18	6,57	7	46,02	CHI
20201170294	BONOPOLIS	BX12193536	SAO MIGUEL DO ARAGUAIA	15/11/2020 13:43	16/11/2020 01:59	15/11/2020 13:43	16/11/2020 01:59	12,26	10	122,59	CHI
20201169573	GUARANI DE GOIAS	GY12267340	IACIARA S2	15/11/2020 13:45	15/11/2020 15:05	15/11/2020 13:45	15/11/2020 15:05	1,33	65	86,47	CHI

20201169577	DIVINOPOLIS DE GOIAS	SD12090135	SAO DOMINGOS	15/11/2020 13:48	15/11/2020 17:38	15/11/2020 13:48	15/11/2020 17:38	3,82	24	91,62	CHI
20201169577	SAO DOMINGOS	SD12090135	SAO DOMINGOS	15/11/2020 13:48	15/11/2020 17:38	15/11/2020 13:48	15/11/2020 17:38	3,82	83	316,85	CHI
20201169600	AVELINOPOLIS	AV12299225	TRINDADE	15/11/2020 13:50	15/11/2020 15:22	15/11/2020 13:50	15/11/2020 15:22	1,52	3	4,57	CHI
20201169600	NAZARIO	AV12299225	TRINDADE	15/11/2020 13:50	15/11/2020 15:22	15/11/2020 13:50	15/11/2020 15:22	1,52	7	10,66	CHI
20201169629	GUARANI DE GOIAS	GY12265440	IACIARA S1	15/11/2020 13:50	15/11/2020 15:32	15/11/2020 13:50	15/11/2020 15:32	1,70	20	33,96	CHI
20201169583	BALIZA	BH12334579	BOM JARDIM	15/11/2020 13:51	15/11/2020 16:40	15/11/2020 13:51	15/11/2020 16:40	2,81	3	8,42	CHI
20201169586	TRINDADE	10012675480	GOYA S2	15/11/2020 13:52	15/11/2020 16:14	15/11/2020 13:52	15/11/2020 16:14	2,36	1	2,36	CHI
20201169835	DIVINOPOLIS DE GOIAS	GH12241948	SAO DOMINGOS	15/11/2020 13:52	15/11/2020 20:11	15/11/2020 13:52	15/11/2020 20:11	6,30	7	44,13	CHI
20201169598	CAMPINACU	UC12055175	PORANGATU	15/11/2020 13:54	15/11/2020 17:04	15/11/2020 13:54	15/11/2020 17:04	3,15	17	53,59	CHI
20201169953	JATAI	SX12080854RE	JATAI S1	15/11/2020 13:54	15/11/2020 19:55	15/11/2020 13:54	15/11/2020 19:55	6,01	50	300,32	CHI
20201169953	SERRANOPOLIS	SX12080854RE	JATAI S1	15/11/2020 13:54	15/11/2020 19:55	15/11/2020 13:54	15/11/2020 19:55	6,01	24	144,15	CHI
20201169591	MONTE ALEGRE DE GOIAS	MA12211597	SAO DOMINGOS	15/11/2020 13:55	15/11/2020 15:49	15/11/2020 13:55	15/11/2020 15:49	1,88	10	18,84	CHI
20201169597	NOVA CRIXAS	NA12380421	NOVA CRIXAS	15/11/2020 13:58	17/11/2020 01:27	15/11/2020 13:58	17/11/2020 01:27	35,47	49	1738,26	CHI
20201169604	GOIANIA	14390954	ATLANTICO S1	15/11/2020 14:00	15/11/2020 14:56	15/11/2020 14:00	15/11/2020 14:56	0,93	1	0,93	CHI
20201169770	ACREUNA	SH12279542	SANTA HELENA S1	15/11/2020 14:00	15/11/2020 18:20	15/11/2020 14:00	15/11/2020 18:20	4,32	3	12,96	CHI
20201169770	SANTA HELENA DE GOIAS	SH12279542	SANTA HELENA S1	15/11/2020 14:00	15/11/2020 18:20	15/11/2020 14:00	15/11/2020 18:20	4,32	9	38,87	CHI
20201169770	SANTO ANTONIO DA BARRA	SH12279542	SANTA HELENA S1	15/11/2020 14:00	15/11/2020 18:20	15/11/2020 14:00	15/11/2020 18:20	4,32	1	4,32	CHI
20201169610	SAO MIGUEL DO ARAGUAIA	10005859369	SAO MIGUEL DO ARAGUAIA	15/11/2020 14:02	16/11/2020 15:46	15/11/2020 14:02	16/11/2020 15:46	25,73	1	25,73	CHI
20201169612	POSSE	1480029017	IACIARA S2	15/11/2020 14:02	15/11/2020 16:22	15/11/2020 14:02	15/11/2020 16:22	2,32	1	2,32	CHI
20201169739	SAO MIGUEL DO ARAGUAIA	SM12358733	SAO MIGUEL DO ARAGUAIA	15/11/2020 14:05	16/11/2020 18:36	15/11/2020 14:05	16/11/2020 18:36	28,50	20	570,09	CHI
20201169622	GOIANIA	10000876150	MEIA PONTE	15/11/2020 14:06	15/11/2020 15:44	15/11/2020 14:06	15/11/2020 15:44	1,62	1	1,62	CHI
20201169624	CORUMBA DE GOIAS	CB11054409	CORUMBA	15/11/2020 14:07	15/11/2020 18:51	15/11/2020 14:07	15/11/2020 18:51	4,72	120	566,43	CHI
20201169627	NIQUELANDIA	NQ21345056	URUACU	15/11/2020 14:08	15/11/2020 18:26	15/11/2020 14:08	15/11/2020 18:26	4,30	1	4,30	CHI
20201169632	LUZIANIA	120397961	RIO VERMELHO	15/11/2020 14:08	15/11/2020 17:59	15/11/2020 14:08	15/11/2020 17:59	3,84	1	3,84	CHI
20201169642	CORUMBA DE GOIAS	CB12221423	CORUMBA	15/11/2020 14:08	15/11/2020 18:44	15/11/2020 14:08	15/11/2020 18:44	4,59	79	362,76	CHI
20201170081	PADRE BERNARDO	PB12305257	PADRE BERNARDO	15/11/2020 14:08	15/11/2020 18:22	15/11/2020 14:08	15/11/2020 18:22	4,23	5	21,16	CHI
20201170081	PLANALTINA	PB12305257	PADRE BERNARDO	15/11/2020 14:08	15/11/2020 18:22	15/11/2020 14:08	15/11/2020 18:22	4,23	67	283,60	CHI
20201169635	IPORA	IR21139415	IPORA	15/11/2020 14:10	15/11/2020 18:58	15/11/2020 14:10	15/11/2020 18:58	4,80	1	4,80	CHI
20201169636	CAMPO ALEGRE DE GOIAS	CM13281440	CAMPO ALEGRE DE GOIAS	15/11/2020 14:10	16/11/2020 16:14	15/11/2020 14:10	16/11/2020 16:14	26,06	5	130,29	CHI
20201169636	CAMPO ALEGRE DE GOIAS	CM13281440	CAMPO ALEGRE DE GOIAS	15/11/2020 14:10	16/11/2020 16:14	16/11/2020 09:49	16/11/2020 16:14	6,41	162	1038,15	CHI
20201169636	CATALAO	CM13281440	CAMPO ALEGRE DE GOIAS	15/11/2020 14:10	16/11/2020 16:14	16/11/2020 09:49	16/11/2020 16:14	6,41	59	378,09	CHI
20201169646	BOM JESUS DE GOIAS	BJ21060788	RIO DOS BOIS	15/11/2020 14:13	16/11/2020 14:27	15/11/2020 14:13	16/11/2020 14:27	24,23	1	24,23	CHI
20201169648	NOVA AURORA	NE21311815	CATALAO S1	15/11/2020 14:14	15/11/2020 19:21	15/11/2020 14:14	15/11/2020 19:21	5,13	1	5,13	CHI
20201169649	PIRACANJUBA	PJ21233069	CALDAS NOVAS S1	15/11/2020 14:15	15/11/2020 16:57	15/11/2020 14:15	15/11/2020 16:57	2,70	1	2,70	CHI
20201169659	CALDAS NOVAS	PJ12263230	CALDAS NOVAS S1	15/11/2020 14:18	15/11/2020 17:35	15/11/2020 14:18	15/11/2020 17:35	3,27	1	3,27	CHI
20201169659	PIRACANJUBA	PJ12263230	CALDAS NOVAS S1	15/11/2020 14:18	15/11/2020 17:35	15/11/2020 14:18	15/11/2020 17:35	3,27	17	55,57	CHI
20201169660	GOIANESIA	GE12215056	GOIANESIA S1	15/11/2020 14:18	15/11/2020 17:02	15/11/2020 14:18	15/11/2020 17:02	2,72	6	16,31	CHI
20201169662	DISTRITO FEDERAL	2900062488	MARAJOARA	15/11/2020 14:19	15/11/2020 18:41	15/11/2020 14:19	15/11/2020 18:41	4,37	1	4,37	CHI
20201169663	VIANOPOLIS	VN12079973	MARAJOARA	15/11/2020 14:19	15/11/2020 15:45	15/11/2020 14:19	15/11/2020 15:45	1,42	6	8,53	CHI
20201169664	CORUMBA DE GOIAS	CB12215010	CORUMBA	15/11/2020 14:19	15/11/2020 20:39	15/11/2020 14:19	15/11/2020 20:39	6,32	11	69,54	CHI
20201169665	SAO LUIZ DO NORTE	10014711964	ITAPACI	15/11/2020 14:19	15/11/2020 17:03	15/11/2020 14:19	15/11/2020 17:03	2,72	1	2,72	CHI
20201169681	CAVALCANTE	TI13340353	MINACU	15/11/2020 14:19	16/11/2020 14:01	15/11/2020 14:21	15/11/2020 15:40	1,30	68	88,44	CHI
20201169681	COLINAS DO SUL	TI13340353	MINACU	15/11/2020 14:19	16/11/2020 14:01	15/11/2020 14:21	15/11/2020 15:40	1,30	412	535,83	CHI
20201169681	NIQUELANDIA	TI13340353	MINACU	15/11/2020 14:19	16/11/2020 14:01	15/11/2020 14:21	15/11/2020 15:40	1,30	1	1,30	CHI
20201169681	URUACU	TI13340353	MINACU	15/11/2020 14:19	16/11/2020 14:01	15/11/2020 14:21	15/11/2020 15:40	1,30	1	1,30	CHI
20201169681	COLINAS DO SUL	NQ10419863	NIQUELANDIA SUBTRANSMISSAO	15/11/2020 14:19	16/11/2020 14:01	15/11/2020 14:19	15/11/2020 15:40	1,34	1143	1530,67	CHI
20201169681	ALTO PARAISO DE GOIAS	NQ10419863	NIQUELANDIA SUBTRANSMISSAO	15/11/2020 14:19	16/11/2020 14:01	15/11/2020 14:19	15/11/2020 15:42	1,37	26	35,71	CHI
20201169681	CAVALCANTE	NQ10419863	NIQUELANDIA SUBTRANSMISSAO	15/11/2020 14:19	16/11/2020 14:01	15/11/2020 14:19	15/11/2020 15:42	1,37	58	79,67	CHI
20201169681	COLINAS DO SUL	NQ10419863	NIQUELANDIA SUBTRANSMISSAO	15/11/2020 14:19	16/11/2020 14:01	15/11/2020 14:19	15/11/2020 15:42	1,37	75	103,02	CHI
20201169681	NIQUELANDIA	NQ10419863	NIQUELANDIA SUBTRANSMISSAO	15/11/2020 14:19	16/11/2020 14:01	15/11/2020 14:19	15/11/2020 15:42	1,37	4	5,49	CHI
20201169681	ALTO PARAISO DE GOIAS	NQ10419863	NIQUELANDIA SUBTRANSMISSAO	15/11/2020 14:19	16/11/2020 14:01	15/11/2020 14:19	15/11/2020 16:33	2,23	12	26,75	CHI



20201169681	COLINAS DO SUL	NQ10419863	NIQUELANDIA SUBTRANSMISSAO	15/11/2020 14:19	16/11/2020 14:01	15/11/2020 14:19	15/11/2020 16:33	2,23	21	46,81	CHI
20201169681	NIQUELANDIA	NQ10419863	NIQUELANDIA SUBTRANSMISSAO	15/11/2020 14:19	16/11/2020 14:01	15/11/2020 14:19	15/11/2020 16:33	2,23	941	2097,38	CHI
20201169681	SAO JOAO D ALIANCA	NQ10419863	NIQUELANDIA SUBTRANSMISSAO	15/11/2020 14:19	16/11/2020 14:01	15/11/2020 14:19	15/11/2020 16:33	2,23	1	2,23	CHI
20201169681	NIQUELANDIA	NQ10419863	NIQUELANDIA SUBTRANSMISSAO	15/11/2020 14:19	16/11/2020 14:01	15/11/2020 14:19	15/11/2020 16:50	2,50	108	270,54	CHI
20201169681	NIQUELANDIA	NQ10419863	NIQUELANDIA SUBTRANSMISSAO	15/11/2020 14:19	16/11/2020 14:01	15/11/2020 14:19	16/11/2020 12:47	22,45	15	336,82	CHI
20201169681	NIQUELANDIA	NQ12265966	NIQUELANDIA SUBTRANSMISSAO	15/11/2020 14:19	16/11/2020 14:01	15/11/2020 14:19	16/11/2020 13:24	23,09	25	577,16	CHI
20201169681	NIQUELANDIA	NQ12141164	NIQUELANDIA SUBTRANSMISSAO	15/11/2020 14:19	16/11/2020 14:01	15/11/2020 14:19	16/11/2020 13:27	23,14	3	69,41	CHI
20201169681	NIQUELANDIA	NQ12182463	NIQUELANDIA SUBTRANSMISSAO	15/11/2020 14:19	16/11/2020 14:01	15/11/2020 14:19	16/11/2020 13:39	23,33	23	536,50	CHI
20201169681	NIQUELANDIA	NQ12133382	NIQUELANDIA SUBTRANSMISSAO	15/11/2020 14:19	16/11/2020 14:01	15/11/2020 14:19	16/11/2020 13:42	23,37	15	350,57	CHI
20201169681	NIQUELANDIA	NQ12254342	NIQUELANDIA SUBTRANSMISSAO	15/11/2020 14:19	16/11/2020 14:01	15/11/2020 14:19	16/11/2020 13:50	23,51	1	23,51	CHI
20201169681	NIQUELANDIA	NQ12232353	NIQUELANDIA SUBTRANSMISSAO	15/11/2020 14:19	16/11/2020 14:01	15/11/2020 14:19	16/11/2020 14:01	23,70	1	23,70	CHI
20201169668	GOIAS	GS21117814	ITABERAI S1	15/11/2020 14:21	15/11/2020 15:25	15/11/2020 14:21	15/11/2020 15:25	1,07	1	1,07	CHI
20201169669	NIQUELANDIA	NQ12243394RE	NIQUELANDIA SUBTRANSMISSAO	15/11/2020 14:21	16/11/2020 10:35	15/11/2020 14:21	16/11/2020 10:35	20,23	37	748,60	CHI
20201169674	POSSE	PS21160056	IACIARA S2	15/11/2020 14:22	15/11/2020 19:01	15/11/2020 14:22	15/11/2020 19:01	4,64	1	4,64	CHI
20201169675	PALMEIRAS DE GOIAS	590026513	PALMEIRAS	15/11/2020 14:23	15/11/2020 20:59	15/11/2020 14:23	15/11/2020 20:59	6,60	1	6,60	CHI
20201172325	PORANGATU	PO12328888	PORANGATU	15/11/2020 14:24	16/11/2020 10:55	15/11/2020 14:24	16/11/2020 10:55	20,51	5	102,54	CHI
20201169926	IACIARA	PS12180908	IACIARA S2	15/11/2020 14:27	15/11/2020 17:07	15/11/2020 14:27	15/11/2020 17:07	2,66	32	85,16	CHI
20201169926	POSSE	PS12180908	IACIARA S2	15/11/2020 14:27	15/11/2020 17:07	15/11/2020 14:27	15/11/2020 17:07	2,66	35	93,15	CHI
20201169683	TRINDADE	TR21001627	TRINDADE	15/11/2020 14:28	15/11/2020 16:01	15/11/2020 14:28	15/11/2020 16:01	1,55	1	1,55	CHI
20201169685	APARECIDA DE GOIANIA	15336694	INDEPENDENCIA S1	15/11/2020 14:28	15/11/2020 16:01	15/11/2020 14:28	15/11/2020 16:01	1,54	1	1,54	CHI
20201169688	PADRE BERNARDO	PB12079720	PADRE BERNARDO	15/11/2020 14:29	15/11/2020 15:12	15/11/2020 14:29	15/11/2020 15:12	0,71	1474	1046,13	CHI
20201169689	PARAUNA	980016514	PARAUNA	15/11/2020 14:29	15/11/2020 15:48	15/11/2020 14:29	15/11/2020 15:48	1,32	1	1,32	CHI
20201169695	DAMOLANDIA	DL12272315	INHUMAS S1	15/11/2020 14:30	15/11/2020 18:05	15/11/2020 14:30	15/11/2020 18:05	3,57	3	10,72	CHI
20201169697	NOVO BRASIL	NB11020195	JUSSARA	15/11/2020 14:30	15/11/2020 18:01	15/11/2020 14:30	15/11/2020 18:01	3,51	128	449,07	CHI
20201169729	ANAPOLIS	AN11003277	ANAPOLIS UNIVERSITARIO S1	15/11/2020 14:30	15/11/2020 16:38	15/11/2020 14:30	15/11/2020 16:38	2,13	159	338,67	CHI
20201169979	PORANGATU	4140214	PORANGATU	15/11/2020 14:30	15/11/2020 17:20	15/11/2020 14:42	15/11/2020 17:20	2,63	21	55,17	CHI
20201170076	CORUMBAIBA	CI12263342LD	VILA CORUMBA	15/11/2020 14:30	15/11/2020 19:19	15/11/2020 14:30	15/11/2020 19:19	4,80	279	1339,66	CHI
20201169702	PIRACANJUBA	PJ12000029	CALDAS NOVAS S1	15/11/2020 14:31	15/11/2020 18:55	15/11/2020 14:31	15/11/2020 18:55	4,39	1	4,39	CHI
20201169706	CRIXAS	2490001742	SERRA DO OURO	15/11/2020 14:33	15/11/2020 23:14	15/11/2020 14:33	15/11/2020 23:14	8,68	1	8,68	CHI
20201169710	BELA VISTA DE GOIAS	SV12171341RE	DAIA S2	15/11/2020 14:34	15/11/2020 17:15	15/11/2020 14:34	15/11/2020 17:15	2,68	1	2,68	CHI
20201169710	CALDAZINHA	SV12171341RE	DAIA S2	15/11/2020 14:34	15/11/2020 17:15	15/11/2020 14:34	15/11/2020 17:15	2,68	21	56,19	CHI
20201169710	SILVANIA	SV12171341RE	DAIA S2	15/11/2020 14:34	15/11/2020 17:15	15/11/2020 14:34	15/11/2020 17:15	2,68	25	66,89	CHI
20201169711	CRIXAS	CX12262895	SERRA DO OURO	15/11/2020 14:34	15/11/2020 17:36	15/11/2020 14:34	15/11/2020 17:36	3,02	9	27,21	CHI
20201169713	GOIANESIA	GE12384180	GOIANESIA S2	15/11/2020 14:34	15/11/2020 19:45	15/11/2020 14:34	15/11/2020 19:45	5,17	4	20,69	CHI
20201169719	RIO VERDE	RV11380631	CABRIUVA S1	15/11/2020 14:35	15/11/2020 20:17	15/11/2020 14:35	15/11/2020 20:17	5,69	166	944,22	CHI
20201169721	PILAR DE GOIAS	GG21387929	SANTA TEREZINHA	15/11/2020 14:36	15/11/2020 20:49	15/11/2020 14:36	15/11/2020 20:49	6,21	1	6,21	CHI
20201169727	GOIAS	GS12310404	ITABERAI S1	15/11/2020 14:38	15/11/2020 16:51	15/11/2020 14:38	15/11/2020 16:51	2,21	45	99,55	CHI
20201169727	ITABERAI	GS12310404	ITABERAI S1	15/11/2020 14:38	15/11/2020 16:51	15/11/2020 14:38	15/11/2020 16:51	2,21	2	4,42	CHI
20201169728	GOIANIA	10030928034	GOYA S1	15/11/2020 14:38	15/11/2020 15:23	15/11/2020 14:38	15/11/2020 15:23	0,74	1	0,74	CHI
20201169730	GOIANIA	GN12000805	XAVANTES	15/11/2020 14:38	15/11/2020 16:26	15/11/2020 14:38	15/11/2020 16:26	1,79	15	26,85	CHI
20201169731	EDEALINA	ED21075067	PONTALINA	15/11/2020 14:38	15/11/2020 19:21	15/11/2020 14:38	15/11/2020 19:21	4,71	1	4,71	CHI
20201170672	CORUMBA DE GOIAS	CB12297694	CORUMBA	15/11/2020 14:38	15/11/2020 19:43	15/11/2020 14:38	15/11/2020 19:43	5,08	36	182,90	CHI
20201169798	MUTUNOPOLIS	PO12391912	PORANGATU	15/11/2020 14:39	16/11/2020 01:08	15/11/2020 14:39	16/11/2020 01:08	10,47	34	356,04	CHI
20201169798	PORANGATU	PO12391912	PORANGATU	15/11/2020 14:39	16/11/2020 01:08	15/11/2020 14:39	16/11/2020 01:08	10,47	46	481,70	CHI
20201169736	DIVINOPOLIS DE GOIAS	GH12151237	SAO DOMINGOS	15/11/2020 14:40	15/11/2020 16:25	15/11/2020 14:40	15/11/2020 16:25	1,75	29	50,73	CHI
20201169736	SAO DOMINGOS	GH12151237	SAO DOMINGOS	15/11/2020 14:40	15/11/2020 16:25	15/11/2020 14:40	15/11/2020 16:25	1,75	21	36,73	CHI
20201169742	APARECIDA DE GOIANIA	16795684	REAL S1	15/11/2020 14:41	15/11/2020 16:18	15/11/2020 14:41	15/11/2020 16:18	1,60	1	1,60	CHI
20201169744	SANTO ANTONIO DO DESCOBERTO	2210048327	AGUAS LINDAS DE GOIAS S2	15/11/2020 14:42	15/11/2020 17:35	15/11/2020 14:42	15/11/2020 17:35	2,88	1	2,88	CHI
20201169750	EDEALINA	ED11359989	PONTALINA	15/11/2020 14:43	15/11/2020 20:16	15/11/2020 14:43	15/11/2020 20:16	5,54	15	83,10	CHI
20201171280	AMARALINA	LC12182475	SAO MIGUEL DO ARAGUAIA	15/11/2020 14:44	16/11/2020 03:40	15/11/2020 14:44	16/11/2020 03:40	12,93	77	995,25	CHI
20201169754	CASTELANDIA	ML12397306	RIO DOS BOIS	15/11/2020 14:45	15/11/2020 19:38	15/11/2020 14:45	15/11/2020 19:38	4,87	4	19,48	CHI



20201169754	MAURILANDIA	ML12397306	RIO DOS BOIS	15/11/2020 14:45	15/11/2020 19:38	15/11/2020 14:45	15/11/2020 19:38	4,87	21	102,26	CHI
20201169755	ARAGOIANIA	AO21253954	GUAPO S2	15/11/2020 14:45	15/11/2020 16:32	15/11/2020 14:45	15/11/2020 16:32	1,77	1	1,77	CHI
20201169756	AGUAS LINDAS DE GOIAS	10019147609	AGUAS LINDAS DE GOIAS S1	15/11/2020 14:45	15/11/2020 16:21	15/11/2020 14:45	15/11/2020 16:21	1,58	1	1,58	CHI
20201169757	FORMOSO	FO12071143	PORANGATU	15/11/2020 14:46	15/11/2020 19:23	15/11/2020 14:46	15/11/2020 19:23	4,62	2	9,23	CHI
20201170098	BARRO ALTO	BA12068485	BARRO ALTO	15/11/2020 14:46	15/11/2020 16:52	15/11/2020 14:46	15/11/2020 16:52	2,09	1	2,09	CHI
20201170098	SANTA RITA DO NOVO DESTINO	BA12068485	BARRO ALTO	15/11/2020 14:46	15/11/2020 16:52	15/11/2020 14:46	15/11/2020 16:52	2,09	32	66,80	CHI
20201169771	PLANALTINA	2960230201	PLANALTINA	15/11/2020 14:50	16/11/2020 00:08	15/11/2020 14:50	16/11/2020 00:08	9,29	1	9,29	CHI
20201169773	GOIANIA	14614212	XAVANTES	15/11/2020 14:51	15/11/2020 16:44	15/11/2020 14:51	15/11/2020 16:44	1,88	1	1,88	CHI
20201169774	CRISTALINA	KR12170161	CRISTALINA S2	15/11/2020 14:51	15/11/2020 17:25	15/11/2020 14:51	15/11/2020 17:25	2,56	31	79,33	CHI
20201169783	PADRE BERNARDO	PB12277183	PADRE BERNARDO	15/11/2020 14:52	15/11/2020 16:05	15/11/2020 14:52	15/11/2020 16:05	1,20	53	63,79	CHI
20201170256	NOVA AURORA	NE12127536	CATALAO S1	15/11/2020 14:53	15/11/2020 18:32	15/11/2020 14:53	15/11/2020 18:32	3,65	9	32,83	CHI
20201170620	AMARALINA	MU12394938	MARA ROSA	15/11/2020 14:53	16/11/2020 10:39	15/11/2020 14:53	16/11/2020 10:39	19,76	6	118,53	CHI
20201170620	BONOPOLIS	MU12394938	MARA ROSA	15/11/2020 14:53	16/11/2020 10:39	15/11/2020 14:53	16/11/2020 10:39	19,76	2	39,51	CHI
20201170620	MUTUNOPOLIS	MU12394938	MARA ROSA	15/11/2020 14:53	16/11/2020 10:39	15/11/2020 14:53	16/11/2020 10:39	19,76	13	256,82	CHI
20201170620	PORANGATU	MU12394938	MARA ROSA	15/11/2020 14:53	16/11/2020 10:39	15/11/2020 14:53	16/11/2020 10:39	19,76	74	1461,91	CHI
20201169796	JATAI	JT21172245	JATAI S2	15/11/2020 14:54	15/11/2020 18:05	15/11/2020 14:54	15/11/2020 18:05	3,17	1	3,17	CHI
20201169799	CRIXAS	10014409710	SERRA DO OURO	15/11/2020 14:55	15/11/2020 19:30	15/11/2020 14:55	15/11/2020 19:30	4,57	1	4,57	CHI
20201169808	CATALAO	10023511336	CATALAO S2	15/11/2020 14:57	15/11/2020 18:48	15/11/2020 14:57	15/11/2020 18:48	3,84	1	3,84	CHI
20201169809	CROMINIA	CQ21344606	PONTALINA	15/11/2020 14:57	15/11/2020 17:39	15/11/2020 14:57	15/11/2020 17:39	2,69	1	2,69	CHI
20201169814	ANICUNS	AC11000003	ANICUNS	15/11/2020 14:58	15/11/2020 18:45	15/11/2020 14:58	15/11/2020 18:45	3,77	128	482,63	CHI
20201169889	AMARALINA	MU12060988RE	MARA ROSA	15/11/2020 14:58	15/11/2020 20:37	15/11/2020 14:58	15/11/2020 20:37	5,65	142	801,79	CHI
20201169889	MUTUNOPOLIS	MU12060988RE	MARA ROSA	15/11/2020 14:58	15/11/2020 20:37	15/11/2020 14:58	15/11/2020 20:37	5,65	30	169,39	CHI
20201169819	NOVO PLANALTO	TA11100823	NOVO PLANALTO	15/11/2020 15:00	16/11/2020 14:40	15/11/2020 15:00	16/11/2020 14:40	23,66	96	2271,65	CHI
20201170643	PORTELANDIA	PW12151592	PARQUE DAS EMAS	15/11/2020 15:00	16/11/2020 11:04	15/11/2020 15:00	16/11/2020 11:04	20,07	5	100,33	CHI
20201169825	JATAI	JT2234321	JATAI S3	15/11/2020 15:01	16/11/2020 01:28	15/11/2020 15:01	16/11/2020 01:28	10,45	4	41,79	CHI
20201169828	ANAPOLIS	AN12390322	NEROPOLIS S1	15/11/2020 15:01	15/11/2020 21:09	15/11/2020 15:01	15/11/2020 21:09	6,12	3	18,37	CHI
20201169828	CAMPO LIMPO	AN12390322	NEROPOLIS S1	15/11/2020 15:01	15/11/2020 21:09	15/11/2020 15:01	15/11/2020 21:09	6,12	3	18,37	CHI
20201169831	PLANALTINA	PI21264734	PLANALTINA	15/11/2020 15:02	16/11/2020 16:17	15/11/2020 15:02	16/11/2020 16:17	25,25	1	25,25	CHI
20201169832	CATURAI	CK11210354	INHUMAS S1	15/11/2020 15:02	15/11/2020 16:52	15/11/2020 15:02	15/11/2020 16:52	1,83	95	173,82	CHI
20201169834	NIQUELANDIA	2750010737	NIQUELANDIA SUBTRANSMISSAO	15/11/2020 15:02	16/11/2020 08:16	15/11/2020 15:02	16/11/2020 08:16	17,22	1	17,22	CHI
20201169850	CHAPADAO DO CEU	DJ12131923	CHAPADAO DO CEU	15/11/2020 15:07	15/11/2020 17:30	15/11/2020 15:07	15/11/2020 17:30	2,38	10	23,81	CHI
20201169858	NOVO GAMA	10010655580	PACAEMBU S1	15/11/2020 15:08	15/11/2020 18:03	15/11/2020 15:08	15/11/2020 18:03	2,91	1	2,91	CHI
20201169952	RIO VERDE	RV12200718LD	RIO VERDE S2	15/11/2020 15:09	16/11/2020 01:38	15/11/2020 15:09	15/11/2020 18:53	3,73	1	3,73	CHI
20201169952	RIO VERDE	RV12200718LD	RIO VERDE S2	15/11/2020 15:09	16/11/2020 01:38	15/11/2020 15:09	15/11/2020 23:10	8,00	9	72,03	CHI
20201169952	SANTA HELENA DE GOIAS	RV12200718LD	RIO VERDE S2	15/11/2020 15:09	16/11/2020 01:38	15/11/2020 15:09	15/11/2020 23:10	8,00	1	8,00	CHI
20201169952	RIO VERDE	RV12200718LD	RIO VERDE S2	15/11/2020 15:09	16/11/2020 01:38	15/11/2020 18:53	15/11/2020 23:10	4,28	1	4,28	CHI
20201169952	RIO VERDE	RV12200718LD	RIO VERDE S2	15/11/2020 15:09	16/11/2020 01:38	15/11/2020 20:00	15/11/2020 23:10	3,17	1	3,17	CHI
20201169952	RIO VERDE	RV12200718LD	RIO VERDE S2	15/11/2020 15:09	16/11/2020 01:38	15/11/2020 15:09	16/11/2020 01:38	10,48	14	146,74	CHI
20201169952	SANTA HELENA DE GOIAS	RV12200718LD	RIO VERDE S2	15/11/2020 15:09	16/11/2020 01:38	15/11/2020 15:09	16/11/2020 01:38	10,48	69	723,20	CHI
20201169868	SAO JOAO D ALIANCA	JL12342390	SAO JOAO D ALIANCA	15/11/2020 15:10	15/11/2020 22:17	15/11/2020 15:10	15/11/2020 22:17	7,11	5	35,55	CHI
20201169869	TURVANIA	TV21083124	FIRMINOPOLIS S2	15/11/2020 15:10	15/11/2020 16:32	15/11/2020 15:10	15/11/2020 16:32	1,35	1	1,35	CHI
20201169871	RUBIATABA	RB21120759	RUBIATABA	15/11/2020 15:11	15/11/2020 17:14	15/11/2020 15:11	15/11/2020 17:14	2,05	2	4,10	CHI
20201170004	GUARANI DE GOIAS	GY12180835	IACIARA S1	15/11/2020 15:11	15/11/2020 16:13	15/11/2020 15:11	15/11/2020 16:13	1,02	337	343,83	CHI
20201170004	IACIARA	GY12180835	IACIARA S1	15/11/2020 15:11	15/11/2020 16:13	15/11/2020 15:11	15/11/2020 16:13	1,02	2	2,04	CHI
20201169877	ARENOPOLIS	AY21212434	ARENOPOLIS	15/11/2020 15:12	15/11/2020 23:15	15/11/2020 15:12	15/11/2020 23:15	8,06	1	8,06	CHI
20201169884	ALTO PARAISO DE GOIAS	BF21159090	NIQUELANDIA SUBTRANSMISSAO	15/11/2020 15:15	15/11/2020 16:06	15/11/2020 15:15	15/11/2020 16:06	0,84	1	0,84	CHI
20201169891	PLANALTINA	PI11071308	PLANALTINA	15/11/2020 15:16	15/11/2020 17:22	15/11/2020 15:16	15/11/2020 17:22	2,09	30	62,62	CHI
20201170051	PORANGATU	PO12350110	PORANGATU	15/11/2020 15:16	15/11/2020 18:52	15/11/2020 15:16	15/11/2020 18:52	3,58	17	60,93	CHI
20201169897	FORMOSA	FA12207282	ITIQUEIRA	15/11/2020 15:17	15/11/2020 18:30	15/11/2020 15:17	15/11/2020 18:30	3,20	15	48,03	CHI
20201169898	LUZIANIA	120208260	RIO VERMELHO	15/11/2020 15:18	15/11/2020 16:20	15/11/2020 15:18	15/11/2020 16:20	1,02	1	1,02	CHI
20201169902	PARAUNA	PU12301614	PARAUNA	15/11/2020 15:20	15/11/2020 19:53	15/11/2020 15:20	15/11/2020 19:53	4,55	2	9,09	CHI

20201169903	CUMARI	CY12034702	CATALAO S1	15/11/2020 15:20	15/11/2020 18:51	15/11/2020 15:20	15/11/2020 18:51	3,51	1	3,51	CHI
20201169965	PORANGATU	PO11053264	PORANGATU	15/11/2020 15:21	15/11/2020 16:20	15/11/2020 15:21	15/11/2020 16:20	0,98	104	102,01	CHI
20201169907	IACIARA	PS11067865	IACIARA S1	15/11/2020 15:22	15/11/2020 16:48	15/11/2020 15:22	15/11/2020 16:48	1,43	75	107,44	CHI
20201169908	SAO JOAO D ALIANCA	JL21049198	SAO JOAO D ALIANCA	15/11/2020 15:22	15/11/2020 23:04	15/11/2020 15:22	15/11/2020 23:04	7,70	1	7,70	CHI
20201170248	MAURILANDIA	ML12271556	RIO DOS BOIS	15/11/2020 15:22	17/11/2020 09:10	15/11/2020 15:22	15/11/2020 23:40	8,29	6	49,75	CHI
20201170248	RIO VERDE	ML12271556	RIO DOS BOIS	15/11/2020 15:22	17/11/2020 09:10	15/11/2020 15:22	15/11/2020 23:40	8,29	6	49,75	CHI
20201170248	RIO VERDE	ML12271556	RIO DOS BOIS	15/11/2020 15:22	17/11/2020 09:10	15/11/2020 20:54	16/11/2020 01:10	4,27	3	12,80	CHI
20201170248	MAURILANDIA	ML12271556	RIO DOS BOIS	15/11/2020 15:22	17/11/2020 09:10	15/11/2020 15:22	17/11/2020 06:37	39,23	3	117,70	CHI
20201170248	RIO VERDE	ML12271556	RIO DOS BOIS	15/11/2020 15:22	17/11/2020 09:10	15/11/2020 15:22	17/11/2020 06:37	39,23	1	39,23	CHI
20201170248	RIO VERDE	ML12271556	RIO DOS BOIS	15/11/2020 15:22	17/11/2020 09:10	16/11/2020 08:32	17/11/2020 06:37	22,08	4	88,33	CHI
20201170248	CASTELANDIA	ML12271556	RIO DOS BOIS	15/11/2020 15:22	17/11/2020 09:10	15/11/2020 15:22	17/11/2020 07:59	40,62	8	324,93	CHI
20201170248	CASTELANDIA	RV12026915LD	RIO DOS BOIS	15/11/2020 15:22	17/11/2020 09:10	15/11/2020 20:54	17/11/2020 07:59	35,10	12	421,19	CHI
20201170248	RIO VERDE	RV12026915LD	RIO DOS BOIS	15/11/2020 15:22	17/11/2020 09:10	15/11/2020 20:54	17/11/2020 07:59	35,10	6	210,60	CHI
20201170248	RIO VERDE	ML12271556	RIO DOS BOIS	15/11/2020 15:22	17/11/2020 09:10	15/11/2020 15:22	17/11/2020 09:10	41,79	4	167,15	CHI
20201169917	RIO VERDE	RV21350924	CABRIUVA S2	15/11/2020 15:24	16/11/2020 13:03	15/11/2020 15:24	16/11/2020 13:03	21,65	1	21,65	CHI
20201169927	GOIANIA	15220709	ATLANTICO S3	15/11/2020 15:25	15/11/2020 18:37	15/11/2020 15:25	15/11/2020 18:37	3,19	1	3,19	CHI
20201169934	TAQUARAL DE GOIAS	TQ12000087	ITABERAI S1	15/11/2020 15:27	15/11/2020 16:09	15/11/2020 15:27	15/11/2020 16:09	0,69	44	30,30	CHI
20201169940	RIO VERDE	RV12191997	MONTIVIDIU T	15/11/2020 15:28	15/11/2020 19:00	15/11/2020 15:28	15/11/2020 19:00	3,52	3	10,56	CHI
20201169948	PANAMA	PX12352622	ITUMBIARA NOVA	15/11/2020 15:28	15/11/2020 17:05	15/11/2020 15:28	15/11/2020 17:05	1,61	6	9,68	CHI
20201169943	LUZIANIA	LZ12383010	MARAJOARA	15/11/2020 15:29	15/11/2020 18:22	15/11/2020 15:29	15/11/2020 18:22	2,88	9	25,88	CHI
20201170600	MUNDO NOVO DE GOIAS	MH12291176	NOVA CRIXAS	15/11/2020 15:29	16/11/2020 09:25	15/11/2020 15:29	16/11/2020 09:25	17,93	9	161,40	CHI
20201171208	NOVO PLANALTO	SM12328903	SAO MIGUEL DO ARAGUAIA	15/11/2020 15:29	16/11/2020 00:13	15/11/2020 15:29	16/11/2020 00:13	8,72	10	87,25	CHI
20201169946	ALTO PARAISO DE GOIAS	BF12365239	SAO JOAO D ALIANCA	15/11/2020 15:30	15/11/2020 23:49	15/11/2020 15:30	15/11/2020 23:49	8,31	4	33,25	CHI
20201169949	CRISTALINA	KR21143716	CRISTALINA S2	15/11/2020 15:30	15/11/2020 16:51	15/11/2020 15:30	15/11/2020 16:51	1,34	1	1,34	CHI
20201169962	GOIANIA	15373411	GOIANIA LESTE S3	15/11/2020 15:32	15/11/2020 16:24	15/11/2020 15:32	15/11/2020 16:24	0,86	1	0,86	CHI
20201170271	CAIAPONIA	CP12344723	MONTIVIDIU T	15/11/2020 15:32	16/11/2020 12:36	15/11/2020 15:32	16/11/2020 12:36	21,06	8	168,46	CHI
20201169970	DIVINOPOLIS DE GOIAS	GH21268357	SAO DOMINGOS	15/11/2020 15:33	15/11/2020 17:25	15/11/2020 15:33	15/11/2020 17:25	1,86	1	1,86	CHI
20201169973	JATAI	JT12182190	JATAI S1	15/11/2020 15:33	16/11/2020 17:48	15/11/2020 15:33	15/11/2020 21:12	5,65	4	22,62	CHI
20201169973	JATAI	JT12182190	JATAI S1	15/11/2020 15:33	16/11/2020 17:48	15/11/2020 19:03	15/11/2020 21:12	2,16	5	10,80	CHI
20201169973	JATAI	JT12182190	JATAI S1	15/11/2020 15:33	16/11/2020 17:48	15/11/2020 15:33	16/11/2020 08:12	16,65	2	33,29	CHI
20201169973	JATAI	JT13214351	JATAI S1	15/11/2020 15:33	16/11/2020 17:48	15/11/2020 19:03	16/11/2020 08:12	13,15	14	184,12	CHI
20201169973	JATAI	JT12182190	JATAI S1	15/11/2020 15:33	16/11/2020 17:48	16/11/2020 09:05	16/11/2020 09:34	0,48	9	4,33	CHI
20201169973	JATAI	JT13214351	JATAI S1	15/11/2020 15:33	16/11/2020 17:48	16/11/2020 09:04	16/11/2020 17:48	8,74	16	139,86	CHI
20201169976	SENADOR CANEDO	SW21094877	SENADOR CANEDO	15/11/2020 15:34	15/11/2020 17:17	15/11/2020 15:34	15/11/2020 17:17	1,71	1	1,71	CHI
20201170240	PORANGATU	PO12057986	PORANGATU	15/11/2020 15:34	15/11/2020 18:21	15/11/2020 15:34	15/11/2020 18:21	2,77	143	396,47	CHI
20201170086	MUTUNOPOLIS	MU12320905	MARA ROSA	15/11/2020 15:36	16/11/2020 14:24	15/11/2020 15:36	16/11/2020 14:24	22,79	6	136,74	CHI
20201169988	SAO LUIZ DO NORTE	10017540753	ITAPACI	15/11/2020 15:37	15/11/2020 19:20	15/11/2020 15:37	15/11/2020 19:20	3,71	1	3,71	CHI
20201170315	BONOPOLIS	BX12079321RE	SAO MIGUEL DO ARAGUAIA	15/11/2020 15:38	15/11/2020 19:43	15/11/2020 15:38	15/11/2020 19:43	4,07	59	239,95	CHI
20201170000	PADRE BERNARDO	PB12342151	PADRE BERNARDO	15/11/2020 15:39	15/11/2020 21:28	15/11/2020 15:39	15/11/2020 21:28	5,80	2	11,61	CHI
20201170005	CAVALCANTE	10029748435	MINACU	15/11/2020 15:40	15/11/2020 16:42	15/11/2020 15:40	15/11/2020 16:42	1,03	1	1,03	CHI
20201170006	POSSE	PS12394113	IACIARA S2	15/11/2020 15:41	15/11/2020 18:48	15/11/2020 15:41	15/11/2020 18:48	3,12	9	28,04	CHI
20201170008	ARAGUAPAZ	AZ11029340	GOIAS	15/11/2020 15:41	16/11/2020 10:50	15/11/2020 15:41	16/11/2020 10:50	19,15	58	1110,49	CHI
20201170010	VILA PROPICIO	5501143350	GOIANESIA S1	15/11/2020 15:41	15/11/2020 19:05	15/11/2020 15:41	15/11/2020 19:05	3,40	1	3,40	CHI
20201170046	TRES RANCHOS	TH12063818RE	CATALAO S1	15/11/2020 15:41	15/11/2020 17:18	15/11/2020 15:41	15/11/2020 17:18	1,61	69	111,43	CHI
20201170042	PORANGATU	PO12192255	PORANGATU	15/11/2020 15:42	15/11/2020 18:52	15/11/2020 15:42	15/11/2020 18:52	3,15	60	189,05	CHI
20201170251	MINACU	IH12242192	MINACU	15/11/2020 15:44	15/11/2020 21:36	15/11/2020 15:44	15/11/2020 21:36	5,86	52	304,52	CHI
20201170956	MONTIVIDIU DO NORTE	MX12168971	PORANGATU	15/11/2020 15:47	16/11/2020 01:01	15/11/2020 15:47	16/11/2020 01:01	9,23	284	2619,98	CHI
20201170043	TRINDADE	40268081	TRINDADE	15/11/2020 15:49	15/11/2020 18:14	15/11/2020 15:49	15/11/2020 18:14	2,41	1	2,41	CHI
20201170044	ITAPURANGA	IK21186837	ITAPURANGA	15/11/2020 15:49	15/11/2020 20:21	15/11/2020 15:49	15/11/2020 20:21	4,52	1	4,52	CHI
20201170045	POSSE	PS12124656	IACIARA S2	15/11/2020 15:49	15/11/2020 18:42	15/11/2020 15:49	15/11/2020 18:42	2,87	95	272,81	CHI
20201170048	GOUVELANDIA	QI10394709	QUIRINOPOLIS	15/11/2020 15:49	15/11/2020 17:22	15/11/2020 15:49	15/11/2020 17:06	1,28	3	3,85	CHI

20201170048	QUIRINOPOLIS	QI10394709	QUIRINOPOLIS	15/11/2020 15:49	15/11/2020 17:22	15/11/2020 15:49	15/11/2020 17:06	1,28	33	42,31	CHI
20201170048	GOUVELANDIA	QI10394709	QUIRINOPOLIS	15/11/2020 15:49	15/11/2020 17:22	15/11/2020 15:49	15/11/2020 17:10	1,36	219	297,11	CHI
20201170048	QUIRINOPOLIS	QI10394709	QUIRINOPOLIS	15/11/2020 15:49	15/11/2020 17:22	15/11/2020 15:49	15/11/2020 17:22	1,55	240	372,33	CHI
20201170055	PLANALTINA	PI12218356	PLANALTINA	15/11/2020 15:52	15/11/2020 18:38	15/11/2020 15:52	15/11/2020 18:38	2,76	31	85,60	CHI
20201170058	POSSE	PS11159718	IACIARA S2	15/11/2020 15:52	15/11/2020 20:39	15/11/2020 15:52	15/11/2020 20:39	4,77	29	138,25	CHI
20201170456	MUTUNOPOLIS	PO12038770	PORANGATU	15/11/2020 15:52	16/11/2020 23:52	15/11/2020 15:52	16/11/2020 23:52	31,99	5	159,97	CHI
20201170456	PORANGATU	PO12038770	PORANGATU	15/11/2020 15:52	16/11/2020 23:52	15/11/2020 15:52	16/11/2020 23:52	31,99	18	575,87	CHI
20201170059	APARECIDA DE GOIANIA	AP21080230	CEPAIGO S1	15/11/2020 15:53	15/11/2020 17:40	15/11/2020 15:53	15/11/2020 17:40	1,78	1	1,78	CHI
20201170204	PORANGATU	PO12403381LD	PORANGATU	15/11/2020 15:54	15/11/2020 21:55	15/11/2020 15:54	15/11/2020 21:55	6,03	366	2206,06	CHI
20201170204	PORANGATU	PO12403381LD	PORANGATU	15/11/2020 15:54	15/11/2020 21:55	15/11/2020 20:23	15/11/2020 21:55	1,53	97	148,57	CHI
20201170584	MONTIVIDIU DO NORTE	MX12192266RE	PORANGATU	15/11/2020 15:54	16/11/2020 03:05	15/11/2020 15:54	16/11/2020 03:05	11,17	62	692,38	CHI
20201170584	TROMBAS	MX12192266RE	PORANGATU	15/11/2020 15:54	16/11/2020 03:05	15/11/2020 15:54	16/11/2020 03:05	11,17	24	268,02	CHI
20201170084	MINEIROS	MY10396070	PARQUE DAS EMAS	15/11/2020 15:56	16/11/2020 01:10	15/11/2020 15:56	15/11/2020 16:02	0,10	38	3,76	CHI
20201170084	MINEIROS	MY10396070	PARQUE DAS EMAS	15/11/2020 15:56	16/11/2020 01:10	15/11/2020 15:56	15/11/2020 17:44	1,80	78	140,49	CHI
20201170084	SERRANOPOLIS	MY10396070	PARQUE DAS EMAS	15/11/2020 15:56	16/11/2020 01:10	15/11/2020 15:56	15/11/2020 17:44	1,80	7	12,61	CHI
20201170084	MINEIROS	MY10396070	PARQUE DAS EMAS	15/11/2020 15:56	16/11/2020 01:10	15/11/2020 17:42	15/11/2020 17:51	0,15	38	5,72	CHI
20201170084	MINEIROS	MY10396070	PARQUE DAS EMAS	15/11/2020 15:56	16/11/2020 01:10	15/11/2020 15:56	15/11/2020 18:33	2,62	16	41,94	CHI
20201170084	MINEIROS	MY12197174	PARQUE DAS EMAS	15/11/2020 15:56	16/11/2020 01:10	15/11/2020 23:02	16/11/2020 00:19	1,28	2	2,55	CHI
20201170084	MINEIROS	MY13324495	PARQUE DAS EMAS	15/11/2020 15:56	16/11/2020 01:10	16/11/2020 00:47	16/11/2020 01:10	0,38	78	29,60	CHI
20201170084	SERRANOPOLIS	MY13324495	PARQUE DAS EMAS	15/11/2020 15:56	16/11/2020 01:10	16/11/2020 00:47	16/11/2020 01:10	0,38	7	2,66	CHI
20201170075	RIO VERDE	RV21028146	SANTA HELENA S1	15/11/2020 15:57	16/11/2020 02:01	15/11/2020 15:57	16/11/2020 02:01	10,07	3	30,20	CHI
20201170080	FORMOSO	2410019610	PORANGATU	15/11/2020 15:57	16/11/2020 19:22	15/11/2020 15:57	16/11/2020 19:22	27,40	1	27,40	CHI
20201170085	APARECIDA DE GOIANIA	14246260	ATLANTICO S2	15/11/2020 15:59	15/11/2020 20:03	15/11/2020 15:59	15/11/2020 20:03	4,05	1	4,05	CHI
20201170088	MINACU	IH21292241	MINACU	15/11/2020 16:00	15/11/2020 21:58	15/11/2020 16:00	15/11/2020 21:58	5,96	1	5,96	CHI
20201170090	GOIANIA	11333406	FERROVIARIO S3	15/11/2020 16:01	15/11/2020 18:48	15/11/2020 16:01	15/11/2020 18:48	2,78	1	2,78	CHI
20201170095	SAO MIGUEL DO ARAGUAIA	SM21328609	SAO MIGUEL DO ARAGUAIA	15/11/2020 16:02	16/11/2020 14:43	15/11/2020 16:02	16/11/2020 14:43	22,68	1	22,68	CHI
20201170097	ITAPURANGA	IK21311343	ITAPURANGA	15/11/2020 16:02	16/11/2020 08:23	15/11/2020 16:02	16/11/2020 08:23	16,34	2	32,68	CHI
20201170099	MORRINHOS	150054634	MORRINHOS	15/11/2020 16:02	15/11/2020 17:01	15/11/2020 16:02	15/11/2020 17:01	0,97	1	0,97	CHI
20201170105	PIRES DO RIO	PR12337219	PIRES DO RIO S1	15/11/2020 16:04	15/11/2020 18:38	15/11/2020 16:04	15/11/2020 18:38	2,57	4	10,26	CHI
20201170106	VILA BOA	VB12243008	IACIARA S2	15/11/2020 16:04	15/11/2020 17:12	15/11/2020 16:04	15/11/2020 17:12	1,13	35	39,61	CHI
20201170109	RIO VERDE	RV12260620	CABRIUVA S1	15/11/2020 16:04	15/11/2020 18:45	15/11/2020 16:04	15/11/2020 18:45	2,67	1	2,67	CHI
20201170113	MONTIVIDIU	MV21296201	MONTIVIDIU T	15/11/2020 16:05	15/11/2020 18:27	15/11/2020 16:05	15/11/2020 18:27	2,36	1	2,36	CHI
20201170114	PALMEIRAS DE GOIAS	590025296	PALMEIRAS	15/11/2020 16:06	15/11/2020 20:29	15/11/2020 16:06	15/11/2020 20:29	4,38	1	4,38	CHI
20201170116	ANAPOLIS	21015946	JUNDIAI S1	15/11/2020 16:06	15/11/2020 17:24	15/11/2020 16:06	15/11/2020 17:24	1,29	1	1,29	CHI
20201170119	SERRANOPOLIS	SX12165995	CHAPADAO DO CEU	15/11/2020 16:07	16/11/2020 08:48	15/11/2020 16:07	16/11/2020 08:48	16,68	4	66,70	CHI
20201170427	PORANGATU	PO11000002	PORANGATU	15/11/2020 16:07	15/11/2020 22:24	15/11/2020 16:07	15/11/2020 22:24	6,27	119	746,53	CHI
20201170124	PLANALTINA	PI12321745	PLANALTINA	15/11/2020 16:08	15/11/2020 21:49	15/11/2020 19:06	15/11/2020 21:49	2,72	5	13,58	CHI
20201170152	GOIATUBA	GT12052893RE	GOIATUBA S1	15/11/2020 16:09	15/11/2020 18:21	15/11/2020 16:09	15/11/2020 18:21	2,19	1	2,19	CHI
20201170152	JOVIANIA	GT12052893RE	GOIATUBA S1	15/11/2020 16:09	15/11/2020 18:21	15/11/2020 16:09	15/11/2020 18:21	2,19	18	39,48	CHI
20201170813	MONTES CLAROS DE GOIAS	ME12204903	IPORA	15/11/2020 16:12	15/11/2020 21:33	15/11/2020 16:12	15/11/2020 21:33	5,35	3	16,04	CHI
20201170946	PORANGATU	PO12328896	PORANGATU	15/11/2020 16:12	16/11/2020 04:54	15/11/2020 16:12	16/11/2020 04:54	12,69	24	304,67	CHI
20201170135	POSSE	PS12232228	IACIARA S2	15/11/2020 16:13	15/11/2020 17:52	15/11/2020 16:13	15/11/2020 17:52	1,65	4	6,59	CHI
20201170137	GOIANIA	GN11000663	ATLANTICO S1	15/11/2020 16:13	15/11/2020 21:31	15/11/2020 16:13	15/11/2020 21:31	5,30	76	402,42	CHI
20201170340	RIO VERDE	SH12273765	SANTA HELENA S1	15/11/2020 16:13	16/11/2020 00:23	15/11/2020 16:13	16/11/2020 00:23	8,16	3	24,49	CHI
20201170340	SANTA HELENA DE GOIAS	SH12273765	SANTA HELENA S1	15/11/2020 16:13	16/11/2020 00:23	15/11/2020 16:13	16/11/2020 00:23	8,16	12	97,95	CHI
20201170146	CRIXAS	CX12252974LD	SANTA TEREZINHA	15/11/2020 16:15	16/11/2020 08:16	15/11/2020 16:15	16/11/2020 08:16	16,03	8	128,22	CHI
20201170148	JANDAIA	JD12238631	ACREUNA	15/11/2020 16:16	16/11/2020 04:36	15/11/2020 16:16	16/11/2020 04:36	12,32	2	24,65	CHI
20201170149	SAO FRANCISCO DE GOIAS	PV21185061	SAO FRANCISCO DE GOIAS	15/11/2020 16:16	15/11/2020 19:36	15/11/2020 16:16	15/11/2020 19:36	3,32	1	3,32	CHI
20201170150	POSSE	PS12123497	IACIARA S2	15/11/2020 16:16	15/11/2020 17:52	15/11/2020 16:16	15/11/2020 17:52	1,58	15	23,76	CHI
20201170156	PORANGATU	PO12208396	PORANGATU	15/11/2020 16:18	16/11/2020 19:06	15/11/2020 16:18	16/11/2020 19:06	26,79	1	26,79	CHI
20201170158	ALTO PARAISO DE GOIAS	BF21129910	FLORES DE GOIAS	15/11/2020 16:19	16/11/2020 08:03	15/11/2020 16:19	16/11/2020 08:03	15,73	1	15,73	CHI

20201170160	GOIANIA	GN11169133	CARAJAS S1	15/11/2020 16:19	15/11/2020 17:05	15/11/2020 16:19	15/11/2020 17:05	0,76	48	36,32	CHI
20201170162	GOIATUBA	GT31048432	GOIATUBA S2	15/11/2020 16:19	15/11/2020 19:21	15/11/2020 16:19	15/11/2020 19:21	3,02	1	3,02	CHI
20201170165	GOIANDIRA	GD12195324	CATALAO S1	15/11/2020 16:20	15/11/2020 18:34	15/11/2020 16:20	15/11/2020 18:34	2,22	93	206,51	CHI
20201170166	GOIANIA	15131555	FERROVIARIO S1	15/11/2020 16:21	15/11/2020 17:59	15/11/2020 16:21	15/11/2020 17:59	1,63	1	1,63	CHI
20201170167	IPORA	IR21187397	ARENOPOLIS	15/11/2020 16:21	15/11/2020 19:37	15/11/2020 16:21	15/11/2020 19:37	3,26	1	3,26	CHI
20201170168	CRIXAS	CX21319117	SERRA DO OURO	15/11/2020 16:21	16/11/2020 14:02	15/11/2020 16:21	16/11/2020 14:02	21,68	1	21,68	CHI
20201170170	SANTA RITA DO NOVO DESTINO	DF11315603	BARRO ALTO	15/11/2020 16:21	15/11/2020 19:07	15/11/2020 16:21	15/11/2020 19:07	2,76	1	2,76	CHI
20201170175	ACREUNA	80244	ACREUNA	15/11/2020 16:21	15/11/2020 17:13	15/11/2020 16:21	15/11/2020 17:04	0,71	38	27,13	CHI
20201170175	ACREUNA	80244	ACREUNA	15/11/2020 16:21	15/11/2020 17:13	15/11/2020 16:21	15/11/2020 17:13	0,87	580	506,69	CHI
20201170175	EDEIA	80244	ACREUNA	15/11/2020 16:21	15/11/2020 17:13	15/11/2020 16:21	15/11/2020 17:13	0,87	13	11,36	CHI
20201170175	TURVANIA	80244	ACREUNA	15/11/2020 16:21	15/11/2020 17:13	15/11/2020 16:21	15/11/2020 17:13	0,87	1	0,87	CHI
20201170175	TURVELANDIA	80244	ACREUNA	15/11/2020 16:21	15/11/2020 17:13	15/11/2020 16:21	15/11/2020 17:13	0,87	31	27,08	CHI
20201170173	ITAUCU	IX12200069LD	INHUMAS S1	15/11/2020 16:22	15/11/2020 19:24	15/11/2020 18:06	15/11/2020 19:24	1,30	143	185,66	CHI
20201170174	MAURILANDIA	ML21316815	RIO DOS BOIS	15/11/2020 16:22	16/11/2020 00:41	15/11/2020 16:22	16/11/2020 00:41	8,30	2	16,61	CHI
20201170409	NOVA AMERICA	NM12243668	RUBIATABA	15/11/2020 16:23	17/11/2020 08:21	15/11/2020 16:23	17/11/2020 08:21	39,96	28	1118,83	CHI
20201170653	MONTVIDIU DO NORTE	MX12187844	PORANGATU	15/11/2020 16:23	16/11/2020 02:02	15/11/2020 16:23	16/11/2020 02:02	9,64	45	433,96	CHI
20201170187	APARECIDA DE GOIANIA	15080869	REAL S2	15/11/2020 16:25	15/11/2020 17:09	15/11/2020 16:25	15/11/2020 17:09	0,73	1	0,73	CHI
20201170188	JARAGUA	JA12221540	JARAGUA	15/11/2020 16:25	15/11/2020 18:05	15/11/2020 16:25	15/11/2020 18:05	1,66	126	208,98	CHI
20201170192	INHUMAS	IN21211020	ARACU	15/11/2020 16:28	15/11/2020 21:38	15/11/2020 16:28	15/11/2020 21:38	5,16	5	25,79	CHI
20201170198	VALPARAISO DE GOIAS	VA11172162	PACAEMBU S1	15/11/2020 16:30	15/11/2020 18:54	15/11/2020 16:30	15/11/2020 18:54	2,39	101	241,17	CHI
20201170203	ACREUNA	2440070689	ACREUNA	15/11/2020 16:31	16/11/2020 00:31	15/11/2020 16:31	16/11/2020 00:31	7,99	1	7,99	CHI
20201170207	SAO DOMINGOS	SD12257734	SAO DOMINGOS	15/11/2020 16:32	15/11/2020 21:20	15/11/2020 16:32	15/11/2020 21:20	4,80	57	273,35	CHI
20201170705	MARA ROSA	MQ12051834	MARA ROSA	15/11/2020 16:33	15/11/2020 21:18	15/11/2020 16:33	15/11/2020 21:18	4,74	13	61,67	CHI
20201170216	NOVA CRIXAS	NA12154611	MOZARLANDIA	15/11/2020 16:34	16/11/2020 16:41	15/11/2020 16:34	16/11/2020 16:41	24,11	1	24,11	CHI
20201171114	JAUPACI	JP12193319	IPORA	15/11/2020 16:34	16/11/2020 12:20	15/11/2020 16:34	16/11/2020 03:02	10,45	3	31,36	CHI
20201171114	JAUPACI	JP12193319	IPORA	15/11/2020 16:34	16/11/2020 12:20	15/11/2020 16:34	16/11/2020 12:20	19,75	1	19,75	CHI
20201170222	BRITANIA	2110026840	BRITANIA	15/11/2020 16:35	15/11/2020 17:28	15/11/2020 16:35	15/11/2020 17:28	0,87	1	0,87	CHI
20201170224	PORANGATU	PO12236042	NOVO PLANALTO	15/11/2020 16:36	17/11/2020 08:15	15/11/2020 16:36	17/11/2020 08:15	39,65	5	198,23	CHI
202011137994	MUTUNOPOLIS	MU12391658	MARA ROSA	15/11/2020 16:36	16/11/2020 17:04	15/11/2020 16:36	16/11/2020 17:04	24,46	34	831,48	CHI
20201170249	QUIRINOPOLIS	QI12301490	QUIRINOPOLIS	15/11/2020 16:40	15/11/2020 18:51	15/11/2020 16:40	15/11/2020 18:51	2,17	8	17,37	CHI
20201170254	SAO JOAO D ALIANCA	JI11130015	SAO JOAO D ALIANCA	15/11/2020 16:42	16/11/2020 07:51	15/11/2020 16:42	16/11/2020 07:51	15,14	7	106,01	CHI
20201170257	SAO MIGUEL DO PASSA QUATRO	SQ21188520	CRISTIANOPOLIS	15/11/2020 16:43	15/11/2020 18:51	15/11/2020 16:43	15/11/2020 18:51	2,13	3	6,40	CHI
20201170264	SENADOR CANEDO	SW21082422	CEPAIGO S2	15/11/2020 16:44	15/11/2020 18:28	15/11/2020 16:44	15/11/2020 18:28	1,72	1	1,72	CHI
20201170269	RIO VERDE	RV12260256	RIO VERDE S1	15/11/2020 16:45	16/11/2020 13:01	15/11/2020 16:45	15/11/2020 23:30	6,73	19	127,95	CHI
20201170269	RIO VERDE	RV13371479B	RIO VERDE S1	15/11/2020 16:45	16/11/2020 13:01	15/11/2020 21:20	15/11/2020 23:30	2,15	326	701,08	CHI
20201170269	SANTA HELENA DE GOIAS	RV13371479B	RIO VERDE S1	15/11/2020 16:45	16/11/2020 13:01	15/11/2020 21:20	15/11/2020 23:30	2,15	54	116,13	CHI
20201170269	RIO VERDE	RV12260256	RIO VERDE S1	15/11/2020 16:45	16/11/2020 13:01	16/11/2020 00:50	16/11/2020 13:01	12,19	19	231,60	CHI
20201170281	CORREGO DO OURO	CO21311136	SAO LUIZ DOS MONTES BELOS	15/11/2020 16:48	15/11/2020 21:52	15/11/2020 16:48	15/11/2020 21:52	5,06	1	5,06	CHI
20201170287	ESTRELA DO NORTE	ET12391909	MARA ROSA	15/11/2020 16:49	15/11/2020 21:42	15/11/2020 16:49	15/11/2020 21:42	4,87	7	34,09	CHI
20201170287	MARA ROSA	ET12391909	MARA ROSA	15/11/2020 16:49	15/11/2020 21:42	15/11/2020 16:49	15/11/2020 21:42	4,87	4	19,48	CHI
20201170691	BONOPOLIS	TA12263013	NOVO PLANALTO	15/11/2020 16:49	15/11/2020 21:09	15/11/2020 16:49	15/11/2020 21:09	4,33	30	129,99	CHI
20201170289	RIO VERDE	RV13301688	RIO VERDE S2	15/11/2020 16:50	16/11/2020 04:37	16/11/2020 03:23	16/11/2020 03:35	0,21	355	74,16	CHI
20201170289	RIO VERDE	RV12093121	RIO VERDE S2	15/11/2020 16:50	16/11/2020 04:37	15/11/2020 16:50	16/11/2020 04:05	11,26	33	371,61	CHI
20201170289	RIO VERDE	RV12093121	RIO VERDE S2	15/11/2020 16:50	16/11/2020 04:37	15/11/2020 16:50	16/11/2020 04:21	11,52	10	115,21	CHI
20201170289	RIO VERDE	RV12246798LD	RIO VERDE S2	15/11/2020 16:50	16/11/2020 04:37	15/11/2020 20:47	16/11/2020 04:21	7,56	3	22,68	CHI
20201170289	RIO VERDE	RV12093121	RIO VERDE S2	15/11/2020 16:50	16/11/2020 04:37	15/11/2020 16:50	16/11/2020 04:31	11,69	33	385,61	CHI
20201170289	RIO VERDE	RV12093121	RIO VERDE S2	15/11/2020 16:50	16/11/2020 04:37	15/11/2020 16:50	16/11/2020 04:37	11,79	33	389,03	CHI
20201171503	RIO VERDE	RV11260968	RIO VERDE S2	15/11/2020 16:50	16/11/2020 12:23	15/11/2020 16:50	16/11/2020 12:23	19,55	20	390,94	CHI
20201170296	SANTA TEREZA DE GOIAS	2430005068	MARA ROSA	15/11/2020 16:51	17/11/2020 13:44	15/11/2020 16:51	17/11/2020 13:44	44,87	1	44,87	CHI
20201170299	GOIANIA	11517499	CAMPINAS S2	15/11/2020 16:52	15/11/2020 19:14	15/11/2020 16:52	15/11/2020 19:14	2,36	1	2,36	CHI
20201170302	SAO SIMAO	SO12305915	CACHOEIRA ALTA	15/11/2020 16:52	15/11/2020 19:25	15/11/2020 16:52	15/11/2020 19:25	2,54	2	5,09	CHI

20201170306	GOIANDIRA	CY21071545	CATALAO S1	15/11/2020 16:53	15/11/2020 20:21	15/11/2020 16:53	15/11/2020 20:21	3,46	1	3,46	CHI
20201170308	CAMPINORTE	UR12074233RE	URUACU	15/11/2020 16:54	15/11/2020 21:49	15/11/2020 16:54	15/11/2020 21:49	4,91	25	122,84	CHI
20201170308	URUACU	UR12074233RE	URUACU	15/11/2020 16:54	15/11/2020 21:49	15/11/2020 16:54	15/11/2020 21:49	4,91	87	427,48	CHI
20201170309	NIQUELANDIA	NQ21146935	NIQUELANDIA SUBTRANSMISSAO	15/11/2020 16:54	16/11/2020 08:09	15/11/2020 16:54	16/11/2020 08:09	15,24	2	30,48	CHI
20201170313	NIQUELANDIA	NQ12055114	NIQUELANDIA SUBTRANSMISSAO	15/11/2020 16:55	16/11/2020 09:56	15/11/2020 16:55	16/11/2020 09:56	17,02	1	17,02	CHI
20201170570	ITAPACI	RB12401680	RUBIATABA	15/11/2020 16:55	15/11/2020 19:53	15/11/2020 16:55	15/11/2020 19:53	2,95	10	29,52	CHI
20201170570	RUBIATABA	RB12401680	RUBIATABA	15/11/2020 16:55	15/11/2020 19:53	15/11/2020 16:55	15/11/2020 19:53	2,95	96	283,39	CHI
20201170320	FORMOSO	FO12391992	PORANGATU	15/11/2020 16:56	16/11/2020 12:14	15/11/2020 16:56	16/11/2020 12:14	19,30	3	57,89	CHI
20201170321	CORUMBA DE GOIAS	CB12295657	ALEXANIA	15/11/2020 16:56	15/11/2020 17:05	15/11/2020 16:56	15/11/2020 17:05	0,15	19	2,79	CHI
20201170322	SENADOR CANEDO	SW21327358	SENADOR CANEDO	15/11/2020 16:56	15/11/2020 19:55	15/11/2020 16:56	15/11/2020 19:55	2,98	5	14,89	CHI
20201170326	PLANALTINA	10004357785	PLANALTINA	15/11/2020 16:56	16/11/2020 00:00	15/11/2020 16:56	16/11/2020 00:00	7,05	1	7,05	CHI
20201170334	SAO MIGUEL DO ARAGUAIA	SM21300971	SAO MIGUEL DO ARAGUAIA	15/11/2020 16:58	17/11/2020 10:19	15/11/2020 16:58	17/11/2020 10:19	41,34	1	41,34	CHI
20201170335	SANTO ANTONIO DO DESCOBERTO	SN21061942	MARAJOARA	15/11/2020 16:58	15/11/2020 18:49	15/11/2020 16:58	15/11/2020 18:49	1,83	1	1,83	CHI
20201170336	CALDAS NOVAS	CN12102170	CALDAS NOVAS S1	15/11/2020 16:59	15/11/2020 17:57	15/11/2020 16:59	15/11/2020 17:57	0,96	161	154,87	CHI
20201170339	RIO VERDE	RV21026189	RIO VERDE S1	15/11/2020 16:59	15/11/2020 18:45	15/11/2020 16:59	15/11/2020 18:45	1,75	1	1,75	CHI
20201170343	ANAPOLIS	21132732	JUNDIAI S2	15/11/2020 17:00	15/11/2020 18:50	15/11/2020 17:00	15/11/2020 18:50	1,82	1	1,82	CHI
20201170345	BARRO ALTO	BA12068485	BARRO ALTO	15/11/2020 17:01	15/11/2020 20:23	15/11/2020 17:01	15/11/2020 20:23	3,36	1	3,36	CHI
20201170345	SANTA RITA DO NOVO DESTINO	BA12068485	BARRO ALTO	15/11/2020 17:01	15/11/2020 20:23	15/11/2020 17:01	15/11/2020 20:23	3,36	32	107,65	CHI
20201170346	PORANGATU	PO21000011	PORANGATU	15/11/2020 17:01	15/11/2020 21:55	15/11/2020 17:01	15/11/2020 21:55	4,90	1	4,90	CHI
20201170349	NIQUELANDIA	NQ21114553	NIQUELANDIA SUBTRANSMISSAO	15/11/2020 17:01	16/11/2020 03:58	15/11/2020 17:01	16/11/2020 03:58	10,93	1	10,93	CHI
20201170436	NIQUELANDIA	NQ12290031	NIQUELANDIA SUBTRANSMISSAO	15/11/2020 17:01	16/11/2020 09:34	15/11/2020 17:01	16/11/2020 09:34	16,54	21	347,42	CHI
20201170351	ANAPOLIS	20988527	JUNDIAI S1	15/11/2020 17:02	15/11/2020 18:41	15/11/2020 17:02	15/11/2020 18:41	1,64	1	1,64	CHI
20201170354	TRES RANCHOS	TH11000133	CATALAO S1	15/11/2020 17:03	15/11/2020 19:31	15/11/2020 17:03	15/11/2020 19:31	2,45	75	184,04	CHI
20201170363	RIO VERDE	RV21249095	CABRIUVA S2	15/11/2020 17:04	15/11/2020 20:56	15/11/2020 17:04	15/11/2020 20:56	3,86	1	3,86	CHI
20201170369	JUSSARA	10000223512	JUSSARA	15/11/2020 17:07	15/11/2020 18:40	15/11/2020 17:07	15/11/2020 18:40	1,55	1	1,55	CHI
20201170374	CRIXAS	CX12314423	RUBIATABA	15/11/2020 17:09	16/11/2020 11:38	15/11/2020 17:09	16/11/2020 11:38	18,48	9	166,30	CHI
20201170648	JAUPACI	JP12354611	IPORA	15/11/2020 17:09	15/11/2020 23:31	15/11/2020 17:09	15/11/2020 23:31	6,36	8	50,92	CHI
20201170378	ALEXANIA	480097781	ALEXANIA	15/11/2020 17:10	15/11/2020 18:17	15/11/2020 17:10	15/11/2020 18:17	1,11	1	1,11	CHI
20201170382	SILVANIA	SV12075014	VIANOPOLIS	15/11/2020 17:10	15/11/2020 22:06	15/11/2020 17:10	15/11/2020 22:06	4,92	8	39,34	CHI
20201170447	PORANGATU	PO12028736	PORANGATU	15/11/2020 17:10	16/11/2020 11:11	15/11/2020 17:10	16/11/2020 11:11	18,01	4	72,06	CHI
20201170387	POSSE	PS12124657	IACIARA S2	15/11/2020 17:12	15/11/2020 18:21	15/11/2020 17:12	15/11/2020 18:21	1,14	14	15,96	CHI
20201170390	GOIANIA	12664200	CARAIAS S2	15/11/2020 17:13	15/11/2020 18:51	15/11/2020 17:13	15/11/2020 18:51	1,62	1	1,62	CHI
202011137996	NAZARIO	NZ12398840	ANICUNS	15/11/2020 17:15	16/11/2020 08:09	16/11/2020 04:48	16/11/2020 08:09	3,34	19	63,40	CHI
202011137996	PALMEIRAS DE GOIAS	NZ12398840	ANICUNS	15/11/2020 17:15	16/11/2020 08:09	16/11/2020 04:48	16/11/2020 08:09	3,34	18	60,07	CHI
202011137996	SANTA BARBARA DE GOIAS	NZ12398840	ANICUNS	15/11/2020 17:15	16/11/2020 08:09	16/11/2020 04:48	16/11/2020 08:09	3,34	21	70,08	CHI
202011137997	NAZARIO	NZ21076353	ANICUNS	15/11/2020 17:15	16/11/2020 08:09	15/11/2020 17:15	16/11/2020 08:09	14,90	4	59,59	CHI
20201170396	JATAI	JT12062162	JATAI S1	15/11/2020 17:16	16/11/2020 01:41	15/11/2020 17:16	15/11/2020 19:30	2,24	34	76,15	CHI
20201170396	JATAI	JT12062162	JATAI S1	15/11/2020 17:16	16/11/2020 01:41	15/11/2020 18:44	15/11/2020 19:30	0,76	2	1,53	CHI
20201170396	JATAI	JT12062162	JATAI S1	15/11/2020 17:16	16/11/2020 01:41	15/11/2020 19:40	15/11/2020 20:40	0,98	18	17,71	CHI
20201170396	JATAI	JT13337032	JATAI S1	15/11/2020 17:16	16/11/2020 01:41	15/11/2020 19:40	15/11/2020 21:51	2,17	15	32,56	CHI
20201170396	JATAI	JT12062164	JATAI S1	15/11/2020 17:16	16/11/2020 01:41	15/11/2020 19:40	16/11/2020 01:41	6,02	3	18,05	CHI
20201170397	IPAMERI	IP21344658	CRISTALINA S2	15/11/2020 17:16	15/11/2020 20:33	15/11/2020 17:16	15/11/2020 20:33	3,28	2	6,56	CHI
20201170398	MARA ROSA	MQ12383636	MARA ROSA	15/11/2020 17:16	16/11/2020 14:03	15/11/2020 17:16	16/11/2020 14:03	20,77	3	62,32	CHI
20201170399	RIO VERDE	10026049013	RIO VERDE S2	15/11/2020 17:16	15/11/2020 21:48	15/11/2020 17:16	15/11/2020 21:48	4,52	1	4,52	CHI
202011138056	TROMBAS	TB12156807	PORANGATU	15/11/2020 17:17	16/11/2020 14:34	15/11/2020 17:17	16/11/2020 14:34	21,28	73	1553,12	CHI
20201170413	GOIAS	90065189	MATRINCHA	15/11/2020 17:18	15/11/2020 22:54	15/11/2020 17:18	15/11/2020 22:54	5,59	1	5,59	CHI
20201170418	CAVALCANTE	CJ21412400	MINACU	15/11/2020 17:19	16/11/2020 11:47	15/11/2020 17:19	16/11/2020 11:47	18,46	1	18,46	CHI
20201170422	MIMOSO DE GOIAS	MJ12305277	PADRE BERNARDO	15/11/2020 17:20	15/11/2020 19:31	15/11/2020 17:20	15/11/2020 19:31	2,17	16	34,75	CHI
20201170424	ACREUNA	2440052316	ACREUNA	15/11/2020 17:21	15/11/2020 20:42	15/11/2020 17:21	15/11/2020 20:42	3,34	1	3,34	CHI
20201170798	MUTUNOPOLIS	MU12068520	MARA ROSA	15/11/2020 17:22	16/11/2020 12:51	15/11/2020 17:22	16/11/2020 12:51	19,47	2	38,94	CHI
20201170798	PORANGATU	MU12068520	MARA ROSA	15/11/2020 17:22	16/11/2020 12:51	15/11/2020 17:22	16/11/2020 12:51	19,47	12	233,66	CHI



20201170429	JATAI	JT21000196	JATAI S2	15/11/2020 17:23	15/11/2020 18:27	15/11/2020 17:23	15/11/2020 18:27	1,06	1	1,06	CHI
20201170650	RIO VERDE	RV12249020	CABRIUVA S2	15/11/2020 17:23	15/11/2020 22:32	15/11/2020 17:23	15/11/2020 22:32	5,15	18	92,66	CHI
20201170459	GAMELEIRA DE GOIAS	SV12056335	DAIA S2	15/11/2020 17:31	15/11/2020 20:35	15/11/2020 17:31	15/11/2020 20:35	3,06	7	21,40	CHI
20201170467	LUZIANIA	KR10406853	CRISTALINA S2	15/11/2020 17:33	16/11/2020 16:37	15/11/2020 17:33	15/11/2020 22:36	5,06	2	10,11	CHI
20201170467	CRISTALINA	KR10406853	CRISTALINA S2	15/11/2020 17:33	16/11/2020 16:37	15/11/2020 22:02	15/11/2020 22:36	0,57	33	18,69	CHI
20201170467	LUZIANIA	KR10406853	CRISTALINA S2	15/11/2020 17:33	16/11/2020 16:37	15/11/2020 22:02	15/11/2020 22:36	0,57	128	72,50	CHI
20201170467	LUZIANIA	LZ12383049	CRISTALINA S2	15/11/2020 17:33	16/11/2020 16:37	15/11/2020 17:33	16/11/2020 11:40	18,12	18	326,15	CHI
20201170467	LUZIANIA	LZ12383049	CRISTALINA S2	15/11/2020 17:33	16/11/2020 16:37	15/11/2020 17:33	16/11/2020 12:21	18,80	4	75,21	CHI
20201170467	LUZIANIA	LZ12383049	CRISTALINA S2	15/11/2020 17:33	16/11/2020 16:37	15/11/2020 17:33	16/11/2020 12:40	19,12	22	420,57	CHI
20201170467	LUZIANIA	LZ12383052LD	CRISTALINA S2	15/11/2020 17:33	16/11/2020 16:37	15/11/2020 17:33	16/11/2020 15:22	21,83	26	567,47	CHI
20201170467	LUZIANIA	LZ12383052LD	CRISTALINA S2	15/11/2020 17:33	16/11/2020 16:37	15/11/2020 17:33	16/11/2020 16:10	22,63	19	429,93	CHI
20201170467	LUZIANIA	LZ12383052LD	CRISTALINA S2	15/11/2020 17:33	16/11/2020 16:37	15/11/2020 17:33	16/11/2020 16:37	23,07	38	876,54	CHI
20201170468	AMARALINA	LC12245311	MARA ROSA	15/11/2020 17:33	15/11/2020 19:00	15/11/2020 17:33	15/11/2020 19:00	1,45	3	4,35	CHI
20201170819	LUZIANIA	OZ12402562RE	PIRES DO RIO S2	15/11/2020 17:33	15/11/2020 20:51	15/11/2020 17:33	15/11/2020 20:51	3,29	133	437,61	CHI
20201170819	ORIZONA	OZ12402562RE	PIRES DO RIO S2	15/11/2020 17:33	15/11/2020 20:51	15/11/2020 17:33	15/11/2020 20:51	3,29	7	23,03	CHI
20201170478	VILA BOA	VB21243081	IACIARA S2	15/11/2020 17:35	15/11/2020 18:54	15/11/2020 17:35	15/11/2020 18:54	1,32	1	1,32	CHI
20201170481	CRISTALINA	KR21163113	CRISTALINA S1	15/11/2020 17:36	15/11/2020 22:15	15/11/2020 17:36	15/11/2020 22:15	4,65	1	4,65	CHI
20201170482	APARECIDA DE GOIANIA	AP11044782	INDEPENDENCIA S2	15/11/2020 17:36	15/11/2020 18:29	15/11/2020 17:36	15/11/2020 18:29	0,88	129	113,52	CHI
20201170486	CACHOEIRA DOURADA	CD21000153	CACHOEIRA DOURADA	15/11/2020 17:36	15/11/2020 19:20	15/11/2020 17:36	15/11/2020 19:20	1,72	1	1,72	CHI
20201170487	CHAPADAO DO CEU	DJ12152817	CHAPADAO DO CEU	15/11/2020 17:36	15/11/2020 18:56	15/11/2020 17:36	15/11/2020 18:56	1,32	18	23,73	CHI
20201170525	PALMEIRAS DE GOIAS	PL12398710	PALMEIRAS	15/11/2020 17:36	15/11/2020 20:13	15/11/2020 17:36	15/11/2020 20:13	2,61	5	13,05	CHI
20201170488	PORANGATU	PO12208401	NOVO PLANALTO	15/11/2020 17:37	16/11/2020 16:22	15/11/2020 17:37	16/11/2020 16:22	22,74	2	45,48	CHI
20201170491	FORMOSA	610116757	ITUIQUIRA	15/11/2020 17:38	15/11/2020 20:38	15/11/2020 17:38	15/11/2020 20:38	3,00	1	3,00	CHI
20201170503	PLANALTINA	PI11000032	PLANALTINA	15/11/2020 17:38	15/11/2020 21:32	15/11/2020 17:38	15/11/2020 21:32	3,89	347	1351,08	CHI
20201170658	FORMOSO	SE12053856	MARA ROSA	15/11/2020 17:38	16/11/2020 19:15	15/11/2020 17:38	16/11/2020 19:15	25,61	6	153,68	CHI
20201170658	SANTA TEREZA DE GOIAS	SE12053856	MARA ROSA	15/11/2020 17:38	16/11/2020 19:15	15/11/2020 17:38	16/11/2020 19:15	25,61	3	76,84	CHI
20201170500	MONTES CLAROS DE GOIAS	ME12004038	IPORA	15/11/2020 17:40	15/11/2020 19:40	15/11/2020 17:40	15/11/2020 19:40	1,99	1	1,99	CHI
20201170502	ITUMBIARA	BG21293165	ITUMBIARA VELHA S2	15/11/2020 17:40	15/11/2020 19:06	15/11/2020 17:40	15/11/2020 19:06	1,42	1	1,42	CHI
20201170872	JATAI	JT12125794LD	JATAI S3	15/11/2020 17:40	15/11/2020 21:36	15/11/2020 17:40	15/11/2020 21:36	3,92	29	113,80	CHI
20201170872	RIO VERDE	JT12125794LD	JATAI S3	15/11/2020 17:40	15/11/2020 21:36	15/11/2020 17:40	15/11/2020 21:36	3,92	5	19,62	CHI
20201170881	CASTELANDIA	QI13000033	QUIRINOPOLIS	15/11/2020 17:41	16/11/2020 00:56	15/11/2020 17:41	16/11/2020 00:56	7,25	3	21,75	CHI
20201170881	QUIRINOPOLIS	QI13000033	QUIRINOPOLIS	15/11/2020 17:41	16/11/2020 00:56	15/11/2020 17:41	16/11/2020 00:56	7,25	20	144,97	CHI
20201170881	RIO VERDE	QI13000033	QUIRINOPOLIS	15/11/2020 17:41	16/11/2020 00:56	15/11/2020 17:41	16/11/2020 00:56	7,25	1	7,25	CHI
20201170881	CASTELANDIA	QI13000033	QUIRINOPOLIS	15/11/2020 17:41	16/11/2020 00:56	15/11/2020 22:45	16/11/2020 00:56	2,19	1	2,19	CHI
20201170881	GOUVELANDIA	QI13000033	QUIRINOPOLIS	15/11/2020 17:41	16/11/2020 00:56	15/11/2020 22:45	16/11/2020 00:56	2,19	2	4,37	CHI
20201170881	QUIRINOPOLIS	QI13000033	QUIRINOPOLIS	15/11/2020 17:41	16/11/2020 00:56	15/11/2020 22:45	16/11/2020 00:56	2,19	272	594,70	CHI
20201170510	TRINDADE	13889357	GOYA S2	15/11/2020 17:42	15/11/2020 19:50	15/11/2020 17:42	15/11/2020 19:50	2,12	1	2,12	CHI
20201170577	SITIO D ABADIA	SI12329755	IACIARA S2	15/11/2020 17:42	15/11/2020 19:58	15/11/2020 17:42	15/11/2020 19:58	2,26	11	24,81	CHI
20201170513	ITARUMA	IM12097096	CACHOEIRA ALTA	15/11/2020 17:43	15/11/2020 18:25	15/11/2020 17:43	15/11/2020 18:25	0,69	2	1,39	CHI
20201170515	PIRACANJUBA	PJ21115182	PIRACANJUBA	15/11/2020 17:43	15/11/2020 23:03	15/11/2020 17:43	15/11/2020 23:03	5,32	1	5,32	CHI
20201170520	PIRACANJUBA	PJ21076778	CALDAS NOVAS S1	15/11/2020 17:44	15/11/2020 19:19	15/11/2020 17:44	15/11/2020 19:19	1,58	1	1,58	CHI
20201170523	SAO MIGUEL DO ARAGUAIA	SM21357409	SAO MIGUEL DO ARAGUAIA	15/11/2020 17:44	16/11/2020 23:12	15/11/2020 17:44	16/11/2020 23:12	29,45	1	29,45	CHI
20201170526	CATALAO	CT12229967	CATALAO S1	15/11/2020 17:44	15/11/2020 20:32	15/11/2020 17:44	15/11/2020 20:32	2,78	1	2,78	CHI
20201170528	NIQUELANDIA	NQ21134928	NIQUELANDIA SUBTRANSMISSAO	15/11/2020 17:45	16/11/2020 08:12	15/11/2020 17:45	16/11/2020 08:12	14,44	1	14,44	CHI
20201170759	GOIANIRA	BW12291579	NEROPOLIS S1	15/11/2020 17:46	15/11/2020 21:46	15/11/2020 17:46	15/11/2020 21:46	3,99	3	11,98	CHI
20201170759	SANTO ANTONIO DE GOIAS	BW12291579	NEROPOLIS S1	15/11/2020 17:46	15/11/2020 21:46	15/11/2020 17:46	15/11/2020 21:46	3,99	2	7,99	CHI
20201170534	HIDROLANDIA	HD11000135	ANHANGUERA	15/11/2020 17:47	15/11/2020 18:47	15/11/2020 17:47	15/11/2020 18:47	1,00	45	44,85	CHI
20201170535	ITARUMA	IM12068691	CACHOEIRA ALTA	15/11/2020 17:47	16/11/2020 15:14	15/11/2020 17:47	16/11/2020 15:14	21,44	1	21,44	CHI
20201170649	FORMOSA	FA11000001	ITUIQUIRA	15/11/2020 17:48	15/11/2020 19:33	15/11/2020 17:48	15/11/2020 19:33	1,75	165	288,52	CHI
20201170543	HIDROLANDIA	HD13058891	ANHANGUERA	15/11/2020 17:49	15/11/2020 23:07	15/11/2020 17:49	15/11/2020 23:07	5,29	38	201,20	CHI
20201170543	HIDROLANDIA	HD13058891	ANHANGUERA	15/11/2020 17:49	15/11/2020 23:07	15/11/2020 21:19	15/11/2020 23:07	1,79	100	179,14	CHI

20201170545	POSSE	PS21235496	IACIARA S2	15/11/2020 17:50	15/11/2020 19:04	15/11/2020 17:50	15/11/2020 19:04	1,23	1	1,23	CHI
20201170548	ALEXANIA	AX21353415	ALEXANIA	15/11/2020 17:52	15/11/2020 19:22	15/11/2020 17:52	15/11/2020 19:22	1,49	1	1,49	CHI
20201170552	CAMPO LIMPO	AN12084795	NEROPOLIS S1	15/11/2020 17:52	15/11/2020 22:45	15/11/2020 17:52	15/11/2020 22:45	4,87	14	68,15	CHI
20201170557	SAO JOAO DA PARAUNA	RP21087032	FIRMINOPOLIS S2	15/11/2020 17:54	15/11/2020 19:22	15/11/2020 17:54	15/11/2020 19:22	1,45	1	1,45	CHI
20201170568	ALTO PARAISO DE GOIAS	BF12364990	SAO JOAO D ALIANCA	15/11/2020 17:56	15/11/2020 22:37	15/11/2020 17:56	15/11/2020 22:37	4,67	15	70,12	CHI
20201170572	PORTELANDIA	PW21013689	PARQUE DAS EMAS	15/11/2020 17:57	16/11/2020 13:21	15/11/2020 17:57	16/11/2020 13:21	19,39	1	19,39	CHI
20201170580	GOIANAPOLIS	GP12351049	DAIA S2	15/11/2020 17:58	15/11/2020 19:02	15/11/2020 17:58	15/11/2020 19:02	1,05	5	5,27	CHI
20201170580	TEREZOPOLIS DE GOIAS	GP12351049	DAIA S2	15/11/2020 17:58	15/11/2020 19:02	15/11/2020 17:58	15/11/2020 19:02	1,05	47	49,53	CHI
20201170590	SAO MIGUEL DO ARAGUAIA	SM12089543	SAO MIGUEL DO ARAGUAIA	15/11/2020 17:58	16/11/2020 17:46	15/11/2020 17:58	16/11/2020 17:46	23,79	8	190,36	CHI
20201170581	CAMPOS BELOS	CH12243118	SAO DOMINGOS	15/11/2020 17:59	15/11/2020 18:55	15/11/2020 17:59	15/11/2020 18:55	0,92	6	5,51	CHI
20201170581	MONTE ALEGRE DE GOIAS	CH12243118	SAO DOMINGOS	15/11/2020 17:59	15/11/2020 18:55	15/11/2020 17:59	15/11/2020 18:55	0,92	3	2,75	CHI
20201170582	NIQUELANDIA	NQ12095766	NIQUELANDIA SUBTRANSMISSAO	15/11/2020 18:00	16/11/2020 15:26	15/11/2020 18:00	16/11/2020 15:26	21,42	72	1542,34	CHI
20201170582	URUACU	NQ12095766	NIQUELANDIA SUBTRANSMISSAO	15/11/2020 18:00	16/11/2020 15:26	15/11/2020 18:00	16/11/2020 15:26	21,42	3	64,26	CHI
20201170583	APARECIDA DE GOIANIA	AP21000053	CEPAIGO S1	15/11/2020 18:01	15/11/2020 20:38	15/11/2020 18:01	15/11/2020 20:38	2,61	1	2,61	CHI
20201170586	RIO VERDE	RV21105838	RIO VERDE S1	15/11/2020 18:01	15/11/2020 19:14	15/11/2020 18:01	15/11/2020 19:14	1,20	1	1,20	CHI
20201171653	DOVERLANDIA	DV12156199	PARQUE DAS EMAS	15/11/2020 18:01	16/11/2020 09:58	15/11/2020 18:01	16/11/2020 09:58	15,93	11	175,28	CHI
20201171147	OUIDOR	OU12000352	CATALAO S1	15/11/2020 18:02	16/11/2020 08:08	15/11/2020 18:02	16/11/2020 08:08	14,10	32	451,08	CHI
20201171147	TRES RANCHOS	OU12000352	CATALAO S1	15/11/2020 18:02	16/11/2020 08:08	15/11/2020 18:02	16/11/2020 08:08	14,10	8	112,77	CHI
20201170598	GOIANIA	15672554	GOYA S1	15/11/2020 18:05	15/11/2020 19:52	15/11/2020 18:05	15/11/2020 19:52	1,77	1	1,77	CHI
20201170599	NIQUELANDIA	NQ21257250	NIQUELANDIA SUBTRANSMISSAO	15/11/2020 18:05	16/11/2020 11:02	15/11/2020 18:05	16/11/2020 11:02	16,94	1	16,94	CHI
20201170673	ITARUMA	IM12058060	CACHOEIRA ALTA	15/11/2020 18:05	15/11/2020 20:16	15/11/2020 18:05	15/11/2020 20:16	2,18	16	34,90	CHI
20201170665	JARAGUA	JA11007207	JARAGUA	15/11/2020 18:06	15/11/2020 22:16	15/11/2020 18:06	15/11/2020 22:16	4,16	125	520,07	CHI
20201170805	CAIAPONIA	CP12207864RE	CAIAPONIA	15/11/2020 18:07	16/11/2020 14:45	15/11/2020 18:07	16/11/2020 14:45	20,63	41	845,75	CHI
20201170805	CAIAPONIA	CP12207864RE	CAIAPONIA	15/11/2020 18:07	16/11/2020 14:45	15/11/2020 23:00	16/11/2020 14:45	15,75	2	31,50	CHI
20201170603	PORANGATU	PO12048411	PORANGATU	15/11/2020 18:08	15/11/2020 19:22	15/11/2020 18:08	15/11/2020 19:22	1,22	17	20,69	CHI
20201170607	SANTO ANTONIO DA BARRA	10024887941	ACREUNA	15/11/2020 18:10	15/11/2020 20:27	15/11/2020 18:10	15/11/2020 20:27	2,28	1	2,28	CHI
20201170751	AMARALINA	LC12286013	NOVA CRIXAS	15/11/2020 18:10	16/11/2020 14:01	15/11/2020 18:10	16/11/2020 14:01	19,85	9	178,64	CHI
20201170751	MARA ROSA	LC12286013	NOVA CRIXAS	15/11/2020 18:10	16/11/2020 14:01	15/11/2020 18:10	16/11/2020 14:01	19,85	1	19,85	CHI
20201170609	RIO VERDE	RV11271718	RIO VERDE S2	15/11/2020 18:11	15/11/2020 20:12	15/11/2020 18:11	15/11/2020 20:12	2,02	13	26,22	CHI
20201170631	NIQUELANDIA	NQ12280978	URUACU	15/11/2020 18:11	15/11/2020 22:30	15/11/2020 18:11	15/11/2020 22:30	4,31	90	388,20	CHI
20201170655	MINEIROS	MY12296347	PARQUE DAS EMAS	15/11/2020 18:11	15/11/2020 22:12	15/11/2020 18:11	15/11/2020 22:12	4,01	2	8,02	CHI
20201170613	QUIRINOPOLIS	80042922	QUIRINOPOLIS	15/11/2020 18:12	15/11/2020 20:31	15/11/2020 18:12	15/11/2020 20:31	2,31	1	2,31	CHI
20201170621	BURITI ALEGRE	BG21229322	ALTO BURITI	15/11/2020 18:15	15/11/2020 20:55	15/11/2020 18:15	15/11/2020 20:55	2,65	1	2,65	CHI
20201170622	BONOPOLIS	BX12203505	SAO MIGUEL DO ARAGUAIA	15/11/2020 18:16	17/11/2020 12:56	15/11/2020 18:16	17/11/2020 12:56	42,66	2	85,32	CHI
20201170625	CALDAS NOVAS	CN12263786	RIO QUENTE	15/11/2020 18:17	15/11/2020 19:29	15/11/2020 18:17	15/11/2020 19:29	1,19	32	38,19	CHI
20201170625	RIO QUENTE	CN12263786	RIO QUENTE	15/11/2020 18:17	15/11/2020 19:29	15/11/2020 18:17	15/11/2020 19:29	1,19	0	0,00	CHI
20201170628	SAO LUIZ DO NORTE	3090002952	ITAPACI	15/11/2020 18:18	15/11/2020 23:13	15/11/2020 18:18	15/11/2020 23:13	4,91	1	4,91	CHI
20201170635	JUSSARA	JR12011813	BRITANIA	15/11/2020 18:19	16/11/2020 15:25	15/11/2020 18:19	16/11/2020 09:59	15,66	7	109,63	CHI
20201170635	JUSSARA	JR12011813	BRITANIA	15/11/2020 18:19	16/11/2020 15:25	15/11/2020 18:19	16/11/2020 12:19	18,00	1	18,00	CHI
20201170635	JUSSARA	JR12011813	BRITANIA	15/11/2020 18:19	16/11/2020 15:25	15/11/2020 18:19	16/11/2020 15:25	21,10	23	485,34	CHI
20201170636	SANTO ANTONIO DA BARRA	BZ21349525	ACREUNA	15/11/2020 18:20	15/11/2020 21:51	15/11/2020 18:20	15/11/2020 21:51	3,51	1	3,51	CHI
20201170637	MONTE ALEGRE DE GOIAS	6882087	SAO DOMINGOS	15/11/2020 18:20	15/11/2020 22:27	15/11/2020 18:20	15/11/2020 22:27	4,11	11	45,22	CHI
20201170639	PIRACANIUBA	PJ21115884	PIRACANIUBA	15/11/2020 18:21	15/11/2020 21:46	15/11/2020 18:21	15/11/2020 21:46	3,41	1	3,41	CHI
20201170642	ANAPOLIS	10015011397	ANAPOLIS UNIVERSITARIO S2	15/11/2020 18:21	15/11/2020 20:37	15/11/2020 18:21	15/11/2020 20:37	2,26	1	2,26	CHI
20201170645	CIDADE OCIDENTAL	10005467983	MARAJOARA	15/11/2020 18:22	15/11/2020 21:52	15/11/2020 18:22	15/11/2020 21:52	3,49	1	3,49	CHI
20201170652	ABADIANIA	AA21050408	ANAPOLIS UNIVERSITARIO S1	15/11/2020 18:24	15/11/2020 20:11	15/11/2020 18:24	15/11/2020 20:11	1,78	2	3,55	CHI
20201171301	CAIAPONIA	CP12207858	PALESTINA	15/11/2020 18:28	16/11/2020 02:25	15/11/2020 18:28	16/11/2020 02:25	7,94	22	174,66	CHI
20201171301	PALESTINA DE GOIAS	CP12207858	PALESTINA	15/11/2020 18:28	16/11/2020 02:25	15/11/2020 18:28	16/11/2020 02:25	7,94	1	7,94	CHI
20201170667	LUZIANIA	3200152227	MARAJOARA	15/11/2020 18:29	15/11/2020 21:28	15/11/2020 18:29	15/11/2020 21:28	3,00	1	3,00	CHI
20201170668	GOIANIA	11079988	AEROPORTO S3	15/11/2020 18:29	15/11/2020 20:35	15/11/2020 18:29	15/11/2020 20:35	2,09	1	2,09	CHI
20201170681	ITARUMA	IM21049640	CACHOEIRA ALTA	15/11/2020 18:33	15/11/2020 21:11	15/11/2020 18:33	15/11/2020 21:11	2,63	1	2,63	CHI

20201170682	BELA VISTA DE GOIAS	BV10401411	BELA VISTA S2	15/11/2020 18:33	15/11/2020 21:10	15/11/2020 21:05	15/11/2020 21:09	0,06	628	36,28	CHI
20201170682	BELA VISTA DE GOIAS	BV12191066	BELA VISTA S2	15/11/2020 18:33	15/11/2020 21:10	15/11/2020 18:33	15/11/2020 21:10	2,61	16	41,70	CHI
20201170696	SANTA FE DE GOIAS	10030312467	BRITANIA	15/11/2020 18:36	16/11/2020 10:18	15/11/2020 18:36	16/11/2020 10:18	15,69	1	15,69	CHI
20201170700	ALVORADA DO NORTE	1510016093	IACIARA S2	15/11/2020 18:37	15/11/2020 20:03	15/11/2020 18:37	15/11/2020 20:03	1,43	1	1,43	CHI
20201170976	ARAGARCAS	AG12334918	ARAGARCAS	15/11/2020 18:40	16/11/2020 07:26	15/11/2020 18:40	16/11/2020 07:26	12,76	3	38,28	CHI
20201170719	CRISTALINA	1060124571	CRISTALINA S1	15/11/2020 18:42	15/11/2020 21:51	15/11/2020 18:42	15/11/2020 21:51	3,15	1	3,15	CHI
20201170730	GOIATUBA	GT12000265	GOIATUBA S2	15/11/2020 18:42	15/11/2020 19:57	15/11/2020 18:42	15/11/2020 19:57	1,25	8	9,99	CHI
20201170720	CATALAO	1990203015	CATALAO S2	15/11/2020 18:43	15/11/2020 21:08	15/11/2020 18:43	15/11/2020 21:08	2,41	1	2,41	CHI
20201170739	PARANAIGUARA	QI12054841	QUIRINOPOLIS	15/11/2020 18:44	15/11/2020 21:46	15/11/2020 18:44	15/11/2020 21:46	3,02	1	3,02	CHI
20201170739	QUIRINOPOLIS	QI12054841	QUIRINOPOLIS	15/11/2020 18:44	15/11/2020 21:46	15/11/2020 18:44	15/11/2020 21:46	3,02	16	48,40	CHI
20201170724	PLANALTINA	PI12291523	PLANALTINA	15/11/2020 18:45	15/11/2020 21:55	15/11/2020 18:45	15/11/2020 21:55	3,16	11	34,71	CHI
20201170729	TERESINA DE GOIAS	TE21218389	FLORES DE GOIAS	15/11/2020 18:46	15/11/2020 21:49	15/11/2020 18:46	15/11/2020 21:49	3,04	1	3,04	CHI
20201170404	ACREUNA	EU13000007	ACREUNA	15/11/2020 18:47	16/11/2020 05:06	15/11/2020 18:47	16/11/2020 05:06	10,30	583	6007,01	CHI
20201170404	EDEIA	EU13000007	ACREUNA	15/11/2020 18:47	16/11/2020 05:06	15/11/2020 18:47	16/11/2020 05:06	10,30	13	133,95	CHI
20201170404	TURVANIA	EU13000007	ACREUNA	15/11/2020 18:47	16/11/2020 05:06	15/11/2020 18:47	16/11/2020 05:06	10,30	1	10,30	CHI
20201170404	TURVELANDIA	EU13000007	ACREUNA	15/11/2020 18:47	16/11/2020 05:06	15/11/2020 18:47	16/11/2020 05:06	10,30	31	319,41	CHI
20201170404	ACREUNA	EU13000007	ACREUNA	15/11/2020 18:47	16/11/2020 05:06	16/11/2020 01:25	16/11/2020 05:06	3,68	1	3,68	CHI
20201170731	NOVA CRIXAS	CX12072330	NOVA CRIXAS	15/11/2020 18:47	17/11/2020 10:49	15/11/2020 18:47	17/11/2020 10:49	40,03	5	200,14	CHI
20201170736	DIVINOPOLIS DE GOIAS	GH12261969	SAO DOMINGOS	15/11/2020 18:50	15/11/2020 23:56	15/11/2020 18:50	15/11/2020 23:56	5,11	55	280,82	CHI
20201170736	MONTE ALEGRE DE GOIAS	GH12261969	SAO DOMINGOS	15/11/2020 18:50	15/11/2020 23:56	15/11/2020 18:50	15/11/2020 23:56	5,11	2	10,21	CHI
20201170736	SAO DOMINGOS	GH12261969	SAO DOMINGOS	15/11/2020 18:50	15/11/2020 23:56	15/11/2020 18:50	15/11/2020 23:56	5,11	12	61,27	CHI
20201170740	PORANGATU	PO12371842	NOVO PLANALTO	15/11/2020 18:51	17/11/2020 11:40	15/11/2020 18:51	17/11/2020 11:40	40,82	1	40,82	CHI
20201170790	BARRO ALTO	BA12185125	BARRO ALTO	15/11/2020 18:51	16/11/2020 19:40	15/11/2020 18:51	16/11/2020 19:40	24,82	40	992,68	CHI
20201170745	PORANGATU	PO12220778	PORANGATU	15/11/2020 18:52	17/11/2020 13:15	15/11/2020 18:52	17/11/2020 13:15	42,37	1	42,37	CHI
20201170768	PETROLINA DE GOIAS	PG16413905	INHUMAS S1	15/11/2020 18:52	16/11/2020 14:35	15/11/2020 18:52	15/11/2020 18:56	0,07	50	3,44	CHI
20201170768	SANTA ROSA DE GOIAS	PG16413905	INHUMAS S1	15/11/2020 18:52	16/11/2020 14:35	15/11/2020 18:52	15/11/2020 18:56	0,07	143	9,85	CHI
20201170768	SANTA ROSA DE GOIAS	SR10413902	INHUMAS S1	15/11/2020 18:52	16/11/2020 14:35	15/11/2020 18:52	15/11/2020 18:56	0,07	428	31,39	CHI
20201170768	PETROLINA DE GOIAS	PG10395831	INHUMAS S1	15/11/2020 18:52	16/11/2020 14:35	15/11/2020 19:23	15/11/2020 19:43	0,33	50	16,42	CHI
20201170768	SANTA ROSA DE GOIAS	PG10395831	INHUMAS S1	15/11/2020 18:52	16/11/2020 14:35	15/11/2020 19:23	15/11/2020 19:43	0,33	143	46,95	CHI
20201170768	ITAUCU	3040214	INHUMAS S1	15/11/2020 18:52	16/11/2020 14:35	15/11/2020 18:52	15/11/2020 19:45	0,89	6	5,32	CHI
20201170768	PETROLINA DE GOIAS	3040214	INHUMAS S1	15/11/2020 18:52	16/11/2020 14:35	15/11/2020 18:52	15/11/2020 19:45	0,89	81	71,80	CHI
20201170768	SANTA ROSA DE GOIAS	3040214	INHUMAS S1	15/11/2020 18:52	16/11/2020 14:35	15/11/2020 18:52	15/11/2020 19:45	0,89	32	28,36	CHI
20201170768	SANTA ROSA DE GOIAS	PG10395831	INHUMAS S1	15/11/2020 18:52	16/11/2020 14:35	15/11/2020 19:23	15/11/2020 19:45	0,36	428	153,84	CHI
20201170768	ITAUCU	3040214	INHUMAS S1	15/11/2020 18:52	16/11/2020 14:35	15/11/2020 22:26	15/11/2020 22:40	0,23	6	1,39	CHI
20201170768	PETROLINA DE GOIAS	3040214	INHUMAS S1	15/11/2020 18:52	16/11/2020 14:35	15/11/2020 22:26	15/11/2020 22:40	0,23	79	18,24	CHI
20201170768	SANTA ROSA DE GOIAS	3040214	INHUMAS S1	15/11/2020 18:52	16/11/2020 14:35	15/11/2020 22:26	15/11/2020 22:40	0,23	460	106,18	CHI
20201170768	PETROLINA DE GOIAS	PG16413905	INHUMAS S1	15/11/2020 18:52	16/11/2020 14:35	15/11/2020 19:44	16/11/2020 14:35	18,84	50	942,03	CHI
20201170768	SANTA ROSA DE GOIAS	PG16413905	INHUMAS S1	15/11/2020 18:52	16/11/2020 14:35	15/11/2020 19:44	16/11/2020 14:35	18,84	143	2694,20	CHI
20201170755	RIO VERDE	RV12260703	CABRIUVA S1	15/11/2020 18:56	16/11/2020 03:16	15/11/2020 18:56	16/11/2020 03:16	8,33	1	8,33	CHI
20201170756	AGUA LIMPA	AL21263207	VILA CORUMBA	15/11/2020 18:56	15/11/2020 21:04	15/11/2020 18:56	15/11/2020 21:04	2,13	1	2,13	CHI
20201170761	FORMOSA	FA21316953	PLANALTINA	15/11/2020 18:57	15/11/2020 20:30	15/11/2020 18:57	15/11/2020 20:30	1,54	1	1,54	CHI
20201170762	ANAPOLIS	20879775	JUNDIAI S1	15/11/2020 18:58	15/11/2020 20:31	15/11/2020 18:58	15/11/2020 20:31	1,55	1	1,55	CHI
20201170773	GOIANIA	10488650	GOIANIA LESTE S3	15/11/2020 19:00	15/11/2020 21:14	15/11/2020 19:00	15/11/2020 21:14	2,22	1	2,22	CHI
20201170779	CRIXAS	CX21181026	SANTA TEREZINHA	15/11/2020 19:02	16/11/2020 10:52	15/11/2020 19:02	16/11/2020 10:52	15,82	1	15,82	CHI
20201170789	GOIANIRA	GR11347551	GOIANIRA	15/11/2020 19:02	15/11/2020 21:49	15/11/2020 19:02	15/11/2020 21:49	2,77	174	481,69	CHI
20201170782	GOIANIA	GN21000285	XAVANTES	15/11/2020 19:03	16/11/2020 11:01	15/11/2020 19:03	16/11/2020 07:00	11,94	1	11,94	CHI
20201170782	GOIANIA	GN13144258LD	XAVANTES	15/11/2020 19:03	16/11/2020 11:01	15/11/2020 22:36	16/11/2020 11:01	12,42	25	310,49	CHI
20201170782	NEROPOLIS	GN13144258LD	XAVANTES	15/11/2020 19:03	16/11/2020 11:01	15/11/2020 22:36	16/11/2020 11:01	12,42	26	322,91	CHI
20201170879	PLANALTINA	PI12324485	PLANALTINA	15/11/2020 19:04	15/11/2020 20:30	15/11/2020 19:04	15/11/2020 20:30	1,43	21	29,96	CHI
20201170893	JATAI	JT11182102	JATAI S2	15/11/2020 19:06	15/11/2020 23:18	15/11/2020 19:06	15/11/2020 23:18	4,19	103	431,34	CHI
20201170795	CACU	CC21159993	CACHOEIRA ALTA	15/11/2020 19:07	15/11/2020 21:28	15/11/2020 19:07	15/11/2020 21:28	2,35	1	2,35	CHI

20201170796	RIO VERDE	630321814	RIO VERDE S2	15/11/2020 19:07	16/11/2020 09:04	15/11/2020 19:07	16/11/2020 09:04	13,94	1	13,94	CHI
20201170812	SAO JOAO D ALIANCA	6910581	SAO JOAO D ALIANCA	15/11/2020 19:09	16/11/2020 11:02	15/11/2020 19:09	16/11/2020 11:02	15,88	5	79,39	CHI
20201170816	GOIANIA	10012905001	REAL S2	15/11/2020 19:09	15/11/2020 21:32	15/11/2020 19:09	15/11/2020 21:32	2,37	1	2,37	CHI
20201170823	NIQUELANDIA	NQ11090405	NIQUELANDIA SUBTRANSMISSAO	15/11/2020 19:09	16/11/2020 16:14	16/11/2020 13:21	16/11/2020 16:14	2,87	206	591,56	CHI
20201170820	GOIANIA	12343092	CAMPINAS S3	15/11/2020 19:10	15/11/2020 22:07	15/11/2020 19:10	15/11/2020 22:07	2,94	1	2,94	CHI
20201170825	CALDAS NOVAS	CN18414869TS	RIO QUENTE	15/11/2020 19:11	15/11/2020 22:12	15/11/2020 19:11	15/11/2020 22:12	3,01	96	289,17	CHI
20201170825	MORRINHOS	CN18414869TS	RIO QUENTE	15/11/2020 19:11	15/11/2020 22:12	15/11/2020 19:11	15/11/2020 22:12	3,01	8	24,10	CHI
20201170825	PIRACANJUBA	CN18414869TS	RIO QUENTE	15/11/2020 19:11	15/11/2020 22:12	15/11/2020 19:11	15/11/2020 22:12	3,01	1	3,01	CHI
20201170825	RIO QUENTE	CN18414869TS	RIO QUENTE	15/11/2020 19:11	15/11/2020 22:12	15/11/2020 19:11	15/11/2020 22:12	3,01	2	6,02	CHI
20201170829	BOM JESUS DE GOIAS	BJ21062911	BOM JESUS DE GOIAS	15/11/2020 19:11	16/11/2020 09:17	15/11/2020 19:11	15/11/2020 09:17	14,09	1	14,09	CHI
20201170845	ACREUNA	SH12271266	SANTA HELENA S1	15/11/2020 19:11	15/11/2020 23:56	15/11/2020 19:11	15/11/2020 23:56	4,74	3	14,23	CHI
20201170845	SANTA HELENA DE GOIAS	SH12271266	SANTA HELENA S1	15/11/2020 19:11	15/11/2020 23:56	15/11/2020 19:11	15/11/2020 23:56	4,74	3	14,23	CHI
20201171086	CRIXAS	CX12213052LD	SERRA DO OURO	15/11/2020 19:11	17/11/2020 08:01	15/11/2020 19:11	17/11/2020 08:01	36,83	5	184,16	CHI
20201170833	GOIANIA	10004870490	REAL S1	15/11/2020 19:12	15/11/2020 21:06	15/11/2020 19:12	15/11/2020 21:06	1,89	1	1,89	CHI
20201171091	SAO MIGUEL DO ARAGUAIA	SM12211095	SAO MIGUEL DO ARAGUAIA	15/11/2020 19:12	16/11/2020 10:20	15/11/2020 19:12	16/11/2020 10:20	15,13	130	1967,26	CHI
20201170835	PORANGATU	PO12320970	NOVO PLANALTO	15/11/2020 19:13	17/11/2020 09:51	15/11/2020 19:13	17/11/2020 09:51	38,62	2	77,25	CHI
20201170842	RIO VERDE	630060320	RIO VERDE S1	15/11/2020 19:16	16/11/2020 15:20	15/11/2020 19:16	16/11/2020 15:20	20,06	1	20,06	CHI
20201170843	FORMOSA	FA21207285	ITUIQUIRA	15/11/2020 19:17	15/11/2020 21:29	15/11/2020 19:17	15/11/2020 21:29	2,19	3	6,56	CHI
20201170846	JATAI	JT12000183	JATAI S2	15/11/2020 19:18	16/11/2020 01:08	15/11/2020 19:18	16/11/2020 01:08	5,82	1	5,82	CHI
20201170847	GUARANI DE GOIAS	1580004729	IACIARA S1	15/11/2020 19:18	15/11/2020 21:10	15/11/2020 19:18	15/11/2020 21:10	1,86	1	1,86	CHI
20201170849	SAO DOMINGOS	SD12347129	SAO DOMINGOS	15/11/2020 19:18	16/11/2020 04:25	15/11/2020 19:18	16/11/2020 04:25	9,10	5	45,51	CHI
20201170851	VILA BOA	VB21243081	IACIARA S2	15/11/2020 19:19	15/11/2020 23:14	15/11/2020 19:19	15/11/2020 23:14	3,91	1	3,91	CHI
20201170854	ACREUNA	EU12214052	ACREUNA	15/11/2020 19:19	15/11/2020 23:07	15/11/2020 19:19	15/11/2020 23:07	3,79	3	11,36	CHI
20201170871	URUACU	UR12317135	URUACU	15/11/2020 19:19	15/11/2020 22:20	15/11/2020 19:19	15/11/2020 22:20	3,00	11	33,01	CHI
20201170858	MONTIVIDIU	MV12249172	MONTIVIDIU T	15/11/2020 19:20	15/11/2020 20:54	15/11/2020 19:20	15/11/2020 20:54	1,56	4	6,26	CHI
20201170864	CAVALCANTE	CJ21409489	MINACU	15/11/2020 19:21	17/11/2020 00:41	15/11/2020 19:21	17/11/2020 00:41	29,33	1	29,33	CHI
20201170876	PARANAIGUARA	PC12070705	QUIRINOPOLIS	15/11/2020 19:21	15/11/2020 20:34	15/11/2020 19:21	15/11/2020 20:34	1,21	36	43,52	CHI
20201170870	ANAPOLIS	20817186	JUNDIAI S1	15/11/2020 19:22	15/11/2020 20:20	15/11/2020 19:22	15/11/2020 20:20	0,95	1	0,95	CHI
20201170873	AGUA FRIA DE GOIAS	TL12204662	SAO JOAO D ALIANCA	15/11/2020 19:23	15/11/2020 23:21	15/11/2020 19:23	15/11/2020 23:21	3,96	15	59,38	CHI
20201170874	ITAJA	2300007673	ITAJA S2	15/11/2020 19:23	15/11/2020 20:51	15/11/2020 19:23	15/11/2020 20:51	1,46	1	1,46	CHI
20201170883	NIQUELANDIA	NQ21292575	URUACU	15/11/2020 19:25	16/11/2020 10:37	15/11/2020 19:25	16/11/2020 10:37	15,18	1	15,18	CHI
20201170885	BURITI ALEGRE	BG21285868	ALTO BURITI	15/11/2020 19:26	15/11/2020 21:39	15/11/2020 19:26	15/11/2020 21:39	2,20	2	4,41	CHI
20201170886	CALDAS NOVAS	CN21263265	CALDAS NOVAS S2	15/11/2020 19:26	15/11/2020 21:27	15/11/2020 19:26	15/11/2020 21:27	2,00	2	4,01	CHI
20201170890	EDEIA	EA12000039	EDEIA	15/11/2020 19:26	15/11/2020 21:51	15/11/2020 19:26	15/11/2020 21:51	2,40	23	55,30	CHI
20201170888	MUNDO NOVO DE GOIAS	MH11274914	NOVA CRIXAS	15/11/2020 19:27	16/11/2020 23:07	15/11/2020 19:27	16/11/2020 23:07	27,67	1	27,67	CHI
20201170910	MORRINHOS	MR12381119	MORRINHOS	15/11/2020 19:27	15/11/2020 20:47	15/11/2020 19:27	15/11/2020 20:47	1,33	23	30,55	CHI
20201170898	ANAPOLIS	AN11000188	ANAPOLIS UNIVERSITARIO S2	15/11/2020 19:29	15/11/2020 20:38	15/11/2020 19:29	15/11/2020 20:38	1,14	75	85,56	CHI
20201170903	PIRENOPOLIS	AN21288941	ANAPOLIS UNIVERSITARIO S2	15/11/2020 19:30	15/11/2020 20:44	15/11/2020 19:30	15/11/2020 20:44	1,23	1	1,23	CHI
20201170909	SANTA HELENA DE GOIAS	10000443270	IPEGUARI	15/11/2020 19:33	16/11/2020 07:39	15/11/2020 19:33	16/11/2020 07:39	12,09	1	12,09	CHI
20201170911	NIQUELANDIA	NQ11226893	URUACU	15/11/2020 19:34	16/11/2020 09:25	15/11/2020 19:34	16/11/2020 09:25	13,84	1	13,84	CHI
20201170915	GOIANIRA	390102829	MEIA PONTE	15/11/2020 19:37	15/11/2020 21:07	15/11/2020 19:37	15/11/2020 21:07	1,50	1	1,50	CHI
20201170922	JARAGUA	70113774	JARAGUA	15/11/2020 19:39	15/11/2020 21:30	15/11/2020 19:39	15/11/2020 21:30	1,85	1	1,85	CHI
20201170924	MAMBAI	MB11037522	IACIARA S2	15/11/2020 19:40	15/11/2020 22:09	15/11/2020 19:40	15/11/2020 22:09	2,48	12	29,76	CHI
20201170926	JATAI	290143238	JATAI S3	15/11/2020 19:40	15/11/2020 22:48	15/11/2020 19:40	15/11/2020 22:48	3,13	1	3,13	CHI
20201170927	SAO JOAO D ALIANCA	JL12244139	SAO JOAO D ALIANCA	15/11/2020 19:40	15/11/2020 19:52	15/11/2020 19:40	15/11/2020 19:52	0,20	1	0,20	CHI
20201170944	MUNDO NOVO DE GOIAS	MH12084354	NOVA CRIXAS	15/11/2020 19:41	16/11/2020 01:11	15/11/2020 19:41	16/11/2020 01:11	5,49	6	32,95	CHI
20201170936	CAIAPONIA	CP12184232	MONTIVIDIU T	15/11/2020 19:42	16/11/2020 10:25	15/11/2020 19:42	16/11/2020 10:25	14,70	1	14,70	CHI
20201170950	CUMARI	CY12036347	CATALAO S1	15/11/2020 19:48	15/11/2020 21:39	15/11/2020 19:48	15/11/2020 21:39	1,84	10	18,43	CHI
20201170950	GOIANDIRA	CY12036347	CATALAO S1	15/11/2020 19:48	15/11/2020 21:39	15/11/2020 19:48	15/11/2020 21:39	1,84	2	3,69	CHI
20201170952	PLANALTINA	PI11071308	PLANALTINA	15/11/2020 19:49	16/11/2020 00:48	15/11/2020 19:49	16/11/2020 00:48	4,97	30	149,11	CHI
20201170954	IPAMERI	IP21348231	IPAMERI	15/11/2020 19:51	15/11/2020 21:29	15/11/2020 19:51	15/11/2020 21:29	1,63	1	1,63	CHI

20201170964	CRIXAS	NA21361471	NOVA CRIXAS	15/11/2020 19:54	16/11/2020 15:03	15/11/2020 19:54	16/11/2020 15:03	19,14	1	19,14	CHI
20201170968	GOIATUBA	GT12000178	BOM JESUS DE GOIAS	15/11/2020 19:55	15/11/2020 22:45	15/11/2020 19:55	15/11/2020 22:45	2,83	27	76,31	CHI
20201170977	ITUMBIARA	IT21134703	CACHOEIRA DOURADA	15/11/2020 19:59	15/11/2020 21:29	15/11/2020 19:59	15/11/2020 21:29	1,48	1	1,48	CHI
20201170993	SANTA HELENA DE GOIAS	SH10394752	IPEGUARI	15/11/2020 20:01	16/11/2020 03:45	15/11/2020 20:01	15/11/2020 20:06	0,08	60	5,02	CHI
20201170993	SANTA HELENA DE GOIAS	SH12296172LD	IPEGUARI	15/11/2020 20:01	16/11/2020 03:45	15/11/2020 20:01	15/11/2020 20:09	0,14	8	1,13	CHI
20201170993	SANTA HELENA DE GOIAS	SH10394752	IPEGUARI	15/11/2020 20:01	16/11/2020 03:45	15/11/2020 21:37	15/11/2020 21:54	0,30	60	17,95	CHI
20201170993	SANTA HELENA DE GOIAS	SH12296172LD	IPEGUARI	15/11/2020 20:01	16/11/2020 03:45	15/11/2020 20:01	16/11/2020 03:45	7,75	45	348,59	CHI
20201170993	SANTA HELENA DE GOIAS	SH12296172LD	IPEGUARI	15/11/2020 20:01	16/11/2020 03:45	15/11/2020 21:37	16/11/2020 03:45	6,15	4	24,59	CHI
20201170985	BOM JESUS DE GOIAS	DM12303633LD	RIO DOS BOIS	15/11/2020 20:03	16/11/2020 14:27	15/11/2020 20:03	16/11/2020 14:27	18,40	5	91,98	CHI
20201171009	NOVA ROMA	TE12398396RE	FLORES DE GOIAS	15/11/2020 20:13	16/11/2020 09:51	15/11/2020 20:13	16/11/2020 09:51	13,63	9	122,64	CHI
20201171009	TERESINA DE GOIAS	TE12398396RE	FLORES DE GOIAS	15/11/2020 20:13	16/11/2020 09:51	15/11/2020 20:13	16/11/2020 09:51	13,63	122	1662,45	CHI
20201171010	JATAI	JT12234319	JATAI S3	15/11/2020 20:14	16/11/2020 03:40	15/11/2020 20:14	16/11/2020 03:40	7,43	4	29,70	CHI
20201171011	BURITI ALEGRE	BG12000136	ITUMBIARA VELHA S2	15/11/2020 20:14	16/11/2020 00:03	15/11/2020 20:14	16/11/2020 00:03	3,80	5	19,01	CHI
20201171016	QUIRINOPOLIS	QI31000038	QUIRINOPOLIS	15/11/2020 20:20	15/11/2020 22:02	15/11/2020 20:20	15/11/2020 22:02	1,70	1	1,70	CHI
20201171020	EDEIA	EA12160385	VICENTINOPOLIS	15/11/2020 20:21	15/11/2020 22:54	15/11/2020 20:21	15/11/2020 22:54	2,54	11	27,95	CHI
20201171023	BONFINOPOLIS	BO11200288	CEPAIGO S2	15/11/2020 20:22	15/11/2020 23:34	15/11/2020 20:22	15/11/2020 23:34	3,18	65	206,95	CHI
20201171026	GOIATUBA	GT121247744	BOM JESUS DE GOIAS	15/11/2020 20:24	15/11/2020 23:39	15/11/2020 20:24	15/11/2020 23:39	3,24	3	9,73	CHI
20201171048	PARAUNA	PU12301167	ACREUNA	15/11/2020 20:27	15/11/2020 21:53	15/11/2020 20:27	15/11/2020 21:53	1,43	15	21,47	CHI
20201171040	CRISTIANOPOLIS	PJ10396076	PIRACANJUBA	15/11/2020 20:29	16/11/2020 20:11	15/11/2020 20:29	16/11/2020 07:38	11,14	5	55,71	CHI
20201171040	PIRACANJUBA	PJ10396076	PIRACANJUBA	15/11/2020 20:29	16/11/2020 20:11	15/11/2020 20:29	16/11/2020 07:38	11,14	37	412,27	CHI
20201171040	PIRACANJUBA	PJ10396076	PIRACANJUBA	15/11/2020 20:29	16/11/2020 20:11	15/11/2020 20:29	16/11/2020 09:09	12,66	36	455,86	CHI
20201171040	CRISTIANOPOLIS	PJ12212176RE	PIRACANJUBA	15/11/2020 20:29	16/11/2020 20:11	15/11/2020 20:29	16/11/2020 09:45	13,26	4	53,02	CHI
20201171040	PIRACANJUBA	PJ12212176RE	PIRACANJUBA	15/11/2020 20:29	16/11/2020 20:11	15/11/2020 20:29	16/11/2020 09:45	13,26	14	185,58	CHI
20201171040	SANTA CRUZ DE GOIAS	PJ12212176RE	PIRACANJUBA	15/11/2020 20:29	16/11/2020 20:11	15/11/2020 20:29	16/11/2020 09:45	13,26	75	994,19	CHI
20201171040	PIRACANJUBA	PJ10396076	PIRACANJUBA	15/11/2020 20:29	16/11/2020 20:11	15/11/2020 20:29	16/11/2020 10:40	14,18	9	127,61	CHI
20201171040	PIRACANJUBA	PJ12223405RE	PIRACANJUBA	15/11/2020 20:29	16/11/2020 20:11	15/11/2020 20:29	16/11/2020 13:00	16,50	6	99,02	CHI
20201171040	SANTA CRUZ DE GOIAS	PJ12223405RE	PIRACANJUBA	15/11/2020 20:29	16/11/2020 20:11	15/11/2020 20:29	16/11/2020 13:00	16,50	6	99,02	CHI
20201171040	SANTA CRUZ DE GOIAS	PJ12223405RE	PIRACANJUBA	15/11/2020 20:29	16/11/2020 20:11	15/11/2020 20:29	16/11/2020 20:11	23,70	27	639,83	CHI
20201171041	MARA ROSA	MQ12031345	MARA ROSA	15/11/2020 20:32	16/11/2020 03:49	15/11/2020 20:32	16/11/2020 03:49	7,28	6	43,69	CHI
20201171044	NOVA VENEZA	NV21009890	INHUMAS S1	15/11/2020 20:33	16/11/2020 00:18	15/11/2020 20:33	16/11/2020 00:18	3,75	2	7,50	CHI
20201171045	CACU	CC12196048	CACHOEIRA ALTA	15/11/2020 20:33	15/11/2020 23:44	15/11/2020 20:33	15/11/2020 23:44	3,17	19	60,17	CHI
20201171052	SANTA CRUZ DE GOIAS	BC12300693	PIRES DO RIO S2	15/11/2020 20:33	15/11/2020 22:49	15/11/2020 20:33	15/11/2020 22:49	2,27	5	11,33	CHI
20201171050	CIDADE OCIDENTAL	DH11292249	MARAJOARA	15/11/2020 20:36	15/11/2020 23:42	15/11/2020 20:36	15/11/2020 23:42	3,09	131	404,24	CHI
20201171055	GOIANIA	17328779	ATLANTICO S1	15/11/2020 20:38	15/11/2020 22:35	15/11/2020 20:38	15/11/2020 22:35	1,94	1	1,94	CHI
20201171059	TRINDADE	TR11129066	TRINDADE	15/11/2020 20:38	15/11/2020 22:06	15/11/2020 20:38	15/11/2020 22:06	1,46	177	259,16	CHI
20201171078	VALPARAISO DE GOIAS	3860214	PACAEMBU S1	15/11/2020 20:40	15/11/2020 20:43	15/11/2020 20:40	15/11/2020 20:43	0,05	6504	337,85	CHI
20201171060	CAMPESTRE DE GOIAS	GC12053748	GUAPO S1	15/11/2020 20:41	15/11/2020 23:00	15/11/2020 20:41	15/11/2020 23:00	2,31	6	13,88	CHI
2020111500067	VALPARAISO DE GOIAS	3862224	PACAEMBU S2	15/11/2020 20:41	15/11/2020 20:45	15/11/2020 20:41	15/11/2020 20:45	0,07	9573	638,20	CHI
20201171071	SAO MIGUEL DO ARAGUAIA	SM12000053	SAO MIGUEL DO ARAGUAIA	15/11/2020 20:47	16/11/2020 13:25	15/11/2020 20:47	16/11/2020 13:25	16,63	4	66,50	CHI
20201171073	CATALAO	CT12266948RE	CATALAO S2	15/11/2020 20:47	15/11/2020 23:33	15/11/2020 20:47	15/11/2020 23:33	2,76	15	41,37	CHI
20201171073	CUMARI	CT12266948RE	CATALAO S2	15/11/2020 20:47	15/11/2020 23:33	15/11/2020 20:47	15/11/2020 23:33	2,76	19	52,40	CHI
20201171074	CABECEIRAS	860018921	ITIQUEIRA	15/11/2020 20:49	15/11/2020 22:27	15/11/2020 20:49	15/11/2020 22:27	1,63	1	1,63	CHI
202011137995	SANTA HELENA DE GOIAS	SH12021128	IPEGUARI	15/11/2020 20:49	16/11/2020 16:50	15/11/2020 20:49	16/11/2020 10:12	13,38	2	26,75	CHI
202011137995	SANTA HELENA DE GOIAS	SH12021128	IPEGUARI	15/11/2020 20:49	16/11/2020 16:50	15/11/2020 20:49	16/11/2020 16:50	20,02	3	60,07	CHI
20201171079	CALDAZINHA	SW12317421	SENADOR CANEDO	15/11/2020 20:50	15/11/2020 22:53	15/11/2020 20:50	15/11/2020 22:53	2,04	24	48,89	CHI
20201171079	SENADOR CANEDO	SW12317421	SENADOR CANEDO	15/11/2020 20:50	15/11/2020 22:53	15/11/2020 20:50	15/11/2020 22:53	2,04	5	10,18	CHI
20201171083	ARAGOIANIA	680016764	GUAPO S2	15/11/2020 20:51	15/11/2020 22:16	15/11/2020 20:51	15/11/2020 22:16	1,40	1	1,40	CHI
20201171084	GOIANIA	10003199914	XAVANTES	15/11/2020 20:52	15/11/2020 22:19	15/11/2020 20:52	15/11/2020 22:19	1,45	1	1,45	CHI
20201171087	SANTO ANTONIO DO DESCOBERTO	2210143026	ALEXANIA	15/11/2020 20:54	15/11/2020 22:45	15/11/2020 20:54	15/11/2020 22:45	1,84	1	1,84	CHI
20201171094	CATALAO	CT12316068	CATALAO S2	15/11/2020 20:57	16/11/2020 09:56	15/11/2020 20:57	16/11/2020 09:56	12,98	11	142,77	CHI
20201171094	CUMARI	CT12316068	CATALAO S2	15/11/2020 20:57	16/11/2020 09:56	15/11/2020 20:57	16/11/2020 09:56	12,98	1	12,98	CHI



20201171095	PIRENOPOLIS	PV21121866	CORUMBA	15/11/2020 20:57	16/11/2020 12:30	15/11/2020 20:57	16/11/2020 12:30	15,54	2	31,07	CHI
20201171097	ACREUNA	EU11200100	ACREUNA	15/11/2020 20:59	16/11/2020 09:07	15/11/2020 20:59	16/11/2020 09:07	12,13	12	145,53	CHI
20201171136	GOIANDIRA	GD10416020	CATALAO S1	15/11/2020 21:06	15/11/2020 22:53	15/11/2020 21:06	15/11/2020 21:09	0,05	962	52,64	CHI
20201171136	GOIANDIRA	GD10416020	CATALAO S1	15/11/2020 21:06	15/11/2020 22:53	15/11/2020 21:06	15/11/2020 21:09	0,05	205	11,22	CHI
20201171136	NOVA AURORA	GD10416020	CATALAO S1	15/11/2020 21:06	15/11/2020 22:53	15/11/2020 21:06	15/11/2020 21:09	0,05	14	0,77	CHI
20201171136	GOIANDIRA	540214	CATALAO S1	15/11/2020 21:06	15/11/2020 22:53	15/11/2020 21:23	15/11/2020 21:34	0,18	1210	213,43	CHI
20201171136	GOIANDIRA	GD10416020	CATALAO S1	15/11/2020 21:06	15/11/2020 22:53	15/11/2020 21:23	15/11/2020 22:53	1,49	962	1436,85	CHI
20201171136	GOIANDIRA	GD10416020	CATALAO S1	15/11/2020 21:06	15/11/2020 22:53	15/11/2020 21:23	15/11/2020 22:53	1,49	204	304,70	CHI
20201171136	NOVA AURORA	GD10416020	CATALAO S1	15/11/2020 21:06	15/11/2020 22:53	15/11/2020 21:23	15/11/2020 22:53	1,49	14	20,91	CHI
20201171136	GOIANDIRA	GD10416020	CATALAO S1	15/11/2020 21:06	15/11/2020 22:53	15/11/2020 22:28	15/11/2020 22:53	0,41	3	1,23	CHI
20201171124	GOIANIA	GN12042878	FERROVIARIO S2	15/11/2020 21:12	15/11/2020 22:52	15/11/2020 21:12	15/11/2020 22:52	1,66	105	174,77	CHI
20201171235	ITAPACI	IW12181387	ITAPACI	15/11/2020 21:14	16/11/2020 01:45	15/11/2020 21:14	16/11/2020 01:45	4,51	4	18,04	CHI
20201171235	NOVA GLORIA	IW12181387	ITAPACI	15/11/2020 21:14	16/11/2020 01:45	15/11/2020 21:14	16/11/2020 01:45	4,51	4	18,04	CHI
20201171128	CIDADE OCIDENTAL	DH12032397	MARAJOARA	15/11/2020 21:16	15/11/2020 23:50	15/11/2020 21:16	15/11/2020 23:50	2,56	93	238,13	CHI
20201171596	PIRACANJUBA	PJ12012972	CALDAS NOVAS S1	15/11/2020 21:19	16/11/2020 10:26	15/11/2020 21:19	16/11/2020 10:26	13,12	7	91,81	CHI
20201171144	AGUA FRIA DE GOIAS	TL21194763	SAO JOAO D ALIANCA	15/11/2020 21:23	16/11/2020 02:28	15/11/2020 21:23	16/11/2020 02:28	5,07	2	10,15	CHI
20201171145	GOIANIA	13910437	GOIANIA LESTE S2	15/11/2020 21:23	15/11/2020 23:11	15/11/2020 21:23	15/11/2020 23:11	1,79	1	1,79	CHI
20201171146	RIO VERDE	RV11271575	CABRIUVA S1	15/11/2020 21:23	16/11/2020 00:23	15/11/2020 22:23	16/11/2020 00:23	1,99	122	242,17	CHI
20201171148	NOVO GAMA	NJ21031843	PACAEMBU S1	15/11/2020 21:25	15/11/2020 22:38	15/11/2020 21:25	15/11/2020 22:38	1,21	1	1,21	CHI
20201171151	GOIANIA	14005219	FERROVIARIO S1	15/11/2020 21:25	15/11/2020 22:22	15/11/2020 21:25	15/11/2020 22:22	0,94	1	0,94	CHI
20201171152	MONTIVIDIU	2840033921	MONTIVIDIU T	15/11/2020 21:25	15/11/2020 22:13	15/11/2020 21:25	15/11/2020 22:13	0,79	1	0,79	CHI
20201171164	ANAPOLIS	AN11346833	ANAPOLIS UNIVERSITARIO S2	15/11/2020 21:29	15/11/2020 22:20	15/11/2020 21:29	15/11/2020 22:20	0,84	14	11,74	CHI
20201171166	LUZIANA	LZ12230287	MARAJOARA	15/11/2020 21:29	15/11/2020 23:37	15/11/2020 21:29	15/11/2020 23:37	2,12	9	19,07	CHI
20201171170	ORIZONA	PR12404788	PIRES DO RIO S1	15/11/2020 21:30	16/11/2020 01:23	15/11/2020 21:30	16/11/2020 01:23	3,87	11	42,55	CHI
20201171170	PIRES DO RIO	PR12404788	PIRES DO RIO S1	15/11/2020 21:30	16/11/2020 01:23	15/11/2020 21:30	16/11/2020 01:23	3,87	53	205,01	CHI
20201171175	GUAPO	710006123	GUAPO S1	15/11/2020 21:33	15/11/2020 22:24	15/11/2020 21:33	15/11/2020 22:24	0,84	1	0,84	CHI
20201171193	SAO MIGUEL DO PASSA QUATRO	SQ21188520	CRISTIANOPOLIS	15/11/2020 21:43	15/11/2020 23:17	15/11/2020 21:43	15/11/2020 23:17	1,55	3	4,66	CHI
20201171206	PONTALINA	3130214	VICENTINOPOLIS	15/11/2020 21:45	16/11/2020 14:36	15/11/2020 21:45	16/11/2020 00:44	2,99	16	47,86	CHI
20201171206	PONTALINA	3130214	VICENTINOPOLIS	15/11/2020 21:45	16/11/2020 14:36	15/11/2020 21:45	16/11/2020 14:36	16,84	48	808,43	CHI
20201171199	CABECEIRAS	CW12042593	ITUIQUIRA	15/11/2020 21:46	15/11/2020 23:11	15/11/2020 21:46	15/11/2020 23:11	1,42	237	335,68	CHI
20201171204	GOIANIA	11951369	GOYA S2	15/11/2020 21:49	16/11/2020 00:05	15/11/2020 21:49	16/11/2020 00:05	2,25	1	2,25	CHI
20201171209	ORIZONA	OZ11140712	PIRES DO RIO S2	15/11/2020 21:51	15/11/2020 22:40	15/11/2020 21:51	15/11/2020 22:40	0,81	149	120,61	CHI
20201171210	CATALAO	CT21067755	CATALAO S2	15/11/2020 21:51	16/11/2020 03:36	15/11/2020 21:51	16/11/2020 03:36	5,75	2	11,51	CHI
20201171212	SANTA TEREZA DE GOIAS	SE1224595	MARA ROSA	15/11/2020 21:52	16/11/2020 10:36	15/11/2020 21:52	16/11/2020 10:36	12,73	3	38,20	CHI
20201171213	MINEIROS	MY21332662	PARQUE DAS EMAS	15/11/2020 21:52	16/11/2020 10:41	15/11/2020 21:52	16/11/2020 10:41	12,81	1	12,81	CHI
20201171214	EDEIA	TD12040336	RIO DOS BOIS	15/11/2020 21:54	16/11/2020 13:52	15/11/2020 21:54	16/11/2020 13:52	15,95	1	15,95	CHI
20201171214	TURVELANDIA	TD12040336	RIO DOS BOIS	15/11/2020 21:54	16/11/2020 13:52	15/11/2020 21:54	16/11/2020 13:52	15,95	3	47,86	CHI
20201171928	AMARALINA	LC12215796	MARA ROSA	15/11/2020 21:55	16/11/2020 10:26	15/11/2020 21:55	16/11/2020 10:26	12,50	13	162,56	CHI
20201171227	PARANAIGUARA	Q112054841	QUIRINOPOLIS	15/11/2020 21:58	15/11/2020 23:11	15/11/2020 21:58	15/11/2020 23:11	1,20	1	1,20	CHI
20201171227	QUIRINOPOLIS	Q112054841	QUIRINOPOLIS	15/11/2020 21:58	15/11/2020 23:11	15/11/2020 21:58	15/11/2020 23:11	1,20	16	19,28	CHI
20201171232	PONTALINA	210035031	PONTALINA	15/11/2020 22:05	16/11/2020 01:07	15/11/2020 22:05	16/11/2020 01:07	3,05	1	3,05	CHI
20201171236	RIO VERDE	630493080	RIO VERDE S1	15/11/2020 22:08	16/11/2020 07:31	15/11/2020 22:08	16/11/2020 07:31	9,37	1	9,37	CHI
20201171241	VALPARAISO DE GOIAS	VA11353941	PACAEMBU S2	15/11/2020 22:09	15/11/2020 23:16	15/11/2020 22:09	15/11/2020 23:16	1,10	36	39,77	CHI
20201171243	BOM JESUS DE GOIAS	BJ12305405	BOM JESUS DE GOIAS	15/11/2020 22:10	16/11/2020 10:59	15/11/2020 22:10	16/11/2020 10:59	12,81	9	115,27	CHI
20201171251	PORANGATU	PO12230431	PORANGATU	15/11/2020 22:12	16/11/2020 08:10	15/11/2020 22:12	16/11/2020 08:10	9,95	2	19,91	CHI
20201171252	QUIRINOPOLIS	Q112371292	QUIRINOPOLIS	15/11/2020 22:13	16/11/2020 01:16	15/11/2020 22:13	16/11/2020 01:16	3,05	1	3,05	CHI
20201171254	SAO DOMINGOS	SD11257821	SAO DOMINGOS	15/11/2020 22:13	16/11/2020 11:38	15/11/2020 22:13	16/11/2020 11:38	13,41	14	187,70	CHI
20201171256	LEOPOLDO DE BULHOES	LB12353166	DAIA S2	15/11/2020 22:16	16/11/2020 01:38	15/11/2020 22:16	16/11/2020 01:38	3,36	4	13,45	CHI
20201171257	SENADOR CANEDO	190049390	SENADOR CANEDO	15/11/2020 22:16	15/11/2020 23:53	15/11/2020 22:16	15/11/2020 23:53	1,61	1	1,61	CHI
20201171268	TERESINA DE GOIAS	TE21320534	FLORES DE GOIAS	15/11/2020 22:22	16/11/2020 12:05	15/11/2020 22:22	16/11/2020 12:05	13,71	1	13,71	CHI
20201171470	GOIANESIA	GE12000185	GOIANESIA S2	15/11/2020 22:25	16/11/2020 08:08	15/11/2020 22:25	16/11/2020 08:08	9,72	6	58,29	CHI

20201171277	CALDAS NOVAS	CN12311854	CALDAS NOVAS S1	15/11/2020 22:26	15/11/2020 23:59	15/11/2020 22:26	15/11/2020 23:59	1,54	4	6,15	CHI
20201171284	INHUMAS	30102273	INHUMAS S2	15/11/2020 22:30	16/11/2020 11:21	15/11/2020 22:30	16/11/2020 11:21	12,84	1	12,84	CHI
20201171293	INHUMAS	IN21049750	INHUMAS S2	15/11/2020 22:35	16/11/2020 04:19	15/11/2020 22:35	16/11/2020 04:19	5,72	2	11,44	CHI
20201171297	ORIZONA	OZ12114463	PIRES DO RIO S2	15/11/2020 22:38	15/11/2020 23:45	15/11/2020 22:38	15/11/2020 23:45	1,11	22	24,34	CHI
20201171335	GOUVELANDIA	GB12303270	QUIRINOPOLIS	15/11/2020 22:38	16/11/2020 08:35	15/11/2020 22:38	16/11/2020 08:35	9,94	8	79,53	CHI
20201171773	MINEIROS	MY12324344	PARQUE DAS EMAS	15/11/2020 22:39	16/11/2020 08:39	15/11/2020 22:39	16/11/2020 08:39	9,99	7	69,90	CHI
20201171307	COCALZINHO DE GOIAS	NP12402058	GOIANESIA S1	15/11/2020 22:48	16/11/2020 11:16	15/11/2020 22:48	16/11/2020 11:16	12,46	1	12,46	CHI
20201171307	PADRE BERNARDO	NP12402058	GOIANESIA S1	15/11/2020 22:48	16/11/2020 11:16	15/11/2020 22:48	16/11/2020 11:16	12,46	11	137,07	CHI
20201171307	VILA PROPICIO	NP12402058	GOIANESIA S1	15/11/2020 22:48	16/11/2020 11:16	15/11/2020 22:48	16/11/2020 11:16	12,46	94	1171,34	CHI
20201171319	MORRINHOS	MR12389873	MORRINHOS	15/11/2020 22:56	16/11/2020 07:39	15/11/2020 22:56	16/11/2020 07:39	8,71	39	339,87	CHI
20201171326	ITUMBIARA	IT10396082	ITUMBIARA NOVA	15/11/2020 22:56	16/11/2020 13:58	15/11/2020 22:56	16/11/2020 09:02	10,10	7	70,70	CHI
20201171326	ITUMBIARA	IT10396082	ITUMBIARA NOVA	15/11/2020 22:56	16/11/2020 13:58	15/11/2020 22:56	16/11/2020 09:33	10,62	37	392,88	CHI
20201171326	ITUMBIARA	IT12000414	ITUMBIARA NOVA	15/11/2020 22:56	16/11/2020 13:58	15/11/2020 22:56	16/11/2020 10:29	11,55	7	80,85	CHI
20201171326	ITUMBIARA	IT10396082	ITUMBIARA NOVA	15/11/2020 22:56	16/11/2020 13:58	15/11/2020 22:56	16/11/2020 10:48	11,88	188	2232,71	CHI
20201171326	PANAMA	IT10396082	ITUMBIARA NOVA	15/11/2020 22:56	16/11/2020 13:58	15/11/2020 22:56	16/11/2020 10:48	11,88	83	985,72	CHI
20201171326	ITUMBIARA	IT10396082	ITUMBIARA NOVA	15/11/2020 22:56	16/11/2020 13:58	15/11/2020 22:56	16/11/2020 13:58	15,04	62	932,65	CHI
20201171326	PANAMA	IT10396082	ITUMBIARA NOVA	15/11/2020 22:56	16/11/2020 13:58	15/11/2020 22:56	16/11/2020 13:58	15,04	24	361,03	CHI
20201171322	FORMOSA	FA21255129	ITUIQUIRA	15/11/2020 22:57	15/11/2020 23:58	15/11/2020 22:57	15/11/2020 23:58	1,00	1	1,00	CHI
20201171330	GOIANIA	GN11042200	FERROVIARIO S2	15/11/2020 23:01	15/11/2020 23:51	15/11/2020 23:01	15/11/2020 23:51	0,83	105	87,00	CHI
20201171331	URUTAI	UT12300803LD	URUTAI	15/11/2020 23:01	16/11/2020 19:18	15/11/2020 23:01	16/11/2020 19:18	20,29	1	20,29	CHI
20201171331	IPAMERI	UT12300803LD	URUTAI	15/11/2020 23:01	16/11/2020 19:18	16/11/2020 10:06	16/11/2020 19:18	9,21	16	147,36	CHI
20201171331	URUTAI	UT12300803LD	URUTAI	15/11/2020 23:01	16/11/2020 19:18	16/11/2020 10:06	16/11/2020 19:18	9,21	53	488,14	CHI
20201171332	GOIANDIRA	2010022665	CATALAO S1	15/11/2020 23:01	15/11/2020 23:41	15/11/2020 23:01	15/11/2020 23:41	0,65	1	0,65	CHI
20201171341	FLORES DE GOIAS	3480006459	FLORES DE GOIAS	15/11/2020 23:13	16/11/2020 00:59	15/11/2020 23:13	16/11/2020 00:59	1,75	1	1,75	CHI
20201171351	CALDAS NOVAS	CN12075110	RIO QUENTE	15/11/2020 23:19	16/11/2020 01:48	15/11/2020 23:19	16/11/2020 01:48	2,48	6	14,87	CHI
20201171526	SANTO ANTONIO DO DESCOBERTO	SN12321753	AGUAS LINDAS DE GOIAS S2	15/11/2020 23:20	16/11/2020 08:10	15/11/2020 23:20	16/11/2020 08:10	8,83	4	35,32	CHI
20201171364	INHUMAS	IN12374035	INHUMAS S2	15/11/2020 23:40	16/11/2020 07:30	15/11/2020 23:40	16/11/2020 07:30	7,82	3	23,46	CHI
20201171373	CRISTALINA	KR21247880	CRISTALINA S2	15/11/2020 23:53	16/11/2020 01:35	15/11/2020 23:53	16/11/2020 01:35	1,69	2	3,39	CHI
20201171376	GOIANIA	15825978	FERROVIARIO S2	15/11/2020 23:57	16/11/2020 01:04	15/11/2020 23:57	16/11/2020 01:04	1,11	1	1,11	CHI
20201171602	PETROLINA DE GOIAS	PG12298071	PETROLINA	16/11/2020 00:03	16/11/2020 12:31	16/11/2020 00:03	16/11/2020 12:31	12,45	44	547,87	CHI
20201171602	SAO FRANCISCO DE GOIAS	PG12298071	PETROLINA	16/11/2020 00:03	16/11/2020 12:31	16/11/2020 00:03	16/11/2020 12:31	12,45	1	12,45	CHI
20201172153	CAMPO ALEGRE DE GOIAS	CM12266823	CAMPO ALEGRE DE GOIAS	16/11/2020 00:27	16/11/2020 09:39	16/11/2020 00:27	16/11/2020 09:39	9,18	43	394,95	CHI
20201171388	ANAPOLIS	AN11258141	ANAPOLIS UNIVERSITARIO S2	16/11/2020 00:30	16/11/2020 01:57	16/11/2020 00:30	16/11/2020 01:57	1,45	111	160,49	CHI
20201171391	GOIANIA	13966649	MEIA PONTE	16/11/2020 00:39	16/11/2020 01:41	16/11/2020 00:39	16/11/2020 01:41	1,04	1	1,04	CHI
20201171393	NOVA VENEZA	NV12272399	INHUMAS S1	16/11/2020 00:45	16/11/2020 00:51	16/11/2020 00:45	16/11/2020 00:51	0,10	8	0,80	CHI
20201171395	GOIANIA	10266781	CAMPINAS S3	16/11/2020 00:45	16/11/2020 02:32	16/11/2020 00:45	16/11/2020 02:32	1,77	1	1,77	CHI
20201171620	PONTALINA	PK12080063	PONTALINA	16/11/2020 00:46	16/11/2020 07:50	16/11/2020 00:46	16/11/2020 07:50	7,05	38	268,01	CHI
20201171694	PIRES DO RIO	PR12390420	PIRES DO RIO S1	16/11/2020 02:08	16/11/2020 08:34	16/11/2020 02:08	16/11/2020 08:34	6,43	132	848,83	CHI
20201171412	SAO MIGUEL DO PASSA QUATRO	SQ12070875	CRISTIANOPOLIS	16/11/2020 02:31	16/11/2020 05:44	16/11/2020 02:31	16/11/2020 05:44	3,20	8	25,63	CHI
20201171424	ABADIA DE GOIAS	GN12099642	CARAJAS S1	16/11/2020 03:02	16/11/2020 07:37	16/11/2020 03:02	16/11/2020 07:37	4,57	125	571,18	CHI
20201171462	GOIANIA	ATL-TR3	ATLANTICO S3	16/11/2020 03:42	16/11/2020 04:35	16/11/2020 03:42	16/11/2020 03:47	0,08	2072	174,39	CHI
20201171462	GOIANIA	GN10383645	ATLANTICO S3	16/11/2020 03:42	16/11/2020 04:35	16/11/2020 03:42	16/11/2020 03:48	0,10	11382	1169,82	CHI
20201171462	GOIANIA	ATL-TR3	ATLANTICO S3	16/11/2020 03:42	16/11/2020 04:35	16/11/2020 03:42	16/11/2020 03:48	0,10	2301	236,49	CHI
20201171462	APARECIDA DE GOIANIA	ATL-TR3	ATLANTICO S3	16/11/2020 03:42	16/11/2020 04:35	16/11/2020 03:42	16/11/2020 03:49	0,11	40	4,46	CHI
20201171462	GOIANIA	ATL-TR3	ATLANTICO S3	16/11/2020 03:42	16/11/2020 04:35	16/11/2020 03:42	16/11/2020 03:49	0,11	9990	1112,78	CHI
20201171462	APARECIDA DE GOIANIA	ATL-TR3	ATLANTICO S3	16/11/2020 03:42	16/11/2020 04:35	16/11/2020 03:42	16/11/2020 03:49	0,12	5672	672,76	CHI
20201171462	GOIANIA	ATL-TR3	ATLANTICO S3	16/11/2020 03:42	16/11/2020 04:35	16/11/2020 03:42	16/11/2020 03:49	0,12	3056	362,48	CHI
20201171462	GOIANIA	ATL-TR3	ATLANTICO S3	16/11/2020 03:42	16/11/2020 04:35	16/11/2020 03:42	16/11/2020 03:52	0,16	4325	711,22	CHI
20201171462	GOIANIA	ATL-TR3	ATLANTICO S3	16/11/2020 03:42	16/11/2020 04:35	16/11/2020 03:42	16/11/2020 03:52	0,17	673	113,66	CHI
20201171462	GOIANIA	GN16425934	ATLANTICO S3	16/11/2020 03:42	16/11/2020 04:35	16/11/2020 03:42	16/11/2020 04:35	0,88	762	669,08	CHI
20201171443	SENADOR CANEDO	SW11141244	SENADOR CANEDO	16/11/2020 03:47	16/11/2020 11:28	16/11/2020 03:47	16/11/2020 11:28	7,68	103	791,27	CHI

20201171453	SANTA RITA DO NOVO DESTINO	BA21036594	GOIANESIA S1	16/11/2020 03:50	16/11/2020 11:02	16/11/2020 03:50	16/11/2020 11:02	7,19	1	7,19	CHI
20201171705	MIMOSO DE GOIAS	4560216	BARRO ALTO	16/11/2020 04:17	16/11/2020 09:28	16/11/2020 04:17	16/11/2020 09:28	5,18	9	46,65	CHI
20201171705	NIQUELANDIA	4560216	BARRO ALTO	16/11/2020 04:17	16/11/2020 09:28	16/11/2020 04:17	16/11/2020 09:28	5,18	184	953,63	CHI
20201171705	VILA PROPICIO	4560216	BARRO ALTO	16/11/2020 04:17	16/11/2020 09:28	16/11/2020 04:17	16/11/2020 09:28	5,18	50	259,14	CHI
20201171511	SANTA BARBARA DE GOIAS	3510214	TRINDADE	16/11/2020 04:30	16/11/2020 11:34	16/11/2020 04:30	16/11/2020 09:27	4,96	831	4120,14	CHI
20201171511	TRINDADE	3510214	TRINDADE	16/11/2020 04:30	16/11/2020 11:34	16/11/2020 04:30	16/11/2020 09:27	4,96	3	14,87	CHI
20201171511	AVELINOPOLIS	3510214	TRINDADE	16/11/2020 04:30	16/11/2020 11:34	16/11/2020 04:30	16/11/2020 09:31	5,02	6	30,14	CHI
20201171511	NAZARIO	3510214	TRINDADE	16/11/2020 04:30	16/11/2020 11:34	16/11/2020 04:30	16/11/2020 09:31	5,02	4	20,10	CHI
20201171511	SANTA BARBARA DE GOIAS	3510214	TRINDADE	16/11/2020 04:30	16/11/2020 11:34	16/11/2020 04:30	16/11/2020 09:31	5,02	354	1778,55	CHI
20201171511	AVELINOPOLIS	3510214	TRINDADE	16/11/2020 04:30	16/11/2020 11:34	16/11/2020 08:15	16/11/2020 09:31	1,28	4	5,12	CHI
20201171511	NAZARIO	3510214	TRINDADE	16/11/2020 04:30	16/11/2020 11:34	16/11/2020 08:15	16/11/2020 09:31	1,28	7	8,96	CHI
20201171511	SANTA BARBARA DE GOIAS	3510214	TRINDADE	16/11/2020 04:30	16/11/2020 11:34	16/11/2020 09:33	16/11/2020 09:37	0,07	831	61,86	CHI
20201171511	TRINDADE	3510214	TRINDADE	16/11/2020 04:30	16/11/2020 11:34	16/11/2020 09:33	16/11/2020 09:37	0,07	3	0,22	CHI
20201171511	SANTA BARBARA DE GOIAS	SB13233293	TRINDADE	16/11/2020 04:30	16/11/2020 11:34	16/11/2020 09:33	16/11/2020 10:00	0,46	310	142,00	CHI
20201171511	AVELINOPOLIS	SB13206095	TRINDADE	16/11/2020 04:30	16/11/2020 11:34	16/11/2020 09:33	16/11/2020 11:34	2,02	10	20,19	CHI
20201171511	NAZARIO	SB13206095	TRINDADE	16/11/2020 04:30	16/11/2020 11:34	16/11/2020 09:33	16/11/2020 11:34	2,02	11	22,21	CHI
20201171511	SANTA BARBARA DE GOIAS	SB13206095	TRINDADE	16/11/2020 04:30	16/11/2020 11:34	16/11/2020 09:33	16/11/2020 11:34	2,02	44	88,84	CHI
20201171484	CAMPO ALEGRE DE GOIAS	CM21171486	CAMPO ALEGRE DE GOIAS	16/11/2020 04:48	16/11/2020 12:21	16/11/2020 04:48	16/11/2020 12:21	7,53	1	7,53	CHI
20201171647	GOIANESIA	GE12317825RE	GOIANESIA S2	16/11/2020 05:03	16/11/2020 08:17	16/11/2020 05:03	16/11/2020 08:17	3,23	82	264,50	CHI
20201171500	GOIANDIRA	GD12250481LD	CATALAO S1	16/11/2020 05:05	16/11/2020 11:13	16/11/2020 05:05	16/11/2020 11:13	6,13	58	355,57	CHI
20201171501	ORIZONA	OZ12085014RE	PIRES DO RIO S2	16/11/2020 05:06	16/11/2020 07:15	16/11/2020 05:06	16/11/2020 07:15	2,15	36	77,32	CHI
20201171501	VIANOPOLIS	OZ12085014RE	PIRES DO RIO S2	16/11/2020 05:06	16/11/2020 07:15	16/11/2020 05:06	16/11/2020 07:15	2,15	7	15,03	CHI
20201171502	SIMOLANDIA	SA21366209	IACIARA S2	16/11/2020 05:07	16/11/2020 09:03	16/11/2020 05:07	16/11/2020 09:03	3,93	1	3,93	CHI
20201171506	CAMPO LIMPO	AN21055362	NEROPOLIS S1	16/11/2020 05:11	16/11/2020 07:44	16/11/2020 05:11	16/11/2020 07:44	2,53	5	12,67	CHI
20201171509	CORUMBAIBA	CI12363786	VILA CORUMBA	16/11/2020 05:15	16/11/2020 07:19	16/11/2020 05:15	16/11/2020 07:19	2,06	18	37,06	CHI
20201172047	CAMPO ALEGRE DE GOIAS	CM12333445RE	CAMPO ALEGRE DE GOIAS	16/11/2020 05:16	16/11/2020 10:23	16/11/2020 05:16	16/11/2020 10:23	5,11	30	153,43	CHI
20201172047	IPAMERI	CM12333445RE	CAMPO ALEGRE DE GOIAS	16/11/2020 05:16	16/11/2020 10:23	16/11/2020 05:16	16/11/2020 10:23	5,11	1	5,11	CHI
202011137999	GOIANDIRA	GD12195324	CATALAO S1	16/11/2020 05:20	16/11/2020 10:34	16/11/2020 05:20	16/11/2020 10:34	5,22	94	490,58	CHI
20201171518	LUZIANIA	10028044329	RIO VERMELHO	16/11/2020 05:23	16/11/2020 06:50	16/11/2020 05:23	16/11/2020 06:50	1,44	1	1,44	CHI
20201171578	INHUMAS	IN12028765	INHUMAS S2	16/11/2020 05:26	16/11/2020 09:51	16/11/2020 05:26	16/11/2020 09:51	4,41	2	8,82	CHI
20201171578	ITAUCU	IN12028765	INHUMAS S2	16/11/2020 05:26	16/11/2020 09:51	16/11/2020 05:26	16/11/2020 09:51	4,41	33	145,56	CHI
20201171578	SANTA ROSA DE GOIAS	IN12028765	INHUMAS S2	16/11/2020 05:26	16/11/2020 09:51	16/11/2020 05:26	16/11/2020 09:51	4,41	10	44,11	CHI
20201171532	ITUMBIARA	BG12384546	ITUMBIARA VELHA S2	16/11/2020 05:28	16/11/2020 07:30	16/11/2020 05:28	16/11/2020 07:30	2,02	11	22,24	CHI
20201171541	LUZIANIA	LZ12261780	RIO VERMELHO	16/11/2020 05:34	16/11/2020 07:42	16/11/2020 05:34	16/11/2020 07:42	2,12	29	61,46	CHI
20201171974	JESUPOLIS	PG12111252	PETROLINA	16/11/2020 05:34	16/11/2020 14:23	16/11/2020 05:34	16/11/2020 14:23	8,81	1	8,81	CHI
20201171974	PETROLINA DE GOIAS	PG12111252	PETROLINA	16/11/2020 05:34	16/11/2020 14:23	16/11/2020 05:34	16/11/2020 14:23	8,81	30	264,35	CHI
20201171624	LUZIANIA	LZ12370854	MARAJOARA	16/11/2020 05:35	16/11/2020 09:20	16/11/2020 05:35	16/11/2020 09:20	3,74	5	18,71	CHI
20201171849	CEZARINA	CZ12099664	GUAPO S2	16/11/2020 05:42	16/11/2020 09:50	16/11/2020 05:42	16/11/2020 09:50	4,12	82	338,16	CHI
20201171849	INDIARA	CZ12099664	GUAPO S2	16/11/2020 05:42	16/11/2020 09:50	16/11/2020 05:42	16/11/2020 09:50	4,12	1	4,12	CHI
20201171560	IPAMERI	IP21195592	CRISTALINA S2	16/11/2020 05:44	16/11/2020 08:10	16/11/2020 05:44	16/11/2020 08:10	2,43	1	2,43	CHI
20201171563	POSSE	PS12344418	IACIARA S1	16/11/2020 05:47	16/11/2020 07:47	16/11/2020 05:47	16/11/2020 07:47	1,99	41	81,77	CHI
20201171565	CALDAS NOVAS	RQ12392166	MORRINHOS	16/11/2020 05:47	16/11/2020 08:22	16/11/2020 05:47	16/11/2020 08:22	2,57	1	2,57	CHI
20201171565	RIO QUENTE	RQ12392166	MORRINHOS	16/11/2020 05:47	16/11/2020 08:22	16/11/2020 05:47	16/11/2020 08:22	2,57	2	5,15	CHI
20201171571	LUZIANIA	LZ12245523	PIRES DO RIO S2	16/11/2020 05:50	16/11/2020 10:04	16/11/2020 05:50	16/11/2020 10:04	4,23	10	42,26	CHI
20201171577	SAO FRANCISCO DE GOIAS	SF21094464	SAO FRANCISCO DE GOIAS	16/11/2020 05:51	16/11/2020 06:54	16/11/2020 05:51	16/11/2020 06:54	1,04	1	1,04	CHI
20201171316	AGUA LIMPA	AL12257036	VILA CORUMBA	16/11/2020 05:52	16/11/2020 08:04	16/11/2020 05:52	16/11/2020 08:04	2,19	113	247,50	CHI
20201171316	BURITI ALEGRE	AL12257036	VILA CORUMBA	16/11/2020 05:52	16/11/2020 08:04	16/11/2020 05:52	16/11/2020 08:04	2,19	3	6,57	CHI
20201171316	CORUMBAIBA	AL12257036	VILA CORUMBA	16/11/2020 05:52	16/11/2020 08:04	16/11/2020 05:52	16/11/2020 08:04	2,19	1	2,19	CHI
20201171316	MORRINHOS	AL12257036	VILA CORUMBA	16/11/2020 05:52	16/11/2020 08:04	16/11/2020 05:52	16/11/2020 08:04	2,19	2	4,38	CHI
20201171607	TRES RANCHOS	TH12149178	CATALAO S1	16/11/2020 05:55	16/11/2020 08:05	16/11/2020 05:55	16/11/2020 08:05	2,16	15	32,43	CHI
20201171595	ORIZONA	OZ12300550	PIRES DO RIO S2	16/11/2020 05:58	16/11/2020 08:22	16/11/2020 05:58	16/11/2020 08:22	2,40	50	119,90	CHI

20201172174	BELA VISTA DE GOIAS	SQ12317631	CRISTIANOPOLIS	16/11/2020 06:05	16/11/2020 09:12	16/11/2020 06:05	16/11/2020 09:12	3,10	28	86,82	CHI
20201171614	GOIANIA	12325727	CARAJAS S1	16/11/2020 06:06	16/11/2020 09:01	16/11/2020 06:06	16/11/2020 09:01	2,91	1	2,91	CHI
20201171202	CATALAO	GD12127624RE	CATALAO S1	16/11/2020 06:10	16/11/2020 10:34	16/11/2020 06:10	16/11/2020 10:34	4,39	14	61,52	CHI
20201171202	GOIANDIRA	GD12127624RE	CATALAO S1	16/11/2020 06:10	16/11/2020 10:34	16/11/2020 06:10	16/11/2020 10:34	4,39	17	74,71	CHI
20201171202	IPAMERI	GD12127624RE	CATALAO S1	16/11/2020 06:10	16/11/2020 10:34	16/11/2020 06:10	16/11/2020 10:34	4,39	7	30,76	CHI
20201171643	FORMOSA	CW12381545	ITIQUEIRA	16/11/2020 06:12	16/11/2020 08:58	16/11/2020 06:12	16/11/2020 08:58	2,75	2	5,50	CHI
20201172048	GOIATUBA	JV12050285	GOIATUBA S1	16/11/2020 06:17	16/11/2020 12:00	16/11/2020 06:17	16/11/2020 12:00	5,70	7	39,90	CHI
20201172048	JOVIANIA	JV12050285	GOIATUBA S1	16/11/2020 06:17	16/11/2020 12:00	16/11/2020 06:17	16/11/2020 12:00	5,70	3	17,10	CHI
20201172048	VICENTINOPOLIS	JV12050285	GOIATUBA S1	16/11/2020 06:17	16/11/2020 12:00	16/11/2020 06:17	16/11/2020 12:00	5,70	9	51,31	CHI
20201171661	FORMOSA	FA12404379	ITIQUEIRA	16/11/2020 06:18	16/11/2020 07:41	16/11/2020 06:18	16/11/2020 07:41	1,38	12	16,59	CHI
20201172537	NOVA ROMA	TE12284926	FLORES DE GOIAS	16/11/2020 06:19	16/11/2020 10:42	16/11/2020 06:19	16/11/2020 10:42	4,38	23	100,77	CHI
20201172537	TERESINA DE GOIAS	TE12284926	FLORES DE GOIAS	16/11/2020 06:19	16/11/2020 10:42	16/11/2020 06:19	16/11/2020 10:42	4,38	11	48,19	CHI
20201171670	ALEXANIA	AX21129480	ALEXANIA	16/11/2020 06:20	16/11/2020 08:05	16/11/2020 06:20	16/11/2020 08:05	1,75	1	1,75	CHI
20201171924	GOIANESIA	GE12255984	GOIANESIA S2	16/11/2020 06:20	16/11/2020 09:21	16/11/2020 06:20	16/11/2020 09:21	3,01	20	60,18	CHI
20201171677	PLANALTINA	PI12085567	PLANALTINA	16/11/2020 06:21	16/11/2020 09:14	16/11/2020 06:21	16/11/2020 09:14	2,88	5	14,40	CHI
20201171850	PONTALINA	PK12182928	PONTALINA	16/11/2020 06:21	16/11/2020 08:53	16/11/2020 06:21	16/11/2020 08:53	2,53	15	37,91	CHI
20201171687	LUZIANIA	120097072	RIO VERMELHO	16/11/2020 06:23	16/11/2020 08:42	16/11/2020 06:23	16/11/2020 08:42	2,31	1	2,31	CHI
20201171703	CORUMBAIBA	CI12110154	VILA CORUMBA	16/11/2020 06:29	16/11/2020 09:35	16/11/2020 06:29	16/11/2020 09:35	3,09	67	207,31	CHI
20201172310	CRISTALINA	KR12287399	CRISTALINA S1	16/11/2020 06:29	16/11/2020 11:31	16/11/2020 06:29	16/11/2020 11:31	5,03	10	50,33	CHI
20201171714	PIRES DO RIO	PR21186603	PIRES DO RIO S1	16/11/2020 06:32	16/11/2020 14:33	16/11/2020 06:32	16/11/2020 14:33	8,01	1	8,01	CHI
20201171716	PIRACANJUBA	PJ12204564	PIRACANJUBA	16/11/2020 06:32	16/11/2020 08:29	16/11/2020 06:32	16/11/2020 08:29	1,94	981	1900,69	CHI
20201171722	HIDROLANDIA	HD12007560	PONTALINA	16/11/2020 06:33	16/11/2020 10:57	16/11/2020 06:33	16/11/2020 10:57	4,40	14	61,53	CHI
20201173104	GOIANDIRA	GD12000012	CATALAO S1	16/11/2020 06:33	16/11/2020 11:53	16/11/2020 06:33	16/11/2020 11:53	5,33	22	117,28	CHI
20201174156	GOIANESIA	BA12036611	GOIANESIA S1	16/11/2020 06:33	16/11/2020 18:32	16/11/2020 06:33	16/11/2020 18:32	11,98	7	83,88	CHI
20201171728	GOIANIA	13938976	GOYA S2	16/11/2020 06:34	16/11/2020 10:23	16/11/2020 06:34	16/11/2020 10:23	3,80	1	3,80	CHI
20201171734	SAO DOMINGOS	SD12254354	SAO DOMINGOS	16/11/2020 06:36	16/11/2020 10:34	16/11/2020 06:36	16/11/2020 10:34	3,97	5	19,83	CHI
20201171751	CALDAS NOVAS	10014513160	CALDAS NOVAS S2	16/11/2020 06:40	16/11/2020 08:28	16/11/2020 06:40	16/11/2020 08:28	1,79	1	1,79	CHI
20201172667	CAMPO ALEGRE DE GOIAS	CT12278103	CATALAO S1	16/11/2020 06:42	16/11/2020 18:41	16/11/2020 06:42	16/11/2020 18:41	11,97	1	11,97	CHI
20201172667	CATALAO	CT12278103	CATALAO S1	16/11/2020 06:42	16/11/2020 18:41	16/11/2020 06:42	16/11/2020 18:41	11,97	15	179,59	CHI
20201172667	DAVINOPOLIS	CT12278103	CATALAO S1	16/11/2020 06:42	16/11/2020 18:41	16/11/2020 06:42	16/11/2020 18:41	11,97	4	47,89	CHI
20201171765	FORMOSA	FA32042677	SAO JOAO D ALIANCA	16/11/2020 06:45	16/11/2020 08:56	16/11/2020 06:45	16/11/2020 08:56	2,17	14	30,42	CHI
20201171766	CIDADE OCIDENTAL	DH12388435	MARAJOARA	16/11/2020 06:45	16/11/2020 11:41	16/11/2020 06:45	16/11/2020 11:41	4,92	3	14,77	CHI
20201172077	GOIATUBA	GT11208072	GOIATUBA S2	16/11/2020 06:45	16/11/2020 08:59	16/11/2020 06:45	16/11/2020 08:59	2,23	31	69,18	CHI
20201171771	MORRINHOS	MR21076813	MORRINHOS	16/11/2020 06:46	16/11/2020 09:07	16/11/2020 06:46	16/11/2020 09:07	2,34	1	2,34	CHI
20201171828	CORUMBAIBA	IP12071442LD	IPAMERI	16/11/2020 06:48	16/11/2020 09:15	16/11/2020 06:48	16/11/2020 09:15	2,45	3	7,35	CHI
20201171828	IPAMERI	IP12071442LD	IPAMERI	16/11/2020 06:48	16/11/2020 09:15	16/11/2020 06:48	16/11/2020 09:15	2,45	16	39,20	CHI
20201172648	CEZARINA	CZ12271995	GUAPO S2	16/11/2020 06:48	16/11/2020 10:34	16/11/2020 06:48	16/11/2020 10:34	3,76	23	86,58	CHI
20201171781	CATALAO	GD12161079	CATALAO S1	16/11/2020 06:49	16/11/2020 08:45	16/11/2020 06:49	16/11/2020 08:45	1,93	4	7,71	CHI
20201171781	GOIANDIRA	GD12161079	CATALAO S1	16/11/2020 06:49	16/11/2020 08:45	16/11/2020 06:49	16/11/2020 08:45	1,93	7	13,49	CHI
20201171784	POSSE	PS12195956	IACIARA S2	16/11/2020 06:50	16/11/2020 09:48	16/11/2020 06:50	16/11/2020 09:48	2,97	3	8,90	CHI
20201173222	GOIANDIRA	GD12064008	CATALAO S1	16/11/2020 06:53	16/11/2020 14:16	16/11/2020 06:53	16/11/2020 14:16	7,37	5	36,84	CHI
20201171809	VIANOPOLIS	VN21157771	VIANOPOLIS	16/11/2020 06:56	16/11/2020 08:14	16/11/2020 06:56	16/11/2020 08:14	1,29	1	1,29	CHI
20201171814	GOIANIA	GN12000811	CAMPINAS S2	16/11/2020 06:57	16/11/2020 08:38	16/11/2020 06:57	16/11/2020 08:38	1,68	764	1280,34	CHI
20201172241	PIRES DO RIO	PR12027079	PIRES DO RIO S1	16/11/2020 06:58	16/11/2020 09:55	16/11/2020 06:58	16/11/2020 09:55	2,95	8	23,58	CHI
20201171835	VALPARAISO DE GOIAS	VA11170143	PACAEMBU S2	16/11/2020 06:59	16/11/2020 09:15	16/11/2020 06:59	16/11/2020 09:15	2,25	146	328,54	CHI
20201172194	CATALAO	CT12134367	CATALAO S1	16/11/2020 07:03	16/11/2020 14:56	16/11/2020 07:03	16/11/2020 14:56	7,88	11	86,67	CHI
20201171853	PADRE BERNARDO	PB12163248	PADRE BERNARDO	16/11/2020 07:04	16/11/2020 14:25	16/11/2020 07:04	16/11/2020 12:09	5,09	6	30,54	CHI
20201171853	PADRE BERNARDO	6370271	PADRE BERNARDO	16/11/2020 07:04	16/11/2020 14:25	16/11/2020 07:04	16/11/2020 14:25	7,35	1	7,35	CHI
20201171854	MORRINHOS	MR12119786	MORRINHOS	16/11/2020 07:04	16/11/2020 09:55	16/11/2020 07:04	16/11/2020 09:55	2,84	6	17,03	CHI
20201172235	POSSE	PS12123497	IACIARA S2	16/11/2020 07:06	16/11/2020 10:15	16/11/2020 07:06	16/11/2020 10:15	3,14	15	47,07	CHI
20201171869	ORIZONA	OZ12052341	PIRES DO RIO S2	16/11/2020 07:08	16/11/2020 10:24	16/11/2020 07:08	16/11/2020 10:24	3,26	3	9,77	CHI

20201172270	PONTALINA	PK12328982	PONTALINA	16/11/2020 07:08	16/11/2020 10:35	16/11/2020 07:08	16/11/2020 10:35	3,45	8	27,57	CHI
20201171873	IACIARA	IA12392240	FLORES DE GOIAS	16/11/2020 07:09	16/11/2020 09:17	16/11/2020 07:09	16/11/2020 09:17	2,13	7	14,93	CHI
20201171876	AGUA FRIA DE GOIAS	TL21205634	SAO JOAO D ALIANCA	16/11/2020 07:09	16/11/2020 09:21	16/11/2020 07:09	16/11/2020 09:21	2,19	2	4,39	CHI
20201171879	ALTO PARAISO DE GOIAS	BF12383370	SAO JOAO D ALIANCA	16/11/2020 07:09	16/11/2020 10:11	16/11/2020 07:09	16/11/2020 10:11	3,02	3	9,06	CHI
20201172150	GOIANESIA	GE12000196LD	GOIANESIA S2	16/11/2020 07:09	16/11/2020 09:16	16/11/2020 07:09	16/11/2020 09:16	2,11	186	392,46	CHI
20201171885	CATALAO	CT21000029	CATALAO S2	16/11/2020 07:10	16/11/2020 11:23	16/11/2020 07:10	16/11/2020 11:23	4,20	1	4,20	CHI
20201171889	GUARANI DE GOIAS	GY21255230	IACIARA S1	16/11/2020 07:11	16/11/2020 09:21	16/11/2020 07:11	16/11/2020 09:21	2,16	1	2,16	CHI
20201171901	TRINDADE	40091508	TRINDADE	16/11/2020 07:13	16/11/2020 10:17	16/11/2020 07:13	16/11/2020 10:17	3,06	1	3,06	CHI
20201171904	LUZIANIA	KR21313788	PAMPLONA	16/11/2020 07:13	16/11/2020 11:43	16/11/2020 07:13	16/11/2020 11:43	4,49	2	8,97	CHI
20201171909	PIRENOPOLIS	PV21311867	CORUMBA	16/11/2020 07:14	16/11/2020 14:49	16/11/2020 07:14	16/11/2020 14:49	7,57	3	22,71	CHI
20201171925	CRISTALINA	KR12313551	CRISTALINA S2	16/11/2020 07:17	16/11/2020 08:51	16/11/2020 07:17	16/11/2020 08:51	1,56	96	149,39	CHI
20201172007	INHUMAS	IN12399091	INHUMAS S2	16/11/2020 07:18	16/11/2020 08:44	16/11/2020 07:18	16/11/2020 08:44	1,43	90	128,63	CHI
20201171943	SILVANIA	SV12346293	VIANOPOLIS	16/11/2020 07:20	16/11/2020 15:32	16/11/2020 07:20	16/11/2020 15:32	8,19	4	32,77	CHI
20201171946	CABECEIRAS	CW21184527	ITUIQUIRA	16/11/2020 07:20	16/11/2020 10:15	16/11/2020 07:20	16/11/2020 10:15	2,91	1	2,91	CHI
20201171983	SAO MIGUEL DO PASSA QUATRO	5240224	CRISTIANOPOLIS	16/11/2020 07:20	16/11/2020 13:37	16/11/2020 07:20	16/11/2020 12:59	5,65	263	1486,53	CHI
20201171983	SAO MIGUEL DO ARAGUAIA	5240224	CRISTIANOPOLIS	16/11/2020 07:20	16/11/2020 13:37	16/11/2020 07:20	16/11/2020 13:02	5,69	1	5,69	CHI
20201171983	SAO MIGUEL DO PASSA QUATRO	5240224	CRISTIANOPOLIS	16/11/2020 07:20	16/11/2020 13:37	16/11/2020 07:20	16/11/2020 13:02	5,69	791	4502,77	CHI
20201171983	VIANOPOLIS	5240224	CRISTIANOPOLIS	16/11/2020 07:20	16/11/2020 13:37	16/11/2020 07:20	16/11/2020 13:02	5,69	38	216,32	CHI
20201171983	SAO MIGUEL DO ARAGUAIA	SQ16423922	CRISTIANOPOLIS	16/11/2020 07:20	16/11/2020 13:37	16/11/2020 13:23	16/11/2020 13:37	0,24	1	0,24	CHI
20201171983	SAO MIGUEL DO PASSA QUATRO	SQ16423922	CRISTIANOPOLIS	16/11/2020 07:20	16/11/2020 13:37	16/11/2020 13:23	16/11/2020 13:37	0,24	791	192,48	CHI
20201171983	VIANOPOLIS	SQ16423922	CRISTIANOPOLIS	16/11/2020 07:20	16/11/2020 13:37	16/11/2020 13:23	16/11/2020 13:37	0,24	38	9,25	CHI
20201171983	SAO MIGUEL DO PASSA QUATRO	SQ16423922	CRISTIANOPOLIS	16/11/2020 07:20	16/11/2020 13:37	16/11/2020 13:23	16/11/2020 13:37	0,24	263	62,90	CHI
20201171950	TRINDADE	40176939	TRINDADE	16/11/2020 07:21	16/11/2020 12:14	16/11/2020 07:21	16/11/2020 12:14	4,88	1	4,88	CHI
20201171959	CORUMBA DE GOIAS	CB12215010	CORUMBA	16/11/2020 07:22	16/11/2020 09:01	16/11/2020 07:22	16/11/2020 09:01	1,64	12	19,70	CHI
20201172001	VICENTINOPOLIS	VI21309823	VICENTINOPOLIS	16/11/2020 07:28	16/11/2020 09:59	16/11/2020 07:28	16/11/2020 09:59	2,51	1	2,51	CHI
20201172003	CATALAO	CT12130971LD	CATALAO S1	16/11/2020 07:29	16/11/2020 11:54	16/11/2020 07:29	16/11/2020 11:54	4,41	9	39,71	CHI
20201172055	FORMOSA	FA12318517	ITUIQUIRA	16/11/2020 07:29	16/11/2020 09:46	16/11/2020 07:29	16/11/2020 09:46	2,28	5	11,40	CHI
20201172009	CRISTALINA	KR21240976	PAMPLONA	16/11/2020 07:30	16/11/2020 12:18	16/11/2020 07:30	16/11/2020 12:18	4,79	2	9,58	CHI
20201172012	PALMELO	PR12064872LD	PIRES DO RIO S1	16/11/2020 07:31	17/11/2020 11:40	16/11/2020 07:31	17/11/2020 11:40	28,15	1	28,15	CHI
20201172012	PIRES DO RIO	PR12064872LD	PIRES DO RIO S1	16/11/2020 07:31	17/11/2020 11:40	16/11/2020 07:31	17/11/2020 11:40	28,15	3	84,44	CHI
20201172012	PALMELO	PR12064872LD	PIRES DO RIO S1	16/11/2020 07:31	17/11/2020 11:40	17/11/2020 08:57	17/11/2020 11:40	2,72	2	5,43	CHI
20201172012	PIRES DO RIO	PR12064872LD	PIRES DO RIO S1	16/11/2020 07:31	17/11/2020 11:40	17/11/2020 08:57	17/11/2020 11:40	2,72	116	315,17	CHI
20201172012	SANTA CRUZ DE GOIAS	PR12064872LD	PIRES DO RIO S1	16/11/2020 07:31	17/11/2020 11:40	17/11/2020 08:57	17/11/2020 11:40	2,72	1	2,72	CHI
20201172012	URUTAI	PR12064872LD	PIRES DO RIO S1	16/11/2020 07:31	17/11/2020 11:40	17/11/2020 08:57	17/11/2020 11:40	2,72	1	2,72	CHI
20201172019	GOIANIA	12518323	CAMPINAS S3	16/11/2020 07:31	16/11/2020 10:08	16/11/2020 07:31	16/11/2020 10:08	2,60	1	2,60	CHI
20201172026	APARECIDA DE GOIANIA	14355462	INDEPENDENCIA S2	16/11/2020 07:33	16/11/2020 09:04	16/11/2020 07:33	16/11/2020 09:04	1,52	1	1,52	CHI
20201172035	GOIANIA	10069410	AEROPORTO S1	16/11/2020 07:34	16/11/2020 08:48	16/11/2020 07:34	16/11/2020 08:48	1,24	1	1,24	CHI
20201172038	ITUMBIARA	BG21294717	ITUMBIARA VELHA S2	16/11/2020 07:34	16/11/2020 08:57	16/11/2020 07:34	16/11/2020 08:57	1,37	1	1,37	CHI
20201172043	AGUAS LINDAS DE GOIAS	SN21149035	AGUAS LINDAS DE GOIAS S1	16/11/2020 07:35	16/11/2020 10:21	16/11/2020 07:35	16/11/2020 10:21	2,76	1	2,76	CHI
20201172386	PIRACANJUBA	PJ12352525	PIRACANJUBA	16/11/2020 07:35	16/11/2020 09:46	16/11/2020 07:35	16/11/2020 09:46	2,18	16	34,83	CHI
20201172050	ARACU	AR12039725	ARACU	16/11/2020 07:37	16/11/2020 16:06	16/11/2020 07:37	16/11/2020 16:06	8,48	6	50,90	CHI
20201172056	FLORES DE GOIAS	FB21330206	FLORES DE GOIAS	16/11/2020 07:38	16/11/2020 10:01	16/11/2020 07:38	16/11/2020 10:01	2,38	1	2,38	CHI
20201172058	PIRENOPOLIS	ZN21259027	COCALZINHO	16/11/2020 07:38	16/11/2020 14:27	16/11/2020 07:38	16/11/2020 14:27	6,81	1	6,81	CHI
20201172059	CAMPOS BELOS	8564829	SAO DOMINGOS	16/11/2020 07:38	16/11/2020 16:08	16/11/2020 07:38	16/11/2020 16:08	8,49	2	16,99	CHI
20201170860	CORUMBA DE GOIAS	CB12144031	CORUMBA	16/11/2020 07:39	16/11/2020 08:59	16/11/2020 07:39	16/11/2020 08:59	1,33	8	10,65	CHI
20201172070	ANICUNS	AC21130204	ARACU	16/11/2020 07:40	16/11/2020 15:13	16/11/2020 07:40	16/11/2020 15:13	7,54	1	7,54	CHI
20201172640	SANTA CRUZ DE GOIAS	BC12389804	PIRES DO RIO S2	16/11/2020 07:40	16/11/2020 17:24	16/11/2020 07:40	16/11/2020 17:24	9,72	22	213,83	CHI
20201172078	SAO MIGUEL DO PASSA QUATRO	SQ12104016	BELA VISTA S2	16/11/2020 07:41	16/11/2020 13:52	16/11/2020 07:41	16/11/2020 13:52	6,18	3	18,53	CHI
20201172809	MORRINHOS	MR12093196	GOIATUBA S1	16/11/2020 07:42	16/11/2020 11:18	16/11/2020 07:42	16/11/2020 11:18	3,59	21	75,34	CHI
20201172097	SAO FRANCISCO DE GOIAS	SF21094464	SAO FRANCISCO DE GOIAS	16/11/2020 07:44	16/11/2020 08:12	16/11/2020 07:44	16/11/2020 08:12	0,46	1	0,46	CHI
20201172102	SAO DOMINGOS	SD12347129	SAO DOMINGOS	16/11/2020 07:45	16/11/2020 11:37	16/11/2020 07:45	16/11/2020 11:37	3,86	5	19,31	CHI



20201172111	CRISTALINA	KR12247906	CRISTALINA S1	16/11/2020 07:46	16/11/2020 13:25	16/11/2020 07:46	16/11/2020 13:25	5,65	8	45,18	CHI
20201172116	ARAGOIANIA	AO21387317	GUAPO S2	16/11/2020 07:46	16/11/2020 10:10	16/11/2020 07:46	16/11/2020 10:10	2,40	2	4,79	CHI
20201172118	PIRES DO RIO	PR12409073	PIRES DO RIO S2	16/11/2020 07:46	16/11/2020 11:22	16/11/2020 07:46	16/11/2020 11:22	3,59	8	28,75	CHI
20201172122	CATALAO	CT12215605	CATALAO S1	16/11/2020 07:47	17/11/2020 00:32	16/11/2020 07:47	17/11/2020 00:32	16,75	4	66,99	CHI
20201172184	IACIARA	IA12257653	IACIARA S1	16/11/2020 07:49	16/11/2020 10:12	16/11/2020 07:49	16/11/2020 10:12	2,38	6	14,26	CHI
202011138000	MORRINHOS	MR12212245	MORRINHOS	16/11/2020 07:50	16/11/2020 11:25	16/11/2020 07:50	16/11/2020 11:25	3,58	6	21,49	CHI
20201172272	ANAPOLIS	AN12351048	ANAPOLIS UNIVERSITARIO S2	16/11/2020 07:55	16/11/2020 09:18	16/11/2020 07:55	16/11/2020 09:18	1,38	17	23,46	CHI
20201172176	IPAMERI	IP21265568	CAMPO ALEGRE DE GOIAS	16/11/2020 07:56	16/11/2020 12:22	16/11/2020 07:56	16/11/2020 12:22	4,43	1	4,43	CHI
20201172189	GOIANIA	16389086	GOYA S2	16/11/2020 07:58	16/11/2020 15:57	16/11/2020 07:58	16/11/2020 15:57	7,98	1	7,98	CHI
20201172705	CORUMBAIBA	CI12110161	VILA CORUMBA	16/11/2020 07:59	16/11/2020 11:03	16/11/2020 07:59	16/11/2020 11:03	3,06	45	137,90	CHI
20201172208	IPAMERI	IP21329636	IPAMERI	16/11/2020 08:00	16/11/2020 10:53	16/11/2020 08:00	16/11/2020 10:53	2,87	1	2,87	CHI
20201172267	MORRINHOS	MR12389873	MORRINHOS	16/11/2020 08:00	16/11/2020 11:49	16/11/2020 08:00	16/11/2020 11:49	3,81	15	57,10	CHI
20201172213	LUZIANIA	LZ12389565	PACAEMBU S2	16/11/2020 08:01	16/11/2020 13:01	16/11/2020 08:01	16/11/2020 13:01	5,00	22	109,90	CHI
20201172213	NOVO GAMA	LZ12389565	PACAEMBU S2	16/11/2020 08:01	16/11/2020 13:01	16/11/2020 08:01	16/11/2020 13:01	5,00	25	124,89	CHI
20201172219	ANAPOLIS	AN12261221	ANAPOLIS UNIVERSITARIO S1	16/11/2020 08:01	16/11/2020 11:33	16/11/2020 08:01	16/11/2020 11:33	3,52	6	21,13	CHI
20201172265	FORMOSA	FA12233612	ITIQUEIRA	16/11/2020 08:02	16/11/2020 11:04	16/11/2020 08:02	16/11/2020 11:04	3,03	61	184,58	CHI
20201172971	ORIZONA	OZ12205055	VIANOPOLIS	16/11/2020 08:02	16/11/2020 17:40	16/11/2020 08:02	16/11/2020 17:40	9,62	5	48,10	CHI
20201172246	FLORES DE GOIAS	FB11383400	FLORES DE GOIAS	16/11/2020 08:05	16/11/2020 08:43	16/11/2020 08:05	16/11/2020 08:43	0,63	29	18,36	CHI
20201172251	GOIANIA	16570868	REAL S1	16/11/2020 08:05	16/11/2020 10:06	16/11/2020 08:05	16/11/2020 10:06	2,00	1	2,00	CHI
20201172261	CIDADE OCIDENTAL	2680147498	MARAJOARA	16/11/2020 08:07	16/11/2020 11:47	16/11/2020 08:07	16/11/2020 11:47	3,65	1	3,65	CHI
20201172269	GOIANIA	14071010	CARAJAS S2	16/11/2020 08:08	16/11/2020 09:55	16/11/2020 08:08	16/11/2020 09:55	1,78	1	1,78	CHI
20201172271	GOIANESIA	550113976	GOIANESIA S2	16/11/2020 08:08	16/11/2020 11:04	16/11/2020 08:08	16/11/2020 11:04	2,93	1	2,93	CHI
20201172289	ITUMBIARA	690275316	ITUMBIARA NOVA	16/11/2020 08:10	16/11/2020 09:22	16/11/2020 08:10	16/11/2020 09:22	1,19	1	1,19	CHI
20201172290	GOIANIA	10728971	ATLANTICO S3	16/11/2020 08:10	16/11/2020 09:49	16/11/2020 08:10	16/11/2020 09:49	1,63	1	1,63	CHI
20201172296	CORUMBA DE GOIAS	ZN12382309	COCALZINHO	16/11/2020 08:11	16/11/2020 10:49	16/11/2020 08:11	16/11/2020 10:49	2,62	64	167,98	CHI
20201172309	CACHOEIRA DOURADA	CD12000086	CACHOEIRA DOURADA	16/11/2020 08:12	16/11/2020 11:02	16/11/2020 08:12	16/11/2020 11:02	2,82	1	2,82	CHI
20201172312	INHUMAS	30091123	INHUMAS S2	16/11/2020 08:13	16/11/2020 10:03	16/11/2020 08:13	16/11/2020 10:03	1,83	1	1,83	CHI
20201172322	SILVANIA	SV21249573	DAIA S2	16/11/2020 08:14	16/11/2020 09:56	16/11/2020 08:14	16/11/2020 09:56	1,70	1	1,70	CHI
20201172329	GOIANIA	GN11194338	ATLANTICO S2	16/11/2020 08:14	16/11/2020 15:51	16/11/2020 08:14	16/11/2020 15:51	7,60	34	258,51	CHI
20201172331	GOIANIA	13373171	CAMPINAS S3	16/11/2020 08:14	16/11/2020 11:08	16/11/2020 08:14	16/11/2020 11:08	2,90	1	2,90	CHI
20201172332	MONTE ALEGRE DE GOIAS	MA12212608	SAO DOMINGOS	16/11/2020 08:14	16/11/2020 11:49	16/11/2020 08:14	16/11/2020 11:49	3,57	55	196,20	CHI
20201172385	GOIANIA	BW16407507	NEROPOLIS S1	16/11/2020 08:14	16/11/2020 08:18	16/11/2020 08:14	16/11/2020 08:18	0,07	112	7,40	CHI
20201172385	NEROPOLIS	BW16407507	NEROPOLIS S1	16/11/2020 08:14	16/11/2020 08:18	16/11/2020 08:14	16/11/2020 08:18	0,07	17	1,12	CHI
20201172385	NOVA VENEZA	BW16407507	NEROPOLIS S1	16/11/2020 08:14	16/11/2020 08:18	16/11/2020 08:14	16/11/2020 08:18	0,07	1	0,07	CHI
20201172385	SANTO ANTONIO DE GOIAS	BW16407507	NEROPOLIS S1	16/11/2020 08:14	16/11/2020 08:18	16/11/2020 08:14	16/11/2020 08:18	0,07	646	42,71	CHI
20201172334	GOIANIA	15734407	CEPAIGO S1	16/11/2020 08:15	16/11/2020 10:26	16/11/2020 08:15	16/11/2020 10:26	2,19	1	2,19	CHI
20201172355	NEROPOLIS	160081592	NEROPOLIS S2	16/11/2020 08:18	16/11/2020 09:36	16/11/2020 08:18	16/11/2020 09:36	1,30	1	1,30	CHI
20201172363	GUARANI DE GOIAS	GY12160070	IACIARA S1	16/11/2020 08:18	16/11/2020 11:18	16/11/2020 08:18	16/11/2020 11:18	2,99	3	8,97	CHI
20201172363	IACIARA	GY12160070	IACIARA S1	16/11/2020 08:18	16/11/2020 11:18	16/11/2020 08:18	16/11/2020 11:18	2,99	2	5,98	CHI
20201172363	SAO DOMINGOS	GY12160070	IACIARA S1	16/11/2020 08:18	16/11/2020 11:18	16/11/2020 08:18	16/11/2020 11:18	2,99	1	2,99	CHI
20201172374	ARAGOIANIA	AO32097682	GUAPO S2	16/11/2020 08:19	17/11/2020 13:55	16/11/2020 08:19	17/11/2020 13:35	29,27	1	29,27	CHI
20201172374	ARAGOIANIA	AO32097682	GUAPO S2	16/11/2020 08:19	17/11/2020 13:55	16/11/2020 08:19	17/11/2020 13:35	29,28	1	29,28	CHI
20201172374	ARAGOIANIA	AO32097682	GUAPO S2	16/11/2020 08:19	17/11/2020 13:55	16/11/2020 08:19	17/11/2020 13:36	29,28	1	29,28	CHI
20201172374	HIDROLANDIA	AO32097682	GUAPO S2	16/11/2020 08:19	17/11/2020 13:55	16/11/2020 08:19	17/11/2020 13:55	29,61	1	29,61	CHI
20201172389	ABADIANIA	AA12327809	DAIA S2	16/11/2020 08:20	16/11/2020 11:03	16/11/2020 08:20	16/11/2020 11:03	2,70	14	37,81	CHI
20201172393	FLORES DE GOIAS	FB12320627	FLORES DE GOIAS	16/11/2020 08:21	16/11/2020 10:40	16/11/2020 08:21	16/11/2020 10:40	2,31	28	64,68	CHI
20201172396	TRINDADE	40166880	TRINDADE	16/11/2020 08:21	16/11/2020 10:42	16/11/2020 08:21	16/11/2020 10:42	2,34	1	2,34	CHI
20201172397	GOIANESIA	GE21284303	GOIANESIA S2	16/11/2020 08:21	16/11/2020 11:51	16/11/2020 08:21	16/11/2020 11:51	3,49	1	3,49	CHI
20201172401	APARECIDA DE GOIANIA	17356684	INDEPENDENCIA S2	16/11/2020 08:22	16/11/2020 09:53	16/11/2020 08:22	16/11/2020 09:53	1,52	1	1,52	CHI
20201172404	VICENTINOPOLIS	VI21263279	VICENTINOPOLIS	16/11/2020 08:22	16/11/2020 10:58	16/11/2020 08:22	16/11/2020 10:58	2,59	1	2,59	CHI
20201172408	POSSE	PS21235489	IACIARA S2	16/11/2020 08:23	16/11/2020 11:54	16/11/2020 08:23	16/11/2020 11:54	3,51	1	3,51	CHI

20201172426	GOIANIA	13870567	FERROVIARIO S2	16/11/2020 08:24	16/11/2020 11:35	16/11/2020 08:24	16/11/2020 11:35	3,17	1	3,17	CHI
20201172429	GOIANIA	12608180	AEROPORTO S2	16/11/2020 08:25	16/11/2020 11:39	16/11/2020 08:25	16/11/2020 11:39	3,23	1	3,23	CHI
20201172431	FORMOSA	FA21131889	ITUIQUIRA	16/11/2020 08:25	16/11/2020 09:54	16/11/2020 08:25	16/11/2020 09:54	1,48	1	1,48	CHI
20201172432	AGUA FRIA DE GOIAS	PI12082205	SAO JOAO D ALIANCA	16/11/2020 08:25	16/11/2020 12:54	16/11/2020 08:25	16/11/2020 12:54	4,48	2	8,95	CHI
20201172434	SAO FRANCISCO DE GOIAS	PV12297991	SAO FRANCISCO DE GOIAS	16/11/2020 08:25	16/11/2020 10:32	16/11/2020 08:25	16/11/2020 10:32	2,11	6	12,64	CHI
20201172437	GOIANESIA	10018382744	GOIANESIA S2	16/11/2020 08:25	16/11/2020 16:15	16/11/2020 08:25	16/11/2020 16:15	7,82	1	7,82	CHI
20201172441	SAO JOAO D ALIANCA	JL12048019	SAO JOAO D ALIANCA	16/11/2020 08:25	16/11/2020 12:04	16/11/2020 08:25	16/11/2020 12:04	3,63	43	156,26	CHI
20201172443	BARRO ALTO	BA21345791	GOIANESIA S1	16/11/2020 08:26	16/11/2020 17:55	16/11/2020 08:26	16/11/2020 17:55	9,48	1	9,48	CHI
20201172447	GOIANIA	12860979	XAVANTES	16/11/2020 08:26	16/11/2020 10:40	16/11/2020 08:26	16/11/2020 10:40	2,22	1	2,22	CHI
20201173071	CRISTALINA	KR12287396	CRISTALINA S1	16/11/2020 08:26	16/11/2020 13:26	16/11/2020 08:26	16/11/2020 13:26	4,99	9	44,95	CHI
20201172474	PLANALTINA	TL1180604	SAO JOAO D ALIANCA	16/11/2020 08:30	17/11/2020 08:55	16/11/2020 08:30	17/11/2020 08:55	24,41	1	24,41	CHI
20201172478	PADRE BERNARDO	9980024725	PADRE BERNARDO	16/11/2020 08:30	16/11/2020 15:19	16/11/2020 08:30	16/11/2020 15:19	6,80	1	6,80	CHI
20201172479	PIRES DO RIO	460081378	PIRES DO RIO S2	16/11/2020 08:30	16/11/2020 17:17	16/11/2020 08:30	16/11/2020 17:17	8,77	1	8,77	CHI
20201172480	PADRE BERNARDO	PB12290575	PADRE BERNARDO	16/11/2020 08:31	16/11/2020 16:52	16/11/2020 08:31	16/11/2020 11:35	3,08	1	3,08	CHI
20201172480	PADRE BERNARDO	PB21290573	PADRE BERNARDO	16/11/2020 08:31	16/11/2020 16:52	16/11/2020 08:31	16/11/2020 16:38	8,13	2	16,26	CHI
20201172480	PADRE BERNARDO	PB12290575	PADRE BERNARDO	16/11/2020 08:31	16/11/2020 16:52	16/11/2020 13:51	16/11/2020 16:52	3,02	1	3,02	CHI
20201172490	ARAGOIANIA	AO21340494	GUAPO S2	16/11/2020 08:32	16/11/2020 14:31	16/11/2020 08:32	16/11/2020 14:31	5,98	1	5,98	CHI
20201172492	ORIZONA	2060042982	PIRES DO RIO S2	16/11/2020 08:32	16/11/2020 15:31	16/11/2020 08:32	16/11/2020 15:31	6,98	1	6,98	CHI
20201172732	BURITI ALEGRE	BG12263620	ALTO BURITI	16/11/2020 08:32	16/11/2020 10:19	16/11/2020 08:32	16/11/2020 10:19	1,77	3	5,31	CHI
20201172495	GOIANIA	10919600	GOIANIA LESTE S1	16/11/2020 08:33	16/11/2020 11:22	16/11/2020 08:33	16/11/2020 11:22	2,82	1	2,82	CHI
20201172586	CORUMBA DE GOIAS	CB12294737	CORUMBA	16/11/2020 08:33	16/11/2020 09:39	16/11/2020 08:33	16/11/2020 09:39	1,08	9	9,76	CHI
20201173623	FORMOSA	610290484	ITUIQUIRA	16/11/2020 08:33	16/11/2020 12:22	16/11/2020 08:33	16/11/2020 12:22	3,81	1	3,81	CHI
20201172507	JARAGUA	SF21339502	SAO FRANCISCO DE GOIAS	16/11/2020 08:34	16/11/2020 12:19	16/11/2020 08:34	16/11/2020 12:19	3,74	1	3,74	CHI
20201172508	ALEXANIA	10003550816	ALEXANIA	16/11/2020 08:34	16/11/2020 10:36	16/11/2020 08:34	16/11/2020 10:36	2,02	1	2,02	CHI
20201174470	BARRO ALTO	BA12210729	BARRO ALTO	16/11/2020 08:34	16/11/2020 17:04	16/11/2020 08:34	16/11/2020 17:04	8,49	5	42,45	CHI
20201172517	LUZIANIA	10004488316	RIO VERMELHO	16/11/2020 08:36	16/11/2020 17:18	16/11/2020 08:36	16/11/2020 17:18	8,70	1	8,70	CHI
20201172519	ALEXANIA	AX21144177	ALEXANIA	16/11/2020 08:36	16/11/2020 11:24	16/11/2020 08:36	16/11/2020 11:24	2,79	1	2,79	CHI
20201172522	CORUMBA DE GOIAS	CB21328025	CORUMBA	16/11/2020 08:36	16/11/2020 10:11	16/11/2020 08:36	16/11/2020 10:11	1,57	1	1,57	CHI
20201172523	LUZIANIA	LZ21245497	MARAJOARA	16/11/2020 08:37	16/11/2020 11:10	16/11/2020 08:37	16/11/2020 11:10	2,55	3	7,65	CHI
20201172525	SANTO ANTONIO DO DESCOBERTO	2210002704	AGUAS LINDAS DE GOIAS S2	16/11/2020 08:37	16/11/2020 12:13	16/11/2020 08:37	16/11/2020 12:13	3,60	1	3,60	CHI
20201172526	GOIANIA	10226175	CAMPINAS S3	16/11/2020 08:37	16/11/2020 12:14	16/11/2020 08:37	16/11/2020 12:14	3,61	1	3,61	CHI
20201172528	VICENTINOPOLIS	VI21013547	VICENTINOPOLIS	16/11/2020 08:37	16/11/2020 11:21	16/11/2020 08:37	16/11/2020 11:21	2,73	2	5,45	CHI
20201172531	RIO QUENTE	2530028820	RIO QUENTE	16/11/2020 08:37	16/11/2020 10:24	16/11/2020 08:37	16/11/2020 10:24	1,77	1	1,77	CHI
20201172906	CATALAO	CT12266069	CATALAO S1	16/11/2020 08:37	17/11/2020 09:06	16/11/2020 08:37	17/11/2020 09:06	24,48	1	24,48	CHI
20201172906	GOIANDIRA	CT12266069	CATALAO S1	16/11/2020 08:37	17/11/2020 09:06	16/11/2020 08:37	17/11/2020 09:06	24,48	3	73,44	CHI
20201172545	SANTO ANTONIO DO DESCOBERTO	SN21198674	ALEXANIA	16/11/2020 08:39	16/11/2020 12:12	16/11/2020 08:39	16/11/2020 12:12	3,54	2	7,09	CHI
20201172560	CRISTALINA	KR21249251	CRISTALINA S1	16/11/2020 08:41	16/11/2020 13:54	16/11/2020 08:41	16/11/2020 13:54	5,21	1	5,21	CHI
20201172563	APARECIDA DE GOIANIA	AP11131340	REAL S1	16/11/2020 08:41	16/11/2020 10:05	16/11/2020 08:41	16/11/2020 10:05	1,39	205	285,41	CHI
20201172727	CATALAO	CT12166743RE	CATALAO S1	16/11/2020 08:41	16/11/2020 14:11	16/11/2020 08:41	16/11/2020 14:11	5,49	35	191,98	CHI
20201172569	ITUMBIARA	IT12065311	CACHOEIRA DOURADA	16/11/2020 08:42	16/11/2020 16:31	16/11/2020 08:42	16/11/2020 16:31	7,81	3	23,43	CHI
20201172572	FORMOSA	FA21106810	ITUIQUIRA	16/11/2020 08:42	16/11/2020 10:59	16/11/2020 08:42	16/11/2020 10:59	2,27	1	2,27	CHI
20201173345	CRISTALINA	KR12276279	CRISTALINA S2	16/11/2020 08:42	16/11/2020 17:46	16/11/2020 08:42	16/11/2020 17:46	9,06	15	135,88	CHI
202011138001	SILVANIA	SV12075014	VIANOPOLIS	16/11/2020 08:42	16/11/2020 10:32	16/11/2020 08:42	16/11/2020 10:32	1,83	8	14,62	CHI
20201172574	GOIATUBA	GT31048432	GOIATUBA S2	16/11/2020 08:43	16/11/2020 09:52	16/11/2020 08:43	16/11/2020 09:52	1,15	1	1,15	CHI
20201172581	GOIANIA	10364468	CAMPINAS S1	16/11/2020 08:43	16/11/2020 11:49	16/11/2020 08:43	16/11/2020 11:49	3,09	1	3,09	CHI
20201172588	GOIANIA	13852255	GOIANIA LESTE S3	16/11/2020 08:43	16/11/2020 09:54	16/11/2020 08:43	16/11/2020 09:54	1,18	1	1,18	CHI
20201172597	GUAPO	710030721	GUAPO S1	16/11/2020 08:45	16/11/2020 17:34	16/11/2020 08:45	16/11/2020 17:34	8,81	1	8,81	CHI
20201172601	CRISTALINA	KR21379617	CRISTALINA S2	16/11/2020 08:45	16/11/2020 09:53	16/11/2020 08:45	16/11/2020 09:53	1,12	1	1,12	CHI
20201172614	TRES RANCHOS	TH21063790	CATALAO S1	16/11/2020 08:47	17/11/2020 11:57	16/11/2020 08:47	17/11/2020 11:57	27,15	5	135,77	CHI
20201172983	OUVIDOR	OU11363451	CATALAO S1	16/11/2020 08:47	16/11/2020 10:25	16/11/2020 08:47	16/11/2020 10:25	1,63	39	63,40	CHI
20201172616	SANTO ANTONIO DE GOIAS	GR21096152	NEROPOLIS S1	16/11/2020 08:48	16/11/2020 11:27	16/11/2020 08:48	16/11/2020 11:27	2,65	2	5,30	CHI

20201172620	CRISTALINA	KR21330868	CRISTALINA S2	16/11/2020 08:48	16/11/2020 18:56	16/11/2020 08:48	16/11/2020 18:56	10,12	1	10,12	CHI
20201172621	PLANALTINA	PI11262124	PLANALTINA	16/11/2020 08:48	16/11/2020 11:27	16/11/2020 08:48	16/11/2020 11:27	2,64	5	13,19	CHI
20201172622	PONTALINA	PK12234562	PONTALINA	16/11/2020 08:48	16/11/2020 12:09	16/11/2020 08:48	16/11/2020 12:09	3,34	3	10,01	CHI
20201172499	FORMOSA	FA12062226LD	ITIQUEIRA	16/11/2020 08:49	16/11/2020 12:02	16/11/2020 08:49	16/11/2020 12:02	3,21	4	12,84	CHI
20201172627	ABADIA DE GOIAS	10018962368	INDEPENDENCIA S2	16/11/2020 08:49	16/11/2020 19:14	16/11/2020 08:49	16/11/2020 19:14	10,41	1	10,41	CHI
20201172639	SANTO ANTONIO DO DESCOBERTO	10001409210	ALEXANIA	16/11/2020 08:50	16/11/2020 10:02	16/11/2020 08:50	16/11/2020 10:02	1,19	1	1,19	CHI
20201172645	CRISTALINA	KR21089660	CRISTALINA S2	16/11/2020 08:51	16/11/2020 10:05	16/11/2020 08:51	16/11/2020 10:05	1,23	1	1,23	CHI
20201172653	HIDROLANDIA	HD32093244	CEPAIGO S1	16/11/2020 08:51	16/11/2020 10:55	16/11/2020 08:51	16/11/2020 10:55	2,05	6	12,31	CHI
20201172665	TRINDADE	11668969	GOYA S2	16/11/2020 08:54	16/11/2020 13:50	16/11/2020 08:54	16/11/2020 13:50	4,93	1	4,93	CHI
20201172674	FORMOSA	FA12262114LD	ITIQUEIRA	16/11/2020 08:55	16/11/2020 22:48	16/11/2020 08:55	16/11/2020 22:48	13,88	3	41,65	CHI
20201172698	GOIANIA	16821609	CARAJAS S2	16/11/2020 08:57	16/11/2020 16:31	16/11/2020 08:57	16/11/2020 16:31	7,56	1	7,56	CHI
20201172706	LUZIANIA	3200042252	MARAJOARA	16/11/2020 08:58	16/11/2020 16:55	16/11/2020 08:58	16/11/2020 16:55	7,94	1	7,94	CHI
20201172707	COCALZINHO DE GOIAS	ZN21345000	COCALZINHO	16/11/2020 08:58	16/11/2020 13:04	16/11/2020 08:58	16/11/2020 13:04	4,09	1	4,09	CHI
20201172715	AGUA FRIA DE GOIAS	JL12270093	SAO JOAO D ALIANCA	16/11/2020 08:59	16/11/2020 14:13	16/11/2020 08:59	16/11/2020 14:13	5,22	1	5,22	CHI
20201172716	APARECIDA DE GOIANIA	17012351	INDEPENDENCIA S2	16/11/2020 08:59	16/11/2020 11:05	16/11/2020 08:59	16/11/2020 11:05	2,09	1	2,09	CHI



### 5. Plotagem das Ocorrências conforme a Especialização das Chuvas

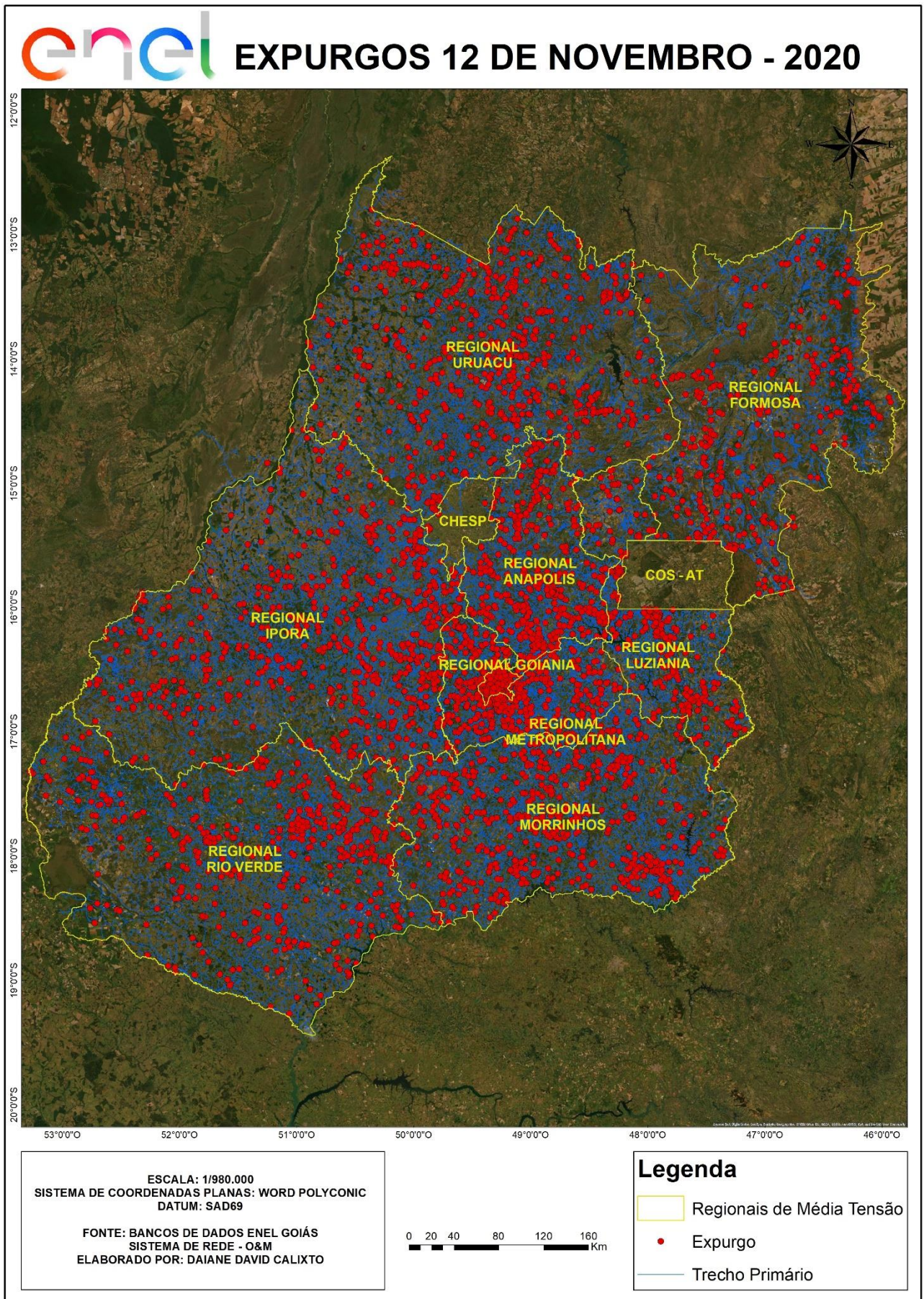



## 6. Clientes Afetados e Impactos Globais

Em análise ao número de clientes interrompidos (CI) na área de concessão da ENEL GO, a figura abaixo apresenta a atipicidade vivenciada no dia 12 a 16 de novembro de 2020, data esta que, conforme laudo meteorológico emitido por empresa especializada, a referida concessão passou por um período de condições climáticas de extrema severidade.

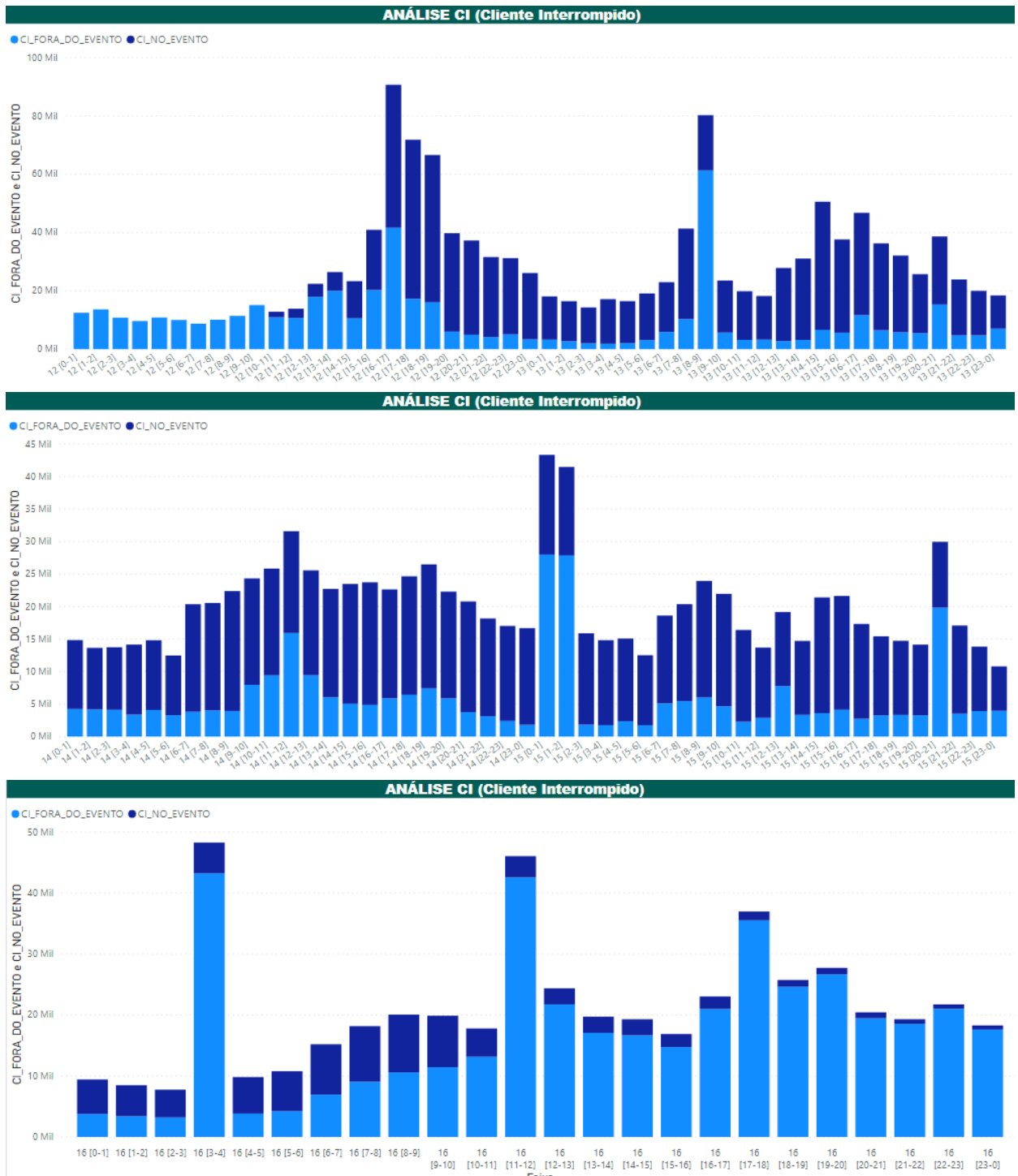

Figuras – Clientes Interrompidos em intervalos de horas



Na figura acima, as barras em azul claro representam a quantidade de clientes interrompidos simultaneamente em condições normais de operação, e as barras azul escuro os clientes interrompidos simultaneamente no período do evento.

## 7. Diagramas Unifilares



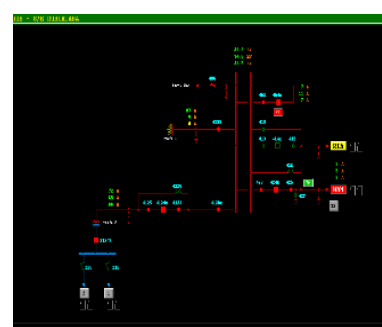
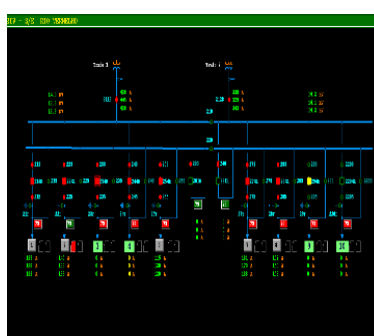
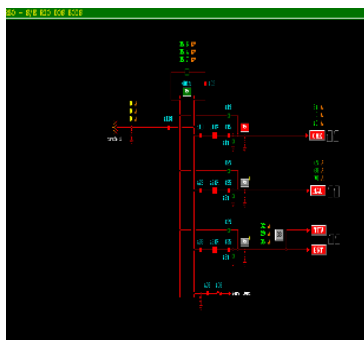
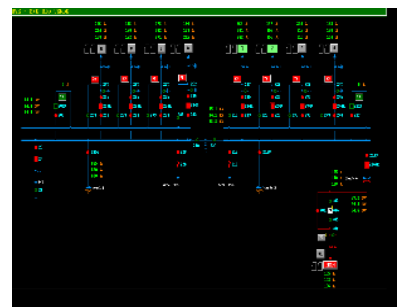
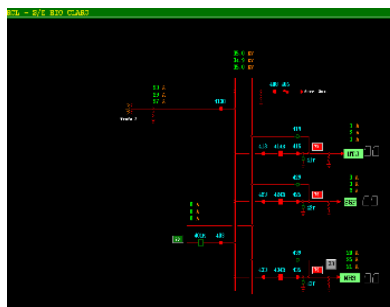
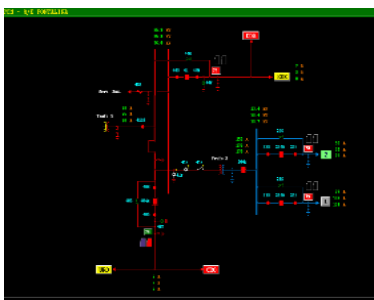
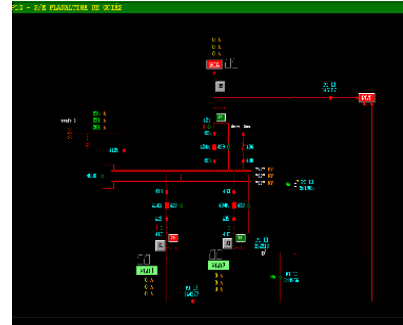
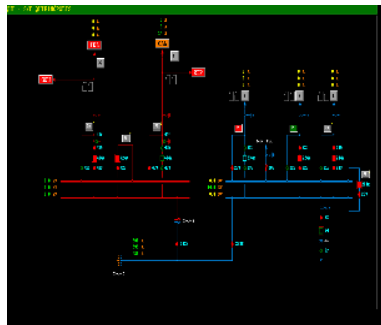
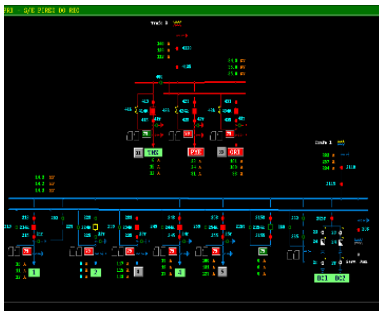
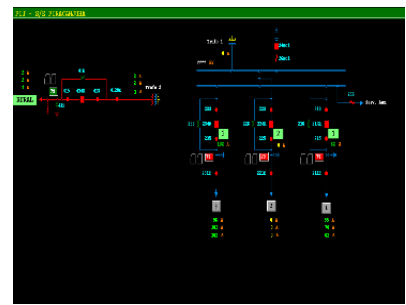
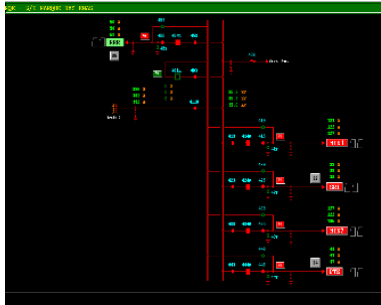
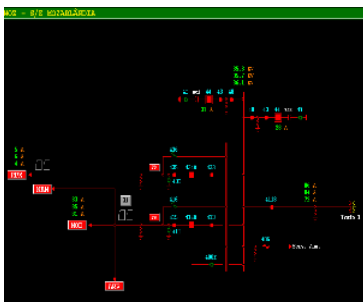
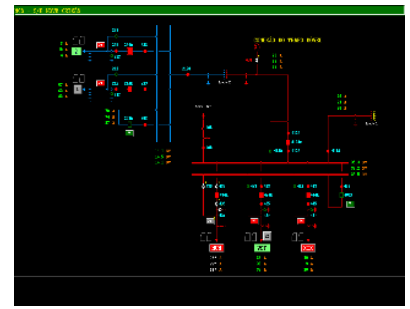
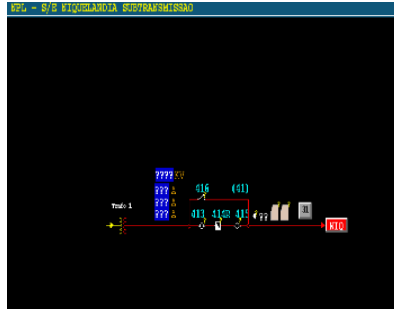

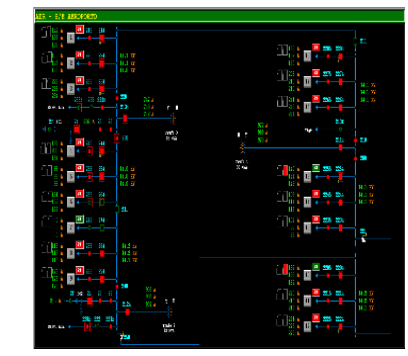
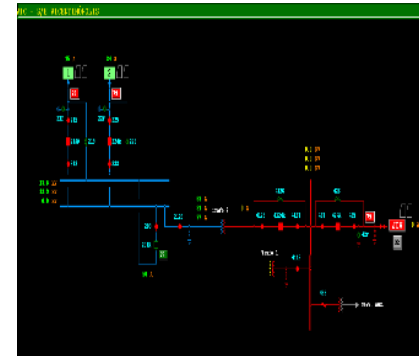
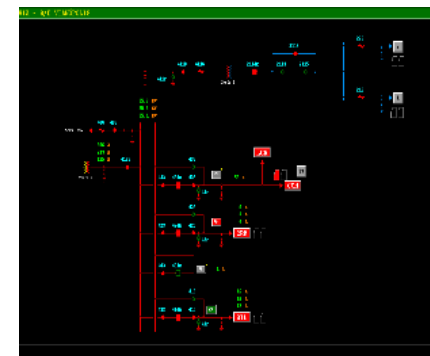
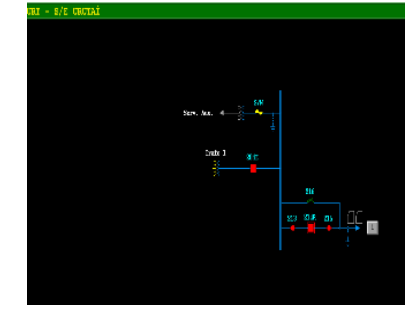
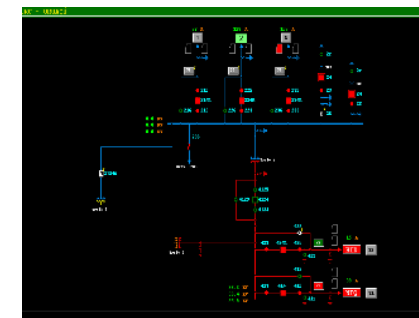
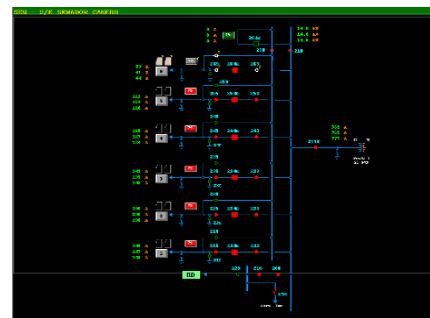
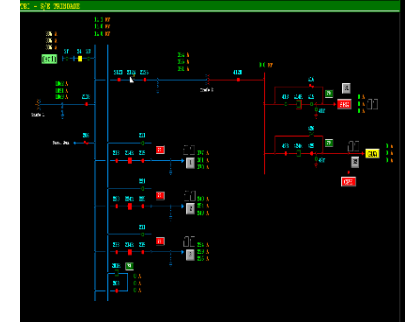
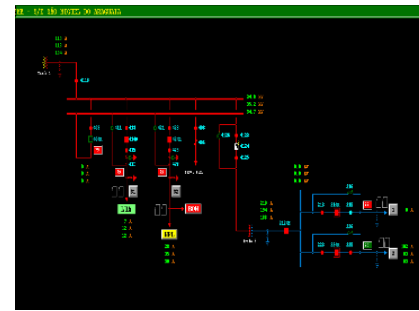
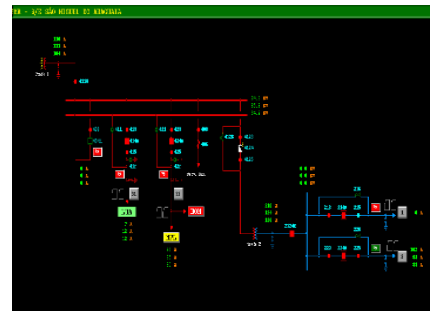
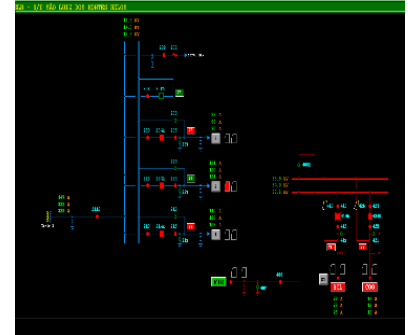
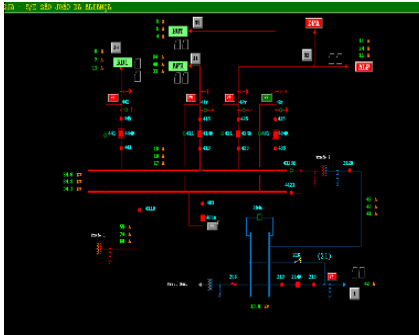
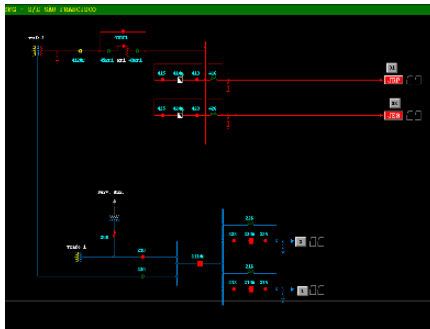
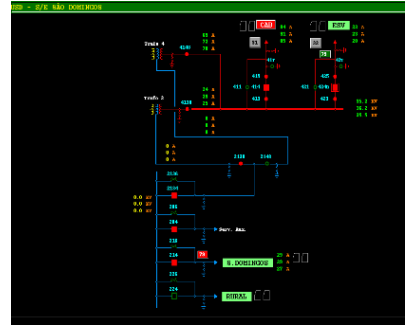
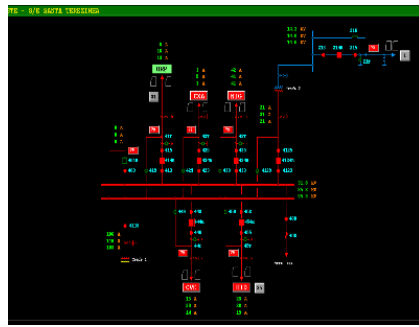
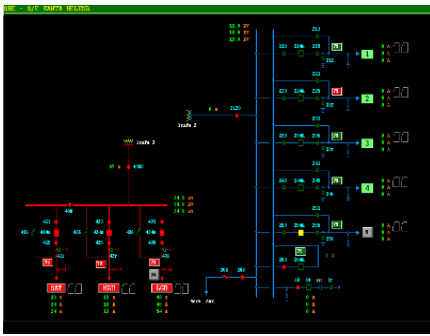

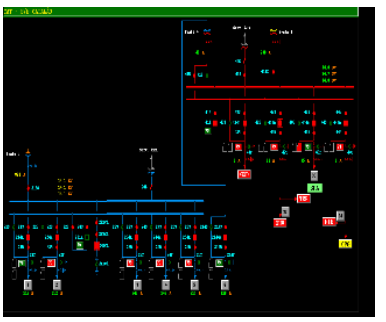
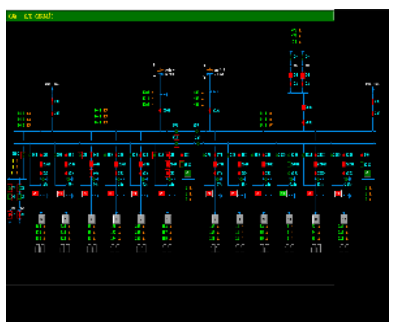
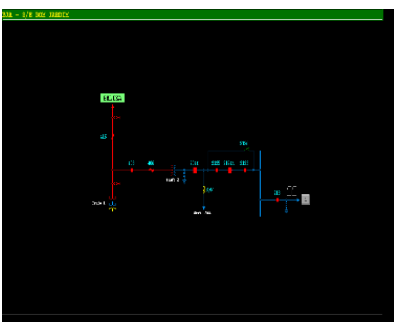
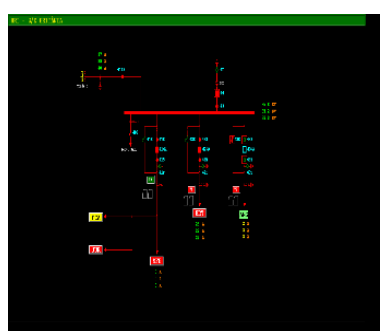
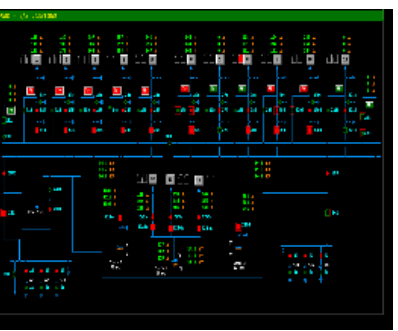
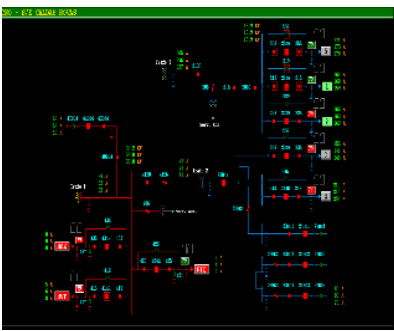
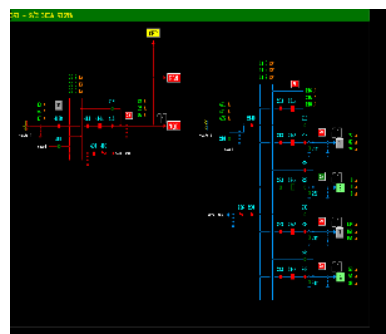
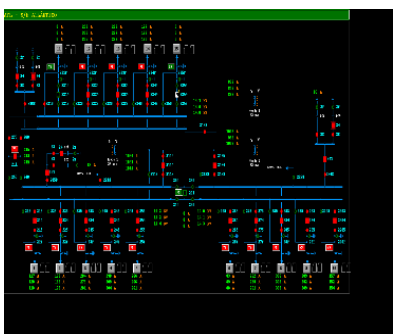
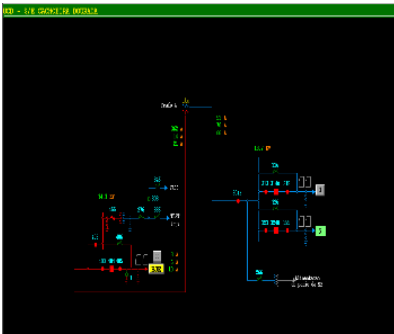
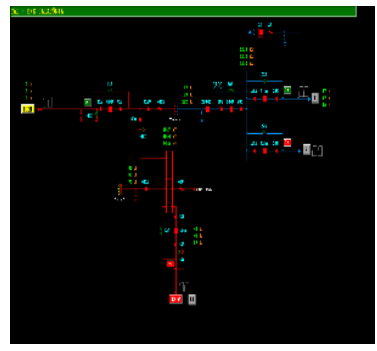
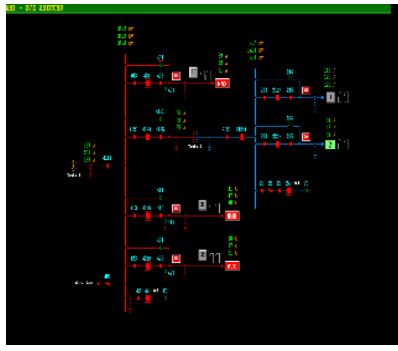
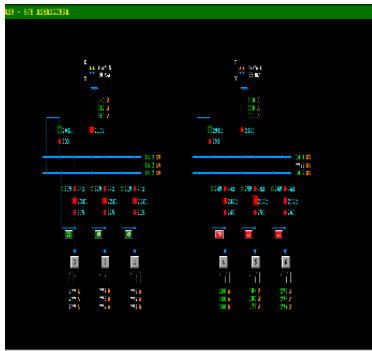
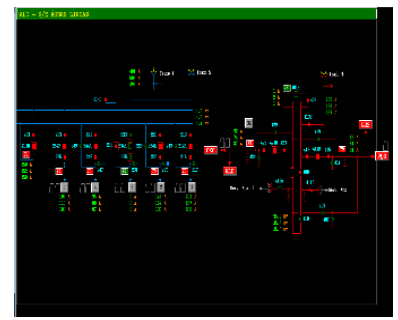
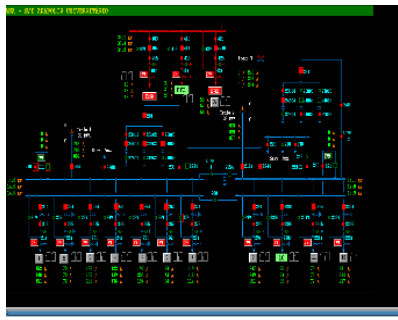
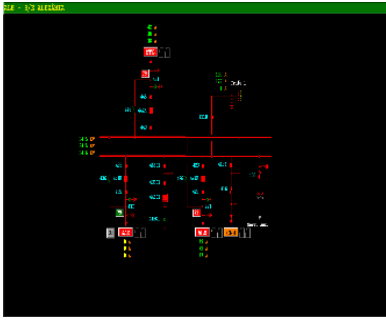



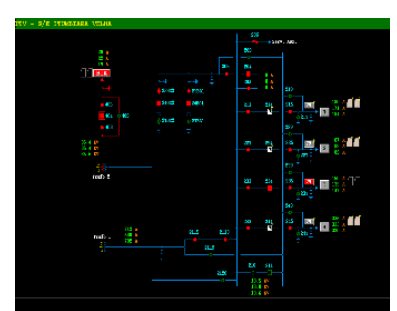
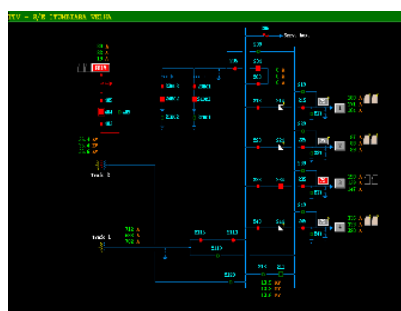
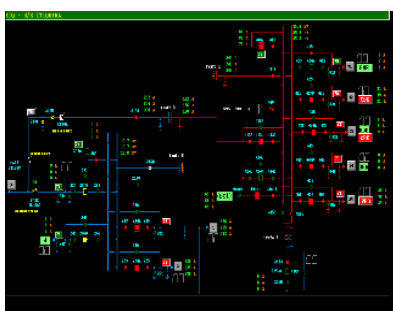
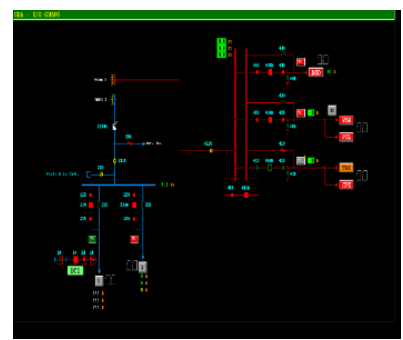
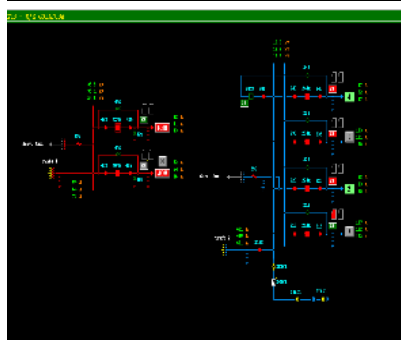
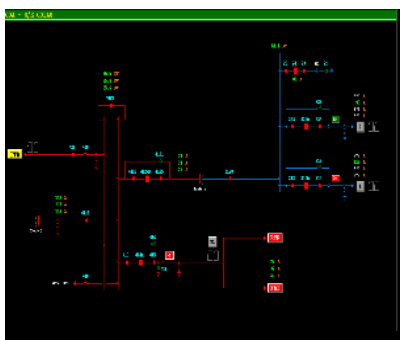
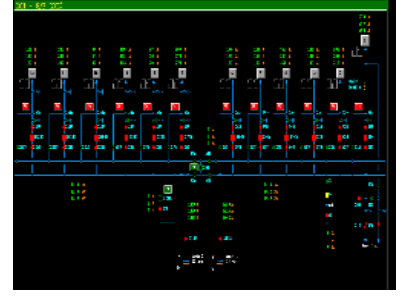
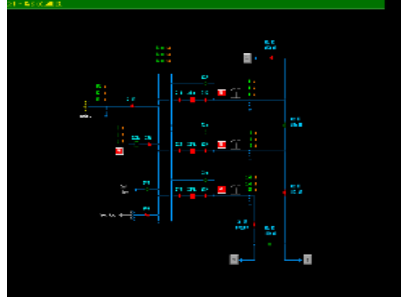
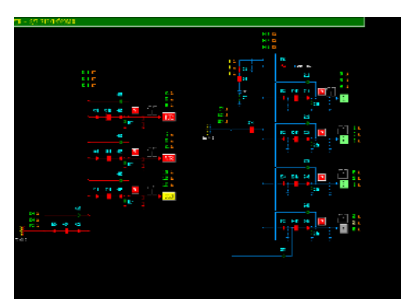
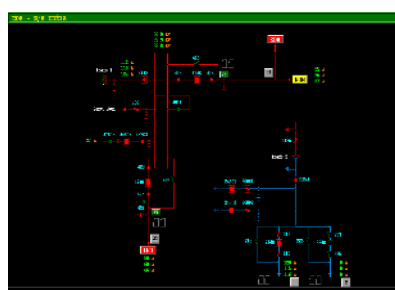
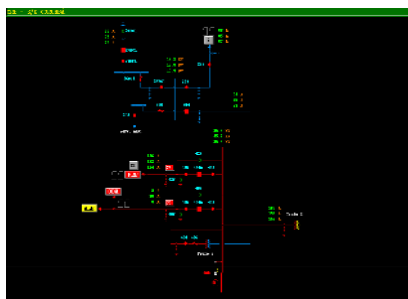
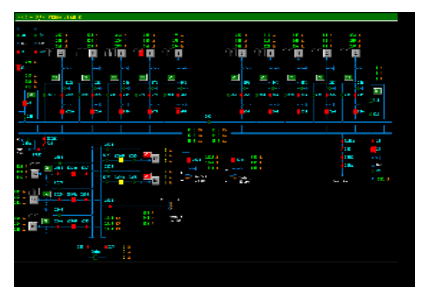
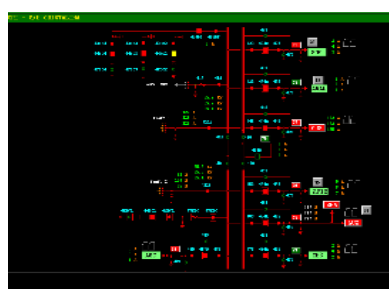
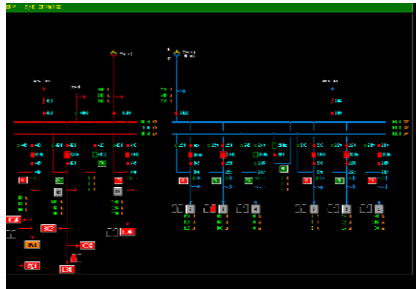
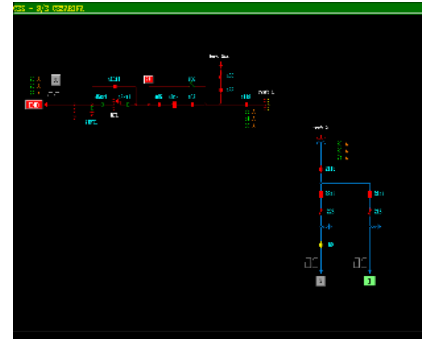
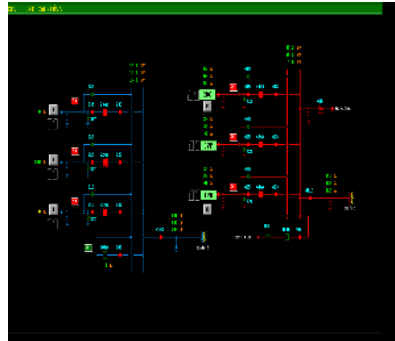
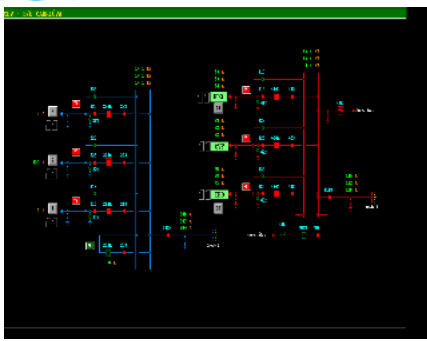

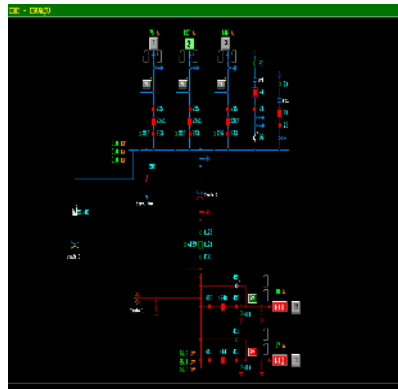
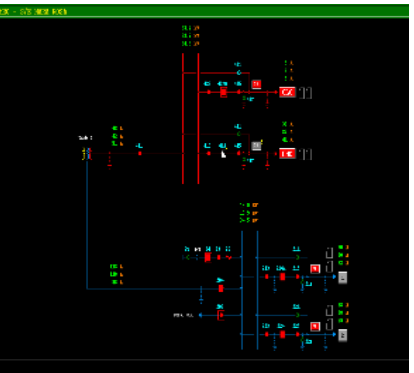
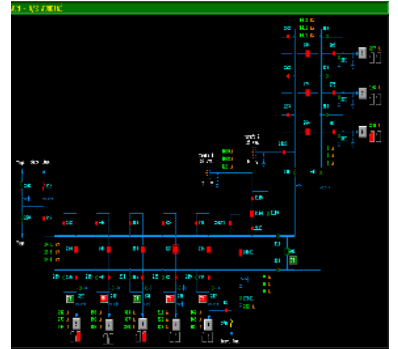
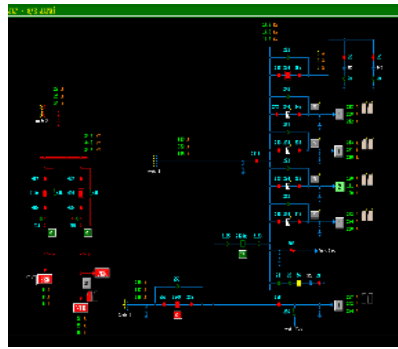
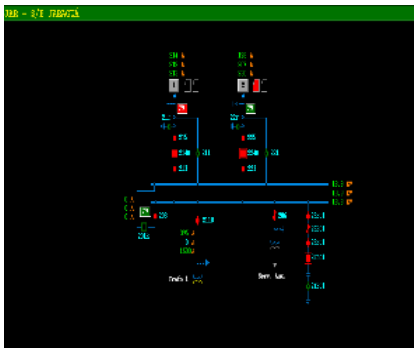

## 8. DEMAIS EVIDÊNCIAS

### 8.1. DADOS TÉCNICO - OPERACIONAIS ENEL GO

Enel - GO

TMAE e OE por Dia - Novembro 2020

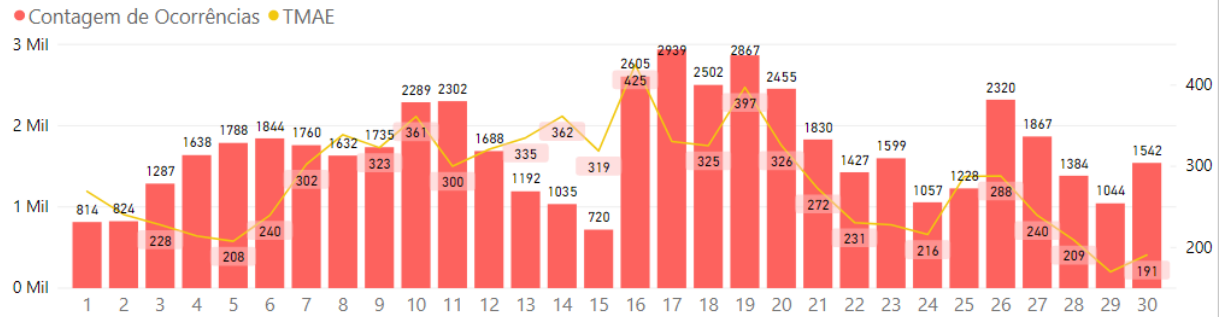

Regional Anápolis – GO

TMAE e OE por Dia - Novembro 2020

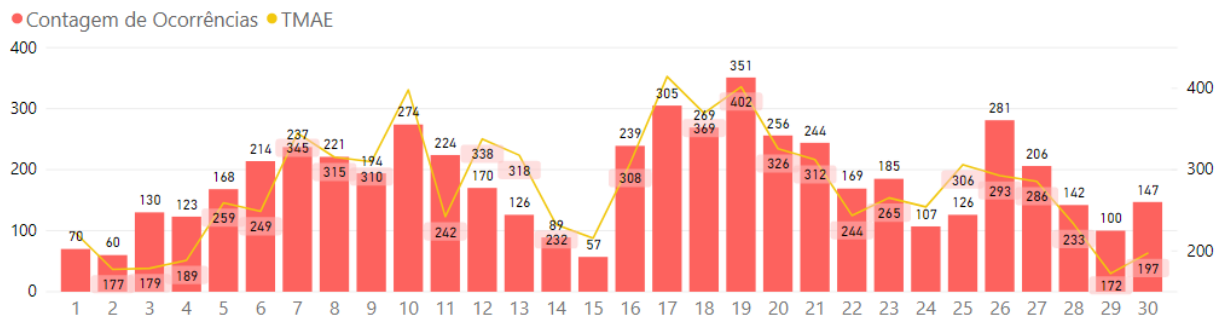

Regional Formosa – GO

TMAE e OE por Dia - Novembro 2020

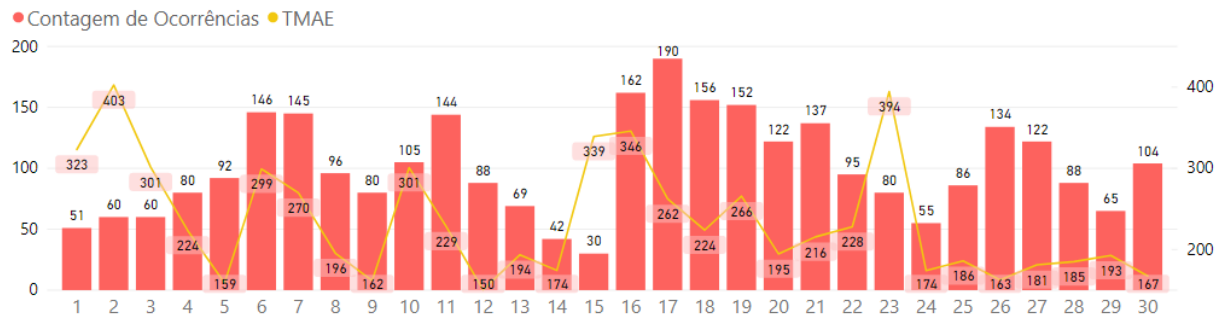

Regional Goiânia – GO

TMAE e OE por Dia - Novembro 2020

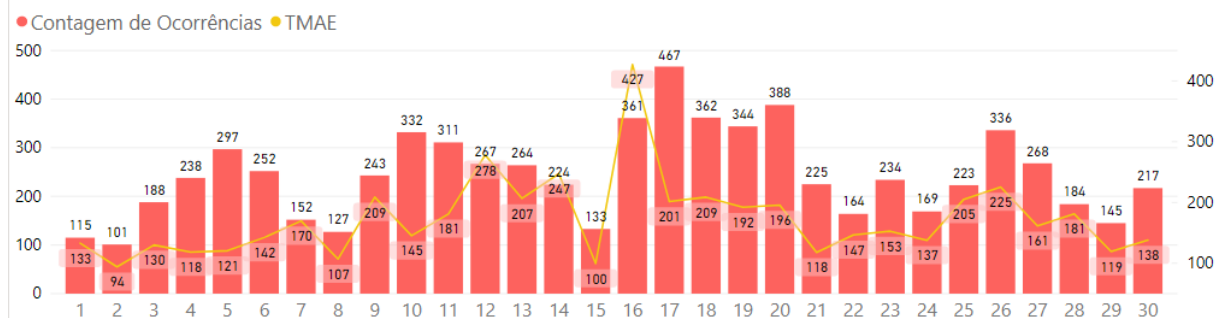

**Regional Iporá – GO**

TMAE e OE por Dia - Novembro 2020

● Contagem de Ocorrências ● TMAE

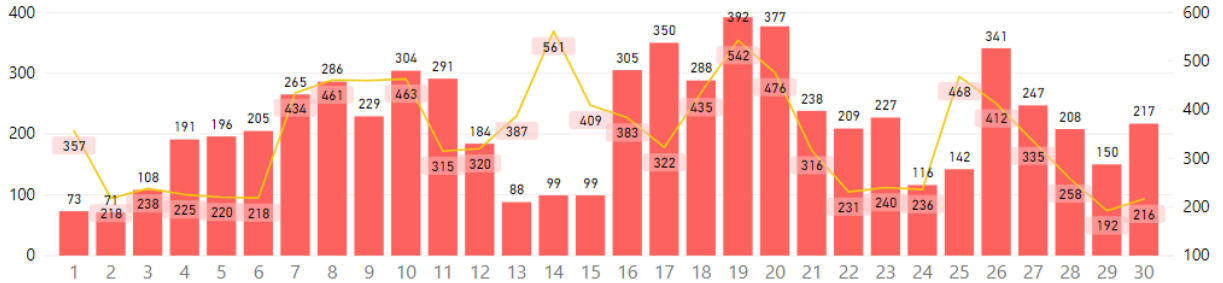

**Regional Luziânia – GO**

TMAE e OE por Dia - Novembro 2020

● Contagem de Ocorrências ● TMAE

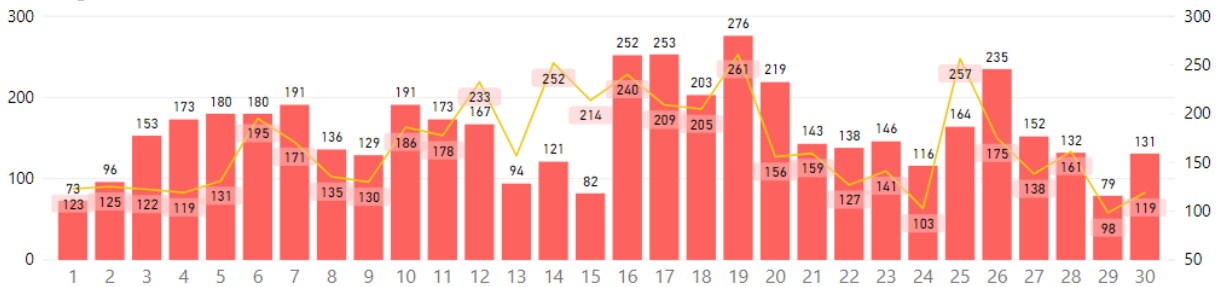

**Regional Metropolitana – GO**

TMAE e OE por Dia - Novembro 2020

● Contagem de Ocorrências ● TMAE

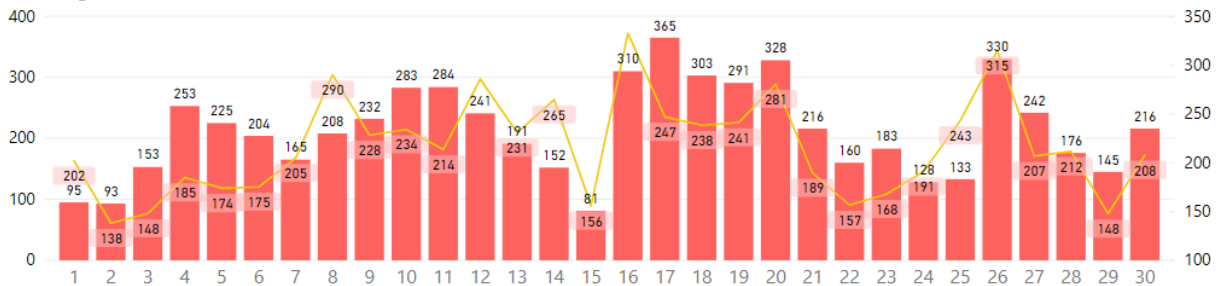

**Regional Morrinhos – GO**

TMAE e OE por Dia - Novembro 2020

● Contagem de Ocorrências ● TMAE

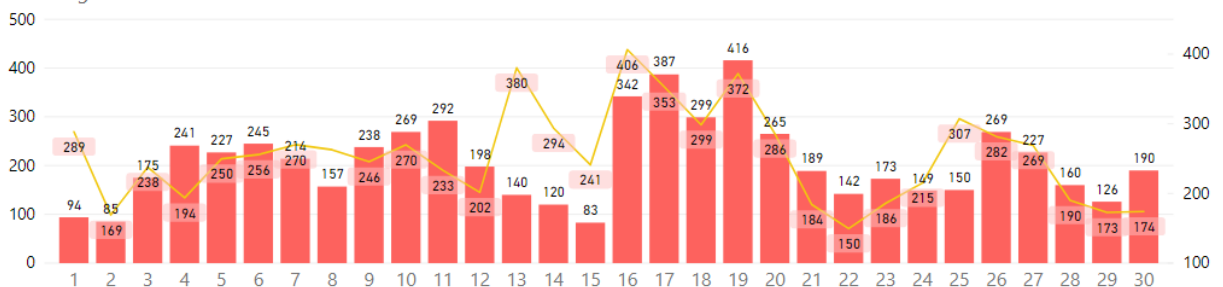

**Regional Rio Verde – GO**

TMAE e OE por Dia - Novembro 2020

● Contagem de Ocorrências ● TMAE

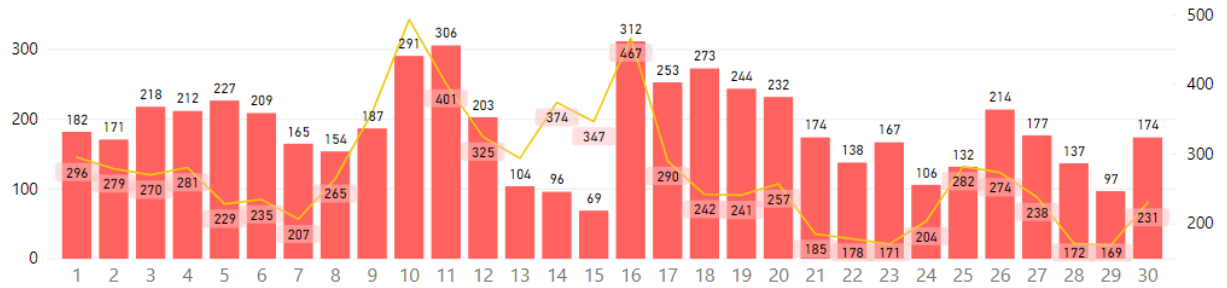

**Regional Uruaçu - GO**

TMAE e OE por Dia - Novembro 2020

● Contagem de Ocorrências ● TMAE

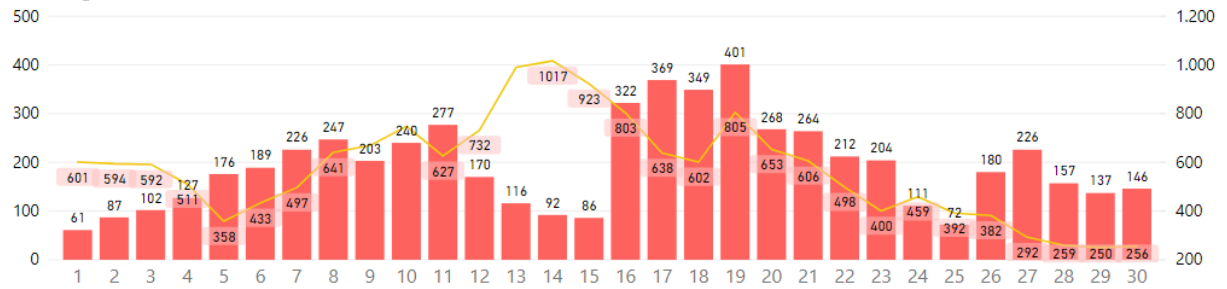

**8.2. Dados climatológicos pelo INMET**

**Instituto Nacional de Meteorologia – INMET**

Chuva Acumulada em 24h || Estação: ARAGARCAS (83368) – 11/2020

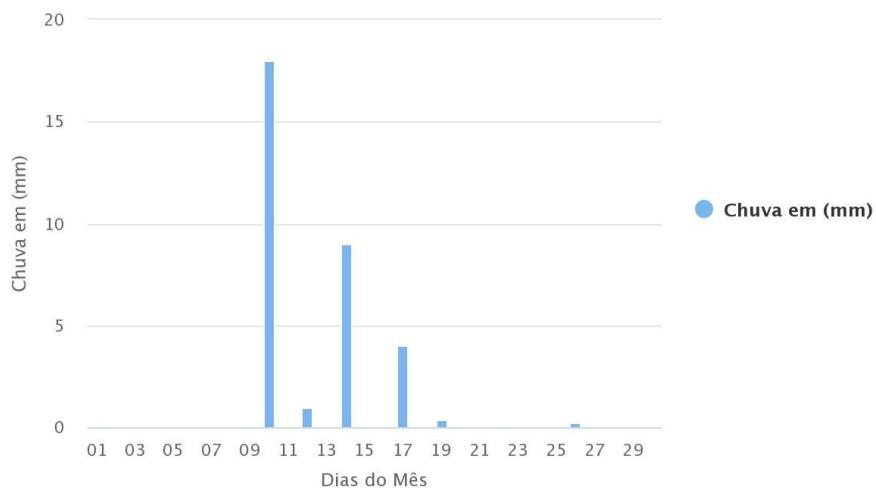



### Instituto Nacional de Meteorologia – INMET

Chuva Acumulada em 24h || Estação: CATALAO (83526) – 11/2020

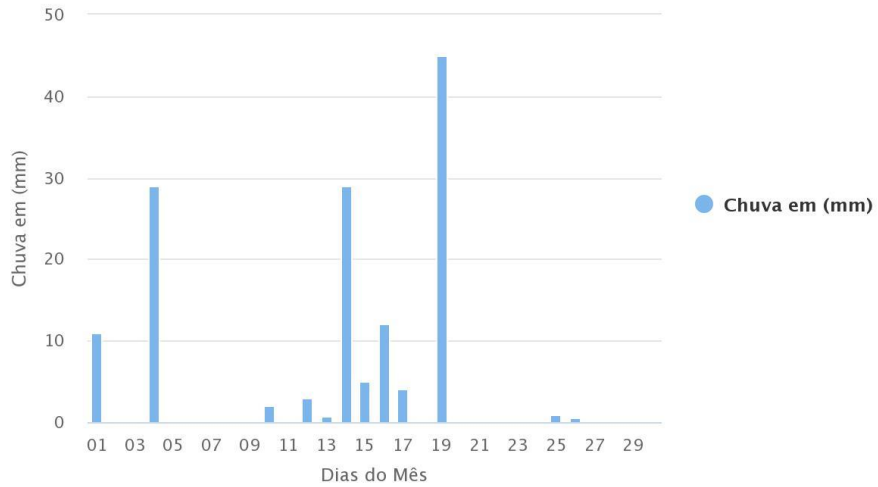

Highcharts.com

### Instituto Nacional de Meteorologia – INMET

Chuva Acumulada em 24h || Estação: FORMOSA (83379) – 11/2020

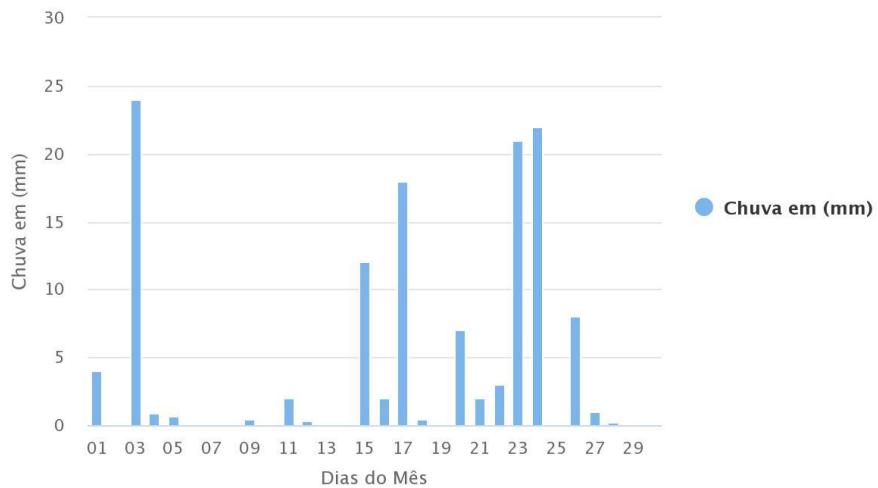

Highcharts.com

### Instituto Nacional de Meteorologia – INMET

Chuva Acumulada em 24h || Estação: GOIANIA (83423) – 11/2020

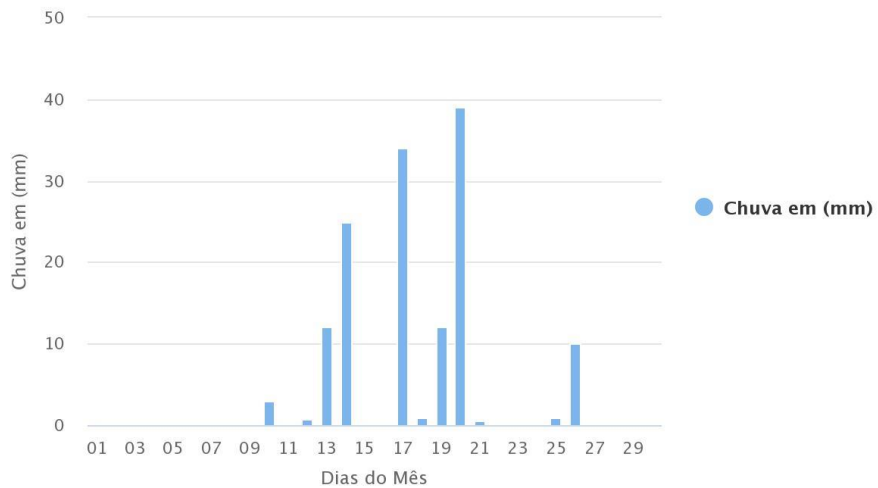

Highcharts.com

### Instituto Nacional de Meteorologia – INMET

Chuva Acumulada em 24h || Estação: IPAMERI (83522) – 11/2020

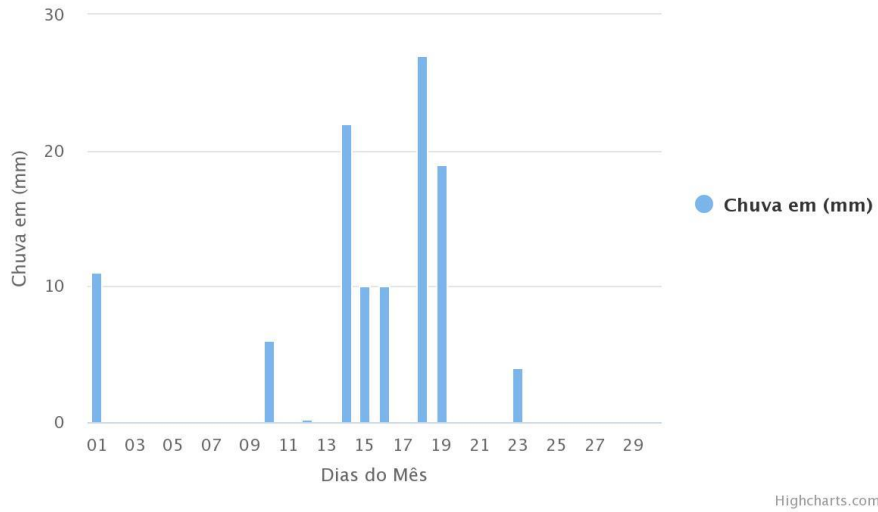

Highcharts.com

### Instituto Nacional de Meteorologia – INMET

Chuva Acumulada em 24h || Estação: PIRENOPOLIS (83376) – 11/2020

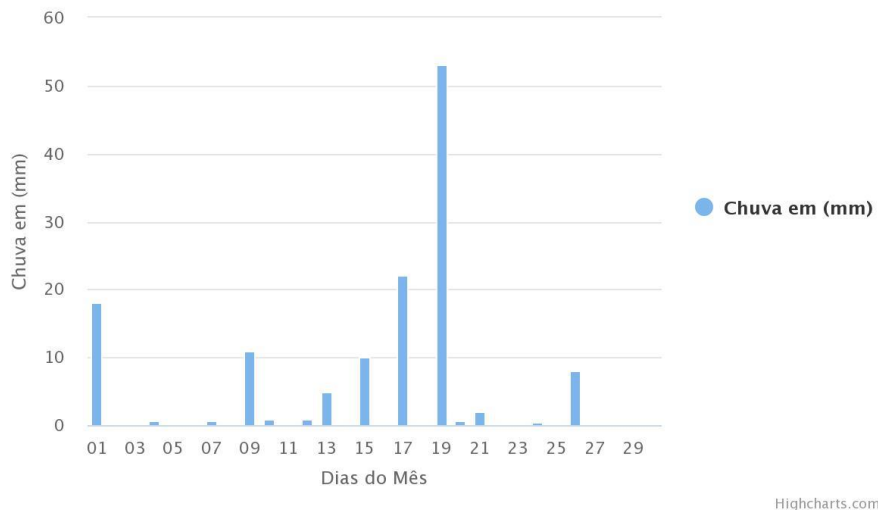

Highcharts.com

### Instituto Nacional de Meteorologia – INMET

Chuva Acumulada em 24h || Estação: POSSE (83332) – 11/2020

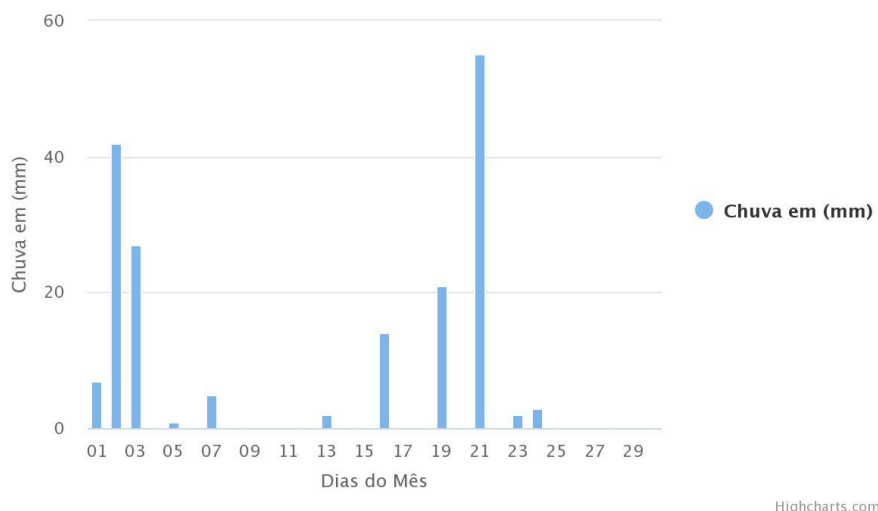

Highcharts.com

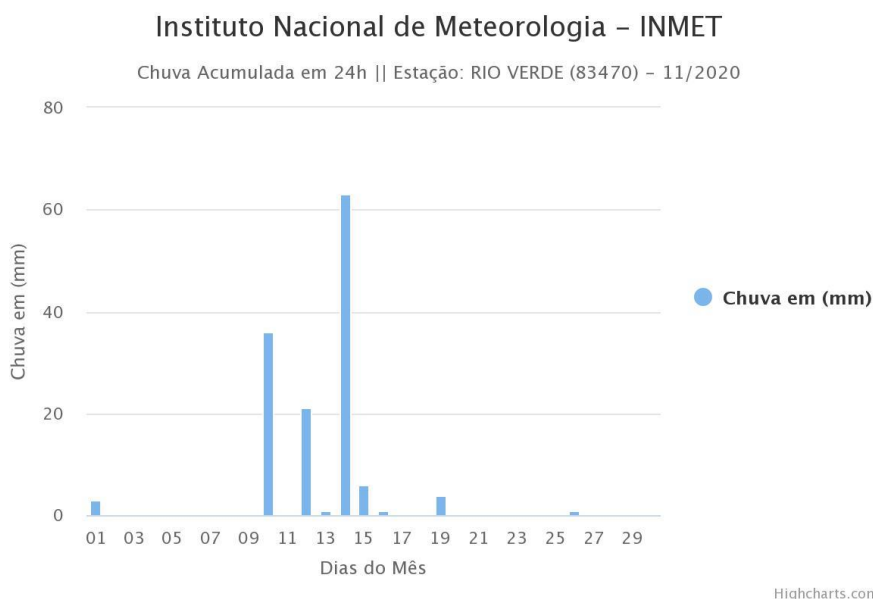

## 9. NOTÍCIAS RELACIONADAS

<https://g1.globo.com/go/goias/noticia/2020/11/12/chuva-destelha-galpoes-alaga-ruas-e-derruba-arvores-na-grande-goiania-video.ghtml>

# Chuva destelha galpões, alaga ruas e derruba árvores na Grande Goiânia; vídeo

Imagens mostram momento em que raio cai e deixa moradores assustados. Temporal ainda atingiu fiação elétrica e travou trânsito.



Chuva destelha galpões, alaga ruas e derruba árvores na Grande Goiânia

A forte chuva que caiu na tarde desta quinta-feira (12) na Grande Goiânia causou inúmeros transtornos. O vento destelhou alguns comércios, além de derrubar várias árvores. Ruas ficaram alagadas.

Na Vila Brasília, em **Aparecida de Goiânia**, um vídeo mostra o momento em que um restaurante e uma oficina são destelhados. Logo em seguida, um raio cai na região e assusta os moradores *(veja acima)*.

As empresas ficam na Rua Tapajós, onde os moradores também ficaram sem energia elétrica. No Jardim Luz e no Setor dos Afonsos, foram registradas quedas de árvores.

## Goiânia

Já em **Goiânia**, no Parque Amazônia, o vendaval foi tão forte que destruiu a fiação dos postes e por pouco não atingiu uma pedestre. Em uma avenida, por causa da queda de árvores, o trânsito chegou a ficar parado por uma hora.

No Setor Campinas, também na capital, algumas ruas ficaram completamente alagadas. Em alguns casos, a enxurrada cobriu até as calçadas.



Chuva destelha galpões na Grande Goiânia — Foto: Reprodução/TV Anhanguera



<http://ohoje.com/noticia/cidades/n/182523/t/chuva-da-ultima-quinta-feira-12-deixa-estragos-em-aparecida-de-goiania>

## Chuva da última quinta-feira (12) deixa estragos em Aparecida de Goiânia

Postado em: 13-11-2020 às 15h47



Na última quinta-feira (12) a chuva e os fortes ventos provocaram diversos alagamentos e danos na capital e região metropolitana. Diversas lojas da Avenida Tapajós em Aparecida de Goiânia tiveram prejuízo causado pela ventania que levou telhados e coberturas.

Além dos estragos no comércio, várias árvores foram arrancadas durante o temporal em Goiânia. A Companhia de Urbanização de Goiânia (Comurg) ainda trabalha para atualizar o total de pés danificados, mas já foram confirmados endereços no Parque Amazônia, Jardim América e Avenida Goiás Norte.

A chuva também causou alagamentos em diversos locais, como a BR-153, nas proximidades do Estádio Serra Dourada; a T-63; Avenida 85; T-9; T-7; Av. Alexandre de Moraes e outros. A previsão do tempo para essa sexta-feira (13) é de chuva no início da noite.

<https://www.instagram.com/p/CHgPKClFmL/>



**maisgoias** • Seguindo

**maisgoias** Situação na Avenida T-9, no Jardim Planalto.

11 sem

+ Adicione um comentário...

**giseleusagomes** @wiilleer 🙏🙏🙏  
🙏 cuidado

11 sem Responder

**luzia6248** 😞😞😞☁️☁️☁️

11 sem 1 curtida Responder

**janaricardinho** 😞😞😞

11 sem Responder

65.672 visualizações

12 DE NOVEMBRO DE 2020

Adicione um comentário... Publicar

<https://www.instagram.com/p/CHgRmd5FMjR/>



**maisgoias** • Seguindo

Áudio original

**maisgoias** Tempo: Veja o momento em que uma rajada de vento atinge a região de pregões no início da Avenida Rio Verde, em Aparecida de Goiânia.

11 sem

+ Adicione um comentário...

**flaviaterapeutaholistica**  
@arthurlinares olha como ta aqui!

11 sem Responder

**fernandostofel**  
@anapaulastofelneuropsico

Curtido por camiloaraujoegito e outras 30.534 pessoas

12 DE NOVEMBRO DE 2020

Adicione um comentário... Publicar

<https://www.instagram.com/p/CHgQnhJFxOI/>



**maisgoias** • Seguindo  
Áudio original

**maisgoias** Durante a chuva dessa tarde, várias árvores caíram na Avenida Alexandre de Morais, no Setor Parque Amazônia.

11 sem

+ (Add comment)

**manuholiveirasilva** Enquanto isso ninguém pode levantar a moto 🤔

11 sem Responder

**wallceria @jeanlucas1412**

11 sem Responder

👍 🗨️ 📍

Curtido por eumichaelribeiro e outras 13.155 pessoas

12 DE NOVEMBRO DE 2020

<https://www.instagram.com/p/CHgqTp3l68I/>



**maisgoias** • Seguindo

**maisgoias** A forte chuva caída na tarde desta quinta-feira (12) causou alagamentos em diversas ruas, queda de árvores e até mesmo o muro de um depósito de piscina, em Goiânia. Um motociclista foi arrastado pela enxurrada e o trânsito ficou congestionado em vários pontos da capital. Vídeos e fotos registradas em toda a cidade mostram os transtornos.

Segundo informações da Companhia de Urbanização de Goiânia (Comurg), foram registradas 8 quedas de árvores nos setores Crimeia Oeste (1), Jaó (2), Parque Amazônia (1), Jardim Curitiba (1), Jardim América (2) e Setor Sul (1). Além das árvores, também houve queda de galhos. Equipes da empresa

**maisgoias**

**Forte chuva causa alagamento, queda de árvores e muro em Goiânia**

👍 🗨️ 📍

6.154 curtidas

12 DE NOVEMBRO DE 2020



<https://www.instagram.com/p/CHkfNhkFL1M/>



**maisgoias** • Seguindo

**maisgoias** Tempo: situação na Avenida Parque Atheneu, no Parque Atheneu, em Goiânia.

11 sem

+

**johnathan\_paulo** Carros são como lanchas, motos são como jet skis e pedestres viram banhistas...

11 sem 4 curtidas Responder

**tuliocesar.carneirofilho** Nesse local está em execução uma grande obra, com duplicação da avenida e implantação de um

43.540 visualizações

14 DE NOVEMBRO DE 2020

<https://www.instagram.com/p/CHqkPm-FZMi/>



**maisgoias** • Seguindo

Áudio original

**maisgoias** Tempo agora: chove forte em Senador Canedo. Vídeo @herik\_jansen

11 sem

+

**junnera777** HAARP SENDO TESTADO NO BRASIL E O GADO SEGUE CALADO

11 sem Responder

**leandrossrs** Olha a chuva @marislino 🙏

11 sem Responder

Curtido por geancarlos17 e outras 8.312 pessoas

16 DE NOVEMBRO DE 2020

10. Laudo Técnico

CLIMATEMPO

**Laudo Meteorológico de Evento Climático  
- ENEL Goiás - 12 de novembro de 2020**

São Paulo, SP, Brasil

Dezembro de 2020



# Sumário

<b>1</b>	<b>ANÁLISE DE EVENTO METEOROLÓGICO.....</b>	<b>2</b>
1.1	Descrição do Evento.....	2
1.2	Abrangência do Evento.....	6
<b>2</b>	<b>CLASSIFICAÇÃO COBRADE.....</b>	<b>16</b>
<b>3</b>	<b>RESUMO DO EVENTO.....</b>	<b>17</b>
<b>4</b>	<b>REFERÊNCIAS.....</b>	<b>20</b>
	<b>ANEXOS.....</b>	<b>21</b>

# 1. Análise de Evento Meteorológico

## 1.1. Descrição do Evento

Na figura a seguir é apresentada a área de concessão da ENEL DISTRIBUIÇÃO GOIÁS, dividida em regiões, a serem analisadas neste relatório.



Figura 1 – Regiões atendidas pela ENEL Goiás.

A presença de um cavado atmosférico, que é a circulação dos ventos em níveis médios da atmosfera que favorece a geração de instabilidades, atuou sobre a região Centro- Oeste e Sudeste do Brasil entre os dias 12 e 15 de novembro de 2020. A instabilidade em níveis médios da atmosfera favoreceu a formação de áreas de baixa pressão em superfície e também a convergência de umidade sobre a região central do Brasil.

Nas Figuras 2 e 3 são apresentadas as descargas atmosféricas nuvem-solo (raios) e nuvem-nuvem detectadas pelo sistema Earth Networks. Entre as 10h00 do dia 12 e 04h10 do dia 16 de novembro de 2020 foram registrados 59531 raios nuvem-solo e 181832 descargas nuvem-nuvem sobre a área da ENEL DISTRIBUIÇÃO GOIÁS.

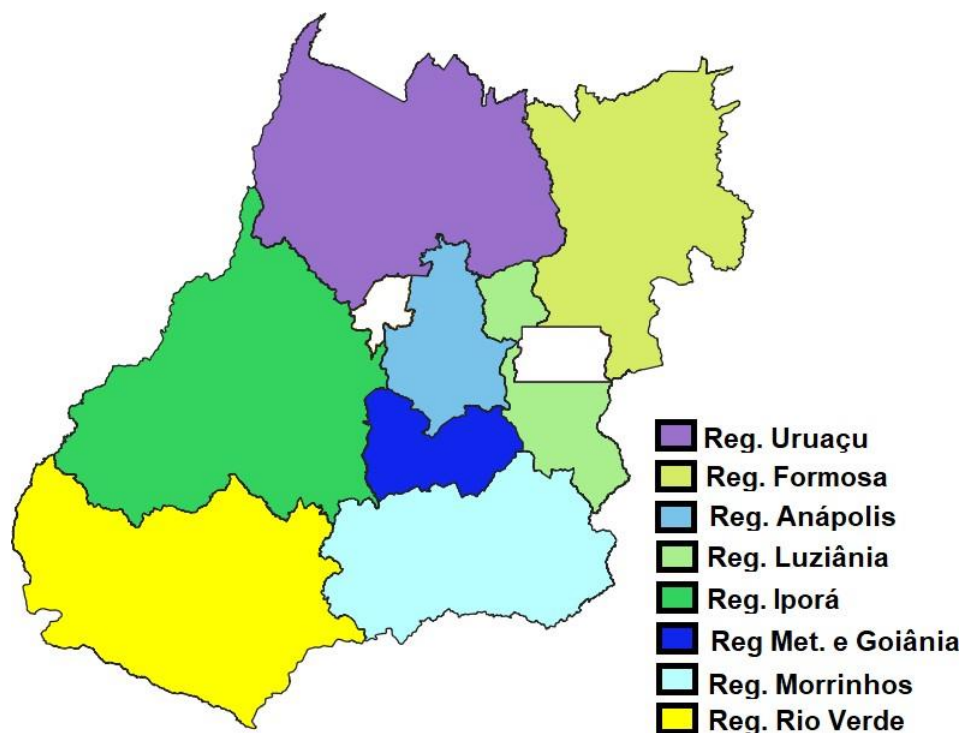

Figura 2 – Descargas atmosféricas nuvem-solo (em preto) detectadas pelo sistema Earth Networks entre 10h00 do dia 12 e 04h10 do dia 16 de novembro de 2020 sobre a área de concessão da ENEL DISTRIBUIÇÃO GOIÁS.



Figura 3 – Descargas atmosféricas nuvem-nuvem (em vermelho) detectadas pelo sistema Earth Networks entre 10h00 do dia 12 e 04h10 do dia 16 de novembro de 2020 sobre a área de concessão da ENEL DISTRIBUIÇÃO GOIÁS.

Na tabela 1 são apresentadas as rajadas de vento iguais ou superiores a 50 km/h registradas por estações do Instituto Nacional de Meteorologia (INMET) representativas da área de concessão da ENEL DISTRIBUIÇÃO GOIÁS. Como é possível observar, o maior valor registrado foi de 61,9 km/h na estação de Caiapônia entre as 16h e 17h do dia 14 de novembro, vento classificado como vento forte pela escala Beaufort.

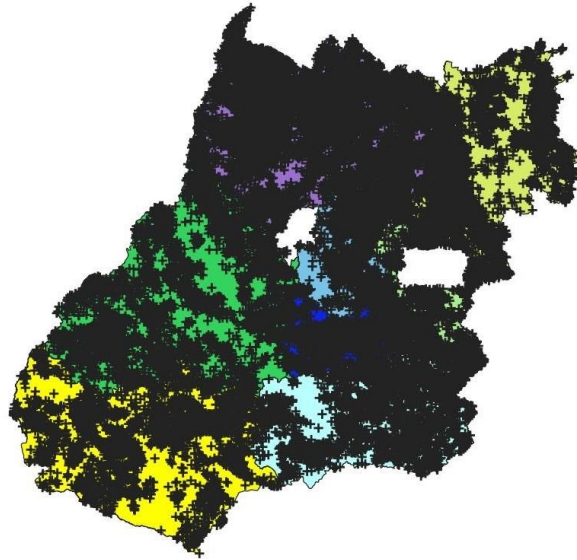
Tabela 1 – Rajadas de vento maiores ou iguais a 50 km/h registradas pelo INMET. Segundo a escala Beaufort, ventos entre 50 e 61 km/h são classificados como vento forte.

Estação	Horário	Rajada (km/h)
Morrinhos	Entre 16h e 17h do dia 12/11/2020	50.8
Morrinhos	Entre 17h e 18h do dia 12/11/2020	50.8
Silvânia	Entre 17h e 18h do dia 12/11/2020	56.5
Catalão	Entre 16h e 17h do dia 13/11/2020	54.7
Caiapônia	Entre 16h e 17h do dia 14/11/2020	61.9

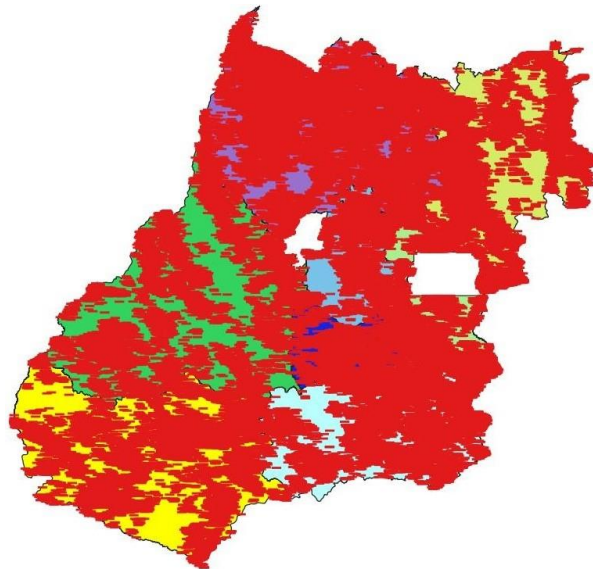
Estações do Instituto Nacional de Meteorologia (INMET), representativas da área de concessão da ENEL DISTRIBUIÇÃO GOIÁS, registraram chuva forte (segundo a American Meteorological Society - Sociedade Meteorológica Americana -, chuvas com taxa entre 2,5mm a 7,6 mm por hora são consideradas moderadas e aquelas com taxa superior a 7,6 mm por hora são consideradas chuva forte). Na tabela 2 são apresentados os registros de acumulados horários superiores a 7,6 mm.

Tabela 2 – Acumulado horário de chuva registrada pelo INMET.

Estação	Horário	Precipitação (mm)
Cristalina	Entre 13h e 14h do dia 12/11/2020	10.4
Silvânia	Entre 17h e 18h do dia 12/11/2020	33.2
Silvânia	Entre 13h e 14h do dia 13/11/2020	8.4
Mineiros	Entre 14h e 15h do dia 13/11/2020	7.8
Silvânia	Entre 14h e 15h do dia 13/11/2020	25.0
Morrinhos	Entre 17h e 18h do dia 13/11/2020	9.2
Goiânia	Entre 19h e 20h do dia 13/11/2020	18.6
Silvânia	Entre 21h e 22h do dia 13/11/2020	14.4
Silvânia	Entre 22h e 23h do dia 13/11/2020	9.6
Jataí	Entre 3h e 4h do dia 14/11/2020	8.8
Paraúna	Entre 3h e 4h do dia 14/11/2020	27.0
Paraúna	Entre 5h e 6h do dia 14/11/2020	25.6
Goiânia	Entre 8h e 9h do dia 14/11/2020	8.8
Pires do Rio	Entre 9h e 10h do dia 14/11/2020	14.8
Posse	Entre 13h e 14h do dia 15/11/2020	10.8
Silvânia	Entre 17h e 18h do dia 15/11/2020	7.8
Itapaci	Entre 20h e 21h do dia 15/11/2020	13.8
Pires do Rio	Entre 20h e 21h do dia 15/11/2020	9.6

Nas tabelas de 3 a 6 são apresentados os acumulados diários registrados pelo INMET no estado de Goiás. Considerando o período entre as 09h00 do dia 12 e 09h00 do dia 14 de novembro, foram acumulados 96,0 mm em Silvânia, volume que corresponde a aproximadamente 48% da média do mês de novembro

Tabela 3 – Precipitação acumulada entre 09h do dia 12 e 09h do dia 13 de novembro de 2020. FONTE: INMET

Estação	Precipitação Acumulada(mm)
SILVANIA	38.4
GOIANIA - AEROPORTO	13.0
GOIANIA	12.0
CRISTALINA	10.6

Tabela 4 – Precipitação acumulada entre 009h do dia 13 e 09h do dia 14 de novembro de 2020. FONTE: INMET

Estação	Precipitação Acumulada(mm)
PARAUNA	63.4
RIO VERDE	63.0
SILVANIA	57.6
MORRINHOS	35.4
GOIANIA	29.2
CATALAO	29.0
GOIANIA - AEROPORTO	27.0
GOIANIA	25.0
IPAMERI	22.0

Tabela 5 – Precipitação acumulada entre 09h do dia 14 e 09h do dia 15 de novembro de 2020. FONTE: INMET

Estação	Precipitação Acumulada(mm)
PIRES DO RIO	22.0
FORMOSA	12.0
JATAÍ	11.0
CRISTALINA	10.0
IPAMERI	10.0
PIRENOPOLIS	10.0

Tabela 6 – Precipitação acumulada entre 009h do dia 15 e 09h do dia 16 de novembro de 2020. FONTE: INMET

Estação	Precipitação Acumulada(mm)
CRISTALINA (FAZENDA SANTA MÔNICA)	40.8
ITAPACI	17.6
POSSE	16.6
POSSE	14.0
SILVANIA	13.8
CATALAO	12.0
PIRES DO RIO	11.4
IPAMERI	10.0



## 1.2. Abrangência do Evento

A seguir são apresentadas as imagens realçadas do satélite GOES-16 entre as 12h00 do dia 12 e 00h00 do dia 16 de novembro de 2020. Os tons em vermelho e preto indicam a presença de nuvens de grande desenvolvimento vertical, geralmente associadas à ocorrência de tempo severo.

### 12h00 - 12 de Novembro de 2020 - BRT



Figura 4 – Imagens realçadas do satélite GOES-16 das 12h00 do dia 12 de Novembro de 2020.  
FONTE: Cptec/INPE.

### 15h00 - 12 de Novembro de 2020 - BRT

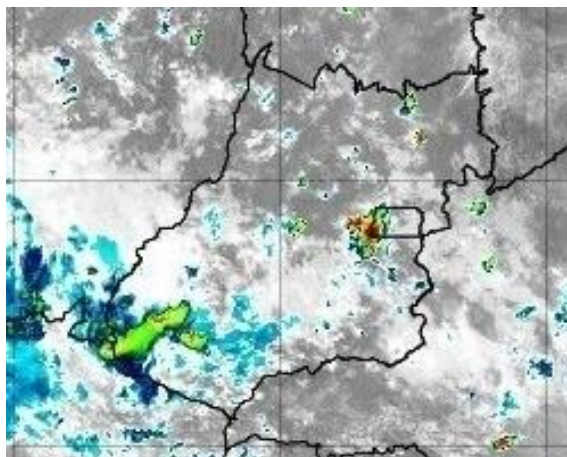

Figura 5 – Imagens realçadas do satélite GOES-16 das 15h00 do dia 12 de Novembro de 2020.  
FONTE: Cptec/INPE.

**18h00 - 12 de Novembro de 2020 - BRT**

Figura 6 – Imagens realçadas do satélite GOES-16 das 18h00 do dia 12 de Novembro de 2020. FONTE: Cptec/INPE.

**21h00 - 12 de Novembro de 2020 - BRT**

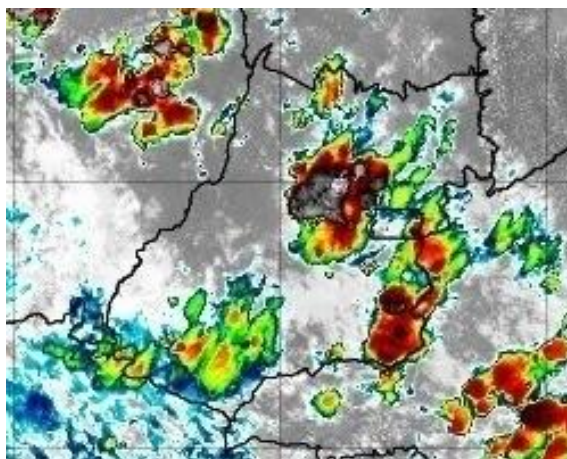
Figura 7 – Imagens realçadas do satélite GOES-16 das 21h00 do dia 12 de Novembro de 2020. FONTE: Cptec/INPE.

**0h00 - 13 de Novembro de 2020 - BRT**

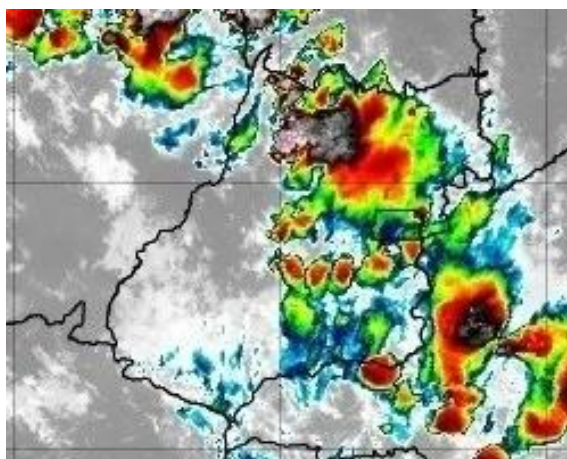
Figura 8 – Imagens realçadas do satélite GOES-16 das 0h00 do dia 13 de Novembro de 2020. FONTE: Cptec/INPE.

**3h00 - 13 de Novembro de 2020 - BRT**

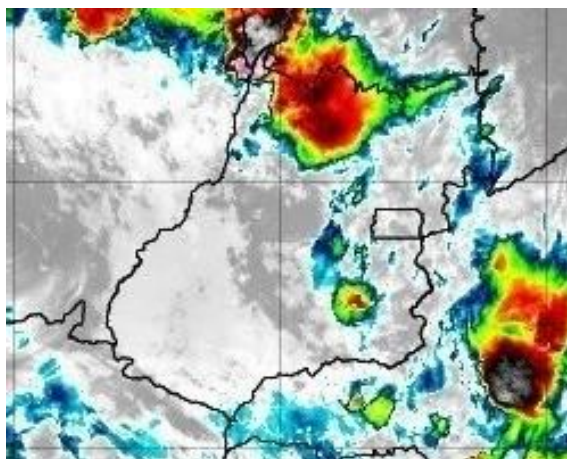
Figura 9 – Imagens realçadas do satélite GOES-16 das 3h00 do dia 13 de Novembro de 2020.  
FONTE: Cptec/INPE.

**6h00 - 13 de Novembro de 2020 - BRT**

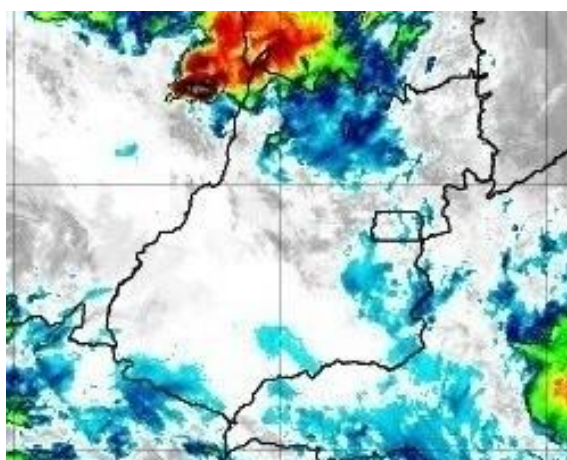
Figura 10 – Imagens realçadas do satélite GOES-16 das 6h00 do dia 13 de Novembro de 2020. FONTE:  
Cptec/INPE.

**9h00 - 13 de Novembro de 2020 - BRT**

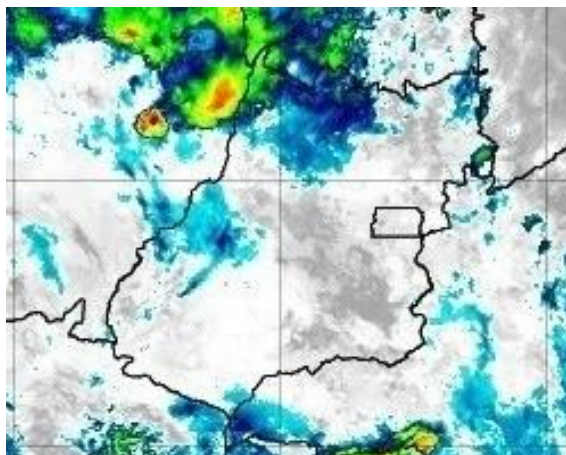
Figura 11 – Imagens realçadas do satélite GOES-16 das 9h00 do dia 13 de Novembro de 2020.  
FONTE: Cptec/INPE.

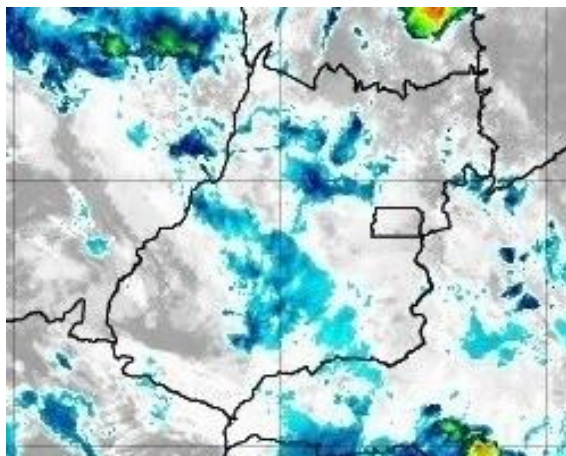

**12h00 - 13 de Novembro de 2020 - BRT**

Figura 12 – Imagens realçadas do satélite GOES-16 das 12h00 do dia 13 de Novembro de 2020.  
FONTE: Cptec/INPE.

**15h00 - 13 de Novembro de 2020 - BRT**

Figura 13 – Imagens realçadas do satélite GOES-16 das 15h00 do dia 13 de Novembro de 2020.  
FONTE: Cptec/INPE.

**18h00 - 13 de Novembro de 2020 - BRT**

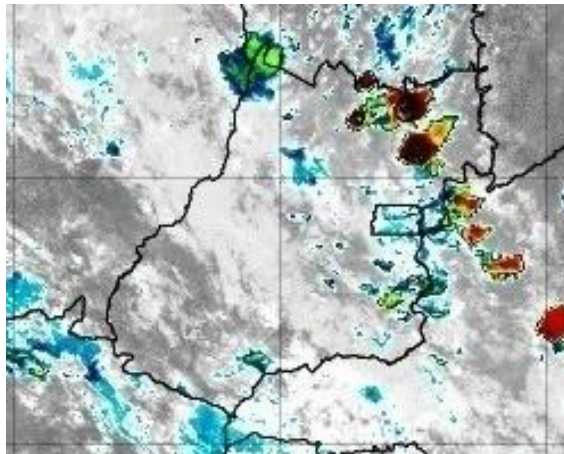
Figura 14 – Imagens realçadas do satélite GOES-16 das 18h00 do dia 13 de Novembro de 2020.  
FONTE: Cptec/INPE.

**21h00 - 13 de Novembro de 2020 - BRT**

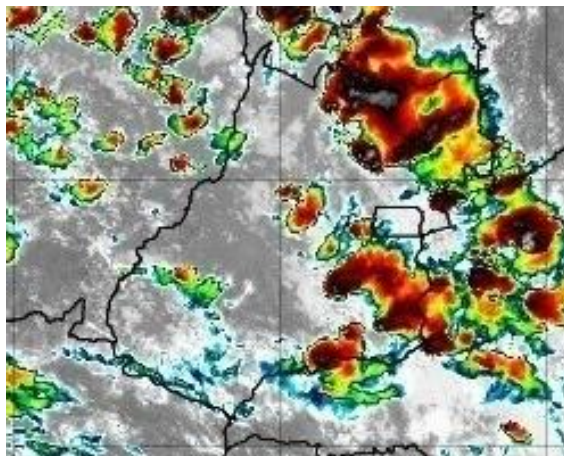
Figura 15 – Imagens realçadas do satélite GOES-16 das 21h00 do dia 13 de Novembro de 2020.  
FONTE: Cptec/INPE.

**0h00 - 14 de Novembro de 2020 - BRT**

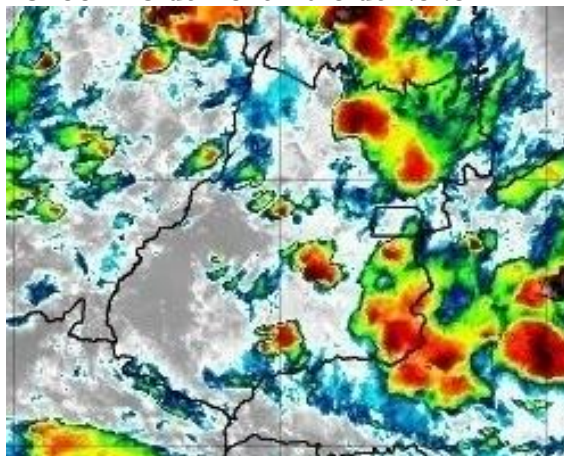
Figura 16 – Imagens realçadas do satélite GOES-16 das 0h00 do dia 14 de Novembro de 2020. FONTE:  
Cptec/INPE.

**3h00 - 14 de Novembro de 2020 - BRT**

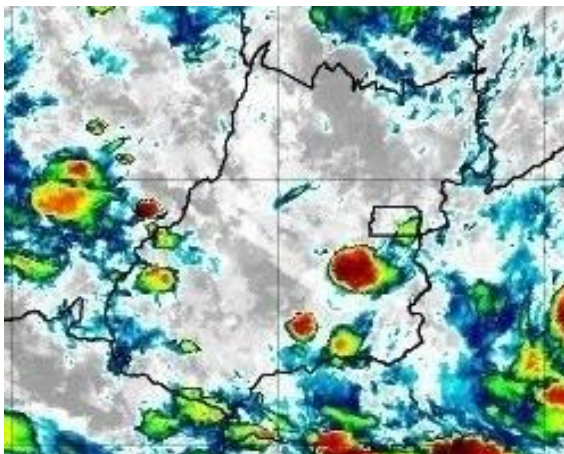
Figura 17 – Imagens realçadas do satélite GOES-16 das 3h00 do dia 14 de Novembro de 2020.  
FONTE: Cptec/INPE.

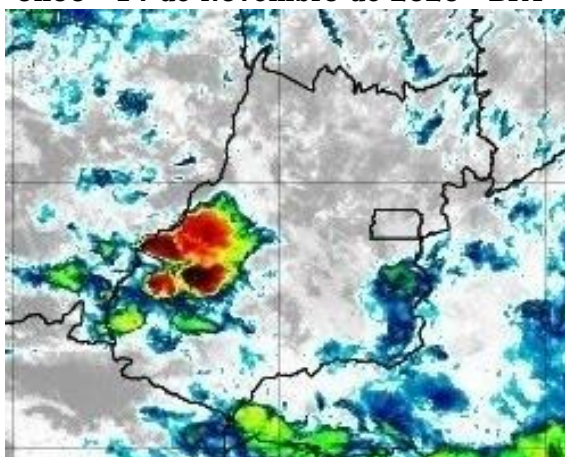

**6h00 - 14 de Novembro de 2020 - BRT**

Figura 18 – Imagens realçadas do satélite GOES-16 das 6h00 do dia 14 de Novembro de 2020. FONTE: Cptec/INPE.

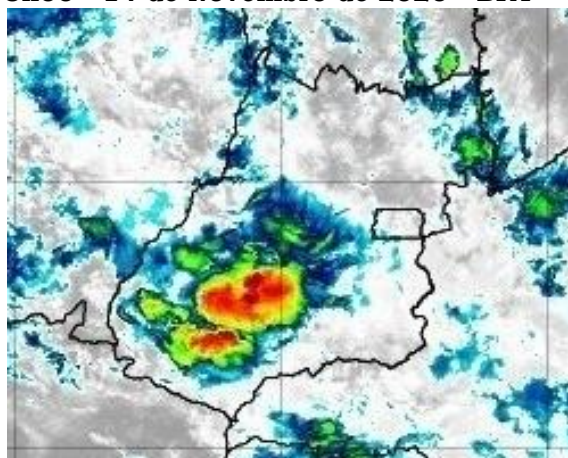
**9h00 - 14 de Novembro de 2020 - BRT**

Figura 19 – Imagens realçadas do satélite GOES-16 das 9h00 do dia 14 de Novembro de 2020. FONTE: Cptec/INPE.

**12h00 - 14 de Novembro de 2020 - BRT**

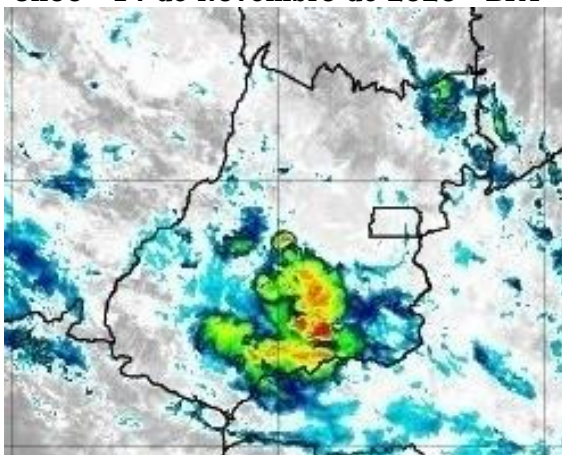
Figura 20 – Imagens realçadas do satélite GOES-16 das 12h00 do dia 14 de Novembro de 2020. FONTE: Cptec/INPE.

**15h00 - 14 de Novembro de 2020 - BRT**

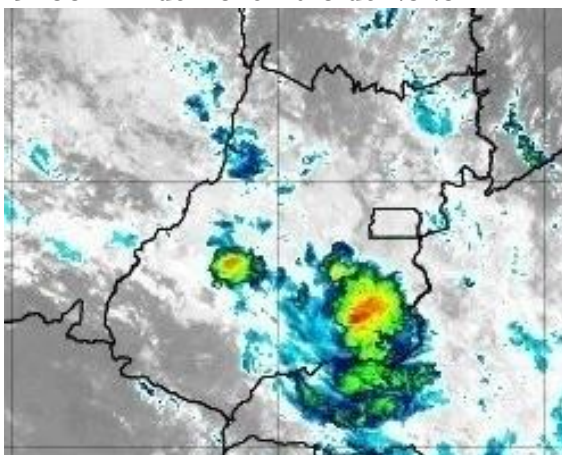
Figura 21 – Imagens realçadas do satélite GOES-16 das 15h00 do dia 14 de Novembro de 2020. FONTE: Cptec/INPE.

**18h00 - 14 de Novembro de 2020 - BRT**

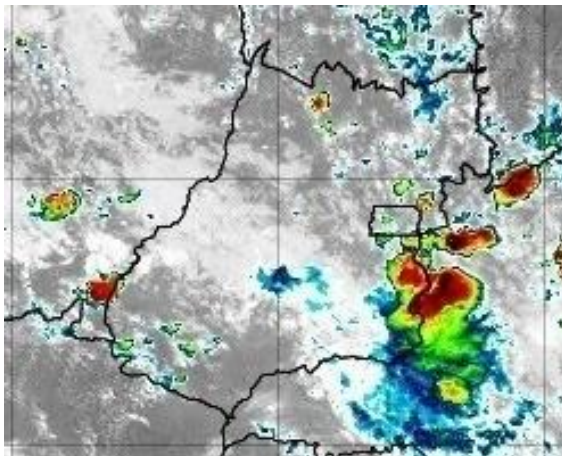
Figura 22 – Imagens realçadas do satélite GOES-16 das 18h00 do dia 14 de Novembro de 2020. FONTE: Cptec/INPE.

**21h00 - 14 de Novembro de 2020 - BRT**

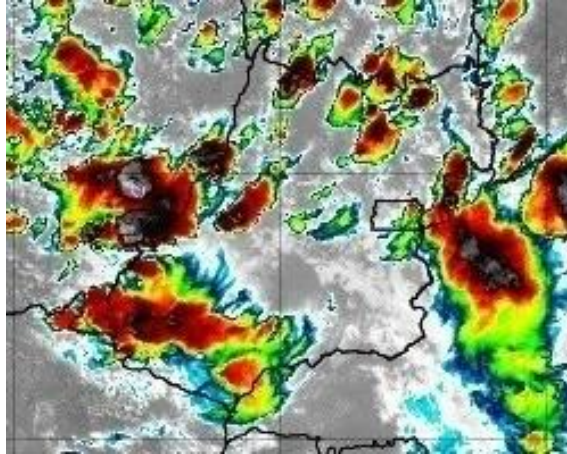
Figura 23 – Imagens realçadas do satélite GOES-16 das 21h00 do dia 14 de Novembro de 2020. FONTE: Cptec/INPE.

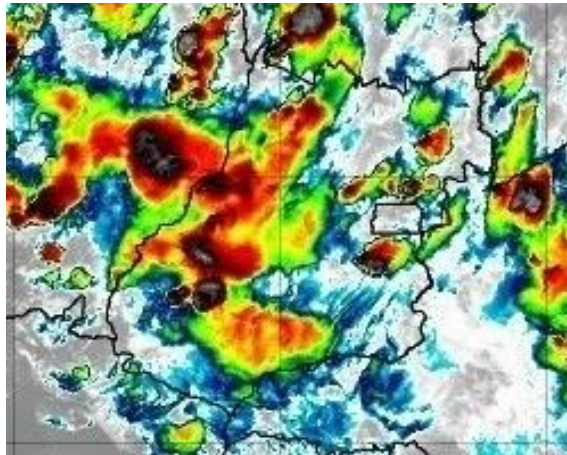

**0h00 - 15 de Novembro de 2020 - BRT**

Figura 24 – Imagens realçadas do satélite GOES-16 das 0h00 do dia 15 de Novembro de 2020. FONTE: Cptec/INPE.

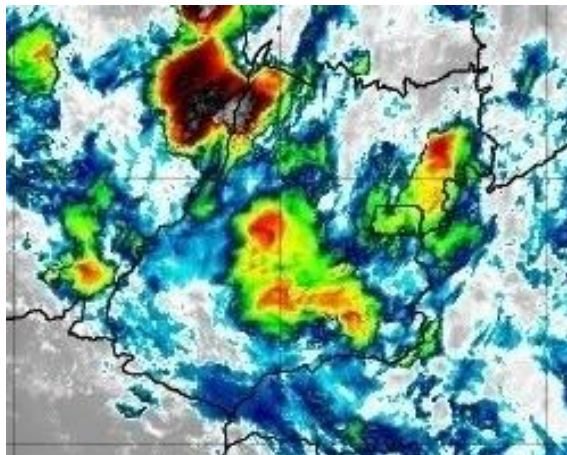
**3h00 - 15 de Novembro de 2020 - BRT**

Figura 25 – Imagens realçadas do satélite GOES-16 das 3h00 do dia 15 de Novembro de 2020. FONTE: Cptec/INPE.

**6h00 - 15 de Novembro de 2020 - BRT**

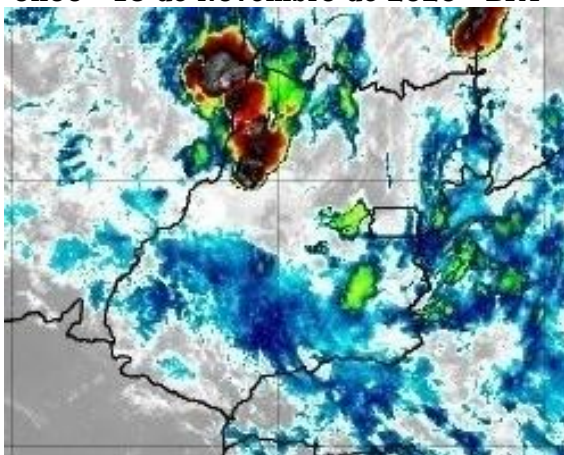
Figura 26 – Imagens realçadas do satélite GOES-16 das 6h00 do dia 15 de Novembro de 2020. FONTE: Cptec/INPE.

**9h00 - 15 de Novembro de 2020 - BRT**

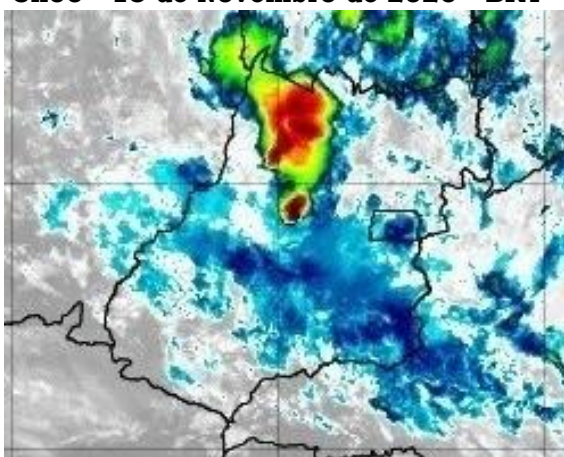
Figura 27 – Imagens realçadas do satélite GOES-16 das 9h00 do dia 15 de Novembro de 2020. FONTE: Cptec/INPE.

**12h00 - 15 de Novembro de 2020 - BRT**

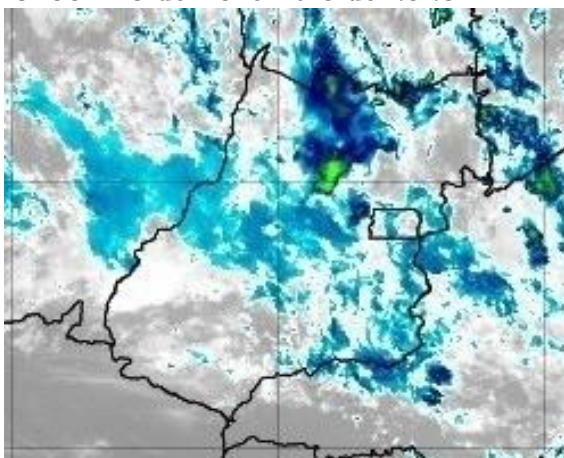
Figura 28 – Imagens realçadas do satélite GOES-16 das 12h00 do dia 15 de Novembro de 2020. FONTE: Cptec/INPE.

**15h00 - 15 de Novembro de 2020 - BRT**

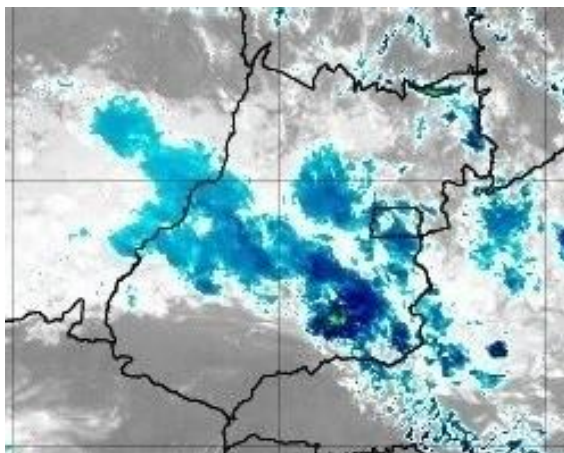
Figura 29 – Imagens realçadas do satélite GOES-16 das 15h00 do dia 15 de Novembro de 2020. FONTE: Cptec/INPE.

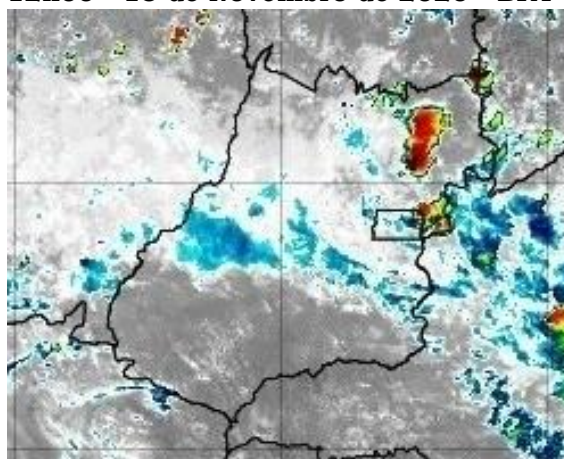

**18h00 - 15 de Novembro de 2020 - BRT**



Figura 30 – Imagens realçadas do satélite GOES-16 das 18h00 do dia 15 de Novembro de 2020. FONTE: Cptec/INPE.

**21h00 - 15 de Novembro de 2020 - BRT**

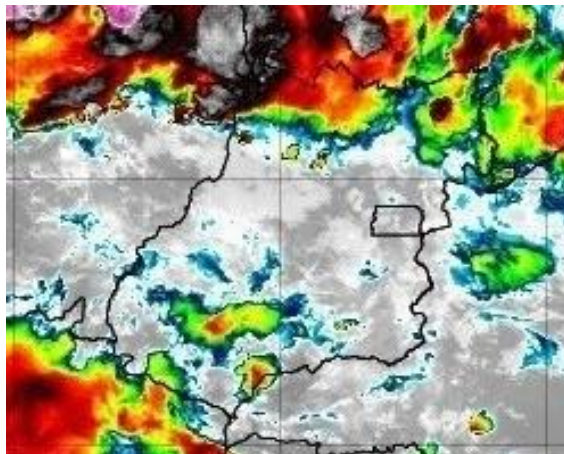

Figura 31 – Imagens realçadas do satélite GOES-16 das 21h00 do dia 15 de Novembro de 2020. FONTE: Cptec/INPE.

**0h00 - 16 de Novembro de 2020 - BRT**



Figura 32 – Imagens realçadas do satélite GOES-16 das 0h00 do dia 16 de Novembro de 2020. FONTE: Cptec/INPE.

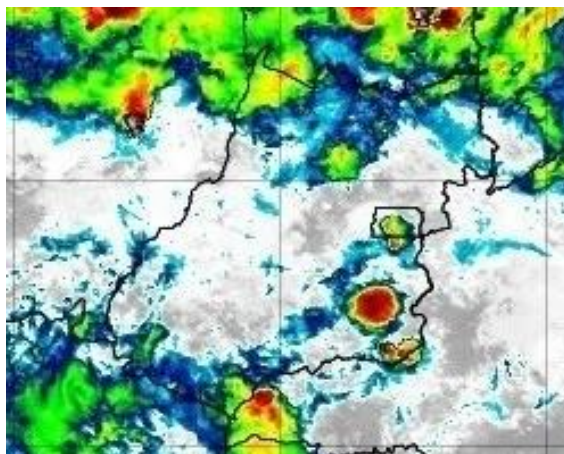

## 2. Classificação COBRADE

O COBRADE (Classificação e Codificação Brasileira de Desastres) foi criado com o intuito de adequar a classificação brasileira à classificação utilizada pela ONU na classificação de desastres e nivelar o país aos demais organismos de gestão de desastres do mundo.

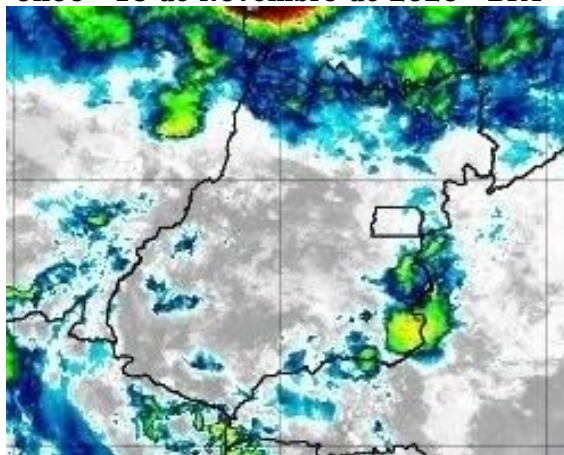
Baseados nos dados analisados nos itens anteriores, podemos classificar o evento ocorrido sobre a área de concessão da ENEL DISTRIBUIÇÃO GOIÁS como Zona de Convergência (Código 1.3.1.2.0).

### 3. Resumo do Evento

Áreas de instabilidade associadas a passagem de um cavado atmosférico, que levou a formação de áreas de baixa pressão e convergência de umidade, predominavam as condições meteorológicas sobre a região central do Brasil entre os dias 12 e 15 de novembro de 2020. As instabilidades foram responsáveis pela geração de nuvens de tempestade, que provocaram chuva significativa, descargas elétricas atmosféricas e vento forte na área de concessão da ENEL GO.

O sistema de detecção da Earth Networks registrou 241363 descargas atmosféricas sobre a área de concessão da ENEL em Goiás entre as 10h00 do dia 12 e 04h10 do dia 16 de novembro de 2020.

Rajadas de vento classificadas como vento forte pela escala Beaufort foram registrados em estações do INMET representativas da região durante o período. Na cidade de Caiapônia rajadas de até 61,9 km/h foram registradas na tarde do dia 14 de novembro.

Chuva forte também foi registrada pelo INMET durante o evento. Entre os dias 12 e 14 de novembro a cidade de Silvânia acumulou 96,0 mm de chuva, aproximadamente 48% da média climatológica para o mês na região.

Tabela 7 – Resumo do evento Regional Rio Verde

Número/Código do Evento	
Número/Código do Relatório	
Descrição	Região ligada à tempestade causada por uma zona de baixa pressão atmosférica, provocando forte deslocamento de massas de ar, vendavais, chuvas intensa e possível queda de granizo.
Código COBRADE	1.3.1.2.0 – Zona de Convergência
Hora início do evento	10h30 do dia 12 de novembro de 2020
Hora fim do evento	23h00 do dia 15 de novembro de 2020
Abrangência	Regional Rio Verde

Tabela 8 – Resumo do evento Regional Morrinhos

Número/Código do Evento	
Número/Código do Relatório	
Descrição	Região ligada à tempestade causada por uma zona de baixa pressão atmosférica, provocando forte deslocamento de massas de ar, vendavais, chuvas intensa e possível queda de granizo.
Código COBRADE	1.3.1.2.0 – Zona de Convergência
Hora início do evento	11h30 do dia 12 de novembro de 2020
Hora de fim do evento	04h00 do dia 16 de novembro de 2020
Abrangência	Regional Morrinhos

Tabela 9 – Resumo do evento Regional Metropolitana e Goiânia

Número/Código do Evento	
Número/Código do Relatório	
Descrição	Região ligada à tempestade causada por uma zona de baixa pressão atmosférica, provocando forte deslocamento de massas de ar, vendavais, chuvas intensa e possível queda de granizo.
Código COBRADE	1.3.1.2.0 – Zona de Convergência
Hora início do evento	10h00 do dia 12 de novembro de 2020
Hora de fim do evento	04h30 do dia 16 de novembro de 2020
Abrangência	Regional Metropolitana e Goiânia

Tabela 10 – Resumo do evento Regional Iporá

Número/Código do Evento	
Número/Código do Relatório	
Descrição	Região ligada à tempestade causada por uma zona de baixa pressão atmosférica, provocando forte deslocamento de massas de ar, vendavais, chuvas intensa e possível queda de granizo.
Código COBRADE	1.3.1.2.0 – Zona de Convergência
Hora início do evento	11h00 do dia 12 de novembro de 2020
Hora de fim do evento	19h00 do dia 15 de novembro de 2020
Abrangência	Regional Iporá

Tabela 11 – Resumo do evento Regional Luziânia

Número/Código do Evento	
Número/Código do Relatório	
Descrição	Região ligada à tempestade causada por uma zona de baixa pressão atmosférica, provocando forte deslocamento de massas de ar, vendavais, chuvas intensa e possível queda de granizo.
Código COBRADE	1.3.1.2.0 – Zona de Convergência
Hora início do evento	11h30 do dia 12 de novembro de 2020
Hora de fim do evento	01h00 do dia 16 de novembro de 2020
Abrangência	Regional Luziânia

Tabela 12 – Resumo do evento Regional Anápolis

Número/Código do Evento	
Número/Código do Relatório	
Descrição	Região ligada à tempestade causada por uma zona de baixa pressão atmosférica, provocando forte deslocamento de massas de ar, vendavais, chuvas intensa e possível queda de granizo.
Código COBRADE	1.3.1.2.0 – Zona de Convergência
Hora início do evento	10h00 do dia 12 de novembro de 2020
Hora de fim do evento	00h00 do dia 16 de novembro de 2020
Abrangência	Regional Anápolis

Tabela 13 – Resumo do evento Regional Uruaçu

Número/Código do Evento	
Número/Código do Relatório	
Descrição	Região ligada à tempestade causada por uma zona de baixa pressão atmosférica, provocando forte deslocamento de massas de ar, vendavais, chuvas intensa e possível queda de granizo.
Código COBRADE	1.3.1.2.0 – Zona de Convergência
Hora início do evento	11h30 do dia 12 de novembro de 2020
Hora de fim do evento	22h30 do dia 15 de novembro de 2020
Abrangência	Regional Uruaçu

Tabela 14 – Resumo do evento Regional Formosa

Número/Código do Evento	
Número/Código do Relatório	
Descrição	Região ligada à tempestade causada por uma zona de baixa pressão atmosférica, provocando forte deslocamento de massas de ar, vendavais, chuvas intensa e possível queda de granizo.
Código COBRADE	1.3.1.2.0 – Zona de Convergência
Hora início do evento	10h30 do dia 12 de novembro de 2020
Hora de fim do evento	03h30 do dia 16 de novembro de 2020
Abrangência	Regional Formosa

---

## 4. Referências

- RMets Royal Meteorological Society – Beaufort Scale -

<https://www.rmets.org/weather-and-climate/observing/beaufort-scale>

- Instituto Nacional de Meteorologia (INMET) - <http://www.inmet.gov.br>

- Cptec/INPE

<https://www.cptec.inpe.br/>

- Centro de Hidrografia da Marinha do Brasil -

<https://www.marinha.mil.br/chm/>

- Meteorology Glossary - American Meteorological Society -

<http://glossary.ametsoc.org/>



# Anexos

## A.1. Carta Sinótica



Figura A1 - Carta sinótica da Marinha do Brasil para as 1200Z do dia 12 de novembro de 2020 (09h00 do dia 12 de novembro de 2020, hora local).



LEGENDA			
	Frente Fria	<b>A</b>	Alta Pressão
	Frente Quente	<b>B</b>	Baixa Pressão
	Instabilidade		Zona de Convergência

Figura A2 - Carta sinótica da Marinha do Brasil para as 1200Z do dia 13 de novembro de 2020 (09h00 do dia 13 de novembro de 2020, hora local).

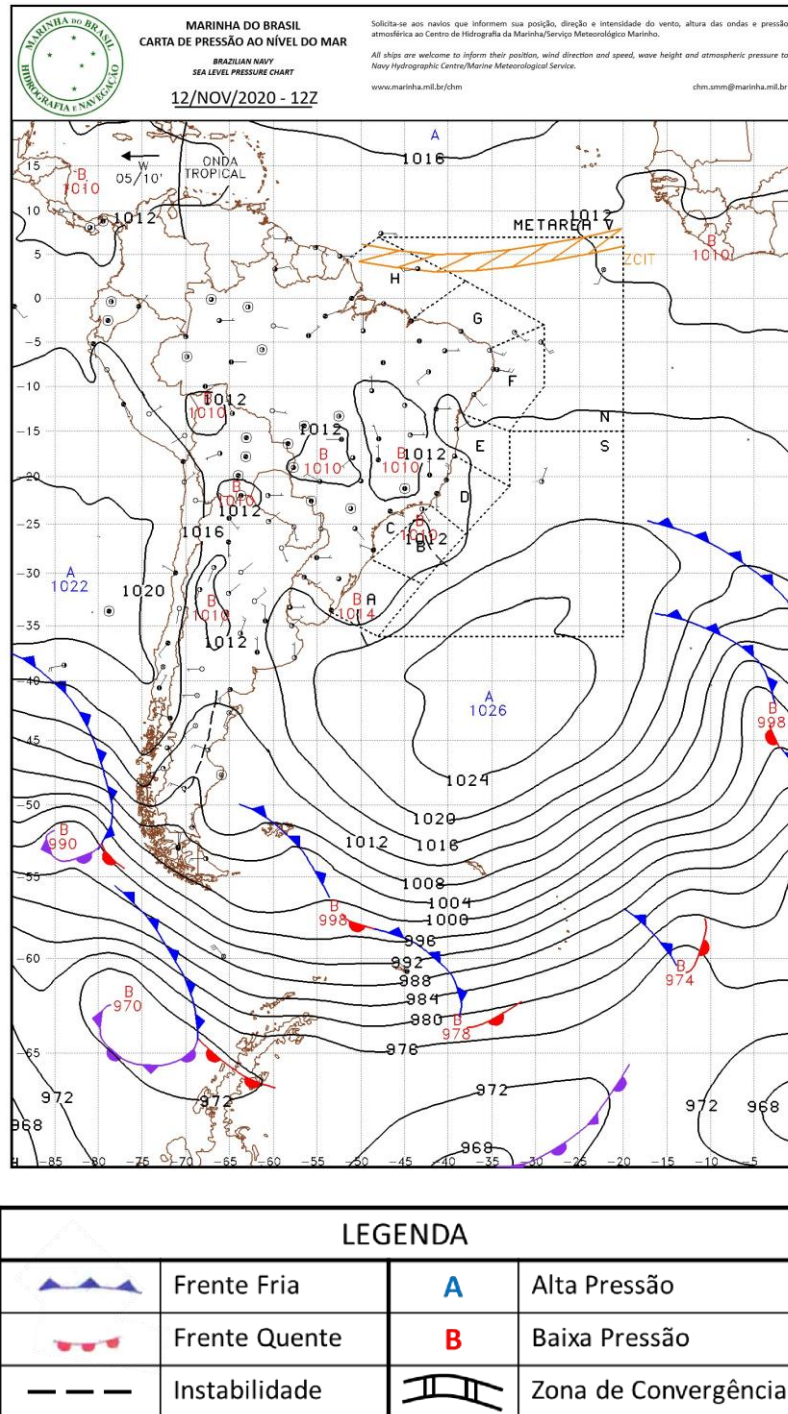
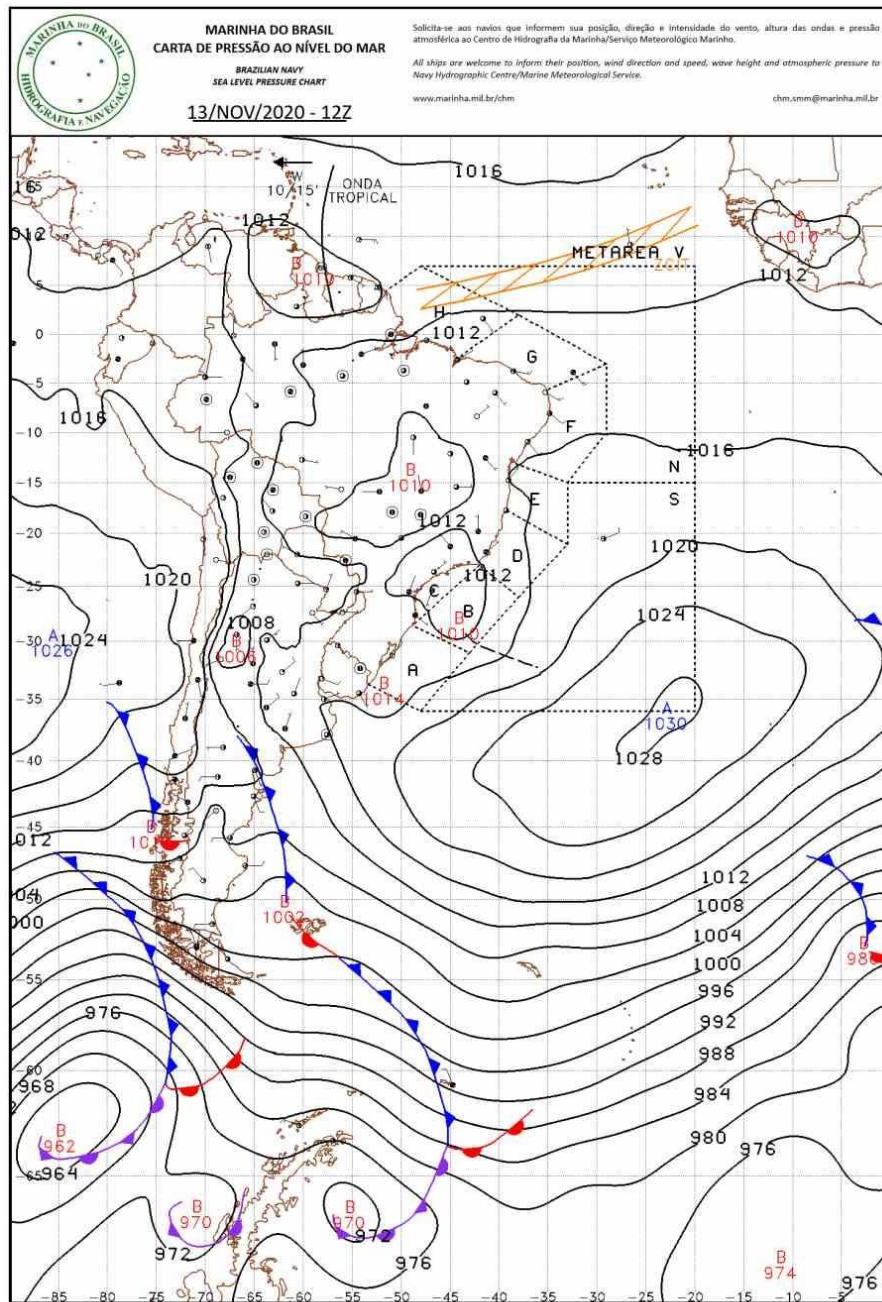
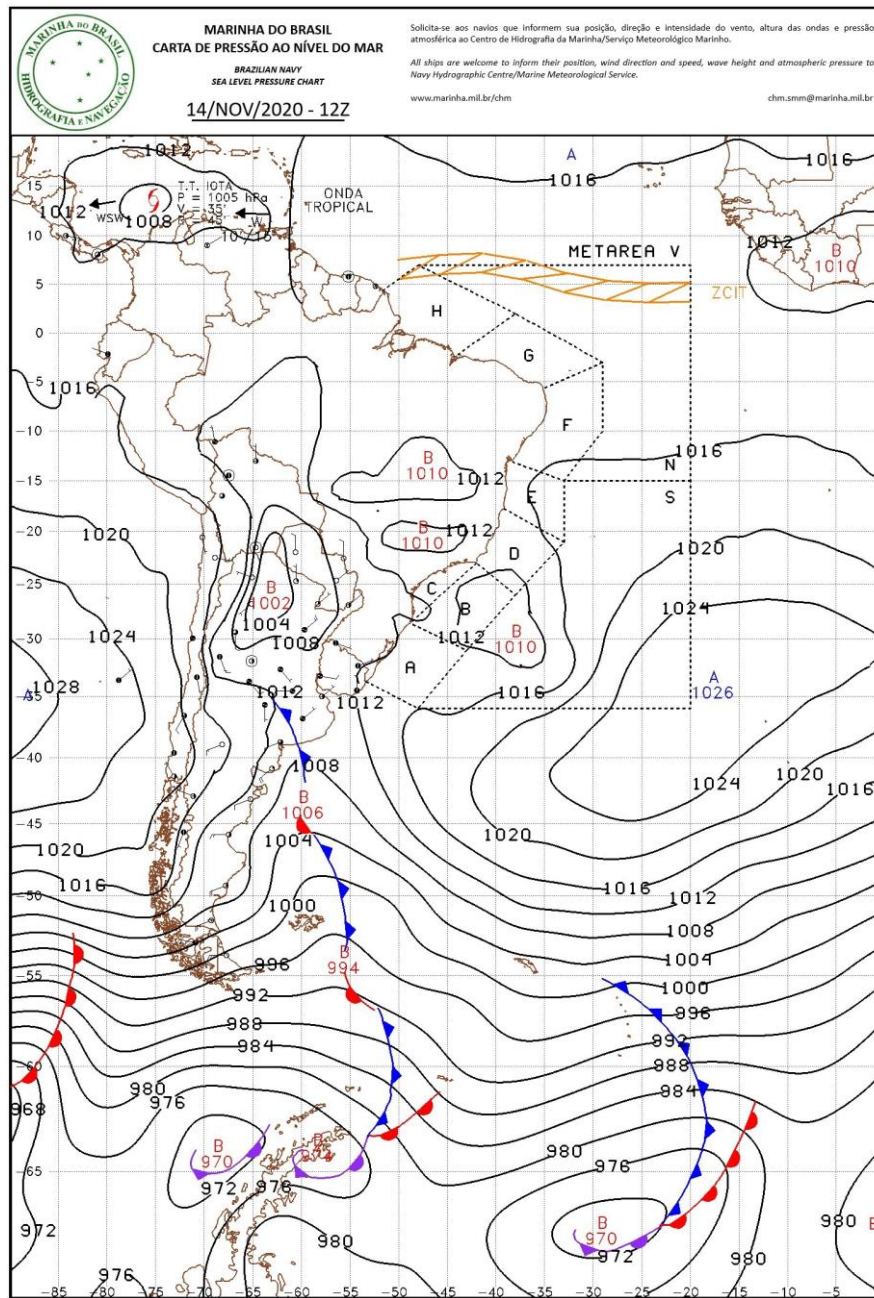

LEGENDA			
	Frente Fria	<b>A</b>	Alta Pressão
	Frente Quente	<b>B</b>	Baixa Pressão
	Instabilidade		Zona de Convergência

Figura A3 - Carta sinótica da Marinha do Brasil para as 1200Z do dia 14 de novembro de 2020 (09h00 do dia 14 de novembro de 2020, hora local).



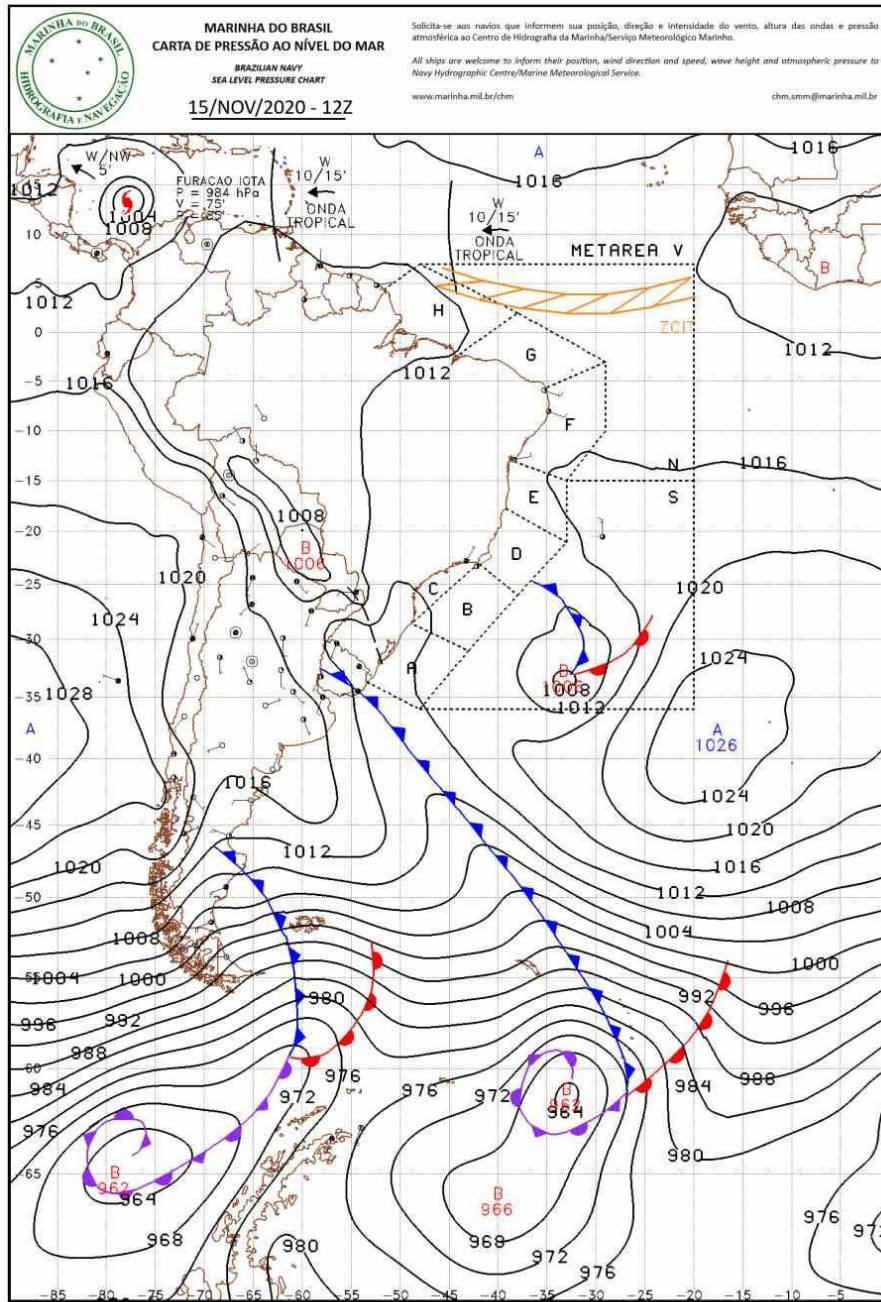

LEGENDA			
	Frente Fria	<b>A</b>	Alta Pressão
	Frente Quente	<b>B</b>	Baixa Pressão
	Instabilidade		Zona de Convergência

Figura A4 - Carta sinótica da Marinha do Brasil para as 1200Z do dia 15 de novembro de 2020 (09h00 do dia 15 de novembro de 2020, hora local).

## A.2. Notícias associadas

- Chuva destelha galpões, alaga ruas e derruba árvores na Grande Goiânia; vídeo  
<https://g1.globo.com/go/goias/noticia/2020/11/12/chuva-destelha-galpoes-alaga-ruas-e-derruba-arvores-na-grande-goiania-video.ghtml>
- Chuva da última quinta-feira (12) deixa estragos em Aparecida de Goiânia  
<http://o hoje.com/noticia/cidades/n/182523/t/chuva-da-ultima-quinta-feira-12-deixa-estragos-em-aparecida-de-goiania>
- Chuva destelha comércios na Vila Brasília, em Aparecida; veja vídeo - O Popular  
<https://www.opopular.com.br/noticias/cidades/chuva-destelha-comercios-na-vila-brasilia-em-aparecida-veja-video-1.2149596>

Bianca Lobo Silva  
Meteorologista CREA  
5063840461



