

ENEL DISTRIBUIÇÃO GOLÁS



Relatório de Evento em Situação de Emergência

Nº CHI-057

1.	INTRODUÇÃO.....	3
2.	DEFINIÇÃO	3
3.	RESUMO EXECUTIVO.....	5
3.1.	RELATÓRIO DE OCORRÊNCIAS DO PERÍODO.....	5
4.	LISTA DE OCORRÊNCIAS	9
5.	PLOTAGEM DAS OCORRÊNCIAS CONFORME A ESPACIALIZAÇÃO DAS CHUVAS.....	55
6.	CLIENTES AFETADOS E IMPACTOS GLOBAIS	56
7.	DIAGRAMAS UNIFILARES	57
8.	DEMAIS EVIDÊNCIAS	63
8.1.	DADOS TÉCNICO - OPERACIONAIS ENEL GO.....	63
8.2.	DADOS CLIMATOLÓGICOS PELO INMET	65
9.	NOTÍCIAS RELACIONADAS.....	69
10.	LAUDO TÉCNICO	71

1. Introdução

As concessionárias do serviço público de distribuição de energia elétrica devem prover o serviço de forma adequada, buscando sempre a eficiência, conforme disposto na legislação e nos respectivos contratos de concessão.

Dentre a legislação vigente, destacam-se os Procedimentos de Distribuição de Energia Elétrica no Sistema Elétrico Nacional – PRODIST, que consistem em documentos elaborados pela Agência Nacional de Energia Elétrica – ANEEL, com a participação dos agentes de distribuição e de outras entidades e associações do setor elétrico nacional, que normatizam e padronizam as atividades técnicas relacionadas ao funcionamento e desempenho dos sistemas de distribuição de energia elétrica.

O Módulo 8 do PRODIST – Revisão 11, mais especificamente em sua Seção 8.2, regulamenta a qualidade do serviço prestado pelas distribuidoras de energia elétrica, estabelecendo a metodologia para apuração dos indicadores de continuidade e dos tempos de atendimento a ocorrências emergenciais.

O referido regulamento prevê que, na apuração dos indicadores coletivos e individuais deverão ser consideradas todas as interrupções de longa duração que atingirem as unidades consumidoras, admitidas algumas exceções (denominadas expurgos), que podem ser encontradas no Item 5.6.2.2 da seção 8.2 do Módulo 8 do PRODIST, transcrito abaixo:

5.6.2.2 Na apuração dos indicadores DEC e FEC devem ser consideradas todas as interrupções, admitidas apenas as seguintes exceções:

i. falha nas instalações da unidade consumidora que não provoque interrupção em instalações de terceiros;

ii. interrupção decorrente de obras de interesse exclusivo do consumidor e que afete somente a unidade consumidora do mesmo;

iii. Interrupção em Situação de Emergência;

iv. suspensão por inadimplemento do consumidor ou por deficiência técnica e/ou de segurança das instalações da unidade consumidora que não provoque interrupção em instalações de terceiros, previstas em regulamentação;

v. vinculadas a programas de racionamento instituídos pela União;

vi. ocorridas em Dia Crítico;

vii. oriundas de atuação de Esquema Regional de Alívio de Carga estabelecido pelo ONS. [grifos nossos]

Para os casos de expurgo por Interrupção em Situação de Emergência (ISE), a alínea “h” do Item 5.12.1 da seção 8.2 do Módulo 8 do PRODIST estabelece a obrigatoriedade das distribuidoras em disponibilizar, em seu sítio eletrônico, relatórios digitais com as evidências do evento que tenha gerado tais interrupções enquadradas no inciso iii do Item 5.6.2.2 do mesmo.

Nesta seara, o presente documento, visa apresentar as evidências de um evento ocorrido na área de concessão da Eletropaulo, bem como informações relevantes a respeito das interrupções em Situação de Emergência decorrentes do mesmo.

Destaca-se que, para o entendimento completo das regras de apuração dos indicadores de continuidade e expurgos, faz-se necessário também a observação das regras contidas nos Módulos 1 e 6 do PRODIST. Todos os módulos destes procedimentos encontram-se disponíveis para consulta no site da ANEEL (www.aneel.gov.br) e as principais definições relacionadas ao tema estão contidas no item 2 deste documento.

2. Definição

Seção 1.2 do Módulo 1 do PRODIST – Revisão 10

2.198 Evento

Acontecimento que afete as condições normais de funcionamento de uma rede elétrica, podendo gerar uma ou mais interrupções no fornecimento de energia.

2.131 e 2.158 DIC

Duração de interrupção individual por unidade consumidora, ou seja, intervalo de tempo que, no período de apuração, em cada unidade consumidora ou ponto de conexão ocorreu descontinuidade da distribuição de energia elétrica.

2.216 e 2.220 FIC

Frequência de interrupção individual por unidade consumidora, ou seja, Número de interrupções ocorridas, no período de apuração, em cada unidade consumidora ou ponto de conexão.

2.87 Consumidor Hora Interrompido (CHI):

Somatório dos DICs dos consumidores atingidos por interrupção no fornecimento de energia, expresso em horas e centésimos de horas.

2.251 Interrupção em Situação de Emergência:

Interrupção originada no sistema de distribuição, resultante de Evento que comprovadamente impossibilite a atuação imediata da distribuidora e que não tenha sido provocada ou agravada por esta e que seja:

- Decorrentes de evento associado a Decreto de Declaração de Situação de Emergência ou Estado de Calamidade Pública emitido por órgão competente; ou
- Decorrentes de Evento cuja soma do CHI das interrupções ocorridas no sistema de distribuição seja superior ao calculado conforme equação a seguir:

$$2.612 \times N^{0,35}$$

N – número de unidades consumidoras faturadas e atendidas em BT ou MT, com 2 (duas) casas decimais, do mês de outubro do ano anterior ao período de apuração

3. Resumo Executivo

O Presente Relatório tem como objetivo a incorporação de informações que sejam relevantes para que se possa fazer a devida associação aos dados contidos no documento objeto da classificação de Situação de Emergência caracterizada pelo Módulo 8 do Prodist. Este enquadramento se apresenta na maioria das vezes em condições climáticas adversas com severidade dos fatores inerentes a situação, caracterizado na maioria dos casos por fortes ventos e chuvas de grande intensidade e continuidade.

No começo da manhã do dia 05/12/2020 – sábado – Nuvens de tempestade associadas a área de instabilidade devido ao ar quente e úmido, avançaram sobre o estado de Goiás, provocando chuva, raios e rajadas de vento, na área de concessão da ENEL GO.

Conforme informações do Climatempo Meteorologia, o Instituto Nacional de Meteorologia (INMET) detectou rajadas de vento acima de 50km/h registradas por estações representativas da área de concessão da ENEL Distribuição Goiás. Na estação de Jataí, o maior valor registrado foi de 68,8 km/h entre as 15h e 16h do dia 05 de dezembro de 2020, classificada como vento forte, segundo a escala Beaufort.

O sistema de detecção da EarthNetworks registrou 140.263 descargas atmosféricas (32.831 nuvem-solo e 107.432 nuvem-nuvem) sobre a área de concessão da ENEL em Goiás entre as 08h30 do dia 05 de dezembro de 2020 e 07h15 do dia 06 de dezembro de 2020, causando grande instabilidade na rede.

Chuva forte foi registrada pelo INMET em estações representativas da área de concessão da ENEL Distribuição Goiás. Na estação de Formosa foram acumulados 66,0 mm de chuva entre as 09h do dia 05 e as 09h do dia 06 de dezembro de 2020, aproximadamente 23% da média climatológica para o mês na região.

3.1. Relatório de Ocorrências do período

Em todo o Estado de Goiás verificou-se também que a intensidade da chuva e dos ventos danificaram a rede de distribuição de energia elétrica em diversos pontos, registrando aproximadamente 339 mil clientes com interrupção no fornecimento de energia elétrica devido a eventos relacionados ao temporal, afetando 224 municípios e 277 Subestações.

Para otimizar o volume de atendimentos e reduzir os tempos de interrupção foram mobilizados os recursos extras da empresa que aumentou o contingente em relação a situação normal de operação. O acompanhamento da quantidade de equipes e o Tempo Médio de Atendimento podem ser consultados na Pág.08 do Relatório em anexo.

O impacto e severidade do evento estão relatados em artigos de mídia, como fotos e reportagens que demonstram os danos na Rede de Distribuição, oriundos dos eventos climáticos no período. Eventos estes que afetaram 339.335 consumidores com CHI de 823.726,98 superior ao de 482.597,74 estabelecido como limite para definição de Situação de Emergência, conforme resumo das informações obrigatórias.

Empresa		ENEL DISTRIBUIÇÃO GOIÁS			
Código do Relatório		CHI-057 - ENEL DISTRIBUIÇÃO GOIÁS			
Evento:		TEMPORAL NA AREA DE CONCESSÃO DA ENEL DISTRIBUIÇÃO GOIAS			
Código COBRADE:	1.3.1.2.0	Data Inicio	05/12/2020	Hora início	08h15
Código do Evento:	CHI-057-ENEL GO	Data Término	06/12/2020	Hora Término	08h59
Valor CHI (Limite e Real)	482.597,74	823.726,98			
Código do Decreto (Se Houver):					
Quantidade de Interrupções (Evento)		2.308			
Início 1ª Incidência (Data e Hora)	05/12/2020 08:35	Subestações Atingidas	ABADIANIA / ABC / ACREUNA / ADELANDIA / AGUA LIMPA (MARZAGAO) / AGUAS LINDAS / ALEXANIA / ALEXANIA TRANSMISSAO / ALOANDIA / ALPHAVILLE / ALTO BURITI / ALTO HORIZONTE / ALTO PARAISO DE GOIAS / ALVORADA DO NORTE / AMERICANO DO BRASIL / AMORINOPOLIS / ANAPOLIS UNIVERSITARIA / ANHANGUERA / ANICUNS / ANTONIO DO VITTO / ARACU / ARAGARCAS / ARAGOIANIA / ARAGUAPAZ / ARARAS / AREIAS / ARENOPOLIS / ASA BRANCA / ATLANTICO / AURILANDIA / AVELINOPOLIS / BACURI (RIO VERDE) / BARBOSELANDIA / BARCELONA / BARREIRO (PORANGATU) / BARRO ALTO / BELA VISTA (TRANSMISSAO) / BOA VISTA / BOM JARDIM / BOM JESUS DE GOIAS / BONFINOPOLIS / BONOPOLIS / BRAZABRANTES / BRITANIA / BRITANIA (TRANSMISSAO) / BURITI ALEGRE / BURITI DE GOIAS / BURITIZINHO / CABECEIRAS / CABRIUVA (RIO VERDE) / CACHOEIRA ALTA / CACHOEIRA DOURADA / CACHOEIRA NOVA / CACU / CAIAPONIA / CALDAS NOVAS / CALDAZINHA / CAMPESTRE / CAMPINAS / CAMPINORTE / CAMPO ALEGRE DE GOIAS / CAMPO LIMPO DE GOIAS / CAMPOS BELOS / CAMPOS VERDES / CARAIBAS / CARAJAS / CASTELANDIA / CATALAO / CATURAI / CEBRASA FABRICA DA AMBEV / CEMAT/BALIZA / CEPALGO / CEZARINA / CHAPADAO DO CEU / CIDADE ECLETICA / CIDADE OCIDENTAL / COCALZINHO / COLINACU / CORREGO DO OURO / CORUMBA / CORUMBAIBA / CRISTALINA / CRISTALINA TRANSMISSAO / CRISTIANOPOLIS / CRIXAS / DAIA - ANAPOLIS / DAMOLANDIA / DAVINOPOLIS / DESFECHO / DESTILARIA BRASIL CENTRAL / DIMIC / DORCELINO PEIXOTO DE MORAES / DOVERLANDIA / EDEALINA / EDEIA / ENERSUL / ESTANIFERA / ESTRELA DO NORTE / FAINA / FAZENDA CANADA / FAZENDA NOVA / FERROVIARIO / FIRMINOPOLIS / FLORES DE GOIAS / FORMIGA / FORMOSO / GAMELEIRA / GIRASSOL / GOIANAPOLIS / GOIANDIRA / GOIANESIA / GOIANIA LESTE / GOIANIRA / GOIAS / GOIATUBA / GOVERLANDIA / GOYA / GUAPO / HIDROLINA / IACIARA / INACIOLANDIA / INDEPENDENCIA / INDIARA / INHUMAS / IPAMERI / IPEGUARI / IPORA / ITABERAI / ITAJA / ITAPACI / ITAPACI (TRANSMISSAO) / ITAPIRAPUA / ITAPURANGA / ITAPURANGA (TRANSMISSAO) / ITAUCU / ITIQUIRA (FORMOSA) / ITUMBIARA NOVA / ITUMBIARA VELHA / JACILANDIA / JANDAIA / JARAGUA / JARANAPOLIS / JATAI / JOVIANIA / JUNDIAI / JURUMIRIM / JUSCELANDIA / JUSSARA / LAGOA DA SERRA / LEOPOLDO DE BULHOES / LUZIANIA / MAMBAI / MARA ROSA / MARAJOARA / MARCIANOPOLIS / MARIAPOLIS (PADRE BERNARDO) / MARZAGAO / MATO GRANDE / MATRINCHA / MEIA PONTE / MINACU / MINEIROS / MINEIROS TRANSMISSAO / MOIPORA / MONTE ALEGRE / MONTES CLAROS DE GOIAS / MONTIVIDIU T / MORRINHOS / MORRO AGUDO / MOZARLANDIA / MUNDO NOVO DE GOIAS / MUTUNOPOLIS / NAVESLANDIA (JATAI) / NAZARIO / NEROPOLIS / NIQUELANDIA / NIQUELANDIA 69KV / NOVA AMERICA / NOVA AURORA / NOVA CRIXAS (TRANSMISSAO) / NOVA IGUACU / NOVA PONTE / NOVA VENEZA / NOVO BRASIL / NOVO PLANALTO / OLHOS DAGUA / ORIZONA / OURO VERDE DE GOIAS / OUVIDOR / PACAEMBU (NOVO GAMA) / PADRE BERNARDO / PALESTINA / PALMEIRAS / PALMEIRAS DE GOIAS / PALMELO / PALMINOPOLIS / PAMPLONA / PARANA / PARANAIBA / PARAUNA SE ALTA TENSÃO / PARQUE DAS EMAS (MINEIROS) / PEROLANDIA / PETROLINA / PILAR / PIRACANJUBA / PIRANHAS T / PIRENOPOLIS / PIRES BELO / PIRES DO RIO / PLANALTINA / PLANALTINA (TRANSMISSAO) / PLANALTO / PONTALINA / PORANGATU / PORTEIRAO / PORTELANDIA / PORTO SAO SIMAO / POSSELANDIA / PROFESSOR JAMIL / QUIRINOPOLIS / REAL / RETIRO / GOIAS / RIO CLARO JATAI MONTIVIDIU / RIO DO PEIXE / RIO DOS BOIS (MAURILANDIA) / RIO PRETO / RIO QUENTE / RIO VERDE / RIO VERMELHO / ROCHEDO (UEH) / RUBIATABA / SANCLERLANDIA / SANTA BARBARA / SANTA FE DE GOIAS / SANTA HELENA / SANTA RITA DO ARAGUAIA / SANTA ROSA / SANTA ROSA DE GOIAS / SANTA TEREZINHA / SANTANA / SANTO ANTONIO DA BARRA / SANTO ANTONIO DE GOIAS / SANTO ANTONIO DO DESCOBERTO / SAO BARTOLOMEU / SAO DOMINGOS / SAO FRANCISCO DE GOIAS / SAO JOAO D ALIANCA / SAO JUDAS TADEU / SAO LUIZ DOS MONTES BELOS / SAO MIGUEL DO ARAGUAIA / SAO MIGUEL DO PASSA QUATRO / SENADOR CANEDO TRANSMISSAO / SERRA AZUL (JATAI) / SERRA DE CALDAS / SERRANOPOLIS / SOUZALANDIA / TAIOBA / TAQUARI / TEREZOPOLIS / TERRA VERMELHA / TRAJANOPOLIS (PADRE BERNARDO) / TRES BARRAS / TRINDADE / TURVANIA / URU / URUACU / URUTAI / USINA DE ACUCAR DE GOIANESIA / VARJAO / VENDA SECA / VIANOPOLIS / VICENTINOPOLIS / VILA BOA / VILA CORUMBA / VILA PROPICIO / XAVANTES / ZELANDIA		

Início Última Incidência (Data e Hora)	06/12/2020 08:59	Municípios Atingidos	ABADIA DE GOIAS / ABADIANIA / ACREUNA / ADELANDIA / AGUA FRIA DE GOIAS / AGUA LIMPA / AGUAS LINDAS DE GOIAS / ALEXANIA / ALTO HORIZONTE / ALTO PARAISO DE GOIAS / AMARALINA / AMERICANO DO BRASIL / AMORINOPOLIS / ANAPOLIS / ANICUNS / APARECIDA DE GOIANIA / APARECIDA DO RIO DOCE / APORE / ARACU / ARAGARCAS / ARAGOIANIA / ARAGUAPAZ / ARENOPOLIS / ARUANA / AURILANDIA / AVELINOPOLIS / BALIZA / BARRO ALTO / BELA VISTA DE GOIAS / BOM JARDIM DE GOIAS / BOM JESUS DE GOIAS / BONFINOPOLIS / BONOPOLIS / BRITANIA / BURITI ALEGRE / BURITI DE GOIAS / BURITINOPOLIS / CABECEIRAS / CACHOEIRA ALTA / CACHOEIRA DE GOIAS / CACHOEIRA DOURADA / CACU / CAIAPONIA / CALDAS NOVAS / CALDAZINHA / CAMPESTRE DE GOIAS / CAMPINACU / CAMPINORTE / CAMPO ALEGRE DE GOIAS / CAMPO LIMPO / CAMPOS BELOS / CAMPOS VERDES / CASTELANDIA / CATALAO / CATURAI / CAVALCANTE / CEZARINA / CIDADE OCIDENTAL / COCALZINHO DE GOIAS / COLINAS DO SUL / CORREGO DO OURO / CORUMBA DE GOIAS / CORUMBAIBA / CRISTALINA / CRISTIANOPOLIS / CRIXAS / DAMOLANDIA / DIORAMA / DISTRITO FEDERAL / DOVERLANDIA / EDEALINA / EDEIA / ESTRELA DO NORTE / FAINA / FAZENDA NOVA / FIRMINOPOLIS / FLORES DE GOIAS / FORMOSA / FORMOSO / GAMELEIRA DE GOIAS / GOIANAPOLIS / GOIANDIRA / GOIANESIA / GOIANIA / GOIANIRA / GOIAS / GOIATUBA / GOUVELANDIA / GUAPO / GUARAITA / GUARANI DE GOIAS / GUARINOS / HEITORAI / HIDROLANDIA / HIDROLINA / IACIARA / INACIOLANDIA / INDIARA / INHUMAS / IPAMERI / IPORA / ISRAELANDIA / ITABERAI / ITAGUARU / ITAJA / ITAPACI / ITAPIRAPUA / ITAPURANGA / ITARUMA / ITAUCU / ITUMBIARA / IVOLANDIA / JANDAIA / JARAGUA / JATAI / JAUPACI / JOVIANIA / JUSSARA / LEOPOLDO DE BULHOES / LUZIANIA / MAMBAI / MARA ROSA / MARZAGAO / MATRINCHA / MIMOSO DE GOIAS / MINACU / MINEIROS / MOIPORA / MONTE ALEGRE DE GOIAS / MONTES CLAROS DE GOIAS / MONTIVIDIU / MONTIVIDIU DO NORTE / MORRINHOS / MORRO AGUDO DE GOIAS / MOSSAMEDES / MOZARLANDIA / MUNDO NOVO DE GOIAS / MUTUNOPOLIS / NAZARIO / NEROPOLIS / NIQUELANDIA / NOVA AMERICA / NOVA AURORA / NOVA CRIXAS / NOVA GLORIA / NOVA IGUACU DE GOIAS / NOVA ROMA / NOVA VENEZA / NOVO BRASIL / NOVO GAMA / NOVO PLANALTO / ORIZONA / OURO VERDE DE GOIAS / OUVIDOR / PADRE BERNARDO / PALESTINA DE GOIAS / PALMEIRAS DE GOIAS / PALMELO / PALMINOPOLIS / PANAMA / PARANAIGUARA / PARAUNA / PEROLANDIA / PETROLINA DE GOIAS / PILAR DE GOIAS / PIRACANJUBA / PIRANHAS / PIRENOPOLIS / PIRES DO RIO / PLANALTINA / PONTALINA / PORANGATU / PORTEIRAO / PORTELANDIA / POSSE / PROFESSOR JAMIL SAFADY / QUIRINOPOLIS / RIO QUENTE / RIO VERDE / RUBIATABA / SANCLERLANDIA / SANTA BARBARA DE GOIAS / SANTA CRUZ DE GOIAS / SANTA FE DE GOIAS / SANTA HELENA DE GOIAS / SANTA ISABEL / SANTA RITA DO ARAGUAIA / SANTA RITA DO NOVO DESTINO / SANTA ROSA DE GOIAS / SANTA TEREZA DE GOIAS / SANTA TEREZINHA DE GOIAS / SANTO ANTONIO DA BARRA / SANTO ANTONIO DE GOIAS / SANTO ANTONIO DO DESCOBERTO / SAO DOMINGOS / SAO FRANCISCO DE GOIAS / SAO JOAO D ALIANCA / SAO JOAO DA PARAUNA / SAO LUIS DE MONTES BELOS / SAO LUIZ DO NORTE / SAO MIGUEL DO ARAGUAIA / SAO MIGUEL DO PASSA QUATRO / SAO SIMAO / SENADOR CANEDO / SERRANOPOLIS / SILVANIA / SIMOLANDIA / SITIO D ABADIA / TAQUARAL DE GOIAS / TERESINA DE GOIAS / TEREZOPOLIS DE GOIAS / TRINDADE / TROMBAS / TURVANIA / TURVELANDIA / UIRAPURU / URUACU / URUTAI / VALPARAISO DE GOIAS / VARJAO / VIANOPOLIS / VICENTINOPOLIS / VILA BOA / VILA PROPICIO
Média de Duração das Incidências (h)	8,13		
Duração da Incidência mais longa (h)	69,91		
Total de Clientes afetados	339.335		

DANOS CAUSADOS			
Equipamentos Danificado	Importância para o Sistema	Local	Quantidade
Disjuntor/Religador Operado	Proteção do Alimentador	Área de Concessão	74
Chaves Fusíveis Operada	Proteção de Ramais de Alimentadores	Área de Concessão	811
Transformador Operado	Proteção do Transformador	Área de Concessão	475

Relato técnico sobre a Intervenção realizada em Goiânia e Região Metropolitana			
<u>Informações sobre Equipes</u>	05/12	06/12	
Quantidade Usual	942	776	turmas
Quantidade Adicional	10	21	turmas
Quantidade Total	951	797	turmas
<u>Tempos Médios</u>			
Preparação	3,97	5,11	Horas
Deslocamento	1,02	1,05	Horas
Execução	1,20	1,14	Horas
TMAE	6,19	7,31	Horas

Principais Dificuldades Encontradas:

Chuvas com ventos fortes provocaram muitos pontos de alagamento e enxurrada, trânsito impedido por vários semáforos desligados dificultando a chegada ao atendimento das ocorrências emergenciais. Em determinadas regiões, decorrente dos fortes ventos, houve o tombamento de árvores nas estruturas de alimentação de média tensão, danos em ramais de ligação dos clientes, impedimentos

Empresa	ENEL DISTRIBUIÇÃO GOIAS		
Valor CHI (Limite e Real)	482.597,74		823.726,98

4. Lista de Ocorrências

DOC ORIGEM	MIUNICIPIO	EQP_ORIGEM	CONJUNTO	INI_OCORRENC	FIM_OCORRENC	DT_INI_EVENTO	DT_FIM_EVENTO	DURAÇ	UC INT	CHI	EXPURGO
20201217171	CRISTALINA	KR11276432	CRISTALINA S2	05/12/2020 08:35	05/12/2020 12:48	05/12/2020 08:35	05/12/2020 12:48	4,21	1	4,21	CHI
20201217226	LUZIANIA	120055582	RIO VERMELHO	05/12/2020 08:44	05/12/2020 10:52	05/12/2020 08:44	05/12/2020 10:52	2,13	1	2,13	CHI
20201217286	NOVO GAMA	4990036968	PACAEMBU S1	05/12/2020 08:54	05/12/2020 11:00	05/12/2020 08:54	05/12/2020 11:00	2,09	1	2,09	CHI
20201217505	ITUMBIARA	BG12000180	PARANAIBA	05/12/2020 09:07	05/12/2020 14:15	05/12/2020 09:07	05/12/2020 14:15	5,12	2	10,24	CHI
20201217497	PONTALINA	ED12223495	PONTALINA	05/12/2020 09:17	05/12/2020 13:16	05/12/2020 09:17	05/12/2020 13:16	3,97	2	7,95	CHI
20201217497	EDEALINA	ED12223495	PONTALINA	05/12/2020 09:17	05/12/2020 13:16	05/12/2020 09:17	05/12/2020 13:16	3,97	4	15,90	CHI
20201217568	SANTA CRUZ DE GOIAS	CN12409034	CALDAS NOVAS S1	05/12/2020 09:23	05/12/2020 15:04	05/12/2020 09:23	05/12/2020 15:04	5,68	14	79,50	CHI
20201217568	CALDAS NOVAS	CN12409034	CALDAS NOVAS S1	05/12/2020 09:23	05/12/2020 15:04	05/12/2020 09:23	05/12/2020 15:04	5,68	3	17,03	CHI
20201217483	CRISTALINA	KR12417561	CRISTALINA S2	05/12/2020 09:29	05/12/2020 11:47	05/12/2020 09:29	05/12/2020 11:47	2,30	2	4,59	CHI
20201217503	CALDAS NOVAS	CN21271744	SERRA DE CALDAS	05/12/2020 09:32	05/12/2020 11:16	05/12/2020 09:32	05/12/2020 11:16	1,72	1	1,72	CHI
20201217515	LUZIANIA	LZ11163760	RIO VERMELHO	05/12/2020 09:35	05/12/2020 11:48	05/12/2020 09:35	05/12/2020 11:48	2,21	95	209,50	CHI
20201217536	GOIANDIRA	CT21134377	CATALAO S1	05/12/2020 09:41	05/12/2020 15:36	05/12/2020 09:41	05/12/2020 15:36	5,90	1	5,90	CHI
20201217558	PLANALTINA	PI21281768	PADRE BERNARDO	05/12/2020 09:51	05/12/2020 15:03	05/12/2020 09:51	05/12/2020 15:03	5,18	1	5,18	CHI
20201217575	CAMPO ALEGRE DE GOIAS	CM12064066	CAMPO ALEGRE DE GOIAS	05/12/2020 09:56	05/12/2020 17:07	05/12/2020 09:56	05/12/2020 17:07	7,18	1	7,18	CHI
20201217577	PADRE BERNARDO	PB12305257	PADRE BERNARDO	05/12/2020 09:57	05/12/2020 15:03	05/12/2020 09:57	05/12/2020 15:03	5,09	5	25,47	CHI
20201217577	PLANALTINA	PB12305257	PADRE BERNARDO	05/12/2020 09:57	05/12/2020 15:03	05/12/2020 09:57	05/12/2020 15:03	5,09	64	326,01	CHI
20201217580	CATALAO	CT12344431	CATALAO S2	05/12/2020 09:57	05/12/2020 12:34	05/12/2020 09:57	05/12/2020 12:34	2,60	3	7,81	CHI
20201217591	GOIANIRA	10019509616	MEIA PONTE	05/12/2020 10:00	05/12/2020 11:37	05/12/2020 10:00	05/12/2020 11:37	1,61	1	1,61	CHI
20201217593	LUZIANIA	LZ12376191	RIO VERMELHO	05/12/2020 10:00	05/12/2020 12:27	05/12/2020 10:00	05/12/2020 12:27	2,44	6	14,63	CHI
20201217602	FORMOSA	2920002291	ITUIQUIRA	05/12/2020 10:03	05/12/2020 12:12	05/12/2020 10:03	05/12/2020 12:12	2,14	1	2,14	CHI
20201217603	SENADOR CANEDO	190026492	SENADOR CANEDO	05/12/2020 10:04	05/12/2020 12:26	05/12/2020 10:04	05/12/2020 12:26	2,36	1	2,36	CHI
20201217604	SANTO ANTONIO DE GOIAS	BW21198319	NEROPOLIS S1	05/12/2020 10:04	05/12/2020 17:32	05/12/2020 10:04	05/12/2020 17:32	7,45	1	7,45	CHI
20201217606	SENADOR CANEDO	16648523	GOIANIA LESTE S1	05/12/2020 10:05	05/12/2020 10:47	05/12/2020 10:05	05/12/2020 10:47	0,69	1	0,69	CHI
20201217608	CORUMBA DE GOIAS	CB21338827	CORUMBA	05/12/2020 10:06	05/12/2020 19:54	05/12/2020 10:06	05/12/2020 19:54	9,80	1	9,80	CHI
20201217614	MARZAGAO	MG21118565	VILA CORUMBA	05/12/2020 10:09	05/12/2020 12:30	05/12/2020 10:09	05/12/2020 12:30	2,34	1	2,34	CHI
20201217621	CALDAS NOVAS	760043620	SERRA DE CALDAS	05/12/2020 10:11	05/12/2020 13:10	05/12/2020 10:11	05/12/2020 13:10	2,97	1	2,97	CHI
20201217622	GOIANIA	10385587	FERROVIARIO S2	05/12/2020 10:11	05/12/2020 11:17	05/12/2020 10:11	05/12/2020 11:17	1,08	1	1,08	CHI
20201217628	CORUMBA DE GOIAS	CB21312009	CORUMBA	05/12/2020 10:14	05/12/2020 16:25	05/12/2020 10:14	05/12/2020 16:25	6,18	1	6,18	CHI
20201217635	GUAPO	710007449	GUAPO S1	05/12/2020 10:15	05/12/2020 12:48	05/12/2020 10:15	05/12/2020 12:48	2,53	1	2,53	CHI
20201217636	CRISTALINA	KR21171574	CRISTALINA S2	05/12/2020 10:16	05/12/2020 11:39	05/12/2020 10:16	05/12/2020 11:39	1,38	1	1,38	CHI
20201217637	NEROPOLIS	NR21009835	NEROPOLIS S2	05/12/2020 10:16	06/12/2020 09:15	05/12/2020 10:16	06/12/2020 09:15	22,97	2	45,95	CHI
20201217641	VILA PROPICIO	PV12400259	GOIANESIA S1	05/12/2020 10:19	06/12/2020 12:19	05/12/2020 10:19	06/12/2020 12:19	25,99	2	51,97	CHI
20201217646	SANTA CRUZ DE GOIAS	BC21311732	PIRES DO RIO S2	05/12/2020 10:20	05/12/2020 13:20	05/12/2020 10:20	05/12/2020 13:20	2,99	1	2,99	CHI
20201217658	SAO FRANCISCO DE GOIAS	SF12055351	SAO FRANCISCO DE GOIAS	05/12/2020 10:23	05/12/2020 13:06	05/12/2020 10:23	05/12/2020 13:06	2,72	165	448,07	CHI
20201217663	VILA PROPICIO	GE21185230	GOIANESIA S1	05/12/2020 10:23	05/12/2020 13:26	05/12/2020 10:23	05/12/2020 13:26	3,04	1	3,04	CHI
20201217670	TRINDADE	TR11356364	GOYA S2	05/12/2020 10:24	05/12/2020 12:27	05/12/2020 10:24	05/12/2020 12:27	2,04	101	205,84	CHI
20201217684	GOIATUBA	GT12016326	BOM JESUS DE GOIAS	05/12/2020 10:29	05/12/2020 13:06	05/12/2020 10:29	05/12/2020 13:06	2,61	4	10,44	CHI
20201217701	ANAPOLIS	10022313700	ANAPOLIS UNIVERSITARIO S2	05/12/2020 10:31	05/12/2020 11:51	05/12/2020 10:31	05/12/2020 11:51	1,32	1	1,32	CHI
20201217706	CAMPO ALEGRE DE GOIAS	CM12231703	CAMPO ALEGRE DE GOIAS	05/12/2020 10:34	05/12/2020 12:35	05/12/2020 10:34	05/12/2020 12:35	2,01	10	20,06	CHI
20201217707	LUZIANIA	LZ12086799	VIANOPOLIS	05/12/2020 10:34	05/12/2020 20:20	05/12/2020 10:34	05/12/2020 20:20	9,77	6	58,60	CHI
20201217708	PONTALINA	PK12328924	VICENTINOPOLIS	05/12/2020 10:35	05/12/2020 18:54	05/12/2020 10:35	05/12/2020 18:54	8,31	1	8,31	CHI
20201217711	CAVALCANTE	CJ12278451	NIQUELANDIA SUBTRANSMISSAO	05/12/2020 10:35	05/12/2020 13:55	05/12/2020 10:35	05/12/2020 13:55	3,32	57	189,18	CHI
20201217728	NIQUELANDIA	NQ12239401	URUACU	05/12/2020 10:35	05/12/2020 12:15	05/12/2020 10:35	05/12/2020 12:15	1,66	43	71,28	CHI
20201217712	BARRO ALTO	BA21095450	BARRO ALTO	05/12/2020 10:36	06/12/2020 00:44	05/12/2020 10:36	06/12/2020 00:44	14,13	2	28,27	CHI
20201217714	GOIANIA	13077119	XAVANTES	05/12/2020 10:36	05/12/2020 12:25	05/12/2020 10:36	05/12/2020 12:25	1,81	1	1,81	CHI
20201217716	BELA VISTA DE GOIAS	BV32058335	BELA VISTA S1	05/12/2020 10:37	05/12/2020 15:26	05/12/2020 10:37	05/12/2020 15:26	4,81	4	19,24	CHI
20201217725	CABECEIRAS	CW21085614	ITUIQUIRA	05/12/2020 10:39	05/12/2020 16:57	05/12/2020 10:39	05/12/2020 16:57	6,30	1	6,30	CHI

20201217732	CAMPO ALEGRE DE GOIAS	CM21304105	CAMPO ALEGRE DE GOIAS	05/12/2020 10:41	05/12/2020 16:20	05/12/2020 10:41	05/12/2020 16:20	5,65	1	5,65	CHI
20201217733	SAO JOAO D ALIANCA	TL12302766	SAO JOAO D ALIANCA	05/12/2020 10:41	05/12/2020 11:40	05/12/2020 10:41	05/12/2020 11:40	0,98	1	0,98	CHI
20201217733	AGUA FRIA DE GOIAS	TL12302766	SAO JOAO D ALIANCA	05/12/2020 10:41	05/12/2020 11:40	05/12/2020 10:41	05/12/2020 11:40	0,98	79	77,53	CHI
20201217735	CAMPOS BELOS	MA12218640	SAO DOMINGOS	05/12/2020 10:41	05/12/2020 12:17	05/12/2020 10:41	05/12/2020 12:17	1,60	2	3,19	CHI
20201217735	MONTE ALEGRE DE GOIAS	MA12218640	SAO DOMINGOS	05/12/2020 10:41	05/12/2020 12:17	05/12/2020 10:41	05/12/2020 12:17	1,60	5	7,98	CHI
20201217736	RUBIATABA	780048090	RUBIATABA	05/12/2020 10:41	05/12/2020 17:03	05/12/2020 10:41	05/12/2020 17:03	6,36	1	6,36	CHI
20201217737	CRIXAS	CX12248232	SANTA TEREZINHA	05/12/2020 10:41	05/12/2020 13:03	05/12/2020 10:41	05/12/2020 13:03	2,36	18	42,41	CHI
20201217739	COLINAS DO SUL	CJ21163047	NIQUELANDIA SUBTRANSMISSAO	05/12/2020 10:42	05/12/2020 15:20	05/12/2020 10:42	05/12/2020 15:20	4,63	1	4,63	CHI
20201217848	PLANALTINA	PB21158408	PADRE BERNARDO	05/12/2020 10:46	05/12/2020 15:02	05/12/2020 10:46	05/12/2020 15:02	4,26	1	4,26	CHI
20201217766	ARAGOIANIA	AO21400492	GUAPO S2	05/12/2020 10:47	05/12/2020 12:20	05/12/2020 10:47	05/12/2020 12:20	1,55	1	1,55	CHI
20201217768	SENADOR CANEDO	13653106	SENADOR CANEDO	05/12/2020 10:47	05/12/2020 12:37	05/12/2020 10:47	05/12/2020 12:37	1,82	1	1,82	CHI
20201217785	GOIANIA	14878239	MEIA PONTE	05/12/2020 10:52	05/12/2020 13:23	05/12/2020 10:52	05/12/2020 13:23	2,51	1	2,51	CHI
20201217787	SAO MIGUEL DO PASSA QUATRO	SQ21378484	CRISTIANOPOLIS	05/12/2020 10:52	05/12/2020 14:06	05/12/2020 10:52	05/12/2020 14:06	3,22	2	6,44	CHI
20201217933	NOVA VENEZA	NV12000111	INHUMAS S1	05/12/2020 10:52	05/12/2020 13:53	05/12/2020 10:52	05/12/2020 13:53	3,02	246	741,76	CHI
20201218236	LUZIANIA	LZ12304864	VIANOPOLIS	05/12/2020 10:52	07/12/2020 10:16	05/12/2020 10:52	07/12/2020 10:16	47,39	4	189,57	CHI
20201218236	LUZIANIA	LZ12304864	VIANOPOLIS	05/12/2020 10:52	07/12/2020 10:16	07/12/2020 00:44	07/12/2020 10:16	9,53	1	9,53	CHI
20201217800	GOIANESIA	GE12004544	GOIANESIA S2	05/12/2020 10:57	05/12/2020 16:09	05/12/2020 10:57	05/12/2020 12:28	1,51	10	15,15	CHI
20201217800	VILA PROPICIO	GE12004544	GOIANESIA S2	05/12/2020 10:57	05/12/2020 16:09	05/12/2020 10:57	05/12/2020 12:28	1,51	29	43,93	CHI
20201217800	VILA PROPICIO	GE12004544	GOIANESIA S2	05/12/2020 10:57	05/12/2020 16:09	05/12/2020 10:57	05/12/2020 16:09	5,20	2	10,40	CHI
20201217802	ANAPOLIS	20910204	ANAPOLIS UNIVERSITARIO S1	05/12/2020 10:57	05/12/2020 11:43	05/12/2020 10:57	05/12/2020 11:43	0,75	1	0,75	CHI
20201217803	MORRINHOS	MR21249758	MORRINHOS	05/12/2020 10:58	05/12/2020 12:32	05/12/2020 10:58	05/12/2020 12:32	1,57	1	1,57	CHI
20201217809	ANAPOLIS	10005799927	JUNDIAI S2	05/12/2020 10:59	05/12/2020 12:51	05/12/2020 10:59	05/12/2020 12:51	1,85	1	1,85	CHI
20201217818	PONTALINA	PK21089350	VICENTINOPOLIS	05/12/2020 11:02	05/12/2020 20:01	05/12/2020 11:02	05/12/2020 20:01	8,98	1	8,98	CHI
20201217830	ITUMBIARA	IT21000270	ITUMBIARA NOVA	05/12/2020 11:06	05/12/2020 15:09	05/12/2020 11:06	05/12/2020 15:09	4,05	2	8,10	CHI
20201217832	VALPARAISO DE GOIAS	2860026430	PACAEMBU S1	05/12/2020 11:06	05/12/2020 12:41	05/12/2020 11:06	05/12/2020 12:41	1,58	1	1,58	CHI
20201217912	GAMELEIRA DE GOIAS	SV12382483	ANAPOLIS UNIVERSITARIO S1	05/12/2020 11:06	05/12/2020 23:59	05/12/2020 11:06	05/12/2020 23:59	12,88	19	244,64	CHI
20201217837	CRISTALINA	KR11170459	CRISTALINA S2	05/12/2020 11:08	05/12/2020 12:38	05/12/2020 11:08	05/12/2020 12:38	1,50	1	1,50	CHI
20201217847	COCALZINHO DE GOIAS	ZN10394600	COCALZINHO	05/12/2020 11:10	06/12/2020 16:17	05/12/2020 11:10	05/12/2020 13:17	2,12	52	110,38	CHI
20201217847	COCALZINHO DE GOIAS	ZN10394600	COCALZINHO	05/12/2020 11:10	06/12/2020 16:17	05/12/2020 11:10	05/12/2020 15:42	4,53	10	45,31	CHI
20201217847	PIRENOPOLIS	ZN10394600	COCALZINHO	05/12/2020 11:10	06/12/2020 16:17	05/12/2020 11:10	05/12/2020 15:42	4,53	49	222,01	CHI
20201217847	COCALZINHO DE GOIAS	ZN10394600	COCALZINHO	05/12/2020 11:10	06/12/2020 16:17	06/12/2020 14:57	06/12/2020 15:43	0,77	62	47,95	CHI
20201217847	PIRENOPOLIS	ZN10394600	COCALZINHO	05/12/2020 11:10	06/12/2020 16:17	06/12/2020 14:57	06/12/2020 15:43	0,77	49	37,89	CHI
20201217847	COCALZINHO DE GOIAS	ZN12295682LD	COCALZINHO	05/12/2020 11:10	06/12/2020 16:17	05/12/2020 11:10	06/12/2020 16:17	29,12	26	757,02	CHI
20201217850	PIRENOPOLIS	PV12360338RE	CORUMBA	05/12/2020 11:10	05/12/2020 21:51	05/12/2020 11:10	05/12/2020 20:55	9,75	39	380,08	CHI
20201217850	PIRENOPOLIS	PV12360338RE	CORUMBA	05/12/2020 11:10	05/12/2020 21:51	05/12/2020 11:10	05/12/2020 21:51	10,67	55	586,79	CHI
20201217850	PIRENOPOLIS	PV12285301	CORUMBA	05/12/2020 11:10	05/12/2020 21:51	05/12/2020 11:10	05/12/2020 21:51	10,67	2	21,34	CHI
20201217846	JOVIANIA	570025643	GOIATUBA S1	05/12/2020 11:11	05/12/2020 15:20	05/12/2020 11:11	05/12/2020 15:20	4,14	1	4,14	CHI
20201217851	FIRMINOPOLIS	FR18417149TS	FIRMINOPOLIS S1	05/12/2020 11:13	05/12/2020 20:57	05/12/2020 11:13	05/12/2020 20:57	9,72	82	797,22	CHI
20201221166	GUARINOS	GF12244419	SANTA TEREZINHA	05/12/2020 11:13	06/12/2020 05:22	05/12/2020 11:13	06/12/2020 05:22	18,14	4	72,56	CHI
20201217856	GOIANDIRA	GD21112496	CATALAO S1	05/12/2020 11:14	05/12/2020 19:42	05/12/2020 11:14	05/12/2020 19:42	8,45	1	8,45	CHI
20201218094	GOIANIA	GN11000706	ATLANTICO S3	05/12/2020 11:14	05/12/2020 18:06	05/12/2020 11:14	05/12/2020 18:06	6,86	78	534,93	CHI
20201218837	CAMPO ALEGRE DE GOIAS	CT12061160	CATALAO S1	05/12/2020 11:17	05/12/2020 19:57	05/12/2020 11:17	05/12/2020 19:57	8,66	1	8,66	CHI
20201218837	CATALAO	CT12061160	CATALAO S1	05/12/2020 11:17	05/12/2020 19:57	05/12/2020 11:17	05/12/2020 19:57	8,66	10	86,58	CHI
20201217875	NOVA GLORIA	NG21181350	RUBIATABA	05/12/2020 11:18	06/12/2020 01:42	05/12/2020 11:18	06/12/2020 01:42	14,39	1	14,39	CHI
20201217876	ITABERAI	IB21281182	ITABERAI S1	05/12/2020 11:19	05/12/2020 13:31	05/12/2020 11:19	05/12/2020 13:31	2,20	1	2,20	CHI
20201217882	NOVA CRIXAS	NA11229702	NOVA CRIXAS	05/12/2020 11:21	05/12/2020 14:46	05/12/2020 11:21	05/12/2020 14:46	3,40	1	3,40	CHI
20201217888	OUVIDOR	OU21061215	CATALAO S1	05/12/2020 11:21	05/12/2020 20:59	05/12/2020 11:21	05/12/2020 20:59	9,62	1	9,62	CHI
20201217897	DIORAMA	DI12065693	IPORA	05/12/2020 11:26	05/12/2020 13:30	05/12/2020 11:26	05/12/2020 13:30	2,06	8	16,50	CHI
20201217981	GOIANDIRA	GD12127591	CATALAO S1	05/12/2020 11:28	05/12/2020 19:52	05/12/2020 11:28	05/12/2020 19:52	8,39	2	16,78	CHI
20201217918	MUNDO NOVO DE GOIAS	MH11181646	NOVA CRIXAS	05/12/2020 11:33	05/12/2020 15:22	05/12/2020 11:33	05/12/2020 15:22	3,81	1	3,81	CHI
20201217922	ABADIANIA	AA12285384	ANAPOLIS UNIVERSITARIO S1	05/12/2020 11:34	05/12/2020 14:37	05/12/2020 11:34	05/12/2020 14:37	3,04	114	346,72	CHI

20201217922	GAMELEIRA DE GOIAS	AA12285384	ANAPOLIS UNIVERSITARIO S1	05/12/2020 11:34	05/12/2020 14:37	05/12/2020 11:34	05/12/2020 14:37	3,04	1	3,04	CHI
20201217924	AGUA FRIA DE GOIAS	TL10402672	SAO JOAO D ALIANCA	05/12/2020 11:34	05/12/2020 17:44	05/12/2020 11:34	05/12/2020 16:53	5,31	23	122,20	CHI
20201217924	AGUA FRIA DE GOIAS	TL10402672	SAO JOAO D ALIANCA	05/12/2020 11:34	05/12/2020 17:44	05/12/2020 11:35	05/12/2020 16:53	5,30	2	10,60	CHI
20201217924	AGUA FRIA DE GOIAS	TL12220968LD	SAO JOAO D ALIANCA	05/12/2020 11:34	05/12/2020 17:44	05/12/2020 11:34	05/12/2020 17:44	6,17	8	49,33	CHI
20201217924	AGUA FRIA DE GOIAS	TL12220968LD	SAO JOAO D ALIANCA	05/12/2020 11:34	05/12/2020 17:44	05/12/2020 11:35	05/12/2020 17:44	6,15	1	6,15	CHI
20201220804	SAO MIGUEL DO ARAGUAIA	SM12096096	SAO MIGUEL DO ARAGUAIA	05/12/2020 11:34	05/12/2020 19:20	05/12/2020 11:34	05/12/2020 19:20	7,76	13	100,93	CHI
20201217983	CRISTALINA	LZ12120015	MARAOARA	05/12/2020 11:35	05/12/2020 19:48	05/12/2020 11:35	05/12/2020 19:48	8,21	11	90,26	CHI
20201217930	BONFINOPOLIS	920014483	CEPAIGO S2	05/12/2020 11:37	05/12/2020 16:24	05/12/2020 11:37	05/12/2020 16:24	4,78	1	4,78	CHI
20201217941	RIO VERDE	RV12301462	ACREUNA	05/12/2020 11:37	05/12/2020 13:48	05/12/2020 11:37	05/12/2020 13:48	2,17	3	6,52	CHI
20201217941	SANTO ANTONIO DA BARRA	RV12301462	ACREUNA	05/12/2020 11:37	05/12/2020 13:48	05/12/2020 11:37	05/12/2020 13:48	2,17	1	2,17	CHI
20201217942	RIO VERDE	630155719	RIO VERDE S1	05/12/2020 11:38	05/12/2020 19:28	05/12/2020 11:38	05/12/2020 19:28	7,82	1	7,82	CHI
20201217946	FAINA	FC21218093	GOIAS	05/12/2020 11:39	05/12/2020 16:55	05/12/2020 11:39	05/12/2020 16:55	5,25	1	5,25	CHI
20201217951	RIO VERDE	RV12230632	CABRIUVA S2	05/12/2020 11:40	05/12/2020 14:41	05/12/2020 11:40	05/12/2020 14:41	3,01	9	27,11	CHI
20201218064	CRISTALINA	KR12250016	PAMPLONA	05/12/2020 11:42	05/12/2020 13:17	05/12/2020 11:42	05/12/2020 13:17	1,58	27	42,73	CHI
20201217958	QUIRINOPOLIS	80018816	QUIRINOPOLIS	05/12/2020 11:43	05/12/2020 12:35	05/12/2020 11:43	05/12/2020 12:35	0,86	1	0,86	CHI
20201218077	BOM JARDIM DE GOIAS	BM12245130	BOM JARDIM	05/12/2020 11:50	05/12/2020 15:31	05/12/2020 11:50	05/12/2020 15:31	3,67	6	22,03	CHI
20201218077	PIRANHAS	BM12245130	BOM JARDIM	05/12/2020 11:50	05/12/2020 15:31	05/12/2020 11:50	05/12/2020 15:31	3,67	4	14,69	CHI
20201217988	ABADIANIA	AA21283595	ANAPOLIS UNIVERSITARIO S1	05/12/2020 11:51	05/12/2020 15:58	05/12/2020 11:51	05/12/2020 15:58	4,11	3	12,33	CHI
20201217989	RIO VERDE	RV21105834	RIO VERDE S1	05/12/2020 11:51	05/12/2020 13:34	05/12/2020 11:51	05/12/2020 13:34	1,71	1	1,71	CHI
20201217991	ITAPURANGA	IK12387676	ITAPURANGA	05/12/2020 11:51	05/12/2020 16:26	05/12/2020 11:51	05/12/2020 16:26	4,57	1	4,57	CHI
20201218035	GOIANIA	GN11001916	CAMPINAS S2	05/12/2020 11:52	05/12/2020 12:39	05/12/2020 11:52	05/12/2020 12:39	0,78	175	135,82	CHI
20201217996	ANICUNS	AC12012920	ANICUNS	05/12/2020 11:53	05/12/2020 13:57	05/12/2020 11:53	05/12/2020 13:57	2,06	4	8,22	CHI
20201217999	APARECIDA DE GOIANIA	00570214	REAL S1	05/12/2020 11:53	05/12/2020 19:40	05/12/2020 11:53	05/12/2020 12:17	0,40	556	220,70	CHI
20201217999	GOIANIA	00570214	REAL S1	05/12/2020 11:53	05/12/2020 19:40	05/12/2020 11:53	05/12/2020 12:17	0,40	3806	1510,77	CHI
20201217999	GOIANIA	GN16404308	REAL S1	05/12/2020 11:53	05/12/2020 19:40	05/12/2020 12:45	05/12/2020 13:10	0,43	5324	2273,05	CHI
20201217999	APARECIDA DE GOIANIA	00570214	REAL S1	05/12/2020 11:53	05/12/2020 19:40	05/12/2020 12:45	05/12/2020 14:33	1,81	529	959,55	CHI
20201217999	GOIANIA	00570214	REAL S1	05/12/2020 11:53	05/12/2020 19:40	05/12/2020 12:45	05/12/2020 14:33	1,81	486	881,55	CHI
20201217999	APARECIDA DE GOIANIA	AP11004999	REAL S2	05/12/2020 11:53	05/12/2020 19:40	05/12/2020 17:28	05/12/2020 19:00	1,52	32	48,75	CHI
20201217999	APARECIDA DE GOIANIA	AP12004997LD	REAL S1	05/12/2020 11:53	05/12/2020 19:40	05/12/2020 12:45	05/12/2020 19:40	6,92	27	186,76	CHI
20201218055	CRISTALINA	KR10400360	PAMPLONA	05/12/2020 11:53	07/12/2020 16:11	05/12/2020 11:53	05/12/2020 15:22	3,48	77	268,13	CHI
20201218055	CRISTALINA	KR10400360	PAMPLONA	05/12/2020 11:53	07/12/2020 16:11	05/12/2020 11:53	05/12/2020 16:11	4,30	6	25,79	CHI
20201218055	CRISTALINA	KR10400360	PAMPLONA	05/12/2020 11:53	07/12/2020 16:11	05/12/2020 11:53	05/12/2020 16:56	5,05	1	5,05	CHI
20201218055	CRISTALINA	KR10400354	PAMPLONA	05/12/2020 11:53	07/12/2020 16:11	05/12/2020 18:47	05/12/2020 19:10	0,38	2	0,75	CHI
20201218055	CRISTALINA	KR10400354	PAMPLONA	05/12/2020 11:53	07/12/2020 16:11	05/12/2020 18:47	05/12/2020 19:10	0,38	2562	965,02	CHI
20201218055	CRISTALINA	KR10400360	PAMPLONA	05/12/2020 11:53	07/12/2020 16:11	05/12/2020 17:31	06/12/2020 00:03	6,53	6	39,19	CHI
20201218055	CRISTALINA	KR10400360	PAMPLONA	05/12/2020 11:53	07/12/2020 16:11	05/12/2020 17:31	06/12/2020 02:14	8,72	1	8,72	CHI
20201218055	CRISTALINA	KR13154745	PAMPLONA	05/12/2020 11:53	07/12/2020 16:11	05/12/2020 17:34	06/12/2020 02:38	9,06	77	697,92	CHI
20201218055	CRISTALINA	KR10414254	PAMPLONA	05/12/2020 11:53	07/12/2020 16:11	05/12/2020 17:35	06/12/2020 03:03	9,47	28	265,07	CHI
20201218055	CRISTALINA	KR10400360	PAMPLONA	05/12/2020 11:53	07/12/2020 16:11	06/12/2020 19:51	06/12/2020 21:37	1,77	111	196,62	CHI
20201218055	CRISTALINA	KR10400354	PAMPLONA	05/12/2020 11:53	07/12/2020 16:11	06/12/2020 21:40	07/12/2020 00:05	2,42	113	272,96	CHI
20201218055	CRISTALINA	KR10400354	PAMPLONA	05/12/2020 11:53	07/12/2020 16:11	06/12/2020 21:40	07/12/2020 00:05	2,42	2341	5654,82	CHI
20201218055	CRISTALINA	KR12168277	PAMPLONA	05/12/2020 11:53	07/12/2020 16:11	05/12/2020 11:53	07/12/2020 00:07	36,23	5	181,17	CHI
20201218055	CRISTALINA	KR10400354	PAMPLONA	05/12/2020 11:53	07/12/2020 16:11	07/12/2020 00:59	07/12/2020 01:04	0,08	2341	187,93	CHI
20201218055	CRISTALINA	KR10400354	PAMPLONA	05/12/2020 11:53	07/12/2020 16:11	07/12/2020 00:59	07/12/2020 01:04	0,08	2	0,16	CHI
20201218055	CRISTALINA	KR10400360	PAMPLONA	05/12/2020 11:53	07/12/2020 16:11	07/12/2020 00:59	07/12/2020 01:05	0,09	116	10,83	CHI
20201218055	CRISTALINA	KR10400354	PAMPLONA	05/12/2020 11:53	07/12/2020 16:11	07/12/2020 13:40	07/12/2020 13:44	0,06	2	0,13	CHI
20201218055	CRISTALINA	KR10400354	PAMPLONA	05/12/2020 11:53	07/12/2020 16:11	07/12/2020 13:40	07/12/2020 13:44	0,06	2562	165,82	CHI
20201218055	CRISTALINA	KR10400360	PAMPLONA	05/12/2020 11:53	07/12/2020 16:11	07/12/2020 13:40	07/12/2020 13:45	0,09	55	4,83	CHI
20201218055	CRISTALINA	KR10400355	PAMPLONA	05/12/2020 11:53	07/12/2020 16:11	05/12/2020 17:35	07/12/2020 15:45	46,16	2	92,31	CHI
20201218055	CRISTALINA	KR21261540	PAMPLONA	05/12/2020 11:53	07/12/2020 16:11	06/12/2020 02:23	07/12/2020 16:11	37,80	1	37,80	CHI
20201218132	GOIANIA	GN11082032	REAL S1	05/12/2020 11:53	05/12/2020 14:48	05/12/2020 11:53	05/12/2020 14:48	2,91	160	465,38	CHI

20201220096	ITAPURANGA	IK12364711	ITAPURANGA	05/12/2020 11:53	05/12/2020 20:49	05/12/2020 11:53	05/12/2020 20:49	8,92	10	89,19	CHI
20201218002	ITAPURANGA	IK13409798B	ITAPURANGA	05/12/2020 11:54	06/12/2020 00:05	05/12/2020 11:54	06/12/2020 00:05	12,18	106	1290,73	CHI
20201218002	GOIAS	IK13409798B	ITAPURANGA	05/12/2020 11:54	06/12/2020 00:05	05/12/2020 11:54	06/12/2020 00:05	12,18	2	24,35	CHI
20201218002	GUARAITA	IK13409798B	ITAPURANGA	05/12/2020 11:54	06/12/2020 00:05	05/12/2020 11:54	06/12/2020 00:05	12,18	18	219,18	CHI
20201218002	ITAPURANGA	IK13409798B	ITAPURANGA	05/12/2020 11:54	06/12/2020 00:05	05/12/2020 21:23	06/12/2020 00:05	2,70	35	94,56	CHI
20201218003	ANAPOLIS	AN11096560	ANAPOLIS UNIVERSITARIO S2	05/12/2020 11:54	05/12/2020 13:15	05/12/2020 11:54	05/12/2020 13:15	1,34	131	175,29	CHI
20201218005	GOIANIA	13015849	REAL S1	05/12/2020 11:55	05/12/2020 13:38	05/12/2020 11:55	05/12/2020 13:38	1,71	1	1,71	CHI
20201218027	ANAPOLIS	AN11000223	JUNDIAI S2	05/12/2020 11:57	05/12/2020 21:20	05/12/2020 11:57	05/12/2020 21:20	9,38	147	1378,13	CHI
20201218028	BARRO ALTO	BA12210738	BARRO ALTO	05/12/2020 11:58	05/12/2020 23:17	05/12/2020 11:58	05/12/2020 23:17	11,31	1	11,31	CHI
20201218046	CATALAO	1990021120	CATALAO S2	05/12/2020 12:00	05/12/2020 15:06	05/12/2020 12:00	05/12/2020 15:06	3,10	1	3,10	CHI
20201218122	GOIANIA	GN11001740	REAL S1	05/12/2020 12:00	05/12/2020 14:20	05/12/2020 12:00	05/12/2020 14:20	2,32	119	276,61	CHI
20201218084	GOIANIA	GN11275628	GOYA S2	05/12/2020 12:04	05/12/2020 15:40	05/12/2020 12:04	05/12/2020 15:40	3,59	112	402,45	CHI
20201218089	CRISTALINA	KR12351959	CRISTALINA S2	05/12/2020 12:04	05/12/2020 14:02	05/12/2020 12:04	05/12/2020 14:02	1,95	35	68,29	CHI
20201218097	LUZIANIA	LZ12396829	MARAOARA	05/12/2020 12:05	05/12/2020 15:13	05/12/2020 12:05	05/12/2020 15:13	3,12	2	6,24	CHI
20201218100	BALIZA	BH21135315	BOM JARDIM	05/12/2020 12:06	05/12/2020 18:37	05/12/2020 12:06	05/12/2020 18:37	6,51	1	6,51	CHI
20201218757	SERRANOPOLIS	SX12241669	JATAI S1	05/12/2020 12:09	05/12/2020 17:47	05/12/2020 12:09	05/12/2020 17:47	5,62	13	73,05	CHI
20201218137	ABADIANIA	AN11289006	ANAPOLIS UNIVERSITARIO S2	05/12/2020 12:11	05/12/2020 18:34	05/12/2020 12:11	05/12/2020 18:34	6,38	9	57,42	CHI
20201218138	PETROLINA DE GOIAS	PG11211750	PETROLINA	05/12/2020 12:11	05/12/2020 13:46	05/12/2020 12:11	05/12/2020 13:46	1,58	41	64,73	CHI
20201218158	TRINDADE	40147368	TRINDADE	05/12/2020 12:14	05/12/2020 13:10	05/12/2020 12:14	05/12/2020 13:10	0,92	1	0,92	CHI
20201218169	GOIANIRA	GR11094697	GOIANIRA	05/12/2020 12:16	05/12/2020 18:45	05/12/2020 12:16	05/12/2020 18:45	6,47	147	951,50	CHI
20201218181	GOIANIA	GN11189701	CAMPINAS S3	05/12/2020 12:19	05/12/2020 16:43	05/12/2020 12:19	05/12/2020 16:43	4,39	69	302,57	CHI
20201218182	GOIANESIA	GE21384237	GOIANESIA S1	05/12/2020 12:20	05/12/2020 14:33	05/12/2020 12:20	05/12/2020 14:33	2,22	1	2,22	CHI
202012179390	DISTRITO FEDERAL	03740424	ITUIQUIRA	05/12/2020 12:25	05/12/2020 16:34	05/12/2020 12:25	05/12/2020 13:57	1,53	1	1,53	CHI
202012179390	CABECEIRAS	03740424	ITUIQUIRA	05/12/2020 12:25	05/12/2020 16:34	05/12/2020 12:25	05/12/2020 13:57	1,53	37	56,46	CHI
202012179390	CABECEIRAS	03740424	ITUIQUIRA	05/12/2020 12:25	05/12/2020 16:34	05/12/2020 12:25	05/12/2020 13:57	1,53	3002	4580,55	CHI
202012179390	FORMOSA	03740424	ITUIQUIRA	05/12/2020 12:25	05/12/2020 16:34	05/12/2020 12:25	05/12/2020 15:53	3,46	4	13,84	CHI
202012179390	CABECEIRAS	03740424	ITUIQUIRA	05/12/2020 12:25	05/12/2020 16:34	05/12/2020 12:25	05/12/2020 16:12	3,79	15	56,88	CHI
202012179390	FORMOSA	03740424	ITUIQUIRA	05/12/2020 12:25	05/12/2020 16:34	05/12/2020 12:25	05/12/2020 16:12	3,79	2	7,58	CHI
202012179390	CABECEIRAS	CW13062243	ITUIQUIRA	05/12/2020 12:25	05/12/2020 16:34	05/12/2020 16:29	05/12/2020 16:34	0,08	37	2,88	CHI
20201218221	APARECIDA DE GOIANIA	AP11004999	REAL S2	05/12/2020 12:26	05/12/2020 15:34	05/12/2020 12:26	05/12/2020 15:34	3,13	32	100,17	CHI
20201219164	GAMELEIRA DE GOIAS	SV12033468	DAIA S2	05/12/2020 12:28	06/12/2020 04:56	05/12/2020 12:28	06/12/2020 04:56	16,46	15	246,89	CHI
20201219164	SILVANIA	SV12033468	DAIA S2	05/12/2020 12:28	06/12/2020 04:56	05/12/2020 12:28	06/12/2020 04:56	16,46	144	2370,12	CHI
20201218220	EDEIA	EA21028222	EDEIA	05/12/2020 12:32	05/12/2020 15:20	05/12/2020 12:32	05/12/2020 15:20	2,78	1	2,78	CHI
20201218228	CAMPO ALEGRE DE GOIAS	CM12042353	CAMPO ALEGRE DE GOIAS	05/12/2020 12:34	05/12/2020 17:53	05/12/2020 12:34	05/12/2020 17:53	5,30	6	31,82	CHI
20201219299	ITAPURANGA	IK12299953	ITAPURANGA	05/12/2020 12:34	05/12/2020 17:01	05/12/2020 12:34	05/12/2020 17:01	4,45	5	22,24	CHI
20201218232	CATALAO	CT12077524	CATALAO S1	05/12/2020 12:35	06/12/2020 12:45	05/12/2020 12:35	05/12/2020 22:12	9,62	2	19,23	CHI
20201218232	CATALAO	CT12077524	CATALAO S1	05/12/2020 12:35	06/12/2020 12:45	05/12/2020 22:13	06/12/2020 11:01	12,80	2	25,59	CHI
20201218232	CATALAO	CT12077524	CATALAO S1	05/12/2020 12:35	06/12/2020 12:45	05/12/2020 12:35	06/12/2020 11:56	23,35	6	140,12	CHI
20201218232	CATALAO	CT12077524	CATALAO S1	05/12/2020 12:35	06/12/2020 12:45	05/12/2020 12:35	06/12/2020 12:45	24,17	1	24,17	CHI
20201218234	BARRO ALTO	GE12092176	GOIANESIA S1	05/12/2020 12:36	05/12/2020 19:37	05/12/2020 12:36	05/12/2020 19:37	7,01	1	7,01	CHI
20201218235	CRISTALINA	KR12025841	PAMPLONA	05/12/2020 12:36	05/12/2020 15:43	05/12/2020 12:36	05/12/2020 15:43	3,10	3	9,31	CHI
20201218282	SILVANIA	SV21324247	VIANOPOLIS	05/12/2020 12:36	05/12/2020 20:45	05/12/2020 12:36	05/12/2020 20:45	8,14	5	40,69	CHI
202012131366	SILVANIA	05400214	VIANOPOLIS	05/12/2020 12:36	05/12/2020 22:18	05/12/2020 12:36	05/12/2020 17:07	4,50	271	1220,70	CHI
202012131366	GAMELEIRA DE GOIAS	05400214	VIANOPOLIS	05/12/2020 12:36	05/12/2020 22:18	05/12/2020 12:36	05/12/2020 17:07	4,50	20	90,09	CHI
202012131366	LUZIANIA	SV10394762	VIANOPOLIS	05/12/2020 12:36	05/12/2020 22:18	05/12/2020 12:36	05/12/2020 18:01	5,42	20	108,33	CHI
202012131366	SILVANIA	SV10394762	VIANOPOLIS	05/12/2020 12:36	05/12/2020 22:18	05/12/2020 12:36	05/12/2020 18:01	5,42	1	5,42	CHI
202012131366	LUZIANIA	SV12376114LD	VIANOPOLIS	05/12/2020 12:36	05/12/2020 22:18	05/12/2020 12:36	05/12/2020 20:20	7,74	4	30,94	CHI
202012131366	LUZIANIA	05400224	VIANOPOLIS	05/12/2020 12:36	05/12/2020 22:18	05/12/2020 12:36	05/12/2020 20:20	7,74	375	2900,63	CHI
202012131366	SILVANIA	05400224	VIANOPOLIS	05/12/2020 12:36	05/12/2020 22:18	05/12/2020 12:36	05/12/2020 20:20	7,74	105	812,18	CHI
202012131366	SILVANIA	SV12376114LD	VIANOPOLIS	05/12/2020 12:36	05/12/2020 22:18	05/12/2020 12:36	05/12/2020 20:20	7,74	20	154,70	CHI
202012131366	GAMELEIRA DE GOIAS	05400214	VIANOPOLIS	05/12/2020 12:36	05/12/2020 22:18	05/12/2020 22:10	05/12/2020 22:15	0,08	20	1,67	CHI

202012131366	SILVANIA	05400214	VIANOPOLIS	05/12/2020 12:36	05/12/2020 22:18	05/12/2020 22:10	05/12/2020 22:15	0,08	271	22,58	CHI
202012131366	LUZIANIA	05400224	VIANOPOLIS	05/12/2020 12:36	05/12/2020 22:18	05/12/2020 22:14	05/12/2020 22:18	0,07	381	25,72	CHI
202012131366	SILVANIA	05400224	VIANOPOLIS	05/12/2020 12:36	05/12/2020 22:18	05/12/2020 22:14	05/12/2020 22:18	0,07	110	7,43	CHI
20201218306	NIQUELANDIA	NQ12239432	URUACU	05/12/2020 12:37	05/12/2020 19:23	05/12/2020 12:37	05/12/2020 19:23	6,76	21	142,04	CHI
20201218240	NAZARIO	PL12000123	PALMEIRAS	05/12/2020 12:38	05/12/2020 17:09	05/12/2020 12:38	05/12/2020 17:09	4,52	2	9,03	CHI
20201218245	LUZIANIA	3200181173	RIO VERMELHO	05/12/2020 12:39	05/12/2020 14:01	05/12/2020 12:39	05/12/2020 14:01	1,36	1	1,36	CHI
20201218253	PARAUNA	PU21194025	ACREUNA	05/12/2020 12:41	05/12/2020 23:16	05/12/2020 12:41	05/12/2020 23:16	10,58	1	10,58	CHI
20201218259	JATAI	JT12234396	JATAI S1	05/12/2020 12:41	05/12/2020 13:47	05/12/2020 12:41	05/12/2020 13:47	1,11	9	9,95	CHI
2020120500120	FORMOSA	03740444	ITIQUIRA	05/12/2020 12:41	05/12/2020 12:46	05/12/2020 12:41	05/12/2020 12:46	0,08	10	0,83	CHI
20201218261	GOIANESIA	GE11171632	GOIANESIA S2	05/12/2020 12:42	05/12/2020 13:14	05/12/2020 12:42	05/12/2020 13:14	0,53	118	62,15	CHI
20201218266	PORTELANDIA	PW11341122	PARQUE DAS EMAS	05/12/2020 12:42	06/12/2020 18:04	05/12/2020 12:42	06/12/2020 18:04	29,35	55	1614,34	CHI
20201218330	TAQUARAL DE GOIAS	00960214	INHUMAS S1	05/12/2020 12:43	05/12/2020 13:37	05/12/2020 12:43	05/12/2020 12:47	0,06	48	2,91	CHI
20201218330	ITAUCU	00960214	INHUMAS S1	05/12/2020 12:43	05/12/2020 13:37	05/12/2020 12:43	05/12/2020 12:47	0,06	172	10,42	CHI
20201218330	ITAUCU	IX16414823	INHUMAS S1	05/12/2020 12:43	05/12/2020 13:37	05/12/2020 12:43	05/12/2020 12:47	0,07	63	4,46	CHI
20201218330	INHUMAS	IX10397295	INHUMAS S1	05/12/2020 12:43	05/12/2020 13:37	05/12/2020 12:43	05/12/2020 12:49	0,09	10	0,91	CHI
20201218330	ITAUCU	IX10397295	INHUMAS S1	05/12/2020 12:43	05/12/2020 13:37	05/12/2020 12:43	05/12/2020 12:49	0,09	115	10,48	CHI
20201218330	ITABERAI	IX16409667	INHUMAS S1	05/12/2020 12:43	05/12/2020 13:37	05/12/2020 12:43	05/12/2020 13:37	0,91	32	28,98	CHI
20201218330	ARACU	IX16409667	INHUMAS S1	05/12/2020 12:43	05/12/2020 13:37	05/12/2020 12:43	05/12/2020 13:37	0,91	8	7,24	CHI
20201218330	ITAUCU	IX16409667	INHUMAS S1	05/12/2020 12:43	05/12/2020 13:37	05/12/2020 12:43	05/12/2020 13:37	0,91	355	321,47	CHI
20201218687	SANTA ROSA DE GOIAS	TQ12120364	INHUMAS S1	05/12/2020 12:45	05/12/2020 15:33	05/12/2020 12:45	05/12/2020 15:33	2,80	19	53,13	CHI
20201218687	TAQUARAL DE GOIAS	TQ12120364	INHUMAS S1	05/12/2020 12:45	05/12/2020 15:33	05/12/2020 12:45	05/12/2020 15:33	2,80	19	53,13	CHI
20201218687	JARAGUA	TQ12120364	INHUMAS S1	05/12/2020 12:45	05/12/2020 15:33	05/12/2020 12:45	05/12/2020 15:33	2,80	2	5,59	CHI
20201218853	MORRO AGUDO DE GOIAS	IK12364740	ITAPURANGA	05/12/2020 12:45	05/12/2020 15:23	05/12/2020 12:45	05/12/2020 15:23	2,63	15	39,42	CHI
20201218853	ITAPURANGA	IK12364740	ITAPURANGA	05/12/2020 12:45	05/12/2020 15:23	05/12/2020 12:45	05/12/2020 15:23	2,63	12	31,54	CHI
20201218713	SANTO ANTONIO DE GOIAS	BW11233006	NEROPOLIS S1	05/12/2020 12:47	05/12/2020 16:43	05/12/2020 12:47	05/12/2020 16:43	3,93	111	436,11	CHI
20201220110	SILVANIA	LB12000008	DAIA S2	05/12/2020 12:47	05/12/2020 18:22	05/12/2020 12:47	05/12/2020 18:22	5,58	98	547,14	CHI
20201220110	LEOPOLDO DE BULHOES	LB12000008	DAIA S2	05/12/2020 12:47	05/12/2020 18:22	05/12/2020 12:47	05/12/2020 18:22	5,58	159	887,71	CHI
20201220110	GAMELEIRA DE GOIAS	LB12000008	DAIA S2	05/12/2020 12:47	05/12/2020 18:22	05/12/2020 12:47	05/12/2020 18:22	5,58	16	89,33	CHI
20201218484	FORMOSA	FA21262354	ITIQUIRA	05/12/2020 12:48	05/12/2020 19:22	05/12/2020 13:06	05/12/2020 19:22	6,26	1	6,26	CHI
202012179324	FORMOSA	03740214	ITIQUIRA	05/12/2020 12:48	05/12/2020 22:16	05/12/2020 13:06	05/12/2020 13:12	0,10	5210	502,19	CHI
202012179324	FORMOSA	03740214	ITIQUIRA	05/12/2020 12:48	05/12/2020 22:16	05/12/2020 13:08	05/12/2020 13:12	0,06	6	0,36	CHI
202012179324	FORMOSA	03740214	ITIQUIRA	05/12/2020 12:48	05/12/2020 22:16	05/12/2020 13:16	05/12/2020 14:46	1,50	4126	6190,15	CHI
202012179324	FORMOSA	FA16404018	ITIQUIRA	05/12/2020 12:48	05/12/2020 22:16	05/12/2020 13:16	05/12/2020 15:54	2,63	328	863,82	CHI
202012179324	FORMOSA	FA13361262	ITIQUIRA	05/12/2020 12:48	05/12/2020 22:16	05/12/2020 13:16	05/12/2020 19:08	5,87	762	4472,09	CHI
2020120500136	FORMOSA	ITQ-TR6	ITIQUIRA	05/12/2020 12:48	05/12/2020 13:10	05/12/2020 13:06	05/12/2020 13:09	0,05	15142	799,16	CHI
2020120500136	FORMOSA	ITQ-TR6	ITIQUIRA	05/12/2020 12:48	05/12/2020 13:10	05/12/2020 13:06	05/12/2020 13:09	0,05	15961	842,39	CHI
2020120500136	ITARUMA	ITQ-TR6	ITIQUIRA	05/12/2020 12:48	05/12/2020 13:10	05/12/2020 13:06	05/12/2020 13:09	0,05	3	0,16	CHI
2020120500136	CABECEIRAS	ITQ-TR1	ITIQUIRA	05/12/2020 12:48	05/12/2020 13:10	05/12/2020 13:06	05/12/2020 13:10	0,06	198	11,77	CHI
2020120500136	CABECEIRAS	ITQ-TR1	ITIQUIRA	05/12/2020 12:48	05/12/2020 13:10	05/12/2020 13:06	05/12/2020 13:10	0,06	147	8,74	CHI
2020120500136	CABECEIRAS	ITQ-TR1	ITIQUIRA	05/12/2020 12:48	05/12/2020 13:10	05/12/2020 13:06	05/12/2020 13:10	0,06	24	1,43	CHI
2020120500136	FORMOSA	ITQ-TR1	ITIQUIRA	05/12/2020 12:48	05/12/2020 13:10	05/12/2020 13:06	05/12/2020 13:10	0,06	797	47,38	CHI
2020120500136	FLORES DE GOIAS	ITQ-TR1	ITIQUIRA	05/12/2020 12:48	05/12/2020 13:10	05/12/2020 13:06	05/12/2020 13:10	0,06	3	0,18	CHI
2020120500136	FORMOSA	ITQ-TR1	ITIQUIRA	05/12/2020 12:48	05/12/2020 13:10	05/12/2020 13:06	05/12/2020 13:10	0,06	33	1,96	CHI
2020120500136	FORMOSA	ITQ-TR1	ITIQUIRA	05/12/2020 12:48	05/12/2020 13:10	05/12/2020 13:06	05/12/2020 13:10	0,06	2	0,12	CHI
2020120500136	FORMOSA	ITQ-TR1	ITIQUIRA	05/12/2020 12:48	05/12/2020 13:10	05/12/2020 13:06	05/12/2020 13:10	0,06	585	34,78	CHI
2020120500136	SAO JOAO D ALIANCA	ITQ-TR1	ITIQUIRA	05/12/2020 12:48	05/12/2020 13:10	05/12/2020 13:06	05/12/2020 13:10	0,06	231	13,73	CHI
2020120500136	VILA BOA	ITQ-TR1	ITIQUIRA	05/12/2020 12:48	05/12/2020 13:10	05/12/2020 13:06	05/12/2020 13:10	0,06	4	0,24	CHI
2020120500136	DISTRITO FEDERAL	ITQ-TR1	ITIQUIRA	05/12/2020 12:48	05/12/2020 13:10	05/12/2020 13:06	05/12/2020 13:10	0,06	2	0,12	CHI
2020120500136	FORMOSA	ITQ-TR1	ITIQUIRA	05/12/2020 12:48	05/12/2020 13:10	05/12/2020 13:06	05/12/2020 13:10	0,06	2552	151,70	CHI
2020120500136	VILA BOA	ITQ-TR1	ITIQUIRA	05/12/2020 12:48	05/12/2020 13:10	05/12/2020 13:06	05/12/2020 13:10	0,06	6	0,36	CHI
2020120500136	VILA BOA	ITQ-TR1	IACIARA S2	05/12/2020 12:48	05/12/2020 13:10	05/12/2020 13:06	05/12/2020 13:10	0,06	1377	81,86	CHI

2020120500136	DISTRITO FEDERAL	ITQ-TR1	ITIQUEIRA	05/12/2020 12:48	05/12/2020 13:10	05/12/2020 13:06	05/12/2020 13:10	0,06	1	0,06	CHI
2020120500136	VILA BOA	ITQ-TR1	ITIQUEIRA	05/12/2020 12:48	05/12/2020 13:10	05/12/2020 13:06	05/12/2020 13:10	0,06	210	12,48	CHI
2020120500136	CABECEIRAS	ITQ-TR1	ITIQUEIRA	05/12/2020 12:48	05/12/2020 13:10	05/12/2020 13:06	05/12/2020 13:10	0,06	39	2,32	CHI
2020120500136	FORMOSA	ITQ-TR1	ITIQUEIRA	05/12/2020 12:48	05/12/2020 13:10	05/12/2020 13:06	05/12/2020 13:10	0,06	34	2,02	CHI
2020120500136	DISTRITO FEDERAL	ITQ-TR1	ITIQUEIRA	05/12/2020 12:48	05/12/2020 13:10	05/12/2020 13:06	05/12/2020 13:10	0,06	1	0,06	CHI
20201219770	CORUMBA DE GOIAS	CB12072262	COCALZINHO	05/12/2020 12:49	05/12/2020 22:00	05/12/2020 12:49	05/12/2020 22:00	9,17	6	55,04	CHI
20201218304	ANAPOLIS	AN11382443	ANAPOLIS UNIVERSITARIO S2	05/12/2020 12:50	05/12/2020 23:21	05/12/2020 12:50	05/12/2020 23:21	10,51	55	578,31	CHI
20201218305	BELA VISTA DE GOIAS	BV32097981	BELA VISTA S1	05/12/2020 12:50	05/12/2020 16:43	05/12/2020 12:50	05/12/2020 16:43	3,88	1	3,88	CHI
20201218314	ITAPURANGA	IK21311355	ITAPURANGA	05/12/2020 12:51	05/12/2020 18:39	05/12/2020 12:51	05/12/2020 18:39	5,79	1	5,79	CHI
20201218570	APARECIDA DE GOIANIA	AP12004870	ATLANTICO S1	05/12/2020 12:51	05/12/2020 20:01	05/12/2020 12:51	05/12/2020 20:01	7,16	460	3292,96	CHI
20201218316	GAMELEIRA DE GOIAS	SV12265347	ANAPOLIS UNIVERSITARIO S2	05/12/2020 12:52	05/12/2020 15:17	05/12/2020 12:52	05/12/2020 15:17	2,41	4	9,65	CHI
20201218422	APARECIDA DE GOIANIA	AP16401530	REAL S2	05/12/2020 12:52	05/12/2020 20:10	05/12/2020 12:52	05/12/2020 12:56	0,06	2987	177,56	CHI
20201218422	APARECIDA DE GOIANIA	AP16401529	ATLANTICO S1	05/12/2020 12:52	05/12/2020 20:10	05/12/2020 12:52	05/12/2020 12:57	0,07	2440	166,06	CHI
20201218422	APARECIDA DE GOIANIA	AP16401530	REAL S2	05/12/2020 12:52	05/12/2020 20:10	05/12/2020 13:18	05/12/2020 18:41	5,38	1862	10018,59	CHI
20201218422	APARECIDA DE GOIANIA	AP12391630	REAL S2	05/12/2020 12:52	05/12/2020 20:10	05/12/2020 13:18	05/12/2020 20:05	6,78	862	5841,01	CHI
20201218422	APARECIDA DE GOIANIA	AP11171209	REAL S2	05/12/2020 12:52	05/12/2020 20:10	05/12/2020 13:18	05/12/2020 20:10	6,86	48	329,27	CHI
20201222933	APARECIDA DE GOIANIA	AP11171212	REAL S2	05/12/2020 12:52	06/12/2020 17:13	05/12/2020 13:18	06/12/2020 17:13	27,91	52	1451,26	CHI
20201218324	LEOPOLDO DE BULHOES	LB12353215	DAIA S2	05/12/2020 12:53	05/12/2020 14:32	05/12/2020 12:53	05/12/2020 14:32	1,63	49	80,10	CHI
20201218328	ANAPOLIS	20070135	JUNDIAI S2	05/12/2020 12:54	05/12/2020 14:20	05/12/2020 12:54	05/12/2020 14:20	1,43	1	1,43	CHI
20201218584	APARECIDA DE GOIANIA	00570294	REAL S2	05/12/2020 12:54	06/12/2020 01:07	05/12/2020 12:54	05/12/2020 12:59	0,08	258	19,42	CHI
20201218584	GOIANIA	00570294	REAL S2	05/12/2020 12:54	06/12/2020 01:07	05/12/2020 12:54	05/12/2020 13:01	0,10	174	17,83	CHI
20201218584	GOIANIA	GN16409413	REAL S2	05/12/2020 12:54	06/12/2020 01:07	05/12/2020 12:56	05/12/2020 13:01	0,07	302	22,23	CHI
20201218584	APARECIDA DE GOIANIA	00570294	REAL S2	05/12/2020 12:54	06/12/2020 01:07	05/12/2020 13:05	05/12/2020 17:53	4,81	578	2778,73	CHI
20201218584	GOIANIA	00570294	REAL S2	05/12/2020 12:54	06/12/2020 01:07	05/12/2020 12:54	06/12/2020 01:07	12,20	194	2367,77	CHI
20201218584	APARECIDA DE GOIANIA	00570294	REAL S2	05/12/2020 12:54	06/12/2020 01:07	05/12/2020 12:54	06/12/2020 01:07	12,20	995	12143,97	CHI
20201218584	APARECIDA DE GOIANIA	00570294	REAL S2	05/12/2020 12:54	06/12/2020 01:07	05/12/2020 12:56	06/12/2020 01:07	12,18	86	1047,15	CHI
20201218336	CORUMBA DE GOIAS	CB21203671	ANAPOLIS UNIVERSITARIO S1	05/12/2020 12:55	05/12/2020 23:37	05/12/2020 12:55	05/12/2020 23:37	10,70	1	10,70	CHI
20201218563	MINEIROS	MY12209755	PARQUE DAS EMAS	05/12/2020 12:55	05/12/2020 13:21	05/12/2020 12:55	05/12/2020 13:21	0,43	17	7,23	CHI
202012179324	FORMOSA	03740214	ITIQUEIRA	05/12/2020 12:55	05/12/2020 22:16	05/12/2020 12:55	05/12/2020 13:03	0,13	5216	683,88	CHI
202012179324	FORMOSA	FA16407040	ITIQUEIRA	05/12/2020 12:55	05/12/2020 22:16	05/12/2020 12:55	05/12/2020 13:26	0,52	1801	938,02	CHI
202012179324	FORMOSA	FA16416902	ITIQUEIRA	05/12/2020 12:55	05/12/2020 22:16	05/12/2020 12:55	05/12/2020 13:28	0,54	779	421,31	CHI
202012179324	FORMOSA	FA10376698	ITIQUEIRA	05/12/2020 12:55	05/12/2020 22:16	05/12/2020 12:55	05/12/2020 13:29	0,57	334	191,22	CHI
202012179324	FORMOSA	FA10396048	ITIQUEIRA	05/12/2020 12:55	05/12/2020 22:16	05/12/2020 12:55	05/12/2020 13:37	0,70	463	322,56	CHI
202012179324	FORMOSA	FA16408145	ITIQUEIRA	05/12/2020 12:55	05/12/2020 22:16	05/12/2020 12:55	05/12/2020 22:16	9,35	4022	37616,87	CHI
20201218348	GOIANIA	13626887	CARAJAS S2	05/12/2020 12:56	05/12/2020 15:20	05/12/2020 12:56	05/12/2020 15:20	2,40	1	2,40	CHI
20201218350	FORMOSA	FA21146122	ITIQUEIRA	05/12/2020 12:56	05/12/2020 20:35	05/12/2020 12:56	05/12/2020 20:35	7,65	1	7,65	CHI
20201219317	APARECIDA DE GOIANIA	AP12312943	REAL S1	05/12/2020 12:56	05/12/2020 16:44	05/12/2020 12:56	05/12/2020 16:44	3,79	1283	4864,00	CHI
20201218371	BOM JARDIM DE GOIAS	BM21241503	BOM JARDIM	05/12/2020 12:57	05/12/2020 14:13	05/12/2020 12:57	05/12/2020 14:13	1,27	1	1,27	CHI
20201219140	NIQUELANDIA	NQ12391958	NIQUELANDIA SUBTRANSMISSAO	05/12/2020 12:57	06/12/2020 09:10	05/12/2020 12:57	06/12/2020 09:10	20,21	22	444,68	CHI
20201218533	SANTA FE DE GOIAS	RN12072191	BRITANIA	05/12/2020 12:58	05/12/2020 14:30	05/12/2020 12:58	05/12/2020 14:30	1,53	11	16,86	CHI
20201218533	JUSSARA	RN12072191	BRITANIA	05/12/2020 12:58	05/12/2020 14:30	05/12/2020 12:58	05/12/2020 14:30	1,53	4	6,13	CHI
20201219098	PIRENOPOLIS	PV12302141	SAO FRANCISCO DE GOIAS	05/12/2020 12:58	05/12/2020 17:56	05/12/2020 12:58	05/12/2020 17:56	4,96	95	471,28	CHI
20201218518	GUARANI DE GOIAS	GY12180835	IACIARA S1	05/12/2020 13:00	05/12/2020 21:43	05/12/2020 13:00	05/12/2020 14:26	1,43	337	480,32	CHI
20201218518	IACIARA	GY12180835	IACIARA S1	05/12/2020 13:00	05/12/2020 21:43	05/12/2020 13:00	05/12/2020 14:26	1,43	2	2,85	CHI
20201218518	GUARANI DE GOIAS	GY12180835	IACIARA S1	05/12/2020 13:00	05/12/2020 21:43	05/12/2020 14:27	05/12/2020 16:48	2,35	74	174,25	CHI
20201218518	IACIARA	GY12262083LD	IACIARA S1	05/12/2020 13:00	05/12/2020 21:43	05/12/2020 14:27	05/12/2020 17:42	3,26	2	6,51	CHI
20201218518	GUARANI DE GOIAS	GY12262083LD	IACIARA S1	05/12/2020 13:00	05/12/2020 21:43	05/12/2020 14:27	05/12/2020 17:42	3,26	212	690,59	CHI
20201218518	GUARANI DE GOIAS	GY12267993	IACIARA S1	05/12/2020 13:00	05/12/2020 21:43	05/12/2020 14:27	05/12/2020 19:12	4,76	46	218,87	CHI
20201218518	GUARANI DE GOIAS	GY12344199	IACIARA S1	05/12/2020 13:00	05/12/2020 21:43	05/12/2020 14:27	05/12/2020 21:23	6,93	3	20,80	CHI
20201218518	GUARANI DE GOIAS	GY12268009LD	IACIARA S1	05/12/2020 13:00	05/12/2020 21:43	05/12/2020 14:27	05/12/2020 21:43	7,28	2	14,55	CHI
20201218875	GOIANIA	00570274	REAL S2	05/12/2020 13:00	05/12/2020 22:01	05/12/2020 21:56	05/12/2020 22:00	0,07	1672	119,83	CHI

20201218875	APARECIDA DE GOIANIA	00570274	REAL S2	05/12/2020 13:00	05/12/2020 22:01	05/12/2020 21:56	05/12/2020 22:00	0,07	1130	80,98	CHI
20201218875	GOIANIA	AP11048671	REAL S2	05/12/2020 13:00	05/12/2020 22:01	05/12/2020 13:00	05/12/2020 22:01	9,02	128	1153,92	CHI
20201219594	LEOPOLDO DE BULHOES	LB12012193	DAIA S2	05/12/2020 13:00	05/12/2020 21:07	05/12/2020 13:00	05/12/2020 21:07	8,11	193	1565,93	CHI
20201218405	RUBIATABA	RB12392305	RUBIATABA	05/12/2020 13:01	05/12/2020 15:39	05/12/2020 13:01	05/12/2020 15:39	2,63	15	39,50	CHI
20201218421	ANAPOLIS	10007245031	JUNDIAI S2	05/12/2020 13:03	05/12/2020 15:28	05/12/2020 13:03	05/12/2020 15:28	2,41	1	2,41	CHI
20201218437	GUARAITA	GK12299661	ITAPURANGA	05/12/2020 13:03	05/12/2020 14:53	05/12/2020 13:03	05/12/2020 14:53	1,82	16	29,13	CHI
20201218437	GOIAS	GK12299661	ITAPURANGA	05/12/2020 13:03	05/12/2020 14:53	05/12/2020 13:03	05/12/2020 14:53	1,82	20	36,41	CHI
20201218621	PIRENOPOLIS	PV12377430	GOIANESIA S1	05/12/2020 13:03	05/12/2020 20:28	05/12/2020 13:03	05/12/2020 20:28	7,40	10	74,05	CHI
20201218430	SANTO ANTONIO DO DESCOBERTO	SN11168710	ALEXANIA	05/12/2020 13:04	05/12/2020 16:07	05/12/2020 13:04	05/12/2020 16:07	3,05	115	350,30	CHI
20201218702	GOIANIA	GN11002225	REAL S2	05/12/2020 13:06	05/12/2020 22:00	05/12/2020 13:06	05/12/2020 22:00	8,89	176	1564,25	CHI
20201218819	GOIANIA	GN12001389	CAMPINAS S2	05/12/2020 13:06	05/12/2020 14:48	05/12/2020 13:06	05/12/2020 14:48	1,70	269	457,08	CHI
20201219239	AGUA FRIA DE GOIAS	PI12325588	SAO JOAO D ALIANCA	05/12/2020 13:06	05/12/2020 20:02	05/12/2020 13:06	05/12/2020 20:02	6,93	1	6,93	CHI
20201219239	PLANALTINA	PI12325588	SAO JOAO D ALIANCA	05/12/2020 13:06	05/12/2020 20:02	05/12/2020 13:06	05/12/2020 20:02	6,93	103	713,76	CHI
20201218454	PLANALTINA	PI21243000	PLANALTINA	05/12/2020 13:07	05/12/2020 21:04	05/12/2020 13:07	05/12/2020 21:04	7,94	1	7,94	CHI
20201218741	GOIANIA	GN11060939	REAL S2	05/12/2020 13:08	05/12/2020 17:42	05/12/2020 13:08	05/12/2020 17:42	4,55	76	345,99	CHI
20201218917	APARECIDA DE GOIANIA	AP11158615	REAL S1	05/12/2020 13:08	05/12/2020 15:30	05/12/2020 13:08	05/12/2020 15:30	2,36	81	190,87	CHI
20201219664	NIQUELANDIA	NQ12181071	NIQUELANDIA SUBTRANSMISSAO	05/12/2020 13:08	05/12/2020 17:58	05/12/2020 13:08	05/12/2020 17:58	4,82	16	77,15	CHI
20201218470	ITUMBIARA	690153454	PARANAIBA	05/12/2020 13:09	05/12/2020 17:02	05/12/2020 13:09	05/12/2020 17:02	3,88	1	3,88	CHI
20201218476	ABADIANA	AA21201386	CORUMBA	05/12/2020 13:10	05/12/2020 18:13	05/12/2020 13:10	05/12/2020 18:13	5,05	1	5,05	CHI
20201218514	NOVA IGUACU DE GOIAS	CX12134501	RUBIATABA	05/12/2020 13:10	05/12/2020 15:34	05/12/2020 13:10	05/12/2020 15:34	2,40	1	2,40	CHI
20201218514	CRIXAS	CX12134501	RUBIATABA	05/12/2020 13:10	05/12/2020 15:34	05/12/2020 13:10	05/12/2020 15:34	2,40	55	132,00	CHI
20201218735	GOIANIA	GN12133483	ATLANTICO S1	05/12/2020 13:10	05/12/2020 15:07	05/12/2020 13:10	05/12/2020 15:07	1,96	584	1142,69	CHI
20201218914	PLANALTINA	PI12100880	PLANALTINA	05/12/2020 13:10	05/12/2020 17:00	05/12/2020 13:10	05/12/2020 17:00	3,82	105	401,42	CHI
20201219562	GOIANIA	GN11167633	ATLANTICO S1	05/12/2020 13:10	05/12/2020 15:33	05/12/2020 13:10	05/12/2020 15:33	2,37	70	166,25	CHI
20201218909	APARECIDA DE GOIANIA	AP11166246	REAL S1	05/12/2020 13:11	05/12/2020 18:46	05/12/2020 13:11	05/12/2020 18:46	5,57	123	684,91	CHI
20201219051	APARECIDA DE GOIANIA	AP11005001	REAL S2	05/12/2020 13:12	05/12/2020 18:55	05/12/2020 13:12	05/12/2020 18:55	5,71	98	559,58	CHI
20201220315	GOIANIA	AP12048793	REAL S2	05/12/2020 13:12	05/12/2020 18:22	05/12/2020 13:12	05/12/2020 18:22	5,15	263	1354,82	CHI
20201218815	APARECIDA DE GOIANIA	AP11169108	REAL S1	05/12/2020 13:13	05/12/2020 14:58	05/12/2020 13:13	05/12/2020 14:58	1,75	238	416,30	CHI
20201218538	APARECIDA DE GOIANIA	200189827	INDEPENDENCIA S2	05/12/2020 13:14	05/12/2020 15:10	05/12/2020 13:14	05/12/2020 15:10	1,92	1	1,92	CHI
20201219139	APARECIDA DE GOIANIA	AP11157886	ATLANTICO S2	05/12/2020 13:15	05/12/2020 23:20	05/12/2020 13:15	05/12/2020 23:20	10,07	138	1390,08	CHI
20201219529	APARECIDA DE GOIANIA	AP12000273LD	REAL S2	05/12/2020 13:15	05/12/2020 16:28	05/12/2020 13:15	05/12/2020 16:28	3,20	1100	3524,89	CHI
20201218544	CAIAPONIA	CP21354312	CAIAPONIA	05/12/2020 13:16	05/12/2020 16:39	05/12/2020 13:16	05/12/2020 16:39	3,38	1	3,38	CHI
20201218551	MINEIROS	MY21374377	PARQUE DAS EMAS	05/12/2020 13:16	05/12/2020 16:18	05/12/2020 13:16	05/12/2020 16:18	3,02	1	3,02	CHI
20201219309	ITAPURANGA	IK12298409	ITAPURANGA	05/12/2020 13:16	06/12/2020 16:24	05/12/2020 13:16	06/12/2020 16:24	27,12	14	379,71	CHI
20201218561	GOIANIA	GN11002297	ATLANTICO S3	05/12/2020 13:17	05/12/2020 18:01	05/12/2020 13:17	05/12/2020 18:01	4,73	155	732,38	CHI
20201218701	APARECIDA DE GOIANIA	AP11036396	REAL S2	05/12/2020 13:17	05/12/2020 15:52	05/12/2020 13:17	05/12/2020 15:52	2,58	155	399,73	CHI
20201219169	GOIANIA	GN11001723	GOIANIA LESTE S3	05/12/2020 13:17	05/12/2020 15:00	05/12/2020 13:17	05/12/2020 15:00	1,71	97	166,06	CHI
20201221087	COCALZINHO DE GOIAS	ZN12041395	COCALZINHO	05/12/2020 13:17	06/12/2020 00:31	05/12/2020 13:17	06/12/2020 00:31	11,22	38	426,25	CHI
20201221087	CORUMBA DE GOIAS	ZN12041395	COCALZINHO	05/12/2020 13:17	06/12/2020 00:31	05/12/2020 13:17	06/12/2020 00:31	11,22	69	773,99	CHI
20201218580	SANTO ANTONIO DO DESCOBERTO	SN21265749	AGUAS LINDAS DE GOIAS S2	05/12/2020 13:18	05/12/2020 14:37	05/12/2020 13:18	05/12/2020 14:37	1,30	1	1,30	CHI
20201218925	GOIANIA	GN11001122	ATLANTICO S2	05/12/2020 13:18	06/12/2020 02:47	05/12/2020 13:18	06/12/2020 02:47	13,48	130	1752,18	CHI
20201222922	APARECIDA DE GOIANIA	AP11030731	REAL S2	05/12/2020 13:18	06/12/2020 04:05	05/12/2020 13:18	06/12/2020 04:05	14,78	163	2408,46	CHI
20201218583	ALEXANIA	AX21318552	ALEXANIA	05/12/2020 13:19	05/12/2020 14:36	05/12/2020 13:19	05/12/2020 14:36	1,28	1	1,28	CHI
20201218835	APARECIDA DE GOIANIA	AP12167646	REAL S1	05/12/2020 13:21	05/12/2020 21:12	05/12/2020 13:21	05/12/2020 21:12	7,84	189	1482,70	CHI
202012116501	GOIANIA	01760224	TRINDADE	05/12/2020 13:21	05/12/2020 20:35	05/12/2020 13:51	05/12/2020 13:57	0,10	55	5,61	CHI
202012116501	TRINDADE	01760224	TRINDADE	05/12/2020 13:21	05/12/2020 20:35	05/12/2020 13:51	05/12/2020 13:57	0,10	16222	1653,74	CHI
202012116501	SANTA BARBARA DE GOIAS	01760224	TRINDADE	05/12/2020 13:21	05/12/2020 20:35	05/12/2020 13:51	05/12/2020 13:57	0,10	23	2,34	CHI
202012116501	SANTA BARBARA DE GOIAS	TR13000010	TRINDADE	05/12/2020 13:21	05/12/2020 20:35	05/12/2020 15:03	05/12/2020 17:24	2,34	23	53,92	CHI
202012116501	TRINDADE	TR13000010	TRINDADE	05/12/2020 13:21	05/12/2020 20:35	05/12/2020 15:03	05/12/2020 17:24	2,34	12407	29084,08	CHI
202012116501	GOIANIA	TR13000010	TRINDADE	05/12/2020 13:21	05/12/2020 20:35	05/12/2020 15:03	05/12/2020 17:24	2,34	55	128,93	CHI
202012116501	TRINDADE	TR13407370	TRINDADE	05/12/2020 13:21	05/12/2020 20:35	05/12/2020 15:03	05/12/2020 17:44	2,69	3815	10269,77	CHI

202012116501	GOIANIA	TR16409407	TRINDADE	05/12/2020 13:21	05/12/2020 20:35	05/12/2020 17:32	05/12/2020 18:20	0,81	55	44,38	CHI
202012116501	TRINDADE	TR16409407	TRINDADE	05/12/2020 13:21	05/12/2020 20:35	05/12/2020 17:32	05/12/2020 18:20	0,81	1226	989,31	CHI
202012116501	TRINDADE	TR10384947	TRINDADE	05/12/2020 13:21	05/12/2020 20:35	05/12/2020 13:21	05/12/2020 19:08	5,78	897	5183,41	CHI
202012116501	TRINDADE	01760224	TRINDADE	05/12/2020 13:21	05/12/2020 20:35	05/12/2020 19:28	05/12/2020 19:44	0,27	4712	1253,92	CHI
202012116501	TRINDADE	TR10394746	TRINDADE	05/12/2020 13:21	05/12/2020 20:35	05/12/2020 13:21	05/12/2020 20:35	7,23	102	737,57	CHI
202012116501	SANTA BARBARA DE GOIAS	TR10394746	TRINDADE	05/12/2020 13:21	05/12/2020 20:35	05/12/2020 13:21	05/12/2020 20:35	7,23	25	180,78	CHI
202012116501	CATURAI	TR10394746	TRINDADE	05/12/2020 13:21	05/12/2020 20:35	05/12/2020 13:21	05/12/2020 20:35	7,23	14	101,24	CHI
202012116501	GOIANIRA	TR10394746	TRINDADE	05/12/2020 13:21	05/12/2020 20:35	05/12/2020 13:21	05/12/2020 20:35	7,23	53	383,25	CHI
20201218623	NIQUELANDIA	NQ11281233	NIQUELANDIA SUBTRANSMISSAO	05/12/2020 13:22	06/12/2020 08:24	05/12/2020 13:22	06/12/2020 08:24	19,02	1	19,02	CHI
20201219089	APARECIDA DE GOIANIA	AP11093008	REAL S2	05/12/2020 13:22	05/12/2020 18:47	05/12/2020 13:22	05/12/2020 18:47	5,40	78	421,57	CHI
20201218933	APARECIDA DE GOIANIA	AP11041278	REAL S2	05/12/2020 13:25	05/12/2020 18:24	05/12/2020 13:25	05/12/2020 18:24	4,97	213	1058,85	CHI
20201218648	SERRANOPOLIS	SX21336916	JATAI S1	05/12/2020 13:26	06/12/2020 23:32	05/12/2020 13:26	06/12/2020 23:32	34,10	2	68,20	CHI
20201218657	GOIANIA	10001915116	CARAJAS S1	05/12/2020 13:26	05/12/2020 15:30	05/12/2020 13:26	05/12/2020 15:30	2,06	1	2,06	CHI
20201219279	ITABERAI	HE12310804	ITABERAI S1	05/12/2020 13:26	06/12/2020 02:48	05/12/2020 13:26	06/12/2020 02:48	13,35	1	13,35	CHI
20201219279	HEITORAI	HE12310804	ITABERAI S1	05/12/2020 13:26	06/12/2020 02:48	05/12/2020 13:26	06/12/2020 02:48	13,35	21	280,37	CHI
20201221788	PIRENOPOLIS	PV11000021	CORUMBA	05/12/2020 13:26	05/12/2020 20:50	05/12/2020 13:26	05/12/2020 20:50	7,39	156	1152,28	CHI
20201218666	JATAI	JT21346054	JATAI S1	05/12/2020 13:27	06/12/2020 08:49	05/12/2020 13:27	06/12/2020 08:49	19,36	1	19,36	CHI
20201218726	MINACU	01970224	MINACU	05/12/2020 13:27	05/12/2020 17:09	05/12/2020 13:27	05/12/2020 13:32	0,09	5402	511,69	CHI
20201218726	MINACU	01970224	MINACU	05/12/2020 13:27	05/12/2020 17:09	05/12/2020 13:28	05/12/2020 13:32	0,08	9	0,74	CHI
20201218726	MINACU	01970224	MINACU	05/12/2020 13:27	05/12/2020 17:09	05/12/2020 13:27	05/12/2020 16:31	3,07	593	1822,65	CHI
20201218726	MINACU	01970224	MINACU	05/12/2020 13:27	05/12/2020 17:09	05/12/2020 13:27	05/12/2020 17:09	3,70	70	259,27	CHI
20201218774	FORMOSA	FA12131868	ITIQUEIRA	05/12/2020 13:27	05/12/2020 17:12	05/12/2020 13:27	05/12/2020 17:12	3,75	690	2585,39	CHI
20201219939	APARECIDA DE GOIANIA	AP12106526	REAL S1	05/12/2020 13:27	05/12/2020 19:31	05/12/2020 13:27	05/12/2020 19:31	6,05	239	1446,95	CHI
20201218669	PLANALTINA	PI21243161	PLANALTINA	05/12/2020 13:28	05/12/2020 22:23	05/12/2020 13:28	05/12/2020 22:23	8,91	1	8,91	CHI
20201219431	APARECIDA DE GOIANIA	15535472	REAL S2	05/12/2020 13:28	05/12/2020 19:54	05/12/2020 13:28	05/12/2020 19:54	6,42	1	6,42	CHI
20201218694	PORTELANDIA	PW21303438	PARQUE DAS EMAS	05/12/2020 13:30	05/12/2020 21:29	05/12/2020 13:30	05/12/2020 21:29	7,98	1	7,98	CHI
20201218696	GOIANIA	GN11001392	GOIANIA LESTE S1	05/12/2020 13:30	05/12/2020 14:29	05/12/2020 14:01	05/12/2020 14:29	0,47	17	7,93	CHI
20201219203	MORRO AGUDO DE GOIAS	MS12113277	ITAPURANGA	05/12/2020 13:30	05/12/2020 17:11	05/12/2020 13:30	05/12/2020 17:11	3,67	18	66,10	CHI
20201221229	APARECIDA DE GOIANIA	AP11167670	REAL S2	05/12/2020 13:30	05/12/2020 19:00	05/12/2020 13:30	05/12/2020 19:00	5,50	82	450,89	CHI
20201218706	URUTAI	PR12080258RE	URUTAI	05/12/2020 13:31	05/12/2020 15:12	05/12/2020 13:31	05/12/2020 15:12	1,67	63	105,24	CHI
20201218706	PIRES DO RIO	PR12080258RE	URUTAI	05/12/2020 13:31	05/12/2020 15:12	05/12/2020 13:31	05/12/2020 15:12	1,67	10	16,71	CHI
20201218708	ANAPOLIS	20668326	ANAPOLIS UNIVERSITARIO S2	05/12/2020 13:31	05/12/2020 15:04	05/12/2020 13:31	05/12/2020 15:04	1,55	1	1,55	CHI
20201218709	RIO QUENTE	CN12263786	RIO QUENTE	05/12/2020 13:31	05/12/2020 15:19	05/12/2020 13:31	05/12/2020 15:19	1,78	1	1,78	CHI
20201218709	CALDAS NOVAS	CN12263786	RIO QUENTE	05/12/2020 13:31	05/12/2020 15:19	05/12/2020 13:31	05/12/2020 15:19	1,78	35	62,43	CHI
20201218789	GOIANIA	GN16414460	ATLANTICO S3	05/12/2020 13:31	05/12/2020 13:35	05/12/2020 13:31	05/12/2020 13:34	0,05	716	39,18	CHI
20201218789	GOIANIA	GN10383773	ATLANTICO S3	05/12/2020 13:31	05/12/2020 13:35	05/12/2020 13:31	05/12/2020 13:35	0,06	6015	372,60	CHI
20201219009	PIRENOPOLIS	PV12084565	CORUMBA	05/12/2020 13:31	05/12/2020 22:33	05/12/2020 13:31	05/12/2020 22:33	9,03	10	90,25	CHI
20201218712	SENADOR CANEDO	SW11169127	CEPAIGO S1	05/12/2020 13:32	05/12/2020 14:59	05/12/2020 13:32	05/12/2020 14:59	1,45	6	8,69	CHI
20201218714	ITAPURANGA	IK21310376	ITAPURANGA	05/12/2020 13:32	05/12/2020 17:43	05/12/2020 13:32	05/12/2020 17:43	4,18	1	4,18	CHI
20201218718	ANAPOLIS	AN11101504	ANAPOLIS UNIVERSITARIO S2	05/12/2020 13:32	05/12/2020 14:44	05/12/2020 13:32	05/12/2020 14:44	1,19	188	223,30	CHI
20201218722	MINEIROS	MY12362701	PARQUE DAS EMAS	05/12/2020 13:33	05/12/2020 15:32	05/12/2020 13:33	05/12/2020 15:32	1,98	4	7,91	CHI
20201218725	DOVERLANDIA	DV21184323	CAIAPONIA	05/12/2020 13:33	05/12/2020 14:00	05/12/2020 13:33	05/12/2020 14:00	0,45	1	0,45	CHI
20201218731	ITABERAI	10017875070	ITABERAI S2	05/12/2020 13:34	05/12/2020 17:14	05/12/2020 13:34	05/12/2020 17:14	3,66	1	3,66	CHI
20201219032	PIRENOPOLIS	PV12000067	CORUMBA	05/12/2020 13:34	05/12/2020 21:59	05/12/2020 13:34	05/12/2020 21:59	8,40	19	159,62	CHI
20201218748	SAO FRANCISCO DE GOIAS	SF11335008	SAO FRANCISCO DE GOIAS	05/12/2020 13:36	05/12/2020 22:00	05/12/2020 13:36	05/12/2020 22:00	8,39	77	646,39	CHI
20201218760	FORMOSA	10003600651	ITIQUEIRA	05/12/2020 13:38	05/12/2020 22:53	05/12/2020 13:38	05/12/2020 22:53	9,25	1	9,25	CHI
20201218776	APARECIDA DE GOIANIA	10014057369	INDEPENDENCIA S1	05/12/2020 13:40	05/12/2020 20:10	05/12/2020 13:40	05/12/2020 20:10	6,50	1	6,50	CHI
20201218782	COCALZINHO DE GOIAS	ZN12377435	COCALZINHO	05/12/2020 13:40	06/12/2020 01:55	05/12/2020 13:40	06/12/2020 01:55	12,24	55	673,18	CHI
20201218830	CATALAO	CT12278138	CATALAO S1	05/12/2020 13:40	05/12/2020 20:47	05/12/2020 13:40	05/12/2020 20:47	7,11	2	14,21	CHI
20201219253	NIQUELANDIA	NQ12235660	NIQUELANDIA SUBTRANSMISSAO	05/12/2020 13:40	05/12/2020 21:12	05/12/2020 13:40	05/12/2020 21:12	7,52	154	1157,99	CHI
20201218787	URUACU	640096438	URUACU	05/12/2020 13:41	05/12/2020 18:27	05/12/2020 13:41	05/12/2020 18:27	4,77	1	4,77	CHI

20201218788	LUZIANIA	LZ12349145	MARAJOARA	05/12/2020 13:41	05/12/2020 17:02	05/12/2020 13:41	05/12/2020 17:02	3,35	2	6,69	CHI
20201218792	MONTE ALEGRE DE GOIAS	MA12212608	SAO DOMINGOS	05/12/2020 13:41	05/12/2020 15:33	05/12/2020 13:41	05/12/2020 15:33	1,86	54	100,23	CHI
20201220083	APARECIDA DE GOIANIA	AP12058923	REAL S1	05/12/2020 13:41	05/12/2020 17:40	05/12/2020 13:41	05/12/2020 17:40	3,97	199	790,25	CHI
20201218809	ANAPOLIS	AN12374471	JUNDIAI S2	05/12/2020 13:43	05/12/2020 15:45	05/12/2020 13:43	05/12/2020 15:45	2,02	154	311,85	CHI
20201218811	PLANALTINA	PI21251003	PLANALTINA	05/12/2020 13:43	06/12/2020 12:20	05/12/2020 13:43	06/12/2020 12:20	22,61	2	45,21	CHI
20201218814	SANTA FE DE GOIAS	1290053460	BRITANIA	05/12/2020 13:43	05/12/2020 16:30	05/12/2020 13:43	05/12/2020 16:30	2,78	1	2,78	CHI
20201219052	APARECIDA DE GOIANIA	AP11067637	REAL S2	05/12/2020 13:43	05/12/2020 18:14	05/12/2020 13:43	05/12/2020 18:14	4,51	147	662,48	CHI
20201219189	MINACU	IH12043797	MINACU	05/12/2020 13:43	05/12/2020 17:33	05/12/2020 13:43	05/12/2020 17:33	3,83	198	758,50	CHI
20201218816	APARECIDA DE GOIANIA	200052949	INDEPENDENCIA S1	05/12/2020 13:44	05/12/2020 16:05	05/12/2020 13:44	05/12/2020 16:05	2,35	1	2,35	CHI
20201218834	LUZIANIA	LZ10403912	MARAJOARA	05/12/2020 13:45	05/12/2020 17:10	05/12/2020 15:05	05/12/2020 15:11	0,10	1730	166,27	CHI
20201218834	LUZIANIA	LZ13409914B	MARAJOARA	05/12/2020 13:45	05/12/2020 17:10	05/12/2020 15:06	05/12/2020 17:10	2,08	9393	19500,91	CHI
20201218836	MONTES CLAROS DE GOIAS	ME12091493RE	IPORA	05/12/2020 13:45	05/12/2020 16:35	05/12/2020 13:45	05/12/2020 16:35	2,83	92	259,93	CHI
20201219247	IVOLANDIA	IV12062833	IPORA	05/12/2020 13:45	06/12/2020 09:30	05/12/2020 13:45	06/12/2020 09:30	19,74	18	355,35	CHI
20201218838	AGUAS LINDAS DE GOIAS	LA11282561	AGUAS LINDAS DE GOIAS S1	05/12/2020 13:46	05/12/2020 20:59	05/12/2020 13:46	05/12/2020 20:59	7,21	14	100,99	CHI
20201219301	CORUMBA DE GOIAS	CB21172010	CORUMBA	05/12/2020 13:46	05/12/2020 19:11	05/12/2020 13:46	05/12/2020 19:11	5,41	1	5,41	CHI
20201219649	BARRO ALTO	GE12000092	GOIANESIA S1	05/12/2020 13:46	05/12/2020 18:00	05/12/2020 13:46	05/12/2020 18:00	4,23	1	4,23	CHI
20201219649	GOIANESIA	GE12000092	GOIANESIA S1	05/12/2020 13:46	05/12/2020 18:00	05/12/2020 13:46	05/12/2020 18:00	4,23	7	29,58	CHI
20201220184	CORUMBA DE GOIAS	CB12258175	CORUMBA	05/12/2020 13:46	05/12/2020 20:22	05/12/2020 13:46	05/12/2020 20:22	6,59	32	210,91	CHI
20201218851	MINEIROS	MY12377570	PARQUE DAS EMAS	05/12/2020 13:47	05/12/2020 15:15	05/12/2020 13:47	05/12/2020 15:15	1,48	50	73,83	CHI
20201218854	INHUMAS	10018694100	INHUMAS S2	05/12/2020 13:47	05/12/2020 15:32	05/12/2020 13:47	05/12/2020 15:32	1,74	1	1,74	CHI
20201218860	LUZIANIA	LZ11097149	RIO VERMELHO	05/12/2020 13:48	05/12/2020 16:51	05/12/2020 13:48	05/12/2020 16:51	3,05	18	54,84	CHI
20201218861	SANTA HELENA DE GOIAS	400063050	IPEGUARI	05/12/2020 13:48	05/12/2020 17:07	05/12/2020 13:48	05/12/2020 17:07	3,31	1	3,31	CHI
20201218864	MORRO AGUDO DE GOIAS	MS12335823	ITAPURANGA	05/12/2020 13:48	05/12/2020 17:03	05/12/2020 13:48	05/12/2020 17:03	3,24	2	6,47	CHI
20201218865	PIRENOPOLIS	AN21362324	SAO FRANCISCO DE GOIAS	05/12/2020 13:48	05/12/2020 20:41	05/12/2020 13:48	05/12/2020 20:41	6,87	1	6,87	CHI
20201219300	ITAPACI	IW12044978	ITAPACI	05/12/2020 13:48	05/12/2020 21:47	05/12/2020 13:48	05/12/2020 21:47	7,97	6	47,83	CHI
20201219600	FAZENDA NOVA	FN12042812	JUSSARA	05/12/2020 13:48	05/12/2020 22:04	05/12/2020 13:48	05/12/2020 22:04	8,26	10	82,58	CHI
20201219655	FIRMINOPOLIS	FR11076436	FIRMINOPOLIS S1	05/12/2020 13:48	05/12/2020 16:48	05/12/2020 13:48	05/12/2020 16:48	3,00	134	401,66	CHI
20201219224	PIRENOPOLIS	PV11264950	CORUMBA	05/12/2020 13:49	05/12/2020 17:36	05/12/2020 13:49	05/12/2020 17:36	3,78	40	151,14	CHI
20201218881	CALDAZINHA	DE21123011	CEPAIGO S2	05/12/2020 13:50	05/12/2020 16:00	05/12/2020 13:50	05/12/2020 16:00	2,15	2	4,30	CHI
20201219214	GOIANIA	GN11050012	REAL S2	05/12/2020 13:51	05/12/2020 17:10	05/12/2020 13:51	05/12/2020 17:10	3,32	73	242,02	CHI
20201219297	MONTIVIDIU DO NORTE	MX12364161	PORANGATU	05/12/2020 13:51	06/12/2020 14:41	05/12/2020 13:51	05/12/2020 19:55	6,06	15	90,97	CHI
20201219297	MONTIVIDIU DO NORTE	MX12168971	PORANGATU	05/12/2020 13:51	06/12/2020 14:41	05/12/2020 13:51	05/12/2020 22:06	8,25	97	800,28	CHI
20201219297	TROMBAS	MX10400351	PORANGATU	05/12/2020 13:51	06/12/2020 14:41	06/12/2020 14:18	06/12/2020 14:41	0,38	24	9,09	CHI
20201219297	MONTIVIDIU DO NORTE	MX10400351	PORANGATU	05/12/2020 13:51	06/12/2020 14:41	06/12/2020 14:18	06/12/2020 14:41	0,38	458	173,40	CHI
20201219696	ANAPOLIS	AN12000617	DAIA S1	05/12/2020 13:51	05/12/2020 17:56	05/12/2020 13:51	05/12/2020 17:56	4,08	38	155,16	CHI
202012179339	MONTIVIDIU DO NORTE	MX10400351	PORANGATU	05/12/2020 13:51	07/12/2020 04:54	05/12/2020 13:51	05/12/2020 17:44	3,89	89	345,94	CHI
202012179339	TROMBAS	MX10400351	PORANGATU	05/12/2020 13:51	07/12/2020 04:54	05/12/2020 13:51	05/12/2020 17:44	3,89	24	93,29	CHI
202012179339	MONTIVIDIU DO NORTE	MX10400351	PORANGATU	05/12/2020 13:51	07/12/2020 04:54	05/12/2020 13:51	05/12/2020 19:14	5,38	257	1381,52	CHI
202012179339	MONTIVIDIU DO NORTE	MX10400351	PORANGATU	05/12/2020 13:51	07/12/2020 04:54	05/12/2020 13:51	07/12/2020 04:54	39,05	188	7340,62	CHI
20201218904	SAO FRANCISCO DE GOIAS	SF21319209	SAO FRANCISCO DE GOIAS	05/12/2020 13:52	05/12/2020 21:31	05/12/2020 13:52	05/12/2020 21:31	7,64	2	15,28	CHI
20201219372	ITABERAI	IB12250696	ITABERAI S1	05/12/2020 13:52	05/12/2020 17:00	05/12/2020 13:52	05/12/2020 17:00	3,13	44	137,62	CHI
20201219674	NIQUELANDIA	MJ18071960FS	PADRE BERNARDO	05/12/2020 13:52	05/12/2020 18:36	05/12/2020 13:52	05/12/2020 18:36	4,72	1	4,72	CHI
20201219674	MIMOSO DE GOIAS	MJ18071960FS	PADRE BERNARDO	05/12/2020 13:52	05/12/2020 18:36	05/12/2020 13:52	05/12/2020 18:36	4,72	160	755,02	CHI
20201218911	ANAPOLIS	OV13151409	NEROPOLIS S1	05/12/2020 13:53	05/12/2020 23:06	05/12/2020 17:34	05/12/2020 23:06	5,54	190	1053,18	CHI
20201218911	CAMPO LIMPO	OV13151409	NEROPOLIS S1	05/12/2020 13:53	05/12/2020 23:06	05/12/2020 17:34	05/12/2020 23:06	5,54	18	99,78	CHI
20201218911	PETROLINA DE GOIAS	OV13151409	NEROPOLIS S1	05/12/2020 13:53	05/12/2020 23:06	05/12/2020 17:34	05/12/2020 23:06	5,54	13	72,06	CHI
20201218911	PIRENOPOLIS	OV13151409	NEROPOLIS S1	05/12/2020 13:53	05/12/2020 23:06	05/12/2020 17:34	05/12/2020 23:06	5,54	48	266,07	CHI
20201218911	OURO VERDE DE GOIAS	OV13151409	NEROPOLIS S1	05/12/2020 13:53	05/12/2020 23:06	05/12/2020 17:34	05/12/2020 23:06	5,54	1444	8004,17	CHI
20201221698	CORUMBA DE GOIAS	CB12377740	CORUMBA	05/12/2020 13:54	05/12/2020 23:24	05/12/2020 13:54	05/12/2020 23:24	9,50	7	66,47	CHI
20201218929	SENADOR CANEDO	190039905	SENADOR CANEDO	05/12/2020 13:55	05/12/2020 16:00	05/12/2020 13:55	05/12/2020 16:00	2,08	1	2,08	CHI
20201218931	RIO VERDE	PU12314958	PARAUNA	05/12/2020 13:55	05/12/2020 23:18	05/12/2020 17:40	05/12/2020 19:16	1,61	2	3,22	CHI

20201218931	PARAUNA	PU12314958	PARAUNA	05/12/2020 13:55	05/12/2020 23:18	05/12/2020 17:40	05/12/2020 19:16	1,61	3	4,82	CHI
20201218931	PARAUNA	PU12314958	PARAUNA	05/12/2020 13:55	05/12/2020 23:18	05/12/2020 13:55	05/12/2020 23:18	9,38	1	9,38	CHI
20201218931	PARAUNA	PU12332613LD	PARAUNA	05/12/2020 13:55	05/12/2020 23:18	05/12/2020 17:40	05/12/2020 23:18	5,64	4	22,57	CHI
20201218939	SANTO ANTONIO DA BARRA	BZ21191786	ACREUNA	05/12/2020 13:56	05/12/2020 19:45	05/12/2020 13:56	05/12/2020 19:45	5,81	1	5,81	CHI
20201219492	ANAPOLIS	AN12327778	JUNDIAI S2	05/12/2020 13:56	05/12/2020 16:50	05/12/2020 13:56	05/12/2020 16:50	2,88	113	325,88	CHI
20201218945	ANAPOLIS	AN21270440	ANAPOLIS UNIVERSITARIO S2	05/12/2020 13:57	05/12/2020 17:23	05/12/2020 13:57	05/12/2020 17:23	3,43	1	3,43	CHI
20201217669	URUACU	UR12398066	CAMPINORTE	05/12/2020 13:58	05/12/2020 17:08	05/12/2020 13:58	05/12/2020 17:08	3,17	6	18,99	CHI
20201218967	SANTA RITA DO ARAGUAIA	SU21219471	SANTA RITA DO ARAGUAIA	05/12/2020 13:58	05/12/2020 21:27	05/12/2020 13:58	05/12/2020 21:27	7,47	1	7,47	CHI
20201221718	DIORAMA	DI12065691	IPORA	05/12/2020 13:58	06/12/2020 03:08	05/12/2020 13:58	06/12/2020 03:08	13,16	8	105,26	CHI
20201219003	CORUMBA DE GOIAS	CB21098043	CORUMBA	05/12/2020 14:02	06/12/2020 10:23	05/12/2020 14:02	06/12/2020 10:23	20,35	1	20,35	CHI
20201219006	GOIANIA	10014357516	MEIA PONTE	05/12/2020 14:02	05/12/2020 15:51	05/12/2020 14:02	05/12/2020 15:51	1,80	1	1,80	CHI
20201219040	GOIAS	GS10406621	GOIAS	05/12/2020 14:02	05/12/2020 15:11	05/12/2020 14:02	05/12/2020 14:17	0,25	487	120,80	CHI
20201219040	GOIAS	GS16410219	GOIAS	05/12/2020 14:02	05/12/2020 15:11	05/12/2020 14:02	05/12/2020 14:18	0,26	1294	332,13	CHI
20201219040	GOIAS	GS16410220	GOIAS	05/12/2020 14:02	05/12/2020 15:11	05/12/2020 14:02	05/12/2020 14:18	0,26	2351	613,87	CHI
20201219040	GOIAS	GS13183227	GOIAS	05/12/2020 14:02	05/12/2020 15:11	05/12/2020 14:27	05/12/2020 15:10	0,72	4132	2977,34	CHI
20201219040	GOIAS	GS10403938	GOIAS	05/12/2020 14:02	05/12/2020 15:11	05/12/2020 14:02	05/12/2020 15:11	1,15	939	1084,28	CHI
20201219013	ITABERAI	IB11268632	ITABERAI S2	05/12/2020 14:03	05/12/2020 16:29	05/12/2020 14:03	05/12/2020 16:29	2,43	94	227,98	CHI
20201219014	FAZENDA NOVA	FN12396224	JUSSARA	05/12/2020 14:03	06/12/2020 00:47	05/12/2020 14:03	06/12/2020 00:47	10,72	3	32,16	CHI
20201219016	GOIANIA	GN11043839	GOIANIA LESTE S2	05/12/2020 14:03	05/12/2020 21:41	05/12/2020 15:30	05/12/2020 21:41	6,18	64	395,75	CHI
20201219056	MOIPORA	SL10400789	SAO LUIZ DOS MONTES BELOS	05/12/2020 14:03	06/12/2020 15:49	05/12/2020 14:03	05/12/2020 16:10	2,12	13	27,56	CHI
20201219056	AURILANDIA	SL10400789	SAO LUIZ DOS MONTES BELOS	05/12/2020 14:03	06/12/2020 15:49	05/12/2020 14:03	05/12/2020 16:10	2,12	27	57,25	CHI
20201219056	SAO LUIS DE MONTES BELOS	SL10400789	SAO LUIZ DOS MONTES BELOS	05/12/2020 14:03	06/12/2020 15:49	05/12/2020 14:03	05/12/2020 16:10	2,12	17	36,04	CHI
20201219056	MOIPORA	SL10400789	SAO LUIZ DOS MONTES BELOS	05/12/2020 14:03	06/12/2020 15:49	05/12/2020 19:31	05/12/2020 19:46	0,25	13	3,26	CHI
20201219056	AURILANDIA	SL10400789	SAO LUIZ DOS MONTES BELOS	05/12/2020 14:03	06/12/2020 15:49	05/12/2020 19:31	05/12/2020 19:46	0,25	27	6,77	CHI
20201219056	SAO LUIS DE MONTES BELOS	SL10400789	SAO LUIZ DOS MONTES BELOS	05/12/2020 14:03	06/12/2020 15:49	05/12/2020 19:31	05/12/2020 19:46	0,25	17	4,26	CHI
20201219056	MOIPORA	MO12003717LD	SAO LUIZ DOS MONTES BELOS	05/12/2020 14:03	06/12/2020 15:49	05/12/2020 14:03	05/12/2020 20:54	6,86	7	48,00	CHI
20201219056	CORREGO DO OURO	MO12003717LD	SAO LUIZ DOS MONTES BELOS	05/12/2020 14:03	06/12/2020 15:49	05/12/2020 14:03	06/12/2020 15:49	25,77	1	25,77	CHI
20201219056	MOIPORA	MO12003717LD	SAO LUIZ DOS MONTES BELOS	05/12/2020 14:03	06/12/2020 15:49	05/12/2020 14:03	06/12/2020 15:49	25,77	1	25,77	CHI
20201219056	MOIPORA	SL12206016LD	SAO LUIZ DOS MONTES BELOS	05/12/2020 14:03	06/12/2020 15:49	05/12/2020 14:03	06/12/2020 15:49	25,77	4	103,09	CHI
20201219056	CORREGO DO OURO	SL12206016LD	SAO LUIZ DOS MONTES BELOS	05/12/2020 14:03	06/12/2020 15:49	05/12/2020 14:03	06/12/2020 15:49	25,77	69	1778,23	CHI
20201219233	APARECIDA DE GOIANIA	AP11161137	ATLANTICO S1	05/12/2020 14:03	05/12/2020 18:39	05/12/2020 14:03	05/12/2020 18:39	4,60	49	225,25	CHI
20201219886	PIRENOPOLIS	PV11200124	CORUMBA	05/12/2020 14:03	05/12/2020 18:15	05/12/2020 14:03	05/12/2020 18:15	4,20	127	533,19	CHI
20201219018	PIRENOPOLIS	PV31082463	SAO FRANCISCO DE GOIAS	05/12/2020 14:04	05/12/2020 19:49	05/12/2020 14:04	05/12/2020 19:49	5,75	1	5,75	CHI
20201219021	APARECIDA DE GOIANIA	10028484230	INDEPENDENCIA S1	05/12/2020 14:04	05/12/2020 16:41	05/12/2020 14:04	05/12/2020 16:41	2,61	0	0,00	CHI
20201215811	GUARINOS	GF12380720	SANTA TEREZINHA	05/12/2020 14:05	05/12/2020 18:59	05/12/2020 14:05	05/12/2020 18:59	4,90	17	83,29	CHI
20201219035	SAO DOMINGOS	SD12211512	SAO DOMINGOS	05/12/2020 14:05	05/12/2020 15:34	05/12/2020 14:05	05/12/2020 15:34	1,48	11	16,30	CHI
20201219037	ISRAELANDIA	IS12184272	IPORA	05/12/2020 14:05	05/12/2020 16:35	05/12/2020 14:05	05/12/2020 16:35	2,50	6	14,98	CHI
20201219042	ITARUMA	CC12075919	CACHOEIRA ALTA	05/12/2020 14:06	05/12/2020 23:42	05/12/2020 14:06	05/12/2020 23:42	9,60	4	38,39	CHI
20201219042	CACU	CC12075919	CACHOEIRA ALTA	05/12/2020 14:06	05/12/2020 23:42	05/12/2020 14:06	05/12/2020 23:42	9,60	1	9,60	CHI
20201219420	COCALZINHO DE GOIAS	ZN12084617	AGUAS LINDAS DE GOIAS S2	05/12/2020 14:06	05/12/2020 22:07	05/12/2020 14:06	05/12/2020 22:07	8,01	25	200,13	CHI
20201219488	ITABERAI	IB12300059RE	ITABERAI S2	05/12/2020 14:06	05/12/2020 17:38	05/12/2020 14:06	05/12/2020 17:38	3,53	16	56,45	CHI
20201219488	GOIAS	IB12300059RE	ITABERAI S2	05/12/2020 14:06	05/12/2020 17:38	05/12/2020 14:06	05/12/2020 17:38	3,53	67	236,38	CHI
20201219919	GOIAS	IU12060535	MATRINCHA	05/12/2020 14:08	05/12/2020 17:24	05/12/2020 14:08	05/12/2020 17:24	3,26	2	6,53	CHI
20201219919	ITAPIRAPUA	IU12060535	MATRINCHA	05/12/2020 14:08	05/12/2020 17:24	05/12/2020 14:08	05/12/2020 17:24	3,26	11	35,90	CHI
20201219065	MARA ROSA	MQ21168875	MARA ROSA	05/12/2020 14:09	05/12/2020 14:51	05/12/2020 14:09	05/12/2020 14:51	0,70	1	0,70	CHI
20201219068	MORRO AGUDO DE GOIAS	MS12376415	ITAPURANGA	05/12/2020 14:09	06/12/2020 09:32	05/12/2020 14:09	05/12/2020 09:32	19,38	9	174,43	CHI
20201219069	NIQUELANDIA	NQ21203463	NIQUELANDIA SUBTRANSMISSAO	05/12/2020 14:09	05/12/2020 16:34	05/12/2020 14:09	05/12/2020 16:34	2,41	2	4,83	CHI
20201219073	COCALZINHO DE GOIAS	ZN12148908	AGUAS LINDAS DE GOIAS S2	05/12/2020 14:09	06/12/2020 10:12	05/12/2020 14:09	06/12/2020 10:12	20,06	2	40,11	CHI
20201222584	COCALZINHO DE GOIAS	ZN12258078	COCALZINHO	05/12/2020 14:09	06/12/2020 02:41	05/12/2020 14:09	06/12/2020 02:41	12,53	57	713,93	CHI
20201219090	RIO QUENTE	CN21000053	RIO QUENTE	05/12/2020 14:11	05/12/2020 15:58	05/12/2020 14:11	05/12/2020 15:58	1,77	1	1,77	CHI
20201219091	FORMOSA	FA12085562	ITUIQUIRA	05/12/2020 14:11	06/12/2020 02:57	05/12/2020 14:11	06/12/2020 02:57	12,75	4	51,02	CHI

20201219095	ANAPOLIS	20991484	ANAPOLIS UNIVERSITARIO S1	05/12/2020 14:12	05/12/2020 21:34	05/12/2020 14:12	05/12/2020 21:34	7,37	1	7,37	CHI
20201219104	NOVA AURORA	NE21328662	CATALAO S1	05/12/2020 14:13	05/12/2020 19:00	05/12/2020 14:13	05/12/2020 19:00	4,77	1	4,77	CHI
20201219161	CORUMBA DE GOIAS	CB12382200	CORUMBA	05/12/2020 14:14	06/12/2020 10:23	05/12/2020 14:14	06/12/2020 10:23	20,15	52	1047,66	CHI
20201219126	MINEIROS	MY11264731	PARQUE DAS EMAS	05/12/2020 14:16	05/12/2020 21:01	05/12/2020 14:16	05/12/2020 21:01	6,74	153	1030,62	CHI
20201219384	ANAPOLIS	NR12402742	NEROPOLIS S2	05/12/2020 14:16	05/12/2020 21:40	05/12/2020 14:16	05/12/2020 21:40	7,39	8	59,14	CHI
20201221016	BOM JARDIM DE GOIAS	BM11005053	BOM JARDIM	05/12/2020 14:16	05/12/2020 21:25	05/12/2020 14:16	05/12/2020 21:25	7,14	133	949,21	CHI
20201220596	GOIANIA	GN11042133	ATLANTICO S3	05/12/2020 14:17	05/12/2020 21:02	05/12/2020 14:17	05/12/2020 21:02	6,75	103	695,14	CHI
20201219396	CAMPO LIMPO	OV12319822	NEROPOLIS S1	05/12/2020 14:18	05/12/2020 16:58	05/12/2020 14:18	05/12/2020 16:58	2,66	9	23,92	CHI
20201219396	OURO VERDE DE GOIAS	OV12319822	NEROPOLIS S1	05/12/2020 14:18	05/12/2020 16:58	05/12/2020 14:18	05/12/2020 16:58	2,66	42	111,65	CHI
20201219759	GOIANIA	AP11251713	REAL S2	05/12/2020 14:19	06/12/2020 03:22	05/12/2020 14:19	06/12/2020 03:22	13,04	89	1160,21	CHI
20201219150	NIQUELANDIA	NQ12384323	URUACU	05/12/2020 14:20	05/12/2020 17:28	05/12/2020 14:20	05/12/2020 17:28	3,13	1	3,13	CHI
20201220156	MIMOSO DE GOIAS	MJ12313854	PADRE BERNARDO	05/12/2020 14:20	05/12/2020 19:16	05/12/2020 14:20	05/12/2020 19:16	4,92	21	103,29	CHI
20201219160	ITAPURANGA	IK21234751	ITAPURANGA	05/12/2020 14:21	05/12/2020 23:31	05/12/2020 14:21	05/12/2020 23:31	9,16	1	9,16	CHI
20201219170	NOVO PLANALTO	TA12365617	SAO MIGUEL DO ARAGUAIA	05/12/2020 14:23	06/12/2020 03:44	05/12/2020 14:23	06/12/2020 03:44	13,34	1	13,34	CHI
20201219174	GOIANIA	10015864454	GOYA S2	05/12/2020 14:23	05/12/2020 16:24	05/12/2020 14:23	05/12/2020 16:24	2,01	1	2,01	CHI
20201219176	LUZIANIA	LZ12351402	MARAJORA	05/12/2020 14:23	05/12/2020 19:19	05/12/2020 14:23	05/12/2020 19:19	4,92	2	9,85	CHI
20201220100	MINACU	IH11208570	MINACU	05/12/2020 14:23	05/12/2020 17:30	05/12/2020 14:23	05/12/2020 17:30	3,11	110	342,25	CHI
20201219314	BALIZA	BH10400432	CAIAPONIA	05/12/2020 14:24	06/12/2020 18:57	05/12/2020 14:24	06/12/2020 18:57	28,54	396	11302,61	CHI
20201219182	AMARALINA	LC21334391	MARA ROSA	05/12/2020 14:25	05/12/2020 16:26	05/12/2020 14:25	05/12/2020 16:26	2,01	1	2,01	CHI
20201219185	MORRINHOS	MR12105036	MORRINHOS	05/12/2020 14:25	05/12/2020 15:42	05/12/2020 14:25	05/12/2020 15:42	1,27	16	20,40	CHI
20201219204	GOIAS	GS12061668	ITABERAI S1	05/12/2020 14:26	05/12/2020 22:00	05/12/2020 14:26	05/12/2020 22:00	7,56	18	136,07	CHI
20201219208	BELA VISTA DE GOIAS	SW21094029	CEPAIGO S2	05/12/2020 14:27	05/12/2020 16:50	05/12/2020 14:27	05/12/2020 16:50	2,37	2	4,74	CHI
20201219251	GOIANIA	GN11001588	ATLANTICO S3	05/12/2020 14:27	05/12/2020 16:26	05/12/2020 14:27	05/12/2020 16:26	1,98	85	168,21	CHI
20201219313	VARJAO	VJ12066127	GUAPU S2	05/12/2020 14:27	06/12/2020 09:02	05/12/2020 14:27	06/12/2020 09:02	18,58	31	576,03	CHI
20201219255	MOSSAMEDES	MD12062634RE	ITABERAI S1	05/12/2020 14:28	05/12/2020 17:12	05/12/2020 14:28	05/12/2020 17:12	2,72	201	546,89	CHI
20201219255	GOIAS	MD12062634RE	ITABERAI S1	05/12/2020 14:28	05/12/2020 17:12	05/12/2020 14:28	05/12/2020 17:12	2,72	7	19,05	CHI
20201219255	ITABERAI	MD12062634RE	ITABERAI S1	05/12/2020 14:28	05/12/2020 17:12	05/12/2020 14:28	05/12/2020 17:12	2,72	4	10,88	CHI
20201219622	GOIAS	GS12310470	ITABERAI S1	05/12/2020 14:30	07/12/2020 16:09	05/12/2020 14:30	07/12/2020 16:09	49,66	3	148,99	CHI
20201219523	MINEIROS	MY12043893	PARQUE DAS EMAS	05/12/2020 14:31	06/12/2020 10:59	05/12/2020 14:31	06/12/2020 10:59	20,47	4	81,87	CHI
20201220067	GOIAS	GS12310766	GOIAS	05/12/2020 14:32	06/12/2020 11:45	05/12/2020 14:32	06/12/2020 11:45	21,21	17	360,57	CHI
20201219260	COCALZINHO DE GOIAS	ZN21211792	AGUAS LINDAS DE GOIAS S2	05/12/2020 14:34	05/12/2020 22:51	05/12/2020 14:34	05/12/2020 22:51	8,27	1	8,27	CHI
20201219264	JATAI	JT1000209	JATAI S1	05/12/2020 14:35	06/12/2020 08:11	05/12/2020 14:35	06/12/2020 08:11	17,59	1	17,59	CHI
20201219656	PIRENOPOLIS	PV11065967	CORUMBA	05/12/2020 14:35	05/12/2020 19:23	05/12/2020 14:35	05/12/2020 19:23	4,79	97	464,44	CHI
20201219273	GOIANIA	GN11168957	FERROVIARIO S2	05/12/2020 14:36	05/12/2020 16:48	05/12/2020 15:16	05/12/2020 16:48	1,53	51	78,20	CHI
20201219486	GOIANIA	GN11002229	REAL S2	05/12/2020 14:36	05/12/2020 18:16	05/12/2020 14:36	05/12/2020 18:16	3,66	109	398,64	CHI
20201219434	CALDAZINHA	SW12218045	CEPAIGO S2	05/12/2020 14:37	05/12/2020 17:49	05/12/2020 14:37	05/12/2020 17:49	3,19	3	9,57	CHI
20201220335	SILVANIA	SV12383419	DAIA S2	05/12/2020 14:37	06/12/2020 00:44	05/12/2020 14:37	06/12/2020 00:44	10,12	6	60,73	CHI
20201219290	RIO VERDE	RV21260147	RIO VERDE S2	05/12/2020 14:38	05/12/2020 17:42	05/12/2020 14:38	05/12/2020 17:42	3,06	1	3,06	CHI
20201219413	ANAPOLIS	AN12381219	NEROPOLIS S1	05/12/2020 14:39	06/12/2020 13:36	05/12/2020 14:39	06/12/2020 13:36	22,93	1	22,93	CHI
20201219413	CAMPO LIMPO	AN12381219	NEROPOLIS S1	05/12/2020 14:39	06/12/2020 13:36	05/12/2020 14:39	06/12/2020 13:36	22,93	3	68,80	CHI
20201219326	GOIANESIA	10025583237	GOIANESIA S2	05/12/2020 14:42	05/12/2020 19:47	05/12/2020 14:42	05/12/2020 19:47	5,08	1	5,08	CHI
20201219331	MINEIROS	MY12348865	PARQUE DAS EMAS	05/12/2020 14:42	05/12/2020 21:56	05/12/2020 14:42	05/12/2020 21:56	7,22	1	7,22	CHI
20201219788	PADRE BERNARDO	PB12084665	PADRE BERNARDO	05/12/2020 14:42	05/12/2020 18:25	05/12/2020 14:42	05/12/2020 18:25	3,70	58	214,87	CHI
20201219333	AGUAS LINDAS DE GOIAS	10000770246	AGUAS LINDAS DE GOIAS S1	05/12/2020 14:43	05/12/2020 16:05	05/12/2020 14:43	05/12/2020 16:05	1,36	1	1,36	CHI
20201219340	ITAPIRAPUA	IU11000008	MATRINCHA	05/12/2020 14:44	05/12/2020 15:50	05/12/2020 14:44	05/12/2020 15:50	1,09	101	109,87	CHI
20201219346	GAMELEIRA DE GOIAS	SV12199935	DAIA S2	05/12/2020 14:45	06/12/2020 09:28	05/12/2020 14:45	06/12/2020 09:28	18,70	6	112,20	CHI
20201219357	MINEIROS	MY12360756	PARQUE DAS EMAS	05/12/2020 14:45	06/12/2020 12:16	05/12/2020 14:45	06/12/2020 12:16	21,50	6	129,01	CHI
20201219478	GOIANAPOLIS	TJ12389754	DAIA S2	05/12/2020 14:47	05/12/2020 20:13	05/12/2020 14:47	05/12/2020 20:13	5,43	2	10,86	CHI
20201219478	TEREZOPOLIS DE GOIAS	TJ12389754	DAIA S2	05/12/2020 14:47	05/12/2020 20:13	05/12/2020 14:47	05/12/2020 20:13	5,43	20	108,56	CHI
20201222242	GUARANI DE GOIAS	GY12268482	SAO DOMINGOS	05/12/2020 14:47	05/12/2020 23:19	05/12/2020 14:47	05/12/2020 23:19	8,53	21	179,11	CHI
20201219358	ITABERAI	IB12220541	ITABERAI S1	05/12/2020 14:48	05/12/2020 16:19	05/12/2020 14:48	05/12/2020 16:19	1,51	4	6,03	CHI

20201219359	MINEIROS	10007945580	PARQUE DAS EMAS	05/12/2020 14:48	05/12/2020 21:34	05/12/2020 14:48	05/12/2020 21:34	6,76	1	6,76	CHI
20201221417	GOIAS	GS12063133	GOIAS	05/12/2020 14:48	05/12/2020 19:12	05/12/2020 14:48	05/12/2020 19:12	4,39	76	333,28	CHI
20201219365	NOVA ROMA	ND12256420	IACIARA S2	05/12/2020 14:49	05/12/2020 16:20	05/12/2020 14:49	05/12/2020 16:20	1,51	30	45,30	CHI
20201219369	LUZIANIA	KR12080375	PAMPLONA	05/12/2020 14:49	05/12/2020 18:18	05/12/2020 14:49	05/12/2020 18:18	3,47	1	3,47	CHI
20201219893	MINEIROS	MY12209755	PARQUE DAS EMAS	05/12/2020 14:49	05/12/2020 23:19	05/12/2020 14:49	05/12/2020 23:19	8,48	17	144,23	CHI
20201220597	GOIANIA	GN11363024	ATLANTICO S3	05/12/2020 14:49	05/12/2020 22:38	05/12/2020 14:49	05/12/2020 22:38	7,81	76	593,88	CHI
20201219377	ITABERAI	19625436	ITABERAI S1	05/12/2020 14:50	06/12/2020 00:42	05/12/2020 14:50	06/12/2020 00:42	9,86	12	118,29	CHI
20201219584	DAMOLANDIA	IN12014368	INHUMAS S1	05/12/2020 14:50	05/12/2020 18:49	05/12/2020 14:50	05/12/2020 18:49	3,97	63	250,09	CHI
20201219584	INHUMAS	IN12014368	INHUMAS S1	05/12/2020 14:50	05/12/2020 18:49	05/12/2020 14:50	05/12/2020 18:49	3,97	55	218,33	CHI
20201219584	PETROLINA DE GOIAS	IN12014368	INHUMAS S1	05/12/2020 14:50	05/12/2020 18:49	05/12/2020 14:50	05/12/2020 18:49	3,97	6	23,82	CHI
20201219738	DOVERLANDIA	DV12138406	CAIAPONIA	05/12/2020 14:50	05/12/2020 19:20	05/12/2020 14:50	05/12/2020 19:20	4,49	12	53,87	CHI
20201219386	IPORA	IR11091245	IPORA	05/12/2020 14:51	05/12/2020 20:29	05/12/2020 14:51	05/12/2020 20:29	5,63	76	427,80	CHI
20201219391	FAINA	FC12274382	GOIAS	05/12/2020 14:51	06/12/2020 01:41	05/12/2020 14:51	06/12/2020 01:41	10,82	5	54,10	CHI
20201219484	GOIANIA	GN11000702	REAL S2	05/12/2020 14:51	05/12/2020 20:04	05/12/2020 14:51	05/12/2020 20:04	5,21	38	197,93	CHI
20201220048	GOIAS	GS12206917	ITABERAI S1	05/12/2020 14:51	05/12/2020 17:35	05/12/2020 14:51	05/12/2020 17:35	2,73	13	35,50	CHI
20201219445	PIRACANJUBA	MR12015135	MORRINHOS	05/12/2020 14:52	05/12/2020 19:31	05/12/2020 14:52	05/12/2020 19:31	4,65	1	4,65	CHI
20201219445	MORRINHOS	MR12015135	MORRINHOS	05/12/2020 14:52	05/12/2020 19:31	05/12/2020 14:52	05/12/2020 19:31	4,65	10	46,49	CHI
20201219588	GOIANIA	GN11001953	ATLANTICO S3	05/12/2020 14:52	05/12/2020 23:49	05/12/2020 14:52	05/12/2020 23:49	8,95	69	617,49	CHI
20201219467	ARAGOIANIA	AO10400702	GUAPO S2	05/12/2020 14:54	06/12/2020 20:38	05/12/2020 14:54	05/12/2020 22:56	8,04	20	160,88	CHI
20201219467	GUAPO	AO10400702	GUAPO S2	05/12/2020 14:54	06/12/2020 20:38	05/12/2020 14:54	05/12/2020 22:56	8,04	12	96,53	CHI
20201219467	GUAPO	AO10400702	GUAPO S2	05/12/2020 14:54	06/12/2020 20:38	05/12/2020 14:54	06/12/2020 20:38	29,74	36	1070,66	CHI
20201220108	CAIAPONIA	CP12036958RE	CAIAPONIA	05/12/2020 14:54	05/12/2020 19:52	05/12/2020 14:54	05/12/2020 19:52	4,95	79	391,12	CHI
20201219417	OUVIDOR	OU21306717	CATALAO S1	05/12/2020 14:55	05/12/2020 18:17	05/12/2020 14:55	05/12/2020 18:17	3,36	1	3,36	CHI
20201219428	PEROLANDIA	DP12103843LD	JATAI S1	05/12/2020 14:56	05/12/2020 16:38	05/12/2020 14:56	05/12/2020 16:38	1,70	13	22,07	CHI
20201219430	DAMOLANDIA	DL121200258	INHUMAS S1	05/12/2020 14:56	05/12/2020 19:14	05/12/2020 14:56	05/12/2020 19:14	4,30	2	8,59	CHI
20201222022	MINEIROS	MY12296343	PARQUE DAS EMAS	05/12/2020 14:58	05/12/2020 20:42	05/12/2020 14:58	05/12/2020 20:42	5,72	9	51,46	CHI
20201219452	PADRE BERNARDO	PB21256575	PADRE BERNARDO	05/12/2020 14:59	06/12/2020 11:49	05/12/2020 14:59	06/12/2020 11:49	20,83	1	20,83	CHI
20201219455	GOIANIA	14163834	SENADOR CANEDO	05/12/2020 14:59	05/12/2020 16:02	05/12/2020 14:59	05/12/2020 16:02	1,05	1	1,05	CHI
20201220380	MONTE ALEGRE DE GOIAS	SD12322677	SAO DOMINGOS	05/12/2020 14:59	05/12/2020 20:05	05/12/2020 14:59	05/12/2020 20:05	5,10	1	5,10	CHI
20201220380	SAO DOMINGOS	SD12322677	SAO DOMINGOS	05/12/2020 14:59	05/12/2020 20:05	05/12/2020 14:59	05/12/2020 20:05	5,10	36	183,59	CHI
20201220380	NOVA ROMA	SD12322677	SAO DOMINGOS	05/12/2020 14:59	05/12/2020 20:05	05/12/2020 14:59	05/12/2020 20:05	5,10	3	15,30	CHI
20201221372	ABADIA DE GOIAS	AO11007315	INDEPENDENCIA S2	05/12/2020 14:59	05/12/2020 22:06	05/12/2020 14:59	05/12/2020 22:06	7,11	17	120,91	CHI
20201219479	DOVERLANDIA	DV21123926	CAIAPONIA	05/12/2020 15:01	05/12/2020 21:25	05/12/2020 15:01	05/12/2020 21:25	6,39	1	6,39	CHI
20201220968	SANTO ANTONIO DE GOIAS	BW11312966	NEROPOLIS S1	05/12/2020 15:02	06/12/2020 04:08	05/12/2020 15:02	06/12/2020 04:08	13,09	34	445,21	CHI
20201219811	GOIANIA	GN11169149	ATLANTICO S2	05/12/2020 15:03	05/12/2020 21:49	05/12/2020 15:03	05/12/2020 21:49	6,76	83	561,38	CHI
20201222784	VIANOPOLIS	VN11048844	VIANOPOLIS	05/12/2020 15:03	06/12/2020 12:21	06/12/2020 07:07	06/12/2020 12:21	5,22	126	658,17	CHI
20201219503	SAO DOMINGOS	8680009443	SAO DOMINGOS	05/12/2020 15:04	05/12/2020 16:50	05/12/2020 15:04	05/12/2020 16:50	1,76	1	1,76	CHI
20201219975	DISTRITO FEDERAL	IJ12200617	ITAJA S2	05/12/2020 15:04	05/12/2020 18:05	05/12/2020 15:04	05/12/2020 18:05	3,01	2	6,03	CHI
20201219975	ITAJA	IJ12200617	ITAJA S2	05/12/2020 15:04	05/12/2020 18:05	05/12/2020 15:04	05/12/2020 18:05	3,01	5	15,07	CHI
202012179341	FAZENDA NOVA	FN21146335	BRITANIA	05/12/2020 15:04	06/12/2020 18:23	05/12/2020 15:04	06/12/2020 18:23	27,32	1	27,32	CHI
20201219508	JATAI	10029753072	JATAI S3	05/12/2020 15:05	06/12/2020 07:06	05/12/2020 15:05	06/12/2020 07:06	16,02	1	16,02	CHI
20201219510	APARECIDA DE GOIANIA	200075366	INDEPENDENCIA S1	05/12/2020 15:05	05/12/2020 16:29	05/12/2020 15:05	05/12/2020 16:29	1,40	1	1,40	CHI
20201219645	COCALZINHO DE GOIAS	CB12043409	COCALZINHO	05/12/2020 15:05	06/12/2020 01:28	05/12/2020 15:05	06/12/2020 01:28	10,37	20	207,42	CHI
20201220157	GOIAS	GS12073672	MATRINCHA	05/12/2020 15:05	06/12/2020 09:01	05/12/2020 15:05	06/12/2020 09:01	17,92	38	681,01	CHI
20201220157	ITAPIRAPUA	GS12073672	MATRINCHA	05/12/2020 15:05	06/12/2020 09:01	05/12/2020 15:05	06/12/2020 09:01	17,92	1	17,92	CHI
20201220157	NOVO BRASIL	GS12073672	MATRINCHA	05/12/2020 15:05	06/12/2020 09:01	05/12/2020 15:05	06/12/2020 09:01	17,92	36	645,17	CHI
20201222442	MORRO AGUDO DE GOIAS	MS12247285	ITAPURANGA	05/12/2020 15:05	06/12/2020 11:10	05/12/2020 15:05	06/12/2020 11:10	20,08	4	80,31	CHI
20201219524	AMERICANO DO BRASIL	KB12065192	ANICUNS	05/12/2020 15:06	05/12/2020 16:26	05/12/2020 15:06	05/12/2020 16:26	1,33	11	14,64	CHI
20201219553	FORMOSA	FA12007784	ITUIQUIRA	05/12/2020 15:06	05/12/2020 16:08	05/12/2020 15:06	05/12/2020 16:08	1,02	66	67,56	CHI
20201219571	ITAPIRAPUA	IU12057824	MATRINCHA	05/12/2020 15:06	05/12/2020 17:14	05/12/2020 15:06	05/12/2020 17:14	2,13	46	98,01	CHI
20201220408	VILA PROPICIO	7587203	GOIANESIA S1	05/12/2020 15:06	05/12/2020 19:56	05/12/2020 15:06	05/12/2020 19:56	4,82	86	414,73	CHI

20201219548	CAMPO LIMPO	CV21371777	NEROPOLIS S1	05/12/2020 15:07	06/12/2020 00:23	05/12/2020 15:07	06/12/2020 00:23	9,26	1	9,26	CHI
20201219550	GOIANIRA	20352691	GOIANIRA	05/12/2020 15:07	05/12/2020 21:18	05/12/2020 15:07	05/12/2020 21:18	6,17	5	30,87	CHI
20201219551	APARECIDA DO RIO DOCE	CC12170574	CACHOEIRA ALTA	05/12/2020 15:07	05/12/2020 22:41	05/12/2020 15:07	05/12/2020 22:41	7,56	10	75,56	CHI
20201219551	CACU	CC12170574	CACHOEIRA ALTA	05/12/2020 15:07	05/12/2020 22:41	05/12/2020 15:07	05/12/2020 22:41	7,56	88	664,96	CHI
20201220054	GOIAS	GS12220498	GOIAS	05/12/2020 15:07	05/12/2020 19:04	05/12/2020 15:07	05/12/2020 19:04	3,94	46	181,18	CHI
20201219560	PIRES DO RIO	PR21300875	PIRES DO RIO S1	05/12/2020 15:08	07/12/2020 15:39	05/12/2020 15:08	07/12/2020 15:39	48,52	2	97,03	CHI
20201219575	SANTA HELENA DE GOIAS	SH12033707	IPEGUARI	05/12/2020 15:08	05/12/2020 20:22	05/12/2020 15:08	05/12/2020 20:22	5,23	6	31,39	CHI
20201219575	RIO VERDE	SH12033707	IPEGUARI	05/12/2020 15:08	05/12/2020 20:22	05/12/2020 15:08	05/12/2020 20:22	5,23	1	5,23	CHI
20201219566	RIO VERDE	RV21384676	CABRIUVA S2	05/12/2020 15:09	05/12/2020 22:08	05/12/2020 15:09	05/12/2020 22:08	6,98	1	6,98	CHI
20201220697	GOIANIA	AP12312906	REAL S2	05/12/2020 15:09	05/12/2020 18:22	05/12/2020 15:09	05/12/2020 18:22	3,20	13	41,63	CHI
20201219573	MINEIROS	MY21260345	PARQUE DAS EMAS	05/12/2020 15:10	05/12/2020 17:07	05/12/2020 15:10	05/12/2020 17:07	1,95	1	1,95	CHI
20201220409	GOIANIA	GN12168434	GOIANIA LESTE S2	05/12/2020 15:10	05/12/2020 20:09	05/12/2020 15:10	05/12/2020 20:09	4,97	189	938,86	CHI
20201219581	GOIANIA	10001276032	CAMPINAS S1	05/12/2020 15:11	05/12/2020 16:31	05/12/2020 15:11	05/12/2020 16:31	1,33	1	1,33	CHI
20201220047	MIMOSO DE GOIAS	MU12304747	PADRE BERNARDO	05/12/2020 15:11	05/12/2020 19:59	05/12/2020 15:11	05/12/2020 19:59	4,78	7	33,49	CHI
20201219596	RIO QUENTE	2530023524	RIO QUENTE	05/12/2020 15:12	05/12/2020 17:46	05/12/2020 15:12	05/12/2020 17:46	2,55	1	2,55	CHI
20201219599	ITAJA	IJ12370148	ITAJA S2	05/12/2020 15:12	05/12/2020 20:39	05/12/2020 15:12	05/12/2020 20:39	5,44	2	10,87	CHI
20201219608	GOIAS	GS12249339	MATRINCHA	05/12/2020 15:13	06/12/2020 17:10	05/12/2020 15:13	06/12/2020 17:10	25,94	10	259,36	CHI
20201219844	MINEIROS	MY12278397	PARQUE DAS EMAS	05/12/2020 15:13	05/12/2020 21:21	05/12/2020 15:13	05/12/2020 21:21	6,12	5	30,61	CHI
20201219844	SERRANOPOLIS	MY12278397	PARQUE DAS EMAS	05/12/2020 15:13	05/12/2020 21:21	05/12/2020 15:13	05/12/2020 21:21	6,12	7	42,86	CHI
20201220644	GOIAS	GS12073710	MATRINCHA	05/12/2020 15:13	05/12/2020 21:55	05/12/2020 15:13	05/12/2020 21:55	6,70	13	87,08	CHI
20201219612	CAIAPONIA	DP21182186	JATAI S1	05/12/2020 15:14	06/12/2020 08:37	05/12/2020 15:14	06/12/2020 08:37	17,37	1	17,37	CHI
20201222244	SAO JOAO D ALIANCA	3840024818	SAO JOAO D ALIANCA	05/12/2020 15:14	05/12/2020 19:54	05/12/2020 15:14	05/12/2020 19:54	4,66	1	4,66	CHI
20201219619	BRITANIA	AK12028880	BRITANIA	05/12/2020 15:15	07/12/2020 13:31	05/12/2020 15:15	06/12/2020 12:00	20,75	1	20,75	CHI
20201219619	ARUANA	AK12028880	BRITANIA	05/12/2020 15:15	07/12/2020 13:31	05/12/2020 15:15	06/12/2020 12:00	20,75	6	124,52	CHI
20201219619	ARUANA	AK12028880	BRITANIA	05/12/2020 15:15	07/12/2020 13:31	05/12/2020 15:15	07/12/2020 13:31	46,28	6	277,69	CHI
20201221017	VIANOPOLIS	OZ12036983	PIRES DO RIO S2	05/12/2020 15:15	05/12/2020 19:59	05/12/2020 15:15	05/12/2020 19:59	4,72	11	51,95	CHI
20201221017	ORIZONA	OZ12036983	PIRES DO RIO S2	05/12/2020 15:15	05/12/2020 19:59	05/12/2020 15:15	05/12/2020 19:59	4,72	1	4,72	CHI
20201219628	JATAI	290114809	JATAI S2	05/12/2020 15:16	06/12/2020 07:54	05/12/2020 15:16	06/12/2020 07:54	16,63	1	16,63	CHI
20201219635	ABADIANIA	AA12411673	ANAPOLIS UNIVERSITARIO S1	05/12/2020 15:17	05/12/2020 17:27	05/12/2020 15:17	05/12/2020 17:27	2,16	23	49,58	CHI
20201219681	MATRINCHA	MP10400391	MATRINCHA	05/12/2020 15:17	08/12/2020 03:20	05/12/2020 15:30	05/12/2020 18:05	2,59	14	36,31	CHI
20201219681	MATRINCHA	MP12064995LD	MATRINCHA	05/12/2020 15:17	08/12/2020 03:20	05/12/2020 15:30	05/12/2020 19:45	4,25	22	93,60	CHI
20201219681	FAINA	MP13299720	MATRINCHA	05/12/2020 15:17	08/12/2020 03:20	05/12/2020 15:30	05/12/2020 20:27	4,95	25	123,81	CHI
20201219681	MATRINCHA	MP13299720	MATRINCHA	05/12/2020 15:17	08/12/2020 03:20	05/12/2020 15:30	05/12/2020 20:27	4,95	35	173,33	CHI
20201219681	MATRINCHA	MP10400392	MATRINCHA	05/12/2020 15:17	08/12/2020 03:20	05/12/2020 22:28	06/12/2020 08:48	10,34	12	124,06	CHI
20201219681	MATRINCHA	MP10400392	MATRINCHA	05/12/2020 15:17	08/12/2020 03:20	05/12/2020 22:28	06/12/2020 09:58	11,51	5	57,56	CHI
20201219681	MATRINCHA	MP10400392	MATRINCHA	05/12/2020 15:17	08/12/2020 03:20	05/12/2020 22:28	06/12/2020 10:48	12,34	109	1345,21	CHI
20201219681	ARUANA	MP10400392	MATRINCHA	05/12/2020 15:17	08/12/2020 03:20	05/12/2020 22:28	06/12/2020 10:48	12,34	5	61,71	CHI
20201219681	MATRINCHA	MP12199954	MATRINCHA	05/12/2020 15:17	08/12/2020 03:20	05/12/2020 15:17	06/12/2020 11:44	20,44	3	61,31	CHI
20201219681	MATRINCHA	AK13387202	MATRINCHA	05/12/2020 15:17	08/12/2020 03:20	06/12/2020 14:01	08/12/2020 03:20	37,32	1	37,32	CHI
20201222593	SAO LUIZ DO NORTE	SZ12190056	ITAPACI	05/12/2020 15:17	05/12/2020 21:49	05/12/2020 15:17	05/12/2020 21:49	6,53	3	19,58	CHI
20201219639	GOIAS	GS21274367	GOIAS	05/12/2020 15:18	06/12/2020 14:59	05/12/2020 15:18	06/12/2020 14:59	23,68	1	23,68	CHI
20201219658	JATAI	JT12187749	JATAI S1	05/12/2020 15:20	06/12/2020 12:08	05/12/2020 15:20	06/12/2020 12:08	20,80	1	20,80	CHI
20201219659	INACIOLANDIA	ID21943303	QUIRINOPOLIS	05/12/2020 15:20	05/12/2020 18:33	05/12/2020 15:20	05/12/2020 18:33	3,21	1	3,21	CHI
20201220133	SANTA FE DE GOIAS	RN12378892	BRITANIA	05/12/2020 15:20	05/12/2020 21:33	05/12/2020 15:20	05/12/2020 21:33	6,22	19	118,09	CHI
20201221749	COCALZINHO DE GOIAS	ZN12327452	GOIANESIA S1	05/12/2020 15:21	06/12/2020 15:52	05/12/2020 15:21	06/12/2020 15:52	24,51	10	245,06	CHI
20201219675	LUZIANIA	LZ1206658	PACAEMBU S2	05/12/2020 15:22	05/12/2020 22:26	05/12/2020 15:22	05/12/2020 22:26	7,06	2	14,11	CHI
20201219676	SAO LUIS DE MONTES BELOS	SL21004183	SAO LUIS DOS MONTES BELOS	05/12/2020 15:22	05/12/2020 18:44	05/12/2020 15:22	05/12/2020 18:44	3,35	2	6,71	CHI
20201220524	LUZIANIA	LZ12000278	MARAJOARA	05/12/2020 15:22	05/12/2020 21:46	05/12/2020 15:22	05/12/2020 21:46	6,40	25	159,94	CHI
20201219731	ABADIA DE GOIAS	AO10400701	INDEPENDENCIA S2	05/12/2020 15:23	06/12/2020 23:08	05/12/2020 15:23	05/12/2020 15:26	0,06	86	5,33	CHI
20201219731	ARAGOIANIA	AO10400701	INDEPENDENCIA S2	05/12/2020 15:23	06/12/2020 23:08	05/12/2020 15:23	05/12/2020 15:26	0,06	510	31,59	CHI
20201219731	GUAPO	AO10400701	INDEPENDENCIA S2	05/12/2020 15:23	06/12/2020 23:08	05/12/2020 15:23	05/12/2020 15:26	0,06	14	0,87	CHI

20201219731	ARAGOIANIA	AO10400701	GUAPO S2	05/12/2020 15:23	06/12/2020 23:08	05/12/2020 15:23	05/12/2020 17:10	1,79	202	360,91	CHI
20201219731	ARAGOIANIA	AO10400701	GUAPO S2	05/12/2020 15:23	06/12/2020 23:08	05/12/2020 15:23	06/12/2020 21:07	29,74	422	12552,16	CHI
20201219731	APARECIDA DE GOIANIA	AO10400701	GUAPO S2	05/12/2020 15:23	06/12/2020 23:08	05/12/2020 15:23	06/12/2020 21:07	29,74	2	59,49	CHI
20201219731	ARAGOIANIA	AO12291291	GUAPO S2	05/12/2020 15:23	06/12/2020 23:08	05/12/2020 15:23	06/12/2020 23:08	31,76	47	1492,54	CHI
20201219731	HIDROLANDIA	AO12291291	GUAPO S2	05/12/2020 15:23	06/12/2020 23:08	05/12/2020 15:23	06/12/2020 23:08	31,76	2	63,51	CHI
20201221522	ITABERAI	IB12108138	ITABERAI S2	05/12/2020 15:23	05/12/2020 21:41	05/12/2020 15:23	05/12/2020 21:41	6,29	29	182,33	CHI
20201223090	ABADIA DE GOIAS	AO11152086	INDEPENDENCIA S2	05/12/2020 15:23	06/12/2020 08:16	05/12/2020 15:23	06/12/2020 08:16	16,88	12	202,50	CHI
20201229819	ARAGOIANIA	AO12094606	GUAPO S2	05/12/2020 15:23	07/12/2020 03:44	05/12/2020 15:23	07/12/2020 03:44	36,35	4	145,39	CHI
20201219687	CRISTALINA	KR12249948	PAMPLONA	05/12/2020 15:24	05/12/2020 19:12	05/12/2020 15:24	05/12/2020 19:12	3,80	13	49,37	CHI
20201219708	CACHOEIRA DE GOIAS	AI12126017	FIRMINOPOLIS S2	05/12/2020 15:26	05/12/2020 19:57	05/12/2020 15:26	05/12/2020 19:57	4,50	4	18,02	CHI
20201219708	AURILANDIA	AI12126017	FIRMINOPOLIS S2	05/12/2020 15:26	05/12/2020 19:57	05/12/2020 15:26	05/12/2020 19:57	4,50	5	22,52	CHI
20201219713	RIO VERDE	RV12296032	RIO VERDE S1	05/12/2020 15:27	06/12/2020 11:21	05/12/2020 15:27	06/12/2020 11:21	19,89	5	99,46	CHI
20201219716	PADRE BERNARDO	PI21251005	PLANALTINA	05/12/2020 15:27	06/12/2020 12:52	05/12/2020 15:27	06/12/2020 12:52	21,41	1	21,41	CHI
20201219932	JARAGUA	JA12000214	JARAGUA	05/12/2020 15:27	05/12/2020 18:24	05/12/2020 15:27	05/12/2020 18:24	2,94	53	155,75	CHI
20201219729	BELA VISTA DE GOIAS	BV21218044	BELA VISTA S1	05/12/2020 15:28	05/12/2020 16:23	05/12/2020 15:28	05/12/2020 16:23	0,90	1	0,90	CHI
20201219733	LUZIANIA	LZ12025119	RIO VERMELHO	05/12/2020 15:29	05/12/2020 19:57	05/12/2020 15:29	05/12/2020 19:57	4,47	23	102,76	CHI
20201219735	CALDAZINHA	10005194073	CEPAIGO S2	05/12/2020 15:29	05/12/2020 16:49	05/12/2020 15:29	05/12/2020 16:49	1,32	1	1,32	CHI
20201220438	LUZIANIA	LZ12330887	RIO VERMELHO	05/12/2020 15:29	05/12/2020 20:59	05/12/2020 15:29	05/12/2020 20:59	5,49	137	751,75	CHI
20201220242	QUIRINOPOLIS	GB12394808	QUIRINOPOLIS	05/12/2020 15:30	05/12/2020 17:39	05/12/2020 15:30	05/12/2020 17:39	2,14	78	166,88	CHI
20201220242	GOUVELANDIA	GB12394808	QUIRINOPOLIS	05/12/2020 15:30	05/12/2020 17:39	05/12/2020 15:30	05/12/2020 17:39	2,14	2	4,28	CHI
20201221317	NOVA VENEZA	NR12356427	NEROPOLIS S2	05/12/2020 15:30	06/12/2020 07:05	05/12/2020 15:30	06/12/2020 07:05	15,58	2	31,15	CHI
20201221317	NEROPOLIS	NR12356427	NEROPOLIS S2	05/12/2020 15:30	06/12/2020 07:05	05/12/2020 15:30	06/12/2020 07:05	15,58	7	109,03	CHI
20201222599	GOIAS	GS12064979	ITAPURANGA	05/12/2020 15:30	06/12/2020 08:46	05/12/2020 15:30	06/12/2020 08:46	17,25	1	17,25	CHI
20201222599	FAINA	GS12064979	ITAPURANGA	05/12/2020 15:30	06/12/2020 08:46	05/12/2020 15:30	06/12/2020 08:46	17,25	3	51,75	CHI
20201219752	JATAI	JT12248447	JATAI S3	05/12/2020 15:31	06/12/2020 08:17	05/12/2020 15:31	06/12/2020 08:17	16,75	2	33,50	CHI
20201219780	IPORA	IR12223066	IPORA	05/12/2020 15:31	05/12/2020 17:34	05/12/2020 15:31	05/12/2020 17:34	2,05	17	34,81	CHI
20201219772	MORRINHOS	MR12212245	MORRINHOS	05/12/2020 15:32	05/12/2020 18:42	05/12/2020 15:32	05/12/2020 18:42	3,16	6	18,98	CHI
20201219881	FORMOSA	03740224	ITIQUIRA	05/12/2020 15:32	05/12/2020 16:01	05/12/2020 15:32	05/12/2020 15:36	0,06	45	2,65	CHI
20201219881	FORMOSA	FA16404276	ITIQUIRA	05/12/2020 15:32	05/12/2020 16:01	05/12/2020 15:32	05/12/2020 15:41	0,15	4965	755,78	CHI
20201219881	FORMOSA	FA16404276	ITIQUIRA	05/12/2020 15:32	05/12/2020 16:01	05/12/2020 15:32	05/12/2020 15:41	0,15	3377	514,05	CHI
20201219881	FORMOSA	FA16408133	ITIQUIRA	05/12/2020 15:32	05/12/2020 16:01	05/12/2020 15:32	05/12/2020 15:42	0,17	2456	416,16	CHI
20201219881	FORMOSA	FA16404017	ITIQUIRA	05/12/2020 15:32	05/12/2020 16:01	05/12/2020 15:32	05/12/2020 15:43	0,19	1414	263,95	CHI
20201219881	FORMOSA	FA16433430	ITIQUIRA	05/12/2020 15:32	05/12/2020 16:01	05/12/2020 15:32	05/12/2020 15:44	0,19	633	122,73	CHI
20201219881	FORMOSA	FA10396051	ITIQUIRA	05/12/2020 15:32	05/12/2020 16:01	05/12/2020 15:32	05/12/2020 15:44	0,20	3938	791,98	CHI
20201219881	FORMOSA	FA10407045	ITIQUIRA	05/12/2020 15:32	05/12/2020 16:01	05/12/2020 15:32	05/12/2020 16:01	0,48	1375	665,73	CHI
20201220155	GUAPO	04660214	GUAPO S2	05/12/2020 15:33	06/12/2020 05:04	05/12/2020 15:33	05/12/2020 16:24	0,85	420	355,83	CHI
20201220155	GUAPO	04660214	GUAPO S2	05/12/2020 15:33	06/12/2020 05:04	05/12/2020 15:33	06/12/2020 05:04	13,52	143	1933,92	CHI
20201220155	CAMPESTRE DE GOIAS	04660214	GUAPO S2	05/12/2020 15:33	06/12/2020 05:04	05/12/2020 15:33	06/12/2020 05:04	13,52	13	175,81	CHI
20201220155	GUAPO	GA16414994	GUAPO S2	05/12/2020 15:33	06/12/2020 05:04	05/12/2020 16:23	06/12/2020 05:04	12,69	5	63,45	CHI
20201220269	DOVERLANDIA	DV12380883	CAIAPONIA	05/12/2020 15:33	05/12/2020 19:55	05/12/2020 15:33	05/12/2020 19:55	4,36	8	34,91	CHI
20201220529	PEROLANDIA	JT12390597	JATAI S1	05/12/2020 15:34	06/12/2020 09:24	05/12/2020 15:34	06/12/2020 09:24	17,83	6	107,00	CHI
20201220529	JATAI	JT12390597	JATAI S1	05/12/2020 15:34	06/12/2020 09:24	05/12/2020 15:34	06/12/2020 09:24	17,83	14	249,67	CHI
20201220962	MINEIROS	PW12374393	PARQUE DAS EMAS	05/12/2020 15:34	05/12/2020 18:29	05/12/2020 15:34	05/12/2020 18:29	2,92	5	14,58	CHI
20201219771	MINEIROS	MY21060204	PARQUE DAS EMAS	05/12/2020 15:35	05/12/2020 18:10	05/12/2020 15:35	05/12/2020 18:10	2,59	1	2,59	CHI
20201219775	MUNDO NOVO DE GOIAS	MH12242017	NOVA CRIXAS	05/12/2020 15:35	05/12/2020 20:09	05/12/2020 15:35	05/12/2020 20:09	4,56	4	18,23	CHI
20201220378	BARRO ALTO	BA12000049	BARRO ALTO	05/12/2020 15:35	05/12/2020 20:48	05/12/2020 15:35	05/12/2020 20:48	5,20	7	36,42	CHI
20201219789	SANTO ANTONIO DO DESCOBERTO	10003536252	AGUAS LINDAS DE GOIAS S2	05/12/2020 15:36	05/12/2020 18:32	05/12/2020 15:36	05/12/2020 18:32	2,92	1	2,92	CHI
20201220334	IPORA	IR12014035	IPORA	05/12/2020 15:36	05/12/2020 19:31	05/12/2020 15:36	05/12/2020 19:31	3,91	18	70,41	CHI
20201220472	PARANAIGUARA	QI12054841	QUIRINOPOLIS	05/12/2020 15:36	06/12/2020 00:02	05/12/2020 15:36	06/12/2020 00:02	8,42	1	8,42	CHI
20201220472	QUIRINOPOLIS	QI12054841	QUIRINOPOLIS	05/12/2020 15:36	06/12/2020 00:02	05/12/2020 15:36	06/12/2020 00:02	8,42	17	143,13	CHI
20201220821	APARECIDA DE GOIANIA	AP11000075	ATLANTICO S1	05/12/2020 15:36	05/12/2020 19:09	05/12/2020 15:36	05/12/2020 19:09	3,54	49	173,35	CHI

20201223091	ABADIA DE GOIAS	AO11078017	INDEPENDENCIA S2	05/12/2020 15:36	06/12/2020 09:10	05/12/2020 15:36	06/12/2020 09:10	17,56	11	193,18	CHI
20201219796	RIO VERDE	RV21240005	RIO VERDE S1	05/12/2020 15:37	05/12/2020 18:01	05/12/2020 15:37	05/12/2020 18:01	2,40	1	2,40	CHI
20201223226	CACU	CC12164172LD	CACHOEIRA ALTA	05/12/2020 15:37	06/12/2020 07:13	05/12/2020 15:37	06/12/2020 07:13	15,59	83	1293,85	CHI
20201220279	SANTA FE DE GOIAS	RN12362415	BRITANIA	05/12/2020 15:38	07/12/2020 08:35	05/12/2020 15:38	07/12/2020 08:35	40,95	18	737,02	CHI
20201219822	SANTA FE DE GOIAS	RN12009765	BRITANIA	05/12/2020 15:39	05/12/2020 20:13	05/12/2020 15:39	05/12/2020 20:13	4,55	22	100,20	CHI
20201219822	JUSSARA	RN12009765	BRITANIA	05/12/2020 15:39	05/12/2020 20:13	05/12/2020 15:39	05/12/2020 20:13	4,55	1	4,55	CHI
20201220196	JATAI	JT12346022	JATAI S3	05/12/2020 15:39	05/12/2020 16:50	05/12/2020 15:39	05/12/2020 16:50	1,18	323	381,77	CHI
20201219835	MINEIROS	MY12195578	PARQUE DAS EMAS	05/12/2020 15:41	05/12/2020 19:07	05/12/2020 15:41	05/12/2020 19:07	3,43	10	34,28	CHI
20201219912	SAO LUIS DE MONTES BELOS	SL11006847	SAO LUIZ DOS MONTES BELOS	05/12/2020 15:41	05/12/2020 18:59	05/12/2020 15:41	05/12/2020 18:59	3,29	270	889,43	CHI
20201220862	GOIANIRA	CK12098407LD	INHUMAS S1	05/12/2020 15:41	06/12/2020 07:49	05/12/2020 15:41	06/12/2020 07:49	16,12	9	145,09	CHI
20201219848	ORIZONA	10005839058	PIRES DO RIO S2	05/12/2020 15:42	05/12/2020 17:10	05/12/2020 15:42	05/12/2020 17:10	1,46	1	1,46	CHI
20201221541	APARECIDA DE GOIANIA	AP11240473	REAL S2	05/12/2020 15:42	05/12/2020 20:11	05/12/2020 15:42	05/12/2020 20:11	4,47	78	349,01	CHI
20201220012	SANTA BARBARA DE GOIAS	SB11215433	TRINDADE	05/12/2020 15:43	06/12/2020 00:12	05/12/2020 15:43	06/12/2020 00:12	8,47	100	847,25	CHI
20201220673	PLANALTINA	PI12196961	PLANALTINA	05/12/2020 15:43	05/12/2020 19:09	05/12/2020 15:43	05/12/2020 19:09	3,43	26	89,19	CHI
20201219863	MINEIROS	MY11377571	PARQUE DAS EMAS	05/12/2020 15:44	05/12/2020 17:35	05/12/2020 15:44	05/12/2020 17:35	1,84	29	53,38	CHI
20201221451	DOVERLANDIA	DV12212770	CAIAPONIA	05/12/2020 15:44	07/12/2020 12:34	05/12/2020 15:44	07/12/2020 12:34	44,83	5	224,14	CHI
20201222932	JATAI	JT11172863	JATAI S2	05/12/2020 15:44	05/12/2020 23:32	05/12/2020 15:44	05/12/2020 23:32	7,79	131	1020,49	CHI
20201220173	COCALZINHO DE GOIAS	ZR12295671	COCALZINHO	05/12/2020 15:45	06/12/2020 11:57	05/12/2020 15:45	06/12/2020 11:57	20,18	13	262,40	CHI
20201219875	CALDAS NOVAS	CN12204407	SERRA DE CALDAS	05/12/2020 15:46	05/12/2020 16:32	05/12/2020 15:46	05/12/2020 16:32	0,77	2	1,53	CHI
20201219903	CRISTALINA	O3940406	CRISTALINA S2	05/12/2020 15:46	05/12/2020 18:00	05/12/2020 15:46	05/12/2020 18:00	2,23	284	634,03	CHI
20201219903	CRISTALINA	O3940406	CRISTALINA S2	05/12/2020 15:46	05/12/2020 18:00	05/12/2020 15:46	05/12/2020 18:00	2,23	649	1448,89	CHI
20201220276	SAO LUIS DE MONTES BELOS	SL18323580TS	SAO LUIZ DOS MONTES BELOS	05/12/2020 15:47	05/12/2020 17:56	05/12/2020 15:47	05/12/2020 17:56	2,14	52	111,48	CHI
20201219901	BELA VISTA DE GOIAS	BV32050197	BELA VISTA S1	05/12/2020 15:49	06/12/2020 18:45	05/12/2020 15:49	06/12/2020 11:19	19,51	15	292,60	CHI
20201219901	BELA VISTA DE GOIAS	BV32050197	BELA VISTA S1	05/12/2020 15:49	06/12/2020 18:45	05/12/2020 15:49	06/12/2020 18:45	26,93	3	80,80	CHI
20201219901	BELA VISTA DE GOIAS	BV32050197	BELA VISTA S1	05/12/2020 15:49	06/12/2020 18:45	06/12/2020 12:07	06/12/2020 18:45	6,62	15	99,26	CHI
20201221537	GOIANESIA	GE11185432	GOIANESIA S2	05/12/2020 15:49	05/12/2020 21:06	05/12/2020 15:49	05/12/2020 21:06	5,27	154	812,22	CHI
20201219922	ITUMBIARA	IT21115843	PARANAIBA	05/12/2020 15:50	05/12/2020 18:18	05/12/2020 15:50	05/12/2020 18:18	2,47	1	2,47	CHI
20201219926	PIRES DO RIO	UT21336168	URUTAI	05/12/2020 15:50	05/12/2020 18:32	05/12/2020 15:50	05/12/2020 18:32	2,69	2	5,38	CHI
20201219929	CRISTALINA	KR12401322	CRISTALINA S1	05/12/2020 15:50	05/12/2020 17:04	05/12/2020 15:50	05/12/2020 17:04	1,22	4	4,87	CHI
20201220676	CRISTALINA	KR12230156	PAMPLONA	05/12/2020 15:50	06/12/2020 17:52	05/12/2020 15:50	06/12/2020 17:52	26,03	23	598,63	CHI
20201220906	JATAI	JT12165942	JATAI S2	05/12/2020 15:50	05/12/2020 19:05	05/12/2020 15:50	05/12/2020 19:05	3,25	463	1503,98	CHI
20201220452	LUZIANIA	LZ12137225	VIANOPOLIS	05/12/2020 15:51	07/12/2020 11:13	05/12/2020 15:51	05/12/2020 23:20	7,49	2	14,97	CHI
20201220452	LUZIANIA	LZ12137225	VIANOPOLIS	05/12/2020 15:51	07/12/2020 11:13	06/12/2020 01:38	06/12/2020 03:07	1,49	2	2,99	CHI
20201220452	LUZIANIA	LZ12137225	VIANOPOLIS	05/12/2020 15:51	07/12/2020 11:13	06/12/2020 13:08	06/12/2020 15:05	1,95	1	1,95	CHI
20201220452	LUZIANIA	LZ12137225	VIANOPOLIS	05/12/2020 15:51	07/12/2020 11:13	06/12/2020 13:08	07/12/2020 07:51	18,73	1	18,73	CHI
20201220452	LUZIANIA	LZ12137225	VIANOPOLIS	05/12/2020 15:51	07/12/2020 11:13	05/12/2020 15:51	07/12/2020 09:55	42,06	6	252,38	CHI
20201220452	LUZIANIA	LZ12137225	VIANOPOLIS	05/12/2020 15:51	07/12/2020 11:13	05/12/2020 15:51	07/12/2020 11:13	43,37	5	216,87	CHI
20201219942	ITABERAÍ	IB12206920	ITABERAÍ S2	05/12/2020 15:52	05/12/2020 17:32	05/12/2020 15:52	05/12/2020 17:32	1,66	4	6,66	CHI
20201219943	MINEIROS	MY21209655	PARQUE DAS EMAS	05/12/2020 15:52	05/12/2020 16:56	05/12/2020 15:52	05/12/2020 16:56	1,06	1	1,06	CHI
20201220659	APARECIDA DE GOIANIA	16297611	REAL S1	05/12/2020 15:52	05/12/2020 17:58	05/12/2020 15:52	05/12/2020 17:58	2,10	1	2,10	CHI
20201219964	JATAI	JT12184194	JATAI S1	05/12/2020 15:53	06/12/2020 07:48	05/12/2020 15:53	06/12/2020 07:48	15,90	10	159,05	CHI
20201220379	TROMBAS	TB12372648	PORANGATU	05/12/2020 15:53	05/12/2020 20:41	05/12/2020 15:53	05/12/2020 20:41	4,79	67	320,91	CHI
20201220379	FORMOSO	TB12372648	PORANGATU	05/12/2020 15:53	05/12/2020 20:41	05/12/2020 15:53	05/12/2020 20:41	4,79	1	4,79	CHI
20201219967	ANAPOLIS	AN21222250	ANAPOLIS UNIVERSITARIO S2	05/12/2020 15:54	05/12/2020 18:31	05/12/2020 15:54	05/12/2020 18:31	2,62	1	2,62	CHI
20201219970	NOVA IGUACU DE GOIAS	NH12202113	SANTA TEREZINHA	05/12/2020 15:54	05/12/2020 19:13	05/12/2020 15:54	05/12/2020 19:13	3,31	65	215,11	CHI
20201219971	RIO VERDE	RV21062664	CABRIUVA S2	05/12/2020 15:54	05/12/2020 20:20	05/12/2020 15:54	05/12/2020 20:20	4,43	1	4,43	CHI
20201219973	APARECIDA DE GOIANIA	AP11050802	REAL S1	05/12/2020 15:54	05/12/2020 21:55	05/12/2020 15:54	05/12/2020 21:55	6,01	42	252,44	CHI
20201219974	MORRINHOS	MR12032250	MORRINHOS	05/12/2020 15:54	05/12/2020 20:52	05/12/2020 15:54	05/12/2020 20:52	4,95	2	9,91	CHI
20201221364	MORRINHOS	MR12381165	MORRINHOS	05/12/2020 15:54	06/12/2020 08:18	05/12/2020 15:54	06/12/2020 08:18	16,40	10	164,00	CHI
20201219978	TROMBAS	TB12256991	PORANGATU	05/12/2020 15:55	05/12/2020 23:24	05/12/2020 15:55	05/12/2020 23:24	7,47	20	149,47	CHI
20201219978	MINACU	TB12256991	PORANGATU	05/12/2020 15:55	05/12/2020 23:24	05/12/2020 15:55	05/12/2020 23:24	7,47	12	89,68	CHI

20201219981	SANTA BARBARA DE GOIAS	SB11215432	TRINDADE	05/12/2020 15:55	05/12/2020 20:49	05/12/2020 15:55	05/12/2020 20:49	4,89	112	547,43	CHI
20201219983	RIO VERDE	CP21057851	MONTIVIDIU T	05/12/2020 15:55	05/12/2020 17:55	05/12/2020 15:55	05/12/2020 17:55	1,99	2	3,97	CHI
20201219985	SANTO ANTONIO DA BARRA	B221302020	ACREUNA	05/12/2020 15:56	05/12/2020 16:47	05/12/2020 15:56	05/12/2020 16:47	0,85	1	0,85	CHI
20201219991	AMORINOPOLIS	1240008433	IPORA	05/12/2020 15:56	05/12/2020 23:46	05/12/2020 15:56	05/12/2020 23:46	7,82	1	7,82	CHI
20201219993	TROMBAS	TB12156807	PORANGATU	05/12/2020 15:56	05/12/2020 23:27	05/12/2020 15:56	05/12/2020 23:27	7,51	73	548,07	CHI
20201220326	JATAI	JT11430779	JATAI S3	05/12/2020 15:56	05/12/2020 21:40	05/12/2020 15:56	05/12/2020 21:40	5,72	199	1139,05	CHI
20201220498	JATAI	JT11191699	JATAI S3	05/12/2020 15:56	05/12/2020 18:18	05/12/2020 15:56	05/12/2020 18:18	2,35	252	592,83	CHI
20201220007	MINEIROS	MY12332634RE	PARQUE DAS EMAS	05/12/2020 15:57	06/12/2020 10:45	05/12/2020 15:57	06/12/2020 10:45	18,78	6	112,70	CHI
20201220342	LUZANIA	LZ12245978	CRISTALINA S2	05/12/2020 15:57	05/12/2020 23:18	05/12/2020 15:57	05/12/2020 23:18	7,34	8	58,74	CHI
20201220621	NOVA IGUACU DE GOIAS	UR12237460	CAMPINORTE	05/12/2020 15:57	05/12/2020 19:01	05/12/2020 15:57	05/12/2020 19:01	3,06	2	6,13	CHI
20201221743	LEOPOLDO DE BULHOES	LB11291580	DAIA S2	05/12/2020 15:57	05/12/2020 21:18	05/12/2020 15:57	05/12/2020 21:18	5,35	80	428,02	CHI
20201220013	CAMPINORTE	CR21431815	CAMPINORTE	05/12/2020 15:58	05/12/2020 17:11	05/12/2020 15:58	05/12/2020 17:11	1,20	1	1,20	CHI
20201220026	ABADIANIA	AA21146388	ANAPOLIS UNIVERSITARIO S1	05/12/2020 15:59	05/12/2020 18:17	05/12/2020 15:59	05/12/2020 18:17	2,29	1	2,29	CHI
20201220679	BOM JARDIM DE GOIAS	PH12259349RE	PIRANHAS	05/12/2020 15:59	05/12/2020 19:11	05/12/2020 15:59	05/12/2020 19:11	3,19	5	15,96	CHI
20201220679	PIRANHAS	PH12259349RE	PIRANHAS	05/12/2020 15:59	05/12/2020 19:11	05/12/2020 15:59	05/12/2020 19:11	3,19	39	124,48	CHI
202012179342	FAZENDA NOVA	RN10394715	BRITANIA	05/12/2020 15:59	06/12/2020 18:23	05/12/2020 15:59	05/12/2020 20:20	4,36	9	39,20	CHI
202012179342	JUSSARA	RN10394715	BRITANIA	05/12/2020 15:59	06/12/2020 18:23	05/12/2020 15:59	05/12/2020 20:20	4,36	297	1293,76	CHI
202012179342	SANTA FE DE GOIAS	RN10394715	BRITANIA	05/12/2020 15:59	06/12/2020 18:23	05/12/2020 15:59	05/12/2020 20:20	4,36	25	108,90	CHI
202012179342	JUSSARA	RN10394715	BRITANIA	05/12/2020 15:59	06/12/2020 18:23	05/12/2020 15:59	06/12/2020 17:03	25,08	11	275,84	CHI
202012179342	JUSSARA	RN10394715	BRITANIA	05/12/2020 15:59	06/12/2020 18:23	05/12/2020 15:59	06/12/2020 18:23	26,41	20	528,14	CHI
202012179342	FAZENDA NOVA	RN10394715	BRITANIA	05/12/2020 15:59	06/12/2020 18:23	05/12/2020 15:59	06/12/2020 18:23	26,41	206	5439,83	CHI
202012179342	JAUPACI	RN10394715	BRITANIA	05/12/2020 15:59	06/12/2020 18:23	05/12/2020 15:59	06/12/2020 18:23	26,41	2	52,81	CHI
20201220031	CAMPOS BELOS	CH12224199	SAO DOMINGOS	05/12/2020 16:00	05/12/2020 18:20	05/12/2020 16:00	05/12/2020 18:20	2,33	4	9,32	CHI
20201220052	GOIANIA	GN11313255	GOYA S1	05/12/2020 16:02	05/12/2020 17:55	05/12/2020 16:02	05/12/2020 17:55	1,88	67	126,15	CHI
20201220136	MUNDO NOVO DE GOIAS	MH12269056	NOVA CRIXAS	05/12/2020 16:02	05/12/2020 17:03	05/12/2020 16:02	05/12/2020 17:03	1,01	22	22,26	CHI
20201220195	RUBIATABA	RB12392305	RUBIATABA	05/12/2020 16:02	05/12/2020 18:32	05/12/2020 16:02	05/12/2020 18:32	2,49	15	37,38	CHI
20201220065	RIO VERDE	JT13136021	MONTIVIDIU T	05/12/2020 16:03	05/12/2020 17:14	05/12/2020 16:03	05/12/2020 17:14	1,20	8	9,57	CHI
20201220065	MONTIVIDIU	JT13136021	MONTIVIDIU T	05/12/2020 16:03	05/12/2020 17:14	05/12/2020 16:03	05/12/2020 17:14	1,20	59	70,55	CHI
20201220065	JATAI	JT13136021	MONTIVIDIU T	05/12/2020 16:03	05/12/2020 17:14	05/12/2020 16:03	05/12/2020 17:14	1,20	3	3,59	CHI
20201220065	MONTIVIDIU	JT13136021	MONTIVIDIU T	05/12/2020 16:03	05/12/2020 17:14	05/12/2020 16:03	05/12/2020 17:14	1,20	37	44,25	CHI
20201220065	JATAI	JT13136021	MONTIVIDIU T	05/12/2020 16:03	05/12/2020 17:14	05/12/2020 16:03	05/12/2020 17:14	1,20	10	11,96	CHI
20201220065	CAIAPONIA	JT13136021	MONTIVIDIU T	05/12/2020 16:03	05/12/2020 17:14	05/12/2020 16:03	05/12/2020 17:14	1,20	23	27,50	CHI
20201220065	CAIAPONIA	JT13136021	MONTIVIDIU T	05/12/2020 16:03	05/12/2020 17:14	05/12/2020 16:03	05/12/2020 17:14	1,20	293	350,38	CHI
20201220065	RIO VERDE	JT13136021	MONTIVIDIU T	05/12/2020 16:03	05/12/2020 17:14	05/12/2020 16:03	05/12/2020 17:14	1,20	160	191,33	CHI
20201220065	RIO VERDE	JT13136021	MONTIVIDIU T	05/12/2020 16:03	05/12/2020 17:14	05/12/2020 16:03	05/12/2020 17:14	1,20	2	2,39	CHI
20201220070	JATAI	JT21187739	JATAI S2	05/12/2020 16:03	06/12/2020 08:31	05/12/2020 16:03	06/12/2020 08:31	16,46	1	16,46	CHI
20201220071	ABADIA DE GOIAS	10030533994	INDEPENDENCIA S2	05/12/2020 16:03	06/12/2020 09:41	05/12/2020 16:03	06/12/2020 09:41	17,62	1	17,62	CHI
20201220072	JATAI	JT12219503	JATAI S3	05/12/2020 16:03	06/12/2020 10:03	05/12/2020 16:03	06/12/2020 10:03	17,99	4	71,95	CHI
20201220074	GOIAS	GS21228462	MATRINCHA	05/12/2020 16:03	06/12/2020 10:49	05/12/2020 16:03	06/12/2020 10:49	18,75	1	18,75	CHI
20201220190	FORMOSA	FA11000069	ITIQUIRA	05/12/2020 16:04	05/12/2020 18:34	05/12/2020 16:04	05/12/2020 18:34	2,51	207	519,45	CHI
20201220086	JATAI	SX12264387RE	JATAI S1	05/12/2020 16:05	06/12/2020 17:23	05/12/2020 16:05	06/12/2020 17:23	25,29	7	177,04	CHI
20201220086	SERRANOPOLIS	SX12264387RE	JATAI S1	05/12/2020 16:05	06/12/2020 17:23	05/12/2020 16:05	06/12/2020 17:23	25,29	23	581,71	CHI
20201220088	ABADIANIA	AN21252290	ANAPOLIS UNIVERSITARIO S2	05/12/2020 16:05	05/12/2020 19:24	05/12/2020 16:05	05/12/2020 19:24	3,30	1	3,30	CHI
20201220089	MINEIROS	MY21303339	PARQUE DAS EMAS	05/12/2020 16:05	06/12/2020 09:59	05/12/2020 16:05	06/12/2020 09:59	17,89	1	17,89	CHI
20201220090	APARECIDA DE GOIANIA	10031099872	REAL S2	05/12/2020 16:06	05/12/2020 21:37	05/12/2020 16:06	05/12/2020 21:37	5,52	1	5,52	CHI
20201220098	ANAPOLIS	10005625600	JUNDIAI S1	05/12/2020 16:06	05/12/2020 20:10	05/12/2020 16:06	05/12/2020 20:10	4,06	1	4,06	CHI
20201220468	SANTA FE DE GOIAS	01650214	BRITANIA	05/12/2020 16:07	05/12/2020 23:22	05/12/2020 16:52	05/12/2020 17:24	0,54	349	187,49	CHI
20201220468	JUSSARA	01650214	BRITANIA	05/12/2020 16:07	05/12/2020 23:22	05/12/2020 16:52	05/12/2020 17:24	0,54	4	2,15	CHI
20201220468	SANTA FE DE GOIAS	01650214	BRITANIA	05/12/2020 16:07	05/12/2020 23:22	05/12/2020 22:52	05/12/2020 22:56	0,05	394	21,45	CHI
20201220468	JUSSARA	01650214	BRITANIA	05/12/2020 16:07	05/12/2020 23:22	05/12/2020 22:52	05/12/2020 22:56	0,05	23	1,25	CHI
20201220468	FAZENDA NOVA	RN10394715	BRITANIA	05/12/2020 16:07	05/12/2020 23:22	05/12/2020 22:52	05/12/2020 23:22	0,50	9	4,46	CHI

20201220468	JUSSARA	RN10394715	BRITANIA	05/12/2020 16:07	05/12/2020 23:22	05/12/2020 22:52	05/12/2020 23:22	0,50	297	147,26	CHI
20201220468	SANTA FE DE GOIAS	RN10394715	BRITANIA	05/12/2020 16:07	05/12/2020 23:22	05/12/2020 22:52	05/12/2020 23:22	0,50	25	12,40	CHI
20201220118	APARECIDA DE GOIANIA	AP11007372	REAL S2	05/12/2020 16:08	06/12/2020 03:51	05/12/2020 16:08	06/12/2020 03:51	11,71	99	1159,59	CHI
20201220123	SERRANOPOLIS	SX12390581	JATAI S1	05/12/2020 16:08	06/12/2020 10:49	05/12/2020 16:08	06/12/2020 10:49	18,67	6	112,01	CHI
20201220126	CALDAS NOVAS	760117690	SERRA DE CALDAS	05/12/2020 16:09	05/12/2020 18:00	05/12/2020 16:09	05/12/2020 18:00	1,85	1	1,85	CHI
20201220138	MORRINHOS	MR21105080	MORRINHOS	05/12/2020 16:09	05/12/2020 23:01	05/12/2020 16:09	05/12/2020 23:01	6,85	1	6,85	CHI
20201220585	PIRENOPOLIS	CB12215044	CORUMBA	05/12/2020 16:10	05/12/2020 19:02	05/12/2020 16:10	05/12/2020 19:02	2,85	2	5,71	CHI
20201220585	CORUMBA DE GOIAS	CB12215044	CORUMBA	05/12/2020 16:10	05/12/2020 19:02	05/12/2020 16:10	05/12/2020 19:02	2,85	23	65,61	CHI
20201220789	SAO LUIS DE MONTES BELOS	SL11000044	SAO LUIZ DOS MONTES BELOS	05/12/2020 16:10	05/12/2020 20:48	05/12/2020 16:10	05/12/2020 20:48	4,63	109	504,88	CHI
20201220198	JARAGUA	JA12328472	JARAGUA	05/12/2020 16:11	05/12/2020 19:28	05/12/2020 16:11	05/12/2020 19:28	3,28	1	3,28	CHI
20201220198	ITAGUARU	JA12328472	JARAGUA	05/12/2020 16:11	05/12/2020 19:28	05/12/2020 16:11	05/12/2020 19:28	3,28	17	55,70	CHI
20201220240	COCALZINHO DE GOIAS	ZN12297506	COCALZINHO	05/12/2020 16:11	06/12/2020 12:25	05/12/2020 16:11	06/12/2020 12:25	20,22	10	202,23	CHI
20201222577	BARRO ALTO	BA12066363	BARRO ALTO	05/12/2020 16:11	05/12/2020 21:47	05/12/2020 16:11	05/12/2020 21:47	5,59	7	39,13	CHI
20201220174	HIDROLINA	HL11253146	URUACU	05/12/2020 16:13	06/12/2020 00:25	05/12/2020 16:13	06/12/2020 00:25	8,19	37	303,21	CHI
20201220178	ITAJA	IJ12200700	ITAJA S2	05/12/2020 16:13	05/12/2020 22:08	05/12/2020 16:13	05/12/2020 22:08	5,90	1	5,90	CHI
20201220187	TROMBAS	TB12143685	PORANGATU	05/12/2020 16:14	05/12/2020 21:46	05/12/2020 16:14	05/12/2020 21:46	5,52	19	104,92	CHI
20201220187	MONTIVIDUI DO NORTE	TB12143685	PORANGATU	05/12/2020 16:14	05/12/2020 21:46	05/12/2020 16:14	05/12/2020 21:46	5,52	10	55,22	CHI
20201223144	GOIAS	GK12299661	ITAPURANGA	05/12/2020 16:14	06/12/2020 08:30	05/12/2020 16:14	06/12/2020 08:30	16,25	20	325,08	CHI
20201223144	GUARAITA	GK12299661	ITAPURANGA	05/12/2020 16:14	06/12/2020 08:30	05/12/2020 16:14	06/12/2020 08:30	16,25	16	260,07	CHI
202012133268	LUZIANIA	LZ12410976LD	RIO VERMELHO	05/12/2020 16:15	05/12/2020 22:50	05/12/2020 16:15	05/12/2020 22:50	6,58	1088	7159,04	CHI
20201220201	NOVO PLANALTO	SM12074386RE	SAO MIGUEL DO ARAGUAIA	05/12/2020 16:16	05/12/2020 18:52	05/12/2020 16:16	05/12/2020 18:52	2,59	6	15,56	CHI
20201220201	SAO MIGUEL DO ARAGUAIA	SM12074386RE	SAO MIGUEL DO ARAGUAIA	05/12/2020 16:16	05/12/2020 18:52	05/12/2020 16:16	05/12/2020 18:52	2,59	134	347,54	CHI
20201220879	JATAI	JT11400161	JATAI S2	05/12/2020 16:16	06/12/2020 00:54	05/12/2020 16:16	06/12/2020 00:54	8,62	18	155,14	CHI
20201220212	APARECIDA DE GOIANIA	10007707302	REAL S1	05/12/2020 16:17	05/12/2020 20:37	05/12/2020 16:17	05/12/2020 20:37	4,33	1	4,33	CHI
20201220216	ANAPOLIS	20115155	JUNDAIA S2	05/12/2020 16:17	05/12/2020 22:39	05/12/2020 16:17	05/12/2020 22:39	6,36	1	6,36	CHI
20201220414	BELA VISTA DE GOIAS	BV12120914LD	BELA VISTA S1	05/12/2020 16:17	06/12/2020 01:14	05/12/2020 16:17	06/12/2020 01:14	8,94	460	4114,57	CHI
20201220507	SAO MIGUEL DO PASSA QUATRO	SV12102994	VIANOPOLIS	05/12/2020 16:17	06/12/2020 01:52	05/12/2020 16:17	06/12/2020 01:52	9,58	19	182,00	CHI
20201220507	VIANOPOLIS	SV12102994	VIANOPOLIS	05/12/2020 16:17	06/12/2020 01:52	05/12/2020 16:17	06/12/2020 01:52	9,58	25	239,48	CHI
20201220507	SILVANIA	SV12102994	VIANOPOLIS	05/12/2020 16:17	06/12/2020 01:52	05/12/2020 16:17	06/12/2020 01:52	9,58	25	239,48	CHI
20201220227	SILVANIA	SV21144142	DAIA S2	05/12/2020 16:18	06/12/2020 04:33	05/12/2020 16:18	06/12/2020 04:33	12,24	1	12,24	CHI
20201220230	SITIO D ABADIA	FB11285754	IACIARA S2	05/12/2020 16:18	05/12/2020 19:15	05/12/2020 16:18	05/12/2020 19:15	2,94	1	2,94	CHI
20201220981	JATAI	JT12182167	JATAI S1	05/12/2020 16:18	05/12/2020 21:27	05/12/2020 16:18	05/12/2020 21:27	5,14	4	20,56	CHI
20201220238	CATALAO	1990268435	CATALAO S2	05/12/2020 16:19	05/12/2020 17:14	05/12/2020 16:19	05/12/2020 17:14	0,91	1	0,91	CHI
20201220244	CORUMBA DE GOIAS	CB12221423	CORUMBA	05/12/2020 16:19	06/12/2020 12:57	05/12/2020 16:19	06/12/2020 12:57	20,62	80	1649,87	CHI
20201220246	ORIZONA	OZ11017102	PIRES DO RIO S2	05/12/2020 16:19	05/12/2020 18:47	05/12/2020 16:19	05/12/2020 18:47	2,45	61	149,47	CHI
20201221740	CRIXAS	CX12145539	RUBIATABA	05/12/2020 16:19	05/12/2020 22:48	05/12/2020 16:19	05/12/2020 22:48	6,47	19	122,89	CHI
20201222195	JATAI	JT12374263	JATAI S2	05/12/2020 16:19	05/12/2020 20:35	05/12/2020 16:19	05/12/2020 20:35	4,27	79	337,00	CHI
20201220373	MATRINCHA	MP11259790	MATRINCHA	05/12/2020 16:20	06/12/2020 18:55	05/12/2020 16:20	06/12/2020 18:55	26,57	48	1275,39	CHI
20201220261	BOM JARDIM DE GOIAS	BM12342030	BOM JARDIM	05/12/2020 16:21	06/12/2020 10:26	05/12/2020 16:21	06/12/2020 10:26	18,08	6	108,47	CHI
20201220263	SAO JOAO D ALIANCA	FB12106993	FLORES DE GOIAS	05/12/2020 16:21	05/12/2020 17:30	05/12/2020 16:21	05/12/2020 17:30	1,14	5	5,72	CHI
20201220263	FORMOSA	FB12106993	FLORES DE GOIAS	05/12/2020 16:21	05/12/2020 17:30	05/12/2020 16:21	05/12/2020 17:30	1,14	136	155,53	CHI
20201220263	FORMOSO	FB12106993	FLORES DE GOIAS	05/12/2020 16:21	05/12/2020 17:30	05/12/2020 16:21	05/12/2020 17:30	1,14	1	1,14	CHI
20201220263	FLORES DE GOIAS	FB12106993	FLORES DE GOIAS	05/12/2020 16:21	05/12/2020 17:30	05/12/2020 16:21	05/12/2020 17:30	1,14	9	10,29	CHI
20201220264	FORMOSO	2410000570	PORANGATU	05/12/2020 16:21	05/12/2020 17:45	05/12/2020 16:21	05/12/2020 17:45	1,39	1	1,39	CHI
20201220902	FORMOSO	FO12391929	PORANGATU	05/12/2020 16:22	05/12/2020 19:54	05/12/2020 16:22	05/12/2020 19:54	3,52	11	38,73	CHI
20201220971	PORANGATU	PO1202073	PORANGATU	05/12/2020 16:22	06/12/2020 08:12	05/12/2020 16:22	06/12/2020 08:12	15,82	47	743,67	CHI
20201220291	BRITANIA	BT12009771	BRITANIA	05/12/2020 16:23	06/12/2020 19:06	05/12/2020 16:23	06/12/2020 12:01	19,63	2	39,25	CHI
20201220291	BRITANIA	BT12203475LD	BRITANIA	05/12/2020 16:23	06/12/2020 19:06	05/12/2020 16:23	06/12/2020 18:44	26,35	6	158,10	CHI
20201220291	BRITANIA	BT12403361	BRITANIA	05/12/2020 16:23	06/12/2020 19:06	05/12/2020 16:23	06/12/2020 19:06	26,71	10	267,11	CHI
20201221361	FORMOSA	FA12383296	ITUIQUIRA	05/12/2020 16:23	05/12/2020 21:09	05/12/2020 16:23	05/12/2020 21:09	4,76	275	1309,23	CHI
20201220299	VIANOPOLIS	VN13200161	VIANOPOLIS	05/12/2020 16:24	06/12/2020 12:43	05/12/2020 16:24	06/12/2020 10:35	18,17	228	4143,27	CHI

20201220299	SILVANIA	VN13200161	VIANOPOLIS	05/12/2020 16:24	06/12/2020 12:43	05/12/2020 16:24	06/12/2020 10:35	18,17	7	127,21	CHI
20201220299	MORRINHOS	VN13200161	VIANOPOLIS	05/12/2020 16:24	06/12/2020 12:43	05/12/2020 16:24	06/12/2020 10:35	18,17	1	18,17	CHI
20201220299	ORIZONA	VN13200161	VIANOPOLIS	05/12/2020 16:24	06/12/2020 12:43	05/12/2020 16:24	06/12/2020 10:35	18,17	55	999,47	CHI
20201220299	ORIZONA	VN13200161	VIANOPOLIS	05/12/2020 16:24	06/12/2020 12:43	06/12/2020 10:02	06/12/2020 10:35	0,55	3	1,65	CHI
20201220299	VIANOPOLIS	VN13200161	VIANOPOLIS	05/12/2020 16:24	06/12/2020 12:43	06/12/2020 10:07	06/12/2020 10:35	0,46	2	0,92	CHI
20201220299	VIANOPOLIS	VN13200161	VIANOPOLIS	05/12/2020 16:24	06/12/2020 12:43	05/12/2020 16:24	06/12/2020 10:43	18,31	163	2984,48	CHI
20201220299	VIANOPOLIS	VN13200161	VIANOPOLIS	05/12/2020 16:24	06/12/2020 12:43	06/12/2020 10:44	06/12/2020 10:58	0,22	393	85,59	CHI
20201220299	MORRINHOS	VN13200161	VIANOPOLIS	05/12/2020 16:24	06/12/2020 12:43	06/12/2020 10:44	06/12/2020 10:58	0,22	1	0,22	CHI
20201220299	SILVANIA	VN13200161	VIANOPOLIS	05/12/2020 16:24	06/12/2020 12:43	06/12/2020 10:44	06/12/2020 10:58	0,22	7	1,52	CHI
20201220299	ORIZONA	VN13200161	VIANOPOLIS	05/12/2020 16:24	06/12/2020 12:43	06/12/2020 10:44	06/12/2020 10:58	0,22	58	12,63	CHI
20201220299	ORIZONA	VN13200161	VIANOPOLIS	05/12/2020 16:24	06/12/2020 12:43	05/12/2020 16:24	06/12/2020 12:43	20,31	15	304,59	CHI
20201220299	VIANOPOLIS	VN13200161	VIANOPOLIS	05/12/2020 16:24	06/12/2020 12:43	05/12/2020 16:24	06/12/2020 12:43	20,31	66	1340,18	CHI
20201220299	VIANOPOLIS	VN10406899	VIANOPOLIS	05/12/2020 16:24	06/12/2020 12:43	06/12/2020 10:07	06/12/2020 12:43	2,59	1	2,59	CHI
20201220510	JATAI	JT11036320	JATAI S3	05/12/2020 16:24	05/12/2020 18:15	05/12/2020 16:24	05/12/2020 18:15	1,84	150	275,71	CHI
20201220317	ARAGARCAS	AG11207811	ARAGARCAS	05/12/2020 16:25	05/12/2020 18:14	05/12/2020 16:25	05/12/2020 18:14	1,80	113	203,43	CHI
20201220322	LUZIANIA	LZ13305103	PAMPLONA	05/12/2020 16:25	06/12/2020 00:39	05/12/2020 16:25	06/12/2020 00:39	8,25	10	82,46	CHI
20201220322	LUZIANIA	LZ13305103	PAMPLONA	05/12/2020 16:25	06/12/2020 00:39	05/12/2020 19:30	06/12/2020 00:39	5,15	20	103,07	CHI
20201220523	JATAI	03280414	MONTIVIDIU T	05/12/2020 16:25	06/12/2020 22:04	05/12/2020 16:25	05/12/2020 20:33	4,13	1	4,13	CHI
20201220523	JATAI	03280414	MONTIVIDIU T	05/12/2020 16:25	06/12/2020 22:04	05/12/2020 22:30	05/12/2020 23:04	0,57	1	0,57	CHI
20201220523	JATAI	03280414	MONTIVIDIU T	05/12/2020 16:25	06/12/2020 22:04	06/12/2020 00:59	06/12/2020 01:57	0,97	1	0,97	CHI
20201220523	JATAI	03280414	MONTIVIDIU T	05/12/2020 16:25	06/12/2020 22:04	05/12/2020 16:25	06/12/2020 12:53	20,46	2	40,92	CHI
20201220523	JATAI	03280414	MONTIVIDIU T	05/12/2020 16:25	06/12/2020 22:04	05/12/2020 16:25	06/12/2020 22:04	29,64	1	29,64	CHI
20201220682	MORRINHOS	MR12041262RE	MORRINHOS	05/12/2020 16:25	06/12/2020 15:40	05/12/2020 16:25	06/12/2020 15:40	23,25	176	4091,56	CHI
20201220682	MORRINHOS	MR12041262RE	MORRINHOS	05/12/2020 16:25	06/12/2020 15:40	05/12/2020 18:27	06/12/2020 15:40	21,22	1	21,22	CHI
20201221303	PALMEIRAS DE GOIAS	PL12000164	PALMEIRAS	05/12/2020 16:25	06/12/2020 13:56	05/12/2020 16:25	06/12/2020 13:56	21,51	5	107,56	CHI
20201220324	TERESINA DE GOIAS	TE11257467	FLORES DE GOIAS	05/12/2020 16:26	06/12/2020 10:19	05/12/2020 16:26	06/12/2020 10:19	17,87	66	1179,24	CHI
20201221124	JATAI	JT12063437	JATAI S3	05/12/2020 16:26	05/12/2020 20:11	05/12/2020 16:26	05/12/2020 20:11	3,73	432	1613,04	CHI
20201221703	PIRANHAS	PH12381043	PIRANHAS	05/12/2020 16:26	05/12/2020 22:09	05/12/2020 16:26	05/12/2020 22:09	5,71	125	713,33	CHI
20201220433	ITAPIRAPUA	IU12018852	MATRINCHA	05/12/2020 16:28	06/12/2020 11:48	05/12/2020 16:28	06/12/2020 11:48	19,32	36	695,67	CHI
20201220592	ANICUNS	AC12020513	ANICUNS	05/12/2020 16:28	05/12/2020 18:03	05/12/2020 16:28	05/12/2020 18:03	1,57	13	20,39	CHI
20201220592	AVELINOPOLIS	AC12020513	ANICUNS	05/12/2020 16:28	05/12/2020 18:03	05/12/2020 16:28	05/12/2020 18:03	1,57	3	4,70	CHI
20201220592	ITABERAI	AC12020513	ANICUNS	05/12/2020 16:28	05/12/2020 18:03	05/12/2020 16:28	05/12/2020 18:03	1,57	12	18,82	CHI
20201222787	GOIAS	GS12068540	MATRINCHA	05/12/2020 16:28	06/12/2020 18:27	05/12/2020 16:28	06/12/2020 18:27	25,99	2	51,97	CHI
20201221621	CRIXAS	CX11371717	SANTA TEREZINHA	05/12/2020 16:29	06/12/2020 11:21	05/12/2020 16:29	06/12/2020 11:21	18,85	1	18,85	CHI
20201225950	SILVANIA	660050250	VIANOPOLIS	05/12/2020 16:29	06/12/2020 16:06	05/12/2020 16:29	06/12/2020 16:06	23,63	1	23,63	CHI
20201220537	SANTA TEREZA DE GOIAS	SE12060934	MARA ROSA	05/12/2020 16:30	05/12/2020 19:18	05/12/2020 16:30	05/12/2020 19:18	2,79	2	5,58	CHI
20201220372	ANICUNS	AC12000020	ANICUNS	05/12/2020 16:31	05/12/2020 19:13	05/12/2020 16:31	05/12/2020 19:13	2,69	3	8,08	CHI
20201220376	JATAI	290256100	JATAI S3	05/12/2020 16:31	06/12/2020 10:59	05/12/2020 16:31	06/12/2020 10:59	18,45	1	18,45	CHI
20201220513	APARECIDA DE GOIANIA	AP11143471	REAL S2	05/12/2020 16:31	05/12/2020 21:59	05/12/2020 16:31	05/12/2020 21:59	5,46	105	572,83	CHI
20201220764	JATAI	JT12378104B	JATAI S2	05/12/2020 16:31	05/12/2020 18:51	05/12/2020 16:31	05/12/2020 18:51	2,34	331	774,26	CHI
20201220764	RIO VERDE	JT12378104B	JATAI S2	05/12/2020 16:31	05/12/2020 18:51	05/12/2020 16:31	05/12/2020 18:51	2,34	33	77,19	CHI
20201220382	SAO DOMINGOS	SD12389183	SAO DOMINGOS	05/12/2020 16:32	05/12/2020 19:55	05/12/2020 16:32	05/12/2020 19:55	3,38	21	71,00	CHI
20201220389	CAMPINACU	UC21289318	PORANGATU	05/12/2020 16:32	05/12/2020 21:36	05/12/2020 16:32	05/12/2020 21:36	5,06	1	5,06	CHI
20201220798	SAO LUIS DE MONTES BELOS	SL12167244	FIRMINOPOLIS S2	05/12/2020 16:32	05/12/2020 18:38	05/12/2020 16:32	05/12/2020 18:38	2,09	2	4,18	CHI
20201221039	JATAI	JT11219264	JATAI S2	05/12/2020 16:32	05/12/2020 19:20	05/12/2020 16:32	05/12/2020 19:20	2,80	100	279,92	CHI
20201220395	TRINDADE	15205370	GOYA S2	05/12/2020 16:33	06/12/2020 07:08	05/12/2020 16:33	06/12/2020 07:08	14,58	1	14,58	CHI
20201220435	PIRENOPOLIS	PV12355915	CORUMBA	05/12/2020 16:33	05/12/2020 19:02	05/12/2020 16:33	05/12/2020 19:02	2,47	22	54,36	CHI
20201220647	PIRANHAS	PH11052933	PIRANHAS	05/12/2020 16:33	05/12/2020 18:16	05/12/2020 16:33	05/12/2020 18:16	1,71	121	206,94	CHI
20201220656	NOVA IGUACU DE GOIAS	MQ12146959	MARA ROSA	05/12/2020 16:33	05/12/2020 20:41	05/12/2020 16:33	05/12/2020 20:41	4,12	12	49,45	CHI
20201220656	MARA ROSA	MQ12146959	MARA ROSA	05/12/2020 16:33	05/12/2020 20:41	05/12/2020 16:33	05/12/2020 20:41	4,12	11	45,33	CHI
20201220404	JARAGUA	JA12273194	JARAGUA	05/12/2020 16:34	06/12/2020 10:26	05/12/2020 16:34	06/12/2020 10:26	17,88	10	178,76	CHI

20201220643	ANICUNS	AC12228150LD	ANICUNS	05/12/2020 16:34	05/12/2020 22:11	05/12/2020 16:34	05/12/2020 20:51	4,28	31	132,65	CHI
20201220643	ANICUNS	AC12228150LD	ANICUNS	05/12/2020 16:34	05/12/2020 22:11	05/12/2020 16:34	05/12/2020 21:36	5,03	28	140,89	CHI
20201220643	ANICUNS	AC12228150LD	ANICUNS	05/12/2020 16:34	05/12/2020 22:11	05/12/2020 16:34	05/12/2020 22:11	5,63	52	292,60	CHI
20201220643	AVELINOPOLIS	AC12228150LD	ANICUNS	05/12/2020 16:34	05/12/2020 22:11	05/12/2020 16:34	05/12/2020 22:11	5,63	1	5,63	CHI
20201220425	ALTO PARAISO DE GOIAS	BF21232055	NIQUELANDIA SUBTRANSMISSAO	05/12/2020 16:35	05/12/2020 17:47	05/12/2020 16:35	05/12/2020 17:47	1,19	2	2,37	CHI
20201220754	ARENOPOLIS	AY12139436	ARENOPOLIS	05/12/2020 16:35	06/12/2020 09:28	05/12/2020 16:35	06/12/2020 09:28	16,88	16	270,11	CHI
20201220754	IPORA	AY12139436	ARENOPOLIS	05/12/2020 16:35	06/12/2020 09:28	05/12/2020 16:35	06/12/2020 09:28	16,88	10	168,82	CHI
20201220873	FORMOSA	FA11000067	ITUIQUIRA	05/12/2020 16:35	05/12/2020 19:25	05/12/2020 16:35	05/12/2020 19:25	2,83	237	669,92	CHI
20201222609	APARECIDA DE GOIANIA	AP12000273LD	REAL S2	05/12/2020 16:36	05/12/2020 22:07	05/12/2020 16:36	05/12/2020 22:07	5,51	1100	6059,47	CHI
20201221658	IVOLANDIA	IV12390185	IPORA	05/12/2020 16:37	05/12/2020 21:23	05/12/2020 16:37	05/12/2020 21:23	4,76	13	61,89	CHI
20201220450	CEZARINA	CZ21031268	CEZARINA	05/12/2020 16:38	05/12/2020 17:35	05/12/2020 16:38	05/12/2020 17:35	0,95	1	0,95	CHI
20201220454	URUACU	UR21141811	URUACU	05/12/2020 16:38	05/12/2020 17:33	05/12/2020 16:38	05/12/2020 17:33	0,91	1	0,91	CHI
20201220463	PORANGATU	PO12079746	PORANGATU	05/12/2020 16:39	05/12/2020 21:22	05/12/2020 16:39	05/12/2020 21:22	4,71	3	14,13	CHI
20201220474	APARECIDA DE GOIANIA	17158266	INDEPENDENCIA S2	05/12/2020 16:40	05/12/2020 19:51	05/12/2020 16:40	05/12/2020 19:51	3,18	1	3,18	CHI
20201221354	GOIAS	GS12054690	GOIAS	05/12/2020 16:40	06/12/2020 07:17	05/12/2020 16:40	06/12/2020 07:17	14,62	14	204,61	CHI
20201220483	GOIANIA	13977430	ATLANTICO S1	05/12/2020 16:41	05/12/2020 17:48	05/12/2020 16:41	05/12/2020 17:48	1,12	1	1,12	CHI
20201220484	BONOPOLIS	TA21151078	NOVO PLANALTO	05/12/2020 16:41	06/12/2020 15:54	05/12/2020 16:41	06/12/2020 15:54	23,22	1	23,22	CHI
20201220488	RIO VERDE	RV12306423	CABRIUVA S2	05/12/2020 16:41	05/12/2020 22:40	05/12/2020 16:41	05/12/2020 22:40	5,98	3	17,95	CHI
20201220489	PIRENOPOLIS	220072905	CORUMBA	05/12/2020 16:41	06/12/2020 01:17	05/12/2020 16:41	06/12/2020 01:17	8,60	1	8,60	CHI
20201221077	NIQUELANDIA	NQ12262797	URUACU	05/12/2020 16:41	05/12/2020 22:59	05/12/2020 16:41	05/12/2020 22:59	6,29	14	88,01	CHI
20201222251	SITIO D ABADIA	AQ12344369	IACIARA S2	05/12/2020 16:41	05/12/2020 21:09	05/12/2020 16:41	05/12/2020 21:09	4,45	3	13,36	CHI
20201222252	ALTO PARAISO DE GOIAS	BF21129910	FLORES DE GOIAS	05/12/2020 16:41	05/12/2020 20:51	05/12/2020 16:41	05/12/2020 20:51	4,15	1	4,15	CHI
20201221083	ARENOPOLIS	AY12000026RE	ARENOPOLIS	05/12/2020 16:42	05/12/2020 20:25	05/12/2020 16:42	05/12/2020 20:25	3,72	81	301,01	CHI
20201221083	PALESTINA DE GOIAS	AY12000026RE	ARENOPOLIS	05/12/2020 16:42	05/12/2020 20:25	05/12/2020 16:42	05/12/2020 20:25	3,72	3	11,15	CHI
20201221291	JATAI	JT12182074	JATAI S1	05/12/2020 16:42	06/12/2020 12:45	05/12/2020 16:42	06/12/2020 12:45	20,05	8	160,40	CHI
20201220516	PORANGATU	PO12391665	PORANGATU	05/12/2020 16:43	05/12/2020 19:34	05/12/2020 16:43	05/12/2020 19:34	2,85	20	56,98	CHI
20201220520	NAZARIO	NZ12003900	ANICUNS	05/12/2020 16:43	05/12/2020 18:30	05/12/2020 16:43	05/12/2020 18:30	1,78	12	21,33	CHI
20201220522	ITABERAI	50104573	ITABERAI S2	05/12/2020 16:43	06/12/2020 03:44	05/12/2020 16:43	06/12/2020 03:44	11,01	1	11,01	CHI
20201220527	PLANALTINA	10005198850	PLANALTINA	05/12/2020 16:43	05/12/2020 18:28	05/12/2020 16:43	05/12/2020 18:28	1,74	1	1,74	CHI
20201220556	CALDAZINHA	BV21056957	CEPAIGO S2	05/12/2020 16:47	06/12/2020 12:29	05/12/2020 16:47	06/12/2020 12:29	19,70	2	39,40	CHI
20201220622	SAO LUIS DE MONTES BELOS	SL11259140	SAO LUIZ DOS MONTES BELOS	05/12/2020 16:47	05/12/2020 18:09	05/12/2020 16:47	05/12/2020 18:09	1,36	87	118,42	CHI
20201220568	APARECIDA DE GOIANIA	10029544511	REAL S1	05/12/2020 16:48	05/12/2020 20:10	05/12/2020 16:48	05/12/2020 20:10	3,36	1	3,36	CHI
20201220578	JARAGUA	JA21155134	JARAGUA	05/12/2020 16:49	05/12/2020 21:02	05/12/2020 16:49	05/12/2020 21:02	4,21	4	16,86	CHI
20201220582	ITABERAI	50029551	ITABERAI S2	05/12/2020 16:49	05/12/2020 17:45	05/12/2020 16:49	05/12/2020 17:45	0,93	1	0,93	CHI
20201220590	GOIATUBA	GT12000178	BOM JESUS DE GOIAS	05/12/2020 16:49	05/12/2020 19:54	05/12/2020 16:49	05/12/2020 19:54	3,07	27	82,88	CHI
20201220626	NOVA ROMA	ND12394116	IACIARA S2	05/12/2020 16:49	05/12/2020 17:54	05/12/2020 16:49	05/12/2020 17:54	1,07	5	5,36	CHI
20201220626	SAO JOAO D ALIANCA	ND12394116	IACIARA S2	05/12/2020 16:49	05/12/2020 17:54	05/12/2020 16:49	05/12/2020 17:54	1,07	15	16,08	CHI
20201220606	URUACU	UR12202045	URUACU	05/12/2020 16:50	05/12/2020 23:06	05/12/2020 16:50	05/12/2020 23:06	6,26	108	675,75	CHI
20201220639	PIRENOPOLIS	PV12382171	CORUMBA	05/12/2020 16:50	05/12/2020 22:57	05/12/2020 16:50	05/12/2020 22:57	6,11	9	54,97	CHI
20201220611	CIDADE OCIDENTAL	DH12261428	MARAJOARA	05/12/2020 16:51	05/12/2020 19:11	05/12/2020 16:51	05/12/2020 19:11	2,33	22	51,22	CHI
20201220617	JATAI	JT11067041	JATAI S2	05/12/2020 16:51	05/12/2020 21:07	05/12/2020 16:51	05/12/2020 21:07	4,25	63	267,86	CHI
20201220637	NOVA CRIXAS	NA10396027	NOVA CRIXAS	05/12/2020 16:51	06/12/2020 03:42	05/12/2020 16:51	05/12/2020 21:34	4,72	19	89,73	CHI
20201220637	NOVA CRIXAS	NA12045646LD	NOVA CRIXAS	05/12/2020 16:51	06/12/2020 03:42	05/12/2020 16:51	05/12/2020 21:50	4,98	20	99,64	CHI
20201220637	MUNDO NOVO DE GOIAS	NA13213156	NOVA CRIXAS	05/12/2020 16:51	06/12/2020 03:42	05/12/2020 16:51	05/12/2020 23:17	6,43	8	51,43	CHI
20201220637	NOVA CRIXAS	NA13213156	NOVA CRIXAS	05/12/2020 16:51	06/12/2020 03:42	05/12/2020 16:51	05/12/2020 23:17	6,43	30	192,85	CHI
20201220637	MUNDO NOVO DE GOIAS	NA13351137	NOVA CRIXAS	05/12/2020 16:51	06/12/2020 03:42	05/12/2020 16:51	06/12/2020 02:43	9,87	37	365,23	CHI
20201220637	NOVA CRIXAS	NA13351137	NOVA CRIXAS	05/12/2020 16:51	06/12/2020 03:42	05/12/2020 16:51	06/12/2020 02:43	9,87	40	394,84	CHI
20201220637	NOVA CRIXAS	NA12263044LD	NOVA CRIXAS	05/12/2020 16:51	06/12/2020 03:42	05/12/2020 16:51	06/12/2020 03:42	10,86	87	944,41	CHI
20201220677	PIRANHAS	PH12343587	CAIAPONIA	05/12/2020 16:51	06/12/2020 13:25	05/12/2020 16:51	06/12/2020 13:25	20,57	12	246,89	CHI
20201220624	RIO VERDE	RV12322313	CABRIUVA S2	05/12/2020 16:52	05/12/2020 21:28	05/12/2020 16:52	05/12/2020 21:28	4,59	1	4,59	CHI
20201220703	GAMELEIRA DE GOIAS	SV12013378	DAIA S2	05/12/2020 16:52	05/12/2020 19:42	05/12/2020 16:52	05/12/2020 19:42	2,83	6	16,96	CHI

20201220640	CAMPOS BELOS	CH12384777	SAO DOMINGOS	05/12/2020 16:54	05/12/2020 18:02	05/12/2020 16:54	05/12/2020 18:02	1,13	13	14,65	CHI
20201220773	BURITI ALEGRE	BG12249831	ITUMBIARA VELHA S2	05/12/2020 16:55	06/12/2020 09:17	05/12/2020 16:55	06/12/2020 09:17	16,35	2	32,70	CHI
20201217939	CEZARINA	CZ12000015	CEZARINA	05/12/2020 16:56	07/12/2020 18:38	05/12/2020 16:56	06/12/2020 15:10	22,24	41	911,67	CHI
20201217939	INDIARA	CZ12000015	CEZARINA	05/12/2020 16:56	07/12/2020 18:38	05/12/2020 16:56	06/12/2020 17:45	24,82	27	670,27	CHI
20201217939	INDIARA	CZ12000015	CEZARINA	05/12/2020 16:56	07/12/2020 18:38	05/12/2020 16:56	07/12/2020 18:38	49,70	10	497,01	CHI
20201217939	CEZARINA	CZ12000015	CEZARINA	05/12/2020 16:56	07/12/2020 18:38	05/12/2020 16:56	07/12/2020 18:38	49,70	21	1043,72	CHI
20201220668	ITAUCU	IX21016909	INHUMAS S1	05/12/2020 16:57	05/12/2020 20:17	05/12/2020 16:57	05/12/2020 20:17	3,32	4	13,27	CHI
20201221209	NIQUELANDIA	NQ12235641	URUACU	05/12/2020 16:57	05/12/2020 22:30	05/12/2020 16:57	05/12/2020 22:30	5,55	27	149,74	CHI
20201221654	CACU	CC12078926	CACHOEIRA ALTA	05/12/2020 16:57	06/12/2020 07:07	05/12/2020 16:57	06/12/2020 07:07	14,16	8	113,30	CHI
20201220674	NIQUELANDIA	NQ11202062	URUACU	05/12/2020 16:58	05/12/2020 20:37	05/12/2020 16:58	05/12/2020 20:37	3,64	74	269,52	CHI
20201220678	EDEALINA	ED21041857	EDEIA	05/12/2020 16:58	05/12/2020 19:11	05/12/2020 16:58	05/12/2020 19:11	2,20	2	4,40	CHI
20201220857	MONTIVIDIU	MV12301552	MONTIVIDIU T	05/12/2020 16:58	05/12/2020 19:46	05/12/2020 16:58	05/12/2020 19:46	2,79	9	25,14	CHI
20201220689	PADRE BERNARDO	PB11275630	PADRE BERNARDO	05/12/2020 17:00	05/12/2020 21:58	05/12/2020 17:00	05/12/2020 21:58	4,96	4	19,85	CHI
20201220698	GOIATUBA	GT12000370	GOIATUBA S2	05/12/2020 17:00	05/12/2020 18:38	05/12/2020 17:00	05/12/2020 18:38	1,62	11	17,79	CHI
20201221140	ITAUCU	IX12018278	INHUMAS S1	05/12/2020 17:00	06/12/2020 00:37	05/12/2020 17:00	06/12/2020 00:37	7,60	75	570,17	CHI
20201221327	EDEALINA	EA12257971	EDEIA	05/12/2020 17:00	05/12/2020 20:04	05/12/2020 17:00	05/12/2020 20:04	3,07	8	24,53	CHI
20201221327	INDIARA	EA12257971	EDEIA	05/12/2020 17:00	05/12/2020 20:04	05/12/2020 17:00	05/12/2020 20:04	3,07	2	6,13	CHI
20201220720	CEZARINA	CZ12233347	CEZARINA	05/12/2020 17:01	07/12/2020 11:38	05/12/2020 17:01	07/12/2020 11:38	42,62	3	127,85	CHI
20201220774	DOVERLANDIA	DV12207831	CAIAPONIA	05/12/2020 17:01	06/12/2020 22:10	05/12/2020 17:01	06/12/2020 22:10	29,14	3	87,42	CHI
20201220711	CIDADE OCIDENTAL	2680182905	MARAJOARA	05/12/2020 17:02	05/12/2020 21:12	05/12/2020 17:02	05/12/2020 21:12	4,16	1	4,16	CHI
20201220718	LUZIANIA	LZ21149924	MARAJOARA	05/12/2020 17:02	05/12/2020 21:56	05/12/2020 17:02	05/12/2020 21:56	4,88	3	14,65	CHI
20201221081	GOIAS	GS11067664	GOIAS	05/12/2020 17:02	05/12/2020 23:38	05/12/2020 17:02	05/12/2020 23:38	6,59	117	771,00	CHI
20201220737	CALDAS NOVAS	CN12363792	SERRA DE CALDAS	05/12/2020 17:04	05/12/2020 20:42	05/12/2020 17:04	05/12/2020 20:42	3,62	132	477,51	CHI
20201220832	RIO VERDE	RV11213400	CABRIUVA S1	05/12/2020 17:04	06/12/2020 01:55	05/12/2020 17:04	06/12/2020 01:55	8,85	130	1150,43	CHI
20201220745	PADRE BERNARDO	PB12347299	PADRE BERNARDO	05/12/2020 17:05	06/12/2020 01:19	05/12/2020 17:05	06/12/2020 01:19	8,25	232	1913,42	CHI
20201220746	INHUMAS	IN11129029	INHUMAS S2	05/12/2020 17:05	05/12/2020 18:13	05/12/2020 17:05	05/12/2020 18:13	1,13	127	143,58	CHI
20201220766	LUZIANIA	LZ11168140	RIO VERMELHO	05/12/2020 17:06	05/12/2020 20:30	05/12/2020 17:06	05/12/2020 20:30	3,39	82	277,82	CHI
20201220778	GOUVELANDIA	GB12303270	QUIRINOPOLIS	05/12/2020 17:07	06/12/2020 10:39	05/12/2020 17:07	06/12/2020 10:39	17,52	8	140,18	CHI
20201220835	GOIAS	GS12076722	GOIAS	05/12/2020 17:07	06/12/2020 09:09	05/12/2020 17:07	06/12/2020 09:09	16,03	14	224,37	CHI
20201221106	PIRANHAS	PH12072404	PIRANHAS	05/12/2020 17:07	06/12/2020 06:55	05/12/2020 17:07	06/12/2020 06:55	13,79	108	1489,29	CHI
20201220782	APARECIDA DE GOIANIA	15625217	ATLANTICO S2	05/12/2020 17:08	06/12/2020 07:51	05/12/2020 17:08	06/12/2020 07:51	14,72	1	14,72	CHI
20201220788	IACIARA	IA12160059	IACIARA S1	05/12/2020 17:08	05/12/2020 17:58	05/12/2020 17:08	05/12/2020 17:58	0,83	23	19,02	CHI
20201220790	ANAPOLIS	20236062	JUNDIAI S2	05/12/2020 17:08	05/12/2020 23:08	05/12/2020 17:08	05/12/2020 23:08	5,99	1	5,99	CHI
20201220799	RIO VERDE	RV21246782	RIO VERDE S2	05/12/2020 17:08	05/12/2020 21:29	05/12/2020 17:08	05/12/2020 21:29	4,34	2	8,68	CHI
20201221394	JATAI	JT11377334	JATAI S3	05/12/2020 17:08	05/12/2020 19:15	05/12/2020 17:08	05/12/2020 19:15	2,12	97	205,34	CHI
20201223444	RIO VERDE	RV16408759	RIO VERDE S2	05/12/2020 17:08	06/12/2020 03:41	05/12/2020 17:08	05/12/2020 17:13	0,07	804	59,18	CHI
20201223444	SANTA HELENA DE GOIAS	RV16408759	RIO VERDE S2	05/12/2020 17:08	06/12/2020 03:41	05/12/2020 17:08	05/12/2020 17:13	0,07	70	5,15	CHI
20201223444	RIO VERDE	01600244	RIO VERDE S2	05/12/2020 17:08	06/12/2020 03:41	05/12/2020 17:08	06/12/2020 03:41	10,55	13	137,12	CHI
20201220807	MONTIVIDIU	MV12249172	MONTIVIDIU T	05/12/2020 17:10	05/12/2020 19:12	05/12/2020 17:10	05/12/2020 19:12	2,02	4	8,09	CHI
20201220808	BARRO ALTO	BA21095402	BARRO ALTO	05/12/2020 17:10	06/12/2020 08:05	05/12/2020 17:10	06/12/2020 08:05	14,90	2	29,81	CHI
20201221650	RIO VERDE	RV11131627	RIO VERDE S1	05/12/2020 17:10	06/12/2020 01:35	05/12/2020 17:10	06/12/2020 01:35	8,41	154	1295,87	CHI
20201220815	PALMEIRAS DE GOIAS	NZ12233489	ANICUNS	05/12/2020 17:11	05/12/2020 20:15	05/12/2020 17:11	05/12/2020 20:15	3,06	3	9,19	CHI
20201220815	NAZARIO	NZ12233489	ANICUNS	05/12/2020 17:11	05/12/2020 20:15	05/12/2020 17:11	05/12/2020 20:15	3,06	38	116,41	CHI
20201221032	PIRACANJUBA	PJ12000054	PIRACANJUBA	05/12/2020 17:11	05/12/2020 21:44	05/12/2020 17:11	05/12/2020 21:44	4,55	21	95,45	CHI
20201221122	BRITANIA	BT11007821	BRITANIA	05/12/2020 17:11	05/12/2020 21:36	05/12/2020 17:11	05/12/2020 21:36	4,40	76	334,65	CHI
20201220824	ITAPIRAPUA	IU12087963	MATRINCHA	05/12/2020 17:12	05/12/2020 19:20	05/12/2020 17:12	05/12/2020 19:20	2,13	43	91,59	CHI
20201220843	RIO VERDE	630548092	RIO VERDE S2	05/12/2020 17:13	06/12/2020 09:13	05/12/2020 17:13	06/12/2020 09:13	15,99	1	15,99	CHI
20201220846	SANTO ANTONIO DE GOIAS	10008620618	NEROPOLIS S1	05/12/2020 17:13	06/12/2020 09:35	05/12/2020 17:13	06/12/2020 09:35	16,35	1	16,35	CHI
20201221205	PALESTINA DE GOIAS	PY12023472	PALESTINA	05/12/2020 17:13	06/12/2020 02:40	05/12/2020 17:13	06/12/2020 02:40	9,43	8	75,48	CHI
20201221475	RIO VERDE	RV12279565	CABRIUVA S1	05/12/2020 17:13	06/12/2020 20:02	05/12/2020 17:13	06/12/2020 11:34	18,36	10	183,55	CHI
20201221475	JATAI	RV12062768LD	CABRIUVA S1	05/12/2020 17:13	06/12/2020 20:02	05/12/2020 17:13	06/12/2020 20:02	26,82	1	26,82	CHI

20201221475	RIO VERDE	RV12062768LD	CABRIUVA S1	05/12/2020 17:13	06/12/2020 20:02	05/12/2020 17:13	06/12/2020 20:02	26,82	21	563,12	CHI
20201220849	AURILANDIA	AI12206461	FIRMINOPOLIS S2	05/12/2020 17:14	05/12/2020 20:57	05/12/2020 17:14	05/12/2020 20:57	3,71	14	51,97	CHI
20201220849	FIRMINOPOLIS	AI12206461	FIRMINOPOLIS S2	05/12/2020 17:14	05/12/2020 20:57	05/12/2020 17:14	05/12/2020 20:57	3,71	16	59,40	CHI
20201220858	ALTO HORIZONTE	NH12202110RE	SANTA TEREZINHA	05/12/2020 17:14	06/12/2020 07:01	05/12/2020 17:14	06/12/2020 07:01	13,78	12	165,32	CHI
20201220858	PILAR DE GOIAS	NH12202110RE	SANTA TEREZINHA	05/12/2020 17:14	06/12/2020 07:01	05/12/2020 17:14	06/12/2020 07:01	13,78	17	234,20	CHI
20201220858	NOVA IGUAQU DE GOIAS	NH12202110RE	SANTA TEREZINHA	05/12/2020 17:14	06/12/2020 07:01	05/12/2020 17:14	06/12/2020 07:01	13,78	1	13,78	CHI
20201220858	SANTA TEREZINHA DE GOIAS	NH12202110RE	SANTA TEREZINHA	05/12/2020 17:14	06/12/2020 07:01	05/12/2020 17:14	06/12/2020 07:01	13,78	23	316,86	CHI
20201221207	RIO VERDE	RV11113526	RIO VERDE S1	05/12/2020 17:14	05/12/2020 22:00	05/12/2020 17:14	05/12/2020 22:00	4,76	176	837,12	CHI
20201220859	CAIAPONIA	PH12079501	PIRANHAS	05/12/2020 17:15	06/12/2020 11:41	05/12/2020 17:15	06/12/2020 11:41	18,42	7	128,94	CHI
20201220859	PIRANHAS	PH12079501	PIRANHAS	05/12/2020 17:15	06/12/2020 11:41	05/12/2020 17:15	06/12/2020 11:41	18,42	2	36,84	CHI
20201221837	RIO VERDE	RV12159300	CABRIUVA S2	05/12/2020 17:16	05/12/2020 22:45	05/12/2020 17:16	05/12/2020 22:45	5,47	12	65,62	CHI
202012179328	ITAPACI	IW12294694	ITAPACI	05/12/2020 17:16	05/12/2020 19:17	05/12/2020 17:16	05/12/2020 19:17	2,01	9	18,09	CHI
20201220867	UIRAPURU	UP12294696	NOVA CRIXAS	05/12/2020 17:17	06/12/2020 15:56	05/12/2020 17:17	06/12/2020 11:16	17,98	4	71,91	CHI
20201220867	SANTA TEREZINHA DE GOIAS	UP12294696	NOVA CRIXAS	05/12/2020 17:17	06/12/2020 15:56	05/12/2020 17:17	06/12/2020 11:16	17,98	1	17,98	CHI
20201220867	MARA ROSA	UP12294696	NOVA CRIXAS	05/12/2020 17:17	06/12/2020 15:56	05/12/2020 17:17	06/12/2020 11:16	17,98	2	35,96	CHI
20201220867	MARA ROSA	UP12294696	NOVA CRIXAS	05/12/2020 17:17	06/12/2020 15:56	05/12/2020 17:17	06/12/2020 11:54	18,62	35	651,70	CHI
20201220867	AMARALINA	UP12294696	NOVA CRIXAS	05/12/2020 17:17	06/12/2020 15:56	05/12/2020 17:17	06/12/2020 11:54	18,62	20	372,40	CHI
20201220867	AMARALINA	MQ12135687LD	NOVA CRIXAS	05/12/2020 17:17	06/12/2020 15:56	06/12/2020 03:00	06/12/2020 11:54	8,91	1	8,91	CHI
20201220867	AMARALINA	UP12294696	NOVA CRIXAS	05/12/2020 17:17	06/12/2020 15:56	06/12/2020 12:05	06/12/2020 13:47	1,70	20	33,99	CHI
20201220867	SANTA TEREZINHA DE GOIAS	UP12294696	NOVA CRIXAS	05/12/2020 17:17	06/12/2020 15:56	06/12/2020 12:05	06/12/2020 13:47	1,70	1	1,70	CHI
20201220867	MARA ROSA	UP12294696	NOVA CRIXAS	05/12/2020 17:17	06/12/2020 15:56	06/12/2020 12:05	06/12/2020 13:47	1,70	36	61,19	CHI
20201220867	UIRAPURU	UP12294696	NOVA CRIXAS	05/12/2020 17:17	06/12/2020 15:56	06/12/2020 12:05	06/12/2020 13:47	1,70	4	6,80	CHI
20201220867	MARA ROSA	MQ12208443	NOVA CRIXAS	05/12/2020 17:17	06/12/2020 15:56	06/12/2020 12:05	06/12/2020 15:29	3,40	1	3,40	CHI
20201220867	AMARALINA	MQ12208443	NOVA CRIXAS	05/12/2020 17:17	06/12/2020 15:56	06/12/2020 12:05	06/12/2020 15:29	3,40	1	3,40	CHI
20201220867	MARA ROSA	UP12294696	NOVA CRIXAS	05/12/2020 17:17	06/12/2020 15:56	05/12/2020 17:17	06/12/2020 15:56	22,65	6	135,91	CHI
20201220867	AMARALINA	UP12294696	NOVA CRIXAS	05/12/2020 17:17	06/12/2020 15:56	05/12/2020 17:17	06/12/2020 15:56	22,65	33	747,50	CHI
20201220977	QUIRINOPOLIS	QI10401491	QUIRINOPOLIS	05/12/2020 17:17	06/12/2020 12:15	05/12/2020 17:17	05/12/2020 17:23	0,11	73	8,27	CHI
20201220977	QUIRINOPOLIS	QI10414860	QUIRINOPOLIS	05/12/2020 17:17	06/12/2020 12:15	05/12/2020 17:17	06/12/2020 12:00	18,72	11	205,90	CHI
20201220977	RIO VERDE	QI10401491	QUIRINOPOLIS	05/12/2020 17:17	06/12/2020 12:15	05/12/2020 17:17	06/12/2020 12:01	18,73	44	824,23	CHI
20201220977	RIO VERDE	QI10401491	QUIRINOPOLIS	05/12/2020 17:17	06/12/2020 12:15	05/12/2020 17:17	06/12/2020 12:01	18,73	116	2172,97	CHI
20201220977	QUIRINOPOLIS	QI10401491	QUIRINOPOLIS	05/12/2020 17:17	06/12/2020 12:15	05/12/2020 17:17	06/12/2020 12:01	18,73	290	5432,43	CHI
20201220977	CACHOEIRA ALTA	QI10401491	QUIRINOPOLIS	05/12/2020 17:17	06/12/2020 12:15	05/12/2020 17:17	06/12/2020 12:01	18,73	3	56,20	CHI
20201220977	CACHOEIRA ALTA	QI10401491	QUIRINOPOLIS	05/12/2020 17:17	06/12/2020 12:15	05/12/2020 17:17	06/12/2020 12:01	18,73	39	730,57	CHI
20201220977	QUIRINOPOLIS	QI13245784	QUIRINOPOLIS	05/12/2020 17:17	06/12/2020 12:15	05/12/2020 17:17	06/12/2020 12:01	18,73	49	917,89	CHI
20201220977	QUIRINOPOLIS	QI10401491	QUIRINOPOLIS	05/12/2020 17:17	06/12/2020 12:15	05/12/2020 17:17	06/12/2020 12:01	18,73	88	1648,46	CHI
20201220977	QUIRINOPOLIS	QI12091051	QUIRINOPOLIS	05/12/2020 17:17	06/12/2020 12:15	05/12/2020 17:17	06/12/2020 12:15	18,97	5	94,85	CHI
20201220887	ABADIANIA	350021004	ANAPOLIS UNIVERSITARIO S1	05/12/2020 17:19	05/12/2020 18:32	05/12/2020 17:19	05/12/2020 18:32	1,20	1	1,20	CHI
20201220888	GOIANIA	15899718	GOYA S2	05/12/2020 17:19	05/12/2020 18:59	05/12/2020 17:19	05/12/2020 18:59	1,65	1	1,65	CHI
20201221078	FIRMINOPOLIS	FR12126033	FIRMINOPOLIS S1	05/12/2020 17:21	06/12/2020 01:28	05/12/2020 17:21	06/12/2020 01:28	8,11	8	64,91	CHI
20201224514	CRIXAS	CX11371718	SANTA TEREZINHA	05/12/2020 17:22	06/12/2020 12:25	05/12/2020 17:22	06/12/2020 12:25	19,04	1	19,04	CHI
20201220932	MINEIROS	10027809046	PARQUE DAS EMAS	05/12/2020 17:23	06/12/2020 10:09	05/12/2020 17:23	06/12/2020 10:09	16,75	1	16,75	CHI
20201221202	RIO VERDE	RV11360964	CABRIUVA S1	05/12/2020 17:23	06/12/2020 01:22	05/12/2020 17:23	06/12/2020 01:22	7,97	29	231,13	CHI
20201222319	RIO VERDE	RV11054317	RIO VERDE S1	05/12/2020 17:23	05/12/2020 21:31	05/12/2020 17:23	05/12/2020 21:31	4,13	180	742,70	CHI
20201220937	GOIANIA	12228072	FERROVIARIO S2	05/12/2020 17:24	05/12/2020 18:56	05/12/2020 17:24	05/12/2020 18:56	1,53	1	1,53	CHI
20201220942	GOIANESIA	GE12185196	GOIANESIA S1	05/12/2020 17:24	06/12/2020 11:40	05/12/2020 17:24	06/12/2020 11:40	18,25	2	36,50	CHI
20201220961	ITAPACI	IW11074945	ITAPACI	05/12/2020 17:24	05/12/2020 23:45	05/12/2020 17:24	06/12/2020 23:45	6,35	137	869,65	CHI
20201222613	JATAI	JT11182134	JATAI S2	05/12/2020 17:24	06/12/2020 06:59	05/12/2020 17:24	06/12/2020 06:59	13,58	97	1316,86	CHI
20201220992	RIO VERDE	RV11000153	CABRIUVA S1	05/12/2020 17:25	05/12/2020 20:42	05/12/2020 17:25	05/12/2020 20:42	3,28	143	468,92	CHI
20201220955	ARAGARCAS	AG21050709	ARAGARCAS	05/12/2020 17:26	05/12/2020 21:33	05/12/2020 17:26	05/12/2020 21:33	4,12	1	4,12	CHI
20201221901	SAO MIGUEL DO ARAGUAIA	SM10396890	SAO MIGUEL DO ARAGUAIA	05/12/2020 17:27	07/12/2020 15:34	05/12/2020 17:27	05/12/2020 21:53	4,43	45	199,51	CHI
20201221901	SAO MIGUEL DO ARAGUAIA	SM12013034	SAO MIGUEL DO ARAGUAIA	05/12/2020 17:27	07/12/2020 15:34	05/12/2020 17:27	05/12/2020 23:00	5,54	19	105,34	CHI

20201221901	SAO MIGUEL DO ARAGUAIA	SM10396890	SAO MIGUEL DO ARAGUAIA	05/12/2020 17:27	07/12/2020 15:34	06/12/2020 01:44	06/12/2020 04:11	2,46	64	157,46	CHI
20201221901	SAO MIGUEL DO ARAGUAIA	SM10396890	SAO MIGUEL DO ARAGUAIA	05/12/2020 17:27	07/12/2020 15:34	06/12/2020 08:36	06/12/2020 08:57	0,36	64	23,20	CHI
20201221901	SAO MIGUEL DO ARAGUAIA	SM10396890	SAO MIGUEL DO ARAGUAIA	05/12/2020 17:27	07/12/2020 15:34	05/12/2020 17:27	06/12/2020 15:08	21,68	5	108,38	CHI
20201221901	SAO MIGUEL DO ARAGUAIA	SM10396890	SAO MIGUEL DO ARAGUAIA	05/12/2020 17:27	07/12/2020 15:34	05/12/2020 17:27	06/12/2020 22:27	28,99	33	956,74	CHI
20201221901	SAO MIGUEL DO ARAGUAIA	SM10396890	SAO MIGUEL DO ARAGUAIA	05/12/2020 17:27	07/12/2020 15:34	06/12/2020 22:28	06/12/2020 22:41	0,21	64	13,21	CHI
20201221901	SAO MIGUEL DO ARAGUAIA	SM16404040	SAO MIGUEL DO ARAGUAIA	05/12/2020 17:27	07/12/2020 15:34	06/12/2020 22:28	07/12/2020 00:35	2,11	5	10,54	CHI
20201221901	SAO MIGUEL DO ARAGUAIA	SM10396890	SAO MIGUEL DO ARAGUAIA	05/12/2020 17:27	07/12/2020 15:34	07/12/2020 08:52	07/12/2020 09:04	0,20	70	14,00	CHI
20201221901	SAO MIGUEL DO ARAGUAIA	SM13182482	SAO MIGUEL DO ARAGUAIA	05/12/2020 17:27	07/12/2020 15:34	06/12/2020 22:28	07/12/2020 12:12	13,73	6	82,38	CHI
20201221901	BONOPOLIS	SM10396890	SAO MIGUEL DO ARAGUAIA	05/12/2020 17:27	07/12/2020 15:34	05/12/2020 17:27	07/12/2020 13:21	43,90	105	4609,85	CHI
20201221901	SAO MIGUEL DO ARAGUAIA	SM10396890	SAO MIGUEL DO ARAGUAIA	05/12/2020 17:27	07/12/2020 15:34	05/12/2020 17:27	07/12/2020 13:21	43,90	10	439,03	CHI
20201221901	SAO MIGUEL DO ARAGUAIA	SM12013036	SAO MIGUEL DO ARAGUAIA	05/12/2020 17:27	07/12/2020 15:34	06/12/2020 22:28	07/12/2020 15:34	17,09	22	376,04	CHI
20201220980	GOIANIA	GN11043860	XAVANTES	05/12/2020 17:29	05/12/2020 19:06	05/12/2020 17:29	05/12/2020 19:06	1,62	8	12,93	CHI
20201220982	MINEIROS	10005850299	PARQUE DAS EMAS	05/12/2020 17:29	06/12/2020 08:57	05/12/2020 17:29	06/12/2020 08:57	15,48	1	15,48	CHI
20201220985	CRISTALINA	KR21228574	PAMPLONA	05/12/2020 17:29	06/12/2020 01:27	05/12/2020 17:29	06/12/2020 01:27	7,96	1	7,96	CHI
20201220991	ANICUNS	AC21021759	ANICUNS	05/12/2020 17:29	05/12/2020 21:25	05/12/2020 17:29	05/12/2020 21:25	3,92	1	3,92	CHI
20201221696	JATAI	JT11182123	JATAI S2	05/12/2020 17:29	05/12/2020 19:48	05/12/2020 17:29	05/12/2020 19:48	2,30	127	292,59	CHI
20201220994	CRISTALINA	KR21330696	CRISTALINA S2	05/12/2020 17:30	05/12/2020 20:39	05/12/2020 17:30	05/12/2020 20:39	3,15	1	3,15	CHI
20201221008	APARECIDA DE GOIANIA	10001415377	INDEPENDENCIA S2	05/12/2020 17:31	05/12/2020 22:48	05/12/2020 17:31	05/12/2020 22:48	5,27	1	5,27	CHI
20201221009	PORANGATU	PO12391647	NOVO PLANALTO	05/12/2020 17:31	05/12/2020 20:20	05/12/2020 17:31	05/12/2020 20:20	2,80	26	72,88	CHI
20201221115	SENADOR CANEDO	SW16407262	SENADOR CANEDO	05/12/2020 17:31	05/12/2020 19:00	05/12/2020 17:31	05/12/2020 19:00	1,48	1089	1609,30	CHI
20201221578	RIO VERDE	RV12214072	RIO VERDE S1	05/12/2020 17:31	05/12/2020 21:43	05/12/2020 17:31	05/12/2020 21:43	4,21	199	836,91	CHI
20201221023	NOVA IGUAQU DE GOIAS	NH12374720	URUACU	05/12/2020 17:33	07/12/2020 10:14	05/12/2020 17:33	07/12/2020 10:14	40,68	8	325,40	CHI
20201221028	GOIANIA	10005250348	FERROVIARIO S1	05/12/2020 17:34	05/12/2020 20:07	05/12/2020 17:34	05/12/2020 20:07	2,55	1	2,55	CHI
20201221034	CRISTALINA	KR21133679	CRISTALINA S1	05/12/2020 17:34	05/12/2020 18:28	05/12/2020 17:34	05/12/2020 18:28	0,88	3	2,65	CHI
20201221043	ABADIANIA	AA12297648	ANAPOLIS UNIVERSITARIO S1	05/12/2020 17:35	06/12/2020 12:43	05/12/2020 17:35	06/12/2020 12:43	19,12	5	95,60	CHI
20201222513	PIRANHAS	PH11023523	PIRANHAS	05/12/2020 17:35	06/12/2020 00:09	05/12/2020 17:35	06/12/2020 00:09	6,55	97	635,54	CHI
20201222626	RIO QUENTE	CN12263786	RIO QUENTE	05/12/2020 17:35	05/12/2020 22:20	05/12/2020 17:35	05/12/2020 22:20	4,73	1	4,73	CHI
20201222626	CALDAS NOVAS	CN12263786	RIO QUENTE	05/12/2020 17:35	05/12/2020 22:20	05/12/2020 17:35	05/12/2020 22:20	4,73	35	165,68	CHI
20201221059	MINEIROS	10023272439	PARQUE DAS EMAS	05/12/2020 17:36	05/12/2020 22:46	05/12/2020 17:36	05/12/2020 22:46	5,17	1	5,17	CHI
20201221551	APARECIDA DE GOIANIA	AP11004901	REAL S1	05/12/2020 17:36	05/12/2020 20:49	05/12/2020 17:36	05/12/2020 20:49	3,20	102	326,46	CHI
20201221085	NOVA CRIXAS	NA21077102	NOVA CRIXAS	05/12/2020 17:38	06/12/2020 08:32	05/12/2020 17:38	06/12/2020 08:32	14,90	1	14,90	CHI
20201221090	PONTALINA	210032716	PONTALINA	05/12/2020 17:38	05/12/2020 19:30	05/12/2020 17:38	05/12/2020 19:30	1,86	1	1,86	CHI
2020120500081	JUSSARA	02502	BRITANIA	05/12/2020 17:38	05/12/2020 17:41	05/12/2020 17:38	05/12/2020 17:41	0,05	24	1,20	CHI
2020120500081	BRITANIA	02502	BRITANIA	05/12/2020 17:38	05/12/2020 17:41	05/12/2020 17:38	05/12/2020 17:41	0,05	1952	97,60	CHI
2020120500081	ARUANA	02531	BRITANIA	05/12/2020 17:38	05/12/2020 17:41	05/12/2020 17:38	05/12/2020 17:41	0,05	27	1,35	CHI
2020120500081	BRITANIA	40501	BRITANIA	05/12/2020 17:38	05/12/2020 17:41	05/12/2020 17:38	05/12/2020 17:41	0,05	12	0,60	CHI
2020120500081	BRITANIA	02501	BRITANIA	05/12/2020 17:38	05/12/2020 17:41	05/12/2020 17:38	05/12/2020 17:41	0,05	1347	67,35	CHI
2020120500081	JUSSARA	02501	BRITANIA	05/12/2020 17:38	05/12/2020 17:41	05/12/2020 17:38	05/12/2020 17:41	0,05	49	2,45	CHI
2020120500081	ITAPIRAPUA	02502	BRITANIA	05/12/2020 17:38	05/12/2020 17:41	05/12/2020 17:38	05/12/2020 17:41	0,05	2	0,10	CHI
2020120500081	BRITANIA	02531	BRITANIA	05/12/2020 17:38	05/12/2020 17:41	05/12/2020 17:38	05/12/2020 17:41	0,05	19	0,95	CHI
2020120500081	ARUANA	02502	BRITANIA	05/12/2020 17:38	05/12/2020 17:41	05/12/2020 17:38	05/12/2020 17:41	0,05	13	0,65	CHI
20201221098	MAMBAL	MB11161460	IACIARA S2	05/12/2020 17:39	05/12/2020 18:25	05/12/2020 17:39	05/12/2020 18:25	0,76	3	2,27	CHI
20201221997	ANICUNS	AC11032074	ANICUNS	05/12/2020 17:39	05/12/2020 19:51	05/12/2020 17:39	05/12/2020 19:51	2,19	158	345,62	CHI
20201221129	PALMINOPOLIS	PP10404111	PALMEIRAS	05/12/2020 17:40	06/12/2020 12:47	05/12/2020 17:40	05/12/2020 21:37	3,96	30	118,81	CHI
20201221129	PALMINOPOLIS	PP10404111	PALMEIRAS	05/12/2020 17:40	06/12/2020 12:47	05/12/2020 17:40	05/12/2020 22:49	5,15	14	72,10	CHI
20201221129	PALMINOPOLIS	PP12233311RE	PALMEIRAS	05/12/2020 17:40	06/12/2020 12:47	05/12/2020 17:40	05/12/2020 23:18	5,63	39	219,68	CHI
20201221129	JANDAIA	PP12233311RE	PALMEIRAS	05/12/2020 17:40	06/12/2020 12:47	05/12/2020 17:40	05/12/2020 23:18	5,63	19	107,02	CHI
20201221129	PALMINOPOLIS	PP10404111	PALMEIRAS	05/12/2020 17:40	06/12/2020 12:47	05/12/2020 17:40	06/12/2020 12:25	18,76	12	225,11	CHI
20201221129	JANDAIA	PP10404111	PALMEIRAS	05/12/2020 17:40	06/12/2020 12:47	05/12/2020 17:40	06/12/2020 12:25	18,76	8	150,07	CHI
20201221129	PALMINOPOLIS	PP10404111	PALMEIRAS	05/12/2020 17:40	06/12/2020 12:47	05/12/2020 17:40	06/12/2020 12:47	19,12	70	1338,09	CHI
20201221129	JANDAIA	PP10404111	PALMEIRAS	05/12/2020 17:40	06/12/2020 12:47	05/12/2020 17:40	06/12/2020 12:47	19,12	29	554,35	CHI

20201221118	MATRINCHA	10021351404	MATRINCHA	05/12/2020 17:41	06/12/2020 20:26	05/12/2020 17:41	06/12/2020 20:26	26,74	1	26,74	CHI
20201221346	ITAPIRAPUA	IU12142895	MATRINCHA	05/12/2020 17:41	06/12/2020 08:05	05/12/2020 17:41	06/12/2020 08:05	14,39	8	115,16	CHI
20201222296	GOIANIA	GN11012184	ATLANTICO S2	05/12/2020 17:41	05/12/2020 23:56	05/12/2020 17:41	05/12/2020 23:56	6,25	215	1343,03	CHI
20201221125	EDEIA	EA11142337	EDEIA	05/12/2020 17:42	05/12/2020 21:05	05/12/2020 17:42	05/12/2020 21:05	3,37	63	212,35	CHI
20201222220	CRISTALINA	KR12305009	PAMPLONA	05/12/2020 17:42	05/12/2020 23:45	05/12/2020 17:42	05/12/2020 23:45	6,05	6	36,27	CHI
20201222202	CACU	BX12168258	SAO MIGUEL DO ARAGUAIA	05/12/2020 17:43	06/12/2020 02:43	05/12/2020 17:43	06/12/2020 02:43	8,99	1	8,99	CHI
20201222202	BONOPOLIS	BX12168258	SAO MIGUEL DO ARAGUAIA	05/12/2020 17:43	06/12/2020 02:43	05/12/2020 17:43	06/12/2020 02:43	8,99	20	179,71	CHI
20201221145	NAZARIO	NZ21206366	ANICUNS	05/12/2020 17:44	06/12/2020 07:54	05/12/2020 17:44	06/12/2020 07:54	14,15	1	14,15	CHI
20201222474	GOIANIA	GN12308742	ATLANTICO S3	05/12/2020 17:44	05/12/2020 21:40	05/12/2020 17:44	05/12/2020 21:40	3,93	119	467,67	CHI
20201221588	GOIANIA	GN11313287	ATLANTICO S3	05/12/2020 17:44	06/12/2020 00:38	05/12/2020 17:44	06/12/2020 00:38	6,90	64	441,37	CHI
20201221153	PEROLANDIA	DP12346700	JATAI S1	05/12/2020 17:45	06/12/2020 10:35	05/12/2020 17:45	06/12/2020 10:35	16,82	1	16,82	CHI
20201221355	MUTUNOPOLIS	MU12129781	MARA ROSA	05/12/2020 17:45	05/12/2020 21:41	05/12/2020 17:45	05/12/2020 21:41	3,92	7	27,47	CHI
20201222260	IACIARA	IA12092593	IACIARA S2	05/12/2020 17:45	06/12/2020 02:25	05/12/2020 17:45	06/12/2020 02:25	8,66	2	17,33	CHI
20201221165	JATAI	JT21136062	JATAI S2	05/12/2020 17:46	06/12/2020 11:36	05/12/2020 17:46	06/12/2020 11:36	17,83	1	17,83	CHI
20201221171	BRITANIA	BT21010494	BRITANIA	05/12/2020 17:46	07/12/2020 09:00	05/12/2020 17:46	07/12/2020 09:00	39,23	1	39,23	CHI
20201221174	NAZARIO	NZ12040406	ANICUNS	05/12/2020 17:46	06/12/2020 09:40	05/12/2020 17:46	06/12/2020 09:40	15,88	1	15,88	CHI
20201221240	NAZARIO	NZ12259134	ANICUNS	05/12/2020 17:46	05/12/2020 22:21	05/12/2020 17:46	05/12/2020 22:21	4,57	3	13,72	CHI
20201221240	PALMEIRAS DE GOIAS	NZ12259134	ANICUNS	05/12/2020 17:46	05/12/2020 22:21	05/12/2020 17:46	05/12/2020 22:21	4,57	3	13,72	CHI
20201221421	FORMOSA	FA12131868	ITUIQUIRA	05/12/2020 17:46	05/12/2020 19:39	05/12/2020 17:46	05/12/2020 19:39	1,89	690	1302,95	CHI
20201221899	RIO VERDE	RV12271290	CABRIUVA S2	05/12/2020 17:46	05/12/2020 22:20	05/12/2020 17:46	05/12/2020 22:20	4,56	22	100,27	CHI
20201221423	PORANGATU	PO12027986	PORANGATU	05/12/2020 17:49	05/12/2020 22:11	05/12/2020 17:49	05/12/2020 22:11	4,36	5	21,82	CHI
20201221200	GOIANIRA	10010471756	GOIANIRA	05/12/2020 17:51	05/12/2020 20:22	05/12/2020 17:51	05/12/2020 20:22	2,51	1	2,51	CHI
20201221204	JATAI	JT12306843	JATAI S1	05/12/2020 17:52	06/12/2020 12:54	05/12/2020 17:52	06/12/2020 12:54	19,03	2	38,06	CHI
20201221210	MINEIROS	MY21303800	PARQUE DAS EMAS	05/12/2020 17:52	05/12/2020 23:59	05/12/2020 17:52	05/12/2020 23:59	6,10	1	6,10	CHI
20201221295	NOVA IGUAUCU DE GOIAS	NH11190115	SANTA TEREZINHA	05/12/2020 17:52	06/12/2020 04:22	05/12/2020 17:52	06/12/2020 04:22	10,50	118	1238,90	CHI
20201221215	CAMPO ALEGRE DE GOIAS	CM21154707	CAMPO ALEGRE DE GOIAS	05/12/2020 17:53	06/12/2020 08:42	05/12/2020 17:53	06/12/2020 08:42	14,80	1	14,80	CHI
20201221335	EDEIA	EA12043985	EDEIA	05/12/2020 17:53	05/12/2020 21:58	05/12/2020 17:53	05/12/2020 21:58	4,08	5	20,42	CHI
20201221216	RIO QUENTE	CN12391497	VILA CORUMBA	05/12/2020 17:54	05/12/2020 23:58	05/12/2020 17:54	05/12/2020 23:58	6,06	1	6,06	CHI
20201221223	ORIZONA	OZ21250400	VIANOPOLIS	05/12/2020 17:54	06/12/2020 18:26	05/12/2020 17:54	06/12/2020 18:26	24,52	1	24,52	CHI
20201221233	NOVA CRIXAS	NA21055711	MOZARLANDIA	05/12/2020 17:55	05/12/2020 22:04	05/12/2020 17:55	05/12/2020 22:04	4,14	1	4,14	CHI
20201222405	MONTIVIDIU	MV12305995	MONTIVIDIU T	05/12/2020 17:55	07/12/2020 15:51	05/12/2020 17:55	06/12/2020 22:38	28,72	2	57,43	CHI
20201222405	PARAUNA	MV12305995	MONTIVIDIU T	05/12/2020 17:55	07/12/2020 15:51	05/12/2020 17:55	06/12/2020 22:38	28,72	4	114,86	CHI
20201222405	CAIAPONIA	MV12305995	MONTIVIDIU T	05/12/2020 17:55	07/12/2020 15:51	05/12/2020 17:55	06/12/2020 22:38	28,72	4	114,86	CHI
20201222405	IVOLANDIA	MV12305995	MONTIVIDIU T	05/12/2020 17:55	07/12/2020 15:51	06/12/2020 15:57	06/12/2020 22:38	6,68	7	46,74	CHI
20201222405	PARAUNA	MV12305995	MONTIVIDIU T	05/12/2020 17:55	07/12/2020 15:51	06/12/2020 15:57	06/12/2020 22:38	6,68	8	53,42	CHI
20201222405	CAIAPONIA	MV12305995	MONTIVIDIU T	05/12/2020 17:55	07/12/2020 15:51	06/12/2020 15:57	06/12/2020 22:38	6,68	23	153,58	CHI
20201222405	MONTIVIDIU	MV12305995	MONTIVIDIU T	05/12/2020 17:55	07/12/2020 15:51	06/12/2020 15:57	06/12/2020 22:38	6,68	10	66,77	CHI
20201222405	MONTIVIDIU	MV12305995	MONTIVIDIU T	05/12/2020 17:55	07/12/2020 15:51	05/12/2020 17:55	06/12/2020 23:21	29,43	10	294,31	CHI
20201222405	MONTIVIDIU	MV13305749	MONTIVIDIU T	05/12/2020 17:55	07/12/2020 15:51	06/12/2020 15:57	06/12/2020 23:21	7,39	3	22,18	CHI
20201222405	PARAUNA	PU12090442LD	MONTIVIDIU T	05/12/2020 17:55	07/12/2020 15:51	05/12/2020 17:55	07/12/2020 08:42	38,78	12	465,38	CHI
20201222405	IVOLANDIA	PU12090442LD	MONTIVIDIU T	05/12/2020 17:55	07/12/2020 15:51	05/12/2020 17:55	07/12/2020 08:42	38,78	3	116,35	CHI
20201222405	MONTIVIDIU	MV12305995	MONTIVIDIU T	05/12/2020 17:55	07/12/2020 15:51	05/12/2020 17:55	07/12/2020 15:51	45,94	2	91,87	CHI
20201222405	CAIAPONIA	MV12305995	MONTIVIDIU T	05/12/2020 17:55	07/12/2020 15:51	05/12/2020 17:55	07/12/2020 15:51	45,94	3	137,81	CHI
20201222405	MONTIVIDIU	MV12075145LD	MONTIVIDIU T	05/12/2020 17:55	07/12/2020 15:51	06/12/2020 15:57	07/12/2020 15:51	23,90	1	23,90	CHI
20201222405	CAIAPONIA	MV12075145LD	MONTIVIDIU T	05/12/2020 17:55	07/12/2020 15:51	06/12/2020 15:57	07/12/2020 15:51	23,90	9	215,09	CHI
20201226523	GOIAS	GS12220301	GOIAS	05/12/2020 17:55	06/12/2020 14:51	05/12/2020 17:55	06/12/2020 14:51	20,92	6	125,54	CHI
20201221242	ITAUCU	IX12000017	INHUMAS S1	05/12/2020 17:56	06/12/2020 02:02	05/12/2020 17:56	06/12/2020 02:02	8,09	10	80,86	CHI
20201221243	CAIAPONIA	CP12076264	MONTIVIDIU T	05/12/2020 17:56	05/12/2020 23:00	05/12/2020 17:56	05/12/2020 23:00	5,05	15	75,77	CHI
20201221243	RIO VERDE	CP12076264	MONTIVIDIU T	05/12/2020 17:56	05/12/2020 23:00	05/12/2020 17:56	05/12/2020 23:00	5,05	8	40,41	CHI
20201221243	JATAI	CP12076264	MONTIVIDIU T	05/12/2020 17:56	05/12/2020 23:00	05/12/2020 17:56	05/12/2020 23:00	5,05	4	20,21	CHI
20201221243	MONTIVIDIU	CP12076264	MONTIVIDIU T	05/12/2020 17:56	05/12/2020 23:00	05/12/2020 21:35	05/12/2020 23:00	1,42	2	2,83	CHI

20201221243	RIO VERDE	CP12076264	MONTIVIDIU T	05/12/2020 17:56	05/12/2020 23:00	05/12/2020 21:35	05/12/2020 23:00	1,42	2	2,83	CHI
20201221243	CAIAPONIA	CP12076264	MONTIVIDIU T	05/12/2020 17:56	05/12/2020 23:00	05/12/2020 21:35	05/12/2020 23:00	1,42	12	17,00	CHI
20201221243	JATAI	CP12076264	MONTIVIDIU T	05/12/2020 17:56	05/12/2020 23:00	05/12/2020 21:35	05/12/2020 23:00	1,42	2	2,83	CHI
20201221333	JATAI	JT12196081RE	JATAI S3	05/12/2020 17:56	06/12/2020 07:12	05/12/2020 17:56	06/12/2020 07:12	13,27	7	92,86	CHI
20201221409	JATAI	JT11036246	JATAI S3	05/12/2020 17:56	05/12/2020 20:33	05/12/2020 17:56	05/12/2020 20:33	2,61	141	368,52	CHI
20201222263	FLORES DE GOIAS	FB12253575	IACIARA S2	05/12/2020 17:57	05/12/2020 23:12	05/12/2020 17:57	05/12/2020 23:12	5,24	69	361,81	CHI
20201222551	RIO QUENTE	MG12120777	VILA CORUMBA	05/12/2020 17:57	05/12/2020 22:28	05/12/2020 17:57	05/12/2020 22:28	4,51	1	4,51	CHI
20201222551	MARZAGAO	MG12120777	VILA CORUMBA	05/12/2020 17:57	05/12/2020 22:28	05/12/2020 17:57	05/12/2020 22:28	4,51	2	9,02	CHI
20201222551	CALDAS NOVAS	MG12120777	VILA CORUMBA	05/12/2020 17:57	05/12/2020 22:28	05/12/2020 17:57	05/12/2020 22:28	4,51	0	0,00	CHI
20201221260	SANTA HELENA DE GOIAS	SH11159473	IPEGUARI	05/12/2020 17:58	05/12/2020 20:04	05/12/2020 17:58	05/12/2020 20:04	2,10	50	105,14	CHI
20201221266	CAMPESTRE DE GOIAS	TR21283845	TRINDADE	05/12/2020 17:58	05/12/2020 23:09	05/12/2020 17:58	05/12/2020 23:09	5,17	1	5,17	CHI
20201221645	PARAUNA	PU12079039	PARAUNA	05/12/2020 17:58	06/12/2020 06:48	05/12/2020 17:58	06/12/2020 06:48	12,83	38	487,57	CHI
20201221272	SANTO ANTONIO DA BARRA	BZ21303288	ACREUNA	05/12/2020 17:59	05/12/2020 20:40	05/12/2020 17:59	05/12/2020 20:40	2,68	1	2,68	CHI
20201221275	SANTO ANTONIO DE GOIAS	BW21158647	NEROPOLIS S1	05/12/2020 17:59	06/12/2020 08:06	05/12/2020 17:59	06/12/2020 08:06	14,11	1	14,11	CHI
20201221277	GOIANIA	10027453683	GOYA S1	05/12/2020 17:59	05/12/2020 20:00	05/12/2020 17:59	05/12/2020 20:00	2,00	1	2,00	CHI
20201221279	GAMELEIRA DE GOIAS	SV21039288	ANAPOLIS UNIVERSITARIO S1	05/12/2020 17:59	05/12/2020 23:28	05/12/2020 17:59	05/12/2020 23:28	5,47	1	5,47	CHI
20201221970	CALDAS NOVAS	PJ12263230	CALDAS NOVAS S1	05/12/2020 17:59	05/12/2020 23:36	05/12/2020 17:59	05/12/2020 23:36	5,61	1	5,61	CHI
20201221970	PIRACANJUBA	PJ12263230	CALDAS NOVAS S1	05/12/2020 17:59	05/12/2020 23:36	05/12/2020 17:59	05/12/2020 23:36	5,61	17	95,42	CHI
20201221282	MUTUNOPOLIS	8150000084	MARA ROSA	05/12/2020 18:00	06/12/2020 01:24	05/12/2020 18:00	06/12/2020 01:24	7,40	1	7,40	CHI
20201221293	RIO VERDE	RV21000135	RIO VERDE S1	05/12/2020 18:00	06/12/2020 01:48	05/12/2020 18:00	06/12/2020 01:48	7,79	1	7,79	CHI
20201221294	NAZARIO	PL12000123	PALMEIRAS	05/12/2020 18:00	06/12/2020 10:59	05/12/2020 18:00	06/12/2020 10:59	16,97	2	33,94	CHI
20201222521	RIO VERDE	RV12023947	RIO VERDE S2	05/12/2020 18:00	05/12/2020 20:57	05/12/2020 18:00	05/12/2020 20:57	2,94	11	32,38	CHI
20201222923	EDEIA	EA11000001	EDEIA	05/12/2020 18:00	06/12/2020 05:38	05/12/2020 18:00	06/12/2020 05:38	11,63	232	2698,35	CHI
20201223049	MATRINCHA	7388456	MATRINCHA	05/12/2020 18:01	07/12/2020 12:23	05/12/2020 18:01	07/12/2020 12:23	42,36	94	3982,28	CHI
20201221320	SAO LUIS DE MONTES BELOS	SL21145869	SAO LUIZ DOS MONTES BELOS	05/12/2020 18:02	06/12/2020 09:25	05/12/2020 18:02	06/12/2020 09:25	15,38	1	15,38	CHI
20201221324	VILA PROPICIO	NP12339454	GOIANESIA S1	05/12/2020 18:02	06/12/2020 00:15	05/12/2020 18:02	06/12/2020 00:15	6,20	112	694,87	CHI
20201221332	INHUMAS	IN21381651	INHUMAS S1	05/12/2020 18:04	06/12/2020 00:08	05/12/2020 18:04	06/12/2020 00:08	6,06	2	12,12	CHI
20201221338	MINEIROS	1390110956	PARQUE DAS EMAS	05/12/2020 18:04	05/12/2020 20:30	05/12/2020 18:04	05/12/2020 20:30	2,42	1	2,42	CHI
20201221667	VIANOPOLIS	VN11083252	VIANOPOLIS	05/12/2020 18:04	06/12/2020 00:53	05/12/2020 18:04	06/12/2020 00:53	6,81	181	1233,16	CHI
20201221340	CIDADE OCIDENTAL	2680013226	MARAJOARA	05/12/2020 18:05	05/12/2020 20:01	05/12/2020 18:05	05/12/2020 20:01	1,93	1	1,93	CHI
20201221344	JARAGUA	JA12298079	JARAGUA	05/12/2020 18:05	06/12/2020 07:15	05/12/2020 18:05	06/12/2020 07:15	13,17	10	131,71	CHI
20201221350	GOIATUBA	GT21247744	BOM JESUS DE GOIAS	05/12/2020 18:05	05/12/2020 20:23	05/12/2020 18:05	05/12/2020 20:23	2,29	3	6,86	CHI
20201221366	CRISTALINA	1060094244	CRISTALINA S1	05/12/2020 18:07	05/12/2020 19:27	05/12/2020 18:07	05/12/2020 19:27	1,33	1	1,33	CHI
20201221367	JATAI	JT21248417	JATAI S3	05/12/2020 18:07	06/12/2020 06:00	05/12/2020 18:07	06/12/2020 06:00	11,88	1	11,88	CHI
20201221585	JATAI	JT11172862	JATAI S3	05/12/2020 18:07	05/12/2020 21:29	05/12/2020 18:07	05/12/2020 21:29	3,36	101	339,61	CHI
20201222047	PANAMA	IT13000050	PARANAIBA	05/12/2020 18:07	07/12/2020 19:37	05/12/2020 18:07	07/12/2020 19:37	49,51	41	2029,73	CHI
20201222047	GOIATUBA	IT13000050	PARANAIBA	05/12/2020 18:07	07/12/2020 19:37	05/12/2020 18:07	07/12/2020 19:37	49,51	6	297,03	CHI
20201222047	ITUMBARA	IT13000050	PARANAIBA	05/12/2020 18:07	07/12/2020 19:37	05/12/2020 18:07	07/12/2020 19:37	49,51	33	1633,68	CHI
20201222047	BURITI ALEGRE	IT13000050	PARANAIBA	05/12/2020 18:07	07/12/2020 19:37	05/12/2020 18:07	07/12/2020 19:37	49,51	8	396,04	CHI
20201221375	URUACU	640134920	URUACU	05/12/2020 18:08	05/12/2020 20:05	05/12/2020 18:08	05/12/2020 20:05	1,94	1	1,94	CHI
20201221378	ANICUNS	AC21073832	ANICUNS	05/12/2020 18:08	06/12/2020 07:02	05/12/2020 18:08	06/12/2020 07:02	12,89	2	25,78	CHI
20201224515	CRIXAS	CX12181172	SANTA TEREZINHA	05/12/2020 18:08	07/12/2020 10:06	05/12/2020 18:08	07/12/2020 10:06	39,96	7	279,71	CHI
20201221383	RIO VERDE	RV21212482	MONTIVIDIU T	05/12/2020 18:09	06/12/2020 10:31	05/12/2020 18:09	06/12/2020 10:31	16,36	1	16,36	CHI
20201221796	GOIANIRA	CK12386231	INHUMAS S1	05/12/2020 18:09	05/12/2020 20:47	05/12/2020 18:09	05/12/2020 20:47	2,62	6	15,70	CHI
20201221796	CATURAI	CK12386231	INHUMAS S1	05/12/2020 18:09	05/12/2020 20:47	05/12/2020 18:09	05/12/2020 20:47	2,62	38	99,46	CHI
20201221804	MONTIVIDIU	MV12267614B	MONTIVIDIU T	05/12/2020 18:09	05/12/2020 23:42	05/12/2020 18:09	05/12/2020 23:42	5,54	5	27,69	CHI
20201222270	FLORES DE GOIAS	FB12106993	FLORES DE GOIAS	05/12/2020 18:09	05/12/2020 23:25	05/12/2020 18:09	05/12/2020 23:25	5,26	14	73,66	CHI
20201222270	SAO JOAO D ALIANCA	FB12106993	FLORES DE GOIAS	05/12/2020 18:09	05/12/2020 23:25	05/12/2020 18:09	05/12/2020 23:25	5,26	5	26,31	CHI
20201222270	FORMOSA	FB12106993	FLORES DE GOIAS	05/12/2020 18:09	05/12/2020 23:25	05/12/2020 18:09	05/12/2020 23:25	5,26	15	78,92	CHI
20201221390	ANICUNS	910055683	ANICUNS	05/12/2020 18:10	06/12/2020 16:56	05/12/2020 18:10	06/12/2020 16:56	22,77	1	22,77	CHI
20201221810	PARAUNA	PU11060470	PARAUNA	05/12/2020 18:10	05/12/2020 23:20	05/12/2020 18:10	05/12/2020 23:20	5,17	227	1173,84	CHI

2020122272	SAO JOAO D ALIANCA	ND12394116	IACIARA S2	05/12/2020 18:10	05/12/2020 21:07	05/12/2020 18:10	05/12/2020 21:07	2,95	15	44,24	CHI
2020122272	NOVA ROMA	ND12394116	IACIARA S2	05/12/2020 18:10	05/12/2020 21:07	05/12/2020 18:10	05/12/2020 21:07	2,95	5	14,75	CHI
20201221499	PALMINOPOLIS	FR12096839RE	FIRMINOPOLIS S1	05/12/2020 18:13	05/12/2020 21:38	05/12/2020 18:13	05/12/2020 21:38	3,41	1	3,41	CHI
20201221499	FIRMINOPOLIS	FR12096839RE	FIRMINOPOLIS S1	05/12/2020 18:13	05/12/2020 21:38	05/12/2020 18:13	05/12/2020 21:38	3,41	70	238,52	CHI
20201221499	SAO JOAO DA PARAUNA	FR12096839RE	FIRMINOPOLIS S1	05/12/2020 18:13	05/12/2020 21:38	05/12/2020 18:13	05/12/2020 21:38	3,41	20	68,15	CHI
20201221422	SERRANOPOLIS	DJ21164263	CHAPADAO DO CEU	05/12/2020 18:14	06/12/2020 16:01	05/12/2020 18:14	06/12/2020 16:01	21,77	1	21,77	CHI
20201221425	SANTA HELENA DE GOIAS	SH11189110	IPEGUARI	05/12/2020 18:15	05/12/2020 19:53	05/12/2020 18:15	05/12/2020 19:53	1,63	143	233,61	CHI
20201221426	LUZIANIA	LZ11183562	RIO VERMELHO	05/12/2020 18:15	06/12/2020 11:00	06/12/2020 08:00	06/12/2020 11:00	3,00	89	267,02	CHI
20201223554	ARENOPOLIS	IV12231088	ARENOPOLIS	05/12/2020 18:16	06/12/2020 08:13	05/12/2020 18:16	06/12/2020 08:13	13,95	4	55,79	CHI
20201223554	IVOLANDIA	IV12231088	ARENOPOLIS	05/12/2020 18:16	06/12/2020 08:13	05/12/2020 18:16	06/12/2020 08:13	13,95	34	474,24	CHI
20201221432	JATAI	JT21219552	JATAI S2	05/12/2020 18:17	06/12/2020 00:40	05/12/2020 18:17	06/12/2020 00:40	6,37	1	6,37	CHI
20201221534	MORRINHOS	CN18414869TS	RIO QUENTE	05/12/2020 18:18	06/12/2020 21:19	05/12/2020 18:18	05/12/2020 21:42	3,39	7	23,73	CHI
20201221534	RIO QUENTE	CN18414869TS	RIO QUENTE	05/12/2020 18:18	06/12/2020 21:19	05/12/2020 18:18	05/12/2020 21:42	3,39	2	6,78	CHI
20201221534	CALDAS NOVAS	CN18414869TS	RIO QUENTE	05/12/2020 18:18	06/12/2020 21:19	05/12/2020 18:18	05/12/2020 21:42	3,39	32	108,48	CHI
20201221534	CALDAS NOVAS	CN18414869TS	RIO QUENTE	05/12/2020 18:18	06/12/2020 21:19	06/12/2020 10:47	06/12/2020 13:24	2,61	32	83,56	CHI
20201221534	MORRINHOS	CN18414869TS	RIO QUENTE	05/12/2020 18:18	06/12/2020 21:19	06/12/2020 10:47	06/12/2020 13:24	2,61	7	18,28	CHI
20201221534	RIO QUENTE	CN18414869TS	RIO QUENTE	05/12/2020 18:18	06/12/2020 21:19	06/12/2020 10:47	06/12/2020 13:24	2,61	2	5,22	CHI
20201221534	CALDAS NOVAS	CN12212735LD	RIO QUENTE	05/12/2020 18:18	06/12/2020 21:19	05/12/2020 18:18	06/12/2020 14:31	20,21	9	181,92	CHI
20201221534	CALDAS NOVAS	CN12212735LD	RIO QUENTE	05/12/2020 18:18	06/12/2020 21:19	05/12/2020 18:18	06/12/2020 20:13	25,92	8	207,33	CHI
20201221534	MORRINHOS	CN13298630	RIO QUENTE	05/12/2020 18:18	06/12/2020 21:19	05/12/2020 18:18	06/12/2020 21:19	27,02	1	27,02	CHI
20201221534	CALDAS NOVAS	CN13298630	RIO QUENTE	05/12/2020 18:18	06/12/2020 21:19	05/12/2020 18:18	06/12/2020 21:19	27,02	48	1296,80	CHI
20201221534	PIRACANJUBA	CN13298630	RIO QUENTE	05/12/2020 18:18	06/12/2020 21:19	05/12/2020 18:18	06/12/2020 21:19	27,02	1	27,02	CHI
20201221598	ANICUNS	AC12382573	ANICUNS	05/12/2020 18:18	05/12/2020 21:46	05/12/2020 18:18	05/12/2020 21:46	3,46	1	3,46	CHI
20201221598	TURVANIA	AC12382573	ANICUNS	05/12/2020 18:18	05/12/2020 21:46	05/12/2020 18:18	05/12/2020 21:46	3,46	22	76,14	CHI
20201221598	NAZARIO	AC12382573	ANICUNS	05/12/2020 18:18	05/12/2020 21:46	05/12/2020 18:18	05/12/2020 21:46	3,46	1	3,46	CHI
20201221690	GOIANIA	GN11002229	REAL S2	05/12/2020 18:18	06/12/2020 07:20	05/12/2020 18:18	06/12/2020 07:20	13,02	109	1419,15	CHI
20201221444	PALMEIRAS DE GOIAS	PL12000059	PALMEIRAS	05/12/2020 18:19	06/12/2020 00:02	05/12/2020 18:19	06/12/2020 00:02	5,71	5	28,53	CHI
20201221894	LUZIANIA	LZ12304862	VIANOPOLIS	05/12/2020 18:19	05/12/2020 23:50	05/12/2020 18:19	05/12/2020 23:50	5,51	4	22,02	CHI
20201222133	JATAI	JT12226486	JATAI S1	05/12/2020 18:20	06/12/2020 08:50	05/12/2020 18:20	06/12/2020 08:50	14,50	28	406,00	CHI
20201221462	GOIANIA	16037637	MEIA PONTE	05/12/2020 18:21	05/12/2020 22:49	05/12/2020 18:21	05/12/2020 22:49	4,45	1	4,45	CHI
20201221472	BOM JESUS DE GOIAS	1250050604	BOM JESUS DE GOIAS	05/12/2020 18:22	05/12/2020 20:11	05/12/2020 18:22	05/12/2020 20:11	1,81	1	1,81	CHI
20201221474	BELA VISTA DE GOIAS	BV12193220	BELA VISTA S2	05/12/2020 18:22	05/12/2020 21:55	05/12/2020 18:22	05/12/2020 21:55	3,54	7	24,77	CHI
20201221597	PALESTINA DE GOIAS	PY12396120	PALESTINA	05/12/2020 18:22	06/12/2020 00:09	05/12/2020 18:22	06/12/2020 00:09	5,78	12	69,37	CHI
20201223250	BELA VISTA DE GOIAS	BV11193219	BELA VISTA S2	05/12/2020 18:22	07/12/2020 18:45	05/12/2020 18:22	07/12/2020 11:49	41,44	3	124,32	CHI
20201223250	BELA VISTA DE GOIAS	BV12193220	BELA VISTA S2	05/12/2020 18:22	07/12/2020 18:45	07/12/2020 17:56	07/12/2020 18:26	0,49	7	3,46	CHI
20201223250	BELA VISTA DE GOIAS	BV12193220	BELA VISTA S2	05/12/2020 18:22	07/12/2020 18:45	07/12/2020 17:56	07/12/2020 18:45	0,81	3	2,43	CHI
20201221512	BONOPOLIS	BX10403942	SAO MIGUEL DO ARAGUAIA	05/12/2020 18:23	06/12/2020 12:34	05/12/2020 18:25	06/12/2020 12:34	18,15	12	217,82	CHI
20201221512	AMARALINA	BX10403942	SAO MIGUEL DO ARAGUAIA	05/12/2020 18:23	06/12/2020 12:34	05/12/2020 18:25	06/12/2020 12:34	18,15	224	4065,97	CHI
20201221634	ABADIA DE GOIAS	LG11312970	GUAPO S1	05/12/2020 18:23	06/12/2020 11:28	05/12/2020 18:23	06/12/2020 11:28	17,08	16	273,24	CHI
20201221488	JATAI	290089920	JATAI S3	05/12/2020 18:24	06/12/2020 12:49	05/12/2020 18:24	06/12/2020 12:49	18,42	1	18,42	CHI
20201221489	RIO VERDE	RV12000192	RIO VERDE S1	05/12/2020 18:24	06/12/2020 03:08	05/12/2020 18:24	06/12/2020 03:08	8,73	23	200,85	CHI
20201221492	ARAGARCAS	10028057315	ARAGARCAS	05/12/2020 18:24	05/12/2020 23:12	05/12/2020 18:24	05/12/2020 23:12	4,79	1	4,79	CHI
20201221503	RIO VERDE	RV12327004	RIO VERDE S2	05/12/2020 18:25	06/12/2020 08:12	05/12/2020 18:25	06/12/2020 08:12	13,78	3	41,33	CHI
20201221508	RIO VERDE	630518889	RIO VERDE S2	05/12/2020 18:25	06/12/2020 01:55	05/12/2020 18:25	06/12/2020 01:55	7,49	1	7,49	CHI
20201222278	SAO DOMINGOS	SD12218836	SAO DOMINGOS	05/12/2020 18:25	06/12/2020 08:54	05/12/2020 18:25	06/12/2020 08:54	14,48	20	289,54	CHI
20201222467	ITAJA	IM12205202	ITAJA S2	05/12/2020 18:26	06/12/2020 17:05	05/12/2020 18:26	06/12/2020 02:01	7,58	1	7,58	CHI
20201222467	ITARUMA	IM12205202	ITAJA S2	05/12/2020 18:26	06/12/2020 17:05	05/12/2020 18:26	06/12/2020 02:01	7,58	2	15,17	CHI
20201222467	ITARUMA	IM12205202	ITAJA S2	05/12/2020 18:26	06/12/2020 17:05	05/12/2020 18:26	06/12/2020 12:17	17,84	8	142,73	CHI
20201222467	ITARUMA	IM12205202	ITAJA S2	05/12/2020 18:26	06/12/2020 17:05	05/12/2020 18:26	06/12/2020 17:05	22,64	2	45,28	CHI
20201221521	CALDAS NOVAS	CN12060250	CALDAS NOVAS S1	05/12/2020 18:27	06/12/2020 20:53	05/12/2020 18:27	06/12/2020 14:55	20,48	3	61,43	CHI
20201221521	SANTA CRUZ DE GOIAS	CN12060250	CALDAS NOVAS S1	05/12/2020 18:27	06/12/2020 20:53	05/12/2020 18:27	06/12/2020 14:55	20,48	1	20,48	CHI

20201221521	PIRACANJUBA	CN13182971	CALDAS NOVAS S1	05/12/2020 18:27	06/12/2020 20:53	05/12/2020 18:27	06/12/2020 20:53	26,44	4	105,74	CHI
20201221521	SANTA CRUZ DE GOIAS	CN13182971	CALDAS NOVAS S1	05/12/2020 18:27	06/12/2020 20:53	05/12/2020 18:27	06/12/2020 20:53	26,44	7	185,05	CHI
20201221577	ITUMBIARA	IT10406885	PARANAIBA	05/12/2020 18:28	06/12/2020 11:37	05/12/2020 18:28	05/12/2020 19:53	1,42	48	68,09	CHI
20201221577	ITUMBIARA	IT10406885	PARANAIBA	05/12/2020 18:28	06/12/2020 11:37	05/12/2020 20:55	05/12/2020 21:12	0,27	48	13,01	CHI
20201221577	ITUMBIARA	IT10406885	PARANAIBA	05/12/2020 18:28	06/12/2020 11:37	05/12/2020 18:28	06/12/2020 11:17	16,82	10	168,16	CHI
20201221577	ITUMBIARA	IT12000087LD	PARANAIBA	05/12/2020 18:28	06/12/2020 11:37	05/12/2020 18:28	06/12/2020 11:37	17,15	4	68,59	CHI
20201221651	CABECEIRAS	CW12154467	ITUIQUIRA	05/12/2020 18:28	05/12/2020 23:01	05/12/2020 18:28	05/12/2020 23:01	4,55	36	163,65	CHI
20201221651	FORMOSA	CW12154467	ITUIQUIRA	05/12/2020 18:28	05/12/2020 23:01	05/12/2020 18:28	05/12/2020 23:01	4,55	3	13,64	CHI
20201221533	NAZARIO	NZ12299080	ANICUNS	05/12/2020 18:29	06/12/2020 08:13	05/12/2020 18:29	06/12/2020 08:13	13,73	4	54,93	CHI
20201222117	MONTIVIDIU	MV12207748	MONTIVIDIU T	05/12/2020 18:30	05/12/2020 21:24	05/12/2020 18:30	05/12/2020 21:24	2,89	7	20,22	CHI
20201221559	NOVA IGUACU DE GOIAS	NH12398038	CAMPINORTE	05/12/2020 18:31	05/12/2020 22:32	05/12/2020 18:31	05/12/2020 22:32	4,00	4	16,02	CHI
20201221560	CAMPOS VERDES	VD12049791	SANTA TEREZINHA	05/12/2020 18:31	05/12/2020 19:21	05/12/2020 18:31	05/12/2020 19:21	0,82	18	14,79	CHI
20201222281	IACIARA	1550026711	IACIARA S2	05/12/2020 18:31	06/12/2020 11:33	05/12/2020 18:31	06/12/2020 11:33	17,02	1	17,02	CHI
20201222290	GOIANIA	GN11059718	REAL S2	05/12/2020 18:31	05/12/2020 22:20	05/12/2020 18:31	05/12/2020 22:20	3,82	157	599,04	CHI
20201221564	MINEIROS	MY21126170	PARQUE DAS EMAS	05/12/2020 18:32	06/12/2020 12:03	05/12/2020 18:32	06/12/2020 12:03	17,51	1	17,51	CHI
20201221595	PALESTINA DE GOIAS	IV12129886	IPORA	05/12/2020 18:32	06/12/2020 01:12	05/12/2020 18:32	06/12/2020 01:12	6,65	12	79,85	CHI
20201221595	IVOLANDIA	IV12129886	IPORA	05/12/2020 18:32	06/12/2020 01:12	05/12/2020 18:32	06/12/2020 01:12	6,65	44	292,80	CHI
20201221579	PLANALTINA	PI21373900	PLANALTINA	05/12/2020 18:33	05/12/2020 19:52	05/12/2020 18:33	05/12/2020 19:52	1,31	1	1,31	CHI
20201221914	SENADOR CANEDO	SW11375184	SENADOR CANEDO	05/12/2020 18:33	05/12/2020 22:02	05/12/2020 18:33	05/12/2020 22:02	3,47	46	159,85	CHI
20201221626	ITUMBIARA	IT11000018	ITUMBIARA VELHA S1	05/12/2020 18:34	06/12/2020 05:19	05/12/2020 18:34	06/12/2020 05:19	10,74	252	2706,06	CHI
20201221602	GUARINOS	GF12181361	SANTA TEREZINHA	05/12/2020 18:35	06/12/2020 09:00	05/12/2020 18:35	06/12/2020 09:00	14,41	2	28,81	CHI
20201221608	NAZARIO	NZ21289748	ANICUNS	05/12/2020 18:36	06/12/2020 08:27	05/12/2020 18:36	06/12/2020 08:27	13,84	1	13,84	CHI
20201221611	GOIAS	90051798	GOIAS	05/12/2020 18:36	06/12/2020 12:19	05/12/2020 18:36	06/12/2020 12:19	17,70	1	17,70	CHI
20201221617	RIO VERDE	630181767	RIO VERDE S1	05/12/2020 18:37	06/12/2020 10:54	05/12/2020 18:37	06/12/2020 10:54	16,28	1	16,28	CHI
20201221627	CORUMBA DE GOIAS	7360267	CORUMBA	05/12/2020 18:38	07/12/2020 10:10	05/12/2020 18:38	07/12/2020 10:10	39,53	7	276,71	CHI
20201221656	JATAI	290320203	JATAI S2	05/12/2020 18:41	06/12/2020 13:41	05/12/2020 18:41	06/12/2020 13:41	19,00	1	19,00	CHI
20201221700	CRISTALINA	KR12163713	CRISTALINA S2	05/12/2020 18:41	06/12/2020 09:34	05/12/2020 18:41	06/12/2020 09:34	14,87	4	59,48	CHI
20201223101	FORMOSA	FA11257637	ITUIQUIRA	05/12/2020 18:41	05/12/2020 23:07	05/12/2020 18:41	05/12/2020 23:07	4,44	112	497,72	CHI
20201221675	JATAI	JT12360224	JATAI S1	05/12/2020 18:42	06/12/2020 15:41	05/12/2020 18:42	06/12/2020 15:41	20,98	3	62,94	CHI
20201224517	CRIXAS	CX12390328	SANTA TEREZINHA	05/12/2020 18:42	07/12/2020 10:57	05/12/2020 18:42	07/12/2020 10:57	40,24	32	1287,74	CHI
20201222615	LEOPOLDO DE BULHOES	LB12000008	DAIA S2	05/12/2020 18:43	05/12/2020 23:11	05/12/2020 18:43	05/12/2020 23:11	4,46	161	718,51	CHI
20201222615	GAMELEIRA DE GOIAS	LB12000008	DAIA S2	05/12/2020 18:43	05/12/2020 23:11	05/12/2020 18:43	05/12/2020 23:11	4,46	16	71,40	CHI
20201222615	SILVANIA	LB12000008	DAIA S2	05/12/2020 18:43	05/12/2020 23:11	05/12/2020 18:43	05/12/2020 23:11	4,46	98	437,35	CHI
20201221701	PALESTINA DE GOIAS	PY18223011TS	PALESTINA	05/12/2020 18:44	06/12/2020 22:51	06/12/2020 08:29	06/12/2020 22:51	14,36	113	1622,62	CHI
202012179372	PALESTINA DE GOIAS	PY21193404	PALESTINA	05/12/2020 18:44	06/12/2020 22:51	05/12/2020 18:44	06/12/2020 22:51	28,10	1	28,10	CHI
20201221707	CABECEIRAS	CW21139864	ITUIQUIRA	05/12/2020 18:45	05/12/2020 23:39	05/12/2020 18:45	05/12/2020 23:39	4,90	1	4,90	CHI
20201221742	EDEALINA	EA12058626	PONTALINA	05/12/2020 18:47	05/12/2020 22:30	05/12/2020 18:47	05/12/2020 22:30	3,70	14	51,85	CHI
20201222132	IACIARA	IA12361389	IACIARA S2	05/12/2020 18:47	05/12/2020 21:12	05/12/2020 18:47	05/12/2020 21:12	2,42	42	101,48	CHI
20201222132	FLORES DE GOIAS	IA12361389	IACIARA S2	05/12/2020 18:47	05/12/2020 21:12	05/12/2020 18:47	05/12/2020 21:12	2,42	1	2,42	CHI
20201222175	SAO LUIZ DO NORTE	SZ12066095	ITAPACI	05/12/2020 18:47	05/12/2020 22:51	05/12/2020 18:47	05/12/2020 22:51	4,06	6	24,38	CHI
20201221755	QUIRINOPOLIS	80076300	QUIRINOPOLIS	05/12/2020 18:49	06/12/2020 04:30	05/12/2020 18:49	06/12/2020 04:30	9,68	1	9,68	CHI
20201205000105	MINACU	01976114	MINACU	05/12/2020 18:49	06/12/2020 00:14	05/12/2020 18:49	06/12/2020 00:13	5,40	4474	24177,00	CHI
20201205000105	TROMBAS	01976114	MINACU	05/12/2020 18:49	06/12/2020 00:14	05/12/2020 18:49	06/12/2020 00:13	5,40	6	32,42	CHI
20201205000105	MINACU	01976114	MINACU	05/12/2020 18:49	06/12/2020 00:14	05/12/2020 18:49	06/12/2020 00:13	5,40	5947	32136,93	CHI
20201205000105	CAMPINACU	01976114	MINACU	05/12/2020 18:49	06/12/2020 00:14	05/12/2020 18:49	06/12/2020 00:13	5,40	29	156,71	CHI
20201205000105	MINACU	01976114	MINACU	05/12/2020 18:49	06/12/2020 00:14	05/12/2020 18:49	06/12/2020 00:13	5,40	2116	11434,63	CHI
20201205000105	NIQUELANDIA	01976114	MINACU	05/12/2020 18:49	06/12/2020 00:14	05/12/2020 18:49	06/12/2020 00:14	5,43	1	5,43	CHI
20201205000105	URUACU	01976114	MINACU	05/12/2020 18:49	06/12/2020 00:14	05/12/2020 18:49	06/12/2020 00:14	5,43	1	5,43	CHI
20201205000105	COLINAS DO SUL	01976114	MINACU	05/12/2020 18:49	06/12/2020 00:14	05/12/2020 18:49	06/12/2020 00:14	5,43	450	2441,38	CHI
20201205000105	MINACU	01976114	MINACU	05/12/2020 18:49	06/12/2020 00:14	05/12/2020 18:49	06/12/2020 00:14	5,43	12	65,10	CHI
20201205000105	CAVALCANTE	01976114	MINACU	05/12/2020 18:49	06/12/2020 00:14	05/12/2020 18:49	06/12/2020 00:14	5,43	383	2077,88	CHI

20201221769	POSSE	PS21257660	IACIARA S2	05/12/2020 18:50	05/12/2020 21:16	05/12/2020 18:50	05/12/2020 21:16	2,43	1	2,43	CHI
20201221772	PALMEIRAS DE GOIAS	PL12026270	PALMEIRAS	05/12/2020 18:50	06/12/2020 05:23	05/12/2020 18:50	06/12/2020 05:23	10,54	4	42,17	CHI
20201221777	CACHOEIRA ALTA	CA21074171	CACHOEIRA ALTA	05/12/2020 18:50	05/12/2020 20:05	05/12/2020 18:50	05/12/2020 20:05	1,24	2	2,48	CHI
20201221778	CORUMBAIBA	CI12363786	VILA CORUMBA	05/12/2020 18:50	05/12/2020 21:19	05/12/2020 18:50	05/12/2020 21:19	2,47	18	44,45	CHI
20201221779	NOVA IGUACU DE GOIAS	UR21258012	CAMPINORTE	05/12/2020 18:50	06/12/2020 08:56	05/12/2020 18:50	06/12/2020 08:56	14,09	1	14,09	CHI
20201221791	JATAI	JT21000208	JATAI S1	05/12/2020 18:51	06/12/2020 11:09	05/12/2020 18:51	06/12/2020 11:09	16,29	1	16,29	CHI
20201221821	NOVO PLANALTO	TA11100823	NOVO PLANALTO	05/12/2020 18:52	06/12/2020 07:47	05/12/2020 18:52	06/12/2020 07:47	12,90	96	1238,75	CHI
20201221843	APARECIDA DE GOIANIA	AP13004980	REAL S2	05/12/2020 18:53	05/12/2020 20:04	05/12/2020 19:59	05/12/2020 20:04	0,07	26	1,90	CHI
20201226154	URUACU	UR12298830	URUACU	05/12/2020 18:53	06/12/2020 14:50	05/12/2020 18:53	06/12/2020 14:50	19,95	6	119,71	CHI
20201222420	CRISTALINA	KR12168153	CRISTALINA S2	05/12/2020 18:54	05/12/2020 21:08	05/12/2020 18:54	05/12/2020 21:08	2,23	12	26,78	CHI
20201221863	ITABERAI	IB21000121	ITABERAI S2	05/12/2020 18:55	05/12/2020 19:58	05/12/2020 18:55	05/12/2020 19:58	1,04	1	1,04	CHI
20201222543	PANAMA	IT12000438	ITUMBIARA NOVA	05/12/2020 18:55	06/12/2020 00:39	05/12/2020 18:55	06/12/2020 00:39	5,72	9	51,45	CHI
20201222543	PANAMA	IT12000438	ITUMBIARA NOVA	05/12/2020 18:55	06/12/2020 00:39	05/12/2020 19:05	06/12/2020 00:39	5,55	1	5,55	CHI
20201221935	JANDAIA	10003022518	PALMEIRAS	05/12/2020 19:00	06/12/2020 00:25	05/12/2020 19:00	06/12/2020 00:25	5,40	1	5,40	CHI
20201221957	JATAI	290334779	JATAI S2	05/12/2020 19:02	06/12/2020 15:11	05/12/2020 19:02	06/12/2020 15:11	20,14	1	20,14	CHI
20201221969	INHUMAS	IN12014368	INHUMAS S1	05/12/2020 19:03	06/12/2020 11:47	05/12/2020 19:03	06/12/2020 02:00	6,94	1	6,94	CHI
20201221969	DAMOLANDIA	IN12014368	INHUMAS S1	05/12/2020 19:03	06/12/2020 11:47	05/12/2020 19:03	06/12/2020 02:00	6,94	1	6,94	CHI
20201221969	DAMOLANDIA	IN12014368	INHUMAS S1	05/12/2020 19:03	06/12/2020 11:47	05/12/2020 19:03	06/12/2020 11:47	16,73	63	1054,15	CHI
20201221969	INHUMAS	IN12014368	INHUMAS S1	05/12/2020 19:03	06/12/2020 11:47	05/12/2020 19:03	06/12/2020 11:47	16,73	53	886,82	CHI
20201221969	PETROLINA DE GOIAS	IN12014368	INHUMAS S1	05/12/2020 19:03	06/12/2020 11:47	05/12/2020 19:03	06/12/2020 11:47	16,73	6	100,40	CHI
20201221969	INHUMAS	IN12014368	INHUMAS S1	05/12/2020 19:03	06/12/2020 11:47	06/12/2020 02:01	06/12/2020 11:47	9,78	1	9,78	CHI
20201221969	INHUMAS	IN12014368	INHUMAS S1	05/12/2020 19:03	06/12/2020 11:47	06/12/2020 08:05	06/12/2020 11:47	3,71	1	3,71	CHI
20201221969	DAMOLANDIA	IN12014368	INHUMAS S1	05/12/2020 19:03	06/12/2020 11:47	06/12/2020 08:05	06/12/2020 11:47	3,71	1	3,71	CHI
20201222510	JUSSARA	JR10401446	BRITANIA	05/12/2020 19:04	06/12/2020 18:18	05/12/2020 19:04	06/12/2020 11:22	16,30	4	65,20	CHI
20201222510	JUSSARA	JR10401446	BRITANIA	05/12/2020 19:04	06/12/2020 18:18	05/12/2020 19:04	06/12/2020 14:00	18,93	15	284,00	CHI
20201222510	MONTES CLAROS DE GOIAS	JR10401446	BRITANIA	05/12/2020 19:04	06/12/2020 18:18	05/12/2020 19:04	06/12/2020 14:10	19,11	421	8045,66	CHI
20201222510	JUSSARA	JR10401446	BRITANIA	05/12/2020 19:04	06/12/2020 18:18	05/12/2020 19:04	06/12/2020 14:10	19,11	124	2369,74	CHI
20201222510	JUSSARA	JR13151663	BRITANIA	05/12/2020 19:04	06/12/2020 18:18	05/12/2020 19:04	06/12/2020 14:10	19,11	6	114,67	CHI
20201222510	MONTES CLAROS DE GOIAS	JR10401446	BRITANIA	05/12/2020 19:04	06/12/2020 18:18	06/12/2020 14:23	06/12/2020 18:18	3,92	435	1706,65	CHI
20201222510	JUSSARA	JR10401446	BRITANIA	05/12/2020 19:04	06/12/2020 18:18	06/12/2020 14:23	06/12/2020 18:18	3,92	165	647,35	CHI
20201222510	JUSSARA	JR10401446	BRITANIA	05/12/2020 19:04	06/12/2020 18:18	06/12/2020 14:23	06/12/2020 18:18	3,92	25	98,08	CHI
20201223195	JATAI	RV12000142	CABRIUVA S1	05/12/2020 19:04	06/12/2020 13:34	05/12/2020 19:04	06/12/2020 13:34	18,49	6	110,93	CHI
20201223195	RIO VERDE	RV12000142	CABRIUVA S1	05/12/2020 19:04	06/12/2020 13:34	05/12/2020 19:04	06/12/2020 13:34	18,49	46	850,48	CHI
20201223195	RIO VERDE	RV12000142	CABRIUVA S1	05/12/2020 19:04	06/12/2020 13:34	06/12/2020 07:50	06/12/2020 13:34	5,74	29	166,34	CHI
20201221996	VICENTINOPOLIS	VI12000153	VICENTINOPOLIS	05/12/2020 19:06	05/12/2020 21:32	05/12/2020 19:06	05/12/2020 21:32	2,43	1	2,43	CHI
20201222028	CASTELANDIA	DM10406868	RIO DOS BOIS	05/12/2020 19:06	06/12/2020 15:30	05/12/2020 19:06	05/12/2020 20:45	1,66	33	54,70	CHI
20201222028	BOM JESUS DE GOIAS	DM10406868	RIO DOS BOIS	05/12/2020 19:06	06/12/2020 15:30	05/12/2020 19:06	05/12/2020 20:45	1,66	9	14,92	CHI
20201222028	BOM JESUS DE GOIAS	DM12303633LD	RIO DOS BOIS	05/12/2020 19:06	06/12/2020 15:30	05/12/2020 19:06	05/12/2020 23:50	4,73	5	23,64	CHI
20201222028	BOM JESUS DE GOIAS	BJ12007751LD	RIO DOS BOIS	05/12/2020 19:06	06/12/2020 15:30	05/12/2020 19:06	06/12/2020 15:30	20,39	2	40,79	CHI
20201222010	JOVIANIA	JV11000002	GOIATUBA S1	05/12/2020 19:07	05/12/2020 19:38	05/12/2020 19:07	05/12/2020 19:38	0,51	69	35,32	CHI
20201222326	CACU	CC12080196	CACHOEIRA ALTA	05/12/2020 19:07	06/12/2020 07:34	05/12/2020 19:07	06/12/2020 07:34	12,45	5	62,23	CHI
20201222159	ITABERAI	AC12323606	ANICUNS	05/12/2020 19:08	06/12/2020 14:37	05/12/2020 19:08	06/12/2020 14:37	19,48	3	58,44	CHI
20201222159	AVELINOPOLIS	AC12323606	ANICUNS	05/12/2020 19:08	06/12/2020 14:37	05/12/2020 19:08	06/12/2020 14:37	19,48	1	19,48	CHI
20201222159	ANICUNS	AC12323606	ANICUNS	05/12/2020 19:08	06/12/2020 14:37	05/12/2020 19:08	06/12/2020 14:37	19,48	12	233,76	CHI
20201222043	NOVA ROMA	8720010141	IACIARA S2	05/12/2020 19:09	05/12/2020 20:06	05/12/2020 19:09	05/12/2020 20:06	0,95	1	0,95	CHI
20201222044	MINEIROS	10018188131	PARQUE DAS EMAS	05/12/2020 19:09	06/12/2020 04:42	05/12/2020 19:09	06/12/2020 04:42	9,56	1	9,56	CHI
20201222052	ARAGOIANIA	680008081	GUAPO S2	05/12/2020 19:09	06/12/2020 09:10	05/12/2020 19:09	06/12/2020 09:10	14,00	1	14,00	CHI
20201222070	SENADOR CANEDO	10022710467	SENADOR CANEDO	05/12/2020 19:11	06/12/2020 00:15	05/12/2020 19:11	06/12/2020 00:15	5,07	1	5,07	CHI
20201222939	EDEIA	EA12257973	EDEIA	05/12/2020 19:11	06/12/2020 04:47	05/12/2020 19:11	06/12/2020 04:47	9,59	33	316,34	CHI
20201222939	INDIARA	EA12257973	EDEIA	05/12/2020 19:11	06/12/2020 04:47	05/12/2020 19:11	06/12/2020 04:47	9,59	7	67,10	CHI
20201222939	ACREUNA	EA12257973	EDEIA	05/12/2020 19:11	06/12/2020 04:47	05/12/2020 19:11	06/12/2020 04:47	9,59	13	124,62	CHI

2020122216	NEROPOLIS	NR11198188	NEROPOLIS S2	05/12/2020 19:13	06/12/2020 02:39	05/12/2020 19:13	06/12/2020 02:39	7,42	107	794,12	CHI
20201222115	PLANALTINA	PI11130057	PLANALTINA	05/12/2020 19:14	05/12/2020 22:59	05/12/2020 19:14	05/12/2020 22:59	3,74	150	560,92	CHI
20201222137	ANAPOLIS	AN11130801	JUNDAI S2	05/12/2020 19:14	05/12/2020 20:58	05/12/2020 19:14	05/12/2020 20:58	1,73	126	218,58	CHI
20201222120	NAZARIO	NZ21012954	ANICUNS	05/12/2020 19:15	06/12/2020 08:42	05/12/2020 19:15	06/12/2020 08:42	13,45	1	13,45	CHI
20201222125	MONTIVIDIU	MV12189021	MONTIVIDIU T	05/12/2020 19:15	05/12/2020 22:34	05/12/2020 19:15	05/12/2020 22:34	3,31	3	9,93	CHI
20201222130	PLANALTINA	8523920	PADRE BERNARDO	05/12/2020 19:15	06/12/2020 09:31	05/12/2020 19:15	06/12/2020 09:31	14,25	1	14,25	CHI
20201222134	BOM JARDIM DE GOIAS	BM21241383	BOM JARDIM	05/12/2020 19:15	06/12/2020 07:12	05/12/2020 19:15	06/12/2020 07:12	11,93	1	11,93	CHI
20201222305	MONTE ALEGRE DE GOIAS	MA12240202	SAO DOMINGOS	05/12/2020 19:15	05/12/2020 20:33	05/12/2020 19:15	05/12/2020 20:33	1,29	4	5,15	CHI
20201222142	TRINIDADE	10029821744	MEIA PONTE	05/12/2020 19:16	06/12/2020 09:49	05/12/2020 19:16	06/12/2020 09:49	14,54	1	14,54	CHI
20201222900	JATAI	RV12104996	JATAI S2	05/12/2020 19:16	06/12/2020 01:04	05/12/2020 19:16	06/12/2020 01:04	5,79	13	75,27	CHI
20201222900	RIO VERDE	RV12104996	JATAI S2	05/12/2020 19:16	06/12/2020 01:04	05/12/2020 19:16	06/12/2020 01:04	5,79	7	40,53	CHI
20201222152	SAO DOMINGOS	SD12161805	SAO DOMINGOS	05/12/2020 19:17	05/12/2020 22:35	05/12/2020 19:17	05/12/2020 22:35	3,29	50	164,72	CHI
20201222160	SANTO ANTONIO DE GOIAS	1360002094	NEROPOLIS S1	05/12/2020 19:17	05/12/2020 23:02	05/12/2020 19:17	05/12/2020 23:02	3,74	1	3,74	CHI
20201222168	SAO SIMAO	SO21261036	CACHOEIRA ALTA	05/12/2020 19:18	05/12/2020 22:20	05/12/2020 19:18	05/12/2020 22:20	3,03	1	3,03	CHI
20201222222	NOVO BRASIL	NB21020252	JUSSARA	05/12/2020 19:22	06/12/2020 08:09	05/12/2020 19:22	06/12/2020 08:09	12,77	1	12,77	CHI
20201222774	MINEIROS	MY12241778	PARQUE DAS EMAS	05/12/2020 19:22	05/12/2020 23:15	05/12/2020 19:22	05/12/2020 23:15	3,89	12	46,62	CHI
20201222298	ACREUNA	2440002167	ACREUNA	05/12/2020 19:24	05/12/2020 21:50	05/12/2020 19:24	05/12/2020 21:50	2,42	1	2,42	CHI
20201222436	CRISTALINA	KR12133541LD	CRISTALINA S1	05/12/2020 19:24	05/12/2020 21:01	05/12/2020 19:24	05/12/2020 21:01	1,62	13	21,01	CHI
2020120500093	PARAUNA	05760414	PARAUNA	05/12/2020 19:24	05/12/2020 19:29	05/12/2020 19:24	05/12/2020 19:29	0,08	82	6,83	CHI
2020120500093	JANDAIA	05760414	PARAUNA	05/12/2020 19:24	05/12/2020 19:29	05/12/2020 19:24	05/12/2020 19:29	0,08	3	0,25	CHI
20201222580	PARAUNA	EU12044261	ACREUNA	05/12/2020 19:26	05/12/2020 23:13	05/12/2020 19:26	05/12/2020 23:13	3,78	10	37,77	CHI
20201222321	PLANALTINA	PI21043466	PLANALTINA	05/12/2020 19:27	05/12/2020 21:42	05/12/2020 19:27	05/12/2020 21:42	2,25	1	2,25	CHI
20201222323	SANTA CRUZ DE GOIAS	BC12068916	PIRES DO RIO S2	05/12/2020 19:27	06/12/2020 10:49	05/12/2020 19:27	06/12/2020 10:49	15,37	12	184,39	CHI
20201222341	NIQUELANDIA	NQ21355540	SAO JOAO D ALIANCA	05/12/2020 19:28	06/12/2020 17:27	05/12/2020 19:28	06/12/2020 17:27	21,97	1	21,97	CHI
20201222342	ITUMBIARA	IT12087207	PARANAIBA	05/12/2020 19:28	06/12/2020 20:07	05/12/2020 19:28	06/12/2020 20:07	24,64	1	24,64	CHI
20201222397	NOVA IGUACU DE GOIAS	NH12202113	SANTA TEREZINHA	05/12/2020 19:28	05/12/2020 22:50	05/12/2020 19:28	05/12/2020 22:50	3,35	65	218,04	CHI
20201222350	CAVALCANTE	BF21264703	FLORES DE GOIAS	05/12/2020 19:29	05/12/2020 21:19	05/12/2020 19:29	05/12/2020 21:19	1,83	1	1,83	CHI
20201222357	PIRANHAS	10013341195	PIRANHAS	05/12/2020 19:30	06/12/2020 08:05	05/12/2020 19:30	06/12/2020 08:05	12,58	1	12,58	CHI
20201222388	NOVA ROMA	ND12164550	IACIARA S2	05/12/2020 19:30	05/12/2020 22:37	05/12/2020 19:30	05/12/2020 22:37	3,10	216	669,66	CHI
20201222388	MONTE ALEGRE DE GOIAS	ND12164550	IACIARA S2	05/12/2020 19:30	05/12/2020 22:37	05/12/2020 19:30	05/12/2020 22:37	3,10	1	3,10	CHI
20201222403	APARECIDA DE GOIANIA	10011574656	INDEPENDENCIA S1	05/12/2020 19:33	06/12/2020 08:41	05/12/2020 19:33	06/12/2020 08:41	13,13	1	13,13	CHI
20201222406	ORIZONA	OZ21087381	PIRES DO RIO S2	05/12/2020 19:33	06/12/2020 11:06	05/12/2020 19:33	06/12/2020 11:06	15,54	2	31,08	CHI
20201222578	VILA PROPICIO	PV12069121	GOIANESIA S1	05/12/2020 19:33	06/12/2020 11:52	05/12/2020 19:33	06/12/2020 00:11	4,63	1	4,63	CHI
20201222578	VILA PROPICIO	PV12069121	GOIANESIA S1	05/12/2020 19:33	06/12/2020 11:52	05/12/2020 21:53	06/12/2020 00:11	2,30	2	4,60	CHI
20201222578	VILA PROPICIO	PV12069121	GOIANESIA S1	05/12/2020 19:33	06/12/2020 11:52	05/12/2020 19:33	06/12/2020 00:33	5,00	2	10,00	CHI
20201222578	VILA PROPICIO	BA12210719	GOIANESIA S1	05/12/2020 19:33	06/12/2020 11:52	05/12/2020 19:33	06/12/2020 00:33	5,00	1	5,00	CHI
20201222578	BARRO ALTO	PV12069121	GOIANESIA S1	05/12/2020 19:33	06/12/2020 11:52	05/12/2020 19:33	06/12/2020 00:33	5,00	1	5,00	CHI
20201222578	VILA PROPICIO	BA12210719	GOIANESIA S1	05/12/2020 19:33	06/12/2020 11:52	05/12/2020 21:53	06/12/2020 00:33	2,67	14	37,33	CHI
20201222578	VILA PROPICIO	PV12069121	GOIANESIA S1	05/12/2020 19:33	06/12/2020 11:52	05/12/2020 19:33	06/12/2020 11:28	15,92	2	31,83	CHI
20201222578	VILA PROPICIO	NP21325158	GOIANESIA S1	05/12/2020 19:33	06/12/2020 11:52	05/12/2020 21:53	06/12/2020 11:52	13,99	1	13,99	CHI
20201222407	DOVERLANDIA	DV21152104	CAIAPONIA	05/12/2020 19:34	05/12/2020 22:30	05/12/2020 19:34	05/12/2020 22:30	2,93	1	2,93	CHI
20201222416	DOVERLANDIA	DV12380977	CAIAPONIA	05/12/2020 19:34	06/12/2020 23:28	05/12/2020 19:34	06/12/2020 23:28	27,90	92	2566,52	CHI
20201222893	ITUMBIARA	CD12000007RE	CACHOEIRA DOURADA	05/12/2020 19:35	05/12/2020 22:54	05/12/2020 19:35	05/12/2020 22:54	3,30	25	82,61	CHI
20201222893	CACHOEIRA DOURADA	CD12000007RE	CACHOEIRA DOURADA	05/12/2020 19:35	05/12/2020 22:54	05/12/2020 19:35	05/12/2020 22:54	3,30	25	82,61	CHI
20201222591	NIQUELANDIA	NQ12232485	URUACU	05/12/2020 19:36	06/12/2020 00:25	05/12/2020 19:36	06/12/2020 00:25	4,80	3	14,41	CHI
20201222603	GOIANIA	GN12000082	ATLANTICO S1	05/12/2020 19:36	05/12/2020 20:50	05/12/2020 19:36	05/12/2020 20:50	1,23	549	672,83	CHI
20201222437	INHUMAS	IN12272326	INHUMAS S1	05/12/2020 19:37	06/12/2020 07:41	05/12/2020 19:37	06/12/2020 07:41	12,06	3	36,17	CHI
20201222812	JANDAIA	JD11244804	PALMEIRAS	05/12/2020 19:37	05/12/2020 22:51	05/12/2020 19:37	05/12/2020 22:51	3,22	46	148,02	CHI
20201222562	PLANALTINA	PI11180930	PLANALTINA	05/12/2020 19:38	05/12/2020 22:36	05/12/2020 19:38	05/12/2020 22:36	2,96	179	529,79	CHI
20201222455	SANTA HELENA DE GOIAS	SH12271428	IPEGUARI	05/12/2020 19:39	06/12/2020 00:17	05/12/2020 19:39	06/12/2020 00:17	4,63	42	194,53	CHI
20201222718	INACIOLANDIA	ID12359397LD	QUIRINOPOLIS	05/12/2020 19:40	05/12/2020 23:52	05/12/2020 19:40	05/12/2020 23:52	4,19	57	238,70	CHI

20201222718	ITUMBIARA	ID12359397LD	QUIRINOPOLIS	05/12/2020 19:40	05/12/2020 23:52	05/12/2020 19:40	05/12/2020 23:52	4,19	3	12,56	CHI
20201222478	PALESTINA DE GOIAS	PY12334768	ARENOPOLIS	05/12/2020 19:41	06/12/2020 08:16	05/12/2020 19:41	06/12/2020 08:16	12,57	8	100,59	CHI
20201222487	URUTAI	UT12027072	URUTAI	05/12/2020 19:42	05/12/2020 21:49	05/12/2020 19:42	05/12/2020 21:49	2,11	1	2,11	CHI
20201222488	MARA ROSA	MQ12289092	SANTA TEREZINHA	05/12/2020 19:42	06/12/2020 01:11	05/12/2020 19:42	06/12/2020 01:11	5,47	4	21,90	CHI
20201222490	RIO VERDE	630493741	RIO VERDE S1	05/12/2020 19:42	06/12/2020 10:48	05/12/2020 19:42	06/12/2020 10:48	15,09	1	15,09	CHI
20201222612	GOIATUBA	VI12329055	VICENTINOPOLIS	05/12/2020 19:42	05/12/2020 22:25	05/12/2020 19:42	05/12/2020 22:25	2,70	13	35,14	CHI
20201222612	VICENTINOPOLIS	VI12329055	VICENTINOPOLIS	05/12/2020 19:42	05/12/2020 22:25	05/12/2020 19:42	05/12/2020 22:25	2,70	23	62,16	CHI
20201223143	MONTES CLAROS DE GOIAS	ME12088922	IPORA	05/12/2020 19:43	08/12/2020 17:38	05/12/2020 19:43	06/12/2020 15:36	19,87	15	298,03	CHI
20201223143	MONTES CLAROS DE GOIAS	ME12088922	IPORA	05/12/2020 19:43	08/12/2020 17:38	05/12/2020 19:43	08/12/2020 17:38	69,91	2	139,82	CHI
20201223143	MONTES CLAROS DE GOIAS	ME12088922	IPORA	05/12/2020 19:43	08/12/2020 17:38	08/12/2020 16:20	08/12/2020 17:38	1,31	15	19,60	CHI
20201222507	AGUAS LINDAS DE GOIAS	LA11149040	AGUAS LINDAS DE GOIAS S1	05/12/2020 19:44	05/12/2020 21:31	05/12/2020 19:44	05/12/2020 21:31	1,77	228	404,57	CHI
20201222509	QUIRINOPOLIS	QI12052826	QUIRINOPOLIS	05/12/2020 19:44	06/12/2020 11:42	05/12/2020 19:44	06/12/2020 11:42	15,95	3	47,86	CHI
20201222908	PIRENOPOLIS	PV11065967	CORUMBA	05/12/2020 19:44	05/12/2020 22:26	05/12/2020 19:44	05/12/2020 22:26	2,70	97	261,85	CHI
202012179358	PANAMA	PX21273919	ITUMBIARA NOVA	05/12/2020 19:45	07/12/2020 17:53	05/12/2020 19:45	07/12/2020 17:53	46,14	1	46,14	CHI
20201223080	SANCLERLANDIA	SC12008814	FIRMINOPOLIS S2	05/12/2020 19:48	06/12/2020 13:07	05/12/2020 19:48	06/12/2020 13:07	17,31	19	328,91	CHI
20201222554	SANTA HELENA DE GOIAS	SH21196643	SANTA HELENA S1	05/12/2020 19:50	05/12/2020 22:08	05/12/2020 19:50	05/12/2020 22:08	2,29	1	2,29	CHI
20201222594	INDIARA	IY10396906	EDEIA	05/12/2020 19:50	06/12/2020 13:59	05/12/2020 19:53	06/12/2020 13:06	17,21	32	550,67	CHI
20201222594	INDIARA	IY12043993	EDEIA	05/12/2020 19:50	06/12/2020 13:59	05/12/2020 19:53	06/12/2020 13:26	17,54	2	35,09	CHI
20201222594	INDIARA	IY13299108	EDEIA	05/12/2020 19:50	06/12/2020 13:59	05/12/2020 19:53	06/12/2020 13:59	18,10	7	126,67	CHI
20201222757	PARAUNA	PU11365519	PARAUNA	05/12/2020 19:51	06/12/2020 00:23	05/12/2020 19:51	06/12/2020 00:23	4,54	48	217,87	CHI
20201222566	ANAPOLIS	20479116	JUNDIAI S2	05/12/2020 19:52	05/12/2020 22:07	05/12/2020 19:52	05/12/2020 22:07	2,25	1	2,25	CHI
20201222747	SAO LUIS DE MONTES BELOS	SL32145768	SAO LUIZ DOS MONTES BELOS	05/12/2020 19:52	06/12/2020 05:15	05/12/2020 19:52	06/12/2020 05:15	9,37	29	271,67	CHI
20201222574	LUZIANIA	LZ11061777	MARAJOARA	05/12/2020 19:53	05/12/2020 21:19	05/12/2020 19:53	05/12/2020 21:19	1,42	26	37,04	CHI
20201222585	ITABERAI	IB21388553	ITABERAI S2	05/12/2020 19:54	06/12/2020 07:48	05/12/2020 19:54	06/12/2020 07:48	11,89	1	11,89	CHI
20201222883	FLORES DE GOIAS	FB12256442	FLORES DE GOIAS	05/12/2020 19:54	06/12/2020 00:10	05/12/2020 19:54	06/12/2020 00:10	4,25	1	4,25	CHI
20201222883	SAO JOAO D ALIANCA	FB12256442	FLORES DE GOIAS	05/12/2020 19:54	06/12/2020 00:10	05/12/2020 19:54	06/12/2020 00:10	4,25	32	136,04	CHI
20201222598	APARECIDA DE GOIANIA	200525037	INDEPENDENCIA S2	05/12/2020 19:56	06/12/2020 07:18	05/12/2020 19:56	06/12/2020 07:18	11,36	1	11,36	CHI
202012179333	ALTO PARAISO DE GOIAS	BF21222892	FLORES DE GOIAS	05/12/2020 19:56	06/12/2020 07:57	05/12/2020 19:56	06/12/2020 07:57	12,02	2	24,03	CHI
202012179333	ALTO PARAISO DE GOIAS	BF21131717	FLORES DE GOIAS	05/12/2020 19:56	06/12/2020 07:57	05/12/2020 21:41	06/12/2020 07:57	10,27	1	10,27	CHI
20201222631	SANTA HELENA DE GOIAS	SH12271266	SANTA HELENA S1	05/12/2020 19:57	05/12/2020 23:59	05/12/2020 19:57	05/12/2020 23:59	4,03	2	8,06	CHI
20201222631	ACREUNA	SH12271266	SANTA HELENA S1	05/12/2020 19:57	05/12/2020 23:59	05/12/2020 19:57	05/12/2020 23:59	4,03	1	4,03	CHI
20201222608	FLORES DE GOIAS	FB12255057	FLORES DE GOIAS	05/12/2020 19:58	05/12/2020 21:54	05/12/2020 19:58	05/12/2020 21:54	1,93	87	168,05	CHI
20201222660	IPORA	IR12321802	IPORA	05/12/2020 19:59	05/12/2020 22:39	05/12/2020 19:59	05/12/2020 22:39	2,66	13	34,61	CHI
20201222637	PIRES DO RIO	460066869	PIRES DO RIO S1	05/12/2020 20:02	05/12/2020 21:26	05/12/2020 20:02	05/12/2020 21:26	1,39	1	1,39	CHI
20201222688	ITAPIRAPUA	IU12362929	JUSSARA	05/12/2020 20:02	06/12/2020 08:19	05/12/2020 20:02	06/12/2020 08:19	12,27	6	73,62	CHI
20201223221	ARACU	AV12083933	ANICUNS	05/12/2020 20:02	06/12/2020 03:20	05/12/2020 20:02	06/12/2020 03:20	7,29	2	14,58	CHI
20201223221	AVELINOPOLIS	AV12083933	ANICUNS	05/12/2020 20:02	06/12/2020 03:20	05/12/2020 20:02	06/12/2020 03:20	7,29	11	80,18	CHI
20201222725	JUSSARA	JR12078132	JUSSARA	05/12/2020 20:03	06/12/2020 13:19	05/12/2020 20:03	06/12/2020 13:19	17,25	5	86,27	CHI
20201222647	ORIZONA	OZ12186210	PIRES DO RIO S2	05/12/2020 20:05	05/12/2020 22:29	05/12/2020 20:05	05/12/2020 22:29	2,39	22	52,58	CHI
20201222648	SAO MIGUEL DO ARAGUAIA	SM12276125	SAO MIGUEL DO ARAGUAIA	05/12/2020 20:05	06/12/2020 12:09	05/12/2020 20:05	06/12/2020 12:09	16,05	45	722,34	CHI
20201222668	UIRAPURU	UP11055328	SANTA TEREZINHA	05/12/2020 20:08	05/12/2020 20:52	05/12/2020 20:08	05/12/2020 20:52	0,73	134	97,82	CHI
20201222672	BRITANIA	BT12060643	BRITANIA	05/12/2020 20:08	05/12/2020 22:35	05/12/2020 20:08	05/12/2020 22:35	2,43	11	26,78	CHI
20201222709	IVOLANDIA	IV12323743	IPORA	05/12/2020 20:09	05/12/2020 22:11	05/12/2020 20:09	05/12/2020 22:11	2,02	6	12,10	CHI
20201222683	PORANGATU	PO12208558	PORANGATU	05/12/2020 20:10	06/12/2020 02:58	05/12/2020 20:10	06/12/2020 02:58	6,80	15	101,98	CHI
20201222695	SANTA TEREZINHA DE GOIAS	GG12237782	URUACU	05/12/2020 20:11	06/12/2020 08:42	05/12/2020 20:11	06/12/2020 08:42	12,50	1	12,50	CHI
20201222695	GUARINOS	GG12237782	URUACU	05/12/2020 20:11	06/12/2020 08:42	05/12/2020 20:11	06/12/2020 08:42	12,50	4	50,00	CHI
20201222710	MINEIROS	MY11350946	PARQUE DAS EMAS	05/12/2020 20:11	05/12/2020 22:50	05/12/2020 20:11	05/12/2020 22:50	2,65	38	100,70	CHI
20201222701	GOIANIA	11816193	CAMPINAS S2	05/12/2020 20:13	05/12/2020 22:20	05/12/2020 20:13	05/12/2020 22:20	2,11	1	2,11	CHI
20201222704	CRISTALINA	KR21304858	CRISTALINA S2	05/12/2020 20:14	05/12/2020 22:08	05/12/2020 20:14	05/12/2020 22:08	1,90	1	1,90	CHI
20201222708	BARRO ALTO	BA12210734	BARRO ALTO	05/12/2020 20:14	06/12/2020 09:16	05/12/2020 20:14	06/12/2020 09:16	13,03	4	52,12	CHI
20201222720	CRISTALINA	KR11076397	CRISTALINA S1	05/12/2020 20:15	05/12/2020 21:41	05/12/2020 20:15	05/12/2020 21:41	1,43	8	11,42	CHI

20201222805	IACIARA	GY12257673	IACIARA S1	05/12/2020 20:15	06/12/2020 00:52	05/12/2020 20:15	06/12/2020 00:52	4,60	6	27,63	CHI
20201222805	GUARANI DE GOIAS	GY12257673	IACIARA S1	05/12/2020 20:15	06/12/2020 00:52	05/12/2020 20:15	06/12/2020 00:52	4,60	96	442,05	CHI
20201222722	MORRINHOS	MR21056630	MORRINHOS	05/12/2020 20:16	05/12/2020 21:23	05/12/2020 20:16	05/12/2020 21:23	1,11	1	1,11	CHI
20201221353	NOVO PLANALTO	2500010333	NOVO PLANALTO	05/12/2020 20:17	06/12/2020 00:33	05/12/2020 20:17	06/12/2020 00:33	4,28	1	4,28	CHI
20201222723	GOUVELANDIA	10014965273	QUIRINOPOLIS	05/12/2020 20:17	06/12/2020 01:48	05/12/2020 20:17	06/12/2020 01:48	5,51	1	5,51	CHI
20201222736	GOIANIA	10005046384	CARAJAS S2	05/12/2020 20:19	06/12/2020 00:24	05/12/2020 20:19	06/12/2020 00:24	4,08	1	4,08	CHI
20201222740	GOIAS	GS12299699	GOIAS	05/12/2020 20:19	06/12/2020 14:59	05/12/2020 20:19	06/12/2020 14:59	18,66	31	578,35	CHI
20201222789	CACHOEIRA DOURADA	CD12000001	CACHOEIRA DOURADA	05/12/2020 20:19	05/12/2020 21:19	05/12/2020 20:19	05/12/2020 21:19	0,99	413	409,44	CHI
20201223341	ARENOPOLIS	AY11056272	IPORA	05/12/2020 20:19	06/12/2020 12:25	05/12/2020 20:19	06/12/2020 12:25	16,09	114	1834,80	CHI
20201223017	APARECIDA DE GOIANIA	AP11075384	REAL S2	05/12/2020 20:20	06/12/2020 14:05	05/12/2020 20:20	06/12/2020 14:05	17,75	136	2413,55	CHI
20201222746	GOIATUBA	BJ12030828	RIO DOS BOIS	05/12/2020 20:21	06/12/2020 09:11	05/12/2020 20:21	06/12/2020 09:11	12,83	5	64,14	CHI
20201222751	INHUMAS	IN12009548	ARACU	05/12/2020 20:22	05/12/2020 23:04	05/12/2020 20:22	05/12/2020 23:04	2,69	2	5,37	CHI
20201222751	CATURAI	IN12009548	ARACU	05/12/2020 20:22	05/12/2020 23:04	05/12/2020 20:22	05/12/2020 23:04	2,69	2	5,37	CHI
20201222951	FLORES DE GOIAS	FB12257743	FLORES DE GOIAS	05/12/2020 20:23	06/12/2020 10:13	05/12/2020 20:23	06/12/2020 10:13	13,83	8	110,64	CHI
20201222764	JARAGUA	JA21112541	JARAGUA	05/12/2020 20:24	05/12/2020 22:23	05/12/2020 20:24	05/12/2020 22:23	1,98	1	1,98	CHI
20201222765	PORTEIRAO	CL12301093	RIO DOS BOIS	05/12/2020 20:24	05/12/2020 22:46	05/12/2020 20:24	05/12/2020 22:46	2,36	2	4,72	CHI
20201222765	TURVELANDIA	CL12301093	RIO DOS BOIS	05/12/2020 20:24	05/12/2020 22:46	05/12/2020 20:24	05/12/2020 22:46	2,36	1	2,36	CHI
20201222766	MONTE ALEGRE DE GOIAS	MA12405108	SAO DOMINGOS	05/12/2020 20:24	05/12/2020 23:41	05/12/2020 20:24	05/12/2020 23:41	3,28	531	1739,32	CHI
20201222766	CAVALCANTE	MA12405108	SAO DOMINGOS	05/12/2020 20:24	05/12/2020 23:41	05/12/2020 20:24	05/12/2020 23:41	3,28	245	802,51	CHI
20201222766	NOVA ROMA	MA12405108	SAO DOMINGOS	05/12/2020 20:24	05/12/2020 23:41	05/12/2020 20:24	05/12/2020 23:41	3,28	57	186,71	CHI
20201222776	SENADOR CANEDO	SW21302537	GOIANIA LESTE S2	05/12/2020 20:25	06/12/2020 00:15	05/12/2020 20:25	06/12/2020 00:15	3,82	1	3,82	CHI
20201222779	PORANGATU	PO12262720	PORANGATU	05/12/2020 20:26	06/12/2020 11:55	05/12/2020 20:26	06/12/2020 11:55	15,48	4	61,91	CHI
202012179363	VIANOPOLIS	3800001571	VIANOPOLIS	05/12/2020 20:26	06/12/2020 07:07	05/12/2020 20:26	06/12/2020 07:07	10,68	1	10,68	CHI
20201222790	PIRENOPOLIS	220052049	CORUMBA	05/12/2020 20:27	06/12/2020 01:47	05/12/2020 20:27	06/12/2020 01:47	5,33	1	5,33	CHI
202012179364	VIANOPOLIS	3800001388	VIANOPOLIS	05/12/2020 20:28	06/12/2020 07:07	05/12/2020 20:28	06/12/2020 07:07	10,65	1	10,65	CHI
20201222804	APORE	AE12000053LD	ITAJA S2	05/12/2020 20:30	05/12/2020 22:03	05/12/2020 20:30	05/12/2020 22:03	1,54	9	13,83	CHI
20201222808	SANTA ISABEL	GE12000139	GOIANESIA S1	05/12/2020 20:32	06/12/2020 09:46	05/12/2020 20:32	06/12/2020 09:46	13,23	14	185,15	CHI
20201222819	RIO VERDE	10008058448	CABRIUVA S1	05/12/2020 20:35	06/12/2020 01:06	05/12/2020 20:35	06/12/2020 01:06	4,50	1	4,50	CHI
20201222821	INDIARA	IY21301632	ACREUNA	05/12/2020 20:36	06/12/2020 17:39	05/12/2020 20:36	06/12/2020 17:39	21,04	2	42,09	CHI
20201222822	SENADOR CANEDO	190110429	SENADOR CANEDO	05/12/2020 20:36	05/12/2020 22:14	05/12/2020 20:36	05/12/2020 22:14	1,63	1	1,63	CHI
20201222824	LUZIANIA	LZ21153300	PACAEMBU S2	05/12/2020 20:36	05/12/2020 22:52	05/12/2020 20:36	05/12/2020 22:52	2,26	1	2,26	CHI
20201223000	PETROLINA DE GOIAS	PV12062894	SAO FRANCISCO DE GOIAS	05/12/2020 20:36	05/12/2020 23:19	05/12/2020 20:36	05/12/2020 23:19	2,71	3	8,13	CHI
20201223000	PIRENOPOLIS	PV12062894	SAO FRANCISCO DE GOIAS	05/12/2020 20:36	05/12/2020 23:19	05/12/2020 20:36	05/12/2020 23:19	2,71	22	59,61	CHI
20201223472	BURITI DE GOIAS	CO10418767	FIRMINOPOLIS S2	05/12/2020 20:36	06/12/2020 00:29	05/12/2020 20:36	06/12/2020 00:29	3,87	59	228,46	CHI
20201223472	CORREGO DO OURO	CO10418767	FIRMINOPOLIS S2	05/12/2020 20:36	06/12/2020 00:29	05/12/2020 20:36	06/12/2020 00:29	3,87	16	61,96	CHI
20201223472	NOVO BRASIL	CO10418767	FIRMINOPOLIS S2	05/12/2020 20:36	06/12/2020 00:29	05/12/2020 20:36	06/12/2020 00:29	3,87	16	61,96	CHI
20201222828	JARAGUA	JA12035312	JARAGUA	05/12/2020 20:37	06/12/2020 01:45	05/12/2020 20:37	06/12/2020 01:45	5,13	6	30,78	CHI
20201222837	ANAPOLIS	20999227	JUNDIAI S2	05/12/2020 20:40	05/12/2020 23:10	05/12/2020 20:40	05/12/2020 23:10	2,50	1	2,50	CHI
20201222846	JATAI	JT11182010	JATAI S2	05/12/2020 20:41	06/12/2020 06:55	05/12/2020 20:41	06/12/2020 06:55	10,22	41	418,93	CHI
20201222995	TRINDADE	TR12000041	TRINDADE	05/12/2020 20:41	06/12/2020 01:22	05/12/2020 20:41	06/12/2020 01:22	4,67	1442	6730,53	CHI
20201222934	AGUAS LINDAS DE GOIAS	LA11164940	AGUAS LINDAS DE GOIAS S1	05/12/2020 20:43	06/12/2020 01:00	05/12/2020 20:43	06/12/2020 01:00	4,28	60	256,85	CHI
202012179386	GOIATUBA	BJ12256996	BOM JESUS DE GOIAS	05/12/2020 20:43	06/12/2020 05:52	05/12/2020 20:43	06/12/2020 05:52	9,15	48	439,29	CHI
202012179386	BOM JESUS DE GOIAS	BJ12256996	BOM JESUS DE GOIAS	05/12/2020 20:43	06/12/2020 05:52	05/12/2020 20:43	06/12/2020 05:52	9,15	15	137,28	CHI
20201222861	PONTALINA	JV12000001	GOIATUBA S1	05/12/2020 20:47	05/12/2020 22:57	05/12/2020 20:47	05/12/2020 22:57	2,16	16	34,48	CHI
20201222861	JOVIANIA	JV12000001	GOIATUBA S1	05/12/2020 20:47	05/12/2020 22:57	05/12/2020 20:47	05/12/2020 22:57	2,16	97	209,06	CHI
20201222884	IPORA	IR21157816	IPORA	05/12/2020 20:53	06/12/2020 13:05	05/12/2020 20:53	06/12/2020 13:05	16,19	1	16,19	CHI
20201222887	CACHOEIRA DE GOIAS	CG12165605	FIRMINOPOLIS S2	05/12/2020 20:53	07/12/2020 19:41	05/12/2020 20:53	06/12/2020 14:30	17,62	9	158,58	CHI
20201222887	CACHOEIRA DE GOIAS	CG12165605	FIRMINOPOLIS S2	05/12/2020 20:53	07/12/2020 19:41	06/12/2020 14:31	07/12/2020 17:41	27,17	8	217,36	CHI
20201222887	CACHOEIRA DE GOIAS	CG12165605	FIRMINOPOLIS S2	05/12/2020 20:53	07/12/2020 19:41	06/12/2020 14:31	07/12/2020 18:36	28,08	1	28,08	CHI
20201222887	CACHOEIRA DE GOIAS	CG12165605	FIRMINOPOLIS S2	05/12/2020 20:53	07/12/2020 19:41	07/12/2020 19:01	07/12/2020 19:41	0,66	9	5,97	CHI
20201222888	ABADIANIA	AA21297725	CORUMBA	05/12/2020 20:54	06/12/2020 10:07	05/12/2020 20:54	06/12/2020 10:07	13,21	1	13,21	CHI

20201222894	ANAPOLIS	10007245031	JUNDIAI S2	05/12/2020 20:55	06/12/2020 00:24	05/12/2020 20:55	06/12/2020 00:24	3,47	1	3,47	CHI
20201222895	APARECIDA DE GOIANIA	AP11004859	ATLANTICO S1	05/12/2020 20:55	06/12/2020 09:45	05/12/2020 20:55	06/12/2020 09:17	12,35	154	1902,63	CHI
20201222895	APARECIDA DE GOIANIA	AP12004870	ATLANTICO S1	05/12/2020 20:55	06/12/2020 09:45	06/12/2020 09:16	06/12/2020 09:45	0,48	306	147,82	CHI
20201223034	SANTA BARBARA DE GOIAS	AV12241071	ANICUNS	05/12/2020 20:55	06/12/2020 02:17	05/12/2020 20:55	06/12/2020 02:17	5,37	8	42,92	CHI
20201223034	AVELINOPOLIS	AV12241071	ANICUNS	05/12/2020 20:55	06/12/2020 02:17	05/12/2020 20:55	06/12/2020 02:17	5,37	128	686,76	CHI
20201223343	PORANGATU	PO12321960	PORANGATU	05/12/2020 20:55	06/12/2020 03:28	05/12/2020 20:55	06/12/2020 03:28	6,53	2	13,07	CHI
20201222904	LUZIANIA	120024822	RIO VERMELHO	05/12/2020 20:57	05/12/2020 22:26	05/12/2020 20:57	05/12/2020 22:26	1,48	1	1,48	CHI
20201222914	ARENOPOLIS	AY21040869	ARENOPOLIS	05/12/2020 21:00	06/12/2020 11:23	05/12/2020 21:00	06/12/2020 11:23	14,38	1	14,38	CHI
20201223355	ALTO PARAISO DE GOIAS	BF12159157	NIQUELANDIA SUBTRANSMISSAO	05/12/2020 21:01	06/12/2020 15:06	05/12/2020 21:01	06/12/2020 15:06	18,08	17	307,41	CHI
20201222937	IPAMERI	IP12275811	IPAMERI	05/12/2020 21:04	05/12/2020 23:40	05/12/2020 21:04	05/12/2020 23:40	2,59	88	227,94	CHI
20201222949	BALIZA	BH12162960	BOM JARDIM	05/12/2020 21:04	06/12/2020 01:49	05/12/2020 21:04	06/12/2020 01:49	4,74	18	85,36	CHI
20201222949	ARAGARCAS	BH12162960	BOM JARDIM	05/12/2020 21:04	06/12/2020 01:49	05/12/2020 21:04	06/12/2020 01:49	4,74	12	56,91	CHI
20201222943	BALIZA	BH21406527	BOM JARDIM	05/12/2020 21:06	06/12/2020 09:16	05/12/2020 21:06	06/12/2020 09:16	12,16	1	12,16	CHI
20201222952	CATALAO	CT121245032	CATALAO S1	05/12/2020 21:07	05/12/2020 23:10	05/12/2020 21:07	05/12/2020 23:10	2,04	1	2,04	CHI
20201222962	MOSSAMEDES	MD12062634RE	ITABERAI S1	05/12/2020 21:08	06/12/2020 09:07	05/12/2020 21:08	06/12/2020 09:07	11,97	201	2406,75	CHI
20201222962	ITABERAI	MD12062634RE	ITABERAI S1	05/12/2020 21:08	06/12/2020 09:07	05/12/2020 21:08	06/12/2020 09:07	11,97	4	47,90	CHI
20201222962	GOIAS	MD12062634RE	ITABERAI S1	05/12/2020 21:08	06/12/2020 09:07	05/12/2020 21:08	06/12/2020 09:07	11,97	7	83,82	CHI
20201222964	PARAUNA	PU12383530	PARAUNA	05/12/2020 21:08	06/12/2020 11:31	05/12/2020 21:08	06/12/2020 11:31	14,37	1	14,37	CHI
20201222967	FORMOSA	FA12404372	ITUIQUIRA	05/12/2020 21:08	05/12/2020 23:38	05/12/2020 21:08	05/12/2020 23:38	2,50	164	410,00	CHI
20201222974	FLORES DE GOIAS	FB12233546	FLORES DE GOIAS	05/12/2020 21:10	06/12/2020 07:08	05/12/2020 21:10	06/12/2020 07:08	9,96	3	29,89	CHI
20201222975	SAO MIGUEL DO ARAGUAIA	830044000	SAO MIGUEL DO ARAGUAIA	05/12/2020 21:10	06/12/2020 00:29	05/12/2020 21:10	06/12/2020 00:29	3,30	1	3,30	CHI
20201222976	COLINAS DO SUL	TI10398398	NIQUELANDIA SUBTRANSMISSAO	05/12/2020 21:11	07/12/2020 04:42	05/12/2020 21:11	05/12/2020 23:51	2,68	30	80,28	CHI
20201222976	CAVALCANTE	TI10398398	NIQUELANDIA SUBTRANSMISSAO	05/12/2020 21:11	07/12/2020 04:42	05/12/2020 21:11	05/12/2020 23:51	2,68	58	155,21	CHI
20201222976	COLINAS DO SUL	TI13256699	NIQUELANDIA SUBTRANSMISSAO	05/12/2020 21:11	07/12/2020 04:42	05/12/2020 21:11	06/12/2020 09:35	12,40	28	347,10	CHI
20201222976	ALTO PARAISO DE GOIAS	TI13256699	NIQUELANDIA SUBTRANSMISSAO	05/12/2020 21:11	07/12/2020 04:42	05/12/2020 21:11	06/12/2020 09:35	12,40	9	111,57	CHI
20201222976	NIQUELANDIA	TI13256717	NIQUELANDIA SUBTRANSMISSAO	05/12/2020 21:11	07/12/2020 04:42	05/12/2020 21:11	06/12/2020 11:12	14,03	4	56,10	CHI
20201222976	COLINAS DO SUL	TI13256717	NIQUELANDIA SUBTRANSMISSAO	05/12/2020 21:11	07/12/2020 04:42	05/12/2020 21:11	06/12/2020 11:12	14,03	17	238,44	CHI
20201222976	ALTO PARAISO DE GOIAS	TI13256717	NIQUELANDIA SUBTRANSMISSAO	05/12/2020 21:11	07/12/2020 04:42	05/12/2020 21:11	06/12/2020 11:12	14,03	13	182,34	CHI
20201222976	CAVALCANTE	TI10398398	NIQUELANDIA SUBTRANSMISSAO	05/12/2020 21:11	07/12/2020 04:42	06/12/2020 11:58	06/12/2020 12:28	0,50	58	28,84	CHI
20201222976	NIQUELANDIA	TI10398398	NIQUELANDIA SUBTRANSMISSAO	05/12/2020 21:11	07/12/2020 04:42	06/12/2020 11:58	06/12/2020 12:28	0,50	4	1,99	CHI
20201222976	ALTO PARAISO DE GOIAS	TI10398398	NIQUELANDIA SUBTRANSMISSAO	05/12/2020 21:11	07/12/2020 04:42	06/12/2020 11:58	06/12/2020 12:28	0,50	22	10,94	CHI
20201222976	COLINAS DO SUL	TI10398398	NIQUELANDIA SUBTRANSMISSAO	05/12/2020 21:11	07/12/2020 04:42	06/12/2020 11:58	06/12/2020 12:28	0,50	75	37,29	CHI
20201222976	ALTO PARAISO DE GOIAS	BF13256692	NIQUELANDIA SUBTRANSMISSAO	05/12/2020 21:11	07/12/2020 04:42	05/12/2020 21:11	07/12/2020 04:42	31,51	4	126,06	CHI
20201223002	FIRMINOPOLIS	FR12028946	FIRMINOPOLIS S1	05/12/2020 21:17	06/12/2020 09:09	05/12/2020 21:17	06/12/2020 09:09	11,86	21	248,97	CHI
20201223007	RIO VERDE	RV11305912	RIO VERDE S1	05/12/2020 21:20	06/12/2020 08:52	05/12/2020 21:20	06/12/2020 08:52	11,53	32	369,00	CHI
20201223009	PORANGATU	PO12020578	PORANGATU	05/12/2020 21:20	05/12/2020 23:23	05/12/2020 21:20	05/12/2020 23:23	2,04	23	46,93	CHI
20201223126	ORIZONA	OZ12114502	PIRES DO RIO S2	05/12/2020 21:23	06/12/2020 14:27	05/12/2020 21:23	06/12/2020 14:27	17,06	15	255,95	CHI
20201223075	PLANALTINA	JL10394706	SAO JOAO D ALIANCA	05/12/2020 21:24	06/12/2020 13:20	05/12/2020 21:25	06/12/2020 02:31	5,11	282	1441,88	CHI
20201223075	AGUA FRIA DE GOIAS	JL10394706	SAO JOAO D ALIANCA	05/12/2020 21:24	06/12/2020 13:20	05/12/2020 21:25	06/12/2020 02:31	5,11	1813	9269,97	CHI
20201223075	AGUA FRIA DE GOIAS	02160414	SAO JOAO D ALIANCA	05/12/2020 21:24	06/12/2020 13:20	05/12/2020 21:25	06/12/2020 02:31	5,11	87	444,84	CHI
20201223075	MIMOSO DE GOIAS	JL10394706	SAO JOAO D ALIANCA	05/12/2020 21:24	06/12/2020 13:20	05/12/2020 21:25	06/12/2020 02:31	5,11	30	153,39	CHI
20201223075	AGUA FRIA DE GOIAS	02160414	SAO JOAO D ALIANCA	05/12/2020 21:24	06/12/2020 13:20	05/12/2020 21:25	06/12/2020 09:55	12,50	60	749,93	CHI
20201223075	SAO JOAO D ALIANCA	02160414	SAO JOAO D ALIANCA	05/12/2020 21:24	06/12/2020 13:20	05/12/2020 21:25	06/12/2020 09:55	12,50	2	25,00	CHI
20201223075	SAO JOAO D ALIANCA	02160414	SAO JOAO D ALIANCA	05/12/2020 21:24	06/12/2020 13:20	05/12/2020 21:25	06/12/2020 10:33	13,13	26	341,43	CHI
20201223075	AGUA FRIA DE GOIAS	02160414	SAO JOAO D ALIANCA	05/12/2020 21:24	06/12/2020 13:20	05/12/2020 21:25	06/12/2020 10:33	13,13	20	262,64	CHI
20201223075	PLANALTINA	02160414	SAO JOAO D ALIANCA	05/12/2020 21:24	06/12/2020 13:20	05/12/2020 21:25	06/12/2020 11:40	14,26	1	14,26	CHI
20201223075	AGUA FRIA DE GOIAS	02160414	SAO JOAO D ALIANCA	05/12/2020 21:24	06/12/2020 13:20	05/12/2020 21:25	06/12/2020 11:40	14,26	26	370,67	CHI
20201223075	AGUA FRIA DE GOIAS	02160414	SAO JOAO D ALIANCA	05/12/2020 21:24	06/12/2020 13:20	05/12/2020 21:25	06/12/2020 11:59	14,57	79	1151,21	CHI
20201223075	SAO JOAO D ALIANCA	02160414	SAO JOAO D ALIANCA	05/12/2020 21:24	06/12/2020 13:20	05/12/2020 21:25	06/12/2020 11:59	14,57	1	14,57	CHI
20201223075	AGUA FRIA DE GOIAS	02160414	SAO JOAO D ALIANCA	05/12/2020 21:24	06/12/2020 13:20	05/12/2020 21:25	06/12/2020 12:18	14,88	1	14,88	CHI
20201223075	AGUA FRIA DE GOIAS	02160414	SAO JOAO D ALIANCA	05/12/2020 21:24	06/12/2020 13:20	05/12/2020 21:25	06/12/2020 12:30	15,09	4	60,37	CHI

20201223075	AGUA FRIA DE GOIAS	02160414	SAO JOAO D ALIANCA	05/12/2020 21:24	06/12/2020 13:20	05/12/2020 21:25	06/12/2020 12:38	15,22	19	289,25	CHI
20201223075	FORMOSA	02160414	SAO JOAO D ALIANCA	05/12/2020 21:24	06/12/2020 13:20	05/12/2020 21:25	06/12/2020 12:38	15,22	1	15,22	CHI
20201223075	AGUA FRIA DE GOIAS	PI13080944	SAO JOAO D ALIANCA	05/12/2020 21:24	06/12/2020 13:20	06/12/2020 13:07	06/12/2020 13:20	0,21	10	2,12	CHI
20201223265	ITAPACI	IW12243398RE	ITAPACI	05/12/2020 21:24	06/12/2020 01:34	05/12/2020 21:24	06/12/2020 01:34	4,15	125	518,99	CHI
20201223265	NOVA GLORIA	IW12243398RE	ITAPACI	05/12/2020 21:24	06/12/2020 01:34	05/12/2020 21:24	06/12/2020 01:34	4,15	27	112,10	CHI
20201223027	FIRMINOPOLIS	FR21105339	FIRMINOPOLIS S1	05/12/2020 21:25	06/12/2020 09:09	05/12/2020 21:25	06/12/2020 09:09	11,73	3	35,19	CHI
20201223032	CAVALCANTE	CJ21117320	FLORES DE GOIAS	05/12/2020 21:26	06/12/2020 12:27	05/12/2020 21:26	06/12/2020 12:27	15,01	1	15,01	CHI
20201223053	CACHOEIRA DOURADA	CD11000006	CACHOEIRA DOURADA	05/12/2020 21:28	05/12/2020 21:49	05/12/2020 21:28	05/12/2020 21:49	0,33	106	35,36	CHI
20201223050	RIO VERDE	RV21109956	CABRIUVA S2	05/12/2020 21:29	06/12/2020 10:14	05/12/2020 21:29	06/12/2020 10:14	12,74	1	12,74	CHI
20201223057	RIO VERDE	RV12301462	ACREUNA	05/12/2020 21:30	06/12/2020 10:25	05/12/2020 21:30	06/12/2020 10:25	12,90	16	206,47	CHI
20201223057	SANTO ANTONIO DA BARRA	RV12301462	ACREUNA	05/12/2020 21:30	06/12/2020 10:25	05/12/2020 21:30	06/12/2020 10:25	12,90	1	12,90	CHI
20201223111	CAMPO ALEGRE DE GOIAS	01480414	PIRES DO RIO S2	05/12/2020 21:31	07/12/2020 01:30	05/12/2020 21:31	06/12/2020 03:18	5,78	19	109,80	CHI
20201223111	IPAMERI	01480414	PIRES DO RIO S2	05/12/2020 21:31	07/12/2020 01:30	05/12/2020 21:31	06/12/2020 03:18	5,78	137	791,75	CHI
20201223111	CAMPO ALEGRE DE GOIAS	IP10400404	CAMPO ALEGRE DE GOIAS	05/12/2020 21:31	07/12/2020 01:30	06/12/2020 02:44	06/12/2020 03:18	0,56	9	5,05	CHI
20201223111	IPAMERI	IP10400404	CAMPO ALEGRE DE GOIAS	05/12/2020 21:31	07/12/2020 01:30	06/12/2020 02:44	06/12/2020 03:18	0,56	81	45,41	CHI
20201223111	PIRES DO RIO	01480414	PIRES DO RIO S2	05/12/2020 21:31	07/12/2020 01:30	05/12/2020 21:31	06/12/2020 10:25	12,90	3	38,69	CHI
20201223111	IPAMERI	01480414	PIRES DO RIO S2	05/12/2020 21:31	07/12/2020 01:30	05/12/2020 21:31	06/12/2020 14:44	17,21	131	2254,91	CHI
20201223111	URUTAI	01480414	PIRES DO RIO S2	05/12/2020 21:31	07/12/2020 01:30	05/12/2020 21:31	06/12/2020 14:44	17,21	6	103,28	CHI
20201223111	ORIZONA	01480414	PIRES DO RIO S2	05/12/2020 21:31	07/12/2020 01:30	05/12/2020 21:31	06/12/2020 14:44	17,21	1	17,21	CHI
20201223111	URUTAI	01480414	PIRES DO RIO S2	05/12/2020 21:31	07/12/2020 01:30	05/12/2020 21:31	06/12/2020 22:56	25,42	66	1677,76	CHI
20201223111	ORIZONA	01480414	PIRES DO RIO S2	05/12/2020 21:31	07/12/2020 01:30	05/12/2020 21:31	06/12/2020 22:56	25,42	2	50,84	CHI
20201223111	PIRES DO RIO	01480414	PIRES DO RIO S2	05/12/2020 21:31	07/12/2020 01:30	05/12/2020 21:31	06/12/2020 22:56	25,42	7	177,94	CHI
20201223111	ORIZONA	01480414	PIRES DO RIO S2	05/12/2020 21:31	07/12/2020 01:30	05/12/2020 21:31	07/12/2020 01:30	27,98	6	167,86	CHI
20201223111	URUTAI	01480414	PIRES DO RIO S2	05/12/2020 21:31	07/12/2020 01:30	05/12/2020 21:31	07/12/2020 01:30	27,98	32	895,25	CHI
20201223078	SAO JOAO D ALIANCA	JL12261887	SAO JOAO D ALIANCA	05/12/2020 21:35	06/12/2020 14:49	05/12/2020 21:35	06/12/2020 12:40	15,10	16	241,54	CHI
20201223078	AGUA FRIA DE GOIAS	JL12261887	SAO JOAO D ALIANCA	05/12/2020 21:35	06/12/2020 14:49	05/12/2020 21:35	06/12/2020 12:40	15,10	6	90,58	CHI
20201223078	AGUA FRIA DE GOIAS	JL12261887	SAO JOAO D ALIANCA	05/12/2020 21:35	06/12/2020 14:49	05/12/2020 21:35	06/12/2020 14:49	17,23	3	51,70	CHI
20201223078	SAO JOAO D ALIANCA	JL12261887	SAO JOAO D ALIANCA	05/12/2020 21:35	06/12/2020 14:49	05/12/2020 21:35	06/12/2020 14:49	17,23	1	17,23	CHI
20201223083	RIO VERDE	10004531815	RIO VERDE S2	05/12/2020 21:35	06/12/2020 00:34	05/12/2020 21:35	06/12/2020 00:34	2,97	1	2,97	CHI
20201223084	PORANGATU	PO12079746	PORANGATU	05/12/2020 21:35	07/12/2020 13:13	05/12/2020 21:35	07/12/2020 13:13	39,63	3	118,88	CHI
20201223098	TRINDADE	TR12000037	TRINDADE	05/12/2020 21:35	05/12/2020 23:46	05/12/2020 21:35	05/12/2020 23:46	2,17	455	987,98	CHI
20201223087	AGUA FRIA DE GOIAS	10032466607	SAO JOAO D ALIANCA	05/12/2020 21:36	06/12/2020 07:03	05/12/2020 21:36	06/12/2020 07:03	9,44	1	9,44	CHI
20201223092	ITUMBIARA	IT12031395	ITUMBIARA NOVA	05/12/2020 21:37	06/12/2020 00:23	05/12/2020 21:37	06/12/2020 00:23	2,75	12	33,05	CHI
20201223093	GOUVELANDIA	2250014950	QUIRINOPOLIS	05/12/2020 21:38	06/12/2020 01:37	05/12/2020 21:38	06/12/2020 01:37	3,98	1	3,98	CHI
20201223096	ANAPOLIS	AN12370439	JUNDIAI S2	05/12/2020 21:39	06/12/2020 05:49	05/12/2020 21:39	06/12/2020 05:49	8,16	162	1322,64	CHI
20201223099	MUNDO NOVO DE GOIAS	4240014397	NOVA CRIXAS	05/12/2020 21:39	05/12/2020 23:28	05/12/2020 21:39	05/12/2020 23:28	1,81	1	1,81	CHI
20201224114	ALTO PARAISO DE GOIAS	BF12208699	FLORES DE GOIAS	05/12/2020 21:41	06/12/2020 07:57	06/12/2020 07:19	06/12/2020 07:57	0,62	1392	864,59	CHI
20201223106	EDEIA	1120021720	EDEIA	05/12/2020 21:43	06/12/2020 07:48	05/12/2020 21:43	06/12/2020 07:48	10,07	1	10,07	CHI
20201223456	BURITINOPOLIS	BQ12011376	IACIARA S2	05/12/2020 21:43	06/12/2020 08:03	05/12/2020 21:43	06/12/2020 08:03	10,33	15	154,92	CHI
20201223107	ALTO PARAISO DE GOIAS	BF12128334	SAO JOAO D ALIANCA	05/12/2020 21:44	06/12/2020 09:14	05/12/2020 21:44	06/12/2020 09:14	11,50	5	57,50	CHI
20201223109	CAIAPONIA	CP12151179	CAIAPONIA	05/12/2020 21:45	06/12/2020 08:13	05/12/2020 21:45	06/12/2020 08:13	10,46	89	930,52	CHI
20201223112	RIO VERDE	RV11214074	RIO VERDE S1	05/12/2020 21:45	06/12/2020 00:02	05/12/2020 21:45	06/12/2020 00:02	2,27	95	215,44	CHI
20201223115	SANTA BARBARA DE GOIAS	SB21248903	TRINDADE	05/12/2020 21:49	06/12/2020 02:49	05/12/2020 21:49	06/12/2020 02:49	4,99	2	9,97	CHI
20201223116	ACREUNA	EA12263394LD	RIO DOS BOIS	05/12/2020 21:50	06/12/2020 09:25	05/12/2020 21:50	06/12/2020 09:25	11,58	5	57,88	CHI
20201223116	EDEIA	EA12263394LD	RIO DOS BOIS	05/12/2020 21:50	06/12/2020 09:25	05/12/2020 21:50	06/12/2020 09:25	11,58	12	138,90	CHI
20201223117	FIRMINOPOLIS	FR12096977LD	FIRMINOPOLIS S1	05/12/2020 21:50	06/12/2020 09:09	05/12/2020 21:50	06/12/2020 09:09	11,30	60	678,23	CHI
20201223932	CAIAPONIA	PY18040163TS	PALESTINA	05/12/2020 21:51	06/12/2020 10:47	05/12/2020 21:51	06/12/2020 10:47	12,93	31	400,80	CHI
20201223932	PALESTINA DE GOIAS	PY18040163TS	PALESTINA	05/12/2020 21:51	06/12/2020 10:47	05/12/2020 21:51	06/12/2020 10:47	12,93	102	1318,77	CHI
20201223129	ABADIANIA	AA12385102	ANAPOLIS UNIVERSITARIO S1	05/12/2020 21:54	06/12/2020 02:55	05/12/2020 21:54	06/12/2020 02:55	5,00	3	15,01	CHI
20201223135	RIO VERDE	RV21191901	CABRIUVA S2	05/12/2020 21:56	06/12/2020 14:54	05/12/2020 21:56	06/12/2020 14:32	16,59	1	16,59	CHI
20201223135	RIO VERDE	RV13402375	CABRIUVA S2	05/12/2020 21:56	06/12/2020 14:54	06/12/2020 12:54	06/12/2020 14:54	2,00	4	8,00	CHI

20201223189	APARECIDA DE GOIANIA	AP11067637	REAL S2	05/12/2020 21:56	06/12/2020 03:56	05/12/2020 21:56	06/12/2020 03:56	5,99	147	880,61	CHI
20201223149	ALTO PARAISO DE GOIAS	BF21048003	SAO JOAO D ALIANCA	05/12/2020 22:00	06/12/2020 16:54	05/12/2020 22:00	06/12/2020 16:54	18,89	1	18,89	CHI
20201223153	CAMPO ALEGRE DE GOIAS	CM12231703	CAMPO ALEGRE DE GOIAS	05/12/2020 22:00	06/12/2020 05:41	05/12/2020 22:00	06/12/2020 05:41	7,67	10	76,69	CHI
20201223162	ORIZONA	OZ12143757	PIRES DO RIO S2	05/12/2020 22:01	06/12/2020 08:59	05/12/2020 22:01	06/12/2020 08:59	10,95	38	416,18	CHI
20201223457	APARECIDA DE GOIANIA	11281121	REAL S2	05/12/2020 22:01	06/12/2020 02:43	05/12/2020 22:01	06/12/2020 02:43	4,70	1	4,70	CHI
20201223177	QUIRINOPOLIS	QI11018008	QUIRINOPOLIS	05/12/2020 22:03	06/12/2020 00:27	05/12/2020 22:03	06/12/2020 00:27	2,40	95	227,58	CHI
20201223181	APARECIDA DE GOIANIA	AP11166586	REAL S1	05/12/2020 22:03	06/12/2020 01:10	06/12/2020 00:33	06/12/2020 01:10	0,63	77	48,42	CHI
20201223247	BOM JARDIM DE GOIAS	BM12334813	IPORA	05/12/2020 22:03	06/12/2020 09:54	05/12/2020 22:03	06/12/2020 09:54	11,84	15	177,58	CHI
20201223252	CRIXAS	MZ12055628	MOZARLANDIA	05/12/2020 22:03	06/12/2020 08:55	05/12/2020 22:03	06/12/2020 08:55	10,86	26	282,31	CHI
20201223252	MOZARLANDIA	MZ12055628	MOZARLANDIA	05/12/2020 22:03	06/12/2020 08:55	05/12/2020 22:03	06/12/2020 08:55	10,86	40	434,32	CHI
20201223182	NIQUELANDIA	NQ21328324	NIQUELANDIA SUBTRANSMISSAO	05/12/2020 22:05	06/12/2020 08:57	05/12/2020 22:05	06/12/2020 08:57	10,86	1	10,86	CHI
20201223280	AGUA FRIA DE GOIAS	TL10402672	SAO JOAO D ALIANCA	05/12/2020 22:07	06/12/2020 04:09	05/12/2020 22:07	06/12/2020 04:09	6,04	38	229,44	CHI
20201223185	BALIZA	BH12369819	BOM JARDIM	05/12/2020 22:08	06/12/2020 09:08	05/12/2020 22:08	06/12/2020 09:08	11,01	2	22,02	CHI
20201223201	SAO LUIZ DO NORTE	SZ12066092	ITAPACI	05/12/2020 22:15	06/12/2020 03:35	05/12/2020 22:15	06/12/2020 03:35	5,32	3	15,95	CHI
20201223215	PIRES DO RIO	PR16435082	PIRES DO RIO S1	05/12/2020 22:16	08/12/2020 00:05	05/12/2020 22:16	06/12/2020 08:06	9,83	53	521,03	CHI
20201223215	PALMELO	PR16435082	PIRES DO RIO S1	05/12/2020 22:16	08/12/2020 00:05	05/12/2020 22:16	06/12/2020 08:06	9,83	6	58,99	CHI
20201223215	PIRES DO RIO	PR16435082	PIRES DO RIO S1	05/12/2020 22:16	08/12/2020 00:05	05/12/2020 22:18	06/12/2020 08:06	9,79	3	29,38	CHI
20201223215	PIRES DO RIO	PR16435082	PIRES DO RIO S1	05/12/2020 22:16	08/12/2020 00:05	05/12/2020 22:16	06/12/2020 10:21	12,09	10	120,91	CHI
20201223215	PALMELO	PR16435082	PIRES DO RIO S1	05/12/2020 22:16	08/12/2020 00:05	05/12/2020 22:16	06/12/2020 10:21	12,09	3	36,27	CHI
20201223215	PIRES DO RIO	PR12064872LD	PIRES DO RIO S1	05/12/2020 22:16	08/12/2020 00:05	05/12/2020 22:18	06/12/2020 10:21	12,05	2	24,11	CHI
20201223215	PIRES DO RIO	01480214	PIRES DO RIO S1	05/12/2020 22:16	08/12/2020 00:05	06/12/2020 10:12	06/12/2020 10:21	0,15	486	71,01	CHI
20201223215	PALMELO	01480214	PIRES DO RIO S1	05/12/2020 22:16	08/12/2020 00:05	06/12/2020 10:12	06/12/2020 10:21	0,15	6	0,88	CHI
20201223215	PIRES DO RIO	PR12064872LD	PIRES DO RIO S1	05/12/2020 22:16	08/12/2020 00:05	06/12/2020 10:23	06/12/2020 12:46	2,38	8	19,06	CHI
20201223215	PIRES DO RIO	PR12216007LD	PIRES DO RIO S1	05/12/2020 22:16	08/12/2020 00:05	06/12/2020 10:23	06/12/2020 13:09	2,76	1	2,76	CHI
20201223215	PALMELO	PR12216007LD	PIRES DO RIO S1	05/12/2020 22:16	08/12/2020 00:05	06/12/2020 10:23	06/12/2020 13:09	2,76	1	2,76	CHI
20201223215	PIRES DO RIO	PR12344710	PIRES DO RIO S1	05/12/2020 22:16	08/12/2020 00:05	06/12/2020 10:23	06/12/2020 13:23	2,99	2	5,98	CHI
20201223215	SANTA CRUZ DE GOIAS	PR16435082	PIRES DO RIO S1	05/12/2020 22:16	08/12/2020 00:05	05/12/2020 22:16	06/12/2020 13:44	15,48	1	15,48	CHI
20201223215	PIRES DO RIO	PR16435082	PIRES DO RIO S1	05/12/2020 22:16	08/12/2020 00:05	05/12/2020 22:16	06/12/2020 13:44	15,48	66	1021,39	CHI
20201223215	URUTAI	PR16435082	PIRES DO RIO S1	05/12/2020 22:16	08/12/2020 00:05	05/12/2020 22:16	06/12/2020 13:44	15,48	1	15,48	CHI
20201223215	PIRES DO RIO	PR12083164LD	PIRES DO RIO S1	05/12/2020 22:16	08/12/2020 00:05	05/12/2020 22:18	06/12/2020 13:44	15,44	5	77,19	CHI
20201223215	URUTAI	PR16429518	PIRES DO RIO S1	05/12/2020 22:16	08/12/2020 00:05	06/12/2020 14:34	06/12/2020 14:41	0,11	1	0,11	CHI
20201223215	SANTA CRUZ DE GOIAS	PR16429518	PIRES DO RIO S1	05/12/2020 22:16	08/12/2020 00:05	06/12/2020 14:34	06/12/2020 14:41	0,11	1	0,11	CHI
20201223215	PIRES DO RIO	PR16429518	PIRES DO RIO S1	05/12/2020 22:16	08/12/2020 00:05	06/12/2020 14:34	06/12/2020 14:41	0,11	406	46,01	CHI
20201223215	PALMELO	PR16429518	PIRES DO RIO S1	05/12/2020 22:16	08/12/2020 00:05	06/12/2020 14:34	06/12/2020 14:41	0,11	7	0,79	CHI
20201223215	PIRES DO RIO	PR12095213LD	PIRES DO RIO S1	05/12/2020 22:16	08/12/2020 00:05	06/12/2020 10:23	06/12/2020 15:15	4,87	1	4,87	CHI
20201223215	PALMELO	PR12095213LD	PIRES DO RIO S1	05/12/2020 22:16	08/12/2020 00:05	06/12/2020 10:23	06/12/2020 15:15	4,87	1	4,87	CHI
20201223215	PALMELO	PZ12202871LD	PIRES DO RIO S1	05/12/2020 22:16	08/12/2020 00:05	06/12/2020 10:23	08/12/2020 00:05	37,69	1	37,69	CHI
20201223263	CATALAO	CT12231641	CATALAO S1	05/12/2020 22:16	06/12/2020 08:18	05/12/2020 22:16	06/12/2020 08:18	10,03	10	100,35	CHI
20201223263	GOIANDIRA	CT12231641	CATALAO S1	05/12/2020 22:16	06/12/2020 08:18	05/12/2020 22:16	06/12/2020 08:18	10,03	3	30,10	CHI
20201223223	VICENTINOPOLIS	VI12218198RE	VICENTINOPOLIS	05/12/2020 22:21	06/12/2020 12:20	05/12/2020 22:21	06/12/2020 11:37	13,26	15	198,96	CHI
20201223223	JOVIANIA	VI12218198RE	VICENTINOPOLIS	05/12/2020 22:21	06/12/2020 12:20	05/12/2020 22:21	06/12/2020 11:37	13,26	5	66,32	CHI
20201223223	PONTALINA	VI13218228	VICENTINOPOLIS	05/12/2020 22:21	06/12/2020 12:20	05/12/2020 22:21	06/12/2020 12:20	13,98	5	69,90	CHI
20201223223	VICENTINOPOLIS	VI13218228	VICENTINOPOLIS	05/12/2020 22:21	06/12/2020 12:20	05/12/2020 22:21	06/12/2020 12:20	13,98	1	13,98	CHI
20201223223	JOVIANIA	VI13218228	VICENTINOPOLIS	05/12/2020 22:21	06/12/2020 12:20	05/12/2020 22:21	06/12/2020 12:20	13,98	25	349,49	CHI
20201223223	PONTALINA	VI13218228	VICENTINOPOLIS	05/12/2020 22:21	06/12/2020 12:20	06/12/2020 07:58	06/12/2020 12:20	4,37	21	91,87	CHI
20201223225	ABADIA DE GOIAS	LG12343065	INDEPENDENCIA S2	05/12/2020 22:22	06/12/2020 15:31	05/12/2020 22:22	06/12/2020 15:31	17,14	23	394,32	CHI
20201224022	TROMBAS	TB12247392	PORANGATU	05/12/2020 22:25	06/12/2020 09:19	05/12/2020 22:25	06/12/2020 09:19	10,89	13	141,59	CHI
20201223239	SANTA CRUZ DE GOIAS	BC21186568	CRISTIANOPOLIS	05/12/2020 22:26	06/12/2020 12:00	05/12/2020 22:26	06/12/2020 12:00	13,56	2	27,12	CHI
20201223251	TURVANIA	TV12005581	FIRMINOPOLIS S2	05/12/2020 22:26	06/12/2020 10:29	05/12/2020 22:26	06/12/2020 10:29	12,05	11	132,51	CHI
20201223243	POSSE	PS12344418	IACIARA S1	05/12/2020 22:27	06/12/2020 09:15	05/12/2020 22:27	06/12/2020 09:15	10,80	41	442,75	CHI
20201223246	MINEIROS	1390055120	PARQUE DAS EMAS	05/12/2020 22:27	06/12/2020 09:55	05/12/2020 22:27	06/12/2020 09:55	11,46	1	11,46	CHI

20201223254	ITABERAI	IB12070828	ITABERAI S1	05/12/2020 22:31	06/12/2020 07:56	05/12/2020 22:31	06/12/2020 07:56	9,41	11	103,49	CHI
20201223268	MARA ROSA	VD12201669	SANTA TEREZINHA	05/12/2020 22:37	07/12/2020 17:33	05/12/2020 22:37	07/12/2020 17:33	42,93	2	85,86	CHI
20201223269	BOM JARDIM DE GOIAS	BM12208862	BOM JARDIM	05/12/2020 22:37	06/12/2020 09:00	05/12/2020 22:37	06/12/2020 09:00	10,37	33	342,37	CHI
20201223271	APARECIDA DE GOIANIA	10029500786	INDEPENDENCIA S1	05/12/2020 22:37	06/12/2020 09:19	05/12/2020 22:37	06/12/2020 09:19	10,69	1	10,69	CHI
20201224738	GOIAS	GS12206887	GOIAS	05/12/2020 22:40	06/12/2020 11:47	05/12/2020 22:40	06/12/2020 11:47	13,10	22	288,27	CHI
20201223287	BALIZA	BH12356619	BOM JARDIM	05/12/2020 22:41	06/12/2020 03:48	05/12/2020 22:41	06/12/2020 03:48	5,11	14	71,52	CHI
20201223292	ORIZONA	OZ11140712	PIRES DO RIO S2	05/12/2020 22:43	06/12/2020 00:02	05/12/2020 22:43	06/12/2020 00:02	1,30	149	194,44	CHI
20201223294	CAIAPONIA	CP21340106	PALESTINA	05/12/2020 22:45	06/12/2020 22:51	05/12/2020 22:45	06/12/2020 22:51	24,10	1	24,10	CHI
20201223298	MINEIROS	10005331380	PARQUE DAS EMAS	05/12/2020 22:47	05/12/2020 23:46	05/12/2020 22:47	05/12/2020 23:46	0,97	1	0,97	CHI
20201223300	PORANGATU	PO21245078	PORANGATU	05/12/2020 22:48	06/12/2020 03:21	05/12/2020 22:48	06/12/2020 03:21	4,54	1	4,54	CHI
20201223315	SILVANIA	VN12400021	VIANOPOLIS	05/12/2020 22:52	06/12/2020 02:50	05/12/2020 22:52	06/12/2020 02:50	3,96	22	87,12	CHI
20201223315	VIANOPOLIS	VN12400021	VIANOPOLIS	05/12/2020 22:52	06/12/2020 02:50	05/12/2020 22:52	06/12/2020 02:50	3,96	117	463,32	CHI
20201223316	IPAMERI	UT12095342	URUTAI	05/12/2020 22:52	06/12/2020 08:16	05/12/2020 22:52	06/12/2020 08:16	9,39	14	131,45	CHI
20201223316	URUTAI	UT12095342	URUTAI	05/12/2020 22:52	06/12/2020 08:16	05/12/2020 22:52	06/12/2020 08:16	9,39	2	18,78	CHI
20201223318	ITUMBIARA	690028568	ITUMBIARA VELHA S1	05/12/2020 22:53	06/12/2020 08:51	05/12/2020 22:53	06/12/2020 08:51	9,97	1	9,97	CHI
20201223319	RIO QUENTE	RQ12063098	RIO QUENTE	05/12/2020 22:54	06/12/2020 02:45	05/12/2020 22:54	06/12/2020 02:45	3,85	11	42,35	CHI
20201223321	NIQUELANDIA	NQ21330292	NIQUELANDIA SUBTRANSMISSAO	05/12/2020 22:55	06/12/2020 10:21	05/12/2020 22:55	06/12/2020 10:21	11,43	1	11,43	CHI
20201223323	INHUMAS	IN21028000	ARACU	05/12/2020 22:56	06/12/2020 08:47	05/12/2020 22:56	06/12/2020 08:47	9,85	1	9,85	CHI
20201223324	GOIANESIA	GE12006558	GOIANESIA S1	05/12/2020 22:56	06/12/2020 03:25	05/12/2020 22:56	06/12/2020 03:25	4,48	23	102,93	CHI
20201223927	PALESTINA DE GOIAS	PY12244702	PALESTINA	05/12/2020 22:57	07/12/2020 18:34	05/12/2020 22:57	07/12/2020 18:34	43,61	2	87,23	CHI
20201223927	CAIAPONIA	PY12244702	PALESTINA	05/12/2020 22:57	07/12/2020 18:34	05/12/2020 22:57	07/12/2020 18:34	43,61	48	2093,47	CHI
20201223328	ESTRELA DO NORTE	ET12136395	MARA ROSA	05/12/2020 22:58	06/12/2020 02:30	05/12/2020 22:58	06/12/2020 02:30	3,52	11	38,71	CHI
20201223328	MARA ROSA	ET12136395	MARA ROSA	05/12/2020 22:58	06/12/2020 02:30	05/12/2020 22:58	06/12/2020 02:30	3,52	9	31,67	CHI
20201223331	SIMOLANDIA	SA12384201	IACIARA S2	05/12/2020 23:01	06/12/2020 09:11	05/12/2020 23:01	06/12/2020 09:11	10,16	2	20,32	CHI
20201223331	POSSE	SA12384201	IACIARA S2	05/12/2020 23:01	06/12/2020 09:11	05/12/2020 23:01	06/12/2020 09:11	10,16	20	203,20	CHI
20201223331	BURITINOPOLIS	SA12384201	IACIARA S2	05/12/2020 23:01	06/12/2020 09:11	05/12/2020 23:01	06/12/2020 09:11	10,16	1	10,16	CHI
20201222173	PORANGATU	PO12139169	PORANGATU	05/12/2020 23:02	06/12/2020 07:50	05/12/2020 23:02	06/12/2020 07:50	8,79	108	949,77	CHI
20201223337	CIDADE OCIDENTAL	2680162918	MARAJOARA	05/12/2020 23:04	06/12/2020 04:22	05/12/2020 23:04	06/12/2020 04:22	5,29	1	5,29	CHI
20201224329	BALIZA	BH12193310	BOM JARDIM	05/12/2020 23:07	06/12/2020 10:36	05/12/2020 23:07	06/12/2020 10:36	11,47	13	149,10	CHI
20201223359	FAZENDA NOVA	FN21147773	JUSSARA	05/12/2020 23:18	06/12/2020 11:08	05/12/2020 23:18	06/12/2020 11:08	11,82	1	11,82	CHI
20201223362	GOIANIA	16237134	ATLANTICO S1	05/12/2020 23:19	06/12/2020 00:29	05/12/2020 23:19	06/12/2020 00:29	1,16	1	1,16	CHI
20201224606	PLANALTINA	PI12067828	PLANALTINA	05/12/2020 23:19	06/12/2020 10:32	05/12/2020 23:19	06/12/2020 10:32	11,21	5	56,07	CHI
20201223367	LUZIANIA	LZ11199597	RIO VERMELHO	05/12/2020 23:21	06/12/2020 09:58	05/12/2020 23:21	06/12/2020 09:58	10,60	92	975,66	CHI
20201223373	PLANALTINA	PI21364057	PLANALTINA	05/12/2020 23:27	06/12/2020 08:30	05/12/2020 23:27	06/12/2020 08:30	9,04	2	18,08	CHI
20201223741	IPAMERI	UT12027140	URUTAI	05/12/2020 23:28	06/12/2020 08:34	05/12/2020 23:28	06/12/2020 08:34	9,09	14	127,33	CHI
20201223741	URUTAI	UT12027140	URUTAI	05/12/2020 23:28	06/12/2020 08:34	05/12/2020 23:28	06/12/2020 08:34	9,09	1	9,09	CHI
20201223385	IPAMERI	IP12016968RE	URUTAI	05/12/2020 23:32	06/12/2020 08:38	05/12/2020 23:32	06/12/2020 08:38	9,10	9	81,89	CHI
20201223385	URUTAI	IP12016968RE	URUTAI	05/12/2020 23:32	06/12/2020 08:38	05/12/2020 23:32	06/12/2020 08:38	9,10	9	81,89	CHI
20201223496	APARECIDA DE GOIANIA	AP11095980	INDEPENDENCIA S1	05/12/2020 23:32	06/12/2020 03:47	05/12/2020 23:32	06/12/2020 03:47	4,24	190	806,29	CHI
20201223387	BOM JESUS DE GOIAS	BJ12000018	BOM JESUS DE GOIAS	05/12/2020 23:33	06/12/2020 11:47	05/12/2020 23:33	06/12/2020 11:47	12,22	7	85,57	CHI
20201223454	APARECIDA DE GOIANIA	AP11166214	REAL S1	05/12/2020 23:34	06/12/2020 02:33	05/12/2020 23:34	06/12/2020 02:33	2,98	132	392,77	CHI
20201223393	FORMOSA	10002979886	ITUIQUIRA	05/12/2020 23:35	06/12/2020 04:35	05/12/2020 23:35	06/12/2020 04:35	5,00	1	5,00	CHI
20201224315	ARACU	AR12200075	ARACU	05/12/2020 23:35	06/12/2020 08:47	05/12/2020 23:35	06/12/2020 08:47	9,19	230	2114,47	CHI
20201224315	INHUMAS	AR12200075	ARACU	05/12/2020 23:35	06/12/2020 08:47	05/12/2020 23:35	06/12/2020 08:47	9,19	22	202,25	CHI
20201224315	ITAUCU	AR12200075	ARACU	05/12/2020 23:35	06/12/2020 08:47	05/12/2020 23:35	06/12/2020 08:47	9,19	6	55,16	CHI
20201223402	TROMBAS	TB12143685	PORANGATU	05/12/2020 23:43	06/12/2020 12:46	05/12/2020 23:43	06/12/2020 12:46	13,05	19	247,93	CHI
20201223402	MONTIVIDIU DO NORTE	TB12143685	PORANGATU	05/12/2020 23:43	06/12/2020 12:46	05/12/2020 23:43	06/12/2020 12:46	13,05	10	130,49	CHI
20201223421	PIRES DO RIO	UT12300798	URUTAI	05/12/2020 23:43	06/12/2020 01:07	05/12/2020 23:43	06/12/2020 01:07	1,40	2	2,80	CHI
20201223421	URUTAI	UT12300798	URUTAI	05/12/2020 23:43	06/12/2020 01:07	05/12/2020 23:43	06/12/2020 01:07	1,40	25	34,95	CHI
20201223412	LUZIANIA	LZ12128830LD	RIO VERMELHO	05/12/2020 23:46	06/12/2020 09:58	05/12/2020 23:46	06/12/2020 09:58	10,19	238	2425,02	CHI
20201223413	COCALZINHO DE GOIAS	CB12089828	AGUAS LINDAS DE GOIAS S2	05/12/2020 23:46	06/12/2020 05:12	05/12/2020 23:46	06/12/2020 05:12	5,42	6	32,51	CHI

20201223414	PIRACANJUBA	PJ21019981	PIRACANJUBA	05/12/2020 23:47	06/12/2020 06:55	05/12/2020 23:47	06/12/2020 06:55	7,12	1	7,12	CHI
20201223427	BELA VISTA DE GOIAS	BV21343193	BELA VISTA S1	05/12/2020 23:58	06/12/2020 03:12	05/12/2020 23:58	06/12/2020 03:12	3,22	2	6,44	CHI
20201223431	ITAPURANGA	IK21300014	ITAPURANGA	05/12/2020 23:59	06/12/2020 07:10	05/12/2020 23:59	06/12/2020 07:10	7,17	1	7,17	CHI
20201223434	MUNDO NOVO DE GOIAS	4240023120	NOVA CRIXAS	05/12/2020 23:59	06/12/2020 05:08	05/12/2020 23:59	06/12/2020 05:08	5,14	1	5,14	CHI
20201223442	APARECIDA DE GOIANIA	AP11277505	REAL S1	06/12/2020 00:03	06/12/2020 08:10	06/12/2020 00:03	06/12/2020 08:10	8,11	8	64,90	CHI
20201223595	NOVA IGUACU DE GOIAS	NH12317131	CAMPINORTE	06/12/2020 00:04	06/12/2020 03:46	06/12/2020 00:04	06/12/2020 03:46	3,70	44	162,67	CHI
20201223453	LUZIANIA	KR12080375	PAMPLONA	06/12/2020 00:11	06/12/2020 03:59	06/12/2020 00:11	06/12/2020 03:59	3,79	1	3,79	CHI
20201224233	IPORA	IR12222975	IPORA	06/12/2020 00:11	06/12/2020 10:49	06/12/2020 00:11	06/12/2020 10:49	10,63	70	744,26	CHI
20201224233	IVOLANDIA	IR12222975	IPORA	06/12/2020 00:11	06/12/2020 10:49	06/12/2020 00:11	06/12/2020 10:49	10,63	6	63,79	CHI
20201224233	MOIPORA	IR12222975	IPORA	06/12/2020 00:11	06/12/2020 10:49	06/12/2020 00:11	06/12/2020 10:49	10,63	20	212,64	CHI
20201223462	GOIANIA	AP11048671	REAL S2	06/12/2020 00:20	06/12/2020 05:48	06/12/2020 00:20	06/12/2020 05:48	5,45	128	697,81	CHI
20201223473	APARECIDA DE GOIANIA	AP12000026	INDEPENDENCIA S1	06/12/2020 00:22	06/12/2020 04:08	06/12/2020 00:22	06/12/2020 04:08	3,75	602	2259,51	CHI
20201223464	BURITI DE GOIAS	CO12049956	FIRMINOPOLIS S2	06/12/2020 00:24	06/12/2020 09:52	06/12/2020 00:24	06/12/2020 09:52	9,46	8	75,64	CHI
20201223465	SANTA CRUZ DE GOIAS	PZ11202900	PIRES DO RIO S2	06/12/2020 00:27	06/12/2020 19:19	06/12/2020 00:27	06/12/2020 19:19	18,86	55	1037,53	CHI
20201223601	CABECEIRAS	CW10401457	ITIQUEIRA	06/12/2020 00:34	06/12/2020 00:59	06/12/2020 00:37	06/12/2020 00:55	0,30	157	46,75	CHI
20201223601	FORMOSA	03740434	ITIQUEIRA	06/12/2020 00:34	06/12/2020 00:59	06/12/2020 00:37	06/12/2020 00:56	0,31	2	0,63	CHI
20201223601	CABECEIRAS	03740434	ITIQUEIRA	06/12/2020 00:34	06/12/2020 00:59	06/12/2020 00:37	06/12/2020 00:56	0,31	16	5,02	CHI
20201223601	CABECEIRAS	CW10407049	ITIQUEIRA	06/12/2020 00:34	06/12/2020 00:59	06/12/2020 00:37	06/12/2020 00:58	0,35	15	5,20	CHI
20201223601	CABECEIRAS	03740434	ITIQUEIRA	06/12/2020 00:34	06/12/2020 00:59	06/12/2020 00:38	06/12/2020 00:58	0,34	24	8,17	CHI
20201223601	DISTRITO FEDERAL	03740434	ITIQUEIRA	06/12/2020 00:34	06/12/2020 00:59	06/12/2020 00:38	06/12/2020 00:58	0,34	1	0,34	CHI
20201223601	CABECEIRAS	CW10407026	ITIQUEIRA	06/12/2020 00:34	06/12/2020 00:59	06/12/2020 00:37	06/12/2020 00:59	0,36	11	4,01	CHI
2020120600126	FORMOSA	ITQ-TR6	ITIQUEIRA	06/12/2020 00:34	06/12/2020 00:44	06/12/2020 00:36	06/12/2020 00:44	0,14	15151	2091,68	CHI
2020120600126	ITARUMA	ITQ-TR6	ITIQUEIRA	06/12/2020 00:34	06/12/2020 00:44	06/12/2020 00:36	06/12/2020 00:44	0,14	3	0,41	CHI
2020120600126	FORMOSA	ITQ-TR6	ITIQUEIRA	06/12/2020 00:34	06/12/2020 00:44	06/12/2020 00:36	06/12/2020 00:44	0,14	15961	2203,50	CHI
2020120600126	FORMOSA	ITQ-TR6	ITIQUEIRA	06/12/2020 00:34	06/12/2020 00:44	06/12/2020 00:36	06/12/2020 00:44	0,14	12609	1740,74	CHI
20201223483	PARAUNA	PU21260050	PARAUNA	06/12/2020 00:50	06/12/2020 10:35	06/12/2020 00:50	06/12/2020 10:35	9,74	1	9,74	CHI
20201224055	VIANOPOLIS	VN11103046	VIANOPOLIS	06/12/2020 00:50	06/12/2020 12:34	06/12/2020 00:50	06/12/2020 12:34	11,73	132	1547,88	CHI
20201223488	ITUMBIARA	690213293	ITUMBIARA NOVA	06/12/2020 00:57	06/12/2020 07:44	06/12/2020 00:57	06/12/2020 07:44	6,78	1	6,78	CHI
20201223490	ORIZONA	OZ12022851	PIRES DO RIO S2	06/12/2020 00:57	06/12/2020 15:13	06/12/2020 00:57	06/12/2020 15:13	14,26	6	85,57	CHI
20201223500	MINACU	IH11052676	MINACU	06/12/2020 01:08	06/12/2020 11:43	06/12/2020 01:08	06/12/2020 11:43	10,58	127	1343,27	CHI
20201223511	SAO JOAO D ALIANCA	JL12342390	SAO JOAO D ALIANCA	06/12/2020 01:22	06/12/2020 20:17	06/12/2020 01:22	06/12/2020 20:17	18,91	5	94,56	CHI
20201223512	MOSSAMEDES	MD12037595	FIRMINOPOLIS S2	06/12/2020 01:24	06/12/2020 04:12	06/12/2020 01:24	06/12/2020 04:12	2,80	4	11,21	CHI
20201223512	ADELANDIA	MD12037595	FIRMINOPOLIS S2	06/12/2020 01:24	06/12/2020 04:12	06/12/2020 01:24	06/12/2020 04:12	2,80	4	11,21	CHI
20201223526	GOIANIA	14325871	CARAJAS S2	06/12/2020 01:48	06/12/2020 04:04	06/12/2020 01:48	06/12/2020 04:04	2,26	1	2,26	CHI
20201223528	COCALZINHO DE GOIAS	ZN12381226	COCALZINHO	06/12/2020 01:51	06/12/2020 20:26	06/12/2020 01:51	06/12/2020 20:26	18,58	4	74,33	CHI
20201223533	APARECIDA DE GOIANIA	AP11050802	REAL S1	06/12/2020 02:02	06/12/2020 12:44	06/12/2020 02:02	06/12/2020 12:44	10,69	42	448,80	CHI
20201223538	ORIZONA	OZ21248900	PIRES DO RIO S2	06/12/2020 02:08	06/12/2020 11:55	06/12/2020 02:08	06/12/2020 11:55	9,77	1	9,77	CHI
20201223568	TROMBAS	TB12345570	PORANGATU	06/12/2020 02:12	06/12/2020 10:53	06/12/2020 02:12	06/12/2020 10:53	8,68	16	138,88	CHI
20201225736	NIQUELANDIA	NQ12140184	SAO JOAO D ALIANCA	06/12/2020 02:22	06/12/2020 16:35	06/12/2020 02:22	06/12/2020 16:35	14,21	58	824,42	CHI
20201223562	LUZIANIA	LZ12112942	PAMPLONA	06/12/2020 02:37	06/12/2020 23:09	06/12/2020 02:37	06/12/2020 21:26	18,81	10	188,06	CHI
20201223562	LUZIANIA	KR12351398LD	PAMPLONA	06/12/2020 02:37	06/12/2020 23:09	06/12/2020 22:26	06/12/2020 23:09	0,72	33	23,64	CHI
20201223594	APARECIDA DE GOIANIA	AP12095648	REAL S2	06/12/2020 02:40	06/12/2020 04:43	06/12/2020 02:40	06/12/2020 04:43	2,04	141	288,15	CHI
20201223693	PORANGATU	PO12391912	PORANGATU	06/12/2020 02:45	06/12/2020 11:45	06/12/2020 02:45	06/12/2020 08:20	5,59	62	346,67	CHI
20201223693	MUTUNOPOLIS	PO12391912	PORANGATU	06/12/2020 02:45	06/12/2020 11:45	06/12/2020 02:45	06/12/2020 08:20	5,59	4	22,37	CHI
20201223693	MUTUNOPOLIS	PO12391912	PORANGATU	06/12/2020 02:45	06/12/2020 11:45	06/12/2020 02:45	06/12/2020 09:49	7,08	20	141,54	CHI
20201223693	PORANGATU	PO12391912	PORANGATU	06/12/2020 02:45	06/12/2020 11:45	06/12/2020 02:45	06/12/2020 09:49	7,08	29	205,24	CHI
20201223693	MUTUNOPOLIS	PO12391912	PORANGATU	06/12/2020 02:45	06/12/2020 11:45	06/12/2020 02:45	06/12/2020 11:07	8,37	8	66,99	CHI
20201223693	PORANGATU	PO12391912	PORANGATU	06/12/2020 02:45	06/12/2020 11:45	06/12/2020 02:45	06/12/2020 11:07	8,37	4	33,49	CHI
20201223693	PORANGATU	PO12391912	PORANGATU	06/12/2020 02:45	06/12/2020 11:45	06/12/2020 02:45	06/12/2020 11:45	9,00	4	36,01	CHI
20201223693	MUTUNOPOLIS	PO12391912	PORANGATU	06/12/2020 02:45	06/12/2020 11:45	06/12/2020 02:45	06/12/2020 11:45	9,00	6	54,01	CHI
20201223599	ANAPOLIS	AN21072941	JUNDIAI S1	06/12/2020 02:46	06/12/2020 04:44	06/12/2020 02:46	06/12/2020 04:44	1,97	1	1,97	CHI

20201223887	VILA PROPICIO	NP12235935	GOIANESIA S1	06/12/2020 02:49	06/12/2020 20:25	06/12/2020 02:49	06/12/2020 20:25	17,59	18	316,64	CHI
20201223605	MORRINHOS	MR11076858	MORRINHOS	06/12/2020 02:57	06/12/2020 10:39	06/12/2020 02:57	06/12/2020 10:39	7,70	141	1085,00	CHI
20201223611	LUZIANIA	LZ12404431	RIO VERMELHO	06/12/2020 03:10	06/12/2020 08:38	06/12/2020 03:10	06/12/2020 08:38	5,46	532	2905,90	CHI
20201223754	PIRACANJUBA	PJ32057770	PIRACANJUBA	06/12/2020 03:16	06/12/2020 08:10	06/12/2020 03:16	06/12/2020 08:10	4,90	13	63,70	CHI
20201225276	SAO JOAO D ALIANCA	FB12248238	FLORES DE GOIAS	06/12/2020 03:20	06/12/2020 12:08	06/12/2020 03:20	06/12/2020 12:08	8,79	39	342,99	CHI
20201225276	FLORES DE GOIAS	FB12248238	FLORES DE GOIAS	06/12/2020 03:20	06/12/2020 12:08	06/12/2020 03:20	06/12/2020 12:08	8,79	95	835,50	CHI
20201224020	ARENOPOLIS	AY12000029	ARENOPOLIS	06/12/2020 03:23	06/12/2020 13:42	06/12/2020 03:23	06/12/2020 13:42	10,30	7	72,10	CHI
20201223642	CALDAS NOVAS	CN12263786	RIO QUENTE	06/12/2020 03:25	06/12/2020 07:38	06/12/2020 03:25	06/12/2020 07:38	4,21	35	147,48	CHI
20201223642	RIO QUENTE	CN12263786	RIO QUENTE	06/12/2020 03:25	06/12/2020 07:38	06/12/2020 03:25	06/12/2020 07:38	4,21	1	4,21	CHI
20201223645	ALTO PARAISO DE GOIAS	BF21194788	SAO JOAO D ALIANCA	06/12/2020 03:30	06/12/2020 11:25	06/12/2020 03:30	06/12/2020 11:25	7,91	1	7,91	CHI
20201223647	BELA VISTA DE GOIAS	BV31085827	BELA VISTA S1	06/12/2020 03:40	06/12/2020 11:18	06/12/2020 03:40	06/12/2020 11:18	7,62	1	7,62	CHI
20201223687	PIRENOPOLIS	PV12295641	SAO FRANCISCO DE GOIAS	06/12/2020 03:46	06/12/2020 08:19	06/12/2020 03:46	06/12/2020 08:19	4,55	186	845,52	CHI
20201225981	FIRMINOPOLIS	SL12004026RE	SAO LUIZ DOS MONTES BELOS	06/12/2020 03:46	06/12/2020 16:44	06/12/2020 03:46	06/12/2020 16:44	12,96	15	194,43	CHI
20201225981	SAO LUIS DE MONTES BELOS	SL12004026RE	SAO LUIZ DOS MONTES BELOS	06/12/2020 03:46	06/12/2020 16:44	06/12/2020 03:46	06/12/2020 16:44	12,96	6	77,77	CHI
20201223665	HIDROLANDIA	HD11265420	ANHANGUERA	06/12/2020 04:07	06/12/2020 16:46	06/12/2020 04:07	06/12/2020 16:46	12,64	48	606,80	CHI
20201223736	LUZIANIA	LZ12016676	RIO VERMELHO	06/12/2020 04:10	06/12/2020 07:47	06/12/2020 04:10	06/12/2020 07:47	3,62	27	97,64	CHI
20201224407	JANDAIA	JD12010996LD	PALMEIRAS	06/12/2020 04:10	06/12/2020 19:13	06/12/2020 04:10	06/12/2020 19:13	15,04	21	315,93	CHI
20201223669	GOIANDIRA	CT12215606RE	CATALAO S1	06/12/2020 04:17	06/12/2020 15:28	06/12/2020 04:17	06/12/2020 10:41	6,41	5	32,04	CHI
20201223669	CATALAO	CT12215606RE	CATALAO S1	06/12/2020 04:17	06/12/2020 15:28	06/12/2020 04:17	06/12/2020 10:41	6,41	18	115,34	CHI
20201223669	GOIANDIRA	CT12229971LD	CATALAO S1	06/12/2020 04:17	06/12/2020 15:28	06/12/2020 04:17	06/12/2020 13:58	9,69	6	58,12	CHI
20201223669	CATALAO	CT12229971LD	CATALAO S1	06/12/2020 04:17	06/12/2020 15:28	06/12/2020 04:17	06/12/2020 13:58	9,69	1	9,69	CHI
20201223669	GOIANDIRA	CT12231642	CATALAO S1	06/12/2020 04:17	06/12/2020 15:28	06/12/2020 04:17	06/12/2020 14:51	10,57	3	31,71	CHI
20201223669	GOIANDIRA	CT12266153LD	CATALAO S1	06/12/2020 04:17	06/12/2020 15:28	06/12/2020 04:17	06/12/2020 15:28	11,19	3	33,56	CHI
20201223671	HIDROLANDIA	HD11350569	ANHANGUERA	06/12/2020 04:18	06/12/2020 14:00	06/12/2020 04:18	06/12/2020 14:00	9,69	15	145,34	CHI
20201223681	MORRINHOS	MR21335147	MORRINHOS	06/12/2020 04:21	06/12/2020 07:00	06/12/2020 04:21	06/12/2020 07:00	2,63	1	2,63	CHI
20201223682	NOVA IGUACU DE GOIAS	NH12236585	CAMPINORTE	06/12/2020 04:24	06/12/2020 10:52	06/12/2020 04:24	06/12/2020 10:52	6,45	6	38,72	CHI
20201223686	FORMOSA	FA12282335	ITIQUEIRA	06/12/2020 04:28	06/12/2020 11:46	06/12/2020 04:28	06/12/2020 11:46	7,29	6	43,74	CHI
20201225440	NEROPOLIS	NR12324579LD	NEROPOLIS S2	06/12/2020 04:32	06/12/2020 16:02	06/12/2020 04:32	06/12/2020 16:02	11,50	32	367,86	CHI
20201223689	EDEIA	EA11223561	EDEIA	06/12/2020 04:33	06/12/2020 08:20	06/12/2020 04:33	06/12/2020 08:20	3,77	231	871,06	CHI
20201223695	APARECIDA DE GOIANIA	AP11041873	REAL S2	06/12/2020 04:46	06/12/2020 12:21	06/12/2020 04:46	06/12/2020 12:21	7,58	235	1781,56	CHI
20201224531	PIRACANJUBA	PJ12000215	PIRACANJUBA	06/12/2020 04:49	06/12/2020 10:02	06/12/2020 04:49	06/12/2020 10:02	5,20	45	234,19	CHI
20201223702	IACIARA	GY12257673	IACIARA S1	06/12/2020 05:02	06/12/2020 22:16	06/12/2020 05:02	06/12/2020 10:19	5,27	6	31,65	CHI
20201223702	GUARANI DE GOIAS	GY12257673	IACIARA S1	06/12/2020 05:02	06/12/2020 22:16	06/12/2020 05:02	06/12/2020 10:19	5,27	76	400,88	CHI
20201223702	GUARANI DE GOIAS	GY12265440	IACIARA S1	06/12/2020 05:02	06/12/2020 22:16	06/12/2020 05:02	06/12/2020 12:06	7,07	13	91,85	CHI
20201223702	GUARANI DE GOIAS	GY12270502LD	IACIARA S1	06/12/2020 05:02	06/12/2020 22:16	06/12/2020 05:02	06/12/2020 22:16	17,23	7	120,59	CHI
20201223899	PONTALINA	EA12223551RE	EDEIA	06/12/2020 05:05	06/12/2020 10:28	06/12/2020 05:05	06/12/2020 10:28	5,37	1	5,37	CHI
20201223899	INDIARA	EA12223551RE	EDEIA	06/12/2020 05:05	06/12/2020 10:28	06/12/2020 05:05	06/12/2020 10:28	5,37	4	21,49	CHI
20201223899	EDEIA	EA12223551RE	EDEIA	06/12/2020 05:05	06/12/2020 10:28	06/12/2020 05:05	06/12/2020 10:28	5,37	63	338,52	CHI
20201223708	LUZIANIA	03460414	PAMPLONA	06/12/2020 05:07	07/12/2020 23:20	06/12/2020 05:07	06/12/2020 13:09	8,04	67	538,62	CHI
20201223708	CRISTALINA	03460414	PAMPLONA	06/12/2020 05:07	07/12/2020 23:20	06/12/2020 05:07	06/12/2020 13:09	8,04	16	128,63	CHI
20201223708	CRISTALINA	03460414	PAMPLONA	06/12/2020 05:07	07/12/2020 23:20	06/12/2020 05:07	06/12/2020 13:32	8,42	1	8,42	CHI
20201223708	LUZIANIA	03460414	PAMPLONA	06/12/2020 05:07	07/12/2020 23:20	06/12/2020 15:57	06/12/2020 16:04	0,12	67	8,26	CHI
20201223708	CRISTALINA	03460414	PAMPLONA	06/12/2020 05:07	07/12/2020 23:20	06/12/2020 15:57	06/12/2020 16:04	0,12	17	2,10	CHI
20201223708	LUZIANIA	03460414	PAMPLONA	06/12/2020 05:07	07/12/2020 23:20	06/12/2020 05:07	07/12/2020 13:30	32,39	1	32,39	CHI
20201223708	CRISTALINA	03460414	PAMPLONA	06/12/2020 05:07	07/12/2020 23:20	06/12/2020 05:07	07/12/2020 13:30	32,39	32	1036,51	CHI
20201223708	LUZIANIA	LZ13305103	PAMPLONA	06/12/2020 05:07	07/12/2020 23:20	07/12/2020 18:48	07/12/2020 23:17	4,47	18	80,55	CHI
20201223708	LUZIANIA	LZ12082807	PAMPLONA	06/12/2020 05:07	07/12/2020 23:20	07/12/2020 14:14	07/12/2020 23:20	9,11	12	109,27	CHI
20201223757	VIANOPOLIS	VN12027119	VIANOPOLIS	06/12/2020 05:11	06/12/2020 11:40	06/12/2020 05:11	06/12/2020 11:40	6,48	29	187,97	CHI
20201223709	ALTO HORIZONTE	AJ12100313	SANTA TEREZINHA	06/12/2020 05:14	06/12/2020 08:26	06/12/2020 05:14	06/12/2020 08:26	3,20	10	31,99	CHI
20201223712	SANTA BARBARA DE GOIAS	SB12186355	TRINDADE	06/12/2020 05:14	06/12/2020 11:16	06/12/2020 05:14	06/12/2020 11:16	6,02	10	60,21	CHI
202012179340	SAO MIGUEL DO ARAGUAIA	SM10388763	SAO MIGUEL DO ARAGUAIA	06/12/2020 05:14	06/12/2020 10:39	06/12/2020 05:14	06/12/2020 10:39	5,42	274	1485,69	CHI

20201223713	SANTA CRUZ DE GOIAS	CN12114775	CALDAS NOVAS S1	06/12/2020 05:16	06/12/2020 09:15	06/12/2020 05:16	06/12/2020 09:15	3,97	91	361,67	CHI
20201223713	CALDAS NOVAS	CN12114775	CALDAS NOVAS S1	06/12/2020 05:16	06/12/2020 09:15	06/12/2020 05:16	06/12/2020 09:15	3,97	35	139,11	CHI
20201223715	VILA BOA	02590206	ITIQUEIRA	06/12/2020 05:17	06/12/2020 12:09	06/12/2020 05:17	06/12/2020 12:09	6,86	4	27,42	CHI
20201223715	FLORES DE GOIAS	02590206	ITIQUEIRA	06/12/2020 05:17	06/12/2020 12:09	06/12/2020 05:17	06/12/2020 12:09	6,86	3	20,57	CHI
20201223715	SAO JOAO D ALIANCA	02590206	ITIQUEIRA	06/12/2020 05:17	06/12/2020 12:09	06/12/2020 05:17	06/12/2020 12:09	6,86	208	1425,96	CHI
20201223715	FORMOSA	02590206	ITIQUEIRA	06/12/2020 05:17	06/12/2020 12:09	06/12/2020 05:17	06/12/2020 12:09	6,86	562	3852,82	CHI
20201223719	SANTO ANTONIO DO DESCOBERTO	SN12133153	AGUAS LINDAS DE GOIAS S2	06/12/2020 05:20	06/12/2020 10:14	06/12/2020 05:20	06/12/2020 10:14	4,89	6	29,32	CHI
20201223722	BURITI DE GOIAS	BS12041419	FIRMINOPOLIS S2	06/12/2020 05:24	06/12/2020 07:31	06/12/2020 05:24	06/12/2020 07:31	2,11	5	10,57	CHI
20201223724	FORMOSA	FA12218264	ITIQUEIRA	06/12/2020 05:24	06/12/2020 08:34	06/12/2020 05:24	06/12/2020 08:34	3,16	92	290,29	CHI
20201223724	VILA BOA	FA12218264	ITIQUEIRA	06/12/2020 05:24	06/12/2020 08:34	06/12/2020 05:24	06/12/2020 08:34	3,16	4	12,62	CHI
20201224159	ALEXANIA	AX13129312	ALEXANIA	06/12/2020 05:25	06/12/2020 12:14	06/12/2020 05:25	06/12/2020 10:45	5,34	24	128,17	CHI
20201224159	ALEXANIA	AX13129312	ALEXANIA	06/12/2020 05:25	06/12/2020 12:14	06/12/2020 09:34	06/12/2020 10:45	1,19	8	9,48	CHI
20201224159	SANTO ANTONIO DO DESCOBERTO	20359443	ALEXANIA	06/12/2020 05:25	06/12/2020 12:14	06/12/2020 05:25	06/12/2020 12:14	6,82	3	20,45	CHI
20201224159	ALEXANIA	20359443	ALEXANIA	06/12/2020 05:25	06/12/2020 12:14	06/12/2020 05:25	06/12/2020 12:14	6,82	176	1199,44	CHI
20201224159	CORUMBA DE GOIAS	20359443	ALEXANIA	06/12/2020 05:25	06/12/2020 12:14	06/12/2020 05:25	06/12/2020 12:14	6,82	7	47,71	CHI
20201223862	VIANOPOLIS	VN12400021	VIANOPOLIS	06/12/2020 05:29	06/12/2020 10:11	06/12/2020 05:29	06/12/2020 10:11	4,69	117	548,99	CHI
20201223862	SILVANIA	VN12400021	VIANOPOLIS	06/12/2020 05:29	06/12/2020 10:11	06/12/2020 05:29	06/12/2020 10:11	4,69	22	103,23	CHI
20201224358	SAO LUIS DE MONTES BELOS	DN12039706	FIRMINOPOLIS S2	06/12/2020 05:30	06/12/2020 17:30	06/12/2020 05:30	06/12/2020 17:30	11,99	39	467,50	CHI
20201224358	TURVANIA	DN12039706	FIRMINOPOLIS S2	06/12/2020 05:30	06/12/2020 17:30	06/12/2020 05:30	06/12/2020 17:30	11,99	2	23,97	CHI
20201224358	ADELANDIA	DN12039706	FIRMINOPOLIS S2	06/12/2020 05:30	06/12/2020 17:30	06/12/2020 05:30	06/12/2020 17:30	11,99	4	47,95	CHI
20201223733	CATURAI	IN12009548	ARACU	06/12/2020 05:35	06/12/2020 11:38	06/12/2020 05:35	06/12/2020 11:38	6,05	2	12,10	CHI
20201223733	INHUMAS	IN12009548	ARACU	06/12/2020 05:35	06/12/2020 11:38	06/12/2020 05:35	06/12/2020 11:38	6,05	2	12,10	CHI
20201223734	SANCLERLANDIA	SC12003889	FIRMINOPOLIS S2	06/12/2020 05:35	06/12/2020 07:27	06/12/2020 05:35	06/12/2020 07:27	1,85	16	29,60	CHI
20201223734	MOSSAMEDES	SC12003889	FIRMINOPOLIS S2	06/12/2020 05:35	06/12/2020 07:27	06/12/2020 05:35	06/12/2020 07:27	1,85	5	9,25	CHI
20201223734	ADELANDIA	SC12003889	FIRMINOPOLIS S2	06/12/2020 05:35	06/12/2020 07:27	06/12/2020 05:35	06/12/2020 07:27	1,85	23	42,56	CHI
20201223735	EDEALINA	ED21158593	PONTALINA	06/12/2020 05:37	06/12/2020 07:47	06/12/2020 05:37	06/12/2020 07:47	2,16	2	4,32	CHI
20201223737	EDEIA	EA21000037	EDEIA	06/12/2020 05:41	06/12/2020 11:53	06/12/2020 05:41	06/12/2020 11:53	6,20	1	6,20	CHI
20201223740	CAMPINORTE	CR12053035	MARA ROSA	06/12/2020 05:47	06/12/2020 08:57	06/12/2020 05:47	06/12/2020 08:57	3,15	5	15,77	CHI
20201223950	SILVANIA	GL12326213	DAIA S2	06/12/2020 05:50	06/12/2020 22:38	06/12/2020 05:50	06/12/2020 22:38	16,78	112	1879,80	CHI
20201223784	VARJAO	VJ32066169	GUAPO S2	06/12/2020 05:51	06/12/2020 08:31	06/12/2020 05:51	06/12/2020 08:31	2,65	15	39,80	CHI
20201223755	CORUMBA DE GOIAS	AX12061965	CORUMBA	06/12/2020 05:53	06/12/2020 13:45	06/12/2020 05:53	06/12/2020 13:45	7,86	2	15,71	CHI
20201224124	AMERICANO DO BRASIL	AC12308555	ANICUNS	06/12/2020 05:55	06/12/2020 11:42	06/12/2020 05:55	06/12/2020 11:42	5,78	19	109,81	CHI
20201224124	ANICUNS	AC12308555	ANICUNS	06/12/2020 05:55	06/12/2020 11:42	06/12/2020 05:55	06/12/2020 11:42	5,78	4	23,12	CHI
20201224124	MOSSAMEDES	AC12308555	ANICUNS	06/12/2020 05:55	06/12/2020 11:42	06/12/2020 05:55	06/12/2020 11:42	5,78	18	104,03	CHI
20201223761	SANTO ANTONIO DO DESCOBERTO	SN21091234	AGUAS LINDAS DE GOIAS S2	06/12/2020 05:58	06/12/2020 11:57	06/12/2020 05:58	06/12/2020 11:57	5,98	2	11,95	CHI
20201223762	ARAGUAPAZ	AZ12242480	MOZARLANDIA	06/12/2020 05:58	06/12/2020 07:45	06/12/2020 05:58	06/12/2020 07:45	1,77	16	28,31	CHI
20201223838	MOSSAMEDES	MD12039138	FIRMINOPOLIS S2	06/12/2020 05:58	06/12/2020 08:31	06/12/2020 05:58	06/12/2020 08:31	2,55	14	35,67	CHI
20201223765	ITUMBIARA	IT12000357	ITUMBIARA NOVA	06/12/2020 05:59	06/12/2020 08:20	06/12/2020 05:59	06/12/2020 08:20	2,34	2	4,67	CHI
20201223833	MORRINHOS	MR12039380	MORRINHOS	06/12/2020 05:59	06/12/2020 08:09	06/12/2020 05:59	06/12/2020 08:09	2,17	12	26,00	CHI
20201223770	AGUA LIMPA	AL21263217	VILA CORUMBA	06/12/2020 06:00	06/12/2020 07:52	06/12/2020 06:00	06/12/2020 07:52	1,86	1	1,86	CHI
20201223828	EDEALINA	ED12039150	PONTALINA	06/12/2020 06:00	06/12/2020 08:39	06/12/2020 06:00	06/12/2020 08:39	2,64	3	7,93	CHI
20201223828	EDEIA	ED12039150	PONTALINA	06/12/2020 06:00	06/12/2020 08:39	06/12/2020 06:00	06/12/2020 08:39	2,64	8	21,14	CHI
20201224337	PORANGATU	MU12094084	MARA ROSA	06/12/2020 06:00	06/12/2020 12:31	06/12/2020 06:00	06/12/2020 12:31	6,51	84	547,17	CHI
20201223773	CAMPINORTE	MQ21051899	MARA ROSA	06/12/2020 06:02	06/12/2020 15:04	06/12/2020 06:02	06/12/2020 15:04	9,03	1	9,03	CHI
20201223811	SAO MIGUEL DO ARAGUAIA	SM12143671	SAO MIGUEL DO ARAGUAIA	06/12/2020 06:02	06/12/2020 08:41	06/12/2020 06:02	06/12/2020 08:41	2,64	276	728,10	CHI
20201223776	BELA VISTA DE GOIAS	BV21343193	BELA VISTA S1	06/12/2020 06:03	06/12/2020 08:27	06/12/2020 06:03	06/12/2020 08:27	2,40	2	4,80	CHI
20201223778	EDEIA	EA11263389	EDEIA	06/12/2020 06:03	06/12/2020 11:30	06/12/2020 06:03	06/12/2020 11:30	5,44	127	691,44	CHI
20201223779	LUZIANIA	KR12163676RE	PAMPLONA	06/12/2020 06:03	06/12/2020 09:30	06/12/2020 06:03	06/12/2020 09:30	3,44	2	6,88	CHI
20201223779	CRISTALINA	KR12163676RE	PAMPLONA	06/12/2020 06:03	06/12/2020 09:30	06/12/2020 06:03	06/12/2020 09:30	3,44	28	96,34	CHI
20201223779	DISTRITO FEDERAL	KR12163676RE	PAMPLONA	06/12/2020 06:03	06/12/2020 09:30	06/12/2020 06:03	06/12/2020 09:30	3,44	2	6,88	CHI
20201224298	PORANGATU	PO12202569	PORANGATU	06/12/2020 06:03	06/12/2020 08:59	06/12/2020 06:03	06/12/2020 08:59	2,92	7	20,43	CHI

20201224548	LUZANIA	LZ12330594	CRISTALINA S2	06/12/2020 06:03	06/12/2020 14:36	06/12/2020 06:03	06/12/2020 14:36	8,55	12	102,54	CHI
20201224116	TRINDADE	TR12087490	TRINDADE	06/12/2020 06:07	06/12/2020 09:10	06/12/2020 06:07	06/12/2020 09:10	3,05	439	1337,61	CHI
20201224249	VARIAO	VJ12346703	GUAPO S2	06/12/2020 06:07	06/12/2020 10:46	06/12/2020 06:07	06/12/2020 10:46	4,64	5	23,22	CHI
20201223791	SANTA FE DE GOIAS	RN12009765	BRITANIA	06/12/2020 06:08	07/12/2020 03:40	06/12/2020 06:08	07/12/2020 03:40	21,53	22	473,56	CHI
20201223791	JUSSARA	RN12009765	BRITANIA	06/12/2020 06:08	07/12/2020 03:40	06/12/2020 06:08	07/12/2020 03:40	21,53	1	21,53	CHI
20201223793	CABECEIRAS	CW21381539	ITUIQUIRA	06/12/2020 06:09	06/12/2020 07:48	06/12/2020 06:09	06/12/2020 07:48	1,65	2	3,29	CHI
20201223352	AMERICANO DO BRASIL	KB12065194	ANICUNS	06/12/2020 06:11	06/12/2020 08:10	06/12/2020 06:11	06/12/2020 08:10	1,98	29	57,36	CHI
20201223352	MOSSAMEDES	KB12065194	ANICUNS	06/12/2020 06:11	06/12/2020 08:10	06/12/2020 06:11	06/12/2020 08:10	1,98	14	27,69	CHI
20201223796	PIRANHAS	1930009887	PIRANHAS	06/12/2020 06:11	06/12/2020 09:41	06/12/2020 06:11	06/12/2020 09:41	3,50	1	3,50	CHI
20201223798	UIRAPURU	UP12390498	NOVA CRIXAS	06/12/2020 06:11	06/12/2020 09:28	06/12/2020 06:11	06/12/2020 09:28	3,27	5	16,37	CHI
20201223798	AMARALINA	UP12390498	NOVA CRIXAS	06/12/2020 06:11	06/12/2020 09:28	06/12/2020 06:11	06/12/2020 09:28	3,27	24	78,57	CHI
20201223798	MARA ROSA	UP12390498	NOVA CRIXAS	06/12/2020 06:11	06/12/2020 09:28	06/12/2020 06:11	06/12/2020 09:28	3,27	1	3,27	CHI
20201223801	MINACU	IH12360453	MINACU	06/12/2020 06:12	06/12/2020 08:38	06/12/2020 06:12	06/12/2020 08:38	2,42	72	174,16	CHI
20201223801	CAMPINACU	IH12360453	MINACU	06/12/2020 06:12	06/12/2020 08:38	06/12/2020 06:12	06/12/2020 08:38	2,42	5	12,09	CHI
20201223802	PIRACANJUBA	PJ12263236	PIRACANJUBA	06/12/2020 06:12	06/12/2020 10:25	06/12/2020 06:12	06/12/2020 10:25	4,20	1	4,20	CHI
20201223806	CORUMBAIBA	IP12107653	IPAMERI	06/12/2020 06:13	06/12/2020 08:39	06/12/2020 06:13	06/12/2020 08:39	2,42	3	7,27	CHI
20201223806	CALDAS NOVAS	IP12107653	IPAMERI	06/12/2020 06:13	06/12/2020 08:39	06/12/2020 06:13	06/12/2020 08:39	2,42	11	26,65	CHI
20201223806	IPAMERI	IP12107653	IPAMERI	06/12/2020 06:13	06/12/2020 08:39	06/12/2020 06:13	06/12/2020 08:39	2,42	91	220,45	CHI
20201223807	BELA VISTA DE GOIAS	BV12080831	CRISTIANOPOLIS	06/12/2020 06:14	06/12/2020 10:31	06/12/2020 06:14	06/12/2020 10:31	4,28	1	4,28	CHI
20201223807	SAO MIGUEL DO PASSA QUATRO	BV12080831	CRISTIANOPOLIS	06/12/2020 06:14	06/12/2020 10:31	06/12/2020 06:14	06/12/2020 10:31	4,28	14	59,88	CHI
20201225572	PIRACANJUBA	PJ12212176RE	PIRACANJUBA	06/12/2020 06:14	06/12/2020 17:58	06/12/2020 06:14	06/12/2020 17:58	11,72	14	164,15	CHI
20201225572	SANTA CRUZ DE GOIAS	PJ12212176RE	PIRACANJUBA	06/12/2020 06:14	06/12/2020 17:58	06/12/2020 06:14	06/12/2020 17:58	11,72	75	879,35	CHI
20201225572	CRISTIANOPOLIS	PJ12212176RE	PIRACANJUBA	06/12/2020 06:14	06/12/2020 17:58	06/12/2020 06:14	06/12/2020 17:58	11,72	4	46,90	CHI
20201223809	PILAR DE GOIAS	GG12190059	ITAPACI	06/12/2020 06:16	06/12/2020 08:36	06/12/2020 06:16	06/12/2020 08:36	2,33	3	6,98	CHI
20201223812	RUBIATABA	RB12060966	RUBIATABA	06/12/2020 06:16	06/12/2020 12:35	06/12/2020 06:16	06/12/2020 12:35	6,31	15	94,58	CHI
20201222511	ITUMBIARA	IT12273873RE	ITUMBIARA NOVA	06/12/2020 06:18	07/12/2020 22:44	06/12/2020 06:30	06/12/2020 19:18	12,80	5	63,98	CHI
20201222511	PANAMA	IT12273873RE	ITUMBIARA NOVA	06/12/2020 06:18	07/12/2020 22:44	06/12/2020 06:30	06/12/2020 19:18	12,80	3	38,39	CHI
20201222511	ITUMBIARA	IT12273873RE	ITUMBIARA NOVA	06/12/2020 06:18	07/12/2020 22:44	07/12/2020 07:49	07/12/2020 08:41	0,85	5	4,27	CHI
20201222511	PANAMA	IT12273873RE	ITUMBIARA NOVA	06/12/2020 06:18	07/12/2020 22:44	07/12/2020 07:49	07/12/2020 08:41	0,85	3	2,56	CHI
20201222511	ITUMBIARA	IT12273873RE	ITUMBIARA NOVA	06/12/2020 06:18	07/12/2020 22:44	06/12/2020 06:30	07/12/2020 15:20	32,82	6	196,91	CHI
20201222511	PANAMA	IT12273873RE	ITUMBIARA NOVA	06/12/2020 06:18	07/12/2020 22:44	06/12/2020 06:30	07/12/2020 15:20	32,82	2	65,64	CHI
20201222511	PANAMA	IT13000088	ITUMBIARA NOVA	06/12/2020 06:18	07/12/2020 22:44	06/12/2020 06:30	07/12/2020 17:53	35,38	2	70,76	CHI
20201222511	PANAMA	IT12273873RE	ITUMBIARA NOVA	06/12/2020 06:18	07/12/2020 22:44	06/12/2020 06:30	07/12/2020 17:53	35,38	70	2476,52	CHI
20201222511	PANAMA	IT12273873RE	ITUMBIARA NOVA	06/12/2020 06:18	07/12/2020 22:44	06/12/2020 06:30	07/12/2020 19:14	36,72	4	146,88	CHI
20201222511	ITUMBIARA	IT12000255	ITUMBIARA NOVA	06/12/2020 06:18	07/12/2020 22:44	06/12/2020 06:30	07/12/2020 19:14	36,72	1	36,72	CHI
20201222511	ITUMBIARA	IT12273873RE	ITUMBIARA NOVA	06/12/2020 06:18	07/12/2020 22:44	06/12/2020 06:30	07/12/2020 22:44	40,23	1	40,23	CHI
20201223984	BURITI DE GOIAS	BS12215292	FIRMINOPOLIS S2	06/12/2020 06:18	07/12/2020 04:56	06/12/2020 06:18	06/12/2020 17:01	10,71	11	117,76	CHI
20201223984	NOVO BRASIL	BS12215292	FIRMINOPOLIS S2	06/12/2020 06:18	07/12/2020 04:56	06/12/2020 06:18	06/12/2020 17:01	10,71	16	171,28	CHI
20201223984	BURITI DE GOIAS	BS12215292	FIRMINOPOLIS S2	06/12/2020 06:18	07/12/2020 04:56	06/12/2020 19:24	06/12/2020 20:25	1,01	11	11,13	CHI
20201223984	NOVO BRASIL	BS12215292	FIRMINOPOLIS S2	06/12/2020 06:18	07/12/2020 04:56	06/12/2020 19:24	06/12/2020 20:25	1,01	16	16,20	CHI
20201223984	BURITI DE GOIAS	BS12215292	FIRMINOPOLIS S2	06/12/2020 06:18	07/12/2020 04:56	06/12/2020 06:18	07/12/2020 04:56	22,64	17	384,80	CHI
20201223984	BURITI DE GOIAS	BS12215292	FIRMINOPOLIS S2	06/12/2020 06:18	07/12/2020 04:56	06/12/2020 14:40	07/12/2020 04:56	14,28	14	199,87	CHI
20201223984	NOVO BRASIL	BS12215292	FIRMINOPOLIS S2	06/12/2020 06:18	07/12/2020 04:56	07/12/2020 00:54	07/12/2020 04:56	4,04	16	64,63	CHI
20201223984	BURITI DE GOIAS	BS12215292	FIRMINOPOLIS S2	06/12/2020 06:18	07/12/2020 04:56	07/12/2020 00:54	07/12/2020 04:56	4,04	11	44,43	CHI
20201226321	MONTIVIDIU DO NORTE	MX12187845RE	PORANGATU	06/12/2020 06:18	07/12/2020 12:58	06/12/2020 06:18	07/12/2020 12:58	30,66	13	398,58	CHI
20201223866	TRINDADE	TR11383861	GOYA S2	06/12/2020 06:22	06/12/2020 08:03	06/12/2020 06:22	06/12/2020 08:03	1,67	92	153,64	CHI
20201223823	SAO LUIS DE MONTES BELOS	SL12312575	FIRMINOPOLIS S2	06/12/2020 06:23	06/12/2020 08:49	06/12/2020 06:23	06/12/2020 08:49	2,43	1	2,43	CHI
20201223824	AMERICANO DO BRASIL	KB21130242	ANICUNS	06/12/2020 06:23	06/12/2020 08:16	06/12/2020 06:23	06/12/2020 08:16	1,88	1	1,88	CHI
20201223827	ALEXANIA	AX21062000	ALEXANIA	06/12/2020 06:23	06/12/2020 07:10	06/12/2020 06:23	06/12/2020 07:10	0,78	1	0,78	CHI
20201224303	VILA PROPICIO	BA12248765	BARRO ALTO	06/12/2020 06:23	06/12/2020 13:02	06/12/2020 06:23	06/12/2020 13:02	6,65	23	152,85	CHI
20201223829	ARAGOIANIA	AO32095549	GUAPO S2	06/12/2020 06:25	06/12/2020 09:30	06/12/2020 06:25	06/12/2020 09:30	3,08	4	12,33	CHI

20201223836	PIRACANJUBA	PJ12223377	ROCHEDO	06/12/2020 06:26	06/12/2020 07:46	06/12/2020 06:26	06/12/2020 07:46	1,33	13	17,26	CHI
20201223837	CAMPO ALEGRE DE GOIAS	IP12114840	PIRES DO RIO S2	06/12/2020 06:26	06/12/2020 12:39	06/12/2020 06:26	06/12/2020 12:39	6,21	4	24,82	CHI
20201223837	IPAMERI	IP12114840	PIRES DO RIO S2	06/12/2020 06:26	06/12/2020 12:39	06/12/2020 06:26	06/12/2020 12:39	6,21	1	6,21	CHI
20201223840	SAO MIGUEL DO PASSA QUATRO	SQ21366306	BELA VISTA S2	06/12/2020 06:28	06/12/2020 12:09	06/12/2020 06:28	06/12/2020 12:09	5,67	1	5,67	CHI
20201223841	PONTALINA	PK32045950	PONTALINA	06/12/2020 06:28	06/12/2020 09:48	06/12/2020 06:28	06/12/2020 09:48	3,32	7	23,26	CHI
20201223843	PONTALINA	PK21372813	GOIATUBA S1	06/12/2020 06:28	06/12/2020 13:06	06/12/2020 06:28	06/12/2020 13:06	6,62	1	6,62	CHI
20201225493	RUBIATABA	RB12272739	RUBIATABA	06/12/2020 06:29	06/12/2020 12:31	06/12/2020 06:29	06/12/2020 12:31	6,03	13	78,33	CHI
20201225493	NOVA AMERICA	RB12272739	RUBIATABA	06/12/2020 06:29	06/12/2020 12:31	06/12/2020 06:29	06/12/2020 12:31	6,03	19	114,48	CHI
20201223882	CORUMBA DE GOIAS	CB12312066	CORUMBA	06/12/2020 06:31	06/12/2020 13:24	06/12/2020 06:31	06/12/2020 13:24	6,87	2	13,75	CHI
20201223852	GOIANESIA	550196249	GOIANESIA S2	06/12/2020 06:32	06/12/2020 11:35	06/12/2020 06:32	06/12/2020 11:35	5,05	1	5,05	CHI
20201223857	EDEIA	EA11182938	EDEIA	06/12/2020 06:32	06/12/2020 13:52	06/12/2020 06:32	06/12/2020 13:52	7,32	28	204,98	CHI
20201224134	COCALZINHO DE GOIAS	ZN12172211	AGUAS LINDAS DE GOIAS S2	06/12/2020 06:32	06/12/2020 12:19	06/12/2020 06:32	06/12/2020 12:19	5,77	5	28,86	CHI
20201225144	BELA VISTA DE GOIAS	7346261	BELA VISTA S1	06/12/2020 06:32	06/12/2020 11:18	06/12/2020 06:32	06/12/2020 11:18	4,77	383	1825,31	CHI
20201224478	BELA VISTA DE GOIAS	BV11235187	BELA VISTA S1	06/12/2020 06:32	06/12/2020 14:05	06/12/2020 06:32	06/12/2020 14:05	7,55	75	566,19	CHI
20201223859	SANTO ANTONIO DE GOIAS	10011751973	NEROPOLIS S1	06/12/2020 06:33	06/12/2020 12:47	06/12/2020 06:33	06/12/2020 12:47	6,23	1	6,23	CHI
20201223860	MINACU	IH11207728	MINACU	06/12/2020 06:33	06/12/2020 12:18	06/12/2020 06:33	06/12/2020 12:18	5,75	2	11,49	CHI
20201223861	PIRES DO RIO	PZ12063775RE	PIRES DO RIO S2	06/12/2020 06:33	06/12/2020 16:16	06/12/2020 06:33	06/12/2020 16:16	9,71	6	58,27	CHI
20201223861	SANTA CRUZ DE GOIAS	PZ12063775RE	PIRES DO RIO S2	06/12/2020 06:33	06/12/2020 16:16	06/12/2020 06:33	06/12/2020 16:16	9,71	28	271,95	CHI
20201223861	PALMELO	PZ12063775RE	PIRES DO RIO S2	06/12/2020 06:33	06/12/2020 16:16	06/12/2020 06:33	06/12/2020 16:16	9,71	24	233,10	CHI
20201223864	APARECIDA DE GOIANIA	AP11169435	REAL S2	06/12/2020 06:33	06/12/2020 08:43	06/12/2020 06:33	06/12/2020 08:43	2,15	28	60,30	CHI
20201223865	PARAUNA	PU12228063	PARAUNA	06/12/2020 06:33	06/12/2020 09:08	06/12/2020 06:33	06/12/2020 09:08	2,57	1	2,57	CHI
20201224106	CALDAZINHA	SW12217284	CEPAIGO S2	06/12/2020 06:34	06/12/2020 08:47	06/12/2020 06:34	06/12/2020 08:47	2,21	6	13,27	CHI
20201224106	LEOPOLDO DE BULHOES	SW12217284	CEPAIGO S2	06/12/2020 06:34	06/12/2020 08:47	06/12/2020 06:34	06/12/2020 08:47	2,21	55	121,66	CHI
20201224334	ALEXANIA	AX11289376	ALEXANIA	06/12/2020 06:34	06/12/2020 20:36	06/12/2020 06:34	06/12/2020 20:36	14,02	37	518,72	CHI
20201225445	MINACU	IH12207727	MINACU	06/12/2020 06:34	06/12/2020 15:11	06/12/2020 06:34	06/12/2020 15:11	8,61	5	43,07	CHI
20201223889	MUTUNOPOLIS	MU12129781	MARA ROSA	06/12/2020 06:35	06/12/2020 17:33	06/12/2020 06:35	06/12/2020 17:33	10,95	7	76,67	CHI
20201224058	PIRES DO RIO	PR12344664	PIRES DO RIO S2	06/12/2020 06:35	06/12/2020 09:53	06/12/2020 06:35	06/12/2020 09:53	3,29	2	6,57	CHI
20201224257	FLORES DE GOIAS	FB12262344	FLORES DE GOIAS	06/12/2020 06:35	08/12/2020 12:26	06/12/2020 06:35	08/12/2020 12:26	53,84	2	107,68	CHI
20201224630	CRISTIANOPOLIS	PJ12082248	PIRACANJUBA	06/12/2020 06:35	06/12/2020 09:29	06/12/2020 06:35	06/12/2020 09:29	2,89	5	14,43	CHI
20201224630	PIRACANJUBA	PJ12082248	PIRACANJUBA	06/12/2020 06:35	06/12/2020 09:29	06/12/2020 06:35	06/12/2020 09:29	2,89	17	49,08	CHI
20201224888	ITAPIRAPUA	IU12018846	MATRINCHA	06/12/2020 06:35	06/12/2020 12:47	06/12/2020 06:35	06/12/2020 12:47	6,18	4	24,74	CHI
20201223881	ANAPOLIS	7302272	NEROPOLIS S1	06/12/2020 06:36	06/12/2020 16:56	06/12/2020 06:36	06/12/2020 16:56	10,33	18	185,97	CHI
20201229722	LUZIANIA	OZ12186208	PIRES DO RIO S2	06/12/2020 06:36	07/12/2020 13:41	06/12/2020 06:36	07/12/2020 13:41	31,07	30	932,21	CHI
20201229723	LUZIANIA	LZ21128331	PIRES DO RIO S2	06/12/2020 06:36	07/12/2020 15:15	06/12/2020 06:36	07/12/2020 15:15	32,64	2	65,28	CHI
20201223888	CALDAS NOVAS	CN12000046	CALDAS NOVAS S2	06/12/2020 06:38	06/12/2020 09:25	06/12/2020 06:38	06/12/2020 09:25	2,78	13	36,18	CHI
20201223892	ALTO PARAISO DE GOIAS	BF12349123	FLORES DE GOIAS	06/12/2020 06:38	06/12/2020 08:44	06/12/2020 06:38	06/12/2020 08:44	2,09	4	8,36	CHI
20201223892	SAO JOAO D ALIANCA	BF12349123	FLORES DE GOIAS	06/12/2020 06:38	06/12/2020 08:44	06/12/2020 06:38	06/12/2020 08:44	2,09	2	4,18	CHI
20201223894	BARRO ALTO	GE12006576	BARRO ALTO	06/12/2020 06:38	06/12/2020 09:06	06/12/2020 06:38	06/12/2020 09:06	2,45	3	7,36	CHI
20201223894	SANTA RITA DO NOVO DESTINO	GE12006576	BARRO ALTO	06/12/2020 06:38	06/12/2020 09:06	06/12/2020 06:38	06/12/2020 09:06	2,45	4	9,82	CHI
20201223902	ITABERAI	IB21310473	ITABERAI S2	06/12/2020 06:40	06/12/2020 09:27	06/12/2020 06:40	06/12/2020 09:27	2,78	1	2,78	CHI
20201223912	IPAMERI	KR12330533	CRISTALINA S1	06/12/2020 06:42	06/12/2020 08:34	06/12/2020 06:42	06/12/2020 08:34	1,86	1	1,86	CHI
20201223912	LUZIANIA	KR12330533	CRISTALINA S1	06/12/2020 06:42	06/12/2020 08:34	06/12/2020 06:42	06/12/2020 08:34	1,86	8	14,91	CHI
20201223912	CRISTALINA	KR12330533	CRISTALINA S1	06/12/2020 06:42	06/12/2020 08:34	06/12/2020 06:42	06/12/2020 08:34	1,86	35	65,23	CHI
20201223913	NOVO GAMA	NJ21171635	PACAEMBU S2	06/12/2020 06:42	06/12/2020 09:22	06/12/2020 06:42	06/12/2020 09:22	2,66	1	2,66	CHI
20201224231	MINACU	IH12150712	MINACU	06/12/2020 06:43	06/12/2020 15:10	06/12/2020 06:43	06/12/2020 15:10	8,44	101	852,02	CHI
20201223938	IACIARA	IA12257653	IACIARA S1	06/12/2020 06:44	06/12/2020 18:28	06/12/2020 06:44	06/12/2020 18:28	11,72	6	70,34	CHI
20201223929	ITAPACI	IW21123081	ITAPACI	06/12/2020 06:45	06/12/2020 08:17	06/12/2020 06:45	06/12/2020 08:17	1,52	1	1,52	CHI
20201224063	LUZIANIA	LZ12396837	MARAJOARA	06/12/2020 06:46	06/12/2020 08:31	06/12/2020 06:46	06/12/2020 08:31	1,75	12	20,96	CHI
20201223935	EDEIA	EA11160391	EDEIA	06/12/2020 06:47	06/12/2020 10:07	06/12/2020 06:47	06/12/2020 10:07	3,33	125	416,67	CHI
20201223936	PIRACANJUBA	PJ12000210	PIRACANJUBA	06/12/2020 06:47	06/12/2020 10:17	06/12/2020 06:47	06/12/2020 10:17	3,50	5	17,48	CHI
20201223939	ITUMBIARA	IT21309026	CACHOEIRA DOURADA	06/12/2020 06:47	06/12/2020 09:05	06/12/2020 06:47	06/12/2020 09:05	2,28	1	2,28	CHI

20201223941	CABECEIRAS	CW12042593	ITIQUEIRA	06/12/2020 06:48	06/12/2020 08:58	06/12/2020 06:48	06/12/2020 08:58	2,16	116	250,82	CHI
20201223946	JOVIANIA	JV12052734	VICENTINOPOLIS	06/12/2020 06:50	06/12/2020 08:12	06/12/2020 06:50	06/12/2020 08:12	1,36	4	5,46	CHI
20201223951	CORUMBAIBA	CI12285073	VILA CORUMBA	06/12/2020 06:50	06/12/2020 08:55	06/12/2020 06:50	06/12/2020 08:55	2,07	1	2,07	CHI
20201223952	TRINDADE	GR12394656	GOIANIRA	06/12/2020 06:50	06/12/2020 10:22	06/12/2020 06:50	06/12/2020 10:22	3,52	2	7,04	CHI
20201223955	FORMOSA	FA12146199	ITIQUEIRA	06/12/2020 06:50	06/12/2020 08:14	06/12/2020 06:50	06/12/2020 08:14	1,38	9	12,46	CHI
20201225364	VILA BOA	FA12146215	ITIQUEIRA	06/12/2020 06:50	06/12/2020 13:07	06/12/2020 06:50	06/12/2020 13:07	6,27	2	12,54	CHI
20201224957	GUARANI DE GOIAS	GY12267340	IACIARA S2	06/12/2020 06:51	06/12/2020 14:38	06/12/2020 06:51	06/12/2020 14:38	7,77	65	504,96	CHI
20201225226	LUZIANIA	LZ12336007	RIO VERMELHO	06/12/2020 06:51	06/12/2020 10:59	06/12/2020 06:51	06/12/2020 10:59	4,12	88	362,34	CHI
20201223960	CRIXAS	NA12220357	MOZARLANDIA	06/12/2020 06:52	06/12/2020 11:35	06/12/2020 06:52	06/12/2020 11:35	4,71	2	9,42	CHI
20201223960	NOVA CRIXAS	NA12220357	MOZARLANDIA	06/12/2020 06:52	06/12/2020 11:35	06/12/2020 06:52	06/12/2020 11:35	4,71	6	28,27	CHI
20201223962	NOVA IGUACU DE GOIAS	NH12390443	CAMPINORTE	06/12/2020 06:52	06/12/2020 11:35	06/12/2020 06:52	06/12/2020 11:35	4,71	6	28,26	CHI
20201223965	BOM JESUS DE GOIAS	BJ12256996	BOM JESUS DE GOIAS	06/12/2020 06:52	08/12/2020 18:16	06/12/2020 06:52	07/12/2020 09:23	26,52	6	159,14	CHI
20201223965	GOIATUBA	BJ12256996	BOM JESUS DE GOIAS	06/12/2020 06:52	08/12/2020 18:16	06/12/2020 06:52	07/12/2020 09:23	26,52	3	79,57	CHI
20201223965	GOIATUBA	BJ12256996	BOM JESUS DE GOIAS	06/12/2020 06:52	08/12/2020 18:16	06/12/2020 06:52	07/12/2020 11:46	28,89	6	173,35	CHI
20201223965	BOM JESUS DE GOIAS	BJ12256996	BOM JESUS DE GOIAS	06/12/2020 06:52	08/12/2020 18:16	06/12/2020 06:52	07/12/2020 11:46	28,89	9	260,03	CHI
20201223965	GOIATUBA	BJ12256996	BOM JESUS DE GOIAS	06/12/2020 06:52	08/12/2020 18:16	06/12/2020 06:52	07/12/2020 15:41	32,82	16	525,08	CHI
20201223965	BOM JESUS DE GOIAS	BJ12256996	BOM JESUS DE GOIAS	06/12/2020 06:52	08/12/2020 18:16	07/12/2020 15:43	07/12/2020 20:06	4,40	15	65,97	CHI
20201223965	GOIATUBA	BJ12256996	BOM JESUS DE GOIAS	06/12/2020 06:52	08/12/2020 18:16	07/12/2020 15:43	07/12/2020 20:06	4,40	22	96,76	CHI
20201223965	GOIATUBA	BJ12256996	BOM JESUS DE GOIAS	06/12/2020 06:52	08/12/2020 18:16	06/12/2020 06:52	07/12/2020 20:06	37,24	1	37,24	CHI
20201223965	BOM JESUS DE GOIAS	BJ12256996	BOM JESUS DE GOIAS	06/12/2020 06:52	08/12/2020 18:16	07/12/2020 22:27	08/12/2020 00:01	1,57	15	23,59	CHI
20201223965	GOIATUBA	BJ12256996	BOM JESUS DE GOIAS	06/12/2020 06:52	08/12/2020 18:16	07/12/2020 22:27	08/12/2020 00:01	1,57	22	34,60	CHI
20201223965	GOIATUBA	BJ13000027	BOM JESUS DE GOIAS	06/12/2020 06:52	08/12/2020 18:16	07/12/2020 15:42	08/12/2020 16:52	25,16	16	402,58	CHI
20201223965	GOIATUBA	BJ12256996	BOM JESUS DE GOIAS	06/12/2020 06:52	08/12/2020 18:16	06/12/2020 06:52	08/12/2020 18:16	59,40	9	534,57	CHI
20201223966	IPAMERI	IP12062746	IPAMERI	06/12/2020 06:52	06/12/2020 10:20	06/12/2020 06:52	06/12/2020 10:20	3,45	3	10,36	CHI
20201224135	ITUMBIARA	IT12000107RE	PARANAIBA	06/12/2020 06:52	06/12/2020 19:19	06/12/2020 06:52	06/12/2020 19:19	12,44	25	311,08	CHI
20201225828	VICENTINOPOLIS	VI12329055	VICENTINOPOLIS	06/12/2020 06:52	07/12/2020 23:42	06/12/2020 06:52	06/12/2020 21:49	14,95	17	254,08	CHI
20201225828	VICENTINOPOLIS	VI12329055	VICENTINOPOLIS	06/12/2020 06:52	07/12/2020 23:42	06/12/2020 22:51	07/12/2020 07:16	8,41	17	143,00	CHI
20201225828	GOIATUBA	VI12329055	VICENTINOPOLIS	06/12/2020 06:52	07/12/2020 23:42	06/12/2020 06:52	07/12/2020 08:32	25,67	12	307,98	CHI
20201225828	VICENTINOPOLIS	VI12329055	VICENTINOPOLIS	06/12/2020 06:52	07/12/2020 23:42	06/12/2020 06:52	07/12/2020 08:32	25,67	8	205,32	CHI
20201225828	VICENTINOPOLIS	VI12329055	VICENTINOPOLIS	06/12/2020 06:52	07/12/2020 23:42	07/12/2020 17:32	07/12/2020 19:18	1,76	25	44,00	CHI
20201225828	GOIATUBA	VI12329055	VICENTINOPOLIS	06/12/2020 06:52	07/12/2020 23:42	07/12/2020 17:32	07/12/2020 19:18	1,76	12	21,12	CHI
20201225828	VICENTINOPOLIS	VI12329055	VICENTINOPOLIS	06/12/2020 06:52	07/12/2020 23:42	06/12/2020 06:52	07/12/2020 20:42	37,83	1	37,83	CHI
20201225828	VICENTINOPOLIS	VI12329055	VICENTINOPOLIS	06/12/2020 06:52	07/12/2020 23:42	06/12/2020 06:52	07/12/2020 21:12	38,34	1	38,34	CHI
20201225828	VICENTINOPOLIS	VI12329055	VICENTINOPOLIS	06/12/2020 06:52	07/12/2020 23:42	06/12/2020 06:52	07/12/2020 21:49	38,95	1	38,95	CHI
20201225828	GOIATUBA	VI12329055	VICENTINOPOLIS	06/12/2020 06:52	07/12/2020 23:42	06/12/2020 06:52	07/12/2020 23:42	40,83	1	40,83	CHI
20201226265	GOIANIRA	GR12053239	NEROPOLIS S1	06/12/2020 06:52	06/12/2020 17:47	06/12/2020 06:52	06/12/2020 17:47	10,90	6	65,41	CHI
20201223971	PARAUNA	PU21240342	FIRMINOPOLIS S2	06/12/2020 06:53	06/12/2020 18:49	06/12/2020 06:53	06/12/2020 18:49	11,93	1	11,93	CHI
20201225203	CORUMBA DE GOIAS	CB12243956	CORUMBA	06/12/2020 06:53	06/12/2020 16:42	06/12/2020 06:53	06/12/2020 16:42	9,81	2	19,62	CHI
20201223978	JANDAIA	JD12083934	PALMEIRAS	06/12/2020 06:54	06/12/2020 17:01	06/12/2020 15:39	06/12/2020 16:53	1,23	13	15,96	CHI
20201223978	JANDAIA	JD12338522	PALMEIRAS	06/12/2020 06:54	06/12/2020 17:01	06/12/2020 15:08	06/12/2020 17:01	1,88	1	1,88	CHI
20201226384	IPAMERI	IP12412787	CRISTALINA S1	06/12/2020 06:55	06/12/2020 21:34	06/12/2020 06:55	06/12/2020 21:34	14,65	4	58,59	CHI
20201223990	CORUMBA DE GOIAS	CB21203671	ANAPOLIS UNIVERSITARIO S1	06/12/2020 06:56	06/12/2020 13:48	06/12/2020 06:56	06/12/2020 13:48	6,86	1	6,86	CHI
20201224169	SAO JOAO DA PARAUNA	FR12000056	FIRMINOPOLIS S1	06/12/2020 06:57	06/12/2020 12:46	06/12/2020 06:57	06/12/2020 12:46	5,80	20	116,07	CHI
20201224169	PALMINOPOLIS	FR12000056	FIRMINOPOLIS S1	06/12/2020 06:57	06/12/2020 12:46	06/12/2020 06:57	06/12/2020 12:46	5,80	1	5,80	CHI
20201224169	FIRMINOPOLIS	FR12000056	FIRMINOPOLIS S1	06/12/2020 06:57	06/12/2020 12:46	06/12/2020 06:57	06/12/2020 12:46	5,80	29	168,30	CHI
20201226046	PIRACANJUBA	PJ12082178	PIRACANJUBA	06/12/2020 06:57	06/12/2020 18:36	06/12/2020 06:57	06/12/2020 18:36	11,64	4	46,57	CHI
20201223996	PIRACANJUBA	PJ21084957	CALDAS NOVAS S1	06/12/2020 06:58	06/12/2020 09:27	06/12/2020 06:58	06/12/2020 09:27	2,47	1	2,47	CHI
20201223998	GOIANIA	GN21210890	REAL S2	06/12/2020 06:58	06/12/2020 08:14	06/12/2020 07:42	06/12/2020 08:14	0,53	1	0,53	CHI
20201229070	GOIATUBA	BJ12392121	BOM JESUS DE GOIAS	06/12/2020 06:58	06/12/2020 23:42	06/12/2020 06:58	06/12/2020 23:42	16,73	16	267,64	CHI
20201224000	URUACU	UR12147094	CAMPINORTE	06/12/2020 06:59	06/12/2020 09:23	06/12/2020 06:59	06/12/2020 09:23	2,40	2	4,79	CHI
20201224003	LUZIANIA	LZ21152826	MARAJOARA	06/12/2020 06:59	06/12/2020 09:45	06/12/2020 06:59	06/12/2020 09:45	2,75	4	11,01	CHI

20201224458	SAO JOAO D ALIANCA	JL12302830	SAO JOAO D ALIANCA	06/12/2020 06:59	06/12/2020 16:40	06/12/2020 06:59	06/12/2020 16:40	9,68	243	2352,51	CHI
20201224458	ALTO PARAISO DE GOIAS	JL12302830	SAO JOAO D ALIANCA	06/12/2020 06:59	06/12/2020 16:40	06/12/2020 06:59	06/12/2020 16:40	9,68	3	29,04	CHI
20201224007	ANICUNS	AC21116645	ANICUNS	06/12/2020 07:00	06/12/2020 14:34	06/12/2020 07:00	06/12/2020 14:34	7,56	2	15,12	CHI
20201224011	ABADIANIA	AA12180462	DAIA S2	06/12/2020 07:00	06/12/2020 10:12	06/12/2020 07:00	06/12/2020 10:12	3,18	3	9,55	CHI
20201224489	VIANOPOLIS	SV12102994	VIANOPOLIS	06/12/2020 07:00	06/12/2020 13:30	06/12/2020 07:00	06/12/2020 13:30	6,49	118	765,23	CHI
20201224489	SAO MIGUEL DO PASSA QUATRO	SV12102994	VIANOPOLIS	06/12/2020 07:00	06/12/2020 13:30	06/12/2020 07:00	06/12/2020 13:30	6,49	62	402,07	CHI
20201224489	SILVANIA	SV12102994	VIANOPOLIS	06/12/2020 07:00	06/12/2020 13:30	06/12/2020 07:00	06/12/2020 13:30	6,49	76	492,86	CHI
20201224013	AGUAS LINDAS DE GOIAS	LA12093935	AGUAS LINDAS DE GOIAS S1	06/12/2020 07:01	06/12/2020 11:54	06/12/2020 07:01	06/12/2020 11:54	4,88	19	92,72	CHI
20201224091	PIRENOPOLIS	PV12084565	CORUMBA	06/12/2020 07:01	06/12/2020 08:53	06/12/2020 07:01	06/12/2020 08:53	1,86	10	18,59	CHI
20201225030	PROFESSOR JAMIL SAFADY	PJ12123653	ROCHEDO	06/12/2020 07:01	06/12/2020 19:37	06/12/2020 07:01	06/12/2020 19:37	12,59	13	163,63	CHI
20201224800	ITAPACI	IW12281203	ITAPACI	06/12/2020 07:02	06/12/2020 10:30	06/12/2020 07:02	06/12/2020 10:30	3,46	2	6,93	CHI
20201224800	GUARINOS	IW12281203	ITAPACI	06/12/2020 07:02	06/12/2020 10:30	06/12/2020 07:02	06/12/2020 10:30	3,46	5	17,32	CHI
20201224033	GOIANIRA	GR12016182	GOIANIRA	06/12/2020 07:03	06/12/2020 09:31	06/12/2020 08:25	06/12/2020 09:31	1,10	2	2,20	CHI
20201224083	GOIAS	GS12076721	GOIAS	06/12/2020 07:05	06/12/2020 09:33	06/12/2020 07:05	06/12/2020 09:33	2,46	23	56,66	CHI
20201224589	IPAMERI	IP12272796LD	IPAMERI	06/12/2020 07:05	06/12/2020 11:07	06/12/2020 07:05	06/12/2020 11:07	4,03	3	12,08	CHI
20201224589	CATALAO	IP12272796LD	IPAMERI	06/12/2020 07:05	06/12/2020 11:07	06/12/2020 07:05	06/12/2020 11:07	4,03	20	80,56	CHI
20201224047	SILVANIA	GL21338881	DAIA S2	06/12/2020 07:07	06/12/2020 16:32	06/12/2020 07:07	06/12/2020 16:32	9,41	2	18,82	CHI
20201224049	CRIXAS	CX12248286	SERRA DO OURO	06/12/2020 07:07	06/12/2020 08:44	06/12/2020 07:07	06/12/2020 08:44	1,61	17	27,30	CHI
20201224056	MINACU	4020005840	MINACU	06/12/2020 07:08	06/12/2020 12:35	06/12/2020 07:08	06/12/2020 12:35	5,43	1	5,43	CHI
20201224062	COCALZINHO DE GOIAS	ZN21353464	AGUAS LINDAS DE GOIAS S2	06/12/2020 07:09	06/12/2020 15:15	06/12/2020 07:09	06/12/2020 15:15	8,09	1	8,09	CHI
20201225082	GOIANIRA	GR12046614	MEIA PONTE	06/12/2020 07:09	06/12/2020 13:58	06/12/2020 07:09	06/12/2020 13:58	6,81	2	13,62	CHI
20201224292	PORANGATU	PO12192315	PORANGATU	06/12/2020 07:10	06/12/2020 09:28	06/12/2020 07:10	06/12/2020 09:28	2,29	19	43,53	CHI
20201224976	SANTA RITA DO NOVO DESTINO	BA12156230	BARRO ALTO	06/12/2020 07:10	06/12/2020 17:46	06/12/2020 07:10	06/12/2020 17:46	10,59	8	84,71	CHI
20201224070	LUZIANIA	LZ11128775	RIO VERMELHO	06/12/2020 07:11	06/12/2020 09:25	06/12/2020 07:11	06/12/2020 09:25	2,23	8	17,83	CHI
20201224074	LUZIANIA	LZ12304862	VIANOPOLIS	06/12/2020 07:12	06/12/2020 10:01	06/12/2020 07:12	06/12/2020 10:01	2,82	4	11,26	CHI
20201224254	INHUMAS	IN32066288	INHUMAS S2	06/12/2020 07:12	06/12/2020 22:05	06/12/2020 07:12	06/12/2020 22:05	14,87	8	118,96	CHI
20201224349	SAO MIGUEL DO ARAGUAIA	SM12099146RE	SAO MIGUEL DO ARAGUAIA	06/12/2020 07:12	06/12/2020 15:09	06/12/2020 07:12	06/12/2020 15:09	7,94	53	420,67	CHI
20201224349	NOVO PLANALTO	SM12099146RE	SAO MIGUEL DO ARAGUAIA	06/12/2020 07:12	06/12/2020 15:09	06/12/2020 07:12	06/12/2020 15:09	7,94	0	0,00	CHI
20201224084	PETROLINA DE GOIAS	PG11148218	PETROLINA	06/12/2020 07:13	06/12/2020 11:21	06/12/2020 07:13	06/12/2020 11:21	4,12	67	275,95	CHI
20201224086	FAINA	IK12186817	ITAPURANGA	06/12/2020 07:14	06/12/2020 09:28	06/12/2020 07:14	06/12/2020 09:28	2,23	15	33,43	CHI
20201224093	NOVO GAMA	NJ11165094	PACAEMBU S1	06/12/2020 07:15	06/12/2020 12:50	06/12/2020 07:15	06/12/2020 12:50	5,57	181	1008,42	CHI
20201224096	JOVIANIA	JV12381188	GOIATUBA S1	06/12/2020 07:16	06/12/2020 10:57	06/12/2020 07:16	06/12/2020 10:57	3,68	4	14,72	CHI
20201224175	PIRES DO RIO	OZ12216210	PIRES DO RIO S2	06/12/2020 07:16	06/12/2020 11:46	06/12/2020 07:16	06/12/2020 11:46	4,49	9	40,40	CHI
20201224175	ORIZONA	OZ12216210	PIRES DO RIO S2	06/12/2020 07:16	06/12/2020 11:46	06/12/2020 07:16	06/12/2020 11:46	4,49	9	40,40	CHI
20201224102	URUACU	UR11281252	URUACU	06/12/2020 07:18	06/12/2020 13:07	06/12/2020 07:18	06/12/2020 13:07	5,81	10	58,14	CHI
20201225326	LUZIANIA	LZ12000278	MARAJOARA	06/12/2020 07:18	06/12/2020 13:54	06/12/2020 07:18	06/12/2020 13:54	6,59	25	164,76	CHI
20201224112	TRINDADE	40178808	TRINDADE	06/12/2020 07:19	06/12/2020 09:07	06/12/2020 07:19	06/12/2020 09:07	1,78	1	1,78	CHI
20201224113	FLORES DE GOIAS	FB12253535	IACIARA S2	06/12/2020 07:20	06/12/2020 18:00	06/12/2020 07:20	06/12/2020 18:00	34,67	69	2391,96	CHI
20201224308	SAO JOAO D ALIANCA	JL12016102	SAO JOAO D ALIANCA	06/12/2020 07:20	06/12/2020 13:12	06/12/2020 07:20	06/12/2020 13:12	5,86	234	1372,22	CHI
20201224123	JARAGUA	JA12035642	JARAGUA	06/12/2020 07:21	06/12/2020 12:02	06/12/2020 07:21	06/12/2020 12:02	4,68	18	84,20	CHI
20201224130	SANTA CRUZ DE GOIAS	BC12309106	PIRES DO RIO S2	06/12/2020 07:22	07/12/2020 13:46	06/12/2020 07:22	07/12/2020 13:46	30,39	1	30,39	CHI
20201224133	FORMOSA	FA11383255	ITIQUEIRA	06/12/2020 07:23	06/12/2020 08:51	06/12/2020 07:23	06/12/2020 08:51	1,46	11	16,06	CHI
20201224148	PADRE BERNARDO	PB12290575	PADRE BERNARDO	06/12/2020 07:24	06/12/2020 11:22	06/12/2020 07:24	06/12/2020 11:22	3,96	3	11,89	CHI
20201224180	FORMOSA	FA12042673	ITIQUEIRA	06/12/2020 07:25	06/12/2020 14:14	06/12/2020 07:25	06/12/2020 14:14	6,81	17	115,83	CHI
20201224286	FLORES DE GOIAS	FB12243096	FLORES DE GOIAS	06/12/2020 07:25	06/12/2020 11:23	06/12/2020 07:25	06/12/2020 11:23	3,97	3	11,90	CHI
20201224167	ARAGARCAS	AG12050708	ARAGARCAS	06/12/2020 07:27	06/12/2020 12:52	06/12/2020 07:27	06/12/2020 12:52	5,40	1	5,40	CHI
20201224366	SAO LUIS DE MONTES BELOS	SL12003812	SAO LUIZ DOS MONTES BELOS	06/12/2020 07:27	07/12/2020 14:51	06/12/2020 07:27	07/12/2020 14:51	31,40	14	439,55	CHI
20201224571	EDEALINA	ED12047071	PONTALINA	06/12/2020 07:27	06/12/2020 12:38	06/12/2020 07:27	06/12/2020 12:38	5,18	3	15,54	CHI
20201224571	EDEIA	ED12047071	PONTALINA	06/12/2020 07:27	06/12/2020 12:38	06/12/2020 07:27	06/12/2020 12:38	5,18	2	10,36	CHI
20201224170	IPAMERI	580075072	IPAMERI	06/12/2020 07:28	06/12/2020 10:27	06/12/2020 07:28	06/12/2020 10:27	2,98	1	2,98	CHI
20201224172	NIQUELANDIA	NQ11280477	NIQUELANDIA SUBTRANSMISSAO	06/12/2020 07:28	06/12/2020 09:43	06/12/2020 07:28	06/12/2020 09:43	2,25	1	2,25	CHI

20201224179	FORMOSA	FA12383272	ITIQUEIRA	06/12/2020 07:29	06/12/2020 14:37	06/12/2020 07:29	06/12/2020 14:37	7,13	39	278,10	CHI
20201224181	IVOLANDIA	IV12165764	IPORA	06/12/2020 07:29	06/12/2020 09:00	06/12/2020 07:29	06/12/2020 09:00	1,51	3	4,53	CHI
20201224181	PARAUNA	IV12165764	IPORA	06/12/2020 07:29	06/12/2020 09:00	06/12/2020 07:29	06/12/2020 09:00	1,51	1	1,51	CHI
20201224567	SILVANIA	SV12101287	VIANOPOLIS	06/12/2020 07:29	06/12/2020 11:25	06/12/2020 07:29	06/12/2020 11:25	3,92	17	66,69	CHI
20201224189	CRISTALINA	KR12244611	CRISTALINA S2	06/12/2020 07:30	06/12/2020 10:48	06/12/2020 07:30	06/12/2020 10:48	3,29	2	6,59	CHI
20201224191	GUAPO	GA13402716	GUAPO S2	06/12/2020 07:30	06/12/2020 12:31	06/12/2020 07:30	06/12/2020 12:31	5,01	12	60,14	CHI
20201224191	VARIAO	GA13402716	GUAPO S2	06/12/2020 07:30	06/12/2020 12:31	06/12/2020 07:30	06/12/2020 12:31	5,01	1	5,01	CHI
20201224195	PIRES DO RIO	PR21154622	PIRES DO RIO S1	06/12/2020 07:30	06/12/2020 18:34	06/12/2020 07:30	06/12/2020 18:34	11,06	1	11,06	CHI
20201224198	SANTO ANTONIO DE GOIAS	GR21026983	NEROPOLIS S1	06/12/2020 07:30	06/12/2020 11:41	06/12/2020 07:30	06/12/2020 11:41	4,17	1	4,17	CHI
20201224670	SAO JOAO D ALIANCA	FB12250123	FLORES DE GOIAS	06/12/2020 07:30	06/12/2020 20:41	06/12/2020 07:30	06/12/2020 20:41	13,18	17	223,98	CHI
20201224670	FLORES DE GOIAS	FB12250123	FLORES DE GOIAS	06/12/2020 07:30	06/12/2020 20:41	06/12/2020 07:30	06/12/2020 20:41	13,18	159	2094,87	CHI
20201225101	COCALZINHO DE GOIAS	SN12261439	AGUAS LINDAS DE GOIAS S1	06/12/2020 07:30	06/12/2020 17:06	06/12/2020 07:30	06/12/2020 17:06	9,59	1	9,59	CHI
20201225101	AGUAS LINDAS DE GOIAS	SN12261439	AGUAS LINDAS DE GOIAS S1	06/12/2020 07:30	06/12/2020 17:06	06/12/2020 07:30	06/12/2020 17:06	9,59	8	76,69	CHI
20201225703	ORIZONA	OZ12300550	PIRES DO RIO S2	06/12/2020 07:30	06/12/2020 21:38	06/12/2020 07:30	06/12/2020 21:38	14,12	53	748,36	CHI
20201224203	PORANGATU	PO12141124	NOVO PLANALTO	06/12/2020 07:31	06/12/2020 08:41	06/12/2020 07:31	06/12/2020 08:41	1,16	20	23,22	CHI
20201224809	ORIZONA	OZ12114525	PIRES DO RIO S2	06/12/2020 07:31	06/12/2020 16:37	06/12/2020 07:31	06/12/2020 16:37	9,10	3	27,29	CHI
20201225009	COCALZINHO DE GOIAS	CB12060039	COCALZINHO	06/12/2020 07:31	06/12/2020 18:30	06/12/2020 07:31	06/12/2020 18:30	10,97	28	307,20	CHI
20201225009	CORUMBA DE GOIAS	CB12060039	COCALZINHO	06/12/2020 07:31	06/12/2020 18:30	06/12/2020 07:31	06/12/2020 18:30	10,97	12	131,66	CHI
20201225151	CAVALCANTE	CJ12163386	FLORES DE GOIAS	06/12/2020 07:31	06/12/2020 15:02	06/12/2020 07:31	06/12/2020 15:02	7,51	9	67,60	CHI
20201224213	FORMOSA	FA12013352	ITIQUEIRA	06/12/2020 07:32	06/12/2020 11:02	06/12/2020 07:32	06/12/2020 11:02	3,50	3	10,50	CHI
20201224221	BELA VISTA DE GOIAS	BV21060816	BELA VISTA S2	06/12/2020 07:32	06/12/2020 12:48	06/12/2020 07:32	06/12/2020 12:48	5,26	1	5,26	CHI
20201224667	ANICUNS	AC12035306	ANICUNS	06/12/2020 07:32	06/12/2020 10:23	06/12/2020 07:32	06/12/2020 10:23	2,85	19	54,10	CHI
20201224226	SILVANIA	SV12382772	DAIA S2	06/12/2020 07:33	06/12/2020 10:32	06/12/2020 07:33	06/12/2020 10:32	2,98	2	5,96	CHI
20201224236	APARECIDA DE GOIANIA	AP11000100	REAL S2	06/12/2020 07:33	06/12/2020 13:47	06/12/2020 11:38	06/12/2020 13:47	2,14	84	179,39	CHI
20201224276	FORMOSA	FB12106993	FLORES DE GOIAS	06/12/2020 07:33	06/12/2020 10:46	06/12/2020 07:33	06/12/2020 10:46	3,21	21	67,36	CHI
20201224276	SAO JOAO D ALIANCA	FB12106993	FLORES DE GOIAS	06/12/2020 07:33	06/12/2020 10:46	06/12/2020 07:33	06/12/2020 10:46	3,21	5	16,04	CHI
20201224276	FLORES DE GOIAS	FB12106993	FLORES DE GOIAS	06/12/2020 07:33	06/12/2020 10:46	06/12/2020 07:33	06/12/2020 10:46	3,21	14	44,91	CHI
20201224658	FORMOSA	FA12058455	SAO JOAO D ALIANCA	06/12/2020 07:33	06/12/2020 12:13	06/12/2020 07:33	06/12/2020 12:13	4,67	8	37,33	CHI
20201224238	GOIANIA	11013400	FERROVIARIO S3	06/12/2020 07:34	06/12/2020 09:52	06/12/2020 07:34	06/12/2020 09:52	2,30	1	2,30	CHI
20201224242	CAMPO ALEGRE DE GOIAS	CM12420390	CAMPO ALEGRE DE GOIAS	06/12/2020 07:34	06/12/2020 11:11	06/12/2020 07:34	06/12/2020 11:11	3,61	18	64,91	CHI
20201224246	TROMBAS	TB11364361	PORANGATU	06/12/2020 07:34	06/12/2020 22:35	06/12/2020 07:34	06/12/2020 22:35	15,00	1	15,00	CHI
20201224771	PADRE BERNARDO	ZN12302505RE	COCALZINHO	06/12/2020 07:34	06/12/2020 11:09	06/12/2020 07:34	06/12/2020 11:09	3,57	1	3,57	CHI
20201224771	COCALZINHO DE GOIAS	ZN12302505RE	COCALZINHO	06/12/2020 07:34	06/12/2020 11:09	06/12/2020 07:34	06/12/2020 11:09	3,57	38	135,79	CHI
20201224248	GOIAS	GS21121478	ITABERAI S1	06/12/2020 07:35	06/12/2020 14:57	06/12/2020 07:35	06/12/2020 14:57	7,37	1	7,37	CHI
20201224252	IACIARA	IA21211518	IACIARA S2	06/12/2020 07:35	06/12/2020 12:52	06/12/2020 07:35	06/12/2020 12:52	5,27	1	5,27	CHI
20201224264	CRISTALINA	KR12097123	CRISTALINA S2	06/12/2020 07:38	06/12/2020 11:51	06/12/2020 07:38	06/12/2020 11:51	4,21	3	12,63	CHI
20201224277	NOVA ROMA	ND21133568	IACIARA S2	06/12/2020 07:42	06/12/2020 12:37	06/12/2020 07:42	06/12/2020 12:37	4,92	1	4,92	CHI
20201224284	LUZIANIA	LZ12349110	MARAJORA	06/12/2020 07:43	06/12/2020 10:50	06/12/2020 07:43	06/12/2020 10:50	3,11	15	46,60	CHI
20201224288	PIRANHAS	1930030554	PIRANHAS	06/12/2020 07:44	06/12/2020 12:59	06/12/2020 07:44	06/12/2020 12:59	5,24	1	5,24	CHI
20201224294	CAIAPONIA	PH12207936	PIRANHAS	06/12/2020 07:45	06/12/2020 11:09	06/12/2020 07:45	06/12/2020 11:09	3,39	8	27,08	CHI
20201224301	GOIAS	GS12162479	GOIAS	06/12/2020 07:47	06/12/2020 11:52	06/12/2020 07:47	06/12/2020 11:52	4,07	2	8,14	CHI
20201224304	VILA PROPICIO	NP11228414	GOIANESIA S1	06/12/2020 07:48	06/12/2020 22:11	06/12/2020 07:48	06/12/2020 22:11	14,38	1	14,38	CHI
20201224306	SANTO ANTONIO DO DESCOBERTO	2210101494	AGUAS LINDAS DE GOIAS S2	06/12/2020 07:48	06/12/2020 14:29	06/12/2020 07:48	06/12/2020 14:29	6,68	1	6,68	CHI
20201226518	LUZIANIA	LZ12320196	RIO VERMELHO	06/12/2020 07:50	06/12/2020 15:53	06/12/2020 07:50	06/12/2020 15:53	8,03	11	88,38	CHI
20201224325	PARAUNA	PU21228065	PARAUNA	06/12/2020 07:51	06/12/2020 11:44	06/12/2020 07:51	06/12/2020 11:44	3,87	1	3,87	CHI
20201225757	NIQUELANDIA	NQ12366185	SAO JOAO D ALIANCA	06/12/2020 07:51	06/12/2020 15:35	06/12/2020 07:51	06/12/2020 15:35	7,73	6	46,37	CHI
20201224333	ITABERAI	IB12021840	ITABERAI S2	06/12/2020 07:52	06/12/2020 09:22	06/12/2020 07:52	06/12/2020 09:22	1,49	11	16,34	CHI
20201224336	LUZIANIA	LZ11128810	RIO VERMELHO	06/12/2020 07:53	06/12/2020 10:03	06/12/2020 07:53	06/12/2020 10:03	2,16	34	73,48	CHI
20201224340	LUZIANIA	LZ11283900	RIO VERMELHO	06/12/2020 07:53	06/12/2020 10:21	06/12/2020 07:53	06/12/2020 10:21	2,46	17	41,78	CHI
20201224762	ORIZONA	OZ12052363	PIRES DO RIO S2	06/12/2020 07:53	06/12/2020 21:02	06/12/2020 07:53	06/12/2020 21:02	13,14	6	78,85	CHI
20201224350	COCALZINHO DE GOIAS	ZN21290613	AGUAS LINDAS DE GOIAS S2	06/12/2020 07:54	06/12/2020 16:23	06/12/2020 07:54	06/12/2020 16:23	8,47	1	8,47	CHI

20201224351	PIRACANJUBA	PJ21012071	CALDAS NOVAS S1	06/12/2020 07:54	06/12/2020 10:12	06/12/2020 07:54	06/12/2020 10:12	2,29	1	2,29	CHI
20201224455	SANTA CRUZ DE GOIAS	BC21311669	PIRES DO RIO S2	06/12/2020 07:54	06/12/2020 19:09	06/12/2020 07:54	06/12/2020 19:09	11,25	2	22,49	CHI
20201224817	FORMOSA	FA11000013	ITIQUEIRA	06/12/2020 07:54	06/12/2020 09:24	06/12/2020 07:54	06/12/2020 09:24	1,49	196	291,11	CHI
20201224360	VICENTINOPOLIS	VI21166482	VICENTINOPOLIS	06/12/2020 07:55	07/12/2020 00:12	06/12/2020 07:55	07/12/2020 00:12	16,27	1	16,27	CHI
20201224364	ITUMBIARA	IT21000090	PARANAIBA	06/12/2020 07:55	06/12/2020 17:11	06/12/2020 07:55	06/12/2020 17:11	9,25	1	9,25	CHI
20201224371	SANTO ANTONIO DO DESCOBERTO	ZN12104983	AGUAS LINDAS DE GOIAS S2	06/12/2020 07:55	06/12/2020 14:20	06/12/2020 07:55	06/12/2020 14:20	6,41	17	109,00	CHI
20201224413	CORUMBA DE GOIAS	CB12221413	CORUMBA	06/12/2020 07:55	06/12/2020 11:39	06/12/2020 07:55	06/12/2020 11:39	3,73	3	11,19	CHI
20201225687	FLORES DE GOIAS	FB12357919	FLORES DE GOIAS	06/12/2020 07:55	07/12/2020 08:40	06/12/2020 07:55	07/12/2020 08:40	24,74	32	791,56	CHI
20201225815	FORMOSA	FA12254248	ITIQUEIRA	06/12/2020 07:55	06/12/2020 18:52	06/12/2020 07:55	06/12/2020 18:52	10,94	6	65,64	CHI
20201224842	FORMOSA	FA32042715	SAO JOAO D ALIANCA	06/12/2020 07:56	06/12/2020 15:47	06/12/2020 07:56	06/12/2020 15:47	7,85	95	745,38	CHI
20201224384	JARAGUA	70009399	JARAGUA	06/12/2020 07:57	06/12/2020 09:04	06/12/2020 07:57	06/12/2020 09:04	1,11	1	1,11	CHI
20201225288	COLINAS DO SUL	TI12156216RE	MINACU	06/12/2020 07:57	07/12/2020 09:07	06/12/2020 07:57	07/12/2020 09:07	25,17	30	754,99	CHI
20201225288	CAVALCANTE	TI12156216RE	MINACU	06/12/2020 07:57	07/12/2020 09:07	06/12/2020 07:57	07/12/2020 09:07	25,17	67	1686,15	CHI
20201224386	FLORES DE GOIAS	FB12218636	IACIARA S2	06/12/2020 07:58	08/12/2020 09:38	06/12/2020 07:58	08/12/2020 09:38	49,67	4	198,67	CHI
20201224388	ANAPOLIS	20244897	ANAPOLIS UNIVERSITARIO S2	06/12/2020 07:58	06/12/2020 13:34	06/12/2020 07:58	06/12/2020 13:34	5,60	1	5,60	CHI
20201224392	PADRE BERNARDO	PB12290529	PADRE BERNARDO	06/12/2020 07:58	06/12/2020 11:48	06/12/2020 07:58	06/12/2020 11:48	3,83	17	65,07	CHI
20201224397	MONTE ALEGRE DE GOIAS	MA21352910	SAO DOMINGOS	06/12/2020 07:59	06/12/2020 12:59	06/12/2020 07:59	06/12/2020 12:59	5,00	1	5,00	CHI
20201224405	JARAGUA	JA12166643	JARAGUA	06/12/2020 07:59	06/12/2020 10:05	06/12/2020 07:59	06/12/2020 10:05	2,08	8	16,67	CHI
20201226189	SAO JOAO D ALIANCA	JL12383335	SAO JOAO D ALIANCA	06/12/2020 07:59	06/12/2020 18:30	06/12/2020 07:59	06/12/2020 18:30	10,50	11	115,54	CHI
20201224408	MINACU	IH12346526	MINACU	06/12/2020 08:00	06/12/2020 17:56	06/12/2020 08:00	06/12/2020 17:56	9,93	69	684,90	CHI
20201224418	SAO JOAO D ALIANCA	JL12270094	SAO JOAO D ALIANCA	06/12/2020 08:00	06/12/2020 22:16	06/12/2020 08:00	06/12/2020 22:16	14,27	8	114,13	CHI
20201224418	AGUA FRIA DE GOIAS	JL12270094	SAO JOAO D ALIANCA	06/12/2020 08:00	06/12/2020 22:16	06/12/2020 08:00	06/12/2020 22:16	14,27	1	14,27	CHI
20201224437	MONTES CLAROS DE GOIAS	ME12334760	IPORA	06/12/2020 08:01	07/12/2020 15:41	06/12/2020 08:01	07/12/2020 15:41	31,68	5	158,39	CHI
20201224429	SANTA CRUZ DE GOIAS	BC12012519	PIRES DO RIO S2	06/12/2020 08:02	06/12/2020 11:54	06/12/2020 08:02	06/12/2020 11:54	3,86	2	7,73	CHI
20201224434	PARAUNA	PU21364931	PARAUNA	06/12/2020 08:02	06/12/2020 15:33	06/12/2020 08:02	06/12/2020 15:33	7,51	1	7,51	CHI
20201224446	FORMOSA	FA31096307	SAO JOAO D ALIANCA	06/12/2020 08:03	06/12/2020 14:49	06/12/2020 08:03	06/12/2020 14:49	6,76	2	13,52	CHI
20201226047	MONTES CLAROS DE GOIAS	ME12198122	IPORA	06/12/2020 08:03	06/12/2020 16:10	06/12/2020 08:03	06/12/2020 16:10	8,10	4	32,41	CHI
20201224452	CALDAS NOVAS	CN12182800LD	SERRA DE CALDAS	06/12/2020 08:04	06/12/2020 11:48	06/12/2020 08:04	06/12/2020 11:48	3,73	10	37,29	CHI
20201224453	ABADIANIA	AA12388792	DAIA S2	06/12/2020 08:04	06/12/2020 17:42	06/12/2020 08:04	06/12/2020 17:42	9,63	2	19,25	CHI
20201224457	MONTE ALEGRE DE GOIAS	MA12238057	SAO DOMINGOS	06/12/2020 08:04	06/12/2020 11:38	06/12/2020 08:04	06/12/2020 11:38	3,55	31	110,14	CHI
20201227715	PIRES DO RIO	450013170	PIRES DO RIO S2	06/12/2020 08:04	06/12/2020 23:18	06/12/2020 08:04	06/12/2020 23:18	15,22	1	15,22	CHI
20201224462	SAO MIGUEL DO ARAGUAIA	SM12192361	SAO MIGUEL DO ARAGUAIA	06/12/2020 08:05	06/12/2020 12:04	06/12/2020 08:05	06/12/2020 12:04	3,97	168	667,10	CHI
20201224509	LUZIANIA	LZ12033418	RIO VERMELHO	06/12/2020 08:05	06/12/2020 13:16	06/12/2020 08:05	06/12/2020 13:16	5,17	20	103,38	CHI
20201225355	MONTES CLAROS DE GOIAS	ME12184484	IPORA	06/12/2020 08:05	06/12/2020 14:58	06/12/2020 08:05	06/12/2020 14:58	6,88	33	227,05	CHI
20201224465	LUZIANIA	LZ21360112	RIO VERMELHO	06/12/2020 08:06	06/12/2020 17:42	06/12/2020 08:06	06/12/2020 17:42	9,60	1	9,60	CHI
20201224469	LUZIANIA	LZ12237853	CRISTALINA S2	06/12/2020 08:06	06/12/2020 22:59	06/12/2020 08:06	06/12/2020 22:59	14,88	1	14,88	CHI
20201224927	NAZARIO	NZ12009528	ANICUNS	06/12/2020 08:06	06/12/2020 19:19	06/12/2020 08:06	06/12/2020 11:21	3,25	2	6,51	CHI
20201224927	NAZARIO	NZ12009528	ANICUNS	06/12/2020 08:06	06/12/2020 19:19	06/12/2020 08:06	06/12/2020 19:19	11,23	5	56,14	CHI
20201224927	NAZARIO	NZ12009528	ANICUNS	06/12/2020 08:06	06/12/2020 19:19	06/12/2020 18:50	06/12/2020 19:19	0,50	2	0,99	CHI
20201225841	CRISTIANOPOLIS	BC12075213	PIRES DO RIO S2	06/12/2020 08:09	06/12/2020 14:45	06/12/2020 08:09	06/12/2020 14:45	6,60	1	6,60	CHI
20201225841	SANTA CRUZ DE GOIAS	BC12075213	PIRES DO RIO S2	06/12/2020 08:09	06/12/2020 14:45	06/12/2020 08:09	06/12/2020 14:45	6,60	32	211,20	CHI
20201224488	FORMOSA	610050047	ITIQUEIRA	06/12/2020 08:10	06/12/2020 10:00	06/12/2020 08:10	06/12/2020 10:00	1,83	1	1,83	CHI
20201224502	FAINA	FC12072193	GOIAS	06/12/2020 08:12	06/12/2020 11:29	06/12/2020 08:12	06/12/2020 11:29	3,27	12	39,25	CHI
20201224597	ITUMBIARA	BG12000162	ALTO BURITI	06/12/2020 08:12	06/12/2020 10:58	06/12/2020 08:12	06/12/2020 10:58	2,75	10	27,52	CHI
20201224597	BURITI ALEGRE	BG12000162	ALTO BURITI	06/12/2020 08:12	06/12/2020 10:58	06/12/2020 08:12	06/12/2020 10:58	2,75	13	35,77	CHI
20201224510	GOIANIA	14788044	INDEPENDENCIA S2	06/12/2020 08:14	06/12/2020 10:25	06/12/2020 08:14	06/12/2020 10:25	2,18	1	2,18	CHI
20201224511	GOIANIA	GN11078477	CAMPINAS S1	06/12/2020 08:14	06/12/2020 12:36	06/12/2020 08:14	06/12/2020 12:36	4,36	67	292,34	CHI
20201228569	PIRES DO RIO	PR12404723	PIRES DO RIO S1	06/12/2020 08:14	07/12/2020 00:48	06/12/2020 08:14	07/12/2020 00:48	16,56	4	66,25	CHI
20201224530	INDIARA	IY21022072	EDEIA	06/12/2020 08:17	06/12/2020 19:52	06/12/2020 08:17	06/12/2020 19:52	11,58	2	23,17	CHI
20201224533	CRISTALINA	KR11171014	CRISTALINA S2	06/12/2020 08:17	06/12/2020 12:06	06/12/2020 08:17	06/12/2020 12:06	3,81	1	3,81	CHI
20201224677	PILAR DE GOIAS	GF12213049	SANTA TEREZINHA	06/12/2020 08:18	06/12/2020 10:19	06/12/2020 08:18	06/12/2020 10:19	2,02	5	10,08	CHI

20201224677	GUARINOS	GF12213049	SANTA TEREZINHA	06/12/2020 08:18	06/12/2020 10:19	06/12/2020 08:18	06/12/2020 10:19	2,02	7	14,11	CHI
20201224549	CRISTALINA	KR12313551	CRISTALINA S2	06/12/2020 08:20	06/12/2020 13:34	06/12/2020 08:20	06/12/2020 13:34	5,22	96	501,52	CHI
20201224847	BALIZA	BH12358780	BOM JARDIM	06/12/2020 08:20	06/12/2020 13:04	06/12/2020 08:20	06/12/2020 13:04	4,72	16	75,56	CHI
20201224563	TURVANIA	TV12215375	FIRMINOPOLIS S1	06/12/2020 08:23	06/12/2020 09:56	06/12/2020 08:23	06/12/2020 09:56	1,54	3	4,62	CHI
20201224564	GOIANIRA	7592821	INHUMAS S1	06/12/2020 08:23	06/12/2020 12:17	06/12/2020 08:23	06/12/2020 12:17	3,90	6	23,37	CHI
20201224566	CALDAS NOVAS	CN12263786	RIO QUENTE	06/12/2020 08:23	06/12/2020 18:42	06/12/2020 08:23	06/12/2020 11:43	3,33	2	6,66	CHI
20201224566	RIO QUENTE	CN12263786	RIO QUENTE	06/12/2020 08:23	06/12/2020 18:42	06/12/2020 08:23	06/12/2020 11:43	3,33	1	3,33	CHI
20201224566	CALDAS NOVAS	CN12263786	RIO QUENTE	06/12/2020 08:23	06/12/2020 18:42	06/12/2020 08:23	06/12/2020 13:21	4,97	19	94,40	CHI
20201224566	CALDAS NOVAS	CN12263786	RIO QUENTE	06/12/2020 08:23	06/12/2020 18:42	06/12/2020 08:23	06/12/2020 18:42	10,31	14	144,27	CHI
20201225329	MINACU	IH12208345	MINACU	06/12/2020 08:23	06/12/2020 16:43	06/12/2020 08:23	06/12/2020 16:43	8,33	98	816,45	CHI
20201224574	ORIZONA	OZ11140712	PIRES DO RIO S2	06/12/2020 08:25	06/12/2020 09:35	06/12/2020 08:25	06/12/2020 09:35	1,15	149	171,56	CHI
20201224627	GAMELEIRA DE GOIAS	LB12000008	DAIA S2	06/12/2020 08:25	06/12/2020 11:52	06/12/2020 08:25	06/12/2020 11:52	3,44	16	55,12	CHI
20201224627	LEOPOLDO DE BULHOES	LB12000008	DAIA S2	06/12/2020 08:25	06/12/2020 11:52	06/12/2020 08:25	06/12/2020 11:52	3,44	159	547,71	CHI
20201224627	SILVANIA	LB12000008	DAIA S2	06/12/2020 08:25	06/12/2020 11:52	06/12/2020 08:25	06/12/2020 11:52	3,44	98	337,58	CHI
20201226368	PIRES DO RIO	PR12402554	PIRES DO RIO S1	06/12/2020 08:26	06/12/2020 17:27	06/12/2020 08:26	06/12/2020 17:27	9,02	4	36,06	CHI
20201224582	LUZIANIA	LZ12277195	RIO VERMELHO	06/12/2020 08:27	06/12/2020 11:12	06/12/2020 08:27	06/12/2020 11:12	2,75	13	35,75	CHI
20201224587	FORMOSA	610340440	ITUIQUARA	06/12/2020 08:28	06/12/2020 10:50	06/12/2020 08:28	06/12/2020 10:50	2,37	1	2,37	CHI
20201224590	NOVA ROMA	NR12394109	IACIARA S2	06/12/2020 08:28	06/12/2020 11:59	06/12/2020 08:28	06/12/2020 11:59	3,51	87	305,42	CHI
20201224948	ALEXANIA	AX12295605	ALEXANIA	06/12/2020 08:28	06/12/2020 15:23	06/12/2020 08:28	06/12/2020 15:23	6,91	5	34,54	CHI
20201225124	SAO LUIS DE MONTES BELOS	SL12019453	FIRMINOPOLIS S2	06/12/2020 08:28	06/12/2020 12:11	06/12/2020 08:28	06/12/2020 12:11	3,71	12	44,49	CHI
20201225124	SANCLERLANDIA	SL12019453	FIRMINOPOLIS S2	06/12/2020 08:28	06/12/2020 12:11	06/12/2020 08:28	06/12/2020 12:11	3,71	30	111,23	CHI
20201225124	ANICUNS	SL12019453	FIRMINOPOLIS S2	06/12/2020 08:28	06/12/2020 12:11	06/12/2020 08:28	06/12/2020 12:11	3,71	1	3,71	CHI
20201225124	MOSSAMEDES	SL12019453	FIRMINOPOLIS S2	06/12/2020 08:28	06/12/2020 12:11	06/12/2020 08:28	06/12/2020 12:11	3,71	5	18,54	CHI
20201225124	ADELANDIA	SL12019453	FIRMINOPOLIS S2	06/12/2020 08:28	06/12/2020 12:11	06/12/2020 08:28	06/12/2020 12:11	3,71	44	163,13	CHI
20201224603	AGUAS LINDAS DE GOIAS	10001503756	AGUAS LINDAS DE GOIAS S1	06/12/2020 08:29	06/12/2020 12:20	06/12/2020 08:29	06/12/2020 12:20	3,84	1	3,84	CHI
20201224605	MARA ROSA	MQ12251030	SANTA TEREZINHA	06/12/2020 08:29	06/12/2020 23:54	06/12/2020 08:29	06/12/2020 23:54	15,40	2	30,81	CHI
20201224610	PIRACANJUBA	PJ12084872	PIRACANJUBA	06/12/2020 08:29	06/12/2020 12:38	06/12/2020 08:29	06/12/2020 12:38	4,13	2	8,27	CHI
20201225133	SAO MIGUEL DO ARAGUAIA	SM12192362	SAO MIGUEL DO ARAGUAIA	06/12/2020 08:29	06/12/2020 16:52	06/12/2020 08:29	06/12/2020 16:52	8,37	2	16,74	CHI
20201226042	CRISTALINA	KR12376280	PAMPLONA	06/12/2020 08:29	06/12/2020 16:50	06/12/2020 08:29	06/12/2020 16:50	8,34	12	100,12	CHI
20201226260	ALEXANIA	AX12297672	ALEXANIA	06/12/2020 08:29	06/12/2020 15:47	06/12/2020 08:29	06/12/2020 15:47	7,30	3	21,90	CHI
20201224611	SANTO ANTONIO DO DESCOBERTO	SN21212141	AGUAS LINDAS DE GOIAS S2	06/12/2020 08:30	06/12/2020 12:49	06/12/2020 08:30	06/12/2020 12:49	4,32	1	4,32	CHI
20201224613	PIRACANJUBA	PJ21150457	CALDAS NOVAS S1	06/12/2020 08:30	06/12/2020 15:00	06/12/2020 08:30	06/12/2020 15:00	6,49	1	6,49	CHI
20201224616	PLANALTINA	PI12355774	PLANALTINA	06/12/2020 08:30	06/12/2020 09:38	06/12/2020 08:30	06/12/2020 09:38	1,13	3	3,38	CHI
20201225102	ORIZONA	OZ12404726	PIRES DO RIO S1	06/12/2020 08:30	06/12/2020 17:33	06/12/2020 08:30	06/12/2020 17:33	9,03	9	81,31	CHI
20201225465	LUZIANIA	LZ12370631	MARAJOARA	06/12/2020 08:30	06/12/2020 12:06	06/12/2020 08:30	06/12/2020 12:06	3,59	31	111,20	CHI
20201223449	PADRE BERNARDO	PB12277183	PADRE BERNARDO	06/12/2020 08:31	06/12/2020 10:44	06/12/2020 08:31	06/12/2020 10:44	2,22	51	113,04	CHI
20201224633	CRISTALINA	1060029161	CRISTALINA S1	06/12/2020 08:31	06/12/2020 10:10	06/12/2020 08:31	06/12/2020 10:10	1,64	1	1,64	CHI
20201224635	NAZARIO	NZ12000034	ANICUNS	06/12/2020 08:31	06/12/2020 10:07	06/12/2020 08:31	06/12/2020 10:07	1,59	8	12,72	CHI
20201225111	COCALZINHO DE GOIAS	ZN12302266	COCALZINHO	06/12/2020 08:31	06/12/2020 23:40	06/12/2020 08:31	06/12/2020 23:40	15,15	8	121,17	CHI
20201225338	ANAPOLIS	OV12384197	NEROPOLIS S1	06/12/2020 08:31	06/12/2020 13:08	06/12/2020 08:31	06/12/2020 13:08	4,61	5	23,03	CHI
20201225338	OURO VERDE DE GOIAS	OV12384197	NEROPOLIS S1	06/12/2020 08:31	06/12/2020 13:08	06/12/2020 08:31	06/12/2020 13:08	4,61	2	9,21	CHI
20201225870	CIDADE OCIDENTAL	LZ12072636	MARAJOARA	06/12/2020 08:31	06/12/2020 14:16	06/12/2020 08:31	06/12/2020 14:16	5,74	19	109,15	CHI
20201226341	ITAPIRAPUA	IU12306811	JUSSARA	06/12/2020 08:31	06/12/2020 20:39	06/12/2020 08:31	06/12/2020 20:39	12,12	7	84,82	CHI
20201224641	LUZIANIA	LZ12383014	VIANOPOLIS	06/12/2020 08:32	06/12/2020 10:55	06/12/2020 08:32	06/12/2020 10:55	2,38	51	121,25	CHI
20201224643	LEOPOLDO DE BULHOES	LB11284863	DAIA S2	06/12/2020 08:32	06/12/2020 12:45	06/12/2020 08:32	06/12/2020 12:45	4,21	14	58,92	CHI
20201224647	MINACU	CR21265814	PORANGATU	06/12/2020 08:32	07/12/2020 12:27	06/12/2020 08:32	07/12/2020 12:27	27,90	1	27,90	CHI
20201224657	CORUMBAIBA	CI12180475	VILA CORUMBA	06/12/2020 08:33	06/12/2020 10:52	06/12/2020 08:33	06/12/2020 10:52	2,30	3	6,91	CHI
20201224664	PIRES DO RIO	PR21100017	PIRES DO RIO S1	06/12/2020 08:34	06/12/2020 10:29	06/12/2020 08:34	06/12/2020 10:29	1,90	1	1,90	CHI
20201225542	PADRE BERNARDO	PB12375230	PADRE BERNARDO	06/12/2020 08:34	06/12/2020 12:26	06/12/2020 08:34	06/12/2020 12:26	3,85	53	204,27	CHI
20201224685	NIQUELANDIA	NQ21294066	URUACU	06/12/2020 08:36	06/12/2020 12:10	06/12/2020 08:36	06/12/2020 12:10	3,56	1	3,56	CHI
20201224725	IPORA	IR12402914	IPORA	06/12/2020 08:36	06/12/2020 11:53	06/12/2020 08:36	06/12/2020 11:53	3,29	3	9,86	CHI

20201224744	IVOLANDIA	IV21374994	ARENOPOLIS	06/12/2020 08:36	06/12/2020 09:07	06/12/2020 08:36	06/12/2020 09:07	0,51	2	1,02	CHI
20201224696	PIRENOPOLIS	PV21121868	CORUMBA	06/12/2020 08:37	06/12/2020 13:33	06/12/2020 08:37	06/12/2020 13:33	4,93	1	4,93	CHI
20201224700	CRISTALINA	KR12163890	CRISTALINA S2	06/12/2020 08:37	06/12/2020 12:29	06/12/2020 08:37	06/12/2020 12:29	3,86	95	366,70	CHI
20201224700	LUZIANIA	KR12163890	CRISTALINA S2	06/12/2020 08:37	06/12/2020 12:29	06/12/2020 08:37	06/12/2020 12:29	3,86	8	30,88	CHI
20201224745	ALEXANIA	AX12000005	ALEXANIA	06/12/2020 08:37	06/12/2020 16:28	06/12/2020 08:37	06/12/2020 16:28	7,85	12	94,19	CHI
20201224958	ANAPOLIS	AN12370432	JUNDIAI S2	06/12/2020 08:37	06/12/2020 10:26	06/12/2020 08:37	06/12/2020 10:26	1,81	112	202,97	CHI
20201224710	ITAUCU	10000068991	INHUMAS S1	06/12/2020 08:38	06/12/2020 10:50	06/12/2020 08:38	06/12/2020 10:50	2,20	1	2,20	CHI
20201224713	CIDADE OCIDENTAL	7700474	MARAJOARA	06/12/2020 08:38	06/12/2020 11:08	06/12/2020 08:38	06/12/2020 11:08	2,49	97	241,07	CHI
20201225304	CIDADE OCIDENTAL	10020448030	MARAJOARA	06/12/2020 08:38	06/12/2020 11:17	06/12/2020 08:38	06/12/2020 11:17	2,64	1	2,64	CHI
20201224720	ITUMBIARA	CD12000284	CACHOEIRA DOURADA	06/12/2020 08:39	06/12/2020 11:33	06/12/2020 08:39	06/12/2020 11:33	2,89	21	60,76	CHI
20201224829	TRINDADE	TR12326279	TRINDADE	06/12/2020 08:39	06/12/2020 09:45	06/12/2020 08:39	06/12/2020 09:45	1,09	4	4,35	CHI
20201225241	FORMOSA	FA12381543	ITUIQUIRA	06/12/2020 08:39	06/12/2020 11:30	06/12/2020 08:39	06/12/2020 11:30	2,84	4	11,34	CHI
20201224733	POSSE	PS12232231	IACIARA S2	06/12/2020 08:40	06/12/2020 10:56	06/12/2020 08:40	06/12/2020 10:56	2,26	16	36,14	CHI
20201224735	GOIAS	GS12217095	GOIAS	06/12/2020 08:40	06/12/2020 12:34	06/12/2020 08:40	06/12/2020 12:34	3,89	14	54,48	CHI
20201224737	CACHOEIRA DOURADA	CD11309942	CACHOEIRA DOURADA	06/12/2020 08:40	07/12/2020 12:41	06/12/2020 08:40	07/12/2020 12:41	28,01	108	3024,81	CHI
20201224770	LUZIANIA	LZ12230142	RIO VERMELHO	06/12/2020 08:43	06/12/2020 10:56	06/12/2020 08:43	06/12/2020 10:56	2,21	26	57,38	CHI
20201224772	ITAPIRAPUA	IU21198830	MATRINCHA	06/12/2020 08:43	06/12/2020 09:49	06/12/2020 08:43	06/12/2020 09:49	1,09	1	1,09	CHI
20201224775	BOM JESUS DE GOIAS	1250016967	BOM JESUS DE GOIAS	06/12/2020 08:44	06/12/2020 13:58	06/12/2020 08:44	06/12/2020 13:58	5,23	1	5,23	CHI
20201224780	MONTIVIDIU DO NORTE	MX21146581	PORANGATU	06/12/2020 08:44	07/12/2020 16:01	06/12/2020 08:44	07/12/2020 15:50	31,09	1	31,09	CHI
20201224780	MONTIVIDIU DO NORTE	MX12187846	PORANGATU	06/12/2020 08:44	07/12/2020 16:01	07/12/2020 13:10	07/12/2020 16:01	2,85	7	19,95	CHI
20201224781	PIRENOPOLIS	220030418	CORUMBA	06/12/2020 08:44	06/12/2020 13:20	06/12/2020 08:44	06/12/2020 13:20	4,59	1	4,59	CHI
20201224782	APARECIDA DE GOIANIA	200348292	INDEPENDENCIA S2	06/12/2020 08:44	06/12/2020 11:00	06/12/2020 08:44	06/12/2020 11:00	2,26	1	2,26	CHI
20201224784	CALDAZINHA	BV21032847	CEPAIGO S2	06/12/2020 08:44	06/12/2020 10:31	06/12/2020 08:44	06/12/2020 10:31	1,77	4	7,08	CHI
20201224786	SANTO ANTONIO DO DESCOBERTO	SN12338386	AGUAS LINDAS DE GOIAS S2	06/12/2020 08:44	06/12/2020 11:53	06/12/2020 08:44	06/12/2020 11:53	3,13	2	6,27	CHI
20201225209	SANTO ANTONIO DO DESCOBERTO	SN12382244	AGUAS LINDAS DE GOIAS S2	06/12/2020 08:44	06/12/2020 11:10	06/12/2020 08:44	06/12/2020 11:10	2,43	14	34,01	CHI
20201225458	CIDADE OCIDENTAL	DH12376198	MARAJOARA	06/12/2020 08:44	06/12/2020 10:47	06/12/2020 08:44	06/12/2020 10:47	2,04	18	36,67	CHI
20201224790	GAMELEIRA DE GOIAS	SV21227744	DAIA S2	06/12/2020 08:45	06/12/2020 12:23	06/12/2020 08:45	06/12/2020 12:23	3,63	1	3,63	CHI
20201224791	PIRACANJUBA	PJ21300891	CRISTIANOPOLIS	06/12/2020 08:45	06/12/2020 13:35	06/12/2020 08:45	06/12/2020 13:35	4,83	1	4,83	CHI
20201224794	IPAMERI	IP21122383	IPAMERI	06/12/2020 08:45	06/12/2020 11:41	06/12/2020 08:45	06/12/2020 11:41	2,93	1	2,93	CHI
20201224796	PORANGATU	PO12145187	PORANGATU	06/12/2020 08:45	06/12/2020 10:42	06/12/2020 08:45	06/12/2020 10:42	1,94	8	15,52	CHI
20201224799	APARECIDA DE GOIANIA	AP11395344	REAL S1	06/12/2020 08:45	06/12/2020 11:43	06/12/2020 08:45	06/12/2020 11:43	2,96	4	11,83	CHI
20201224801	ANICUNS	AC21016396	ARACU	06/12/2020 08:45	06/12/2020 16:14	06/12/2020 08:45	06/12/2020 16:14	7,47	1	7,47	CHI
20201224804	AGUA LIMPA	AL12000263RE	VILA CORUMBA	06/12/2020 08:46	06/12/2020 12:07	06/12/2020 08:46	06/12/2020 12:07	3,35	8	26,77	CHI
20201224807	SAO DOMINGOS	SD12254497	SAO DOMINGOS	06/12/2020 08:46	06/12/2020 09:35	06/12/2020 08:46	06/12/2020 09:35	0,81	8	6,47	CHI
20201224886	LUZIANIA	LZ12372287	CRISTALINA S2	06/12/2020 08:46	06/12/2020 12:32	06/12/2020 08:46	06/12/2020 12:32	3,75	14	52,51	CHI
20201224996	NIQUELANDIA	NQ12314130	NIQUELANDIA SUBTRANSMISSAO	06/12/2020 08:46	06/12/2020 11:10	06/12/2020 08:46	06/12/2020 11:10	2,40	12	28,77	CHI
20201224821	VARJAO	VJ21381661	GUAPO S2	06/12/2020 08:47	06/12/2020 12:43	06/12/2020 08:47	06/12/2020 12:43	3,92	1	3,92	CHI
20201224826	PIRENOPOLIS	PV12093270	SAO FRANCISCO DE GOIAS	06/12/2020 08:48	06/12/2020 12:47	06/12/2020 08:48	06/12/2020 12:47	3,97	8	31,78	CHI
20201225298	MUNDO NOVO DE GOIAS	MH12269055	NOVA CRIXAS	06/12/2020 08:48	06/12/2020 20:36	06/12/2020 08:48	06/12/2020 20:36	11,79	29	341,99	CHI
20201224833	SAO MIGUEL DO PASSA QUATRO	SQ21373969	BELA VISTA S2	06/12/2020 08:49	06/12/2020 11:54	06/12/2020 08:49	06/12/2020 11:54	3,08	1	3,08	CHI
20201224834	AVELINOPOLIS	AV21138865	ANICUNS	06/12/2020 08:49	06/12/2020 15:16	06/12/2020 08:49	06/12/2020 15:16	6,44	1	6,44	CHI
20201224838	LEOPOLDO DE BULHOES	LB21032420	DAIA S2	06/12/2020 08:49	06/12/2020 11:11	06/12/2020 08:49	06/12/2020 11:11	2,35	1	2,35	CHI
20201224849	ORIZONA	PR21090299	PIRES DO RIO S2	06/12/2020 08:50	06/12/2020 10:49	06/12/2020 08:50	06/12/2020 10:49	1,98	1	1,98	CHI
20201224852	PONTALINA	PK12106143	GOIATUBA S1	06/12/2020 08:50	06/12/2020 12:13	06/12/2020 08:50	06/12/2020 12:13	3,37	4	13,48	CHI
20201224852	JOVIANIA	PK12106143	GOIATUBA S1	06/12/2020 08:50	06/12/2020 12:13	06/12/2020 08:50	06/12/2020 12:13	3,37	1	3,37	CHI
20201228665	COCALZINHO DE GOIAS	CB12090420	COCALZINHO	06/12/2020 08:50	06/12/2020 23:14	06/12/2020 08:50	06/12/2020 23:14	14,39	14	201,44	CHI
20201224866	CAMPINACU	UC21239733	PORANGATU	06/12/2020 08:52	06/12/2020 16:43	06/12/2020 08:52	06/12/2020 16:43	7,84	2	15,69	CHI
20201224868	EDEALINA	1130014955	PONTALINA	06/12/2020 08:52	06/12/2020 10:14	06/12/2020 08:52	06/12/2020 10:14	1,36	1	1,36	CHI
20201226527	ALEXANIA	AX12353458	ALEXANIA	06/12/2020 08:52	06/12/2020 16:28	06/12/2020 08:52	06/12/2020 16:28	7,59	17	129,04	CHI
20201224889	NOVO GAMA	10000198879	PACAEMBU S2	06/12/2020 08:53	06/12/2020 13:57	06/12/2020 08:53	06/12/2020 13:57	5,05	1	5,05	CHI
20201224909	MORRINHOS	MR12204554	MORRINHOS	06/12/2020 08:53	06/12/2020 12:50	06/12/2020 08:53	06/12/2020 12:50	3,94	6	23,65	CHI

20201225964	ALEXANIA	AX12326379	ALEXANIA	06/12/2020 08:54	06/12/2020 14:07	06/12/2020 08:54	06/12/2020 14:07	5,21	108	562,59	CHI
20201224910	TROMBAS	TB12284700	PORANGATU	06/12/2020 08:56	07/12/2020 16:08	06/12/2020 08:56	07/12/2020 16:08	31,20	2	62,40	CHI
20201224912	FORMOSA	FA32218560	SAO JOAO D ALIANCA	06/12/2020 08:56	07/12/2020 16:44	06/12/2020 08:56	07/12/2020 16:44	31,80	1	31,80	CHI
20201224917	MONTES CLAROS DE GOIAS	ME12270281	IPORA	06/12/2020 08:56	06/12/2020 17:50	06/12/2020 08:56	06/12/2020 17:50	8,89	1	8,89	CHI
20201224921	URUTAI	UT32063557	URUTAI	06/12/2020 08:56	06/12/2020 17:14	06/12/2020 08:56	06/12/2020 17:14	8,29	1	8,29	CHI
20201224925	CATALAO	CT21134406	CATALAO S1	06/12/2020 08:57	06/12/2020 16:31	06/12/2020 08:57	06/12/2020 16:31	7,56	1	7,56	CHI
20201224929	FORMOSA	FA11344132	SAO JOAO D ALIANCA	06/12/2020 08:57	06/12/2020 18:49	06/12/2020 08:57	06/12/2020 18:49	9,86	1	9,86	CHI
20201224930	ITAPACI	IW12335647	RUBIATABA	06/12/2020 08:57	06/12/2020 20:38	06/12/2020 08:57	06/12/2020 20:38	11,68	2	23,35	CHI
20201224930	GUARINOS	IW12335647	RUBIATABA	06/12/2020 08:57	06/12/2020 20:38	06/12/2020 08:57	06/12/2020 20:38	11,68	2	23,35	CHI
20201224934	IVOLANDIA	10017971428	IPORA	06/12/2020 08:57	06/12/2020 15:00	06/12/2020 08:57	06/12/2020 15:00	6,04	1	6,04	CHI
20201224936	GOIANIRA	390047843	GOIANIRA	06/12/2020 08:58	06/12/2020 12:06	06/12/2020 08:58	06/12/2020 12:06	3,13	1	3,13	CHI
20201224938	JANDAIA	JD21008649	PALMEIRAS	06/12/2020 08:58	06/12/2020 20:46	06/12/2020 08:58	06/12/2020 20:46	11,80	1	11,80	CHI
20201226975	SAO JOAO D ALIANCA	ND12302636	IACIARA S2	06/12/2020 08:58	06/12/2020 17:31	06/12/2020 08:58	06/12/2020 17:31	8,55	13	111,09	CHI
20201226975	NOVA ROMA	ND12302636	IACIARA S2	06/12/2020 08:58	06/12/2020 17:31	06/12/2020 08:58	06/12/2020 17:31	8,55	101	863,10	CHI
20201226975	ALTO PARAISO DE GOIAS	ND12302636	IACIARA S2	06/12/2020 08:58	06/12/2020 17:31	06/12/2020 08:58	06/12/2020 17:31	8,55	18	153,82	CHI
20201224942	NIQUELANDIA	NQ21136318	URUACU	06/12/2020 08:59	06/12/2020 11:41	06/12/2020 08:59	06/12/2020 11:41	2,70	2	5,39	CHI
20201227115	AMARALINA	MQ12050047	MARA ROSA	06/12/2020 08:59	06/12/2020 19:14	06/12/2020 08:59	06/12/2020 19:14	10,24	233	2385,73	CHI

5. Plotagem das Ocorrências conforme a Especialização das Chuvas

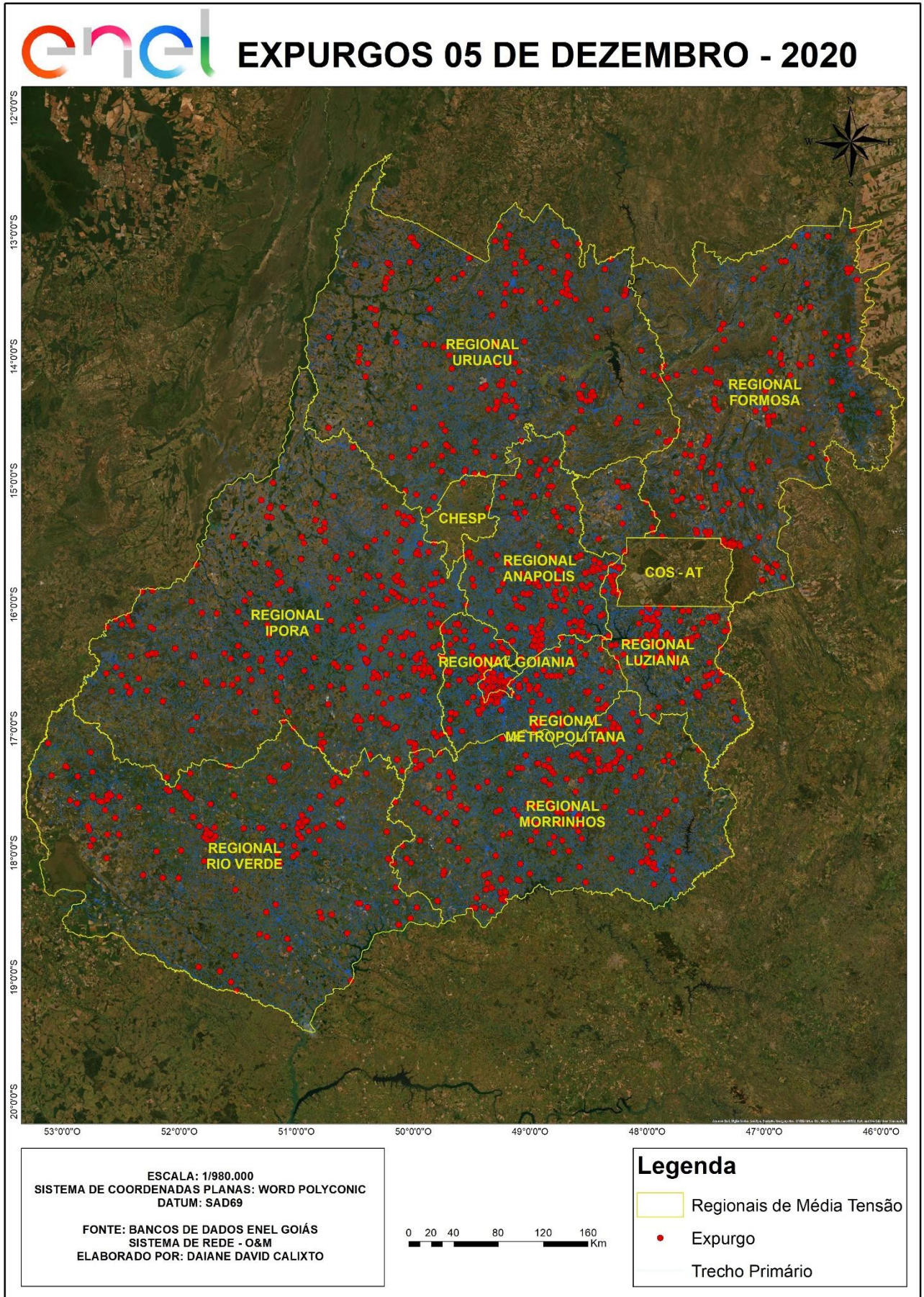

6. Clientes Afetados e Impactos Globais

Em análise ao número de clientes interrompidos (CI) na área de concessão da ENEL GO, a figura abaixo apresenta a atipicidade vivenciada no dia 05 e 06 de dezembro de 2020, data esta que, conforme laudo meteorológico emitido por empresa especializada, a referida concessão passou por um período de condições climáticas de extrema severidade.

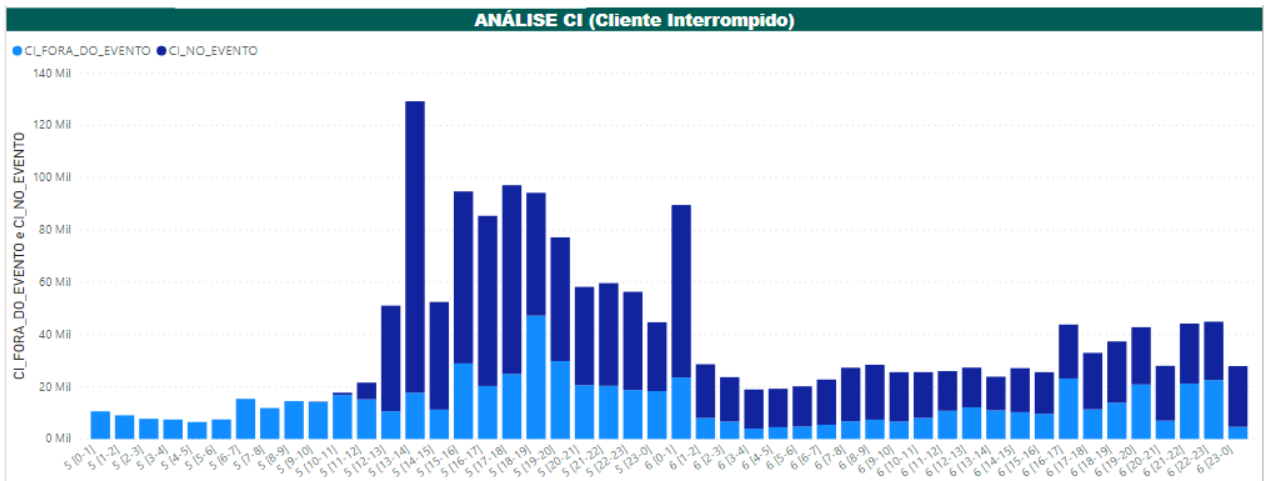

Figuras – Clientes Interrompidos em intervalos de horas

Na figura acima, as barras em azul claro representam a quantidade de clientes interrompidos simultaneamente em condições normais de operação, e as barras azul escuro os clientes interrompidos simultaneamente no período do evento.

7. Diagramas Unifilares

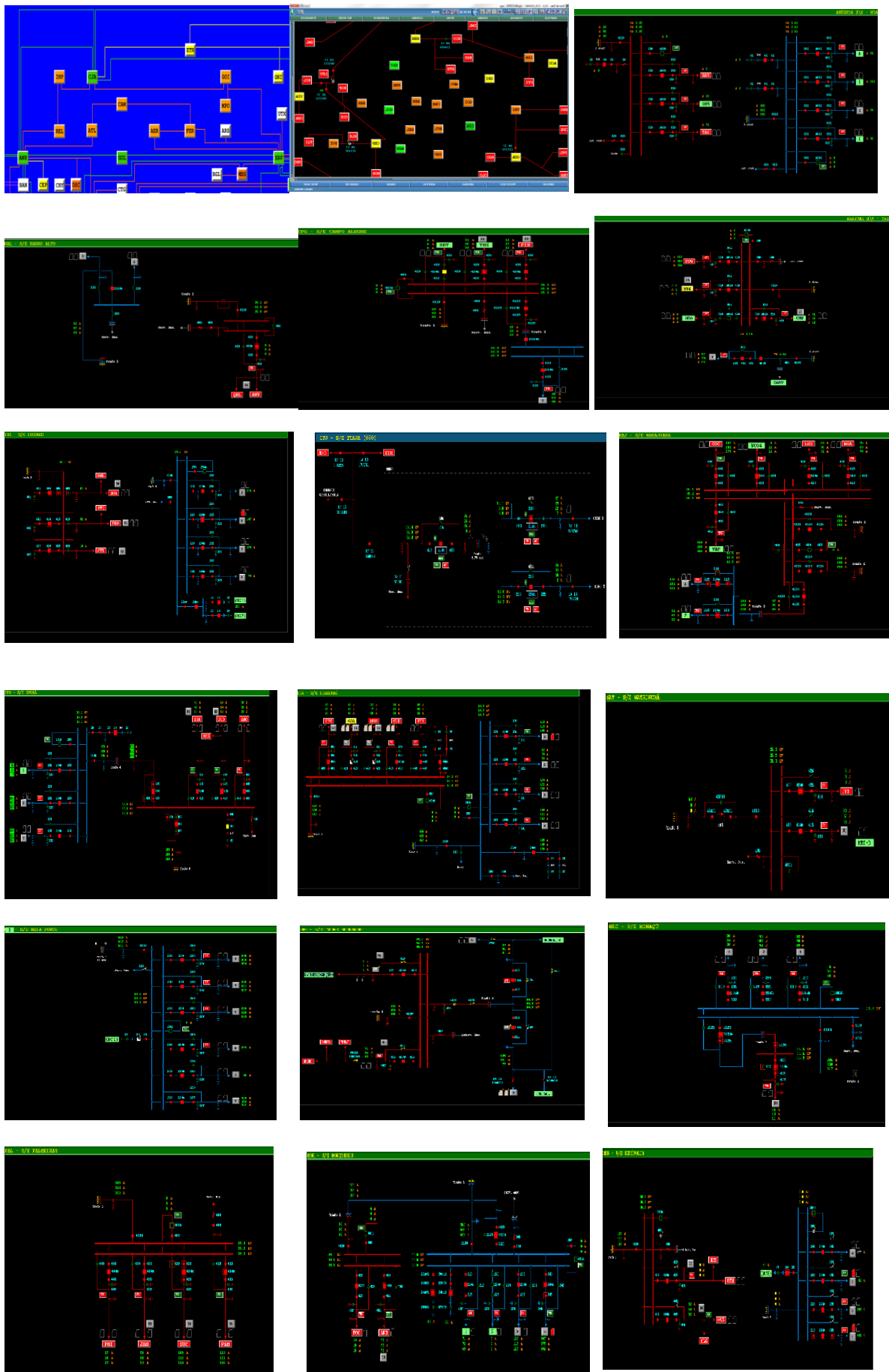

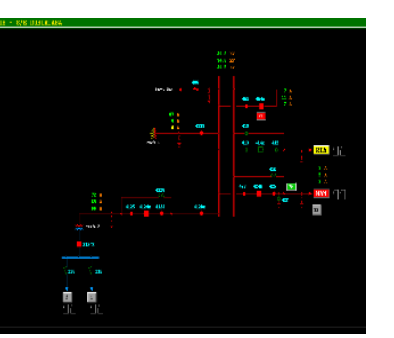
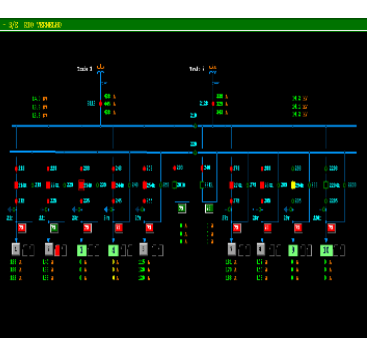
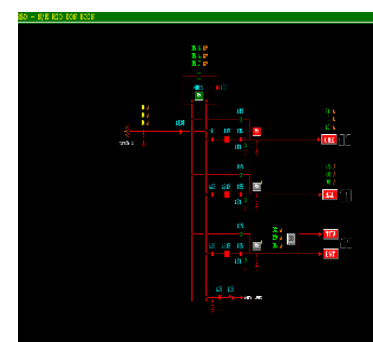
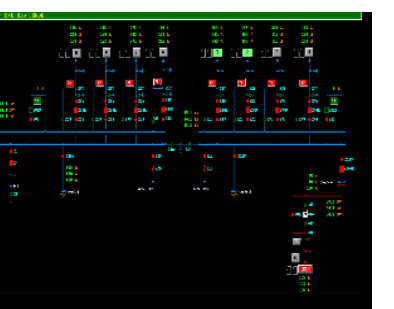
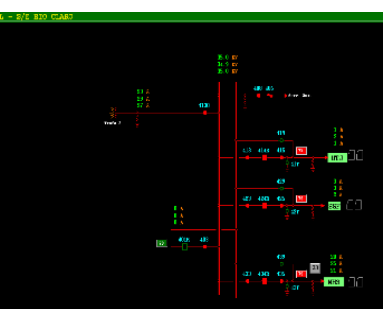
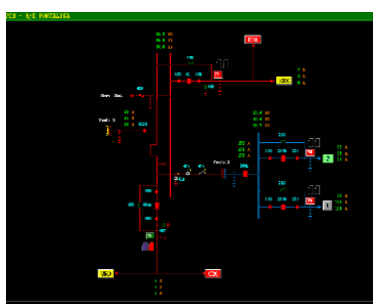
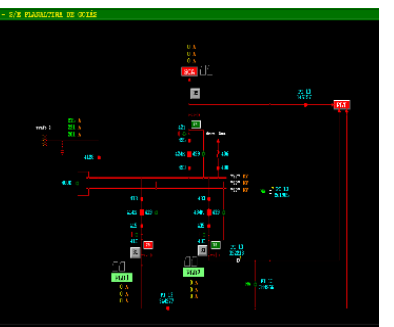
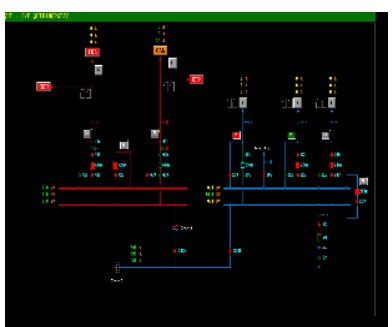
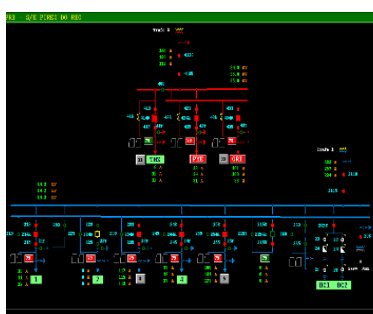
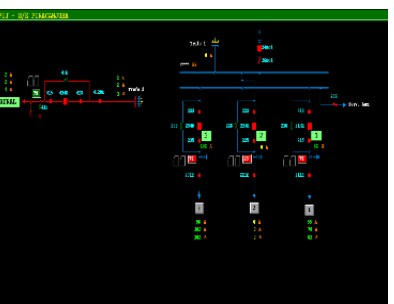
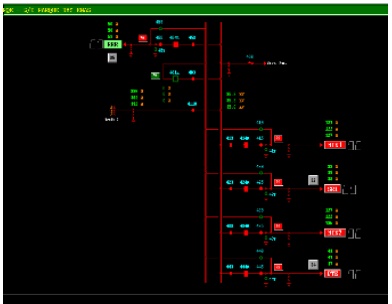
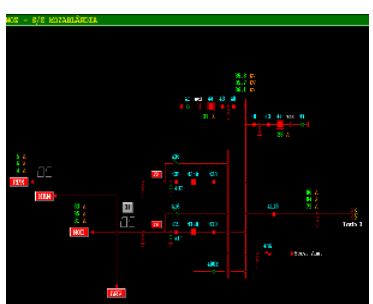
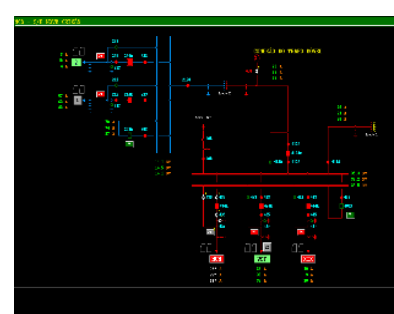
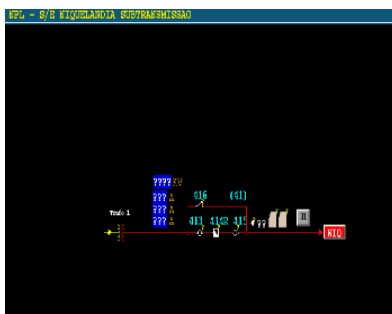
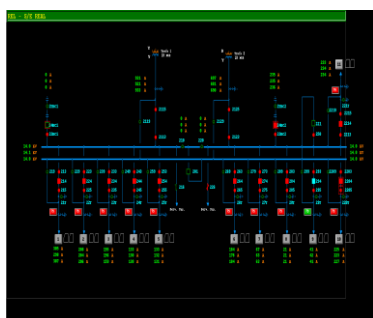

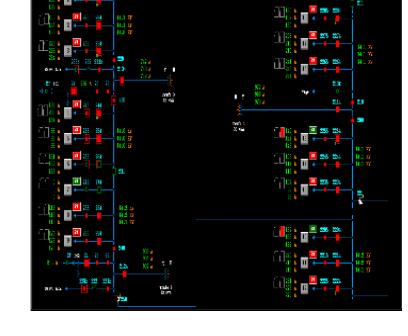
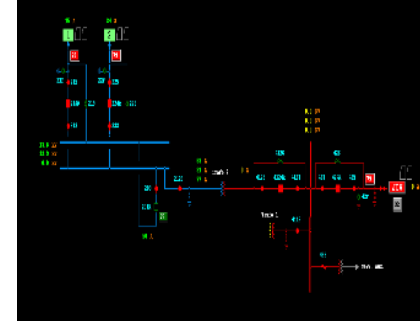
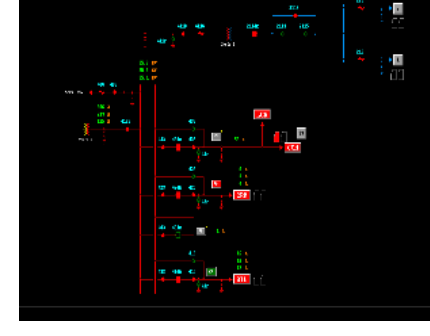
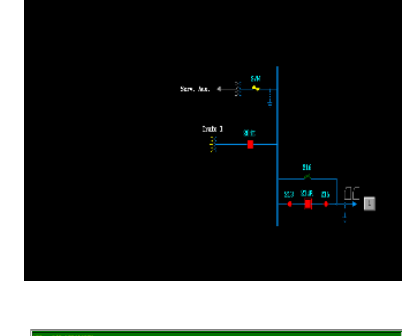
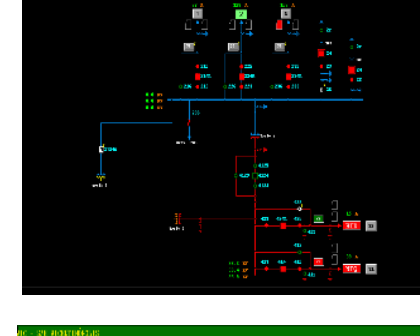
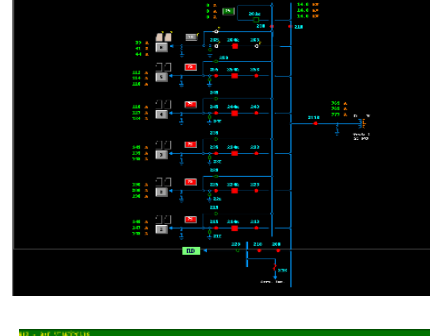
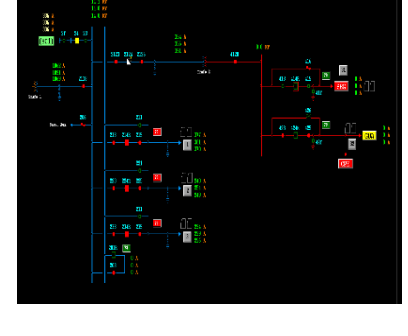
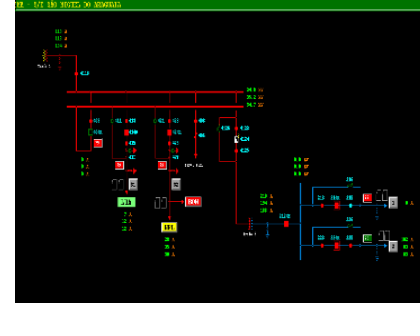
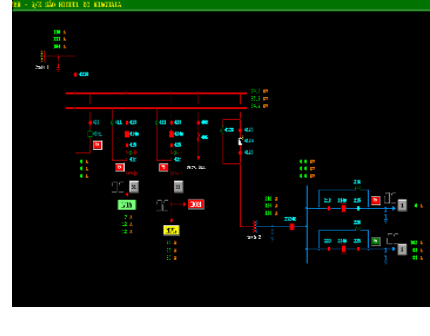
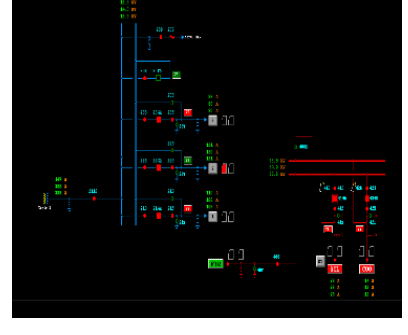
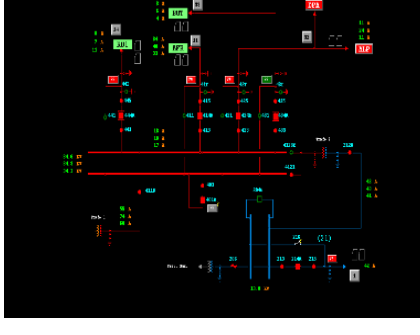
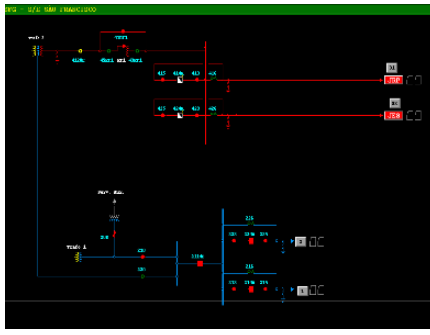
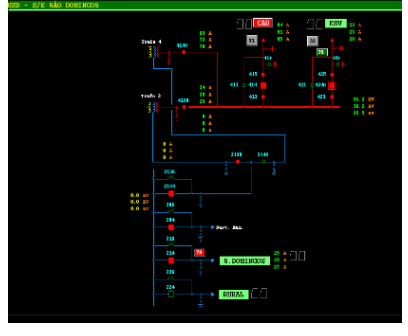
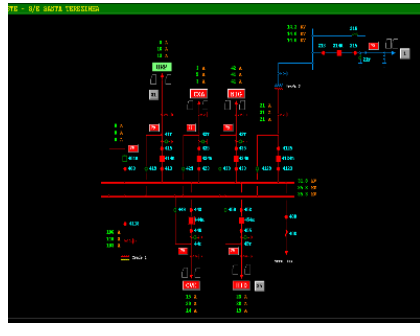
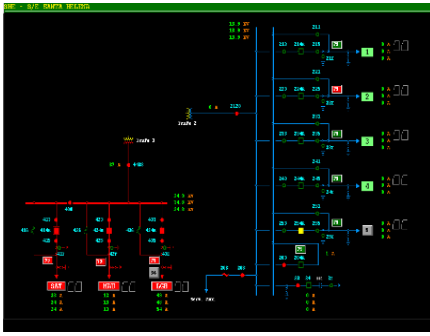

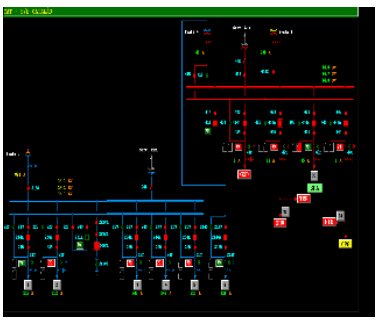
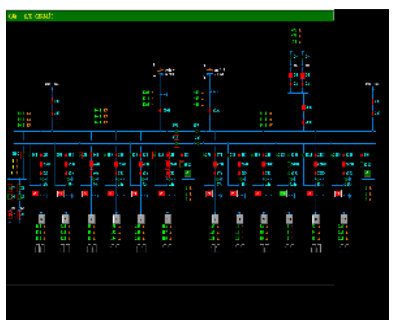
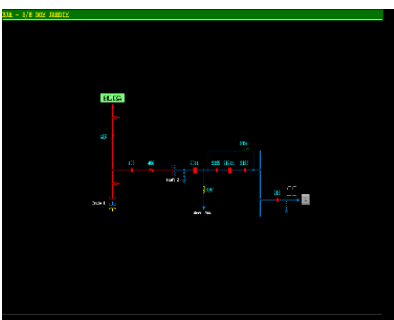
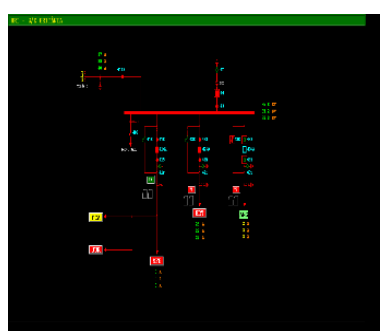
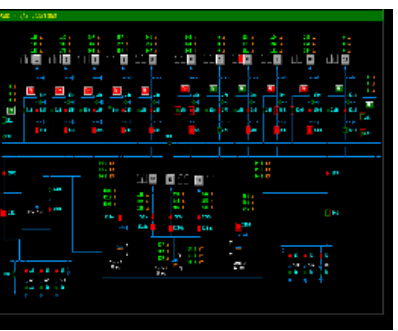
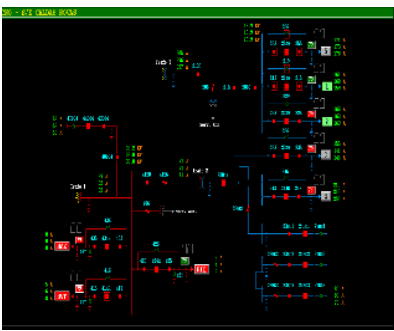
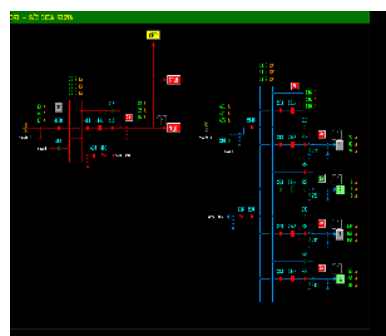
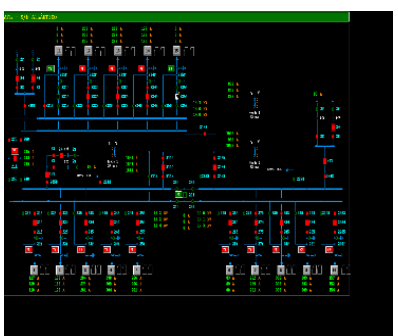
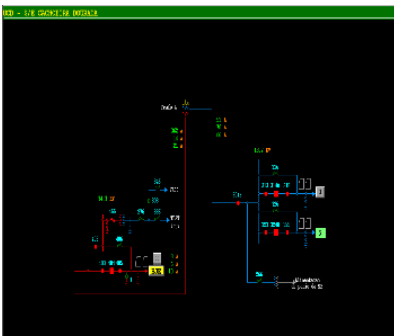
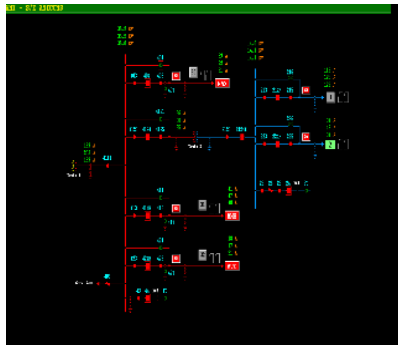
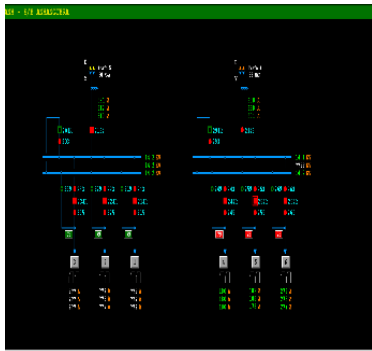
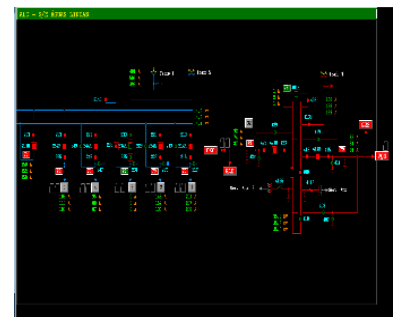
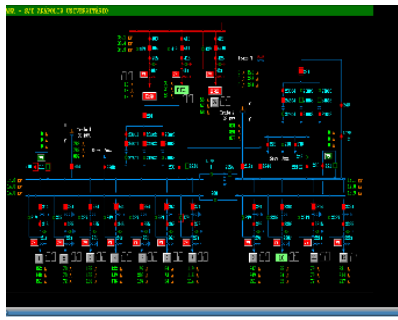
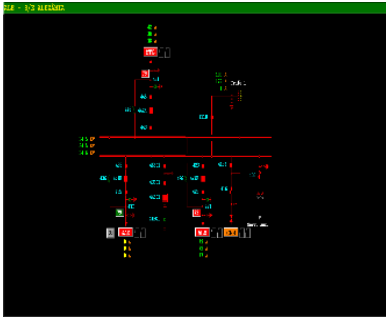

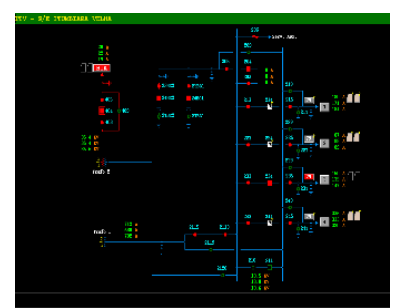
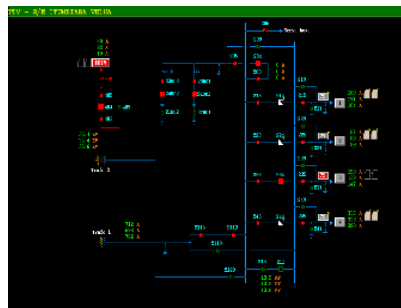
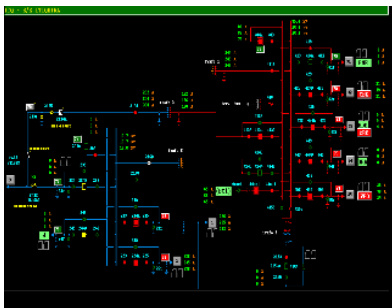
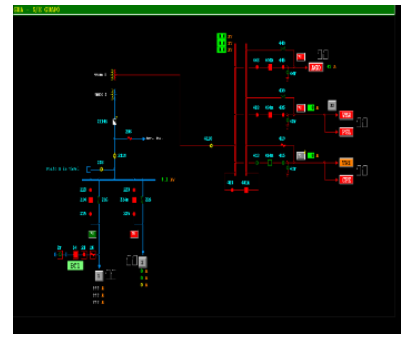
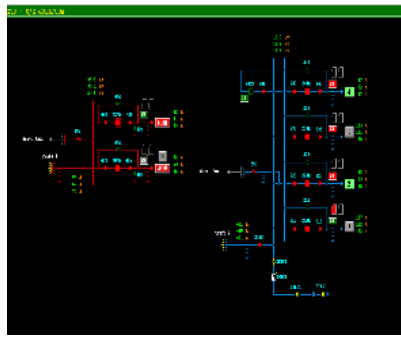
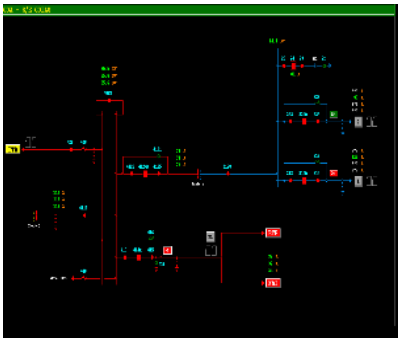
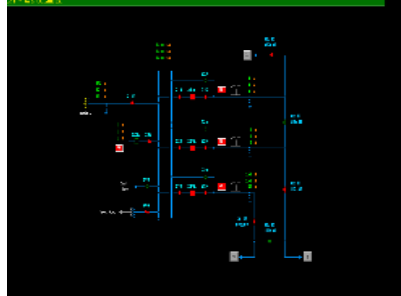
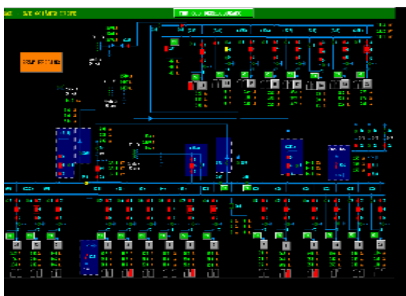
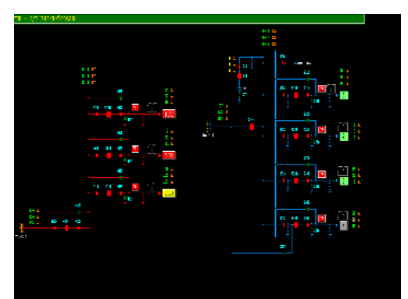
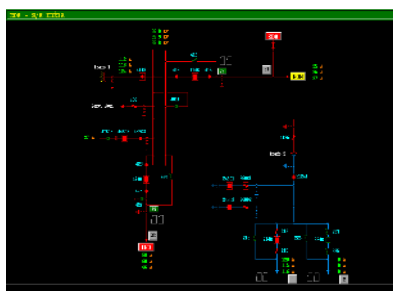
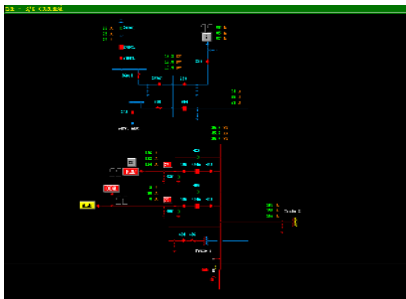
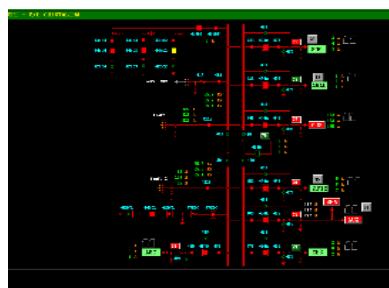
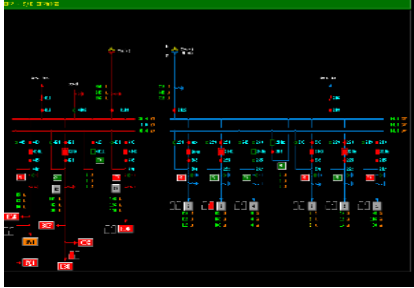
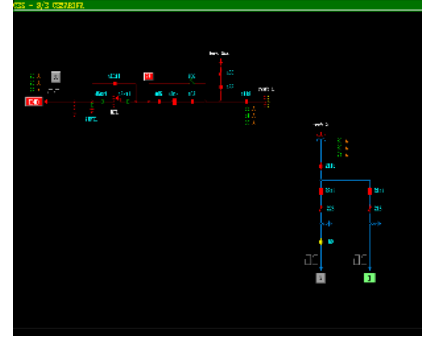
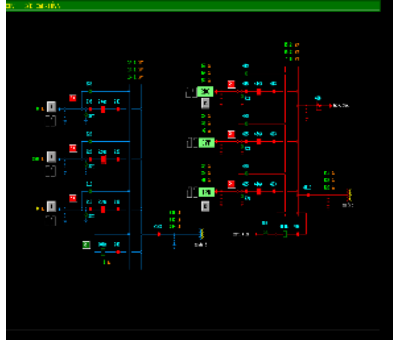
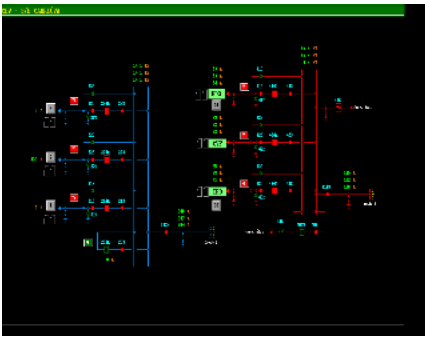

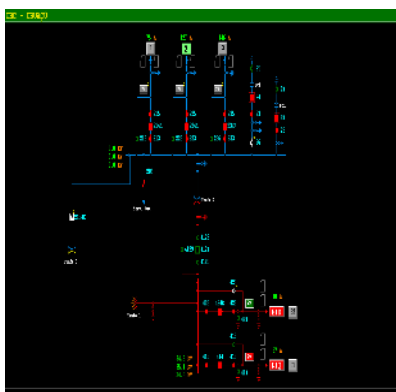
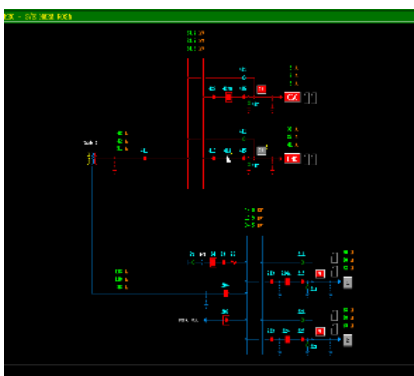
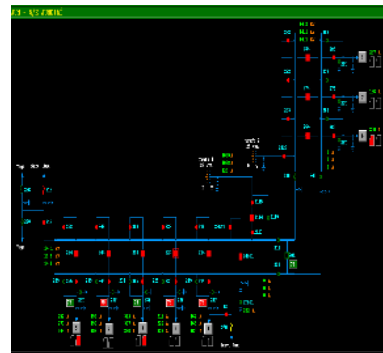
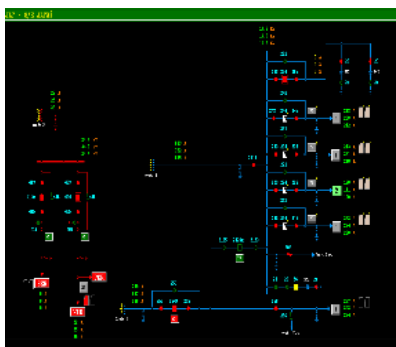
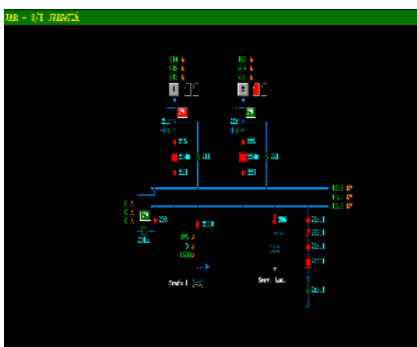

8. DEMAIS EVIDÊNCIAS

8.1. DADOS TÉCNICO - OPERACIONAIS ENEL GO

Enel - GO

TMAE e OE por Dia - Dezembro 2020

● Contagem de Ocorrências ● TMAE

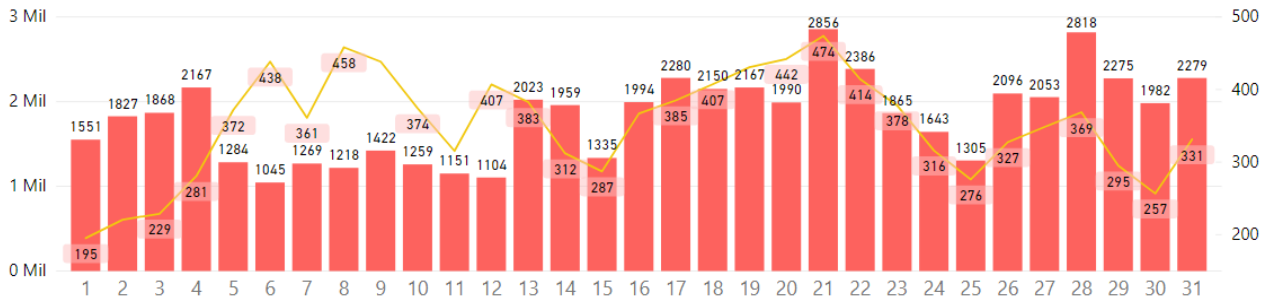

Regional Anápolis – GO

TMAE e OE por Dia - Dezembro 2020

● Contagem de Ocorrências ● TMAE

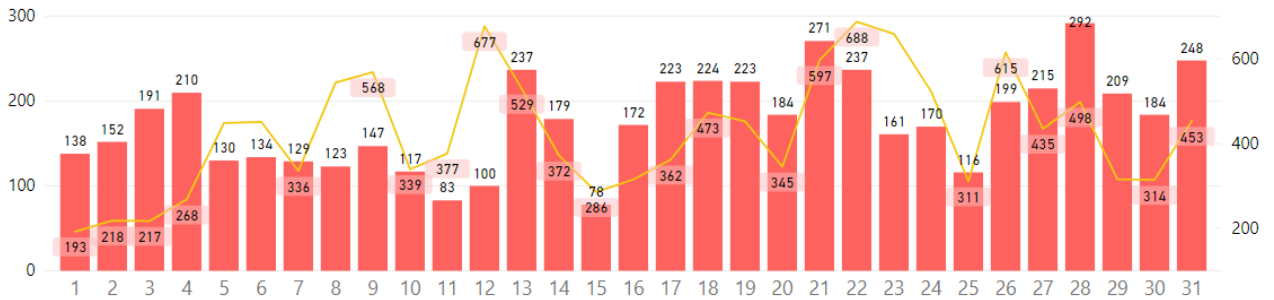

Regional Formosa – GO

TMAE e OE por Dia - Dezembro 2020

● Contagem de Ocorrências ● TMAE

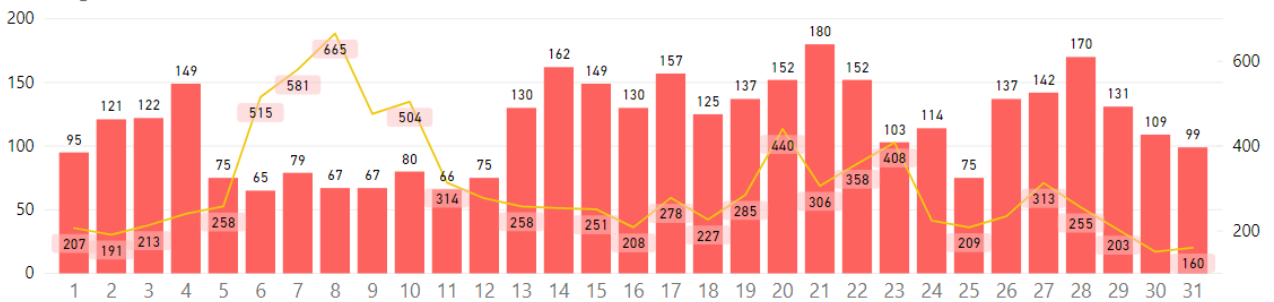

Regional Goiânia – GO

TMAE e OE por Dia - Dezembro 2020

● Contagem de Ocorrências ● TMAE

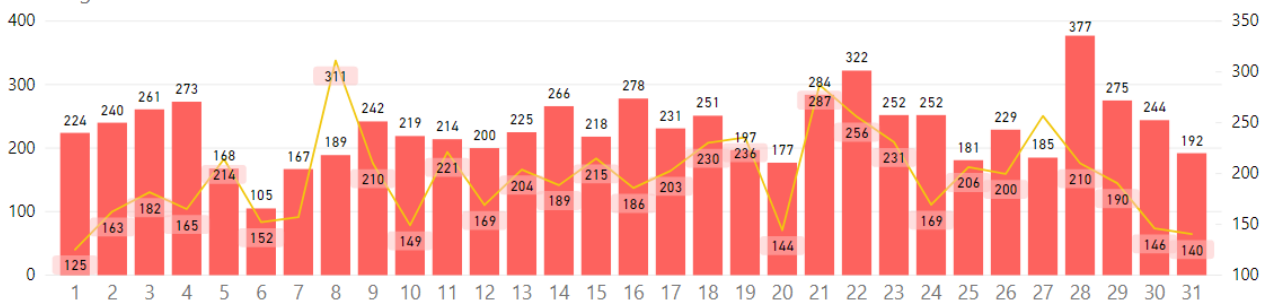

Regional Iporá – GO

TMAE e OE por Dia - Dezembro 2020

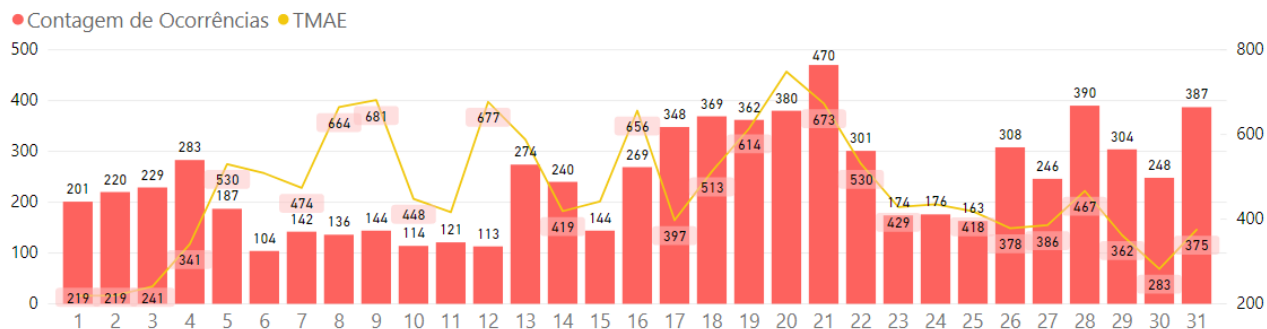

Regional Luziânia – GO

TMAE e OE por Dia - Dezembro 2020

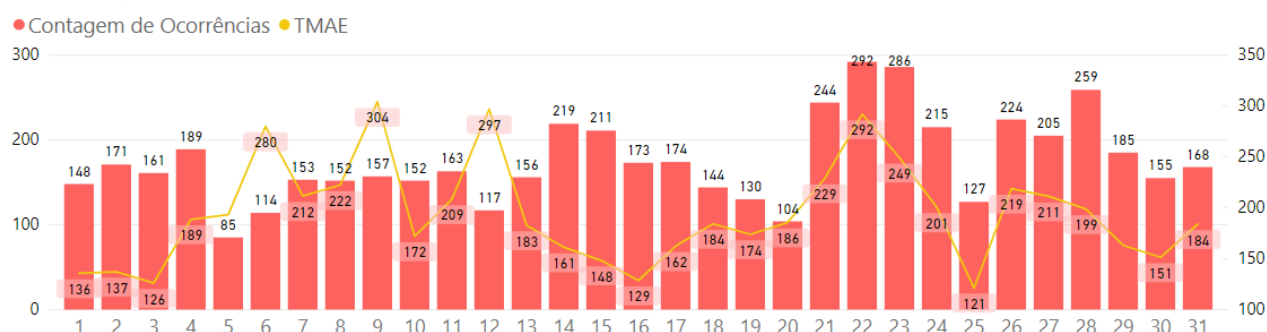

Regional Metropolitana – GO

TMAE e OE por Dia - Dezembro 2020

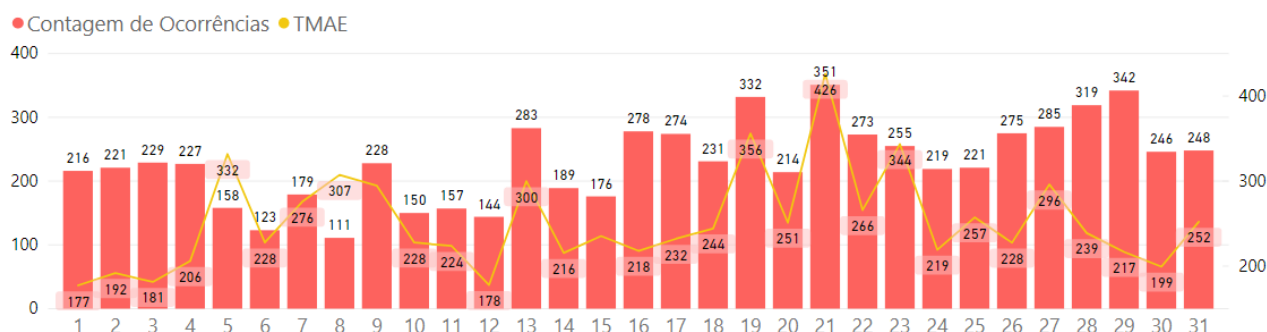

Regional Morrinhos – GO

TMAE e OE por Dia - Dezembro 2020

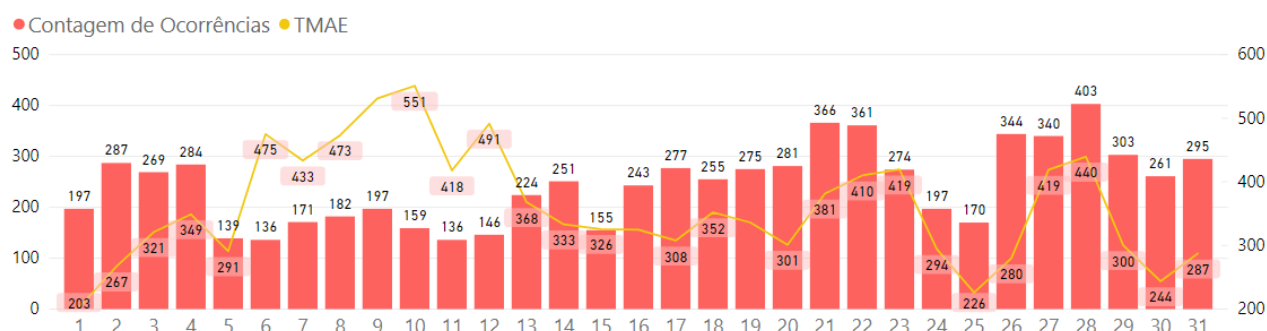

Regional Rio Verde – GO

TMAE e OE por Dia - Dezembro 2020

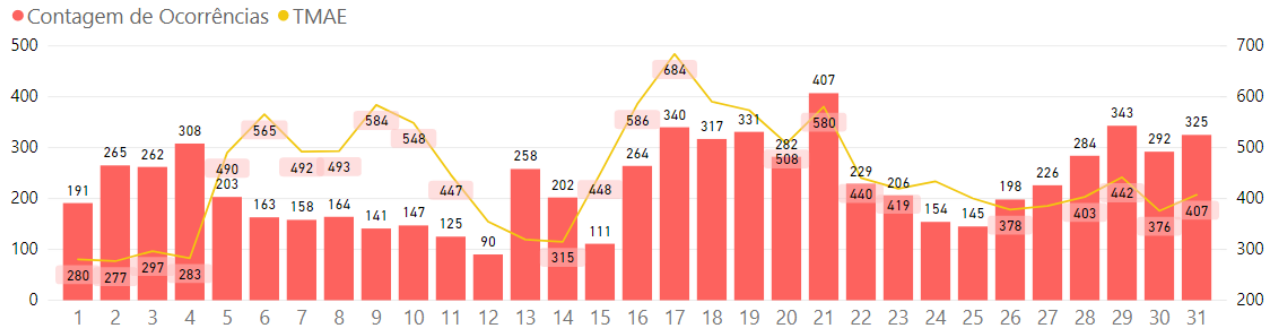

Regional Uruaçu - GO

TMAE e OE por Dia - Dezembro 2020

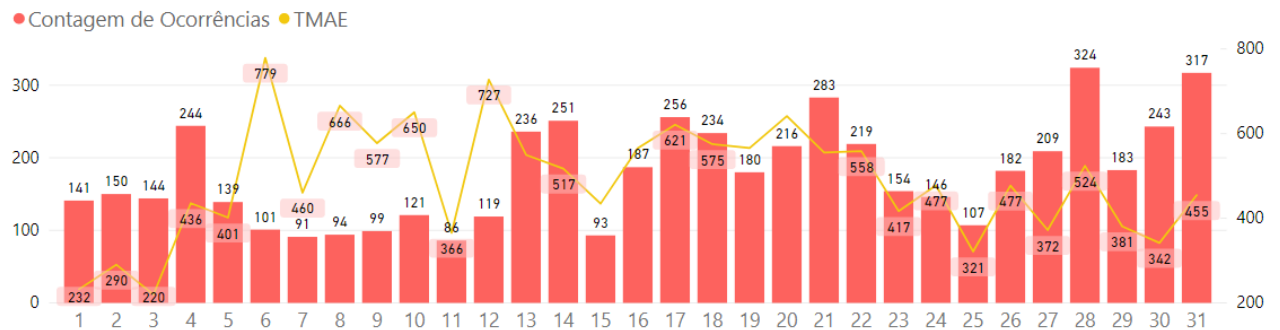

8.2. Dados climatológicos pelo INMET

Instituto Nacional de Meteorologia – INMET

Chuva Acumulada em 24h || Estação: ARAGARCAS (83368) – 12/2020

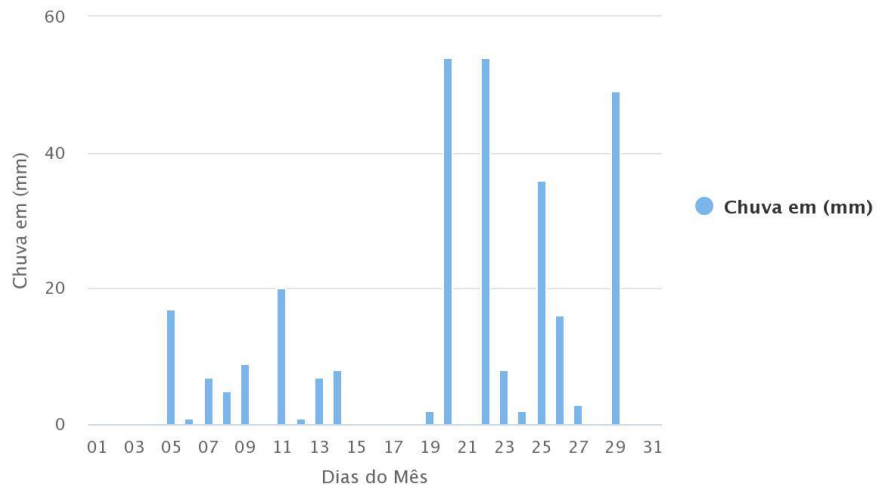

Instituto Nacional de Meteorologia – INMET

Chuva Acumulada em 24h || Estação: CATALAO (83526) – 12/2020

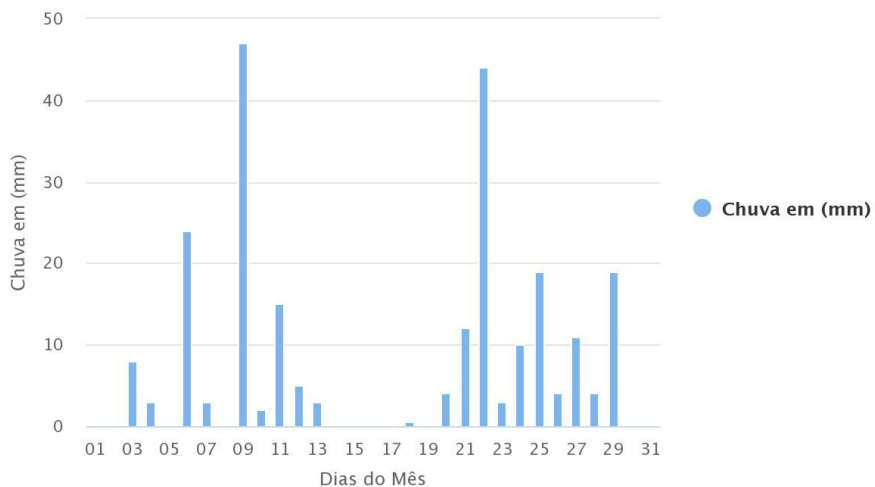

Highcharts.com

Instituto Nacional de Meteorologia – INMET

Chuva Acumulada em 24h || Estação: FORMOSA (83379) – 12/2020

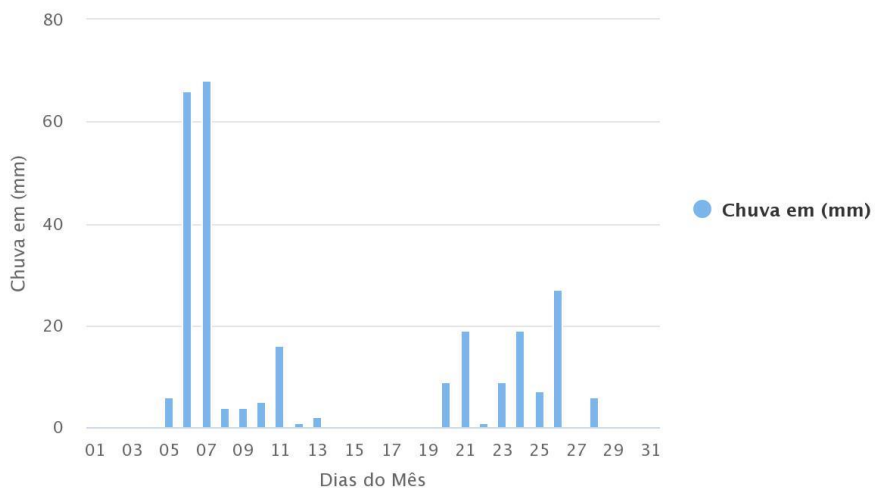

Highcharts.com

Instituto Nacional de Meteorologia – INMET

Chuva Acumulada em 24h || Estação: GOIANIA (83423) – 12/2020

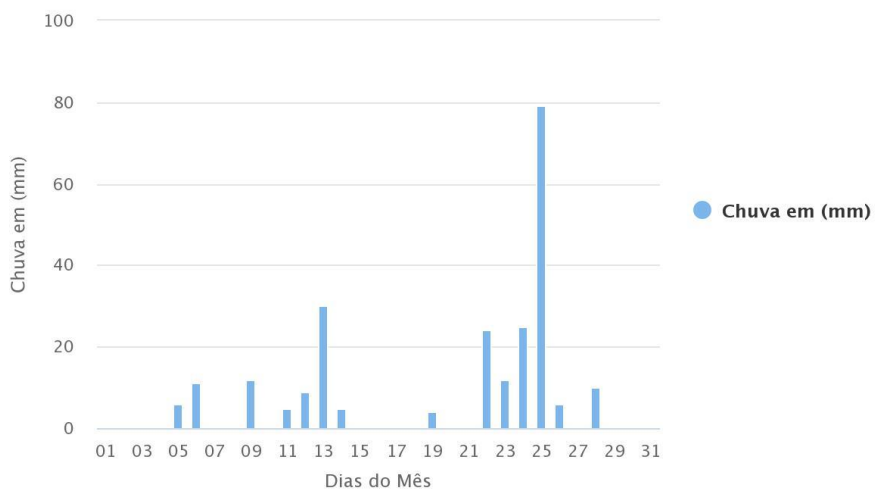

Highcharts.com

Instituto Nacional de Meteorologia – INMET

Chuva Acumulada em 24h || Estação: IPAMERI (83522) – 12/2020

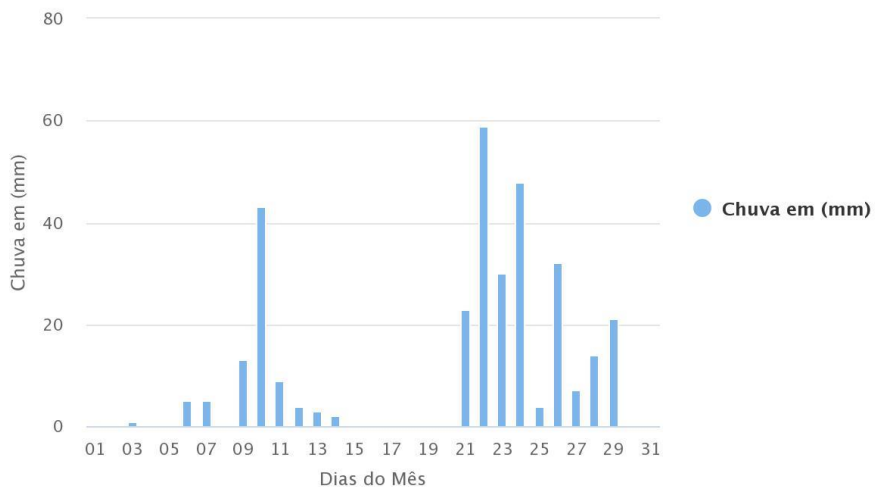

Highcharts.com

Instituto Nacional de Meteorologia – INMET

Chuva Acumulada em 24h || Estação: JATAI (83464) – 12/2020

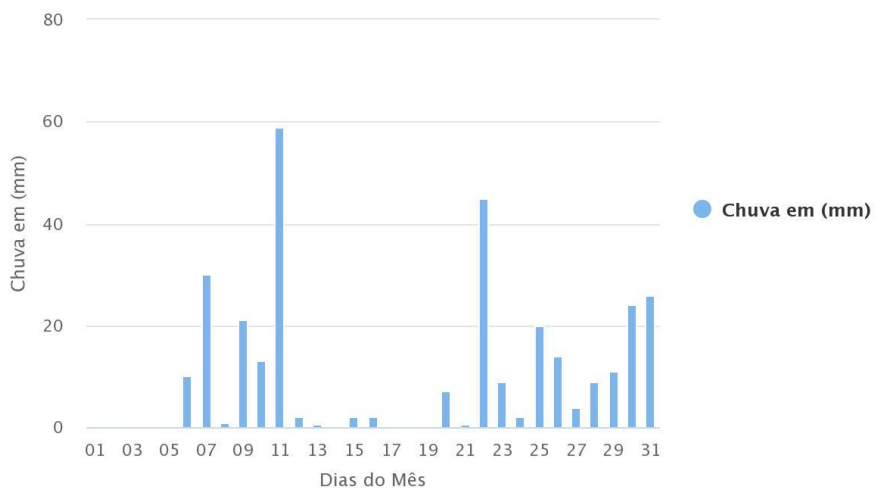

Highcharts.com

Instituto Nacional de Meteorologia – INMET

Chuva Acumulada em 24h || Estação: PIRENOPOLIS (83376) – 12/2020

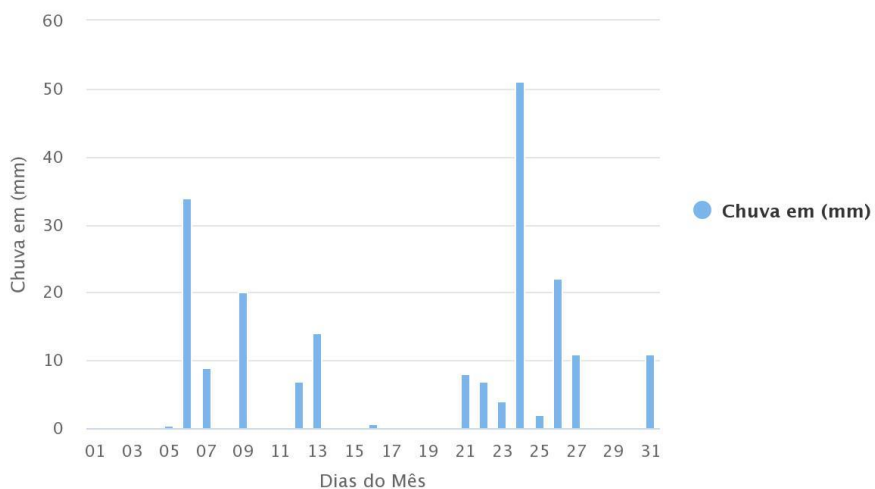

Highcharts.com

Instituto Nacional de Meteorologia – INMET

Chuva Acumulada em 24h || Estação: RIO VERDE (83470) – 12/2020

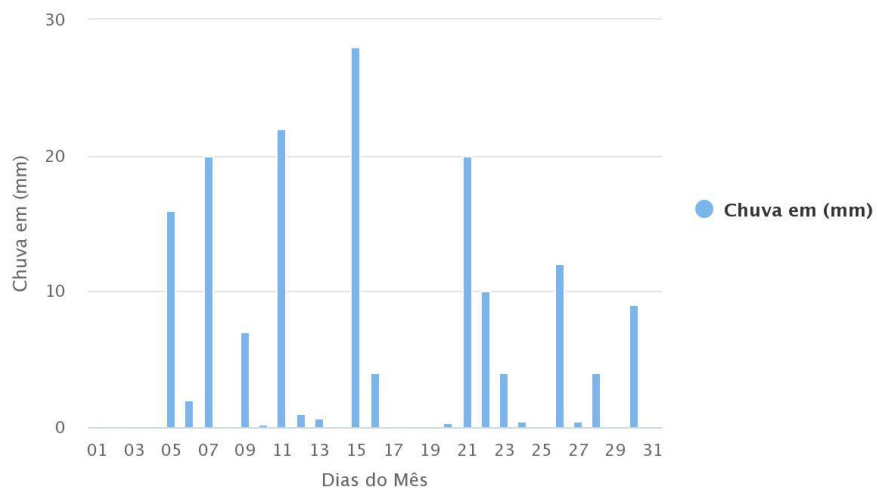

Highcharts.com

9. NOTÍCIAS RELACIONADAS

<https://globoplay.globo.com/v/9079304>

#JornalAnhanguera

JJA

JA 2ª Edição >

Por conta da chuva, árvores caem em diferentes regiões de Goiânia

2 min Exibição em 5 dez 2020

Uma delas foi no bairro Vila Redenção.

<https://globoplay.globo.com/v/9079305>

#JornalAnhanguera

JJA

JA 2ª Edição >

Telespectadores registram chuva forte em Pirenópolis e Aparecida de Goiânia

26 seg Exibição em 5 dez 2020

Vídeos mostram vento forte e ruas alagadas.

<https://www.instagram.com/p/C1bcD0gFpZl/>

maisgoiás

Final de semana será de chuva em Goiânia; confira a previsão

maisgoias • Seguindo

maisgoias O goianiense que esperava ansioso pela chuva pode comemorar. De acordo com informações do Instituto Nacional de Meteorologia (Inmet), Goiânia terá um final de semana chuvoso. As pancadas de chuva devem ocorrer até a próxima segunda-feira (7).

Segundo o Inmet, neste sábado (5) o tempo será de muitas nuvens com possibilidade de chuvas isoladas na capital, com maior possibilidade de temporais no período da noite. A temperatura mínima será de 23°C e a máxima de 32°C. A umidade máxima do ar ficará em 80%, e a mínima em 40%.

Curtido por camiloaraujoegito e outras 11.557 pessoas

5 DE DEZEMBRO DE 2020

Adicione um comentário... [Publicar](#)

<https://www.instagram.com/p/C1bAxjwKQu/>

maisgoiás

maisgoias Tempo: chove forte nesse momento em vários bairros de Aparecida de Goiânia.

12 sem

nascimento.aida Que delícia.

28.945 visualizações

5 DE DEZEMBRO DE 2020

Adicione um comentário... [Publicar](#)

10. Laudo Técnico

CLIMATEMPO

**Laudo Meteorológico de Evento Climático -
ENEL Goiás - 05 de dezembro de 2020**

São Paulo, SP, Brasil

Janeiro de 2021

Sumário

1	ANÁLISE DE EVENTO METEOROLÓGICO.....	2
1.1	Descrição do Evento.....	2
1.2	Abrangência do Evento.....	5
2	CLASSIFICAÇÃO COBRADE.....	8
3	RESUMO DO EVENTO.....	9
4	REFERÊNCIAS.....	13
	ANEXOS.....	14

1. Análise de Evento Meteorológico

1.1. Descrição do Evento

Na figura a seguir é apresentada a área de concessão da ENEL DISTRIBUIÇÃO GOIÁS, dividida em regiões, a serem analisadas neste relatório.



Figura 1 – Regiões atendidas pela ENEL Goiás.

Uma massa de ar quente e úmido predominava sobre o estado de Goiás no dia 05 de dezembro de 2020, e as condições eram favoráveis à formação de nuvens de tempestades sobre a área de concessão da ENEL GO.

Nas Figuras 2 e 3 são apresentadas as descargas atmosféricas nuvem-solo (raios) e nuvem-nuvem detectadas pelo sistema Earth Networks. Entre as 08h30 do dia 05 e 07h15 do dia 06 de dezembro de 2020 foram registrados 32831 raios nuvem-solo e 107432 descargas nuvem-nuvem sobre a área da ENEL DISTRIBUIÇÃO GOIÁS.

Na tabela 1 são apresentadas as rajadas de vento de 50 km/h ou mais registradas por estações do Instituto Nacional de Meteorologia (INMET) representativas da área de concessão da ENEL GO. O maior valor registrado foi de 68,8 km/h em Jataí entre as 15h e 16h do dia 05 de dezembro, vento classificado como ventania pela escala Beaufort.

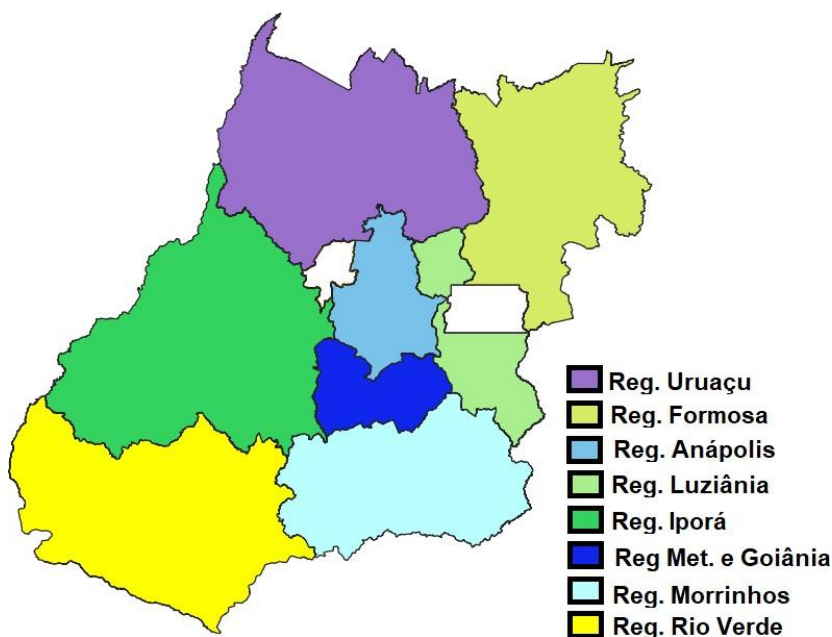
As estações do INMET também registraram chuva forte (segundo a American Meteorological Society - Sociedade Meteorológica Americana -), chuvas com taxa entre



Figura 2 – Descargas atmosféricas nuvem-solo (em preto) detectadas pelo sistema Earth Networks entre 08h30 do dia 05 e 07h15 do dia 06 de dezembro de 2020 sobre a área de concessão da ENEL DISTRIBUIÇÃO GOIÁS.



Figura 3 – Descargas atmosféricas nuvem-nuvem (em vermelho) detectadas pelo sistema Earth Networks entre 08h30 do dia 05 e 07h15 do dia 06 de dezembro de 2020 sobre a área de concessão da ENEL DISTRIBUIÇÃO GOIÁS.

Tabela 1 – Rajadas de vento maiores ou iguais a 50 km/h registradas pelo INMET. Se-gundo a escala Beaufort, ventos entre 50 e 61 km/h são classificados como vento forte e entre 62 e 74 km/h como ventania.

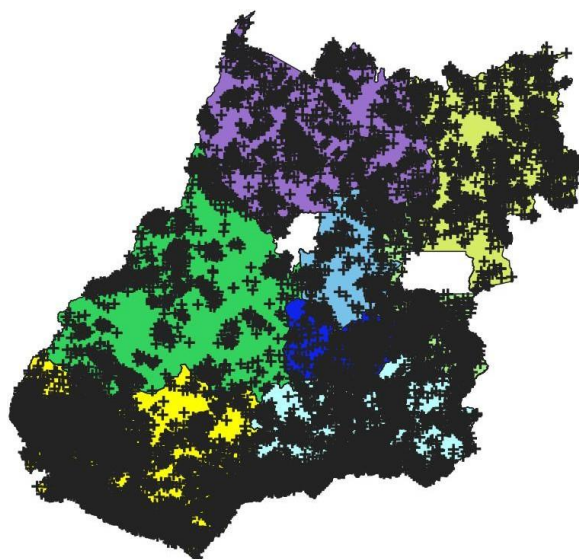
Estação	Horário	Rajada (km/h)
Alto Araguaia	Entre 12h e 13h do dia 5/12/2020	50.0
Goiás	Entre 13h e 14h do dia 5/12/2020	66.6
Caiapônia	Entre 15h e 16h do dia 5/12/2020	50.8
Jataí	Entre 15h e 16h do dia 5/12/2020	68.8

2,5mm a 7,6 mm por hora são consideradas moderadas e aquelas com taxa superior a 7,6 mm por hora são consideradas chuva forte). Na tabela 2 são apresentados os registros de acumulados horários superiores a 7,6 mm.

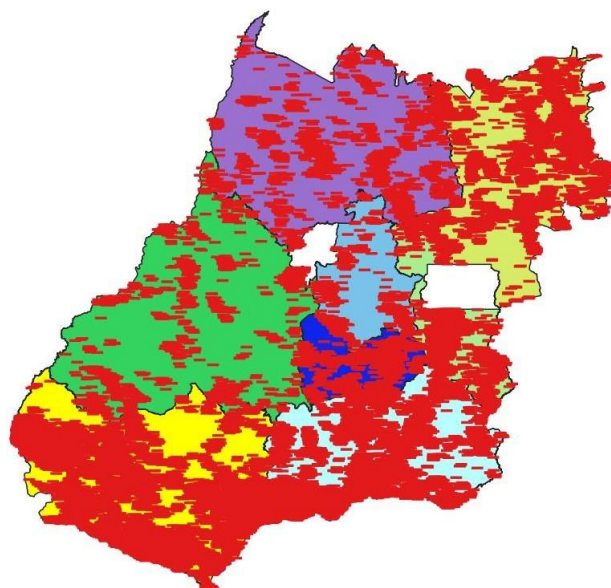
Tabela 2 – Acumulado horário de chuva registrada pelo INMET.

Estação	Horário	Precipitação (mm)
Mineiros	Entre 13h e 14h do dia 5/12/2020	15.0
Jataí	Entre 15h e 16h do dia 5/12/2020	9.6
Monte Alegre de Goiás	Entre 19h e 20h do dia 5/12/2020	9.8
Catalão	Entre 3h e 4h do dia 6/12/2020	16.4
Cristalina	Entre 3h e 4h do dia 6/12/2020	16.6

Na tabela 3 são apresentados os maiores acumulados em 24 horas registrados pelo INMET. O maior valor foi registrado em Formosa, com total de 66,0 mm, que corresponde aproximadamente 23% da média climatológica para o mês.

Tabela 3 – Precipitação acumulada entre 09h do dia 05 e 09h do dia 06 de dezembro de 2020. FONTE: INMET

Estação	Precipitação Acumulada(mm)
FORMOSA	66.0
PIRENOPOLIS	34.0
CRISTALINA	31.8
CATALÃO	30.6

1.2. Abrangência do Evento

A seguir são apresentadas as imagens realçadas do satélite GOES-16 entre as 12h00 do dia 05 e 06h00 do dia 06 de dezembro de 2020. Os tons em vermelho, preto e rosa indicam a presença de nuvens de grande desenvolvimento vertical, geralmente associadas à ocorrência de tempo severo.

12h00 - 05 de Dezembro de 2020 - BRT



Figura 4 – Imagens realçadas do satélite GOES-16 das 12h00 do dia 05 de Dezembro de 2020.
FONTE: Cptec/INPE.

15h00 - 05 de Dezembro de 2020 - BRT

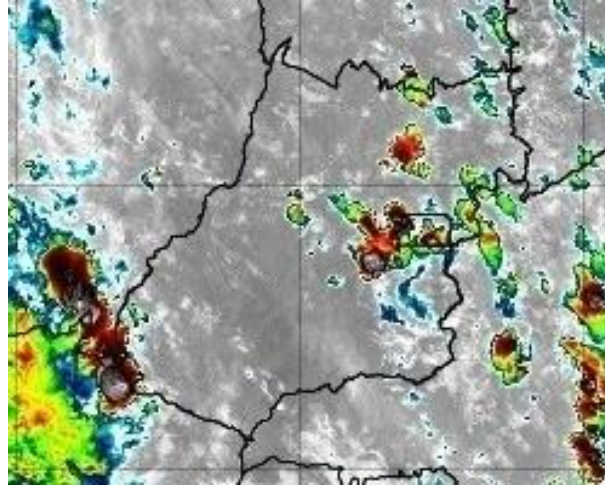

Figura 5 – Imagens realçadas do satélite GOES-16 das 15h00 do dia 05 de Dezembro de 2020.
FONTE: Cptec/INPE.

18h00 - 05 de Dezembro de 2020 - BRT

Figura 6 – Imagens realçadas do satélite GOES-16 das 18h00 do dia 05 de Dezembro de 2020.
FONTE: Cptec/INPE.

21h00 - 05 de Dezembro de 2020 - BRT

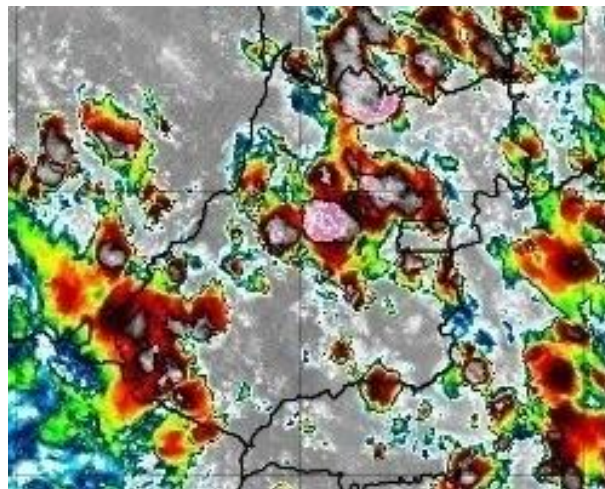
Figura 7 – Imagens realçadas do satélite GOES-16 das 21h00 do dia 05 de Dezembro de 2020.
FONTE: Cptec/INPE.

0h00 - 06 de Dezembro de 2020 - BRT

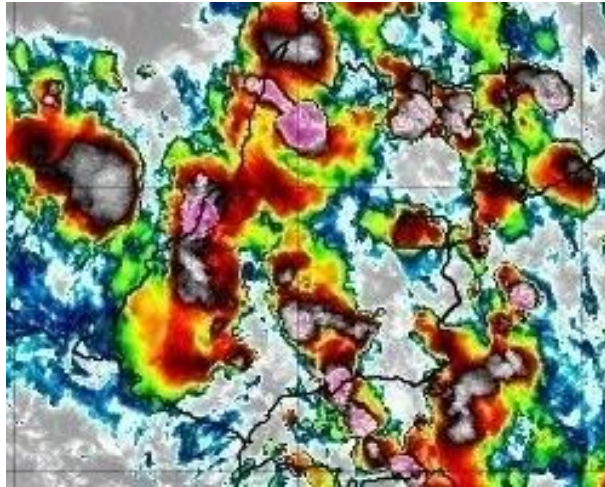
Figura 8 – Imagens realçadas do satélite GOES-16 das 0h00 do dia 06 de Dezembro de 2020.
FONTE: Cptec/INPE.

3h00 - 06 de Dezembro de 2020 - BRT

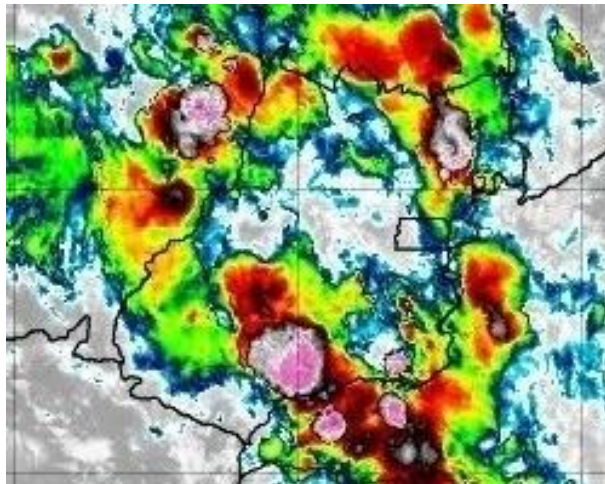
Figura 9 – Imagens realçadas do satélite GOES-16 das 3h00 do dia 06 de Dezembro de 2020.
FONTE: Cptec/INPE.

6h00 - 06 de Dezembro de 2020 - BRT

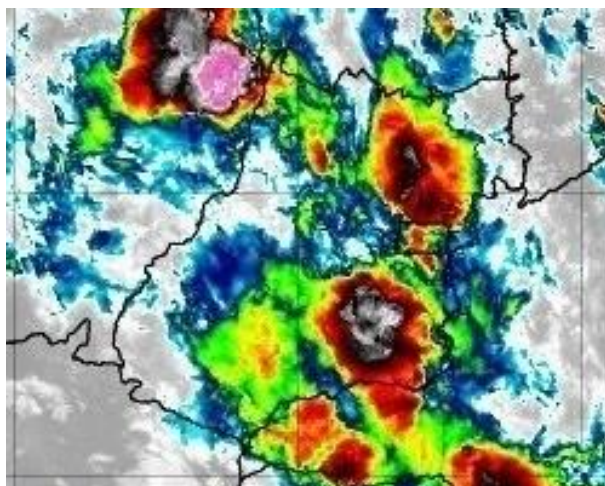
Figura 10 – Imagens realçadas do satélite GOES-16 das 6h00 do dia 06 de Dezembro de 2020.
FONTE: Cptec/INPE.

2. Classificação COBRADE

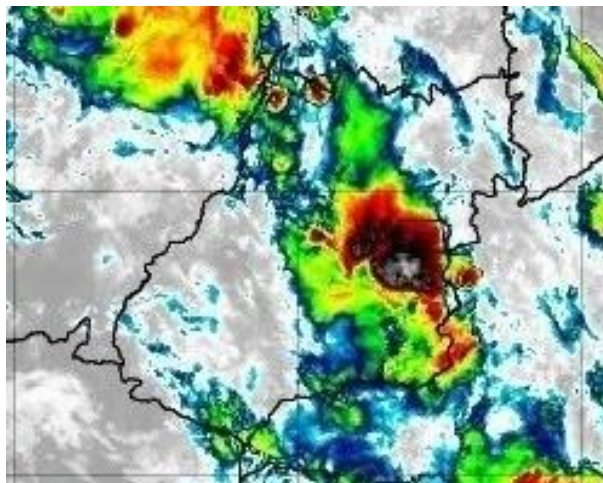
O COBRADE (Classificação e Codificação Brasileira de Desastres) foi criado como intuito de adequar a classificação brasileira à classificação utilizada pela ONU na classificação de desastres e nivelar o país aos demais organismos de gestão de desastres do mundo.

Baseados nos dados analisados nos itens anteriores, podemos classificar o evento ocorrido sobre a área de concessão da ENEL Distribuição Goiás como Tempestade de Raios (Código 1.3.2.1.2), Chuvas Intensas (Código 1.3.2.1.4) e Vendaival (Código 1.3.2.1.5).

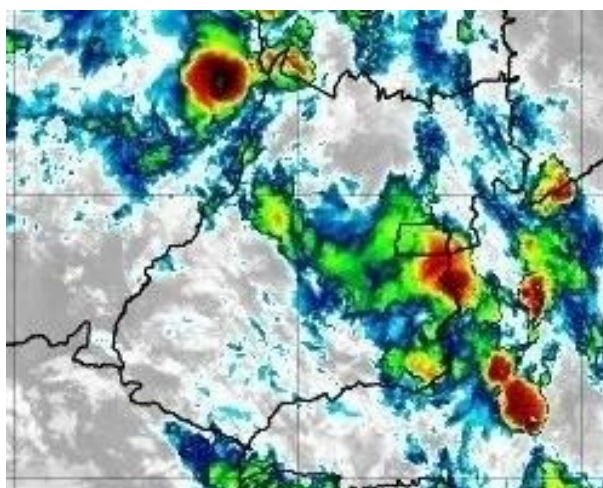
3. Resumo do Evento

Áreas de instabilidade associadas ao ar quente e úmido favoreceram a formação de nuvens de tempestade que avançaram sobre o estado de Goiás, provocando chuva, rajadas de vento, entre a manhã do dia 05 e a manhã do dia 06 de dezembro de 2020.

O sistema de detecção da Earth Networks registrou 140263 descargas atmosféricas sobre a área de concessão da ENEL em Goiás entre as 08h30 do dia 05 e 07h15 do dia 06 de dezembro de 2020.

Rajadas de vento classificadas como vento forte e ventania pela escala Beaufort foram registradas em estações do INMET representativas da região durante o período. Na cidade de Jataí rajadas de até 68,8 km/h foram registradas na tarde do dia 05 de dezembro.

Chuva forte e significativa também foi registrada pelo INMET durante o evento. Em Formosa, entre os dias 05 e 06 de dezembro, foi acumulado o equivalente a 23% da média climatológica do mês.

Tabela 4 – Resumo do evento Regional Rio Verde

Número/Código do Evento	
Número/Código do Relatório	
Descrição	Tempestade com intensa atividade elétrica no interior das nuvens, com grande desenvolvimento vertical. Chuvas com acumulados significativos. Forte deslocamento de uma massa de ar em uma região.
Código COBRADE	Tempestade de raios - 1.3.2.1.2, Chuvas intensas - 1.3.2.1.4 e Vendaval - 1.3.2.1.5
Hora início do evento	11h30 do dia 05 de dezembro de 2020
Hora fim do evento	23h00 do dia 05 de dezembro de 2020
Abrangência	Regional Rio Verde

Tabela 5 – Resumo do evento Regional Morrinhos

Número/Código do Evento	
Número/Código do Relatório	
Descrição	Tempestade com intensa atividade elétrica no interior das nuvens, com grande desenvolvimento vertical. Chuvas com acumulados significativos. Forte deslocamento de uma massa de ar em uma região.
Código COBRADE	Tempestade de raios - 1.3.2.1.2, Chuvas intensas - 1.3.2.1.4 e Vendaval - 1.3.2.1.5
Hora início do evento	09h00 do dia 05 de dezembro de 2020
Hora de fim do evento	04h45 do dia 06 de dezembro de 2020
Abrangência	Regional Morrinhos

Tabela 6 – Resumo do evento Regional Metropolitana e Goiânia

Número/Código do Evento	
Número/Código do Relatório	
Descrição	Tempestade com intensa atividade elétrica no interior das nuvens, com grande desenvolvimento vertical. Chuvas com acumulados significativos. Forte deslocamento de uma massa de ar em uma região.
Código COBRADE	Tempestade de raios - 1.3.2.1.2, Chuvas intensas - 1.3.2.1.4 e Vendaval - 1.3.2.1.5
Hora início do evento	10h00 do dia 05 de dezembro de 2020
Hora de fim do evento	03h00 do dia 06 de dezembro de 2020
Abrangência	Regional Metropolitana e Goiânia

Tabela 7 – Resumo do evento Regional Iporá

Número/Código do Evento	
Número/Código do Relatório	
Descrição	Tempestade com intensa atividade elétrica no interior das nuvens, com grande desenvolvimento vertical. Chuvas com acumulados significativos. Forte deslocamento de uma massa de ar em uma região.
Código COBRADE	Tempestade de raios - 1.3.2.1.2, Chuvas intensas - 1.3.2.1.4 e Vendaval - 1.3.2.1.5
Hora início do evento	11h00 do dia 05 de dezembro de 2020
Hora de fim do evento	05h15 do dia 06 de dezembro de 2020
Abrangência	Regional Iporá

Tabela 8 – Resumo do evento Regional Luziânia

Número/Código do Evento	
Número/Código do Relatório	
Descrição	Tempestade com intensa atividade elétrica no interior das nuvens, com grande desenvolvimento vertical. Chuvas com acumulados significativos. Forte deslocamento de uma massa de ar em uma região.
Código COBRADE	Tempestade de raios - 1.3.2.1.2, Chuvas intensas - 1.3.2.1.4 e Vendaval - 1.3.2.1.5
Hora início do evento	08h15 do dia 05 de dezembro de 2020
Hora de fim do evento	06h00 do dia 06 de dezembro de 2020
Abrangência	Regional Luziânia

Tabela 9 – Resumo do evento Regional Anápolis

Número/Código do Evento	
Número/Código do Relatório	
Descrição	Tempestade com intensa atividade elétrica no interior das nuvens, com grande desenvolvimento vertical. Chuvas com acumulados significativos. Forte deslocamento de uma massa de ar em uma região.
Código COBRADE	Tempestade de raios - 1.3.2.1.2, Chuvas intensas - 1.3.2.1.4 e Vendaval - 1.3.2.1.5
Hora início do evento	10h00 do dia 05 de dezembro de 2020
Hora de fim do evento	03h00 do dia 06 de dezembro de 2020
Abrangência	Regional Anápolis

Tabela 10 – Resumo do evento Regional Uruaçu

Número/Código do Evento	
Número/Código do Relatório	
Descrição	Tempestade com intensa atividade elétrica no interior das nuvens, com grande desenvolvimento vertical. Chuvas com acumulados significativos. Forte deslocamento de uma massa de ar em uma região.
Código COBRADE	Tempestade de raios - 1.3.2.1.2, Chuvas intensas - 1.3.2.1.4 e Vendaval - 1.3.2.1.5
Hora início do evento	10h30 do dia 05 de dezembro de 2020
Hora de fim do evento	07h30 do dia 06 de dezembro de 2020
Abrangência	Regional Uruaçu

Tabela 11 – Resumo do evento Regional Formosa

Número/Código do Evento	
Número/Código do Relatório	
Descrição	Tempestade com intensa atividade elétrica no interior das nuvens, com grande desenvolvimento vertical. Chuvas com acumulados significativos. Forte deslocamento de uma massa de ar em uma região.
Código COBRADE	Tempestade de raios - 1.3.2.1.2, Chuvas intensas - 1.3.2.1.4 e Vendaval - 1.3.2.1.5
Hora início do evento	10h00 do dia 05 de dezembro de 2020
Hora de fim do evento	01h30 do dia 06 de dezembro de 2020
Abrangência	Regional Formosa

4. Referências

- RMets Royal Meteorological Society – Beaufort Scale -
<https://www.rmets.org/weather-and-climate/observing/beaufort-scale>
- Instituto Nacional de Meteorologia (INMET) - <http://www.inmet.gov.br>
- Cptec/INPE
<https://www.cptec.inpe.br/>
- Centro de Hidrografia da Marinha do Brasil -
<https://www.marinha.mil.br/chm/>
- Meteorology Glossary - American Meteorological Society -
<http://glossary.ametsoc.org/>

Anexos

A.1. Carta Sinótica



Figura A1 - Carta sinótica da Marinha do Brasil para as 1200Z do dia 05 de dezembro de 2020 (09h00 do dia 05 de dezembro de 2020, hora local).

A.2. Notícias associadas

- Por conta da chuva, árvores caem em diferentes regiões de Goiânia

<https://globoplay.globo.com/v/9079304/>

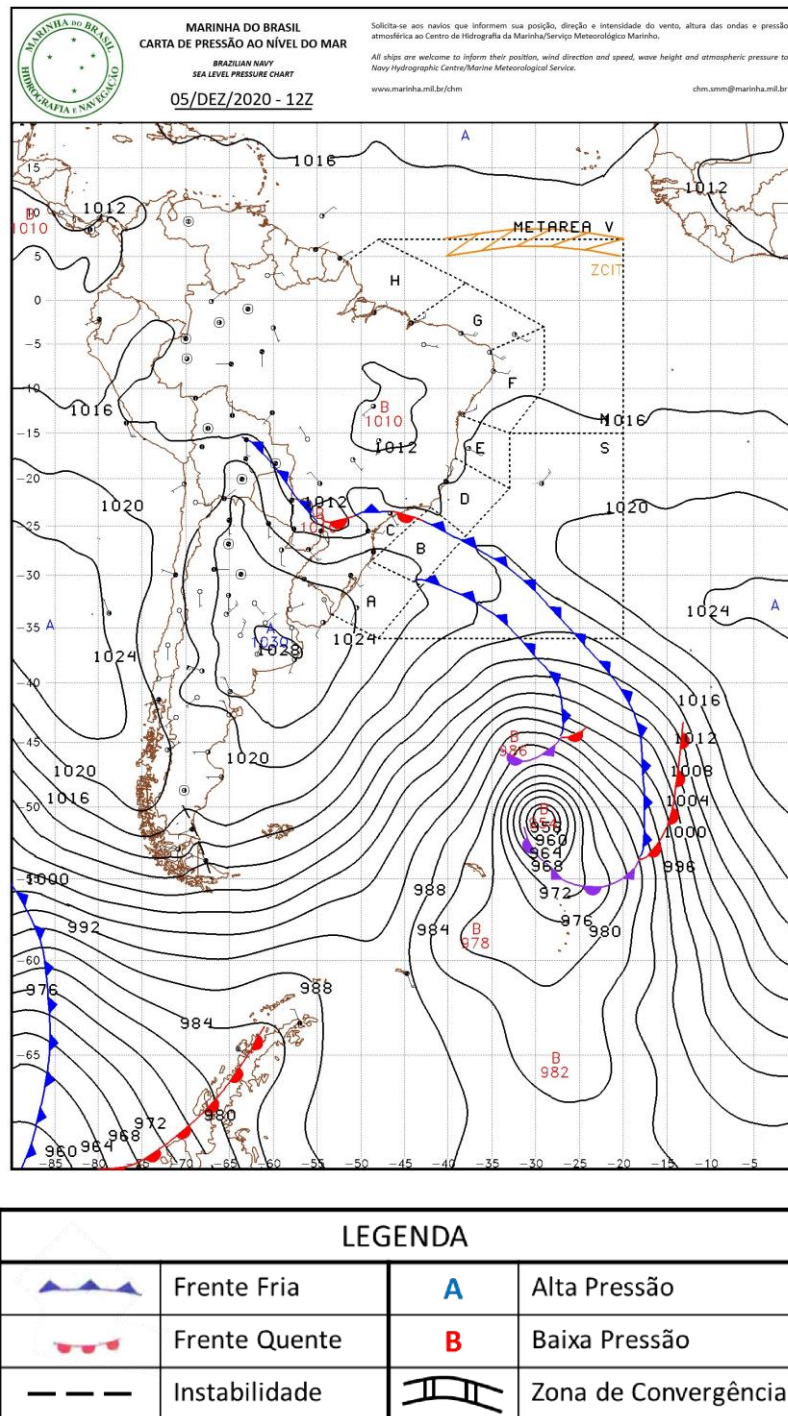
- Telespectadores registram chuva forte em Pirenópolis e Aparecida de Goiânia

<https://globoplay.globo.com/v/9079305/>

Bianca Lobo Silva
Meteorologista CREA
5063840461